

FINAL PROJECT REPORT # 00042134-05-2A

GRANT: DTRT13-G-UTC45
Project Period: 5/1/2014 – 12/31/2019

Volume III: High-Volume Recycled Materials for Sustainable Pavement Construction

Participating Consortium Member:
Missouri University of Science and Technology
Polytechnic Institute of New York University
Southern University and A&M College
University of Illinois at Urbana-Champaign
University of Oklahoma

Authors:
Jeffery S. Volz, S.E., P.E., Ph.D.
Julie Ann Hartell, Ph.D.
Lexis Allen, Research Assistant
Jonathan Drury, Ph.D., Research Assistant
Rex McLauchlin, Research Assistant
Mohammad Zare Banadkoki, Research Assistant



RE-CAST:
REsearch on Concrete Applications for
Sustainable Transportation
Tier 1 University Transportation Center



DISCLAIMER

The contents of this report reflect the views of the authors, who are responsible for the facts and the accuracy of the information presented herein. This document is disseminated under the sponsorship of the U.S. Department of Transportation's University Transportation Centers Program, in the interest of information exchange. The U.S. Government assumes no liability for the contents or use thereof.

TECHNICAL REPORT DOCUMENTATION PAGE

1. Report No. RECAST UTC # 00042134-05-2A	2. Government Accession No.	3. Recipient's Catalog No.
4. Title and Subtitle Volume III: High-Volume Recycled Materials for Sustainable Pavement Construction		5. Report Date January 2020
		6. Performing Organization Code:
7. Author(s) Jeffery S. Volz, Julie Ann Hartell, Lexis Allen, Jonathan Drury, Rex McLaughlin, Mohammad Zare Banadkoki		8. Performing Organization Report No. Project # 00042134-05-2A
		10. Work Unit No.
9. Performing Organization Name and Address RE-CAST – Missouri University of Science and Technology 500 W. 16 th St., 223 ERL Rolla, MO 65409-0710		11. Contract or Grant No. USDOT: DTRT13-G-UTC45
		13. Type of Report and Period Covered: Final Report Period: 5/1/2014 – 12/31/2019
12. Sponsoring Agency Name and Address Office of the Assistant Secretary for Research and Technology U.S. Department of Transportation 1200 New Jersey Avenue, SE Washington, DC 20590		14. Sponsoring Agency Code:
		15. Supplementary Notes The investigation was conducted in cooperation with the U. S. Department of Transportation.
16. Abstract Concrete production uses a considerable amount of non-renewable natural resources and generates a significant amount of greenhouse gases. To obtain a more sustainable solution requires examining the two main components of concrete – aggregates and cement. Recycling concrete as aggregate for new concrete reduces construction waste, diverts material from already over-burdened landfills, and lowers demand for virgin aggregate. Using supplementary cementitious materials – such as fly ash, blast furnace slag, and glass powder – also diverts material from landfills and reduces the carbon footprint of concrete. The Federal Highway Administration (FHWA) estimates that two billion tons of new aggregate are produced each year in the United States (1). Aggregate demand is anticipated to increase to two and a half billion tons per year by 2020. With such a high demand for new aggregates, concern arises about the depletion of current sources of natural aggregates and the availability of new sources. Similarly, construction waste produced in the United States is expected to continue increasing. From building demolition alone, the annual production of construction waste is estimated to be 123 million tons (1), with concrete accounting for up to two-thirds of the total weight (2). Currently, this waste is most commonly disposed of in landfills. To address both the increasing demand for new aggregates and the increasing production of waste, many states have begun to recognize that more sustainable solutions exist in recycling waste concrete for use as aggregate in new concrete – recycled concrete aggregate (RCA). RCA helps address the question of how to sustain modern construction demands for aggregates and reduce the amount of waste entering already over-burdened landfills. Many states have begun to implement RCA in new construction. For instance, 41 states have recognized the many uses of RCA as a raw material for riprap, soil stabilization, pipe bedding, and even landscape materials (1). Of these, 38 states have gone a step further in taking the additional step of integrating RCA into roadway systems for use as aggregate base course material. However, only 11 states have begun using RCA in portland cement concrete for pavement construction. The production of portland cement – the active ingredient in concrete – generates a significant amount of greenhouse gas emissions. Cement production accounts for approximately 4.5% of global CO ₂ emissions from industry (3). According to the World Business Council for Sustainable Development, CO ₂ emissions from cement manufacturing vary across worldwide regions from 0.73 to 0.99 lb. of CO ₂ for each pound of cement produced, and cement production is expected to reach four billion tons by the year 2020 (4). One method of reducing the carbon footprint of concrete is to incorporate high volumes of supplementary cementitious materials (SCMs), such as fly ash, blast furnace slag, and glass powder, which are also waste products. However, most current specifications significantly limit the percentages of SCMs in concrete. Combining RCA with SCMs will lower the carbon footprint of concrete, reduce waste entering landfills, preserve virgin material sources, and, if done correctly, reduce the overall cost. However, research is needed to determine the appropriate guidelines for incorporating these high volumes of recycled materials without compromising performance and service life.		
17. Key Words Concrete; Concrete pavements; Infrastructure; Paving; Recycled materials; Sustainable development		18. Distribution Statement No restrictions. This document is available to the public.
19. Security Classification (of this report) Unclassified	20. Security Classification (of this page) Unclassified	21. No of Pages 129

HIGH-VOLUME RECYCLED MATERIALS FOR SUSTAINABLE PAVEMENT CONSTRUCTION

Final Report

Jeffery S. Volz, S.E., P.E., Ph.D.
Julie Ann Hartell, Ph.D.

Lexis Allen, Research Assistant
Jonathan Drury, Ph.D., Research Assistant
Rex McLauchlin, Research Assistant
Mohammad Zare Banadkoki, Research Assistant

University of Oklahoma, Norman, Oklahoma

TABLE OF CONTENTS

	Page
LIST OF FIGURES.....	v
LIST OF TABLES.....	ix
Section	
1. INTRODUCTION.....	1
1.1. Problem Statement	1
1.2. Background	2
1.3. Research Objective.....	4
2. LITERATURE REVIEW.....	5
2.1. Introduction	5
2.2. Use of Supplementary Cementitious Materials in Concrete Production	5
2.2.1. Fly Ash	5
2.2.2. Slag Cement.....	6
2.2.3. Silica Fume	8
2.3. Use of Recycled Concrete Aggregate in Concrete Production.....	9
2.3.1. Background	9
2.3.2. Engineering Properties of Recycled Concrete Aggregate	10
2.4. Properties of Concrete Containing Recycled Concrete Aggregate.....	11
2.4.1. Fresh Properties	12
2.4.2. Compressive Strength.....	12
2.4.3. Splitting Tensile Strength	13
2.4.4. Flexural Strength.....	13
2.5. Durability of Concrete Containing Recycled Concrete Aggregate	13
2.5.1. Chloride Ion Permeability	13
2.5.2. Freeze/Thaw Resistance.....	14
2.5.3. De-Icing Salt Scaling	14
2.5.4. Absorption	14
2.6. Recycled Concrete Aggregate in Rigid Pavement Construction	14
3. VIRGIN AND RECYCLED CONCRETE AGGREGATE CHARACTERIZATION... 16	
3.1. Virgin Aggregate Testing.....	16

3.2. Recycled Concrete Aggregate Testing.....	16
3.3. Aggregate Imaging System.....	20
3.3.1. Angularity Measurements.....	21
3.3.2. Texture Measurements.....	23
3.3.3. Summary.....	24
4. MIX DEVELOPMENT – PHASE I.....	27
4.1. Mix Design Development.....	27
4.2. Fresh Properties.....	29
4.3. Material Properties.....	30
4.4. Conclusions.....	32
5. DURABILITY – PHASE I.....	33
5.1. Mix Designs.....	33
5.2. Durability Tests and Specimen Fabrication.....	34
5.3. Results of Freeze/Thaw Testing.....	38
5.4. Results of Salt Scaling Testing.....	40
5.5. Conclusions.....	43
6. RESISTIVITY AND DURABILITY – PHASE I.....	44
6.1. Electrical Resistivity.....	44
6.1.1. Surface Electrical Resistivity Test.....	44
6.1.2. Bulk Electrical Resistivity Test.....	45
6.2. Mix Designs.....	45
6.3. Electrical Resistivity Measurements.....	46
6.3.1. Surface Electrical Resistivity Measurements.....	46
6.3.2. Bulk Electrical Resistivity Measurements.....	49
6.4. Durability.....	50
6.4.1. Results of Freeze/Thaw Testing.....	53
6.4.2. Results of Salt Scaling Testing.....	55
6.5. Conclusions.....	61
7. RCA ABSORPTION BEHAVIOR.....	63
7.1. RCA Absorption Rate.....	63
7.2. Hydrostatic Weighing.....	68

7.3. Centripetal Acceleration Method Development	70
7.4. Conclusions.....	73
8. MIX DEVELOPMENT – PHASE II.....	74
8.1. Mix Design Development	74
8.2. Fresh Properties.....	75
8.3. Material Properties	77
8.4. Conclusions.....	80
9. DURABILITY – PHASE II.....	81
9.1. Mix Designs.....	81
9.2. Durability Tests and Specimen Fabrication	82
9.3. Results of Freeze/Thaw Testing.....	86
9.4. Results of Salt Scaling Testing.....	88
9.5. Conclusions.....	89
10. FULL SCALE PAVEMENT TEST SECTIONS.....	92
10.1. Mix Designs.....	92
10.2. Test Bed Location, Layout, and Preparation	92
10.3. Pavement Details and Instrumentation	93
10.4. Pavement Construction	99
10.5. Volume Change Measurements	100
10.6. Visual Observations	101
10.7. Falling Weight Deflectometer Testing	101
10.8. Conclusions.....	102
11. SUMMARY AND RECOMMENDATIONS	104
11.1. Summary.....	104
11.2. Recommendations	107
REFERENCES.....	110

LIST OF FIGURES

	Page
Figure 2-1. Physical Comparison of Portland Cement (left) and Fly Ash (right)	7
Figure 2-2. Physical Comparison of Portland Cement (left) and Slag Cement (right)	8
Figure 2-3. Multiple Interfacial Transition Zones in Concrete Containing RCA.....	10
Figure 3-1. Dolese Bros. Co. Davis Quarry	16
Figure 3-2. No. 57 Limestone (left) and Recycled Concrete Aggregate (right).....	20
Figure 3-3. Aggregate Shape Properties.....	21
Figure 3-4. AIMS Limestone Gradient Angularity Analysis.....	22
Figure 3-5. AIMS RCA Gradient Angularity Analysis.....	23
Figure 3-6. AIMS Limestone Texture Index Analysis	24
Figure 3-7. AIMS RCA Texture Index Analysis	25
Figure 5-1. Freeze/Thaw Specimens within Test Chamber.....	34
Figure 5-2. Longitudinal Dynamic Modulus of Elasticity Test Setup.....	35
Figure 5-3. Constant Temperature Lime Water Tempering Tank.....	36
Figure 5-4. Salt Scaling Specimens as Cast	37
Figure 5-5. Salt Scaling Specimens Air Curing	37
Figure 5-6. Salt Scaling Specimens within Environmental Chamber.....	38
Figure 5-7. Freeze/Thaw Dynamic Modulus Test Results.....	39
Figure 5-8. Control Mix Specimen at 304 Freeze/Thaw Cycles	39
Figure 5-9. Mix 1-25 Specimen at 304 Freeze/Thaw Cycles.....	40
Figure 5-10. Mix 2-20 Specimen at 304 Freeze/Thaw Cycles.....	40
Figure 5-11. Mix 3-40 Salt Scaling Specimens.....	41
Figure 5-12. Mix 1-100 Salt Scaling Specimens.....	42
Figure 5-13. Control Mix Salt Scaling Specimens	42
Figure 5-14. Mix 3-60 Salt Scaling Specimens.....	43
Figure 6-1. Surface Electrical Resistivity Test.....	45
Figure 6-2. Bulk Electrical Resistivity Test	46
Figure 6-3. Surface Resistivity as a Function of RCA Replacement	47
Figure 6-4. Surface Resistivity as a Function of Fly Ash Replacement	48

Figure 6-5. Surface Resistivity as a Function of Fly Ash Replacement for Mixes with 100 Percent RCA Replacement	49
Figure 6-6. Bulk Resistivity as a Function of RCA Replacement	50
Figure 6-7. Bulk Resistivity as a Function of Fly Ash Replacement	50
Figure 6-8. Bulk Resistivity as a Function of Fly Ash Replacement for Mixes with 100 Percent RCA Replacement	51
Figure 6-9. Freeze/Thaw Testing	52
Figure 6-10. Salt Scaling Specimen Fabrication	53
Figure 6-11. Dynamic Modulus as a Function of RCA Replacement	54
Figure 6-12. Dynamic Modulus as a Function of Fly Ash Replacement for Mixes with 100 Percent RCA Replacement	54
Figure 6-13. Salt Scaling Test Results as a Function of RCA Replacement	55
Figure 6-14. Salt Scaling Test Results as a Function of Fly Ash Replacement for Mixes with 100 Percent RCA Replacement	56
Figure 6-15. Control Specimen After 25 Cycles	57
Figure 6-16. 25 Percent RCA Specimen After 15 Cycles	57
Figure 6-17. 50 Percent RCA Specimen After 50 Cycles	58
Figure 6-18. 75 Percent RCA Specimen After 50 Cycles	58
Figure 6-19. 100 Percent RCA Specimen After 50 Cycles	59
Figure 6-20. 20 Percent Fly Ash Plus 100 Percent RCA After 50 Cycles	59
Figure 6-21. 40 Percent Fly Ash Plus 100 Percent RCA After 35 Cycles	60
Figure 6-22. 60 Percent Fly Ash Plus 100 Percent RCA After 10 Cycles	60
Figure 7-1. Washing of RCA Samples	64
Figure 7-2. Aggregate Preparation for Moisture Measurements	64
Figure 7-3. RCA Absorption as a Function of Time	65
Figure 7-4. RCA Absorption as a Function of Time	66
Figure 7-5. RCA Absorption as a Function of Time	67
Figure 7-6. RCA Absorption as a Function of Time	67
Figure 7-7. Valor 7000 Scale for Hydrostatic Weighing of RCA Samples	68
Figure 7-8. Hydrostatic Weighing Setup	69

Figure 7-9. Hydrostatic Weighing Method vs. ASTM C127 Method for Determining RCA Rate of Absorption.....	71
Figure 7-10. Schematic of Centripetal Acceleration Method	72
Figure 7-11. Centripetal Acceleration Method Compared to ASTM C127 Method	72
Figure 7-12. Full-Scale Centripetal Acceleration Method Setup.....	73
Figure 9-1. Freeze/Thaw Specimens within Test Chamber.....	82
Figure 9-2. Longitudinal Dynamic Modulus of Elasticity Test Setup.....	83
Figure 9-3. Constant Temperature Lime Water Tempering Tank.....	84
Figure 9-4. Salt Scaling Specimens with Foam Dike.....	85
Figure 9-5. Salt Scaling Specimens within Environmental Chamber.....	85
Figure 9-6. Freeze/Thaw Dynamic Modulus Test Results.....	86
Figure 9-7. Mix 2-20 Specimen at 304 Freeze/Thaw Cycles.....	87
Figure 9-8. Mix 2-60 Specimen at 304 Freeze/Thaw Cycles.....	87
Figure 9-9. Mix 3-40 Specimen at 304 Freeze/Thaw Cycles.....	88
Figure 9-10. Control Mix Salt Scaling Specimen at 50 Cycles	90
Figure 9-11. Mix 1-100 Salt Scaling Specimen at 50 Cycles.....	90
Figure 9-12. Mix 3-40 Salt Scaling Specimen at 50 Cycles.....	91
Figure 9-13. Mix 3-60 Salt Scaling Specimen at 50 Cycles.....	91
Figure 10-1. Location of Pavement Implementation Project.....	93
Figure 10-2. Test Bed and Pavement Panel Locations	94
Figure 10-3. Excavation and Preparation of Subbase for Pavement Construction.....	94
Figure 10-4. Installation (l) and Compaction (r) of Pavement Aggregate Base	95
Figure 10-5. Pavement Dowel Bar Placement	95
Figure 10-6. Vibrating Wire Strain Gage Placement	96
Figure 10-7. Dimensions of Tree No. 1 Perpendicular to Traffic	96
Figure 10-8. Dimensions of Tree No. 1 Parallel to Traffic.....	97
Figure 10-9. Dimensions of Tree Nos. 2 and 3 Perpendicular to Traffic.....	97
Figure 10-10. Dimensions of Tree Nos. 2 and 3 Parallel to Traffic.....	98
Figure 10-11. VWS Gage Layout (l) and Close-up of Tree No. 1 (r) for Panel No. 8.....	98
Figure 10-12. Concrete Placement (l) and Consolidation (r)	99
Figure 10-13. Concrete Floating (l) and Finishing (r).....	99

Figure 10-14. Pavement Panel Shrinkage Comparison of Class A and 3-50 Mixes....	100
Figure 10-15. Condition of Panels 5 Through 8 After Two Years in Service	101
Figure 10-16. FWD Testing of Pavement Panels	102

LIST OF TABLES

	Page
Table 3-1: Aggregate Tests and ASTM References.....	17
Table 3-2: No. 57 Coarse Aggregate Gradation and Percent Passing Limits.....	17
Table 3-3: Fine Aggregate Gradation and Percent Passing Limits.....	18
Table 3-4: Aggregate Properties	18
Table 3-5: Coarse Aggregate Gradations and Percent Passing Limits of RCA Sources.....	19
Table 3-6: Fine Aggregate Gradations and Percent Passing Limits of RCA Sources ...	19
Table 3-7: Virgin and RCA Aggregate Properties.....	20
Table 3-8: Summary of AIMS Results	25
Table 4-1: ODOT Requirements for a Class A Concrete Pavement	27
Table 4-2: Class A Concrete Mix Design per Cubic Yard.....	27
Table 4-3: Mix Design Matrix.....	28
Table 4-4: Chemical and Physical Properties of Cementitious Materials	28
Table 4-5: Phase I Mix Designs per Cubic Yard.....	29
Table 4-6: Fresh Concrete Properties	30
Table 4-7: Material Properties	31
Table 4-8: Normalized Material Properties	32
Table 5-1: Phase I Mix Designs per Cubic Yard.....	33
Table 5-2: Specific Mixes Undergoing Durability Testing	34
Table 5-3: Visual Rating Scale for Salt Scaling Resistance	36
Table 5-4: Scaling Resistance Visual Rating vs. Number of Cycles.....	41
Table 6-1: Resistivity and Durability Mix IDs	47
Table 6-2: Specific Mixes Undergoing Durability Testing	51
Table 6-3: Concrete Properties for 0.44 Water/Cement Ratio Mixes	53
Table 7-1: RCA Moisture Content as a Function of Time	65
Table 8-1: ODOT Requirements for a Class A Concrete Pavement	74
Table 8-2: Class A Concrete Mix Design per Cubic Yard.....	74
Table 8-3: Mix Design Matrix.....	75

Table 8-4: Phase II Mix Designs per Cubic Yard.....	76
Table 8-5: Fresh Concrete Properties	77
Table 8-6: Material Properties	78
Table 8-7: Normalized Material Properties	79
Table 9-1: Phase II Mix Designs per Cubic Yard.....	81
Table 9-2: Specific Mixes Undergoing Durability Testing	82
Table 9-3: Visual Rating Scale for Salt Scaling Resistance	84
Table 9-4: Scaling Resistance Visual Rating vs. Number of Cycles.....	88
Table 10-1: Implementation Project Mix Designs per Cubic Yard	92
Table 10-2: FWD Test Results	102

1. INTRODUCTION

1.1 PROBLEM STATEMENT

Concrete production uses a considerable amount of non-renewable natural resources and generates a significant amount of greenhouse gases. To obtain a more sustainable solution requires examining the two main components of concrete – aggregates and cement. Recycling concrete as aggregate for new concrete reduces construction waste, diverts material from already over-burdened landfills, and lowers demand for virgin aggregate. Using supplementary cementitious materials – such as fly ash, blast furnace slag, and glass powder – also diverts material from landfills and reduces the carbon footprint of concrete.

The Federal Highway Administration (FHWA) estimates that two billion tons of new aggregate are produced each year in the United States (1). Aggregate demand is anticipated to increase to two and a half billion tons per year by 2020. With such a high demand for new aggregates, concern arises about the depletion of current sources of natural aggregates and the availability of new sources.

Similarly, construction waste produced in the United States is expected to continue increasing. From building demolition alone, the annual production of construction waste is estimated to be 123 million tons (1), with concrete accounting for up to two-thirds of the total weight (2). Currently, this waste is most commonly disposed of in landfills.

To address both the increasing demand for new aggregates and the increasing production of waste, many states have begun to recognize that more sustainable solutions exist in recycling waste concrete for use as aggregate in new concrete – recycled concrete aggregate (RCA). RCA helps address the question of how to sustain modern construction demands for aggregates and reduce the amount of waste entering already over-burdened landfills.

Many states have begun to implement RCA in new construction. For instance, 41 states have recognized the many uses of RCA as a raw material for riprap, soil stabilization, pipe bedding, and even landscape materials (1). Of these, 38 states have gone a step further in taking the additional step of integrating RCA into roadway systems for use as aggregate base course material. However, only 11 states have begun using RCA in portland cement concrete for pavement construction.

The production of portland cement – the active ingredient in concrete – generates a significant amount of greenhouse gas emissions. Cement production accounts for approximately 4.5% of global CO₂ emissions from industry (3). According to the World Business Council for Sustainable Development, CO₂ emissions from cement manufacturing vary across worldwide regions from 0.73 to 0.99 lb. of CO₂ for each pound of cement produced, and cement production is expected to reach four billion tons by the year 2020 (4).

One method of reducing the carbon footprint of concrete is to incorporate high volumes of supplementary cementitious materials (SCMs), such as fly ash, blast furnace slag, and glass powder, which are also waste products. However, most current specifications significantly limit the percentages of SCMs in concrete.

Combining RCA with SCMs will lower the carbon footprint of concrete, reduce waste entering landfills, preserve virgin material sources, and, if done correctly, reduce the overall cost. However, research is needed to determine the appropriate guidelines for incorporating these high volumes of recycled materials without compromising performance and service life.

1.2 BACKGROUND

According to ODOT's 2015-2040 Long Range Transportation Plan: Moving Oklahoma Forward, the DOT has identified approximately 6,400 centerline miles of the State Highway System that will need reconstruction, with an additional 120 miles of expansion (5). The development of a sustainable concrete pavement approach will help ODOT lower the carbon footprint of the State Highway System, reduce waste entering landfills, preserve virgin material sources, and, if done correctly, reduce the overall cost to ODOT and the citizens of Oklahoma. This sustainable concrete pavement approach will be achieved through the use of high amounts of recycled materials, including recycled concrete aggregates (RCAs) and supplementary cementitious materials (SCMs). The research team will achieve this goal by maximizing the percentages of recycled materials beyond anything attempted to date. However, this approach must maintain performance and service life of the concrete pavement, particularly in the face of increasing weather extremes and climate variability.

RCA is typically regarded as a double-phase material, consisting of the original virgin aggregate and the adhered residual mortar. When used to produce concrete, RCA results in two types of interfacial transition zones (ITZs) – the first being between the original virgin coarse aggregate and the adhered mortar, and the second being between the new mortar and the RCA. This double ITZ has a significant effect on the hardened material properties of RCA concrete (1,6).

As a result of the high amounts of adhered mortar content in recycled aggregates, RCA can have higher water absorption, lower specific gravity, and higher porosity compared to natural aggregate (6). Due to the crushing process, both fine and coarse RCA particles are believed to have increased angularity compared to virgin aggregate. Some technical problems make using RCA more challenging; these include weak ITZ between the cement paste and aggregate, porosity and transverse cracks within demolition concrete, high levels of sulfate and chloride contents, impurities, and high variations in quality. In general, the properties of concrete containing RCA are tied to the properties of the original waste concrete, the new composition, the mixing approach, and the deterioration conditions of the recycled aggregates (1).

With regard to fresh properties, as the percentage of RCA increases, unit weight and workability of the concrete mixture decreases (7,8). The decrease in unit weight is attributed to the residual mortar content of the RCA. The decrease in workability is usually attributed to the increased angularity of the RCA compared to virgin aggregate, but it is more related to the percentage of fines within the RCA (7,9). RCA tends to have a higher percentage of fines compared to typical coarse aggregate, and these fines are highly angular, thus decreasing workability. Removing the majority of fines during RCA preparation significantly reduces any negative effect on workability.

With regard to hardened mechanical properties, results have varied among researchers, but in general, as the percentage of RCA increases, compressive strength, tensile strength, modulus of rupture, modulus of elasticity, and fracture energy decrease while creep and shrinkage increase (6-14). However, there are many instances where the mechanical properties were relatively unchanged compared to their conventional concrete control mixtures, typically when the replacement levels were below 50%. The decrease in compressive strength, tensile strength, modulus of rupture, and fracture energy is generally attributed to the double ITZ. The decrease in modulus of elasticity and increase in creep and shrinkage results from the residual mortar content of the RCA.

Research on fatigue of concrete containing RCA has been more limited and with mixed results. Thomas et al. (15) investigated fatigue in compression for concretes containing RCA and found that at substitution rates below 20%, no decrease in fatigue performance occurred. However, at higher substitution rates, fatigue performance decreased with increasing RCA. Under flexural fatigue, Arora and Singh (16) showed a decrease in fatigue performance at increasing percentages of RCA while Sobhan et al. (17) found comparable results to concrete containing virgin aggregates.

With regard to durability, results have varied among researchers. Some researchers have found a decrease in freeze/thaw resistance with increasing percentage of RCA (8,18) while others have found no significant difference in performance compared to conventional concrete (19-21). Under deicing salt scaling tests, Movassaghi (22) reported that scaling resistance increased with increasing age of the RCA source, while Speare and Ben-Othman (23) reported no difference between concrete with RCA and conventional concrete.

With regard to the use of RCA in concrete pavement, in the 1980s and 1990s, several states constructed experimental pavement sections that incorporated RCA. An FHWA-sponsored study collected data on their long term performance (24). The sections were located in Connecticut, Kansas, Minnesota, Wisconsin, and Wyoming. In general, the RCA pavements exhibited good overall performance, tracking close to that of conventional concrete. However, RCA pavements with higher residual mortar contents showed an increased degree of cracking compared to the control pavements. Cores removed from the pavement sections showed comparable compressive and tensile

strengths but decreased modulus of elasticity for the RCA pavements compared to the conventional concrete pavements. One of the important conclusions of the study was the need for better characterization of the properties of RCA and the influence on a portland cement concrete pavement mixture.

Supplementary cementitious materials (SCMs) have been used in concrete for many years. However, with the continued interest in sustainability and greenhouse gas emissions, researchers have begun to study higher replacement levels of SCMs in concrete. Several researchers have investigated concrete produced with Class C and Class F fly ash at replacement levels of up to 75% (25-30). In general, high-volume fly ash mixtures exhibit increased workability but decreased hardened mechanical properties compared to conventional concrete mixtures. The use of powder additives such as gypsum and lime can restore a portion of this strength reduction. In terms of durability, high-volume fly ash mixes have shown comparable freeze-thaw resistance but decreased salt scaling resistance, particularly at replacement levels above 50%. Naik et al. (30) collected data on the long-term performance of high-volume fly ash concrete pavements over a period of 14 years. The data indicated that these pavements performed as well as the conventional concrete control sections except for some minor surface scaling.

No studies to date have examined the combination of high volumes of RCA and SCMs in concrete pavement performance.

1.3 RESEARCH OBJECTIVE

The main **objective** of this research was to produce concrete for conventional portland cement concrete pavement construction that incorporated at least 50% recycled materials without compromising performance and service life.

2. LITERATURE REVIEW

2.1 INTRODUCTION

The following chapter examines the state-of-the-art on supplementary cementitious materials and recycled concrete aggregate. This information formed the basis for this research study on using high levels of recycled materials to develop a more sustainable concrete pavement.

2.2 USE OF SUPPLEMENTARY CEMENTITIOUS MATERIALS IN CONCRETE PRODUCTION

Supplementary cementitious materials (SCMs) are industrial by-products that are typically used to either replace or augment the portland cement used to produce concrete (31-33). SCMs contribute to the hardened properties of concrete through either hydraulic or pozzolanic activity. Hydraulic activity occurs where the chemical composition of the SCM is such that it will react with water to form a hardened and water-resistant material. Pozzolanic activity occurs where the chemical composition of the SCM is such that it requires calcium hydroxide, a by-product of the hydration of portland cement, and water in order to form a hardened and water-resistant material. SCMs are often added to concrete to improve the fresh and hardened properties, reduce costs, and increase sustainability of the finished product. The most common SCMs are fly ash, slag cement, and silica fume.

2.2.1 Fly Ash

Fly ash is a coal ash recovered at coal-fired thermal power plants and contains small amounts of iron, magnesium, and calcium as well as the main elements of silica and aluminum. Most thermal power plants use furnaces fired with pulverized coal. As the coal travels through the high-temperature zone in the furnace, the volatile matter and carbon are burnt off whereas most of the mineral impurities are carried away by the flue gas in the form of ash (34). These ash particles become fused in the combustion zone of the furnace but once they leave the combustion zone, the molten ash is cooled rapidly and solidifies as spherical, glassy particles, which are subsequently trapped by electrostatic precipitators.

ASTM C618 (35) "Standard Specification for Coal Fly Ash and Raw or Calcined Natural Pozzolan for Use in Concrete" uses the bulk chemical composition to subdivide fly ashes into two classes, C and F, which reflect the composition of the inorganic fractions. However, this standard does not address the nature or reactivity of the particles. Class F fly ashes are produced from either anthracite bituminous or sub-bituminous coals. Class C fly ashes derive from sub-bituminous or lignitic coals. In other words, the two classes of fly ash are distinguished by the silica oxide content of the type of coal burned. Fly ash can be cementitious or pozzolanic, or both. Class F fly ash is pozzolanic while Class C fly ash is both cementitious and pozzolanic (34).

Low calcium fly ashes (Class F) contain chemically inactive crystalline phases: quartz, mullite, ferrite spinel, and hematite class. High calcium fly ashes (Class C) contain the previously mentioned phases but may also contain additional crystalline phases such as anhydrite, alkali sulfate, dicalcium silicate, tricalcium aluminate, lime, melilite, merwinite, periclase, and sodalite (36). These additional phases found in the Class C fly ash are reactive, and this is why Class C fly ash exhibits both cementitious and pozzolanic properties.

Fly ash looks very similar to portland cement in appearance. However, when magnified, fly ash will appear as spherical particles, similar to ball bearings, whereas cement appears angular, more like crushed rock as shown in Figure 2-1. The small size of the fly ash particles is the key to producing smooth cement paste, allowing better bonding between aggregate and cement, and resulting in a more durable concrete. The round shape of the particles increases the concrete workability without adding extra water.

The use of fly ash (Class C and Class F) in concrete offers several significant advantages such as:

- Improved freeze-thaw durability
- Improved long-term strength of the concrete
- Increased workability (plasticity) of the concrete
- Increased flexural and compressive strength of the concrete
- Increased pumpability
- Reduced permeability
- Reduced water-to-cementitious materials ratio
- Reduced concrete segregation
- Reduced heat of hydration
- Reduced bleeding of the concrete

2.2.2 Slag Cement

Slag cement is a recovered industrial by-product derived from the slag produced in an industrial iron blast furnace (37-39). A blast furnace is a vertical shaft furnace that produces liquid metals by the reaction of a flow of air introduced under pressure into the bottom of the furnace with a mixture of metallic ore, coke, and flux fed into the top. In most cases, limestone or dolomite are used as the flux in the iron smelting process within a modern blast furnace. Slag and iron collect in the bottom of the hearth, where the molten slag floats on top of the molten iron. The slag, primarily composed of silica, alumina, and calcium oxides, is periodically tapped and subsequently cooled. Depending on the method of cooling, different end products are produced.

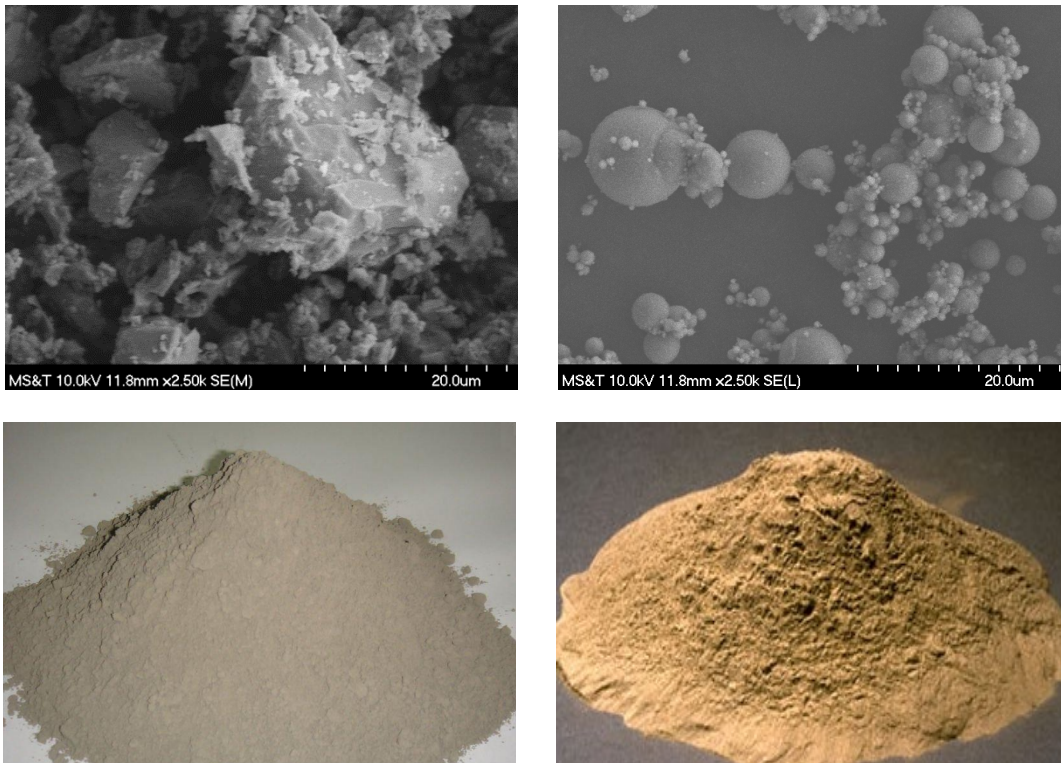

Figure 2-1. Physical Comparison of Portland Cement (left) and Fly Ash (right)

Slag cement is created by rapid water quenching of the molten slag to produce a glassy, granulated material with little or no crystallization, followed by grinding to a fine powder similar in size to portland cement (37-39). The degree of reactivity of the slag cement is a direct function of the chemistry and glass content of the rapidly cooled slag, and the chemical composition of the slag is a direct result of the chemical composition of the iron ore, flux, and impurities in the coke charged into the blast furnace. Slag cement is both cementitious and pozzolanic.

ASTM C989 (40) “Standard Specification for Slag Cement for Use in Concrete and Mortars” designates three strength grades of slag cement – 80, 100, and 120 – based on reactivity. The grade is a function of the compressive strength of a 50:50 slag cement-portland cement mortar compared to that for a mortar of portland cement alone, expressed as a percentage. An approximate measure, the slag-activity index is a function of the particular portland cement used in the test, and ASTM C989 specifies total alkali limits and 28-day compressive strength for the reference portland cement. In terms of physical appearance, slag cement looks very similar to portland cement, as shown in Figure 2-2.

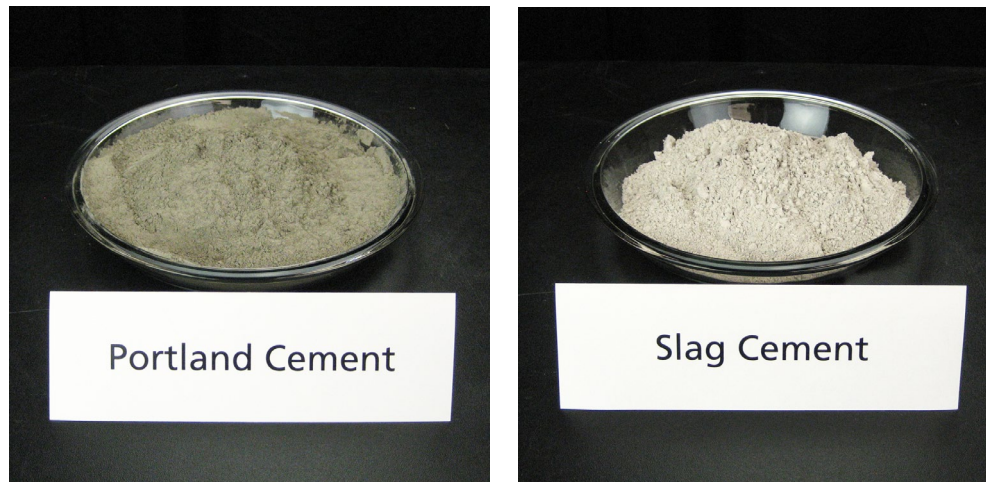

Figure 2-2. Physical Comparison of Portland Cement (left) and Slag Cement (right) (courtesy Slag Cement Association, 2019)

The use of slag cement in concrete offers several significant advantages such as:

- Improved freeze-thaw durability
- Improved long-term strength of the concrete
- Improved alkali-silica reactivity (ASR) resistance
- Improved sulfate resistance
- Increased workability (plasticity) of the concrete
- Increased flexural and compressive strength of the concrete
- Reduced permeability

2.2.3 Silica Fume

Silica fume is a condensed gas vapor that is captured during the production of silicon metals or ferrosilicon alloys in a submerged electric arc furnace (41-43). An electric arc furnace passes current through electrodes to form an arc that melts the raw materials, such as quartz, coal, and woodchips for the production of silicon metals or ferrosilicon alloys. A submerged electric arc furnace is one in which the electrode tips are buried within the material being smelted. Within the electric arc, silicon vapor forms and escapes to the top of the furnace as exhaust gases, which are subsequently cooled by the introduction of outside air. This cooling process causes the silicon vapor to oxidize and condense into very fine spherical particles of amorphous silicon dioxide, which are collected with fans and bag filters.

The composition of silica fume is a function of the specific manufacturing process, such as furnace temperature, furnace exhaust temperature, type of product being produced, use of wood chips versus coal, and composition of the wood chips (41-43). In general,

most silica fume consists of at least 90 percent silicon dioxide, with the color varying from light to dark gray as a function of the trace non-silica components, such as carbon and iron oxides. Considered an ultrafine material, the spherical silica fume particles range in size from 0.1 to 0.3 microns in diameter, which is 100 to 150 times smaller than a typical grain of cement. Silica fume is pozzolanic.

ASTM C1240 (44) "Standard Specification for Silica Fume Used in Cementitious Mixtures" requires a minimum silicon dioxide content of 85% and an accelerated pozzolanic activity index of 105% at 7 days. The pozzolanic activity index is a function of the compressive strength of a mortar containing silica fume and portland cement compared to that of a mortar of portland cement alone, expressed as a percentage. The control portland cement mortar consists of 500 grams of portland cement, 1375 grams of standard sand, and 242 ml of water. The silica fume and portland cement mortar substitutes 50 grams of portland cement with silica fume.

The use of silica fume in concrete offers several significant advantages such as:

- Improved durability and resistance to chemical attacks
- Improved long-term strength of the concrete
- Increased cohesiveness of the plastic concrete
- Increased flexural and compressive strength of the concrete
- Increased bond strength
- Reduced permeability
- Reduced concrete segregation
- Reduced bleeding and plastic shrinkage of the concrete

2.3 USE OF RECYCLED CONCRETE AGGREGATE IN CONCRETE PRODUCTION

2.3.1 Background

As a result of the increasing rate of demolition, it is becoming essential to effectively reuse demolition waste in order to conserve natural resources. Decreasing natural aggregate sources as well as increasing problems with waste management support the idea of using recycled waste as aggregate for new concrete production (45). Although there are obvious positives from using recycled concrete aggregate (RCA), there are some technical obstacles limiting its use in concrete production. It should be remembered that RCA is actually a small piece of concrete containing original coarse aggregate as well as the adhered mortar. For a clear understanding of the RCA matrix, the separate parts must be identified and understood separately (46).

RCA is typically regarded as a double phase material consisting of the original virgin aggregate and the adhered residual mortar, as shown in Figure 2-3 (8). Consequently,

concrete produced with RCA will result in a hardened material that has two types of interfacial transition zones (ITZs). The first is the old ITZ between the original virgin coarse aggregate and the adhered mortar, and the second is between the new mortar and the RCA. In general, an ITZ represents a potential weak plane in conventional concrete, thus the presence of two ITZs can have a negative effect on the hardened material properties and durability of concrete containing RCA.

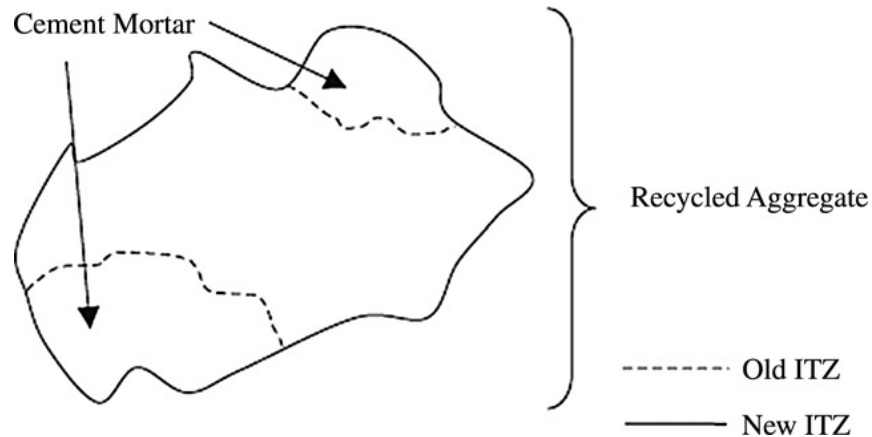

Figure 2-3. Multiple Interfacial Transition Zones in Concrete Containing RCA (8)

2.3.2 Engineering Properties of Recycled Concrete Aggregate

As a result of the usually high amounts of adhered mortar content in RCA, these types of aggregates have higher water absorption, lower density, lower specific gravity, and higher porosity compared to natural aggregates (47-49). Some technical problems render the use of RCA difficult, including weak interfacial transition zones between cement paste and aggregate, porosity and traverse cracks within demolished concrete, high levels of sulphates and chloride contents, impurities, poor grading, and high variations in quality. It is usually believed that the adhered mortar is the main cause of the lower properties of recycled aggregates compared to virgin natural aggregates.

It is also said that the recycling process may cause cracks in the recycled aggregates which in turn cause defects in the performance of the RCA (50). However, through a fluorescent microscopy and image analysis carried out on laboratory produced RCA, it was observed that adhered mortar is not always the primary parameter determining the quality of recycled coarse aggregate. The researchers reported that sandstone coarse aggregate originally had defects in the form of voids and cracks and further processing of the recycled coarse aggregate enhanced their properties.

Padmini et al. (45) performed studies to analyze the effects between the parent concrete properties on both the RCA as well as the recycled aggregate concrete (RAC). Three different gradations of natural aggregates with differing maximum aggregate sizes were used to produce concrete. For each gradation, three different concrete

compressive strengths were studied. Also, for each of those nine mixes, three different workabilities were studied to produce a total of twenty-seven mixes. Then, using a jaw crusher and adjusting its opening size to match the maximum size of the aggregate used in the parent concrete, recycled aggregates were produced to be used in making RAC specimens. The results of the study indicated that:

- As the strength of the parent concrete was increased, specific gravities increased marginally, and the quantity of adhered mortar increased due to increased bond between the aggregate and the mortar.
- The reduced specific gravity of recycled aggregate results in a reduced amount of coarse aggregate in RAC.
- The water absorption of the recycled aggregate was significantly higher than the parent aggregate, which was due to: i) type of parent aggregate, ii) strength of parent concrete, and iii) the maximum aggregate size used in the parent concrete.
- The percentage of water absorption increased with increasing strength of parent concrete due to the higher content of adhered mortar on the recycled aggregates.
- Water absorption increased with decreasing maximum aggregate size used in the parent concrete due to the higher surface area available for mortar to adhere to the original aggregates for equal volume of aggregates.

2.4 PROPERTIES OF CONCRETE CONTAINING RECYCLED CONCRETE AGGREGATE

In general, the quality of recycled aggregate concrete (RAC) is tied to the properties of the original waste concrete, the new composition, the mixing approach, and the deterioration conditions of the recycled aggregates (51). Initial investigations on the use of recycled aggregate usually focused on incorporating recycled coarse aggregate and its influence on mechanical and durability properties of the RAC. It was an adopted concept that although the use of recycled coarse aggregate may be viable, a decrease in the performance of the RAC should be regarded as a normal outcome which can be mitigated through various approaches such as increasing the cement content of the mixture, decreasing the amount of fine aggregate, and increasing the amount of water-reducing admixtures (45,52).

It also should be noted that results for concrete containing fine recycled aggregate were consistently negative, leading to recommendations not to use them (53). However, recent researches reveal the fact that properly determining the characteristics of the recycled coarse aggregate together with taking advantage of suitable mix proportioning approaches will result in producing RACs of desired performance levels and concrete made with these aggregates have the potential to satisfy the current requirements for many applications including structural applications, producing self-consolidating

concrete (SCC), etc. However, in order to encourage and promote the wider use of concrete produced with RCA as structural material, standard procedures for its production and for the evaluation of its properties should be established (2).

2.4.1 Fresh Properties

As a result of high amounts of adhered mortar that forms part of RCA, the density of RCA is usually lower than that of virgin aggregates, which in turn decreases the unit weight of concrete containing RCA (8). However, the conclusions on the workability properties of the RAC do not always reveal inferior properties in these types of concretes.

Hoffmann et al. (48) reported that a relatively high amount of water is needed in concrete production to reach good workability due to high water absorption of the RCA if the aggregate is not pre-soaked. From that, and the known high absorption of the RCA, it is evident that accurate water amounts in the concrete can only be obtained from accurate moisture content measurements prior to mixing.

Domingo et al. (9) reported that increasing the presence of RCA in the mix decreased the workability of the concrete, which may be traced to the shape, texture, and absorption of the RCA. They stated that due to that, it is necessary to use pre-saturated RCA or a larger amount of superplasticizing additives. Sagoe et al. (54), however, reported that plant processed RCA resulted in relatively smooth, spherical particles which lead to improved concrete workability when compared to natural aggregates.

Although it is generally accepted that using RCA reduces the workability of the concrete, it has been observed that through proper mix proportioning and the use of superplasticizing additives, workability goals can be met.

2.4.2 Compressive Strength

The use of RCA can have a significant effect on the compressive strength of recycled aggregate concrete (RAC). This is mainly due to the inferior properties of the residual mortar phase of the RCA particles. However, this effect can be negligible for replacement levels up to 30% (8).

Etxeberria et al. (55) reported that concrete made with a complete replacement of natural coarse aggregate with RCA resulted in a 20 to 25 percent reduction in compressive strength for a given water/cement ratio and cement content. They also reported that a complete replacement of the coarse aggregate required a high amount of cement to obtain high compressive strengths and was therefore not economically feasible. They stated that when producing medium strength concretes, a maximum of 25 percent replacement was economical. Other researchers including Domingo et al. (9) and Sim and Park (56) reported increases in concrete strengths with increasing RCA replacement percentages.

Due to the controversies present in the literature with regard to the issue of compressive strength, very few conclusions can be made. It can be concluded that the water/cement ratio is one of the main contributors affecting the compressive strength. Also, with the increased absorption of the RCA, water management will be very important. Through proper water management, the effective water/cement ratio can be kept constant.

2.4.3 Splitting Tensile Strength

It is generally reported that RCA replacement results in a decrease in splitting tensile strength of concrete. Ravindrarajah and Tam (14) reported that the splitting tensile strength of RAC was consistently 10% lower than that of conventional concrete. Tabsh and Abdelfatah (12) reported that about 25%–30% drop in the tensile strength was observed in concrete made with RCA. Kou et al. (6), observed that regardless of the type of the recycled aggregate used, the splitting tensile strength of the specimens decreased as a function of increasing RCA replacement ratio before the age of 28 days.

However, for some types of RCAs used, an increase in the splitting tensile strength at the age of 90 days is observed. Sagoe et al. (54) reported that there is no significant difference between the splitting tensile strength of a reference concrete and the RAC specimens. On the other hand, Limbachiya (10) and Yong and Teo (57) reported that while replacing up to 50% of coarse aggregate with RCA, there was no difference in splitting tensile and flexural strengths between the RAC and the reference, but at complete replacement, results were improved for RCA due to better interlocking.

2.4.4 Flexural Strength

It is usually reported that RCA replacement does not have significant negative effects on flexural strength of concrete. Xiao and Li (58), Hu (59), and Cheng (60) have reported that RCA replacement only has marginal effects on flexural strength of concrete. Ravindrarajah and Tam (14) have also reported that increasing the RCA content does not have a significant effect on flexural strength. Topçu and Sengel (61) have reported that the flexural strength decreases with an increase in RCA replacement level.

2.5 DURABILITY OF CONCRETE CONTAINING RECYCLED CONCRETE AGGREGATE

It is generally believed that the durability of RAC is inferior to that of conventional concrete with no recycled aggregates. The porosity and high absorption value of recycled aggregates compared with virgin aggregates may be regarded as one of the most important factors in this regard.

2.5.1 Chloride Ion Permeability

It is usually reported that the chloride ion permeability of concrete made with RCA is inferior to that of conventional concrete (8). However, in the case of high quality RCA, it

is observed that there is little difference between the chloride ion penetration of RAC and conventional concrete.

Sim and Park (56) observed that in the case of concrete made with coarse RCA and partial replacement of fine recycled aggregates, there is no significant difference between the total charge passed through the specimens of up to 100% fine recycled aggregate replacement. However, as the curing time increases, the higher fine recycled aggregate replacement results in a decrease in the total charge passed. Based upon their results, it seems that increasing the curing period as well as incorporating proper types and amounts of supplementary cementitious materials (SCMs), the chloride ion permeability may be controlled.

Kou et al. (6) reported that the chloride ion permeability increases as a result of an increase in the coarse RCA replacement level. However, the negative effect is more significant in the case of low grade RCA. Similar results were reported by Otsuki et al. (62) and Shayan and Xu (63).

2.5.2 Freeze/Thaw Resistance

It is generally believed that RAC mixtures are more susceptible to damage due to freeze/thaw cycles, particularly as the percentage of RCA increases (8,18). However, several researchers have found no significant difference in performance compared to conventional concrete given similar strength grades (19-21).

2.5.3 De-Icing Salt Scaling

Under deicing salt scaling tests, Movassaghi (22) reported that scaling resistance increased with increasing age of the RCA source, while Speare and Ben-Othman (23) reported no difference between concrete with RCA and conventional concrete.

2.5.4 Absorption

Absorption of RAC is usually reported to be higher than that of virgin aggregate concrete. This is mainly due to the attached porous mortar content of the RCA particles that can provide more water reservoirs, thus maintaining higher relative humidity inside the pore solution (64).

2.6 RECYCLED CONCRETE AGGREGATE IN RIGID PAVEMENT CONSTRUCTION

Most of the application of RCA in the U.S. involves the use of RCA as aggregate in base and subbase layers (1). Other applications include cement-treated base, backfill, embankment, stabilization, erosion control (riprap), and landscaping (65). According to a survey conducted by Garber et al. (66), the use of RCA in new concrete production is rather advanced in European and East Asian countries.

Regarding the use of RCA in concrete pavement, in the 1980s and 1990s, several states constructed experimental pavement sections that incorporated RCA. An FHWA-

sponsored study collected data on their long term performance (24). The sections were located in Connecticut, Kansas, Minnesota, Wisconsin, and Wyoming. In general, the RCA pavements exhibited good overall performance, tracking close to that of conventional concrete. However, RCA pavements with higher residual mortar contents showed an increased degree of cracking compared to the control pavements. Cores removed from the pavement sections showed comparable compressive and tensile strengths but decreased modulus of elasticity for the RCA pavements compared to the conventional concrete pavements. One of the important conclusions of the study was the need for better characterization of the properties of RCA and the influence on a portland cement concrete pavement mixture.

3. VIRGIN AND RECYCLED CONCRETE AGGREGATE CHARACTERIZATION

The following chapter discusses the virgin and recycled aggregate characterization. The virgin aggregates consisted of natural sand for the fine aggregate and limestone for the coarse aggregate. The research team investigated several sources of recycled concrete aggregate (RCA) for the study. In addition to standard aggregate tests, such as density, abrasion resistance, and sieve analysis, the RCA and limestone coarse aggregates also underwent aggregate imaging analysis to evaluate their surface characteristics, which can have a significant effect on workability.

3.1 VIRGIN AGGREGATE TESTING

Virgin aggregates for the research study consisted of natural sand and limestone donated by Dolese Bros. Co. from their Davis Quarry, Figure 3-1. The fine aggregate consisted of natural river sand while the coarse aggregate consisted of a No. 57 limestone. Table 3-1 summarizes the standard ASTM tests used to characterize the aggregates. The aggregate gradations and Oklahoma Department of Transportation (ODOT) gradation limits are provided in Tables 3-2 and 3-3 for the limestone and sand, respectively, both of which met the requirements. The specific gravity, dry rodded unit weight (DRUW), absorption, and LA abrasion values for both aggregate types are provided in Table 3-4. Both aggregates met all requirements of the ODOT specifications.



Figure 3-1. Dolese Bros. Co. Davis Quarry
(courtesy Dolese Bros. Co., 2017)

3.2 RECYCLED CONCRETE AGGREGATE TESTING

The research team investigated three different potential sources of RCA. Samples randomly selected from their respective stockpiles were tested for gradation and percentage of fines. One of the potential difficulties with RCA is the larger percentage as well as the type of fines compared to virgin aggregate. RCA fines – consisting

primarily of cement paste – tend to have a significantly higher level of absorption and are also the result of a crushing operation, which means they are generally more angular than natural sand and can thus cause negative issues with respect to workability of the concrete mix.

Table 3-1: Aggregate Tests and ASTM References

Aggregate Property	ASTM Reference	Description
Dry Rodded Unit Weight	ASTM C29	Bulk density and air voids
Density and Absorption	ASTM C127	Density, specific gravity, and absorption for coarse aggregate
Density and Absorption	ASTM C128	Density, specific gravity, and absorption for fine aggregate
Abrasion Resistance	ASTM C131	Resistance to degradation of coarse aggregate by abrasion and impact
Sieve Analysis	ASTM C136	Sieve analysis of fine and coarse aggregates

Table 3-2: No. 57 Coarse Aggregate Gradation and Percent Passing Limits

Sieve Size/No.	Sieve Opening (mm)	ODOT Lower Bound	Percent Passing	ODOT Upper Bound
1-1/2"	37.5	100	100	100
1"	25	95	99	100
3/4"	19	-	79	-
1/2"	12.5	25	47	60
3/8"	9.5	-	10	-
#4	4.75	0	1	10
#8	2.36	0	0.5	5
#16	1.18	-	0.4	-
#200	0.075	0	0.04	2

Table 3-3: Fine Aggregate Gradation and Percent Passing Limits

Sieve Size/No.	Sieve Opening (mm)	ODOT Lower Bound	Percent Passing	ODOT Upper Bound
3/8"	9.5	100	100	100
#4	4.75	95	99	100
#8	2.36	80	95	100
#16	1.18	50	80	85
#30	0.60	25	47	60
#50	0.30	5	14	30
#100	0.15	0	2	10
#200	0.075	0	0	3

Table 3-4: Aggregate Properties

Aggregate	Specific Gravity	DRUW (pcf)	Absorption (%)	LA Abrasion (%)
Sand	2.58	-	0.40	-
No. 57	2.64	101.5	0.86	24

Coarse aggregate gradations of the three No. 57 RCA sources are shown in Table 3-5. RCA Source No. 3 came closest to meeting all the gradation limits for a No. 57 coarse aggregate, only missing the 1" sieve lower bound limit, indicating a slightly larger percentage of aggregate greater than 1" in size. RCA Source No. 1 had a very poor gradation in the middle of the sieve sizes, with too much passing the 1/2" sieve. RCA Source No. 1 also had the highest percentage of fines, significantly exceeding the upper bound gradation limits. RCA Source No. 2 retained a large portion of aggregate on the 1/2" sieve as well as having a significant percentage of fines as well.

Fines removed from the No. 57 RCA sources also underwent gradation testing, with the results shown in Table 3-6. Only RCA Source No. 3 met the fine aggregate gradation limits, which is likely due to the high percentage of fines within the No. 57 for the other two RCA sources.

Table 3-5: Coarse Aggregate Gradations and Percent Passing Limits of RCA Sources

Sieve Size/No.	ODOT Lower Bound	RCA Source No. 1	RCA Source No. 2	RCA Source No. 3	ODOT Upper Bound
1-1/2"	100	100	100	100	100
1"	95	93	82	85	100
3/4"	-	84	56	79	-
1/2"	25	72	21	35	60
3/8"	-	35	19	10	-
#4	0	22	17	5	10
#8	0	17	14	3	5
#16	-	10	12	1	-
#200	0	5	2	1	2

Table 3-6: Fine Aggregate Gradations and Percent Passing Limits of RCA Sources

Sieve Size/No.	ODOT Lower Bound	RCA Source No. 1	RCA Source No. 2	RCA Source No. 3	ODOT Upper Bound
3/8"	100	100	100	100	100
#4	95	75	90	100	100
#8	80	60	90	80	100
#16	50	50	60	60	85
#30	25	35	47	40	60
#50	5	20	25	21	30
#100	0	10	12	9	10
#200	0	5	5	5	3

Based on the gradation results, the research team chose RCA Source No. 3 to move forward with additional testing. This RCA source also had the highest level of quality control, repeatability, and scalability, all necessary characteristics for successful implementation to full scale production.

The specific gravity, dry rodded unit weight (DRUW), absorption, and LA abrasion values for RCA Source No. 3 are provided in Table 3-7, along with the previous results for the No. 57 limestone and natural river sand for comparison. Photographs of the limestone and RCA are shown in Figure 3-2. As expected, the RCA had much higher absorption, lower density and unit weight, and increased material loss during abrasion testing. Nonetheless, RCA Source No. 3 met all the ODOT specification requirements except for a slightly higher percentage of aggregate retained on the 1" sieve, approximately 10 percent higher than the prescribed limit. The decision was made to move forward with additional testing of RCA Source No. 3.

Table 3-7: Virgin and RCA Aggregate Properties

Aggregate	Specific Gravity	DRUW (pcf)	Absorption (%)	LA Abrasion (%)
River Sand	2.58	-	0.40	-
Fine RCA	2.41	-	6.82	-
No. 57 Limestone	2.64	101.5	0.86	24
No. 57 Coarse RCA	2.38	91.5	4.27	37



Figure 3-2. No. 57 Limestone (left) and Recycled Concrete Aggregate (right)

3.3 AGGREGATE IMAGING SYSTEM

The Aggregate Imaging System (AIMS) is a computer-automated video system that directly analyzes texture, angularity, and shape of both coarse and fine aggregates (67). Research done in the past has shown that there are repeatable trends when using the AIMS. Due to the more descriptive, rapid, and automated nature of the AIMS, it is the recommended method for determining aggregate texture, angularity, and shape of both coarse and fine aggregates.

Form, angularity (or roundness), and surface texture are all terms that completely describe an aggregate's particle geometry. Figure 3-3 depicts all three measures on a single aggregate. Form reflects variations in the proportions of a particle, angularity reflects variations at the corners of a particle, and surface texture reflects the degree of surface variations along the planes of a particle. These measures are distinguished by the scale of each with respect to the particle size, with form at the highest scale and related to the overall shape, angularity at the next scale and related to the edges, and texture at the lowest scale and related to the surfaces.

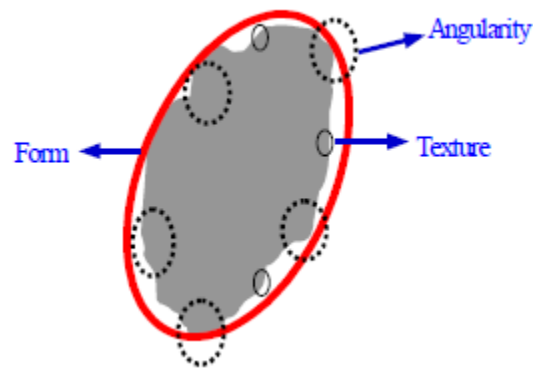

Figure 3-3. Aggregate Shape Properties (67)

Aggregate angularity is determined by placing each aggregate on a glass grid that has backlighting used to create simple, black and white images, resulting in an easy way to calculate the aggregate's form (67). The AIMS can measure texture for aggregates on the same grid. However, this calculation is more complicated and therefore has a wider range for miscalculation and over conservatism. Instead of using backlighting underneath the glass grid, a top lighted ring mounted around the outside of the microscope lens is used. The computer control system automatically adjusts the lighting intensity when using the top lighting scheme for dark versus light colored aggregates. The contrast of dark versus light colored aggregates, along with the computer's ability to determine the aggregate depth measurement, is how the texture index is calculated.

AIMS aggregate testing focused mainly on the angularity and texture of RCA in comparison to the limestone. For both measurements, the angularity and texture of three representative samples of limestone and three representative samples of RCA were analyzed using the AIMS testing apparatus.

3.3.1 Angularity Measurements

The AIMS measures aggregate angularity on a range from 0 to 8000 (67). FHWA states that an angularity index value of 5000 or above is typical for a highly angular aggregate, while an angularity index value of 2000 or less is classified as round aggregate. For comparison, gravel has an average angularity index value of approximately 2400,

limestone has an average angularity index value of approximately 2800, and granite has an average angularity index value of approximately 3000.

Figure 3-4 plots the angularity indices for all three limestone samples analyzed. From the figure, it is apparent that approximately 90 percent of the limestone used in this research is in the middle range. The AIMS also calculated an average angularity index value of 3224 for the limestone.

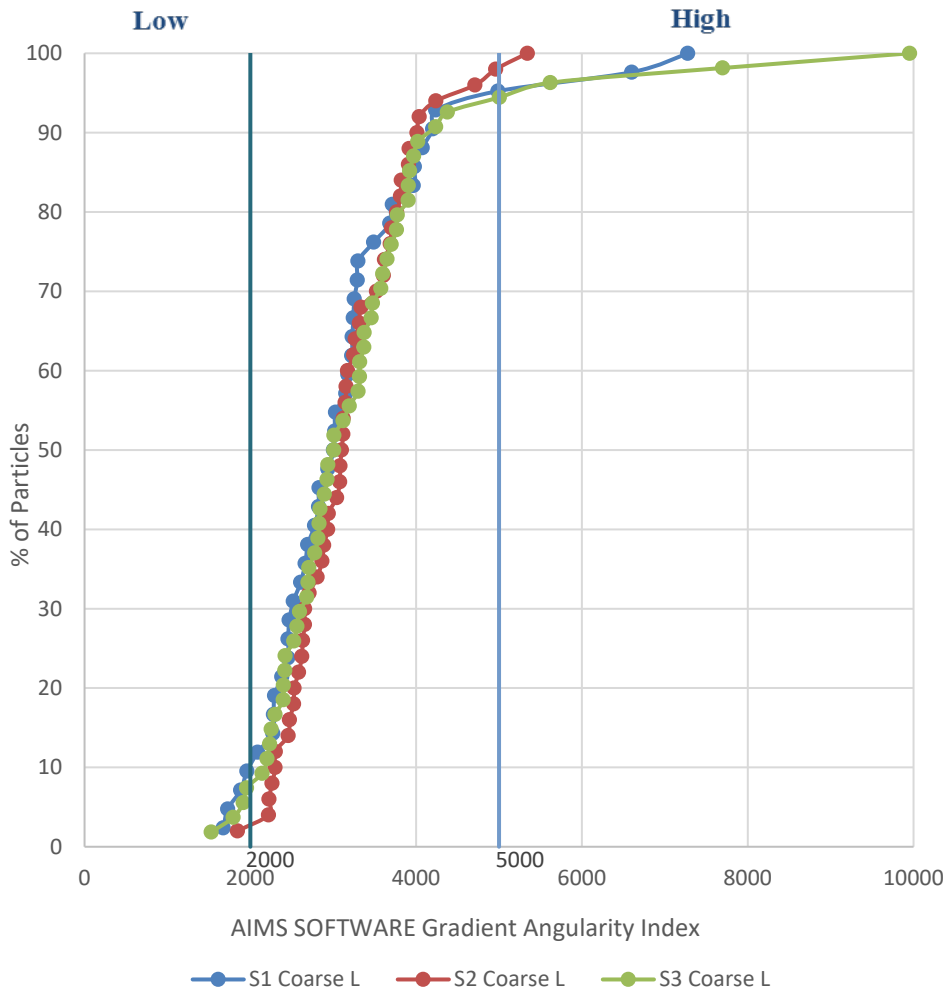

Figure 3-4. AIMS Limestone Gradient Angularity Analysis

Figure 3-5 plots the angularity indices for all three RCA samples analyzed. From the figure, it is apparent that approximately 80 percent of the RCA used in this research is in the middle range. The AIMS also calculated an average angularity index value of 3043 for the RCA.

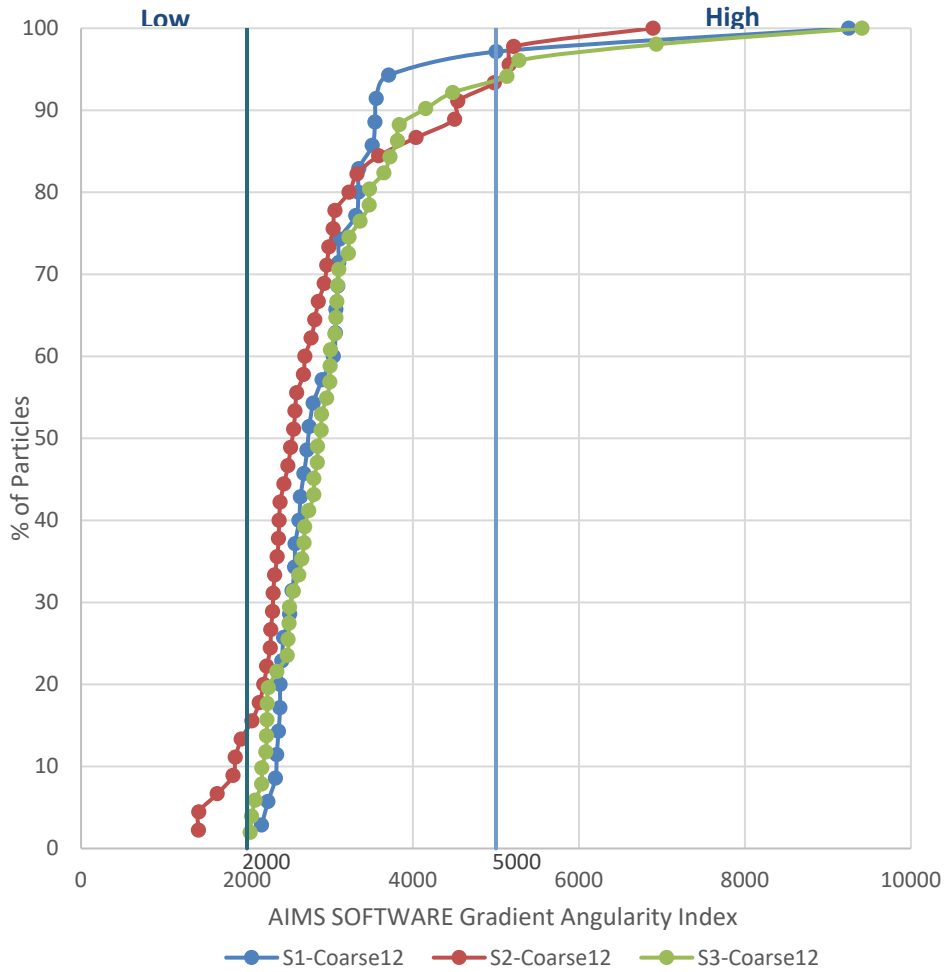

Figure 3-5. AIMS RCA Gradient Angularity Analysis

3.3.2 Texture Measurements

The AIMS measures aggregate texture on a range from 0 to 800 (67). FHWA states that a texture index value of 500 or above is typical for a highly rough aggregate, while a texture index value of 150 or less is classified as polished aggregate. For comparison, gravel has an average texture index value of approximately 148 and limestone has an average texture index value of approximately 187.

Figure 3-6 plots the texture indices for all three limestone samples analyzed. From the figure, it is apparent that approximately 55 percent of the limestone used in this research is in the middle range and approximately 40 percent is in the lower range. The AIMS also calculated an average texture index value of 208 for the limestone.

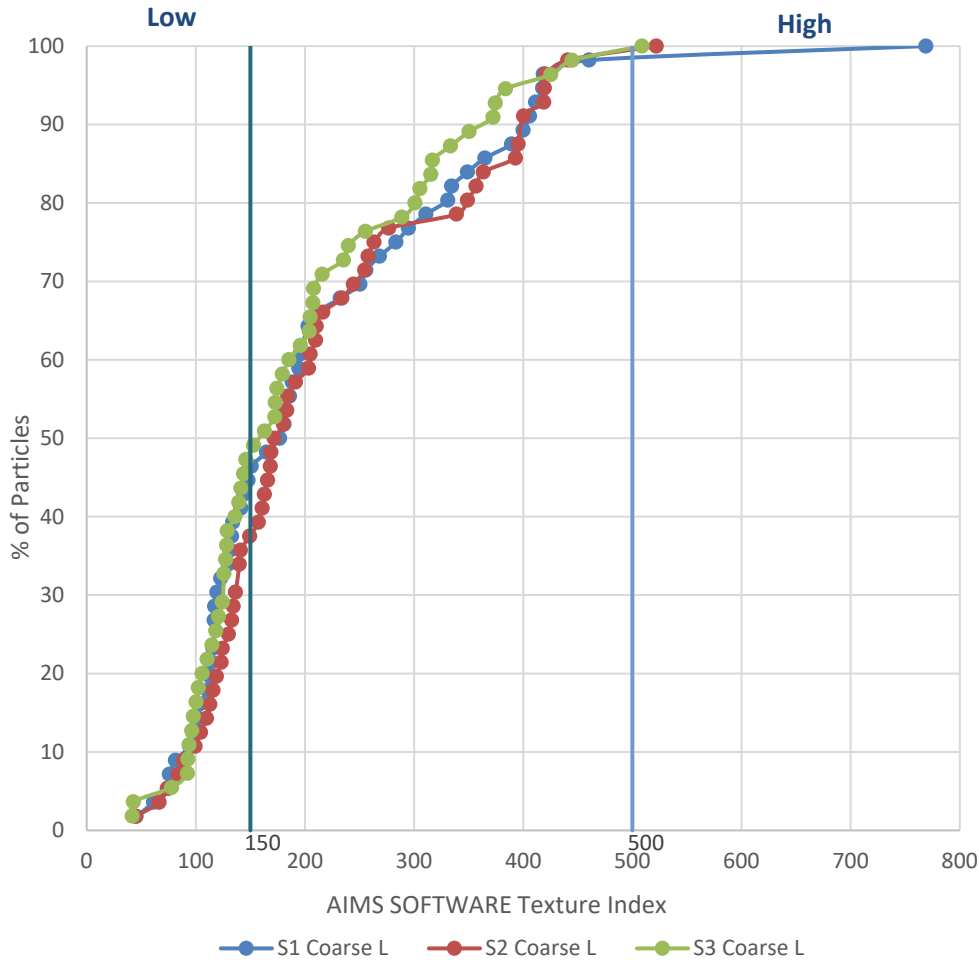

Figure 3-6. AIMS Limestone Texture Index Analysis

Figure 3-7 plots the texture indices for all three RCA samples analyzed. From the figure, it is apparent that approximately 60 percent of the RCA used in this research is categorized as low texture particles. The AIMS also calculated an average texture index value of 148 for the RCA.

3.3.3 Summary

A concise summary of the AIMS results for the limestone and RCA used in this research is shown in Table 3-8. As the table indicates, the RCA proved to be less angular and less rough than the limestone according to the AIMS analysis.

However, as previously mentioned, the AIMS is known for being overly conservative when analyzing texture. In fact, samples of RCA were analyzed multiple times, with the second test series using unwashed aggregate to determine if this might affect the texture results. The AIMS indicated an even smoother texture for the unwashed RCA, directly opposite to the anticipated result. It seems that the AIMS has difficulty with

lighter colored aggregate in terms of accurately determining texture, and the RCA is much lighter than the virgin limestone due to the adhered mortar and even more so prior to washing off loose grains of mortar surrounding the aggregate.

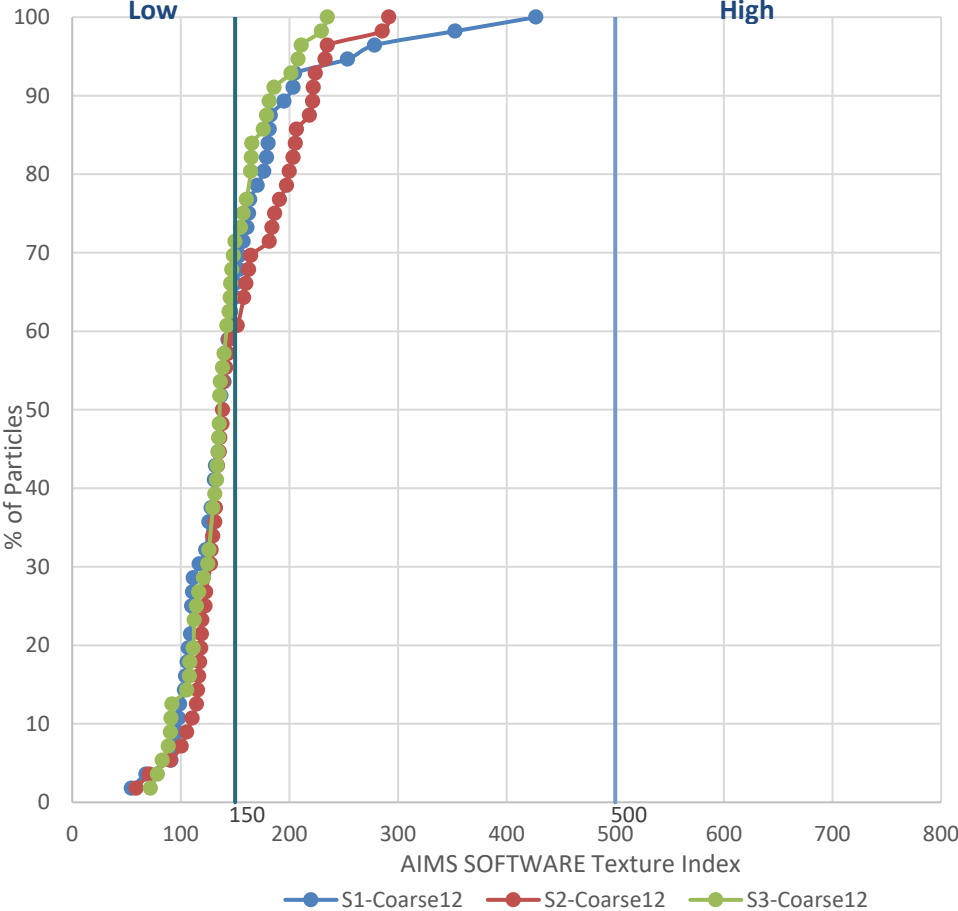

Figure 3-7. AIMS RCA Texture Index Analysis

Table 3-8: Summary of AIMS Results

Aggregate	Angularity	Texture
Limestone	3,224	208
RCA	3,043	148

When performing a sort of tactile test – comparing the feeling of the surface of the RCA versus the surface of the limestone with touch – as well as a visual test (for example, Figure 3-2), it is easily distinguishable that the RCA is rougher than the limestone. Therefore, the RCA texture result provided by the AIMS should be disregarded. Thus, the most important takeaway from the angularity and texture analyses is that the limestone aggregate is more angular yet has smoother surface planes than the RCA, and as a result, it is believed that workability will likely remain the same when substituting RCA for limestone as these two conditions will tend to balance.

4. MIX DEVELOPMENT – PHASE I

The primary goal of this research was to produce concrete for conventional pavement construction that incorporated at least 50% recycled materials without compromising performance and service life. To accomplish this goal, the research team investigated the use of recycled concrete aggregate (RCA) and fly ash on the fresh and hardened properties of potential concrete pavement mix designs. The RCA was used to replace portions of the virgin coarse aggregate, and fly ash was chosen as the supplementary cementitious material due to its ready availability and significant use in the State of Oklahoma. This chapter discusses the effect of these recycled materials on the performance of potential mix designs when used both separately and together.

4.1 MIX DESIGN DEVELOPMENT

The basis for the mix designs developed for this research is an ODOT Class A concrete pavement mix design, the requirements of which are shown in Table 4-1. A standard mix design based on these requirements is shown in Table 4-2. (Note that the slump requirements are prior to the addition of water-reducing admixtures.) In addition to serving as the basis for the recycled material mix design study, this concrete mixture also served as the control for subsequent fresh and hardened property and durability comparisons.

Table 4-1: ODOT Requirements for a Class A Concrete Pavement

Minimum Cement Content (lb./yd. ³)	Air Content (%)	Water/Cement Ratio	Slump (in.)	Minimum Compressive Strength (psi)
517	6±1.5	0.25 – 0.48	2±1	3,000

Table 4-2: Class A Concrete Mix Design per Cubic Yard

Cement Content	w/c	Sand	Limestone	Air Entraining Admixture	Water Reducing Admixture
517 lb.	0.48	1,465 lb.	1,850 lb.	0.3 oz./cwt	4.5 oz./cwt

The mix design matrix, shown in Table 4-3, consisted of the Class A control mix design plus three different series of mixes. The first series examined the effect of varying the amount of RCA replacement of the virgin coarse aggregate. The second series examined the effect of varying the amount of fly ash replacement of the cement. The third series examined the effect of using the combination of both recycled materials, RCA and fly ash.

Table 4-3: Mix Design Matrix

Mix ID	Description	RCA or Fly Ash Replacement Level
C	Control (Class A Mix)	-
1-25	Series No. 1 RCA Replacement	25% RCA
1-50		50% RCA
1-75		75% RCA
1-100		100% RCA
2-20	Series No. 2 Fly Ash Replacement	20% Fly Ash
2-40		40% Fly Ash
2-60		60% Fly Ash
3-40	Series No. 3 Fly Ash Replacement with 100% RCA	40% Fly Ash
3-50		50% Fly Ash
3-60		60% Fly Ash

The chemical and physical properties of the Type I/II cement and Class C fly ash used in this research study are shown in Table 4-4.

Table 4-4: Chemical and Physical Properties of Cementitious Materials

Property	Type I/II Cement	Class C Fly Ash
SiO ₂ , %	19.8	35.5
Al ₂ O ₃ , %	4.8	20.5
Fe ₂ O ₃ , %	3.1	6.8
CaO, %	63.2	26.3
MgO, %	1.4	5.5
SO ₃ , %	3.1	2.4
LOI, %	2.7	0.3
Specific Gravity	3.1	2.7
Blaine Fineness, m ² /kg	395	475

The mix designs for Phase I of the research program are shown in Table 4-5, which were based on the mix design matrix shown in Table 4-3. AEA indicates air-entraining admixture, and HRWRA indicates high-range water-reduction admixture. The water/cement ratio and the admixtures dosages were kept constant in order to evaluate the effect of the other constituents on the response and behavior of the mixes.

Table 4-5: Phase I Mix Designs per Cubic Yard

Mix ID	w/c	Cement (lb.)	Fly Ash (lb.)	Sand (lb.)	Limestone (lb.)	RCA (lb.)	AEA (oz./cwt)	HRWRA (oz./cwt)
C	0.48	517	-	1,465	1,850	-	0.3	4.5
1-25	0.48	517	-	1,465	1,387	432	0.3	4.5
1-50	0.48	517	-	1,428	924	863	0.3	4.5
1-75	0.48	517	-	1,393	462	1,294	0.3	4.5
1-100	0.48	517	-	1,357	0	1,725	0.3	4.5
2-20	0.48	414	103	1,465	1,850	-	0.3	4.5
2-40	0.48	310	207	1,465	1,850	-	0.3	4.5
2-60	0.48	207	310	1,465	1,850	-	0.3	4.5
3-40	0.48	310	207	1,357	0	1,725	0.3	4.5
3-50	0.48	259	259	1,357	0	1,725	0.3	4.5
3-60	0.48	207	310	1,357	0	1,725	0.3	4.5

4.2 FRESH PROPERTIES

The fresh concrete properties for the 11 research mixes are summarized in Table 4-6. Series No. 1, the RCA replacement of the coarse aggregate, had inconsistent results with respect to both the slump and unit weight. It was expected that as the percentage of RCA increased, the slump would decrease due to the increased roughness of the RCA compared to the limestone, but the slump for the 25 percent and 75 percent replacement levels exceeded the control and no obvious pattern resulted. The unit weights track with the slump in that the higher slump mixes had lower unit weights compared to the control.

Series No. 2, the fly ash replacement of the cement, on the other hand, provided expected results in that the slump increased and unit weight decreased as the percentage of fly ash replacement increased.

Series No. 3, the combination of RCA and fly ash replacement, also lacked a consistent pattern of response, most likely due to the inconsistencies shown by Series No. 1. The slump of all three mixes was approximately equal even though the increasing amount of fly ash should have increased the slump due to improved workability.

Table 4-6: Fresh Concrete Properties

Mix ID	Slump	Air Content	Unit Weight
C	3-1/4"	6.5%	143.9 pcf
1-25	7-3/4"	7.0%	137.8 pcf
1-50	3-1/2"	6.0%	142.6 pcf
1-75	5-1/4"	7.5%	139.3 pcf
1-100	1-1/4"	5.5%	141.0 pcf
2-20	5-3/4"	7.0%	142.9 pcf
2-40	7-1/2"	7.5%	140.6 pcf
2-60	8"	7.0%	139.4 pcf
3-40	8-3/4"	7.3%	136.3 pcf
3-50	8-1/4"	6.5%	135.9 pcf
3-60	8-1/4"	7.5%	133.9 pcf

4.3 MATERIAL PROPERTIES

The material properties for the 11 research mixes are summarized in Table 4-7. Series No. 1, the RCA replacement of the coarse aggregate, although not following the expected trend of decreasing strength for increasing RCA replacement, the results were at least consistent with the slump values in that for the higher slump mixes, the strengths were lower. Conversely, for the lower slump mixes, the strengths were higher. In examining the mixes closer, it turns out that the high slump mixes, 1-25 and 1-75, had much lower water content of the aggregate and, therefore, required extra mix water to account for the high absorption of the RCA. Perhaps the RCA failed to absorb the water during mixing, and the result was an increased effective water/cement ratio, which would increase the slump and decrease the compressive strength.

Series No. 2, the fly ash replacement of the cement, on the other hand, had expected results in that the 28-day compressive strengths decreased for increasing fly ash replacement of the cement. Fly ash generally hydrates at a slower rate, which means it

may be more appropriate to consider 56-day compressive strengths for these high fly ash replacement levels.

Series No. 3, the combination of RCA and fly ash replacement, has a somewhat consistent pattern of response, most likely due to the inconsistencies shown by Series No. 1. The strengths decreased with increasing fly ash replacement, and the compressive strengths of the series were much lower than either the RCA replacement mixes or the fly ash replacement mixes.

Table 4-7: Material Properties

Mix ID	Compressive Strength	Modulus of Rupture	Split Cylinder Strength	Modulus of Elasticity
C	5,250 psi	602 psi	385 psi	4,260,000 psi
1-25	4,370 psi	533 psi	383 psi	3,668,000 psi
1-50	5,110 psi	605 psi	450 psi	4,320,000 psi
1-75	4,760 psi	551 psi	399 psi	3,777,000 psi
1-100	4,940 psi	585 psi	426 psi	4,350,000 psi
2-20	4,430 psi	517 psi	416 psi	3,870,000 psi
2-40	4,385 psi	549 psi	381 psi	3,590,000 psi
2-60	3,630 psi	418 psi	362 psi	3,245,000 psi
3-40	3,360 psi	330 psi	330 psi	3,450,000 psi
3-50	3,190 psi	287 psi	287 psi	3,275,000 psi
3-60	2,640 psi	275 psi	275 psi	3,130,000 psi

In terms of strength requirements, only one mix, 3-60, did not reach the ODOT minimum compressive strength requirement of 3,000 psi at 28-days. Furthermore, four of the research mixes – 2-60, 3-40, 3-50, and 3-60 – did not reach the project goal minimum compressive strength of 4,000 psi. However, all four of these mixes had significant levels of fly ash replacement, and fly ash hydrates much more slowly than cement. As a result, it may be more appropriate to consider 56-day compressive strengths for these mixes going forward.

Table 4-8 contains the normalized mechanical properties of the 11 research mixes. The modulus of rupture and modulus of elasticity values were normalized with respect to the square root of the compressive strength, while the split cylinder strength was

normalized with respect to the compressive strength taken to the two-thirds power. These are common normalization techniques used to compare concretes with different compressive strengths. In general, the normalizations are consistent between the three series, indicating that the material properties track well with the compressive strengths.

4.4 CONCLUSIONS

The results of the Phase I mix development indicated a potential issue with respect to the rate of absorption of the RCA. In general, the absorption of RCA is typically much higher than virgin aggregates, primarily due to the adhered mortar. It also appears that a combination of the rate of absorption as well as the relatively high porosity of the RCA may result in an increase in the effective water/cement ratio when the RCA is very dry prior to mixing. In other words, the amount of extra mix water necessary to saturate the RCA does not get fully absorbed by the RCA and, instead, causes a noticeable increase in the actual water/cement ratio of the cement paste, increasing slump and decreasing material properties.

Table 4-8: Normalized Material Properties

Mix ID	Modulus of Rupture	Split Cylinder Strength	Modulus of Elasticity
C	8.31	1.27	58,794
1-25	8.06	1.43	55,487
1-50	8.46	1.52	60,433
1-75	7.99	1.41	54,643
1-100	8.32	1.47	61,891
2-20	7.77	1.54	58,145
2-40	8.29	1.42	54,214
2-60	6.94	1.53	53,859
3-40	7.47	1.47	59,518
3-50	6.98	1.32	57,985
3-60	6.62	1.44	60,918

5. DURABILITY – PHASE I

The primary goal of this research was to produce concrete for conventional pavement construction that incorporated at least 50% recycled materials without compromising performance and service life. Chapter 4 contains the results of a series of mix designs used to evaluate the effect of recycled concrete aggregate (RCA) and fly ash on concrete performance – specifically the fresh and hardened material properties – when used both separately and together. This chapter discusses the effect of these recycled materials on the durability of potential mix designs when used both separately and together.

5.1 MIX DESIGNS

The mix designs from Chapter 4 are repeated in Table 5-1. They include a control mix plus three different series of mixes. The first series examined the effect of varying the amount of RCA replacement of the virgin coarse aggregate. The second series examined the effect of varying the amount of fly ash replacement of the cement. The third series examined the effect of using the combination of both recycled materials, RCA and fly ash.

Table 5-1: Phase I Mix Designs per Cubic Yard

Mix ID	w/c	Cement (lb.)	Fly Ash (lb.)	Sand (lb.)	Limestone (lb.)	RCA (lb.)	AEA (oz./cwt)	HRWRA (oz./cwt)
C	0.48	517	-	1,465	1,850	-	0.3	4.5
1-25	0.48	517	-	1,465	1,387	432	0.3	4.5
1-50	0.48	517	-	1,428	924	863	0.3	4.5
1-75	0.48	517	-	1,393	462	1,294	0.3	4.5
1-100	0.48	517	-	1,357	0	1,725	0.3	4.5
2-20	0.48	414	103	1,465	1,850	-	0.3	4.5
2-40	0.48	310	207	1,465	1,850	-	0.3	4.5
2-60	0.48	207	310	1,465	1,850	-	0.3	4.5
3-40	0.48	310	207	1,357	0	1,725	0.3	4.5
3-50	0.48	259	259	1,357	0	1,725	0.3	4.5
3-60	0.48	207	310	1,357	0	1,725	0.3	4.5

5.2 DURABILITY TESTS AND SPECIMEN FABRICATION

Two different durability tests were performed on the research mixes – Freeze/Thaw Resistance, ASTM C666, and Salt Scaling Resistance, ASTM C672. Due to limitations with the testing equipment and the minimum number of required samples for each test, not all mix designs underwent the durability tests. Table 5-2 lists the two tests and the mixes on which they were performed. The selected mixes represented a broad range of the three series of mixes and included the control as a reference.

Table 5-2: Specific Mixes Undergoing Durability Testing

Durability Test	Mixes Tested
Freeze/Thaw Resistance (ASTM C666)	C, 1-25, 1-100, 2-20, 2-60, 3-40, 3-60
Salt Scaling Resistance (ASTM C672)	C, 1-100, 3-40, 3-60

Freeze/thaw resistance testing followed ASTM C666 Procedure A, where the specimens were always completely surrounded by water while they were subjected to the 300 freeze/thaw cycles. Figure 5-1 shows the specimens within the freeze/thaw chamber. The green wires in the figure maintain the required thickness of water around each specimen and allow easy removal of the specimens for periodic visual examination and testing.



Figure 5-1. Freeze/Thaw Specimens within Test Chamber

In accordance with ASTM C666, the research team determined the longitudinal dynamic modulus of elasticity of each specimen at intervals of approximately 36 freeze/thaw cycles using an Emodometer, as shown in Figure 5-2. The process involved removing the specimens from the freeze/thaw chamber and placing them in a constant temperature, lime water, tempering tank for 24 hours prior to testing, as shown in Figure 5-3. This process allowed the specimens to thoroughly thaw and maintain a consistent level of saturation for repeatability of the dynamic modulus measurements. After each series of dynamic modulus tests, the specimen locations were rotated within the freeze/thaw chamber to eliminate the effect of any preferential conditions within the chamber. The first sequence of 36 cycles began after the required 14-day moist cure period for the specimens.



Figure 5-2. Longitudinal Dynamic Modulus of Elasticity Test Setup

Salt scaling resistance testing follow ASTM C672, where the specimens underwent 50 cycles of periodic freezing and thawing while the top surface was covered in a solution of calcium chloride and water to a depth of approximately 1/4 inch. Testing required a minimum of two specimens for each mix, with each specimen having a minimum ponded area of 72 square inches. As this test is a comparative measure, all specimens must have the same finish and surface treatment. Also, the dike used to maintain the solution of calcium chloride and water may be mortar, epoxy, or any other suitable material that will retain the solution during the freeze/thaw cycling. At intervals of every

5 cycles, the specimens were thoroughly flushed and visually examined at 5, 10, 15, 25, and 50 cycles. The visual rating system is shown in Table 5-3.

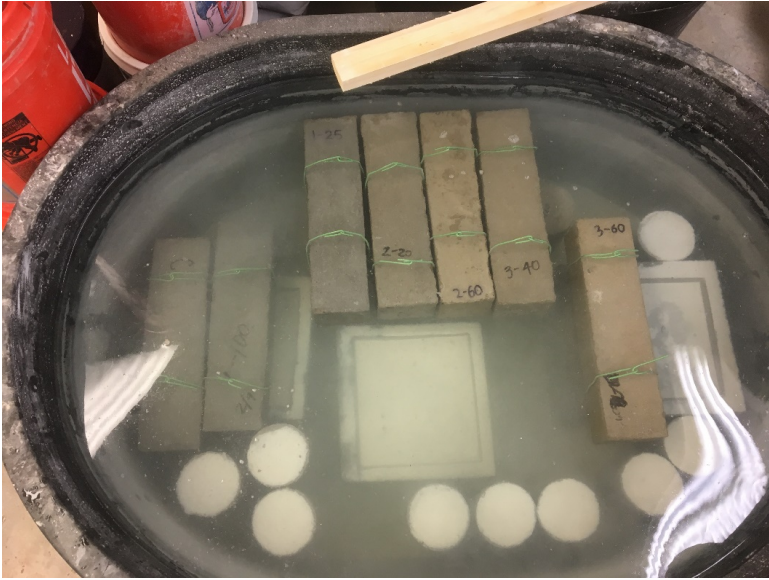

Figure 5-3. Constant Temperature Lime Water Tempering Tank

Table 5-3: Visual Rating Scale for Salt Scaling Resistance

Rating	Condition of Surface
0	No scaling
1	Very slight scaling (1/8 in. depth max., no coarse aggregate visible)
2	Slight to moderate scaling
3	Moderate scaling (some coarse aggregate visible)
4	Moderate to severe scaling
5	Severe scaling (coarse aggregate visible over entire surface)

The specimens were cast upside down, as shown in Figure 5-4, to help form the retaining dike and so that each specimen would have a consistent formed surface for testing as opposed to a finished surface, which might have more variability. All specimens underwent the required 14-day moist cure followed by a 14-day air cure, as shown in Figure 5-5. At 28 days of age, the calcium chloride and water solution was placed along the top surfaces, and each specimen was placed into an environmental chamber for the required freeze/thaw cycling, shown in Figure 5-6.



Figure 5-4. Salt Scaling Specimens as Cast



Figure 5-5. Salt Scaling Specimens Air Curing



Figure 5-6. Salt Scaling Specimens within Environmental Chamber

5.3 RESULTS OF FREEZE/THAW TESTING

The results for the freeze/thaw testing of the research mixes are shown in Figure 5-7. The plot shows the decrease in dynamic modulus as a function of the number of freeze/thaw cycles. ODOT requires a minimum of 50% at 300 cycles. As a result, only two of the mixes met the ODOT minimum durability requirements. The two fly ash mixes, 2-20 and 2-60, performed extremely well in terms of their dynamic modulus performance, whereas the control mix had the worst performance. The mixes containing RCA, either with or without fly ash, performed very similarly, although they all failed to meet the minimum durability requirements.

The visual response of the freeze/thaw specimens tells a slightly different story depending on the particular specimen. A Control specimen is shown in Figure 5-8 at the end of testing, 304 cycles. Visual examination supports the extremely poor freeze/thaw performance indicated by the dynamic modulus test, with noticeable mass loss and deterioration. Similarly, the mix containing 25 percent RCA and no fly ash, 1-25, performed better than the Control in terms of both the visual response and the dynamic modulus, as shown in Figure 5-9. On the other hand, although the fly ash mixes without RCA – 2-20 and 2-60 – performed exceptionally well in terms of their dynamic modulus results, with durability factors exceeding 97, they suffered significant mass loss and deterioration, as shown in Figure 5-10.

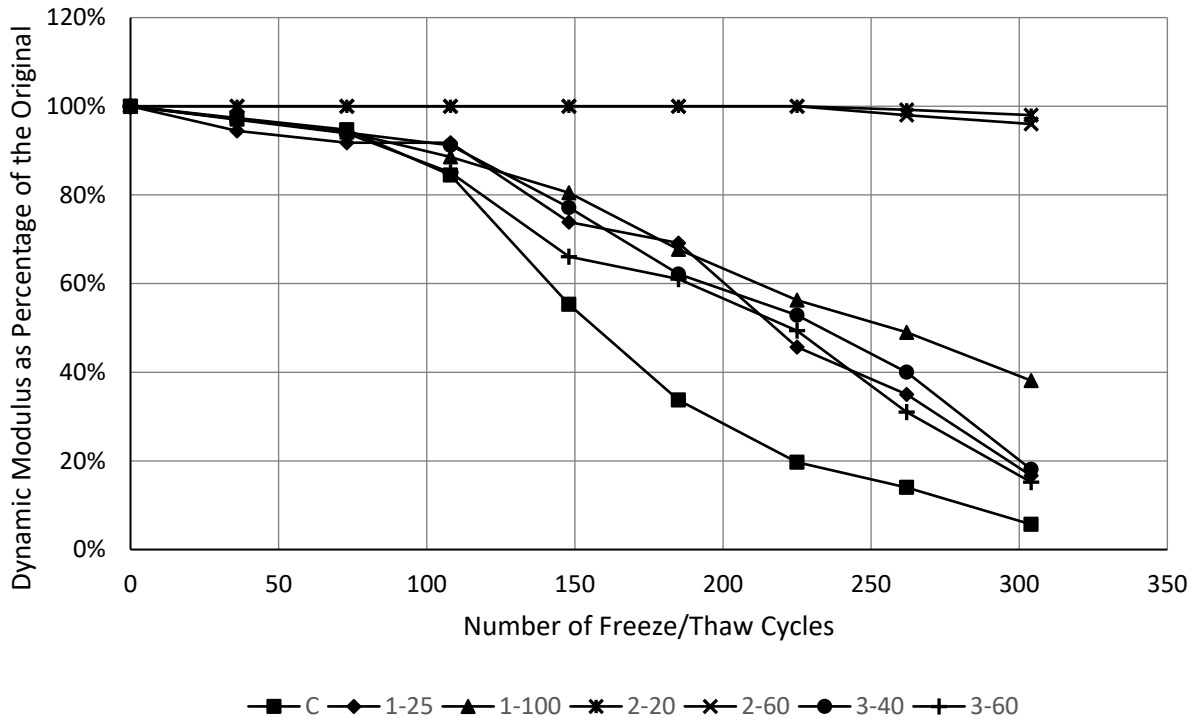

Figure 5-7. Freeze/Thaw Dynamic Modulus Test Results

It is unusual for the dynamic modulus measurements and the visual observations to tell a different story. It is possible that the high replacements of fly ash caused a denser cementitious matrix that also continued to hydrate over time during the freeze/thaw cycling, partially counterbalancing the destructive forces of freezing and thawing acting on the specimen. Additional freeze/thaw testing possibly coupled with petrographic examination may yield further understanding of this phenomenon.



Figure 5-8. Control Mix Specimen at 304 Freeze/Thaw Cycles



Figure 5-9. Mix 1-25 Specimen at 304 Freeze/Thaw Cycles



Figure 5-10. Mix 2-20 Specimen at 304 Freeze/Thaw Cycles

5.4 RESULTS OF SALT SCALING TESTING

The results for the salt scaling testing of the research mixes are shown in Table 5-4. The visual rating results indicate an increase in the amount of scaling as a function of the number of freeze/thaw cycles. ODOT does not require a particular level of scaling resistance except for bridge deck patch repairs, which require no scaling and thus a visual rating of zero at the end of 50 freeze/thaw cycles. However, in terms of a comparison with the Control mix, two of the mixes performed as well or better, 1-100 and 3-60, while the third mix, 3-40, underwent a higher amount of scaling. In general, mixes with high amounts of fly ash (3-40 and 3-60) tend to underperform in salt scaling testing but usually perform well in service (34).

Table 5-4: Scaling Resistance Visual Rating vs. Number of Cycles

Mix ID	5 cycles	10 cycles	15 cycles	25 cycles	50 cycles
C	0	0	0	0	1
1-100	0	0	0	1	2
3-40	0	0	2	3	3
3-60	0	0	0	1	1

Photographs of four of the specimens before and after the full 50 freeze/thaw cycles are shown in Figures 5-11 through 5-14. As indicated by the photographs, one of the fly ash mixes, 3-40, perform very poorly, with moderate scaling across the entire surface, Figure 5-11. This mixture also had 100 percent replacement of the coarse aggregate with RCA. However, the mixture with no fly ash and 100 percent replacement of the coarse aggregate with RCA performed better, as shown in Figure 5-12, but still had slight to moderate scaling. In comparison, the control mix performed slightly better, yet still had signs of scaling at some locations of the surface, as shown in Figure 5-13. Most unusually, the mixture containing the highest amount of fly ash replacement, 3-60, performed much better than the mixture with 40 percent fly ash, 3-40, with the same ratings as the control mixture specimens, showing signs of scaling as some locations of the surface, as shown in Figure 5-14.

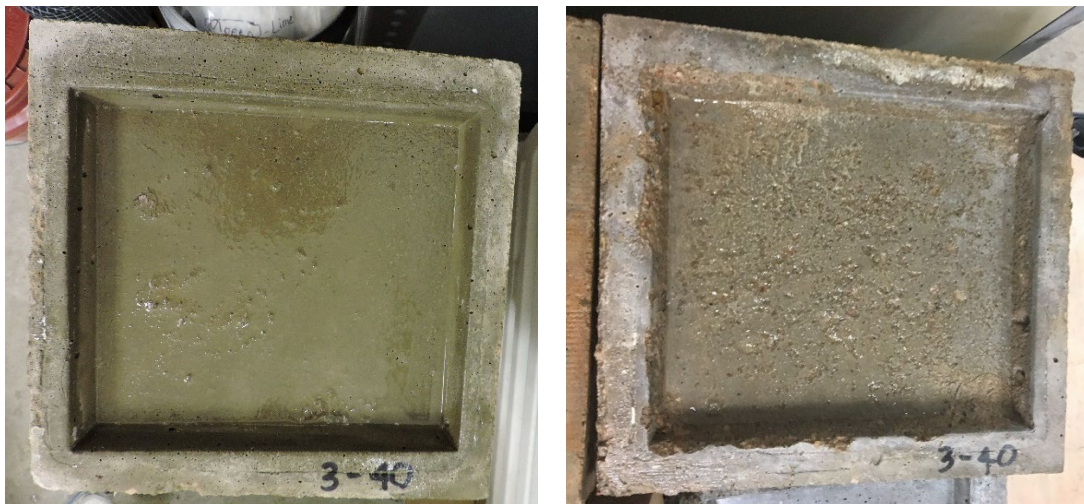

(a) 0 Cycles

(b) 50 Cycles

Figure 5-11. Mix 3-40 Salt Scaling Specimens

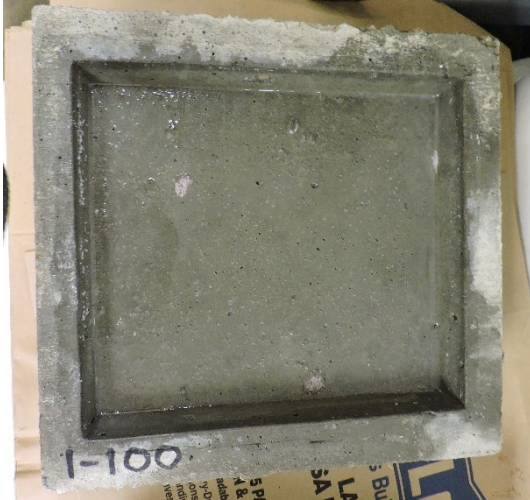

(a) 0 Cycles



(b) 50 Cycles

Figure 5-12. Mix 1-100 Salt Scaling Specimens

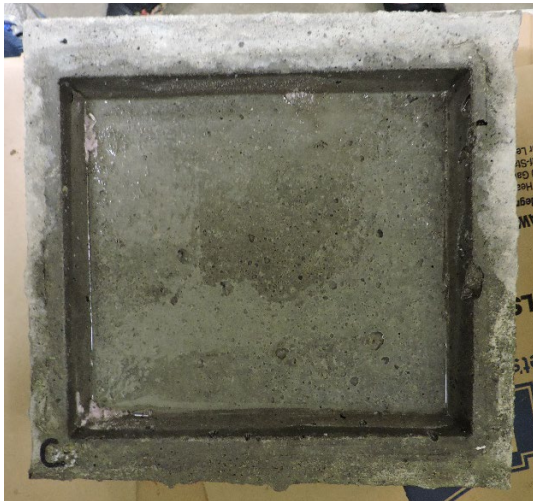

(a) 0 Cycles



(b) 50 Cycles

Figure 5-13. Control Mix Salt Scaling Specimens

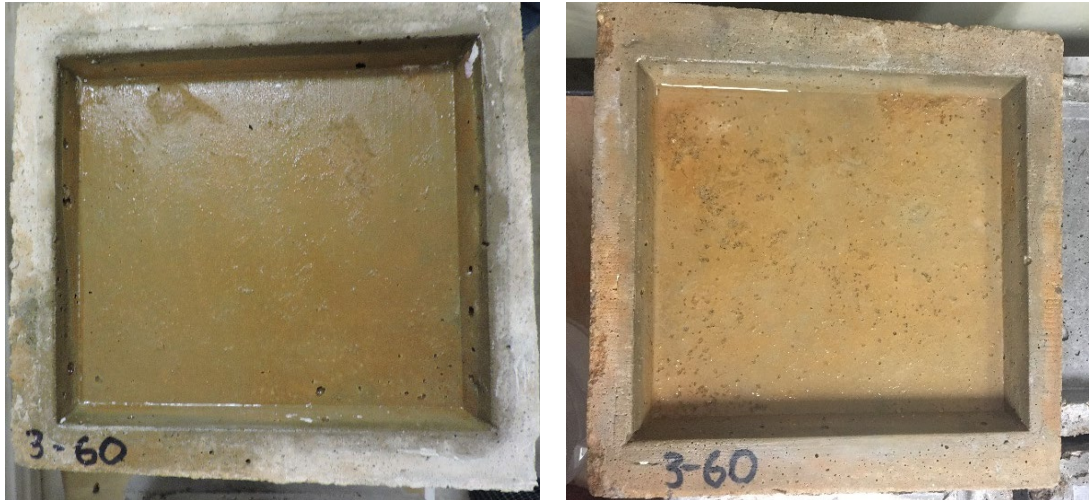

(a) 0 Cycles

(b) 50 Cycles

Figure 5-14. Mix 3-60 Salt Scaling Specimens

5.5 CONCLUSIONS

The results of the Phase I durability testing had mixed results. Regarding freeze/thaw resistance, the mixes with high amounts of fly ash but without any RCA replacement performed extremely well in terms of dynamic modulus. However, visual observations of these specimens revealed significant mass loss and deterioration. It is also worth noting that the control mix performed the worst in terms of freeze/thaw resistance, and that the mixtures containing both RCA and fly ash performed similarly, although they all still failed to meet the minimum ODOT durability requirements.

Regarding salt scaling resistance, the control specimens performed the best, with only slight signs of scaling at some locations of the surface. The specimens containing 40 percent fly ash and 100 percent replacement of the coarse aggregate with RCA performed the worst, with moderate scaling across the entire surface. On the other hand, the specimens without fly ash yet containing 100 percent replacement of the coarse aggregate with RCA performed much better, with results similar to the control mix specimens. Most unusually, the specimens containing the highest amount of fly ash replacement, 60 percent, as well as containing 100 percent replacement of the coarse aggregate with RCA also had similar results to the control mix specimens.

6. RESISTIVITY AND DURABILITY – PHASE I

Electrical resistivity measurements offer a potential non-destructive, repeatable method of estimating the long-term durability of concrete. Changes in the constituents of a concrete mix have a noticeable effect on the hardened properties, including electrical resistivity and durability. As a result, the use of recycled concrete aggregate (RCA) and fly ash in this research study offers the potential to evaluate the effect of these recycled materials on the relationship between resistivity and durability. This chapter evaluates both resistivity and durability of the potential mix designs developed in Chapter 4.

6.1 ELECTRICAL RESISTIVITY

Electrical resistivity of concrete can be explained as the resistance of concrete against ions transfer while it is subjected to an electrical field. Electrical resistivity is a ratio between the applying voltage and the output flow so that resistivity is independent of sample geometry (68). Concrete resistivity varies in a range of $10^6 \Omega\text{m}$ for oven-dried samples to $10 \Omega\text{m}$ for the saturated ones (69). Electrical resistivity of concrete is attributed to the microstructure characteristics such as porosity, pore solution properties, the amount of moisture present in pore structure (70,71,72) and the temperature of the sample (73).

The rapid chloride permeability test used to be employed to measure electrical resistivity of concrete. In this method, a constant voltage is applied to the concrete sample and the electrical current passed from the sample is measured in saturated condition. However, this method has limitations. For example, it is destructive. Additionally, the process results in heat production, which can cause variation in results. Currently, researchers attempted to discover a new method of testing electrical resistivity without these limitations. With the development of this new method, testing electrical resistivity has become more rapid, cost-effective, and able to perform large-scale testing (74,75,76). In the present study, the electrical resistance of concrete was measured by two techniques including the four-point (Wenner probe) method and the two-point uniaxial method.

6.1.1 Surface Electrical Resistivity Test

In the four-point (Wenner probe) method, the surface electrical resistivity of concrete samples is measured. Each sample is divided by four, for surface area, and then is marked. As such, the test is performed every time on the same locations and, as a result, it provides a reasonable trend for following the results. Once the samples are marked, they are placed on a solid support, ensuring stability while performing the measurements. The surface resistivity is measured by placing the Wenner probe on the surface of the concrete samples and then applying slight pressure until the value stabilizes, as shown in Figure 6-1. This device consists of four electrodes in which the outer probes are generating an alternative current while the inner probes assess the electrical potential. It is important to note that having samples in a saturated surface dry

(SSD) condition is vital for accuracy and repeatability. For this research, the test was performed in a drying room at a relative humidity of 50 percent using a Resipod Proceq device. The Resipod Proceq is capable of providing the electrical surface resistivity directly in terms of K-ohm-cm.



Figure 6-1. Surface Electrical Resistivity Test

6.1.2 Bulk Electrical Resistivity Test

In the two-point uniaxial method, the concrete sample is placed between two metal parallel electrodes covered by a slightly moist sponge to guarantee an appropriate electrical contact, as shown in Figure 6-2. The plates are connected to an alternate current source. The alternate current is applied to the concrete and then the drop in the potential is measured between the two plates. This method is highly dependent on the moisture content of the sponge. Therefore, the sponge must be kept completely wet. The application of this test takes only a few seconds and due to its non-destructive characteristics, it can be performed on the same cylindrical samples prepared for other tests. A GIATEC RCON2™ was used to determine the bulk electrical resistivity.

6.2 MIX DESIGNS

The following resistivity and durability study examined both the mixes developed previously, as shown in Table 4-5, and the same mixes with a water/cement ratio of 0.44 instead of 0.48. Although the ODOT Class A mix design requirements allow a water/cement ratio as high as 0.48, it is generally agreed that a maximum water/cement ratio of 0.45 or lower is preferable for concrete exposed to freeze/thaw cycling and deicing chemicals. As such, the mix identifications for the following study were revised to reflect these two series of mixes that were identical except for the water/cement ratio. The identification follows the convention of XX-YY-ZZ, with the first number signifying

the water cement ratio, the second number signifying the percent RCA replacement of the coarse aggregate, and the third number signifying the percent fly ash replacement of cement. For example, 48-100-40 indicates a mix design with a water/cement ratio of 0.48, 100 percent replacement of the coarse aggregate with RCA, and 40 percent replacement of the cement with fly ash, and 44-100-40 is the same mix but with a water/cement ratio of 0.44. The revised mix identifications are shown in Table 6-1.

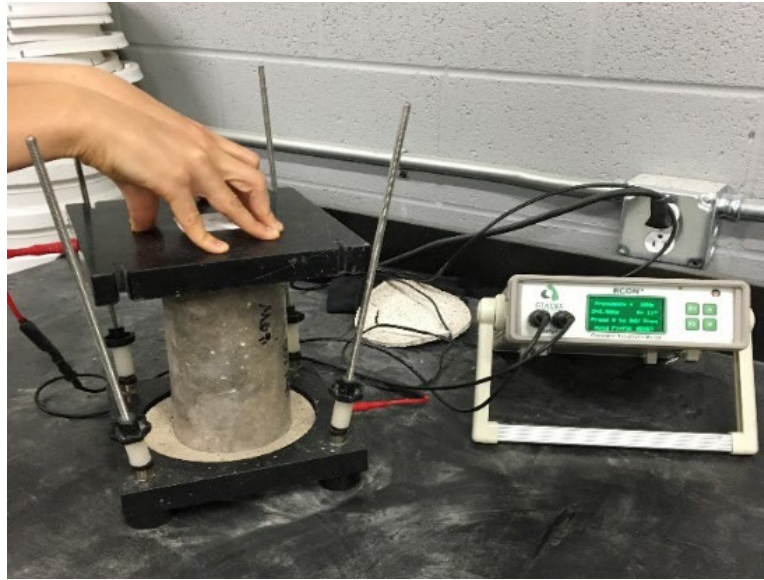

Figure 6-2. Bulk Electrical Resistivity Test

6.3 ELECTRICAL RESISTIVITY MEASUREMENTS

6.3.1 Surface Electrical Resistivity Measurements

The research team performed surface resistivity testing of the proposed mixes with a water/cement ratio of 0.48. In order to better understand the independent effects of the RCA and fly ash on the concrete, the results are presented with three separate graphs. The first graph shows the lone impact of RCA, the second graph shows the lone impact of fly ash, and the third diagram shows the concurrent impact of RCA and fly ash. The results from the Control mix are shown in each plot as a reference.

Surface electrical resistivity decreased when using all percentages of RCA, as shown in Figure 6-3. There was no significant difference between 25 percent and 50 percent RCA replacement, with both decreasing by 29% compared to the Control specimens. However, both the 75 percent and 100 percent RCA replacements decreased more, by 37.5 percent and 42 percent, respectively. It appears that the surface electrical resistivity decreases with increasing RCA replacement in comparison to the Control specimens.

Table 6-1: Resistivity and Durability Mix IDs

Previous Mix ID	w/c	Revised Mix ID	w/c	New Mix ID
C	0.48	48-00-00	0.44	44-00-00
1-25	0.48	48-25-00	0.44	44-25-00
1-50	0.48	48-50-00	0.44	44-50-00
1-75	0.48	48-75-00	0.44	44-75-00
1-100	0.48	48-100-00	0.44	44-100-00
2-20	0.48	48-00-20	0.44	44-00-20
2-40	0.48	48-00-40	0.44	44-00-40
2-60	0.48	48-00-60	0.44	44-00-60
3-40	0.48	48-100-40	0.44	44-100-40
3-50	0.48	48-100-40	0.44	44-100-40
3-60	0.48	48-100-40	0.44	44-100-40

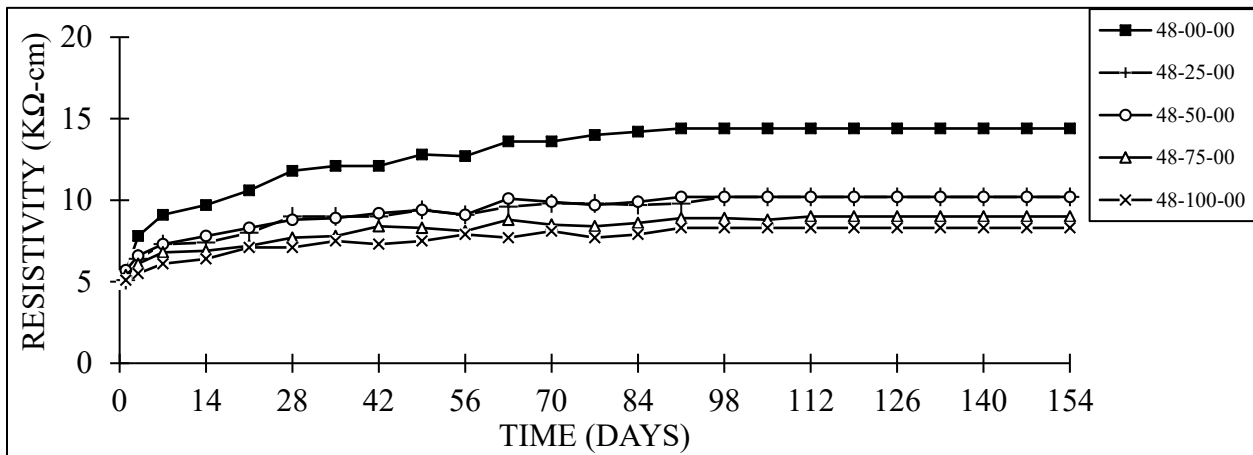

Figure 6-3. Surface Resistivity as a Function of RCA Replacement

Due to the slower rate of hydration for fly ash compared to portland cement, the relative relationship between the resistivity values for specimens with and without fly ash varies as a function of time. As shown in Figure 6-4, at early ages (0-14 days), the higher the percentage of fly ash, the lower the values for electrical resistivity compared to the Control specimens, whereas at later ages, the resistivity of the fly ash specimens

increases much faster compared to the Control specimens. At 154 days, 20, 40, and 60 percent fly ash replacements resulted in a 91, 270, and 200 percent increase in electrical resistivity compared to the Control specimens, respectively. It appears that the optimum fly ash replacement level in terms of resistivity is somewhere around 40 percent but that all replacement levels increase the resistivity compared to using portland cement alone.

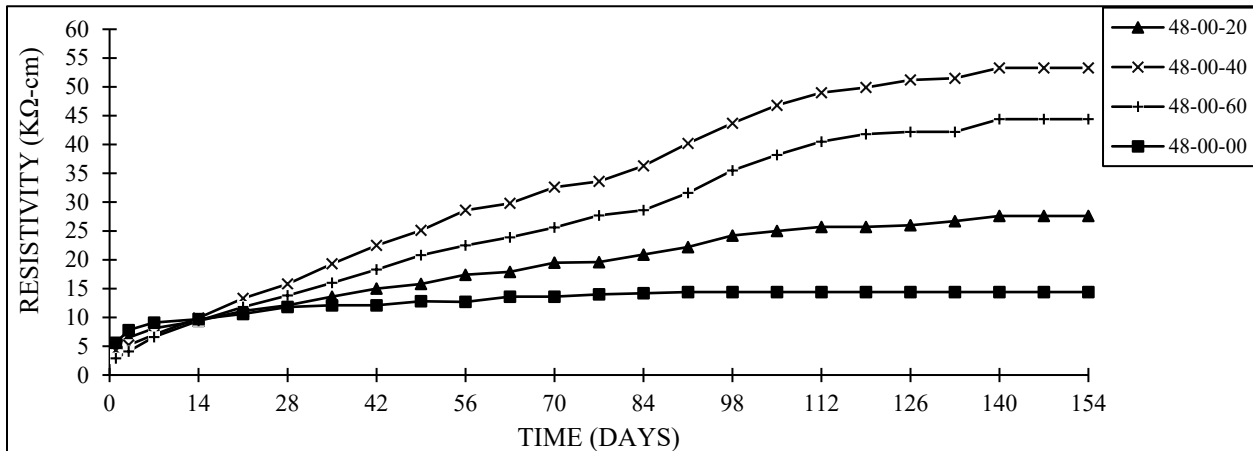

Figure 6-4. Surface Resistivity as a Function of Fly Ash Replacement

Again, due to the slower rate of hydration for fly ash compared to portland cement, the relative relationship between resistivity values for specimens with and without fly ash varies as a function of time, even with 100 percent RCA replacement. As shown in Figure 6-5, at early ages (0-14 days), the higher the percentage of fly ash, the lower the values for electrical resistivity compared to the Control specimens, whereas at later ages, the resistivity of the fly ash specimens increases much faster compared to the Control specimens. At 154 days, 40, 50, and 60 percent fly ash replacements resulted in a 19, 44, and 13 percent increase in electrical resistivity compared to the Control specimens, respectively, even though all the mixes containing fly ash contain 100 percent RCA replacement compared to the Control mix which has only virgin aggregate. It appears that the optimum fly ash replacement level in terms of resistivity is somewhere around 50 percent and that the RCA mitigates the gains made in resistivity. In other words, in comparing the three plots, fly ash significantly increases resistivity while RCA decreases resistivity but to a lesser degree, resulting in resistivity that exceeds the Control when both materials are used.

According to AASHTO TP95 (77), electrical resistivity can be used to measure a concrete's resistance to chloride penetration. Furthermore, electrical resistivity can be used to evaluate ionic mobility within the pore solution of concrete, which is a leading factor of corrosion. Table 6-2 shows the chloride penetrability levels in terms of electrical resistivity. The mixtures containing fly ash and virgin aggregate would be classified as moderate to low chloride ion penetrability, which is superior to mixtures

containing no supplementary cementitious materials. The latter mixtures would be classified as highly susceptible to chloride ion penetrability. The addition of Class C fly ash to mixtures containing 100 percent RCA does provide long-term potential for resistivity gain. After 56 days, these mixtures surpass the Control, reaching a moderate chloride ion penetrability classification.

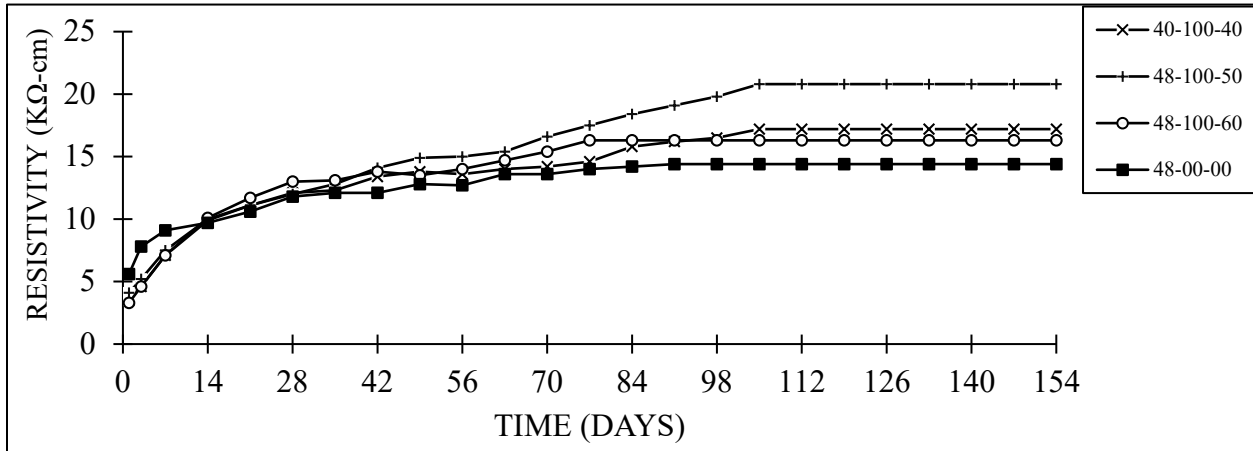

Figure 6-5. Surface Resistivity as a Function of Fly Ash Replacement for Mixes with 100 Percent RCA Replacement

Table 6-2: Chloride Penetrability Based on AASHTO TP 95

Chloride Ion Penetrability	Resistivity (KΩ-cm)
High	< 12
Moderate	12 to 21
Low	21 to 37
Very Low	37 to 254
Negligible	> 254

6.3.2 Bulk Electrical Resistivity Measurements

The research team also performed bulk resistivity testing of the proposed mixes with a water/cement ratio of 0.48. As before, in order to better understand the independent effects of the RCA and fly ash on the concrete, the results are presented with three separate graphs. The first graph shows the lone impact of RCA, the second graph shows the lone impact of fly ash, and the third diagram shows the concurrent impact of RCA and fly ash. The results from the Control mix are shown in each plot as a reference.

The plots are shown in Figures 6-6, 6-7, and 6-8 for the RCA, fly ash, and RCA plus fly ash mixes, respectively. The results are consistent with the results from the surface resistivity measurements, confirming that the effects of the fly ash and RCA permeate throughout the concrete matrix.

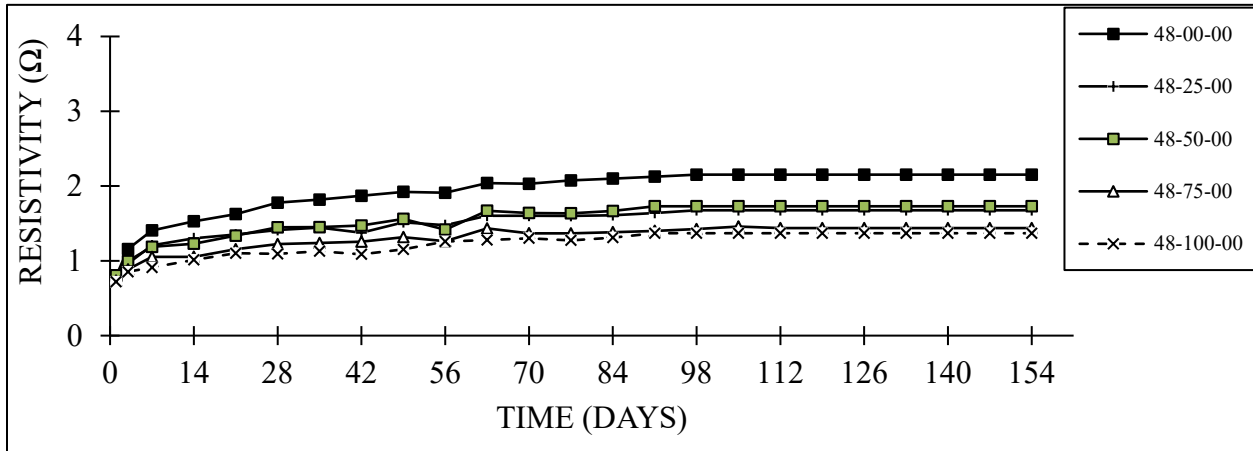

Figure 6-6. Bulk Resistivity as a Function of RCA Replacement

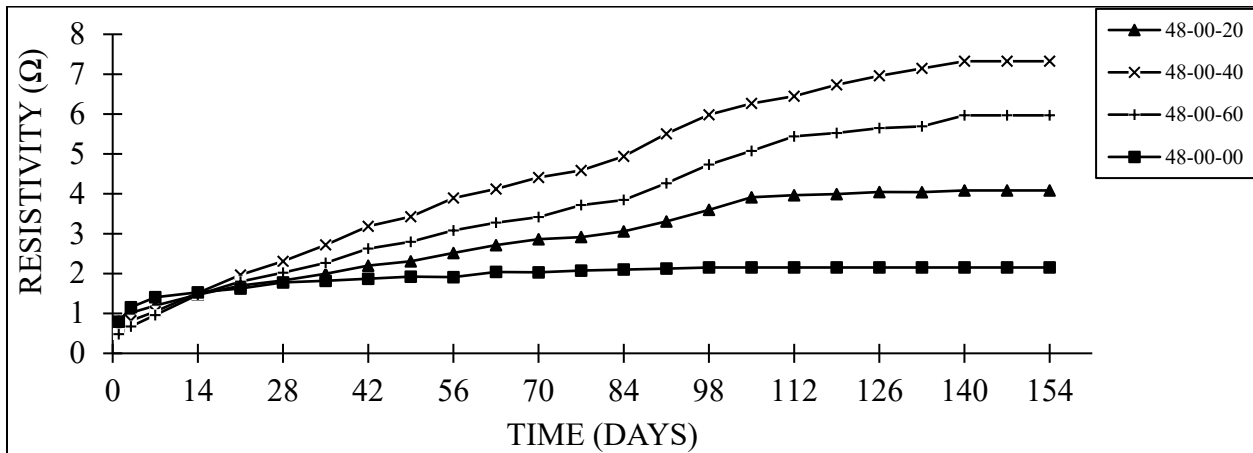

Figure 6-7. Bulk Resistivity as a Function of Fly Ash Replacement

6.4 DURABILITY

The following durability study examined the proposed mix designs with a revised water/cement ratio of 0.44 instead of 0.48. Two different durability tests were performed on these revised research mixes – Freeze/Thaw Resistance, ASTM C666, and Salt Scaling Resistance, ASTM WK9367. Unlike the earlier durability testing, the research team changed to a new scaling test method instead of using ASTM C672. It has been recommended that in the case of using supplementary cementitious materials in concrete, such as fly ash, ASTM C672 may not be reliable, and as such this test cannot

accurately simulate actual field conditions. Therefore, in this next stage of durability testing, ASTM WK 9367, which is known as the modified BNQ test, was implemented for the evaluation of concrete mixtures for salt scaling resistance.

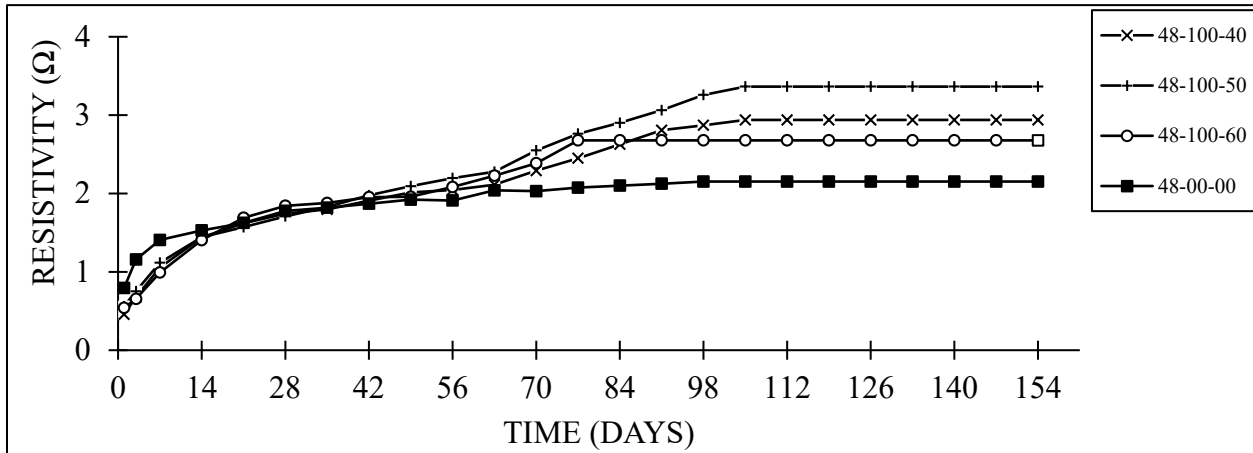

Figure 6-8. Bulk Resistivity as a Function of Fly Ash Replacement for Mixes with 100 Percent RCA Replacement

Due to limitations with the testing equipment and the minimum number of required samples for each test, not all mix designs underwent this second set of durability tests. Table 6-2 lists the two tests and the mixes on which they were performed. The selected mixes were meant to examine the effect of RCA and the combined effect of RCA and fly ash, with the Control mix serving as a reference point.

Table 6-2: Specific Mixes Undergoing Durability Testing

Durability Test	Mixes Tested
Freeze/Thaw Resistance (ASTM C666)	44-00-00, 44-25-00, 44-50-00, 44-75-00, 44-100-00, 44-100-20, 44-100-40, 44-100-60
Salt Scaling Resistance (ASTM WK9367)	44-00-00, 44-25-00, 44-50-00, 44-75-00, 44-100-00, 44-100-20, 44-100-40, 44-100-60

Freeze/thaw resistance testing followed ASTM C666 Procedure A, where the specimens were always completely surrounded by water while they were subjected to the 300 freeze/thaw cycles. Figure 6-9(a) shows the specimens within the freeze/thaw chamber. The dynamic modulus of elasticity of each specimen was determined at intervals of approximately 36 freeze/thaw cycles, as shown in Figure 6-9(b). The process involved removing the specimens from the freeze/thaw chamber and placing them in a constant temperature tempering tank for 24 hours prior to testing. This

process allowed the specimens to thoroughly thaw and maintain a consistent level of saturation for repeatability of the dynamic modulus measurements. After each series of dynamic modulus tests, the specimen locations were rotated within the freeze/thaw chamber to eliminate the effect of any preferential conditions within the chamber. The first sequence of 36 cycles began after the required 14-day moist cure period for the specimens.

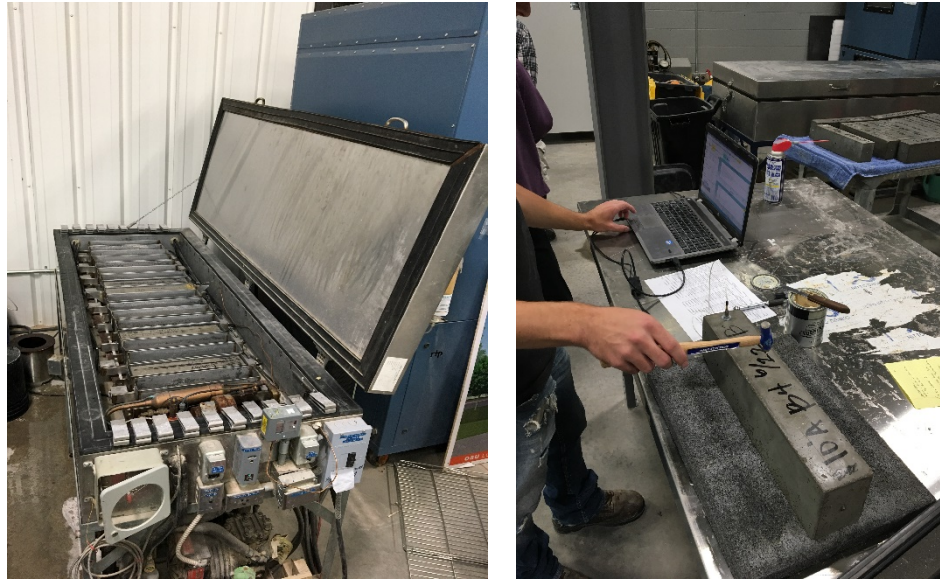

(a) Chamber

(b) Modulus Testing

Figure 6-9. Freeze/Thaw Testing

The proposed ASTM WK 9367 procedure requires 50 rounds of a 24-hour freeze/thaw cycle, where each cycle consists of 16 ± 1 h of freezing followed by 8 ± 1 h of thawing. During the test procedures, the surface of the slabs were covered by plastic sheet to prevent evaporation. After each five cycles, the mass loss of the specimens was recorded while the surface of the specimens were rinsed and filled with new saline solution to continue the test. In order to measure the mass loss of the specimens, an $80\mu\text{m}$ filter was used, which was placed in the oven prior to weight measurements. After 50 cycles, the cumulative mass loss of each specimen was measured and an average mass loss of $0.5 \text{ kg}/\text{m}^2$ is regarded as the passing limit. Figure 6-10(a) shows the salt scaling specimen before demolding, and Figure 6-10(b) shows the foam frame recommended for isolating the edges of the sample.

The fresh properties and 28-day compressive strength for the mixes used in this next stage of the durability study are shown in Table 6-3.



(a) Cast Specimen



(b) Foam Isolation

Figure 6-10. Salt Scaling Specimen Fabrication

Table 6-3: Concrete Properties for 0.44 Water/Cement Ratio Mixes

Mix ID	Slump	Air Content	Unit Weight	Compressive Strength
44-00-00	1-1/4"	6.2%	148.8 pcf	4,920 psi
44-25-00	1"	5.5%	146.2 pcf	4,740 psi
44-50-00	1/2"	5.6%	145.6 pcf	6,990 psi
44-75-00	1-1/2"	5.6%	144.0 pcf	6,700 psi
44-100-00	3/4"	5.1%	143.2 pcf	6,110 psi
44-100-20	2-3/4"	6.6%	140.8 pcf	5,580 psi
44-100-40	8"	7.0%	139.2 pcf	5,090 psi
44-100-60	7-3/4"	8.5%	136.8 pcf	3,520 psi

6.4.1 Results of Freeze/Thaw Testing

The results for the freeze/thaw testing of the 0.44 water/cement ratio research mixes are shown in Figures 6-11 and 6-12. The plots show the decrease in dynamic modulus as a function of the number of freeze/thaw cycles. Figure 6-11 shows the impact of RCA replacement on freeze/thaw resistance, and Figure 6-12 shows the impact of both RCA

and fly ash replacement on the freeze/thaw resistance. All but one of the mixes failed to meet a minimum durability factor of 60 or more at 300 cycles, which is considered the cutoff for good performance of concrete when exposed to freeze/thaw cycles. However, all the mixes outperformed the Control mix.

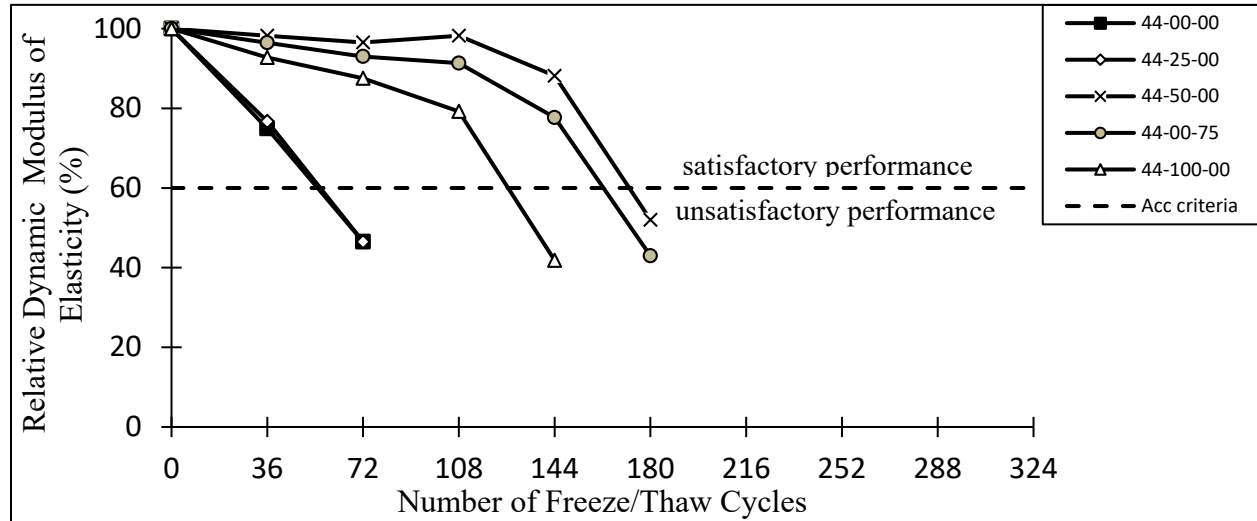

Figure 6-11. Dynamic Modulus as a Function of RCA Replacement

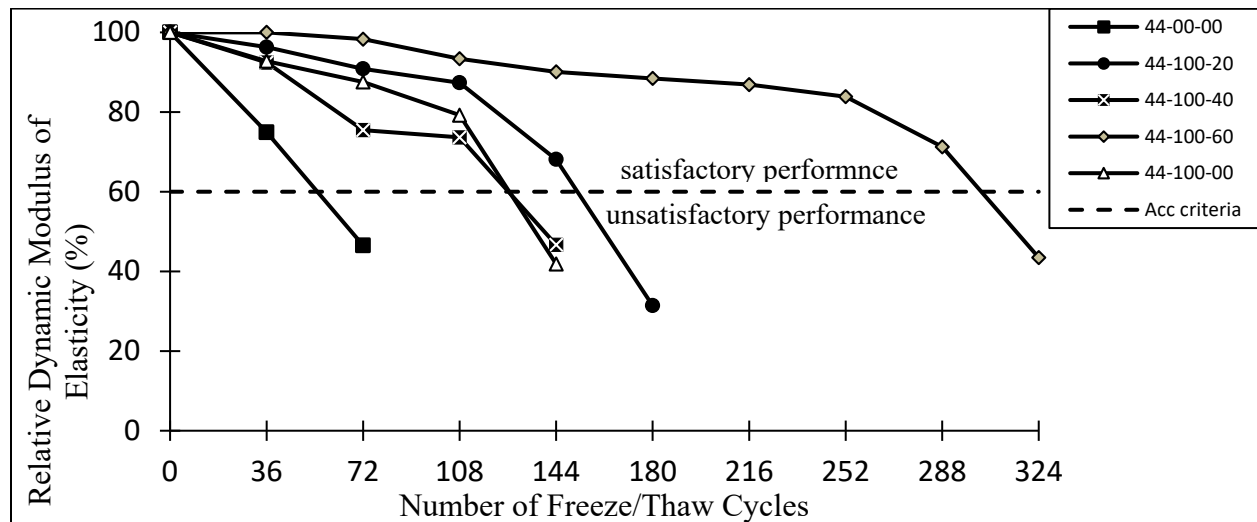

Figure 6-12. Dynamic Modulus as a Function of Fly Ash Replacement for Mixes with 100 Percent RCA Replacement

In terms of the effect of the RCA, Figure 6-11, the mixes with more than 25 percent replacement showed a noticeable improvement compared to the Control mix. In terms of the combination of RCA and fly ash, Figure 6-12, fly ash replacements of 20 and 60 percent with 100 percent RCA outperformed the 100 percent RCA mix without any fly

ash. However, the 40 percent fly ash replacement did not seem to have much effect, with its performance essentially matching that of the 100 percent RCA mix without any fly ash. Of all the mixes, the one with the highest replacement of recycled materials, 100 percent RCA and 60 percent fly ash, was the only mix to meet the minimum durability criteria at 300 cycles.

According to ACI 318 (78), for mixes with a nominal maximum aggregate size of 1 inch, the required minimum air contents should be 4.5 percent and 5 percent for moderate and severe exposure conditions, respectively. Furthermore, ACI 318 suggests a minimum compressive strength of 4,500 psi for moderate and severe exposure conditions. As shown in Table 6-3, all of the mixes except the one with 100 percent RCA and 60 percent fly ash met these minimum air content and compressive strength requirements yet failed the freeze/thaw test. However, the 100 percent RCA and 60 percent fly ash, which did not meet the minimum strength requirement, passed the test with a durability factor of 62 at 300 cycles.

6.4.2 Results of Salt Scaling Testing

The results for the salt scaling testing of the 0.44 water/cement ratio research mixes are shown in Figures 6-13 and 6-14. The plots show the cumulative mass loss as a function of the number of salt scaling cycles. Figure 6-13 shows the impact of RCA replacement on scaling resistance, and Figure 6-14 shows the impact of both RCA and fly ash replacement on the scaling resistance. In accordance with the BNQ NQ 2621-900 standard, having less than 500 grams of salt scaling residue in one square meter is considered as the passing limit for the test.

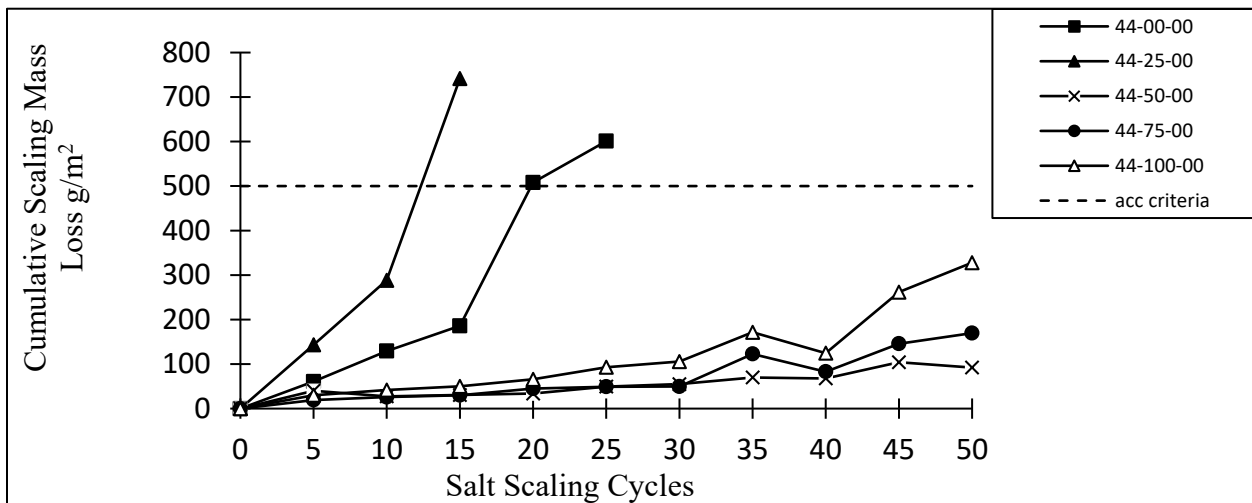

Figure 6-13. Salt Scaling Test Results as a Function of RCA Replacement

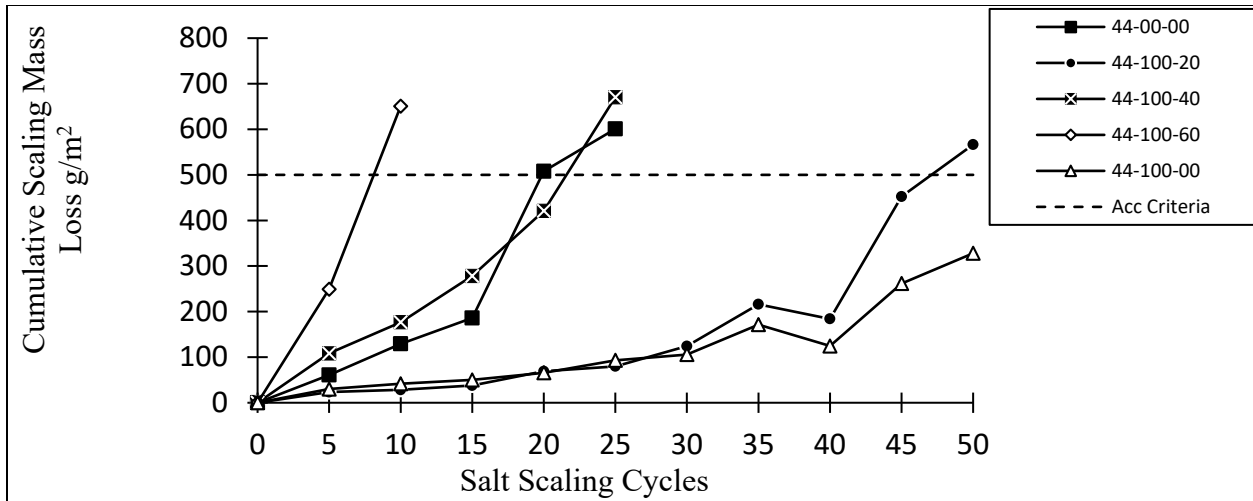

Figure 6-14. Salt Scaling Test Results as a Function of Fly Ash Replacement for Mixes with 100 Percent RCA Replacement

As shown in both figures, the Control specimens failed the salt scaling test. However, in terms of the effect of the RCA, Figure 6-13, the mixes with more than 25 percent RCA replacement showed a noticeable improvement compared to the Control mix, and all specimens passed the test. Unfortunately, in terms of the combination of RCA and fly ash, Figure 6-14, none of the mixes passed the test although the 20 percent fly ash replacement came very close. In general, mixes with high amounts of fly ash (44-100-40 and 44-100-60) tend to underperform in salt scaling testing but usually perform well in service (34).

Photographs of all the specimens either at 50 cycles or at failure if less than 50 cycles are shown in Figures 6-15 through 6-22. The RCA specimens appear to undergo more localized mass loss compared to the specimens containing high percentages of fly ash (40 and 60 percent) and RCA, which lose cementitious paste across nearly the entire surface. This behavior would seem to indicate that the freeze/thaw cycles begin to deteriorate the aggregate/cementitious matrix at locations where the RCA is closest to the surface for those mixes without fly ash. However, these mixes still pass the freeze/thaw test. The specimens containing fly ash, on the other hand, suffer deterioration throughout the cementitious matrix along the surface. The fly ash appears to generally degrade the cementitious matrix, and only the specimen with the lowest percentage of fly ash manages to pass the test.



Figure 6-15. Control Specimen After 25 Cycles



Figure 6-16. 25 Percent RCA Specimen After 15 Cycles



Figure 6-17. 50 Percent RCA Specimen After 50 Cycles



Figure 6-18. 75 Percent RCA Specimen After 50 Cycles



Figure 6-19. 100 Percent RCA Specimen After 50 Cycles



Figure 6-20. 20 Percent Fly Ash Plus 100 Percent RCA After 50 Cycles



Figure 6-21. 40 Percent Fly Ash Plus 100 Percent RCA After 35 Cycles



Figure 6-22. 60 Percent Fly Ash Plus 100 Percent RCA After 10 Cycles

6.5 CONCLUSIONS

Resistivity measurements are a useful non-destructive method to determine the resistance of a concrete mixture to chloride ion penetration. The higher the resistance, the better the long-term durability performance. Both surface and bulk electrical resistivity measurements indicated that the resistivity of the concrete decreases with increasing RCA replacement in comparison to virgin aggregates alone. Fly ash, on the other hand, significantly increases the resistivity compared to portland cement alone. As a result, when the two materials are used together, the fly ash not only mitigates the decrease in resistivity due to the RCA but compensates enough that the concrete mix has higher resistivity than the Control mix. The amount of improvement is a function of the amount of RCA and fly ash replacement. A mix with 100 percent RCA replacement of the virgin aggregate would require at least 40 percent fly ash replacement of the portland cement to reach a moderate chloride ion penetrability classification compared to the highly susceptible rating for the Control mix. These resistivity measurements were based on the original research mix designs that used an upper bound water/cement ratio limit of 0.48.

The original series of research mixes used the upper bound limit of 0.48 on the water/cement ratio. However, lower water/cement ratios will improve durability performance. As a result, the research team examined a second series of mixes identical to the original mixes but with a reduced water/cement ratio of 0.44. As before, the high absorption of the RCA combined with its slow rate of absorption resulted in inconsistencies in the fresh and hardened material properties. Nonetheless, the research team used these mixes to perform freeze/thaw and salt scaling tests to evaluate the long-term durability of mixes containing high amounts of recycled materials.

The results of these durability tests indicated that in terms of freeze/thaw resistance, mixes with more than 25 percent RCA replacement showed a noticeable improvement compared to the Control mix. However, none of the mixes met the minimum durability criteria at the end of testing. In terms of the combination of RCA and fly ash, fly ash replacements of 20 and 60 percent with 100 percent RCA outperformed the 100 percent RCA mix without any fly ash. However, the 40 percent fly ash replacement did not seem to have much effect, with its performance essentially matching that of the 100 percent RCA mix without any fly ash. Of all the mixes, the one with the highest replacement of recycled materials, 100 percent RCA and 60 percent fly ash, was the only mix to meet the minimum durability criteria at 300 cycles. It appears that the use of both recycled materials is necessary to reach an adequate level of freeze/thaw resistance.

In terms of salt scaling resistance, mixes with more than 25 percent RCA replacement showed a noticeable improvement compared to the Control mix, with all specimens passing the test whereas all the Control specimens failed. Unfortunately, in terms of the combination of RCA and fly ash, none of the mixes passed the test although the 20

percent fly ash replacement came very close. High dosages of fly ash (40 percent or higher) appeared to weaken the cementitious matrix as these specimens revealed significant overall scaling of the specimen surfaces.

Based on these results, a careful balancing of RCA and fly ash is required to achieve acceptable levels of durability. For some durability measures, RCA helps performance, such as salt scaling resistance, but in others, it reduces performance, such as freeze/thaw resistance. Fly ash, on the other hand, decreases salt scaling resistance but increases freeze/thaw resistance and resistance to chloride ion ingress. Acceptable mix designs must find a balance between these two materials to maximize the use of these recycled materials in concrete.

7. RCA ABSORPTION BEHAVIOR

If the recycled concrete aggregate (RCA) is derived from air entrained concrete, it will have a relatively high absorption, typically between 4 and 8 percent due to the air entrainment of the paste plus the absorption of the original virgin coarse and fine aggregates. Knowledge of this absorption value and the actual moisture content of the RCA at the time of mixing is necessary in order to adjust the amount of mix water to achieve the necessary design mix proportions. Although the previous work accounted for the high absorption level of the RCA, it did not consider the rate at which that water would be absorbed and whether this potential time delay would impact the results. The following chapter evaluates not only the absorption of the RCA but also the rate of absorption as well. The results indicate that presoaking the RCA similar to the process used with lightweight aggregate is necessary to achieve consistent and accurate results.

7.1 RCA ABSORPTION RATE

Previously, the absorption of the RCA was determined following the procedures in ASTM C127, Standard Test Method for Relative Density (Specific Gravity) and Absorption of Coarse Aggregate. This same method was used to evaluate the rate of absorption of the RCA by evaluating the amount of moisture absorbed by oven dry samples of RCA as a function of time.

The saturated surface dry method of determining RCA absorption rates was initiated by preparing nine sieves to contain the samples during soaking, massing, and oven drying. The sieves were carefully washed and cleaned. Excess water was removed from the sieves by way of bursts of compressed air, the sieves were massed, and the wet mass of each sieve recorded. The sieves were next placed in an oven at 230°F for 24 hours, removed from the oven, massed, and the dry mass of each sieve recorded. Into the sieves was placed nine separate representative samples of coarse RCA, with each sample measuring slightly more than 8.8 lb. The samples were then washed by submerging them in a tub of water and agitating them, as shown in Figure 7-1.

The sieves and the washed aggregate were then placed into an oven at 230°F for 24 hours and dried to a constant mass. The samples were left to cool to room temperature, massed, and that mass was recorded. The oven dry sample was then fully submerged in room temperature (72°F) water, and the samples were periodically agitated to facilitate the release of air bubbles that may have become trapped on the surface of the samples or between the stack of sieves. The samples were removed at time increments of 15, 30, 60, 120, 240, 480, 720, 1440, 2880, and 4320 minutes (1/4, 1/2, 1, 2, 4, 8, 12, 24, 48, and 72 hours). The contents of the sieves were removed to a towel, as shown in Figure 7-2.



Figure 7-1. Washing of RCA Samples



Figure 7-2. Aggregate Preparation for Moisture Measurements

Excess water was then removed from the sieve using bursts of compressed air and the sieve was set to the side. The sample was then brought to a surface dry condition by rolling and patting the aggregate in the towel, as specified in ASTM C127. The surface dry sample was returned to the sieve, massed, and the surface dry mass recorded. The sample was then set aside, and the process repeated upon the following sample, after which the samples were then returned to the room temperature water. This process was repeated until the surface dry mass of each sample at each time increment had been determined. Once the testing was complete, the moisture content of each sample at each time increment was determined in accordance with ASTM C127, and the results

are shown in Table 7-1 and presented visually in the linear and semi-log plots of Figures 7-3 and 7-4, respectively.

Table 7-1: RCA Moisture Content as a Function of Time

ID	Time (minutes)									
	15	30	60	120	240	480	720	1440	2880	4320
1	4.67%	4.81%	4.52%	4.90%	5.09%	5.17%	5.37%	5.64%	5.59%	5.56%
2	4.84%	4.97%	4.93%	4.83%	5.02%	5.24%	5.27%	5.51%	5.59%	5.64%
3	4.55%	4.69%	4.63%	4.72%	4.67%	4.83%	4.92%	5.01%	5.23%	5.26%
4	4.96%	5.23%	5.12%	5.11%	5.08%	5.03%	5.24%	5.45%	5.59%	5.84%
5	4.77%	5.09%	5.36%	5.32%	5.43%	5.47%	5.27%	5.45%	5.98%	5.96%
6	4.58%	4.79%	4.91%	5.01%	5.21%	5.27%	5.10%	5.27%	5.33%	5.74%
7	4.77%	4.95%	4.86%	5.11%	5.34%	5.39%	5.30%	5.35%	5.38%	5.67%
8	4.67%	5.01%	5.06%	5.31%	5.50%	5.63%	5.67%	5.72%	5.61%	5.87%
9	4.78%	4.79%	5.03%	5.27%	5.36%	5.40%	5.61%	5.77%	5.73%	5.76%

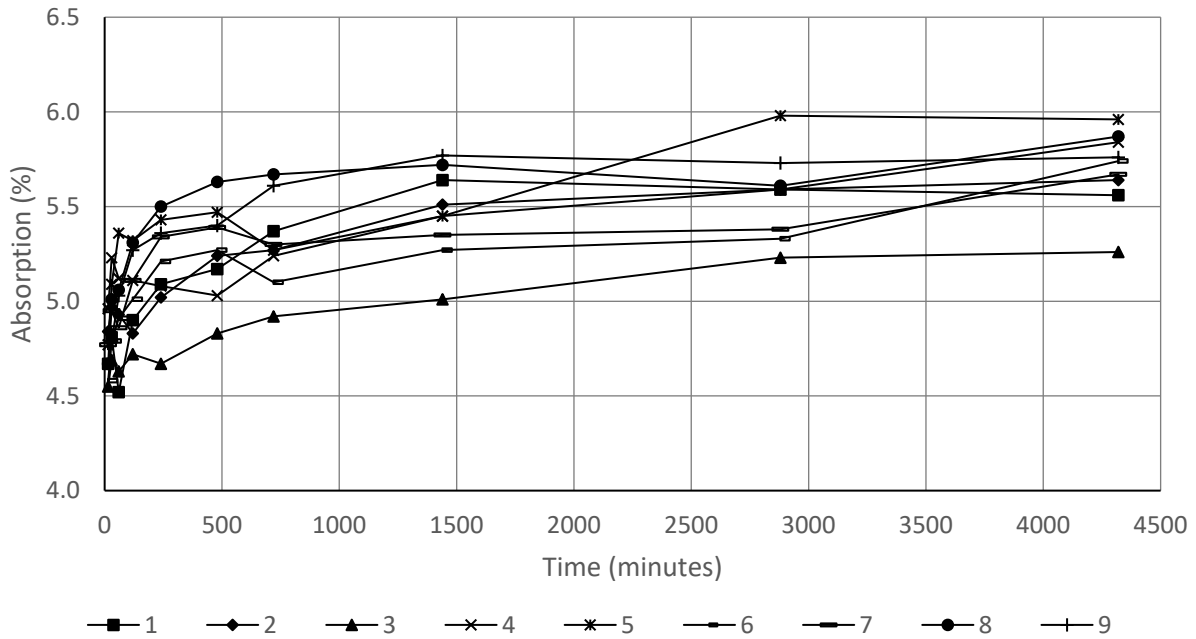

Figure 7-3. RCA Absorption as a Function of Time

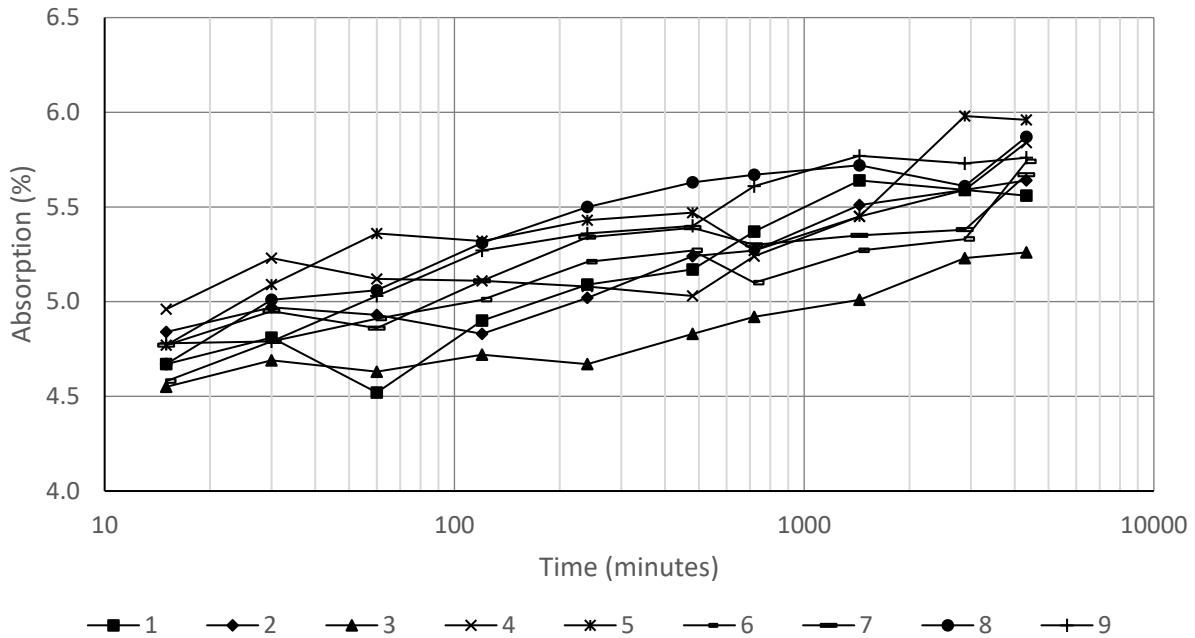

Figure 7-4. RCA Absorption as a Function of Time

The results indicate that the RCA absorbs a significant amount of moisture rather quickly, within the first 15 minutes. However, the results also show that there is a significant delay in the absorption of the remaining water. As shown in both Figures 7-3 and 7-4, although there is a noticeable variation between the nine samples, they all behave very similarly overall, with a period of significant absorption within the first hour followed by a significantly slower and relatively constant rate of absorption from hours 1 thru 72. Based on an average mixing time of 30 minutes for the laboratory mixes, the RCA would absorb another 1 percent of water, on average, from 30 minutes to 72 hours.

The mechanism of water absorption of the aggregate during curing is complex and subject to a fair amount of conjecture, but this example certainly points out that when dealing with very dry RCA, the amount of extra mixing water for the RCA to reach a saturated surface dry condition may never actually be absorbed by the aggregate. The result would potentially increase the water/cement ratio of a mix from a planned value of 0.45 to an actual value of 0.49, which is a considerable difference that would noticeably increase slump and decrease compressive strength as well as other strength properties and also durability properties.

The RCA absorption results are replotted in Figures 7-5 and 7-6 using the high, low, and average values from Table 7-1. These plots show the general trends more clearly and will be used later to compare alternative methods of reaching a saturated surface dry condition for the RCA material.

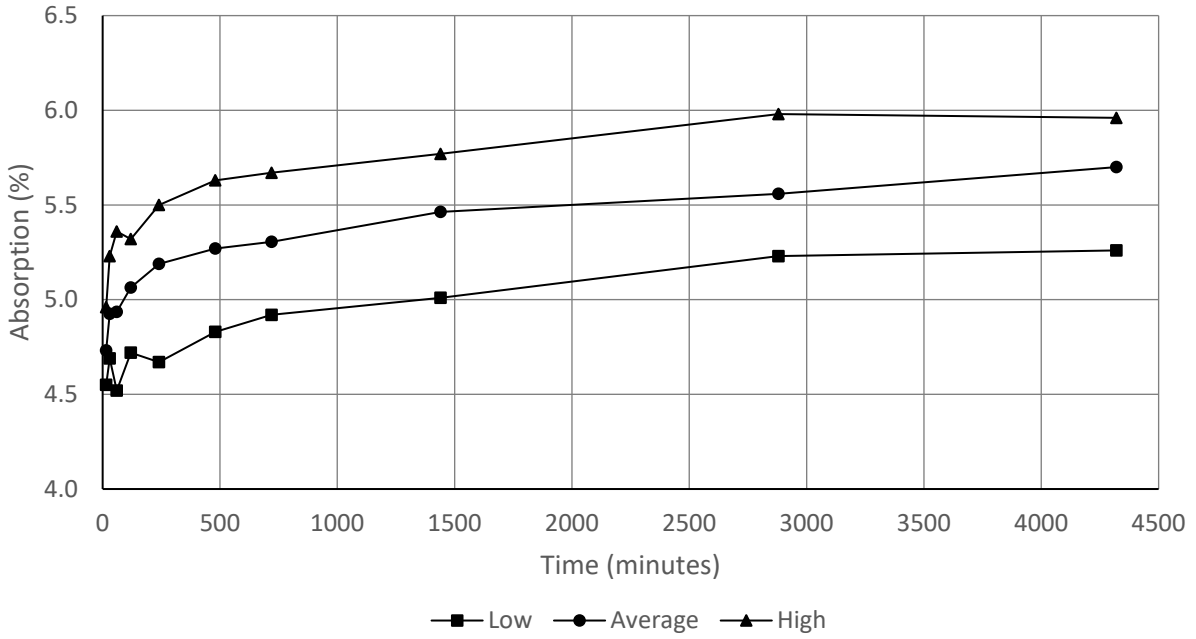

Figure 7-5. RCA Absorption as a Function of Time

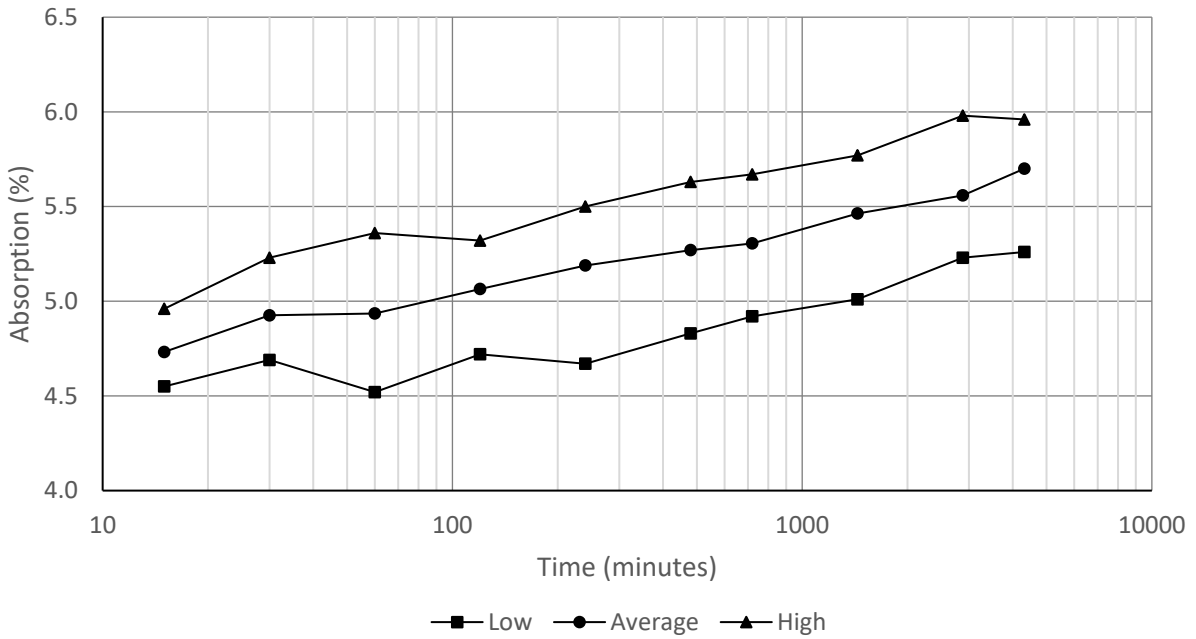

Figure 7-6. RCA Absorption as a Function of Time

7.2 HYDROSTATIC WEIGHING

There are some potential issues with the procedure used previously to evaluate the rate of RCA absorption. Disturbing the sample at each time increment may result in a loss of some of the finer RCA material, which would reduce the mass of the sample and underestimate the absorption. In addition, the ASTM C127 towel dry method for reaching a surface dry condition possesses a fair amount of test-to-test variability and may thus alter the results slightly at each time increment. These two issues lead the research team to try an alternative method of determining the rate of RCA absorption based on hydrostatic weighing.

Hydrostatic weighing involves measuring the submerged weight of an object. In terms of determining the rate of absorption of the RCA, the concept involved placing an oven dry sample in water and measuring the change in hydrostatic weight over time. Once the sample is submerged, water will infiltrate the aggregate over time, displacing air and filling the voids of the RCA and increasing its buoyant weight. By observing the change in buoyant weight over time, the change in moisture content can be determined without removing the sample from the water and, more importantly, without introducing the variability involved with applying the towel dry method (ASTM C127) for reaching a surface dry condition. Hydrostatic weighing of the RCA samples was performed with a Valor 7000 scale with a capacity of 15 lb., a precision of 0.0005 lb., and a weigh below hook capability as shown in Figure 7-7.

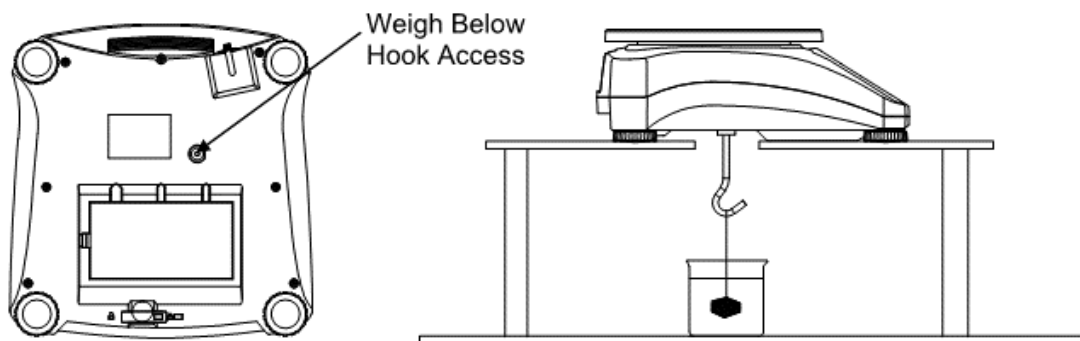

Figure 7-7. Valor 7000 Scale for Hydrostatic Weighing of RCA Samples (courtesy OHAUS Corp., 2016)

The moisture content of a sample suspended in the hydrostatic weighing device can be found by the ratio of mass of water within the sample to the mass of the oven dry sample. The mass of the oven dry sample is easily found, but in this case the mass of the sample at any time during the hydrostatic weighing process requires an estimate of the buoyant force acting upon the submerged sample. The buoyant force due to the displacement of water could be known if the exact volume of water displaced by the

aggregate was known. It was therefore necessary to be able to measure the displacement of the RCA directly after it had been submerged. This displacement would provide the volume of water displaced and the buoyant force acting upon the aggregate as it was submerged. A glass tube and a rule with millimeter demarcations was plumbed to the side of the bucket in which the sample would be hanging. A bobber placed in a glass tube measured the level of the water, which was recorded before and after the basket containing the RCA was lowered into the water. The apparatus is shown in Figure 7-8.



Figure 7-8. Hydrostatic Weighing Setup

The mass of the volume of water was monitored in the device over a period of 24 hours and found that there was negligible change in mass and evaporation was determined not to be an issue. The bucket used was not perfectly cylindrical, but slightly tapered. The inner diameter of the bucket was recorded at the upper and lower bounds of the possible water level during testing. These diameters were indexed to the visible markings of the external rule so that the volume of water displaced by any object could be estimated accurately. The lab temperature was a constant 72°F and deionized water was used in all experiments. The density of deionized water at 72°C was taken to be 0.9982 g/cm³. The dry weight, displacement, and buoyant weight of the specific gravity basket was determined and recorded.

RCA is a two-phase material with a significant portion of cured cement paste, and as such it contains numerous small void spaces. As the RCA absorbed water while submerged, air was forced out of the voids within it and would often cling to the rough exterior of the aggregate. Large amounts of air bubbles clinging to the aggregate could provide a buoyant force and influence the hydrostatic weight, as well as lower the percentage of surface area of the aggregate exposed to water. To counter the buildup

of air bubbles on the sample during data collection, the entire apparatus was placed on a vibration table, (see Figure 7-8) and the entire apparatus was vibrated for 10 seconds at regular intervals.

This process of hydrostatic weighing was performed on three RCA samples. For each sample, approximately 8.8 lb. of oven dry RCA was placed in a specific gravity basket and the dry mass recorded. The height of the water column was observed and recorded. A camera was set on a tripod in a position to view the LCD display of the scale. The basket of aggregate was hung from the scale and lowered into the volume of water. The height of the water column with the basket of aggregate submerged within the volume of water was immediately observed and recorded. The video was used to ensure that the initial, rapidly changing measurements could be accurately recorded. The hydrostatic weight was recorded at time increments of 30 seconds, and 1, 2, 4, 8, 15, 30, 60, 120, 240, 480, 720, and 1440 minutes. At the 24-hour mark, the height of the water column was observed and recorded, and the RCA was removed from the volume of water.

The results from the three samples were averaged and plotted in Figure 7-9, which also contains the average absorption values determined from the ASTM C127 method performed previously. Although the results for the hydrostatic weighing method are much lower than the ASTM C127 method, the results track very well in comparison, with nearly the same slope for the time periods coinciding with the ASTM C127 method. It is possible that the hydrostatic weighing method was unable to remove all the displaced air from clinging to the RCA, which would decrease the measured buoyant weight and calculated absorption. Also, a refinement of the displaced water measure might provide a higher level of accuracy and closer agreement with the ASTM C127 method. The hydrostatic weighing method does offer the advantage of an undisturbed sample and the ability to start recording the absorption immediately after immersion. Further studies of this technique for determining rate of aggregate absorption are certainly warranted.

7.3 CENTRIPETAL ACCELERATION METHOD DEVELOPMENT

This investigation into the strength and durability of RCA as a replacement for conventional aggregates required that multiple sizeable batches of concrete be fabricated. Using the towel dry method to render hundreds of pounds of RCA to a saturated surface dry (SSD) condition for each of the multiple batches produced was not a viable option. A centripetal acceleration method (CAM) was settled on as a potentially reliable method to remove free water from large volumes of RCA. A spinning basket method was developed using gravity as the driving force.

In order to establish that a spinning basket method could render the RCA SSD, a small-scale experiment was performed. Two 8 in. x 8 in. (depth x height) specific gravity baskets capable of containing 8.8 lb. samples of RCA were used in the procedure. The baskets were carefully cleaned and washed. Excess water was removed from the baskets by way of bursts of compressed air, the baskets were massed, and the wet

mass of each basket recorded. The baskets were left to dry in the open air of the laboratory, and later they were massed in the dry state and the dry mass of each basket was recorded. Two samples of RCA that had been washed, placed in an oven at 230°F for 24 hours, and left to cool to room temperature were prepared and placed in the dry baskets, massed, and the mass recorded. The baskets were in turn placed in room temperature (72°F) water to soak. A rope was attached to a frame in two places. After a period of 15 minutes, one of the baskets was retrieved from the water, the timer was stopped, and the rope twisted until a predetermined point on the rope was reached. The basket was then suspended from the rope and allowed to spin down to its resting position. The gravity driven centripetal setup is illustrated in Figure 7-10.

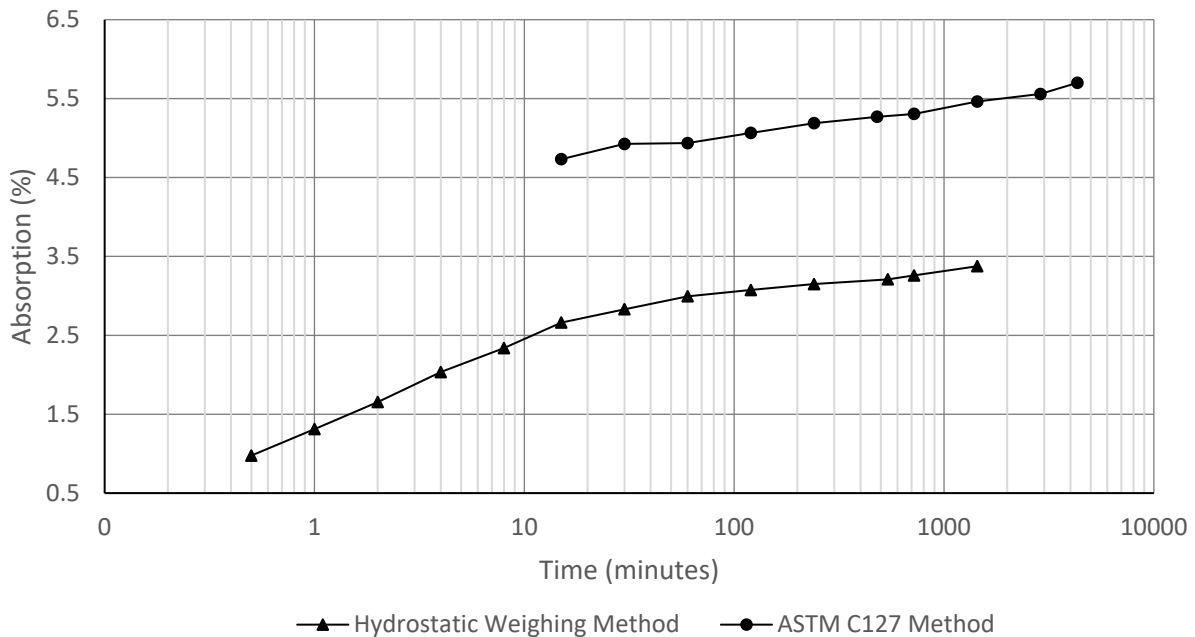

Figure 7-9. Hydrostatic Weighing Method vs. ASTM C127 Method for Determining RCA Rate of Absorption

Once the excess water had been removed by the CAM, the basket was removed from the rope and massed, the wet mass was recorded, and the basket containing the wet RCA was returned to soak in the room temperature water, and the timer was restarted. The CAM procedure was repeated at the same time increments as that used for the ASTM C127 towel dry method, namely 15, 30, 60, 120, 240, 480, 720, 1440, 2880, and 4320 minutes (1/4, 1/2, 1, 2, 4, 8, 12, 24, 48, and 72 hours). Once the testing was complete, the moisture content of both samples at each time increment was calculated, and the results are shown in the semi-log plot of Figure 7-11, which also contains the high, low, and average moisture content values from the ASTM C127 towel dry method used previously.

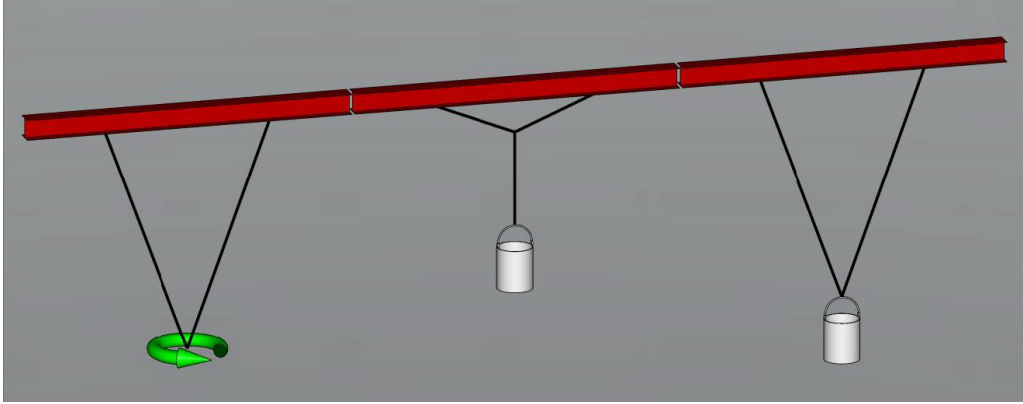

Figure 7-10. Schematic of Centripetal Acceleration Method

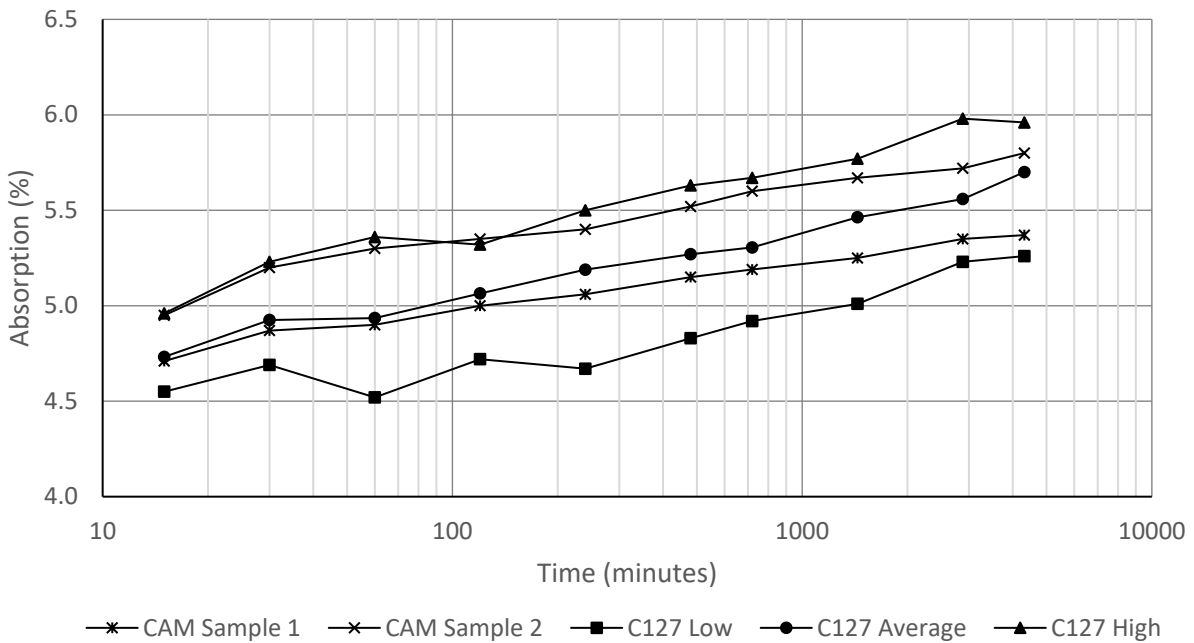

Figure 7-11. Centripetal Acceleration Method Compared to ASTM C127 Method

The results of the small-scale spinning basket method revealed moisture contents that correlated well with the ASTM C127 towel dry method, as shown in Figure 7-11. The small-scale CAM experiments used the same 8.8 lb. sample size as the towel drying method. However, it was necessary to scale up the size of the baskets, and a stainless-steel mesh basket measuring 10 in. x 12 in. was obtained that could handle between 25-35 lb. of spinning RCA. The length of rope and distance between points of attachment was adjusted to maximize the angular momentum and rotational time of the basket. The setup was tested, and it was found that the CAM would shed the free water very reliably from the presoaked RCA, and the moisture contents compared very well

with the small-scale basket method. The unrestrained nature of the hanging spinning basket allowed for it to act as its own dampening system, making for safe operation. An image of the final large-scale basket setup is shown in Figure 7-12. This setup was used to render several hundred pounds of RCA to a saturated surface dry condition for eventual use in the research mixes of Phase 2. Once conditioned, the material was stored in 55-gallon, heavy duty, plastic drums, also shown in Figure 7-12, which also included mylar drum liners to maintain the conditioned moisture level.



Figure 7-12. Full-Scale Centripetal Acceleration Method Setup

7.4 CONCLUSIONS

Some of the results from the previous mix design phase indicated inconsistencies when using RCA as a replacement for all or a part of the virgin coarse aggregate. It was believed that the rate of absorption of the RCA may be just as important as the total absorption, particularly when dealing with very dry RCA and having to provide additional mixing water to compensate. Several methods were used to investigate the rate of absorption of RCA, including the ASTM C127 towel dry method, hydrostatic weighing, and centripetal acceleration. Based on these approaches, a full-scale, centripetal acceleration setup was used to render several hundred pounds of presoaked RCA to a saturated surface dry condition for eventual use in the research mixes of Phase II.

8. MIX DEVELOPMENT – PHASE II

The primary goal of this research was to produce concrete for conventional pavement construction that incorporated at least 50% recycled materials without compromising performance and service life. However, some of the results from the previous mix design phase indicated inconsistencies when using recycled concrete aggregate (RCA) as a replacement for all or a part of the virgin coarse aggregate. The previous chapter discussed the efforts to examine the rate of absorption of the RCA as it was believed that this property may be just as important as the total absorption, particularly when dealing with very dry RCA and having to provide additional mixing water to compensate. After several studies, the research team developed a full-scale, centripetal acceleration setup to render several hundred pounds of presoaked RCA to a saturated surface dry condition. This conditioned RCA was used to reexamine the previous mix designs in order to maximize the potential for recycled materials in concrete pavement.

8.1 MIX DESIGN DEVELOPMENT

As mentioned previously, the basis for the mix designs developed for this research study is an ODOT Class A concrete pavement mix design, the requirements of which are shown in Table 8-1. However, unlike the previous study, in order to maximize material properties and durability, the water/cement ratio was set at a value of 0.40 for Phase II instead of the upper bound limit of 0.48 allowed by the ODOT specification.

A standard mix design based on the ODOT requirements is shown in Table 8-2. (Note that the slump requirements are prior to the addition of water-reducing admixtures.) In addition to serving as the basis for the recycled material mix design study, this concrete mixture also served as the control for subsequent fresh and hardened property and durability comparisons.

Table 8-1: ODOT Requirements for a Class A Concrete Pavement

Minimum Cement Content (lb./yd. ³)	Air Content (%)	Water/Cement Ratio	Slump (in.)	Minimum Compressive Strength (psi)
517	6±1.5	0.25 – 0.48	2±1	3,000

Table 8-2: Class A Concrete Mix Design per Cubic Yard

Cement Content	w/c	Sand	Limestone	Air Entraining Admixture	Water Reducing Admixture
517 lb.	0.40	1,201 lb.	1,784 lb.	0.6 oz./cwt	7.0 oz./cwt

As before, the mix design matrix, shown in Table 8-3, consisted of the Class A control mix design plus three different series of mixes. The first series examined the effect of varying the amount of RCA replacement of the virgin coarse aggregate. The second series examined the effect of varying the amount of fly ash replacement of the cement. The third series examined the effect of using the combination of both recycled materials, RCA and fly ash.

Table 8-3: Mix Design Matrix

Mix ID	Description	RCA or Fly Ash Replacement Level
C	Control (Class A Mix)	-
1-25	Series No. 1 RCA Replacement	25% RCA
1-50		50% RCA
1-75		75% RCA
1-100		100% RCA
2-20	Series No. 2 Fly Ash Replacement	20% Fly Ash
2-40		40% Fly Ash
2-60		60% Fly Ash
3-40	Series No. 3 Fly Ash Replacement with 100% RCA	40% Fly Ash
3-50		50% Fly Ash
3-60		60% Fly Ash

The mix designs for Phase II of the research program are shown in Table 8-4, which were based on the mix design matrix shown in Table 8-3. AEA indicates air-entraining admixture, and HRWRA indicates high-range water-reduction admixture. The water/cement ratio and AEA dosage were kept constant in order to evaluate the effect of the other constituents on the response and behavior of the mixes. However, the HRWRA dosage was adjusted downward for the mixes containing fly ash due to the significantly increased workability for mixes containing high amounts of fly ash.

8.2 FRESH PROPERTIES

The fresh concrete properties for the 11 research mixes are summarized in Table 8-5, and the results are significantly improved compared to the Phase I mix designs. Series No. 1, the RCA replacement of the coarse aggregate, revealed that the addition of RCA did not cause a decrease in the workability of the mix. Although the RCA has rougher surface planes than the virgin limestone aggregate, the virgin limestone aggregate is

more angular than the RCA. These two aggregate traits appear to balance each other, and the workability remained essentially constant as the amount of RCA replacement increased. Also, due to the lower density of the RCA, the unit weights decreased as the RCA replacement increased.

Table 8-4: Phase II Mix Designs per Cubic Yard

Mix ID	w/c	Cement (lb.)	Fly Ash (lb.)	Sand (lb.)	Limestone (lb.)	RCA (lb.)	AEA (oz./cwt)	HRWRA (oz./cwt)
C	0.40	517	-	1,201	1,784	-	0.6	7.0
1-25	0.40	517	-	1,201	1,338	471	0.6	7.0
1-50	0.40	517	-	1,201	892	942	0.6	7.0
1-75	0.40	517	-	1,201	446	1,413	0.6	7.0
1-100	0.40	517	-	1,201	0	1,884	0.6	7.0
2-20	0.40	414	103	1,201	1,784	-	0.6	5.0
2-40	0.40	310	207	1,201	1,784	-	0.6	5.0
2-60	0.40	207	310	1,201	1,784	-	0.6	5.0
3-40	0.40	310	207	1,201	0	1,884	0.6	5.0
3-50	0.40	259	259	1,201	0	1,884	0.6	5.0
3-60	0.40	207	310	1,201	0	1,884	0.6	5.0

Series No. 2, the fly ash replacement of the cement, again performed as expected in that the slump increased and the unit weight decreased as the percentage of fly ash replacement increased. (The decrease in HRWRA dosage for Series No. 2 also balanced the increased workability of the fly ash particles as shown most readily by comparing the 2-20 mix slump results with the control mix slump results.) Due to the lower density of fly ash compared to cement, the unit weights decreased as the fly ash replacement level increased.

Series No. 3, the combination of RCA and fly ash replacement, had results that were readily predictable based on the results from Series Nos. 1 and 2. For instance, the addition of 100 percent RCA did not change the workability of the mixes when comparing Series No. 3 to Series No. 2. The 3-40 mix, as an example, had essentially the same slump as the 2-40 mix, which is consistent with the results of Series No. 1 that proved that the addition of RCA should not alter the workability. Similar results occurred when comparing the 3-60 and 2-60 mixes.

Table 8-5: Fresh Concrete Properties

Mix ID	Slump	Air Content	Unit Weight
C	4-1/4"	7.0%	146.3 pcf
1-25	4-1/2"	8.0%	145.2 pcf
1-50	4-3/4"	8.0%	140.6 pcf
1-75	4-1/2"	8.0%	138.2 pcf
1-100	4-1/2"	7.5%	138.8 pcf
2-20	4-1/2"	6.0%	147.2 pcf
2-40	7-1/2"	8.0%	144.6 pcf
2-60	8-1/4"	6.5%	142.2 pcf
3-40	6-1/4"	6.2%	140.4 pcf
3-50	8-1/4"	8.0%	139.9 pcf
3-60	8-1/2"	6.0%	136.6 pcf

8.3 MATERIAL PROPERTIES

The material properties for the 11 research mixes are summarized in Table 8-6, and the results are also significantly improved compared to the Phase I mix designs. Series No. 1, the RCA replacement of the coarse aggregate, indicates that as the percentage of RCA replacement increases, the compressive strength decreases. This result is consistent with previous research and is generally due to the double interfacial transition zone of the RCA compared to virgin aggregate. It is also possibly due to the crushing operation in that the adhered mortar of the RCA is slightly damaged during processing of the concrete used to manufacture the RCA. The modulus of rupture, split cylinder strength, and modulus of elasticity also decreased with increasing percentage of RCA, but those properties are typically a direct function of compressive strength. As a result, normalized values of these properties are examined later in this section.

Series No. 2, the fly ash replacement of the cement, again performed as expected in that the 28-day compressive strengths decreased for increasing fly ash replacement of the cement. Fly ash generally hydrates at a slower rate, which means it may be more appropriate to consider 56-day compressive strengths for these high fly ash replacement levels. The other material properties also decreased with increasing percentage of fly ash, but those will be examined through normalized values later in this section as well.

Series No. 3, the combination of RCA and fly ash replacement, had results that were readily predictable based on the results from Series Nos. 1 and 2. For example, the compressive strength for the 3-40 and 3-60 mixes were lower than those for the 2-40 and 2-60 mixes, respectively, showing that the addition of RCA decreases the compressive strength. Furthermore, a similar result is found by comparing the compressive strengths of all the Series No. 3 mixes with that of the 1-100 mix. All four of those mixes contain 100 percent RCA replacement, and as fly ash is then added for the Series No. 3 mixes, their strengths are lower than that of the 1-100 mix. The end result is that the addition of both RCA and fly ash noticeably decrease the compressive strength. As mentioned previously, the other material properties will be examined through normalization values later in this section to examine any trends.

All the Phase II mixes met the ODOT minimum compressive strength requirement of 3,000 psi at 28-days. Furthermore, all the Phase II mixes also reached the project goal minimum compressive strength of 4,000 psi. This result is another benefit of the RCA SSD conditioning method, which resulted in much more accurate water/cement ratios for the mixes. Reducing the water/cement ratio to 0.40 for Phase II also helped increase the compressive strengths as well.

Table 8-6: Material Properties

Mix ID	Compressive Strength	Modulus of Rupture	Split Cylinder Strength	Modulus of Elasticity
C	6,580 psi	845 psi	562 psi	4,972,000 psi
1-25	6,520 psi	803 psi	541 psi	4,987,000 psi
1-50	5,760 psi	736 psi	488 psi	4,490,000 psi
1-75	5,655 psi	705 psi	465 psi	4,202,000 psi
1-100	5,595 psi	637 psi	456 psi	3,998,000 psi
2-20	5,695 psi	766 psi	504 psi	4,333,000 psi
2-40	5,315 psi	746 psi	463 psi	4,227,000 psi
2-60	4,845 psi	654 psi	433 psi	4,049,000 psi
3-40	5,165 psi	705 psi	415 psi	3,988,000 psi
3-50	4,330 psi	621 psi	345 psi	3,892,000 psi
3-60	4,105 psi	603 psi	324 psi	3,694,000 psi

Table 8-7 contains the normalized mechanical properties of the 11 research mixes. The modulus of rupture and modulus of elasticity values were normalized with respect to the square root of the compressive strength, while the split cylinder strength was normalized with respect to the compressive strength taken to the two-thirds power. These are common normalization techniques used to compare concretes with different compressive strengths.

In general, the normalizations are consistent between the three series, indicating that the material properties track well with the compressive strengths and that decreases in these properties as a result of RCA replacement and fly ash replacement are consistent with the decreases observed in compressive strength. Although there is a fair amount of scatter in the data, it does appear that the use of RCA results in a slight decrease in modulus of elasticity, possibly due to the double interfacial transition zone or the lower stiffness of the adhered mortar to that of the virgin aggregate. The combination of RCA and fly ash also indicate a slight decrease in split cylinder strength, although the same response is not true for the modulus of rupture. Again, this decrease may be due to the double interfacial transition zone of the RCA.

Table 8-7: Normalized Material Properties

Mix ID	Modulus of Rupture	Split Cylinder Strength	Modulus of Elasticity
C	10.42	1.60	61,294
1-25	9.94	1.55	61,761
1-50	9.70	1.52	59,161
1-75	9.38	1.46	55,878
1-100	8.52	1.45	53,449
2-20	10.15	1.58	57,417
2-40	10.23	1.52	57,980
2-60	9.40	1.51	58,170
3-40	9.81	1.39	55,491
3-50	9.44	1.30	59,146
3-60	9.41	1.26	57,655

8.4 CONCLUSIONS

The results of the Phase II mix development were much improved compared to Phase I. The use of the conditioned RCA improved the consistency of the process, revealed behavior that was in line with previous research, and allowed an evaluation of the effect of combining high amounts of RCA replacement with high amounts of fly ash replacement. In general, the use of RCA in place of virgin aggregate does not alter the workability of a specific mix. Although the RCA surfaces are rougher than virgin aggregate due to the adhered mortar, which would decrease workability, the edges are more rounded than virgin aggregate, which balances any impact on workability. Regarding material properties, both RCA and fly ash decrease the compressive strength, modulus of rupture, split cylinder strength, and modulus of elasticity. The reductions in split cylinder strength and modulus of elasticity are slightly greater than the expected reduction as a result of lower compressive strength. However, all the research mixes met both the minimum ODOT strength requirements and the higher project strength requirements, indicating the potential for using high amounts of RCA and fly ash in concrete mixes for pavement construction. Presoaking the RCA is necessary, however, in order to achieve consistent results.

9. DURABILITY – PHASE II

The primary goal of this research was to produce concrete for conventional pavement construction that incorporated at least 50% recycled materials without compromising performance and service life. Chapter 8 contains the results of a revised series of mix designs used to evaluate the effect of recycled concrete aggregate (RCA) and fly ash on concrete performance – specifically the fresh and hardened material properties – when used both separately and together. This chapter discusses the effect of these recycled materials on the durability of potential mix designs when used both separately and together.

9.1 MIX DESIGNS

The mix designs from Chapter 8 are repeated in Table 9-1. They include a control mix plus three different series of mixes. The first series examined the effect of varying the amount of RCA replacement of the virgin coarse aggregate. The second series examined the effect of varying the amount of fly ash replacement of the cement. The third series examined the effect of using the combination of both recycled materials, RCA and fly ash.

Table 9-1: Phase II Mix Designs per Cubic Yard

Mix ID	w/c	Cement (lb.)	Fly Ash (lb.)	Sand (lb.)	Limestone (lb.)	RCA (lb.)	AEA (oz./cwt)	HRWRA (oz./cwt)
C	0.40	517	-	1,201	1,784	-	0.6	7.0
1-25	0.40	517	-	1,201	1,338	471	0.6	7.0
1-50	0.40	517	-	1,201	892	942	0.6	7.0
1-75	0.40	517	-	1,201	446	1,413	0.6	7.0
1-100	0.40	517	-	1,201	0	1,884	0.6	7.0
2-20	0.40	414	103	1,201	1,784	-	0.6	5.0
2-40	0.40	310	207	1,201	1,784	-	0.6	5.0
2-60	0.40	207	310	1,201	1,784	-	0.6	5.0
3-40	0.40	310	207	1,201	0	1,884	0.6	5.0
3-50	0.40	259	259	1,201	0	1,884	0.6	5.0
3-60	0.40	207	310	1,201	0	1,884	0.6	5.0

9.2 DURABILITY TESTS AND SPECIMEN FABRICATION

Two different durability tests were performed on the research mixes – Freeze/Thaw Resistance, ASTM C666, and Salt Scaling Resistance, ASTM C672. Due to limitations with the testing equipment and the minimum number of required samples for each test, not all mix designs underwent the durability tests. Table 9-2 lists the two tests and the mixes on which they were performed. The selected mixes represented a broad range of the three series of mixes and included the control as a reference.

Table 9-2: Specific Mixes Undergoing Durability Testing

Durability Test	Mixes Tested
Freeze/Thaw Resistance (ASTM C666)	C, 1-25, 1-100, 2-20, 2-60, 3-40, 3-60
Salt Scaling Resistance (ASTM C672)	C, 1-100, 3-40, 3-60

Freeze/thaw resistance testing followed ASTM C666 Procedure A, where the specimens were always completely surrounded by water while they were subjected to the 300 freeze/thaw cycles. Figure 9-1 shows the specimens within the freeze/thaw chamber. The green wires in the figure maintain the required thickness of water around each specimen and allow easy removal of the specimens for periodic visual examination and testing.



Figure 9-1. Freeze/Thaw Specimens within Test Chamber

In accordance with ASTM C666, the research team determined the longitudinal dynamic modulus of elasticity of each specimen at intervals of approximately 36 freeze/thaw cycles using an Emodimeter, as shown in Figure 9-2. The process involved removing the specimens from the freeze/thaw chamber and placing them in a constant temperature, lime water, tempering tank for 24 hours prior to testing, as shown in Figure 9-3. This process allowed the specimens to thoroughly thaw and maintain a consistent level of saturation for repeatability of the dynamic modulus measurements. After each series of dynamic modulus tests, the specimen locations were rotated within the freeze/thaw chamber to eliminate the effect of any preferential conditions within the chamber. The first sequence of 36 cycles began after the required 14-day moist cure period for the specimens.



Figure 9-2. Longitudinal Dynamic Modulus of Elasticity Test Setup

Salt scaling resistance testing follow ASTM C672, where the specimens underwent 50 cycles of periodic freezing and thawing while the top surface was covered in a solution of calcium chloride and water to a depth of approximately 1/4 inch. Testing required a minimum of two specimens for each mix, with each specimen having a minimum ponded area of 72 square inches. As this test is a comparative measure, all specimens must have the same finish and surface treatment. Also, the dike used to maintain the solution of calcium chloride and water may be mortar, epoxy, or any other suitable material that will retain the solution during the freeze/thaw cycling. At intervals of every

5 cycles, the specimens were thoroughly flushed and visually examined at 5, 10, 15, 25, and 50 cycles. The visual rating system is shown in Table 9-3.



Figure 9-3. Constant Temperature Lime Water Tempering Tank

Table 9-3: Visual Rating Scale for Salt Scaling Resistance

Rating	Condition of Surface
0	No scaling
1	Very slight scaling (1/8 in. depth max., no coarse aggregate visible)
2	Slight to moderate scaling
3	Moderate scaling (some coarse aggregate visible)
4	Moderate to severe scaling
5	Severe scaling (coarse aggregate visible over entire surface)

The specimens were cast upside down so that each specimen would have a consistent formed surface for testing as opposed to a finished surface, which might have more variability. All specimens underwent the required 14-day moist cure followed by a 14-day air cure. At 28 days of age, a rigid foam dike was attached to the outer edge of each specimen with epoxy adhesive, as shown in Figure 9-4. Once the epoxy cured, the calcium chloride and water solution was placed along the top surface, and then each

specimen was placed into an environmental chamber for the required freeze/thaw cycling, shown in Figure 9-5.

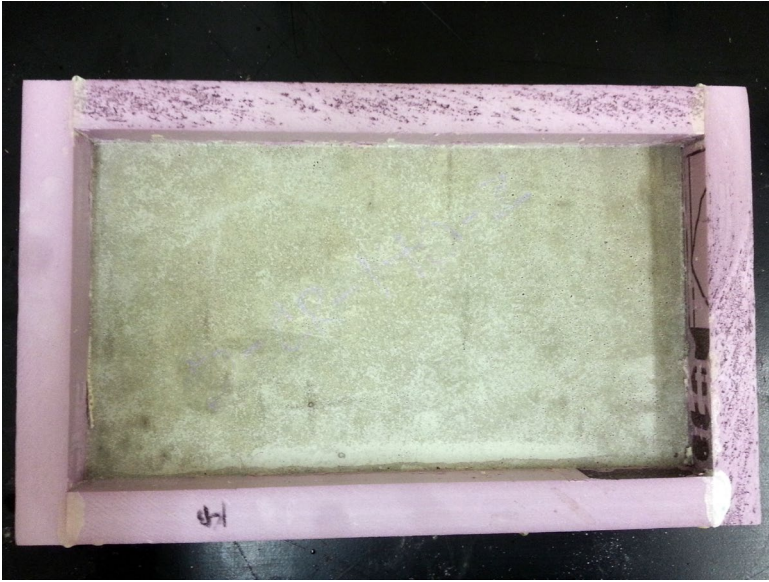

Figure 9-4. Salt Scaling Specimens with Foam Dike



Figure 9-5. Salt Scaling Specimens within Environmental Chamber

9.3 RESULTS OF FREEZE/THAW TESTING

The results for the freeze/thaw testing of the revised research mixes are shown in Figure 9-6. The plot shows the decrease in dynamic modulus as a function of the number of freeze/thaw cycles. ODOT requires a minimum of 50% at 300 cycles. As a result, only three of the mixes met the ODOT minimum durability requirement, the control mix and the two fly ash mixes, 2-20 and 2-60. This result is similar to the Phase I durability testing in that the fly ash mixes without RCA performed extremely well. In particular, the mix with the highest amount of fly ash, 2-60, had the best performance with a durability factor of 96. However, unlike the Phase I testing, the control mix exceeded the minimum ODOT requirement with a respectable durability factor of 79.

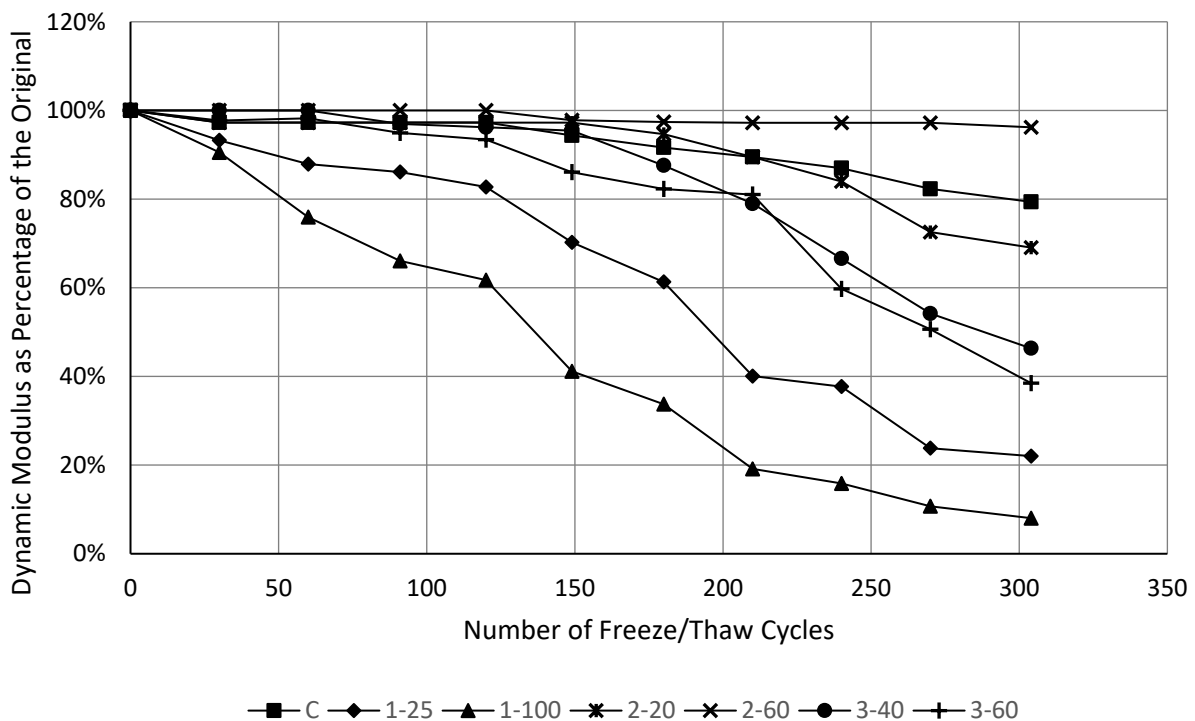

Figure 9-6. Freeze/Thaw Dynamic Modulus Test Results

In terms of the mixes containing RCA, although none of them met the minimum durability requirement, the addition of fly ash markedly improved the performance of mixes containing RCA. This result is evident by comparing the performance of mix 1-100, which contained 100 percent RCA without fly ash, with mixes 3-40 and 3-60, both of which contained 100 percent RCA but also contained 40 percent and 60 percent fly ash, respectively. In fact, the 3-40 mix almost met the ODOT requirement with a durability factor of 46.

However, the visual response of the freeze/thaw specimens tells a slightly different story depending on the particular specimen. Although the 2-20 mix performed well, with a

durability factor of 70, the specimen showed signs of deterioration with noticeable mass loss, as shown in Figure 9-7. Even more unusual was the response of the 2-60 mix, which performed extremely well with a durability factor of 96 yet showed signs of deterioration with noticeable mass loss as well, as shown in Figure 9-8. Furthermore, the 3-40 mix nearly met the ODOT minimum durability requirement, with a durability factor of 46, yet showed significant signs of freeze/thaw deterioration, with one end losing a significant amount of material, as shown in Figure 9-9.

It is unusual for the dynamic modulus measurements and the visual observations to tell a different story. It is possible that the high replacements of fly ash caused a denser cementitious matrix that also continued to hydrate over time during the freeze/thaw cycling, partially counterbalancing the destructive forces of freezing and thawing acting on the specimen. Additional freeze/thaw testing possibly coupled with petrographic examination may yield further understanding of this phenomenon.



Figure 9-7. Mix 2-20 Specimen at 304 Freeze/Thaw Cycles



Figure 9-8. Mix 2-60 Specimen at 304 Freeze/Thaw Cycles

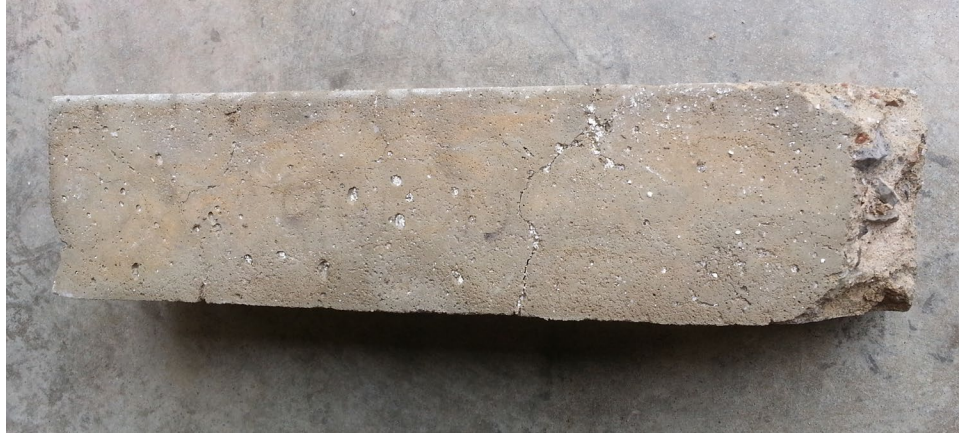

Figure 9-9. Mix 3-40 Specimen at 304 Freeze/Thaw Cycles

9.4 RESULTS OF SALT SCALING TESTING

The results for the salt scaling testing of the revised research mixes are shown in Table 9-4, with two specimens for each mix tested. The visual rating results indicate an increase in the amount of scaling as a function of the number of freeze/thaw cycles. ODOT does not require a particular level of scaling resistance except for bridge deck patch repairs, which require no scaling and thus a visual rating of zero at the end of 50 freeze/thaw cycles.

Table 9-4: Scaling Resistance Visual Rating vs. Number of Cycles

Mix ID	Specimen	5 cycles	10 cycles	15 cycles	25 cycles	50 cycles
C	No. 1	0	0	0	1	1
	No. 2	0	0	0	0	1
1-100	No. 1	0	0	0	0	1
	No. 2	0	0	0	1	2
3-40	No. 1	0	0	1	1	2
	No. 2	0	0	0	1	2
3-60	No. 1	0	0	1	2	3
	No. 2	0	0	1	1	3

The Control mix had the highest scaling resistance, with a visual rating of 1 for both specimens, while the 3-60 mix had the lowest scaling resistance, with a visual rating of 3 for both specimens. The 3-60 mix represents the highest amount of recycled

materials, with 100 percent RCA replacement and 60 percent fly ash replacement. The 3-40 mix did slightly better, with a visual rating of 2, and this mix contained 100 percent RCA replacement but only 40 percent fly ash replacement. This would seem to indicate that fly ash decreases scaling resistance, which is also evident by comparing the results for the 1-100 mix with the 3-40 mix. The 1-100 mix contained 100 percent RCA without any fly ash and received a visual rating of 1 for one of the specimens and 2 for the other specimen, so an average of 1.5, which was slightly better than the visual rating of 2 for both the 3-40 mix specimens. In general, mixes with high amounts of fly ash (3-40 and 3-60) tend to underperform in salt scaling testing but usually perform well in service (34). Nonetheless, salt scaling resistance appears to decrease with increasing percentages of both RCA and fly ash.

Photographs of one of the specimens for each mix at the end of testing are shown in Figures 9-10 through 9-13. It is important to note that the visual rating system is somewhat subjective and that two specimens with the same rating may show different amounts of scaling as each rating number represents a range of deterioration. Nonetheless, the visual results do seem to indicate a decrease in salt scaling resistance with increasing percentages of both RCA and fly ash.

9.5 CONCLUSIONS

The results of the Phase II durability testing were much improved compared to Phase I. The use of the conditioned RCA improved the consistency of the process and allowed an evaluation of the effect of combining high amounts of RCA replacement with high amounts of fly ash replacement. In terms of mixes containing RCA, although none of them met the freeze/thaw durability requirements, the addition of fly ash markedly improved the performance of mixes containing RCA. However, the use of high amounts of fly ash indicated unusual results when examining the specimens visually in comparison to the measured modulus results. Although the fly ash specimens showed signs of mass loss and deterioration, the freeze/thaw resistance as measured by the dynamic modulus did not show a corresponding decrease. It is possible that the high replacements of fly ash caused a denser cementitious matrix that also continued to hydrate over time during the freeze/thaw cycling, partially counterbalancing the destructive forces of freezing and thawing acting on the specimen. In terms of salt scaling resistance, the addition of RCA resulted in a slight decrease in durability compared to the control specimens. However, the addition of both RCA and fly ash had a noticeable decrease in salt scaling resistance.

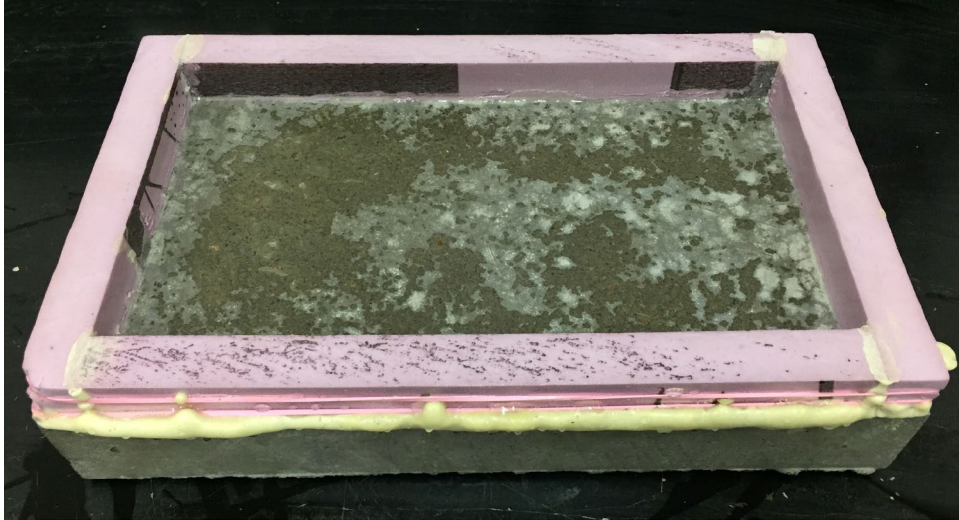

Figure 9-10. Control Mix Salt Scaling Specimen at 50 Cycles

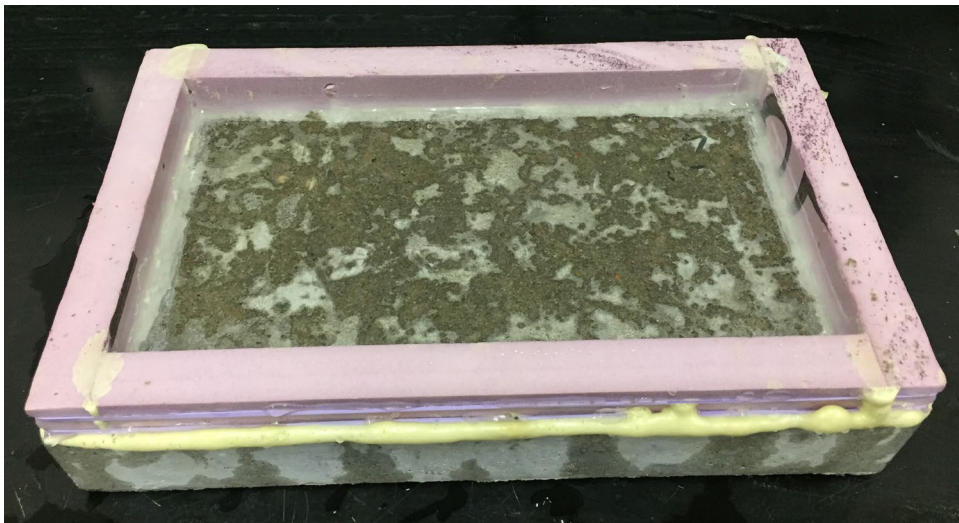

Figure 9-11. Mix 1-100 Salt Scaling Specimen at 50 Cycles

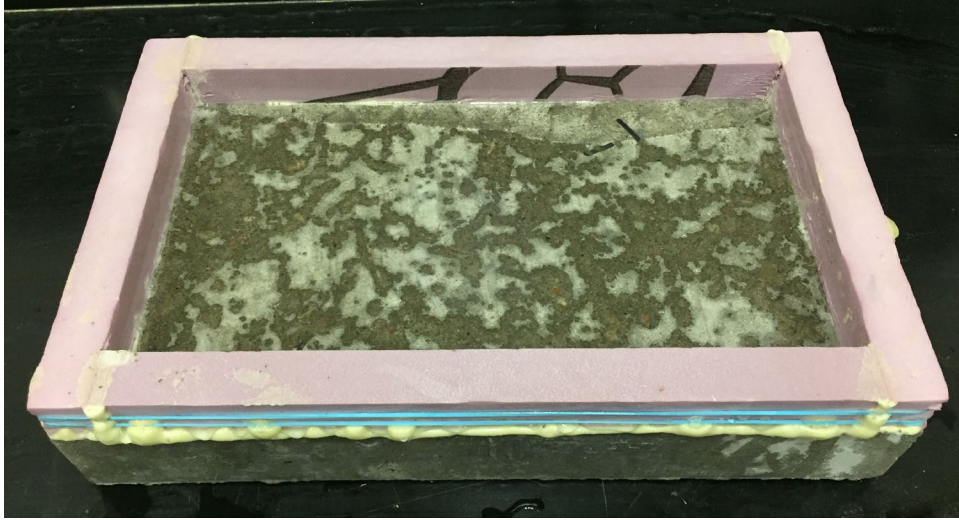

Figure 9-12. Mix 3-40 Salt Scaling Specimen at 50 Cycles



Figure 9-13. Mix 3-60 Salt Scaling Specimen at 50 Cycles

10. FULL SCALE PAVEMENT TEST SECTIONS

Previous chapters discussed the development and testing of concrete mixes containing high percentages of recycled materials, including recycled concrete aggregate (RCA) and fly ash. This chapter presents the transitioning of this technology from the laboratory to the field through an implementation project. The Decatur Avenue Pavement Project offered an opportunity to work with the Oklahoma Department of Transportation (ODOT), Garver Engineering, and the City of Norman to examine the potential of conventional concrete pavement constructed with concrete containing at least 50% recycled materials.

10.1 MIX DESIGNS

The two mix designs used for the implementation project included the ODOT Class A mix used as the Control for the previous development and testing, and the 3-50 mix, which incorporated 100 percent replacement of the virgin coarse aggregate with RCA and 50 percent replacement of the cement with fly ash. The mix designs are shown in Table 10-1. AEA indicates air-entraining admixture, and HRWRA indicates high-range water-reduction admixture. Both mixes used the revised water/cement ratio of 0.40 that was changed during the Phase II mix development stage as discussed in Chapter 8. Mix 3-50 met the project goal of incorporating at least 50 percent recycled materials for conventional concrete pavement.

Table 10-1: Implementation Project Mix Designs per Cubic Yard

Mix ID	w/c	Cement (lb.)	Fly Ash (lb.)	Sand (lb.)	Limestone (lb.)	RCA (lb.)	AEA (oz./cwt)	HRWRA (oz./cwt)
C	0.40	517	-	1,201	1,784	-	0.6	7.0
3-50	0.40	259	259	1,201	0	1,884	0.6	5.0

10.2 TEST BED LOCATION, LAYOUT, AND PREPARATION

The Decatur Avenue Pavement Project involved replacement of stormwater lines, regrading, and replacement of the existing asphalt pavement. Decatur Avenue is a north/south street located on the South Research Campus of the University of Oklahoma, shown in Figure 10-1. It is positioned between Lawrence Avenue on the west and Preble Avenue on the east and runs from Constitution Avenue on the north to Congress Avenue on the south.

The test bed location was positioned just north of the intersection of Decatur Avenue and Chesapeake Street and involved construction of eight (8) pavement panels, as shown in Figure 10-2. Four (4) of the pavement panels – Nos. 1 through 4 – were

constructed with the Class A mix, and four (4) of the pavement panels – Nos. 5 through 8 – were constructed with the 3-50 mix.

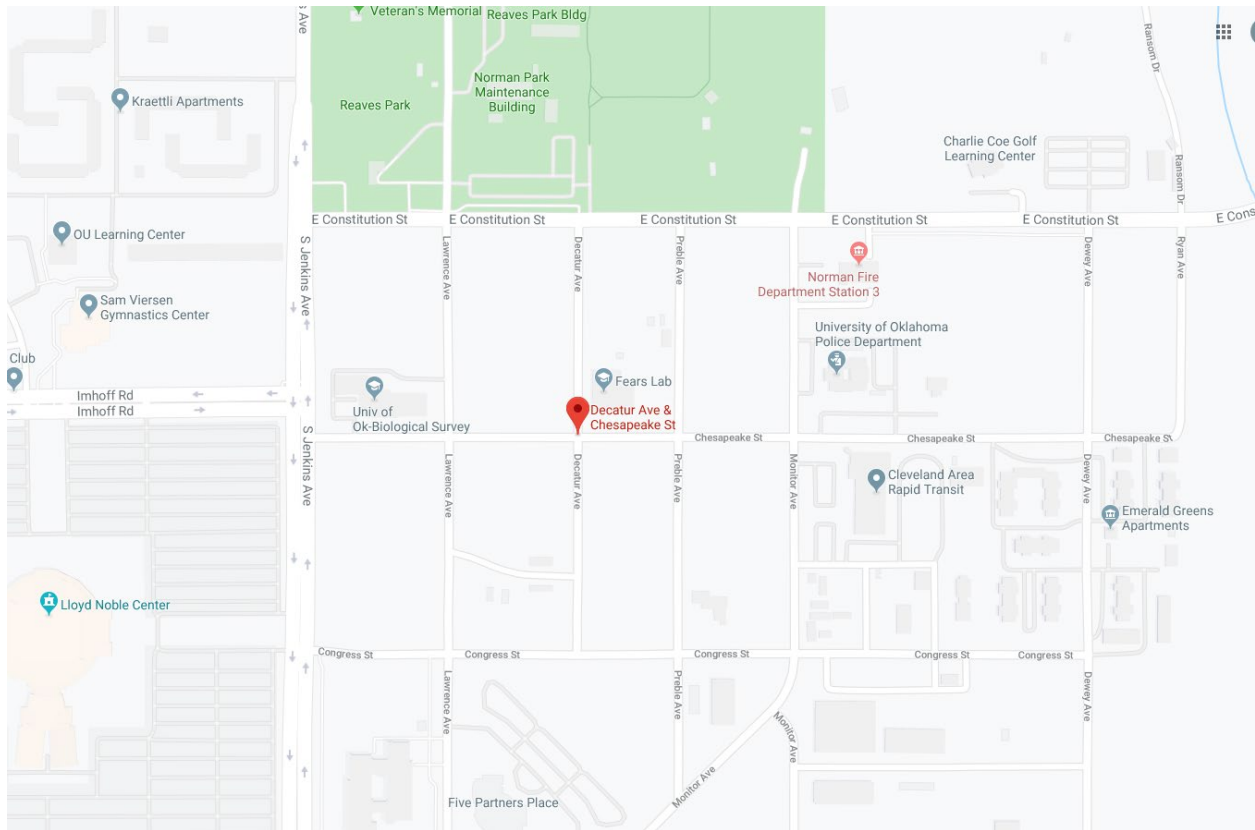

Figure 10-1. Location of Pavement Implementation Project

Preparation work for the pavement included removal of the existing asphalt roadway, base, and subbase, as shown in Figure 10-3, lime modification and compaction of the subgrade, and installation and compaction of the 6-in.-thick aggregate base, as shown in Figure 10-4. The research team documented the construction work and performed testing of the subgrade and base in accordance with ODOT's specifications.

10.3 PAVEMENT DETAILS AND INSTRUMENTATION

The pavement design, shown in Figure 10-5, consisted of an 8-in.-thick, dowel jointed concrete pavement (DJCP) with contraction joints spaced 16 ft. longitudinally and 11 ft. transversely. In accordance with ODOT design requirements, the transverse joints used 1-in.-diameter, 18-in.-long epoxy coated smooth dowels spaced 12 in. on center, while the longitudinal joints use 2 ft.-6 in.-long deformed #4 bars spaced 2 ft.-6 in. on center. All joints were butt-type joints without any special surface preparation other than a thorough cleaning prior to placement of the adjacent panel.



Figure 10-2. Test Bed and Pavement Panel Locations



Figure 10-3. Excavation and Preparation of Subbase for Pavement Construction



Figure 10-4. Installation (l) and Compaction (r) of Pavement Aggregate Base

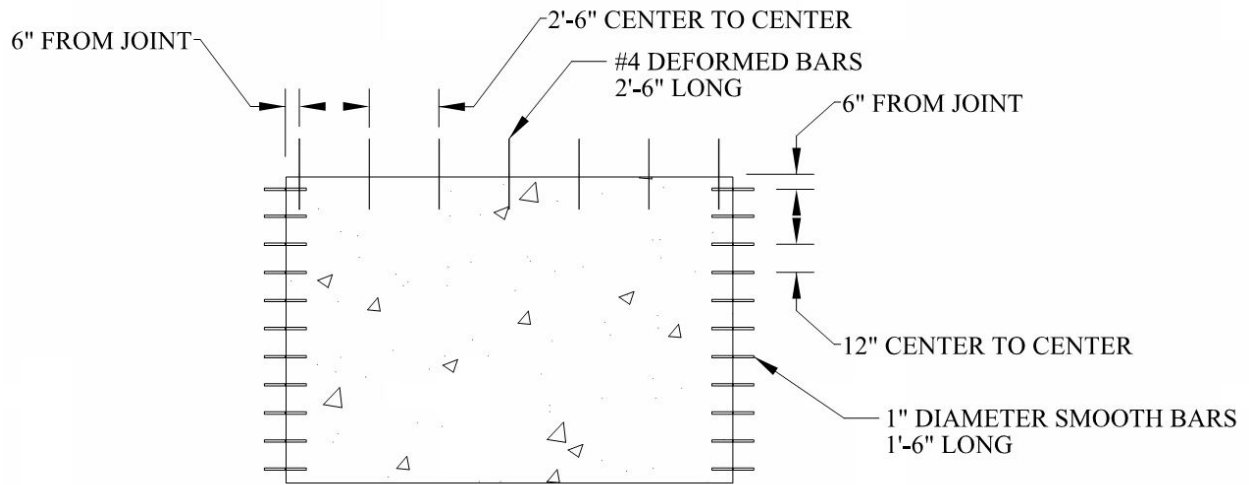

Figure 10-5. Pavement Dowel Bar Placement

Instrumentation for the pavement sections consisted of vibrating wire strain (VWS) gages placed in “trees” at three locations within each pavement section, as shown in Figure 10-6. Two of the trees were placed directly under the wheel load of a vehicle traveling on the roadway, while the third was placed in the direct center of the panel. A total of 8 VWS gages were installed in each panel, with Tree No. 1 using 4 gages and Tree Nos. 2 and 3 using 2 gages each. The gage orientation allowed for measuring both transverse and longitudinal shrinkage and temperature strains within the pavement sections. Figures 10-7 and 10-8 show the dimensions for Tree No. 1, and Figures 10-9 and 10-10 show the dimensions for Tree No. 2.

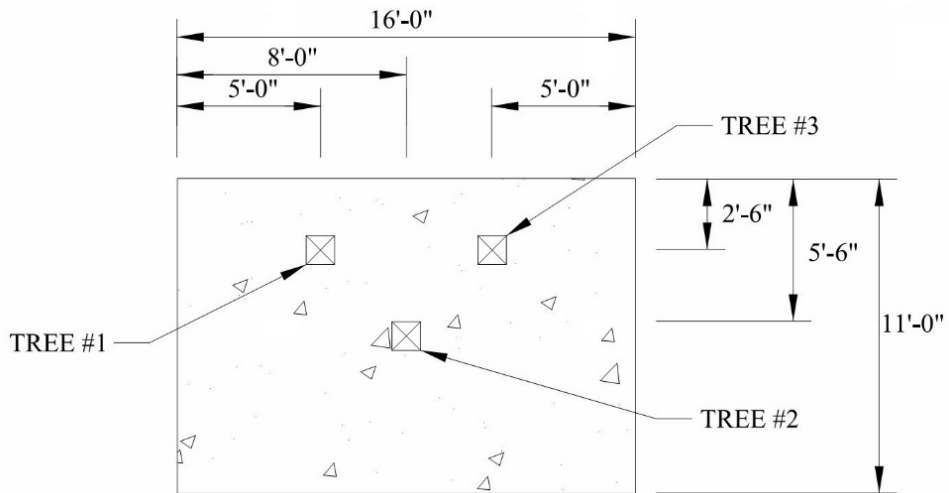

Figure 10-6. Vibrating Wire Strain Gage Placement

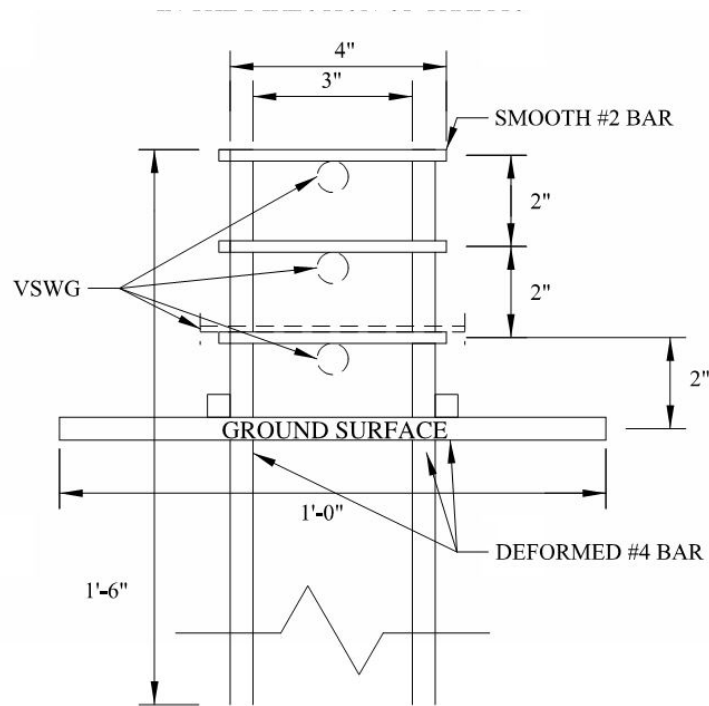

Figure 10-7. Dimensions of Tree No. 1 Perpendicular to Traffic

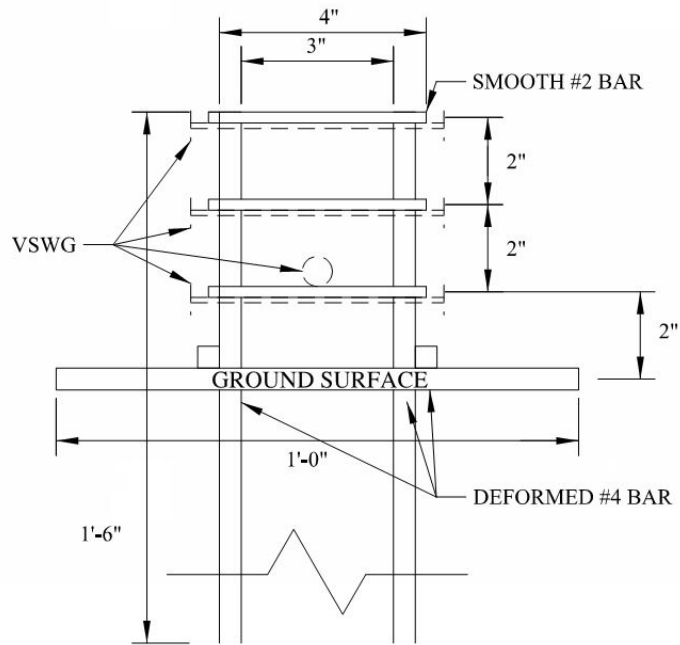

Figure 10-8. Dimensions of Tree No. 1 Parallel to Traffic

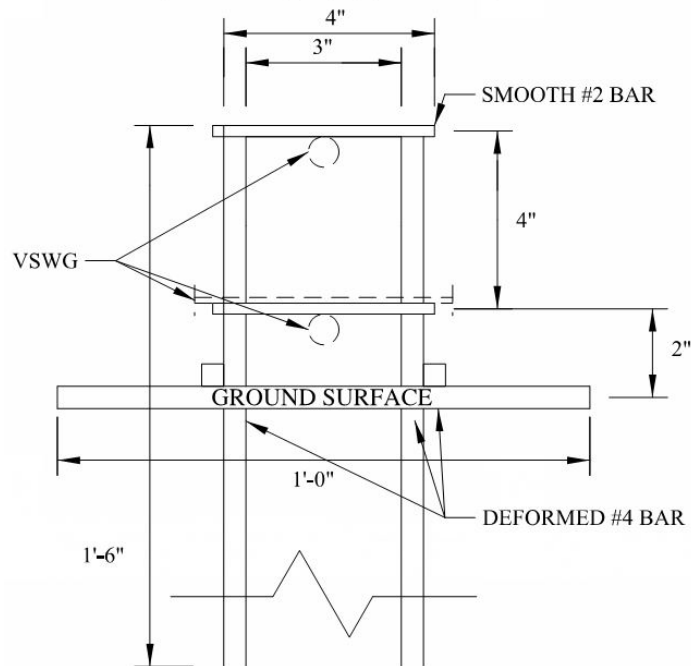

Figure 10-9. Dimensions of Tree Nos. 2 and 3 Perpendicular to Traffic

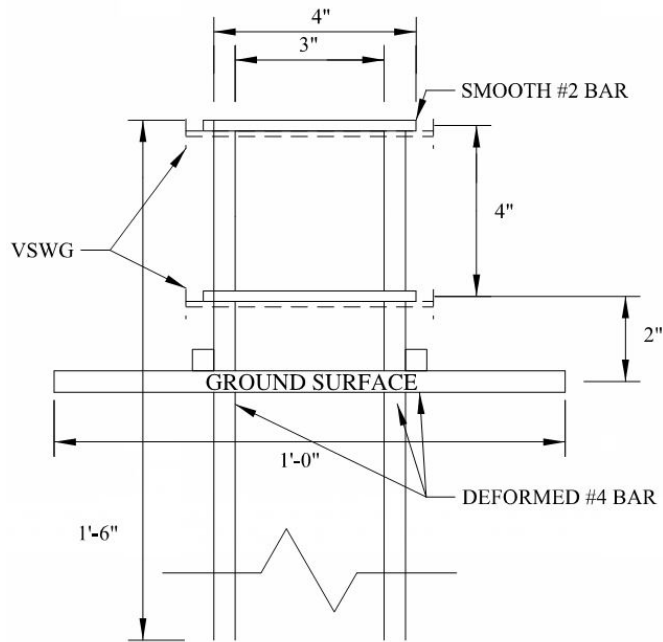

Figure 10-10. Dimensions of Tree Nos. 2 and 3 Parallel to Traffic

Photographs of the VWS gage placement for Panel No. 8 are shown in Figure 10-11, which includes the overall layout as well as a close-up of Tree No. 1. Lead wires for the gages were run to Geokon data acquisition (DAQ) boxes, which were placed within steel lockboxes for protection. The DAQ recorded shrinkage and temperature strains at 30-minute intervals for the initial 28 days and then at 2-hour increments for the remainder of the data acquisition period.



Figure 10-11. VWS Gage Layout (l) and Close-up of Tree No. 1 (r) for Panel No. 8

10.4 PAVEMENT CONSTRUCTION

The concrete for both the Class A and 3-50 mix was supplied by the Norman Plant of Dolese Bros. Co. (Dolese). The research team worked with Dolese on the specifications for the 3-50 mix, including the need to presoak the RCA similar to the approach used for lightweight aggregate. After several trial mixes, the final protocols were established, and the fresh and hardened material properties of the mass-produced concrete were consistent with the laboratory mixes developed in Chapter 8.

Figures 10-12 and 10-13 detail the concrete placement, consolidation, and finishing for one of the pavement panels constructed with the 3-50 mix. In general, the concrete contractor indicated that the 3-50 mix was, in many ways, easier to place and finish than the Class A mix. In particular, the 3-50 mix readily maintained consistency throughout the placement and was easier to finish due to the high fly ash content. In their words, the 3-50 mix was less harsh and creamier than the Class A mix.



Figure 10-12. Concrete Placement (l) and Consolidation (r)



Figure 10-13. Concrete Floating (l) and Finishing (r)

10.5 VOLUME CHANGE MEASUREMENTS

A comparison of the shrinkage data from one of the Class A pavement panels and one of the 3-50 mix pavement panels is shown in Figure 10-14. These measurements are for the initial 90-day period following placement and exclude both ambient and solar temperature strains. The plots are typical of all panels within the test bed. As shown in the plot, both pavement sections exhibit nearly identical behavior. Nonetheless, the Class A pavement displayed an increased initial shrinkage within the first 10 to 12 days compared to the 3-50 pavement, which is likely due to the faster rate of hydration for the 100 percent portland cement Class A mix compared to the 50/50 portland cement/fly ash 3-50 mix. After that point, the two concrete types display a similar rate of shrinkage for the remaining time period. As a result, at 90 days, the Class A pavement had a total shrinkage of approximately 387 microstrain compared to approximately 350 microstrain for the 3-50 pavement. Both pavements also displayed a period of shrinkage recovery between approximately 40 and 50 days (960 and 1200 hours) after placement. This shrinkage recovery coincided with a very wet weather period. After 50 days (1200 hours), both pavement types resumed a standard shrinkage behavior.

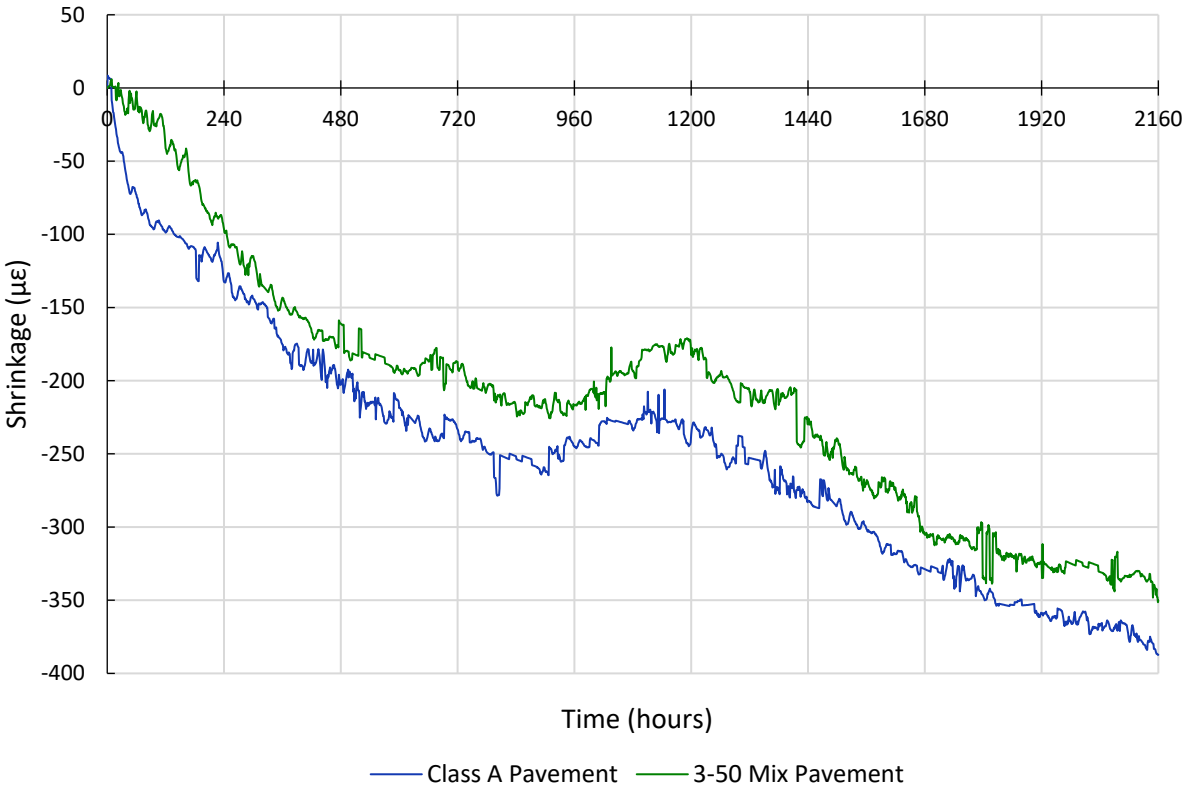

Figure 10-14. Pavement Panel Shrinkage Comparison of Class A and 3-50 Mixes

10.6 VISUAL OBSERVATIONS

Although only in service for two years, the four (4) pavement panels constructed with the 3-50 mix do not show any signs of cracking, scaling, spalling, pop-outs, or other forms of deterioration, as shown in Figure 10-15.



Figure 10-15. Condition of Panels 5 Through 8 After Two Years in Service

10.7 FALLING WEIGHT DEFLECTOMETER TESTING

The research team contracted with a company to perform falling weight deflectometer (FWD) testing of the test bed pavements. FWD can determine the stiffness (modulus) of a rigid pavement as well as the degree of interlock between adjacent pavement sections. Measurement of the degree of interlock, commonly referred to as load transfer efficiency (LTE), is obtained by placing the FWD load plate tangent to one side of the joint to be evaluated.

Figure 10-16 shows the FWD device in operation, and Table 10-2 shows the results for the four pavement panels tested, two of the Class A panels – Nos. 1 and 3 – and two of the 3-50 mix panels – Nos. 5 and 7. The results indicated that the Class A pavement sections are slightly stiffer than the 3-50 pavement sections, most likely due to the effect of the RCA and fly ash. However, the decrease in stiffness is less than 10 percent. Regarding the LTE values, the panels behaved very similarly, with nearly identical load transfer efficiency ratings.



Figure 10-16. FWD Testing of Pavement Panels

Table 10-2: FWD Test Results

Panel	Pavement Modulus (ksi)	LTE (%)
1 (Class A)	6490	86.4
3 (Class A)	6080	85.7
5 (3-50 Mix)	5605	84.1
7 (3-50 Mix)	5890	84.8

10.8 CONCLUSIONS

The 3-50 mix containing 100 percent RCA and 50 percent fly ash performed very well in the exterior test bed in comparisons with the Class A concrete. In general, the 3-50 mix maintained consistency and was easier to finish than the Class A concrete. The shrinkage behavior over time was also nearly identical between the two mixes, with the 3-50 mix experiencing a little over 10 percent less shrinkage at the end of 90 days of testing. Interestingly, both mixes experienced a period of shrinkage recovery during a particularly wet weather period during a portion of pavement monitoring period. Visual observations after two years in service did not reveal any signs of cracking, scaling, spalling, pop-outs, or other forms of deterioration in the pavement panels for either

concrete types. The results of falling weight deflectometer testing revealed nearly identical behavior between the two concrete types in terms of both stiffness and load transfer efficiency. The implementation project revealed that the 3-50 mix performed very well in comparison to the Class A concrete in an actual pavement application.

11. SUMMARY AND RECOMMENDATIONS

The following chapter contains a summary of the work performed in this research study along with a series of recommendations on the use of high volumes of recycled materials in the production of portland cement concrete pavement. The recommendations pertain to the use of recycled concrete aggregate (RCA) and fly ash both separately and together in the production of a more sustainable approach to concrete paving operations.

11.1 SUMMARY

The primary goal of this research was to produce concrete for conventional portland cement concrete pavement construction that incorporated at least 50% recycled materials without compromising performance and service life. The research team investigated the use of recycled concrete aggregate (RCA) and fly ash as a means of achieving this goal. A series of mix designs were developed to examine the effect of RCA and fly ash on the fresh and hardened material properties as well as durability and long-term performance.

The mix design matrix consisted of a Class A control mix design plus three different series of mixes. The first series examined the effect of varying the amount of RCA replacement of the virgin coarse aggregate. The second series examined the effect of varying the amount of fly ash replacement of the cement. The third series examined the effect of using the combination of both recycled materials, RCA and fly ash.

Some of the results from the initial series of mix designs, Phase I, indicated inconsistencies when using RCA as a replacement for all or a part of the virgin coarse aggregate. It was believed that the rate of absorption of the RCA may be just as important as the total absorption, particularly when dealing with very dry RCA and having to provide additional mixing water to compensate. Several methods were used to investigate the rate of absorption of RCA, including the ASTM C127 towel dry method, hydrostatic weighing, and centripetal acceleration. Based on these approaches, a full-scale, centripetal acceleration setup was used to render several hundred pounds of presoaked RCA to a saturated surface dry condition for eventual use in the mixes of the second phase.

The results of the Phase II mix development were much improved compared to Phase I. The use of the conditioned RCA improved the consistency of the process, revealed behavior that was in line with previous research, and allowed an evaluation of the effect of combining high amounts of RCA replacement with high amounts of fly ash replacement. In general, the use of RCA in place of virgin aggregate does not alter the workability of a specific mix. Although the RCA surfaces are rougher than virgin aggregate due to the adhered mortar, which would decrease workability, the edges are more rounded than virgin aggregate, which balances any impact on workability.

Regarding material properties, both RCA and fly ash decrease the compressive strength, modulus of rupture, split cylinder strength, and modulus of elasticity. The reductions in split cylinder strength and modulus of elasticity are slightly greater than the expected reduction as a result of lower compressive strength. However, all the research mixes met both the minimum ODOT strength requirements and the higher project strength requirements, indicating the potential for using high amounts of RCA and fly ash in concrete mixes for pavement construction. Presoaking the RCA is necessary, however, in order to achieve consistent results.

Resistivity measurements were used in Phase I as a useful non-destructive method to determine the resistance of a concrete mixture to chloride ion penetration. The higher the resistance, the better the long-term durability performance. Both surface and bulk electrical resistivity measurements indicated that the resistivity of the concrete decreases with increasing RCA replacement in comparison to virgin aggregates alone. Fly ash, on the other hand, significantly increases the resistivity compared to portland cement alone. As a result, when the two materials are used together, the fly ash not only mitigates the decrease in resistivity due to the RCA but compensates enough that the concrete mix has higher resistivity than the Control mix. The amount of improvement is a function of the amount of RCA and fly ash replacement. A mix with 100 percent RCA replacement of the virgin aggregate would require at least 40 percent fly ash replacement of the portland cement to reach a moderate chloride ion penetrability classification compared to the highly susceptible rating for the Control mix.

The results of durability tests of the Phase I mixes indicated that in terms of freeze/thaw resistance, mixes with more than 25 percent RCA replacement showed a noticeable improvement compared to the Control mix. However, none of the mixes met the minimum durability criteria at the end of testing. In terms of the combination of RCA and fly ash, fly ash replacements of 20 and 60 percent with 100 percent RCA outperformed the 100 percent RCA mix without any fly ash. However, the 40 percent fly ash replacement did not seem to have much effect, with its performance essentially matching that of the 100 percent RCA mix without any fly ash. Of all the mixes, the one with the highest replacement of recycled materials, 100 percent RCA and 60 percent fly ash, was the only mix to meet the minimum durability criteria at 300 cycles. It appears that the use of both recycled materials is necessary to reach an adequate level of freeze/thaw resistance.

In terms of salt scaling resistance, mixes with more than 25 percent RCA replacement showed a noticeable improvement compared to the Control mix, with all specimens passing the test whereas all the Control specimens failed. Unfortunately, in terms of the combination of RCA and fly ash, none of the mixes passed the test although the 20 percent fly ash replacement came very close. High dosages of fly ash (40 percent or higher) appeared to weaken the cementitious matrix as these specimens revealed significant overall scaling of the specimen surfaces.

Based on these results, a careful balancing of RCA and fly ash is required to achieve acceptable levels of durability. For some durability measures, RCA helps performance, such as salt scaling resistance, but in others, it reduces performance, such as freeze/thaw resistance. Fly ash, on the other hand, decreases salt scaling resistance but increases freeze/thaw resistance and resistance to chloride ion ingress. Acceptable mix designs must find a balance between these two materials to maximize the use of these recycled materials in concrete.

The results of the Phase II durability testing were much improved compared to Phase I. The use of the conditioned RCA improved the consistency of the process and allowed an evaluation of the effect of combining high amounts of RCA replacement with high amounts of fly ash replacement. In terms of mixes containing RCA, although none of them met the freeze/thaw durability requirements, the addition of fly ash markedly improved the performance of mixes containing RCA. However, the use of high amounts of fly ash indicated unusual results when examining the specimens visually in comparison to the measured modulus results. Although the fly ash specimens showed signs of mass loss and deterioration, the freeze/thaw resistance as measured by the dynamic modulus did not show a corresponding decrease. It is possible that the high replacements of fly ash caused a denser cementitious matrix that also continued to hydrate over time during the freeze/thaw cycling, partially counterbalancing the destructive forces of freezing and thawing acting on the specimen. In terms of salt scaling resistance, the addition of RCA resulted in a slight decrease in durability compared to the control specimens. However, the addition of both RCA and fly ash had a noticeable decrease in salt scaling resistance.

The final task of the research involved an implementation phase, which included construction of pavement sections using the Class A mix and the 3-50 mix. The 3-50 mix contained 100 percent RCA and 50 percent fly ash and performed very well in the exterior test bed in comparisons with the Class A concrete. In general, the 3-50 mix maintained consistency and was easier to finish than the Class A concrete. The shrinkage behavior over time was also nearly identical between the two mixes, with the 3-50 mix experiencing a little over 10 percent less shrinkage at the end of 90 days of testing. Interestingly, both mixes experienced a period of shrinkage recovery during a particularly wet weather period during a portion of pavement monitoring period. Visual observations after two years in service did not reveal any signs of cracking, scaling, spalling, pop-outs, or other forms of deterioration in the pavement panels for either concrete types. The results of falling weight deflectometer testing revealed nearly identical behavior between the two concrete types in terms of both stiffness and load transfer efficiency. The implementation project revealed that the 3-50 mix performed very well in comparison to the Class A concrete in an actual pavement application.

11.2 RECOMMENDATIONS

Based on the research performed in this study, the following recommendations are presented regarding the use of high volumes of recycled concrete aggregate (RCA) and fly ash in the production of portland cement concrete pavement.

Recommendations regarding the use of RCA in portland cement concrete pavement include the following:

- Perform standard aggregate testing of RCA sources including sieve analysis, dry rodded unit weight, absorption, and abrasion resistance.
- Apply same gradation limits to RCA as that used for virgin coarse aggregates.
- Limit the amount of RCA fines within the coarse RCA material to 10 percent and avoid the use of RCA fines to replace natural sand fine aggregates.
- Limit abrasion loss of RCA to 40 percent in accordance with ASTM C131.
- Ensure RCA sources meet the same quality requirements normally used for virgin aggregate sources in accordance with ASTM C33 or AASHTO M80.
- Ensure RCA sources are free of harmful components such as chlorides and reactive materials
- Proportion concrete mixtures containing RCA using the same procedures used for concrete containing virgin aggregates. However, adjust water/cement ratio or cement content to compensate for the potential of up to a 20 percent reduction in material properties when using high volumes of RCA replacement.
- Increase air entraining admixture dosages in order to develop the required amount and quality of the air void system necessary for adequate freeze/thaw resistance.
- Presoak RCA to help maintain uniformity of absorbed water during production. RCA should be stored and moistened using procedures commonly used for lightweight and slag aggregate, such as continuous sprinkling prior to batching.
- Perform laboratory and field trials of concrete mixtures containing RCA to ensure that the fresh and hardened properties meet the project requirements.
- Perform freeze/thaw testing (ASTM C666) to ensure trial mixes meet project requirements.
- Perform salt scaling testing (ASTM C672) to ensure trial mixes meet project requirements.

Recommendations regarding the use of more than 20 percent fly ash replacements in portland cement concrete pavement include the following:

- Perform standard testing of fly ash sources including fineness, specific gravity, and chemical composition.
- Limit sulfur trioxide content to 5 percent to control potential expansion.
- Limit loss of ignition to 5 percent.
- Limit amount retained on the No. 325 sieve to 33 percent.
- Limit fly ash replacement of portland cement to 50 percent.
- Proportion concrete mixtures containing fly ash using the same procedures used for concrete containing portland cement. However, reduce water/cement ratio or water reducing admixtures to compensate for increased workability.
- Increase air entraining admixture dosages in order to develop the required amount and quality of the air void system necessary for adequate freeze/thaw resistance.
- Specify hardened material properties at 56 days of curing to account for the slower hydration of mixes containing high volumes of fly ash replacement.
- Perform laboratory and field trials of concrete mixtures containing RCA to ensure that the fresh and hardened properties meet the project requirements.
- Perform freeze/thaw testing (ASTM C666) to ensure trial mixes meet project requirements but consider 56-day curing period due to slower hydration of mixes containing high volumes of fly ash replacement.
- Perform salt scaling testing (ASTM C672) to ensure trial mixes meet project requirements but consider 56-day curing period due to slower hydration of mixes containing high volumes of fly ash replacement.

Recommendations regarding the use of the combination of RCA and fly ash in portland cement concrete pavement include the following:

- Apply the recommendations stated previously for the separate use of RCA or fly ash in portland cement concrete pavement.
- Proportion concrete mixtures containing RCA and fly ash using the same procedures used for concrete containing virgin aggregates and portland cement. However, adjust water/cement ratio or cement content to compensate for the

potential of up to a 30 percent reduction in material properties when using high volumes of both materials.

- Balance the combination of RCA and fly ash replacement. Fly ash will reduce the water demand, which will increase the hardened material properties. RCA has the potential to decrease freeze/thaw resistance, but fly ash can increase freeze/thaw resistance. Fly ash has the potential to decrease scaling resistance.

REFERENCES

1. FHWA. (2004). Transportation Applications of Recycled Concrete Aggregate, FHWA State of the Practice National Review, U.S. Department of Transportation, Federal Highway Administration, Washington, D.C., 47 pp.
2. Abbas, A., Fathifazl, G., Fournier, B., Isgor, O.B., Zavadil, R., Razaqpur, A.G., and Foo, S. (2009). "Quantification of the Residual Mortar Content in Recycled Concrete Aggregates by Image Analysis," *Material Characterization*, 60:716-728.
3. Marland, G., Boden, T.A., and Andres, R.J. (2008). Global, Regional, and National Fossil Fuel CO₂ Emissions. In Trends: A Compendium of Data on Global Change, Carbon Dioxide Information Analysis Center, Oak Ridge National Laboratory, U.S. Department of Energy, Oak Ridge, Tennessee, 388 pp.
4. Hanle, L.J., Jayaraman, K.R., and Smith, J.S. (2004). "CO₂ Emissions Profile of the U.S. Cement Industry," *Proceedings of the 13th International Emissions Inventory Conference*, Clearwater, Florida, 14 pp.
5. ODOT. (2015). 2015-2040 Oklahoma Long Range Transportation Plan: Moving Oklahoma Forward, prepared for the Oklahoma Department of Transportation by CDM Smith and approved by the Oklahoma Transportation Commission on August 10, 2015, Oklahoma City, Oklahoma, 152 pp.
6. Kou, S.C. and Poon, C.S. (2012). "Enhancing the Durability Properties of Concrete Prepared with Coarse Recycled Aggregate," *Construction and Building Materials*, 35:69-76.
7. Volz, J., Khayat, K., Arezoumandi, M., Drury, J., Sadati, S., Smith, A., and Steele, A. (2014). Recycled Concrete Aggregate (RCA) for Infrastructure Elements, Final Report MoDOT TRyy1317, Missouri Department of Transportation, Jefferson City, Missouri, 471 pp.
8. Xiao, J., Li, W., Fan, Y., and Huang, X. (2012). "An Overview of Study on Recycled Aggregate Concrete in China (1996-2011)," *Construction and Building Materials*, 31:354-383.
9. Domingo, A., Lazaro, C., Lopez-Gayarre, F., Serrano-Lopez, M.A., Serna, P., and Castano-Tabares, J.O. (2009). "Creep and Shrinkage of Recycled Aggregate Concrete," *Construction and Building Materials*, 23:2545-2553.
10. Limbachiya, M., Seddik, M., and Ouchangur, Y. (2012). "Performance of Portland/Silica Fume Cement Concrete Produced with Recycled Concrete Aggregate," *ACI Materials Journal*, 109(1):91-100.

11. Fathifazl, G., Razaqpur, A.G., Isgor, O.B., Abbas, A., Fournier, B., and Foo, S. (2011). "Creep and Drying Shrinkage Characteristics of Concrete Produced with Coarse Recycled Concrete Aggregate," *Cement and Concrete Composites*, 33:1026-1037.
12. Tabsh, S.W. and Abdelfatah, A.S. (2009). "Influence of Recycled Concrete Aggregates on Strength Properties of Concrete," *Construction and Building Materials*, 23:1163-1167.
13. Young, P.C. and Teo, D.C.L. (2009). "Utilization of Recycled Aggregate as Coarse Aggregate in Concrete," *UNIMAS E-Journal of Civil Engineering*, 1(1):1-6.
14. Ravindrarajah, S.R. and Tam, C.T. (1985). "Properties of Concrete Made with Crushed Concrete as Coarse Aggregate," *Magazine of Concrete Research*, 37(130):29-38.
15. Thomas, C., Sosa, I., Setien, J., Polanco, J.A., and Cimentada, A.I. (2014). "Evaluation of the Fatigue Behavior of Recycled Aggregate Concrete," *Journal of Cleaner Production*, 65:397-405.
16. Arora, S. and Singh, S.P. (2015). "Flexural Fatigue Analysis of Concrete Made with 100% Recycled Concrete Aggregates," *Journal of Materials and Engineering Structures*, 2:77-89.
17. Sobhan, K., Gonzalez, L., and Reddy, D.V. (2015). "Durability of a Pavement Foundation Made from Recycled Aggregate Concrete Subjected to Cyclic Wet-Dry Exposure and Fatigue Loading," *Materials and Structures*, DOI 10.1617/s1 1527-015-0648-9.
18. Huda, S.B. and Alam, M.S. (2015). "Mechanical and Freeze-Thaw Durability Properties of Recycled Aggregate Concrete Made with Recycled Coarse Aggregate," *Journal of Materials in Civil Engineering*, 10.1061/(ASCE)MT.1943-5533.0001237, 04015003.
19. Medina, C., Isabel, S., and Frias, M. (2013). "Freeze-Thaw Durability of Recycled Concrete Containing Ceramic Aggregate," *Journal of Cleaner Production*, 40:151-160.
20. Richardson, A., Coventry, K., and Bacon, J. (2011). "Freeze/Thaw Durability of Concrete with Recycled Demolition Aggregate Compared to Virgin Aggregate Concrete," *Journal of Cleaner Production*, 19(2-3):272-277.
21. Ajdukiewicz, A. and Kliszceqicz, A. (2002). "Influence of Recycled Aggregates on Mechanical Properties of HS/HPC," *Cement and Concrete Composites*, 24(2):269-279.

22. Movassaghi, R. (2006). Durability of Reinforced Concrete Incorporating Recycled Concrete Aggregate (RCA), A thesis presented to the University of Waterloo in fulfillment of the requirements for Master of Applied Science in Mechanical Engineering, University of Waterloo, Canada, 160 pp.
23. Speare, P.R. and Ben-Othman, B. (1993). "Recycled Concrete Coarse Aggregates and Their Influence on Durability," Proceedings of Concrete 2000: Economic and Durable Construction through Excellence, Dundee, Scotland, United Kingdom, pp. 419-432.
24. Cuttell, G.D., Snyder, M.B., Vandenbossche, J.M., and Wade, M.J. (1997). "Performance of Rigid Pavements Containing Recycled Concrete Aggregate," Transportation Research Record 1574, Transportation Research Board, National Research Council, Washington, D.C., pp. 89-98.
25. Richardson, D., Beckemeier, K., and Volz, J. (2015). "Effects of Powder Additives on High-Volume Fly Ash Mixtures," ACI Materials Journal, 112(4):535-546.
26. Volz, J., Myers, J., Richardson, D., Arezoumandi, M., Beckemeier, K., Davis, D., Holman, K., Looney, T., and Tucker, B. (2012). Design and Evaluation of High-Volume Fly Ash (HVFA) Concrete Mixes, Final Report MoDOT TRyy1110, Missouri Department of Transportation, Jefferson City, Missouri, 817 pp.
27. Bentz, D.P. (2010). "Powder Additions to Mitigate Retardation in High-Volume Fly Ash Mixtures," ACI Materials Journal, 107(5):508-514.
28. Bentz, D.P. and Ferraris, C.F. (2010). "Rheology and Setting of High Volume Fly Ash Mixtures," Cement and Concrete Composites, 32(4):265-270.
29. Bentz, D.P., Chiara, F.F., De La Varge, I., Peltz, M.A., and Winpigler, J.A. (2010). "Mixture Proportioning Options for Improving High Volume Fly Ash Concretes," International Journal of Pavement Research and Technology, 3(5):234-240.
30. Naik, T.R., Ramme, B.W., Kraus, R.N., and Siddique, R. (2003). "Long-Term Performance of High-Volume Fly Ash Concrete Pavements," ACI Materials Journal, 100(2):150-155.
31. de Brito, J. and Agrela, F. (Eds.). (2019). New Trends in Eco-Efficient and Recycled Concrete, Woodhead Publishing, Elsevier Ltd., 610 pp.
32. Aïtcin, P.C. and Flatt, R. (Eds.). (2016). Science and Technology of Concrete Admixtures, Woodhead Publishing, Elsevier Ltd., 665 pp.

33. Neuwald, A.D. (2010). "What are SCMs and How Can You Use Them to Your Advantage?", *Precast Magazine*, National Precast Concrete Association, Carmel, Indiana, pp. 23-25.
34. Malhotra, V.M. and Mehta, P.K. (2008). High-Performance, High-Volume Fly Ash Concrete for Building Sustainable and Durable Structures, (3rd ed.), Supplementary Cementing Materials for Sustainable Development, Inc., Ottawa, Canada, 142 pp.
35. ASTM C618. (2008). Standard Specification for Coal Fly Ash and Raw or Calcined Natural Pozzolan for Use in Concrete, ASTM International, West Conshohocken, Pennsylvania.
36. ACI Committee 232. (2003). Use of Fly Ash in Concrete (ACI 232.2R-03). American Concrete Institute, Farmington Hills, Michigan.
37. Grubeša, I.N., Barišić, I, Fucic, A., and Bansode, S.S. (2016). Characteristics and Uses of Steel Slag in Building Construction, Woodhead Publishing, Elsevier Ltd., 194 pp.
38. ACI Committee 232. (2017). Guide to the Use of Slag Cement in Concrete and Mortar (ACI 233R-17). American Concrete Institute, Farmington Hills, Michigan.
39. Liu, Z.L., El-Tawil, S., Hansen, W., and Wang, F. (2018). "Effect of Slag Cement on the Properties of Ultra-High Performance Concrete," *Construction and Building Materials*, 190:830-837.
40. ASTM C989. (2018). Standard Specification for Slag Cement for Use in Concrete and Mortars, ASTM International, West Conshohocken, Pennsylvania.
41. Khatib, J.M. (Ed.). (2016). Sustainability of Construction Materials, Woodhead Publishing, Elsevier Ltd., 742 pp.
42. ACI Committee 234. (2012). Guide for the Use of Silica Fume in Concrete (ACI 234R-12). American Concrete Institute, Farmington Hills, Michigan.
43. Xie, J., Huang, L., Guo, Y., Li, Z., Fang, C., Li, L., and Wang, J. (2018). "Experimental Study on the Compressive and Flexural Behavior of Recycled Aggregate Concrete Modified with Silica Fume and Fibers," *Construction and Building Materials*, 178:612-623.
44. ASTM C1240. (2015). Standard Specification for Silica Fume Used in Cementitious Mixtures, ASTM International, West Conshohocken, Pennsylvania.

45. Padmini, A.K., Ramamurthy, K., Mathews, M.S. (2009). "Influence of Parent Concrete on the Properties of Recycled Aggregate Concrete", *Construction and Building Materials*, 23:829-836.
46. Nagataki, S., Gokceb, A., and Saekic, T. (2012). "Effects of Recycled Aggregate Characteristics on Performance Parameters of Recycled Aggregate Concrete", *Proceedings of Fifth CANMET/ACI International Conference on Durability of Concrete*, Barcelona, pp. 51-71
47. Kou. S., Poon. C., and Wan. H. (2012). "Properties of Concrete Prepared with Low-Grade Recycled Aggregates," *Construction and Building Materials*, 36:881–889.
48. Hoffmann, C., Schubert, S., Leemann, A., and Motavalli, M. (2012). "Recycled Concrete and Mixed Rubble as Aggregates: Influence of Variations in Composition on the Concrete Properties and Their Use as Structural Material," *Construction and Building Materials*, 35:701-709.
49. Yehia, S., Helal, K., Abusharkh, A., Zaher, A., and Istaitiyeh, H. (2015). "Strength and Durability Evaluation of Recycled Aggregate Concrete," *International Journal of Concrete Structures and Materials*, 9(2):219-239.
50. S. Nagatakia, S., Gokceb, A., Saekic, T., and Hisada, M. (2004). "Assessment of Recycling Process Induced Damage Sensitivity of Recycled Concrete Aggregates," *Cement and Concrete Research*, 34:965–971.
51. Li. W., Xiao. J., Sun. Z., Kawashima. S., and Shah. S.P. (2012). "Interfacial Transition Zones in Recycled Aggregate Concrete with Different Mixing Approaches," *Construction and Building Materials*, 35:1045–1055.
52. Bagragi N. K., Vidyahara H. S., and Ravandeh K. (1990). "Mix Design Procedure for Recycled Aggregate Concrete", *Construction and Building Materials*, 4(4):188-193.
53. Pereira, P., Evangelista, L., and de Brito, J. (2012). "The Effect of Superplasticizers on the Workability and Compressive Strength of Concrete Made with Fine Recycled Concrete Aggregates," *Construction and Building Materials* 28:722-729.
54. Sagoe, K., Brown, T., Taylor, A. H. (2001). "Performance of Concrete Made with Commercially Produced Coarse Recycled Concrete Aggregate", *Cement and Concrete Research*, 31:707-712.
55. Etxeberria, M., Vazquez, E., Mari, A., Barra, M. (2007). "Influence of Amount of Recycled Coarse Aggregates and Production Process on Properties of Recycled Aggregate Concretes," *Cement and Concrete Research*, 37:735-742.

56. Sim, J. and Park, C. (2011). "Compressive Strength and Resistance to Chloride Ion Penetration and Carbonation of Recycled Aggregate Concrete with Varying Amount of Fly Ash and Fine Recycled Aggregate," *Waste Management*, 31:2352-2360.
57. Yong, P. C. and Teo, D.C.L. (2009). "Utilization of Recycled Aggregate as Coarse Aggregate in Concrete," *UNIMAS E-Journal of Civil Engineering*, 1(1):1-6.
58. Xiao, J. and Li, W. (2005). "Study on Relationships Between Strength Indexes of Recycled Concrete," *Chinese Journal of Building Materials*, 9(2):197-201.
59. Hu, M.P. (2007). "Mechanical Properties of Concrete Prepared with Different Recycled Coarse Aggregate Replacement Rates," *Chinese Concrete Journal*, 2:52-54.
60. Cheng, G.Y. (2005). "Experimental Study on the Basic Performance of Recycled Aggregate Concrete with Different Replacement Ratio", *Chinese Concrete Journal*, 1167-70.
61. Topçu I.B. and Sengel S. (2004). "Properties of Concretes Produced with Waste Concrete Aggregate," *Cement and Concrete Research*, 34(8):1307-1312.
62. Otsuki. N., Miyazato. S., and Yodsudjai. W. (2003). "Influence of Recycled Aggregate on Interfacial Transition Zone, Strength, Chloride Penetration and Carbonation of Concrete," *Journal of Materials in Civil Engineering*, 15:443-451.
63. Shayan, A. and Xu, A. (2003). "Performance and Properties of Structural Concrete Made with Recycled Concrete Aggregate," *ACI Materials Journal*, 100(5):371-380.
64. Volz J., Khayat K., Arezoumandi M., Drury J., Sadati S., Smith A., and Steele A. (2014). Recycled Concrete Aggregate (RCA) for Infrastructural Elements, Final Report MoDOT Tryy1317, Missouri Department of Transportation, Jefferson City, Missouri, 486 pp.
65. ACPA. (2009), Recycling Concrete Pavement, American Concrete Pavement Association, Skokie, Illinois.
66. Garber S., Rasmussen R., Cackler T., Taylor P., Harrington D., Fick G., Snyder M., Van Dam T., and Lobo C. (2011). A Technology Development Plan for the Use of Recycled Concrete Aggregates in Concrete Paving Mixtures, National Concrete Pavement Technology Center, Ames, Iowa.
67. Masad, E., Al-Rousan, T., Button, J., Little, D., and Tutumluer, E. (2007). Test Methods for Characterizing Aggregate Shape, Texture, and Angularity, National Cooperative Highway Research Program NCHRP Report 555, Federal Highway Administration, Washington, D.C., 84 pp.

68. Polder, R., Andrade, C., Elsener, B., Vennesland, Ø., Gulikers, J., Weidert, R., and Raupach, M. (2000). "Test Methods for On-Site Measurement of Resistivity of Concrete," *Materials and Structures*, 33(10):603-611.
69. Whiting, D. A. and Nagi, M. A. (2003). Electrical Resistivity of Concrete – A Literature Review, R&D Serial No. 2457, Portland Cement Association, Skokie, Illinois.
70. Elkey, W. and Sellevold, E.J. (1995). Electrical Resistivity of Concrete, Norwegian Public Roads Administration Publication, 33 pp.
71. Gjørsv, O. E., Vennesland, Ø. E., and El-Busaidy, A. H. S. (1977). "Electrical Resistivity of Concrete in the Oceans," Proceedings of the Offshore Technology Conference, Offshore Technology Conference.
72. Büchler, M., & Schiegg, Y. (2008). Untersuchungen zur Potenzialfeldmessung an Stahlbetonbauten.
73. Østvik, J. M. (2005). Thermal Aspects of Corrosion of Steel in Concrete, Norwegian University of Science and Technology, Trondheim.
74. Andrade, C., D'Andrea, R., Castillo, A., and Castellote, M. (2009). "The Use of Electrical Resistivity as NDT Method for the Specification of the Durability of Reinforced Concrete," Proceedings of the 7th International Symposium on Non-Destructive Testing in Civil Engineering (LCPC 2009), Nantes, V. 30.
75. Nokken, M. R. and Hooton, R. D. (2006). "Electrical Conductivity Testing," *Concrete International*, 28(10):58-63.
76. Layssi, H., Ghods, P., Alizadeh, A., and Salehi, M. (2015). "Electrical Resistivity of Concrete," *Concrete International*, 41-46.
77. AASHTO TP95. (2011). Standard Method of Test for Surface Resistivity Indication of Concrete's Ability to Resist Chloride Ion Penetration, AASHTO Provisional Standards, 2011 Edition.
78. American Concrete Institute. (2014). ACI 318-14 Building Code Requirements for Structural Concrete and Commentary, American Concrete Institute, Farmington Hills, Michigan.