



RESEARCH & DEVELOPMENT

Evaluation of Railway Station Passenger Boarding Platform Gap Filler Solutions for North Carolina

**Institute for Transportation Research & Education,
North Carolina State University:
Mathew Palmer, MURP
Joy Davis, MPA, PMP
Christopher Cunningham, MSCE, PE
Waugh Wright
Jeffery Chang, PE**

NCDOT Project 2018-027

FHWA/NC/2018-027

November 2018

This page is intentionally blank.



Evaluation of Railway Station Passenger Boarding Platform Gap Filler Solutions for North Carolina



Mathew Palmer
Joy Davis
Christopher Cunningham
Waugh Wright
Jeffery Chang

November 2018

Technical Documentation Page

Report No. 2018-027	Government Accession No.	Recipient's Catalog No.	
4. Title and Subtitle Evaluation of Railway Station Passenger Boarding Platform Gap Filler Solutions for North Carolina		Report Date November 30, 2018	Performing Organization Code
		Performing Organization Report No.	
Author(s) Mathew Palmer, MURP; Joy Davis, MPA, PMP; Christopher Cunningham, MSCE, PE; Waugh Wright; Jeffery Chang, PE		Work Unit No. (TRAIS)	
Performing Organization Name and Address Institute for Transportation Research and Education North Carolina State University Centennial Campus Box 8601, Raleigh, NC		Contract or Grant No.	
		Type of Report and Period Covered Final Project Report August 2017 to November 2018	
Sponsoring Agency Name and Address North Carolina Department of Transportation Research and Analysis Group 104 Fayetteville Street Raleigh, North Carolina 27601		Sponsoring Agency Code 2009-08	
		Supplementary Notes:	
<p>Abstract:</p> <p>In July 2018, the new Raleigh Union Station (RUS) opened for business in the Warehouse District of downtown Raleigh to address forecasted population growth and the operational need for expanded service capabilities. The Americans with Disabilities Act (ADA) requires that railway platforms be easily accessible and usable for all individuals, including those with disabilities, with the stipulation that passenger platform gaps be a maximum of 3 inches (75mm). The North Carolina Department of Transportation (NCDOT) needed to identify a platform gap filler product that meets ADA requirements and suitable for use at RUS. This project identifies the optimal platform gap filler solution for high platform rail stations in North Carolina and introduces a documentation process necessary to implement the recommended gap filler solution. After extensive research, the platform gap filler product developed by Delkor Rail was selected as the recommended product for RUS and other NC high platform rail stations. In addition to identifying the optimal platform gap filler solution for RUS and NC, the state's first Gap Safety Management Plan was developed through this project. Ultimately, the results of this project will enable the NCDOT Rail Division to continue to grow the state's rail system and to ensure that the system is safe and accessible for all passengers while also saving staff time and money.</p>			
Key Words Rail, Gap Filler, Safety, Accessibility, Multimodal, Performance Measurement		Distribution Statement	
Security Classif. (of this report) Unclassified	Security Classif. (of this page) Unclassified	No. of Pages 57	Price

Disclaimer

The contents of this document reflect the views of the authors and are not necessarily the views of the Institute for Transportation Research and Education or North Carolina State University. The authors are responsible for the facts and the accuracy of the data presented herein. The contents do not necessarily reflect the official views or policies of the North Carolina Department of Transportation or the Federal Highway Administration at the time of publication. This report does not constitute a standard, specification, or regulation.

Acknowledgements

The research team thanks the North Carolina Department of Transportation for supporting and funding this project. The research team is particularly grateful to the Steering and Implementation Committee members for the exceptional guidance and support they provided throughout this project.

In particular, the research team is grateful for the leadership and support provided by NCDOT Rail Division Facilities Engineer Consultant Craig Newton throughout the project. In addition to the Steering and Implementation Committee, the research team would like to express special gratitude to Kyle Anderson, NCDOT Rail Operations Manager, who provided access to Capital Yard and was essential to the testing processes of this project. Special thanks also goes to John Kirby of NCDOT Research and Development, who continues to help guide the project along and offered assistance with meeting scheduling and contractual questions.

Without the help of all the above individuals, the research team would not be able to be complete the project in a successful and timely manner.

Executive Summary

Raleigh's Cabarrus Street Amtrak Station is one of the busiest stations in the southeastern U.S. Each year, more than 160,000 passengers are served by the railway station. In July 2018, the new Raleigh Union Station (RUS) opened for business in the Warehouse District of downtown Raleigh to address forecasted population growth and the operational need for expanded service capabilities. RUS is one of several planned improvements to the railway corridor between Raleigh and Charlotte designed to increase railroad capacity, efficiency, and safety.

The new facility is designed to be a multimodal hub that will provide increased transportation capacity for the Research Triangle region of North Carolina. As such, the design and operations of RUS must reflect the mobility needs of all transit riders that will be utilizing Amtrak services, including those with disabilities. Moreover, the Americans with Disabilities Act (ADA) requires that railway platforms be easily accessible and usable for all individuals, including those with disabilities, with the stipulation that passenger platform gaps be a maximum of 3 inches (75mm). Such gaps, which refer to the horizontal or vertical space between a rail car and the edge of the station platform, can create hazards for station users and can increase over time due to settling of the track and platform.

Gap fillers, which can be mounted along the edge of a train platform to reduce the gap distance between the platform and the entrance of a passenger train, are considered the optimal solution for addressing the gap issue at RUS. Gap filling technology allows passengers to board and alight safely, increases the efficiency of boarding and alighting times, and eases wheelchair access on and off a train. In addition, gap fillers are more permanent solutions compared to bridge plates and require minimal maintenance. All of these benefits can help improve staff productivity and passenger independence.

The North Carolina Department of Transportation (NCDOT) needed to identify a platform gap filler product that meets ADA requirements and suitable for use at RUS. Additionally, the NCDOT needed a solution that was applicable for other high platform stations within the NC rail system. This project identifies the optimal platform gap filler solution for high platform rail stations in North Carolina and introduces a documentation process necessary to implement the recommended gap filler solution. After extensive research, the platform gap filler product developed by Delkor Rail was selected as the recommended product for RUS and other NC high platform rail stations. An Australian company, Delkor Rail has a manufacturing facility in the United States and years of experience providing platform gap fillers for rail stations across the world.

In addition to identifying the optimal platform gap filler solution for RUS and NC, the state's first Gap Safety Management Plan was developed through this project. This plan, which aligns with FRA requirements, highlights hazards in the RUS platform area and documents how RUS partners will address these hazards in the future to support station safety. Ultimately, the results of this project will enable the NCDOT Rail Division to continue to grow the state's rail system and to ensure that the system is safe and accessible for all passengers while also saving staff time and money.

Table of Contents

Technical Documentation Page..... 3

Disclaimer 5

Acknowledgements 5

Executive Summary 6

Table of Contents 7

List of Exhibits 8

1. Introduction..... 9

2. Background..... 10

 2.1. Objectives.....10

 2.2. Scope11

3. Approach 11

 3.1. Review AMTRAK Clearance Requirements.....11

 3.2. Review Platform Filler Products.....12

 3.3. Platform Gap Filler Recommendation and Documentation.....12

 3.4. Create a Gap Safety Management Plan.....12

4. Requirements and Regulations..... 12

 4.1. Federal Standards13

 4.2. Amtrak14

 4.3. RUS and Future North Carolina Stations14

5. Gap Safety Management Plan 15

 5.1. Hazard Analysis.....15

 5.2. Plan Application.....16

 5.3. Plan Considerations16

6. Product Selection Process 16

 6.1. Vendors and Product Characteristics17

 6.2. User Experiences.....18

 6.3. Testing.....21

 6.4. Product Recommendation.....23

7. Conclusion 23

8. References..... 25

9. Appendices 26

List of Exhibits

Exhibit 1: ADA-Compliant Platform Gap Allowances (ADA Accessibility Guidelines 1003.2.5).... 13

Exhibit 2: Platform Gap Filler (Delkor, 2017) 17

Exhibit 3: Benefits and Challenges of Platform Gap Fillers..... 17

Exhibit 4: Potential Gap Filler Vendors Identified 18

Exhibit 5: Summary of Platform Gap Filler User Experiences at Other Stations 19

Exhibit 6: Testing Gap Filler Sample at the NCDOT Rail Maintenance Yard 21

Exhibit 7: Testing Installation Methods and Measurements at Locomotive Ladder, Including
Wooden Board 22

Exhibit 8: Testing Example of Platform Safety Before and After Gap Filler Installation 22

Exhibit 9: 302 Cabarrus Street Station Onboarding and Exiting in 1,000s from 2010-2016 27

Exhibit 10: Train Schedule (as of November 2018) 28

Exhibit 11: NCDOT Rail Division Preventive Maintenance (PM) Procedures 29

Exhibit 12: Hazard Analysis Process (FRA, 2007) 31

Exhibit 13: RUS Intercity Platform Clearances 45

Exhibit 14: RUS Proposed Platform West End Detail..... 46

Exhibit 15: RUS Proposed Platform East End Detail 47

Exhibit 16: RUS Proposed Amtrak Silver Star #92 NB (EB) Platform Gaps 48

Exhibit 17: Amtrak Clearance Diagram 49

Exhibit 18: 56 Seat Coach (ADA) Diagram..... 50

Exhibit 19: 66 Seat Coach (ADA) Diagram..... 51

Exhibit 20: Lounge-Baggage (ADA) Diagram..... 52

Exhibit 21: F59PH Locomotive Diagram..... 53

Exhibit 22: F59PHI Locomotive Diagram..... 54

Exhibit 23: Delkor Platform Gap Diagram..... 55

Exhibit 24: Delkor Platform Gap Filler 56

Exhibit 25: Main Characteristics of Delkor Rail’s Platform Gap Fillers 57

1. Introduction

As of 2014, more than 160,000 passengers are served each year by the Raleigh Cabarrus Street railway station, making it one of the busiest stations in the southeastern U.S. Due to this high volume and rapid regional growth, Phase 1 of Raleigh Union Station (RUS), a new multimodal transit facility, opened for business on July 10, 2018 in the Warehouse District of downtown Raleigh within the railway corridor. Upon opening, passenger rail service moved from the Cabarrus Street location to RUS.

The new station, which currently serves five daily round-trip passenger trains, provides North Carolina with new room to expand rail passenger activity and service to accommodate the Triangle region's population growth, which is expected to grow 34% between 2010 and 2035 (Carolina Population Center, 2015). RUS is designed to serve as a multimodal transportation center for the area. The project is one of several planned improvements to the railway corridor between Raleigh and Charlotte aimed at increasing railroad capacity, efficiency, and safety.

RUS is the first station in North Carolina with an elevated level boarding platform, also defined as a high level platform, which creates a new challenge for providing equal access to rail service. RUS incorporates high level platforms and larger spaces, or gaps, between a rail car and the edge of the station platform to accommodate the diverse types of rail traffic planned for the multimodal facility. The current design at RUS includes a 7-inch platform gap because Amtrak has strict clearance requirements for locomotives that are wider than passenger cars, which can result in gaps of this width. As with other stations across the nation, RUS must comply with Americans with Disabilities Act (ADA) standards, which is designed to ensure that all station facilities, including rail platforms be easily accessible and safe for all individuals, including those with disabilities. However, ADA Accessibility Guidelines (ADAAG), in Chapter 10 – 1003.2.5 Rail-to-Platform Height, state that “for rapid rail, light rail, commuter rail, high-speed rail and intercity rail systems in new stations, the horizontal gap, measured when the new vehicle is at rest, shall be 3 inches (75mm) maximum.”

To meet safety and accessibility standards required by the ADA, rail stations often utilize methods that reduce existing gaps. Most commonly, a train operator may deploy a bridge plate or a gap filler product may be fixed to the platform to close the gap (FRA, 2007). After initial research, the North Carolina Department of Transportation (NCDOT) identified gap fillers as the optimal solution for RUS. Gap fillers, unlike temporary applications like bridge plates, are mounted along the edge of a train platform to reduce the gap between the platform and the entrance of a passenger train. Alternatively, non-fixed platform gap solutions like bridge plates can be more time consuming and invasive for passengers with disabilities. Additionally, gap filler technology allows passengers to board and alight safely, increases the efficiency of boarding and alighting times, and eases wheelchair access on and off a train. All of these benefits can help increase staff productivity and passenger independence (Hunter-Zaworski et al., 2017).

Consequently, this study was commissioned by NCDOT to identify a platform gap filler product that meets the ADA 3-inch gap requirement as well as Federal Rail Administration (FRA) and Amtrak standards. While this research focuses on identifying the optimal gap filler solution for RUS, the project results can be applied at future high platform stations within the NC rail system to expedite the installation of an ADA-compliant solutions. The clear and user-friendly documentation developed can save the state, rail providers, and passengers time and money as rail system service is expanded and enhanced. Overall, this project delivers new information about the current rail platform gap filler landscape that the state can build upon as it strives to meet a growing demand for transportation connectivity.

2. Background

Railway platform gaps, which can be horizontal and/or vertical in nature, are an accessibility and safety concern, especially during periods of rail passenger boarding and alighting (Moug, Coxon, & Napper, 2016). Such platform gaps are not uncommon at rail stations, often due to legacy designs, track geometry, equipment and platforms constructed to different and incompatible height and width standards. Additionally, rail wear, wheel wear, and the condition of rail suspension and passenger load can also lead to gap increases.

Due to the physical accessibility challenges that platform gaps can create, the Americans with Disabilities Act (ADA) regulations stipulate that rail platforms should be “readily accessible to and usable to individuals with disabilities, including individuals that use wheelchairs” (49 CFR Part 37). In addition, platform–train interface (PTI) accidents are an important safety concern for many transit agencies (Anderson and Hunter-Zaworski, 2015). These safety concerns can be more severe in nature for those with visual impairments or for distracted passengers, which are of increasing concern given the widespread adoption of handheld technology (Anderson and Hunter-Zaworski, 2015).

Gap filler products are increasingly used at railway platforms around the world to mitigate the accessibility and safety problems that can be inherent with platform gaps. After a hands-on group trial that examined the impact of gap filler technology on safety and mobility, Moug, Coxon, & Napper (2016) found that gap fillers enhanced user comfort and safety, including for those with disabilities. However, gap filler technology must be installed according to manufacturer specifications in order to ensure optimal results, as improper or inadequately performing filling materials can lead to injury and reduced mobility (Anderson and Hunter-Zaworski, 2015; Loomis, 2016). Consequently, a thorough evaluation of the best gap mitigation approach needs to be conducted before employing a gap filler solution (Moug, Coxon, & Napper, 2016).

Instead of addressing platform gaps on a station-by-station basis, the FRA *Guide for Managing Gap Safety at Passenger Rail Platforms* (2008) advises agencies to develop system-wide gap standards, although Moug, Coxon, & Napper (2016) note that specific station platform characteristics still need to be considered before implementing a particular gap filler solution. In addition, the FRA guide suggests that agencies address platform gap safety issues and requirements as part of a larger gap safety management program, and that a system should be examined to identify those stations where a smaller gap is feasible and those where a larger gap may be necessary. As part of this process, the FRA also suggests that agencies should perform a hazard analysis to identify, evaluate, and mitigate potential hazards associated with gap filling approaches.

2.1. Objectives

Throughout the project, the research team focused on accomplishing the following primary objectives:

- Review and document rail requirements relevant to implementing a gap filler solution, including those from the ADA, the FRA, and other agencies.
- Examine Amtrak clearance requirements and platform gap scenarios at representative Amtrak stations along the Northeast Corridor (NEC).
- Research platform filler options to identify a “best” product solution that meets necessary standards and can be used at RUS and other Amtrak rail system locations in NC.
- Identify the “best” solution, document product implementation details and create mockup of the proposed solution.

- Establish a Gap Safety Management Plan in alignment with FRA best practices and complete processes required to implement the advised “best” solution, including a Buy America Act waiver and other paperwork, as needed.
- Construct a report encompassing project processes and resulting documentation.

2.2. Scope

This project provides the NCDOT with seven key deliverables. Including:

1. Documentation showing NCDOT Rail Division approval for a single “best product”
2. A mockup of the selected gap filler solutions(s) at the Capital Yard facility
3. Documentation outlining the anticipated frequency of use, wear characteristics, durability, and other relevant parameters of the product(s)
4. Rail platform gap filler geometry (shape), material characteristics, installation method, and other relevant parameters
5. Recommendations for the suitability of the suggested implementation at other NC rail stations will be created
6. A completed Gap Safety Management plan for RUS developed using the FRA *Guide to Managing Gap Safety at Passenger Rail Platforms*
7. A final report that integrates each of the six previous deliverable and outlines the suitability of the rail gap platform products available on the international market

As an eighth project deliverable outlined in the project proposal, completing a Buy American Act waiver for the product, was not conducted because the product recommended by the research team is manufactured in the United States.

One of the key deliverables created through this project, the Gap Safety Management Plan, will further the NCDOT Rail Division’s goal to enhance safe transit systems across the state and will help mitigate gap hazards at NC rail stations as well as other locations within Amtrak’s national system. The Gap Safety Management Plan will also help ensure that NC rail systems are in compliance with ADA regulations and that the state is adhering to FRA gap safety guidelines to maintain the safety of all rail users. Ultimately, the results of this research will enable the NCDOT Rail Division to select and implement a platform gap filler solution that is optimal for RUS and the NC Amtrak rail system in general.

3. Approach

To develop these seven deliverables, the research team focused on the tasks outlined in the following sections.

3.1. Review AMTRAK Clearance Requirements

The research team first studied Amtrak clearance requirements by conducting a review of existing documentation as well as interviewing Amtrak and Rail Division staff. In addition, platform gap scenarios at representative Amtrak stations along the Northeast Corridor (NEC) were examined. Platform gap standards for Amtrak stations in the same area were confirmed through a review of Amtrak materials and discussion with Amtrak stakeholders.

3.2. Review Platform Filler Products

Existing gap filler product options available both nationally and internationally were identified by the research team through extensive research, discussions with other rail systems, and conversations with potential vendors. Details on product frequency of use, wear characteristics, durability, and other relevant parameters of the product were documented to create a system for product comparison. ADA, Amtrak, and other requirements were heavily considered in the review, in addition to the design of RUS and future NC rail projects.

Once the vendor options were narrowed down to a smaller list, the research team identified rail stations in other parts of the U.S. and world that employed gap filler products from these vendors. Appropriate station personnel were interviewed about their experiences with the products and the results were documented. The research team analyzed the resulting quantitative and qualitative data to determine which platform gap filler products were potentially suitable for implementation at RUS, the future Charlotte Gateway Station, and other Amtrak locations within the NC rail system.

3.3. Platform Gap Filler Recommendation and Documentation

Through the extensive product review, a “best” product was selected and recommended for RUS. The research team collaborated with the NCDOT Rail Division to gain initial approval of the recommended product. To aid NCDOT with the formal approval process, the research team documented the geometry (shape), material characteristics, installation method, and other details associated with the selected gap filler solution. The research team worked with the advised gap filler vendors to develop mockups of proposed solutions and to provide cost estimations. In addition, the research team demonstrated the product application at RUS using passenger train locomotives and railcars with the assistance of the NCDOT Rail Division and Amtrak.

3.4. Create a Gap Safety Management Plan

The gap filler product selection was also informed by the development of the Gap Safety Management Plan (GSMP) for RUS. This plan is designed to help ensure the safety of all individuals in and around the platform area of the station, including the gap between the platform and the rail engine and cars. The FRA Office of Safety’s *Approach to Managing Gap Safety* was utilized to ensure that the RUS GSMP aligns with industry standards for safety and management. The research team contacted the Federal Rail Administration (FRA) to gain more insight into the process. The RUS GSMP was developed in collaboration with the FRA, Amtrak, the City of Raleigh, and other stakeholders. While designed for RUS, this document can be easily adapted for use at existing and future NC rail stations.

4. Requirements and Regulations

Historically there has been no nationwide standard for gaps between railcar openings and elevated level boarding platform, also called high level platforms. Individual stations often have their own idiosyncrasies, where gaps are sometime measured in feet rather than inches (Daniel and Rotter, 2009). Many different factors affect the size of the gap including “the sharpness of the curve, the length of the rail car, the truck spacing, the location of the doors relative to the trucks, and whether the platform is located on the inside or the outside of the curve” (FRA, 2007). Even small gaps may pose risk of injury and increase vehicle dwell time, particularly if passengers are intoxicated, have luggage, or if a manually-operated bridge plate is required.

4.1. Federal Standards

The Federal Railroad Administration (FRA) strives to make the trains, railroads, and rail stations as safe as they can be and has developed plans and guidelines to manage gap safety (FRA, 2007). Historically, standards for gaps at railway stations “were based on freight car needs, rather than passenger safety” (FRA, 2007), but with the development of Americans with Disabilities Act (ADA), the focus shifted to emphasizing safety at the platform-gap interface.

In 2006 the US Department of Transportation adopted the “Americans with Disabilities Act (ADA) Standards for Transportation Facilities”, based off of ADA accessibility Guidelines 36 CFR Part 1192. In regards to railway stations, these standards are intended to promote safety in all aspects of the station, including platform slope, signage, public address systems, track crossings, etc. For platform and vehicle floor coordination, high level platforms are the preferred alignment, with efforts focused on minimizing both the vertical and horizontal gaps (US DOT, ADA Official Requirements, 2006).

Although the ADA requirements originally stated that at least one door of each railcar had to meet its standards, this was amended in 2011 to say that passengers with disabilities must be able to use every door of a railcar for entering or leaving the train (Hunter-Zaworski et al., 2017). These standards state that for “rapid rail, light rail, commuter rail, high speed rail, and intercity rail systems in new stations, the horizontal gap, measured when the new vehicle is at rest, shall be 3 inches (75 mm) maximum” (US DOT, 2006). The maximum vertical gap allowed is 5/8 inch for new vehicles and 1.5 inches for existing vehicles as seen in Exhibit 1.

Exhibit 1: ADA-Compliant Platform Gap Allowances (ADA Accessibility Guidelines 1003.2.5)

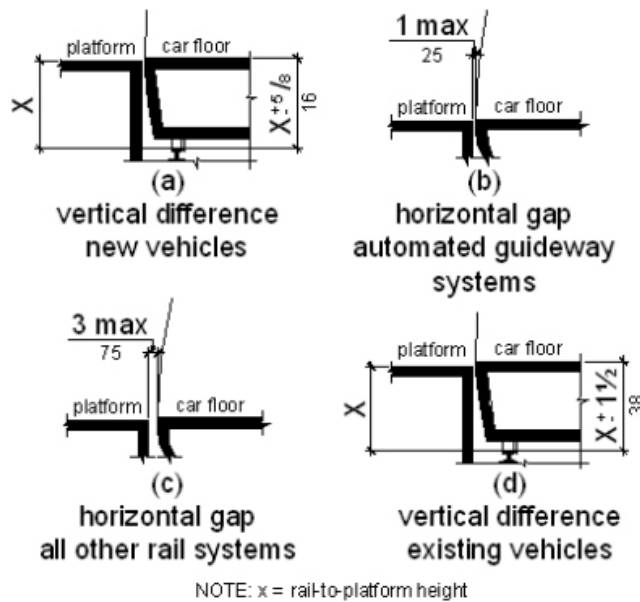

Furthermore, “in light rail, commuter rail, and intercity rail systems where it is not operationally or structurally feasible to meet the horizontal gap or vertical difference requirements of part 1192 or 49 CFR part 38, mini-high platforms, car-borne or platform-mounted lifts, ramps or bridge plates or similarly manually deployed devices, meeting the requirements of 49 CFR part 38, shall suffice” (US Access Board, 2015).

Generally, whenever the horizontal gap is greater than 3 inches or the vertical gap is greater than 5/8ths of inch (or other times when deemed necessary), a bridge plate is recommended. In order to reduce the need for operating a bridge plate for passengers, “any device or procedure which reduces the horizontal and vertical gap specified is encouraged” (US Access Board, 2015)

4.2. Amtrak

In addition to ADA and USDOT standards, Amtrak has various requirements in regards to its fleet and the platform-gap interface. For high level platforms, Amtrak requires that the edges of the platform are a minimum of 5’7” from the centerline of the track. This is to allow sufficient space for wider sections of trainsets, such as the locomotives or extensions such as grab bars and ladders, to travel safely through stations. In addition to avoiding damage from a train striking the platform, this distance is also intended to keep waiting passengers further from a traveling train. Within the Amtrak fleet, locomotives and coaches vary in width from 10’0” to 10’8.5”. With a minimum of 5’7” from centerline, this could produce gaps of up to 7”. Although the Amfleet and Superliner equipment typically have clearances of between 10’2” and 10’6”, the doors are inset and have a width of 10’0”.

Currently a gap of up to 7 inches is eliminated by use of a bridge plate when disabled passengers are boarding or alighting. However, use of a bridge plate increases vehicle dwell time, as station agents or conductors are required to obtain a bridge plate from its storage place on the platform, align it in the correct position, and then replace it. Furthermore, the gap impacts many passengers who do not necessitate the use of a bridge plate, but may be hampered or slowed down by it nonetheless, particularly the very young or the very old, or anyone wheeling luggage onto the train. Many potential solutions to this gap problem also increase vehicle dwell time, such as manually operated bridges, platform edge extenders, and gauntlet tracks (Hunter-Zaworski et al., 2017).

4.3. RUS and Future North Carolina Stations

Raleigh Union Station has several factors impacting the size of the gap between the train door and the platform. First of all, the tracks are slightly curved as they come into the station on both sides of the platform. This creates a varying gap along each car of the train. When the train is on the outside track on the curved platform, there is wider gap near either end of the car and a smaller gap in the middle. Conversely, when the train is on the inside of the curved platform (Track One), the gap is widest in the middle of each car and widens to either end.

Secondly, Amtrak employs a variety of different trains on its regular schedule into Raleigh. The Silver Star and The Carolinian use P42 engines for their locomotives, which also have a width of 5’0” from centerline and Amfleet or Viewliner coaches, which also have a width of 5’0”. However, the Amfleet and Viewliner coaches are slightly convex on their sides, meaning the width is slightly less at platform height and the resulting gap is slightly wider. The Piedmont uses an EMD F59PHI locomotive that is 5’3” from centerline and 56- and 66- seat coaches that are 5’3.25” from centerline. This means that reducing the gap on the widest train to zero with a static solution would still result in an approximately 3.25” gap. Full details, including clearance envelope and platform diagrams are included in Appendix 2.

A resolved issue with trains running through RUS was the engine grab bars that extended beyond the desired clearance envelope. During the course of this project, NCDOT worked with other stakeholders to modify these to reduce their probability of striking a gap filler product while maintaining functionality.

While the focus of this study is to determine the applicability of a platform gap filler specifically for RUS, it is expected that the findings will be transferable to the needs of other stations in North Carolina and elsewhere, including the Charlotte Gateway Station, which is currently under construction. Any high-level platform station with trainsets with varying widths, either between different trains or between cars and locomotives, will have gaps that could be potentially larger than 3 inches. This is particularly true on curved platforms and when different train types share the same platform, such as commuter rail, inter-city rail, and freight.

5. Gap Safety Management Plan

According to the FRA, a gap safety management program should “use engineering evaluation and analysis to establish gap standards for all high level stations and apply mitigation strategies to further reduce the risk of gap accidents” (FRA, 2007). The FRA notes that developing such a program is essential because high level stations can introduce new hazards. As such, a gap can vary from day to day and from car to car. Maintenance of the trains, platform and track can also affect the gap. Consequently, the FRA highlights the importance of putting procedures in place to address situations in which a gap is out of tolerance, to identify the limits that will trigger action, and to ensure that gap inspections involve the train, track, and platform.

In addition, the American Public Transportation Association (APTA, 2013) recommends that rail stations document a gap safety management program approach that includes the:

1. Development and implementation of a hazard management program that supports decisions on setting and maintaining nominal gap requirements
2. Development and implementation of visual and audible public awareness programs that communicate information about the railroad’s gap
3. Development and implementation of a training component for on-board railroad personnel in regard to their role in maintaining passenger safety while traversing the gap
4. Implementation of inspection procedures to monitor station platform conditions
5. Verification that maintenance procedures for track and vehicles maintain the system’s nominal gap as required by the railroad
6. Development and implementation of a training component for maintenance and construction personnel as necessary

The FRA also advises that the details of a gap safety management program be outlined in a Gap Safety Management Plan (GSMP), a living document in which hazard mitigation strategies are “identified, recorded and tracked to completion” (FRA, 2007). Specifically, the FRA suggests that a GSMP addresses: 1) station gap standards, 2) hazard management, 3) maintenance procedures, 4) inspections procedures, 5) hazard mitigation strategies, and 6) gap safety management follow-up (FRA, 2007).

5.1. Hazard Analysis

FRA guidance notes that the development of the GSMP should be informed by the results of a hazard analysis technique. One such technique described by the FRA is a hazard analysis, a process through which hazards are “identified and recorded and corresponding hazard mitigation strategies are identified, recorded and tracked to completion” (FRA, 2007). A hazard analysis approach was used to develop the RUS GSMP because the process serves as an opportunity to facilitate discussion with diverse stakeholders about the opportunities and threats to safety on and around the station platform.

Stakeholders can employ a number of methods for identifying hazards (FRA, 2007), including, but not limited to:

- Examine data from previous accidents, operating experience, and case studies
- Develop what if scenarios
- Develop hazard checklists pertinent to platform gap safety
- Take pictures and conduct system tour
- Implement formal hazard analysis techniques
- Examine design data and drawing
- Analyze and compare similar systems
- Identify codes, standards, and regulations.

The RUS hazard analysis utilized several of these methods. The hazard analysis document was developed through a facilitated station walk through on May 15, 2018 and a tabletop discussion on August 10, 2018. Participants included representatives from NCDOT, FRA, Amtrak, and the City of Raleigh. The research team facilitated discussions and documented the results. The complete RUS GSMP, including the hazard analysis results, is in Appendix 1.

5.2. Plan Application

The GSMP developed through this project is designed to be a living document that is regularly referenced for guidance and updated periodically. As such, RUS leadership should update the plan as related protocols, policies, and station characteristics like the environment and staffing level, change. Therefore, responsible staff should update the GSMP as these changes occur and updates are required to ensure the safety of platform users. The FRA recommends that the station maintain a regular GSMP review schedule to help ensure that the plan is as accurate as possible and no potential hazards are overlooked. With each edit, the plan should be updated with a new date on the front cover to avoid erroneous usage.

This document may be of particular value in situations of extreme weather and heavy passenger traffic. The Rail Safety and Standards Board notes that there is an increase in rail station accident rates by nearly 5% when weather is wet or icy compared to dry conditions and those without ice, and that when wet and icy conditions occur together, the increase in incidents is approximately 20% (RSBB, 2013).

5.3. Plan Considerations

The RUS GSMP developed through this project is focused on addressing the hazards in the RUS platform area, and should not be applied in full to other rail stations. However, this GSMP process and corresponding documentation may be adapted for use at other NC stations, and possibly other stations in the Southeastern US and beyond.

6. Product Selection Process

After discussion with RUS stakeholders, the research team decided to investigate the potential for using a rubberized platform gap filler. A gap filler, shown in Exhibit 2, is bolted onto an existing platform and consists of rubber fingers that extend out towards the train. These fingers shorten or close the gap between the platform and the train, while being sturdy enough for passengers to walk on or roll on with wheelchairs or luggage. However, the filler material remains somewhat flexible in a horizontal direction so that it can bend if struck by a passing train that is of a larger width or has an appendage outside the

clearance envelope. For this project the research team examined the existing literature to determine the efficacy of platform gap fillers, located and investigated vendors who sell the product, and interviewed users about their experiences with the product. The research team obtained samples from one vendor to conduct demonstrations and further testing at RUS.

Exhibit 2: Platform Gap Filler (Delkor, 2017)

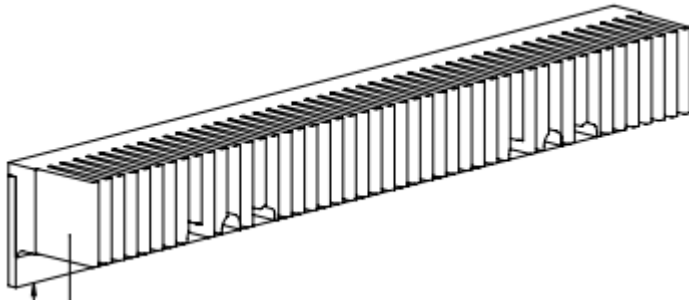

Although not widely used, platform gap fillers have been employed for more than a decade in various stations across the world including Australia, the United Kingdom, Hong Kong, and the United States (Venables and Enderson, 2016). Moug et al. (2016) notes that “current industry understanding recognises the effectiveness of the rubber comb arrangement in extending the lateral coping edge of platform surface.” Their study tested how gap fillers impact accessibility for people in wheelchairs and found that users preferred them to metal bridge plates and had few problems with wheel entrapment. Devadoss et al. (2012) analyzed different solutions to the gap problem and identified the following benefits and challenges associated with using gap fillers, as shown in Exhibit 3.

Exhibit 3: Benefits and Challenges of Platform Gap Fillers

Platform Gap Filler	
Benefits	Challenges
No delay in train operations	Limited ability to reduce vertical gap
Inexpensive installation and maintenance	Need to know gaps for all rolling stock
No major platform modification required	Possible wear and tear if contact with train
Plug and play	
Fixed system	
No external systems required	
No special training required	
Less implementation time	
Additional warning (if colored)	

6.1. Vendors and Product Characteristics

The research team made significant efforts to identify and verify as many platform gap filler product vendors as possible. Worldwide very few companies sell a rubberized finger, or gap filler, product as part of their main product line. The research team identified several options via secondary sources that mentioned companies that produced a platform gap filler or a related product. However, few of the companies actually offered such products for purchase. Many of these companies create related projects, like rail doors, but have not developed rail gap fillers. Additionally, the research team

experienced language barriers with at least one company that makes gap fillers, DRB in South Korea, which reduced the opportunity for further investigation. In total, the research team contacted the nine vendors listed in Exhibit 4.

Exhibit 4: Potential Gap Filler Vendors Identified

Company	Location	Product
Delkor	Australia (design), United States (manufacturing)	Platform Gap Filler
F.B. Wright	Detroit, USA	Platform Gap Filler
DRB	South Korea	Platform Gap Filler
Knorr-Bremse GmbH	Germany	Rail Doors
Pipex Px	United Kingdom	Platform Bumps
STRAIL	Germany	Not Specified
CDM	Europe	Not Specified
Vulcanite	Australia	Rubber Solutions
Kyosan Electric Mfg. C. Ltd.	Japan	Not Specified

Of the nine vendors, only three have clearly produced a usable gap filler that could potentially meet the requirements of RUS: Delkor Rail, F.B. Wright, and DRB. The products these vendors make are similar overall in design and material composition and each product has been in operation for at least seven years. It is important to note that maintenance, and sometimes installation, was generally performed by the stations themselves. Therefore, the vendors did not always have complete information to share about these and other characteristics.

Of the three potential vendors, F.B. Wright in Michigan was the first to produce a platform gap filler, installing the technology on the Detroit People Mover thirty years ago. They have more recently completed or begun work on projects in Albuquerque, Tampa, Miami, and Las Vegas. Delkor Rail has created gap fillers for stations in Australia, the United States and across Europe. Delkor is an Australian company whose sister company Boge US manufactures the product for the American market. DRB manufactures their product in South Korea and began installing the product at 15 stations in Seoul in 2014 and have since worked with the Mumbai Monorail in India. Although DRB has been successful in Asia, the difficulties of communicating with the vendor and users, as well as the issue with overseas manufacturing led the ITRE research team remove DRB from the candidate list.

6.2. User Experiences

The research team conducted interviews and email communications with stations that have used the Delkor and F.B. Wright gap filler products to gather more information about their experiences with the two gap filler products. A summary of the information collected through these interviews and subsequent follow-up conversations within the U.S. and other countries is detailed in Exhibit 5.

Exhibit 5: Summary of Platform Gap Filler User Experiences at Other Stations

	Metro Trains Melbourne	Heathrow Express	Detroit People Mover	Albuquerque Rapid Transit
Vendor	Delkor	Delkor	F.B. Wright	F.B. Wright
Location	Melbourne, Aus.	London, UK	Detroit, MI	Albuquerque, NM
Type	Commuter Rail	Subway	People mover	Bus
Trains in Fleet	502	14	12	Under construction
Trainsets	496 Electric multiple units (Comeng, Siemens, Nexas, X'Trapolis 100, HCMT) and 6 Diesel locomotives (Sprinter and T Class)	Electric multiple units (Class 332)	ICTS Mark I cars	Buses
System Length	600 miles	14 miles	3 miles	N/A
Stations Installed	70	3	13	N/A
Installation	2011	2014	1987	2018
Gap Issues	4 different rolling stock with different clearances	Each station has unique configuration. Most passengers have luggage.	Gap relatively uniform	Gap uniform
Does Product Strike Equipment	One tram strikes product at one station, with no damage after 3 years	No	No	No
Inspection Schedule	As needed/Not scheduled	Yearly	Monthly	N/A
Replacement Schedule	As needed (10 year estimate)	As needed	Twice in 30 years	10 year estimate
Outdoor Exposure	Most	None	11 of 13 stations	All
Weather Damage	None	N/A	None	N/A
Weatherization		N/A	Heat lamps (entire platform)	
Effect on Incidents	Reduced dwell time	Incidents reduced from 30+ per year to 0. Reduced dwell time.	N/A	N/A

Because the Detroit People Mover installed the F.B. Wright gap filler product before opening, they were unable to provide before and after comparisons, but communicated that overall the product met their expectations. F.B. Wright also supplied the product for Albuquerque, but they had yet to install the product at the time of the interview.

Delkor Rail installed its first gap filler product at stations in Melbourne, Australia in 2011. Based on interviews, the Melbourne Metro indicated that the product reduces dwell times, primarily by allowing wheelchair passengers to board and alight unassisted. Rail passengers have “embraced the product,” according to the project manager. The Heathrow Express links the two stations at Heathrow Airport with downtown London and began installing the Delkor gap filler product at the airport terminals in 2015. Heathrow Express runs 150 trains a day, carrying over 18,000 passengers. The majority of these passengers are carrying luggage of some sort, leading to long dwell times and more risk to passengers before the product was installed. In the two years prior to installation there were 65 platform train interface incidents and none in the year afterwards (Gwyn Topham, *The Guardian*, April 30, 2015). The system has since won a safety award for this improvement. Overall, their project manager says their “experience has been very positive” and that “Delkor Rail were proactive in coming up with design/installation suggestions.”

6.3. Testing

Delkor provided the research team with three different samples of their rubberized finger gap filler product to test for usability at RUS. Prior to testing at RUS, the sample of the dimensions most likely to be used at RUS was tested at the NCDOT rail maintenance yard in Raleigh. The sample was affixed at a height above the tracks equivalent to the platform at RUS. The ends of the “fingers” on the trainward side were positioned to reduce the gap at the passenger doors to approximately 3 inches.

To examine the interaction between the train and the gap filler, the same trains that service passengers at RUS were moved alongside the gap filler sample. While there was a sufficient gap for the majority of the length of the cars and locomotives to pass by untouched, some of the locomotives included a grab bar at the ladder to the locomotive engine at the platform height. This grab bar extended out far enough from the locomotive to push back the fingers of the foam model, as shown in Exhibit 6. Upon further review of the fleet, NCDOT modified the grab bars to help ensure that the equipment will no longer strike a gap filler product at that height.

Exhibit 6: Testing Gap Filler Sample at the NCDOT Rail Maintenance Yard



Once the grab bars were modified, the research team conducted tests with the gap filler at RUS, including simulations of passenger on- and off-boarding. For safety reasons, the gap filler was attached to the wooden sacrificial board using cords, as shown in Exhibit 7. Testing started only after the train was parked and RUS staff confirmed that it was safe to operate in the area.

The ladder, as shown in Exhibit 7, represents the widest part of the rolling stock that will be passing along the gap filler product. As exhibited, the gap was approximately 0.5 inches at the nearest point at the locomotive engines boarding location. The product provided a 1.5-inch gap at the tightest point of the train landing areas and the platform. Consequently, removal of the sacrificial board upon

installation is recommended to help ensure that the gap filler is secured tightly to the concrete wall and that a larger gap is allowed at such tight points.

Exhibit 7: Testing Installation Methods and Measurements at Locomotive Ladder, Including Wooden Board

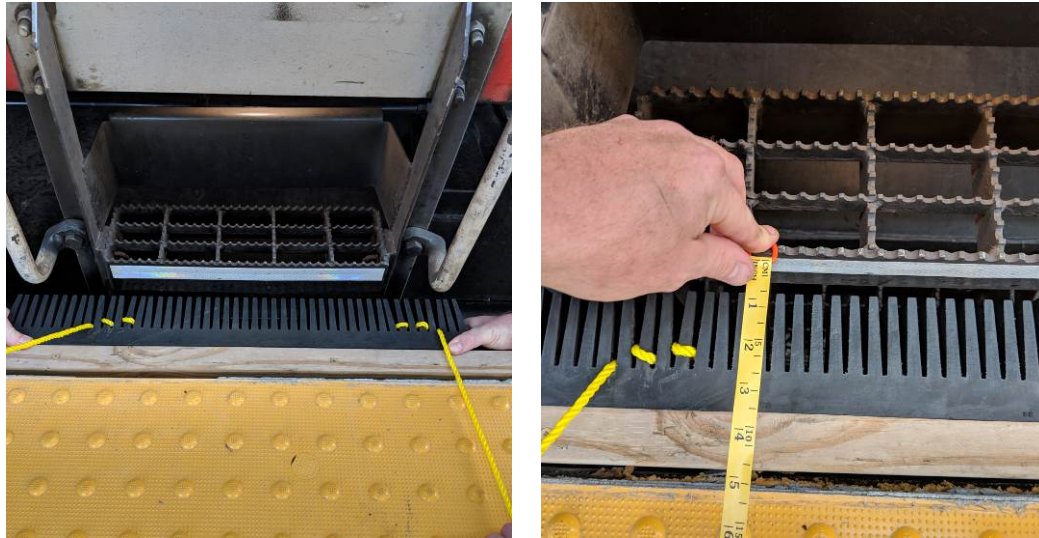

The research team also demonstrated the safety of the filler, including simulations of passenger on- and off-boarding. This simulation exhibited that the gap filler solution significantly reduced the platform gap space, therefore reducing safety risks such as tripping, falling, and wedging a foot between the platform and the train. An example of the demonstration with and without the gap filler treatment is shown in Exhibit 8. This example shows a gap of approximately 7 inches on the left was reduced to 3.5 inches after the gap filler was attached.

Exhibit 8: Testing Example of Platform Safety Before and After Gap Filler Installation

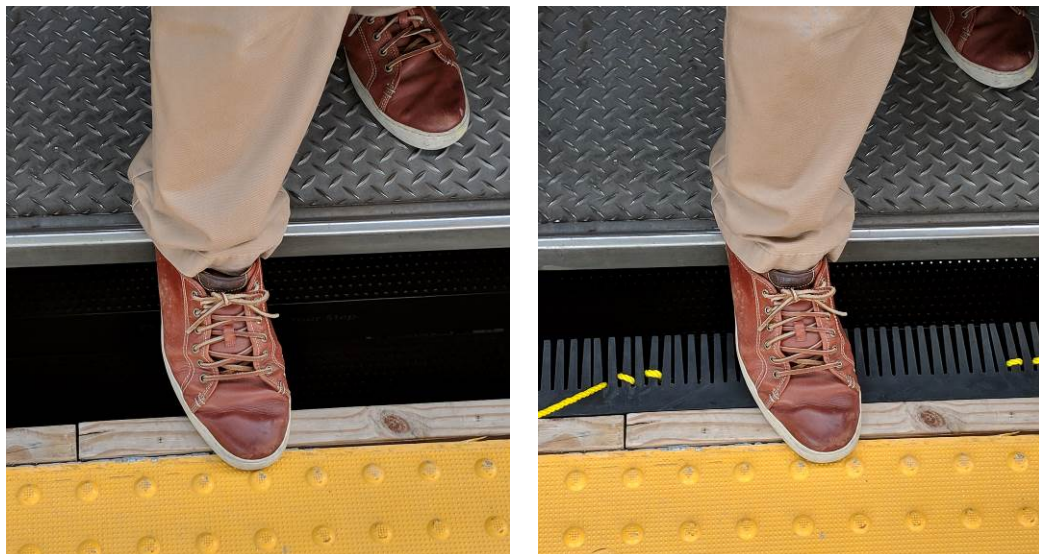

6.4. Product Recommendation

Based on literature review, communications with vendors, and interviews with users, both Delkor Rail and F.B. Wright manufacture an American-made gap filler product that is optimal for the needs of RUS. However, based upon their track record and the ability to easily test the product, the research team recommends Delkor Rail as the provider for RUS. Delkor Rail is an Australian company that has been a leading supplier of railway products, including platform gap filler for over 30 years (Delkor, 2018). Since 2011 they have been a subsidiary of Zhuzhou Times New Material Technology Co. Ltd. While the design for customized products such as platform gap fillers remains in Australia, the manufacturing of the product can be completed in the United States by its sister company, Boge US. Delkor gap fillers have been used in Australian railway stations for eight years. Delkor gap fillers are also used at stations in Germany, New Zealand, the United States (at the maintenance yards for the Denver and San Francisco airports), and in the United Kingdom, where the Heathrow Express has won safety awards for reducing the number of injuries.

The section length for each Delkor gap filler is 750 mm (2.5 ft.) and the vertical height is 36-75 mm (1.4-3.0 in.). The depth of the product from base to the end of the rubberized fingers is customizable, but standard lengths are 48 mm (1.9 in.), 65 mm (2.6 in.), and 90 mm (3.5 in.). Delkor has experience installing gap fillers on curved platforms well beyond the extent of curvature found at RUS. The gap fillers are designed to operate between temperatures of -55 C and 145 C (-67 F to 293 F). Diagrams and other pertinent information about the Delkor gap filler product are shown in Appendix 3.

From testing with wheel chairs, the vertical strength exceeds 300 kg (660 lbs.). If struck by a passing train along a horizontal access, the material folds to 30-40% of its length, depending upon the design. At one station in Australia the light rail tram makes slight contact along a turn every time it enters the station and there has been no damage after 4 years of use.

Installation involves drilling into the platform concrete and can be completed by station staff in ten minutes or less per section. Delkor recommends that the station check the mounting bolts for tightness after six months, and then annually as part of the Gap Safety Management Plan maintenance procedures. Neither Heathrow nor the Australian stations have needed to replace sections as of yet, except for one time when a snow plow was added to a locomotive in Melbourne and damaged the gap filler product.

In conversations with Delkor, they provided the research team with estimated implementation costs. The length of platform edge at RUS requiring gap filler is 1,611 linear feet, counting both sides of the platform combined. A total of 655 sections of the Delkor product will be required, at a cost for materials and shipping of approximately \$100,000. The installation cost is estimated to be \$100,000, including railroad flagging.

7. Conclusion

The Delkor Rail platform gap filler product is recommended as the optimal platform gap filler solution for Raleigh Union Station. This determination was made using a rigorous GSMP analysis that included:

1. A thorough review of the rail requirements relevant to implementing a gap filler solution, including those from the ADA, the FRA, and other agencies.
2. An examination of the Amtrak clearance requirements and platform gap scenarios at representative Amtrak stations along the Northeast Corridor (NEC).

3. International market research focused on identifying platform filler options that meets necessary standards and can be used at RUS and other Amtrak rail system locations in NC, including interviews with users of platform gap filler products at other US and international stations.
4. Documentation of product implementation details and the creation of a mockup of recommended solutions for use at RUS.
5. The development of a Gap Safety Management Plan in alignment with FRA best practices and complete processes required to implement the recommended solution.
6. The creation of this report, which includes details on all project processes and resulting documentation.

Through these steps, the research team has provided deliverables that can be used to increase the accessibility and safety of RUS in the platform area, thus providing benefits to the NCDOT Rail Division, Amtrak, and the Federal Rail Administration, and North Carolina citizens and visitors. The efficiencies associated with the use of the permanent gap filler product solution may also improve passenger safety and boarding and alighting times, and may save the state, Amtrak, and riders time and money in the future. In addition, documentation regarding requirements relevant to implementing a gap filler solution as well as the international and national gap filler market evaluation will aid the Rail Division in selecting the gap filler solution that is optimal for RUS and NC as a whole.

Furthermore, North Carolina's first Gap Safety Management Plan was developed through this project. This plan, which aligns with FRA requirements, highlights hazards in the RUS platform area and documents how RUS partners will address these hazards into the future to support station safety. Although this plan is designed for RUS, it can be easily adapted for use at other existing or future NC stations with high level platforms.

Ultimately, the results of this project will enable the NCDOT Rail Division to continue to grow the state's rail system and to ensure that the system is safe and accessible for all passengers while also saving staff time and money. In terms of future research, evaluating changes to measures such as boarding and alighting time, safety, and accessibility before and after the product installation will better equip NCDOT to understand the long-term costs and benefits associated with the use of a platform gap filler solution. This information can also help NCDOT, Amtrak, and other stakeholders make more informed decisions about the use of such solutions at other stations in North Carolina.

8. References

- ADA Standards for Transportation Facilities. (2006). Retrieved November 28, 2018, from <https://www.access-board.gov/guidelines-and-standards/transportation/facilities/ada-standards-for-transportation-facilities>
- Anderson, D., and Hunter-Zaworski, K. (August 2014). *Platform Edge Detection and Protection Effects on Platform–Train Interface Safety*. Transportation Research Record: Journal of the Transportation Research Board, No. 2534, Transportation Research Board of the National Academies, Washington, D.C.
- Carolina Population Center. (2015). Retrieved November 28, 2018, from <https://www.cpc.unc.edu/>
- Daniel, J.R., and Rotter, N.G. (July 2009). *Customer Behavior Relative to Gap Between Platform and Train*, FHWA-NJ-2009-009. New Jersey Department of Transportation.
- Devadoss, R., Ahmad, S. S., & Raman, D., Dr. (2012). Platform–train interface for rail passengers – a technology review (Rep. No. R3.115).
- Federal Railroad Administration. (2007). "Passenger Rail Station Gap Management Guide, FRA Approach to Managing Gap Safety."
- Hunter-Zaworski, K., Anderson, D., Rutenberg, U., Tomaszewska, E., & McConnell, J. (2017). *Manual to Improve Rail Transit Safety at Platform/Vehicle and Platform/Guideway Interfaces*. Transit Cooperative Research Program Research Report 189, Transportation Research Board.
- Loomis, R.M. (2016). *Innovative Technology for ADA Compliance and the Improved Safety of New Construction and Existing Track Crossings*. International Conference on Transportation and Development 2016, American Society of Civil Engineers.
- Moug, V., Coxon, S., and Napper, R. (2016). *Evaluating accessibility provisions for existing rail station platforms in Melbourne, Australia*. Australasian Transport Research Forum 2016 Proceedings, Melbourne, Australia, 2016.
- Proposed ADA Standards for Accessible Design. (2004, July 23). Retrieved November 28, 2018, from https://www.ada.gov/archive/NPRM2008/ada_standards/proposedadastds.htm
- Rail Safety and Standards Board. (2013). "Risk at the platform-train interface." (pp. 1-27, Rep.).
- Sheys, K. M. (2008). More on Minding the Gap – FRA Releases a Guide for Managing Gap Safety at Passenger Rail Platforms. K&L Gates.
- Topham, G. (2015, April 30). The Guardian. Retrieved from <https://www.theguardian.com/profile/gwyntopham>
- Trosino, M., Smith, D., Barry, J., Kloehn, D., Peters, G., Miller, M., Otsuka, A. (2013). Developing a Gap Safety Management Program. American Public Transportation Association.
- United States Access Board. (2015). Retrieved from <https://www.access-board.gov/guidelines-and-standards/buildings-and-sites/about-the-aba-standards/aba-standards>
- Venables, M., and Enderson, P. (July 2016). "LU PTI – PEDs Project, Task Order 7 Report on Passive Gap Filler Testing." Creative Design Limited.

9. Appendices

Appendix 1 Raleigh Union Station - Gap Safety Management Plan Updated November 30, 2018

Purpose, Goals, Objectives, and Authority

The purpose of this Gap Safety Management Plan (GSMP) is to provide a description of policies, practices, and recommendations focused on preventing and responding to safety hazards at the Raleigh Union Station (RUS) platform gap. GSMPs are implemented through the: 1) development and application of safety policies, 2) identification and engagement of organizational relationships and personnel relevant to platform gap safety hazards, and 3) ensuring compliance with federal, state, and local laws, codes, ordinances, and regulations. The North Carolina Department of Transportation intends to develop GSMPs for RUS and all future high level platforms in North Carolina to help ensure the safety of passengers, employees, and workers at passenger rail stations.

Standard engineering evaluation and analysis approaches are incorporated in this plan to establish gap standards for RUS and strategies to reduce the risk of platform gap accidents. The plan development process and results are outline in the following sections. RUS stakeholders can use this information to mitigate platform risks and to scan for new risks as they arise.

IMPORTANT NOTES: Although this plan is designed to document known risks and mitigation strategies, this plan is not exhaustive. Events outside of those considered in this document may occur. This plan is a living document that can and should be updated as strategies and station characteristics change. Only those parties authorized by NCDOT, Amtrak, and the City of Raleigh should make such changes.

Station Characteristics

Raleigh Union Station features a new dedicated passenger rail platform that is the first of its kind in North Carolina. This section considers the infrastructure, environment, and operations that interface at RUS to provide passenger rail service. The people, procedures, equipment and facilities, and environment that may positively or negatively affect safety are discussed in detail. Therefore, the station characteristics of RUS are thoroughly described in the following sections.

People

Regarding platform safety and operations, the passengers served at RUS and the staff that attend patrons and operate the station and trains are taken into consideration. The Rail Passengers Association publishes ridership statistics on an annual basis to include ridership trends, population served, miles traveled, and other metrics (<http://narprail.org/all-aboard/tools-info/ridership-statistics/>). The number of passengers that utilized the 320 Cabarrus Street Amtrak station in Raleigh did not grown significantly between 2010 and 2016, as shown in Exhibit 9. The average annual on-off figure at Raleigh Station is 156,400, excluding the high station utilization in 2011.

Exhibit 9: Raleigh (302 Cabarrus Street Station) Onboarding and Exiting in 1,000s from 2010-2016

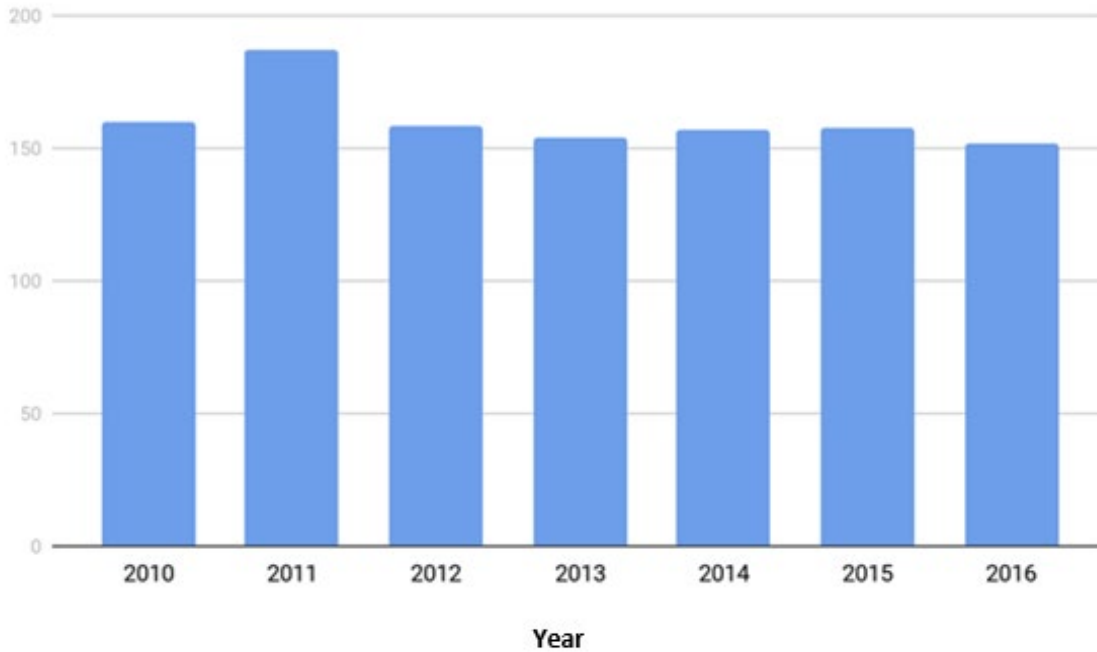

Amtrak service to Raleigh included four daily trains - one long-distance train from Miami, FL to New York, NY (Silver Star, Route 16), one state-supported train from Charlotte, NC to New York, NY (Carolinian, Route 66), and two state-supported trains from Charlotte, NC to New York, NY (Piedmont, Route 67). The table below shows the passenger activity at the station by train route services.

Activity by route (On-Off and Percentage of Annual Total)			
Route	2014	2015	2016
16 - Silver Star	40,549 (25.8%)	41,442 (26.3%)	39,446 (26.0%)
66 - Carolinian	64,241 (40.9%)	66,156 (42.1%)	65,359 (43.0%)
67 - Piedmont	52,352 (33.3%)	49,699 (31.6%)	47,047 (31.0%)
<i>Total</i>	<i>157,142</i>	<i>157,297</i>	<i>151,852</i>

The NCDOT Rail Division currently receives monthly performance reports from Amtrak that include ticket sales information for the state-supported routes. This data provides a breakdown of ticket sales by passenger types for the Carolinian and Piedmont services. Considering the monthly data for Fiscal Year 2017 (October 2016 - September 2017), children (ages 2 to 12) account for 5.1% and 6.3% of the ridership on the Carolinian and Piedmont, respectively. Both services experience an uptick in the number of children riding during the summer months of June, July, and August. Disabled passengers account for 4.6% and 3.2% percent of the ridership for the Carolinian and Piedmont, respectively. Seniors (ages 65 and older), comprise more than one-fifth, 20.6%, of Carolinian ridership and around one-tenth, 10.9% of Piedmont ridership.

Amtrak staffs each station with Customer Service Representatives (CSRs) and operates all services with train crews. The staffing level in Raleigh (at the 320 Cabarrus Street station) has been two CSRs per shift, including a 5:45a.m. - 2:30p.m. shift and a 2:30p.m. - 11p.m. shift. During busier times such as special events and holidays, additional staffing is available by request. NC Train Hosts are volunteers and

ambassadors on board the Carolinian and Piedmont that assist passengers, promote passenger services, and answer questions regarding routes, ground transportation, and local attractions. In terms of station security, at Raleigh Union Station, the City of Raleigh contracts with an agency to provide security on-site 24 hours a day and 7 days a week. The Amtrak detective for statewide passenger operations is based at RUS, but will frequently travel throughout the week. Raleigh City police also regularly patrol the station. For additional details about risks associated with usage of the platform, see the “Hazard Analysis Documentation for Raleigh Union Station Platform” at the end of this plan.

Procedures

The station is open for train operations from 5:45a.m. to 11p.m. The departure times for each train are shown in Exhibit 10 below.

Exhibit 10: Train Schedule (as of November 2018)

Time	Train	Direction	Destinations
6:30 a.m.	#73 Piedmont	Southbound	Raleigh to Charlotte
10 a.m.	#75 Piedmont	Southbound	Raleigh to Charlotte
3 p.m.	#77 Piedmont	Southbound	Raleigh to Charlotte
5:16 p.m.	#79 Carolinian	Southbound	New York to Charlotte
9:01 p.m.	#91 Silver Star	Southbound	New York to Florida
8:45 a.m.	#92 Silver Star	Northbound	Florida to New York
(ar) 10:05 a.m.	#80 Carolinian	Northbound	Charlotte to New York
(ar) 1:41 p.m.	#74 Piedmont	Northbound	Charlotte to Raleigh
(ar) 6:26 p.m.	#76 Piedmont	Northbound	Charlotte to Raleigh
(ar) 10:11 p.m.	#78 Piedmont	Northbound	Charlotte to Raleigh

Source: <https://www.ncbytrain.org/stations/raleigh/Pages/default.aspx>

Other procedures that may positively and negatively affect safety at the platform gap include passenger services and maintenance. RUS offers ticketing, accommodations for special needs, baggage, and bicycle service. Checked baggage are handled inside the station by the ticket counter. Station staff check passengers for tickets at the entrance of the concourse prior to permitting access onto the platform. Passenger dwell time on the platform is to be limited, and access will only be permitted shortly before scheduled train arrival times.

For boarding and alighting, both station staff and train crew assist passengers on and off trains. On the Piedmont, the train doors are manually operated swing doors. The Carolinian and Silver Star utilize Amtrak equipment with automatically operated sliding pocket doors. For passengers requiring assistance, four bridge plates are available on the platform to cover the platform gap. The station staff and train crew will use bridge plates as needed.

Alighting passengers will exit before boarding passengers are allowed to enter the trains. Baggage for arrivals are handled by station staff and transferred from the platform to the baggage claim area inside the station for passenger retrieval. An electric people mover and lowboy baggage carts are available to assist with passenger and baggage transfers. Cameras are installed throughout the station and platform, and video will be monitored by security and recorded for playback. Incident reports are completed, submitted, and filed by station staff and law enforcement personnel.

Regarding regular maintenance and inspections, the City of Raleigh owns and is responsible for the station and platform. Amtrak will have ongoing contractual leases with the City to operate passenger services. The proceeds of the lease will cover basic maintenance expenses. Amtrak station staff will perform light cleaning and tidying to maintain the station and platform. The track and right-of-way is owned by the North Carolina Railroad Company (NCRR), and Norfolk Southern has an operating lease and maintains the station tracks.

The rolling stock used for the Piedmont service are owned by the North Carolina Department of Transportation, and are maintained and inspected at Capital Yard by in-house contractors. The NCDOT Rail Division developed Preventive Maintenance (PM) procedures that serve as a systematic check for its locomotives and passenger cars. The document provides descriptions, methods, and pictures of rolling stock maintenance. The procedures listed in Exhibit 11 are most prevalent to the alignment of the train and platform, and should be considered for potential hazards that could affect gap safety. The Carolinian and Silver Star trains are Amtrak-owned and maintained. For additional details about procedures related to the platform, see the “Hazard Analysis Documentation for Raleigh Union Station Platform” at the end of this plan.

Exhibit 11: NCDOT Rail Division Preventive Maintenance (PM) Procedures

NCDOT Rail Division Preventive Maintenance Procedures		
Type	Purpose	Frequency
Inspect/Gauge Wheels (Locomotive)	To identify excessive wear, sharp flanges, cracks, flat spots, out of limits rim thickness	90 days
Inspect Truck Frames (Locomotive)	To identify damaged, missing, or improperly adjusted parts	90 days
Visually Inspect Vertical, Lateral, and YAW Dampers (Locomotive)	To identify excessive wear, sharp flange, shelling, cracks, flat spots, out of limits rim thickness, crack or broken axle, missing caps, worn bushings, and worn or broken brake shoes	90 days
Inspect Coach/Lounge Wheels (Passenger Car)	To identify broken or missing parts	180 days
Inspect Wheelsets (Passenger Car)	To identify broken or missing parts	360 days
Inspect Truck Frames (Passenger Car)	To identify damaged, missing, or improperly adjusted parts	180 days

Visually Inspect Vertical, Lateral, and YAW Dampers (Passenger Car)	To identify excessive wear, sharp flange, shelling, cracks, flat spots, out of limits rim thickness, crack or broken axle, missing caps, worn bushings, and worn or broken brake shoes	180 days
---	--	----------

Equipment and Facilities

The characteristics equipment and facilities of a rail station can greatly influence accessibility and safety. RUS currently includes a 920-foot center island platform with boarding from either side and two dedicated passenger tracks with curved alignment on both sides and both ends of the platform. Emergency egresses are located at both ends of the platform. In regards to equipment, NCDOT owns the rolling stock for Piedmont service while Amtrak-owns the rolling stock for Carolinian service and Silver Star service. A number of benches and trash bins are in and around the platform.

To help insure safe usage of the platform, 2-foot yellow tactile tiles on platform edge include a yellow borderline and stenciled in “Stay Behind the Line” platform marking and the platform marking for no board zones. Additionally, the platform is lit during morning and evening hours with photocell automated lighting that is maintained by the City of Raleigh. Amtrak is designing and will install a passenger information display system (PIDS) to provide visual announcements that correspond with audio announcements from the existing PA system. For additional details about equipment and facilities in and around the platform, see the “Hazard Analysis Documentation for Raleigh Union Station Platform” at the end of this plan.

Environment

Environmental considerations such as weather, drainage, and changes to station usage can significantly impact the presence of platform hazards. RUS has both day and night operating hours and train service. Regarding weather, the area surrounding the station experiences occasional hurricanes accompanied by heavy rain and wind. During colder months, the station may experience winter weather including freeze-thaw conditions, and The City of Raleigh currently plans to use shovels and chemical deicers for snow and ice removal.

In terms of the overall platform environment, while there are currently no planned freight rail operations, there is the potential for freight to enter RUS during emergency situations. Additionally, the platform includes a restricted no-boarding zone and a coarse finish concrete for grip and 1% downward grade from centerline to platform edge for drainage. Other environmental considerations include on-site and off-site special events include concerts, conferences, the North Carolina State Fair, and holidays, during which traffic patterns may be irregular and inexperienced passengers may use the platform. For additional details about risks associated with the environment around the platform, see the “Hazard Analysis Documentation for Raleigh Union Station Platform” at the end of this plan.

Hazard Analysis: Identification and Assessment

This plan was developed using a hazard analysis, a tool that passenger railroads can use to evaluate hazards systematically outlined by the Federal Railroad Administration (FRA) Office of Safety (2007). Through this process, hazards in a station area of interest are discussed and documented with key station stakeholders. Hazardous conditions are identified for the purpose of eliminating or controlling risk throughout the lifecycle of a system. The five steps of the hazard analysis process are shown in the diagram below and further discussed in more detail.

According to the FRA, the development of a hazard analysis involves the steps shown in Exhibit 12 and outlined below.

Exhibit 12: Hazard Analysis Process (FRA, 2007)

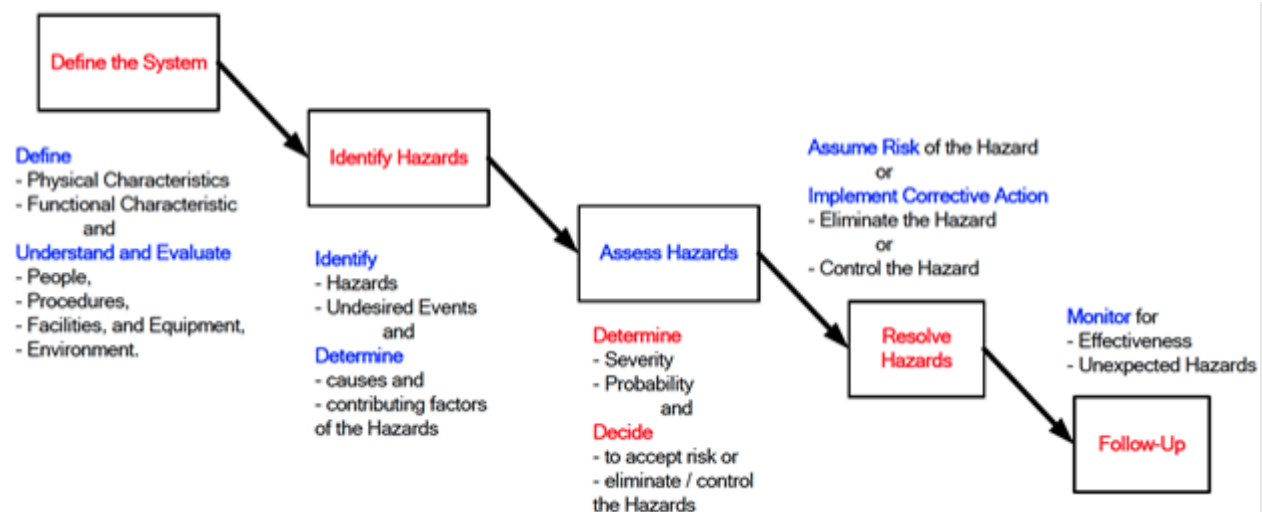

The following sections were developed based on FRA (2007) guidance and recommended practices from the American Public Transportation Association (2013).

Step 1 - System Definition

The system definition is a detailed description of the physical and functional characteristics that make up the passenger rail system or subsystem under consideration. It includes the people, procedures, facilities, equipment, and environment that interface together to provide passenger rail operations. The system elements that potentially have positive and negative impacts are especially important to consider. At a minimum, train operations, rolling stock, track configuration, infrastructure, and environment should be fully understood.

Step 2 - Hazard Identification

A hazard management team with representatives familiar with system safety, operations, mechanical, track, and signal should identify potential hazards that may exist on railroad property and during operations.

Step 3 - Hazard Assessment

When viable hazards have been identified, each one should be classified and assessed. The findings and resolutions throughout the entire process should be documented in a hazard analysis worksheet. MIL-STD-882 was developed by the United States Department of Defense as a practical method to assessing the hazard severity, frequency, and risk. It can be used for both quantitative and qualitative measures, and is adaptable for the railroad environment.

1. Classify hazards by severity or into criticality categories. The category, description, and definitions below can be used or adjusted to be meaningful for gap safety.

Category	Description	Definition
1	Catastrophic	Death, system loss, or severe environmental damage.
2	Critical	Severe injury, severe occupational illness, major system or environmental damage.
3	Marginal	Minor injury, minor occupational illness, or minor system or environmental damage.
4	Negligible	Less than minor injury, occupational illness, or less than minor system or environmental damage.

2. Establish frequency of hazard occurrence. Hazard frequency can be determined quantitatively using failure rates or accident/incident statistical data as well as qualitatively based on relative frequency of expected occurrence. A time based method may also be appropriate for gap hazard analysis.

Level	Description	Quantitative Definition	Qualitative Definition	Time
A	Frequent	$x > 0.1$	Likely to occur frequently. Continuously experienced.	Once a week
B	Probable	$0.1 > x > 0.01$	Will occur several times in life of an item. Will occur frequently.	Once a month
C	Occasional	$0.01 > x > 0.001$	Likely to occur sometime in life of an item. Unlikely but can reasonably be expected to occur.	Once a year
D	Remote	$0.001 > x > 0.000001$	Unlikely but possible to occur in life of item. Unlikely but can reasonably be expected to occur.	Once every 10 years
E	Improbable	$0.000001 > x$	So unlikely, it can be assumed occurrence may not be experienced. Unlikely to occur, but possible.	Less than once in 10 years

3. Determine the level of risk and acceptability of hazards. By combining severity and frequency, a hazard risk index for each hazard is established. The index is used to determine whether or not the risk is acceptable and what action to take.

	Hazard Category			
Frequency of Occurrence	Catastrophic (1)	Critical (2)	Marginal (3)	Negligible (4)
Frequent (A)	1A	2A	3A	4A
Probable (B)	1B	2B	3B	4B
Occasional (C)	1C	2C	3C	4C
Remote (D)	1D	2D	3D	4D
Improbable (E)	1E	2E	3E	4E

Hazard Risk Index	Suggested Action
1A, 1B, 1C, 2A, 2B, 3A	Unacceptable, eliminate hazard
1D, 2C, 2D, 3B, 3C	Undesirable (decision required to accept or reject)
1E, 2E, 3D, 3E, 4A, 4B	Acceptable with review
4C, 4D, 4E	Acceptable without review

Step 4 - Hazard Resolution

Following the hazard assessment, mitigation strategies should be adopted to bring hazard risk indices to acceptable level by reducing the severity and/or frequency of each hazard. The hazard analysis worksheet will document strategies, show revised severity and/or frequency, and track the status and responsibility of mitigating actions. Hazards may require more than one mitigation strategy, and strategies will vary in feasibility and timing. The hazard precedence approach shown below can be applied to eliminate and control hazards through the system life cycle:

- Design to eliminate hazard
- Design to reduce hazard
- Provide safety devices
- Provide warning devices
- Provide special procedures or training
- Accept hazard or dispose of the system

Step 5 - Follow Up

A hazard analysis will serve as the basis for a gap safety management plan. The hazard analysis worksheet should be regularly reviewed to ensure that mitigation strategies are being implemented and to address system changes that may impact platform gap safety. The worksheet will transparent record and can be referenced to justify capital expenditures.

Hazard Analysis Documentation for Raleigh Union Station Platform

The below information are the results of Hazard Analysis discussions conducted on 5/15/18 and 8/10/18 for the Raleigh Union Station platform by the Institute for Transportation Research and Education. This analysis was conducted based on existing designs, inspections, conversations with stakeholders, and data from RUS and similar stations. The key to the categories and coloring system are in the pages following the table.

Note:

- “S” Category, with “Rev.” is the revised status with hazard mitigation strategies
- “P” Category, with “Rev.” is the revised status with hazard mitigation strategies
- Assessed risk is the combination of S and P (Example: 4D)

Hazard Identification						Mitigation Approach					
No.	Hazard Description	Cause	Effects	S	P	Mitigation Strategy	Rev. S	Rev. P	Status	Responsibility	Comments
1.a.	Horizontal Gap Too Large	Current: Relative fixed position of track and platform	Passenger legs can become stuck between train and platform, leading to possible injury	2	C	Install gap filler product	4	D	Proposed	NCDOT/City of Raleigh	Large (~10”) gap on Track 1 will be addressed before track is used.
1.b.	Horizontal Gap Too Large	Current: Relative fixed position of track and platform	Mobility-impaired individuals (e.g., using wheelchairs, canes, crutches, etc.) could have trouble crossing and possibly become stuck between train and platform, leading to inconvenience and possible injury	2	C	Use bridge plate and train staff on how use them	4	E	Implemented	Amtrak station staff	Bridge plate needs a minimum 3 inch gap to secure onto platform

Hazard Identification						Mitigation Approach					
No.	Hazard Description	Cause	Effects	S	P	Mitigation Strategy	Rev. S	Rev. P	Status	Responsibility	Comments
1.c.	Horizontal Gap Too Large	Potential Hazard: Change in relative position of track and platform over time, due to water or soil issues (relatively small sizes of passenger locomotives makes this less of an issue than with shared tracks)	See 1.a. and 1.b.	2	C	Measure platform-gap interface regularly and resolve immediately to maintain alignment	4	D	Planned	Norfolk-Southern, as contracted by the City of Raleigh to maintain tracks and alignment, but Amtrak is responsible for visibly monitoring gap and reporting issues to City to resolve	The initial hazard for 1.c. assumes the mitigation for 1.a. has not taken place. With proper maintenance as listed in the mitigation strategy, the hazard risk should be decreased.
2.a.	Vertical Gap Too Large	Potential Hazard: Not observed, but possible in future due to wear and tear on equipment and rails (see 1.c.)	A vertical gap could lead to passengers tripping while entering or exiting the train	2	D	Inspect platform-gap interface regularly and resolve immediately to maintain alignment	4	E	Planned	Norfolk-Southern, as contracted by the City of Raleigh	To meet Amtrak ADA compliance standards, the vertical gap cannot be above 5". Exceeding this gap is unlikely, but tripping can occur with smaller gaps. Regular maintenance is needed to mitigate this hazard. In this case, the revised

Hazard Identification						Mitigation Approach					
No.	Hazard Description	Cause	Effects	S	P	Mitigation Strategy	Rev. S	Rev. P	Status	Responsibility	Comments
											level of risk is similar because the maintenance will help reduce the risk that the gap increase with time.
2.b.	Vertical Gap Too Large	Potential Hazard: Not observed, but possible in future due to water or soil issues (see 1.c.)	A vertical gap could lead to passengers tripping while entering or exiting the train	2	D	Deploy a bridge plate as needed	4	E	Planned	Amtrak station staff	See 2.a.
3.a.	Uneven Transition between Platform and Train	Potential Hazard: Damage to sacrificial board or gap filler product could lead to uneven edge	The gap would increase in spots, leading to a greater chance of tripping or stepping into gap	3	C	Inspect platform edge regularly and resolve any issues	4	E	Proposed	City of Raleigh	A slightly damaged gap filler product should still provide greater safety than none. Frequency that board will need to be replaced is uncertain.
3.b.	Uneven Transition between Platform and Train	Potential Hazard: Freight train enters RUS and damages platform edge material	The gap would increase in spots, leading to a greater chance of tripping or stepping into gap; equipment damage	2	C	Regular communication between operational partners to ensure freight	4	E	Planned	Amtrak to notify City to repair	Potential for this hazard will decrease or increase based on communication between partners.

Hazard Identification						Mitigation Approach					
No.	Hazard Description	Cause	Effects	S	P	Mitigation Strategy	Rev. S	Rev. P	Status	Responsibility	Comments
						trains do not enter RUS space					Explicit directions for dispatchers regarding which trains should not enter RUS space can help reduce the risk of this hazard.
4.a.	Insufficient Platform Lighting	Lights under canopy emitting an inadequate number of lumens	Light may be insufficient for some users. An insufficiently lighted platform increases the possibility of accidents	4	C	Electrical engineer can measure light levels at night. If necessary, solutions, such as installing reflective shields can be determined	4	E	Planned	City of Raleigh	Seventeen lights were added to increase visibility. All lights in the platform area should be inspected regularly and replaced if burned out or otherwise compromised.
4.b.	Insufficient Platform Lighting	Lights under canopy dulled due to residue buildup	Light may be insufficient for some users. An insufficiently lighted platform increases the possibility of accidents	4	C	Regularly clean lights in the platform area	4	E	Planned	City of Raleigh	Lights should be cleaned regularly to ensure adequate brightness.

Hazard Identification						Mitigation Approach					
No.	Hazard Description	Cause	Effects	S	P	Mitigation Strategy	Rev. S	Rev. P	Status	Responsibility	Comments
5.a.	Insufficient Platform Markings or Signage	Potential Hazard: Current 4" lettering are compliant, but could fade in time or be obscured	With inadequate warning, passengers may not exercise proper caution when approaching the platform edge and may be injured	3	D	The platform can be inspected regularly to determine if cleaning or repainting is needed	4	D	Planned	City of Raleigh	Platform includes black lettering on a yellow field to increase visibility. The potential hazard was noted by an Amtrak ADA representative
5.b.	Platform Not Sufficiently Marked or Signed	Potential Hazard: Current 24" contrasting tactile surface compliant, but could erode in time or be compromised	If tactile surface were to erode or be covered up, then visually impaired individuals would have less warning that the edge was near	3	D	The platform can be inspected to make sure the tactile surface is cleaned and examined semi-annually to make sure no tactile tiles have become dislodged or worn down	4	E	Proposed	City of Raleigh	The potential hazard was noted by an Amtrak ADA representative
5.c.	Platform Not Sufficiently Marked or Signed	"Do Not Board" striping is may fade in time or be obscured	Passengers waiting in the wrong area may be inclined to board at an incorrect door, such as that of a baggage car or a locomotive, which	3	D	"Do Not Board" striping can be regularly inspected and maintained	4	E	Planned	City of Raleigh	This hazard will remain of concern after gap filler installation, as the gap varies along the platform the "Do Not Board"

Hazard Identification						Mitigation Approach					
No.	Hazard Description	Cause	Effects	S	P	Mitigation Strategy	Rev. S	Rev. P	Status	Responsibility	Comments
			raises the risk of injuries								sections are designed to limit passenger exposure to larger gaps.
6	Slippery Platform	Platform is currently not slippery in normal conditions but is at risk in heavy rains or icy conditions	Passengers can slip and hurt themselves or others on the platform or in the platform-gap interface	3	B	Snow shovels can be used to push snow onto tracks and calcium chloride (or a similar product) can be used when necessary, both before and after snowfall.	3	C	Planned	City of Raleigh	
7.a.	Risky or Dangerous Human Behavior	Passenger or trespasser may act in unsafe manner, such as being too close to the platform-gap interface or even falling off the platform	These passengers are more likely to injure themselves or others	2	B	Staff can be trained how to identify at-risk individuals and how to change their behavior. A contact list of proper security channels to	3	C	Planned	Amtrak station staff	This issue may occur with anyone near the RUS platform area, but particularly the inebriated, young, old or distracted. Amtrak employees an on-site police detective and full

Hazard Identification						Mitigation Approach					
No.	Hazard Description	Cause	Effects	S	P	Mitigation Strategy	Rev. S	Rev. P	Status	Responsibility	Comments
						contact under different circumstances can be provided to staff.					time security staff who can monitor video surveillance, but under most circumstances they would be directed to contact the Raleigh Police Department to address the situation. Between train times, it is possible that station agents may enter the platform area to monitor a situation.
7.b.	Risky or Dangerous Human Behavior	Passenger or trespasser may act in unsafe manner, such as being too close to the platform-gap interface or even falling off the platform	These passengers are more likely to injure themselves or others	2	B	Signage and announcements on public address system can warn individuals.	3	C	Planned	Amtrak station staff	This issue may occur with anyone near the RUS platform area, but particularly the inebriated, young, old or distracted.

Hazard Identification						Mitigation Approach					
No.	Hazard Description	Cause	Effects	S	P	Mitigation Strategy	Rev. S	Rev. P	Status	Responsibility	Comments
7.c.	Risky or Dangerous Human Behavior	Passenger or trespasser may drop a personal item and attempt to retrieve it	Without a train in the station, this can pose a risk to passengers on a high platform; with a train in, entering, or leaving the station, this poses a very high risk of injury	2	B	Staff can be trained to identify these situations, stop individuals from attempting to retrieve personal articles, and assist them when it is safe to do so.	3	C	Implemented	Amtrak station staff	See 7.b.
8	Service Vehicles/ Other Equipment	Staff drive service vehicles (baggage carts) on or near platform	Nearby passengers, equipment, and infrastructure may be at risk of collision	3	B	Staff can be trained on proper use of vehicles	3	D	Implemented	Amtrak station staff	Amtrak has a “stop and look” policy about which all staff are trained, as well as ongoing safety briefings. Conflicts between these vehicles may also occur at grade crossings outside of the platform area.
9	Introduction of Equipment with Varied	Equipment with characteristics different than that planned to	The platform edge, including the sacrificial board and/or gap filler	3	B	Monitor introduction of new equipment and	3	E	Proposed	NCDOT, Amtrak	This will require ongoing communication between RUS

Hazard Identification						Mitigation Approach					
No.	Hazard Description	Cause	Effects	S	P	Mitigation Strategy	Rev. S	Rev. P	Status	Responsibility	Comments
	Characteristics	enter RUS is introduced	product may be damaged and passengers standing too near the platform-gap interface may be injured			compare to the specifications and clearance requirements of the platform area.					partners.
10.a	Access to Rails to/ from Outside Property	Pedestrians can walk on rails from Cabarrus Street toward the platform area	Pedestrians can enter from the neighborhood and walk on the rails, putting them at risk from rolling stock and they can also approach the platform area	1	D	Install "No Trespassing" signs. Install video surveillance and monitor from ticketing area and inform platform staff if there are trespassers.	1	E	Planned	City of Raleigh	This hazard exists most places where rail travels through neighborhood areas. Some signage has been added in the Cabarrus Street area.
10.b	Access to Rails to/ from Outside Property	Passengers could try to exit station platform area by crossing tracks (Ex: straight into Boylan Heights)	Pedestrians could be struck by rolling stock while on the track	1	D	Install intratrack fence between freight and passenger rail areas	1	E	Planned	City of Raleigh	An intratrack fence will be installed after Norfolk-Southern conducts their final testing. This fence is planned to extend the length of the platform.

Hazard Identification						Mitigation Approach					
No.	Hazard Description	Cause	Effects	S	P	Mitigation Strategy	Rev. S	Rev. P	Status	Responsibility	Comments
10.c	Access to Rails to/ from Outside Property	Passengers could try to exit station platform area by crossing tracks (Ex: straight into Boylan Heights)	Pedestrians could be struck by rolling stock while on the track	1	D	Staff can be trained to identify these situations and taking the appropriate actions to mitigate potential for injury.	1	E	Implemented	City of Raleigh	
11.	Slope of Platform	The slope of the platform is downwards from center to edge	Passengers in wheelchairs and other wheeled equipment are in danger of excessive rolling	3	B	Staff can be trained to keep watch for rolling items each day and can intervene as needed to mitigate injuries.	4	C	Implemented	Amtrak station staff	The slope of the platform is Amtrak ADA compliant.
12.	Height of Signs on Platform	Platform sign height is lower than some equipment that may be used on platform	Equipment such as forklifts may hit platform signs due to their height, potentially causing equipment damage and/or injury	2	C	Trash cans and benches positioned under low signs to deter equipment from the area	4	E	Implemented	City of Raleigh, Amtrak station staff	Mitigation responsibility shared because the hazard involves both infrastructure and daily operations on the platform

Hazard Identification						Mitigation Approach					
No.	Hazard Description	Cause	Effects	S	P	Mitigation Strategy	Rev. S	Rev. P	Status	Responsibility	Comments
13.	Bridge Plate Storage Container Location	Bridge plates in wrong locations could be not readily available and are in main traffic areas on the platform	Passenger platform gap injury risk is higher because bridge plate is not quickly accessible and/or people walking on platform may trip on container	3	D	Bridge plate containers located next to platform columns for quick access and reduced tripping risk	4	E	Implemented	Amtrak station staff	

Appendix 2 Raleigh Union Station Layout and Amtrak Trainsets

Exhibit 13: RUS Intercity Platform Clearances

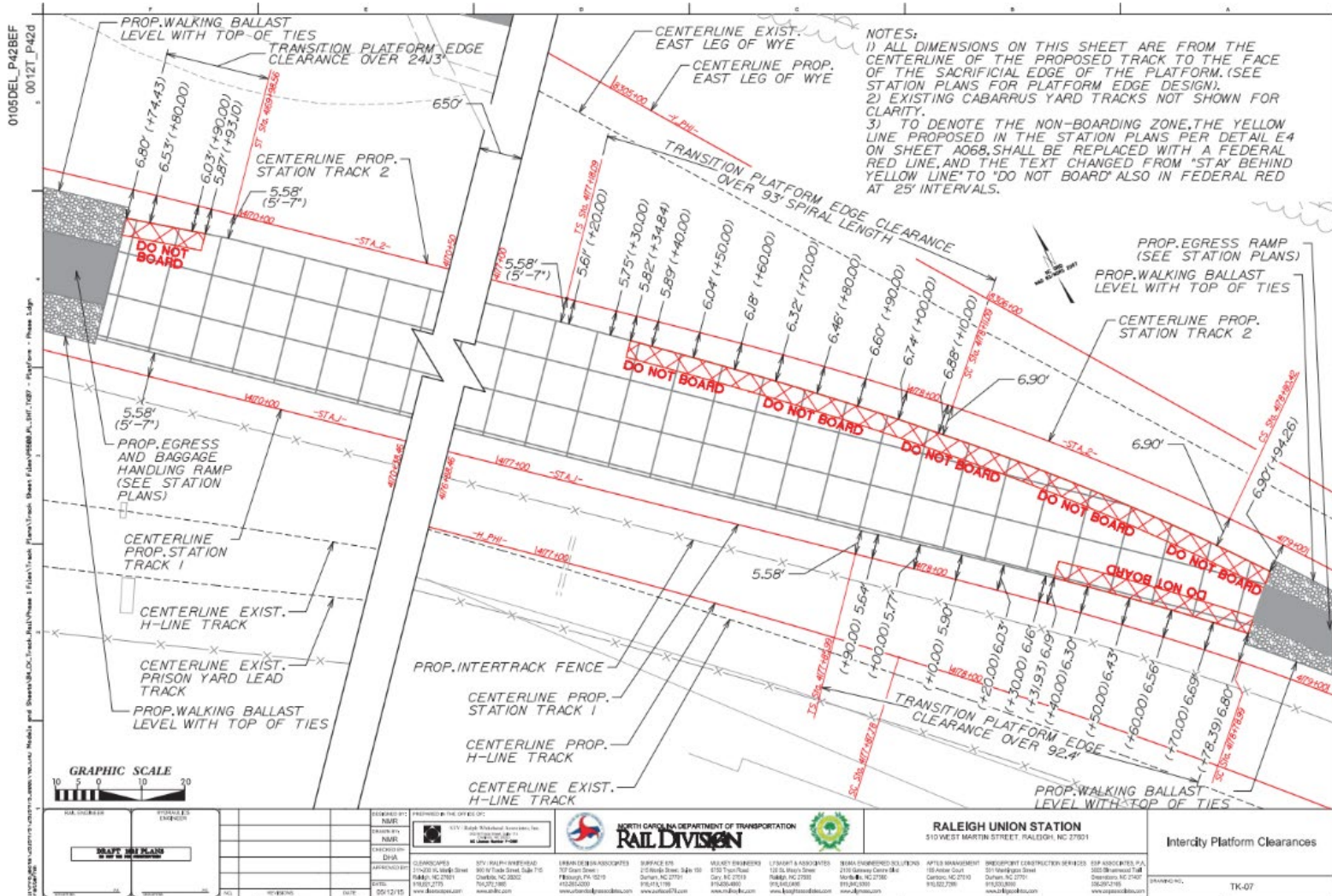

Exhibit 14: RUS Proposed Platform West End Detail

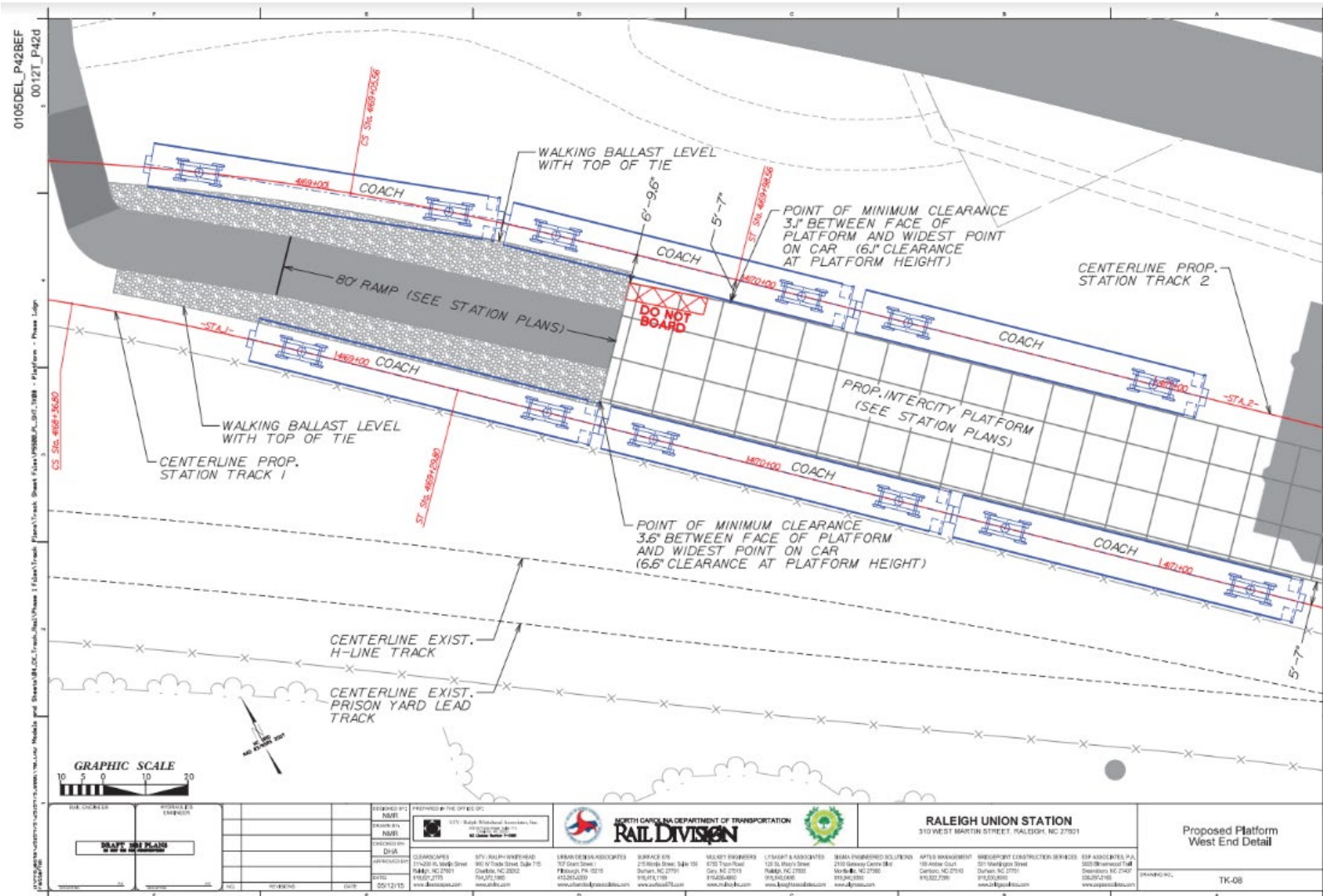

Exhibit 15: RUS Proposed Platform East End Detail

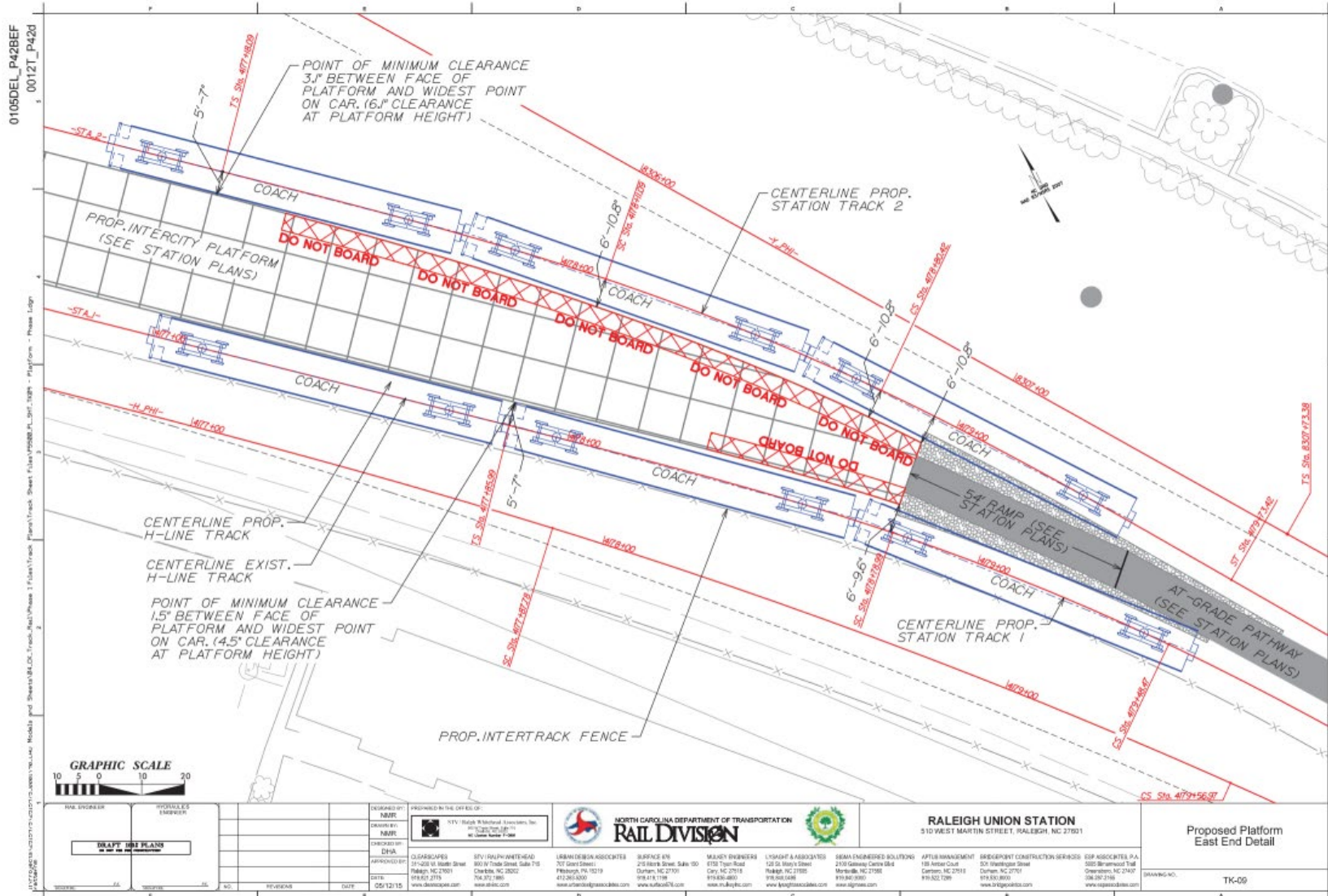

Exhibit 16: RUS Proposed Amtrak Silver Star #92 NB (EB) Platform Gaps

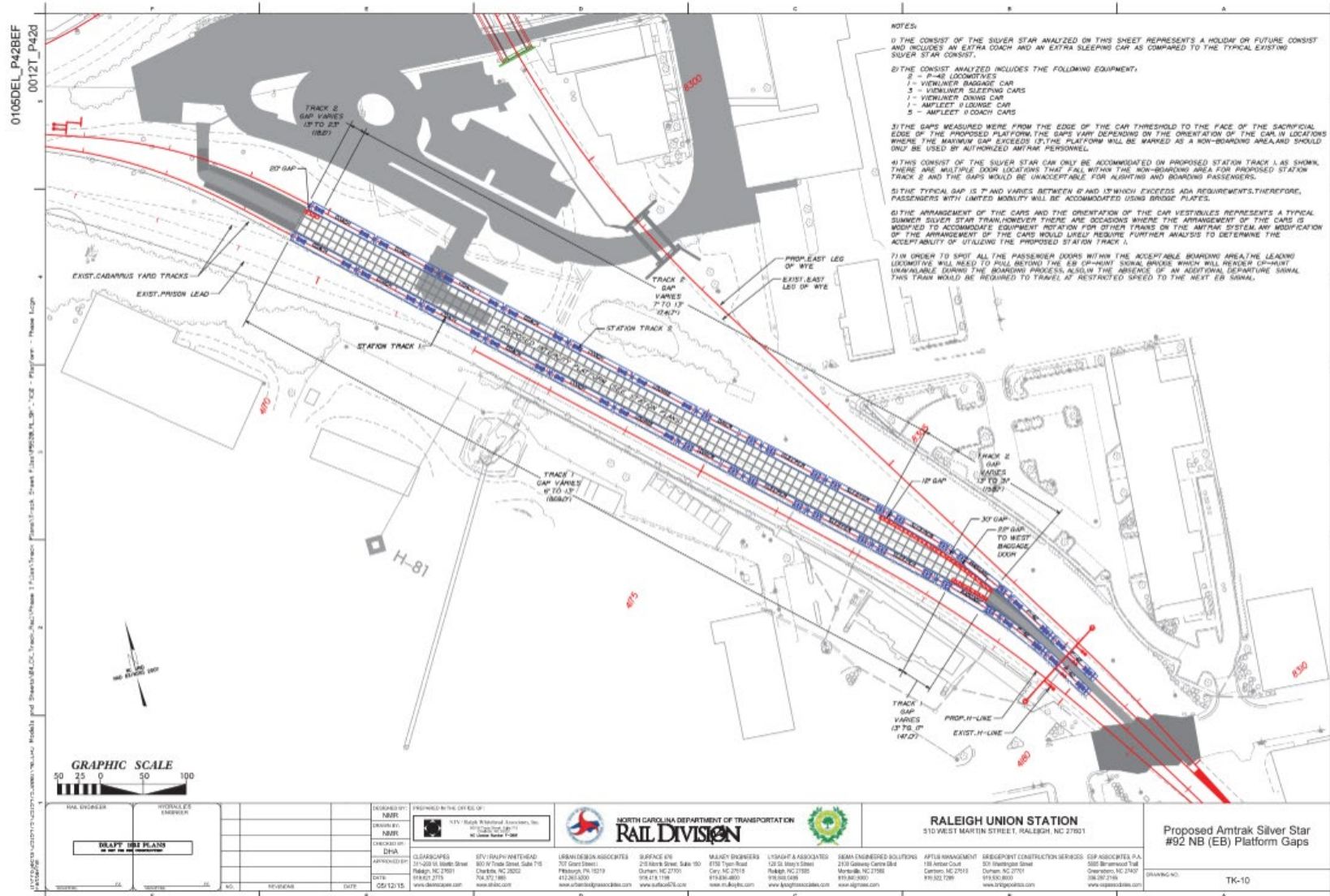

Exhibit 17: Amtrak Clearance Diagram

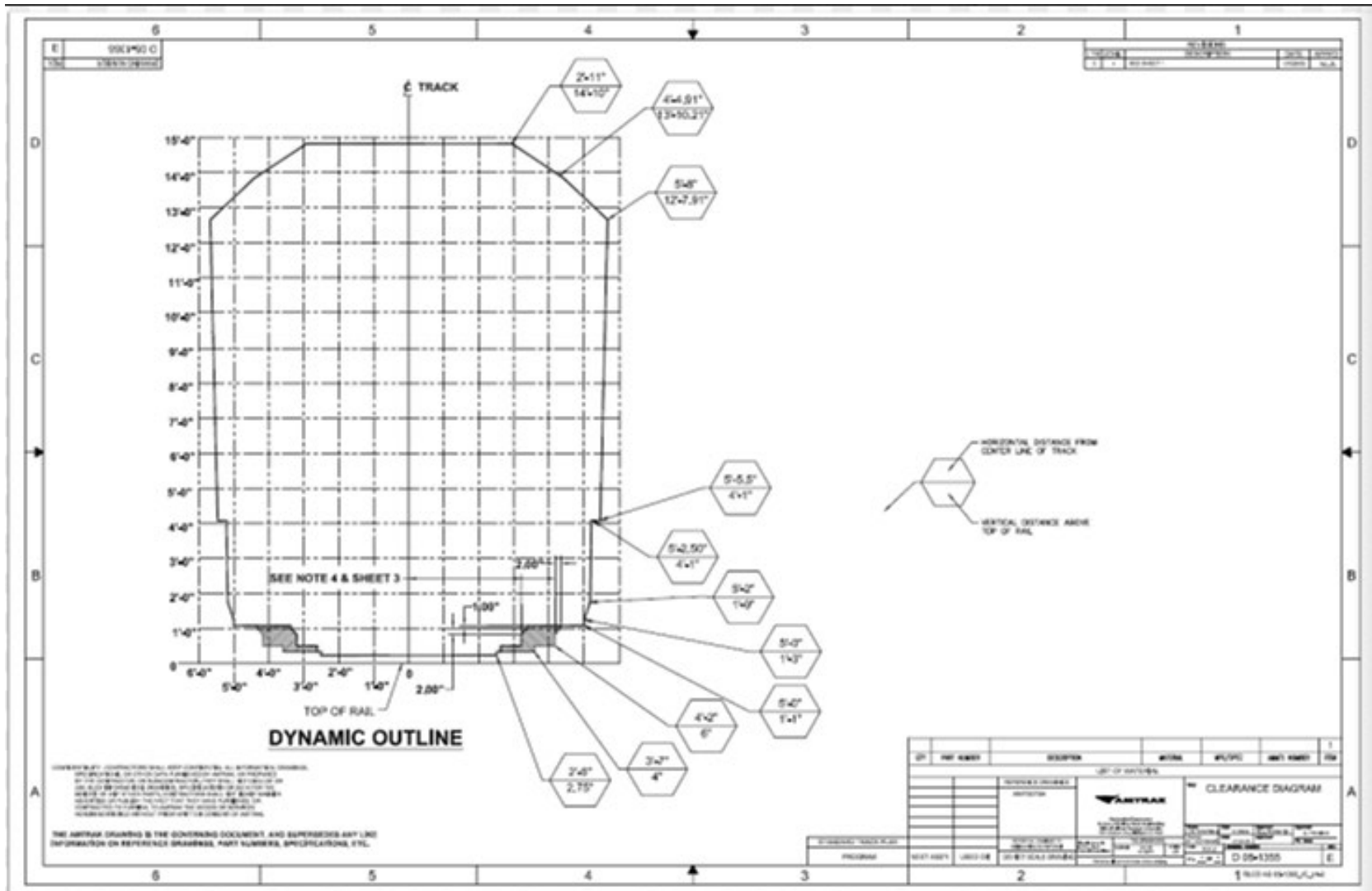

Exhibit 18: 56 Seat Coach (ADA) Diagram

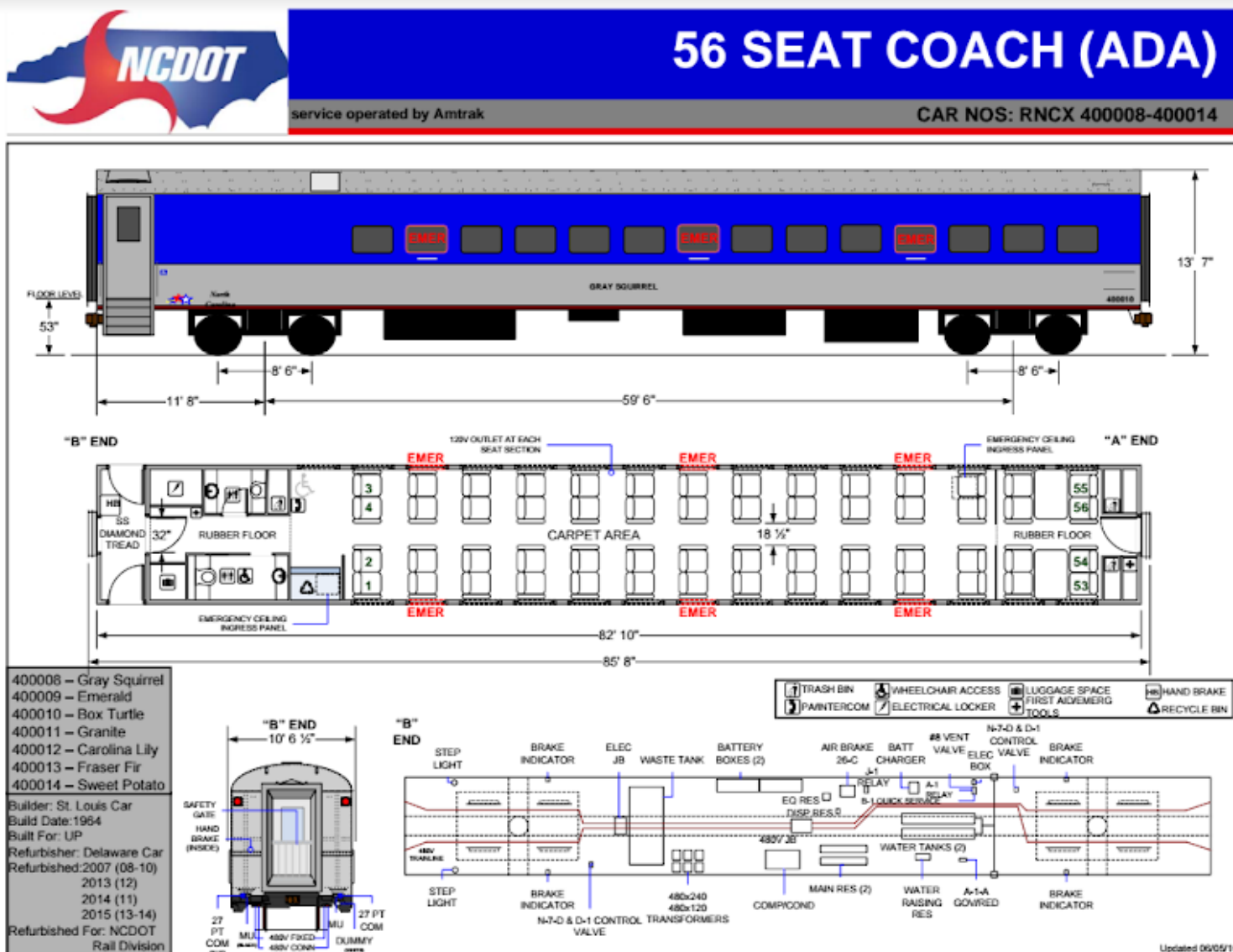

Exhibit 19: 66 Seat Coach (ADA) Diagram

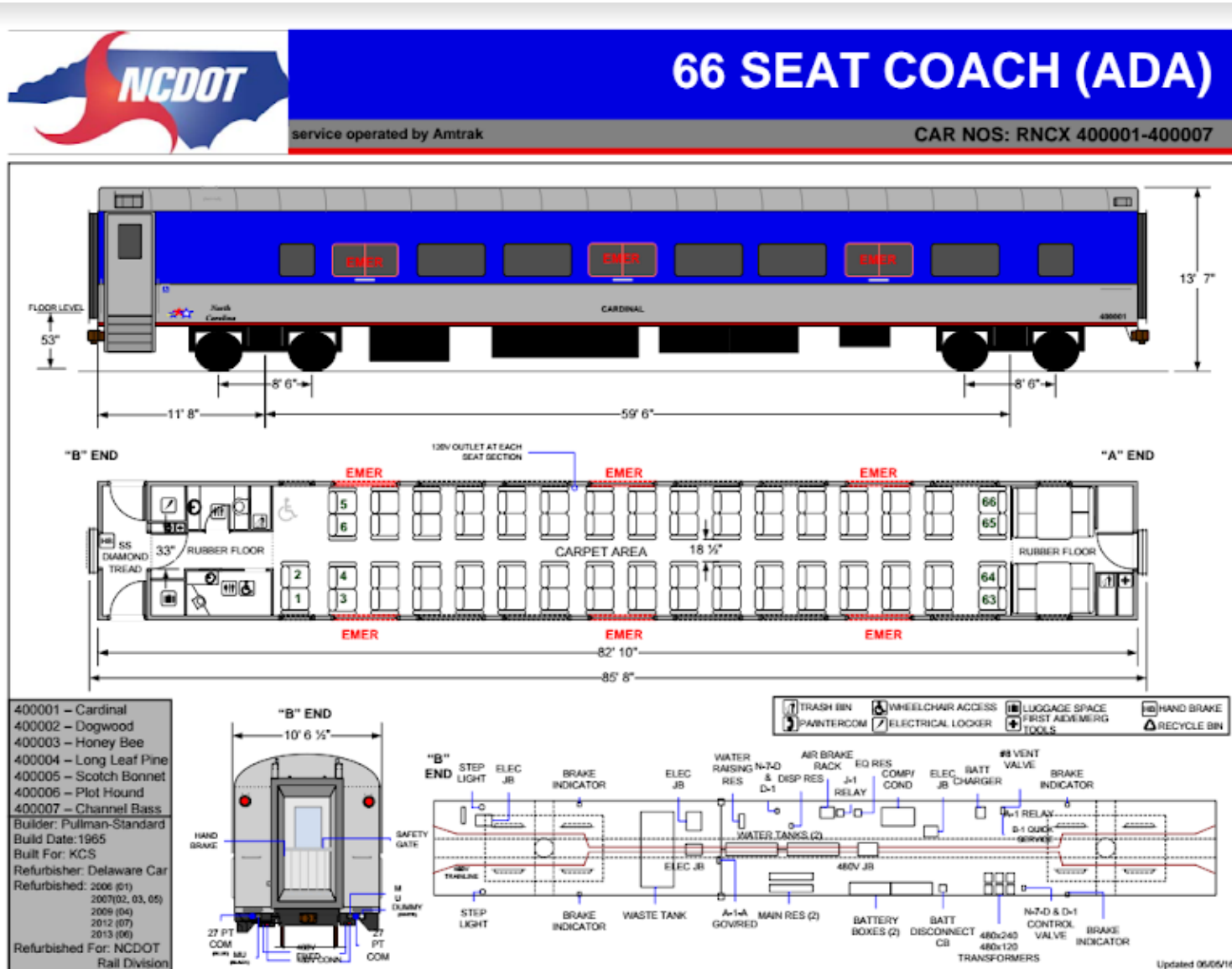

Exhibit 20: Lounge-Baggage (ADA) Diagram

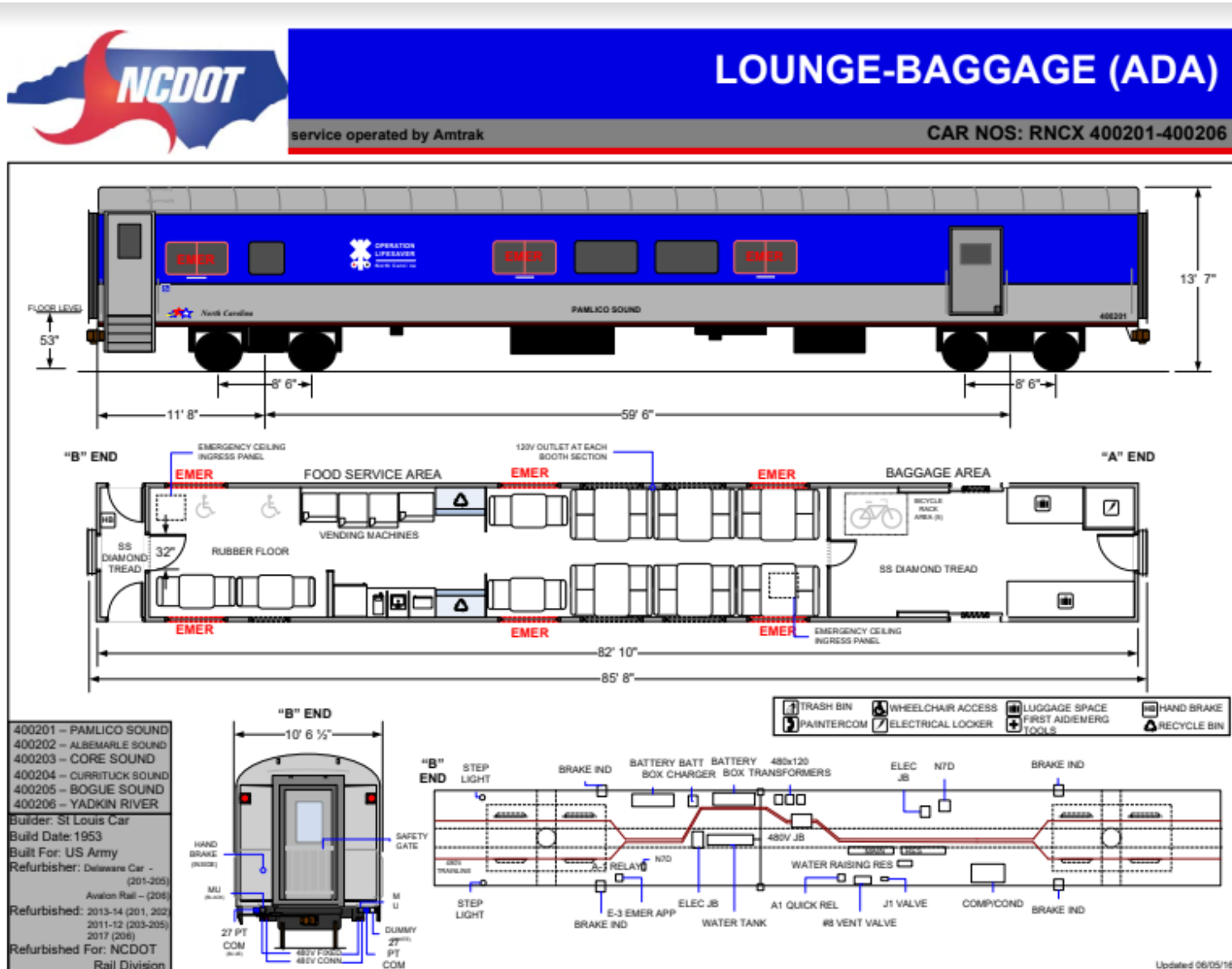

Exhibit 21: F59PH Locomotive Diagram

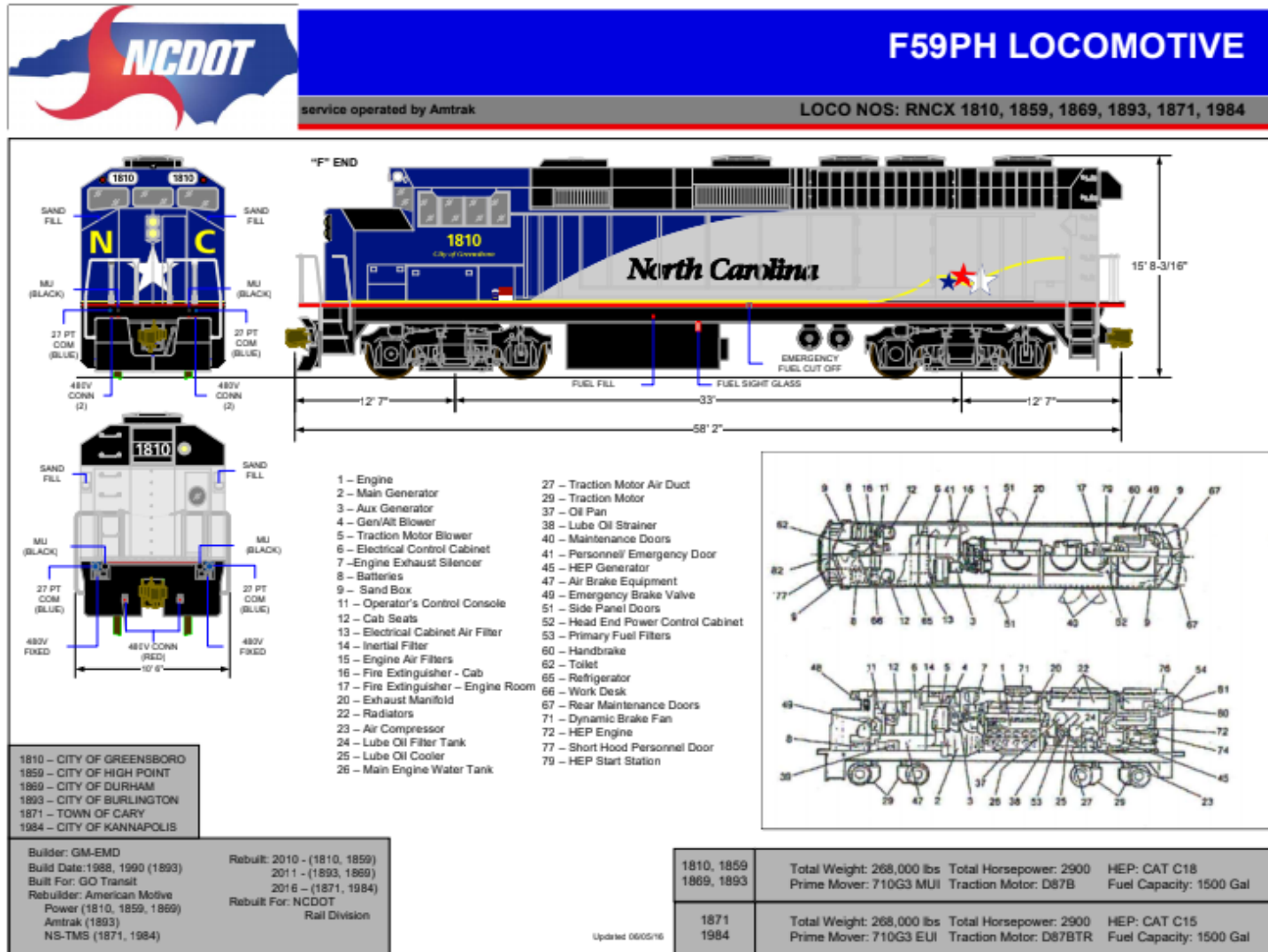
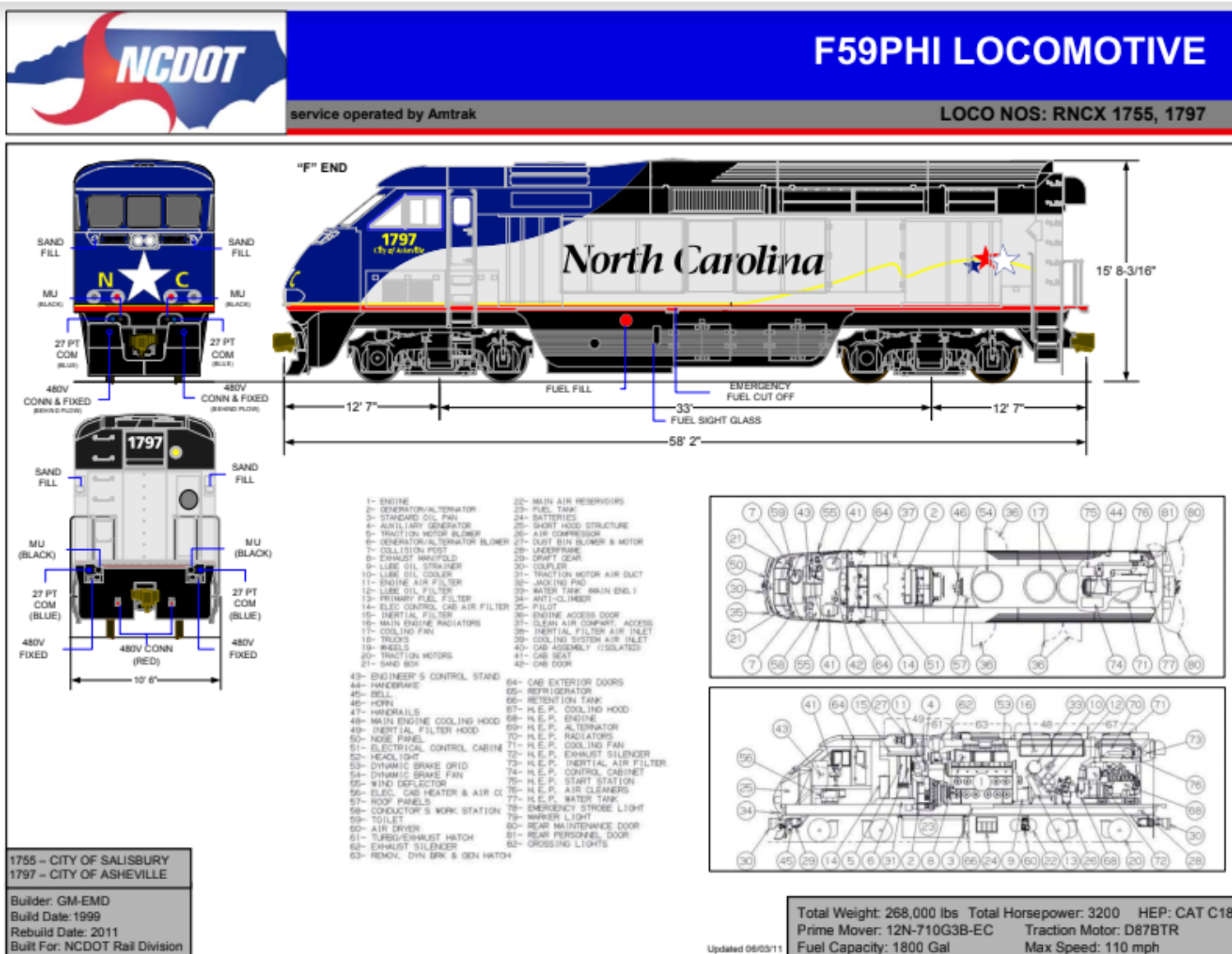

Exhibit 22: F59PHI Locomotive Diagram



Appendix 3 Delkor Gap Filler Product Specifications

Exhibit 23: Delkor Platform Gap Diagram

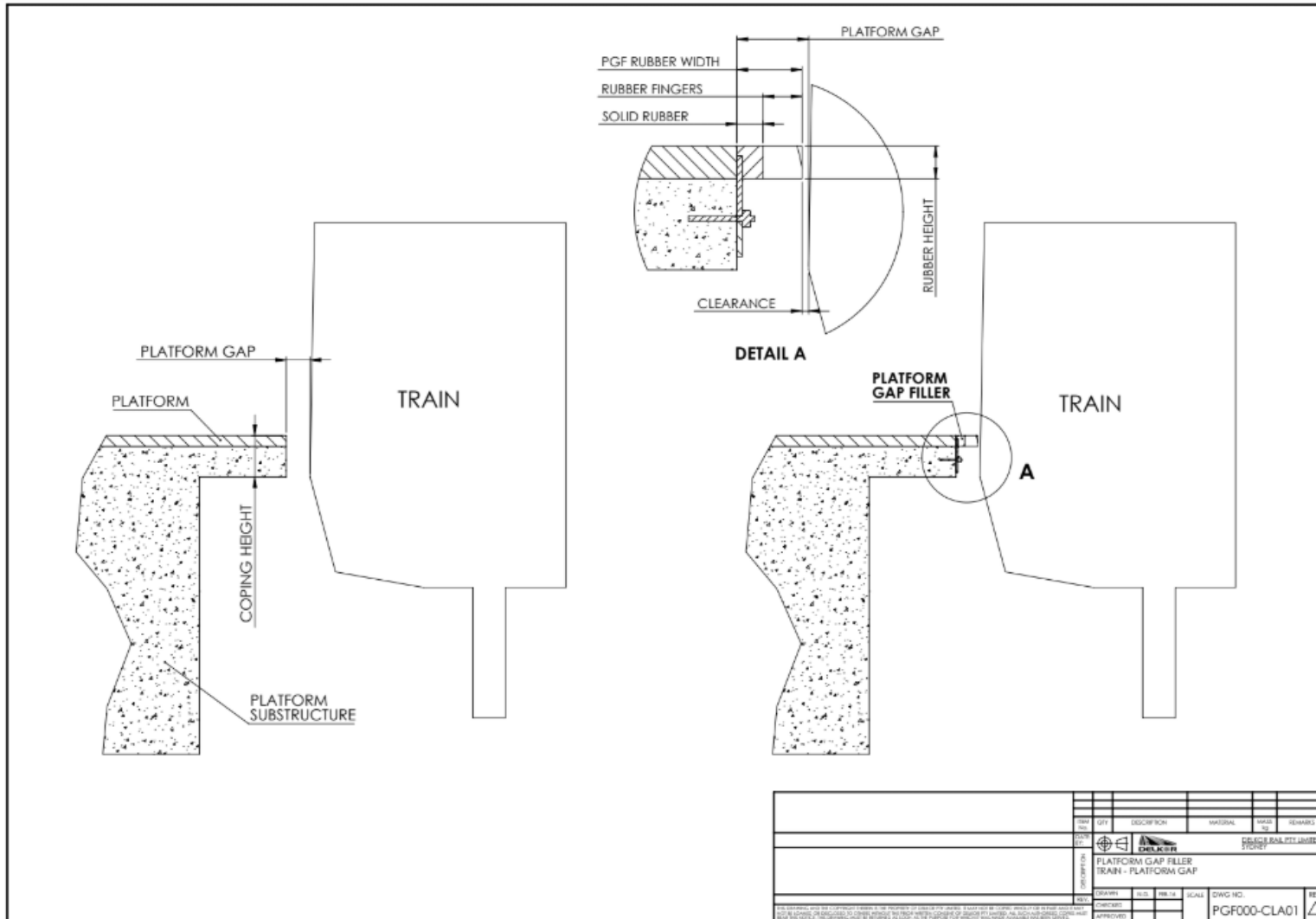

Exhibit 24: Delkor Platform Gap Filler

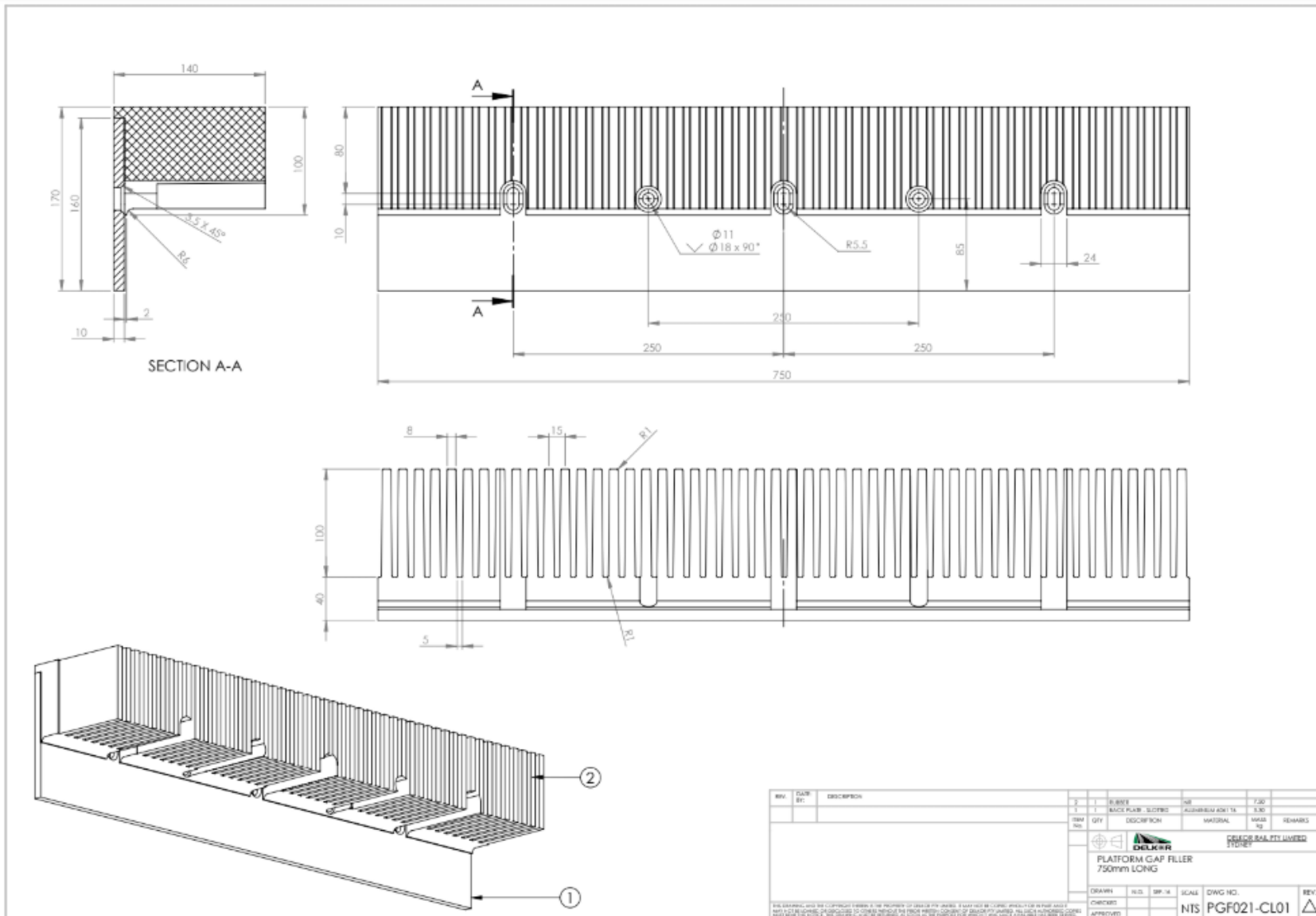

Exhibit 25: Main Characteristics of Delkor Rail's Platform Gap Fillers



Main Characteristics of Delkor Rail's Platform Gap Fillers

1. Different size and styles available
2. Custom design on request
3. Fire resistant, non-toxic
 - a. Smoke density: $A_0 \leq 220$ (BS6853:1999 Annex D)
 - b. Flame spread: class 2 (BS476:Part 7)
 - c. Toxic: $R \leq 5.0$ (BS6853:1999 Annex B)
4. Delkor Rail uses the Ozone Resistance test Standards are:
 - a. ISO 1431-1:2004 Rubber, vulcanized or thermoplastic- Resistance to ozone cracking –Part 1: Static and dynamic strain test;
 - b. DIN 53509-1:2001 Testing of rubber - Determination of resistance to ozone cracking - Part 1: Static conditions.
5. Delkor Rail uses the UV Resistance Test Standards are:
 - a. GB/T14522-2008 Artificial weathering test method for plastics, coating and rubber materials used for machinery industrial products
 - b. GB/T16585-1996 Rubber, vulcanized- Test method of resistance to artificial weathering