

1. REPORT NUMBER CA20-2970	2. GOVERNMENT ASSOCIATION NUMBER N/A	3. RECIPIENT'S CATALOG NUMBER N/A
4. TITLE AND SUBTITLE Vision-Based Sensor System for Site Monitoring: Wrong-Way Driving, Phase 1		5. REPORT DATE June 5, 2020
7. AUTHOR Ty A. Lasky, Kin Yen, Stephen Donecker, Wil White, Duane Bennett, Travis Swanston, and Bahram Ravani		6. PERFORMING ORGANIZATION CODE AHMCT Research Center, UC Davis
9. PERFORMING ORGANIZATION NAME AND ADDRESS AHMCT Research Center UCD Dept. of Mechanical & Aerospace Engineering Davis, California 95616-5294		8. PERFORMING ORGANIZATION REPORT NO. UCD-ARR-19-09-30-03
12. SPONSORING AGENCY AND ADDRESS California Department of Transportation P.O. Box 942873, MS #83 Sacramento, CA 94273-0001		10. WORK UNIT NUMBER N/A
15. SUPPLEMENTARY NOTES N/A		11. CONTRACT OR GRANT NUMBER IA65A0560, Task 2970
16. ABSTRACT This report presents results for research on a Vision-Based Site Monitoring (VBSM) system for monitoring Wrong-Way Driving (WWD) events. This system integrates a camera, solar power panels, and a modem into a pole-mounted package for deployment on freeway exit ramps to monitor for WWD events. The system incorporates on-camera analytics for WWD detection as well as traffic counts. Collection of WWD video is triggered by the camera analytics, and the system stores the videos for a period before and after the WWD event. The system was deployed at ten exit ramps in Northern California, and two exit ramps in Southern California. Data collected over a 39-month period (June 5, 2016-August 31, 2019) is presented, illustrating the effective performance of the VBSM system as a self-contained system for WWD monitoring application. The analysis of the data for WWD events collected shows agreement with the results of prior research studies, while providing a more complete picture of driver behavior.		13. TYPE OF REPORT AND PERIOD COVERED Final Report October 2015 – September 2019
17. KEY WORDS Wrong-way driving, vision-based monitoring, decision support system	14. SPONSORING AGENCY CODE Caltrans	
19. SECURITY CLASSIFICATION (of this report) Unclassified	18. DISTRIBUTION STATEMENT No restrictions. This document is available to the public through the National Technical Information Service, Springfield, Virginia 22161.	21. COST OF REPORT CHARGED N/A
20. NUMBER OF PAGES 136		

DISCLAIMER

The research reported herein was performed by the Advanced Highway Maintenance and Construction Technology (AHMCT) Research Center, within the Department of Mechanical and Aerospace Engineering at the University of California – Davis, for the Division of Research, Innovation and System Information (DRISI) at the California Department of Transportation. AHMCT and DRISI work collaboratively to complete valuable research for the California Department of Transportation.

This document is disseminated in the interest of information exchange. The contents of this report reflect the views of the authors who are responsible for the facts and accuracy of the data presented herein. The contents do not necessarily reflect the official views or policies of the State of California or the Federal Highway Administration. This publication does not constitute a standard, specification or regulation. This report does not constitute an endorsement by the Department of any product described herein.

The contents of this report do not necessarily reflect the official views or policies of the University of California. This report does not constitute an endorsement by the University of California of any product described herein.

For individuals with sensory disabilities, this document is available in alternate formats. For information, call (916) 654-8899, TTY 711, or write to California Department of Transportation, Division of Research, Innovation and System Information, MS-83, P.O. Box 942873, Sacramento, CA 94273-0001



Advanced Highway Maintenance and Construction Technology Research Center

Department of Mechanical and Aerospace Engineering
University of California at Davis

Vision-Based Sensor System for Site Monitoring: Wrong-Way Driving, Phase 1

Ty A. Lasky, Kin Yen, Stephen Donecker,
Wil White, Duane Bennett, Travis Swanston, &
Bahram Ravani: Principal Investigator

Report Number: CA20-2970
AHMCT Research Report: UCD-ARR-19-09-30-03
Final Report of Contract: IA65A0560, Task 2970

June 5, 2020

California Department of Transportation

Division of Research, Innovation and System Information

Executive Summary

Wrong-way driving (WWD) can result in collisions and fatal injuries. WWD incidents have gained attention after a series of wrong-way collisions in the first half of 2015 resulted in several fatalities in the Sacramento and San Diego areas. More recently, a WWD incident in San Diego led to the death of two medical school students. According to the California Highway Patrol (CHP), from 2001 to 2014 a total of 193 fatal collisions and 685 injury collisions occurred on state highways in California because of WWD. The goal of this research was to collect data to better understand the nature and cause of WWD collisions in a passive fashion by monitoring the sites where such collisions are prevalent. As part of this effort, the Advanced Highway Maintenance and Construction Technology (AHMCT) Research Center developed a Vision-Based Site Monitoring (VBSM) system to monitor traffic behavior at key exit ramps to capture WWD incidents and traffic volume data. The monitoring system uses a large area of coverage that includes areas prior to the entry points of WWD location to capture driver-corrected WWD incidents as well as better understand the effects of roadway geometric design and signage on WWD incidents. An additional goal was evaluation of the performance of mitigation techniques implemented by Caltrans to minimize or eliminate WWD incidents. In order to achieve this evaluation, the mitigated sites were typically monitored before and after mitigation. Furthermore, several sites have been outfitted with VBSM systems but without mitigation to provide a basis for comparing data between mitigated and non-mitigated sites.

Research Objectives

- Collect exit ramp traffic volume data over the day at regular collection intervals.
- Capture and evaluate WWD events on study exit ramps.
- Determine the number of wrong-way events before and after mitigation.
- Determine when most of the wrong-way events occur.
- Determine the percentage of wrong-way drivers who turn around and exit back down the same exit ramp.
- For any commercial wrong-way detection systems installed by Caltrans during this research, determine how well these systems perform in terms of detection as well as successfully turning a wrong-way driver back.

- To the best extent possible, assess factors that can be contributing causes of wrong-way events.

The site monitoring and analysis results reported herein cover a 39-month period from June 5, 2016 through August 31, 2019. Any commercial data received outside this period is not included in the analysis. This report answers these questions and addresses these objectives based upon this data.

Methodology

A Vision-Based Site Monitoring (VBSM) system was developed and installed on ten exit ramps in Sacramento and two exit ramps in San Diego to capture video of WWD incidents in order to observe WWD driver behaviors and achieve the noted research objectives. The solar-powered VBSM system consists of a solar panel, solar battery charger/Power-Over-Ethernet (PoE) power supply, two batteries, a camera, and a cellular data modem. VBSM systems are mounted on a wooden pole, and camera analytics software detect WWD events and capture short video clips of all WWD events. The camera analytics also collect traffic volume data. Chapter 2 provides the details of the VBSM system. Chapter 3 documents system optimizations for power usage and performance.

The site monitoring results reported herein cover a 39-month period from June 5, 2016 through August 31, 2019. Any commercial data received outside this period is not included in the analysis. The Sacramento site installations occurred from June 2016 through August 2016, nearly three months, so the duration of monitoring varies by site. Six of the Sacramento exit ramps with a VBSM system received WWD mitigation (Tapco system along with pavement marking enhancements), and four additional exit ramps with VBSM were monitored with no mitigation. The San Diego exit ramps were installed in December 2017, so the monitoring duration in District 11 was approximately twenty months. The San Diego exit ramps received WWD mitigation (TraffiCalm system along with pavement marking enhancements).

Results

In the period evaluated for this research study, the VBSM systems captured 34 significant WWD events in which it appears that the drivers were initially unaware of driving in the wrong direction up the exit ramp. A summary of these WWD events are as follows:

- 28 (82%) of the 34 WWD events occurred on the Sacramento mitigated exit ramps. Two (6%) of the WWD events on the San Diego mitigated exit ramps. Four (12%) of the WWD events occurred on the Sacramento non-mitigated exit ramps.

- For the Sacramento mitigated exit ramps, the rate of wrong-way events per year per exit ramp dropped from 3.0 to 1.4 in the period following installation of mitigations, a 53% drop in the rate of wrong-way events.
- 19 (56%) of the 34 WWD events occurred in the early morning hours (midnight to 6 am), consistent with the results of prior research.
- 12 (35%) of the 34 WWD events were due to wrong-way travel on a one-way street, followed by direct entry to the exit ramp.
- 11 (32%) of the 34 WWD events occurred at the same exit ramp (westbound (WB) US 50 at South River Road), with essentially identical behaviors, indicating that there may be an issue with exit ramp configuration or signage. Similar conclusions apply for WB US 50 at 26th Street, southbound (SB) State Route (SR) 51 at J Street, and WB US 50 at 10th Street (see Table 4.1). All of these exit ramps exhibited a higher percentage of events. Caltrans has been proactively addressing the results observed in this research effort. For example, they have added multiple signs at the South River Road exit ramp, as discussed in Chapter 4.
- One WWD event occurred under poor visibility and rain conditions.
- In one WWD event, the driver appears to be under the influence based on the car's weaving during its approach to the exit ramp. In that case, the WWD driver passed five or more vehicles driving in the right direction and still proceeded wrong-way onto the exit ramp (see Figure 4.16).

In addition to the above WWD events, numerous events were recorded in this research that were intentional WWD events and are outside the scope of this study. These intentional WWD events include:

- Bicyclists riding up the exit ramp (extremely common for certain exit ramps).
- Maintenance and emergency response vehicles moving up the exit ramp.
- Tow trucks backing up the exit ramp to provide assistance to disabled vehicles.
- Vehicles backing up the exit ramp to change lanes.
- Passenger vehicles deliberately entering the exit ramp to assist other vehicles.
- At least one case of an apparent road rage event, discussed in Appendix A.

Conclusions

The data collected in this research show the effectiveness of the Vision-Based Monitoring System (VBSM) in capturing WWD events. The conclusions from analysis of the data collected are as follows:

1. The data suggest that for a given exit ramp, the likelihood of a WWD event is higher during the hours when the traffic volume is lower. This matches with the literature, e.g. [29], which found that wrong-way movements tended to originate from points with low land-use density and in places and times with low traffic volume.
2. Approximately 35% of the WWD events captured were due to wrong-way travel on a one-way street, followed by direct entry to the exit ramp.
3. For several of the exit ramps in this study, the exit ramps feed to a one-way street. For these, the local authority rather than Caltrans has jurisdiction.
4. The events tended to be in the early morning hours, i.e. from about midnight to 6 am (56% of events in study). This result related to the time of day for the WWD events essentially matches results from prior research.
5. The ratio of WWD events for daytime to nighttime was approximately 1:2.
6. The exit ramp configuration, e.g. exit onto a one-way street, or signage on approaching streets, seems to have a significant influence on the number of WWD incidences.
7. Time of day was also observed to play an important factor based on representative ramp volume patterns. During commute hours (typically Monday – Friday, 7-9 AM and 3-6 PM), ramp volume is higher, so that the (possibly confused) WWD vehicle operators may have a better chance of correction since a WW driver can see more cars coming in the opposite direction. Also, lighting is typically better in these periods. Because of these combined factors, the likelihood of WWD events as well as potential severity of such events are viewed as significantly reduced.
8. While the collected data indicate that WWD events are spread throughout the week and throughout the day, the collected data also indicate that there is a higher concentration of WWD events in the midnight to 6 am period, which is consistent with a connection to DUI. However, the data collected over approximately three years indicates that driver confusion, in general, appears to be a more significant factor in WWD events.
9. The collected data indicate that most drivers (85%) recognize their WWD error fairly quickly, and turn around or otherwise correct their driving before they enter the freeway. This helps to explain the

difference in some of the results of this research vs. the previous literature that only considered WWD events leading to collisions.

10. For the Sacramento mitigated exit ramps, the WWD event rate dropped from 3.0 events/ramp/year before mitigation to 1.4 after mitigation, a 53% drop in the rate of wrong-way events. Such a significant drop seems to be a strong indicator of the effectiveness of the mitigations selected and installed by Caltrans.

Recommendations

Based on the data collected, the analysis performed, and experience gained in performing this research the researchers make the following recommendations:

1. Expansion of general exit ramp mitigation efforts, with deployment staged according to perceived level of need. This would involve deploying the mitigation approaches which have been shown effective in the current research and in Caltrans' pilot study [15].
2. Replacing retro-reflective pavement markers on the exit ramp as follows:
 - a. Change existing one-way white to two-way white/red (W/R) for the lane line(s), channelizing line(s), and gore areas.
 - b. Change existing one-way yellow to two-way yellow/red (Y/R) for the left edge line
3. Install Y/R and W/R retro-reflective pavement markers with 12-ft spacing for 240 ft and 6-ft spacing for 120 ft starting 120 ft from the end of the exit ramp.
4. Consider installing active monitoring systems on the most operationally critical exit ramps with recurring WWD instances. Should Caltrans decide to install any, it is highly recommended to configure systems with dual forward- and rear-facing cameras as opposed to a single camera, since Caltrans' testing has shown that this significantly increases the ability to verify and characterize WWD instances.
5. Consider signage improvements for key exit ramps. This should be approached in a manner similar to Caltrans' signage improvements for South River Road.
6. Due to resource constraints, only a subset of exit ramps were monitored in this research. It may be feasible to generalize results for some of the monitored exit ramps, as there are typically strong similarities for certain exit ramp types and configurations. As such, the researchers recommend an assessment of the applicability of the

findings within this study to a broader number of exit ramps, in order to maximize the safety benefits.

7. Share these research results with municipalities. Certain exit ramps studied feed into one-way streets under a local jurisdiction. Exit ramps with this configuration were shown in this research to have increased risk for WWD events. Mitigation of these exit ramps may require some additional action by a city or local agency, as Caltrans does not typically have jurisdiction.

Table of Contents

Executive Summary	ii
Research Objectives	ii
Methodology	iii
Results	iii
Conclusions	iv
Recommendations	vi
Table of Contents	viii
List of Figures	x
List of Tables	xv
List of Acronyms and Abbreviations	xvi
Acknowledgments	xviii
Chapter 1: Introduction	1
Problem	1
Literature	1
Research Methodology	3
Chapter 2: Vision-Based Site Monitoring System	6
Camera	9
Analytics	10
Power Supply	11
Communications	11
Chapter 3: System Optimization	12
Video Quality Optimization	12
Imaging Direction Optimal Setting	13
Automatic or Manual Notification and Download Settings	14
Software Customizations	15
Solar Power	15
Mounting	18
Reliability	21
Axis Q1615-E Camera	21
Sierra Wireless GX450 modem	22
Deka Gel-8G22NF 51 A-Hr lead acid battery	22
Solar Charge Controller	22
Chapter 4: Site Monitoring Results	24
Exit Ramp Traffic Count Data	27

WWD Event Classification _____	34
WWD Events by Exit Ramp and Group _____	39
WWD Events by Time of Day _____	41
WWD Events by Day of Week _____	44
WWD Events by Time of Day and Day of Week _____	45
WWD Events by Month _____	45
WWD Events by Entry Manner _____	46
Driver-Corrected and Driver-Uncorrected WWD Events _____	59
Effect of Mitigation _____	60
COTS WWD Detections _____	62
All VBSM-Captured Events by Entity and by Exit Ramp _____	76
Chapter 5: Conclusions, Recommendations, and Future Research _____	79
Conclusions _____	79
Recommendations _____	82
Future Research _____	83
References _____	84
Appendix A: Additional WWD Incident Information _____	86
Road Rage Incident _____	86
Additional Vehicle Trajectories for WWD Events of Interest _____	88
Appendix B: All Vehicular WWD Incidents in Data Collection Period _____	108
Appendix C: VBSM Contributions, Conclusions, and Recommendations _____	114
VBSM Contributions and Conclusions _____	114
VBSM Recommendations _____	115

List of Figures

Figure 2.1: The WWD VBSM system block diagram _____ 7

Figure 2.2: The WWD VBSM system component details _____ 8

Figure 2.3: The WWD VBSM system installed at an exit ramp _____ 9

Figure 2.4: Multiple WWD detection zones as configured for US 50 WB South River Road exit ramp _____ 10

Figure 3.1: Exit ramp FOV for (a) Desired imaging direction towards intersection and (b) Sub-optimal imaging direction up the exit ramp _____ 14

Figure 3.2: Example of tree trimming required to provide better camera FOV (US 50 WB 10th St exit) _____ 16

Figure 3.3: US 50 WB 10th St camera view before and after tree trimming _____ 16

Figure 3.4: Solar panel output per day over the full year for various panel tilt angles from horizontal for Sacramento and San Diego, California _____ 17

Figure 3.5: Battery voltage and device (camera motherboard, camera image sensor, and LTE modem) temperature showing camera shutdown due to degraded system battery _____ 18

Figure 3.6: Effect of pole twist on one WWD monitoring installations' lane masks. US 50 WB South River Road exit ramp. Note the significant discrepancy between mask lines and actual lane lines. These were aligned at the time of camera installation. _____ 19

Figure 3.7: Effect of pole twist on the US 50 WB South River Road exit ramp WWD monitoring installation. (a) Camera FOV immediately after installation. (b) Camera FOV three months after installation. _____ 20

Figure 3.8: Illustration of the IR filter failure. The left image was taken before the camera replacement. The right image was taken after the camera replacement. _____ 21

Figure 4.1: Camera view of the six mitigated Sacramento area exit ramps subject to WWD monitoring _____ 25

Figure 4.2: Camera view of the four non-mitigated Sacramento area exit ramps subject to WWD monitoring _____ 26

Figure 4.3: Camera view of the two mitigated San Diego area exit ramps subject to WWD monitoring _____ 26

Figure 4.4: Traffic count as determined from camera analytics for eastbound (EB) US 50 to 5th Street exit ramp in Sacramento _____ 28

Figure 4.5: Traffic count as determined from camera analytics for westbound (WB) US 50 to South River Road exit ramp in West Sacramento _____ 28

Figure 4.6: Traffic count as determined from camera analytics for WB US 50 to Jefferson Boulevard exit ramp in West Sacramento _____ 29

Figure 4.7: Traffic count as determined from camera analytics for WB US 50 to 10th Street exit ramp in Sacramento _____ 29

Figure 4.8: Traffic count as determined from camera analytics for WB US 50 to 16 th Street exit ramp in Sacramento	30
Figure 4.9: Traffic count as determined from camera analytics for WB US 50 to 26 th Street exit ramp in Sacramento	30
Figure 4.10: Traffic count as determined from camera analytics for southbound (SB) State Route (SR) 51 to J Street exit ramp in Sacramento	31
Figure 4.11: Traffic count as determined from camera analytics for northbound (NB) SR 51 to H Street exit ramp in Sacramento	31
Figure 4.12: Traffic count as determined from camera analytics for NB SR 51 to N Street exit ramp in Sacramento	32
Figure 4.13: Traffic count as determined from camera analytics for NB SR 51 to T Street exit ramp in Sacramento	32
Figure 4.14: Traffic count as determined from camera analytics for WB I-8 to Sunset Cliffs Boulevard exit ramp in San Diego	33
Figure 4.15: Traffic count as determined from camera analytics for SB I-5 to Sea World Drive exit ramp in San Diego	33
Figure 4.16: Wrong-way driver (circled in yellow) entering the exit ramp at WB US 50 at 10 th Street. The driver continued onto the exit ramp despite at least five cars passing in the other (correct) direction.	38
Figure 4.17: All WWD events classified by exit ramp	40
Figure 4.18: All WWD events per year per exit ramp	41
Figure 4.19: All WWD events classified by time of day	43
Figure 4.20: All WWD events classified by day of week	44
Figure 4.21: All WWD events classified by month	46
Figure 4.22: All WWD events classified by entry manner	47
Figure 4.23: View of the approach from the north to the South River Road exit ramp. A right turn would lead to a WWD event. Image courtesy of Google Street View.	49
Figure 4.24: Aerial view of the 10/21/2016 1:52 pm WWD event on the South River Road exit ramp. Approximate vehicle trajectory is shown in red. Aerial image courtesy of Google Maps.	50
Figure 4.25: Aerial view of the 11/6/2016 1:53 pm WWD event on the South River Road exit ramp. Approximate vehicle trajectory is shown in red. Aerial image courtesy of Google Maps.	50
Figure 4.26: Aerial view of the 3/29/2017 9:51 am WWD event on the South River Road exit ramp. Approximate vehicle trajectory is shown in red. Aerial image courtesy of Google Maps.	51
Figure 4.27: Aerial view of the 7/30/2017 6:13 am WWD event on the South River Road exit ramp. Approximate vehicle trajectory is shown in red. Aerial image courtesy of Google Maps.	51
Figure 4.28: Aerial view of the 4/17/2018 1:05 pm WWD event on the South River Road exit ramp. Approximate vehicle trajectory is shown in red. Aerial image courtesy of Google Maps.	52

Figure 4.29: Aerial view of the 5/18/2018 5:15 pm WWD event on the South River Road exit ramp. Approximate vehicle trajectory is shown in red. Aerial image courtesy of Google Maps.	52
Figure 4.30: Aerial view of the 5/26/2018 7:31 am WWD event on the South River Road exit ramp. Approximate vehicle trajectory is shown in red. Aerial image courtesy of Google Maps.	53
Figure 4.31: Aerial view of the 11/4/2018 11:30 pm WWD event on the South River Road exit ramp. Approximate vehicle trajectory is shown in red. Aerial image courtesy of Google Maps.	53
Figure 4.32: Aerial view of the 2/28/2019 1:28 am WWD event on the South River Road exit ramp. Approximate vehicle trajectory is shown in red. Aerial image courtesy of Google Maps.	54
Figure 4.33: Aerial view of the 5/3/2019 4:21 pm WWD event on the South River Road exit ramp. Approximate vehicle trajectory is shown in red. Aerial image courtesy of Google Maps.	54
Figure 4.34: Aerial view of the 5/18/2019 3:33 pm WWD event on the South River Road exit ramp. Approximate vehicle trajectory is shown in red. Aerial image courtesy of Google Maps.	55
Figure 4.35: Caltrans' sign addition for northbound 5 th Street on the south side of the intersection at the South River Road exit ramp. Image courtesy of Google Street View.	56
Figure 4.36: Caltrans' sign addition for northbound 5 th Street on the north side of the intersection at the South River Road exit ramp. Image courtesy of Google Street View.	56
Figure 4.37: Caltrans' sign addition for westbound Bridge Street on the southwest side of the intersection at the South River Road exit ramp. Image courtesy of Google Street View.	57
Figure 4.38: Caltrans' sign addition for southbound 5 th Street on the north side of the intersection at the South River Road exit ramp. Image courtesy of Google Street View.	58
Figure 4.39: Caltrans' sign modifications and additions for southbound 5 th Street on the south side of the intersection at the South River Road exit ramp. Image courtesy of Google Street View.	58
Figure 4.40: Early and late images of the vehicle entering the ramp for the WWD event of 8/18/2018 7:21 am on the 5 th Street exit ramp	60
Figure 4.41: TAPCO radar sensor blocked by informational sign for the 16 th Street exit ramp system. The AHMCT VBSM can be seen behind the TAPCO system.	69
Figure 4.42: Bird's-eye view of TrafficCalm system configuration at Sunset Cliffs Blvd. exit ramp, including sign location and numbering. Courtesy of TrafficCalm.	71
Figure 4.43: Photos (images 1 – 6 of 14) provided by TAPCO system for a typical WWD event. TAPCO provides 14-16 photos for a WWD event. Courtesy of TAPCO.	72

Figure 4.44: Photos (images 7 – 12 of 14) provided by TAPCO system for a typical WWD event. TAPCO provides 14-16 photos for a WWD event. Courtesy of TAPCO. _____	73
Figure 4.45: Photos (images 13 – 14 of 14) provided by TAPCO system for a typical WWD event. TAPCO provides 14-16 photos for a WWD event. Courtesy of TAPCO. _____	74
Figure 4.46: Photo provided by TrafficCalm system for a typical WWD event. TrafficCalm provides one photo for a WWD event. Courtesy of TrafficCalm. _	74
Figure 4.47: All captured events classified by entity _____	77
Figure 4.48: All captured events classified by exit ramp _____	78
Figure 4.49: Vehicle events classified by exit ramp _____	78
Figure A.1: Snapshots from the August 27, 2016 road rage incident on the J Street exit ramp _____	87
Figure A.2: Aerial view of the 5/1/2018 3:46 am WWD event on the Sunset Cliffs exit ramp. Approximate vehicle trajectory is shown in red. Aerial image courtesy of Google Earth. _____	88
Figure A.3: Aerial view of the 6/2/2019 2:03 am WWD event on the Sunset Cliffs exit ramp. Approximate vehicle trajectory is shown in red. Aerial image courtesy of Google Earth. _____	88
Figure A.4: Aerial view of the 1/9/2017 1:50 am WWD event on the J Street exit ramp. Approximate vehicle trajectory is shown in red. Aerial image courtesy of Google Maps. _____	89
Figure A.5: Aerial view of the 4/13/2017 1:51 am WWD event on the J Street exit ramp. Approximate vehicle trajectory is shown in red. Aerial image courtesy of Google Maps. _____	90
Figure A.6: Aerial view of the 3/8/2018 1:30 am WWD event on the J Street exit ramp. Approximate vehicle trajectory is shown in red. Aerial image courtesy of Google Maps. _____	91
Figure A.7: Aerial view of the 1/23/2019 2:01 am WWD event on the J Street exit ramp. Approximate vehicle trajectory is shown in red. Aerial image courtesy of Google Maps. _____	92
Figure A.8: Aerial view of the 8/18/2018 7:21 am WWD event on the EB 5 th Street exit ramp. Approximate vehicle trajectory is shown in red. Aerial image courtesy of Google Maps. _____	93
Figure A.9: Aerial view of the 12/22/2016 5:41 am WWD event on the WB 10 th Street exit ramp. Approximate vehicle trajectory is shown in red. Aerial image courtesy of Google Maps. _____	94
Figure A.10: Aerial view of the 5/4/2017 3:47 am WWD event on the WB 10 th Street exit ramp. Approximate vehicle trajectory is shown in red. Aerial image courtesy of Google Maps. _____	94
Figure A.11: Aerial view of the 5/16/2017 11:43 pm WWD event on the WB 10 th Street exit ramp. Approximate vehicle trajectory is shown in red. Aerial image courtesy of Google Maps. _____	95

Figure A.12: Aerial view of the 2/4/2019 1:37 am WWD event on the WB 10 th Street exit ramp. Approximate vehicle trajectory is shown in red. Aerial image courtesy of Google Maps.	95
Figure A.13: Aerial view of the 11/2/2016 1:05 am WWD event on the WB 26 th Street exit ramp. Approximate vehicle trajectory is shown in red. Aerial image courtesy of Google Maps.	96
Figure A.14: Aerial view of the 5/26/2017 4:12 am WWD event on the WB 26 th Street exit ramp. Approximate vehicle trajectory is shown in red. Aerial image courtesy of Google Maps.	97
Figure A.15: Aerial view of the 10/10/2017 3:13 pm WWD event on the WB 26 th Street exit ramp. Approximate vehicle trajectory is shown in red. Aerial image courtesy of Google Maps.	98
Figure A.16: Aerial view of the 11/23/2017 7:49 am WWD event #1 on the WB 26 th Street exit ramp. Approximate vehicle trajectory is shown in red. Aerial image courtesy of Google Maps.	99
Figure A.17: Aerial view of the 11/23/2017 7:49 am WWD event #2 on the WB 26 th Street exit ramp. Approximate vehicle trajectory is shown in red. Aerial image courtesy of Google Maps.	100
Figure A.18: Aerial view of the 12/2/2018 3:33 am WWD event on the WB 26 th Street exit ramp. Approximate vehicle trajectory is shown in red. Aerial image courtesy of Google Maps.	101
Figure A.19: Aerial view of the 1/14/2019 5:26 am WWD event on the WB 26 th Street exit ramp. Approximate vehicle trajectory is shown in red. Aerial image courtesy of Google Maps.	102
Figure A.20: Aerial view of the 1/30/2019 4:14 am WWD event on the WB 26 th Street exit ramp. Approximate vehicle trajectory is shown in red. Aerial image courtesy of Google Maps.	103
Figure A.21: Aerial view of the 6/22/2019 3:06 am WWD event on the WB 26 th Street exit ramp. Approximate vehicle trajectory is shown in red. Aerial image courtesy of Google Maps.	104
Figure A.22: Aerial view of the 6/22/2019 4:58 am WWD event on the WB 26 th Street exit ramp. Approximate vehicle trajectory is shown in red. Aerial image courtesy of Google Maps.	105
Figure A.23: Aerial view of the 8/11/2016 4:11 am WWD event on the Jefferson Boulevard exit ramp. Approximate vehicle trajectory is shown in red. Aerial image courtesy of Google Maps.	106
Figure A.24: Aerial view of the 8/23/2017 12:49 am WWD event on the Jefferson Boulevard exit ramp. Approximate vehicle trajectory is shown in red. Aerial image courtesy of Google Maps.	107

List of Tables

Table 1.1: Wrong-way driving monitoring exit ramp installations _____ 5

Table 3.1: Video properties for research and thumbnail clips _____ 13

Table 4.1: WWD event summary. Figure references are for aerial vehicle trajectory view for each event. _____ 35

Table 4.2: All WWD events classified by exit ramp and group _____ 40

Table 4.3: All WWD events classified by time of day _____ 42

Table 4.4: All WWD events classified by daytime or nighttime, including number of events where driver turned around (driver-corrected) _____ 42

Table 4.5: All WWD events classified by day of week _____ 44

Table 4.6: All WWD events by both time of day and day of week _____ 45

Table 4.7: All WWD events classified by month _____ 46

Table 4.8: All WWD events classified by entry manner _____ 47

Table 4.9: All WWD events classified by whether driver turned around (driver-corrected) or did not (driver-uncorrected) _____ 59

Table 4.10: All wrong-way events in the Sacramento mitigated exit ramps group classified by mitigation period _____ 61

Table 4.11: TAPCO alerts received for relevant VBSM-detected WWD events __ 64

Table 4.12: TAPCO activations for relevant VBSM-detected WWD events ____ 64

Table 4.13: WWD events which occurred during the collection period for all District 3 exit ramps which had both the VBSM and TAPCO systems installed _____ 67

Table 4.14: Detailed breakdown of all COTS-identified WWD events and the corresponding VBSM detection status _____ 67

Table 4.15: TrafficCalm alerts received for relevant VBSM-detected WWD events _____ 70

Table 4.16: TrafficCalm activations for relevant VBSM-detected WWD events __ 70

Table 4.17: Summary event counts for each ramp for each of the three systems and the corresponding WWD event rates _____ 75

Table 4.18: All captured events classified by entity _____ 77

Table 4.19: All captured events classified by exit ramp and group _____ 77

Table B.1: All vehicular WWD events in data collection period. Blue events are the main events detected by the VBSM only. Gold events are those detected by TAPCO only. Gray events are those detected by TrafficCalm only. Purple events are those detected by both the VBSM and TAPCO. Orange events are those detected by both the VBSM and TrafficCalm. Green events are remaining VBSM-only detections which were not included in the analysis. _____ 108

List of Acronyms and Abbreviations

Acronym	Definition
AHMCT	Advanced Highway Maintenance and Construction Technology Research Center
BAC	Blood Alcohol Concentration
Caltrans	California Department of Transportation
CHP	California Highway Patrol
CIF	Common Interchange Format
COTS	Commercial Off-The-Shelf
DMV	Department of Motor Vehicles
DOT	Department of Transportation
DSL	Direct Subscriber Line
DUI	Driving Under the Influence
EB	Eastbound
FARS	Fatality Analysis Reporting System
FOV	Field of View
FPS	Frames Per Second
HDTV	High-Definition Television
IP66	Ingress Protection 66
IR	Infrared
LH	Left-Hand
LTE	Long-Term Evolution
MUTCD	Manual on Uniform Traffic Control Devices
NB	Northbound
NEMA	National Electrical Manufacturers Association

Acronym	Definition
NTSB	National Transportation Safety Board
PoE	Power over Ethernet
RH	Right-Hand
SB	Southbound
SD	Secure Digital
SIM	Subscriber Identification Module
SIO	Sign Installation Order
SR	State Route
SSR	Solid-State Relay
TAPCO	Traffic & Parking Control Co. Inc.
TMC	Transportation Management Center
VBSM	Vision-Based Site Monitoring
WB	Westbound
WDR	Wide Dynamic Range
W/R	White/Red
WWD	Wrong-Way Driving
Y/R	Yellow/Red

Acknowledgments

The authors thank the California Department of Transportation (Caltrans) for their support, in particular Steve Block, Bart Bloom, Wayne Brazelton, Kyle Bremer, Troy Bucko, Mike Chappell, Pat Day, Pedro Diaz, Trevor Evans, Paul Featherstone, Dave Gamboa, Mohssen Ghassemi, Kirk Hemstalk, Rick Hernandez, James Ledesma, Robert Leo, Victor Lopez, Steven Lowell, Jose Luna, David Neumann, Stan Richins, Richard Schwegerl, Chris Seale, Chris Smith, Eric Souza, Joyce Stewart, Noel Tapia, Stephen Weber, and Jeff Woody with the Division of Maintenance; Brian Alconcel with the Division of Traffic Operations; Gilbert Mohtes-Chan, the Public Information Officer for Caltrans District 3; and John Slonaker, Joe Horton, and Greg Larson with the Division of Research, Innovation and System Information. The authors also acknowledge Scott Hogden, Josh Johnson, Shaun Johnson, Chris McLean, Amanda Schulz, and Max Smith of Traffic & Parking Control Co., Inc. (TAPCO) and Adam Goyen and Andy Pedersen of TraffiCalm. The authors also acknowledge Irv Rosenblum and Tad Carter of Citilog, an Axis Communications company. The authors acknowledge Officers Scott Baland, Robert Brown, Brian Cook, and Robin Johnson of the California Highway Patrol. The authors also acknowledge the dedicated efforts of the AHMCT team who have made this work possible.

Chapter 1: Introduction

Problem

Wrong-way driving (WWD) can result in collisions and injuries and is a major safety concern. In California, WWD on state highways kills approximately 35 Californians each year, and collisions caused by WWD are more likely to result in fatal or serious injuries than other types of collision [5][9]. According to the California Highway Patrol (CHP), from 2001 to 2014 a total of 193 fatal collisions and 685 injury collisions occurred on state highways in California because of WWD. Wrong-way collision rates in the first half of 2015 were unusually high, resulting in several fatal collisions in the Sacramento and San Diego areas. These wrong-way collisions were, as usual, deadly. More recently, a WWD incident in San Diego led to the death of two medical school students [6]. According to Vaswani, the fatality rate for wrong-way driving collisions on controlled highways is about 27 times higher than that for other collisions [7].

Literature

WWD incidents have merited increasing national attention. In the United States, there are approximately 350 deaths per year due to WWD collisions [8]; California accounts for 10% of these collisions and 10% of deaths, second only to Texas [9]. In 2015 by May 12, there were 14 fatalities in wrong-way head-on collisions in the Sacramento area [10]. According to data from CHP, between 2011 and 2014, 69 people were killed in 49 *fatal* WWD collisions on divided highways, and 346 people were injured in 237 *injury-only* WWD collisions. Given the recent increase in WWD fatalities and the historical problem, California agencies needed to assess the magnitude of the WWD problem in California and evaluate the efficacy of treatments and technologies with the potential to reduce the number of instances of wrong-way driving on state highways.

Baratian-Ghorghi et al. [9] examined statistical records from the National Transportation Safety Board's (NTSB) Fatality Analysis Reporting System (FARS) database for WWD fatal crashes in the USA. From this data, they were able to provide an overview of the general trend of WWD fatal crashes in the US, discuss general characteristics of WWD fatal crashes, and delineate contributing factors such as crash location, driver gender, age, and impairment. Baratian-Ghorghi et al.'s study, which examined data from 2004-2011, found an average of 269 fatal WWD crashes in the US, resulting in 359 deaths per year, and the data clearly indicated no decrease in the rate of WWD crashes or fatalities. Similar studies are available internationally, e.g. [11]–[13].

In a California Department of Transportation (Caltrans) report, Copelan [1] found that impaired drivers were involved in nearly 60% of *all* WWD collisions in California and nearly 77% of *fatal* WWD collisions. Other states show similar findings with respect to WWD and driver impairment [9]. Copelan's report provided several fairly low-technology methods to reduce WWD crashes [1]. Prior research by Caltrans indicated that simply lowering the mounting height for Wrong Way/Do Not Enter signs can reduce WWD incidents by as much as 90% [14]—a significant gain. According to the NTSB, Caltrans mandates more than twice the signs per interchange than required by the *Manual on Uniform Traffic Control Devices* (MUTCD) and requires lowered sign heights so that signs are placed in the headlights and direct line of vision of oncoming traffic [3].

The Florida Department of Transportation (DOT) and Florida State University used a driving simulator to assess the effectiveness of WWD countermeasures (Boot et al. 2015). The Texas DOT and Texas A&M Transportation Institute conducted a recent study of WWD countermeasures and mitigation methods, including closed-course studies on the effectiveness of countermeasures for alcohol-impaired drivers [2].

Concurrent with the research reported herein, Caltrans executed a pilot project in two of its districts to install enhancements on eight exit ramps (six in Sacramento, two in San Diego) to mitigate the problem of vehicles entering exit ramps [15]. Active monitoring systems capable of identifying wrong-way drivers, transmitting information to a central location such as a Transportation Management Center (TMC), and activating local flashing beacons were installed. Two active monitoring and alerting systems, Traffic & Parking Control Co., Inc. (TAPCO) and TraffiCalm, are currently being used in Caltrans' investigation [16]; TAPCO systems were part of the Sacramento enhanced mitigation package in the Caltrans pilot study, while TraffiCalm systems were used in San Diego. As additional mitigations on the mitigated ramps, existing white and yellow one-way retro-reflective pavement markers in the lane lines, channelizing lines, and gore areas were replaced by two-way white/red (W/R) and yellow/red (Y/R) markers.

As part of the preparation for the pilot study and the current research, Caltrans performed a preliminary investigation into the WWD issue [16]. This investigation included an overview of the most common wrong-way driver characteristics (69% DUI), the most problematic interchange type (partial cloverleaf), and research and reports by the NTSB [3] and the Arizona [17], [18]; Florida [19], [20]; Illinois [21], [22]; and Texas DOTs [2], [23]. All of these studies investigated signage and other prevention measures. Arizona, Florida, and Illinois also investigated detection technologies. The Arizona study included a useful set of vehicle driving patterns for controlled detector testing [17]. The NTSB report investigated driver impairment, traffic control devices, and highway design approaches to establish different views for motorists approaching on-

and exit ramps, monitoring and intervention programs, and in-vehicle driver support systems [3]. Cooner et al. [23] developed a set of guidelines and recommended practices for WWD countermeasures for use in Texas and elsewhere. Finley et al. [2] combined search of multiple databases with a heat map technique to identify WWD concentrations on Texas freeways. This study also included closed-course testing with deliberately alcohol-impaired drivers to determine where alcohol-impaired drivers look in the forward driving scene, provided insight into how alcohol-impaired drivers recognize and read signs, and assessed the conspicuity of select WWD countermeasures from the perspective of alcohol-impaired drivers. A Caltrans WWD study noted that impaired drivers on California freeways accounted for almost 60% of all WWD crashes and almost 77% of fatal WWD crashes from 1983 to 1987 [1]. Unlike many other crash categories, WWD collisions and fatalities are not declining [3].

During the course of this research, Caltrans issued a report to the California State Legislature [24]. This report discussed the trends with respect to wrong-way driving in California, some of the individual efforts by Caltrans and the California Highway Patrol (CHP) to reduce the frequency and impact of wrong-way driving, and collaborative efforts by Caltrans and the CHP, including a wrong-way driver working group initiated in 2015. The report also presents findings from a survey of traffic engineers in several states (Illinois, Maine, Michigan, Montana, Texas, and Washington) regarding current practices with the potential to reduce the number of instances of wrong-way driving on state highways.

Various experimental and commercial systems rely on radar for WWD detection [17]. Both Forthoffer et al. [25] and Matsumoto et al. [26] investigated vision-based detection of WWD; such an approach is central to the system used in the current research. Researchers in Auckland, New Zealand performed field trials of camera-based WWD detection [27]. Simpson and the Arizona DOT investigated the performance of a range of detection technologies, including (as they classify sensors) microwave sensors, Doppler radar, video imaging, thermal sensors, and magnetic sensors [17]; note that the first two items appear to be variations on microwave radar, and the report describes the specifics of each sensor class [17]. The study noted that each technology did exhibit some false alarms, but none of the systems were installed under the vendors' ideal conditions. The primary detection mechanism for the two commercial systems used in Caltrans' pilot study is radar, supplemented by camera(s) for documentation and manual verification.

Research Methodology

This final report describes a Vision-Based Site Monitoring (VBSM) system developed in this research by the Advanced Highway Maintenance and Construction Technology (AHMCT) Research Center to monitor traffic behavior at key exit ramps to detect and record WWD incidents. Data has been

collected by these VBSM systems over a 39-month period from June 5, 2016 through August 31, 2019 at ten exit ramps in Sacramento, California, and at two exit ramps in San Diego, California, as shown in Table 1.1. This includes the six Sacramento exit ramps and two San Diego exit ramps receiving mitigation and four additional Sacramento exit ramps that are monitored with no mitigation. Any commercial data received outside this period is not included in the analysis. This report discusses the details of the VBSM system design for optimized performance and the results and findings of the site monitoring data obtained from ten system installations. Data and results are provided that show the effectiveness of the VBSM system and the magnitude of the WWD problem in California, along with assessment of driver behavior. Note that this research addresses WWD resulting from erroneous entry via exit ramps; some WWD events stem from illegal U-turns or median crossings within the system, and this research does not address these event types.

The list of mitigated and unmitigated exit ramps is provided in Table 1.1. This table includes the approximate installation date for the VBDSM along with the installation date, if applicable, for additional mitigations.

The research answers several questions:

- What is the average, daily exit ramp traffic volume at regular collection intervals?
- For pre- and post-mitigation, how many wrong-way events are observed?
- When do most of the wrong-way events occur?
- What percentage of wrong-way drivers turn around and exit back down the same exit ramp?
- For any commercial wrong-way detection systems installed by Caltrans during this research, how well do these systems perform in terms of detection as well as successfully turning a wrong-way driver back?
- What are the observed causes of wrong-way events?

Table 1.1: Wrong-way driving monitoring exit ramp installations

Location	City	Mitigated?	Approx. Install	Mitigation Install
EB US 50 to 5 th St.	Sacramento	Yes	8/21/16	11/9/16
WB US 50 to South River Rd.	West Sacramento	Yes	6/8/16	11/9/16
WB US 50 to Jefferson Blvd.	West Sacramento	Yes	6/8/16	11/9/16
WB US 50 to 10 th St.	Sacramento	Yes	8/21/16	11/9/16
WB US 50 to 16 th St.	Sacramento	Yes	8/21/16	11/9/16
WB US 50 to 26 th St.	Sacramento	Yes	8/21/16	11/9/16
WB I-8 to Sunset Cliffs Blvd.	San Diego	Yes	12/13/17	1/23/18
SB I-5 to Sea World Dr.	San Diego	Yes	12/13/17	1/23/18
SB SR 51 to J St.	Sacramento	No	6/5/16	N/A
NB SR 51 to H St.	Sacramento	No	6/16/16	N/A
NB SR 51 to N St.	Sacramento	No	6/5/16	N/A
NB SR 51 to T St.	Sacramento	No	6/5/16	N/A

This report answers these questions and addresses the research project objectives based upon data collected from June 2016 through August 2019. The report is organized as follows: Chapter 2 provides the details of the VBSM system developed as part of this research; Chapter 3 documents system optimizations for power usage and performance; Chapter 4 presents the site monitoring results using the VBSM system; and Chapter 5 presents the conclusions of this report.

Chapter 2:

Vision-Based Site Monitoring System

There are several detection technologies that are well suited for detecting WWD and providing alerts of WWD events. These include microwave radar, magnetometers, etc. However, none of these technologies can answer the bulk of the questions noted at the end of Chapter 1, i.e. the key focus of this research. Vision-based information processing and analytics for WWD detection have advanced to the point where it is feasible to use in-camera analytics for WWD detection and the triggering of video recording for each WWD event. The goals of detecting WWD events in this research included capturing driver behavior leading up to the WWD event—including the direction the driver came from prior to the event—thus a video-based system was ideal. A VBSM system was therefore developed for this work.

In developing the VBSM system, one objective was to maximize the use of commercial off-the-shelf (COTS) hardware and software in order to maximize its potential future use by Caltrans and other DOTs. With the minor exception of site-specific mounting hardware and a small amount of custom scripting/glue software, this goal was completely achieved. In addition, the system had to be rugged in order to survive deployment in the field for the duration of the research study. All components were selected with this in mind. However, some components did need replacement in the field as discussed in the reliability section of Chapter 3. The system block diagram is provided in Figure 2.1. The system component details are shown in Figure 2.2. An example system installation is shown in Figure 2.3.

The VBSM system consists of four main components: the camera, the software analytics, the power supply, and the communication equipment. Each component is described in the following sections.

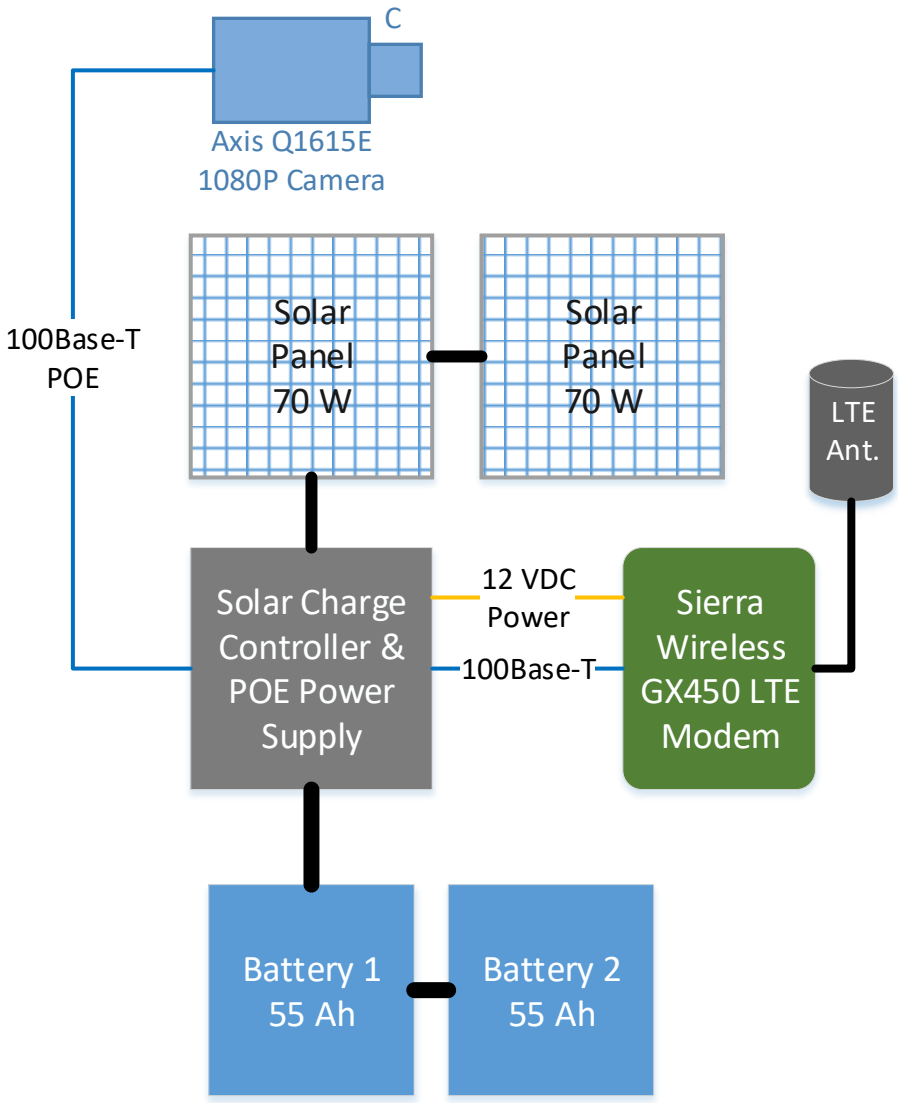

Figure 2.1: The WWD VBSM system block diagram

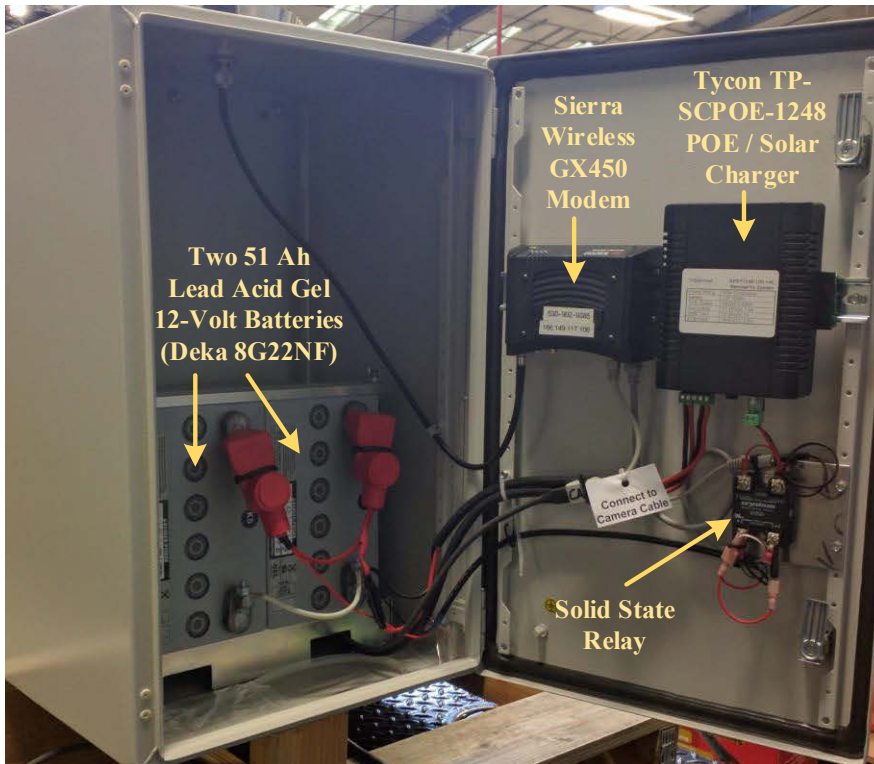
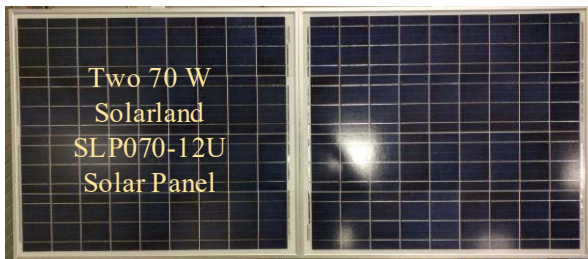
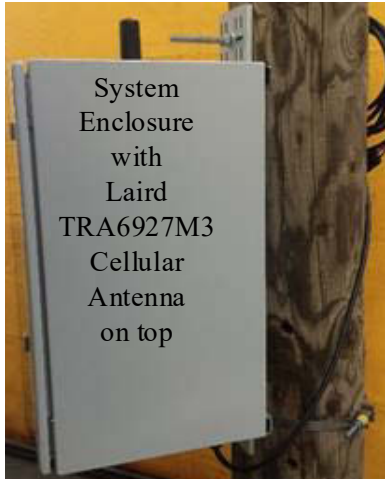

Figure 2.2: The WWD VBSM system component details

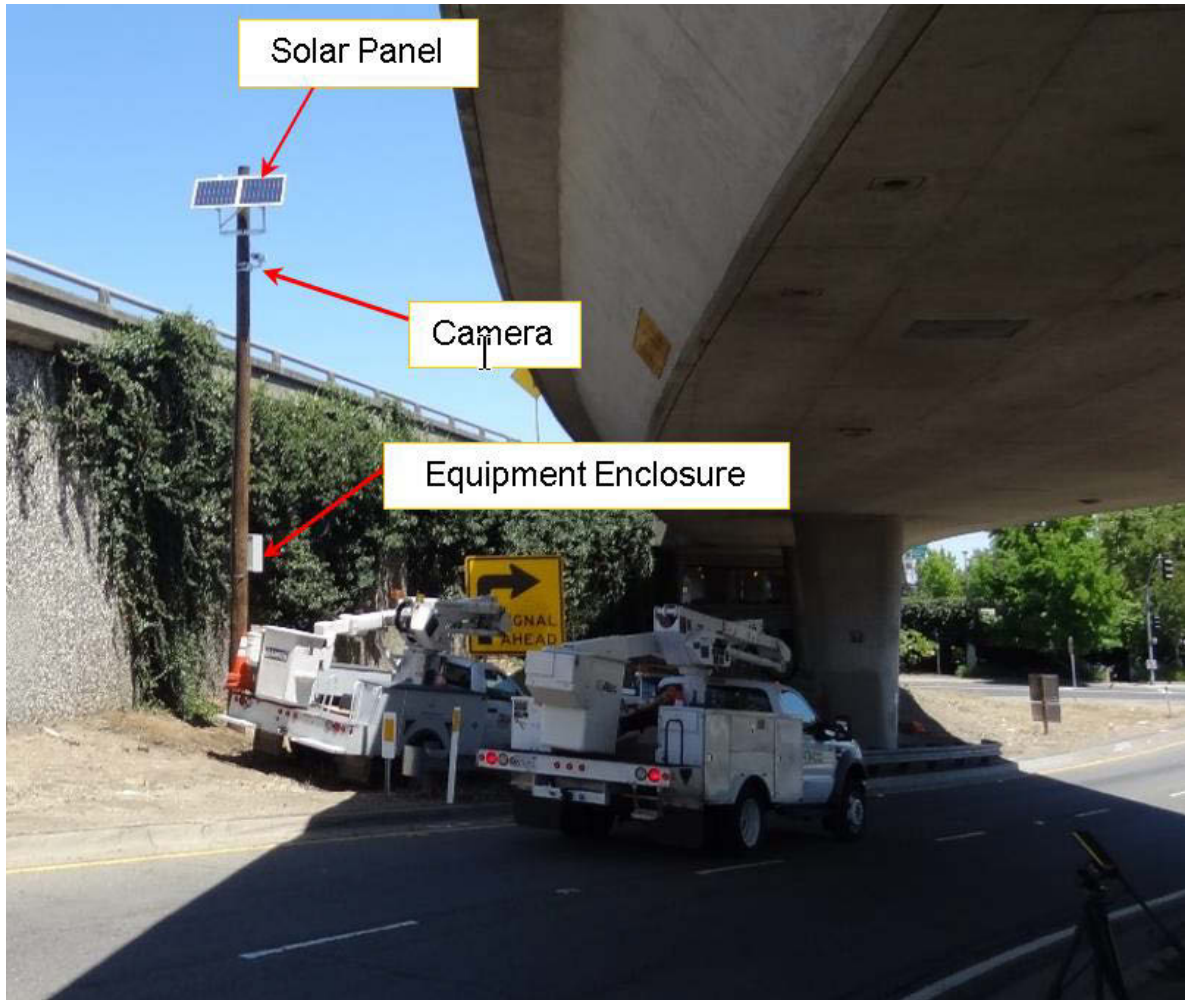

Figure 2.3: The WWD VBSM system installed at an exit ramp

Camera

Several cameras were evaluated. Key criteria included sufficient resolution, low-light video capture performance, ruggedization, and ability to run analytics directly on the camera. The final choice was the Axis Q1615-E network camera. This outdoor-ready camera has Ingress Protection 66 (IP66) and is National Electrical Manufacturers Association (NEMA) 4X rated, with an operating range from -40 °F to 140 °F. The camera provides high-definition television (HDTV) resolution video (1080p, 1920x1080) at up to 60 frames per second (FPS), and 30 fps in Wide Dynamic Range mode. It has a wide dynamic range and an automatically removable infrared-cut filter for improved night and low lighting operation. It has built-in H.264 video compression. Its built-in processor can support on-board analytics for WWD detection and traffic volume counter, along with numerous protocols and security features. A SanDisk high-endurance 64 GB microSD (Secure Digital) card was added to each Axis Q1615-E network camera to enable local storage for video recording files. These key features,

along with its use in existing Caltrans operations, made the Axis camera an excellent choice as the primary sensor for the VBSM.

Analytics

A few COTS analytics software packages were considered. The final choice was from the French company Citilog (now a subsidiary of Axis Communications), based on a combination of capabilities, cost, and support. This software, which runs directly on the Axis camera's CPU, includes multiple modules. The wrong-way vehicle module allows the user to configure the system for multiple detection zones (see Figure 2.4 for example), e.g. each lane of an exit ramp, and uses optical flow to detect vehicles (or any sufficiently large object) moving against the normal traffic direction. The Citilog software also contains a traffic count module, which was also used for this research.

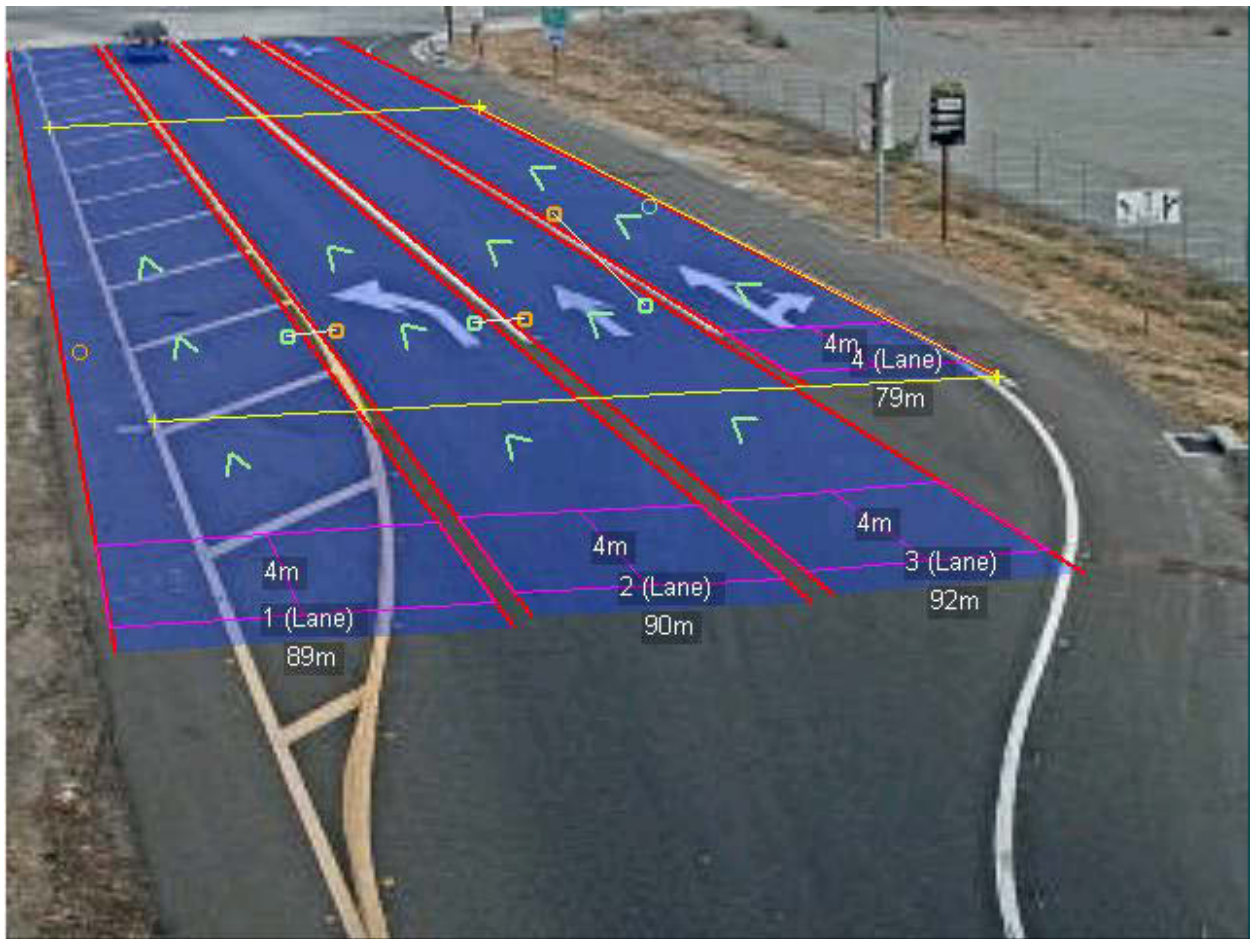

Figure 2.4: Multiple WWD detection zones as configured for US 50 WB South River Road exit ramp

Power Supply

Since continuous AC power infrastructure was not available at any of the installation sites, solar power including battery backup was selected to power the VBSM. Several commercial systems were evaluated. The final selection was a Tycon Systems RemotePRO 35 W solar power system. The Tycon system is an integrated system that includes two 70-W solar panels, 48 V 32 W Power-Over-Ethernet (PoE) power supply with integrated solar charge controller, two 51 A-hr lead acid gel batteries, and an electronics enclosure. All VBSM system electronics were placed in the enclosure with the exception of the solar panels, the modem antenna, and the camera.

Communications

Communications to the VBSM systems was needed for configuring, monitoring, and resetting cameras as well as updating software and firmware. In addition, outbound communication from the VBSM systems was required to transmit video clips back to the researchers' server. There was no existing communications landline network, e.g. fiber or direct subscriber line (DSL), at the selected monitoring sites. Long-Term Evolution (LTE) cellular was selected as a cost-effective solution for meeting the system's communication requirements. The VBSM systems were equipped with a Sierra Wireless modem (AirLink GX450) provisioned with Verizon service to provide an LTE communication link. Moreover, the AirLink GX450 modem measures the battery voltage and sends data (battery voltage and device temperature) to the researchers' server for continuous system health monitoring and remote diagnostics. AirLink GX450 modem has a digital input/output port that is connected to a Solid-State Relay (SSR) to enable a remote power connect and disconnect to the camera.

Chapter 3:

System Optimization

There were several key constraints on this system. First, only cellular communications were available to interact with and control the systems and more importantly, to transmit video to the researchers' server. The per-system LTE cellular data plan is 5 GB per month with higher cost rates for usage over 5 GB per month. In addition, optimization was needed due to limited power from the solar panels. These constraints made the implementation much more challenging than simply deploying the COTS hardware, leading to several tradeoffs and component-level design and optimization issues as discussed in the remainder of this chapter.

Video Quality Optimization

The maximum image resolution for the Q1615-E is 1920x1080 at 30 FPS in Wide Dynamic Range (WDR) mode. The camera's native internal analytics use Common Interchange Format (CIF) 352x240 resolution to enable rapid processing. If CIF resolution were used for transmission, even with the below noted manual download approach, the monthly cellular data allotment would be quickly consumed, and costs to the DOT for data transmission above that amount would be prohibitively expensive. One of the lower resolution options provided by the camera was deemed sufficient for research purposes. In addition to the footage recorded at the above resolution for any detected incident, the camera also recorded a lower resolution and shorter "thumbnail" video clip; use of this thumbnail is discussed below.

The video properties for the two clips are provided in Table 3.1. Both use H.264 encoding with compression. Event recordings start 30 seconds before the event trigger and end 2.5 minutes after the event trigger. The camera buffers a sufficient duration of preceding video for review by the researchers. The times for the research clip provide sufficient footage to see the WWD vehicle entry point, direction, and behavior through the event itself and to the point of possible recovery from the WWD. The times for the thumbnail clip provide sufficient footage to determine whether the research clip should be downloaded. All video clips were stored locally on the camera's internal microSD chip.

Table 3.1: Video properties for research and thumbnail clips

	Research Clip	Thumbnail Clip
Resolution	800x600	320x240
Rate (FPS)	15	15
Start (sec)	-30	-10
End (sec)	150	10

Imaging Direction Optimal Setting

The camera analytics vendor Citilog states that the optimal configuration for their algorithm is when the camera is mounted at approximately 30 feet above ground located close to the intersection of the exit ramp and the corresponding street with the camera pointed back up the exit ramp, because a vehicle driving the wrong way would enter the field of view (FOV) close to the camera and occupy a larger number of pixels. Thus, it would be easiest for the algorithm to acquire and track this image over the established mask. In the alternative configuration, i.e. camera located further up the exit ramp and pointing towards the intersection, the wrong-way vehicle starts with a relatively small number of pixels and is thus harder to acquire and track.

However, a key component of our research was viewing vehicles as they entered the exit ramp in order to ascertain direction and manner of entry as well as the possible reason for wrong-way entry. Such data is important to assess driver behaviors and understand the effects of roadway design on such behaviors. As such, the alternative configuration pointing towards the intersection was used whenever exit ramp configuration allowed it. We tested this configuration under controlled conditions and found it to be quite effective. For a small number of exit ramps, it was not possible to use this configuration, typically due to length limitation or safety constraints; in these cases, we used the vendor's recommended configuration and omitted the view of the intersection. A two-camera configuration was developed and validated for use in such situations to support imaging of the intersection; after a project panel discussion, this configuration was not deployed in the field due to cost considerations. The two imaging direction installations are shown in Figure 3.1.

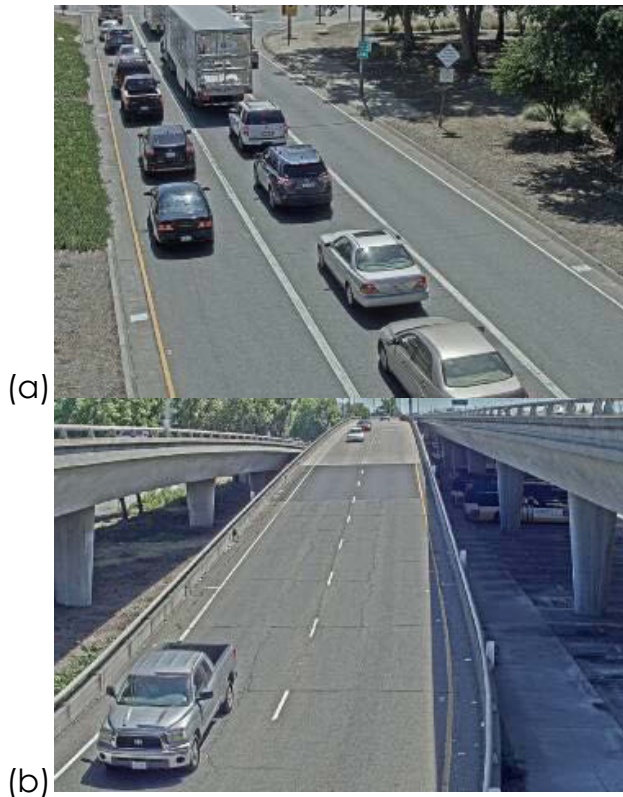

Figure 3.1: Exit ramp FOV for (a) Desired imaging direction towards intersection and (b) Sub-optimal imaging direction up the exit ramp

Automatic or Manual Notification and Download Settings

The purpose of the VBSM system in this research was to assess the magnitude of the WWD problem and understand driver behaviors so that countermeasures can be developed to improve roadway safety in a more holistic manner. The purpose was not to detect WWD events and alert the DOT or any other agency (although this capability can be added to the system). Based on this early decision, the VBSM was designed to be overly sensitive to WWD-like triggers, allowing for researcher assessment following any triggered collection. Because of this overly sensitive design, alerting was deliberately omitted.

For each detected WWD event, the system recorded a full resolution clip (800x600) and a thumbnail clip (320x240) onto the internal microSD card installed in the camera. At regular intervals, the researchers logged into the camera and grabbed the thumbnail videos for the new events; this required minimal LTE data bandwidth consumption. The thumbnail video clips were viewed to determine relevance to the WWD research questions. For those that were relevant, the researchers downloaded the full resolution videos for

subsequent detailed analysis and storage on our server. Video clips were then purged from the camera when they were no longer needed.

Software Customizations

The COTS WWD and traffic analytics were customized to optimize event detection and minimize LTE data usage. Numerous internal parameters were tuned for the WWD analytics. This tuning was done cooperatively between the researchers and Citilog. As the exact physical meaning of many of the parameters is uncertain to the researchers, these details are omitted. This tuning led to enhanced WWD event detection.

To control LTE data usage, the researchers had to make a significant revision to the COTS ecosystem. Citilog's architecture includes a centralized server called MediaServer. This software is designed to be used in a Transportation Management Center (TMC) where it is essential to have continuous access to video from the field cameras. In this scenario, landline communications infrastructure is used with a corresponding lower data usage cost. For the current research, it was essential to limit data usage in order to cap data usage costs. During the initial system testing phase, the researchers realized that the cameras were automatically uploading captured videos to the Citilog MediaServer software continuously, exceeding the 5 GB data limit in one day. Researchers were unable to disable this function through configuration changes. The MediaServer software played an important role in configuring and communicating with the cameras. To resolve this, the researchers had to re-implement these key configuration and communication capabilities without the use of Citilog MediaServer software.

Solar Power

The solar power system was optimized specifically to maximize winter daily power output rather than total annual power. In the test areas, ample solar power is available in spring through fall, but winter solar power is limited due to reduced daylight due to rain, fog, overcast skies, etc. All systems were aimed with azimuth 180° (south). The Sacramento installations were aimed at 60° from the horizon based on latitude 38.5°, while the San Diego panels were angled at 45° based on latitude 32.5°. The battery backup was estimated to require two lead acid 51 A-Hr gel batteries based on assumed winter conditions. This estimate proved low in the winter of 2016-2017 for Sacramento. An additional lead acid 51 A-Hr gel battery was added to some monitoring sites. The camera was remotely turned off during daylight hours if a storm or overcast skies were forecasted to last over a few days. To maximize solar power at some locations or to clear the camera's FOV, surrounding trees were trimmed in several locations. Solar panel power output assuming 10% system losses is shown in Figure 3.4.



Figure 3.2: Example of tree trimming required to provide better camera FOV (US 50 WB 10th St exit)



US 50 WB 10th St exit before tree trimming

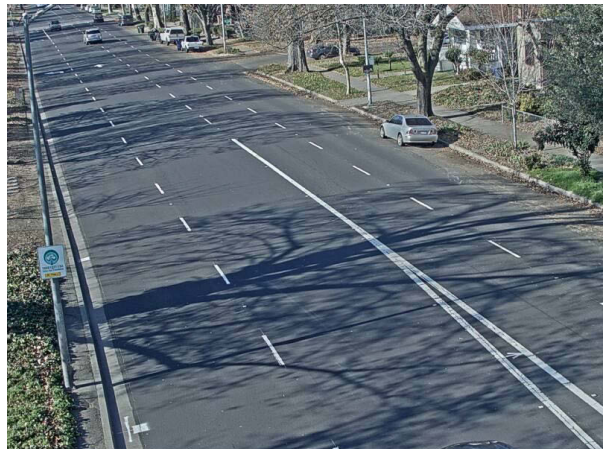

US 50 WB 10th St exit after tree trimming
(12/21/2016)

Figure 3.3: US 50 WB 10th St camera view before and after tree trimming

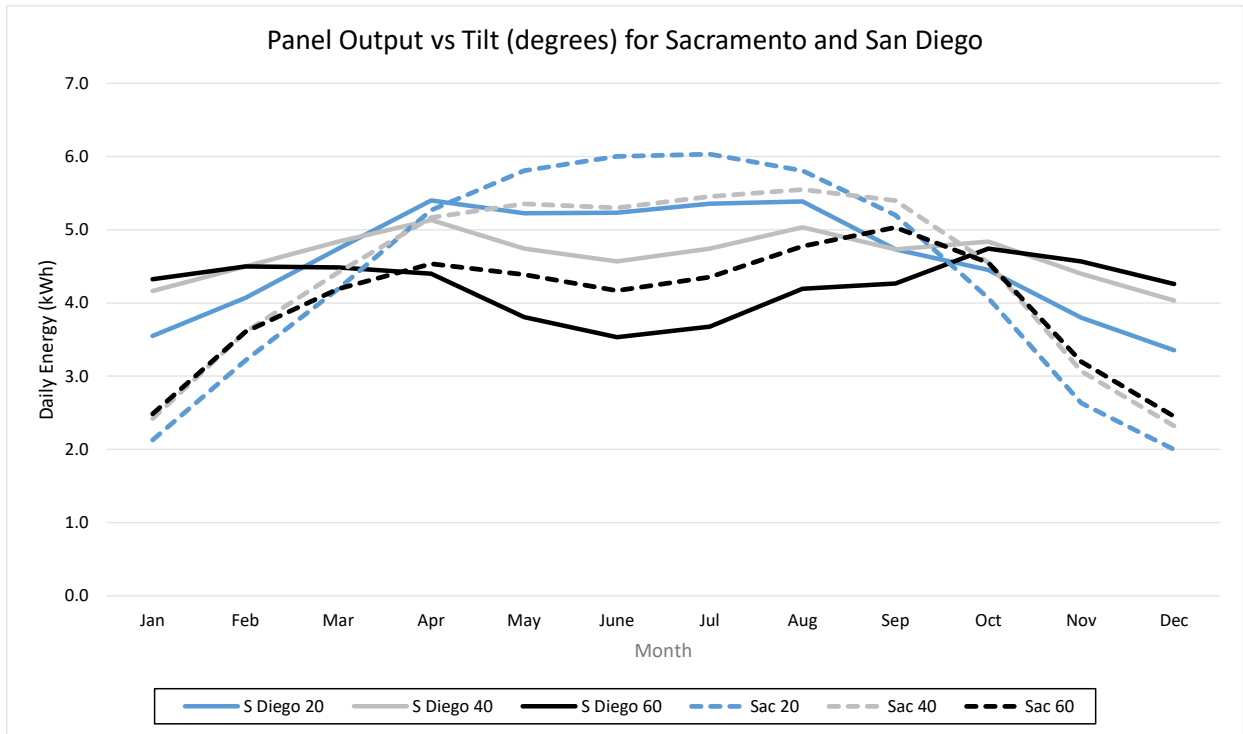

Figure 3.4: Solar panel output per day over the full year for various panel tilt angles from horizontal for Sacramento and San Diego, California¹

To allow remote diagnostics, we added automatic reporting and web-based viewing of several system operating parameters, including battery voltage and device temperature on the camera motherboard, camera image sensor, and LTE modem. This was very useful for assessing solar power sufficiency, solar charge controller health, and battery condition. It was also crucial in troubleshooting one system where the camera was automatically shutting down. In this instance, the researchers determined that one of the system batteries was failing and needed replacement. The data illustrating this is provided in Figure 3.5.

¹National Renewable Energy Laboratory (NREL) (<http://pvwatts.nrel.gov/pvwatts.php>)

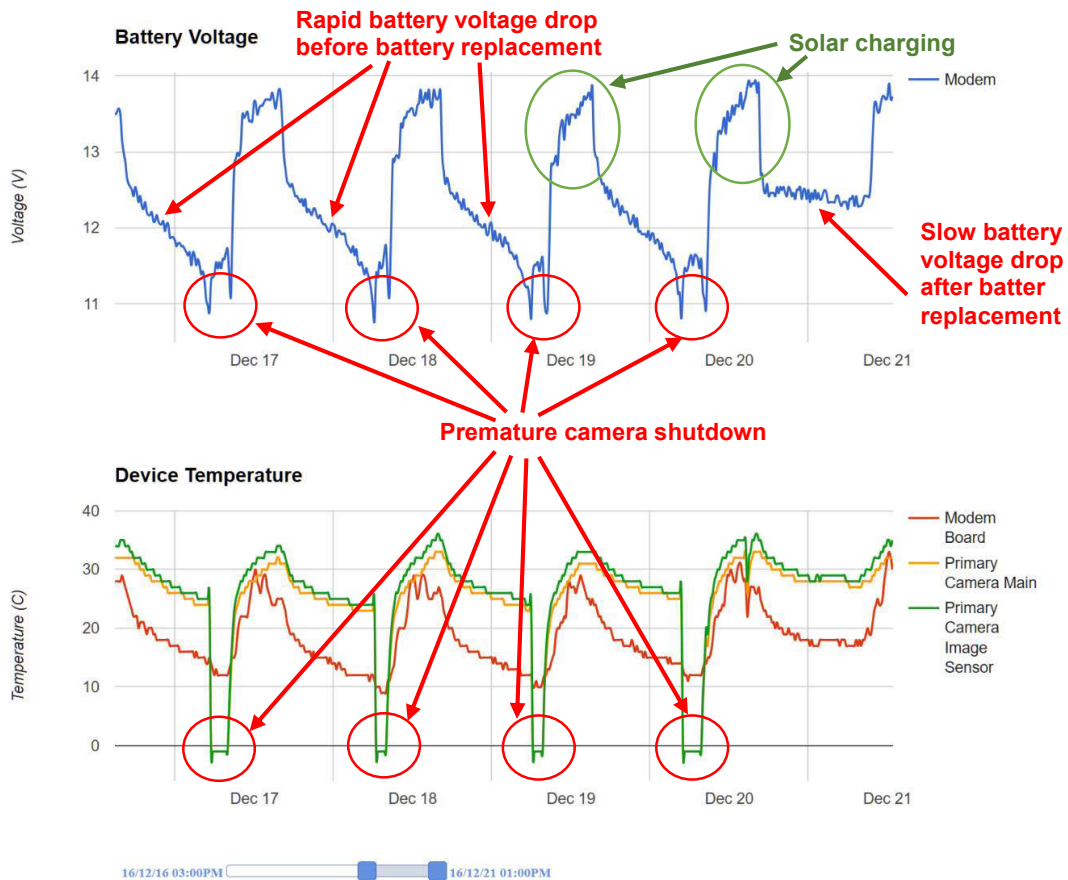

Figure 3.5: Battery voltage and device (camera motherboard, camera image sensor, and LTE modem) temperature showing camera shutdown due to degraded system battery

Mounting

There are tradeoffs for installation time, safety requirements, installation of attenuators, and system maintenance, including road closures and cost of poles used for the VBSM system installations. The main consideration was the use of metal poles versus wooden utility poles. Metal poles are preferred since they are subject to less distortion due to weather and moisture; however, they have higher unit and installation costs. Attenuators were not used in any of the installation sites in this research.

Wooden poles were used due to their lower hardware and installation costs. The poles were 40 ft tall; 10 ft buried below ground and 30 ft above ground. The wooden poles introduced substantial, unanticipated operational and maintenance problems. The poles slowly twist by a significant amount, likely due

to wood grain twist and drying over the season. Fixed camera aim and FOV is essential for the proper and reliable operation of the WWD analytics.

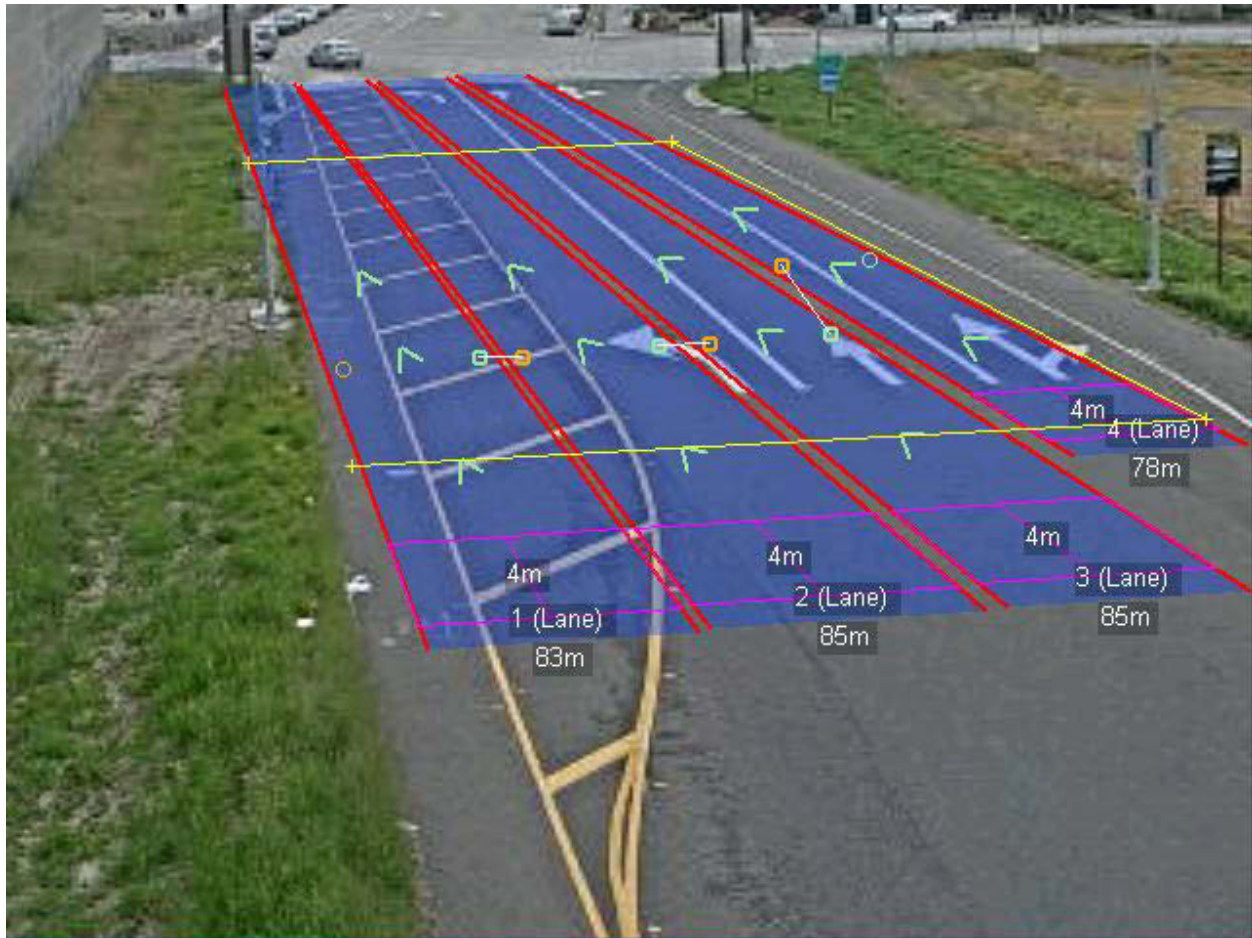

Figure 3.6: Effect of pole twist on one WWD monitoring installations' lane masks. US 50 WB South River Road exit ramp. Note the significant discrepancy between mask lines and actual lane lines. These were aligned at the time of camera installation.

Because of the twist, first, the lane masks had to be updated frequently to properly observe vehicles in each lane, as illustrated in Figure 3.6. Second, and more importantly, as the pole twist increased, the camera FOV moved far enough that key regions of the lanes of interest moved out of the camera FOV. At this point, a maintenance crew needed to go into the field, establish a lane or full ramp closure, and re-aim the camera with the assistance of a researcher. This maintenance was costly and time-consuming and increased exposure of the workers to traffic. If budget, safety, and other constraints allow, the researchers recommend avoiding the use of wooden poles for this type of installation. The effect of pole twist on one installation's FOV is shown in Figure 3.7. Alternatively, more expensive cameras with a built-in pan tilt motor can be employed, which would enable researchers to have the ability to re-aim

the camera remotely. However, this option increases continuous operating labor cost for constant camera aim adjustment and reconfiguration of the WWD analytics software.



Figure 3.7: Effect of pole twist on the US 50 WB South River Road exit ramp WWD monitoring installation. (a) Camera FOV immediately after installation. (b) Camera FOV three months after installation.

It is well known in the timber industry that trees generally have a distinct twist pattern to their grain, either left-hand (LH) or right-hand (RH) [28]. LH trees are typically LH from the tree's core to the surface. RH trees are LH at the core, go through a straight transition region, and end up RH at and near the surface. Poles and logs made from trees will twist in the direction of their grain as they dry. LH poles will twist much more (up to 40° over five years in one experiment) than RH poles (RH poles twisted up to 15° in five years). RH poles twist less due to the mixed LH and RH grain patterns counteracting each other. All of our installations either remained stable or twisted to the right, indicative of RH poles.

One speculation is that pole manufacturers are quite aware of this issue and select RH poles for reduced twist and other advantageous properties.

Reliability

VBSM component reliability is vital for future deployment by Caltrans. Travel and labor to perform field repairs can be costly, particularly for the two systems deployed in San Diego. Due to the rapid deployment of the VBSM system requirement, VBSM components were selected and procured without sufficient time for component testing and reliability assessment. The researchers were comfortable with Axis camera and Sierra Wireless modem reliability from previous working experience. There were component failures and replacements through the more than three years of the research data collection period.

Axis Q1615-E Camera

One Axis Q1615-E camera had internal failure which eliminated the built-in infrared (IR) filter causing a red tone in the image and video as shown in Figure 3.8. The failure occurred right after the field installation. The camera was repaired under warranty.



Figure 3.8: Illustration of the IR filter failure. The left image was taken before the camera replacement. The right image was taken after the camera replacement.

Two Axis Q1615-E cameras were replaced due to their intermittent availability. Both cameras were unreliable in providing telemetry data, including occasional WWD analytics service disruption. Rebooting the camera would temporarily resolve the problem, and normal operation would resume for a period of time. However, both cameras would exhibit similar subsequent erratic behavior. Regular monitoring on these two cameras to ensure continuous operation and availability was time consuming. The best option was replacement with spare cameras to ensure reliable WWD detection services.

Sierra Wireless GX450 modem

The GX450 modem hardware was reliable. One GX450 modem failed to make an LTE connection. The problem was fixed by taking the Subscriber Identification Module (SIM) card out and re-inserting it back into the GX450 SIM card slot. Occasionally, some modem connections were slow, but the modem connections resumed normal speed after the modem was remotely rebooted. To ensure reliable LTE connections, all GX450 modems were set to reboot automatically every day. The modem reboot does not affect camera operation.

Deka Gel-8G22NF 51 A-Hr lead acid battery

Lead acid batteries require replacement at regular intervals. Lead acid battery energy storage capacity degrades over time due to operating temperature, number of charge and discharge cycles, and state of discharge in each charge/discharge cycle. Battery replacement was governed by a data-driven process using the battery voltage measurement collected remotely every 15 minutes. Batteries were replaced based on the analysis of the voltage measurements throughout the charging and discharging cycles. In addition, based on power consumption and solar power availability in winter months, an extra battery was added to some systems to support longer uninterrupted operation. Poor battery health/capacity is generally exhibited during the winter season when there is less solar energy per day and more cloudy days.

The batteries taken out of the field installation were tested in the laboratory to evaluate their remaining energy storage capacity in order to estimate the battery degradation of other batteries in the field. Consequently, the researchers could estimate the number of batteries that would require replacement before the end of the research project.

Solar Charge Controller

Six Tycon TP-SCPOE-1248 POE and Solar Battery Charging Controllers failed during the research duration of over 2.5 years. The TP-SCPOE-1248 provides 48 Volts POE to the camera and the solar battery charging function. All six failures were limited to the solar battery charging function. A total of 17 TP-SCPOE-1248 were deployed with six failures (35%). While the number of systems is low and does not represent a statistically significant sample, this is an egregious failure rate. The researchers are seeking a more reliable solar battery charger replacement.

A Maximum Power Point Tracking (MPPT) Blue solar charger with data logging from Victron Energy was installed in the VBSM system at the US 50 South River Road exit ramp and the laboratory VBSM system for evaluation. In theory, the MPPT solar charger would increase solar power output to the system batteries

and may increase VBSM system availability during the winter season. The three Victron MPPT solar chargers were installed in the field with no failures to date, and they performed well, particularly in cloudy winter conditions. The data logging feature and smartphone app—which provides real-time solar power output, battery voltage, and charging current—were useful in system diagnostics. Future system improvement would include streaming the real-time solar charging measurements over the LTE modem to the researchers' server for data logging. A total of ten Victron MPPT solar chargers were purchased as spares. The MPPT chargers were installed whenever any system field repair was performed.

Chapter 4:

Site Monitoring Results

The site monitoring results reported herein cover a 39-month period from June 5, 2016 (the date of the first site installation in Sacramento in Caltrans District 3) through August 31, 2019. Any data received outside this period is not included in the analysis. As shown in Table 1.1, the Sacramento site installations occurred from June 5, 2016 through August 21, 2016, i.e. over nearly three months, so the duration of monitoring varies a small amount by site. Both installations in San Diego were completed on December 13, 2017, resulting in a shorter monitoring duration, which may partly explain the low number of detections for these sites. Figures 4.1-4.3 provide a view of the twelve exit ramps subject to WWD monitoring. Figure 4.1 presents the Sacramento area mitigated exit ramps. Figure 4.2 presents the Sacramento area non-mitigated exit ramps. Figure 4.3 presents the San Diego area mitigated exit ramps.



US 50 WB South River Rd exit ramp



US 50 WB Jefferson Blvd exit ramp



US 50 EB 5th St exit ramp



US 50 WB 10th St exit ramp



US 50 WB 16th St exit ramp



US 50 WB 26th St exit ramp

Figure 4.1: Camera view of the six mitigated Sacramento area exit ramps subject to WWD monitoring



Figure 4.2: Camera view of the four non-mitigated Sacramento area exit ramps subject to WWD monitoring

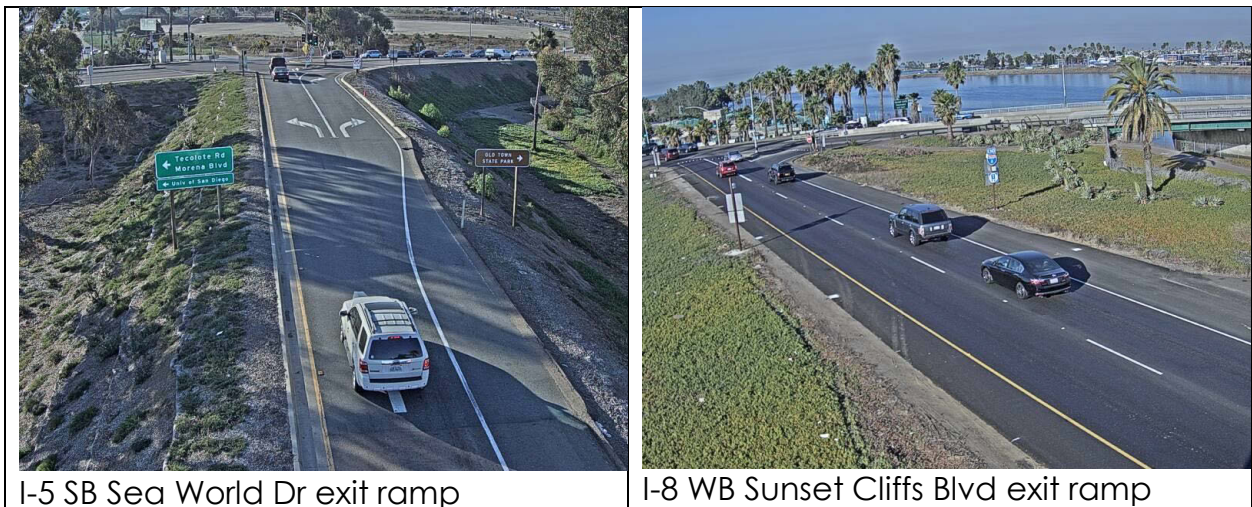

Figure 4.3: Camera view of the two mitigated San Diego area exit ramps subject to WWD monitoring

510 events were logged at the twelve sites in the research period. These events are classified and analyzed below. Some of these 510 events could legitimately be classified as WWD events but would not be of interest to Caltrans. For example, 327 events were recorded of bicyclists riding up exit ramps, which is, by California Department of Motor Vehicles (DMV) definition, a vehicle going up the exit ramp in the wrong direction. These incidents are omitted from the analysis, except where explicitly indicated. As noted earlier, the system was deliberately tuned to be highly sensitive to the point of false detections. The intention was to capture any potentially relevant event and use researcher review to determine actual relevance. Other irrelevant captured events include:

- Maintenance vehicles moving up the exit ramp.
- Pedestrians walking up the exit ramp.
- Tow trucks backing up the exit ramp to provide assistance to disabled vehicles.
- Vehicles backing up the exit ramp to change lanes.
- Passenger vehicles deliberately entering the exit ramp to assist other vehicles.
- Road rage, incident discussed in Appendix A.
- A crow flying onto the camera.

As an indication of the deliberate sensitivity of the system, of the 510 events, 476 events by their nature should not have been reported in real time, or approximately 93%. To reiterate, the system was designed to identify not only urgent wrong-way driving events but also any event that included objects above a threshold that were moving in the direction opposite to traffic.

Exit Ramp Traffic Count Data

The camera analytics provide traffic count data. Traffic count data vs. time of day for weekdays and weekends are provided in Figures 4.4-4.15. Counts for each exit ramp are separated into weekday and weekend periods as there are generally distinct differences in both traffic volume and patterns over a 24-hour period. Day of week is also an important consideration for WWD events. Traffic data must be interpreted carefully with respect to WWD as the correlation between different circumstances and effects is uncertain. The researchers speculate that for a given exit ramp, the likelihood of a WWD event is higher during the hours when the traffic volume is lower. This matches with the literature, e.g. [29] which found that wrong-way movements tended to originate from points with low land-use density and in places and times with low traffic volume.

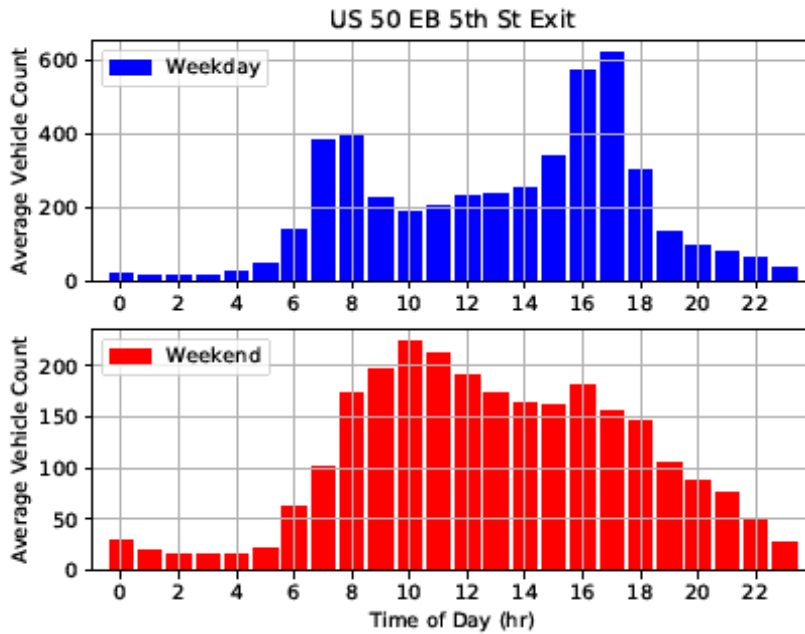

Figure 4.4: Traffic count as determined from camera analytics for eastbound (EB) US 50 to 5th Street exit ramp in Sacramento

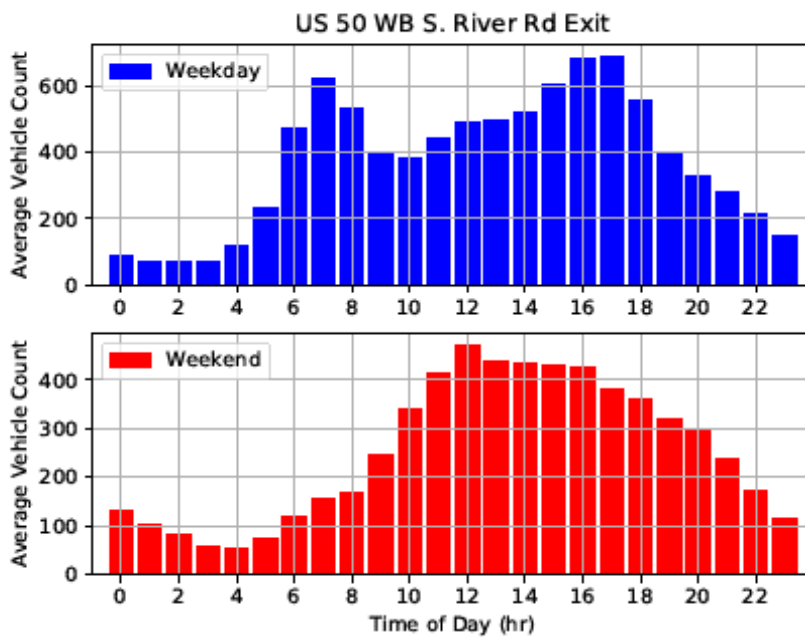

Figure 4.5: Traffic count as determined from camera analytics for westbound (WB) US 50 to South River Road exit ramp in West Sacramento

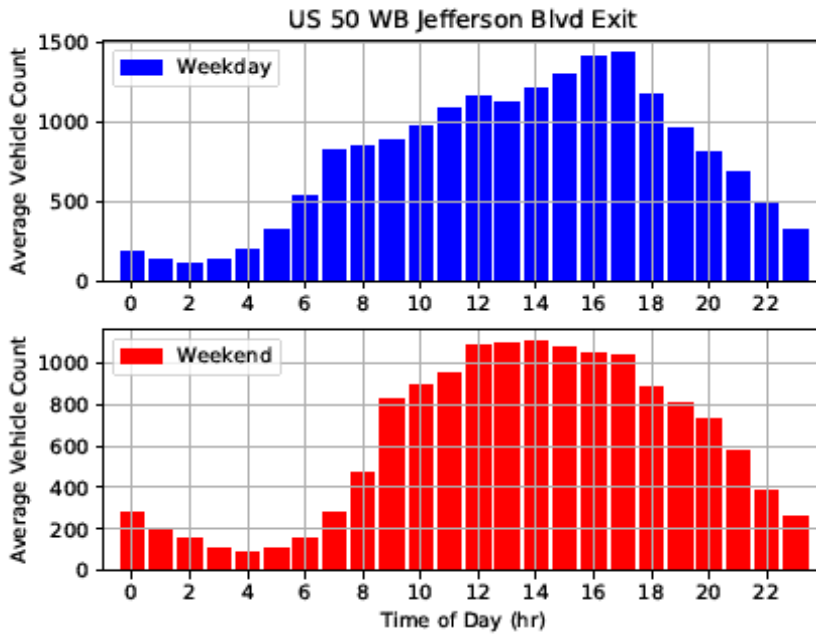

Figure 4.6: Traffic count as determined from camera analytics for WB US 50 to Jefferson Boulevard exit ramp in West Sacramento

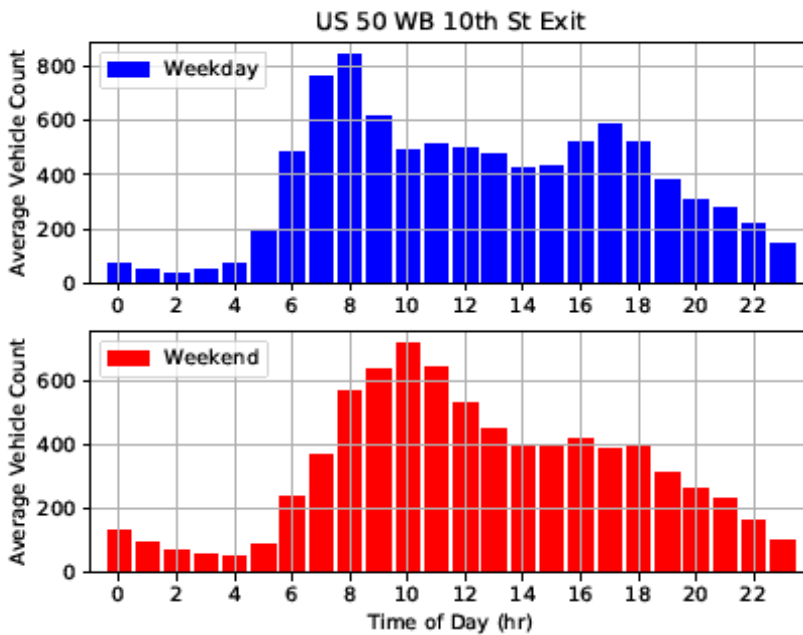

Figure 4.7: Traffic count as determined from camera analytics for WB US 50 to 10th Street exit ramp in Sacramento

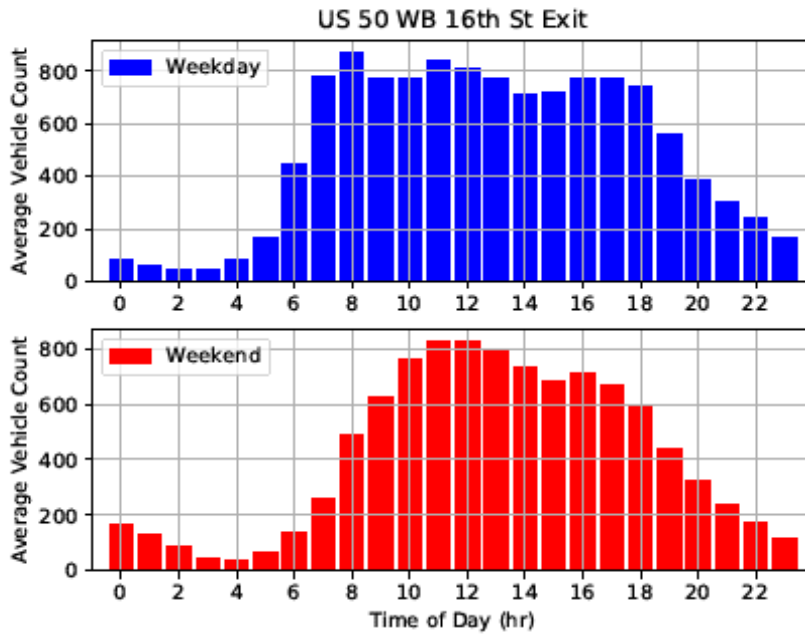

Figure 4.8: Traffic count as determined from camera analytics for WB US 50 to 16th Street exit ramp in Sacramento

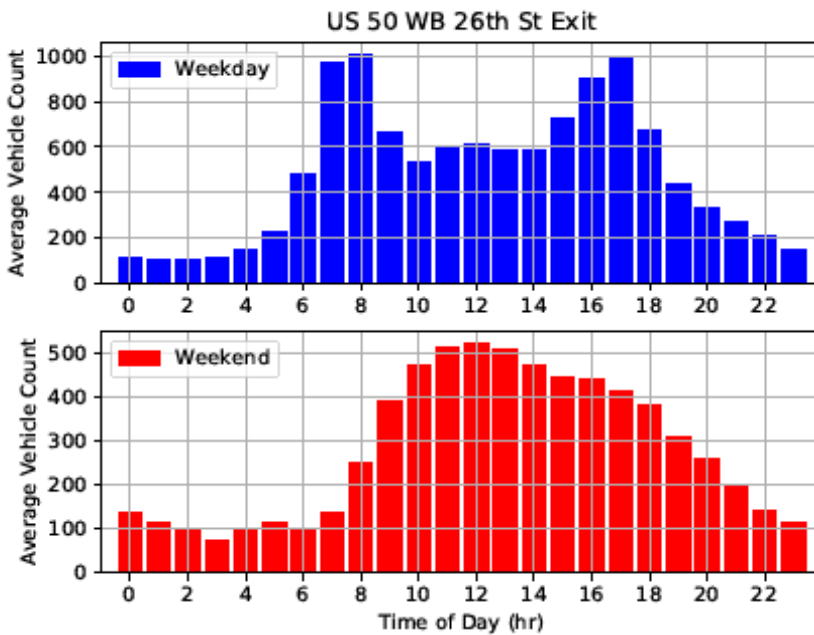

Figure 4.9: Traffic count as determined from camera analytics for WB US 50 to 26th Street exit ramp in Sacramento

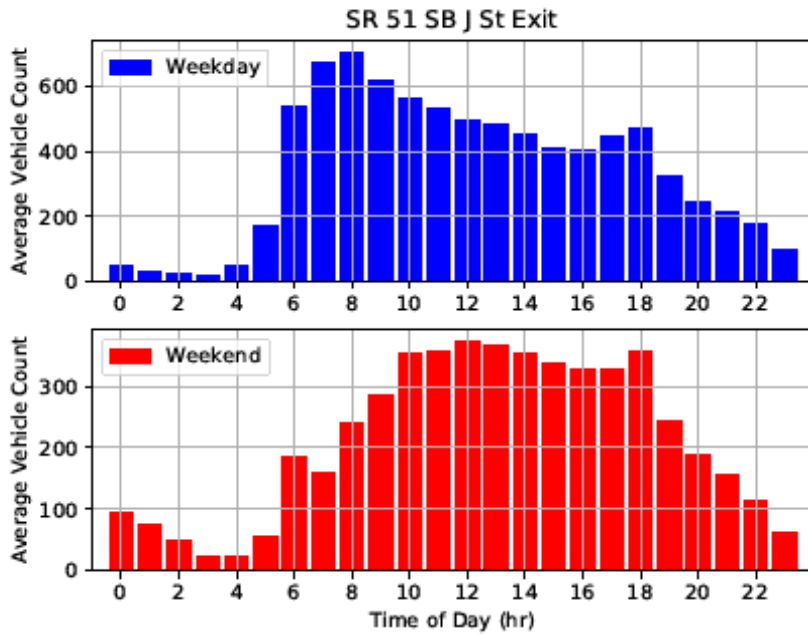

Figure 4.10: Traffic count as determined from camera analytics for southbound (SB) State Route (SR) 51 to J Street exit ramp in Sacramento

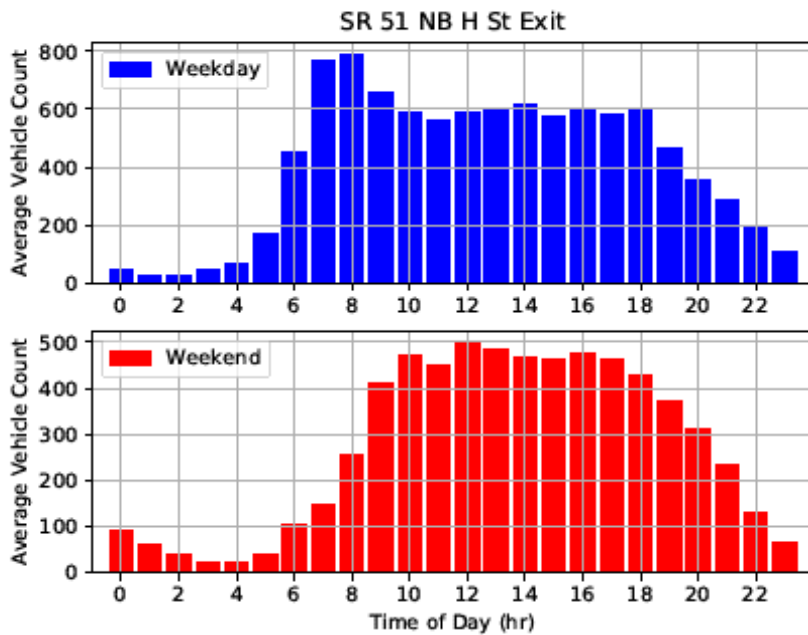

Figure 4.11: Traffic count as determined from camera analytics for northbound (NB) SR 51 to H Street exit ramp in Sacramento

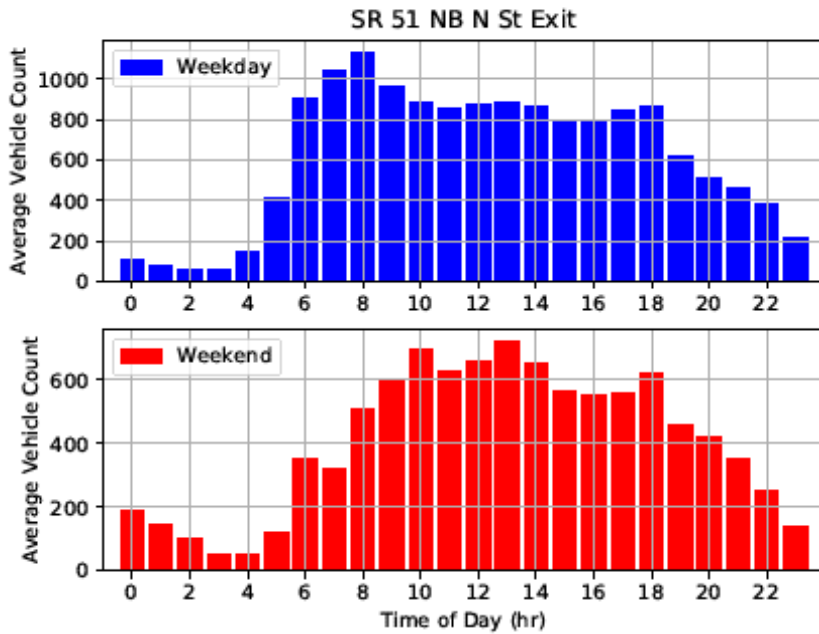

Figure 4.12: Traffic count as determined from camera analytics for NB SR 51 to N Street exit ramp in Sacramento

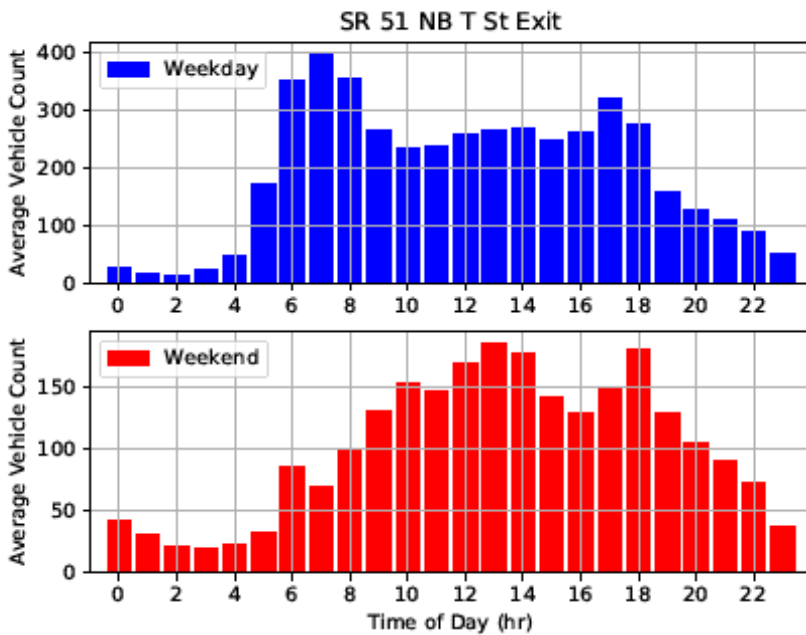

Figure 4.13: Traffic count as determined from camera analytics for NB SR 51 to T Street exit ramp in Sacramento

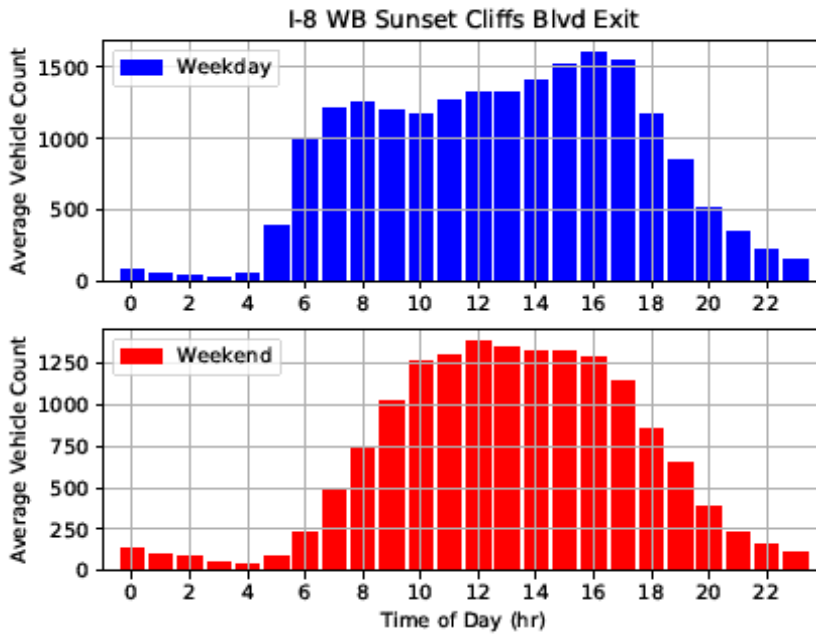

Figure 4.14: Traffic count as determined from camera analytics for WB I-8 to Sunset Cliffs Boulevard exit ramp in San Diego

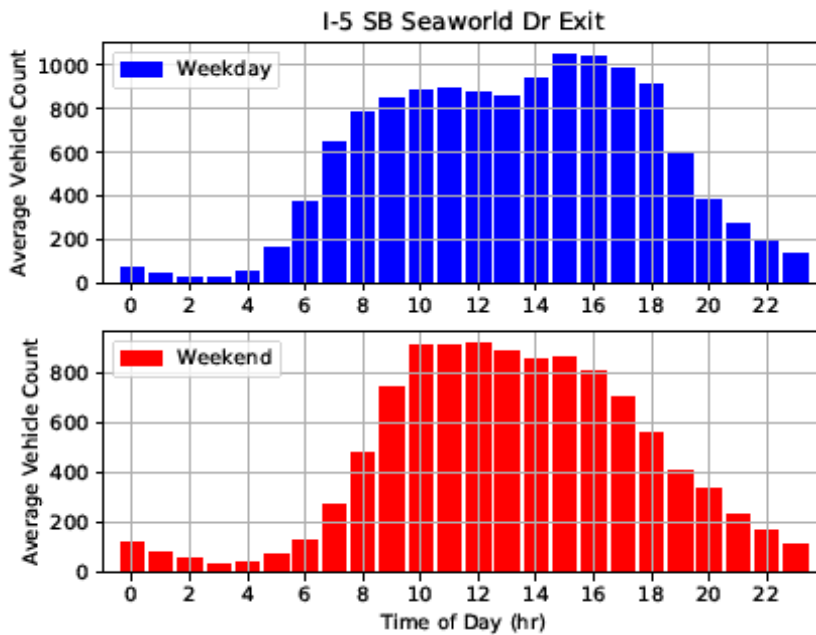

Figure 4.15: Traffic count as determined from camera analytics for SB I-5 to Sea World Drive exit ramp in San Diego

WWD Event Classification

The WWD events to date are summarized in Table 4.1. In the 39-month evaluation period from June 5, 2016 through August 31, 2019, 34 WWD events are of most interest to Caltrans and researchers. Video files for these events have been provided to DRISI. Key observations include:

- 19 of these WWD events (56%) occurred between midnight and 6 am, which is consistent with the results of prior research [1], [23].
- 12 WWD events (35%) were due to wrong-way travel on a one-way street, followed by direct entry to the exit ramp. For several of the exit ramps in this study, the exit ramps feed to a one-way street. For these exit ramps, the local authority has jurisdiction and therefore Caltrans cannot add signs beyond the ramps for proper driver notification.
- 11 WWD events (32%) occurred at the WB US 50 at South River Road exit ramp with nine WWD events initiating with a right turn onto the exit ramp, and two WWD events initiating with a left turn onto the exit ramp; the large number of right-turn initiated events may indicate an issue with exit ramp configuration or signage.
- WB US 50 at 26th Street had 10 WWD events (29%); 7 of these events (70%) initiated with a vehicle driving the wrong way on the one-way only W Street before entering the exit ramp. As noted in prior studies, wrong-way travel on surface streets is a significant causal factor for wrong-way freeway driving [22], [24].
- Southbound SR 51 at J Street had 4 WWD events (12%), 3 of which (75%) were initiated via a left turn onto the exit ramp, again perhaps indicative of a signage or similar issue. One of these four events appears to be related to poor visibility and rain.
- At least one driver appears to be visibly under the influence based on how the car weaved as it approached the exit ramp. The wrong-way driver passed five or more vehicles driving in the right direction and still proceeded onto the exit ramp (see Figure 4.16). Determination of impairment level is speculative using visual means, and does not provide the level of certainty of a blood alcohol concentration (BAC) or similar test.

Additional vehicular based events were observed by either the VBSM or the TAPCO systems. All vehicular events are presented in Table B.1 in Appendix B, including those events that did not meet the criteria for a WWD event.

Table 4.1: WWD event summary. Figure references are for aerial vehicle trajectory view for each event.

Location	Date	Time	After Mitigate	Entry Manner	Note
SB SR 51@J St.	1/9/17	1:50 am	No	Left Turn	Fig. A4, Past camera, medium recovery, very rainy
SB SR 51@J St.	4/13/17	1:51 am	No	Left Turn	Fig. A.5, Medium recovery, 3-point turn
SB SR 51@J St.	3/8/18	1:30 am	No	Right Turn	Fig. A.6, Most of the way to the camera, 3-point turn
WB US 50 @Jefferson Blvd	8/11/16	4:11 am	No	Left Turn	Fig. A.23, Past camera, long recovery
WB US 50 @Jefferson Blvd	8/23/17	12:49 am	Yes	Right Turn	Fig. A.24, Through camera, eventually recovered
WB US 50 @South River Rd.	10/21/16	1:53 pm	No	Right Turn	Fig. 4.24, Recovered quickly
WB US 50 @South River Rd.	11/6/16	4:47 pm	No	Right Turn	Fig. 4.25, Recovered quickly
WB US 50 @South River Rd.	3/29/17	9:51 am	Yes	Left Turn	Fig. 4.26, Left from 5 th , onto shoulder, then quick U-turn recover
WB US 50 @South River Rd.	7/30/17	6:13 am	Yes	Right Turn	Fig. 4.27, Truck turned right onto exit ramp into middle lane, recovered (U-turn) before camera
WB US 50 @South River Rd.	4/17/18	1:05 pm	Yes	Right Turn	Fig. 4.28, Right onto exit ramp, tried to go lane 1, blocked, swerved to shoulder, then U-turn recover

Location	Date	Time	After Mitigate	Entry Manner	Note
WB US 50 @South River Rd.	5/18/18	5:15 pm	Yes	Right Turn	Fig. 4.29, Entered on shoulder, quick U-turn recovery
WB US 50 @South River Rd.	5/26/18	7:31 am	Yes	Left Turn	Fig. 4.30, Entered on shoulder, most of way to camera, then U-turn recover
WB US 50@10 th St.	12/22/16	5:41 am	Yes	One Way	Fig. A.9, Likely impaired, all the way onto exit ramp
WB US 50@10 th St.	5/4/17	3:47 am	Yes	One Way	Fig. A.10, Wrong way up W St, quick U-turn recover
WB US 50@10 th St.	5/16/17	11:43 pm	Yes	Right Turn	Fig. A.11, Right onto W, seems to go around block, recovery at 1:20 on 12th St
WB US 50@26 th St.	11/2/16	1:05 am	No	One Way	Fig. A.13, Recovered quickly
WB US 50@26 th St.	5/26/17	4:12 am	Yes	Right Turn	Fig. A.14, Turned onto side street just before committing to exit ramp
WB US 50@26 th St.	10/10/17	3:13 pm	Yes	Left Turn	Fig. A.15, Left from 26 th onto W, U-turn just into exit ramp
WB US 50@26 th St.	11/23/17	7:49 am	Yes	One Way	Fig. A.16, Red SUV, wrong way up W St, took street left of exit ramp. See other unrelated 11/23 incident.
WB US 50@26 th St.	11/23/17	7:50 am	Yes	One Way	Fig. A.17, Silver car, wrong way up W St, U-turn just after entering

Location	Date	Time	After Mitigate	Entry Manner	Note
					exit ramp. See other unrelated 11/23 incident.
EB US 50 @5 th St.	8/18/18	7:21 am	Yes	One Way	Fig. A.8, Full wrong-way, no recovery, broad daylight, drove right past a car coming down the exit ramp
WB I-8 Sunset Cliffs Blvd.	5/1/18	3:46 am	Yes	Right Turn	Fig. A.2, Entered on shoulder, most of way to camera, then corrected. Likely prompted by either a sign or pavement arrow marking.
WB US 50 @South River Rd.	11/4/18	11:30 pm	Yes	Right Turn	Fig. 4.31, Realizes quickly due to oncoming vehicle
WB US 50@26 th St.	12/2/18	3:33 am	Yes	Left Turn	Fig. A.18, Quick turn-around, stops to take a break at side of road
WB US 50@26 th St.	1/14/19	5:26 am	Yes	Left Turn	Fig. A.19, Doesn't enter ramp, continues wrong way on W Street
SB SR 51@J St.	1/23/19	2:01 am	Yes	Left Turn	Fig. A.7, Looks like recovered, but not certain from video
WB US 50@26 th St.	1/30/19	4:14 am	Yes	Right Turn	Fig. A.20, Doesn't enter ramp, continues wrong way on W Street
WB US 50@10 th St.	2/4/19	1:37 am	Yes	One Way	Fig. A.12, Full wrong-way, no recovery
WB US 50 @South River Rd.	2/28/19	1:28 am	Yes	Right Turn	Fig. 4.32, Parked on exit ramp in prior deliberate event, returns to vehicle, drives onto freeway, no recovery

Location	Date	Time	After Mitigate	Entry Manner	Note
WB US 50 @South River Rd.	5/3/19	4:21 pm	Yes	Right Turn	Fig. 4.33, Realizes quickly due to oncoming vehicle
WB US 50 @South River Rd.	5/18/19	3:33 pm	Yes	Right Turn	Fig. 4.34, Realizes quickly due to oncoming vehicle
WB I-8 Sunset Cliffs Blvd.	6/2/19	2:03 am	Yes	Left Turn	Fig. A.3, Motorcycle or scooter, full wrong-way, no recovery
WB US 50@26 th St.	6/22/19	3:06 am	Yes	One Way	Fig. A.21, Doesn't enter ramp, continues wrong way on W Street
WB US 50@26 th St.	6/22/19	4:58 am	Yes	One Way	Fig. A.22, Full wrong-way, no recovery



Figure 4.16: Wrong-way driver (circled in yellow) entering the exit ramp at WB US 50 at 10th Street. The driver continued onto the exit ramp despite at least five cars passing in the other (correct) direction.

The 34 WWD events have been classified below according to various characteristics. In addition, comparisons for a set of exit ramps for before and after mitigations is provided. The classifications and comparisons are provided in the following subsections.

It is clear that time of day is a significant factor with midnight – 6:00 am presenting a higher likelihood (19 of 34 events or 56% of the WWD events occur in these six hours or 25% of a day) of WWD incidents. In addition, there is some indication that exit ramp configuration and signage (design issues) are causative factors, particularly for the South River Road exit ramp.

In only one of the 34 WWD events could the researchers deduce with some certainty that the driver was driving under the influence from the video recording. Furthermore, with regard to BAC, it is essential to note that we have no data or quantitative measure to assess this. The one event indicated as Driving Under the Influence (DUI) is based on the observed driving behavior and other correlating factors, and this assessment is speculative. Trends noted in this research generally correlate well with prior research results [10],[12],[13],[21].

WWD Events by Exit Ramp and Group

This section provides information on the 34 WWD events in the period as classified by individual exit ramps and exit ramp groups. The groupings are based on both geography (Sacramento – District 3 vs. San Diego – District 11) and whether exit ramps were at some point mitigated. Both San Diego exit ramps were mitigated on January 23, 2018. Six Sacramento exit ramps were mitigated on November 9, 2016, while four were not mitigated during the period of this study, in part to provide some baseline information over a longer period. The monitoring periods for the two geographic regions differ significantly. For the Sacramento exit ramps, monitoring through August 31, 2019 had been done for between 3.0 and 3.2 years. For the San Diego exit ramps, monitoring was done for 1.7 years, due to the later install of those systems. In order to normalize WWD events, Table 4.2 provides both the raw count of the number of WWD events per exit ramp as well as the rate of WWD events per year. Figure 4.17 provides a plot of WWD events per exit ramp, while Figure 4.18 plots WWD events per year for each exit ramp. The WWD events per exit ramp figure is the more informative value. The following six exit ramps have the most observed WWD events captured per year in descending order:

1. US50@South River Road,
2. US50@26th Street,
3. US50@10th Street, SR51@J Street,
5. I-8@Sunset Cliffs Boulevard, US50@Jefferson Blvd.

Table 4.2: All WWD events classified by exit ramp and group

Exit ramp	Quantity	Percent	Events/year
US 50 WB S. River Rd	11	32.4%	3.4
US 50 WB Jefferson Blvd	2	5.9%	0.6
US 50 WB 10th St	4	11.8%	1.3
US 50 WB 16th St	0	0.0%	0.0
US 50 WB 26th St	10	29.4%	3.3
US 50 EB 5th St	1	2.9%	0.3
I-8 WB Sunset Cliffs Blvd	2	5.9%	1.2
I-5 SB Sea World Drive	0	0.0%	0.0
SR 51 SB J St	4	11.8%	1.2
SR 51 NB H St	0	0.0%	0.0
SR 51 NB N St	0	0.0%	0.0
SR 51 NB T St	0	0.0%	0.0
Total	34	100.0%	
<i>By exit ramp group</i>			
Sacramento ramps with mitigation	28	82.4%	1.5
San Diego ramps with mitigation	2	5.9%	0.6
Sacramento ramps without mitigation	4	11.8%	0.3

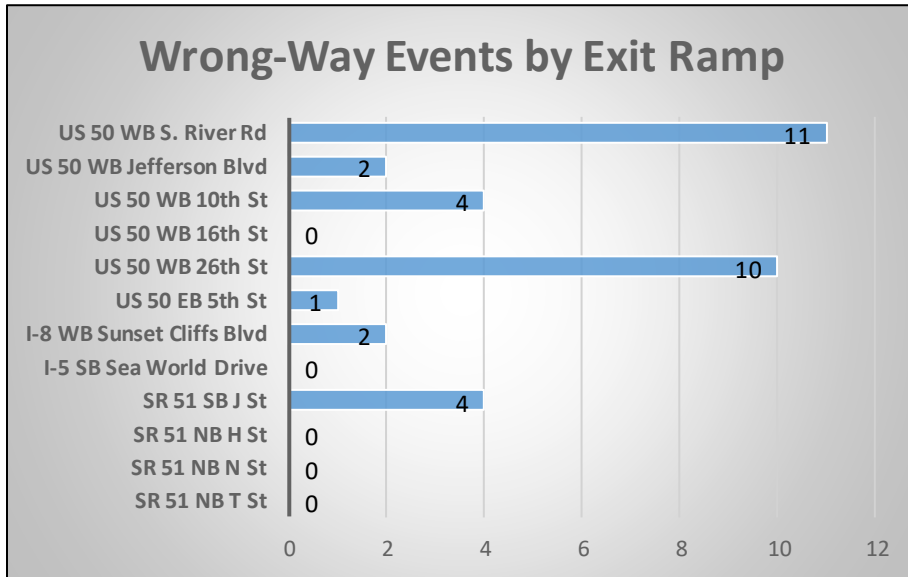

Figure 4.17: All WWD events classified by exit ramp

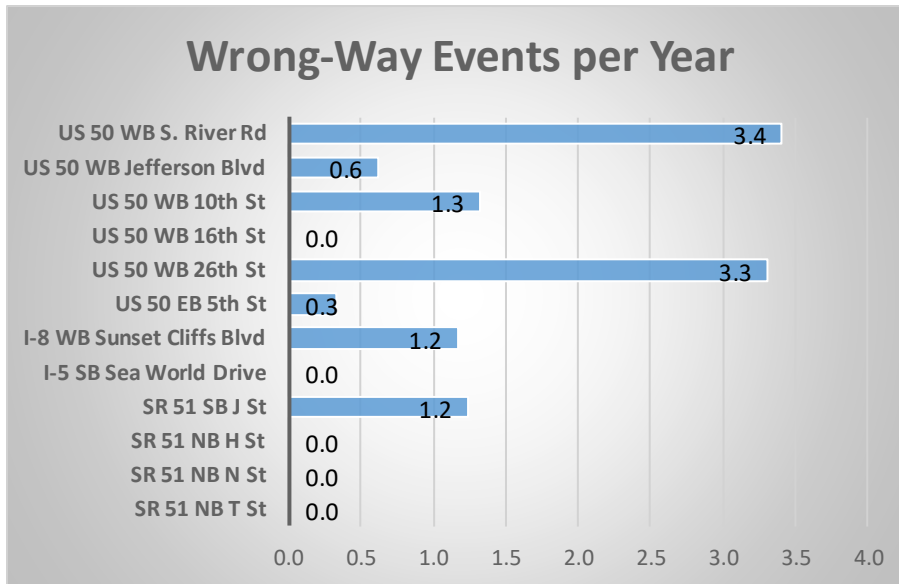

Figure 4.18: All WWD events per year per exit ramp

WWD Events by Time of Day

Time of day is a very important factor for wrong-way driving. The consensus in the literature is that WWD events are significantly more likely in the nighttime vs. the daytime, and that WWD events are typically clustered in the early morning hours, i.e. between about midnight and 6:00 am. Table 4.3 shows the count and percentage by hour of the day for the WWD events, while Table 4.4 shows the breakdown of WWD events by daytime vs. nighttime, including whether the driver corrected on their own, i.e. recognized the error and turned around and drove back down the exit ramp. Note that the research clips provide information for approximately 2.5 minutes after the WWD event trigger occurs, and the conclusion on whether the driver corrected is based solely on this available video. For cases identified as “driver-uncorrected,” it is entirely possible that the driver did correct at some time after the end of the video clip. Figure 4.19 plots the WWD events by hour.

Time of day is also an important consideration based on representative ramp volume patterns. During commute hours (typically Monday – Friday, 7-9 AM and 3-6 PM), ramp volume is higher, as can be seen in Figures 4.4 – 4.15. With higher ramp volume, confused or other WWD vehicle operators may have a better chance of correction since a WW driver can see more cars coming in the opposite direction. Also, lighting is typically better in these periods. Because of these combined factors, the likelihood of WWD events as well as potential severity of such events should be significantly reduced.

Table 4.3: All WWD events classified by time of day

Time of day	Quantity	Percent
12:00 AM	0	0.0%
1:00 AM	6	17.6%
2:00 AM	2	5.9%
3:00 AM	4	11.8%
4:00 AM	5	14.7%
5:00 AM	2	5.9%
6:00 AM	1	2.9%
7:00 AM	4	11.8%
8:00 AM	0	0.0%
9:00 AM	1	2.9%
10:00 AM	0	0.0%
11:00 AM	0	0.0%
12:00 PM	0	0.0%
1:00 PM	2	5.9%
2:00 PM	0	0.0%
3:00 PM	2	5.9%
4:00 PM	2	5.9%
5:00 PM	1	2.9%
6:00 PM	0	0.0%
7:00 PM	0	0.0%
8:00 PM	0	0.0%
9:00 PM	0	0.0%
10:00 PM	0	0.0%
11:00 PM	2	5.9%
Total	34	100.0%

Table 4.4: All WWD events classified by daytime or nighttime, including number of events where driver turned around (driver-corrected)

	Quantity	Percent	Driver-corrected	% Driver-corrected
Daytime	12	35.3%	11	91.7%
Nighttime	22	64.7%	18	81.8%
Total	34	100.0%	29	85.3%

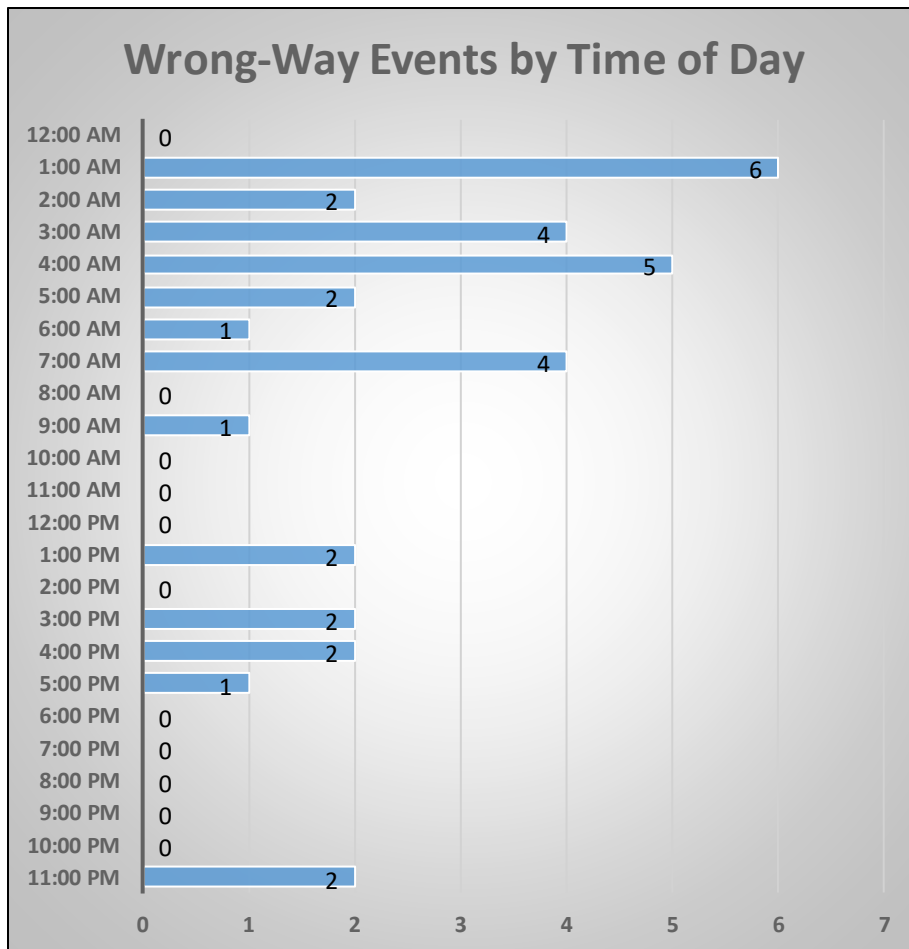

Figure 4.19: All WWD events classified by time of day

The data collected in the research period aligns well with the literature with respect to the prevalence of WWD events in the early morning hours, 19 events between midnight and 6:00 am, or 56%. The data shows an approximately 1:2 distribution of WWD events between daytime (12, 35%) and nighttime (22, 65%). In the independent Caltrans pilot study mentioned earlier, approximately 40% of WWD incidents were in daytime hours (6:00 am to midnight) [15]. The rate of WWD event driver correction for daytime (11/12, 92%) is somewhat higher than that for nighttime (18/22, 82%). The distribution between daytime and nighttime events is roughly that seen in prior research [3]. In assessing the results in the current research vs. historical WWD studies, it is essential to note the current methodology vs. those of typical wrong-way studies. Typical studies are driven by wrong-way collisions and other events serious enough to be reported; such WWD events are more likely to occur at night, particularly during hours with a higher likelihood of DUI. However, in the current study, exit ramps were monitored continuously so that any wrong-way activity, even a very brief entry into the exit ramp, would be captured. Hence, the universe of WWD events in this study is comprehensive to better get at the causes for any WWD behavior.

The researchers hypothesize, based on the data to date, that the ratio of all wrong-way driving is approximately 1:2 for daytime and nighttime driving, but that the likelihood of a serious wrong-way incident is higher at nighttime. In addition, as noted above, the researchers concur that the number of wrong-way incidents is significantly higher in the 12 am-6 am period.

WWD Events by Day of Week

Day of week is typically also considered an important factor in WWD. Table 4.5 provides the breakdown of the 34 WWD events by day of week, while Figure 4.20 provides a plot. The results here do not align well with the typical findings or views in the literature. The expectation would be a higher percentage of WWD events for weekends (Friday night through early Sunday) based on higher likelihood of DUI. The results in this section indicate highest likelihood of WWD event for Thursday, followed by Sunday, Wednesday, and Saturday. WWD events on Thursday are 60% more likely than on the next closest days. The researchers do not have any explanation for this distribution, and make no conclusions. The data is provided as is mainly for consideration by Caltrans.

Table 4.5: All WWD events classified by day of week

Day of week	Quantity	Percent
Sunday	5	14.7%
Monday	3	8.8%
Tuesday	4	11.8%
Wednesday	5	14.7%
Thursday	8	23.5%
Friday	4	11.8%
Saturday	5	14.7%
Total	34	100.0%

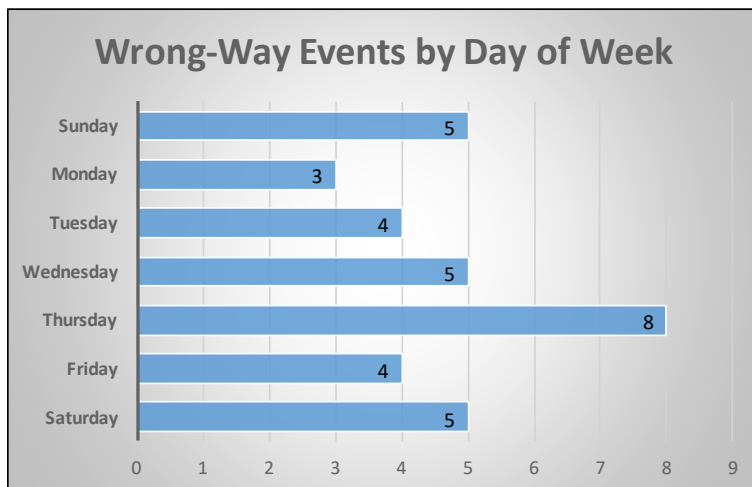

Figure 4.20: All WWD events classified by day of week

WWD Events by Time of Day and Day of Week

Table 4.6 provides the count of WWD events by both time of day and day of week, e.g. there were a total of three WWD incidents on Thursdays from 1:00 am – 2:00 am. The data in this table also shows that WWD incidents occur every day of the week although the frequency can be different. The data is however limited to make any conclusions on frequency. It is difficult to discern any other pattern from these results, except with respect to time of day, which was discussed earlier. The data is provided for potential future interpretation.

Table 4.6: All WWD events by both time of day and day of week

Time of day	Sunday	Monday	Tuesday	Wednesday	Thursday	Friday	Saturday	Total
12:00 AM	0	0	0	0	0	0	0	0
1:00 AM	0	2	0	1	3	0	0	6
2:00 AM	1	0	0	1	0	0	0	2
3:00 AM	1	0	1	0	1	0	1	4
4:00 AM	0	0	0	2	1	1	1	5
5:00 AM	0	1	0	0	1	0	0	2
6:00 AM	1	0	0	0	0	0	0	1
7:00 AM	0	0	0	0	2	0	2	4
8:00 AM	0	0	0	0	0	0	0	0
9:00 AM	0	0	0	1	0	0	0	1
10:00 AM	0	0	0	0	0	0	0	0
11:00 AM	0	0	0	0	0	0	0	0
12:00 PM	0	0	0	0	0	0	0	0
1:00 PM	0	0	1	0	0	1	0	2
2:00 PM	0	0	0	0	0	0	0	0
3:00 PM	0	0	1	0	0	0	1	2
4:00 PM	1	0	0	0	0	1	0	2
5:00 PM	0	0	0	0	0	1	0	1
6:00 PM	0	0	0	0	0	0	0	0
7:00 PM	0	0	0	0	0	0	0	0
8:00 PM	0	0	0	0	0	0	0	0
9:00 PM	0	0	0	0	0	0	0	0
10:00 PM	0	0	0	0	0	0	0	0
11:00 PM	1	0	1	0	0	0	0	2
Total	5	3	4	5	8	4	5	34

WWD Events by Month

Table 4.7 provides the breakdown of the 34 WWD events by month, while Figure 4.21 provides a plot. To the knowledge of the researchers, the literature does not typically consider month of WWD event, so there is no prior expectation. The results in this section indicate highest likelihood of WWD event for May followed by November and January. Due to the small number of WWD events, this may not statistically significant, and no conclusion is provided here. The data is provided as is mainly for consideration by the DOT.

Table 4.7: All WWD events classified by month

Month	Quantity	Percent
January	4	11.8%
February	2	5.9%
March	2	5.9%
April	2	5.9%
May	8	23.5%
June	3	8.8%
July	1	2.9%
August	3	8.8%
September	0	0.0%
October	2	5.9%
November	5	14.7%
December	2	5.9%
Total	34	100.0%

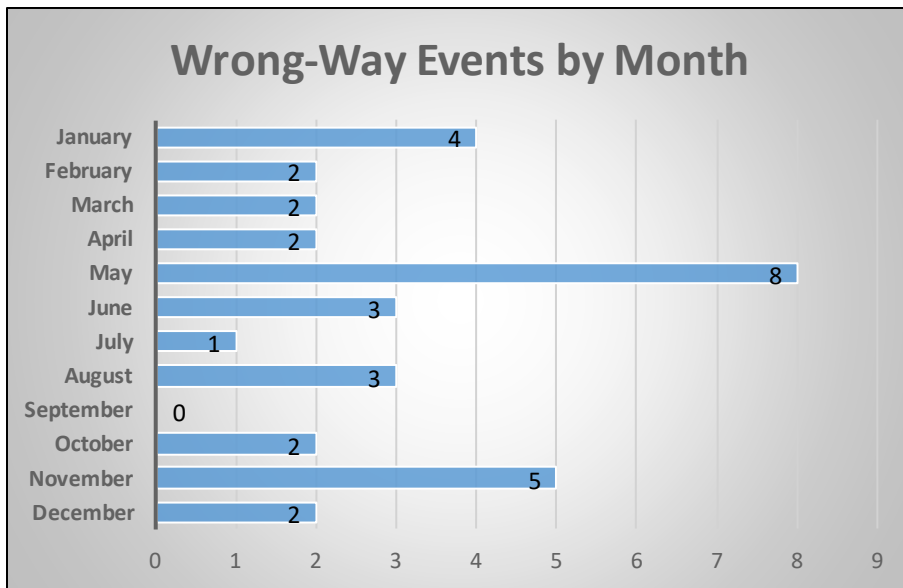

Figure 4.21: All WWD events classified by month

WWD Events by Entry Manner

The manner of entry onto the exit ramp is of particular importance for consideration of geometric, signage, and other design issues. Table 4.8 provides the breakdown of the 34 WWD events by entry manner with a plot in Figure 4.22. By a small amount, entry by right turn is the largest category. Were it not for the large number of right-turn entries for South River Road, wrong-way travel on a one-way street would be by far the significant cause. In any case, such one-way street entry is definitely a strong concern in cities with a large number of one-way streets being fed by exit ramps.

Table 4.8: All WWD events classified by entry manner

Entry manner	Quantity	Percent
Right Turn	13	38.2%
Left Turn	9	26.5%
One-Way	12	35.3%
Total	34	100.0%

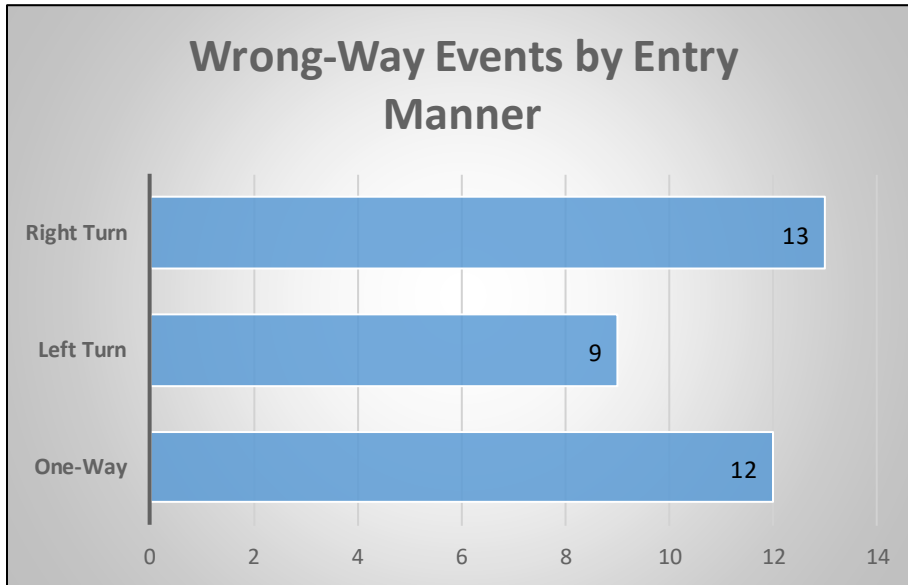

Figure 4.22: All WWD events classified by entry manner

Eight of the eleven WWD events (73%) occurring on the US 50 at South River Road exit ramp occurred in daylight with clear visibility. Nine of the eleven WWD events (82%) were initiated by a right turn onto the South River Road exit ramp, with the remainder initiated by a left turn. Along with the larger number and higher rate of WWD incidents for this exit ramp, this rate of right-turn entry seems to indicate that there was a design or signage issue for the US 50 at South River Road exit ramp. Figure 4.23 shows the driver's view approaching this exit ramp from the north. It seems likely that one or more additional signs on southbound 5th Street providing warning about wrong-way entry and/or some indicative pavement marking might significantly alleviate this problem. There is a "no right turn" sign at the throat of the exit ramp; however, it does seem that additional signage, which would likely require coordination with the city, would be beneficial. The problem is aggravated by a large building blocking the view of the exit ramp and its signage from the right-turn direction. The ramp geometry may also factor into the higher prevalence of WWD events. The ramp and its shoulders are quite wide, and the ramp is straight for a long distance from the intersection. These geometric elements may combine to give drivers the impression that this ramp is actually a conventional street. Because of the prevalence of WWD events for the South River Road exit ramp, and particularly the prevalence of events initiated by a right turn, sketches of the aerial views of

these WWD events are provided in Figures 4.24-4.34 in chronological order (similar aerial views for the WWD incidents on the other ramps are provided in Appendix A). The South River Road figures are annotated with traffic directions, painted traffic island divider, locations of “do not enter wrong way” signs, and location of a “no right turn” sign. Each figure shows the approximate vehicle travel trajectory using a red line including arrowheads for travel direction. The right-turn WWD events are shown in Figure 4.24 (10/21/16), Figure 4.25 (11/6/16), Figure 4.27 (7/30/17), Figure 4.28 (4/17/18), Figure 4.29 (5/18/18), Figure 4.31 (11/4/18), Figure 4.32 (2/28/19), Figure 4.33 (5/3/19), and Figure 4.34 (5/18/19); the left-turn WWD events are shown in Figure 4.26 (3/29/17) and Figure 4.30 (5/26/18). Similar vehicle trajectory illustrations are provided for the WWD events on other exit ramps in Figures A.2-A.24 in Appendix A. Consideration of possible mitigations for this exit ramp would include assessment of signage and pavement marking recommendations from the literature. Copelan, for example, notes carrying edgelines on the crossing streets directly across the exit ramp to discourage right turns into exit ramps or placing heavier stop bars at the exit

ramp [1].



Figure 4.23: View of the approach from the north to the South River Road exit ramp. A right turn would lead to a WWD event. Image courtesy of Google Street View.

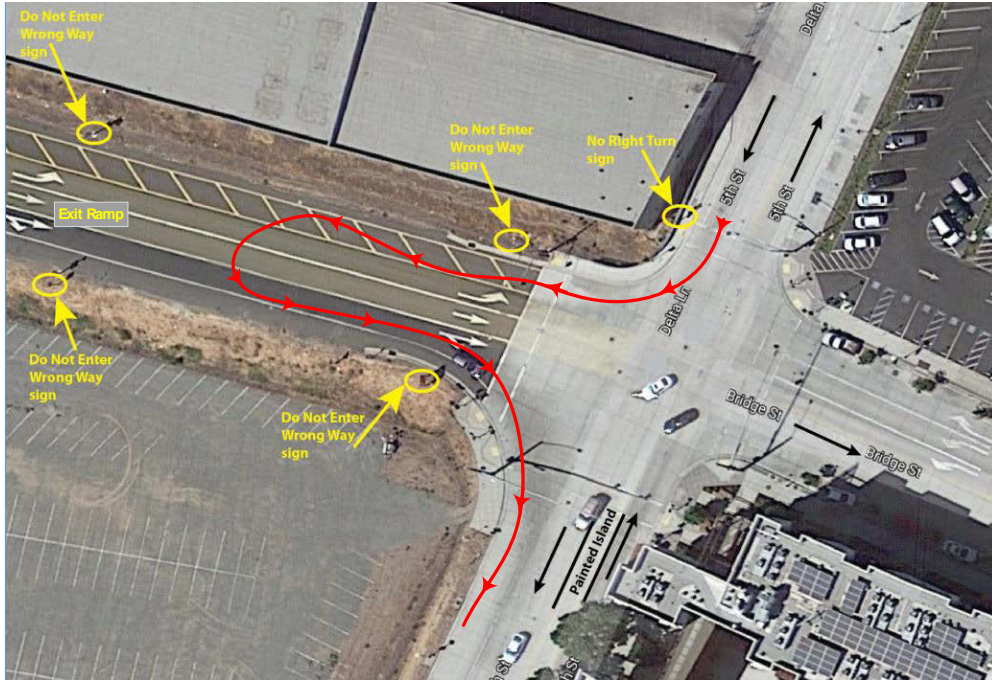

Figure 4.24: Aerial view of the 10/21/2016 1:52 pm WWD event on the South River Road exit ramp. Approximate vehicle trajectory is shown in red. Aerial image courtesy of Google Maps.

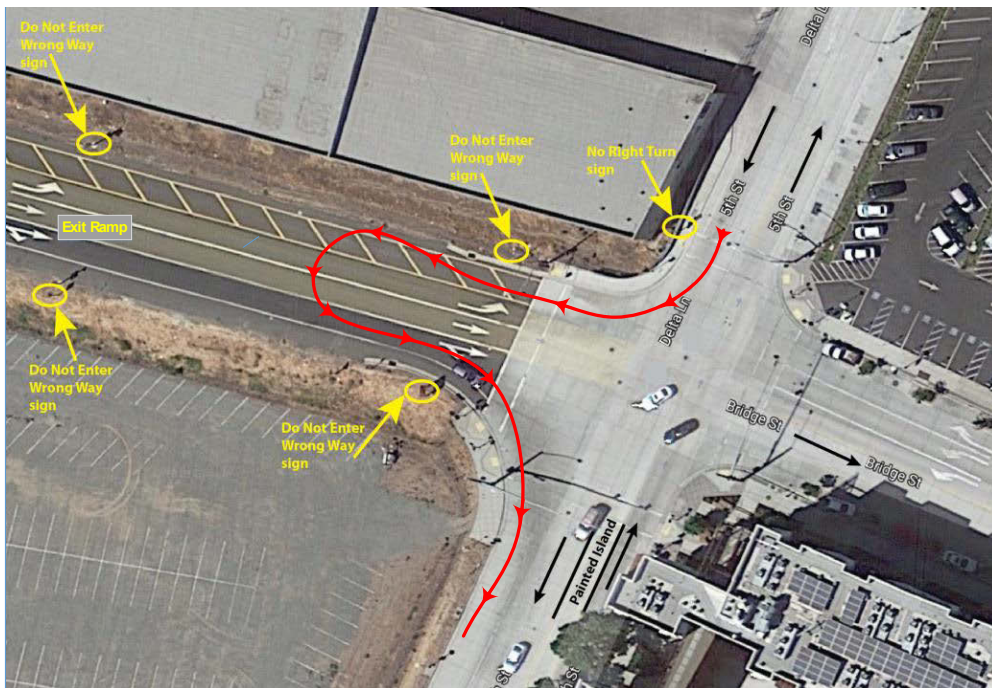

Figure 4.25: Aerial view of the 11/6/2016 1:53 pm WWD event on the South River Road exit ramp. Approximate vehicle trajectory is shown in red. Aerial image courtesy of Google Maps.

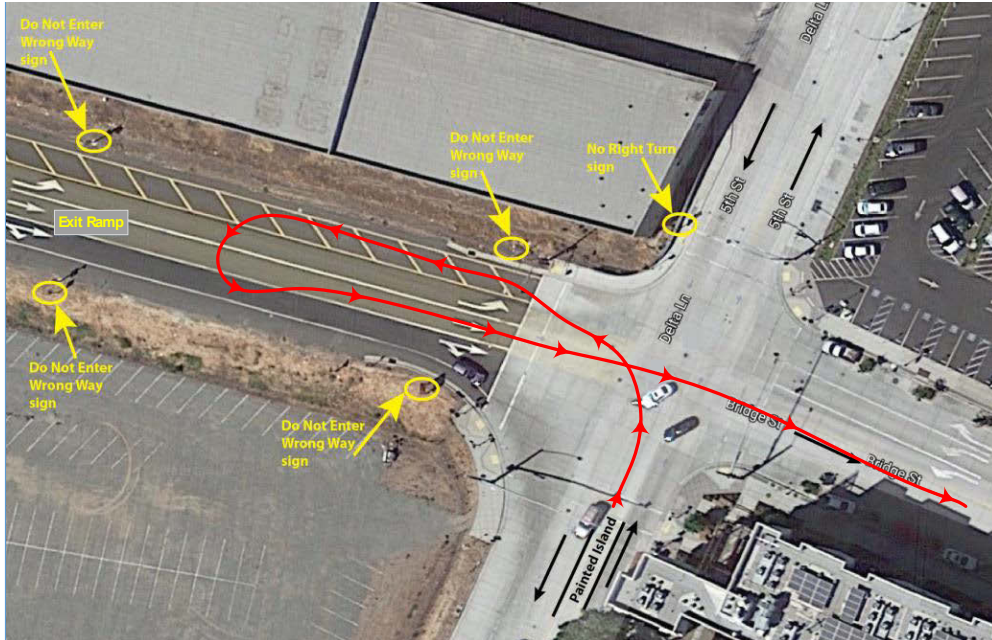

Figure 4.26: Aerial view of the 3/29/2017 9:51 am WWD event on the South River Road exit ramp. Approximate vehicle trajectory is shown in red. Aerial image courtesy of Google Maps.

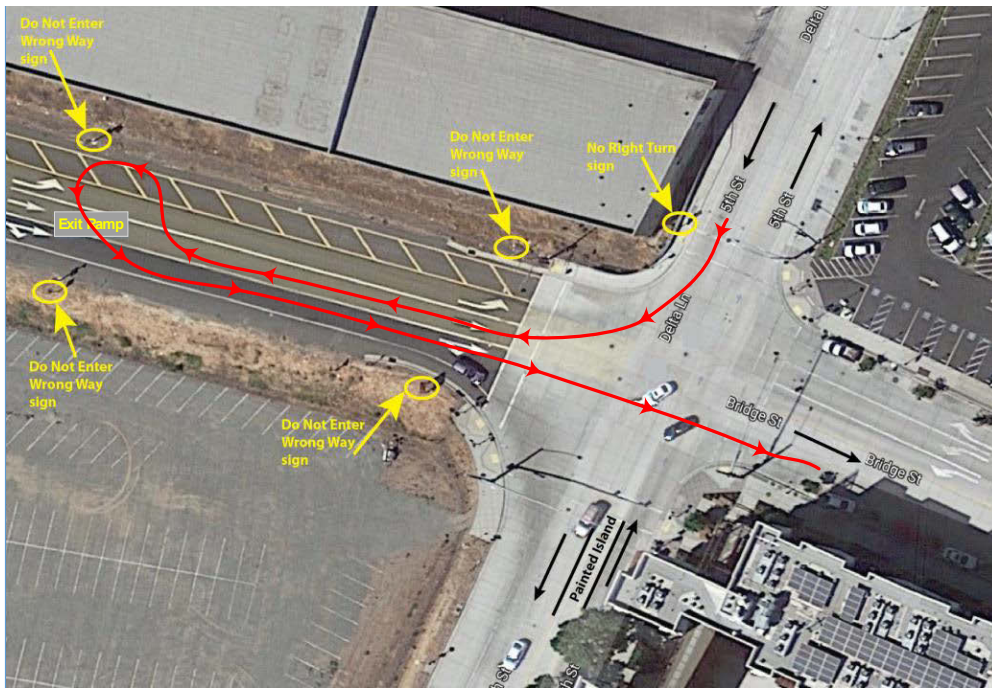

Figure 4.27: Aerial view of the 7/30/2017 6:13 am WWD event on the South River Road exit ramp. Approximate vehicle trajectory is shown in red. Aerial image courtesy of Google Maps.

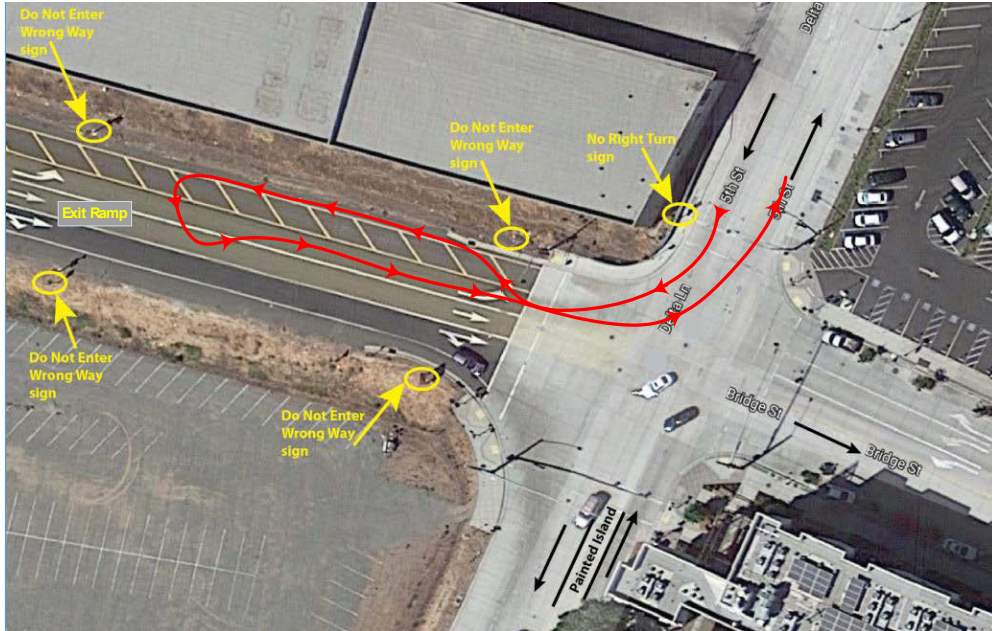

Figure 4.28: Aerial view of the 4/17/2018 1:05 pm WWD event on the South River Road exit ramp. Approximate vehicle trajectory is shown in red. Aerial image courtesy of Google Maps.

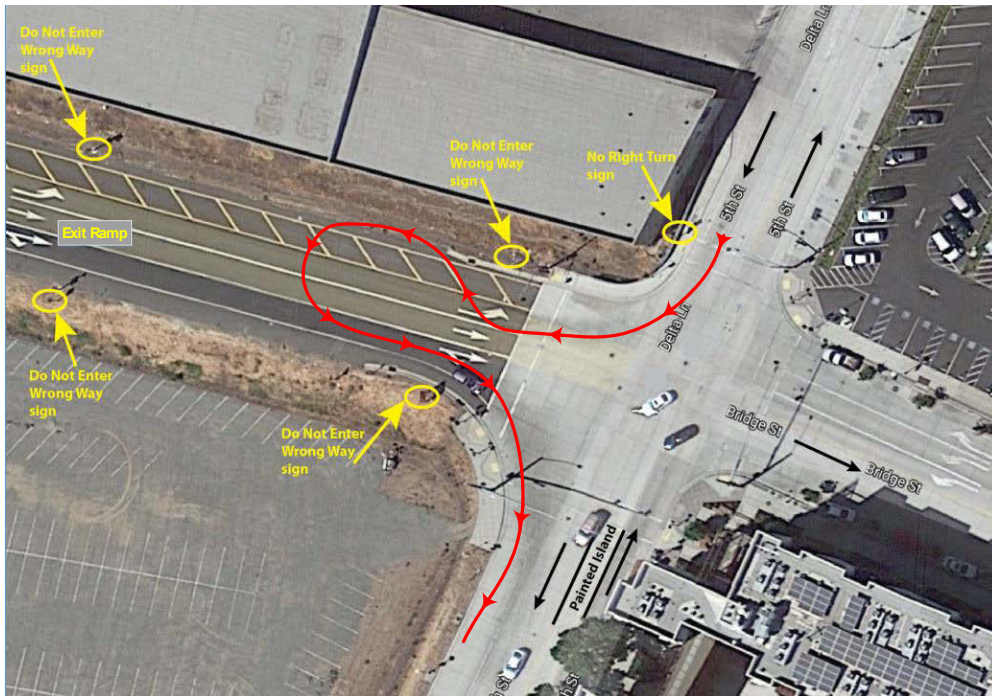

Figure 4.29: Aerial view of the 5/18/2018 5:15 pm WWD event on the South River Road exit ramp. Approximate vehicle trajectory is shown in red. Aerial image courtesy of Google Maps.

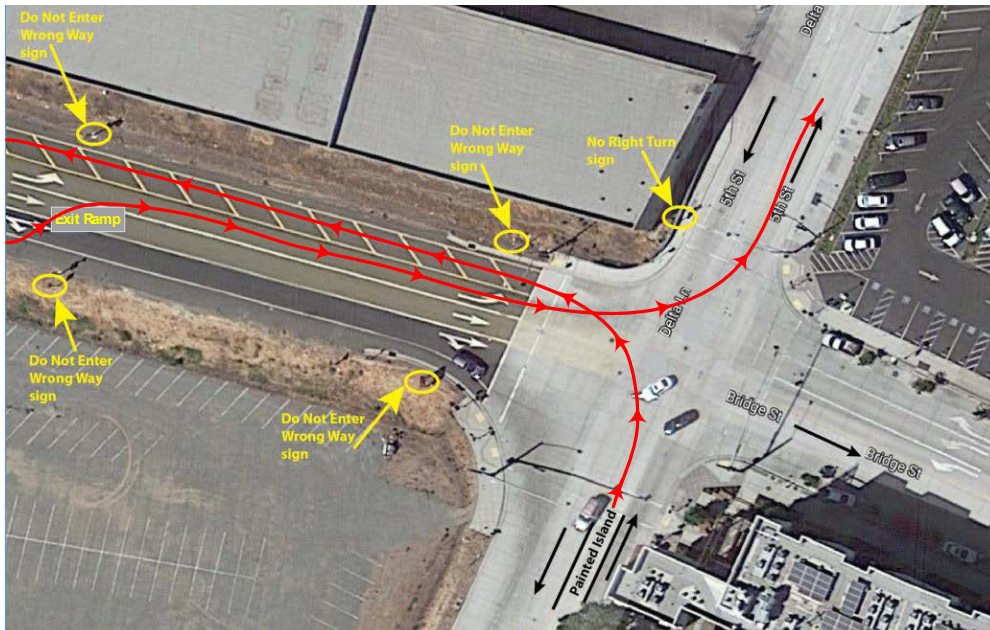

Figure 4.30: Aerial view of the 5/26/2018 7:31 am WWD event on the South River Road exit ramp. Approximate vehicle trajectory is shown in red. Aerial image courtesy of Google Maps.

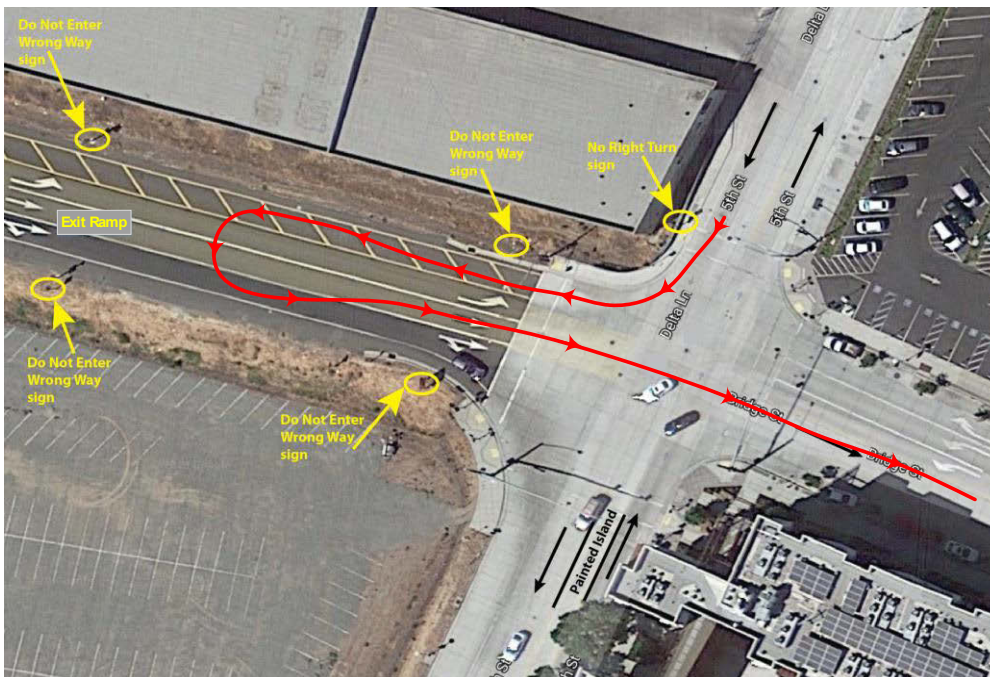

Figure 4.31: Aerial view of the 11/4/2018 11:30 pm WWD event on the South River Road exit ramp. Approximate vehicle trajectory is shown in red. Aerial image courtesy of Google Maps.

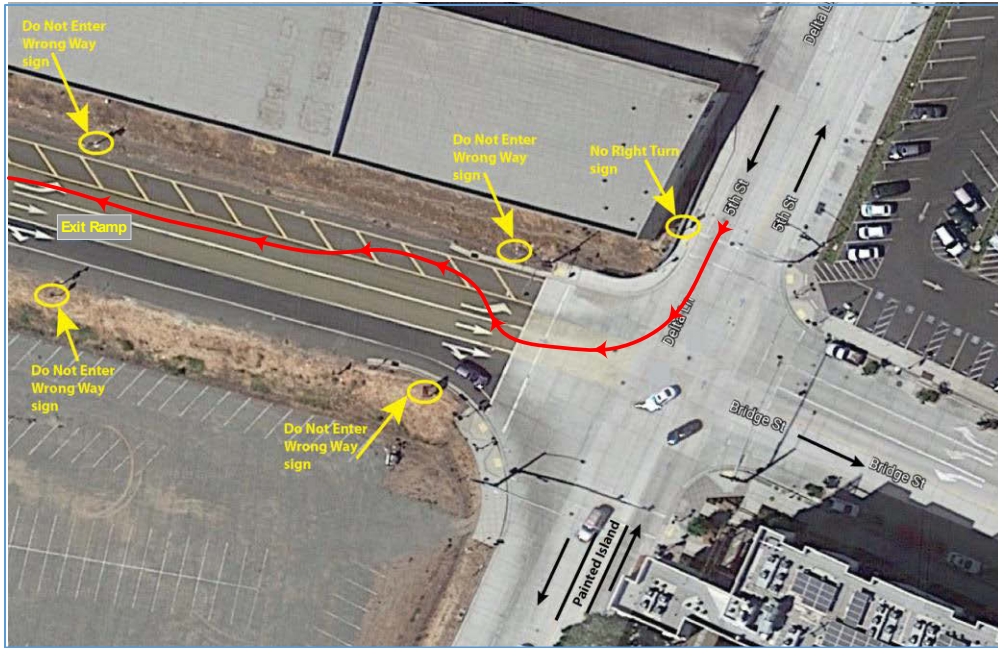

Figure 4.32: Aerial view of the 2/28/2019 1:28 am WWD event on the South River Road exit ramp. Approximate vehicle trajectory is shown in red. Aerial image courtesy of Google Maps.

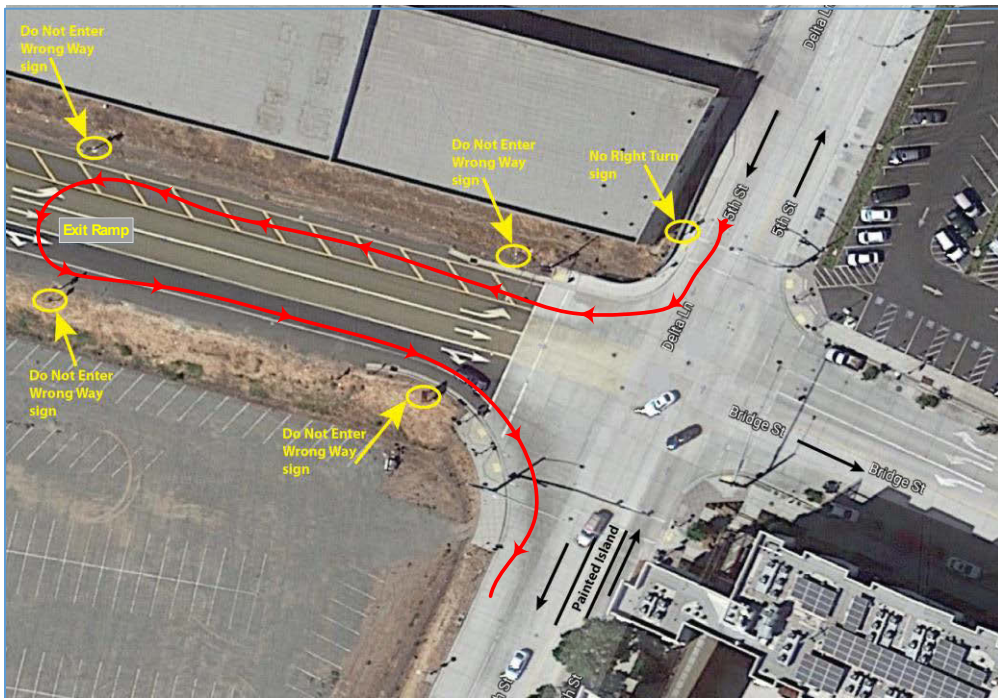

Figure 4.33: Aerial view of the 5/3/2019 4:21 pm WWD event on the South River Road exit ramp. Approximate vehicle trajectory is shown in red. Aerial image courtesy of Google Maps.

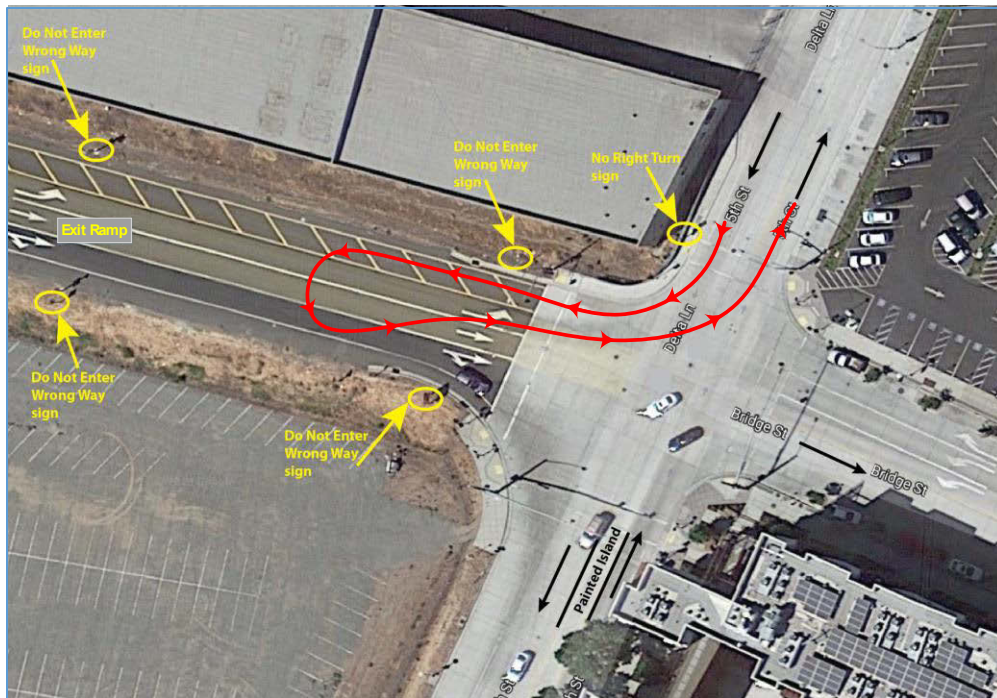

Figure 4.34: Aerial view of the 5/18/2019 3:33 pm WWD event on the South River Road exit ramp. Approximate vehicle trajectory is shown in red. Aerial image courtesy of Google Maps.

Following initial indications regarding the frequency of events for the South River Road exit ramp from this research, Caltrans assessed the location for possible remediation. Caltrans quickly developed a plan for sign installations, and issued a Sign Installation Order (SIO). This order included installation of two new signs on northbound 5th Street (straight/right signs, Figures 4.35 and 4.36), direction clarification sign (left turn, right turn, Figures 4.37) for westbound Bridge Street heading at the exit ramp, and, most important, four new signs on southbound 5th Street (straight/left, no right, straight, and left signs, Figures 4.38 and 4.39). These signs, particularly those on southbound 5th Street, should significantly reduce the likelihood of WWD events for this exit ramp. As with other similar exit ramps, there will still be occasional events. However, Caltrans has quickly responded to the identification of a potentially problematic exit ramp, and has provided new relevant signage to mitigate the situation. This illustrates a proactive response by Caltrans as pertinent WWD data were generated in this research. In locations where addition of mitigation signage will not be within Caltrans jurisdiction, Caltrans would need to work directly with the municipality which would have jurisdiction for the location.



Figure 4.35: Caltrans' sign addition for northbound 5th Street on the south side of the intersection at the South River Road exit ramp. Image courtesy of Google Street View.

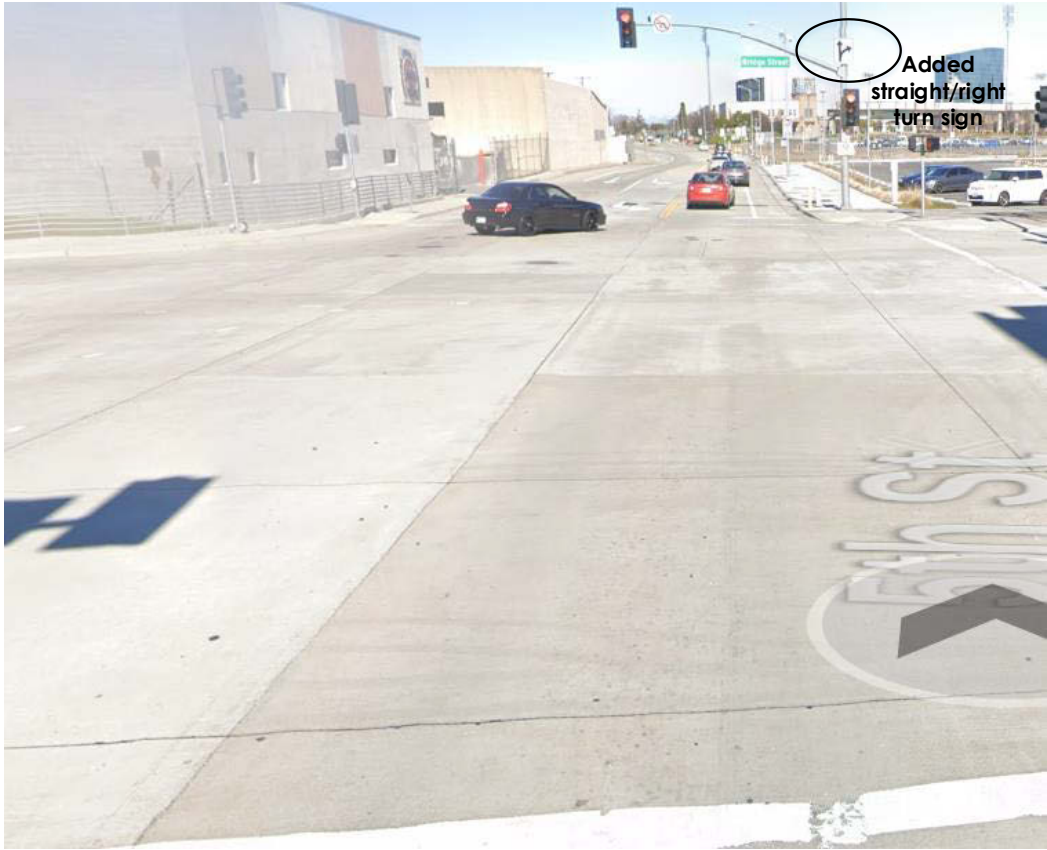

Figure 4.36: Caltrans' sign addition for northbound 5th Street on the north side of the intersection at the South River Road exit ramp. Image courtesy of Google Street View.

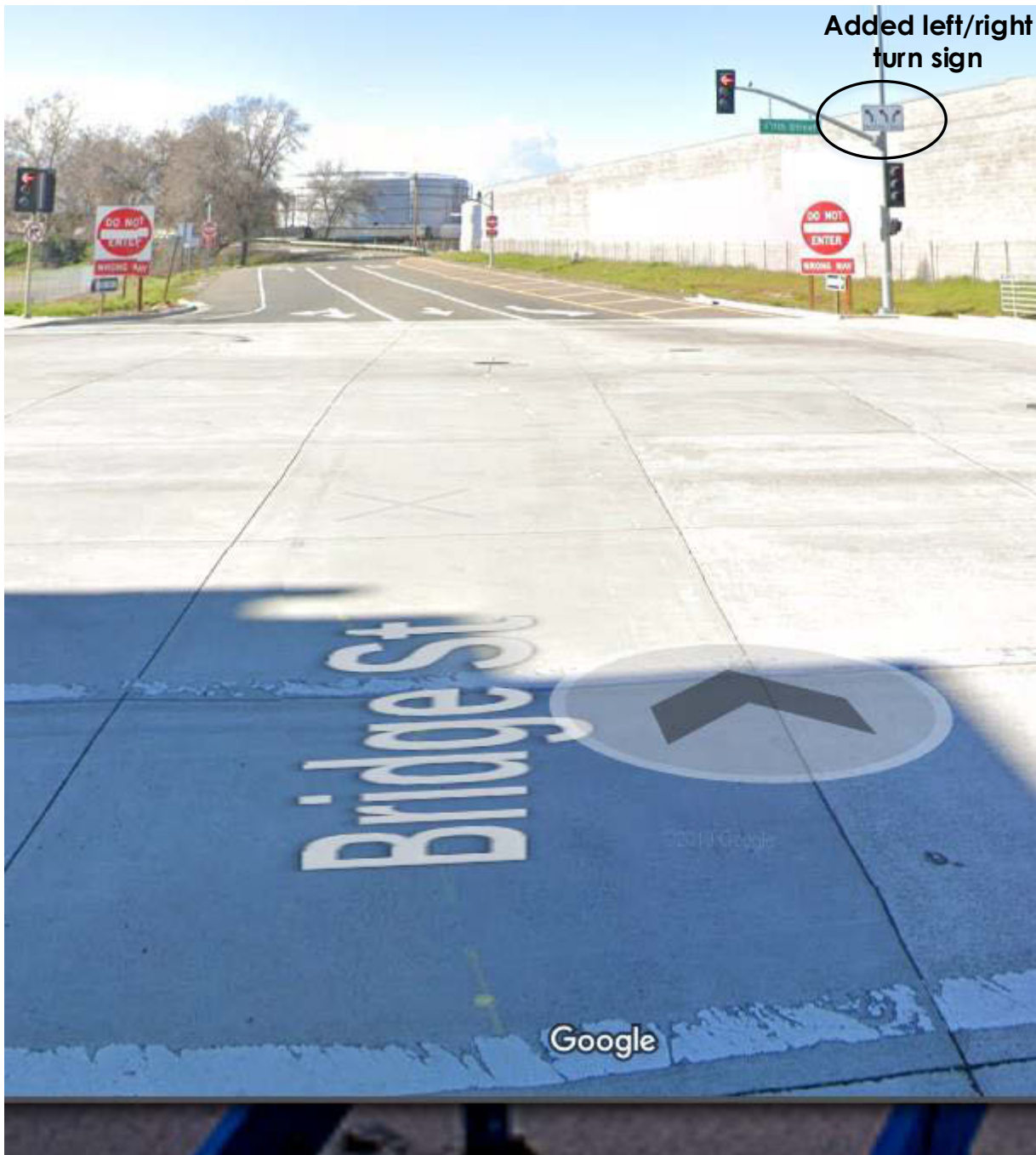

Figure 4.37: Caltrans' sign addition for westbound Bridge Street on the southwest side of the intersection at the South River Road exit ramp. Image courtesy of Google Street View.



Figure 4.38: Caltrans' sign addition for southbound 5th Street on the north side of the intersection at the South River Road exit ramp. Image courtesy of Google Street View.



Figure 4.39: Caltrans' sign modifications and additions for southbound 5th Street on the south side of the intersection at the South River Road exit ramp. Image courtesy of Google Street View.

Driver-Corrected and Driver-Uncorrected WWD Events

A key issue for any WWD event is whether the driver realized the error and turned around and drove back down the exit ramp (driver-corrected) or did not realize the error and continued onto the freeway (driver-uncorrected). This section examines this factor for the 34 WWD events. As noted above, the research clips provide information for approximately 2.5 minutes after the WWD event trigger occurs, and the conclusion on whether the driver corrected is based solely on this available video. For cases identified as “driver-uncorrected,” it is entirely possible that the driver did correct at some time after the end of the video clip. The division of the WWD events into driver-corrected vs. driver-uncorrected is provided in Table 4.9. The essential point here is that most (29, 85%) WWD events are corrected before the driver ever enters the freeway and within 2.5 minutes, i.e. before there could be a collision on the freeway.

This distribution of driver-corrected to driver-uncorrected events again helps to explain the difference in some of the results of this research vs. the previous literature. Again, as the research involved watching for wrong-way behavior of any sort 24 hours a day for over three years, behavior patterns were seen which have not been noted in previous studies. Based on the methodologies used in prior studies, of the 34 WWD events found in the twelve exit ramps over three years, at most the five driver-uncorrected WWD events (15%) would have been noted. However, it is questionable whether even these WWD events would have been noted as none led to any reported collision. This fundamental distinction between the current research and prior studies definitely leads to different conclusions regarding causal factors for wrong-way driving in general as opposed to wrong-way driving leading to collisions.

Table 4.9: All WWD events classified by whether driver turned around (driver-corrected) or did not (driver-uncorrected)

Driver-corrected	Quantity	Percent
Yes	29	85.3%
No	5	14.7%
Total	34	100.0%

An early and late image of the vehicle entering the ramp for the uncorrected WWD event of 8/18/2018 7:21 am on the 5th Street exit ramp is shown in Figure 4.40. This vehicle’s approach is difficult to determine due to the constrained camera location for this exit ramp. The approach could be from driving the wrong way on X Street, a one-way street. It could also be from a left turn from 5th Street or a right turn from 5th Street. Based on geometry, the right turn is the least likely option. Immediately before the WWD vehicle appeared in

the camera image, a right-way vehicle drove down the exit ramp and slowed and swerved to the right upon seeing the WWD vehicle approaching. Immediately before the WWD vehicle enters the camera image, the TAPCO flashing LED warning lights are clearly activated. The WWD vehicle moves slowly up the ramp and appears to pause at one location right after the TAPCO signs and after passing the other vehicle. However, the vehicle does proceed all the way up the ramp and does not slow down while passing the “Signal Ahead” pavement markings. Two other vehicles did emerge from the exit ramp, but the WWD vehicle did not re-emerge. Thus, this event was classified as driver-uncorrected. The researchers speculate, in this case, that the driver did realize the error, but possibly chose not to make a three-point turn on a narrow and typically busy exit ramp to correct. The actual resolution of the event beyond the three-minute video is unknown.



Figure 4.40: Early and late images of the vehicle entering the ramp for the WWD event of 8/18/2018 7:21 am on the 5th Street exit ramp

Effect of Mitigation

On eight of the twelve exit ramps in this study, Caltrans installed various mitigations to reduce WWD incidents. Four of the exit ramps had no mitigations installed in order to provide baseline information. The specific mitigations, according to Caltrans, included:

- A. Replace retro-reflective pavement markers on the exit ramp
 - Change existing one-way white to two-way white/red (W/R) for the lane line(s), channelizing line(s), and gore area.
 - Change existing one-way yellow to two-way yellow/red (Y/R) for the left edge line
 - Install or refresh for a left turn to an on-ramp where there is an adjacent exit ramp

- B. Install Y/R and W/R retro-reflective pavement markers with 12-ft spacing for 240 ft and 6-ft spacing for 120 ft starting 120 ft from the end of the exit ramp.
- C. Install an active monitoring system which can identify, record, and transmit WWD information to a central location while activating flashing beacon(s). Examples of such a system include:
 - TAPCO Blinkersign R5-1A (Wrong Way) Dual Radar w/ Camera and BlinkLink Alert Network solar-powered LED-bordered sign(s),^{2,3} used at six Caltrans District 3 Sacramento exit ramps
 - TrafficCalm Wrong Way Alert system,⁴ used at two Caltrans District 11 San Diego exit ramps

A primary research goal was to assess the impact of the mitigations on the rate of WWD incidents. This was done only for the six Sacramento mitigated exit ramps. The San Diego exit ramps were not included as there was only approximately one month of data collection before the mitigations were installed due to delays in the installation of the VBSM on the San Diego exit ramps. Table 4.10 provides the WWD event information for the 28 events observed on the six Sacramento mitigated exit ramps in the study period. The table provides the number of events in each period along with the start, end, and duration of the before and after periods. The key information in this table is the number of WWD events per year per exit ramp. For the Sacramento mitigated exit ramps, the WWD event rate dropped from 3.0 events/ramp/year before mitigation to 1.4 after mitigation, a 53% drop in the rate of wrong-way events. Such a significant drop seems a strong indicator regarding the effectiveness of the mitigations selected and installed by Caltrans.

Table 4.10: All wrong-way events in the Sacramento mitigated exit ramps group classified by mitigation period

Period	Events	Start	End	Years	Events/Year/Ramp
Before mitigation	4	8/21/2016	11/9/2016	0.22	3.0
After mitigation	24	11/10/2016	8/31/2019	2.81	1.4
Total	28				

Additional information on mitigation effectiveness is available from Caltrans' internal pilot study [15]. The most dramatic results from the pilot study were for improvements due to installation of retroreflective red on the backside of the pavement markers, and for LED-illuminated wrong-way signs. The red on backside pavement markers led to a 44% reduction in WWD incidents, while the

² TAPCO (<https://www.tapconet.com/>)

³ TAPCO BlinkLink (<http://blinklink.net/>)

⁴ TrafficCalm Wrong Way Alert system (<https://trafficalm.com/wwa/>)

LED-illuminated wrong-way signs yielded a 62% reduction. Both are clearly substantial reductions which can yield significant safety improvements. Caltrans is moving ahead on long-term changes based on these pilot study results. For example, due to the strong safety benefit at very low cost (less than one cent per marker), Caltrans has developed new standard detailed plans for use of the red on backside of pavement markers, and the new Standard Plans have been in place for statewide use since May 31, 2018 [15]. Based on findings in the current research, i.e. that a significant portion of WWD events are caused by driver confusion, these two mitigations should show dramatic improvements on any exit ramp subject to driver confusion.

COTS WWD Detections

Two COTS active WWD detection systems were included in the Caltrans exit ramp mitigations and were thus assessed as part of this study. The six mitigated exit ramps in Sacramento had TAPCO systems installed, specifically TAPCO Blinkersign R5-1A (Wrong Way) Dual Radar w/ Camera and BlinkLink Alert Network solar-powered LED-bordered sign(s). The two mitigated exit ramps in San Diego had TraffiCalm Wrong Way Alert systems installed (specifically the TraffiCalm Tier 3 Wrong Way Alert System, SKU: M75-DETC-A-M000).

The two systems operate on similar principles. They use radar for WWD vehicle detection and use video and photos as a means of corroboration and/or additional detection and filtering in order to reduce false alarms. Based upon available data, the two systems seem to provide similar detection features. However, they do currently differ in terms of available reporting, photographic record, and archival logging features. As these seem to be mainly software features, this situation could certainly change over time with new software updates. This section examines primarily the performance of the TAPCO systems as the collection period, number of exit ramps, and resulting number of relevant events was much higher. For the TraffiCalm systems, the researchers only collected one WWD event in the period. This WWD event will be discussed below, but more data is required to draw significant conclusions.

For each COTS WWD detection system, not all WWD events are relevant. Any VBSM-detected WWD events before the installation of the COTS WWD detection system were excluded in the comparison. In addition, the installation locations and corresponding field of view for the research system (the VBSM) and the COTS WWD detection system were often separated by significant distance due to the differing constraints of the two systems, as well as installation requirements and safety aspects identified by Caltrans. This is also influenced by the differing purposes for the two systems: the COTS system was meant to identify WWD events in real time and provide alerts to the TMC and the driver, while the research system was meant to monitor the entire range of WWD behavior. These two distinct purposes dictated different locations for many of the exit ramps. As

such, certain events that were identified by the VBSM would certainly not have been within the field of view of the COTS system. It is unreasonable to count these WWD events against the COTS system as there was no chance that the COTS system could have identified these WWD events.

TAPCO Assessment

The TAPCO COTS system has two levels of WWD detection and corresponding action. For a full-on WWD event wherein a vehicle drives completely through all TAPCO detection zones triggering all radar and camera systems, the TAPCO system will issue an **alert** to the TMC indicating an actual WWD event with a series of WWD event images (see Figure 4.43) for TMC operator corroboration. For lower-level WWD events, i.e. situations where a driver proceeds up the exit ramp, enters TAPCO's initial radar detection zone, but does not go far enough to trigger an alert, the TAPCO system will issue an **activation**. In this situation, the TAPCO system will turn on flashing lights on its wrong-way signs in an attempt to alert the wrong-way driver and get them to turn back. This is an important part of the COTS wrong-way system as, when effective, it will stop a WWD incident before it can turn deadly.

The six Sacramento area mitigated ramps had 24 WWD events after the mitigation. Given the above considerations, 10 of these 24 WWD events were relevant for **alerting** by the TAPCO systems. Table 4.11 provides the identified alerts received from TAPCO systems for the ten relevant WWD events. The researchers received an alert from TAPCO for 3 of the 10 relevant WWD events. This indicates no alert was received for 7 of the 10 WWD events that were identified by the VBSM. This may not be an accurate representation of the performance of the TAPCO system. The difference in system locations provides one explanation for the discrepancy. The additional difference in system purpose also explains part of the difference. In looking at the VBSM videos of the specific WWD events, in at least one of the WWD events the driver turned around after the VBSM camera but possibly before the TAPCO alerting zone. Based on the vehicle behavior and timing in the video, the researchers assumed in this case that the vehicle would not have triggered an alert. In another situation, the uncorrected WWD incident on 8/18/2018 on the EB 5th exit ramp, the WWD vehicle may have been blocked from TAPCO radar detection by a right-way vehicle. This vehicle likely caused occlusion of TAPCO's incoming-facing radar's detection, preventing the WWD vehicle from being tracked for 100 feet to generate an output for the second detection zone. TAPCO has a newer detection sensor available, a thermal imaging detector, which allows for higher mounting or even overhead mounting to substantially reduce occlusion. The researchers include this as a missed detection, as it does indicate a vulnerability of the currently installed technology. For a true comparison, further study would be needed with both systems sharing essentially the same field of

view and with the VBSM configured with an additional camera to monitor the TAPCO alerting zone.

Table 4.11: TAPCO alerts received for relevant VBSM-detected WWD events

	Quantity	Percent
Relevant wrong-way events for alert	10	100%
Tapco did alert	3	30%
Tapco did not alert	7	70%

Out of the 24 post-mitigation WWD events, 14 were relevant for **activation** by the TAPCO systems. Table 4.12 provides the identified TAPCO activations for the 14 relevant WWD events out of the original 24. The TAPCO logs indicate an activation for 9 of the 14 relevant WWD events. Based upon the TAPCO logs, it appears there was no activation issued for 5 of the 14 relevant WWD events. This may again be due to the difference in system locations. Several of the WWD events involved drivers turning around after driving a short distance up the exit ramp; in these cases, the vehicle may not have triggered an activation due to the short time in the trigger zone or perhaps not entering the TAPCO trigger zone at all. For a true comparison, further study would be needed with both systems sharing essentially the same field of view.

The primary indication of a TAPCO activation was the relevant TAPCO log file. This proved inaccurate in at least one incident, and possibly in two others. For the 12/22/2016 incident on the 10th Street exit ramp, the log does not indicate an activation; however, closer inspection of the video clearly shows a reflection of the blinking TAPCO lights, thus an activation. For two other incidents, 7/30/2017 and 5/18/2018 on South River Road exit ramp, the log does not indicate an activation. These incidents were in the daytime, so there is no reflection from blinking lights. TAPCO is investigating whether the system did activate; in the meanwhile, the researchers assume the system did not activate. TAPCO is also investigating the 12/22/2016 event to determine why there was no log entry even though the system clearly did activate.

Table 4.12: TAPCO activations for relevant VBSM-detected WWD events

	Quantity	Percent
Relevant wrong-way events for activation	14	100.0%
Tapco did activate sign	9	64.3%
Tapco did not activate sign	5	35.7%

TAPCO representatives indicated that over time, environmental conditions including high wind, rain, and ground settling can cause the sensors to shift slightly. Understanding this, TAPCO recommends that preventative maintenance

be performed on the systems annually, or as often as quarterly, to ensure system components and detection are always in good working condition. TAPCO indicated plans for site visits to verify all systems are working properly.

In addition to the TAPCO assessment within this research, Caltrans included a pilot study of TAPCO systems at other interchanges [15]. The four systems, all on exit ramps for Interstate 15, experienced a high false positive rate, 60 false positives out of 113 total events, or 53%. Such a high false positive rate would have significant implications for widespread deployment with automatic event notification sent to the TMC. That said, these four TAPCO systems were adjusted part way through the pilot study to reduce detection of normal traffic driving past on the interstate [15]. These adjustments did reduce the false positive rate, but data is not available to determine the reduced false positive rate.

Systems which provide both forward- and rear-facing cameras provide significant benefits for WWD event verification and characterization over single-camera systems. The District 11 TAPCO systems had both camera types, which made those systems much more effective than the single-camera District 3 systems with respect to showing vehicle trajectories. For example, District 11 staff could tell that vehicles that passed two-camera TAPCOs were making a U-turn at the gore point and thus entering the freeway in the correct direction, as opposed to continuing straight in the wrong direction.

Table 4.13 provides the WWD events which occurred during the collection period (June 5, 2016 through August 31, 2019) for all District 3 exit ramps which had both the VBSM and TAPCO systems installed. Of these 42 events, 27 were detected only by the VBSM (blue entries), 14 were detected only by the TAPCO system (gold entries), and 1 event was detected by both (purple entry). Photos from TAPCO-captured events can be found in [15]. There are logical explanations for the difference in detections for cases examined within this research, i.e. cases where the researchers had sufficient available information. Here, broadly applicable explanations will be presented, as these are more generally useful than very specific cases. The primary reason for varying detection between the two systems is significant difference in default field of view. Many of the AHMCT VBSM systems were positioned close to the exit ramp throat, in order to observe entry manner, while the TAPCO systems tended to be located further up the exit ramp toward the main freeway, perhaps to optimize their detection and warning capabilities. This meant that for WWD events where the offending vehicle recovered quickly and went back down the ramp, the TAPCO may not see the offending vehicle at all, or the vehicle may not pass through the requisite detection zones for either an activation or an alert [15]. There are similarly some cases where a vehicle would bypass the AHMCT VBSM field of view, but subsequently drive through the TAPCO zones, leading to a missed detection by the VBSM. AHMCT noted one case where a vehicle drove off-road and missed the exit ramp throat completely, but then drove through

the TAPCO detection zones, on the 26th Street exit ramp. The discussion here was for the nominal AHMCT VBSM fields of view. As discussed in Chapter 3, the wooden mounting poles introduced twist, which caused the field of view for the VBSM to shift dramatically vs. the roadway. In these situations, WWD vehicles would drive up the exit ramp and would pass through what should have been the VBSM field of view, and the VBSM would not detect the vehicle due to the shifted field of view. Finally, there were some exit ramp-specific situations which reduced the normal effectiveness of either the VBSM or the TAPCO. For example, on the 16th Street exit ramp, an informational sign was installed in front of the TAPCO rear-facing radar, so it wasn't able to detect passing vehicles, and thus would not have sent any alerts to the TMC (see Figure 4.41). For future installation and maintenance of such systems, it would be essential to avoid these kinds of post-installation obstruction. A detailed breakdown of all COTS WWD events and the corresponding VBSM detection status is provided in Table 4.14.

Table 4.13: WWD events which occurred during the collection period for all District 3 exit ramps which had both the VBSM and TAPCO systems installed

Date	Time	Ramp	VBSM	TAPCO	Note / Resolution
8/11/2016	4:10 AM	US 50 WB Jefferson Blvd	X		left to exit ramp, through camera, recovered
10/21/2016	1:52 PM	US 50 WB S. River Rd	X		right to exit ramp, quick recovery
11/2/2016	1:04 AM	US 50 WB 26th St	X		up one-way (W), just onto ramp, recovered
11/6/2016	4:46 PM	US 50 WB S. River Rd	X		right to exit ramp, quick recovery
12/22/2016	5:41 AM	US 50 WB 10th St	X		Likely impaired, all the way onto exit ramp
3/25/2017	2:44 AM	US 50 WB 26th St		X	construction WW driver
3/29/2017	9:51 AM	US 50 WB S. River Rd	X		Left from 5th, onto shoulder, then quick u-turn recover
4/17/2017	7:22 PM	US 50 WB S. River Rd		X	wrong way vehicle
5/4/2017	3:47 AM	US 50 WB 10th St	X		Wrong way up W St, quick U-turn recover
5/16/2017	11:43 PM	US 50 WB 10th St	X		Right onto W, seems to go around block, out at 1:20 on 12th St
5/26/2017	4:12 AM	US 50 WB 26th St	X		Right onto W, mostly in lane 2, seems to be turning around, never seen again, but not up exit ramp. Probably turned onto 27th.
7/19/2017	3:13 AM	US 50 WB 26th St		X	wrong way vehicle
7/25/2017	6:48 PM	US 50 WB S. River Rd		X	wrong way vehicle
7/30/2017	6:12 AM	US 50 WB S. River Rd	X		truck right on ramp, recovers before camera
7/31/2017	11:16 PM	US 50 WB S. River Rd		X	wrong way vehicle
8/1/2017	11:30 PM	US 50 WB Jefferson Blvd		X	wrong way vehicle
8/23/2017	12:49 AM	US 50 WB Jefferson Blvd	X		Through camera, eventually recovers
9/13/2017	5:39 AM	US 50 WB 16th St		X	WW Veh chase by law Enforcement
10/10/2017	3:12 PM	US 50 WB 26th St	X		Left from 26th onto W, u-turn just into ramp
11/23/2017	7:48 AM	US 50 WB 26th St	X		red SUV wrong way up W, see next clip, 2 unrelated
11/23/2017	7:48 AM	US 50 WB 26th St	X		silver car wrong way up W, see previous clip, 2 unrelated
4/17/2018	1:04 PM	US 50 WB S. River Rd	X		right onto ramp, tries to go lane 1, blocked, swerves to zero
5/18/2018	5:14 PM	US 50 WB S. River Rd	X		enters on shoulder, quick recovery
5/26/2018	7:31 AM	US 50 WB S. River Rd	X		enters on shoulder, most of way to camera, then u-turn recover
6/5/2018	8:58 PM	US 50 WB S. River Rd		X	wrong way vehicle
8/7/2018	1:14 PM	US 50 WB S. River Rd		X	wrong way vehicle
8/18/2018	7:21 AM	US 50 EB 5th St	X		full-on wrong-way, no recovery, broad daylight
11/4/2018	11:30 PM	US 50 WB S. River Rd	X		vehicle, realizes quickly due to oncoming vehicle
11/19/2018	9:07 AM	US 50 WB S. River Rd		X	wrong way vehicle
12/2/2018	3:32 AM	US 50 WB 26th St	X		vehicle, wrong way, stops, takes a wee
1/14/2019	5:26 AM	US 50 WB 26th St	X		vehicle, wrong way, doesn't enter ramp, continues wrong way on W
1/30/2019	4:13 AM	US 50 WB 26th St	X		vehicle, wrong way, doesn't enter ramp, continues wrong way on W
2/2/2019	1:47 AM	US 50 WB 10 th St		X	WW law enforcement
2/4/2019	1:36 AM	US 50 WB 10 th St	X	X	Wrong-way, never returns
2/28/2019	1:28 AM	US 50 WB S. River Rd	X		see event 1:22, returns to vehicle, drives onto freeway
4/21/2019	5:41 PM	US 50 WB S. River Rd		X	pedestrian
5/3/2019	4:21 PM	US 50 WB S. River Rd	X		vehicle, realizes quickly due to oncoming vehicles
5/18/2019	3:33 PM	US 50 WB S. River Rd	X		vehicle, realizes quickly due to oncoming vehicles
6/16/2019	12:18 AM	US 50 WB S. River Rd		X	scooter wrong way
6/22/2019	3:06 AM	US 50 WB 26th St	X		vehicle, wrong way, doesn't enter ramp, continues wrong way on W
6/22/2019	4:58 AM	US 50 WB 26th St	X		vehicle, wrong way, up ramp, no recovery
7/21/2019	10:02 PM	US 50 WB S. River Rd		X	wrong way vehicle

Table 4.14: Detailed breakdown of all COTS-identified WWD events and the corresponding VBSM detection status

#	Date	Time	COTS System	Ramp	VBSM Detection Note	COTS Resolution
1	3/25/2017	2:44 AM	TAPCO	US 50 WB 26th St	Not detected. We cannot determine reason.	Construction WWD
2	4/17/2017	7:22 PM	TAPCO	US 50 WB S. River Rd	Detected. Not classified as WWD, deliberate, assisting another motorist	Wrong Way Vehicle

#	Date	Time	COTS System	Ramp	VBSM Detection Note	COTS Resolution
3	7/19/2017	3:13 AM	TAPCO	US 50 WB 26th St	Not detected. Vehicle travels off-road, bypasses the VBSM field of view.	Wrong Way Vehicle
4	7/25/2017	6:48 PM	TAPCO	US 50 WB S. River Rd	Not detected. Sedan at edge of shoulder. Vehicle may be outside detection mask.	Wrong Way Vehicle
5	7/31/2017	11:16 PM	TAPCO	US 50 WB S. River Rd	Detected. Not classified as WWD, deliberate, maintenance vehicle	Wrong Way Vehicle
6	8/1/2017	11:30 PM	TAPCO	US 50 WB Jefferson Blvd	Detected. Not classified as WWD, deliberate, CHP	Wrong Way Vehicle
7	9/13/2017	5:39 AM	TAPCO	US 50 WB 16th St	Not detected. We cannot determine reason.	WW Veh chase by law Enforcement
8	5/1/2018	3:45 AM	TraffiCalm	I-8 WB Sunset Cliffs Blvd	Detected. WWD.	Wrong Way Vehicle
9	6/5/2018	8:58 PM	TAPCO	US 50 WB S. River Rd	Not detected. CHP motorcycle, hugging very edge of pavement. Likely outside detection mask.	Wrong Way Vehicle
10	8/7/2018	1:14 PM	TAPCO	US 50 WB S. River Rd	Not detected. We cannot determine reason.	Wrong Way Vehicle
11	11/19/2018	9:07 AM	TAPCO	US 50 WB S. River Rd	Not detected. We cannot determine reason.	Wrong Way Vehicle
12	2/2/2019	1:47 AM	TAPCO	US 50 WB 10th St	Not detected. We cannot determine reason.	WW Law Enforcement
13	2/4/2019	1:37 AM	TAPCO	US 50 WB 10th St	Detected. WWD.	Wrong Way Vehicle
14	4/21/2019	5:41 PM	TAPCO	US 50 WB S. River Rd	Not detected. We cannot determine reason.	Pedestrian
15	5/24/2019	3:20 AM	TraffiCalm	I-5 SB Sea World Drive	Not detected. Insufficient information from photo to determine reason.	Wrong Way Vehicle
16	6/16/2019	12:18 AM	TAPCO	US 50 WB S. River Rd	Not detected. We cannot determine reason.	Scooter Wrong Way
17	7/21/2019	10:02 PM	TAPCO	US 50 WB S. River Rd	Not detected. We cannot determine reason.	Wrong Way Vehicle



Figure 4.41: TAPCO radar sensor blocked by informational sign for the 16th Street exit ramp system. The AHMCT VBSM can be seen behind the TAPCO system.

TraffiCalm Assessment

Due in part to the smaller number of exit ramps instrumented with the TraffiCalm system, and the reduced monitoring time, only two related WWD events were detected on TraffiCalm-equipped ramps by the VBSM in the study period. Both of these VBSM-detected WWD events were on the WB I-8 exit ramp at Sunset Cliffs Boulevard. The TraffiCalm system issued an alert for one of the two VBSM-detected WWD events. In the first event (May 1, 2018), the TraffiCalm system did not issue an alert; this would be expected as the wrong-way driver turned around (corrected) essentially at the second pair of TraffiCalm signs, well before the final detection zone that needs to be breached to trigger an alert. However, TraffiCalm did confirm that the second set of flashing warning lights (signs 3 and 4) were triggered by this event, i.e. the system was activated. The TraffiCalm system did issue an alert for the second WWD event (June 2, 2019). This was a full WWD event with no recovery. The vehicle was a small scooter traveling at the very edge of the shoulder. Note that the TraffiCalm system also detected a WWD vehicle and issued an alert on 5/24/2019, event #15 of Table 4.14; for unknown reasons, the VBSM did not detect this vehicle. For an overview of the TraffiCalm configuration, including sign locations, see Figure 4.42. In addition, the TraffiCalm system was installed and configured so

that the lights on their sign 1 and sign 2 (wrong way signs) are always flashing. From the 5/1/18 WWD event video recorded by the VBSM, the driver clearly turns around approximately at signs 3 and 4. The driver may have been alerted by the signs and/or their flashing lights. It is also feasible that the driver noticed the large painted arrows on the pavement, and realized the error. This confirms that passive notification means, as provided by both the TrafficCalm and the TAPCO systems, are an important part of mitigation. Table 4.15 provides the identified alerts received from TrafficCalm systems for the two relevant WWD events. Table 4.16 provides the identified TrafficCalm activations for the two relevant WWD events. It is again important to emphasize that with only two events on one ramp and zero events on the second ramp, this data is not statistically significant.

Table 4.15: TrafficCalm alerts received for relevant VBSM-detected WWD events

	Quantity	Percent
Relevant wrong-way events for alert	2	100.0%
TrafficCalm did alert	1	50.0%
TrafficCalm did not alert	1	50.0%

Table 4.16: TrafficCalm activations for relevant VBSM-detected WWD events

	Quantity	Percent
Relevant wrong-way events for activation	2	100.0%
TrafficCalm did activate sign	2	100.0%
TrafficCalm did not activate sign	0	0.0%

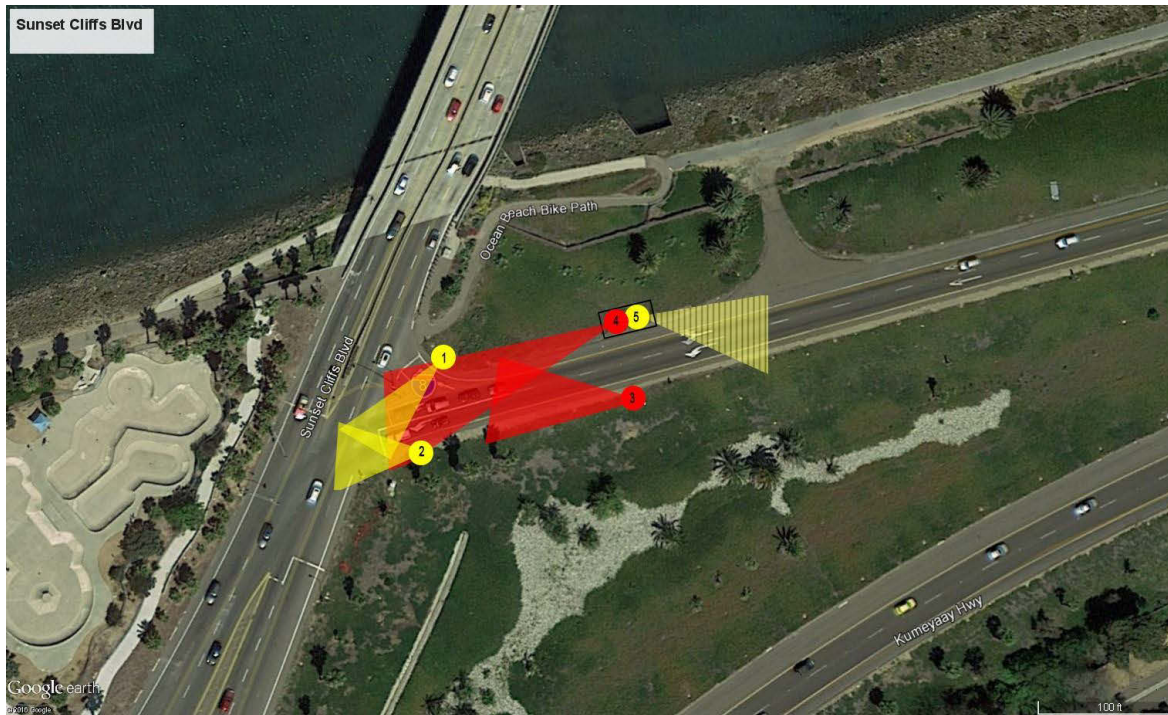

Figure 4.42: Bird's-eye view of TrafficCalm system configuration at Sunset Cliffs Blvd. exit ramp, including sign location and numbering. Courtesy of TrafficCalm.

TAPCO and TrafficCalm Imagery and Web Sites



Figure 4.43: Photos (images 1 – 6 of 14) provided by TAPCO system for a typical WWD event. TAPCO provides 14-16 photos for a WWD event. Courtesy of TAPCO.



Figure 4.44: Photos (images 7 – 12 of 14) provided by TAPCO system for a typical WWD event. TAPCO provides 14-16 photos for a WWD event. Courtesy of TAPCO.



Figure 4.45: Photos (images 13 – 14 of 14) provided by TAPCO system for a typical WWD event. TAPCO provides 14-16 photos for a WWD event. Courtesy of TAPCO.



Figure 4.46: Photo provided by TrafficCalm system for a typical WWD event. TrafficCalm provides one photo for a WWD event. Courtesy of TrafficCalm.

The two COTS warning systems are configured to provide one or more images in the case of a WWD alert. These images serve at least two purposes. First, a subset of the images is sent immediately to the TMC, which can help the TMC to determine whether the alert represents a genuine WWD event. This reduces the number of false responses. The images also provide an archival record of the WWD event for each issued alert. The TAPCO system provides 14-16 images for a WWD event, as shown in Figures 4.43 – 4.45, and archives these

images and other WWD event and system information on its BlinkLink site.⁵ The older generation TAPCO systems installed in Sacramento provide 14 images for a WWD event, while the newer generation TAPCO systems installed in San Diego provide 16 images for a WWD event. In the early stages of this research, TAPCO typically did not have information on whether a vehicle recovered and turned around for a given WWD event. At a certain point, TAPCO began issuing two entries for a given WWD event. In so doing, they often captured images that would indicate if a vehicle did recover and turn around. The TAPCO site includes their resolution (conclusion) for each alert. The site also includes the ability to download system activations for the previous three years' operation. This TAPCO tool was extremely valuable in the research. The research team had less opportunity and time to interact with TraffiCalm's tools. The TraffiCalm system appears to issue one photo for a given WWD event as shown in Figure 4.46. For research purposes, additional photos are needed. In addition, the researchers are not aware of a tool from TraffiCalm similar to the web site provided by TAPCO.

Overall Wrong-Way Driving Event Rates Considering All Detection Systems

The three systems (VBSM, TAPCO, and TraffiCalm) monitored the twelve exit ramps for between about two to three years. Numerous WWD events were detected over this period. The summary event counts for each ramp for each of the three systems, or a detection by more than one of the systems, are provided in Table 4.17. This table also includes the duration in years for monitoring of each ramp by at least one of the systems, and the corresponding WWD event rate per year for each of the ramps. This information may provide a helpful metric or diagnostic for Caltrans.

Table 4.17: Summary event counts for each ramp for each of the three systems and the corresponding WWD event rates

Exit Ramp	VBSM Events	TAPCO Events	TraffiCalm Events	Combo Events	Total Events	Collection Duration (years)	WWD Events/Year
US 50 WB S. River Rd	11	9	0	0	20	3.23	6.2
US 50 WB Jefferson Blvd	2	1	0	0	3	3.23	0.9
US 50 WB 10th St	4	1	0	1	6	3.03	2.0
US 50 WB 16th St	0	1	0	0	1	3.03	0.3

⁵ [TAPCO BlinkLink \(http://blinklink.net/\)](http://blinklink.net/)

Exit Ramp	VBSM Events	TAPCO Events	TraffiCalm Events	Combo Events	Total Events	Collection Duration (years)	WWD Events/Year
US 50 WB 26th St	10	2	0	0	12	3.03	4.0
US 50 EB 5th St	1	0	0	0	1	3.03	0.3
I-8 WB Sunset Cliffs Blvd	2	0	1	1	4	1.72	2.3
I-5 SB Sea World Dr	0	0	1	0	1	1.72	0.6
SR 51 SB J St	4	0	0	0	4	3.24	1.2
SR 51 NB H St	0	0	0	0	0	3.21	0.0
SR 51 NB N St	0	0	0	0	0	3.24	0.0
SR 51 NB T St	0	0	0	0	0	3.24	0.0

All VBSM-Captured Events by Entity and by Exit Ramp

The classifications in the above subsections are specifically with respect to the 34 WWD events. The classification in the current subsection is for all the events of sufficient interest to capture in the research. Table 4.18 provides classification of this set of 510 events by the type of entity involved with a corresponding plot in Figure 4.47. As noted previously, bicycle events technically represent a WWD event. They have been omitted from the primary analysis as they are not the focus of this study. However, it may be important to Caltrans to be aware of the large number of bicycle-related events.

This group also includes types of wrong-way vehicular events that are also of less interest to Caltrans, such as vehicles backing up at the exit ramp throat to change lanes for a turn or vehicles backing up during a road rage incident (discussed in Appendix A). This group also includes vehicles (tow trucks, passenger vehicles) deliberately entering the exit ramp, e.g. to help drivers of disabled vehicles on the exit ramp shoulder. Table 4.19 provides classification for all captured events by exit ramp. Figures 4.48 and 4.49 provide plots for these two classifications.

Table 4.18: All captured events classified by entity

Entity	Quantity	Percent
Vehicle	137	26.9%
Tractor	1	0.2%
Bicycle	327	64.1%
Pedestrian	45	8.8%
Total	510	100.0%

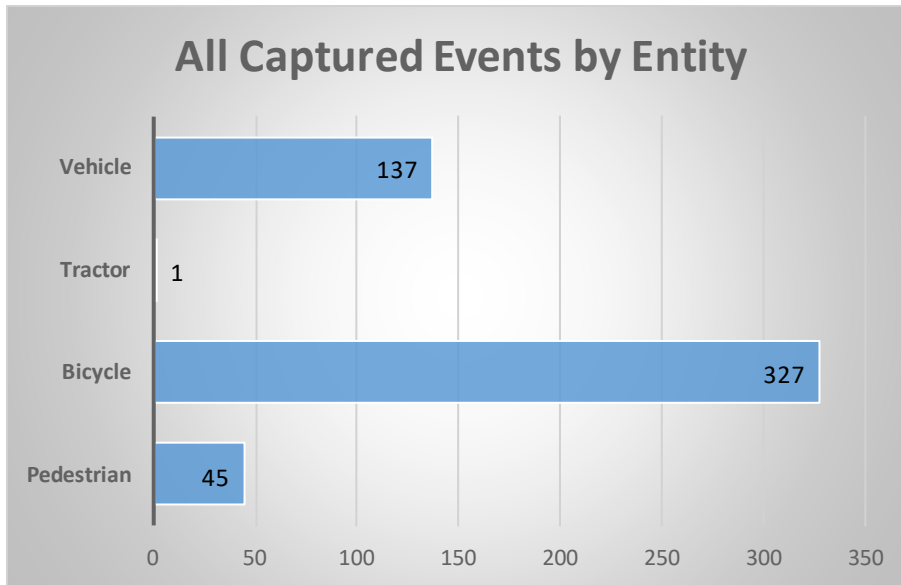

Figure 4.47: All captured events classified by entity

Table 4.19: All captured events classified by exit ramp and group

Exit ramp	Quantity	Percent
US 50 WB S. River Rd	84	16.5%
US 50 WB Jefferson Blvd	40	7.8%
US 50 WB 10th St	13	2.5%
US 50 WB 16th St	7	1.4%
US 50 WB 26th St	329	64.5%
US 50 EB 5th St	1	0.2%
I-8 WB Sunset Cliffs Blvd	11	2.2%
I-5 SB Sea World Drive	9	1.8%
SR 51 SB J St	14	2.7%
SR 51 NB H St	1	0.2%
SR 51 NB N St	1	0.2%
SR 51 NB T St	0	0.0%
Total	510	100.0%
<i>By exit ramp group</i>		
Sacramento ramps with mitigation	474	92.9%
San Diego ramps with mitigation	20	3.9%
Sacramento ramps without mitigation	16	3.1%

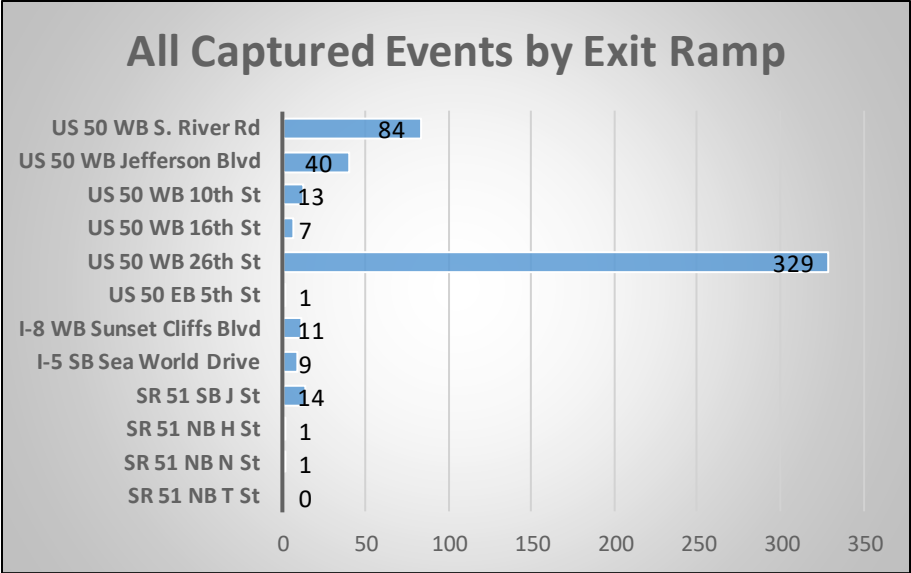

Figure 4.48: All captured events classified by exit ramp

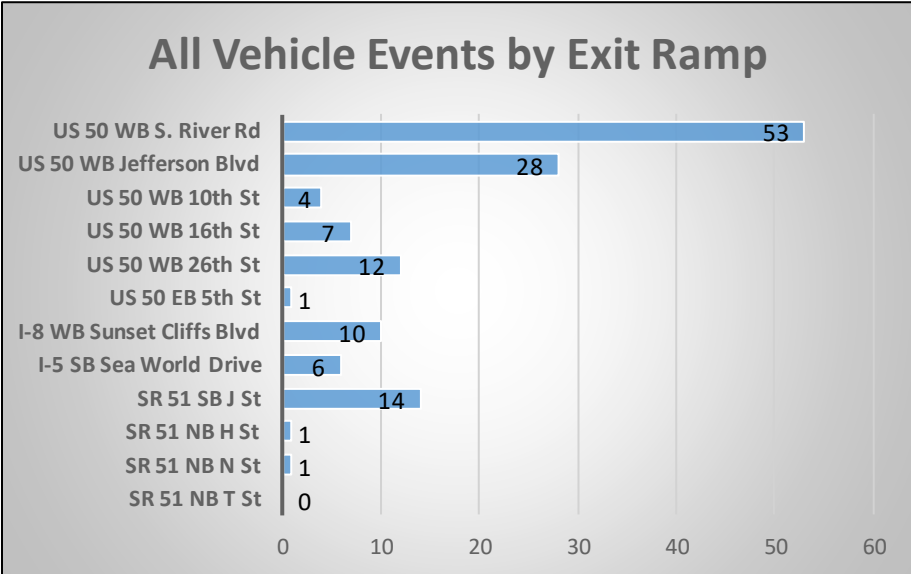

Figure 4.49: Vehicle events classified by exit ramp

Chapter 5: Conclusions, Recommendations, and Future Research

Conclusions

This research has captured data and has evaluated all WWD events for a key set of Caltrans exit ramps in the Sacramento and San Diego areas. The study found 34 events over a three-year period that met the researchers' criteria for WWD events. For the specific ramps that were monitored, the WWD event rates ranged from 0.0 to 6.2 WWD events per year. As part of this research, a Vision-Based Monitoring System (VBSM) was developed that could capture vehicle trajectories on wrong way approach and entrance to the exit ramp. Such data have provided more details related to the cause of WWD incidences and potential countermeasures. In addition, the effect of certain types of mitigation was evaluated at certain locations by monitoring WWD events before and after mitigation. The VBSM system developed in support of this research provides a strong tool for monitoring WWD events, and for capturing vehicle trajectories on wrong way approach and entrance to the exit ramp that can lead to an understanding of the cause of each event. The ability to determine cause, even for minor "nose in" events, is a substantial improvement over prior approaches. The system can do this because it uses video to monitor motion of vehicles and other entities on the exit ramp, and to automatically detect and record events for entities moving in the wrong direction on the exit ramp. More importantly, for most exit ramps, the system can be installed so that it has a view of the exit ramp throat, i.e. the streets around the exit ramp. As such, the system can view the origin, turning behavior, lane choices, and other driving behavior for the WWD event vehicle. For certain ramps, the system must be installed looking up the ramp, which removes this capability. However, for such cases, the researchers provided a dual-camera capability so that this important information regarding event cause could still be captured. In addition, as the system is automated and based on video, it provides continuous 24-hour per day monitoring of each site. In this manner, this research has evaluated 12 carefully selected exit ramps of interest to Caltrans.

By monitoring these exit ramps continuously, the researchers were able to more clearly characterize wrong-way driving behavior and to identify some trends and behaviors that have not been clearly noted previously in the literature. Prior studies have typically relied upon wrong-way driving crash reports and similar incident reports; thus they are influenced by the selective

nature of the incidents studied. This point has been emphasized by other researchers, e.g. in [29], [30], suggesting that as low as 1% of wrong-way events end in crashes. As crashes represent a small subset of wrong-way events, inferences from these cases may not yield broadly generalizable conclusions, though this information does identify the highest-risk populations. On the contrary, the current study monitored the instrumented exit ramps 24 hours a day for approximately two to three years (depending on site) and collected any behavior that remotely resembled wrong-way driving for further assessment and analysis. The monitoring also identified specific exit ramps included in the study that are more prone to wrong-way driving incidents, and this report flagged these exit ramps for consideration by Caltrans for additional signage and/or design revisions. As this research involved watching for wrong-way behavior for 24 hours a day for over three years, driving behavior patterns were seen which have not been noted in previous studies. Based on the methodologies used in prior studies, of the 34 WWD events found in the twelve exit ramps over three years, at most five drivers did not correct their WWD events (15%). However, it is questionable whether even these WWD events would have been noted as WWD events in previous type of studies since they did not lead to any reported collisions. This fundamental distinction between the current research and prior studies definitely leads to different conclusions regarding causal factors for wrong-way driving in general as opposed to wrong-way driving leading to collisions.

Finally, research involved continuous monitoring of the mitigated exit ramps before and after the mitigations were installed. Because of this, the researchers were able to identify an approximately 53% reduction in the wrong-way event rate for these exit ramps following installation of mitigations.

In addition to on-board WWD event analytics, the VBSM is also able to capture traffic count for the exit ramps. Average vehicle count per hour for both weekdays and weekends is provided for each ramp in Chapter 4. Traffic data must be interpreted carefully with respect to WWD as the correlation between different circumstances and effects is uncertain. The conclusions include:

1. The data suggests that for a given exit ramp, the likelihood of a WWD event is higher during the hours when the traffic volume is lower. This matches with the literature, e.g. [29] which found that wrong-way movements tended to originate from points with low land-use density and in places and times with low traffic volume.
2. Approximately 35% of the WWD events captured were due to wrong-way travel on a one-way street, followed by direct entry to the exit ramp.
3. For several of the exit ramps in this study, the exit ramps feed to a one-way city street. For these, the local authority rather than Caltrans has jurisdiction.

4. The events tended to be in the early morning hours, i.e. from about midnight to 6 am (56% of events in study). This result related to the time of day for the WWD events essentially matches results from prior research.
5. The ratio of WWD events for daytime to nighttime was approximately 1:2.
6. The exit ramp configuration, e.g. exit onto a one-way street or signage on approaching streets, seems to have a significant influence on the number of WWD incidents.
7. Time of day was also observed to play an important factor based on representative ramp volume patterns. During commute hours (typically Monday – Friday, 7-9 AM and 3-6 PM), ramp volume is higher, so that the (possibly confused) WWD vehicle operators may have a better chance of correction since a WW driver can see more cars coming in the opposite direction. Also, lighting is typically better in these periods. Because of these combined factors, the likelihood of WWD events as well as potential severity of such events are viewed as significantly reduced.
8. The collected data indicate that WWD events are spread throughout the week, and throughout the day.
9. The collected data also indicate that there is a higher concentration of WWD events in the midnight to 6 am period, which is consistent with a connection to DUI. However, the data collected over approximately three years indicates that driver confusion, in general, appears to be a more significant factor in WWD events.
10. The collected data indicate that most drivers (85%) recognize their WWD error fairly quickly, and turn around or otherwise correct their driving before they enter the freeway. This helps to explain the difference in some of the results of this research vs. the previous literature that only considered WWD events leading to collisions.
11. For the Sacramento mitigated exit ramps, the WWD event rate dropped from 3.0 events/ramp/year before mitigation to 1.4 after mitigation, a 53% drop in the rate of wrong-way events. Such a significant drop seems to be a strong indicator of the effectiveness of the mitigations selected and installed by Caltrans.

The ability to monitor entry manner for each WWD event was a crucial element of this research. With such monitoring, patterns of driver behavior could be assessed for certain exit ramps. For example, on one exit ramp, most of the WWD events were due to drivers making a right-hand turn onto the exit ramp after passing a large building that obscures the view of the ramp. Based on the

data collected in this research, Caltrans quickly added signs at the intersection as discussed in Chapter 4, improving the signage based upon the detected behavior pattern. As such, the ability to monitor the manner of vehicle entry is critical in assessing exit ramps in need of mitigation, and in focusing on the most pressing issues to address in any mitigation.

Recommendations

Based upon the research findings, the following recommendations are made:

1. Expansion of general exit ramp mitigation efforts, with deployment staged according to perceived level of need. This would involve deploying the mitigation approaches which have been shown effective in the current research and in Caltrans' pilot study [15].
2. Replacing retro-reflective pavement markers on the exit ramp as follows:
 - Change existing one-way white to two-way white/red (W/R) for the lane line(s), channelizing line(s), and gore areas.
 - Change existing one-way yellow to two-way yellow/red (Y/R) for the left edge line
3. Install Y/R and W/R retro-reflective pavement markers with 12-ft spacing for 240-ft and 6-ft spacing for 120 ft starting 120 ft from the end of the exit ramp.
4. Consider installing active monitoring systems on the most operationally critical exit ramps with recurring WWD instances. Should Caltrans decide to install any, it is highly recommended to configure systems with dual forward- and rear-facing cameras as opposed to a single camera, since Caltrans' testing has shown that this significantly increases the ability to verify and characterize WWD instances.
5. Consider signage improvements for key exit ramps. This should be approached in a manner similar to Caltrans' signage improvements for South River Road.
6. Due to resource constraints, only a subset of exit ramps were monitored in this research. It may be feasible to generalize results for some of the monitored exit ramps, as there are typically strong similarities for certain exit ramp types and configurations. As such, the researchers recommend an assessment of the applicability of the findings within this study to a broader number of exit ramps, in order to maximize the safety benefits.

7. Share these research results with municipalities. Certain exit ramps feed into one-way city streets under a local jurisdiction. Exit ramps with this configuration were shown in this research to have increased risk for WWD events. Mitigation of these exit ramps would typically require action by the local authority, as Caltrans does not have jurisdiction. Cooperation by way of shared research and monitoring, along with discussions for mitigation approaches are recommended.

Future Research

The current study provided strong findings regarding wrong-way driving behavior. However, it would be beneficial to increase the amount of data collected and thus increase the statistical significance of the results. Additional collection for the sites in this research, or perhaps a subset, would be immediately useful. Expanding the number and diversity of exit ramps would also be useful. Finally, it is feasible that more information on wrong-way driving behavior as well as the impacts of mitigation could be found through modified approaches to establish baseline data.

Additional research may be needed to assess the benefits of other commercially available WWD monitoring and/or mitigation systems. As such systems are identified by Caltrans, the VBSM and the associated techniques developed in the current research would be valuable for quantitative assessment of performance and benefits.

References

- [1] J. E. Copelan, "Prevention of Wrong Way Accidents on Freeways," Caltrans Division of Traffic Operations, FHWA/CA-TE-89-2, Jun. 1989.
- [2] M. D. Finley *et al.*, "Assessment of the Effectiveness of Wrong-Way Driving Countermeasures and Mitigation Methods," Texas A&M Transportation Institute, 0-6769-1, Dec. 2014.
- [3] National Transportation Safety Board, "Wrong-Way Driving," National Transportation Safety Board, NTSB/SIR-12/01, Dec. 2012.
- [4] Huaguo Zhou and Mahdi Pour Rouholamin, "Guidelines for Reducing Wrong-Way Crashes on Freeways," Illinois Center for Transportation, UIU-ENG-2014-2010, May 2014.
- [5] F. Rodriguez, *State Highways: Wrong-Way Driving*. 2015.
- [6] K. Davis and P. Sisson, "Wrong-Way Crash Stole Two Bright Minds," 2015. [Online]. Available: <https://www.sandiegouniontribune.com/sdut-wrong-way-follow-up-2015may20-story.html>. [Accessed: 26-May-2015].
- [7] N. K. Vaswani, *Measures for Preventing Wrong-Way Entries on Highways*. Virginia Highway Research Council, 1973.
- [8] S. Moler, "Stop. You're Going the Wrong Way!," *Public Roads*, vol. 66, no. 2, pp. 24–29, 2002.
- [9] F. Baratian-Ghorghi, H. Zhou, and J. Shaw, "Overview of Wrong-Way Driving Fatal Crashes in the United States," *ITE Journal*, vol. 84, no. 8, pp. 41–47, 2014.
- [10] M. Glover, "Crash on Highway 50 Kills Two; CHP Looks into Possibility of Wrong-Way Driver," 2015. [Online]. Available: <https://www.sacbee.com/news/local/crime/article21277467.html>. [Accessed: 26-May-2015].
- [11] M. De Niet and A. Blokpoel, "Heading in the Wrong Direction: Descriptive Research on Wrong-Way Driving on Dutch Motorways: Background, Causes, Liability and Measures," 2000.
- [12] E. Kemel, "Wrong-Way Driving Crashes on French Divided Roads," *Accident Analysis & Prevention*, vol. 75, pp. 69–76, 2015, doi: 10.1016/j.aap.2014.11.002.
- [13] J. Xing, "Characteristics of Wrong-Way Driving on Motorways in Japan," *IET Intelligent Transport Systems*, vol. 9, no. 1, pp. 3–11, 2014, doi: 10.1049/iet-its.2014.0017.
- [14] M. Pour-Rouholamin, H. Zhou, J. Shaw, and P. Tobias, "Current Practices of Safety Countermeasures for Wrong-Way Driving Crashes," presented at the Transportation Research Board 94th Annual Meeting, 2015, pp. 15–28.
- [15] T. Bucko, "Wrong Way Prevention Pilot Projects for Prevention of Wrong Way Collisions on Freeways," California Department of Transportation, 2019.
- [16] CTC & Associates LLC, "Wrong-Way Driving Prevention Methods," California Department of Transportation Preliminary Investigation, Oct. 2015.

- [17] S. A. Simpson, "Wrong-Way Vehicle Detection: Proof of Concept," Arizona DOT Research Center, 697, Mar. 2013.
- [18] C. Wince, "ADOT Installs Lower, Larger Signs to Fight Wrong-Way Drivers," 2014. [Online]. Available: <https://www.azcentral.com/story/news/local/phoenix/2014/06/25/phoenix-wrong-way-drivers-adot-signs-abrk/11361437/>. [Accessed: 26-May-2015].
- [19] C. Codd, "Exclusive: Pilot Program Shows Hope for Preventing Wrong Way Wrecks," 2014. [Online]. Available: <https://miami.cbslocal.com/2014/12/12/exclusive-pilot-program-shows-hope-for-preventing-wrong-way-wrecks/>. [Accessed: 26-May-2015].
- [20] R. Ponnaluri, "Sunguide Disseminator: Wrong-Way Pilot Projects in Florida Update." Florida DOT, 2014.
- [21] B. Schlikerman, "What to Do About Wrong-Way Drivers," 2012. [Online]. Available: <https://www.chicagotribune.com/news/ct-xpm-2012-02-08-ct-met-wrong-way-drivers-0208-20120208-story.html>. [Accessed: 26-May-2015].
- [22] H. Zhou *et al.*, "Investigation of Contributing Factors Regarding Wrong-Way Driving on Freeways," *FHWA-ICT-12-010*, 2012.
- [23] S. A. Cooner, A. S. Cothron, and S. E. Ranft, "Countermeasures for Wrong-Way Movement on Freeways: Guidelines and Recommended Practices," Texas Transportation Institute, Texas A & M University System, 2004.
- [24] California Department of Transportation, "Prevention and Detection of Wrong-Way Collisions on Freeways," Final Report to the Legislature, Jul. 2016.
- [25] M. Forthoffer, S. Bouzar, F. Lenoir, J. M. Blossville, and D. Aubert, "Automatic Incident Detection: Wrong-Way Vehicle Detection Using Image Processing," presented at the Intelligent Transportation: Realizing the Future. Abstracts of the Third World Congress on Intelligent Transport Systems, 1996.
- [26] S. Matsumoto, Y. Mizushima, and H. Nagasaki, "Development of a System that Prevents Wrong-Way Driving," presented at the 20th ITS World Congress, 2013.
- [27] R. Baisyet and A. Stevens, "Combating Wrong Way Drivers on Divided Carriageways," presented at the Institution of Professional Engineers New Zealand (IPENZ) Transportation Conference, Christchurch, New Zealand, 2015.
- [28] R. W. Chambers, "Spiral Grain—The Inside Story," *Log Building News*, vol. 63, pp. 6–8, 2007.
- [29] P. N. Scifres, "Wrong-Way Movements on Divided Highways," Purdue University School of Engineering, JHRP-74-3, 1974.
- [30] A. Lew, "Wrong-Way Driving (Phase 3)/Final Report/Driver Characteristics, Effectiveness of Remedial Measures, and Effect of Ramp Type," 1971.

Appendix A:

Additional WWD Incident Information

This appendix provides additional information regarding various WWD incidents. In particular, the appendix provides:

- Images and discussion of the road rage incident.
- Aerial trajectory views for the remaining WWD events of interest.

Road Rage Incident

On August 27, 2016, at approximately 7:39 pm, the system on SR51 J Street exit ramp captured what appears to be a minor road rage incident. This section documents this event, as there has been interest. Note that this event does not qualify as a "WWD event of interest" for the analysis in this research. However, as with all other detected events, it was recorded and logged, and is thus available for the current discussion.

The incident occurred in the early evening in the summer of 2016, with well-lit conditions. Four vehicles were proceeding in the correct direction down the J Street exit ramp. The stop light to turn onto J Street was red. Two of the four vehicles stopped correctly at the intersection. The third vehicle (V3), an SUV, appears to have stopped properly as well. The fourth vehicle (V4), also an SUV, stops behind the third vehicle. V3 then backed up the exit ramp in what appears to be an attempt to impact V4. V4 then backed up the exit ramp to get away from V3. Then, the vehicles proceed to the intersection, V3 stops in an apparent attempt to keep V4 from proceeding, and finally all move through the intersection. Several snapshots of the incident are provided in Figure A.1.

This incident was not included in the WWD analysis in this research, as it did not meet the criteria for event selection. In particular, this event was deliberate and could bias the analysis, and thus excluded.



Figure A.1: Snapshots from the August 27, 2016 road rage incident on the J Street exit ramp

Additional Vehicle Trajectories for WWD Events of Interest

Figures A-2 – A.23 provide sketches of the aerial view of the vehicle trajectory for the WWD incidents of interest for the analysis. The corresponding sketches for the South River Road incidents are provided in Chapter 4, as they are directly relevant to specific analysis and discussion therein.

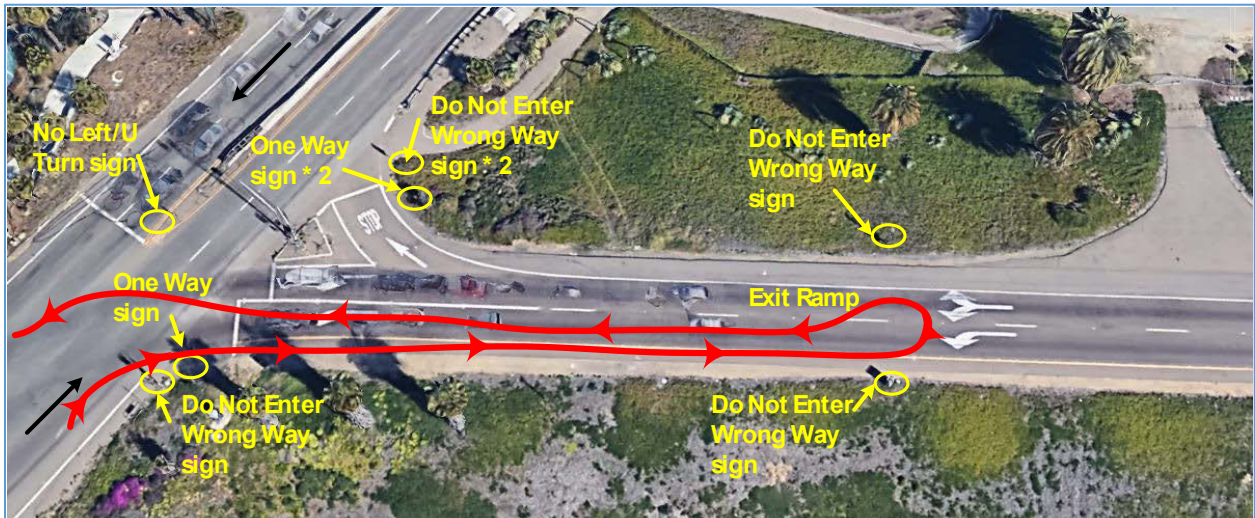

Figure A.2: Aerial view of the 5/1/2018 3:46 am WWD event on the Sunset Cliffs exit ramp. Approximate vehicle trajectory is shown in red. Aerial image courtesy of Google Earth.

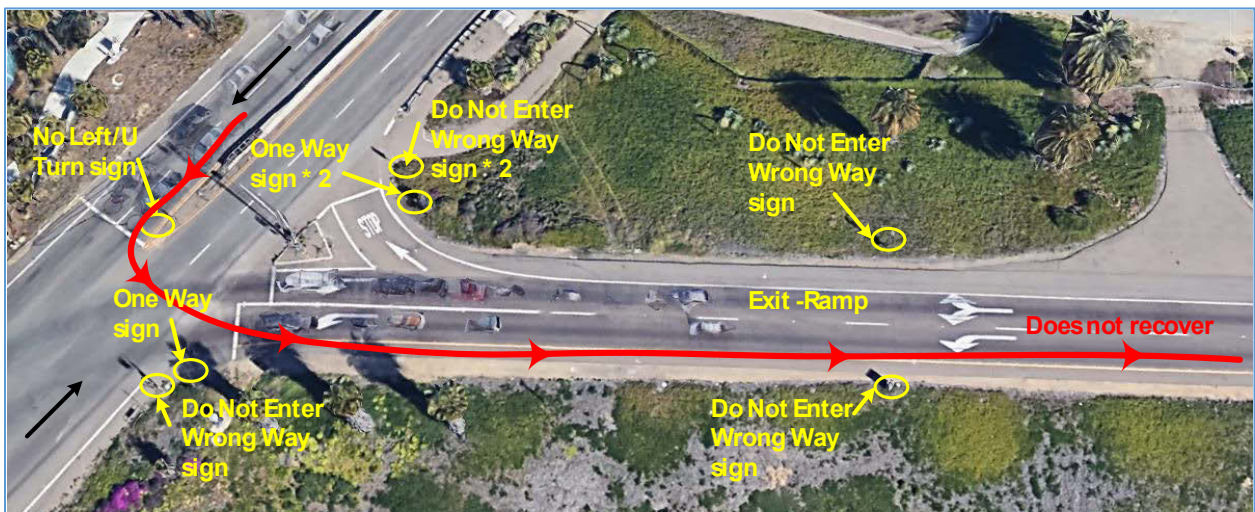

Figure A.3: Aerial view of the 6/2/2019 2:03 am WWD event on the Sunset Cliffs exit ramp. Approximate vehicle trajectory is shown in red. Aerial image courtesy of Google Earth.

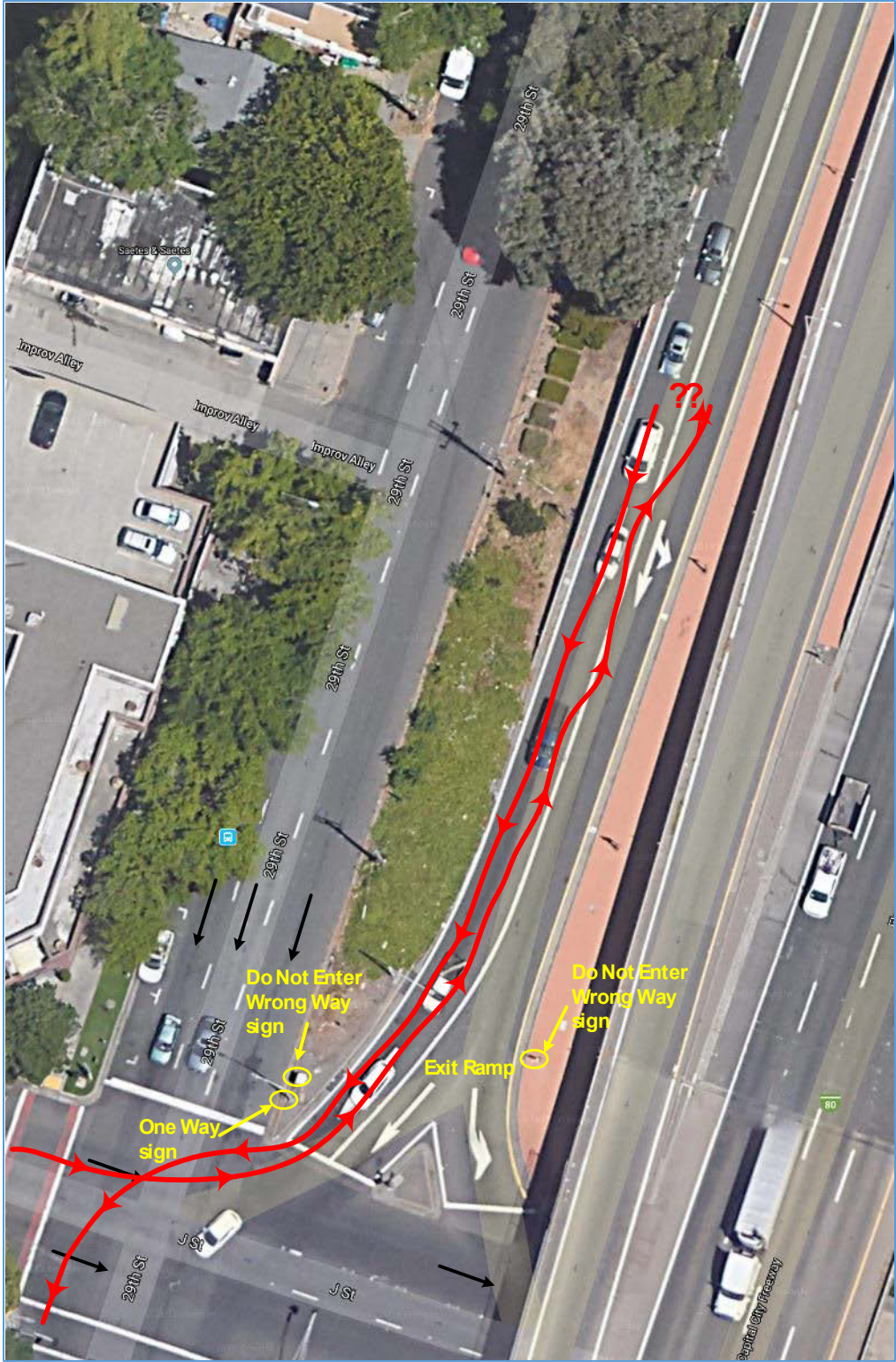

Figure A.4: Aerial view of the 1/9/2017 1:50 am WWD event on the J Street exit ramp. Approximate vehicle trajectory is shown in red. Aerial image courtesy of Google Maps.

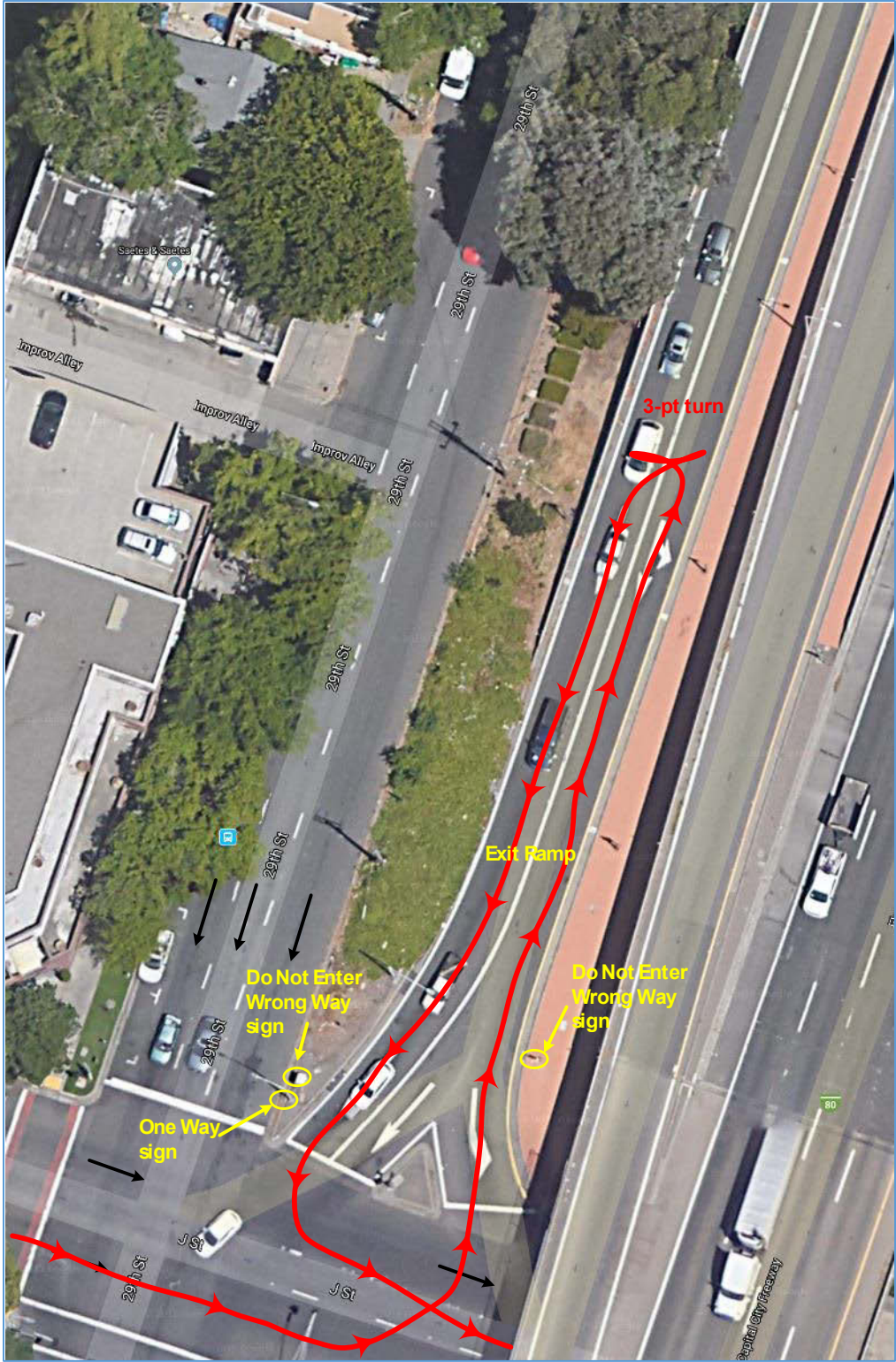

Figure A.5: Aerial view of the 4/13/2017 1:51 am WWD event on the J Street exit ramp. Approximate vehicle trajectory is shown in red. Aerial image courtesy of Google Maps.

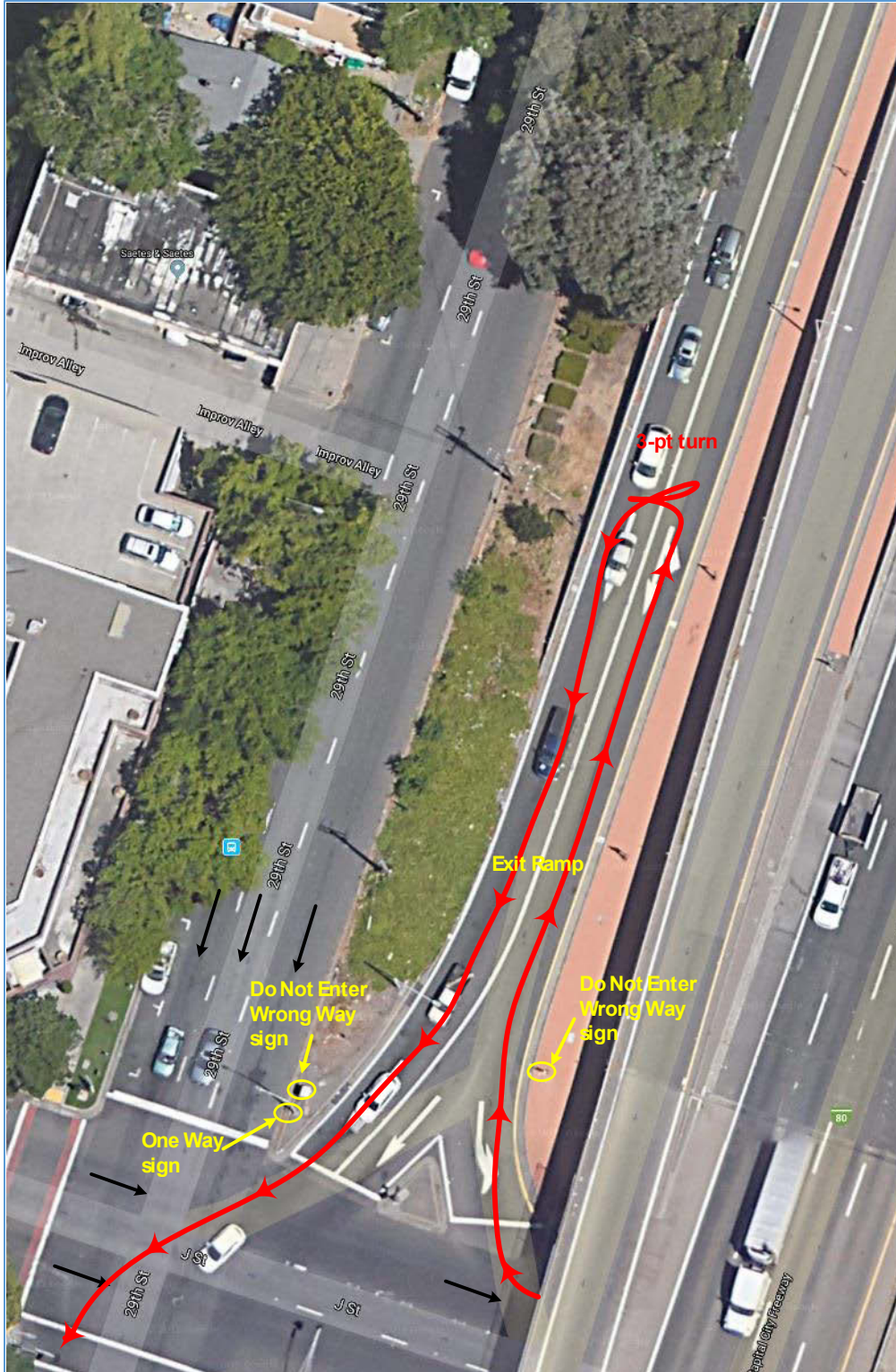

Figure A.6: Aerial view of the 3/8/2018 1:30 am WWD event on the J Street exit ramp. Approximate vehicle trajectory is shown in red. Aerial image courtesy of Google Maps.

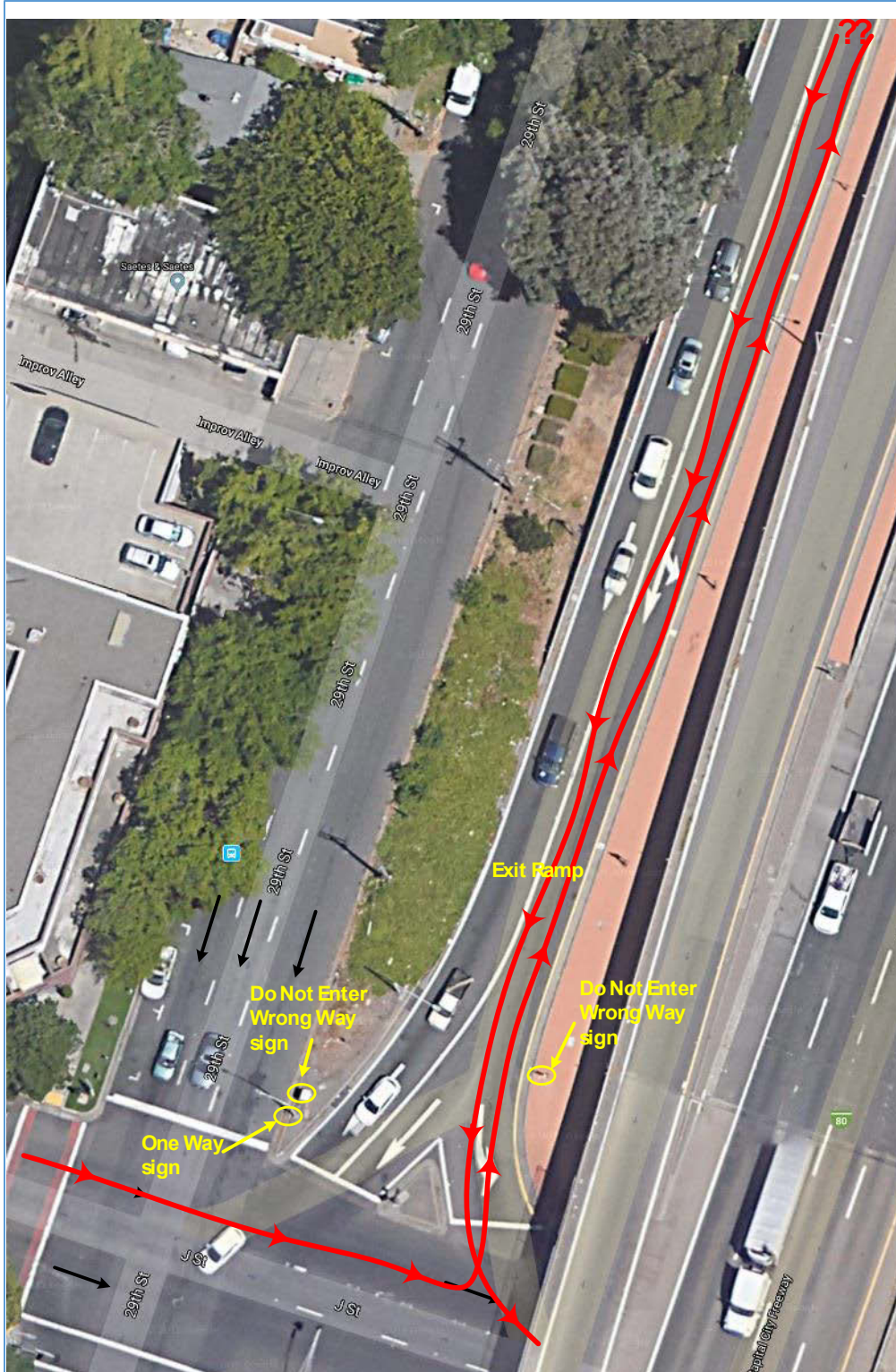

Figure A.7: Aerial view of the 1/23/2019 2:01 am WWD event on the J Street exit ramp. Approximate vehicle trajectory is shown in red. Aerial image courtesy of Google Maps.



Figure A.8: Aerial view of the 8/18/2018 7:21 am WWD event on the EB 5th Street exit ramp. Approximate vehicle trajectory is shown in red. Aerial image courtesy of Google Maps.

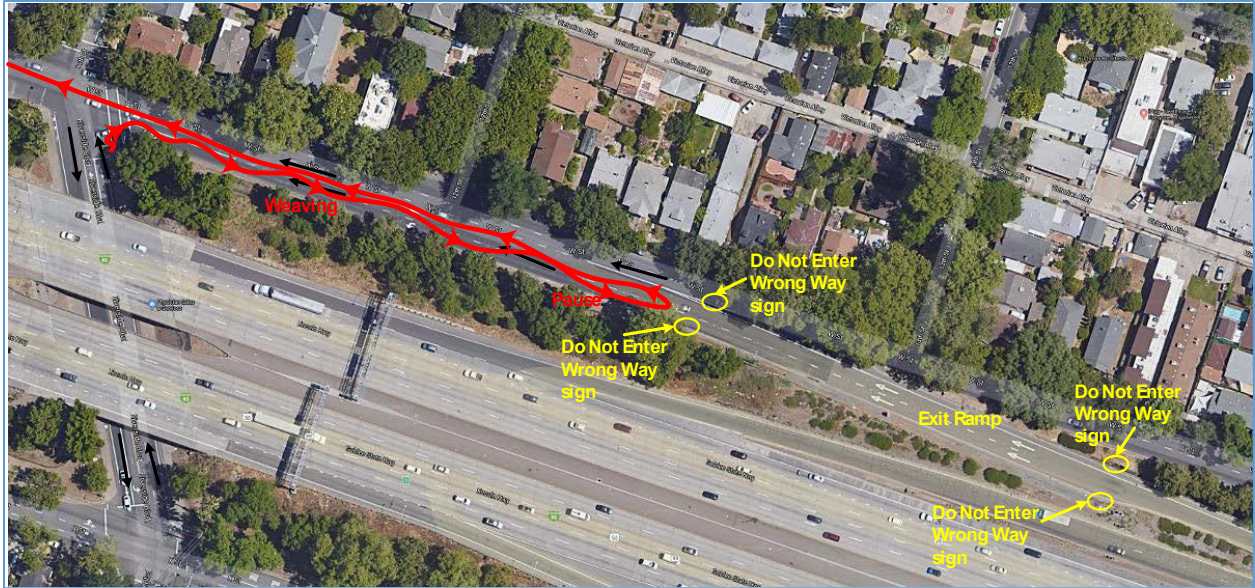

Figure A.9: Aerial view of the 12/22/2016 5:41 am WWD event on the WB 10th Street exit ramp. Approximate vehicle trajectory is shown in red. Aerial image courtesy of Google Maps.



Figure A.10: Aerial view of the 5/4/2017 3:47 am WWD event on the WB 10th Street exit ramp. Approximate vehicle trajectory is shown in red. Aerial image courtesy of Google Maps.

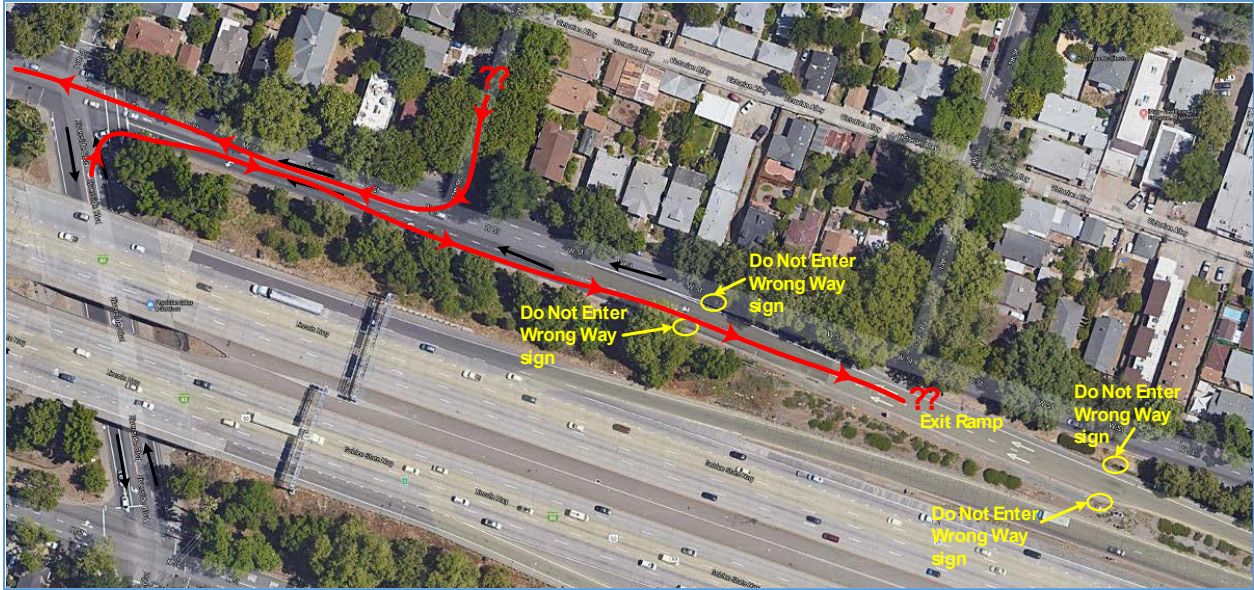

Figure A.11: Aerial view of the 5/16/2017 11:43 pm WWD event on the WB 10th Street exit ramp. Approximate vehicle trajectory is shown in red. Aerial image courtesy of Google Maps.

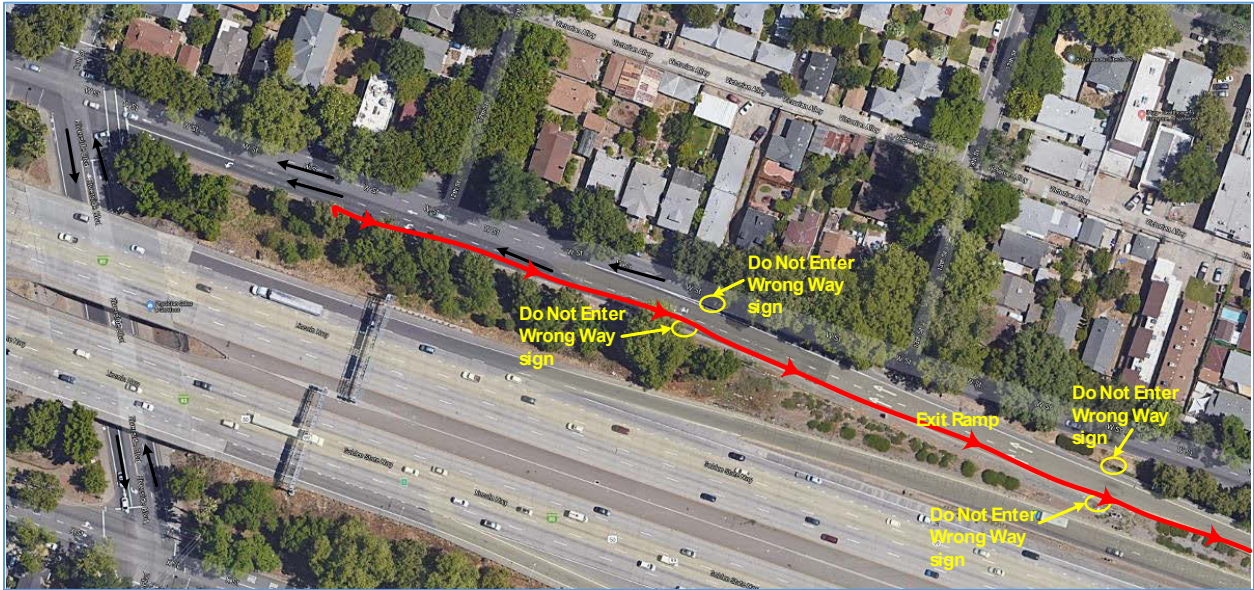

Figure A.12: Aerial view of the 2/4/2019 1:37 am WWD event on the WB 10th Street exit ramp. Approximate vehicle trajectory is shown in red. Aerial image courtesy of Google Maps.

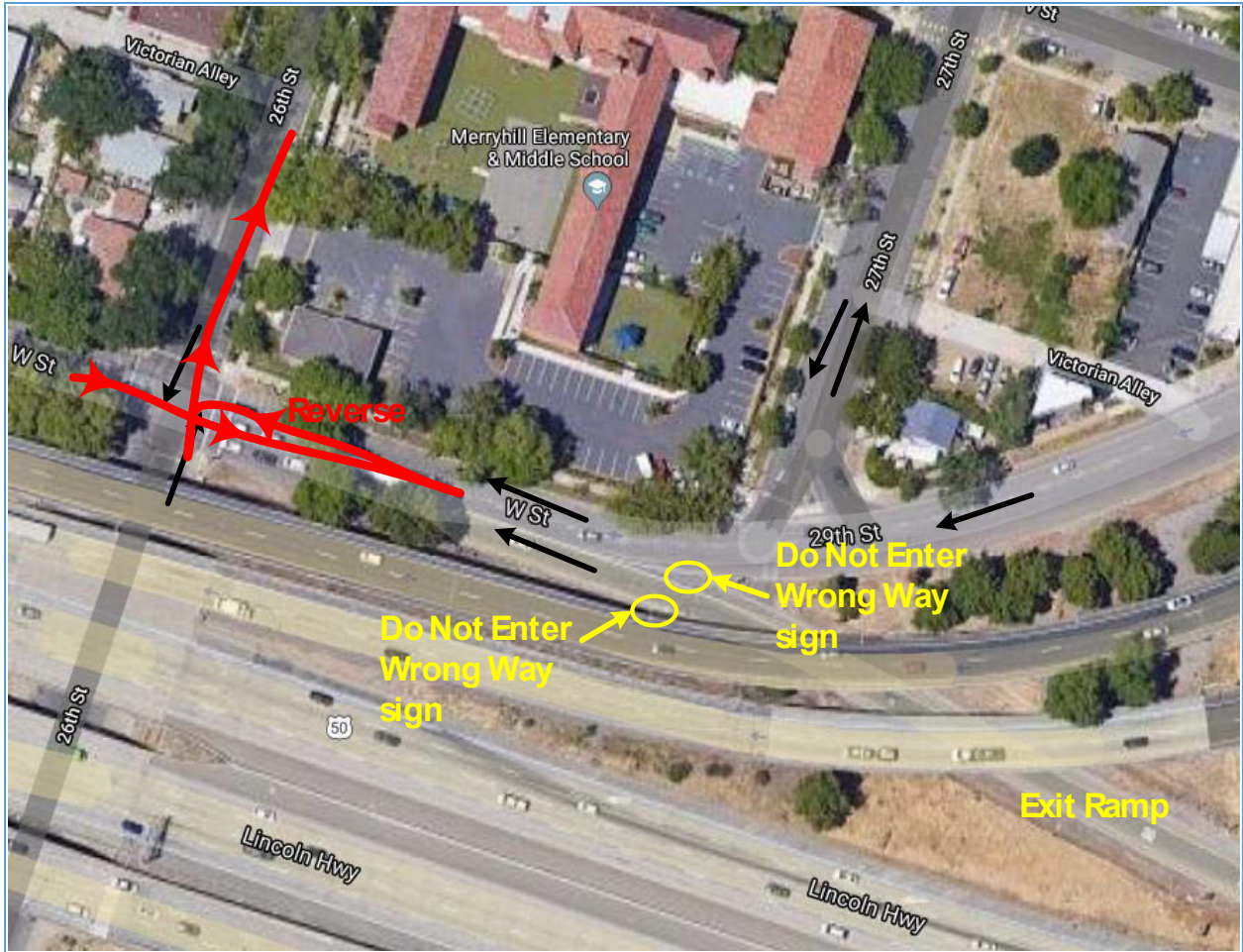

Figure A.13: Aerial view of the 11/2/2016 1:05 am WWD event on the WB 26th Street exit ramp. Approximate vehicle trajectory is shown in red. Aerial image courtesy of Google Maps.

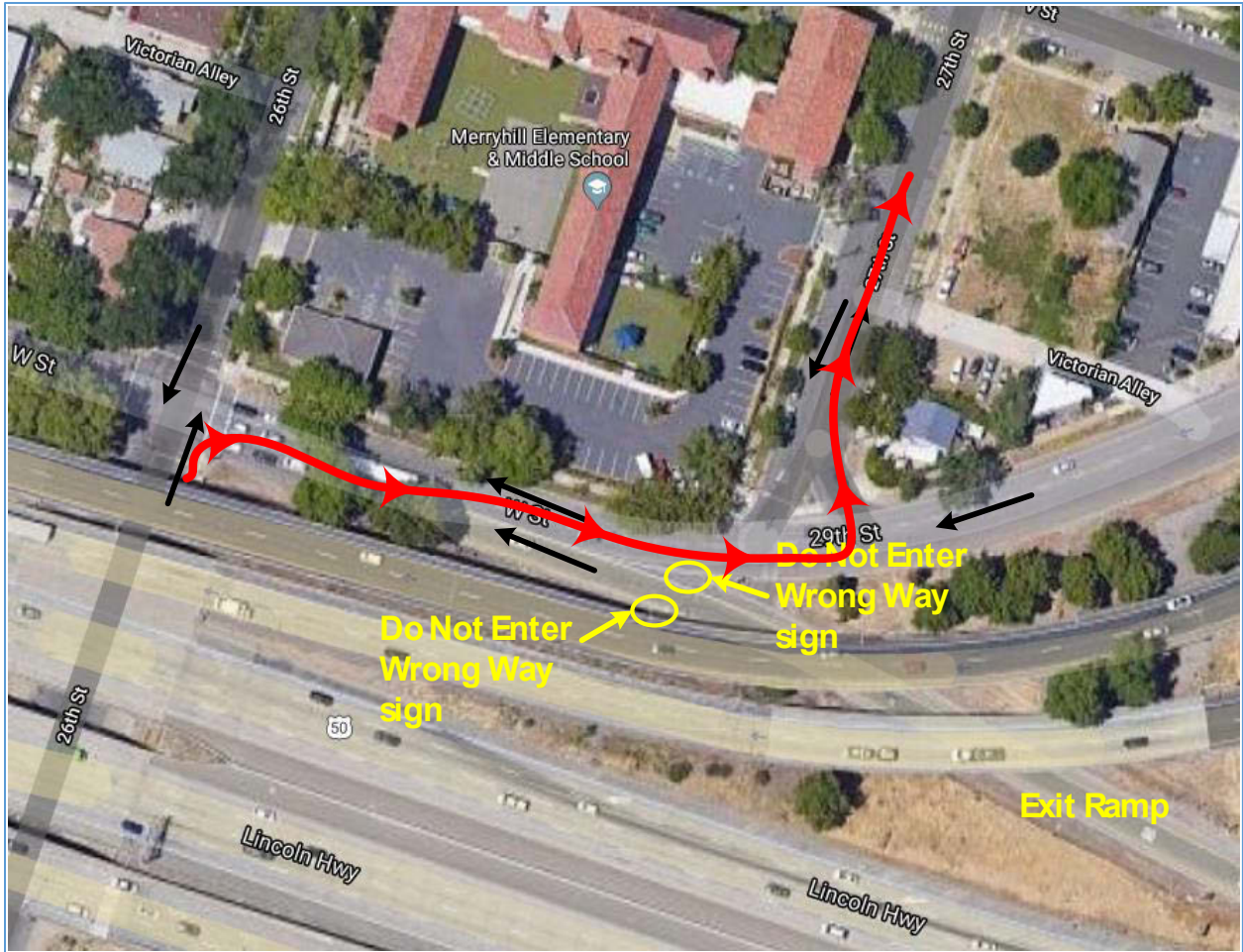

Figure A.14: Aerial view of the 5/26/2017 4:12 am WWD event on the WB 26th Street exit ramp. Approximate vehicle trajectory is shown in red. Aerial image courtesy of Google Maps.

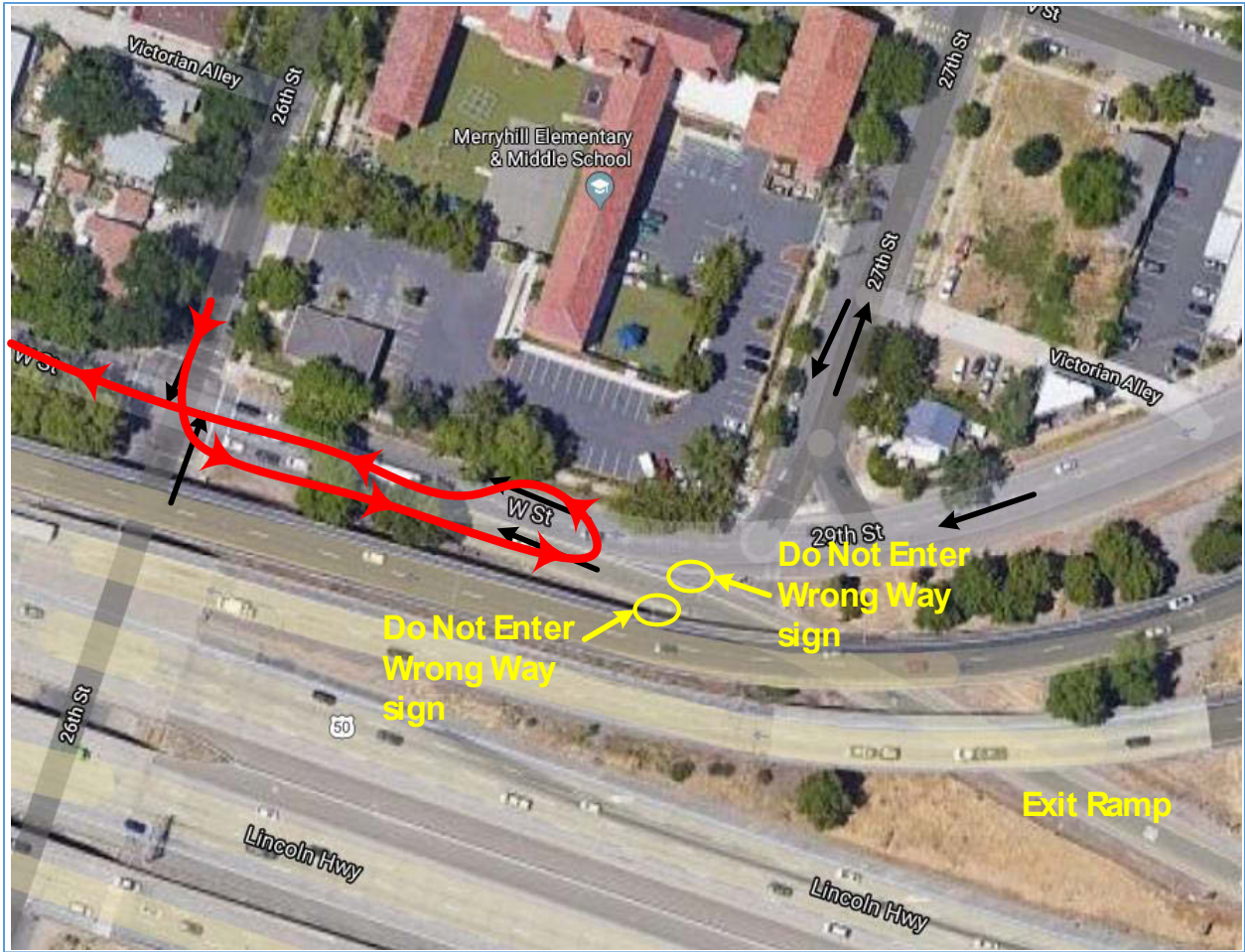

Figure A.15: Aerial view of the 10/10/2017 3:13 pm WWD event on the WB 26th Street exit ramp. Approximate vehicle trajectory is shown in red. Aerial image courtesy of Google Maps.

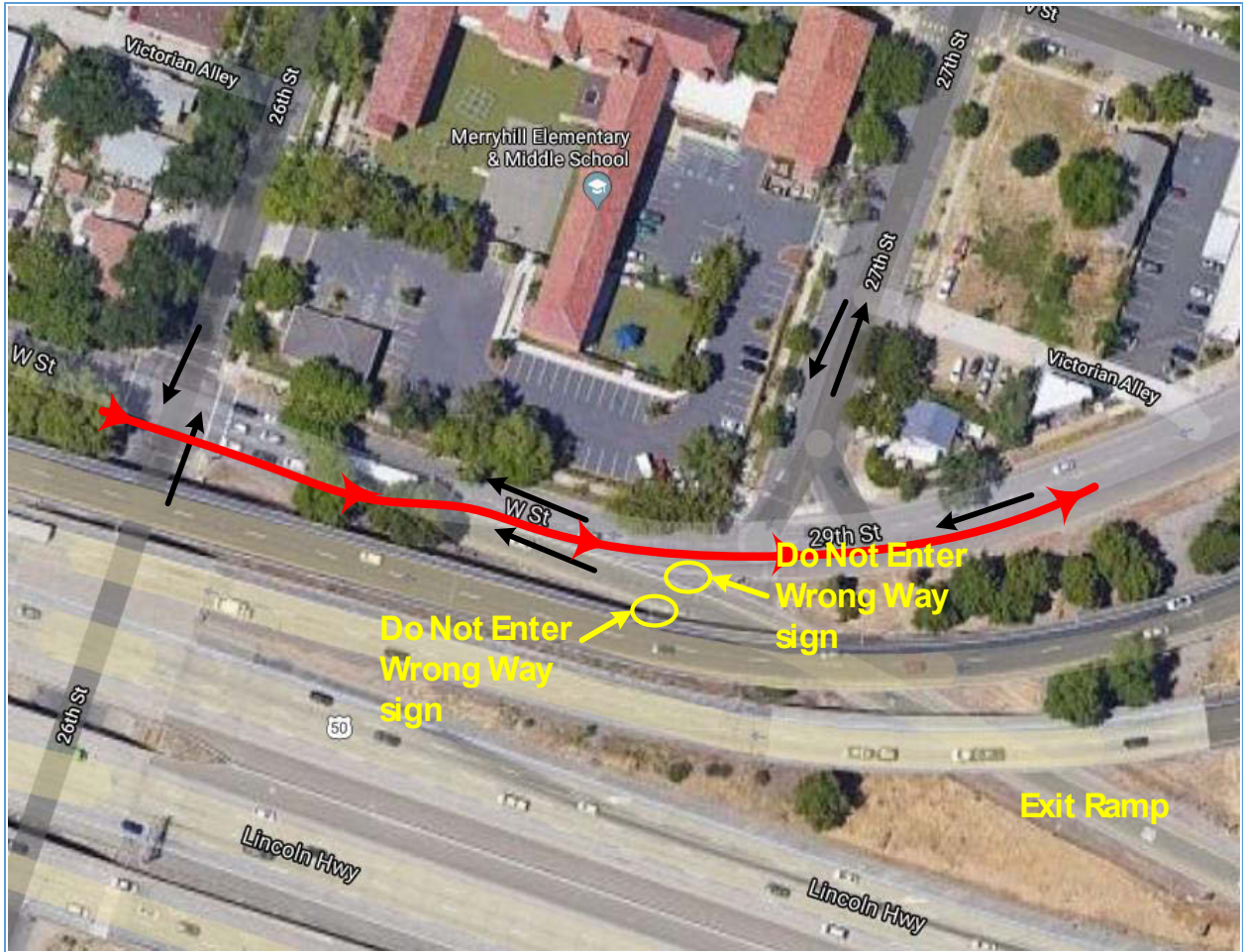

Figure A.16: Aerial view of the 11/23/2017 7:49 am WWD event #1 on the WB 26th Street exit ramp. Approximate vehicle trajectory is shown in red. Aerial image courtesy of Google Maps.

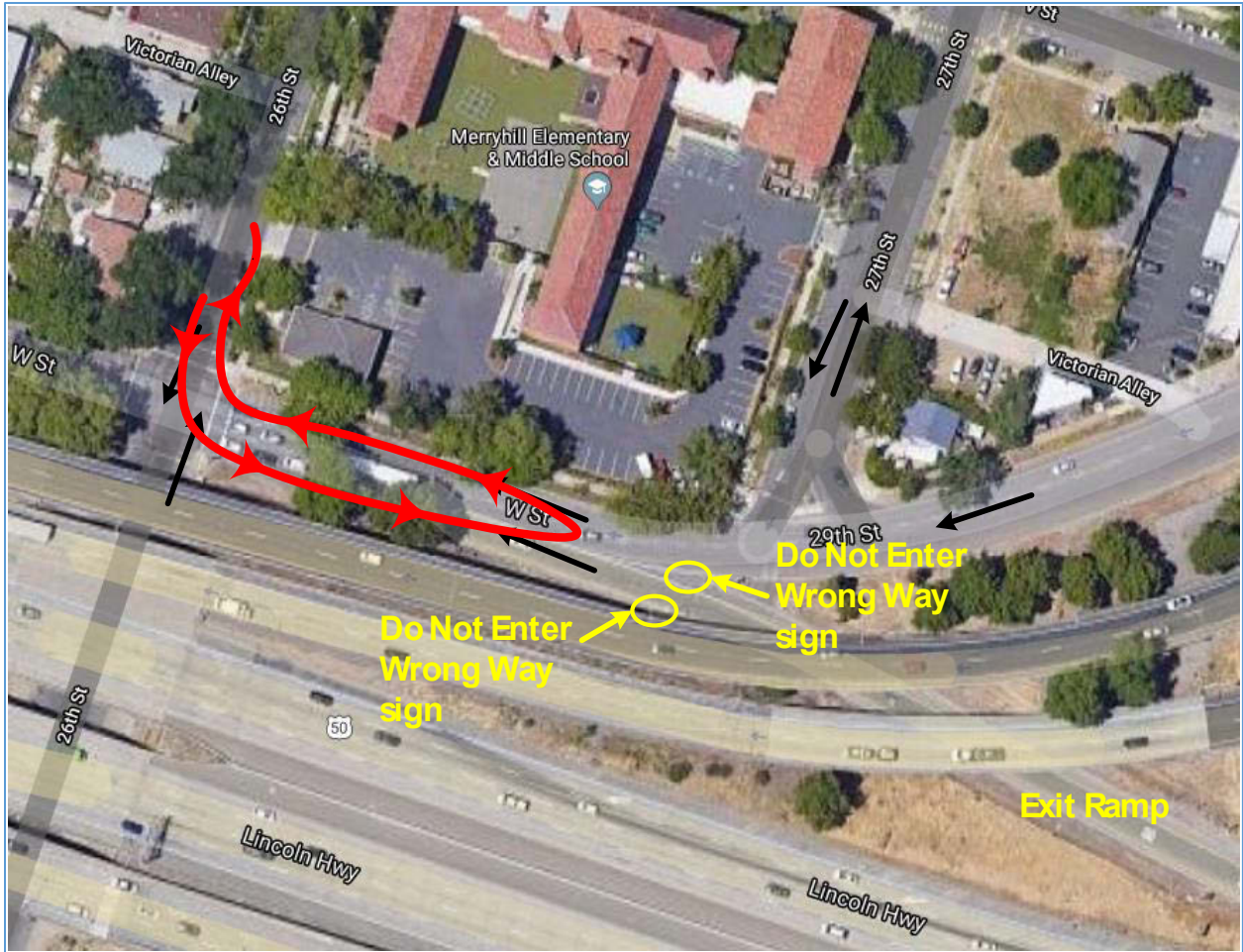

Figure A.17: Aerial view of the 11/23/2017 7:49 am WWD event #2 on the WB 26th Street exit ramp. Approximate vehicle trajectory is shown in red. Aerial image courtesy of Google Maps.

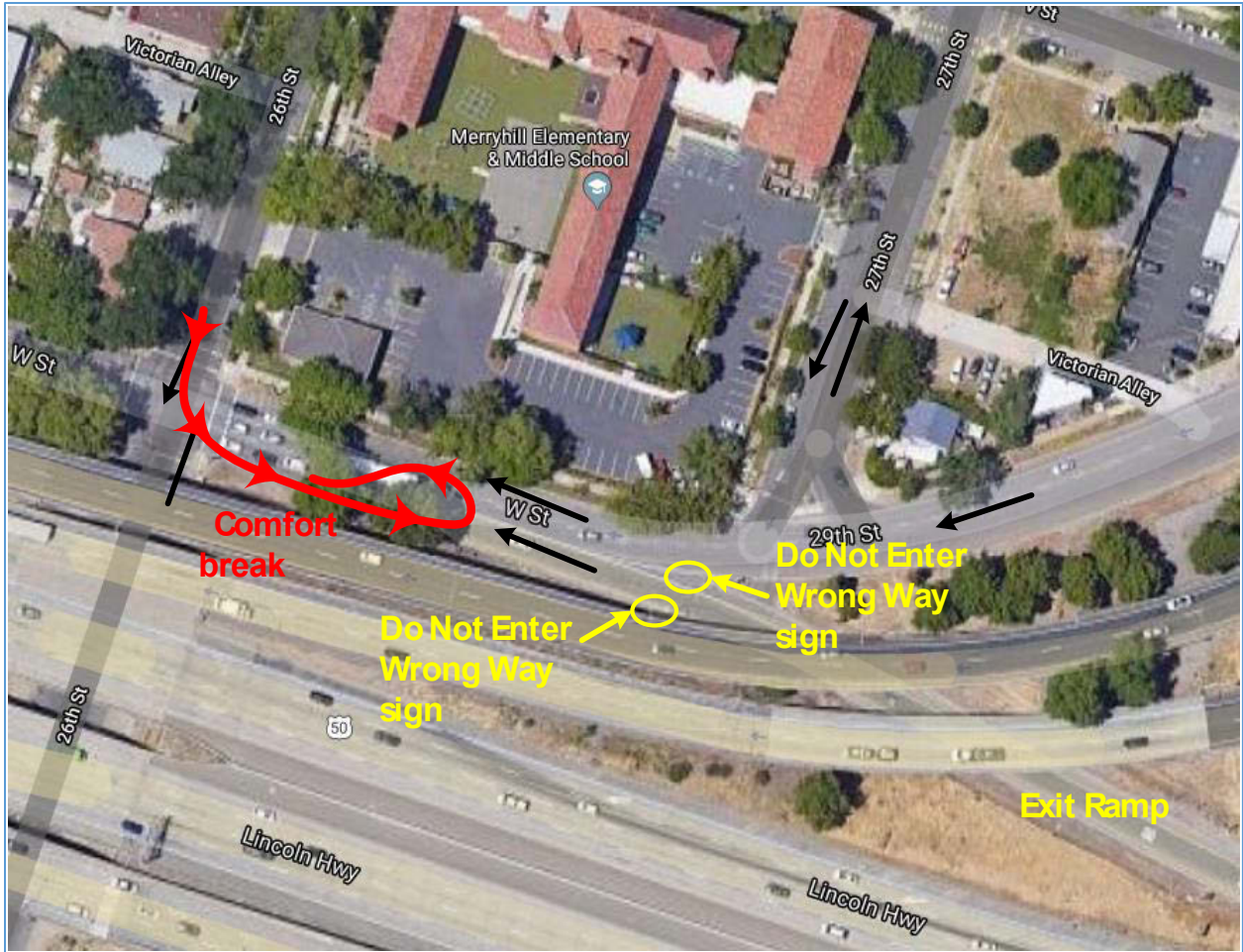

Figure A.18: Aerial view of the 12/2/2018 3:33 am WWD event on the WB 26th Street exit ramp. Approximate vehicle trajectory is shown in red. Aerial image courtesy of Google Maps.

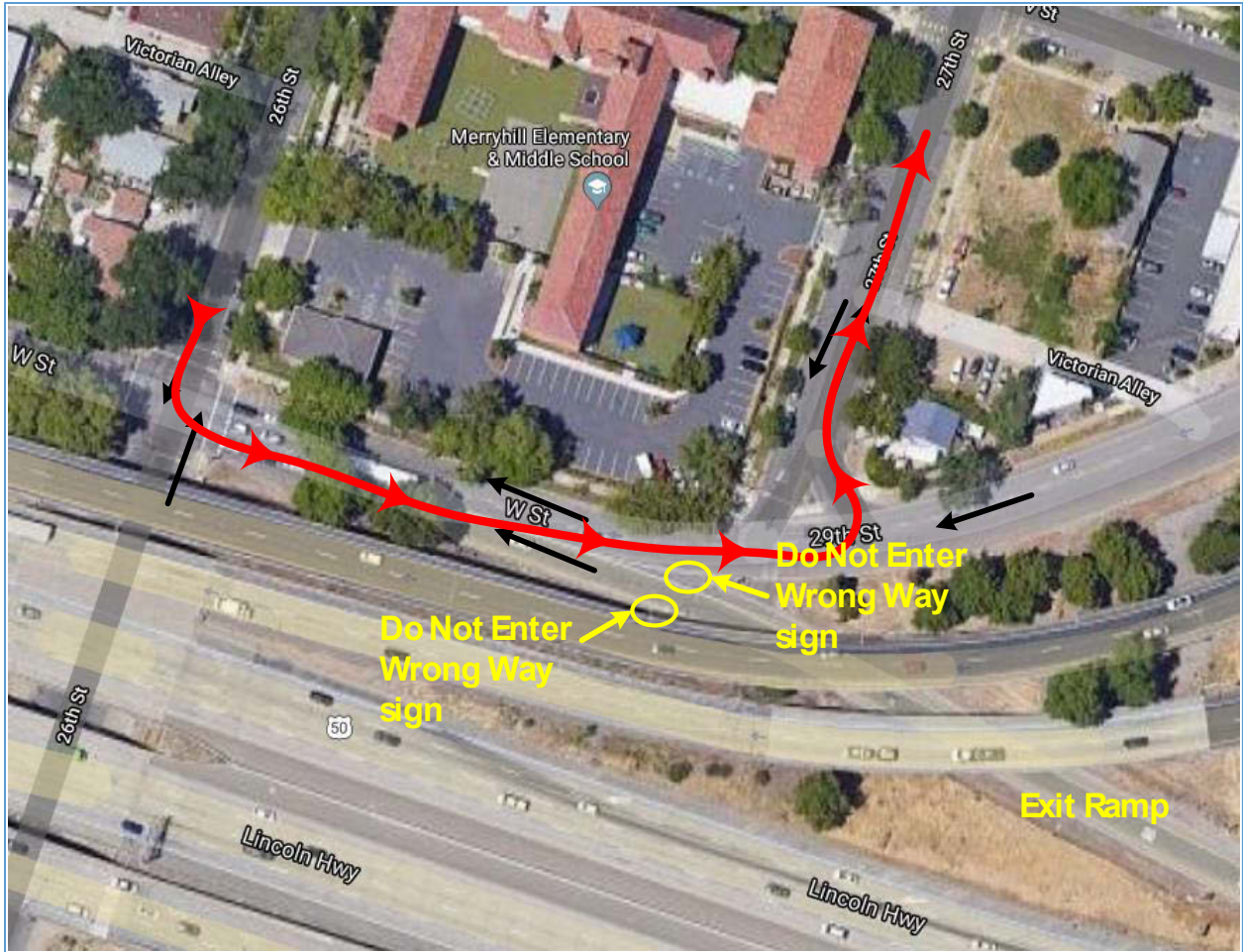

Figure A.19: Aerial view of the 1/14/2019 5:26 am WWD event on the WB 26th Street exit ramp. Approximate vehicle trajectory is shown in red. Aerial image courtesy of Google Maps.

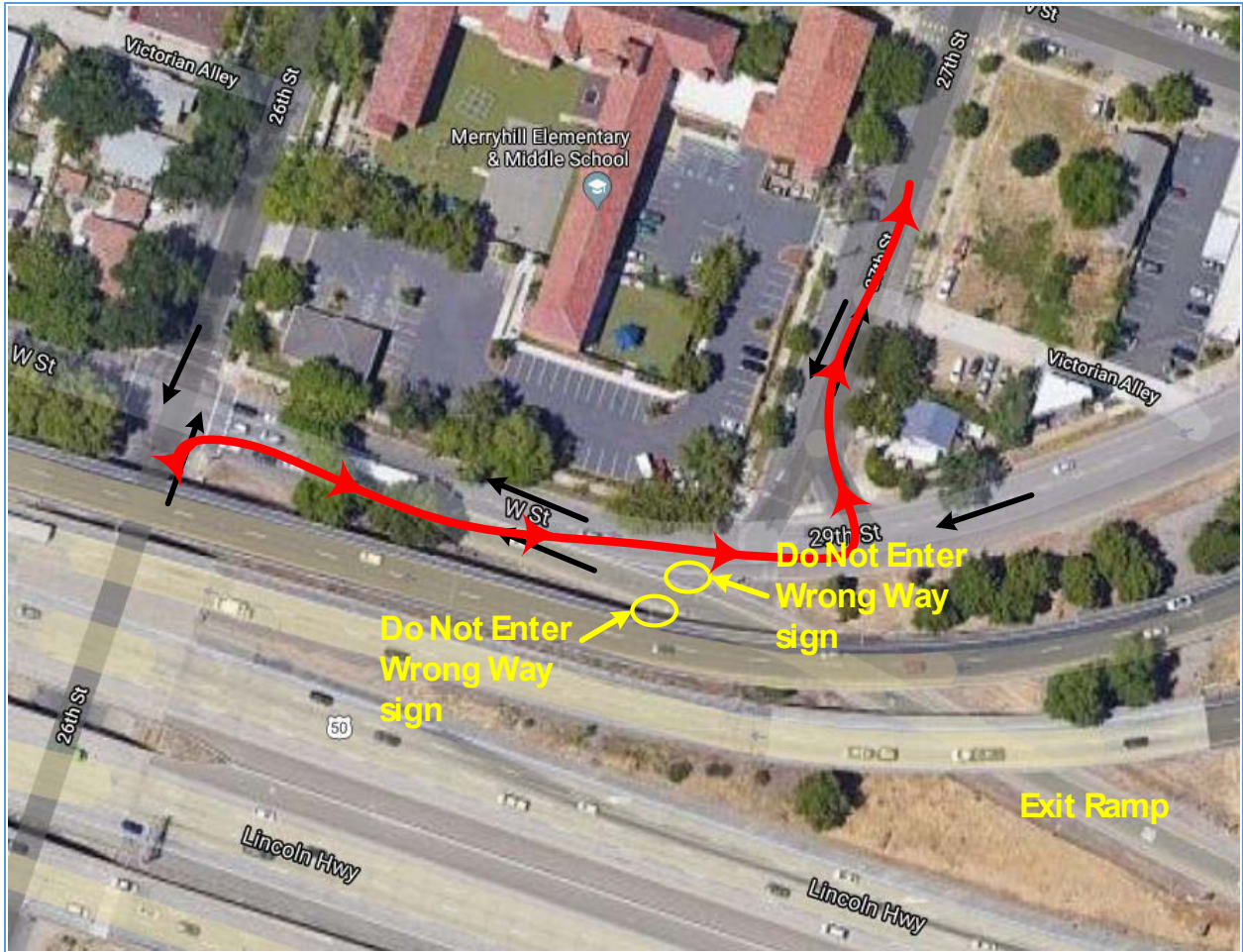

Figure A.20: Aerial view of the 1/30/2019 4:14 am WWD event on the WB 26th Street exit ramp. Approximate vehicle trajectory is shown in red. Aerial image courtesy of Google Maps.

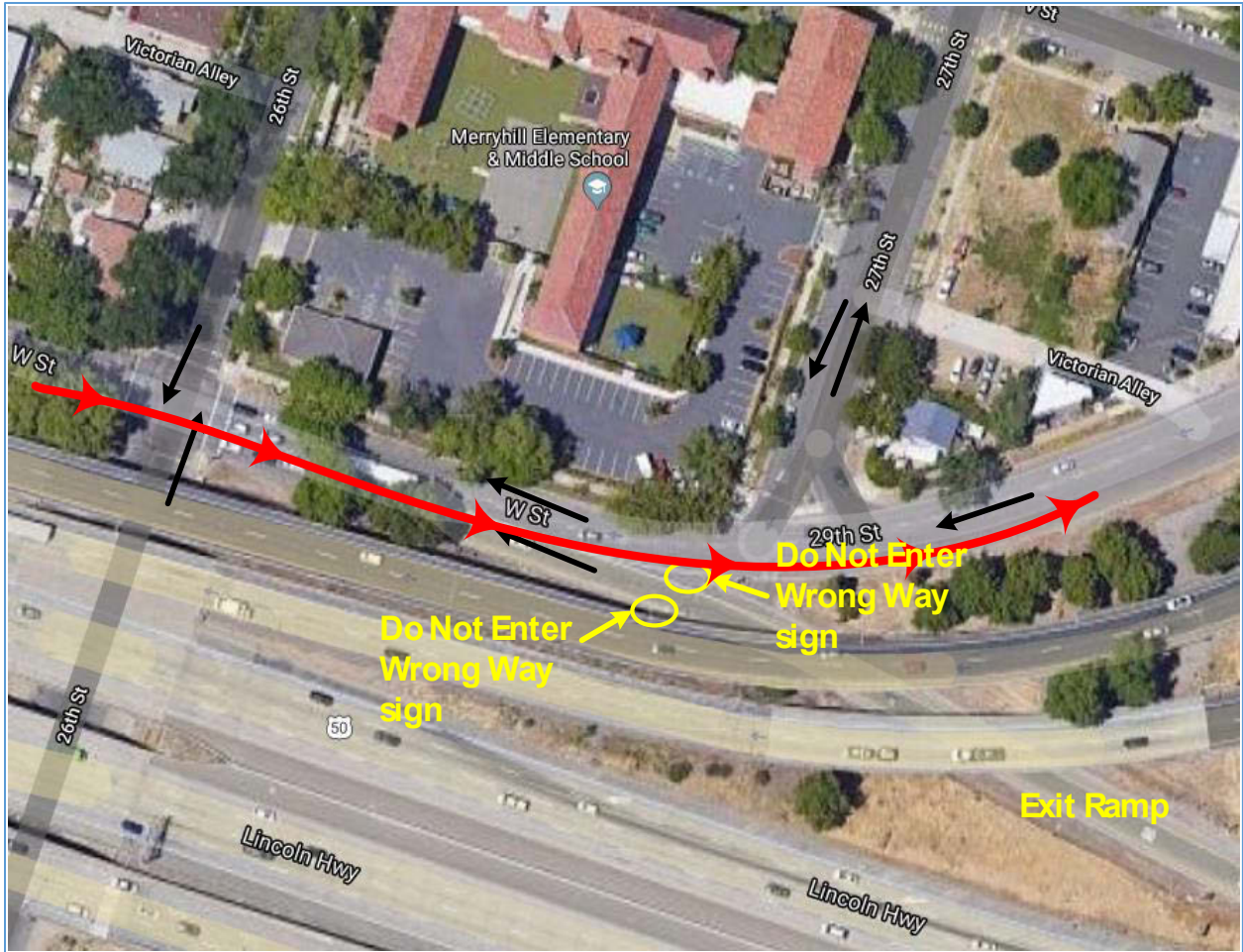

Figure A.21: Aerial view of the 6/22/2019 3:06 am WWD event on the WB 26th Street exit ramp. Approximate vehicle trajectory is shown in red. Aerial image courtesy of Google Maps.

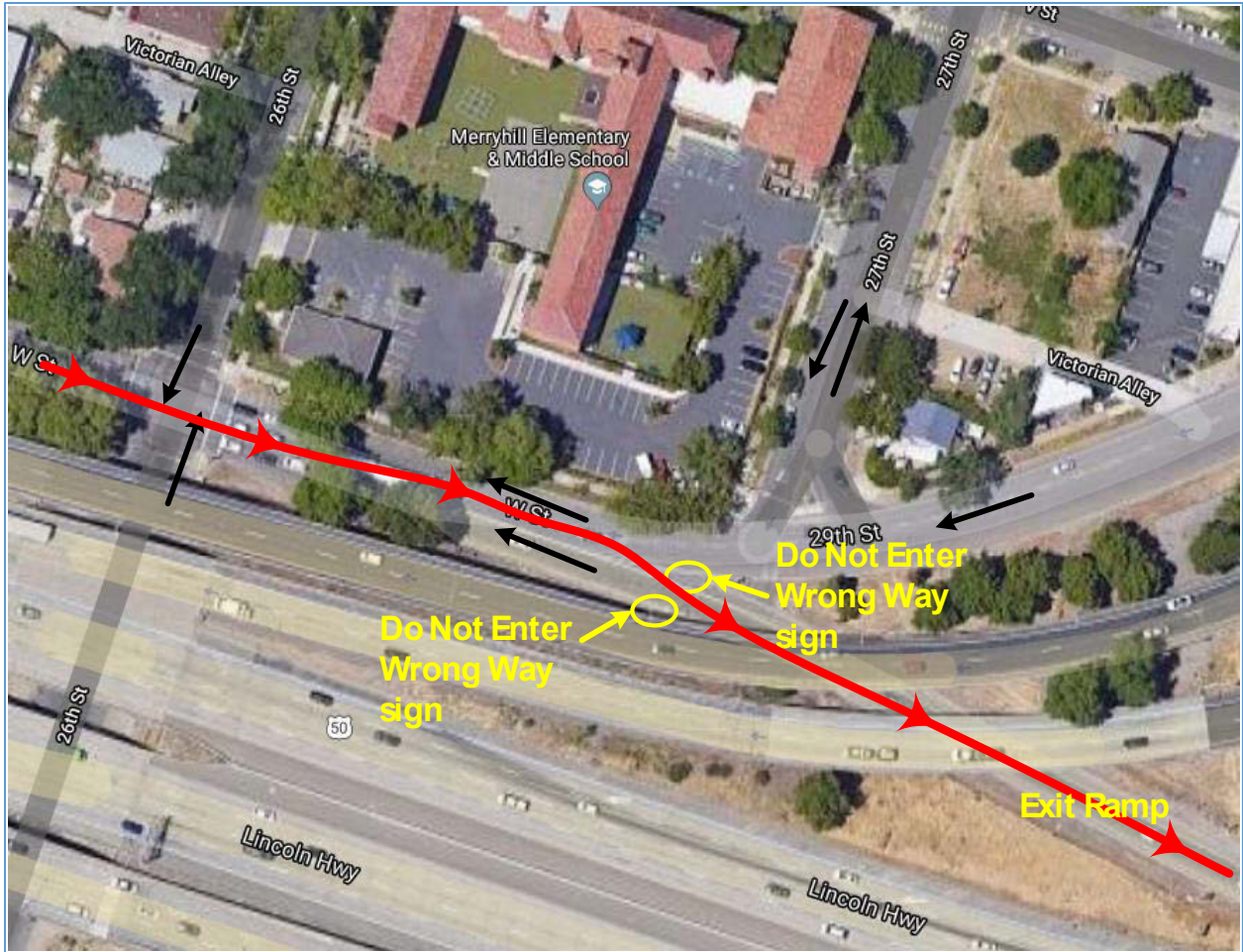

Figure A.22: Aerial view of the 6/22/2019 4:58 am WWD event on the WB 26th Street exit ramp. Approximate vehicle trajectory is shown in red. Aerial image courtesy of Google Maps.

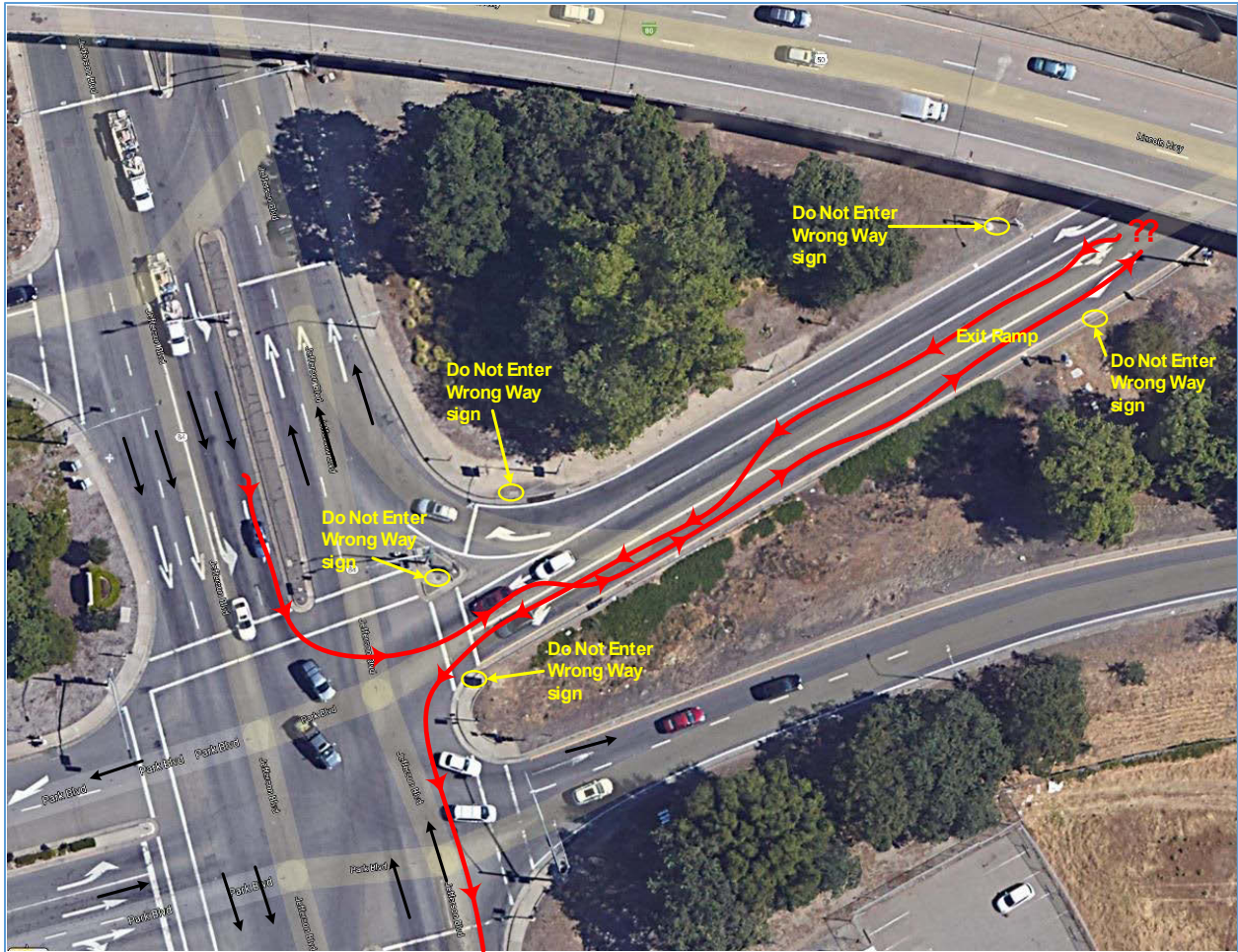

Figure A.23: Aerial view of the 8/11/2016 4:11 am WWD event on the Jefferson Boulevard exit ramp. Approximate vehicle trajectory is shown in red. Aerial image courtesy of Google Maps.

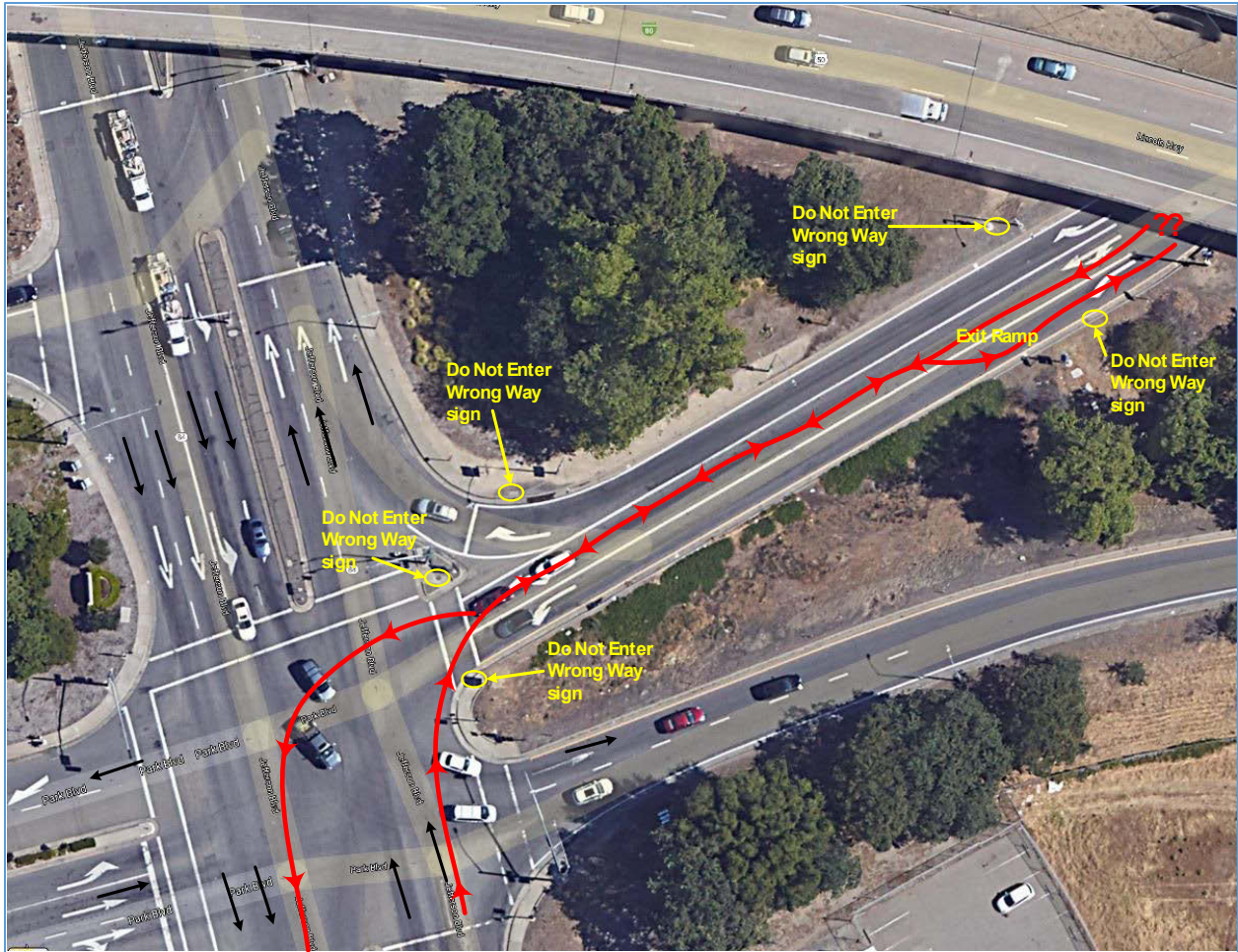

Figure A.24: Aerial view of the 8/23/2017 12:49 am WWD event on the Jefferson Boulevard exit ramp. Approximate vehicle trajectory is shown in red. Aerial image courtesy of Google Maps.

Appendix B:

All Vehicular WWD Incidents in Data Collection Period

Table B.1: All vehicular WWD events in data collection period. Blue events are the main events detected by the VBSM only. Gold events are those detected by TAPCO only. Gray events are those detected by TrafficCalm only. Purple events are those detected by both the VBSM and TAPCO. Orange events are those detected by both the VBSM and TrafficCalm. Green events are remaining VBSM-only detections which were not included in the analysis.

Date	Time	Ramp	Note / Resolution
6/30/2016	1:18 AM	US 50 WB Jefferson Blvd	
7/2/2016	6:06 AM	US 50 WB S. River Rd	
7/18/2016	1:50 AM	US 50 WB Jefferson Blvd	
8/11/2016	4:10 AM	US 50 WB Jefferson Blvd	left to exit ramp, through camera, recovered
8/16/2016	3:57 AM	SR 51 SB J St	
8/27/2016	7:38 PM	SR 51 SB J St	road rage
9/1/2016	2:09 AM	US 50 WB Jefferson Blvd	
9/19/2016	8:12 AM	US 50 WB S. River Rd	
10/9/2016	1:03 AM	US 50 WB Jefferson Blvd	
10/21/2016	1:52 PM	US 50 WB S. River Rd	right to exit ramp, quick recovery
11/2/2016	1:04 AM	US 50 WB 26 th St	up one-way (W), just onto ramp, recovered
11/6/2016	4:46 PM	US 50 WB S. River Rd	right to exit ramp, quick recovery
11/23/2016	11:10 AM	US 50 WB S. River Rd	car in lane 2, backs up to switch to lane 1 to turn left
12/20/2016	10:34 AM	US 50 WB S. River Rd	AHMCT testing
12/20/2016	9:23 PM	US 50 WB S. River Rd	Tapco testing
12/20/2016	9:34 PM	US 50 WB S. River Rd	Tapco testing
12/21/2016	3:52 AM	US 50 WB 16 th St	Tapco testing
12/22/2016	5:41 AM	US 50 WB 10 th St	Likely impaired, all the way onto exit ramp
1/9/2017	1:49 AM	SR 51 SB J St	left to exit ramp, through camera, recovered

Date	Time	Ramp	Note / Resolution
1/21/2017	9:12 PM	US 50 WB S. River Rd	u-turn to jump another vehicle
1/24/2017	10:58 AM	US 50 WB S. River Rd	Caltrans doing Crazy Ivan circles
2/16/2017	2:44 PM	SR 51 SB J St	Right lane car backs up to switch and go left
3/5/2017	9:15 AM	SR 51 SB J St	Left lane car backs up to switch and go right
3/25/2017	2:44 AM	US 50 WB 26 th St	construction WW driver
3/27/2017	6:09 PM	US 50 WB S. River Rd	Vehicle backing up along shoulder
3/29/2017	9:51 AM	US 50 WB S. River Rd	Left from 5 th , onto shoulder, then quick u-turn recover
4/10/2017	10:11 AM	US 50 WB S. River Rd	Right lane, backed up to go left
4/13/2017	1:50 AM	SR 51 SB J St	Left from J, up in lane 1, then 3 point turn
4/17/2017	7:21 PM	US 50 WB S. River Rd	Car drives in, seems to be helping someone
4/17/2017	7:22 PM	US 50 WB S. River Rd	wrong way vehicle
4/23/2017	9:21 AM	US 50 WB S. River Rd	Contractors putting up a sign in shoulder
5/4/2017	3:47 AM	US 50 WB 10 th St	Wrong way up W St, quick U-turn recover
5/16/2017	11:43 PM	US 50 WB 10 th St	Right onto W, seems to go around block, out at 1:20 on 12th St
5/21/2017	1:38 PM	US 50 WB S. River Rd	Contractors taking down a sign in shoulder
5/26/2017	4:12 AM	US 50 WB 26 th St	Right onto W, mostly in lane 2, seems to be turning around, never seen again, but not up exit ramp. Probably turned onto 27th.
7/8/2017	10:31 AM	US 50 WB S. River Rd	vehicle parked on right shoulder, pedestrian walking around vehicle
7/8/2017	10:31 AM	US 50 WB S. River Rd	vehicle parked on right shoulder, pedestrian walking around vehicle
7/19/2017	3:13 AM	US 50 WB 26 th St	wrong way vehicle
7/22/2017	9:04 AM	US 50 WB Jefferson Blvd	CHP
7/22/2017	11:55 AM	US 50 WB Jefferson Blvd	CHP
7/22/2017	12:16 PM	US 50 WB Jefferson Blvd	CHP
7/22/2017	3:07 PM	US 50 WB Jefferson Blvd	CHP
7/22/2017	3:19 PM	US 50 WB Jefferson Blvd	CHP
7/25/2017	6:48 PM	US 50 WB S. River Rd	wrong way vehicle
7/25/2017	7:56 PM	US 50 WB S. River Rd	Contractor
7/29/2017	2:15 AM	US 50 WB Jefferson Blvd	CHP
7/29/2017	7:09 AM	US 50 WB Jefferson Blvd	CHP
7/29/2017	8:30 AM	US 50 WB Jefferson Blvd	CHP
7/29/2017	11:04 AM	US 50 WB Jefferson Blvd	CHP

Date	Time	Ramp	Note / Resolution
7/29/2017	1:00 PM	US 50 WB Jefferson Blvd	CHP
7/29/2017	11:19 PM	US 50 WB Jefferson Blvd	CHP
7/30/2017	6:12 AM	US 50 WB S. River Rd	truck right on ramp, recovers before camera
7/31/2017	7:53 PM	US 50 WB S. River Rd	three sweepers come from correct direction, u-turn, back up ramp
7/31/2017	11:15 PM	US 50 WB S. River Rd	maintenance vehicle
7/31/2017	11:16 PM	US 50 WB S. River Rd	wrong way vehicle
8/1/2017	11:30 PM	US 50 WB Jefferson Blvd	wrong way vehicle
8/1/2017	11:30 PM	US 50 WB Jefferson Blvd	CHP
8/2/2017	3:25 AM	US 50 WB Jefferson Blvd	CHP
8/5/2017	8:17 AM	US 50 WB S. River Rd	Contractor dropping off driver for low-bed truck
8/5/2017	2:32 PM	US 50 WB Jefferson Blvd	CHP
8/5/2017	7:42 PM	US 50 WB Jefferson Blvd	CHP
8/6/2017	9:27 AM	US 50 WB Jefferson Blvd	CHP or similar (truck)
8/8/2017	1:52 AM	US 50 WB Jefferson Blvd	paneled truck, drives up, backs down, y-turn, then backs up ramp all the way
8/14/2017	7:57 PM	US 50 WB Jefferson Blvd	CHP
8/17/2017	6:03 PM	US 50 WB S. River Rd	fire truck
8/17/2017	6:12 PM	US 50 WB S. River Rd	fire truck
8/23/2017	12:49 AM	US 50 WB Jefferson Blvd	Through camera, eventually recovers
8/26/2017	9:38 AM	US 50 WB Jefferson Blvd	CHP
8/29/2017	2:37 PM	US 50 WB S. River Rd	vehicle coming in to assist horse trailer
9/7/2017	11:23 PM	US 50 WB S. River Rd	car backed on to help another car
9/13/2017	5:39 AM	US 50 WB 16 th St	WW Veh chase by law Enforcement
9/18/2017	9:28 PM	US 50 WB S. River Rd	car backing up, perhaps to assist another
9/29/2017	9:12 AM	US 50 WB 16 th St	truck backing up to change lanes
10/6/2017	6:57 PM	US 50 WB S. River Rd	truck, picking up item from bed
10/10/2017	3:12 PM	US 50 WB 26 th St	Left from 26th onto W, u-turn just into ramp
10/11/2017	3:59 PM	US 50 WB 16 th St	car backing up to change lanes
10/30/2017	11:20 PM	US 50 WB S. River Rd	pedestrian helping stalled vehicle
11/17/2017	4:35 AM	US 50 WB Jefferson Blvd	CHP, backs up ramp from light
11/23/2017	7:48 AM	US 50 WB 26 th St	red SUV wrong way up W, see next clip, 2 unrelated

Date	Time	Ramp	Note / Resolution
11/23/2017	7:48 AM	US 50 WB 26 th St	silver car wrong way up W, see previous clip, 2 unrelated
12/14/2017	1:21 AM	I-8 WB Sunset Cliffs Blvd	pedestrian walking around stalled vehicle
12/14/2017	4:12 AM	I-8 WB Sunset Cliffs Blvd	vehicle backs up a bit, then forward, then leaves ramp (test)
12/14/2017	4:37 AM	I-8 WB Sunset Cliffs Blvd	vehicle backs from lane 2 into lane 1 (test)
12/14/2017	4:52 AM	I-5 SB Sea World Drive	truck backs up lanes 1 and 2 (test)
1/7/2018	10:34 PM	I-8 WB Sunset Cliffs Blvd	rental truck (maintenance) backing on shoulder (test)
1/8/2018	12:28 AM	I-5 SB Sea World Drive	rental truck (maintenance) backing (test)
3/8/2018	1:29 AM	SR 51 SB J St	Most of the way to the camera, 3-point turn
4/7/2018	3:59 AM	SR 51 SB J St	reverses while at light, to make left turn
4/16/2018	11:46 PM	US 50 WB Jefferson Blvd	CHP backing up, and bucket truck blocking. Test.
4/17/2018	1:04 PM	US 50 WB S. River Rd	right onto ramp, tries to go lane 1, blocked, swerves to zero
5/1/2018	3:45 AM	I-8 WB Sunset Cliffs Blvd	enters on shoulder, most of way to camera, then corrects
5/2/2018	3:04 AM	US 50 WB S. River Rd	starts in left lane, backs up to switch one lane, still turns left
5/7/2018	1:20 AM	I-8 WB Sunset Cliffs Blvd	starts in left lane, backs up to switch one lane, then stays in lane
5/8/2018	9:17 AM	US 50 WB S. River Rd	starts in right lane, backs up for no apparent reason, then stays in lane
5/18/2018	5:14 PM	US 50 WB S. River Rd	enters on shoulder, quick recovery
5/26/2018	7:31 AM	US 50 WB S. River Rd	enters on shoulder, most of way to camera, then u-turn recover
5/26/2018	10:38 PM	US 50 WB S. River Rd	CHP, motorcycle, controlling an event
6/3/2018	5:12 AM	I-5 SB Sea World Drive	CHP motorcycle
6/3/2018	7:56 AM	I-5 SB Sea World Drive	CHP motorcycle
6/3/2018	12:25 PM	I-5 SB Sea World Drive	CHP motorcycle
6/5/2018	8:58 PM	US 50 WB S. River Rd	wrong way vehicle
6/20/2018	8:02 PM	US 50 WB 26 th St	stops on left, backs, looks out door, then goes forward
6/23/2018	3:47 PM	US 50 WB S. River Rd	Contractors putting up a sign in shoulder
6/23/2018	7:49 PM	US 50 WB S. River Rd	Contractors takes sign away (never accomplished anything)
6/26/2018	11:35 PM	SR 51 NB H St	maint veh, test
6/27/2018	12:58 AM	US 50 WB S. River Rd	Contractors putting up a sign in shoulder
7/3/2018	5:25 PM	US 50 WB S. River Rd	CHP motorcycle during incident
7/27/2018	3:04 PM	US 50 WB S. River Rd	contractor putting out sign
8/7/2018	1:14 PM	US 50 WB S. River Rd	wrong way vehicle

Date	Time	Ramp	Note / Resolution
8/10/2018	8:31 AM	US 50 WB 16 th St	in lane 1, backs up to go to lane 3 for right turn
8/11/2018	4:09 PM	US 50 WB 16 th St	in lane 2, backs up to go to lane 3 for right turn, although unnecessary
8/18/2018	7:21 AM	US 50 EB 5 th St	full-on wrong-way, no recovery, broad daylight
8/19/2018	4:30 PM	US 50 WB S. River Rd	clowns attempting to jumpstart a car with assistance from additional clowns
8/22/2018	11:59 AM	US 50 WB 16 th St	in lane 3, backs up to go to lane 2 for straight
8/30/2018	10:01 PM	US 50 WB S. River Rd	emergency response vehicles, incident management
9/8/2018	2:50 PM	US 50 WB S. River Rd	motorcycle checking on another
9/27/2018	4:53 AM	SR 51 SB J St	Emergency response vehicles (2), up, do not come back
10/9/2018	2:00 AM	I-8 WB Sunset Cliffs Blvd	Stops at light, backs up, then goes forward through light
10/11/2018	12:11 AM	SR 51 SB J St	Most of the way to the camera, 3-point turn, then backs up the ramp. Likely a contractor.
10/15/2018	12:47 AM	SR 51 SB J St	Caltrans, up ramp, no return
11/4/2018	11:30 PM	US 50 WB S. River Rd	vehicle, realizes quickly due to oncoming vehicle
11/18/2018	10:34 AM	US 50 WB 26 th St	vehicle backs up to pick up a lazy pedestrian
11/19/2018	9:07 AM	US 50 WB S. River Rd	wrong way vehicle
12/2/2018	3:32 AM	US 50 WB 26 th St	vehicle, wrong way, stops, takes a wee
12/25/2018	10:58 PM	US 50 WB Jefferson Blvd	vehicle backs up to make right turn
12/27/2018	1:57 AM	I-8 WB Sunset Cliffs Blvd	vehicle stops right shoulder, backs up ramp, unknown reason
1/14/2019	5:26 AM	US 50 WB 26 th St	vehicle, wrong way, doesn't enter ramp, continues wrong way on W
1/23/2019	2:01 AM	SR 51 SB J St	Wrong-way, looks like recovered, see 1:45 – 2:00
1/30/2019	4:13 AM	US 50 WB 26 th St	vehicle, wrong way, doesn't enter ramp, continues wrong way on W
1/31/2019	10:36 PM	SR 51 NB N St	CHP, stops at top of ramp
2/2/2019	1:47 AM	WB US 50 at 10 th St	WW law enforcement
2/4/2019	1:36 AM	US 50 WB 10 th St	Wrong way, never returns
2/27/2019	11:35 AM	US 50 WB S. River Rd	vehicle backs to assist broken down vehicle
2/28/2019	1:22 AM	US 50 WB S. River Rd	seems to just be parking
2/28/2019	1:28 AM	US 50 WB S. River Rd	see event 1:22, returns to vehicle, drives onto freeway
4/6/2019	7:17 AM	SR 51 SB J St	vehicle backs up to make left turn
4/12/2019	4:06 AM	I-8 WB Sunset Cliffs Blvd	vehicle backs up to make left turn, and then again

Date	Time	Ramp	Note / Resolution
4/21/2019	5:41 PM	US 50 WB S. River Rd	pedestrian
5/3/2019	4:21 PM	US 50 WB S. River Rd	vehicle, realizes quickly due to oncoming vehicles
5/15/2019	8:09 AM	US 50 WB S. River Rd	stalled vehicle, then backs up a few times
5/18/2019	3:33 PM	US 50 WB S. River Rd	vehicle, realizes quickly due to oncoming vehicles
5/24/19	3:20 AM	I 5 SB Sea World Drive	unknown WWD vehicle
5/24/2019	9:07 PM	US 50 WB S. River Rd	stalled vehicle, then backs up a small amount
6/2/2019	2:03 AM	I-8 WB Sunset Cliffs Blvd	scooter, all the way up, no recovery
6/2/2019	10:32 AM	I-5 SB Sea World Drive	CHP, circling on ramp for event
6/16/2019	12:18 AM	US 50 WB S. River Rd	scooter wrong way
6/22/2019	3:06 AM	US 50 WB 26 th St	vehicle, wrong way, doesn't enter ramp, continues wrong way on W
6/22/2019	4:58 AM	US 50 WB 26 th St	vehicle, wrong way, up ramp, no recovery
6/22/2019	12:58 PM	US 50 WB S. River Rd	stalled vehicle, then backs up to go straight
7/20/2019	9:58 PM	SR 51 SB J St	CHP, all the way up, no headlights
7/21/2019	10:02 PM	US 50 WB S. River Rd	wrong way vehicle
8/11/2019	6:28 PM	US 50 WB 16 th St	vehicle in left turn lane, backs up, changes lane to go straight

Appendix C:

VBSM Contributions, Conclusions, and Recommendations

The VBSM provides an excellent tool for WWD monitoring. Through use of additional analytics, the system could be used for event-based monitoring in other driver behavior research. The monitoring device system was designed to be an ideal tool for the collection of traffic incident data to allow for the assessment and mitigation of issues for highway locations if an issue can be identified visually. Additional use could include detecting and capturing driver behavior at gore points and highway on- and exit ramps. AHMCT researchers would look into other applications for the system and help develop the relevant accessories to ensure high quality, robust data. Ultimately, this would lead to the creation of a site monitoring toolbox that would be broadly applicable.

The report body provides the research contributions, conclusions, and recommendations. This appendix provides similar specifically for the VBSM. These items are provided separately, as they are not inherent aspects of the research. However, the VBSM is the primary enabling tool for the research reported herein, and it provides a useful tool for similar future investigations.

VBSM Contributions and Conclusions

A significant part of the early research effort was dedicated to the design, development, testing, and deployment of the VBSM system for monitoring WWD events and providing data on WWD behavior that could lead to improvements in WWD countermeasures. The self-contained VBSM system supports continuous remote monitoring of an exit ramp, automatic detection of WWD events with associated trigger-based data collection, remote viewing of low-resolution event snapshots, and transfer of high-resolution video for subsequent analysis. This VBSM would be beneficial for DOTs and transportation agencies to characterize, quantify, and document their WWD issues.

As the VBSM system is stand-alone, it is well suited for use at any exit ramp where the geometry and vegetation are appropriate for good camera FOV. When considering use of the system at any site, the operator should give attention to the cost, performance, reliability, and safety tradeoffs of wooden vs. metal poles. The former provide the lowest up-front costs, but introduce the pole twist issue discussed in Chapter 4, which often means additional work and road closures to adjust camera aim. If wooden poles are selected, then

cameras with a pan-tilt mechanism should be used. Depending on environmental factors, the operator should also consider providing direct AC power to the system; should solar power be selected, the system should include a larger panel and/or more batteries. Finally, an operator should also consider providing fixed (perhaps fiber) communications as cellular data transmission, particularly for video, can introduce high operating costs. These issues must be considered on a site-by-site basis, subject to physical and cost constraints of the operator. As previously noted, the system can be stand-alone, so it does provide the flexibility needed for sites without power or communications.

The VBSM system was very effective at detecting WWD events for the exit ramps. The optimizations discussed in Chapter 3 yielded an ideal system for WWD monitoring. There were a few hardware failures during the research, but the failure count was acceptable given the number of site installations and the duration of the testing. However, reliability improvements are always desirable to lower maintenance cost.

The system was deliberately tuned to err on the side of false positives. This was perfect for the research as all potential WWD events were first previewed using a short and low resolution video clip and only after previewing were transmitted back to the server in the case that the potential WWD event represented an actual WWD event or was otherwise of interest, e.g. for troubleshooting. Due to this tuning, the system is not suited for real-time WWD detection and warning. The false alarm rate would be unacceptably high, particularly given the high urgency represented by a true WWD incident. There are commercial systems available that provide excellent WWD incident detection and warning. Such systems, e.g. the TAPCO and TrafficCalm systems currently under Caltrans evaluation, incorporate multiple sensors, such as a camera combined with two radar sensors, in order to significantly reduce false positives and enhance the reliability of warnings.

VBSM Recommendations

The VBSM provides a powerful tool for detecting WWD events for exit ramps. It is highly recommended for this use in future research. It could provide on-going monitoring for critical locations for a DOT or a municipality. AHMCT recommends maintaining an appropriate number of systems to support near-term WWD research.

While the VBSM is well-suited for WWD event monitoring research, it is not suited for real-time alerting of WWD events. This stems from the inherent incompatibility between the need for high sensitivity to capture potential WWD events for research and analysis vs. the high importance of a low false alarm rate for real-time detection and alerting to the TMC or to law enforcement agencies. The highly sensitive detection required for research purposes would lead to an unacceptably high number of false alarms being sent to the TMC,

with associated costs for personnel monitoring and response. The COTS systems evaluated as part of this research are properly designed and tuned, generally, for such real-time alerting. Even these COTS systems have exhibited false positive rates above a desired level, per the data in [15]. This factor must be weighed carefully as part of any decision to deploy real-time WWD alerting systems.