

VIRGINIA I-66 CONCRETE PAVEMENT REPLACEMENT USING PRECAST CONCRETE PAVEMENT SYSTEMS

**Final Report
June 2013**

HIGHWAYS FOR LIFE

Accelerating Innovation for the American Driving Experience.



U.S. Department of Transportation
Federal Highway Administration

FOREWORD

The purpose of the Highways for LIFE (HfL) pilot program is to accelerate the use of innovations that improve highway safety and quality while reducing congestion caused by construction. **LIFE** is an acronym for **L**onger-lasting highway infrastructure using **I**nnovations to accomplish the **F**ast construction of **E**fficient and safe highways and bridges.

Specifically, HfL focuses on speeding up the widespread adoption of proven innovations in the highway community. “Innovations” is an inclusive term used by HfL to encompass technologies, materials, tools, equipment, procedures, specifications, methodologies, processes, and practices used to finance, design, or construct highways. HfL is based on the recognition that innovations are available that, if widely and rapidly implemented, would result in significant benefits to road users and highway agencies.

Although innovations themselves are important, HfL is as much about changing the highway community’s culture from one that considers innovation something that only adds to the workload, delays projects, raises costs, or increases risk to one that sees it as an opportunity to provide better highway transportation service. HfL is also an effort to change the way highway community decision makers and participants perceive their jobs and the service they provide.

The HfL pilot program, described in Safe, Accountable, Flexible, Efficient Transportation Equity Act: A Legacy for Users (SAFETEA-LU) Section 1502, includes funding for demonstration construction projects. By providing incentives for projects, HfL promotes improvements in safety, construction-related congestion, and quality that can be achieved through the use of performance goals and innovations. This report documents one such HfL demonstration project.

Additional information on the HfL program is at www.fhwa.dot.gov/hfl.

NOTICE

This document is disseminated under the sponsorship of the U.S. Department of Transportation in the interest of information exchange. The U.S. Government assumes no liability for its contents or use thereof. This report does not constitute a standard, specification, or regulation.

The U.S. Government does not endorse products or manufacturers. Trade and manufacturers’ names appear in this report only because they are considered essential to the object of the document.

1. Report No.	2. Government Accession No	3. Recipient's Catalog No	
3. Title and Subtitle Virginia I-66 Concrete Pavement Replacement Using Precast Concrete Pavement Systems		5. Report Date June 2013	6. Performing Organization Code
		8. Performing Organization Report No.	
7. Authors Chetana Rao, Ph.D., Suri Sadasivam, Ph.D., Paul Littleton, P.E., Gerry Ullman, Ph.D., P.E., and Jagannath Mallela		10. Work Unit No. (TRAIS) C6B	
9. Performing Organization Name and Address Applied Research Associates, Inc. 100 Trade Centre Drive, Suite 200 Champaign, IL 61820		11. Contract or Grant No.	
		13. Type of Report and Period Covered Final Report June 2008 – February 2012	
12. Sponsoring Agency Name and Address Office of Infrastructure Highways for LIFE Federal Highway Administration 1200 New Jersey Avenue SE Washington, DC 20590		14. Sponsoring Agency Code	
		15. Supplementary Notes Contracting Officers Technical Representative (COTR): Byron Lord, Mary Huie	
16. Abstract As part of a national initiative sponsored by the Federal Highway Administration under the Highways for LIFE (HfL) program, the Virginia Department of Transportation (VDOT) was awarded a \$1 million grant to showcase and demonstrate the use of precast concrete pavement system (PCPS) technology for the replacement of concrete slabs. The I-66 rehabilitation project in Fairfax was selected to implement this technology, and the replacement was done on two segments—a 1,020-ft length of the mainline spanning 4 lanes using precast prestressed concrete pavement (PPCP) panels and a 3,552-ft-long segment of the outside lane of the ramp leading to US-50 West using a jointed precast pavement system, Super-Slab®. The construction activities were performed between 9:00 pm and 5:00 am. The mainline was repaired using two-lane or three-lane closures, while the ramp was repaired using full ramp closures and providing detours. This report documents all details of this project, including a description of the PCPS technologies and their design, the construction staging techniques and maintenance of traffic, slab installation, and the performance evaluations and economic analysis. This report also contains other items relevant to HfL projects, including a description of HfL goals, other technology transfer activities on the project, and a detailed analysis of data to evaluate if the HfL goals were satisfied. A detailed economic analysis is included in the report to evaluate the cost-effectiveness of using the innovative technology. Individual analyses were performed for the mainline and the ramp segments. Overall, it was determined that VDOT met the HfL goals on this project and realized cost savings of about 7 percent relative to cast-in-place alternatives.			
17. Key Words Highways for LIFE, precast concrete pavement systems (PCPS), precast prestressed concrete pavement (PPCP), Super Slab®, jointed reinforced concrete pavement (JRCP), jointed concrete pavement, accelerated pavement construction (APC), full lane closure, partial lane closure, prefabricated elements, project performance goals, innovative bidding, max bid price,		18. Distribution Statement No restriction. This document is available to the public through the National Technical Information Service 5285 Port Royal Road Springfield VA 22161	
Security Classif. (of this report) Unclassified	19. Security Classif. (of this page) Unclassified	20. No. of Pages 207	21. Price

SI* (MODERN METRIC) CONVERSION FACTORS				
APPROXIMATE CONVERSIONS TO SI UNITS				
Symbol	When You Know	Multiply By	To Find	Symbol
LENGTH				
(none)	mil	25.4	micrometers	µm
in	inches	25.4	millimeters	mm
ft	feet	0.305	meters	m
yd	yards	0.914	meters	m
mi	miles	1.61	kilometers	km
AREA				
in ²	square inches	645.2	square millimeters	mm ²
ft ²	square feet	0.093	square meters	m ²
yd ²	square yards	0.836	square meters	m ²
ac	acres	0.405	hectares	ha
mi ²	square miles	2.59	square kilometers	km ²
VOLUME				
fl oz	fluid ounces	29.57	milliliters	mL
gal	gallons	3.785	liters	L
ft ³	cubic feet	0.028	cubic meters	m ³
yd ³	cubic yards	0.765	cubic meters	m ³
NOTE: volumes greater than 1000 L shall be shown in m ³				
MASS				
oz	ounces	28.35	grams	g
lb	pounds	0.454	kilograms	kg
T	short tons (2000 lb)	0.907	megagrams (or "metric ton")	Mg (or "t")
TEMPERATURE (exact degrees)				
°F	Fahrenheit	5 (F-32)/9 or (F-32)/1.8	Celsius	°C
ILLUMINATION				
fc	foot-candles	10.76	lux	lx
fl	foot-Lamberts	3.426	candela per square meter	cd/m ²
FORCE and PRESSURE or STRESS				
lbf	poundforce	4.45	Newtons	N
lbf/in ² (psi)	poundforce per square inch	6.89	kiloPascals	kPa
k/in ² (ksi)	kips per square inch	6.89	megaPascals	MPa
DENSITY				
lb/ft ³ (pcf)	pounds per cubic foot	16.02	kilograms per cubic meter	kg/m ³
APPROXIMATE CONVERSIONS FROM SI UNITS				
Symbol	When You Know	Multiply By	To Find	Symbol
LENGTH				
µm	micrometers	0.039	mil	(none)
mm	millimeters	0.039	inches	in
m	meters	3.28	feet	ft
m	meters	1.09	yards	yd
km	kilometers	0.621	miles	mi
AREA				
mm ²	square millimeters	0.0016	square inches	in ²
m ²	square meters	10.764	square feet	ft ²
m ²	square meters	1.195	square yards	yd ²
ha	hectares	2.47	acres	ac
km ²	square kilometers	0.386	square miles	mi ²
VOLUME				
mL	milliliters	0.034	fluid ounces	fl oz
L	liters	0.264	gallons	gal
m ³	cubic meters	35.314	cubic feet	ft ³
m ³	cubic meters	1.307	cubic yards	yd ³
MASS				
g	grams	0.035	ounces	oz
kg	kilograms	2.202	pounds	lb
Mg (or "t")	megagrams (or "metric ton")	1.103	short tons (2000 lb)	T
TEMPERATURE				
°C	Celsius	1.8C+32	Fahrenheit	°F
ILLUMINATION				
lx	lux	0.0929	foot-candles	fc
cd/m ²	candela per square meter	0.2919	foot-Lamberts	fl
FORCE and PRESSURE or STRESS				
N	Newtons	0.225	poundforce	lbf
kPa	kiloPascals	0.145	poundforce per square inch	lbf/in ² (psi)
MPa	megaPascals	0.145	kips per square inch	k/in ² (ksi)

ACKNOWLEDGMENTS

The project team would like to acknowledge the invaluable insights and guidance of Federal Highway Administration (FHWA) Highways for LIFE (HfL) Team Leader Byron Lord and Program Coordinators Mary Huie and Kathleen Bergeron, who served as the technical panel on this demonstration project. Their vast knowledge and experience with the various aspects of construction, technology deployment, and technology transfer helped immensely in developing both the approach and the technical matter for this document. The team is grateful for the text review and critical feedback from Sam Tyson and Claude Napier from FHWA, and Rodolfo Maruri from the FHWA Virginia Division office.

The authors also thank Virginia Department of Transportation (VDOT) District Materials Engineer David P. Shiells, P.E., and Program Manager Karen L. Consiglio, P.E., who provided the necessary support and coordination in monitoring this project. They also provided detailed project information in developing this report, which is much appreciated. Mr. Shiells was also available for direct communication with the HfL team to provide feedback on behalf of VDOT about the general success of this project. Finally, the feedback received from the contractor, Lane Construction Corporation, was immensely helpful in summarizing the construction related activities for this project. Specifically, Superintendent Erich R. Brown, P. E., provided detailed information on several aspects of the project.

TABLE OF CONTENTS

INTRODUCTION.....	1
HIGHWAYS FOR LIFE DEMONSTRATION PROJECTS	1
REPORT SCOPE AND ORGANIZATION.....	3
PROJECT OVERVIEW AND LESSONS LEARNED.....	4
PROJECT OVERVIEW	4
DATA COLLECTION.....	6
ECONOMIC ANALYSIS.....	7
LESSONS LEARNED	8
CONCLUSIONS.....	12
PROJECT DETAILS	13
BACKGROUND.....	13
REHABILITATION PROJECT DETAILS	19
PCPS TECHNOLOGIES.....	24
TRIAL INSTALLATIONS FOR THE I-66 PROJECT.....	35
REHABILITATION OF I-66 USING PCPS.....	39
DESIGN AND PANEL FABRICATION.....	39
MATERIALS.....	41
TRAFFIC CONTROL AND CONSTRUCTION STAGING.....	43
FIELD INSTALLATION.....	47
SCHEDULE AND PRODUCTIVITY	60
DATA COLLECTION AND ANALYSIS	62
SAFETY	62
CONSTRUCTION CONGESTION AND TRAVEL TIME STUDY.....	64
QUALITY	68
USER SATISFACTION.....	70
PERFORMANCE EVALUATION.....	71
JOINT LOAD TRANSFER EVALUATION	71
NONDESTRUCTIVE EVALUATION OF GROUT CONSOLIDATION	76
TECHNOLOGY TRANSFER.....	77
ECONOMIC ANALYSIS	79
VDOT USER COST ANALYSIS	80
INITIAL CONSTRUCTION COST ESTIMATES.....	81
USER COSTS PARAMETERS CONSIDERED FOR ECONOMIC ANALYSIS.....	82
USER COST ESTIMATES	85
COST SUMMARY.....	89
APPENDIX A. TABULATION OF BIDS	A
APPENDIX B. SAMPLE SHOP DRAWINGS FOR PPCP	B

APPENDIX C. SAMPLE SHOP DRAWINGS FOR SUPER-SLAB® FABRICATION AND INSTALLATION C

APPENDIX D. MIX DESIGNS AND PERMEABILITY TEST RESULTS FOR CONCRETE MIXES USED IN THE FABRICATION OF PCPS PANELS D

APPENDIX E. CONTRACTOR’S PROPOSED SCHEDULE.....E

APPENDIX F. OSHA FORM 300A FOR HIGHWAYS FOR LIFE PROJECT ON I-66 IN VIRGINIAF

APPENDIX G. NDT REPORT..... G

APPENDIX H. HIGHWAYS FOR LIFE: VIRGINIA I-66 PCPS SHOWCASE AGENDA H

LIST OF FIGURES

Figure 1. Location of project on I-66 in Northern Virginia west of Washington, DC.	13
Figure 2. Westbound I-66 mainline with three lanes and an auxiliary shoulder.	14
Figure 3. Ramp from I-66 to US 50 West with two lanes and a shoulder.	15
Figure 4. Weekday hourly traffic distribution on I-66 westbound – Monday (top) and Friday (bottom).....	17
Figure 5. Weekend hourly traffic distribution on I-66 westbound – Saturday (top) and Sunday (bottom).....	18
Figure 6. Surface condition of I-66 mainline and ramp leading to US 50 West in 2008.	19
Figure 7. HfL I-66 Virginia project site.....	21
Figure 8. Roadway curvature along Area A ramp.	22
Figure 9. Area A repairs identified by VDOT for contractor bids.....	23
Figure 10. Area A repairs proposed by the selected contractor.	23
Figure 11. PCPS applications compared to CIP.	25
Figure 12. PPCP section panels and features (from original design reported by Merritt et al., 2000)	27
Figure 13. Shear key in PPCP panels for vertical alignment of slabs.....	27
Figure 14. Ducts for post-tensioning strands.	28
Figure 15. Use of polyethylene sheet underneath the slab for reducing friction.	28
Figure 16. Temporary post-tensioning and slab alignment.	30
Figure 17. Use of specialized grading devices and base finish achieved (image from project in New York State, 2002).	31
Figure 18. Hand-operated grader supported on rails (image from project in New York State, 2002).	31
Figure 19. Mechanical connectors for tie bars and installed tie bars (image from project in New York State, 2002).	32
Figure 20. Inverted dovetail slots and foam gaskets underneath slab to control flow (image from project in New York State, 2002).	32
Figure 21. Grout ports provided on the slab (image from project in New York State, 2002).	33
Figure 22. Grout distribution channel and foam gasket for bedding grout (image from project in New York State, 2002).	33
Figure 23. Verification of dowel grout and bedding grout distribution for uniform support (image from project in New York State, 2002).	34
Figure 24. Verification of dowel grout consolidation (cores taken after installation).....	34
Figure 25. Warped slab geometry in Super-Slab [®] design.	35
Figure 26. Trial installation for Super-Slab [®]	37
Figure 27. Trial installation for the PPCP system.....	38
Figure 28. Shear key provided for slab alignment.	39
Figure 29. PPCP formwork set up at precast plant, curing, and yard storage.	40
Figure 30. Precasting operations and form work details for the Super-Slab [®]	41
Figure 31. Phase I for rehabilitation of inside lanes and shoulder using 12-ft-wide PPCP.	44
Figure 32. Phase II for rehabilitation of outside lanes using 27-ft-wide PPCP.	44
Figure 33. Stage construction – step 1.	45
Figure 34. Stage construction – step 2.	45

Figure 35. Stage construction – step 3.....	45
Figure 36. Stage construction – step 4.....	46
Figure 37. Stage construction – step 5.....	46
Figure 38. Stage construction – step 6.....	46
Figure 39. Stage construction – step 7.....	47
Figure 40. Westbound I-66 traffic maneuvering lane closure for mainline slab replacement.....	48
Figure 41. Removal of existing slabs.....	48
Figure 42. Base preparation and grading No. 10 aggregate for PPCP installation.....	49
Figure 43. Geotextile fabric spread on graded base material to reduce slab-subbase friction.....	49
Figure 44. Slab placement and alignment (top and bottom).....	50
Figure 45. Initial post-tensioning.....	51
Figure 46. Cold patch in blockouts.....	51
Figure 47. Final post-tensioning.....	52
Figure 48. Grout leak from post-tensioning ducts.....	53
Figure 49. Issues with vertical and horizontal alignment of slabs and large joint openings.....	53
Figure 50. Transverse joint misalignment.....	54
Figure 51. Crack in slab #109 at keyway. Note top of keyway rests on lower slab.....	55
Figure 52. Misalignment of post-tensioning duct.....	55
Figure 53. Detour marked for ramp closure during Super-Slab® installation.....	56
Figure 54. Removal of existing slab along ramp for Super-Slab® installation.....	57
Figure 55. Fine grading of subbase material.....	57
Figure 56. Anchoring tie bars in existing pavement in adjacent lane.....	58
Figure 57. Slab installation.....	58
Figure 58. Spalling at joints on the ramp. Note panels were in contact.....	59
Figure 59. Slab cracking observed in the jointed PCPS panels on the ramp.....	59
Figure 60. Delay and queue lengths each night.....	67
Figure 61. OBSI dual probe system and the SRTT.....	69
Figure 62. Mean A-weighted sound intensity frequency spectra.....	69
Figure 63. High-speed inertial profiler mounted behind the test vehicle.....	70
Figure 64. LTE across the joints tested in lanes 3 and 4 of the mainline.....	73
Figure 65. LTE across the Super-Slab® panels on the ramp.....	74
Figure 66. Virginia I-66 PCPS showcase workshop and field visit.....	78

LIST OF TABLES

Table 1. Hourly traffic distribution over a 24-hour period for I-66 westbound (from 2009).....	16
Table 2. Total area of PCPS in the project (as built).....	24
Table 3. Unit price for PCPS technology and total bid amount.....	24
Table 4. VDOT specification requirements for classes A5 and A4 concrete.....	42
Table 5. Grout compressive strength results, load in lb/strength in psi.....	43
Table 6. Summary of peak productivity achieved for various systems.....	61
Table 7. VDOT’s accident records along project site 3 years before construction.....	63
Table 8. Post construction crash data.....	63
Table 9. Pre and post construction crash rates.....	63

Table 10. Travel time data.	66
Table 11. Historical hourly traffic volumes on I-66 westbound near US 50.	67
Table 12. Vehicle-hours of delay during work zone lane closures.	68
Table 13. Summary of IRI.	70
Table 14. LTE measured from FWD tests on lanes 3 and 4 of the mainline.	72
Table 15. LTE measured at joints on Super-Slab [®] panels on the ramp.	75
Table 16. Vehicle class distribution and value of time.	81
Table 17. Calculation of initial construction cost for the mainline and ramp for as-built cases. ..	83
Table 18. Calculation of initial construction cost for the mainline and ramp for baseline cases. .	84
Table 19. Summary of user costs for mainline as-built case.	86
Table 20. Inputs used in <i>RealCost</i> calculations for delay costs and VOC.	86
Table 21. Summary of user costs for mainline baseline case.	87
Table 22. Summary of user costs for ramp as-built case.	88
Table 23. Vehicle operating costs for cars – Estimates for VOC for passenger cars in 2010 dollars (cents/vehicle mile).	89
Table 24. Vehicle operating costs for trucks – American Transportation Research Institute estimates of VOC for trucks in 2008 dollars (cents/vehicle mile)	89
Table 25. Cost comparison of as-built and baseline alternatives for mainline on I-66 HfL project.	90
Table 26. Cost comparison of as-built and baseline alternatives for ramp on I-66 HfL project. ..	90
Table 27. Total discounted costs for the entire project – mainline and ramp combined.	90

ABBREVIATIONS AND SYMBOLS

AADT	Average Annual Daily Traffic
AASHTO	American Association of State Highway and Transportation Officials
CIP	Cast-In-Place
dB(A)	A-weighted decibel
DOT	Department of Transportation
FHWA	Federal Highway Administration
FWD	Falling Weight Deflectometer
GPR	Ground Penetrating Radar
HfL	Highways for LIFE
HUB-CAP	Highway User Benefit-Cost Analysis Program
IRI	International Roughness Index
JRCP	Jointed Reinforced Concrete Pavement
LTAP	Local Technical Assistance Program
LTE	Load Transfer Efficiency
MOT	Maintenance of Traffic
NDT	Nondestructive Testing
OBSI	Onboard Sound Intensity
OSHA	Occupational Safety and Health Administration
PCPS	Precast Concrete Pavement System
PPCP	Precast Prestressed Concrete Pavement System
PSPA	Portable Seismic Pavement Analyzer
SAFETEA-LU	Safe, Accountable, Flexible, Efficient Transportation Equity Act: A Legacy for Users
SHRP	Strategic Highway Research Program
SI	Sound Intensity
SRTT	Standard Reference Test Tire
TIG	Technology Implementation Group
VDOT	Virginia Department of Transportation
VOC	Vehicle Operating Cost

INTRODUCTION

HIGHWAYS FOR LIFE DEMONSTRATION PROJECTS

The Highways for LIFE (HfL) pilot program, the Federal Highway Administration (FHWA) initiative to accelerate innovation in the highway community, provides incentive funding for demonstration construction projects. Through these projects, the HfL program promotes and documents improvements in safety, construction-related congestion, and quality that can be achieved by setting performance goals and adopting innovations.

The HfL program—described in the Safe, Accountable, Flexible, Efficient Transportation Equity Act: A Legacy for Users (SAFETEA-LU)—may provide incentives to a maximum of 15 demonstration projects a year. The funding amount may total up to 20 percent of the project cost, but not more than \$5 million. Also, the Federal share for an HfL project may be up to 100 percent, thus waiving the typical State-match portion. At the State's request, a combination of funding and waived match may be applied to a project.

To be considered for HfL funding, a project must involve constructing, reconstructing, or rehabilitating a route or connection on an eligible Federal-aid highway. It must use innovative technologies, manufacturing processes, financing, or contracting methods that improve safety, reduce construction congestion, and enhance quality and user satisfaction. To provide a target for each of these areas, HfL has established demonstration project performance goals.

The performance goals emphasize the needs of highway users and reinforce the importance of addressing safety, congestion, user satisfaction, and quality in every project. The goals define the desired result while encouraging innovative solutions, raising the bar in highway transportation service and safety. User-based performance goals also serve as a new business model for how highway agencies can manage the highway project delivery process.

HfL project promotion involves showing the highway community and the public how demonstration projects are designed and built and how they perform. Broadly promoting successes encourages more widespread application of performance goals and innovations in the future.

Project Solicitation, Evaluation, and Selection

FHWA issued open solicitations for HfL project applications in fiscal years 2006, 2007, 2008, and 2009. State highway agencies submitted applications through FHWA Divisions. The HfL team reviewed each application for completeness and clarity, and contacted applicants to discuss technical issues and obtain commitments on project issues. Documentation of these questions and comments was sent to applicants, who responded in writing.

The project selection panel consisted of representatives of the FHWA offices of Infrastructure, Safety, and Operations; the Resource Center Construction and Project Management team; the Division offices; and the HfL team. After evaluating and rating the applications and

supplemental information, panel members convened to reach a consensus on the projects to recommend for approval. The panel gave priority to projects that accomplish the following:

- Address the HfL performance goals for safety, construction congestion, quality, and user satisfaction.
- Use innovative technologies, manufacturing processes, financing, contracting practices, and performance measures that demonstrate substantial improvements in safety, congestion, quality, and cost-effectiveness. An innovation must be one the applicant State has never or rarely used, even if it is standard practice in other States.
- Include innovations that will change administration of the State's highway program to more quickly build long-lasting, high-quality, cost-effective projects that improve safety and reduce congestion.
- Will be ready for construction within 1 year of approval of the project application. For the HfL program, FHWA considers a project ready for construction when the FHWA Division authorizes it.
- Demonstrate the willingness of the applicant department of transportation (DOT) to participate in technology transfer and information dissemination activities associated with the project.

HfL Project Performance Goals

The HfL performance goals focus on the expressed needs and wants of highway users. They are set at a level that represents the best of what the highway community can do, not just the average of what has been done. States are encouraged to use all applicable goals on a project:

- **Safety**
 - Work zone safety during construction—Work zone crash rate equal to or less than the preconstruction rate at the project location.
 - Worker safety during construction—Incident rate for worker injuries of less than 4.0, based on incidents reported via Occupational Safety and Health Administration (OSHA) Form 300.
 - Facility safety after construction—Twenty percent reduction in fatalities and injuries in 3-year average crash rates, using preconstruction rates as the baseline.
- **Construction Congestion**
 - Faster construction—Fifty percent reduction in the time highway users are impacted, compared to traditional methods.
 - Trip time during construction—Less than 10 percent increase in trip time compared to the average preconstruction speed, using 100 percent sampling.
 - Queue length during construction—A moving queue length of less than 0.5 mile (mi) (0.8 kilometer (km)) in a rural area or less than 1.5 mi (2.4 km) in an urban area (in both cases at a travel speed 20 percent less than the posted speed).
- **Quality**
 - Smoothness—International Roughness Index (IRI) measurement of less than 48 inches per mile.
 - Noise—Tire-pavement noise measurement of less than 96.0 A-weighted decibels (dB(A)), using the onboard sound intensity (OBSI) test method.

- **User Satisfaction**—An assessment of how satisfied users are with the new facility compared to its previous condition and with the approach used to minimize disruption during construction. The goal is a measurement of 4-plus on a 7-point Likert scale.

REPORT SCOPE AND ORGANIZATION

This report documents the HfL demonstration project on I-66 in Northern Virginia, which involved the use of one of HfL's vanguard technologies, the precast concrete pavement system (PCPS) for rapid slab replacement as well as alternate nighttime construction schedules to improve safety and alternate contracting methods for cost-effectiveness. Two types of PCPS were used in this project—the precast prestressed concrete pavement (PPCP) and a proprietary jointed precast concrete pavement system called Super-Slab[®].

In the next chapter, the report presents a summary of the Virginia Department of Transportation's (VDOT) project and lists the lessons learned from this project. Next, the report describes the project and explains the innovative technologies that were adopted. The next chapter provides a detailed description of the design and the rehabilitation, including the various stages of construction. This section of the report provides the necessary information on the fabrication and installation of the PCPS along with the maintenance of traffic (MOT) during project construction. This is followed by a section on the performance evaluation for this project. Finally, technology transfer activities that took place during the project and economic analysis performed for the project are discussed.

The report also includes appendices that contain details of items discussed in the report.

PROJECT OVERVIEW AND LESSONS LEARNED

PROJECT OVERVIEW

The Virginia HfL project involved the rehabilitation of the concrete pavement on the westbound traffic lanes on mainline I-66 and the ramp from I-66 leading to US 50W towards Chantilly. This section of the pavement was a four-lane jointed reinforced concrete pavement (JRCP) highway built in the early 1960s, and the slabs were highly deteriorated. Specifically, the slabs experienced extensive joint problems and mid-slab spalling that necessitated immediate repair to maintain safe operation.

This section of the highway also carries very heavy traffic. The traffic was estimated to be 184,000 vehicles per day with 5 percent trucks in 2008. The auxiliary shoulders in this section of the highway are used for traffic from 5:30 am to 11:00 am in the eastbound direction and from 2 pm to 8:00 pm in the westbound direction. The ramp leading to 50 West carries roughly 28,000 vehicles per day in two lanes.

VDOT evaluated several challenges inherent to the project site. For example, this section of I-66 carries heavy traffic volumes, making it difficult to close lanes during construction. From a design and construction standpoint, the existing structure has variable thicknesses. Under the circumstances, the adoption of PCPS was considered a feasible alternative to conventional cast-in-place (CIP) rigid pavement reconstruction. All construction activities were accomplished during nighttime hours within a 6-hour work window (excluding traffic control set-up and removal).

Two types of PCPS were used in this project—the PPCP and a proprietary jointed precast concrete pavement system from Fort Miller Company, Inc., called Super-Slab[®]. The horizontal segment of the westbound I-66 mainline that was rehabilitated was roughly 1,020 feet in length and used the PPCP system. This included four lanes of slab replacement along the project. The ramp segment of the project was roughly 3,550 feet in length and used the Super-Slab[®] system. One lane along the ramp was replaced within this project. The other areas of the ramp were replaced using CIP patches for rapid repair.

The ability to maintain traffic on the highway during the construction phase primarily directed the choice of PCPS for rapid slab replacement in this project. To minimize traffic impacts during construction, the slab replacement on the mainline was performed with a requirement to keep at least one lane open to traffic during construction. The existing geometry and topography of the ramp area did not allow two lanes of traffic on the ramp during construction. The construction on the ramp was limited to the nighttime, with no traffic between the hours of 9 pm and 5 am.

There were several other factors critically evaluated during the planning, designing, bidding, and construction stages in selecting PCPS relative to CIP construction. These factors include:

- Cost and innovative bidding alternatives.
- Construction issues as well as additional mobilization and planning.

- Availability of proven PCPS technologies that have demonstrated good field performance.
- Availability of qualified contractors in the area.
- Availability of precasters that can fabricate the selected PCPS slabs at required production rates.
- Proprietary issues associated with the Super-Slab[®] system.
- Timeframe involved in developing designs for the new PCPS types, shop drawings, casting, and installation.
- MOT requirements.
- Quality assurance and inspection requirements, both in the precast plant and in the field.
- Quality of product, including additional durability benefits derived from off-site fabrication and structural benefits derived from the use of prestressing (pretensioning and post-tensioning).
- Long-term performance and potential for extended service life.
- Smoothness of final pavement surface and additional need for diamond grinding after slab installation.

VDOT adopted a unique bidding scheme to maximize the extent of pavement replacement within a specified area of repair. The total contract value was limited to \$5 million for the bidding contractors. The competitive element in the bidding process, however, was the extent of pavement replacement proposed for the bid price. VDOT provided a repair plan outlining the required repairs as well as optional repair areas. The bids selection process therefore considered the total area that was proposed for the PCPS repairs.

VDOT undertook a significant level of preparation before the selected PCPS technologies were used on field. Trial installations of the PPCP and the Super-Slab[®] were performed. The technologies were evaluated prior to the installations on the project site. The special provisions for PPCP and jointed precast pavement developed by the American Association of State Highway and Transportation Officials (AASHTO) Technology Implementation Group (TIG) were used for the trial installation as well as for the project.

Provided below are some of the strategies that helped VDOT complete the project successfully:

- Willingness to adopt an innovative, yet proven, technology. This technology was a good alternative to CIP construction which also minimized construction-related traffic impacts, offered good performance, and provided slab replacement at a rapid rate.
- System approval and trial installations. Trial installations helped VDOT evaluate and gain a comfort level with the technologies to be used on the project. The trial installations helped verify the systems and also helped identify potential problems with each PCPS type, providing VDOT and the contractor an opportunity to address them as necessary on the actual job site.
- Innovative contracting. This maximized the total area of pavement replacement within the total bid amount for the combined cost of materials and labor.
- Ample lead time. Good planning and organization are key to efficient project execution. VDOT provided optimal lead time for the contractor to plan and schedule the

construction job. The contractor's attention to details was also crucial for completing the project successfully.

- Survey accuracy. This was critical to the success of the project, especially along the ramp where the Super-Slab[®] was used. The ramp contained a horizontal curve and required the fabrication of warped slabs to meet grade requirements. Accurate surveying was necessary to customize slab dimensions for each location. This was critical for achieving the target smoothness on the finished pavement.
- Granting the contractor the flexibility to plan construction within the confines of specifications. Providing the contractor the flexibility in staging the construction and lane closures required for the construction while also specifying minimum requirements from the standpoint of the number of lanes open to traffic during construction and the times when all lanes needed to be opened to traffic. These helped the contractor plan and stage the activities, as needed, when changes were required in the construction schedule.
- Controlled fabrication conditions. The precast plants that fabricated the PCPS slabs adopted strict quality control measures to ensure that the tolerances on the slabs were met and to ensure that the slabs were well cured. Durability issues may be eliminated under such conditions.

DATA COLLECTION

Safety, traffic congestion, construction quality, and cost data were collected before, during, and after construction to demonstrate that the PCPS technology coupled with innovative contracting methods can be used to achieve the HfL performance goals of safety, construction congestion reduction, and quality.

VDOT's goal for safety was to bring the incident rate for worker injury to zero; however, due to the nature of the project (i.e., accelerated construction performed at night), VDOT made additional efforts to address all factors contributing to the potential for incidents. The construction operation for the project resulted in only one worker injury, which was not traffic related. On the other hand, it is reasonable to assume that compared with traditional CIP patching, the potential for incidents was perhaps less because of a significant reduction in the hours of construction activities and working adjacent to moving traffic on a busy highway. Furthermore, there were no work zone crashes reported during this project. These safety standards, in large part, may be credited to the strict safety standards maintained by the contractor, including safety training provided for all field crew personnel prior to the project. However, the post construction crash rates indicate that the safety performance of the facility after construction has not achieved the HfL goal of twenty percent reduction in injuries and fatalities.

The use of PCPS made a positive impact on construction congestion. Initial estimates suggested that, for the ramp segment of the project alone, slab rehabilitation using CIP would require about 100 or more days of construction including significant disruptions to daytime traffic and non-recoverable queuing problems. The use of PCPS enabled undisturbed traffic flow during the morning hours. Traffic disruptions were minimal during the scheduled nighttime construction, as the traffic volumes typically decrease significantly at night, which could be accommodated by the lanes left open to traffic. VDOT had expected about 35 nights of construction for the ramp

segment of the project. However, as the project involved the rehabilitation of both the ramp and the mainline—more than double the area of construction—approximately 70 lane closures were required during construction.

Detailed travel time data were collected during construction. Because of the sequential process used to close travel lanes, the resulting delays and queue lengths varied somewhat from hour to hour and from night to night.

Detailed materials and design information were collected. The following is a list of data and/documents reviewed:

- Approved mix design for concrete used in PPCP slabs.
- Approved mix design for concrete used in Super-Slab[®].
- Project plans and related specifications.

A variety of test data were collected and analyzed to evaluate the functional and structural adequacy of the pavement, from the standpoint of both the construction quality and the technology adopted. The data collected included the following:

- Preconstruction and postconstruction smoothness and noise data for pavement ride quality. Monolithic placement of slabs in CIP construction produces smooth transition across slabs/joints. With PCPS, the smoothness of the pavement depends on a combination of factors, including the joint design in the PCPS technology, the quality of slab installation, and the effectiveness of the specifications to produce a smooth riding surface.
- Falling weight deflectometer (FWD) testing data at several joints along the project to evaluate the load transfer efficiency across the joints between PCPS slabs. In the absence of aggregate interlock that exists in CIP construction, PCPS slabs rely entirely on the joint load transfer mechanism inherent to the PCPS technology.
- Nondestructive testing (NDT) data using the portable seismic pavement analyzer (PSPA) to evaluate the consolidation of the grout materials in the dowel sockets of the Super-Slab[®] and in the post-tensioning ducts of the PPCP. NDT was performed at selected joints based on the FWD testing results.

The tests indicated that the construction and ride quality are at acceptable levels.

ECONOMIC ANALYSIS

The benefits and costs of the innovative features of the project were compared with the costs incurred for the conventional CIP repair. VDOT supplied all of the cost figures for the as-built project and the information pertinent to most of the cost assumptions made.

Based on an economic analysis, VDOT realized a total cost savings of about \$481,244 over conventional construction practices. These savings resulted from reduced delay costs, improved performance, and reduced need for reconstruction, even though the initial construction cost was

marginally higher with the use of PCPS panels for slab replacement. Overall, the savings to VDOT represent about 7 percent of the total project cost.

LESSONS LEARNED

The Virginia I-66 HfL project was the first demonstration project under the HfL program that used PCPS technologies for rapid repair of highways. Through this project, VDOT gained technical insights into two PCPS types and their installation procedures. VDOT learned many valuable lessons that can be incorporated into similar projects in Virginia and other States.

Perhaps an important lesson easily overlooked from pilot projects is that, with careful planning and commitment to the undertaking, an agency can implement an innovative and proven technology successfully with minimal prior experience. This is obvious with VDOT's completion of slab replacement on a major route such as I-66. Further, such a demonstration project has intangible benefits. The knowledge and experience gained from them make future implementation of the innovative features relatively easier. Interestingly, as the construction progressed, the construction crew was able to achieve higher efficiency compared to an initial learning phase.

Based on the outcome of the I-66 project, VDOT acknowledged lessons learned from PCPS installation in general as well as the individual Super-Slab[®] and PPCP systems. The lessons learned and the recommendations for future implementation are listed below under broad categories.

Site Selection and PCPS Selection

- PCPS alternatives are suitable and cost-effective for high traffic urban areas where conventional CIP can be a challenging proposition.
- In evaluating the engineering feasibility and cost effectiveness of PCPS for a specific project, consider the impact and cost of items such as utilities, drainage inlets that extend into the replacement slabs, loop detectors, overhead clearances underneath bridge overpasses or signs, etc. Also, consider the other planning and preparatory needs, such as traffic patterns and MOT requirements.
- The selection of PCPS type/technology might be dictated by site conditions relative to the features and capabilities of each PCPS technology. For example, if the rehabilitation segment includes horizontal or vertical curves, ensure that the PCPS selected can accommodate the roadway profile. Also consider the contractor's experience with the system, presence of qualified precaster, and proprietary issues associated with each technology.
- The productivity that can be achieved with PCPS depends on the hours of operation. Analyze delays associated with proposed hours of operation—evaluate weekend closures vs. nighttime closures or a combination of both.
- If exit ramps or access to other roadways exist on the project segment, evaluate the benefits of closing access to ramp or cross street. In the interest of safety, always provide access to emergency facilities (such as hospitals, for example).

Planning and Scheduling

- VDOT recognized the value of good preparation and planning for a successful project. Planning the construction mobilization and scheduling the various construction activities becomes critical especially for a project with stringent construction time windows.
- It helps to keep the crew size to a minimum to prevent crowding of the work zone area.
- A contractor might benefit immensely if adequate time for precasting is provided. This allows the panels to cure longer in the casting bed, and they can be removed after the concrete is well set. Also, if the precasting and the installation are being performed concurrently, there is a likelihood that the contractor will outpace the precasting process. Stockpiling the PCPS slabs will allow the contractor to work at the required pace or readjust the schedule as needed.
- The project should utilize a staging area depending on the hauling distance between the precast plant and the project location. If the precast yard is located far enough to make on time slab delivery less reliable, then the slabs should be staged at a location with easy access to the project site.
- Trial installations for the two PCPS were very helpful for the contractor and the DOT to familiarize themselves with the technology and the installation procedures. The trial installations should be conducted offsite and should be included as a separate pay item in the contract. Trial installations also can be used to validate the load transfer efficiency achieved across joints.
- In addition, to the trial installations, all materials used in the project should be evaluated prior to construction. While trial batches are necessary for concrete mix designs, trial batching of the grout materials also is recommended.
- If both directions of a highway are to be replaced, first perform PCPS replacement in the direction less critical for opening to morning rush hour traffic. This way, the contractor and other construction crew are familiar with PCPS installation when replacing slabs in the more critical direction.

Specifications and Quality Assurance

- The use of PCPS requires a comprehensive set of specifications that result in good material and construction quality as well as performance over time. Special provisions need to be developed if existing specifications do not address PCPS construction. The special provisions may be developed based on AASHTO TIG specifications.
- The project should establish a set of construction inspection and quality assurance testing appropriate for the selected PCPS technologies.
- All these additional specification and quality requirements call for effective communication among the DOT, the contractor, and the various subcontractors involved in the project. Also important is their participation in the quality assurance program. For example, the precaster or the subcontractor for post-tensioning should participate.
- In the design of PCPS slabs, especially when the design is performed by the contractor, it should be recognized that a specific design may have more stringent specifications than those required by VDOT for conventional pavement designs. For example, the permeability requirement for the concrete used for precast slabs is more stringent than that used for CIP pavement slabs.

- Grinding is necessary to guarantee acceptable final ride quality. The ride quality is quite poor at highway speeds. It is possible to achieve International Roughness Index (IRI) requirements for high speed/interstate pavements, which is typically in the range of 70 in/mile. Specify 50 feet of grinding at run-on and run-off ends to tie into existing slabs.
- Specify burlap drag finish or light broom finish for all panels for short-term ride quality prior to diamond grinding.
- Do not allow curing compound on the panels.

Engineering and Design

- Prior to design, a significant amount of field data/information needs to be gathered for the design and fabrication of PCPS. The thickness of the existing slabs can vary along an existing project. Slab thicknesses should be verified using cores. The variability of PCC thickness can be as great as 1 to 2 inches.
- Perform a detailed survey to obtain accurate grade/cross slope of the pavement surface. This information needs to be supplied to the contractor and/or precaster. This is especially important for the Super-Slab[®] system.
- Along a selected roadway segment, the cross slope might vary. Choose uniform cross slope for the finished pavement surface, perhaps at average of the existing cross slopes. This can be especially useful for achieving tight tolerances during precasting and installation. Note that this approach might call for increased MOT considerations because of uneven surfaces (bump or dip) depending on where each night's production stops.
- Verify the stability of the existing subbase. Encountering unstable subbase or soft-spots can pose several risks that might need extra attention during construction.

Design Features and Installation

Installation: Care should be taken to keep the joint widths at a minimum. This is key to achieving good load transfer across the joints for good long-term performance.

While the Super-Slab[®] system installation uses a survey references, the PPCP relies on a combination of surveying and proper installation. If the PPCP slabs are not properly abutted to the adjacent slabs, there may be difficulty with panel alignment due to casting tolerances. This can result in out-of-square slab orientation.

Joint openings were larger than desirable in the PPCP as a result of having to align both longitudinal and transverse joints simultaneously during slab installation. The best strategy was to set the longitudinal line and work to that line. This might, however, cause some transverse joints to be more open on one side than the other. The transverse face of abutting panel joints should be coated with epoxy of sufficient thickness to ensure a good seal of the transverse joint.

Longitudinal Joints: The Super-Slab[®] was placed along one lane of the entire length of the ramp. This necessitated tying the Super-Slab[®] panels to the existing pavement. Additionally, select slabs in the existing pavement were replaced using high early strength concrete in CIP construction. This process resulted in several challenges, and as a lesson learned, VDOT suggests that it might have been more productive to replace both lanes of the ramp using PCPS

even if that resulted in slab replacement over a shorter length of the ramp (i.e., same area of replacement). In other words, the replacement of both lanes is preferable to replacing one lane that needs to be tied to the adjacent existing lane. The issues regarding the existing pavement are:

- Condition of longitudinal joint typically is unknown and variable.
- The existing pavement consists of joints (expansion joints, construction joints, and contraction joints) at varying locations that requires changes to the PCPS installation procedures.
- Much additional grout is needed to fill the spalled areas of the longitudinal edge on the existing pavement.
- It might be more effective to cut a new longitudinal joint rather than tie to the slabs with deteriorated slab conditions.

Regardless of the PCPS technology used, it is important to not tie the new slab to more than one existing slab. This increases the potential for excessive stresses (stress concentration) in the slab that result in increased transverse cracking across new slabs. Note that by tying the new PCPS to more than one existing slab, the differential movements from them cannot be accommodated by the single new slab. (This is true of CIP construction as well. If one of the lanes were to be replaced with CIP construction, the transverse joints have to be aligned with those in the existing lane.)

The PPCP system does not include a means to tie the lanes together. In other words, the PPCP slabs are not tied or post-tensioned in the transverse direction. Further verification is needed to determine whether this is needed.

Transverse Joints: In the Super-Slab[®] installations, there was a considerable amount of grout that filled up the transverse joint openings. This grout at joints should be sawed out full-width and filled with joint sealant. In some instances along the I-66 project, the grout remaining was of small width (1/8 – 1/4 inch), and was popping out. This needs to be managed. Also, if joint width is large and impractical to saw and seal full width, make sure the joint sealant is on the bond-breaker side of the joint so the remaining grout is adhered to the panel.

Panel Design: Cracking occurred over grout channels. Consider changing the orientation of grout channels (longitudinal instead of transverse), especially for longer panels.

Grade Preparation: Hand operated grader was used in this project for the replacement of slabs along the ramp. Hand operated graders are not intended to cut hard base material. If base is likely to contain high spots and is known to be very hard, other provisions/tools for cutting to grade are needed.

Post-tensioning: This is an important aspect of the PPCP slab installation. Allow the post-tensioning contractor to work directly with the precaster at the plant. This is also necessary for pretensioning requirements in the design.

On the field, the clearance for post-tensioning provided should more than the 1 foot minimum specified in this project. Also, the gaskets on the transverse ducts tend to pull off as the panels are slid into position. This should be controlled.

A positive sealed post-tensioning system is required. Gasket seals for post-tensioning duct splices should be avoided as they may be prone to leaking. The foam gasket should not be allowed as a seal and the neoprene gasket will not provide a positive seal to prevent grout leakage or the intrusion of chlorides into the post-tensioning system. Special sealing couplers similar to segmented post-tensioning duct splice connections or positive duct connections sealed with adhesive and shrink wrap tape can be better alternatives for post-tensioning duct splice connections.

Precautionary Measures and Other Miscellaneous Items: Attention to details during planning, design, precasting, and installation helped in several ways. Those identified by VDOT include the following:

- Casting is key for achieving tolerances on field. Higher quality control during the casting process could provide huge pay offs in ease of installation as well as quality of product. VDOT believes the project could have benefited from additional inspection at the precast plant, both from the precaster (Fort Miller included) and from VDOT.
- Crane outriggers should not be placed on panel and definitely not on corners. This ensures that the slabs do not chip, spall, or get damaged.
- Survey accuracy extremely important with the Super-Slab[®] system and was a key to success.
- Take care to keep cold patch out of the expansion joint and grout ports.
- VDOT recommends the use of California profilograph specification for ride quality.
- Closing the ramp during the work hours rather than open one lane to traffic was a good decision and aided the slab installation process. The impact on nighttime traffic using the ramp was minimal. The benefits of ramp closure far outweighed the negative impacts.

Alternative Contracting

The contracting approach adopted by VDOT was a large success. When limited funding is available, it is possible to derive highest value by selecting the contractor offering the largest scope during the bidding process.

CONCLUSIONS

VDOT accomplished a very successful pilot project utilizing PCPS for rapid repair of pavements in an urban area with high traffic volumes. From the standpoint of construction speed, user and agency costs, worker and motorist safety, and community satisfaction, VDOT's project exemplified the principles of the HfL program. Thorough planning and meticulous execution on the part of the precaster, the contractor and the other field crew were primary reasons for project completion on time and within budget while also maintaining safety.

PROJECT DETAILS

BACKGROUND

I-66 is a busy interstate west of the I-495 loop around Washington, DC, and is the main non-toll connector between Fairfax County and Washington, DC. The HfL project was conducted on the westbound lanes of I-66 in the vicinity of the exit ramp leading to US 50 West. The I-66 mainline segment is located between the exits leading to US 50 and SR 123 Chain Bridge Road. The general project location is shown in Figure 1. Here, the westbound direction of I-66 mainline has four lanes, which includes three travel lanes and an auxiliary shoulder as seen in Figure 2. The ramp has two lanes and a shoulder, as seen in Figure 3.

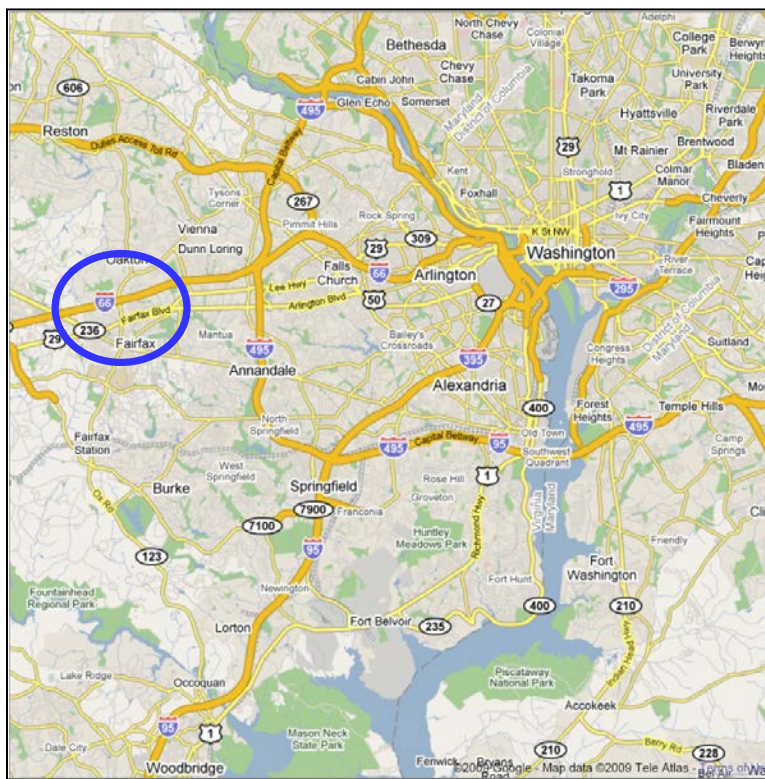

Figure 1. Location of project on I-66 in Northern Virginia west of Washington, DC.

Traffic Patterns on I-66

This segment of I-66 historically has carried very heavy traffic. In 2007 and 2008, the annual average daily traffic (AADT) was reported to be 184,000 vehicles per day in both directions and 91,000 in the westbound direction with 5 percent truck traffic (per online information from the VDOT Traffic Engineering Division). Review of historical traffic data indicates that this location saw a big reduction in truck traffic (11 percent to 5 percent) between 2002 and 2004 but an average increase of 4.7 percent in total number of vehicles between 2002 and 2005. This suggests that the roadway is used by a large number of passenger cars. However, the traffic has

remained fairly stable since 2005, showing marginal increases/decreases annually. For example, the AADT was 90,000 vehicles per day in 2009 in the westbound direction. Additionally, the ramp was reported to carry roughly 28,000 vehicles per day in 2006 and remained about the same through 2009.



Figure 2. Westbound I-66 mainline with three lanes and an auxiliary shoulder.



Figure 3. Ramp from I-66 to US 50 West with two lanes and a shoulder.

Also, given the proximity to the Washington, DC, metro area, this segment of the interstate is primarily a commuter route, and the weekend traffic is roughly about 83 percent of the weekday traffic.

In addition, traffic patterns differ by the time of day. The hourly traffic distribution on the I-66 westbound mainline is shown in [Table 1](#) (as reported in the user cost analysis performed by VDOT). The hourly traffic distribution for weekday and weekend traffic are shown in [Figure 4](#) and [Figure 5](#), respectively, which suggest that weekday traffic peaks at about 7:30 am and again between 3:00 and 7:00 pm. The weekend traffic plateaus at its highest between 11:00 am and 6:00 pm.

Clearly, the rehabilitation strategy to be adopted by VDOT required a careful consideration of the traffic demands and subsequent MOT requirements.

Table 1. Hourly traffic distribution over a 24-hour period for I-66 westbound (from 2009).

Hour	# of vehicles	% of daily traffic
Midnight	1,213	1.35%
1:00 AM	738	0.82%
2:00 AM	587	0.65%
3:00 AM	467	0.52%
4:00 AM	466	0.52%
5:00 AM	1,192	1.32%
6:00 AM	2,835	3.15%
7:00 AM	3,879	4.31%
8:00 AM	4,297	4.77%
9:00 AM	4,433	4.93%
10:00 AM	4,291	4.77%
11:00 AM	4,792	5.32%
Noon	5,154	5.73%
1:00 PM	5,500	6.11%
2:00 PM	6,086	6.76%
3:00 PM	6,642	7.38%
4:00 PM	6,932	7.70%
5:00 PM	6,682	7.42%
6:00 PM	6,125	6.81%
7:00 PM	5,402	6.00%
8:00 PM	3,866	4.30%
9:00 PM	3,431	3.81%
10:00 PM	2,976	3.31%
11:00 PM	2,014	2.24%
Total	90,000	100%

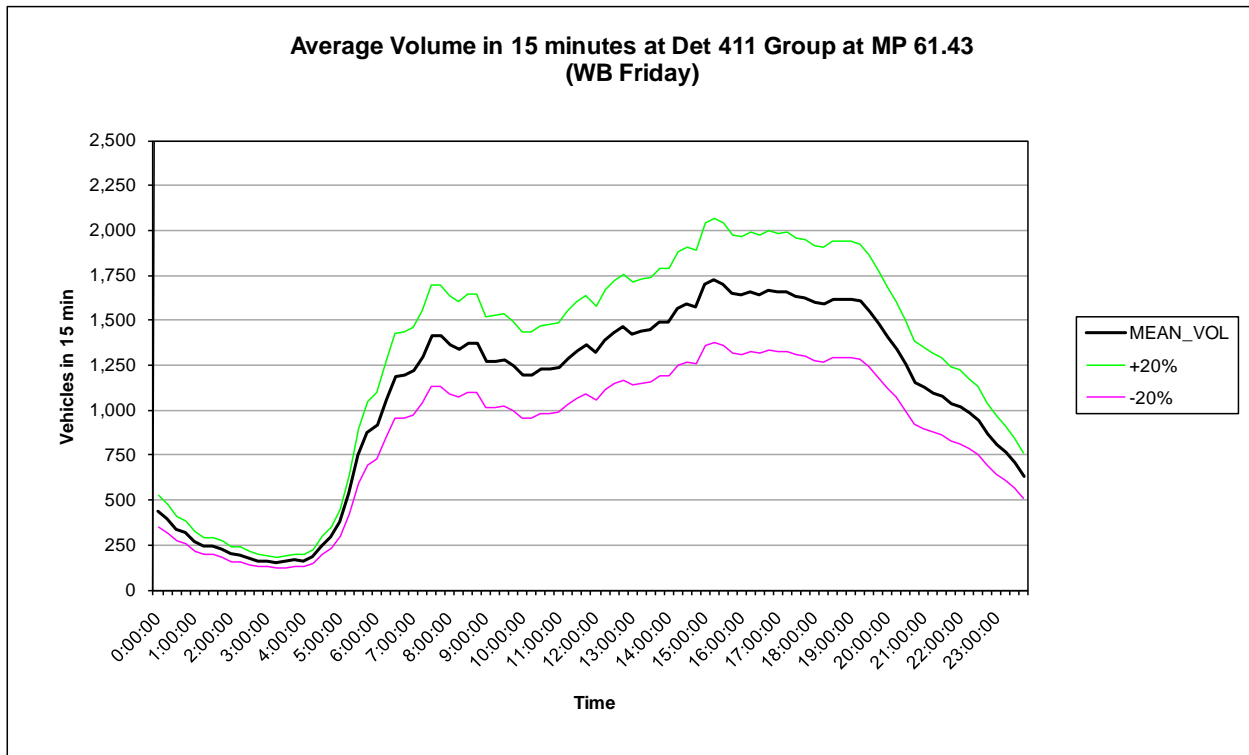
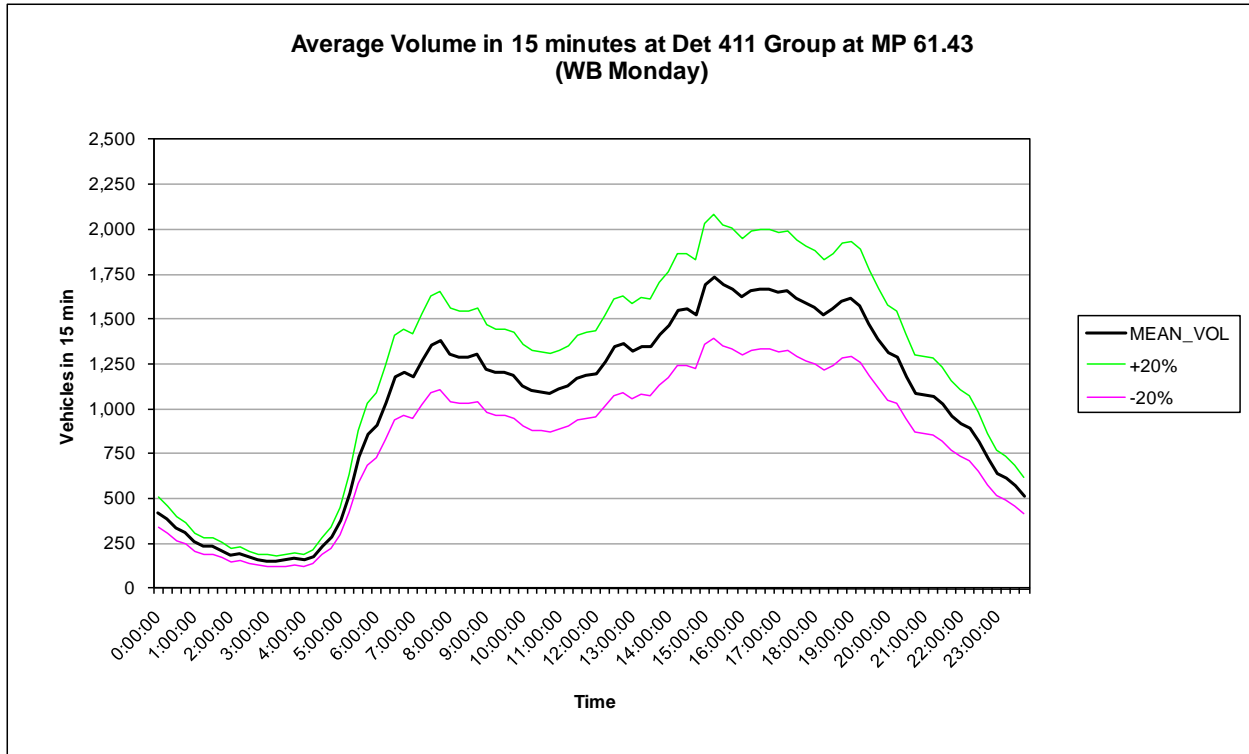

Figure 4. Weekday hourly traffic distribution on I-66 westbound – Monday (top) and Friday (bottom).

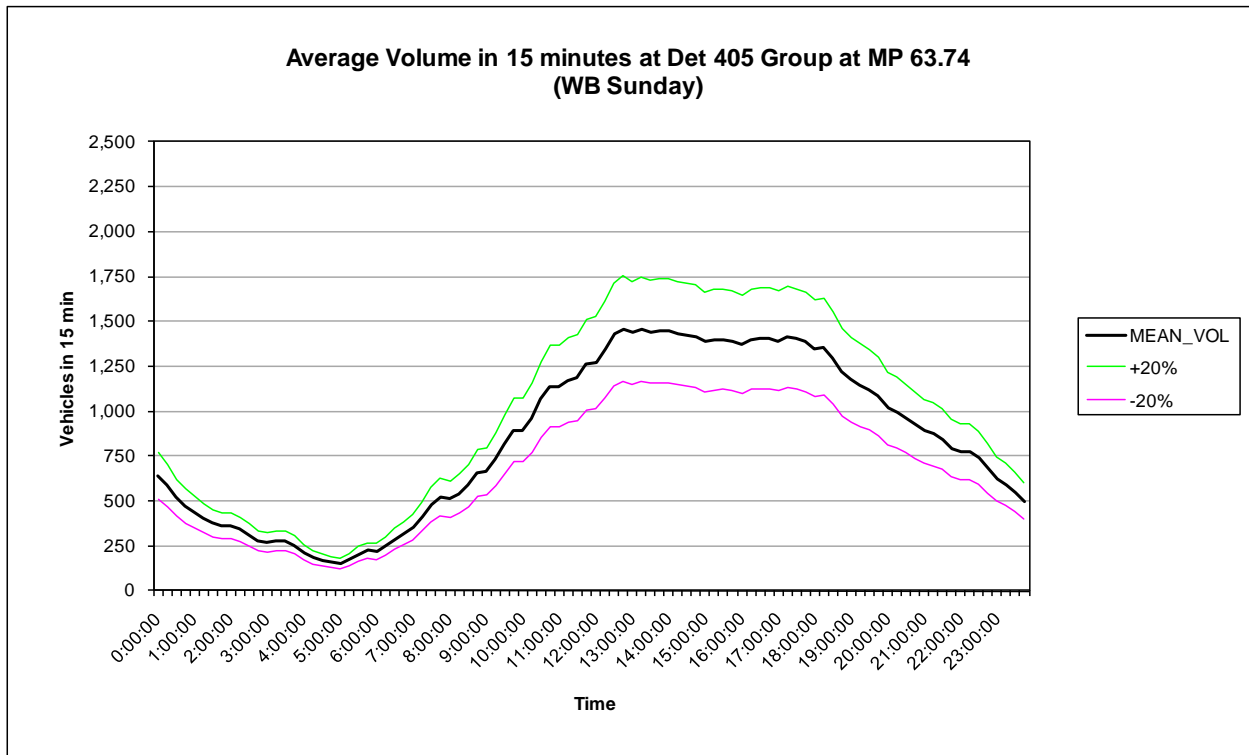
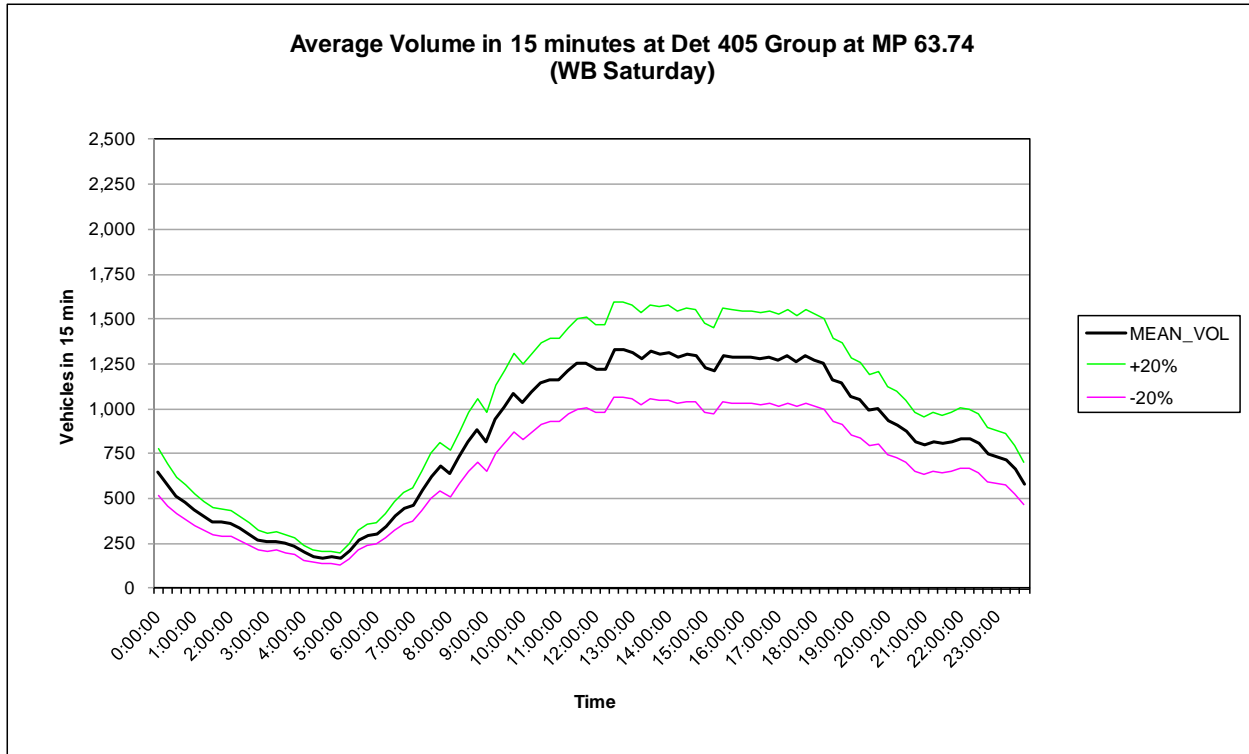

Figure 5. Weekend hourly traffic distribution on I-66 westbound – Saturday (top) and Sunday (bottom).

Existing Pavement Condition and Need for Rehabilitation

The existing pavement in this area, built in the 1960s, was in a highly deteriorated condition. The pavement structure consisted of a 9-inch jointed reinforced concrete slab over 6 inches of aggregate subbase, which was placed over a 6-inch cement stabilized subgrade. The pavement along the mainline and the US-50 West ramp suffered from extensive cracking, mid-slab spalling and deteriorated joints, as shown in Figure 6. This highway had undergone intermittent slab repairs over the last several years; however, the condition was poor enough to warrant an overall rehabilitation.



Figure 6. Surface condition of I-66 mainline and ramp leading to US 50 West in 2008.

REHABILITATION PROJECT DETAILS

The project for the rehabilitation and repair of I-66 was a prime candidate for PCPS applications involving nighttime construction. The potential of PCPS to reduce construction congestion, improve safety, and provide longer pavement life was utilized fully. Its promotion by HfL as a vanguard technology was appropriate for VDOT to submit an HfL Project Application.

At the time of preparing the HfL application, VDOT had considered only the ramp segment for rehabilitation using the PPCP technology. However, when the project was designed and bid, VDOT had included two segments—I-66 mainline segment rehabilitation using PPCP and the

ramp segment using the Super-Slab[®] which previously had been used on curved segments with success. The following were identified in the HfL application.

Project Purpose: The purpose was identified as the repair of the distressed slabs on I-66 and the application of the new PPCP technology for the ramp on I-66 W to US 50W in Fairfax County.

Innovative Features and Project Goals: The main innovative feature listed was the use of PCPS for rapid repair, a technology that could improve safety, reduce congestion, and improve pavement performance.

- ***Safety:*** Despite the high traffic levels, this highway has shown satisfactory levels of safety over the years. The accident history at or near the ramp was relatively low. For example, the records indicate 9 accidents from January 2003 to October 2006. The removal of distressed slabs was expected to further improve postconstruction safety. Further, the use of elaborate MOT schemes was expected to improve work zone safety for motorists. The project's goal was to bring the incident rate for worker injury to zero.
- ***Construction Congestion:*** Using PCPS, the project's goal was to reduce construction congestion by 50 percent. VDOT's traffic analysis showed that, for traditional CIP construction, any lane transitions from two to one during the peak rush hour time would create non-recoverable queuing problems for approximately 1.5 to 2.0 miles. For the accelerated construction, the queuing was expected to reduce to 500 feet during the peak night hours. In addition, the HfL goal for trip time increase during construction is less than 10 percent. VDOT did not quantitatively define a goal for trip time increase in the project but considered that a value slightly higher than 10 percent, but lower than that associated with CIP construction, would be achieved.
- ***Quality:*** VDOT's goal was to achieve the HfL requirement for 48 in/mile by diamond grinding the slabs after installation. Also, consistent with HfL goals, noise levels below 96.0 decibels using the OBSI were expected on the project after diamond grinding. Finally, VDOT also expected structural and durability benefits because of prestressing and providing adequate off-site curing.
- ***User Satisfaction:*** VDOT's goal was to improve driver comfort and safety levels immediately during construction as well as over the long term by ensuring less traffic disruption due to maintenance.

Project Scope per VDOT Advertisement for Contractor Bids

VDOT based the project site selection on several factors. The project site included the ramp and a segment of the I-66 mainline, identified as area A and area B in Figure 7 (contrary to the HfL application, which outlined only the ramp in the project scope). Two approved PCPS were permitted for use in areas A and B. Jointed precast concrete pavement with 9-inch thickness was specified for one lane of the ramp. PPCP with 8-inch thickness for specified for all four lanes of the mainline. Diamond grinding was specified for the entire area repaired using PCPS in areas A and B with an additional 50 feet each end of the PCPS installations.

VDOT considered several factors in selecting the project site. The mainline segment identified was on the westbound lanes that are less critical for morning rush hour traffic headed east. Other factors included the condition of the existing pavement, available working space (barriers, drainage inlets, etc.), overhead clearances, presence of utilities, and loop detectors. Also critical to the selection of PCPS for each area were the horizontal and vertical profiles of the rehabilitation areas. Area A, the curved section (see Figure 8), was specified the jointed system as at least one of the approved jointed systems, Super-Slab[®], was proven for use on roadways with horizontal and vertical slopes using warped slabs.

The project also included extensive CIP patching for the outside lane of the ramp. The existing asphalt shoulder on the ramp was milled and resurfaced. Several other items incidental to the repair, such as construction mobilization, surveying, base filler material, MOT, and lane markings were included in the contract, as was the cost associated with trial installations.



Figure 7. HfL I-66 Virginia project site.

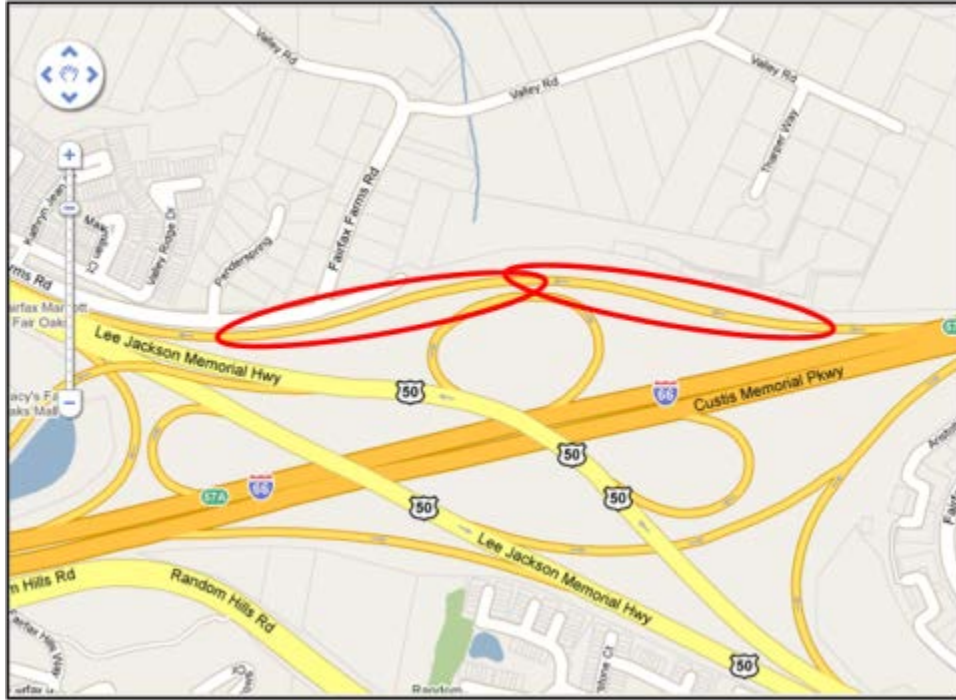

Figure 8. Roadway curvature along Area A ramp.

The bids received for the project are tabulated in Appendix A. The advertisement divided the project into four sections, 001 through 004, covering different portions of the ramp and the mainline, each identifying the portion to be repaired using PPCP, jointed PCPS, and CIP patches.

VDOT offered the contractor design options. For the mainline, 8-inch-thick PPCP were specified. For the right lane of the ramp, the first 802 feet were specified for Super-Slab[®] repair with options for the last 378 feet and up to the complete lane to be replaced with precast panels, as shown in Figure 9. The left lane and the remainder of the right lane (not included in the precast panels) were to be repaired using CIP patches of the same 9-inch thickness.

Project Award

The project award was based on the total area of pavement repair proposed by each contractor within the \$5,000,000 project budget. Lane Construction Corporation was the selected contractor. The three top vendors were within \$30,000 on the bid amount, as tabulated in Appendix A. In addition, Lane Construction offered jointed PCPS repair for the right lane of the entire 3500+ feet length of the ramp, as shown in Figure 10. The total area of replacement using each method of repair for each section is shown in Table 2. Table 3 presents the unit price for PCPS technology and total bid amount.



Figure 9. Area A repairs identified by VDOT for contractor bids.

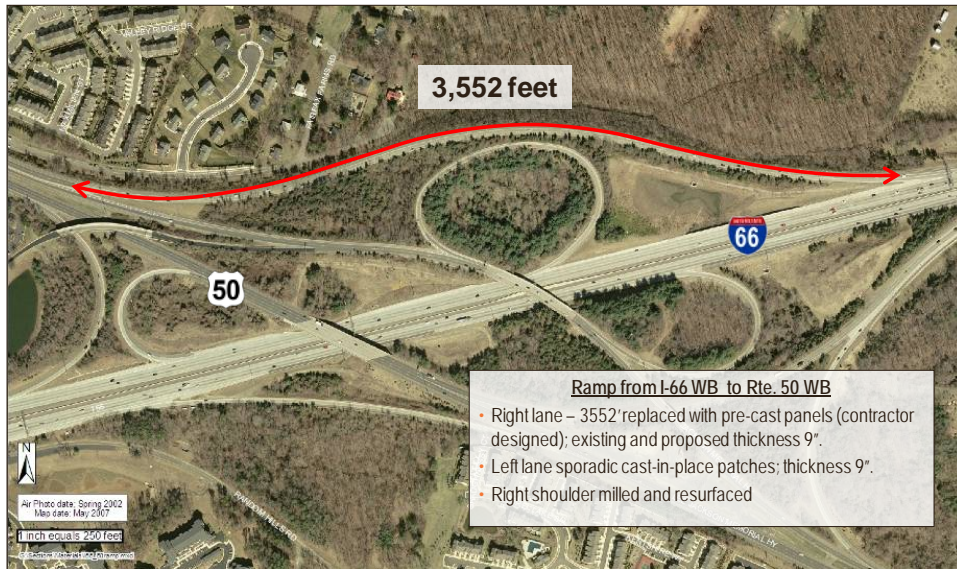

Figure 10. Area A repairs proposed by the selected contractor.

Table 2. Total area of PCPS in the project (as built).

Section	Areas covered in scope	Ramp Super-Slab [®] area ¹ , SY	Mainline PPCP area ² , SY	Total PCPS area, SY	CIP, SY
001	Ramp + Mainline	1,067	4,533	5,600	1,023
002	Ramp	503	N/A	503	
003	Mainline	N/A	1,247	1,247	
004 ³	Ramp	3,140	N/A	3,140	
TOTAL ⁴		4,710	5,780	10,490	
¹ Pavement 9-inch thickness ² Pavement 8-inch thickness ³ Optional area to be repaired using Super-Slab [®] ⁴ Total area of slab replacement. Total area of grinding was 11,190 SY					

Table 3. Unit price for PCPS technology and total bid amount.

Contractor	Super-Slab [®] , \$/SY	Proposed Super-Slab [®] repair area, SY (proposed area in optional section, SY)	PPCP, \$/SY	CIP, \$/SY	Contract total, \$
Rank 1	\$350	4,710 (3,140)	\$410	\$225	\$4,971,360
Rank 2	\$395	3,670 (2,100)	\$405	\$380	\$5,000,000
Rank 3	\$565	2,943 (1,373)	\$377	\$350	\$4,999,451

Project Timeline

The following marks the timeline for the contract award and project execution:

- Advertisement date: February 24, 2009.
- Receipt of bids: March 25, 2009.
- Notice to proceed: May 28, 2009.
- Trial installations: July 1, 2009 for Super-Slab[®] and July 28, 2009 for the PPCP system.
- Precast panel installation start date: August 2, 2009.
- Completion date: November 19, 2009.

The time between contract start on May 28, 2009, and the first on-site installation was taken up with design and shop drawing approvals, precasting of the panels, trial installations, in-situ testing of the PCP trial installation, and transportation/staging of the panels.

PCPS TECHNOLOGIES

The PCPS that exist today are products of several decades of trials and improvements to accommodate the needs of agencies and the construction industry while also providing adequate structural capacity and ride quality. Several proprietary and non-proprietary PCPS are available, and they each employ a unique design for the slab and load transfer features.

PCPS has many applications in rapid repair and construction of roadways. Figure 11 illustrates the different repair and construction applications contrasted by the conventional methods. Specifically, PCPS may be useful for rapid repairs and/or when projects involve the construction or repair of ramps and interchanges, slabs under bridge underpasses (low vertical clearance), intersections, bridge approach slabs, and when sensors need to be embedded in panels.

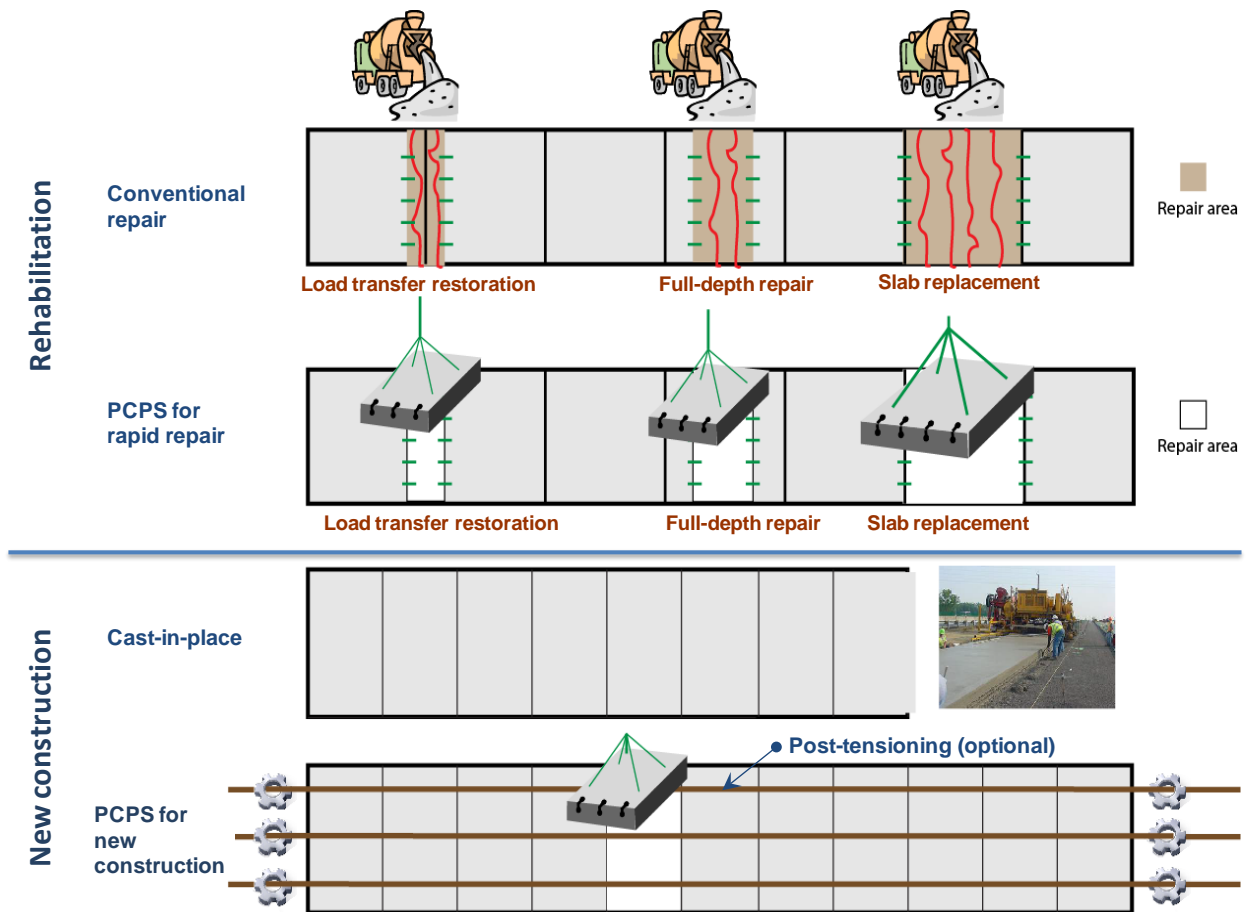

Figure 11. PCPS applications compared to CIP.

Note: Figure is conceptual and is not drawn to scale; all dowel bars shown are those that are placed during the repair process, and existing dowels are not shown; the figure does not represent any specific PCPS technology.

The two systems that have demonstrated successful field performance, and that have been promoted by HfL, were used on this project: the PPCP and the Super-Slab[®] system. A brief description of each system follows.

PPCP

The PPCP has evolved from a sequence of research activities conducted by the Center for Transportation Research at the University of Texas since the early 1980s. In 2002, a feasibility study was performed in Georgetown, Texas, to use precast prestressed concrete pavements in

projects requiring expedited pavement construction and has since been used on projects in California, Missouri, Iowa, Alaska, and Delaware. The I-66 rehabilitation was the next project using large-scale PPCP installations. It has since been used on two other projects in California.

The PPCP uses a combination of pre-tensioning and post-tensioning; the slabs are pre-tensioned in the precast plant in the transverse direction (perpendicular to the direction of traffic) and post-tensioned in the longitudinal direction (parallel to traffic flow) during installation. They also have been post-tensioned in both directions on-site without plant pretensioning.

The post-tensioning tendons are grouted to create a bonded system which permits future slab removal if needed. The other reason for grouting is corrosion protection for the strands. The design includes a large precast pocket in the slab for the post-tensioning duct.

A PPCP section is essentially a series of precast pre-tensioned slabs. Depending on the length of the project, multiple PPCP sections may be installed. In the original design developed in 2000, each PPCP section included three types of slabs:

- Two *joint panels*, placed on either end of a section. They contain dowelled expansion joints to accommodate expansion and contraction of the entire section.
- One *central panel*, placed mid-length of the section and used for post-tensioning. The post-tensioning tendons are fed into the ducts from this panel and post-tensioned.
- Multiple *base panels*, which are placed between the joint panel and the central panel. They make up the bulk of the section length and the number of base panels in a section is dictated by the section length.

Figure 12 shows a typical layout of the PPCP panels and key design features of each panel type. The slabs can be cast at varied lengths—full lane width, partial width, or two lane widths.

The transverse edges of the slabs are provided with a continuous shear key to help align the slabs in the vertical direction, as shown in Figure 13. In the longitudinal direction, the slabs contain ducts to pass the post-tensioning strands in the longitudinal direction after the slabs are installed, as shown in Figure 14. The transverse prestressing ducts can be designed flat to allow a slight misalignment of slabs. The PPCP system attempts to provide some measure of corrosion protection. Epoxy-coated strands are used, and an epoxy coating is applied to the side of the slab prior to the installation of the next slab.

To permit slab movement (sliding) while post-tensioning, a frictionless surface beneath the slab is used. Regardless of the base type—asphalt, cement stabilized, or granular—a single layer of polyethylene sheet underneath the slab is used to permit effective post-tensioning (see Figure 15).

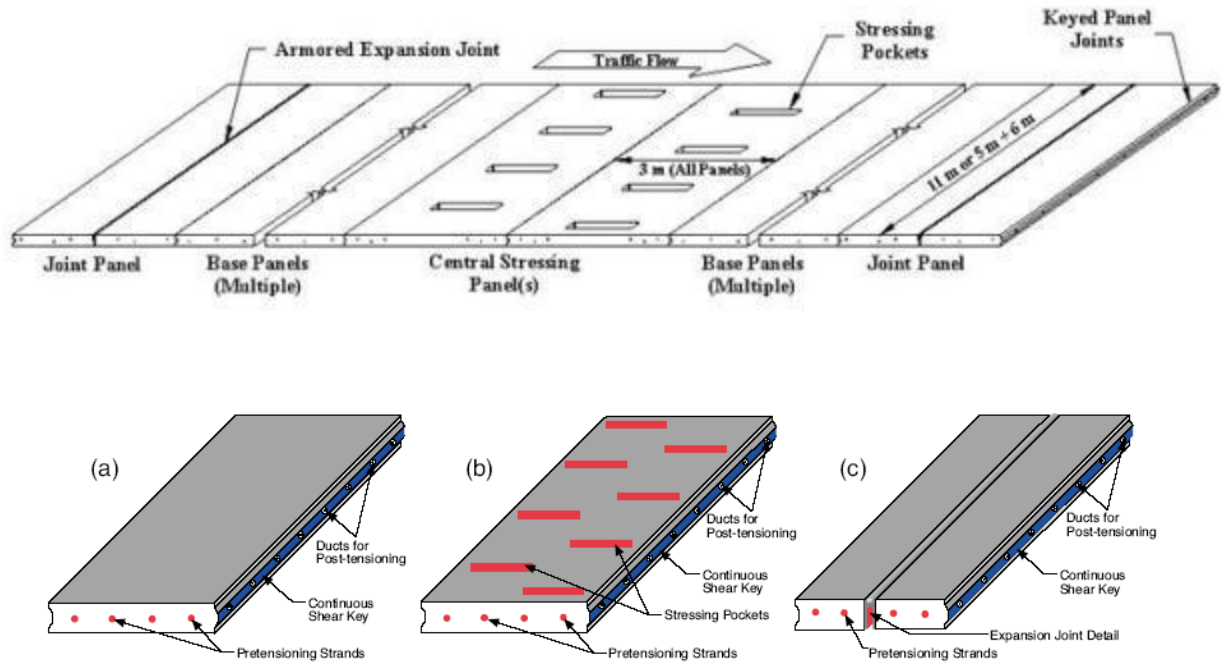

(a) base panel, (b) central stressing panel, and (c) joint panel.

Figure 12. PPCP section panels and features (from original design reported by Merritt et al., 2000)¹



Figure 13. Shear key in PPCP panels for vertical alignment of slabs.

¹ Merritt, D.K., McCullough, B.F., and Burns, N.H., and Shindler, A.K., *The Feasibility of Using Precast Concrete Panels to Expedite Highway Pavement Construction*, Report No. 9-1517-3, Prepared for Federal Highway Administration, Report No. 1517-S, Project Summary Report, Prepared for University of Texas, 2000.



Figure 14. Ducts for post-tensioning strands.



Figure 15. Use of polyethylene sheet underneath the slab for reducing friction.

When VDOT considered this technology for the I-66 project, the typical production rates were about three slabs per hour with 1 to 3 hours per section for grouting and post-tensioning.

In summary, the field demonstrations had demonstrated that PPCP was a viable alternative, especially for projects involving urban pavements with high traffic volumes and high truck traffic, as well as all roadways that can be only partially closed and only during nighttime hours.

Innovations to the PPCP System for the I-66 Project

The I-66 project provided an opportunity for FHWA to evaluate certain innovative design features that came to be deviations from the original designs. PPCP projects, over the years, have adopted minor modifications to the design in an effort to improve on the installation and field performance aspects of the design. On this project, each slab was post-tensioned partially during installation. This process was termed “temporary post-tensioning” and utilized bars at two of the post-tensioning ducts instead of tendons. This process also used minimal post-tensioning forces and served to improve the alignment of each slab as it was installed. Temporary post-tensioning, shown in Figure 16, also served to hold the slabs tight together so that the roadway could be opened to traffic prior to permanent post-tensioning.

Note that, after the placement of all slabs, a final post-tensioning operation was performed. The final post-tensioning was performed from the end instead of from the central panel, as in the original PPCP design. Each section therefore included a joint panel at either end along with multiple series of seven joint panels and an anchor panel. All slabs within a section length of 160 feet were post-tensioned.

Also, to improve corrosion protection of the post-tensioning tendons, epoxy-filled and epoxy-coated 0.6-inch Grade 270, 7-wire low-relaxation strands were used for post-tensioning the PPCP panels together on field. A high-performance grout material approved by VDOT was used to grout the post-tensioning ducts.

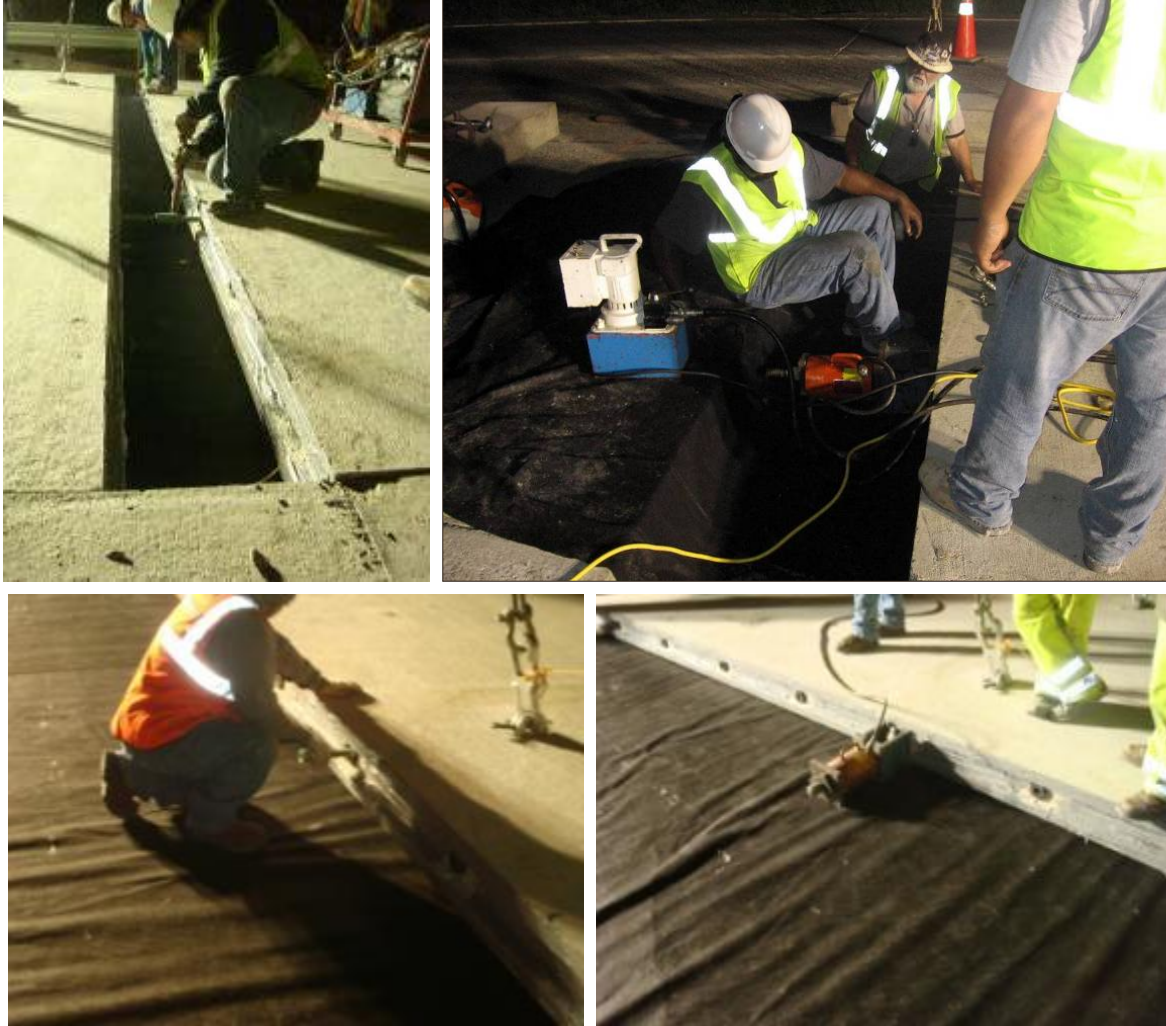

Figure 16. Temporary post-tensioning and slab alignment.

Jointed Precast Concrete Pavement System – Super-Slab[®]

The Super-Slab[®] precast concrete slab system was developed by the Fort Miller Co., Inc., with assistance from the New York State Thruway Authority and New York DOT. This system was designed as a precast, non-prestressed concrete slab with a provision for inserting tie bars and dowel bars across the longitudinal and transverse joints, respectively. The design of this system makes it most suitable for intermittent repairs. Super-Slab[®] uses specialized construction methods; notable of them are the use of a laser-guided grader for base finishing, specialized base filler material, grouting material with specified flow properties and strength gain rates. The Super-Grader, shown in Figure 17, finishes and grades the bedding material to an accuracy of 1/16th of an inch, making the surface exactly parallel to the surface of the finished pavement. On smaller projects, or for intermittent slab repair jobs, base finishing is achieved through the use of a hand-operated grader that is supported on rails as shown in Figure 18.



Figure 17. Use of specialized grading devices and base finish achieved (image from project in New York State, 2002).



Figure 18. Hand-operated grader supported on rails (image from project in New York State, 2002).

The unique feature of this precast slab technology is in its joint design. Dowel bars and tie bars are threaded into a slab through a prefabricated mechanical connector at mid-depth of the slab (Figure 19). The adjacent slab is provided with inverted dovetail slots—interconnecting slots at the bottom of the slab that perfectly align with the dowel and tie bars projecting from the first slab (slab threaded with the dowel), as shown in Figure 20.



Figure 19. Mechanical connectors for tie bars and installed tie bars (image from project in New York State, 2002).



Figure 20. Inverted dovetail slots and foam gaskets underneath slab to control flow (image from project in New York State, 2002).

The Super-Slab[®] system also has a unique design for grouting the dowel bars and the bedding layer. Grout ports are provided on the top of the slab for the dowel grout and the bedding grout, as shown in Figure 21. Additionally, for even distribution of the bedding grout, grout distribution channel and foam gaskets are provided underneath the slab, shown in Figure 20 and Figure 22.

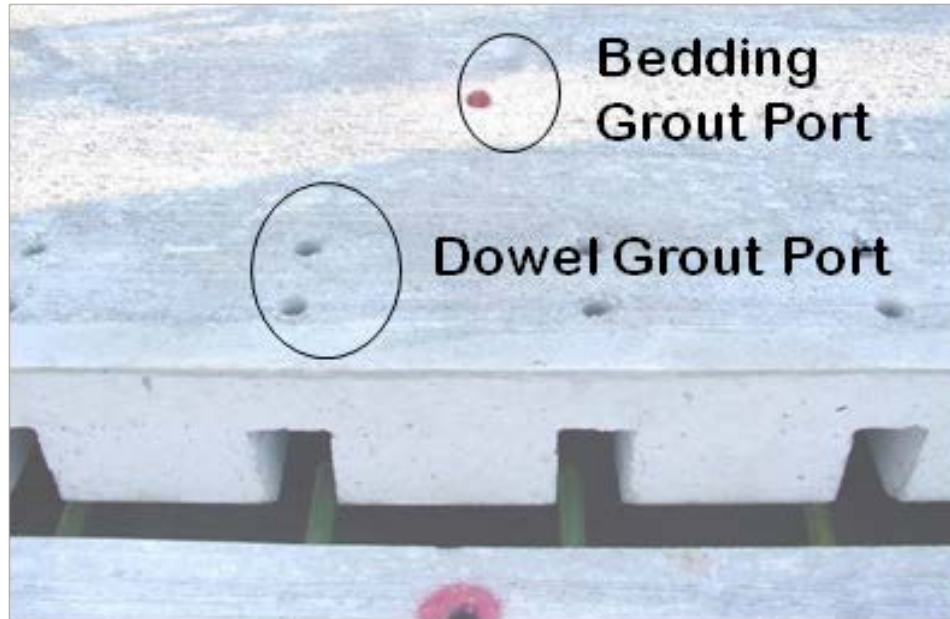

Figure 21. Grout ports provided on the slab (image from project in New York State, 2002).



Figure 22. Grout distribution channel and foam gasket for bedding grout (image from project in New York State, 2002).

The dovetail slots are filled with a non-shrink, rapid setting grout pumped in from the top of the installed slab. The bedding grout is also pumped in from the grout port to provide uniformity and slab support. Figure 23 shows the bedding grout operation in progress, where the grout is pumped from one end of the slab and the material is seen coming out of the port at the other end

of the slab. The grouting is performed after the slab is installed and may be performed even on the next day after installation.



Figure 23. Verification of dowel grout and bedding grout distribution for uniform support (image from project in New York State, 2002).

Grout consolidation may be verified through cores, as shown in Figure 24. The dovetail shape of the slot and the dowel can be seen. The dowel slots, cast in the bottom of the slabs, provide outstanding resistance to dowel bar pop out, greatly enhancing the efficiency of the connection. The slots on the bottom of the slab additionally keep the dowel grout protected from de-icing salts.



Figure 24. Verification of dowel grout consolidation (cores taken after installation).

Super-Slab[®] panels can be cast to desired dimensions. They also may be cast in a single plane or as warped slabs. Single plane slabs are flat planes in which the cross slope is constant from one end to the other. Warped slabs have three corners of the slab in the same plane while the fourth corner is either higher or lower than the plane of the other three. Therefore, in warped slabs the cross slope varies uniformly from one end of the slab to the other, as shown in Figure 25.



Figure 25. Warped slab geometry in Super-Slab[®] design.

The success of the Super-Slab[®] technology depends on two important factors, casting of the three-dimensional slabs and preparing a matching subgrade surface. Specific “x,” “y,” “z” coordinates are calculated for every corner of every slab, and slabs are cast such that all sides are vertically and horizontally straight between slab corners. Warped slab installation also requires appropriate grade control. The subgrade surface must be built exactly parallel to the three-dimensional roadway surface because all of the slabs are of a constant thickness.

It should be pointed out that patented warped Super-Slab[®] panels match normally specified profile grades and cross slopes exactly, in vertical profile tangents, outside of super-elevations. In vertical curves and in super-elevation transitions, the cross slope matches exactly what is specified while the lengths of the slabs represents chords to the specified vertical curve and only match the vertical curve at the corners of the slabs. The subgrade surface is graded exactly the same way, to ensure it matches the slabs exactly.

The Super-Slab[®] has been used primarily as a full-depth repair option on several projects, including the nation’s busiest roadways—Tappan Zee Bridge toll plazas, sections of the New York Thruway System, and several other highways predominantly in the eastern US. As of 2007, over 800,000 square feet of slab installations have been completed using this technology.

TRIAL INSTALLATIONS FOR THE I-66 PROJECT

The contractor performed trial installations for both precast pavement systems used in the project. These trial installations were observed closely and evaluated by both VDOT and contractor personnel. The purpose was to gain a level of familiarity with the technologies and the installation processes and for VDOT to verify the effectiveness of the specifications and special provisions being used in relation to achieving good construction quality and performance.

Super-Slab[®] Trial Installations

Six trial panels were fabricated and installed in June 2009 at Virginia Paving’s new office site in Stafford. Three panels were installed on the first day and three on the second day. Materials, specifications, and installation practices were similar to those planned for the project site. The panels were 12 feet wide by 10 feet long and were 8.75 inches thick. The six panels were placed in a 2 x 3 grid. Figure 26 shows the activities during the trial installation of the Super-Slab[®].

One of the key evaluations of the design and installation process was based on the joint performance. The load transfer efficiency was measured at 37 joints using the FWD. Tests were conducted at load levels of 6,000, 9,000, 12,000, and 16,000 lb using four drops per load level. The tests included cases with the load plate on the grouted side as well as the cast side of the dowel.

The minimum criteria identified in the specification were to achieve load transfer efficiency greater than 80 percent and a differential deflection of less than 0.005 inches under a 9,000-lb load. The results indicated that not all of the 37 test locations achieved the load transfer efficiency goal. However, all test locations showed differential deflections below 0.005 inches. All differential deflections were less than or equal to 0.002 inches.

Within 10 days of slab installation, 11 cores were taken at the joints to examine the flow and consolidation of the dowel grout. Two cores had to be discarded, and the remaining nine cores were used to assess the grout quality. Certain concerns were noted initially; for example, the dowel grout did not appear to penetrate the dowel pockets or the adjacent joints completely. Cracking was observed in the grout.

Six cube samples were cast for the dowel grout and the bedding grout used in the Super-Slab[®] system. The average strengths were 2,019 psi at 13 hours and 5,321 psi at 16 hours, much higher than the specification requirement of 2,500 psi and 500 psi at 12 hours, respectively.

VDOT also observed inconsistencies in the placement of the reinforcing steel relative to the drawings and plans. Additionally, in the installation process, the bedding grout was mixed and placed by hand, which was disallowed as per the specification.

Therefore, the trial installations served to review all details of the plans and specifications, and the inadequacies and shortcomings were rectified for the final field installation.



Figure 26. Trial installation for Super-Slab®.

PPCP Trial Installations

A similar scale of trial installation was performed for the PPCP system at a selected location, as shown in Figure 27. While a detailed report was not developed on the trial installation process for the PPCP, similar installation issues that might be critical for field use were identified during the process. A design modification to increase the thickness of the slab by ½ inch was done to obtain proper coverage. The trial installation process also showed the importance of fabrication accuracy for proper slab alignment and post-tensioning duct alignment.

Finally, it was clear that close collaboration between VDOT, the contractor, and the precaster was necessary for making improvements to the design and installation process as well as for the overall success of the project.



Figure 27. Trial installation for the PPCP system.

REHABILITATION OF I-66 USING PCPS

DESIGN AND PANEL FABRICATION

The PCPS technologies discussed previously were implemented on the I-66 slab replacement/reconstruction project. However, each project requires specific designing and detailing in order to fit within the existing pavement structure and alignment. FHWA provided the technology support for the design of PPCP system used on the mainline. Fort Miller, Inc., the developer of the Super-Slab[®] system, provided support with design and shop drawings. The precasters that collaborated with Lane Construction were Smith Midland Corporation for the PPCP system and M&M Precast, Inc., for the Super-Slab[®]. The post-tensioning and grouting contractor was Freyssinet, Inc., who worked directly with Smith Midland at the fabrication plant.

Samples of the shop drawings for the fabrication of PPCP and the Super-Slab[®] are included in Appendix B and Appendix C, respectively.

PPCP

The PPCP slabs were 8.75 inches thick, and their dimensions were 12 by 10 feet and 27 by 10 feet for the single lane (lanes 1 and 2 individual) and double lane (lanes 3 and 4 simultaneous) replacements, respectively. The slabs were reinforced using Grade 60 epoxy-coated steel to withstand stresses resulting during handling and transportation. They were pretensioned in the transverse direction using 8-wire 0.5-inch strands. As shown in Figure 28, a 4-inch-high and 1.5-inch-deep tapered key way was provided along the slab edges to help with slab alignment. The slabs were broom finished on the surface. Smith Midland precast a total of 306 panels for this project. Figure 29 shows the form work used in the precasting operation.

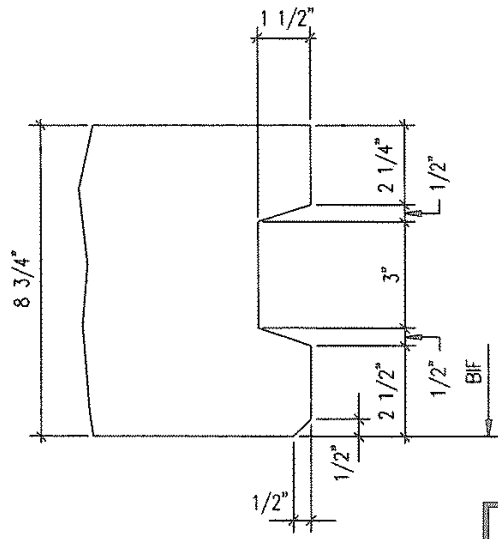

Figure 28. Shear key provided for slab alignment.



Figure 29. PPCP formwork set up at precast plant, curing, and yard storage.

Expansion joints were provided at ends of each section (16 slabs and 160 feet in length). In the field, the slabs were post-tensioned using Grade 270 monostrand tendons, 0.6-inch diameter at 2.5 feet on center with two 1-inch threaded bars replacing the strands at the quarter points. Therefore, each slab had two 2.375-inch bar post-tensioning ducts and three 1.4375-inch tendon post-tensioning ducts. The threaded bars were used for initial post-tensioning one slab at a time (shown in Figure 16). During final post-tensioning, slabs in each section were post-tensioned from expansion joints at the ends. The project had a total of eight expansion joints, including those at the beginning and end of the project.

Super-Slab[®]

The Super-Slab[®] was designed and precast as a reinforced concrete slab with a thickness of 8.75 inches. Each slab was cast to meet the dimensional requirements of the ramp geometry and elevation requirements. Therefore, each panel was typically 15 feet in length and 12 feet in width, with a few shorter panels to accommodate ramp curvature.

The slab was cast with two mats of reinforcement, one on the top and the other at the bottom of the slab with a 2-inch cover. The reinforcement was Grade 60 reinforcement with a steel-to-concrete cross sectional ratio of 0.0018. The plans allowed one layer steel with a cross sectional ratio of 0.0014 if the slab were to be fully grouted before opening to traffic. The dowels and ties

used were also Grade 60 steel. The dowels and tie bars were spaced at 12 inches and 30 inches c/c, respectively. M&M Precast cast a total of 224 panels for this project. Figure 30 shows the precast operations for the Super-Slab®.



Figure 30. Precasting operations and form work details for the Super-Slab®.

MATERIALS

The materials used in the PCPS fabrication and installation were selected based on requirements specified by the AASHTO TIG. Note that the material properties specified by the TIG account for the design requirements for each specific system. In addition, the materials were compliant with VDOT standard specifications. While details of the reinforcement used in each system were discussed in the previous section, concrete and grout material properties are discussed below.

Concrete Properties

The concrete mixes used in the fabrication of the precast panels complied with the requirements for hydraulic cement concrete as per VDOT specifications. The mix design for the PPCP system was a Class A5 concrete that typically is used for prestressed and other special designs. The Super-Slab® panels used a Class A4 general concrete. VDOT standard specification requirements

for Classes A5 and A4 are provided in Table 4. Additionally, as VDOT considers concrete permeability an important factor for concrete durability, adequate permeability tests were performed for the A4 mix. All permeability test results were below 2,500 coulombs. The concrete mix designs and the permeability test results are included in Appendix D.

Table 4. VDOT specification requirements for classes A5 and A4 concrete.

Material property or mix design parameter	A5 class (used for PPCP)	A4 class (used for Super-Slab®)
Design Min. Laboratory Compressive Strength at 28 days (f'c) (psi)	5,000 or as specified on plans	4,000
Aggregate Size No.	57 or 68	56 or 57
Design Max. Laboratory Permeability at 28 days (Coulombs)	1,500	2,500
Design Max. Laboratory Permeability at 28 days – Over tidal water (Coulombs)	1,500	2,000
Nominal Max. Aggregate Size (in)	1	1
Min. Grade Aggregate	A	A
Min. Cementitious Content (lb/cu.yd)	635	635
Max. Water/Cementitious Mat.	0.40	0.45
Consistency (in of slump)	0-4	2-4
Air Content (percent)	4 1/2 ±1 1/2	6 1/2 ±1 1/2

Grout Properties

The grout materials used on the project met VDOT specification requirements and/or specific requirements of the respective PCPS. For example, the grout used in the post-tensioning ducts, Sika 300PT grout, was in accordance with Class C grout specified by the Post-Tensioning Institute. The Pro Spec Slab Dowel Grout used in for the dowel slots in the Super-Slab® system was required to gain a compressive strength of 2,500 psi prior to traffic opening. The bedding grout is expected to develop a strength of 600 psi in 12 hours, and since its main function is to flow into and fill the voids, it is specified to have a flow rate of 17 to 20 seconds.

The dowel grout in the Super-Slab® system and the tendon grout in the PPCP system were tested at the Wilson Bridge Lab during September and October 2009. The test results from compressive strength testing of 2 x2 cubes are presented in Table 5.

Table 5. Grout compressive strength results, load in lb/strength in psi.

Sample	Dowel grout	Tendon grout
Sample 1	25400/6350	26600/6650
Sample 2	28000/7000*	28000/7000*
Sample 3	28000/7000*	27200/6800
Samples cast on	October 4, 2009	September 17, 2009
Samples tested on	October 13, 2009	September 24, 2009
*Loading was stopped at 28,000 lb		

TRAFFIC CONTROL AND CONSTRUCTION STAGING

Traffic control and construction staging were most critical for the mainline, as the entire slab replacement was conducted in a nighttime work window with at least one lane open to traffic. All traffic control devices and signs necessary for MOT were installed, maintained, and removed by the contractor.

The construction was staged in two phases, as shown in Figure 31 and Figure 32. Phase I involved the repair of the inside shoulder and the replacement of lanes 1 and 2. Lanes 1 and 2, both 12 feet wide, were replaced using 12-foot-wide PPCP slabs. They could be replaced one lane at a time or both lanes together and still keep within VDOT's MOT requirements. The contractor replaced one lane at a time for a very short segment and then reverted to replacing both lanes in parallel. Phase II involved the replacement of lane 3 and the auxiliary shoulder or lane 4 that were 12 feet and 15 feet wide, respectively. The auxiliary shoulder is converted to a traffic lane during rush hour traffic. The replacement of this entire width was performed using 27-foot-wide PPCP slabs. Note that in both phases of the staged construction one lane was always open to traffic.

The work progress, illustrated in Figure 33 through Figure 39, can be described in seven steps as follows:

1. Remove existing pavement in both lanes 1 and 2.
2. Install 12-ft-wide PPCP slabs in lane 1 along with initial post-tensioning.
3. Install 12-ft-wide PPCP slabs in lane 2 along with initial post-tensioning.
4. Repeat steps 1 through 3 for the entire mainline project length and complete post-tensioning, duct and slab grouting, filling post-tensioning block-outs and closure pour.
5. Remove pavement in both lanes 3 and 4 for the same length.
6. Install 27-ft-wide PPCP slabs spanning across lanes 3 and 4 along with initial post-tensioning.
7. Repeat steps 5 and 6 for the entire mainline project length and complete post-tensioning, duct and slab grouting, filling post-tensioning block-outs and closure pour.

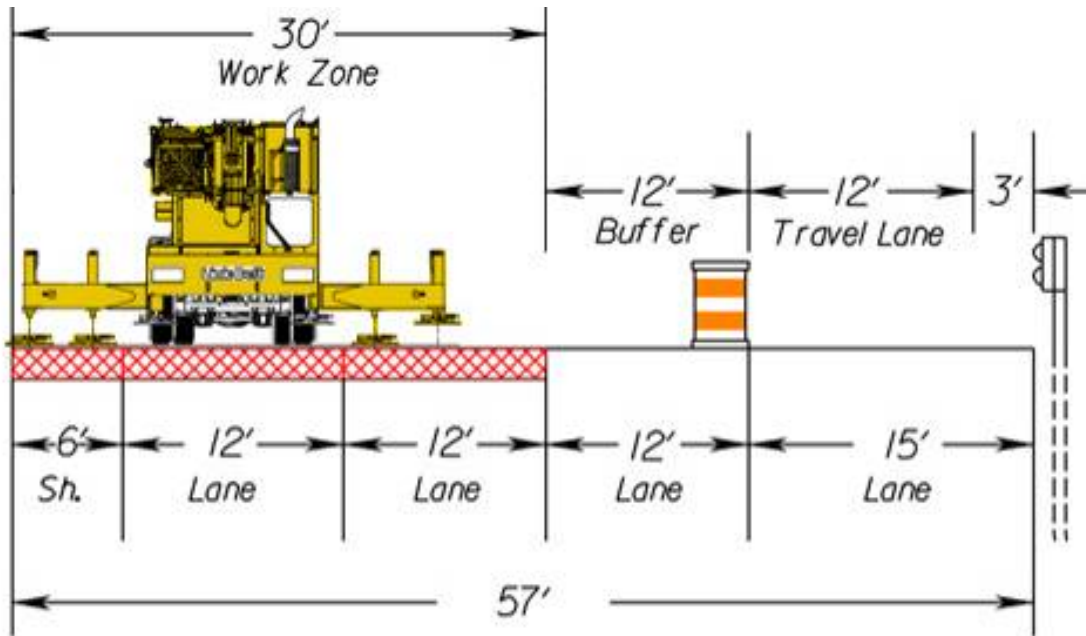

Figure 31. Phase I for rehabilitation of inside lanes and shoulder using 12-ft-wide PPCP.

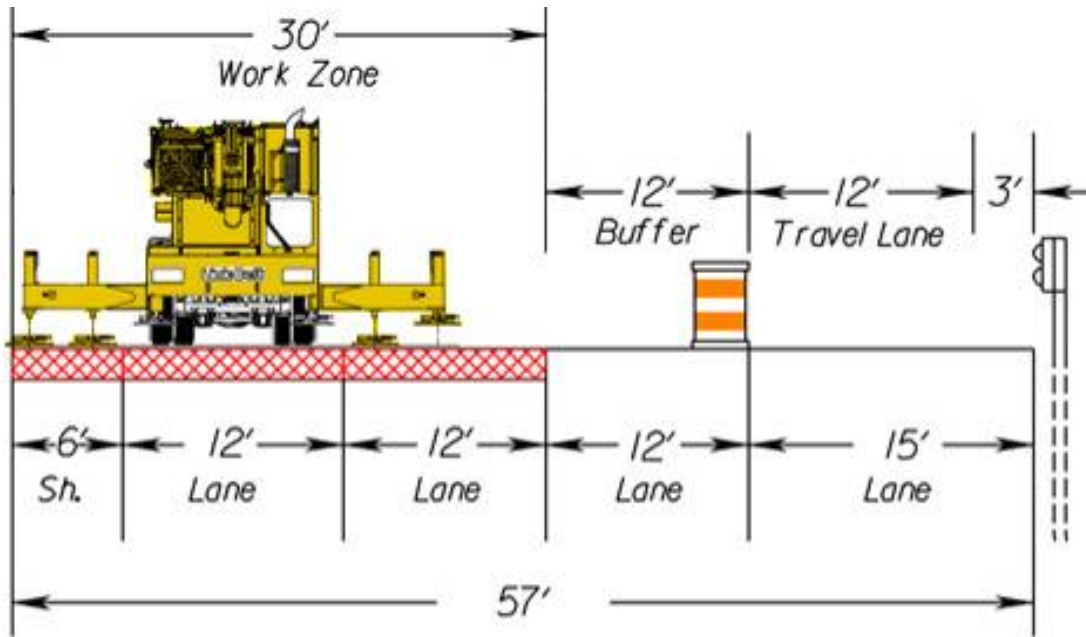

Figure 32. Phase II for rehabilitation of outside lanes using 27-ft-wide PPCP.

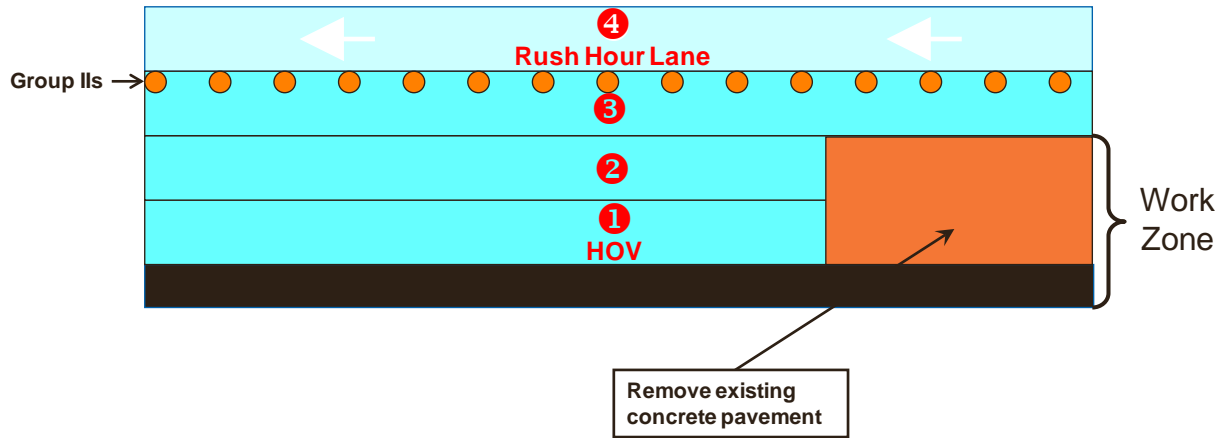

Figure 33. Stage construction – step 1.

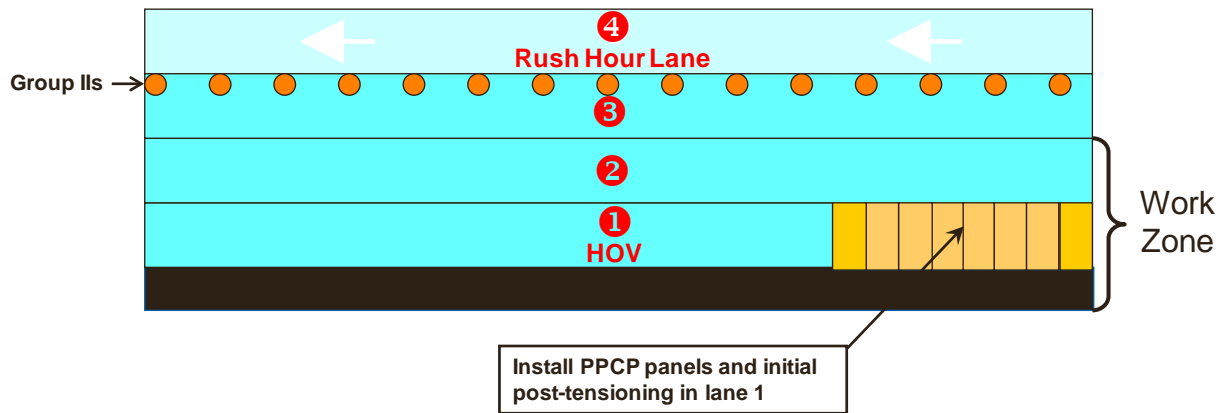

Figure 34. Stage construction – step 2.

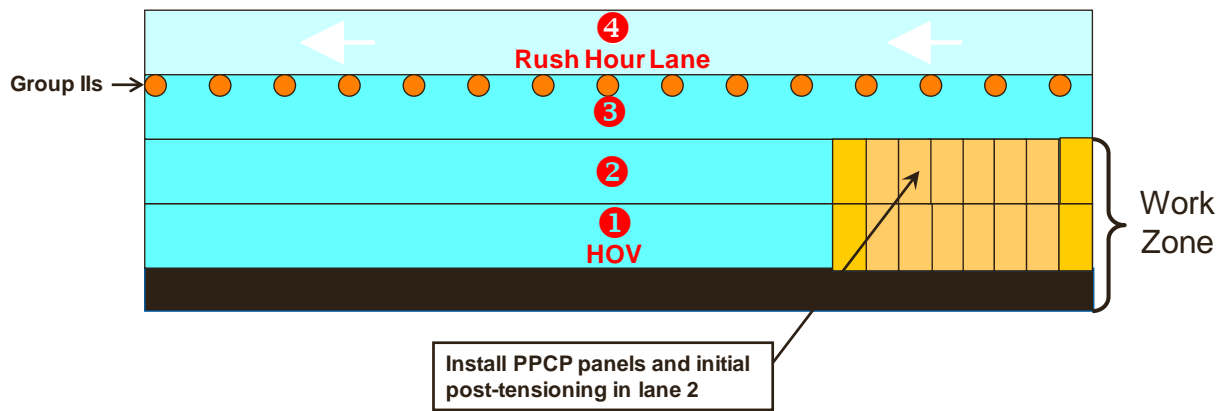

Figure 35. Stage construction – step 3.

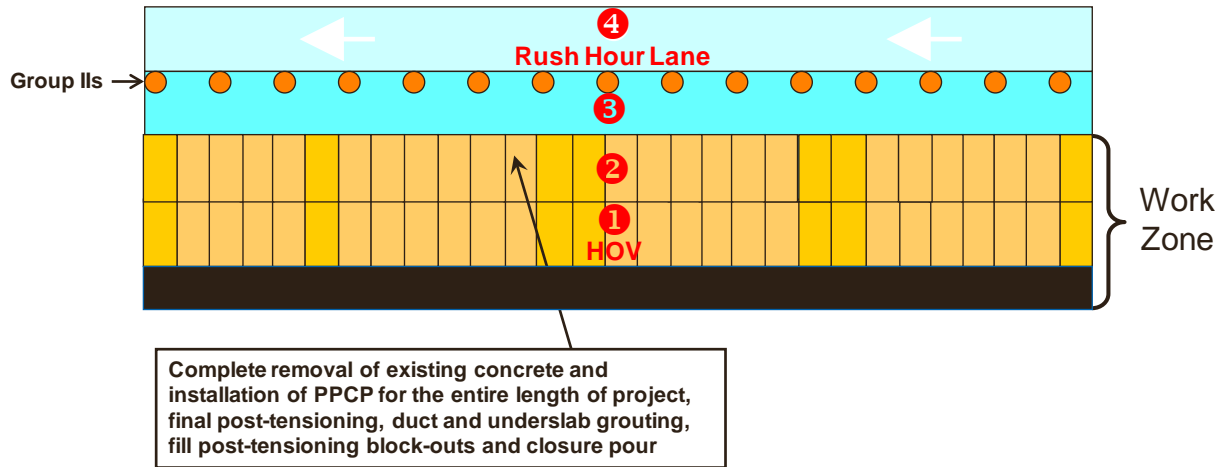

Figure 36. Stage construction – step 4.

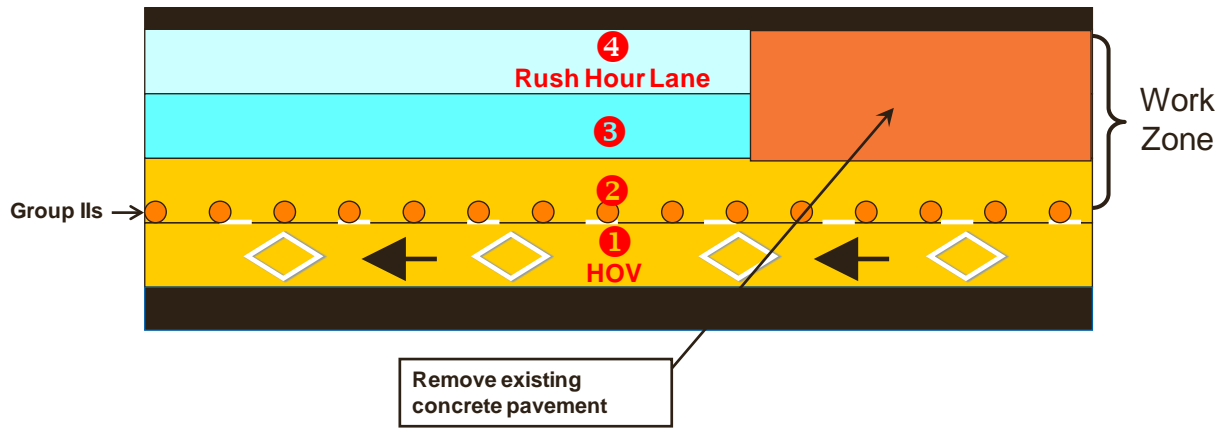

Figure 37. Stage construction – step 5.

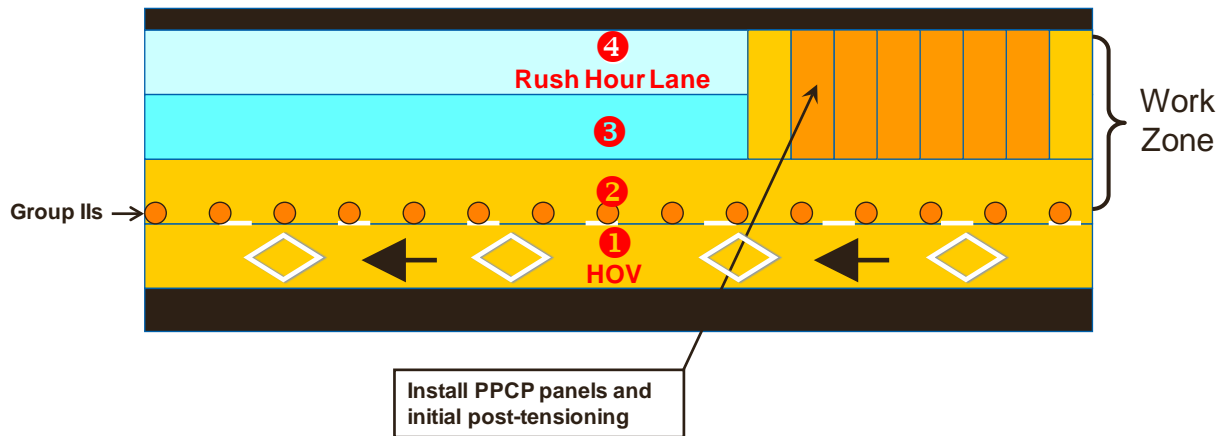

Figure 38. Stage construction – step 6.

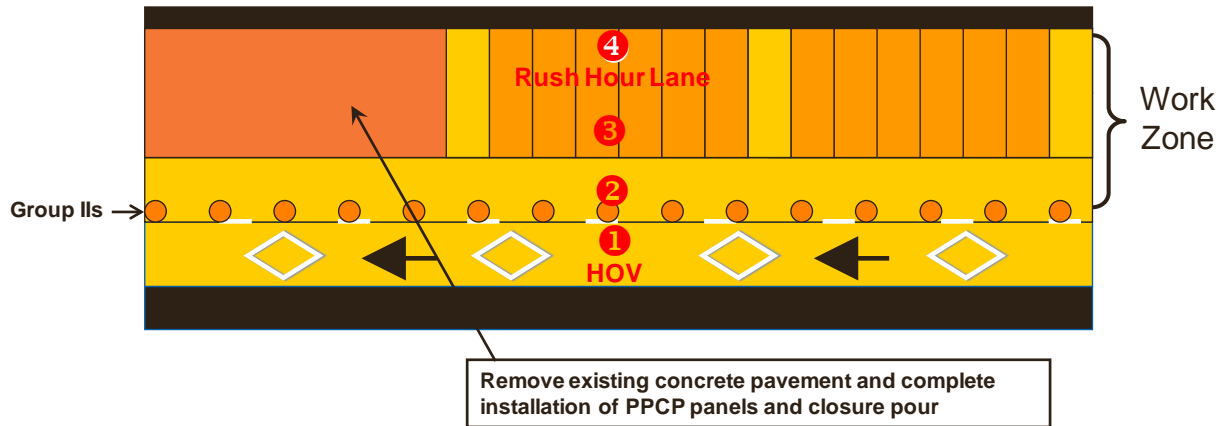

Figure 39. Stage construction – step 7.

The ramp was fully closed during the replacement of the outside lane using Super-Slab[®]. The construction was performed between 9 pm and 5 am on both the mainline and the ramp.

FIELD INSTALLATION

PPCP

The PPCP slabs were delivered to the project site for installation. Field installation of PPCP was carried out in the following main steps:

1. Lane closure and maintenance of traffic (see Figure 40). Two lanes were closed at 9 pm; third lane closed at 10 pm; all lanes opened to traffic by 5 am.
2. Removal of existing pavement (Figure 41).
3. Grading and leveling No. 10 aggregate (Figure 42). String line and straight edge were used for grading on the mainline.
4. Spreading geotextile fabric as a friction reducing layer (Figure 43).
5. Installation of panels (Figure 44).
6. Temporary post-tensioning (Figure 45).
7. Placement of temporary panel and cold patch in blockouts (Figure 46).
8. Final post-tensioning and grouting (Figure 47).
9. Grinding for smoothness requirements. During this process significant smoothness improvements were made. In some areas, more than half an inch of the slab surface was milled.

The project had successful PPCP installation for most part. However, a few challenges were faced on field. The grout used in the post-tensioning ducts tended to leak form the joints, as shown in Figure 48. This can be overcome by providing foam gaskets at duct openings. There also were some issues with keyway fit that related to precast tolerances. This was more of an issue with the 27-foot panels, as they tended to shift or rotate more under initial post-tensioning. Fine grading of the subbase is also critical to obtain the fit and vertical elevation desired.

Achieving precast tolerances is also very important, and perhaps a tighter quality control process can be instituted at the precast plant. These tolerances are critical to align the panels in the longitudinal and lateral direction simultaneously. Lack of attention to this detail can result in elevation differences at joints and large joint openings (see Figure 49).



Figure 40. Westbound I-66 traffic maneuvering lane closure for mainline slab replacement.



Figure 41. Removal of existing slabs.



Figure 42. Base preparation and grading No. 10 aggregate for PPCP installation.



Figure 43. Geotextile fabric spread on graded base material to reduce slab-subbase friction.



Figure 44. Slab placement and alignment (top and bottom).



Figure 45. Initial post-tensioning.



Figure 46. Cold patch in blockouts.



a) Tendon inserted in anchor panel blockouts

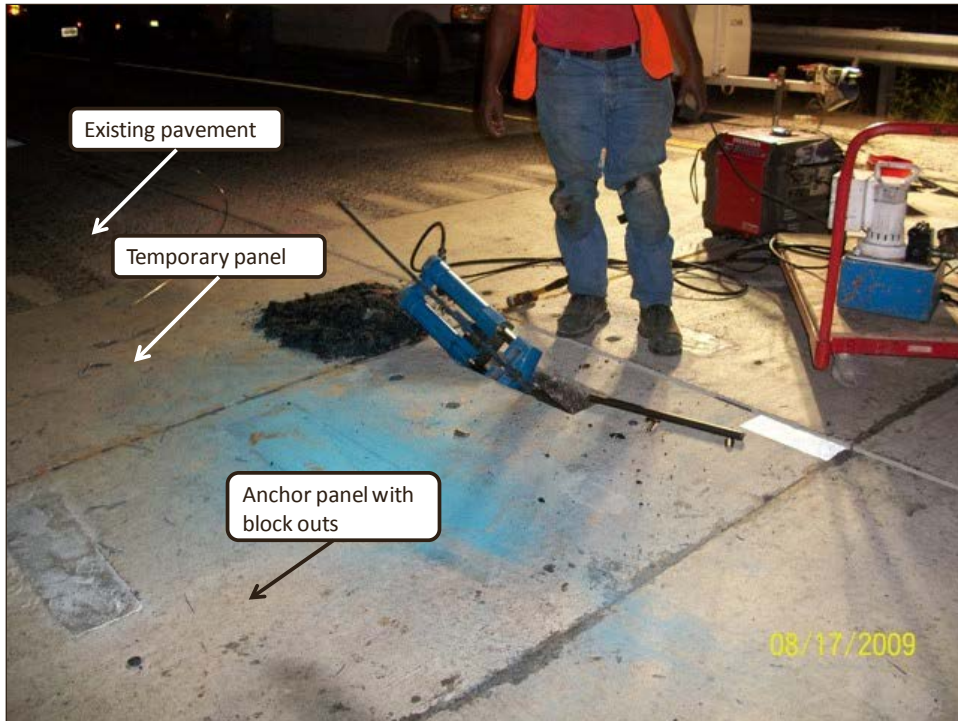

b) Post-tensioning

Figure 47. Final post-tensioning.



Figure 48. Grout leak from post-tensioning ducts.



Figure 49. Issues with vertical and horizontal alignment of slabs and large joint openings.

There also were some challenges faced in maintaining the joint against the existing pavement. It was found that it was important to use the survey baseline as a reference rather than attempt to perfect the alignment of each slab. A temporary cold patch or a closure pour is necessary to open the roadway to traffic after the end of a day's installation.



Figure 50. Transverse joint misalignment.

There were isolated cracks in the panel at the keyway after the highway was opened to traffic. This typically was observed when the top of the keyway was resting on the lower slab, as shown in Figure 51.

At one joint, the contractor observed that there was a misalignment of the post-tensioning duct, as shown in Figure 52a. This was due primarily to a design limitation that included a relatively small post-tensioning duct diameter of 0.57 inches after accounting for specification tolerances relative to the tendon diameter of 0.6 inches, as shown in Figure 52b.

The contractor and VDOT reported these challenges as items that need to be addressed in routine implementation of the PPCP technology in Virginia and nationwide.



Figure 51. Crack in slab #109 at keyway. Note top of keyway rests on lower slab.



a) Top view across the transverse joint



b) Illustration of design limitation

Figure 52. Misalignment of post-tensioning duct.

Super-Slab[®]

The Super-Slab[®] panels were staged at a temporary location and delivered to the site during the installation. The installation process included the same phases as outlined previously in the report. The main steps included:

1. Ramp closure and guiding traffic to use the detour route shown in Figure 53. It was confirmed that VDOT posted signs for motorists to use the detour identified as the one

marked on the plans in Figure 53. The detour marked on the website was an alternate route depending on the final destination of the motorists on US-50 West.

2. Removal of existing pavement as seen in Figure 54.
3. Super-grading of base layer using a rail supported and hand operated grader. A thin layer (~1/2 inch) of fine bedding material was placed, fully compacted and graded to provide a precise subgrade surface in accordance with the surveys. This was finished accurate to $\pm 1/8$ inch.
4. Anchoring tie bars in adjacent lane (see Figure 56) and threading dowels in adjacent Super-Slab[®] panel installed earlier.
5. Installation of Super-Slab[®] panels (Figure 57).
6. Grouting of dowel sockets and bedding layer (shown previously in Figure 23).
7. Grinding for smoothness requirements. The grinding operation was necessary to meet smoothness requirements in the Super-Slab[®] panels as well.

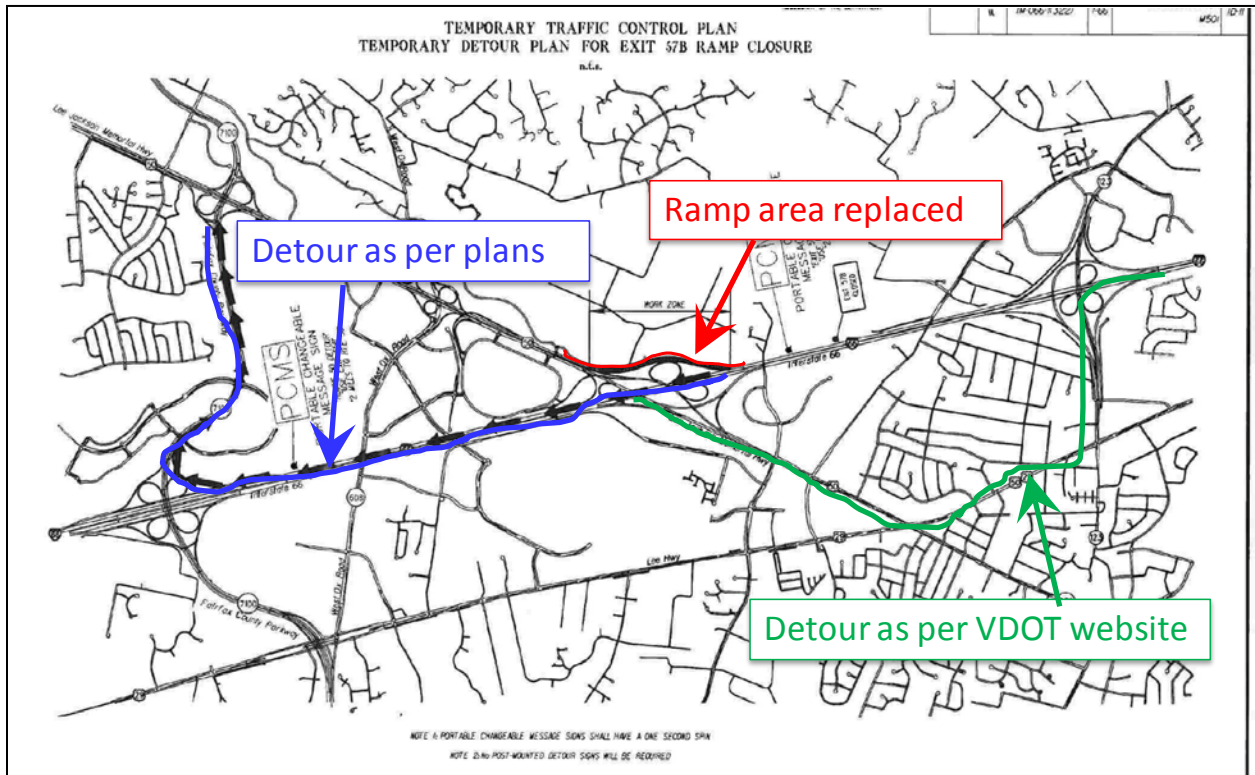

Figure 53. Detour marked for ramp closure during Super-Slab[®] installation.



Figure 54. Removal of existing slab along ramp for Super-Slab[®] installation.



Figure 55. Fine grading of subbase material.



Figure 56. Anchoring tie bars in existing pavement in adjacent lane.



Figure 57. Slab installation.

The contractor and VDOT identified certain construction challenges with this system. Occasional spalling was observed in the slabs after the ramp was open to traffic. The spalling was noticeable when corners of adjacent slabs were in contact (partial misalignment), as shown in Figure 58.

The condition of the existing lane and/or the condition of the longitudinal joint was unknown (or not determined) for each Super-slab[®] panel installation. At times, the poor condition of the joint necessitated the use of additional grout. In the event the longitudinal joint is in a bad condition, either it should be factored into the design, or it is better to replace both lanes. In this project, within the budget constraints, it could imply that both lanes of the ramp could be replaced over a shorter distance rather than one lane replaced over a longer length.



Figure 58. Spalling at joints on the ramp. Note panels were in contact.

Finally, the jointed PCPS slabs also showed evidence of cracks at random locations. It was found that it is necessary to grout the panels as soon as possible and before trafficking if possible. Also, each jointed PCPS slab should not be tied along the longitudinal joint to more than one CIP slab. That way, there are no differential movements that can cause slab cracking.



Figure 59. Slab cracking observed in the jointed PCPS panels on the ramp.

SCHEDULE AND PRODUCTIVITY

Project Schedule

The project schedule developed by the contractor prior to the job is shown in Appendix E.

Slab installation started on August 2, 2009, and ended on November 19, 2009. The project construction was performed Sunday through Thursday each week. The contractor originally planned to complete the mainline replacement (Area B) first and then progress to the ramp replacement (Area A). However, because the contractor's placement on the mainline outpaced the precasters' production, the contractor decided to pull off from the PPCP system and move to the Super-Slab[®] system on the ramp beginning the week of August 23. After 2 weeks of repairs on the ramp, which was adequate time to complete the fabrication of PPCP slabs, the contractor returned to the mainline. During a project showcase held on September 22-23, 2009, the contractor returned to the ramp segment as the workshop site visit was planned for demonstration of the Super-Slab[®].

With the PPCP system, the single lane replacements using 12-ft-wide slabs on lanes 1 and 2 was conducted prior to the two lane replacements on lanes 3 and 4. The final post-tensioning for each section was conducted after the complete installation of the section panels. Slab replacement along the ramp was performed sequentially starting from the I-66 end and progressing towards US-50W.

Even though the construction window spanned from 9 pm to 5 am, the third lane closure was set at 10 pm, so the slab removal typically began after 10 pm. The panel setting usually was performed between 11:30 pm and 2 am. Grouting of slabs was performed between 2 am and 5 am.

Productivity

The contractor and his subcontractors made significant improvements in their process and procedures as the project progressed. For example, with the PPCP installations on the mainline, the contractor got no more than eight panels per night during the first 2 weeks. Although the overall operation went relatively smoothly for placing the panels, there were certain problems with the temporary post-tensioning of the panels to close the transverse joints.

The post-tensioning operation was improved significantly, and during the third week, the contractor was targeting 10 panels per night. By the end of the project, the contractor had achieved productivity levels up to 12 panels for the single lane width and 6 panels for the double lane width installations during a 6-hour work window.

For the Super-Slab[®], peak productivity was about 12 slabs per night. A summary of the peak productivity achieved for the various systems is included in Table 6.

Table 6. Summary of peak productivity achieved for various systems.

Measure \ System	CIP	PCP	PPCP	PPCP
Panels and Size (ft)	N/A	12 No. 16 x 12	12 No. 10 x 12	6 No. 10 x 27
Lane Length (LF)	40	192	120	120
Area (SY)	53	256	160	180

DATA COLLECTION AND ANALYSIS

In keeping with the HfL goals for safety, congestion, quality and user satisfaction, the project team collected data on the I-66 project suitable for analysis to evaluate project success. The primary objective of acquiring these data was to provide HfL with sufficient performance information to support the feasibility of the proposed innovations. This section discusses the data collected and the analysis involved to evaluate the project based on HfL's performance goals.

SAFETY

The HfL performance goals for safety include meeting both worker and motorist safety goals during construction. All site personnel, field crews, designers, inspectors, and owner's representatives received site-specific orientation and safety training before working on this project. In addition, all construction workers received quarterly safety training and attended mandatory weekly safety meetings.

During this project, only one incident of worker injury was recorded. The worker involved suffered from a lower back injury, specifically lumbar strain. Overall, the contractor exceeded the HfL goal for worker safety (incident rate of less than 4.0). The OSHA Form 300A for this project is presented in Appendix F.

For the safety of the traveling public, VDOT's foremost solution was to minimize traffic disruption and interaction with construction activities and workers. Safety was a major factor in the adoption of PCPS technology for nighttime construction. In the 3 years before construction began, the crash rates were minimal, as shown in Table 7.

During construction, the contractors took extraordinary steps to assure that incidents were kept to a minimum. The many safeguards put in place to prevent crashes during construction were effective. These included using the assistance of local police for traffic changes construction periods as well as the use of signs and detour routes. During the construction phase, there were no accidents involving motorists in the work zone.

The safety performance of the facility after construction was evaluated using the post construction crash data (see Table 8). The crash rates for both pre and post construction periods are presented in table 9 by their severity types. As indicated, the total crashes increased significantly by 84 percent after construction; the injury rates by 80.4 percent and the property damage rates by 88.3 percent, while no fatal incident was recorded after construction. The significant increase in post construction crash rates indicate that the safety performance of the facility has not met the HfL goal of 20 percent reduction in injuries and fatalities after construction.

Table 7. VDOT's accident records along project site 3 years before construction.

Incident	1	2	3	4	5
Location	I-66 W mainline	ramp	ramp	ramp	ramp
Document Num	91960346	92660039	91671123	91900996	82050548
Date	1/24/2009	3/2/2009	12/15/2008	1/21/2009	7/11/2008
Node	279147	278790	278790	278769	278790
Distance	0.5	Unavailable	0.53	0.2	0.7
Direction	W	NW	NW	E	NW
Type	Rear end	Fixed object off road from outside of ditch	Deer	Deer	Rear end
Weather	Clear	Snowing	Mist	Clear	Clear
Surface	Dry	Snowy	Dry	Dry	Dry
Vehicle count	2	1	2	1	2
Fatality	None	None	None	None	None
Pedestrian Fatality	None	None	None	None	None
Injury	1	0	1		2
Pedestrian	0	0	0	0	0
Property Damage	\$1,000	\$20,620	\$6,000	\$5,000	\$7,000

Table 8. Post construction crash data

Year	Fatalities	Injuries	PDO	ADT
2009	0	3	2	90442
2010	0	33	21	90024
2011	0	13	18	86673
Total	0	49	41	

Table 9. Pre and post construction crash rates

	Pre-construction	Post-Construction	Difference
Days of Coverage	424	1036	
Average ADT	90786	89046	
Section Length	0.38	0.38	
Million Vehicle Miles Travelled	14.6	35.1	
Total Crashes	0.41	2.57	84.0%
Fatalities	0.00	0.00	-
Injuries	0.27	1.40	80.4%
PDO	0.14	1.17	88.3%

CONSTRUCTION CONGESTION AND TRAVEL TIME STUDY

As part of the travel time studies integral to HfL projects, travel time data were collected during the week of September 14, 2009, when nightly lane closures were being used to assess the impacts of the work activity on motorists.

The westbound direction of I-66 is four lanes approaching the US 50 interchange. During the nights of travel time data collection, work activity was occurring approximately 1 mile before the exit ramp to US 50 westbound. For most nights of work, the highway contractor utilized a staggered lane closure schedule. Initially, one of the four lanes was closed beginning around 9 pm. A second lane was then closed around 9:30 pm, and a third lane was closed around 10 pm, leaving one lane open until the work operation for the night was completed and the travel lanes were returned to service before the morning peak period.

Data Collection

During each travel time data collection run, researchers utilized the floating vehicle methodology to collect travel times, attempting to mimic the “typical” driving speed of other vehicles along the various roadway segments. Travel times were collected at 30 to 45 minute intervals between 8 pm and 1 am each night. The travel times were initiated upstream of the I-495/I-66 interchange, and continued through the I-66/US 50 interchange.

Contacts with VDOT personnel verified that under normal roadway conditions, travel on I-66 at night normally occurred at about free-flow speed (55 mph or higher). Consequently, any queues and delays that occurred during the nighttime work hours could be attributed to the presence of the work zone. The project team opted to not collect travel times on the primary alternative route to I-66 (US 29), even though it is possible that some traffic normally using I-66 chose to use this route. Researchers believed it was more important to gather frequent I-66 travel times to obtain a complete picture of the queuing and delay patterns that developed on that facility.

To compensate for any potential diversion, the project team applied the delay values measured during the lane closures to the historical traffic volumes on the facility in the vicinity of the work zone. This approach assumes that any traffic which did divert also experienced increased travel time equal to that experienced by those who remained on I-66. However, it does not take into consideration any increased travel time on the diversion routes to traffic normally on those routes. Given the magnitude and duration of delays that were measured, it is believed that the amount of diversion was minimal and likely did not adversely affect operations on US 29 or other surface streets in the vicinity of the work zone.

Travel Time Results

Travel time data were entered into a spreadsheet for reduction and analysis. Because traffic volumes decrease significantly through the nighttime hours, and because of the sequential process used to close travel lanes, the delays and queues created varied fairly dramatically from hour to hour and from night to night. Table 10 presents the delay and queue lengths measured during each travel time run each night. These are presented graphically in Figure 60.

Overall, one sees considerable differences between the maximum delays experienced each night. Two nights (September 15 and 16) saw the maximum delays briefly exceed 20 minutes per vehicle. Part of the increased delays could be attributed to light occasional rain showers on September 15 (which likely made motorists more cautious approaching and within the queue and work zone), and a rear-end accident at the lane closure point on September 16. Conversely, delays on September 17 were very minor, due to the contractor waiting until about 11:45 pm to close the third lane.

Comparing the delay and queue length graphs in Figure 60, slightly different patterns can be observed for each night. Although delay and queue lengths are related, they do not have a direct correlation under all conditions. Queue lengths briefly reach a maximum of two miles on September 15 and 16, but only reached a maximum of 1.5 miles on the other two nights. The duration of queuing also varied, ranging between 3 and 4 hours per night.

The per-vehicle delays measured through the travel time studies were then used in combination with historical traffic volumes westbound on I-66 to estimate the total vehicle-hours of delay created each night due to the work activity. Table 11 summarizes the hourly traffic volumes used in the analysis. Table 12 presents the results of the delay analysis. Once again, a dramatic range of impacts are evident from night to night. Summed over the duration of queuing, total delays per night ranged from a low of 145.5 vehicle-hours on the night of September 17, to a high of 1812.5 vehicle-hours on the night of September 16. Examined over all four nights, the work operation generated an average of 1071 vehicle-hours of delay per night.

Table 10. Travel time data.

Date and time	Queue length, miles	Delay, minutes
September 14-15		
8:15 pm	0.0	0.0
8:45 pm	0.0	0.0
9:15 pm	0.6	1.3
9:45 pm	1.3	1.8
10:30 pm	1.5	13.0
11:00 pm	1.5	14.3
11:45 pm	0.8	4.5
12:15 am	0.0	0.0
September 15-16		
8:00 pm	0.2	0.4
8:30 pm	0.0	0.2
9:00 pm	0.0	0.7
9:30 pm	1.6	4.7
10:00 pm	1.4	12.9
11:00 pm	2.0	22.9
11:30 pm	1.4	13.0
12:15 am	0.8	4.2
12:45 am	0.0	0.0
September 16-17		
8:30 pm	0.0	0.0
9:00 pm	0.0	0.0
9:30 pm	1.6	3.8
10:00 pm	1.4	15.2
11:00 pm	2.1	25.9
11:30 pm	1.4	11.1
12:15 am	0.8	3.2
12:45 am	0.0	0.0
September 17-18		
8:15 pm	0.0	0.0
8:45 pm	0.0	0.0
9:15 pm	0.0	0.0
9:45 pm	1.3	2.5
10:15 pm	1.1	3.3
11:00 pm	0.2	0.0
11:45 pm	0.5	0.7
12:15 am	0.0	0.0

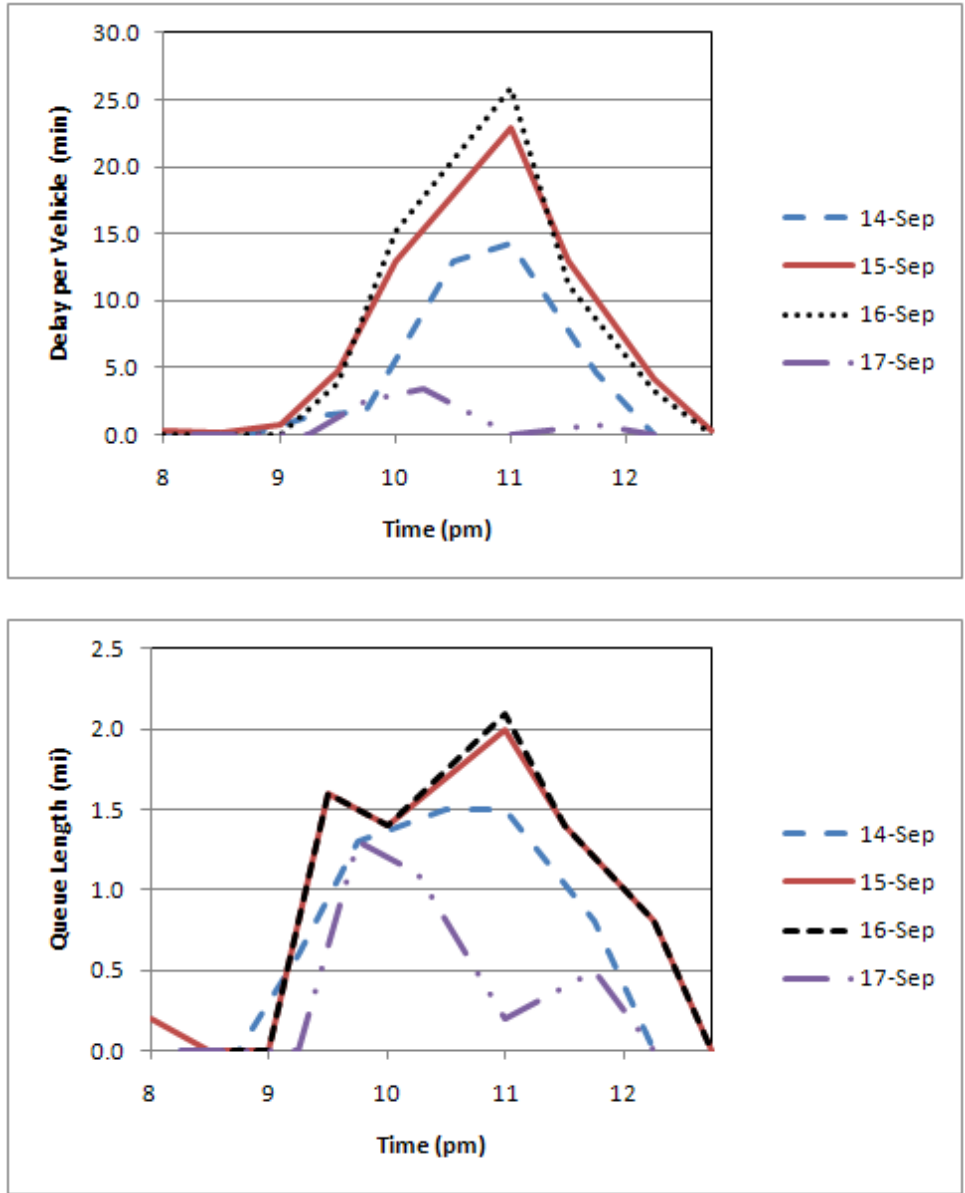

Figure 60. Delay and queue lengths each night.

Table 11. Historical hourly traffic volumes on I-66 westbound near US 50.

Hour	Volume, vehicles/hour
8:00-9:00 pm	3197
9:00-10:00 pm	3047
10:00-11:00 pm	2539
11:00-12:00 pm	1656
12:00-1:00 am	943
1:00-2:00 am	575

Table 12. Vehicle-hours of delay during work zone lane closures.

Time	Sep - 14	Sep - 15	Sep - 16	Sep - 17
8-9 pm	0.0	21.5	0.0	67.8
9-10 pm	73.3	319.2	327.5	74.1
10-11 pm	371.8	757.0	910.5	6.5
11 pm – 12 am	222.9	491.9	548.6	0.0
12-1 am	35.5	34.2	25.8	0.0
TOTAL	703.4	1623.9	1812.5	145.5

To interpret the results of this analysis properly, it would be necessary to determine how the work would have been accomplished if the precast panels had not been utilized on this project. Assuming that the full depth of concrete pavement would still be the desired outcome of the work, it would have been necessary to close one or more lanes at a time on a long-term basis, and allow the contractor to remove the old pavement, install new pavement, and allow it to cure sufficiently prior to opening the lanes back up to traffic. This would have resulted in either (a) a significant reduction in roadway capacity at the work zone (with unacceptably high delays, queues, and perhaps even gridlock created during peak periods) or (b) significantly additional construction costs to first build temporary pavement adjacent to the existing roadway to shift lanes onto while some of the lanes were removed from service. Obviously, the increased user costs created by the nightly lane closures would pale in comparison to either of those alternatives.

QUALITY

Sound Intensity Testing

Sound intensity (SI) measurements were made using the current OBSI technique AASHTO TP 76-08, which uses dual vertical sound intensity probes and an ASTM-recommended standard reference test tire (SRTT). The sound measurements were recorded and analyzed using an onboard computer and data collection system. A minimum of five runs were made at highway speed in the right wheel path of the mainline lanes and the ramp. The two microphone probes simultaneously captured noise data from the leading and trailing tire-pavement contact areas. Figure 61 shows the dual probe instrumentation and the tread pattern of the SRTT.

The average of the front and rear SI values was computed to produce SI values. Raw noise data were normalized for the ambient air temperature and barometric pressure at the time of testing. The resulting mean sound intensity levels were A-weighted to produce the noise-frequency spectra in one-third octave bands, shown in Figure 62.

Sound levels were calculated by using logarithmic addition of the one-third octave band frequencies between 315 and 4,000 hertz (Hz). The mainline the sound intensity level was 105.4 dB(A) for the original distressed pavement and 102.9 dB(A) for the new pavement. The ramp

sound intensity values dropped from 106.6 dB(A) to 102.1 dB(A) after reconstruction. Newly constructed longitudinally diamond ground concrete pavements typically have an SI ranging from 95.5 to 102.5 dB(A).² Although the HfL goal of 96.0 dB(A) was not met, the sound level of the new pavement is reasonable.



Figure 61. OBSI dual probe system and the SRTT.

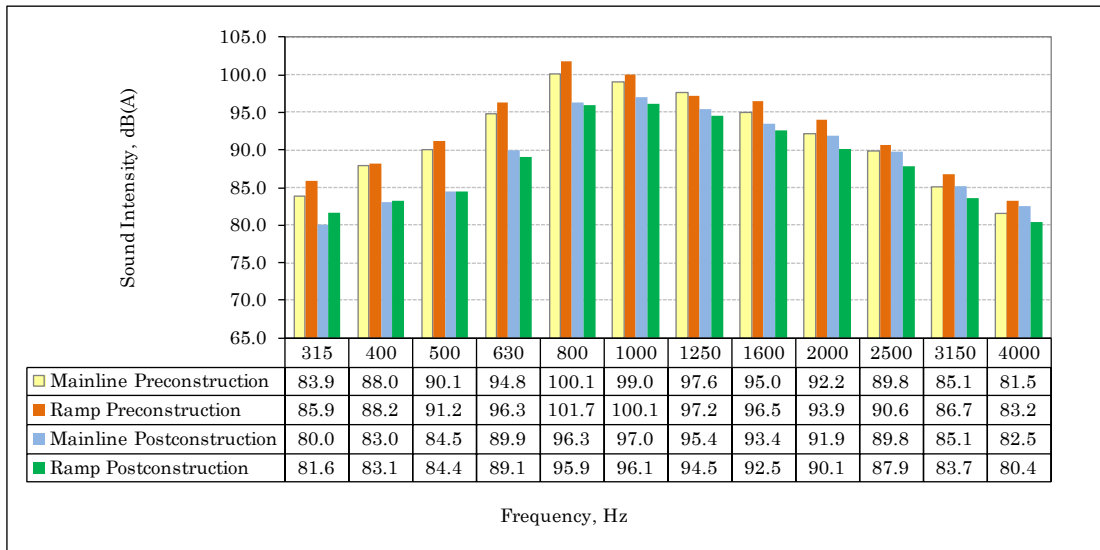

Figure 62. Mean A-weighted sound intensity frequency spectra.

Smoothness Measurement

Smoothness testing, required by HfL as a quality indicator, was performed following the ASTM E 950 method in conjunction with noise testing for the original and the newly reconstructed ramp pavement using a high-speed inertial profiler built into the noise test vehicle. A similar vehicle

² Hall, J.W., Smith, K.L., Littleton, P., *Texturing of Concrete Pavements* (NCHRP Report 634), National Cooperative Highway Research Program, Transportation Research Board, Washington, DC, 2009.

with identical onboard data collection system was utilized to test the newly reconstructed ramp and mainline pavements. Figure 63 shows the test vehicle with the profiler positioned in line with the right rear wheel.



Figure 63. High-speed inertial profiler mounted behind the test vehicle.

For comparison, data were collected from representative test sections in the approach to the newly reconstructed mainline pavement. The comparison data for the ramp were taken from the same location on the ramp prior to and after reconstruction. Table 13 summarizes the smoothness test results. The results show a 41 and 38 percent drop in the IRI value for the mainline and ramp pavements, respectively. The new pavement does not meet the HfL target value of 48 inches per mile but is still an improvement over the original pavement. The original pavement values are much more variable, largely because of the cumulative effects of patches and transverse cracking.

Table 13. Summary of IRI.

	Original distressed pavement		Newly reconstructed pavement	
	IRI, in/mi	Standard deviation	IRI, in/mi	Standard deviation
Mainline	134	41.0	79	9.3
Ramp	154	34.0	96	5.9

USER SATISFACTION

User's satisfaction surveys were not performed under this project.

PERFORMANCE EVALUATION

To date, PCPS technology has been used on a limited basis, such as for isolated repairs and rehabilitation, pavement replacement under overpasses, etc. Larger scale applications are hindered by cost, lack of long-term performance data, and a detailed design procedure. Field performance issues have been associated primarily with poor performance of the joints and poor ride quality resulting from non-monolithic construction. The structural capacity of the slab is less of a concern with this technology, as a precast slab should demonstrate the same or better flexural capacity than a CIP slab of the same thickness. The evaluation therefore was limited to the joint locations to evaluate the efficiency of the joint and the performance of the grout materials used in both the PPCP and Super-Slab[®] installations.

JOINT LOAD TRANSFER EVALUATION

Nondestructive testing was performed using the FWD to evaluate the load transfer efficiency across the transverse joints on the mainline and the ramp installations.

Load Transfer Efficiency on Mainline

On the mainline, FWD tests were conducted on lanes 1 and 2 that used the 12-foot-wide PPCP slabs, that were referred to lanes 4 and 3 by the FWD testing protocol, respectively. A total of 48 joints were tested on each lane. Note that this did not include every slab on the mainline. The tests were conducted by two independent agencies, VDOT and a testing contractor. The results of the FWD tests and the measured load transfer efficiency (LTE) across all joints tested are tabulated in Table 14 for the PPCP slabs in lanes 3 and 4. The LTE reported is the average from the two independent FWD evaluations. Further, the values reported are an average of LTE measurements from four load plate drops for each of the four load levels used, 6,000, 9,000, 12,000, and 16,000 lbf. The percent difference between the LTE measurements by the two agencies is also reported. The test results indicate no more than 10 percent difference between tests conducted by the two agencies, except for two joint locations where the difference is within 15 percent.

The measured LTE ranged from 66 percent to 100 percent with an average of 88.5 percent. This range suggests there is a wide variability in the quality of load transfer across these joints. Figure 64 shows the distribution of LTE values across the 96 joints tested in lanes 3 and 4 in total. The LTE of the joints is rated as low, medium, and high in Table 14. LTE value below 85 percent is considered low, 85 to 93 percent is considered medium, and above 93 percent is rated as high. Note that this rating system is not VDOT-specified ratings; instead, it provides a simple means to categorize the distribution of load transfer efficiency values in the project. Out of the 96 joints tested, the numbers of joints that fall under the low, medium and high categories are 28, 53, and 15, suggesting that more than half of the joints are in the range of 85 to 93 percent. Further, more than 15 percent of the joints show excellent LTE.

Table 14. LTE measured from FWD tests on lanes 3 and 4 of the mainline.

Joint #	Lane 4 (inside lane) ²			Lane 3 (2 nd lane from inside) ²		
	LTE, %	% difference ¹	L/M/H	LTE	% difference ¹	L/M/H
	75.02	-12.29	Low*	88.58	1.79	Medium
	90.89	-2.69	Medium	91.18	-0.82	Medium
	92.50	-0.95	Medium	85.81	1.67	Medium
	91.16	0.93	Medium	85.88	9.36	Medium
	88.30	0.85	Medium	90.60	-4.01	Medium
	87.14	NO test result from VDOT - N/A	Medium	94.19	NO test result from VDOT - N/A	High
	93.82		High	91.48		Medium
	93.28		High	93.24		High
	91.16		Medium	87.16		Medium
	94.58	-3.47	High	91.57	5.78	Medium
	90.32	-0.76	Medium	87.72	-1.68	Medium
	89.04	1.24	Medium	93.19	3.12	Medium
	83.47	-8.11	Low	87.29	-0.19	Medium
	86.02	1.14	Medium	88.07	2.85	Medium
	73.19	-4.72	Low	88.19	1.15	Medium
	95.11	1.25	High	92.02	-0.56	Medium
	87.24	NO test result from VDOT - N/A	Medium	86.32	NO test result from VDOT - N/A	Medium
	88.32		Medium	90.65		Medium
	88.08		Medium	86.21		Medium
	87.77		Medium	86.36		Medium
	85.87		Medium	92.24		Medium
	78.73		Low	92.13		Medium
	84.91		Low	99.67		High
	80.70		Low	82.10		Low
	82.70		Low	77.35		Low
	84.81		Low	88.37		Medium
	94.31	-0.08	High	89.28	3.88	Medium
		5.51	Medium	84.89	1.49	
		-14.28	Medium	92.10	-7.43	
		0.49	Medium	83.68	4.61	

Table 14. LTE measured from FWD tests on lanes 3 and 4 of the mainline, continued.

Joint #						

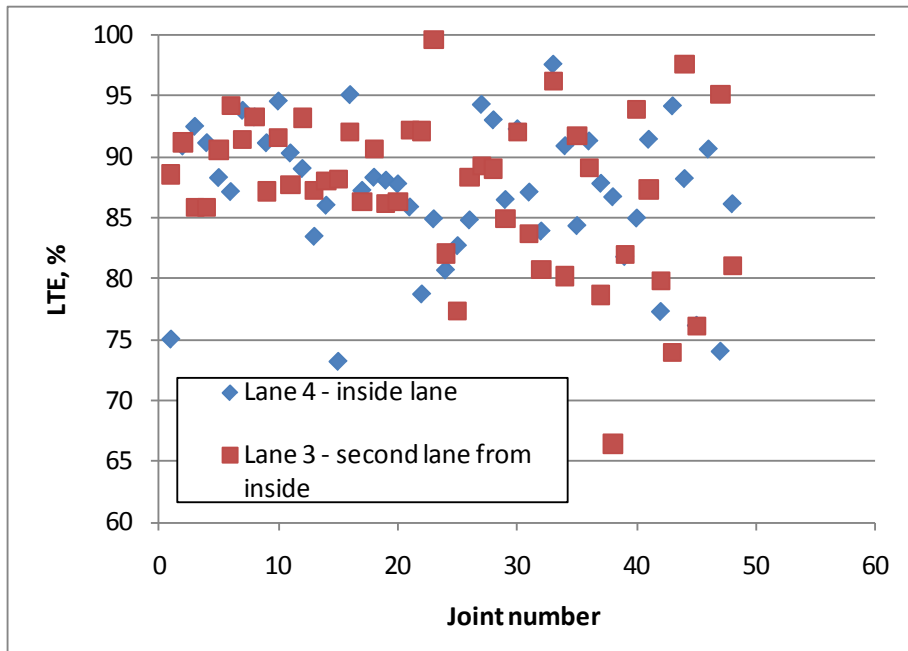

Figure 64. LTE across the joints tested in lanes 3 and 4 of the mainline.

Under a Strategic Highway Research Program 2 (SHRP 2) study, FWD testing was conducted on lane 3 in the lane adjacent to the outside lanes with the 27-foot panels. Tests on the inner wheel path indicated a load transfer efficiency of 75 to 90 percent at expansion joints, and joint deflections ranged from 15 to 30 mils for the 9,000 lbf load level, which typically are considered very high compared to deflections in the slab interior. Void analysis indicated 5 to 15 mils of voids under the joints. Tests in the interior of the slab resulted in 3 to 6 mils of deflection for the 9,000 lbf load level.

Load Transfer Efficiency on Ramp

VDOT also performed FWD testing at the transverse joints of the Super-Slab® installation on the ramp. A total of 85 joints were tested under FWD plate loads of about 6,000, 9,000, 12,000, and 15,000 lb with four repetitions under each load level. The average of the LTE values measured at each point is tabulated in Table 15. This table also lists the standard deviation of the measurements at each point. Since these numbers are all on an average between 1 to 1.5 percent, it is reasonable to conclude that the testing was repeatable. The LTE values ranged from 77 percent to 100 percent with an average of 89.6 percent. As shown in Figure 65, except two joints, the vast majority of the joints were measured to have a LTE greater than 80 percent.

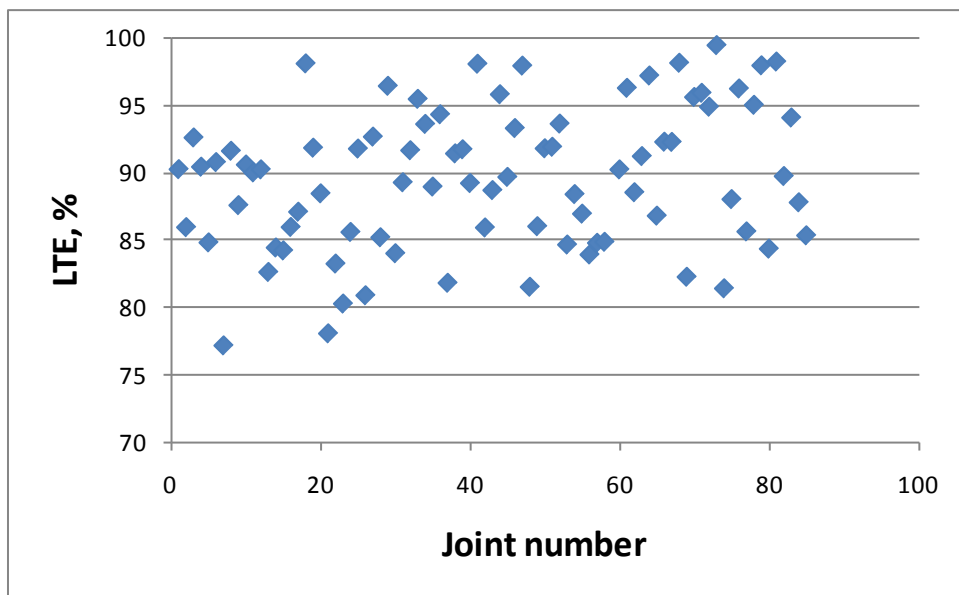

Figure 65. LTE across the Super-Slab® panels on the ramp.

The FWD test results from the mainline and the ramp indicate that the PCPS panel installations have higher LTE than VDOT’s requirement of 80 percent, for most part.

Table 15. LTE measured at joints on Super-Slab® panels on the ramp.

Joint #	LTE, %	Std dev.	L/M/H	Joint #	LTE, %	Std dev.	L/M/H
1	90.21	1.04	Medium	43	88.66	0.95	Medium
2	85.91	0.94	Medium	44	95.77	1.42	High
3	92.56	0.62	Medium	45	89.64	0.57	Medium
4	90.39	1.67	Medium	46	93.26	0.84	Medium
5	84.78	2.84	Low	47	97.89	0.75	High
6	90.73	0.98	Medium	48	81.49	1.92	Low
7	77.14	2.81	Low	49	85.98	1.64	Medium
8	91.57	1.63	Medium	50	91.76	0.47	Medium
9	87.54	0.80	Medium	51	91.87	1.56	Medium
10	90.55	0.74	Medium	52	93.59	0.91	Medium
11	89.97	1.29	Medium	53	84.62	2.73	Low
12	90.20	1.26	Medium	54	88.36	1.05	Medium
13	82.59	0.84	Low	55	86.91	2.07	Medium
14	84.40	1.61	Low	56	83.88	2.95	Low
15	84.18	2.67	Low	57	84.75	1.28	Low
16	85.92	0.78	Medium	58	84.82	2.86	Low
17	87.05	0.62	Medium	59	100.14	0.96	High
18	98.05	0.77	High	60	90.19	1.61	Medium
19	91.80	0.87	Medium	61	96.24	0.52	High
20	88.42	1.25	Medium	62	88.50	1.08	Medium
21	78.04	0.91	Low	63	91.18	1.22	Medium
22	83.21	0.94	Low	64	97.16	1.26	High
23	80.24	2.14	Low	65	86.76	1.08	Medium
24	85.55	0.63	Medium	66	92.24	1.40	Medium
25	91.74	0.38	Medium	67	92.23	0.93	Medium
26	80.86	0.47	Low	68	98.10	0.68	High
27	92.62	0.50	Medium	69	82.23	1.61	Low
28	85.16	1.43	Medium	70	95.56	0.67	High
29	96.39	0.57	High	71	95.87	1.29	High
30	83.98	1.79	Low	72	94.84	0.50	Medium
31	89.24	0.66	Medium	73	99.41	0.16	High
32	91.61	0.74	Medium	74	81.38	1.69	Low
33	95.42	0.91	High	75	87.99	0.82	Medium
34	93.57	0.70	Medium	76	96.19	0.33	High
35	88.92	2.13	Medium	77	85.59	2.37	Medium
36	94.28	0.76	Medium	78	94.98	1.16	Medium
37	81.78	1.54	Low	79	97.91	0.91	High
38	91.38	1.11	Medium	80	84.32	3.39	Low
39	91.68	0.96	Medium	81	98.19	0.77	High
40	89.18	0.58	Medium	82	89.70	1.93	Medium
41	98.03	0.41	High	83	94.04	0.78	Medium
42	85.89	0.54	Medium	84	87.75	1.87	Medium
				85	85.31	2.50	Medium

NONDESTRUCTIVE EVALUATION OF GROUT CONSOLIDATION

Various FHWA and VDOT staff expressed interest in a closer evaluation of the grout consolidation and grout strength in the post-tensioning ducts of the PPCP panels and in the dowel slots of the Super-Slab[®] panels. ARA and the University of Texas at El Paso performed an independent evaluation using the PSPA and ground penetrating radar (GPR). This testing also assessed the effectiveness of using GPR and PSPA in assessing the quality of the grout in the ducts and possible voids in the precast concrete panels. The GPR technology was used primarily to detect the location of ducts and reinforcing steel within the slabs. The PSPA was used to determine the modulus of the concrete and grout material. The data obtained from the seismic testing and GPR testing is provided in Appendix G.

The PSPA and GPR testing was performed on selected joints that were rated to have low, medium, and high LTE values. The testing was quite conclusive about the value of GPR testing but not decisive about the effectiveness of the PSPA to predict the modulus of the grout (and, therefore, its uniformity within the slot).

Summary Reported from NDT

The GPR technology was successful in detecting the presence and location of ducts and reinforcing steel. Within the locations tested, no anomalies were identified in the quality of joint construction. The PSPA was able to identify some areas with substantially low modulus. Dispersion curves were developed to estimate the modulus profiles along the depth of the slab. The dispersion curves from the locations with low modulus were able to demonstrate quantitatively the range of depths with low grout moduli. However, no cores were taken, and it was not possible to validate the results. A validation exercise requires that the tested areas be cored to understand the relationship between the lower stiffness zones and the physical anomalies in the grout.

The intent of the NDT was to identify potential test procedures other than the FWD that may be used to more accurately assess the quality of joints. While the FWD provides a good estimate of joint load transfer, it cannot be used to isolate grout quality for acceptance. Load transfer testing with the FWD can be confounded by several other parameters including the effects of voids under the joint, base support, as well as the ability of dowel bar to transfer load across the joint. Another confounding factor is aggregate interlock at the joint faces of two slabs but it is not a concern here since the joints are not saw cut and have smooth faces.

Neither the GPR nor the PSPA were conclusive about the presence of voids within the grout. An analysis to correlate PSPA-measured modulus with FWD test results showed that the deflection measurements do not have a significant correlation with the modulus values. Additionally, the PSPA-measured modulus did not correlate with the average LTE at the joint.

TECHNOLOGY TRANSFER

To accelerate the nationwide adoption of PCPS technology, a showcase was held on the Virginia I-66 project. The event was held September 22-23, 2009, in Fairfax, managed by the Florida Local Technical Assistance Program (LTAP) center. A field visit was scheduled for the night of September 22. The workshop featured presentations on the project, the PCPS technology, and its implementation on the I-66 project. The agenda for the showcase is included in Appendix H.

The workshop featured presentations by representatives of VDOT, FHWA, developers of the precast pavement technologies adopted, the precasters, general contractor, the prestressing and post-tensioning subcontractor, the design consultant, the concrete paving industry, and the HfL support contractor. Speakers from the FHWA HfL team provided an overview of the HfL program and presented the national perspective on the use of innovative techniques. The developers of the two PCPS used described the engineering design, modifications made for the I-66 project, and the installation details critical to the respective systems. VDOT staff provided an overview of the project, and the contractor provided an update of the construction status.

The site visit allowed participants to view the installation of Super-Slab[®] panels along the US 50 ramp. The participants observed slab removal, grading, installation, and grouting.

On the afternoon of September 23, the workshop continued with presentations by contractors sharing their perspective on the technology as well as the project as a whole. This included the general contractor, the precasters, and individuals from the prestressing industry. The workshop also provided ample time for participant discussions and panel discussions. Next, the workshop included a presentation on the activities of the AASHTO TIG for PCPS along with information on resources available. Finally, the participants received the industry perspective from representatives of the National Precast Concrete Association, the American Concrete Paving Association, and the Precast/Prestressed Concrete Institute.

Photographs from the showcase showing invitees attending the workshop presentations and visiting the project site are included in Figure 66.



Figure 66. Virginia I-66 PCPS showcase workshop and field visit.

ECONOMIC ANALYSIS

A key aspect of HfL demonstration projects is quantifying, as much as possible, the value of the innovations deployed. This entails comparing the benefits and costs associated with the innovations adopted on an HfL project (i.e., as-built) with those from a more traditional approach, which may be considered a baseline case.

Analysis Cases

The economic analysis performed for the project consisted of two independent evaluations, one for the mainline and one for the ramp. The analyses were conducted individually for the two scenarios for the following reasons:

- The mainline and the ramp used two different PCPS technologies that have different installation procedures.
- The two systems have different unit costs, and cost data were available for both.
- The mainline and the ramp carry very different levels of traffic, resulting in very different user cost estimates.
- The project used different lane closure configurations and construction staging for the two scenarios.

Baseline Cases

This baseline case is an important component of the economic analysis. In the economic analysis performed on this project, the baseline case was simply a hypothetical scenario where the current project would have utilized conventional methods for the repair and rehabilitation of both the mainline and ramp segments. A combination of field data from the current project and feedback from VDOT and the contractor were used in generating the cost data for the baseline case. The baseline cases assumed for the economic analyses are described below for the mainline and ramp segments.

Baseline for Mainline Analysis

The baseline case assumed replacement of all four lanes using CIP high early strength concrete. Construction phasing and stage construction were similar to the PCPS construction staging. However, given that more extensive construction equipment will be used, it was assumed that lanes 1 and 2 would be replaced simultaneously, leaving lane 3 within the work zone and lane 4 open to traffic. Likewise, lanes 3 and 4 would be replaced simultaneously, leaving lane 2 within the work zone and lane 1 open to traffic. This essentially implies that, for the baseline case, the mainline slab replacement will be performed with one lane open to traffic at all times. The productivity rates achieved for CIP on this project (as reported in Table 6) were used to develop the number of nights of three-lane closures required.

VDOT also indicated that the use of a high early strength concrete mix would result in shorter life expectancy. A typical design life assumed by VDOT for CIP using early strength mixes is 10 years, after which the slab is to be replaced.

Baseline for Ramp Analysis

The baseline case assumed replacement of all four lanes using CIP concrete. It was assumed that the ramp would be closed overnight at 9 pm and opened to traffic at 5 am. The productivity rates were similar to the productivity achieved with Super-Slab[®] installation. This assumption was based on the estimate obtained from Lane Construction's Superintendent on the project, whose opinions on CIP construction for similar projects were sought in conducting these analyses.

VDOT and the contractor indicated that, in a conventional slab replacement scenario for the ramp, the decision might be dictated by the ability to use a 12-hour concrete mix and close the ramp to traffic for a weekend with a 55-hour closure. However, because the user costs were driving the results, the analysis attempted to provide an equal and fair comparison of construction schedules. For example, based on the argument that a 55-hour closure could have been used for the Super-Slab[®] installations too, it was decided that it was appropriate to use the same construction schedules for both the alternatives. Therefore, the baseline case for the ramp also assumed nightly closures that spanned the same number of nights as the Super-Slab[®] (as per estimates provided by the contractor).

VDOT USER COST ANALYSIS

VDOT developed a user fee analysis report. VDOT used the Highway User Benefit-Cost Analysis Program (HUB-CAP) program to assess the user costs for the various lane closure scenarios in the reconstruction of the ramp and mainline on this project. The report concluded the following:

The User Fee amounts recommended for inclusion as part of this contract are substantiated by use of the HUB program and are conservative. The User Fees proposed is less than the calculated amount. As the proposed User Fees are less than the calculated amounts, judgment has been employed to keep the potential fees proportional to the projects size, scope and complexity.

The User Fee amounts identified should ensure that the contractor is out of the road within the lane closure hours and avoid road user fee costs by adequately planning his/her work according to the sequence of construction provided in the contract documents and prosecuting the work in a continuous fashion. Assigning amounts greater than recommended for this contract would likely lead to higher costs, invite contract administration challenges and limit the number of bidders.

Towards the economic analysis performed for the mainline on the I-66 project, the following data were obtained from VDOT’s HUB-CAP analysis:

- Vehicle class distribution on the I-66 and value of time as shown in Table 16.
- Total hourly capacity of 6,100 for three lanes and 2100 for one lane.
- Hourly volume before construction, also same as after construction, shown in Table 1.

Table 16. Vehicle class distribution and value of time

Vehicle type	Distribution (before and after construction)¹	Value of time, \$/hr
Auto	95%	10.67
Truck class 4-5	2.0%	21.24
Truck class 6-7	1.0%	21.24
Truck class 8+	2.0%	25.00
¹ This information was also corroborated with the traffic data available on VDOT Traffic Engineering Division website		

INITIAL CONSTRUCTION COST ESTIMATES

Mainline and Ramp PCPS Costs

VDOT provided the final cost estimate submitted by the contractor. The final estimate used field quantities and bid rates to compute the total contract amount that was paid out by VDOT. The cost summary was used to determine the initial construction cost for the mainline and the ramp as summarized in Table 17. Several items were specific to each PCPS, while some items were relevant to both the PCPS technologies and both the areas of construction. A reasonable weighting factor was used to apportion cost of each item to the mainline and the ramp. In addition to the cost of the materials and labor, the Professional Engineer’s (P.E.) costs that were provided by VDOT, were added as a line item in Table 17.

The total initial construction cost for the as-built case was determined to be:

- \$2,936,654.17 for the mainline.
- \$2,203,497.33 for the ramp.

Baseline Case Costs

For the baseline case, the initial construction cost estimate shown in Table 18 was calculated, largely using the values shown in Table 17 for the quantities and prices for all items not-related to PCPS installation. For the CIP construction, the contractor bid unit price (see Table 3) was used. Also, all costs related to PCPS installation, such as trial installation, grouting and grinding, were zeroed for the baseline case.

The total initial construction cost for the as-built case was determined to be:

- \$1,513,395.53 for the mainline.
- \$1,261,846.31 for the ramp.

USER COSTS PARAMETERS CONSIDERED FOR ECONOMIC ANALYSIS

Generally, three categories of user costs are used in an economic life cycle cost analysis: vehicle operating costs (VOC), delay costs, and crash- and safety-related costs. The cost differential in delay costs (due either to queuing on the mainline or detour routes for the ramp) was included in this analysis to identify the differences in costs between the baseline and as-built alternatives. The following parameters that impact user costs were considered in the economic analysis.

Construction Time

As per the construction records, the following construction times were reported for the mainline and the ramp:

- Mainline: 44 nights of three-lane closures and 27 nights of two-lane closures.
- Ramp: 52 nights of ramp closure. However, the ramp also was closed for the random slab replacements using CIP construction and shoulder repairs. As per the contractor, about 30 nights of ramp closures were needed for the Super-Slab[®] replacement on the outside lane.

Detour

The pavement replacement on the mainline using PPCP was performed without the need for detours. Therefore, in the economic analysis for the mainline, user costs were associated with work zone speed change and VOC due to lane closures as well as crash rates. However, for the replacement of the ramp, the ramp closure necessitated posted detours and alternate routes, as shown in Figure 53. In the economic analysis for the ramp segment, user costs primarily were associated with additional time and distance needed to use a detour as well as crash rates.

Crash Costs

Crash costs were determined based on the crash rates reported in Table 7 for the ramp and the mainline.

Table 17. Calculation of initial construction cost for the mainline and ramp for as-built cases.

Contractor provided project final estimate					Percent allocated		Initial construction cost	
	<i>Item description</i>	<i>Quantity</i>	<i>Unit price</i>	<i>Cumulative</i>	<i>Mainline</i>	<i>Ramp</i>	<i>Mainline</i>	<i>Ramp</i>
General items	PE Cost	6%	\$5,000,000.00	\$300,000.00	0.50	0.50	\$150,000.00	\$150,000.00
	Mobilization	1	\$265,000.00	\$265,000.00	0.50	0.50	\$132,500.00	\$132,500.00
	Surveying	1	\$55,590.00	\$55,590.00	0.25	0.75	\$13,897.50	\$41,692.50
	Aggregate Base	459.53	\$35.00	\$16,083.55	0.55	0.45	\$8,862.05	\$7,221.50
PCPS Related Items	PPCP	5780	\$410.00	\$2,369,800.00	1.00	0.00	\$2,369,800.00	\$0.00
	PPCP	4710	\$350.00	\$1,648,500.00	0.00	1.00	\$0.00	\$1,648,500.00
	Grinding	5769.3	\$8.00	\$46,154.40	1.00	0.00	\$46,154.40	\$0.00
	Grinding	4710	\$8.00	\$37,680.00	0.00	1.00	\$0.00	\$37,680.00
	Joint Sealant	1	\$14,391.00	\$14,391.00	0.55	0.45	\$7,929.45	\$6,461.55
	Fill Material Related	5785.7	\$21.10	\$122,078.27	0.55	0.45	\$67,265.24	\$54,813.03
	Grouting	507	\$121.54	\$61,620.78	0.55	0.45	\$33,953.11	\$27,667.67
	Trial Installation	1	\$100,000.00	\$100,000.00	0.50	0.50	\$50,000.00	\$50,000.00
Traffic control related items	Cons. Signs	692	\$25.00	\$17,300.00	0.58	0.42	\$9,986.18	\$7,313.82
	Truck Mounted Attenuator	1010	\$35.00	\$35,350.00	0.58	0.42	\$20,405.28	\$14,944.72
	Channelizing Devices	18906		\$4,726.50	0.58	0.42	\$2,728.30	\$1,998.20
	Portable Sign	1489	\$1.00	\$1,489.00	0.58	0.42	\$859.50	\$629.50
	Electronic Arrow	1496.5	\$1.00	\$1,496.50	0.58	0.42	\$863.83	\$632.67
	Flagger Service	1	\$46.00	\$46.00	0.58	0.42	\$26.55	\$19.45
Pavement marking related items	Cl. VI Line Marking 6"	2139	\$3.50	\$7,486.50	0.50	0.50	\$3,743.25	\$3,743.25
	Cl. VI Line Marking (Contrast)	6035	\$4.00	\$24,140.00	0.50	0.50	\$12,070.00	\$12,070.00
	Cl. VI Line Marking 12"	660	\$6.50	\$4,290.00	0.50	0.50	\$2,145.00	\$2,145.00
	Pavement Marking Diamond	2	\$100.00	\$200.00	0.50	0.50	\$100.00	\$100.00
	Marking Eradication	1044	\$1.00	\$1,044.00	0.50	0.50	\$522.00	\$522.00
	Constr. Pave. Mark	2520	\$1.25	\$3,150.00	0.50	0.50	\$1,575.00	\$1,575.00
	Snow Plow. Raised Pave. Marker	39	\$65.00	\$2,535.00	0.50	0.50	\$1,267.50	\$1,267.50
INDIVIDUAL TOTAL INITIAL COST FOR MAINLINE AND RAMP – AS-BUILT CASE							\$2,936,654.17	\$2,203,497.33

Table 18. Calculation of initial construction cost for the mainline and ramp for baseline cases.

Contractor provided project final estimate and bid unit costs					Percent allocated		Initial construction cost	
	<i>Item description</i>	<i>Quantity</i>	<i>Unit price</i>	<i>Cumulative</i>	<i>Mainline</i>	<i>Ramp</i>	<i>Mainline</i>	<i>Ramp</i>
General items	PE Cost	12%	\$2,477,894.50	\$297,347.34	0.50	0.50	\$148,673.67	\$148,673.67
	Mobilization	0	\$265,000.00	\$0.00	0.50	0.50	\$0.00	\$0.00
	Surveying	0	\$55,590.00	\$0.00	0.25	0.75	\$0.00	\$0.00
	Aggregate Base	0	\$35.00	\$0.00	0.55	0.45	\$0.00	\$0.00
PCPS Related Items	PPCP/ CIP Concrete	5780	\$225.00	\$1,300,500.00	1.00	0.00	\$1,300,500.00	\$0.00
	PPCP/ CIP Concrete	4710	\$225.00	\$1,059,750.00	0.00	1.00	\$0.00	\$1,059,750.00
	Grinding	0	\$8.00	\$0.00	1.00	0.00	\$0.00	\$0.00
	Grinding	0	\$8.00	\$0.00	0.00	1.00	\$0.00	\$0.00
	Joint Sealant	1	\$14,391.00	\$14,391.00	0.55	0.45	\$7,929.45	\$6,461.55
	Fill Material Related	0	\$21.10	\$0.00	0.55	0.45	\$0.00	\$0.00
	Grouting	0	\$121.54	\$0.00	0.55	0.45	\$0.00	\$0.00
	Trial Installation	0	\$100,000.00	\$0.00	0.50	0.50	\$0.00	\$0.00
Traffic control related items	Cons. Signs	692	\$25.00	\$17,300.00	0.58	0.42	\$9,986.18	\$7,313.82
	Truck Mounted Attenuator	1010	\$35.00	\$35,350.00	0.58	0.42	\$20,405.28	\$14,944.72
	Channelizing Devices	18906		\$4,726.50	0.58	0.42	\$2,728.30	\$1,998.20
	Portable Sign	1489	\$1.00	\$1,489.00	0.58	0.42	\$859.50	\$629.50
	Electronic Arrow	1496.5	\$1.00	\$1,496.50	0.58	0.42	\$863.83	\$632.67
	Flagger Service	1	\$46.00	\$46.00	0.58	0.42	\$26.55	\$19.45
Pavement marking related items	Cl. VI Line Marking 6"	2139	\$3.50	\$7,486.50	0.50	0.50	\$3,743.25	\$3,743.25
	Cl. VI Line Marking (Contrast)	6035	\$4.00	\$24,140.00	0.50	0.50	\$12,070.00	\$12,070.00
	Cl. VI Line Marking 12"	660	\$6.50	\$4,290.00	0.50	0.50	\$2,145.00	\$2,145.00
	Pavement Marking Diamond	2	\$100.00	\$200.00	0.50	0.50	\$100.00	\$100.00
	Marking Eradication	1044	\$1.00	\$1,044.00	0.50	0.50	\$522.00	\$522.00
	Constr. Pave. Mark	2520	\$1.25	\$3,150.00	0.50	0.50	\$1,575.00	\$1,575.00
	Snow Plow. Raised Pave. Marker	39	\$65.00	\$2,535.00	0.50	0.50	\$1,267.50	\$1,267.50
INDIVIDUAL TOTAL INITIAL COST FOR MAINLINE AND RAMP – BASELINE CASE							\$1,513,395.53	\$1,261,846.31

USER COST ESTIMATES

Mainline As-Built Case

The user cost estimate for the mainline as-built case was calculated to be \$962,939.57, as determined from delay and VOC as well as crash costs as shown in Table 19. The delay and VOC were determined using the RealCost program; the inputs that were used for the RealCost analysis, several of which were defaults in the program, are tabulated in Table 20 along with the source of the information. Note that the delay and VOC are calculated separately for three-lane and two-lane closures.

Mainline Baseline Case

User cost estimates for the mainline baseline case were estimated for two construction events, the initial construction in 2010 and a reconstruction after 10 years to account for the design life. In calculating the user costs after 10 years, a traffic growth of 10 years was assumed. Also, the productivity for CIP was assumed to be between 225 and 300 square yards/6-hour paving shift, bringing the total number of nights of paving to 26. The user costs were determined to be \$557,913.30 for the initial construction and \$949,507.10 for the reconstruction at the end of 10 years. The detailed calculations are shown in Table 21.

As with the mainline as-built case, the user costs for the mainline baseline case were determined from delay costs and VOC as well as crash costs, as shown in Table 21. The delay and VOC were determined using the RealCost program; the inputs that were used for the RealCost analysis, several of which were defaults in the program, are tabulated in Table 20 along with the source of the information. Note that the delay and VOC are calculated only for three-lane closures over 26 nights of paving.

Ramp As-Built Case

The user costs for the ramp construction used VOC and value of time costs as well as crash costs. The details of the calculations are shown in Table 22, which also explains the assumptions made and the sources of the data used. The inputs used in the calculation of VOC for cars and trucks were obtained from other sources that are summarized in Table 23 and Table 24 respectively. The total user cost for the construction of the as-built ramp using PCPS technology is \$252,225.

Ramp Baseline Case

The user cost for the ramp baseline case includes the initial construction as well as a reconstruction after 10 years. It was assumed that CIP paving for the ramp will require the same number of days as the time required for the PCPS installation. This assumption in the economic analysis is based on feedback received from the contractor, who stated, "It will require at least the same number of nights to pave the ramp using CIP concrete." This is therefore a conservative assumption.

Table 19. Summary of user costs for mainline as-built case.

Item 1: Delay and Vehicle Operating Costs			
MOT strategy	Three lanes closed	Two lanes closed	Comments
Work days	44	27	
Lane closure timings	10pm-5am	9pm-5am	
WZ speed change VOC	\$78.00	\$392.00	Values determined from RealCost analysis. RealCost inputs are shown in Table 18.
WZ speed change delay	\$34.00	\$168.00	
WZ reduced speed delay	\$73.00	\$103.00	
Queue stopping delay	\$454.40	\$0.00	
Queue stopping VOC	\$810.30	\$0.00	
Queue added travel time	\$18,436.00	\$0.00	
Queue idle VOC	\$1,540.00	\$0.00	
Total Delay & VOC	$\$21,425.70 \times 44$ = \$942,730.80	$\$663.00 \times 27$ = \$17,901.00	
Length of influence zone	2.00 miles	Between I-66/US50 and I-66/Rt. 123	
Length of WZ	0.19 miles		
Number of non-WZ days	365	Number of days crash data represents	
Number of WZ days	71		
WZ risk elevation	66%	Increase in crash risk in work zone	
PDO/1 year average	\$1,000		
Number of reported injuries	1		
KABCO scale	Unknown		
Crash geometry	Unknown		
Injury costs (2001 \$)	\$95,368	The conversion factor to convert 2001\$ to 2010\$ based on Employment Cost Index is 1.299	
Injury costs (2010 \$)	\$123,883.03		
Crash Costs	\$2,307.77		

Table 20. Inputs used in *RealCost* calculations for delay costs and VOC.

Cost item				

Table 21. Summary of user costs for mainline baseline case.

Item 1: Delay and Vehicle Operating Costs			
	Initial construction	Reconstruction after 10 years	Comments
MOT strategy	Three lanes closed	Three lanes closed	
Work days	26	26	
Lane closure timings	10pm-5am	9pm-5pm	
WZ speed change VOC	\$78.00	\$70.00	Values determined from RealCost analysis. RealCost inputs are shown in Table 18.
WZ speed change delay	\$34.00	\$30.00	
WZ reduced speed delay	\$73.00	\$80.00	
Queue stopping delay	\$454.40	\$535.00	
Queue stopping VOC	\$810.30	\$953.00	
Queue added travel time	\$18,436.00	\$32,135.00	
Queue idle VOC	\$1,540.00	\$2,684.00	
Total Delay & VOC	$\$21,425.70 \times 26$ = \$557,068.20	$\$36,487.00 \times 26$ = \$948,662.00	Daily cost x no. of lane closure days
Length of influence zone	2.00 miles	2.00 miles	Between I-66/US50 and I-66/Rt. 123
Length of WZ	0.19 miles	0.19 miles	
Number of non-WZ days	365	365	Number of days crash data represents
Number of WZ days	26	26	
WZ risk elevation	66%	66%	Increase in crash risk in work zone
PDO/1 year average	\$1,000	\$1,000	
Number of reported injuries	1	1	
KABCO scale	Unknown	Unknown	
Crash geometry	Unknown	Unknown	
Injury costs (2001 \$)	\$95,368	\$95,368	2001\$ to 2010\$ conversion factor is 1.299
Injury costs (2010 \$)	\$123,883.03	\$123,883.03	
Crash Costs	\$845.10	\$845.10	

Table 22. Summary of user costs for ramp as-built case.

Item 1: VOC and Value of Time Costs			
MOT strategy	Full closure		
Work days	30		
Lane closure timings	9pm-5am		
Number of vehicles affected	5460	Represents vehicles between 9pm and 5am using same hourly distribution as mainline	
Normal distance (mi)	3.1	(between rt 123 and end of ramp)	
Normal speed (mph)	55	(ramp speed)	
Detour length (mi)	5.3	(from maps in Figure 53)	
Detour speed (mph)	40	(from maps)	
Additional time (min)	4.57	Additional time due to closure determined as arithmetic difference	
Additional distance (mi)	2.2	Additional distance due to ramp closure determined as arithmetic difference	
	Traffic composition	\$ Value of Travel Time	VOC \$/mile ¹
Cars	97%	\$10.67	\$0.17
Single-unit	3%	\$21.24	\$0.82
Combination	2%	\$25.00	\$0.82
Total Daily Cost		\$4,775.24	\$2,508.23
Length of influence zone	0.70 miles		
Length of WZ	0.70 miles		
Number of non-WZ days	365		
Number of WZ days	30		
WZ risk elevation	66%		
PDO/1 year average	\$38,620		
Number of reported injuries	3		
KABCO scale	Unknown		
Crash geometry	Unknown		
Injury costs (2001 \$)	\$286,104		
Injury costs (2010 \$)	\$371,649.10	The conversion factor to convert 2001 \$ to 2010 \$ based on Employment Cost Index is 1.299	
Crash costs	\$33,720.75		
TOTAL USER COSTS	\$252,225	Sum of time, VOC, and crash costs (\$4,775.24+\$2,508.23)*30 + \$33,720.75)	
1 See Table 21 for source of data			

Table 23. Vehicle operating costs for cars – Estimates for VOC for passenger cars in 2010 dollars (cents/vehicle mile)³.

Cost component	Small sedan	Medium sedan	Large sedan	4WD sport utility vehicle	Minivan
Fuel	9.24	11.97	12.88	16.38	13.7
Maintenance and oil	4.21	4.42	5	4.95	4.86
Tires	0.65	0.91	0.94	0.98	0.75
Total	14.1	17.3	18.82	22.31	19.31

Table 24. Vehicle operating costs for trucks – American Transportation Research Institute estimates of VOC for trucks in 2008 dollars (cents/vehicle mile)⁴

Cost component	Trucks
Diesel fuel (@ \$4.69/gallon) no surcharge	63.4
Fuel taxes	6.2
Maintenance	9.2
Tires	3.0
Total	81.8

The user costs for the baseline construction case are based on the same calculations shown in Table 22. The user cost for the initial construction is \$252,225, and the cost for the 10-year reconstruction is \$277,447.18 using a 1 percent linear growth in traffic over 10 years.

COST SUMMARY

Table 25, Table 26, and Table 27 represent a cost comparison summary of the as-built and baseline alternatives for the mainline, ramp, and the entire project. The as-built costs include the initial construction cost and the user costs from the I-66 project data. The baseline CIP alternative costs include the agency costs from the initial construction and the reconstruction required after 10 years as well as the related user costs. These tables essentially summarize the sum totals reported in Table 17 through Table 22. The costs have been normalized to 2010 dollars using a discount rate of 2.10 percent over 10 years.

The results also show that, on the mainline, VDOT had a net savings of \$172,451 or 4.24 percent using the PPCP method for slab replacement, and on the ramp, the net savings were \$308,792 or 11.1 percent using the Super-Slab[®] for slab replacement. Overall, with the use of the two PCPS

³ AAA's Your Driving Costs, American Automobile Association, 2010.

<http://www.aaaexchange.com/Assets/Files/201048935480.Driving%20Costs%202010.pdf>

⁴ Trego, T. and D. Murray, An Analysis of the Operational Costs of Trucking, Paper #10-2307, DVD Compendium of Papers of the TRB 89th Annual Meeting, Transportation Research Board, Washington, 2010.

technologies for the entire project, as shown in Table 27, VDOT has achieved a net savings of \$481,244, or 7.04 percent over traditional CIP methods.

Table 25. Cost comparison of as-built and baseline alternatives for mainline on I-66 HfL project.

Cost category	Actual cost		Discounted cost	
	PPCP as-built case	Baseline CIP alternative	PCPS as-built case	Baseline CIP alternative
Agency Costs	\$2,936,654	\$1,513,396 – initial	\$2,936,654	\$2,742,801
		\$1,513,396 – 10 year reconstruction		
User Costs	\$962,940	\$557,913 – initial	\$962,940	\$1,329,244
		\$949,507 – 10 year reconstruction		
Initial cost and user cost - Total			\$3,899,594	\$4,072,045
Total savings with PPCP technology			\$172,451	
Percent savings			4.24%	

Table 26. Cost comparison of as-built and baseline alternatives for ramp on I-66 HfL project.

Cost category	Actual cost		Discounted cost	
	Super-Slab [®] as-built case	Baseline CIP alternative	Super-Slab [®] as-built case	Baseline CIP alternative
Agency Costs	\$2,203,497	\$1,261,846 – initial	\$2,203,497	\$2,286,906
		\$1,261,846 – 10 year reconstruction		
User Costs	\$252,225	\$252,224.7 – initial	\$252,225	\$477,609
		\$277,447 – 10 year reconstruction		
Initial cost and user cost - Total			\$2,455,722	\$2,764,514
Total savings with PPCP technology			\$308,792	
Percent savings			11.17%	

Table 27. Total discounted costs for the entire project – mainline and ramp combined.

Cost category	PCPS as-built		CIP alternative	
	Mainline	Ramp	Mainline	Ramp
Initial construction costs	\$2,936,654	\$2,203,497	\$2,742,801	\$2,286,906
User costs	\$962,940	\$252,225	\$1,329,244	\$477,609
Total	\$3,899,594	\$2,455,722	\$4,072,045	\$2,764,514
Total Mainline and Ramp	\$6,355,316		\$6,836,559	
Total cost savings	\$481,244			
Percent cost savings	7.04%			

APPENDIX A. TABULATION OF BIDS

APPENDIX B. SAMPLE SHOP DRAWINGS FOR PPCP

**APPENDIX C. SAMPLE SHOP DRAWINGS FOR SUPER-SLAB®
FABRICATION AND INSTALLATION**

**APPENDIX D. MIX DESIGNS AND PERMEABILITY TEST
RESULTS FOR CONCRETE MIXES USED IN THE FABRICATION
OF PCPS PANELS**

APPENDIX E. CONTRACTOR'S PROPOSED SCHEDULE

**APPENDIX F. OSHA FORM 300A FOR HIGHWAYS FOR LIFE
PROJECT ON I-66 IN VIRGINIA**

APPENDIX G. NDT REPORT

**APPENDIX H. HIGHWAYS FOR LIFE: VIRGINIA I-66 PCPS
SHOWCASE AGENDA**