

# Rhode Island Demonstration Project: Replacement of Frenchtown Brook Bridge No. 435

Final Report  
January 2013

***HIGHWAYS FOR LIFE***  
*Accelerating Innovation for the American Driving Experience.*



U.S. Department of Transportation  
**Federal Highway Administration**

## FOREWORD

The purpose of the Highways for LIFE (HfL) pilot program is to accelerate the use of innovations that improve highway safety and quality while reducing congestion caused by construction. **LIFE** is an acronym for **L**onger-lasting highway infrastructure using **I**nnovations to accomplish the **F**ast construction of **E**fficient and safe highways and bridges.

Specifically, HfL focuses on speeding up the widespread adoption of proven innovations in the highway community. Such “innovations” encompass technologies, materials, tools, equipment, procedures, specifications, methodologies, processes, and practices used to finance, design, or construct highways. HfL is based on the recognition that innovations are available that, if widely and rapidly implemented, would result in significant benefits to road users and highway agencies.

Although innovations themselves are important, HfL is as much about changing the highway community’s culture from one that considers innovation something that only adds to the workload, delays projects, raises costs, or increases risk to one that sees it as an opportunity to provide better highway transportation service. HfL is also an effort to change the way highway community decisionmakers and participants perceive their jobs and the service they provide.

The HfL pilot program, described in Safe, Accountable, Flexible, Efficient Transportation Equity Act: A Legacy for Users (SAFETEA-LU) Section 1502, includes funding for demonstration construction projects. By providing incentives for projects, HfL promotes improvements in safety, construction-related congestion, and quality that can be achieved through the use of performance goals and innovations. This report documents one such HfL demonstration project.

Additional information on the HfL program is at [www.fhwa.dot.gov/hfl](http://www.fhwa.dot.gov/hfl).

## NOTICE

This document is disseminated under the sponsorship of the U.S. Department of Transportation in the interest of information exchange. The U.S. Government assumes no liability for its contents or use thereof. This report does not constitute a standard, specification, or regulation.

The U.S. Government does not endorse products or manufacturers. Trade and manufacturers’ names appear in this report only because they are considered essential to the object of the document.

1. Report No.	2. Government Accession No	3. Recipient's Catalog No	
3. Title and Subtitle Rhode Island Demonstration Project: Replacement of Frenchtown Brook Bridge No. 435		5. Report Date January 2013	
		6. Performing Organization Code	
7. Authors Amar Bhajandas and Jagannath Mallela		8. Performing Organization Report No.	
9. Performing Organization Name and Address Applied Research Associates, Inc. 100 Trade Centre Drive, Suite 200 Champaign, IL 61820		10. Work Unit No. (TRAIS) C6B	
		11. Contract or Grant No.	
12. Sponsoring Agency Name and Address Office of Infrastructure Federal Highway Administration 1200 New Jersey Avenue, SE Washington, DC 20590		13. Type of Report and Period Covered Final Report August 2011–November 2012	
		14. Sponsoring Agency Code	
15. Supplementary Notes Contracting Officers Technical Representatives: Byron Lord, Mary Huie			
16. Abstract As part of a national initiative sponsored by the Federal Highway Administration (FHWA) under the Highways for LIFE program, the Rhode Island Department of Transportation (RIDOT) was awarded a \$620,000 grant to demonstrate the use of proven, innovative accelerated bridge construction technologies to deliver this \$1.9 million project in substantially less time than conventional construction.  This report details the replacement of the 57-year old Frenchtown Brook Bridge featuring prefabricated superstructure, substructure, and foundation systems. The new bridge was completely prefabricated offsite and installed in place—a first in Rhode Island. The accelerated construction approach and innovations in this project increased safety, enhanced quality, and allowed the contractor to replace the bridge during a 33-day road closure instead of the 6 months required under traditional construction methods.  Use of prefabricated bridge systems and innovative materials increased the initial bridge construction cost compared to traditional construction by \$47,000. However, a comprehensive economic analysis including user costs shows that the project saved road users about \$2 million (or about 45 percent of the total project costs for conventional construction). The experience gained on this successful project will help RIDOT implement these innovations more routinely on future projects.  Encouraged by the success of this project, RIDOT announced that it will evaluate all future bridge projects to determine if they can be built using accelerated bridge construction techniques.			
17. Key Words Highways for LIFE, prefabricated bridge systems, innovative construction, incentive clause, economic analysis		18. Distribution Statement No restriction. This document is available to the public through the Highways for LIFE Web site: <a href="http://www.fhwa.dot.gov/hfl">www.fhwa.dot.gov/hfl</a>	
Security Classification (of this report) Unclassified	19. Security Classification (of this page) Unclassified	20. No. of Pages 54	21. Price

**SI\* (MODERN METRIC) CONVERSION FACTORS**

<b>Symbol</b>	<b>When You Know</b>	<b>Multiply By</b>	<b>To Find</b>	<b>Symbol</b>
<b>LENGTH</b>				
(none)	mil	25.4	micrometers	µm
in	inches	25.4	millimeters	mm
ft	feet	0.305	meters	m yd
	yards	0.914	meters	m
mi	miles	1.61	kilometers	km
<b>AREA</b>				
in <sup>2</sup>	square inches	645.2	square millimeters	mm <sup>2</sup>
ft <sup>2</sup>	square feet	0.093	square meters	m <sup>2</sup>
yd <sup>2</sup>	square yards	0.836	square meters	m <sup>2</sup>
ac	acres	0.405	hectares	ha
mi <sup>2</sup>	square miles	2.59	square kilometers	km <sup>2</sup>
<b>VOLUME</b>				
fl oz	fluid ounces	29.57	milliliters	mL
gal	gallons	3.785	liters	L
ft <sup>3</sup>	cubic feet	0.028	cubic meters	m <sup>3</sup>
yd <sup>3</sup>	cubic yards	0.765	cubic meters	m <sup>3</sup>
NOTE: volumes greater than 1000 L shall be shown in m <sup>3</sup>				
<b>MASS</b>				
oz	ounces	28.35	grams	g
lb	pounds	0.454	kilograms	kg
T	short tons (2000 lb)	0.907	megagrams (or "metric ton")	Mg (or "t")
<b>TEMPERATURE (exact degrees)</b>				
°F	Fahrenheit	5 (F-32)/9 or (F-32)/1.8	Celsius	°C
<b>ILLUMINATION</b>				
fc	foot-candles	10.76	lux	lx
fl	foot-Lamberts	3.426	candela per square meter	cd/m <sup>2</sup>
<b>FORCE and PRESSURE or STRESS</b>				
lbf	poundforce	4.45	Newtons	N
lbf/in <sup>2</sup> (psi)	poundforce per square inch	6.89	kiloPascals	kPa
k/in <sup>2</sup> (ksi)	kips per square inch	6.89	megaPascals	MPa
<b>DENSITY</b>				
lb/ft <sup>3</sup> (pcf)	pounds per cubic foot	16.02	kilograms per cubic meter	kg/m <sup>3</sup>

<b>Symbol</b>	<b>When You Know</b>	<b>Multiply By</b>	<b>To Find</b>	<b>Symbol</b>
<b>LENGTH</b>				
µm	micrometers	0.039	mil	(none)
mm	millimeters	0.039	inches	in
m	meters	3.28	feet	ft
m	meters	1.09	yards	yd
km	kilometers	0.621	miles	mi
<b>AREA</b>				
mm <sup>2</sup>	square millimeters	0.0016	square inches	in <sup>2</sup>
m <sup>2</sup>	square meters	10.764	square feet	ft <sup>2</sup>
m <sup>2</sup>	square meters	1.195	square yards	yd <sup>2</sup>
ha	hectares	2.47	acres	ac
km <sup>2</sup>	square kilometers	0.386	square miles	mi <sup>2</sup>
<b>VOLUME</b>				
mL	milliliters	0.034	fluid ounces	fl oz
L	liters	0.264	gallons	gal
m <sup>3</sup>	cubic meters	35.314	cubic feet	ft <sup>3</sup> m <sup>3</sup>
	cubic meters	1.307	cubic yards	yd <sup>3</sup>
<b>MASS</b>				
g	grams	0.035	ounces	oz
kg	kilograms	2.202	pounds	lb
Mg (or "t")	megagrams (or "metric ton")	1.103	short tons (2000 lb)	T
<b>TEMPERATURE</b>				
°C	Celsius	1.8C+32	Fahrenheit	°F
<b>ILLUMINATION</b>				
lx	lux	0.0929	foot-candles	fc
cd/m <sup>2</sup>	candela per square meter	0.2919	foot-Lamberts	fl
<b>FORCE and PRESSURE or STRESS</b>				
N	Newtons	0.225	poundforce	lbf
kPa	kiloPascals	0.145	poundforce per square inch	lbf/in <sup>2</sup> (psi)
MPa	megaPascals	0.145	kips per square inch	k/in <sup>2</sup> (ksi)

\*SI is the symbol for the International System of Units. Appropriate rounding should be made to comply with Section 4 of ASTM E380. (Revised March 2003)

## **ACKNOWLEDGMENTS**

The project team would like to acknowledge the invaluable insights and guidance of Federal Highway Administration (FHWA) Highways for LIFE Team Leader Byron Lord and Program Coordinators Mary Huie and Kathleen Bergeron. Their vast knowledge and experience with the various aspects of construction, technology deployment, and technology transfer helped immensely in developing both the approach and the technical matter for this document. The team also is indebted to Rhode Island Department of Transportation Engineers Rahmat Noorparvar and John Capelli and FHWA Engineer Anthony Rotondo for their tireless advice and assistance during this project. The team also thanks Wayne Singleton and John Wayland of Gordon R. Archibald Engineers for sharing project-related information, photographs, and valuable insights on lessons learned from the design and the Turino Group for the weekly updates on construction.

## Contents

<b>INTRODUCTION.....</b>	<b>1</b>
<b>HIGHWAYS FOR LIFE DEMONSTRATION PROJECTS .....</b>	<b>1</b>
Project Solicitation, Evaluation, and Selection .....	1
HfL Project Performance Goals .....	2
<b>REPORT SCOPE AND ORGANIZATION .....</b>	<b>3</b>
<b>PROJECT OVERVIEW AND LESSONS LEARNED .....</b>	<b>4</b>
PROJECT OVERVIEW .....	4
HfL PERFORMANCE GOALS .....	5
ECONOMIC ANALYSIS .....	6
LESSONS LEARNED.....	6
CONCLUSIONS.....	7
<b>PROJECT DETAILS.....</b>	<b>8</b>
BACKGROUND.....	8
PROJECT DESCRIPTION.....	8
<b>DATA ACQUISITION AND ANALYSIS.....</b>	<b>28</b>
SAFETY .....	28
CONSTRUCTION CONGESTION .....	28
QUALITY .....	30
USER SATISFACTION .....	30
<b>ECONOMIC ANALYSIS .....</b>	<b>33</b>
CONSTRUCTION TIME .....	33
CONSTRUCTION COSTS .....	33
VOC.....	35
Delay Costs .....	36
COST SUMMARY .....	37
<b>APPENDIX: SHOP DRAWINGS.....</b>	<b>38</b>

## FIGURES

Figure 1. Project location.....	9
Figure 2. Old Frenchtown Brook Bridge. ....	10
Figure 3. Typical bridge section. ....	10
Figure 4. Conceptual typical wall element. ....	11
Figure 5. Bridge before closure. ....	12
Figure 6. Closure of Davisville Road. ....	13
Figure 7. Demolition of old structure in process with stream diversion in place. ....	13
Figure 8. Demolition showing slab removal with abutment walls left in place. ....	14
Figure 9. Abutment walls of old bridge left in place so work does not impact stream. ....	14
Figure 10. Plan view of structure.....	16
Figure 11. Bridge element support detail.....	17
Figure 12. Precast foundation units being lifted off tractor-trailer. ....	17
Figure 13. Precast foundation unit being placed on subfooting.....	18
Figure 14. Modular prefabricated footings in place.....	18
Figure 15. Main bridge element with cable tie on flatbed. ....	19
Figure 16. Modular main bridge elements lowered into place. ....	19
Figure 17. All 25 main bridge elements lowered into place.....	20
Figure 18. Modular headwall being lowered into place. ....	20
Figure 19. Wingwall support detail. ....	21
Figure 20. Modular wingwall being lowered into place.....	21
Figure 21. Another wingwall being lowered into place.....	22
Figure 22. Far end headwall being lowered into place. ....	22
Figure 23. Closeup of headwall anchors.....	23
Figure 24. Closeup of wingwall anchors. ....	23
Figure 25. Prefabricated structure showing joints sealed and wrapped.....	24
Figure 26. Stockpiled structure backfill.....	24
Figure 27. Gravel backfill being rolled into place. ....	25
Figure 28. Bituminous material being rolled into place. ....	25
Figure 29. Davisville Road opened to traffic.....	26
Figure 30. Completed structure with guardrail and riprap in place. ....	26
Figure 31. Bridge opening with riprap placed behind old structure abutment walls.....	27
Figure 32. Traffic management plan.....	29
Figure 33. Rating of approaches to design, scheduling, and traffic management on projects.....	31
Figure 34. Chart showing results of user responses on approaches to design, scheduling, and traffic management. ....	32

## TABLES

Table 1. Construction cost analysis. ....	34
Table 2. Comparison of project costs. ....	37

## **ABBREVIATIONS AND SYMBOLS**

AADT	average annual daily traffic
AASHTO	American Association of State Highway and Transportation Officials
ABC	accelerated bridge construction
dB(A)	A-weighted decibel
DOT	department of transportation
FHWA	Federal Highway Administration
HfL	Highways for LIFE
IRI	International Roughness Index
OBSI	onboard sound intensity
OSHA	Occupational Safety and Health Administration
PCI	Precast/Prestressed Concrete Institute
SAFETEA-LU	Safe, Accountable, Flexible, Efficient Transportation Equity Act: A Legacy for Users
SI	sound intensity
VOC	vehicle operating cost
VPD	vehicles per day



# INTRODUCTION

## HIGHWAYS FOR LIFE DEMONSTRATION PROJECTS

The Highways for LIFE (HfL) pilot program, the Federal Highway Administration (FHWA) initiative to accelerate innovation in the highway community, provides incentive funding for demonstration construction projects. Through these projects, the HfL program promotes and documents improvements in safety, construction-related congestion, and quality that can be achieved by setting performance goals and adopting innovations.

The HfL program—described in the Safe, Accountable, Flexible, Efficient Transportation Equity Act: A Legacy for Users (SAFETEA-LU)—may provide incentives to a maximum of 15 demonstration projects a year. The funding amount may total up to 20 percent of the project cost, but not more than \$5 million. Also, the Federal share for an HfL project may be up to 100 percent, thus waiving the typical State-match portion. At the State's request, a combination of funding and waived match may be applied to a project.

To be considered for HfL funding, a project must involve constructing, reconstructing, or rehabilitating a route or connection on an eligible Federal-aid highway. It must use innovative technologies, manufacturing processes, financing, or contracting methods that improve safety, reduce construction congestion, and enhance quality and user satisfaction. To provide a target for each of these areas, HfL has established demonstration project performance goals.

The performance goals emphasize the needs of highway users and reinforce the importance of addressing safety, congestion, user satisfaction, and quality in every project. The goals define the desired result while encouraging innovative solutions, raising the bar in highway transportation service and safety. User-based performance goals also serve as a new business model for how highway agencies can manage the project delivery process.

HfL project promotion involves showing the highway community and the public how demonstration projects are designed and built and how they perform. Broadly promoting successes encourages more widespread application of performance goals and innovations in the future.

### **Project Solicitation, Evaluation, and Selection**

FHWA has issued open solicitations for HfL project applications annually since fiscal year 2006. State highway agencies submitted applications through FHWA Divisions. The HfL team reviewed each application for completeness and clarity, and contacted applicants to discuss technical issues and obtain commitments on project issues. Documentation of these questions and comments was sent to applicants, who responded in writing.

The project selection panel consisted of representatives of the FHWA offices of Infrastructure, Safety, and Operations; the Resource Center Construction and Project Management team; the Division offices; and the HfL team. After evaluating and rating the applications and

supplemental information, panel members convened to reach a consensus on the projects to recommend for approval. The panel gave priority to projects that accomplish the following:

- Address the HfL performance goals for safety, construction congestion, quality, and user satisfaction.
- Use innovative technologies, manufacturing processes, financing, contracting practices, and performance measures that demonstrate substantial improvements in safety, congestion, quality, and cost-effectiveness. An innovation must be one the applicant State has never or rarely used, even if it is standard practice in other States.
- Include innovations that will change administration of the State's highway program to more quickly build long-lasting, high-quality, cost-effective projects that improve safety and reduce congestion.
- Will be ready for construction within 1 year of approval of the project application. For the HfL program, FHWA considers a project ready for construction when the FHWA Division authorizes it.
- Demonstrate the willingness of the applicant department of transportation (DOT) to participate in technology transfer and information dissemination activities associated with the project.

### **HfL Project Performance Goals**

The HfL performance goals focus on the expressed needs and wants of highway users. They are set at a level that represents the best of what the highway community can do, not just the average of what has been done. States are encouraged to use all applicable goals on a project:

- **Safety**
  - Work zone safety during construction—Work zone crash rate equal to or less than the preconstruction rate at the project location.
  - Worker safety during construction—Incident rate for worker injuries of less than 4.0, based on incidents reported on Occupational Safety and Health Administration (OSHA) Form 300.
  - Facility safety after construction—Twenty percent reduction in fatalities and injuries in 3-year average crash rates, using preconstruction rates as the baseline.
- **Construction Congestion**
  - Faster construction—Fifty percent reductions in the time highway users are impacted, compared to traditional methods.
  - Trip time during construction—Less than 10 percent increase in trip time compared to the average preconstruction speed, using 100 percent sampling.
  - Queue length during construction—A moving queue length of less than 0.5 miles (mi) in a rural area or less than 1.5 mi in an urban area (in both cases at a travel speed 20 percent less than the posted speed).
- **Quality**
  - Smoothness—International Roughness Index (IRI) measurement of less than 48 inches per mile.
  - Noise—Tire-pavement noise measurement of less than 96.0 A-weighted decibels (dB(A)), using the onboard sound intensity (OBSI) test method.

- **User Satisfaction**—An assessment of how satisfied users are with the new facility compared to its previous condition and with the approach used to minimize disruption during construction. The goal is a measurement of 4 or more on a 7-point Likert scale.

## **REPORT SCOPE AND ORGANIZATION**

This report details the replacement of the 57-year old Frenchtown Brook Bridge featuring prefabricated superstructure, substructure, and foundation systems. The new bridge was completely prefabricated offsite and installed in place—a first in Rhode Island. The accelerated construction approach and innovations used on this project increased safety, enhanced quality, and allowed the contractor to replace the bridge during a 33-day road closure instead of the 6 months required under traditional construction methods. The report presents project details relevant to the HfL program, including bridge replacement and construction highlights, accelerated bridge construction (ABC) methods and materials, HfL performance metrics measurement, and economic analysis.

# PROJECT OVERVIEW AND LESSONS LEARNED

## PROJECT OVERVIEW

The project consisted of replacing a bridge on Davisville Road over Frenchtown Brook in East Greenwich, RI, just north of the East Greenwich–North Kingston boundary. The existing bridge suffered from constant weight reductions. The replacement structure was designed to increase the structural capacity of the bridge, improve roadway conditions, minimize disturbance to the Frenchtown Brook, and minimize inconvenience to users by limiting road closure to less than a third of the period required for conventional construction.

The focus of this demonstration project was the innovation of combining precast bridge elements and incentives to reduce road closure and construction periods. Lessons learned on this project can help guide similar projects in the future. Featured in the project are prefabricated culvert-like three-sided bridge elements (two legs and roof) that span 28 feet (ft) over Frenchtown Brook and are placed on precast concrete footings. Each element is 6 ft wide and 7 ft high at its centerline. The four prefabricated wingwalls consist of wall stems that are also placed on precast concrete footings.

The technologies incorporated into this bridge project have been used successfully around the United States on a limited basis, such as a HfL demonstration project in Washington, DC, featuring a prefabricated substructure and steel and concrete modular superstructure system.<sup>1</sup> Furthermore, the New Hampshire Department of Transportation presented a project that used techniques similar to this project, and its success set the stage for the all-precast method for the Rhode Island Department of Transportation (RIDOT). The fact that several diverse structural systems have been assembled and incorporated into a single project reinforces the concept that innovation does not necessarily mean creating something completely new, but rather facilitating incremental improvements in a number of specific bridge details to fully leverage previously successful work.

Under traditional construction methods, RIDOT estimated the bridge would have been closed for 6 months to accommodate cast-in-place construction. Central to the ABC approach adopted on this project was condensing the bridge closure to only 65 days, which was eventually reduced to 33 days by a \$3,000-per-day contractor incentive capped at \$90,000. This was enough time to facilitate both removal of the old bridge and construction of the new bridge.

Preliminary analysis of alternatives for the replacement bridge showed that the bridge with precast elements would be competitive with a conventional bridge at the site. The conventional bridge would have been a butted prestressed beam superstructure on cast-in-place abutments.

Construction on the project was completed without delays because of offsite fabrication and no handling, transportation, or erection difficulties. Also, user delay costs from roadway closure were reduced by more than 80 percent.

---

<sup>1</sup> *Reconstruction of Eastern Avenue Bridge Over Kenilworth Avenue in Washington, DC*, August 2011, Federal Highway Administration, [www.fhwa.dot.gov/hfl/summary/projects\\_summary.cfm](http://www.fhwa.dot.gov/hfl/summary/projects_summary.cfm).

Encouraged by the success of this project, RIDOT announced that it will evaluate all future bridge projects to determine if they can be built using ABC techniques, taking into account factors such as the impact of total road closures that projects of this type normally require and the complexity of utility relocations.

## **HfL PERFORMANCE GOALS**

Safety, construction congestion, quality, and user satisfaction data were collected before, during, and after construction to demonstrate that innovations can be an integral part of a project while simultaneously meeting the HfL performance goals in these areas.

- **Safety**
  - Work zone safety during construction—As expected, no incidents occurred during the entire construction period including the full closure period, which meets the HfL goal of achieving a work zone crash rate equal to or less than the preconstruction rate.
  - Worker safety during construction—No workers were injured on the project, so the contractor achieved a score of 0 on the OSHA Form 300, meeting the HfL goal of less than 4.0.
  - Facility safety after construction—Normally, 3-year crash rates after construction are determined and compared to the preconstruction crash rates. With no change in roadway width (44 ft) before and after construction, the crash rate attributable to roadway width should be the same. However, traffic volume and flow are likely to affect facility safety after construction. The pre-construction Davisville Road consisted of two lanes and two shoulders carrying one-way traffic north toward Frenchtown Road and the on-ramp to Route 4 North. Post-construction, Davisville Road will no longer be part of Route 403 under the relocated Route 403 project and will serve as a two-way local road with less than 75 percent of its preconstruction traffic volume.
  
- **Construction Congestion**
  - Faster construction — Compressing the time it took to replace the bridge from an estimated 6 months to only 33 days under the ABC approach drastically reduced the impact on motorists and went beyond the HfL goal of a 50 percent reduction in the time traffic is impacted compared to traditional construction methods.
  - Trip time — Considering the cumulative trip time over the 33-day detour compared to 6 months of detour estimated for traditional construction, motorists experienced a substantial reduction in trip time, meeting the HfL goal of no more than a 10 percent increase in trip time.
  - Queue length during construction — There were no traffic backups observed along the detour routes. The project, therefore, met the HfL goal of less than a 0.5-mi queue length in a rural area.
  
- **Quality**
  - Smoothness—Because of the new asphalt surface on the bridge, motorists will notice a smoother ride.

- The quality of the products used was superior because the contract required that the manufacturing plant furnishing precast bridge members be certified by the Precast/Prestressed Concrete Institute (PCI) Certification program at a minimum of B3 category. Furthermore, it required that dimensional tolerances not exceed those recommended in the latest edition of the PCI manual for quality control for plants and production of precast and prestressed concrete products. This assessment is based on the products meeting all specifications and the belief that disciplined procedures enforced at certified plants audited by external personnel are likely to yield better quality control than those at a construction site where quality control of concrete cast in place is dispersed among several entities and individuals. These personnel range from those at batch plants proportioning aggregates, cement, and water to drivers transporting the mixes in concrete trucks to inspectors responsible for ensuring that placing, compacting, and curing of concrete conforms to specifications.
- User satisfaction—A formal user satisfaction survey was not conducted on this project. It is, however, evident to the project team that with reduction in roadway closure time by more than 80 percent compared to conventional construction, users are likely to be very satisfied and their responses would easily meet the goal of 4 or more points on a 7-point Likert scale.

In a similar study on the use of ABC on U.S. 6 over Keg Creek<sup>2</sup> in Iowa, where the roadway closure was reduced from 6 months to 2 weeks through the use of prefabricated bridge elements, user satisfaction was quite positive. 92 percent of respondents to the survey considered using prefabricated components to speed construction as important or somewhat important and 100 percent of the respondents found condensing closure to 2 weeks to be important.

## **ECONOMIC ANALYSIS**

The costs and benefits of this innovative project approach were compared with those of a project of similar size and scope delivered using a more traditional approach. A comprehensive economic analysis that accounted for construction and road user costs revealed that RIDOT's innovative approach realized a cost savings of about \$1.5 million, or 38 percent of the total project cost, over conventional construction practices. A significant amount of the cost savings stemmed from avoiding delay costs to road users through the use of ABC techniques.

## **LESSONS LEARNED**

Through this project, RIDOT gained valuable insights on the innovative techniques and materials—both those that were successful and those that need improvement in future project deliveries. The following are some of the lessons learned on using prefabricated elements:

- The 65-day bridge closure allowed in the contract was adequate for demolition and construction of a bridge of this size. In fact, the contractor completed the work in 33

---

<sup>2</sup> *Iowa Demonstration Project: Accelerated Bridge Construction on U.S. 6 Over Keg Creek*, March 2012, Federal Highway Administration, [www.fhwa.dot.gov/hfl/summary/projects\\_summary.cfm](http://www.fhwa.dot.gov/hfl/summary/projects_summary.cfm).

days, qualifying for the incentive of \$3,000 per day capped at \$90,000. This was enough time to completely remove the existing bridge and set the precast elements in place despite a significant rain event that disrupted operations. The contractor typically did not have to work past dusk during this period.

- A muddy job site would have made moving the heavy bridge elements difficult, but this did not occur.
- By reducing the construction time at the site with accelerated construction using prefabricated elements, the amount of time construction crews and motorists were exposed to the dangers of the work zone was also reduced.
- Onsite construction time is often limited by weather and environmental permitting requirements. Because of prefabrication and accelerated construction, limited available construction time was not a factor and the project was easily completed during the construction season.
- While precast concrete produced at a certified plant has the advantage of being constructed in a controlled environment with higher production and curing standards than normally found in the field, there is debate on the impact this has on costs and the need to evaluate this requirement for simple elements. The positive side of plant certification is that internal quality control is apt to be at least satisfactory, but the negative aspect is that all elements must be shipped from a certified facility that may be a long way from the construction site, increasing transportation cost. Transportation also involves restriction on the size and weight of individual elements. The option of allowing near-site fabrication versus fabrication at a certified facility should be considered on future projects that involve prefabricated elements.
- The incentives in the actual contract helped offset some of the risk in the contractor's bid decision making process.

## CONCLUSIONS

RIDOT gained valuable insights on this project on the use of innovative ABC techniques. These innovations were key to successfully achieving the HfL performance goals of increasing safety, reducing traveler inconvenience from construction, and increasing quality at a lower cost.

## PROJECT DETAILS

### BACKGROUND

Frenchtown Brook Bridge No. 435 carries Davisville Road, an urban minor arterial that starts at Frenchtown Road in the town of East Greenwich and proceeds generally in the southeasterly direction to U.S. Route 1 (Post Road) in North Kingston (shown in Figure 1). RIDOT included replacement of this bridge as part of its relocated Route 403 project, a major undertaking.

The 16-ft-wide rectangular slab bridge built in 1955 at a 60-degree skew resembles a culvert (Figure 2). It was functionally obsolete and structurally deficient with a load rating of only 12 tons for a HS-20 vehicle. The concrete abutments that supported the structure had substandard dimensions. RIDOT decided to leave a portion of the existing substructure in place to minimize the impact on Frenchtown Brook, an important tributary of Hunt River.

Under the relocated Route 403 project, Davisville Road is no longer part of Route 403. The two one-way lanes and two shoulders to the north toward Frenchtown Road and the on-ramp to Route 4 North before relocation will serve as lanes for two-way traffic, a lane in each direction. With relocation, traffic volume of 10,200 vehicles per day (vpd) is estimated to drop to 7,300.

The traffic analysis in conjunction with the project indicated that it was feasible to detour traffic because the detour was short and the impacted traffic was primarily local.

### PROJECT DESCRIPTION

RIDOT considered six alternatives to replace the structure, the first two of which appeared the most promising:

- Alternative 1: Precast concrete arch with varying gravel over top and bituminous pavement. The bridge would have a span of 28 ft square with no skew.
- Alternative 2: Butted prestressed concrete box beams with 3-inch (in) minimum pavement. The bridge would have a span of 94 ft for a skew angle of 45 degrees.

It was estimated that alternative 2 would cost \$360,000 more if piling was needed and about \$40,000 more if no piling was needed. Alternative 1 would not require piling because the loads on the footings would be much less because of the shorter span and more uniform bearing pressures.

RIDOT decided to go with option 1 and use precast elements for all segments of the structure for the first time in its project delivery history. This included both the footings and three-sided (roof and two legs) bridge segments for the main structure and precast elements for the footings and the wall stems for the four wingwalls of the bridge. See Figure 3 and Figure 4.

To complete the bridge construction work as quickly as possible and to lessen the impact of the project, RIDOT concluded that it would have to close Davisville Road to traffic. RIDOT further



estimated that by using precast elements for all components, the closure period would be reduced from 6 to 2 months.

RIDOT applied for an HfL grant designed to advance longer-lasting highway infrastructure using innovations to accomplish fast construction of efficient and safe highways and bridges. A grant of \$620,000 was made to RIDOT under the program.



Figure 1. Project location.



Figure 2. Old Frenchtown Brook Bridge.

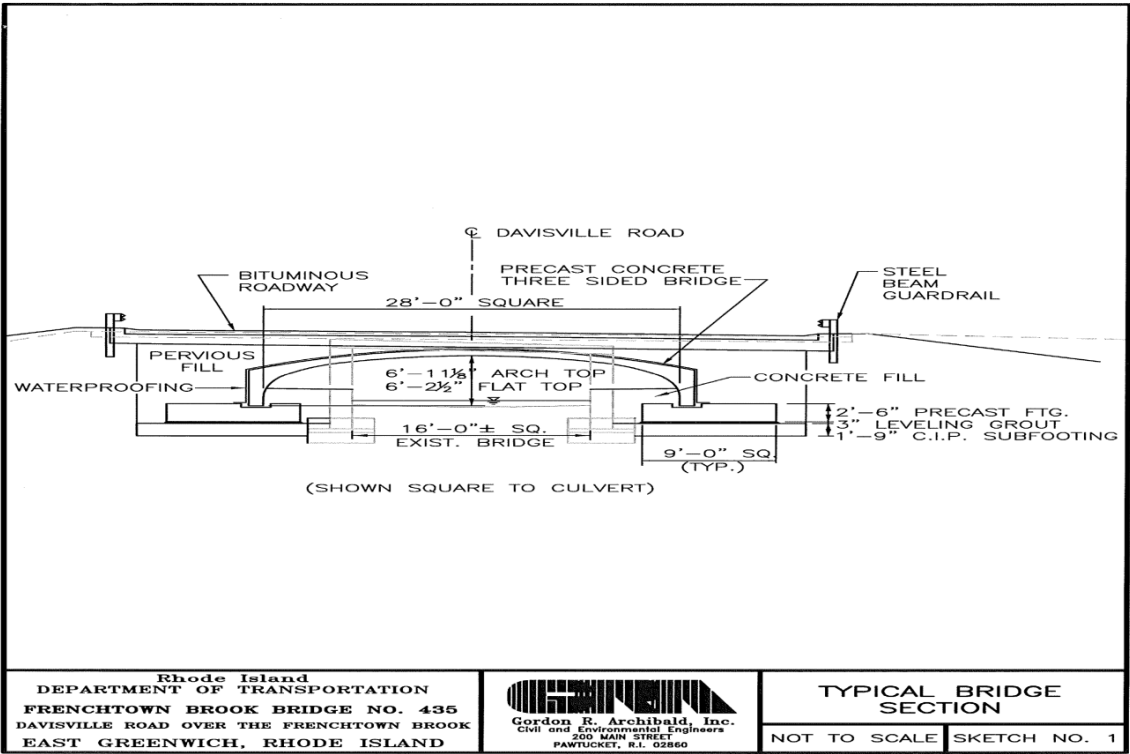

Figure 3. Typical bridge section.



- The butt joint made by two adjacent precast bridge units was to be covered with a piece of preformed bituminous joint sealant.
- The entire top and sides of the precast bridge units were to receive rubberized asphalt liquid membrane to the limits shown on the plans.

The contract was awarded to Aetna Bridge Co. of Pawtucket, RI, which had a low bid of \$1.9 million. The contractor chose Contech Engineered Solutions of Palmer, MA, as its prefabricated elements subcontractor, located about 85 mi from the project site. The consultant designer on the project was Gordon R. Archibald, Inc. Professional Engineers of Pawtucket, RI.

The contractor started the roadway closure on July 30, 2012, for bridge construction. Approved shop drawings for the project are shown in the Appendix. The shop drawing package includes the bridge plan, foundation plan, upstream and downstream elevations, and a variety of connection details and specifications for manufacture and installation.

Construction of the project is highlighted in Figure 5 through Figure 31.

The contractor started with dewatering measures, installation of demolition shield, demolition of wingwalls, and excavation behind the abutments. To minimize impact on Frenchtown Brook, a portion of the existing abutment was left in place (see Figure 7 through Figure 9).



Figure 5. Bridge before closure.



Figure 6. Closure of Davisville Road.



Figure 7. Demolition of old structure in process with stream diversion in place.



Figure 8. Demolition showing slab removal with abutment walls left in place.



Figure 9. Abutment walls of old bridge left in place so work does not impact stream.

Figure 10 shows the plan view of the structure 150 ft long with 25 6-ft elements. The original plans called for concrete and grout subfooting under the precast foundation elements, but the contractor's value engineering proposal to use a crushed stone subfooting wrapped in geotextile was approved instead. The precast foundation units were lifted off a tractor-trailer and placed on the subfooting. See Figure 11 for the construction detail and Figure 12 through Figure 14 for the modular foundation element placement. The interior foundation elements are 23 ft, 11.5 in long, 6 ft wide and 2.5 ft high. The end units are of the same width and height and 26 ft, 11.75 in long. The units were hollow to facilitate transport and handling and were subsequently filled with concrete at the site. See the shop drawings in the Appendix for more details.

The three-sided 6-ft-wide bridge elements with an internal span of 28 ft shown in Figure 15 were lifted off the trucks and placed on the footings (see Figure 16). These elements came with a cable tie. The cables were removed after arch units had been erected and the concrete placed in the foundation units and at the arch unit had been allowed to cure to 2,000 psi. The headwall elements with their counterforts and wingwall elements with anchors were then placed. The butt joints between adjacent bridge elements were filled with preformed bituminous joint sealant and a 9-in-wide continuous joint wrap. A primer compatible with the joint wrap was applied for a minimum width of 9 in on each side of the joint. Other joints between the bridge elements and headwalls and bridge elements and wingwalls were similarly sealed (see Figure 17 through Figure 25).

See the Appendix for grouting requirements at the joints. Minimum 28-day strength of 11,000 psi was required. The specifications for manufacture and installation also required that the lifting and erection anchor recesses be filled with grout.

Approved backfill shown in Figure 26 was rolled into place (Figure 27) and covered by a 5-in modified base course in two 2.5-in lifts followed by a 2-in bituminous surface course (Figure 28).

The road, which once served one-way traffic, was striped for two-way traffic (Figure 29) and opened on Friday, August 31, 2012, in time for the Labor Day weekend, just 33 days after it was closed to traffic. Figure 30 shows the completed structure with guardrail and riprap in place, and Figure 31 shows a view of the bridge opening with riprap placed behind old structure abutment walls.

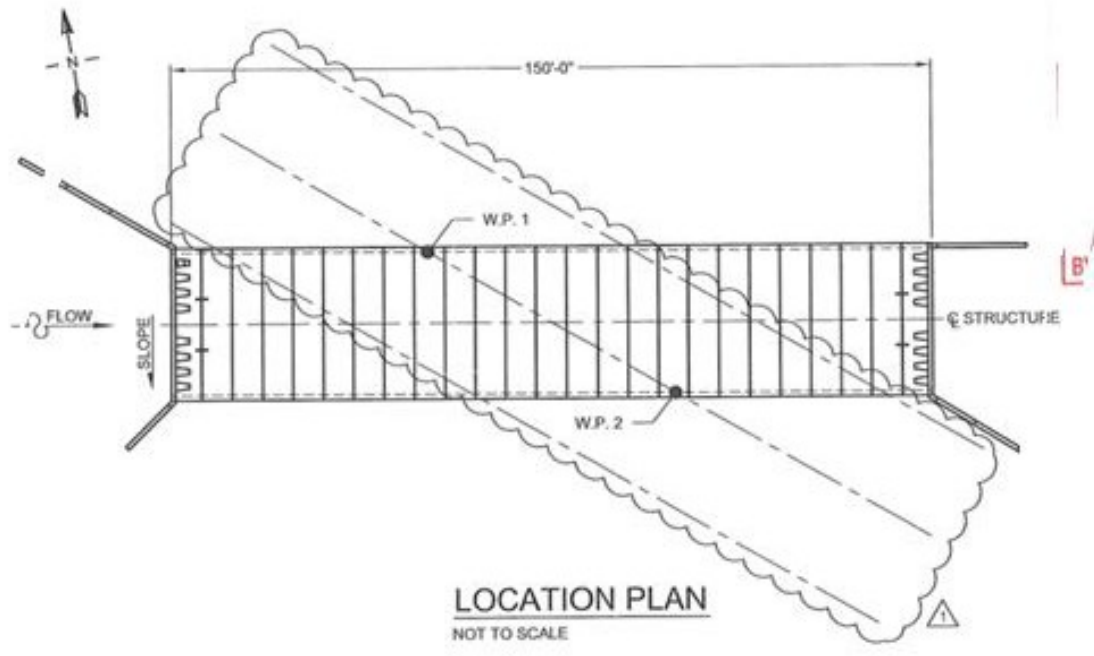

Figure 10. Plan view of structure.



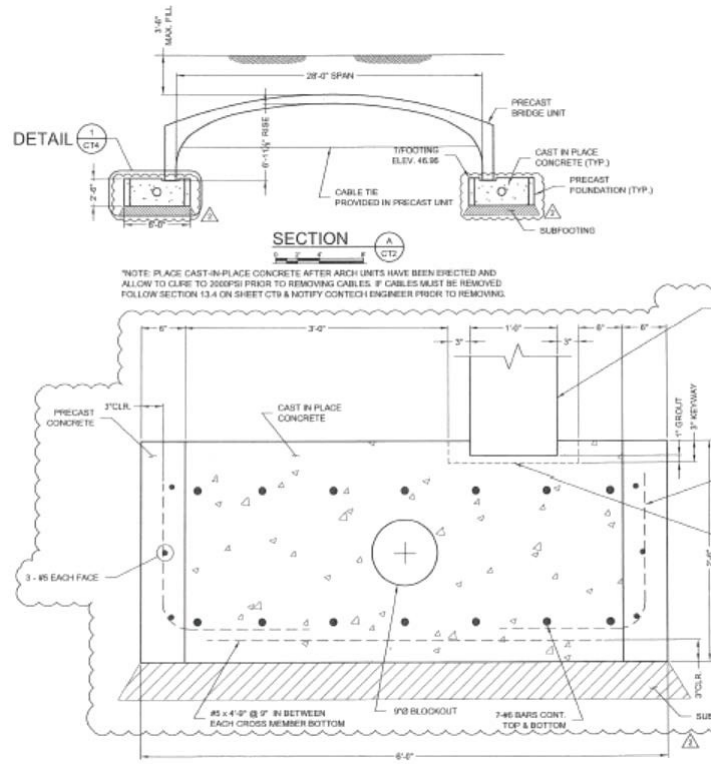

Figure 11. Bridge element support detail.



Figure 12. Precast foundation units being lifted off tractor-trailer.



Figure 13. Precast foundation unit being placed on subfooting.



Figure 14. Modular prefabricated footings in place.



Figure 15. Main bridge element with cable tie on flatbed.



Figure 16. Modular main bridge elements lowered into place.



Figure 17. All 25 main bridge elements lowered into place.



Figure 18. Modular headwall being lowered into place.

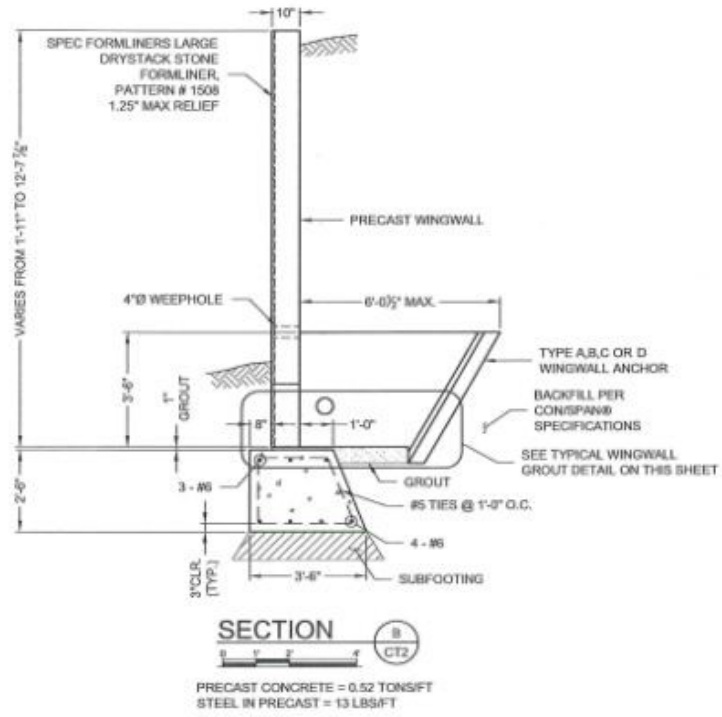

Figure 19. Wingwall support detail.



Figure 20. Modular wingwall being lowered into place.



Figure 21. Another wingwall being lowered into place.



Figure 22. Far end headwall being lowered into place.



Figure 23. Closeup of headwall anchors.



Figure 24. Closeup of wingwall anchors.



Figure 25. Prefabricated structure showing joints sealed and wrapped.



Figure 26. Stockpiled structure backfill.





Figure 27. Gravel backfill being rolled into place.



Figure 28. Bituminous material being rolled into place.



Figure 29. Davisville Road opened to traffic.



Figure 30. Completed structure with guardrail and riprap in place.



Figure 31. Bridge opening with riprap placed behind old structure abutment walls.

## **DATA ACQUISITION AND ANALYSIS**

Data on safety, traffic flow, and quality before, during, and after construction were collected to determine if this project met the HfL performance goals. The primary objective of acquiring these types of data was to quantify project performance to provide an objective basis to determine the feasibility of the project innovations and demonstrate that the innovations can be used to do the following:

- Achieve a safer work environment for the traveling public and workers.
- Reduce construction time and minimize traffic interruptions.
- Produce a high-quality project and gain user satisfaction.

This section discusses how well the RIDOT project met the HfL performance goals related to these areas.

### **SAFETY**

The project included the HfL performance goal of achieving a work zone crash rate equal to or less than the existing conditions. During this project, no crashes occurred, satisfying the HfL goal. Work zone safety was ensured by completely closing the bridge to traffic, accelerating construction, and using prefabricated bridge components. Accelerated construction methods, including the use of prefabricated bridge components, made the brief traffic detour feasible.

The project included the performance goal of achieving an incident rate for worker injuries of less than 4.0 based on the OSHA 300 rate. Not only did closing the bridge to traffic help achieve this goal, but precasting the bridge system at an approved facility eliminated the need for workers to spend most of their time exposed to falling hazards, which would have been required with traditional cast-in-place construction methods. No work-related injuries occurred during construction, resulting in an OSHA Form 300 score of 0.

It is difficult to compare crash data before and after construction at this site because both the traffic volume and flow have changed. Davisville Road under the relocated Route 403 project, a major undertaking of RIDOT of which this project was a part, is no longer part of Route 403. The two one-way lanes and two shoulders to the north toward Frenchtown Road and the on-ramp to Route 4 North before relocation now serve as two-way traffic with a lane and a shoulder in each direction. With relocation, traffic volume of 10,200 vpd was estimated to drop to 7,300 vpd.

### **CONSTRUCTION CONGESTION**

Accelerated construction techniques reduced the time highway users were affected by more than 50 percent. The estimated roadway closure time for bridge construction would have been 6 months under non-accelerated construction. The actual impact on traffic lasted only 33 days, from July 30 to August 31, 2012.

The impact started when Davisville Road was closed to traffic on July 30, 2012, and the traffic was detoured. Figure 32 shows detours that were set in place. The primary detour route used

Route 402 (Frenchtown Road) in East Greenwich and Route 1 (Post Road) and School Street in North Kingston. Motorists on Devil's Foot Road (which turns into Davisville Road) could access the new Route 403 at West Davisville Road using the alternate route and take the exit for Route 4 North. They could also take the exit for Route 4 South to Route 402 (Frenchtown Road).

During the 33-day closure, detours eliminated traffic queuing and congestion at the construction site, allowing efficient installation of the modular bridge components.

The innovative accelerated bridge construction technique enabled reduction of the traffic detour duration by more than 80 percent, from an estimated 6 months for conventional construction to only 33 days.

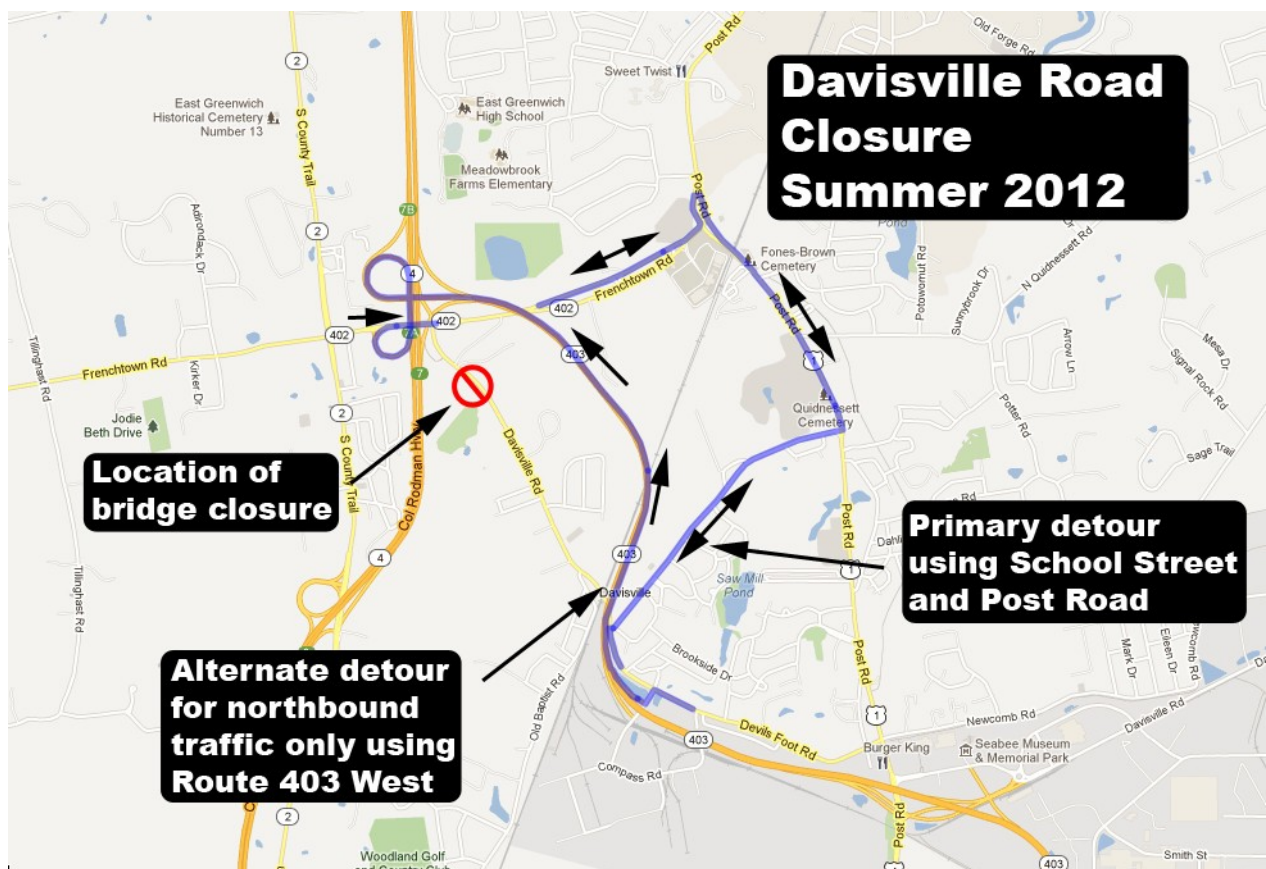

Figure 32. Traffic management plan.

Researchers collected trip time data before Davisville Road was closed to traffic and during the closure. No queuing was observed on the primary or alternate routes. In general, the traffic flow along the both detour routes was light and flowed freely without backups or congestion at or above the posted speed limits.

The following nodes were established for trip time data collection:

- Node 1—Intersection of Davisville Road and Frenchtown Road
- Node 2—Intersection of Frenchtown Road and Post Road (Route 1)
- Node 3—Intersection of Post Road (Route 1) and School Street
- Node 4—Intersection of School Street and Davisville Road

When Davisville Road was open, the average travel time from Node 1 to Node 4 was 2.59 minutes based on morning, midday, and afternoon runs. Travel along the primary detour from Node 1 to Node 4 increased this average time from 2.59 to 5.26 minutes, an increase of 2.67 minutes. Travel along the alternative route averaged 3.99 minutes, an increase of 1.40 minutes.

The cost associated with the additional time to traverse the detour route is presented later in this report.

## **QUALITY**

The load restrictions on the bridge because of structural inadequacy will no longer be needed. The new bridge meets all current standards for structural adequacy and is open to all traffic. Furthermore, motorists will notice a smoother ride when traversing the bridge because of its new asphalt surface.

The quality of the products used was superior because the contract required that the manufacturing plant furnishing precast bridge members be PCI certified at a minimum of B3 category. Furthermore, it required that dimensional tolerances not exceed those recommended in the latest edition of the PCI manual for quality control for plants and production of precast and prestressed concrete products. This assessment is based on the products meeting all specifications and the belief that disciplined procedures enforced at certified plants audited by external personnel are likely to yield better quality control than those at a construction site where quality control of concrete cast in place is dispersed among several entities and individuals. These personnel range from those at batch plants proportioning aggregates, cement, and water to drivers transporting the mixes in concrete trucks to inspectors responsible for ensuring that placing, compacting, and curing of concrete conform to specifications.

## **USER SATISFACTION**

The September 7, 2012, *AASHTO Journal Weekly Transportation Report*, published by the American Association of State Highway and Transportation Officials, featured the Frenchtown Brook Bridge. The article includes the following quote from RIDOT Director Michael Lewis:

“Going into this project, we knew it would take only a third of the time to replace this bridge compared with the time it would have taken if we used traditional construction methods. We are pleased to be able to take this approach with the Frenchtown Brook Bridge and reopen it as quickly as possible for drivers in East Greenwich and North Kingston who rely on this bridge on a daily basis.”

The article goes on to state, “The project was so successful that RIDOT noted it will evaluate all future bridge projects to see if they could be built using the ABC method.”

It is clear from these statements that RIDOT is pleased with the decisions made on this project. It is also evident to the project team that absent formal user satisfaction surveys, based on the data and chart shown in Figure 33 and Figure 34, users of Davisville Road would be quite satisfied with RIDOT's approach to minimizing the impact of construction on this project from 6 months for conventional construction to just 1 month using innovative ABC methods. Figure 33 and Figure 34 show results of a user satisfaction survey on a similar ABC project using precast components in Iowa. Clearly, the responses were positive (very important and important) on a number of decisions made on this project:

1. Closing a road or bridge to reduce cost and time (90 percent positive)
2. Creating alternative routes while project is underway (100 percent positive)
3. Reducing time to complete project through incentives (80 percent positive)

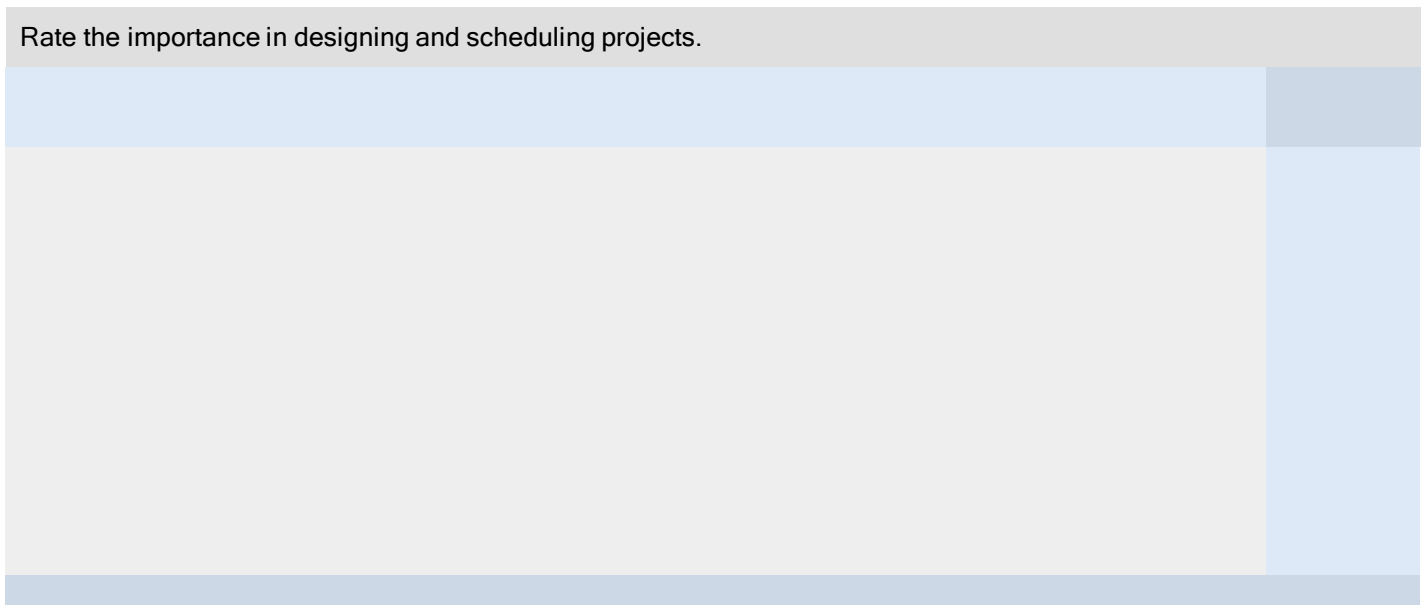

Figure 33. Rating of approaches to design, scheduling, and traffic management on projects.

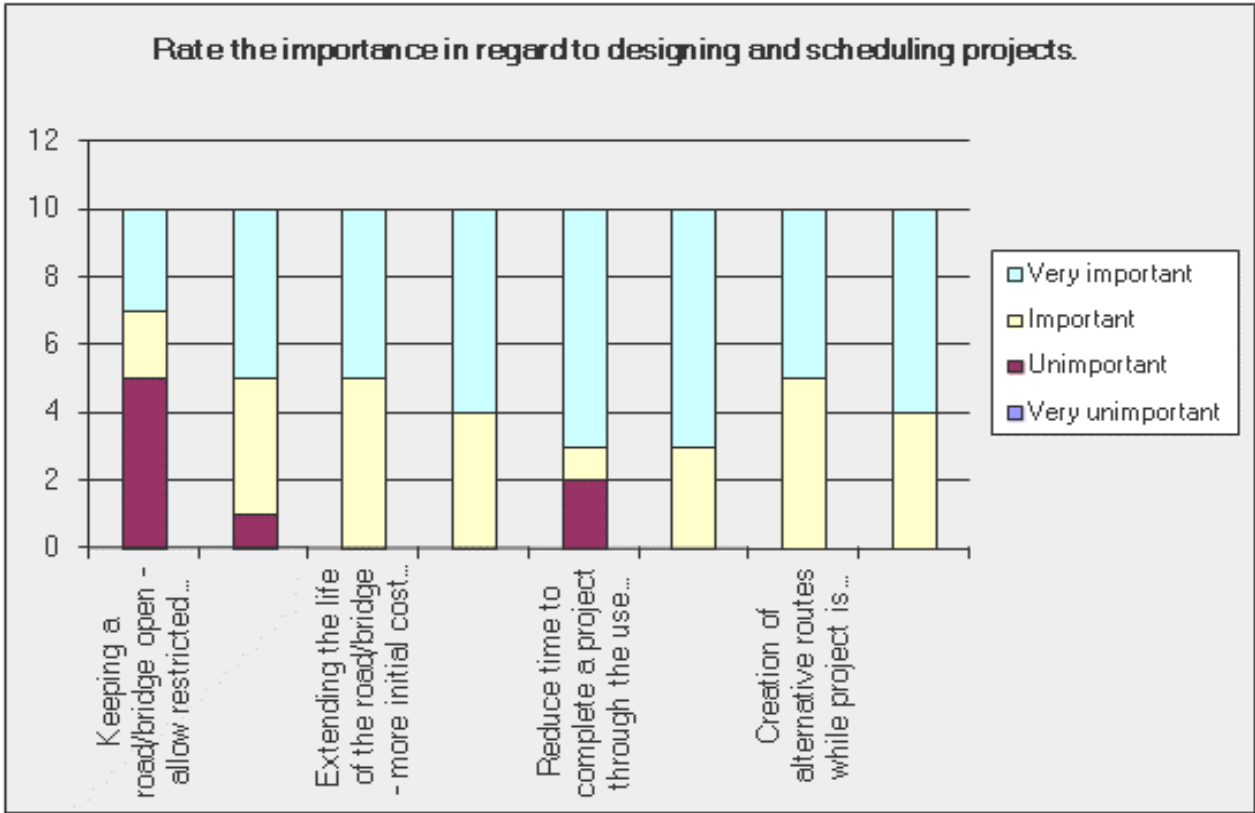

Figure 34. Chart showing results of user responses on approaches to design, scheduling, and traffic management.



## ECONOMIC ANALYSIS

A key aspect of HfL demonstration projects is quantifying, as much as possible, the value of the innovations deployed. This involves comparing the benefits and costs associated with the innovative project delivery approach adopted on an HfL project with those from a more traditional delivery approach on a project of similar size and scope. The latter type of project is referred to as a baseline case and is an important component of the economic analysis.

For this economic analysis, RIDOT supplied the cost figures for the as-built project and baseline construction. Traditional methods would have involved the use of cast-in-place construction coupled with standard pretensioned precast concrete bridge beams.

### CONSTRUCTION TIME

The baseline scenario would have closed the bridge for at least 6 months to accommodate traditional cast-in-place construction methods. The ABC approach allowed the contractor to fabricate the bridge components ahead of time and use a condensed 33-day closure to assemble the bridge.

### CONSTRUCTION COSTS

The alternative analysis for the Frenchtown Brook bridge project itemized costs for six options, with the following three lowest cost options:

1. Precast arch option (\$1,800,000)
2. Butted box beam option (\$1,840,000 without piles, \$2,160,000 if piling needed)
3. Spread box beam option (\$1,880,000 without piles, \$2,190,000 if piling needed)

Details of the analysis are shown in Table 1.

The precast arch option was estimated to cost \$40,000 less than the conventional alternative of butted box beam and \$360,000 less if piling was needed for the butted box beam structure.

The successful (lowest) bid on the project was \$1,945,063.80.

Assuming that the conventional bridge would have been bid proportionately higher, the difference between the conventional option and the precast arch option is estimated as follows:

$\$1,945,063.80 * 40,000/1,800,000 = \$43,223.64$  or about \$43,000.

However, with the incentive of \$90,000 for completing the project ahead of the time allotted, the innovative option cost **\$47,000** more than the conventional option.

Table 1. Construction cost analysis.

Relocated Route 403  
 Reconstruction of Frenchtown Brook Bridge No.435

ITEM CODE	DESCRIPTION	UNIT	UNIT PRICE	ALTERNATIVE 1 PRECAST ARCH		ALTERNATIVE 2 BUNDLED BOXES		ALTERNATIVE 3 SPREAD BOXES	
2010409	R&D FLEXIBLE PAVEMENT	SY	\$15	1100	\$16,600	1300	\$19,600	1650	\$24,750
203.D100	STRUCTURAL EXCAVATION EARTH	CY	\$15	3500	\$52,600	1700	\$25,500	1700	\$25,500
203.0650	CRUSHED STONE FILL UNDER STRUCTURES	CY	\$50	170	\$6,500	75	\$3,750	75	\$3,750
203.0700	PERVIOUS FILL	CY	\$50	3200	\$100,000	980	\$49,000	960	\$49,000
301.0001	GRAVEL BORROW BASE COURSE	CY	\$23	410	\$9,430	300	\$6,900	420	\$9,660
401.0200	BITUMINOUS PAVEMENT	TON	\$70	400	\$28,000	440	\$30,800	550	\$38,500
803.9901	R & D PORTIONS OF EXISTING BRIDGE	CY	\$200	370	\$74,000	310	\$62,000	310	\$62,000
804.9901	H-PILES	LF	\$100	0	\$0	2100	\$260,000	2100	\$260,000
806.2000	TEMPORARY SHEET PILING STEEL FURNISH AND DRIVE	SF	\$90	1400	\$126,000	500	\$45,000	500	\$45,000
808.0322	CONCRETE SUBSTRUCTURE CLASS HP 3/4" ENOPOSTS	CY	\$1,400	6	\$6,400	6	\$6,400	6	\$8,400
808.0323	CONCRETE SUBSTRUCTURE CLASS HP 3/4" PARAPETS	CY	\$1,400	26	\$36,400	40	\$84,400	50	\$70,000
806.0504	CONCRETE SUBSTRUCTURE CLASS HP 3/4" WALL FOOTING	CY	\$850	130	\$84,600	66	\$42,900	77	\$50,050
806.0806	CONCRETE SUBSTRUCTURE CLASS HP 3/4" WALL STEM	CY	\$650	20	\$13,000	80	\$39,000	65	\$55,250
806.0806	CONCRETE SUBSTRUCTURE CLASS HP 3/4" ABUTMENT STEMS	CY	\$650	0	\$0	175	\$113,750	175	\$113,750
808.0508	CONCRETE SUBSTRUCTURE CLASS HP 3/4" APPROACH SLABS	CY	\$300	0	\$0	55	\$18,500	55	\$18,500
808.0602	CONCRETE SUBSTRUCTURE CLASS HP 3/4" CURB WALLS	CY	\$1,000	0	\$0	16	\$18,000	24	\$24,000
808.1501	CONCRETE SUPERSTRUCTURE CLASS HP 3/4" BRIDGE DECKS	CY	\$1,000	0	\$0	0	50	120	\$120,000
809.0821	PRESTRESSED CONCRETE AASHTO BEAM TYPE 2 FF&E CLASS HP 3/4"	LF	\$125	0	\$0	0	50	0	\$0
809.0924	PRESTRESSED CONCRETE BOXES 811-48 FF&E CLASS HP 3/4"	SF	\$80	0	\$0	4700	\$376,000	0	\$0
8011.0934	PRESTRESSED CONCRETE BOXES 811-48 FF&E CLASS HP 3/4"	SF	\$90	0	\$0	0	\$0	2330	\$209,700
809.1012	PRESTRESSED CONCRETE BULB TEES 200 FF&E CLASS HP 3/4"	LF	\$300	0	\$0	0	\$0	0	\$0
809.1146	PRESTRESSED CONCRETE SLABS 18" FF&E CLASS HP 3/4"	SF	\$75	0	\$0	0	\$0	0	\$0
809.9901	PRECAST CONCRETE ARCH CLASS HP 3/4"	LS	\$400,000	1	\$400,000	0	\$0	0	\$0
810.0300	EPOXY COATED BARS GRADE 80	LBS	\$1	60000	\$60,000	8000	\$85,000	114000	\$114,000
813.0400	RUBBERIZED ASPHALT LIQUID MEMBRANE (WATERPROOFING MEMBRANE)	SY	\$00	690	\$34,500	515	\$25,750	515	\$25,750
828.0303	ELASTOMERIC BEARINGS LAMINATED	EA	\$500	0	\$0	24	\$12,000	12	\$6,000
833.0400	GRANITE IDENTIFICATION TABLETS	EA	\$400	4	\$1,600	4	\$1,800	4	\$1,800
834.91101	VERTICAL FACE GRANITE BRIDGE CURB	LF	\$45	176	\$7,920	200	\$13,050	304	\$13,880
801.0183	STEEL BEAM BRIDGE CONNECTION APPROACH END (W/O NESTED RAIL)	EA	\$2,000	2	\$4,000	2	\$4,000	2	\$4,000
901.0184	STEEL BEAM BRIDGE CONNECTION TRAILING END (W/O NESTED RAIL)	EA	\$3,000	2	\$6,000	2	\$8,000	2	\$6,000
820.0086	DULLES COUNTY RIP-RAP R-1, R-2 STQ 8.3.0	CY	\$40	150	\$6,000	120	\$4,800	120	\$4,800
838.0110	M08-w/NO N	LS	\$100,000	1	\$100,000	1	\$100,000	1	\$100,000
937.D200	MAINTENANCE AND MOVEMENT MAFFIC PROTECTION	LS	\$300,000	0.5	\$150,000	1	\$300,000	1	\$300,000

	\$1,798,583	\$2,152,000	\$2,189,550
<b>Rounded Total Cost PHes for Alternatives 2, 3, 4 &amp; 6 (With 25% Misc.) =</b>	<b>\$11,800,000</b>	<b>\$2,180,000</b>	<b>\$2190,000</b>
	\$1,706,563	\$1,839,500	\$1,877,050
<b>Rounded Total Cost without PHes for Alternatives 2, 3, 4 &amp; 6 (With 25% Misc.) =</b>	<b>\$1,800,000</b>	<b>\$1,840,000</b>	<b>\$1,880,000</b>

F:\V\FIN\CCOM\7ene-3&E\table1.xls

## User Costs

Generally, three categories of user costs are used in an economic and life cycle cost analysis: vehicle operating costs (VOC), delay costs, and crash- and safety-related costs. Because the bridge would have been closed to traffic under both the baseline and as-built cases, the possible safety hazard to the traveling public from a work zone was eliminated, so safety-related costs were not evaluated. However, VOC and delay costs were compared and are discussed in the following subsections.

### VOC

The savings in VOC from using ABC are essentially the difference between the mileage-related VOC applied to the 6 months (183 days) of detour time for the baseline case and the 33 days for the as-built case applied to an average extra detour distance of 2 mi.

Assuming an average unit cost of \$0.81 per mile for commercial vehicles (light and heavy trucks)<sup>2</sup> and \$0.32 per mile for an average sedan<sup>3</sup> for the variable operating costs (including costs for fuel, maintenance and repair, tires, and depreciation) and given the 2012 annual average daily traffic (AADT) of 7,300 with 6 percent trucks for this project, the following VOC is computed:

#### Baseline Case

$$\begin{aligned}\text{VOC (Auto)} &= 7,300 \text{ (AADT)} * 0.94 \text{ (percent autos)} * 2 \text{ (mi)} * \$0.32 \text{ (per mi)} * 183 \text{ (days)} \\ &= \$803,677\end{aligned}$$

$$\begin{aligned}\text{VOC}_{\text{Truck}} &= 7,300 \text{ (AADT)} * 0.06 \text{ (percent trucks)} * 2 \text{ (mi)} * \$0.81 \text{ (per mi)} * 183 \text{ (days)} \\ &= \$129,849\end{aligned}$$

$$\begin{aligned}\text{VOC (Total)} &= \$803,677 + \$129,849 \\ &= \mathbf{\$933,527}\end{aligned}$$

#### As-Built Case

The detour was in effect for 33 days, hence the VOC (total) for the as-built case is as follows:

$$\begin{aligned}&= 33 * 933,527 / 183 \\ &= \mathbf{\$168,341}\end{aligned}$$

$$\begin{aligned}\text{VOC}_{\text{Differential}} &= \$933,527_{\text{baseline}} - \$168,341_{\text{As-built}} \\ &= \mathbf{\$765,186}\end{aligned}$$

---

<sup>2</sup> Barnes and Langworthy, *The Per-Mile Costs of Operating Automobiles and Trucks*, 2003, Report No. MN/RC 2003-19, Minnesota Department of Transportation. Adjusted for fuel price increase and inflation in 2011.

<sup>3</sup> American Automobile Association, *Your Driving Costs 2012*, Both operating costs and per mile depreciation costs were considered. <http://newsroom.aaa.com/wp-content/uploads/2012/04/YourDrivingCosts2012.pdf>

## Delay Costs

The delay time using the primary and alternate detour routes averaged 2.67 minutes (0.0445 hour) and 1.40 minutes (0.0233 hour), respectively, more than travel before closure. RIDOT estimated that traffic would be distributed about 50 percent on each detour route. The average delay time is calculated as follows:

$$\begin{aligned}\text{Delay time per vehicle} &= 0.5 * 0.0445 \text{ hour} + 0.5 * 0.0233 \text{ hour} \\ &= 0.0339 \text{ hour}\end{aligned}$$

The savings in delay cost can be determined by applying an hourly value to the extra time needed to traverse the detour and assuming a monetary hourly value of \$19.68 and \$23.57 an hour for autos and trucks, respectively<sup>4</sup>:

### Baseline Case

$$\begin{aligned}\text{Delay (Auto)} &= 7,300 \text{ (AADT)} * 0.94 \text{ (percent autos)} * 0.0339 \text{ (hr/veh)} * \$19.68 \text{ (per hr)} * 183 \text{ (days)} \\ &= \$837,773\end{aligned}$$

$$\begin{aligned}\text{Delay (Truck)} &= 7,300 \text{ (AADT)} * 0.06 \text{ (percent trucks)} * 0.0339 \text{ (hr/veh)} * \$23.57 \text{ (per hr)} * 183 \text{ (days)} \\ &= \$64,045\end{aligned}$$

$$\begin{aligned}\text{Delay (Total)} &= \$837,773 + \$64,045 \\ &= \mathbf{\$901,818}\end{aligned}$$

### As-Built Case

$$\begin{aligned}\text{Delay (Auto)} &= 7,300 \text{ (AADT)} * 0.94 \text{ (percent autos)} * 0.0339 \text{ (hr/veh)} * \$19.68 \text{ (per hr)} * 33 \text{ (days)} \\ &= \$151,074\end{aligned}$$

$$\begin{aligned}\text{Delay (Truck)} &= 7,300 \text{ (AADT)} * 0.06 \text{ (percent trucks)} * 0.0339 \text{ (hr/veh)} * \$23.57 \text{ (per hr)} * 33 \text{ (days)} \\ &= \$11,549\end{aligned}$$

$$\begin{aligned}\text{Delay (Total)} &= \$151,074 + \$11,549 \\ &= \mathbf{\$162,623}\end{aligned}$$

The total saving in delay costs between baseline and as-built scenarios is as follows:

$$\begin{aligned}\text{Delay Differential} &= \mathbf{\$901,818}_{\text{Baseline}} - \mathbf{\$162,623}_{\text{As-built}} \\ &= \mathbf{\$739,195}\end{aligned}$$

---

<sup>4</sup> Mallela and Sadasivam, Work Zone Road User Costs and Applications, Report No. FHWA-HOP-12-005, Federal Highway Administration, 2011. Per hour travel delay cost for autos was adjusted for Rhode Island's 2011 median annual household income of \$49,033.

## COST SUMMARY

From a construction cost standpoint, the innovative ABC delivery approach cost RIDOT about \$43,000 less than traditional construction. However, with \$90,000 in incentive for early completion, the construction cost for the ABC delivery approach ended up costing **\$47,000** more.

User costs, however, were substantially lower for the ABC delivery approach. Compared to the conventional (baseline) approach, VOC costs were \$765,186 lower and delay costs were also lower by \$739,195 (see Table 2).

In summary, in terms of total costs, the conventional (baseline) approach would have cost **3,823,409** or about **62 percent** more than the cost of **\$2,366,028** for the innovative ABC delivery method implemented on this project.

This project saved users **\$1,457,381** or about **38 percent** of the total project costs for conventional construction.

Table 2. Comparison of project costs.

<b>Item</b>	<b>Innovative Method</b>	<b>Conventional Method</b>	<b>Difference</b>
Construction Cost	\$1,945,064	\$1,988,064	\$ 43,000
Vehicle Operating Cost (VOC)	\$ 168,341	\$ 933,527	\$ 765,186
Delay Cost	\$ 162,623	\$ 901,818	\$ 739,195
Incentive	\$ 90,000	0	\$ (90,000)
<b>Total</b>	<b>\$2,366,028</b>	<b>\$3,823,409</b>	<b>\$1,457,381</b>

## **APPENDIX: SHOP DRAWINGS**

NOTES  
GENERAL NOTES:

DESIGN DATA

BRIDGE HEIGHTS: K. AL  
 HIGHS: INH. F. A. E. S. J. U. A. • U. Y. I. O. O. S. & F. O. W. W. I. E  
 W. H. G. W. O. R. S. E. N. I. T. M. F. I. S. U. G. • I. N. H. O. F. O. S. L. F. O. I. A. A. I. K  
 I. S. O. N. F. L. H. E. I. G. H. T. F. O. M. N. : 3.4 MAX  
 F. I. O. N. I. O. F. O. F. C. R. O. M. I. T. O. T. O. I. O. -  
 C. X. - "G. N. M. F. I. - F. O. L. C. H. A. P. I. S. I. N. G. / I. T. C. T. O. A. K. J. I. I. O  
 := W • I b i D ' N < a

FOUNDATION EXCAVATION AND SUBGRADE PREPARATION SHALL BE  
 IN ACCORDANCE WITH THE GEOTECHNICAL REPORT FOR THIS PROJECT  
 PREPARED BY GZA GEOTECHNICAL, INC. DATED: 02/12/12  
 CONTRACTOR NOT RESPONSIBLE FOR CONFIRMATION OF SOIL CONDITIONS  
 INCLUDING SOIL ANALYSIS.

MATERIALS

F. I. H. C. M. I. N. T. S. & W. I. I. I. C. O. N. S. I. R. U. C. H. D. / C. I. N. S. T. A. U. M  
 A. C. C. O. N. W. E. T. W. C. I. O. N. I. A. T. I. O. N. S. .  
 F. O. N. E. T. F. O. F. O. T. A. N. Y. C. . . . . .  
 S. T. A. S. G. I. H. O. I. 1. 0. 0. F. I. S. I. T. I. F. O. R  
 F. C. M. I. D. S. S. H. I. U. O. I. C. I. I. W. X. G. A. I. W. N. I. O. I. F. I. I. I  
 F. H. P. I. W. . . . . . C. Q. C. - O. - R.  
 C. C. I. N. C. I. V. ( 1. 0. I. E. I. I. X. I. N. D. I. S. I. U. C. H. & I. N. : I. U. I. ) N. O. I.  
 F. C. T. J. A. T. . . . . . U. . . . . O. H. I. A. R. A. J. E. O. F. I.  
 C. I. W. I. C. Y. M. D. I. N. W. I. I. 4. C. F. D. I. G. O. F. T. M. ( I. Q. I. ) C  
 I. A. I. C. I. N. 0. 9. P. E. I. - I. C. A. I. O. H. S.

THE ENGINEER HAS REVIEWED THE DESIGN AND FOUND IT TO BE IN ACCORDANCE WITH THE SPECIFICATIONS AND STANDARDS OF THE PROFESSION. THE ENGINEER'S REVIEW IS LIMITED TO THE DESIGN AND DOES NOT CONSTITUTE A GUARANTEE OF THE ACCURACY OF THE INFORMATION PROVIDED OR THE ADEQUACY OF THE DESIGN FOR THE INTENDED USE. THE CONTRACTOR SHALL BE RESPONSIBLE FOR THE CONSTRUCTION OF THE PROJECT IN ACCORDANCE WITH THE DESIGN AND SPECIFICATIONS.

REPLACEMENT OF  
 FRENCHTOWN BROOK BRIDGE NO. 435  
 RI CONTRACT NO 2011-CB-077, F.A. NO BR0-0435(001)  
 EAST GREENWICH, RHODE ISLAND

*Vertical Substation*

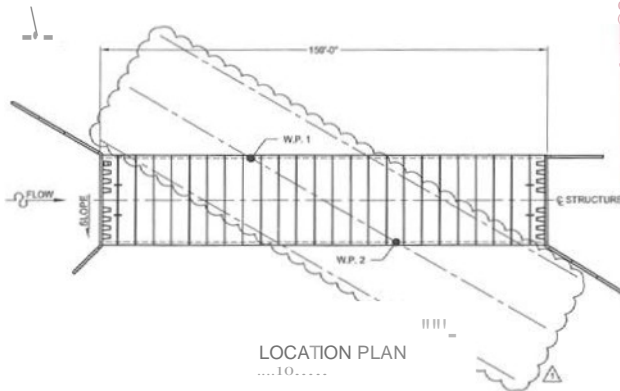

APPROVED  REVISE & RESUBMIT  
 APPROVED AS CORRECTED  NOT APPROVED

**NOTE FOR CONTRACTOR - IMPORTANT**

ALL INFORMATION CONTAINED HEREIN IS THE PROPERTY OF GORDON R. ARCHIBALD, INC. AND IS TO BE USED ONLY FOR THE PROJECT AND SITE SPECIFICALLY IDENTIFIED HEREIN. ANY REUSE OR MODIFICATION OF THIS INFORMATION WITHOUT THE WRITTEN CONSENT OF GORDON R. ARCHIBALD, INC. IS STRICTLY PROHIBITED.

GORDON R. ARCHIBALD, INC.  
 CIVIL & ENVIRONMENTAL ENGINEERS  
 PLYMOUTH, R.I.

BY: *John J. Archibald* DATE: *5/7/12*

MICHAEL G. CARIAGNO

No. 8105

REGISTERED PROFESSIONAL ENGINEER  
 CIVIL

*Michael G. Cariagno*  
 5-4-12

RI CONTRACT NO 2011-CB-077, F.A. NO BRQ-0435(001)

PROJECT NO.	351166	DWG NO.	001	DATE	1/17/2012
DESIGNED BY	JCR	DRAWN BY	KKB		
CHECKED BY	RKL	APPROVED BY	MGC		
SHEET NO.	CT1 of CT9				



-r

2S-24.0" SP... RSSE... LONG  
PRECAST CONCRETE BRIDGE UNITS  
US 24 JOINTS PER JOINT

f

4"0 PERFORATED BACKFLI DRAIN  
SUPPLIED WITH WINGWALL  
(4"0 SCHEDULE 40 PIPE)  
SEE PERFORATED DOWN  
DETAIL ON SHEET T & &

BRIDGE PL...

O

TOP OF PRECAST  
BRIDGE UNIT

1/4" SQUARE PECE OF  
CONCS-212

MICHAEL CARFAGNO

No.

&

LIFTING INSERT

PRECAST BRIDGE UNIT,  
HEADWALL OR WINGWALL

LIFTING INSERTS

TYPICAL LIFT POINT SEALING DETAIL

NOT TO SCALE



51412012 NOCHNIGESTOTHISHEET



SPAN



51312012 REUSE OPER HGAERREVIEW

CONSTRUCTION PRODUCT

BRIDGESYSTEMS

CMCCO.RD. I wac

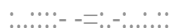

fmSC...Pdttte...w.io...OH...DI

[ coS

cr ]

REPLACEMENT OF  
FRENCHTOWN BROOK BRIDGE NO. 435  
RI CONTRACT NO 2011-CB-077, F.A. NO BR0-0435(001)  
EAST GREENWICH, RHODE ISLAND



*W. H. H. H.*  
*5-4-12*

PROJECT No.	351166	SER. No.	001	DATE	1/17/2012
DESIGNED	JDR	DRAWN	KKB	APPROVED:	

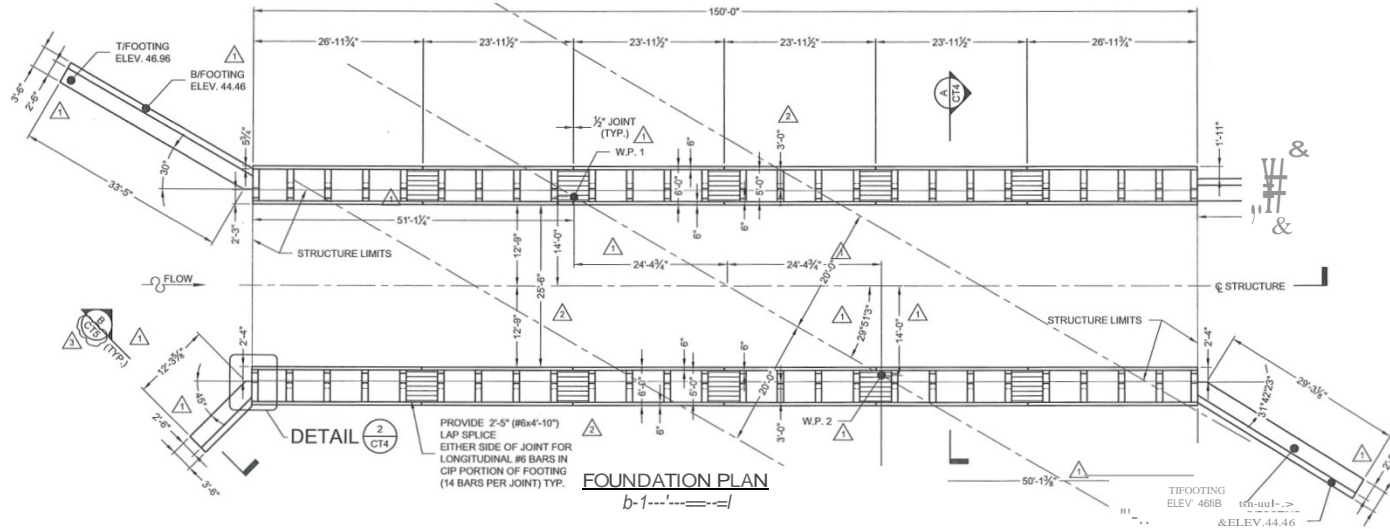

FOUNDATION PLAN  
b-1

MICHAEL O. CARFAGNO  
No. 8105  
REGISTERED PROFESSIONAL ENGINEER CIVIL

REVISIONS  
1. REVISED PER HONORABLE  
2. REVISED PER HONORABLE

CONSTRUCTION PRODUCTS INC.  
BRIOCO SYSTEMS

REPLACEMENT OF  
FRENCHTOWN BROOK BRIDGE NO. 435  
EAST GREENWICH, RHODE ISLAND

351166	001	1/17/2012
DESIGNED: JDR	DRAWN: KKB	
APPROVED:		

CT3 w CT9

CONTRACT NO 2011-CB-077.F.A. NO BR0-0435(001)

MGC

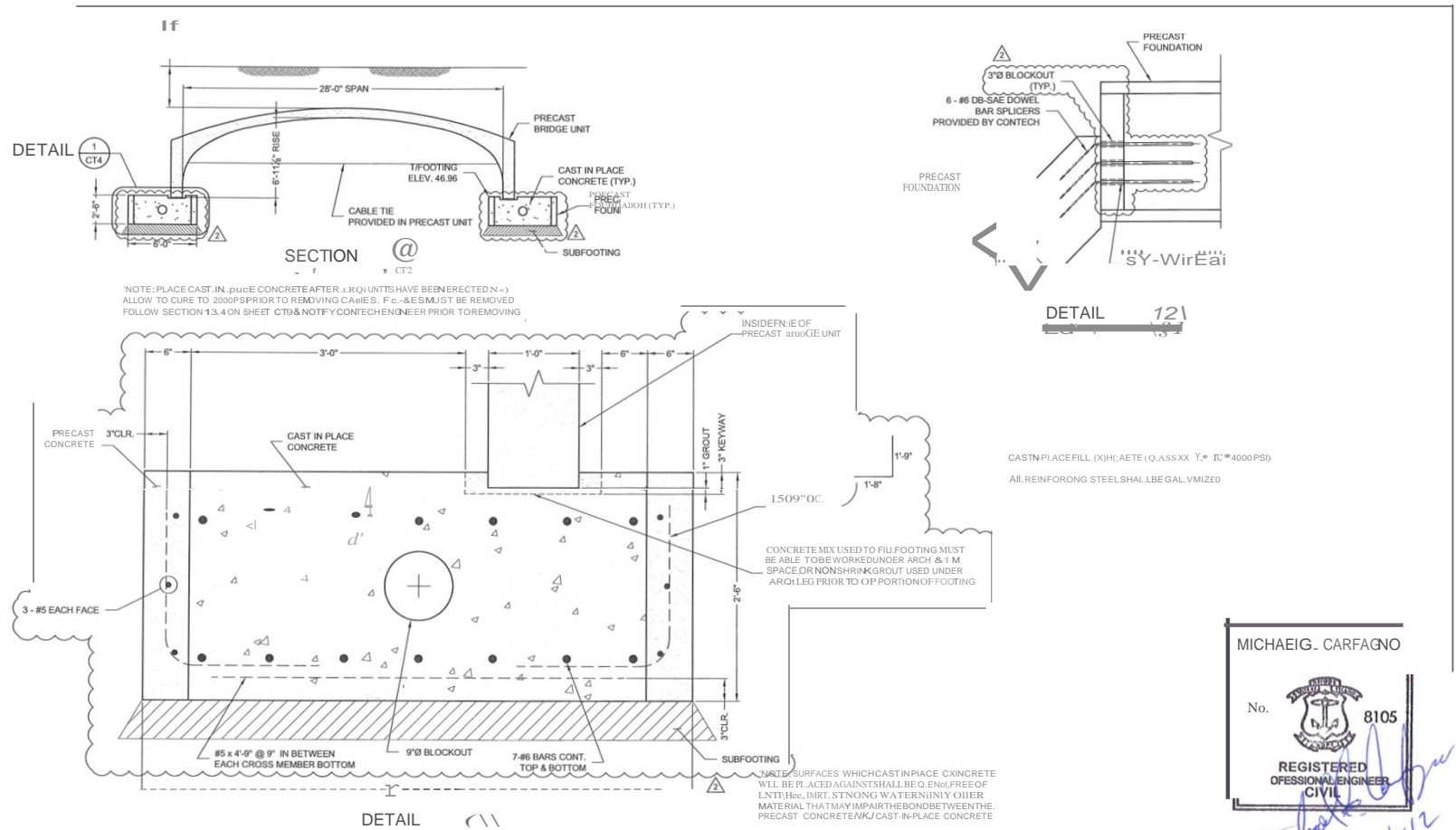

NOTE: PLACE CAST-IN-PLACE CONCRETE AFTER ALL PRECAST UNITS HAVE BEEN ERECTED AND ALLOW TO CURE TO 2000 PSI PRIOR TO REMOVING CABLES. F.C. & E.S. MUST BE REMOVED FOLLOW SECTION 13.4 ON SHEET CT9 & NOTIFY CONTRACTOR PRIOR TO REMOVING.

CAST-IN-PLACE FILL (X) SHALL BE TYPE III 4000 PSI ALL REINFORCING STEEL SHALL BE GALVANIZED

CONCRETE MIX USED TO FILL FOOTING MUST BE ABLE TO BE WORKED UNDER ARCH & 1 M SPACE OR NON-SHRINK GROUT USED UNDER ARCH LEG PRIOR TO TOP PORTION OF FOOTING

NOTE: SURFACES WHICH CAST-IN-PLACE CONCRETE WILL BE PLACED AGAINST SHALL BE CLEAN, FREE OF LINT, OIL, GREASE, WATER, AND OTHER MATERIAL THAT MAY IMPAIR THE BOND BETWEEN THE PRECAST CONCRETE AND CAST-IN-PLACE CONCRETE

MICHAEL G. CARFAGNO

No. 8105

REGISTERED PROFESSIONAL ENGINEER CIVIL

*Michael G. Carfagno*  
5-4-12

REVISION		PROJECT NO. 351166		SEQ. NO. 001		DATE 1/17/2012	
DESIGNED JDR		DRAWN KKB		APPROVED MGC			

BRIDGE SYSTEMS FRENCHTOWN BROOK BRIDGE NO. 435 BR0-0435(001)

CONSTRUCTION PRODUCTS INC. 100-338-1122 511-445-7000 517-903-FAA

REVISION

CT4 CT9

CONTRACT NO 2011-CB-077, FA NO EAST GREENWICH, RHODE ISLAND



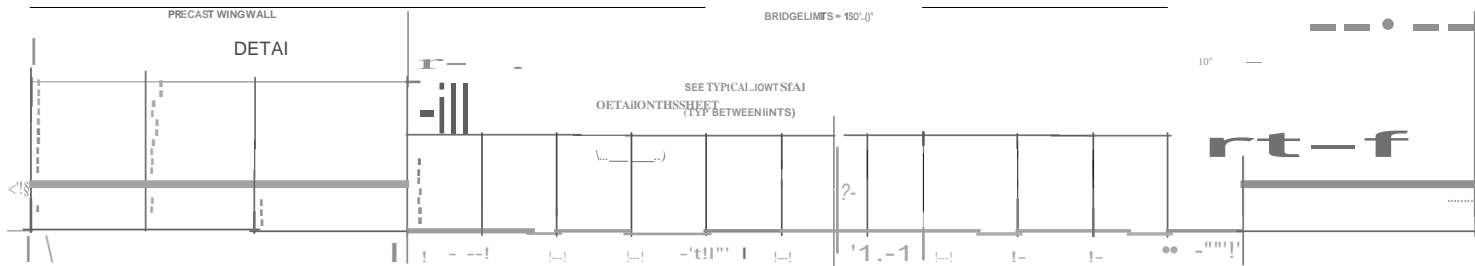

ELEVATION @

SECTION (TYP) 1

SECTION (TYP) 1

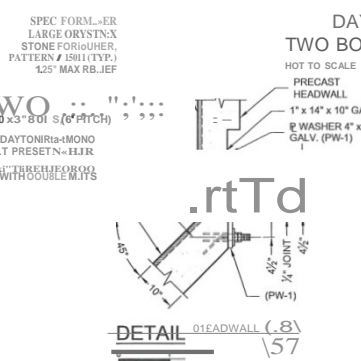
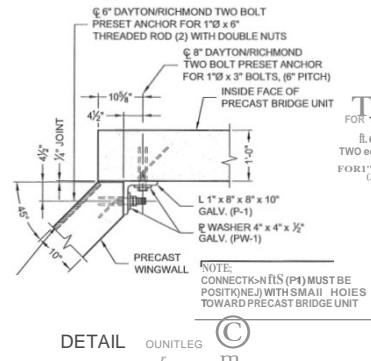
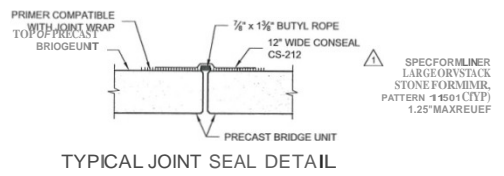
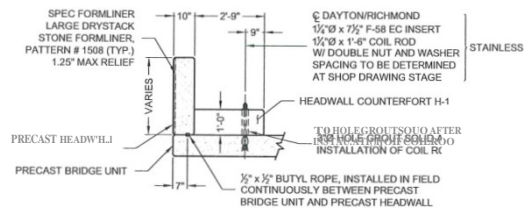

REVISION

CONSPAN

REPLACEMENT OF FRENCHTOWN BROOK BRIDGE NO. 435

RI CONTRACT NO 2011-CB-077, FA NO BR0-0435(001)

PROJECT NO. 351166	DESIGNED: JDR	DATE: 3/17/2012
SECT. NO. 001	DRAWN: KKB	
	APPROVED: MGC	

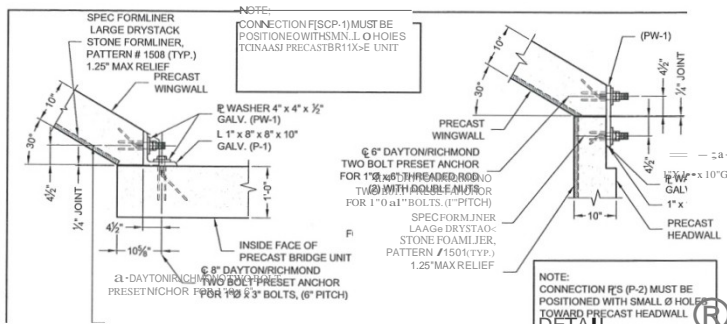

DETAIL CT2

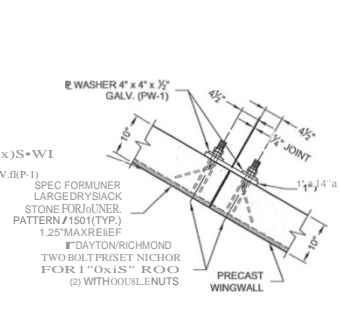

DETAIL CT2

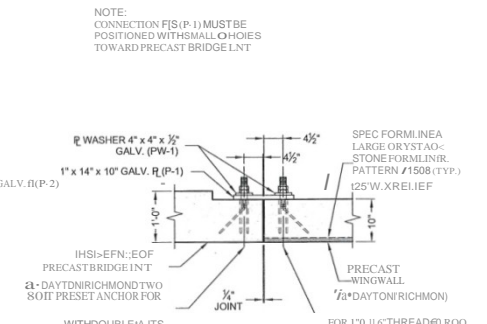

DETAIL CT2

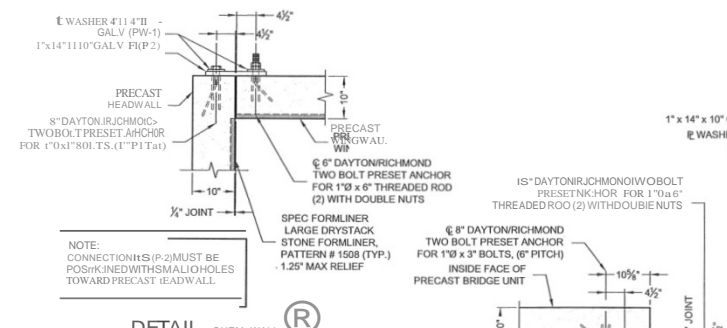

DETAIL CT2

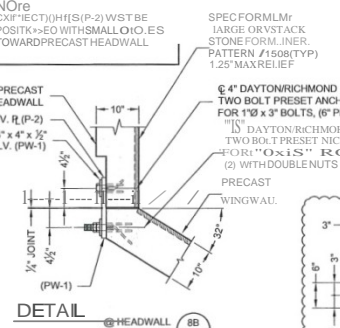

DETAIL CT2

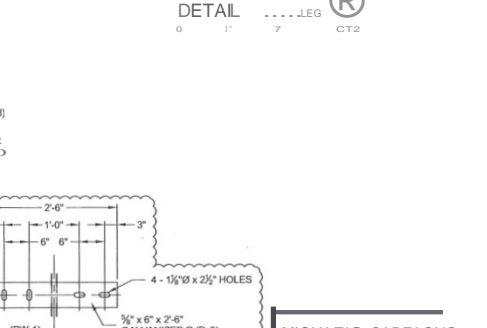

DETAIL CT2



DETAIL CT2



DETAIL CT2

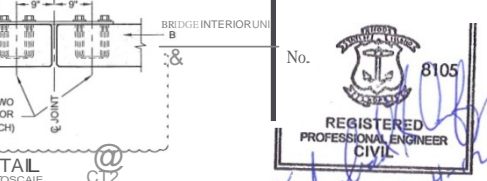

DETAIL CT2

MICHAEL G. CARFAGNO  
 No. 8105  
 REGISTERED PROFESSIONAL ENGINEER CIVIL



SPECIFICATIONS FOR MANUFACTURE AND INSTALLATION OF CON/SPAN® BRIDGE SYSTEMS (CONT'D)

12. INSTALLATION PREPARATION  
 TO ENSURE CORRECT INSTALLATION OF THE PRECAST CONCRETE BRIDGE SYSTEM, CARE AND CAUTION MUST BE EXERCISED IN FORMING THE SUPPORT AREAS FOR BRIDGE UNITS, HEADWALLS AND WINGWALL ELEMENTS. EMERGING SPECIAL CARE WILL FACILITATE THE RAPID INSTALLATION OF THE PRECAST COMPONENTS.

12.1. FOOTINGS  
 DO NOT OVER EXCAVATE FOUNDATIONS UNLESS DIRECTED BY SITE SOIL ENGINEER TO REMOVE UNSUITABLE SOIL.

12.2. HEADWALLS AND WINGWALLS  
 THE CONSTRUCTION OF HEADWALLS AND WINGWALLS SHALL BE IN ACCORDANCE WITH THE CONTRACT DOCUMENTS AND AS EXPLAINED IN THE PUBLICATION CONSPAN BRIDGE SYSTEMS INSTALLATION HANDBOOK.

12.3. LIFTING  
 LIFTING - IT IS THE RESPONSIBILITY OF THE CONTRACTOR TO ENSURE THAT THE BRIDGE UNITS ARE LIFTED IN A MANNER THAT WILL NOT DAMAGE THE UNITS OR THE SUPPORTS.

13. INSTALLATION  
 13.1. GENERAL - THE INSTALLATION OF THE PRECAST CONCRETE ELEMENTS SHALL CONFORM TO THE CONTRACT DOCUMENTS AND AS EXPLAINED IN THE PUBLICATION CONSPAN BRIDGE SYSTEMS INSTALLATION HANDBOOK.

13.1.1. LIFTING - IT IS THE RESPONSIBILITY OF THE CONTRACTOR TO ENSURE THAT THE BRIDGE UNITS ARE LIFTED IN A MANNER THAT WILL NOT DAMAGE THE UNITS OR THE SUPPORTS.

13.1.2. CONSTRUCTION EQUIPMENT WEIGHT RESTRICTIONS - IN NO CASE SHALL EQUIPMENT OPERATING IN EXCESS OF THE DESIGN LOAD BE PERMITTED OVER THE BRIDGE UNITS UNLESS APPROVED BY THE CONTRACTOR.

13.1.3. LEVELING PADDINGS - THE BRIDGE UNITS AND WINGWALLS SHALL BE SET ON MASONRY OR STEEL SHIMS MEASURING 3" x 3" MINIMUM UNLESS SHOWN OTHERWISE ON THE PLANS.

13.2. BACKFILL REQUIREMENTS  
 13.2.1. BACKFILL SHALL CONFORM TO THE CONTRACT DOCUMENTS AND THE NOTES HEREIN.

13.2.2. BACKFILL SHALL BE PLACED AGAINST ANY STRUCTURAL ELEMENTS UNTIL THEY HAVE BEEN APPROVED BY THE ENGINEER.

13.2.3. BACKFILL SHALL BE CONSIDERED AS ALL REPLACED EXCAVATION AND NEW EMBANKMENT ADJACENT TO THE PRECAST CONCRETE ELEMENTS.

13.2.4. BACKFILL ZONES  
 ZONE A - CONSTRUCTED EMBANKMENT OR OVERFILL  
 ZONE B - FILL THAT IS DIRECTLY VIBRATED WITH PRECAST CONCRETE BRIDGE INSTALLATION

13.2.5. REQUIRED BACKFILL PROPERTIES  
 13.2.5.1. IN-SITU SOIL - NATURAL GROUND IS TO BE SUFFICIENTLY STABLE TO ALLOW EFFECTIVE SUPPORT TO THE PRECAST CONCRETE BRIDGE UNITS.

13.2.5.2. ZONE A - ZONE A REQUIRES FILL MATERIAL WITH SPECIFICATIONS AND COMPACTING PROCEDURES EQUAL TO THAT FOR NORMAL ROADWAY CONSTRUCTION.

13.2.5.3. ZONE B - PERVIOUS FILL PER CONTRACT DOCUMENTS.

13.2.5.4. ZONE C - ZONE C REQUIRES FILL PER CONTRACT DOCUMENTS.

13.2.5.5. ZONE D - ZONE D REQUIRES FILL PER CONTRACT DOCUMENTS.

IN ADDITION, IF THE CABLE TIE/SITE RODS MUST BE REMOVED PRIOR TO SETTING ARCH UNITS, THE FOLLOWING QUALITY CONTROL PROCEDURES MUST BE FOLLOWED:

- (1) FIND "MEASURED SPAN" UPON ARCH UNITS DELIVERY TO SITE. PRIOR TO LIFTING FROM TRUCK AND REMOVING CABLE TIE/SITE RODS, "MEASURED SPAN" SHALL BE THE AVERAGE OF (A) SPAN MEASUREMENTS ALONG THE LAY LENGTH OF THE ARCH UNIT.

(2) IN-TOTAL, ONE (1) SET OF MIDLINE MEASUREMENTS SHALL BE TAKEN AT THE MIDLINE OF THE ARCH UNIT.

(3) THE MEASUREMENTS SHALL BE TAKEN AT THE MIDLINE OF THE ARCH UNIT.

(4) THE MEASUREMENTS SHALL BE TAKEN AT THE MIDLINE OF THE ARCH UNIT.

(5) THE MEASUREMENTS SHALL BE TAKEN AT THE MIDLINE OF THE ARCH UNIT.

(6) THE MEASUREMENTS SHALL BE TAKEN AT THE MIDLINE OF THE ARCH UNIT.

(7) THE MEASUREMENTS SHALL BE TAKEN AT THE MIDLINE OF THE ARCH UNIT.

(8) THE MEASUREMENTS SHALL BE TAKEN AT THE MIDLINE OF THE ARCH UNIT.

(9) THE MEASUREMENTS SHALL BE TAKEN AT THE MIDLINE OF THE ARCH UNIT.

(10) THE MEASUREMENTS SHALL BE TAKEN AT THE MIDLINE OF THE ARCH UNIT.

(11) THE MEASUREMENTS SHALL BE TAKEN AT THE MIDLINE OF THE ARCH UNIT.

(12) THE MEASUREMENTS SHALL BE TAKEN AT THE MIDLINE OF THE ARCH UNIT.

(13) THE MEASUREMENTS SHALL BE TAKEN AT THE MIDLINE OF THE ARCH UNIT.

(14) THE MEASUREMENTS SHALL BE TAKEN AT THE MIDLINE OF THE ARCH UNIT.

(15) THE MEASUREMENTS SHALL BE TAKEN AT THE MIDLINE OF THE ARCH UNIT.

(16) THE MEASUREMENTS SHALL BE TAKEN AT THE MIDLINE OF THE ARCH UNIT.

(17) THE MEASUREMENTS SHALL BE TAKEN AT THE MIDLINE OF THE ARCH UNIT.

(18) THE MEASUREMENTS SHALL BE TAKEN AT THE MIDLINE OF THE ARCH UNIT.

(19) THE MEASUREMENTS SHALL BE TAKEN AT THE MIDLINE OF THE ARCH UNIT.

(20) THE MEASUREMENTS SHALL BE TAKEN AT THE MIDLINE OF THE ARCH UNIT.

14.0. QUALITY CONTROL  
 THE CONTRACTOR SHALL BE RESPONSIBLE FOR THE QUALITY CONTROL OF THE PRECAST CONCRETE ELEMENTS.

14.1. TESTING  
 TESTING SHALL BE PERFORMED IN ACCORDANCE WITH THE CONTRACT DOCUMENTS.

14.2. RECORDS  
 RECORDS SHALL BE MAINTAINED THROUGHOUT THE CONSTRUCTION PROCESS.

14.3. INSPECTION  
 INSPECTION SHALL BE CONDUCTED AT THE MIDLINE OF THE ARCH UNIT.

14.4. ACCEPTANCE  
 ACCEPTANCE SHALL BE OBTAINED FROM THE ENGINEER BEFORE PROCEEDING.

14.5. DEFECTS  
 DEFECTS SHALL BE REPAIRED IMMEDIATELY UPON DISCOVERY.

14.6. PROTECTION  
 PROTECTION SHALL BE PROVIDED FOR ALL EXPOSED SURFACES.

14.7. CLEANUP  
 CLEANUP SHALL BE COMPLETED AT THE END OF EACH WORKING DAY.

14.8. SAFETY  
 SAFETY SHALL BE MAINTAINED AT ALL TIMES DURING CONSTRUCTION.

14.9. ENVIRONMENT  
 ENVIRONMENTAL CONCERNS SHALL BE ADDRESSED AS THEY ARISE.

14.10. COMMUNITY  
 COMMUNITY CONCERNS SHALL BE ADDRESSED AS THEY ARISE.

14.11. DOCUMENTATION  
 DOCUMENTATION SHALL BE MAINTAINED THROUGHOUT THE PROJECT.

14.12. TRAINING  
 TRAINING SHALL BE PROVIDED FOR ALL WORKERS.

14.13. SUBMITTALS  
 SUBMITTALS SHALL BE PROVIDED AS REQUIRED BY THE CONTRACT DOCUMENTS.

14.14. PROTECTION OF EXISTING UTILITIES  
 PROTECTION OF EXISTING UTILITIES SHALL BE MAINTAINED AT ALL TIMES.

14.15. PROTECTION OF ADJACENT PROPERTIES  
 PROTECTION OF ADJACENT PROPERTIES SHALL BE MAINTAINED AT ALL TIMES.

14.16. PROTECTION OF PUBLIC ACCESS  
 PROTECTION OF PUBLIC ACCESS SHALL BE MAINTAINED AT ALL TIMES.

14.17. PROTECTION OF TRAFFIC  
 PROTECTION OF TRAFFIC SHALL BE MAINTAINED AT ALL TIMES.

14.18. PROTECTION OF ENVIRONMENTAL FEATURES  
 PROTECTION OF ENVIRONMENTAL FEATURES SHALL BE MAINTAINED AT ALL TIMES.

14.19. PROTECTION OF HISTORIC RESOURCES  
 PROTECTION OF HISTORIC RESOURCES SHALL BE MAINTAINED AT ALL TIMES.

14.20. PROTECTION OF CULTURAL RESOURCES  
 PROTECTION OF CULTURAL RESOURCES SHALL BE MAINTAINED AT ALL TIMES.

14.21. PROTECTION OF SCIENTIFIC RESOURCES  
 PROTECTION OF SCIENTIFIC RESOURCES SHALL BE MAINTAINED AT ALL TIMES.

14.22. PROTECTION OF EDUCATIONAL RESOURCES  
 PROTECTION OF EDUCATIONAL RESOURCES SHALL BE MAINTAINED AT ALL TIMES.

14.23. PROTECTION OF RECREATIONAL RESOURCES  
 PROTECTION OF RECREATIONAL RESOURCES SHALL BE MAINTAINED AT ALL TIMES.

14.24. PROTECTION OF AESTHETIC RESOURCES  
 PROTECTION OF AESTHETIC RESOURCES SHALL BE MAINTAINED AT ALL TIMES.

14.25. PROTECTION OF OTHER RESOURCES  
 PROTECTION OF OTHER RESOURCES SHALL BE MAINTAINED AT ALL TIMES.

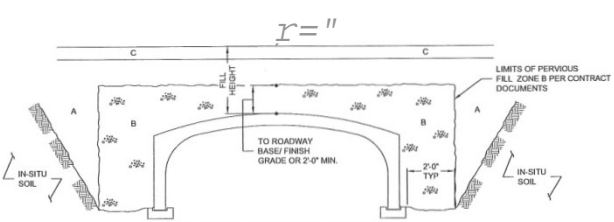

SPAN	FILL HEIGHT	ACCEPTABLE MATERIAL INSIDE ZONE B
≤ 24'-0"	≥ 12'-0"	A1, A3
≤ 24'-0"	< 12'-0"	A1, A2, A3, A4
≥ 24'-0"	ALL	A1, A3

BACKFILL REQUIREMENTS

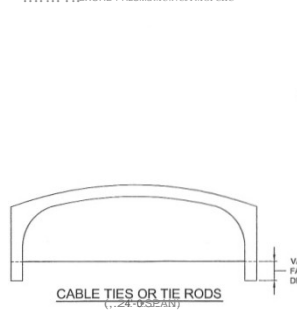

CABLE TIES OR TIE RODS  
 WALL BACKFILL REQUIREMENTS

REPLACEMENT OF FRENCHTOWN BROOK BRIDGE NO. 435

RI CONTRACT NO 2011-CB-077, F.A. NO BR0-0435(001)  
 EAST GREENWICH, RHODE ISLAND

MICHAEL G. CARFAGNO  
 No. 8105  
 REGISTERED PROFESSIONAL ENGINEER  
 CIVIL

*Michael G. Carfagno*  
 5-4-12

PROJECT No.	SEQ. No.	DATE
351196	001	1/17/2012

DESIGNED	DRAWN
JDR	KKB

APPROVED
RKL

41202012  
 REVISIONS

CONSTRUCTION PRODUCTS INC.

CONSTRUCTION PRODUCTS INC.

CONSTRUCTION PRODUCTS INC.

CONSTRUCTION PRODUCTS INC.

CONSTRUCTION PRODUCTS INC.

CONSTRUCTION PRODUCTS INC.

CONSTRUCTION PRODUCTS INC.

CONSTRUCTION PRODUCTS INC.

CONSTRUCTION PRODUCTS INC.

CONSTRUCTION PRODUCTS INC.

CONSTRUCTION PRODUCTS INC.

CONSTRUCTION PRODUCTS INC.

CONSTRUCTION PRODUCTS INC.

CONSTRUCTION PRODUCTS INC.

CONSTRUCTION PRODUCTS INC.

CONSTRUCTION PRODUCTS INC.

CONSTRUCTION PRODUCTS INC.

CONSTRUCTION PRODUCTS INC.

CONSTRUCTION PRODUCTS INC.

CONSTRUCTION PRODUCTS INC.

CONSTRUCTION PRODUCTS INC.

CONSTRUCTION PRODUCTS INC.

CONSTRUCTION PRODUCTS INC.

CONSTRUCTION PRODUCTS INC.

CONSTRUCTION PRODUCTS INC.

CONSTRUCTION PRODUCTS INC.

CONSTRUCTION PRODUCTS INC.

CONSTRUCTION PRODUCTS INC.

CONSTRUCTION PRODUCTS INC.

CONSTRUCTION PRODUCTS INC.

CONSTRUCTION PRODUCTS INC.

CONSTRUCTION PRODUCTS INC.

CONSTRUCTION PRODUCTS INC.

CONSTRUCTION PRODUCTS INC.

CONSTRUCTION PRODUCTS INC.

CONSTRUCTION PRODUCTS INC.

CONSTRUCTION PRODUCTS INC.

CONSTRUCTION PRODUCTS INC.

CONSTRUCTION PRODUCTS INC.

CONSTRUCTION PRODUCTS INC.

CONSTRUCTION PRODUCTS INC.

CONSTRUCTION PRODUCTS INC.

CONSTRUCTION PRODUCTS INC.

CONSTRUCTION PRODUCTS INC.

CONSTRUCTION PRODUCTS INC.

CONSTRUCTION PRODUCTS INC.

CONSTRUCTION PRODUCTS INC.