

# Iowa Demonstration Project: Accelerated Bridge Construction on US 6 over Keg Creek

Final Report  
June 2013

**HIGHWAYS FOR LIFE**

*Accelerating Innovation for the American Driving Experience.*



U.S. Department of Transportation  
**Federal Highway Administration**

## FOREWORD

The purpose of the Highways for LIFE (HfL) pilot program is to accelerate the use of innovations that improve highway safety and quality while reducing congestion caused by construction. **LIFE** is an acronym for **L**onger-lasting highway infrastructure using **I**nnovations to accomplish the **F**ast construction of **E**fficient and safe highways and bridges.

Specifically, HfL focuses on speeding up the widespread adoption of proven innovations in the highway community. Such “innovations” encompass technologies, materials, tools, equipment, procedures, specifications, methodologies, processes, and practices used to finance, design, or construct highways. HfL is based on the recognition that innovations are available that, if widely and rapidly implemented, would result in significant benefits to road users and highway agencies.

Although innovations themselves are important, HfL is as much about changing the highway community’s culture from one that considers innovation something that only adds to the workload, delays projects, raises costs, or increases risk to one that sees it as an opportunity to provide better highway transportation service. HfL is also an effort to change the way highway community decisionmakers and participants perceive their jobs and the service they provide.

The HfL pilot program, described in Safe, Accountable, Flexible, Efficient Transportation Equity Act: A Legacy for Users (SAFETEA-LU) Section 1502, includes funding for demonstration construction projects. By providing incentives for projects, HfL promotes improvements in safety, construction-related congestion, and quality that can be achieved through the use of performance goals and innovations. This report documents one such HfL demonstration project.

Additional information on the HfL program is at [www.fhwa.dot.gov/hfl](http://www.fhwa.dot.gov/hfl).

## NOTICE

This document is disseminated under the sponsorship of the U.S. Department of Transportation in the interest of information exchange. The U.S. Government assumes no liability for its contents or use thereof. This report does not constitute a standard, specification, or regulation.

The U.S. Government does not endorse products or manufacturers. Trade and manufacturers’ names appear in this report only because they are considered essential to the object of the document.

1. Report No.	2. Government Accession No	3. Recipient's Catalog No	
3. Title and Subtitle Iowa Demonstration Project: Accelerated Bridge Construction on US 6 over Keg Creek		5. Report Date June 2013	6. Performing Organization Code
		8. Performing Organization Report No.	
7. Authors Paul Littleton, P.E and Jagannath Mallela		10. Work Unit No. (TRAIS) C6B	
9. Performing Organization Name and Address Applied Research Associates, Inc. 100 Trade Centre Drive, Suite 200 Champaign, IL 61820		11. Contract or Grant No.	
12. Sponsoring Agency Name and Address Office of Infrastructure Federal Highway Administration 1200 New Jersey Avenue, SE Washington, DC 20590		13. Type of Report and Period Covered Final Report August 2011 –July 2012	
		14. Sponsoring Agency Code	
15. Supplementary Notes Contracting Officers Technical Representatives: Byron Lord, Mary Huie			
16. Abstract As part of a national initiative sponsored by the Federal Highway Administration (FHWA) under the Highways for LIFE program, the Iowa Department of Transportation (DOT) was awarded a \$400,000 grant to demonstrate the use of proven, innovative accelerated bridge construction (ABC) technologies to deliver this \$2.7 million project in less time than conventional construction. This project represents a cooperative effort among the FHWA, Iowa DOT, and the Strategic Highway Research Program (SHRP 2) project R04 research team to demonstrate the latest advances in ABC methods.  This report details the ABC innovations used to replace the US 6 bridge over Keg Creek featuring prefabricated superstructure and substructure systems, high- and ultra-high-performance concrete, self-consolidating concrete, and fully contained flooded backfill. The new bridge was completely prefabricated off-site and installed into place—a first in Iowa and in the United States. The ABC approach and innovations in this project increased safety, enhanced quality, and allowed the contractor to replace the bridge during a 16-day road closure instead of 6 months, as would have been required under traditional construction methods.  Using prefabricated bridge systems and innovative materials nearly doubled the initial bridge construction cost compared to traditional construction. However, a comprehensive economic analysis including user cost savings shows that the project saved road users about \$0.44 million (or about 29 percent less than conventional construction). The experience gained on this successful project will help the Iowa DOT implement these innovations more routinely on future projects.			
17. Key Words Highways for LIFE, prefabricated bridge systems, innovative construction, high-performance materials, UHPC, fully contained flooded backfill, self-consolidating concrete, economic analysis		18. Distribution Statement No restriction. This document is available to the public through the Highways for LIFE website: <a href="http://www.fhwa.dot.gov/hfl/">http://www.fhwa.dot.gov/hfl/</a>	
Security Classif.(of this report) Unclassified	19. Security Classif. (of this page) Unclassified	20. No. of Pages 55	21. Price

SI* (MODERN METRIC) CONVERSION FACTORS				
APPROXIMATE CONVERSIONS TO SI UNITS				
Symbol	When You Know	Multiply By	To Find	Symbol
<b>LENGTH</b>				
(none)	mil	25.4	micrometers	µm
in	inches	25.4	millimeters	mm
ft	feet	0.305	meters	m
yd	yards	0.914	meters	m
mi	miles	1.61	kilometers	km
<b>AREA</b>				
in <sup>2</sup>	square inches	645.2	square millimeters	mm <sup>2</sup>
ft <sup>2</sup>	square feet	0.093	square meters	m <sup>2</sup>
yd <sup>2</sup>	square yards	0.836	square meters	m <sup>2</sup>
ac	acres	0.405	hectares	ha
mi <sup>2</sup>	square miles	2.59	square kilometers	km <sup>2</sup>
<b>VOLUME</b>				
fl oz	fluid ounces	29.57	milliliters	mL
gal	gallons	3.785	liters	L
ft <sup>3</sup>	cubic feet	0.028	cubic meters	m <sup>3</sup>
yd <sup>3</sup>	cubic yards	0.765	cubic meters	m <sup>3</sup>
NOTE: volumes greater than 1000 L shall be shown in m <sup>3</sup>				
<b>MASS</b>				
oz	ounces	28.35	grams	g
lb	pounds	0.454	kilograms	kg
T	short tons (2000 lb)	0.907	megagrams (or "metric ton")	Mg (or "t")
<b>TEMPERATURE (exact degrees)</b>				
°F	Fahrenheit	5 (F-32)/9 or (F-32)/1.8	Celsius	°C
<b>ILLUMINATION</b>				
fc	foot-candles	10.76	lux	lx
fl	foot-Lamberts	3.426	candela per square meter	cd/m <sup>2</sup>
<b>FORCE and PRESSURE or STRESS</b>				
lbf	poundforce	4.45	Newtons	N
lbf/in <sup>2</sup> (psi)	poundforce per square inch	6.89	kiloPascals	kPa
k/in <sup>2</sup> (ksi)	kips per square inch	6.89	megaPascals	MPa
<b>DENSITY</b>				
lb/ft <sup>3</sup> (pcf)	pounds per cubic foot	16.02	kilograms per cubic meter	kg/m <sup>3</sup>
APPROXIMATE CONVERSIONS FROM SI UNITS				
Symbol	When You Know	Multiply By	To Find	Symbol
<b>LENGTH</b>				
µm	micrometers	0.039	mil	(none)
mm	millimeters	0.039	inches	in
m	meters	3.28	feet	ft
m	meters	1.09	yards	yd
km	kilometers	0.621	miles	mi
<b>AREA</b>				
mm <sup>2</sup>	square millimeters	0.0016	square inches	in <sup>2</sup>
m <sup>2</sup>	square meters	10.764	square feet	ft <sup>2</sup>
m <sup>2</sup>	square meters	1.195	square yards	yd <sup>2</sup>
ha	hectares	2.47	acres	ac
km <sup>2</sup>	square kilometers	0.386	square miles	mi <sup>2</sup>
<b>VOLUME</b>				
mL	milliliters	0.034	fluid ounces	fl oz
L	liters	0.264	gallons	gal
m <sup>3</sup>	cubic meters	35.314	cubic feet	ft <sup>3</sup>
m <sup>3</sup>	cubic meters	1.307	cubic yards	yd <sup>3</sup>
<b>MASS</b>				
g	grams	0.035	ounces	oz
kg	kilograms	2.202	pounds	lb
Mg (or "t")	megagrams (or "metric ton")	1.103	short tons (2000 lb)	T
<b>TEMPERATURE</b>				
°C	Celsius	1.8C+32	Fahrenheit	°F
<b>ILLUMINATION</b>				
lx	lux	0.0929	foot-candles	fc
cd/m <sup>2</sup>	candela per square meter	0.2919	foot-Lamberts	fl
<b>FORCE and PRESSURE or STRESS</b>				
N	Newtons	0.225	poundforce	lbf
kPa	kiloPascals	0.145	poundforce per square inch	lbf/in <sup>2</sup> (psi)
MPa	megaPascals	0.145	kips per square inch	k/in <sup>2</sup> (ksi)

\*SI is the symbol for the International System of Units. Appropriate rounding should be made to comply with Section 4 of ASTM E380. (Revised March 2003)

## **ACKNOWLEDGMENTS**

The project team would like to acknowledge the invaluable insights and guidance of Federal Highway Administration (FHWA) Highways for LIFE Team Leader, Byron Lord, and Program Coordinators Mary Huie and Kathleen Bergeron, as well as the Strategic Highway Research Program 2 Senior Program Officer, Dr. Monica Starnes, who served as the technical panel on this demonstration project. Their vast knowledge and experience with the various aspects of construction, technology deployment, and technology transfer helped immensely in developing both the approach and the technical matter for this document. The team also is indebted to Iowa Department of Transportation Engineers, Ahmad Abu-Hawash and Bruce Flippin, and FHWA Engineers Andrew Wilson and Benjamin Beerman for their assistance during this project. Thanks to Mike LaViolette of HNTB Corporation for sharing photographs and valuable insights into the lessons learned from the design and construction process.

## TABLE OF CONTENTS

<b>INTRODUCTION</b> .....	<b>1</b>
<b>HIGHWAYS FOR LIFE DEMONSTRATION PROJECTS</b> .....	<b>1</b>
<b>REPORT SCOPE AND ORGANIZATION</b> .....	<b>3</b>
<b>PROJECT OVERVIEW AND LESSONS LEARNED</b> .....	<b>4</b>
<b>PROJECT OVERVIEW</b> .....	<b>4</b>
<b>HfL PERFORMANCE GOALS</b> .....	<b>6</b>
<b>ECONOMIC ANALYSIS</b> .....	<b>8</b>
<b>LESSONS LEARNED</b> .....	<b>8</b>
<b>CONCLUSIONS</b> .....	<b>11</b>
<b>PROJECT DETAILS</b> .....	<b>12</b>
<b>BACKGROUND</b> .....	<b>12</b>
<b>PROJECT DESCRIPTION</b> .....	<b>13</b>
<b>DATA ACQUISITION AND ANALYSIS</b> .....	<b>29</b>
<b>SAFETY</b> .....	<b>29</b>
<b>CONSTRUCTION CONGESTION</b> .....	<b>29</b>
<b>QUALITY</b> .....	<b>32</b>
<b>USER SATISFACTION</b> .....	<b>35</b>
<b>TECHNOLOGY TRANSFER</b> .....	<b>37</b>
<b>ECONOMIC ANALYSIS</b> .....	<b>39</b>
<b>CONSTRUCTION TIME</b> .....	<b>39</b>
<b>CONSTRUCTION COSTS</b> .....	<b>39</b>
<b>USER COSTS</b> .....	<b>41</b>
<b>COST SUMMARY</b> .....	<b>42</b>
<b>APPENDIX</b> .....	<b>43</b>

## LIST OF FIGURES

Figure 1. Project location (source: Google maps) .....	13
Figure 2. Existing bridge.....	14
Figure 3. Newly reconstructed bridge.....	14
Figure 4. Temporary supports used for the bridge modules during fabrication. ....	15
Figure 5. View during the modular section pour. ....	15
Figure 6. Modular section plan and cross section.....	16
Figure 7. Cross section of a typical exterior module. ....	17
Figure 8. Lifting an exterior module into place. ....	17
Figure 9. Aerial view showing placement of bridge modules. ....	18
Figure 10. Drilled shafts next to existing bridge (left) and workers positioning rebar.....	19
Figure 11. Cap to column detail.....	19
Figure 12. Detail of the drilled shaft to column connection. ....	20
Figure 13. Suspended backwall detail. ....	21
Figure 14. Suspended backwall of an interior module (source: HNTB Corp.). ....	22
Figure 15. Workers spread granular backfill behind an abutment.....	23
Figure 16. Water is applied to consolidate the fully-contained flooded backfill.....	23
Figure 17. Approach slab cross section. ....	24
Figure 18. Pier joint reinforcement. ....	25
Figure 19. Workers place UHPC in a longitudinal joint.....	26
Figure 20. Post-tension retrofit design.....	27
Figure 21. Post-tension retrofit installation. ....	28
Figure 22. Map. Detour route with travel time nodes (source: Google Maps). ....	31
Figure 23. OBSI dual probe system and the SRTT. ....	33
Figure 24. Mean A-weighted SI frequency spectra before and after construction. ....	33
Figure 25. High-speed inertial profiler mounted behind the test vehicle. ....	34
Figure 26. Mean IRI values computed at 20-ft intervals before and after construction. ....	34
Figure 27. Sandra Larson gives opening remarks at the showcase.....	37
Figure 28. Showcase participants discuss UHPC. ....	38

## LIST OF TABLES

Table 1. Detour route travel times. ....	31
Table 2. Bid results. ....	39
Table 3. Capital cost calculation table. ....	40
Table 4. Crash history table. ....	43

## ABBREVIATIONS AND SYMBOLS

AADT	average annual daily traffic
AASHTO	American Association of State Highway and Transportation Officials
ABC	accelerated bridge construction
ADT	average daily traffic
dB(A)	A-weighted decibel
DOT	Department of Transportation
EDC	Every Day Counts
FHWA	Federal Highway Administration
HfL	Highways for LIFE
HPC	high performance concrete
HPS	high performance steel
IRI	International Roughness Index
ITS	intelligent transportation system
OBSI	onboard sound intensity
OSHA	Occupational Safety and Health Administration
PBES	prefabricated bridge elements and systems
PCC	portland cement concrete
SAFETEA-LU	Safe, Accountable, Flexible, Efficient Transportation Equity Act: A Legacy for Users
SAVER	Safety Analysis, Visualization, and Exploration Resource
SCC	self-consolidating concrete
SHRP 2	Strategic Highway Research Program
SI	sound intensity
SRTT	standard reference test tire
TRB	Transportation Research Board
UHPC	ultra high performance concrete
VOC	vehicle operating cost



# INTRODUCTION

## HIGHWAYS FOR LIFE DEMONSTRATION PROJECTS

The Highways for LIFE (HfL) pilot program, the Federal Highway Administration (FHWA) initiative to accelerate innovation in the highway community, provides incentive funding for demonstration construction projects. Through these projects, the HfL program promotes and documents improvements in safety, construction-related congestion, and quality that can be achieved by setting performance goals and adopting innovations.

The HfL program—described in the Safe, Accountable, Flexible, Efficient Transportation Equity Act: A Legacy for Users (SAFETEA-LU)—may provide incentives to a maximum of 15 demonstration projects a year. The funding amount may total up to 20 percent of the project cost, but not more than \$5 million. Also, the Federal share for an HfL project may be up to 100 percent, thus waiving the typical State-match portion. At the State's request, a combination of funding and waived match may be applied to a project.

To be considered for HfL funding, a project must involve constructing, reconstructing, or rehabilitating a route or connection on an eligible Federal-aid highway. It must use innovative technologies, manufacturing processes, financing, or contracting methods that improve safety, reduce construction congestion, and enhance quality and user satisfaction. To provide a target for each of these areas, HfL has established demonstration project performance goals.

The performance goals emphasize the needs of highway users and reinforce the importance of addressing safety, congestion, user satisfaction, and quality in every project. The goals define the desired result while encouraging innovative solutions, raising the bar in highway transportation service and safety. User-based performance goals also serve as a new business model for how highway agencies can manage the project delivery process.

HfL project promotion involves showing the highway community and the public how demonstration projects are designed and built and how they perform. Broadly promoting successes encourages more widespread application of performance goals and innovations in the future.

### **Project Solicitation, Evaluation, and Selection**

FHWA issued open solicitations for HfL project applications in fiscal years 2006, 2007, 2008, and 2009. State highway agencies submitted applications through FHWA Divisions. The HfL team reviewed each application for completeness and clarity, then contacted applicants to discuss technical issues and obtain commitments on project issues. Documentation of these questions and comments was sent to applicants, who responded in writing.

The project selection panel consisted of representatives of the FHWA offices of Infrastructure, Safety, and Operations; the Resource Center Construction and Project Management team; the Division offices; and the HfL team. After evaluating and rating the applications and

supplemental information, panel members convened to reach a consensus on the projects to recommend for approval. The panel gave priority to projects that accomplish the following:

- Address the HfL performance goals for safety, construction congestion, quality, and user satisfaction.
- Use innovative technologies, manufacturing processes, financing, contracting practices, and performance measures that demonstrate substantial improvements in safety, congestion, quality, and cost-effectiveness. An innovation must be one the applicant State has never or rarely used, even if it is standard practice in other States.
- Include innovations that will change administration of the State's highway program to more quickly build long-lasting, high-quality, cost-effective projects that improve safety and reduce congestion.
- Will be ready for construction within 1 year of approval of the project application. For the HfL program, FHWA considers a project ready for construction when the FHWA Division authorizes it.
- Demonstrate the willingness of the applicant department of transportation (DOT) to participate in technology transfer and information dissemination activities associated with the project.

### **HfL Project Performance Goals**

The HfL performance goals focus on the expressed needs and wants of highway users. They are set at a level that represents the best of what the highway community can do, not just the average of what has been done. States are encouraged to use all applicable goals on a project:

- **Safety**
  - Work zone safety during construction—Work zone crash rate equal to or less than the preconstruction rate at the project location.
  - Worker safety during construction—Incident rate for worker injuries of less than 4.0, based on incidents reported on Occupational Safety and Health Administration (OSHA) Form 300.
  - Facility safety after construction—Twenty percent reduction in fatalities and injuries in 3-year average crash rates, using preconstruction rates as the baseline.
- **Construction Congestion**
  - Faster construction—Fifty percent reduction in the time highway users are impacted, compared to traditional methods.
  - Trip time during construction—Less than 10 percent increase in trip time compared to the average preconstruction speed, using 100 percent sampling.
  - Queue length during construction—A moving queue length of less than 0.5 miles in a rural area or less than 1.5 miles in an urban area (in both cases at a travel speed 20 percent less than the posted speed).
- **Quality**
  - Smoothness—International Roughness Index (IRI) measurement of less than 48 in/mi.
  - Noise—Tire-pavement noise measurement of less than 96.0 A-weighted decibels (dB(A)), using the onboard sound intensity (OBSI) test method.

- User satisfaction—An assessment of how satisfied users are with the new facility compared to its previous condition and with the approach used to minimize disruption during construction. The goal is a measurement of 4 or more on a 7-point Likert scale.

## **REPORT SCOPE AND ORGANIZATION**

This report documents the Iowa DOT's HfL demonstration project featuring innovative bridge replacement of the US 6 bridge over Keg Creek. The report presents project details relevant to the HfL program, including bridge replacement and construction highlights, accelerated bridge construction (ABC) methods and materials, HfL performance metrics measurement, and economic analysis. The report also discusses the technology transfer activities that took place during the project and lessons learned.

# PROJECT OVERVIEW AND LESSONS LEARNED

## PROJECT OVERVIEW

The project consisted of replacing a bridge located on US 6 over Keg Creek in Pottawattamie County, Iowa, about 10 miles east of Council Bluffs. The new bridge was designed to increase the structural capacity of the bridge, improve roadway conditions, and enhance user safety by providing a wider bridge and approaching roadway.

The focus of this demonstration project is the innovation of combining several cutting edge ABC materials and methods together in a single bridge design and construction project that can help guide similar projects in the future. Featured in the project are prefabricated superstructure and substructure systems, ultra-high-performance concrete (UHPC), self-consolidating concrete (SCC), and fully contained flooded backfill.

The technologies incorporated into this bridge project have been used successfully in other constructed projects drawn from around the US, albeit on a limited basis, such as the HfL demonstration project in Washington, DC, featuring a prefabricated substructure and steel/concrete modular superstructure system.<sup>1</sup> The fact that several diverse structural systems have been assembled and incorporated into a single project reinforces the concept that innovation does not necessarily mean creating something completely new, but rather facilitating incremental improvements in a number of specific bridge details to fully leverage previously successful work.

Under traditional construction methods and considering the rural locale and relatively low amount of traffic, the Iowa DOT estimated the bridge would need to have been closed for a 6-month period to accommodate conventional cast-in-place construction.<sup>2</sup> Central to the ABC approach adopted on this project was condensing the bridge closure to only 16 days, which was enough time to facilitate both removal of the old bridge and construction of the new bridge. The positive benefits of such work zone management techniques have been demonstrated in other HfL projects such as Minnesota's TH 36 project.<sup>3</sup>

Construction prior to the full closure included drilling pier shafts outside the footprint of the existing bridge and casting footings. Meanwhile, the farmland around the bridge was used as a casting yard to precast the steel/concrete modular superstructure elements, piers, pier caps, abutments, wingwalls, and approach slabs. Both longitudinal and pier joints were filled with UHPC, and finally the whole deck was diamond ground prior to reopening to traffic.

---

<sup>1</sup> *Reconstruction of Eastern Avenue Bridge over Kenilworth Avenue on Washington, DC*, August 2011. Federal Highway Administration. [http://www.fhwa.dot.gov/hfl/summary/projects\\_summary.cfm](http://www.fhwa.dot.gov/hfl/summary/projects_summary.cfm)

<sup>2</sup> Price and Sivakumar, "Two-week notice," June 2011. *Roads & Bridges*.

<sup>3</sup> *Reconstruction of Trunk Highway 36 in North St. Paul*, June 2010. Federal Highway Administration [http://www.fhwa.dot.gov/hfl/summary/projects\\_summary.cfm](http://www.fhwa.dot.gov/hfl/summary/projects_summary.cfm)

The Iowa DOT partnered with the Transportation Research Board (TRB) Strategic Highway Research Program 2 (SHRP 2) project R04 (Innovative Designs for Rapid Renewal ) research team to further advance and implement the use of standardized approaches to ABC. The success of this project will validate the SHRP 2 effort and will pave the way for the introduction of standardized ABC design details and construction methods.

Videos of this project as well as discussion of the SHRP2 program can be found on the TRB website<sup>4</sup>. Three videos are available:

- “ABC for Everyday Bridges”–details how typical bridges can be quickly and cost effectively replaced using ABC techniques.
- “One Design–10,000 bridges”–discusses new ABC tools for designing and constructing bridges.
- “Time-Lapse Video of Keg Creek Bridge Replacement”–shows the bridge construction during the accelerated closure period.

A concrete drainage flume separate from the bridge, was also part of the overall contract but was outside of the HfL scope and is not addressed in this report. The standard reinforced concrete flume was designed to carry storm water from an adjacent ditch to Keg Creek.

In Iowa's previous HfL project, the DOT successfully applied the following ABC techniques to accelerate the reconstruction of a busy interchange in Council Bluffs<sup>5</sup>:

- Cost-plus-time bidding to reduce the time required to deliver the project.
- Full-depth, precast bridge deck panels made with self-consolidating, high-performance concrete (HPC) to ensure quality, increase speed of construction, and improve safety.
- HPC used throughout the bridge and high performance steel (HPS) welded plate girders to increase quality of the completed bridge.
- Incorporation of a structural health monitoring system to evaluate and document the performance of the in-service materials after project completion.
- Fully contained flooded granular backfill installed behind the abutments to mitigate settlement that inevitably occurs with conventionally compacted backfill.
- Intelligent transportation system (ITS) technology used to optimize traffic control during construction.

---

<sup>4</sup> <http://www.trb.org/StrategicHighwayResearchProgram2SHRP2/SHRP2Videos.aspx>

<sup>5</sup> *Improvements to the 24<sup>th</sup> Street Bridge–I29/80 Interchange in Council Bluffs*, November 2009. Federal Highway Administration. [http://www.fhwa.dot.gov/hfl/summary/projects\\_summary.cfm](http://www.fhwa.dot.gov/hfl/summary/projects_summary.cfm)

## HfL PERFORMANCE GOALS

Safety, construction congestion, quality, and user satisfaction data were collected before, during, and after construction to demonstrate that innovations can be an integral part of a project while simultaneously meeting the HfL performance goals in these areas.

- **Safety**
  - Work zone safety during construction—As expected, no incidents occurred during the entire construction period including the full closure period, which meets the HfL goal of achieving a work zone crash rate equal to or less than the preconstruction rate.
  - Worker safety during construction—No workers were injured on the project, so the contractor achieved a score of 0.0 on the OSHA Form 300, meeting the HfL goal of less than 4.0.
  - Facility safety after construction—The additional bridge width and updated side barriers and beam guards are improvements over the existing bridge. The net effect that these safety improvements are expected to have a positive impact on the HfL goal of 20 percent reduction in fatalities and injuries in 3-year crash rates after construction. However, due to the historically low crash rate at the site, the goal of a 20 percent reduction was not directly applicable for this project.
  
- **Construction Congestion**
  - Faster construction—Compressing the time it took to replace the bridge from an estimated 6 months to only 16 days under the ABC approach drastically reduced the impact to motorists and went beyond the HfL goal of a 50 percent reduction in the time traffic is impacted compared to traditional construction methods.
  - Trip time— Considering the cumulative trip time over the 16-day detour compared to 6 months of detour estimated for traditional construction, motorists experienced a reduction in trip time, meeting the HfL goal of no more than a 10 percent increase in trip time compared to the average preconstruction conditions.
  - Queue length during construction—The project met the HfL goal of less than a 0.5-mile queue length in a rural area, as there were no traffic backups along the detour route.
  
- **Quality**
  - Smoothness —Smoothness increased across the bridges. IRI decreased from 221 in/mi before construction to 179 in/mi after construction. Motorists will notice a smoother ride, although the HfL goal for IRI of 48 in/mi—typically expected to be attainable on long, open stretches of pavement—was not met on this project.
  - Noise—The sound intensity (SI) data showed a noticeable 3.2 dB(A) increase in noise from a preconstruction value of 98 dB(A) to 101.2 dB(A) after construction which does not meet the HfL requirement of 96.0 dB(A) or less. The new texture of the bridge surface—while aiding traction and increasing safety—is prone to increasing noise.
  - User satisfaction—Users of the new bridge understood the importance of completely closing the bridge to get the bridge replaced quickly and indicated overall satisfaction

with the project meeting the performance goal of 4 or more points on a 7-point Likert scale.

## **ECONOMIC ANALYSIS**

The costs and benefits of this innovative project approach were compared with those of a project of similar size and scope delivered using a more traditional approach. A comprehensive economic analysis that accounted for construction, road user, and safety costs revealed that Iowa DOT's innovative approach realized a cost savings of \$0.44 million, or 29 percent, less than conventional construction practices. A significant amount of the cost savings stemmed from avoiding the delay costs to the road users through the use of ABC techniques.

## **LESSONS LEARNED**

Through this project, the Iowa DOT gained valuable insights into the innovative techniques and materials—both those that were successful and those that need improvement in future project deliveries. The following are some of the lessons learned:

- **General Items Regarding ABC**
  - The condensed bridge closure duration was adequate for demolition and construction of a rural bridge of this size. There was enough time to completely remove the existing bridge and set the precast elements in place, and fill the deck joints with UHPC. The contractor worked long shifts from dawn to a few hours after dusk each day during the closure but did not need to work around the clock.
  - A major rain event could have made the bridge closure window problematic. Flooding of Keg Creek was the major concern, as the land around the bridge was mostly bare earth, easily turned to mud. A muddy job site would have made moving the heavy bridge modules and approach panels especially difficult.
  - Regarding risk, the construction tasks (i.e., moving the bridge elements, placing UHPC, installing the approach panels) were less of a risk compared to the possibility of heavy rain occurring once the bridge closure began.
  - Isometric drawings detailing how the superstructure connects to the abutment would have been helpful, as the joint proved to be complex and difficult to visualize in the field. Less steel reinforcing in the joint would have made erection easier. Overall, fit-up was not an issue but difficulties arose due to a survey error in the abutments.
  
- **Steel/Concrete Bridge Modules and Substructure Elements**
  - The contractor used more of a custom construction approach to building the modules in contrast to the earlier Iowa HfL project on the 24<sup>th</sup> Street Bridge project, which had many similar deck panels fabricated at a precast plant in a repetitive technique. Custom construction ensured each module fit with the others as one continuous superstructure.
  - On-site module construction allowed the contractor to build in a comfortable level of tolerances, such as a slightly thicker concrete deck to account for some loss of thickness after diamond grinding.
  - A precast plant likely would have difficulty handling the steel beams associated with the deck modules. A typical precast plant would have forms and equipment



readily available to make standard concrete panels and beams but not steel/concrete composite bridge modules.

- The sheer weight of the deck modules would have likely presented an obstacle for precast plant fabrication.
- The weight (in excess of 70 tons) and size of the individual deck modules would have made overland transport difficult and would have involved obtaining load permits.
- Multiple trucks would have been needed to ship and temporarily store the modules on site on the day(s) of placement.
- The bridge module construction approach was well suited for a spacious site with ample access to both ends of the bridge.
- Making the modules at a precast plant may be economical if multiple bridges were built under one or a group of contracts and if the bridges were similar.
- On-site construction made it possible for the contractor to build all the modules in the final configuration so the proper fit of the modules could be guaranteed.
- Cambering the beams would likely make connecting the steel beams easier. It was the designer's decision not to camber the beams since it did not affect the structural integrity and there were no vertical clearance issues.
- Use embedded lift points and eliminate the pockets. The deck pockets were patched after module installation but the patches could become a durability problem in time.

- **Contractor's Perspective**

- Most of the risk on this project was from predicting the weather during the short bridge closure and the possibility of damaging a module during handling.
- There also was risk associated with the new and unfamiliar type of construction.
- The contractor chose to cast the modules on site, as opposed to at their own yard, due in part to the difficulties and risk associated with transporting the heavy bridge elements.
- The contractor likely would have cast the sleeper slabs over the backfill instead of trying to bring the backfill to the perfect elevation for the precast sleeper slabs. On future projects, the DOT could leave this construction detail to the contractor to decide how best to set the approach slabs.
- ABC projects like this one should have two independent construction surveys as part of the contract specifications because mistakes can be costly if discovered during the ABC bridge closure period.

- **Cost**

- The cost of furnishing a thick stone haul road as part of the contract specifications should be considered on future projects. This should be done regardless of ABC project or not, and permits for the temporary haul road should be obtained ahead of time (which is typical of most projects to have as part of the contract plans). Unique to this project was that the stone for the haul road was reused as riprap for a drainage flume next to the bridge.

- To limit the risk (and associated cost) of weather impacting construction progress during the short closure period, the contract could be structured to limit disincentives to a maximum of 10 percent of the contract value or another manageable/predictable amount.
- The contract could allow for the closure period to be extended for extreme weather events without penalty, which would encourage competitive bidding.
- The incentives in the actual contract helped to offset some of the risk in the contractor's bid decision making process. The contractor was awarded \$22,000 for one day of incentive.

- **UHPC**

- UHPC is sensitive to temperature and wind. The ambient air temperature should be between about 32 and 73 degrees Fahrenheit for optimum placement and cure.
- Once mixed, UHPC is liquid and challenging to handle.
- Forms need to be water tight. Leakage at the abutment was a critical problem. Next time, the pour should be strategically bulkheaded, sealed, and tested with water before pouring UHPC.
- Casting the deck joints  $\frac{3}{4}$  inches high and then grinding to the designed height ensured the joints were never underfilled. The contractor secured  $\frac{3}{4}$ -inch wood boards along the joint to act as forms so the joint could be overfilled initially at one end of the joint in an effort to keep the joint from being underfilled as the UHPC flowed ahead of the pour.
- Grinding removed the exposed surface of the UHPC, which likely will increase durability because this removes the skin formed during curing and any of the material that would otherwise have been subject to surface shrinkage cracks.
- Bottom forming the deck joints was necessary. The contractor had no problem doing this.
- UHPC has the proven ability to penetrate the surface of cured concrete and create a strong bond. Research into texturing the joints by sandblasting or other chemical and mechanical means may further improve bonding of the UHPC to the deck concrete.
- Iowa DOT will monitor the finished joints in the bridge deck for leakage but is considering a thin asphalt overlay to seal the joints from rain and snow melt.
- Plan for bulkheads inside the joint when using UHPC. Even though the bulkheads could be considered a “means and method” it would be prudent to show the bulkheads in the contract plans to focus the contractor’s attention on the need to check the flow of the UHPC.
- For this ABC project, UHPC had constructability challenges but was a suitable solution to close the deck joints because UHPC is 1) very strong, rigid, and durable, 2) develops high strength very quickly, and 3) affords short embedment development strength for reinforcing steel.
- Considering future projects, “buy American” waivers may be needed to ensure prompt acquisition of the metal fibers for the UHPC. This is important, as some or all of the fibers or other UHPC constituents may come from outside the US. Acquiring the UHPC constituents could otherwise impact the construction schedule.

## **CONCLUSIONS**

The Iowa DOT gained valuable insights into the use of several innovative ABC techniques and materials, such as prefabricated superstructure and substructure systems, HPC and UHPC, SCC, and fully contained flooded backfill. These innovations were key to successfully achieving the HfL performance goals of increasing safety, reducing congestion, and increasing quality.

## PROJECT DETAILS

### BACKGROUND

The need to standardize ABC technology for use nationwide brought together the Iowa DOT and the SHRP 2 project R04 project team to collaborate on this HfL demonstration project. Efforts also involved industry leaders and researchers from the Iowa State University to help develop national ABC standards.

The Iowa DOT chose the Keg Creek site because the three-span bridge configuration is typical throughout Iowa and other States, making the lessons learned from this project valuable to as many designers as possible. Incorporating a combination of precast elements and innovative materials into the bridge design and reducing the 6-month closure to 16 days showcased the viability of the ABC concept.

This project represents the first time in Iowa that steel girder/concrete deck modules were jointed on site with UHPC. Durability of UHPC made it possible to join the deck panels and open the bridge to traffic without an overlay otherwise required to protect the joints made from standard materials. Eliminating the overlay saved time during the accelerated construction schedule and helped keep the closure to a minimum. Even though the bridge deck was fully functional after opening to traffic, the bridge may be overlaid with asphalt sometime in the future to protect the joints from water and deicing salts. An overlay would also hide the bridge deck's unusual appearance as a result of the many closure pours and lifting pocket pours.

The bid price for only the bridge portion of the project, excluding roadwork traffic control and drainage improvements, was \$2.3 million, which is essentially double the estimated cost of a similar three-span conventional bridge. The Iowa DOT received a \$400,000 HfL grant and a \$250,000 grant from the SHRP 2 program to offset some of the additional costs incurred.

The project was located about 10 miles east of Council Bluffs, as indicated in Figure 1. Local geology was typical of western Iowa. Fine-grained soils surrounded the project with sands and gravel along Keg Creek and sedimentary bedrock at about 75 ft below the creek. Keg Creek flowed continuously at seasonal levels during the time of construction.

The average annual daily traffic (AADT) was 3,890 vehicles per day with 9 percent trucks in 2009 and is estimated to increase to 5,380 vehicles per day in 2029.

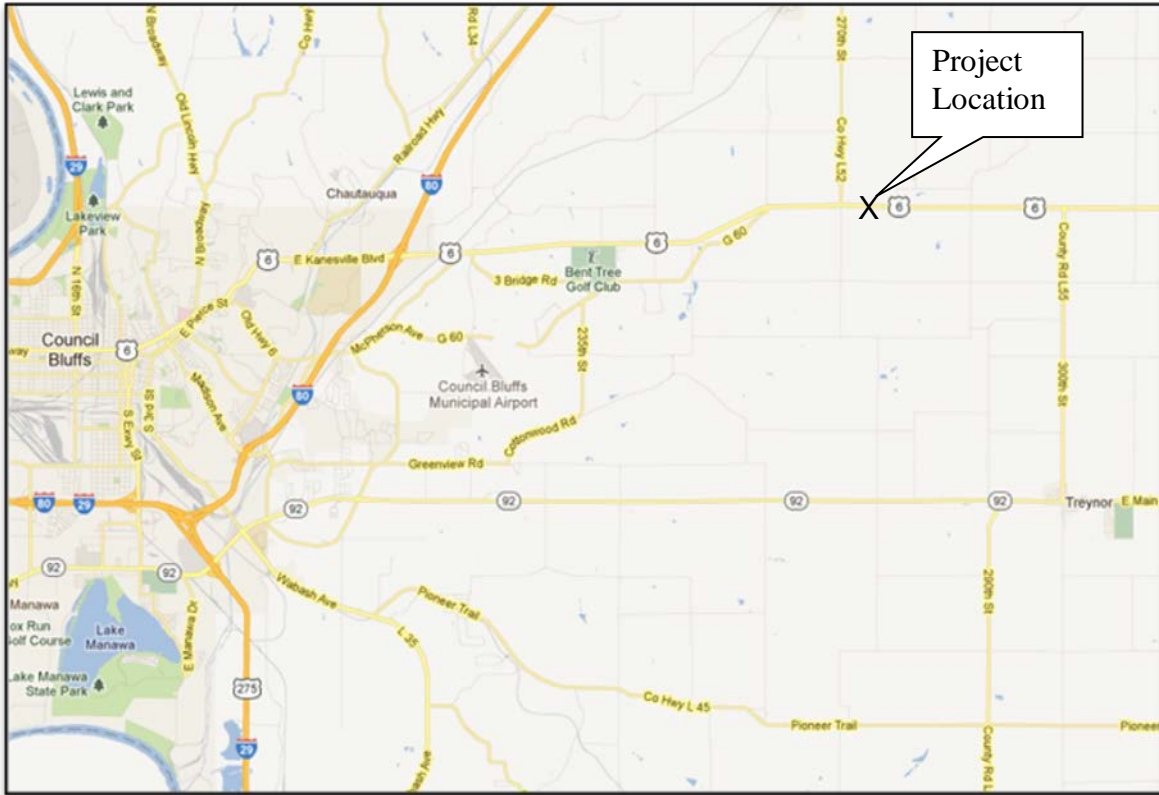

Figure 1. Project location (source: Google maps)

## PROJECT DESCRIPTION

The existing 28-ft-wide by 180-ft-long three-span continuous concrete hunched girder bridge (FHWA # 043230) was constructed in 1953 and was classified as structurally deficient with sufficiency rating of 33. The replacement bridge has the same three-span configuration but is 47 ft wide by 210 ft long, consisting of a 70-ft interior span and two 67-ft, 3-inch end spans. The new and old bridge alignments were set at a zero skew. Figure 2 shows the deteriorated existing bridge, and Figure 3 shows the newly reconstructed bridge.

HNTB Corporation furnished the bridge design and the Iowa DOT provided construction engineering inspection. Godberson-Smith Construction was awarded a \$2.3 million contract to reconstruct the bridge (\$2.7 million total project) with the following requirements:

- Fabricate the modular superstructure units, precast substructure components, and precast bridge approach panels at a casting yard off-site or near the bridge site prior to road closure.
- Construct the drilled shafts (located outside the footprint of the existing bridge) for the new piers prior to road closure.
- Establish an offsite detour to be used during the bridge closure to allow field erection and bridge completion.

Originally, a 14-day closure was part of the contract however due to a survey error in the abutment piling and the addition of post-tension hardware retrofitting the closure lasted 16 days. Iowa DOT added 3 days to the 14 day closure to account for the additional post-tensioning retrofit work. Therefore the contractor was awarded one day of incentive pay (\$22,000).

Although it was not fully detailed in the design plans, the contractor was allowed to propose a precast concrete modular alternative. The steel modular option was chosen based on early discussions with local contractors and fabricators.



Figure 2. Existing bridge.



Figure 3. Newly reconstructed bridge.

**Modular Sections**

The major bridge elements above ground were precast on site using conventional construction equipment. The pier columns, pier caps, abutment walls, approach slabs, and modular superstructure sections were precast in a farm field converted to a temporary staging area adjacent to the bridge. Figure 4 shows the wood supports used in the staging area to support the steel/concrete modular deck panels during fabrication. These wood piles and beams were used in the staging area to create mock pier caps and abutments so the modular sections could be

prefabricated in the planned bridge arrangement. This allowed the contractor to understand how the sections fit together at ground level in the staging area before setting them into place.

Figure 5 is a view during the simultaneous casting of the modular sections. Note the precast pier columns in the upper part of the image and the precast abutment elements just right of the pour.



Figure 4. Temporary supports used for the bridge modules during fabrication.

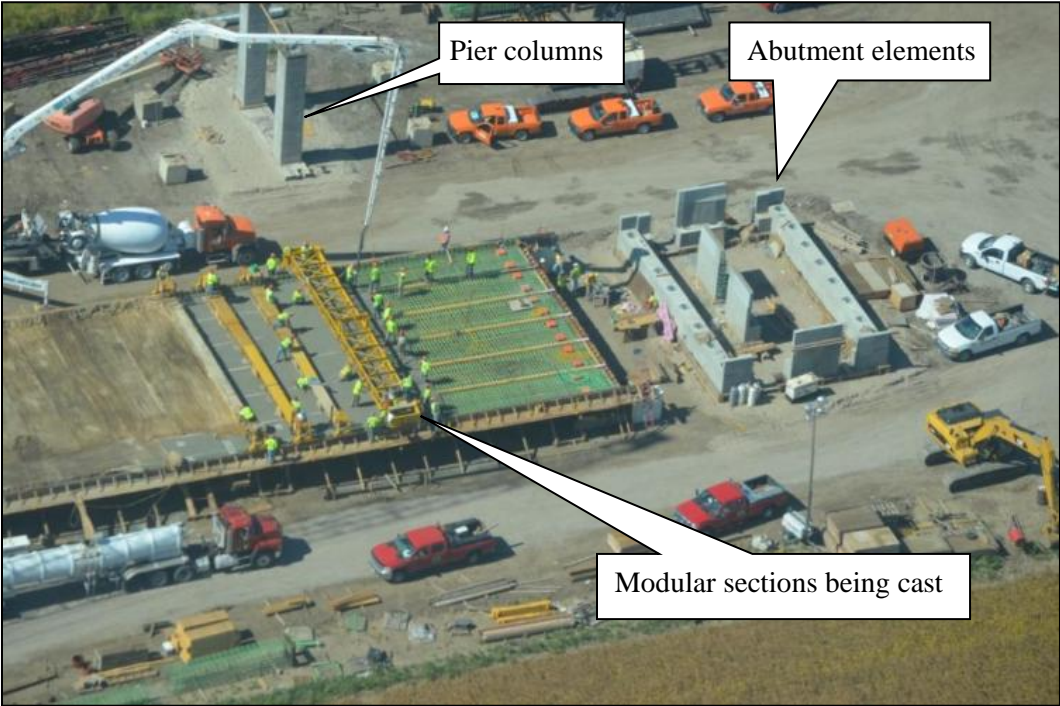

Figure 5. View during the modular section pour.

Figure 6 shows the modular section plan and cross section taken at an abutment location. Six rows of modular sections spanned the length of the bridge with 3 sections per row for a total of 18 sections.

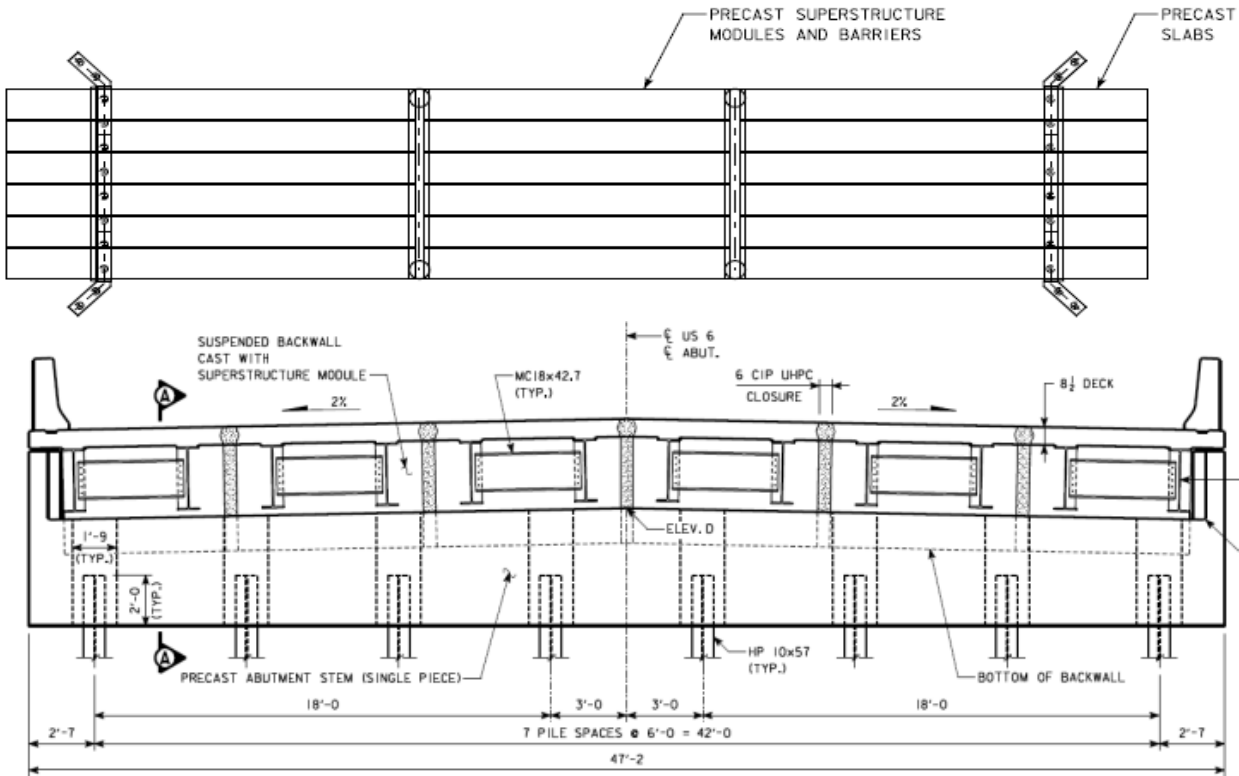

Figure 6. Modular section plan and cross section.

Exterior modules were cast with an integrated barrier wall, as shown in Figure 7, but were otherwise similar to the interior modules. Both types consisted of two parallel W30x99 steel beams topped with an 8.5-inch reinforced concrete deck. It was the designer's decision not to camber the beams since it did not affect the structural integrity and there were no vertical clearance issues. Slight sag can be noticed in the bottom flange of the uncambered beams in Figure 3.

HPC was used to form all precast elements, including the modules. The joining edges of the concrete deck were concave with protruding hairpin reinforcing bars that overlapped when the modules were joined. Joint openings were typically 6 inches wide.



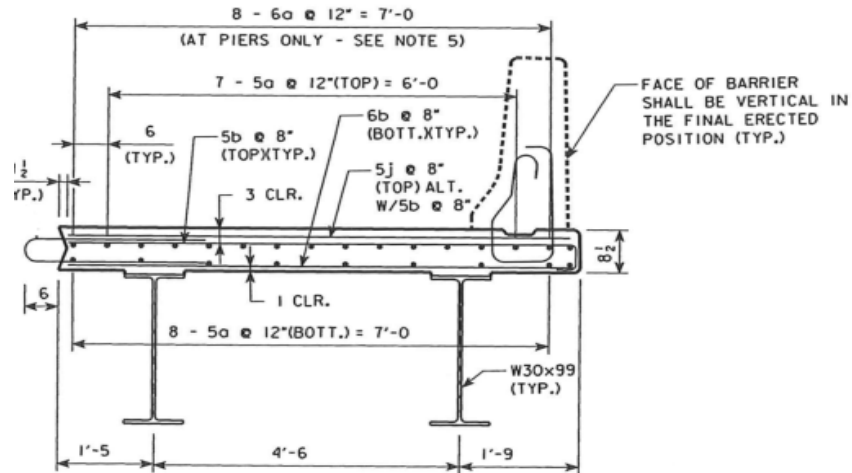

Figure 7. Cross section of a typical exterior module.

Crews moved modules from the staging area to the bridge with a flat-bed semi-truck and set them into place using two cranes. Figure 8 shows an exterior module being loaded on the delivery truck. Figure 9 is an aerial view of the two cranes lifting an interior module into place. Most of the staging area was bare earth except for a riprap access road across the creek.

At this point in the accelerated construction schedule, the effect of a substantial rain could have turned the exposed ground to mud and negatively impacted the contractor's ability to move the modules and the heavy precast substructure elements safely. Fortunately, dry weather prevailed during the ABC period.



Figure 8. Lifting an exterior module into place.



Figure 9. Aerial view showing placement of bridge modules.

### **Drilled Shafts**

The first stage of construction involved excavating the area under and around the bridge to accommodate equipment traffic and then installing 6-ft-diameter drilled shafts outside the existing bridge footprint. Figure 10 shows a shaft being drilled and workers installing reinforcing steel in one of the shafts. Once the drilled shafts were complete, the ABC portion (second stage) of the project began, at which time traffic was detoured and the existing bridge demolished.



Figure 10. Drilled shafts next to existing bridge (left) and workers positioning rebar.

Substructure work, such as assembling the precast columns, setting the precast pier cap beams, and setting the abutment elements, occurred in the second construction stage. Grouted splice couplers were used to make the connection between the drilled shaft and columns and pier caps (refer to Figure 11 and Figure 12). H-piles were driven to bedrock to support the precast abutment stems and wingwalls.

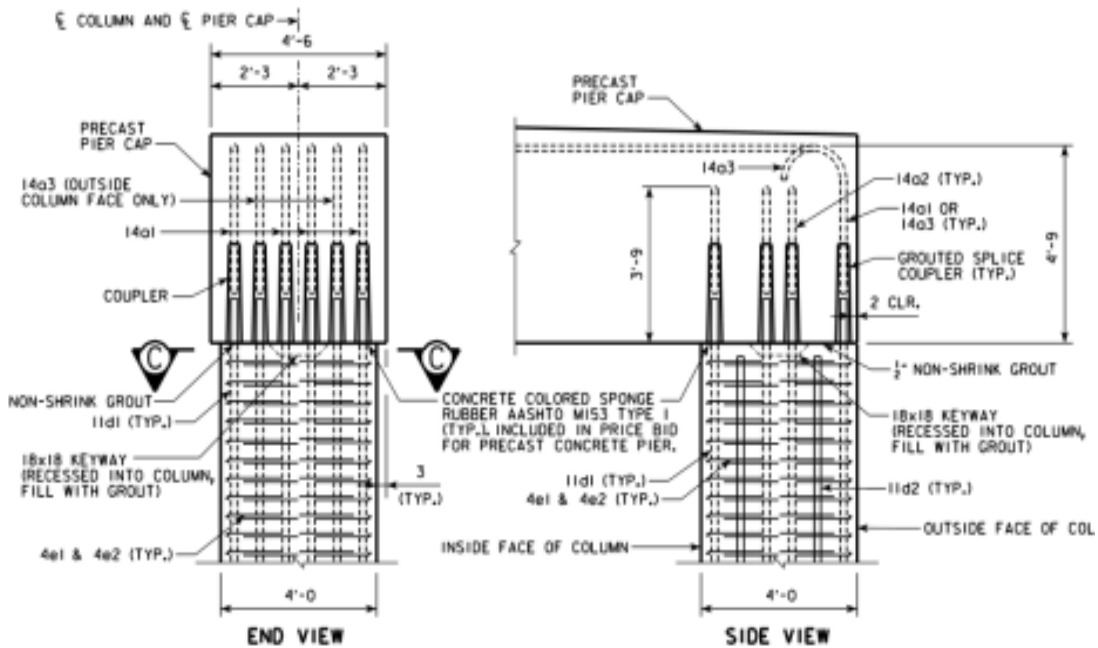

Figure 11. Cap to column detail.

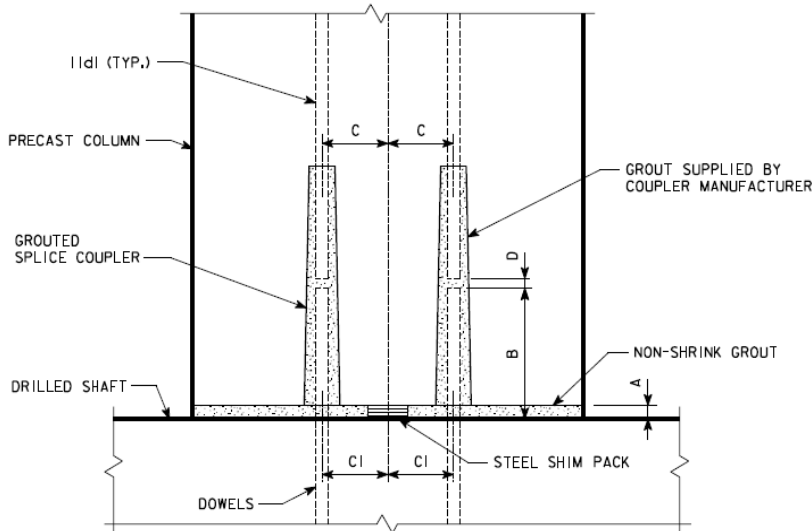

Figure 12. Detail of the drilled shaft to column connection.

During this critical stage, a surveying error was discovered during the west abutment pile installation resulting in extra effort to keep the schedule on track while correcting the mistake. Once adjustments were made in response to the survey error (resulting in an abutment alignment offset of 4 inches) the pile pockets in the abutments and abutment closures were filled with high early strength SCC. The third construction stage involved assembling the modular superstructure, placing backfill and placing precast approach slabs.

### Fully-Contained Flooded Granular Backfill

The backfill process began after the superstructure modules were set. The end modules incorporated a suspended abutment backwall designed with a step to support the approach slabs. Figure 13 shows the suspended backwall detail. Figure 14 shows the suspended backwall of an interior module in place over the abutment.

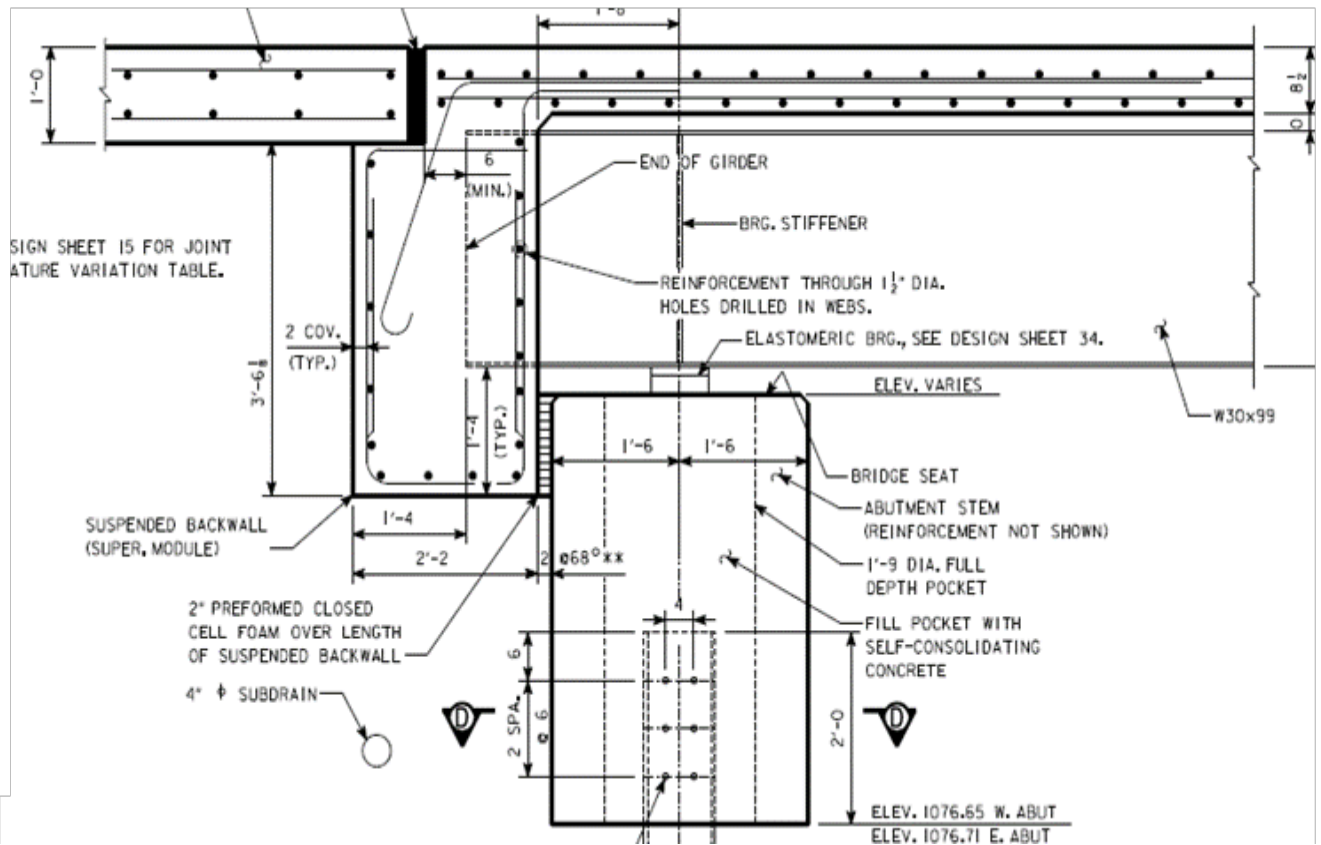

Figure 13. Suspended backwall detail.



Figure 14. Suspended backwall of an interior module (source: HNTB Corp.).

Workers placed fully-contained flooded granular backfill behind the abutments. They used standard materials, and the backfilling procedure was specified in the plans directing the contractor to line the excavation and backwall with geotextile filter fabric, place a 4-inch subdrain at the toe of the rear of the excavation backslope, and then partially fill the excavation with porous material fill. The remaining work involved placing granular material in layers, as shown in Figure 15, surface flooding, as shown in Figure 16, and finally compacting the material with a vibrating compactor.

The contractor had positive experience placing the backfill on this project. Other bridge sites in Iowa where this backfill technique has been applied are currently being reviewed for evidence of any under-pavement void development or approach pavement distress.



Figure 15. Workers spread granular backfill behind an abutment.



Figure 16. Water is applied to consolidate the fully-contained flooded backfill.

Before the approach slabs were set in place, standard modified subbase material was placed on top of the backfill and leveled to receive the approach slabs. Precast sleeper slabs were used to support the approach panels. Figure 17 details the approach panel and sleeper slab plan.

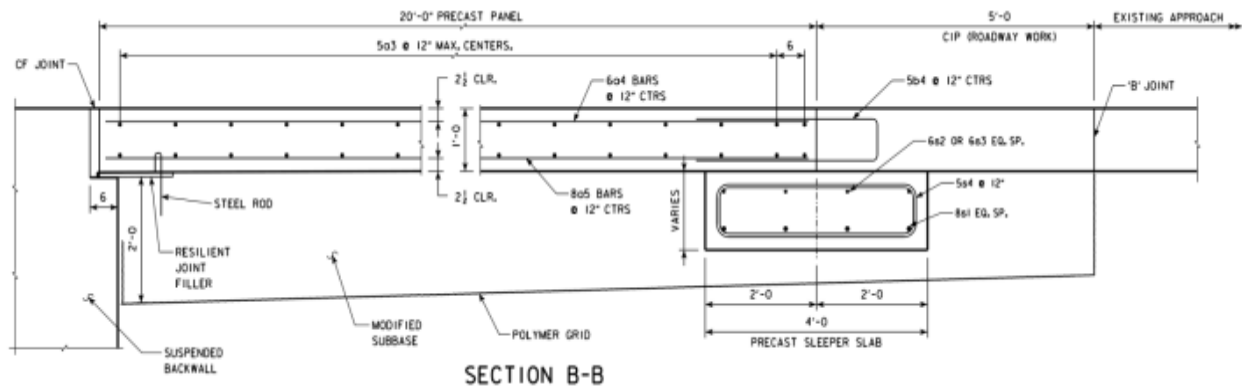

Figure 17. Approach slab cross section.

## UHPC

UHPC is characterized by its ability form strong bonds with compressive strengths up to 32,000 lb/in<sup>2</sup> and flexural strengths up to 7,000 lb/in<sup>2</sup>. The material is not only strong, but ductile, in the sense that it can deform and support flexural and tensile loads even after initial cracking. These qualities, coupled with inherently high abrasion resistance similar to natural rock and superb impermeability, made UHPC the chosen material to join the modular superstructures.

Key to the material's ductility is the inclusion of steel fibers intended to arrest initial micro cracking while providing the capacity for the joint to flex under loading. The aggregates used in the mix were of uniform size to produce a compact arrangement of particles while providing space between the particles for the fibers. The fibers used in this project were brass-coated to aid in their manufacturing.

Both the longitudinal and pier joints were filled with UHPC. This demonstration project was the first time for using UHPC to form the critical moment-resisting joints positioned over the piers. UHPC was chosen partly because of its ability to achieve a high strength bond between the modules at such an important connection. A bonding agent was applied to the transverse panel edge in lieu of sand/water blasting. The contractor used a pressure washer to water blast all the precast joint surfaces as well. Figure 18 shows an example of the pier joint reinforcement.





Figure 18. Pier joint reinforcement.

The UHPC constituents were measured by hand and blended in an on-site mixer. Motorized buggies, like the one shown in Figure 19, were used to transport and pour the mix into the joints. The contractor made a custom wooden funnel to expedite placing the UHPC into the narrow joint.

Once mixed, the UHPC was fluid (similar to grout) and easily flowed into the joints and around crowded reinforcing steel. The fluid property of the mix challenged the contractor to contain the material at the intended depth in the joints because the mix would flow lengthwise in the joint, resulting in the UHPC dropping slightly below the top of the joint. In this situation, the surface of the UHPC would begin to harden before the next batch could be mixed and poured. The contractor's solution was to secure wood strips along both sides of a joint (seen in the lower left of Figure 19) and pour the UHPC about  $\frac{3}{4}$  inches high, allowing for some slump and insuring the joints were not under filled. Additionally, temporary acrylic bulkheads were placed ahead of the pour to help contain the UHPC.



Figure 19. Workers place UHPC in a longitudinal joint.

As part of the design, the entire bridge deck was diamond ground to a maximum depth of  $\frac{1}{2}$  inch (making the effective deck thickness 8 inches), and any UHPC left too high in the joints was removed by the grinding.

Prior to construction, the contractor participated in mockup construction of the UHPC joints as the SHRP2 R04 project team conducted laboratory testing on full-scale transverse test joints at the Iowa State University (ISU) to verify the strength properties as well as handling characteristics of the fresh mix and the serviceability of the bridge joints. Strain gauges embedded in the test specimen and fixed to the surface measured strains during 1 million simulated service load cycles and during ultimate failure loading.

Although UHPC has the proven ability to penetrate the surface of cured concrete and create a strong bond, ISU's test results<sup>6</sup> submitted to HNTB suggested a lack of adequate bond performance at the interface between the UHPC joint material and the HPC deck, which could limit the joints' ability to resist moment forces. As a precaution, and to prevent water and deicing chemicals from penetrating the interface between the UHPC and the bridge modules, the transverse joints over the piers were retrofitted with 1 inch diameter high-strength steel post-tensioning bars anchored to the upper web of the deck beams to limit strain levels at the joint.

---

<sup>6</sup> *Laboratory Testing of Ultra High Performance Concrete Deck Joints for use in Accelerated Bridge Construction, 2011, Iowa State University.*

Figure 20 illustrates the post-tension retrofit design, and Figure 21 show workers installing the hardware on an exterior module. Because the post-tensioning was added to prevent cracking of the HPC deck (a serviceability issue), the retrofit was not tested under cyclic loads for fatigue. The retrofitted connection was, however, tested to AASHTO Service Level II loading which is intended to represent a fatigue limit state.

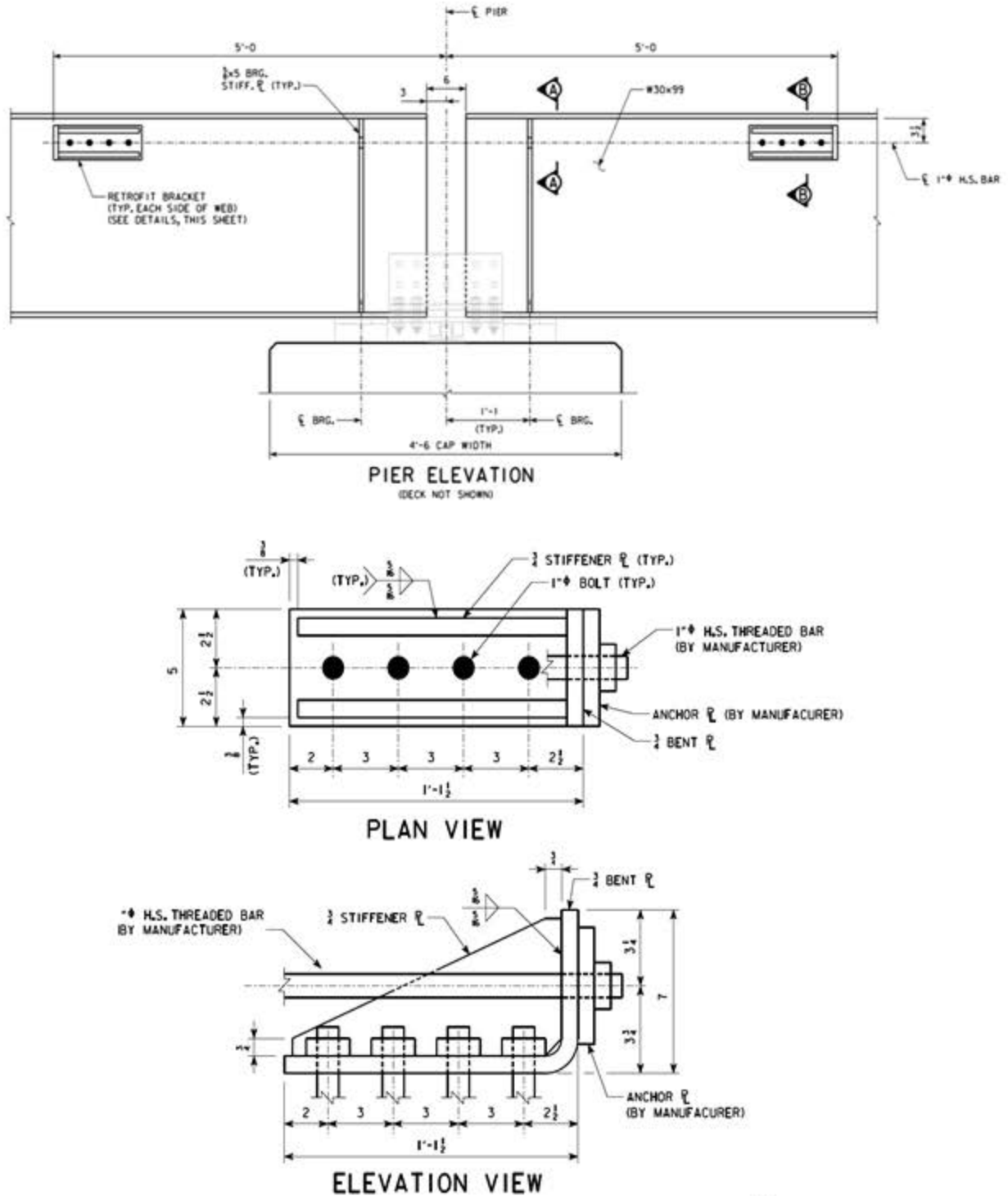

Figure 20. Post-tension retrofit design.



Figure 21. Post-tension retrofit installation.

## **DATA ACQUISITION AND ANALYSIS**

Data on safety, traffic flow, quality, and user satisfaction before, during, and after construction were collected to determine if this project met the HfL performance goals. The primary objective of acquiring these types of data was to quantify project performance and provide an objective basis from which to determine the feasibility of the project innovations and to demonstrate that the innovations can be used to do the following:

- Achieve a safer work environment for the traveling public and workers.
- Reduce construction time and minimize traffic interruptions.
- Produce a high-quality project and gain user satisfaction.

This section discusses how well the Iowa DOT project met the HfL performance goals related to these areas.

### **SAFETY**

The project included the HfL performance goal of achieving a work zone crash rate equal to or less than the existing conditions. Current crash data for the project location indicate that there was one crash involving minor injuries within the last 3 years. During this project, no crashes occurred, satisfying the HfL goal. Work zone safety was ensured by completely closing the bridge to traffic, accelerated construction, and use of prefabricated bridge components.

Accelerated construction methods, including the use of prefabricated bridge components, made the brief traffic detour feasible.

The project included the performance goal of achieving an incident rate for worker injuries less than 4.0 based on the OSHA 300 rate. Not only did closing the bridge to traffic help to achieve this goal, but precasting the bridge system on ground level eliminated the need for workers to spend most of their time exposed to falling hazards, as would have been required with traditional cast-in-place construction methods. No work-related injuries occurred during construction, resulting in an OSHA Form 300 score of 0.0.

Crash data provided by Iowa DOT's Safety Analysis, Visualization, and Exploration Resource (SAVER) shows a single crash in the 3 years prior to the start of this project. The complete crash history is included in the appendix. Due to the low crash rate at the site, the goal of a 20 percent reduction was not directly applicable. However, the increased durability of the driving surface created by the precast deck components and the use of flooded backfill should reduce the potential for vehicles to lose control while driving over a degraded portion of the deck or settled pavement at the end of the bridge. Moreover, it is expected that constructing the bridge to the current standard bridge width will decrease potential for future crashes due to the greater horizontal distance to the barrier rail.

### **CONSTRUCTION CONGESTION**

The combination of accelerated construction techniques reduced the duration that highway users were impacted by more than 50 percent. Estimated construction time requiring the bridge to be

closed would have been 6 months under non-accelerated construction. The actual impact on traffic lasted only 16 days.

The first stage of construction took place with the roadway remaining open to traffic. Modular components were constructed off site, and the drilled shaft foundation construction was completed adjacent to the existing bridge. Given that this stage was completed while the bridge remained fully open to traffic, the trip time across the bridge was not increased and met the HfL goal of less than a 10 percent increase in trip time during construction as compared to the average preconstruction time. On occasion, brief interruptions to traffic did occur for supply and equipment deliveries, but these interruptions did not result in significant traffic implications.

The second stage of construction occurred during the bridge closure while traffic was detoured. During the closure, the detour eliminated traffic queuing and congestion at the construction site. The modular bridge components were installed on site in a highly accelerated fashion. This innovative technique reduced the traffic detour duration by more than 90 percent. The shorter duration of closure relates to the significant reduction of total trip time as compared to the estimated duration for more traditional construction methods.

## **Travel Time**

Data were collected utilizing the floating vehicle methodology in an effort to match the driving speeds of other vehicles along the 21-mile detour route in both directions. (Note that the effective detour was only 12 miles, taking into account the 9 miles motorist would have traveled if the bridge was open [21 mi - 9 mi = 12 mi]). For continuity, the 21-mile detour was evaluated for this travel time study and later in this report for the user cost analysis.

Researchers collected data during the bridge closure on October 27, 2011, and after the bridge was open to traffic on November 22, 2011. On these visits, researchers collected data on weekdays during daylight hours (7:00 am to 5:00 pm) when traffic demand was relatively high and the detour would have the greatest impact on travel time. In general, the traffic flow along the rural detour route was light and flowed freely without backups or congestion at or above the posted speed limit.

Figure 22 shows the detour route and identifies travel time nodes used in the data collection process. Table 1 identifies the cumulative distance along the route and the average time on each segment when the bridge was closed. No significant travel time peaks were noticed, so the data from both directions along the detour were averaged together.

When the bridge was open, the most direct route between node 1 at the intersection of US 6 and 300<sup>th</sup> Street and node 4 at the intersection of US 6 and I-80 was 9 miles along US 6 and took an average 10.08 minutes (0.17 hr) to travel. The average travel time during closure using the 21-mile detour between nodes 1 and 4 was 24.67 minutes (0.41 hr), or more than twice the time without the closure. The cost associated with the additional time to traverse the detour route is presented later in this report.

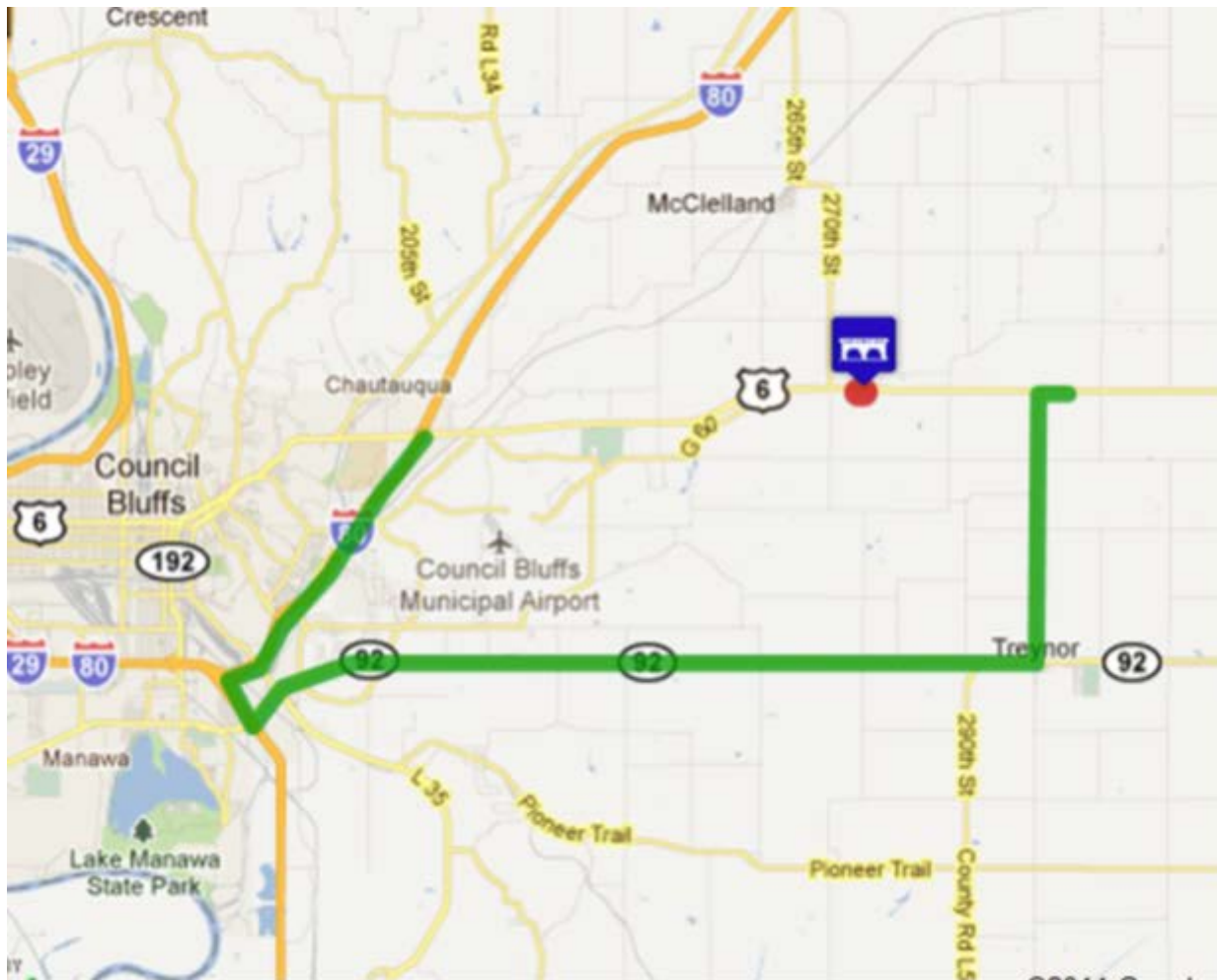

Figure 22. Map. Detour route with travel time nodes (source: Google Maps).

Table 1. Detour route travel times.

Node	Description	Cumulative Distance (mi)	Average Cumulative Travel Time (min)
<b>Westbound</b>			
1	US 6 & 300 <sup>th</sup> St.	0	0
2	300 <sup>th</sup> St. & State Hwy 92	4	5.43
3	State Hwy 92 & I-29	16	17.76
4	I-80 & US 6	21	24.51
<b>Eastbound</b>			
4	I-80 & US 6	0	0
3	State Hwy 92 & I-29	5	6.21
2	300 <sup>th</sup> St. & State Hwy 92	17	19.39
1	US 6 & 300 <sup>th</sup> St.	21	24.84
<b>Combined Average Cumulative Travel Time</b>			<b>24.67</b>

Evaluating trip time for the HfL goal is comparable by considering the work zone across the bridge would have been closed and traffic detoured for either 16 days or for 6 months (as

estimated for traditional construction methods). Because the ABC approach reduced the days motorists spent traveling the detour, trip time was reduced and met the HfL goal of less than 10 percent increase in trip time compared to traditional construction.

The Iowa DOT received comments from their user satisfaction survey (discussed later in this report) stating that several crashes occurred on State Highway 92, (refer to question #11 in the appendix) during the detour period. The 2011 annual crash total on State Highway 92 was slightly less than the average annual crash total over the past 3 years. Crash data provided by Iowa DOT's SAVER program recorded 34 crashes in 2011 whereas the highway averaged 36 annual crashes from 2008 to 2010 indicating the additional detour traffic on the highway did not increase the number of overall crashes on an annual basis.

## **QUALITY**

### **Pavement Test Site**

Researchers collected sound intensity and smoothness test data from both eastbound and westbound directions of US 6 across the bridge before construction. Comparing these data to the test results after construction provides a measure of the quality of the finished bridge.

### **Sound Intensity Testing**

Presently, Iowa DOT does not use the OBSI test method on any projects. However, this method was used to collect tire-pavement SI measurements from the existing and newly constructed bridges for comparison.

Researchers recorded SI measurements using the current accepted OBSI technique described in American Association of State Highway and Transportation Officials (AASHTO) TP 76-10, which includes dual vertical sound intensity probes and an ASTM-recommended Standard Reference Test Tire (SRTT). SI data collection occurred prior to construction and on the new bridge surfaces shortly after opening to traffic. The SI measurements were recorded and analyzed using an onboard computer and data collection system. Researchers made a minimum of three runs in the right wheelpath of the project. The two microphone probes simultaneously captured noise data from the leading and trailing tire/pavement contact areas. Figure 23 shows the dual probe instrumentation and the tread pattern of the SRTT.





Figure 23. OBSI dual probe system and the SRTT.

The average of the front and rear OBSI values from both lane directions was computed to produce the global SI level. Raw noise data were normalized for the ambient air temperature and barometric pressure at the time of testing. The resulting mean SI level was A-weighted to produce the SI frequency spectra in one-third octave bands, as shown in Figure 24.

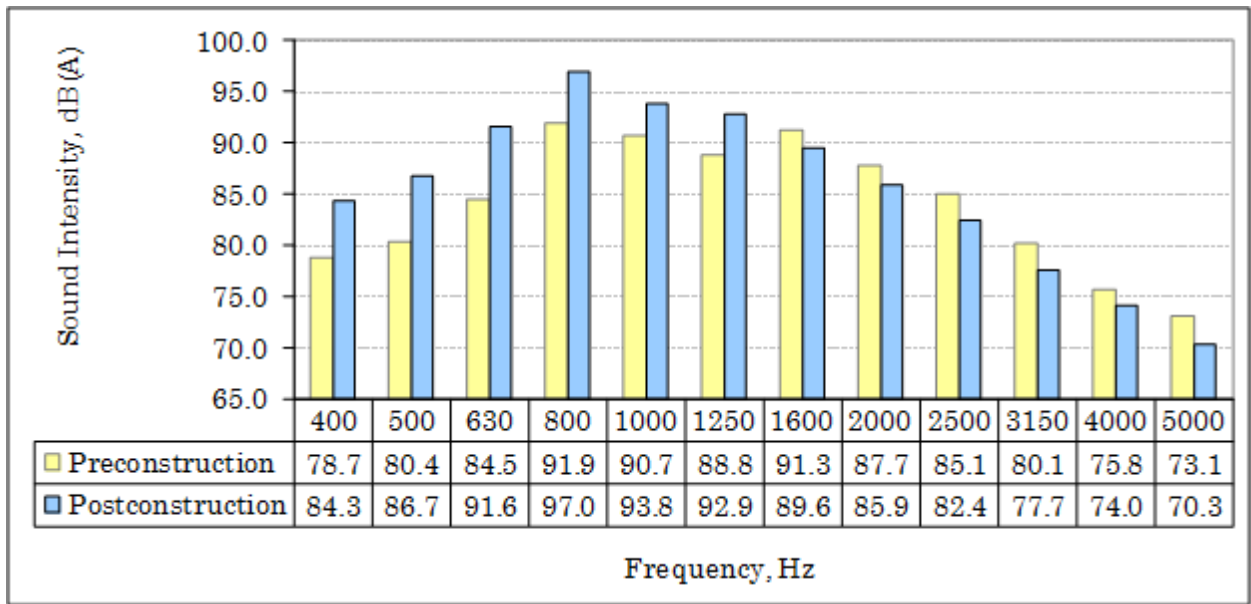

Figure 24. Mean A-weighted SI frequency spectra before and after construction.

SI levels were calculated using logarithmic addition of the one-third octave band frequencies across the spectra. The SI level increased 3.2 dB(A) from 98.0 DB(A) before construction to 101.2 dB(A) after construction. The new bridge did not meet the HfL goal of 96.0 dB(A) or less. The new texture of the bridge surface—while aiding traction and increasing safety—is prone to increasing noise.

### Smoothness Measurement

Smoothness data collection occurred in conjunction with the SI runs utilizing a high-speed inertial profiler integrated into the noise test vehicle. The profile data collected with this equipment provide IRI values, with lower values indicating a higher quality ride. Figure 25 is an

image of the test vehicle showing the profiler positioned in-line with the right rear wheel. Figure 26 graphically presents the IRI values at 20-ft intervals for the existing bridge surfaces and shows most of the postconstruction values plotted lower than the preconstruction values.

The increased smoothness of the newly constructed bridge resulted in a reduction in IRI value from 222 in/mi to 179 in/mi. While not meeting the HfL goal of less than 48 in/mi after construction, the new bridge surface is an improvement.



Figure 25. High-speed inertial profiler mounted behind the test vehicle.

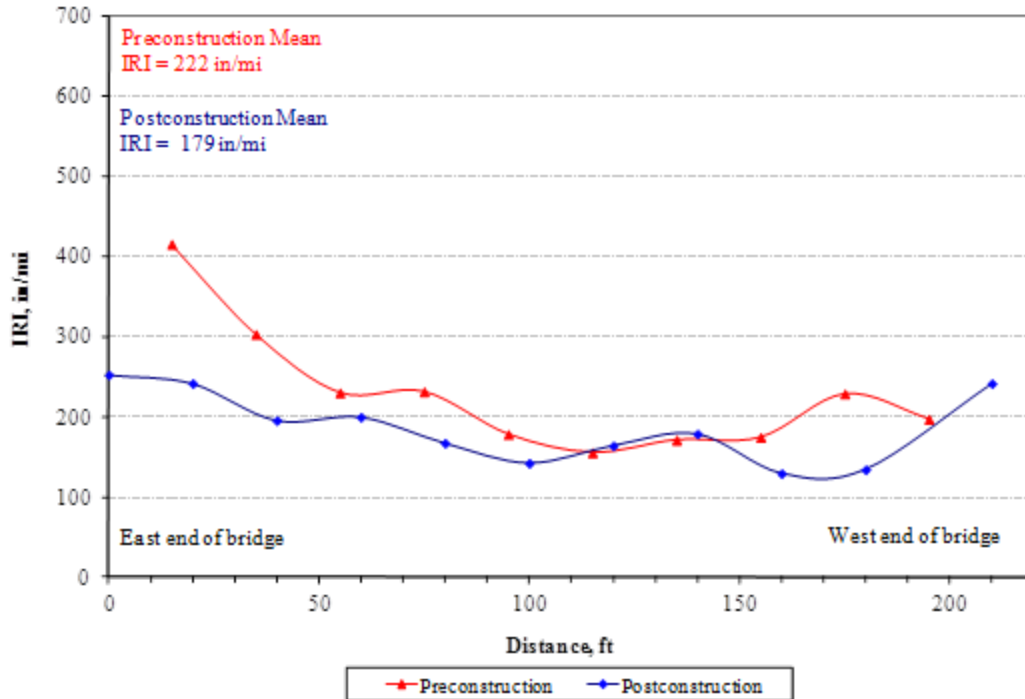

Figure 26. Mean IRI values computed at 20-ft intervals before and after construction.

## USER SATISFACTION

The HfL requirement for user satisfaction includes a performance goal of 4 or more on a Likert scale from 1 to 7 (in other words, 57 percent or more participants showing favorable response) for the following two questions:

- How satisfied is the user with the new facility compared with its previous condition?
- How satisfied is the user with the approach (ABC) used to construct the new facility in terms of minimizing disruption?

As an alternative to the HfL questions, the Iowa DOT posed 12 questions to roadway users, asking them to rate their responses or to select an answer category. The following questions were asked:

1. Rate your level of use of the US 6 Keg Creek Bridge before construction.
2. How would you best describe yourself?
3. Rate how important you believe each approach is and how well it was carried out on this project (approaches include closing US 6 during construction, providing signage for commuters in the area, condensing closure to two weeks, using stronger materials to extend bridge life, using prefabricated components to speed construction, using multiple methods (message signs, radio, texts, etc.) to advise motorists of construction and alternative routes).
4. Knowing it would mean traffic delays and driving through construction areas, how important was it to close US 6 during construction?
5. How satisfied are you with the way the Iowa DOT kept you informed about the construction work?
6. What means of communication do you use most often to learn about traffic issues/roads information?
7. What are the best methods to keep you informed regarding traffic issues/road construction?
8. Rate the following aspects of the new US 6 Keg Creek Bridge and surrounding areas as compared to its previous condition (aspects included lane width, visibility, signage, lighting, aesthetics).
9. Rate the level of inconvenience you experienced as a user of the US 6 Keg Creek Bridge.
10. Did construction on the US 6 Keg Creek Bridge deter you from visiting businesses along US 6?
11. Were there any safety issues/concerns raised during the US 6 Keg Creek Bridge project?
12. Rate the importance in regard to designing and scheduling projects. Answer options were: keeping a road/bridge open-allow restricted traffic, closing a road/bridge-no traffic and reducing cost and time, extending the life of the road/bridge-more initial cost, reducing future maintenance costs-more initial cost, reduce time to complete a project through the use of incentives to contractors, reduce time to complete a project through design/material selection, creation of alternative routes while project is underway, use of multiple methods (technology) to inform the public of work zone conditions.

Overall, the responses to the questions were favorable and met or exceeded the HfL performance goal. Most roadway users (7 out of 9) responding to question 8 indicated the lane width and visibility of the new bridge was better or much better than the old bridge under, which closely addresses the HfL question of how satisfied the user is with the new facility. Ten of 12 respondents to question 4 indicated that it was important to close the bridge, knowing it would mean traffic delays. This implies a favorable response to the HfL question gauging how satisfied the user is with the approach used to construct the new facility in terms of minimizing disruption. The complete results of the survey are contained in the appendix.

## TECHNOLOGY TRANSFER

To promote the innovations—prefabricated bridge elements, high-performance materials and accelerated construction methods—the Iowa DOT in conjunction with the FHWA and SHRP 2 sponsored a 1-day showcase. The showcase was held October 28, 2011, at the Hilton Garden Inn in Council Bluffs. The event featured presentations by representatives of the FHWA, Iowa DOT, SHRP 2, Iowa State University, HNTB Corporation, and the contractor, followed by a field trip to the project site to observe the forming of the deck joints with UHPC.



Figure 27. Sandra Larson gives opening remarks at the showcase.

The showcase attracted 80 registered attendees from 14 states including other DOT's, transportation authorities, and the construction industry. The appendix contains the workshop agenda. John Adams and Sandra Larson of the Iowa DOT provided the introduction and opening remarks. Neil Hawks presented an overview of the SHRP 2 program, followed by an overview of the HfL program by Lubin Quinones.

Benjamin Beerman from the FHWA provided a national perspective on prefabricated bridge elements and systems (PBES) and the FHWA Every Day Counts (EDC) initiative. He examined various elements of PBES construction and decision making tools on-line with the agency to help DOT's with their projects.

Norm McDonald of the Iowa DOT shared the State's experiences with PBES by highlighting completed projects from around the State plus PBES projects that address specific bridge performance issues, such as bridge approach settlement.

Bala Sivakumar of the HNTB Corporation discussed innovative bridge designs for rapid renewal from the SHRP 2 Project R04. He explained three tiers of ABC concepts from the SHRP 2 program, including tier 1 projects in which bridges are replaced overnight or on the weekend utilizing such technology as self-propelled modular transporters or lateral slide techniques; tier 2 projects completed in 1 to 2 weeks, typical with PBES; and the tier 3 concept of accelerating a statewide bridge program. Example projects and goals of each tier were presented.

Mike LaViolette of the HNTB Corporation detailed the superstructure and substructure element designs of the demonstration project in his presentation. This presentation included aerial photos taken at intervals during construction, which gave the audience a clear understanding of the construction sequence. Ahmad Abu-Hawash of the Iowa DOT gave the owner's perspective of PBES versus conventional bridge construction. He outlined the Iowa DOT's decision-making process used to compare direct costs, user costs, project goals, and related criteria between conventional and ABC delivery approaches.

Mike LaViolette presented the contractor's perspective of PBES versus conventional bridge construction on behalf of Kim Triggs of Godbersen-Smith Construction who was not available to present. Vic Perry of Lafarge North America, Inc., and Matt Rouse of Iowa State University discussed research findings regarding the particular UHPC used in this project. UHPC was a popular topic during the showcase, and participants took the opportunity to discuss in detail the material properties and application in this project. Figure 28 shows participants discussing UHPC next to a longitudinal joint.



Figure 28. Showcase participants discuss UHPC.

## ECONOMIC ANALYSIS

A key aspect of HfL demonstration projects is quantifying, as much as possible, the value of the innovations deployed. This involves comparing the benefits and costs associated with the innovative project delivery approach adopted on an HfL project with those from a more traditional delivery approach on a project of similar size and scope. The latter type of project is referred to as a baseline case and is an important component of the economic analysis.

For this economic analysis, the Iowa DOT supplied the cost figures for the as-built project and baseline construction. Traditional methods would have involved the use of cast-in-place construction coupled with standard pre-tension precast concrete bridge beams.

### CONSTRUCTION TIME

The baseline scenario would have closed the bridge for at least 6 months to accommodate traditional cast-in-place construction methods. The ABC approach allowed the contractor to fabricate the bridge components ahead of time and then assemble the bridge during a minimal 16-day bridge closure.

### CONSTRUCTION COSTS

The project was awarded based on lowest bid. There were 7 qualified bids received of which Godbersen-Smith Construction Company was the lowest bid at \$ 2,658,823.35. Table 2 lists the results of the 7 bids.

Table 2. Bid results.

Contractor	Bid	Percent of low bid
Godbersen-Smith Construction Co.	\$ 2,658,823.35	100.00
A.M. Cohron & Son, Inc.	\$ 3,202,409.35	120.44
Cramer & Assoc., Inc.	\$ 3,245,342.21	122.05
Hawkins Construction Co.	\$ 3,495,701.97	131.47
United Contractors Inc.	\$ 3,614,301.52	135.93
Jensen Construction Co.	\$ 3,925,936.43	147.65
Kiewit Infrastructure Co.	\$ 3,990,723.50	150.09

Table 3 presents the 2011 construction costs of the baseline and the as-built alternatives based on the awarded as-built contract and Iowa DOT estimates. Assumptions regarding the baseline case include:

- The use of steel piles to support the piers instead of drilled shafts.
- Cast-in-place construction of the substructure.
- Cast-in-place construction of the superstructure with precast-pretensions beams.
- The traffic is maintained on the detour route for the entire 6-month construction duration.
- Given the good condition of the detour route pavements and the relatively low amount of detoured traffic, improvements or additional maintenance on the detour roads would not be necessary.

Table 3. Capital cost calculation table.

Bid Item Description	As-Built ABC Bid Costs			Baseline Conventional Cost Estimate		
	Quantity	Rate	Total	Quantity	Rate	Total
Excavation, Class 10, Channel	10,977 CY	\$ 4	\$ 43,908	10,829 CY	\$ 10	\$ 108,290
Removal of Existing Bridge	1 LS	\$ 200,000	\$ 200,000	1 LS	\$ 70,000	\$ 70,000
Excavation, Class 20, Bridge	304 CY	\$ 25	\$ 7,600	365 CY	\$ 20	\$ 7,300
Excavation, Class 21, Bridge	-	\$ -	\$ -	293 CY	\$ 165	\$ 48,345
Structural Concrete (Bridge)	-	\$ -	\$ -	675.7 CY	\$ 420	\$ 283,794
Reinforcing Steel	46,594 LB	\$ 1	\$ 39,605	45,133 LB	\$ 1	\$ 34,301
Reinforcing Steel, Epoxy Coated	3,754 LB	\$ 1	\$ 3,454	75,092 LB	\$ 1	\$ 56,319
Beams, Pre-tensioned, Pre-stressed, PCC, C46	-	\$ -	\$ -	7 EACH	\$ 6,000	\$ 42,000
Beams, Pre-tensioned, Pre-stressed, PCC, C80	-	\$ -	\$ -	14 EACH	\$ 9,000	\$ 126,000
Structural Steel	-	\$ -	\$ -	5,539 LB	\$ 2	\$ 9,416
Concrete Barrier Railing	-	\$ -	\$ -	473.3 LF	\$ 47	\$ 22,245
Piles, Steel, HP 10 X 57	1,920 LF	\$ 48	\$ 92,160	3,730 LF	\$ 35	\$ 130,550
Pre-bored Holes	-	\$ -	\$ -	180 LF	\$ 39	\$ 7,020
Engineering Fabric	3,295 SY	\$ -	\$ 9,885	3,295 SY	\$ 3	\$ 9,885
Revetment, Class E	3,209 TON	\$ 40	\$ 128,360	2,495 TON	\$ 33	\$ 82,335
Erosion Stone	-	\$ -	\$ -	476 TON	\$ 28	\$ 13,328
Mobilization	1 LS	\$ -	\$ 250,000	1 LS	\$ 84,500	\$ 84,500
Longitudinal Grooving	1300 SY	\$ 4	\$ 4,550	1,300 SY	\$ 4	\$ 4,550
Drilled Shafts	300 LF	\$ 550	\$ 165,000	-	\$ -	-
Demonstration Drilled Shaft	75 LF	\$ 550	\$ 41,250	-	\$ -	-
Construction Survey	1 LS	\$ 7,000	\$ 7,000	1 LS	\$ 7,000	\$ 7,000
Precast Abutment Stem	2 EACH	\$ 30,000	\$ 60,000	-	\$ -	-
Precast Abutment Wingwall	4 EACH	\$ 15,000	\$ 60,000	-	\$ -	-
Exterior Superstructure Module 1	4 EACH	\$ 50,000	\$ 200,000	-	\$ -	-
Exterior Superstructure Module 2	2 EACH	\$ 56,000	\$ 112,000	-	\$ -	-
Interior Superstructure, Module 1	8 EACH	\$ 56,000	\$ 448,000	-	\$ -	-
Interior Superstructure, Module 2	4 EACH	\$ 56,000	\$ 224,000	-	\$ -	-
Pier Cap	2 EACH	\$ 54,000	\$ 108,000	-	\$ -	-
Pier Column	4 EACH	\$ 20,000	\$ 80,000	-	\$ -	-
Grinding	1,300 SY	\$ 5	\$ 5,850	-	\$ -	-
Macadam Stone Slope Protection	70 SY	\$ 55	\$ 3,850	-	\$ -	-
Bridge Cost (\$)			<b>\$ 2,294,472</b>			<b>\$ 1,147,178</b>
Deck Area (SF)			\$ 9,921			\$ 9,225
Unit Cost (\$/SF)			\$ 231			\$ 124
Incentive			\$ 22,000			\$ 0
Roadway Improvements			\$ 305,967			\$ 305,967
Traffic Control			\$ 3,200			\$ 3,200
Reinforced Concrete Flume			\$ 55,185			\$ 55,185
Total Project			<b>\$ 2,680,823</b>			<b>\$ 1,511,530</b>
<p>Abbreviations used in this table:</p> <p>CY cubic yard            LB pound            LF linear foot            LS lump sum            PCC portland cement concrete            SF square foot            SY square yard</p>		<p>Notes:</p> <ul style="list-style-type: none"> <li>The costs for the baseline substructure (abutments, wingwalls, piers, and pier caps) are accounted for in the costs of the structural concrete; epoxy coated reinforcing steel and steel piles. The cost of HPC and UHPC is included in the cost of the superstructure modules.</li> <li>Mobilization costs for the as-built case includes costs associated with the mobilizing the equipment used for fabricating the precast elements in the nearby casting yard.</li> <li>Traffic control includes the detour signage which is assumed to be the same for the as-built and baseline scenarios.</li> </ul>				



The comparison shows the as-built total cost was \$2,680,823 compared to \$1,511,530 for the baseline total cost. Considering only the bridge portion of the contract, the as-built costs were nearly double the baseline bridge costs. Contract items such as roadway improvements, traffic control, and the reinforced concrete flume were assumed to cost the same in either case.

## USER COSTS

Generally, three categories of user costs are used in an economic/life cycle cost analysis: vehicle operating costs (VOC), delay costs, and crash- and safety-related costs. Because the bridge would have been closed to traffic under both the baseline and as-built case, the possible safety hazard to the traveling public from a work zone was eliminated, so safety-related costs were not evaluated. However, VOC and delay costs were compared and are discussed in the following subsections.

## VOC

The savings in VOC from using ABC is essentially the difference between the mileage-related VOC applied to the 6 months (183 days) of detour time for the baseline case and the 16 days for the as-built case applied to the detour distance of 21 miles. In the absence of actual vehicle count data, the VOC can be estimated conservatively by considering only commercial vehicles (light and heavy trucks) traveling the designated route due to weight restrictions on other county roads in the area. Passenger vehicles are discounted because there are numerous county roads which could serve as non-planned detour routes preventing an accurate traffic estimation based solely on the AADT on US 6.

Assuming an average unit cost of \$0.81 per mile<sup>7</sup> for commercial vehicles for the variable operating costs (including costs for fuel, maintenance and repair, tires, and depreciation) based on highway travel and given the 2009 AADT of 3,890 with 9 percent commercial vehicles, the following VOC is computed:

### Baseline Case

$$\begin{aligned} \text{VOC}_{\text{commercial}} &= 3,890 \text{ (AADT)} * 0.09 \text{ (percent commercial vehicles)} * 21 \text{ (mi)} * \$0.81 \text{ (per mi)} * 183 \text{ (days)} \\ &= \$1,089,802 \end{aligned}$$

### As-Built Case

$$\begin{aligned} \text{VOC}_{\text{commercial}} &= 3,890 \text{ (AADT)} * 0.09 \text{ (percent commercial vehicles)} * 21 \text{ (mi)} * \$0.81 \text{ (per mi)} * 16 \text{ (days)} \\ &= \$95,283 \end{aligned}$$

The total saving in VOC because of the detour differential between the baseline and as-built scenarios is as follows:

$$\text{VOC}_{\text{Differential}} = \$1,089,802_{\text{baseline}} - \$95,283_{\text{As-built}} = \mathbf{\$994,519}$$

---

<sup>7</sup> Barnes and Langworthy, *The Per-Mile Costs of Operating Automobiles and Trucks*, 2003. Report No. MN/RC 2003-19, Minnesota Department of Transportation. Adjusted for fuel price increase and inflation in 2011.

## Delay Costs

As with the VOC calculation, only delay costs occurred by commercial vehicles were considered since passenger vehicles could have chosen an alternate detour route. The effect of reducing the duration of the bridge closure saved \$615,267. The following provides a basis for this conclusion:

- The savings in delay cost can be determined by applying an hourly value to the time commercial vehicle operators needed to traverse the detour.
- The monetary value of truck travel time based on work zone road user costs was \$25.67 per hour in 2011.<sup>8</sup>
- The average detour time was 24.67 minutes, or 0.41 hours per vehicle.

Using these assumptions and cost figures, the saving in delay cost is as follows:

### Baseline Case

$$\text{Delay}_{\text{commercial}} = 3,890 \text{ (AADT)} * 0.09 \text{ (percent commercial vehicles)} * 0.41 \text{ (hrs/vehicle)} * \$25.67 \text{ (per hour)} * 183 \text{ (days)} = \$674,215$$

### As-Built Case

$$\text{Delay}_{\text{commercial}} = 3,890 \text{ (AADT)} * 0.09 \text{ (percent commercial vehicles)} * 0.41 \text{ (hrs/vehicle)} * \$25.67 \text{ (per hour)} * 16 \text{ (days)} = \$58,948$$

The total saving in delay costs between baseline and as-built scenarios is as follows:

$$\text{Delay Differential} = \$674,215_{\text{Baseline}} - \$58,948_{\text{As-built}} = \mathbf{\$615,267}$$

## COST SUMMARY

From a construction cost standpoint, the ABC delivery approach cost the Iowa DOT \$1,169,293 more than traditional construction but saved time users would have otherwise been detoured. Considering the savings in user costs of \$1,609,785 from combined VOC and delay costs (\$994,519 + \$615,267), the cost differential is \$440,492 or 29 percent less than traditional construction for a project of this size and scope.

---

<sup>8</sup> Mallela and Sadasivam, *Work Zone Road User Costs Concepts and Applications*, 2011. Report No. FHWA-HOP-12-005, Federal Highway Administration.

## APPENDIX

Table 4. Crash history table.

<b>2001 - 2011 Reportable Crash History</b> <b>Crashes involving US 6 and Keg Creek Bridge</b> <b>Pottawattamie County, Iowa</b> (* 2011 data remains preliminary - downloaded 2/3/2011)													
Year	County	Crashes						Injuries					
		Crashes	Fatal	Major	Minor	Poss/ Unk	Property Damage Only	Injury	Fatal	Major	Minor	Possible	Unknown
2001	Pottawattamie	0	0	0	0	0	0	0	0	0	0	0	0
2002	Pottawattamie	0	0	0	0	0	0	0	0	0	0	0	0
2003	Pottawattamie	0	0	0	0	0	0	0	0	0	0	0	0
2004	Pottawattamie	0	0	0	0	0	0	0	0	0	0	0	0
2005	Pottawattamie	0	0	0	0	0	0	0	0	0	0	0	0
2006	Pottawattamie	0	0	0	0	0	0	0	0	0	0	0	0
2007	Pottawattamie	0	0	0	0	0	0	0	0	0	0	0	0
2008	Pottawattamie	0	0	0	0	0	0	0	0	0	0	0	0
2009	Pottawattamie	1	0	0	0	0	1	0	0	0	0	0	0
2010	Pottawattamie	0	0	0	0	0	0	0	0	0	0	0	0
2011	Pottawattamie	0	0	0	0	0	0	0	0	0	0	0	0
	Totals:	1	0	0	0	0	1	0	0	0	0	0	0

Feature Count Report (Monday, February 20, 2012 8:10:23 AM Central Standard Time)  
 produced using: Iowa's Safety Analysis, Visualization, and Exploration Resource (SAVER)

Results of the user satisfaction survey.

Results of user satisfaction survey question #1.

Rate your level of use of the US 6 Keg Creek bridge before construction?		
Answer Options	Response Percent	Response Count
All the time	35.0%	7
Frequent	20.0%	4
Moderate	10.0%	2
Occasional	25.0%	5
Never	10.0%	2
<i>answered question</i>		20
<i>skipped question</i>		1

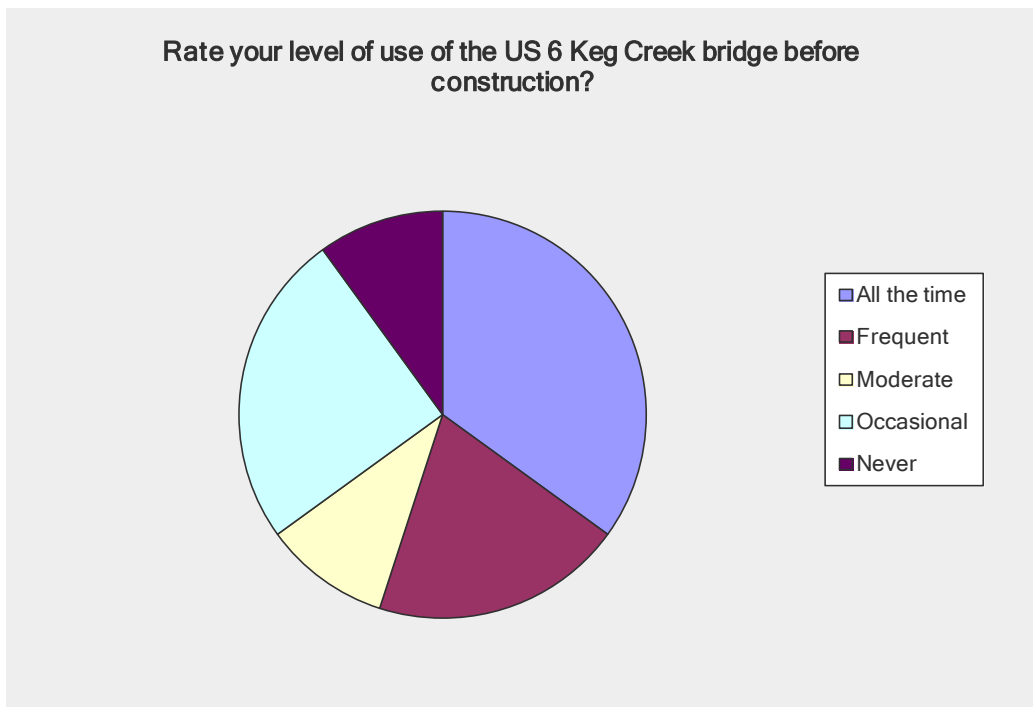

Results of user satisfaction survey question #2.

How would you best describe yourself (check all that apply).		
Answer Options	Response Percent	Response Count
I own a business along US 6 close to Keg Creek bridge.	0.0%	0
I work at a business along US 6 close to Keg Creek bridge.	10.5%	2
I live close to Keg Creek bridge.	21.1%	4
I regularly visit a business along US 6 close to Keg Creek bridge.	0.0%	0
I often travel close to or visit areas near Keg Creek bridge.	5.3%	1
I typically use US 6 to get somewhere else.	42.1%	8
I don't typically drive US 6.	21.1%	4
<i>answered question</i>		<b>19</b>
<i>skipped question</i>		<b>2</b>

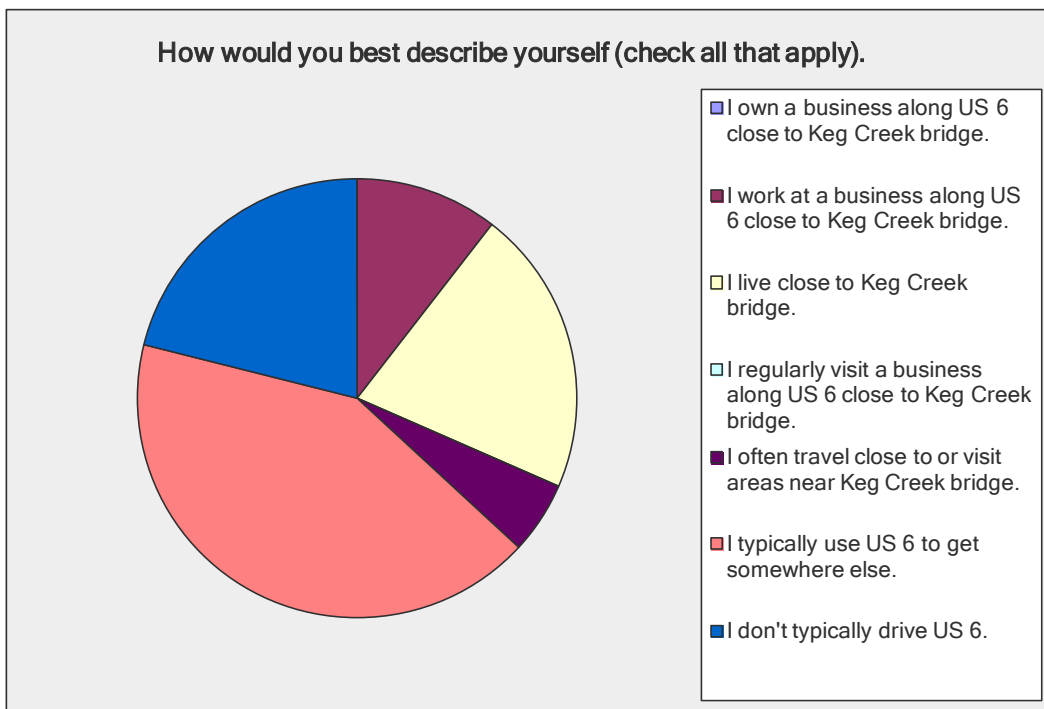

Results of user satisfaction survey question #3.

Rate how important you believe each approach is and how well it was carried out on this project.					
Importance					
Answer Options	Important	Somewhat Important	Somewhat Unimportant	Unimportant	Response Count
Closing US 6 during construction	12	1	0	0	13
Providing signage for commuters in the area	12	0	0	0	12
Condensing closure to two weeks	11	1	0	0	12
Using stronger materials to extend bridge life and reduce future disruptions for maintenance	10	2	0	0	12
Using prefabricated components to speed construction	10	1	1	0	12
Using multiple methods (message signs, radio, texts, etc.) to advise motorists of construction and alternative routes	11	1	0	0	12
How well					
Answer Options	Very Good	Good	Poor	Very Poor	Response Count
Closing US 6 during construction	7	3	0	1	11
Providing signage for commuters in the area	7	4	0	0	11
Condensing closure to two weeks	9	1	1	0	11
Using stronger materials to extend bridge life and reduce future disruptions for maintenance	9	2	0	0	11
Using prefabricated components to speed construction	10	1	0	0	11
Using multiple methods (message signs, radio, texts, etc.) to advise motorists of construction and alternative routes	8	3	0	0	11
					<b>Totals</b>
Comments					3
					<i>answered question</i>
					<i>skipped question</i>
					13
					8
Number	Response Date	Comments	Categories		
1	Oct 31, 2011 4:43 PM	think it should have been closed during summer instead of harvest			
2	Oct 28, 2011 10:53 PM	Gravel road for detour was not cared for.			
3	Oct 14, 2011 2:12 PM	I live in Atlantic, and work in Bellevue NE. I drive Highway 6 EVERYDAY.			

Results of user satisfaction survey question #4.

Knowing it would mean traffic delays and driving through construction areas, how important was it to close US 6 during construction?		
Answer Options	Response Percent	Response Count
Important	83.3%	10
Somewhat important	16.7%	2
Somewhat unimportant	0.0%	0
Unimportant	0.0%	0
<i>answered question</i>		<b>12</b>
<i>skipped question</i>		<b>9</b>

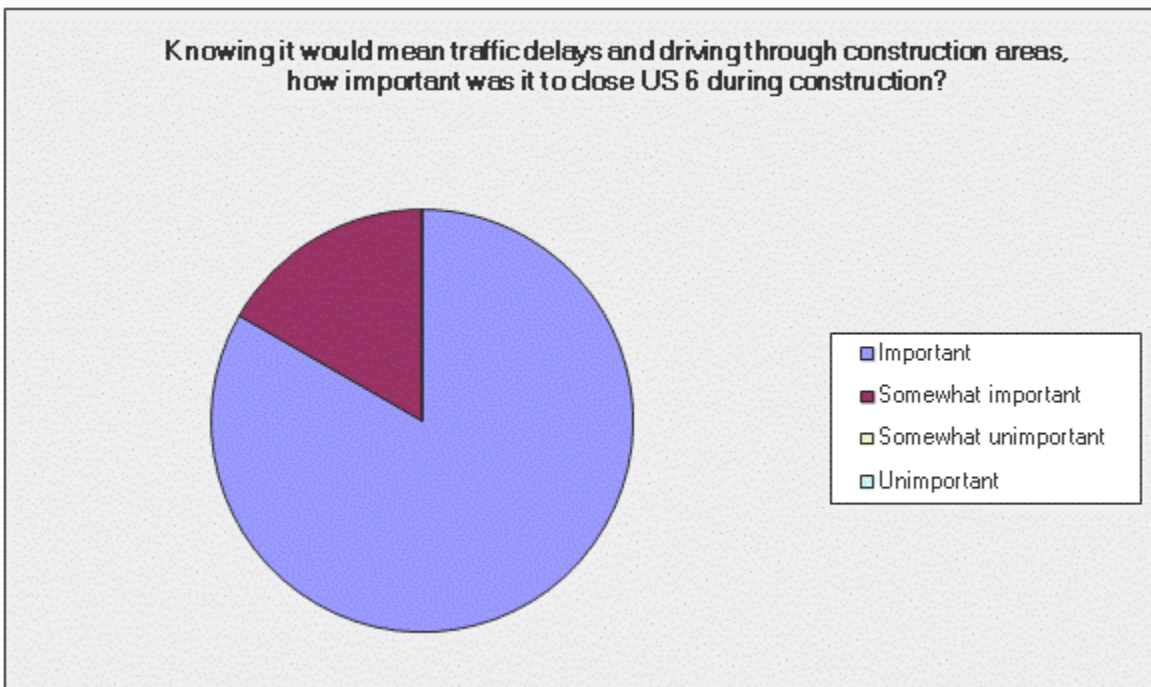

Results of user satisfaction survey question #5.

How satisfied are you with the way the Iowa DOT kept you informed about the construction work?		
Answer Options	Response Percent	Response Count
Satisfied	63.6%	7
Somewhat satisfied	36.4%	4
Somewhat dissatisfied	0.0%	0
Dissatisfied	0.0%	0
<i>answered question</i>		<b>11</b>
<i>skipped question</i>		<b>10</b>

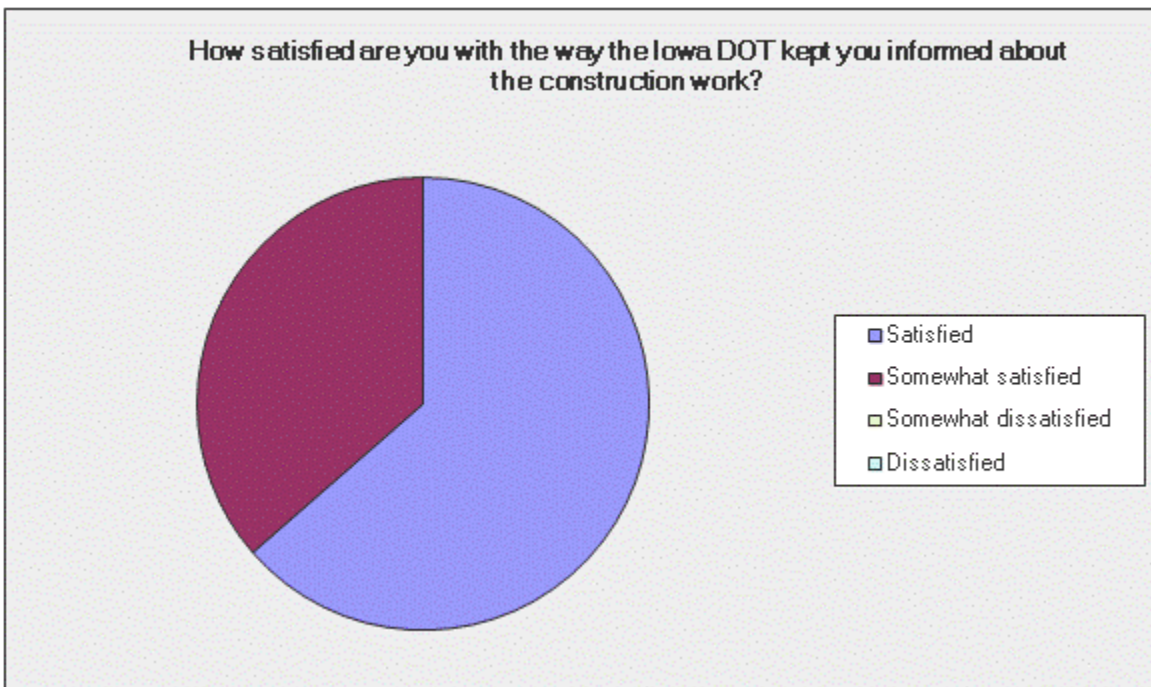



Results of user satisfaction survey question #6.

What means of communication do you USE MOST OFTEN to learn about traffic issues/roads information?			
Answer Options		Response Percent	Response Count
Radio		33.3%	4
Web sites		41.7%	5
Text messages		8.3%	1
E-Alerts		16.7%	2
Changeable message signs		66.7%	8
Other (please specify)			2
<i>answered question</i>			<b>12</b>
<i>skipped question</i>			<b>9</b>
Number	Response Date	Other (please specify)	Categories
1	Oct 28, 2011 10:54 PM	Television	
2	Oct 14, 2011 2:15 PM	I found the story on the bridge at WOWT.COM today, October 14th. I knew the bridge was being built to the side, but was not able to determine how it would be moved over. This is awesome.	

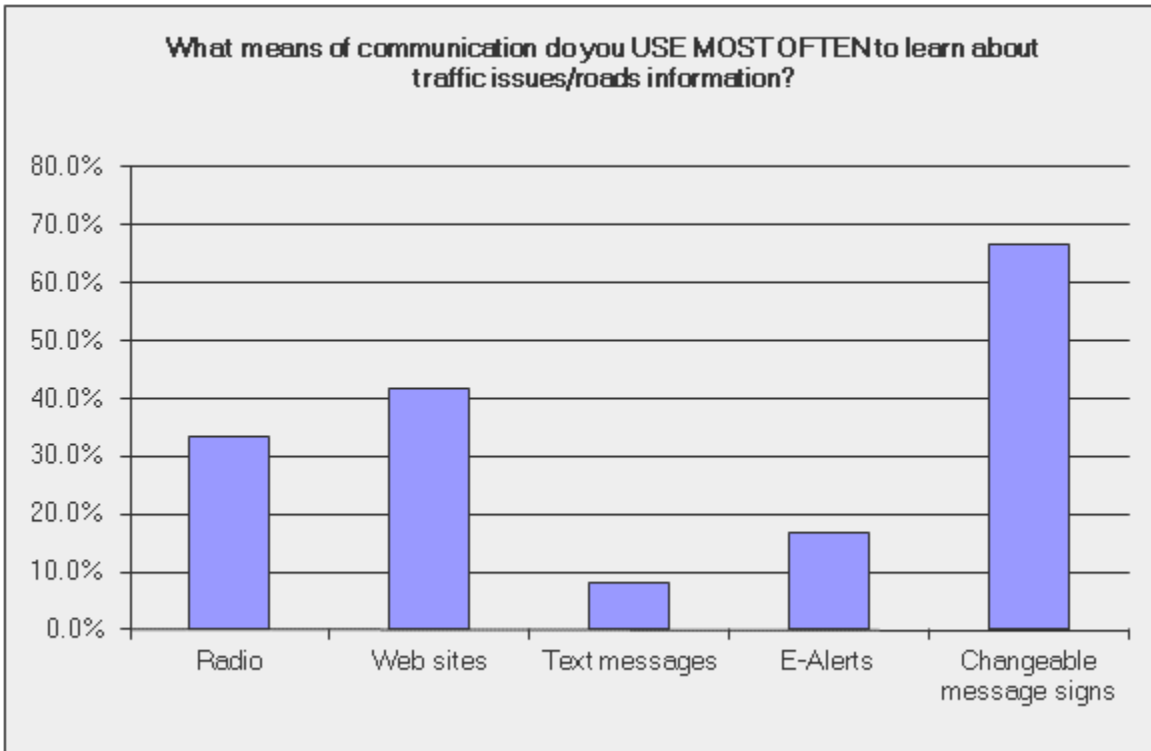

Results of user satisfaction survey question #7.

What are the BEST METHODS to keep you informed regarding traffic issues/road construction?			
Answer Options		Response Percent	Response Count
Radio		53.8%	7
Web sites		30.8%	4
Text messages		7.7%	1
E-Alerts		23.1%	3
Changeable message signs		61.5%	8
Other (please specify)			2
<i>answered question</i>			<b>13</b>
<i>skipped question</i>			<b>8</b>
Number	Response Date	Other (please specify)	Categories
1	Oct 28, 2011 10:54 PM	Television	
2	Oct 14, 2011 2:15 PM	Using the mobile trailers (signs) you could put them up a little sooner with information on how to get more information, like this website with the details on when the closure is, and the detour information etc. Maybe even sign up for emails and/or text message updates on the schedule, etc.	

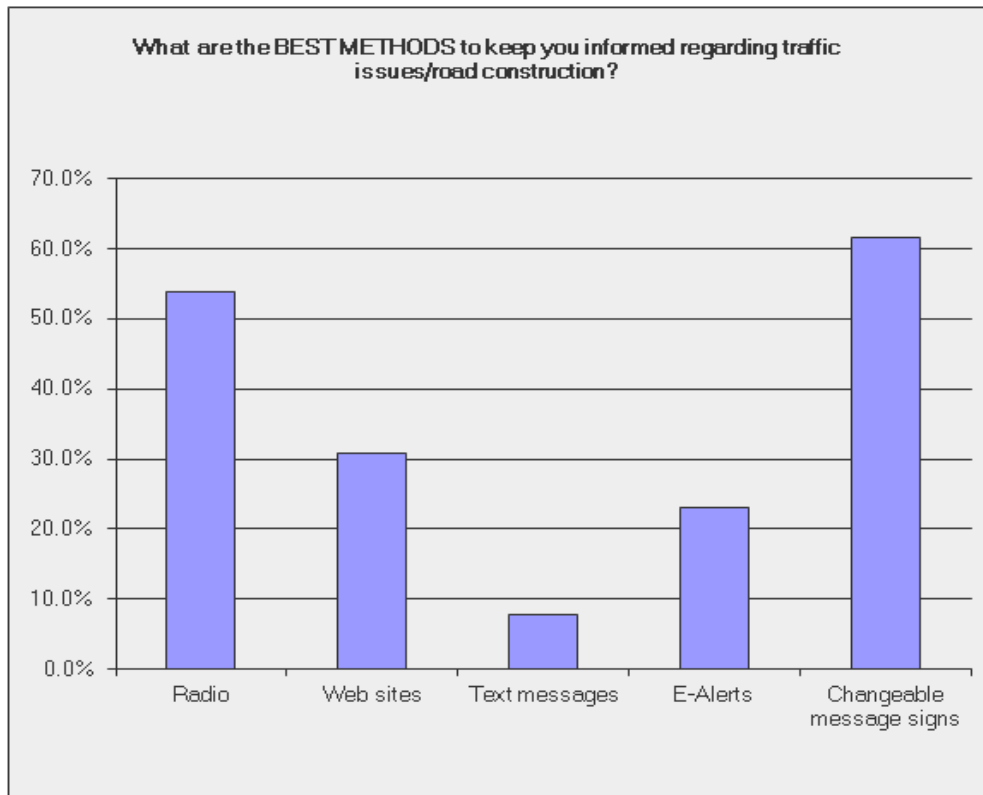

Results of user satisfaction survey question #8.

Rate the following aspects of the new US 6 Keg Creek bridge and surrounding areas as compared to its previous condition.						
Answer Options	Much Better	Better	Unchanged	Worse	Much Worse	Response Count
Lane width	7	2	0	0	0	9
Visibility	3	4	2	0	0	9
Signage	2	4	2	0	0	8
Lighting	0	2	5	0	0	7
Aesthetics (appearance)	3	3	2	0	0	8
Other (please specify)						3
						<i>answered question</i>
						<b>9</b>
						<i>skipped question</i>
						<b>12</b>
Number	Response Date	Other (please specify)	Categories			
1	10/31/11	did survey before drove on new bridge				
2	10/30/11	haven't seen the new bridge yet, still closed				
3	10/14/11	Will there be lights on the bridge when it is complete?				

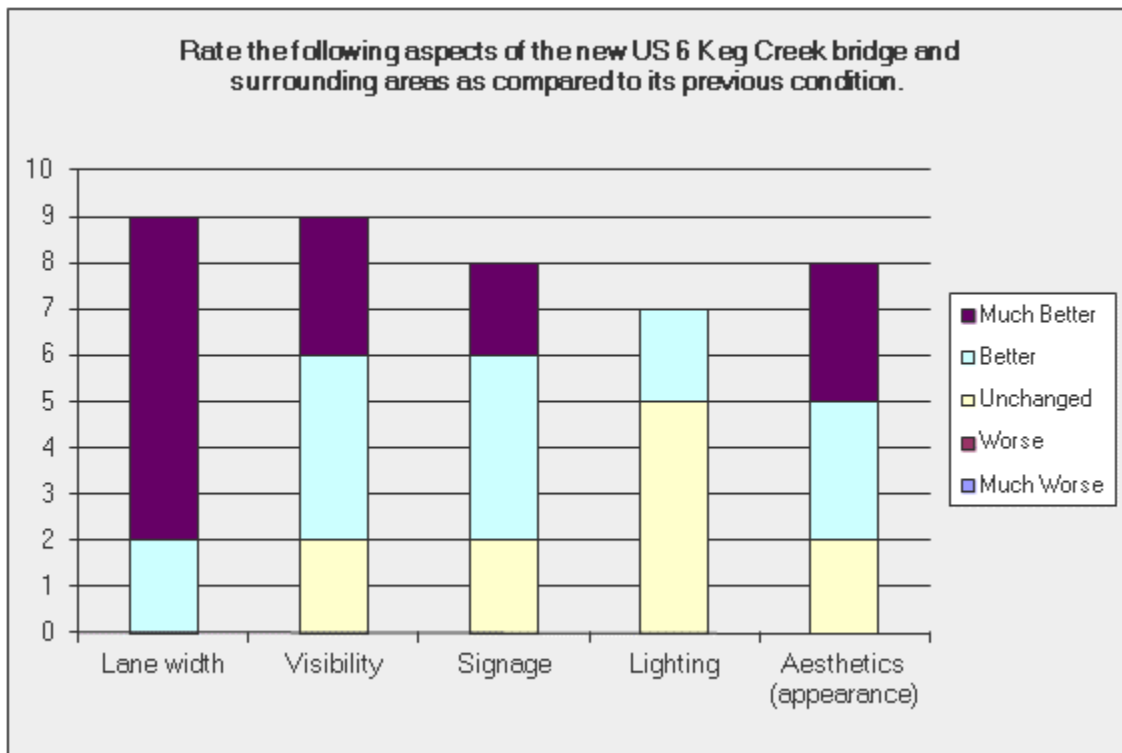

Results of user satisfaction survey question #9.

Rate the level of inconvenience you experienced as a user of the US 6 Keg Creek bridge.		
Answer Options	Response Percent	Response Count
Minimal	33.3%	4
Moderate	58.3%	7
Serious	8.3%	1
<i>answered question</i>		<b>12</b>
<i>skipped question</i>		<b>9</b>

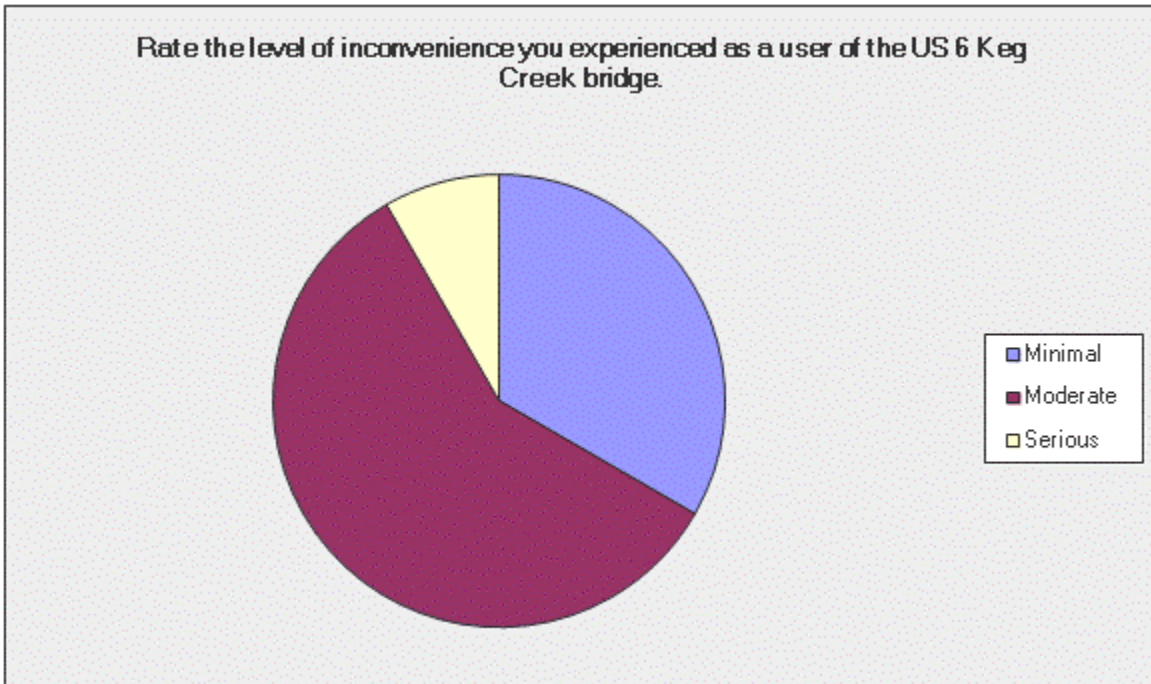

Results of user satisfaction survey question #10.

Did construction on the US 6 Keg Creek bridge deter you from visiting businesses along US 6?			
Answer Options		Response Percent	Response Count
Yes		8.3%	1
No		91.7%	11
If yes, please specify.			1
<i>answered question</i>			<b>12</b>
<i>skipped question</i>			<b>9</b>
Number	Response Date	If yes, please specify.	Categories
1	Nov 2, 2011 5:19 AM	businesses on that end of CB [Council Bluffs]...Fareway, Kmart, etc	

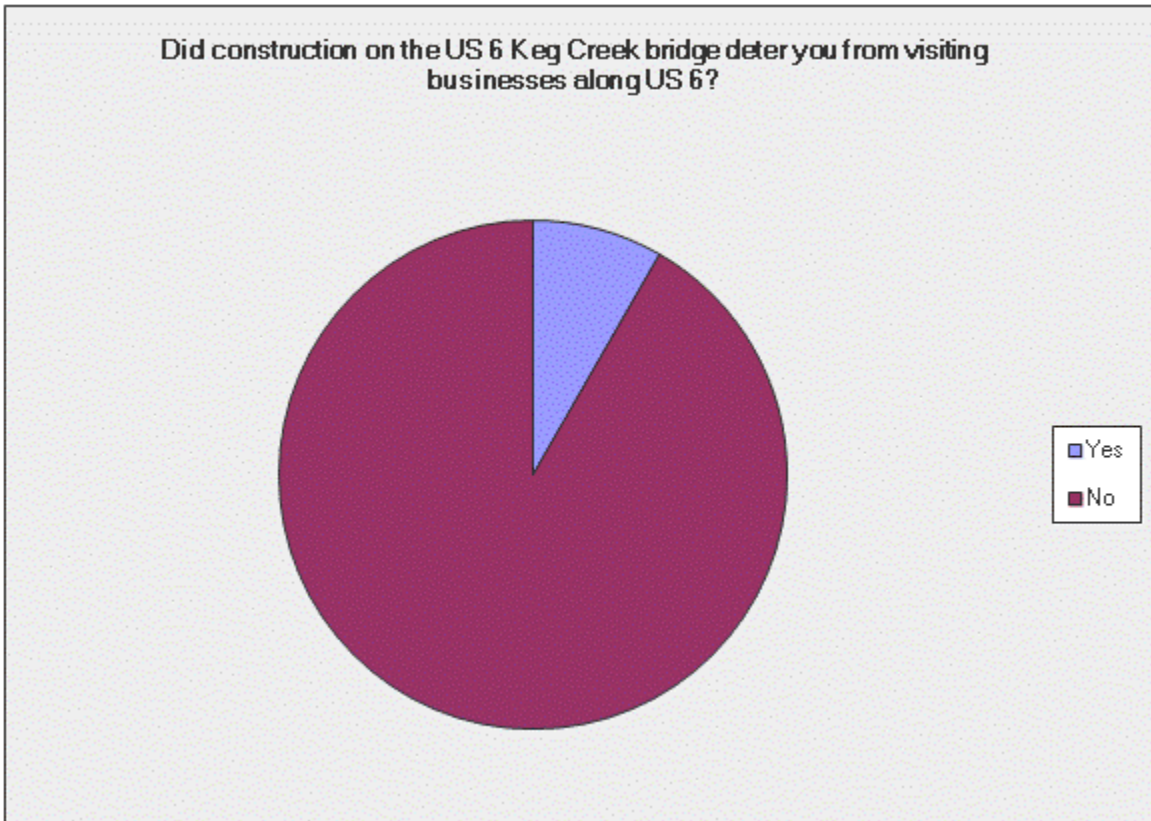

Results of user satisfaction survey question #11.

Were there any safety issues/concerns raised during the US 6 Keg Creek bridge project?			
Answer Options		Response Percent	Response Count
Yes		30.8%	4
No		69.2%	9
If yes, were they dealt with appropriately? How could they be handled better in the future?			3
<i>answered question</i>			<b>13</b>
<i>skipped question</i>			<b>8</b>
Number	Response Date	If yes, were they dealt with appropriately? How could they be handled better in the future?	Categories
1	Oct 31, 2011 4:47 PM	seen five accidents between treynor and metro crossings lights in two weeks, thk extra traffic might have contibuted	
2	Oct 28, 2011 10:55 PM	Traffic..especially semi trucks not following the signs.	
3	Oct 14, 2011 2:18 PM	I felt that when the construction required the use of the traffic signals to reduce the lanes down to one lane, that the signs on the EAST side of the bridge should have been much farther back than they were because they were at the top of the blind hill, and large vehicles like semi's that need a lot more stopping distance would have been at a disadvantage with such short notice, especially if traffic was backed up at all.	

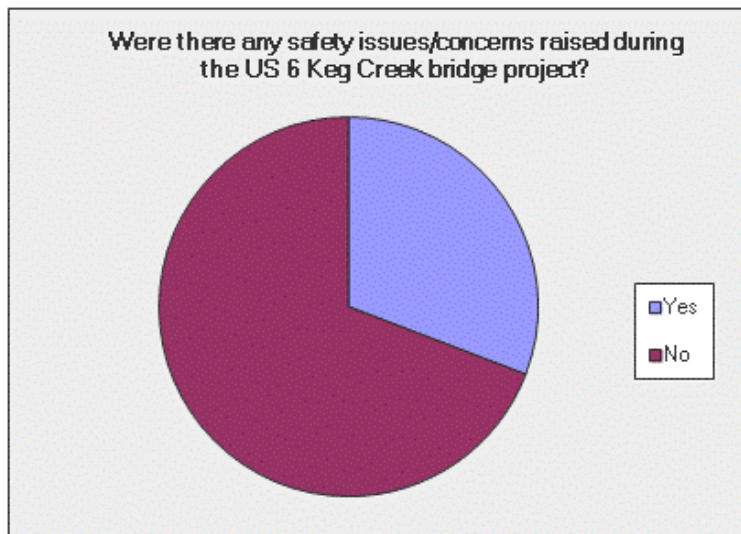

Results of user satisfaction survey question #12.

Rate the importance in regard to designing and scheduling projects.					
Answer Options	Very important	Important	Unimportant	Very unimportant	Response Count
Keeping a road/bridge open - allow restricted traffic, increase cost and time	3	2	5	0	10
Closing a road/bridge - no traffic, reduce cost and time	5	4	1	0	10
Extending the life of the road/bridge - more initial cost but less life cycle cost	5	5	0	0	10
Reducing future maintenance needs - more initial cost but fewer disruptions	6	4	0	0	10
Reduce time to complete a project through the use of incentives to contractors	7	1	2	0	10
Reduce time to complete a project through design/material selection	7	3	0	0	10
Creation of alternative routes while project is underway	5	5	0	0	10
Use of multiple methods (technology) to inform the public of work zone conditions	6	4	0	0	10
Other (please specify)					2
<i>answered question</i>					<b>10</b>
<i>skipped question</i>					<b>11</b>

Number	Response Date	Other (please specify)
1	Nov 2, 2011 11:31 PM	It has been lots of fun watching the bridge be built on the side of the road and while I hated taking hwy 92 at least it was only for a short time. I do wish some care had been taken to fix the terrible rough joints on highway 92 before switching so much extra traffic to it. Thanks for getting hwy 6 back open so fast!!
2	Oct 14, 2011 2:19 PM	With the close proximity of US Highway 92, this is a perfect solution to replace this bridge. I hope to see it used if other highway 6 bridges are getting replaced since Highway 92 parallels highway 6.



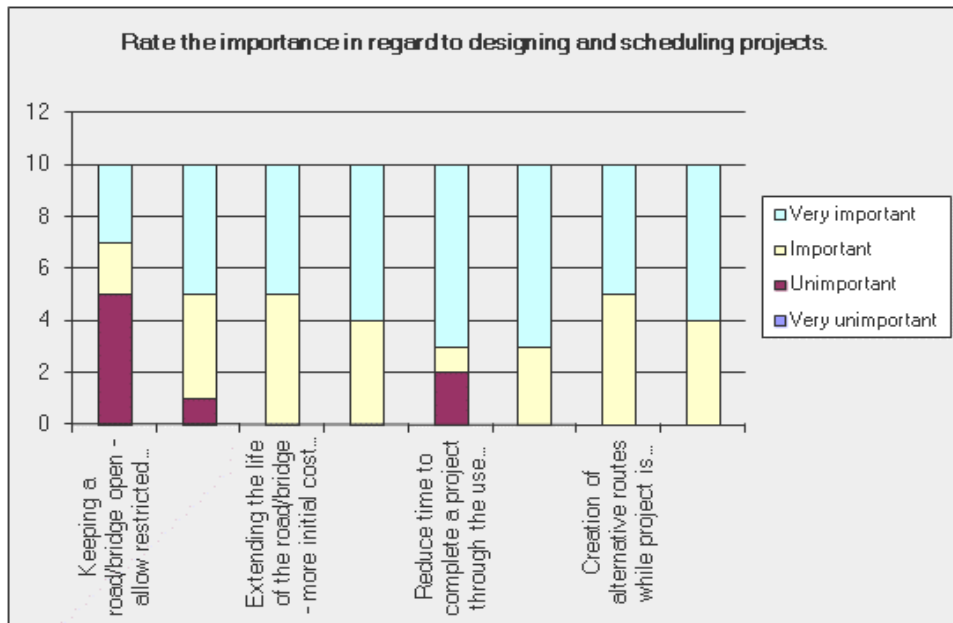

# Iowa DOT Keg Creek Bridge Replacement Showcase

Friday, October 28, 2011

## AGENDA



Moderator: George Feazell, District Construction Engineer – Iowa Department of Transportation

<b>7:30am</b>	<b>Registration/Check-in</b>
<b>8:00am - 8:20am</b>	<b>Introduction and Opening Remarks</b> John Adam, Highway Division Director - Iowa Department of Transportation Sandra Larson, Research and Technology Bureau Director – Iowa Department of Transportation
<b>8:20am - 8:35am</b>	<b>SHRP 2 Overview</b> Neil Hawks, Director of SHRP 2 – Transportation Research Board
<b>8:35am - 8:50am</b>	<b>Highways for LIFE Overview</b> Lubin Quinones, Division Administrator – FHWA, Iowa Division
<b>8:50am - 9:10am</b>	<b>National Perspective on Prefabricated Bridge Elements and Systems (PBES)</b> Benjamin Beerman, Senior Structural Engineer – Federal Highway Administration
<b>9:10am - 9:25am</b>	<b>Iowa DOT Experience with PBES</b> Norm McDonald, State Bridge Engineer – Iowa Department of Transportation
<b>9:25am - 9:55am</b>	<b>SHRP 2: Innovative Bridge Designs for Rapid Renewal</b> Bala Sivakumar, Co-principal Investigator for SHRP 2, Project R04 - HNTB Corporation
<b>9:55am - 10:25am</b>	<b>Demonstration Bridge Design (Superstructure &amp; Substructure)</b> Mike LaViolette, Bridge Practice Leader – HNTB Corporation
<b>10:25am - 10:40am</b>	<b>Break</b>
<b>10:40am - 11:00am</b>	<b>Owner’s Perspective: PBES vs. Conventional</b> Ahmad Abu-Hawash, Chief Structural Engineer – Iowa Department of Transportation
<b>11:00am - 11:20am</b>	<b>Contractor’s Perspective: PBES vs. Conventional</b> Kim Triggs, Vice President – Godbersen-Smith Construction
<b>11:20am - 11:45am</b>	<b>Ultra High Performance Concrete (UHPC) &amp; Lab Testing</b> Vic Perry, Vice President – Lafarge North America, Inc. Matt Rouse, Assistant Professor – Iowa State University
<b>11:45am - 12:00pm</b>	<b>Safety Briefing</b> Bruce Flippin, Council Bluffs RCE – Iowa Department of Transportation
<b>12:00pm - 1:00pm</b>	<b>Lunch</b> Open Panel Discussion (12:30pm)
<b>1:00pm</b>	<b>Load Buses</b>
<b>1:15pm</b>	<b>Buses Depart for Site Visit</b>
<b>1:15pm - 3:00pm</b>	<b>Site Visit</b>
<b>3:00pm</b>	<b>Buses Depart for Hotel</b>
<b>3:30pm</b>	<b>Adjourn</b>