

# Vermont Demonstration Project: Rehabilitation of Culverts in South Burlington and Colchester

Final Report  
June 2013

**HIGHWAYS FOR LIFE**  
*Accelerating Innovation for the American Driving Experience.*



U.S. Department of Transportation  
**Federal Highway Administration**

## FOREWORD

The purpose of the Highways for LIFE (HfL) pilot program is to accelerate the use of innovations that improve highway safety and quality while reducing congestion caused by construction. **LIFE** is an acronym for **L**onger-lasting highway infrastructure using **I**nnovations to accomplish the **F**ast construction of **E**fficient and safe highways and bridges.

Specifically, HfL focuses on speeding up the widespread adoption of proven innovations in the highway community. “Innovations” is an inclusive term used to encompass technologies, materials, tools, equipment, procedures, specifications, methodologies, processes, and practices used to finance, design, or construct highways. HfL is based on the recognition that innovations are available that, if widely and rapidly implemented, would result in significant benefits to road users and highway agencies.

Although innovations themselves are important, HfL is as much about changing the highway community’s culture from one that considers innovation something that only adds to the workload, delays projects, raises costs, or increases risk to one that sees it as an opportunity to provide better highway transportation service. HfL is also an effort to change the way highway community decision makers and participants perceive their jobs and the service they provide.

The HfL pilot program, described in Safe, Accountable, Flexible, Efficient Transportation Equity Act: A Legacy for Users (SAFETEA-LU) Section 1502, includes funding for demonstration construction projects. By providing incentives for projects, HfL promotes improvements in safety, construction-related congestion, and quality that can be achieved through the use of performance goals and innovations. This report documents one such HfL demonstration project.

Additional information on the HfL program is available at [www.fhwa.dot.gov/hfl](http://www.fhwa.dot.gov/hfl).

## NOTICE

This document is disseminated under the sponsorship of the U.S. Department of Transportation in the interest of information exchange. The U.S. Government assumes no liability for its contents or use thereof. This report does not constitute a standard, specification, or regulation.

The U.S. Government does not endorse products or manufacturers. Trade and manufacturers’ names appear in this report only because they are considered essential to the object of the document.

1. Report No.	2. Government Accession No	3. Recipient's Catalog No	
3. Title and Subtitle Vermont Demonstration Project: Rehabilitation of Culverts in South Burlington and Colchester		5. Report Date June 2013	6. Performing Organization Code
7. Authors Amar Bhajandas and Jagannath Mallela		8. Performing Organization Report No.	
9. Performing Organization Name and Address Applied Research Associates, Inc. 100 Trade Centre Drive, Suite 200 Champaign, IL 61820		10. Work Unit No. (TRAIS) C6B	11. Contract or Grant No.
12. Sponsoring Agency Name and Address  Office of Infrastructure Federal Highway Administration 1200 New Jersey Avenue SE Washington, DC 20590		13. Type of Report and Period Covered  Final Report	14. Sponsoring Agency Code
15. Supplementary Notes Contracting Officers Technical Representative (COTR): Byron Lord, Mary Huie			
16. Abstract As part of a national initiative sponsored by the Federal Highway Administration under the Highways for LIFE (HfL) program, the Vermont Agency of Transportation (VTrans) was awarded a grant to demonstrate the use of trenchless technology in rehabilitating two structurally deficient culverts located along Interstate 89 in South Burlington and Colchester, VT. The scope of work included adding a new 60-inch diameter culvert alongside the existing culvert at each location using trenchless technology under 40 feet of fill. This report documents the entire work effort, including the use of the innovative trenchless technique of pipe ramming. The addition of a culvert will improve hydraulic capacity and make future maintenance safer and easier.  The project included development of a geotechnical baseline report to minimize unexpected geotechnical conditions. After some early construction challenges, the project team successfully implemented the pipe ramming trenchless technology. The lessons learned on this project will be useful when addressing other projects of this type. VTrans was able to perform the work without closing any lanes or interfering with traffic flow. The benefits of using trenchless technology included the following:  <ul style="list-style-type: none"> <li>• Eliminated traffic delays and lane closures</li> <li>• Provided a safer environment for the traveling public and workers by eliminating exposure to traffic and construction activities inherent in conventional open-cut construction</li> <li>• Eliminated costs associated with traffic control and roadway excavation</li> <li>• Completed work for about \$1.2 million versus an estimated cost of \$4 million for open-cut construction</li> <li>• Completed the project in one construction season versus two for conventional construction</li> </ul>			
17. Key Words Highways for LIFE, innovative culvert rehabilitation, sliplining, trenchless technologies, pipe ramming		18. Distribution Statement No restriction. This document is available to the public through the Highways for LIFE website: <a href="http://www.fhwa.dot.gov/hfl/">www.fhwa.dot.gov/hfl/</a>	
Security Classif. (of this report) Unclassified	19. Security Classif. (of this page) Unclassified	20. No. of Pages 36	21. Price

SI* (MODERN METRIC) CONVERSION FACTORS				
APPROXIMATE CONVERSIONS TO SI UNITS				
Symbol	When You Know	Multiply By	To Find	Symbol
<b>LENGTH</b>				
(none)	mil	25.4	micrometers	µm
in	inches	25.4	millimeters	mm
ft	feet	0.305	meters	m
yd	yards	0.914	meters	m
mi	miles	1.61	kilometers	km
<b>AREA</b>				
in <sup>2</sup>	square inches	645.2	square millimeters	mm <sup>2</sup>
ft <sup>2</sup>	square feet	0.093	square meters	m <sup>2</sup>
yd <sup>2</sup>	square yards	0.836	square meters	m <sup>2</sup>
ac	acres	0.405	hectares	ha
mi <sup>2</sup>	square miles	2.59	square kilometers	km <sup>2</sup>
<b>VOLUME</b>				
fl oz	fluid ounces	29.57	milliliters	mL
gal	gallons	3.785	liters	L
ft <sup>3</sup>	cubic feet	0.028	cubic meters	m <sup>3</sup>
yd <sup>3</sup>	cubic yards	0.765	cubic meters	m <sup>3</sup>
NOTE: volumes greater than 1000 L shall be shown in m <sup>3</sup>				
<b>MASS</b>				
oz	ounces	28.35	grams	g
lb	pounds	0.454	kilograms	kg
T	short tons (2000 lb)	0.907	megagrams (or "metric ton")	Mg (or "t")
<b>TEMPERATURE (exact degrees)</b>				
°F	Fahrenheit	5 (F-32)/9 or (F-32)/1.8	Celsius	°C
<b>ILLUMINATION</b>				
fc	foot-candles	10.76	lux	lx
fl	foot-Lamberts	3.426	candela per square meter	cd/m <sup>2</sup>
<b>FORCE and PRESSURE or STRESS</b>				
lbf	poundforce	4.45	Newtons	N
lbf/in <sup>2</sup> (psi)	poundforce per square inch	6.89	kiloPascals	kPa
k/in <sup>2</sup> (ksi)	kips per square inch	6.89	megaPascals	MPa
<b>DENSITY</b>				
lb/ft <sup>3</sup> (pcf)	pounds per cubic foot	16.02	kilograms per cubic meter	kg/m <sup>3</sup>
APPROXIMATE CONVERSIONS FROM SI UNITS				
Symbol	When You Know	Multiply By	To Find	Symbol
<b>LENGTH</b>				
µm	micrometers	0.039	mil	(none)
mm	millimeters	0.039	inches	in
m	meters	3.28	feet	ft
m	meters	1.09	yards	yd
km	kilometers	0.621	miles	mi
<b>AREA</b>				
mm <sup>2</sup>	square millimeters	0.0016	square inches	in <sup>2</sup>
m <sup>2</sup>	square meters	10.764	square feet	ft <sup>2</sup>
m <sup>2</sup>	square meters	1.195	square yards	yd <sup>2</sup>
ha	hectares	2.47	acres	ac
km <sup>2</sup>	square kilometers	0.386	square miles	mi <sup>2</sup>
<b>VOLUME</b>				
mL	milliliters	0.034	fluid ounces	fl oz
L	liters	0.264	gallons	gal
m <sup>3</sup>	cubic meters	35.314	cubic feet	ft <sup>3</sup>
m <sup>3</sup>	cubic meters	1.307	cubic yards	yd <sup>3</sup>
<b>MASS</b>				
g	grams	0.035	ounces	oz
kg	kilograms	2.202	pounds	lb
Mg (or "t")	megagrams (or "metric ton")	1.103	short tons (2000 lb)	T
<b>TEMPERATURE</b>				
°C	Celsius	1.8C+32	Fahrenheit	°F
<b>ILLUMINATION</b>				
lx	lux	0.0929	foot-candles	fc
cd/m <sup>2</sup>	candela per square meter	0.2919	foot-Lamberts	fl
<b>FORCE and PRESSURE or STRESS</b>				
N	Newtons	0.225	poundforce	lbf
kPa	kiloPascals	0.145	poundforce per square inch	lbf/in <sup>2</sup> (psi)
MPa	megaPascals	0.145	kips per square inch	k/in <sup>2</sup> (ksi)

## **ACKNOWLEDGMENTS**

The project team would like to acknowledge the invaluable insights and guidance of Federal Highway Administration (FHWA) Highways for LIFE Team Leader Byron Lord and Program Coordinators Mary Huie and Kathleen Bergeron, who served as the technical panel on this demonstration project. Their vast knowledge and experience with the various aspects of construction, technology deployment, and technology transfer helped immensely in developing both the approach and the technical matter for this document. The team also is indebted to Mark Richter of the FHWA Vermont Division for his effective coordination effort and to Vermont Agency of Transportation Structures Design Engineer Wayne Symonds, Project Manager Dan Landry, and Construction Engineer Greg Wilcox. The project team was instrumental in making this project a success and provided the information that helped shape this report.

# Contents

<b>INTRODUCTION.....</b>	<b>1</b>
<b>HIGHWAYS FOR LIFE DEMONSTRATION PROJECTS .....</b>	<b>1</b>
<b>Project Solicitation, Evaluation, and Selection .....</b>	<b>1</b>
<b>HfL Project Performance Goals .....</b>	<b>2</b>
<b>REPORT SCOPE AND ORGANIZATION .....</b>	<b>3</b>
<b>PROJECT OVERVIEW AND LESSONS LEARNED .....</b>	<b>4</b>
<b>PROJECT OVERVIEW .....</b>	<b>4</b>
<b>DATA COLLECTION .....</b>	<b>7</b>
<b>ECONOMIC ANALYSIS .....</b>	<b>7</b>
<b>LESSONS LEARNED.....</b>	<b>8</b>
<b>Public Involvement .....</b>	<b>9</b>
<b>CONCLUSIONS.....</b>	<b>9</b>
<b>PROJECT DETAILS.....</b>	<b>10</b>
<b>BACKGROUND.....</b>	<b>10</b>
<b>PROJECT DESCRIPTION.....</b>	<b>10</b>
<b>DATA ACQUISITION AND ANALYSIS.....</b>	<b>23</b>
<b>SAFETY .....</b>	<b>23</b>
<b>CONSTRUCTION CONGESTION .....</b>	<b>23</b>
<b>QUALITY .....</b>	<b>23</b>
<b>USER SATISFACTION .....</b>	<b>24</b>
<b>ECONOMIC ANALYSIS .....</b>	<b>25</b>
<b>CONSTRUCTION COSTS .....</b>	<b>26</b>
<b>USER COSTS.....</b>	<b>26</b>
<b>COST COMPARISON.....</b>	<b>28</b>
<b>APPENDIX .....</b>	<b>A-1</b>

## LIST OF FIGURES

Figure 1 – Culvert Location Relative to Crest of Embankment .....	4
Figure 2 – Typical Condition of Exiting Culverts .....	4
Figure 3 - Slip Liner in Existing Culvert at Colchester site.....	5
Figure 4 – End View of Slip Liner at Colchester Site .....	5
Figure 5 – Steel Casing and Existing Culvert with Liner .....	6
Figure 6 – Headwall with two openings. ....	7
Figure 7. Project location.....	11
Figure 8. Aerial view of site. ....	12
Figure 9. South Burlington project layout plan. ....	12
Figure 10. Profile of existing and new culverts. ....	13
Figure 11. Layout of pipe ramming operation. ....	14
Figure 12. Schematic of pipe ramming pit.....	15
Figure 13. Concrete slab for pipe ramming equipment. ....	16
Figure 14. Sprocket assembly.....	17
Figure 15. Ramming of pipe using Grundrum Koloss hammer. ....	17
Figure 16. Offset and elevation monitoring graphs. ....	18
Figure 17. Auger bit removing the spoils from 24-in casing.....	19
Figure 18. Cutting shoe detail.....	20
Figure 19. View of 60-in steel casing on guide rails. ....	20
Figure 20. Headwall under construction for additional pipe. ....	21
Figure 21. Completed headwall showing both pipes. ....	22
Figure 22. Single lane crossover strategy for the baseline case.....	25
Figure 23. Comparison of hourly traffic demand and capacity in single direction. ....	27

## LIST OF TABLES

Table 1. Construction costs for the baseline alternative. ....	26
Table 2. Traffic related inputs used <i>RealCost</i> in user cost analysis.....	27
Table 3. Cost inputs used in <i>RealCost</i> user cost analysis. ....	27
Table 4. Summary of user costs computed using <i>RealCost</i> .....	28
Table 5. Cost comparison of as-built and baseline alternatives.....	28

## **ABBREVIATIONS AND SYMBOLS**

ADT	average daily traffic
dB(A)	A-weighted decibel
FHWA	Federal Highway Administration
HfL	Highways for LIFE
IRI	International Roughness Index
NHS	National Highway System
OBSI	onboard sound intensity
OSHA	Occupational Safety and Health Administration
SAFETEA-LU	Safe, Accountable, Flexible, Efficient Transportation Equity Act: A Legacy for Users
USDOT	United States Department of Transportation
VOC	Vehicle Operating Costs
VTrans	Vermont Agency of Transportation



# INTRODUCTION

## HIGHWAYS FOR LIFE DEMONSTRATION PROJECTS

The Highways for LIFE (HfL) pilot program, the Federal Highway Administration (FHWA) initiative to accelerate innovation in the highway community, provides incentive funding for demonstration construction projects. Through these projects, the HfL program promotes and documents improvements in safety, construction-related congestion, and quality that can be achieved by setting performance goals and adopting innovations.

The HfL program—described in the Safe, Accountable, Flexible, Efficient Transportation Equity Act: A Legacy for Users (SAFETEA-LU)—may provide incentives to a maximum of 15 demonstration projects a year. The funding amount may total up to 20 percent of the project cost, but not more than \$5 million. Also, the Federal share for an HfL project may be up to 100 percent, thus waiving the typical State-match portion. At the State's request, a combination of funding and waived match may be applied to a project.

To be considered for HfL funding, a project must involve constructing, reconstructing, or rehabilitating a route or connection on an eligible Federal-aid highway. It must use innovative technologies, manufacturing processes, financing, or contracting methods that improve safety, reduce construction congestion, and enhance quality and user satisfaction. To provide a target for each of these areas, HfL has established demonstration project performance goals.

The performance goals emphasize the needs of highway users and reinforce the importance of addressing safety, congestion, user satisfaction, and quality in every project. The goals define the desired result while encouraging innovative solutions, raising the bar in highway transportation service and safety. User-based performance goals also serve as a new business model for how agencies can manage the highway project delivery process.

HfL project promotion involves showing the highway community and the public how demonstration projects are designed and built and how they perform. Broadly promoting successes encourages more widespread application of performance goals and innovations in the future.

### **Project Solicitation, Evaluation, and Selection**

FHWA has issued open solicitations for HfL project applications annually since fiscal year 2006. State highway agencies submitted applications through FHWA Divisions. The HfL team reviewed each application for completeness and clarity, and contacted applicants to discuss technical issues and obtain commitments on project issues. Documentation of these questions and comments was sent to applicants, who responded in writing.

The project selection panel consisted of representatives of the FHWA offices of Infrastructure, Safety, and Operations; the Resource Center Construction and Project Management team; the Division offices; and the HfL team. After evaluating and rating the applications and

supplemental information, panel members convened to reach a consensus on the projects to recommend for approval. The panel gave priority to projects that accomplish the following:

- Address the HfL performance goals for safety, construction congestion, quality, and user satisfaction.
- Use innovative technologies, manufacturing processes, financing, contracting practices, and performance measures that demonstrate substantial improvements in safety, congestion, quality, and cost-effectiveness. An innovation must be one the applicant State has never or rarely used, even if it is standard practice in other States.
- Include innovations that will change administration of the State's highway program to more quickly build long-lasting, high-quality, cost-effective projects that improve safety and reduce congestion.
- Will be ready for construction within 1 year of approval of the project application. For the HfL program, FHWA considers a project ready for construction when the FHWA Division authorizes it.
- Demonstrate the willingness of the applicant department of transportation to participate in technology transfer and information dissemination activities associated with the project.

### **HfL Project Performance Goals**

The HfL performance goals focus on the expressed needs and wants of highway users. They are set at a level that represents the best of what the highway community can do, not just the average of what has been done. States are encouraged to use all applicable goals on a project:

- **Safety**
  - Work zone safety during construction—Work zone crash rate equal to or less than the preconstruction rate at the project location.
  - Worker safety during construction—Incident rate for worker injuries of less than 4.0, based on incidents reported via Occupational Safety and Health Administration (OSHA) Form 300.
  - Facility safety after construction—Twenty percent reduction in fatalities and injuries in 3-year average crash rates, using preconstruction rates as the baseline.
- **Construction Congestion**
  - Faster construction—Fifty percent reduction in the time highway users are impacted, compared to traditional methods.
  - Trip time during construction—Less than 10 percent increase in trip time compared to the average preconstruction speed, using 100 percent sampling.
  - Queue length during construction—A moving queue length of less than 0.5 mile (mi) (0.8 kilometer (km)) in a rural area or less than 1.5 mi (2.4 km) in an urban area (in both cases, at a travel speed 20 percent less than the posted speed).
- **Quality**
  - Smoothness—International Roughness Index (IRI) measurement of less than 48 inches (in) per mile.

- Noise—Tire-pavement noise measurement of less than 96.0 A-weighted decibels (dB(A)), using the onboard sound intensity (OBSI) test method.
- **User Satisfaction**—An assessment of how satisfied users are with the new facility compared to its previous condition and with the approach used to minimize disruption during construction. The goal is a rating of 4 or more points on a 7-point Likert scale.

## **REPORT SCOPE AND ORGANIZATION**

This report documents the Vermont Agency of Transportation's (VTrans) HfL demonstration project, which involved inserting a 60-in diameter culvert alongside an existing culvert using trenchless technology under 40 feet (ft) of fill to enhance hydraulic capacity. The report presents project details relevant to the HfL program, including the use of pipe ramming trenchless technology and the lessons learned in the process, HfL performance metrics measurement, and an economic analysis.

## PROJECT OVERVIEW AND LESSONS LEARNED

### PROJECT OVERVIEW

The purpose of this project was to rehabilitate two structurally deficient culverts located beneath Interstate 89 in South Burlington and Colchester, VT, and increase their hydraulic capacity. The South Burlington culvert with a nominal diameter of 72 inches and 287 feet long is located at mile marker 89.636 about 0.8 mi north of Exit 14, and the Colchester culvert with a nominal diameter of 110 inches and 313 feet long is located at mile marker 95.183 about 2.7 mi south of Exit 17. The crest of the embankment at both locations is approximately 40 feet above the culvert invert elevation. Figure 1 shows culvert location relative to the crest of the embankment and Figure 2 shows typical condition of the existing culvert at each site.



Figure 1 – Culvert Location Relative to Crest of Embankment



Figure 2 – Typical Condition of Existing Culverts

The initial plan was to rehabilitate the existing culvert at each site using a slip liner and adding capacity by inserting a 60-in diameter culvert alongside the existing culvert using trenchless technology. The successful bidder presented a value engineering proposal to line the culverts with larger liners and eliminate the need for the parallel pipe at each location and the trenchless technology associated with it. The project team accepted the contractor's proposal of using an 84-in. slip liner at the Colchester site primarily because it met AASHTO hydraulic guidelines, the geography at the location allowed for vast storage upstream and reduction in project costs by approximately \$281,000. Figure 3 shows the slip liner in the existing culvert at Colchester and Figure 4 provides an end view of the inserted liner.



Figure 3 - Slip Liner in Existing Culvert at Colchester site



Figure 4 - End View of Slip Liner at Colchester Site

The project team denied the value engineering proposal for the South Burlington site and decided to pursue innovative trenchless technology at this site as planned.

VTrans considered three trenchless technologies—pipe jacking, auger boring, and pipe ramming—and gave the contractor the flexibility to choose the technology to use. The contractor, Morrill Construction, Inc. of North Haverhill, NH, chose pipe ramming technology in which pneumatic percussive blows drive the pipe through the ground.

The contract called for performing a pilot bore to help achieve the line and grade of 1.37 percent during pipe ramming. The contractor used a directional drill attached to a 24-in steel casing. This 24-in casing served as a guide for the 60-in diameter steel casing. The directional drilling worked acceptably well, but the 24-in casing encountered an obstruction and deflected. The deflection sheared off the drill just ahead of the attachment point. The 24-in casing and the directional steel were abandoned as a guide. The drill steel was removed. The 24-ft steel casing was left in place (about 84 ft into the embankment) until the 60-in steel casing was inserted to a point beyond the leading edge of the 24-in casing. The 24-in casing was removed before continuing with the insertion of the 60-in casing. The 60-in steel casing was inserted successfully, free of any guidance. Figure 5 shows the steel casing in relation to the existing culvert with liner inserted and Figure 6 shows completed headwall with the two openings.

By using trenchless technology, VTrans eliminated the need for lane closures, eliminating construction-related traffic congestion and the costs associated with maintenance and protection of traffic control and roadway excavation. The culverts with pipe linings improved the structural integrity of the pipes while enhancing hydraulic capacities and improving passage of sediments through the pipes.



Figure 5 – Steel Casing and Existing Culvert with Liner



Figure 6 – Headwall with two openings.

## **DATA COLLECTION**

No worker injuries or motorist incidents were reported during construction, which means VTrans exceeded the HfL requirements for worker safety. No motorist incidents have been reported since the rehabilitation of the pipes.

Although the quality and hydraulic capacity of the pipes improved because of the project, the rehabilitation process had no impact on the noise and smoothness quality of the pavement. The project had no impact on traffic flow because the work was done beyond the shoulder edge, so it attained the HfL performance goal for construction congestion. Traffic was continuous during culvert rehabilitation, with no impact on trip time or queue length through the construction zone.

## **ECONOMIC ANALYSIS**

Traditional construction for adding a culvert pipe of this type would be open cut design. With a culvert location under a heavily traveled four-lane roadway (average daily traffic (ADT) of 52,600 vehicles), maintaining two lanes of travel in each direction during construction would have been important. This means construction would have been in phases, starting with construction of a temporary crossover to shift two lanes of traffic from the active construction area and followed by excavation and placement of pipe under lanes in one direction and, after the pipe was covered, shifting of traffic in the opposite direction and completion of the pipe installation. This phase would also have included restoring traffic to existing alignments, removing the crossover, and final site cleanup. The cost of this conventional approach was

estimated at \$4 million at each site. Furthermore, the project would have required two construction seasons to complete.

In contrast, the bid for the innovative option for the work at the two locations was \$2.4 million. The culvert length was 313 ft at the Colchester site and 287 ft at the South Burlington site. Assuming the cost of construction to be the same at each site, the cost at the South Burlington site was estimated at \$1.2 million despite its shorter pipe length. Thus, the construction cost of \$1.2 million for the innovative option was about 30 percent of the cost of \$4 million for the conventional option. This is comparing construction costs alone. User cost from delays caused by staged construction would have been additional for the conventional option.

Therefore, in higher traffic areas where lane closures and traffic delays are substantial and must be avoided, trenchless technology could totally eliminate interference with traffic flow and be economically advantageous.

## **LESSONS LEARNED**

Vermont has more than 125 culverts buried beneath an average of more than 20 ft of fill. This project demonstrated that trenchless technology to add or replace pipes under substantial fill heights is not only feasible but cost-effective, especially in high-traffic areas. Because of the success of this project, VTrans plans to use trenchless technology in the future. The project manager indicated that with the experience gained on this project, the project team recommends that the following considerations be incorporated in future projects:

- Prequalify contractors of specialty items and tasks such as pipe ramming for both technical and financial capability.
- Require technical submittals on trenchless technology to be in a single package versus multiple submissions.
- Continue to allow the contractor to choose the trenchless technology of its choice from those VTrans considers viable.
- Consider performance specifications that allow reasonable tolerances for achieving specified line and grade.
- Ensure that the survey of the project site is not limited and is extensive enough to accommodate ground monitoring points.
- Consider making the pilot tube optional rather than a requirement, based on ground conditions, boring logs, and the contractor's experience.
- Consider a specification that requires the contractor to submit a geotechnical baseline report versus being provided with one, making the contractor more vested in the subsurface investigation. This could lengthen contract duration, but reduce claim risk.
- Consider calculations and methods used to monitor pile driving performance as guides to monitor performance of the pipe ramming process because the ramming calculations to ensure that the casing was not overstressed were too conservative. The contractor was required to stop temporarily if the calculations showed that the casing was overstressed before the completion of the installation and was required to clean out the spoils in the casing to reduce skin friction.



- Consider requiring the headwall design at the inlet end to be finalized once trenchless operations are completed because of the potential shift of the insertion point when construction problems are encountered. The design should be about 80 percent complete going into construction. Similarly, the cradle headwall or full headwall at the outlet end wall should be about 80 percent complete going into construction, but it should be finalized after the exact location of the outlet is known after the trenchless operation.
- Require that the steel casing be wrapped with expansion material at the ends in the headwall and that a joint be added above each pipe to control cracking.

## **Public Involvement**

The user satisfaction survey completed by a representative of the property next to the site indicated no impact from construction. On a Montana project that used trenchless technology to rehabilitate existing culverts,<sup>1</sup> 93 nearby residents responded to a user satisfaction survey, and it appeared that most of travelers on the roadway under which the pipes were being rehabilitated did not notice the work because the construction activities were inconspicuous.

## **CONCLUSIONS**

The insertion of 60-in diameter pipe under 40 ft of fill using trenchless pipe technology was successfully accomplished after some early challenges. VTrans easily met the HfL performance goals on motorist and worker safety, construction congestion, quality, and user satisfaction. By using innovative technology, VTrans was able to perform the work without closing any lanes or interfering with traffic flow. Furthermore, VTrans was able complete the work in one construction season versus two for conventional open-cut construction and at a cost of 30 percent of conventional methods.

---

<sup>1</sup> Ahmad Ardani, P.E., Jagannath Mallela, Gary Hoffman, P.E., R.L.S., *Montana Demonstration Project: Innovative Culvert Rehabilitation Using Trenchless Technologies*, Federal Highway Administration, May 2009.

## **PROJECT DETAILS**

### **BACKGROUND**

The Interstate Highway System in Vermont was constructed between 1960 and 1975. Throughout much of the system, many metal culverts have reached or are rapidly reaching their design life of 50 years and many are in advanced states of deterioration because of aggressive soil and stream chemistry. Historically, deteriorated culverts have been rehabilitated by lining or replaced using open-cut construction methodology.

Rehabilitation challenges have included loss of hydraulic capacity, impacts on aquatic organism passage, and inherent limitations of original pipes that may not have been sized properly for the contributing watershed. Challenges of using open-cut construction to rehabilitate or replace culverts have included impacts on the traveling public, traffic management costs, congestion during construction, constructability issues, and dewatering and stream bypass issues during construction. High embankments and traffic volumes make this process costly, time consuming, and challenging. VTrans has more than 125 interstate culverts buried beneath an average of 20 ft of fill, 28 of which were rated in 2009 in poor or worse condition or could not be rated because of their location.

Typically, deteriorated deep culverts under heavily traveled roads have been rehabilitated with capacity loss and often higher pipe velocities, negatively affecting aquatic passage and requiring more erosion protection.

VTrans explored alternative methods that would have minimal traffic impacts, cost less, and be faster than conventional open-cut construction. VTrans considered trenchless technology of pipe insertion that has been successfully used in the Pacific Northwest. The agency was awarded a Highways for LIFE grant to implement the technology on a project in the State.

### **PROJECT DESCRIPTION**

VTrans selected the South Burlington–Colchester project to rehabilitate two structurally deficient culverts located along I-89 in South Burlington and Colchester and increase their hydraulic capacity. The South Burlington culvert is located at mile marker 89.636 about 0.8 mi north of Exit 14 and the Colchester culvert under I-89 is located at mile marker 95.183 about 2.7 mi south of Exit 17 (Figure 7).

The scope of work was to rehabilitate the existing culvert at each site, including installation of pipe liners and headwalls and construction of new culverts using trenchless technology alongside the existing culverts. Morrill Construction, Inc. of North Haverhill, NH, had a low bid of \$2.35 million and was awarded the contract.

The successful bidder presented a value engineering proposal to line the existing culvert at Colchester with an 84-in slip liner that would meet hydraulic requirements and reduce project cost. The project team accepted the value engineering proposal and decided to pursue innovative trenchless technology to insert the culvert at the South Burlington site only. The culvert at this

location would be 287 ft long and have 40 ft of cover. Figure 8 shows the site, figure 9 shows the layout plan, and figure 10 shows the profile of the existing and new culverts.

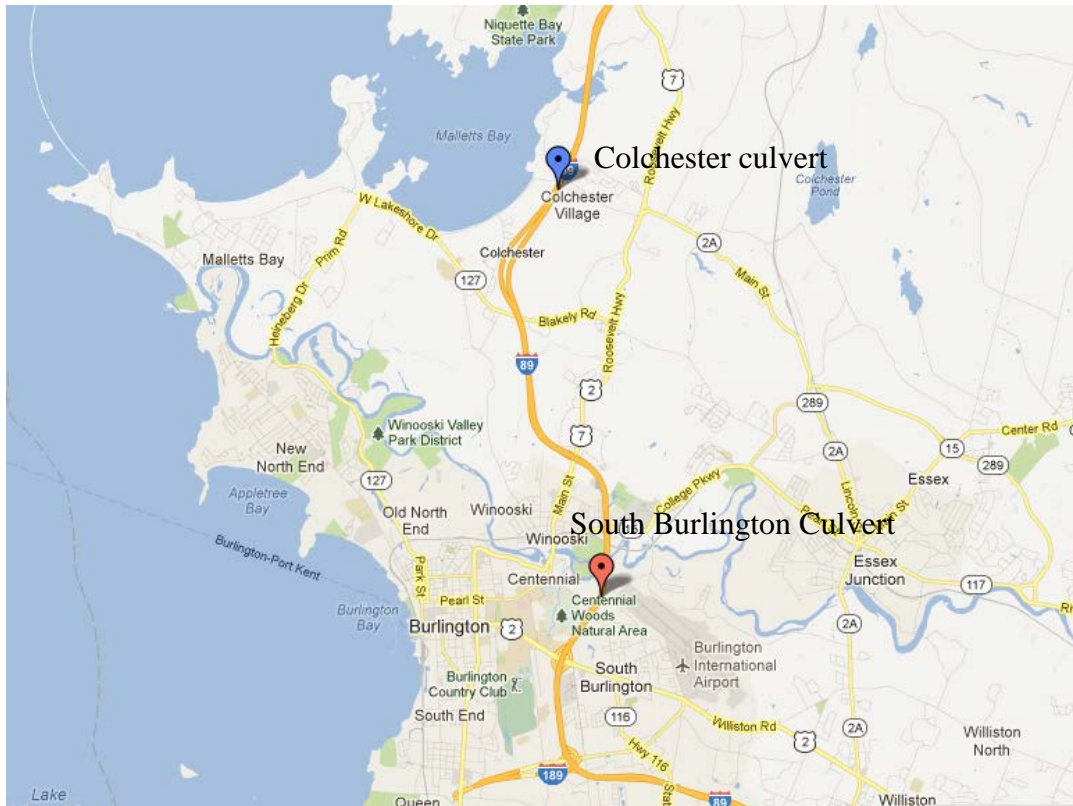

Figure 7. Project location.

VTrans considered three methodologies for trenchless pipe insertion—pipe jacking, boring, and pipe ramming—and gave the contractor the flexibility to choose the methodology to use. Pipe jacking calls for hydraulic jacks to push pipe segments horizontally, auger boring uses a laser-guided or personnel-occupied tunnel machine, and pipe ramming uses pneumatic percussive blows to drive the pipe through the ground.

VTrans invested in a geotechnical baseline report to reduce the risk of encountering unexpected geotechnical conditions. Good geotechnical information provides greater confidence in bidding and reduces the chances of conflict between the contractor and the agency because of unforeseen conditions.

The contractor selected pipe ramming and chose Boretch of Johnsbury, VT, to assist with the methodology.

Before Boretch mobilized the site, the contractor completed the stream diversion, dewatering of the ramming site, excavation and support of the embankment toe by sheet pile walls, and construction of a concrete slab for the trenchless equipment setup. The site layout is shown in figure 11, a schematic of the pipe ramming pit in figure 12, and the concrete slab for supporting the pipe ramming equipment in figure 13.



Figure 8. Aerial view of site.

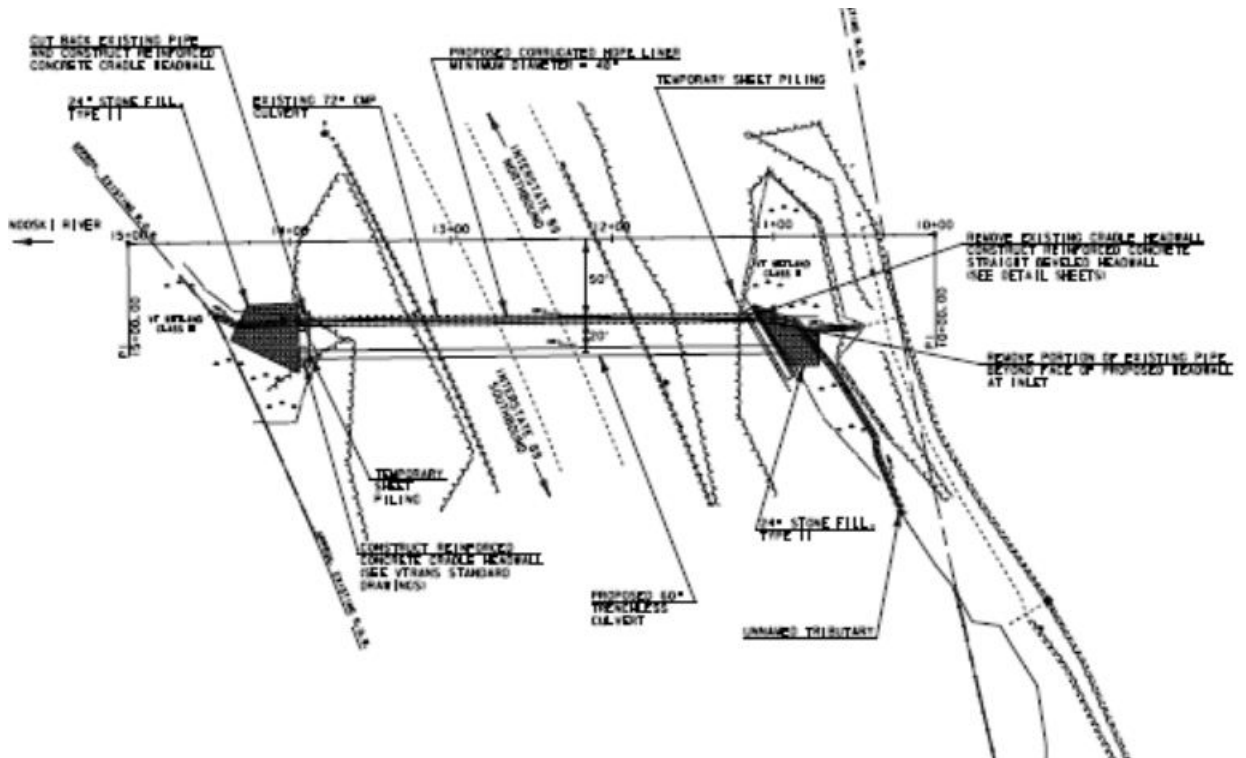
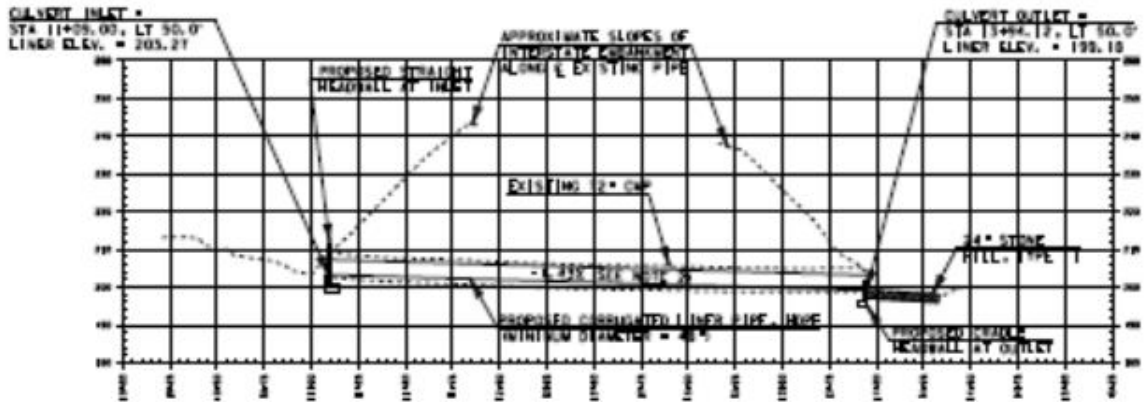
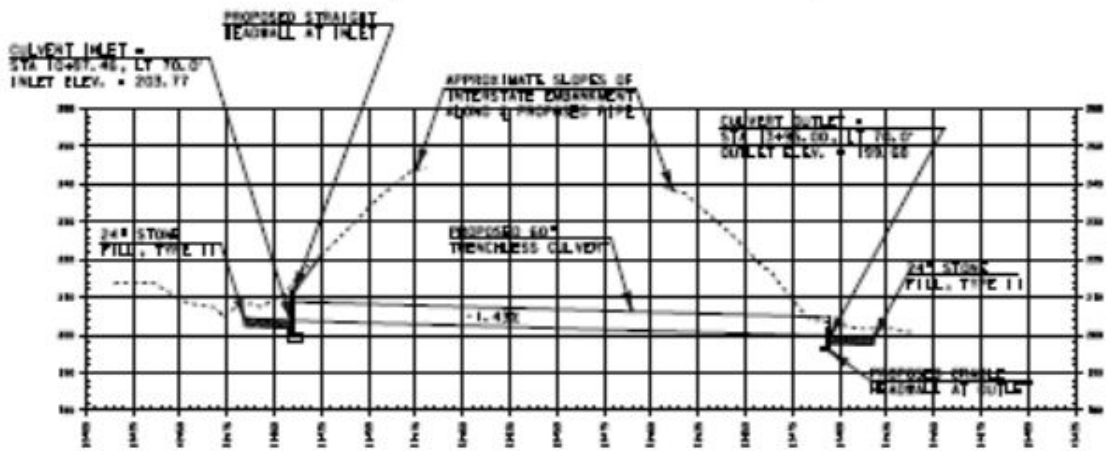

Figure 9. South Burlington project layout plan.



EXISTING CULVERT WITH LINER  
SOUTH BURLINGTON BRIDGE NO. 69-1



PROPOSED 60" TRENCHLESS CULVERT  
SOUTH BURLINGTON BRIDGE NO. 69-1

Figure 10. Profile of existing and new culverts.

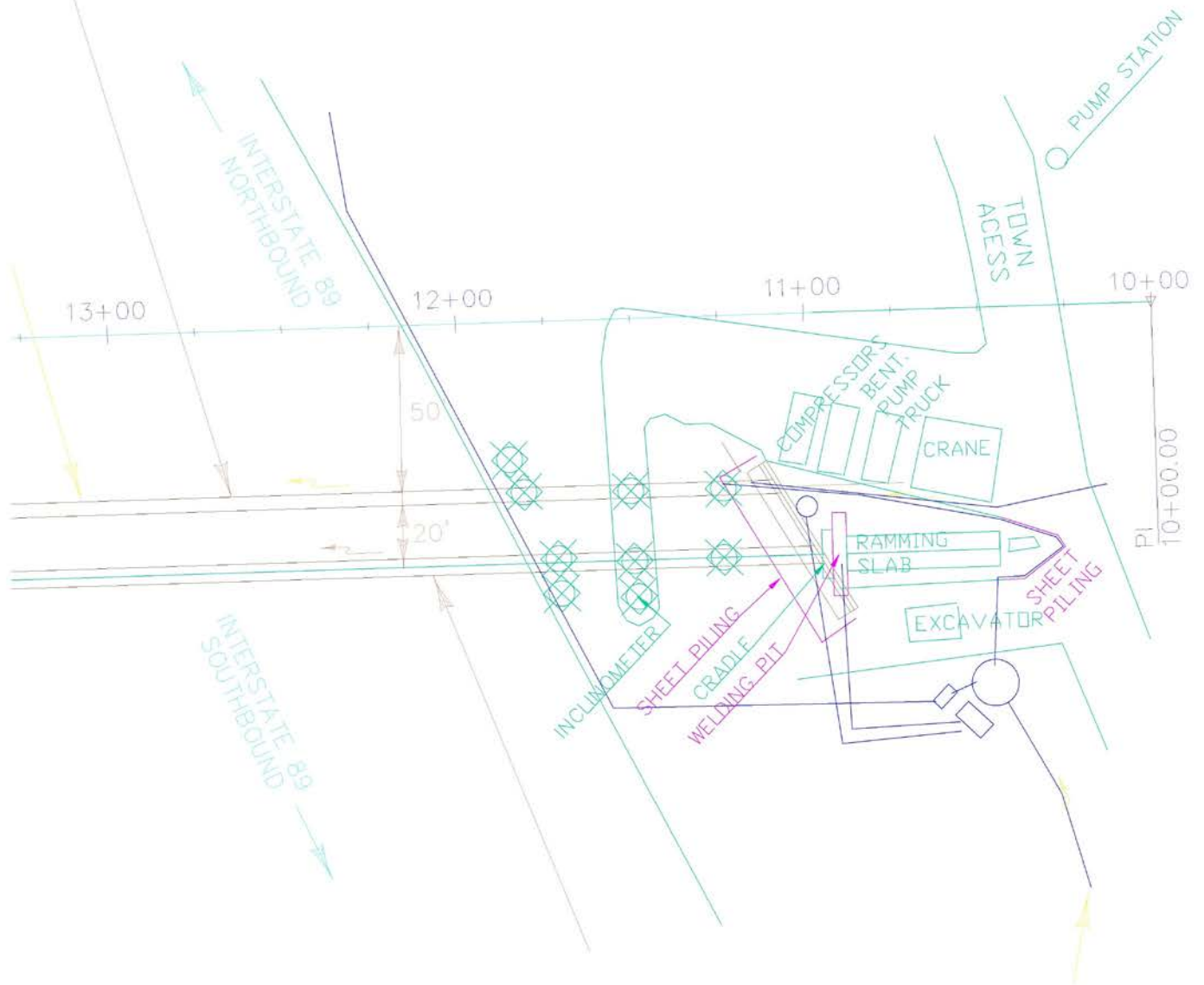

Figure 11. Layout of pipe ramming operation.

# BORE TECH

1323 Industrial Parkway  
St Johnsbury, Vt 05819  
Phone: 802-748-6555  
Fax: 802-748-6822

Morrill Construction  
So Burlington I89 Pipe Ramming

Pipe Ramming Pit  
Taurus Pipe Rammer  
American Augers 36-600

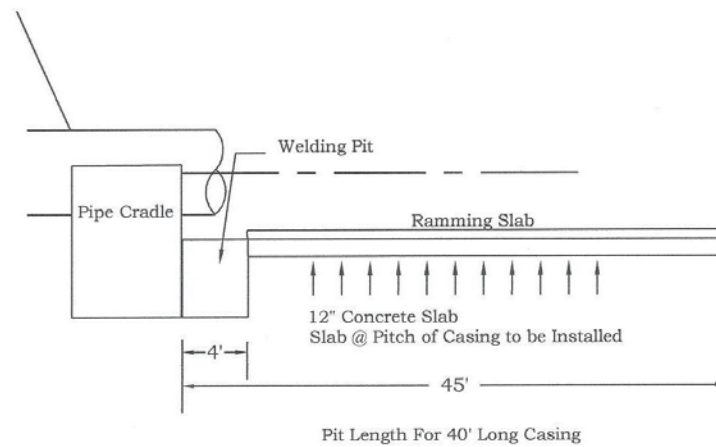
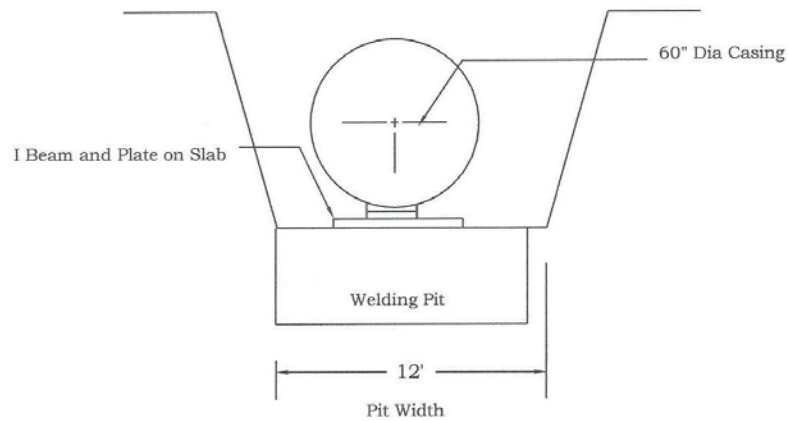

Figure 12. Schematic of pipe ramming pit.



Figure 13. Concrete slab for pipe ramming equipment.

The contract called for performing a pilot bore to help achieve the line and grade during pipe ramming and to centralize the steel casing around the pilot bore. The casing diameter and means and method of the pilot bore were left to the contractor. Boretch chose to use a directional drill from the inlet end with a casing of 3.5 in, checking line and grade every 15 ft (with the exception of the interstate lanes) to confirm accuracy. Once the directional steel was completely across the interstate, a 24-in diameter, 3/8-in thick steel casing was placed on guide rails on the inlet end. The joining of the drill steel to the 24-ft casing was accomplished using a field-fabricated sprocket about 18 in long. The sprocket was field welded to the interior walls of the casing (figure 14). This 24-in casing was to serve as a guide for the 60-in diameter steel casing that was to be left in the embankment.

After attaching the drill steel and 24-in casing, the crew attached a Grundrum Koloss hammer to the end of the first section of the 24-in casing and proceeded to ram the pipe in place (figure 15). Pipe ramming uses pneumatic percussive blows to drive the pipe through the ground.

The crew rammed the first section of casing (39.82 ft), spliced the second section (31.33 ft), and rammed this section as well. The second and third sections were then spliced and the third section was rammed. At about 80 ft into the embankment, the pile stopped advancing and it was theorized that the sprocket broke away from the drill steel after the casing hit a tree stump. The contractor also found that the pilot tube had broken off. (See graphs on offset and elevation developed from monitoring equipment at the site in figure 16.) At that point the contractor abandoned the plan to jack the 24-in steel casing and began jacking the 60-in diameter, 1-in thick steel casing around the 24-in steel casing and the pilot tube. Because jacking is not steerable, the



contractor chose to move the culvert one foot away from the designated distance of 20 ft from the centerline of the existing culvert. This meant the headwall had to be redesigned.



Figure 14. Sprocket assembly.



Figure 15. Ramming of pipe using Grundrum Koloss hammer.

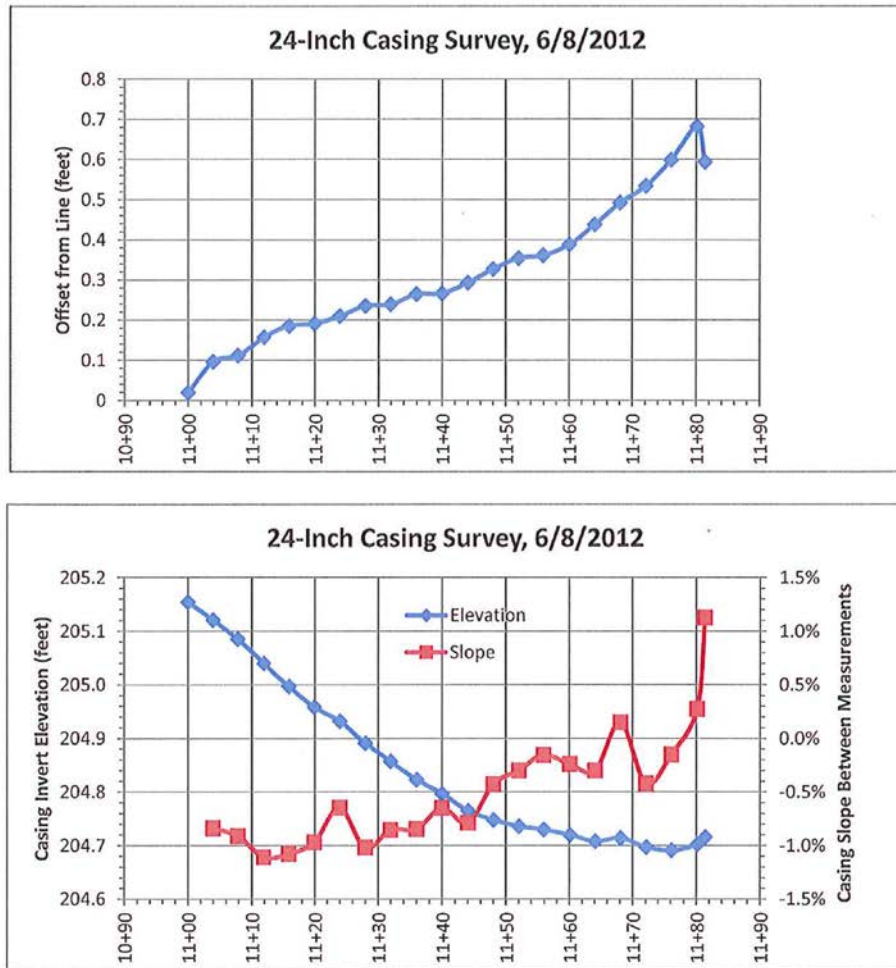

Figure 16. Offset and elevation monitoring graphs.

The crew cleaned out the 24-in casing using a drill rig with a 24-in auger bit (see figure 17). The drill steel was removed and the 24-in steel casing was left in place until the 60-in casing was inserted beyond the leading edge of the 24-ft casing.

In pipe ramming, the leading edge of the pipe is generally open. Its shape allows a small overcut (shown in figure 18 on the cutting shoe detail) to reduce friction between the pipe and the soil and to improve load conditions on the pipe. The soil is directed inward into the pipe instead of being compacted outside the pipe. The project manager stated that as part of the submittals from the contractor, calculations were required to show that the ramming forces would not damage the steel casing (shown in figure 19). The calculations are made by estimating the resistance to driving the casing by considering the resistance from the soil at the front end of the pipe (tip resistance) and the frictional force along the length of the installed pipe (skin friction). If the calculations show that the casing may be overstressed before installation is completed, ramming is temporarily stopped to permit the cleanout of the spoils in the casing to reduce the skin friction. The ramming can then be resumed.

The calculations that the contractor's engineer provided showed that as the casing is driven deeper into the fill, the rate of penetration should take longer because of the increased skin

friction. However, field observations showed the opposite. This suggests that the calculations may be overly conservative. There may be some benefits to development of a standard monitoring method for use during construction to ensure that the casing is not overstressed by the ramming process, possibly similar to calculations and methods used to monitor pile driving performance.



Figure 17. Auger bit removing the spoils from 24-in casing.

# BORE TECH

1323 Industrial Parkway  
St. Johnsbury, Vt. 05819  
PH: 802-748-6555  
Fax: 802-748-6822

## CUTTING SHOE DETAIL

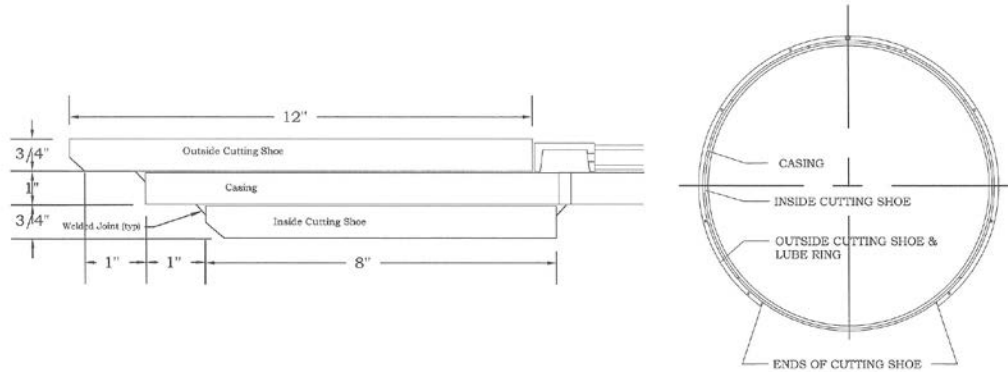

Figure 18. Cutting shoe detail.



Figure 19. View of 60-in steel casing on guide rails.

The design of the headwall was modified to accommodate the shift in the centerline of the new pipe. Its construction is shown in figure 20. The outlet end of the pipe was designed to rest on a cradle wall. This also had to be redesigned because of the shift in the centerline. Furthermore, the cradle wall was changed to a full headwall to protect against slope failure (figure 21).

The concrete headwall developed a small crack above the steel casing, probably because of expansion and contraction of the casing. In future contracts, VTrans intends to require that the steel casing be wrapped with expansion material at the ends in the headwall and that a joint be added just above each pipe to control cracking.



Figure 20. Headwall under construction for additional pipe.



Figure 21. Completed headwall showing both pipes.

By using trenchless technologies, VTrans eliminated the need for lane closures, eliminating construction-related traffic congestion and the costs associated with maintenance and protection of traffic control and roadway excavation. The culverts with pipe linings improved the structural integrity of the pipes while enhancing hydraulic capacities and improving passage of sediments through the pipes.

## **DATA ACQUISITION AND ANALYSIS**

Data collection and analysis on the VTrans project consisted of acquiring and comparing data before, during, and after construction to provide sufficient performance information to support the feasibility of the proposed innovation and to demonstrate that innovative trenchless culvert rehabilitation technologies can be used to do the following:

- Achieve a safer environment for the traveling public and workers.
- Reduce construction duration and minimize traffic interruptions.
- Achieve better quality because work is done in a more controlled environment.
- Attain user satisfaction.

### **SAFETY**

The traditional culvert removal and replacement process involves excavating the roadway and removing the existing culvert, which requires lane closures and traffic control while pipes are being removed and replaced. This causes significant traffic disruption and exposes both the traveling public and workers in the work zone to safety hazards. One attribute of trenchless technologies is that they do not require lane closures during installation. As a result, these technologies have no impact on traffic flow and provide a substantially safer environment for motorists and workers.

Traditional construction using open-cut technology is inherently dangerous because it is done in confined spaces to reduce excavation and temporary fills may not be properly stabilized. Higher construction duration exposes workers and the traveling public to more safety risk as well.

On the South Burlington project, no worker injuries or highway user incidents were reported. Therefore, VTrans exceeded the safety performance goals set by HfL.

Future safety is enhanced by the presence of two culverts. Both culverts are less apt to plug at the same time, reducing the risk of maintenance under high water conditions. Furthermore, maintenance forces can divert the stream flow to one culvert while they conduct work on the other under relatively dry conditions.

### **CONSTRUCTION CONGESTION**

The HfL performance goal criteria for construction congestion was easily attained because the project had no impact on traffic flow. All work was accomplished beyond the outside edge of the shoulders. Traffic was continuous during culvert rehabilitation, with no impact on trip time or queue length in the construction area.

### **QUALITY**

The IRI and tire-pavement interface noise at the project site were not impacted because innovative trenchless technology was used to insert culverts without disturbing the driving

surface. The steel pipe casing with lining will have a life expectancy beyond 50 years. The new culvert enhances hydraulic capacity at this location.

#### **USER SATISFACTION**

Because the trenchless culvert rehabilitation techniques did not interfere with traffic flow, VTrans received no negative comments from the traveling public about the project, perhaps because the public did not notice any work being done. Therefore, VTrans' score for user satisfaction on a Likert scale is greater than 4 for both the approach used to rehabilitate the culverts and the final product. VTrans sent a questionnaire to the lone property owner next to the site impacted. His positive response is shown in the Appendix.



## ECONOMIC ANALYSIS

A key aspect of HfL demonstration projects is quantifying, as much as possible, the value of the innovations deployed. This section entails comparing the benefits and costs associated with the innovations adopted on an HfL project (i.e., as-built) with those from a more traditional approach, which may be considered a baseline case. The economic analysis performed for the project consisted of comparison of the construction and user costs for both the as-built and baseline cases.

### Baseline Case

Traditional construction for adding a culvert pipe of this type would be open-cut design. With a culvert location under a heavily traveled four-lane roadway with ADT of 52,600, maintaining two lanes of travel in each direction during construction would have been important. However, maintaining four lanes (two lanes in each direction) would not have been possible without major construction (bridges or embankments). The alternative scenario would be to construct a temporary single lane crossover i.e. two lanes are reduced to a single lane in each direction. This would mean that construction would have been in three phases:

- Phase 1: Constructing a temporary crossover.
- Phase 2: Shifting two lanes of traffic from the active construction area, followed by excavating and placing pipe under lanes in one direction and covering the pipe.
- Phase 3: Shifting traffic in the opposite direction and completing the balance of the pipe installation. This phase would also include restoring traffic to existing alignments, removing the crossover, and final site cleanup.

Figure 22 shows the schematic single lane crossover configuration for the baseline case. It is assumed that the traditional case would have taken one construction season (i.e. 180 days) to complete the culvert replacement at each location. The analysis shown below is for the South Burlington location.

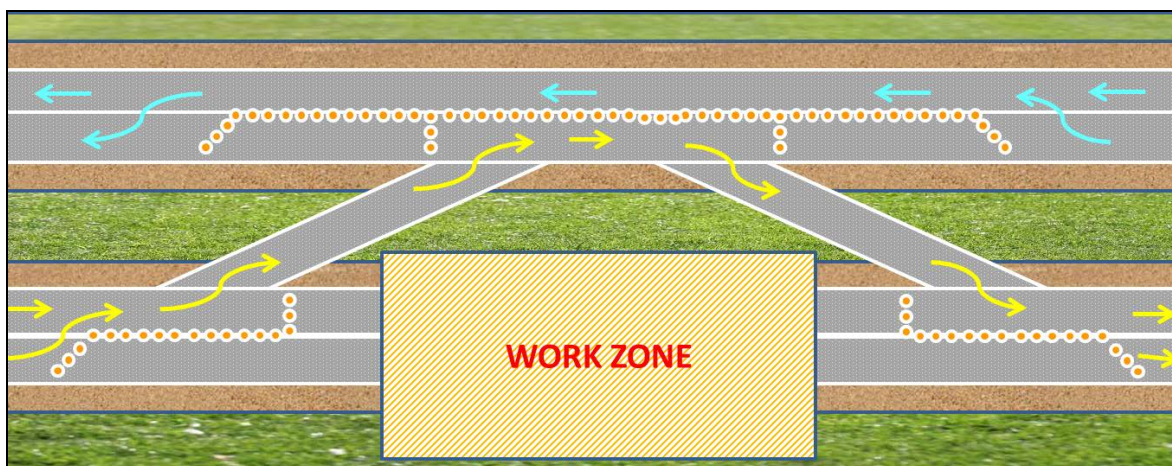

Figure 22. Single lane crossover strategy for the baseline case.

## CONSTRUCTION COSTS

VTrans estimated the cost of traditional construction at \$4 million at the South Burlington site. Details are tabulated in table 1:

Table 1. Construction costs for the baseline alternative.

<b>Construction items</b>	<b>Cost</b>
Culvert including headwall	\$ 200,000
Earthwork	\$ 400,000
Selects	\$ 90,000
Pavement	\$ 250,000
Sheeting and earth retaining structures	\$ 750,000
Traffic control including crossover construction	\$ 1,500,000
SUBTOTAL A	\$ 3,190,000
Mobilization (5 percent of SUBTOTAL A)	\$ 159,500
SUBTOTAL B	\$ 3,349,500
Contingency (20 percent of SUBTOTAL B)	\$ 669,900
TOTAL COST (Baseline Case)	\$ 4,019,400

In contrast, the bid for the innovative option for the work at the two locations was \$2.4 million. The culvert length was 313 ft at the Colchester site and 287 ft at the South Burlington site. Conservatively assuming the cost to be the same at each site despite the culvert being shorter at the South Burlington site, the cost at each site was estimated at \$1.2 million. Thus, the construction cost of the innovative option was about 30 percent of the conventional option. Furthermore, because of the proximity of Colchester and South Burlington sites and the substantial delays at each location using the traditional approach, the project would likely have spread over two construction seasons instead of one.

## USER COSTS

For the as-built case, all work was accomplished beyond the outside edge of the shoulders. Traffic was continuous during culvert rehabilitation, and therefore, the project had no impact on traffic flow. Contrastingly, for the baseline case, user cost from delays caused by staged construction of the conventional option would be significant.

Delay and vehicle operating costs (VOC) were determined for user cost analysis using the *RealCost* program. The traffic and cost inputs that were used for the *RealCost* analysis, are tabulated in table 2 and table 3 along with the source of the information. Figure 23 presents the comparison of hourly traffic demand and lane capacity in a single direction. Note that the hourly demand exceeds the available lane capacity from 7:00 am through 6:00 pm as high as 60 percent during peak hours.

The daily user costs were determined to be \$1,543,703 for both directions. The detailed calculations are shown in table 4. Approximately 95 percent of the user costs are attributed to travel time delay costs resulting from the building up of vehicle queue. Assuming that the traditional culvert replacement would have taken 180 days, the total RUC is estimated to be \$277,866,522.

Table 2. Traffic related inputs used *RealCost* in user cost analysis.

Input parameter	Input value	Source
Two-way ADT	52,300	Project records
Percent Trucks	7.0%	Project records
Hourly traffic distribution	Averages obtained from Continuous Traffic Counters (Station P6D091)	Vermont Agency of Transportation Technical Services Division
Normal lane capacity	2250	Highway Capacity Manual 2011
Work zone lane capacity	1400	Highway Capacity Manual 2011
Normal speed limit	55	Project records
Work zone speed limit	45	Project records
Work zone length	0.5	Project records
Lane closure timing	24-hours/day	Assumed

Table 3. Cost inputs used in *RealCost* user cost analysis.

Cost item	Cars	Single unit trucks	Combination trucks	Source
Value of time(\$/hour)	\$21.88	\$23.06	\$29.65	Computed using USDOT guidelines
Idling cost VOC (\$/hour)	\$1.06	\$1.17	\$1.26	RealCost defaults (updated to current year using Consumer Price Index)
Speed Change VOC per 1000 stops (55 mph to 45 mph to 55 mph)	\$36.98	\$53.23	\$275.83	
Queue stopping VOC per 1000 stops (55 mph to 0 to 55 mph)	\$144.23	\$278.01	\$1,247.19	

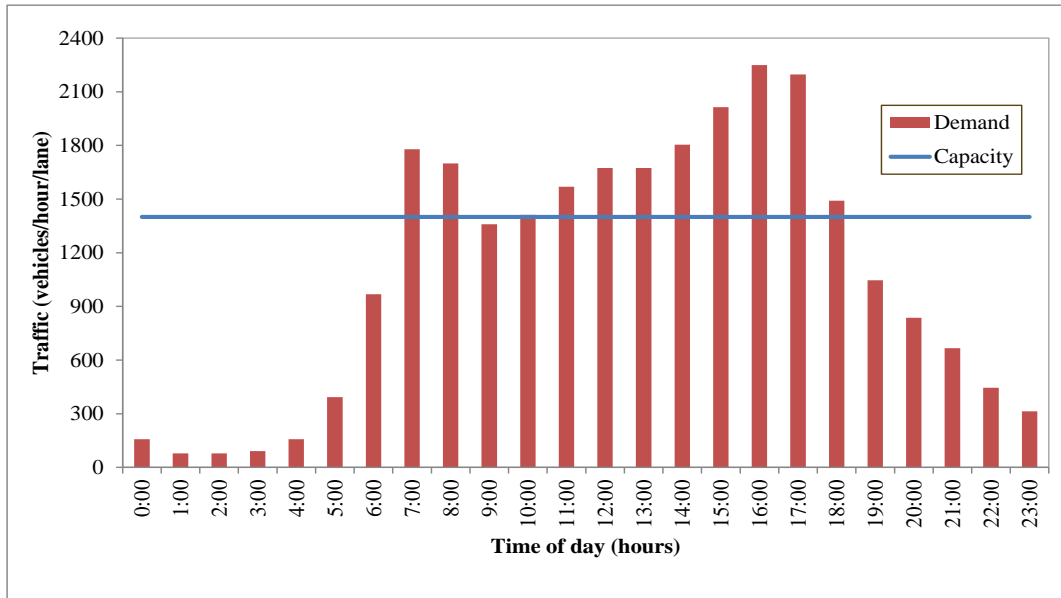

Figure 23. Comparison of hourly traffic demand and capacity in single direction.

Table 4. Summary of user costs computed using *RealCost*.

<b>Delay and VOC cost type</b>	<b>Estimated cost</b>
WZ speed change VOC	\$193
WZ speed change delay	\$122
WZ reduced speed delay	\$2,363
Queue stopping delay	\$7,673
Queue stopping VOC	\$10,329
Queue added travel time	\$1,453,414
Queue idle time	\$69,609
Total daily use cost	\$1,543,703

## **COST COMPARISON**

Table 5 presents a cost comparison summary of the as-built and baseline alternatives for the mainline, ramp, and the entire project. The as-built costs include the construction costs only since the use of trenchless technologies had no interference with the I-89 traffic. The baseline costs include both the construction costs as well as user costs tabulated in table 1 and table 4 respectively.

The results show that, with the use of trenchless technologies, the agency had cost savings of \$2.8 million in direct costs; equally important was the impact of traffic and associated savings in the user costs. The results also show that the staged construction, traditional single-lane crossovers in work zones and longer construction duration associated with traditional methods cause significant impact to traffic, particularly in high traffic areas. In such instances, to manage traffic impacts effectively, the owner agency would ideally use a comprehensive traffic management plan that may include temporary bridge construction, detour routes, alternative contracting, public and motorist information strategies etc. The use of these strategies could have incurred additional agency costs. On the other hand, the use of trenchless technologies had no adverse mobility and safety impacts of the work zone traffic.

Table 5. Cost comparison of as-built and baseline alternatives.

<b>Cost category</b>	<b>As-built case</b>	<b>Baseline case</b>
Construction costs	\$1,200,000	\$4,019,400
User costs	\$0	\$277,866,522
Total	\$1,200,000	\$281,885,922

Therefore, the project showed that in higher traffic areas where lane closures and traffic delays are substantial and must be avoided, trenchless technology could totally eliminate interference with traffic flow and be economically advantageous.

## APPENDIX

### USER SATISFACTION SURVEY FOR SOUTH BURLINGTON–COLCHESTER CULVERT PROJECT

A culvert rehabilitation project was recently completed on I-89 within the boundaries of the State of Vermont right-of-way bordering lands owned by the city of South Burlington off Patchen Road.

Would you please take a few minutes to respond to the following User Satisfaction Survey?

1. Did the recent construction in anyway impact your operation?

*No*

2. Did you receive any complaints from anyone using the landfill facility?

*No, Morrill and State employees were very respectful of both our and the general public's space.*

3. Did you receive any complaints from landowners near the construction zone?

*No*

4. Were you aware of any traffic issues on Patchen Road due to the recent construction?

*Not on Patchen Road, though I did hear about issues on I-89, but can in no way verify if those were valid concerns.*

5. Were you satisfied with the condition of the project area after completion of construction?

*Yes*