



U.S. Department
of Transportation

**Federal Highway
Administration**

Publication No. FHWA HI 97-031
July 1997

NHI Course No. 13152

SUPERPAVE for the Generalist Engineer and Project Staff

Participant Manual



National Highway Institute



***Superpave for the
Generalist Engineer and
Project Staff***



Participant Manual



Contents

- I Superpave: The Future of Asphalt
- II Improving HMA Performance with Superpave
- III Superpave Binders
- IV Superpave Aggregates
- V Superpave Mixtures
- VI Asphalt Mixture Volumetrics
- VII Superpave Mix Design
- VIII Impact of Superpave on HMA Construction
- IX Superpave Mix Analysis and Testing
- X Superpave Implementation Activities



I: Superpave: The Future of Asphalt

COURSE OBJECTIVES

Superpave is an acronym for Superior Performing Asphalt Pavements. Superpave is a new, comprehensive asphalt mix design and analysis system, a product of the Strategic Highway Research Program. Congress established SHRP in 1987 as a five-year, \$150 million research program to improve the performance and durability of United States roads and to make those roads safer for both motorists and highway workers. \$50 million of the SHRP research funds were used for the development of performance based asphalt material specifications to relate laboratory analysis with field performance.

Since the completion of the SHRP research in 1993, the asphalt industry and most highway agencies have been focusing great effort in implementing the Superpave system in their highway design and construction practices. Much of the implementation effort has involved training personnel in the proper use of Superpave technology, from introductory courses on how Superpave works to detailed laboratory courses for providing hands-on instruction with the new Superpave materials testing equipment.

This course is another step toward informing highway industry personnel of the benefits of Superpave. The intended audience for this course are those involved in the design and construction of hot mix asphalt pavements, including contractors, agency personnel, and consulting engineers. The primary goals of this course are to describe the Superpave components, the critical requirements, why they are needed, and how this new system could impact the production and construction procedures for hot mix asphalt.

This course begins with an introduction to the origins of the research that produced Superpave. Then the ways in which Superpave can improve pavement performance are investigated, including a review of the behavior of hot mix asphalt materials. An overview of the Superpave material tests is next, followed by a discussion of how asphalt and aggregate materials are selected in a Superpave mix design. Asphalt mixture volumetrics remain a primary element of the Superpave mix design system, and a review of basic volumetric principles precedes a detailed example describing the major steps of a Superpave mix design. After the design example, there is a discussion of the possible handling differences that Superpave requirements could bring about during hot mix asphalt production, placement and compaction. The course concludes with a brief look at the Superpave mix analysis procedures that continue to evolve, and an update of the ongoing activities involved with implementing the Superpave system.

To benefit as much as possible from this course, participants are encouraged to ask questions and share experience, especially those related to their job activities. In order to have a comprehensive reference when you leave, you are encouraged to take notes directly in this book.

WHY SUPERPAVE?

To fully understand the evolution of the Superpave system, it may help to review a bit of the history of the development of highways and the asphalt industry.

Since the development of the gas engine and the discovery of the petroleum asphalt refining process, asphalt has seen increasingly widespread use in pavement applications. From road oiling of local roads to heavy duty airfield applications, the versatility of asphalt materials has provided the pavement engineer with a valuable material resource.

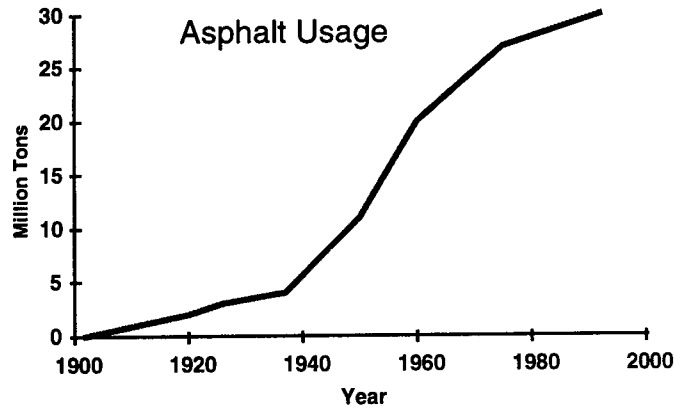

The design of asphalt mixtures evolved with its increasing use. The Hubbard-Field method was originally developed in the 1920s for sheet asphalt mixtures with 100 percent passing the 4.75 mm sieve, and later modified to cover the design of coarser asphalt mixtures. The Hubbard-Field Stability test measured the strength of the asphalt mixture with a punching-type shear load.

Hveem Mix Design was developed by the California Department of Highways Materials and Design Engineer in the 1930s. The Hveem stabilometer measures an asphalt mixture's ability to resist lateral movement under a vertical load. Hveem mix design is still used in California and other western states.

Marshall mix design was originally developed by a Mississippi State Highway Department Engineer and later refined in the 1940s by the Corps of Engineers for designing asphalt mixtures for airfield pavements. The primary features of Marshall mix design are a density/voids analysis and the stability/flow test. Prior to Superpave, Marshall mix design was widely used in the United States, and is by far the most commonly used mix design procedure worldwide.

Refinements to the concepts of asphalt mix design procedures came about not only with the increasing use of asphalt, but also with the increasing demand placed on the mixtures by increases in traffic volume and loading. The authorization of the Interstate Highway System in 1956 set the cornerstone for the United States reliance on highway transportation for its primary mode of transporting goods and people.

The AASHO Road Test, conducted from 1958 to 1962, set the standard for pavement structural design, and the data that the Road Test produced is still the basis for the majority of pavement design procedures. The researchers were aware that the Road Test was limited to one set of soils and climatic conditions, and other studies were planned to extend their findings to other geographic areas. Generally, these studies were not conducted, and the AASHO Road Test results were extrapolated to fit other design conditions.

The growth of the Interstate system was matched by the increase in trucking as a mode for shipping goods -- vehicles-miles traveled increased 75 percent between 1973 and 1993. Provided with an infrastructure to transport the goods, the trucking industry pushed for increased productivity, and the legal load limit was raised from 73,280 to 80,000 lb. in 1982. This seemingly small increase actually increases the stress to the pavement 40 to 50 percent for a given structural design. The advent of more economical radial tires also increased the stress to the pavement.

As the transportation industry grew, the use of hot mix asphalt in heavy-duty pavement applications grew, and the results were not always favorable. Many theories were suggested to explain the reduction in performance of asphalt pavements: since the 1973 oil embargo, the oil companies have taken the "goodies" out of the asphalt to make more gasoline; the increased use of reclaimed asphalt pavement (RAP) has led to weaker mixtures; drum mixers don't make as good a mixture as batch plants.

Although none of these theories was found to have any basis, in truth the states were finding an increasingly fine line developing between mixtures that performed well and mixtures that performed poorly. The materials were the same, but the increases in traffic load and volume were pushing the need for a better understanding of asphalt materials and pavement performance.

STRATEGIC HIGHWAY RESEARCH PROGRAM

Against this background of declining performance and diminishing research funding, SHRP was approved by Congress in 1987 as a five year, \$150 million research program to improve the performance and durability of United States roads and to make those roads safer for both motorists and highway workers. One third of the SHRP research funds were directed for the development of performance based asphalt material specifications to more closely relate laboratory measurements with field performance.

SHRP was originally proposed in Transportation Research Board Special Report No. 202, "America's Highways: Accelerating the Search for Innovation." This report outlined the need for a concentrated effort to produce major innovations for increasing the productivity of the nation's highways. Various problems in areas of highway performance and safety had been hampering the highway industry, and this report called for a renewed effort to solve these problems. However, this report did not just call for funding of research in these areas, but also emphasized the need for conducting the research with implementation in mind. A "program designed without taking into account obstacles on implementation of research will fail" noted the report, and this statement continues to guide the highway industry now that the SHRP research has been completed and its products are being evaluated and implemented.

The goal of the SHRP asphalt research was the development of a system that would relate the material characteristics of hot mix asphalt to pavement performance. Asphalt materials have typically been tested and designed with empirical laboratory procedures, meaning that field experience was still required to determine if the laboratory analysis implied good pavement performance. However, even with proper adherence to these procedures and the development of mix design criteria, asphalt technologists have had various degrees of success in overcoming the three main asphalt pavement distresses: permanent deformation or rutting; fatigue cracking, which leads to alligator cracking; and low temperature cracking.

The opinions of what issues needed to be resolved by the SHRP asphalt research varied. Some industry personnel felt that a chemical based specification would provide the answer to developing a more "robust" asphalt cement to ensure better pavement performance in light of increased traffic and higher wheel loads. Other engineers believed that poor pavement performance was a combination of inadequate mix design procedures and poor construction practices, and that focusing solely on the asphalt cement would be unproductive. Consequently, SHRP researchers set out to develop a chemically based asphalt binder specification and investigate improved methods of mix design.

A final product of the SHRP asphalt research is the Superpave asphalt mixture design and analysis system. Superpave is an acronym for Superior Performing Asphalt Pavements. Superpave represents an improved, performance-based system for specifying asphalt binders and mineral aggregates, performing asphalt mixture design, and analyzing pavement performance. The system includes an asphalt binder specification that uses new binder physical property tests; a series of aggregate tests and specifications; a hot mix asphalt (HMA) design and analysis system; and computer software to integrate the system components. As with any design process, field control measurements are still necessary to ensure the field produced mixtures match the laboratory design. The Superpave binder specification and mix design procedures incorporate various test equipment, test methods, and design criteria.

A unique feature of the Superpave system is that its tests are performed at temperatures and aging conditions that more realistically represent those encountered by in-service pavements. If the pavement distresses addressed by Superpave (rutting, fatigue cracking, and low temperature cracking) do occur in the pavement, they do so at relatively typical stages in a pavement's life and under relatively common temperature conditions. The Superpave performance graded (PG) binder specification makes use of these tendencies to test the asphalt under a project's expected climatic and aging conditions to help reduce pavement distress. SHRP researchers developed new equipment standards as well as incorporated equipment used by other industries to develop the binder tests.

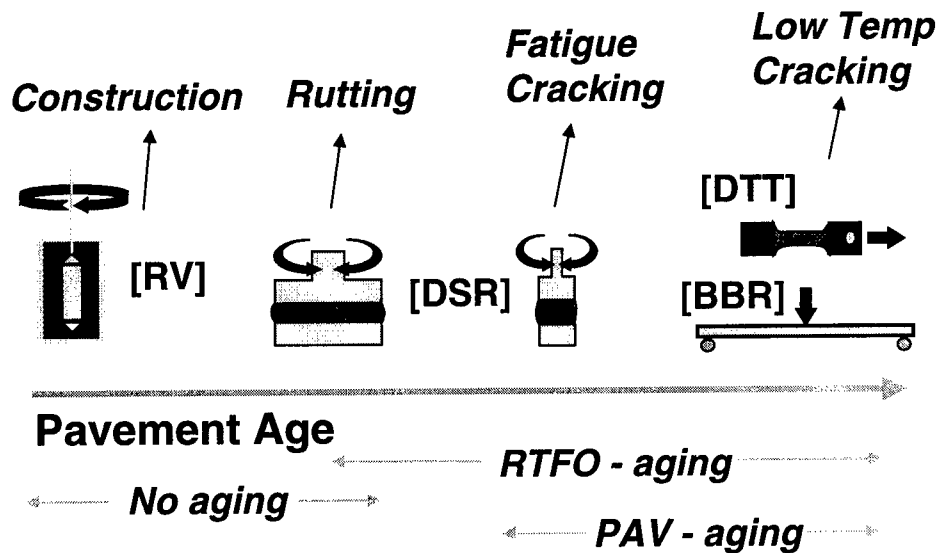

The Superpave mixture design and analysis system uses increasingly rigorous degrees of testing and analysis to provide a well performing mixture for a given pavement project. The Superpave mix design procedure involves careful material selection and volumetric proportioning as a first approach in producing a mix that will perform successfully. The four basic steps of Superpave asphalt mix design are materials selection, selection of the design aggregate structure, selection of the design asphalt binder content, and evaluation of the mixture for moisture sensitivity.

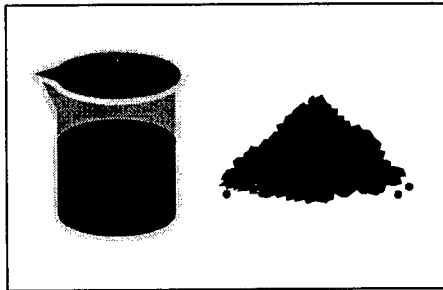

1. Materials Selection

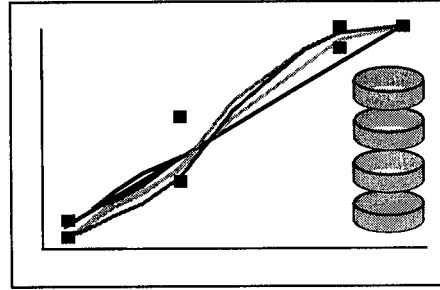

2. Design Aggregate Structure

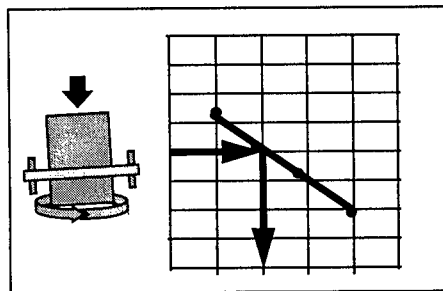

3. Design Binder Content

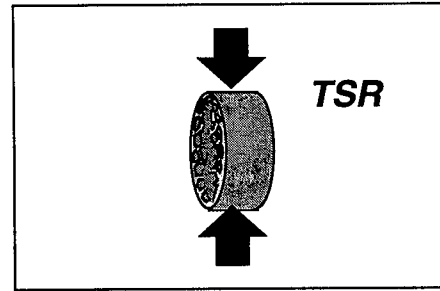

4. Moisture Sensitivity

4 Steps of Superpave Mix Design

Asphalt mixes in more critical, higher traffic volume projects can be optimized for the actual project conditions using an analysis to estimate pavement performance. The analysis procedures, still under development, will use increasingly sophisticated and comprehensive testing and modeling of the design asphalt mixture, as desired and necessary to predict performance for the actual pavement structure, climate, and traffic.

SUPERPAVE IMPLEMENTATION

How far along are the asphalt and highway industries toward routine use of Superpave? That question will be answered in detail in the final section of this course. At this point it is sufficient to note that the FHWA, the states and the asphalt industry are working together in the many on-going Superpave implementation and validation activities. Through AASHTO, the Superpave test methods and specifications are being standardized, which will further accelerate and facilitate the acceptance and use of this new and improved asphalt mix design and analysis system.



II. Improving HMA Performance with Superpave

To understand how the performance based specifications of Superpave are used to improve pavement performance requires an understanding of the characteristics of the individual materials that make up hot mix asphalt (HMA), and how they behave together as an asphalt mixture. Both the individual properties and their combination affect the pavement performance. Superpave uses these characteristics in ways that are new to the asphalt industry, as well as in ways that have been used for many years. A comparison between the old and the new helps bridge the understanding to the Superpave system.

The objectives of this session will be to describe the material properties of HMA, both of the individual components of HMA (asphalt and aggregate) and the HMA mixture itself. This description will include the tests and specifications that are used to characterize HMA materials, both prior to Superpave and under the new Superpave system. Most importantly, the session will describe how the Superpave system uses the tests and specifications to improve upon the three primary distresses in HMA pavements: permanent deformation, fatigue cracking and low temperature cracking.

HOW ASPHALT BEHAVES

Asphalt is a *viscoelastic* material. This term means that asphalt has the properties of both a viscous material, such as motor oil, or more realistically, water, and an elastic material, such as a rubber. However, the property that asphalt exhibits, whether viscous, elastic, or most often, a combination of both, depends on *temperature* and *time of loading*. The flow behavior of an asphalt could be the same for one hour at 60°C or 10 hours at 25°C.

In other words, the effects of time and temperature are related; the behavior at high temperatures over short time periods is equivalent to what occurs at lower temperatures and longer times. This is often referred to as the time-temperature shift or superposition concept of asphalt cement.

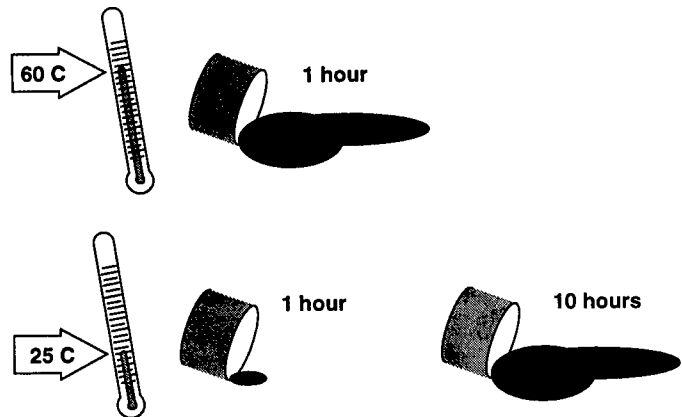

High Temperature Behavior

In hot conditions (e.g., desert climate) or under sustained loads (e.g., slow moving trucks), asphalts cements behave like *viscous* liquids and flow. Viscosity is the material characteristic used to describe the resistance of liquids to flow.

Viscous liquids like hot asphalt are sometimes called *plastic* because once they start flowing, they do not return to their original position. This is why in hot weather, some asphalt pavements flow under repeated wheel loads and wheel path ruts form. However, rutting in asphalt pavements during hot weather is also influenced by aggregate properties and it is probably more correct to say that the asphalt *mixture* is behaving like a plastic.

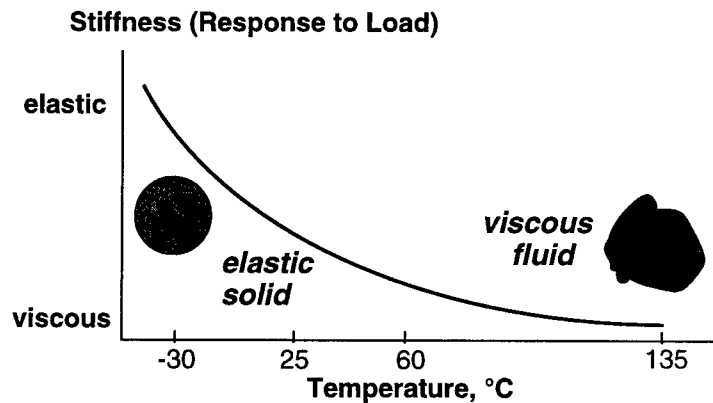

Low Temperature Behavior

In cold climates (e.g., winter days) or under rapid loading (e.g., fast moving trucks), asphalt cement behaves like an *elastic* solid. Elastic solids are like rubber bands; when loaded they deform, and when unloaded, they return to their original shape. Any elastic deformation is completely recovered.

If too much load is applied, elastic solids may break. Even though asphalt is an elastic solid at low temperatures, it may become too brittle and crack when excessively loaded. This is the reason low temperature cracking sometimes occurs in asphalt pavements during cold weather. In these cases, loads are applied by internal stresses that accumulate in the pavement when it tries to shrink and is restrained (e.g., as when temperatures fall during and after a sudden cold front).

Intermediate Temperature Behavior

Most environmental conditions lie between the extreme hot and cold situations. In these climates, asphalt binders exhibit the characteristics of both viscous liquids and elastic solids. Because of this range of behavior, asphalt is an excellent adhesive material to use in paving, but an extremely complicated material to understand and explain. When heated, asphalt acts as a lubricant, allowing the aggregate to be mixed, coated, and tightly-compacted to form a smooth, dense surface. After cooling, the asphalt acts as the glue to hold the aggregate together in a solid matrix. In this finished state, the behavior of the asphalt is termed viscoelastic; it has both elastic and viscous characteristics, depending on the temperature and rate of loading.

Conceptually, this kind of response to load can be related to an automobile shock absorbing system. These systems contain a spring and a liquid filled cylinder. The spring is elastic and returns the car to the original position after hitting a bump. The viscous liquid within the cylinder dampens the force of the spring and its reaction to the bump. Any force exerted on the car causes a parallel reaction in both the spring and the cylinder. In hot mix asphalt, the spring represents the immediate elastic response of both the asphalt and the aggregate. The cylinder symbolizes the slower, viscous reaction of the asphalt, particularly in warmer temperatures. Most of the response is elastic or viscoelastic, (recoverable with time), while some of the response is plastic and non-recoverable.

Aging Behavior

Because asphalt cements are composed of organic molecules, they react with oxygen from the environment. This reaction is called oxidation and it changes the structure and composition of asphalt molecules. Oxidation causes the asphalt cement to become more brittle, generating the term oxidative hardening or age hardening.

In practice, a considerable amount of oxidative hardening occurs before the asphalt is placed. At the hot mix facility, asphalt cement is added to the hot aggregate and the mixture is maintained at elevated temperatures for a period of time. Because the asphalt cement exists in thin films covering the aggregate, the oxidation reaction occurs at a much faster rate. "Short term aging" is used to describe the aging that occurs in this stage of the asphalt's "life".

Oxidative hardening also occurs during the life of the pavement, due to exposure to air and water. "Long term aging" happens at a relatively slow rate in a pavement, although it occurs faster in warmer climates and during warmer seasons. Because of this hardening, old asphalt pavements are more susceptible to cracking. Improperly compacted asphalt pavements may exhibit premature oxidative hardening. In this case, inadequate compaction leaves a higher percentage of interconnected air voids, which allows more air to penetrate into the asphalt mixture, leading to more oxidative hardening.

Other forms of hardening include volatilization and physical hardening. Volatilization occurs during hot mixing and construction, when volatile components tend to evaporate from the asphalt. Physical hardening occurs when asphalt cements have been exposed to low temperatures for long periods. When the temperature stabilizes at a constant low value, the asphalt cement continues to shrink and harden. Physical hardening is more pronounced at temperatures less than 0°C and must be considered when testing asphalt cements at very low temperatures.

PRE-SUPERPAVE ASPHALT PROPERTY MEASUREMENTS

Because of its chemical complexities, asphalt specifications have been developed around physical property tests, using such tests as penetration, viscosity, and ductility. These physical property tests are performed at standard test temperatures, and the test results are used to determine if the material meets the specification criteria. However, there are limitations in what these test procedures provide. Many of these tests are empirical, meaning that field experience is required before the test results yield meaningful information. Penetration is an example of this. The penetration test represents the stiffness of the asphalt, but any relationship between asphalt penetration and performance has to be gained by experience. An additional drawback of empiricism is that the relationship between the test and performance may not be very good.

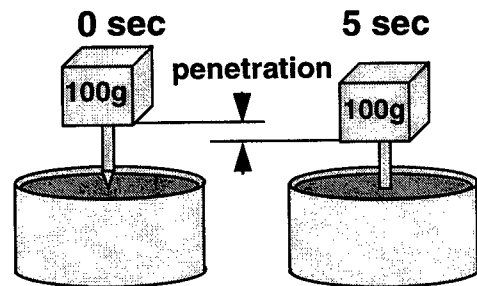

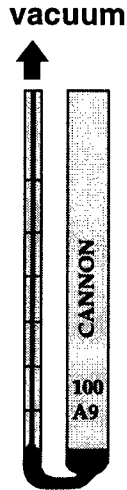

Another limitation to these tests and specifications is that the tests do not give information for the entire range of typical pavement temperatures. Although viscosity is a fundamental measure of flow, it only provides information about higher temperature viscous behavior -- the standard test temperatures are 60°C and 135°C. Lower temperature elastic behavior cannot be realistically determined from this data to completely predict performance. As well, penetration describes only the consistency at a medium temperature (25°C). No low temperature properties are directly measured in the current grading systems.

The penetration and viscosity asphalt specifications can classify different asphalts with the same grading, when in fact these asphalts may have very different temperature and performance characteristics. As an example, this figure shows three asphalts that have the same viscosity grade because they are within the specified viscosity limits at 60°C, have the minimum penetration at 25°C, and reach the minimum viscosity at 135°C. While Asphalts A and B display the same temperature dependency, they have much different consistency at all temperatures. Asphalts A and C have the same consistency at low temperatures, but remarkably different high temperature consistency. Asphalt B has the same consistency at 60°C, but shares no other similarities with Asphalt C. Because these asphalts meet the same grade specifications, one might erroneously expect the same characteristics during construction and the same performance during hot and cold weather conditions.

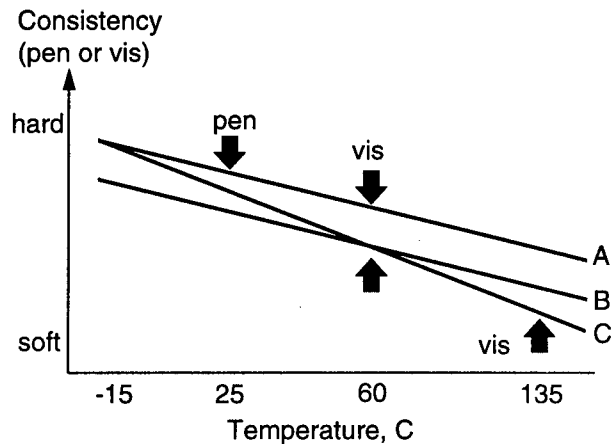

SUPERPAVE BINDER PROPERTY MEASUREMENTS

The new Superpave binder tests measure physical properties that can be related directly to field performance by engineering principles. Each of these new tests will be described in detail later in this text. At this point in the course, the key detail is that the Superpave tests characterize asphalt at a wide range of temperatures and ages. Superpave characterizes them at the actual pavement temperatures that they will experience, and at the periods of time when the asphalt distresses are most likely to occur.

Superpave Binder Test	Purpose
Dynamic Shear Rheometer (DSR)	Measure properties at high and intermediate temperatures
Rotational Viscometer (RV)	Measure properties at high temperatures
Bending Beam Rheometer (BBR) Direct Tension Tester (DTT)	Measure properties at low temperatures
Rolling Thin Film Oven (RTFO) Pressure Aging Vessel (PAV)	Simulate hardening (durability) characteristics

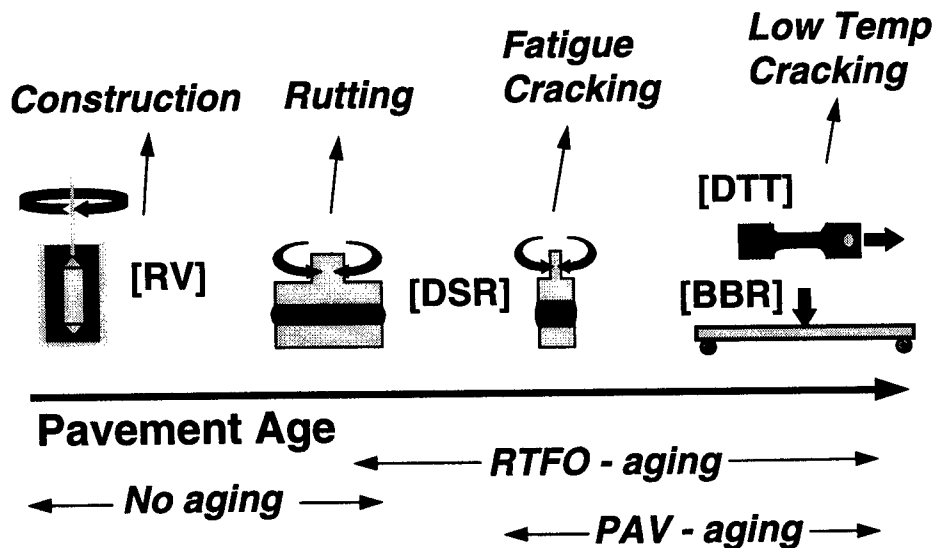
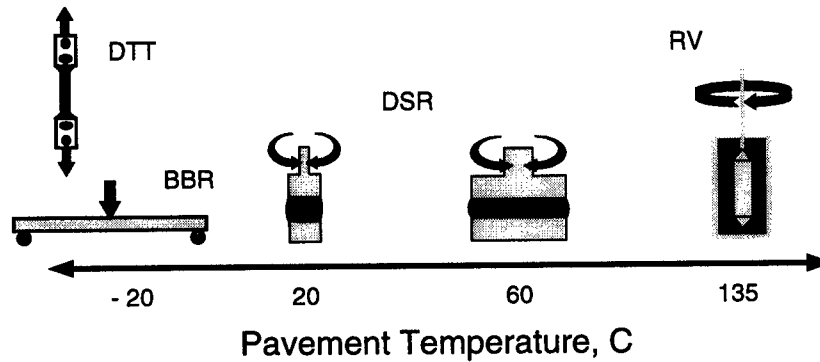

MINERAL AGGREGATE BEHAVIOR

A wide variety of mineral aggregates have been used to produce HMA. Some materials are referred to as *natural* aggregate because they are simply mined from river or glacial deposits and are used without further processing to manufacture HMA. These are often called “bank-run” or “pit-run” materials.

Processed aggregate can include natural aggregate that has been separated into distinct size fractions, washed, crushed, or otherwise treated to enhance certain performance characteristics of the finished HMA. In most cases, the main processing consists of crushing and sizing.

Synthetic aggregate consists of any material that is not mined or quarried and in many cases represents an industrial by-product. Blast furnace slag is one example. Occasionally, a synthetic aggregate will be produced to impart a desired performance characteristic to the HMA. For example, light-weight expanded clay or shale is sometimes used as a component to improve the skid resistance properties of HMA.

An existing pavement can be removed and reprocessed to produce new HMA. Reclaimed asphalt pavement or “RAP” is a growing and important source of aggregate for asphalt pavements.

Increasingly, waste products are used as aggregate or otherwise disposed of in asphalt pavements. Scrap tires and glass are the two most well known waste products that have been successfully “landfilled” in asphalt pavements. In some cases, waste products can actually be used to enhance certain performance characteristics of HMA. In other cases, it is considered sufficient that a solid waste disposal problem has been solved and no performance enhancing benefit from the waste material is expected. However, it is hoped that performance will not be sacrificed simply to eliminate a solid waste material.



Cubical Aggregate

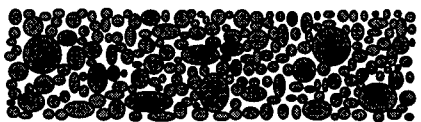

Rounded Aggregate

Regardless of the source, processing method, or mineralogy, aggregate is expected to provide a strong, stone skeleton to resist repeated load applications. Cubical, rough-textured aggregates provide more strength than rounded, smooth-textured aggregates. Even though a cubical piece and rounded piece of aggregate may possess the same inherent strength, cubical aggregate particles tend to lock together resulting in a stronger mass of material. Instead of locking together, rounded aggregate particles tend to slide by each other.

When a mass of aggregate is loaded, there may occur within the mass a plane where aggregate particles begin to slide by or “shear” with respect to each other, which results in permanent deformation of the mass. It is at this plane where the “shear stress” exceeds the “shear strength” of the aggregate mass. Aggregate shear strength is of critical importance in HMA.

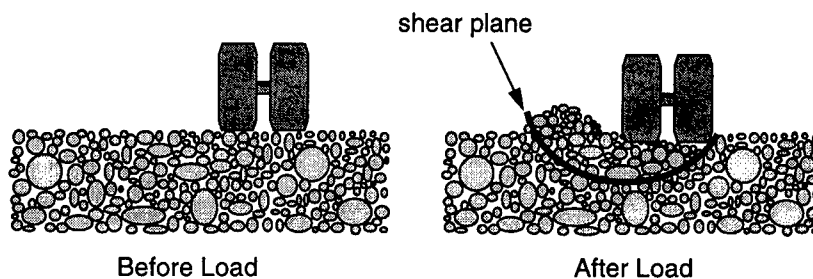

Contrasting aggregate shear strength behavior can easily be observed in aggregate stockpiles since crushed (i.e., mostly cubical) aggregates form steeper, more stable piles than rounded aggregates. The slope on stockpiles is the angle of repose. The angle of repose of a crushed aggregate stockpile is greater than that of an uncrushed aggregate stockpile.

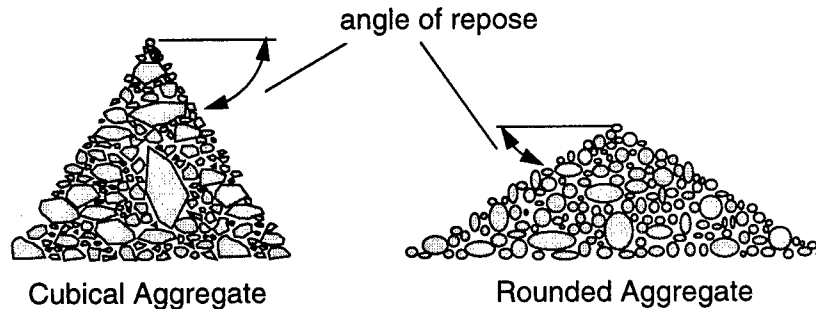

Engineers explain the shearing behavior of aggregates and other materials using Mohr-Coulomb theory, named after the individuals who originated the concept. This theory declares that the shear strength of an aggregate mixture is dependent on how well the aggregate particles hold together in a mass (often called cohesion), the stress the aggregates may be under, and the internal friction of the aggregate. The Mohr-Coulomb equation used to express the shear strength of a material is:

$$\tau = c + \sigma \times \tan \phi$$

where, τ = shear strength of aggregate mixture,
 c = cohesion of aggregate,
 σ = normal stress to which the aggregate is subjected
 ϕ = angle of internal friction.

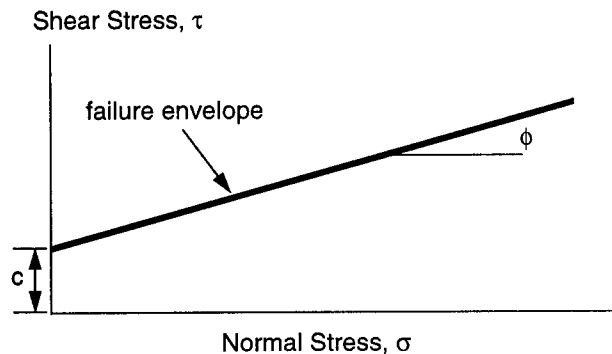

A mass of aggregate has relatively little cohesion. Thus, the shear strength is primarily dependent on the resistance to movement provided by the aggregates. In addition, when loaded, the mass of aggregate tends to be stronger because the resulting stress tends to hold the aggregate more tightly together. In other words, shear strength is increased. The angle of internal friction indicates the ability of aggregate to interlock, and thus, create a mass of aggregate that is almost as strong as the individual pieces.

To ensure a strong aggregate blend for HMA, engineers typically have specified aggregate properties that enhance the internal friction portion of the overall shear strength. Normally, this is accomplished by specifying a certain percentage of crushed faces for the coarse portion of an aggregate blend. Because natural sands tend to be rounded, with poor internal friction, the amount of natural sand in a blend is often limited.

SUPERPAVE MINERAL AGGREGATE PROPERTY MEASUREMENTS

During the SHRP research, pavement experts were surveyed to ascertain which aggregate properties were most important. There was general agreement that aggregate properties played a central role in overcoming permanent deformation. Fatigue cracking and low temperature cracking were less affected by aggregate characteristics. SHRP researchers relied on the experience of these experts and their own to identify two categories of aggregate properties that needed to be used in the Superpave system: consensus properties and source properties. In addition, a new way of specifying aggregate gradation was developed. It is called the design aggregate structure.

Consensus Properties

It was the consensus of the pavement experts that certain aggregate characteristics were critical and needed to be achieved in all cases to arrive at well performing HMA. These characteristics were called "consensus properties" because there was wide agreement in their use and specified values. Those properties are:

- coarse aggregate angularity,
- fine aggregate angularity,
- flat, elongated particles, and
- clay content.

There are required standards for these aggregate properties. The consensus standards are not uniform. They are based on traffic level and position within the pavement structure. Materials near the pavement surface subjected to high traffic levels require more stringent consensus standards. They are applied to a proposed aggregate blend rather than individual components. However, many agencies currently apply such requirements to individual aggregates so undesirable components can be identified. Each of these consensus property tests will be described in detail later in this text.

Source Properties

In addition to the consensus aggregate properties, pavement experts believed that certain other aggregate characteristics were critical. However, critical values of these properties could not be reached by consensus because needed values were source specific. Consequently, a set of "source properties" was recommended. Specified values are established by local agencies. While these properties are relevant during the mix design process, they may also be used as source acceptance control. Those properties are:

- toughness,
- soundness, and
- deleterious materials

Gradation

To specify gradation, Superpave uses a modification of an approach already used by some agencies. It uses the 0.45 power gradation chart to define a permissible gradation. An important feature of the 0.45 power chart is the maximum density gradation. This gradation plots as a straight line from the maximum aggregate size through the origin. Superpave uses a standard set of ASTM sieves and the following definitions with respect to aggregate size:

- **Maximum Size:** One sieve size larger than the nominal maximum size.
- **Nominal Maximum Size:** One sieve size larger than the first sieve to retain more than 10 percent.

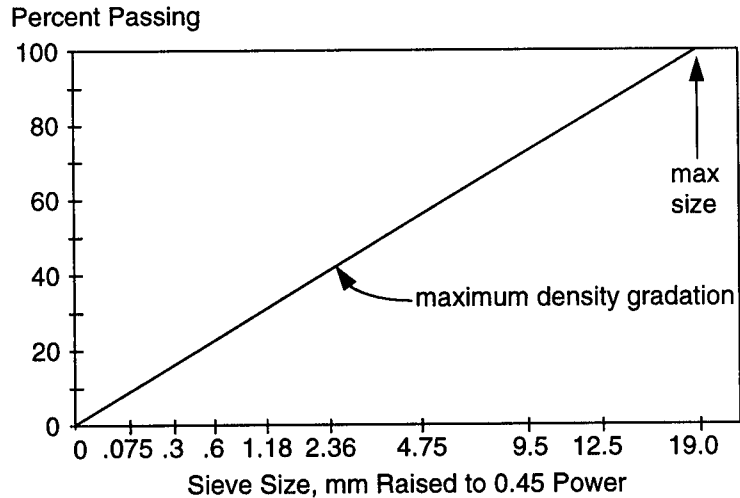

The maximum density gradation represents a gradation in which the aggregate particles fit together in their densest possible arrangement. Clearly this is a gradation to avoid because there would be very little aggregate space within which to develop sufficiently thick asphalt films for a durable mixture. Shown is a 0.45 power gradation chart with a maximum density gradation for a 19 mm maximum aggregate size and 12.5 mm nominal maximum size.

To specify aggregate gradation, two additional features are added to the 0.45 power chart: control points and a restricted zone. Control points function as master ranges through which gradations must pass. They are placed on the nominal maximum size, an intermediate size (2.36 mm), and the dust size (0.075 mm). Illustrated are the control points and restricted zone for a 12.5 mm Superpave mixture.

The restricted zone resides along the maximum density gradation between the intermediate size (either 4.75 or 2.36 mm) and the 0.3 mm size. It forms a band through which gradations should not pass. Gradations that pass through the restricted zone have often been called "humped gradations" because of the characteristic hump in the grading curve that passes through the restricted zone. In most cases, a humped gradation indicates a mixture that possesses too much fine sand in relation to total sand. This gradation practically always results in tender mix behavior, which is manifested by a mixture that is difficult to compact during construction and offers reduced resistance to permanent deformation during its performance life. Gradations that violate the restricted zone possess weak aggregate skeletons that depend too much on asphalt binder stiffness to achieve mixture shear strength. These mixtures are also very sensitive to asphalt content and can easily become plastic.

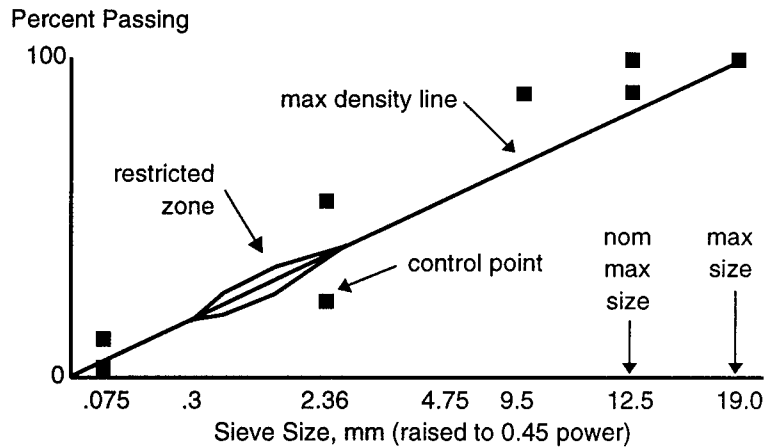

The term used to describe the cumulative frequency distribution of aggregate particle sizes is the *design aggregate structure*. A design aggregate structure that lies between the control points and avoids the restricted zone meets the requirements of Superpave with respect to gradation. Superpave defines five mixture types as defined by their nominal maximum aggregate size:

Superpave Mixtures		
Superpave Mixture Designation	Nominal Maximum Size, mm	Maximum Size, mm
37.5 mm	37.5	50
25 mm	25	37.5
19 mm	19	25
12.5 mm	12.5	19
9.5 mm	9.5	12.5

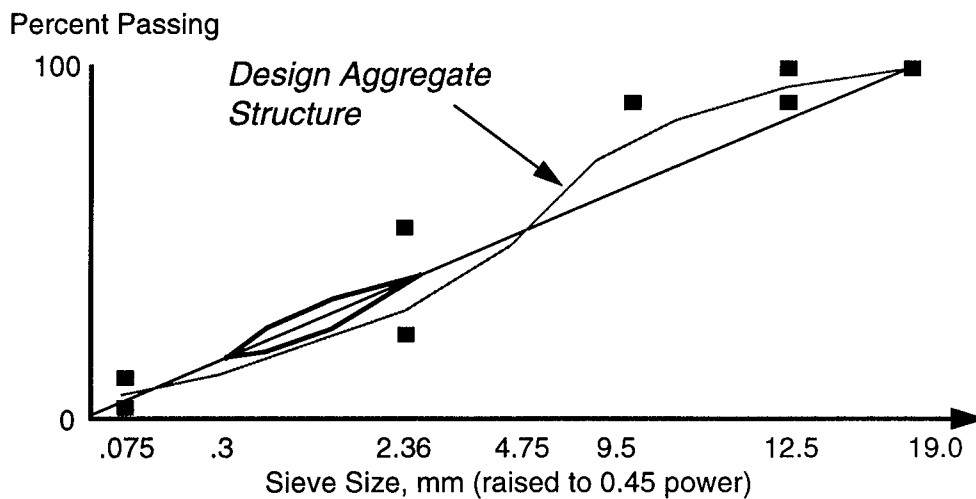

ASPHALT MIXTURE BEHAVIOR

When a wheel load is applied to a pavement, two stresses are transmitted to the HMA: vertical compressive stress within the asphalt layer, and horizontal tensile stress at the bottom of the asphalt layer. The HMA must be internally strong and resilient to resist the compressive stresses and prevent permanent deformation within the mixture. In the same manner, the material must also have enough tensile strength to withstand the tensile stresses at the base of the asphalt layer, and also be resilient to withstand many load applications without fatigue cracking. The asphalt mixture must also resist the stresses imparted by rapidly decreasing temperatures and extremely cold temperatures.

While the individual properties of HMA components are important, asphalt mixture behavior is best explained by considering asphalt cement and mineral aggregate acting together. One way to understand asphalt mixture behavior is to consider the primary asphalt pavement distress types that engineers try to avoid: permanent deformation, fatigue cracking, and low temperature cracking. These are the distresses analyzed in Superpave.

Permanent Deformation

Permanent deformation is the distress that is characterized by a surface cross section that is no longer in its design position. It is called "permanent" deformation because it represents an accumulation of small amounts of deformation that occurs each time a load is applied. This deformation cannot be recovered. Wheel path rutting is the most common form of permanent deformation. While rutting can have many sources (e.g., underlying HMA weakened by moisture damage, abrasion, and traffic densification), it has two principal causes.

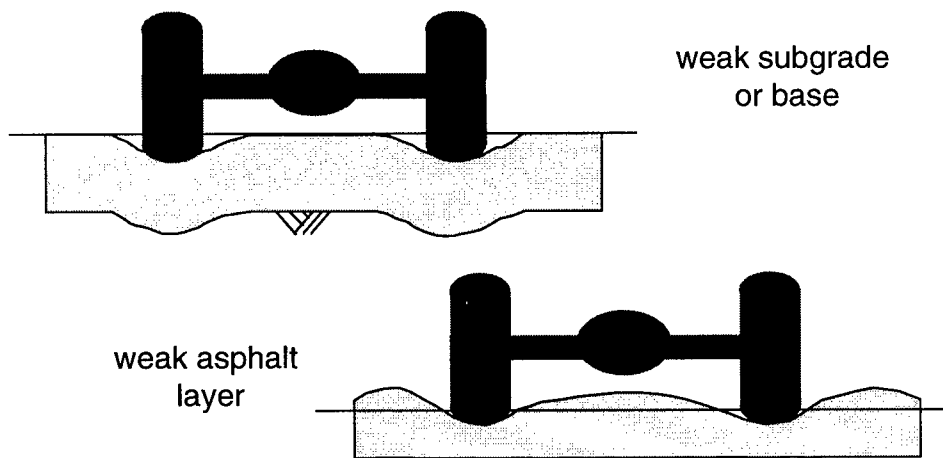
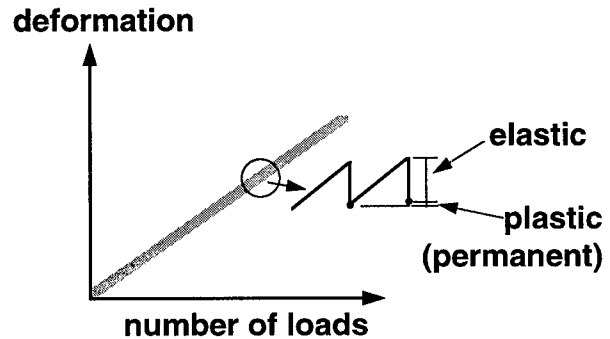

In one case, the rutting is caused by too much repeated stress being applied to the subgrade (or subbase or base) below the asphalt layer. Although stiffer paving materials will partially reduce this type of rutting, it is normally considered more of a structural problem rather than a materials problem. Essentially, there is not enough pavement strength or thickness to reduce the applied stresses to a tolerable level. A pavement layer that has been unexpectedly weakened by the intrusion of moisture may also cause it. The deformation occurs in the underlying layers rather than in the asphalt layers.

The type of rutting of most concern to asphalt designers is deformation in the asphalt layers. This rutting results from an asphalt mixture without enough shear strength to resist the repeated heavy loads. A weak mixture will accumulate small, but permanent, deformations with each truck pass, eventually forming a rut characterized by a downward and lateral movement of the mixture. The rutting may occur in the asphalt surface course, or the rutting that shows on the surface may be caused to a weak underlying asphalt course.

Rutting of a weak asphalt mixture typically occurs during the summer under higher pavement temperatures. While this might suggest that rutting is solely an asphalt cement problem, it is more correct to address rutting by considering the mineral aggregate and asphalt cement. In fact, the previously described Mohr-Coulomb equation ($\tau = c + \sigma \times \tan \phi$) can again be used to illustrate how both materials can affect rutting.

$$\tau = c + \sigma(\tan \phi)$$

shear strength asphalt binder contribution normal stress aggregate contribution

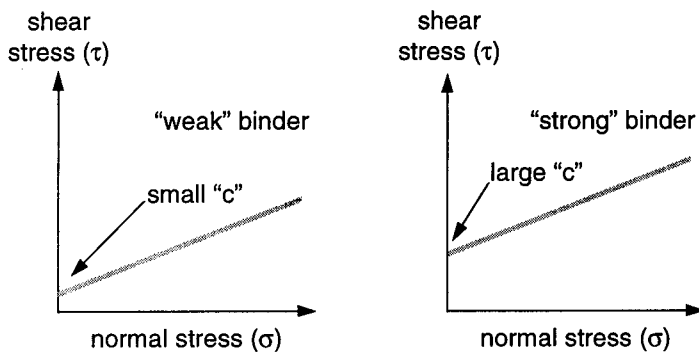

In this case, τ is considered the shear strength of the asphalt mixture. The cohesion (c) can be considered the portion of the overall mixture shear strength provided by the asphalt cement. Because rutting is an accumulation of very small permanent deformations, one way to ensure that asphalt cement provides its "fair share" of shear strength is to use an asphalt cement that is not only stiffer but also behaves more like an elastic solid at high pavement temperatures. That way, when a load is applied to the asphalt cement in the mixture, it tends to act more like a rubber band and spring back to its original position rather than stay deformed.

Another way to increase the shear strength of an asphalt mixture is by selecting an aggregate that has a high degree of internal friction (ϕ). This is accomplished by selecting an aggregate that is cubical, has a rough surface texture, and graded in a manner to develop particle-to-particle contact. When a load is applied to the aggregate in the mixture, the aggregate particles lock tightly together and function not merely as a mass of individual particles, but more as a *large, single, elastic stone*. As with the asphalt cement, the aggregate will act like a rubber band and spring back to its original shape when unloaded. In that way, no permanent deformation accumulates.

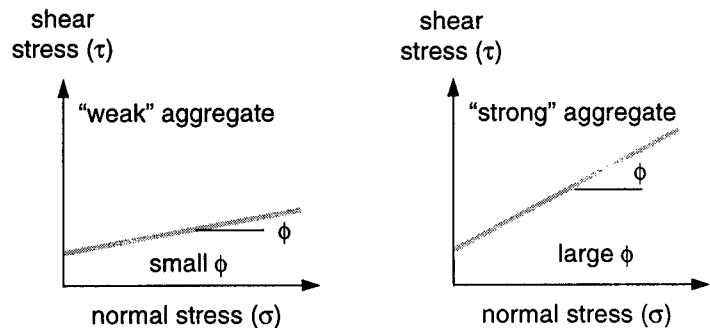

While it is obvious that the largest portion of the resistance to permanent deformation of the mixture is provided by the aggregate, the portion provided by the asphalt binder is very important. Binders that have low shear characteristics due to composition or temperature minimize cohesion and to a certain extent, the confining "normal" stress. Thus the mixture begins to behave more like an unbound aggregate mass.

Fatigue Cracking

Fatigue cracking occurs when the applied loads overstress the asphalt materials, causing cracks to form. An early sign of fatigue cracking consists of intermittent longitudinal cracks in the traffic wheel path. Fatigue cracking is progressive because at some point the initial cracks will join, causing even more cracks to form. An advanced stage of fatigue cracking is called alligator cracking, characterized by transverse cracks joining the longitudinal cracks. In extreme cases, a pothole forms when pavement pieces become dislodged by traffic.

Fatigue cracking is usually caused by a number of factors occurring simultaneously. Obviously, repeated heavy loads must be present. Thin pavements or those with weak underlying layers are prone to high deflections under heavy wheel loads. High deflections increase the horizontal tensile stresses at the bottom of the asphalt layer, leading to fatigue cracking. Poor drainage, poor construction, and/or an underdesigned pavement can contribute to this problem.



Often, fatigue cracking is merely a sign that a pavement has received the design number of load applications, in which case the pavement is simply in need of planned rehabilitation. Assuming that the fatigue cracking occurs at the end of the design period, it would be considered a natural progression of the pavement design strategy. If the observed cracking occurs much sooner than the design period, it may be a sign that traffic loads were underestimated.

Consequently, the best ways to overcome fatigue cracking are:

- adequately account for the anticipated number of heavy loads during design,
- keep the subgrade dry using whatever means available,
- use thicker pavements,
- use paving materials that are not excessively weakened in the presence of moisture, and
- use paving materials that are resilient enough to withstand normal deflections.

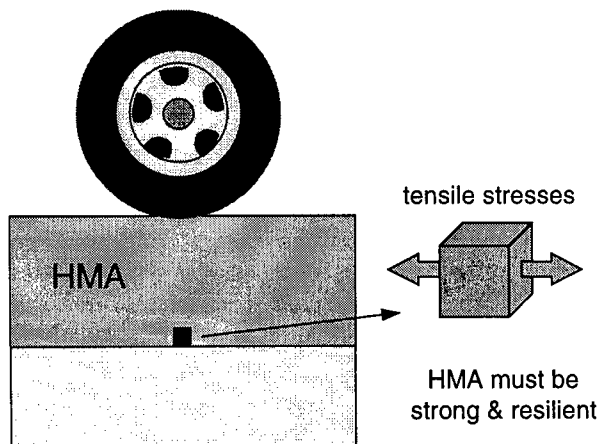

Only the last item, selection of resilient materials, can be strictly addressed using materials selection and design. As a load is applied, horizontal tensile stresses occur near the bottom of an asphalt layer. The HMA must have enough tensile strength to withstand the applied tensile stress, and be resilient enough to withstand repeated load applications without cracking. Thus, HMA must be designed to behave like a soft elastic material when loaded in tension to overcome fatigue cracking. This is accomplished by placing an upper limit on the asphalt cement's stiffness properties, since the tensile behavior of HMA is strongly influenced by the asphalt cement. In effect, soft asphalts have better fatigue properties than hard asphalts.

Low Temperature Cracking

Low temperature cracking is caused by adverse environmental conditions rather than by applied traffic loads. It is characterized by intermittent transverse cracks that occur at a surprisingly consistent spacing.

Low temperature cracks form when an asphalt pavement layer shrinks in cold weather. As the pavement shrinks, tensile stresses build within the layer. At some point along the pavement, the tensile stress exceeds the tensile strength and the asphalt layer cracks. Low temperature cracks occur primarily from a single cycle of low temperature, but can develop from repeated low temperature cycles.

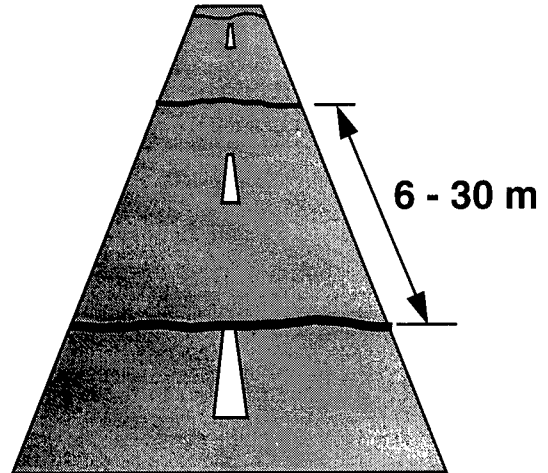

The asphalt binder plays the key role in low temperature cracking. In general, hard asphalt binders are more prone to low temperature cracking than soft asphalt binders. Asphalt binders that are excessively aged, because they are unduly prone to oxidation and/or contained in a mixture constructed with too many air voids, are more prone to low temperature cracking. Thus, to overcome low temperature cracking engineers must use a soft binder that is not overly prone to aging, and control in-place air void content and pavement density so that the binder does not become excessively oxidized.

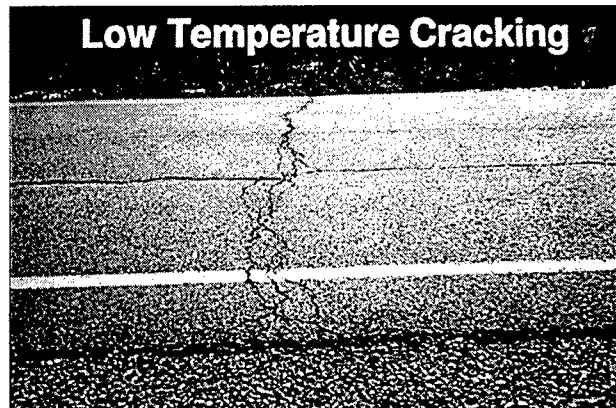

PRE-SUPERPAVE ASPHALT MIXTURE DESIGN PROCEDURES

Most agencies currently use the Marshall mix design method. It is by far the most common procedure used in the world to design HMA. Developed by Bruce Marshall of the Mississippi State Highway Department, the U.S. Army Corps of Engineers refined and added certain features to Marshall's approach and it was formalized as ASTM D 1559, *Resistance to Plastic Flow of Bituminous Mixtures Using the Marshall Apparatus* (AASHTO T 245). The Marshall method entails a laboratory experiment aimed at developing a suitable asphalt mixture using stability/flow and density/voids analyses.

One of the strengths of the Marshall method is its attention to density and voids properties of asphalt materials. This analysis ensures the proper volumetric proportions of mixture materials for achieving a durable HMA. Another advantage is that the required equipment is relatively inexpensive and portable, and thus, lends itself to remote quality control operations. Unfortunately, many engineers believe that the impact compaction used with the Marshall method does not simulate mixture densification as it occurs in a real pavement.

Furthermore, Marshall stability does not adequately estimate the shear strength of HMA. These two situations make it difficult to assure the rutting resistance of the designed mixture. Consequently, asphalt technologists agree that the Marshall method has outlived its usefulness for modern asphalt mixture design.

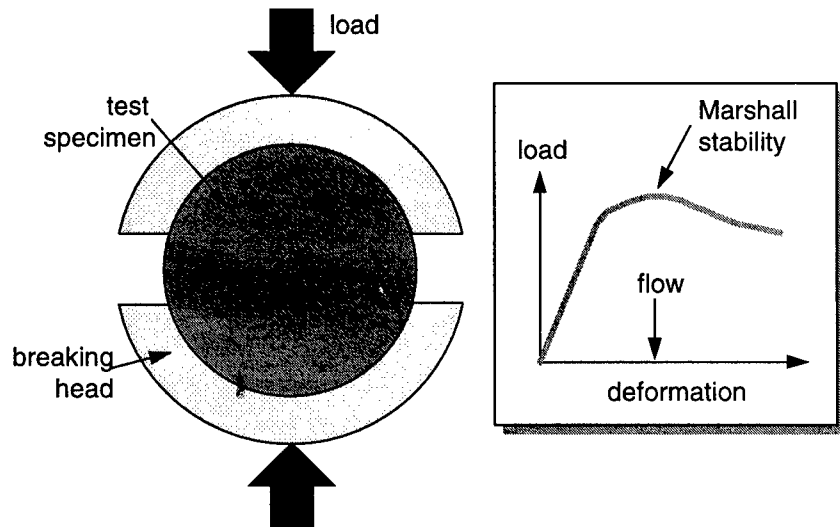

Francis Hveem of the California Department of Transportation developed the Hveem mix design procedure. Hveem and others refined the procedure, which is detailed in ASTM D 1560, *Resistance to Deformation and Cohesion of Bituminous Mixtures by Means of Hveem Apparatus*, (AASHTO T246) and ASTM D 1561, *Preparation of Bituminous Mixture Test Specimens by Means of California Kneading Compactor* (AASHTO T247). The Hveem method is not commonly used for HMA outside the western United States.

The Hveem method also entails a density/voids and stability analysis. The mixture's resistance to swell in the presence of water is also determined. The Hveem method has two primary advantages. First, the kneading method of laboratory compaction is thought to better simulate the densification characteristics of HMA in a real pavement. Second, Hveem stability is a direct measurement of the internal friction component of shear strength. It measures the ability of a test specimen to resist lateral displacement from application of a vertical load.

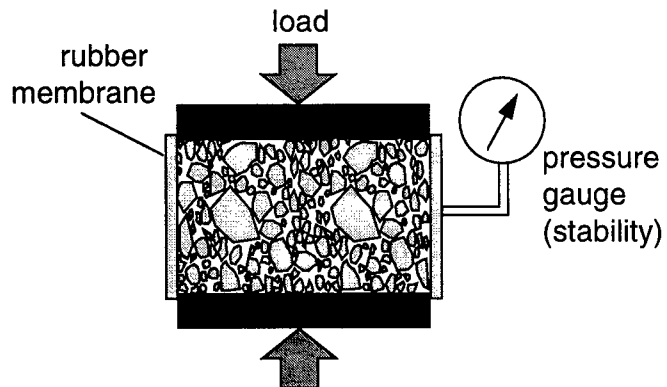

A disadvantage of the Hveem procedure is that the testing equipment is somewhat expensive and not very portable. Furthermore, some important mixture volumetric properties that are related to mix durability are not routinely determined as part of the Hveem procedure. Some engineers believe that the method of selecting asphalt content in the Hveem method is too subjective and may result in non-durable HMA with too little asphalt.

SUPERPAVE ASPHALT MIXTURE DESIGN

Key features in the Superpave system are laboratory compaction and testing for mechanical properties. Laboratory compaction is accomplished by means of a Superpave Gyratory Compactor (SGC). While this device shares some common traits with the Texas gyratory compactor, it is a completely new device with new operational characteristics. Its main utility is to fabricate test specimens. However, by capturing data during SGC compaction, a mix design engineer can also gain insight into the compactability of HMA. The SGC can help avoid mixtures that exhibit tender mix behavior or densify to dangerously low air void contents under the long-term action of traffic.

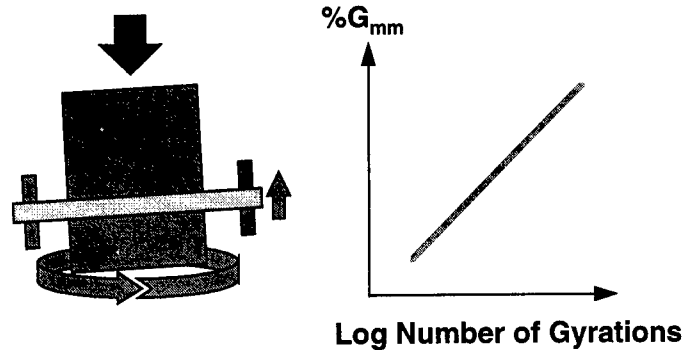

The performance of HMA immediately after construction is influenced by mixture properties that result after hot mixing and compaction. Consequently, incorporated into the Superpave system is a short term aging protocol that required the loose mixture to be oven aged for four hours at 135°C prior to compaction in the SGC.

The SHRP asphalt research program also developed a number of HMA performance prediction tests. Output from these tests will eventually be used to make detailed predictions of pavement performance. In other words, test procedures and the final performance prediction models will allow an engineer to estimate the performance life of a prospective HMA in terms of equivalent axle loads (ESALs) or time to achieve a certain level of rutting, fatigue cracking, and low temperature cracking. This integrated mixture and structural analysis system will allow the designer to evaluate and compare the costs associated with using various materials and applications.

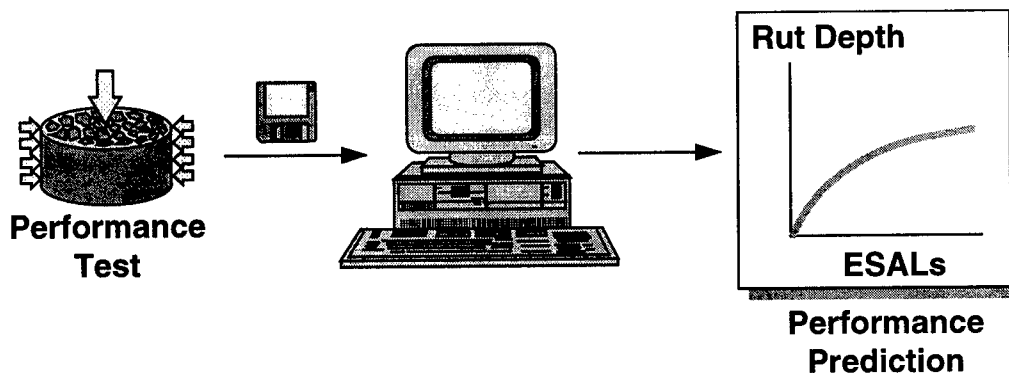

Two new sophisticated testing devices were developed: the Superpave Shear Tester (SST) and Indirect Tensile Tester (IDT). The test output from these devices can provide direct indications of mix behavior, or will eventually generate input to performance prediction models.

Using the mechanical properties of the HMA and these performance prediction models, mix design engineers will be able to estimate the combined effect of asphalt binders, aggregates, and mixture proportions. The models will take into account the structure, condition, and properties of the existing pavement (if applicable) and the amount of traffic to which the proposed mixture will be subjected over its performance life. The output of the models will be millimeters of rutting, percent area of fatigue cracking, and spacing (in meters) of low temperature cracks. By using this approach, the Superpave system will become the ultimate design procedure by linking material properties with pavement structural properties to predict actual pavement performance. When the pavement modeling is completed, the benefit (or detriment) of new materials, different mix designs, asphalt modifiers, and other products can be quantified in terms of cost versus predicted performance. This capability would reduce the dependency on field test sections for relative comparisons.



III. Superpave Binders

Superpave uses a completely new system for testing, specifying, and selecting asphalt binders. The objectives of this section will be to:

- describe the Superpave binder test equipment
- discuss where the tests fit into the range of material conditions (temperature and aging conditions) experienced by asphalt pavements
- explain the Superpave specification requirements and how they are used in preventing permanent deformation, fatigue cracking and low temperature cracking
- discuss how to select the performance grade (PG) binder for a project's climatic and traffic conditions

SUPERPAVE BINDER TESTS

Binder Aging Methods

A central theme of the Superpave binder specification is its reliance on testing asphalt binders in conditions that simulate critical stages during the binder's life. The three most critical stages are:

- during transport, storage, and handling,
- during mix production and construction, and
- after long periods in a pavement

Tests performed on unaged asphalt represent the first stage of transport, storage, and handling.

Aging the binder in a rolling thin film oven (RTFO) simulates the second stage, during mix production and construction. The RTFO aging technique was developed by the California Highway Department and is detailed in AASHTO T-240 (ASTM D 2872). This test exposes films of binder to heat and air and approximates the exposure of asphalt to these elements during hot mixing and handling.

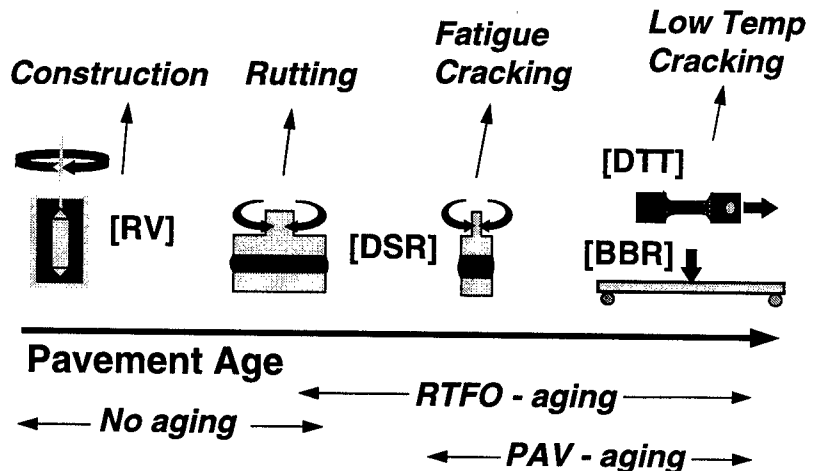

The third stage of binder aging occurs after a long period in a pavement. This stage is simulated by use of a pressure aging vessel (PAV). This test exposes binder samples to heat and pressure in order to simulate, in a matter of hours, years of in-service aging in a pavement.

It is important to note that for specification purposes, binder samples aged in the PAV have already been aged in the RTFO. Consequently, PAV residue represents binder that has been exposed to all the conditions to which binders are subjected during production and in-service.

ROLLING THIN FILM OVEN (RTFO)

Test Equipment

The RTFO procedure requires an electrically heated convection oven. Specific oven requirements are detailed in AASHTO T 240, "Effect of Heat and Air on a Moving Film of Asphalt (Rolling Thin Film Oven Test)." The oven contains a vertical circular carriage that contains holes to accommodate sample bottles. The carriage is mechanically driven and rotates about its center. The oven also contains an air jet that is positioned to blow air into each sample bottle at its lowest travel position while being circulated in the carriage.

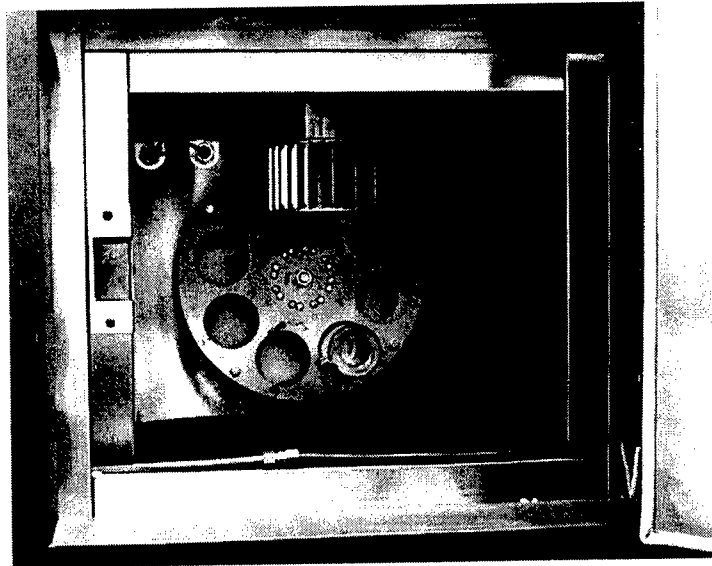
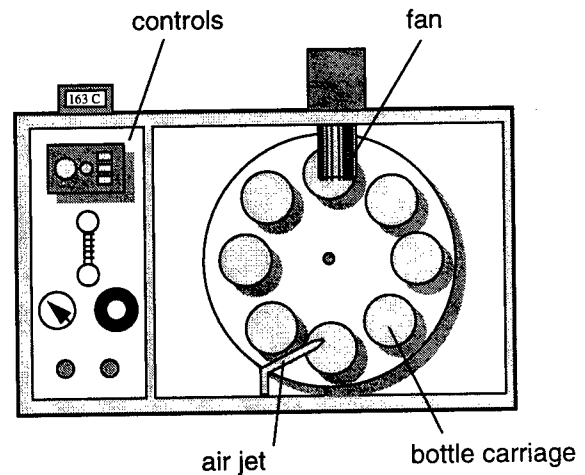

Specimen Preparation

To prepare for RTFO aging, a binder sample is heated until sufficiently fluid to pour. In no case should the sample be heated to 150° C. RTFO bottles are loaded with 35 ± 0.5 g of binder. The RTFO has an eight bottle capacity; however, the contents of two bottles must be used to determine mass loss. If mass loss is being determined, the two bottles containing samples should be cooled and weighed to the nearest 0.001 g. Otherwise, the RTFO residues from the eight bottles are poured into a single container and stirred to ensure homogeneity. RTFO residue should be poured from the coated bottle and not scraped. This material may be used for DSR testing or transferred into PAV pans for additional aging or equally proportioned into small containers and stored for future use.

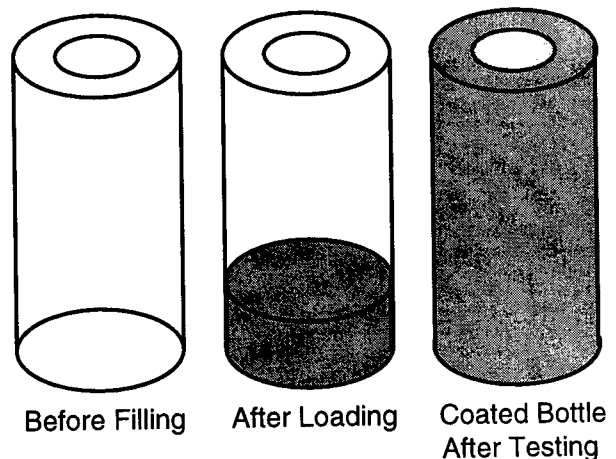

Overview of Procedure

The RTFO oven must be preheated at the aging temperature, $163^{\circ} \pm 0.5^{\circ} \text{C}$, for a minimum of 16 hours prior to use. The thermostat should be set so that the oven will return to this temperature within 10 minutes after the sample bottles are loaded.

Bottles are loaded into the carriage with any unused slots filled with empty bottles. The carriage should be started and rotated at a rate of $15 \pm 0.2 \text{ rev/min}$. The air flow should be set at a rate of $4000 \pm 200 \text{ ml/min}$. The samples are maintained under these conditions for 85 minutes.

If mass loss is being determined, the mass loss sample and bottles are allowed to cool to room temperature and weighed to the nearest 0.001 g.

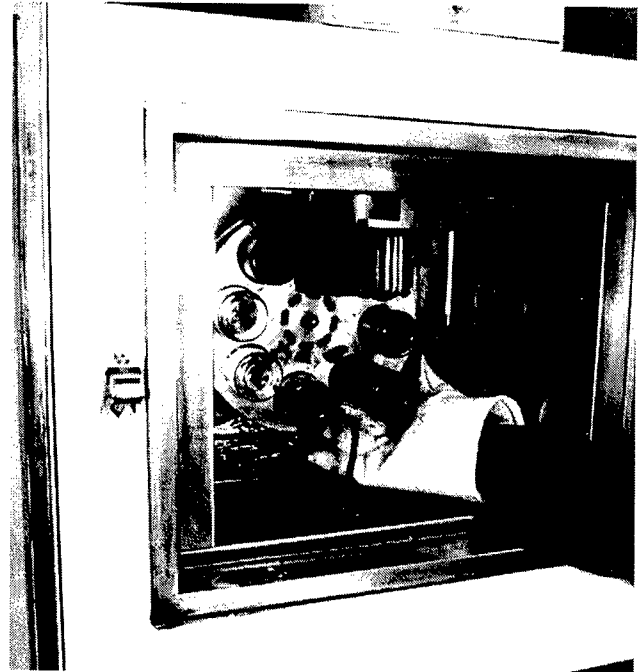

Data Presentation

The primary purpose of RTFO procedure is the preparation of aged binder materials for further testing and evaluation with the Superpave binder tests. The RTFO procedure is also used to determine the mass loss, a measure of the material vaporized by the RTFO procedure. A high mass loss value would identify a material with excessive volatiles, and one that could age excessively. Mass loss is reported as the average of the two samples after RTFO aging, and is calculated by this formula:

$$\text{Mass Loss, \%} = \frac{(\text{Original mass} - \text{Aged mass})}{\text{Original Mass}} \times 100 \%$$

PRESSURE AGING VESSEL

Test Equipment

Two types of pressure aging devices have been developed. The first type consisted of the stand-alone pressure aging vessel that was placed inside a temperature chamber. The second type consists of the pressure vessel built as part of the temperature chamber. The operating principles of the equipment are the same. Specific equipment details can be found in AASHTO PP1, "Accelerated Aging of Asphalt Binder Using a Pressurized Aging Vessel (PAV)". For illustrative purposes, the separate vessel type is shown and described here.

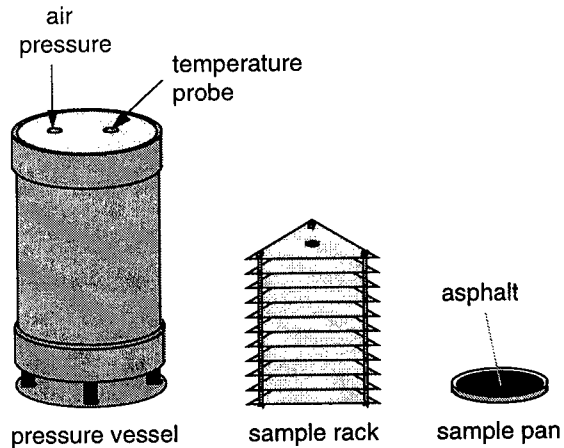

The pressure vessel is fabricated from stainless steel and is designed to operate under the pressure and temperature conditions of the test (2070 kPa and either 90°, 100°, or 110° C). The vessel must accommodate at least 10 sample pans and does so by means of a sample rack, which is a frame that fits conveniently into the vessel. The vessel lid is secured to prevent pressure loss.

Air pressure is provided by a cylinder of dry, clean compressed air with a pressure regulator, release valve, and a slow release bleed valve. The vessel lid is fitted with a pressure coupling and temperature transducer. The temperature transducer connects to a digital indicator that allows visual monitoring of internal vessel temperature throughout the aging period. Continuous monitoring of temperature is required during the test.

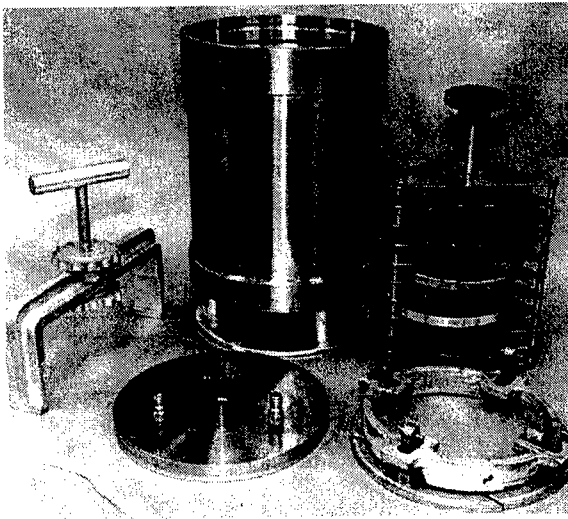

A forced draft oven is used as a temperature chamber. The oven should be able to control the test temperature to within $\pm 0.5^\circ \text{C}$ for the duration of the test. A digital proportional control and readout of internal vessel temperature is required.

Specimen Preparation

To prepare for the PAV, RTFO residue is transferred to individual PAV pans. The sample should be heated only to the extent that it can be readily poured and stirred to ensure homogeneity. Each PAV sample should weigh 50 g. Residue from approximately two RTFO bottles is normally needed for one 50-g sample.

Overview of Procedure

The temperature chamber (oven) is turned on and the vessel is placed in the chamber, unpressurized, and allowed to reach the desired test temperature.

The PAV pans are placed in the sample rack. When the test temperature has been achieved the vessel is removed from the oven and the samples in the sample rack are placed in the hot vessel. The lid is

installed and the lid is secured. This step should be completed as quickly as possible to avoid excessive loss of vessel heat.

The temperature chamber and the pressure hose and temperature transducer are coupled to their respective mates. When the vessel temperature is within 2° C of the test temperature, air pressure is applied using the valve on the air cylinder regulator. When air pressure has been applied, the timing for the test begins.

After 20 hours, the pressure is slowly released using the bleed valve. Usually, 8 to 10 minutes are required to gradually release the pressure. If pressure is released more quickly, excessive air bubbles will be present in the sample and it may foam.

The pans are removed from the sample holder and placed in an oven at 163° C for 30 minutes. This step removes entrapped air from the samples. The samples are then transferred to a container that stores the material for further testing.

Data Presentation

The sole purpose of the PAV procedure is the preparation of aged binder materials for further testing and evaluation with the Superpave binder tests. A report for the PAV procedure contains:

- sample identification,
- aging test temperature to the nearest 0.1° C,
- maximum and minimum aging temperature recorded to the nearest 0.1° C,
- total time during aging that temperature was outside the specified range to the nearest 0.1 min., and
- total aging time in hours and minutes.



Pressure Vessel Built into Oven



Pressure Aging Vessel Inside of Oven

Rotational Viscometer

Rotational viscosity is used to evaluate high temperature workability of binders. A rotational coaxial cylinder viscometer, such as the Brookfield apparatus is used rather than a capillary viscometer. Some asphalt technologists refer to this measure as "Brookfield viscosity." This method of measuring viscosity is detailed in AASHTO TP48, "*Viscosity Determination of Asphalt Binders Using Rotational Viscometer.*"

High temperature binder viscosity is measured to ensure that the asphalt is fluid enough when pumping and mixing. Consequently, rotational viscosity is measured on unaged or "tank" asphalt and must not, according to the Superpave binder specification, exceed 3 Pa-s when measured at 135° C.

Rotational viscosity is determined by measuring the torque required to maintain a constant rotational speed of a cylindrical spindle while submerged in a sample at a constant temperature.

The torque required to rotate the spindle at a constant speed is directly related to the viscosity of the binder sample, which is determined automatically by the viscometer.

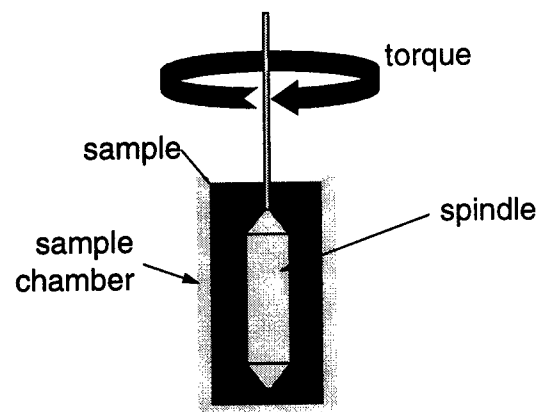

Specimen Preparation

Approximately 30 g of binder is heated in an oven so that it is sufficiently fluid to pour. In no case should the sample be heated above 150° C. During heating, the sample occasionally should be stirred to remove entrapped air. Asphalt is weighed into the sample chamber. The amount of asphalt used varies depending on the spindle. A larger spindle means that less asphalt can be placed in the chamber. Typically, less than 11 grams are used. The sample chamber containing the binder sample is placed in the thermo container and is ready to test when the temperature stabilizes, usually about 15 minutes.

Test Equipment

The apparatus used to measure rotational viscosity consists of two items:

- Brookfield viscometer
- Thermosel™ system

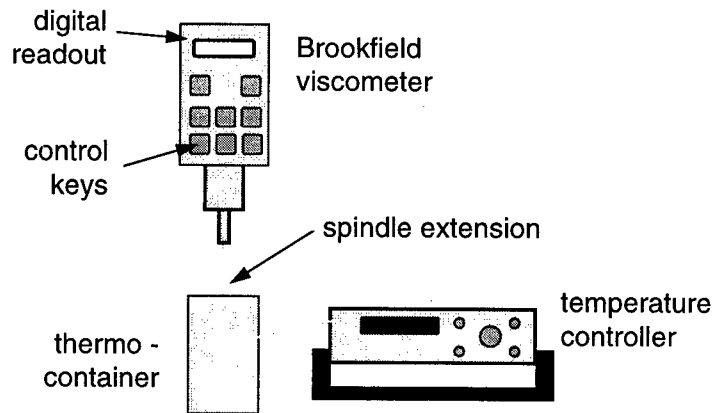

The Brookfield viscometer consists of a motor, spindle, control keys, and digital readout. The motor powers the spindle through a spring. The spring is wound as the torque increases. A rotary transducer measures torque in the spring. For most rotational viscometers and specification testing, the motor should be set at 20 rpm.

The spindle is cylindrical in shape and resembles a plumb bob. It resists rotation due to the viscosity of the binder in which it is submerged. Many spindles are available for the Brookfield apparatus. The proper spindle is selected based on the viscosity of the binder being tested. Many binders can be tested with only two spindles: Nos. 21 and 27. Of these, spindle No. 27 is used most frequently.

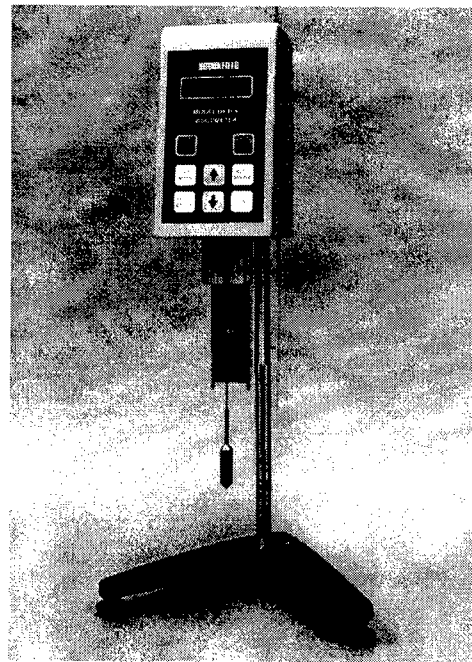

Applied torque and rotational speed are indicated on the digital readout. The control keys are used to input test parameters such as spindle number, which tells the viscometer which spindle is being used. The keys also are used to set rotational speed and turn the motor on and off.

The viscometer must be leveled to function properly. A bubble-type level indicator is located on top of the viscometer and is adjusted by means of leveling screws on the base.

The Thermosel system consists of the sample chamber, thermo container, and temperature controller. The sample chamber is a stainless steel cup in the shape of a test tube. An extracting tool is used to handle the sample chamber when hot.

The thermo-container holds the sample chamber and consists of electric heating elements that maintain or change test temperature. The temperature controller allows the operator to set the test temperature at the required 135° C. A bubble-type level mounted on the base of the thermo-container stand ensures that the thermo-container is level.



Overview of Procedure

When the digital indicator on the temperature controller shows that the sample temperature has equalized, the sample can be tested. The spindle is lowered into the chamber containing the hot sample and the spindle is coupled with the viscometer using a threaded connector.

A waiting period (normally about 15 minutes) is required to allow the sample temperature to return to 135°C. During this period, the viscometer motor is turned-on and the operator can observe the viscosity reading. As the temperature equalizes, the viscosity reading will stabilize and the operator can begin to obtain test results.

The operator can set the digital display to show viscosity information that needed for the report. This information is: viscosity, test temperature, spindle number, and speed. Three viscosity readings should be recorded at 1-minute intervals. Note that in selection the display information, only the upper-left item in the display changes.

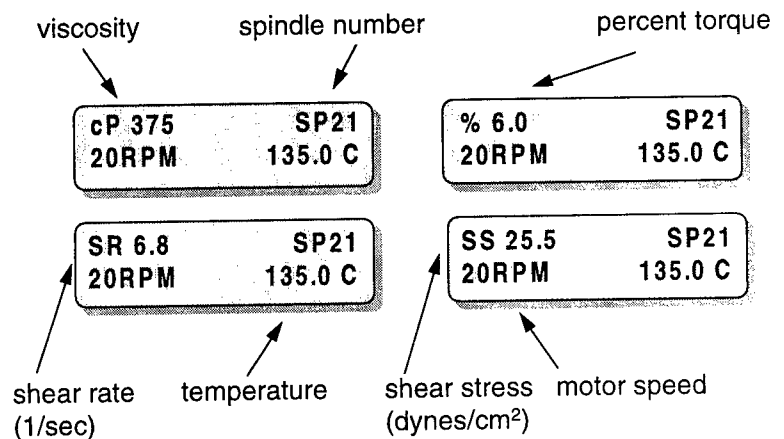

In some cases, it may be desirable to determine binder viscosity at temperatures other than 135°C. For example, most agencies use equiviscous temperatures for mixing and compaction during mix design. To accomplish this, the Thermosel™ controller is reset to the desired temperature, such as 165°C, until the thermo-container brings the sample to this temperature. This step takes about 30 minutes, after which, the test is again performed as described above.

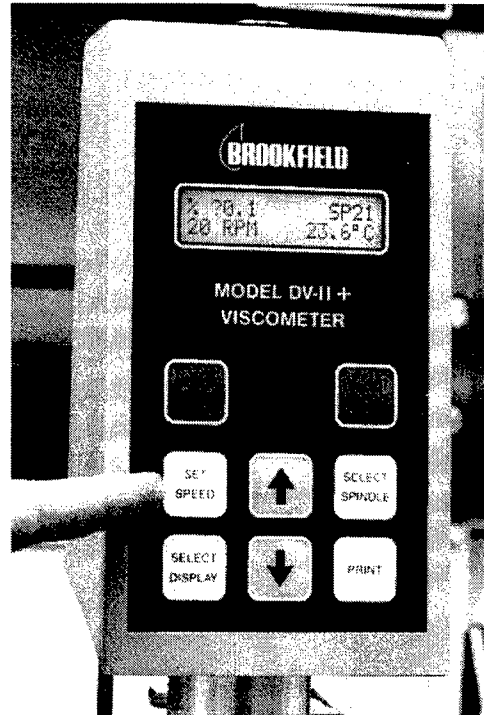
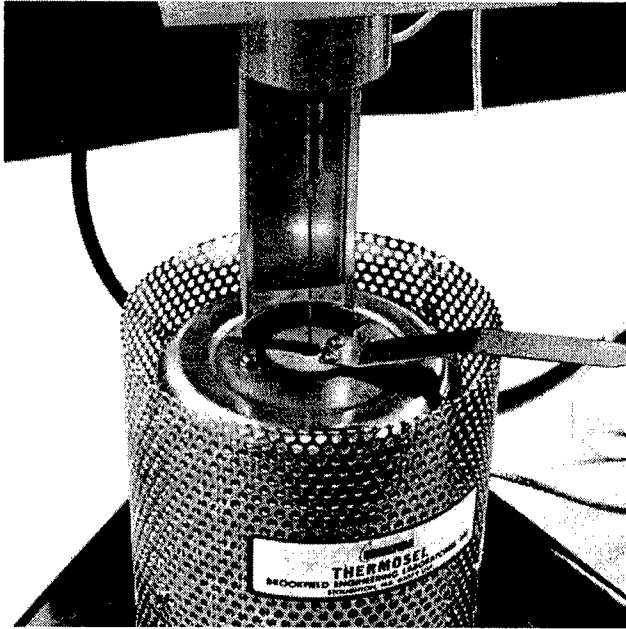

Data Presentation

The viscosity at 135°C is reported as the average of three readings. The digital output of the rotational viscosity test is viscosity in units of centipoise (cP) while the Superpave binder specification uses Pa·s. To convert, this equation is used:

$$1000 \text{ cP} = 1 \text{ Pa}\cdot\text{s}$$

Therefore, multiply the Brookfield viscosity output in cP by 0.001 to obtain the viscosity in Pa·s. As mentioned previously, in addition to viscosity, the test temperature, spindle number, and speed are required items to be reported.

Dynamic Shear Rheometer

As discussed earlier, asphalt is a viscoelastic material, meaning that it simultaneously shows the behavior of an elastic material (e.g. rubber band) and a viscous material (e.g. molasses). The relationship between these two properties is used to measure the ability of the binder to resist permanent deformation and fatigue cracking. To resist rutting, a binder needs to be stiff and elastic; to resist fatigue cracking, the binder needs to be flexible and elastic. The balance between these two needs is a critical one.

The Dynamic Shear Rheometer (DSR) is used to characterize the viscous and elastic behavior of asphalt binders. It does this by measuring the viscous and elastic properties of a thin asphalt binder sample sandwiched between an oscillating and a fixed plate. Operational details of the DSR can be found in AASHTO TP5 "Determining the Rheological Properties of Asphalt Binder Using a Dynamic Shear Rheometer."

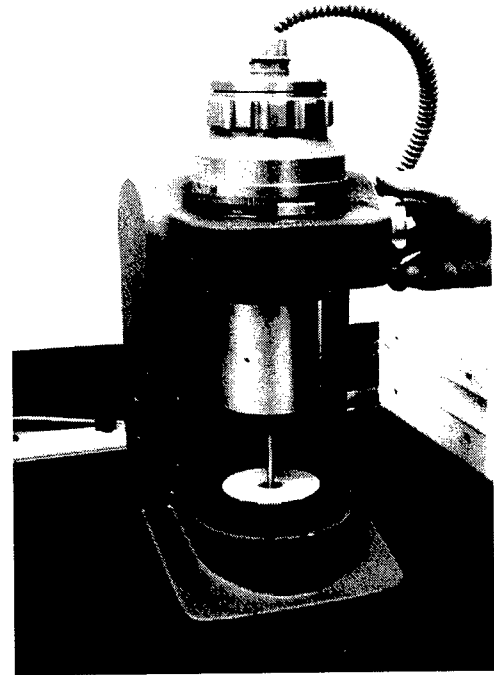

Test Equipment

The principle of operation of the DSR is straightforward. An asphalt sample is sandwiched between an oscillating spindle and the fixed base. The oscillating plate (often called a "spindle") starts at point A and moves to point B. From point B the oscillating plate moves back, passing point A on the way to point C. From point C the plate moves back to point A. This movement, from A to B to C and back to A comprises one cycle.

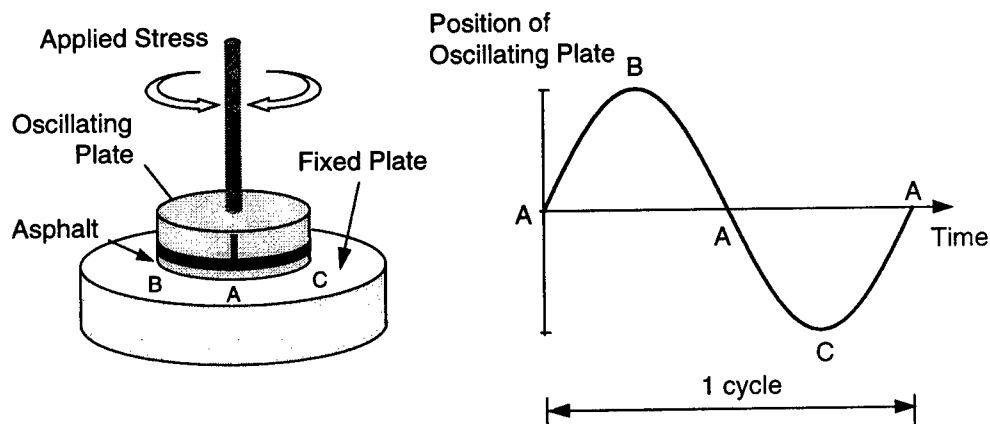

As the force (or shear stress, τ) is applied to the asphalt by the spindle, the DSR measures the response (or shear strain, γ) of the asphalt to the force. If the asphalt were a perfectly elastic material, the response would coincide immediately with the applied force, and the time lag between the two would be zero. A perfectly viscous material would have a large time lag between load and response. Very cold asphalt performs like an elastic material. Very hot asphalt performs like a viscous material.

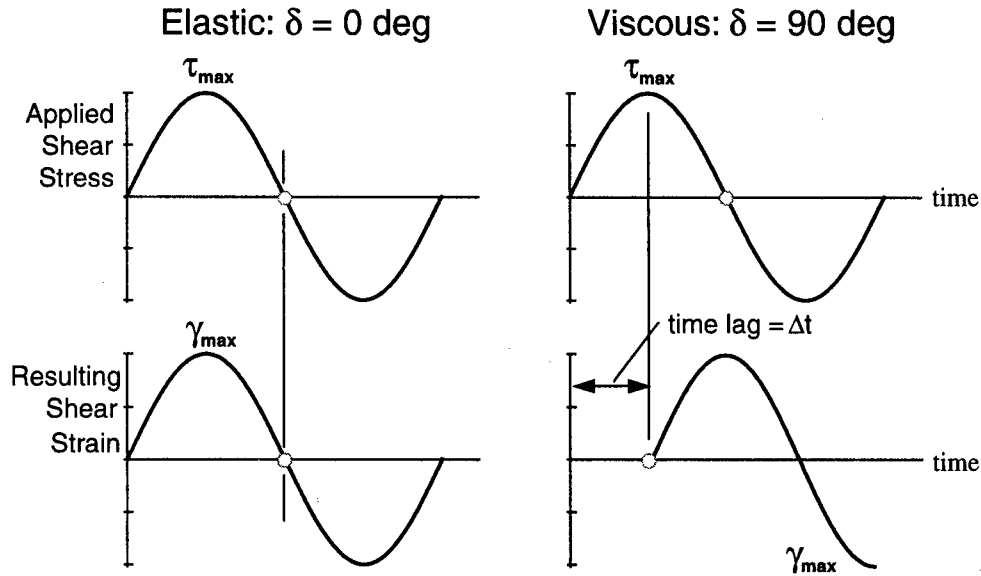

At temperatures where most pavements carry traffic, asphalt behaves both like an elastic solid and a viscous liquid. The relationship between the applied stress and the resulting strain in the DSR quantifies both types of behavior, and provides information necessary to calculate two important asphalt binder properties: the complex shear modulus (G^* - "G star") and phase angle (δ - "delta").

G^* is the ratio of maximum shear stress (τ_{max}) to maximum shear strain (γ_{max}). The time lag between the applied stress and the resulting strain is the phase angle δ . For a perfectly elastic material, the phase angle, δ , is zero, and all of the deformation is temporary. For a viscous material (such as hot asphalt), the phase angle approaches 90 degrees, and all of the deformation is permanent. In the DSR, a viscoelastic material such as asphalt at normal service temperatures displays a stress-strain response between the two extremes, as shown below.

Viscoelastic: $0 < \delta < 90^\circ$

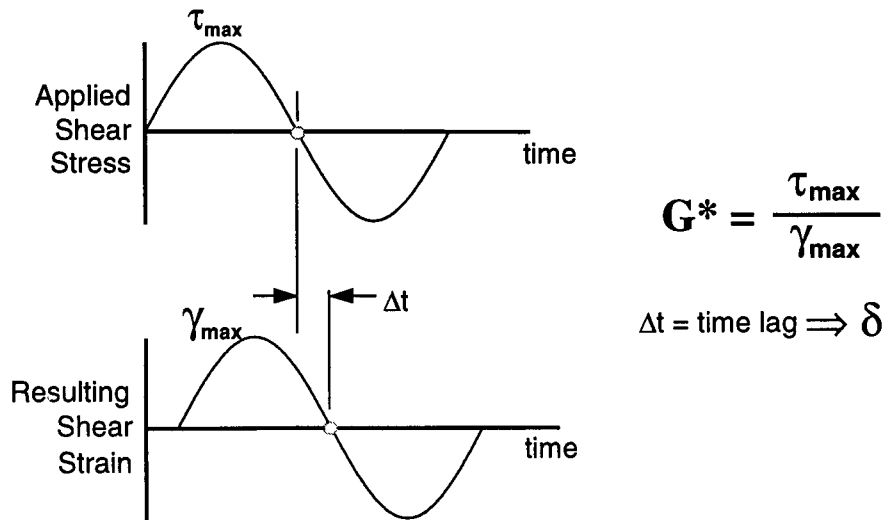

Describing this viscoelastic behavior in a different manner, G^* is a measure of the total resistance of a material to deforming when repeatedly sheared. It consists of two parts: a part that is elastic (temporary deformation) as shown by the horizontal arrow, and a part that is viscous (permanent deformation) as indicated by the vertical arrow. δ , the angle made with the horizontal axis, indicates the relative amounts of temporary and permanent deformation. In this example, even though both asphalts are viscoelastic, asphalt 2 is more elastic than asphalt 1 because of its smaller δ . By determining both G^* and δ , the DSR provides a more complete picture of the behavior of asphalt at pavement service temperatures.

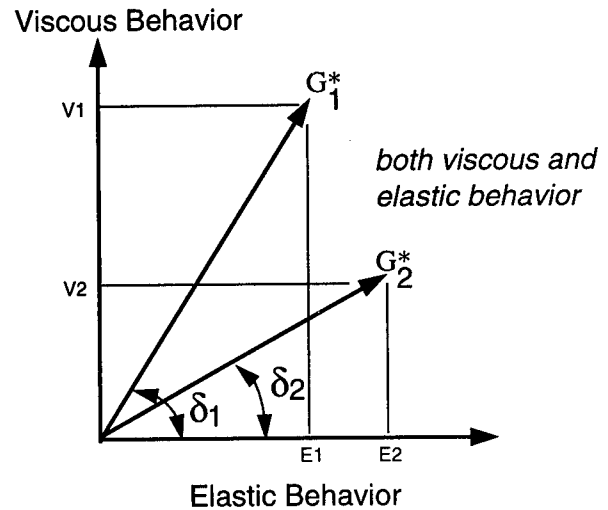

For asphalt, the values of G^* and δ are highly dependent on the temperature and frequency of loading. Therefore, it is important to know the climate of the project where the pavement is being constructed, as well as the relative speed of the traffic to be using the facility. These concepts will be furthered discussed later in this section.

The formulas used by the rheometer software to calculate τ_{max} and γ_{max} are:

$$\tau_{max} = 2T/\pi r^3 \text{ and}$$

$$\gamma_{max} = \Theta r/h$$

where T = maximum applied torque,
 r = radius of specimen/plate (either 12.5 or 4 mm),
 Θ = deflection (rotation) angle,
 h = specimen height (either 1 or 2 mm).

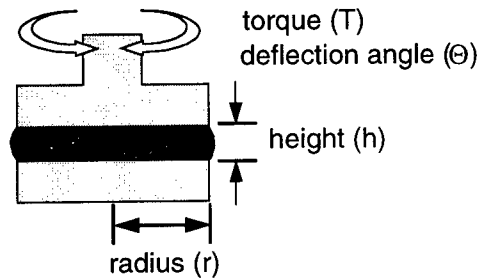

Because the properties of asphalt binders are so temperature dependent, rheometers must have a precise means of controlling the temperature of the sample. This is normally accomplished by means of a circulating fluid bath or forced air bath. Fluid baths normally use water to surround the sample. The water is circulated through a temperature controller that precisely adjusts and maintains the sample temperature uniformly at the desired value. Air baths operate in the same manner as water baths except that they surround the sample with heated air during testing. In either case, the temperature of the air or water must be controlled so that the temperature of the sample across the gap is uniform and varies by no more than 0.1° C.

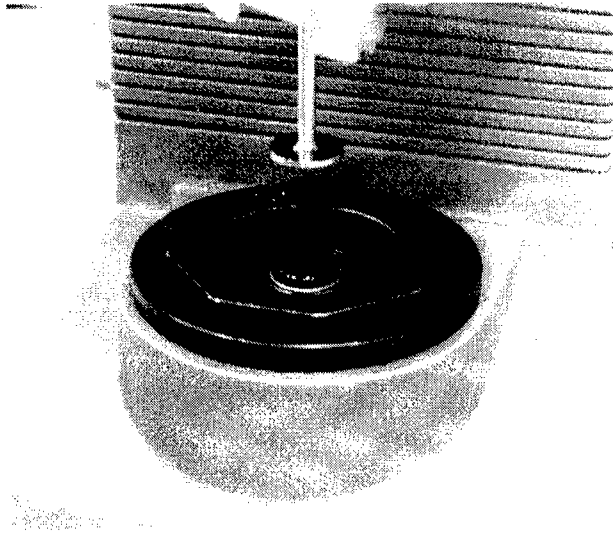

Again, the operator need not worry about performing these calculations since they are performed automatically by the rheometer software. However, the radius of the specimen is a crucial factor since its value is raised to the fourth power in the G^* calculations, so careful specimen trimming is very important. Specimen height (i.e. the gap between the plates) is also an important factor that is mostly affected by the control and skill of the operator.

Specimen Preparation

The thickness of the asphalt disk sandwiched between the spindle and the fixed plate must be carefully controlled. The proper specimen thickness is achieved by adjusting the gap between the spindle and fixed plate. This gap must be set before mounting the asphalt sample but while the spindle and base plate are mounted in the rheometer and at the test temperature. The gap is adjusted by means of a micrometer wheel. The micrometer wheel is graduated, usually in units of microns. Turning the wheel allows precise positioning of the spindle and base plate relative to each other. On some rheometers the micrometer wheel moves the spindle down. On other rheometers, it moves the base plate up. The thickness of gap used depends on the test temperature and the aged condition of the asphalt. Unaged and RTFO aged asphalt, tested at high temperatures of 46°C or greater, require a small gap of 1000 microns (1 mm). PAV aged asphalts, tested at intermediate test temperatures, in the range of 4° to 40°C, require a larger gap of 2000 microns (2 mm). Likewise, two spindle diameters are used. High temperature tests require a large spindle (25 mm), and intermediate test temperatures require a small spindle (8 mm).

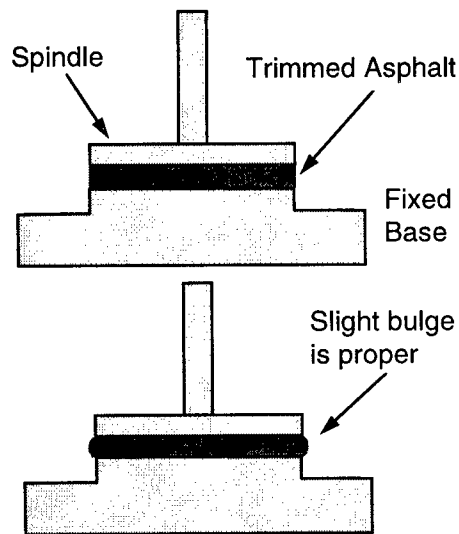

The operator normally sets the gap before mounting the specimen, at the desired value (1000 or 2000 microns) plus an extra 50 microns. This 50 microns is dialed out using the micrometer wheel after final specimen trimming.

A disk of asphalt with diameter equal to the oscillating plate of the DSR is needed for testing. There are two ways to prepare the sample:

- (1) asphalt can be poured directly onto the spindle in the proper quantity to provide the appropriate thickness of material
- (2) a mold can be used to form the asphalt disk, then the asphalt can be placed between the spindle and fixed plate of the DSR.

In the first method, experience is necessary to apply the proper amount of asphalt. There must not be too much or too little material. If there is too little, the test will be inaccurate. If there is too much, excess sample trimming will be required.

In the second method, asphalt is heated until fluid enough to pour. The heated asphalt is poured into a silicone mold and allowed to cool until solid enough to remove the asphalt from the mold. After removal from the mold, the asphalt disk is placed between the fixed plate and the oscillating spindle of the DSR. As before, excess asphalt beyond the edge of the spindle should be trimmed.

After specimen trimming, the final step in preparing the specimen is to close the gap between the spindle and lower plate by 50 mm, so that a slight bulge is evident near the edge of the spindle. This step normally occurs immediately prior to testing.

Overview of Procedure

After the asphalt sample is correctly in place and the test temperature appears stable, the operator must allow about ten minutes for the temperature of the specimen to equilibrate to the test temperature. The actual temperature equilibration time is equipment and asphalt dependent and should be checked using a dummy specimen equipped with very accurate temperature sensing capabilities.

A computer is used with the DSR to control test parameters and record test results. Testing consists of using the rheometer software to apply a constant oscillating stress, and then recording the resulting strain and time lag. The Superpave specifications require the oscillation speed to be 10 radians/second, which is approximately 1.59 Hz.

The operator enters the value of applied stress that will cause an approximate amount of shear strain (sometimes called "strain amplitude") in the asphalt. Shear strain values vary from one to 12 percent and depend on the stiffness of the binder being tested. Relatively soft materials tested at high temperatures, (e.g., unaged binders and RTFO aged binders) are tested at strain values of approximately ten to twelve percent. Hard materials (e.g., PAV residues tested at intermediate temperatures) are tested at strain values of about one percent.



Pouring asphalt onto spindle



Pouring asphalt into molds

The stiffness of the material tested also relates to the spindle size used for testing. Unaged binders and RTFO aged binders are tested using the 25 mm spindle. PAV aged binders are tested using the 8 mm spindle.

In the initial stages of the procedure, the rheometer is used to measure the stress required to achieve the specified shear strain and then maintains this stress level very precisely during the test. The shear strain can vary in small amounts from the set value during the test. The rheometer software controls variation in shear stress.

To begin the test, the sample is first conditioned by loading the specimen for 10 cycles. Ten additional cycles are then applied to obtain test data. The rheometer software automatically computes and reports G^* and δ , which can be compared with specification requirements.

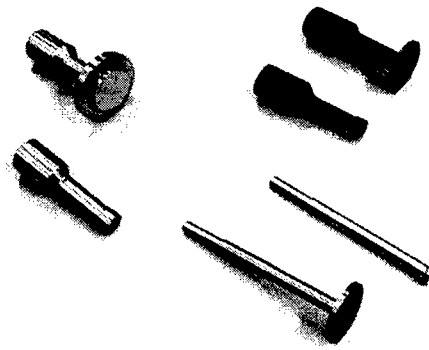

Data Presentation

The DSR is capable of measuring asphalt response over a range of temperature, frequency, and strain levels. However, G^* and δ are required for Superpave specification testing at specific conditions. The DSR software calculates G^* and δ . Therefore, it is a simple matter of comparing results with requirements of the Superpave specification to determine compliance. A complete report includes:

- G^* to the nearest three significant figures,
- δ to the nearest 0.1 degrees,
- test plate size to the nearest 0.1 mm and gap to nearest 1 μm ,
- test temperature to the nearest 0.1° C,
- test frequency to the nearest 0.1 rad/sec, and
- strain amplitude to the nearest 0.01 percent.

G^* is divided by $\sin \delta$ to develop a “high temperature stiffness” factor that addressed rutting; G^* is multiplied by $\sin \delta$ to develop an “intermediate temperature stiffness” factor that addresses fatigue cracking. The use of these parameters is discussed later in this section.

Bending Beam Rheometer

The Bending Beam Rheometer (BBR) is used to measure the stiffness of asphalts at very low temperatures. The test uses engineering beam theory to measure the stiffness of a small asphalt beam sample under a creep load. A creep load is used to simulate the stresses that gradually build up in a pavement when temperature drops. Two parameters are evaluated with the BBR. *Creep stiffness* is a measure of how the asphalt resists constant loading and the *m-value* is a measure of how the asphalt stiffness changes as loads are applied.

Details of the BBR test procedure can be found in AASHTO TP1 "Determining the Flexural Creep Stiffness of Asphalt Binder Using the Bending Beam Rheometer (BBR)."



Test Equipment

The BBR gets its name from the test specimen geometry and loading method used during testing. The key elements of the BBR are a loading frame, controlled temperature fluid bath, computer control and data acquisition system, and test specimen. The BBR uses a blunt-nosed shaft to apply a midpoint load to the asphalt beam, which is supported at two locations. A load cell is mounted on the loading shaft, which is enclosed in an air bearing to eliminate any frictional resistance when applying load. A deflection measuring transducer is affixed to the shaft to monitor deflections. Loads are applied by pneumatic pressure and regulators are provided to adjust the load applied through the loading shaft.

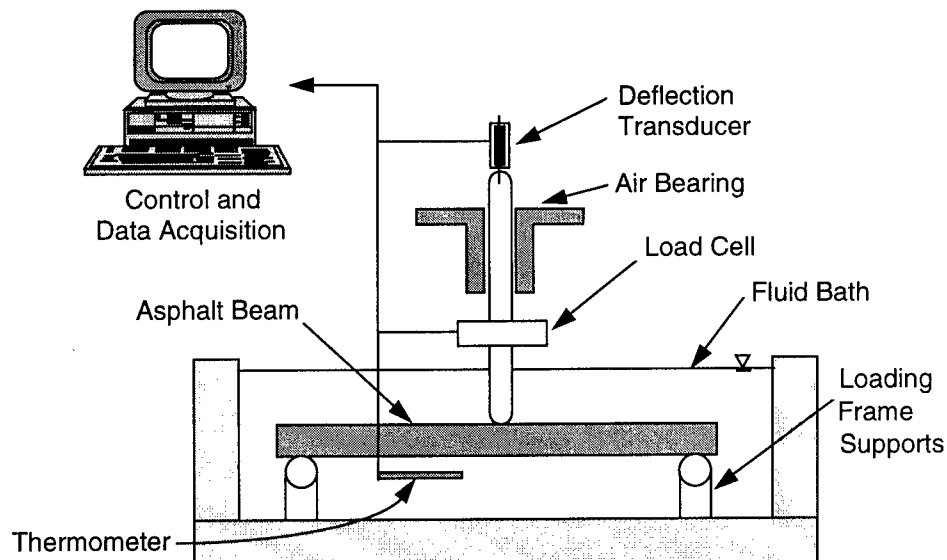

The temperature bath contains a fluid consisting of ethylene glycol, methanol, and water. This fluid is circulated between the test bath and a circulating bath that controls the fluid temperature to within 0.1°C. Circulation or other bath agitation must not disturb the test specimen in a manner that would influence the testing process. The data acquisition system consists of a computer (with software) connected to the BBR for controlling test parameters and acquiring load and deflection test results.

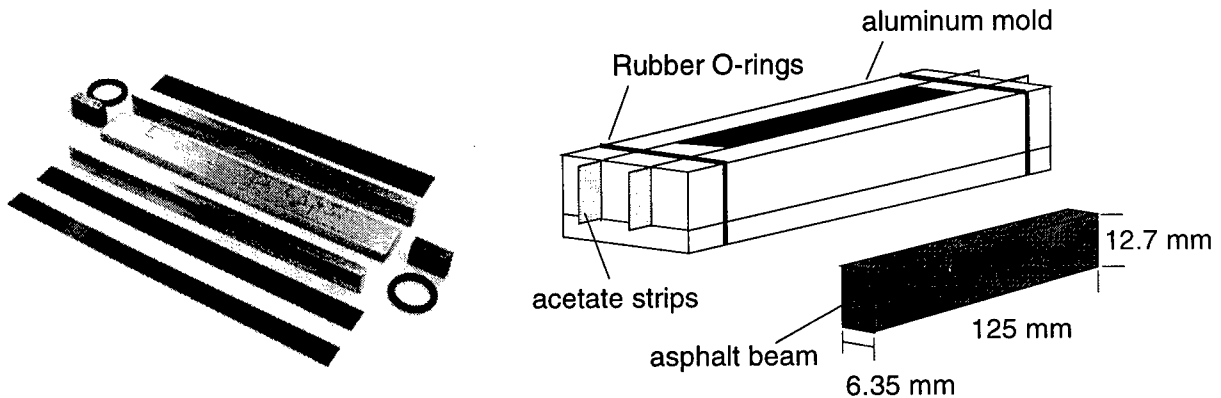

Specimen Preparation

Pouring heated asphalt into a rectangular mold forms the asphalt beam. The aluminum mold pieces are greased with petroleum jelly. Acetate strips are placed against the greased faces. The end pieces are treated with a release agent composed of glycerin and talc that have been mixed to achieve a paste-like consistency. Silicone rubber molds are also available to fabricate beam test specimens.

After a cooling period of about 45 to 60 minutes, excess asphalt is trimmed from the upper surface using a hot spatula. The asphalt specimen should remain in the mold at room temperature and demolded only when the testing procedure is ready to begin, but in no case more than three hours.

To demold the specimen, cool the assembly in a freezer for five to ten minutes or an ice bath for 30 to 45 seconds. In addition, do not use the rheometer testing bath since this may cause excessive fluctuations in the bath temperature.

After removal of the aluminum and acetate, the resulting asphalt beams are ready for temperature conditioning. This requires that they be placed in the test bath for 60 ± 5 minutes. At the end of this period, the beams may be tested. Because the test procedure requires this tight tolerance on testing, the operator must carefully coordinate equipment preparation and specimen preparation.

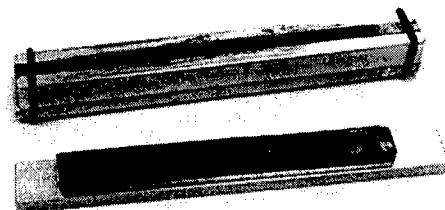
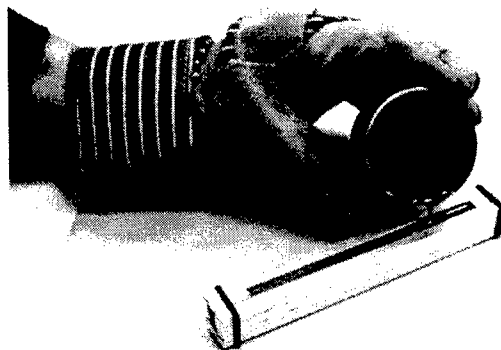

Overview of Procedure

The operator initiates the control software before the test begins. While the test specimens are brought to test temperature in the testing bath, systems calibration and compliance are accomplished. These include calibration of the displacement transducer and load cell. Compliance of the test device is checked with a rigid stainless steel reference beam. The temperature transducer is also checked by using a calibrated mercury-in-glass thermometer. A thinner reference beam is also supplied that can be periodically used to check the performance of the overall system. This beam functions as a dummy test specimen allowing quick checks on rheometer performance. The rheometer software controls most of the system calibration and the operator need only follow the instructions provided by the software.

At the end of the 60-minute thermal conditioning period, the asphalt beam is placed on the supports by gently grasping it with forceps. A 2.5- to 3.5-gram (30 ± 5 mN) preload is manually applied by the operator to ensure that the beam is firmly in contact with the supports. A 100-gram (980 mN) seating load is automatically applied for one second by the rheometer software. After this seating step, the load is automatically reduced to the preload for a 20-second recovery period. At the end of the recovery period, a 100-gram (980 ± 5 mN) load is applied to the beam for a total of 240 seconds. The deflection of the beam is recorded during this period.

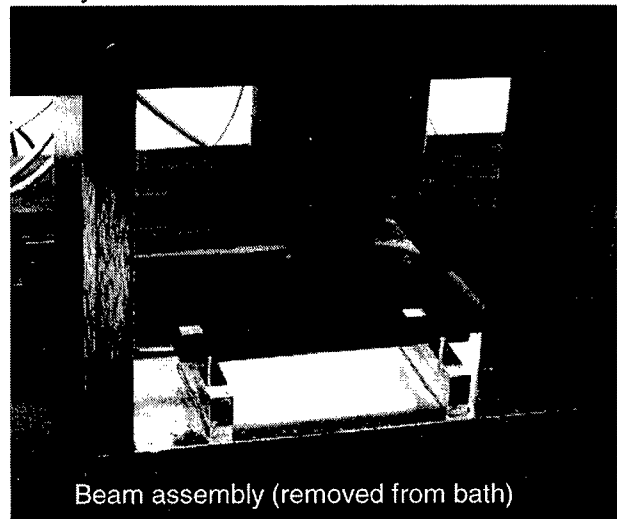

Beam assembly (removed from bath)

As the 100-gram (980 mN) load bends the beam, the deflection transducer monitors the movement. This deflection is plotted against time to determine creep stiffness and m-value. During the test, load and deflection versus time plots are continuously generated on the computer screen for the operator to observe. At the end of 240 seconds, the test load is automatically removed and the rheometer software calculates creep stiffness and m-value.

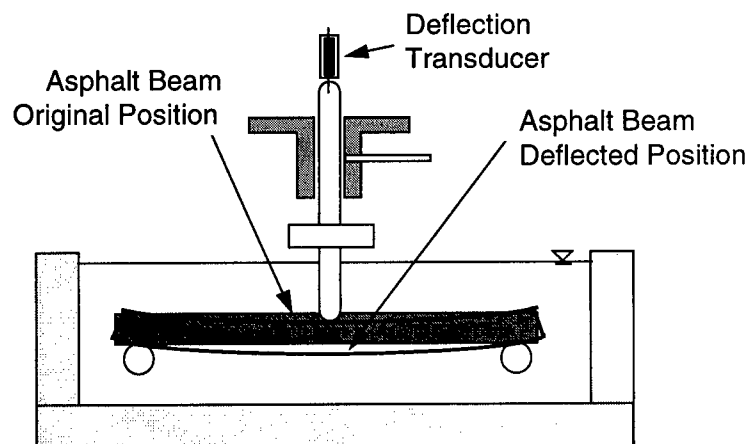

Data Presentation

Beam analysis theory is used to obtain creep stiffness of the asphalt in this test. The formula for calculating creep stiffness, $S(t)$, is:

$$S(t) = \frac{PL^3}{4bh^3\Delta(t)}$$

where, $S(t)$ = creep stiffness at time, $t = 60$ seconds
 P = applied constant load, 100 g (980 mN)
 L = distance between beam supports, 102 mm
 b = beam width, 12.5 mm
 h = beam thickness, 6.25 mm
 $\Delta(t)$ = deflection at time, $t = 60$ seconds

Although the BBR uses a computer to make this calculation, it can be determined manually by reading deflection data from the graph of deflection versus time from the printer connected to the computer.

By using the equation for $S(t)$ and the deflection from the graph, the stiffness at time, $t=60$ seconds can be obtained. Creep stiffness is desired at the minimum pavement design temperature after two hours of load. However, SHRP researchers discovered that by raising the test temperature 10°C , an equal stiffness is obtained after a 60 second loading. The obvious benefit is that a test result can be measured in a much shorter period of time.

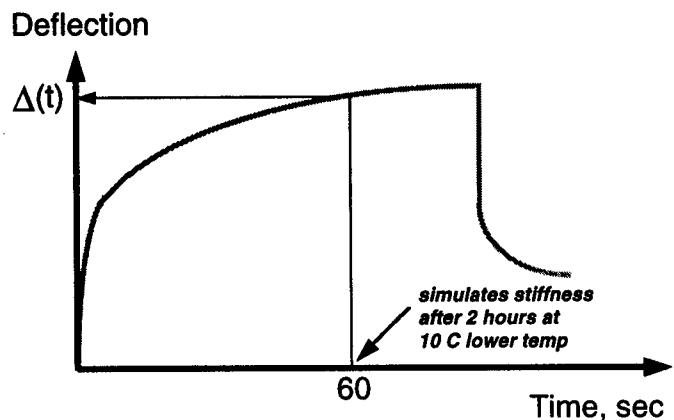

The second parameter needed from the bending beam test is the m -value. The m -value represents the rate of change of the stiffness, $S(t)$, versus time. This value also is calculated automatically by the bending beam computer. However, to check the results from the computer, the value for m is easily obtained. To obtain m -value, the stiffness is calculated at several loading times. These values are then plotted against time. The m -value is the slope of the log stiffness versus log time curve at any time, t .

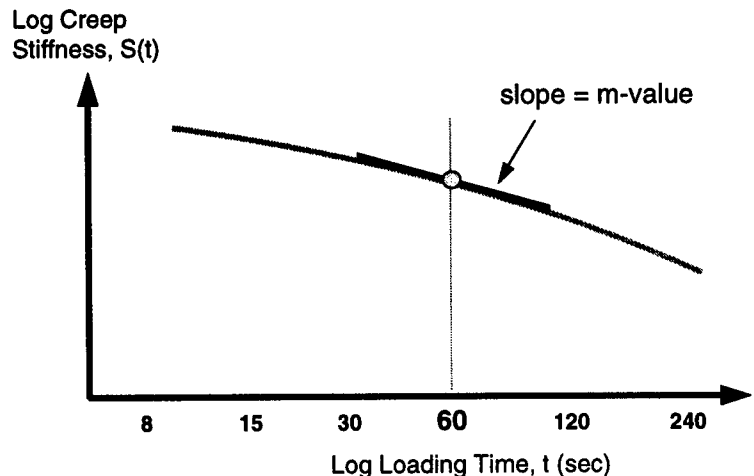

Computer-generated output for the bending beam test automatically reports all required reporting items. It includes plots of deflection and load versus time, actual load and deflection values at various times, test parameters, and operator information.

Direct Tension Tester

The direct tension test measures the low temperature ultimate tensile strain of an asphalt binder. The test is performed at relatively low temperatures ranging from 0° to -36° C, the temperature range within which asphalt exhibits brittle behavior. Furthermore, the test is performed on binders that have been aged in a rolling thin film oven and pressure aging vessel. Consequently, the test measures the performance characteristics of binders as if they had been exposed to hot mixing in a mixing facility and some in-service aging.

A small dog-bone shaped specimen is loaded in tension at a constant rate. The strain in the specimen at failure (ϵ_f) is the change in length (ΔL) divided by the effective gauge length (L).

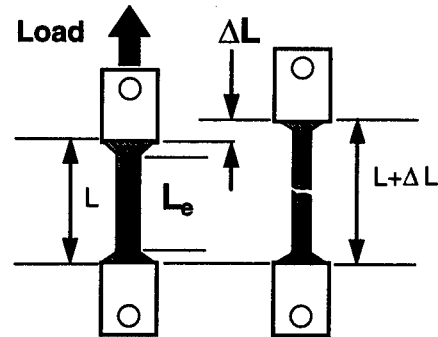
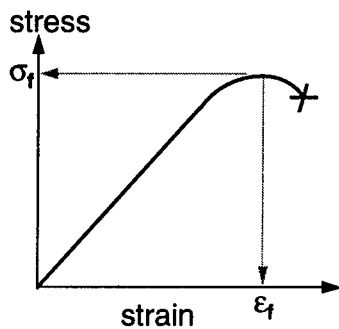

$$\text{failure strain } (\epsilon_f) = \frac{\text{change in length } (\Delta L)}{\text{effective length } (L_e)}$$

In the direct tension test, failure is defined by the stress where the load on the specimen reaches its maximum value, and not necessarily the load when the specimen breaks. Failure stress (σ_f) is the failure load divided by the original cross section of the specimen (36 mm²).

The stress-strain behavior of asphalt binders depends greatly on their temperature. If an asphalt were tested in the direct tension tester at many temperatures, it would exhibit the three types of tensile failure behavior: brittle, brittle-ductile, and ductile.

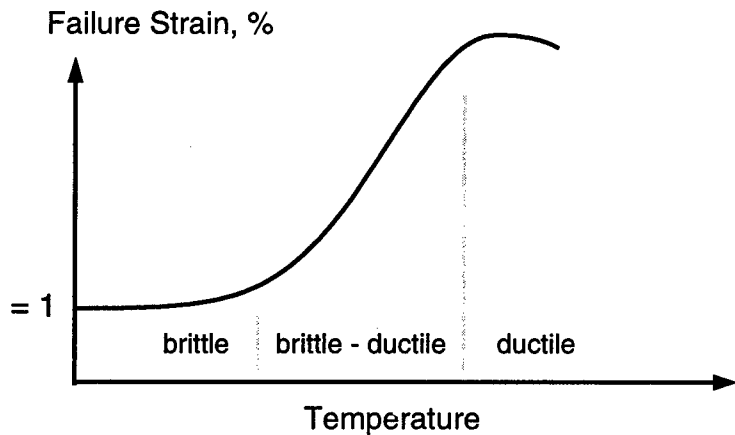

In illustrating the characteristic stress-strain relationships in this figure, the three different lines could represent the same asphalt tested at multiple temperatures or different asphalts tested at the same temperature. Brittle behavior means that the asphalt very quickly picks up load and elongates only a small amount before it cracks. An asphalt that is ductile may not even crack in the direct tension test but rather "string-out" until its elongation exceeds the stroke of the loading frame. That is why the point at which the specimen stops picking up load, which is the strain at peak stress, defines tensile failure strain.

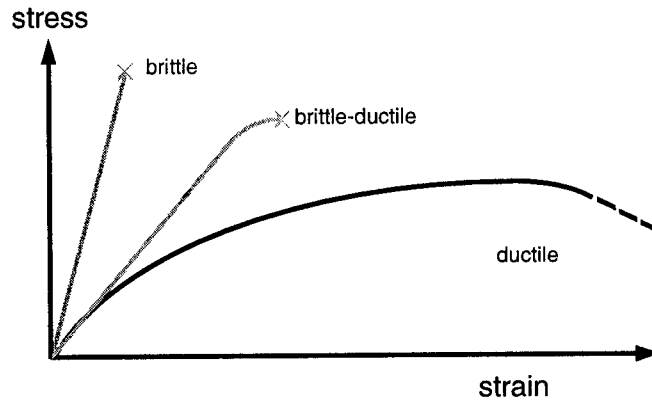

Test Equipment

The apparatus used to perform the direct tension test consists of three components:

- a testing machine to apply tensile load,
- an elongation measuring system, and
- an environmental system

The universal testing machine is a loading device capable up to 500 N at a loading rate of 1.0 mm/min. The machine must be equipped with an electronic load cell capable of resolutions of ± 0.1 N. A computer is used to acquire data. The test equipment and procedure are detailed in AASHTO TP3 "Determining the Fracture Properties of Asphalt Binder in Direct Tension (DT)."

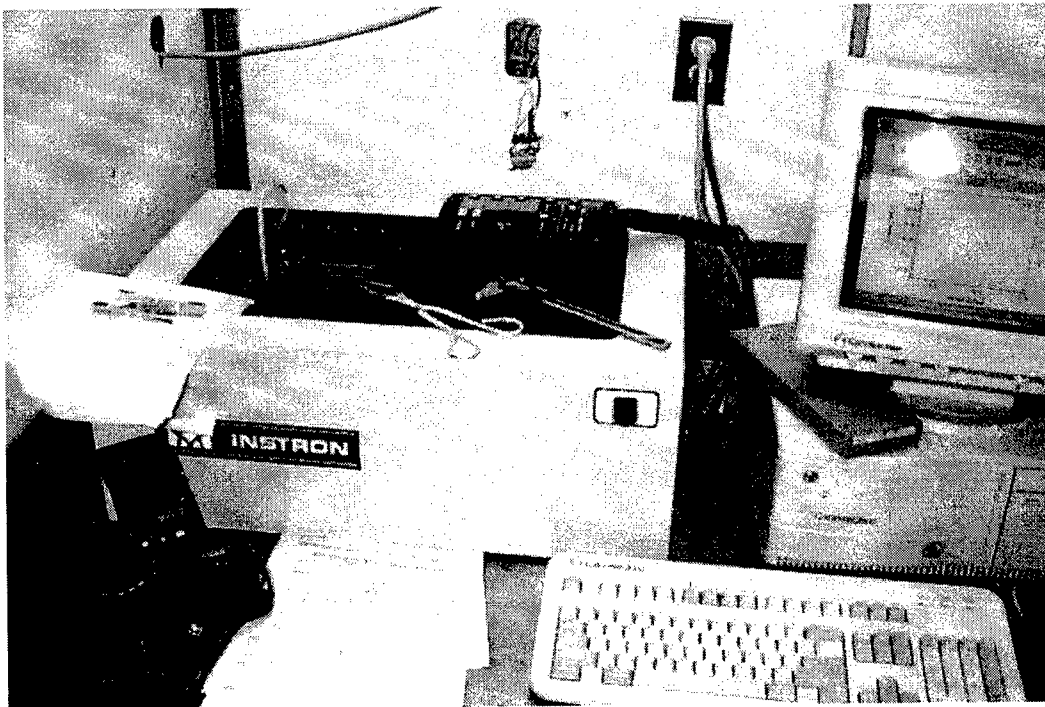

A key feature to the testing machine is the gripping system used to attach specimens to the alignment rods that apply tensile load. The grips have a ball joint connection that ensures no bending is induced in the specimen.

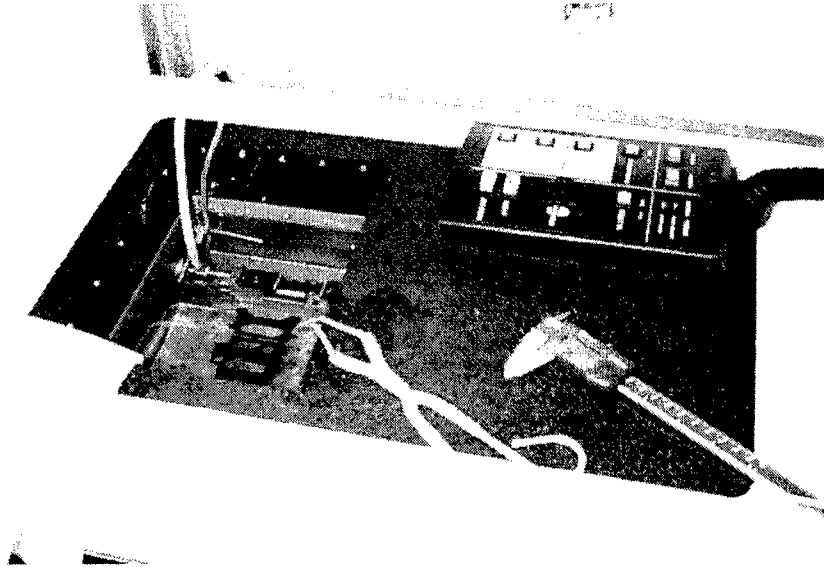
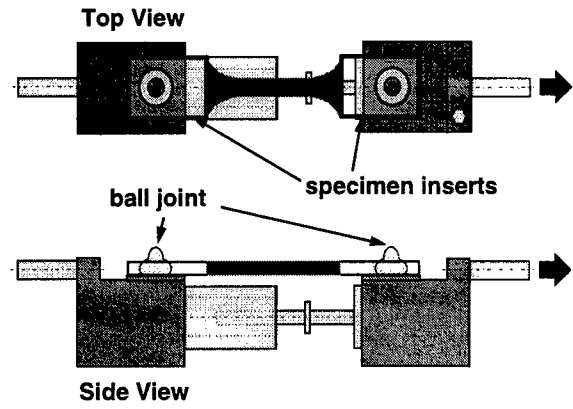

Specimen Preparation

Direct tension specimens are formed in a silicone rubber mold. The mold allows fabrication of four specimens. These four specimens are used to produce one test result. Plastic end inserts are placed in the mold and hot asphalt is poured in the space between the inserts.

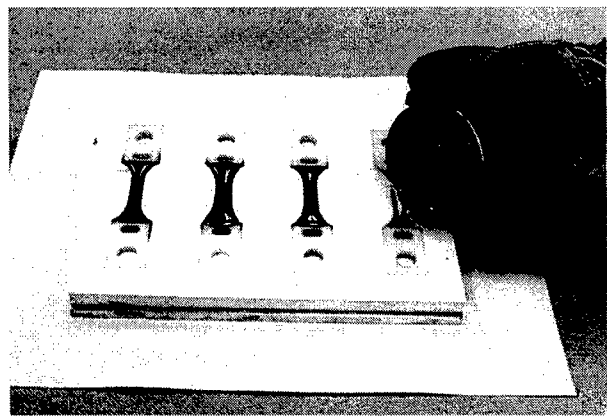
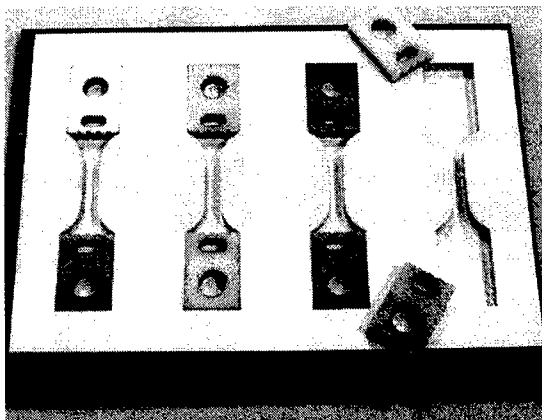
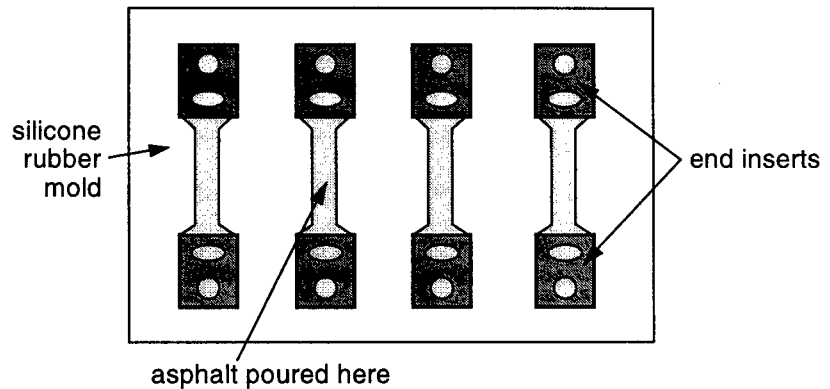

Test specimens weigh approximately 2 g and are 100 mm long, including the end inserts. The inserts are each 30 mm long and the formed binder test specimen is 40 mm long. The nominal cross section is 6 mm by 6 mm. A 12 mm radius is used to gradually widen the specimen to 20 mm, the end insert width. The end inserts are composed of polymethylmethacrylate, or other suitable material with a linear coefficient of thermal expansion similar to asphalt ($0.00006 \text{ mm/mm/}^\circ\text{C}$). Asphalt readily adheres to these materials and no bonding agent is necessary.

After the specimens are poured, trimmed, and demolded, they must be tested within 60 ± 10 minutes. Because the test procedure requires this tolerance on testing, the operator must carefully coordinate equipment preparation with specimen preparation.

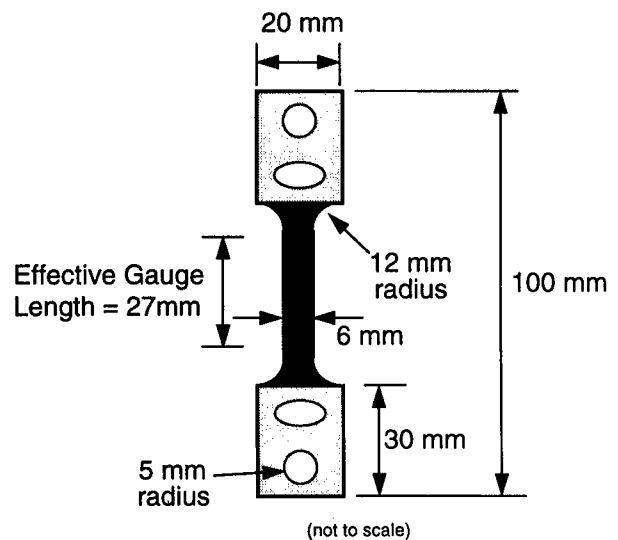

Overview of Procedure

Specimens are tested individually. A specimen is mounted on the ball joint, and the operator initializes the load and strain indicators. A tensile load is applied until the specimen fails. A normal test requires less than a minute from application of load until specimen failure. A test is considered acceptable when fracture occurs within the narrow, center portion of the specimen.

Data Presentation

A single test result consists of the average strain to failure of the four specimens. The table below demonstrates typical test output.

Batch Number - Acme Refining 759AC1196-16				
Operator - Smith				
Date - 3/15/97				
Time - 14:16:26				
Test Number	Peak Load, N	Peak Stress, kPa	Strain at Peak Stress, mm/mm	Peak Elong., mm
000091	65.70	1845.9	0.00369	0.099
000092	64.72	1818.6	0.00540	0.146
000093	56.45	1586.9	0.00459	0.124
000094	64.94	1825.6	0.00549	0.148
Mean	62.95	1769.3	0.00479	0.129
Std Dev	4.36	122.1	0.00083	0.023







In this case, the test result of interest is the average of strain at peak stress, 0.00479 mm/mm, which is 0.5 percent strain (i.e., $0.00479 \times 100 \% = 0.479 \%$ or with rounding, 0.5 %). This value would *not* meet the specification requirement of one percent minimum strain. Although they are not used to determine specification compliance the following are also required reporting items:

- test temperature to the nearest 0.1° C,
- rate of elongation to the nearest 0.01 mm/min,
- failure stress to the nearest 0.01 MPa,
- peak load to the nearest N, and
- type of break observed (brittle, brittle-ductile, or no break).

SUPERPAVE ASPHALT BINDER SPECIFICATION

The Superpave asphalt binder specification (the complete provisional specification is shown in Appendix A) is intended to improve performance by limiting the potential for the asphalt binder to contribute to permanent deformation, low temperature cracking and fatigue cracking in asphalt pavements. The specification provides for this improvement by designating various physical properties that are measured with the equipment described previously. This section will explain how each of the new test parameters relates to pavement performance, and how to select the asphalt binder for a specific project.

One important difference between the currently used asphalt specifications and the Superpave specification is the overall format of the requirements. The physical properties remain constant for all of the performance grades(PG). However, the temperatures at which these properties must be achieved vary depending on the climate in which the binder is expected to serve. As an example, this partial view of the specification shows that a PG 58-22 grade is designed to sustain the conditions of an environment where the average seven day maximum pavement temperature of 58°C and a minimum pavement design temperature is -22°C.

Avg		PG 58				PG 64				PG 70				PG 76				PG 82									
1-		-46	-16	-22	-28	-34	-40	-10	-16	-22	-28	-34	-40	-10	-16	-22	-28	-34	-10	-16	-22	-28	-34				
Spec Requirement Remains Constant																											
	≥ 230 °C																										
	≤ 3 Pa·s @ 135 °C																										
	≥ 1.00 kPa	46	52																					70	76	82	
(ROLLING T)																											
	≥ 2.20 kPa	46	52																					70	76	82	
(PRESSURE AGING VE)																											
20 Hours, 2.07 M						100				100 (110)				100 (110)				110 (110)									
	≤ 5000																										
(meter) DSR G																											
$S \leq 300$ MPa	$m \geq 0.500$																										
(Bending Beam Rheometer) BBR "S" St																											
"m"- value		-24	-30	-36	0	-6	-12	-18	-24	-30	-36	-6	-12	-18	-24	-30	0	-6	-12	-18	-24	-30	0	-6	-12	-18	-24
Report Value																											
(Bending Beam Rheometer) BBR Physical P																											
	≥ 1.00 %																										
(Direct Tension) DT																											

Test Temperature Changes

Permanent Deformation (Rutting)

As discussed earlier in the section describing the DSR, the total response of asphalt binders to load consists of two components: elastic (recoverable) and viscous (non-recoverable). Pavement rutting or permanent deformation is the accumulation of the non-recoverable component of the responses to load repetitions at high service temperatures. If permanent deformation occurs, it generally does so early on in the life of a pavement, so Superpave addresses rutting using unaged binder and binder aged in the RTFO.

The Superpave specification defines and places requirements on a rutting factor, $G^*/\sin \delta$, that represents the high temperature viscous component of overall binder stiffness. This factor is called "G star over sine delta," or the high temperature stiffness. It is determined by dividing the complex modulus (G^*) by the sine of the phase angle (δ), both measured by the DSR. $G^*/\sin \delta$ must be at least 1.00 kPa for the original asphalt binder and a minimum of 2.20 kPa after aging in the rolling thin film oven test. Binders with values below these may be too soft to resist permanent deformation.

Viscosity, ASTM D 4402: ^b Maximum, 3 Pa-s (3000 cP), Test Temp, C
Dynamic Shear, TP5: ^c $G^*/\sin \delta$, Minimum, 1.00 kPa Test Temperature @ 10 rad/s, C
Rolling Thin Film Oven (T240)
Mass Loss, Maximum, %
Dynamic Shear, TP5: $G^*/\sin \delta$, Minimum, 2.20 kPa Test Temp @ 10 rad/sec, C

Spec Requirements to Address Rutting

Higher values of G^* and lower values of δ are considered desirable attributes from the standpoint of rutting resistance. For the two materials A and B shown there is a significant difference between the values for $\sin \delta$. $\sin \delta$ for Material A (4/5) is larger than $\sin \delta$ for Material B (3/5). This means that when divided into G^* (equal for both A and B), the value for $G^*/\sin \delta$ will be smaller for Material A (6.25) than Material B (8.33). Therefore, Material B should provide better rutting performance than Material A. This is sensible because Material B has a much smaller viscous part than Material A.

Material A

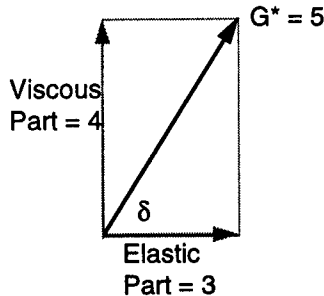

$$\sin \delta = \frac{\text{Viscous Part}}{G^*} = \frac{4}{5}$$

$$\frac{G^*}{\sin \delta} = \frac{5}{4/5} = 6.25$$

Material B

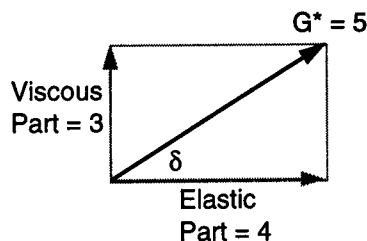

$$\sin \delta = \frac{\text{Viscous Part}}{G^*} = \frac{3}{5}$$

$$\frac{G^*}{\sin \delta} = \frac{5}{3/5} = 8.33$$

Larger value means behaves more like elastic solid

Fatigue Cracking

G^* and δ are also used in the Superpave asphalt specification to help control fatigue in asphalt pavements. Since fatigue generally occurs at low to moderate pavement temperatures after the pavement has been in service for a period of time, the specification addresses these properties using binder aged in both the RTFO and PAV.

The DSR is again used to generate G^* and $\sin \delta$. However, instead of dividing the two parameters, the two are multiplied to produce a factor related to fatigue. The fatigue cracking factor is $G^* \sin \delta$, which is called "G star sine delta," or the intermediate temperature stiffness. It is the product of the complex modulus, G^* , and the sine of the phase angle, δ . The Superpave binder specification places a maximum value of 5000 kPa on $G^* \sin \delta$.

PAV Aging Temp, C
Dynamic Shear, TP5: $G^* \sin \delta$, Maximum, 5000 kPa Test Temp @ 10 rad/sec, C
Physical Hardening ^e
Creep Stiffness, TP1. ^f S, Maximum, 300 MPa m-value, Minimum, 0.300 Test Temp, @60 sec, C
Direct Tension, TP3. ^f Failure Strain, Minimum, 1.0% Test Temp @ 1.0 mm/min, C

Specification requirement to address fatigue cracking

The ability to function as a soft elastic material and recover from many loadings is a desirable binder trait in resisting fatigue cracking. As shown below, for two materials with the same stiffness, the material with a smaller value of δ would be more elastic, and that would improve its fatigue properties. It is possible that a combination of G^* and δ could result in a value for $G^* \sin \delta$ so large that the viscous and elastic parts would become too high and the binder would no longer be able to effectively resist fatigue cracking. This is why the specification places a maximum limit of 5000 kPa for $G^* \sin \delta$.

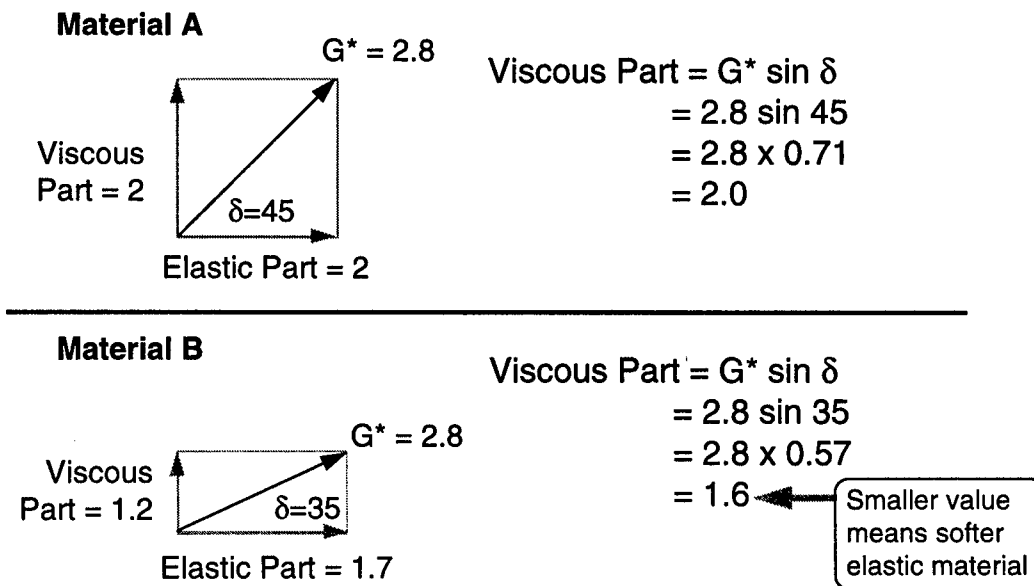

Low Temperature Cracking

When the pavement temperature decreases HMA shrinks. Since friction against the lower pavement layers prevents movement, tensile stresses build-up in the pavement. When these stresses exceed the tensile strength of the asphalt mix, a low temperature crack occurs -- a difficult distress to alleviate. The bending beam rheometer is used to apply a small creep load to the beam specimen and measure the creep stiffness -- the binder's resistance to load. If creep stiffness is too high, the asphalt will behave in a brittle manner, and cracking is more likely to occur. To prevent this cracking, creep stiffness has a maximum limit of 300 MPa.

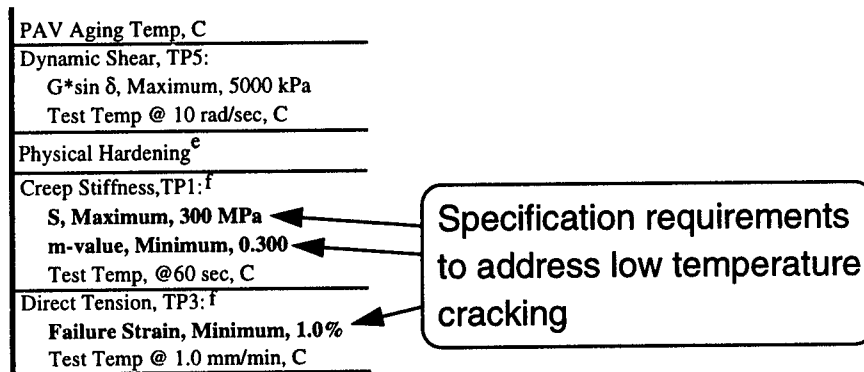

The rate at which the binder stiffness changes with time at low temperatures is controlled using the m-value. A high m-value is desirable because as the temperature decreases and thermal stresses accumulate, the stiffness will change relatively fast. A relatively fast change in stiffness means that the binder will tend to shed stresses that would otherwise build up to a level where low temperature cracking would occur. A minimum m-value of 0.300 is required by the Superpave binder specification.

As the temperature of a pavement decreases, it shrinks. This shrinkage causes stresses to build in the pavement. When these stresses exceed the strength of the binder, a crack occurs. Studies have shown that if the binder can stretch to more than 1% of its original length during this shrinkage, cracks are less likely to occur. Therefore, the direct tension test is included in the Superpave specification. It is only applied to binders that have a creep stiffness between 300 and 600 MPa. If the creep stiffness is below 300 MPa, the direct tension test need not be performed, and the direct tension requirement does not apply. The test pulls an asphalt sample in tension at a very slow rate, that which simulates the condition in the pavement as shrinkage occurs. The amount of strain that occurs before the sample breaks is recorded and compared to the 1.0 percent minimum value allowed in the specification.

Miscellaneous Specification Criteria

Other binder requirements are contained in the specification. They are included to control handling and safety characteristics of asphalt binders.

The flash point test (AASHTO T 48) is used to address safety concerns. The minimum value for all grades is 230°C. This test is performed on unaged binders.

To ensure that binders can be pumped and handled at the hot mixing facility, the specification contains a maximum viscosity requirement on unaged binder. This value is 3 Pa·s (3000 cP on rotational viscometer) for all grades. Purchasing agencies may waive this requirement if the binder supplier warrants that the binder can be pumped and mixed at safe temperatures.

A mass loss requirement is specified to guard against a binder that would age excessively from volatilization during hot mixing and construction. The mass loss is calculated using the RTFO procedure and must not exceed 1.00 percent.

During storage or other stationary periods, particularly at low temperatures, physical hardening occurs in asphalt binders. Chemical association of asphalt molecules causes physical hardening. Because of this physical hardening phenomenon, the Superpave specification requires that physical hardening be quantified. To measure this hardening, the bending beam test is performed on pressure aged binder after it has been conditioned for 24 hours at the required test temperature. Therefore, two sets of beams are fabricated for creep stiffness and m-value measurements. One set is tested after one hour of conditioning, while the other set is tested after 24 hours of conditioning. The creep stiffness and m-value are reported for information purposes. Currently, no specified values must be achieved.

SELECTING ASPHALT BINDERS

Performance graded asphalt binders are selected based on the climate in which the pavement will serve. The distinction among the various binder grades is the specified minimum and maximum pavement temperatures at which the requirements must be met.

Appendix A provides a listing of the more common binder grades in the Superpave specification. However, the PG grades are not limited to those given classifications. In actuality, the specification temperatures are unlimited, extending unbounded in both directions. The high and low temperatures extend as far as necessary in the standard six-degree increments. For example, even though a PG 58-10 is not shown, it exists as a legitimate grade in the system.

A module in the Superpave software assists users in selecting binder grades. Superpave contains three methods by which the user can select an asphalt binder grade:

- **By Geographic Area:** An Agency would develop a map showing binder grade to be used by the designer based on weather and/or policy decisions.
- **By Pavement Temperature:** The designer would need to know design pavement temperature.
- **By Air Temperature:** The designer determines design air temperatures, which are converted to design pavement temperatures.

The Superpave software contains a database of weather information for 6092 reporting weather stations in the US and Canada that allows users to select binder grades for the climate at the project location. For each year that these weather stations have been in operation, the hottest seven-day period was determined and the average maximum air temperature for this seven-day period was calculated. SHRP researchers selected this seven-day average value as the optimum method to characterize the high temperature design condition. For all the years recorded, the mean and standard deviation of the **seven-day average maximum air temperature** have been computed. Similarly, the **one-day minimum air temperature** of each year was identified and the mean and standard deviation of all the years of record was calculated. Weather stations with less than 20 years of records were not used.

However, the design temperatures to be used for selecting asphalt binder grade are the pavement temperatures, not the air temperatures. Superpave defines the high pavement design temperature at a depth 20 mm below the pavement surface, and the low pavement design temperature at the pavement surface.

Using theoretical analyses of actual conditions performed with models for net heat flow and energy balance, and assuming typical values for solar absorption (0.90), radiation transmission through air (0.81), atmospheric radiation (0.70), and wind speed (4.5 m/sec), this equation was developed for the:

$$T_{20\text{mm}} = (T_{\text{air}} - 0.00618 \text{ Lat}^2 + 0.2289 \text{ Lat} + 42.2) (0.9545) - 17.78$$

where $T_{20\text{mm}}$ = high pavement design temperature at a depth of 20 mm
 T_{air} = seven-day average high air temperature
 Lat = the geographical latitude of the project in degrees.

The low pavement design temperature at the pavement surface is defined as the low air temperature.

The Superpave system allows the designers to use reliability measurements to assign a degree of design risk to the high and low pavement temperatures used in selecting the binder grade. As defined in Superpave, reliability is the percent probability in a single year that the actual temperature (one-day low or seven-day average high) will not exceed the design temperatures.

Superpave binder selection is very flexible in that a different level of reliability can be assigned to high and low temperature grades. Consider summer air temperatures in Topeka, Kansas, which has a mean seven-day maximum of 36°C and a standard deviation of 2°C. In an average year there is a 50 percent chance the seven-day maximum air temperature will exceed 36°C. However, only a two percent chance exists that the temperature will exceed 40°C; hence, a design air temperature of 40°C will provide 98 percent reliability.

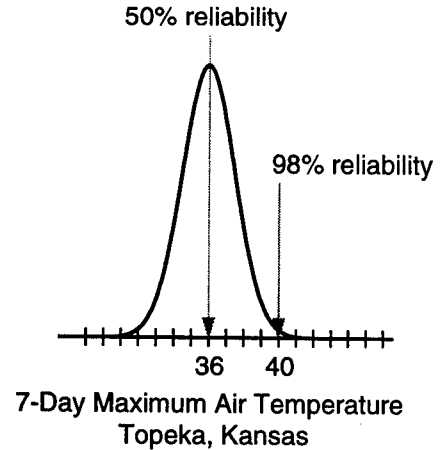

Start with Air Temperature

To see how the binder selection works assume that an asphalt mixture is designed for Topeka. In a normal summer, the average seven-day maximum air temperature is 36°C with a standard deviation of 2°C. In a normal winter, the average coldest temperature is -23°C. For a very cold winter the temperature is -31°C, with a standard deviation of 4°C.

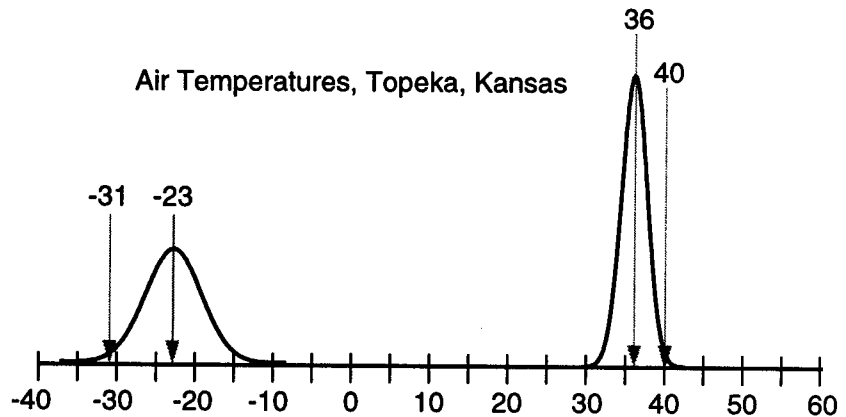

Convert to Pavement Temperature

Superpave software calculates high pavement temperature 20 mm below the pavement surface and low temperature at the pavement surface. For a wearing course at the top of a pavement section, the pavement temperatures in Topeka are 56°C and -23°C for 50 percent reliability and 60°C (56°C + 2 standard deviations) and -31°C for 98 percent reliability.

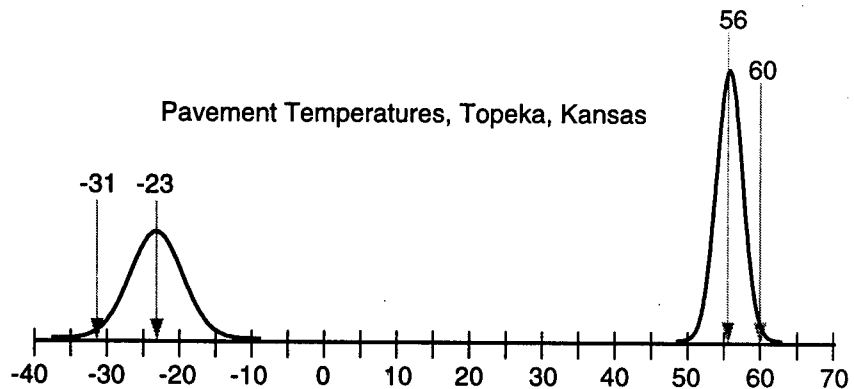

Select the Binder Grade

For a reliability of at least 50 percent, the high temperature grade for Topeka must be PG 58. Selecting a PG 58 would actually result in a higher level of reliability, about 85 percent, because of the "rounding up" to the next standard grade. The next lower grade only protects to 52°C, less than 50 percent reliability. The low temperature grade must be a PG -28. Likewise, rounding to this standard low temperature grade results in almost 90

percent reliability. For 98 percent reliability, the needed high temperature grade is PG 64; the low temperature grade is PG -34. Also, the reliabilities of the high and low temperature grades could be selected at different levels depending upon the needs of the design project. For instance, if low temperature cracking was more of a concern, the binder could be selected as a PG 58-34.

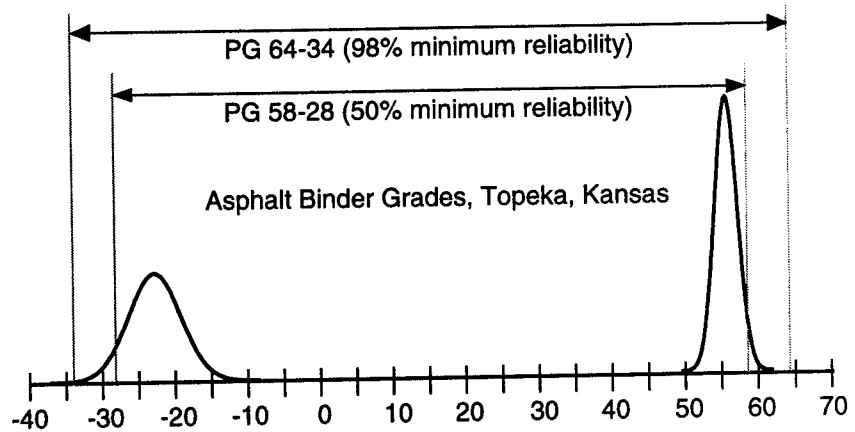

Manipulating temperature frequency distributions is not a task that the designer needs to worry about. Superpave software handles the calculations. For any site, the user can enter a minimum reliability and Superpave will calculate the required asphalt binder grade. Alternately the user can specify a desired asphalt binder grade and Superpave will calculate the reliability obtained.

Effect of Traffic Speed and Volume on Binder Selection

The Superpave binder selection procedure described is the basic procedure for typical highway traffic conditions. Under these conditions, it is assumed that the pavement is subjected to a design number of fast, transient loads. For the high temperature design situation, controlled by specified properties relating to permanent deformation, the traffic speed has an additional effect on performance. The AASHTO MP1 specification includes an additional shift in the selected high temperature binder grade for slow and standing traffic situations. Similar to the time-temperature shift described with the test temperature for the BBR (testing at 10°C higher temperature reduced the test duration from 2 hours to 60 seconds), higher maximum temperature grades are used to offset the effect of the slower traffic speed. For slow moving traffic loads, the binder should be selected one high temperature grade to the right (one grade "warmer"), such as a PG 64 instead of a PG 58. For standing traffic loads, the binder should be selected two high temperature grades to the right or two grades "warmer", such as a PG 70 instead of a PG 58.

Also, a shift is included for extraordinarily high numbers of heavy traffic loads. These are locations where the design lane traffic is expected to exceed 10,000,000 equivalent single axle loads (ESAL). If the design traffic is expected to be between 10,000,000 and 30,000,000 ESAL, then the engineer may consider selecting one high temperature binder grade higher than the selection based on climate. If the design traffic is expected to be greater than 30,000,000 ESAL, then the binder should be selected one high temperature grade higher.

Traffic Analysis

Superpave material selection criteria are based on the traffic volume of the design project, expressed in equivalent single axle loads (ESAL). This brief synopsis describes the calculation of ESALs. For further information, see the Asphalt Institute's *Thickness Design -- Asphalt Pavements for Highways and Streets*, Manual Series No. 1.

An ESAL is defined as one 18,000-pound (80-kN) four-tired dual axle and is the unit used by most pavement thickness design procedures to quantify the various types of axle loadings into a single design traffic number. If an axle contains more or less weight, it is related to the ESAL using a *load equivalency factor*. The relationship between axle load and ESAL is not a one to one equivalency, but a fourth power relationship. If you double an 18,000 lb load, the ESAL is not 2, but almost the fourth power of two, (2^4) or about 14. As well, if axles are grouped together, such as in tandem or tridem axle arrangements, the total weight carried by the axle configuration determines its load equivalency factor.

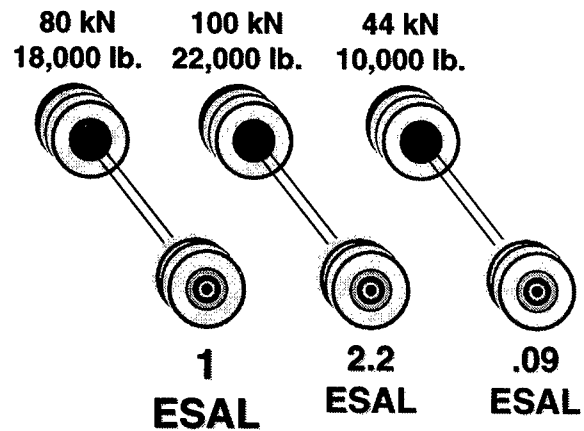

For a given vehicle the load equivalency factors are totaled to provide the *truck factor* for that vehicle. Truck factors can be calculated for any type of trucks or combination of truck types. Traffic count and classification data is then used in combination of the truck factor for each vehicle classification to determine the design traffic in ESAL.

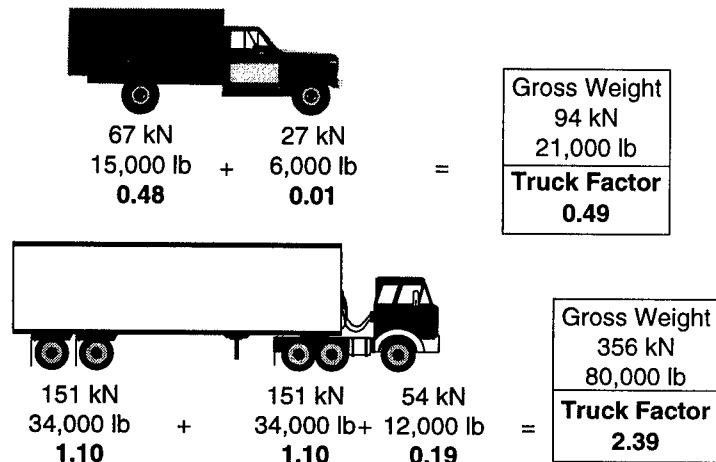

The Superpave binder specification and tests are intended for both unmodified and modified binders. However, there are certain occasions, such as RTFO aging, binder selection and budgeting, when it would be helpful to know if the binder is modified. The difference between the high and low temperature grades can provide some indication whether the binder may be modified. A very general rule of thumb in the industry says if the difference is greater than 90, the binder may be modified, and the likelihood and quantity of modification increases as the difference increases. For instance, the difference between the high and low temperature grades of a PG 64-34 is 98. This grade will probably include a modifier in the binder. However, many factors affect the value (90) of this "rule", such as the viscosity of the binder and the crude oil source.

Class Example Binder Selection

○ Southcentral Pennsylvania

- rural 4-lane access road
- 11 million ESAL
- many traffic lights



○ Budget for project : \$29/ton mix

○ Governor's mother's street needs repairs

- milling & leveling equivalent of \$6/ton
- patching costs equivalent of \$2/ton

Which PG would you select ?

PG 52-16, 52-22, 58-22 : \$23/ton
PG 64-22, 58-28 : \$27/ton
PG 70-22, 64-28 : \$29/ton
PG 70-28 : \$43/ton
PG 76-28 : \$52/ton

Class Example Binder Selection Southcentral Pennsylvania Project

ST	County	Dist	Station	Long	Lat	Elev	Air Temp			
							Low Temp		High Temp	
							Avg	Std	Avg	Std
PA	Perry	8	Newport	77.13	40.48	116	-20	4	33	2
PA	York	30	Harrisburg	76.85	40.22	104	-17	3	33	2
PA	Cumb.	31	Carlisle	77.22	40.20	143	-19	4	34	2

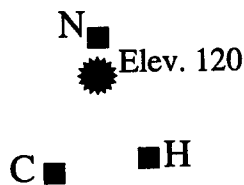

50% Reliability						
TEMPERATURES				Binder Grade		
MaxAir	MaxPvt	MinAir	MinPvt	PG	HT	LT
33	53	-20	-20			
33	53	-17	-17	PG	??	
34	54	-19	-19			

98% Reliability						
TEMPERATURES				Binder Grade		
MaxAir	MaxPvt	MinAir	MinPvt	PG	HT	LT
35	57	-28	-28			
37	57	-23	-23	PG	??	
38	58	-27	-27			

IV. Superpave Aggregates

Superpave refined existing methods for testing and specifying aggregates for HMA. The objectives of this section will be to:

- describe the Superpave aggregate test procedures
- explain the Superpave aggregate specification requirements and how they are used in preventing permanent deformation and fatigue cracking
- discuss the Superpave aggregate gradation evaluation procedure

AGGREGATE TESTS AND SPECIFICATIONS

Consensus Properties

It was the consensus of the SHRP pavement researchers that certain aggregate characteristics were critical and needed to be achieved in all cases to arrive at well performing HMA. These characteristics were called "consensus properties" because there was wide agreement in their use and specified values. Those properties are:

- coarse aggregate angularity,
- fine aggregate angularity,
- flat, elongated particles, and
- clay content.

COARSE AGGREGATE ANGULARITY

This property ensures a high degree of aggregate internal friction and rutting resistance. It is defined as the percent by weight of aggregates larger than 4.75 mm with one or more fractured faces.

The test procedure for measuring coarse aggregate angularity is ASTM D 5821, *Standard Test Method for Determining the Percentage of Fractured Particles in Coarse Aggregate*. The procedure involves manually counting particles to determine fractured faces. A fractured face is defined as any fractured surface that occupies more than 25 percent of the area of the outline of the aggregate particle visible in that orientation.



The required minimum values for coarse aggregate angularity are a function of traffic level and position within the pavement. These requirements apply to the final aggregate blend, although estimates can be made on the individual aggregate stockpiles.

Superpave Coarse Aggregate Angularity Requirements		
Traffic, million ESALs	Percent, Minimum	
	Depth from Surface	
	< 100 mm	> 100 mm
< 0.3	55/-	-/-
< 1	65/-	-/-
< 3	75/-	50/-
< 10	85/80	60/-
< 30	95/90	80/75
< 100	100/100	95/90
≥ 100	100/100	100/100

Note: "85/80" means that 85 % of the coarse aggregate has one fractured face and 80 % has two fractured faces.

FINE AGGREGATE ANGULARITY

This property ensures a high degree of fine aggregate internal friction and rutting resistance. It is defined as the percent air voids present in loosely compacted aggregates smaller than 2.36 mm. Higher void contents mean more fractured faces.

The test procedure used to measure this property is AASHTO T 304 "Uncompacted Void Content - Method A." In the test, a sample of fine aggregate is poured into a small calibrated cylinder by flowing through a standard funnel. By determining the weight of fine aggregate (W) in the filled cylinder of known volume (V), void content can be calculated as the difference between the cylinder volume and fine aggregate volume collected in the cylinder. The fine aggregate bulk specific gravity (G_{sb}) is used to compute fine aggregate volume.

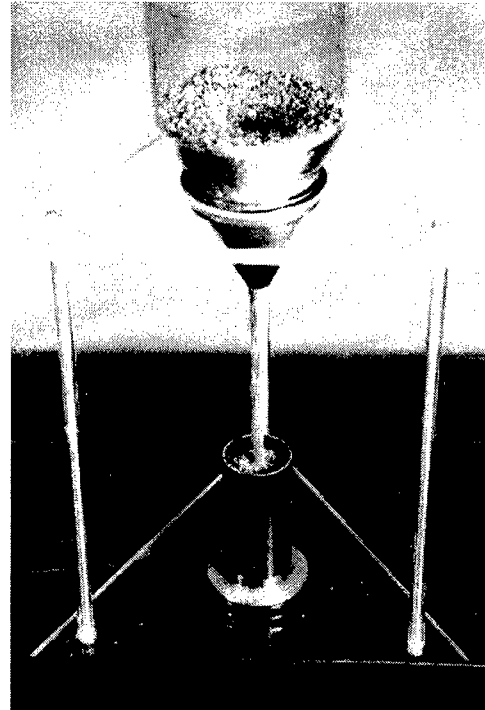
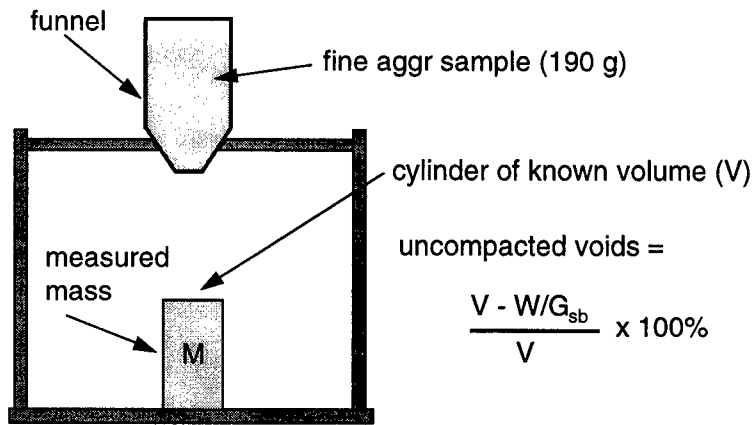

The required minimum values for fine aggregate angularity are a function of traffic level and position within pavement. These requirements apply to the final aggregate blend, although estimates can be made on the individual aggregate stockpiles.

Superpave Fine Aggregate Angularity Requirements		
Traffic, million ESALs	Percent, Minimum	
	Depth from Surface	
	< 100 mm	> 100 mm
< 0.3	-	-
< 1	40	-
< 3	40	40
< 10	45	40
< 30	45	40
< 100	45	45
≥ 100	45	45

Note: Criteria are presented as percent air voids in loosely compacted fine aggregate.

FLAT, ELONGATED PARTICLES

This characteristic is the percentage by weight of coarse aggregates that have a maximum to minimum dimension of greater than five. Elongated particles are undesirable because they have a tendency to break during construction and under traffic.

The test procedure used is ASTM D 4791, *Standard Test for Flat Particles, Elongated Particles, or Flat and Elongated Particles in Coarse Aggregate* and it is performed on coarse aggregate larger than 4.75 mm. The procedure uses a proportional caliper device to measure the dimensional ratio of a representative sample of aggregate particles. The aggregate particle is first placed with its largest dimension between the swinging arm and fixed post at position A. The swinging arm then remains stationary while the aggregate is placed between the swinging arm and fixed post at position B. If the aggregate passes through this gap, then it is counted as a flat or elongated particle. The total flat, elongated, or flat and elongated particles are measured.

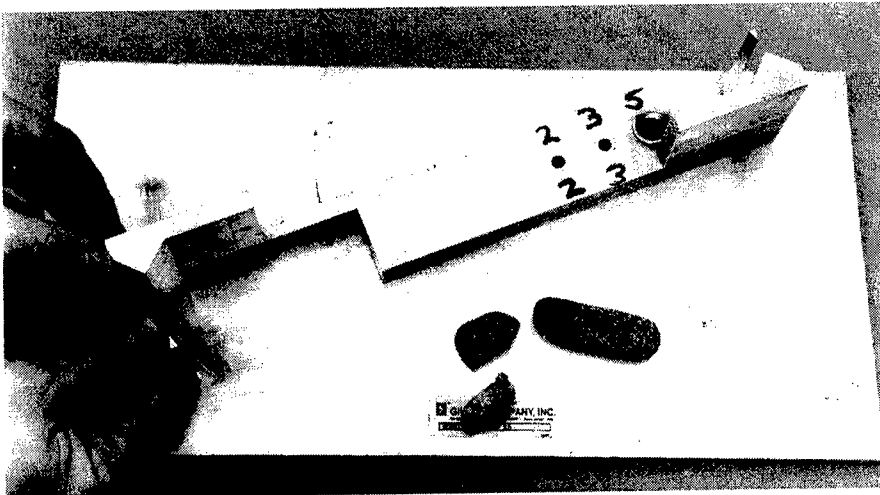
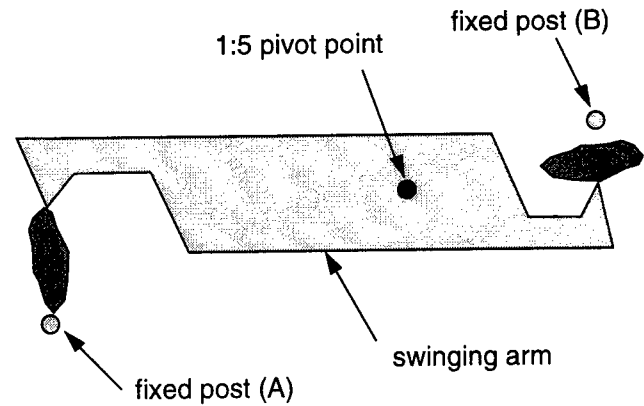

The required maximum values for flat, elongated particles in coarse aggregate are a function of traffic level. These requirements apply to the final aggregate blend, although estimates can be made on the individual aggregate stockpiles.

Superpave Flat, Elongated Particle Requirements	
Traffic, million ESALs	Percent, maximum
< 0.3	-
< 1	-
< 3	10
< 10	10
< 30	10
< 100	10
≥ 100	10

Note: Criteria are presented as maximum percent by weight of flat and elongated particles.

CLAY CONTENT

Clay content is the percentage of clay material contained in the aggregate fraction that is finer than a 4.75 mm sieve. It is measured by AASHTO T 176, *Plastic Fines in Graded Aggregates and Soils by Use of the Sand Equivalent Test*.

In this test, a sample of fine aggregate is placed in a graduated cylinder with a flocculating solution and agitated to loosen clayey fines present in and coating the aggregate. The flocculating solution forces the clayey material into suspension above the granular aggregate. After a period that allows sedimentation, the cylinder height of suspended clay and sedimented sand is measured. The sand equivalent value is computed as a ratio of the sand to clay height readings expressed as a percentage.

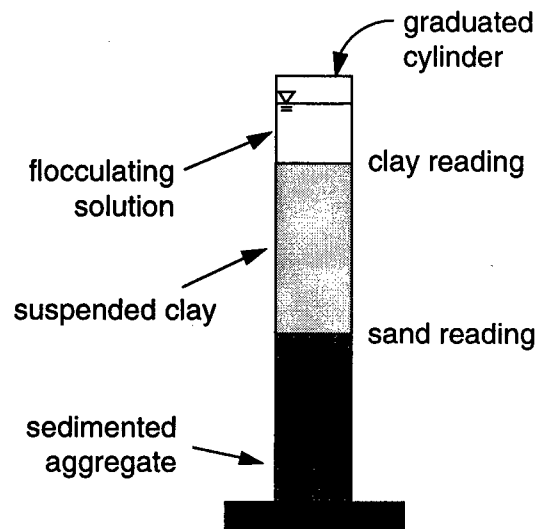

The required clay content values for fine aggregate are expressed as a minimum sand equivalent and are a function of traffic level. These requirements apply to the final aggregate blend, although estimates can be made on the individual aggregate stockpiles

Superpave Clay Content Requirements	
Traffic, million ESALs	Sand Equivalent, minimum
< 0.3	40
< 1	40
< 3	40
< 10	45
< 30	45
< 100	50
≥ 100	50

Source Properties

In addition to the consensus aggregate properties, pavement experts believed that certain other aggregate characteristics were critical. However, critical values of these properties could not be reached by consensus because needed values were source specific. Consequently, a set of "source properties" were recommended. Specified values are established by local agencies. While these properties are relevant during the mix design process, they may also be used as source acceptance control. Those properties are:

- toughness,
- soundness, and
- deleterious materials.

TOUGHNESS

Toughness is the percent loss of materials from an aggregate blend during the Los Angeles Abrasion test. The procedure is stated in AASHTO T 96, "Resistance to Abrasion of Small Size Coarse Aggregate by Use of the Los Angeles Machine." This test estimates the resistance of coarse aggregate to abrasion and mechanical degradation during handling, construction, and in-service. It is performed by subjecting the coarse aggregate, usually larger than 2.36 mm, to impact and grinding by steel spheres. The test result is percent loss, which is the weight percentage of coarse material lost during the test as a result of the mechanical degradation. Maximum loss values typically range from approximately 35 to 45 percent.

SOUNDNESS

Soundness is the percent loss of materials from an aggregate blend during the sodium or magnesium sulfate soundness test. The procedure is stated in AASHTO T 104, "Soundness of Aggregate by Use of Sodium Sulfate or Magnesium Sulfate." This test estimates the resistance of aggregate to weathering while in-service. It can be performed on both coarse and fine aggregate. The test is performed by alternately exposing an aggregate sample to repeated immersions in saturated solutions of sodium or magnesium sulfate each followed by oven drying. One immersion and drying is considered one soundness cycle. During the drying phase, salts precipitate in the permeable void space of the aggregate. Upon re-immersion the salt re-hydrates and exerts internal expansive forces that simulate the expansive forces of freezing water. The test result is total percent loss over various sieve intervals for a required number of cycles. Maximum loss values range from approximately 10 to 20 percent for five cycles.

DELETERIOUS MATERIALS

Deleterious materials are defined as the weight percentage of contaminants such as shale, wood, mica, and coal in the blended aggregate. This property is measured by AASHTO T 112, "Clay Lumps and Friable Particles in Aggregates." It can be performed on both coarse and fine aggregate. The test is performed by wet sieving aggregate size fractions over prescribed sieves. The weight percentage of material lost as a result of wet sieving is reported as the percent of clay lumps and friable particles. A wide range of maximum permissible percentage of clay lumps and friable particles is evident. Values range from as little as 0.2 percent to as high as 10 percent, depending on the exact composition of the contaminant.

Gradation

Superpave uses the 0.45 power gradation chart to define a permissible gradation. This chart uses a unique graphing technique to judge the cumulative particle size distribution of a blend of aggregate. The ordinate of the chart is percent passing. The abscissa is an arithmetic scale of sieve size in millimeters, raised to the 0.45 power. As an example, the 4.75 mm sieve is plotted at 2.02 units to the right of the origin. This number, 2.02, is the sieve size, 4.75 mm, raised to 0.45 power. Normal 0.45 power charts do not show arithmetic abscissa labels arithmetically. Instead, the scale is annotated with the actual sieve size.

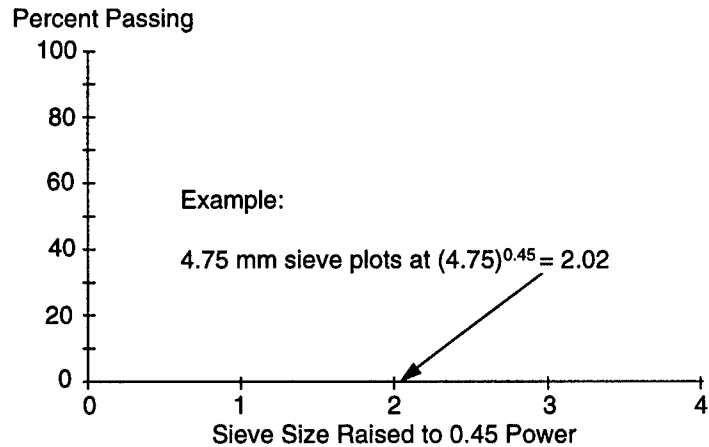

An important feature of this chart is the maximum density gradation. This gradation plots as a straight line from the maximum aggregate size through the origin. Superpave uses a standard set of ASTM sieves and these definitions with respect to aggregate size (Appendix B shows sieve sizes used by Superpave):

- **Maximum Size:** One sieve size larger than the nominal maximum size.
- **Nominal Maximum Size:** One sieve size larger than the first sieve to retain more than 10 percent.

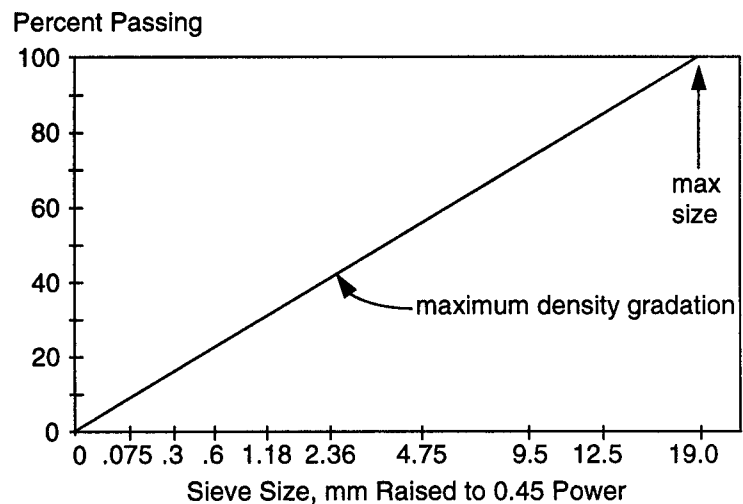

The maximum density gradation represents a gradation in which the aggregate particles fit together in their densest possible arrangement. This is a gradation to avoid because there would be very little aggregate space within which to develop sufficiently thick asphalt films for a durable mixture.

To specify aggregate gradation, two additional features are added to the 0.45 power chart: control points and a restricted zone. Control points function as master ranges through which gradations must pass. They are placed on the nominal maximum size, an intermediate size (2.36 mm), and the dust size (0.075 mm).

The restricted zone resides along the maximum density gradation between the intermediate size (either 4.75 or 2.36 mm, depending on the maximum size) and the 0.3 mm size. It forms a band through which gradations should not pass. Gradations that pass through the restricted zone have often been called "humped gradations" because of the characteristic hump in the grading curve that passes through the restricted zone. In most cases, a humped gradation indicates a mixture that possesses too much fine sand in relation to total sand. This gradation practically always results in tender mix behavior, which is manifested by a mixture that is difficult to compact during construction and offers reduced resistance to permanent deformation during its performance life. Gradations that violate the restricted zone possess weak aggregate skeletons that depend too much on asphalt binder stiffness to achieve mixture shear strength. These mixtures are also very sensitive to asphalt content and can easily become plastic.

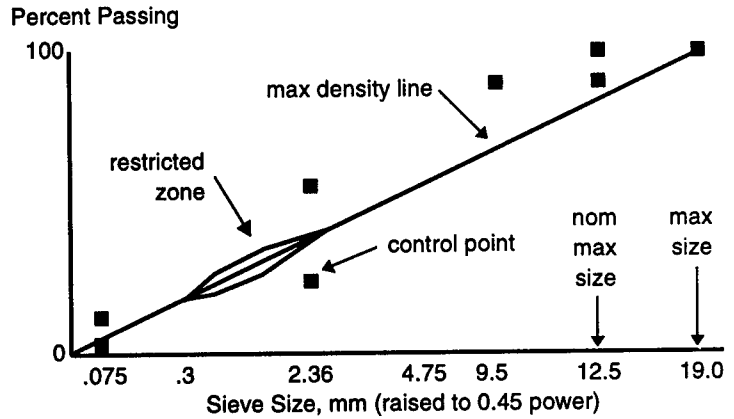

The term used to describe the cumulative distribution of aggregate particle sizes is the *design aggregate structure*. A design aggregate structure that lies between the control points and avoids the restricted zone meets the requirements of Superpave with respect to gradation. Superpave defines five mixture types as defined by their nominal maximum aggregate size. Appendix B shows the gradation limits for the five Superpave mixtures.

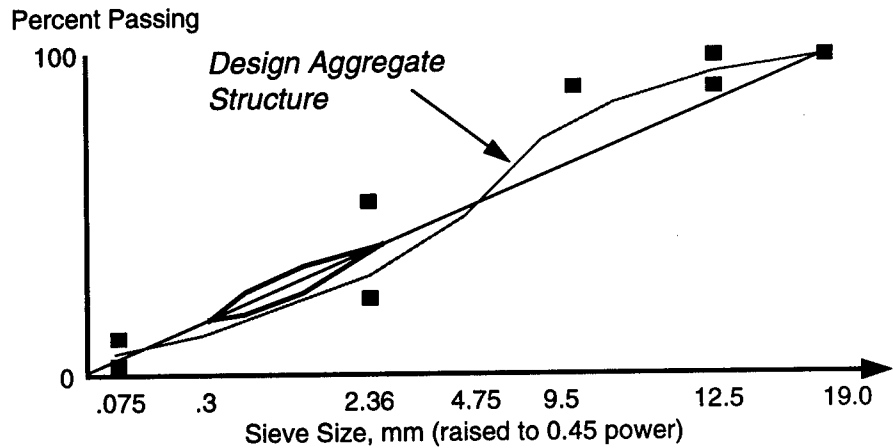

Superpave Mixtures		
Superpave Mixture Designation	Nominal Maximum Size, mm	Maximum Size, mm
37.5 mm	37.5	50
25 mm	25	37.5
19 mm	19	25
12.5 mm	12.5	19
9.5 mm	9.5	12.5

Superpave recommends, but does not require, mixtures to be graded below the restricted zone. It also recommends that as project traffic level increases, gradations move closer to the coarse (lower) control points. Furthermore, the Superpave gradation control requirements were not intended to be applied to special purpose mix types such as stone matrix asphalt or open graded mixtures.

Superpave Aggregate Gradation Example

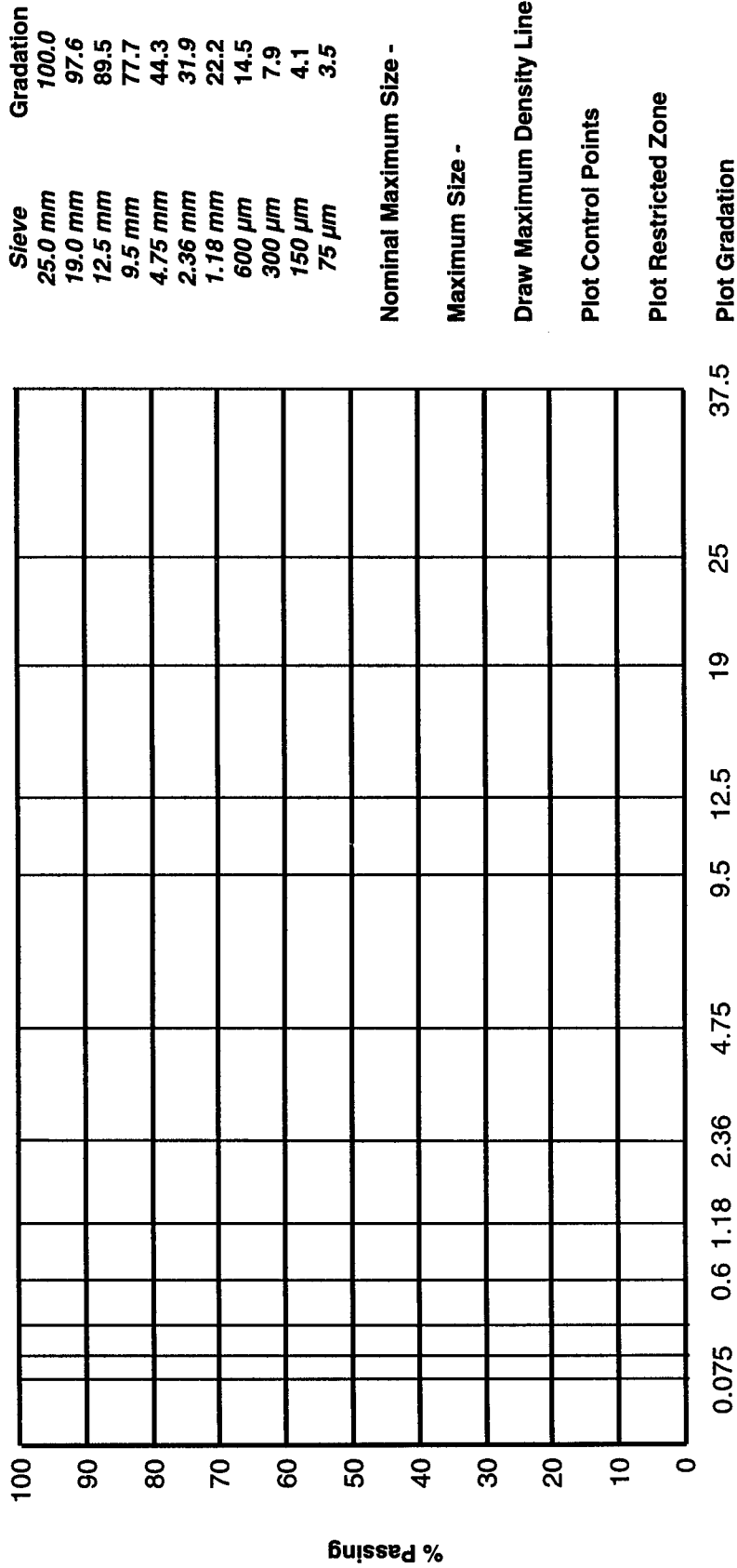

Sieve	Gradation
25.0 mm	100.0
19.0 mm	97.6
12.5 mm	89.5
9.5 mm	77.7
4.75 mm	44.3
2.36 mm	31.9
1.18 mm	22.2
600 μm	14.5
300 μm	7.9
150 μm	4.1
75 μm	3.5

Nominal Maximum Size -

Maximum Size -

Draw Maximum Density Line

Plot Control Points

Plot Restricted Zone

Plot Gradation

Meet criteria?

Sieve Size (mm) raised to 0.45 power



V. Superpave Mixtures

Superpave asphalt mixture requirements were developed from both previously established criteria, and new criteria that were developed in conjunction with new compaction equipment. The objectives of this section will be to:

- describe the Superpave Gyratory Compactor
- review the Superpave mixture criteria, including mixture compaction requirements and mixture volumetric criteria
- describe the moisture sensitivity test and criteria

ASPHALT MIXTURE TESTS

Superpave Gyratory Compaction

SHRP researchers had several goals in selecting a method of laboratory compaction. Most important, they desired a device that would realistically compact trial mix specimens to densities achieved under actual pavement climate and loading conditions. The device needed to be capable of accommodating large aggregates. Furthermore, it was desired that the device afford a measure of compactability so that potential tender mixture behavior and similar compaction problems could be identified. A high priority for SHRP researchers was a device that was well suited to mixing facility quality control and quality assurance operations. No compactor in current use achieved all these goals. Consequently, a new compactor was developed, the Superpave Gyratory Compactor (SGC).

The basis for the SGC was a large Texas gyratory compactor modified to use the compaction principles of a French gyratory compactor. The Texas device accomplished the goals of achieving realistic specimen densification and it was reasonably portable. Its 6-inch sample diameter (ultimately 150 mm on an SGC) could accommodate mixtures containing aggregate up to 50 mm maximum (37.5 nominal) size. SHRP researchers modified the Texas device by lowering its angle and speed of gyration and adding real time specimen height recordation.

Test Equipment

The SGC is a mechanical device comprised of the following system of components:

- reaction frame, rotating base, and motor,
- loading system, loading ram, and pressure gauge,
- height measuring and recordation system, and
- mold and base plate.

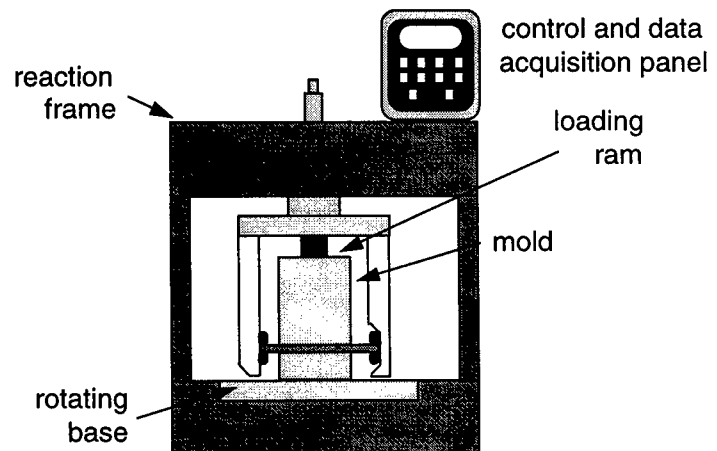

The reaction frame provides a stiff structure against which the loading ram can push when compacting specimens. The base of the SGC rotates and is affixed to the loading frame. It supports the mold while compaction occurs. The SGC uses a mold with an inside diameter of 150 mm and a nominal height of at least 250 mm. A base plate fits in the bottom of the mold to afford specimen confinement during compaction. Reaction bearings are used to position the mold at a compaction angle of 1.25 degrees, which is the compaction angle of the SGC. An electric motor drives the rotating base at a constant speed of 30 revolutions per minute.

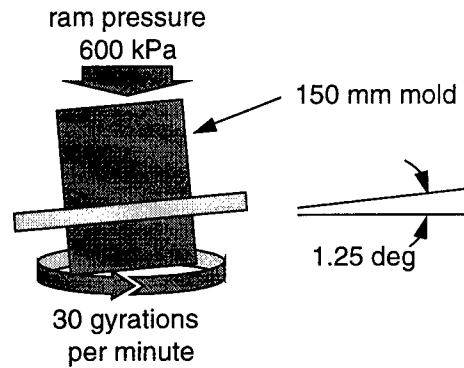

A hydraulic or mechanical system applies a load to the loading ram, which imparts 600 kPa compaction pressure to the specimen. The loading ram diameter nominally matches the inside diameter of the mold, which is 150 mm. A pressure gauge measures the ram pressure during compaction. As the specimen densifies during compaction, the pressure gauge and loading ram maintain compaction pressure.

Specimen height measurement is an important function of the SGC. Using the mass of material placed in the mold, the diameter of the mold, and the specimen height, an estimate of specimen density can be made at any time throughout the compaction process. Specimen density is computed by dividing the mass by the volume of the specimen. The specimen volume is calculated as the volume of a smooth-sided cylinder with a diameter of 150 mm and the measured height. Height is recorded by measuring the position of the ram before and during the test. The vertical change in ram position equals the change in specimen height. The specimen height signal is connected to a personal computer, printer, or other device to record height (i.e., density) measurements throughout the compaction process. By this method, a compaction characteristic is developed as the specimen is compacted.

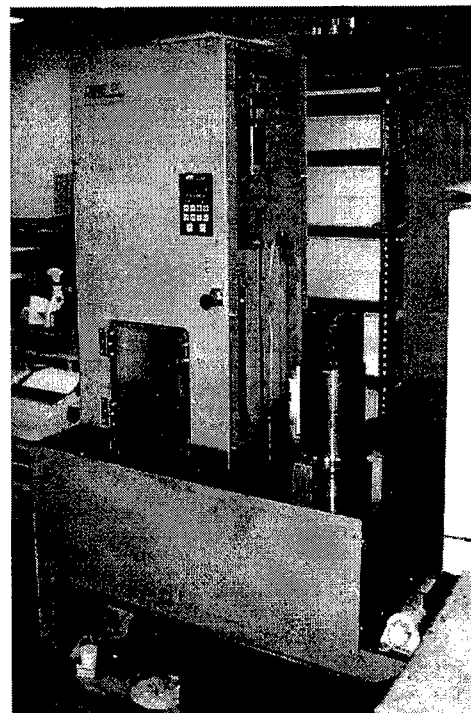
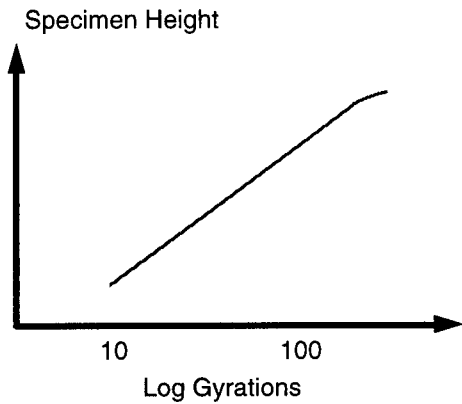

Specimen Preparation

To normalize the effect of the binder, compaction specimens require mixing and compaction under equiviscous temperature conditions corresponding to 0.170 ± 20 Pa·s and 0.280 ± 30 Pa·s, respectively, as determined from the temperature-viscosity characteristics for the asphalt binder. If the temperature-viscosity plot produces a mixing temperature higher than 170°C , it may indicate that the asphalt is modified. Because of their distinctive characteristics, modified asphalts can frequently be mixed and compacted at higher viscosities (lower temperatures) than the shaded ranges shown above. It should be noted that temperatures above 177°C may lead to binder thermal degradation and should not be used. The binder supplier should always be consulted for recommendations of the optimum laboratory and field mixing and compaction temperatures for modified binders. Users may defer to the manufacturer's recommendations for all PG binder grades.

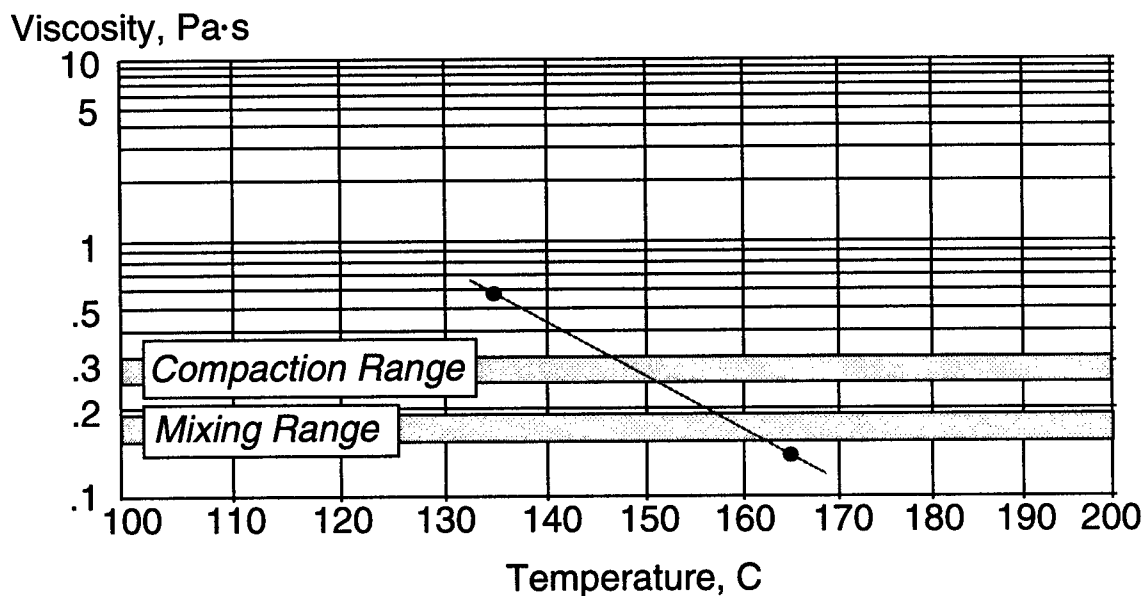

Mixing is accomplished using a mechanical mixer. After mixing, loose test specimens are subjected to four hours of short term aging in a forced draft oven maintained at a constant 135°C . During short term aging, loose mix specimens are required to be spread into a thickness resulting in 21 to 22 kg per square meter and stirred every hour to ensure uniform aging. The compaction molds and base plates should also be placed in an oven at 135°C for at least 30 to 45 minutes prior to use.

Three specimen sizes are used. If specimens are to be used for volumetric determinations only, use sufficient mix to arrive at a specimen $115 \text{ mm} \pm 5 \text{ mm}$ height. This requires approximately 4500 grams of mixture. In this case, the test specimen produced is tested without trimming. Alternatively, to produce specimens for performance testing, approximately 5500 grams of mixture is used to fabricate a specimen that is 150 mm in diameter by approximately 135 mm height. In this case, specimens will have to be trimmed to 50 mm before testing in the SST or IDT. At least one loose sample should remain uncompacted to obtain a maximum theoretical specific gravity using AASHTO T 209. For performing moisture sensitivity tests (AASHTO T283), test specimens are fabricated to a height of 95 mm, which requires approximately 3500 grams of mixture.

Overview of Procedure

After short term aging the loose test specimens are ready for compacting. The compactor is initiated by turning on its main power. The vertical pressure should be set at 600 kPa (± 18 kPa). The gyration counter should be zeroed and set to stop when the desired number of gyrations is achieved. Three gyration levels are of interest:

- design number of gyrations (N_{design} or N_{des}).
- initial number of gyrations (N_{initial} , or N_{ini}), and
- maximum number of gyrations (N_{maximum} or N_{max}).

Test specimens are compacted using N_{max} gyrations. The relationship between N_{des} , N_{max} , and N_{ini} are:

$$\text{Log}_{10} N_{\text{max}} = 1.10 \times \text{Log}_{10} N_{\text{des}}$$

$$\text{Log}_{10} N_{\text{ini}} = 0.45 \times \text{Log}_{10} N_{\text{des}}$$

The design number of gyrations (N_{des}) ranges from 68 to 172 and is a function of the climate in which the mix will be placed and the traffic level. The average design high air temperature is provided by Superpave software and represents the average seven-day maximum air temperature for project conditions. The range of values for N_{des} , N_{max} , and N_{ini} are shown:

Superpave Design Gyrotory Compactive Effort												
Design ESALs (millions)	Average Design High Air Temperature											
	<39°C			39 - 40°C			41 - 42°C			43 - 44°C		
	N_{ini}	N_{des}	N_{max}	N_{ini}	N_{des}	N_{max}	N_{ini}	N_{des}	N_{max}	N_{ini}	N_{des}	N_{max}
< 0.3	7	68	104	7	74	114	7	78	121	7	82	127
0.3 - 1	7	76	117	7	83	129	7	88	138	8	93	146
1 - 3	7	86	134	8	95	150	8	100	158	8	105	167
3 - 10	8	96	152	8	106	169	8	113	181	9	119	192
10 - 30	8	109	174	9	121	195	9	128	208	9	135	220
30 - 100	9	126	204	9	139	228	9	146	240	10	153	253
> 100	9	142	233	10	158	262	10	165	275	10	172	288

After the base plate is in place, a paper disk is placed on top of the plate and the mold is charged in a single lift. The top of the uncompacted specimen should be slightly rounded. A paper disk is placed on top of the mixture.

The mold is placed in the compactor and centered under the ram. The ram is then lowered until it contacts the mixture and the resisting pressure is 600 kPa (± 18 kPa). The angle of gyration ($1.25^\circ \pm 0.02^\circ$) is then applied and the compaction process begins.

When N_{max} has been reached, the compactor automatically stops. After the angle and pressure are released, the mold containing the compacted specimen is then removed. After a suitable cooling period, the specimen is extruded from the mold.

The bulk specific gravity of test specimens should be measured using AASHTO T 166. Maximum theoretical specific gravity should be measured using AASHTO T 209.

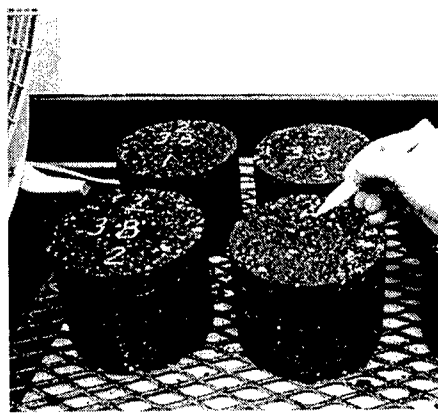
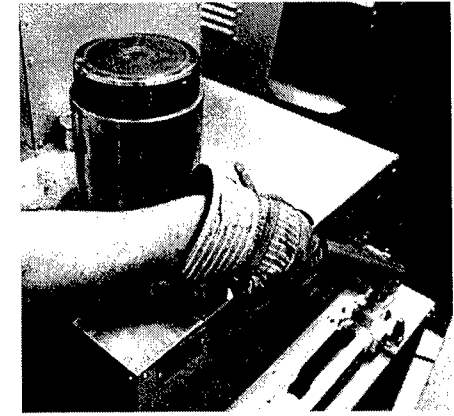
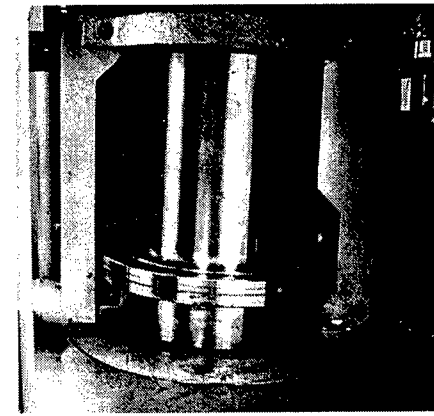
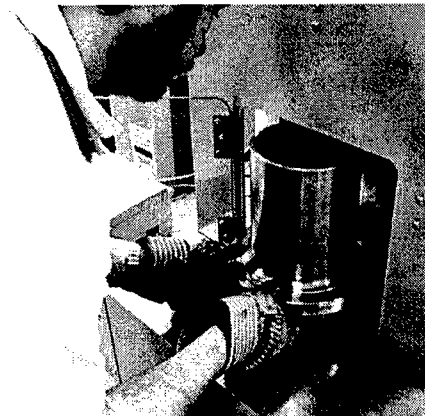
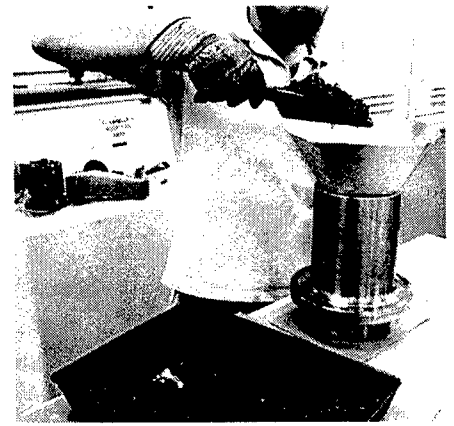
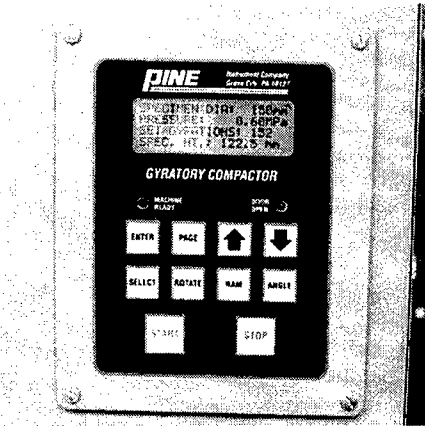
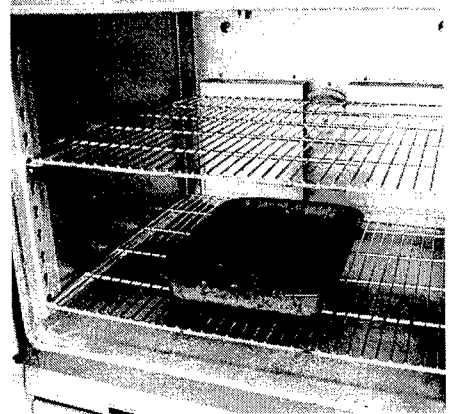
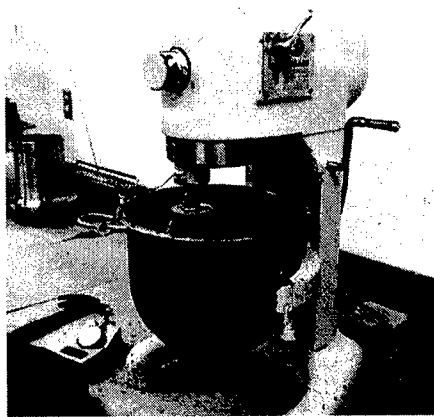
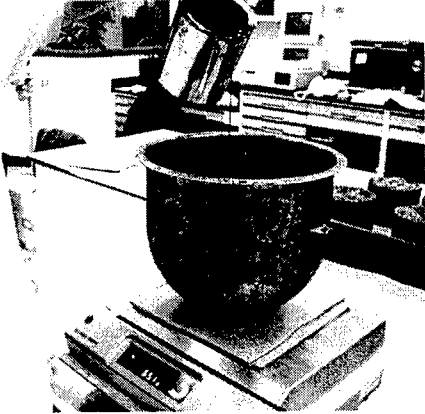

Data Presentation

Superpave gyratory compaction data is analyzed by computing the maximum theoretical specific gravity for each desired gyration. This example specimen compaction information illustrates this analysis:

Specimen No. 1: Total Mass = 4869 g		
No. of Gyration	Height, mm	% G _{mm}
8 (N _{ini})	127.0	86.5
50	118.0	93.1
100	115.2	95.4
109 (N _{des})	114.9	95.6
150	113.6	96.7
174 (N _{max})	113.1	97.1
G _{mb}	2.489	
G _{mm}	2.563	

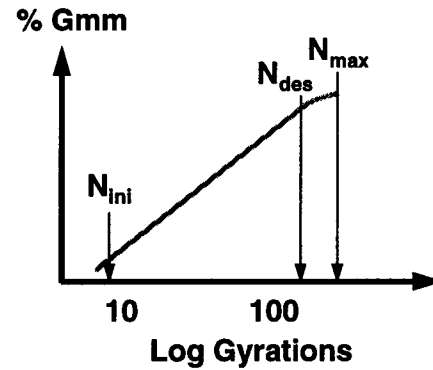

Project conditions for this mixture are such that N_{max} = 174, N_{des} = 109, and N_{ini} = 8 gyrations. During compaction, the height is measured after each gyration and recorded for the number of gyrations shown in the first column. After compaction, the specimen is removed from the cylinder and, after cooling, the G_{mb} is measured. G_{mb} is then divided by G_{mm} to determine the % G_{mm} @ N_{max}. The % G_{mm} at any number of gyrations (N_x) is then calculated by multiplying % G_{mm} @ N_{max} by the ratio of the heights at N_{max} and N_x. The calculations for this example are illustrated here:

$$G_{mb} = 2.489$$

$$G_{mm} = 2.563$$

$$\% G_{mm} @ N_{max} = G_{mb} \div G_{mm} = 2.489 \div 2.563 \times 100\% = 97.1\%$$

$$\% G_{mm} @ N_x = \% G_{mm} @ N_{max} \times (H_{max} \div H_x)$$

$$\text{For } N = 50, \quad \% G_{mm} @ N_{50} = \% G_{mm} @ N_{max} \times (H_{max} \div H_{50}) = 97.1 \times (113.1 \div 118.0) = 93.1\%$$

If this example had been for a mix design, a companion specimen would have been compacted and average percent G_{mm} values resulting from the two specimens would have been used for further analysis. A compaction characteristic curve for this example showing two specimens and an average is shown:

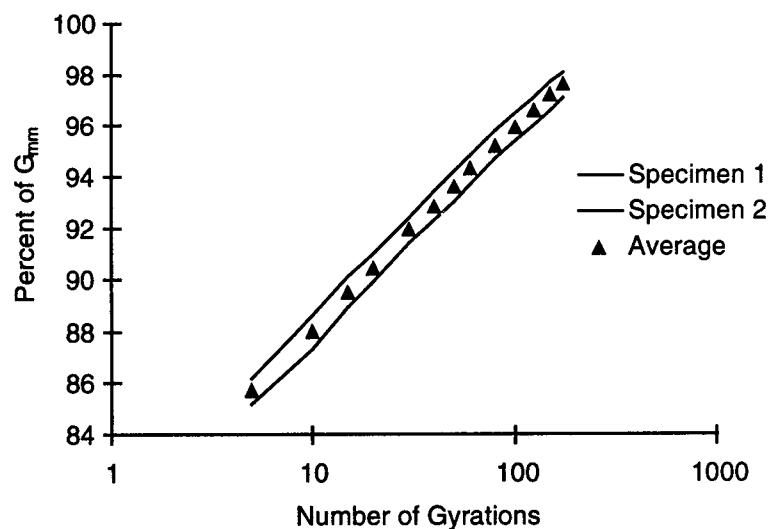

ASPHALT MIXTURE REQUIREMENTS

Asphalt mixture design requirements in Superpave consist of:

- mixture volumetric requirements,
- dust proportion, and
- moisture susceptibility.

Specified values for these parameters are applied during mixture design.

Mixture Volumetric Requirements

Mixture volumetric requirements consist of air voids, voids in the mineral aggregate, voids filled with asphalt, and the mixture density during compaction at N_{ini} and N_{max} . Air void content is an important property because it is used as the basis for asphalt binder content selection. In Superpave, the **design air void content is four percent**.

VOIDS IN THE MINERAL AGGREGATE

Superpave defines voids in the mineral aggregate (VMA) as the sum of the volume of air voids and effective (i.e., unabsorbed) binder in a compacted sample. It represents the void space between aggregate particles. The goal is to furnish enough space for the asphalt binder so it can provide adequate adhesion to bind the aggregates, but without bleeding when the temperatures rise and the asphalt expands. Specified minimum values for VMA at the design air void content of four percent are a function of nominal maximum aggregate size.

Superpave VMA Requirements	
Nominal Maximum Aggregate Size	Minimum VMA, %
9.5 mm	15.0
12.5 mm	14.0
19 mm	13.0
25 mm	12.0
37.5 mm	11.0

VOIDS FILLED WITH ASPHALT

Voids filled with asphalt (VFA) is defined as the percentage of the VMA containing asphalt binder. Consequently, VFA is the volume of effective asphalt binder expressed as a percentage of the VMA. Although VFA, VMA and air voids are all interrelated and only two of the values are necessary to solve for the other, including the VFA criteria helps prevent the design of mixes with marginally acceptable VMA. The main effect of the VFA criteria is to limit maximum levels of VMA, and, subsequently, maximum levels of asphalt content. The acceptable range of VFA at four percent air voids is a function of traffic level.

Superpave VFA Requirements	
Traffic, ESALs	Design VFA, %
$< 3 \times 10^5$	70 - 80
$< 1 \times 10^6$	65 - 78
$< 3 \times 10^6$	65 - 78
$< 1 \times 10^7$	65 - 75
$< 3 \times 10^7$	65 - 75
$< 1 \times 10^8$	65 - 75
$> 3 \times 10^8$	65 - 75

DENSITY REQUIREMENTS

Maximum specimen density criteria are specified at N_{ini} and N_{max} . The compaction characteristic curve developed during gyratory compaction illustrates the limits of 89 percent maximum density at N_{ini} and 98 percent maximum density at N_{max} .

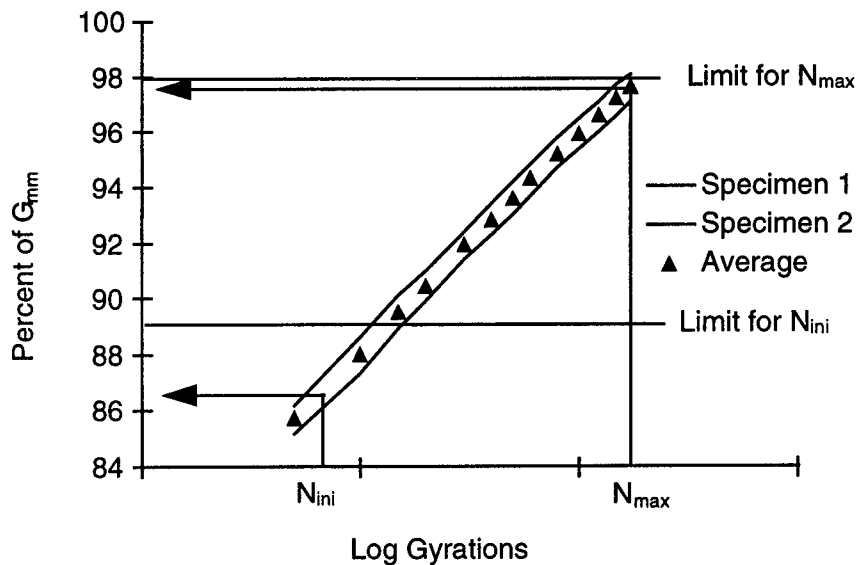

The compaction characteristic curve developed during gyratory compaction provides information about the relative strength of aggregate structures and binder contents. At the same asphalt content, weaker aggregate structures will have flatter slopes and higher density than stronger aggregate structures. For the same aggregate structure, an increase in binder content will produce a mixture with increased density

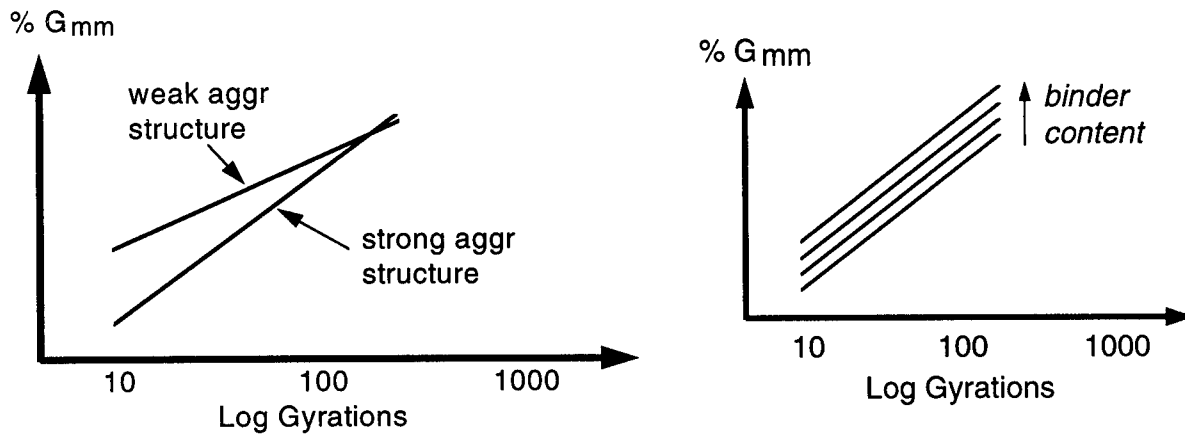

Specifying a maximum value of percent density N_{ini} prevents design of a mixture that has a weak aggregate structure and low internal friction, indicators of a tender mix. Specifying a maximum value of percent density at N_{max} prevents design of a mixture that will not compact excessively under the design traffic, become plastic, and produce permanent deformation. Since N_{max} represents a compactive effort that would be equivalent to traffic much greater than the design traffic, excessive compaction under traffic will not occur.

Dust Proportion

Another mixture requirement is the dust proportion. This is computed as the ratio of the percentage by weight of aggregate finer than the 0.075 mm sieve to the effective asphalt content expressed as a percent by weight of total mix. Effective asphalt content is the total asphalt used in the mixture less the percentage of absorbed asphalt. Dust proportion is used during the mixture design phase as a design criterion. An acceptable dust proportion is in the range from 0.6 to 1.2, inclusive for all mixtures. Low dust proportion values are indicative of mixtures that may be unstable, and high dust proportion values indicate mixtures that lack sufficient durability.

MOISTURE SUSCEPTIBILITY

The adhesion between the asphalt and aggregate is an important, yet complex and not well understood, property that helps ensure good pavement performance. The loss of bond, or stripping, caused by the presence of moisture between the asphalt and aggregate is a problem in some areas and can be severe in some cases. Many factors such as aggregate characteristics, asphalt characteristics, environment, traffic, construction practices and drainage can contribute to stripping.

The moisture susceptibility test used to evaluate HMA for stripping is AASHTO T 283, "*Resistance of Compacted Bituminous Mixtures to Moisture Induced Damage.*" This test is not a performance based test but serves two purposes. First, it identifies whether a combination of asphalt binder and aggregate is moisture susceptible. Second, it measures the effectiveness of anti-stripping additives.

In the test, two subsets of test specimens are produced. Specimens are compacted have a specimen height of 95 mm and to achieve an air void content in the range from six to eight percent with a target value of seven percent. Test specimens should be sorted so that each subset has the same air void content. One subset is moisture conditioned by vacuum saturation to a constant degree of saturation in the range from 55 to 80 percent. This is followed by an optional freeze cycle. The final conditioning step is a hot water soak. After conditioning both subsets are tested for indirect tensile strength. The test result reported is the ratio of tensile strength of the conditioned subset to that of the unconditioned subset. This ratio is called the "tensile strength ratio" or TSR. This table outlines the current test parameters in AASHTO T 283:

Test Parameter	Test Requirement
Short-Term Aging	Loose mix ¹ : 16 hrs at 60° C Compacted mix: 72-96 hrs at 25° C
Air Voids Compacted Specimens	6 to 8 %
Sample Grouping	Average air voids of two subsets should be equal
Saturation	55 to 80 %
Swell Determination	None
Freeze	Minimum 16 hrs at -18° C (optional)
Hot Water Soak	24 hrs at 60° C
Strength Property	Indirect tensile strength
Loading Rate	51 mm/min at 25° C
Precision Statement	None
¹ Short-term aging protocol of AASHTO T 283 does not match short-term aging protocol of Superpave. Suggest using T283 procedure of 16 hours at 60° C.	

Superpave requires a minimum TSR of 80 percent. Lower values are indicative of mixtures that may exhibit stripping problems after construction.

VI: Asphalt Mixture Volumetrics

A factor that must be taken into account when considering asphalt mixture behavior is the *volumetric proportions* of asphalt binder and aggregate components, or more simply, *asphalt mixture volumetrics*. The volumetric properties of a compacted paving mixture [air voids (V_a), voids in the mineral aggregate (VMA), voids filled with asphalt (VFA), and effective asphalt content (P_{be})] provide some indication of the mixture's probable pavement service performance. It is necessary to understand the definitions and analytical procedures described in this chapter to be able to make informed decisions concerning the selection of the design asphalt mixture.

This chapter describes volumetric analysis of HMA, which plays a significant role in most mixture design procedures, including the Superpave system. This chapter reviews the component relationships (mass and volume, aggregate and asphalt), presents the calculations for conducting a volumetric analysis, and describes the Superpave volumetric requirements. The information here applies to both paving mixtures that have been compacted in the laboratory, and to undisturbed samples that have been cut from a pavement in the field.

COMPONENT DIAGRAM

A tool that can assist in analyzing the properties of HMA is the component diagram -- a diagram that illustrates the individual components that make up the HMA: asphalt, aggregate and air. The simplified layout of the component diagram helps visualize the volumetric and mass relationships that are used in the analysis of HMA.

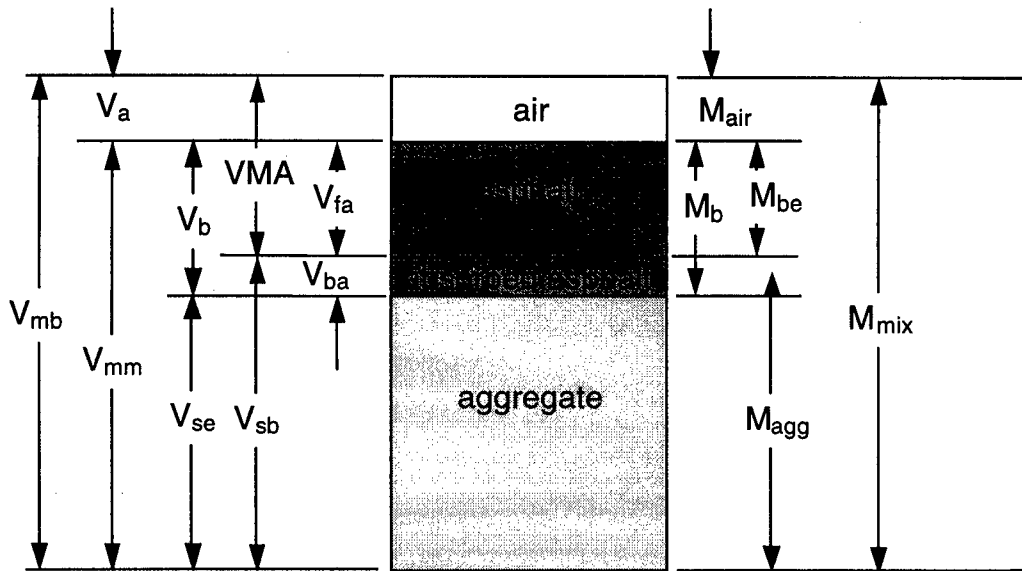

- | | |
|------------------------------------------------------------------------|---------------------------------------------|
| VMA = Volume of voids in mineral aggregate | M = Total mass of asphalt mixture |
| V_{mb} = Bulk volume of compacted mix | M_b = Mass of asphalt binder |
| V_{mm} = Voidless volume of paving mix | M_{be} = Mass of effective asphalt binder |
| V_{fa} = Volume of voids filled with asphalt | M_{agg} = Mass of aggregate |
| V_a = Volume of air voids | M_{air} = Mass of air = 0 |
| V_b = Volume of asphalt binder | |
| V_{ba} = Volume of absorbed asphalt binder | |
| V_{sb} = Volume of mineral aggregate (by bulk specific gravity) | |
| V_{se} = Volume of mineral aggregate (by effective specific gravity) | |

DEFINITIONS

Volumetric Properties of Asphalt Mixtures

Air Voids, V_a - the total volume of the small pockets of air between the coated aggregate particles throughout a compacted paving mixture, expressed as percent of the total volume of the compacted paving mixture.

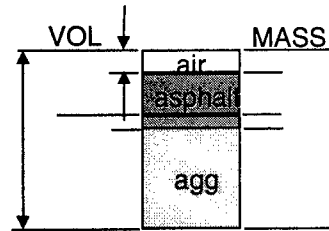

Voids in the Mineral Aggregate, VMA - the volume of intergranular void space between the aggregate particles of a compacted paving mixture that includes the air voids and the effective asphalt content, expressed as a percent of the total volume of the compacted paving mixture.

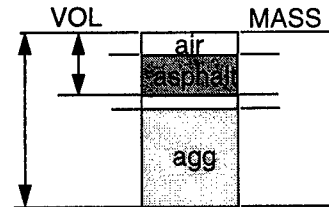

Voids Filled with Asphalt, VFA - the percentage portion of the volume of intergranular void space between the aggregate particles that is occupied by the effective asphalt. It is expressed as the ratio of $(VMA - V_a)$ to VMA.

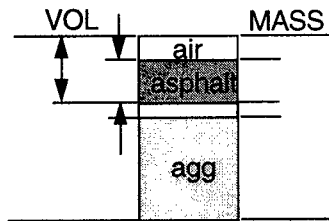

Asphalt Content, P_b - the total asphalt content of a paving mixture

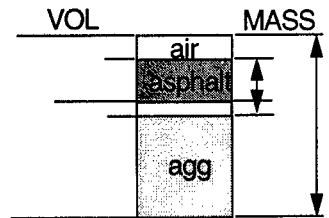

Effective Asphalt Content, P_{be} - the total asphalt content of a paving mixture minus the portion of asphalt absorbed into the aggregate particles.

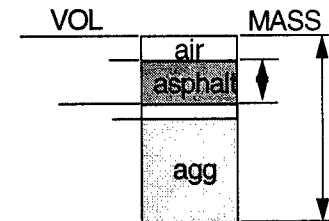

Absorbed Asphalt Content, P_{ba} - the portion of asphalt absorbed into the aggregate particles.

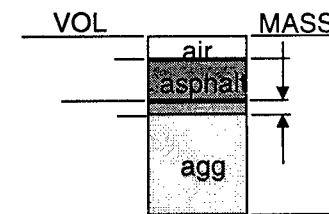

Specific Gravity

Specific gravity is "the ratio of the mass of a unit volume of a material to the mass of the same volume of water at stated temperatures." The mass of an object divided by its volume is its density, so another way to describe specific gravity is the density of an object divided by the density of water. Conveniently, at 25°C the density of water is 1.000 g/cm³. Since the density of water is 1.000 at 25°C, the specific gravity of any object at 25°C is its weight divided by its volume. By knowing the specific gravity of an object, the volume can be calculated after measuring its mass, or the mass can be calculated after measuring its volume. Although the units for specific gravity and density are not the same, the terms are often used interchangeably. In fact, when using the metric units of g/cm³, the values of density and specific gravity are numerically identical.

In the analysis of HMA, the specific gravities of the specific components of the HMA, as well as the specific gravities of the mixture, are used as "bridges" to go between the mass side of the component diagram and the volume side of the component diagram. Specific gravity is abbreviated using the letter G.

AGGREGATE SPECIFIC GRAVITIES

Mineral aggregate is porous and can absorb water and asphalt to a variable degree. Furthermore, the ratio of water to asphalt absorption varies with each aggregate. The three methods of measuring aggregate specific gravity take these variations into consideration. These methods are bulk, apparent, and effective specific gravities:

Bulk Specific Gravity, G_{sb} - the ratio of the mass in air of a unit volume of a permeable material (including both permeable and impermeable voids normal to the material) at a stated temperature to the mass in air of equal density of an equal volume of gas-free distilled water at a stated temperature. In other words, the aggregate bulk specific gravity includes the volume of the water permeable voids in the aggregate (often termed the "saturated surface dry" or SSD volume of the aggregate).

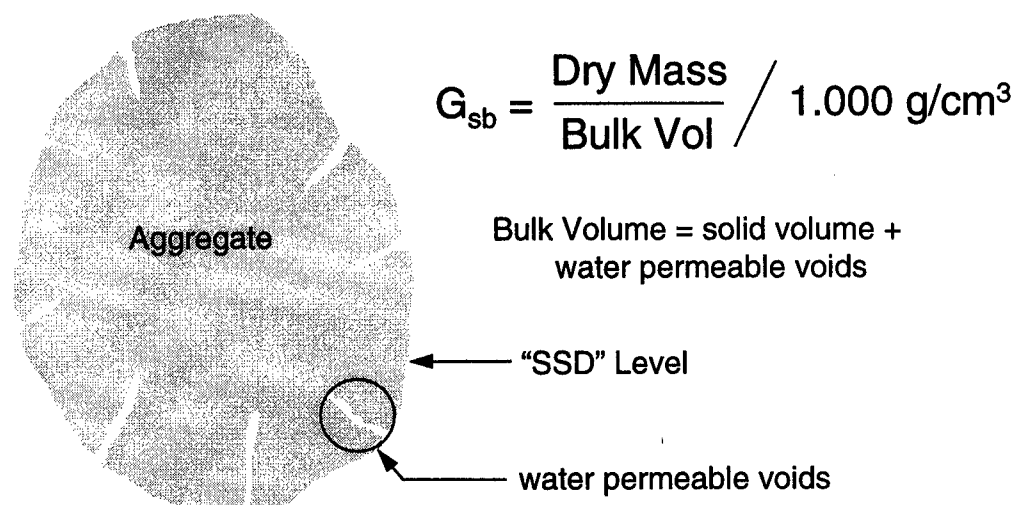

Apparent Specific Gravity, G_{sa} - the ratio of the mass in air of a unit volume of an impermeable material at a stated temperature to the mass in air of equal density of an equal volume of gas-free distilled water at a stated temperature. In other words, the aggregate apparent specific gravity does not include the volume of the water permeable voids in the aggregate

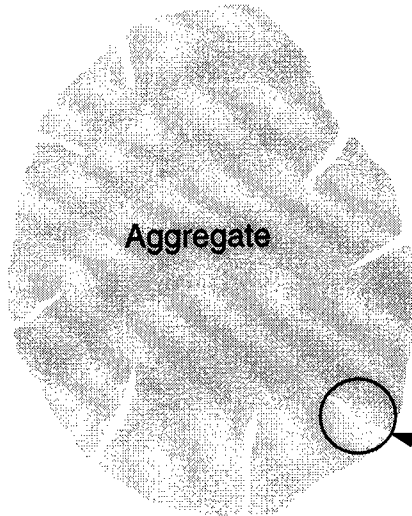

$$G_{sa} = \frac{\text{Dry Mass}}{\text{App Vol}} / 1.000 \text{ g/cm}^3$$

Apparent Volume = volume of solid aggr particle

Apparent volume does not include volume of surface pores

Effective Specific Gravity, G_{se} - the ratio of the mass in air of a unit volume of a permeable material (excluding voids permeable to asphalt) at a stated temperature to the mass in air of equal density of an equal volume of gas-free distilled water at a stated temperature. In other words, the effective specific gravity includes the volume of the water permeable voids in the aggregate that cannot be reached by the asphalt.

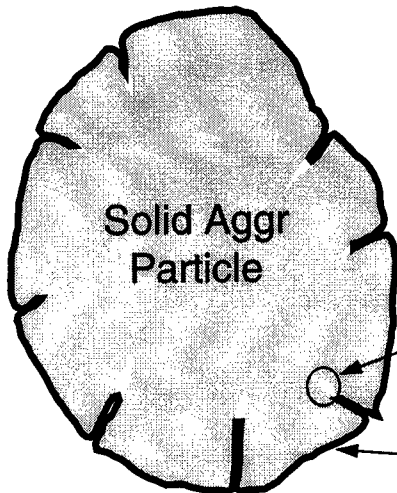

$$G_{se} = \frac{\text{Dry Mass}}{\text{Eff Vol}} / 1.000 \text{ g/cm}^3$$

Effective Volume = volume of solid aggr particle + volume of water permeable pores not filled with asphalt

volume of water permeable pores not filled with asphalt

effective asphalt binder

When comparing specific gravities, the mass of the aggregate does not change; the volume does change. The bulk volume is greater than the effective volume, which is greater than the apparent volume. Since mass is divided by volume in calculating the specific gravity, G_{sa} will be larger than G_{se} , which will be larger than G_{sb} . Written symbolically, $V_{sb} > V_{se} > V_{sa}$, and $G_{sa} > G_{se} > G_{sb}$.

MIXTURE SPECIFIC GRAVITIES

Two measurements of the specific gravity of the HMA mixture are important in determining the volumetric properties of the HMA: the maximum theoretical specific gravity, G_{mm} , and bulk specific gravity, G_{mb} .

Maximum Theoretical Specific Gravity, G_{mm} - the ratio of the mass in air of a unit volume of the asphalt and aggregate in the mixture at a stated temperature to the mass in air of equal density of an equal volume of gas-free distilled water at a stated temperature. In other words, the maximum theoretical specific gravity, G_{mm} , is the mass of the asphalt and aggregate mixture divided by the volume, not including the air voids.

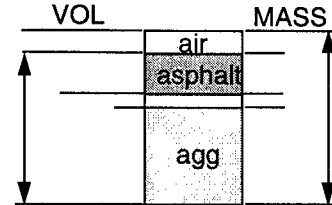

Bulk Specific Gravity, G_{mb} - the ratio of the mass in air of a unit volume of the compacted asphalt and aggregate mixture at a stated temperature to the mass in air of equal density of an equal volume of gas-free distilled water at a stated temperature. In other words, the bulk specific gravity, G_{mb} , is the mass of the asphalt and aggregate mixture divided by the volume, including the air voids.

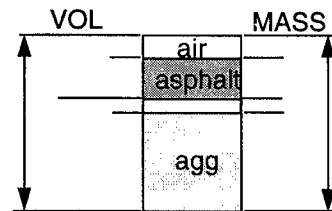

Superpave mix design calculates VMA values for compacted paving mixtures in terms of aggregate bulk specific gravity, G_{sb} . Use of other aggregate specific gravities to compute VMA means that the VMA criteria no longer apply and the mixture may not meet the requirements of Superpave. The aggregate effective specific gravity, G_{se} , should be the basis for calculating the air voids in a compacted asphalt paving mixture.

Voids in the mineral aggregate (VMA) and air voids (V_a) are expressed as percent by volume of the paving mixture. Voids filled with asphalt (VFA) is the percentage of VMA filled by the effective asphalt. In Superpave, the total asphalt content and the effective asphalt content are expressed as a percentage of the total mass of the paving mixture.

Because air voids, VMA and VFA are volume quantities and therefore cannot be easily, a paving mixture must first be designed or analyzed in terms of volumes calculated from mass measurements. For mix production purposes, these volume quantities are later changed over to mass quantities to provide a job-mix formula that can be controlled at the plant.

ANALYZING A COMPACTED PAVING MIXTURE

Two methods can be used to analyze the volumetric properties of compacted asphalt mixture. The first involves using the component diagram and various specific gravity measurements to calculate the relative masses and volumes of the mixture components, and then in turn calculating the volumetric properties. The second method uses the same specific gravity measurements with mathematical formulas to directly determine the mixture properties.

The first method is often used to illustrate the concepts behind the volumetric analysis of asphalt mixtures, and is therefore included in the presentation materials in this course. The second method, because the mathematical formulas can easily be placed into spreadsheet calculations, is more often used in laboratory mix design and analysis. These formulas are included in the text for information purposes, but are not detailed in the course presentation.

Component Diagram Method

This component diagram shows five properties (four specific gravities and the asphalt content) of a compacted specimen of HMA that have been measured at 25°C. Using only these few values, all of the volumetric properties and mass quantities of the HMA can be determined, as demonstrated in the course presentation.

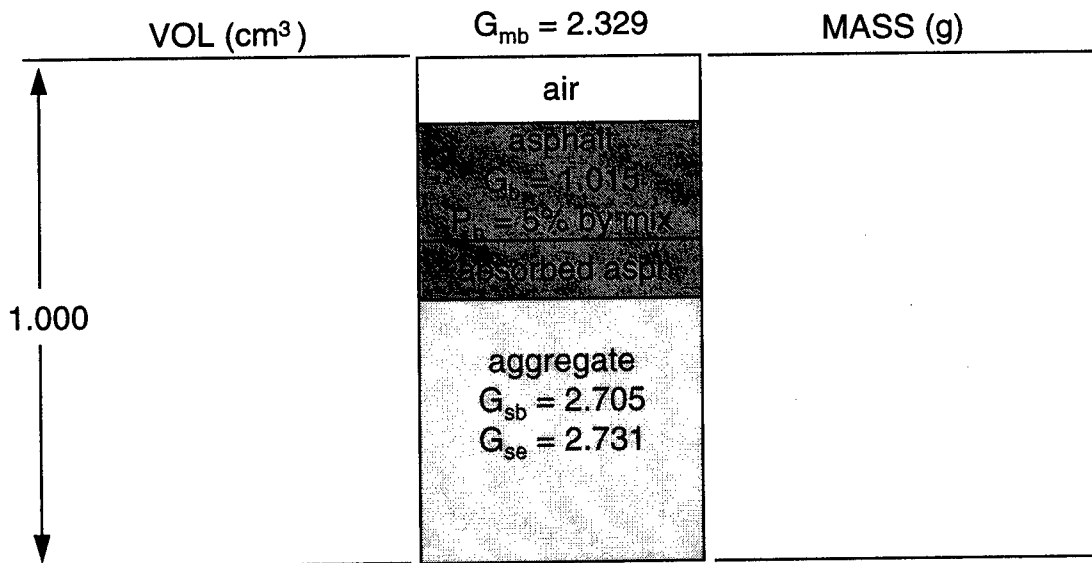

These are the volumetric properties and mass quantities of this compacted specimen of HMA:

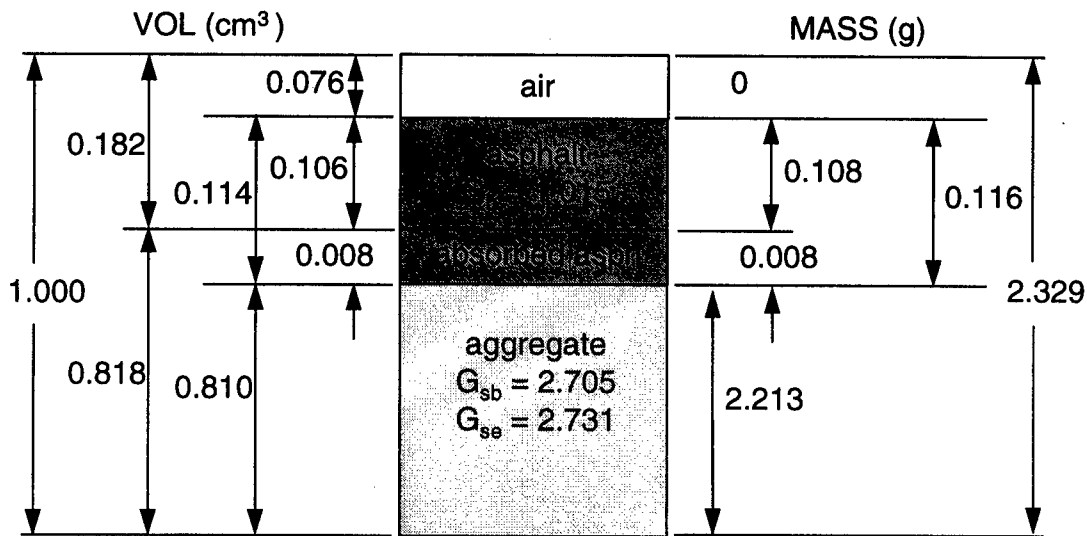

Air Voids = 7.6%
 VMA = 18.2 %
 VFA = 58.2 %

Effective Asphalt Content = 4.6%
 Absorbed Asphalt Content = 0.4%
 Max Theo Sp Grav = 2.521

Mathematical Equations Method

The measurements and calculations needed for a voids analysis are:

- Measure the bulk specific gravities of the coarse aggregate (AASHTO T 85 or ASTM C 127) and of the fine aggregate (AASHTO T 84 or ASTM C 128).
- Measure the specific gravity of the asphalt cement (AASHTO T 228 or ASTM D 70) and of the mineral filler (AASHTO T 100 or ASTM D 854).
- Calculate the bulk specific gravity of the aggregate combination in the paving mixture.
- Measure the maximum specific gravity of the loose paving mixture (ASTM D 2041 or AASHTO T209).
- Measure the bulk specific gravity of the compacted paving mixture (ASTM D 1188/D 2726 or AASHTO T166).
- Calculate the effective specific gravity of the aggregate.
- Calculate the maximum specific gravity at other asphalt contents.
- Calculate the asphalt absorption of the aggregate.
- Calculate the effective asphalt content of the paving mixture.
- Calculate the percent voids in the mineral aggregate in the compacted paving mixture.
- Calculate the percent air voids in the compacted paving mixture.
- Calculate the percent voids filled with asphalt in the compacted paving mixture.

Equations for these calculations are found below.

This table provides the basic data for a sample of paving mixture. These design data are used in the sample calculations used in the remainder of this chapter.

Basic Data for Sample of Paving Mixture

Mixture Components				
Material	Specific Gravity		Mix Composition	
		Bulk	Percent by Mass of Total Mix	Percent By Mass of Total Aggregate
Asphalt Cement	1.030(G_b)		5.3 (P_b)	5.6 (P_b)
Coarse Aggregate		2.716(G_1)	47.4(P_1)	50.0(P_1)
Fine Aggregate		2.689(G_2)	47.3(P_2)	50.0(P_2)
Mineral Filler	---		---	---

Paving Mixture
 Bulk specific gravity of compacted paving mixture sample, $G_{mb} = 2.442$
 Maximum specific gravity of paving mixture sample, $G_{mm} = 2.535$

Bulk Specific Gravity of Aggregate

When the total aggregate consists of separate fractions of coarse aggregate, fine aggregate, and mineral filler, all having different specific gravities, the bulk specific gravity for the total aggregate is calculated using:

$$G_{sb} = \frac{P_1 + P_2 + \dots + P_N}{\frac{P_1}{G_1} + \frac{P_2}{G_2} + \dots + \frac{P_N}{G_N}}$$

where G_{sb} = bulk specific gravity for the total aggregate
 P_1, P_2, P_N = individual percentages by mass of aggregate
 G_1, G_2, G_N = individual bulk specific gravities of aggregate

The bulk specific gravity of mineral filler is difficult to determine accurately. However, if the apparent specific gravity of the filler is substituted, the error is usually negligible.

Using the sample paving mixture data:

$$G_{sb} = \frac{50.0 + 50.0}{\frac{50.0}{2.716} + \frac{50.0}{2.689}} = \frac{100}{18.41 + 18.59} = 2.703$$

Effective Specific Gravity of Aggregate

When based on the maximum specific gravity of a paving mixture, G_{mm} , the effective specific gravity of the aggregate, G_{se} , includes all void spaces in the aggregate particles except those that absorb asphalt. G_{se} is determined using:

$$G_{se} = \frac{P_{mm} - P_b}{\frac{P_{mm}}{G_{mm}} - \frac{P_b}{G_b}}$$

where G_{se} = effective specific gravity of aggregate
 G_{mm} = maximum specific gravity (ASTM D 2041/AASHTO T 209) of paving mixture (no air voids)
 P_{mm} = percent by mass of total loose mixture = 100
 P_b = asphalt content at which ASTM D 2041/AASHTO T 209 test was performed, percent by total mass of mixture
 G_b = specific gravity of asphalt

Using the sample paving mixture data:

$$G_{se} = \frac{100 - 5.3}{\frac{100}{2.535} - \frac{5.3}{1.030}} = \frac{94.7}{39.45 - 5.15} = 2.761$$

NOTE: The volume of asphalt binder absorbed by an aggregate is almost invariably less than the volume of water absorbed. Consequently, the value for the effective specific gravity of an aggregate should be between its bulk and apparent specific gravities. When the effective specific gravity falls outside these limits, its value must be assumed to be incorrect. The calculations, the maximum specific gravity of the total mix by ASTM D 2041/AASHTO T 209, and the composition of the mix in terms of aggregate and total asphalt content should then be rechecked to find the source of the error.

Maximum Specific Gravity of Mixtures with Different Asphalt Contents

In designing a paving mixture with a given aggregate, the maximum specific gravity, G_{mm} , at each asphalt content is needed to calculate the percentage of air voids for each asphalt content. While the maximum specific gravity can be determined for each asphalt content by ASTM D 2041/AASHTO T 209, the precision of the test is best when the mixture is close to the design asphalt content. Also, it is preferable to measure the maximum specific gravity in duplicate or triplicate.

After calculating the effective specific gravity of the aggregate from each measured maximum specific gravity and averaging the G_{se} results, the maximum specific gravity for any other asphalt content can be obtained using the equation shown below. The equation assumes the effective specific gravity of the aggregate is constant, and this is valid since asphalt absorption does not vary appreciably with changes in asphalt content.

$$G_{mm} = \frac{P_{mm}}{\frac{P_s}{G_{se}} + \frac{P_b}{G_b}}$$

where G_{mm} = maximum specific gravity of paving mixture (no air voids)
 P_{mm} = percent by mass of total loose mixture = 100
 P_s = aggregate content, percent by total mass of mixture
 P_b = asphalt content, percent by total mass of mixture
 G_{se} = effective specific gravity of aggregate
 G_b = specific gravity of asphalt

Using the specific gravity data from the sample paving mixture data, the effective specific gravity, G_{se} , and an asphalt content, P_b , of 4.0 percent:

$$G_{mm} = \frac{100}{\frac{96.0}{2.761} + \frac{4.0}{1.030}} = \frac{100}{34.77 + 3.88} = 2.587$$

Asphalt Absorption

Absorption is expressed as a percentage by mass of aggregate rather than as a percentage by total mass of mixture. Asphalt absorption, P_{ba} , is determined using:

$$P_{ba} = 100 \times \frac{G_{se} - G_{sb}}{G_{sb} G_{se}} \times G_b$$

where P_{ba} = absorbed asphalt, percent by mass of aggregate
 G_{se} = effective specific gravity of aggregate
 G_{sb} = bulk specific gravity of aggregate
 G_b = specific gravity of asphalt

Using the bulk and effective aggregate specific gravities determined earlier and the asphalt specific gravity from the sample paving mixture data:

$$P_{ba} = 100 \times \frac{2.761 - 2.703}{2.703 \times 2.761} \times 1.030 = 100 \times \frac{0.058}{7.463} \times 1.030 = 0.8$$

Effective Asphalt Content of a Paving Mixture

The effective asphalt content, P_{be} , of a paving mixture is the total asphalt content minus the quantity of asphalt lost by absorption into the aggregate particles. It is the portion of the total asphalt content that remains as a coating on the outside of the aggregate particles and it is the asphalt content which governs the performance of an asphalt paving mixture. The formula is:

$$P_{be} = P_b - \frac{P_{ba}}{100} \times P_s$$

where P_{be} = effective asphalt content, percent by total mass of mixture

P_b = asphalt content, percent by total mass of mixture

P_{ba} = absorbed asphalt, percent by mass of aggregate

P_s = aggregate content, percent by total mass of mixture

Using the sample paving mixture data:

$$P_{be} = 5.3 - \frac{0.8}{100} \times 94.7 = 4.5$$

Percent VMA in Compacted Paving Mixture

The voids in the mineral aggregate, VMA, are defined as the intergranular void space between the aggregate particles in a compacted paving mixture that includes the air voids and the effective asphalt content, expressed as a percent of the total volume. The VMA is calculated on the basis of the bulk specific gravity of the aggregate and is expressed as a percentage of the bulk volume of the compacted paving mixture. Therefore, the VMA can be calculated by subtracting the volume of the aggregate determined by its bulk specific gravity from the bulk volume of the compacted paving mixture. The calculation is illustrated for each type of mixture percentage content.

If the mix composition is determined as percent by mass of total mixture:

$$VMA = 100 - \frac{G_{mb} \times P_s}{G_{sb}}$$

where VMA = voids in mineral aggregate (percent of bulk volume)

G_{sb} = bulk specific gravity of total aggregate

G_{mb} = bulk specific gravity of compacted mixture (ASTM D 1188 or D 2726/AASHTO T 166)

P_s = aggregate content, percent by total mass of mixture

Using the sample paving mixture data:

$$VMA = 100 - \frac{2.442 \times 94.7}{2.703} = 100 - 85.6 = 14.4$$

Or, if the mix composition is determined as percent by mass of aggregate:

$$VMA = 100 - \frac{G_{mb}}{G_{sb}} \times \frac{100}{100 + P_b} \times 100$$

where P_b = asphalt content, percent by mass of aggregate.

Using the sample paving mixture data:

$$VMA = 100 - \frac{2.442}{2.703} \times \frac{100}{100 + 5.6} \times 100 = 100 - 85.6 = 14.4$$

Percent Air Voids in Compacted Mixture

The air voids, V_a , in the total compacted paving mixture consist of the small air spaces between the coated aggregate particles. The volume percentage of air voids in a compacted mixture can be determined using:

$$V_a = 100 \times \frac{G_{mm} - G_{mb}}{G_{mm}}$$

where V_a = air voids in compacted mixture, percent of total volume
 G_{mm} = maximum specific gravity of paving mixture (as calculated earlier or as determined directly for a paving mixture by ASTM D 2041/AASHTO T 209)
 G_{mb} = bulk specific gravity of compacted mixture

Using the sample paving mixture data:

$$V_a = 100 \times \frac{2.535 - 2.442}{2.535} = 3.7$$

Percent VFA in Compacted Mixture

The percentage of the voids in the mineral aggregate that are filled with asphalt, VFA, not including the absorbed asphalt, is determined using:

$$VFA = 100 \times \frac{VMA - V_a}{VMA}$$

where, VFA = voids filled with asphalt, percent of VMA
 VMA = voids in mineral aggregate, percent of bulk volume
 V_a = air voids in compacted mixture, percent of total volume

Using the sample paving mixture data:

$$VFA = 100 \times \frac{14.4 - 3.7}{14.4} = 74.3$$

EFFECT OF CHANGING ASPHALT CONTENT ON VOLUMETRIC PROPERTIES

Maximum Theoretical Specific Gravity at Other Asphalt Contents

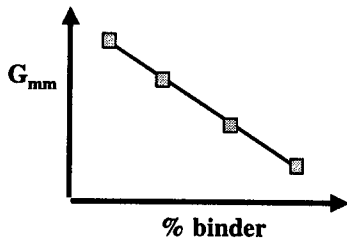

Air Void Content

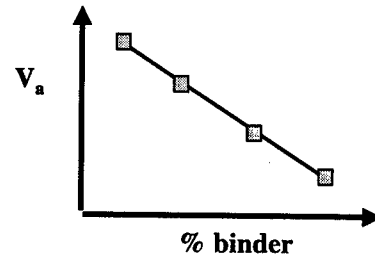

Voids in the Mineral Aggregate

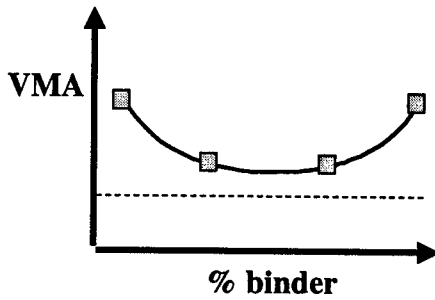

Voids Filled With Asphalt

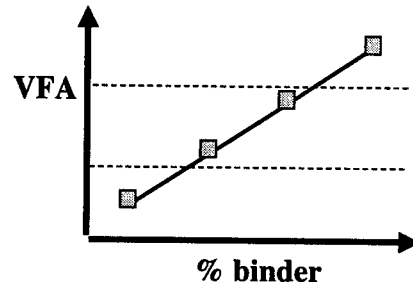

Absorbed Asphalt Content

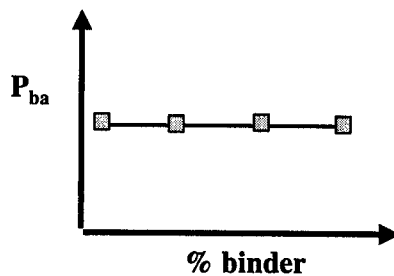

Effective Asphalt Content

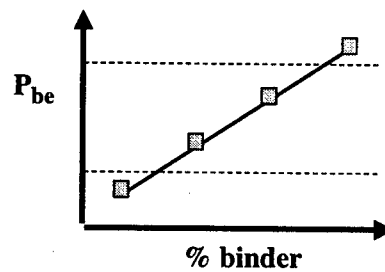



VII. Superpave Mix Design

The chapter presents a full Superpave volumetric mix design example.

Volumetric mix design plays a central role in Superpave mixture design. The best way of illustrating its steps is by means of an example. This section provides the Superpave mixture design test results for a project that was constructed in 1992 by the Wisconsin Department of Transportation on IH-43 in Milwaukee. The information presented follows the logical progression of testing and data analysis involved in a Superpave mixture design and encompasses the concepts outlined in previous sections. There are four major steps in the testing and analysis process:

1. selection of materials (aggregates, binders, modifiers, etc.),
2. selection of a design aggregate structure,
3. selection of a design asphalt binder content,
4. evaluation of moisture sensitivity of the design mixture.

Selection of materials consists of determining the traffic and environmental factors for the paving project. From that, the performance grade of asphalt binder required for the project is selected. Aggregate requirements are determined based on traffic level and layer depth. Materials are selected based on their ability to meet or exceed the established criteria.

Selection of the design aggregate structure is a trial-and-error process. This step consists of blending available aggregate stockpiles at different percentages to arrive at aggregate gradations that meet Superpave requirements. Three trial blends are normally employed for this purpose. A trial blend is considered acceptable if it possesses suitable volumetric properties (based on traffic and environmental conditions) at a predicted design binder content. Once selected, the trial blend becomes the design aggregate structure.

Selection of a design asphalt binder content consists of varying the amount of asphalt binder with the design aggregate structure to obtain acceptable volumetric and compaction properties when compared to the mixture criteria, which are based on traffic and environmental conditions. This step is a verification of the results obtained from the previous step. This step also allows the designer to observe the sensitivity of volumetric and compaction properties of the design aggregate structure to asphalt content. The design aggregate structure at the design asphalt binder content becomes the job-mix formula.

Evaluation of moisture sensitivity consists of testing the designed mixture by AASHTO T283 to determine if the mix will be susceptible to moisture damage.

MATERIALS SELECTION

For the IH-43 project, design ESALs are determined to be 18 million in the design lane. This places the design in the traffic category from 10 to 30 million ESALs. Traffic level is used to determine design requirements such as number of design gyrations for compaction, aggregate physical property requirements, and mixture volumetric requirements. The traffic level also determines the level of mixture design required. For 18 million ESALs and higher, a complete analysis is required. Consequently, the design process requires a volumetric mixture design, followed by performance testing and analysis required by a complete analysis.

The mixture in this example is an intermediate course mixture. It will have a nominal maximum particle size of 19.0 mm. It will be placed at a depth less than 100 mm from the surface of the pavement.

Binder Selection

Environmental conditions are determined from weather station data stored in the Superpave weather database. The data can be retrieved from the report *Weather Database for the Superpave Mix Design System*, SHRP-A-648A, or from the SHRPBIND software released by the Long-Term Pavement Performance (LTPP) Division of the FHWA. The project near Milwaukee has 2 weather stations:

Project Environmental Conditions and Binder Grades				
Weather Station	Min. Pvmt. Temp. (°C)	Max. Pvmt. Temp. (°C)	Binder Grade	Design Air Temp. (°C)
Low Reliability (50%)				
Milwaukee Mt. Mary	-26	51	PG 52-28	32
Milwaukee WSO AP	-25	51	PG 52-28	31
Paving Location (Assumed)	-26	51	PG 52-28	32
High Reliability (98%)				
Milwaukee Mt. Mary	-32	55	PG 58-34	36
Milwaukee WSO AP	-33	54	PG 58-34	34
Paving Location (Assumed)	-33	55	PG 58-34	35

Low and high reliability level binders are shown. Reliability is the percent probability that the actual temperature will not exceed the design pavement temperatures listed in the binder grade. In this example, the designer chooses high reliability for all conditions. Thus, a PG 58-34 binder is needed. The average Design High Air Temperature is 35°C.

Having determined the need for a PG 58-34 binder, the binder is selected and tested for specification compliance. Binder test results are:

Test	Property	Test Result	Criteria
Original Binder			
Flash Point	n/a	304°C	230°C minimum
Rotational Viscosity	135°C	0.575 Pa·s	3 Pa·s maximum
Rotational Viscosity	175°C	0.142 Pa·s	n/a
Dynamic Shear Rheometer	$G^*/\sin \delta @ 58^\circ\text{C}$	1.42 kPa	1.00 kPa minimum
RTFO-aged Binder			
Mass Loss	n/a	0.14%	1.00% maximum
Dynamic Shear Rheometer	$G^*/\sin \delta @ 58^\circ\text{C}$	2.41 kPa	2.20 kPa minimum
PAV-aged Binder			
Dynamic Shear Rheometer	$G^*\sin \delta @ 16^\circ\text{C}$	1543 kPa	5000 kPa maximum
Bending Beam Rheometer	Stiffness @ -24°C	172.0 MPa	300.0 MPa maximum
Bending Beam Rheometer	m-value @ -24°C	0.321	0.300 minimum

Comparing the test results to specifications, the designer verifies that the asphalt binder meets the requirements of a PG 58-34 grade. Specification testing requires only that rotational viscosity be performed at 135°C. Additional testing was performed at 165°C to establish laboratory mixing and compaction temperatures. The illustration of the temperature-viscosity relationship for this binder shows that the mixing temperature range is selected between 165°C and 172°C. The compaction temperature range is selected between 151°C and 157°C.

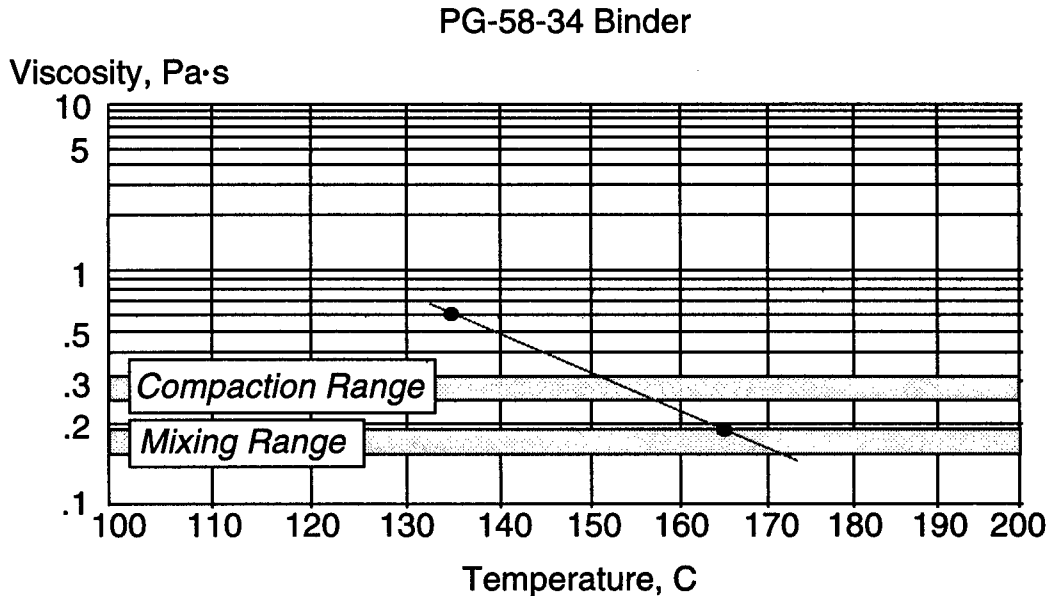

Aggregate Selection

Next, the designer selects the aggregates to use in the mixture. For this example, there are 5 stockpiles of materials consisting of three coarse materials and two fine materials. It is assumed that the mixing facility will have at least 5 cold feed bins. If fewer cold feed bins are available, fewer stockpiles will be used. The materials are split into representative samples, and a washed sieve analysis is performed for each aggregate. These test results are shown in the section on selecting design aggregate structure.

The bulk and apparent specific gravities are determined for each aggregate. These specific gravities are used in trial binder content and VMA calculations.

Aggregate Specific Gravities		
Aggregate	Bulk Sp. Gravity	Apparent Sp. Gravity
#1 Stone	2.703	2.785
12.5 mm Chip	2.689	2.776
9.5 mm Chip	2.723	2.797
Manuf. Sand	2.694	2.744
Screen Sand	2.679	2.731

In addition to sieve analysis and specific gravity determination, Superpave requires that consensus aggregate tests be performed to assure that the aggregates selected for the mix design are acceptable. The four tests required are: coarse aggregate angularity, fine aggregate angularity, thin and elongated particles, and clay content. In addition, the specifying agency can select any other aggregate tests deemed important. These tests can include items such as soundness, toughness, and deleterious materials among others.

Superpave consensus aggregate criteria are applied to combined aggregate gradations rather than individual aggregate components. However, some designers find it useful to perform the aggregate tests on the individual aggregate components. This step allows the designer to use the test results in narrowing the acceptable range of blend percentages for the aggregates. It also allows for greater flexibility if multiple trial blends are attempted. The test results from the components can be used to estimate the results for a given combination of materials. The drawback to this procedure is that it takes more time to perform this additional testing. For this example, the aggregate properties are measured for each stockpile as well as for the aggregate trial blends.

Coarse Aggregate Angularity

This test is performed on the coarse aggregate particles of the aggregate stockpiles. The coarse aggregate particles are defined as particles larger than 4.75 mm.

Coarse Aggregate Angularity Test Results				
Aggregate	1+ Fractured Faces	Criterion	2+ Fractured Faces	Criterion
#1 Stone	92%	95% min	88%	90% min
12.5 mm Chip	97%		94%	
9.5 mm Chip	99%		95%	

Note that this test is not performed on the two fine aggregates, even though they have some small percentage retained on the 4.75 mm sieve. The manufactured sand has 4.5% retained and the Screen Sand has 10.5% retained on the 4.75 mm sieve.

The test results table also shows the criteria for fractured faces based on traffic (18 million ESALs) and depth from the surface (< 100 mm). The criteria change as the traffic level and layer position (relative to the surface) change. The criteria are also based on the test results from the aggregate *blend* rather than individual materials. Thus, even though the #1 Stone is below the minimum criteria, it can be used as long as the selected *blend* of aggregates meets the criteria.

Fine Aggregate Angularity

This test is performed on the fine aggregate particles of the aggregate stockpiles. The fine aggregate particles are defined as particles smaller than 2.36 mm.

Fine Aggregate Angularity		
Aggregate	% Air Voids (Loose)	Criterion
Manufactured Sand	52%	45% min
Screen Sand	40%	

Note that this test is not performed on the three coarse aggregates, even though they have a small percentage passing the 2.36 millimeter sieve. The #1 Stone has 1.9% passing, the 1/2" Chip has 2.6% passing, and the 3/8" Chip has 3.0% passing the 2.36 mm sieve. The test results table also indicates the criterion for fine aggregate angularity based on traffic and depth from the surface. Even though the Screen Sand is below the minimum criterion, it can be used as long as the selected *blend* of aggregates meets the criterion.

Flat, Elongated Particles

This test is performed on the coarse aggregate particles of the aggregate stockpiles. The coarse aggregate particles are defined as particles larger than 4.75 mm.

Flat, Elongated Particles		
Aggregate	% Flat/Elongated	Criterion
#1 Stone	0%	10% max
12.5 mm Chip	0%	
9.5 mm Chip	0%	

Note that this test is not performed on the two fine aggregates, even though they have some small percentage retained on the 4.75 mm sieve. The manufactured sand has 4.5% retained and the Screen Sand has 10.5% retained on the 4.75 mm sieve. The test results table also indicates the criterion for percentage of flat and elongated particles, which is based on traffic only. The criterion changes as the traffic level changes. In this case, the aggregates are cubical and not in danger of failing the criterion.

Clay Content (Sand Equivalent)

This test is performed on the fine aggregate particles of the aggregate stockpiles. The fine aggregate particles are defined as particles smaller than 4.75 mm.

Clay Content (Sand Equivalent)		
Aggregate	Sand Equivalent	Criterion
Manufactured Sand	47	45 min
Screen Sand	70	

Note that this test is not performed on the three coarse aggregates, even though they have some small percentage passing the 4.75 mm sieve. The #1 Stone has 2.1% passing, the 1/2" Chip has 3.1% passing, and the 3/8" Chip has 4.8% passing the 4.75 mm sieve. The test results table also indicates the criterion for clay content (sand equivalent) based on traffic only. The criterion changes as the traffic level changes. The criterion is also based on the test results from the aggregate *blend* rather than individual materials. Both fine aggregates are above the minimum requirement, so there is reasonable expectation that the blend will also meet the clay content requirement. Once all of the aggregate testing is complete, the material selection process is complete. The next step is to select the design aggregate structure.

SELECT DESIGN AGGREGATE STRUCTURE

To select the design aggregate structure, the designer establishes trial blends by mathematically combining the gradations of the individual materials into a single gradation. The blend gradation is then compared to the specification requirements for the appropriate sieves. Gradation control is based on four control sieves: the maximum sieve, the nominal maximum sieve, the 2.36 mm sieve, and the 75 micron sieve.

The nominal maximum sieve is one sieve size larger than the first sieve to retain more than ten percent of combined aggregate. The maximum sieve size is one sieve size greater than the nominal maximum sieve. The restricted zone is an area on either side of the maximum density line. For a 19.0 mm nominal mixture, it starts at the 2.36 mm sieve and extends to the 300 micron sieve. Any proposed trial blend gradation has to pass between the control points established on the four sieves. In addition, it has to be outside of the area bounded by the limits set for the restricted zone.

Gradation Criteria for 19.0 mm Nominal Mixture			
Gradation Control Item	Sieve Size, mm	Minimum, %	Maximum, %
Control Points	25.0	100.0	
	19.0	90.0	100.0
	12.5		90.0
	2.36	23.0	49.0
	0.075	2.0	8.0
Restricted Zone	2.36	34.6	34.6
	1.18	22.3	28.3
	0.600	16.7	20.7
	0.300	13.7	13.7

Any number of trial blends can be attempted, but three is the standard number of blends. Trial blending consists of varying stockpile percentages of each aggregate to obtain blend gradations meeting the gradation requirements for that particular mixture. For this example, three trial blends are used: an intermediate blend (Blend 1), a coarse blend (Blend 2), and a fine blend (Blend 3). The intermediate blend is combined to produce a gradation that is not close to either the gradation limits for the control sieves, or the restricted zone. The coarse blend is combined to produce a gradation that is close to the minimum criteria for the nominal maximum sieve, the 2.36 mm sieve, and the 75 micron sieve. The fine blend is combined to produce a gradation that is close to the maximum criteria for the nominal maximum sieve, and the restricted zone.

IH-43 Trial Gradations

	#1 Stone	12.5 mm chip	9.5 mm chip	Mfg sand	Scr. sand
Blend 1	25.0%	15.0%	22.0%	18.0%	20.0%
Blend 2	30.0%	25.0%	13.0%	17.0%	15.0%
Blend 3	10.0%	15.0%	30.0%	31.0%	14.0%

Sieve						Blend 1 Gradation	Blend 2 Gradation	Blend 3 Gradation
25.0 mm	100.0	100.0	100.0	100.0	100.0	100.0	100.0	100.0
19.0 mm	76.1	100.0	100.0	100.0	100.0	94.0	92.8	97.6
12.5 mm	14.3	87.1	100.0	100.0	100.0	76.6	71.1	89.5
9.5 mm	3.8	26.0	94.9	100.0	99.8	63.7	51.9	77.7
4.75 mm	2.1	3.1	4.8	95.5	89.5	37.1	31.7	44.3
2.36 mm	1.9	2.6	3.0	63.5	76.7	28.3	23.9	31.9
1.18 mm	1.9	2.4	2.8	38.6	63.5	21.1	17.6	22.2
600 μm	1.8	2.3	2.6	21.9	45.6	14.4	12.0	14.5
300 μm	1.8	2.2	2.5	11.0	23.1	7.9	6.8	7.9
150 μm	1.7	2.1	2.4	5.7	8.4	4.0	3.6	4.1
75 μm	1.6	1.9	2.2	5.7	4.7	3.1	2.9	3.5

All three of the trial blends are shown graphically. Note that all three trial blends pass below the restricted zone. This is not a requirement. Superpave allows but does not recommend blends that plot above the restricted zone.

**IH-43 Trial Gradations
19.0 mm Nominal Mixture**

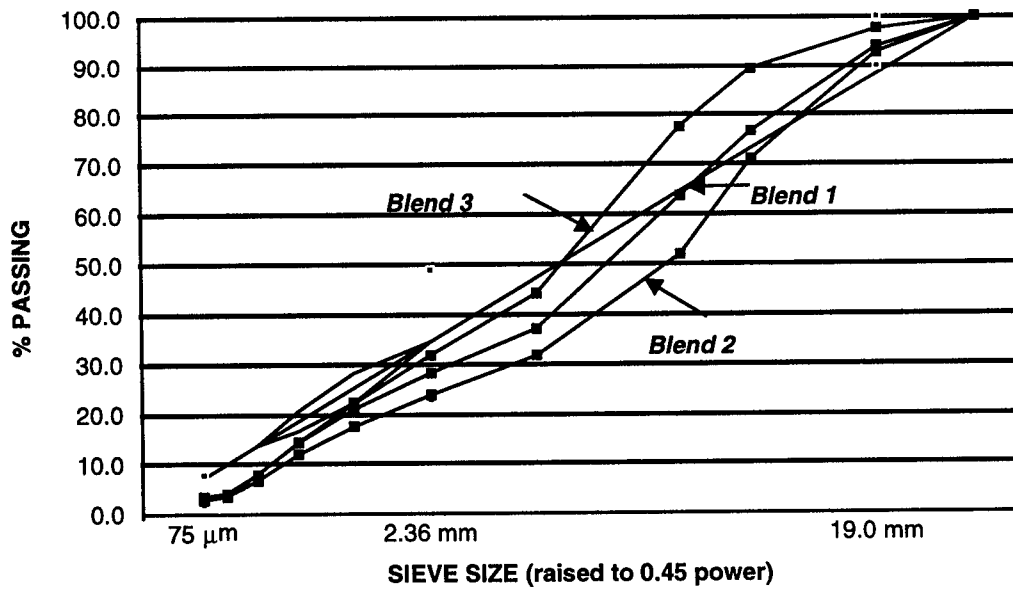

Once the trial blends are selected, a preliminary determination of the blended aggregate properties is necessary. This can be estimated mathematically from the aggregate properties.

Estimated Aggregate Blend Properties				
Property	Criteria	Trial Blend 1	Trial Blend 2	Trial Blend 3
Coarse Ang.	95%/90% min.	96%/92%	95%/92%	97%/93%
Fine Ang.	45% min.	46%	46%	48%
Thin/Elongated	10% max.	0%	0%	0%
Sand Equivalent	45 min.	59	58	54
Combined G_{sb}	n/a	2.699	2.697	2.701
Combined G_{sa}	n/a	2.768	2.769	2.767

Values for coarse aggregate angularity are shown as percentage of one or more fractured faces followed by percentage of two or more fractured faces. Based on the estimates, all three trial blends are acceptable. When the design aggregate structure is selected, the blend aggregate properties will need to be verified by testing.

SELECT TRIAL ASPHALT BINDER CONTENT

The next step is to evaluate the trial blends by compacting specimens and determining the volumetric properties of each trial blend. For each blend, a minimum of two specimens will be compacted using the SGC. The trial asphalt binder content is determined for each trial blend by estimating the effective specific gravity of the blend and using the calculations shown below. The effective specific gravity (G_{se}) of the blend is estimated by:

$$G_{se} = G_{sb} + 0.8 \times (G_{sa} - G_{sb})$$

The factor, 0.8, can be adjusted at the discretion of the designer. Absorptive aggregates may require values closer to 0.6 or 0.5. The blend calculations are shown below:

$$\begin{aligned} \text{Blend 1:} & \quad G_{se} = 2.699 + 0.8 \times (2.768 - 2.699) = 2.754 \\ \text{Blend 2:} & \quad G_{se} = 2.697 + 0.8 \times (2.769 - 2.697) = 2.755 \\ \text{Blend 3:} & \quad G_{se} = 2.701 + 0.8 \times (2.767 - 2.701) = 2.754 \end{aligned}$$

The volume of asphalt binder (V_{ba}) absorbed into the aggregate is estimated using this equation:

$$V_{ba} = \frac{P_s \times (1 - V_a)}{\left(\frac{P_b}{G_b} + \frac{P_s}{G_{se}}\right)} \times \left(\frac{1}{G_{sb}} - \frac{1}{G_{se}}\right)$$

where

- V_{ba} = volume of absorbed binder, cm^3/cm^3 of mix
- P_b = percent of binder (assumed 0.05),
- P_s = percent of aggregate (assumed 0.95),
- G_b = specific gravity of binder (assumed 1.02),
- V_a = volume of air voids (assumed $0.04 \text{ cm}^3/\text{cm}^3$ of mix)

$$\text{Blend 1: } V_{ba} = \frac{0.95 \times (1 - 0.04)}{\left(\frac{0.05}{1.02} + \frac{0.95}{2.754}\right)} \times \left(\frac{1}{2.699} - \frac{1}{2.754}\right) = 0.0171 \text{ cm}^3/\text{cm}^3 \text{ of mix}$$

$$\text{Blend 2: } V_{ba} = \frac{0.95 \times (1 - 0.04)}{\left(\frac{0.05}{1.02} + \frac{0.95}{2.755}\right)} \times \left(\frac{1}{2.697} - \frac{1}{2.755}\right) = 0.0181 \text{ cm}^3/\text{cm}^3 \text{ of mix}$$

$$\text{Blend 3: } V_{ba} = \frac{0.95 \times (1 - 0.04)}{\left(\frac{0.05}{1.02} + \frac{0.95}{2.754}\right)} \times \left(\frac{1}{2.701} - \frac{1}{2.754}\right) = 0.0165 \text{ cm}^3/\text{cm}^3 \text{ of mix}$$

The volume of the effective binder (V_{be}) can be determined from this equation:

$$V_{be} = 0.081 - 0.02931 \times [\ln(S_n)]$$

where S_n = the nominal maximum sieve size of the aggregate blend (in inches)

$$\text{Blend 1-3: } V_{be} = 0.081 - 0.02931 \times [\ln(0.75)] = 0.089 \text{ cm}^3/\text{cm}^3 \text{ of mix}$$

Finally, the initial trial asphalt binder (P_{bi}) content is calculated from this equation:

$$P_{bi} = \frac{G_b \times (V_{be} + V_{ba})}{(G_b \times (V_{be} + V_{ba})) + W_s} \times 100$$

where P_{bi} = percent (by weight of mix) of binder
 W_s = weight of aggregate, grams

$$W_s = \frac{P_s \times (1 - V_a)}{\left(\frac{P_b}{G_b} + \frac{P_s}{G_{sc}}\right)}$$

$$\text{Blend 1: } W_s = \frac{0.95 \times (1 - 0.04)}{\left(\frac{0.05}{1.02} + \frac{0.95}{2.754}\right)} = 2.315$$

$$P_{bi} = \frac{1.02 \times (0.089 + 0.0171)}{(1.02 \times (0.089 + 0.0171)) + 2.315} \times 100 = 4.46\% \quad (\text{by mass of mix})$$

$$\text{Blend 2: } W_s = \frac{0.95 \times (1 - 0.04)}{\left(\frac{0.05}{1.02} + \frac{0.95}{2.755}\right)} = 2.316$$

$$P_{bi} = \frac{1.02 \times (0.089 + 0.0181)}{(1.02 \times (0.089 + 0.0171)) + 2.316} \times 100 = 4.46\% \quad (\text{by mass of mix})$$

$$\text{Blend 3: } W_s = \frac{0.95 \times (1 - 0.04)}{\left(\frac{0.05}{1.02} + \frac{0.95}{2.754}\right)} = 2.315$$

$$P_{bi} = \frac{1.02 \times (0.089 + 0.0165)}{(1.02 \times (0.089 + 0.0171)) + 2.315} \times 100 = 4.46\% \quad (\text{by mass of mix})$$

Next, a minimum of two specimens for each trial blend is compacted using the SGC. Two specimens are also prepared for determination of the mixture's maximum theoretical specific gravity (G_{mm}). An aggregate weight of 4500 grams is usually sufficient for the compacted specimens. An aggregate weight of 2000 grams is usually sufficient for the specimens used to determine maximum theoretical specific gravity (G_{mm}). AASHTO T 209 should be consulted to determine the minimum sample size required for various mixtures.

Specimens are mixed at the appropriate mixing temperature, which is 165°C to 172°C for the selected PG 58-34 binder. The specimens are then short-term aged by placing the loose mix in a flat pan, in a forced draft oven at 135°C, for 4 hours. Next, the specimens are brought to compaction temperature range (151°C to 157°C) by placing them in another oven for a short time (generally less than 30 minutes). Finally, the specimens are then removed and either compacted or allowed to cool loose (for G_{mm} determination).

The number of gyrations used for compaction is determined based on the design high air temperature of the paving location (35°C) and the traffic level.

Gyratory Compactive Effort												
Design ESALs (millions)	Average Design High Air Temperature											
	<39°C			39° - 40°C			41° - 42°C			43° - 44°C		
	N_{ini}	N_{des}	N_{max}	N_{ini}	N_{des}	N_{max}	N_{ini}	N_{des}	N_{max}	N_{ini}	N_{des}	N_{max}
< 0.3	7	68	104	7	74	114	7	78	121	7	82	127
0.3 - 1	7	76	117	7	83	129	7	88	138	8	93	146
1 - 3	7	86	134	8	95	150	8	100	158	8	105	167
3 - 10	8	96	152	8	106	169	8	113	181	9	119	192
10 - 30	8	109	174	9	121	195	9	128	208	9	135	220
30 - 100	9	126	204	9	139	228	9	146	240	10	153	253
> 100	9	143	235	10	158	262	10	165	275	10	172	288

The number of gyrations for initial compaction, design compaction, and maximum compaction are:

$N_{ini} = 8$ gyrations

$N_{des} = 109$ gyrations

$N_{max} = 174$ gyrations

Each specimen will be compacted to the maximum number of gyrations, with specimen height data collected during the compaction process. This is tabulated for each Trial Blend. SGC compaction data reduction is accomplished as follows.

During compaction, the height of the specimen is continuously monitored. After compaction is complete, the specimen is extruded from the mold and allowed to cool. Next, the bulk specific gravity (G_{mb}) of the specimen is determined using AASHTO T166. The G_{mm} of each blend is determined using AASHTO T209. G_{mb} is then divided by G_{mm} to determine the % G_{mm} @ N_{max} . The % G_{mm} at any number of gyrations (N_x) is then calculated by multiplying % G_{mm} @ N_{max} by the ratio of the heights at N_{max} and N_x .

The SGC data reduction for the three trial blends is shown in the accompanying tables. The most important points of comparison are % G_{mm} at N_{ini} , N_{des} , and N_{max} , which are highlighted in these tables. Figures illustrate the compaction plots for data generated in these tables. The figures show % G_{mm} versus the logarithm of the number of gyrations.

Densification Data for Trial Blend 1					
Specimen 1			Specimen 2		AVG
Gyrations	Ht, mm	%G _{mm}	Ht, mm	%G _{mm}	%G _{mm}
5	129.0	85.2	130.3	86.2	85.7
8	127.0	86.5	128.1	87.6	87.1
10	125.7	87.3	126.7	88.6	88.0
15	123.5	88.9	124.7	90.1	89.5
20	122.2	89.9	123.4	91.0	90.4
30	120.1	91.4	121.5	92.4	91.9
40	119.0	92.3	120.2	93.4	92.8
50	118.0	93.0	119.3	94.2	93.6
60	117.2	93.7	118.5	94.8	94.3
80	116.0	94.7	117.3	95.8	95.2
100	115.2	95.4	116.4	96.5	95.9
109	114.9	95.6	116.1	96.7	96.2
125	114.4	96.0	115.6	97.1	96.6
150	113.7	96.6	115.0	97.7	97.2
174	113.1	97.1	114.5	98.1	97.6
G _{mb}	2.489		2.514		
G _{mm}	2.563		2.563		

IH-43, 19.0 mm Nominal, 4.4% AC, Trial Blend 1

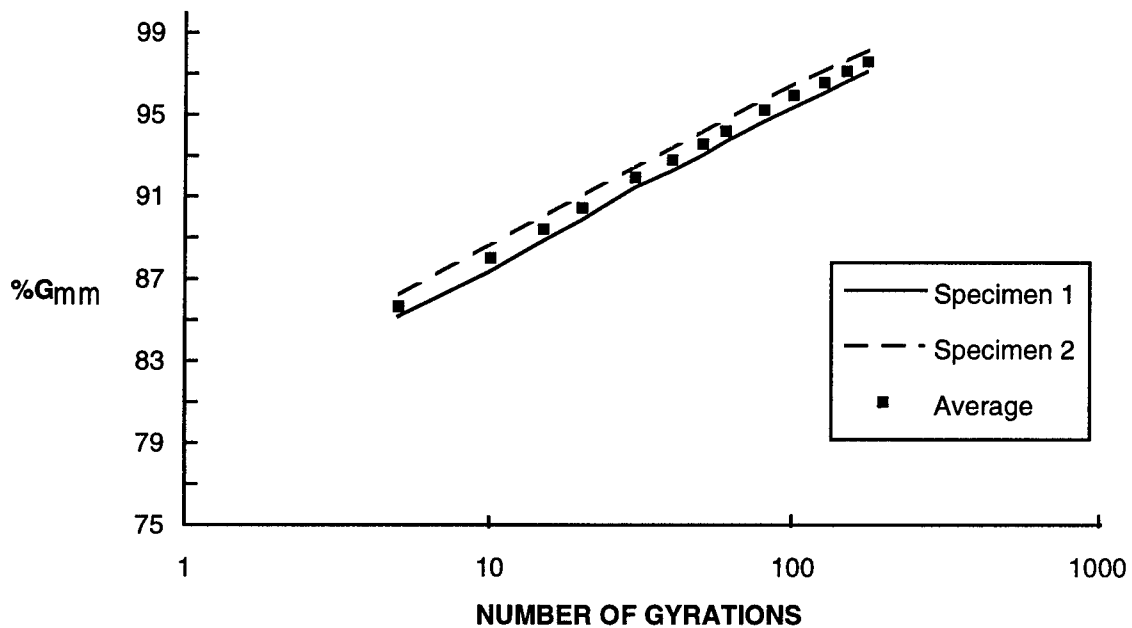

Densification Data for Trial Blend 2					
Specimen 1			Specimen 2		AVG
Gyrations	Ht, mm	%G _{mm}	Ht, mm	%G _{mm}	%G _{mm}
5	131.7	84.2	132.3	84.2	84.2
8	129.5	85.6	130.1	85.6	85.6
10	128.0	86.6	128.7	86.6	86.6
15	125.8	88.1	126.5	88.1	88.1
20	124.3	89.2	124.9	89.2	89.2
30	122.2	90.7	122.7	90.8	90.7
40	120.7	91.8	121.2	91.9	91.9
50	119.6	92.7	120.1	92.8	92.7
60	118.7	93.4	119.2	93.5	93.4
80	117.3	94.5	117.8	94.6	94.5
100	116.3	95.3	116.8	95.4	95.4
109	115.9	95.6	116.4	95.7	95.7
125	115.3	96.1	115.8	96.2	96.2
150	114.6	96.7	115.1	96.8	96.8
174	113.9	97.3	114.4	97.4	97.4
G _{mb}	2.496		2.498		
G _{mm}	2.565		2.565		

IH-43, 19.0 mm Nominal, 4.4% AC, Trial Blend 2

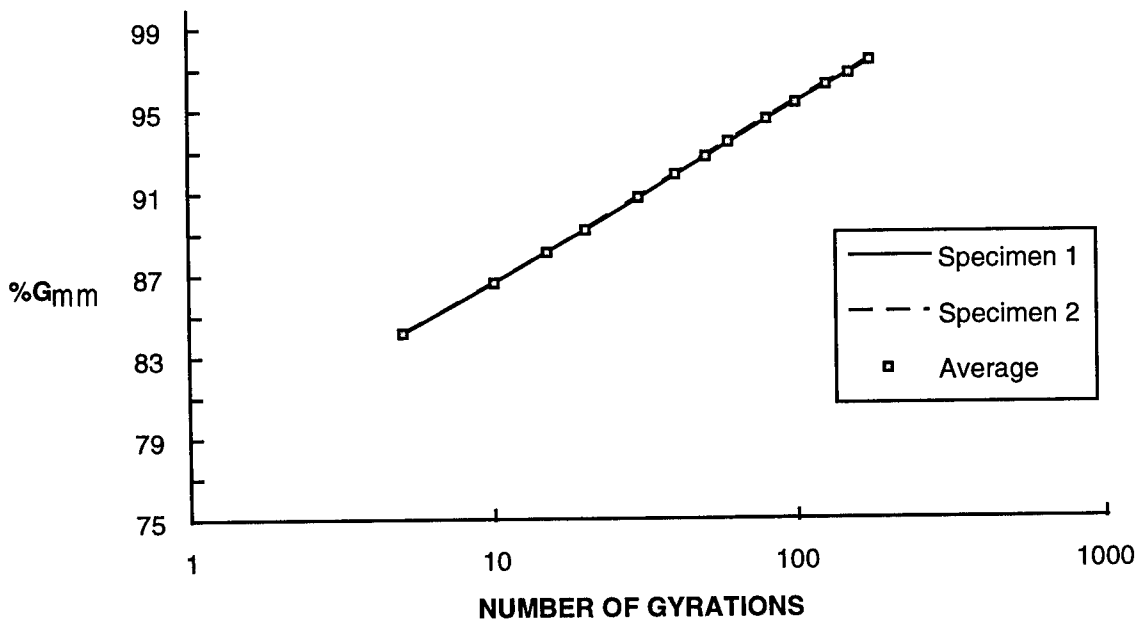

Densification Data for Trial Blend 3					
Specimen 1			Specimen 2		AVG
Gyrations	Ht, mm	%G _{mm}	Ht, mm	%G _{mm}	%G _{mm}
5	130.9	84.4	129.5	85.2	84.8
8	127.2	85.9	127.3	86.6	86.3
10	127.2	86.9	125.9	87.6	87.3
15	125.1	88.3	124.1	89.0	88.7
20	123.7	89.3	122.8	89.9	89.6
30	121.8	90.7	121.0	91.2	91.0
40	120.5	91.7	119.7	92.2	91.9
50	119.6	92.5	118.7	93.0	92.7
60	118.8	93.1	118.1	93.5	93.3
80	117.6	94.0	116.9	94.4	94.2
100	116.7	94.7	116.1	95.1	94.9
109	116.4	95.0	115.8	95.3	95.2
125	115.9	95.4	115.2	95.7	95.6
150	115.3	95.8	114.6	96.3	96.1
174	114.8	96.3	114.1	96.7	96.5
G _{mb}	2.473		2.483		
G _{mm}	2.568		2.568		

IH-43, 19.0 mm Nominal, 4.4% AC, Trial Blend 3

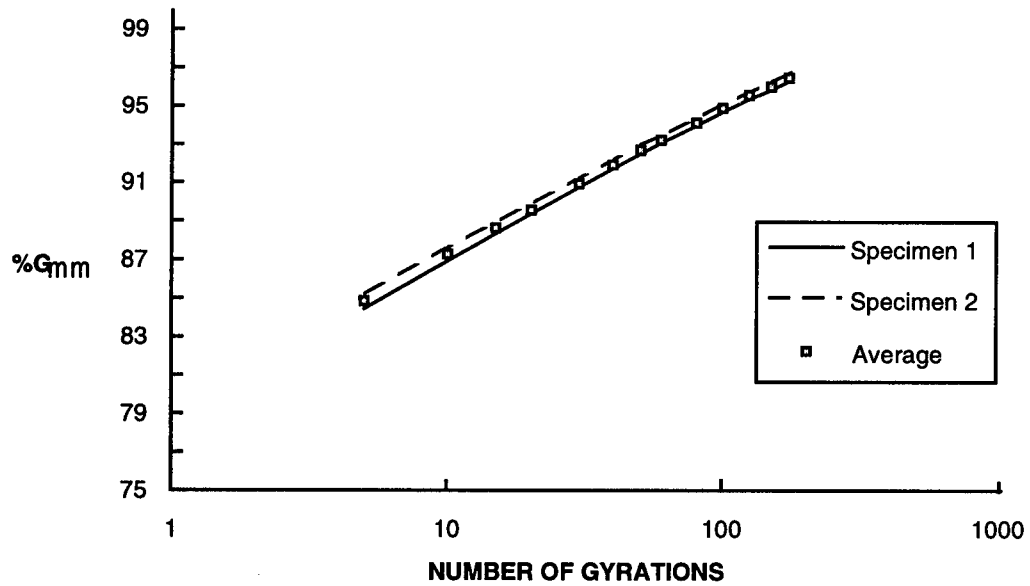

EVALUATE TRIAL BLENDS

The average %G_{mm} is determined for N_{ini} (8 gyrations), N_{des} (109 gyrations), and N_{max} (174 gyrations) for each trial blend. This data is taken directly from the compaction data tables. The summary of these values for Trial Blends 1, 2, and 3 is:

Trial Blend	% G _{mm} @ N _{ini}	% G _{mm} @ N _{des}	% G _{mm} @ N _{max}
1	87.1	96.2	97.6
2	85.6	95.7	97.4
3	86.3	95.2	96.5

The percent of air voids and voids in the mineral aggregate (VMA) are determined at N_{des}. The percent air voids is calculated using this equation:

$$\% \text{Air Voids} = 100 - \%G_{mm} @ N_{des}$$

Blend 1: %Air Voids = 100 - 96.2 = 3.8%
 Blend 2: %Air Voids = 100 - 95.7 = 4.3%
 Blend 3: %Air Voids = 100 - 95.2 = 4.8%

The percent voids in the mineral aggregate is calculated using this equation:

$$\% \text{VMA} = 100 - \left(\frac{\%G_{mm} @ N_{des} \times G_{mm} \times P_s}{G_{sb}} \right)$$

Blend 1: %VMA = 100 - $\left(\frac{96.2\% \times 2.563 \times 0.956}{2.699} \right)$ = 12.7%

Blend 2: %VMA = 100 - $\left(\frac{95.7\% \times 2.565 \times 0.956}{2.697} \right)$ = 13.0%

Blend 3: %VMA = 100 - $\left(\frac{95.2\% \times 2.568 \times 0.956}{2.701} \right)$ = 13.5%

Blend	%AC	%G _{mm} @ N=8	%G _{mm} @ N=174	%G _{mm} @ N=109	%Air Voids	%VMA
1	4.4%	87.1%	97.6%	96.2%	3.8%	12.7%
2	4.4%	85.6%	97.4%	95.7%	4.3%	13.0%
3	4.4%	86.3%	96.5%	95.2%	4.8%	13.5%

The table above shows the compaction summary of the trial blends. The central premise in Superpave volumetric mix design is that the correct amount of asphalt binder is used in each trial blend so that each blend achieves exactly 96% of G_{mm} or 4% air void content at N_{des} . Clearly, this did not happen for any of the three IH-43 trial blends. Because the trial blends exhibit different air void contents at N_{des} , the other volumetric and compaction properties cannot be properly compared. For example, Trial Blend 1 contained slightly too much asphalt to achieve 4% air voids at N_{des} . Instead, it had only 3.8% air voids. The VMA of Trial Blend 1 is also too low. The designer must ask the question, "If I had used less asphalt in Trial Blend 1 to achieve 4% air voids at N_{des} , would the VMA and other required properties improve to acceptable levels?"

Providing an answer to this question is an important step in volumetric mix design. To answer this question, an estimated asphalt binder content to achieve 4% air voids (96% G_{mm} at N_{des}) is determined for each trial blend using this formula:

$$P_{b,estimated} = P_{bi} - (0.4 \times (4 - V_a))$$

where $P_{b,estimated}$ = estimated percent binder
 P_{bi} = initial (trial) percent binder
 V_a = percent air voids at N_{des}

Blend 1: $P_{b,estimated} = 4.4 - (0.4 \times (4 - 3.8)) = 4.3\%$

Blend 2: $P_{b,estimated} = 4.4 - (0.4 \times (4 - 4.3)) = 4.5\%$

Blend 3: $P_{b,estimated} = 4.4 - (0.4 \times (4 - 4.8)) = 4.7\%$

The volumetric (VMA and VFA) and mixture compaction properties are then estimated at this asphalt binder content using the equations below. These steps are solely aimed at answering the question, "What would have been the trial blend properties if I had used the right amount of asphalt to achieve 4% air voids at N_{des} ?" It is by these steps that a proper comparison among trial blends can be accomplished.

For VMA:

$$\%VMA_{estimated} = \%VMA_{initial} + C \times (4 - V_a)$$

where: $\%VMA_{initial}$ = %VMA from trial asphalt binder content
 C = constant (either 0.1 or 0.2)
 Note: C = 0.1 if V_a is less than 4.0%
 C = 0.2 if V_a is greater than 4.0%

Blend 1: $\%VMA_{estimated} = 12.7 + (0.1 \times (4.0 - 3.8)) = 12.7\%$

Blend 2: $\%VMA_{estimated} = 13.0 + (0.2 \times (4.0 - 4.3)) = 13.0\%$

Blend 3: $\%VMA_{estimated} = 13.5 + (0.2 \times (4.0 - 4.8)) = 13.3\%$

For VFA:

$$\%VFA_{\text{estimated}} = 100\% \times \frac{(\%VMA_{\text{estimated}} - 4.0)}{\%VMA_{\text{estimated}}}$$

$$\text{Blend 1: } \%VFA_{\text{estimated}} = 100\% \times \frac{(12.7 - 4.0)}{12.7} = 68.5\%$$

$$\text{Blend 2: } \%VFA_{\text{estimated}} = 100\% \times \frac{(13.0 - 4.0)}{13.0} = 69.2\%$$

$$\text{Blend 3: } \%VFA_{\text{estimated}} = 100\% \times \frac{(13.4 - 4.0)}{13.4} = 70.1\%$$

For %G_{mm} at N_{ini}:

$$\%G_{\text{mm estimated}} @ N_{\text{ini}} = \%G_{\text{mm trial}} @ N_{\text{ini}} - (4.0 - V_a)$$

$$\text{Blend 1: } \%G_{\text{mm estimated}} @ N_{\text{ini}} = 87.1 - (4.0 - 3.8) = 86.9\%$$

$$\text{Blend 2: } \%G_{\text{mm estimated}} @ N_{\text{ini}} = 85.6 - (4.0 - 4.3) = 85.9\%$$

$$\text{Blend 3: } \%G_{\text{mm estimated}} @ N_{\text{ini}} = 86.3 - (4.0 - 4.8) = 87.1\%$$

For %G_{mm} at N_{max}:

$$\%G_{\text{mm estimated}} @ N_{\text{max}} = \%G_{\text{mm trial}} @ N_{\text{max}} - (4.0 - V_a)$$

$$\text{Blend 1: } \%G_{\text{mm estimated}} @ N_{\text{max}} = 97.6 - (4.0 - 3.8) = 97.4\%$$

$$\text{Blend 2: } \%G_{\text{mm estimated}} @ N_{\text{max}} = 97.4 - (4.0 - 4.3) = 97.7\%$$

$$\text{Blend 3: } \%G_{\text{mm estimated}} @ N_{\text{max}} = 96.5 - (4.0 - 4.8) = 97.3\%$$

Finally, there is a required range on the dust proportion. This criteria is constant for all levels of traffic. It is calculated as the percent by mass of the material passing the 0.075 mm sieve (by wet sieve analysis) divided by the effective asphalt binder content (expressed as percent by mass of mix). The effective asphalt binder content is calculated using:

$$P_{\text{be, estimated}} = -(P_s \times G_b) \times \left(\frac{G_{\text{se}} - G_{\text{sb}}}{G_{\text{se}} \times G_{\text{sb}}} \right) + P_{\text{b, estimated}}$$

$$\text{Blend 1: } P_{\text{be, estimated}} = -(95.7 \times 1.02) \times \left(\frac{2.754 - 2.699}{2.754 \times 2.699} \right) + 4.3 = 3.6\%$$

$$\text{Blend 2: } P_{\text{be, estimated}} = -(95.5 \times 1.02) \times \left(\frac{2.755 - 2.697}{2.755 \times 2.697} \right) + 4.5 = 3.7\%$$

Blend 3:
$$P_{be, estimated} = -(95.3 \times 1.02) \times \left(\frac{2.754 - 2.701}{2.754 \times 2.701} \right) + 4.7 = 4.0\%$$

Dust Proportion is calculated using:

$$DP = \frac{P_{.075}}{P_{be, estimated}}$$

Blend 1:
$$DP = \frac{3.1}{3.6} = 0.86$$

Blend 2:
$$DP = \frac{2.9}{3.7} = 0.78$$

Blend 3:
$$DP = \frac{3.5}{4.0} = 0.88$$

The dust proportion must be between 0.6 and 1.2.

Dust Proportion of Trial Blends		
Blend	Dust Proportion	Criterion
Trial Blend 1	0.86	0.6 - 1.2
Trial Blend 2	0.78	
Trial Blend 3	0.88	

These tables show the estimated volumetric and mixture compaction properties for the trial blends at the asphalt binder content that should result in 4.0% air voids at N_{des} :

Estimated Mixture Volumetric Properties @ N_{des}						
Blend	Trial %AC	Est. %AC	%Air Voids	%VMA	%VFA	D.P.
1	4.4%	4.3%	4.0%	12.7%	68.5%	0.86
2	4.4%	4.5%	4.0%	13.0%	69.2%	0.78
3	4.4%	4.7%	4.0%	13.3%	70.1%	0.88

Estimated Mixture Compaction Properties				
Blend	Trial %AC	Est. %AC	%G _{mm} @ N=8	%G _{mm} @ N=174
1	4.4%	4.3%	86.9%	97.4%
2	4.4%	4.5%	85.9%	97.7%
3	4.4%	4.7%	87.1%	97.3%

Estimated properties are compared against the mixture criteria. For the design traffic and nominal maximum particle size, the volumetric and densification criteria are:

% Air Voids	4.0%
% VMA	13.0% (19.0 mm nominal mixture)
% VFA	65% - 75% (10-30 × 10 ⁶ ESALs)
% G _{mm} @ N _{ini}	less than 89%
%G _{mm} @ N _{max}	less than 98%
Dust Proportion	0.6 - 1.2

After establishing all the estimated mixture properties, the designer can observe the values for the trial blends and decide if one or more are acceptable, or if further trial blends need to be evaluated.

Blend 1 is unacceptable based on a failure to meet the minimum VMA criteria. Blend 2 is acceptable, but the VMA is at the minimum. Blend 3 has acceptable VMA as well as meeting the criteria for VFA, dust proportion, and the densification criteria. From this data, Trial Blend 3 is selected as the design aggregate structure.

What could be done at this point if none of the blends were acceptable? Additional combinations of the current aggregates could be tested, or additional materials from different sources could be obtained and included in the trial blend analysis.

SELECT DESIGN ASPHALT BINDER CONTENT

Once the design aggregate structure is selected, Trial Blend 3 in this case, specimens are compacted at varying asphalt binder contents. The mixture properties are then evaluated to determine a design asphalt binder content.

A minimum of two specimens are compacted at each of the following asphalt contents:

- estimated binder content
- estimated binder content ± 0.5%, and
- estimated binder content + 1.0%.

For Trial Blend 3, the binder contents for the mix design are 4.2%, 4.7%, 5.2%, and 5.7%. Four asphalt binder contents are a minimum in Superpave mix design.

A minimum of two specimens is also prepared for determination of maximum theoretical specific gravity at the estimated binder content. Specimens are prepared and tested in the same manner as the specimens from the "Select Design Aggregate Structure" section.

The following tables indicate the test results for each trial asphalt binder content. The average densification curves for each trial asphalt binder content are graphed for comparative illustration.

Densification Data for Blend 3, 4.2% Asphalt Binder					
Specimen 1			Specimen 2		AVG
Gyrations	Ht, mm	%G _{mm}	Ht, mm	%G _{mm}	%G _{mm}
5	131.3	83.9	131.0	84.7	84.3
8	129.0	85.4	128.8	86.1	85.7
10	127.5	86.4	127.4	87.1	86.7
15	125.4	87.8	125.5	88.4	88.1
20	124.0	88.8	124.2	89.3	89.1
30	122.1	90.2	122.4	90.6	90.4
40	120.9	91.1	121.1	91.6	91.4
50	119.9	91.9	120.1	92.4	92.1
60	119.1	92.5	119.4	92.9	92.7
80	117.9	93.4	118.3	93.8	93.6
100	117.0	94.1	117.4	94.5	94.3
109	116.7	94.4	117.1	94.7	94.6
125	116.2	94.8	116.6	95.1	95.0
150	115.6	95.2	115.9	95.7	95.5
174	115.1	95.7	115.4	96.1	95.9
G _{mb}	2.471		2.481		
G _{mm}	2.582		2.582		

Densification Data for Blend 3, 4.7% Asphalt Binder					
Specimen 1			Specimen 2		AVG
Gyrations	Ht, mm	%G _{mm}	Ht, mm	%G _{mm}	%G _{mm}
5	130.4	85.8	130.8	85.5	85.7
8	128.2	87.2	128.8	86.9	87.1
10	126.8	88.2	127.4	87.8	88.0
15	124.8	89.6	125.5	89.1	89.4
20	123.5	90.6	124.1	90.1	90.3
30	121.5	92.1	122.1	91.5	91.8
40	120.3	93.0	120.8	92.6	92.8
50	119.3	93.7	119.9	93.3	93.5
60	118.5	94.4	119.0	94.0	94.2
80	117.2	95.4	117.9	94.9	95.1
100	116.4	96.1	117.0	95.6	95.8
109	116.1	96.4	116.7	95.8	96.1
125	115.6	96.8	116.2	96.2	96.5
150	115.0	97.3	115.5	96.8	97.0
174	114.5	97.7	115.0	97.2	97.5
G _{mb}	2.503		2.490		
G _{mm}	2.562		2.562		

Densification Data for Blend 3, 5.2% Asphalt Binder					
Specimen 1			Specimen 2		AVG
Gyrations	Ht, mm	%G _{mm}	Ht, mm	%G _{mm}	%G _{mm}
5	132.0	86.0	132.6	85.8	85.9
8	129.8	87.5	130.4	87.4	87.4
10	128.3	88.5	128.9	88.4	88.4
15	126.2	90.0	126.7	89.8	89.9
20	124.8	91.0	125.2	90.9	91.0
30	122.8	92.5	123.2	92.4	92.4
40	121.4	93.5	121.7	93.5	93.5
50	120.3	94.4	120.7	94.3	94.3
60	119.5	95.1	119.9	95.0	95.0
80	118.2	96.1	118.6	96.0	96.0
100	117.3	96.8	117.7	96.7	96.8
109	117.0	97.1	117.4	97.0	97.1
125	116.4	97.6	116.8	97.4	97.5
150	115.8	98.1	116.1	98.1	98.1
174	115.3	98.5	115.6	98.5	98.5
G _{mb}	2.504		2.504		
G _{mm}	2.542		2.542		

Densification Data for Blend 3, 5.7% Asphalt Binder					
Specimen 1			Specimen 2		AVG
Gyrations	Ht, mm	%G _{mm}	Ht, mm	%G _{mm}	%G _{mm}
5	130.4	87.4	131.5	87.2	87.3
8	128.6	88.7	129.4	88.6	88.6
10	127.4	89.5	128.0	89.6	89.5
15	125.4	90.8	126.2	90.8	90.8
20	124.0	91.9	124.9	91.8	91.8
30	122.4	93.1	123.1	93.1	93.1
40	120.5	94.6	121.3	94.5	94.5
50	119.4	95.5	120.2	95.4	95.4
60	118.9	95.9	119.5	96.0	95.9
80	117.6	96.9	118.2	97.0	96.9
100	116.7	97.7	117.2	97.8	97.8
109	116.2	98.1	116.7	98.2	98.2
125	115.4	98.7	115.9	98.9	98.8
150	114.9	99.2	115.5	99.3	99.2
174	114.3	99.7	114.9	99.8	99.8
G _{mb}	2.515		2.518		
G _{mm}	2.523		2.523		

IH-43, 19.0 mm Nominal, Blend 3

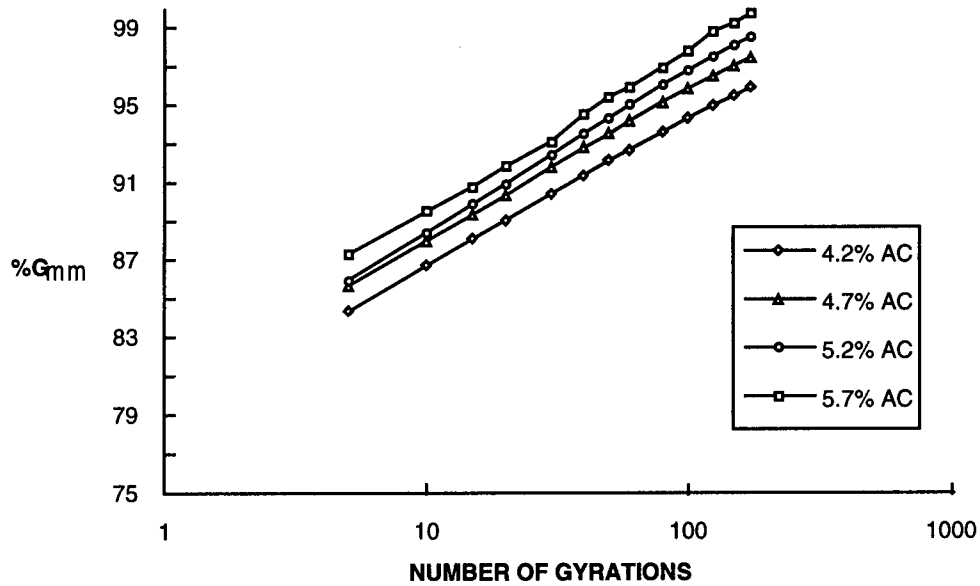

Average Densification Curves for Blend 3, Varying Asphalt Binder Content

Mixture properties are evaluated for the selected blend at the different asphalt binder contents, by using the densification data at N_{ini} (8 gyrations), N_{des} (109 gyrations), and N_{max} (174 gyrations). These tables show the response of the mixture's compaction and volumetric properties with varying asphalt binder contents:

Summary of Blend 3 - Mix Compaction Properties			
%AC	%G _{mm} @ N=8	%G _{mm} @ N=174	%G _{mm} @ N=109
4.2%	85.8%	95.9%	94.5%
4.7%	87.1%	97.5%	96.1%
5.2%	87.4%	98.5%	97.0%
5.7%	88.6%	99.8%	98.1%

Summary of Blend 3 - Mix Volumetric Properties at N_{des}				
%AC	%Air Voids	%VMA	%VFA	Dust Proportion
4.2%	5.5%	13.4%	59.3%	1.10
4.7%	3.9%	13.2%	70.1%	0.89
5.2%	3.0%	13.4%	77.9%	0.78
5.7%	1.9%	13.6%	86.2%	0.70

The volumetric properties are calculated at the design number of gyrations (N_{des}) for each trial asphalt binder content. From these data points, the designer can generate graphs of air voids, VMA, and VFA versus asphalt binder content. The design asphalt binder content is established at 4.0% air voids.

In this example, the design asphalt binder content is 4.7% - the value that corresponds to 4.0% air voids at $N_{des} = 109$ gyrations. All other mixture properties are checked at the design asphalt binder content to verify that they meet criteria.

Design Mixture Properties at 4.7% Binder Content		
Mix Property	Result	Criteria
% Air Voids	4.0%	4.0%
%VMA	13.2%	13.0% min.
%VFA	70.0%	65% - 75%
Dust Proportion	0.88	0.6 - 1.2
%G _{mm} @ N _{ini} = 8	87.1%	less than 89%
%G _{mm} @ N _{max} = 174	97.5%	less than 98%

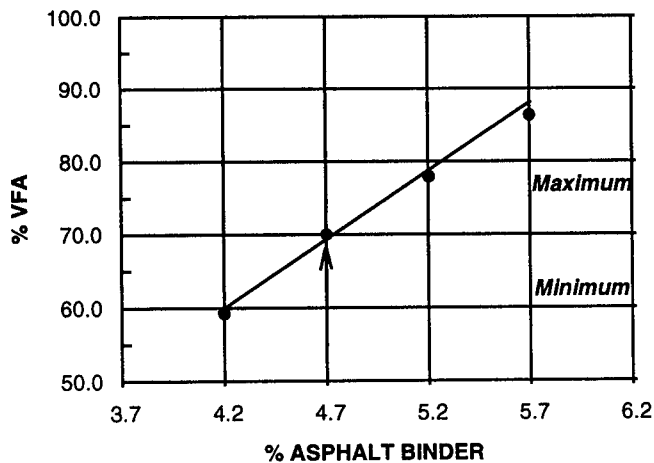
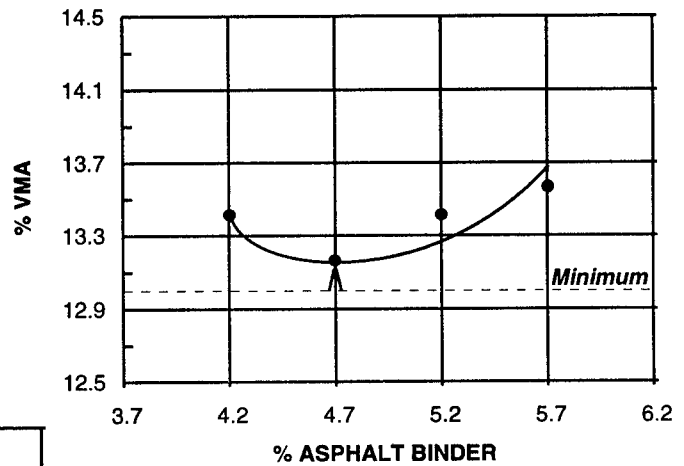
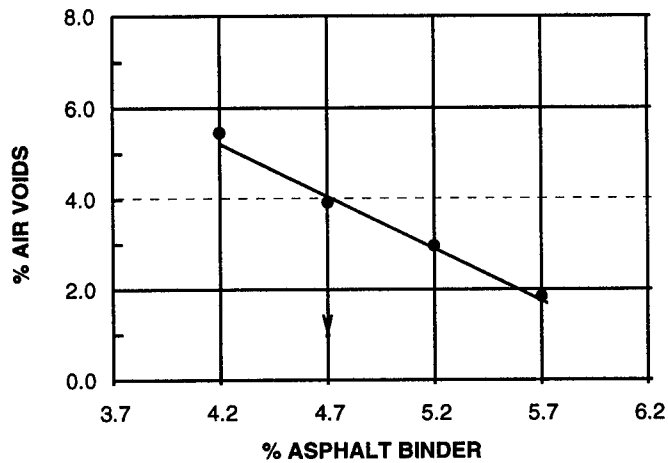

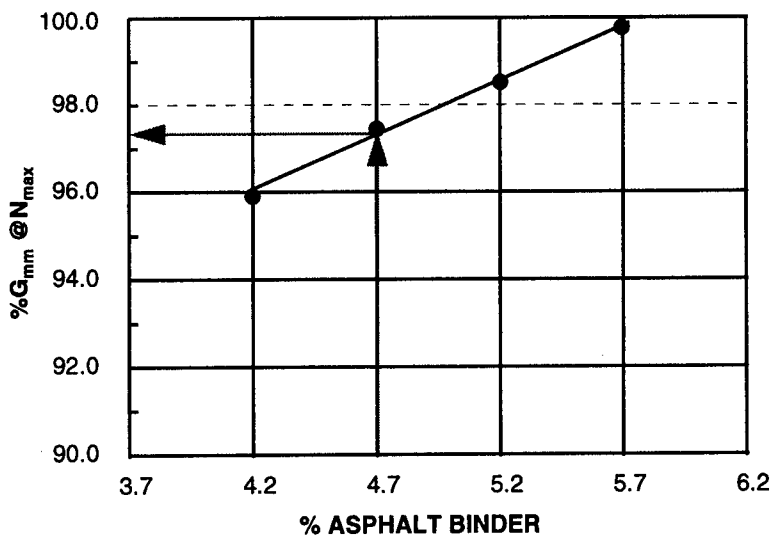
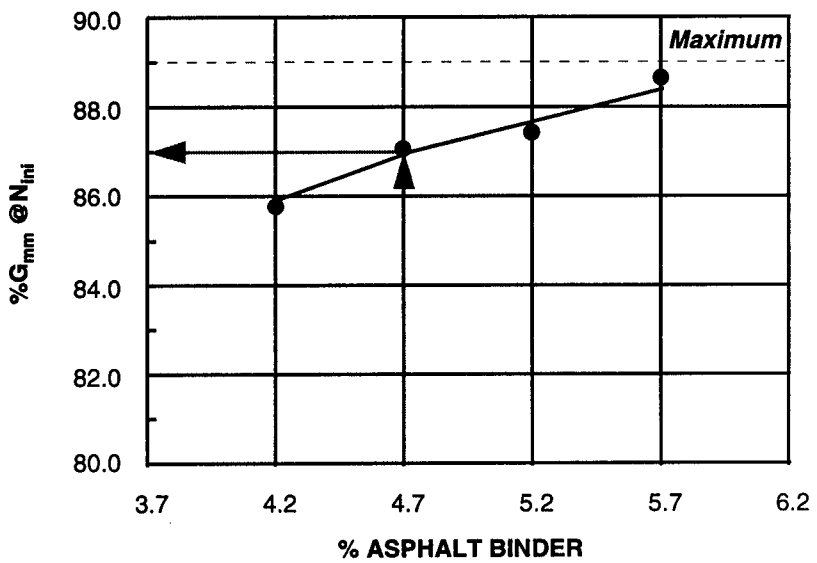
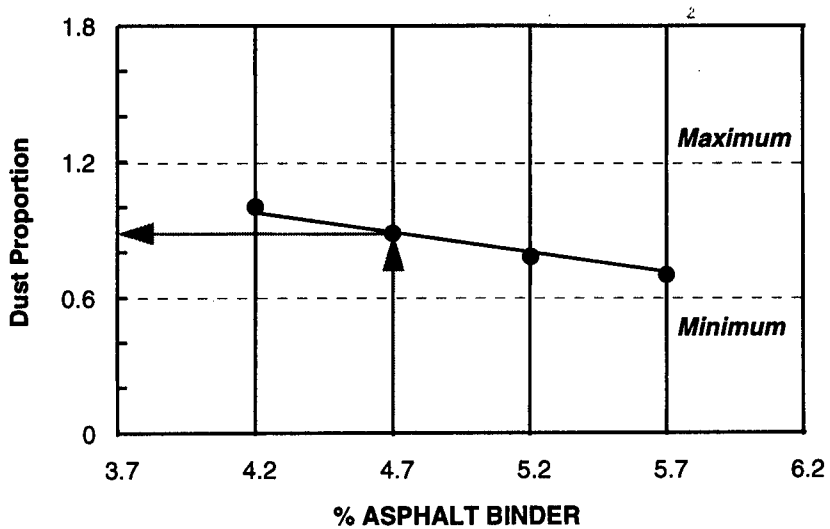

EVALUATE MOISTURE SENSITIVITY

The final step in the Superpave mix design process is to evaluate the moisture sensitivity of the design mixture. This step is accomplished by performing AASHTO T 283 testing on the design aggregate blend at the design asphalt binder content. Specimens are compacted to approximately 7% air voids. One subset of three specimens is considered control specimens. The other subset of three specimens is the conditioned subset. The conditioned subset is subjected to vacuum saturation followed by an optional freeze cycle, followed by a 24 hour thaw cycle at 60° C. All specimens are tested to determine their indirect tensile strengths. The moisture sensitivity is determined as a ratio of the tensile strengths of the conditioned subset divided by the tensile strengths of the control subset. The table shows the moisture sensitivity data for the mixture at the design asphalt binder content.

Moisture Sensitivity Data for Blend 3 at 4.7% Design Asphalt Binder Content							
SAMPLE		1	2	3	4	5	6
Diameter, mm	D	150.0	150.0	150.0	150.0	150.0	150.0
Thickness, mm	t	99.2	99.4	99.4	99.3	99.2	99.3
Dry mass, g	A	3986.2	3981.3	3984.6	3990.6	3987.8	3984.4
SSD mass, g	B	4009.4	4000.6	4008.3	4017.7	4013.9	4008.6
Mass in Water, g	C	2329.3	2321.2	2329.0	2336.0	2331.5	2329.0
Volume, cc (B-C)	E	1680.1	1679.4	1679.3	1681.7	1682.4	1679.6
Bulk Sp Gravity (A/E)	F	2.373	2.371	2.373	2.373	2.370	2.372
Max Sp Gravity	G	2.558	2.558	2.558	2.558	2.558	2.558
% Air Voids(100(G-F)/G)	H	7.2	7.3	7.2	7.2	7.3	7.3
Vol Air Voids (HE/100)	I	121.8	123.0	121.6	121.7	123.4	122.0
Load, N	P				20803	20065	20354
Saturated							
SSD mass, g	B'	4060.9	4058.7	4059.1			
Mass in water, g	C'	2369.4	2373.9	2372.8			
Volume, cc (B'-C')	E'	1691.5	1684.8	1686.3			
Vol Abs Water, cc (B'-A)	J'	74.7	77.4	74.5			
% Saturation (100J'/I)		61.3	62.9	61.3			
% Swell (100(E'-E)/E)		0.7	0.3	0.4			
Conditioned							
Thickness, mm	t"	99.5	99.4	99.4			
SSD mass, g	B"	4070.8	4074.9	4074.8			
Mass in water, g	C"	2373.7	2380.3	2379.0			
Volume, cc (B"-C")	E"	1697.1	1694.6	1695.8			
Vol Abs Water, cc (B"-A)	J"	84.6	93.6	90.2			
% Saturation (100J"/I)		69.5	76.1	74.2			
% Swell (100(E"-E)/E)		1.0	0.9	1.0			
Load, N	P"	16720	16484	17441			
Dry Str. (2000P/(tDp))	S _{td}				889	858	870
Wet Str. (2000P"/(t"Dp))	S _{tm}	713	704	745			
Average Dry Strength (kPa)		872					
Average Wet Strength (kPa)		721					
%TSR		82.6%					

The minimum criteria for tensile strength ratio 80%. The design blend (82.6%) exceeded the criteria. The Superpave volumetric mix design is now complete for the intermediate mixture for IH-43.



VIII: Impact of Superpave on HMA Construction

To meet the Superpave mix design requirements, personnel in the asphalt industry may begin working with materials that are slightly or even drastically different than those they have encountered previously. Although many current sources of materials can be used in Superpave, some may not be acceptable for every design situation and new sources of materials may be required. Binders with different handling characteristics may be specified. Different sizes and size distributions of aggregates from local sources may be required to create appropriate gradations for Superpave mixtures.

Using these new materials has the potential to affect the production and construction characteristics of the resulting mixture. The degree of difference encountered will depend on prior practice. If the commonly used mixes are fine-graded and contain appreciable quantities of rounded sands, more fines, and/or relatively high asphalt contents (which make paving "easy"), significant differences in the overall construction process will be noted. However, if the producer is already familiar with mixes having a high degree of stone-to-stone contact (such as SMA), the differences will not be as pronounced. Depending on climate and traffic, a modified asphalt binder may be selected for the project mixture. If the producer has no experience with modified asphalt binders, adjustments to the construction process may be required.

To foster a complete understanding of what is involved with Superpave mixes, it is strongly recommended that a prepping conference be held with all involved parties. If expected differences in materials characteristics are identified and anticipated in the design process, as well as recognized and communicated in the construction phase, the impact need not be significant.

This section is intended to describe how Superpave mixtures *could* behave differently during some of the phases of construction as well as offer suggestions for modifying current handling operations.

MATERIALS HANDLING AND PLANT OPERATIONS

Superpave mixes may or may not contain components that are different from previous experience. The degree of difference will depend on the composition of current mixes. The asphalt binder, the aggregate sizes or blends, and the material sources may need to be changed. Drastically different materials may require different handling procedures from those routinely used with current ingredients.

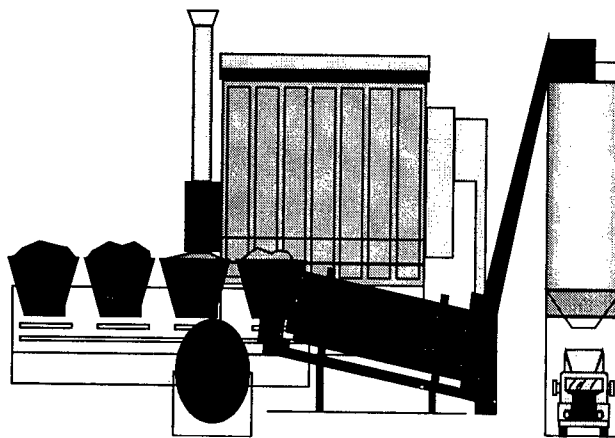

Binders

Depending on the PG grade of the AC/AR/pen graded binders used until now, the new PG-graded binders could impact the construction process in several ways. If a mix producer is involved with multiple projects, the traffic volumes of the different jobs may require that more than one grade of binder be stored at the plant at a given time. Depending on current availability, this variation in binder may create the need for additional storage tanks to provide sufficient on-site production capacity. Even if enough tanks are available, precautions must be taken.

Any material remaining in a storage tank should be purged before adding different binders. Intermixing different grades of PG binders should be avoided. Since there are numerous ways of producing binders of the same PG grade, different formulations of even the same grade may not be compatible and should never be combined in the same tank. The asphalt supplier should be contacted when considering the intermixing of binders.

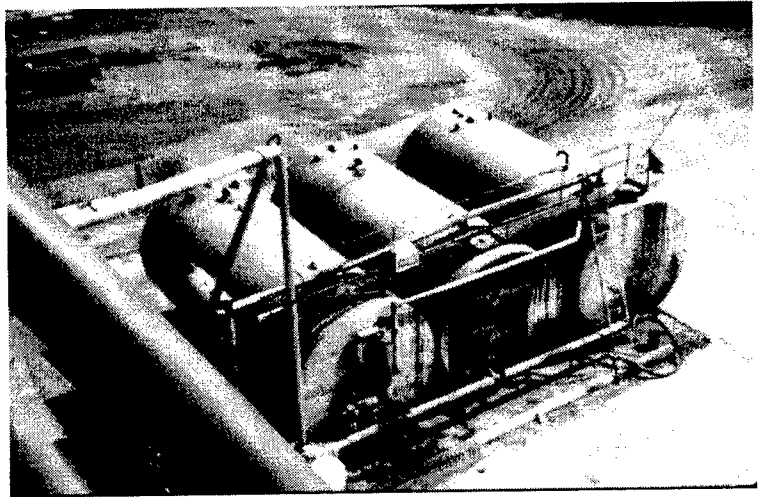

The storage temperature of the asphalt binder may need to be adjusted to facilitate pumping from the storage tank to the mixing chamber. Some PG binders will contain some type of modifier. Generally, less storage time is recommended for modified binders and storage temperatures up to 170°C may be necessary. If the binder is to be stored for more than a few days, some suppliers of modified binders recommend lowering the storage temperature after the first three or four days of storage to prevent thermal degradation of the modifier. Thermal degradation can result in the asphalt binder losing its performance benefits.

Similarly, some means of circulation or agitation of the asphalt within the storage tank may be needed to keep the binder homogenous. In-place horizontal tanks can be adapted with additional mixers in existing manholes. If additional tanks are considered, vertical tanks generally work more efficiently and have less "stagnant zones" in the circulatory flow pattern.

If allowed by the agency, an in-line blending process may sometimes produce PG binders. In-line blending will typically occur in a "mixing unit" installed in the asphalt supply line. Sampling valves should be located downstream of the mixing unit where blending occurs. For this situation, an understanding of the details regarding blending procedures, reaction time, sampling, testing, and acceptance is needed.

Overheating can be a problem for all asphalt binders; however, for some polymer-modified binders, contact with super-heated surfaces (greater than 200°C) should be avoided to prevent thermal degradation. Therefore, tanks with hot-oil heated coils are strongly recommended over tanks that use direct-fired burners.

Common asphalt cement additives such as silicone or liquid anti-stripping agents may change the performance characteristics of any binder. The incorporation of these additives may change the high-temperature portion of the PG classification of marginally graded binders enough to cause the resulting binder to "go out of grade". This becomes more of a consideration when the additives are introduced into the binder at the mixing plant. The blended asphalt may be used before it can be tested. It is important that the specifier and the contractor mutually agree on how these kinds of additions will be managed.

In any case, the binder supplier should be contacted for instructions regarding storage temperature and time, required circulation, introduction of additives, and any other product-specific needs.

In order to reduce delays while PG binders are being tested for approval, many agencies have adopted procedures for binder suppliers to certify their material. AASHTO PP26, *Standard Practice for an Approved Supplier Certification System for Suppliers of Performance-Graded Binders*, contains standardized procedures developed by industry and agency personnel. It is recommended that all parties become familiar with the binder approval requirements.

Aggregates

Different aggregate types, shapes, sources, sizes, or combinations may be necessary to meet Superpave requirements. These materials may have different properties that could change the construction characteristics of the mix.

In order to meet all Superpave mix design requirements, several different types or sizes of aggregates may have to be blended. Depending on current capacity, this may call for having additional stockpiles and more cold-feed bins. The type of crusher used to process the aggregate can affect particle shape, which can ultimately influence the VMA. Cubical-shaped particles are preferred in Superpave mixes. The particle shape may be improved by utilizing a different type of crusher.

The blend chosen as the design aggregate structure may also handle differently through the plant. Minor modifications in drying time, screening rate, hot bin balance, mixing time and temperature, etc., should be recognized. Since the aggregates used in Superpave mixes are required to be "clean", any differences observed may be a positive improvement. The drying time may be reduced and the screening rate for batch plants may be improved. The hot bin balance will depend on how closely the cold-feed aggregates match the design aggregate structure. If there are sizable discrepancies between the anticipated grading of the individual aggregates and the selected final blend, the hot bins will be unbalanced, and some wasting of unneeded aggregate fractions will be necessary.



Mixtures

In general, experience has shown that Superpave mixes are produced like commonly used mixes. Differences in how the Superpave mixture handle through the plant will obviously depend on how much changed in the mixture specifications. Changes in production rate and the effect on motors, baghouse, potential for segregation, etc., may need to be considered.

For example, because Superpave mixes use substantially greater amounts of coarse aggregate (4.75mm to 19mm), slightly larger screens may be needed on the screen deck to maintain production rates. Higher concentrations of coarse aggregate can cause less veiling of aggregate in the drum, possibly resulting in increased stack temperatures. Mixes having these characteristics can be successfully produced as demonstrated by the routine production of open-graded mixes.

Differences encountered with Superpave mixes can be positive. If clean, low-absorptive aggregate is used, the loads on motors and the dust collection system may actually be reduced and the production rate increased.

Segregation at the Plant

Typically, Superpave mixes will have a higher concentration of coarse aggregate than some conventional mixes. As a result, these mixes may be more prone to segregation than finer-graded mixes. However, segregation may not be as noticeable if the mix is uniformly coarse. Precautionary steps to minimize segregation throughout the plant-related operations should be implemented if they are not part of the current process.

The aggregate stockpiles should be constructed in the proper manner in uniform layers and to a maximum layer depth of four to five feet. The aggregate must be removed from the stockpile and placed (not dropped) into the cold-feed bins in such a way that the material is not segregated. The coated mix should be handled carefully. Conveyors should be aligned so that they do not toss and segregate the particles. If a surge-bin is used, the batcher (or other means of charging the bin) should be timed and operated to drop the material as a single, large mass within the silo.

The loading of the mix into the truck must be done properly. The mix should not be trickled into the truck; it should, again, be dumped in a mass. With surge storage, enough mix should be in the bin or silo to load the truck before starting the loading process. The drops within the truck bed should be positioned to limit the opportunities for larger particles to roll away from the mass. The initial drops should be positioned against the front and back of the truck bed, and then, subsequent drops should be made against the earlier drops.

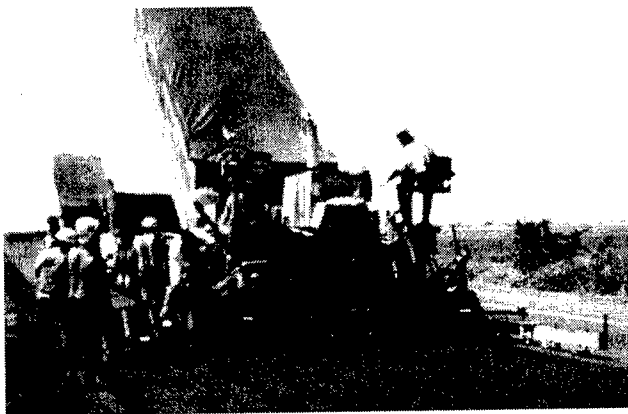
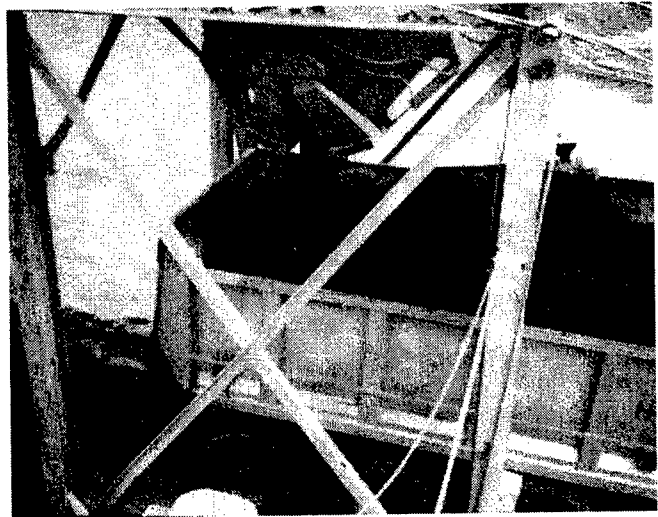

Modified binders will be stiffer than straight run asphalt, so retention of heat to facilitate workability and compaction is important. Covering the truck beds with tarps or insulating the trucks will help minimize the loss of heat.

Quality Control Operations

In selecting the Superpave gyratory compactor as the compaction device for use in the Superpave system, SHRP listed suitability for field quality control (QC) operations as a main concern. By the end of SHRP, many states had implemented, or had considered implementing, verification of the volumetric properties of the asphalt mixture. Therefore, it was necessary that the compaction device for the new mix design and analysis system be useful not only in mix design, but also in field quality control operations. The researchers believed that the Superpave gyratory compactor (SGC) would meet these needs.

Virtually every Superpave test section built since the first projects in 1992 had some form of field quality control testing involving the Superpave gyratory compactor. In 1993, a national research project, NCHRP 9-7, was authorized to study field procedures and equipment to implement the SHRP asphalt research. This research will provide recommendations for field quality control testing of Superpave mixtures. In addition, the Federal Highway Administration-sponsored asphalt trailers have provided Superpave field quality control testing assistance.



Although a definitive quality control program has not yet been developed, several key answers to the question of Superpave field quality control testing have been answered. Essentially, Superpave contractor quality control procedures should be very similar to current quality control testing programs. Determination of asphalt content and gradation will remain necessary components of a quality control testing program. Superpave has done nothing to dispel or lessen the necessity of these tests. Determination of asphalt mixture volumetric properties remains a key issue. The main difference in the Superpave QC program and conventional QC programs lies in determination of volumetric properties.

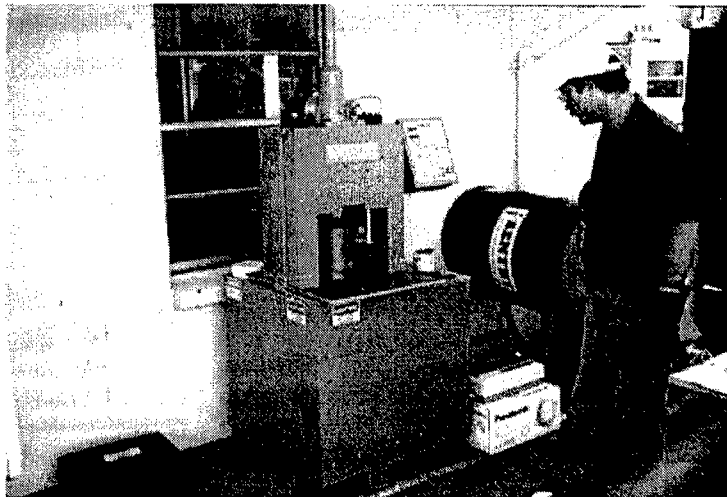

In the Superpave system, a sample will consist of a minimum of two specimens compacted using the Superpave gyratory compactor. Current Marshall QC testing plans generally require a minimum of three compacted specimens. The time required for compacting two SGC specimens is approximately the same as the time required for three Marshall specimens. Two SGC specimens are considered sufficient since studies have indicated that the bulk specific gravities of the SGC specimens have a smaller standard deviation than the Marshall specimens. No additional aging of the asphalt mixture is necessary in the Superpave system.

Once compacted, volumetric analysis is the same for SGC specimens as with Marshall specimens. A noted disadvantage of the SGC is that the specimens are much larger; approximately four times the mass of a Marshall specimen. The larger specimens will require longer to cool than the Marshall specimens, thereby slowing the ability to determine the bulk specific gravity of the compacted specimen. This in turn slows QC test results. Consequently, some researchers are attempting to devise a quicker turnaround time on test results.

None of the SHRP research or subsequent Superpave implementation research addressed the frequency of sampling. It is assumed that sampling and testing frequency will remain the same using Superpave as with conventional mixtures.

PAVING AND COMPACTION

Superpave mixes may also handle somewhat differently than current mixes during the paving and compaction operations. Some of the potential concerns with Superpave mixes, if coarser than the norm, include: minimizing segregation, lessening tender mix problems, limiting hand-working or raking, and achieving density.

Segregation at the Paver

Superpave mixes are not inherently prone to segregation, but some of the design requirements lead to aggregate choices that can be susceptible to segregation. Typically, for projects with heavy traffic, the design aggregate structure of a Superpave mix will contain a relatively high concentration of coarse aggregate. Or, some specifiers may elect to use a mix having a larger maximum size aggregate than the mix that is routinely used. These situations can contribute to the potential for segregation to occur if proper construction practices are not followed.

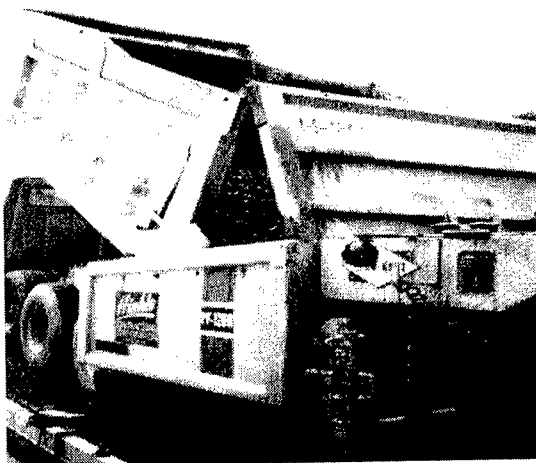
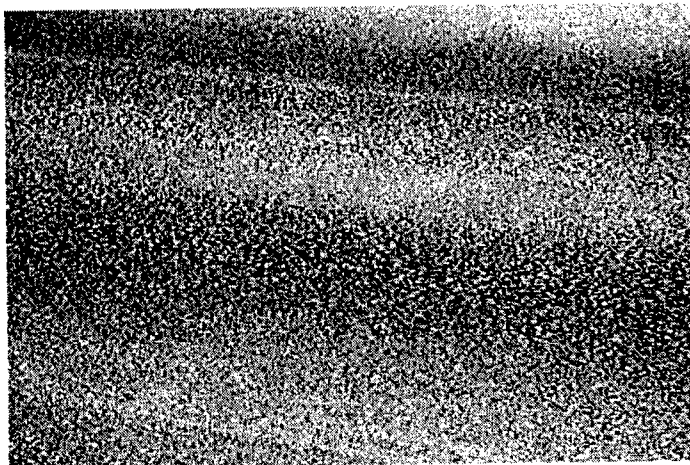

In addition to the guidelines described previously for materials handling at the plant, standard precautions for handling the mix at the paving site apply. Minimizing segregation on-site begins with correctly unloading the trucks. The mix must be removed from the truck in mass rather than allowing the mix to trickle into the paver hopper from the truck. Truck beds should be lifted slowly to allow the mix to slide back against the tailgate before opening the gate to allow mix to drop into the paver hopper.

The commonly heard warning, “do not dump the hopper wings”, is also appropriate for Superpave mixes. Similarly, the normal recommended practices of keeping an adequate depth of mix in the hopper, feeding sufficient material to the auger, etc., are also applicable. A materials transfer vehicle helps to minimize segregation by “reblending” multiple truckloads of mix as well as maintaining a constant supply of mix to the paver. The quality of the mat may be improved by including such a device in the paving process.

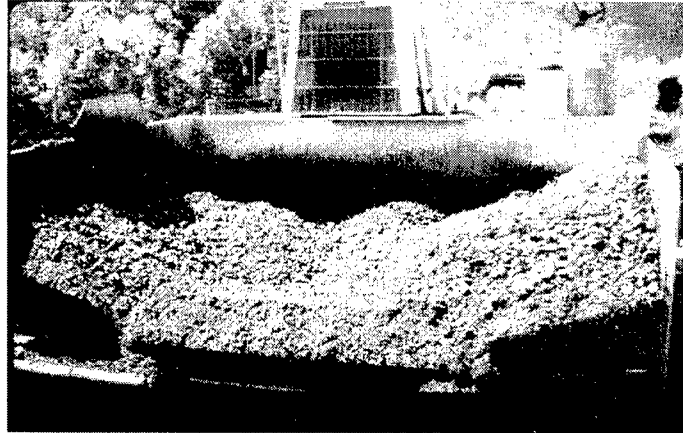

Paver Operations

Some adjustments to the normal operating settings of the paver may be necessary when constructing a Superpave pavement. In particular, the normal operation of the paver screed may be different with Superpave mixes. The same stiffer mix properties that improve rutting resistance are also likely to cause the Superpave mix to be more resistant to easy placement. Typical adjustments may include changing the vertical angle of the screed plate slightly or increasing the effort of the compacting mechanism (vibratory, tamping-bar, etc.) of the screed. If the Superpave mixtures are coarser than typically used, lift thickness may need increasing to ensure a smoothly constructed mat.

Handwork and Joint Construction

The specified properties of Superpave mixes (stiffer binders, higher concentrations of coarse aggregate, more angular coarse aggregate, less rounded sand, etc.) that contribute to the improved rutting resistance may also cause the mix to be more difficult to lute or otherwise work by hand. It is recommended that any handwork be kept to a minimum. Similarly, the relatively coarse aggregate structure selected for some Superpave mixtures may make the construction of a dense, low-permeability longitudinal joint more difficult than for finer graded mixes.

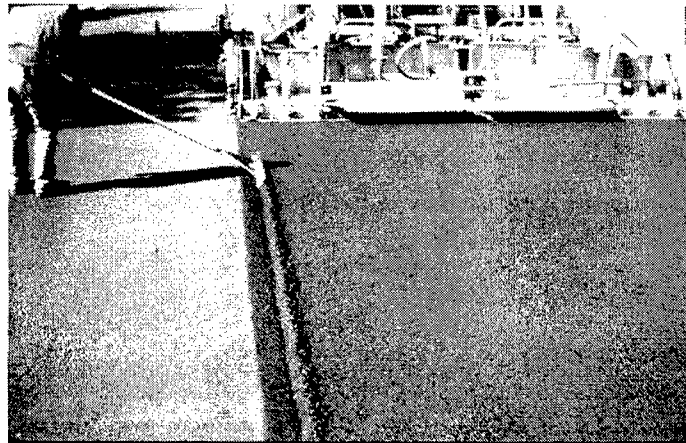

Compaction

Superpave mix design requirements emphasize the use of clean aggregate and proper volumetric properties. Early experience with some Superpave mixes has shown that some users are designing mixes that have a relatively high VMA. In order to meet the air voids requirements, high binder contents

are used with these mixes. This results in a mix that is well lubricated and potentially tender despite meeting all Superpave criteria.

An extremely over-asphalted mixture could potentially be subject to asphalt draindown like that sometimes experienced with SMA mixtures. The designer should re-evaluate any mix that appears to have an unusually high VMA and determine if the grading can be revised to achieve a mix that is less susceptible to tenderness and potentially less expensive to produce. It is strongly recommended that asphalt content, VMA, and VFA be reviewed in terms of handling and construction as a final step of every mix design.

It is also possible that a Superpave mix will be tougher than current mixes. If the local mix generally contained excessive amounts of medium to fine-sized sands (such that the gradation plotted through or above the restricted zone), it may have been easier to place or even tender during rolling. These mixtures may have been compacted by allowing the mat to cool before the application of the rollers. Eliminating the excess sand to meet Superpave requirements may improve the compactability and resolve the tenderness issue.

Due to their relative coarseness, Superpave mixes may be somewhat more difficult to compact than fine-graded mixes. It is strongly recommended that a test strip be constructed to establish the optimal rolling pattern. The optimum type, size, and number of rollers and their operating patterns should be determined prior to mainline paving. In general, experience has shown that compaction of most Superpave mixes is best achieved by keeping the breakdown roller immediately behind the paver. The amount of time available to compact a Superpave mix before it stiffens and becomes

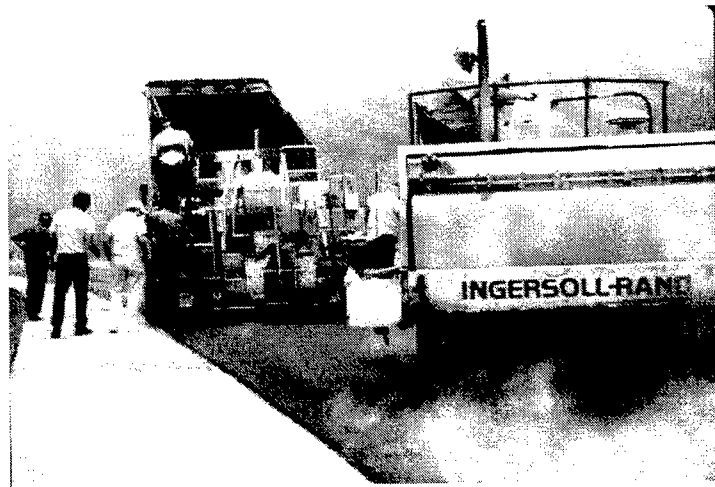

extremely difficult to compact may be less than for commonly used mixes. To facilitate compaction, thicker courses of Superpave mixes may be necessary to retain heat and maintain the workability.

If the PG binder contains a modifier, exercise care with the use of pneumatic rollers. These binders are usually very sticky and tend to adhere to the rubber tires of the roller even when properly heated. This tackiness can cause pickup of particles from the freshly placed mat. For base courses, this problem may be tolerable, but pneumatic rollers are best avoided when compacting surface mixes containing polymer modifiers.

Conclusion

Some Superpave mixes may handle and respond somewhat differently from the present experience with some current mixes; however, with communication, planning, and attention to good construction practices, these mixes can deliver the superior performance they were designed to provide.

IX. Superpave Mix Analysis and Testing

Superpave volumetric mix design is the key step in developing a well-performing HMA mixture. Under SHRP, additional laboratory analysis tests and material performance models were developed to further determine the capabilities of Superpave mixtures to perform well for the specific project design traffic and climatic condition. This chapter describes the benefits that can be derived from conducting Superpave Mix Analysis and discusses the system of models and test procedures currently being evaluated/refined.

THE GOAL OF SUPERPAVE MIX ANALYSIS

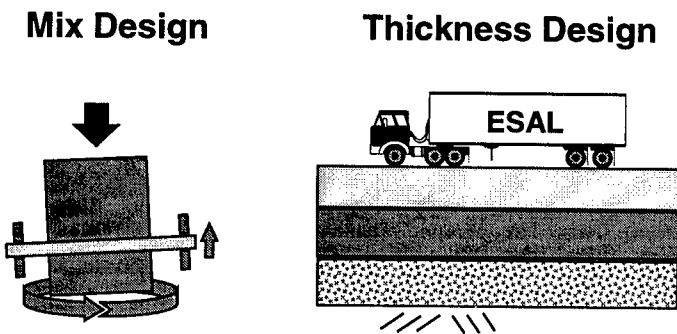

Superpave Mix Analysis would ideally allow us to truly link the design of the asphalt mixture with the design of the pavement cross-section. Currently, most highway agencies perform these functions in completely different departments that rarely interact. In reality, these two tasks are so well connected, that it may be much more effective to integrate the design process.

The Ultimate Link !

Mix behavior and performance are greatly affected by the conditions that exist at the specific project. "Standard" mix designs should not be used for all circumstances because the best mix for one location may be the worst mix for another. Conditions such as the predominant type of wheel loads, the climate, the thickness of the new layer, and the type of structural support (soft or hard, asphalt or concrete) affect mix selection. A truly integrated mix analysis system would provide us with the capability to understand, evaluate, and optimize these factors.

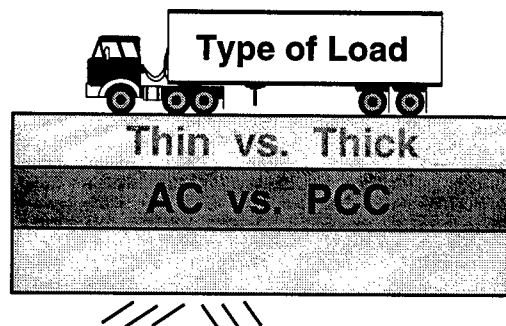

SHRP MIX ANALYSIS DEVELOPMENTS

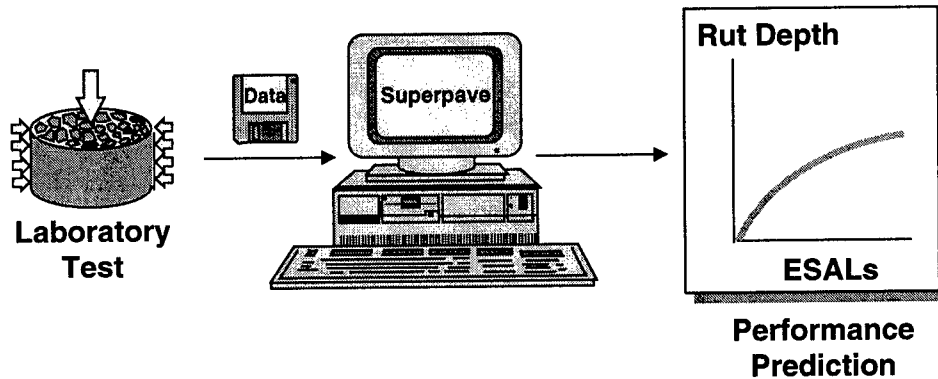

The framework of the Superpave asphalt mix analysis system that was developed under SHRP includes a system of analytical pavement performance models that take results from laboratory tests and determine if the design mixture would perform under the design conditions. Several test procedures were developed to impose various stress and temperature conditions to asphalt mixture specimens to characterize the many properties necessary to model pavement behavior. SHRP developed two performance test devices: the Superpave Shear Tester (SST) and the Indirect Tensile Tester (IDT).

Recently, the University of Maryland critically evaluated the original SHRP analytical models under an FHWA contract. Some concerns and suggestions for improvement were documented in a Models Evaluation Report. As a result of the models evaluation, changes will be made in the system that was developed under SHRP. What the extent of these changes will be and what the final Superpave Mix Analysis System will look like can only be conjectured at this point. However, the basic performance analysis framework and the test equipment that were developed under SHRP are still valid, and are discussed further in this section.

Performance Models

While much attention in SHRP was focused on the new test equipment and testing protocols, a key ingredient for using the test results were the performance models. These models are the mathematical theory and equations that process the laboratory measurements and provide output in the form of predicted pavement performance. The models are needed to determine the properties of the new asphalt mixture being designed and to incorporate the conditions of the existing climate and support of the in-place pavement in the analysis. The use of mix analysis testing and performance prediction models represents an important new capability for engineers in designing and optimizing pavements.

The modeling framework established by SHRP uses four basic components:

- material property model,
- environmental effects model,
- pavement response model, and
- pavement distress model.

Laboratory test results (loads and deflections recorded over time) can be used as input to the material property model to determine various properties, such as non-linear elastic, viscoelastic, plastic, and fracture. The environmental effects model calculates the pavement temperature as a function of air temperatures available in a database, depth, and thermal properties assumed for the pavement layers in the cross-section. These temperatures are used to adjust the material properties for the various seasons of the year.

The pavement response model uses the properties from the material property and environmental effects models to predict stresses and strains caused by traffic (fatigue cracking and rutting) or climatic changes (low temperature cracking) at critical locations within the layered pavement system. These calculated responses and adjusted material properties may then be used by the pavement distress model to predict rutting, fatigue, and low temperature cracking as it occurs with time or number of traffic repetitions. This framework is illustrated graphically below; although some of the modeling will be revised in the future, the overall approach is still valid and appropriate.

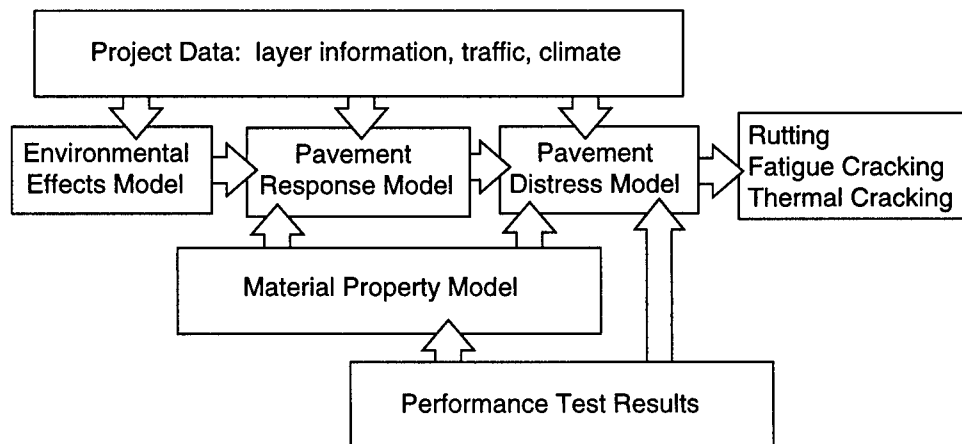

The models evaluation determined that the low temperature cracking model was basically sound, while the modeling for the load-related fatigue cracking and permanent deformation portions of the system will probably change. Even so, the overall mechanistic principles documented in the SHRP reports for how these different distresses form in the pavement still apply. For this reason, the concepts of distress predictions will only be highlighted in this course text.

PERMANENT DEFORMATION

The development of permanent deformation or rutting can be separated into three distinctive phases, when plotted on log-log scale. Initially, the mix in the pavement typically compacts an initial, small amount immediately after construction. Then, the pavement usually compacts gradually for many load repetitions. Because this portion plots as a straight line on log-log scale, it is also referred to as linear deformation. If the mixture is stable, this linear range will continue indefinitely.

However, if the mixture densifies to a point of low air voids during secondary compaction, about two to three percent, the mix may become unstable and deform "plastically". This condition is known as *tertiary flow* and it occurs when there is too much binder for the aggregate structure of the mix. In tertiary flow, an asphalt mixture exhibits extreme plastic flow with very few load applications as shown in the figure. The modeling of permanent deformation is difficult because of the many types of behavior and material properties that are involved. This will be a challenge for a future research contract.

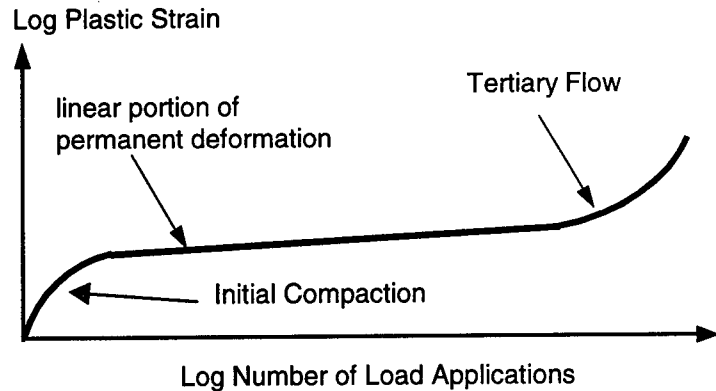

FATIGUE CRACKING

The approach to modeling fatigue cracking is divided into two stages:

- crack initiation caused by repeated bending under load
- crack propagation through the entire layer by fracture due to repeated loads causing high stress at the crack tip

The classical theory for fatigue cracking is that the layer begins to crack at the bottom and the crack propagates upward with increasing numbers of load repetitions. However, more recent observations appear to indicate that some fatigue cracking may also initiate at the top of the layer, near the edge of the tire or wheel path, and then propagate downward. A future research contract will be developing the models to consider both types of fatigue distress.

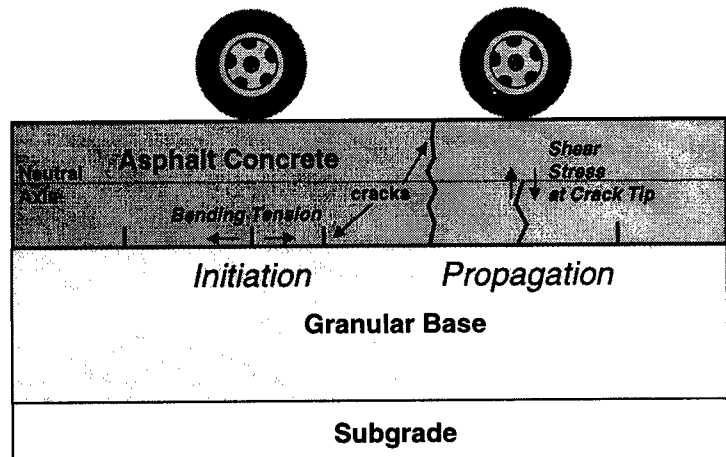

LOW TEMPERATURE CRACKING

At very cold temperatures, the asphalt mixture tries to contract. Because the layer is somewhat “bonded” to the underlying layers, the asphalt layer shrinkage is restrained. This resistance causes tensile stresses to build up in the asphalt layer. If these stresses continue to increase and do not diminish through “relaxation”, the tensile strength of the mixture may be exceeded, causing a *low temperature crack* to occur. This crack usually begins at the top of the layer, where the tensile stress is the greatest, and propagates downward until the layer is completely “fractured”. Normally, these cracks are spaced far apart initially; however, in a severe condition, these cracks may occur at regular intervals of 6 to 30 m.

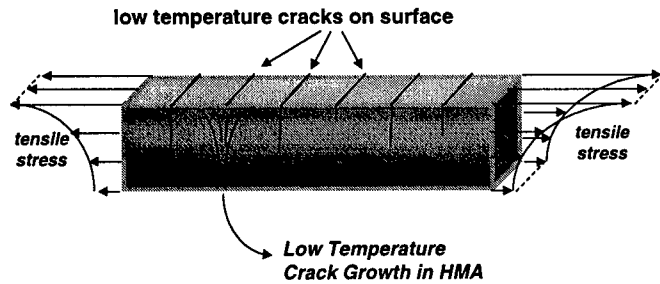

For this modeling, Superpave uses a property called the relaxation modulus and an m-value, similar to the binder specification, to predict:

- stress in the layer due to cold weather contraction
- growth of the crack and ultimate fracture in the layer

Superpave Test Procedures

Two mechanical test devices were developed under SHRP: the Superpave Shear Tester (SST) and the Indirect Tensile Tester (IDT). The original Superpave mix analysis procedures used the results from tests in these equipment to determine the extent of permanent deformation, fatigue cracking, and low temperature cracking that would develop under the project conditions. Depending on the traffic level, either an intermediate or complete analysis of the design mixture would be performed. An intermediate analysis could be used for traffic levels up to ten million ESALs. A complete analysis would be used for heavily trafficked pavements, those exceeding ten million ESALs.

This table describes the original Superpave mix analysis test procedures. All of these tests would be performed for the evaluation of a mix used in a new pavement. If an overlay were being designed, only the permanent deformation tests would be conducted. The difficulty in differentiating reflective cracking from fatigue and low temperature cracking precluded their evaluation for overlays.

Superpave Mix Analysis Testing			
Type of Analysis	Type of Distress		
	Permanent Deformation	Fatigue Cracking	Low Temperature Cracking
Intermediate	Simple shear test at constant height. Frequency sweep test at constant height. Repeated shear test at constant stress ratio	Simple shear test at constant height. Frequency sweep test at constant height. Indirect tensile strength.	Indirect tensile creep compliance. Indirect tensile strength. Binder creep stiffness (S) and creep rate (m).
Complete	Frequency sweep test at constant height. Uniaxial strain test. Volumetric test. Simple shear test at constant height. Repeated shear test at constant stress ratio	Indirect tensile strength.	Indirect tensile creep compliance. Indirect tensile strength. Binder creep stiffness (S) and creep rate (m).

Superpave Mix Design

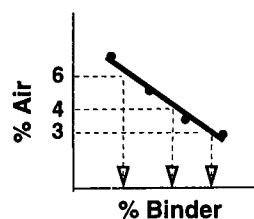

Superpave mix analysis testing is usually performed on specimens compacted at multiple asphalt binder contents. Typically, the binder contents are selected based on the results of the Superpave Mix Design. For tests concerned with permanent deformation, fatigue cracking, and low temperature cracking, binder contents that result in three, four, and six percent air voids at N_{des} are selected to cover the possible range.

Superpave Mix Analysis test specimens are cut from taller compacted specimens that are fabricated in the SGC to a specific height using fewer gyrations to achieve test specimens containing approximately seven percent air voids. In the testing used for permanent deformation and fatigue cracking, two replicate specimens are prepared. In the testing conducted for low temperature cracking, three replicate specimens are required by the modeling software.

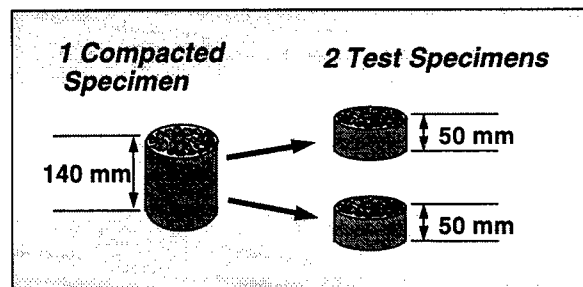

SUPERPAVE SHEAR TESTER

The SST is a closed-loop feedback, servo-hydraulic system that consists of four major components: the testing apparatus, the test control unit and data acquisition system, the environmental control chamber, and the hydraulic system.

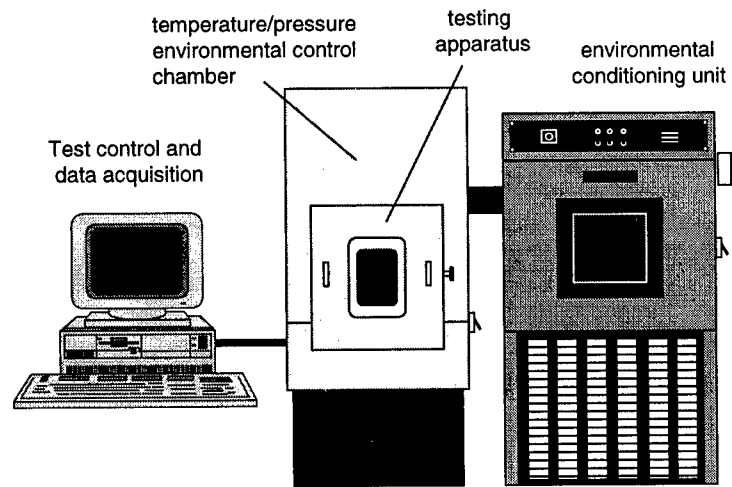

The testing apparatus includes a reaction frame and shear table. It also serves to house the various components that are driven by other system components such as temperature/pressure control, hydraulic actuators, and input and output transducers. The reaction frame is extremely rigid so that precise specimen displacement measurements can be achieved without worrying about displacements from frame compliance. The shear table holds specimens during testing and can be actuated to impart shear loads.

The test control unit consists of the system hardware and software. The hardware interfaces with the testing apparatus through input and output transducers, and it consists of controllers, signal conditioners, and a computer and its peripherals. The software consists of the algorithms required to control the testing apparatus and to acquire data during a test.

Linear variable differential transducers (LVDTs) are affixed to specimens and measure the response of specimens to applied testing loads. The LVDTs make it possible for the system to also operate in a closed loop feedback mode, which means that LVDT signals are used to control applied testing loads.

The environmental control unit is required to control the temperature and air pressure inside the testing chamber at a constant level. The unit is capable of maintaining temperatures within a wide range from 1° to 80° C. Air pressure and the rate of pressure change within the chamber is precisely controlled. Air pressure is normally applied at a rate of 70 kPa per second, up to a maximum value of 840 kPa. This is achieved by storing compressed air in separate storage tanks that can be emptied into the testing chamber at the required rate. Air pressure provides specimen confinement for two of the six tests.

The hydraulic system provides the force required to load specimens in different testing conditions. A hydraulic motor powers two actuators, each with a capacity of approximately 32 kN. The vertical actuator applies an axial force to test specimens. The horizontal actuator drives the shear table, which imparts shear loads to the specimen.

Specimen Preparation and Instrumentation

The first step in specimen preparation is to trim test specimens to a thickness of 50 mm. For the three tests that require no confining pressure, the specimen is glued between two platens.

A gluing device is used to squeeze the specimen between the platens while the glue cures. Epoxy glue such as Devcon Plastic Steel is used. The gluing device rigidly holds the platens and specimen to ensure that the platen faces are parallel.

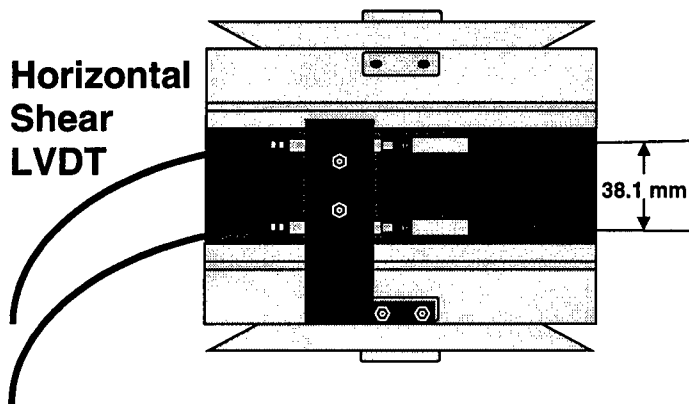
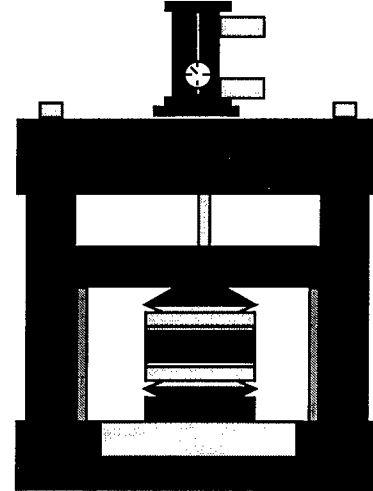

After the glue has cured, four screws are affixed to the side of the specimen using a gap filling variety of cyanoacrylate glue. These screws are used to affix the bracket that holds the horizontal LVDT. Axial LVDTs are affixed to the platens.

A different specimen configuration is used for confined tests. Test specimens are still placed between platens. However, no glue is used. A rubber membrane surrounds the specimen. A collar that surrounds the perimeter of the specimen affixes the radial LVDT. Axial LVDTs are affixed to the platens.

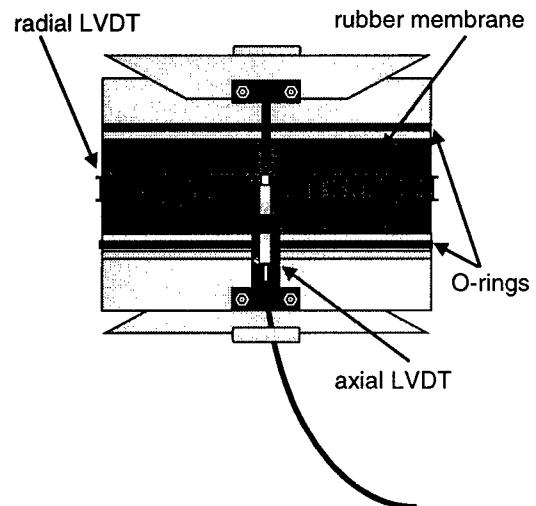

Test Procedures

Six tests are performed using the SST:

- volumetric test,
- uniaxial strain test,
- repeated shear test at constant stress ratio,
- repeated shear test at constant height (not required by Superpave),
- simple shear test at constant height, and
- frequency sweep test at constant height.

The volumetric and uniaxial strain tests use confining pressure. These two tests are performed to provide additional stress states for a complete analysis. Repeated shear at constant stress ratio, simple shear at constant height, and frequency sweep at constant height tests are used in both intermediate and complete analysis. The repeated shear test at constant height is a stand-alone test that can be used for rut depth estimation and it is not a part of the Superpave mixture design and analysis system. A brief description of each test follows. A full description of the test procedures can be found in AASHTO TP7 "Test Method for Determining the Permanent Deformation and Fatigue Cracking Characteristics of Hot Mix Asphalt (HMA) Using the Simple Shear Test (SST) Device"

Volumetric Test

The volumetric test is one of two tests that use confining pressure. The volumetric test results are used for permanent deformation and fatigue cracking analysis in a complete analysis. It is performed at three temperatures and pressures:

Volumetric Test Parameters	
Temperature, °C	Pressure, kPa
4	830
20	690
40	550

The test is performed by increasing the confining stress at a rate of 70 kPa per second up to the values shown and measuring the circumferential or radial strain using the radial LVDT. This figure shows the change in confining pressure versus time during the volumetric test at 20° C.

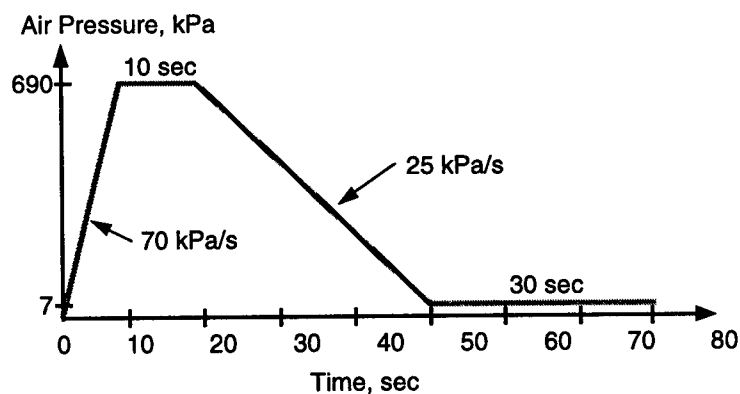

Uniaxial Strain Test

The uniaxial strain test also uses confining pressure. The uniaxial test is used for permanent deformation and fatigue cracking analysis in a complete analysis. In this test, axial stress is applied to the test specimen and the specimen tries to increase its circumference. A radial LVDT senses this change in circumference and air pressure is applied so that the circumference remains constant. As such, the signal from the radial LVDT is used as feedback for the purpose of applying confining pressure to prevent radial deformation. Three axial stress levels are used depending on the test temperature:

Uniaxial Strain Test Parameters	
Temperature, °C	Axial Stress, kPa
4	655
20	550
40	345

Confining pressure is measured throughout the test. Axial deformation is measured on both sides of the specimen by the vertical LVDTs. Axial load is also measured. Radial deformation is also measured although it should be relatively small. This figure shows the application of axial stress during the test.

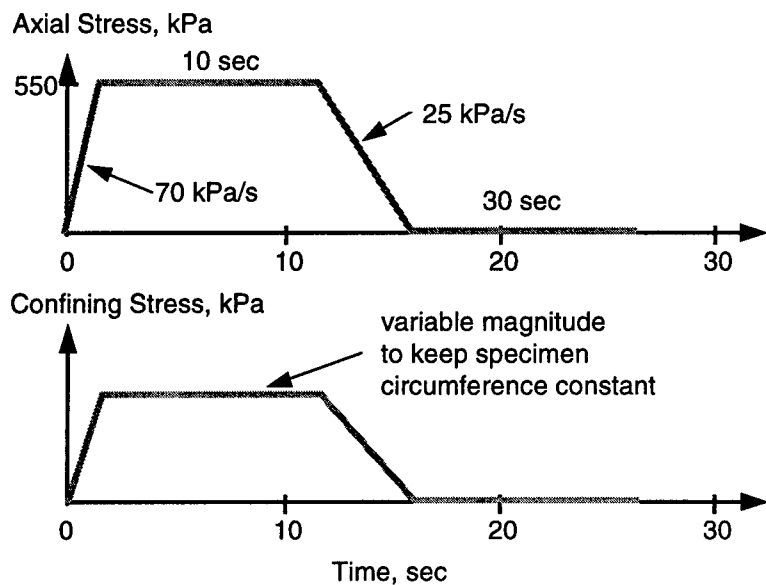

Repeated Shear Test at Constant Stress Ratio

The repeated shear test at constant stress ratio is performed for either an intermediate and complete analysis as a screening test to identify an asphalt mixture that is subject to tertiary rutting. This form of rutting occurs at low air void contents and is the result of bulk mixture instability.

In this test, repeated synchronized haversine shear and axial load pulses are applied to the specimen. The 0.7-second load cycle consists of a 0.1-second load followed by 0.6-second rest period. Test specimens are subjected to a varying number of load cycles in the range from 5000 to 120,000, depending on the traffic level and climate conditions or until accumulated permanent strain reaches five percent. The ratio of axial to shear stress is maintained constant in the range from 1.2 to 1.5. The magnitude of stresses is selected to simulate actual in-place stresses that will be encountered by the mixture.

The test temperature used is called the control temperature (T_c) for permanent deformation. It is computed by Superpave as a function of the project traffic conditions and climate. The test is typically performed at high asphalt contents corresponding to three percent air voids, which is the extreme condition for tertiary rutting. During the test axial and shear loads and deformations are measured and recorded.

Repeated Shear Test at Constant Height

This test is performed as an option to intermediate or complete analysis to estimate rut depth and is not a required by Superpave. A haversine shear load is applied to achieve a controlled shear stress level of 68 kPa. When the repeated shear load is applied, the test specimen seeks to dilate. The signal from the axial LVDT is used as feedback by the vertical actuator to apply sufficient axial load to keep the specimen from dilating.

A load cycle consists of 0.7-second, which is comprised of 0.1-second shear load application followed by 0.6-second rest period. Test specimens are subjected to 5000 load cycles or until the permanent shear strain reaches five percent. The test temperature used is T_{max} , which is the seven-day maximum pavement temperature at 50 mm depth. During the test, axial and shear loads and deformations are measured and recorded.

Simple Shear Test at Constant Height

This test is used for permanent deformation and fatigue cracking analysis in intermediate or complete analysis. A controlled shearing stress is applied to a test specimen, causing the specimen to dilate and increase in height. The vertical actuator uses the signal from the axial LVDT to apply sufficient axial stress to keep the specimen height constant. The test is performed at different stress levels and temperatures depending on whether an intermediate or complete analysis is being performed:

Simple Shear Test Parameters		
Analysis Level	Temperature, °C	Shear Stress, kPa
Intermediate	$T_{eff}(PD)$	35
	$T_{eff}(FC)$	105
Complete	4	345
	20	105
	40	35

In this table, $T_{eff}(FC)$ is the effective pavement temperature for fatigue cracking. It is computed by Superpave as a function of climate, depth of mixture in pavement, and designer selected reliability level in the same manner as $T_{eff}(PD)$.

This figure shows the application of stresses during the test. During the test axial and shear loads and deformations are measured and recorded.

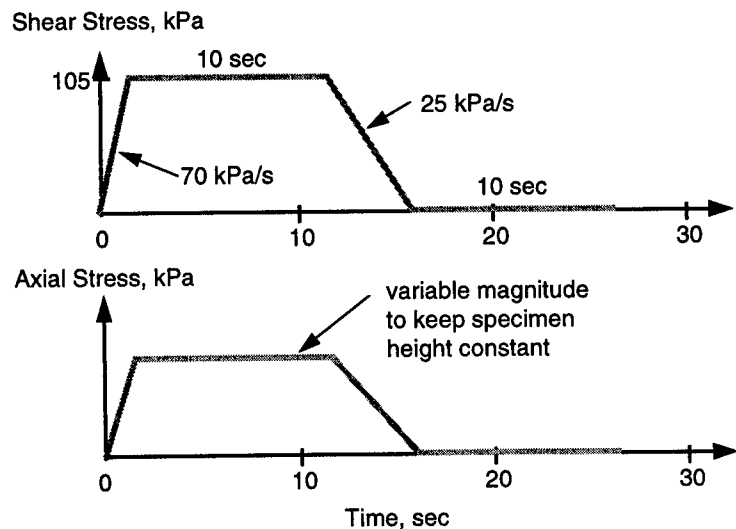

Frequency Sweep Test at Constant Height

This test is used for permanent deformation and fatigue cracking analysis in intermediate or complete analysis. A repeated sinusoidal shearing load is applied to the specimen to achieve a controlled shearing strain of 0.005 percent. One hundred cycles are used for the test at various loading frequencies.

As the test specimen is sheared, it wants to dilate and increase in height. The vertical actuator uses the signal from the axial LVDT to apply enough axial stress to keep the specimen height constant. The test is performed at different temperatures depending on whether an intermediate or complete analysis is being performed:

Frequency Sweep Test Parameters	
Analysis Level	Temperature, °C
Intermediate	$T_{\text{eff}}(\text{PD})$
	$T_{\text{eff}}(\text{FC})$
Complete	4
	20
	40

During the test axial and shear loads and deformations are measured and recorded. This figure illustrates the application of shearing strains and axial stresses during the test.

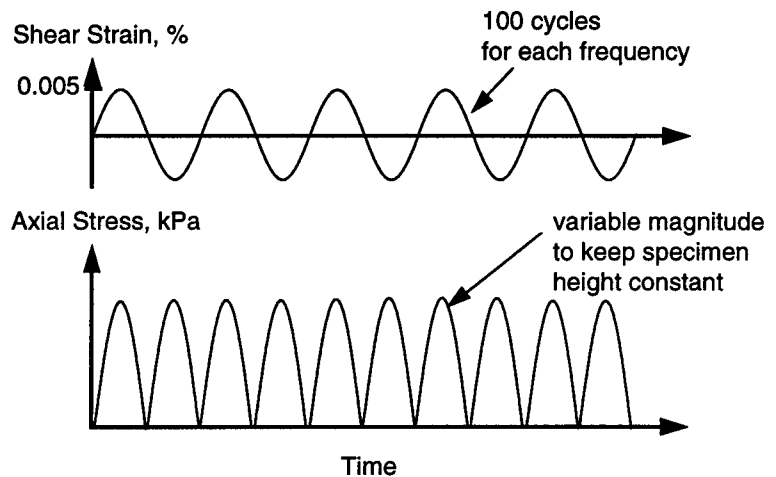

INDIRECT TENSILE TESTER

The IDT measures the creep compliance and strength of asphalt mixtures using indirect tensile loading techniques at intermediate to low temperatures ($< 20^{\circ}\text{C}$). Indirect tensile testing involves applying a compressive load across the diametrical axis of a cylindrical specimen. The mechanics of the test place a nearly uniform state of tensile stress across the diametrical plane.

The IDT device has four components: the testing apparatus, the test control unit and data acquisition system, load measuring device, and the environmental control chamber.

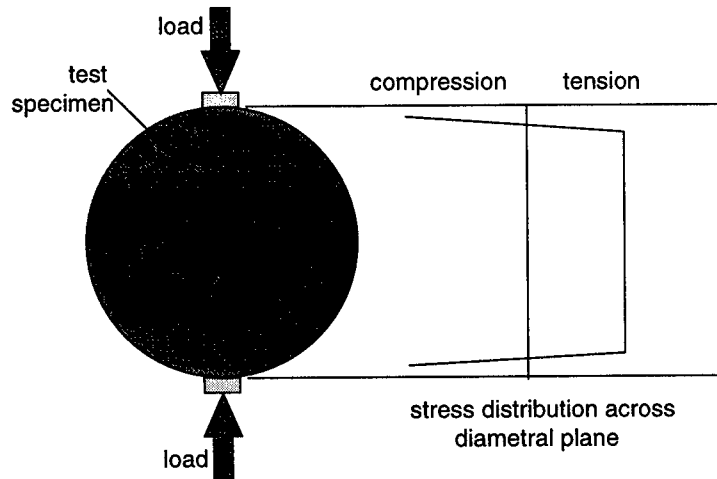

Axial Loading Device

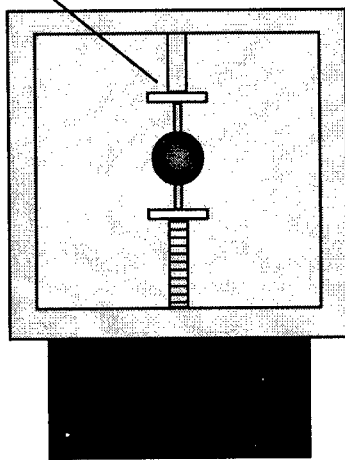

Environmental Chamber

Control and Data Acquisition

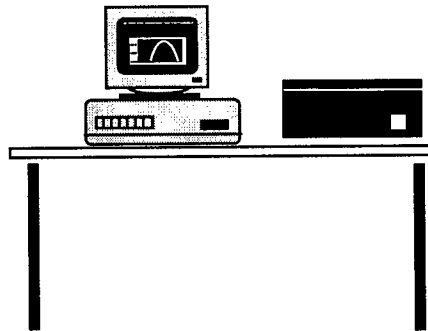

The testing apparatus consists of a closed-loop servo-hydraulic, or mechanical screw system capable of resolving static loads as low as 5 N. A rigid loading frame is also necessary so that precise displacement measurements can be made without frame movement.

The reaction of specimens to load can be measured using a strip chart recorder or a data acquisition device. Applied loads are measured and controlled using an electronic load cell. The environmental chamber controls test temperatures in the range from -20° to 20°C and accommodates at least three test specimens and the loading frame.

Specimen Preparation and Instrumentation

The first step in specimen preparation is to trim test specimens to a thickness-to-diameter ratio greater than 0.33. For a 150-mm diameter specimen, the minimum specimen thickness is 50 mm. The trimmed specimens must have smooth, parallel surfaces for mounting measurement gauges.

The load response of test specimens is measured by LVDTs mounted to the face of the specimen. Two sets of two LVDTs are mounted at right angles on each side of the specimen.

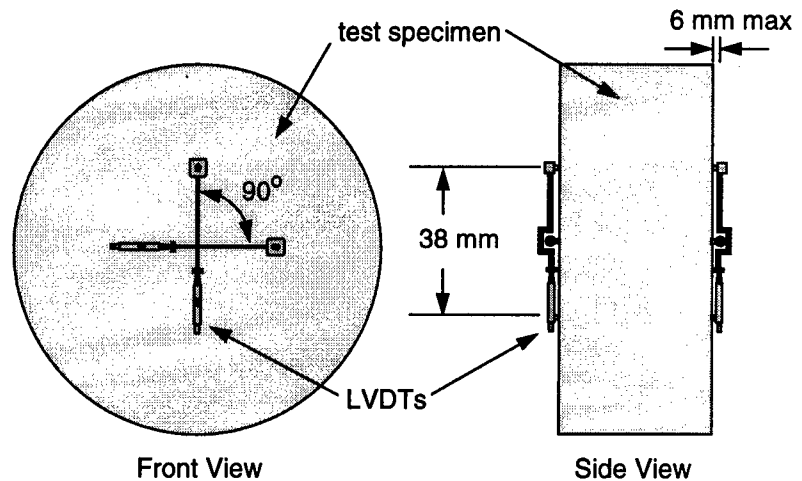

Test Procedures

Two tests are performed using the IDT: Creep Compliance and Strength at Low Temperatures and IDT Strength at Intermediate Temperatures. A full description of the procedures can be found in AASHTO TP9 "Test Method for Determining the Creep Compliance and Strength of Hot Mix Asphalt (HMA) Using the Indirect Tensile Test Device".

IDT Creep Compliance and Strength (Low Temperature Cracking Analysis)

This test is used to analyze mixtures for low temperature cracking. It is performed at three temperatures (0°, -10°, and -20°C) for both intermediate and complete analysis.

Initially, a static creep load of fixed magnitude is placed on the specimen. The load applied should be that which produces between 50 and 750 horizontal microstrain in the test specimen during the 100-second creep phase of the test. Vertical and horizontal deformations are measured on both sides of the specimen throughout the test.

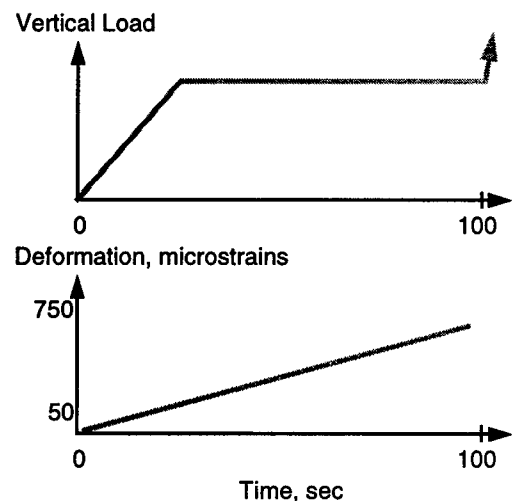

After the 100-second creep loading, the specimen is loaded until failure (peak load) by applying additional load at a rate of 12.5 mm per minute. Vertical and horizontal movements and load are measured. Measurements are taken until the load has decreased to a value of at least 10 percent less than peak load.

For intermediate analysis, test specimens are tested for creep compliance at 0°, -10°, and -20°C with tensile strength measured only at -10°C. Complete analysis requires that creep compliance and tensile strength be measured at all three temperatures.

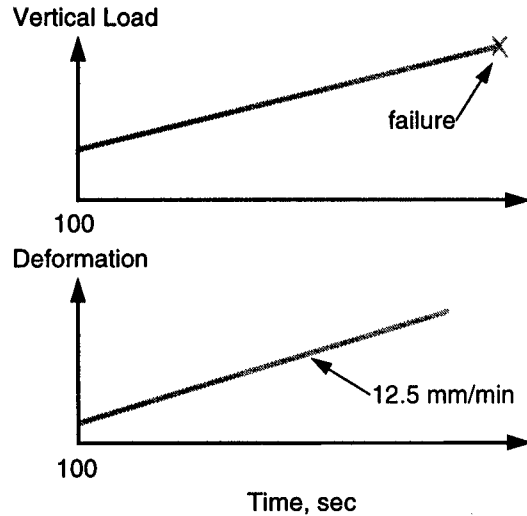

IDT Strength (Fatigue Cracking Analysis)

This test is used to analyze mixtures for fatigue cracking resistance. Intermediate and complete analysis use various temperatures ranging from -10°C to 20°C:

Indirect Tensile Strength Test Parameters	
Analysis Level	Temperature, °C
Intermediate	$T_{\text{eff}}(\text{FC})$
Complete	-10, 4, 20

In this test, the specimen is loaded at a constant deformation rate of 50 mm per minute of vertical ram movement. The specimen is loaded until failure -- peak load. Load and deformation are measured throughout the test.

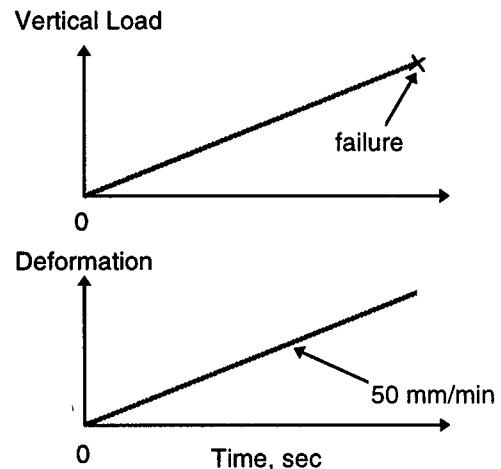

DATA ANALYSIS AND INTERPRETATION

The data collected from mix analysis testing can be analyzed separately by looking at individual properties or eventually, these files will be used in the performance prediction models in Superpave to predict pavement performance for various combinations of asphalt binder and mineral aggregate. Performance plots such as those shown are used to select a mixture that offers the desired level of performance. In these figures, Materials A, B, and C might be three entirely different materials. If so, the performance prediction would be considered part of an *analysis* procedure. This methodology is suited to evaluating the performance effects of aggregate types and proportions, asphalt and mixture modifiers, or any other potentially innovative HMA ingredient.

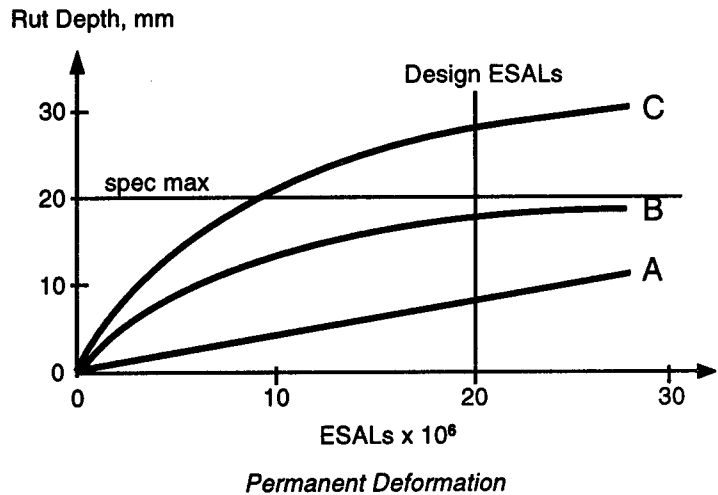

For the materials represented in the figures, no material meets all the distress criteria at the design number of ESALs. However, if cracking distress, such as fatigue or low temperature, were the primary concern, Material C would be a clear choice since it meets the specified performance values. Unfortunately, Material C would exhibit significant rutting after relatively few load applications. Both Materials A and B meet the rutting criterion but they fail the cracking criteria. Because fatigue life is greatly affected by pavement thickness, it may be possible to slightly increase the layer thickness so that Material B would meet the fatigue cracking criterion.

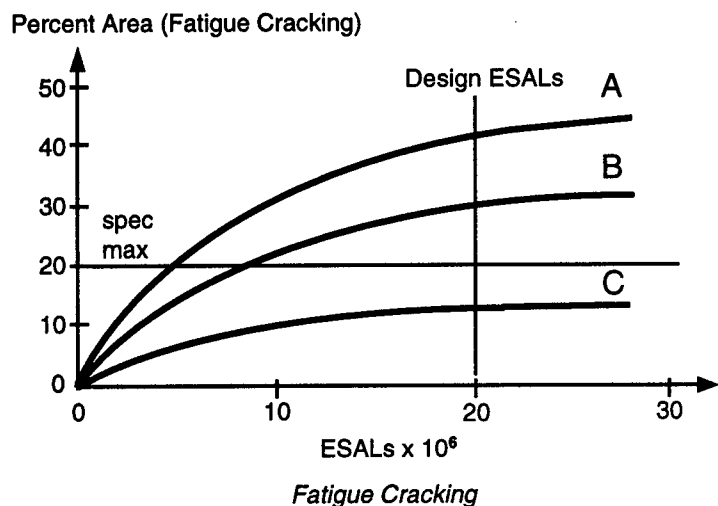

Alternatively, Materials A, B, and C might be the same aggregate blend with varying binder content. Material A has the lowest binder content while Material C has the highest binder content. Material B has a median value of binder content. In that case, the performance prediction would be considered a *design* procedure and three additional design plots would be useful. These design plots would define the range of binder contents meeting performance standards. In this example, a binder content that lies approximately two-thirds of the way between B and C would optimize pavement performance. This type of information would also be useful in establishing job control tolerances.

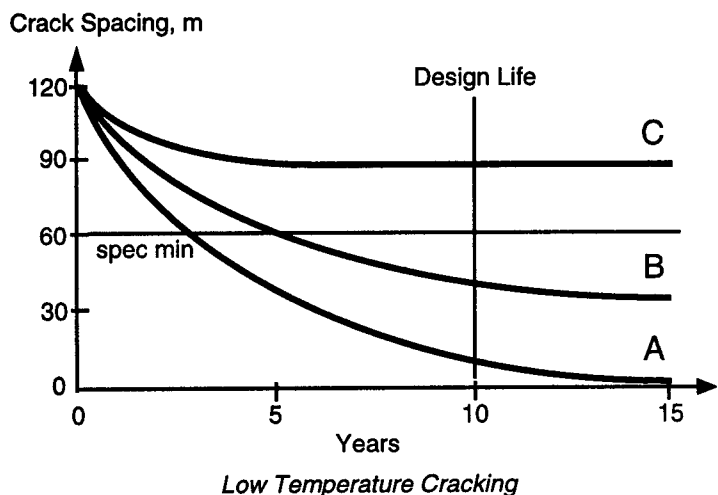

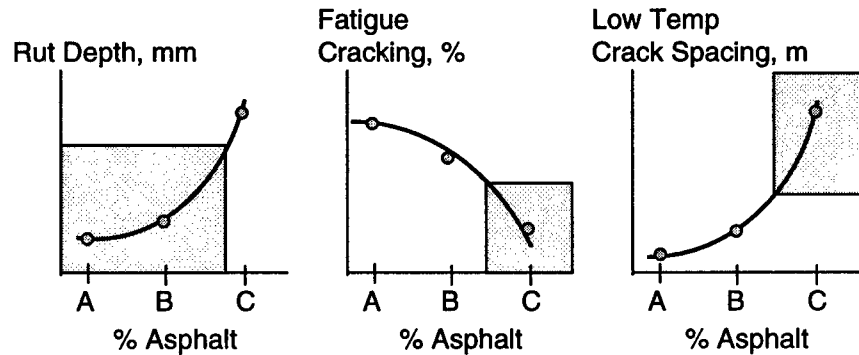

Design Chart

In summary, the interpretation of data in a mix analysis is usually a balancing act between opposing factors. With alternative mixtures, many times a compromise is necessary between cost and performance; mixes with special additives typically require more money than one with more conventional materials. When selecting the optimum binder content, lower values are more favorable for rutting while higher values are more favorable to cracking. Sometimes, a compromise may not be possible; it may be decided by which kind of distress is more critical.

Finally, the ultimate utilization of a fully-functional Superpave Mix Analysis System would be to compare not only mix alternatives, but structural alternatives as well. Because the mix performance is greatly dependent on the structure in which it is placed, there may exist some optimizations and tradeoffs between the properties and components of a mixture and the layer design thickness.



X: Superpave Implementation Activities

Even before the SHRP research began, it was recognized that a "program designed without taking into account obstacles on implementation of research will fail," in TRB Report 202, which proposed the development of the Strategic Highway Research Program. Eventually, more money will be spent on the implementation of the SHRP products than on the research itself.

This section will discuss some of the activities surrounding the implementation of Superpave. Many of the Superpave implementation programs and activities are interrelated, and this text may reference some activities before they are fully explained. By the end of the section, the activities will be fully described, and the reader should know where any necessary help could be obtained.

FUNDING AND PLANS

Although the 5-year, \$150 million SHRP program did not end until March 1993, planning for implementation had started well before that date. Funding and leadership for SHRP implementation was officially established on December 18, 1991, with the signing of the Intermodal Surface Transportation Efficiency Act (ISTEA). ISTEA allocated a total of \$108 million to FHWA to implement the products of SHRP and to continue the Long Term Pavement Performance (LTPP) Program.

The strategic plan for implementation of all of the SHRP products is described in "Implementation Plan - SHRP Products", June 1993, FHWA-SA-93-054. The SHRP implementation plan describes the internal and external organizational structure, partners and partnerships, purpose, roles, implementation mechanisms, and support functions that are used to accomplish the FHWA Implementation Program. It also details the framework under which the various entities function in carrying out this mission.

The development and execution of national implementation plans for specific products or groups of products is accomplished through four Technical Working Groups (TWGs):

- Asphalt
- Concrete and Structures
- Highway Operations
- Long Term Pavement Performance

The initial meetings of these TWGs were held in the summer of 1993.

The implementation plan for the asphalt program is described in "Strategic Highway Research Program Asphalt Research Output and Implementation Program", September 1993, FHWA-SA-94-025. For more recent information and the current status of the Superpave Asphalt Implementation Program, contact:

Asphalt TWG

Chairman	Don Steinke	Highway Operations	202-366-0392
Secretary	John D'Angelo	Engineering Applications	202-366-0121

The complete Superpave System incorporates over 25 individual SHRP asphalt research products. It includes performance-based asphalt binder specifications, tests, and testing equipment; performance-based asphalt-aggregate mixture specifications, design, analysis, tests, and testing equipment; protocols for the use and handling of modified asphalt binders; and software that incorporates all elements into an asphalt pavement mix design and analysis system. Superpave was officially turned over to the FHWA for implementation in the spring of 1993.

FHWA IMPLEMENTATION ACTIVITIES

To provide a forum for the SHRP researchers to present the research and development results and to review the decision-making processes that took place, FHWA sponsored a SHRP Asphalt Technology Conference in Reno, Nevada. This technical forum, held October 24-28, 1994, served as a foundation for the many future implementation efforts.

FHWA has a series of initiatives underway that will provide assistance to State Highway Agencies and the asphalt industry in the implementation of the Superpave System. The FHWA implementation activities for asphalt actually began in 1992 and are projected to continue until the end of the decade. The program includes six major initiatives and numerous related projects:

- Technical Assistance Program
- Superpave Pooled-Fund Equipment Purchase
- National Asphalt Training Center
- Superpave Regional Centers
- Mobile Laboratory Program
- Research Activities

Superpave Technology Delivery Team

To serve as a focal point for all Superpave implementation activities, FHWA formed the Superpave Technology Delivery Team (TDT) using representatives from various offices. This team will provide leadership, coordination, and support for the many initiatives and staff involved in Superpave implementation. For more information, contact:

Gary Henderson, *Team Leader*, Highway Operations Division

Phone: 202 - 366 - 1549
FAX: 202 - 366 - 9981
e-mail : gary.henderson@fhwa.dot.gov

Technical Assistance Program

To implement a new technology, the industry must be familiar with it and comfortable with all of its many aspects. In 1993 and 1994, FHWA purchased five sets of the Superpave binder test equipment and loaned the equipment to the five newly-formed regional asphalt user-producer groups. This early trial period served to introduce the equipment to the asphalt industry and provide preliminary training for the tests. The user-producer groups typically placed this equipment in their associated Superpave Regional Center. During this period, equipment refinement continued, resulting in the final specifications of the Superpave binder equipment. There was significant redesign of all of the protocols, especially for the PAV, DTT, and SGC.

The asphalt user-producer groups consist of representatives from state, federal and local agencies (users) and material producers and suppliers (producers). By having a forum where each group can present their views on very complex issues, the points of view of all sides can be understood, and resolutions can be more easily reached by balancing the needs of all parties.

Under TE Project 39, *Superpave Asphalt Support Services*, engineers and technicians are available through several sources to assist the states and industry in setting up equipment and conducting preliminary training. This assistance includes workshops and mini-classes; equipment installation assistance, operation, and data collection; field tests (SPS-9); data analysis; and a variety of other activities.

FHWA support staff have visited several states to provide training and technical support:

Missouri	Rhode Island	Massachusetts	District of Columbia
Delaware	Maine	Arizona	Arkansas
Indiana	Kentucky	Michigan	North Carolina
Washington	Montana	Minnesota	South Dakota

Several states have had difficulty setting up and operating some of their binder equipment. The same FHWA support staff have worked with many of the DOTs and manufacturers to try to resolve these problems and ensure that each state has properly operating equipment.

Technicians were also involved in conducting the ruggedness testing of the binder equipment. Several engineers and technicians from private laboratories have also been trained at the FHWA Office of Technology Binder Lab at the Turner-Fairbank Highway Research Center (TFHRC).

Pooled-Fund Equipment

In February 1992, SHRP accepted the research recommendations for the accelerated performance tests (APT). In March 1992, FHWA, working with Draft Number 6 of the asphalt binder specifications, initiated the planning of the Highway Planning and Research (HPR) pooled-fund Superpave equipment purchase, after a joint meeting with the State Materials Engineers. The states had agreed to pool a portion of their Federal-Aid research money to purchase sets of testing equipment for the Superpave binder and mixture procedures. The original plan included these eight pieces of laboratory equipment:

Binder Equipment :

- Pressure Aging Vessel (PAV)
- Rotational Viscometer (RV)
- Bending Beam Rheometer (BBR)
- Dynamic Shear Rheometer (DSR)
- Direct Tension Tester (DTT)

Mix Equipment :

- Superpave Gyrotory Compactor (SGC)
- Superpave Shear Tester (SST)
- Indirect Tensile Tester (IDT)

The original estimate for the pooled fund project was \$335,000:

- \$98,000 for binder equipment
- \$227,000 for mix equipment
- \$10,000 for training

All of the pooled-fund asphalt binder equipment, except the DTT, has been delivered to the 52 participating highway agencies. Based on this purchase of equipment, the expected cost for a laboratory to buy a complete set of binder equipment is approximately \$85,000:

PAV	\$10,000
RV	\$5,000
DSR	\$25,000
BBR	\$20,000
DTT	\$25,000

These costs are estimated based on individual purchases of each piece of equipment. The possibility exists for savings in a multiple purchase agreement. Any additional options desired to accompany the equipment would obviously increase the cost.

The pooled-fund buy for the DTT is on hold until new equipment, test procedures, and specifications are developed. A new prototype for the DTT was delivered in January 1996 and a preliminary evaluation has been completed. The new equipment can perform all the required functions and it has proven that repeatable results can be achieved. Five more units are being purchased prior to executing a general pooled-fund buy and these units will be used for ruggedness testing and resolving any questions about the accuracy of the test procedures. The general purchase is expected to occur in 1997.

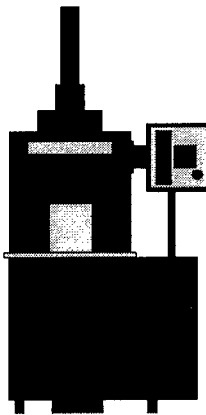

The pooled-fund purchase of the SGC is complete; all 52 participating highway agencies have taken delivery of their first device. At the time, there were two manufacturers of the SGC. Both pieces of equipment cost about \$25,000.

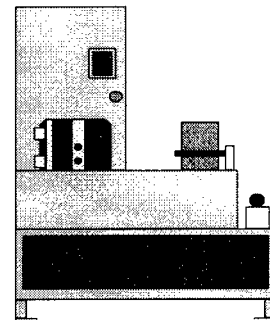

Due to the complexity, cost, and technical uncertainty of the SST and IDT and the need to use the Superpave software to analyze the output of the test equipment, the initial buy was restricted to one first article of each along with an additional five units each. The first article testing was completed in 1995 at the FHWA TFHRC. The remaining units were loaned to the five states with the Superpave Regional Centers and installed in their laboratories.

Since January 1996, the devices have been delivered and set-up and preliminary testing and evaluation of the equipment, procedures, and test output data has been conducted at TFHRC and the Superpave Regional Centers. The procedural ruggedness testing of all twelve units (six SST and six IDT) and the test methods has been underway since November 1996.

There is continued interest in developing a less sophisticated shear tester that would have less capability (confinement pressure) along with a smaller purchase price. However, the current SST will be fully evaluated prior to the final development of a simplified version for the states.

Long-Term Pavement Performance

Part of the SHRP research included the Long-Term Pavement Performance (LTPP) program. The LTPP program involved developing pavement monitoring and management tools for testing and evaluating the performance of in-place pavements. A major portion of the LTPP program was the selection and testing of hundreds of General Pavement Study (GPS) sites across North America. These GPS sites represented all types of pavements, climates and soil conditions, in an effort to analyze the hows and whys of long term pavement performance.

In 1993, the FHWA assumed the management of the LTPP. The experimental project selection and development, data collection and analysis, and information sharing will continue into the next century. The design and construction of Specific Pavement Study sections (SPS-9) will be used to validate the Superpave binder selection criteria, mix design requirements, and the mix analysis predictions.

The original SPS-9 experiment has been split into two separate, yet related studies :

SPS-9A, Superpave Binder Specification and Mix Design

SPS-9B, Pavement Structural Factors and Reliability of Performance Prediction

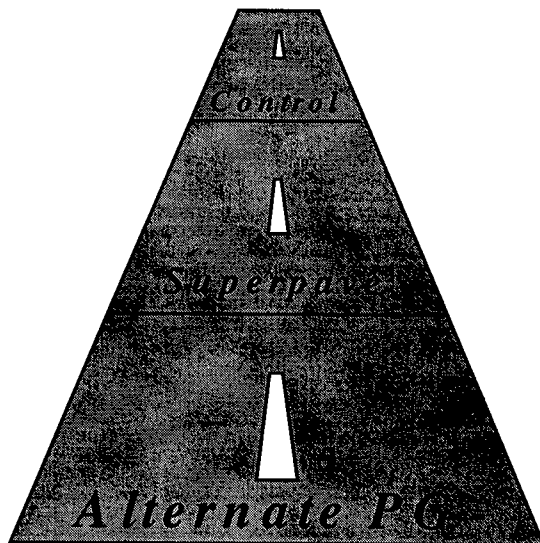

By dividing up the experiment, it allowed the first part to begin while the second part was still being formulated. The data collection can also be more easily managed. For the complete SPS-9A experiment, it is hoped to have 32 test sites with three test sections at each site. Each test section is a minimum of 305 m long; half of that will be for monitoring performance, the other half will be for drilling and sampling. A 31-m transition section will be constructed between each test section. The three test sections are intended to represent these conditions:

Control: designed and built using State's conventional specifications

Superpave: designed using Superpave PG binder and mix design

Alternate PG: designed using Superpave PG (one grade shift) binder and mix design

The SPS-9B experiment is being developed as the FHWA Superpave Support and Performance Models Management contract progresses.

Mobile Lab Program

Since 1987, the FHWA has had a mobile asphalt laboratory program, which has provided assistance in volumetric mix design and quality control of mixes at the plant site. This program was expanded in 1992, and two new mobile laboratories have been equipped to bring the principles of the Superpave volumetric mix design to the construction site. This effort was the first introduction of the concept of field management with volumetric mix design. At each project, there are two objectives:

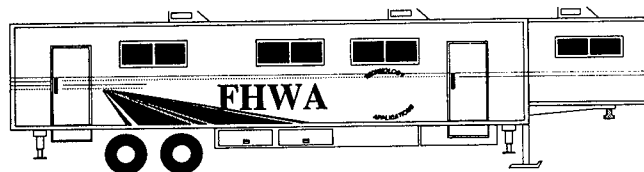

1. Current mix is tested to Superpave standards.
2. A full independent Superpave mix design and analysis is performed.

At each site, the mobile lab personnel offer to hold a one- or two-day workshop. The workshop covers an introduction to the Superpave specifications and procedures for volumetric mix design. The two demonstration trailers are equipped with a Superpave Gyrotory Compactor. These states have been visited :

With a prototype gyrotory compactor:

Colorado	Kansas	North Carolina	Delaware
West Virginia	Georgia	New Hampshire	South Carolina
Arizona	Florida		

With an SGC:

Alberta	Michigan	Illinois	Pennsylvania
Nevada	Virginia	North Carolina	Texas
Georgia	Tennessee	Oregon	New York
Ohio	Arkansas	Florida	South Carolina
Maine	Delaware	Minnesota	Montana
Louisiana	Utah	Colorado	

The first priority of the mobile labs are supporting the mix design activities involved with the SPS-9 studies. One of the trailers supported the construction of WesTrack, the test track for the Performance Related Asphalt Specification near Reno, Nevada. The trailer developed the Superpave mix designs and also assisted in the construction quality control testing for the track. These personnel have also been used to compare the results of different SGCs and operators with the same mixes.

A third trailer is equipped with a full set of the Superpave binder equipment and is available to provide states with technical support.

NATC

In September 1992, FHWA established the National Asphalt Training Center at the Asphalt Institute in Lexington, Kentucky. The primary activities of the NATC were to develop training materials for hands-on laboratory courses in Superpave asphalt binder testing and volumetric mix design. Over 550 participants representing State DOT, industry, university, and FHWA received training under this initial contract in 16, one-week, Superpave Binder courses and 14, one-week, Superpave Mix Design courses. As an additional part of the NATC activities, the Superpave Gyratory Compactor ruggedness experiment was conducted to establish sources of test procedure variability. These test data were later used to revise a few of the tolerances of the AASHTO provisional method, TP4, *Standard Method for Preparing and Determining the Density of Hot Mix Asphalt (HMA) Specimens by Means of the SHRP Gyratory Compactor*. This first NATC contract was completed in March 1995.

On September 1, 1995, a second contract (NATC II) was established with the Asphalt Institute to continue the Superpave training and to provide on-site technical assistance and laboratory testing for the next five years. This contract included the development of additional training materials and courses for Superpave Mix Analysis, as well as coordinating with the Superpave Regional Centers in performing the ruggedness experiment(s) on the various test procedures of the Superpave Shear Tester (SST) and the Indirect Tensile Tester (IDT).

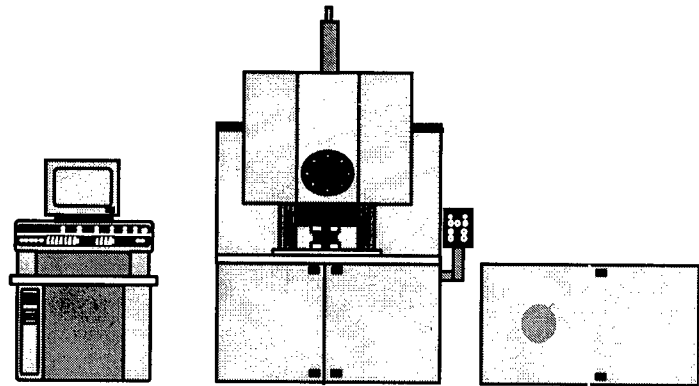

The SST and IDT ruggedness testing will be used to reduce the testing problems and variability of the eight draft test methods included in AASHTO TP7, *Standard Test Method for Determining the Permanent Deformation and Fatigue Cracking Characteristics of Hot Mix Asphalt (HMA) Using the Simple Shear Test Device* and AASHTO TP9, *Standard Test Method for Determining the Creep Compliance and Strength of Hot Mix Asphalt (HMA) Using the Indirect Tensile Test Device*. AI will be assisting in numerous other joint projects with the Superpave Regional Centers, dealing with technical assistance and training workshops.

To date, five additional one-week Superpave Mix Design Courses and three additional one-week Superpave Binder Courses have been given. Over 700 engineers and technicians have attended all of these courses given under both contracts. The binder and mix design training manuals are complete and currently available from the FHWA Report Center. Two one-week and one two-week Superpave Mix Analysis courses have also been conducted for Superpave Regional Center personnel and others who have the SST and IDT equipment available in their laboratories.

As part of the NATC II technical assistance, on-site visits have been made to assist others in dealing with the various implementation issues of Superpave mix design. These states were provided various customized workshops or presentations:

Tennessee
New Hampshire
Nevada

Michigan
Kentucky

Connecticut
Minnesota

Various laboratory experiments and evaluations are also being conducted as part of the technical assistance effort, including:

- Analysis of Maryland RAP material (Extraction and Grading)
- Intermediate Mix Analysis of South Carolina Mix
- Statistical Analysis of Short-Term Aging Procedure
- Examination of PG Blending Charts for RAP
- Evaluation of Missouri Mix Design
- Reevaluation of N_{design} Compaction Levels
- Comparison of Superpave Gyratory Compactors
- SST and IDT Evaluation of Various PG 76-22 Binders
- Comparison of Bending Beam Rheometers
- RAP Extraction Comparisons

Superpave Regional Centers

Five Superpave Regional Centers were established in 1995 to provide technical leadership and assistance on a more-localized, regional basis for the implementation of Superpave. The Centers are evaluating Superpave equipment and procedures and helping the State highway agencies put the technology into practice. They provide another valuable source of hands-on training and experience for engineers and technicians in the area.

The Superpave Regional Centers were established in these locations:

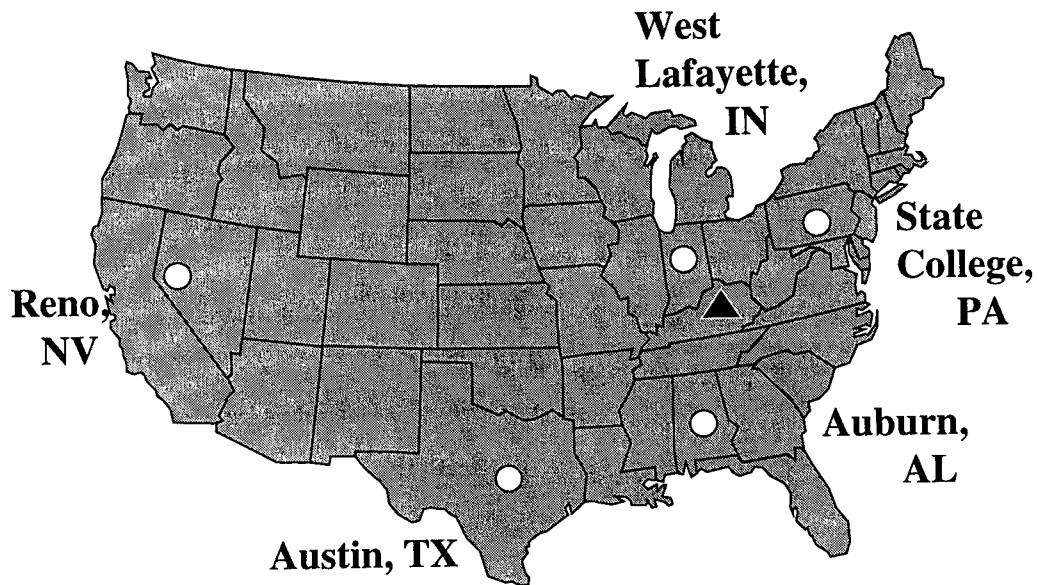

Rocky Mountain Center
Reno, Nevada
Contact: Jon Epps

Phone: 702 - 784 - 6873
FAX: 702 - 784 - 1429
e-mail: epps@unr.edu

South Central Center
Austin, Texas
Contact: Bob McGennis

Phone: 512 - 475 - 7912
FAX: 512 - 475 - 7914
e-mail: bmcgennis@mail.utexas.edu

SouthEast Center
Auburn, Alabama
Contact: Doug Hanson

Phone: 334 - 844 - 6240
FAX: 334 - 844 - 6248
e-mail: hansodi@mail.auburn.edu

North Central Center
West Lafayette, Indiana
Contact: Rebecca McDaniel

Phone: 765 - 463 - 2317
FAX: 765 - 497 - 2402
e-mail: rsmcdani@ce.ecn.purdue.edu

NorthEast Center
State College, Pennsylvania
Contact: Anne Stonex

Phone: 814 - 863 - 5789
FAX: 814 - 865 - 3039
e-mail: asx60@psu.edu

Each host state has a working relationship with a local university and has established a detailed operations plan with them.

Beyond technical assistance, the initial plans for the Centers include performing the testing for the SST and IDT ruggedness experiments. After this testing is completed, this equipment will be used for testing SPS-9B field sections. Each Center is supporting the surrounding states with the evaluation of their mixes.

Superpave Models

Also during 1992, FHWA recognized the need to complete development of Superpave performance prediction models and revise the initial version of the Superpave software. On July 20, 1995, the Superpave Support and Performance Models Management contract was awarded to the University of Maryland. This contract is divided into two phases.

In Phase I, which ended on December 31, 1996, the existing Superpave performance models were critiqued and a revised version of the original software was beta-tested and evaluated for technical accuracy. A report documented necessary corrections, improvements and suggested enhancements to the models and software. After meeting with FHWA on their findings, in Phase II their main emphasis in the modeling area will be asphalt concrete materials characterization. In addition, the original Superpave software will be completely revised and updated based on the findings in Phase I. A Windows version 2.0 of the Superpave Mix Design software is expected to be complete in 1997.

As an interim measure, until the entire modeling system can be completely revised, their staff will also work on a mixture strength test to supplement Superpave Volumetric Mix Design. This test is currently scheduled to be available in early 1999.

A long-term program is being planned to eventually develop the final performance models based on the revised system framework to be established under this contract. Using the data and materials that are currently being collected under LTPP, a field verification study of these new models will then be conducted to document their statistical accuracy.

WesTrack

To accelerate the validation of the Superpave Mix Design method and to develop performance parameters for Performance Related Specifications (PRS) for asphalt pavements, FHWA awarded a contract to the Nevada Automotive Test Center in September 1994. An accelerated test track facility, "WesTrack," was completed in November 1995 about 100-km southeast of Reno, Nevada.

The 2.9-km track includes 26 test sections to evaluate the effect of variations in binder content, gradation, and density on the Superpave Mix Design System. Four sections were designed by strictly following all of the Superpave recommendations. Both a coarse gradation, made from crushed gravel and local natural sands, and a fine gradation, made from all crushed material, were used on the track. Another fine mix included three percent additional dust (minus 0.075 mm) material. Three levels of binder content (optimum, optimum -0.7 percent, optimum + 0.7 percent) and three levels of in-place air voids (4, 8, and 12 percent) were evaluated.

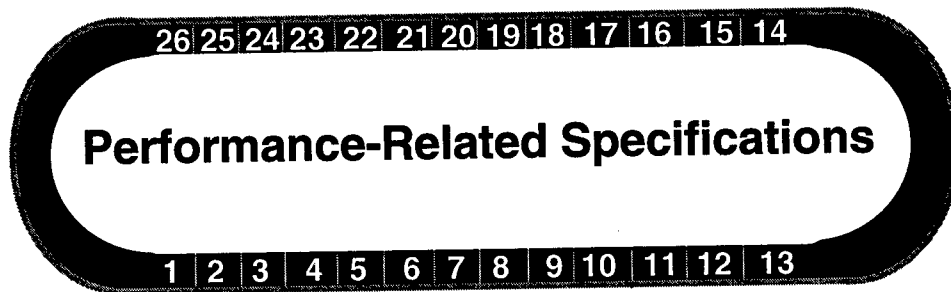

An automated vehicle guidance system was designed and installed in March 1996, and four heavily loaded triple-trailer driverless trucks began trafficking at 65 kph for 15 hours each day. As planned, the track will be subjected to ten million equivalent single axle loads (ESAL) in two years. The initial traffic on the track was applied with very little lateral wander, which is unrealistic compared to actual highway conditions. This "wheel tracking" was later modified. By September 1996, approximately one million ESAL had been applied and several test sections were experiencing various degrees of rutting. As expected, the sections placed with the highest binder content are exhibiting the most severe deformation. These distressed sections will be rehabilitated in the near future.

A number of cores have been obtained and various tests are being conducted to examine the causes of the premature rutting. Early findings indicate that the size of the aggregate is not as critical as the angularity, shape, and texture quality of the particles, when the pavement is being asked to endure heavy traffic.

Accelerated Loading Facility (ALF)

An Accelerated Loading Facility (ALF) is a mobile testing device that applies truck traffic loadings to pavement test sections. Much like the automated trafficking at WestTrack, an ALF can apply a concentrated number of loadings in a short period of time. The FHWA has an ALF at the Turner-Fairbank Highway Research Center.

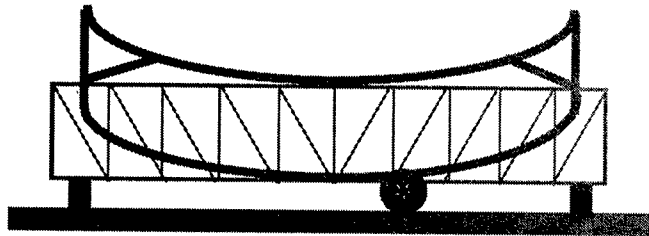

The pavement sections for the ALF at TFHRC were reconstructed to isolate and evaluate Superpave binder effects on specific types of mixtures. A second ALF has also been delivered to further expedite the testing. Five different PG binders (52-34, 58-28, 64-28, 82-34, and 70-22) and two different gradations (19 mm and 38 mm maximum aggregate size) are included in this experiment.

The initial testing for the rutting and fatigue experiment is now completed. Future testing will be conducted on sections at differing temperatures to explore this effect.

NCHRP Studies

The National Cooperative Highway Research Program is a program administered by the National Academy of Sciences and funded by the individual states to investigate research needs identified by the state highway and transportation departments. NCHRP has several projects related to Superpave implementation and validation:

- 9-7 Field Procedures and Equipment to Implement SHRP Asphalt Specifications
(This project is complete and the final report is being prepared.)
- 9-9 Refinement of the Superpave Gyratory Compaction Procedure
- 9-10 Superpave Protocols for Modified Asphalt Binders
- 9-12 Incorporation of Reclaimed Asphalt Pavement in the Superpave System
- 9-13 Evaluation of the AASHTO T283 Water Sensitivity Test

The latter four projects are in the initial stages of the study.

Expert Task Groups (ETG)

Expert Task Groups (ETGs) have been formed to provide technical guidance for the activities of the Technical Working Groups (TWGs). Three ETGs support the Asphalt TWG: the Binder ETG, the Mixtures ETG, and the Models/Software ETG.

The Binder ETG reviews issues related to the AASHTO provisional binder specifications and test methods. A number of issues are being considered, including:

- Alternative binder fatigue criteria
- New Direct Tension Tester and modification of criteria
- Revisions necessary for testing modified binders
- Revision of the low pavement temperature calculation
- PG asphalt binder supplier certification system

The Mixtures ETG reviews issues related to the AASHTO provisional specifications, test methods, and practices related to mix and aggregate. A number of issues are being discussed, including:

- Objectives of the gradation restricted zone
- Refinements to gradation control points
- Fine aggregate angularity test and level of criteria
- Gyratory Compaction Levels (N_{design})
- Short-term oven aging duration
- Incorporation of Reclaimed Asphalt Pavement (RAP)

The Software/Models ETG reviews issues related to the AASHTO provisional test methods related to mix analysis; the various material, structural, and performance models; and the framework for the Superpave software. Ideas being discussed include:

- Modeling of rutting
- Modeling of fatigue
- Characterization of material properties
- Modeling the lower layers of the pavement structure
- Need of a reflective cracking model
- Form of traffic load input
- Data necessary for field verification
- Content of Superpave software

Lead States Pool of Expertise

With the goal of shortening the learning period for others, a "Lead State" initiative was advanced at a conference held in St. Louis, Missouri, in September 1996. The objective of AASHTO and the FHWA was to form teams of people from states that had lots of experience using a particular SHRP product or technology.

A team of lead states with Superpave experience is sharing what they have learned from implementing the Superpave technology. Engineers and technicians from these six Superpave lead states are available to provide technical support and assistance, by telephone, regarding binder testing, mix design and analysis, and construction:

Florida
Indiana
Maryland
New York
Texas
Utah

These personnel can help disseminate information concerning lessons learned or any proposed changes to the Superpave System. Some on-site technical assistance may be available and conference presentations are possible. The FHWA has dedicated some funding to support this activity.



Appendix A

Standard Specification for Performance Graded Asphalt Binder

AASHTO Designation: MP1¹

1. Scope - This specification covers asphalt binders graded by performance. Grading designations are related to average 7-day maximum pavement design temperatures and minimum pavement design temperatures.

Note 1 -- For asphalt cements graded by penetration at 25°C, see M20. For asphalt cements graded by viscosity at 60°C see M226.

Note 2 -- Guide PP5 provides information on the evaluation of modified asphalt binders.

Note 3 -- Guide PP6 provides information for determining the performance grade of an asphalt binder.

2. Reference Documents

2.1 AASHTO Documents:

PP5	Guide for the Laboratory Evaluation of Modified Asphalt Systems
PP6	Guide for Grading or Verifying the Performance Grade of an Asphalt Binder
PPX	Selection of Asphalt Binders (Being Developed)
M20	Specification for Penetration Graded Asphalt Cement
M226	Specification for Viscosity Graded Asphalt Cement
PP1	Practice for Accelerated Aging of Asphalt Binder Using a Pressurized Aging Vessel (PAV)
T40	Practice for Sampling Bituminous Materials
T44	Solubility of Bituminous Materials in Organic Solvents
T48	Method for Flash and Fire Points by Cleveland Open Cup
T55	Method for Water in Petroleum Products and Bituminous Materials
T179	Test Method for Effect of Heat and Air on Asphalt Materials (Thin-Film Oven Test)
T201	Kinematic Viscosity of Asphalts
T202	Viscosity of Asphalts by Vacuum Capillary Viscometer
T240	Test Method for Effect of Heat and Air on a Moving Film of Asphalt (Rolling Thin Film Oven Test)
TP1	Test Method for Determining the Flexural Creep Stiffness of Asphalt Binder Using the Bending Beam Rheometer (BBR)
TP3	Test Method for Determining the Fracture Properties of Asphalt Binder in Direct Tension (DT)
TP5	Test Method for Determining Rheological Properties of Asphalt Binder Using a Dynamic Shear Rheometer (DSR)

¹ This standard is based on SHRP Product 1001.

2.2 ASTM Documents:

D8 Standard Definitions of Terms Relating to Materials for Roads and Pavements
D4402 Method for Viscosity Determinations of Unfilled Asphalt Using the Brookfield Thermosel Apparatus

2.3 SHRP Documents:

P00X Superpave Software (being developed)

3. Terminology

3.1 Definitions

3.1.1 Definitions for many terms common to asphalt cement are found in ASTM D8.

3.1.2 asphalt binder, n -- an asphalt-based cement that is produced from petroleum residue either with or without the addition of non-particulate organic modifiers.

4. Ordering Information - When ordering under this specification, include in the purchase order the performance grade of asphalt binder required from Table 1 (e.g. PG 52-16 or PG 64-34).

4.1 Asphalt binder grades may be selected by following the procedures described in provisional practice PPX, Selection of Asphalt Binders.

5. Materials and Manufacture

5.1 Asphalt cement shall be prepared by the refining of crude petroleum by suitable methods, with or without the addition of modifiers.

5.2 Modifiers may be any organic material of suitable manufacture, used in virgin or recycled condition, and that is dissolved, dispersed or reacted in asphalt cement to enhance its performance.

5.3 The base asphalt binder shall be homogeneous, free from water and deleterious materials, and shall not foam when heated to 175°C.

5.4 The base asphalt binder shall be at least 99.0% soluble in trichloroethylene as determined by AASHTO T44.

5.5 The bending beam rheometer test, TP1, the direct tension test, TP3, and the dynamic shear rheometer test, TP5, are not suitable for asphalt binders in which fibers or other discrete particles are larger than 250 μm in size.

5.6 The grades of asphalt binder shall conform to the requirements given in Table 1.

6. Sampling - The material shall be sampled in accordance with Method T 40.

7. Test Methods - The properties outlined in 5.3, 5.4 and 5.6 shall be determined in accordance with T44, T48, T55, T179, T240, PP1, TP1, TP3, TP5, and ASTM D4402.

8. Inspection and Certification - Inspection and certification of the material shall be agreed upon between the purchaser and the seller. Specific requirements shall be made part of the purchase contract.

9. Rejection and Rehearing - If the results of any test do not conform to the requirements of this specification, retesting to determine conformity is performed as indicated in the purchase order or as otherwise agreed upon between the purchaser and the seller.

10. Key Words - Asphalt binder, asphalt cement, modifier, performance specifications, rheology, direct tension, pressure aging, flash point.

Table 1. Performance Graded Asphalt Binder Specification

PERFORMANCE GRADE	PG 46-			PG 52-						PG 58-					PG 64-						
	34	40	46	10	16	22	28	34	40	46	16	22	28	34	40	10	16	22	28	34	40
Average 7-day Maximum Pavement Design Temperature, °C ^a	<46			<52						<58					<64						
Minimum Pavement Design Temperature, °C ^a	>-34	>-40	>-46	>-10	>-16	>-22	>-28	>-34	>-40	>-46	>-16	>-22	>-28	>-34	>-40	>-10	>-16	>-22	>-28	>-34	>-40
ORIGINAL BINDER																					
Flash Point Temp, T48: Minimum °C	230																				
Viscosity, ASTM D4402: ^b Maximum, 3 Pa·s, Test Temp, °C	135																				
Dynamic Shear, TP5: ^c G'/sinδ, Minimum, 1.00 kPa Test Temp @ 10 rad/s, °C	46			52						58					64						
ROLLING THIN FILM OVEN (T240) OR THIN FILM OVEN RESIDUE (T179)																					
Mass Loss, Maximum, percent	1.00																				
Dynamic Shear, TP5: G'/sinδ, Minimum, 2.20 kPa Test Temp @ 10 rad/s, °C	46			52						58					64						
PRESSURE AGING VESSEL RESIDUE (PP1)																					
PAV Aging Temperature, °C ^d	90			90						100					100						
Dynamic Shear, TP5: G'/sinδ, Maximum, 5000 kPa Test Temp @ 10 rad/s, °C	10	7	4	25	22	19	16	13	10	7	25	22	19	16	13	31	28	25	22	19	16
Physical Hardening ^e	Report																				
Creep Stiffness, TP1: ^f S, Maximum, 300 MPa, m - value, Minimum, 0.300 Test Temp @ 60s, °C	-24	-30	-36	0	-6	-12	-18	-24	-30	-36	-6	-12	-18	-24	-30	0	-6	-12	-18	-24	-30
Direct Tension, TP3: ^g Failure Strain, Minimum, 1.0% Test Temp @ 1.0 mm/min, °C	-24	-30	-36	0	-6	-12	-18	-24	-30	-36	-6	-12	-18	-24	-30	0	-6	-12	-18	-24	-30

- ^a Pavement temperatures are estimated from air temperatures using an algorithm contained in the SUPERPAVE software program, may be provided by the specifying agency, or by following the procedures as outlined in PPX.
- ^b This requirement may be waived at the discretion of the specifying agency if the supplier warrants that the asphalt binder can be adequately pumped and mixed at temperatures that meet all applicable safety standards.
- ^c For quality control of unmodified asphalt cement production, measurement of the viscosity of the original asphalt cement may be substituted for dynamic shear measurements of G'/sinδ at test temperatures where the asphalt is a Newtonian fluid. Any suitable standard means of viscosity measurement may be used, including capillary or rotational viscometry (AASHTO T201 or T202).
- ^d The PAV aging temperature is based on simulated climatic conditions and is one of three temperatures 90°C, 100°C or 110°C. The PAV aging temperature is 100°C for PG 64- and above, except in desert climates, where it is 110°C.
- ^e Physical Hardening -- TP1 is performed on a set of asphalt beams according to Section 13.1, except the conditioning time is extended to 24 hrs ± 10 minutes at 10°C above the minimum performance temperature. The 24-hour stiffness and m-value are reported for information purposes only.

If the creep stiffness is below 300 MPa, the direct tension test is not required. If the creep stiffness is between 300 and 600 MPa the direct tension failure strain requirement can be used in lieu of the creep stiffness requirement. The *m*-value requirement must be satisfied in both cases.

Table 1. Performance Graded Asphalt Binder Specification
(Continued)

PERFORMANCE GRADE	PG 70-						PG 76-					PG 82-				
	10	16	22	28	34	40	10	16	22	28	34	10	16	22	28	34
Average 7-day Maximum Pavement Design Temp, °C ^b	<70						<76					<82				
Minimum Pavement Design Temperature, °C ^b	>-10	>-16	>-22	>-28	>-34	>-40	>-10	>-16	>-22	>-28	>-34	>-10	>-16	>-22	>-28	>-34
ORIGINAL BINDER																
Flash Point Temp, T48: Minimum °C	230															
Viscosity, ASTM D4402: ^a Maximum, 3 Pa·s, Test Temp, °C	135															
Dynamic Shear, TP5: ^c G'/sinδ, Minimum, 1.00 kPa Test Temp @ 10 rad/s, °C	70						76					82				
ROLLING THIN FILM OVEN (T240) OR THIN FILM OVEN (T179) RESIDUE																
Mass Loss, Maximum, percent	1.00															
Dynamic Shear, TP5: G'/sinδ, Minimum, 2.20 kPa Test Temp @ 10 rad/s, °C	70						76					82				
PRESSURE AGING VESSEL RESIDUE (PP1)																
PAV Aging Temperature, °C ^d	100(110)						100(110)					100(110)				
Dynamic Shear, TP5: G'/sinδ, Maximum, 5000 kPa Test Temp @ 10 rad/s, °C	34	31	28	25	22	19	37	34	31	28	25	40	37	34	31	28
Physical Hardening ^e	Report															
Creep Stiffness, TP1: ^f S, Maximum, 300.0 MPa, <i>m</i> -value, Minimum, 0.300 Test Temp @ 60s, °C	0	-6	-12	-18	-24	-30	0	-6	-12	-18	-24	0	-6	-12	-18	-24
Direct Tension, TP3: ^g Failure Strain, Minimum, 1.0% Test Temp @ 1.0 mm/min, °C	0	-6	-12	-18	-24	-30	0	-6	-12	-18	-24	0	-6	-12	-18	-24

Appendix B: Superpave Asphalt Mixture Gradation Requirements

37.5 MM NOMINAL SIZE

Sieve, mm	Control Points		Restricted Zone Boundary	
	Minimum	Maximum	Minimum	Maximum
50	100.0			
37.5	90.0	100.0		
25		90.0		
19				
12.5				
9.5				
4.75			34.7	34.7
2.36	15.0	41.0	23.3	27.3
1.18			15.5	21.5
0.600			11.7	15.7
0.300			10	10
0.150				
0.075	0.0	6.0		

25 MM NOMINAL SIZE

Sieve, mm	Control Points		Restricted Zone Boundary	
	Minimum	Maximum	Minimum	Maximum
37.5	100.0			
25	90.0	100.0		
19		90.0		
12.5				
9.5				
4.75			39.5	39.5
2.36	19.0	45.0	26.8	30.8
1.18			18.1	24.1
0.600			13.6	17.6
0.300			11.4	11.4
0.150				
0.075	1.0	7.0		

19 MM NOMINAL SIZE

Sieve, mm	Control Points		Restricted Zone Boundary	
	Minimum	Maximum	Minimum	Maximum
25	100.0			
19	90.0	100.0		
12.5		90.0		
9.5				
4.75				
2.36	23.0	49.0	34.6	34.6
1.18			22.3	28.3
0.600			16.7	20.7
0.300			13.7	13.7
0.150				
0.075	2.0	8.0		

12.5 MM NOMINAL SIZE

Sieve, mm	Control Points		Restricted Zone Boundary	
	Minimum	Maximum	Minimum	Maximum
19	100.0			
12.5	90.0	100.0		
9.5		90.0		
4.75				
2.36	28.0	58.0	39.1	39.1
1.18			25.6	31.6
0.600			19.1	23.1
0.300			15.5	15.5
0.150				
0.075	2.0	10.0		

9.5 MM NOMINAL SIZE

Sieve, mm	Control Points		Restricted Zone Boundary	
	Minimum	Maximum	Minimum	Maximum
12.5	100.0			
9.5	90.0	100.0		
4.75		90.0		
2.36	32.0	67.0	47.2	47.2
1.18			31.6	37.6
0.600			23.5	27.5
0.300			18.7	18.7
0.150				
0.075	2.0	10.0		

Appendix C: Outline of Steps in Superpave Mix Design

I. MATERIALS SELECTION

A. Selection of Asphalt Binder

1. Determine project weather conditions using weather database
2. Select reliability
3. Determine design temperatures
4. Verify asphalt binder grade
5. Temperature-viscosity relationship for lab mixing and compaction

B. Selection of Aggregates

1. Consensus properties
 - a. Combined gradation
 - b. Coarse aggregate angularity
 - c. Fine aggregate angularity
 - d. Flat and elongated particles
 - e. Clay content
2. Agency and Other properties
 - a. Specific gravity
 - b. Toughness
 - c. Soundness
 - d. Deleterious materials
 - e. Other

C. Selection of Modifiers

II. SELECTION OF DESIGN AGGREGATE STRUCTURE

A. Establish Trial Blends

1. Develop three blends
2. Evaluate combined aggregate properties

B. Compact Trial Blend Specimens

1. Establish trial asphalt binder content
 - a. Superpave method
 - b. Engineering judgment method
2. Establish trial blend specimen size
3. Determine N_{design} & N_{initial} & N_{maximum}
4. Batch trial blend specimens
5. Compact specimens and generate densification tables
6. Determine mixture properties (G_{mm} & G_{mb})

C. Evaluate Trial Blends

1. Determine $\%G_{\text{mm}}$ @ N_{initial} & N_{design} & N_{maximum}
2. Determine $\%\text{Air Voids}$ and $\%\text{VMA}$
3. Estimate asphalt binder content to achieve 4% air voids
4. Estimate mix properties @ estimated asphalt binder content
5. Determine dust proportion
6. Compare mixture properties to criteria

D. Select Most Promising Design Aggregate Structure for Further Analysis

III. SELECTION OF DESIGN ASPHALT BINDER CONTENT

A. Compact Design Aggregate Structure Specimens at Multiple Binder Contents

1. Batch design aggregate structure specimens
2. Compact specimens and generate densification tables

B. Determine Mixture Properties versus Asphalt Binder Content

1. Determine %G_{mm} @ N_{initial} & N_{design} & N_{maximum}
2. Determine volumetric properties
3. Determine dust proportion
4. Graph mixture properties versus asphalt binder content

C. Select Design Asphalt Binder Content

1. Determine asphalt binder content at 4% air voids
2. Determine mixture properties at selected asphalt binder content
3. Compare mixture properties to criteria

IV. EVALUATION OF MOISTURE SENSITIVITY OF DESIGN ASPHALT MIXTURE USING AASHTO T283

1
2
3
4
5
6
7
8
9
10
11
12
13
14
15
16
17
18
19
20
21
22
23
24
25

