



U.S. Department of Transportation

Best Management Practices for Erosion and Sediment Control

Report No. FHWA-FLP-94-005

**Eastern Federal Lands Highway Design
Federal Highway Administration
21400 Ridgetop Circle
Sterling, Virginia 20166**

June 1995

Notice

This document is disseminated under the sponsorship of the Department of Transportation in the interest of information exchange. The United States Government assumes no liability for its contents or use thereof.

The contents do not necessarily reflect the official policy of the Department of Transportation.

This report does not constitute a standard, specification, or a regulation.

The United States Government does not endorse products or manufacturers. Trade or manufacturers' names appear herein only because they are considered essential to the object of this document.

1. Report No. FHWA-FLP-94-005	2. Government Accession No.	3. Recipient's Catalog No.	
4. Title and Subtitle Best Management Practices for Erosion and Sediment Control		5. Report Date June 1995	6. Performing Organization Code HFL-15
		8. Performing Organization Report No.	
7. Author(s) Brian C. Roberts, P.E.		10. Work Unit No. (TRAIS) CTIP Study H-12	
9. Performing Organization Name and Address Eastern Federal Lands Highway Division Federal Highway Administration 21400 Ridgetop Circle Sterling, VA 20166		11. Contract or Grant No.	
		13. Type of Report and Period Covered Final Report 10/88 - 6/95	
12. Sponsoring Agency Name and Address U.S. Department of Transportation Federal Highway Administration Federal Lands Highway Program Washington, DC 20590		14. Sponsoring Agency Code HFL-23	
		15. Supplementary Notes This study was part of the Coordinated Federal Lands Technology Implementation Program (CTIP).	
16. Abstract The purpose of this manual is to provide guidance in preventing erosion and controlling sediment on highway construction projects. It addresses the selection of erosion and sediment control measures and the development of erosion control plans. Construction and inspection of the measures are presented for each practice.			
17. Key Words Sediment traps/basins; hydrologic soil; sodding; topsoiling; energy dissipators; silt fence; diversions; check dams; spillway		18. Distribution Statement No restrictions. This document is available through the National Technical Information Service, Springfield, VA 22161	
19. Security Classif. (of this report) Unclassified	20. Security Classif. (of this page) Unclassified	21. No of Pages 187	22. Price

Best Management Practices for Erosion and Sediment Control

Report No. FHWA-FLP-94-005

June 1995

PREFACE

The purpose of this manual is to provide guidance in preventing erosion and controlling sediment on highway construction projects. Specifically, this publication addresses the selection of erosion and sediment control measures and development of erosion control plans. Construction and inspection of the measures are presented for each practice. The regulatory environment is discussed as it relates to the Environmental Protection Agency's (EPA's) National Pollutant Discharge Elimination System (NPDES).

Chapter 1, Erosion and Sedimentation Process, presents the types of erosion and the factors influencing erosion. It is important to understand the process in order to address the problem of erosion. The chapter relates the fundamentals of erosion and sediment control to the highway environment.

Chapter 2 presents an overview of the EPA's NPDES permit program for construction activities. This includes: who is covered under the program, the basic administrative requirements, and the elements of a Pollution Prevention Plan. This section applies to a limited number of states. It is important to recognize that although all states have some type of NPDES program, each may vary. Contact the particular state where the project is located to obtain specific NPDES requirements. Appendix A contains the Federal Registers with the Final NPDES General Permits for Construction Activities.

Chapter 3, Developing Erosion Control Plans, provides a procedure for how to select controls and incorporate them into the construction drawings. The basic principles of erosion control are discussed as well as three phases of erosion control to be addressed with the plans. By following the principles through each phase of construction, a logical procedure is available.

Chapter 4 provides available stabilization practices for preventing erosion. This is especially important because proper stabilization of the site is both the highest priority and the most effective means of erosion control. Vegetative as well as other stabilization practices are presented. The chapter contains a section on erosion control blankets and matting and lists appropriate types of vegetation for the eastern United States. The designer should consult state agencies such as highway departments and Soil Conservation Districts to obtain appropriate species, application rates, and fertilizer requirements for the particular project.

Chapter 5 lists the most common types of structural erosion control practices used during construction. Information is provided for each practice including a description and application, design guidance, construction and inspection. Although specific practices and design criteria may vary from region to region, these are generally the most accepted practices for preventing erosion and controlling sediment during construction.

Although sediment traps and basins are also structural measures, a separate Chapter 6 is provided to focus on their unique application. These are larger, more complex devices that warrant separate consideration. Smaller, more common sediment traps are first discussed followed by the larger sediment basins. A design procedure is provided for each device but the designer is cautioned to seek expertise when designing sediment basins. The size of the structures can result in damage if failure should occur.

Table of Contents

<u>Chapter</u>	<u>Page</u>
List of Tables	iii
List of Figures	iv
1. EROSION AND SEDIMENTATION PROCESS	1
TYPES OF EROSION	1
CHANNEL EROSION	3
FACTORS INFLUENCING EROSION	3
HYDROLOGIC SOIL GROUPS	6
2. NATIONAL POLLUTANT DISCHARGE ELIMINATION SYSTEM	7
GENERAL PERMITS	8
POLLUTION PREVENTION PLAN	9
3. DEVELOPING EROSION CONTROL PLANS	15
EROSION CONTROL PRINCIPLES	16
EROSION CONTROL PHASES	17
Phase I: Perimeter Controls	18
Phase II: Intermediate Controls	18
Phase III: Final Controls	19
4. STABILIZATION METHODS	21
TEMPORARY SEEDING	21
PERMANENT SEEDING	22
SODDING	25
TOPSOILING	26
MULCHING	27

Table of Contents (Cont.)

<u>Chapter</u>	<u>Page</u>
EROSION CONTROL BLANKETS AND MATTING	30
TYPES OF VEGETATION	31
5. STRUCTURAL EROSION CONTROL MEASURES	43
CHECK DAMS	43
DIVERSIONS	47
TEMPORARY SLOPE DRAIN	52
OUTLET PROTECTION	54
ENERGY DISSIPATORS	58
SILT FENCE	59
STRAW BALES	64
BRUSH BARRIERS	67
INLET PROTECTION	69
6. SEDIMENT TRAPS AND BASINS	75
TEMPORARY SEDIMENT TRAPS	75
SEDIMENT BASINS	83
REFERENCES	107
APPENDIX A: FINAL NPDES GENERAL PERMIT	A-1
APPENDIX B: FHWA 23 CFR PART 650	B-1
APPENDIX C: STANDARD DRAWINGS	C-1

List of Tables

<u>Table</u>	<u>Page</u>
4.1 Temporary Seeding	22
4.2 Recommended Perennial Seed Mixtures	24
5.1 Spacing for a Standard Check Dam	46
5.2 Slope Drain Sizes	53
5.3 Maximum Slope Lengths for Silt Fence	62
5.4 Maximum Slope Lengths for Straw Bales	65
6.1 Weir Lengths for Sediment Traps	78
6.2 Pipe Outlet Diameters	78
6.3 Concrete Pipe Flow Chart, $n = 0.013$	97
6.4 CMP Flow Chart, $n = 0.025$	98
6.5 Emergency Spillway Design Data	99
6.6 Anti-Vortex Design	105

List of Figures

<u>Figure</u>	<u>Page</u>
5.1 Check Dam Cross Section	44
5.2 Spacing Between Check Dams	45
5.3 Diversion Channel and Berm	48
5.4 Diversion Channel and Berm	49
5.5 Diversion for Culvert Installation	50
5.6 Temporary Slope Drain	52
5.7 Outlet Protection	55
5.8 Outlet Protection Design	57
5.9 Types of Energy Dissipators	58
5.10 Silt Fence	59
5.11 Silt Fence as a Perimeter Control	60
5.12 Silt Fence Protecting Waterway	61
5.13 Straw Bale as a Perimeter Control	64
5.14 Straw Bale Installation	66
5.15 Brush Barrier Application	67
5.16 Block and Gravel Drop Inlet Protection	71
5.17 Gravel and Wire Mesh and Silt Fence Inlet Protection	72
5.18 Curb Opening Drop Inlet Protection	73

List of Figures (Cont.)

<u>Figure</u>	<u>Page</u>
6.1 Stone Outlet Sediment Trap	79
6.2 Pipe Outlet Sediment Trap	80
6.3 Sediment Basin	85
6.4 Sediment Basin Design Elevations	86
6.5 Principal Spillway Design	89
6.6 Dewatering Device	91
6.7 Emergency Spillway	93
6.8 Riser Inflow Curves	96
6.9 Riser Pipe Anchors	100
6.10 Anti-seep Collar Details	101
6.11 Pipe Length in Saturated Zone	102
6.12 Anti-seep Collar Design	103
6.13 Anti-Vortex Device Details	104

CHAPTER 1

EROSION AND SEDIMENTATION PROCESS

Erosion and sedimentation are naturally occurring processes that are accelerated by human activities. Erosion is often described as the detachment of soil particles by some force. This force may be due to rainfall, wind, or other forces. Once detachment occurs, the particles are transported. Most often this is done by water action but wind can also be a major contributor. This manual will focus on rainfall induced erosion, however, it is important to recognize that in some parts of the United States, more erosion results from wind forces than from rainfall.

Simply stated, sedimentation is the process of deposition of soil particles. In order to deal most effectively with erosion control, it is important to distinguish between erosion and sedimentation.

TYPES OF EROSION

The four types of rainfall erosion are: raindrop splash, sheet erosion, rilling, and gullying.

Raindrop Splash

The erosion process is initiated with the raindrop splash. The raindrop impacts the soil with tremendous energy causing the soil particles to be dislodged or detached. Raindrops typically fall with velocities in the 6 to 9 meters/second (20 to 30 feet/second) range. The energy imposed on the ground surface can cause soil particles to be splashed more than 0.6 meters (2 feet) vertically and 1.5 meters (5 feet) laterally.^{5,6} On bare ground it has been estimated that as much as 225 tons/hectare (90 tons/acre) can be splashed into the air during a heavy storm.

In addition to the erosion, the impact of the rainfall on bare soil can change the structure of the soil. The impact destroys the open structure of the soil and increases the compaction. Fine particles and organic matter are separated from heavier soil particles reducing the infiltration capacity of the soil and increasing the runoff potential. The resulting compacted soil structure also inhibits plant establishment.

The role of rainfall splash in the erosion process cannot be over emphasized. This is the first step in the erosion process and should be minimized through erosion control techniques. The method used to prevent erosion from raindrop splash is stabilization. This includes establishment of temporary and permanent vegetation, mulching, and the use of erosion control matting and blankets.

Sheet Erosion

Sheet erosion is the removal of soil from sloping land in thin layers or sheets. Sheet erosion is the transporting mechanism of soil loosened by the raindrop splash. The potential for sheet erosion is a function of soil type, and depth and velocity of flow on the slope. In erodible materials, the potential increases with the length and steepness of slope as well as the contributing drainage area.

Sheet erosion is a primary concern in highway construction due to the presence of cuts and fills. The same stabilization methods used for the rainfall splash should be applied to prevent sheet erosion. In addition, it can be minimized by diverting as much flow as possible away from the exposed slope. Any structural practice that will reduce the amount of runoff contributing to the exposed area will reduce the sheet erosion.

Rill Erosion

Rill erosion occurs where sheetflow becomes concentrated in small, defined channels which are typically a few centimeters deep. It has been stated that rilling is the form of erosion in which most rainfall erosion occurs. Rilling can be repaired with standard construction practices such as discing or tilling. Rilling commonly occurs on highway construction slopes and can be prevented by proper

EROSION AND SEDIMENTATION PROCESS

slope stabilization and diversion techniques. Any signs of rilling must be repaired and stabilized immediately so that gullies do not form.

Gully Erosion

Gully erosion is the result of concentrated flow much greater than with rills. This is often the result from rills that have not been repaired. Gullying is caused by concentrated flows which form gullies that cannot be covered by mere tilling or discing. These can be very costly to repair due to the equipment and earthwork required.

CHANNEL EROSION

In addition to rainfall erosion, we may also have stream channel erosion. This is important to the highway engineer when designing stable channels or stream modifications. Types of channel erosion include: toe undercutting, bank erosion, bank sloughing, flow slides, and piping. By providing proper channel protection, toe undercutting and bank erosion can be prevented. Larger channel protection is best addressed in FHWA's Hydraulic Engineering Circular 11 (HEC 11), "Design of Riprap Revetment" while smaller stable channel design is covered in HEC-15, "Design of Roadside Channels with Flexible Linings."

FACTORS INFLUENCING EROSION

Rainfall erosion is a function of climate, soil, topography, and vegetative cover.

Climate

Climatic conditions have both a direct and indirect impact on erosion. The most direct impact is due to rainfall intensity and duration. A very intense rainfall of short duration is more damaging than a

longer, less intense rainfall. Rainfall intensity and duration (and frequency) have a direct impact on the amount of runoff generated. Indirectly, climatic conditions also have an impact on erosion. Areas of high rainfall often have more vegetation to protect the soil from erosion, while arid regions with little vegetation are more susceptible to erosion.

In some climates it may be necessary to avoid earthwork construction activities during certain periods or seasons. It is also common to avoid certain types of construction activity, such as work in streams during seasons of intense rainfall. More commonly, climatic conditions are anticipated and sites must be adequately prepared. For example, in most parts of the United States, establishment of permanent vegetation is reserved for the spring and fall.

Soil Characteristics

The erodibility of a soil is dependent upon its texture, organic matter content, structure, and its permeability. The texture of a soil refers to the sizes and proportions of the particles in its composition. The three major classes of soil particles are sand, silt, and clay. Organic matter improves the soil structure and increases the permeability, water holding capacity, and soil fertility. The organic matter consists of plant and animal litter in various stages of decomposition. Soil structure which affects the soil's ability to absorb water is the arrangement of soil particles into aggregates. This also influences the infiltration rate of the soil and thus the runoff potential. The permeability of a soil is a measure of the ability of air and water to pass through the soil. Permeability is influenced by the texture, organic content, and structure.

Topography

The topography of a site has an influence on its erosion potential. In highway construction, the slope length and steepness are important factors in erosion. A steeper slope generates a higher flow velocity and tends to concentrate flows. Flatter slopes reduce the potential for sheet, rill, and gully erosion by reducing the runoff velocity and maintaining sheet flow conditions. In addition, as the slope length increases, the volume of runoff increases due to the larger area. In general, slopes longer than 30 meters (100 feet) are difficult to stabilize. The slope or grade of the roadway and

EROSION AND SEDIMENTATION PROCESS

corresponding ditch is critical to the stability of the lining. With steeper slopes, flexible linings such as vegetation and riprap must be abandoned for rigid linings like asphalt and concrete.

The topography of the watershed and surrounding area also influence the erosion process. The size, shape, and slope of the watershed influence the amount of runoff. As the runoff increases, the potential for erosion increases. The orientation of the slope can also impact the ability to establish vegetation. South facing slopes may be hotter and drier preventing the establishment of vegetation.

Vegetation

Vegetative cover is the most critical factor influencing erosion. The presence of vegetation provides the following benefits:

- Reduces the raindrop impact
- Reduces the velocity of runoff
- Provides structural integrity to the soil from the root system
- Filters contaminants and sediment from runoff
- Increases infiltration
- Increases evapo-transpiration

All of these benefits support the principle of preserving and maintaining vegetation on site to minimize erosion. Where possible, existing vegetation including trees and shrubs should be kept in place. Temporary and permanent vegetation should be established as soon as practicable after a site is disturbed. In addition, the amount of area disturbed and the duration of exposure should be minimized. Vegetative practices are discussed in detail in Chapter 4.

Where vegetation cannot be established due to other constraints, cover materials should be used to stabilize the site. These include mulches, erosion control blankets and matting, etc.

HYDROLOGIC SOIL GROUPS

The Soil Conservation Service has classified soils into four major hydrologic groups according to the minimum infiltration rate for bare soil after prolonged wetting.

Group A (low runoff potential): These soils have high infiltration rates even when thoroughly wetted and are primarily sand or gravel. They are deep and well to excessively drained. These soils have a high rate of transmission, which indicates the rate at which the water moves within the soil. Water readily passes through Group A soils.

Group B (average runoff potential): These soils have moderate infiltration rates when thoroughly wetted. They consist primarily of moderately deep to deep, moderately well to well drained soils, with average to moderately coarse textures. These soils have an average rate of water transmission.

Group C (high runoff potential): These soils have slow infiltration rates when thoroughly wetted. They consist chiefly of soils with layers that impede downward movement of water, or of soil with moderately fine to fine texture. These soils have a slow rate of water transmission.

Group D (very high runoff potential): These soils have very slow infiltration rates when thoroughly wetted. They consist chiefly of clay soils with a high swelling potential, soils with a permanent high water table, soils with a clay pan or clay layer at or near the surface, and shallow soils over impervious material. These soils have a very slow rate of water transmission.

CHAPTER 2

NATIONAL POLLUTANT DISCHARGE ELIMINATION SYSTEM

The 1987 amendments to the Clean Water Act required the Environmental Protection Agency (EPA) to establish the National Pollutant Discharge Elimination System (NPDES) for point source dischargers of storm water. This led to permit requirements for municipalities greater than 100,000 people and dischargers from industrial activities. In these regulations, construction sites that disturb more than 2 hectares (5 acres) are classified as industrial dischargers. This requires operators/owners to obtain permits authorizing the discharge of storm water from these sites.

The storm water regulations provide two options for construction sites. The first option is to submit an individual application. The second option is to file a Notice of Intent (NOI) to be covered under a general permit in accordance with the requirements of an issued general permit.

Although different permitting options are allowable, most states have elected the option of filing an NOI to be covered under a general permit. In addition to containing information about the construction activity, the NOI is a certification that a storm water pollution prevention plan has been prepared for the site. This also certifies that the plan is in compliance with all State and local requirements (plans and/or permits) for erosion control and storm water management. States not covered under the September 9 and 25, 1992 permit have developed similar regulations for their particular states.

GENERAL PERMITS

Submitting an NOI is significantly less burdensome than submitting an individual application. The NOI requirements for general permits usually address only general information and typically do not require the collection of monitoring data.

Most States have been delegated the authority to administer the NPDES program. The program will vary depending on which state the construction activities are taking place. In general, the guidelines in this manual meet the requirements for erosion and sediment control however, the issue of storm water management has not been addressed. In all cases, an NOI must be filed with the state to be covered under a general permit. The deadlines for filing may differ from state to state.

There are eleven states that do not have NPDES permitting authority and are subject to EPA storm water requirements. These states are:

States:	Alaska	Arizona	Florida
	Idaho	Louisiana	Maine
	Massachusetts	New Hampshire	New Mexico
	Oklahoma	Texas	

Territories: District of Columbia, Puerto Rico, Johnston Atoll, Midway and Wake Islands

Indian lands:	Alaska	Arizona	California
	Colorado	Florida	Idaho
	Louisiana	Maine	Massachusetts
	Mississippi	Montana	New Hampshire
	New Mexico	Nevada	North Carolina
	North Dakota	Oklahoma	Texas
	Utah	Washington	Wyoming

Federal facilities:	Colorado	Louisiana	New Mexico
	Oklahoma	Texas	Washington

NATIONAL POLLUTANT DISCHARGE ELIMINATION SYSTEM

The specific requirements for these states and some federal lands were published in the Federal Register on September 9 and 25, 1992. A copy of these rules can be found in Appendix A. These states are required to submit their NOI directly to EPA.

POLLUTION PREVENTION PLAN

In addition to containing information about the construction activity, the NOI is a certification that a storm water pollution prevention plan has been prepared for the site and that the plan is in compliance with State and local requirements (plans and/or permits) for erosion control and storm water management. Although requirements vary in states having NPDES permitting authority, the following information is required in the EPA Pollution Prevention Plan:

Site Description	Controls to Reduce Pollutants	Maintenance
Inspection	Non-storm Water Discharges	

Site Description

The site description should contain the following sections:

Nature of activity

Describe the purpose or goal of the construction project (e.g., single family residential, shopping mall, highway reconstruction).

Sequence of activity (soil disturbing)

Describe the intended sequence of major soil disturbing activities (e.g., clearing, grubbing, rough grading, final grading, stabilization, etc.).

Estimates of total site area and disturbed area

- Total site area: Includes area within property boundaries, all easements and right-of-ways.
Source: Deeds, record plats, survey, site maps.
Disturbed area: From site plan measure all disturbed areas using planimeter, grids, or CADD. Subtract any preserved areas.

Estimates of post-developed runoff coefficients

The runoff coefficient, or "C" value, represents the portion of rainfall that results in runoff from a site. It is most commonly used in the Rational Equation. EPA suggests using a weighted "C" value for each drainage basin. This requires measuring the area of each different land use within the site limits and assigning a "C" value to that land use. An overall "C" value is then computed using the following equation:

$$C = \frac{A_1C_1 + A_2C_2 + \dots + A_xC_x}{A_1 + A_2 + \dots + A_x}$$

Existing water quality data if available

Name of receiving water and areal extent of wetland acreage at site

Site map indicating:

Drainage patterns:

Indicate post-developed drainage patterns/divides.

Consider showing drainage areas and off-site contributing areas.

Anticipated post-grading slopes:

Show existing and proposed contours, if available.

Otherwise, show arrows and final slopes (e.g., 3 horizontal to 1 vertical).

Areas of soil disturbance:

Show "limit of disturbance" on plan.

NATIONAL POLLUTANT DISCHARGE ELIMINATION SYSTEM

Outline of areas undisturbed:

Indicate areas to be preserved, show limits of protection for trees.

Location of major structural and nonstructural controls

Location of areas with stabilization practices

Location of surface waters and wetlands

Location where storm water is discharged to surface waters:

Indicate outfalls of storm sewers, channels, etc.

Other major features:

Show potential pollutant sources such as location of impervious structures and soil stockpiles.

Controls to Reduce Pollutants

This should contain the following sections:

Erosion and sediment controls

Stabilization (seeding, mulching, etc.):

Disturbed areas where construction has permanently or temporarily ceased must be stabilized within 14 days of the last disturbance. Semi-arid and arid areas should be stabilized as soon as practicable. (Areas which will be re-disturbed within 21 days do not have to be stabilized).

Structural Controls:

Sites with common drainage locations that serve 10 or more disturbed acres must have a sediment basin installed where it is attainable (where a basin is not attainable, sediment traps, silt fence or other equivalent measures must be installed). Sediment basins must provide 250 m³/ha (3600 cubic feet of storage per acre) drained. Drainage locations which serve less than 10 disturbed acres must have installed either

a sediment basin, sediment trap, or as a minimum, silt fence along the down slope and side slope perimeter.

Storm Water Management

Permits address only installation and maintenance of storm water management prior to final stabilization of the site.

Storm Water Management Measures:

Onsite Infiltration

Flow Attenuation by Vegetation or Natural Depressions

Outfall Velocity Dissipation Devices

Retention Structures/Artificial Wetlands

Water Quality Detention Structures

The plan must provide an explanation of the technical basis used to select practices to control pollution where flows exceed pre-developed levels. This should include a number of factors including pollutant removal efficiencies, costs, site specific factors, and others.

Velocity dissipation devices are required at discharge locations as necessary to provide non-erosive velocities.

The permittee must consider installing measures (storm water detention structures, infiltration measures, etc.) to control pollutants after construction is complete.

Other controls

The plan must ensure that other materials are not carried by storm water into receiving waters. Measures must be taken to prevent construction vehicles from tracking soil off the construction site, and to reduce dust generation at the construction site. The operator must comply with State and/or local sanitary sewer or septic system regulations.

NATIONAL POLLUTANT DISCHARGE ELIMINATION SYSTEM

State and local controls

The plan must ensure and demonstrate compliance with applicable State and/or local sanitary sewer, septic system, and waste disposal regulations. Permittees are required to provide a certification that their storm water pollution prevention plan reflects requirements related to protecting water resources that are specified in State or local sediment and erosion plans or storm water management plans.

In addition, permittees are required to amend their storm water pollution prevention plans to reflect any change in a sediment and erosion site plan or site permit or storm water management site plan or site permit approved by State or local officials for which the permittee receives written notice. Where such amendments are made, the permittee must provide a recertification that the storm water pollution prevention plan has been modified.

State and Local Programs:

Where State and local programs for sediment and erosion control, storm water management or site permits exist, the pollution prevention plan must certify that the plan reflects and is in compliance with the requirements of the applicable State or local program.

Maintenance

Plans must contain a description of prompt and timely maintenance and repair procedures addressing all measures identified in the site plan to ensure that they are kept in good and effective operating condition.

Inspections

Procedures in a plan must provide that specified areas on the site are inspected by qualified personnel a minimum of once every seven calendar days and within 24 hours after any storm event of greater than 13 mm (0.5 inches). Where sites have been temporarily or finally stabilized, or during seasonal

arid periods in arid and semi-arid areas, the inspection must be conducted at least once every month. Locations where vehicles enter or exit the site must be inspected for evidence of off-site sediment tracking.

Based on the results of the inspection, the site description and the pollution prevention measures identified in the plan must be revised as soon as possible after an inspection that reveals inadequacies. The inspection and plan review process must provide for timely implementation of any changes to the plan within 7 calendar days following the inspection.

An inspection report must be prepared and contain the following:

- Summary of the scope of the inspection

- Name(s) and qualifications of personnel conducting the inspection

- Dates of the inspection

- Major observations relating to the implementation of the plan

Actions taken must be retained as part of the plan for at least three years after the date of inspection. The report must be signed in accordance with the signatory requirements in the Standard Conditions section of these permits.

CHAPTER 3

DEVELOPING EROSION CONTROL PLANS

The purpose of the erosion control plan is to provide the best available guidance in preventing erosion and controlling sediment during construction. These plans are usually developed by the designer of the project. Many of the controls identified in the plan require engineering computations that may have been performed for the design of various structures.

The erosion control plans describe the location and type of controls to be implemented during construction. The controls should address erosion from the initial clearing stage to the final stabilization of the site. The plans should reference standard drawings detailing the construction and installation of the particular control. Special resources such as wetlands, surface waters, etc., are clearly identified on the plan along with protection measures. Any known problems including highly erodible soils, unstable slopes, etc., are also identified. In addition, the plans typically include basic drainage information such as drainage patterns, drainage areas, and the size and location of drainage structures.

In most cases, a narrative is included to assist in the implementation of the plan. The narrative addresses issues that may not be clearly conveyed with a drawing. This may relate to construction sequences, maintenance on the controls, timing of stabilization, or other critical factors. The narrative consists of brief notes and comments while an in depth discussion can be found in the NPDES Pollution Prevention Plan.

EROSION CONTROL PRINCIPLES

In developing the erosion control plans, several overall principles are observed. By following these principles through each stage of construction, the appropriate controls can be selected and erosion will be minimized.

Stabilization

The key to successful erosion and sediment control is the prevention of erosion. In highway construction, this is best achieved through effective stabilization of the slopes and waterways. By initially preventing erosion from occurring, the overall net loss of sediment from the site is minimized. Stabilization is achieved with temporary and permanent turf establishment, mulching, erosion control mats and blankets. It is much more effective to prevent erosion from occurring than to try to filter or trap sediment with other measures. Controls based on the principles of filtering and trapping have limited efficiencies and are used as backup measures.

Limit Exposure

Another related principle to minimize erosion is to limit the time and area of exposure. The potential for erosion is greatly reduced if less area is disturbed or if the area is disturbed for a shorter duration. In some instances, stabilization can occur as construction progresses instead of waiting until the final grade is established. Stabilization is ultimately required for all disturbed areas, so timely stabilization is also cost effective. Although minimizing the area disturbed may be difficult, it should be considered in determining the construction limits. These limits should be clearly shown on the plans.

Retain Sediment On Site

A third principle in controlling erosion and sedimentation is to retain the sediment on the site. This is achieved by using devices that filter sediment from runoff or detain runoff so that soil particles will settle out. By using controls such as silt fence, straw bales or brush barriers, sediment can be filtered from runoff before it leaves the site. These devices should be used only for sheet flow or low concentrations of flow. Where flow occurs in greater quantities, runoff can be detained in settling

DEVELOPING EROSION CONTROL PLANS

structures until the particles settle out. These temporary devices are called sediment traps, or for larger areas, sediment basins. Settling structures are suitable where disturbed areas of sufficient size drain to one location. The structure's size is based on the contributing drainage area. Since these structures can become quite large, sufficient area must be available to construct the facility on the site. These larger devices have limited application to highway construction due to right-of-way constraints.

Management of Runoff

An additional principle that should be followed is to manage only the sediment and runoff from the site. This becomes more challenging in highway construction where off-site drainage intercepts roadways or where roads cross streams. When possible, runoff from undisturbed areas should be diverted around disturbed areas by constructing diversion berms and channels. Also, streams and swales should remain uncontrolled, allowing clean water to pass through the site. It is inefficient to combine sediment laden runoff with clean runoff before passing through filter barriers or settling structures. With settling structures, the storage volume becomes very large if drainage from undisturbed areas is allowed to flow to the structure.

EROSION CONTROL PHASES

Erosion control plans should be developed with the previously discussed principles in mind. In addition, the plans must address the different stages of construction. By dividing the construction into three separate phases, the selection of the erosion controls is easier, especially on larger, more complicated projects. The three phases that the erosion control plans should address are the initial clearing phase, the intermediate grading phase, and final stabilization of the site. The initial phase should address the perimeter controls required at the initial clearing stage to prevent sediment from leaving the site. The intermediate phase should reflect the controls required during construction. This includes the point from grubbing operations until final grade is reached. The third phase of erosion control is the final stabilization of the site and installation of the permanent controls.

Phase I: Perimeter Controls

This phase addresses the type and location of the initial perimeter erosion controls. Ideally, these controls will be installed after clearing and prior to any grubbing of the site. The controls will be located based on the natural topography of the site and the limits of construction. The purpose of these controls is to prevent any off-site damage by minimizing sediment from leaving the site. In most cases, these controls will remain in place throughout the construction of the project. Typical perimeter controls include:

Filter barriers

Diversion structures

Settling structures

Filter barriers such as silt fence, straw bales, and brush barriers are placed around the perimeter of the site to filter out sediment from sheet flow. They are the primary control used in this phase.

Where large amounts of sheet flow from undisturbed areas intercept the construction limits, it may be effective to divert this runoff around the site, thereby minimizing the erosion and the amount of runoff to be controlled. This is done by constructing diversion berms and channels around the site.

When sufficiently large disturbed areas drain to an appropriate location, settling structures may be used to detain the runoff and settle out sediment. These devices are called sediment traps and sediment basins. Diversions may be used to channel sediment laden runoff to these structures.

Phase II: Intermediate Controls

The most critical and difficult phase of erosion control is the intermediate phase, especially in new construction. Intermediate controls are implemented as the project progresses from the grubbing stage to the final grade. This is the stage of construction when earth moving activities are at a maximum. At this point, both the extent of exposure and the duration of exposure is greatest, making the site most susceptible to erosion. Temporary erosion controls must be implemented in

DEVELOPING EROSION CONTROL PLANS

incremental stages as construction progresses. In addition, some permanent structural controls such as culverts, storm sewers, and some waterways are installed. Intermediate controls include:

- Temporary slope drains
- Temporary channel linings
- Mulching
- Temporary and permanent turf establishment
- Checkdams
- Settling structures
- Inlet protection

When practical, turf establishment or stabilization may be performed in incremental stages on cut and fill slopes. As the cut or fill progresses, areas may be seeded and mulched in fifteen to twenty foot vertical increments. This turf establishment may be temporary or permanent. Regardless of the use of vegetation, mulching practices should be an integral measure in this phase.

Phase III: Final Controls

The last phase of erosion control consists of the final stabilization of the site. This includes final stabilization of the slopes and waterways, stabilization of outfalls, and other disturbed areas. Most final controls are permanent, however some temporary controls may be used. Final controls include:

- Permanent turf establishment
- Channel linings
- Temporary slope drains
- Checkdams
- Outlet protection

Some controls may actually serve in more than one phase. For instance, filter barriers and settling structures may control sediment from the initial phase through the final slope stabilization. Also, in some reconstruction projects, the only erosion control phases may be the initial and final controls. The most important factor is to ensure that each appropriate phase is considered when selecting controls and developing erosion control plans.

CHAPTER 4

STABILIZATION METHODS

TEMPORARY SEEDING

Temporary seeding is an effective means of preventing erosion by stabilizing denuded areas that will remain disturbed for periods less than one year. This is normally done by seeding with rapid-growing annual grasses.

Application areas for temporary seeding include slopes that are not ready for permanent stabilization, areas that remain denuded for more than 30 days, areas that will be re-disturbed, and soil stockpiles. In addition, other practices that require temporary stabilization are diversions, dams, sediment, traps and basins. If vegetation is needed for more than one year, **Permanent Seeding** should be applied. If an area is to remain denuded for more than 14 days or will be re-disturbed within 21 days, **Mulching** without seeding should be considered.

Seedbed Preparation

If the area to be stabilized is loosened and provides an adequate seedbed, no further treatment is required. If the seedbed is packed, crusted, and hard, the top layer of soil should be loosened by discing, raking, harrowing or other acceptable means before seeding.

For temporary seeding, fertilizer should be applied at a rate of 680 kg/ha (600 lbs/acre) or 7.3 kg/100 m² (15 lbs/1000 square feet), using 10-10-10 (% Nitrogen - % Phosphorus - % Potash), 10-20-10 or equivalent. Soils which are highly acidic should be limed. Mulch should be applied as described in the **Mulching** Section.

Seeding

Selection of the proper seed mix is essential to the successful establishment of temporary vegetation. This should be based on the particular region and season of the project. In the absence of site specific seed information, Table 4.1 provides recommended seed mixes for the eastern United States.

Table 4.1 Temporary Seeding

Planting Dates	Species	Rate kg/ha (lbs/acre)
Sept. 1 - Feb. 15	50/50 Mix of Annual Ryegrass (<i>Iolium multi-florum</i>) and Cereal (Winter) Rye (<i>Secale cereale</i>)	60-115 (50 - 100)
Feb. 16 - Apr. 30	Annual Ryegrass	70-115 (60 - 100)
May 1 - Aug. 31	German Millet (<i>Setaria italica</i>)	60 (50)

Source: VA Division of Soil and Water Conservation

The seed should be evenly applied with a broadcast seeder, drill, cultipacker seeder, or hydroseeder. Small grains should be planted no more than 40 mm (1 1/2 inches) deep. Small seeds, such as Kentucky Bluegrass, should be planted no more than 5 mm (1/4 inch) deep. Other grasses and legumes should be planted from 5 to 10 mm (1/4 to 1/2 inches) deep.

PERMANENT SEEDING

Permanent seeding is used to stabilize disturbed areas after the final grade is reached and no further disturbance of the site is anticipated for at least one year. This is accomplished with perennial grass seed or seed mixtures.

STABILIZATION METHODS

Seedbed Preparation

A soils test should be performed to determine proper fertilizer and lime requirements. If the test cannot be performed, apply 4500 kg/ha (4000 lbs/acre) of dolomitic limestone.

Apply ground limestone at the rate of 4500 kg/ha (4000 lbs/acre) or 50 kg/100 m² (100 lbs/1000 ft²) where the soil is acidic or composed of heavy clays.

Fertilize at a rate of 1140 kg/ha (1000 lbs/acre) or 12 kg/100 m² (25 lbs/1000 ft²) of 10-10-10, 10-20-10 or equivalent. For longer lasting fertilization, apply 680 kg/ha (600 lbs/acre) of 10-10-10 and during seeding disk an additional 450 kg/ha (400 lbs/acre) of ureaform fertilizer of at least 30-0-0. For Legumes, 5-20-10 is the preferred fertilizer.

Apply the lime and fertilizer before seeding and harrow or disk uniformly into the soil to a depth of 100 to 150 mm (4 to 6 inches) on slopes flatter than 3 horizontal to 1 vertical.

The soil may be insufficiently deep, too coarse or dense, or of an improper pH to be suitable for establishing vegetation. Soil conditioners including peat, sand, vermiculite, raw manure, rotted sawdust, and treated sewage sludge may be added to existing soils to improve their ability to support vegetation. If it is determined that the soil is unsuitable and cannot be improved with the use of soil conditioners, topsoil must be applied in accordance with the **Topsoiling** section.

Seeding

Selection of the proper seed mix is essential to the successful establishment of vegetation, particularly with permanent vegetation. The selection should be based on the particular region and season of the project. Refer to information available from the particular State or locality where the site is located. In the absence of site specific seed information, Table 4.2 provides recommended seed mixes.

Table 4.2 Recommended Perennial Seed Mixtures, kg/ha (lbs/ac)

	Mountain Region	Piedmont Region	Coastal Plain Area
Minimum Care Lawn	230-280 kg (200-250 lbs)	200-230 kg (175-200 lbs)	200-230 kg (175-200 lbs)
Kentucky 31 or Turf-Type Tall Fescue	90-100%	95-100%	
Improved Perennial Ryegrass	0-10%	0-5%	
Kentucky Bluegrass	0-10%	0-5%	
High-Maintenance Lawn	140 kg (125 lbs)	230-280 kg (200-250 lbs)	230-280 kg (200-250 lbs)
General Slope (3Hor:1Vert or less)			
Kentucky 31 Fescue	145 kg (128 lbs)	145 kg (128 lbs)	145 kg (128 lbs)
Redtop Grass	2 kg (2 lbs)	2 kg (2 lbs)	2 kg (2 lbs)
Seasonal Nurse Crop	<u>23 kg (20 lbs)</u>	<u>23 kg (20 lbs)</u>	<u>23 kg (20 lbs)</u>
	170 kg (150 lbs)	170 kg (150 lbs)	170 kg (150 lbs)
Low-Maintenance Slope (Steeper than 3Hor:1Vert)			
Kentucky 31 Fescue	123 kg (108 lbs)	123 kg (108 lbs)	105-123 kg (93-108 lbs)
Redtop Grass	2 kg (2 lbs)	2 kg (2 lbs)	0-17 kg (0-15 lbs)
Seasonal Nurse Crop	23 kg (20 lbs)	23 kg (20 lbs)	2 kg (2 lbs)
Crown Vetch	23 kg (20 lbs)	23 kg (20 lbs)	23 kg (20 lbs)
Sericea Lespedeza	<u>-</u>	<u>-</u>	<u>23 kg (20 lbs)</u>
	171 kg (150 lbs)	171 kg (150 lbs)	170 kg (150 lbs)

Source: VA Division of Soil and Water Conservation

The seed should be evenly applied with a broadcast seeder, drill, cultipacker seeder or hydroseeder. Small seeds, such as Kentucky Bluegrass, should be planted no more than 5 mm (1/4 inch) deep. Other grasses and legumes should be planted from 5 to 10 mm (1/4 to 1/2 inches) deep. All permanent seeding should be mulched immediately upon completion of seed application (see **Mulching**).

SODDING

Use of sod is an effective means of providing immediate permanent turf establishment to disturbed areas. This is especially applicable in drainage swales, residential and other areas of aesthetic concern, and around drop inlets. Although the costs are somewhat higher, the advantage of sod is the immediate stabilization and low risk of failure during establishment of the vegetation.

Site Preparation

A soils test should be performed to determine proper fertilizer and lime requirements. If there is insufficient time for a soils test, fertilizer and lime should be applied as follows:

Apply ground limestone at the rate of 4500 kg/ha (4000 lbs/acre) or 50 kg/100 m² (100 lbs/1000 ft²) where the soil is acidic or composed of heavy clays. Apply 1140 kg/ha (1000 lbs/acre) or 12 kg/100 m² (25 lbs/1000 ft²) of 10-10-10 fertilizer uniformly and mix in the top 75 mm (3 inches) of soil with the required lime.

Installation

Lightly irrigate the soil immediately before laying the sod during periods of excessively high temperatures. Lay the first row of sod in a straight line with subsequent rows placed parallel to and tightly wedged against each other. Stagger lateral joints to promote more uniform growth and strength. Insure that the sod is not stretched or overlapped and that all joints are butted tight in order to prevent voids which would cause air drying of the roots.

On sloping areas where erosion may occur, lay the sod with the long edges parallel to the contour and with staggered joints. Secure the sod by tamping and pegging or other approved methods. Water the sod immediately after rolling or tamping until the underside of the new sod pad and soil surface below the sod are thoroughly wet. The entire operation should be complete within eight hours.

Maintenance

Water daily or as often as necessary during the first week and in sufficient quantity to maintain moist soil conditions to a depth of 100 mm (4 inches). This should be timed around the heat of the day to prevent wilting. After the first week, water the sod as necessary to maintain adequate moisture and insure establishment. The first mowing should not be attempted until the sod is firmly rooted (2 - 3 weeks). No more than 1/3 of the grass leaf should be removed during the cutting. Maintain the grass height between 50 and 75 mm (2 and 3 inches).

Specifications

1. Class of turfgrass sod should be State Certified or State approved sod.
2. Sod should be machine cut at a uniform soil thickness of 20 mm (3/4 inches), plus or minus 5 mm (1/4 inch), at time of cutting. This does not include top growth and thatch.
3. Sod should not be harvested or transplanted when the moisture content (excessively dry or wet) may adversely affect its survival.
4. Sod should be harvested, delivered and installed within a period of 36 hours. Sod not transplanted within this period should be inspected and approved prior to its installation.

TOPSOILING

Topsoiling is the placement of a surface layer of soil enriched in organic matter over a prepared subsoil prior to the establishment of vegetation. The purpose is to provide a suitable growth medium for final stabilization of the site with vegetation.

Topsoiling is used when the existing soil is unsuitable for establishing vegetation due to acidity, lack of nutrients, texture, presence of toxic substances, or other conditions that cannot be remedied with

STABILIZATION METHODS

soil additives. Topsoiling is also used when the soil material is too shallow to support root growth. Topsoiling is not recommended on slopes steeper than 2 horizontal to 1 vertical.

Site Preparation

If the subsoil is highly acidic or composed of heavy clays, ground limestone should be added at a rate based on soil tests or 9100 - 18,000 kg/ha (8000 - 16,000 lbs/acre) or 100 - 200 kg/100 m² (200-400 lbs/ 1000 ft²). Prior to dumping and spreading the topsoil, the subsoil (with limestone if it is required) should be loosened by discing or scarifying to a depth of at least 75 mm (3 inches). This will ensure bonding of the topsoil to the subsoil.

Application

The topsoil should be uniformly distributed over the subsoil to a minimum compacted depth of 50 mm (2 inches) on slopes steeper than 3 horizontal to 1 vertical and 100 mm (4 inches) on flatter slopes. The topsoil should not be placed while in a frozen or muddy condition, when the subsoil is excessively wet, frozen or in a condition that is detrimental to proper grading or seedbed preparation. The final surface should be prepared so that any irregularities are corrected and depressions and water pockets do not form. If the topsoil has been treated with soil sterilants, it should not be placed until the toxic substances have dissipated.

MULCHING

Mulching is a method of temporary stabilization where various materials are applied to disturbed or exposed surfaces. This is one of the most important methods of erosion control because it can prevent erosion from occurring from the start. Mulching protects the soil from the rainfall impact and overland flow. Mulch also promotes the growth of vegetation by protecting the seed and fostering germination. The materials are most commonly organic but synthetic or chemical materials are also used.

Temporary and permanent seeding should be mulched immediately after applying the seed. Extremely sensitive areas can be mulched at the end of a days operations or within 3 days of the disturbance. The NPDES regulations require that an area may not be left disturbed more than 14 days (see Chapter 2 and Appendix A). Mulching is an excellent way of providing temporary stabilization. Stockpiles should be mulched to prevent erosion if they will be undisturbed for long periods.

In highway construction, slopes should be mulched as grading operations proceed. This is done as an intermediate control. Also, if the timing of grading operations does not allow vegetation establishment due to seasonal constraints, Mulch can be applied to stabilize the slopes until seasonal conditions improve and the timing is right for permanent stabilization.

Materials

Mulches

Hay and Straw:

Straw is the most common and one of the most effective methods of mulching, usually used in conjunction with seeding. The straw should come from wheat or oats and be free of troublesome weed seeds. Hay may be used where weeds are not considered a problem. The method of application for both is by hand or machine. Both straw and hay should be anchored to prevent it from being windblown.

Fiber Mulch (Hydraulic):

Fiber mulch is composed of wood cellulose or grass straw cellulose fibers used in hydroseeding operations and is applied as part of the slurry. The fibers do not require tacking. Although it provides excellent seed soil contact, it does not provide sufficient protection to highly erodible soils. It is not recommended during the dry summer months or as a late fall mulch cover.

Mulch Anchoring

Mechanical Methods

A mulch anchoring tool, or crimper, is a mechanical method of anchoring straw. A tractor drawn device is driven over the surface immediately after spreading the mulch. This device punches the straw into the ground.

Fiber Mulch

Fiber mulch described above is suitable for anchoring straw. The fiber mulch is applied with a hydroseeder at a rate of 570 to 850 kg/ha (500 to 750 lbs/acre) over the straw or hay mulch.

Soil binders (tackifiers)

Soil binders and chemical mulches are available as spray-on materials to stabilize and protect the soil surface. They are used alone or in conjunction with fiber mulches or straw. Although they stabilize the soil, they do not insulate it or retain the moisture as organic mulches do. They typically decompose in 60 to 90 days. Some examples are:

- Emulsified asphalt
- Nonasphaltic emulsion
- Polyvinyl acetate
- Acrylic copolymers

EROSION CONTROL BLANKETS AND MATTING

Organic

Wood Fiber (Excelsior)

Curled wood mat consists of curled wood with wood fibers, 80 percent of which are 150 mm (6 inches) or longer, with a consistent thickness and an even distribution of fiber over the entire mat. The top side of the mat is covered with a biodegradable plastic mesh. The mat is placed in the channel or on the slope parallel to the direction of flow and secured with staples and check slots. This is applied immediately after seeding operations.

Jute net

Jute net consists of jute yarn, approximately 5 mm (1/4 inch) in diameter, woven into a net with openings that are approximately 10 by 20 mm (3/8 by 3/4 inch). The jute net is loosely laid in the channel parallel to the direction of flow. The net is secured with staples and check slots at intervals along the channel. Placement of the jute net is done immediately after seeding operations.

Coconut Coir Fiber

Coconut blankets are constructed of biodegradable coconut fibers that resist decay for five to ten years to provide long, temporary erosion control protection. The materials are often encased in UV stabilized nets and sometimes have a composite, polypropylene structure to provide permanent turf reinforcement. These materials are best used for waterway stabilization and slopes that require longer periods to stabilize.

Synthetic

Unlike organic mats and blankets, synthetic mats are constructed from non-biodegradable materials and remain in place for many years. Although they are permanent in nature, they are classified as temporary measures since one purpose is for the establishment of vegetation. They are generally

STABILIZATION METHODS

classified into two categories: Turf Reinforcement Mats (TRM's) and Erosion Control and Revegetation Mats (ECRM's).

Turf Reinforcement Mats (TRM)

TRM's are three dimensional polymer nettings or monofilaments formed into a mat. They have sufficient thickness (> 13 mm or 0.5 inch) and void space (>90%) to allow for soil filling and retention. The mat acts as a traditional mat to protect the seed and increase germination. As the turf establishes, the mat remains in place as part of the root structure, This gives the established turf a higher strength and resistance to erosion.

Erosion Control and Revegetation Mats (ECRM)

ECRM's are composed of continuous monofilaments bound by heat fusion or stitched between nettings. They are thinner than TRM's and do not have the void space to allow for filling of soil. They act as a permanent mulch and allow vegetation to grow through the mat.

TYPES OF VEGETATION¹⁴

Annual Grasses

Annual grasses are quick to germinate and provide the fastest ground cover of any group of plants. They are useful for quick, temporary cover or as nurse crops for slower-growing perennials. Common examples are annual ryegrass, oats, and barley.

Winter Rye

Winter rye is usually superior to other winter annuals (wheat, oats, crimson clover, etc.) for both temporary seeding and as a nurse crop in perennial mixtures. It has more cold-hardiness than other annuals and will germinate and grow at lower temperatures. By maturing early, it offers less competition during the late spring period, a critical time in establishment of

perennial species. Rye grain germinates quickly and is tolerant of poor soils. Including rye grain in fall seeded mixtures is almost always advantageous, but it is particularly helpful on difficult soils and erodible slopes or when seeding is late. Because overly thick stands of rye grain will suppress the growth of perennial seedlings, limit seeding to the suggested level. About 55 kg/ha (50 lb/acre) is the maximum for this purpose, and where lush growth is expected, that rate should either be cut in half, or rye grain should be eliminated from the mixture.

Annual Ryegrass

Unlike winter rye, annual ryegrass is not recommended in areas where permanent vegetation will eventually be established. It may be used as temporary vegetation. It provides dense cover quickly, but may be more harmful than beneficial in areas that are to be permanently stabilized. Annual ryegrass is highly competitive, and if included in mixtures, it crowds out most other species before it matures in late spring or early summer, leaving little or no lasting cover. It can be effective as a temporary seeding, but if allowed to mature, the seed volunteers and seriously interferes with subsequent efforts to establish permanent cover. Winter rye is preferable in most applications.

German Millet

German millet is a fine-stemmed summer annual, useful for temporary seeding as a nurse crop and for tacking mulch. It is better adapted to sandy soils than are the Sudangrasses. Normal seeding dates are between the last frost in spring and the middle of August.

Sudangrass

Like German millet, Sudangrass is useful for temporary seeding and as a nurse crop, but it is adapted to soils higher in clay content. Only small-stemmed varieties of Sudangrass should be used. Seed for common Sudangrass is not always available, but other small-stemmed types may be used, such as the hybrid Trudan. The coarse-stemmed sorghum-Sudangrass hybrids

STABILIZATION METHODS

are not satisfactory as nurse plants and are not appropriate for erosion control. Seeding dates are similar to those for German millet.

Annual Lespedeza

Annual lespedeza is a warm-season, self-reseeding annual legume that is tolerant of low fertility and is adapted to climate and most soils. It is an excellent nurse crop in the spring, filling in weak or spotty stands the first season without suppressing the perennial seedlings. It is often seeded with scirocco lespedeza. Annual lespedeza can heal damaged areas in the perennial cover for several years after initial establishment. Two varieties of annual lespedeza are generally available: Kobe and Korean. Kobe is superior on sandy soils and generally preferable in the Coastal Plain. Korean is better in the mountains as the seeds mature earlier. The preferred seeding dates for lespedeza are in late winter to early spring. It can be mixed with fall seedings, in which case some seeds remain dormant over the winter and germinate the following spring. However, it is more effective to overseed with lespedeza in February or March.

Perennial Grasses

Perennial grasses develop slower than annuals and require more moisture and soil. Seedlings do not compete well in mixtures with annual grasses. Some commonly used perennial grasses are red fescue, tall fescue, and perennial ryegrass. Cool-season perennial produce most of their growth during the spring and fall and are generally more cold-hardy than most warm-season species.

Tall Fescue

Tall fescue, a cool-season grass, is one of the most widely used species for erosion control. It is well-adapted to all but the most droughty soils in the Coastal Plain regions. It thrives in full sun to partial shade and is easy to establish. If seeded in the fall, it provides stabilization early in the first growing season. Because of tall fescue's bunchy growth habit, it is best used in mixture. It does not fill in well where areas are damaged by disease or weather; however,

short rhizomes enable individual plants to expand substantially in thin stands. It is adapted to both high and low maintenance uses, tolerating frequent mowing or no mowing at all. Liberal amounts of fertilizer and proper liming are essential for prompt establishment of tall fescue, but once firmly in place it can tolerate minimal maintenance almost indefinitely.

Kentucky Bluegrass

Kentucky bluegrass is the dominant lawn grass in the Mountains and Upper Piedmont regions of the Eastern United States. It has higher lime and fertility requirements than the other perennial grasses. Bluegrass spreads by strong rhizomes and, where adapted, is an excellent soil stabilizer, readily filling in damaged spots.

Redtop

Redtop is a tough, cool-season perennial grass tolerant of infertile, droughty, somewhat acid soils. It can be a useful component of mixtures on dry, stony slopes in mountainous regions.

Warm season perennials initiate growth later in the spring than cool-season species and experience their greatest growth during the hot summer months. Most species thrive only in the Coastal Plain areas and are not generally used in the mountains.

Bermudagrass

Bermudagrass is an aggressive, sod-forming, warm-season perennial adapted to a wide range of well-drained to excessively drained soils throughout the eastern Piedmont and Coastal Plain. It is very drought-resistant, has considerable salt tolerance, and can be very useful for erosion control, particularly on deep sands and near the coast. It is not shade tolerant.

Common Bermudagrass should be used with extreme care because it spreads quickly to croplands, gardens, and landscape plantings. It is difficult to control and almost impossible to eradicate.

STABILIZATION METHODS

Common Bermudagrass is normally seeded in late spring using hulled seed. Unhulled seed may be used in fall-seeded mixtures because it lies dormant over winter and germinates in the spring. Hybrid varieties are planted in early spring while soil moisture is still adequate. They may be planted later if water is available for irrigation.

Centipedegrass

Centipedegrass is adapted to well-drained, medium to coarse-textured soils in the eastern Piedmont and Coastal Plain. Generally used as a low to moderate maintenance turf, it is tolerant of infertile, low pH soils, heat, drought, and cold. A serious problem with the centipedegrass is its slow growth rate. Also, when grown on dry sands, irrigation is required to avoid severe pest injury. It is not tolerant to traffic or compaction. It can be established from seed or sprigs, but a nurse crop must be used to provide initial erosion control. The best planting months are March through July.

Legumes

Legumes are a type of vegetation that has the ability to make its own nitrogen which is a valuable addition to infertile soils. They may be planted alone or in combination with grasses. Legume seed must be coated (inoculated) with the correct bacteria immediately before seeding.

Crown Vetch

Crown vetch is a deep-rooted, perennial legume with spreading rootstocks, adapted to the Mountain region and the cool slopes in the Piedmont. It is useful on steep slopes and rocky areas that are to be left unmowed. Crown vetch requires a specific *Rhizobium* inoculant. It can be seeded in the spring or fall. Crown vetch does not respond well to mowing.

Sericea Lespedeza

Sericea lespedeza is a deep-rooted, drought-resistant perennial legume, adapted to all but the poorly drained soils. It is long-lived, tolerant of low fertility soils, and pest free, and it fixes

nitrogen. It can be a valuable component in most low maintenance mixtures. Sericea is a slow starter and should not be expected to contribute much to the prevention of erosion the first year; however, it strengthens rapidly and persists indefinitely on suitable sites. Seedings that include sericea require mulch and should include nurse plants such as German millet, Sudangrass, or annual lespedeza. Scarified, or roughened seed should be used for spring seeding of sericea because it germinates more readily. Unscarified seed is recommended for fall-seed mixtures because many of the seeds will lie dormant over winter and germinate early the next spring. Sericea does not tolerate frequent mowing and may be considered unsightly because the old top growth breaks down slowly.

CHARACTERISTICS OF COMMONLY SELECTED GRASSES

COMMON NAME (Botanical Name)	Life Cycle	Season	pH Range	Germination Time In Days	Optimum Germination Temperature (°F)	Winter Hardiness	Drought Tolerance	Fertility	Soil Drainage Tolerance	Seeds Per Pound	MAINTENANCE REQUIREMENTS	REMARKS
TALL FESCUE (Festuca arundinacea)	P	C	5.5- 6.2	10-14	60-85	F	F	M	SPD	225K	Low when used for erosion control; high when used in lawn.	Better suited for erosion control and rough turf application.
TALL FESCUES (Improved)	P	C	5.5- 6.2	10-14	60-85	F	G	M	SPD	220K	Responds well to high maintenance.	Excellent for lawn and fine turf.
KENTUCKY BLUEGRASS (Poa pratense)	P	C	6.0- 6.5	14	60-75	G	P	M	SPD	2.2m	Needs fertile soil, favorable moisture. Requires several years to become well established.	Excellent for fine turfs-takes traffic, mowing. Poor drought/heat tolerance.
PERENNIAL RYEGRASS (Lolium perenne)	P	C	5.8- 6.2	7-10	60-75	F	F	M-H	SPD	227K	Will tolerate traffic.	May be added to mixes. Improved varieties will perform well all year.

KEY

A = Annual P = Perennial C = Cool Season Plant W = Warm Season Plant G = Good F = Fair P = Poor VP = Very Poor H = High
M = Medium L = Low SPD = Somewhat Poorly Drained MPD = Moderately Poorly Drained PD = Poorly Drained VPD = Very Poorly Drained

CHARACTERISTICS OF COMMONLY SELECTED GRASSES

COMMON NAME (Botanical Name)	Life Cycle	Season	pH Range	Germination Time In Days	Optimum Germination Temperature (°F)	Winter Hardness	Drought Tolerance	Fertility	Soil Drainage Tolerance	Seeds Per Pound	MAINTENANCE REQUIREMENTS	REMARKS
FINE FESCUES	HARD FESCUE (<i>Festuca Longifolia</i>)	C	5.0- 6.2	10- 14	60-80	VG	G	L	MWD	400K	Grows well in sun or shade and will tolerate infertile soils; improved disease resistance.	Exceeds all fine fescues in most tests. Excellent for low- maintenance situations.
	CHEWINGS FESCUE	C	5.0- 6.2	10-14	60-80	VG	G	L	MWD	400K	Tolerates shade, dry infertile soils.	Poor traffic tolerance, less thatch than other fine fescues.
	RED FESCUE (<i>Festuca Rubra</i>)	C	5.0- 6.2	10-14	60-80	VG	G	L	MWD	400K	Low to medium fertility requirements. Requires well-drained soil.	Spreads by rhizomes, tillers and stolons. Will not take traffic - very shade tolerant.
REED CANARYGRASS (<i>Phalaris arundinacea</i>)	P	C	5.8- 6.2	21	70-85	G	G	M-H	VPD	530K	Do not mow closely or often.	Conservation cover in wet areas.
REDTOP (<i>Agrostis alba</i>)	P	C	5.8- 6.2	10	65-85	G	F	L	PD	5m	Will tolerate poor, infertile soils; deep rooted.	Does well in erosion control mixes - not for lawns.

KEY

A = Annual P = Perennial C = Cool Season Plant W = Warm Season Plant G = Good F = Fair P = Poor VP = Very Poor H = High
M = Medium L = Low SPD = Somewhat Poorly Drained MPD = Moderately Poorly Drained PD = Poorly Drained VPD = Very Poorly Drained

CHARACTERISTICS OF COMMONLY SELECTED GRASSES

COMMON NAME (Botanical Name)	Life Cycle	Season	pH Range	Germination Time In Days	Optimum Germination Temperature (°F)	Winter Hardness	Drought Tolerance	Fertility	Soil Drainage Tolerance	Seeds Per Pound	MAINTENANCE REQUIREMENTS	REMARKS
WEeping LOVEGRASS (<i>Eragrostis curvula</i>)	P	W	4.5- 6.2	14	65-85	F-P	G	L-M	SPD	1.5m	Low-fertility requirements; excellent drought tolerance.	Fast-growing, warm season bunch grass. Excellent cover for erosion control.
BERMUDAGRASS (<i>Cynodon dactylon</i>)	P	W	5.8- 6.2	21	70-95	P	G	M-H	SPD	1.8m hulled	High nitrogen utilization, excellent drought tolerance. Some varieties adapted to western VA.	Common varieties used for erosion control. Hybrids used for fine turf.
ORCHARDGRASS (<i>Dactylis glomerata</i>)	P	C	5.8- 6.2	18	60-75	F	F	M	SPD	625K	Does best on well- drained, loamy soil.	Good pasture selection - may be grazed.
ANNUAL RYEGRASS (<i>Lolium multiflorum</i>)	A	C	5.8- 6.2	7	60-70	G	P	M-H	SPD	227K	Will grow on most Virginia soils. Do not use in fine-turf areas.	May be added into mixes or established alone as temporary cover in spring and fall.

KEY

A = Annual P = Perennial C = Cool Season Plant W = Warm Season Plant G = Good F = Fair P = Poor VP = Very Poor H = High
M = Medium L = Low SPD = Somewhat Poorly Drained MPD = Moderately Poorly Drained PD = Poorly Drained VPD = Very Poorly Drained

CHARACTERISTICS OF COMMONLY SELECTED GRASSES

COMMON NAME (Botanical Name)	Life Cycle	Season	pH Range	Germination Time In Days	Optimum Germination Temperature (°F)	Winter Hardness	Drought Tolerance	Fertility	Soil Drainage Tolerance	Seeds Per Pound	MAINTENANCE REQUIREMENTS	REMARKS
RYE (Secale Cereale)	A	C	5.8- 6.2	7	55-70	VG	G	L-M	SPD	18K	Will establish in most all Virginia soils. Do not use in fine-turf areas.	May be added into mixes or established alone for late fall/winter cover.
FOXTAIL MILLET (Setaria italica)	A	W	5.8- 6.2	10	65-85	VP	G	M	MWD	220K	Establishes well during summer. Very low moisture requirements.	May be added to erosion-control mixes or established alone.
CROWN VETCH (Coronilla varia)	P	C	6.0- 6.5	14-21	70	G	VG	M	MWD	110K	Does best on well- drained soils. Minimum maintenance when established. May need phosphorous. Inoculation is essential.	Excellent for steep, rocky slopes. Produces colorful blooms in May/June. Slow to establish. Does best when seeded in spring.

KEY

A = Annual P = Perennial C = Cool Season Plant W = Warm Season Plant G = Good F = Fair P = Poor VP = Very Poor H = High
 M = Medium L = Low SPD = Somewhat Poorly Drained MPD = Moderately Poorly Drained PD = Poorly Drained VPD = Very Poorly Drained

CHARACTERISTICS OF COMMONLY SELECTED GRASSES

COMMON NAME (Botanical Name)	Life Cycle	Season	pH Range	Germination Time In Days	Optimum Germination Temperature (°F)	Winter Hardiness	Drought Tolerance	Fertility	Soil Drainage Tolerance	Seeds Per Pound	MAINTENANCE REQUIREMENTS	REMARKS
SERICEA LESPEDEZA (Lespedeza cuneata)	P	W	5.8- 6.2	21-28	70-85	F	VG	L	MWD	335K	Grows in most well- drained soils. Low fertility requirements. Inoculation is essential.	Use hulled seed in spring; unhulled in fall. Very deep- rooted legume. Excellent choice for eastern VA.
FLATPEA (Lathyrus silvestrus)	P	C	5.0- 7.0	14-28	65-75	G	G	L	PD	15K	Needs lime and high phosphorus. Good shade tolerance.	Tolerates acidic and wetter soils better than other legumes.
BIRDSFOOT TREFOIL (Lotus corniculatus)	P	C	6.0- 6.5	7	65-70	G	F	M	SPD	375K	Inoculation is essential. Grows in medium- fertile, slightly acid soils.	Grows better on poorly drained soils than most legumes. Poor drought/heat tolerance.

KEY

A = Annual P = Perennial C = Cool Season Plant W = Warm Season Plant G = Good F = Fair P = Poor VP = Very Poor H = High
M = Medium L = Low SPD = Somewhat Poorly Drained MPD = Moderately Poorly Drained PD = Poorly Drained VPD = Very Poorly Drained

CHARACTERISTICS OF COMMONLY SELECTED GRASSES

COMMON NAME (Botanical Name)	Life Cycle	Season	pH Range	Germination Time In Days	Optimum Germination Temperature (°F)	Winter Hardness	Drought Tolerance	Fertility	Soil Drainage Tolerance	Seeds Per Pound	MAINTENANCE REQUIREMENTS	REMARKS
ANNUAL LESPEDEZAS (<i>Lespedeza striata</i> , L. Stipulacea)	A	W	5.8- 6.2	14	70-85	F	VG	L	MWD	200K	Will grow on almost any well-drained soil.	Choose Kobe for southeastern VA; needs almost no nitrogen to survive.
RED CLOVER (<i>Trifolium pratense</i>)	P	C	6.0- 6.5	7-14	70	G	F	M	SPD	275K	Needs high levels of phosphorous and potassium.	Acts as a biennial. Can be added to low- maintenance mixes.
WHITE CLOVER (<i>Trifolium repens</i>)	P	C	6.0- 6.5	10	70	G	P	M	PD	700K	Requires favorable moisture, fertile soils, high pH.	Spreads by soil surface stolons, white flowers.

KEY

A = Annual P = Perennial C = Cool Season Plant W = Warm Season Plant G = Good F = Fair P = Poor VP = Very Poor H = High
 M = Medium L = Low SPD = Somewhat Poorly Drained MPD = Moderately Poorly Drained PD = Poorly Drained VPD = Very Poorly Drained

CHAPTER 5

STRUCTURAL EROSION CONTROL MEASURES

CHECK DAMS

A check dam is a small, temporary obstruction in a ditch or waterway used to prevent erosion by reducing the velocity of flow. A dam placed in the ditch or channel causes water to pond behind the structure thereby reducing the velocity and force acting on the soil or lining. Although some bed material may be deposited behind the structure, check dams do not function as sediment trapping devices, and should not be used as such.

Check dams are most commonly constructed of loose rock riprap and sometimes logs or compacted earth. Silt fence or straw bales should not be used as substitutes for checkdams due to stability problems, however these materials may be used in swales with very low flows to filter runoff (see **Silt Fence and Straw Bales**).

Check dams can be used in temporary ditches constructed during grading operations where a permanent lining is not feasible. They may also be used in temporary or permanent ditches while vegetation is being established or before the permanent lining has been constructed. In general, check dams should not be used in streams as a temporary erosion control device.

Design

A standard check dam is 0.6 meters (2.0 feet) high with a 1.2 meter (4.0 feet) base and 2 horizontal to 1 vertical side slopes. The center of the crest is typically 150 mm (6 inches) below the sides of the crest. These dimensions may be modified based on the individual needs and for larger flows.

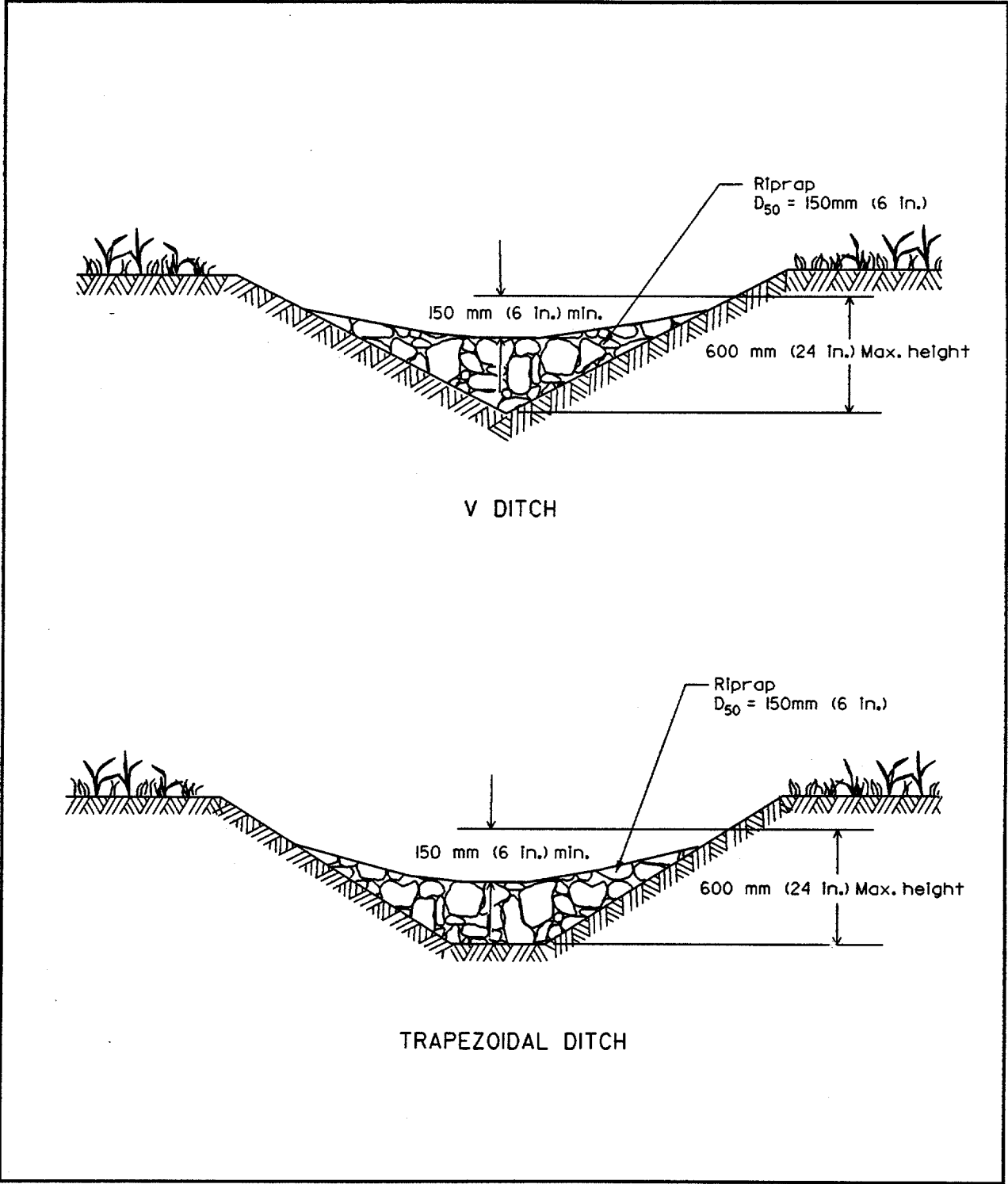

Figure 5.1 Check Dam Cross Section

STRUCTURAL EROSION CONTROL MEASURES

The spacing between structures is dependent on the height of the check dam, the grade of the waterway and the desired length of the backwater effect. In order to protect the channel between the check dams, the devices should be spaced such that the elevation of the toe of the upstream check dam is equal to the elevation of the crest of the downstream check dam (see Figure 5.2). Table 5.1 gives the required spacing for a 0.6 meter (2.0 foot) high structure for various channel slopes. On steeper slopes, the ponding of water will not extend as far upstream as on flatter slopes. For this reason, check dams are not effective on steep slopes.

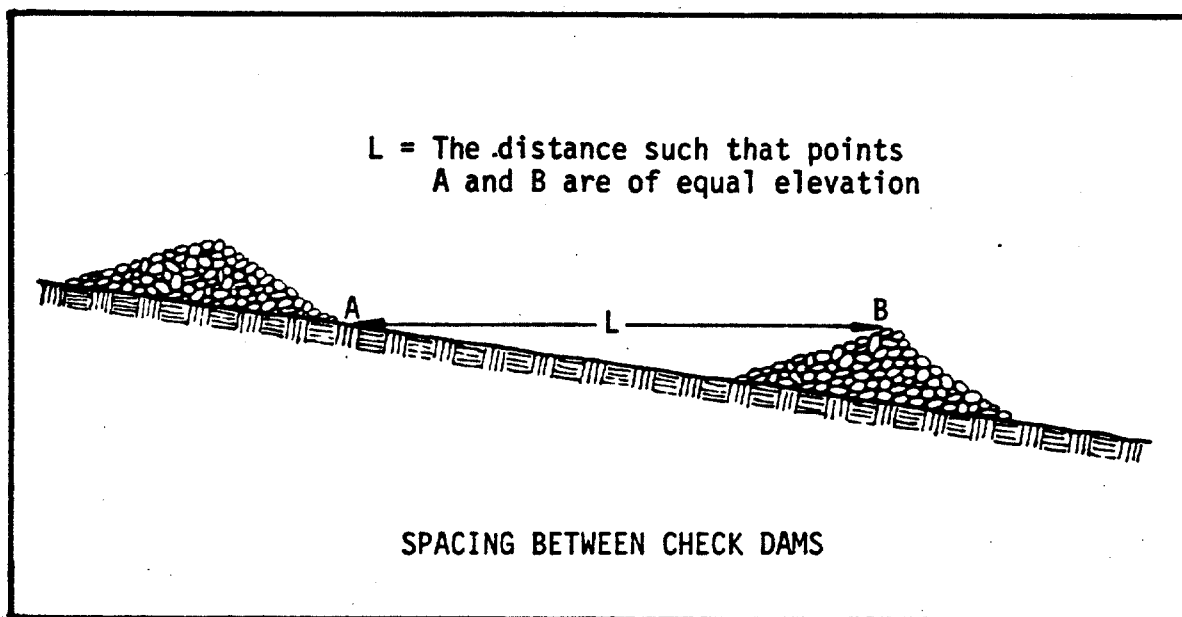

Figure 5.2 Spacing Between Check Dams

Source: VA SWCC

Checkdams may be designed for site specific applications if necessary. For site specific designs, the size or height of the structure and the spacing will vary. The device should be sized to pass the two year storm without overtopping the roadway or side slopes of the ditch. A weir equation can be used to determine the depth of flow over the structure if necessary. The spacing is determined based on the height and slope of the channel.

Table 5.1 Spacing for a Standard Check Dam (0.6 meter (2.0 ft) high)

Ditch Grade	Check Dam Spacing
0.02 m/m (ft/ft)	23 m (75 ft)
0.03 m/m (ft/ft)	15 m (50 ft)
0.04 m/m (ft/ft)	12 m (40 ft)
0.05 m/m (ft/ft)	9 m (30 ft)
0.06 m/m (ft/ft)	8 m (25 ft)

Construction

1. Place stone in locations as shown in the plan on a filter fabric foundation.
2. Unless different dimensions are specified, the base of the check dam should be 1.2 meters (4 feet) wide with 2 horizontal to 1 vertical side slopes. The maximum height of the check dam should be 0.6 meters (2 feet) with the center 150 mm (6 inches) below the sides of the dam.
3. The spacing of the checkdams should be as specified in the plan or such that the elevation of the toe of the upstream check dam is equal to the elevation of the crest of the downstream check dam.

Maintenance

Checkdams should be inspected after rainfall to ensure proper functioning. Large flows can cause sediment accumulation, wash-outs, or damage to the filter material. The overflow areas and toe of the check dam are especially susceptible to erosion. These areas should be stabilized immediately if any damage has occurred. Also, any displaced stones should be replaced. Remove and properly dispose of sediment when it has accumulated half way up the dam height or it interferes with the performance of the structure.

STRUCTURAL EROSION CONTROL MEASURES

DIVERSIONS

Diversions are measures used on a temporary or permanent basis to divert water around an area that is either under construction, being stabilized, or prone to erosion. This is accomplished by constructing channels, berms, or temporary culverts. Specific applications include diverting runoff around a large denuded area as a perimeter control, diverting runoff around a cut slope as a temporary or permanent measure, and diverting concentrated flows for culvert installations.

As a perimeter control, channels and/or berms may be constructed above a large disturbed area to better manage the runoff from the site. These serve two purposes. First, the amount of runoff over the disturbed area is reduced, thereby reducing the erosion potential. Secondly, clean water can be separated from the sediment laden water and can be passed through the site. These devices minimize the water to be managed and the erosion control measures are less stressed by the volume of water. This is an important principle in developing erosion control plans. Diversions may also be used to direct the sediment laden water to a specific control such as a sediment trap or basin.

Another specific use of a diversion is to keep water off cut slopes. This is achieved by constructing a channel and/or berm above the top of the cut slope and conveying it to a stable outfall. This may be done as a temporary measure while vegetation is being established or as a permanent measure to remain in place after the slope has been stabilized.

Diversions are also used during culvert installations where water must be temporarily diverted around the construction area. This diversion can be performed with construction of a stable channel or with the use of a temporary culvert.

Design

In designing diversions, the channel must provide an adequate cross section and a stable lining. Detailed design procedures are available in FHWA's Hydraulic Engineering Circular Number 15,

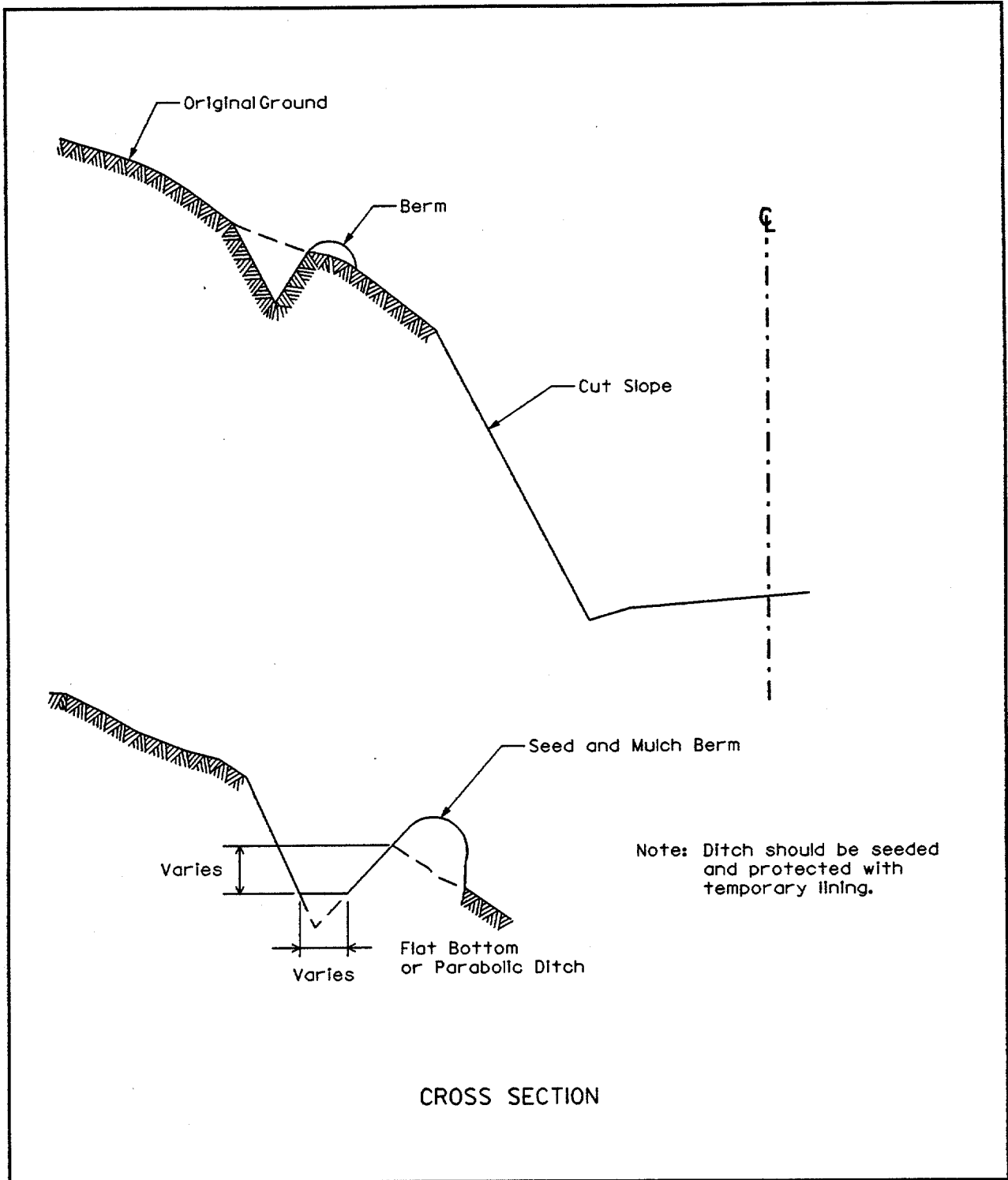

Figure 5.3 Diversion Channel and Berm

STRUCTURAL EROSION CONTROL MEASURES

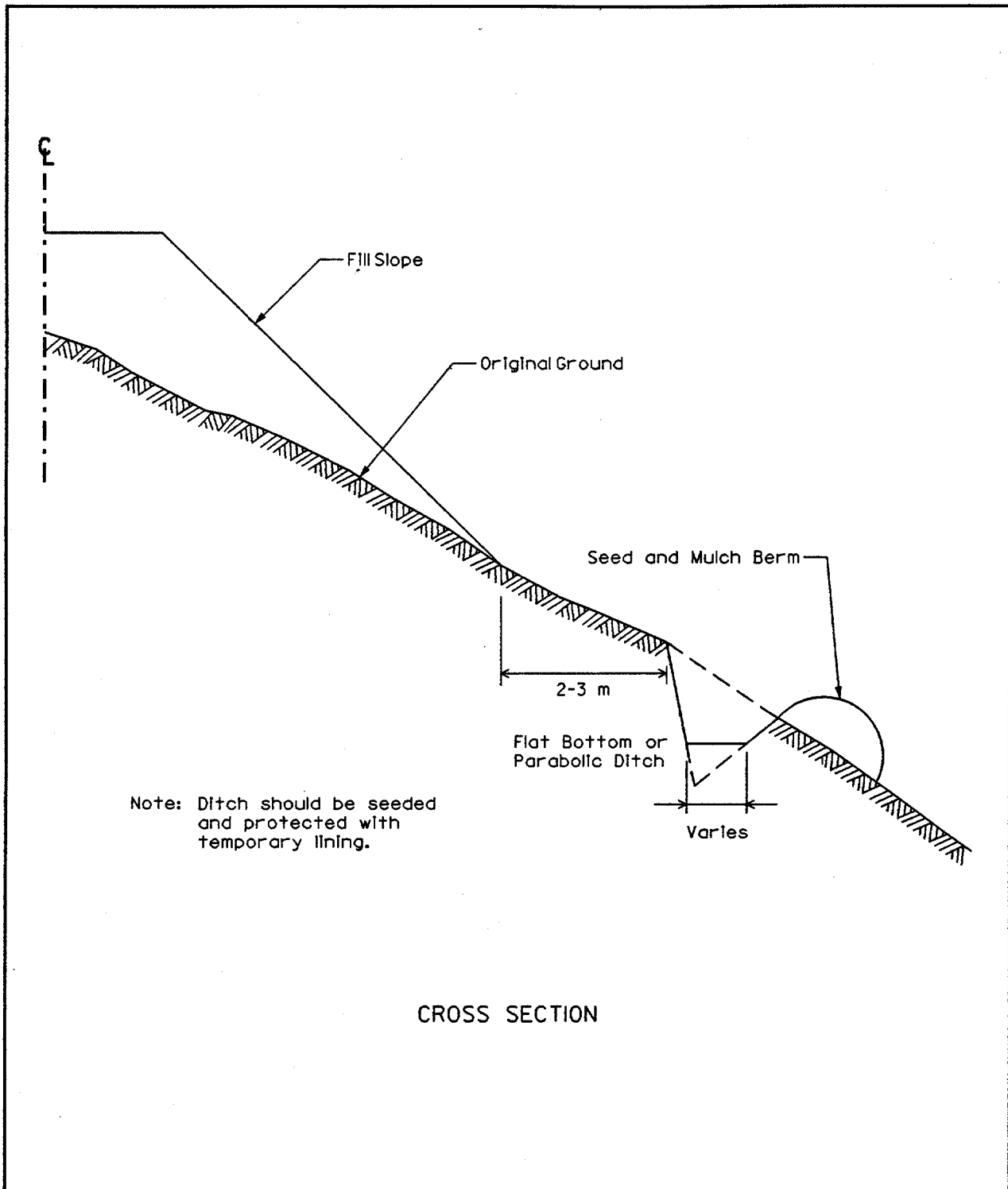

Figure 5.4 Diversion Channel and Berm

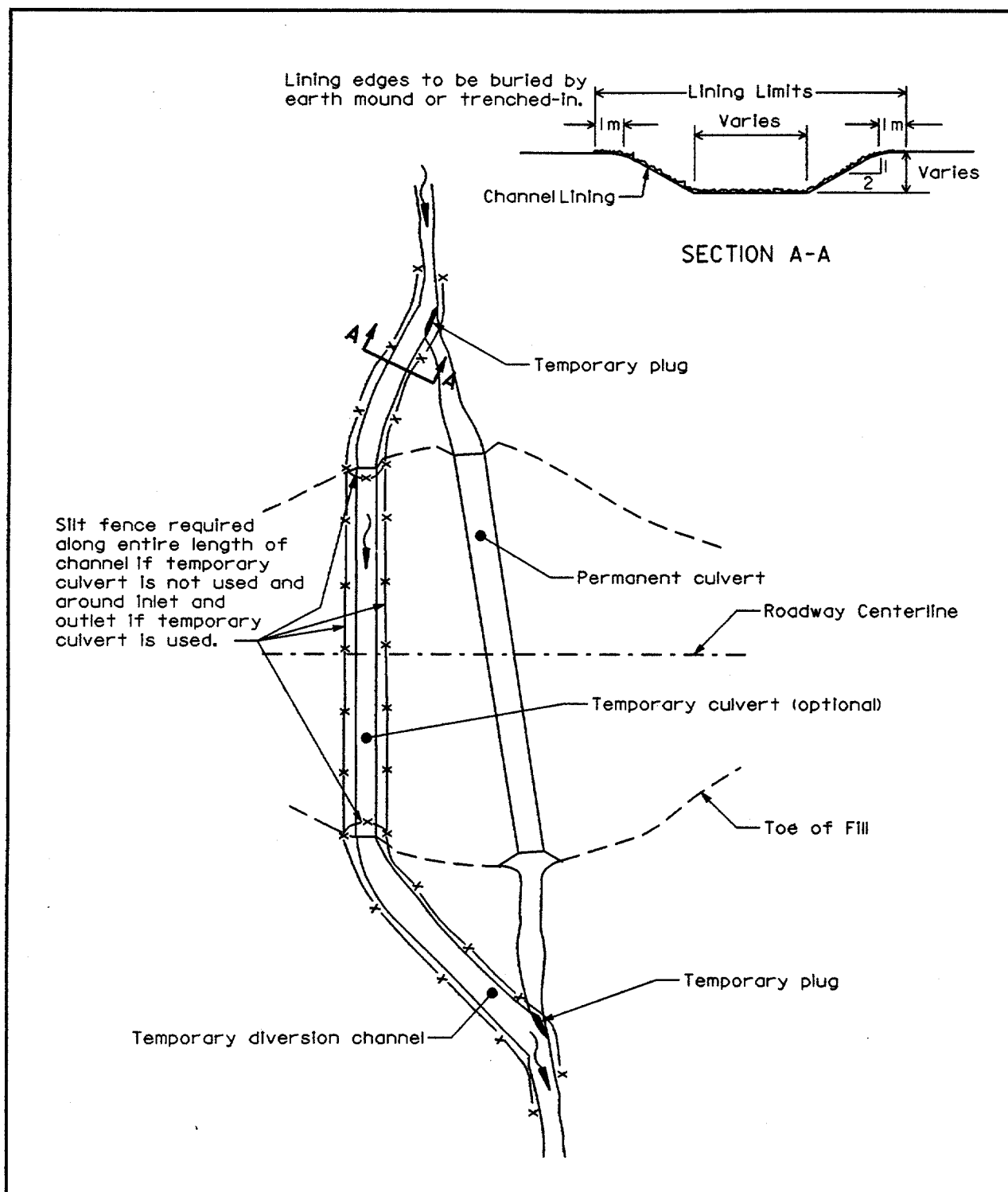

Figure 5.5 Diversion for Culvert Installation

STRUCTURAL EROSION CONTROL MEASURES

"Design of Stable Channels with Flexible Linings." These procedures have been automated for the microcomputer in the program HYCHL which is part of the HYDRAIN computer package. As a temporary measure, the two year design frequency storm should be used to size the structure and check the stability of the lining. As a permanent measure, the minimum design flow should be the ten year storm, however, a larger recurrence interval may be required based on a risk evaluation of the consequences of failure.

For culvert installations, the temporary culvert should be sized for the two year storm using the FHWA procedures in Hydraulic Design Series Number 5, "Hydraulic Design of Highway Culverts." A temporary channel sized for the two year storm may also be used with riprap or plastic as a lining material.

Construction

Diversion channels for perimeter controls should be constructed after the area has been cleared but before grubbing and grading operations begin. The material excavated for the temporary channel can be used as a berm on the side of the channel. The berm should be immediately seeded with temporary vegetation and mulched. The channel should be immediately lined with the appropriate lining material.

For culvert installations, the temporary diversion channel should be excavated as designed, leaving plugs at both ends. For riprap linings, filter fabric should be installed before the riprap is placed. If a plastic lining is used, the laps should run transverse to the flow direction and should overlap at least 0.6 meters (2 feet). Check slots should be placed every 8 meters (25 feet). These are 150 mm (6 inch) slots dug perpendicular to the direction of flow. The material is folded and tucked into the slot. Outside edges should be secured at the top of the channel with compacted earth. When the liner installation is complete, remove the plugs at both ends (downstream first) and divert the flow into the diversion with sandbags. After the installation of the permanent drainage structure is complete, replug the diversion, salvage the diversion lining, and backfill in the channel.

Maintenance

The channel should be inspected periodically and after every rainfall to ensure proper functioning. Any damage in the lining should be repaired or revegetated. All debris should be removed and properly disposed of to provide adequate flow conveyance.

TEMPORARY SLOPE DRAIN

A temporary slope drain is a flexible or rigid conduit used to effectively transport runoff down disturbed slopes. These are temporary measures that are used during grading operations, until the permanent drainage structures are installed, and until the slopes are permanently stabilized. The pipe material is typically corrugated plastic or flexible tubing. For flatter, shorter slopes, a polyethylene lined channel is sometimes used.

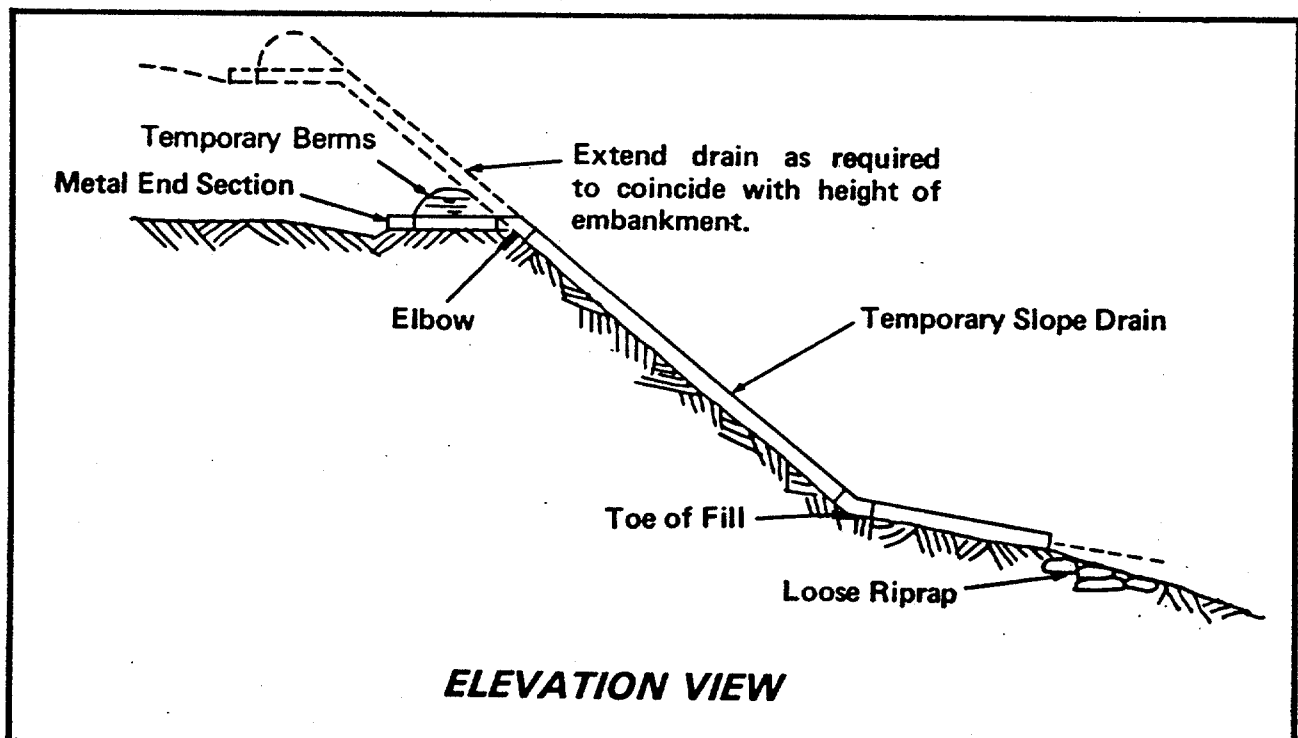

Figure 5.6 Temporary Slope Drain

STRUCTURAL EROSION CONTROL MEASURES

Design

Temporary slope drains should be designed to adequately convey runoff for a two year frequency storm. Both the size and the spacing can be determined based on the contributing drainage area. Table 5.2 below provides estimates of the pipe diameter based on drainage areas. Drains are spaced at intervals corresponding to the specified drainage areas. For larger drainage areas and critical locations, the drains should be sized on an individual basis using FHWA culvert design procedures.

Table 5.2 Slope Drain Sizes

Contributing Drainage Area	Pipe Diameter
0.2 ha (0.5 ac)	300 mm (12 inch)
0.6 ha (1.5 ac)	450 mm (18 inch)
1.4 ha (3.5 ac)	600 mm (24 inch)

Slope drains should be constructed in conjunction with diversion berms such that the berms are not overtopped (see **Diversions**). At the pipe inlet, the top of the berm should be a minimum of 300 mm (12 inches) higher than the top of the pipe. The entrance should be constructed of a standard flared end section or a Tee section if designed properly. The entrance should be placed in a 150 mm (6 inches) minimum depressed sump.

The outlet of the slope drain must be protected with a riprap apron (see **Outlet Protection**). If the slope drain is draining a disturbed area and sufficient right-of-way is available, the drain may empty into a sediment trap (see **Sediment Trap**).

Construction

1. Place slope drains on undisturbed or well-compacted fill at sites specified in the plans.
2. Place the entrance of the drain in a 150 mm (6 inch) sump at the top of the slope.

3. Hand tamp the soil under and around the entrance in 150 mm (6 inch) lifts.
4. Fill and compact soil 300 mm (12 inches) over the top of the entrance.
5. Use watertight fittings at all slope drain connections.
6. Securely fasten pipe sections with grommets or stakes at 3 m (10 foot) spacings.
7. Extend the drain beyond the toe of the slope and provide riprap outlet protection.
8. Construct the diversion berm 300 mm (12 inches) above the top of the pipe at the pipe entrance. Compact and stabilize the berm.

Maintenance

Slope drains should be inspected weekly and after every rainfall to ensure proper functioning. Any erosion of the slope, berm, or outlet should be repaired and stabilized immediately. After the slope has been permanently stabilized and the permanent drainage system has been installed, the drains may be removed and the remaining disturbed areas should be stabilized.

OUTLET PROTECTION

Outlet protection is used as a temporary or permanent measure to prevent erosion at the outlet of structures. The most common material used is rock riprap. Other possible materials are broken concrete or gabions. In some instances of lower velocities, synthetic materials may be used in conjunction with vegetation. Where extremely high velocities occur or where pipe diameters are larger than 900 to 1200 mm (36 to 48 inches), outlet energy dissipators should be constructed.

Design

The design of outlet protection involves determining the size of riprap and the dimensions of the apron. The apron dimensions include the width at the downstream section and the length of the apron as shown in Figure 5.7. The procedures included in this manual are based on a method developed by the Soil Conservation Service (SCS) for low tailwater conditions. This method provides conservative results for apron conditions. Alternative procedures can be found in the FHWA

STRUCTURAL EROSION CONTROL MEASURES

publication, Hydraulic Engineering Circular Number 14, "Hydraulic Design of Energy Dissipators for Culverts and Channels." The HEC-14 procedures for riprap basins should be used for pipes larger than 900 mm to 1200 mm (36 inches to 48 inches).

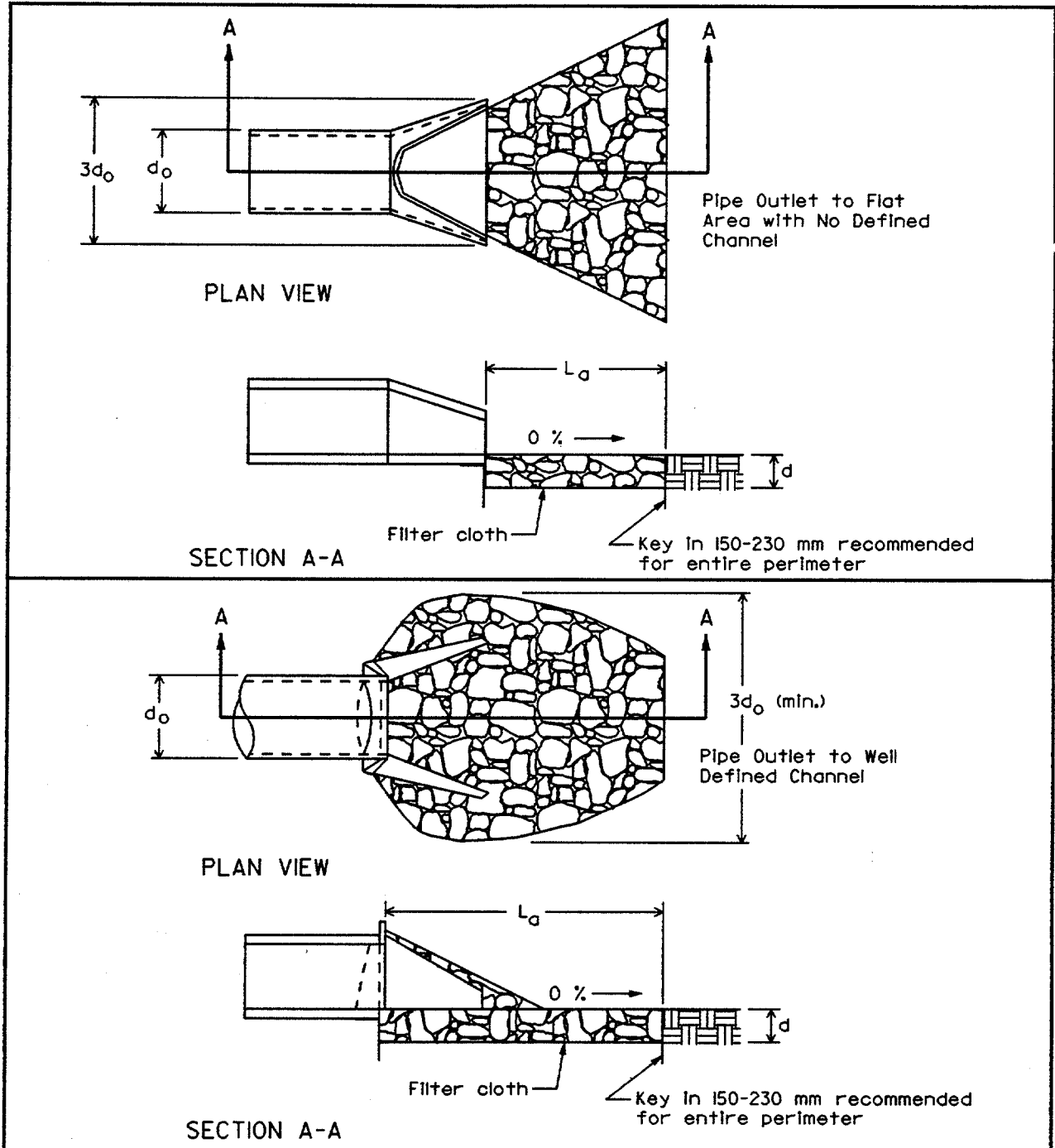

Figure 5.7 Outlet Protection

Outlet Protection Design Procedures

Step 1: Based on the pipe diameter and discharge, determine the median stone size (D_{50}) and length of apron, L_a , from Figure 5.8.

Step 2: When the pipe discharges directly into a well-defined channel, the apron should extend across the channel bottom and up the channel banks to an elevation one foot above the maximum tailwater depth or to the top of the bank, whichever is less.

If the pipe discharges onto a flat area with no defined channel, the width of the upstream end of the apron should be three times the diameter of the outlet pipe. The downstream end of the apron should be equal to the pipe diameter plus the length of the apron.

Step 3: The bottom grade of the apron should be constructed on a flat grade (0%). The invert of the apron should be equal to the invert of the receiving channel. If the pipe discharges into a well-defined channel, the side slopes should be no steeper than 2 horizontal to 1 vertical.

STRUCTURAL EROSION CONTROL MEASURES

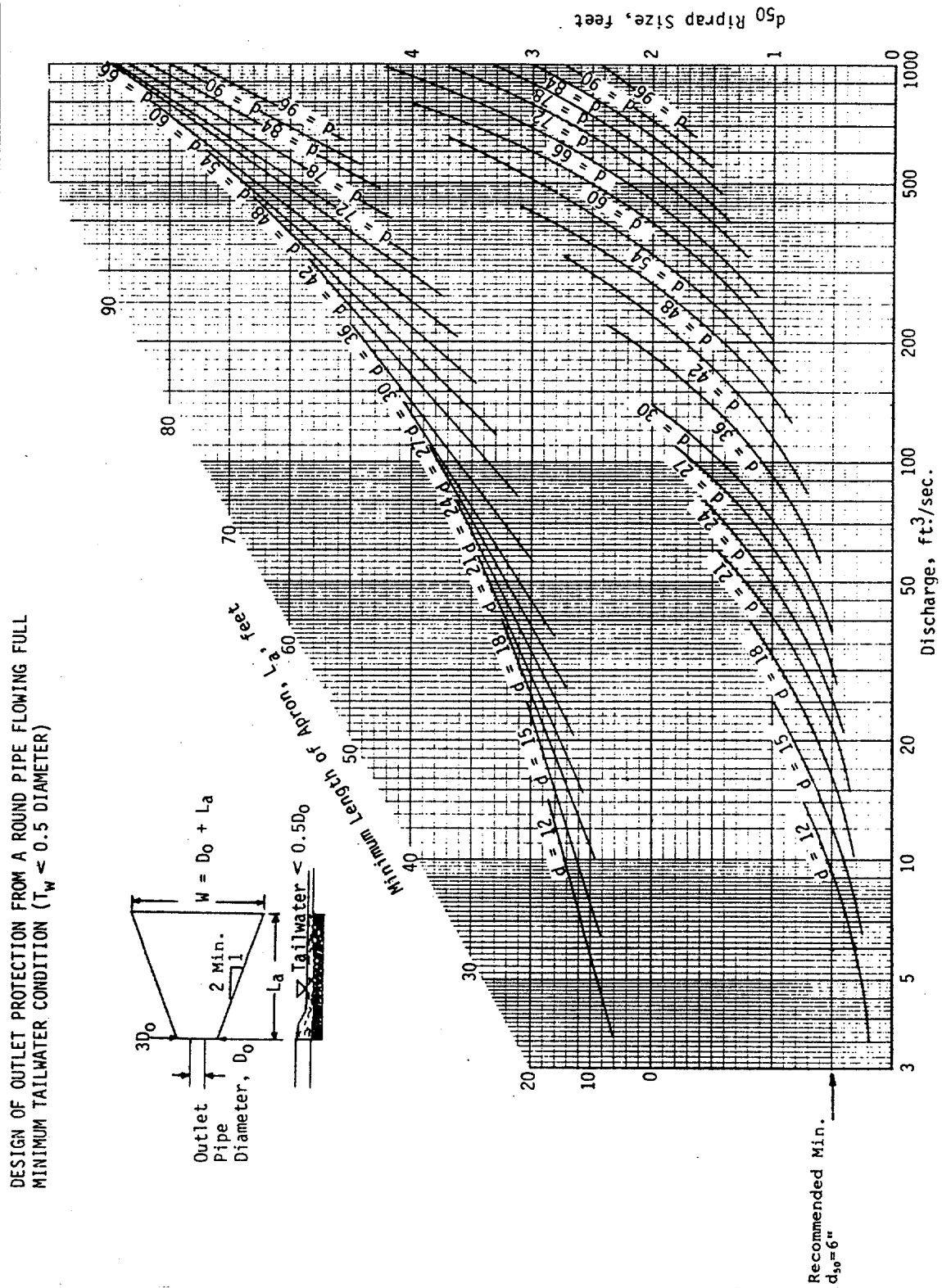

Figure 5.8 Outlet Protection Design

ENERGY DISSIPATORS

Energy dissipators are permanent structural devices used to reduce high velocities at the outlet of pipes to prevent scouring. These are warranted on steep slopes and high flows where outlet protection will not suffice. Many types of dissipators are available for various flow conditions. The more common types are illustrated in Figure 5.9. The application and design of these structures are detailed in FHWA's Hydraulic Engineering Circular Number 14, "Hydraulic Design of Energy Dissipators for Culverts and Channels."

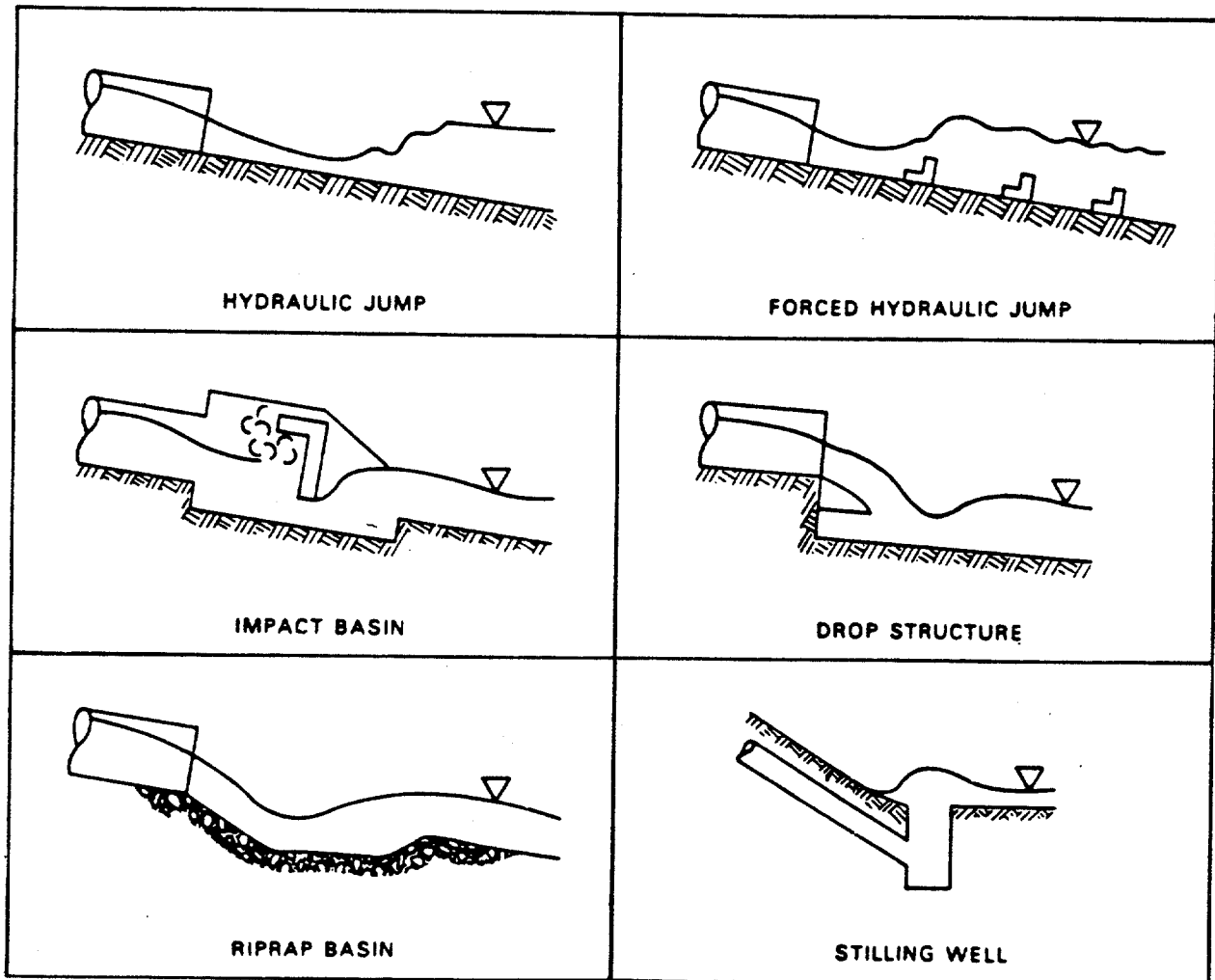

Figure 5.9 Types of Energy Dissipators

STRUCTURAL EROSION CONTROL MEASURES

SILT FENCE

A silt fence is a temporary barrier used to filter sediment from sheet flow. This barrier can also cause water to pond behind the fence thereby promoting deposition of the sediment. The fence is constructed with a synthetic filter fabric mounted on posts and embedded in the ground. This is the most common type of perimeter control used to remove sediment before the runoff leaves the site.

Silt fence is commonly placed at the toe of fills and along the edge of waterways to trap sediment before it enters the waterway (see Figure 5.10). Silt fence is not intended for use in ditches and swales where concentrated flows can exceed $0.03 \text{ m}^3/\text{s}$ (1 cfs). It may be used in minor ditches and swales.

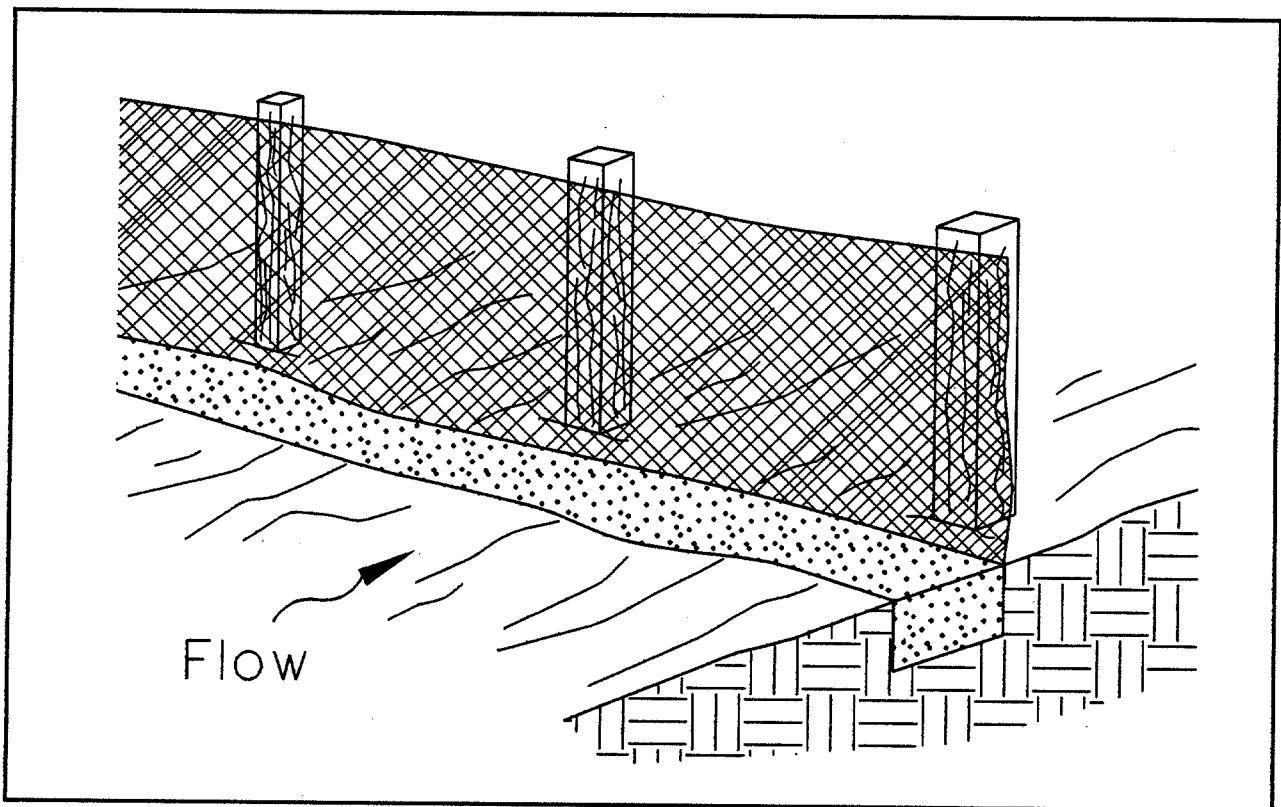

Figure 5.10 Silt Fence

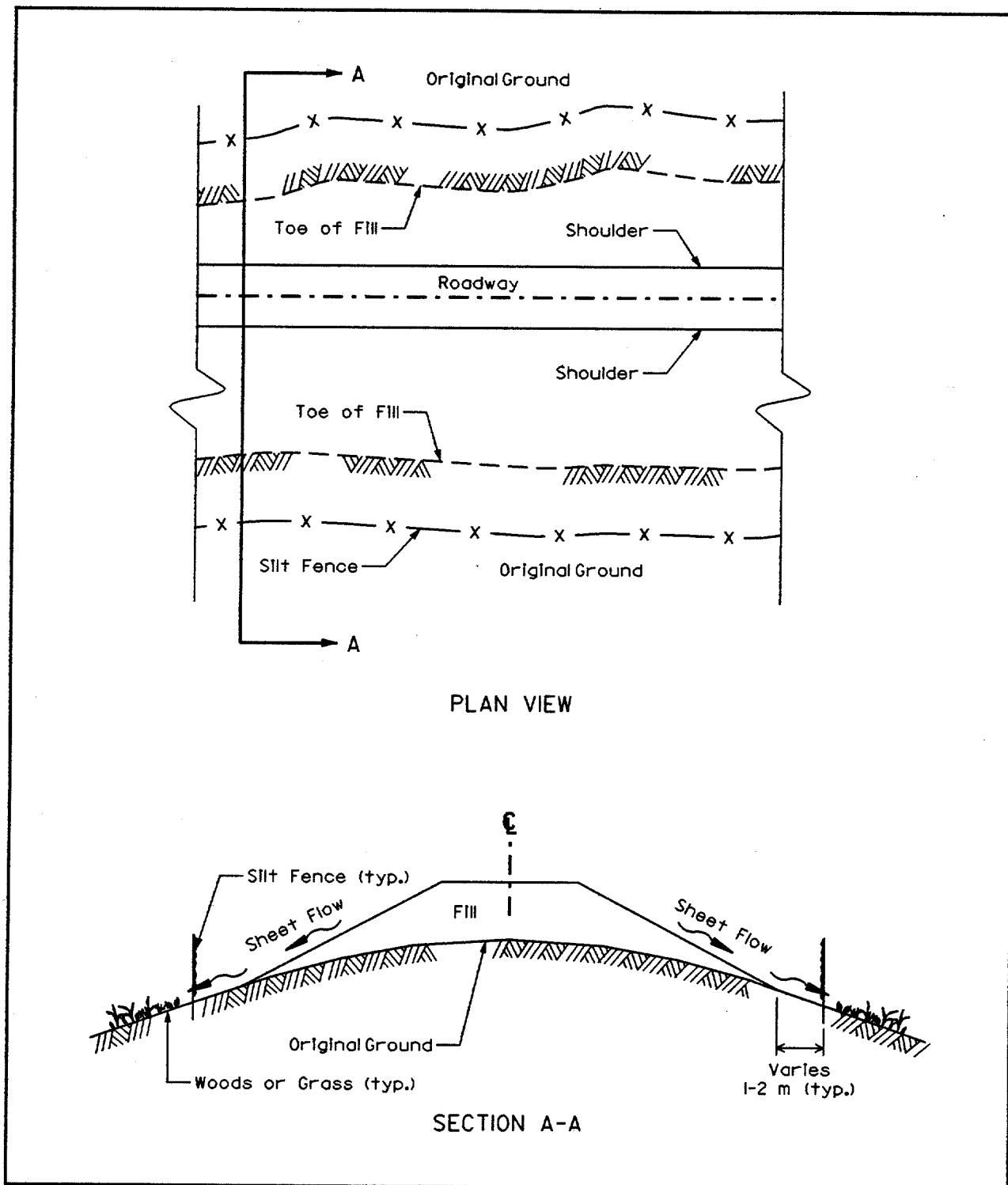

Figure 5.11 Silt Fence as a Perimeter Control

STRUCTURAL EROSION CONTROL MEASURES

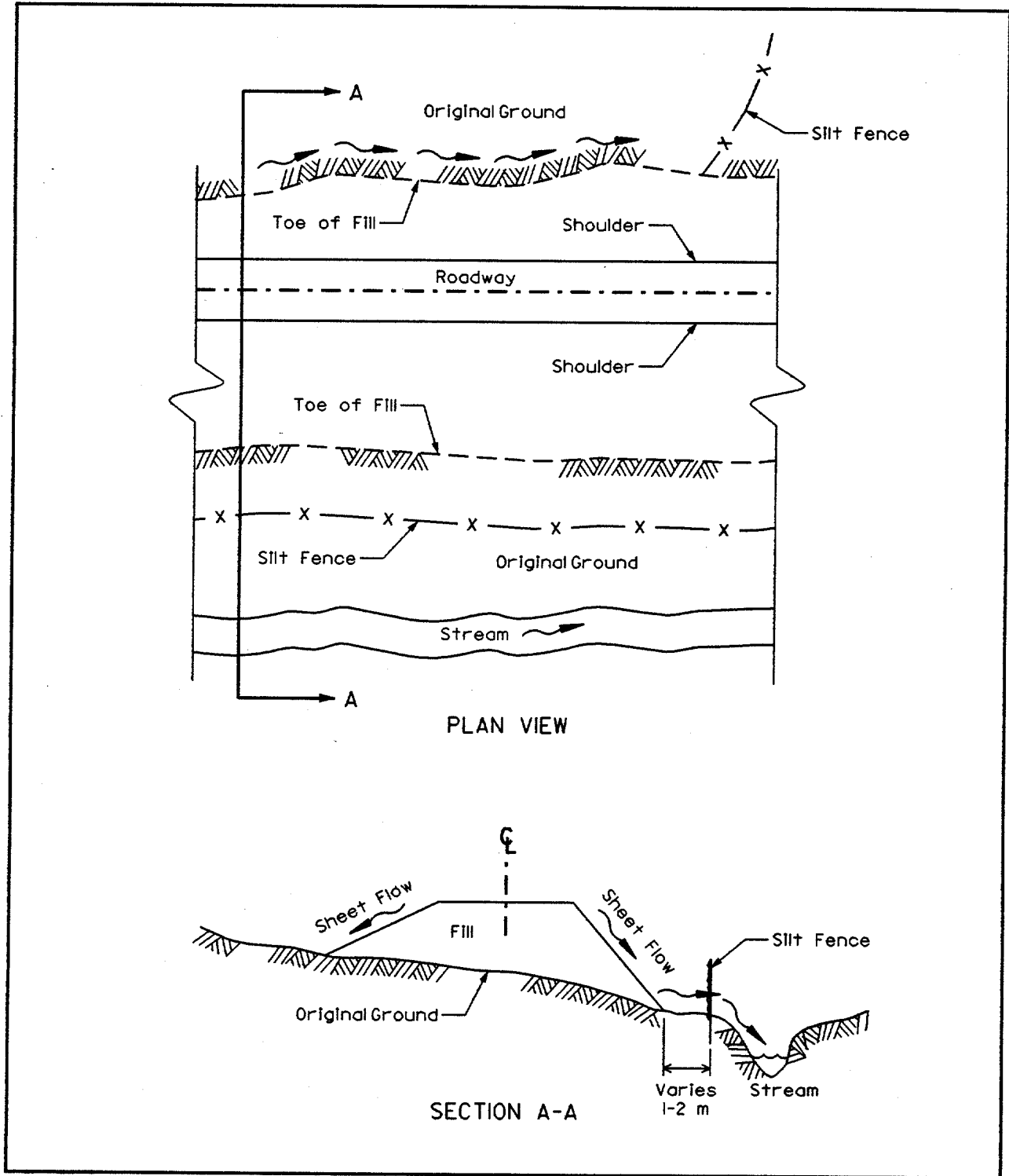

Figure 5.12 Silt Fence Protecting Waterway

Design

No formal design is required for silt fence. The contributing area for sheet flow applications should not exceed 0.3 hectare per 100 meters (1/4 acre per 100 feet) of fence. Ponding water should be limited to a height of 460 mm (1.5 feet). In swale or ditch applications, the two year discharge should be checked to see that it does not exceed 0.03 m³/s (1 cfs). Table 5.3 provides guidelines for limiting slope length based on slope.

Table 5.3 Maximum Slope Lengths for Silt Fence

Slope (%)	460 mm (18 in) Fence	760 mm (30 in) Fence
2 (or less)	75 m (250 ft)	150 m (500 ft)
5	30 m (100 ft)	75 m (250 ft)
10	15 m (50 ft)	45 m (150 ft)
15	10 m (35 ft)	30 m (100 ft)
20	8 m (25 ft)	21 m (70 ft)
25	6 m (20 ft)	17 m (55 ft)
30	5 m (15 ft)	14 m (45 ft)
35	5 m (15 ft)	12 m (40 ft)
40	5 m (15 ft)	10 m (35 ft)
45	3 m (10 ft)	9 m (30 ft)
50	3 m (10 ft)	8 m (25 ft)

STRUCTURAL EROSION CONTROL MEASURES

Construction

1. Construct the silt fence barrier of standard strength or extra strength synthetic filter fabrics.
2. Ensure that the height of the silt fence does not exceed 900 mm (36 inches) above the ground surface.
3. Construct the filter fabric from a continuous roll cut to the length of the barrier to avoid joints. When joints are necessary, securely fasten the filter cloth only at a support post with overlap to the next post.
4. Place posts at a spacing not to exceed 1.8 meters (6 feet). If wire mesh backing is used, posts may be placed at a maximum 3 meters (10 feet) spacing.
5. Excavate a trench approximately 100 mm (4 inches) wide and 100 mm (4 inches) deep along the line of posts and upslope of the barrier.
6. Staple or wire the filter fabric directly to the posts. Extend the filter fabric 200 mm (8 inches) into the trench.
7. Backfill the trench and compact the soil over the filter fabric.

Maintenance

Silt fence should be inspected for damage weekly and after rainfall. Common failures are tearing, undermining, and collapsing. Any damaged fence should be repaired immediately. Accumulated sediment should be removed and properly disposed of before the next rainfall. When the disturbed areas have been properly stabilized, the fence may be removed and any remaining areas stabilized.

STRAW BALES

Straw bales are temporary measures used to filter sediment from runoff in sheet flow applications. Straw bales are recommended only for applications of short duration, usually less than 3 months, due to the tendency to degrade quickly.

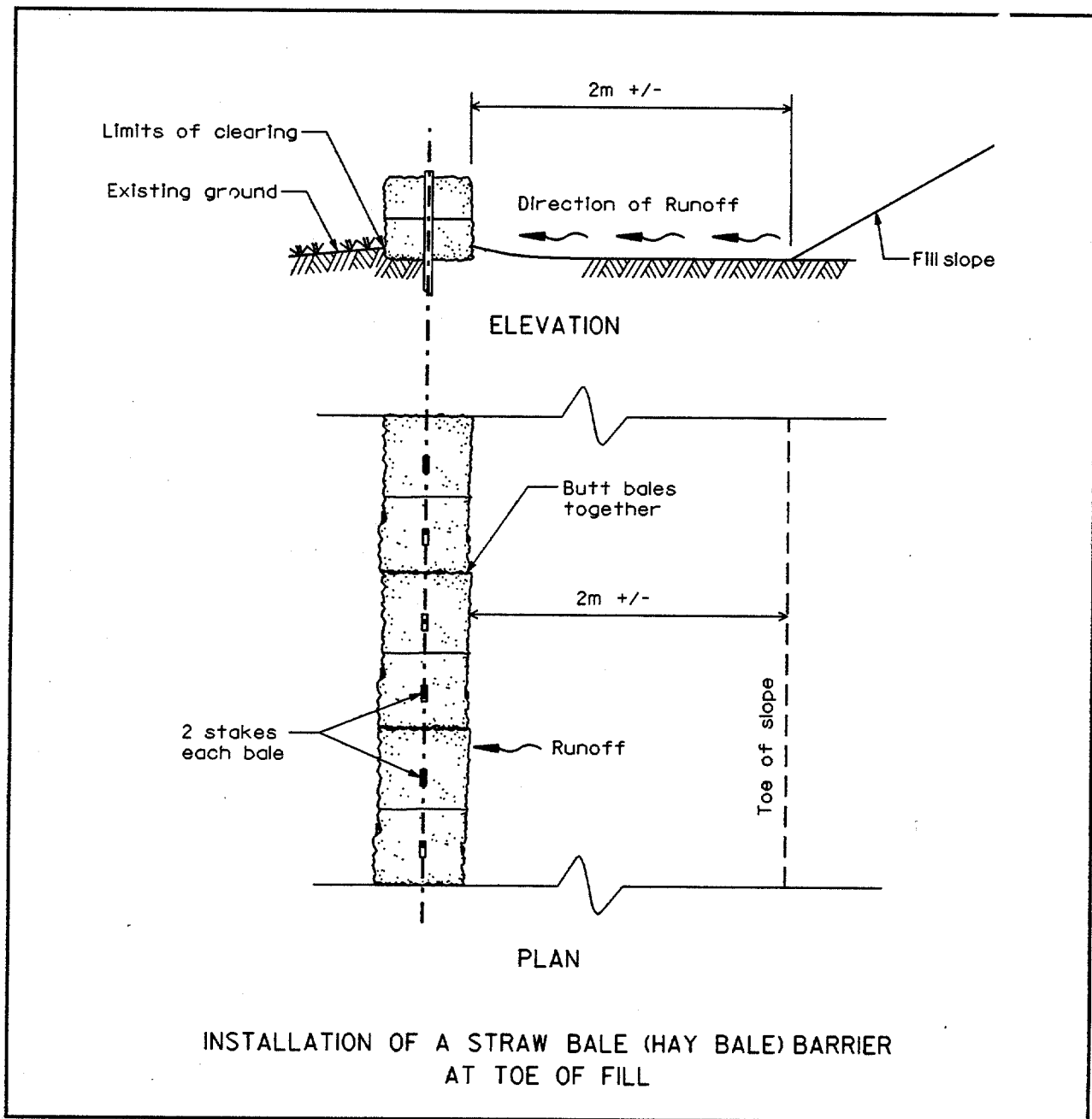

Figure 5.13 Straw Bale as a Perimeter Control

STRUCTURAL EROSION CONTROL MEASURES

Design

No formal design is required for straw bales, however, the contributing drainage area for sheetflow applications generally should not exceed 0.3 hectare per 100 meters (1/4 acre per 100 feet) of bales. Ponding water should be limited to a height of 460 mm (1.5 feet). In swale or ditch applications, the two year discharge should be checked to see that it does not exceed 0.03 m³/s (1 cfs). Table 5.4 provides guidelines for limiting slope length based on slope.

Table 5.4 Maximum Slope Lengths for Straw Bales

Slope (%)	Slope Length
2 (or less)	75 m (250 ft)
5	30 m (100 ft)
10	15 m (50 ft)
15	10 m (35 ft)
20	8 m (25 ft)
25	6 m (20 ft)
30	5 m (15 ft)
35	5 m (15 ft)
40	5 m (15 ft)
45	3 m (10 ft)
50	3 m (10 ft)

Construction

1. Place bales in a single row, lengthwise on the contour with ends of adjacent bales tightly abutting one another.
2. Use bales that are either wire-bound or string-tied. Install straw bales so that bindings are oriented around the sides rather than along the tops and bottoms of the bales (in order to prevent deterioration of the bindings).
3. Entrench and backfill the barrier. Excavate a trench the width of the bale and the length of the proposed barrier to a minimum 100 mm (4 inch) depth. After the bales are staked and gaps between the bales have been chinked with straw, backfill the excavated soil against the barrier.
4. Securely anchor each bale with at least two stakes or rebars driven through the bale. Drive the first stake in each bale toward the previously laid bale to force the bales together. Drive the stakes or rebars a minimum 300 mm (12 inches) into the ground.

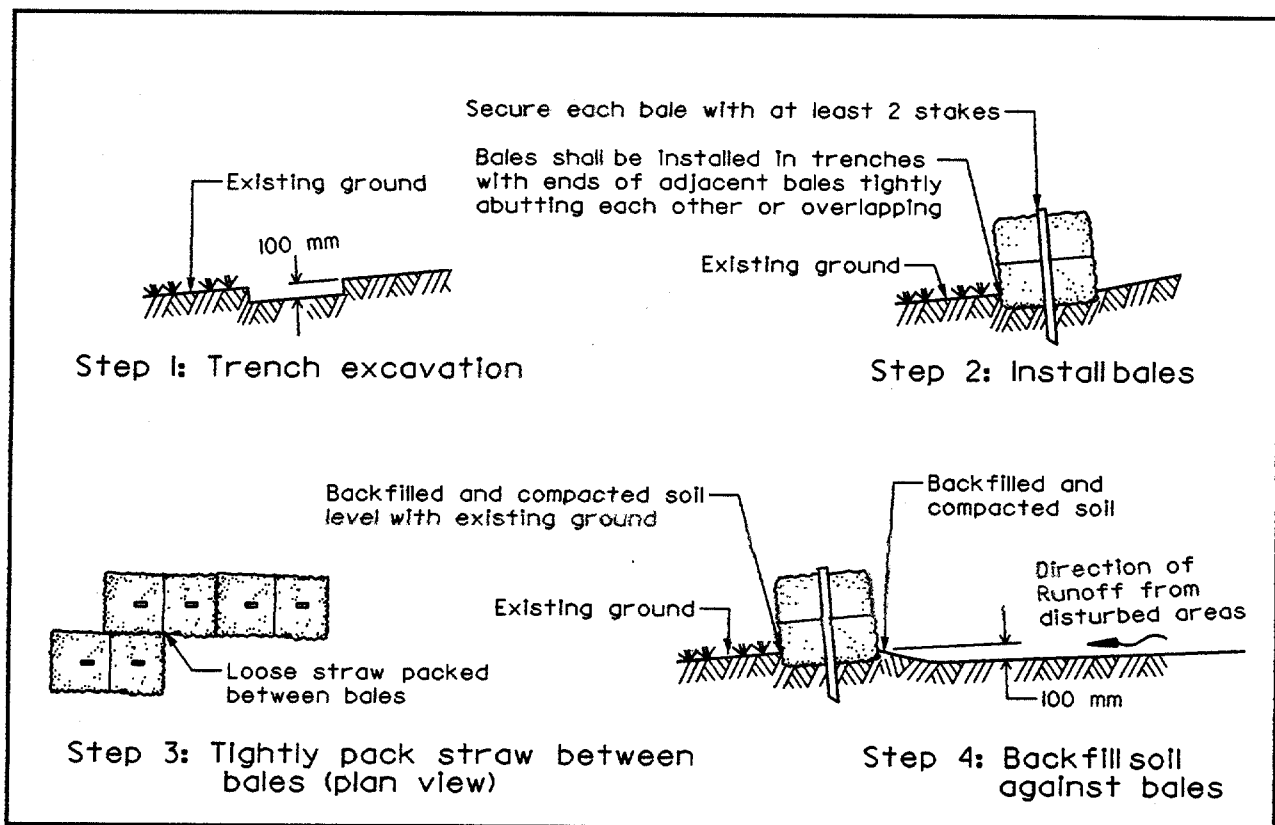

Figure 5.14 Straw Bale Installation

STRUCTURAL EROSION CONTROL MEASURES

Maintenance

Straw bales should be inspected for damage weekly and after rainfall. Any damaged or displaced bales should be replaced immediately. Accumulated sediment should be removed and properly disposed of before the next rainfall. When the disturbed areas have been properly stabilized, the bales may be removed and any remaining areas stabilized.

BRUSH BARRIERS

A brush barrier is a temporary measure constructed from residue materials available from clearing and grubbing operations. These materials, in conjunction with filter fabric, filter sediment from runoff before leaving a site. Brush barriers are perimeter controls constructed at the time of clearing and grubbing and consist of brush, limbs, root mat, weeds, vines, and unmerchantable timber.

Brush barriers should not be used in developed areas or locations where esthetics are a concern. Brush barriers are typically used at the toe of fills and are left in place (without the fabric) to degrade when the project is completed.

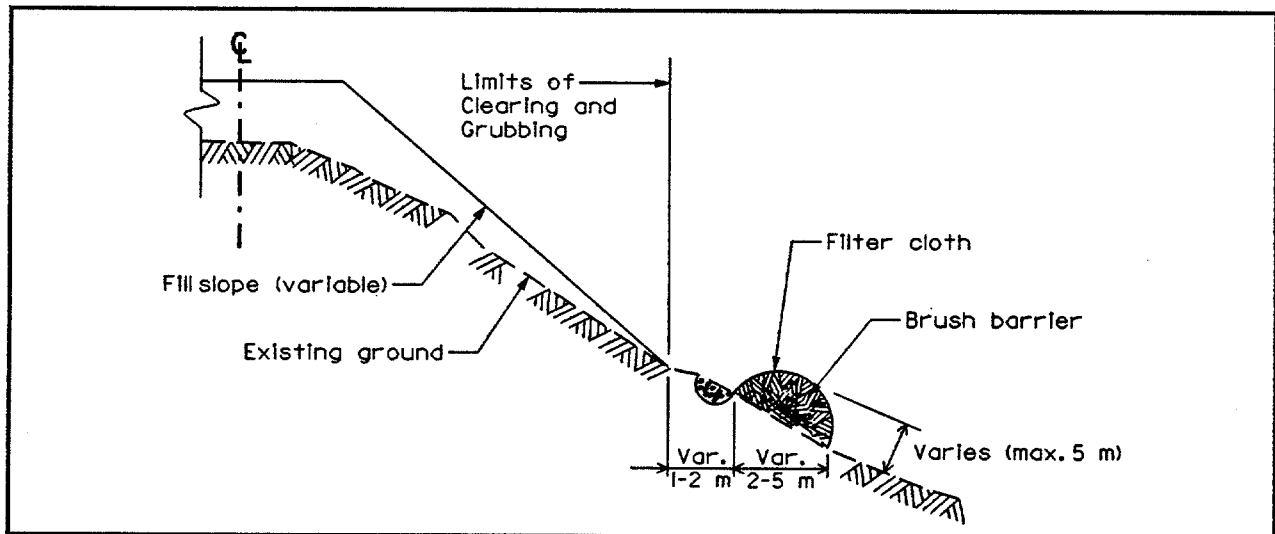

Figure 5.15 Brush Barrier Application

Construction

1. Construct the brush barrier to a minimum height of 900 mm (3 feet).
2. The minimum width of the brush barrier is 1.5 meters (5 feet) at its base.
3. Construct the barrier by piling brush, stone, root mat and other material from the clearing operations into a mounded row on the contour.
4. Cut the filter fabric into lengths sufficient to lay across the barrier from its upslope base to just beyond its peak. Where joints are necessary, splice the fabric together with a minimum 150 mm (6 inch) overlap and securely seal.
5. Excavate a trench 150 mm (6 inches) wide and 100 mm (4 inches) deep along the length of the barrier and immediately uphill from the barrier.
6. Drape the lengths of the filter fabric across the width of the barrier with the uphill edge placed in the trench and the edges of adjacent pieces overlapping each other.
7. Secure the filter fabric in the trench with stakes set approximately 915 mm (36 inches) on center.
8. Backfill the trench and compact the soil over the filter fabric.
9. Set stakes into the ground along the downhill edge of the brush barrier, and anchor the fabric by tying twine from the fabric to the stakes.

Maintenance

Brush barriers should be inspected for damage weekly and after rainfall. Any damage should be repaired immediately. Sediment should be removed and properly disposed of when accumulations reach half the height of the barrier. When the project is complete, the barriers may be left in place after removing the fabric to decompose or they may be removed when the disturbed areas have been stabilized.

STRUCTURAL EROSION CONTROL MEASURES

INLET PROTECTION

Inlet protection consists of several methods of filtering runoff before it enters a drainage inlet and storm sewer system. In most cases, inlet protection is a "last chance" effort to control sediment after other methods to control erosion have already been employed. Inlet protection by itself is not a very efficient method of controlling sedimentation. In most cases, some type of stabilization should be in place to reduce erosion at the source.

The method of inlet protection used depends on the type of inlet and the consequences of allowing water to pond in the vicinity of the inlet. The two general types of inlets used are curb openings and grates. Both are physically different and require different types of inlet protection. All types of inlet protection rely on principles of filtering to remove sediment.

The hydraulics of the particular application must be carefully evaluated. Namely, the impacts of allowing water to pond at the inlet must be determined. This will lead to the selection of a method based on the need for an overflow weir or some type of relief. In some cases, ponding water may not be a major inconvenience at the site. Therefore, a small relief weir, or perhaps no relief is required. In other situations, ponding water may cause more erosion or even safety concerns. In this case, a weir must be placed so that water can only pond to a certain elevation. All water above this elevation flows directly into the inlet. In the extreme case where ponding is not allowed, inlet protection should not be installed.

The other hydraulic factor that must be considered is the original design of the inlets. The structures are designed to intercept flow at certain efficiencies. Placing obstructions around these inlets greatly impacts their efficiency. Inlets on grade, for example, may pose severe problems if water is allowed to bypass and accumulate in an inappropriate location. For this reason, it may not be advisable to use inlet protection for some inlets on grade.

Drop Inlet Protection

Three types of inlet protection are available for drop inlets as shown in the following figures. These are Block and Gravel, Gravel and Wire Mesh, and Silt Fence Inlet Protection. Block and Gravel Drop Inlet Protection is used where the depth of ponding must be limited to approximately 300 mm (12 inches). concrete blocks are placed around the drop inlet. Water must pass through a wire supported gravel filter before entering the drop inlet. When runoff exceeds the elevation of the top of the blocks, it overflows directly into the drop inlet.

If ponding water is not a concern, two other types of drop inlet protection may be used. Gravel and Wire Mesh is similar to the Block and Gravel protection, however, the grate is completely covered by the gravel filter medium supported by wire mesh. If this structure is located in a sump with sufficient storage volume, then it behaves like a sediment trap.

The most common type of protection is silt fence inlet protection. This device consists of silt fence supported by a 50 x 100 mm (2 x 4 inch) wooden frame surrounding a drop inlet. Runoff is filtered by the silt fence. These devices can cause considerable ponding and the impacts must be evaluated.

Curb Opening Inlet Protection

Two types of curb inlet protection are used for controlling sediment. These are Block and Gravel Curb Inlet Protection and Wooden Weir. Both methods filter the runoff through a gravel medium, however the Block and Gravel design provides a larger opening to limit ponding water as shown in Figure 5.18. Concrete blocks are placed around the entrance spaced one block length back from the opening. Gravel wrapped in wire mesh filters the water before it passes through the block openings.

The Wooden Weir configuration provides a much smaller emergency overflow. The device is constructed with 50 x 100 mm (2 inch x 4 inch) wood supporting the gravel enclosed mesh around the curb opening. A gap the width of a 50 x 100 mm (2 inch x 4 inch) provides the overflow when ponding exceeds the top of the curb opening. These devices are used when excessive ponding is not a concern.

STRUCTURAL EROSION CONTROL MEASURES

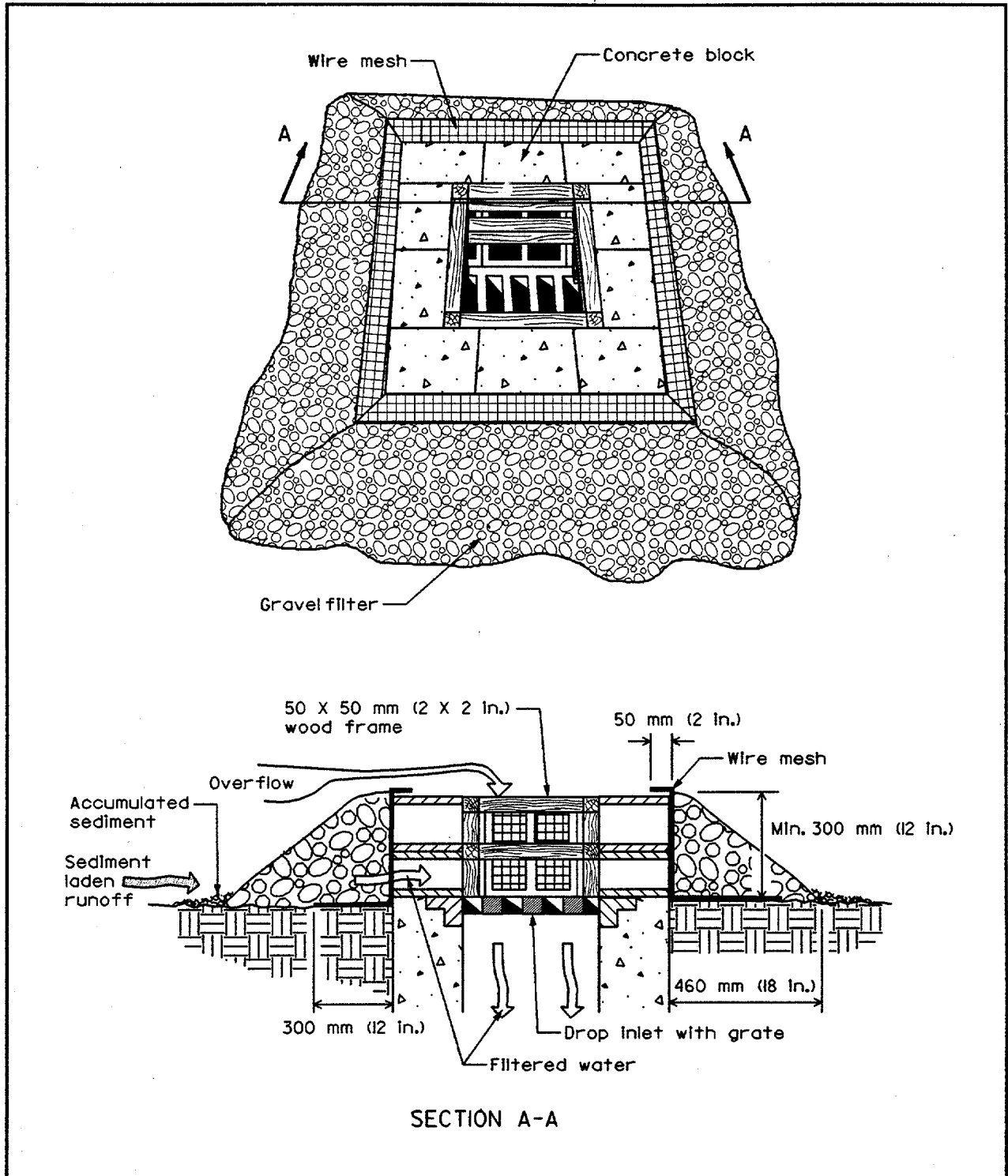
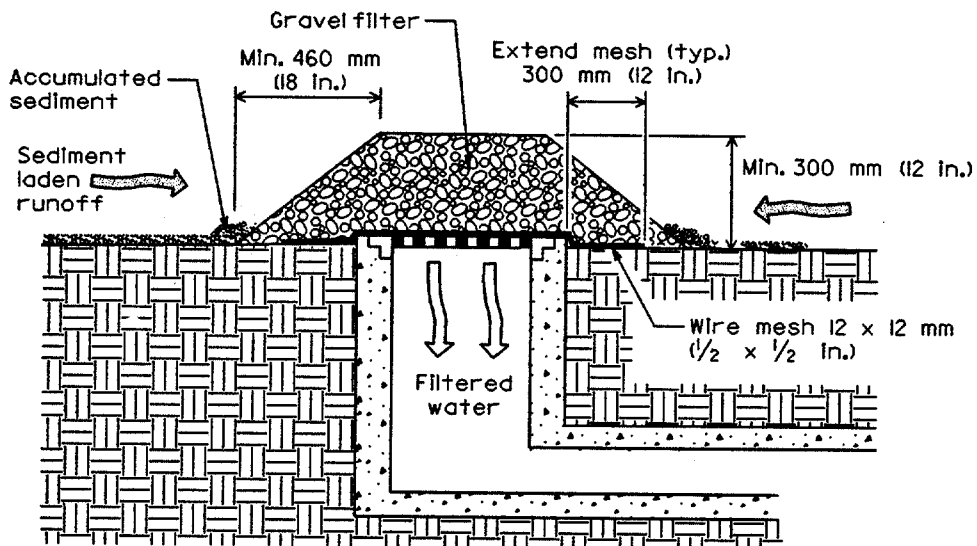
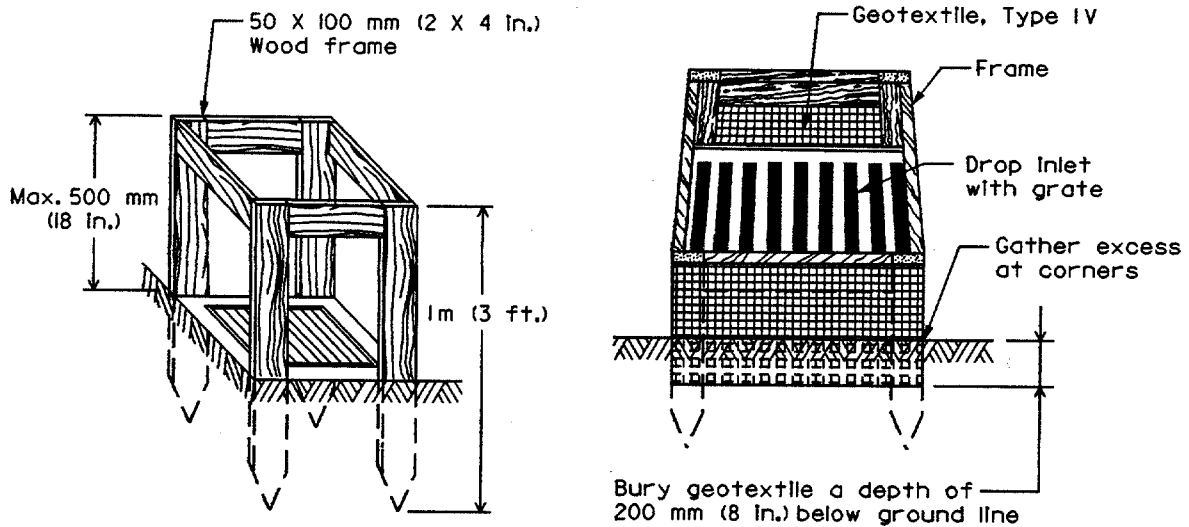

Figure 5.16 Block and Gravel Drop Inlet Protection



GRAVEL AND WIRE MESH DROP INLET PROTECTION

Note: Use Gravel and wire mesh inlet protection only in sump locations where heavy concentrated flows are expected. Do not use where ponding around the structure might cause inconvenience or damage.



SILT FENCE DROP INLET PROTECTION

Note: Use Silt Fence Inlet protection in sump locations only.

Figure 5.17 Gravel and Wire Mesh and Silt Fence Inlet Protection

STRUCTURAL EROSION CONTROL MEASURES

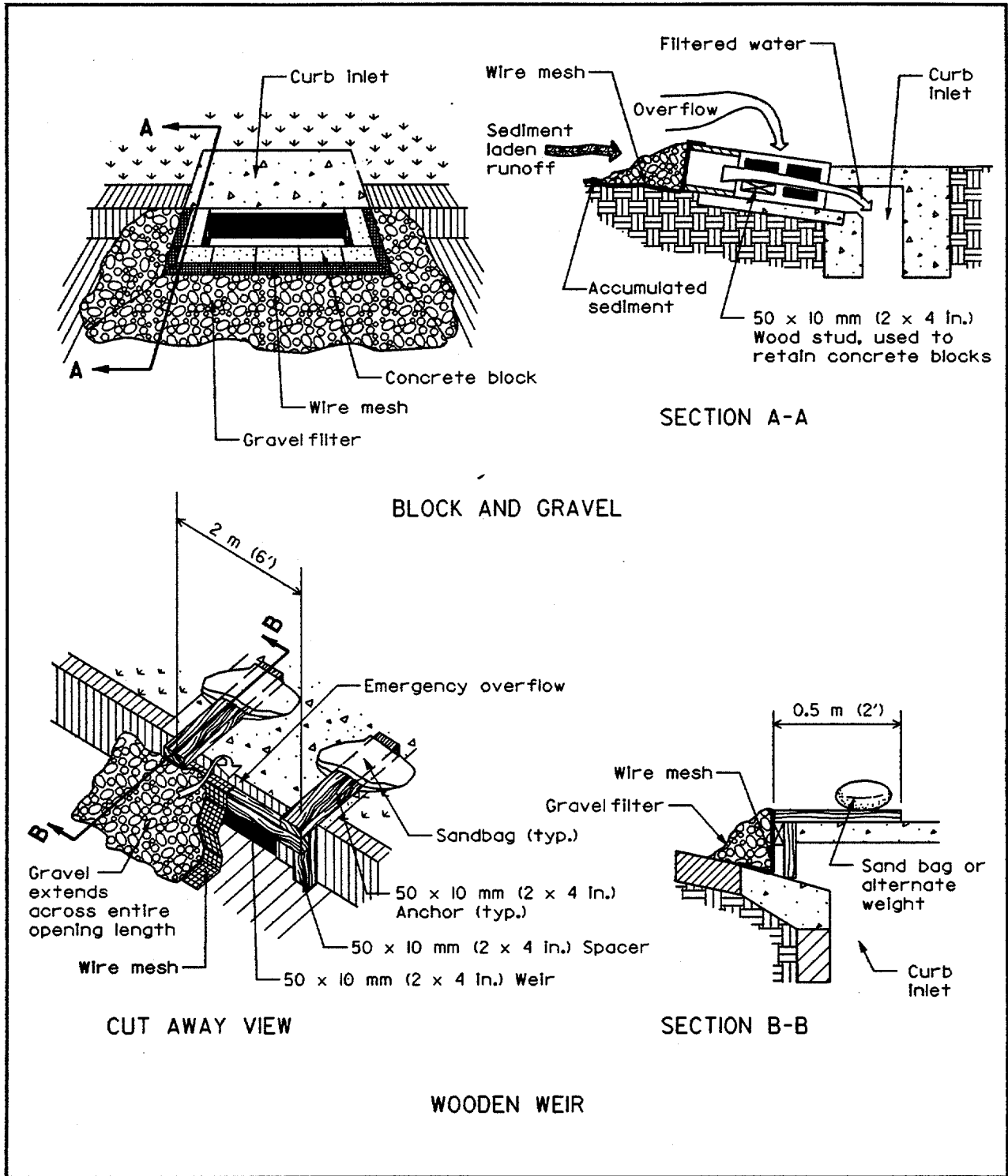

Figure 5.18 Curb Opening Drop Inlet Protection

Maintenance

Inlet Protection should be inspected for damage weekly and after rainfall. Common failures are tearing, undermining, and collapsing of the silt fence and clogging of the wire mesh and gravel. Any damaged materials should be repaired immediately. Accumulated sediment should be removed and properly disposed of before the next rainfall. When the disturbed areas have been properly stabilized, the protection may be removed. Inlet protection is one of the last controls removed from a site.

CHAPTER 6

SEDIMENT TRAPS AND BASINS

TEMPORARY SEDIMENT TRAPS

A sediment trap is a temporary structure that is used to detain runoff from small drainage areas so that sediment can settle out. These devices are constructed by excavation and construction of an embankment that will provide a determined storage volume. The flow from the structure, or release, is controlled by a rock spillway or pipe outlet. Sediment traps are generally limited to a contributing drainage area of 2 hectares (5 acres). For larger drainage areas, see **Sediment Basins**.

When properly designed, located, and constructed, sediment traps can perform at efficiencies of up to 80%. They are excellent perimeter controls, provided that runoff from disturbed areas drains to one location, and sufficient right-of-way and storage volume are available. Temporary sediment traps can also be constructed around drop inlets during grading operations but only if sufficient storage volume can be created.

Traps should only be used to intercept runoff from disturbed areas. It is inefficient to route clean runoff through a sediment trap. Traps can be used in combination with diversions to better manage sediment-laden water.

Design

The design of sediment traps involves determining the required storage volume, the dimensions of the spillway, and elevations. In most cases, a simple approach is used to determine the storage volume. This volume is determined as a function of the contributing drainage area. Also, the length of the spillway can be computed as a function of the drainage area. This method is acceptable for

small drainage areas, however, a more precise and efficient trap may be sized using the procedures described for sediment basins.

Location

The location of sediment traps is critical in their design and should be determined based on the existing and proposed topography of the site. As a perimeter control, locate the trap where one to two disturbed hectares (two to five acres) drain to one location. Try to choose a location where maximum storage can be obtained from the natural topography. This will minimize the required excavation. This location should be at a site that will minimize interference with construction activities and will allow the trap to remain in service until the site is stabilized. The site must be accessible for future clean-out of the sediment trap. Also, evaluate the risk of failure of the structure and the consequences of failure.

Storage Volume

In order for the sediment trap to function properly, it is important that the required storage volume be provided. This volume is created by a combination of excavation and/or construction of an embankment to detain the runoff. In the past, the minimum required volume has been computed as 126 cubic meters per hectare (67 cubic yards per acre) of drainage area. This corresponds to trapping the first 12.5 mm (0.5 inches) of runoff. The current practice is to increase the storage volume requirement to 252 cubic meters per hectare (134 cubic yards per acre) of drainage area. In using these larger structures, the total storage volume is divided equally between wet and dry storage. A permanent storage area (permanent pool) of 126 cubic meters per hectare (67 cubic yards per acre) is excavated below the embankment. This is the wet storage. An additional 126 cubic meters per hectare (67 cubic yards per acre) is provided below the crest of the spillway as temporary storage (dry). If the larger volume cannot be obtained due to site constraints, a minimum of 126 cubic meters per hectare (67 cubic yards per acre) must be provided.

SEDIMENT TRAPS AND BASINS

To compute the volume in a natural depression, approximate it as $\text{Volume} = 0.4 \times \text{surface area} \times \text{maximum depth}$. The volume of a trapezoidal basin can be computed by the following equation:

$$V = LWD + (L + W)ZD^2 + 4/3 Z^2D^3$$

where: V = Storage volume
L = Length of basin
W = Width of basin
D = Depth of basin
Z = Side slope (Z:1 Horizontal:Vertical)

Embankment

The embankment of the structure should be constructed of compacted earth and should be a maximum height of 1.5 meters (5 feet). State or local dam safety regulations may apply to heights exceeding 1.5 meters and should be investigated. The top width of the embankment should be 1.2 meters (4 feet) and the side slopes should be 2 horizontal to 1 vertical or flatter. Temporary vegetative stabilization should be applied immediately.

Outlet

Two types of outlet structures may be constructed for the sediment trap. A rock spillway or a riser pipe may be used. A rock spillway, Figure 6.1, is the most common type which is constructed with the crest of the spillway 0.3 meters (1 foot) below the top of the embankment. The weir length of the spillway is determined based on the contributing drainage area and is given in Table 6.1 below.

Table 6.1 Weir Lengths for Sediment Traps

Contributing Drainage Area	Weir Length
0.4 ha (1 ac)	1.2 m (4 ft)
0.8 ha (2 ac)	1.5 m (5 ft)
1.2 ha (3 ac)	1.8 m (6 ft)
1.6 ha (4 ac)	3.0 m (10 ft)
2.0 ha (5 ac)	3.6 m (12 ft)

A corrugated metal or PVC pipe riser structure may be used as an alternative as shown in Figure 6.2. The pipe diameter is based on the drainage area as shown in the Table 6.2 below. The top of the pipe is 1.5 feet below the embankment elevation. The riser pipe is perforated with 25 mm (1 inch) diameter holes or 13 mm by 150 mm (1/2 inch by 6 inch) slits in the upper two-thirds of the pipe. The location of the perforations is defined in Figure 6.2.

Table 6.2 Pipe Outlet Diameters

Maximum Drainage Area	Minimum Barrel Diameter	Minimum Riser Diameter
0.4 ha (1 ac)	300 mm (12 in)	375 mm (15 in)
0.8 ha (2 ac)	375 mm (15 in)	460 mm (18 in)
1.2 ha (3 ac)	460 mm (18 in)	525 mm (21 in)
1.6 ha (4 ac)	525 mm (21 in)	600 mm (24 in)
2.0 ha (5 ac)	525 mm (21 in)	675 mm (27 in)

SEDIMENT TRAPS AND BASINS

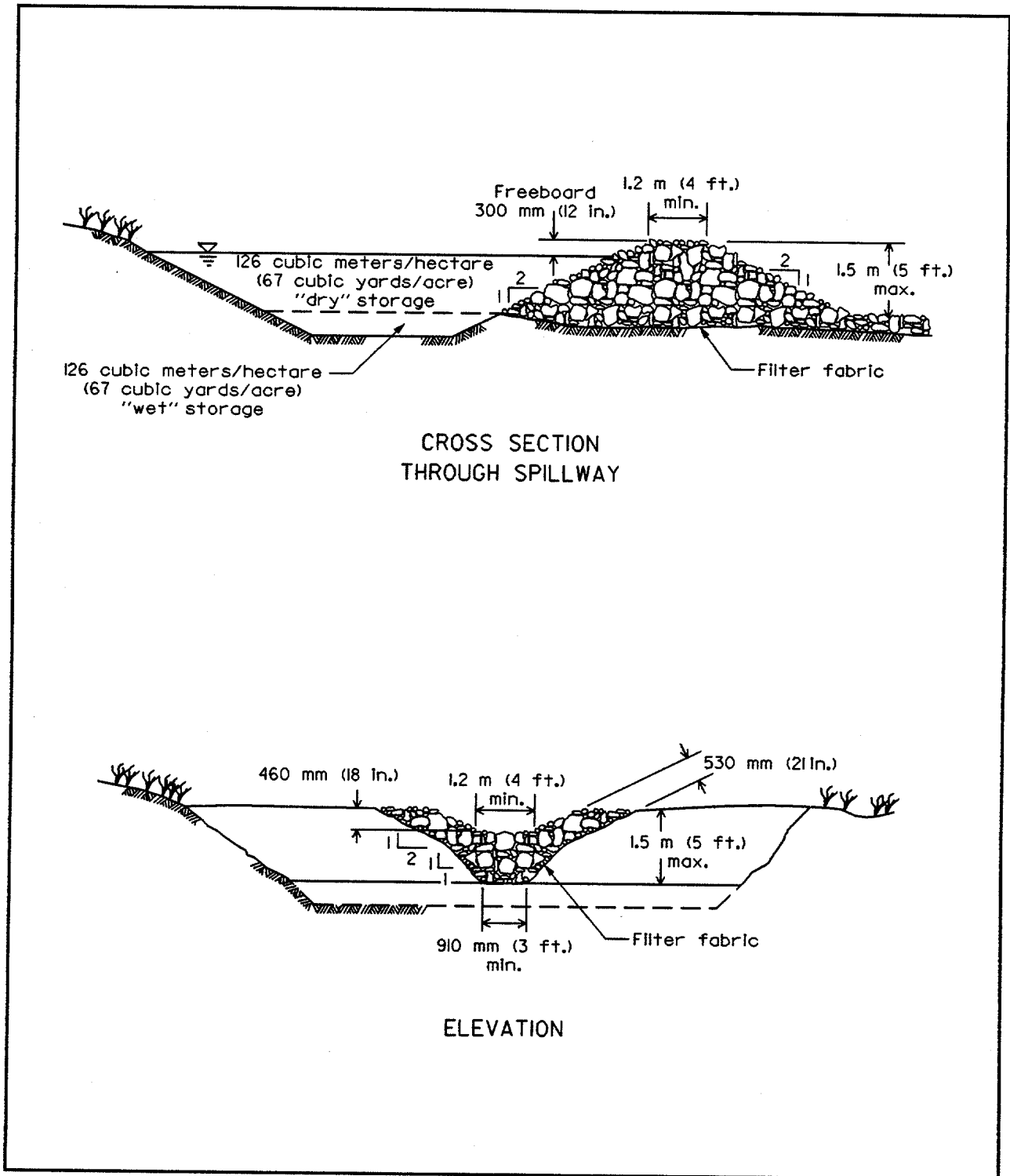

Figure 6.1 Stone Outlet Sediment Trap

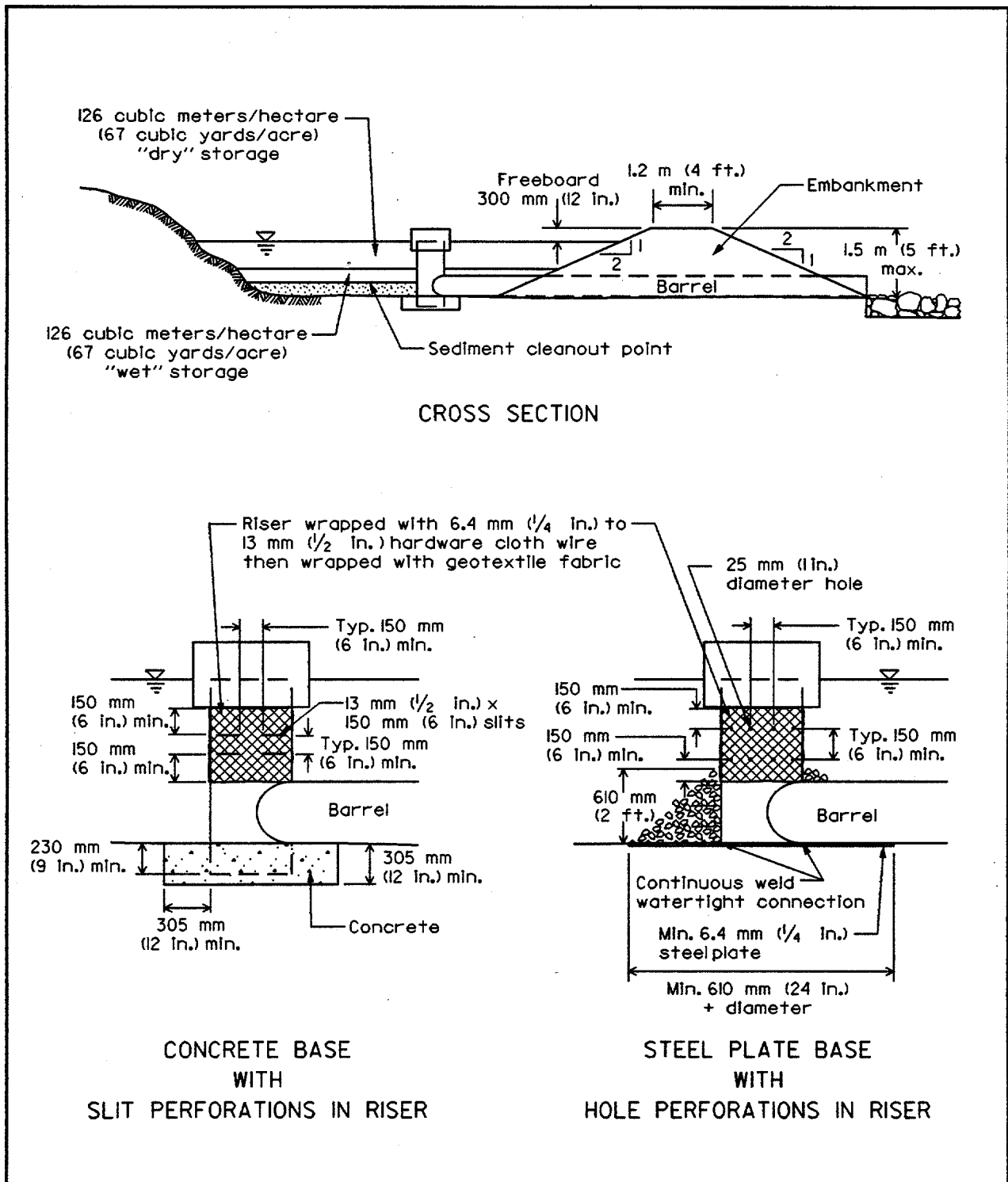

Figure 6.2 Pipe Outlet Sediment Trap

Construction

Stone Outlet

1. The area under the embankment should be cleared, grubbed, and stripped of all vegetation and root mat. The pool area should be cleared to reduce debris buildup and facilitate cleanout.
2. Excavate as required in the plan to obtain the necessary storage volume.
3. Use fill material for the embankment that is free of roots and other woody vegetation, organic material, large stones, and other objectionable material. Compact the embankment in 200 mm (8 inch) layers by traversing with construction equipment.
4. Construct the riprap spillway to the dimensions shown on the plan. Place filter fabric beneath all riprap.
5. Provide temporary or permanent stabilization of the embankment immediately after construction.

Pipe Outlet

1. The area under the embankment should be cleared, grubbed, and stripped of all vegetation and root mat. The pool area should be cleared to reduce debris buildup and facilitate cleanout.
2. Excavate as required in the plan to obtain the necessary storage volume.
3. Use fill material for the embankment that is free of roots and other woody vegetation, organic material, large stones, and other objectionable material. Compact the embankment in 200 mm (8 inch) layers by traversing with construction equipment.
4. Perforate the riser with 13 mm wide by 150 mm long (1/2 inch by 6 inch) slits or 25 mm (1 inch) diameter holes spaced 150 mm (6 inches) vertically and horizontally above the wet storage elevation.
5. Wrap the riser with 6.4 to 13 mm (1/4 inch to 1/2 inch) hardware cloth (wire) and cover with geotextile fabric. Extend the geotextile fabric 150 mm (6 inches) above

the highest slit and 150 mm (6 inches) below the lowest slit. Overlap, fold, and fasten the geotextile fabric where the ends come together to prevent bypass. Replace the fabric as necessary to prevent clogging.

6. Use straps or connecting bands to hold the geotextile fabric and wire in place. Place at the top and bottom of the cloth.
7. Hand compact the fill material around the spillway in 100 mm (4 inch) layers. Place a minimum of 610 mm (2 feet) of hand compacted backfill over the pipe spillway before crossing it with construction equipment.
8. Anchor the riser with either a concrete base or steel base plate to prevent flotation. For concrete bases, use a 300 mm (12 inch) depth with the riser embedded 230 mm (9 inches). Attach a minimum 6 mm (1/4 inch) thick steel plate to the riser by a continuous weld around the bottom to form a watertight connection and cover with 610 mm (2 feet) of stone or gravel.
9. Construct riprap outlet protection at the outlet of the barrel to prevent scour from occurring. Provide a stable channel to convey the discharge to the receiving channel.
10. Provide temporary or permanent stabilization of the embankment immediately after construction.

Maintenance

Sediment shall be removed and the trap restored to its original dimensions when the sediment has accumulated to one-half of the wet storage volume. Removed sediment shall be deposited in a suitable area and in such a manner that it will not erode. The structure shall be inspected after each rain and repairs made as needed.

SEDIMENT BASINS

A sediment basin, like a sediment trap, is a temporary impoundment used to detain runoff so that sediment will settle out before it is released. Sediment basins are much larger than sediment traps, serving up to 40 hectare (100 acre) drainage areas. If properly planned and designed, the basins may also serve as permanent storm water management facilities.

A sediment basin is constructed with a combination of embankment and excavated storage area. The storage area is divided between a permanent pool, "wet" area, and a temporary, "dry" storage volume. The principal spillway consists of a riser pipe and barrel that releases the dry storage volume. Often an emergency spillway is provided to release the flow from larger storms.

The basin is used when contributing drainage areas exceed 2 to 4 hectares (5 to 10 acres). As with sediment traps, there must be an appropriate location which contains sufficient space and favorable topography. Because of the enormous size of these structures and the application to large contributing drainage areas, sediment basins have limited use in highway construction.

Design

The design guidelines presented are a simplified approach for sediment basins. Detailed hydraulic computations are not provided and hydraulic routing is not performed. Since these structures can serve very large drainage areas and the consequences of failure can be serious, discretion should be exercised in their design. More extensive engineering computations should be performed if conditions dictate. The design of these structures should be performed by an engineer thoroughly knowledgeable in hydraulic engineering.

Basin Size and Capacity

Adequate storage volume is critical to the performance of the basin. Sediment basins that are undersized will perform at much lower efficiency rates. The most efficient basins will operate at up to 80% sediment removal efficiencies. The current practice is to provide a storage volume of 252 m³/ha (134 yd³/acre) of contributing drainage area. The total storage volume is divided equally between "wet" and "dry" storage. A permanent pool of wet storage provides 126 cubic meters per hectare (67 cubic yards per acre) below the orifice in the riser pipe. An additional 126 cubic meters per hectare (67 cubic yards per acre) is provided below the crest of the principal spillway as temporary dry storage.

The storage volume in a trapezoidal basin can be computed using the same equation provided for sediment traps. If the required volume is known, the equation can be rearranged to determine the required length as a function of the width to length ratio, r. The recommended length to width ratio is 2:1.

$$L = \frac{-ZD(r+1) + [Z^2D^2(r+1)^2 - 16/3 Z^2D^2r + 4r V/D]^{1/2}}{2r}$$

where: V = Storage volume

L = Length of basin

D = Depth of basin

Z = Side slope (Z:1 Horizontal:Vertical)

r = Ratio of basin width/length at the base

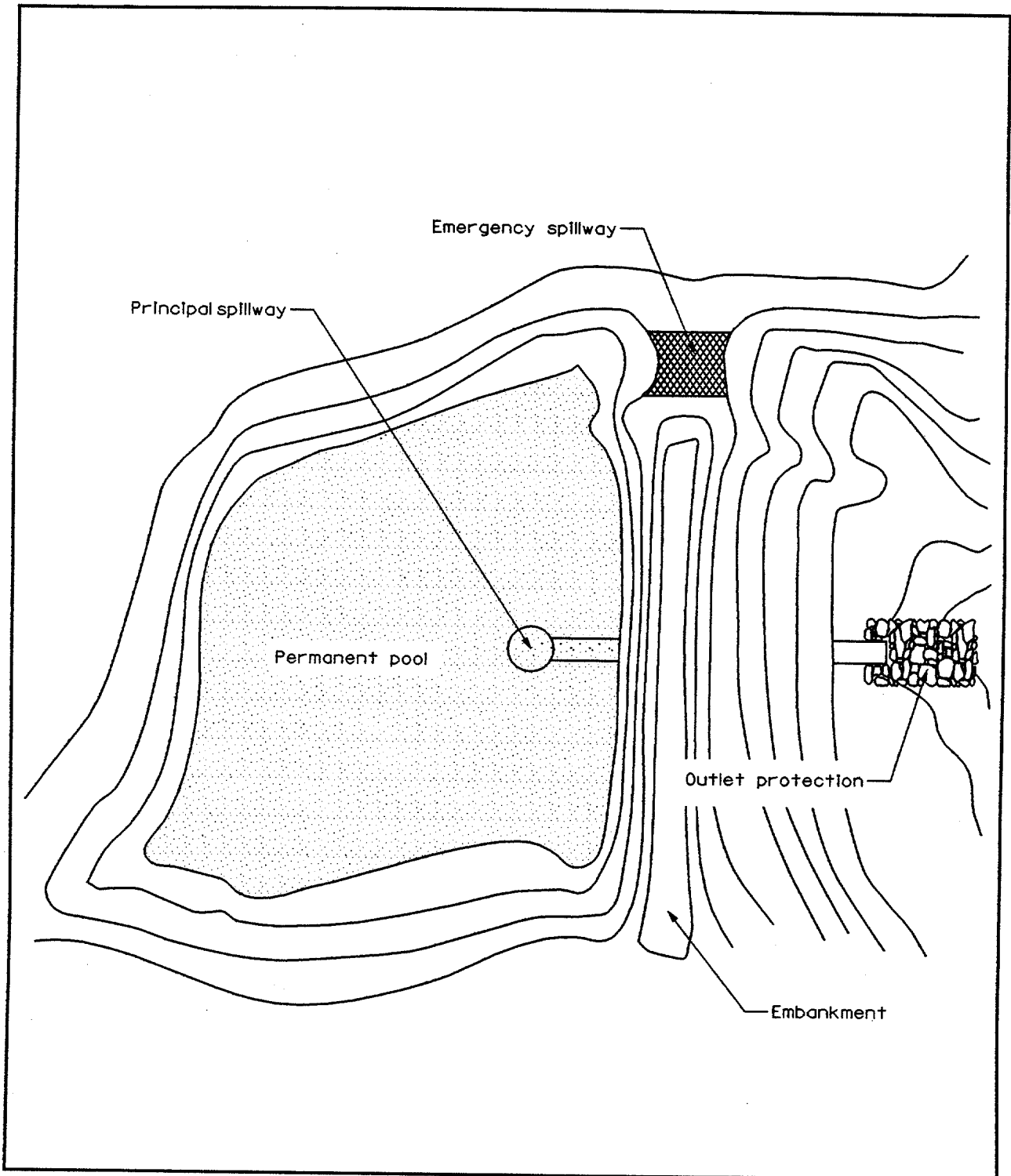

Figure 6.3 Sediment Basin

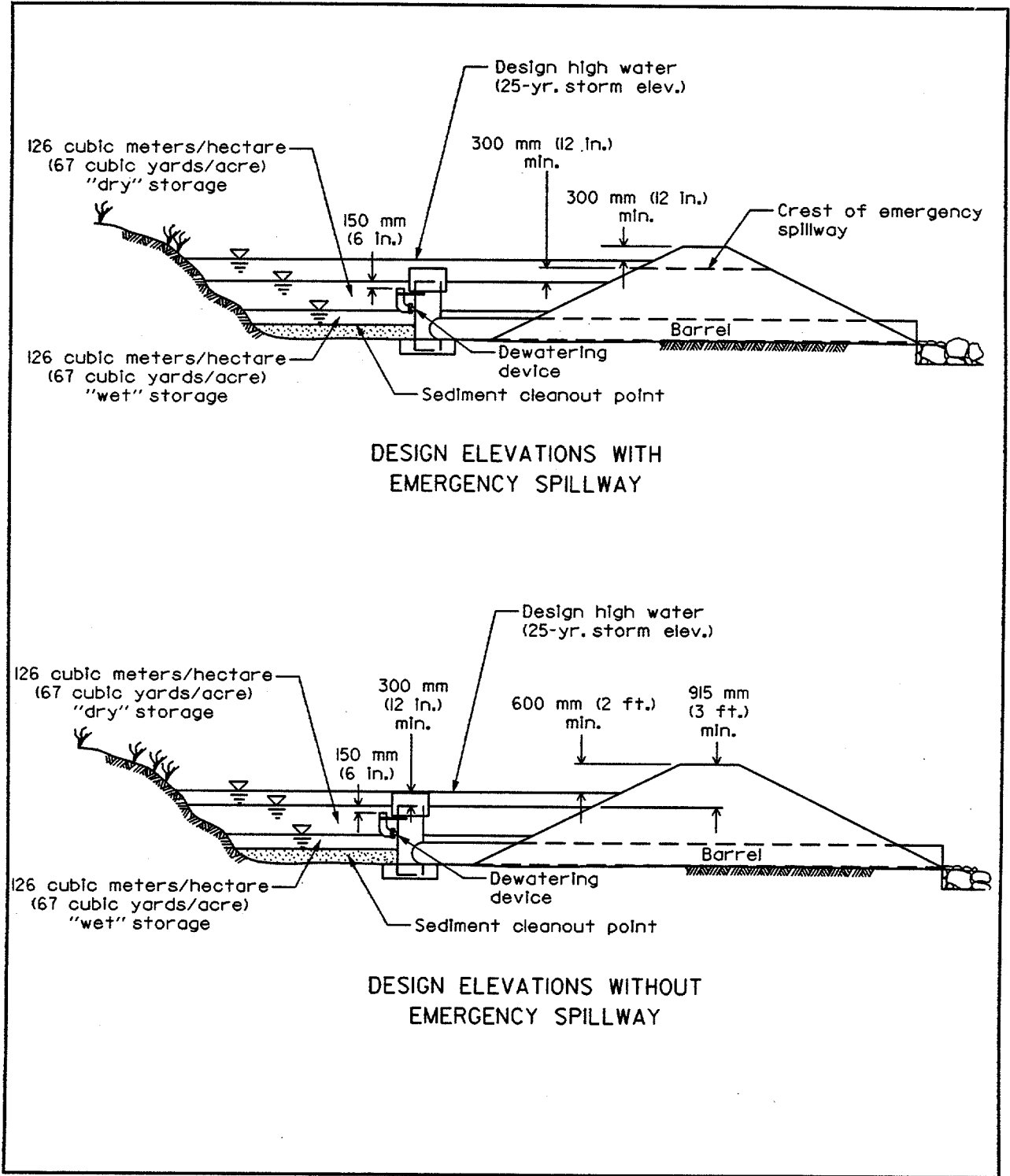

Figure 6.4 Sediment Basin Design Elevations

Principal Spillway

The principal spillway is the structure which passes a given design storm. It also contains a de-watering device that slowly releases the water contained in the temporary dry storage. If an emergency spillway is constructed, the principal spillway is typically designed to pass the 2-year storm. If an emergency spillway is not provided, the principal spillway must pass the 25-year storm. These are recommended guidelines, however, each locality may have different design criteria.

For temporary basins, the intake structure consists of a vertical riser pipe connected at the base to a horizontal barrel. The barrel carries the water through the embankment and discharges it into a stable outlet. The barrel and riser may be constructed of corrugated metal or concrete pipe or boxes.

The steps in designing the principal spillway are as follows:

1. Determine the design discharges, Q_p
2. Determine the allowable head on the riser
3. Determine the diameter of the riser pipe
4. Determine the diameter of the barrel
5. Determine the size of the required de-watering orifice

The design discharge for the principal spillway is dependent on the presence of an emergency spillway. If no emergency spillway will be constructed, Q_p is the 25-year storm, Q_{25} . If an emergency spillway will be used, Q_p is the 2-year storm, Q_2 . If local design criteria differ, use those discharges. Hydrologic computations should be performed using accepted methods.

The size of the riser pipe is a function of the allowable head acting on the top of the pipe. If an emergency spillway is used, this head is the difference between the elevation of the crest

of the emergency spillway and the elevation of the top of the riser pipe (see Figure 6.4 and 6.5). If no emergency spillway is provided, the allowable head is determined based on the top of the embankment minus 600 mm (2 feet) of freeboard. Therefore, the head is computed as the elevation of the embankment minus 600 mm (2 feet) minus the elevation of the top of the riser pipe. Based on the allowable head, h , and the design discharge, Q_p , the smallest diameter riser pipe is determined from Figure 6.8.

The size of the barrel is a function of its length and the total head acting on the barrel. This head, H , is the difference in elevation of the centerline of the outlet of the barrel and the maximum elevation of the water. This elevation is either the elevation of the emergency spillway or, as with the riser pipe, the elevation 600 mm (2 feet) below the top of the embankment. Based on these two values, H and L , the smallest barrel diameter which will pass the design flow, Q_p , can be determined from Tables 6.3 and 6.4. A correction factor should be applied if the length is different than 21 meters (70 feet).

SEDIMENT TRAPS AND BASINS

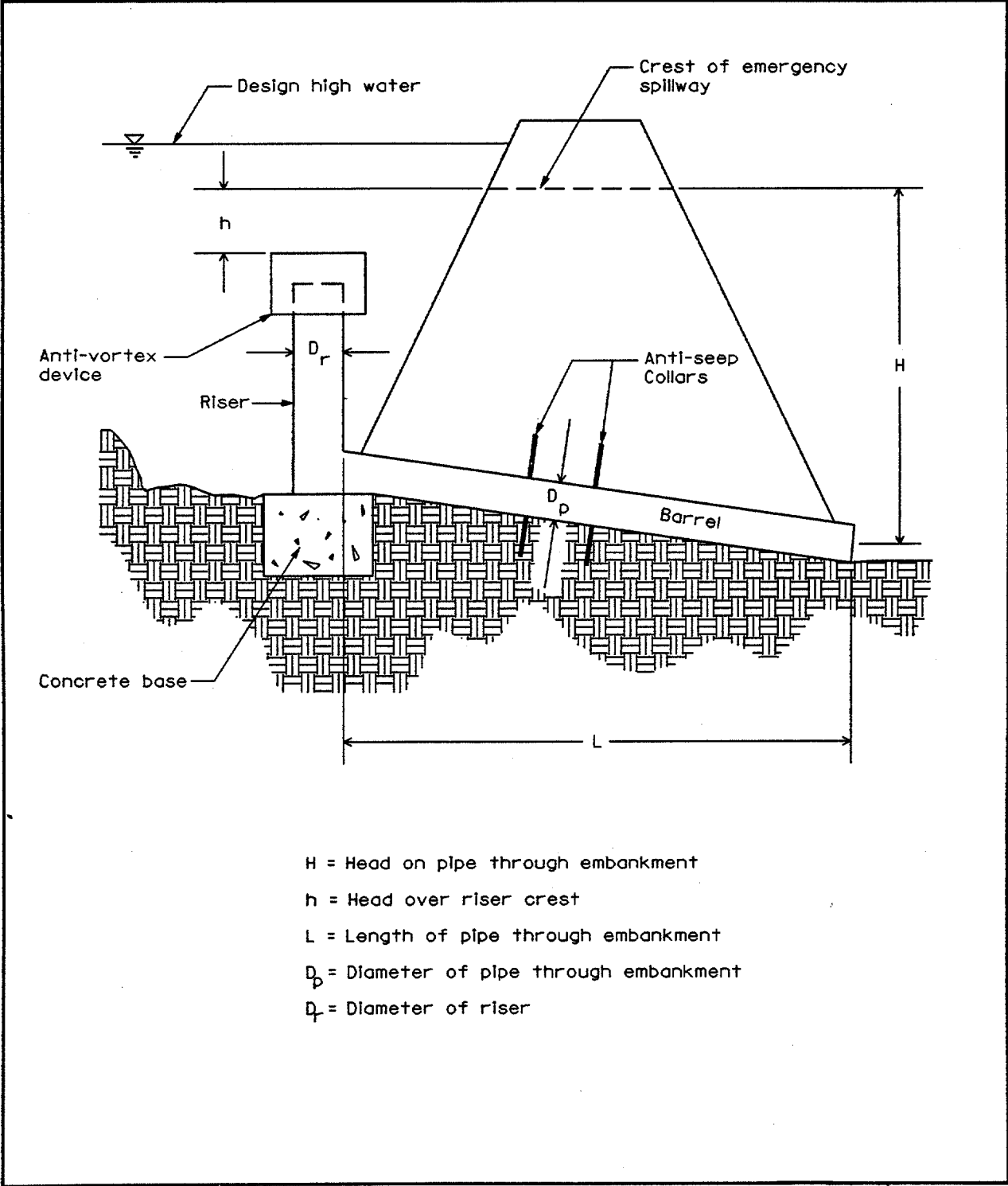

Figure 6.5 Principal Spillway Design

Source: VA DSWC

The purpose of the dewatering device is to release the runoff accumulated in the dry storage over an extended period. This is referred to as drawdown. The equation provided below uses a drawdown of 6 hours. A small orifice is placed in the riser pipe or dewatering attachment at a certain elevation. The two variables are therefore the diameter of the orifice, d , and the average head acting on the orifice, h . An average head is used since the calculations do not involve storage routing and the calculations are not made at different time intervals. In reality, the discharge through the orifice is changing over time as the water surface elevation changes.

$$A = \frac{Q}{(64.3 \times h/2)^{0.5} (0.6)} \quad \text{and}; \quad d = 2 \times (A/3.14)^{0.5}$$

- where: A = Flow area of orifice, in square feet
 d = Diameter of circular orifice, in inches
 h = Average head acting on the orifice
 (maximum possible head measured from the radius of orifice to crest of the principal spillway divided by 2), in feet
 S = Total dry storage available, in cubic feet
 Q = Flow rate through orifice needed to achieve a 6-hour drawdown, cubic feet per second
 Q = $S/21,600$ seconds

SEDIMENT TRAPS AND BASINS

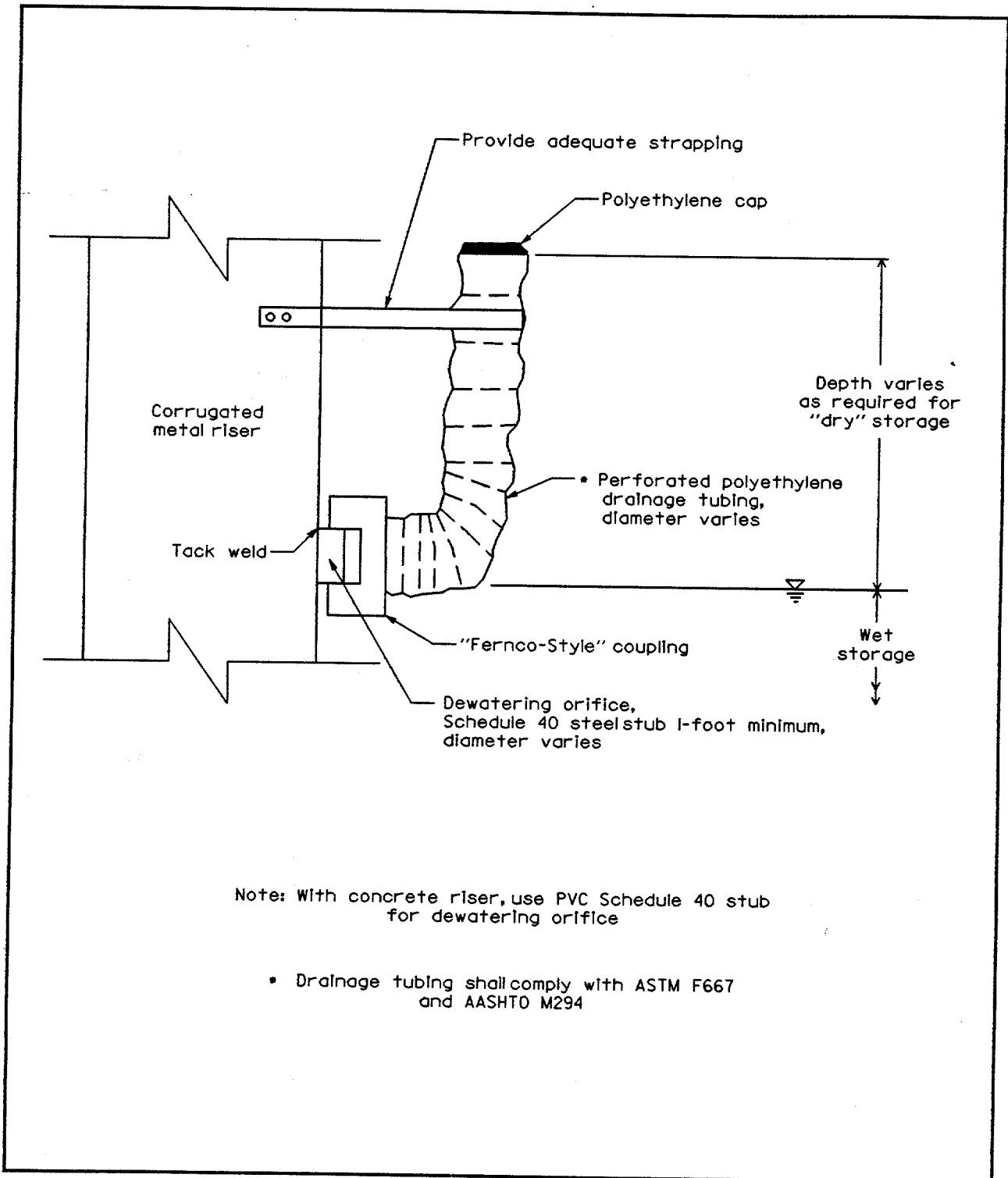

Figure 6.6 Dewatering Device

Source: VA DSWC

Emergency Spillway

When possible, an emergency spillway is provided to safely pass all flows exceeding the design storm for the principal spillway. It is a separate spillway constructed on natural undisturbed material that will not erode from the expected forces. In some cases, riprap protection must be provided. This spillway channels the excess runoff to a stable channel or outfall below the embankment.

In order to determine the hydraulic characteristics of the emergency spillway, a control section must be provided (see Figure 6.7). This is done by constructing a level spillway crest at least 6 meters (20 feet) in length. Below the crest, the exit channel is at a slope steep enough to ensure supercritical flow. This enables the designer to compute the critical depth at the spillway (the control section) and therefore can be certain of the water surface elevation in the basin. If these criteria are met, then the procedures below can be used to size the emergency spillway. If not, water surface profile computations must be performed.

The following steps are taken in the design of the emergency spillway:

1. Determine the design discharge
2. Estimate the dimensions of the emergency spillway
3. Check the hydraulic capacity based on the dimensions
4. Refine the design dimensions

The emergency spillway must pass the remainder of the 25-year storm not carried by the principal spillway. Therefore, the design discharge, $Q_e = Q_{25} - Q_p$.

Based on the site and basin's dimensions, find approximate values for the bottom width of the spillway crest, b ; the exit channel slope, s ; and the minimum exit channel length, X . With these dimensions, the stage, or head, on the spillway, H_p , can be determined from Table 6.5. When possible, avoid using the data to the right of the heavy lines in the table.

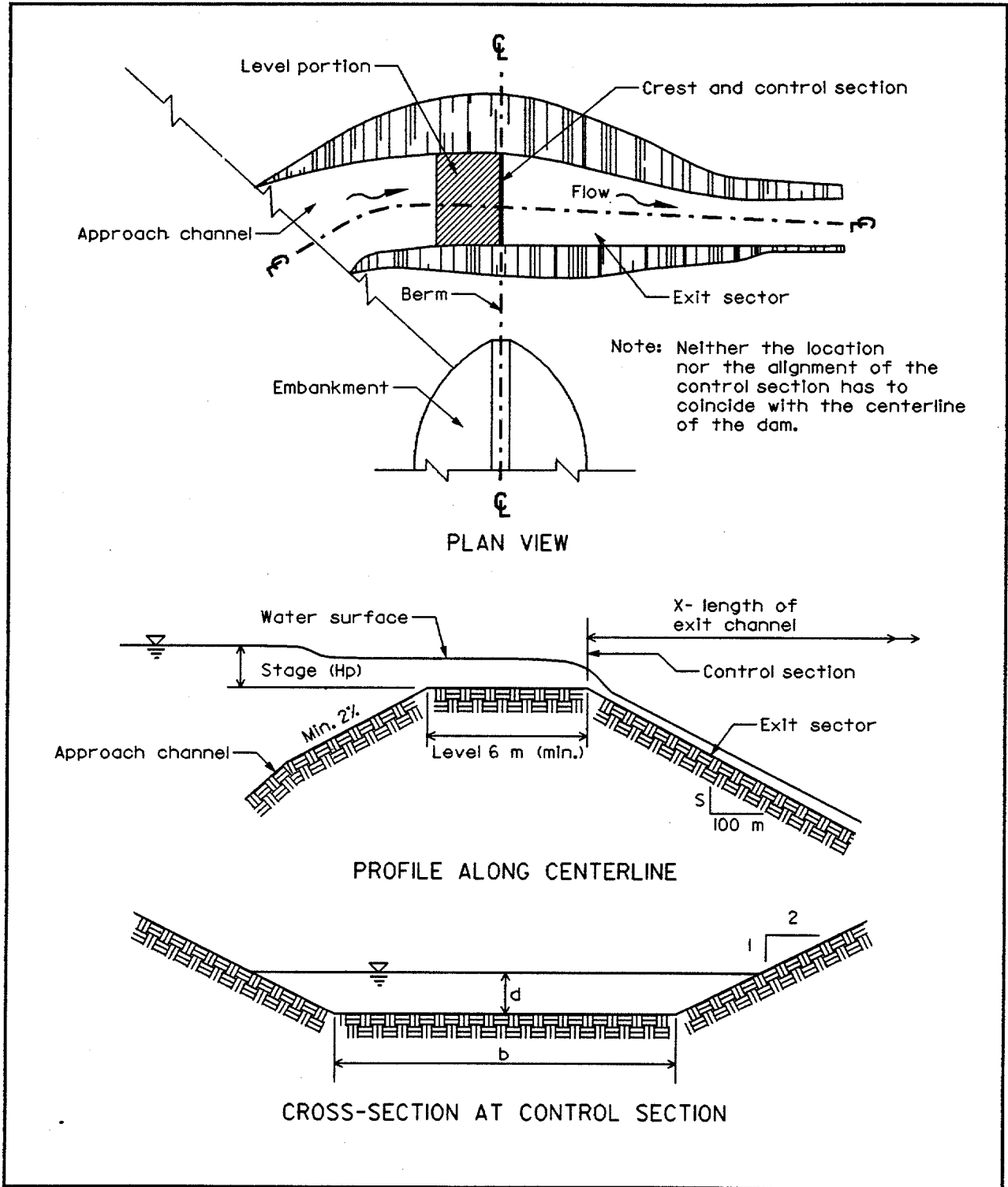

Figure 6.7 Emergency Spillway

Source: USDA-SCS

Construction

Site Preparation

Areas under the embankment and any structures should be cleared, grubbed, and stripped of topsoil to remove trees, vegetation, roots, or other objectionable material. In order to facilitate cleanout and restoration, the pool area should be cleared of all brush and trees.

Cutoff Trench

A cutoff trench should be excavated along the centerline of the dam. The minimum depth should be 600 mm (2 feet). The cutoff trench should extend up both abutments to the riser crest elevation. The minimum bottom width should be 1.2 meters (4 feet), but wide enough to permit operation of compaction equipment. The side slopes should be no steeper than 1 horizontal to 1 vertical.

Compaction requirements should be the same as those for the roadway embankment. The trench should be drained during backfilling-compaction operations.

Principal Spillway

The riser of the principal spillway should be securely attached to the barrel by a watertight connection. The barrel and riser should be placed on a compacted soil foundation. The base of the riser should be firmly anchored according to design criteria to prevent floating (see Figure 6.9). Pervious materials such as sand, gravel or crushed stone should not be used as backfill around the barrel or anti-seep collars. Fill material should be placed around the pipe in 100 mm (4 inch) layers and compacted by hand to the same density as the embankment. A minimum of 600 mm (2 feet) of fill should be hand-compacted over the barrel before crossing it with construction equipment.

SEDIMENT TRAPS AND BASINS

Embankment

The fill material should be taken from approved borrow areas. It should be clean soil, free of roots, woody vegetation, oversized stones, rocks, or other objectionable material. Areas on which fill is to be placed should be scarified prior to the placement of fill. Fill material will be placed in 150 to 200 mm (6 to 8 inch) continuous layers over the entire length of the fill. Compaction should be obtained by routing the hauling equipment over the fill so that the entire surface of the fill is traversed by at least one wheel or tread track of the equipment, or by using a compactor.

Vegetative Stabilization

The embankment and emergency spillway of the sediment basin should be stabilized with temporary vegetation immediately after completion of the basin.

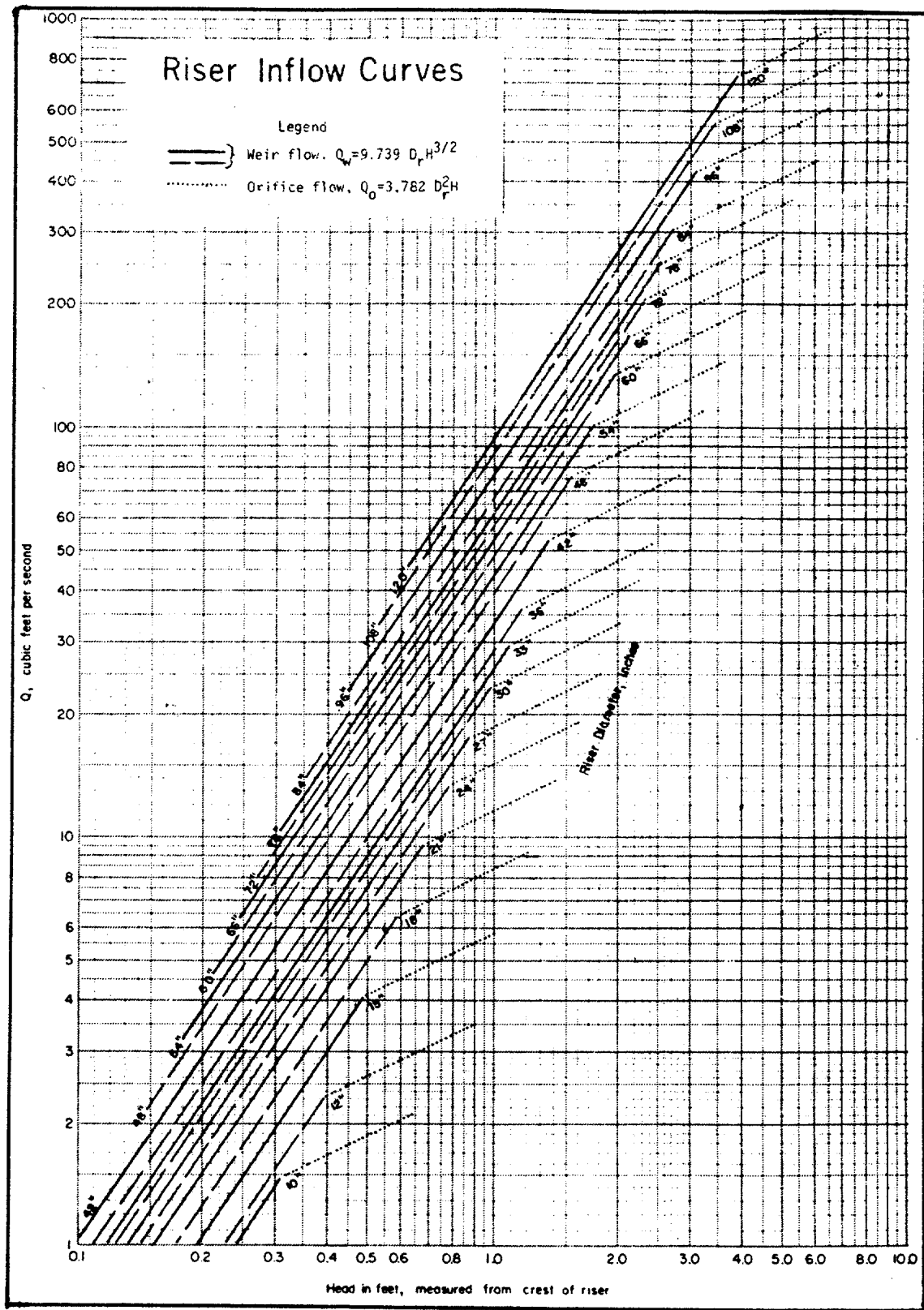

Figure 6.8 Riser Inflow Curves

Source: USDA-SCS

PIPE FLOW CHART, n = 0.013

FOR REINFORCED CONCRETE PIPE INLET $K_m = K_a + K_b = 0.65$ AND 70 FEET OF REINFORCED CONCRETE PIPE CONDUIT (full flow assumed)

Note correction factors for pipe lengths other than 70 feet diameter of pipe in inches

H, in	12"	15"	18"	21"	24"	30"	36"	42"	48"	54"	60"	66"	72"	78"	84"	90"	96"	102"
1	3.22	5.44	8.29	11.8	15.9	26.0	38.6	53.8	71.4	91.5	114	139	167	197	229	264	302	342
2	4.55	7.69	11.7	16.7	22.5	36.8	54.6	76.0	101	129	161	197	236	278	324	374	427	483
3	5.57	9.42	14.4	20.4	27.5	45.0	66.9	93.1	124	159	198	241	289	341	397	458	523	592
4	6.43	10.9	16.6	23.5	31.8	52.0	77.3	108	143	183	228	278	334	394	459	529	604	683
5	7.19	12.2	18.5	26.3	35.5	58.1	86.4	120	160	205	255	311	373	440	513	591	675	764
6	7.88	13.3	20.3	28.8	38.9	63.7	94.6	132	175	224	280	341	409	482	562	647	739	837
7	8.51	14.4	21.9	31.1	42.0	68.8	102	142	189	242	302	368	441	521	607	699	798	904
8	9.10	15.4	23.5	33.3	44.9	73.5	109	152	202	259	323	394	472	557	645	748	854	966
9	9.65	16.3	24.9	35.3	47.7	78.0	116	161	214	275	342	418	500	590	688	793	905	1025
10	10.2	17.2	26.2	37.2	50.2	82.2	122	170	226	289	361	440	527	622	725	836	954	1080
11	10.7	18.0	27.5	39.0	52.7	86.2	128	178	237	304	379	462	553	653	761	877	1001	1133
12	11.1	18.9	28.7	40.8	55.0	90.1	134	186	247	317	395	482	578	682	794	916	1045	1184
13	11.6	19.6	29.9	42.4	57.3	93.7	139	194	257	330	411	502	601	710	827	953	1088	1232
14	12.0	20.4	31.0	44.1	59.4	97.3	145	201	267	342	427	521	624	736	858	989	1129	1278
15	12.5	21.1	32.1	45.6	61.5	101	150	208	277	354	442	539	646	762	888	1024	1169	1323
16	12.9	21.8	33.2	47.1	63.5	104	155	215	286	366	457	557	667	787	917	1057	1207	1367
17	13.3	22.4	34.2	48.5	65.5	107	159	222	294	377	471	574	688	812	946	1090	1244	1409
18	13.7	23.1	35.2	49.9	67.4	110	164	228	303	388	484	591	708	835	973	1121	1280	1450
19	14.0	23.7	36.1	51.3	69.2	113	168	234	311	399	497	607	727	858	1000	1152	1315	1489
20	14.4	24.3	37.1	52.6	71.0	116	173	240	319	409	510	623	746	880	1026	1182	1350	1528
21	14.7	24.9	38.0	53.9	72.8	119	177	246	327	419	523	638	764	902	1051	1211	1383	1566
22	15.1	25.5	38.9	55.2	74.5	122	181	252	335	429	535	653	782	923	1076	1240	1415	1603
23	15.4	26.1	39.8	56.5	76.2	125	186	258	342	439	547	668	800	944	1100	1268	1447	1639
24	15.8	26.7	40.6	57.7	77.8	127	189	263	350	448	559	682	817	964	1123	1295	1478	1674
25	16.1	27.2	41.5	58.9	79.4	130	193	269	357	458	571	696	834	984	1147	1322	1509	1708
26	16.4	27.7	42.3	60.0	81.0	133	197	274	364	467	582	710	850	1004	1169	1348	1539	1742
27	16.7	28.3	43.1	61.2	82.5	135	201	279	371	476	593	727	867	1023	1192	1373	1568	1775
28	17.0	28.8	43.9	62.3	84.1	138	204	285	378	484	604	737	883	1041	1214	1399	1597	1808
29	17.3	29.3	44.7	63.4	85.5	140	208	290	384	493	615	750	898	1060	1235	1423	1625	1840
30	17.6	29.8	45.4	64.5	87.0	142	212	294	391	501	625	763	913	1078	1256	1448	1653	1871

L, in	20	30	40	50	60	70	80	90	100	120	140	160
20	1.30	1.24	1.21	1.18	1.15	1.12	1.10	1.08	1.07	1.06	1.05	1.04
30	1.22	1.18	1.15	1.13	1.12	1.09	1.08	1.06	1.05	1.04	1.03	1.02
40	1.15	1.13	1.11	1.10	1.08	1.07	1.05	1.05	1.04	1.03	1.02	1.02
50	1.09	1.08	1.07	1.06	1.05	1.04	1.04	1.03	1.03	1.02	1.02	1.01
60	1.04	1.04	1.03	1.03	1.03	1.02	1.02	1.02	1.01	1.01	1.01	1.01
70	1.00	1.00	1.00	1.00	1.00	1.00	1.00	1.00	1.00	1.00	1.00	1.00
80	.96	.97	.97	.97	.98	.98	.98	.99	.99	.99	.99	.99
90	.93	.94	.94	.95	.95	.96	.97	.97	.98	.98	.98	.99
100	.90	.91	.92	.93	.93	.95	.96	.96	.97	.97	.98	.98
120	.84	.86	.87	.89	.90	.91	.93	.94	.94	.96	.96	.97
140	.80	.82	.83	.85	.86	.88	.90	.91	.92	.93	.94	.95
160	.76	.78	.80	.82	.83	.86	.88	.89	.90	.91	.92	.93

Correction Factors For Other Pipe Lengths

Table 6.3 Concrete Pipe Flow Chart, n = 0.013

Source: USDA-SCS

PIPE FLOW CHART, n = 0.025

FOR CORRUGATED METAL PIPE INLET $V_m = K_e + K_b = 1.0$ AND 70 FEET OF CORRUGATED METAL PIPE CONDUIT (full flow assumed)

Note: correction factors for pipe lengths other than 70 feet
diameter of pipe in inches

H, in feet	6"	8"	10"	12"	15"	18"	21"	24"	30"	36"	42"	48"	54"	60"	66"	72"	78"	84"	90"	96"	102"
1	0.33	0.70	1.25	1.98	3.48	5.47	7.99	11.0	18.8	28.8	41.1	55.7	72.6	91.8	113	137	163	191	222	255	290
2	0.47	0.99	1.76	2.80	4.92	7.74	11.3	15.6	26.6	40.8	58.2	78.8	103	130	160	194	231	271	314	360	410
3	0.58	1.22	2.16	3.43	6.02	9.48	13.8	19.1	32.6	49.9	71.2	96.5	126	159	196	237	282	331	384	441	502
4	0.67	1.40	2.49	3.97	6.96	10.9	16.0	22.1	37.6	57.7	82.3	111	145	184	226	274	326	383	444	510	580
5	0.74	1.57	2.79	4.43	7.78	12.2	17.9	24.7	42.1	64.5	92.0	125	162	205	253	306	365	428	496	570	648
6	0.82	1.72	3.05	4.86	8.52	13.4	19.6	27.0	46.1	70.6	101	136	178	225	277	336	399	469	544	624	710
7	0.88	1.86	3.30	5.25	9.20	14.5	21.1	29.2	49.8	76.3	109	147	192	243	300	362	431	506	587	674	767
8	0.94	1.99	3.53	5.61	9.84	15.5	22.6	31.2	53.2	81.5	116	158	205	260	320	388	461	541	628	721	820
9	1.00	2.11	3.74	5.95	10.4	16.4	24.0	33.1	56.4	86.5	123	167	218	275	340	411	489	574	666	764	870
10	1.05	2.22	3.94	6.27	11.0	17.3	25.3	34.9	59.5	91.2	130	176	230	290	358	433	516	605	702	806	917
11	1.10	2.33	4.13	6.58	11.5	18.2	26.5	36.6	62.4	95.6	136	185	241	304	376	454	541	635	736	845	962
12	1.15	2.43	4.32	6.87	12.1	19.0	27.7	38.2	65.2	99.9	142	193	252	318	392	475	565	663	769	883	1004
13	1.20	2.53	4.49	7.15	12.6	19.7	28.8	39.8	67.8	104	148	201	262	331	408	494	588	690	800	919	1045
14	1.25	2.63	4.66	7.42	13.0	20.5	29.9	41.3	70.4	108	154	208	272	343	424	513	610	716	830	953	1085
15	1.29	2.72	4.83	7.68	13.5	21.2	30.9	42.8	72.8	112	159	216	281	355	439	531	631	741	860	987	1123
16	1.33	2.81	4.99	7.93	13.9	21.9	32.0	44.2	75.2	115	165	223	290	367	453	548	652	765	888	1019	1160
17	1.37	2.90	5.14	8.18	14.3	22.6	32.9	45.5	77.5	119	170	230	299	378	467	565	672	789	915	1051	1195
18	1.41	2.98	5.29	8.41	14.8	23.2	33.9	46.8	79.8	120	174	236	308	389	480	581	692	812	942	1081	1230
19	1.45	3.06	5.43	8.64	15.2	23.9	34.8	48.1	82.0	126	179	243	316	400	494	597	711	834	967	1111	1264
20	1.49	3.14	5.57	8.87	15.6	24.5	35.7	49.4	84.1	129	184	249	325	410	506	613	729	856	993	1139	1297
21	1.53	3.22	5.71	9.09	15.9	25.1	36.6	50.6	86.2	132	188	255	333	421	519	628	747	877	1017	1168	1329
22	1.56	3.29	5.85	9.30	16.3	25.7	37.5	51.8	88.2	135	193	261	341	430	531	643	765	898	1041	1195	1360
23	1.60	3.37	5.98	9.51	16.7	26.2	38.3	53.0	90.2	138	197	267	348	440	543	657	782	918	1064	1222	1390
24	1.63	3.44	6.11	9.72	17.0	26.8	39.1	54.1	92.1	141	201	273	356	450	555	671	799	937	1087	1248	1420
25	1.66	3.51	6.23	9.92	17.4	27.4	39.9	55.2	94.0	144	206	279	363	459	566	685	815	957	1110	1274	1450
26	1.70	3.58	6.36	10.1	17.7	27.9	40.7	56.3	95.9	147	210	284	370	468	577	699	831	976	1132	1299	1478
27	1.73	3.65	6.48	10.3	18.1	28.4	41.5	57.4	97.7	150	214	290	377	477	588	712	847	994	1153	1324	1507
28	1.76	3.72	6.60	10.5	18.4	29.0	42.3	58.4	99.5	153	218	295	384	486	599	725	863	1013	1174	1348	1534
29	1.79	3.78	6.71	10.7	18.7	29.5	43.0	59.5	101	155	221	300	391	494	610	738	878	1030	1195	1372	1561
30	1.82	3.85	6.83	10.9	19.1	30.0	43.7	60.5	103	158	225	305	398	503	620	750	893	1048	1216	1396	1588

Correction Factors For Other Pipe Lengths

L, in feet	1.70	1.69	1.63	1.58	1.53	1.47	1.42	1.37	1.34	1.28	1.24	1.20	1.18	1.16	1.14	1.13	1.11	1.10	1.09	1.08	1.07	1.06	1.05	1.04	1.03	1.02	1.01	1.00
20	1.69	1.63	1.58	1.53	1.47	1.42	1.37	1.34	1.28	1.24	1.20	1.18	1.16	1.14	1.13	1.11	1.10	1.09	1.08	1.07	1.06	1.05	1.04	1.03	1.02	1.01	1.00	1.00
30	1.44	1.41	1.39	1.36	1.32	1.29	1.27	1.24	1.21	1.18	1.15	1.13	1.12	1.11	1.10	1.09	1.08	1.07	1.06	1.05	1.04	1.03	1.02	1.01	1.00	1.00	1.00	1.00
40	1.28	1.27	1.25	1.23	1.21	1.20	1.18	1.17	1.14	1.12	1.11	1.10	1.09	1.08	1.07	1.06	1.05	1.04	1.03	1.02	1.01	1.00	1.00	1.00	1.00	1.00	1.00	1.00
50	1.16	1.16	1.15	1.14	1.13	1.12	1.11	1.10	1.09	1.08	1.07	1.06	1.06	1.05	1.04	1.03	1.03	1.02	1.01	1.00	1.00	1.00	1.00	1.00	1.00	1.00	1.00	1.00
60	1.07	1.07	1.07	1.06	1.06	1.05	1.05	1.05	1.04	1.04	1.03	1.03	1.03	1.03	1.02	1.02	1.01	1.00	1.00	1.00	1.00	1.00	1.00	1.00	1.00	1.00	1.00	1.00
70	1.00	1.00	1.00	1.00	1.00	1.00	1.00	1.00	1.00	1.00	1.00	1.00	1.00	1.00	1.00	1.00	1.00	1.00	1.00	1.00	1.00	1.00	1.00	1.00	1.00	1.00	1.00	1.00
80	.94	.94	.94	.95	.95	.95	.96	.96	.96	.96	.97	.97	.97	.98	.98	.98	.98	.98	.98	.98	.98	.98	.98	.98	.98	.98	.98	.98
90	.89	.89	.89	.90	.90	.91	.91	.92	.92	.93	.94	.94	.95	.95	.96	.96	.96	.96	.96	.96	.96	.96	.96	.96	.96	.96	.96	.96
100	.85	.85	.85	.86	.86	.87	.88	.89	.89	.90	.91	.92	.93	.93	.94	.94	.94	.94	.94	.94	.94	.94	.94	.94	.94	.94	.94	.94
120	.78	.78	.79	.79	.80	.81	.82	.83	.83	.85	.86	.87	.88	.89	.90	.91	.91	.91	.91	.91	.91	.91	.91	.91	.91	.91	.91	.91
140	.72	.73	.74	.75	.76	.77	.78	.79	.79	.81	.82	.84	.85	.86	.87	.88	.88	.88	.88	.88	.88	.88	.88	.88	.88	.88	.88	.88
160	.68	.69	.69	.70	.71	.73	.74	.75	.75	.77	.79	.80	.82	.83	.84	.85	.85	.85	.85	.85	.85	.85	.85	.85	.85	.85	.85	.85

Table 6.4 CMP Flow Chart, n = 0.025

Source: USDA-SCS

SEDIMENT TRAPS AND BASINS

STAGE (No) IN FEET	SPILLWAY VARIABLES	BOTTOM WIDTH (b) IN FEET																			
		8	10	12	14	16	18	20	22	24	26	28	30	32	34	36	38	40			
0.5	Q	6	7	8	10	11	13	14	15	17	18	20	21	22	24	25	27	28			
	V	2.7	2.7	2.7	2.7	2.7	2.7	2.7	2.7	2.7	2.7	2.7	2.7	2.7	2.7	2.7	2.7	2.7			
	S	3.9	3.9	3.9	3.9	3.8	3.8	3.8	3.8	3.8	3.8	3.8	3.8	3.8	3.8	3.8	3.8	3.8			
	X	32	33	33	33	33	33	33	33	33	33	33	33	33	33	33	33	33			
0.6	Q	8	10	12	14	16	18	20	22	24	26	28	30	32	34	35	37	39			
	V	3.0	3.0	3.0	3.0	3.0	3.0	3.0	3.0	3.0	3.0	3.0	3.0	3.0	3.0	3.0	3.0	3.0			
	S	3.7	3.7	3.7	3.7	3.6	3.6	3.6	3.6	3.6	3.6	3.6	3.6	3.6	3.6	3.6	3.6	3.6			
	X	36	36	36	36	36	36	37	37	37	37	37	37	37	37	37	37	37			
0.7	Q	11	13	16	18	20	23	25	28	30	33	35	38	41	43	44	46	48			
	V	3.2	3.2	3.3	3.3	3.3	3.3	3.3	3.3	3.3	3.3	3.3	3.3	3.3	3.3	3.3	3.3	3.3			
	S	3.5	3.5	3.4	3.4	3.4	3.4	3.4	3.4	3.4	3.4	3.4	3.4	3.4	3.4	3.4	3.4	3.4			
	X	38	40	40	40	41	41	41	41	41	41	41	41	41	41	41	41	41			
0.8	Q	13	16	19	22	26	29	32	35	38	42	45	46	48	51	54	57	60			
	V	3.5	3.5	3.5	3.6	3.6	3.6	3.6	3.6	3.6	3.6	3.6	3.6	3.6	3.6	3.6	3.6	3.6			
	S	3.3	3.3	3.3	3.2	3.2	3.2	3.2	3.2	3.2	3.2	3.2	3.2	3.2	3.2	3.2	3.2	3.2			
	X	44	44	44	44	45	45	45	45	45	45	45	45	45	45	45	45	45			
0.9	Q	17	20	24	28	32	35	39	43	47	51	53	57	60	64	68	71	75			
	V	3.7	3.8	3.8	3.8	3.8	3.8	3.8	3.8	3.8	3.8	3.8	3.8	3.8	3.8	3.8	3.8	3.8			
	S	3.2	3.1	3.1	3.1	3.1	3.1	3.1	3.1	3.1	3.1	3.1	3.1	3.1	3.1	3.1	3.1	3.1			
	X	47	47	48	48	48	48	48	48	48	48	49	49	49	49	49	49	49			
1.0	Q	20	24	29	33	38	42	47	51	56	61	63	68	72	77	81	86	90			
	V	4.0	4.0	4.0	4.0	4.0	4.0	4.0	4.0	4.0	4.0	4.0	4.0	4.0	4.0	4.0	4.0	4.0			
	S	3.1	3.0	3.0	3.0	3.0	3.0	3.0	3.0	3.0	3.0	3.0	3.0	3.0	3.0	3.0	3.0	3.0			
	X	51	51	51	51	52	52	52	52	52	52	52	52	52	52	52	52	52			
1.1	Q	23	28	34	39	44	49	54	60	65	70	74	79	84	89	95	100	105			
	V	4.2	4.2	4.2	4.3	4.3	4.3	4.3	4.3	4.3	4.3	4.3	4.3	4.3	4.3	4.3	4.3	4.3			
	S	2.9	2.9	2.9	2.9	2.9	2.9	2.9	2.9	2.9	2.9	2.8	2.8	2.8	2.8	2.8	2.8	2.8			
	X	55	55	55	55	55	55	55	56	56	56	56	56	56	56	56	56	56			
1.2	Q	28	33	40	45	51	58	64	69	76	80	86	92	98	104	110	116	122			
	V	4.4	4.4	4.4	4.4	4.4	4.5	4.5	4.5	4.5	4.5	4.5	4.5	4.5	4.5	4.5	4.5	4.5			
	S	2.9	2.9	2.8	2.8	2.8	2.8	2.8	2.8	2.8	2.8	2.8	2.8	2.8	2.8	2.8	2.8	2.8			
	X	58	58	59	59	59	59	59	59	60	60	60	60	60	60	60	60	60			
1.3	Q	32	38	46	53	58	65	73	80	86	91	99	106	112	119	125	133	140			
	V	4.5	4.6	4.6	4.6	4.6	4.6	4.6	4.7	4.7	4.7	4.7	4.7	4.7	4.7	4.7	4.7	4.7			
	S	2.8	2.8	2.8	2.7	2.7	2.7	2.7	2.7	2.7	2.7	2.7	2.7	2.7	2.7	2.7	2.7	2.7			
	X	62	62	62	63	63	63	63	63	63	63	63	63	64	64	64	64	64			
1.4	Q	37	44	51	59	66	74	82	90	96	103	111	119	127	134	142	150	158			
	V	4.7	4.8	4.8	4.8	4.8	4.8	4.8	4.8	4.8	4.9	4.9	4.9	4.9	4.9	4.9	4.9	4.9			
	S	2.8	2.7	2.7	2.7	2.7	2.7	2.7	2.6	2.6	2.6	2.6	2.6	2.6	2.6	2.6	2.6	2.6			
	X	65	66	66	66	66	67	67	67	67	67	67	68	68	68	68	68	69			
1.5	Q	41	50	58	66	75	85	92	101	108	116	125	133	142	150	160	169	178			
	V	4.8	4.9	4.9	5.0	5.0	5.0	5.0	5.0	5.0	5.0	5.0	5.0	5.0	5.0	5.1	5.1	5.1			
	S	2.7	2.7	2.6	2.6	2.6	2.6	2.6	2.6	2.6	2.6	2.6	2.6	2.6	2.6	2.5	2.5	2.5			
	X	69	69	70	70	71	71	71	71	71	71	71	72	72	72	72	72	72			
1.6	Q	46	56	65	75	84	94	104	112	122	132	142	149	158	168	178	187	197			
	V	5.0	5.1	5.1	5.1	5.1	5.2	5.2	5.2	5.2	5.2	5.2	5.2	5.2	5.2	5.2	5.2	5.2			
	S	2.6	2.6	2.6	2.6	2.5	2.5	2.5	2.5	2.5	2.5	2.5	2.5	2.5	2.5	2.5	2.5	2.5			
	X	72	74	74	75	75	76	76	76	76	76	76	76	76	76	76	76	76			
1.7	Q	52	62	72	83	94	105	115	126	135	145	156	167	175	187	196	206	217			
	V	5.2	5.2	5.2	5.3	5.3	5.3	5.3	5.4	5.4	5.4	5.4	5.4	5.4	5.4	5.4	5.4	5.4			
	S	2.6	2.6	2.5	2.5	2.5	2.5	2.5	2.5	2.5	2.5	2.5	2.5	2.5	2.5	2.5	2.5	2.5			
	X	76	78	79	80	80	80	80	80	80	80	80	80	80	80	80	80	80			
1.8	Q	58	69	81	93	104	116	127	138	150	160	171	182	194	204	214	226	233			
	V	5.3	5.4	5.4	5.5	5.5	5.5	5.5	5.5	5.5	5.5	5.5	5.6	5.6	5.6	5.6	5.6	5.6			
	S	2.5	2.5	2.5	2.5	2.4	2.4	2.4	2.4	2.4	2.4	2.4	2.4	2.4	2.4	2.4	2.4	2.4			
	X	80	82	83	84	84	84	84	84	84	84	84	84	84	84	84	84	84			
1.9	Q	64	76	88	102	114	127	140	152	164	175	188	201	213	225	235	248	260			
	V	5.5	5.5	5.5	5.6	5.6	5.6	5.7	5.7	5.7	5.7	5.7	5.7	5.7	5.7	5.7	5.7	5.7			
	S	2.5	2.5	2.5	2.4	2.4	2.4	2.4	2.4	2.4	2.4	2.4	2.4	2.4	2.4	2.4	2.4	2.4			
	X	84	85	86	87	88	88	88	88	88	88	88	88	88	88	88	88	88			
2.0	Q	71	83	97	111	125	138	153	164	178	193	204	218	232	245	256	269	283			
	V	5.6	5.7	5.7	5.7	5.8	5.8	5.8	5.8	5.8	5.8	5.8	5.8	5.9	5.9	5.9	5.9	5.9			
	S	2.5	2.4	2.4	2.4	2.4	2.4	2.4	2.4	2.3	2.3	2.3	2.3	2.3	2.3	2.3	2.3	2.3			
	X	88	90	91	91	91	91	92	92	92	92	92	92	92	92	92	92	92			
2.1	Q	77	91	107	122	135	149	162	177	192	207	220	234	250	267	276	291	305			
	V	5.7	5.8	5.9	5.9	5.9	5.9	5.9	6.0	6.0	6.0	6.0	6.0	6.0	6.0	6.0	6.0	6.0			
	S	2.4	2.4	2.4	2.4	2.4	2.3	2.3	2.3	2.3	2.3	2.3	2.3	2.3	2.3	2.3	2.3	2.3			
	X	92	93	95	95	95	95	95	95	95	95	96	96	96	96	96	96	96			
2.2	Q	84	100	116	131	146	163	177	194	210	224	238	253	269	288	301	314	330			
	V	5.9	5.9	6.0	6.0	6.0	6.1	6.1	6.1	6.1	6.1	6.1	6.1	6.1	6.2	6.2	6.2	6.2			
	S	2.4	2.4	2.4	2.3	2.3	2.3	2.3	2.3	2.3	2.3	2.3	2.3	2.3	2.3	2.3	2.3	2.3			
	X	96	98	99	99	99	99	99	100	100	100	100	100	100	100	100	100	100			
2.3	Q	90	108	124	140	158	175	193	208	226	243	258	275	292	306	323	341	354			
	V	6.0	6.1	6.1	6.1	6.2	6.2	6.2	6.2	6.3	6.3	6.3	6.3	6.3	6.3	6.3	6.3	6.3			
	S	2.4	2.4	2.3	2.3	2.3	2.3	2.3	2.3	2.2	2.2	2.2	2.2	2.2	2.2	2.2	2.2	2.2			
	X	100	102	102	103	103	104	104	104	104	105	105	105	105	105	105	105	105			
2.4	Q	99	116	136	152	170	189	206	224	241	260	275	294	312	327	346	364	378			
	V	6.1	6.2	6.2	6.3	6.3	6.3	6.4	6.4	6.4	6.4	6.4	6.4	6.4	6.4	6.4	6.4	6.4			
	S	2.3	2.3	2.3	2.3	2.3	2.2	2.2	2.2	2.2	2.2	2.2	2.2	2.2	2.2	2.2	2.2	2.2			
	X	105	105	106	107	107	108	108	108	108	109	109	109	109	109	109	109	109			

Table 6.5 Emergency Spillway Design Data

Source: USDA-SCS

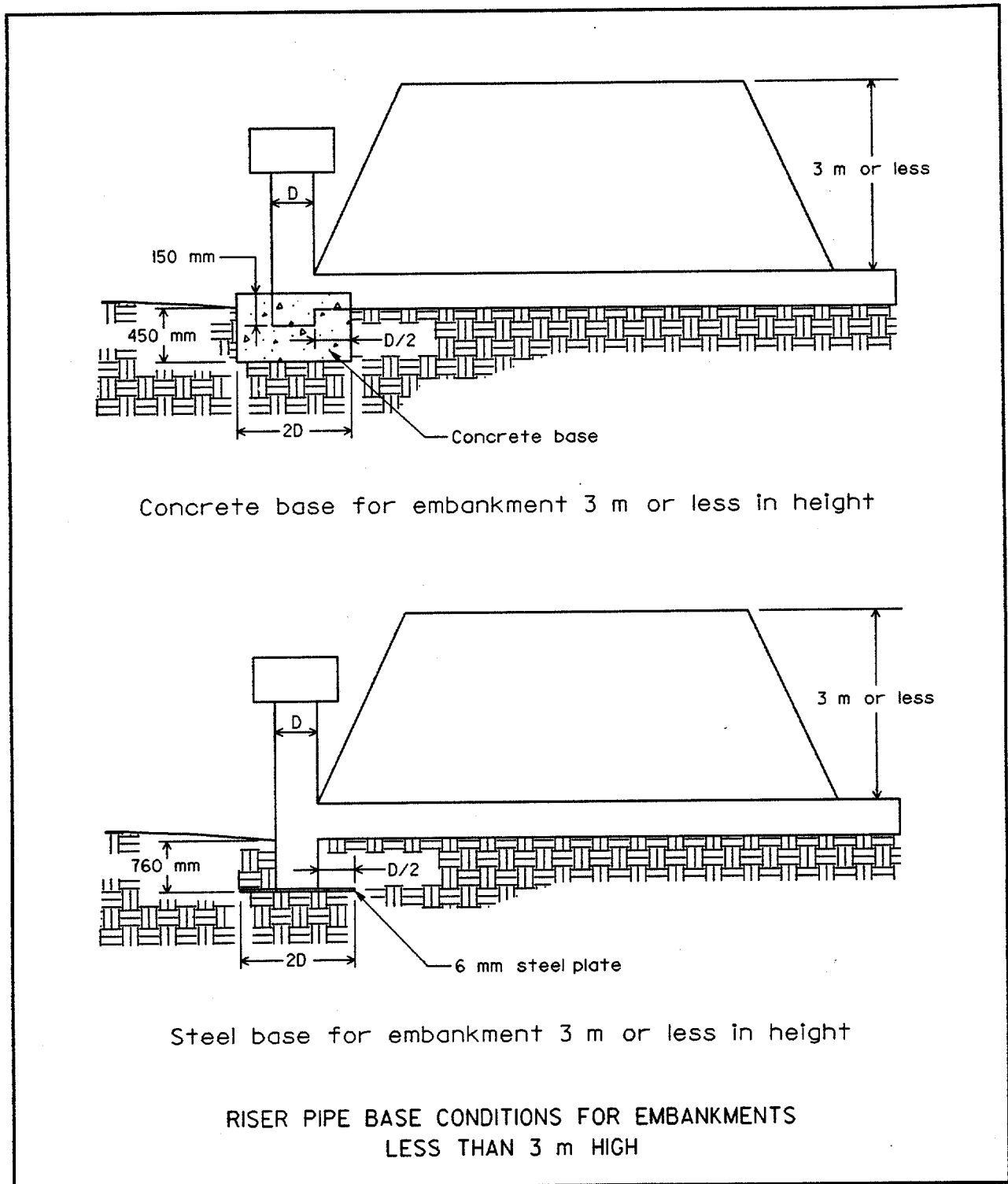
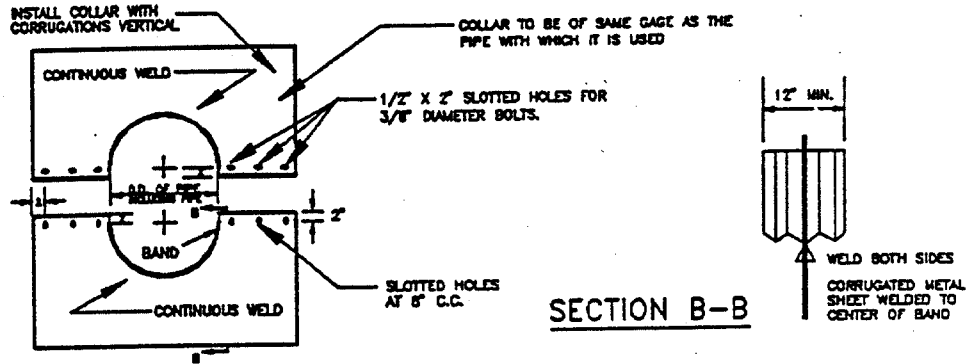

Figure 6.9 Riser Pipe Anchors

Source: VA DSWC

DETAILS OF CORRUGATED METAL ANTI-SEEP COLLAR



ELEVATION OF UNASSEMBLED COLLAR

NOTES FOR COLLARS:

1. ALL MATERIALS TO BE IN ACCORDANCE WITH CONSTRUCTION AND CONSTRUCTION MATERIAL SPECIFICATIONS.
2. WHEN SPECIFIED ON THE PLANS, COATING OF COLLARS SHALL BE IN ACCORDANCE WITH CONSTRUCTION AND CONSTRUCTION MATERIAL SPECIFICATIONS.
3. UNASSEMBLED COLLARS SHALL BE MARKED BY PAINTING OR TAGGING TO IDENTIFY MATCHING PAIRS.
4. THE LAP BETWEEN THE TWO HALF SECTIONS AND BETWEEN THE PIPE AND CONNECTING BAND SHALL BE CAULKED WITH ASPHALT MASTIC AT TIME OF INSTALLATION.
5. EACH COLLAR SHALL BE FURNISHED WITH TWO 1/2" DIAMETER RODS WITH STANDARD TANK LUGS FOR CONNECTING COLLARS TO PIPE.

DETAIL OF HELICAL PIPE ANTI-SEEP COLLAR

SIZE AND SPACING OF SLOTTED OPENINGS SHALL BE THE SAME AS SHOWN FOR CM COLLAR. USE RODS AND LUGS TO CLAMP BANDS SECURELY TO PIPE.

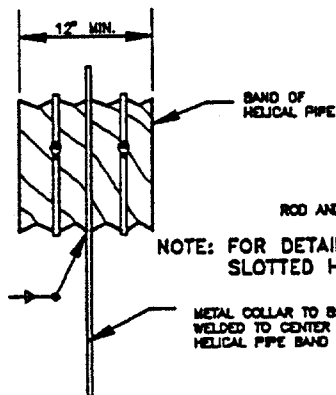

PARTIAL ELEVATION

REF: ENGR. FIELD MANUAL

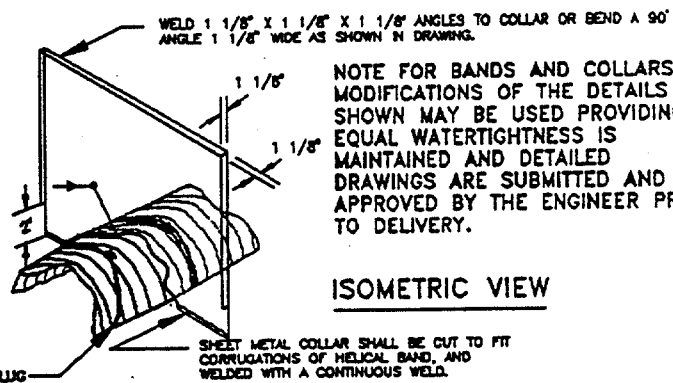

NOTE FOR BANDS AND COLLARS: MODIFICATIONS OF THE DETAILS SHOWN MAY BE USED PROVIDING EQUAL WATERTIGHTNESS IS MAINTAINED AND DETAILED DRAWINGS ARE SUBMITTED AND APPROVED BY THE ENGINEER PRIOR TO DELIVERY.

ISOMETRIC VIEW

NOTE: FOR DETAILS OF FABRICATION DIMENSIONS, MINIMUM GAGES, SLOTTED HOLES, AND NOTES, SEE DETAIL ABOVE.

NOTE: TWO OTHER TYPES OF ANTI-SEEP COLLARS ARE:

1. CORRUGATED METAL, SIMILAR TO UPPER, EXCEPT SHOP WELDED TO A SHORT (4FT.) SECTION OF THE PIPE AND CONNECTED WITH CONNECTING BANDS TO THE PIPE.
2. CONCRETE, SIX INCHES THICK FORMED AROUND THE PIPE WITH #3 REBAR SPACED 15" HORIZONTALLY AND VERTICALLY.

Figure 6.10 Anti-seep Collar Details

Source: USDA-SCS

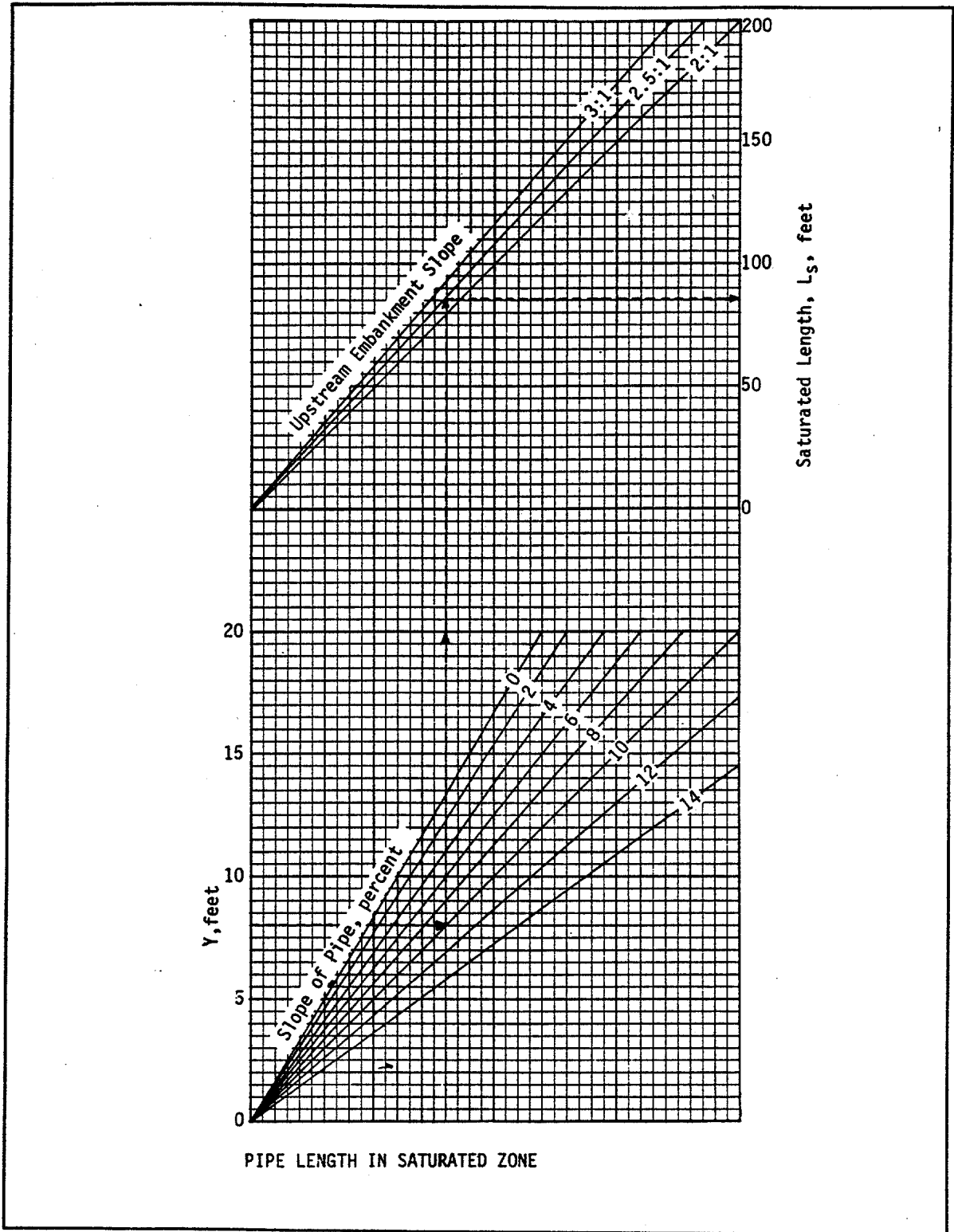

Figure 6.11 Pipe Length in Saturated Zone

Source: USDA-SCS

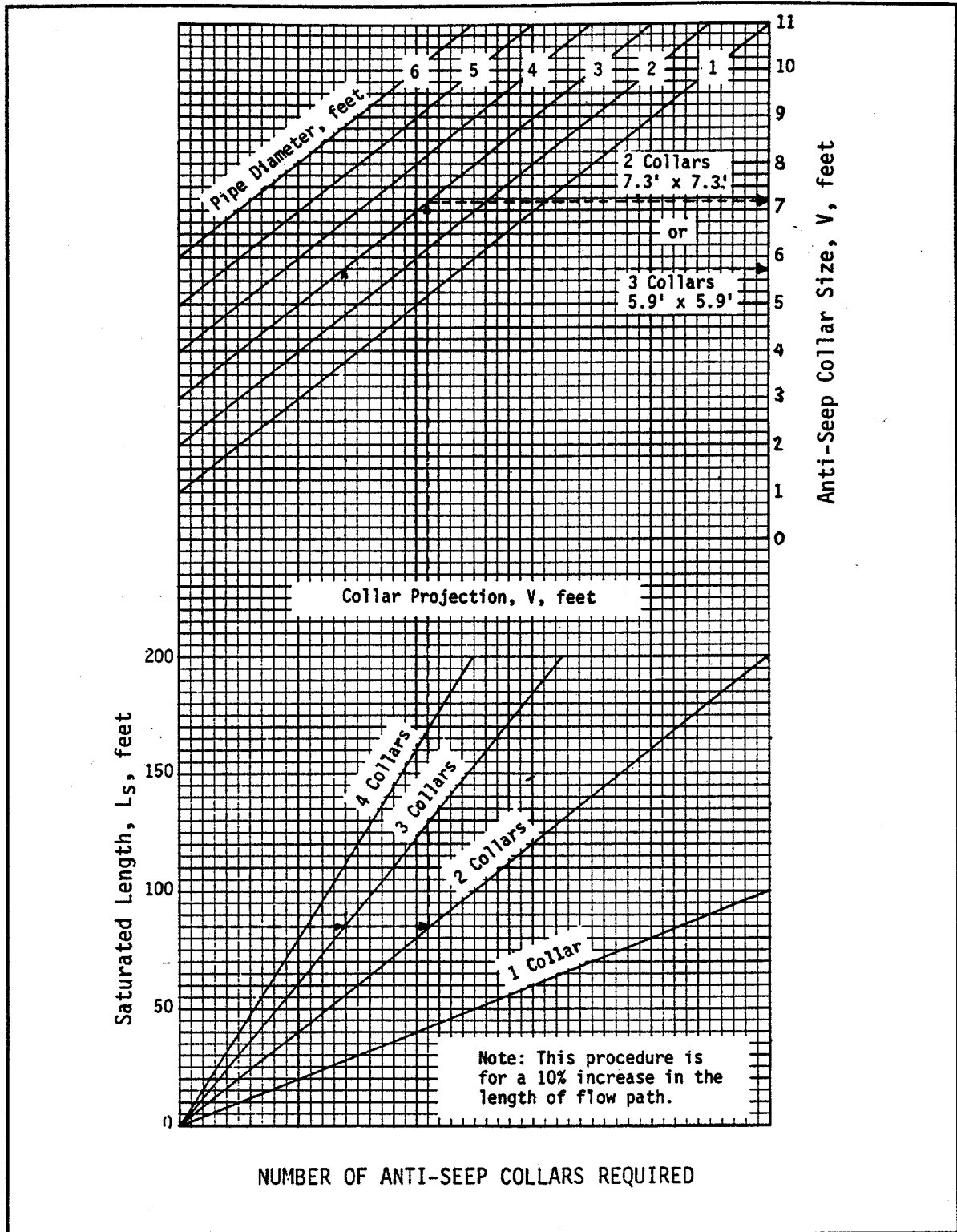

Figure 6.12 Anti-seep Collar Design

Source: USDA-SCS

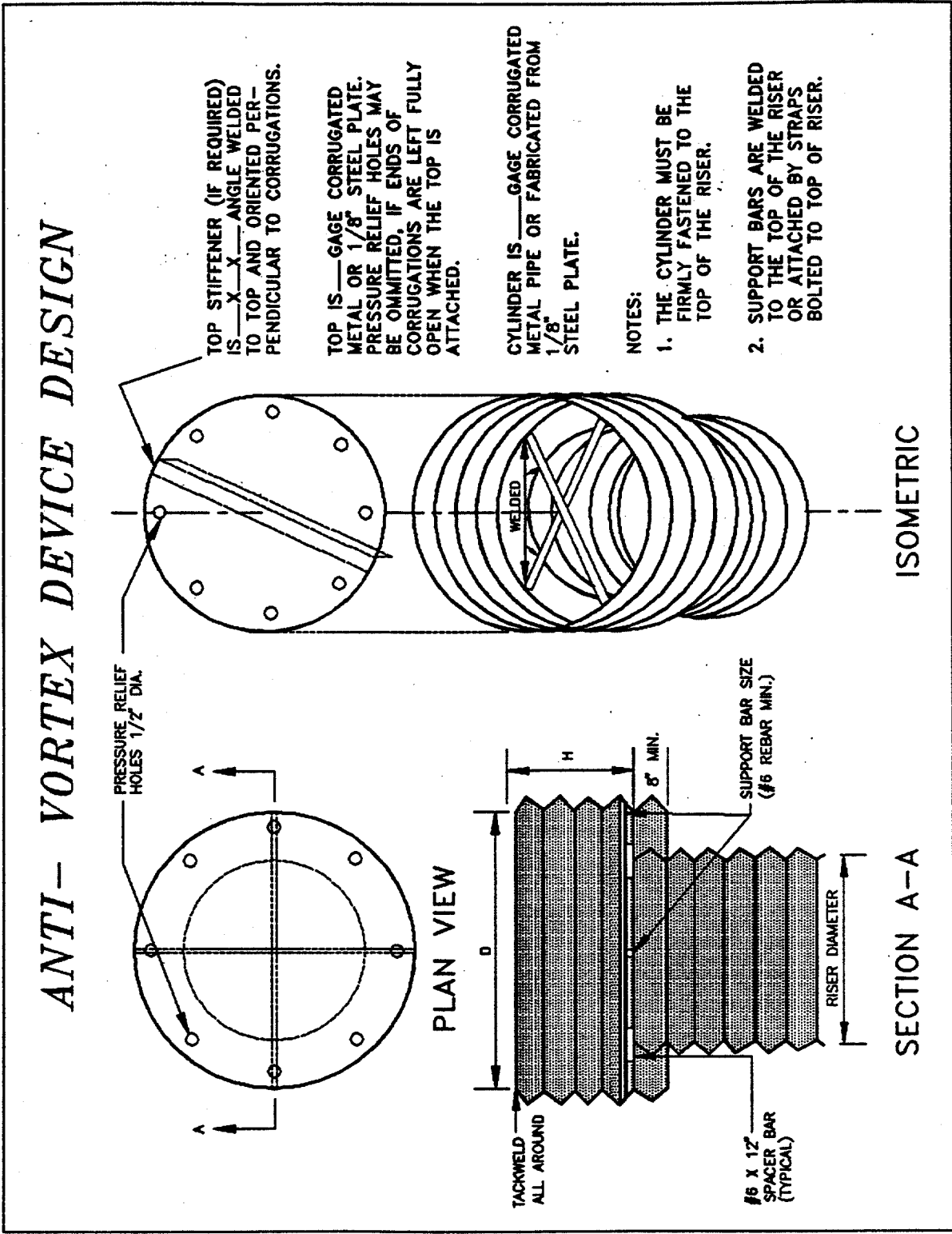

Figure 6.13 Anti-Vortex Device Details

Source: USDA-SCS

SEDIMENT TRAPS AND BASINS

Riser Diam., in.	Cylinder		Height, inches	Minimum Size Support Bar	Minimum Top	
	Diameter, inches	Thickness, gage			Thickness	Stiffener
12	18	16	6	#6 Rebar or 1½" x 1½" x 3/16" angle	16 ga. (F & C)	-
15	21	16	7	" "	" "	-
18	27	16	8	" "	" "	-
21	30	16	11	" "	16 ga. (C), 14 ga. (F)	-
24	36	16	13	" "	" "	-
27	42	16	15	" "	" "	-
36	54	14	17	#8 Rebar	14 ga. (C), 12 ga. (F)	-
42	60	16	19	" "	" "	-
48	72	16	21	1¼" pipe or 1¼" x 1¼" x ¼" angle	14 ga. (C), 10 ga. (F)	-
54	78	16	25	" "	" "	-
60	90	14	29	1½" pipe or 1½" x 1½" x ¼" angle	12 ga. (C), 8 ga. (F)	-
66	96	14	33	2" pipe or 2" x 2" x 3/16" angle	12 ga. (C), 8 ga. (F) w / stiffener	2" x 2" x ¼" angle
72	102	14	36	" "	" "	2½" x 2½" x ¼" angle
78	114	14	39	2½" pipe or 2" x 2" x ¼" angle	" "	" "
84	120	12	42	2½" pipe or 2½" x 2½" x ¼" angle	" "	2½" x 2½" x 5/16" angle

Note₁: The criterion for sizing the cylinder is that the area between the inside of the cylinder and the outside of the riser is equal to or greater than the area inside the riser. Therefore, the above table is invalid for use with concrete pipe risers.

Note₂: Corrugation for 12"-36" pipe measures 2½" x ½"; for 42"-84" the corrugation measures 5" x 1" or 8" x 1".

Note₃: C = corrugated; F = flat.

Adapted from USDA-SCS and Carl M. Henshaw
Drainage Products Information

Table 6.6 Anti-Vortex Design

REFERENCES

1. April 2, 1992 Federal Register (57 FR 11394) - Application Deadlines, General Permit Requirements and Reporting Requirements, Final Rule.
2. Brown, Scott A., and Clyde, Eric S., "Design of Riprap Revetment," U.S. Department of Transportation, Federal Highway Administration, Hydraulic Engineering Circular Number 11, FHWA-IP-89-016, 1989.
3. Chen, Y. H., and Cotton, G. K., "Design of Roadside Channels with Flexible Linings," U.S. Department of Transportation, Federal Highway Administration, Hydraulic Engineering Circular Number 15, FHWA-IP-87-7, 1988.
4. Corry, M. L., Thompson, P. L., Watts, F. J., Jones, J. S., and Richards, D. L., "Hydraulic Design of Energy Dissipators for Culverts and Channels," U.S. Department of Transportation, Federal Highway Administration, Hydraulic Engineering Circular Number 14, FHWA-SA-92-0, 1983.
5. Goldman, Steven J., Jackson, Katharine, and Bursztynsky, Taras A., Erosion and Sediment Control Handbook. McGraw-Hill, New York, 1986.
6. Gray, Donald H. and Leiser, Andrew T., Biotechnical Slope Protection and Erosion Control. Van Nostrand Reinhold Company Inc., New York, 1982.
7. Maryland Department of the Environment, "Standards and Specifications for Soil Erosion and Sediment Control." Baltimore, Maryland, 1991.
8. Middleton, Lloyd M., and Richards, Dennis L., "Best Management Practices for Erosion and Sediment Control." U.S. Department of Transportation, Federal Highway Administration, Region 15, December, 1978.
9. North Carolina Department of Natural Resources and Community Development, Division of Land Resources, "Erosion and Sediment Control Planning and Design Manual." Land Quality Section, Raleigh, North Carolina, 1988.
10. Pennsylvania Department of Environmental Resources, Bureau of Soil and Water Conservation, "Erosion and Sediment Control Program Manual." Pennsylvania, 1990.

11. Roberts, Brian C., "Developing Erosion Control Plans for Highway Construction," Erosion Control. May/June, 1994.
12. September 9, 1992 Federal Register (57 FR 41176) - Final NPDES General Permits for Storm Water Discharges from Construction Sites; Notice.
13. September 25, 1992 Federal Register (57 FR 44412) - Final NPDES General Permits for Storm Water Discharges from Construction Sites; Notice.
14. Virginia Department of Conservation and Recreation, Division of Soil and Water Conservation, "Virginia Erosion and Sediment Control Handbook," Third Edition. Richmond, Virginia, 1992.
15. U.S. Environmental Protection Agency, "Summary Guidance: Storm Water Management For Construction Activities, Developing Pollution Prevention Plans and Best Management Practices, EPA Office of Water, EPA 833-R-92-001. October 1992.
16. U.S. Environmental Protection Agency, "Storm Water Management For Construction Activities, Developing Pollution Prevention Plans and Best Management Practices, EPA Office of Water, EPA 832-R-92-005.

**APPENDIX A: FINAL NPDES GENERAL PERMIT FOR
CONSTRUCTION ACTIVITIES**

ENVIRONMENTAL PROTECTION AGENCY
AGENCY: Environmental Protection Agency (EPA).

[FRL-4202-4]
57 FR 41176
September 9, 1992

Final NPDES General Permits for Storm Water
Discharges from Construction Sites

ACTION: Notice of final NPDES general permits.

SUMMARY: The Regional Administrators of Regions I, II, III, IV, V, VI, VIII, IX, and X (the "Regions" or the "Directors") are issuing final National Pollutant Discharge Elimination System (NPDES) general permits for storm water discharges associated with industrial activity from construction sites in 10 States (Alaska, Arizona, Idaho, Louisiana, Maine, New Hampshire, New Mexico, Oklahoma, South Dakota, and Texas); the Territories of Puerto Rico, Johnston Atoll, and Midway and Wake Islands; on Indian lands in Alaska, Arizona, California, Colorado, Florida, Idaho, Maine, Massachusetts, Mississippi, Montana, New Hampshire, Nevada, North Carolina, North Dakota, Utah, Washington, and Wyoming; from Federal facilities in Colorado, and Washington; and from Federal facilities and Indian lands in Louisiana, New Mexico, Oklahoma, and Texas.

These general permits establish Notice of Intent (NOI) requirements, special conditions, requirements to develop and implement storm water pollution prevention plans, and requirements to conduct site inspections for facilities with discharges authorized by the permit.

DATES: These general permits shall be effective on September 9, 1992. This effective date is necessary to provide appropriate dischargers with the opportunity to comply with the October 1, 1992 deadline for submitting an NPDES application for storm water discharges associated with industrial by submitting a Notice of Intent (NOI) to be covered by the permits.

Deadlines for submittal of Notices of Intent (NOIs) are provided in section IV.A.1 of the Fact Sheet and part II.A of the general permits. Today's general permits also provide additional dates for compliance with the terms of the permit. **ADDRESSES:** Notices of Intent to be authorized to discharge under these permits should be sent to: Storm Water Notices of Intent, PO Box 1215, Newington, VA 22122.

Other submittals of information required under these permits or individual permit applications should be sent to the appropriate EPA Regional Office. The addresses of the Regional Offices and the name and phone number of the Storm Water Regional Coordinator is provided in section IV.F of the Fact Sheet.

The index to the administrative records for these permits are available at the appropriate Regional Office. The complete administrative record is located at EPA Headquarters, EPA Public Information Reference Unit, room 2402, 401 M Street SW., Washington, DC 20460. A reasonable fee may be charged for copying. Specific record information will be made available at the appropriate Regional Office as requested.

FOR FURTHER INFORMATION CONTACT: For further information on the final NPDES general permits and for copies of the Notice of Intent form (the Notice of Intent form in appendix C of this notice can be copied and submitted) contact the NPDES Storm Water Hotline at (703) 821-4823, or the appropriate EPA Regional Office. The name, address and phone number of the Regional Storm Water Coordinators are provided in section IV.F of the Fact Sheet.

TEXT: SUPPLEMENTARY INFORMATION:

I. Introduction

II. Coverage of General Permits

III. Summary of Options for Controlling Pollutants; and

IV. Summary of Permit Conditions

A. Notice of Intent Requirements

1. Deadlines for Submitting NOIs
2. Authorization to Discharge
3. Contents of the NOI
4. Additional Notification

B. Special Conditions

1. Prohibition on Non-Storm Water Discharges
2. Releases of Reportable Quantities of Hazardous Substances and Oil

C. Storm Water Pollution Prevention Plan Requirements

1. Contents of the Plan
 - a. Site Description
 - b. Controls to Reduce Pollutants
 - c. Maintenance
 - d. Inspections
 - e. Non-Storm Water Discharges

2. Deadlines for Plan Preparation and Compliance
3. Signature and Plan Review
4. Keeping Plans Current
5. Additional Requirements
6. Contractors

D. Retention of Records

E. Notice of Termination Requirements

F. Regional Offices

V. Cost Estimates

VI. Economic Impact (Executive Order 12291)

VII. Paperwork Reduction Act

VIII. Section 401 Certification

IX. Regulatory Flexibility Act

I. Introduction

The Regional Administrators of the United States Environmental Protection Agency (EPA) are issuing final general permits for the majority of storm water discharges associated with industrial activity as follows:

Region I -- For the States of Maine and New Hampshire; for Indian lands located in Massachusetts, New Hampshire, and Maine.

Region II -- For the Commonwealth of Puerto Rico.

Region IV -- For Indian lands located in Florida (two tribes), Mississippi, and North Carolina.

Region VI -- For the States of Louisiana, New Mexico, Oklahoma, and Texas; and for Indian lands located in Louisiana, New Mexico (except Navajo lands and Ute Mountain Reservation lands), Oklahoma, and Texas.

Region VIII -- For the State of South Dakota; for Indian lands located in Colorado (including the Ute Mountain Reservation in Colorado), Montana, North Dakota, Utah (except Goshute Reservation and Navajo Reservation lands), and Wyoming; for Federal facilities in Colorado; and for the Ute Mountain Reservation New Mexico.

Region IX -- For the State of Arizona; for the Territories of Johnston Atoll, and Midway and Wake Island; and for Indian lands located in California, and Nevada; and for the Goshute Reservation in Utah and Nevada, the Navajo Reservation in Utah, New Mexico, and Arizona, the Duck Valley Reservation in Nevada and Idaho.

Region X -- For the State of Alaska, and Idaho; for Indian lands located in Alaska, Idaho (except Duck Valley Reservation lands), and Washington; and for Federal facilities in Washington.

This notice contains four sets of appendices. Appendix A summarizes EPA's response to major comments received on the draft general permits published on August 16, 1991, (56 FR 40948). Appendix B provides the language of the final general permits. The permits in appendix B are similar. Appendix B provides the language of the final general permits. Except as provided in part X of the permits, parts I through IX apply to all permits. Part X of the permit contains conditions which only apply in the State indicated. Appendix C is a copy of the Notice of Intent (NOI) form (and associated instructions) to be used by dischargers wanting to obtain coverage under the general permits. Appendix D is a copy of the Notice of Termination (NOT) form (and associated instructions) that can be used by dischargers wanting to notify EPA that their storm water discharges associated with industrial activity have been terminated or that the permittee has transferred operation of the facility.

On August 16, 1991, (56 FR 40948) EPA requested public comment on draft general permits that were the basis for today's final general permits. In addition to addressing storm water discharges from construction activities, the August 16, 1991, draft general permits addressed storm water discharges from other industrial activities. The permits in this notice only address storm water associated with construction activity. Elsewhere in today's Federal Register, EPA is publishing NPDES permits for storm water discharges from nonconstruction industrial facilities.

EPA received over 125 comments on construction issues associated with the draft general permits. In addition, public hearings to discuss the draft general permits were held in Dallas, TX; Oklahoma City, OK; Baton Rouge, LA; Albuquerque, NM; Seattle, WA; Boise, ID; Juneau, AK; Pierre, SD; Phoenix, AZ; Orlando, FL; Tallahassee, FL; Augusta, ME; Boston, MA; and Manchester, NH.

EPA is incorporating portions of the detailed fact sheet for the draft general permits published on August 16, 1991, as part of the final fact sheet and statement of basis for today's final permits. The sections of the prior fact sheet being incorporated are Section 1, Background; Section 2, Types of Discharges Covered; and Section 3, Description of Discharges Covered; and Section 5, The Federal/Municipal Partnership: The Role of Municipal Operators of Large and Medium Municipal Separate Storm Sewers.

II. Coverage of General Permits

Section 402(p) of the Clean Water Act (CWA) clarifies that storm water discharges associated with industrial activity to waters of the United States must be authorized by an NPDES permit. On November 16, 1990, EPA published regulations under the NPDES program which defined the term "storm water discharge associated with industrial activity" to include storm water discharges from construction activities (including clearing, grading, and excavation activities) that result in the disturbance of five or more acres of total land area, including areas that are part of a larger common plan of development or sale (40 CFR 122.26(b)(14)(x)).¹ The term "storm water discharge from construction activities" will be used in this document to refer to storm water discharges from construction sites that meet the definition of a storm water discharge associated with industrial activity.

These final general permits may authorize storm water discharges from existing construction sites (facilities where construction activities began before October 1, 1992, and final stabilization is to occur after October 1, 1992) and new construction sites. New construction sites are those facilities where disturbances associated construction activities commence after October 1, 1992. To obtain authorization under today's permits, a discharger must submit a complete NOI and comply with the terms of the permit. The terms of the permit, including the requirements for submitting an NOI, are discussed in more detail below.

The following discharges are not authorized by these final general permits:

- Storm water discharges associated with industrial activity that originate from the site after construction activities have been completed and the site has undergone final stabilization;
- Non-storm water discharges (except certain non-storm water discharges specifically listed in

today's general permits). However, today's permits can authorize storm water discharges from construction activities where such discharges are mixed with non-storm water discharges that are authorized by a different NPDES permit;

-- Storm water discharges from construction sites that are covered by an existing NPDES individual or general permit. However, storm water discharges associated with industrial activity from a construction site that are authorized by an existing permit may be authorized by today's general permit after the existing permit expires, provided the expired permit did not establish numeric limitations for such discharges;

-- Storm water discharges from construction sites that the Director has determined to be or may reasonably be expected to be contributing to a violation of a water quality standard; and

-- Storm water discharges from construction sites if the discharges are likely to adversely affect a listed endangered or threatened species or a species that is proposed to be listed as endangered or threatened or its critical habitat.

III. Summary of Options for Controlling Pollutants

Most controls for construction activities can be categorized into two groups: (1) Sediment and erosion controls; and (2) storm water management measures. Sediment and erosion controls generally address pollutants in storm water generated from the site during the time when construction activities are occurring. Storm water management measures generally are installed during and before completion of the construction process, but primarily result in reductions of pollutants in storm water discharged from the site after the construction has been completed. Additional measures include housekeeping best management practices.

A. Sediment and Erosion Controls

Erosion controls provide the first line of defense in preventing offsite sediment movement and are designed to prevent erosion through protection and preservation of soils. Sediment controls are designed to remove sediment from runoff before the runoff is discharged from the site. Sediment and erosion controls can be further divided into two major classes of controls: Stabilization practices and structural practices. Major types of sediment and erosion practices are summarized

below. A more complete description of these practices is given in "Storm Water Management for Construction Activities: Developing Pollution Prevention Plans and Best Management Practices", U.S. EPA, 1992.

1. Sediment and Erosion Controls: Stabilization Practices

Stabilization, as discussed here, refers to covering or maintaining an existing cover over soils. The cover may be vegetation, such as grass, trees, vines, or shrubs. Stabilization measures can also include nonvegetative controls such as geotextiles, riprap, or gabions (wire mesh boxes filled with rock). Mulches, such as straw or bark, are most effective when used in conjunction with establishing vegetation, but can be used without vegetation. Stabilization of exposed and denuded soils is one of the most important factors in minimizing erosion while construction activities occur. A vegetation cover reduces the erosion potential of a site by absorbing the kinetic energy of raindrops that would otherwise disturb unprotected soil; intercepting water so that it infiltrates into the ground instead of running off the surface; and slowing the velocity of runoff, thereby promoting deposition of sediment in the runoff. Stabilization measures are often the most important measures taken to prevent offsite sediment movement and can provide large reductions of suspended sediment levels in discharges and receiving waters.² Examples of stabilization measures are summarized below.

a. Temporary seeding. Temporary seeding provides for temporary stabilization by establishing vegetation at areas of the site where activities will temporarily cease until later in the construction project. Without temporary stabilization, soils at these areas are exposed to precipitation for an extended time period, even though work is not occurring on these areas. Temporary seeding practices have been found to be up to 95 percent effective in reducing erosion.³

b. Permanent seeding. Permanent seeding involves establishing a sustainable ground cover at a site. Permanent seeding stabilizes the soil to reduce sediment in runoff from the site by controlling erosion and is typically required at most sites for aesthetic reasons.

c. Mulching. Mulching is typically conducted as part of permanent and temporary seeding practices. Where temporary and permanent seeding is not feasible, exposed soils can be stabilized by applying plant residues or other suitable materials to the soil surface. Although generally not as effective as seeding practices, mulching by itself, does provide some erosion control. Mulching in conjunction with seeding provides erosion

protection prior to the onset of vegetation growth. In addition, mulching protects seeding activities, providing a higher likelihood of successful establishment of vegetation. To maintain optimum effectiveness, mulches must be anchored to resist wind displacement.

d. Sod stabilization. Sod stabilization involves establishing long-term stands of grass with sod on exposed surfaces. When installed and maintained properly, sodding can be more than 99 percent effective in reducing erosion,⁴ making it the most effective vegetation practice available. The cost of sod stabilization (relative to other vegetative controls) typically limits its use to exposed soils where a quick vegetative cover is desired and sites which can be maintained with ground equipment. In addition, sod is sensitive to climate and may require intensive watering and fertilization.

e. Vegetative buffer strips. Vegetative buffer strips are preserved or planted strips of vegetation at the top and bottom of a slope, outlining property boundaries, or adjacent to receiving waters such as streams or wetlands. Vegetative buffer strips can slow runoff flows at critical areas, decreasing erosion and allowing sediment deposition.

f. Protection of trees. This practice involves preserving and protecting selected trees that exist on the site prior to development. Mature trees provide extensive canopy and root systems which help to hold soil in place. Shade trees also keep soil from drying rapidly and becoming susceptible to erosion. Measures taken to protect trees can vary significantly, from simple measures such as installing tree fencing around the drip line and installing tree armoring, to more complex measures such as building retaining walls and tree wells.

2. Sediment and Erosion Controls: Structural Practices

Structural practices involve the installation of devices to divert flow, store flow, or limit runoff. Structural practices have several objectives. First, structural practices can be designed to prevent water from crossing disturbed areas where sediment may be removed. This involves diverting runoff from undisturbed upslope areas through use of earth dikes, temporary swales, perimeter dike/swales, or diversions to stable areas. A second objective of structural practices can be to remove sediment from site runoff before the runoff leaves the site. Approaches to removing sediment from site runoff include diverting flows to a trapping or storage device or filtering diffuse

flow through silt fences before it leaves the site. All structural practices require proper maintenance (removal of sediment) to remain functional.

a. Earth dike. Earth dikes are temporary berms or ridges of compacted soil that channel water to a desired location. Earth dikes should be stabilized with vegetation.

b. Silt fence. Silt fences are a barrier of geotextile fabric (filter cloth) used to intercept sediment in diffuse runoff. They must be carefully maintained to ensure structural stability and to remove excess sediment.

c. Drainage swales. A drainage swale is a drainage channel lined with grass, riprap, asphalt, concrete, or other materials. Drainage swales are installed to convey runoff without causing erosion.

d. Sediment traps. Sediment traps can be installed in a drainage way, at a storm drain inlet, or other points of discharge from a disturbed area.

e. Check dams. Check dams are small temporary dams constructed across a swale or drainage ditch to reduce the velocity of runoff flows, thereby reducing erosion of the swale or ditch. Check dams should not be used in a live stream. Check dams reduce the need for more stringent erosion control practices in the swale due to the decreased velocity and energy of runoff.

f. Level spreader. Level spreaders are outlets for dikes and diversions consisting of an excavated depression constructed at zero grade across a slope. Level spreaders convert concentrated runoff into diffuse runoff and release it onto areas stabilized by existing vegetation.

g. Subsurface drain. Subsurface drains transport water to an area where the water can be managed effectively. Drains can be made of tile, pipe, or tubing.

h. Pipe slope drain. A pipe slope drain is a temporary structure placed from the top of a slope to the bottom of a slope to convey surface runoff down slopes without causing erosion.

i. Temporary storm drain diversion. Temporary storm drain diversions are used to re-direct flow in a storm drain to discharge into a sediment trapping device.

j. Storm drain inlet protection. Storm drain inlet protection can be provided by a sediment filter or an excavated impounding area around a storm drain inlet.

These devices prevent sediment from entering storm drainage systems prior to permanent stabilization of the disturbed area.

k. Rock outlet protection. Rock protection placed at the outlet end of culverts or channels can reduce the depth, velocity, and energy of water so that the flow will not erode the receiving downstream reach.

l. Other controls. Other controls include temporary sediment basins, sump pits, entrance stabilization measures, waterway crossings, and wind breaks.

B. Storm Water Management Measures

Storm water management measures are installed during and prior to the completion of the construction process, but primarily result in reductions of pollutants in storm water discharged from the site after the construction has been completed. Construction activities often result in significant changes in land use. Such changes typically involve an increase in the overall imperviousness of the site, which can result in dramatic changes to the runoff patterns of a site. As the amount within a drainage area increases, the amount of pollutants carried by the runoff increases. In addition, activities such as automobile travel on roads can result in higher pollutant concentrations in runoff compared to preconstruction levels. Traditional storm water management controls attempt to limit the increases in the amount of runoff and the amount of pollutants discharged from a site associated with the change in land use.

Major classes of storm water management measures include infiltration of runoff onsite; flow attenuation by vegetation or natural depressions; outfall velocity dissipation devices; storm water retention structures and artificial wetlands; and storm water detention structures. For many sites, a combination of these controls may be appropriate. A summary of storm water management controls is provided below. A more complete description of storm water management controls is found in "Storm Water Management for Construction Activities: Developing Pollution Prevention Plans and Best Management Practices", U.S. EPA, 1992, and "A Current Assessment of Urban Best Management Practices," Metropolitan Washington Council of Governments, March 1992.

1. Onsite Infiltration

A variety of infiltration technologies, including infiltration trenches and infiltration basins, can reduce

the volume and pollutant loadings of storm water discharges from a site. Infiltration devices tend to mitigate changes to predevelopment hydrologic conditions. Properly designed and installed infiltration devices can reduce peak discharges, provide ground water recharge, augment low flow conditions of receiving streams, reduce storm water discharge volumes and pollutant loads, and protect downstream channels from erosion. Infiltration devices are a feasible option where soils are permeable and the water table and bedrock are well below the surface. Infiltration basins can also be used as sediment basins during construction.⁵ Infiltration trenches can be more easily placed into under-utilized areas of a development and can be used for small sites and infill developments. However, trenches may require regular maintenance to prevent clogs, particularly where grass inlets or other pollutant removing inlets are not used. In some situations, such as low density areas of parking lots, porous pavement can provide for infiltration.

2. Flow Attenuation by Vegetation or Natural Depressions

Flow attenuation provided by vegetation or natural depressions can provide pollutant removal and infiltration and can lower the erosive potential of flows.⁶ In addition, these practices can enhance habitat values and the appearance of a site. Vegetative flow attenuation devices include grass swales and filter strips as well as trees that are either preserved or planted during construction.

Typically the costs of vegetative controls are less than other storm water practices. The use of check dams incorporated into flow paths can provide additional infiltration and flow attenuation.⁷ Given the limited capacity to accept large volumes of runoff, and potential erosion problems associated with large concentrated flows, vegetative controls should usually be used in combination with other storm water devices.

Grass swales are typically used in areas such as low or medium density residential development and highway medians as an alternative to curb and gutter drainage systems.⁸

3. Outfall Velocity Dissipation Devices

Outfall velocity dissipation devices include riprap and stone or concrete flow spreaders. Outfall velocity dissipation devices slow the flow of water discharged from a site to lessen erosion caused by the discharge.

4. Retention Structures/Artificial Wetlands

Retention structures include ponds and artificial wetlands that are designed to maintain a permanent pool of water. Properly installed and maintained retention structures (also known as wet ponds) and artificial wetlands⁹ can achieve a high removal rate of sediment, BOD, organic nutrients and metals, and are most cost-effective when used to control runoff from larger, intensively developed sites.¹⁰ These devices rely on settling and biological processes to remove pollutants. Retention ponds and artificial wetlands can also create wildlife habitat, recreation, and landscape amenities, as well as corresponding higher property values.

5. Water Quality Detention Structures

Storm water detention structures include extended detention ponds, which control the rate at which the pond drains after a storm event. Extended detention ponds are usually designed to completely drain in about 24 to 40 hours, and will remain dry at other times. They can provide pollutant removal efficiencies that are similar to those of retention ponds.¹¹ Extended detention systems are typically designed to provide both water quality and water quantity (flood control) benefits.¹²

C. Housekeeping BMPs

Pollutants that may enter storm water from construction sites because of poor housekeeping include oils, grease, paints, gasoline, concrete truck washdown, raw materials used in the manufacture of concrete (e.g., sand, aggregate, and cement), solvents, litter, debris, and sanitary wastes. Construction site management plans can address the following to prevent the discharge of these pollutants:

- Designate areas for equipment maintenance and repair;
- Provide waste receptacles at convenient locations and provide regular collection of wastes;
- Locate equipment washdown areas on site, and provide appropriate control of washwaters;
- Provide protected storage areas for chemicals, paints, solvents, fertilizers, and other potentially toxic materials; and
- Provide adequately maintained sanitary facilities.

IV. Summary of Permit Conditions

These general permits contain Notice of Intent requirements, a prohibition on discharging sources of non-storm water, requirements for releases of hazardous substances or oil in excess of reporting quantities, requirements for developing and implementing storm water pollution prevention plans, and requirements for site inspections.

A. Notice of Intent Requirements

NPDES general permits for storm water discharges associated with industrial activity require that dischargers submit a Notice of Intent (NOI) to be covered by the permit prior to the authorization of their discharges under such permit (see 40 CFR 122.28(b)(2), (April 2, 1992, (57 FR 11394))). Consistent with these regulatory requirements, today's permits establish NOI requirements. Dischargers that submit a complete NOI are not required to submit an individual permit application for such discharge, unless the Director specifically notifies the discharger that an individual permit application must be submitted.

Dischargers who want to obtain coverage under these permits must submit NOIs using the form provided by EPA (or a photocopy thereof). The NOI form is provided in appendix C of this notice and can be photocopied for use in submittals. NOI forms are also available from EPA's Storm Water Hotline ((703) 821-4823) and EPA Regional Offices (see part F of today's notice). Completed NOI forms must be submitted to the following address: Storm Water Notices of Intent, PO Box 1215, Newington, VA 22122.

Dischargers operating under approved State or local sediment and erosion plans, grading plans, or storm water management plans, must, in addition to filing copies of the NOI with EPA, submit signed copies of the NOI to the State or local agency approving such plans by the deadlines stated below.

1. Deadlines for Submitting NOIs

Deadlines for submittal of NOIs to be authorized to discharge under these permits are as follows:

-- On or before October 1, 1992, for storm water discharges from construction sites where disturbances associated with a construction project occur on or before October 1, 1992, and final stabilization¹³ is completed at the site after October 1, 1992;

-- At least 2 days prior to the commencement of construction activities (e.g., the initial disturbance of soils associated with clearing, grading, excavation

activities, or other construction activities), where such activities commence after October 1, 1992; and

-- For storm water discharges from construction sites where the operator changes, (including projects where an operator is selected after an NOI has been submitted), an NOI shall be submitted at least 2 days prior to when the operator commences work at the site.

EPA will accept an NOI at a later date. However, in such instances, EPA may bring appropriate enforcement actions.

2. Authorization

Dischargers who submit a complete NOI in accordance with the requirements of these permits are authorized to discharge storm water from construction sites under the terms and conditions of this permit 2 days after the date that the NOI is postmarked, unless notified by EPA.

EPA may deny coverage under this permit and require submittal of an individual NPDES permit application based on a review of the completeness and/or content of the NOI or other information (e.g., water quality information, compliance history, etc.). Where EPA requires a discharger authorized under the general permit to apply for an individual NPDES permit or an alternative general permit, EPA will notify the discharger in writing that a permit application is required. Coverage under this general permit will automatically terminate if the discharger fails to submit the required permit application in a timely manner. Where the discharger does submit a requested permit application, coverage under this general permit will automatically terminate on the effective date of the issuance or denial of the individual NPDES permit or the alternative general permit as it applies to the individual permittee.

3. Contents of the NOI

A photocopy of the NOI in appendix C of today's notice may be completed and submitted to EPA's central address to obtain authorization to discharge under today's permits. The NOI form requires the following information:

-- The mailing address of the construction site for which the notification is submitted. Where a mailing address for the site is not available, the location of the approximate center of the site must be described in terms of the latitude and longitude to the nearest 15

seconds, or the section, township, and range to the nearest quarter;

-- The site owner's name, address, and telephone number;

-- The name, address, and telephone number of the operator(s) with day-to-day operational control who have been identified at the time of the NOI submittal, and their status as a Federal, State, private, public, or other entity. Where multiple operators have been selected at the time of the initial NOI submittal, NOIs must be attached and submitted in the same envelope. When an additional operator submits an NOI for a site with a preexisting NPDES permit, the NOI of the additional operator must indicate the preexisting NPDES permit number for discharge(s) from the site;

-- The name of the receiving water(s), or if the discharge is through a municipal separate storm sewer, the name of the municipal operator of the storm sewer and the ultimate receiving waters);

-- The permit number of any NPDES permit(s) for any other discharge(s) (including any other storm water discharges or any non-storm water discharges) from the site;

-- An indication of whether the operator has existing sampling data that describe the concentration of pollutants in storm water discharges. Existing data should not be included as part of the NOI and should not be submitted unless and until requested by EPA; and

-- An estimate of project start date and completion dates, estimates of the number of acres of the site on which soil will be disturbed, and a certification that a storm water pollution prevention plan has been prepared for the site in accordance with the permit and that such plan complies with approved State and/or local sediment and erosion plans or permits and/or storm water management plans or permits. A copy of the plans or permits should not be included with the NOI submission, and should not be submitted unless and until requested by EPA.

The NOI must be signed in accordance with the signatory requirements of 40 CFR 122.22. A complete description of these signatory requirements is provided in the instructions accompanying the NOI (see appendix C).

4. Additional Notification

In addition to submitting the NOI to EPA, facilities operating under approved State or local sediment and erosion plans, grading plans, or storm water management plans are required to submit signed copies of the NOI to the State or local agency approving such plans by the deadlines stated above. Failure to do so constitutes a violation of the permit.

B. Special Conditions

1. Prohibition on Non-Storm Water Discharges

Today's permits do not authorize non-storm water discharges that are mixed with storm water except for specific classes of non-storm water discharges specified in the permits. Non-storm water discharges that can be authorized under today's permits include discharges from firefighting activities; fire hydrant flushings; waters used to wash vehicles or control dust in accordance with permit requirements; potable water sources including waterline flushings; irrigation drainage; routine external building washdown that does not use detergents; pavement washwaters where spills or leaks of toxic or hazardous materials have not occurred (unless all spilled material has been removed) and where detergents are not used; air conditioning condensate; springs; uncontaminated ground water; and foundation or footing drains where flows are not contaminated with process materials such as solvents.¹⁴

To be authorized under today's permits, these sources of non-storm water (except flows from firefighting activities) must be specifically identified in the storm water pollution prevention plan prepared for the facility. (Plan requirements are discussed in more detail below). Where such discharges occur, the plan must also identify and ensure the implementation of appropriate pollution prevention measures for the non-storm water components of the discharge. For example, to reduce pollutants in irrigation drainage, a plan could identify low maintenance lawn areas that do not require the use of fertilizers or biocides; for higher maintenance lawn areas, a plan could identify measures such as limiting fertilizer use based on seasonal and agronomic considerations, decreasing biocide use with an integrated pest management program, introducing natural vegetation or more hearty species, and reducing water use (thereby reducing the volume of irrigation drainage).

Today's permits do not require pollution prevention measures to be identified and implemented for non-storm water flows from firefighting activities since these flows will usually occur as unplanned emergency

situations where it is necessary to take immediate action to protect the public.

The general prohibition on non-storm water discharges in today's permits ensures that non-storm water discharges (except for those classes of non-storm water discharges that are conditionally authorized) are not inadvertently authorized by these permits. Where a storm water discharge is mixed with process wastewaters or other sources of non-storm water prior to discharge, and the discharge is currently not authorized by an NPDES permit, the discharge cannot be covered by today's permits and the discharger should (1) submit the appropriate application forms (Forms 1 and 2C) to obtain permit coverage or (2) discontinue the discharge.

2. Releases of Reportable Quantities of Hazardous Substances and Oil

Today's permits provide that the discharge of hazardous substances or oil from a facility must be eliminated or minimized in accordance with the storm water pollution plan developed for the facility. Where a permitted storm water discharge contains a hazardous substance or oil in an amount equal to or in excess of a reporting quantity established under 40 CFR 110, 40 CFR 117, or 40 CFR 302, during a 24-hour period, today's permits require the following actions:

- The permittee must notify the National Response Center (NRC) (800-424-8802; in the Washington, DC metropolitan area 202-426-2675) in accordance with the requirements of 40 CFR 110, 40 CFR 117, and 40 CFR 302, as soon as they have knowledge of the discharge;

-- The permittee must modify the storm water pollution prevention plan for the facility within 14 calendar days of knowledge of the release to provide (1) a description of the release, (2) the date of the release and (3) the circumstances leading to the release. In addition, the permittee must modify the plan, as appropriate, to identify measures to prevent the reoccurrence of such releases and to respond to such releases.

- Within 14 calendar days of the knowledge of the release, the permittee must submit to EPA (1) a written description of the release (including the type and estimated amount of material released), (2) the date that such release occurred, (3) the circumstances leading to the release, and (4) any steps to be taken to modify the storm water pollution prevention plan for the facility.

Where a discharge of a hazardous substance or oil in excess of reporting quantities is caused by a non-storm water discharge (e.g., a spill of oil into a separate storm sewer), the spill is not authorized by this permit. The discharger must report the spill as required under 40 CFR 110. In the event of a spill, the requirements of section 311 of the CWA and otherwise applicable provisions of sections 301 and 402 of the CWA continue to apply. This approach is consistent with the requirements for reporting releases of hazardous substances and oil-requirements that make a clear distinction between hazardous substances typically found in storm water discharges and those associated with spills that are not considered part of a normal storm water discharge (see 40 CFR 117.12(d)(2)(i)).

C. Storm Water Pollution Prevention Plan Requirements

The pollution prevention plans required by today's permits focus on two major tasks: (1) Providing a site description that identifies sources of pollution to storm water discharges associated with industrial activity from the facility and (2) identifying and implementing appropriate measures to reduce pollutants in storm water discharges to ensure compliance with the terms and conditions of these permits.

In developing these permits, the Agency reviewed a significant number of existing State and local sediment and erosion control and storm water management requirements. State and local data were reviewed for a wide range of climates and varying types of construction activities.

1. Contents of the Plan

Storm water pollution prevention plans must include a site description; a description of controls that will be used at the site (e.g., erosion and sediment controls, storm water management measures); a description of maintenance and inspection procedures; and a description of pollution prevention measures for any non-storm water discharges that exist.

a. Site description. Storm water pollution prevention plans must be based on an accurate understanding of the pollution potential of the site. The first part of the plan requires an evaluation of the sources of pollution at a specific construction site. The plan must identify potential sources of pollution that may reasonably be expected to affect the quality of storm water discharges from the construction site. In addition, the source identification components for pollution prevention plans must provide a description of the site and the

construction activities. This information is intended to provide a better understanding of site runoff and major pollutant sources. At a minimum, plans must include the following:

-- A description of the nature of the construction activity. This would typically include a description of the ultimate use of the project (e.g., low-density residential, shopping mall, highway).

-- A description of the intended sequence of major activities that disturb soils for major portions of the site (e.g., grubbing, excavation, grading).

-- Estimates of the total area of the site and the total area of the site that is expected to be disturbed by excavation, grading, or other activities. Where the construction activity is to be staged, it may be appropriate to describe areas of the site that will be disturbed at different stages of the construction process.

-- Estimates of the runoff coefficient of the site after construction activities are completed as well as existing data describing the quality of any discharge from the site or the soil. The runoff coefficient is defined as the fraction of total rainfall that will appear at the conveyance as runoff. Runoff coefficients can be estimated from site plan maps, which provide estimates of the area of impervious structures planned for the site and estimates of areas where vegetation will be precluded or incorporated. Runoff coefficients are one tool for evaluating the volume of runoff that will occur for a site when construction is completed. These coefficients assist in evaluating pollutant loadings, potential hydraulic impacts to receiving waters, and flooding impact. They are also used for sizing of post-construction storm water management measures.

-- A site map indicating drainage patterns and approximate slopes anticipated after major grading activities, areas of soil disturbance; and outline of areas that will not be disturbed; the location of major structural and nonstructural controls identified in the plan; the location of areas where stabilization practices are expected to occur; the location of surface waters (including wetlands); and locations where storm water is discharged to a surface water. Site maps should also include other major features and potential pollutant sources, such as the location of impervious structures and the location of soil piles during the construction process.

-- The name of the receiving water(s), and areal extent of wetland acreage at the site.

b. Controls to reduce pollutants. The storm water pollution prevention plan must describe and ensure that implementation of practices that will be used to reduce the pollutants in storm water discharges from the site and assure compliance with the terms and conditions of the permit. Permittees are required to develop a description of four classes of controls appropriate for inclusion in the facility's plan, and implement controls identified in the plan in accordance with the plan. The description of controls must address (1) erosion and sediment controls, (2) storm water management, (3) a specified set of other controls, and (4) any applicable procedures and requirements of State and local sediment and erosion plans or storm water management plans.

The pollution prevention plan must clearly describe the intended sequence of major activities and when, in relation to the construction process, the control will be implemented. Good site planning and preservation of mature vegetation are primary control techniques for controlling sediment in storm water discharges during construction activities as well as for developing a strategy for storm water management that controls pollutants in storm water discharges after the completion of construction activities. Properly staging major earth disturbing activities can also dramatically decrease the costs of sediment and erosion controls. The description of the intended sequence of major activities will typically describe the intended staging of activities on different parts of the site.

Permittees must develop and implement four classes of controls in the pollution prevention plan, each of which is discussed below.

i. Erosion and sediment controls. The requirements for erosion and sediment controls for construction activities in these permits have three goals: (1) To divert upslope water around disturbed areas of the site; (2) to limit the exposure of disturbed areas to the shortest duration possible; and (3) to remove sediment from storm water before it leaves the site. Erosion and sediment controls include both stabilization practices and structural practices.

Stabilization Practices. Pollution prevention plans must include a description of interim and permanent stabilization practices, including site-specific scheduling of the implementation of the practices. The plans should ensure that existing vegetation is preserved where attainable and that disturbed portions of the site are stabilized as quickly as possible. Stabilization practices are the first line of defense for prevention erosion; they include temporary seeding, permanent seeding, mulching, geotextiles, sod stabilization, vegetative

buffer strips, protection of trees, preservation of mature vegetative buffer strips, and other appropriate measures. Temporary stabilization practices are often cited as the single most important factor in reducing erosion at construction sites.¹⁵

Stabilization also involves preserving and protecting selected trees that were on the site prior to development. Mature trees have extensive canopy and root systems, which help to hold soil in place. Shade trees also keep soil from drying rapidly and becoming susceptible to erosion. Measures taken to protect trees can vary significantly, from simple measures such as installing tree fencing around the drip line and installing tree armoring, to more complex measures such as building retaining walls and tree wells.

Since stabilization practices play such an important role in preventing erosion, it is critical that they are rapidly employed in appropriate areas. These permits provide that, except in three situations, stabilization measures be initiated on disturbed areas as soon as practicable, but no more than 14 days after construction activity on a particular portion of the site has temporarily or permanently ceased. The three exceptions to this requirement are the following:

- Where construction activities will resume on a portion of the site within 21 days from when the construction activities ceased.

- Where the initiation of stabilization measures is precluded by snow cover, in which case, stabilization measures must be initiated as soon as practicable.

- In arid areas (areas with an average annual rainfall of 0 to 10 inches) and semi-arid areas (areas with an average annual rainfall of 10 to 20 inches), where the initiation of stabilization measure is precluded by seasonal arid conditions, in which case, stabilization measures must be initiated as soon as practicable.

Structural Practices. The pollution prevention plan must include a description of structural practices to the degree economically attainable, to divert flows from exposed soils, store flows, or otherwise limit runoff and the discharge of pollutants from exposed areas of the site. Structural controls are necessary because vegetative controls cannot be employed at areas of the site that are continually disturbed and because a finite time period is required before vegetative practices are fully effective. Options for such controls include silt fences, earth dikes, drainage swales, check dams, subsurface drains, pipe slope drains, level spreaders, storm drain inlet protection, rock outlet protection,

sediment traps, rock outlet protection, reinforced soil retaining systems, gabions, and temporary or permanent sediment basins. Structural measures should be placed on upland soils to the degree possible.

For sites with more than 10 disturbed acres at one time that are served by a common drainage location, a temporary or permanent sediment basin providing 3,600 cubic feet of storage per acre drained, or equivalent control measures (such as suitably sized dry wells or infiltration structures), must be provided where economically attainable until final stabilization of the site has been accomplished. Flows from offsite areas and flows from onsite areas that are either undisturbed or have undergone final stabilization may be diverted around both the sediment basin and the disturbed area. The requirement to provide 3,600 cubic feet of storage area per acre drained does not apply to such diverted flows.

For the drainage locations which serve more than 10 disturbed acres at one time and where a sediment basin providing storage or equivalent controls for 3,600 cubic feet per acre drained is not economically attainable, smaller sediment basins or sediment traps should be used. At a minimum, silt fences, or equivalent sediment controls are required for all sideslope and downslope boundaries of the construction area. Diversion structures should be used on upland boundaries of disturbed areas to prevent runoff from entering disturbed areas.

For drainage locations serving 10 or less acres, smaller sediment basins or sediment traps should be used and at a minimum, silt fences, or equivalent sediment controls are required for all sideslope and downslope boundaries of the construction area. Alternatively, the permittee may provide a sediment basin providing storage for 3,600 cubic feet of storage per acre drained. Diversion structures should be used on upland boundaries of disturbed areas to prevent runoff from entering disturbed areas.

- ii. Storm water management. The plan must include a description of "storm water management" measures.¹⁶ These permits address only the installation of storm water management measures and not the ultimate operation and maintenance of such structures after the construction activities have been completed and the site has undergone final stabilization. Permittees are responsible only for the installation and maintenance of storm water management measures prior to final stabilization of the site and are not responsible for maintenances after storm water discharges associated with construction activities have been eliminated from the site.

Land development can significantly increase storm water discharge volumes and peak velocities where appropriate storm water management measures are not implemented. In addition, storm water discharges will typically contain higher levels of pollutants, including total suspended solids (TSS), heavy metals, nutrients, and oxygen demanding constituents.¹⁷

Storm water management measures that are installed during the construction process can control the volume of storm water discharged and peak discharge velocities, as well as reduce the amount of pollutants discharged after the construction operations have been completed. Reductions in peak discharge velocities and volumes can also reduce pollutant loads, as well as reduce physical impacts such as stream bank erosion and stream bed scour. Storm water management measures that mitigate changes to predevelopment runoff characteristics assist in protecting and maintaining the physical and biological characteristics of receiving streams and wetlands.

Structural measures should be placed on upland soils to the degree attainable. The installation of such devices may be subject to section 404 of the CWA if the devices are placed in wetlands (or other waters of the United States).

Options for storm water management measures that are to be evaluated in the development of plans include infiltration of runoff on site; flow attenuation by use of open vegetated swales and natural depressions; storm water retention structures and storm water detention structures (including wet ponds); and sequential systems that combine several practices.

The pollution prevention plan must include an explanation of the technical basis used to select the practices to control pollution where flows exceed predevelopment levels. The explanation of the technical basis for selecting practices should address how a number of factors were evaluated, including the pollutant removal efficiencies of the measures, the costs of the measure, site specific factors that will affect the application of the measures, the economic achievability of the measure at a particular site, and other relevant factors.

EPA anticipates that storm water management measures at many sites will be able to provide for the removal of at least 80 percent of total suspended solids (TSS).¹⁸ A number of storm water management measures can be used to achieve this level of control, including properly designed and installed wet ponds, infiltration trenches, infiltration basins, sand filter system, manmade storm water wetlands, and multiple

pond systems. The pollutant removal efficiencies of various storm water management measures can be estimated from a number of sources, including "Storm Water Management for Construction Activities: Developing Pollution Prevention Plans and Best Management Practices", U.S. EPA, 1992, and "A Current Assessment of Urban Best Management Practice", prepared for U.S. EPA by Metropolitan Washington Council of Governments, March 1992. Proper selection of a technology depends on site factors and other conditions.

In selecting storm water management measures, the permittee should consider the impacts of each method on other water resources, such as ground water. Although storm water pollution prevention plans primarily focus on storm water management, EPA encourages facilities to avoid creating ground water pollution problems. For example, if the water table is unusually high in an area or soils are especially sandy and porous, an infiltration pond may contaminate a ground water source unless special preventive measures are taken. Under EPA's July 1991 Ground Water Protection Strategy, States are encouraged to develop Comprehensive State Ground Water Protection Programs (CSGWPP). Efforts to control storm water should be compatible with State ground water objectives as reflected in CSGWPPs.

The evaluation of whether the pollutant loadings and the hydrologic conditions (the volume of discharge) of flows exceed predevelopment levels can be based on hydrologic models which consider conditions such as the natural vegetation which is typical for the area.

Increased discharge velocities can greatly accelerate erosion near the outlet of onsite structural measures. To mitigate these effects, these permits require that velocity dissipation devices be placed at discharge locations and along the length of any outfall channel as necessary to provide a non-erosive velocity flow from the structure to a water course. Velocity dissipation devices maintain and protect the natural physical and biological characteristics and functions of the watercourse, e.g., hydrologic conditions, such as the hydroperiod and hydrodynamics, that were present prior to the initiation of construction activities.

iii. Other controls. Other controls to be addressed in storm water pollution prevention plans for construction activities require that no non-storm water solid materials, including building material wastes shall be discharged at the site, except as authorized by a section 404 permit.

These final permits require that offsite vehicle tracking of sediments and the generation of dust be minimized. This can be accomplished by measures such as providing gravel or paving at access entrance and exit drives, parking areas, and unpaved roads on the site carrying significant amounts of traffic (e.g., more than 25 vehicles per day); providing entrance wash racks or stations for trucks; and/or providing street sweeping.

In addition, these permits require that the plan shall ensure and demonstrate compliance with applicable State and/or local sanitary sewer, septic system, and waste disposal regulations.¹⁹

iv. State and local controls. Many municipalities and States have developed sediment and erosion control requirements for construction activities. A significant number of municipalities and States have also developed storm water management controls. These general permits require that storm water pollution prevention plans for facilities that discharge storm water associated with industrial activity from construction activities include procedures and requirements of State and local sediment and erosion control plans or storm water management plans. Permittees are required to provide a certification that their storm water pollution prevention plan reflects requirements related to protecting water resources that are specified in State or local sediment and erosion plans or storm water management plans.²⁰

In addition, permittees are required to amend their storm water pollution prevention plans to reflect any change in a sediment and erosion site plan or site permit or storm water management site plan or site permit approved by State or local officials for which the permittee receives written notice. Where such amendments are made, the permittee must provide a recertification that the storm water pollution prevention plan has been modified. This provision does not apply to provisions of master plans, comprehensive plans, nonenforceable guidelines, or technical guidance documents, but rather to site-specific State or local permits or plans.

c. Maintenance. Erosion and sediment controls can become ineffective if they are damaged or not properly maintained. Maintenance of controls has been identified as a major part of effective erosion and sediment programs. Plans must contain a description of prompt and timely maintenance and repair procedures addressing all erosion and sediment control measures (e.g., sediment basins, traps, silt fences), vegetation, and other measures identified in the site plan to ensure that such measures are kept in good and effective operating condition.

d. Inspections. Procedures in a plan must provide that specified areas on the site are inspected by qualified personnel provided by the discharger a minimum of once every seven calendar days and within 24 hours after any storm event of greater than 0.5 inches. Areas of the site that must be observed during such inspections include disturbed areas, areas used for storage of materials that are exposed to precipitation, structural control measures, and locations where vehicles enter or exit the site. Where sites have been temporarily or finally stabilized, or during seasonal arid periods in arid areas (areas with an average annual rainfall of 0 to 10 inches) and semi-arid areas (with an average annual rainfall of 10 to 20 inches) the inspection must be conducted at least once every month.

Disturbed areas and areas used for storage of materials that are exposed to precipitation must be inspected for evidence of, or the potential for, pollutants entering the runoff from the site. Erosion and sediment control measures identified in the plan must be observed to ensure that they are operating correctly. Observations can be made during wet or dry weather conditions. Where discharge locations or points are accessible, they must be inspected to ascertain whether erosion control measures are effective in preventing significant impacts to receiving waters. This can be done by inspecting receiving waters to see whether any signs of erosion or sediment are associated with the discharge location. Locations where vehicles enter or exit the site must be inspected for evidence of offsite sediment tracking.

Based on the results of the inspection, the site description and the pollution prevention measures identified in the plan must be revised as soon as possible after an inspection that reveals inadequacies. The inspection and plan review process must provide for timely implementation of any changes to the plan within 7 calendar days following the inspection.

An inspection report that summarizes the scope of the inspection, name(s) and qualifications of personnel conducting the inspection, the dates of the inspection, major observations relating to the implementation of the storm water pollution prevention plan, and actions taken must be retained as part of the storm water pollution prevention plan for at least three years after the date of inspection. The report must be signed in accordance with the signatory requirements in the Standard Conditions section of these permits.

Diligent inspections are necessary to ensure adequate implementation of onsite sediment and erosion controls, particularly in the later stages of construction when the

volume of runoff is greatest and the storage capacity of the sediment basins has been reduced.²¹

e. Non-storm water discharges. Today's permits may authorize storm water discharges from construction activities that are mixed with discharges from firefighting activities, fire hydrant flushings, waters used to wash vehicles or control dust in accordance with efforts to minimize offsite sediment tracking, potable water sources including waterline flushings, irrigation drainage from watering vegetation, routine exterior building washdown that does not use detergents, pavement washwaters where spills or leaks of toxic or hazardous materials have not occurred (unless all spilled material has been removed) and where detergents are not used, air conditioning condensate, springs, uncontaminated ground water (including dewatering ground water infiltration), and foundation or footing drains where flows are not contaminated with process materials such as solvents, provided the non-storm water component of the discharge is specifically identified in the pollution prevention plan. In addition, the plan must identify and ensure the implementation of appropriate pollution prevention measures for each of the non-storm water component(s) of the discharge.²²

EPA believes that where these classes of non-storm water discharges are identified in a pollution prevention plan and where appropriate pollution prevention measures are evaluated, identified, and implemented, they generally pose low risks to the environment. The Agency also notes that it can request individual permit applications for such discharges where appropriate. The Agency is not requiring that flows from fire-fighting activities be identified in plans because of the emergency nature of such discharges coupled with their low probability and the unpredictability of their occurrence.

2. Deadlines for Plan Preparation and Compliance

Today's permits establish the following deadlines for storm water pollution prevention plan development and compliance:

– The plan must be completed prior to the submittal of an NOI to be covered under this permit and updated as appropriate.

– For construction activities that have begun on or before October 1, 1992, except for sediment basins, the plan shall provide for compliance with the terms and schedule of the plan beginning on October 1, 1992. The plan shall provide for compliance with sediment basins

required under the permits by no later than December 1, 1992.

– For construction activities that have begun after October 1, 1992, the plan must provide for compliance with the terms and schedule of the plan beginning with the initiation of construction activities.

3. Signature and Plan Review

Signature and plan review requirements are as follows:

– The plan must be signed by all permittees for a site in accordance with the signatory requirements in the Standard Permit Conditions section of the permit, and must be retained on site at the facility that generates the storm water discharge.

– The permittee must make plans available, upon request, to EPA, and State or local agency approved sediment and erosion plans, grading plans, or storm water management plans. In the case of a storm water discharge associated with industrial activity that discharges through a municipal separate storm sewer system with an NPDES permit, permittees must make plans available to the municipal operator of the system upon request.

– EPA may notify the permittee at any time that the plan does not meet one or more of the minimum requirements. Within 7 days of such notification from EPA (or as otherwise requested by EPA), the permittee must make the required changes to the plan and submit to EPA a written certification that the requested changes have been made.

4. Keeping Plans Current

The permittee must amend the plan whenever there is a change in design, construction, operation, or maintenance, that has a significant effect on the potential for the discharge of pollutants to waters of the United States or to municipal separate storm sewer systems. The plan must also be amended if it proves to be ineffective in eliminating or significantly minimizing pollutants in the storm water discharges from the construction activity. In addition, the plan shall be amended to identify any new contractor and/or subcontractor that will implement a measure of the storm water pollution prevention plan. Amendments to the plan will be reviewed by EPA as described above.

5. Additional Requirements

These permits authorize a storm water discharge associated with industrial activity from a construction site that is mixed with a storm water discharge from an industrial source other than construction, only under the following conditions:

-- The industrial source other than construction is located on the same site as the construction activity; and

-- Storm water discharges from where the construction activities are occurring are in compliance with the terms of this permit.

6. Contractors

The storm water pollution prevention plan must clearly identify for each measure identified in the plan, the contractor(s) and/or subcontractor(s) that will implement the measure. All contractors and subcontractors identified in the plan must sign a copy of the certification statement presented below before conducting any professional service at the site identified in the pollution prevention plan:

"I certify under penalty of law that I understand the terms and conditions of the general National Pollutant Discharge Elimination System (NPDES) permit that authorizes the storm water discharges associated with industrial activity from the construction site identified as part of this certification."

All certifications must be included in the storm water pollution prevention plan.

D. Retention of Records

The permittee is required to retain records or copies of all reports required by this permit, including storm water pollution prevention plans and records of all data used to complete the NOI to be covered by the permit, for a period of at least three years from the date of final stabilization. This period may be extended by request of the Director.

E. Notice of Termination

A discharger may submit a Notice of Termination (NOT) to EPA in two sets of circumstances: (1) After a site has undergone final stabilization and the facility no longer discharges storm water associated with industrial activity from a construction site and (2) when the permittee has transferred operational control to another permittee and is no longer an operator for the site. NOTs must be submitted using the form provided by the Director (or a photocopy thereof). A copy of the NOT

form is in Appendix D and can be photocopied for use. NOTs will assist EPA in tracking the status of the discharger.

Today's permits define final stabilization for the purpose of submitting an NOT as occurring when all soil disturbing activities are completed and a uniform perennial vegetative cover with a density of 70 percent for the unpaved areas and areas not covered by permanent structures has been established or equivalent stabilization measures have been employed. Equivalent stabilization measures include permanent measures other than establishing vegetation, such as the use of rip-rap, gabions, and/or geotextiles.

A copy of the NOT, and instructions for completing the NOT, are provided in Appendix D of today's notice. The NOT form requires the following information:

-- The mailing address of the construction site for which the notification is submitted. Where a mailing address for the site is not available, the location of the approximate center of the site must be described in terms of the latitude and longitude to the nearest 15 seconds, or the section, township, and range to the nearest quarter.

-- The name, address, and telephone number of the operator addressed by the NOT.

-- The NPDES permit for the storm water discharge identified by the NOT.

-- The following certification:

"I certify under penalty of law that all storm water discharges associated with industrial activity from the identified facility that are authorized by an NPDES general permit have been eliminated or that I am no longer the operator of the facility or construction site. I understand that by submitting this notice of termination, I am no longer authorized to discharge storm water associated with industrial activity under this general permit, and that discharging pollutants in storm water associated with industrial activity to waters of the United States is unlawful under the Clean Water Act where the discharge is not authorized by a NPDES permit. I also understand that the submittal of this notice of termination does not release an operator from liability for any violations of this permit form the Clean Water Act."

Notices of Termination are to be sent to the following address: Storm Water Notice of Termination, P.O. Box 1185, Newington, Virginia 22122.

The NOT must be signed by the appropriate individual in accordance with the signatory requirements of 40 CFR 122.22. A description of these signatory requirements is provided in the instructions accompanying the NOT (see appendix D).

Submittal of a NOT, by itself, does not relieve permittees from the obligations of the permit, such as the requirement to stabilize the site. Appropriate enforcement actions may still be taken for permit violations where a permittee submits a NOT but the permittee has not transferred operational control to another permittee or the site has not undergone final stabilization.

F. Regional Offices

Notices of Intent to be authorized to discharge under these permits should be sent to: Storm Water Notices of Intent, P.O. Box 1215, Newington, VA 22122.

Other submittals of information required under these permits or individual permit applications or other written correspondence concerning discharges in any State, Indian land, or from any Federal Facility covered, should be sent to the appropriate EPA Regional Office listed below:

CT, MA, ME, NH, RI, VT

United States EPA, Region I, Water Management Division, (WCP-2109), Storm Water Staff, John F. Kennedy Federal Building, room 2209, Boston, MA 02203. Contact: Veronica Harrington, (617) 565-3525.

NJ, NY, PR, VI

United States EPA, Region II, Water Management Division, (2WM-WPC), Storm Water Staff, 26 Federal Plaza, New York, NY 10278. Contact: Jose Rivera, (212) 264-2911.

AL, FL, GA, KY, MS, NC, SC, TN

United States EPA, Region IV, Water Management Division, (FPB-3), Storm Water Staff, 345 Courtland Street, NE., Atlanta, GA 30365. Contact: Chris Thomas, (404) 347-3012.

AR, LA, NM (except see Region IX for Navajo lands and see Region VIII for Ute Mountain Reservation land), OK, TX

United States EPA, Region VI, Water Management Division, (6W-EA), Storm Water Staff, First Interstate Bank Tower at Fountain Place, 1445 Ross Avenue, 12th

Floor, Suite 1200, Dallas, TX 75202. Contact: Region VI Storm Water Hotline at (214) 655-xxxx.

CO, MT, ND, SD, WY, UT (except see Region IX for Goshute Reservation and Navajo Reservation lands)

United States EPA, Region VIII, Water Management Division, NPDES Branch (8WM-C), Storm Water Staff, 999 18th Street, Denver, CO 80202-2466. Contact: Vern Berry, (303) 293-1630.

Note. – For Montana Indian Lands, please use the following address:

United States EPA, Montana Operations Office, Federal Office Building, Drawer 10096, 301 South Park, Helena, MT 59620-0026. Contact: Paul Montgomery, (406) 449-5486.

AZ, CA, HI, NV, American Samoa, Guam, the Goshute Reservation in UT and NV, the Navajo Reservation in UT, NM, and AZ, the Duck Valley Reservation in NV and ID, Johnston Atoll, Midway and Wake Island

United States EPA, Region IX, Water Management Division, (W-5-1), Storm Water Staff, 75 Hawthorne Street, San Francisco, CA 94105. Contact: Eugene Bromley, (415) 744-1906.

AK, ID (except see Region IX for Duck Valley Reservation lands), OR, WA

United States EPA, Region X, Water Management Division, (WD-134), Storm Water Staff, 1200 Sixth Street, Seattle, WA 98101. Contact: Steve Bubnick, (202) 553-8399.

V. Cost Estimates

The two major costs associated with pollution prevention plans for construction activities include the costs of sediment and erosion controls (see Table 1) and the costs of storm water management measures (see Table 2). Today's permits provide flexibility in developing controls for construction activities. Typically, most construction sites will employ several types of sediment and erosion controls and storm water management controls, but not all the controls listed in Tables 1 and 2. In general, sites that disturb a large area will incur higher pollution prevention costs.

Table 1. -- Sediment and Erosion Control Costs

Temporary seeding	\$1.00 per square foot.
Permanent seeding	\$1.00 per square foot.
Mulching	\$1.25 per square foot.
Sod stabilization	\$4.00 per square foot.
Vegetative buffer strips	\$1.00 per square foot.
Protection of trees	\$30.00 to \$200.00 per tree set.
Earth dikes	\$5.50 per linear foot.
silt fences	\$6.00 per linear foot.
drainage swales -- grass	\$3.00 per square yard.
drainage swales -- sod	\$4.00 per square yard.
drainage swales -- riprap	\$45.00 per square yard.
drainage swales -- asphalt	\$35.00 per square yard.
drainage swales -- concrete	\$65.00 per square yard.
check dams -- rock	\$100.00 per dam.
check dams -- covered straw bales	\$50.00 per dam.
level spreader -- earthen	\$4.00 per square yard.
level spreader -- concrete	\$65.00 per square yard.
subsurface drain	\$2.25 per linear foot.
Pipe slope drain	\$5.00 per linear foot.
Temporary storm drain diversion	variable.
storm drain inlet protection	\$300.00 per inlet.
rock outlet protection	\$45.00 per square yard.
sediment traps	\$500 to \$7,000 per trap.
temporary sediment basins	\$5,000 to \$50,000 per basin.
sump pit	\$500 to \$7,000.
Entrance stabilization	\$1,500 to \$5,000 per entrance.
Entrance wash rack	\$2,000 per rack.
Temporary waterway crossing	\$500 to \$1,500.
Wind breaks	\$2.50 per linear foot.

Practices such as sod stabilization and tree protection increase property values and satisfy consumer aesthetic needs.

Sources: "Means Site Work Cost Data", 9th edition, 1990, R.S. Means Company.

"Sediment and Erosion Control, An Inventory of Current Practices", by Kamber Engineering for U.S. EPA, April 1990.

Table 2. -- Annualized Costs of Several Storm Water Management Options for Construction Sites

	Annualized Cost for 9-acre area	Annualized Cost for 20-acre area
Wet Ponds	\$5,872	\$9,820
Dry Ponds	3,240	5,907
Dry Ponds with Extended Detention	3,110	5,413
Infiltration Trenches	4,134	6,359

Estimates based on methodology presented in "Cost of Urban Runoff Quality Controls", Wiegand, C., Schueler, T., Chittenden, W., and Jellick, D., Urban Runoff Quality-Impact and Quality Enhancement Technology, Proceedings of an Engineering Foundation Conference, ASCE, 1986, edited by B. Urbonas and L.A. Roesner.

Costs are presented in 1992 dollars. Annualized costs are based on a 10 year period and 10 percent discount rate. Estimates include a contingency cost of 25 percent of the construction cost and operation and maintenance costs of 5 percent of the construction cost. Land costs are not included.

- ¹ On June 4, 1992, the United States Court of Appeals for the Ninth Circuit remanded the exemption for construction sites of less than five acres to the EPA for further rulemaking (*Natural Resources Defense Council v. EPA*, Nos. 90-70671 and 91-70200, slip op. at 6217 (9th Cir. June 4, 1992).
- ² "Performance of Current Sediment Control Measures at Maryland Construction Sites", January 1990, Metropolitan Washington Council of Governments.
- ³ "Guides for Erosion and Sediment Control in California," USDA, Soil Conservation Service, Davis CA, Revised 1985.
- ⁴ "Guides for Erosion and Sediment Control in California," USDA Soil Conservation Service, Davis CA, Revised 1985.
- ⁵ "Controlling Urban Runoff: A Practical Manual for Planning and Designing Urban BMPs", July, 1987, Metropolitan Washington Council of Governments.
- ⁶ "Urban Targeting and BMP Selection", United States EPA, Region V, November 1990.
- ⁷ "Standards and Specifications for Infiltration Practices", 1984, Maryland Water Resources Administration.
- ⁸ "Controlling Urban Runoff: A Practical Manual for Planning and Designing Urban BMPs", Metropolitan Washington Council of Governments, July 1987.
- ⁹ See "Wetland basins for Storm Water Treatment: Discussion and Background", Maryland Sediment and Stormwater Division, 1987 and "The Value of Wetlands for Nonpoint Source Control -- Literature Summary", Strecker, E., et. al., 1990.
- ¹⁰ "Controlling Urban Runoff, A Practical Manual for Planning and Designing Urban BMPs", Metropolitan Washington Council of Governments, 1987.
- ¹¹ "Urban Targeting and BMP Selection", United States EPA, Region V, November 1990.
- ¹² "Urban Surface Water Management", Welsh, S.G., Wiley, 1989.
- ¹³ The term "final stabilization" is defined in today's permits and is discussed in more detail in the Notice of Termination section of today's fact sheet.
- ¹⁴ These discharges are consistent with the allowable classes of non-storm water discharges to municipal separate storm sewer systems (40 CFR 122.26(d)(iv)(D)).
- ¹⁵ "New York Guidelines for Urban Erosion and Sediment Control", USDA, Soil Conservation Service, March 1988.
- ¹⁶ For the purpose of the special requirements for construction activities, the term "storm water management" measures refers to controls that will primarily reduce the discharge of pollutants in storm water from sites after completion of construction activities.
- ¹⁷ See "Nationwide Urban Runoff Program," EPA, 1984.
- ¹⁸ TSS can be used as an indicator parameter to characterize the control of other pollutants, including heavy metals, oxygen demanding pollutants, and nutrients, commonly found in storm water discharges.
- ¹⁹ In rural and suburban areas that are served by septic systems, malfunctioning septic systems can contribute pollutants to storm water discharges. Malfunctioning septic tanks may be a more significant surface runoff pollution problem than a ground water problem. This is because a malfunctioning septic system is less likely to cause ground water contamination where a bacterial mat in the soil retards the downward movement of wastewater. Surface malfunctions are caused by clogged or impermeable soils, or when stopped up or collapsed pipes force untreated wastewater to the

surface. Surface malfunctions can vary in degree from occasional damp patches on the surface to constant pooling or runoff of wastewater. These discharges have high bacteria, nitrate, and nutrient levels and can contain a variety of household chemicals. This permit does not establish new criteria for septic systems, but rather addresses existing State or local criteria.

- ²⁰ Operators of storm water discharges from construction activities which, based on an evaluation of site specific conditions, believe that State and local plans do not adequately represent BAT and BCT requirements for the facility may request to be excluded from the coverage of the general permit by submitting to the Director an individual application with a detailed explanation of the reasons supporting the request, including any supporting documentation showing that certain permit conditions are not appropriate.
- ²¹ "Performance of Current Sediment Control Measures at Maryland Construction Sites", January 1990, Metropolitan Washington Council of Governments.
- ²² This is consistent with the allowable types of non-storm water discharges to municipal separate storm sewer systems (40 CFR 122.26(d)(2)(iv)(A)).

ENVIRONMENTAL PROTECTION AGENCY
AGENCY: Environmental Protection Agency (EPA).

[FRL-4511-2]
57 FR 44412
September 25, 1992

Final NPDES General Permits for Storm Water
Discharges From Construction Sites

ACTION: Notice of Final NPDES General Permits.

SUMMARY: The Regional Administrators of Regions I, II, III, IV, and IX (the "Regions" or the "Directors") are today issuing final National Pollutant Discharge Elimination System (NPDES) general permits for storm water discharges associated with industrial activity from construction sites in Florida (except from Indian lands), Massachusetts, the District of Columbia, Guam and American Samoa; on Indian lands in New York; and from Federal facilities in Delaware.

These general permits establish Notice of Intent (NOI) requirements, special conditions, requirements to develop and implement storm water pollution prevention plans, and requirements to conduct site inspections for facilities with discharges authorized by the permit.

DATES: These general permits shall be effective on November 25, 1992. This effective date is necessary to provide appropriate dischargers with the opportunity to comply with the October 1, 1992 deadline for submitting an NPDES application for storm water discharges associated with industrial by submitting a Notice of Intent (NOI) to be covered by the permits.

Deadlines for submittal of Notices of Intent (NOIs) are provided in Part II.A of the general permits. Today's general permits also provide additional dates for compliance with the terms of the permit.

ADDRESSES: Notices of Intent to be authorized to discharge under these permits should be sent to: Storm Water Notices of Intent, PO Box 1215, Newington, VA 22122.

Other submittals of information required under these permits or individual permit applications should be sent to the appropriate EPA Regional Office. The addresses of the Regional Offices and the name and phone number of the Storm Water Regional Coordinator is provided in Section II of the Fact Sheet.

The index to the administrative records for these permits is available at the appropriate Regional Office. The complete administrative record is located at EPA Headquarters, EPA Public Information Reference Unit, room 2402, 401 M Street SW., Washington, DC 20460. A reasonable fee may be charged for copying. Specific record information will be made available at the appropriate Regional Office as requested.

FOR FURTHER INFORMATION CONTACT: For further information on the final NPDES general permits and for copies of the Notice of Intent form (the Notice of Intent form in appendix C of this notice can be copied and submitted) contact the NPDES Storm Water Hotline at (703) 821-4823, or the appropriate EPA Regional Office. The name, address and phone number of the Regional Storm Water Coordinators are provided in Section II of the Fact Sheet.

TEXT: SUPPLEMENTARY INFORMATION:

I. Introduction

II. Regional Contacts

III. Section 401 Certification

IV. Economic Impact (Executive Order 12291)

V. Paperwork Reduction Act

VI. Regulatory Flexibility Act

Other submittals of information required under these permits or individual permit applications should be sent to the appropriate EPA Regional Office. The addresses of the Regional Offices and the name and phone number of the Storm Water Regional Coordinator is provided in Section II of the Fact Sheet.

The index to the administrative records for these permits is available at the appropriate Regional Office. The complete administrative record is located at EPA Headquarters, EPA Public Information Reference Unit, room 2402, 401 M Street SW, Washington DC 20460. A reasonable fee may be charged for copying. Specific record information will be made available at the appropriate Regional Office as requested.

I. Introduction

The Regional Administrators of the United States Environmental Protection Agency (EPA) are issuing final general permits for the majority of storm water

discharges associated with industrial activity from construction activities as follows:

Region I -- for the State of Massachusetts.

Region II -- for Indian lands located in New York.

Region III -- for the District of Columbia and for Federal facilities in Delaware.

Region IV -- for the State of Florida.

Region IX -- for Guam and American Samoa.

On August 16, 1991, (56 FR 40948), EPA requested public comment on draft National Pollutant Discharge Elimination System (NPDES) general permits that were the basis for today's final general permits. In addition to addressing storm water discharges from construction activities, the August 16, 1991, draft general permits addressed storm water discharges from other industrial activities. The permits in this notice only address storm water associated with construction activity.

EPA received over 125 comments on construction issues associated with the draft general permits. In addition, public hearings to discuss the draft general permits were held in Dallas, TX; Oklahoma City, OK; Baton Rouge, LA; Albuquerque, NM; Seattle, WA; Boise, ID; Juneau, AK; Pierre, SD; Phoenix, AZ; Orlando, FL; Tallahassee, FL; Augusta, ME; Boston, MA; and Manchester, NH.

On September 9, 1992 (57 FR 41176), EPA published final National Pollutant Discharge Elimination System (NPDES) general permits for storm water discharges associated with industrial activity from construction sites in 10 States (Alaska, Arizona, Idaho, Louisiana, Maine, New Hampshire, New Mexico, Oklahoma, South Dakota, and Texas); the Territories of Puerto Rico, Johnston Atoll, and Midway and Wake Islands; on Indian lands in Alaska, Arizona, California, Colorado, Florida, Idaho, Maine, Massachusetts, Mississippi, Montana, New Hampshire, Nevada, North Carolina, North Dakota, Nevada, Utah, Washington, and Wyoming; from Federal facilities in Colorado, and Washington; and from Federal facilities and Indian lands in Louisiana, New Mexico, Oklahoma, and Texas.

EPA is incorporating portions of the detailed fact sheet for the general permit for storm water discharges from construction activity published on September 9, 1992, as part of the final fact sheet and statement of basis for today's final permit. The sections of the fact sheet published on September 9, 1992 n1 being

incorporated are Section I, Introduction; Section II, Coverage of General Permits; Section III, Summary of Options for Controlling Pollutants; Section IV, Summary of Permit Conditions; and Section V, Cost Estimates; and Appendix A -- Summary of Responses to Public Comments on the August 16, 1991, Draft General Permits.

Today's notice addresses final NPDES general permits for storm water discharges associated with industrial activity from construction sites in Florida (except from Indian lands), Massachusetts, District of Columbia, Guam and American Samoa; on Indian lands in New York; and from Federal facilities in Delaware. Today's notice contains four sets of appendices. Appendix A incorporates Appendix A -- Summary of Responses to Public Comments on the August 16, 1991, Draft General Permits, of the September 9, 1992 permits. Appendix B provides the language of the final general permits. The permits in Appendix B are similar, and are similar to the final permits published on September 9, 1992. Except as provided in Part X of the permits. Parts I through IX apply to all permits. Part X of the permit contains conditions which only apply to dischargers in the State indicated. Appendix C is a copy of the Notice of Intent (NOI) form (and associated instructions) to be used by dischargers wanting to obtain coverage under the general permits. Appendix D is a copy of the Notice of Termination (NOT) form (and associated instructions) that can be used by dischargers wanting to notify EPA that their storm water dischargers have been terminated or that the permittee has transferred operation of the facility.

II. Regional Contacts

Notices of Intent to be authorized to discharge under these permits must be sent to: Storm Water Notices of Intent, PO Box 1215, Newington, VA 22122.

Other submittal of information required under these permits or individual permit applications or other written correspondence concerning discharges in any State, Indian land, or from any Federal Facility covered, should be sent to the appropriate EPA Regional Office listed below:

Massachusetts

United States EPA, Region I, Water Management Division (WCP-2109), Storm Water Staff, John F. Kennedy Federal Building, Room 2209, Boston, MA 02203, Contact: Veronica Harrington, (617) 565-3525

New York (Indian Lands)

United States EPA, Region II, Water Management Division (2WM-WPC), Storm Water Staff, 26 Federal Plaza, New York, NY 10278, Contact: Jose Rivera, (212) 264-2911

District of Columbia, Delaware (Federal Facilities)

United States EPA, Region III, Water Management Division (3WM55), 841 Chestnut Building, Philadelphia, PA 19107, Contact: Kevin Magerr, (215) 597-1651

Florida

United States EPA, Region IV, Water Management Division (FPB-3), Storm Water Staff, 345 Courtland Street, NE Atlanta, GA 30365, Contact: Chris Thomas, (404) 347-3012

Guam and American Samoa

United States EPA, Region IX, Water Management Division (W-5-1), Storm Water Staff, 75 Hawthorne Street, San Francisco, CA 94105, Contact: Eugene Bromley, (415) 744-1906

III. Section 401 – Certification

Section 401 of the CWA provides that no Federal license or permit, including NPDES permits, to conduct any activity that may result in any discharge into navigable waters shall be granted until the State in which the discharge originates certifies that the discharge will comply with the applicable provisions of Sections 301, 302, 303, 306, and 307 of the CWA. The Section 401 certification process has been completed for all States, Indian lands and Federal facilities covered by today's general permits. The following summary indicates where additional permit requirements have been added as a result of the certification process.

Massachusetts

See the following and Part X.A of the general permit for 401 conditions. As a condition for certification under section 401 of the CWA, the Commonwealth of Massachusetts required inclusion of the following conditions necessary to ensure compliance with State water quality concerns.

Storm water discharges not eligible for coverage under this permit include new or increased storm water discharges to coastal water segments within Massachusetts designated as "Areas of Critical Environmental Concern (ACEC)" (for information on ACEC, please contact the Executive Office of Environmental Affairs, Coastal Zone Management at (617) 727-9530). In addition, new or increased discharges, as defined at 314 CMR 4.02(19), which meet the definition of "storm water discharge," as defined at 314 CMR 3.04(2)(a)(1) or (2)(b), to Outstanding Resource Waters which have not met the provisions of 314 CMR 4.04(3) and Part III C.1 of this permit (as amended by the special requirements for discharges in Massachusetts), are not eligible for coverage under this permit.

Permittees in Massachusetts are to submit NOIs to the following address: Storm Water Staff, Storm Water Notice of Intent, US EPA Region 1, MA, PO Box 1215, Newington, VA 22122. A copy of the NOI for all discharges to Outstanding Resource Waters shall be submitted to the Commonwealth of Massachusetts at the following address: Massachusetts Department of Environmental Protection, Storm Water Notice of Intent, BRP-WP 43, PO Box 4062, Boston, Massachusetts, 02211.

For details on filing for permits with MA DEP see 310 CMR 4.00, Timely Action Schedule and Fee Provisions. For other information call the MA DEP Information Services at (617) 338-2255 or the Technical Services Section of the DEP Division of Water Pollution Control at (508) 792-7470.

Massachusetts 401 certification requires the following best management practices. Storm water discharge outfall pipes to Outstanding Resource Waters shall be removed and the discharge set back from the receiving water when dischargers are seeking to increase the discharge or change the site drainage system; all new discharge outfalls must be set back from the receiving water. Receiving swales for outfall pipes shall be prepared to minimize erosion and maximize infiltration prior to discharge. The goal is to infiltrate as much as feasible; infiltration trenches and basins, filter media dikes and/or other BMPs shall be used to meet the goal. Protecting Water Quality in Urban Areas by the Minnesota Pollution Control Agency, Division of Water Quality is a reference for BMPs.

Storm water discharges to waters that are not classified as Outstanding Resource Waters shall be subject to the requirements of this permit. New discharge outfall pipes shall be designed to be set back

from the receiving water when site conditions allow. For existing discharge outfall pipes, when the storm water drainage system is undergoing changes, outfall pipes shall be set back from the receiving water. A receiving swale, infiltration trench or basin, filter media dike or other BMP should be prepared with the goal to minimize erosion yet maximize infiltration or otherwise improve water quality prior to discharge.

All discharges to Outstanding Resource Waters authorized under this permit must be provided the best practical method of treatment to protect and maintain the designated use of the outstanding resource.

Delaware

See the following discussion and Part X.C of the general permit for additional 401 conditions. As a condition for certification under section 401 of the CWA, the State of Delaware required inclusion of the following conditions necessary to insure compliance with State water quality concerns.

In addition to submitting all NOIs to the central NOI receiving office in Newington, VA, permittees in Delaware also must submit a copy of all NOIs to the State of Delaware at the following address: Water Pollution Control Branch, NPDES Storm Water Program, Delaware Department of Natural Resources and Environmental Control, 89 Kings Highway, P.O. Box 140, Dover, DE 19903. All Discharge Monitoring Reports (DMRs), pollution prevention plans, as well as subsequent revisions, must be submitted to the State of Delaware at this same address. DMRs also must be submitted to the NPDES Programs Director, U.S. EPA Region III, Water Management Division (3WM55), Storm Water Staff, 841 Chestnut Building, Philadelphia, PA 19107.

Delaware's general permit stipulates that all permittees comply with the requirements of 7 Delaware Code Chapter 40 and the Delaware Sediment and Storm Water Regulations (January, 1991).

Applicants are required to obtain a certification of consistency with the Delaware Coastal Management Program (CZMA 1972, 16 U.S.C. 1451).

District of Columbia

See the following discussion and Part X.D of the general permit for additional 401 conditions. As a condition for certification under section 401 of the

CWA, the District of Columbia required inclusion of the following special conditions.

Any unpermitted discharges that are subject to the NPDES program, excluding discharges associated with construction activity, are not authorized by this permit.

Florida

See the following discussion and Part X.E of the general permit for additional 401 conditions.

As a condition for certification under section 401 of the CWA, the State of Florida required inclusion of the following conditions necessary to insure compliance with State water quality concerns.

In addition to the NOI requirements set forth in Part II of this permit, the State of Florida requires that prior to submitting an NOI, the owner of a storm water management system must receive a State of Florida storm water permit from either the Florida Department of Environmental Regulation (FDER) or a Florida Water Management District (FWMD).

The permittee shall submit a narrative statement certifying that the storm water pollution prevention plan for the facility provides compliance with approved State of Florida issued permits, erosion and sediment control plans and storm water management plans. In addition, the permittee also shall submit a copy of the cover page of the State permit issued by FDER or a FWMD to the facility for the storm water associated with construction activities.

Please note that facilities that discharge storm water associated with construction activities to a municipal separate storm sewer system within Broward, Dade, Duval, Escambia, Hillsborough, Orange, Palm Beach, Pineallas, Polk or Sarasota Counties shall submit a copy of the NOI to the operator of the municipal separate storm sewer system. Included within these counties, the Florida Department of Transportation (FDOT), incorporated municipalities and Chapter 298 Special Districts shall also be notified where they own or operate a municipal separate storm sewer system receiving storm water discharges associated with construction activity covered by this permit.

Florida's general permit stipulates that any non-storm water component (as defined at Part III (A)(2)(b)) of a facility's discharge must be in compliance with paragraph IV.D.5 and the storm water management system must be designed to accept these

discharges and provide treatment of the non-storm water component sufficient to meet Florida water quality standards. Discharges resulting from ground water dewatering activities at construction sites are not covered by this permit. The applicant may seek coverage for these discharges under NPDES General Permit No. FLG830000, published on July 17, 1989 (54 FR 29986) and modified on August 29, 1991 (56 FR 42736).

Permittees must submit a copy of all pollution prevention plans to the State agency which issued the storm water permit, and shall make plans available upon request to the Director.

The permittee must amend the plan whenever there is a change in design, construction, operation, or maintenance, which has a significant effect on the potential for the discharge of pollutants to the waters of the United States, including the addition of or change in location of storm water discharge points. Amendments to the plan must be submitted to the State agency which issued the State storm water permit.

In providing an estimate of the runoff coefficient of the site before, during and after construction, permittees must utilize the "C" from the Rational Method; also, permittees must provide an estimate of the size of the drainage area for each outfall.

All storm water management controls, required pursuant to Part IV of this permit, shall be consistent with the requirements set forth in State Water Policy of Florida (Chapter 17-40, Florida Administrative Code), the applicable storm water permitting requirements of the FDER or appropriate FWMD, and the guidelines contained in the Florida Development Manual: A Guide to Sound Land and Water Management (FDER, 1988) and any subsequent amendments.

Florida's general permit requires that site stabilization measures be initiated as soon as practicable in portions of the site where construction activities have temporarily or permanently ceased. Please note that paragraphs (a), (b) and (c), which provide exceptions to these required stabilization practices, have been deleted to meet Florida water quality concerns.

As part of the pollution prevention plan, permittees must provide a description of structural practices to divert flows from exposed soils, store flows or otherwise limit runoff and the discharge or pollutants from exposed areas of the site in accordance with the requirements set forth in Section 17-40, 420, F.A.C., and the applicable storm water regulations of the FDER

or appropriate FWMD. Structural practices shall be placed on upland soils unless a State of Florida wetland resource management permit issued pursuant to Chapters 373 or 403, F.S., and the applicable regulations of the FDER or FWMD authorize otherwise.

The description of controls in Part IV of the permit shall be consistent with the requirements set forth in the State Water Policy of Florida (Chapter 17-40, F.A.C.), the applicable storm water permitting regulations of the FDER or appropriate FWMD, and the guidelines contained in the Florida Development Manual: A Guide to Sound Land and Water Management (FDER, 1988), and any subsequent amendments. Structural measures shall be placed on upland soils unless a State of Florida wetland resource management permit issued pursuant to Chapters 373 or 403, F.S., and the applicable regulations of the FDER or FWMD authorize otherwise. The installation of these devices may be subject to section 404 of the CWA. This NPDES permit only addresses the installation of storm water management measures, and not the ultimate operation and maintenance of such structures after the construction activities have been completed and the site has undergone final stabilization. Permittees are only responsible for the installation and maintenance of storm water management measures prior to final stabilization of the site, and are not responsible for maintenance after storm water discharges associated with industrial activity have been eliminated from the site. However, all storm water management systems shall be operated and maintained in perpetuity after final site stabilization in accordance with the requirements set forth in the State of Florida storm water permit issued for the site.

Pursuant to the requirements of Section 17-40, 420, F.A.C., the storm water management system shall be designed to remove at least 80 percent of the average annual load of pollutants which cause or contribute to violations of water quality standards (95 percent if the system discharges to an Outstanding Florida Water).

Regarding velocity dissipation devices, equalization of the pre-development and post-development storm water peak discharge rate and volume shall be a goal in the design of the post-development storm water management system.

No solid materials, including building materials, shall be discharged to waters of the United States, except as authorized by a Section 404 permit and by a State of Florida wetland resource management permit issued pursuant to Chapters 373 or 403, F.S., and the applicable regulations of the FDER or FWMD.

The plan shall address the proper application rates and methods for the use of fertilizers and pesticides at the construction site and set forth how these procedures will be implemented and enforced.

Florida's general permit requires that qualified personnel (provided by the discharger) inspect all points of discharge into waters of the United States or to a municipal separate storm sewer system. In addition to those items required to be inspected under Part IV of this permit, designated personnel must also inspect storm water management systems.

Permittees must inspect disturbed areas and areas used for storage of materials that are exposed to precipitation for evidence of, or the potential for, pollutants entering the storm water management system. In addition, the storm water management system and erosion and sediment control measures identified in the plan must be observed to ensure that they are operating correctly. Where discharge locations or points are accessible, they must be inspected to ascertain whether erosion control and storm water management measures are effective in meeting the performance standards set forth in State Water Policy (Chapter 17-40, F.A.C.) and the applicable storm water permitting regulations of the FDER or appropriate FWMD.

Permittees must allow the Director or an authorized representative of EPA, the State, or a municipal separate storm sewer system, to sample or monitor at reasonable times, for the purposes of assuring permit compliance or as otherwise authorized by the CWA, any substances or parameter at any location on the site.

A copy of the Notice of Termination shall be sent to the State agency which issued the State storm water permit for the site and, if the storm water management system discharges to a municipal separate storm sewer system within Broward, Dade, Duval, Escambia, Hillsborough, Orange, Palm Beach, Pinellas, Polk or Sarasota Counties, to the owner of that system. Included within these counties, the Florida Department of Transportation (FDOT), incorporated municipalities, and Chapter 298 Special Districts also shall be notified where they own or operate a municipal separate storm sewer system receiving storm water discharges associated with construction activity covered by this permit.

American Samoa

See the following discussion and Part X.F of the general permit for additional 401 conditions. As a

condition for certification under section 401 of the CWA, the territory of American Samoa required inclusion of the following special conditions.

Permittees must submit a copy of all NOIs and pollution prevention plans to the American Samoa Environmental Protection Agency.

Guam

See the following and Part X.G for 401 conditions. As a condition for certification under section 401 of the CWA, the territory of Guam required inclusion of the following special conditions.

Permittees must submit a copy of all NOIs to the Guam Environmental Protection Agency at the following address: D-107 Harmon Plaza, 130 Rojas St., Harmon, Guam 95911, and to other appropriate Government of Guam agencies. All pollution prevention plans and discharge monitoring reports (DMRs) also must be submitted to Guam EPA.

IV. Economic Impact (Executive Order 12291)

EPA has submitted this notice to the Office of Management and Budget for review under Executive Order 12291.

V. Paperwork Reduction Act

EPA has reviewed the requirements imposed on regulated facilities in these final general permits under the Paperwork Reduction Act of 1980, 44 U.S.C. 3501 et seq. EPA did not prepare an Information Collection Request (ICR) document for today's permits because the information collection requirements in these permits have already been approved by the Office of Management and Budget (OMB) in submissions made for the NPDES permit program under the provisions of the Clean Water Act.

VI. Regulatory Flexibility Act

Under the Regulatory Flexibility Act, U.S.C. 601 et seq., EPA is required to prepare a Regulatory Flexibility Analysis to assess the impact of rules on small entities. No Regulatory Flexibility Analysis is required, however, where the head of the agency certifies that the rule will not have a significant

economic impact on a substantial number of small entities.

Today's permits provide small entities with an application option that is less burdensome than individual applications or participating in a group application. The other requirements have been designed to minimize significant economic impacts of the rule on small entities and does not have a significant impact on industry. In addition, the permits reduce significant administrative burdens on regulated sources. Accordingly, I hereby certify pursuant to the provisions of the Regulatory Flexibility Act, that these permits will not have a significant impact on a substantial number of small entities.

Authority: Clean Water Act, 33 U.S.C. 1251 et seq.

Dated: September 17, 1992.
Paul Keough,
Acting Regional Administrator, Region I.

Dated: September 3, 1992.
Constantine Sidamon-Eristoff,
Regional Administrator, Region II.

Dated: September 11, 1992.
A.R. Morris,
Acting Regional Administrator, Region III.

Dated: September 17, 1992.
Donald J. Guinyard,
Acting Regional Administrator, Region IV.

Dated: September 16, 1992.
John Wise,
Regional Administrator, Region IX.

Appendix A -- Summary of Response to Public Comments on the August 16, 1991, Draft General Permits

The Summary of responses to Public Comment on the August 16, 1991, draft general permits presented in Appendix A of the September 9, 1992, final general permits at 57 FR 41189, is hereby incorporated in Appendix A of today's notice.

Appendix B -- NPDES General Permits for Storm Water Discharges From Construction Activities That are Classified as "Associated With Industrial Activity"

Authorization to Discharge Under the National Pollutant Discharge Elimination System

[Permit No. MAR100000]

In compliance with the provisions of the Clean Water Act, as amended (33 U.S.C. . . 1251 et. seq; the Act), except as provided in Part I.B.3 of this permit, operators of storm water discharges from construction activities that are classified as "associated with industrial activity", located in the State of Massachusetts, are authorized to discharge in accordance with the conditions and requirements set forth herein.

Operators of storm water discharges from construction activities within the general permit area who intend to be authorized by these permits must submit a Notice of Intent in accordance with Part II of this permit. Operators of storm water discharges associated with industrial activity who fail to submit a Notice of Intent in accordance with Part II of this permit are not authorized under this general permit.

This permit shall become effective on September 25, 1992.

This permit and the authorization to discharge shall expire at midnight, September 25, 1997.

Signed and issued this 17th day of September 1992.
Larry Brill,
Acting Director, Water Management Division.

This signature is for the permit conditions in Parts I through IX and for any additional conditions in part X which apply to facilities located in the State of Massachusetts.

[NPDES Permit Number NYR10000F]

Authorization To Discharge Under the National Pollutant Discharge Elimination System

In compliance with the provisions of the Clean Water Act, as amended, (33 U.S.C. . . 1251 et. seq; the Act), except as provided in Part I.B.3 of this permit, operators of storm water discharges from construction activities that are classified as "associated with industrial activity", located on Indian Lands in New York State are authorized to discharge in accordance with the conditions and requirements set forth herein.

Operators of storm water discharges from construction activities within the general permit area who intend to be authorized by these permits must submit a Notice of Intent in accordance with Part II of this permit. Operators of storm water discharges

associated with industrial activity who fail to submit a Notice of Intent in accordance with Part II of this permit are not authorized under this general permit.

This permit shall become effective on September 25, 1992.

This permit and the authorization to discharge shall expire at midnight, September 25, 1997.

Signed and Issued this 3rd day of September 1992.
Richard L. Caspe, P.E.,
Director, Water Management Division, U.S.
Environmental Protection Agency, Region II.

[Permit No. -- R100000 or DE R100000F (for only Indian lands and/or Fed. fac)]

Authorization to Discharge Under the National Pollutant Discharge Elimination System

In compliance with the provisions of the Clean Water Act, as amended, (33 U.S.C. . . 1251 et. seq; the Act), except as provided in Part I.B.3 of this permit, operators of storm water discharges from construction activities that are classified as "associated with industrial activity", located in Federal Facilities in the state of Delaware, are authorized to discharge in accordance with the conditions and requirements set forth herein.

Operators of storm water discharges from construction activities within the general permit area who intend to be authorized by these permits must submit a Notice of Intent in accordance with Part II of this permit. Operators of storm water discharges associated with industrial activity who fail to submit a Notice of Intent in accordance with Part II of this permit are not authorized under this general permit.

This permit shall become effective on September 25, 1992.

This permit and the authorization to discharge shall expire at midnight, September 25, 1997.

Signed and issued this 16th day of September 1992
A.R. Morris,
(signature of Water Management Director or
Regional Administrator).

[Permit No. D/C R100000 or -- R100000F (for only Indian lands and/or Fed. fac)]

Authorization to Discharge Under the National Pollutant Discharge Elimination System

In compliance with the provisions of the Clean Water Act, as amended, (33 U.S.C. . . 1251 et. seq; the Act), except as provided in Part I.B.3 of this permit, operators of storm water discharges from construction activities that are classified as "associated with industrial activity", located in the District of Columbia, are authorized to discharge in accordance with the conditions and requirements set forth herein.

Operators of storm water discharges from construction activities within the general permit area who intend to be authorized by these permits must submit a Notice of Intent in accordance with Part II of this permit. Operators of storm water discharges associated with industrial activity who fail to submit a Notice of Intent in accordance with Part II of this permit are not authorized under this general permit.

This permit shall become effective on September 25, 1992.

This permit and the authorization to discharge shall expire at midnight, September 25, 1997.

Signed and issued this 16th day of September 1992
A.R. Morris,
(signature of Water Management Director or
Regional Administrator).

[General Permit Number FLR100000]

Region IV: Authorization To Discharge Under the National Pollutant Discharge Elimination System

In compliance with the provisions of the Clean Water Act, as amended (33 U.S.C. 1251 et seq., the "Act"), except as provided in Part I.B.3 of this permit, operators of storm water discharges from construction activities that are classified as "associated with industrial activity", located in the State of Florida are authorized to discharge in accordance with the conditions and requirements set forth herein.

Operators of storm water discharges from construction activities within the general permit area who intend to be authorized by this permit must submit a Notice of Intent in accordance with Part II of this permit. Operators of storm water discharges associated with industrial activity who fail to submit a Notice of Intent in accordance with Part II of this permit are not authorized under this general permit.

This permit shall become effective on September 25, 1992.

This permit and the authorization to discharge shall expire at midnight, September 25, 1997.

Signed and Issued: September 17, 1992.
Allan E. Antley,
Acting Director, Water Management Division.

This signature is for the permit conditions in Parts I through IX and for any additional conditions in Part X which apply to facilities located in the State of Florida.

[Storm Water General Permit for Construction Activities] [Permit No. GUR100000]

Authorization To Discharge Under the National Pollutant Discharge Elimination System

In compliance with the provisions of the Clean Water Act, as amended (U.S.C. . . 1251 et. seq.; the Act), except as provided in Part I.B.3 of this permit, operators of storm water discharges from construction activities that are classified as "associated with industrial activity", located on the Island of Guam are authorized to discharge in accordance with the conditions and requirements set forth herein.

Operators of storm water discharges from construction activities within the general permit area who intend to be authorized by this permit must submit a Notice of Intent in accordance with Part II of this permit. Operators of storm water discharges associated with industrial activity who fail to submit a Notice of Intent in accordance with Part II of this permit are not authorized under this general permit.

This permit shall become effective on September 25, 1992.

This permit and the authorization to discharge shall expire at midnight, September 25, 1997.

Signed and issued this 16th day of September, 1992.
Catherine Kuhlman,
Acting Director, Water Management Division.

This signature is for the permit conditions in Parts I through IX and for any additional conditions in Part X which apply to facilities located on the Island of Guam.

[Storm Water General Permit for Construction Activities] [Permit No. ASR100000]

Authorization To Discharge Under the National Pollutant Discharge Elimination System

In compliance with the provisions of the Clean Water Act, as amended (U.S.C. . . 1251 et. seq.; the Act), except as provided in Part I.B.3 of this permit, operators of storm water discharges from construction activities that are classified as "associated with industrial activity", located on America Samoa are authorized to discharge in accordance with the conditions and requirements set forth herein.

Operators of storm water discharges from construction activities within the general permit area who intend to be authorized by this permit must submit a Notice of Intent in accordance with Part II of this permit. Operators of storm water discharges associated with industrial activity who fail to submit a Notice of Intent in accordance with Part II of this permit are not authorized under this general permit.

This permit shall become effective on September 25, 1992.

This permit and the authorization to discharge shall expire at midnight, September 25, 1997.

Signed and issued this 16th day of September, 1992.
Catherine Kuhlman,
Acting Director, Water Management Division.

This signature is for the permit conditions in Parts I through IX and for any additional conditions in Part X which apply to facilities located on American Samoa.

NPDES General Permits for Storm Water Discharges From Construction Activities That Are Classified as "Associated With Industrial Activity"

Table of Contents

Part I. Coverage Under this Permit

- A. Permit Area.
- B. Eligibility.
- C. Authorization.

Part II. Notice of Intent Requirements

- A. Deadlines for Notification.
- B. Contents of Notice of Intent.
- C. Where to Submit.

- D. Additional Notification.
- E. Renotification.

Part III. Special Conditions

- A. Prohibition on non-storm water discharges.
- B. Releases in excess of Reportable Quantities.

Part IV. Storm Water Pollution Prevention Plans

- A. Deadlines for Plan Preparation and Compliance
- B. Signature and Plan Review
- C. Keeping Plans Current
- D. Contents of Plan
- E. Contractors

Part V. Retention of Records

Part VI. Standard Permit Conditions

- A. Duty to Comply.
- B. Continuation of the Expired General Permit.
- C. Need to halt or reduce activity not a defense.
- D. Duty to Mitigate.
- E. Duty to Provide Information.
- F. Other Information.
- G. Signatory Requirements.
- H. Penalties for Falsification of Reports.
- I. Oil and Hazardous Substance Liability.
- J. Property Rights.
- K. Severability.
- L. Requiring an individual permit or an alternative general permit.
- M. State Laws.
- N. Proper Operation and Maintenance.
- O. Inspection and Entry.
- P. Permit Actions.

Part VII. Reopener Clause

Part VIII. Notice of Termination

- A. Notice of Termination
- B. Addresses

Part IX. Definitions

Part X. State Specific Conditions

- A. Massachusetts
- B. Delaware (Federal facilities)
- C. District of Columbia
- D. Florida
- E. American Samoa
- F. Guam

Preface

The Clean Water Act (CWA) provides that storm water discharges associated with industrial activity from a point source (including discharges through a municipal separate storm sewer system) to waters of the United States are unlawful, unless authorized by a National Pollutant Discharge Elimination System (NPDES) permit. The terms "storm water discharge associated with industrial activity", "point source" and "waters of the United States" are critical to determining whether a facility is subject to this requirement. Complete definitions of these terms are found in the definition section (Part IX) of this permit.

The United States Environmental Protection Agency (EPA) has established the Storm Water Hotline at (703) 821-4823 to assist the Regional Offices in distributing notice of intent forms and storm water pollution prevention plan guidance, and to provide information pertaining to the storm water regulations.

Part I. Coverage Under this Permit

- A. Permit Area. The permit covers all areas of:

Region I -- the State of Massachusetts.

Region II -- Indian lands in New York.

Region III -- the District of Columbia and Federal facilities in the State of Delaware.

Region IV -- the State of Florida.

Region IX -- American Samoa and Guam.

- B. Eligibility

1. This permit may authorize all discharges of storm water associated with industrial activity from construction sites, (those sites or common plans of development or sale that will result in the disturbance of five or more acres total land areas), n2 (henceforth referred to as storm water discharges from construction activities) occurring after the effective date of this permit (including discharges occurring after the effective date of this permit where the construction activity was initiated before the effective date of this permit), except for discharges identified under paragraph I.B.3.

2. This permit may only authorize a storm water discharge associated with industrial activity from a construction site that is mixed with a storm water

discharge from an industrial source other than construction, where:

a. the industrial source other than construction is located on the same site as the construction activity;

b. storm water discharges associated with industrial activity from the areas of the site where construction activities are occurring are in compliance with the terms of this permit; and

c. storm water discharges associated with industrial activity from the areas of the site where industrial activity other than construction are occurring (including storm water discharges from dedicated asphalt plants and dedicated concrete plants) are covered by a different NPDES general permit or individual permit authorizing such discharges.

3. Limitations on Coverage. The following storm water discharges from construction sites are not authorized by this permit:

a. storm water discharges associated with industrial activity that originate from the site after construction activities have been completed and the site has undergone final stabilization.

b. discharges that are mixed with sources of non-storm water other than discharges which are identified in Part III.A of this permit and which are in compliance with Part IV.D.5 (non-storm water discharges) of this permit.

c. storm water discharges associated with industrial activity that are subject to an existing NPDES individual or general permit or which are issued a permit in accordance with paragraph VI.L (requiring an individual permit or an alternative general permit) of this permit. Such discharges may be authorized under this permit after an existing permit expires provided the existing permit did not establish numeric limitations for such discharges;

d. storm water discharges from construction sites that the Director (EPA) has determined to be or may reasonably be expected to be contributing to a violation of a water quality standard; and

e. storm water discharges from construction sites if the discharges may adversely affect a listed or proposed to be listed endangered or threatened species or its critical habitat.

C. Authorization

1. A discharger must submit a Notice of Intent (NOI) in accordance with the requirements of Part II of this permit, using a NOI form provided by the Director (or a photocopy thereof), in order for storm water discharges from construction sites to be authorized to discharge under this general permit. n3

2. Where a new operator is selected after the submittal of an NOI under Part II, a new Notice of Intent (NOI) must be submitted by the operator in accordance with Part II, using a NOI form provided by the Director (or a photocopy thereof).

3. Unless notified by the Director to the contrary, dischargers who submit an NOI in accordance with the requirements of this permit are authorized to discharge storm water from construction sites under the terms and conditions of this permit 2 days after the date that the NOI is postmarked. The Director may deny coverage under this permit and require submittal of an application for an individual NPDES permit based on a review of the NOI or other information (see Part VI.L of this permit).

Part II. Notice of Intent Requirements

A. Deadlines for Notification

1. Except as provided in paragraphs II.A.2, II.A.3, and II.A.4, individuals who intend to obtain coverage for storm water discharges from a construction site (where disturbances associated with the construction project commence before October 1, 1992), under this general permit shall submit a Notice of Intent (NOI) in accordance with the requirements of this Part on or before October 1, 1992;

2. Individuals who intend to obtain coverage under this general permit for storm water discharges from a construction site where disturbances associated with the construction project commence after October 1, 1992, shall submit a Notice of Intent (NOI) in accordance with the requirements of this Part at least 2 days prior to the commencement of construction activities (e.g. the initial disturbance of soils associated with clearing, grading, excavation activities, or other construction activities);

3. For storm water discharges from construction sites where the operator changes (including projects where an operator is selected after a NOI has been submitted under Parts II.A.1 or U.A.2) a NOI in accordance with the requirements of this Part shall be submitted at least 2 days prior to when the operator commences work at the site; and

4. EPA will accept an NOI in accordance with the requirements of this part after the dates provided in Parts II.A.1, 2 or 3 of this permit. In such instances, EPA may bring appropriate enforcement actions.

B. Contents of Notice of Intent.

The Notice(s) of Intent shall be signed in accordance with Part VI.G of this permit by all of the entities identified in Part II.B.2 and shall include the following information:

1. The mailing address of the construction site for which the notification is submitted. Where a mailing address for the site is not available, the location of the approximate center of the site must be described in terms of the latitude and longitude to the nearest 15 seconds, or the section, township and range to the nearest quarter section;

2. The name, address and telephone number of the operator(s) with day to day operational control that have been identified at the time of the NOI submittal, and operator status as a Federal, State, private, public or other entity. Where multiple operators have been selected at the time of the initial NOI submittal, NOIs must be attached and submitted in the same envelope. When an additional operator submits an NOI for a site with a preexisting NPDES permit, the NOI for the additional operator must indicate the number for the preexisting NPDES permit;

3. The name of the receiving water(s), or if the discharge is through a municipal separate storm sewer, the name of the municipal operator of the storm sewer and the ultimate receiving water(s);

4. The permit number of any NPDES permit(s) for any discharge(s) (including any storm water discharges or any non-storm water discharges) from the site;

5. An indication of whether the operator has existing quantitative data which describes the concentration of pollutants in storm water discharges (existing data should not be included as part of the NOI); and

6. An estimate of project start date and completion dates, estimates of the number of acres of the site on which soil will be disturbed, and a certification that a storm water pollution prevention plan has been prepared for the site in accordance with Part IV of this permit, and such plan provides compliance with approved State and/or local sediment and erosion plans or permits and/or storm water management plans or permits in accordance with Part IV.D.2.d of this permit. (A copy

of the plans or permits should not be included with the NOI submission).

C. Where to Submit

1. Facilities which discharge storm water associated with industrial activity must use a NOI form provided by the Director (or photocopy thereof). The form in the Federal Register notice in which this permit was published may be photocopied and used. Forms are also available by calling (703) 821-4823. NOIs must be signed in accordance with Part VI.G of this permit. NOIs are to be submitted to the Director of the NPDES program in care of the following address: Storm Water Notice of Intent, P.O. Box 1215, Newington, VA 22122.

2. A copy of the NOI or other indication that storm water discharges from the site are covered under a NPDES permit, and a brief description of the project shall be posted at the construction site in a prominent place for public viewing (such as alongside a building permit).

D. Additional Notification.

Facilities which are operating under approved State or local sediment and erosion plans, grading plans, or storm water management plans shall submit signed copies of the Notice of Intent to the State or local agency approving such plans in accordance with the datelines in Part II.A of this permit (or sooner where required by State or local rules), in addition to submitting the Notice of Intent to EPA in accordance with paragraph II.C.

E. Renotification.

Upon issuance of a new general permit, the permittee is required to notify the Director of his intent to be covered by the new general permit.

Part III. Special Conditions, Management Practices, and Other Non-Numeric Limitations

A. Prohibition on non-storm water discharges.

1. Except as provided in paragraph I.B.2 and III.A.2, all discharges covered by this permit shall be composed entirely of storm water.

2. a. Except as provided in paragraph III.A.2.(b), discharges of material other than storm water must be in compliance with a NPDES permit (other than this permit) issued for the discharge.

b. The following non-storm water discharges may be authorized by this permit provided the non-storm water component of the discharge is in compliance with paragraph IV.D.5: discharges from fire fighting activities; fire hydrant flushings; waters used to wash vehicles or control dust in accordance with Part IV.D.2.c.(2); potable water sources including waterline flushings; irrigation drainage; routine external building washdown which does not use detergents; pavement washwaters where spills or leaks of toxic or hazardous materials have not occurred (unless all spilled material has been removed) and where detergents are not used; air conditioning condensate; springs; uncontaminated ground water; and foundation or footing drains where flows are not contaminated with process materials such as solvents.

B. Releases in excess of Reportable Quantities.

1. The discharge of hazardous substances or oil in the storm water discharge(s) from a facility shall be prevented or minimized in accordance with the applicable storm water pollution prevention plan for the facility. This permit does not relieve the permittee of the reporting requirements of 40 CFR part 117 and 40 CFR part 302. Where a release containing a hazardous substance in an amount equal to or in excess of a reporting quantity established under either 40 CFR 117 or 40 CFR 302, occurs during a 24 hour period:

a. The permittee is required to notify the National Response Center (NRC) (800-424-8802; in the Washington, DC metropolitan area 202-426-2675) in accordance with the requirements of 40 CFR 117 and 40 CFR 302 as soon as he or she has knowledge of the discharge;

b. The permittee shall submit within 14 calendar days of knowledge of the release a written description of: the release (including the type and estimate of the amount of material released), the date that such release occurred, the circumstances leading to the release, and steps to be taken in accordance with Part III.B.3 of this permit to the appropriate EPA Regional Office at the address provided in Part V.C (addresses) of this permit; and

c. The storm water pollution prevention plan required under Part IV of this permit must be modified within 14 calendar days of knowledge of the releases to: provide a description of the release, the circumstances leading to the release, and the date of the release. In addition, the plan must be reviewed to identify measures to prevent the reoccurrence of such releases and to

respond to such releases, and the plan must be modified where appropriate.

2. Spills. This permit does not authorize the discharge of hazardous substances or oil resulting from an on-site spill.

Part IV. Storm Water Pollution Prevention Plans

A storm water pollution prevention plan shall be developed for each construction site covered by this permit. Storm water pollution prevention plans shall be prepared in accordance with good engineering practices. The plan shall identify potential sources of pollution which may reasonably be expected to affect the quality of storm water discharges from the construction site. In addition, the plan shall describe and ensure the implementation of practices which will be used to reduce the pollutants in storm water discharges associated with industrial activity at the construction site and to assure compliance with the terms and conditions of this permit. Facilities must implement the provisions of the storm water pollution prevention plan required under this part as a condition of this permit.

A. Deadlines for Plan Preparation and Compliance

The plan shall:

1. Be completed (including certifications required under Part IV.E) prior to the submittal of an NOI to be covered under this permit and updated as appropriate;

2. For construction activities that have begun on or before October 1, 1992, except for sediment basins required under Part IV.D.2.a.(2) (structural practices) of this permit, the plan shall provide for compliance with the terms and schedule of the plan beginning on October 1, 1992. The plan shall provide for compliance with sediment basins required under Part IV.D.2.a.(a) of this permit by no later than December 1, 1992;

3. For construction activities that have begun after October 1, 1992, the plan shall provide for compliance with the terms and schedule of the plan beginning with the initiation of construction activities.

B. Signature and Plan Review

1. The plan shall be signed in accordance with Part VI.G, and be retained on-site at the facility which generates the storm water discharge in accordance with Part V (retention of records) of this permit.

2. The permittee shall make plans available upon request to the Director; a State or local agency approving sediment and erosion plans, grading plans, or storm water management plans; or in the case of a storm water discharge associated with industrial activity which discharges through a municipal separate storm sewer system with an NPDES permit, to the municipal operator of the system.

3. The Director, or authorized representative, may notify the permittee at any time that the plan does not meet one or more of the minimum requirements of this Part. Such notification shall identify those provisions of the permit which are not being met by the plan, and identify which provisions of the plan requires modifications in order to meet the minimum requirements of this Part. Within 7 days of such notification from the Director, (or as otherwise provided by the Director), or authorized representative, the permittee shall make the required changes to the plan and shall submit to the Director a written certification that the requested changes have been made.

C. Keeping Plans Current.

The permittee shall amend the plan whenever there is a change in design, construction, operation, or maintenance, which has a significant effect on the potential for the discharge of pollutants to the waters of the United States and which has not otherwise been addressed in the plan or if the storm water pollution prevention plan proves to be ineffective in eliminating or significantly minimizing pollutants from sources identified under Part IV.D.2 of this permit, or in otherwise achieving the general objectives of controlling pollutants in storm water discharges associated with industrial activity. In addition, the plan shall be amended to identify any new contractor and/or subcontractor that will implement a measure of the storm water pollution prevention plan (see Part IV.E). Amendments to the plan may be reviewed by EPA in the same manner as Part IV.B above.

D. Contents of Plan.

The storm water pollution prevention plan shall include the following items:

1. Site Description. Each plan shall provide a description of pollutant sources and other information as indicated:

a. A description of the nature of the construction activity;

b. A description of the intended sequence of major activities which disturb soils for major portions of the site (e.g. grubbing, excavation, grading);

c. Estimates of the total area of the site and the total area of the site that is expected to be disturbed by excavation, grading, or other activities;

d. An estimate of the runoff coefficient of the site after construction activities are completed and existing data describing the soil or the quality of any discharge from the site;

e. A site map indicating drainage patterns and approximate slopes anticipated after major grading activities, areas of soil disturbance, an outline of areas which may not be disturbed, the location of major structural and nonstructural controls identified in the plan, the location of areas where stabilization practices are expected to occur, surface waters (including wetlands), and locations where storm water is discharged to a surface water; and

f. The name of the receiving water(s), and areal extent of wetland acreage at the site.

2. Controls. Each plan shall include a description of appropriate controls and measures that will be implemented at the construction site. The plan will clearly describe for each major activity identified in Part IV.D.1.b appropriate control measures and the timing during the construction process that the measures will be implemented. (For example, perimeter controls for one portion of the site will be installed after the clearing and grubbing necessary for installation of the measure, but before the clearing and grubbing for the remaining portions of the site. Perimeter controls will be actively maintained until final stabilization of those portions of the site upward of the perimeter control. Temporary perimeter controls will be removed after final stabilization). The description and implementation of controls shall address the following minimum components:

a. Erosion and Sediment Controls.

(1). Stabilization Practices. A description of interim and permanent stabilization practices, including site-specific scheduling of the implementation of the practices. Site plans should ensure that existing vegetation is preserved where attainable and that disturbed portions of the site are stabilized. Stabilization practices may include: temporary seeding, permanent seeding, mulching, geotextiles, sod stabilization, vegetative buffer strips, protection of trees, preservation

of mature vegetation, and other appropriate measures. A record of the dates when major grading activities occur, when construction activities temporarily or permanently cease on a portion of the site, and when stabilization measures are initiated shall be included in the plan. Except as provided in paragraphs IV.D.2.(a).(1). (a), (b), and (c) below, stabilization measures shall be initiated as soon as practicable in portions of the site where construction activities have temporarily or permanently ceased, but in no case more than 14 days after the construction activity in that portion of the site has temporarily or permanently ceased.

(a). Where the initiation of stabilization measures by the 14th day after construction activity temporarily or permanently cease is precluded by snow cover, stabilization measures shall be initiated as soon as practicable.

(b). Where construction activity will resume on a portion of the site within 21 days from when activities ceased, (e.g., the total time period that construction activity is temporarily ceased is less than 21 days) then stabilization measures do not have to be initiated on that portion of site by the 14th day after construction activity temporarily ceased.

(c). In arid areas (areas with an average annual rainfall of 0 to 10 inches) and semi-arid areas (areas with an average annual rainfall of 10 to 20 inches), where the initiation of stabilization measures by the 14th day after construction activity has temporarily or permanently ceased is precluded by seasonal arid conditions, stabilization measures shall be initiated as soon as practicable.

(2). Structural Practices. A description of structural practices to divert flows from exposed soils, store flows or otherwise limit runoff and the discharge of pollutants from exposed areas of the site to the degree attainable. Such practices may include silt fences, earth dikes, drainage swales, sediment traps, check dams, subsurface drains, pipe slope drains, level spreaders, storm drain inlet protection, rock outlet protection, reinforced soil retaining systems, gabions, and temporary or permanent sediment basins. Structural practices should be placed on upland soils to the degree attainable. The installation of these devices may be subject to Section 404 of the CWA.

(a) For common drainage locations that serve an area with 10 or more disturbed acres at one time, a temporary (or permanent) sediment basin providing 3,600 cubic feet of storage per acre drained, or

equivalent control measures, shall be provided where attainable until final stabilization of the site. The 3,600 cubic feet of storage area per acre drained does not apply to flows from offsite areas and flows from onsite areas that are either undisturbed or have undergone final stabilization where such flows are diverted around both the disturbed area and the sediment basin. For drainage locations which serve 10 or more disturbed acres at one time and where a temporary sediment basin providing 3,600 cubic feet of storage per acre drained, or equivalent controls is not attainable, smaller sediment basins and/or sediment traps should be used. At a minimum, silt fences, or equivalent sediment controls are required for all sideslope and downslope boundaries of the construction area.

(b) For drainage locations serving less than 10 acres, sediment basins and/or sediment traps should be used. At a minimum, silt fences or equivalent sediment controls are required for all sideslope and downslope boundaries of the construction area unless a sediment basin providing storage for 3,600 cubic feet of storage per acre drained is provided.

b. Storm Water Management. A description of measures that will be installed during the construction process to control pollutants in storm water discharges that will occur after construction operations have been completed. Structural measures should be placed on upland soils to the degree attainable. The installation of these devices may be subject to Section 404 of the CWA. This permit only addresses the installation of storm water management measures, and not the ultimate operation and maintenance of such structures after the construction activities have been completed and the site has undergone final stabilization. Permittees are only responsible for the installation and maintenance of storm water management measures prior to final stabilization of the site, and are not responsible for maintenance after storm water discharges associated with industrial activity have been eliminated from the site.

(1). Such practices may include: storm water detention structures (including wet ponds); storm water retention structures; flow attenuation by use of open vegetated swales and natural depressions; infiltration of runoff onsite; and sequential systems (which combine several practices). The pollution prevention plan shall include an explanation of the technical basis used to select the practices to control pollution where flows exceed predevelopment levels.

(2). Velocity dissipation devices shall be placed at discharge locations and along the length of any outfall channel for the purpose of providing a non-erosive

velocity flow from the structure to a water course so that the natural physical and biological characteristics and functions are maintained and protected (e.g. no significant changes in the hydrological regime of the receiving water).

c. Other Controls.

(1). Waste Disposal. No solid materials, including building materials, shall be discharged to waters of the United States, except as authorized by a section 404 permit.

(2). Off-site vehicle tracking of sediments and the generation of dust shall be minimized.

(3). The plan shall ensure and demonstrate compliance with applicable State and/or local waste disposal, sanitary sewer or septic system regulations.

d. Approved State or Local Plans.

(1) Permittees which discharge storm water associated with industrial activity from construction activities must include in their storm water pollution prevention plan procedures and requirements specified in applicable sediment and erosion site plans or site permits, or storm water management site plans or site permits approved by State or local officials. Permittees shall provide a certification in their storm water pollution prevention plan that their storm water pollution prevention plan reflects requirements applicable to protecting surface water resources in sediment and erosion site plans or site permits, or storm water management site plans or site permits approved by State or local officials. Permittees shall comply with any such requirements during the term of the permit. This provision does not apply to provisions of master plans, comprehensive plans, non-enforceable guidelines or technical guidance documents that are not identified in a specific plan or permit that is issued for the construction site.

(2) Storm water pollution prevention plans must be amended to reflect any change applicable to protecting surface water resources in sediment and erosion site plans or site permits, or storm water management site plans or site permits approved by State or local officials for which the permittee receives written notice. Where the permittee receives such written notice of a change, the permittee shall provide a recertification in the storm water pollution plan that the storm water pollution prevention plan has been modified to address such changes.

(3) Dischargers seeking alternative permit requirements shall submit an individual permit application in accordance with Part VI.L of the permit at the address indicated in Part V.C of this permit for the appropriate Regional Office, along with a description of why requirements in approved State or local plans or permits, or changes to such plans or permits, should not be applicable as a condition of an NPDES permit.

3. Maintenance. A description of procedures to ensure the timely maintenance of vegetation, erosion and sediment control measures and other protective measures identified in the site plan in good and effective operating condition.

4. Inspections. Qualified personnel (provided by the discharger) shall inspect disturbed areas of the construction site that have not been finally stabilized, areas used for storage of materials that are exposed to precipitation, structural control measures, and locations where vehicles enter or exit the site at least once every seven calendar days and within 24 hours of the end of a storm that is 0.5 inches or greater. Where sites have been finally stabilized, or during seasonal arid periods in arid areas (areas with an average annual rainfall of 0 to 10 inches) and semi-arid areas (areas with an average annual rainfall of 10 to 20 inches) such inspection shall be conducted at least once every month.

a. Disturbed areas and areas used for storage of materials that are exposed to precipitation shall be inspected for evidence of, or the potential for, pollutants entering the drainage system. Erosion and sediment control measures identified in the plan shall be observed to ensure that they are operating correctly. Where discharge locations or points are accessible, they shall be inspected to ascertain whether erosion control measures are effective in preventing significant impacts to receiving waters. Locations where vehicles enter or exit the site shall be inspected for evidence of offsite sediment tracking.

b. Based on the results of the inspection, the site description identified in the plan in accordance with paragraph IV.D.1 of this permit and pollution prevention measures identified in the plan in accordance with paragraph IV.D.2 of this permit shall be revised as appropriate, but in no case later than 7 calendar days following the inspection. Such modifications shall provide for timely implementation of any changes to the plan within 7 calendar days following the inspection.

c. A report summarizing the scope of the inspection, name(s) and qualifications of personnel making the

inspection, the date(s) of the inspection, major observations relating to the implementation of the storm water pollution prevention plan, and actions taken in accordance with paragraph IV.D.4.b of the permit shall be made and retained as part of the storm water pollution prevention plan for at least three years from the date that the site is finally stabilized. Such reports shall identify any incidents of non-compliance. Where a report does not identify any incidents of non-compliance, the report shall contain a certification that the facility is in compliance with the storm water pollution prevention plan and this permit. The report shall be signed in accordance with Part VI.G of this permit.

5. Non-Storm Water Discharges -- Except for flows from fire fighting activities, sources of non-storm water listed in Part III.A.2 of this permit that are combined with storm water discharges associated with industrial activity must be identified in the plan. The plan shall identify and ensure the implementation of appropriate pollution prevention measures for the non-storm water component(s) of the discharge.

E. Contractors

1. The storm water pollution prevention plan must clearly identify for each measure identified in the plan, the contractor(s) and/or subcontractor(s) that will implement the measure. All contractors and subcontractors identified in the plan must sign a copy of the certification statement in Part IV.E.2 of this permit in accordance with Part VI.G of this permit. All certifications must be included in the storm water pollution prevention plan.

2. Certification Statement. All contractors and subcontractors identified in a storm water pollution prevention plan in accordance with Part IV.E.1 of this permit shall sign a copy of the following certification statement before conducting any professional service identified in the storm water pollution prevention plan:

"I certify under penalty of law that I understand the terms and conditions of the general National Pollutant Discharge Elimination System (NPDES) permit that authorizes the storm water discharges associated with industrial activity from the construction site identified as part of this certification."

The certification must include the name and title of the person providing the signature in accordance with Part VI.G of this permit; the name, address and telephone number of the contracting firm; the address

(or other identifying description) of the site; and the date the certification is made.

Part V. Retention of Records

A. The permittee shall retain copies of storm water pollution prevention plans and all reports required by this permit, and records of all data used to complete the Notice of Intent to be covered by this permit, for a period of at least three years from the date that the site is finally stabilized. This period may be extended by request of the Director at any time.

B. The permittee shall retain a copy of the storm water pollution prevention required by this permit at the construction site from the date of project initiation to the date of final stabilization.

C. Addresses. Except for the submittal of NOIs (see Part II.C of this permit), all written correspondence concerning discharges in any State, Indian land or from any Federal Facility covered under this permit and directed to the U.S. Environmental Protection Agency, including the submittal of individual permit applications, shall be sent to the address of the appropriate Regional Office listed below:

1. Massachusetts

United States EPA, Region I, Water Management Division, (WCP-2109), Storm Water Staff, John F. Kennedy Federal Building, room 2209, Boston, MA 02203

2. Indian Lands in New York

United States EPA, Region II, Water Management Division, (2WM-WPC), Storm Water Staff, 26 Federal Plaza, New York, NY 10278

3. District of Columbia, and Federal facilities in Delaware

United States EPA, Region III, Water Management Division, (3WM55), Storm Water Staff, 841 Chestnut Building, Philadelphia, PA 19107

4. Florida

United States EPA, Region IV, Water Management Division, (FPB-3), Storm Water

Staff, 345 Courtland Street, NE, Atlanta, GA
30365

5. American Samoa and Guam

United States EPA, Region IX, Water
Management Division, (W-5-1), Storm Water
Staff, 75 Hawthorne Street, San Francisco, CA
94105

Part VI. Standard Permit Conditions

A. Duty to Comply

1. The permittee must comply with all conditions of this permit. Any permit noncompliance constitutes a violation of CWA and is grounds for enforcement action; for permit termination, revocation and reissuance, or modification; or for denial of a permit renewal application.

2. Penalties for Violations of Permit Conditions.

a. Criminal

(1). Negligent Violations. The CWA provides that any person who negligently violates permit conditions implementing sections 301, 302, 306, 307, 308, 318, or 405 of the Act is subject to a fine of not less than \$2,500 nor more than \$25,000 per day of violation, or by imprisonment for not more than 1 year, or both.

(2). Knowing Violations. The CWA provides that any person who knowingly violates permit conditions implementing Sections 301, 302, 306, 307, 308, 318, or 405 of the Act is subject to a fine of not less than \$5,000 nor more than \$50,000 per day of violation, or by imprisonment for not more than 3 years, or both.

(3). Knowing Endangerment. The CWA provides that any person who knowingly violates permit conditions implementing Sections 301, 302, 306, 307, 308, 318, or 405 of the Act and who knows at that time that he is placing another person in imminent danger of death or serious bodily injury is subject to a fine of not more than \$250,000, or by imprisonment for not more than 15 years, or both.

(4). False Statement. The CWA provides that any person who knowingly makes any false material statement, representation, or certification in any application, record, report, plan, or other document filed or required to be maintained under the Act or who

knowingly falsifies, tampers with, or renders inaccurate, any monitoring device or method required to be maintained under the Act, shall upon conviction, be punished by a fine of not more than \$10,000 or by imprisonment for not more than 2 years, or by both. If a conviction is for a violation committed after a first conviction of such person under this paragraph, punishment shall be by a fine of not more than \$20,000 per day of violation, or by imprisonment of not more than 4 years, or by both. (See Section 309.c.4 of the Clean Water Act).

b. Civil Penalties -- The CWA provides that any person who violates a permit condition implementing Sections 301, 302, 306, 307, 308, 318, or 405 of the Act is subject to a civil penalty not to exceed \$25,000 per day for each violation.

c. Administrative Penalties -- The CWA provides that any person who violates a permit condition implementing Sections 301, 302, 306, 307, 308, 318, or 405 of the Act is subject to an administrative penalty, as follows:

(1). Class I penalty. Not to exceed \$10,000 per violation nor shall the maximum amount exceed \$25,000.

(2). Class II penalty. Not to exceed \$10,000 per day for each day during which the violation continues nor shall the maximum amount exceed \$125,000.

B. Continuation of the Expired General Permit

This permit expires on [insert date five years after publication date]. However, an expired general permit continues in force and effect until a new general permit is issued. Permittees must submit a new NOI in accordance with the requirements of Part II of this permit, using a NOI form provided by the Director (or photocopy thereof) between August 1, 1997 and [insert date five years after publication date] to remain covered under the continued permit after [insert date five years after publication date]. Facilities that had not obtained coverage under the permit by [insert date five years after publication date] cannot become authorized to discharge under the continued permit.

C. Need to halt or reduce activity not a defense. It shall not be a defense for a permittee in an enforcement action that it would have been necessary to halt or reduce the permitted activity in order to maintain compliance with the conditions of this permit.

D. Duty to Mitigate. The permittee shall take all reasonable steps to minimize or prevent any discharge in violation of this permit which has a reasonable likelihood of adversely affecting human health or the environment.

E. Duty to Provide Information. The permittee shall furnish to the Director; an authorized representative of the Director; a State or local agency approving sediment and erosion plans, grading plans, or storm water management plans; or in the case of a storm water discharge associated with industrial activity which discharges through a municipal separate storm sewer system with an NPDES permit, to the municipal operator of the system, any information which is requested to determine compliance with this permit or other information.

F. Other Information. When the permittee becomes aware that he or she failed to submit any relevant facts or submitted incorrect information in the Notice of Intent or in any other report to the Director, he or she shall promptly submit such facts or information.

G. Signatory Requirements. All Notices of Intent, storm water pollution prevention plans, reports, certifications or information either submitted to the Director or the operator of a large or medium municipal separate storm sewer system, or that this permit requires be maintained by the permittee, shall be signed as follows:

1. All Notices of Intent shall be signed as follows:

a. For a corporation: by a responsible corporate officer. For the purpose of this section, a responsible corporate officer means: (1) a president, secretary, treasurer, or vice-president of the corporation in charge of a principal business function, or any other person who performs similar policy or decision-making functions for the corporation; or (2) the manager of one or more manufacturing, production or operating facilities employing more than 250 persons or having gross annual sales or expenditures exceeding \$25,000,000 (in second-quarter 1980 dollars) if authority to sign documents has been assigned or delegated to the manager in accordance with corporate procedures;

b. For a partnership or sole proprietorship: by a general partner or the proprietor, respectively; or

c. For a municipality, State, Federal, or other public agency: by either a principal executive officer or ranking elected official. For purposes of this section, a

principal executive officer of a Federal agency includes (1) the chief executive officer of the agency, or (2) a senior executive officer having responsibility for the overall operations of a principal geographic unit of the agency (e.g., Regional Administrators of EPA).

2. All reports required by the permit and other information requested by the Director or authorized representative of the Director shall be signed by a person described above or by a duly authorized representative of that person. A person is a duly authorized representative only if:

a. The authorization is made in writing by a person described above and submitted to the Director.

b. The authorization specifies either an individual or a position having responsibility for the overall operation of the regulated facility or activity, such as the position of manager, operator, superintendent, or position of equivalent responsibility or an individual or position having overall responsibility for environmental matters for the company. (A duly authorized representative may thus be either a named individual or any individual occupying a named position).

c. Changes to authorization. If an authorization under paragraph II.B.3. is no longer accurate because a different operator has responsibility for the overall operation of the construction site, a new notice of intent satisfying the requirements of paragraph II.B must be submitted to the Director prior to or together with any reports, information, or applications to be signed by an authorized representative.

d. Certification. Any person signing documents under paragraph VI.G shall make the following certification:

"I certify under penalty of law that this document and all attachments were prepared under my direction or supervision in accordance with a system designed to assure that qualified personnel properly gathered and evaluated the information submitted. Based on my inquiry of the person or persons who manage the system, or those persons directly responsible for gathering the information, the information submitted is, to the best of my knowledge and belief, true, accurate, and complete. I am aware that there are significant penalties for submitting false information, including the possibility of fine and imprisonment for knowing violations."

H. Penalties for Falsification of Reports.

Section 309(c)(4) of the Clean Water Act provides that any person who knowingly makes any false material statement, representation, or certification in any record or other document submitted or required to be maintained under this permit, including reports of compliance or noncompliance shall, upon conviction, be punished by a fine or not more than \$10,000, or by imprisonment for not more than 2 years, or by both.

I. Oil and Hazardous Substance Liability.

Nothing in this permit shall be construed to preclude the institution of any legal action or relieve the permittee from any responsibilities, liabilities, or penalties to which the permittee is or may be subject under section 311 of the CWA or section 106 of the Comprehensive Environmental Response, Compensation and Liability Act of 1980 (CERCLA).

J. Property Rights.

The issuance of this permit does not convey any property rights of any sort, nor any exclusive privileges, nor does it authorize any injury to private property nor any invasion of personal rights, nor any infringement of Federal, State or local laws or regulations.

K. Severability.

The provisions of this permit are severable, and if any provision of this permit, or the application of any provision of this permit to any circumstance, is held invalid, the application of such provision to other circumstances, and the remainder of this permit shall not be affected thereby.

L. Requiring an individual permit or an alternative general permit.

1. The Director may require any person authorized by this permit to apply for and/or obtain either an individual NPDES permit or an alternative NPDES general permit. Any interested person may petition the Director to take action under this paragraph. Where the Director requires a discharger authorized to discharge under this permit to apply for an individual NPDES permit, the Director shall notify the discharger in writing that a permit application is required. This notification shall include a brief statement of the reasons for this decision, an application form, a statement setting a deadline for the discharger to file the application, and a statement that on the effective date of issuance or denial of the individual NPDES permit or the alternative general permit as it applies to the individual permittee, coverage under this general permit

shall automatically terminate. Applications shall be submitted to the appropriate Regional Office indicated in Part V.C of this permit. The Director may grant additional time to submit the application upon request of the applicant. If a discharger fails to submit in a timely manner an individual NPDES permit application as required by the Director under this paragraph, then the applicability of this permit to the individual NPDES permittee is automatically terminated at the end of the day specified by the Director for application submittal.

2. Any discharger authorized by this permit may request to be excluded from the coverage of this permit by applying for an individual permit. In such cases, the permittee shall submit an individual application in accordance with the requirements of 40 CFR 122.26(c)(1)(ii), with reasons supporting the request, to the Director at the address for the appropriate Regional Office indicated in Part V.C of this permit. The request may be granted by issuance of any individual permit or an alternative general permit if the reasons cited by the permittee are adequate to support the request.

3. When an individual NPDES permit is issued to a discharger otherwise subject to this permit, or the discharger is authorized to discharge under an alternative NPDES general permit, the applicability of this permit to the individual NPDES permittee is automatically terminated on the effective date of the individual permit or the date of authorization of coverage under the alternative general permit, whichever the case may be. When an individual NPDES permit is denied to an owner or operator otherwise subject to this permit, or the owner or operator is denied for coverage under an alternative NPDES general permit, the applicability of this permit to the individual NPDES permittee is automatically terminated on the date of such denial, unless otherwise specified by the Director.

M. State/Environmental Laws.

1. Nothing in this permit shall be construed to preclude the institution of any legal action or relieve the permittee from any responsibilities, liabilities, or penalties established pursuant to any applicable State law or regulation under authority preserved by section 510 of the Act.

2. No condition of this permit shall release the permittee from any responsibility or requirements under other environmental statutes or regulations.

N. Proper Operation and Maintenance.

The permittee shall at all times properly operate and maintain all facilities and systems of treatment and control (and related appurtenances) which are installed or used by the permittee to achieve compliance with the conditions of this permit and with the requirements of storm water pollution prevention plans. Proper operation and maintenance also includes adequate laboratory controls and appropriate quality assurance procedures. Proper operation and maintenance requires the operation of backup or auxiliary facilities or similar systems, installed by a permittee only when necessary to achieve compliance with the conditions of the permit.

O. Inspection and Entry.

The permittee shall allow the Director or an authorized representative of EPA, the State, or, in the case of a construction site which discharges through a municipal separate storm sewer, an authorized representative of the municipal operator or the separate storm sewer receiving the discharge, upon the presentation of credentials and other documents as may be required by law, to:

1. Enter upon the permittee's premises where a regulated facility or activity is located or conducted or where records must be kept under the conditions of this permit;
2. Have access to and copy at reasonable times, any records that must be kept under the conditions of this permit; and
3. Inspect at reasonable times any facilities or equipment (including monitoring and control equipment).

P. Permit Actions.

This permit may be modified, revoked and reissued, or terminated for cause. The filing of a request by the permittee for a permit modification, revocation and reissuance, or termination, or a notification of planned changes or anticipated noncompliance does not stay any permit condition.

Part VII. Reopener Clause

A. If there is evidence indicating potential or realized impacts on water quality due to any storm water discharge associated with industrial activity covered by this permit, the discharger may be required to obtain individual permit or an alternative general permit in accordance with Part I.C of this permit or the permit

may be modified to include different limitations and/or requirements.

B. Permit modification or revocation will be conducted according to 40 CFR 122.62, 122.63, 122.64 and 124.5.

Part VIII. Termination of Coverage

A. Notice of Termination.

Where a site has been finally stabilized and all storm water discharges from construction activities that are authorized by this permit are eliminated, or where the operator of all storm water discharges at a facility changes, the operator of the facility may submit a Notice of Termination that is signed in accordance with Part VI.G of this permit. The Notice of Termination shall include the following information:

1. The mailing address of the construction site for which the notification is submitted. Where a mailing address for the site is not available, the location of the approximate center of the site must be described in terms of the latitude and longitude to the nearest 15 seconds, or the section, township and range to the nearest quarter section;
2. The name, address and telephone number of the operator addressed by the Notice of Termination;
3. The NPDES permit number for the storm water discharge identified by the Notice of Termination;
4. An indication of whether the storm water discharges associated with industrial activity have been eliminated or the operator of the discharges has changed; and
5. The following certification signed in accordance with Part VI.G (signatory requirements) of this permit:

"I certify under penalty of law that all storm water discharges associated with industrial activity from the identified facility that are authorized by an NPDES general permit have been eliminated or that I am no longer the operator of the facility or construction site. I understand that by submitting this notice of termination, I am no longer authorized to discharge storm water associated with industrial activity under this general permit, and that discharging pollutants in storm water associated with industrial activity to waters of the United States is unlawful under the Clean Water Act where the discharge is not authorized by a NPDES

permit. I also understand that the submittal of this notice of termination does not release an operator from liability for any violations of this permit or the Clean Water Act."

For the purposes of this certification, elimination of storm water discharges associated with industrial activity means that all disturbed soils at the identified facility have been finally stabilized and temporary erosion and sediment control measures have been removed or will be removed at an appropriate time, or that all storm water discharges associated with construction activities from the identified site that are authorized by a NPDES general permit have otherwise been eliminated.

B. Addresses.

All Notices of Termination are to be sent, using the form provided by the Director (or a photocopy thereof), n4 to the following address: Storm Water Notice of Termination, PO Box 1185, Newington, VA 22122.

Part IX. Definitions

Best Management Practices (BMPs) means schedules of activities, prohibitions of practices, maintenance procedures, and other management practices to prevent or reduce the pollution of waters of the United States. BMPs also include treatment requirements, operating procedures, and practices to control plant site runoff, spillage or leaks, sludge or waste disposal, or drainage from raw material storage.

Commencement of Construction -- The initial disturbance of soils associated with clearing, grading, or excavating activities or other construction activities.

CWA means the Clean Water Act or the Federal Water Pollution Control Act.

Dedicated portable asphalt plant -- A portable asphalt plant that is located on or contiguous to a construction site and that provides asphalt only to the construction site that the plant is located on or adjacent to. The term dedicated portable asphalt plant does not include facilities that are subject to the asphalt emulsion effluent limitation guideline at 40 CFR 443.

Dedicated portable concrete plant -- A portable concrete plant that is located on or contiguous to a construction site and that provides concrete only to the construction site that the plant is located on or adjacent to.

Director means the Regional Administrator of the Environmental Protection Agency or an authorized representative.

Final Stabilization means that all soil disturbing activities at the site have been completed, and that a uniform perennial vegetative cover with a density of 70% of the cover for unpaved areas and areas not covered by permanent structures has been established or equivalent permanent stabilization measures (such as the use of riprap, gabions, or geotextiles) have been employed.

Flow-weighted composite sample means a composite sample consisting of a mixture of aliquots collected at a constant time interval, where the volume of each aliquot is proportional to the flow rate of the discharge.

Large and Medium municipal separate storm sewer system means all municipal separate storm sewers that are either: (i) located in an incorporated place (city) with a population of 100,000 or more as determined by the latest Decennial Census by the Bureau of Census (these cities are listed in Appendices F and G of 40 CFR Part 122); or (ii) located in the counties with unincorporated urbanized populations of 100,000 or more, except municipal separate storm sewers that are located in the incorporated places, townships or towns within such counties (these counties are listed in Appendices H and I of 40 CFR Part 122); or (iii) owned or operated by a municipality other than those described in paragraph (i) or (ii) and that are designated by the Director as part of the large or medium municipal separate storm sewer system.

NOI means notice of intent to be covered by this permit (see Part II of this permit.)

NOT means notice of termination (see Part VIII of this permit).

Point Source means any discernible, confined, and discrete conveyance, including but not limited to, any pipe, ditch, channel, tunnel, conduit, well, discrete fissure, container, rolling stock, concentrated animal feeding operation, landfill leachate collection system, vessel or other floating craft from which pollutants are or may be discharges. This term does not include return flows from irrigated agriculture or agricultural storm water runoff.

Runoff coefficient means the fraction of total rainfall that will appear at the conveyance as runoff.

Storm Water means storm water runoff, snow melt runoff, and surface runoff and drainage.

Storm Water Associated with Industrial Activity means the discharge from any conveyance which is used for collecting and conveying storm water and which is directly related to manufacturing, processing or raw materials storage areas at an industrial plant. The term does not include discharges from facilities or activities excluded from the NPDES program. For the categories of industries identified in paragraphs (i) through (x) of this definition, the term includes, but is not limited to, storm water discharges from industrial plant years; immediate access roads and rail lines used or traveled by carriers of raw materials, manufactured products, waste material, or by-products used or created by the facility; material handling sites; refuse sites; sites used for the application or disposal of process waste waters (as defined at 40 CFR 401); sites used for the storage and maintenance of material handling equipment; sites used for residual treatment, storage, or disposal; shipping and receiving areas; manufacturing buildings; storage areas (including tank farms) for raw materials, and intermediate and finished products; and areas where industrial activity has taken place in the past and significant materials remain and are exposed to storm water. For the categories of industries identified in paragraph (xi) of this definition, the term includes only storm water discharges from all areas (except access roads and rail lines) listed in the previous sentence where material handling equipment or activities, raw materials, intermediate products, final products, waste materials, by-products, or industrial machinery are exposed to storm water. For the purposes of this paragraph, material handling activities include the: storage, loading and unloading, transportation, or conveyance of any raw material, intermediate product, finished product, by-product or waste product. The term excludes areas located on plant lands separate from the plant's industrial activities, such as office buildings and accompanying parking lots as long as the drainage from the excluded areas is not mixed with storm water drained from the above described areas. Industrial facilities (including industrial facilities that are Federally, State or municipally owned or operated that meet the description of the facilities listed in this paragraph (i)-(xi) of this definition) include those facilities designated under 122.26(a)(1)(v). The following categories of facilities are considered to be engaging in "industrial activity" for purposes of this subsection: (i) Facilities subject to storm water effluent limitations guidelines, new source performance standards, or toxic pollutant effluent standards under 40 CFR subchapter N (except facilities with toxic pollutant effluent standards which are exempted under category

(xi) of this definition); (ii) Facilities classified as Standard Industrial Classifications 24 (except 2434), 26 (except 265 and 267), 28 (except 283), 29, 311, 32 (except 323), 33, 3441, 373; (iii) Facilities classified as Standard Industrial Classifications 10 through 14 (mineral industry) including active or inactive mining operations (except for areas of coal mining operations no longer meeting the definition of a reclamation area under 40 CFR 434.11(1) because the performance bond issued to the facility by the appropriate SMCRA authority has been released, or except for areas of non-coal mining operations which have been released from applicable State or Federal reclamation requirements after December 17, 1990) and oil and gas exploration, production, processing, or treatment operations, or transmission facilities that discharge storm water contaminated by contact with or that has come into contact with, any overburden, raw material, intermediate products, finished products, byproducts or waste products located on the site of such operations; inactive mining operations are mining sites that are not being actively mined, but which have an identifiable owner/operator;

(iv) Hazardous waste treatment, storage, or disposal facilities, including those that are operating under interim status or a permit under Subtitle C of RCRA;

(v) Landfills, land application sites, and open dumps that have received any industrial wastes (waste that is received from any of the facilities described under this subsection) including those that are subject to regulation under Subtitle D of RCRA;

(vi) Facilities involved in the recycling of materials, including metal scrap yards, battery reclaimers, salvage yards, and automobile junkyards, including but limited to those classified as Standard Industrial Classification 5015 and 5093;

(vii) Steam electric power generating facilities, including coal handling sites;

(viii) Transportation facilities classified as Standard Industrial Classifications 40, 41, 42 (except 4221-25), 43, 44, 45 and 5171 which have vehicle maintenance shops, equipment cleaning operations, or airport deicing operations. Only those portions of the facility that are either involved in vehicle maintenance (including vehicle rehabilitation, mechanical repairs, painting, fueling, and lubrication), equipment cleaning operations, airport deicing operations, or which are otherwise identified under paragraphs (i)-(vii) or (ix)-(xi) of this subsection are associated with industrial activity;

(ix) Treatment works treating domestic sewage or any other sewage sludge or wastewater treatment device or system, used in the storage treatment, recycling, and reclamation of municipal or domestic sewage, including land dedicated to the disposal of sewage sludge that are located within the confines of the facility, with a design flow of 1.0 mgd or more, or required to have an approved pretreatment program under 40 CFR 403. Not included are farm lands, domestic gardens or lands used for sludge management where sludge is beneficially reused and which are not physically located in the confines of the facility, or areas that are in compliance with 40 CFR 503;

(x) Construction activity including clearing, grading and excavation activities except: operations that result in the disturbance of less than five acres of total land area which are not part of a larger common plan of development or sale;

(xi) Facilities under Standard Industrial Classifications 20, 21, 22, 23, 2434, 25, 265, 267, 27, 283, 285, 30, 31 (except 311), 323, 34 (except 3441), 35, 36, 37 (except 373), 38, 39, 4221-25, (and which are not otherwise included within categories (i)-(x)). n5

Waters of the United States means:

(a) All waters which are currently used, were used in the past, or may be susceptible to use in interstate or foreign commerce, including all waters which are subject to the ebb and flow of the tide;

(b) All interstate waters, including interstate "wetlands";

(c) All other waters such as interstate lakes, rivers, streams (including intermittent streams), mudflats, sandflats, wetlands, sloughs, prairie potholes, wet meadows, playa lakes, or natural ponds the use, degradation, or destruction of which would affect or could affect interstate or foreign commerce including any such waters:

(1) Which are or could be used by interstate or foreign travelers for recreational or other purposes;

(2) From which fish or shellfish are or could be taken and sold in interstate or foreign commerce; or

(3) Which are used or could be used for industrial purposes by industries in interstate commerce;

(d) All impoundments of waters otherwise defined as waters of the United States under this definition;

(e) Tributaries of waters identified in paragraphs (a) through (d) of this definition;

(f) The territorial sea; and

(g) Wetlands adjacent to waters (other than waters that are themselves wetlands) identified in paragraphs (a) through (f) of this definition.

Waste treatment systems, including treatment ponds or lagoons designed to meet the requirements of CWA are not waters of the United States.

Part X. State Specific Conditions

The provisions of this Part provide modifications or additions to the applicable conditions of Parts I through IX of this permit to reflect specific additional conditions identified as part of the State section 401 certification process. The additional revisions and requirements listed below are set forth in connection with particular State, Indian lands and Federal facilities and only apply to the States and Federal facilities specifically referenced.

A. Massachusetts. Massachusetts 401 certification special permit conditions revise the permit as follows:

1. Part I of the permit is revised to read as follows:

Part I. Coverage Under This Permit

A. Permit Area. This permit covers all areas of the Commonwealth of Massachusetts.

B. Eligibility.

* * * * *

3. Limitations on Coverage.

* * * * *

h. new or increased storm water discharges to coastal water segments within Massachusetts designated as "Areas of Critical Environmental Concern (ACEC)" (for information on ACEC, please contact the Executive Office of Environmental Affairs, Coastal Zone Management at (617) 727-9530);

i. new or increased discharges, as defined at 314 CMR 4.02(19), which meet the definition of "storm water discharge," as defined at 314 CMR 3.04(2)(a)(1) or (2)(b), to Outstanding Resource Waters which have not met the provisions of 314 CMR 4.04(3) and Part III C.1 of this permit.

2. Part II of the permit is revised to read as follows:

Part II. Notice of Intent Requirements

C. Where to Submit.

1. Facilities which discharge storm water associated with industrial activity must use a NOI form provided by the Director (or photocopy thereof). The form in the Federal Register notice in which this permit was published may be photocopied and used. Forms are also available by calling the Storm Water Hotline at (703) 821-4823, or the NPDES Programs Operations Section at US EPA Region 1 at (617) 565-3525. NOIs must be signed in accordance with Part VII.G (signatory requirements) of this permit. NOIs are to be submitted to the Director of the NPDES program in care of the following address: Storm Water Notice of Intent, US EPA Region 1, MA, PO Box 1215, Newington, VA 22122.

2. A copy of the NOI for all discharges to Outstanding Resource Waters shall be submitted to the Commonwealth of Massachusetts at the following address: Massachusetts Department of Environmental Protection, Storm Water Notice of Intent, BRP – WP 43, PO Box 4062, Boston, Massachusetts 02211.

For details on filing for permits with MA DEP see 310 CMR 4.00, Timely Action Schedule and Fee Provisions. For other information call the MA DEP Information Services Section at (617) 338-2255 or the Technical Services Section of the DEP Division of Water Pollution Control at (508) 792-7470.

3. Part III of the permit is revised to read as follows:

Part III. Special Conditions

C. Set Backs and Best Management Practices

1. Storm water discharge outfall pipes to public water supplies and other Outstanding Resource Waters shall be removed and set back when dischargers are seeking to increase the discharge or change the site storm water drainage system; all new discharge outfalls must be set back from the receiving water. Receiving swales for outfall pipes shall be prepared to minimize erosion and maximize infiltration prior to discharge. The goal is to infiltrate as much as feasible; infiltration trenches and basins, filter media dikes and/or other BMPs shall be used to meet the goal. Discharges shall employ Best Management Practices (BMPs) for controlling storm water. See Protecting Water Quality in Urban Areas by the Minnesota Pollution Control Agency, Division of Water Quality as a reference for BMPs.

2. Storm water discharges to waters that are not classified as Outstanding Resource Waters shall be subject to the requirements of this permit. New discharge outfall pipes shall be designed to be set back from the receiving water when site conditions allow. For existing discharge outfall pipes, when the storm water drainage system is undergoing changes, outfall pipes shall be set back from the receiving water. A receiving swale, infiltration trench or basin, filter media dikes or other BMPs should be prepared with the goal to minimize erosion yet maximize infiltration or otherwise improve water quality prior to discharge.

3. All discharges to Outstanding Resource Waters authorized under this permit must be provided the best practical method of treatment to protect and maintain the designated use of the outstanding resource.

B. Delaware . Delaware 401 certification special permit conditions revise the permit as follows:

1. Part I of the permit is revised to read:

Part I. Coverage Under This Permit

A. Permit Area. This permit covers all Federal facilities administered by Region 3 in the State of Delaware.

2. Part II of the permit is revised to read as follows:

Part II. Notice of Intent Requirements

C. Where to Submit.

1. Facilities which discharge storm water associated with industrial activity must use a NOI form provided by the Director (or photocopy thereof). The form in the Federal Register notice in which this permit was published may be photocopied and used. Forms are also available by calling (703) 821-4823. NOIs must be signed in accordance with Part VII.G (signatory requirements) of this permit. NOIs are to be submitted to the Director of the NPDES program in care of the following address: Storm Water Notice of Intent, PO Box 1215, Newington, VA 22122.

2. A copy of all Notices of Intent (NOIs) shall be submitted to the State of Delaware at the following address: Water Pollution Control Branch, NPDES Storm Water Program, Delaware Department of Natural Resources and Environmental Control, 89 Kings Highway, P.O. Box 1401, Dover, DE 19903.

3. The following section is added to Part III of the permit:

Part III. Special Conditions, Management Practices and Other Non-Numeric Limitations

C. Special Conditions. The permittee must comply with the requirements of 7 Delaware Code Chapter 40 and the Delaware Sediment and Storm Water Regulations (January, 1991).

4. Part IV of the permit is revised to read as follows:

Part IV. Storm Water Pollution Prevention Plan

B. Signature and Plan Review

1. The plan shall be signed in accordance with Part VII.G (signatory requirements), and be retained on-site at the facility which generates the storm water discharge in accordance with Part VI.E (retention of records) of this permit. A copy of the plan, as well as subsequent revisions, shall also be submitted to the State of Delaware at the following address: Water Pollution

Control Branch, NPDES Storm Water Program, Delaware Department of Natural Resources and Environmental Control, 89 Kings Highway, P.O. Box 1401, Dover, DE 19903.

C. District of Columbia. District of Columbia 401 certification special permit conditions revise the permit as follows:

1. Part I of the permit is revised to read as follows:

Part I. Coverage Under This Permit

A. Permit Area. The permit covers all areas administered by Region 3 in the District of Columbia.

B. Eligibility.

3. Limitations on Coverage. The following storm water discharges from construction sites are not authorized by this permit:

f. unpermitted discharges that are subject to the NPDES program, excluding discharges associated with construction activity.

D. Florida. Florida 401 certification special permit conditions revise the permit as follows:

1. Part I of the permit is revised to read as follows:

Part I. Coverage Under This Permit

A. Permit Area. The permit covers all areas administered by Region 4 in the State of Florida.

2. Part II of the permit is modified to read as follows:

Part II. Notice of Intent Requirements

A. Deadlines for Notification.

2. Individuals who intend to obtain coverage under this general permit for storm water discharges from a

construction site where disturbances associated with the construction project commence after October 1, 1992, shall submit a Notice of Intent (NOI) in accordance with the requirements of this Part at least 2 days prior to the commencement of construction activities (e.g. the initial disturbance of soils associated with clearing, grading, excavation activities, or other construction activities). Prior to submitting this NOI, the owner of a storm water management system must receive a State of Florida storm water permit from either the Florida Department of Environmental Regulation (FDER) or a Florida Water Management District (FWMD).

B. Contents of Notice of Intent.

6. An estimate of project start date and completion dates, estimates of the number of acres of the site on which soil will be disturbed, and a certification that a storm water pollution prevention plan has been prepared for the site in accordance with Part IV of this permit. (A copy of the plans or permits should not be included with the NOI submission). The applicant shall submit a narrative statement certifying that the storm water pollution prevention plan for the facility provides compliance with approved State of Florida issued permits, erosion and sediment control plans and storm water management plans. The applicant shall also submit a copy of the cover page of the State permit issued by FDER or a FWMD to the facility for the storm water associated with construction activities.

D. Additional Notification. Facilities which are operating under approved State or local sediment and erosion plans, grading plans, or storm water management plans shall submit signed copies of the Notice of Intent to the State or local agency approving such plans in accordance with the deadlines in Part II.A of this permit (or sooner where required by State or local rules), in addition to submitting the Notice of Intent to EPA in accordance with paragraph II.C. Facilities which discharge storm water associated with construction activities to a municipal separate storm water system within Broward, Dade, Duval, Escambia, Hillsborough, Orange, Palm Beach, Pinellas, Polk or Sarasota Counties shall submit a copy of the NOI to the operator of the municipal separate storm sewer system. Included within these counties, the Florida Department of Transportation (FDOT), incorporated municipalities

and Chapter 298 Special Districts shall also be notified where they own or operate a municipal separate storm sewer system receiving storm water discharges associated with construction activity covered by this permit.

3. Part III of the permit is revised to read as follows:

Part III. Special Conditions, Management Practices and Other Non-Numeric Limitations

A. Prohibition on Non-Storm Water Discharges

2.

b. The following non-storm water discharges may be authorized by this permit provided the non-storm water component of the discharge is in compliance with paragraph IV.D.5 and the storm water management system is designed to accept these discharges and provide treatment of the non-storm water component sufficient to meet Florida water quality standards: discharges from fire fighting activities; fire hydrant flushings; waters used to wash vehicles or control dust in accordance with Part IV.D.2.c.(2); potable water sources including waterline flushing; irrigation drainage; routine external building washdown which does not use detergents; pavement washwaters where spills or leaks of toxic or hazardous materials have not occurred (unless all spilled material has been removed) and where detergents are not used; air conditioning condensate; springs; uncontaminated ground water; and foundation or footing drains where flows are not contaminated with process materials such as solvents. Discharges resulting from ground water dewatering activities at construction sites are not covered by this permit. The applicant may seek coverage for these discharges under NPDES General Permit No. FLG830000, published on July 17, 1989 (54 FR 29986) and modified on August 29, 1991 (56 FR 42736).

4. Part IV of the permit is revised to read as follows:

Part IV. Storm Water Pollution Prevention Plans

B. Signature and Plan Review

2. The permittee shall submit plans to the State agency which issued the storm water permit and shall make plans available upon request to the Director; a state or local agency approving sediment and erosion plans, grading plans, or storm water management plans; or in the case of a storm water discharge associated with industrial activity which discharges through a municipal separate storm sewer system with an NPDES permit, to the municipal operator of the system.

C. Keeping Plans Current

The permittee shall amend the plan whenever there is change in design, construction, operation, or maintenance, which has a significant effect on the potential for the discharge of pollutants to the waters of the United States, including the addition of or change in location of storm water discharge points, and which has not otherwise been addressed in the plan or if the storm water pollution prevention plan proves to be ineffective in eliminating or significantly minimizing pollutants from sources identified under Part IV.D.2 of this permit, or in otherwise achieving the general objectives of controlling pollutants in storm water discharges associated with industrial activity. In addition, the plan shall be amended to identify any new contractor and/or subcontractor that will implement a measure of the storm water pollution prevention plan (see Part IV.E). Amendments to the plan may be reviewed by EPA in the same manner as Part IV.B above. Amendments to the plan must be submitted to the State agency which issued the State storm water permit.

D. Contents of Plan

1. Site Description

d. An estimate of the runoff coefficient of the site before, during and after construction using "C" from the Rational Method, existing data describing the soil or the quality of any discharge from the site and an estimate of the size of the drainage area for each outfall;

2. Controls

Each plan shall include a description of appropriate controls and measures that will be implemented at the construction site. The plan will clearly describe for each major activity identified in Part IV.D.1.b appropriate control measures and the timing during the construction process that the measures will be implemented. (For example, perimeter controls for one portion of the site will be installed after the clearing and grubbing necessary for installation of the measure, but before the clearing and grubbing for the remaining portions of the site. Perimeter controls will be actively maintained until final stabilization of those portions of the site upward of the perimeter control. Temporary perimeter controls will be removed after final stabilization). All controls shall be consistent with the requirements set forth in the State Water Policy of Florida (Chapter 17-40, Florida Administrative Code), the applicable storm water permitting requirements of the FDER or appropriate FWMD, and the guidelines contained in the Florida Development Manual: A Guide to Sound Land and Water Management (FDER, 1988) and any subsequent amendments. The description and implementation of controls shall address the following minimum components:

a. Erosion and sediment controls

(1) stabilization practices. A description of interim and permanent stabilization practices, including site-specific scheduling of the implementation of the practices. Site plans should ensure that existing vegetation is preserved where attainable and that disturbed portions of the site are stabilized. Stabilization practices may include: temporary seeding, permanent seeding, mulching, geotextiles, sod stabilization, vegetative buffer strips, protection of trees, preservation of mature vegetation, and other appropriate measures. A record of the dates when major grading activities occur, when construction activities temporarily or permanently cease on a portion of the site, and when stabilization measures are initiated shall be included in the plan. Stabilization measures shall be initiated as soon as practicable in portions of the site where construction activities have temporarily or permanently ceased.

(a) paragraph deleted

(b) paragraph deleted

(c) paragraph deleted

(2) Structural Practices. A description of structural practices to divert flows from exposed soils, store flows or otherwise limit runoff and the discharge of pollutants from exposed areas of the site in accordance with the requirements set forth in Section 17-40, 420, F.A.C., and the applicable storm water regulations of the FDER or appropriate FWMD. Such practices may include silt fences, earth dikes, drainage swales, sediment traps, check dams, subsurface drains, pipe slope drains, level spreaders, storm drain inlet protection, rock outlet protection, reinforced soil retaining systems, gabions, and temporary or permanent sediment basins. Structural practices shall be placed on upland soils unless a State of Florida wetland resource management permit issued pursuant to Chapters 373 or 403, F.S., and the applicable regulations of the FDER or FWMD authorize otherwise. The installation of these devices may be subject to Section 404 of the CWA.

* * * * *

b. Storm water management. A description of measures that will be installed during the construction process to control pollutants in storm water discharges that will occur after construction operations have been completed. The description of controls shall be consistent with the requirements set forth in the State Water Policy of Florida (Chapter 17-40, F.A.C.), the applicable storm water permitting regulations of the FDER or appropriate FWMD, and the guidelines contained in the Florida Development Manual: A Guide to Sound Land and Water Management (FDER, 1988), and any subsequent amendments. Structural measures shall be placed on upland soils unless a State of Florida wetland resource management permit issued pursuant to Chapters 373 or 403, F.S., and the applicable regulations of the FDER or FWMD authorize otherwise. The installation of these devices may be subject to Section 404 of the CWA. This NPDES permit only addresses the installation of storm water management measures, and not the ultimate operation and maintenance of such structures after the construction activities have been completed and the site has undergone final stabilization. Permittees are only responsible for the installation and maintenance of storm water management measures prior to final stabilization of the site, and are not responsible for maintenance after storm water discharges associated with industrial activity have been eliminated from the site. However, all storm water management systems shall be operated and maintained in perpetuity after final site stabilization in accordance with the requirements set forth in the State of Florida storm water permit issued for the site.

(1) Such practices may include: storm water detention structures (including wet ponds); storm water retention structures; flow attenuation by use of open vegetated swales and natural depressions; infiltration of runoff onsite; and sequential systems (which combine several practices). Pursuant to the requirements of section 17-40, 420, F.A.C., the storm water management system shall be designed to remove at least 80 percent of the average annual load of pollutants which cause or contribute to violations of water quality standards (95 percent if the system discharges to an Outstanding Florida Water). The pollution prevention plan shall include an explanation of the technical basis used to select the practices to control pollution where flows exceed predevelopment levels.

(2) Velocity dissipation devices shall be placed at discharge locations and along the length of any outfall channel for the purpose of providing a non-erosive velocity flow from the structure to a water course so that the natural physical and biological characteristics and functions are maintained and protected. Equalization of the predevelopment and post-development storm water peak discharge rate and volume shall be a goal in the design of the post-development storm water management system.

c. Other controls

(1) waste disposal. No solid materials, including building materials, shall be discharged to waters of the United States, except as authorized by a section 404 permit and by a State of Florida wetland resource management permit issued pursuant to chapters 373 or 403, F.S., and the applicable regulations of the FDER or FWMD.

* * * * *

(4) The plan shall address the proper application rates and methods for the use of fertilizers and pesticides at the construction site and set forth how these procedures will be implemented and enforced.

* * * * *

4. Inspections. Qualified personnel (provided by the discharger) shall inspect all points of discharge into waters of the United States or to a municipal separate storm sewer system and all disturbed areas of the construction site that have not been finally stabilized, areas used for storage of materials that are exposed to precipitation, structural control measures, storm water management systems, and locations where vehicles enter or exit the site at least once every seven calendar days

and within 24 hours of the end of a storm that is 0.25 inches or greater. Where sites have been finally stabilized, or during seasonal arid periods in arid areas (areas with an average annual rainfall of 0 to 10 inches) and semi-arid areas (areas with an average annual rainfall of 10 to 20 inches) such inspection shall be conducted at least once every month.

a. Disturbed areas and areas used for storage of materials that are exposed to precipitation shall be inspected for evidence of, or the potential for, pollutants entering the storm water management system. The storm water management system and erosion and sediment control measures identified in the plan shall be observed to ensure that they are operating correctly. Where discharge locations or points are accessible, they shall be inspected to ascertain whether erosion control and storm water management measures are effective in meeting the performance standards set forth in State Water Policy (chapter 17-40, F.A.C.) and the applicable storm water permitting regulations of the FDER or appropriate FWMD. Locations where vehicles enter or exit the site shall be inspected for evidence of offsite sediment tracking.

* * * * *

5. Part VI of the permit is revised to read as follows:

Part VI. Standard Permit Conditions

* * * * *

O. Inspection and Entry

* * * * *

4. Sample or monitor at reasonable times, for the purposes of assuring permit compliance or as otherwise authorized by the CWA, any substances or parameter at any location on the site.

* * * * *

6. Part VIII of the permit is revised to read as follows:

Part VIII. Termination of Coverage

* * * * *

C. Additional Notification.

A copy of the Notice of Termination shall be sent to the State agency which issued the State storm water permit for the site and, if the storm water management system discharges to a municipal separate storm sewer system within Broward, Dade, Duval, Escambia, Hillsborough, Orange, Palm Beach, Pinellas, Polk or Sarasota Counties, to the owner of that system. Included within these counties, the Florida Department of Transportation (FDOT), incorporated municipalities, and chapter 298 Special Districts also shall be notified where they own or operate a municipal separate storm sewer system receiving storm water discharges associated with construction activity covered by this permit.

E. American Samoa. American Samoa 401 certification special permit conditions revise the permit as follows:

1. Part I of the permit is revised to read:

Part I. Coverage Under This Permit

A. Permit Area. The permit covers all areas administered by EPA Region IX in American Samoa.

2. Part II of the permit is revised to read as follows:

Part II. Notice of Intent Requirements

* * * * *

C. Where to Submit

* * * * *

1. A copy of the NOI shall be submitted to American Samoa Environmental Protection Agency at the same time as submittal to the U.S. EPA.

3. The following paragraph is added to Part IV of the permit:

Part IV. Storm Water Pollution Prevention Plan

* * * * *

B. Signature and Plan Review

* * * * *

4. All pollution prevention plans for storm water discharges in American Samoa shall be submitted to the American Samoa Environmental Protection Agency for review and approval.

F. Guam. Guam 401 certification special permit conditions revise the permit as follows:

1. Part I of the permit is revised to read:

Part I. Coverage Under This Permit

A. Permit Area. The permit covers all areas administered by EPA Region IX in Guam.

2. Part II of the permit is revised to read as follows:

Part II. Notice of Intent Requirements

C. Where to Submit

1. Facilities which discharge storm water associated with industrial activity must use a NOI form provided by the Director (or photocopy thereof). The form in the Federal Register notice in which this permit was published may be photocopied and used. Forms are also available by calling (703) 821-4823. NOIs must be signed in accordance with part VII.G (signatory requirements) of this permit. NOIs are to be submitted to the Director of the NPDES program in care of the following address: Storm Water Notice of Intent, PO Box 1215, Newington, VA 22122.

2. A copy of the NOI also shall be submitted to appropriate Government of Guam agencies and the Guam Environmental Protection Agency at the following address: D-107 Harmon Plaza, 130 Rojas St., Harmon, Guam 95911.

3. Part IV of the permit is revised to read as follows:

Part IV. Storm Water Pollution Prevention Plan

B. Signature and Plan Review

1. The plan shall be signed in accordance with Part VII.G (signatory requirements), and be retained on-site at the facility which generates the storm water discharge in accordance with Part VI.E (retention of records) of this permit. A copy of the plan shall also be submitted to the Guam Environmental Protection Agency at the following address: D-107 Harmon Plaza, 130 Rojas St., Harmon, Guam 95911.

4. Part VI of the permit is revised to read:

Part VI. Monitoring and Reporting Requirements

D. Reporting: Where to Submit

1.

d. Signed copies of discharge monitoring reports required under Parts VI.D.1.a, VI.D.1.b, and VI.D.1.c, individual permit applications and all other reports required herein, shall be submitted to the Director of the NPDES program at the address of the appropriate Regional Office: United States EPA, Region IX, Water Management Division, (W-5-1), Storm Water Staff, 75 Hawthorne Street, San Francisco, CA 94105, and to the Guam Environmental Protection Agency at the following address: D-107 Harmon Plaza, 130 Rojas St., Harmon, Guam 95911.

- ¹ The September 9, 1992, fact sheets incorporate portions of the draft general permits published on August 16, 1991 (56 FR 40948). These portions of the August 16, 1991, fact sheets are also incorporated into today's permits. Sections of the August 16, 1991, fact sheet being incorporated are section 1, Background; section 4, Summary of Options for Controlling Pollutants; and section 5, The Federal/Municipal Partnership: The Role of Municipal Operators of Large and Medium Municipal Separate Storm Sewers.
- ² On June 4, 1992, the United State Court of Appeals for the Ninth Circuit remanded the exemption for construction sites of less than five acres to the EPA for further rulemaking. (Nos. 90-70671) and 91-70200).
- ³ A copy of the approved NOI form is provided in Appendix C of this notice.
- ⁴ A copy of the approved NOT form is provided in Appendix D of this notice.
- ⁵ On June 4, 1992, the United States Court of Appeals for the Ninth Circuit remanded the exclusion for manufacturing facilities in category (xi) which do not have materials or activities exposed to storm water to the EPA for further rulemaking. (Nos. 90-70671 and 91-70200).

APPENDIX B: FHWA 23 CFR PART 650

FEDERAL-AID POLICY GUIDE
December 7, 1994,
Transmittal 12
23 CFR 650B

SUBCHAPTER G - ENGINEERING AND TRAFFIC OPERATIONS

PART 650 - BRIDGES, STRUCTURES, AND HYDRAULICS

Subpart B - Erosion and Sediment Control on Highway Construction Projects

Sec.

650.201 Purpose.

650.203 Policy.

650.205 Definitions.

650.207 Plans, specifications, and estimates.

650.209 Construction.

650.211 Guidelines.

Authority: 23 U.S.C. 109 (a) and (h), 144, 151, 315, and 319; 23 CFR 1.32; 49 CFR 1.48(b), E.O. 11988 (3 CFR, 1977 Comp. p. 117); Department of Transportation Order 5650.2 dated April 23, 1979 (44 FR 24678); section 161 of Public Law 97-424, 96 Stat. 2097, 3135; section 4(b) of Public Law 97-134, 95 Stat. 1699; and 33 U.S.C. 401, 491 et seq., 511 et seq.; and section 1057 of Public Law 102-240, 105 Stat. 2002.

Source: 39 FR 36332, Oct. 9, 1974, unless otherwise noted.

Sec. 650.201 Purpose.

The purpose of this subpart is to prescribe policies and procedures for the control of erosion, abatement of water pollution, and prevention of damage by sediment deposition from all construction projects funded under title 23, United States Code.

Sec. 650.203 Policy.

It is the policy of the Federal Highway Administration (FHWA) that all highways funded in whole or in part under title 23, United States Code, shall be located, designed, constructed and operated according to standards that will minimize erosion and sediment damage to the highway and adjacent properties and abate pollution of surface and ground water resources. Guidance for the

development of standards used to minimize erosion and sediment damage is referenced in Sec. 650.211 of this part.

Sec. 650.205 Definitions.

Erosion control measures and practices are actions that are taken to inhibit the dislodging and transporting of soil particles by water or wind, including actions that limit the area of exposed soil and minimize the time the soil is exposed.

Permanent erosion and sediment control measures and practices are installations which remain in place and in service on completion of the construction project.

Pollutants are substances, including sediment, which cause deterioration of water quality when added to surface or ground waters in sufficient quantity.

Sediment control measures and practices are actions taken to control the disposition of sediments resulting from surface runoff.

Temporary erosion and sediment control measures and practices are actions taken on an interim basis during construction to minimize the disturbance, transportation and unwanted deposition of sediment.

Sec. 650.207 Plans, specifications and estimates.

- (a) Emphasis shall be placed on erosion control in the preparation of plans, specifications and estimates.
- (b) All reasonable steps shall be taken to insure that highway project designs for the control of erosion and sedimentation and the protection of water quality comply with applicable standards and regulations of other agencies.

Sec. 650.209 Construction.

- (a) Permanent erosion and sediment control measures and practices shall be established and implemented at the earliest practicable time consistent with good construction and management practices.
- (b) Implementation of temporary erosion and sediment control measures and practices shall be coordinated with permanent measures to assure economical, effective and continuous control throughout construction.

- (c) Erosion and sediment control measures and practices shall be monitored and maintained or revised to insure that they are fulfilling their intended function during the construction of the project.
- (d) Federal-aid funds shall not be used in erosion and sediment control actions made necessary because of contractor oversight, carelessness, or failure to implement sufficient control measures.
- (e) Pollutants used during highway construction or operation and material from sediment traps shall not be stockpiled or disposed of in a manner which makes them susceptible to being washed into any watercourse by runoff or high water. No pollutants shall be deposited or disposed of in watercourses.

Sec. 650.211 Guidelines.

- (a) The FHWA adopts the AASHTO Highway Drainage Guidelines, Volume III, "Erosion and Sediment Control in Highway Construction," 1992, [This document is available for inspection from the FHWA headquarters and field offices as prescribed by 49 CFR part 7, appendix D. It may be purchased from the American Association of State and Transportation Officials offices at Suite 225, 444 North Capitol Street, NW., Washington, DC. 20001.] as guidelines to be followed on all construction projects funded under title 23, United States Code. These guidelines are not intended to preempt any requirements made by or under State law if such requirements are more stringent.
- (b) Each State highway agency should apply the guidelines referenced in paragraph (a) of this section or apply its own guidelines, if these guidelines are more stringent, to develop standards and practices for the control of erosion and sediment on Federal-aid construction projects. These specific standards and practices may reference available resources, such as the procedures presented in the AASHTO "Model Drainage Manual," 1991. [This document is available for inspection from the FHWA headquarters and field offices as prescribed by 49 CFR part 7, appendix D. It may be purchased from the American Association of State and Transportation Officials offices at Suite 225, 444 North Capitol Street, NW., Washington, DC. 20001.]
- (c) Consistent with the requirements of section 6217(g) of the Coastal Zone Act Reauthorization Amendments of 1990 (Pub. L. 101-508, 104 Stat. 1388-299), highway construction projects funded under title 23, United States Code, and located in the coastal zone management areas of States with coastal zone management programs approved by the United States Department of Commerce, National Oceanic and Atmospheric Administration, should utilize "Guidance Specifying Management Measures for Sources of Nonpoint Source Pollution in Coastal Water," 84-B-92-002, U.S. EPA, January 1993. [This document is available for inspection and copying as prescribed by 49 CFR part 7, appendix D.] State highway agencies should refer to this Environmental Protection Agency guidance document for the design of projects within coastal zone management areas.

FEDERAL REGISTER
VOL. 59, No. 142

Rules and Regulations

DEPARTMENT OF TRANSPORTATION (DOT)
Federal Highway Administration (FHWA)

23 CFR Part 650

[FHWA Docket No. 93-6]
RIN 2125-AD08

Erosion and Sediment Control on Highway Construction
Projects

59 FR 37935

DATE: Tuesday, July 26, 1994

ACTION: Final rule.

SUMMARY: Section 1057 of the Intermodal Surface Transportation Efficiency Act of 1991 (ISTEA) requires the Secretary of Transportation to develop erosion control guidelines for States to follow when carrying out Federal-aid construction projects. Pursuant to this authority, the existing erosion and sediment control regulation, issued in 1974, is being updated and modified by the FHWA to reflect current state-of-the-art practices and management techniques. To fulfill the requirements of section 1057, the FHWA is adopting, as guidelines, the American Association of State Highway and Transportation Officials (AASHTO) publication Highway Drainage Guidelines, Volume III, "Erosion and Sediment Control in Highway Construction," 1992. The updated regulation includes a statement recommending that each State highway agency (SHA) apply these guidelines, or their own more stringent guidelines, to develop specific standards and practices for the control of erosion.

EFFECTIVE DATE: July 26, 1994.

FOR FURTHER INFORMATION CONTACT: Mr. Robin L. Schroeder, Office of Engineering, HNG-23, 202-366-1577; or Mr. Robert J. Black, Office of the Chief Counsel, HCC-31, 202-366-1359; Federal Highway Administration, 400 Seventh Street, SW., Washington D.C. 20590. Office hours are 7:45 a.m. to 4:15 p.m., e.t., Monday through Friday, except legal Federal holidays.

SUPPLEMENTARY INFORMATION:

Background

Section 1057 of the ISTEA (Pub. L. 102-240, 105 Stat. 1914, 2002) requires the Secretary to develop erosion control guidelines for the States to follow in carrying out federally funded construction projects. It requires that these guidelines not preempt any requirement under State law if such requirement is more stringent than the guidelines. It also requires that these guidelines be consistent with nonpoint source management programs under section 319 of the Federal Water Pollution Control Act (33 U.S.C. 1339) and coastal nonpoint pollution control guidance under section 6217(g) of the Coastal Zone Act Reauthorization Amendments of 1990 codified at 16 U.S.C. @ 1455b (Pub. L. 101-508, 104 Stat. 1388-299, as amended) (Coastal Zone Act).

To satisfy this requirement the FHWA is adopting, as guidance, the AASHTO publication Highway Drainage Guidelines, Volume III, "Erosion and Sediment Control in Highway Construction," 1992. Other minor editorial changes to 23 CFR 650 were also made to correct typographical errors and to change the wording to reflect current practice. A notice of proposed rulemaking (NPRM) proposing to revise 23 CFR 650, subpart B to reference this AASHTO publication was published in the Federal Register on March 1, 1993, at 58 FR 11814.

Comments To Docket

Nine comments were submitted to the docket. Eight comments were received from SHA's and one comment from a Federal Government agency. The following is a summary of the comments and the FHWA responses: [*37936]

Supportive of Change

The North Carolina Department of Transportation (DOT) supported FHWA's proposal to adopt the AASHTO guidelines.

The Connecticut Department of Transportation submitted a letter stating that they had no comment concerning the guidelines.

Existing Guidelines More Stringent

The California Department of Transportation (CALTRANS) did not object to the changes to 23 CFR

650 subpart B. CALTRANS stated that it has adopted requirements and guidelines for erosion control on construction projects that are equal to or more stringent than the guidelines set forth in the AASHTO publication.

National Pollutant Discharge Elimination System (NPDES) Requirements

The Hawaii Department of Transportation stated that the FHWA should adopt the AASHTO publication. It suggested, though, that the final rule reference the NPDES permit requirements in 23 CFR 650. The NPDES permits are issued under the authority of the Environmental Protection Agency (EPA) in compliance with the provisions of the Federal Water Pollution Control Act (FWPCA), (33 U.S.C. 1251 et seq., as amended by Pub. L. 92-500).

The FHWA does not believe that it is necessary to specifically reference NPDES permit requirements in 23 CFR 650. There is a statement in 23 CFR 650.207(b) that the FHWA shall take all reasonable steps to insure that all project designs for control of erosion and sedimentation comply with applicable standards and regulations of other agencies. This would include the NPDES permit requirements as well as any other State or local regulations concerning the control of erosion and sedimentation.

Guidelines

Four of the SHA respondents had comments concerning specific sections of the AASHTO publication Highway Drainage Guidelines, Volume III, "Erosion and Sediment Control in Highway Construction," 1992.

The Nebraska Department of Roads (NDOR) questioned the use of a hydraulic engineer in the design and review of diversion dikes and ditches, and temporary slope drains. The NDOR believed that normal roadway design engineers would be adequate for most hydraulic designs. Hydraulic engineers, the NDOR argued, could be used for the design and review of complex sediment and erosion control systems.

While the FHWA agrees that a roadway design engineer may be capable of conducting an adequate hydraulic design, it is important that erosion and sediment control structures are designed properly. These structures should be sized and located based on flows resulting from the design year storm. Proper design of the project requires a working knowledge of hydraulic

engineering. While it is not required that a hydraulic engineer conduct the design and review of the erosion and sediment control structures, the design must be conducted by someone competent in hydraulic design procedures. While the FHWA does not agree with the NDOR suggestion that the reference to a hydraulic engineer be removed from the guidance, it does agree that a person who is competent in hydraulic design could adequately fulfill the intent of the guidelines.

The Arkansas State Highway Department had no reservations about adopting the AASHTO guidelines, but suggested that a summary be added indicating that the level of effort dedicated to the planning of a project and the development of the erosion control plan be commensurate with size and complexity of project. While the FHWA agrees that more complex projects or projects that may affect sensitive ecosystems such as wetlands, streams, rivers, or other water bodies will include detailed erosion and sediment control plans, every project should be planned, located, designed, and constructed with the intent of limiting the project's effects on the environment. Though projects may differ in the type and extent of the mitigation measures and practices that are implemented, the level of effort put forth to limit the environmental effects for smaller, less complex projects should be equal to that put forth on larger, more complex ones.

The Georgia Department of Transportation (GDOT) found the AASHTO document acceptable but had the following minor comments. The GDOT argued that detailed erosion and sediment control plans should not be required as part of the contract document in order to allow the contractor the necessary flexibility to develop a site and operational-specific plan. Instead the GDOT argued that the contract plans should include any extremely sensitive areas such as lakes, wetlands, and streams and sufficient quantities of erosion control devices should be provided as a bid item to mitigate possible erosion and sedimentation effects. According to the GDOT this would allow the contractor and the project engineer the flexibility to customize the erosion control measures employed to the contractor's approach to the work.

While the FHWA agrees erosion and sediment control plans should be flexible, both contractors and contracting agencies should be fully aware of the possible environmental effects of their projects. Therefore, all potential environmental impacts associated with erosion and sedimentation, not just those affecting sensitive areas, and the measures and practices required to mitigate these impacts, should be included in the plans, specifications, and special provisions. As

previously mentioned, the effectiveness of many erosion and sediment control measures is dependent upon proper design and installation.

The FHWA believes it is inappropriate to delegate responsibility for the planning and design of erosion and sediment control measures to the contractor or the project engineer, who may or may not have sufficient design expertise in this area. However, erosion and sediment control plans should be flexible enough to properly fulfill their intended purpose. Accordingly, each erosion and sediment control plan should be periodically evaluated to insure that all necessary controls are being implemented correctly and that unnecessary or improperly installed controls are eliminated or revised. Additions, deletions, or revisions to the erosion and sediment control plan should be reviewed by a person competent in erosion and sediment control design.

The GDOT and the Michigan Department of Transportation had minor technical comments on specific design details contained in the AASHTO publication. While the FHWA may agree with some of these design-related comments, the agency emphasizes that the AASHTO publication is intended to provide guidance on the development and implementation of erosion and sediment control measures and practices. The design details that are included are provided as a basis for the development of more detailed project-specific designs. Each State should apply the AASHTO guidelines or its own guidelines, if those guidelines are more stringent, to develop standards and practices for the control of erosion and sedimentation on Federal-aid construction projects. Although the AASHTO guidelines can be used for the development of a statewide implementation program for controlling erosion and sedimentation, each project [*37937] must be analyzed separately to assure that the most appropriate and effective erosion and sediment control measures and practices are designed, implemented, and maintained.

Revisions to Part 650

A comment concerning the revisions to Part 650 was made by the EPA's Office of Wetlands, Oceans and Watersheds. Although the EPA supported the regulatory changes proposed in the NPRM, it had two specific comments. Both concerned the requirement of the ISTEA that FHWA erosion control guidelines be consistent with nonpoint source management programs under section 319 of the FWPCA and coastal nonpoint pollution control guidance issued by the EPA in January

1993, under section 6217(g) of the Coastal Zone Act of 1990.

Request to Add a New Paragraph

The EPA proposed that the FHWA add a specific paragraph to 23 CFR Part 650 that would quote a management measure contained in the section 6217(g) management measure guidance document (see footnote # 1). The management measure at issue is in Chapter 4.II.A., "New Development Management Measure," and concerns reducing the amount of total suspended solids (TSS) leaving the site after construction has been completed and the site is permanently stabilized. It allows for two options to accomplish this goal. Under the first option, after construction, the average amount of TSS (including sediment) leaving the project site would be reduced by 80 percent. The second option would limit the post-development discharge of suspended solids to an amount equal to or less than pre-development conditions.

Guidance under section 6217(g) specifies management measures for a wide range of pollutant sources. These include agricultural, forestry, urban area, and marina and recreational boating sources. The management measure cited by the EPA is found under Chapter 4: "Management Measures for Urban Areas," and specifically under Section II, "Urban Runoff." It is intended to be applied by States in areas within the designated coastal zone, under the authority of the Coastal Zone Management Act of 1972 (Pub. L. 92-583, 86 Stat. 1280, as amended), to control urban runoff and treat associated pollutants from new development, redevelopment, and new and relocated roads, highways, and bridges.

This management measure deals with the post construction control of erosion and sedimentation. It applies to the reduction of TSS after the project has been fully stabilized. However, during several meetings between the EPA and the FHWA, the EPA emphasized that this reduction can be accomplished through design or by performance. In other words, projects should be designed, using the best available technology, with the intent of reducing or limiting TSS by the specified amount. The intent was not to require the actual measurement of the TSS leaving the project site either before or after construction but to establish guidance relative to project design standards.

The section 6217(g) guidance does not apply to storm water discharges covered by the NPDES storm water permit program. This includes all highway

construction projects disturbing five or more acres of land. In addition, the section 6217(g) guidance does not apply to States without coastal zone management programs approved by the United States Department of Commerce.

The ability to limit or reduce the amount of TSS leaving a specific site will depend on the type of best management practice (BMP) selected. Each BMP has its own strengths and weaknesses, and no one BMP will be applicable to every situation. The effectiveness of the selected BMP can also be highly variable. For example, wet ponds, which are one of the most reliable and attractive BMPs that exist, have a reported sediment removal rate of between 50 to 90 percent. Extended detention ponds, or dry ponds, on the other hand, have a sediment removal efficiency of only 30 to 70 percent. Both of these BMPs may need to be supplemented by other controls to conform with the 6217(g) guidance.

Key design factors in determining the effectiveness of particular BMPs include size, configuration, retention time and long term maintenance. The effectiveness of a particular BMP is influenced by a variety of locational factors as well. For example, problems will be encountered if wet ponds are located in areas experiencing long periods of dry weather and/or high evaporation rates, or long periods of cold weather when the pond is frozen. In any case, many aspects related to BMP performance are not well understood and all BMP options will require careful site assessment prior to design.

The provisions of 23 CFR part 650, subpart B, deal with erosion and sediment control for all federally funded construction projects nationwide. Their objectives are to control erosion and sedimentation during the construction of highway projects and to assure that highway projects are located, designed, and operated to minimize erosion and sediment damage. The AASHTO guidelines that are being proposed for adoption as guidance include three objectives for erosion and sediment control. These objectives are:

1. Limit off-site effects to acceptable levels,
2. Facilitate project construction and minimize overall cost, and
3. Comply with Federal, State, and local regulations.

As stated in the first objective, an intent of these guidelines is not to establish specific design standards but to limit off-site effects to acceptable levels. The determination of what constitutes an undesirable effect

is not specified. The intent is to assess possible adverse off-site effects and to implement BMPs as appropriate to minimize these effects.

The FHWA agrees with the EPA that a goal of any highway construction project would be to limit the amount of erosion and resulting sedimentation attributable to that project. The FHWA also recognizes that within the coastal zone there may be water bodies that are extremely sensitive to the deposition of sedimentation. However, the FHWA believes that it is inappropriate to set specific design standards for all projects nationwide. The FHWA is amending 23 CFR part 650 to add @ 650.211 which provides that projects located within coastal zone management areas, as specified by States with coastal zone management programs approved by the United States Department of Commerce, National Oceanic and Atmospheric Administration, utilize "Guidance Specifying Management Measures for Sources of Nonpoint Source Pollution in Coastal Waters."

Request to Incorporate Additional Guidance

The EPA also requested that the FHWA add a new paragraph to Part 650 that incorporates, by reference, certain portions of the section 6217(g) guidance. These other management measures, found under Chapter 4.VIII, "Roads, Highways, and Bridges," would include management measures in the areas of planning, siting, and developing roads and highways; bridges; construction projects; construction site chemical control; operation and maintenance; and road, highway and bridge runoff systems.

Section 1057 of the ISTEA requires that the guidelines that are developed be [*37938] consistent with the section 6217(g) guidance. The AASHTO guidelines that the FHWA is now adopting deal primarily with erosion and sediment control during construction. However, the guidelines also state that, "While much of the effort for control of erosion and sedimentation is expended during the construction phase of highway development, a successful program must address erosion and sediment control during the planning, location, design, and future maintenance phases as well." The AASHTO guidelines provide comprehensive guidance concerning the establishment of criteria and controls for erosion and sedimentation. These guidelines provide detailed information that addresses and is consistent with the pertinent sections of the section 6217(g) guidance.

However, as previously stated, the FHWA is amending 23 CFR Part 650 to add @ 650.211 which provides that highway construction projects covered under the provisions of the section 6217(g) guidance should utilize "Guidance Specifying Management Measures for Sources of Nonpoint Source Pollution in Coastal Waters."

Additional Revisions

The language of @ 650.209(c), dealing with monitoring erosion and sediment control measures and practices, has been revised from that proposed in the NPRM. As set forth in the NPRM, this section implied that if a problem in the effectiveness of the erosion and sediment control measure is indicated, revision of that measure would be required. The intent of this section is to ensure that erosion and sediment control measures are periodically reviewed to assure their effectiveness. This would include maintenance of the existing measures as well as revising those measures that are found to be less than fully effective. The language of @ 650.209(c) has been revised to clarify this issue.

Rulemaking Analyses and Notices

Administrative Procedure Act

This final rule is made effective upon publication. The FHWA believes that this final rule is exempt from the 30-day delayed effective date requirement of 5 U.S.C. @ 553(d) for the following reason. The FHWA finds that good cause exists to dispense with the 30-day delay because an earlier version of the AASHTO erosion and sediment control publication adopted by this action has already been adopted, as guidance "to provide valuable information in attaining good design" in highway construction projects. See 23 CFR 625.5. This final rule simply amends title 23, Code of Federal Regulations, to reference the updated AASHTO guidelines on this subject and it includes this reference under 23 CFR part 650, which specifically addresses erosion and sediment control on highway construction projects. Therefore, this final rule imposes no new requirements or mandates on State highway agencies. Instead, it simply cites the revised AASHTO guidelines with the aim of assisting States in assuring that highway projects are located, designed, and operated to minimize erosion and sediment damage.

Executive Order 12866 (Regulatory Planning and Review) and DOT Regulatory Policies and Procedures

The FHWA has determined that this action is not a significant regulatory action within the meaning of Executive Order 12866 or significant within the meaning of Department of Transportation regulatory policies and procedures. The FHWA (at 23 CFR 650, Subpart B) and other Federal agencies currently have regulations regarding erosion and sediment control. Adopting the AASHTO guidelines would merely update and reinforce existing policy. Therefore, it is anticipated that the economic impact of this rulemaking will be minimal and a full regulatory evaluation is not required.

Regulatory Flexibility Act

In compliance with the Regulatory Flexibility Act (5 U.S.C. 601-612), the FHWA has evaluated the effects of this rule on small entities. The FHWA concluded that it and other Federal agencies currently have regulations dealing with erosion and sediment control, and adopting the 1992 AASHTO guidelines would merely reinforce existing policy. Therefore, the FHWA hereby certifies that this rulemaking will not have a significant economic impact on a substantial number of small entities.

Executive Order 12612 (Federalism Assessment)

This action has been analyzed in accordance with the principles and criteria contained in Executive Order 12612, and it has been determined that this action would not have sufficient federalism implications to warrant the preparation of a federalism assessment.

Executive Order 12372 (Intergovernmental Review)

Catalog of Federal Domestic Assistance Program Number 20.205, Highway Planning and Construction. The regulations implementing Executive Order 12372 regarding intergovernmental consultation on Federal programs and activities apply to this program.

Paperwork Reduction Act

This action does not contain a collection of information requirement for purposes of the Paperwork Reduction Act of 1980, 44 U.S.C. 3501-3520.

National Environmental Policy Act

This rulemaking will provide guidance to State Highway Agencies when implementing or developing erosion and sediment control guidelines. This will aid in the control and prevention of nonpoint source pollutants. It does not constitute a major action having a significant effect on the environment, and therefore does not require the preparation of an environmental impact statement pursuant to the National Environmental Policy Act of 1969 (42 U.S.C. 4321 et seq.).

Regulation Identification Number

A regulation identification number (RIN) is assigned to each regulatory action listed in the Unified Agenda of Federal Regulations. The Regulatory Information Service Center publishes the Unified Agenda in April and October of each year. The RIN contained in the heading of this document can be used to cross reference this action with the Unified Agenda.

List of Subjects in 23 CFR Part 650

Grant programs-transportation, Highways and roads, Soil conservation.

In consideration of the foregoing, the FHWA is amending title 23, Code of Federal Regulations, part 650, subpart B as set forth below.

Issued on: July 18, 1994.

Rodney E. Slater,

Federal Highway Administrator.

PART 650-BRIDGES, STRUCTURES, AND HYDRAULICS [AMENDED]

1. The authority for part 650 is revised to read as follows:

Authority: 23 U.S.C. 109 (a) and (h), 144, 151, 315, and 319; 23 CFR 1.32; 49 CFR 1.48(b), E.O. 11988 (3 CFR, 1977 Comp., p. 117); Department of Transportation Order 5650.2 dated April 23, 1979 (44 FR 24678); @ 161 of Public Law 97-424, 96 Stat. 2097, 3135; @ 4(b) of Public Law 97-134, 95 Stat. 1699; 33 U.S.C. 401, 491 et seq., 511 et seq.; and @ 1057 of Public Law 102-240, 105 Stat. 2002. [*37939]

Subpart B-Erosion and Sediment Control on Highway Construction Projects

2. Part 650 is amended by revising @@ 650.201, 650.203, 650.205 and 650.209 and by adding @ 650.211 to read as follows:

@ 650.201 -- Purpose.

The purpose of this subpart is to prescribe policies and procedures for the control of erosion, abatement of water pollution, and prevention of damage by sediment deposition from all construction projects funded under title 23, United States Code.

@ 650.203 -- Policy.

It is the policy of the Federal Highway Administration (FHWA) that all highways funded in whole or in part under title 23, United States Code, shall be located, designed, constructed and operated according to standards that will minimize erosion and sediment damage to the highway and adjacent properties and abate pollution of surface and ground water resources. Guidance for the development of standards used to minimize erosion and sediment damage is referenced in @ 650.211 of this part.

@ 650.205 -- Definitions.

Erosion control measures and practices are actions that are taken to inhibit the dislodging and transporting of soil particles by water or wind, including actions that limit the area of exposed soil and minimize the time the soil is exposed.

Permanent erosion and sediment control measures and practices are installations and design features of a construction project which remain in place and in service after completion of the project.

Pollutants are substances, including sediment, which cause deterioration of water quality when added to surface or ground waters in sufficient quantity.

Sediment control measures and practices are actions taken to control the deposition of sediments resulting from surface runoff.

Temporary erosion and sediment control measures and practices are actions taken on an interim basis during construction to minimize the disturbance, transportation, and unwanted deposition of sediment.

* * * * *

@ 650.209 -- Construction.

(a) Permanent erosion and sediment control measures and practices shall be established and implemented at the earliest practicable time consistent with good construction and management practices.

(b) Implementation of temporary erosion and sediment control measures and practices shall be coordinated with permanent measures to assure economical, effective, and continuous control throughout construction.

(c) Erosion and sediment control measures and practices shall be monitored and maintained or revised to insure that they are fulfilling their intended function during the construction of the project.

(d) Federal-aid funds shall not be used in erosion and sediment control actions made necessary because of contractor oversight, carelessness, or failure to implement sufficient control measures.

(e) Pollutants used during highway construction or operation and material from sediment traps shall not be stockpiled or disposed of in a manner which makes them susceptible to being washed into any watercourse by runoff or high water. No pollutants shall be deposited or disposed of in watercourses.

@ 650.211 -- Guidelines.

(a) The FHWA adopts the AASHTO Highway Drainage Guidelines, Volume III, "Erosion and Sediment Control in Highway Construction," 1992, n1 as guidelines to be followed on all construction projects funded under title 23, United States Code. These guidelines are not intended to preempt any requirements made by or under State law if such requirements are more stringent.

(b) Each State highway agency should apply the guidelines referenced in paragraph (a) of this section or apply its own guidelines, if these guidelines are more stringent, to develop standards and practices for the control of erosion and sediment on Federal-aid construction projects. These specific standards and practices may reference available resources, such as the procedures presented in the AASHTO "Model Drainage Manual," 1991. n2

(c) Consistent with the requirements of section 6217(g) of the Coastal Zone Act Reauthorization Amendments of 1990 (Pub. L. 101-508, 104 Stat.

1388-299), highway construction projects funded under title 23, United States Code, and located in the coastal zone management areas of States with coastal zone management programs approved by the United States Department of Commerce, National Oceanic and Atmospheric Administration, should utilize "Guidance Specifying Management Measures for Sources of Nonpoint Source Pollution in Coastal Waters," 84-B-92-002, U.S. EPA, January 1993. n3 State highway agencies should refer to this Environmental Protection Agency guidance document for the design of projects within coastal zone management areas.

- ¹ The final guidance document "Guidance Specifying Management Measures for Sources of Nonpoint Source Pollution in Coastal Waters," 84-B-92-002, U.S. Environmental Protection Agency, January 1993, is available in FHWA docket 93-6 for inspection and copying in Room 4232, HCC-10, Office of the Chief Counsel, Federal Highway Administration, 400 Seventh Street, SW., Washington D.C. 20590.
- ² "A Current Assessment of Urban Best Management Practices, Techniques for Reducing Non-Point Source Pollution in the Coastal Zone," Metropolitan Washington Council of Governments, 1993.
- ³ This document is available for inspection and copying as prescribed by 49 CFR part 7, appendix D.

INFORMATION: Erosion and Sediment Control Final Rule

Director, Office of Engineering

HNG-23

Regional Federal Highway Administrators
Division Administrators
Federal Lands Highway Program Administrator

On July 26, 1994, in **Federal Register** Volume 59, No. 142, 37935-37939, the Federal Highway Administration (FHWA) published a final rule revising 23 CFR 650, Subpart B, Erosion and Sediment Control on Highway Construction Projects. This revision formally adopts Volume III of the American Association of State Highway and Transportation Officials (AASHTO) Highway Drainage Guidelines 1992, as guidelines to be followed on all projects funded under Title 23, United States Code. The adoption of these guidelines fulfills the requirement of Section 1057 of the Intermodal Transportation Efficiency Act of 1991.

As part of this revision, a statement was included recommending that each State highway agency (SHA) apply either these guidelines, or their own more stringent guidelines, to develop specific standards and practices for the control of erosion. These specific standards and practices may reference available resources, such as the procedures presented in the AASHTO Model Drainage Manual, 1991.

One copy of the AASHTO Highway Drainage Guidelines is being provided to each region, division and Federal Lands office. However, due to cost considerations, the AASHTO Model Drainage Manual is being transmitted to the region offices only. The final rule as it was published in the **Federal Register** is attached for your information.

The FHWA is committed to ensuring that all highway construction projects are located, designed, constructed and maintained according to standards that will minimize erosion and control associated sedimentation. Volume III of the AASHTO Highway Drainage Guidelines provides excellent guidance concerning these factors. The following is a summary of some of the important issues.

- ▶ This regulation and the accompanying guidelines apply to all projects funded under 23 U.S.C. This includes projects on or off the National Highway System.
- ▶ Erosion and sediment control plans shall be included in the PS&E for all applicable projects, not just larger or more complex projects. It is no longer satisfactory to specify that the contractor is responsible for all damages resulting from the construction operation or to leave the development of erosion and sediment control plans to the contractor or to project personnel after the project has been awarded.
- ▶ Erosion and sediment control plans shall be developed by qualified personnel. This would normally be a hydraulic engineer.

- ▶ As a minimum, erosion and sediment control plans should identify erosion and sediment sensitive areas and provide a mechanism for minimizing any adverse effects. It is not acceptable to provide a bid item for various erosion and sediment control items without including a corresponding plan indicating how and where these items shall be placed.
- ▶ During construction, erosion and sediment control plans should be periodically evaluated to assess the effectiveness of the implemented management practices. Erosion and sediment control plans should be revised and updated as needed to ensure that the intended purpose is achieved.
- ▶ For those States participating in the coastal zone management program, the SHA should be utilizing the Environmental Protection Agency document "Guidance Specifying Management Measures for Sources of Nonpoint Source Pollution in Coastal Waters" to control erosion and sedimentation on highway construction projects located in coastal zone management areas. While it would be advantageous to be aware of your State's involvement in the coastal zone management program, no effort beyond FHWA's normal activities will be required to implement or monitor the requirements of this program.

The FHWA Eastern Federal Lands Highway Division is developing a manual entitled, "Best Management Practices For Erosion and Sediment Control." This document will provide design and implementation guidance on specific erosion and sediment control management practices and procedures. It is expected that this document will be available by the end of the year. In addition, if sufficient SHA interest is indicated, an erosion and sediment control training course may be developed. If you have any questions or require further information contact Mr. Robin L. Schroeder, Construction and Maintenance Division, Materials Branch (HNG-23) at 202-366-1577.

William A. Weseman



APPENDIX C: STANDARD DRAWINGS

REG.	STATE	PROJECT	SHEET TOTAL
			NO. SHEETS

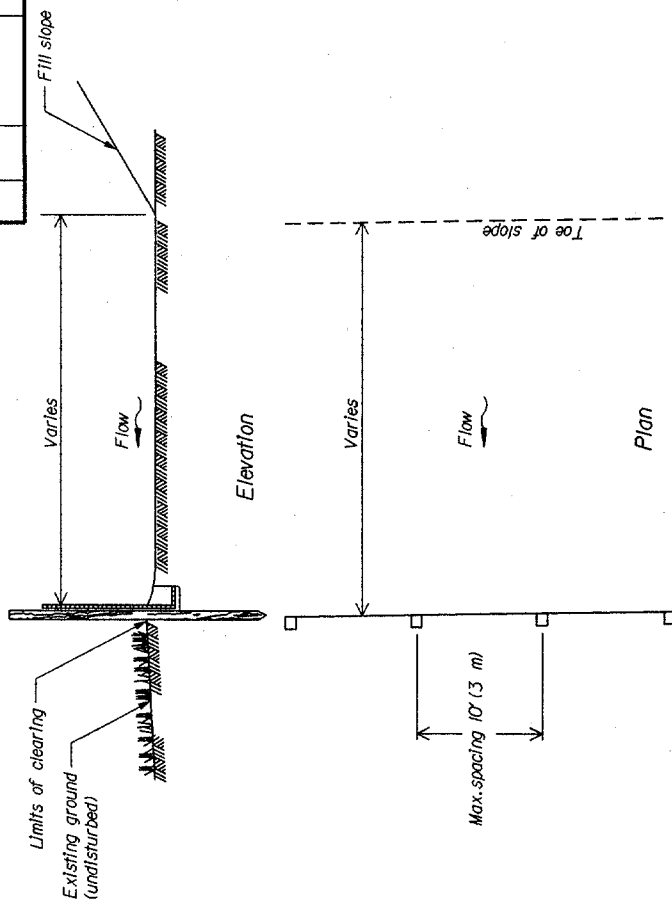

SILT FENCE INSTALLATION AT TOE OF FILL

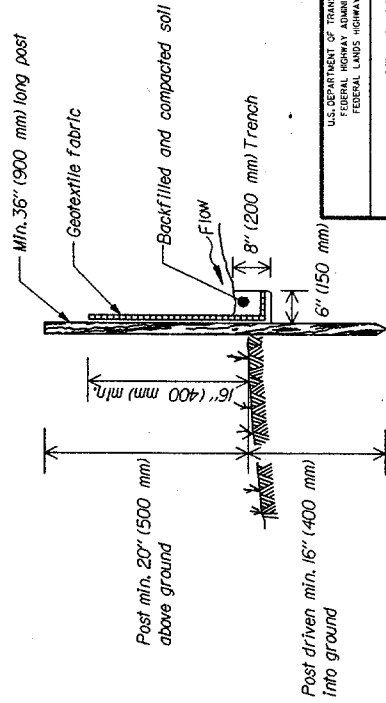

Note:
Alternate pre-assembled silt fence options will be allowed as long as specified minimums are satisfied. Follow manufacturer's information for installation procedures.

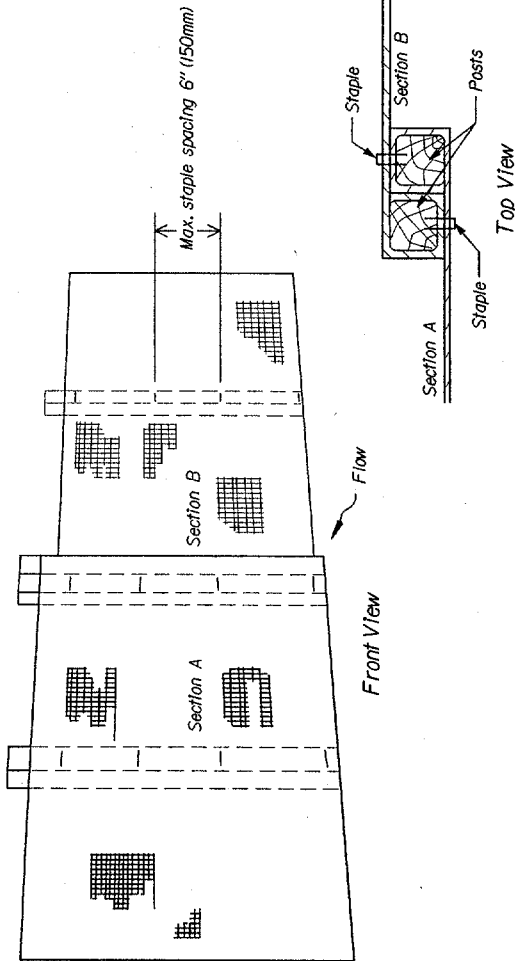

JOINING TWO ADJACENT SILT FENCE SECTIONS

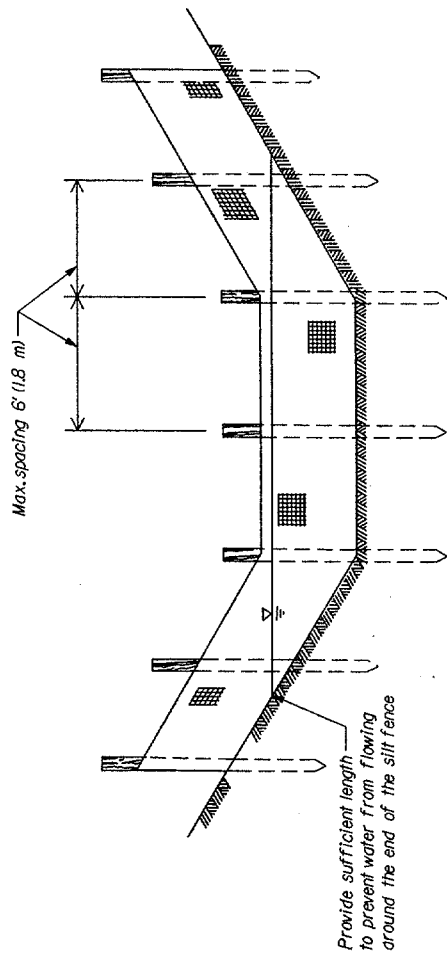

SILT FENCE INSTALLATION IN A DRAINAGE DITCH

Note: Use drainage ditch installation for low flow conditions only when specified on Erosion Control Plan.

U.S. DEPARTMENT OF TRANSPORTATION
FEDERAL LANDS HIGHWAY OFFICE

STANDARD
SILT FENCE

STANDARD APPROVED FOR USE 12/23/81
REVISED 10/24
157-1

REC	STATE	PROJECT	SHEET NO.	TOTAL SHEETS
-----	-------	---------	-----------	--------------

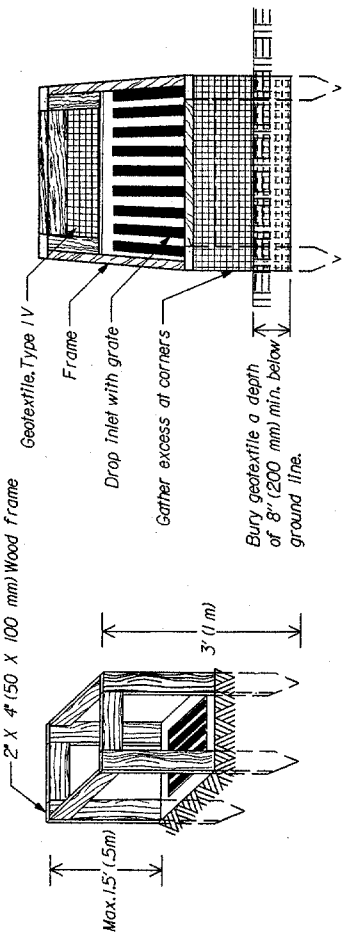

SILT FENCE DROP INLET PROTECTION (TYPE A)

Note: Use Type A Inlet protection in sump locations only.

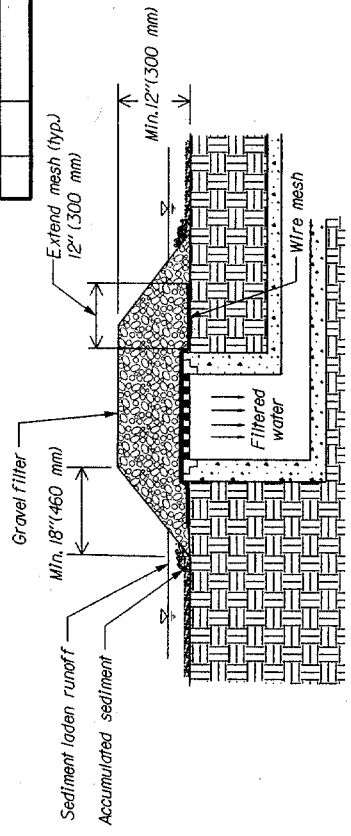

GRAVEL AND WIRE MESH DROP INLET PROTECTION (TYPE B)

Note: Use Type B Inlet protection only in sump locations where heavy concentrated flows are not expected. Do not use where ponding around the structure might cause inconvenience or damage.

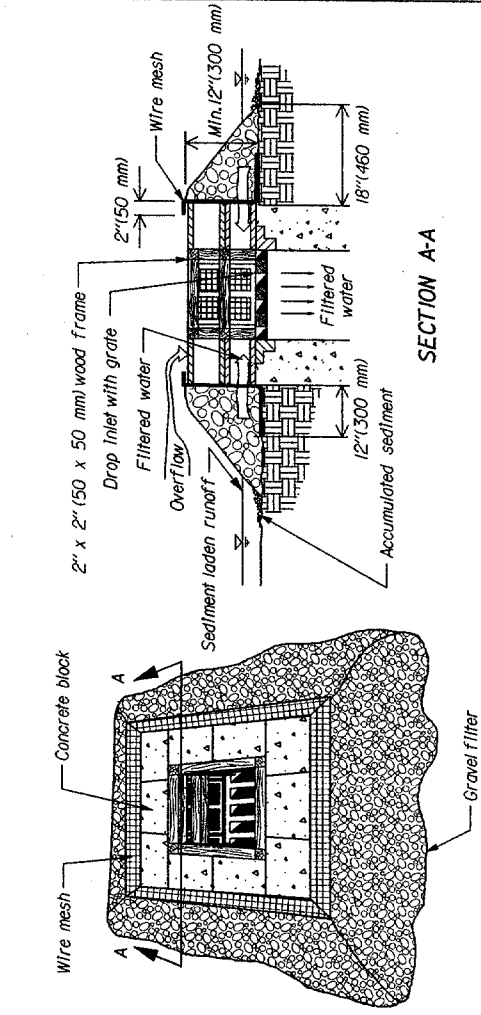

BLOCK AND GRAVEL DROP INLET PROTECTION (TYPE C)

General Notes:
 1. For gravel filters use 2" - 3" (50 mm - 75 mm) diameter coarse aggregate.
 2. Use wire mesh with 1/2" x 1/2" (12 mm x 12 mm) openings.

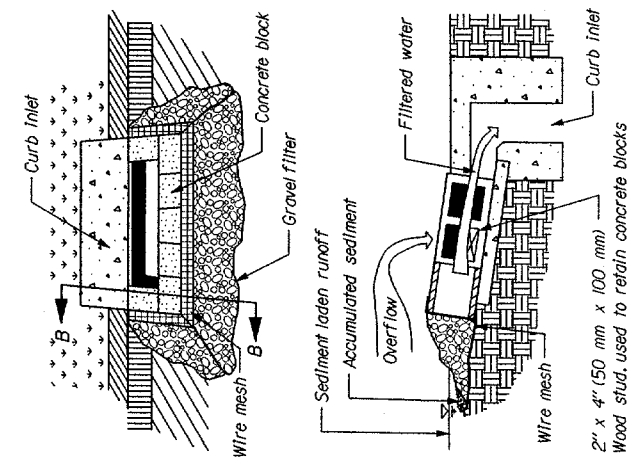

SECTION B-B

CURB INLET PROTECTION, BLOCK AND GRAVEL (TYPE D)

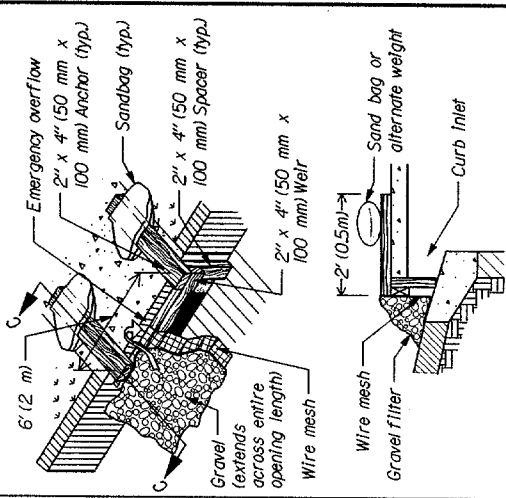

SECTION C-C

CURB INLET PROTECTION, WOODEN WEIR (TYPE E)

U.S. DEPARTMENT OF TRANSPORTATION
 FEDERAL HIGHWAY ADMINISTRATION
 FEDERAL LANDS - HIGHWAY OFFICE

STANDARD APPROVED FOR USE 33433	STANDARD
REVISION: 10/24	157-2

(not to scale)

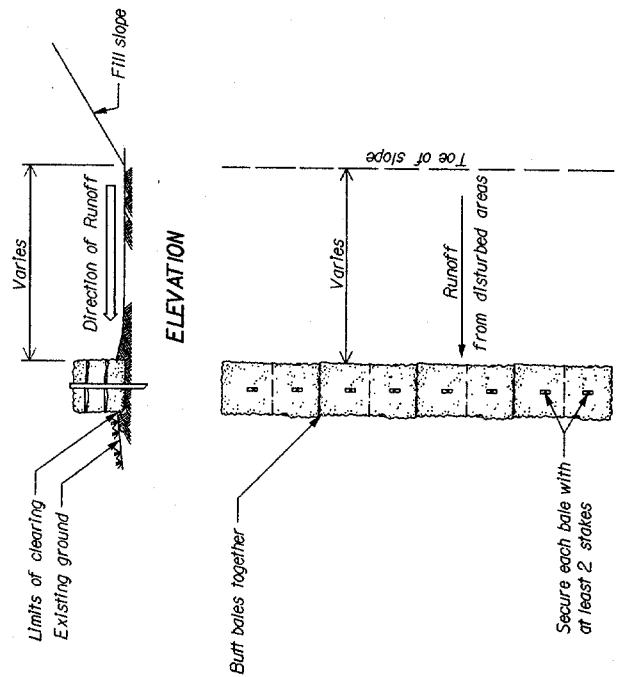

ELEVATION

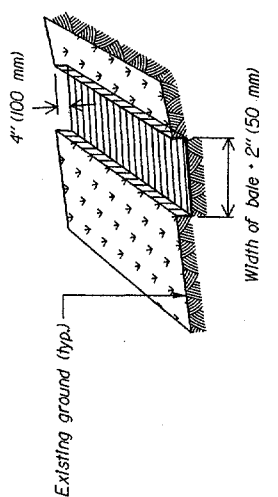

Step 1: Excavate trench

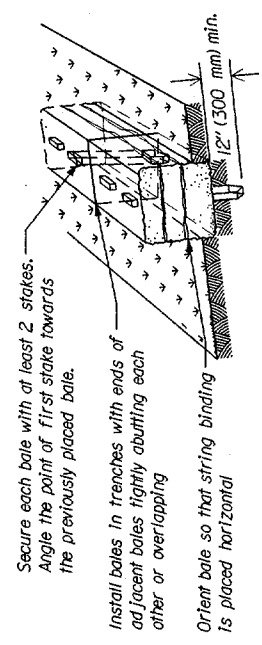

Step 2: Install bales

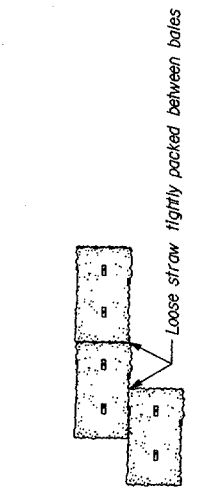

Step 3: Tightly pack straw between bales (plan view of bales)

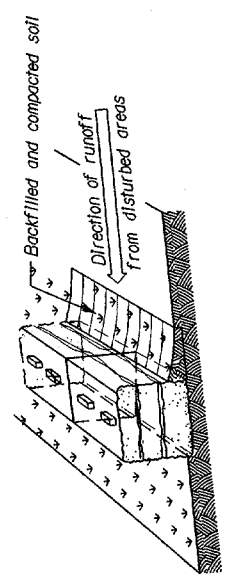

Step 4: Backfill soil against bales

INSTALLATION OF A STRAW BALE BARRIER AT TOE OF FILL

PROPERLY STAKED AND ENTRENCHED STRAW BALES

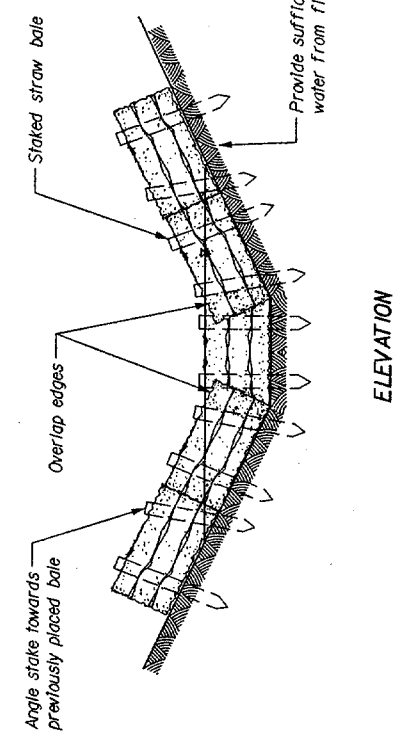

ELEVATION

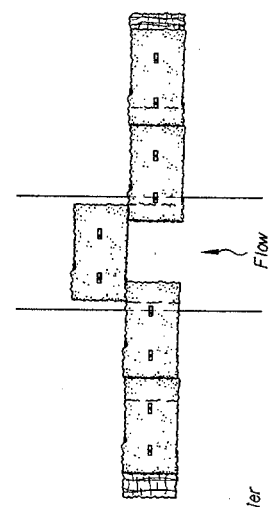

PLAN

Note:
Use straw bales in drainage ditches only for low flow conditions and when specified on the Erosion Control Plans.

INSTALLATION OF A STRAW BALE BARRIER IN DITCH

U.S. DEPARTMENT OF TRANSPORTATION FEDERAL HIGHWAY ADMINISTRATION FEDERAL LANDS HIGHWAY OFFICE	
STANDARD	STRAW BALES
STANDARD APPROVED FOR USE 3/23/23	STANDARD
REVISED: 10/23	157-3

(not to scale)

REG.	STATE	PROJECT	SHEET NO.	TOTAL SHEETS

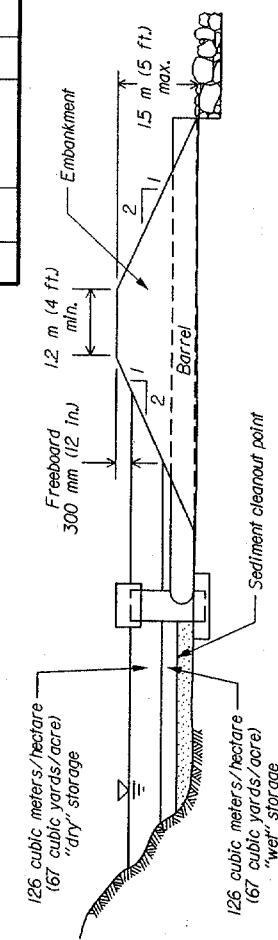

CROSS SECTION THROUGH SPILLWAY

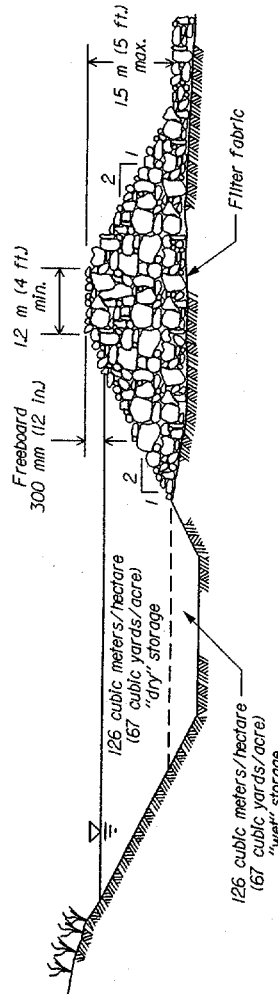

ELEVATION SEDIMENT TRAP (TYPE A) RIPRAP OUTLET

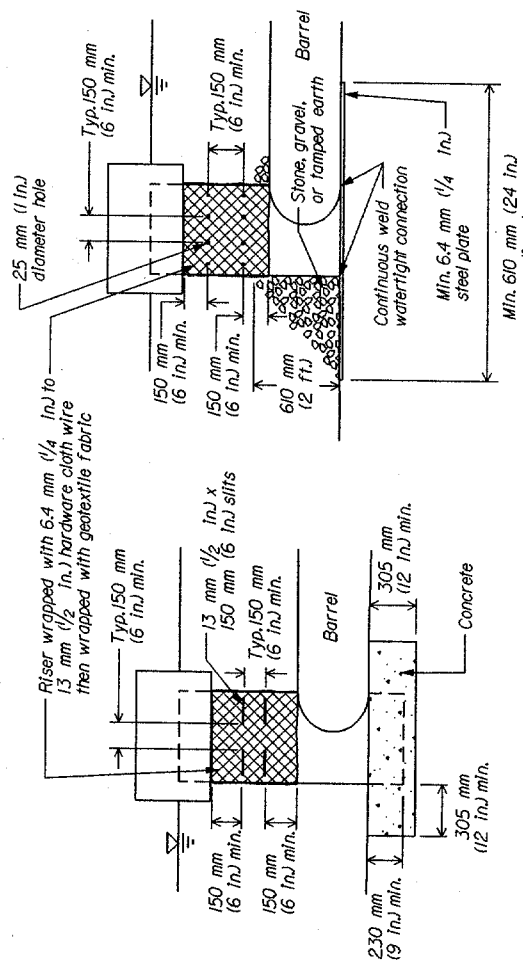

CONCRETE BASE WITH SLIT PERFORATIONS IN RISER
 STEEL PLATE BASE WITH HOLE PERFORATIONS IN RISER
 SEDIMENT TRAP (TYPE B) PIPE OUTLET

NOTES:

1. Clear, grub, and remove all vegetative matter including root mat before constructing Sediment Trap.
2. Remove vegetative matter, other organic material, and large stones from embankment fill material.
3. Compact embankment in 8-inch layers using construction equipment for compaction of each layer.
4. Seed the soil embankment and all cut slopes with temporary or permanent vegetation within 7 days of construction.
5. Remove sediment from Sediment Trap when accumulated sediment reaches half the design water storage of the trap.
6. Inspect Sediment Trap regularly for damage and accumulated sediment and especially after each storm event. Make repairs as required.
7. Remove the Sediment Trap and stabilize the location by grading and seeding when the upslope drainage area has been stabilized against erosion.
8. Do not use sediment traps for drainage areas over 5 acres.

U.S. DEPARTMENT OF TRANSPORTATION
 FEDERAL HIGHWAY ADMINISTRATION
 FEDERAL LANDS - HIGHWAY DIVISION

STANDARD
 SEDIMENT TRAP

STANDARD APPROVED FOR USE 8X243
 REVISED: 8X243

STANDARD
 157-4

REG	STATE	PROJECT	SHEET NO.	TOTAL SHEETS
-----	-------	---------	-----------	--------------

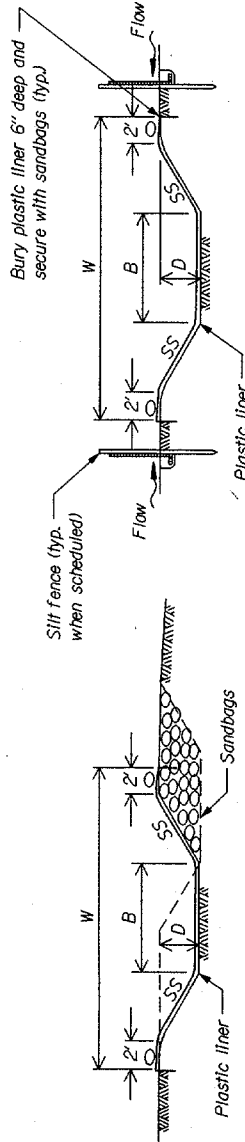
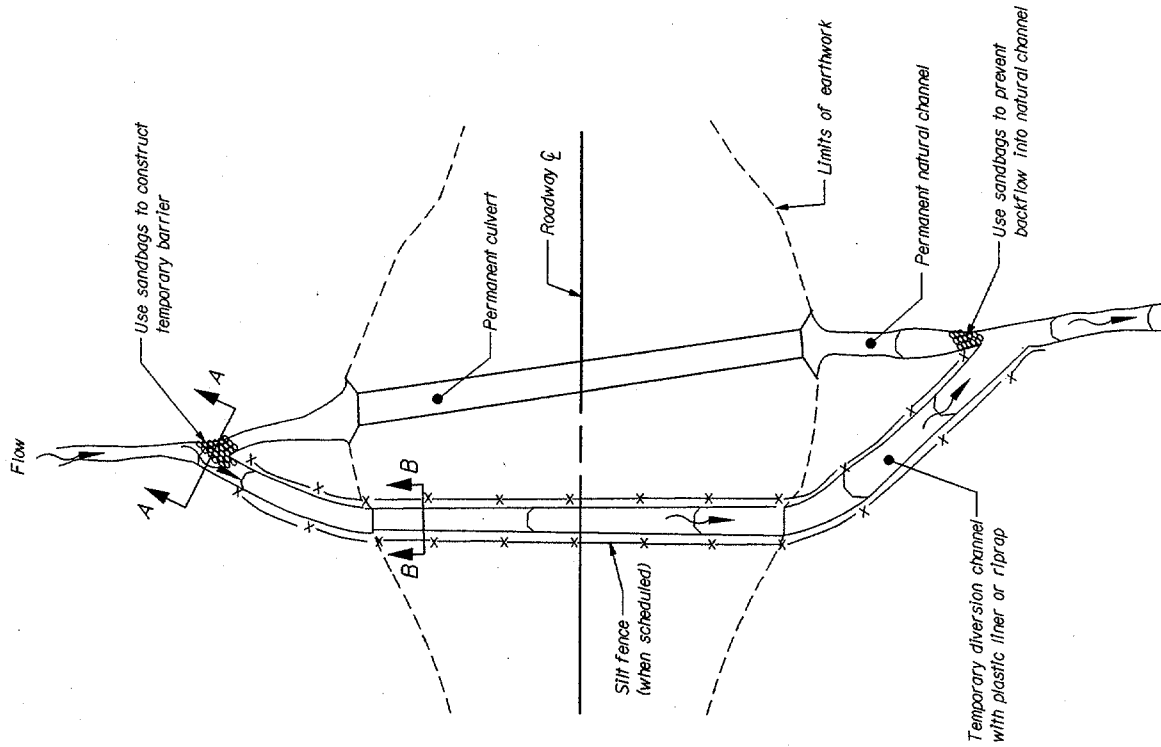

SECTION A-A

PLASTIC LINED DIVERSION CHANNEL

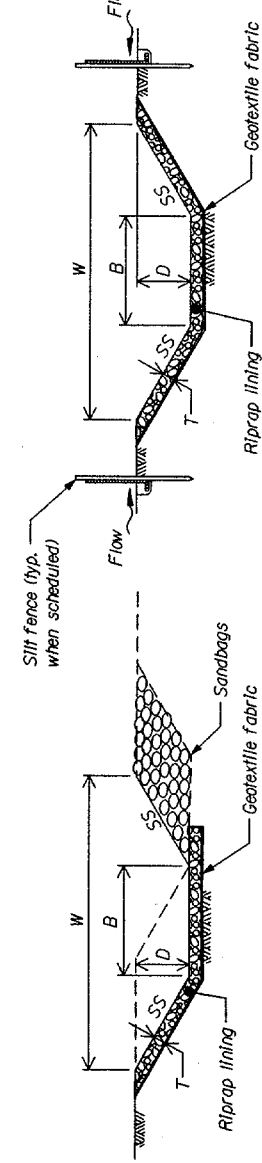

SECTION A-A

RIPRAP LINED DIVERSION CHANNEL

PLAN

Notes:

1. See Erosion Control Schedule for riprap class, channel dimensions and quantities.
2. Use plastic liner or riprap along the entire length and width of the temporary diversion channel.
3. Construct channel at a minimum grade of 0.5 percent.
4. Do not construct with longitudinal joints if using a plastic liner. Bury the upstream edge of the liner a minimum of 6" deep and secure with riprap or sandbags.

(not to scale)

U.S. DEPARTMENT OF TRANSPORTATION
 FEDERAL HIGHWAY ADMINISTRATION
 FEDERAL LANDS HIGHWAY OFFICE

STANDARD
TEMPORARY DIVERSION CHANNELS
 STANDARD APPROVED FOR USE 33X23X

REVISED 10/64

STANDARD 157-5

REG	STATE	PROJECT	SHEET NO.	TOTAL SHEETS

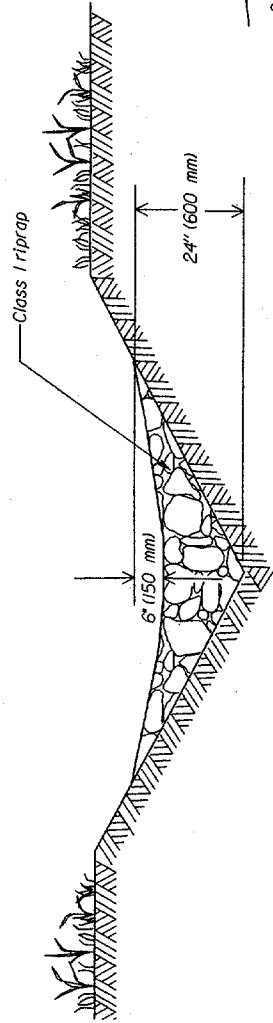

CROSS SECTION
V DITCH

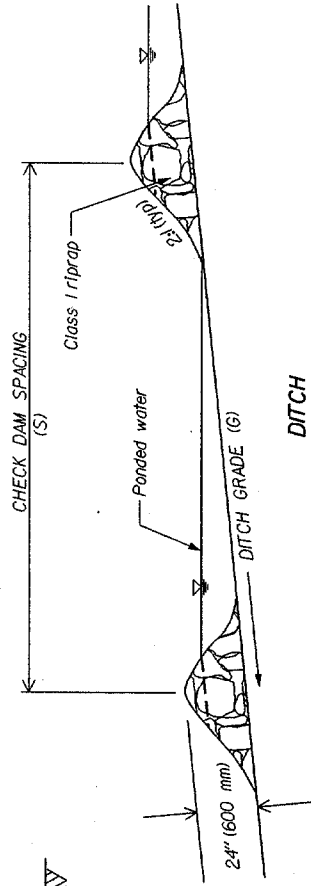

DITCH
PROFILE VIEW

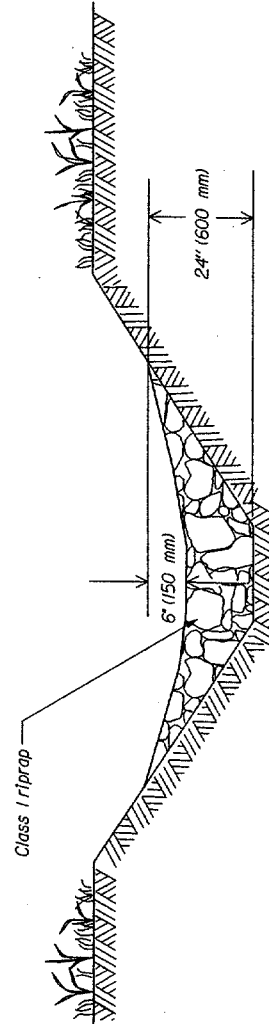

CROSS SECTION
TRAPEZOIDAL DITCH

DITCH GRADE (G) *	CHECK DAM SPACING(S)
.02 ft/ft (m/m)	75 ft (23 m)
.03 ft/ft (m/m)	50 ft (15 m)
.04 ft/ft (m/m)	40 ft (12 m)
.05 ft/ft (m/m)	30 ft (9 m)
.06 ft/ft (m/m)	25 ft (7.5 m)

* do not use Check Dams below
2% or above 6% ditch grades

U.S. DEPARTMENT OF TRANSPORTATION
FEDERAL HIGHWAY ADMINISTRATION
FEDERAL LANDS ADMINISTRATION

STANDARD
CHECK DAM

STANDARD APPROVED FOR USE 386288
REVISED 10/34

(not to scale)

STANDARD
157-6

REG	STATE	PROJECT	SHEET NO.	TOTAL SHEETS

PLASTIC LINED WATERWAY

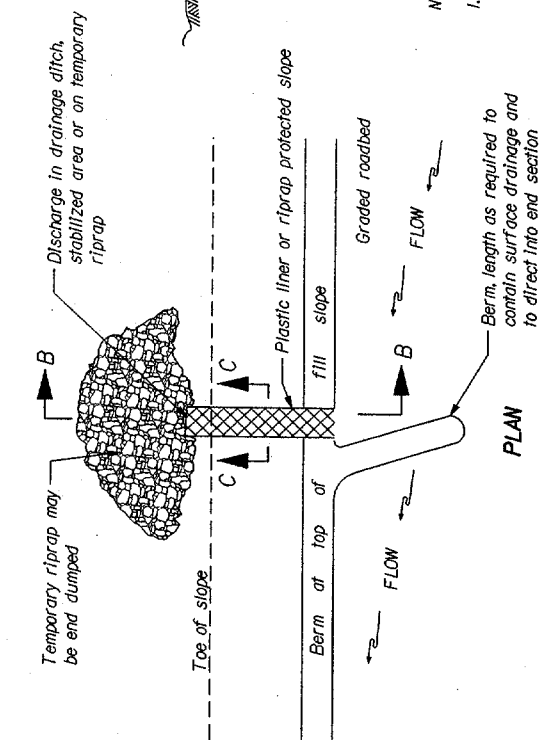

SLOPE DRAINS

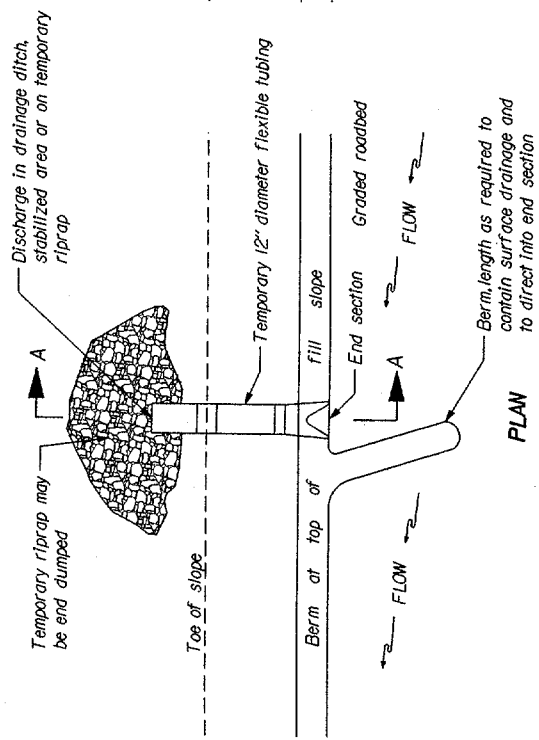

Notes:

1. Use temporary slope drains (berms, drains, and riprap) as the embankment is constructed. Use spacings as shown on the Erosion Control Plans or as designated by the CO. Place all slope drains at the end of each work shift. Use slope drains until the slopes are permanently stabilized.
2. Construct temporary berms at the top of all erodible cut slopes as shown on the Erosion Control Plans or as designated by the CO. Use check dams to reduce the runoff velocity when existing grades are steep.
3. Do not use transverse or longitudinal joints in plastic liner.
4. Plastic liner is not required for rock embankments.
5. Use toe-of-fill slope berms to divert off-site runoff away from disturbed areas.
6. Seed and mulch all cut slope berms and toe-of-fill berms immediately after berm construction.

SECTION C-C

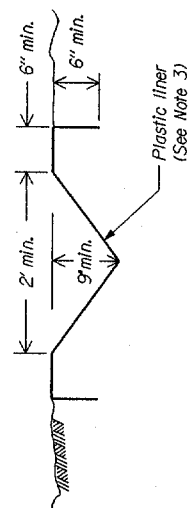

PLAN

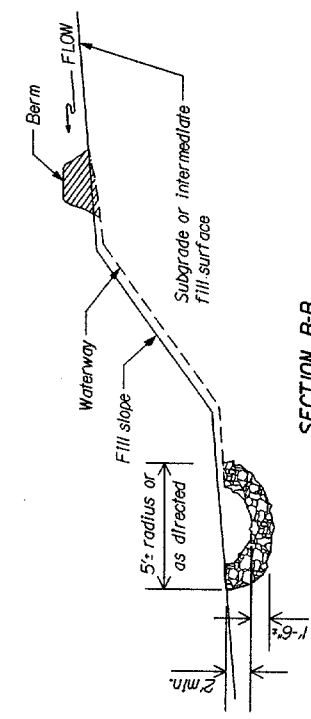

SECTION B-B

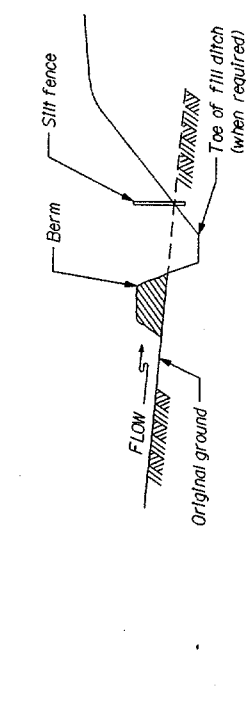

PLAN

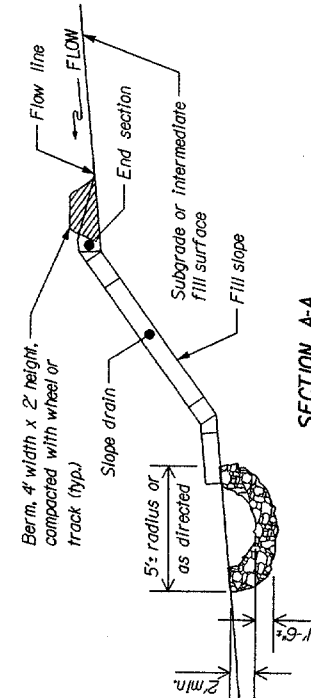

SECTION A-A

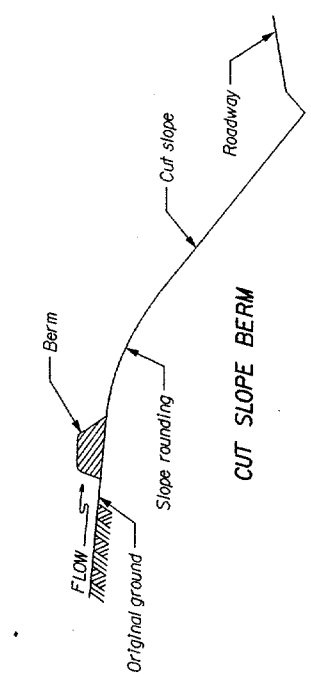

CUT SLOPE BERM

TOE-OF-FILL SLOPE BERM

(not to scale)

U.S. DEPARTMENT OF TRANSPORTATION
FEDERAL HIGHWAY ADMINISTRATION
FEDERAL LAND HIGHWAY OFFICE

STANDARD
TEMPORARY EROSION CONTROL
BERMS, SLOPE DRAINS
AND LINED WATERWAYS

STANDARD APPROVED FOR USE 8828X
REVISED: 10/24

STANDARD
15.7-7

DEPTH (D)	
Riprap Class	Depth (d) (ft)
I	12
II	18
III	24
IV	30
V	42
VI	48

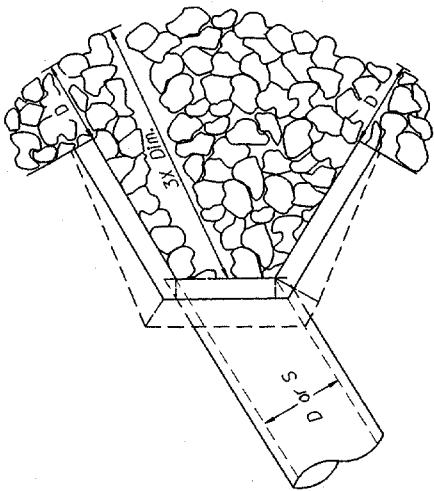

PLAN

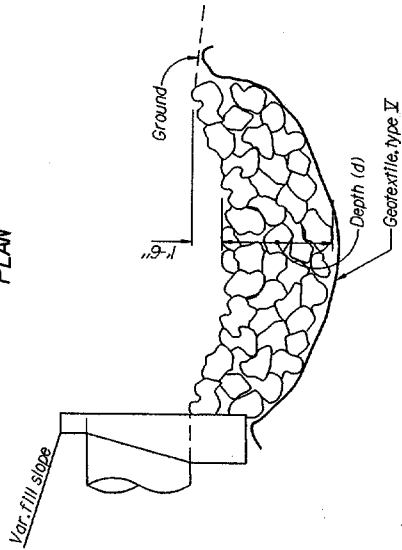

ELEVATION

CULVERT WITH HEADWALL

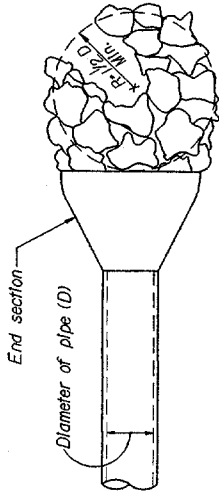

PLAN

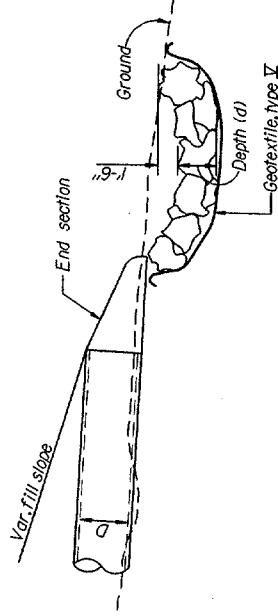

ELEVATION

CULVERT WITH END SECTION

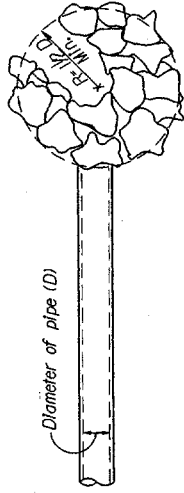

PLAN

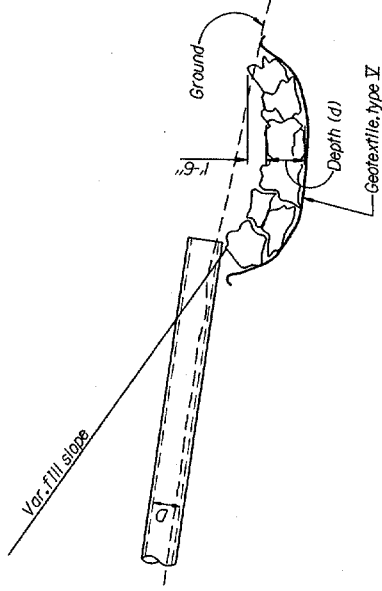

ELEVATION

CULVERT WITH NO END TREATMENT

NOT TO SCALE

U.S. DEPARTMENT OF TRANSPORTATION
FEDERAL HIGHWAY ADMINISTRATION
EASTERN FEDERAL LANDS ROYALTY DIVISION

DETAIL
LOOSE RIPRAP
AT CULVERT

DETAIL APPROVED FOR USE 10/29/84
REVISED 1
251-1

NOTE:
For arch or elliptical pipes, use
equivalent diameter for (D) dimension