



International
Hurricane Research
Center



Engineering
& Computing

FINAL REPORT

Date: March 2019

Contract Title:

Assessment of the Performance of Vehicular Traffic Signal Assemblies during Hurricane Force Winds

Contract No.: BDV29 977-27

FINAL REPORT BDV29 977-27

SUBMITTED TO:

Florida Department of Transportation Research Center

Project Manager:

Jeff Morgan

SUBMITTED BY:

Wall of Wind Research Facility

International Hurricane Research Center

Florida International University

Principal Investigator:

Ioannis Zisis, Ph.D.

Co-Principal Investigator:

Peter Irwin, Ph.D.

Arindam Chowdhury, Ph.D.

Graduate Research Assistant:

Manuel Matus, M.S.

Ziad Azzi, EIT

Johnny Estephan, M.S.

Research Scientist:

Bodhisatta Hajra, Ph.D.

Disclaimer

The opinions, findings, and conclusions expressed in this publication are those of the authors and not necessarily those of the State of Florida Department of Transportation.

Metric Conversion Table

| <i>Symbol</i> | <i>When You Know</i> | <i>Multiply by</i> | <i>To Find</i> | <i>Symbol</i> |
|------------------|----------------------|--------------------|--------------------|-----------------|
| Length | | | | |
| in | inches | 25.4 | millimeters | mm |
| ft. | feet | 0.305 | meters | m |
| Area | | | | |
| in ² | square inches | 645.2 | square millimeters | mm ² |
| ft. ² | square feet | 0.093 | square meters | m ² |
| Force | | | | |
| lbs | pound-force | 4.45 | Newton | N |

Technical Report Documentation Page

| | | | |
|--|--|--|---------------------------------|
| 1. Report No. BDV29 TWO 977-27 | 2. Government Accession No. | 3. Recipient's Catalog No. | |
| 4. Title and Subtitle Assessment of the Performance of Vehicular Traffic Signal Assemblies during Hurricane Force Winds | | 5. Report Date March 2019 | 6. Performing Organization Code |
| | | 8. Performing Organization Report No. | |
| 7. Author(s) I. Zisis, P. Irwin and A. Chowdhury | | 10. Work Unit No. (TRAVIS) | |
| 9. Performing Organization Name and Address Florida International University Department of Civil & Environmental Engineering 10555 W. Flagler Street Miami, Florida 33174 | | 11. Contract or Grant No. BDV29 TWO 977-27 | |
| | | 13. Type of Report and Period Covered Final Report April 2016 – March 2019 | |
| 12. Sponsoring Agency Name and Address Florida Department of Transportation 605 Suwannee Street, MS 30 Tallahassee, FL 32399 | | 14. Sponsoring Agency Code | |
| 15. Supplementary Notes | | | |
| 16. Abstract <p>The performance of span-wire mounted traffic signals during past hurricane seasons indicated to FDOT the need to explore new methods to improve traffic signal assembly survivability during hurricane force winds. FDOT and FIU embarked on a collaborative research program to study the performance of span-wire traffic signal systems subjected to extreme winds with the goal to enhance their resiliency and survivability and potentially find a methodology that could be utilized to certify the different products used in span-wire traffic signal assemblies.</p> <p>The current research project served as a companion project to BDV29 TWO 977-20 and added additional full-scale testing cases using a modified (long-span) test frame. The execution of the different tasks generated a plethora of experimentally and numerically derived outcomes. The findings from the current research project are of great value and significance since it was the first time that these systems were tested at full-scale in a controlled and realistic environment. The aerodynamic instability that has been observed in the field was identified and quantified for the very first time in a laboratory setting using both a short- and a long-span test frame. Numerous recommendations have been generated following the findings of this research that will assist FDOT to enhance the survivability of span-wire traffic signals during extreme wind events.</p> | | | |
| 17. Key Word traffic signal, wind load, cable systems, signal supports, hangers, hurricanes, wind resistant design | | 18. Distribution Statement No restrictions | |
| 19. Security Classif. (of this report) Unclassified | 20. Security Classif. (of this page) Unclassified | 21. No. of Pages | 22. Price |

Acknowledgements

The authors would like to thank the Florida Department of Transportation (FDOT) for providing the funds for this project. The FDOT State Traffic Engineering and Operations Office, Traffic Engineering Research Lab assisted in acquiring the necessary traffic signal assemblies and components for full-scale tests and organized the donation of necessary equipment from various traffic hardware manufacturers. We thank the manufacturers that sent the donated equipment and took the time to attend test days. The authors also thank Horsepower Electric Inc. electrical contractors for their unlimited support by providing experienced teams for the installation of traffic signals and changing equipment between tests. Their hard work and patience is greatly appreciated. Finally, thanks are given to all of our fellow researchers and technical team at the Wall of Wind Research Facility who gave their time to this project to ensure the installation of various instrumentations and assure they worked smoothly.

Executive Summary

The performance of span-wire mounted traffic signals during the past hurricane seasons indicated to FDOT the need to explore new methods to improve traffic signal assembly survivability during hurricane force winds. Prior research determined that to further improve the safety of signalized intersections during and after hurricane conditions and to reduce the cost of damage to the State's traffic control infrastructure, serviceability of the traffic signal assembly required additional research. FDOT and FIU embarked on a collaborative research program to study the performance of span-wire traffic signal systems subjected to extreme winds with the goal to enhance their resiliency and survivability and potentially find a methodology that could be utilized to certify the different products used in span-wire traffic signal assemblies. This report discusses the findings of research project BDV29 TWO 977-27 which is a companion project to BDV29 TWO 977-20.

The tasks of this research project included: Task 1 - Determine the nature of wind loading and system response of wire supported traffic signal assemblies for winds up to 150 MPH. This was achieved through full scale testing using an 80ft span test frame for a single wind direction; and Task 2 - Determine the nature of wind loading and system response of wire supported traffic signal assemblies for winds up to 150 MPH. This was achieved through full scale testing using a 20ft span test frame for multiple wind directions.

The execution of the different tasks generated a plethora of experimentally and numerically derived outcomes. Among others, the full-scale tests revealed that depending on the rigidity of the hanger, the traffic signal assembly is more susceptible to aerodynamic instabilities in the form of galloping. Flexible hangers have a tendency to undergo higher along-wind inclinations at lower wind speeds which appear to trigger this instability at lower wind speeds (about 70 mph) than a rigid hanger, while for the rigid hanger the instability appears when the extension bars severely bend (about 110 mph). The 5-section signal has been found to be susceptible to damage regardless of the type of hanger used. This may be due to its increased weight as well as the increased surface area compared to the 3-section signal. It is recommended to find an alternative to replace usage of 5-section signal. A common failure observed was with the 72-tooth serrated edge connection between the adjustable-hanger and the disconnect-box and also between the

disconnect-box to signal-housing point. The failure mode with this connection point was when the serrated edge would shear, allowing the connection to turn. A resilient connection at these points should be considered to enhance the survivability of the signal under wind induced loads. Moreover, it was determined that Florida DOT specified aluminum alloy 535 should be continued due to its outstanding performance during testing and maximum overlap at tri-stud adjustable-hanger and extension-bar connection points should be used (top and bottom portions/connections).

The above findings are of great value and significance since it was the first time that these systems were tested at full-scale in a controlled and realistic environment. The aerodynamic instability that has been observed in the field was identified and quantified for the very first time in a laboratory setting. Numerous recommendations have been generated following the findings of this research that will assist FDOT to enhance the survivability of span-wire traffic signals during extreme wind events.

Table of Contents

| | |
|--|-------|
| FINAL REPORT BDV29 977-27 | i |
| Disclaimer | ii |
| Metric Conversion Table | iii |
| Technical Report Documentation Page | iv |
| Acknowledgements | v |
| Executive Summary | vi |
| Table of Contents | viii |
| List of Figures | xiv |
| List of Tables | xxvii |
| Chapter 1 – Introduction | 1 - |
| 1.1 Test Setup for Task 1 and Task 2 | 1 - |
| 1.1.1 Long Span Rig | 1 - |
| 1.1.2 Short Span Rig | 2 - |
| 1.2 Instrumentation for Task 1 and Task 2 | 3 - |
| Chapter 2 - Task 1: LONG SPAN LENGTH FULL SCALE TESTING - Case 1 | 15 - |
| 2.1 Introduction | 15 - |
| 2.2 Experimental methodology | 16 - |
| 2.2.1 Test Setup | 16 - |
| 2.2.2 Instrumentation | 16 - |
| 2.2.3 Test Method | 17 - |
| 2.3 Results and discussion | 23 - |
| 2.3.1 Wind induced forces | 23 - |
| 2.3.2 rms of accelerations | 24 - |

| | | |
|--|---|--------|
| 2.3.3 | Inclinations of the traffic signals | - 25 - |
| 2.4 | Performance of traffic signals during the tests | - 30 - |
| 2.5 | Conclusions | - 32 - |
| Chapter 3 - Task 1: LONG SPAN LENGTH FULL SCALE TESTING - Case 2 | | - 33 - |
| 3.1 | Introduction | - 33 - |
| 3.2 | Experimental Methodology | - 34 - |
| 3.2.1 | Test Setup..... | - 34 - |
| 3.2.2 | Instrumentation | - 34 - |
| 3.2.3 | Test Method | - 35 - |
| 3.3 | Results and Discussion | - 41 - |
| 3.3.1 | Wind induced forces | - 41 - |
| 3.3.2 | rms of accelerations | - 42 - |
| 3.3.3 | Inclinations of the traffic signals | - 43 - |
| 3.4 | Performance of traffic signals during the tests | - 48 - |
| 3.5 | Conclusions | - 51 - |
| Chapter 4 - Task 1: LONG SPAN LENGTH FULL SCALE TESTING - Case 3 | | - 52 - |
| 4.1 | Introduction | - 52 - |
| 4.2 | Experimental methodology..... | - 53 - |
| 4.2.1 | Test Setup..... | - 53 - |
| 4.2.2 | Instrumentation | - 53 - |
| 4.2.3 | Test Method | - 54 - |
| 4.3 | Results and discussion | - 60 - |
| 4.3.1 | Wind induced forces | - 60 - |
| 4.3.2 | rms of accelerations | - 62 - |

| | | |
|--|---|---------|
| 4.3.3 | Inclinations of the traffic signals | - 62 - |
| 4.4 | Performance of traffic signals during the tests | - 67 - |
| 4.5 | Conclusions | - 70 - |
| Chapter 5 - Task 1: LONG SPAN LENGTH FULL SCALE TESTING - Case 4 | | - 71 - |
| 5.1 | Introduction | - 71 - |
| 5.2 | Experimental methodology | - 72 - |
| 5.2.1 | Test Setup | - 72 - |
| 5.2.2 | Instrumentation | - 72 - |
| 5.2.3 | Test Method | - 73 - |
| 5.3 | Results and discussion | - 79 - |
| 5.3.1 | Wind induced forces | - 79 - |
| 5.3.2 | rms of accelerations | - 80 - |
| 5.3.3 | Inclinations of the traffic signals | - 81 - |
| 5.4 | Performance of traffic signals during the tests | - 86 - |
| 5.5 | Conclusions | - 91 - |
| Chapter 6 - Task 1: LONG SPAN LENGTH FULL SCALE TESTING - Case 5 | | - 92 - |
| 6.1 | Introduction | - 92 - |
| 6.2 | Experimental methodology | - 93 - |
| 6.2.1 | Test Setup | - 93 - |
| 6.2.2 | Instrumentation | - 93 - |
| 6.2.3 | Test Method | - 94 - |
| 6.3 | Results and discussion | - 100 - |
| 6.3.1 | Wind induced forces | - 100 - |
| 6.3.2 | rms of accelerations | - 102 - |

| | | |
|--|---|---------|
| 6.3.3 | Inclinations of the traffic signals | - 102 - |
| 6.4 | Performance of traffic signals during the tests | - 107 - |
| 6.5 | Conclusions | - 110 - |
| Chapter 7 - Task 2: LONG SPAN LENGTH FULL SCALE TESTING - Case 1 | | - 111 - |
| 7.1 | Introduction | - 111 - |
| 7.2 | Experimental Methodology | - 111 - |
| 7.2.1 | Test Setup..... | - 111 - |
| 7.2.2 | Instrumentation | - 112 - |
| 7.2.3 | Test Method | - 112 - |
| 7.3 | Results and Discussion | - 118 - |
| 7.3.1 | Wind induced forces | - 118 - |
| 7.3.2 | rms of accelerations | - 120 - |
| 7.3.3 | Inclinations of the traffic signals | - 120 - |
| 7.4 | Performance of traffic signals during the tests | - 126 - |
| 7.5 | Conclusions | - 128 - |
| Chapter 8 - Task 2: LONG SPAN LENGTH FULL SCALE TESTING - Case 2 | | - 129 - |
| 8.1 | Introduction | - 129 - |
| 8.2 | Experimental Methodology | - 129 - |
| 8.2.1 | Test Setup..... | - 129 - |
| 8.2.2 | Instrumentation | - 130 - |
| 8.2.3 | Test Method | - 131 - |
| 8.3 | Results and Discussion | - 137 - |
| 8.3.1 | The effect of drop in cable forces during the tests at 65 mph | - 137 - |
| 8.3.2 | Wind induced forces | - 137 - |

| | | |
|--|---|---------|
| 8.3.3 | rms of accelerations | - 139 - |
| 8.3.4 | Inclinations of the traffic signals | - 139 - |
| 8.4 | Performance of traffic signals during the tests | - 147 - |
| 8.5 | Conclusions | - 147 - |
| Chapter 9 - Task 2: SHORT SPAN LENGTH FULL SCALE TESTING - Case 3 | | - 149 - |
| 9.1 | Introduction | - 149 - |
| 9.2 | Experimental Methodology | - 149 - |
| 9.2.1 | Test Setup..... | - 149 - |
| 9.2.2 | Instrumentation | - 150 - |
| 9.2.3 | Test Method | - 150 - |
| 9.3 | Results and Discussion | - 158 - |
| 9.3.1 | Wind induced forces | - 158 - |
| 9.3.2 | rms of accelerations | - 159 - |
| 9.3.3 | Inclinations of the traffic signals | - 160 - |
| 9.4 | Performance of traffic signals during the tests | - 165 - |
| 9.5 | Conclusions | - 170 - |
| Chapter 10 - Task 2: SHORT SPAN LENGTH FULL SCALE TESTING - Case 4 | | - 171 - |
| 10.1 | Introduction | - 171 - |
| 10.2 | Experimental Methodology | - 171 - |
| 10.2.1 | Test Setup..... | - 171 - |
| 10.2.2 | Instrumentation | - 172 - |
| 10.2.3 | Test Method | - 172 - |
| 10.3 | Results and Discussion | - 179 - |
| 10.3.1 | Wind induced forces | - 179 - |

| | | |
|------------|--|---------|
| 10.3.2 | rms of accelerations | - 180 - |
| 10.3.3 | Inclinations of the traffic signals | - 180 - |
| 10.4 | Performance of traffic signals during the tests | - 186 - |
| 10.5 | Conclusions | - 190 - |
| Chapter 11 | - Task 2: SHORT SPAN LENGTH FULL SCALE TESTING - Case 5 | - 191 - |
| 11.1 | Introduction | - 191 - |
| 11.2 | Experimental Methodology | - 191 - |
| 11.2.1 | Test Setup..... | - 191 - |
| 11.2.2 | Instrumentation | - 192 - |
| 11.2.3 | Test Method | - 192 - |
| 11.3 | Results and Discussion | - 200 - |
| 11.3.1 | Wind induced forces | - 200 - |
| 11.3.2 | rms of accelerations..... | - 201 - |
| 11.3.3 | Inclinations of the traffic signals | - 201 - |
| 11.4 | Performance of traffic signals during the tests | - 207 - |
| 11.5 | Conclusions | - 210 - |
| Chapter 12 | - Overview of Conclusions, Findings, and Recommendations | - 211 - |
| 12.1 | Full-scale Tests | - 211 - |
| References | | - 213 - |
| Appendix A | - Task 2: SHORT SPAN LENGTH FULL SCALE TESTING - Case 3 | - 214 - |
| Appendix B | - Task 2: SHORT SPAN LENGTH FULL SCALE TESTING - Case 4 | - 229 - |
| Appendix C | - Task 2: SHORT SPAN LENGTH FULL SCALE TESTING – Case 5 | - 244 - |
| Appendix D | - Comparison of solid (non-louvered) backplates and louvered backplates cases- | 259 |

-

List of Figures

| | |
|--|--------|
| Figure 1: Plan view of long span test rig | - 4 - |
| Figure 2: Profile Elevation View of long span test rig | - 5 - |
| Figure 3: End Elevation of View of long span test rig | - 6 - |
| Figure 4: Reinforced long span test rig | - 7 - |
| Figure 5: Plan view of reinforced long span test rig | - 8 - |
| Figure 6: Profile Elevation View of reinforced long span test rig | - 9 - |
| Figure 7: End Elevation of View of reinforced long span test rig | - 10 - |
| Figure 8: Plan view of reinforced short span test rig..... | - 11 - |
| Figure 9: Profile elevation view of reinforced short span test rig | - 12 - |
| Figure 10: End elevation view of reinforced short span test rig..... | - 13 - |
| Figure 11: Pictures of 6 degrees of freedom loadcell..... | - 13 - |
| Figure 12: Signal assembly components..... | - 14 - |
| Figure 13: Signal assemblies installed on test frame (before testing)..... | - 19 - |
| Figure 14: View of rear of test setup (looking into wind tunnel) | - 20 - |
| Figure 15: Close-up view of the pivotal hanger connection | - 20 - |
| Figure 16: Direction of x, y, z components for each loadcell (direction of each axis shown represents 'positive direction')..... | - 21 - |
| Figure 17: Location of accelerometers and inclinometers in 5-section signal | - 22 - |
| Figure 18: Location of accelerometers and inclinometers in 3-section signal | - 22 - |
| Figure 19: Mean forces on loadcells 2 (messenger wire) and 4 (catenary wire) at 0-degree wind direction | - 26 - |
| Figure 20: Mean forces on loadcells 1 (catenary wire) and 5 (messenger wire) at 0-degree wind direction | - 26 - |
| Figure 21: Peak forces at 0-degree wind direction on loadcells 2 (messenger wire) and 4 (catenary wire)' | - 27 - |
| Figure 22: Peak forces at 0-degree wind direction on loadcells 1 (catenary wire) and 5 (messenger wire) | - 27 - |

Figure 23: Drag (F_y) and lift (F_x) forces on the traffic signals at 0 degrees: a) Mean; b) Peak. - 28 -

Figure 24: rms of accelerations on the 3-section and 5-section signals at 0 degrees..... - 29 -

Figure 25: Inclinations (mean and max) obtained at 0 degrees for inclinometers 1 and 3 - 29 -

Figure 26: Signal Assembly after full wind speed test - 31 -

Figure 27: 5-section signal figures showing slight rotation of 5-section signal assembly - 31 -

Figure 28: Signal assemblies installed on test rig (before testing) - 37 -

Figure 29: Signal Setup for the test; b) Magnified view of the connection - 38 -

Figure 30: Direction of x, y, z components for each loadcell (direction of each axis shown) .. - 39 -

Figure 31: Location of accelerometers and inclinometers in 5-section signal - 40 -

Figure 32: Location of accelerometers and inclinometers in 3-section signal - 40 -

Figure 33: Mean forces on loadcells 2 (messenger wire) and 4 (catenary wire) at 0-degree wind direction - 44 -

Figure 34: Mean forces on loadcells 1 (catenary wire) and 5 (messenger wire) at 0-degree wind direction - 44 -

Figure 35: Peak forces at 0-degree wind direction on loadcells 2 (messenger wire) and 4 (catenary wire) - 45 -

Figure 36: Peak forces at 0-degree wind direction on loadcells 1 (catenary wire) and 5 (messenger wire) - 45 -

Figure 37: Drag (F_y) and lift (F_x) forces on the traffic signals at 0 degrees: a) Mean; b) Peak. - 46 -

Figure 38: rms of accelerations on the 3-section and 5-section signals at 0 degrees..... - 47 -

Figure 39: Inclinations (mean and max) obtained at 0 degrees for inclinometers 1 and 3 - 47 -

Figure 40: The 5-section signal with damaged back plates and visors..... - 49 -

Figure 41: Traffic signals after completion of 130 mph test..... - 49 -

Figure 42: Disconnect-to-adjustable hanger connection for 5-section signal with signs of rotation - 50 -

Figure 43: Disconnect box for 3-section signal with no visible damage..... - 50 -

Figure 44: Signal assemblies installed on test frame (before testing)..... - 56 -

Figure 45: a) Setup for the test; b) Magnified view of the connection - 57 -

Figure 46: Direction of x, y, z components for each loadcell (direction of each axis shown ... - 58 -

Figure 47: Location of accelerometers and inclinometers in 5-section signal for case 1 - 59 -

Figure 48: Location of accelerometers and inclinometers in 3-section signal for case 1 - 59 -

Figure 49: Mean forces on loadcells 2 (messenger wire) and 4 (catenary wire) at 0-degree wind direction - 63 -

Figure 50: Mean forces on loadcells 1 (catenary wire) and 5 (messenger wire) at 0-degree wind direction - 63 -

Figure 51: Peak forces at 0-degree wind direction on loadcells 2 (messenger wire) and 4 (catenary wire) - 64 -

Figure 52: Peak forces at 0-degree wind direction on loadcells 1 (catenary wire) and 5 (messenger wire) - 64 -

Figure 53: Drag (F_y) and lift (F_x) forces on the traffic signals at 0 degrees: a) Mean; b) Peak. - 65 -

Figure 54: rms of accelerations on the 3-section and 5-section signals at 0 degrees..... - 66 -

Figure 55: Inclinations (mean and max) obtained at 0 degrees for inclinometers 1 and 3 - 66 -

Figure 56: Signal assembly after 115 mph - 68 -

Figure 57: 5-section signal after completion of test - 68 -

Figure 58: East 3-section signal hanger attachment - 69 -

Figure 59: Signal assemblies installed on test rig (before testing) - 75 -

Figure 60: a) Signal setup for the test; b) View of the connection - 76 -

Figure 61: Direction of x, y, components for each loadcell (direction of each axis shown represents "positive direction") - 77 -

Figure 62: Location of accelerometers and inclinometers in 5-section signal - 77 -

Figure 63: Location of accelerometers and inclinometers in 3-section signal - 78 -

Figure 64: Mean forces on loadcells 2 (messenger wire) and 4 (catenary wire) at 0-degree wind direction - 82 -

Figure 65: Mean forces on loadcells 1 (catenary wire) and 5 (messenger wire) at 0-degree wind direction - 82 -

Figure 66: Peak forces at 0-degree wind direction on loadcells 2 (messenger wire) and 4 (catenary wire) - 83 -

Figure 67: Peak forces at 0-degree wind direction on loadcells 1 (catenary wire) and 5 (messenger wire) - 83 -

Figure 68: Drag (Fy) and lift (Fx) forces on the traffic signals at 0 degrees: a) Mean; b) Peak. - 84 -

Figure 69: rms of accelerations on the 3-section and 5-section signals at 0 degrees..... - 85 -

Figure 70: Inclinations (mean and max) obtained at 0 degrees for inclinometers 1 and 3 - 85 -

Figure 71: Pelco adjustable hanger assembly with cable dampener after full range test - 87 -

Figure 72: Traffic signals after 30 to 130 mph wind speeds test..... - 88 -

Figure 73: a) 5-section traffic signal b) center 3-section traffic signal c) west 3-section traffic signal after test..... - 89 -

Figure 74: Lower visor from 5-section traffic signal after test - 90 -

Figure 75: Signal assemblies installed on test frame (before testing)..... - 96 -

Figure 76: a) Traffic signal set up, b) Cable hanger assembly with reinforced disconnect hanger. - 97 -

Figure 77: Direction of x, y, z components for each loadcell (direction of each axis shown represents 'positive direction')..... - 98 -

Figure 78: Location of accelerometers and inclinometers in 5-section signal - 98 -

Figure 79: Location of accelerometers and inclinometers in 3-section signal - 99 -

Figure 80: Mean forces on loadcells 2 (messenger wire) and 4 (catenary wire) at 0-degree wind direction - 103 -

Figure 81: Mean forces on loadcells 1 (catenary wire) and 5 (messenger wire) at 0-degree wind direction - 103 -

Figure 82: Peak forces at 0-degree wind direction on loadcells 2 (messenger wire) and 4 (catenary wire) - 104 -

Figure 83: Peak forces at 0-degree wind direction on loadcells 1 (catenary wire) and 5 (messenger wire) - 104 -

Figure 84: Drag (Fy) and lift (Fx) forces on the traffic signals at 0 degrees: a) Mean; b) Peak- 105 -

Figure 85: rms of accelerations on the 3-section and 5-section signals at 0 degrees..... - 106 -

Figure 86: Inclinations (mean and max) obtained at 0 degrees for inclinometers 1 and 3 ... - 106 -

Figure 87: Damaged visor from 3-section signal (center visor missing)..... - 108 -

Figure 88: Damage after full range of wind speeds (damage to back plates and visors)..... - 108 -

Figure 89: East 3-section signal with sheared off visor screw - 109 -

Figure 90: Signal assemblies installed on test rig (before testing) - 114 -

Figure 91: : a) Signal Setup for the test; b) Magnified view of the connection..... - 115 -

Figure 92: Direction of x, y, z components for each loadcell (direction of each axis shown) - 116 -

Figure 93: Location of accelerometers and inclinometers in 5-section signal - 117 -

Figure 94: Location of accelerometers and inclinometers in 3-section signal - 117 -

Figure 95: Mean forces on loadcells 2 (messenger wire) and 4 (catenary wire) at 0 degrees wind direction - 121 -

Figure 96: Mean forces on loadcells 1 (catenary wire) and 5 (messenger wire) at 0 degrees wind direction - 121 -

Figure 97: Peak forces at 0 degrees wind direction on loadcells 2 (messenger wire) and 4 (catenary wire) - 122 -

Figure 98: Peak forces at 0 degrees wind direction on loadcells 1 (catenary wire) and 5 (messenger wire) - 122 -

Figure 99: Drag (F_y) and lift (F_x) forces on the traffic signals at 0 degrees: a) Mean; b) Peak- 123 -

Figure 100: rms of accelerations from various accelerometers at 0 degrees - 124 -

Figure 101: Inclinations obtained at 0 degrees from inclinometers: a) mean; b) peak - 125 -

Figure 102: 5-Section signal with damaged back plates..... - 127 -

Figure 103: Signal assemblies installed on test rig (before testing) - 133 -

Figure 104: a) Signal Setup for the test; b) Magnified view of the connection..... - 134 -

Figure 105: Direction of x, y, z components for each loadcell (direction of each axis shown)- 135 -

-

Figure 106: Location of accelerometers and inclinometers in 5-section signal - 136 -

Figure 107: Location of accelerometers and inclinometers in 3-section signal - 136 -

Figure 108: Force time history plots at 65 mph for F_x (lift) and F_y (drag) on loadcell 2 (messenger) and loadcell 4 (catenary)..... - 140 -

Figure 109: Acceleration time histories at 65 mph: a) Accelerometer 6 (3-section signal); b) Accelerometer 2 (5-section signal) – test duration 33 min - 141 -

Figure 110: Mean forces on loadcells 2 (messenger wire) and 4 (catenary wire) at 0 degrees wind direction - 142 -

Figure 111: Mean forces on loadcells 1 (catenary wire) and 5 (messenger wire) at 0 degrees wind direction - 142 -

Figure 112: Peak forces at 0 degrees wind direction on loadcells 2 (messenger wire) and 4 (catenary wire)..... - 143 -

Figure 113: Peak forces at 0 degrees wind direction on loadcells 1 (catenary wire) and 5 (messenger wire) - 143 -

Figure 114: Drag (F_y) and lift (F_x) forces on the traffic signals at 0 degrees: a) Mean; b) Peak- 144 -

-

Figure 115: rms of accelerations from various accelerometers at 0 degrees - 145 -

Figure 116: Inclinations obtained at 0 degrees from inclinometers: a) mean; b) peak (wind speed of 65 mph, after loss of tension values reported) - 146 -

Figure 117: Test rig - 152 -

Figure 118: Signal assemblies installed on test rig (before testing) - 153 -

Figure 119: a) Signal setup for the test; b) Magnified view of the connection - 154 -

Figure 120: Direction of x,y,z components for each loadcell (direction of each axis shown represents 'positive direction') - 156 -

Figure 121: Location of accelerometers and inclinometers in 5-section signal - 157 -

Figure 122: Location of accelerometers and inclinometers in 3-section signal - 157 -

Figure 123: Mean Forces on loadcells 2 (catenary wire) and 4 (messenger wire) at 0 degrees wind direction - 161 -

Figure 124: Mean Forces on loadcells 1 (catenary wire) and 5 (messenger wire) at 0 degrees wind direction - 161 -

Figure 125: Peak Forces on loadcells 2 (catenary wire) and 4 (messenger wire) at 0 degrees wind direction - 162 -

Figure 126: Peak Forces on loadcells 1 (catenary wire) and 5 (messenger wire) at 0 degrees wind direction - 162 -

Figure 127: Drag (F_y) and lift (F_x) forces on the traffic signal at 0 degrees: a) Mean; b) Peak- 163 -

Figure 128: rms of accelerations on the 3-section and 5-section signals at 0 degrees..... - 164 -

Figure 129: Inclinations (mean and max) obtained at 0 degrees for inclinometer 2..... - 164 -

Figure 130: Signal assembly after test - 166 -

Figure 131: Adjustable hanger to disconnect box connection failure (5-section assembly) . - 167 -

Figure 132: 5-Section signal disconnect box with damaged serrated teeth - 168 -

Figure 133: 5-Section signal with damaged serrated teeth and rotation of bottom signals (picture inverted)..... - 169 -

Figure 134: Test rig - 174 -

Figure 135: Signal assemblies installed on test rig (before testing) - 175 -

Figure 136: a) Signal setup for the test; b) Magnified view of the connection - 177 -

Figure 137: Direction of x,y,z components for each loadcell (direction of each axis shown represents 'positive direction') - 177 -

Figure 138: Location of accelerometers and inclinometers in 5-section signal - 178 -

Figure 139: Location of accelerometers and inclinometers in 3-section signal - 178 -

Figure 140: Mean forces on loadcells 2 (catenary wire) and 4 (messenger wire) at 0 degrees wind direction - 182 -

Figure 141: Mean forces on loadcells 1 (catenary wire) and 5 (messenger wire) at 0 degrees wind direction - 182 -

Figure 142: Peak forces on loadcells 2 (catenary wire) and 4 (messenger wire) at 0 degrees wind direction - 183 -

Figure 143: Peak forces on loadcells 1 (catenary wire) and 5 (messenger wire) at 0 degrees wind direction - 183 -

Figure 144: Drag (F_y) and lift (F_x) forces on the traffic signal at 0 degrees: a) Mean; b) Peak- 184 -

Figure 145: rms of accelerations on the 3-section and 5-section signals at 0 degrees..... - 185 -

Figure 146: Inclinations (mean and max) obtained at 0 degrees for inclinometer 2..... - 185 -

Figure 147: Sheared teeth from hanger to disconnect-box connection - 187 -

Figure 148: 5-section signal rotation from top-signal to bottom-4-signal connection - 188 -

Figure 149: 5-section signal broken hold down bar - 189 -

Figure 150: 5-section signal gusseted tube to tri-stud hanger broken bracket - 189 -

Figure 151: Test rig - 194 -

Figure 152: Signal assembly installed on test rig (before testing)..... - 195 -

Figure 153: a) Signal Setup for the test; b) Magnified view of the connection..... - 196 -

Figure 154: Direction of x,y,z components for each loadcell (direction of each axis shown represents 'positive direction') - 198 -

Figure 155: Location of accelerometers and inclinometers in 3-section signal - 199 -

Figure 156: Mean Forces on loadcells 2 (catenary wire) and 4 (messenger wire) at 0 degrees wind direction - 203 -

Figure 157: Mean Forces on loadcells 1 (catenary wire) and 5 (messenger wire) at 0 degrees wind direction - 203 -

Figure 158: Peak Forces on loadcells 2 (catenary wire) and 4 (messenger wire) at 0 degrees wind direction - 204 -

Figure 159: Peak Forces on loadcells 1 (catenary wire) and 5 (messenger wire) at 0 degrees wind direction - 204 -

Figure 160: Drag (F_y) and lift (F_x) forces on the traffic signal at 0 degrees: a) Mean; b) Peak- 205 -

-

Figure 161: rms of accelerations on the 3-section and 5-section signals at 0 degrees..... - 206 -

Figure 162: Inclinations (mean and max) obtained at 0 degrees for inclinometer 2..... - 206 -

Figure 163: Signal assembly after test - 208 -

Figure 164: Hanger connection after test..... - 209 -

Figure A-1: Mean forces at 45 degrees wind direction on loadcells 2 (catenary wire) and 4 (messenger wire) - 214 -

Figure A-2: Mean forces at 45 degrees wind direction on loadcells 1 (catenary wire) and 5 (messenger wire) - 214 -

Figure A-3: Peak forces at 45 degrees wind direction on loadcells 2 (catenary wire) and 4 (messenger wire) - 215 -

Figure A-4: Peak forces at 45 degrees wind direction on loadcells 1 (catenary wire) and 5 (messenger wire) - 215 -

Figure A-5: rms of accelerations at 45 degrees wind direction for various wind speeds - 216 -

Figure A-6: Mean forces at 80 degrees wind direction on loadcells 2 (catenary wire) and 4 (messenger wire) - 217 -

Figure A-7: Mean forces at 80 degrees wind direction on loadcells 1 (catenary wire) and 5 (messenger wire) - 217 -

Figure A-8: Peak forces at 80 degrees wind direction on loadcells 2 (catenary wire) and 4 (messenger wire) - 218 -

Figure A-9: Peak forces at 80 degrees wind direction on loadcells 1 (catenary wire) and 5 (messenger wire) - 218 -

Figure A-10: rms of accelerations at 80 degrees wind direction for various wind speeds - 219 -

Figure A-11: Mean forces at 100 degrees wind direction on loadcells 2 (catenary wire) and 4 (messenger wire) - 220 -

Figure A-12: Mean forces at 100 degrees wind direction on loadcells 1 (catenary wire) and 5 (messenger wire) - 220 -

Figure A-13: Peak forces at 100 degrees wind direction on loadcells 2 (catenary wire) and 4 (messenger wire) - 221 -

Figure A-14: Peak forces at 100 degrees wind direction on loadcells 1 (catenary wire) and 5 (messenger wire) - 221 -

Figure A-15: rms of accelerations at 100 degrees wind direction for various wind speeds .. - 222 -

Figure A-16: Mean forces at 135 degrees wind direction on loadcells 2 (catenary wire) and 4 (messenger wire) - 223 -

Figure A-17: Mean forces at 135 degrees wind direction on loadcells 1 (catenary wire) and 5 (messenger wire) - 223 -

Figure A-18: Peak forces at 135 degrees wind direction on loadcells 2 (catenary wire) and 4 (messenger wire) - 224 -

Figure A-19: Peak forces at 135 degrees wind direction on loadcells 1 (catenary wire) and 5 (messenger wire) - 224 -

Figure A-20: rms of accelerations at 135 degrees wind direction for various wind speeds .. - 225 -

Figure A-21: Mean forces at 180 degrees wind direction on loadcells 2 (catenary wire) and 4 (messenger wire) - 226 -

Figure A-22: Mean forces at 180 degrees wind direction on loadcells 1 (catenary wire) and 5 (messenger wire) - 226 -

Figure A-23: Peak forces at 180 degrees wind direction on loadcells 2 (catenary wire) and 4 (messenger wire) - 227 -

Figure A-24: Peak forces at 180 degrees wind direction on loadcells 1 (catenary wire) and 5 (messenger wire) - 227 -

Figure A-25: rms of accelerations at 180 degrees wind direction for various wind speeds .. - 228 -

Figure B 1: Mean forces at 45 degrees wind direction on loadcells 2 (catenary wire) and 4 (messenger wire) - 229 -

Figure B 2: Mean forces at 45 degrees wind direction on loadcells 1 (catenary wire) and 5 (messenger wire) - 229 -

Figure B 3: Peak forces at 45 degrees wind direction on loadcells 2 (catenary wire) and 4 (messenger wire) - 230 -

Figure B 4: Peak forces at 45 degrees wind direction on loadcells 1 (catenary wire) and 5 (messenger wire) - 230 -

Figure B 5: rms of accelerations at 45 degrees wind direction for various wind speeds..... - 231 -

Figure B 6: Mean forces at 80 degrees wind direction on loadcells 2 (catenary wire) and 4 (messenger wire) - 232 -

Figure B 7: Mean forces at 80 degrees wind direction on loadcells 1 (catenary wire) and 5 (messenger wire) - 232 -

Figure B 8: Peak forces at 80 degrees wind direction on loadcells 2 (catenary wire) and 4 (messenger wire) - 233 -

Figure B 9: Peak forces at 80 degrees wind direction on loadcells 1 (catenary wire) and 5 (messenger wire) - 233 -

Figure B 10: rms of accelerations at 80 degrees wind direction for various wind speeds..... - 234 -

Figure B 11: Mean forces at 100 degrees wind direction on loadcells 2 (catenary wire) and 4 (messenger wire) - 235 -

Figure B 12: Mean forces at 100 degrees wind direction on loadcells 1 (catenary wire) and 5 (messenger wire) - 235 -

Figure B 13: Peak forces at 100 degrees wind direction on loadcells 2 (catenary wire) and 4 (messenger wire) - 236 -

Figure B 14: Peak forces at 100 degrees wind direction on loadcells 1 (catenary wire) and 5 (messenger wire) - 236 -

Figure B 15: rms of accelerations at 100 degrees wind direction for various wind speeds... - 237 -

Figure B 16: Mean forces at 135 degrees wind direction on loadcells 2 (catenary wire) and 4 (messenger wire) - 238 -

Figure B 17: Mean forces at 135 degrees wind direction on loadcells 1 (catenary wire) and 5 (messenger wire) - 238 -

Figure B 18: Peak forces at 135 degrees wind direction on loadcells 2 (catenary wire) and 4 (messenger wire) - 239 -

Figure B 19: Peak forces at 135 degrees wind direction on loadcells 1 (catenary wire) and 5 (messenger wire) - 239 -

Figure B 20: rms of accelerations at 135 degrees wind direction for various wind speeds... - 240 -

Figure B 21: Mean forces at 180 degrees wind direction on loadcells 2 (catenary wire) and 4 (messenger wire) - 241 -

Figure B 22: Mean forces at 180 degrees wind direction on loadcells 1 (catenary wire) and 5 (messenger wire) - 241 -

Figure B 23: Peak forces at 180 degrees wind direction on loadcells 2 (catenary wire) and 4 (messenger wire) - 242 -

Figure B 24: Peak forces at 180 degrees wind direction on loadcells 1 (catenary wire) and 5 (messenger wire) - 242 -

Figure B 25: rms of accelerations at 180 degrees wind direction for various wind speeds... - 243 -

Figure C 1: Mean forces at 45 degrees wind direction on loadcells 2 (catenary wire) and 4 (messenger wire) - 244 -

Figure C 2: Mean forces at 45 degrees wind direction on loadcells 1 (catenary wire) and 5 (messenger wire) - 244 -

Figure C 3: Peak forces at 45 degrees wind direction on loadcells 2 (catenary wire) and 4 (messenger wire) - 245 -

Figure C 4: Peak forces at 45 degrees wind direction on loadcells 1 (catenary wire) and 5 (messenger wire) - 245 -

Figure C 5: rms of accelerations at 45 degrees wind direction for various wind speeds..... - 246 -

Figure C 6: Mean forces at 80 degrees wind direction on loadcells 2 (catenary wire) and 4 (messenger wire) - 247 -

Figure C 7: Mean forces at 80 degrees wind direction on loadcells 1 (catenary wire) and 5 (messenger wire) - 247 -

Figure C 8: Peak forces at 80 degrees wind direction on loadcells 2 (catenary wire) and 4 (messenger wire) - 248 -

Figure C 9: Peak forces at 80 degrees wind direction on loadcells 1 (catenary wire) and 5 (messenger wire) - 248 -

Figure C 10: rms of accelerations at 80 degrees wind direction for various wind speeds..... - 249 -

Figure C 11: Mean forces at 100 degrees wind direction on loadcells 2 (catenary wire) and 4 (messenger wire) - 250 -

Figure C 12: Mean forces at 100 degrees wind direction on loadcells 1 (catenary wire) and 5 (messenger wire) - 250 -

Figure C 13: Peak forces at 100 degrees wind direction on loadcells 2 (catenary wire) and 4 (messenger wire) - 251 -

Figure C 14: Peak forces at 100 degrees wind direction on loadcells 1 (catenary wire) and 5 (messenger wire) - 251 -

Figure C 15: rms of accelerations at 100 degrees wind direction for various wind speeds... - 252 -

Figure C 16: Mean forces at 135 degrees wind direction on loadcells 2 (catenary wire) and 4 (messenger wire) - 253 -

Figure C 17: Mean forces at 135 degrees wind direction on loadcells 1 (catenary wire) and 5 (messenger wire) - 253 -

Figure C 18: Peak forces at 135 degrees wind direction on loadcells 2 (catenary wire) and 4 (messenger wire) - 254 -

Figure C 19: Peak forces at 135 degrees wind direction on loadcells 1 (catenary wire) and 5 (messenger wire) - 254 -

Figure C 20: rms of accelerations at 135 degrees wind direction for various wind speeds... - 255 -

Figure C 21: Mean forces at 180 degrees wind direction on loadcells 2 (catenary wire) and 4 (messenger wire) - 256 -

Figure C 22: Mean forces at 180 degrees wind direction on loadcells 1 (catenary wire) and 5 (messenger wire) - 256 -

Figure C 23: Peak forces at 180 degrees wind direction on loadcells 2 (catenary wire) and 4 (messenger wire) - 257 -

Figure C 24: Peak forces at 180 degrees wind direction on loadcells 1 (catenary wire) and 5 (messenger wire) - 257 -

Figure C 25: rms of accelerations at 180 degrees wind direction for various wind speeds... - 258 -

Figure D-1: Mean forces of Louvered backplates case; a) loadcells 1 & 2 catenary wire,) loadcells 4 & 5 messenger wire) - 261 -

Figure D-2: Mean forces of Solid (non-louvered) backplates case; a) loadcells 1 & 2 catenary wire, b) loadcells 4 & 5 messenger wire)..... - 262 -

Figure D-3: Mean inclinations of louvered backplates case - 263 -

Figure D-4: Mean inclinations of solid (non-louvered) backplates case..... - 263 -

List of Tables

| | |
|--|---------|
| Table 1: Assembly components (Task 1: Case 1) | - 18 - |
| Table 2: Test protocol (Task 1: Case 1) | - 18 - |
| Table 3: Components of traffic assembly (Task 1: Case 2) | - 36 - |
| Table 4 Test Protocol (Task 1: Case 2) | - 36 - |
| Table 5: Components of signal assembly (Task 1: Case 3)..... | - 55 - |
| Table 6: Test Protocol (Task 1: Case 3) | - 55 - |
| Table 7: Signal assembly components (Task 1: Case 4) | - 74 - |
| Table 8: Test Protocol (Task 1: Case 4) | - 74 - |
| Table 9: Signal assembly components (Task 1: Case 5) | - 95 - |
| Table 10: Test Protocol (Task 1: Case 5) | - 95 - |
| Table 11: Components of signal assembly (Task 2: Case 1)..... | - 113 - |
| Table 12: Test Protocol (Task 2: Case 1) | - 113 - |
| Table 13: Signal assembly components (Task 2: Case 2) | - 132 - |
| Table 14: Test Protocol (Task 2: Case 2) | - 132 - |
| Table 15: Test protocol (Task 2: Case 3) | - 151 - |
| Table 16: - Signal assembly components (Task 2: Case 3)..... | - 151 - |
| Table 17: Test protocol (Task 2: Case 4) | - 173 - |
| Table 18: Signal assembly components (Task 2: Case 4) | - 173 - |
| Table 19: Test protocol (Task 2: Case 5) | - 193 - |
| Table 20: Signal assembly components (Task 2: Case 5) | - 193 - |

Chapter 1 – Introduction

The extensive vehicular traffic signal damage during past hurricane seasons has compelled FDOT to investigate new methods to improve vehicular traffic signal assembly survivability during hurricane force winds. Prior research performed in this area determined that to further improve the safety of signalized intersections during hurricane conditions and to reduce the cost associated with damage to the State’s intersection traffic control infrastructure, serviceability of vehicular traffic signal assemblies should be investigated. In this case, serviceability is defined as ensuring the signal assembly (from catenary wire to bottom of signal) is capable of withstanding hurricane level wind speeds without structural damage that would prevent the signal from functioning properly and remaining properly aligned with approaching motorists as originally installed. This report discusses the findings of research project BDV29 TWO 977-27 which is a companion project to BDV29 TWO 977-20.

The experimental tasks involved and discussed in this report were carried out in the Wall of Wind (WOW) Research Facility at Florida International University (FIU) and are as follows:

Task 1 (Chapters 2-6): Determine the nature of wind loading and system response of wire supported traffic signal assemblies for winds up to 150 MPH. This was achieved through full scale testing using an 80ft span test frame for a single wind direction.

Task 2 (Chapters 7-11): Determine the nature of wind loading and system response of wire supported traffic signal assemblies for winds up to 150 MPH. This was achieved through full scale testing using a 20ft span test frame for multiple wind directions.

1.1 Test Setup for Task 1 and Task 2

1.1.1 Long Span Rig

Traffic signals to be tested were installed on a special test rig with a span of 70.5 ft. The test rig was designed using SAP2000 finite element based structural analysis and design software and drafted on AutoCAD 2014. There were two different hollow structural sections (HSS) that were utilized, HSS 10” x 6”x 3/8” and HSS 6” x 6” x 3/8”. The total length of the test rig is 72.6 ft and the width is 7.5 ft. The two support columns are 15.5 ft tall supported on top of HSS 10” x 6” x 3”

sections. A plan view of the test rig is shown in Figure 1, a profile elevation view is shown in Figure 2, and an end elevation view is shown in Figure 3. For Task 2, the same rig used for Task 1 was utilized, however, it was added some reinforcement due to concerns with the deflection of the columns during the tests. Figure 4 shows the end reinforced column. Figure 5 to Figure 7 show a plan view, profile view and end elevation view of the reinforced test rig.

1.1.2 Short Span Rig

For cases 3, 4 and 5 of Task 2, a reinforced short-span rig was utilized. Traffic signals to be tested were installed on a special test rig with a span of 21 ft 11 in. The test rig was designed using SAP2000 finite element based structural analysis and design software and drafted on AutoCAD 2014. There were two different hollow structural sections (HSS) that were utilized, HSS 10" x 6" x 3/8" and HSS 6" x 6" x 3/8". The total length of the test rig is 24 ft and the width is 7 ft and 6 in. The two support columns are 15 ft 6 in tall supported on top of HSS 10" x 6" x 3" sections. Total weight of the test rig is approximately 4,100 lbs. A plan view, profile elevation and end elevation of the reinforced short-span rig is shown in Figure 8 to Figure 10.

A 3/8-inch diameter catenary cable was connected to an eyebolt on both ends of the test rig span (short and long span rig). The eyebolt was welded to the top plate of the loadcell which was attached to the test rig column. The center of the circular loadcell was located 6 in from the top of the column.

The catenary cable was configured to represent 5% sag in the field, per FDOT Standard Specifications for Road and Bridge Construction, Section 634. Therefore, for a typical 80 ft span in the field the sag length is 4 ft.

The center of the circular loadcell at both ends of the messenger cable was located approximately 7 ft below the top catenary loadcells. The messenger cable was tensioned to approximately 240 lbs per FDOT Standard Specifications for Road and Bridge Construction, Section 634, 3/8-inch diameter messenger wires are to be installed with wire tension of 340 lbs /100 ft, linearly prorating cable tensions for other lengths.

The length between the catenary and messenger cables at the lowest point of the catenary cable where the hanger assemblies were installed was approximately 3 ft.

1.2 Instrumentation for Task 1 and Task 2

The instruments used during testing included four 6 degree of freedom loadcells that measured x, y and z, force and moment components at the ends of the catenary and messenger cables. The loadcells have 1500lb capacity (note that this value does not consider the pre-tension applied to the system). Pictures of the 6 degree of freedom loadcell are shown in Figure 11. The location of instruments may vary from case to case and thus are presented in each case.

Failure was considered when a component of the assembly failed causing the signal assembly to stop functioning properly: for example, the signal did not remain powered and/or properly aligned with approaching motorists as originally installed. Any breach of the housing, any damage to the hanger assembly or if catenary or messenger wires ruptured, any damage to visors where LED signals cannot be seen was also considered a failure, whereas damage to back plates was not considered a failure. Although erratic behavior, such as aerodynamic fluttering, may not cause an initial failure of the signal equipment, it may lead to additional testing to confirm this behavior will not cause failure of the equipment when experienced for long-term.

All tests took place at the WOW Research Facility at FIU. This facility is comprised of a series of 12 fans able to produce winds in excess of 150 mph [4, 5]. The facility includes a 16 ft. 6 in. diameter turntable which allows the test structure to be rotated to different angles of exposure to the wind field.

For the reader's convenience, the different parts used in the span-wire traffic assembly are identified in Figure 12.

Plan View

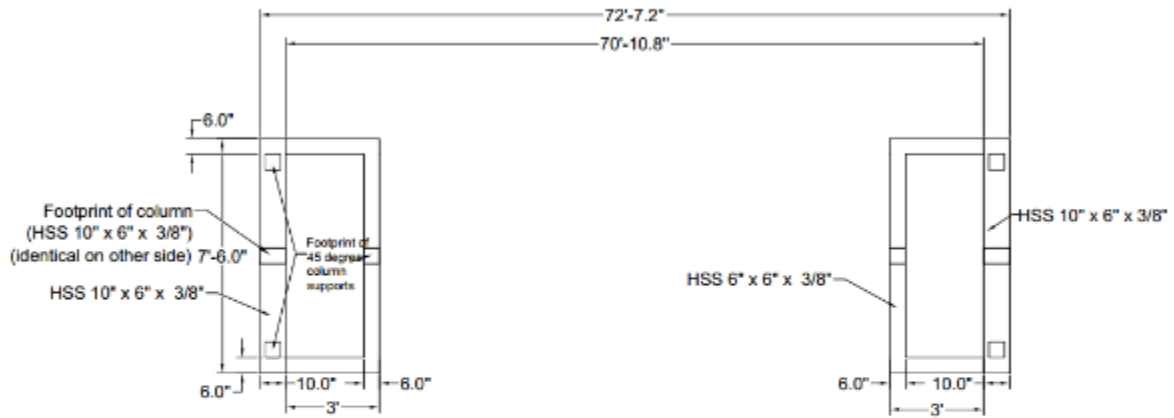

Notes:

1. Cap columns on top to prevent water entry.
2. Add one coat of primer to all sections.
3. Weld all connections.
4. Section sizes to be used are HSS 10" x 6" x 3/8" and HSS 6" x 6" x 3/8" as shown above.

| | |
|-----------------|-----------------------------------|
| Project Number: | Research Project BDV25 TWO 977-27 |
| Item: | Structural Traffic Signal Support |
| University: | Florida International University |
| Drawn by: | B. Berlanga |
| Date: | 7/10/2016 |

Figure 1: Plan view of long span test rig

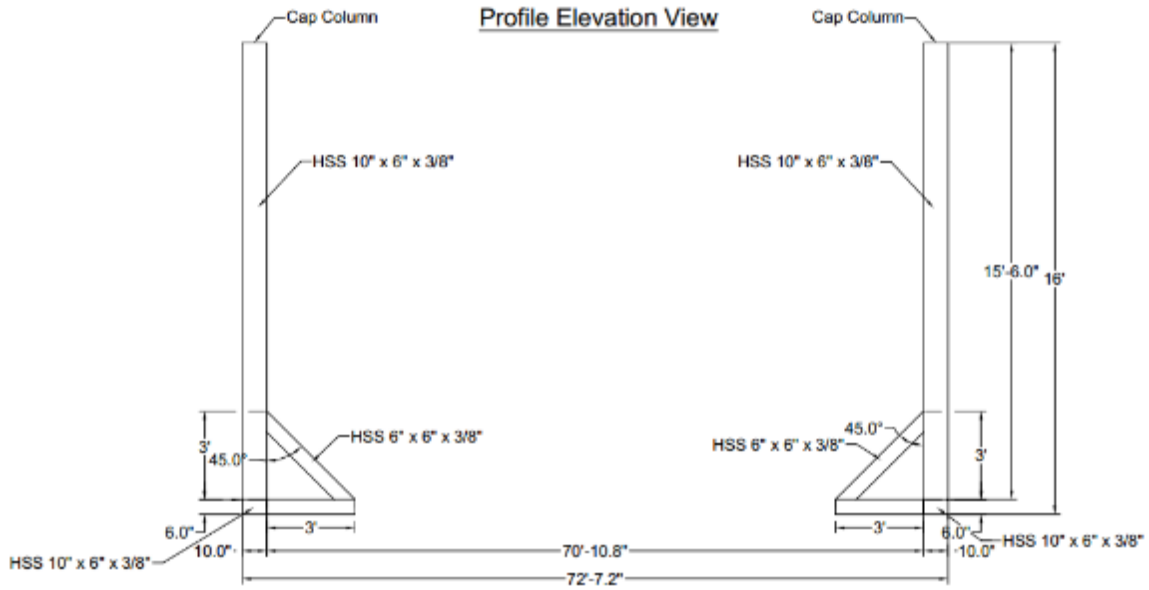

Notes:

1. Cap columns on top to prevent water entry.
2. Add one coat of primer to all sections.
3. Weld all connections.
4. Section sizes to be used are HSS 10" x 6" x 3/8" and HSS 6" x 6" x 3/8" as shown above.

| | |
|-----------------|-----------------------------------|
| Project Number: | Research Project BDV29 TWO 977-27 |
| Item: | Structural Traffic Signal Support |
| University: | Florida International University |
| Drawn by: | B.A. Barlanga |
| Date: | 7/10/2016 |

Figure 2: Profile Elevation View of long span test rig

Notes:

1. All thru holes are 0.5625" diameter.
3. First thru hole will be located 1" from the top of the column and the last thru hole is 8' from the top of the column.
4. Drill thru holes on the vertical centerline of both 6" faces of the column.
5. All thru holes are located 6" center on center.

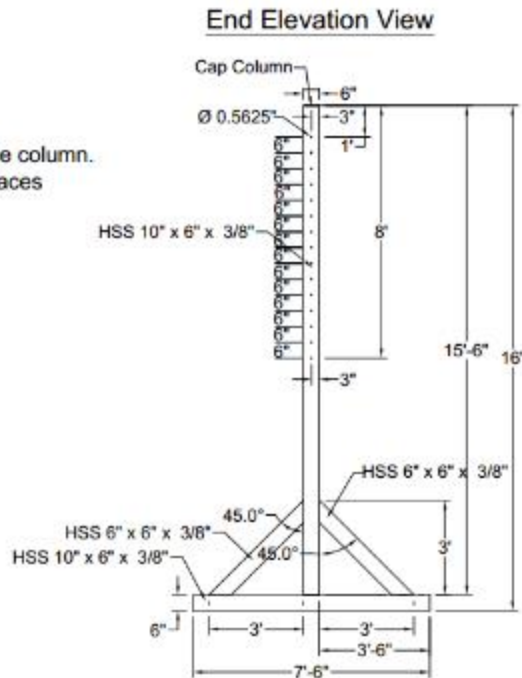

Notes:

1. Cap columns on top to prevent water entry.
2. Add one coat of primer to all sections.
3. Weld all connections.
4. Section sizes to be used are HSS 10" x 6" x 3/8" and HSS 6" x 6" x 3/8" as shown above.
5. Bolt hole diameter 1 1/8".

| | |
|-----------------|-----------------------------------|
| Project Number: | Research Project BDV29 TWO 977-27 |
| Icon: | Structural Traffic Signal Support |
| University: | Florida International University |
| Drawn by: | B. Berlanga |
| Date: | 7/10/2016 |

Figure 3: End Elevation of View of long span test rig



Figure 4: Reinforced long span test rig

Plan View

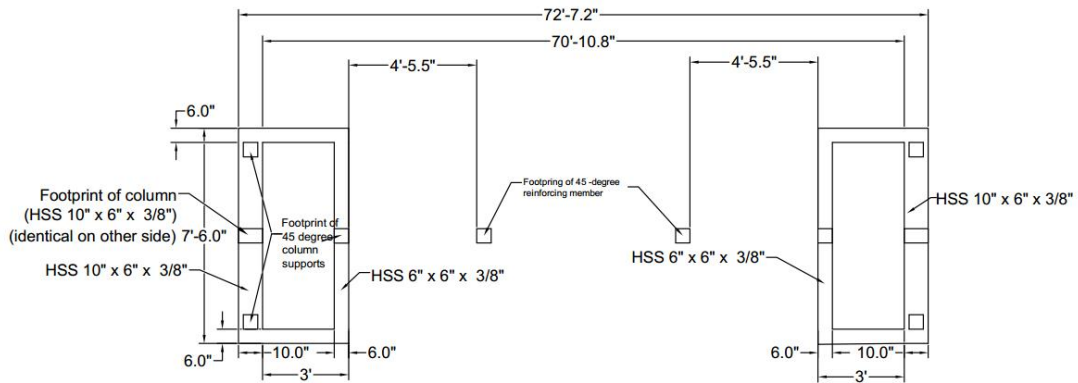

Notes:

1. Cap columns on top to prevent water entry.
2. Add one coat of primer to all sections.
3. Weld all connections.
4. Section sizes to be used are HSS 10" x 6" x 3/8" and HSS 6" x 6" x 3/8" as shown above.

| | |
|-----------------|-----------------------------------|
| Project Number: | Research Project BDV29 TWO 977-20 |
| Item: | Structural Traffic Signal Support |
| University: | Florida International University |
| Drawn by: | B. Berlanga |
| Date: | 7/18/2017 |

Figure 5: Plan view of reinforced long span test rig

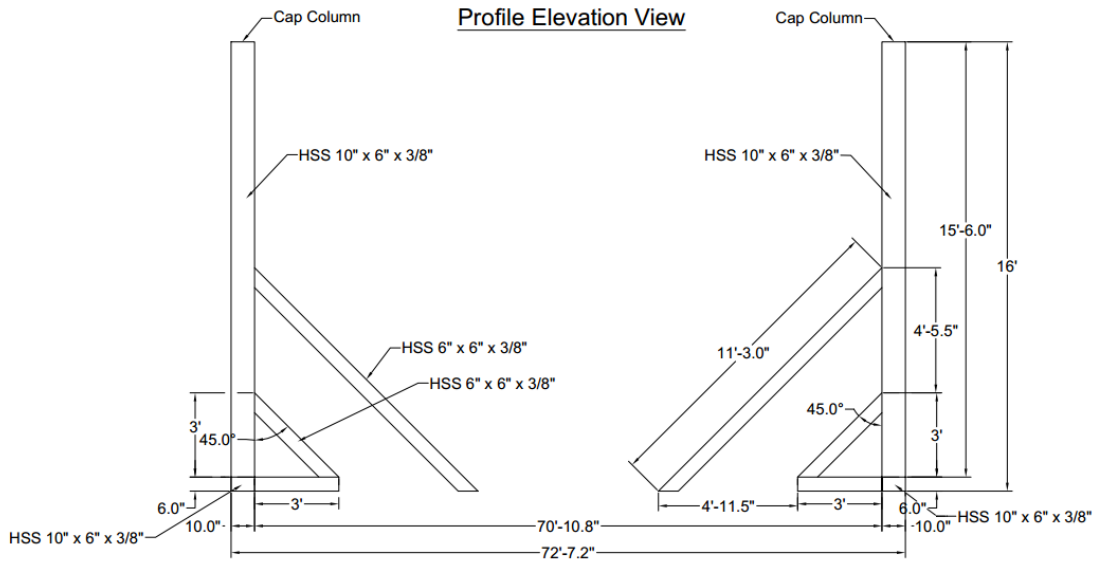

Notes:

1. Cap columns on top to prevent water entry.
2. Add one coat of primer to all sections.
3. Weld all connections.
4. Section sizes to be used are HSS 10" x 6" x 3/8" and HSS 6" x 6" x 3/8" as shown above.

| | |
|-----------------|-----------------------------------|
| Project Number: | # |
| Item: | Structural Traffic Signal Support |
| University: | Florida International University |
| Drawn by: | B.A Berlanga |
| Date: | 7/18/2017 |

Figure 6: Profile Elevation View of reinforced long span test rig

Notes:

1. All thru holes are 0.5625" diameter.
3. First thru hole will be located 1" from the top of the column and the last thru hole is 8' from the top of the column.
4. Drill thru holes on the vertical centerline of both 6" faces of the column.
5. All thru holes are located 6" center on center.

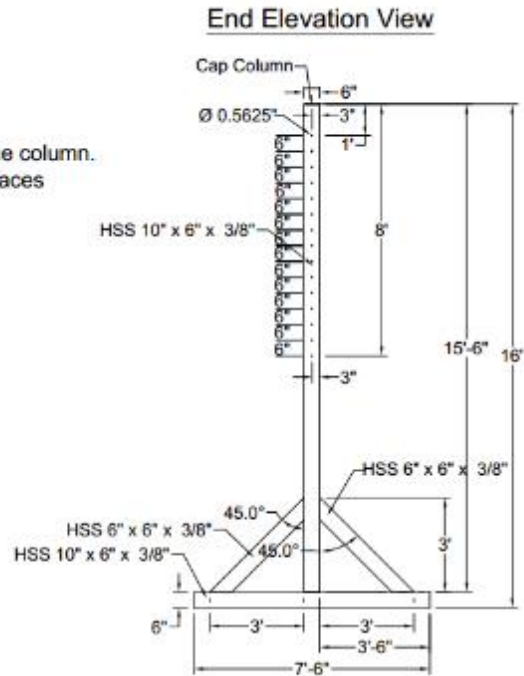

Notes:

1. Cap columns on top to prevent water entry.
2. Add one coat of primer to all sections.
3. Weld all connections.
4. Section sizes to be used are HSS 10" x 6" x 3/8" and HSS 6" x 6" x 3/8" as shown above.
5. Bolt hole diameter 1 1/8".

| | |
|-----------------|-----------------------------------|
| Project Number: | Research Project BDV29 TWO 977-27 |
| Item: | Structural Traffic Signal Support |
| University: | Florida International University |
| Drawn by: | B. Berlanga |
| Date: | 7/10/2016 |

Figure 7: End Elevation of View of reinforced long span test rig

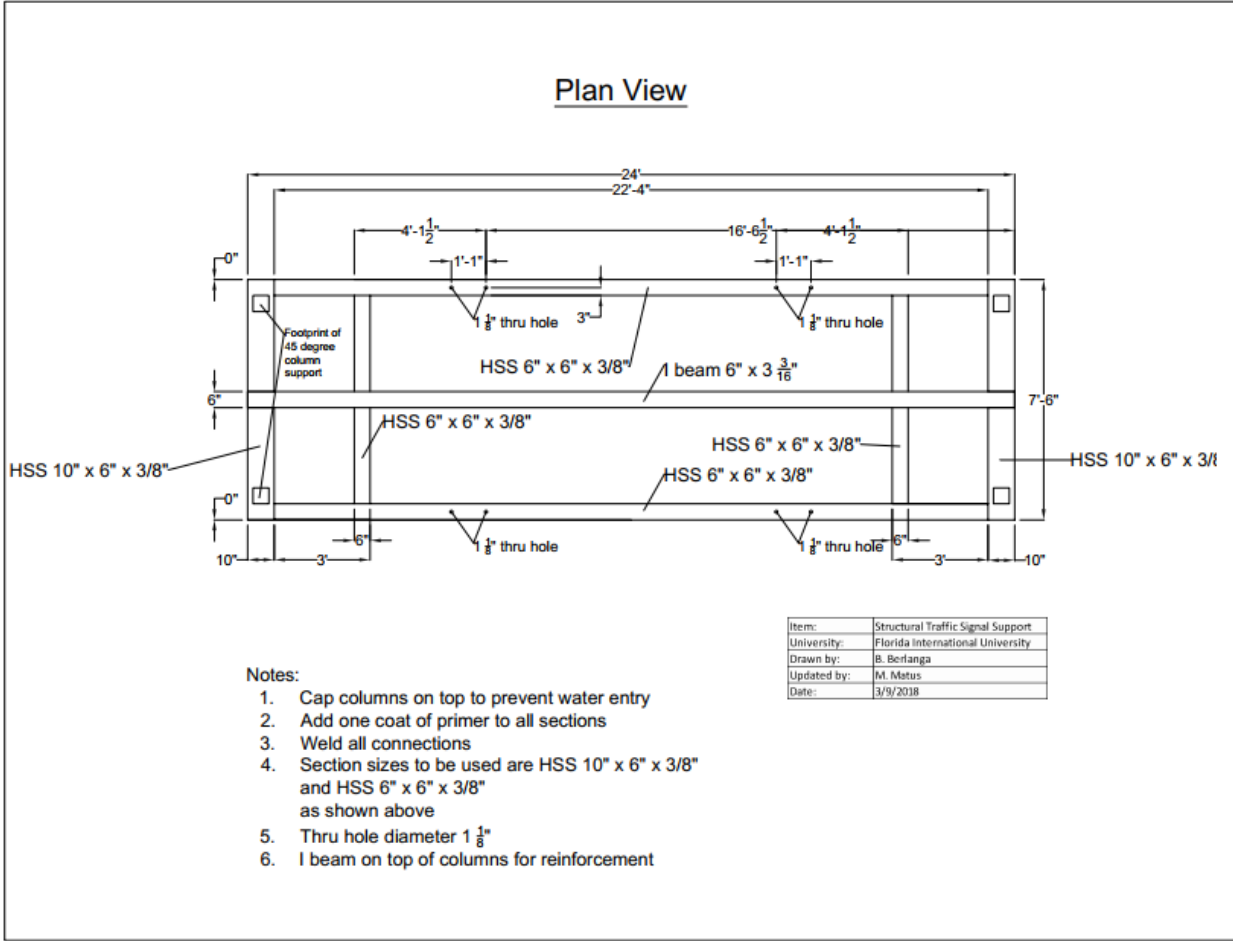
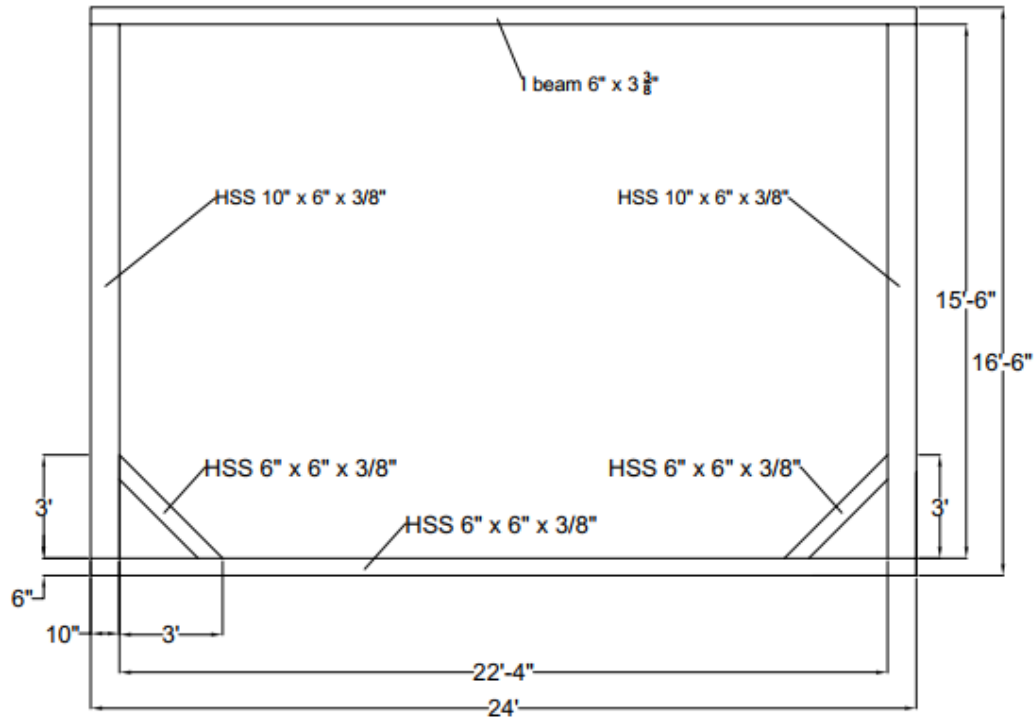

Figure 8: Plan view of reinforced short span test rig

Profile Elevation View



Notes:

1. Cap columns on top to prevent water entry
2. Add one coat of primer to all sections
3. Weld all connections
4. Section sizes to be used are HSS 10" x 10" x 3/8" and HSS 6" x 6" x 3/8", as shown above
5. Bolt hole diameter $1\frac{1}{8}$ "
6. Top I beam added to reinforce columns

| | |
|-------------|-----------------------------------|
| Item: | Structural Traffic Signal Support |
| University: | Florida International University |
| Drawn by: | B. Berlanga |
| Updated by: | M. Matus |
| Date: | 3/9/2018 |

Figure 9: Profile elevation view of reinforced short span test rig

End Elevation View

Notes:

1. All thru holes are 0.5625" diameter.
3. First thru hole will be located 1' from the top of the column and the last thru hole is 8' from the top of the column.
4. Drill thru holes on the vertical centerline of both 6" faces of the column.
5. All thru holes are located 6" center on center.

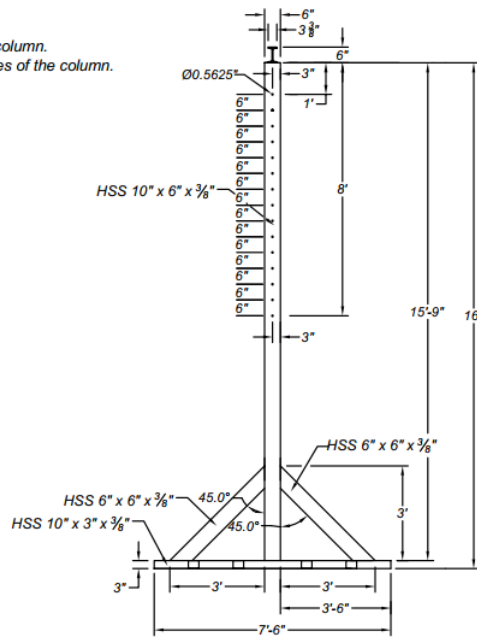

Notes:

1. Cap columns on top to prevent water entry.
2. Add one coat of primer to all sections.
3. Weld all connections.
4. Section sizes to be used are HSS 10" x 6" x 3/8", HSS 6" x 6" x 3/8", HSS 10" x 3" x 3/8" and HSS 6" x 3" x 3/8" as shown above.
5. Thru hole diameter 1 1/8".
6. Two separate structural end supports shall be manufactured.
7. Top I beam added for reinforcement of columns

| | |
|-------------|-----------------------------------|
| Item: | Structural Traffic Signal Support |
| University: | Florida International University |
| Drawn by: | B. Berlanga |
| Updated by: | M. Matus |
| Date: | 3/9/2018 |

Figure 10: End elevation view of reinforced short span test rig



Figure 11: Pictures of 6 degrees of freedom loadcell

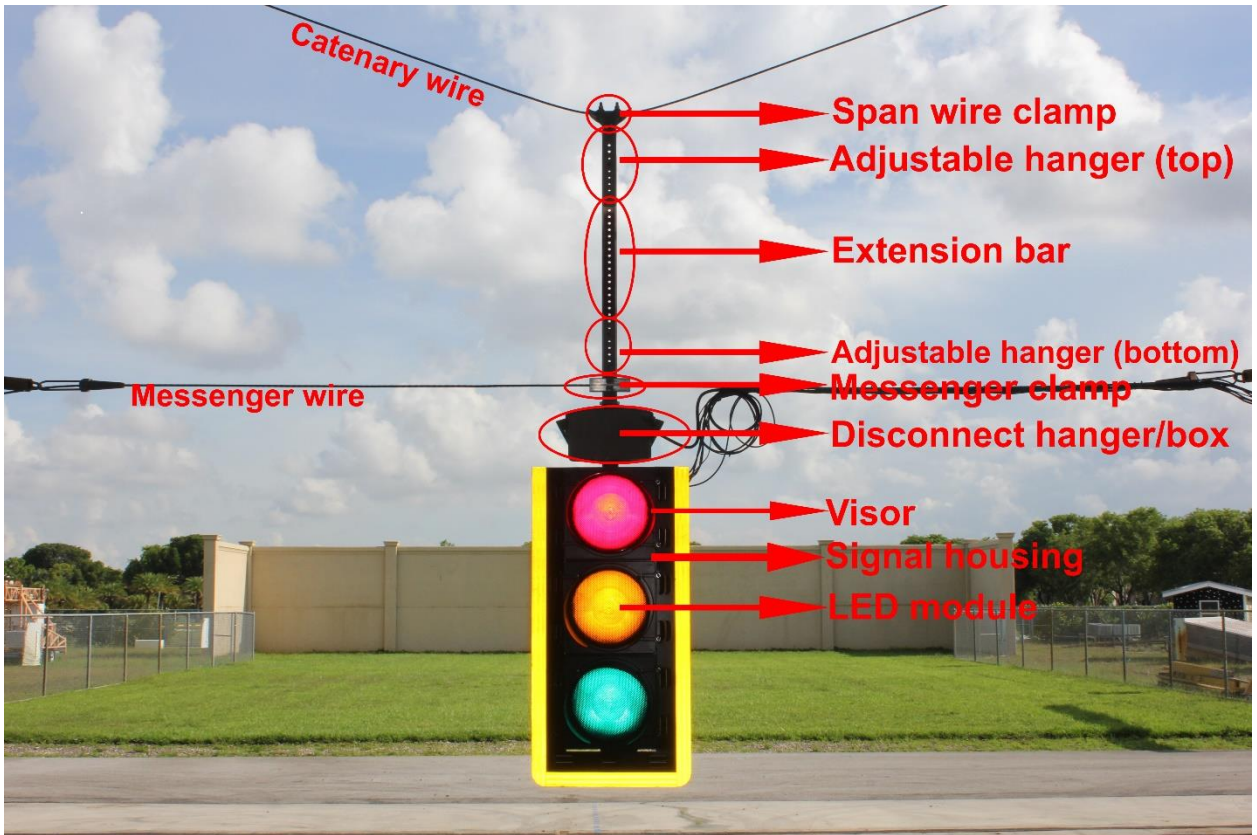

Figure 12: Signal assembly components

Chapter 2 - Task 1: LONG SPAN LENGTH FULL SCALE TESTING - Case 1

“Pivotal Adjustable Hanger with Disconnect Hanger Reinforcement Rod and Disconnect Hanger/Signal Head Reinforcement Plates with Aluminum Housing” (vendor: Signal Safe) - Test Date: 06/30/2016

2.1 Introduction

Previous studies involving the FDOT and WOW Research Facility at FIU identified a ‘base’ test configuration consisting of two 3-section and one 5-section traffic signals. Considering the knowledge acquired from these tests that utilized a short span length test frame placed on a turntable and using springs on the catenary and messenger spans to simulate longer typical spans, the scope of the current research project serves as dual purpose; use the existing test frame to test, for multiple wind directions, five additional traffic signal assemblies as specified by FDOT and develop and use an 80ft span test frame to test, for a single critical wind direction, five signal assemblies as specified by FDOT. With a full span length test frame, the full dynamic response of the system was replicated and more detailed information on components of the different assemblies, like stresses and deflections, was obtained through loadcells, accelerometers, inclinometers and inertia sensors. This test served as a validation of the performance of the short span length test rig and the use of springs to represent a full span length. A 70.5ft test frame was used to test various span wire traffic signal configurations connected to the catenary and messenger wires via a **“Pivotal Adjustable Hanger Assembly with Disconnect Hanger, Reinforcement Rod and Disconnect Hanger/Signal Head Reinforcement Plates with Aluminum Signal Housing” (vendor: Signal Safe)**. The tests carried out at wind direction of 0 degrees and wind speeds ranging from 30 to 150 mph. The instrumentation that was used include loadcells, accelerometers and inclinometers.

This chapter presents the results from the tests conducted on the traffic signal assembly using a **“Pivotal Adjustable Hanger Assembly with Disconnect Hanger, Reinforcement Rod and Disconnect Hanger/Signal Head Reinforcement Plates with Aluminum Signal Housing” (vendor: Signal Safe)** at the WOW.

2.2 Experimental methodology

2.2.1 Test Setup

The 3-3-5 signal assembly was installed on a long-span rig (described in Chapter 1) by means of a **“Pivotal Adjustable Hanger Assembly with Disconnect Hanger, Reinforcement Rod and Disconnect Hanger/Signal Head Reinforcement Plates with Aluminum Signal Housing” (vendor: Signal Safe)**. Figure 13 to Figure 15 show the traffic signal assembly installed for testing as well as a close-up of the pivotal adjustable hanger assembly. The bottom of all signals was at approximately 4 ft 6 in above the concrete floor. Signals were made of aluminum and included louvered back plates and visors. Table 1 shows the components used for this assembly tested. The test protocol is presented in Table 2.

2.2.2 Instrumentation

The directions of the x, y and z components for each loadcell are shown in Figure 16. Loadcells number 2 and 5 were located at either end of the messenger cable and loadcells number 1 and 4 located at either end of the catenary cable.

Tri-axial accelerometers were installed in the traffic signals to measure accelerations. There was one accelerometer placed on the center top of the signal, Accel5, another placed on the bottom right side, Accel002, and a third placed on the bottom left side, Accel003 for the 5-section signal as shown in Figure 17. Accelerometer Accel007, was installed on the top center, accelerometer Accel004, was installed on the bottom left side and accelerometer Accel006, was installed on the bottom right side of the 3-section signal as shown in Figure 18.

Inclinometers were also installed on each signal to measure the inclination of the signals during wind exposure. The inclinometers measured inclination in two directions, one relative to an axis parallel to the wind direction and another relative to an axis perpendicular to the wind direction. There was one inclinometer installed on the top center of the signal, Inc4, and another on the bottom center of the signal, Inc3, for the 5-section signal as shown in Figure 17. Inclinometer, Inc2, was installed on the top center and inclinometer, Inc1, was installed on the bottom center of the of the 3-section signal as shown Figure 18.

2.2.3 Test Method

The test set up was first tested for 'zero wind' conditions, and the values of the various 'quantities' (forces, accelerations and inclinations) obtained were later deducted from quantities obtained for different wind speeds (also known as "zero drift removal" process).

Table 1: Assembly components (Task 1: Case 1)

| Component | Manufacturer |
|-------------------|---------------------|
| Span wire clamp | Signal Safe |
| Adjustable hanger | Signal Safe |
| Extension bar | Pelco (standard) |
| Messenger clamp | Signal Safe |
| Disconnect Hanger | Pelco (standard) |
| Signal Assembly | Signal Safe |
| Backplate | Signal Safe |
| Visor | Signal Safe |
| LED Modules | Unknown |

Table 2: Test protocol (Task 1: Case 1)

| Wind Speed (mph) | Wind Direction (degrees) | Total Duration (min) |
|-----------------------------|-------------------------------------|---------------------------------|
| 30 | 0 | 1 |
| 40 | 0 | 1 |
| 55 | 0 | 1 |
| 70 | 0 | 1 |
| 85 | 0 | 1 |
| 100 | 0 | 1 |
| 115 | 0 | 1 |
| 130 | 0 | 1 |
| 140 | 0 | 1 |
| 150 | 0 | 1 |
| TOTAL | | 10 |



Figure 13: Signal assemblies installed on test frame (before testing)



Figure 14: View of rear of test setup (looking into wind tunnel)



Figure 15: Close-up view of the pivotal hanger connection

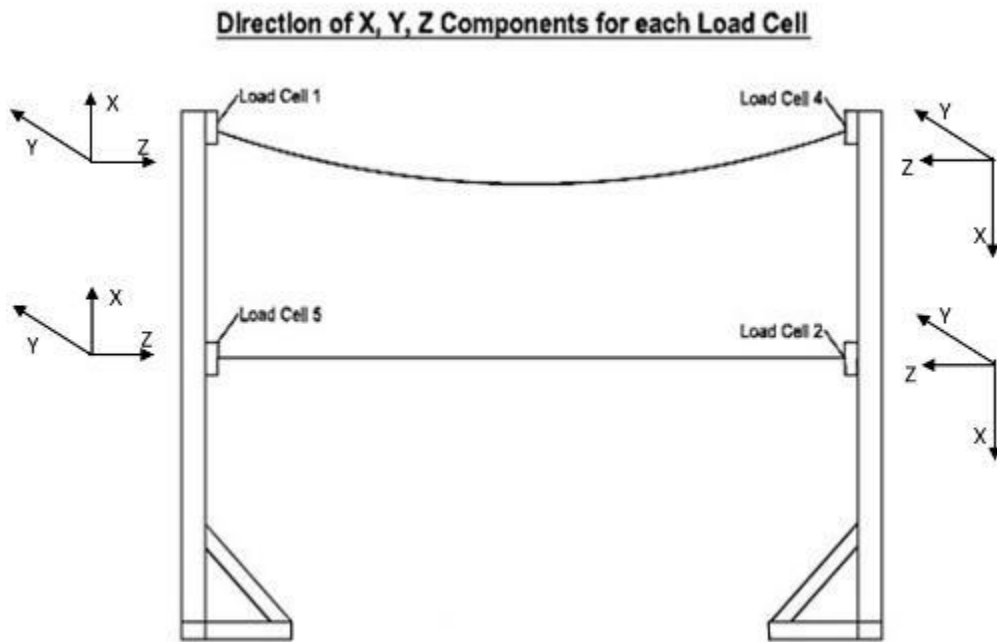

Figure 16: Direction of x, y, z components for each loadcell (direction of each axis shown represents 'positive direction')

Figure 17: Location of accelerometers and inclinometers in 5-section signal

Figure 18: Location of accelerometers and inclinometers in 3-section signal

2.3 Results and discussion

The tests at the WOW were performed in the presence of the representatives from the Florida Department of Transportation (FDOT) Traffic Engineering and Operations Office and Traffic Engineering Research Lab (TERL), representatives from Signal Safe, installation technicians from Horsepower Electric Inc. and members of the WOW technical team. The results in this chapter are presented for 0-degree wind direction.

2.3.1 Wind induced forces

The directions of the forces are shown in Figure 16. The mean and peak forces obtained at various wind speeds are discussed in this section. Figure 19 presents the wind induced mean forces on loadcell 2 (messenger wire) and loadcell 4 (catenary wire) at 0-degree wind direction, for increasing wind speeds. It may be noted that the 'y' and 'z' components of the forces correspond to the 'drag' and 'cable tensions' respectively, while the 'x' component represents the uplift forces.

Data show that F_z on loadcell 2 (messenger wire) increased with increasing wind speed up to 55 mph. The maximum range of the loadcell is 1500 lbs (i.e. without considering the pre-tension applied to the system), and hence measurements of F_z on loadcell 2 was stopped at wind speed greater than 55 mph. F_z on loadcell 4 (catenary) also increased with increasing wind speed, although beyond wind speed of 55 mph the magnitude of forces decreased. F_x on loadcells 2 (messenger wire) and 5 (catenary wire) experienced minimal change despite an increase in wind speed. Although F_y on loadcell 2 increased with increasing wind speed, negligible change of F_y on loadcell 4 was observed despite increasing wind speeds. In general, the messenger wire experienced higher cable tension than the catenary wire for any given wind speed.

Similar observations were made for the mean forces on loadcell 5 (messenger) and loadcell 1 (catenary) as shown in Figure 20. For instance, F_z on loadcell 5 increased initially with increasing wind speed of up to 55 mph, where it yielded 960 lbs. Beyond 55mph, measurements of F_z on loadcell 5 were not recorded because the loadcells maximum range of 1500 lbs (without considering the pre-tension applied to the system) was reached. F_z on loadcell 1 increased with increasing wind speed and attains a nearly constant value of 325 lbs in the wind speed range of

55 – 100 mph; beyond 100 mph a slight decrease in the tension was observed. Negligible changes were observed in F_x on loadcells 1 (catenary wire) and 5 (messenger wire) despite an increase in wind speed. Although F_y on loadcell 5 experienced a slight increase in the force beyond 130 mph. The messenger wire experienced higher cable tensions than the catenary wire for any given wind speed.

The peak forces at 0-degree wind direction for loadcell 2 and loadcell 4 are shown in Figure 21. The peak force F_z on loadcell 2 increased with increasing wind speed and yielded a value of 740 lbs at 40 mph, beyond which measurements of F_z were avoided since the maximum range of the loadcell is 1500 lbs (without considering the pre-tension applied to the system). The peak forces of F_y on loadcell 4 (catenary) and loadcell 2 (messenger) increased with increasing wind speed up to 130 mph, beyond which both components of peak experienced a slight drop in forces. Negligible increase in peak values of F_x (loadcells 4 and 2) were observed with increasing wind speeds.

Figure 22 presents results for loadcell 5 (messenger) and loadcell 1 (catenary). F_z (cable tensions) on loadcell 5 (messenger wire) was recorded up to 40 mph due to reasons explained previously. F_z on loadcell 1 (catenary wire) experienced an increase in the peak force up to wind speed of 70 mph, beyond which the magnitude of the peaks dropped. F_y on loadcell 5 (messenger wire) increased with increasing wind speeds, while a negligible change in the peaks of F_y on loadcell 1 was observed for increasing wind speeds. F_x on loadcells 1 and 5 experienced a marginal increase in the peaks for increasing wind speed.

Figure 23 (a) presents the ‘total’ mean drag and lift forces on the traffic signals. Results show that the drag on the traffic signals increased with an increase in wind speed – highest value of 440 lbs was obtained at 150 mph at 0-degree wind direction. The lift forces increased initially with an increase in wind speed, with the highest value of 172 lbs obtained at 150 mph. The peak drag and lift are shown in Figure 23 (b). Like the mean values, the peak drag and lift increased with increasing wind speeds - highest peak lift of 272 lbs was obtained at 150 mph.

2.3.2 rms of accelerations

The root mean square (rms) of accelerations are presented in Figure 24. Accelerometers 4, 6 and 7 were located on the 3-section signal, while accelerometers 2, 3 and 5 were located on the

5-section signal (see Figure 17 and Figure 18). In general, the rms of accelerations obtained from all the accelerometers increased gradually with an increase in wind speed. At 130 mph the sensors were removed to avoid damage, and hence results are reported for wind speeds of up to 115 mph.

2.3.3 Inclinations of the traffic signals

Figure 25 shows the inclinations (mean and maximum) obtained from inclinometer 1 (3-section) and inclinometer 3 (5-section) at 0-degree wind direction. It may be noted that for inclinometer 1, '1-1' refers to the component of inclination perpendicular to the wind, while '1-2' refers to the component of inclination in the direction of wind. For inclinometers 1 and 3, the mean components '1-2' and '3-2' were found to be 39 degrees at 70 mph. Similarly, the maximum value of about 45 degrees was obtained at a wind speed of 70 mph for the inclinometer components 1-2 and 3-2. The values of inclinations were negligible for 1-1 and 3-1 components in the wind speed range of 0-70 mph. Beyond 70 mph, an erratic movement of the traffic signals (aerodynamic flutter) was observed, resulting in a wide range of inclinations.

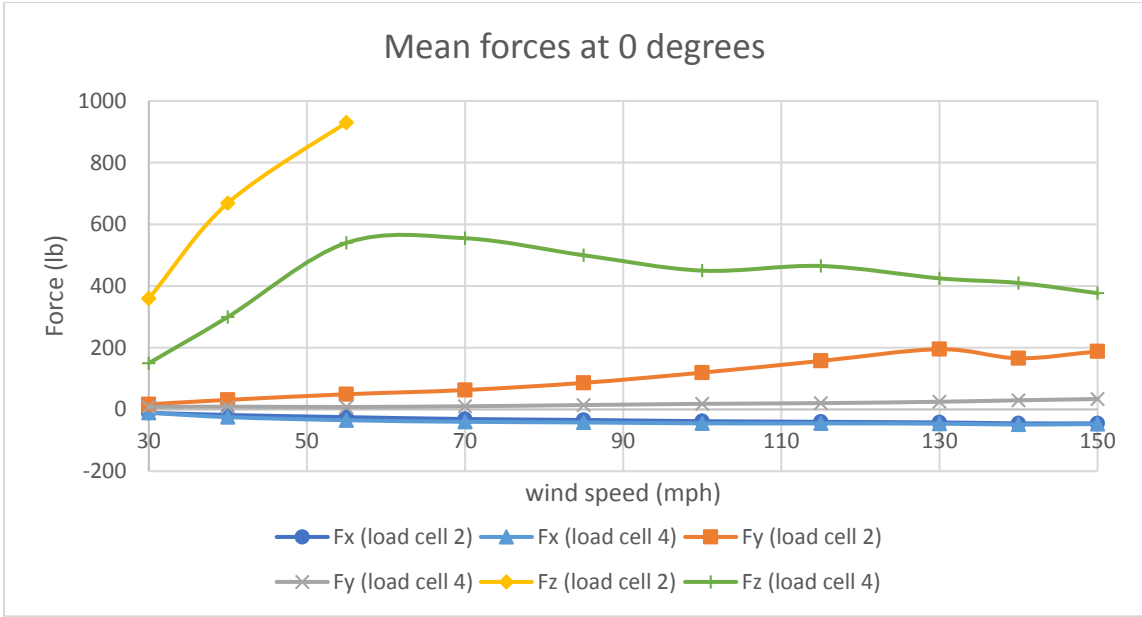

Figure 19: Mean forces on loadcells 2 (messenger wire) and 4 (catenary wire) at 0-degree wind direction

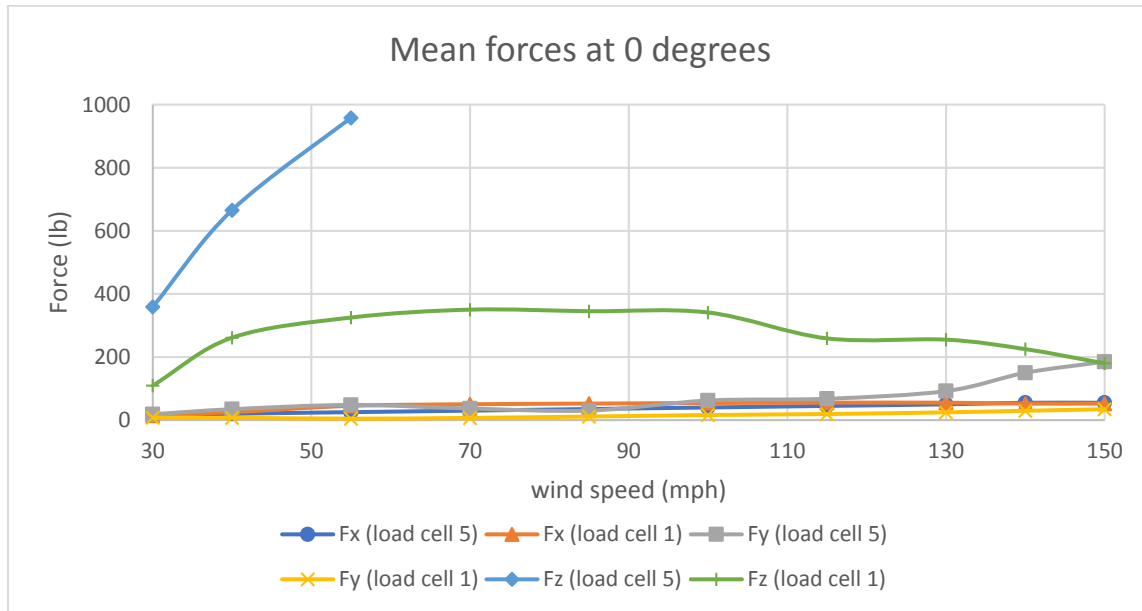

Figure 20: Mean forces on loadcells 1 (catenary wire) and 5 (messenger wire) at 0-degree wind direction

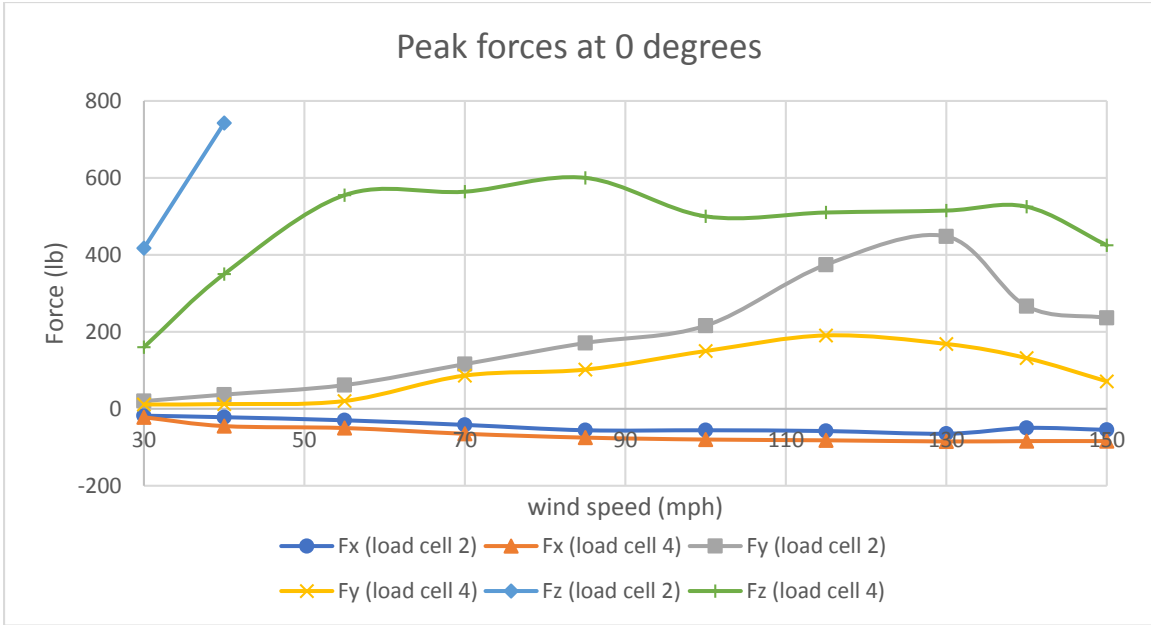

Figure 21: Peak forces at 0-degree wind direction on loadcells 2 (messenger wire) and 4 (catenary wire)

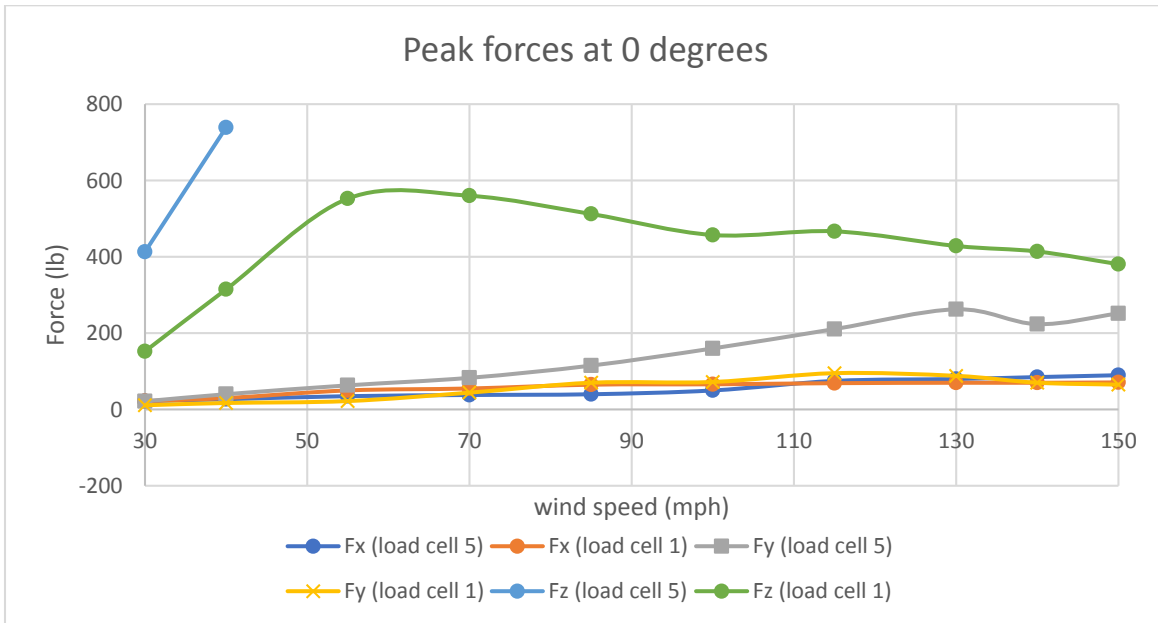
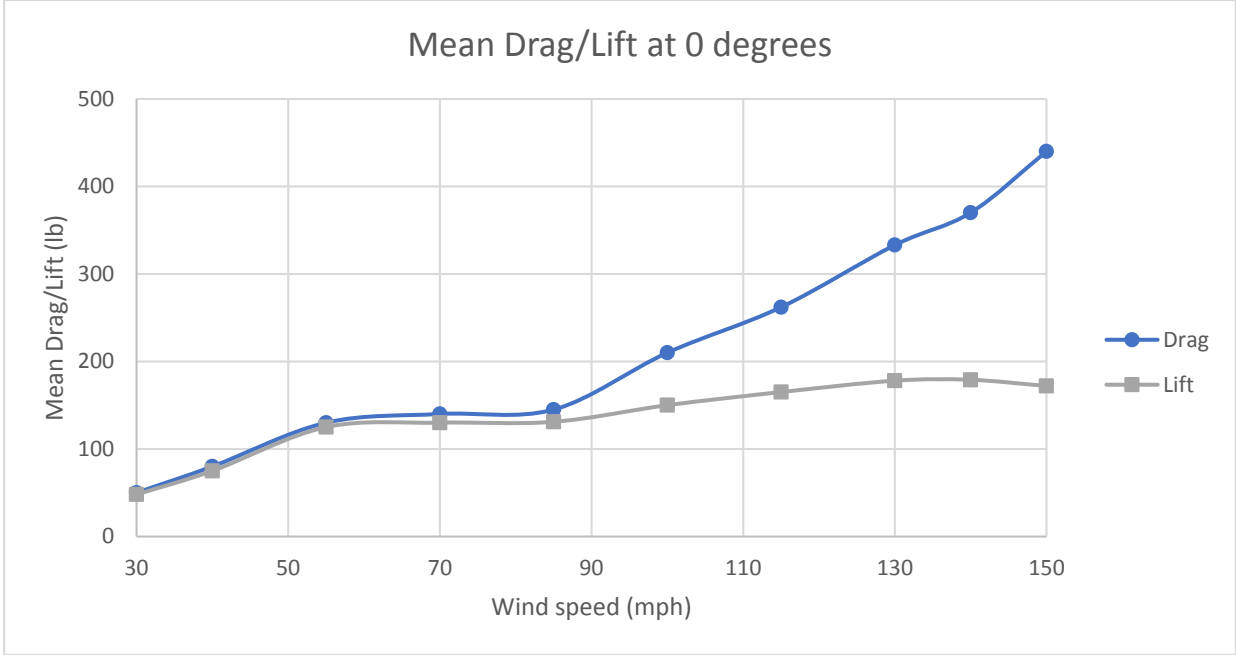
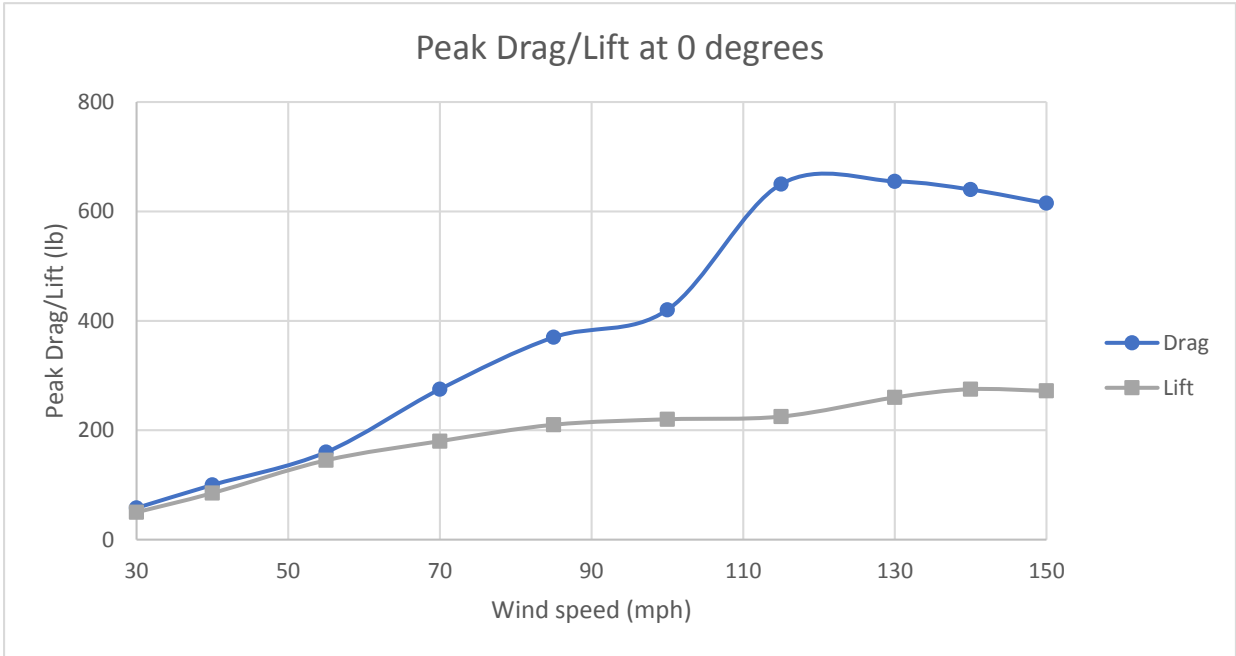

Figure 22: Peak forces at 0-degree wind direction on loadcells 1 (catenary wire) and 5 (messenger wire)



a)



b)

Figure 23: Drag (F_y) and lift (F_x) forces on the traffic signals at 0 degrees: a) Mean; b) Peak

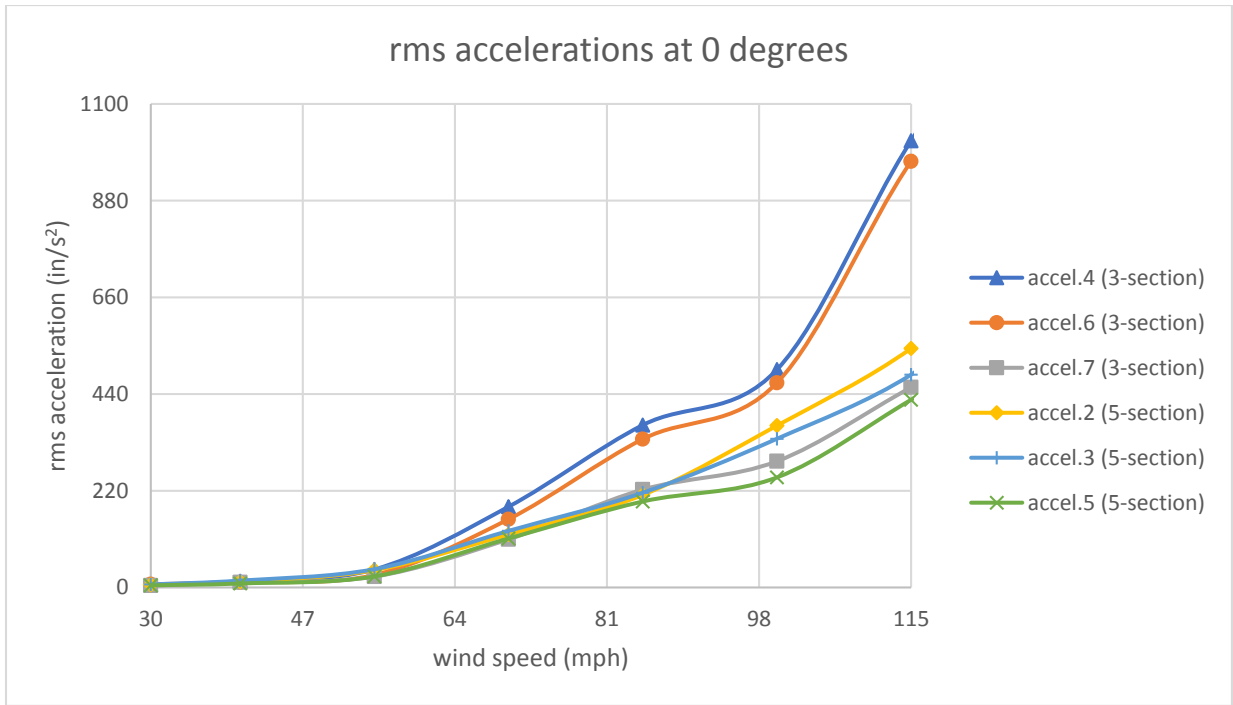

Figure 24: rms of accelerations on the 3-section and 5-section signals at 0 degrees

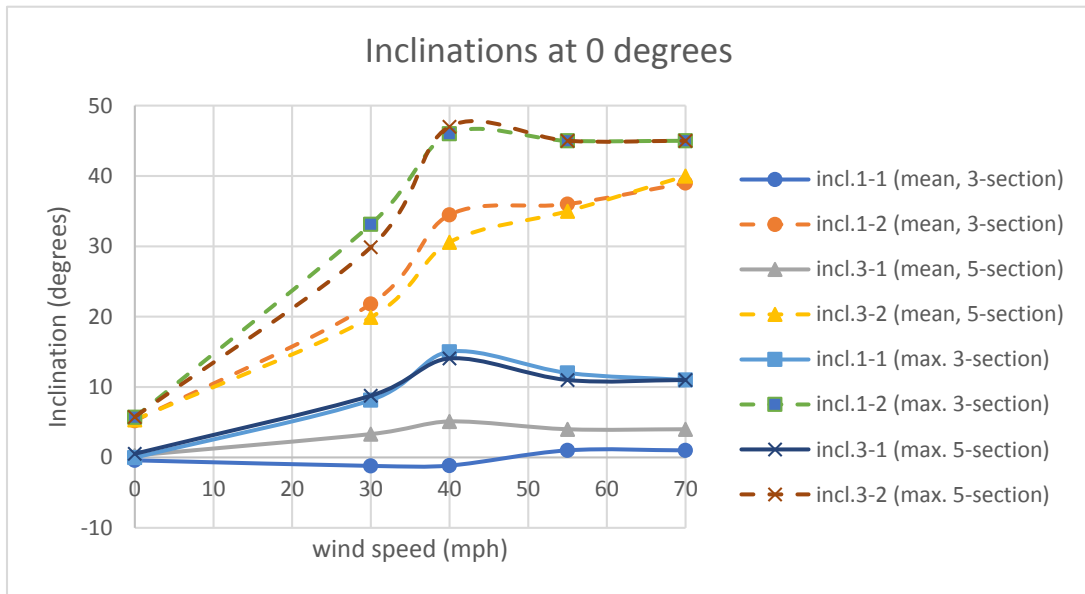

Figure 25: Inclinations (mean and max) obtained at 0 degrees for inclinometers 1 and 3

2.4 Performance of traffic signals during the tests

This test utilized two 3-section and one 5-section aluminum traffic signals installed in span wire configuration connected to the catenary and messenger wires by means of a **“Pivotal Adjustable Hanger Assembly with Disconnect Hanger, Reinforcement Rod and Disconnect Hanger/Signal Head Reinforcement Plates with Aluminum Signal Housing” (vendor: Signal Safe)**.

At 70 mph, a galloping movement was first observed which continued throughout the test and back plates from all signals showed some bending. Continuing with the test at 85 mph, top back plates from 5-section signal blew away and it was noted that galloping movement was intensified. More intense galloping movement was seen to occur at 100 mph. At this point the 3-section signal back plates detached. At 115 mph, the 5-section signal showed minor rotation at the connection between the red (top) signal and the bracket that connects to the lower 4 signals. When reaching 140 mph galloping movement lessened. The 5-section and 3-section signal back plates continued to detach from the signal housing and eventually flew away. Figure 26 and Figure 27 show the signal assembly after full wind speed test and a summary of the observed damages is as follows:

- Damage to signal hanger: No permanent visual damage observed.
- Damage to disconnect hanger (box): No permanent visual damage observed.
- Damage to signal housing assembly: Other than damage to the back plates, no other permanent visual damage was observed. Some minor rotation of the 5-section signal at the connection between the red (top) signal and the bracket that connects to the lower 4 signals.



Figure 26: Signal Assembly after full wind speed test



Figure 27: 5-section signal figures showing slight rotation of 5-section signal assembly

2.5 Conclusions

This chapter summarizes the results of a test conducted at WOW at FIU for a 70.5 ft span wire traffic signal assembly consisting of two 3-section and a 5-section traffic signal, connected using a **“Pivotal Adjustable Hanger Assembly with Disconnect Hanger, Reinforcement Rod and Disconnect Hanger/Signal Head Reinforcement Plates with Aluminum Signal Housing” (vendor: Signal Safe)**. Wind speeds were varied from 30 to 150 mph. The various instruments used for this test included: loadcells to measure forces, accelerometers to measure accelerations and inclinometers to measure the inclinations. This study reports the data for 0-degree wind direction, in terms of: wind induced forces (drag (y-component), lift (x-component) and cable tension (z-component)), rms of accelerations and inclinations. Results indicate that along wind forces (drag) and cable tensions generally increased in the messenger wire with an increase in wind speed. The lift on the messenger wire increased only marginally with increasing wind speeds. The catenary wire experienced only a minor increase of all three components of wind forces with an increase in wind speed. At any given wind speed the messenger wire experienced higher tension forces than the catenary wire. In general, the rms of accelerations increased with increasing wind speeds. In the range of 40 to 70 mph for 0-degree wind direction, the mean inclinations in the along wind direction varied from 30 to 45 degrees, with a maximum value of about 47 degrees observed at 40 mph for inclinometer component 3-2. Beyond 70 mph, an erratic movement of the signals was observed (aerodynamic flutter) which was intensified as wind speed was increased. No failure was observed on the hanger, but severe damage was observed in most of sections back plates. Also, the 5-section signal showed minor rotation at the connection between the red (top) signal and the bracket that connects to the lower 4 signals.

Chapter 3 - Task 1: LONG SPAN LENGTH FULL SCALE TESTING - Case 2

“Tri-stud Adjustable Hanger with Aluminum Housing” (FDOT Base Condition) - Test Date:
06/27/2016

3.1 Introduction

Previous studies involving the FDOT and WOW Research Facility at FIU identified a ‘base’ test configuration consisting of two 3-section and one 5-section traffic signals. Considering the knowledge acquired from these tests that utilized a short span length test frame placed on a turntable and using springs on the catenary and messenger spans to simulate longer typical spans, the scope of the current research project serves as dual purpose; use the existing test frame to test, for multiple wind directions, five additional traffic signal assemblies as specified by FDOT and develop and use an 80ft span test frame to test, for a single critical wind direction, five signal assemblies as specified by FDOT. With a full span length test frame, the full dynamic response of the system was replicated and more detailed information on components of the different assemblies, like stresses and deflections, was obtained through loadcells, accelerometers, inclinometers and inertia sensors. This test served as a validation of the performance of the short span length test rig and the use of springs to represent a full span length. A 70.5 ft test frame was used to test various span wire traffic signal configurations. The tests were carried out at wind direction of 0-degree and wind speeds ranging from 30 to 150 mph. The instrumentation that was used included loadcells, accelerometers and inclinometers.

This chapter presents the results from the tests conducted on the traffic signal assembly with the **“Tri-stud Adjustable Hanger with Aluminum Housing” (also known as FDOT base condition)** at the WOW.

3.2 Experimental Methodology

3.2.1 Test Setup

The 3-3-5 signal assembly was installed on a long-span rig (described in Chapter 1) by means of a **“Tri-stud Adjustable Hanger with Aluminum Housing” (also known as FDOT base condition)**. Figure 28 and Figure 29 show the traffic signal assembly as well as the tri-stud adjustable hanger (also known as FDOT base condition) assembly. The bottom of all signals were at approximately 4.5 ft above the concrete floor. All signals were made of aluminum and included louvered back plates and visors. The different components used for this test are shown in Table 3. The test protocol is presented in Table 4.

3.2.2 Instrumentation

The directions of the x, y and z components for each loadcell are shown in Figure 30. Loadcells number 2 and 5 were located at either end of the messenger cable and loadcells number 1 and 4 located at either end of the catenary cable.

Tri-axial accelerometers were installed in the traffic signals to measure accelerations. There was one accelerometer placed on the center top of the signal, Accel5, another placed on the bottom right side, Accel002, and a third placed on the bottom left side, Accel003 for the 5-section signal as shown in Figure 31. Accelerometer Accel007, was installed on the top center, accelerometer Accel004, was installed on the bottom left side and accelerometer Accel006, was installed on the bottom right side of the 3-section signal as shown in Figure 32.

Inclinometers were also installed on each signal to measure the inclination of the signals during wind exposure. The inclinometers measured inclination in two directions, one relative to an axis parallel to the wind direction and another relative to an axis perpendicular to the wind direction. There were inclinometers installed on the top center of the signal, Inc4, and another on the bottom center of the signal, Inc3, for the 5-section signal as shown in Figure 31. Inclinometer, Inc2, was installed on the top center and inclinometer, Inc1, was installed on the bottom center of the of the 3-section signal as shown Figure 32.

3.2.3 Test Method

The test set up was first tested for 'no wind' conditions, and the values of the various 'quantities' (forces, accelerations and inclinations) obtained were later deducted from quantities obtained for different wind speeds (also known as "zero drift removal" process).

Table 3: Components of traffic assembly (Task 1: Case 2)

| Component | Manufacturer |
|-------------------|---------------------------|
| Span wire clamp | Costcast |
| Adjustable hanger | Costcast |
| Extension bar | Pelco (standard) |
| Messenger clamp | Costcast |
| Disconnect Hanger | Pelco (standard) |
| Signal Assembly | McCain |
| Backplate | TCS |
| Visor | McCain |
| LED Modules | GE - Dialight - Duralight |

Table 4 Test Protocol (Task 1: Case 2)

| Wind Speed (mph) | Wind Direction | Total Duration (min) |
|-------------------------|-----------------------|-----------------------------|
| 30 | 0 | 1 |
| 40 | 0 | 1 |
| 55 | 0 | 1 |
| 70 | 0 | 1 |
| 85 | 0 | 1 |
| 100 | 0 | 1 |
| 115 | 0 | 1 |
| 130 | 0 | 1 |
| 140 | 0 | 1 |
| 150 | 0 | 1 |
| TOTAL | | 10 |



Figure 28: Signal assemblies installed on test rig (before testing)



a)



b)

Figure 29: Signal Setup for the test; b) Magnified view of the connection

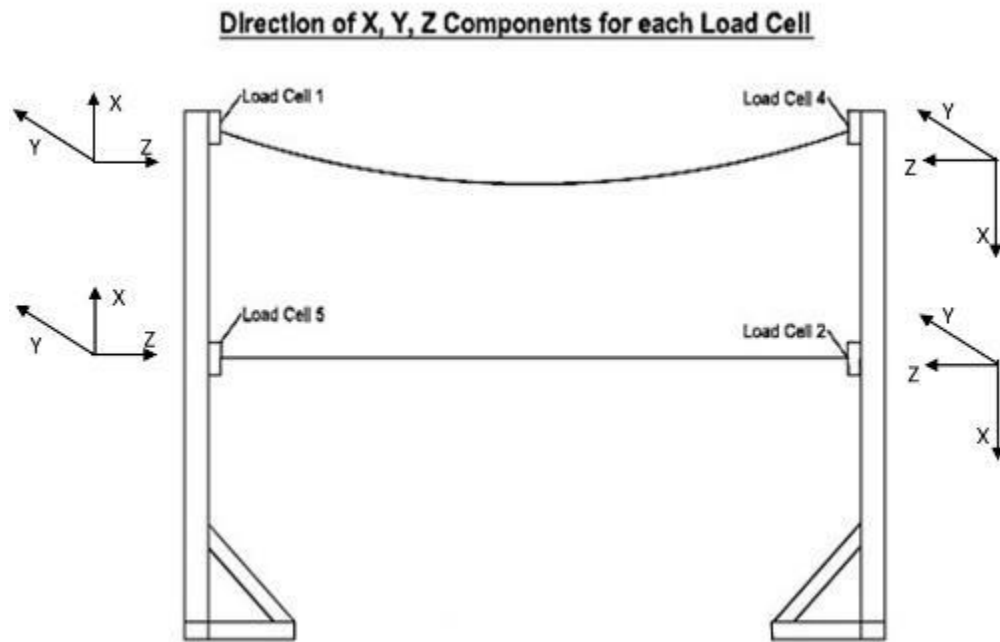

Figure 30: Direction of x , y , z components for each loadcell (direction of each axis shown)

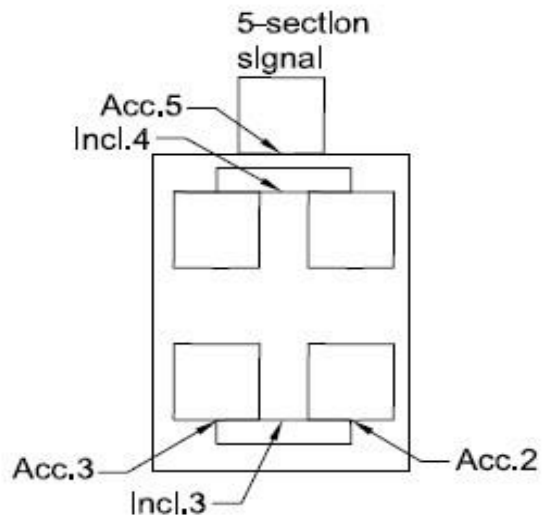

Figure 31: Location of accelerometers and inclinometers in 5-section signal

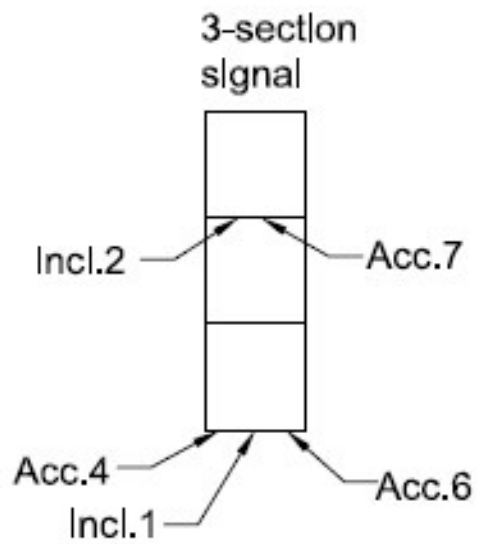

Figure 32: Location of accelerometers and inclinometers in 3-section signal

3.3 Results and Discussion

The tests at the WOW were performed in the presence of the representatives from the Florida Department of Transportation (FDOT) Traffic Engineering and Operations Office and Traffic Engineering Research Lab (TERL), installation technicians from Horsepower Electric Inc. and members of the WOW technical team. The results in this chapter are presented for 0-degree wind direction.

3.3.1 Wind induced forces

The directions of the forces are shown in Figure 30. The mean and peak forces obtained at various wind speeds are discussed in this section. Figure 33 presents the wind induced mean forces on loadcell 2 (messenger wire) and loadcell 4 (catenary wire) at 0-degree wind direction, for increasing wind speeds. It may be noted that the 'y' and 'z' components of the forces correspond to the 'drag' and 'cable tensions' respectively, while the 'x' component represents the uplift forces.

Data show that the mean along wind forces (F_y) increased with increasing wind speed at loadcell 2 (messenger wire), while F_y at loadcell 4 (catenary wire) experienced minimal change with increasing wind speeds. The highest along wind force of 180 lbs was found at loadcell 2 at 150 mph. F_z on loadcell 2 (messenger wire) was found to be 840 lbs at 40 mph, beyond which F_z on loadcell 2 was not recorded since the loadcells maximum range is 1500 lbs (i.e. without considering the pre-tension applied to the system). F_z on loadcell 4 (catenary wire) also experienced an increase in forces with increasing wind speed; at 150 mph a force of 666 lbs was measured. This shows that the messenger wire experienced higher tension and drag than the catenary wire for increasing wind speeds. The uplift forces (F_x) on loadcell 2 (messenger wire) and loadcell 4 (catenary wire) increased in magnitude marginally with increase in wind speed.

Similar observations were made for the mean forces on loadcell 5 (messenger) and loadcell 1 (catenary) as shown in Figure 34. For instance, F_y (drag) increased with increasing wind speed on loadcell 5 (messenger wire), while F_y on loadcell 1 experienced minimal change despite increasing wind speed. F_z on loadcell 5 was only recorded up to 40 mph due to reasons explained previously. F_z on loadcell 1 (catenary) experienced an increase in force with increasing wind

speed up to 70 mph, beyond which the forces dropped slightly. F_x on loadcell 5 also increased with increasing wind speed. F_x on loadcell 1 experienced negligible change despite an increase in wind speed. In general, the messenger wire (loadcell 5) experienced higher cable tensions than the catenary wire (loadcell 1).

The peak forces at 0-degree wind direction for loadcell 2 and loadcell 4 are shown in Figure 35. The peak force of F_z on loadcell 2 (messenger wire) was found to be 970 lbs at 40 mph, beyond which measurements of F_z was not taken due to the maximum range of 1500 lbs of the loadcell (without considering the pre-tension applied to the system). Peak F_z on loadcell 4 (catenary wire) increased with increasing wind speed. F_y in loadcell 2 increased with increasing wind speeds, although minimal change in F_y in loadcell 4 was observed despite increasing wind speeds.

Figure 36 presents peak forces for loadcell 5 (messenger) and loadcell 1 (catenary). F_z (cable tensions) on loadcell 5 was recorded up to 40 mph due to reasons explained previously. Peak of F_z on loadcell 1 (catenary wire) increased with increasing wind speeds and attains a value of 648 lbs at 150 mph. The peak of F_y (drag) on loadcell 5 increased gradually with higher wind speeds, although the peaks undergo minimal change despite increasing wind speeds for loadcell 1. F_x (lift) on loadcells 5 and 1 increased slightly with increasing wind speeds.

Figure 37 (a) presents the 'total' mean drag and lift forces on the traffic signals. Results show that the drag on the traffic signals increased with an increase in wind speed – highest drag of 470 lbs was obtained at 150 mph at 0-degree wind direction. The lift forces increased initially with increase in wind speed, with the highest value of 365 lbs obtained at 150 mph. The peak drag and lift are shown in Figure 3-5 (b). Similar to the mean values, the peak drag and lift increased with increasing wind speeds - highest drag of 585 lbs and highest lift of 505 lbs were obtained at 150 mph.

3.3.2 rms of accelerations

The root mean square (rms) of accelerations are presented in Figure 38. Accelerometers 4, 6 and 7 were located on the 3-section signal, while accelerometers 2, 3 and 5 were located on the 5-section signal (see Figure 31 and Figure 32). In general, the rms of accelerations obtained from all the accelerometers increased gradually with an increase in wind speed. Beyond 115 mph, the

sensors were removed to avoid further damage due to vibrations and hence results are only reported for wind speeds of up to 115 mph.

3.3.3 Inclinations of the traffic signals

Figure 39 shows the inclinations (mean and maximum) obtained from inclinometer 1 (3-section) and inclinometer 3 (5-section) at 0-degree wind direction. It may be noted that for inclinometer 1, '1-1' refers to the component of inclination perpendicular to the wind, while '1-2' refers to the component of inclination in the direction of wind. For inclinometers 1 and 3, the mean components '1-2' and '3-2' were found to be 40 degrees at 70 mph. Similarly, the maximum value of about 58 degrees was obtained at a wind speed of 70 mph for the inclinometer components 1-2 and 3-2. The values of inclinations were negligible for 1-1 and 3-1 components in the wind speed range of 0-70 mph.

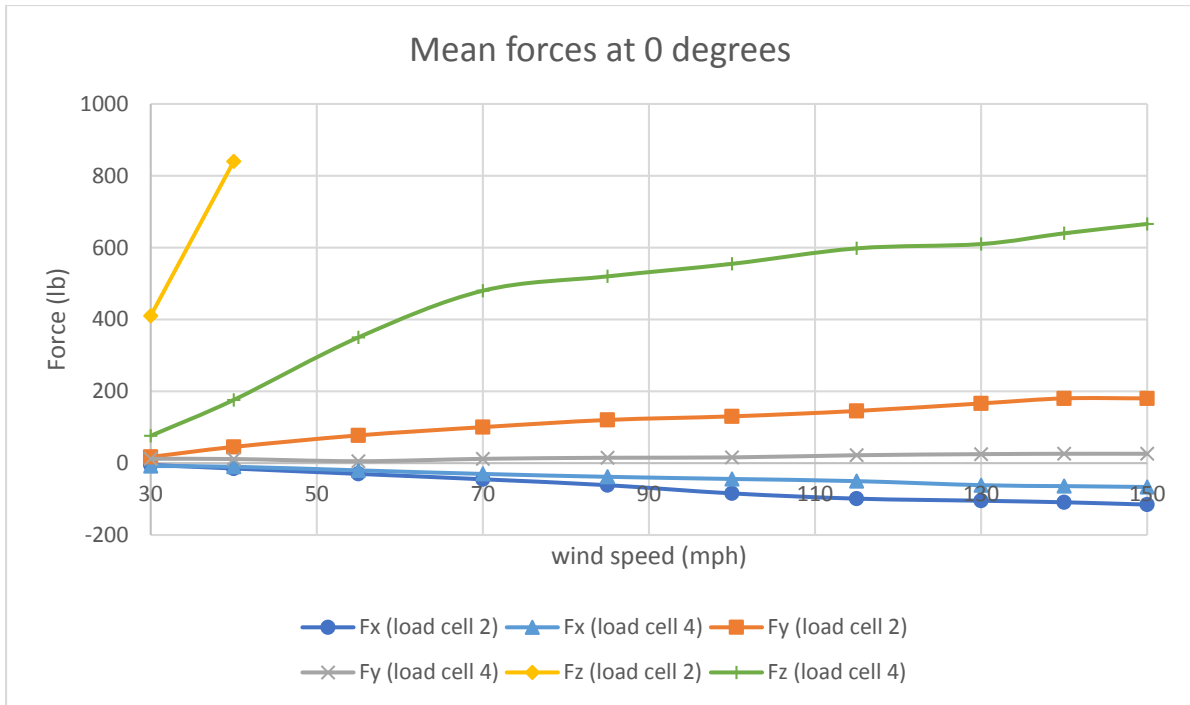

Figure 33: Mean forces on loadcells 2 (messenger wire) and 4 (catenary wire) at 0-degree wind direction

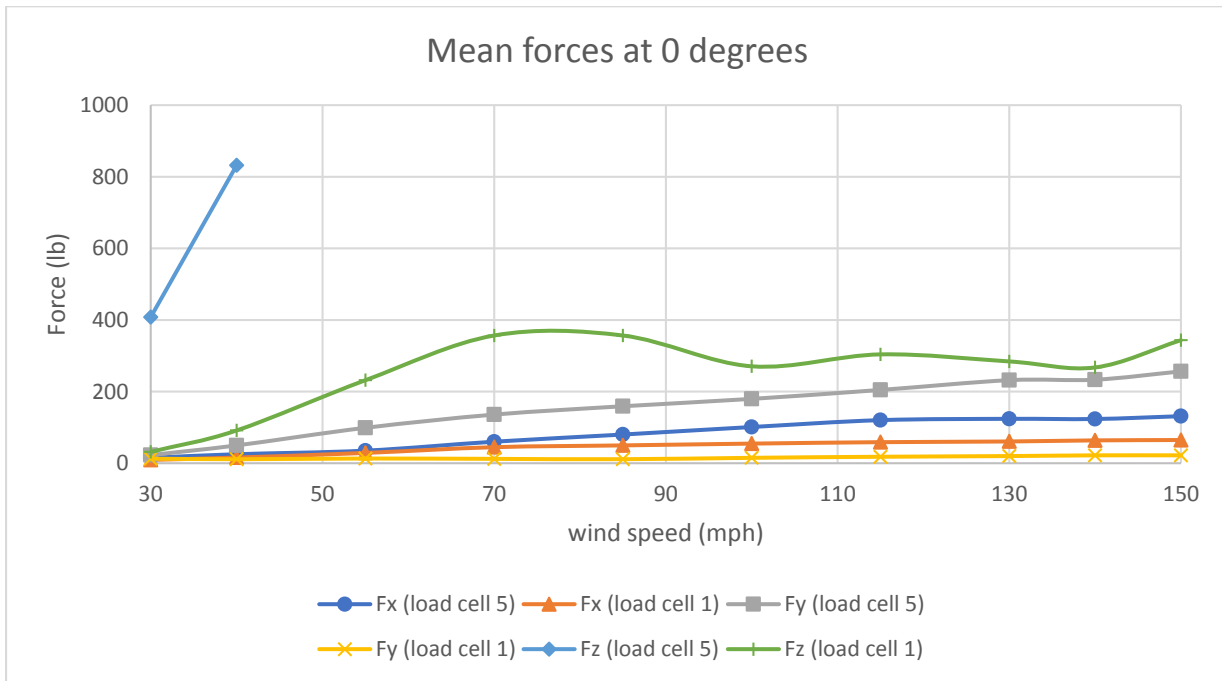

Figure 34: Mean forces on loadcells 1 (catenary wire) and 5 (messenger wire) at 0-degree wind direction

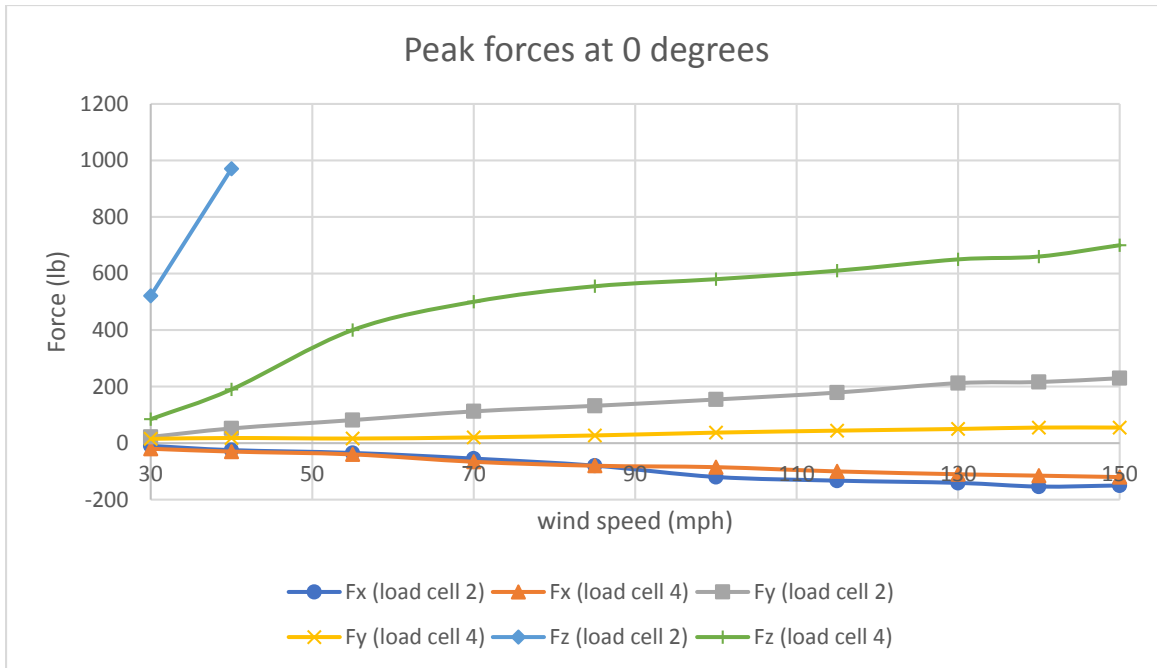

Figure 35: Peak forces at 0-degree wind direction on loadcells 2 (messenger wire) and 4 (catenary wire)

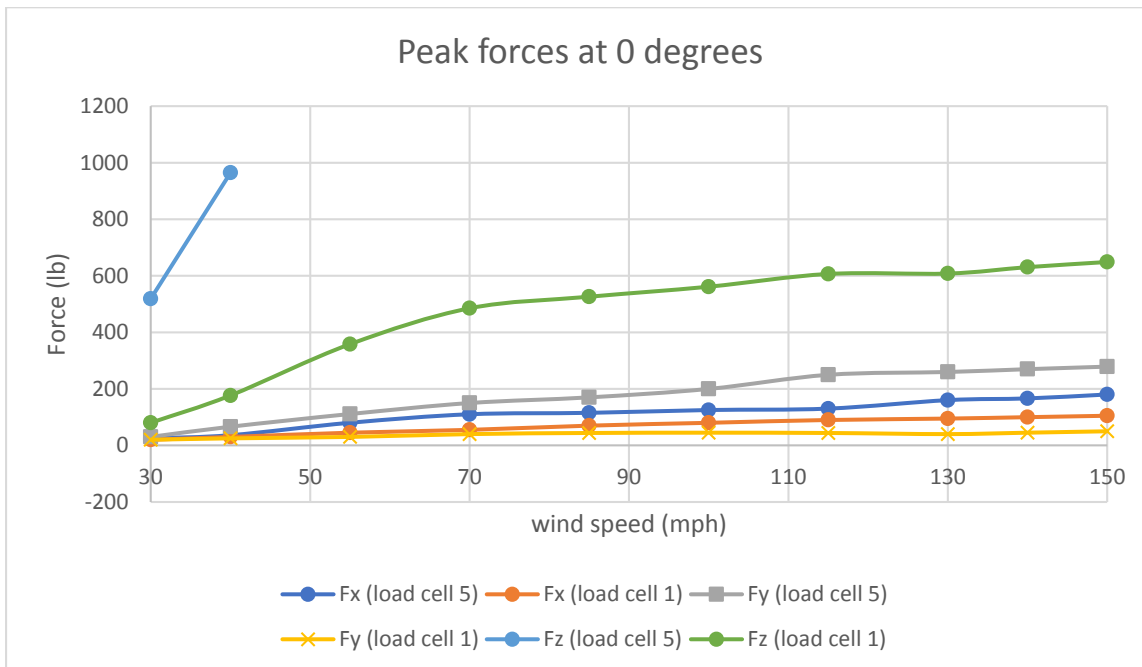
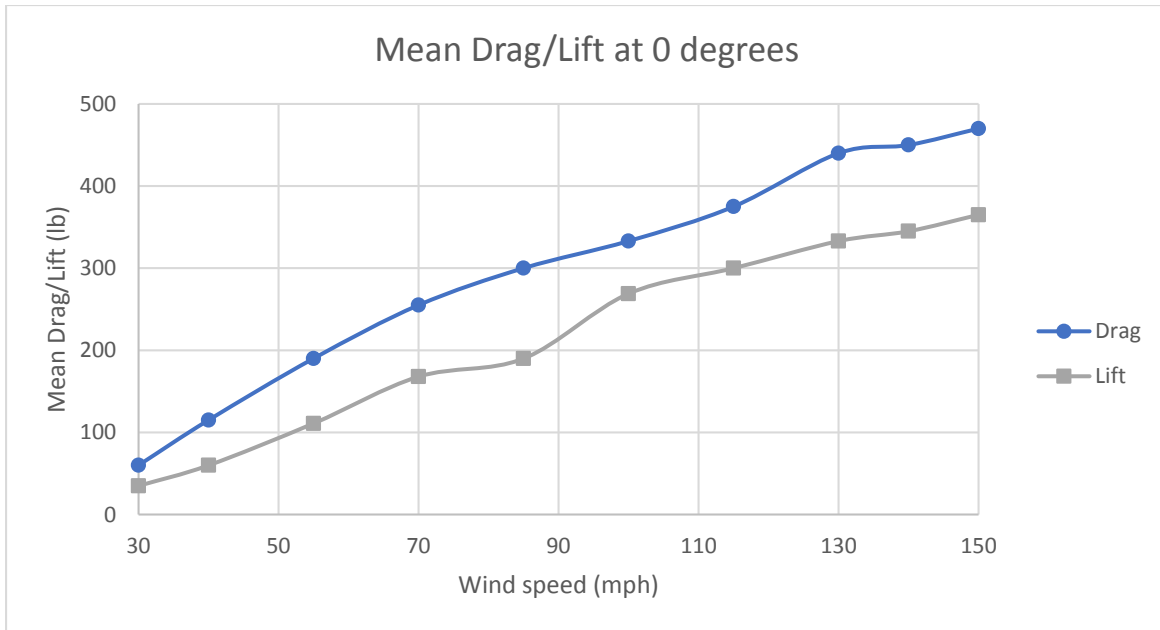
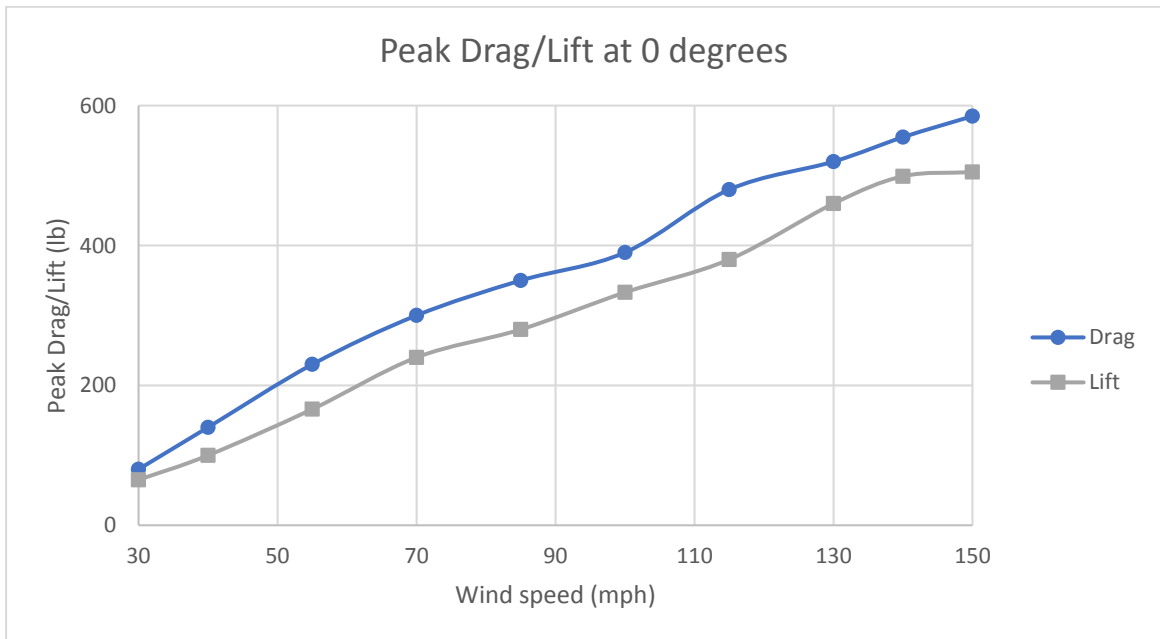

Figure 36: Peak forces at 0-degree wind direction on loadcells 1 (catenary wire) and 5 (messenger wire)



a)



b)

Figure 37: Drag (F_y) and lift (F_x) forces on the traffic signals at 0 degrees: a) Mean; b) Peak

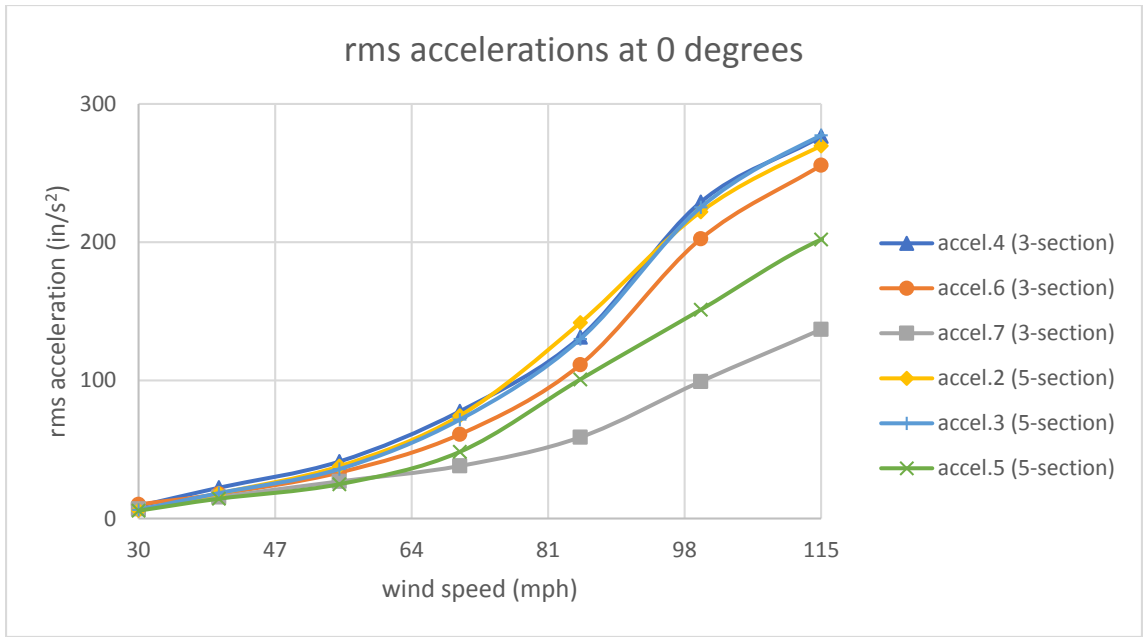

Figure 38: rms of accelerations on the 3-section and 5-section signals at 0 degrees

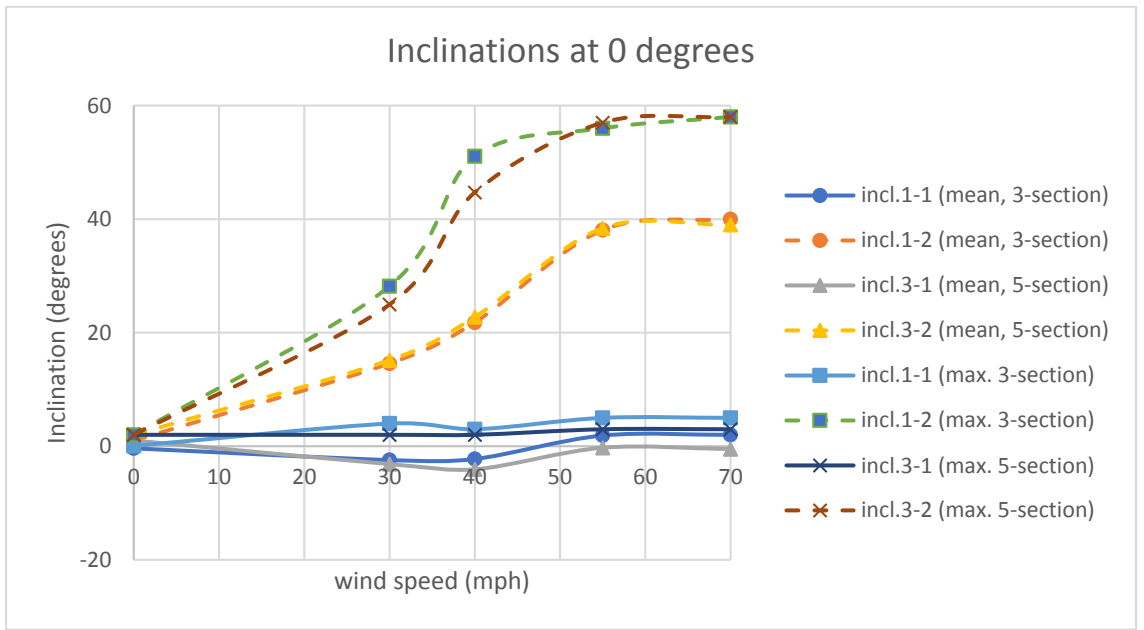

Figure 39: Inclinations (mean and max) obtained at 0 degrees for inclinometers 1 and 3

3.4 Performance of traffic signals during the tests

This test utilized two 3-section and one 5-section aluminum traffic signals installed in a span wire configuration connected to the catenary and messenger wires by means of a **“Tri-stud Adjustable Hanger with Aluminum Housing” (also known as FDOT base condition)**.

There was no visible evidence of damage to any section of the signal assembly up to 70 mph, where slight flexure of the tri-stud adjustable hangers and back plates was seen. Visors were intact. Progressing to 100 mph, there was no visible signs of damage to the traffic signals and visors other than bending of back plates from 5-section signal. At 115 mph, there was higher degree of flexure observed on the tri-stud adjustable hanger assemblies, especially on the 5-section assembly. At 130 mph a slight permanent bend occurred, again mainly on the 5-section assembly, while the left side of back plates became detached. At 150 mph, visors from center 3-section signal and 5-section signal began detaching and 5-section signal rotated from disconnect-to adjustable hanger connection. Most damage occurred on the 5-section signal with severe damage in back plates, visors and disconnect box. All 3 tri-stud adjustable hangers were bent. Throughout the test, there was no visible galloping movement.

The 5-section signal that shows more damage is shown in Figure 40. Figure 41 shows the traffic signals after the completion of 130 mph wind speed test. The disconnect boxes for the 3-section traffic signals displayed no visible damage at the end of 150 mph wind speed test as shown in Figure 42 and Figure 43 respectively. A summary of the observed damage is as follows:

- Damage to signal hanger: High degree of flexure in the tri-stud hangers creating a slight permanent bend on all 3 tri-stud adjustable hangers.
- Damage to disconnect hanger (box): No permanent visual damage observed. 5-section signal rotated from disconnect-to-adjustable hanger connection.
- Damage to signal housing assembly: Damage to visors and back plate of the 5-section signal. No other permanent visual damage observed.



Figure 40: The 5-section signal with damaged back plates and visors



Figure 41: Traffic signals after completion of 130 mph test



Figure 42: Disconnect-to-adjustable hanger connection for 5-section signal with signs of rotation



Figure 43: Disconnect box for 3-section signal with no visible damage

3.5 Conclusions

This chapter summarizes the results of a test conducted at WOW at FIU for a span wire traffic signal assembly consisting of two 3-section and a 5-section traffic signal, connected using a **“Tri-stud Adjustable Hanger with Aluminum Housing” (also known as FDOT base condition)**. Wind speeds were varied from 30 to 150 mph at and wind of 0 degrees. The various instruments used for this test included: loadcells to measure forces, accelerometers to measure accelerations and inclinometers to measure the inclinations. This study reports the data for 0-degree wind direction, in terms of: wind induced forces (drag (y-component), lift (x-component) and cable tension (z-component)), rms of accelerations and inclinations. Results indicate that the mean and peak drag and lift on the traffic signals increased with increasing wind speeds. The cable tensions (mean and peak) increased in the messenger wire with increase in wind speed from 30 to 150 mph. At any given wind speed, the messenger wire experienced higher tensions and drag compared to the catenary wire. The rms of accelerations increased with increasing wind speed from 30 mph to 115 mph. In the range of 40 to 70 mph for 0-degree wind direction, the mean inclinations in the along wind direction varied from 22 to 38 degrees, with a maximum value of about 58 degrees observed at 70 mph. At 130 mph, left side of 5-section signal back plates were loosened and windblown. At 150 mph, visors from 5section signal and center 3-section signal detached from attachment points and 5-section signal rotated from disconnect-to-adjustable hanger connection. There was no aerodynamic instability (aerodynamic flutter) behavior throughout the entire test.

Chapter 4 - Task 1: LONG SPAN LENGTH FULL SCALE TESTING - Case 3

“Trajan Signal Assembly with Stainless Steel Pivotal Hanger and ABS Housing” (vendor: Trajan Signal Systems) - Test Date: 07/01/2016

4.1 Introduction

Previous studies involving the FDOT and WOW Research Facility at FIU identified a ‘base’ test configuration consisting of two 3-section and one 5-section traffic signals. Considering the knowledge acquired from these tests that utilized a short span length test frame placed on a turntable and using springs on the catenary and messenger spans to simulate longer typical spans, the scope of the current research project serves as dual purpose; use the existing test frame to test, for multiple wind directions, five additional traffic signal assemblies as specified by FDOT and develop and use an 80ft span test frame to test, for a single critical wind direction, five signal assemblies as specified by FDOT. With a full span length test frame, the full dynamic response of the system was replicated and more detailed information on components of the different assemblies, like stresses and deflections, was obtained through loadcells, accelerometers, inclinometers and inertia sensors. This test served as a validation of the performance of the short span length test rig and the use of springs to represent a full span length. A 70.5 ft test frame was used to test the span wire traffic signal configurations connected to the catenary and messenger wires via a **“Trajan Signal Assembly with Stainless Steel Pivotal Hanger and ABS Housing” (vendor: Trajan Signal Systems)**. The tests were carried out at wind direction of 0 degrees and wind speeds ranging from 30 to 115 mph. The instrumentation that was used include loadcells, accelerometers and inclinometers.

This chapter presents the results from the tests conducted on the traffic signal assembly with the **“Trajan Signal Assembly with Stainless Steel Pivotal Hanger and ABS Housing” (vendor: Trajan Signal Systems)** at the WOW.

4.2 Experimental methodology

4.2.1 Test Setup

The 3-3-5 signal assembly was installed on a long-span rig (described in chapter 1) by means of a **“Trajan Signal Assembly with Stainless Steel Pivotal Hanger and ABS Housing” (vendor: Trajan Signal Systems)**. Figure 44 and Figure 45 show the Trajan signal assembly installed for testing. The bottom of all signals were at approximately 4.5 ft above the concrete floor. The different components used for this round of test are shown in Table 5. The test protocol is presented in Table 6.

4.2.2 Instrumentation

The directions of the x, y and z components for each loadcell are shown in Figure 46. Loadcells number 2 and 5 were located at either end of the messenger cable and loadcells number 1 and 4 located at either end of the catenary cable.

Tri-axial accelerometers were installed in the traffic signals to measure accelerations. There was one accelerometer placed on the center top of the signal, Accel5, another placed on the bottom right side, Accel002, and a third placed on the bottom left side, Accel003 for the 5-section signal as shown in Figure 47. Accelerometer Accel007, was installed on the top center, accelerometer Accel004, was installed on the bottom left side and accelerometer Accel006, was installed on the bottom right side of the 3-section signal as shown in Figure 48.

Inclinometers were also installed on each signal to measure the inclination of the signals during wind exposure. The inclinometers measured inclination in two directions, one relative to an axis parallel to the wind direction and another relative to an axis perpendicular to the wind direction. There were inclinometers installed on the top center of the signal, Inc4, and another on the bottom center of the signal, Inc3, for the 5-section signal as shown in Figure 47. Inclinometer, Inc2, was installed on the top center and inclinometer, Inc1, was installed on the bottom center of the of the 3-section signal as shown Figure 48.

4.2.3 Test Method

The test set up was first tested for 'no wind' conditions, and the values of the various 'quantities' (forces, accelerations and inclinations) obtained were later deducted from quantities obtained for different wind speeds (also known as "zero drift removal" process).

Table 5: Components of signal assembly (Task 1: Case 3)

| Component | Manufacturer |
|-------------------|-----------------------|
| Span wire clamp | Trajan Signal Systems |
| Adjustable hanger | Trajan Signal Systems |
| Extension bar | Trajan Signal Systems |
| Messenger clamp | Trajan Signal Systems |
| Disconnect Hanger | None |
| Signal Assembly | Trajan Signal Systems |
| Backplate | Trajan Signal Systems |
| Visor | Trajan Signal Systems |
| LED Modules | Trajan Signal Systems |

Table 6: Test Protocol (Task 1: Case 3)

| Wind Speed (mph) | Wind Direction (degrees) | Total Duration (min) |
|-------------------------|---------------------------------|-----------------------------|
| 30 | 0 | 1 |
| 40 | 0 | 1 |
| 55 | 0 | 1 |
| 70 | 0 | 1 |
| 85 | 0 | 1 |
| 100 | 0 | 1 |
| 115 | 0 | 1 |
| 130 | 0 | Cancelled |
| 140 | 0 | Cancelled |
| 150 | 0 | Cancelled |
| TOTAL | | 7 |

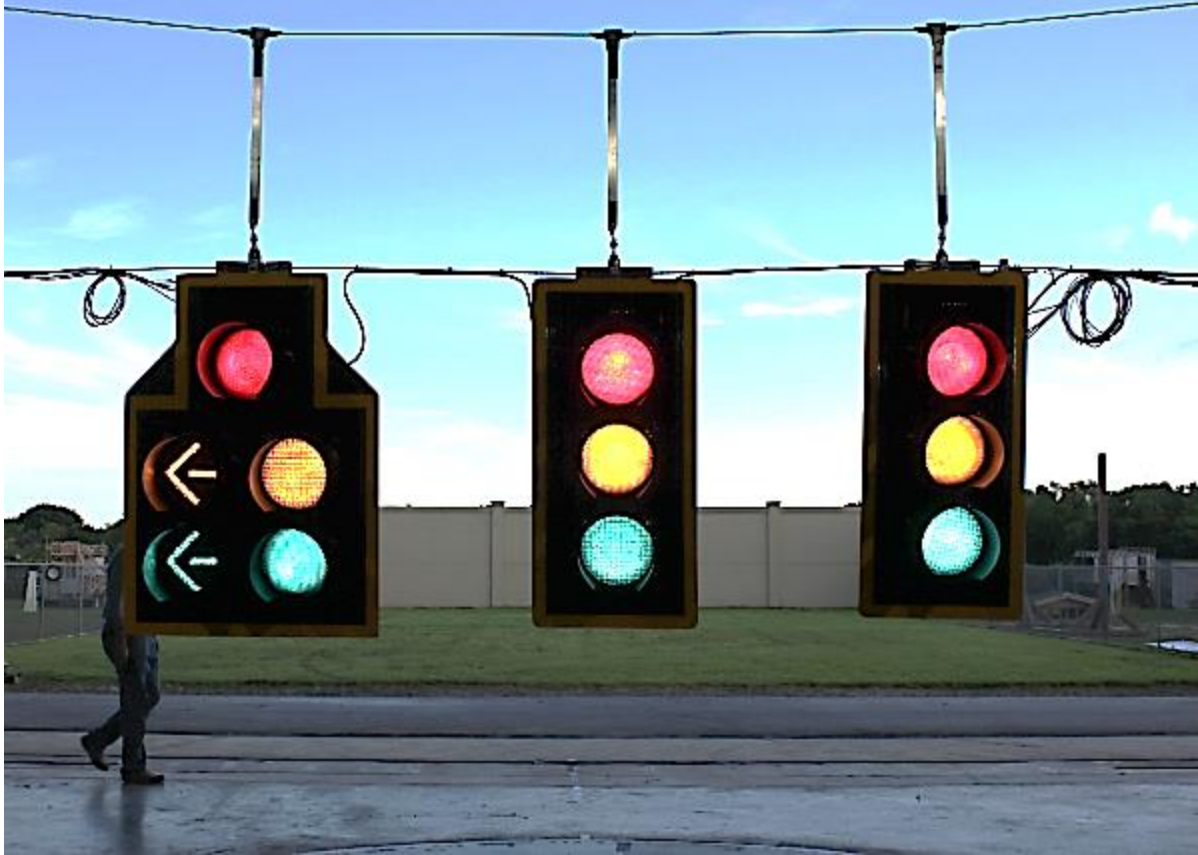

Figure 44: Signal assemblies installed on test frame (before testing)



a)



b)

Figure 45: a) Setup for the test; b) Magnified view of the connection

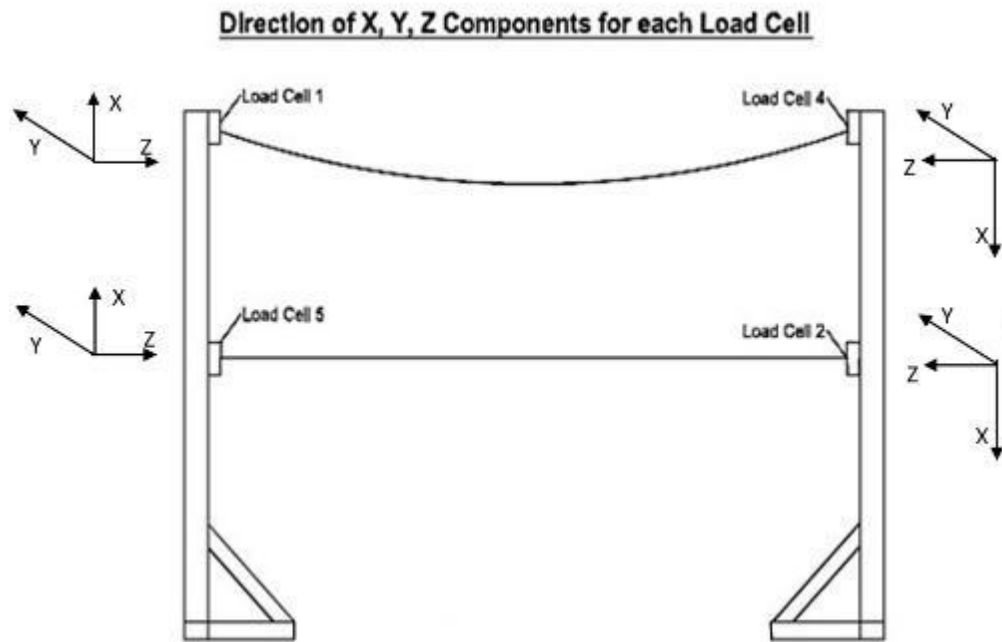

Figure 46: Direction of x, y, z components for each loadcell (direction of each axis shown)

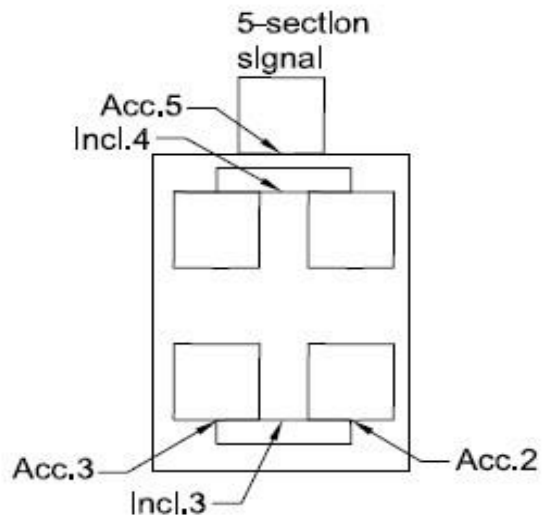

Figure 47: Location of accelerometers and inclinometers in 5-section signal for case 1

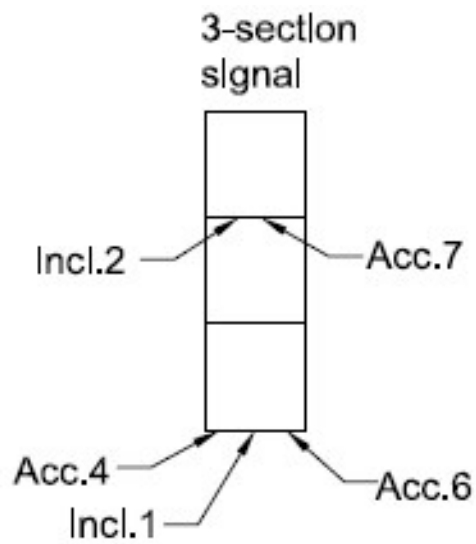

Figure 48: Location of accelerometers and inclinometers in 3-section signal for case 1

4.3 Results and discussion

The tests at the WOW were performed in the presence of the representatives from the Florida Department of Transportation (FDOT) Traffic Engineering and Operations Office and Traffic Engineering Research Lab (TERL), representatives from Trajan Signal Systems, installation technicians from Horsepower Electric Inc. and members of the WOW technical team. The results in this chapter are presented for 0-degree wind direction.

4.3.1 Wind induced forces

The directions of the forces are shown in Figure 46. The mean and peak forces obtained at various wind speeds are discussed in this section. Figure 49 presents the wind induced mean forces on loadcell 2 (messenger wire) and loadcell 4 (catenary wire) at 0-degree wind direction, for increasing wind speeds. It may be noted that the 'y' and 'z' components of the forces correspond to the 'drag' and 'cable tensions' respectively, while the 'x' component represents the uplift forces.

Data show that F_z on loadcell 2 (messenger) increased with increase in wind speed, and a force of 750 lbs was obtained at 40 mph. Beyond wind speed of 40 mph, measurements were not carried out since the tension forces exceeded the loadcells range of 1500 lbs (i.e. without considering the pre-tension applied to the system). F_z on loadcell 4 increased initially with increase in wind speed, and beyond 55 mph attains a nearly constant value of about 500 lbs up to wind speed of 100 mph.

F_x on loadcells 2 (messenger wire) and 4 (catenary wire) experienced minimal change despite an increase in wind speed. Although F_y on loadcell 2 increased with increasing wind speed, negligible change in F_y on loadcell 4 was observed despite increasing wind speeds. In general, the messenger wire experienced higher magnitudes of forces than the catenary wire for any given wind direction.

Similar observations were made for the mean forces on loadcell 5 (messenger) and loadcell 1 (catenary) as shown in Figure 50. For instance, F_z on loadcell 5 (messenger) were recorded at wind speeds of 30 mph and 40 mph, beyond which the measurements were not recorded since the loadcells range of 1500 lbs (i.e. without considering the pre-tension applied to the system)

was exceeded; at 40 mph, magnitude of F_z was found to be 750 lbs. F_z on loadcell 1 also experienced an increase in force with increasing wind speed, although beyond 100 mph a small reduction of force was experienced. Negligible changes were observed in F_x on loadcells 1 (catenary wire) and 5 (messenger wire) despite an increase in wind speed. Although F_y on loadcell 5 increased with increasing wind speeds. The messenger wire experienced higher cable tensions than the catenary wire for any given wind speed.

The peak forces at 0-degree wind direction for loadcell 2 and loadcell 4 are shown in Figure 51. Peak force on loadcell 2 was only recorded at wind speed of 30 mph, beyond which the loadcells maximum range was exceeded (1500lbs without considering the pre-tension applied to the system). Peak F_z on loadcell 4 increased with increasing wind speed initially, although beyond wind speed of 85 mph a constant force of about 550 lbs was obtained. F_x in loadcells 2 (messenger wire) and 4 (catenary wire) underwent minimal change despite increasing wind speeds. F_y on loadcells 2 (messenger wire) and 4 (catenary wire) increased with increasing wind speed, although the magnitude of forces in loadcell 2 was somewhat higher than in loadcell 4 at wind speeds above 55 mph.

Figure 52 presents peak forces for loadcell 5 (messenger) and loadcell 1 (catenary). F_z (cable tensions) on loadcell 5 was only recorded at 30 mph wind speed due to reasons explained previously. F_z on loadcell 1 increased with increasing wind speed, although beyond wind speed of 85 mph the forces decreased slightly. F_y on loadcells 1 and 5 increased with increasing wind speed, although the forces in the latter were higher in magnitude beyond wind speed of 90 mph. F_x on loadcells 1 and 5 experienced an increase with increasing wind speed, although the magnitude of forces in the former for a given wind speed were higher than the latter

Figure 53 (a) presents the 'total' mean drag and lift forces on the traffic signals. Results show that both the drag and lift on the traffic signals increased with an increase in wind speed. The peak drag and lift are shown in Figure 53 (b). Similar to the mean values, the peak drag and lift increased with increasing wind speeds - highest peak drag of 1100 lbs and peak lift of 700 lbs were obtained at 100 mph.

4.3.2 rms of accelerations

The root mean square (rms) of accelerations are presented in Figure 54. Accelerometers 4, 6 and 7 were located on the 3-section signal, while accelerometers 2, 3 and 5 were located on the 5-section signal (see Figures 2-8 and 2-9). In general, the rms of accelerations obtained from all the accelerometers increased gradually with an increase in wind speed. Beyond 100 mph, the sensors were removed to prevent damage due to excessive vibration.

4.3.3 Inclinations of the traffic signals

Figure 55 shows the inclinations (mean and maximum) obtained from inclinometer 1 (3-section) and inclinometer 3 (5-section) at 0-degree wind direction. It may be noted that for inclinometer 1, '1-1' refers to the component of inclination perpendicular to the wind, while '1-2' refers to the component of inclination in the direction of wind. For inclinometers 1 and 3, the mean components '1-2' and '3-2' were 39 degrees at 70 mph. Similarly, the maximum value of 58 degrees was obtained at a wind speed of 70 mph for the inclinometer components 1-2 and 3-2. The values of inclinations were negligible for 1-1 and 3-1 components in the wind speed range of 0-70 mph.

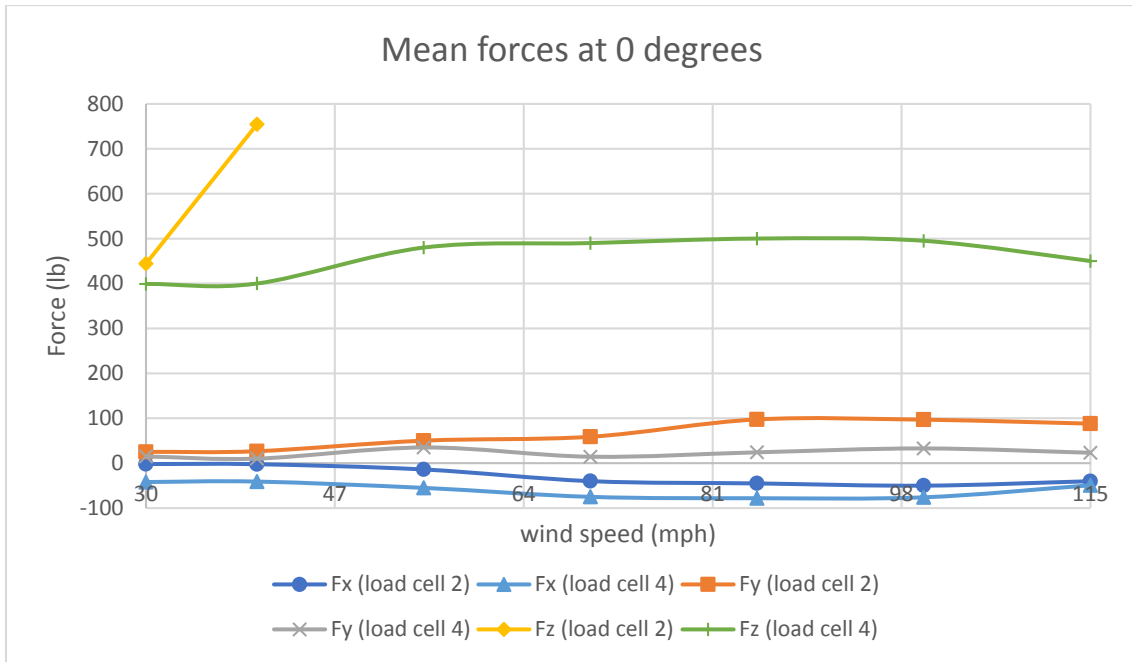

Figure 49: Mean forces on loadcells 2 (messenger wire) and 4 (catenary wire) at 0-degree wind direction

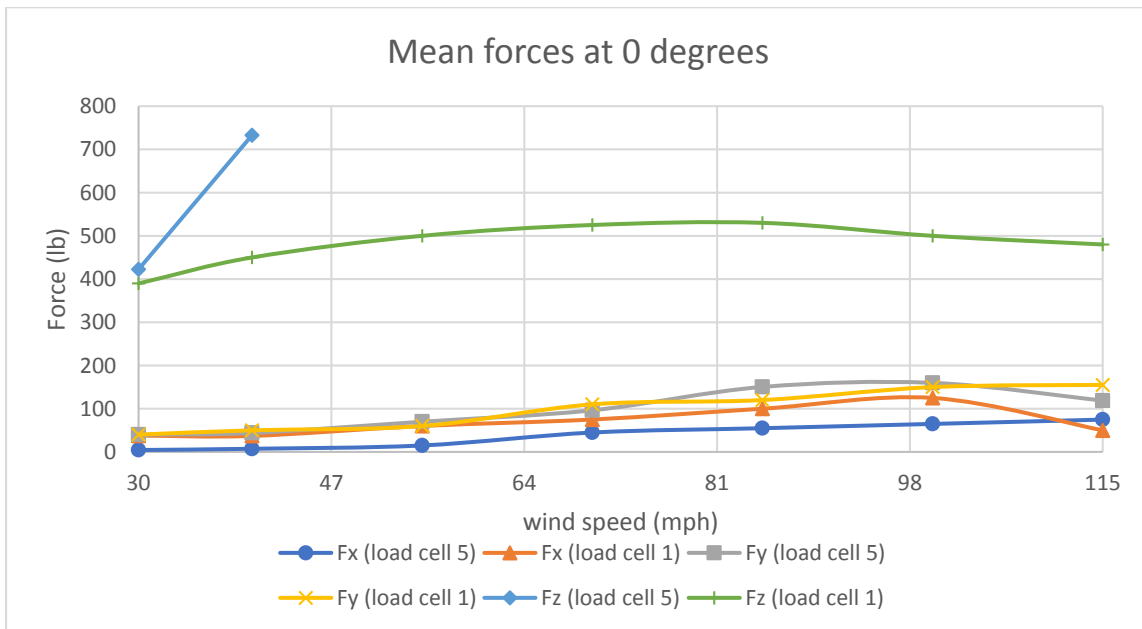

Figure 50: Mean forces on loadcells 1 (catenary wire) and 5 (messenger wire) at 0-degree wind direction

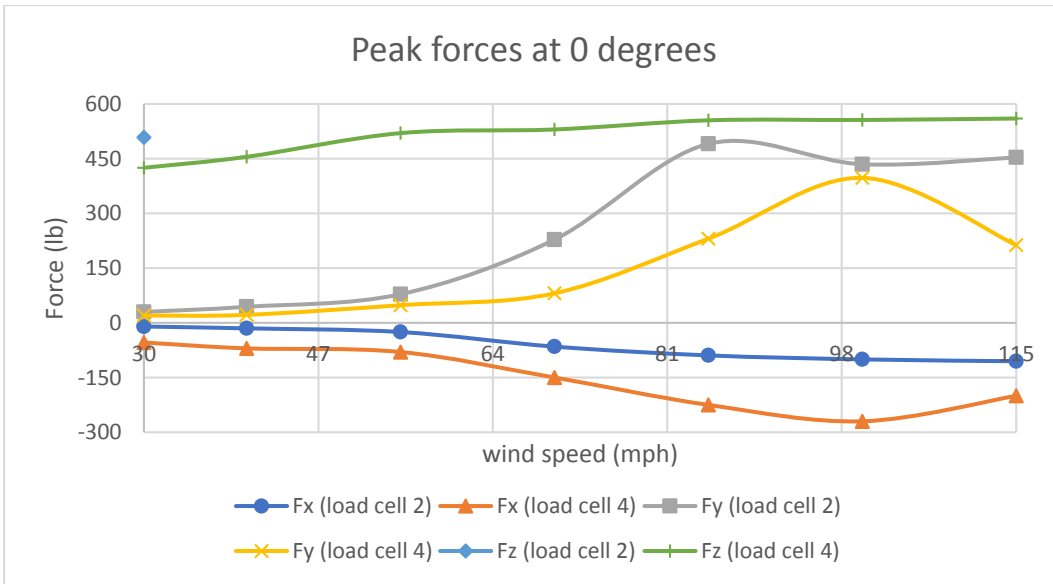

Figure 51: Peak forces at 0-degree wind direction on loadcells 2 (messenger wire) and 4 (catenary wire)

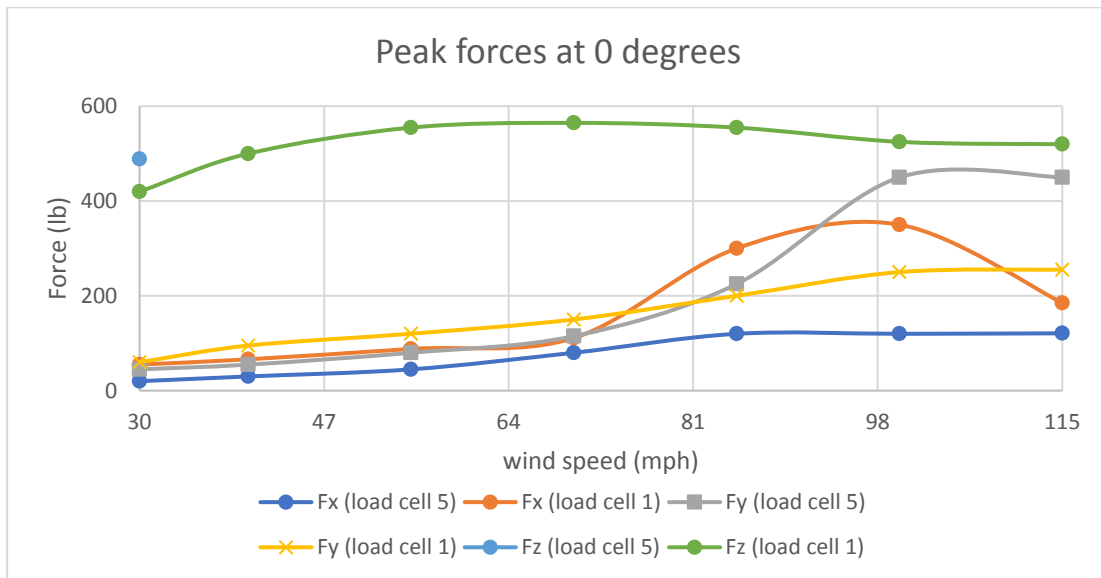
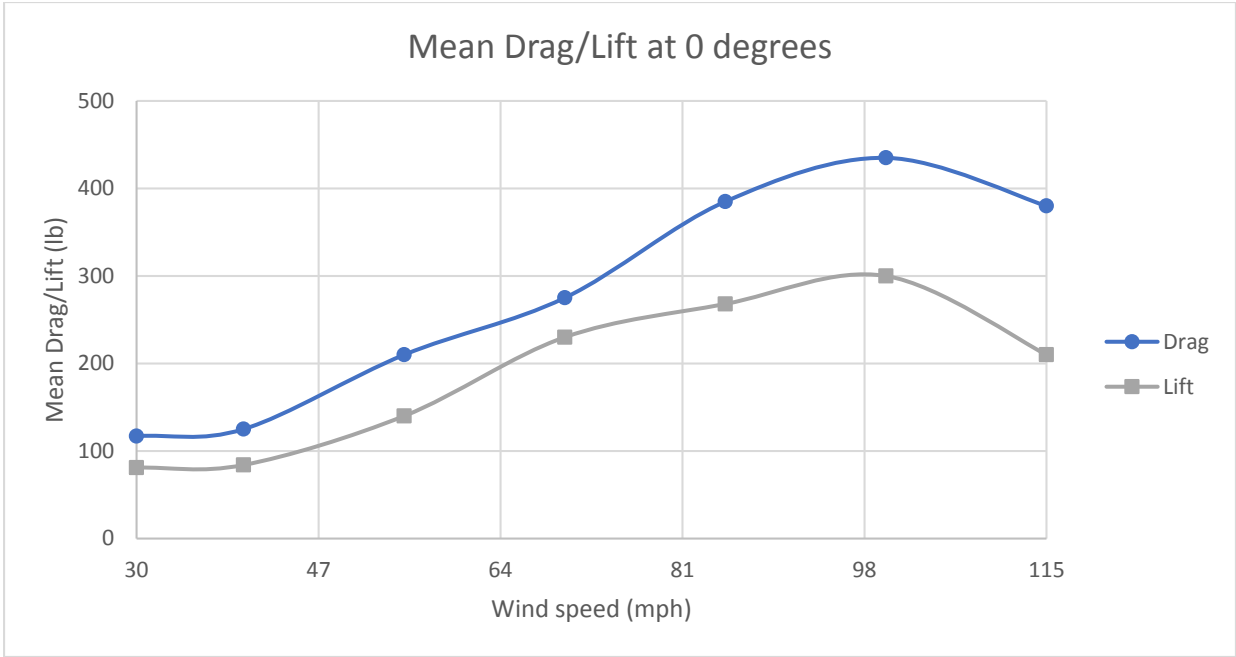
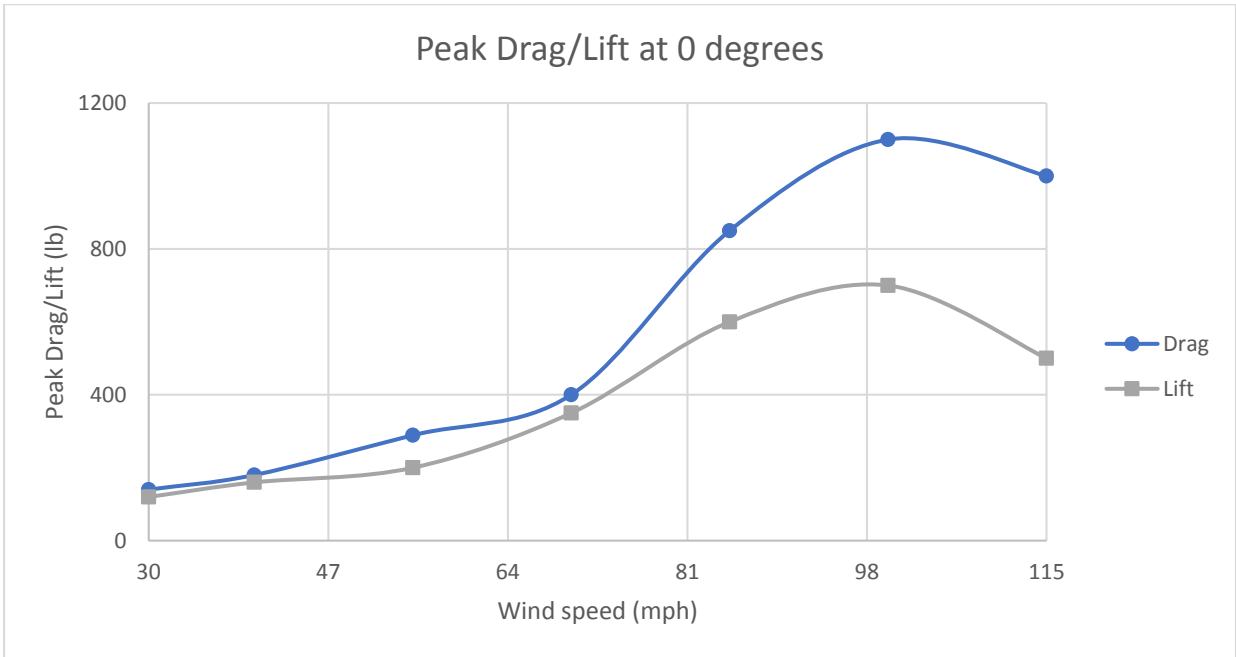

Figure 52: Peak forces at 0-degree wind direction on loadcells 1 (catenary wire) and 5 (messenger wire)



a)



b)

Figure 53: Drag (F_y) and lift (F_x) forces on the traffic signals at 0 degrees: a) Mean; b) Peak

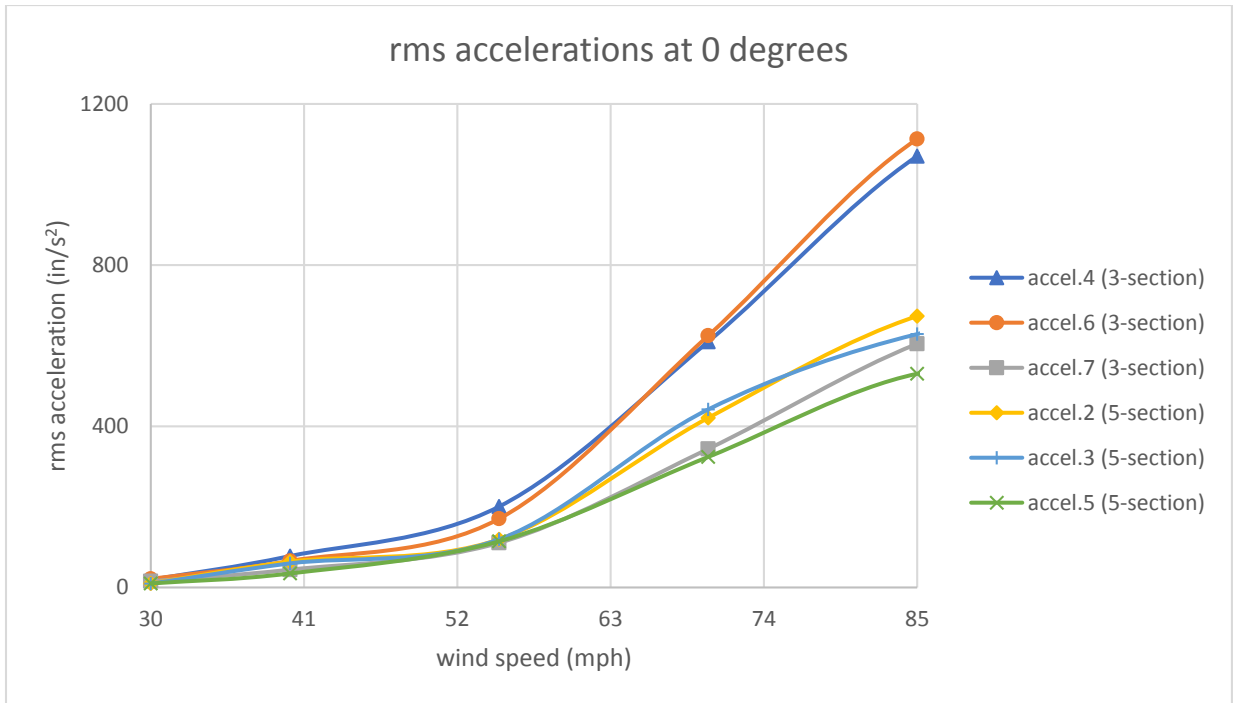

Figure 54: rms of accelerations on the 3-section and 5-section signals at 0 degrees

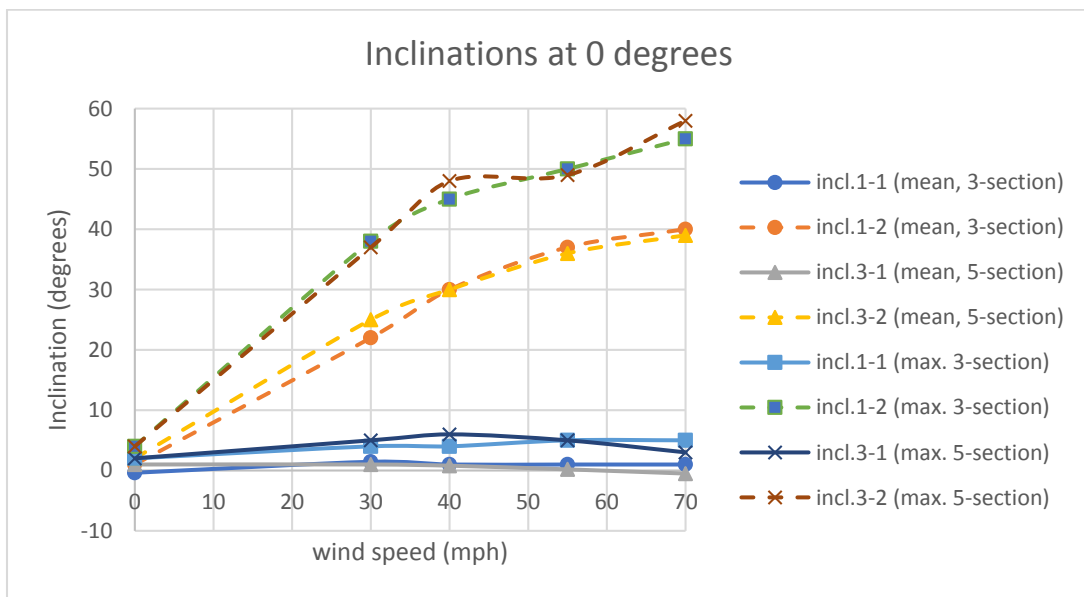

Figure 55: Inclinations (mean and max) obtained at 0 degrees for inclinometers 1 and 3

4.4 Performance of traffic signals during the tests

This test utilized two 3-section and one 5-section traffic signals installed in a span wire configuration connected to the catenary and messenger wires by means of a **“Trajan Signal Assembly with Stainless Steel Pivotal Hanger and ABS Housing” (vendor: Trajan Signal Systems)**.

Commencing the test at 30 mph there was no visible evidence of damage to any section of the signal assembly. A slight galloping movement was first seen when reaching a wind speed of 40 mph. At 55 mph, aerodynamic flutter became clearly visible and continued and intensified throughout the entire testing. Progressing to 85 mph, it was noticed that the bottom visor from east 3-section signal was damaged due to vibration and the center 3-section signal housing was completely destroyed. It was noticed that damage occurred when signal doors opened. After the signal failed, wires commenced shorting. After the center 3-section signal failed, the two remaining signals showed an increased galloping movement with some small fluttering. At 100 mph, the 5-section signal lower doors opened and flew off. The test was stopped at 115 mph when what was left of the 5-section signal started rotating from the connection between signal and messenger wire, and the east 3-section signal failed (rod broke) and flew off.

The signal assembly at the end of the test is shown in Figure 56. Figure 57 shows the 5-section traffic signal and Figure 58 shows the 3-section signal hanger attachment after the completion of 115 mph wind speed test. A summary of the observed damages is as follows:

- Damage to signal hanger: No permanent visual damage observed.
- Damage to disconnect hanger (box): Major damage. Housing completely destroyed. Note: In this assembly, the disconnect hanger (box) is integral to the signal housing (i.e., not a separate component).
- Damage to signal housing assembly: Major damage. Housing completely destroyed on 5 section and center 3 section. East 3 section broke off and flew away.

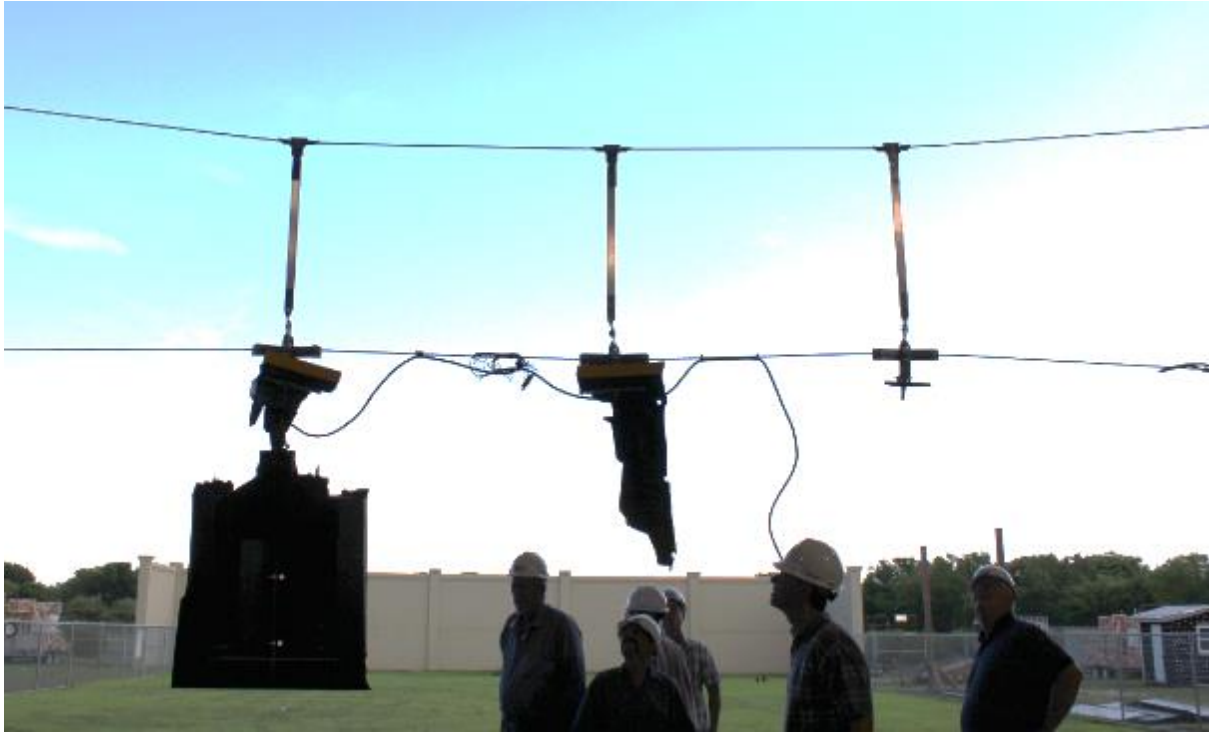

Figure 56: Signal assembly after 115 mph



Figure 57: 5-section signal after completion of test



Figure 58: East 3-section signal hanger attachment

4.5 Conclusions

This chapter summarizes the results of a test conducted at WOW at FIU for a 70.5 ft span wire traffic signal assembly consisting of two 3-section and a 5-section traffic signal, connected using a **“Trajan Signal Assembly with Stainless Steel Pivotal Hanger and ABS Housing” (vendor: Trajan Signal Systems)**. Wind speeds were varied from 30 to 115 mph and wind direction of 0 degrees. The various instruments used for this test included: loadcells to measure forces, accelerometers to measure accelerations and inclinometers to measure the inclinations. This study reports the data for 0-degree wind direction, in terms of: wind induced forces (drag (y-component), lift (x-component) and cable tension (z-component)), rms of accelerations and inclinations. Results indicate that the mean and peak drag and lift on the traffic signals increased with increasing wind speeds. The cable tensions (mean and peak) increased in the messenger wire with increase in wind speed from 30 to 115 mph. At any given wind speed, the messenger wire experienced higher tensions and drag compared to the catenary wire. The rms of accelerations increased with increasing wind speed from 30 mph to 85 mph. In the range of 40 to 70 mph for 0-degree wind direction, the mean inclinations in the along wind direction varied from 30 to 39 degrees, with a maximum value of about 58 degrees observed at 70 mph. A slight galloping movement started at 40 mph. This instability became clearly noticeable at 55 mph and continued and intensified throughout the entire test. Damage was observed at 85 mph with the total failure of the center 3-section signal housing. Total failure of the 5-section housing occurred at 100 mph. The test was terminated at 115-mph when failure occurred with the remaining 3-section signal when its internal rod broke and the signal housing flew away.

Chapter 5 - Task 1: LONG SPAN LENGTH FULL SCALE TESTING - Case 4

Adjustable Hanger Assembly with Cable Dampener and Reinforced Disconnect Hanger with Aluminum Housing (vendor: Pelco Products) - Test Date: 06/28/2016

5.1 Introduction

Previous studies involving the FDOT and WOW Research Facility at FIU identified a ‘base’ configuration consisting of two 3-section and one 5-section traffic signals. Considering the knowledge acquired from these tests that utilized a short span length test frame placed on a turntable and using springs on the catenary and messenger spans to simulate longer typical spans, the scope of the current research project serves as dual purpose; use the existing test frame to test, for multiple wind directions, five additional traffic signal assemblies as specified by FDOT and develop and use an 80ft span test frame to test, for a single critical wind direction, five signal assemblies as specified by FDOT. With a full span length test frame, the full dynamic response of the system was replicated and more detailed information on components of the different assemblies, like stresses and deflections, was obtained through loadcells, accelerometers, inclinometers and inertia sensors. This test served as a validation of the performance of the short span length test rig and the use of springs to represent a full span length. A 70.5 ft test frame was used to test the span wire traffic signal configurations connected to the catenary and messenger wires via a **“Adjustable Hanger Assembly with Cable Dampener and Reinforced Disconnect Hanger” (vendor: Pelco Products)**. The tests were carried out at wind direction of 0-degree and wind speeds ranging from 30 to 150 mph. The instrumentation used consisted of loadcells, accelerometers and inclinometers.

This chapter presents the results from the tests conducted on the traffic signal assembly with the **“Adjustable Hanger Assembly with Cable Dampener and Reinforced Disconnect Hanger” (vendor: Pelco Products)** at the WOW.

5.2 Experimental methodology

5.2.1 Test Setup

The 3-3-5 signal assembly was installed on a long-span rig (described in chapter 1) by means of a **“Adjustable Hanger Assembly with Cable Dampener and Reinforced Disconnect Hanger” (vendor: Pelco Products)**. Figure 59 and Figure 60 show the traffic signal assembly as well as the adjustable hanger with cable dampener and reinforced disconnect hanger with aluminum housing assembly. The bottom of all signals were at approximately 4.5 ft above the concrete floor. All the signals were made of aluminum and included louvered back plates and visors. The list of components used for this round of tests are shown in Table 7. The test protocol is presented in Table 8.

5.2.2 Instrumentation

The directions of the x, y and z components for each loadcell are shown in Figure 61. Loadcells number 2 and 5 were located at either end of the messenger cable and loadcells number 1 and 4 located at either end of the catenary cable.

Tri-axial accelerometers were installed in the traffic signals to measure accelerations. There was one accelerometer placed on the center top of the signal, Accel5, another placed on the bottom right side, Accel002, and a third placed on the bottom left side, Accel003 for the 5-section signal as shown in Figure 62. Accelerometer Accel007, was installed on the top center, accelerometer Accel004, was installed on the bottom left side and accelerometer Accel006, was installed on the bottom right side of the 3-section signal as shown in Figure 63.

Inclinometers were also installed on each signal to measure the inclination of the signals during wind exposure. The inclinometers measured inclination in two directions, one relative to an axis parallel to the wind direction and another relative to an axis perpendicular to the wind direction. There was one inclinometer installed on the top center of the signal, Inc4, and another on the bottom center of the signal, Inc3, for the 5-section signal as shown in Figure 62. Inclinometer, Inc2, was installed on the top center and inclinometer, Inc1, was installed on the bottom center of the of the 3-section signal as shown Figure 63.

5.2.3 Test Method

The test set up was first tested for 'no wind' conditions, and the values of the various 'quantities' (forces, accelerations and inclinations) obtained were later deducted from quantities obtained for different wind speeds (also known as "zero drift removal" process).

Table 7: Signal assembly components (Task 1: Case 4)

| Component | Manufacturer |
|-------------------|---------------------------|
| Span wire clamp | Pelco (standard) |
| Adjustable hanger | Pelco (standard) |
| Extension bar | Pelco (standard) |
| Messenger clamp | Pelco (standard) |
| Disconnect Hanger | Pelco (standard) |
| Signal Assembly | McCain |
| Backplate | TCS |
| Visor | McCain |
| LED Modules | GE - Dialight - Duralight |

Table 8: Test Protocol (Task 1: Case 4)

| Wind Speed (mph) | Wind Direction (degrees) | Total Duration (min) |
|-------------------------|---------------------------------|-----------------------------|
| 30 | 0 | 1 |
| 40 | 0 | 1 |
| 55 | 0 | 1 |
| 70 | 0 | 1 |
| 85 | 0 | 1 |
| 100 | 0 | 1 |
| 115 | 0 | 1 |
| 130 | 0 | 1 |
| 140 | 0 | 1 |
| 150 | 0 | 1 |
| TOTAL | | 10 |



Figure 59: Signal assemblies installed on test rig (before testing)



a)



b)

Figure 60: a) Signal setup for the test; b) View of the connection

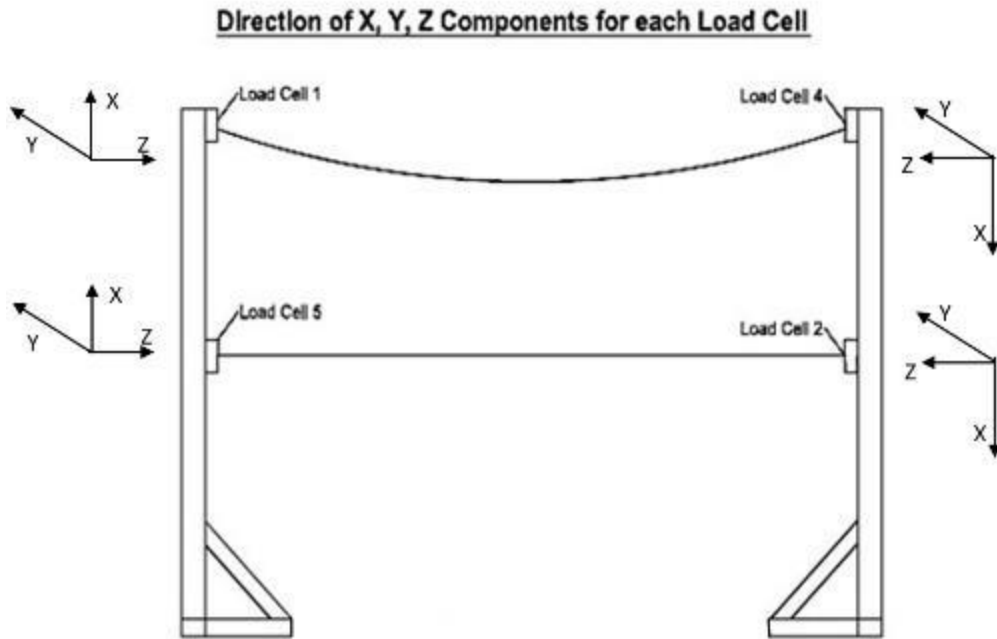

Figure 61: Direction of x, y, components for each loadcell (direction of each axis shown represents "positive direction")

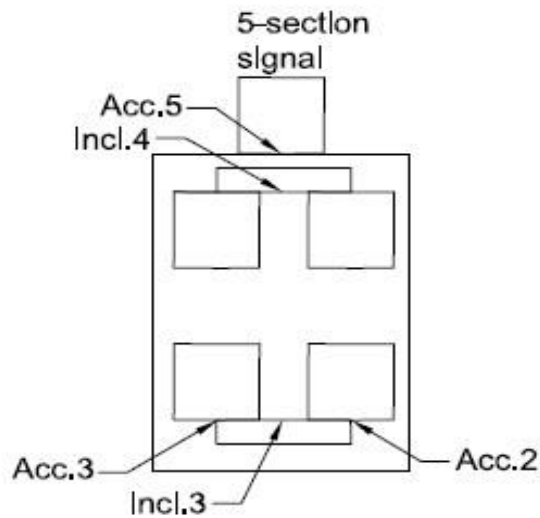

Figure 62: Location of accelerometers and inclinometers in 5-section signal

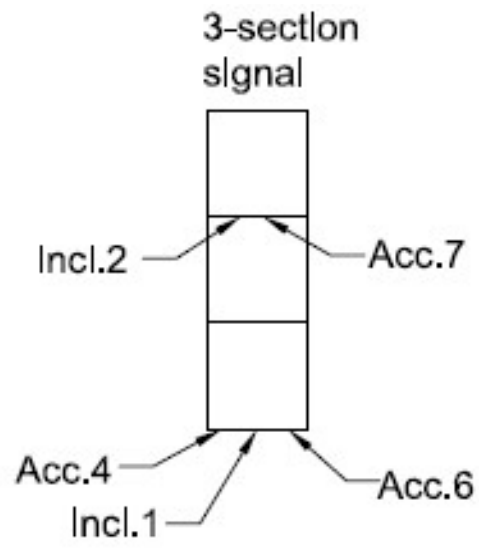

Figure 63: Location of accelerometers and inclinometers in 3-section signal

5.3 Results and discussion

The tests at the WOW were performed in the presence of the representatives from the Florida Department of Transportation (FDOT) Traffic Engineering and Operations Office and Traffic Engineering Research Lab (TERL), representatives from Pelco Products, installation technicians from Horsepower Electric Inc. and members of the WOW technical team. The results in this chapter are presented for 0-degree wind direction.

5.3.1 Wind induced forces

The directions of the forces are shown in Figure 61. The mean and peak forces obtained at various wind speeds are discussed in this section. Figure 64 presents the wind induced mean forces on loadcell 2 (messenger wire) and loadcell 4 (catenary wire) at 0-degree wind direction, for increasing wind speeds. It may be noted that the 'y' and 'z' components of the forces correspond to the 'drag' and 'cable tensions' respectively, while the 'x' component represents the uplift forces.

Data show that F_z on loadcell 2 increased with increasing wind speed. However, beyond 40 mph the maximum range of the loadcell (1500 lbs without considering the pre-tension applied to the system) was exceeded, and hence measurements of F_z on loadcell 2 were restricted to 40 mph where a force of 800 lbs was obtained. F_z on loadcell 4 experienced an increase in force with increase in wind speed up to 70 mph, beyond which the magnitude of the tensions forces decreased. F_y on loadcell 2 (messenger) increased with increasing wind speed, while F_y on loadcell 4 (catenary) increased marginally with increasing wind speed. F_x on loadcells 2 (messenger wire) and 4 (catenary wire) experienced minimal change despite an increase in wind speed. In general, the messenger wire experienced higher magnitudes of cable tensions and drag than the catenary wire for any given wind speed.

Similar observations were made for the mean forces on loadcell 5 (messenger) and loadcell 1 (catenary) as shown in Figure 65. For instance, F_z on loadcell 5 (messenger) was measured up to wind speed of 40 mph due to reasons explained previously. Likewise, F_z on loadcell 1 increased with increasing wind speed up to 70 mph and drops thereafter. F_y on loadcells 5 increased with increasing wind speed, although negligible increase in F_y on loadcell 1 was observed for

increasing wind speed. Fx on loadcells 1 and 5 experience minimal change despite changes in wind speeds. In general, the messenger wire experienced higher cable tensions than the catenary wire for any given wind speed.

The peak forces at 0-degree wind direction for loadcell 2 and loadcell 4 are shown in Figure 66. Fz (cable tension) in loadcell 2 was not recorded beyond 40 mph due to reasons explained previously; at wind speed of 40 mph, peak value of 900 lbs was obtained. Fz in loadcell 4 increased with increasing wind speed up to 115 mph, beyond which the tensions decrease. Fy on loadcells 2 and 4 increase with increasing wind speed, although the magnitude of forces is greater in the former than the latter for any given wind speed. Fx on loadcells 2 and 4 experienced minimal change with increasing wind speeds.

Figure 67 presents results for peak forces on loadcell 5 (messenger) and loadcell 1 (catenary). Fz (cable tension) on loadcell 5 were only recorded for wind speeds of 30 and 40 mph since at wind speeds beyond 40 mph the maximum range of the loadcell was exceeded as explained previously. Fz on loadcell 1 increased with increasing wind speed up to 85 mph, beyond which the forces decrease. Fy in loadcells 5 and 1 increased with increasing wind speeds, although loadcell 5 (messenger) experienced higher forces than loadcell 1 (catenary) for a given wind speed. Fx on loadcells 5 and 1 experienced minimal change for increasing wind speeds.

Figure 68 (a) presents the 'total' mean drag and lift forces on the traffic signals. Results show that the drag on the traffic signals increased with an increase in wind speed – highest value of 510 lbs was obtained at 150 mph at 0-degree wind direction. The lift forces increased initially with increase in wind speed, with the highest value of 200 lbs obtained at wind speed of 150 mph. The peak drag and lift are shown in Figure 68 (b). Like the mean values, the peak drag and lift increased with increasing wind speeds - highest drag of 655 lbs and highest lift of 310 lbs were obtained at wind speed of 150 mph.

5.3.2 rms of accelerations

The root mean square (rms) of accelerations are presented in Figure 69. Accelerometers 4, 6 and 7 were located on the 3-section signal, while accelerometers 2, 3 and 5 were located on the 5-section signal (see Figures 2-8 and 2-9). In general, the rms of accelerations obtained from all the accelerometers increased gradually with an increase in wind speed up to 85 mph. Beyond 85

mph, the accelerometers were not used for measurements in order to avoid damage due to excessive vibration.

5.3.3 Inclinations of the traffic signals

Figure 70 shows the inclinations (mean and maximum) obtained from inclinometer 1 (3-section) and inclinometer 3 (5-section) at 0-degree wind direction. It may be noted that for inclinometer 1, '1-1' refers to the component of inclination perpendicular to the wind, while '1-2' refers to the component of inclination in the direction of wind. For inclinometers 1 and 3, the mean components '1-2' and '3-2' were found to be 40 degrees at 70 mph. The values of inclinations were negligible for 1-1 and 3-1 components in the wind speed range of 0-70 mph. Beyond 85 mph, an erratic movement of the traffic signals (aerodynamic flutter) was observed, resulting in a wide range of inclinations.

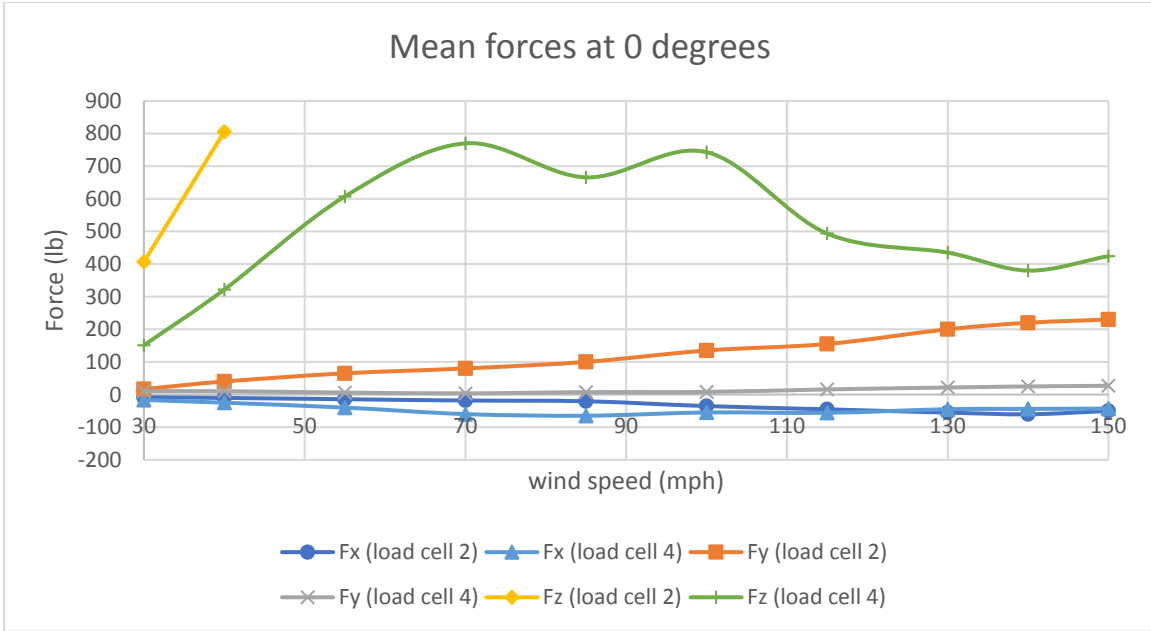

Figure 64: Mean forces on loadcells 2 (messenger wire) and 4 (catenary wire) at 0-degree wind direction

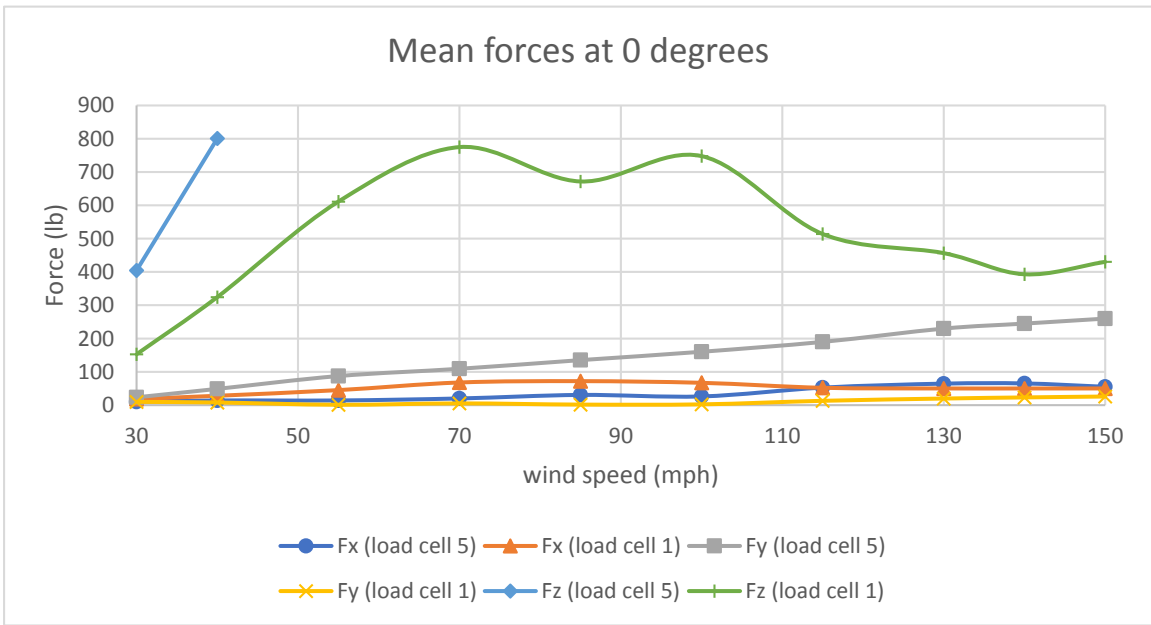

Figure 65: Mean forces on loadcells 1 (catenary wire) and 5 (messenger wire) at 0-degree wind direction

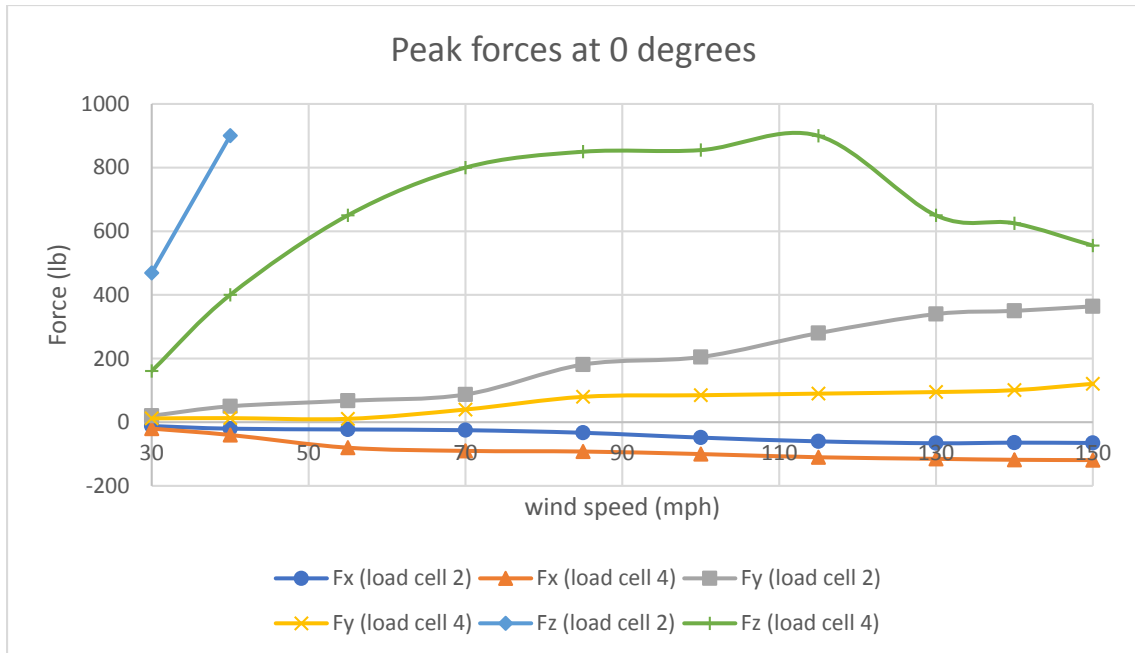

Figure 66: Peak forces at 0-degree wind direction on loadcells 2 (messenger wire) and 4 (catenary wire)

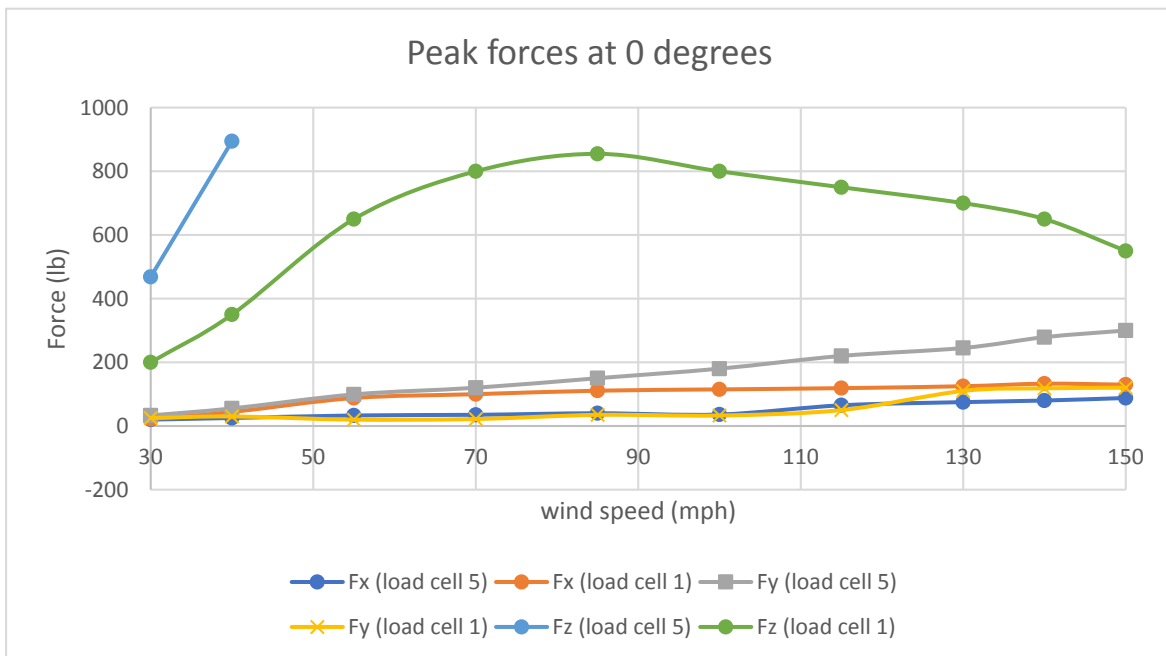
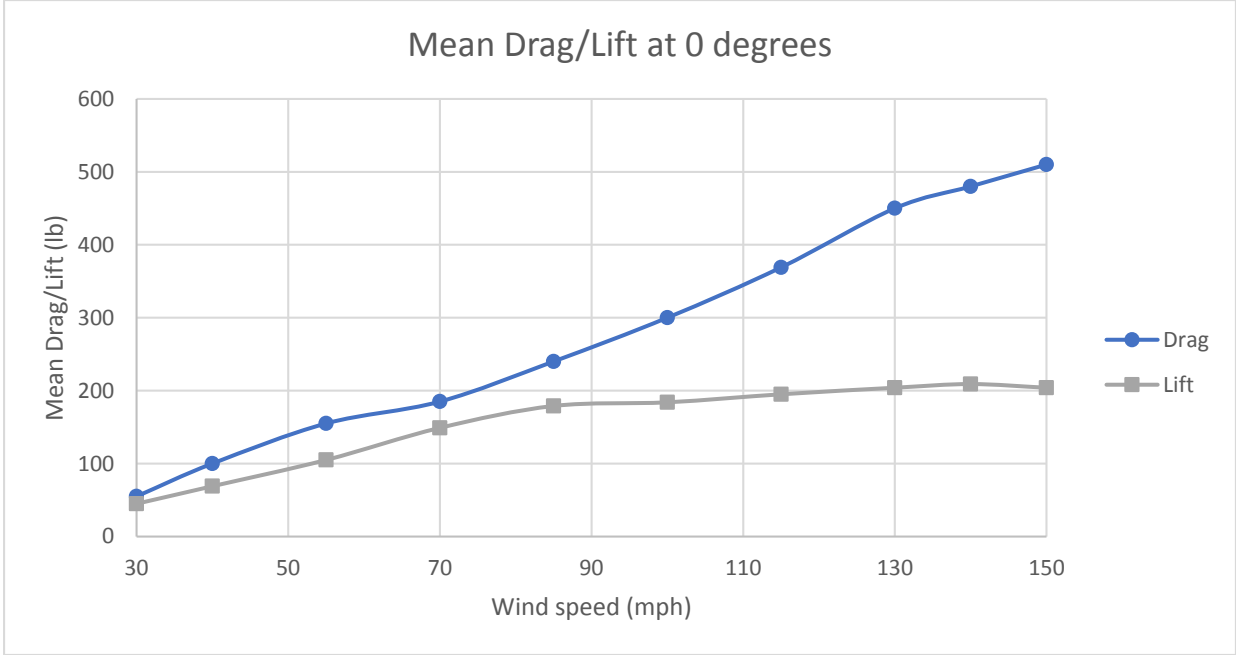
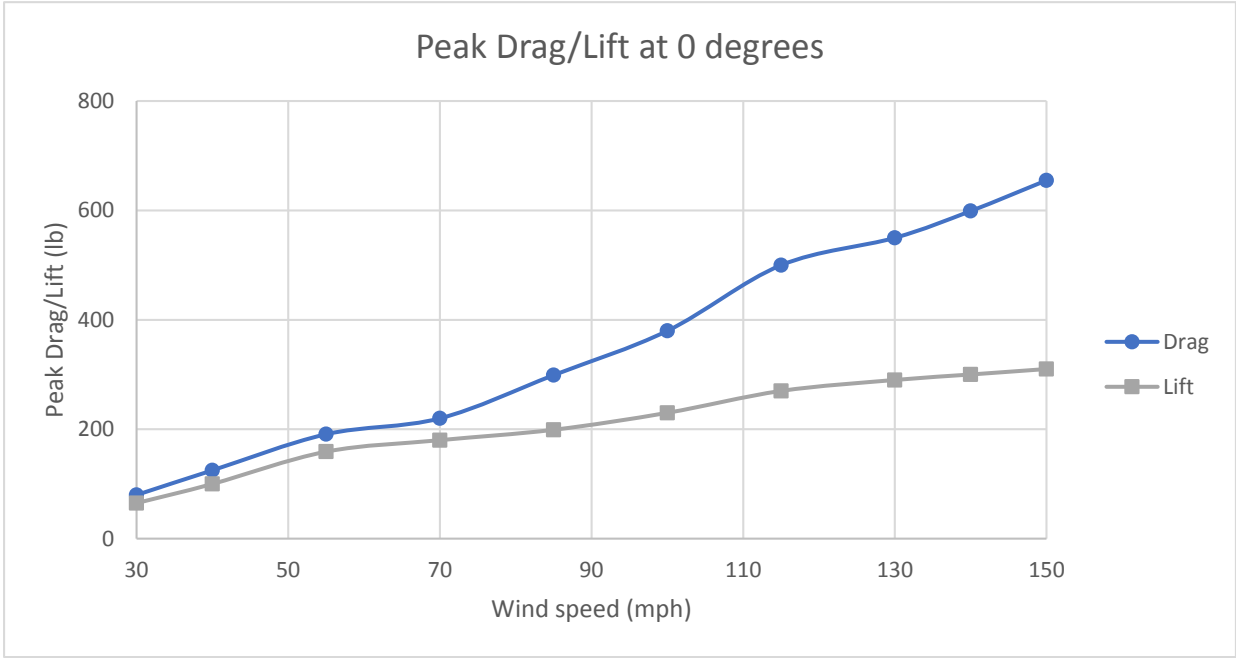

Figure 67: Peak forces at 0-degree wind direction on loadcells 1 (catenary wire) and 5 (messenger wire)



a)



b)

Figure 68: Drag (F_y) and lift (F_x) forces on the traffic signals at 0 degrees: a) Mean; b) Peak

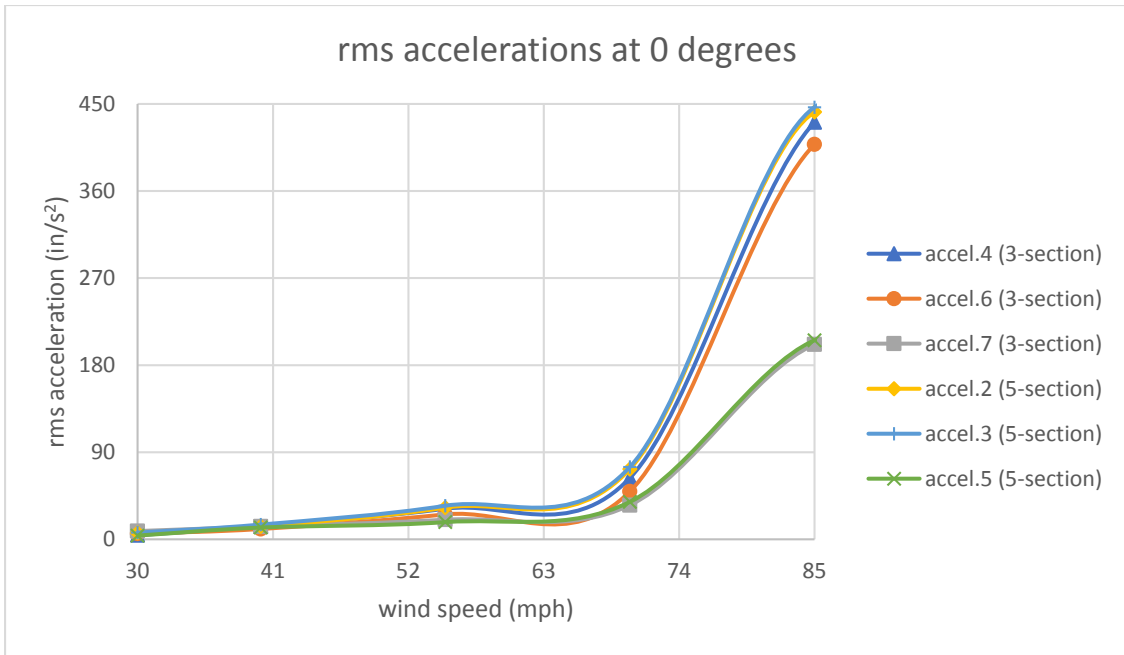

Figure 69: rms of accelerations on the 3-section and 5-section signals at 0 degrees

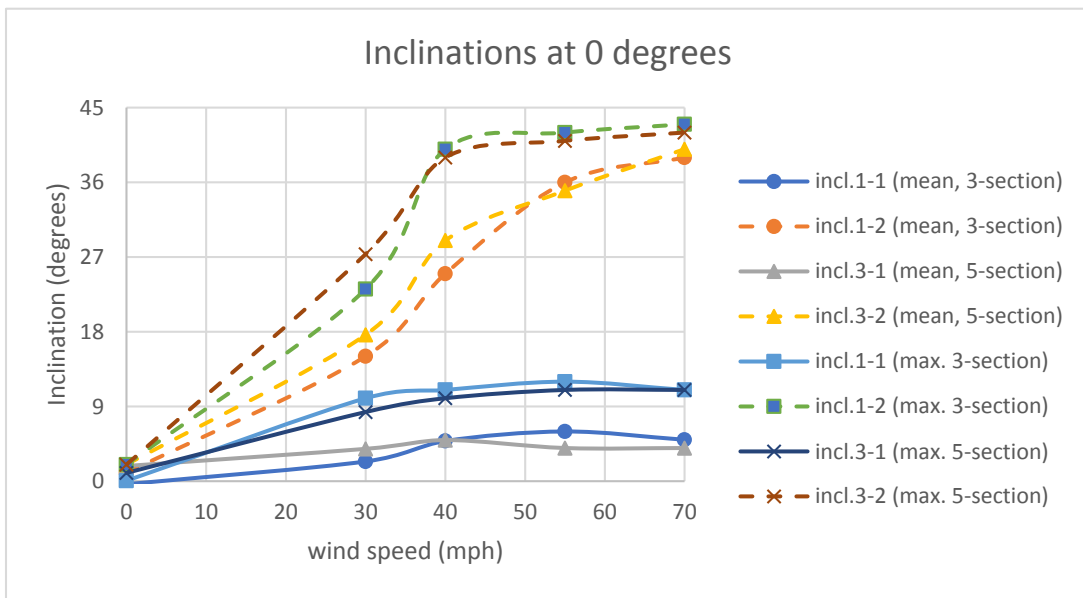

Figure 70: Inclinations (mean and max) obtained at 0 degrees for inclinometers 1 and 3

5.4 Performance of traffic signals during the tests

This test utilized two 3-section and one 5-section aluminum traffic signals installed in a span wire configuration connected to the catenary and messenger wires by means of an **“Adjustable Hanger Assembly with Cable Dampener and Reinforced Disconnect Hanger” (vendor: Pelco Products)**.

From the beginning of the test throughout the full range of wind speeds there was flexible bending of the cable dampener portion of the Pelco hanger assembly. Once the wind subsided the cable dampener recovered almost completely from its bent position showing only a very slight permanent bend. The Pelco adjustable hanger assembly after completion of test is shown in Figure 71. Traffic signals began galloping commencing at 85 mph throughout all ranges of wind speeds left. At 100 mph a large portion of back plates from the 5-section signal started detaching and blowing away. At 130 mph there were no back plates attached to 5-section and middle 3-section signals. Also, visors began to come loose and blew away. Figure 72 shows the traffic signals after the completion of the 30 to 130 mph wind speeds. Test continued at 140 mph, where galloping movement of all three assemblies was seen to be very erratic. Visors from 5-section signal assembly started vibrating strongly. At 150 mph, lower visor from 5-section signal became detached from anchorage points but it did not blow away.

The reinforced disconnect boxes for the 5-section and 3-section traffic signals exhibited no visible damage after the full range of wind speed test. Damages after the completion of the test are shown in Figure 73 and Figure 74. A summary of the observed damages is as follows:

- Damage to signal hanger: Flexible bending of the cable portion. Very slight permanent visual bend observed.
- Damage to disconnect hanger (box): No permanent visual damage observed.
- Damage to signal housing assembly: Damage to one visor and back plate. No other permanent visual damage observed.



Figure 71: Pelco adjustable hanger assembly with cable dampener after full range test



Figure 72: Traffic signals after 30 to 130 mph wind speeds test



a)



b)



c)

Figure 73: a) 5-section traffic signal b) center 3-section traffic signal c) west 3-section traffic signal after test

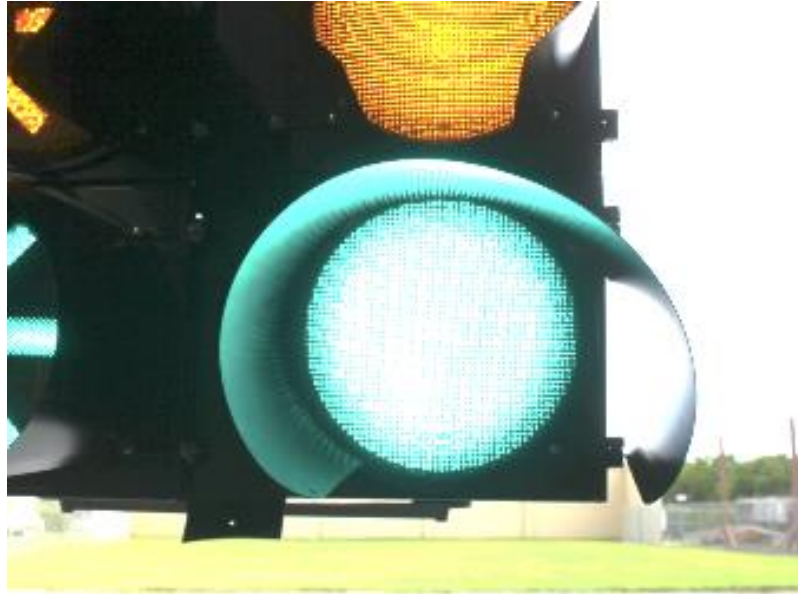

Figure 74: Lower visor from 5-section traffic signal after test

5.5 Conclusions

This chapter summarizes the results of a test conducted at WOW Research Facility at FIU for a span wire traffic signal assembly consisting of two 3-section and a 5-section traffic signal, connected using an **“Adjustable Hanger Assembly with Cable Dampener and Reinforced Disconnect Hanger” (vendor: Pelco Products)**. Wind speeds were varied from 30 to 150 mph at 0-degree wind direction. The various instruments used for this test included: loadcells to measure forces, accelerometers to measure accelerations and inclinometers to measure the inclinations. This study reports the data for 0-degree wind direction, in terms of: wind induced forces (drag (y-component), lift (x-component) and cable tension (z-component)), rms of accelerations and inclinations. Results indicate that the mean and peak drag on the traffic signals increased with increasing wind speeds. The mean and peak lift on the traffic signals increased initially, but attains a nearly constant value beyond 100 mph. The cable tensions (mean and peak) increased in the messenger wire with increase in wind speed from 30 to 150 mph. At any given wind speed, the messenger wire experienced higher tensions and drag compared to the catenary wire. The rms of accelerations increased with increasing wind speed from 40 mph to 85 mph. In the range of 40 to 70 mph for 0-degree wind direction, the mean inclinations in the along wind direction varied from 25 to 40 degrees, with a maximum value of 42 degrees observed at 70 mph. Beyond 85 mph, an erratic movement of the signals was observed (aerodynamic flutter). There was no visible failure observed in the adjustable hanger assembly. Traffic signal housings did not suffer any detectable damage other than detaching of back plates and LED lights loosening. Fragments of back plates became unfastened at 100 mph and were blown away at 130 mph. Some visors began to detach from anchorage points but did not fail.

Chapter 6 - Task 1: LONG SPAN LENGTH FULL SCALE TESTING - Case 5

“Cable Hanger Assembly with Reinforced Disconnect Hanger with Aluminum Signal Housing”
(vendor: Engineered Castings/Pelco Products) - Test Date: 06/29/2016

6.1 Introduction

Previous studies involving the FDOT and WOW Research Facility at FIU identified a ‘base’ configuration consisting of two 3-section and one 5-section traffic signals. Considering the knowledge acquired from these tests that utilized a short span length test frame placed on a turntable and using springs on the catenary and messenger spans to simulate longer typical spans, the scope of the current research project serves as dual purpose; use the existing test frame to test, for multiple wind directions, five additional traffic signal assemblies as specified by FDOT and develop and use an 80ft span test frame to test, for a single critical wind direction, five signal assemblies as specified by FDOT. With a full span length test frame, the full dynamic response of the system was replicated and more detailed information on components of the different assemblies, like stresses and deflections, was obtained through loadcells, accelerometers, inclinometers and inertia sensors. This test served as a validation of the performance of the short span length test rig and the use of springs to represent a full span length. A 70.5 ft test frame was used to test the span wire traffic signal configurations connected to the catenary and messenger wires via a **“Cable Hanger Assembly with Reinforced Disconnect Hanger with Aluminum Signal Housing” (vendor: Engineered Castings/Pelco Products)**. The tests were carried out at wind direction of 0-degree and wind speeds ranging from 30 to 150 mph. The instrumentation that was used included loadcells, accelerometers and inclinometers.

This chapter presents the results from the tests conducted on the traffic signal assembly with the **“Cable Hanger Assembly with Reinforced Disconnect Hanger with Aluminum Signal Housing” (vendor: Engineered Castings/Pelco Products)** at the WOW.

6.2 Experimental methodology

6.2.1 Test Setup

The 3-3-5 signal assembly was installed on a long-span rig (described in chapter 1) by means of a **“Cable Hanger Assembly with Reinforced Disconnect Hanger with Aluminum Signal Housing” (vendor: Engineered Castings/Pelco Products)**. Figure 75 and Figure 76 show the traffic signal assembly installed for testing and the cable hanger connection. The bottom of all signals were at approximately 4 ft 6 in above the concrete floor. All the signals were made of aluminum and included louvered back plates and visors. The different components used for this round of tests are listed in Table 9. The test protocol is presented in Table 10.

6.2.2 Instrumentation

The directions of the x, y, z components for each loadcell are shown in Figure 77. Loadcells number 2 and 5 were located at either end of the messenger cable and loadcells number 1 and 4 located at either end of the catenary cable.

Tri-axial accelerometers were installed in the traffic signals to measure accelerations. There was one accelerometer placed on the center top of the signal, Accel5, another placed on the bottom right side, Accel002, and a third placed on the bottom left side, Accel003 for the 5-section signal as shown in Figure 78. Accelerometer Accel007, was installed on the top center, accelerometer Accel004, was installed on the bottom left side and accelerometer Accel006, was installed on the bottom right side of the 3-section signal as shown in Figure 79.

Inclinometers were also installed on each signal to measure the inclination of the signals during wind exposure. The inclinometers measured inclination in two directions, one relative to an axis parallel to the wind direction and another relative to an axis perpendicular to the wind direction. There was one inclinometer installed on the top center of the signal, Inc4, and another on the bottom center of the signal, Inc3, for the 5-section signal as shown in Figure 78. Inclinometer, Inc2, was installed on the top center and inclinometer, Inc1, was installed on the bottom center of the of the 3-section signal as shown Figure 79.

6.2.3 Test Method

The test set up was first tested for 'zero wind' conditions, and the values of the various 'quantities' (forces, accelerations and inclinations) obtained were later deducted from quantities obtained for different wind speeds (also known as "zero drift removal" process).

Table 9: Signal assembly components (Task 1: Case 5)

| Component | Manufacturer |
|-------------------|---------------------------|
| Span wire clamp | Pelco |
| Adjustable hanger | None |
| Extension bar | None |
| Messenger clamp | Pelco |
| Disconnect Hanger | Engineered Castings |
| Signal Assembly | McCain |
| Backplate | TCS |
| Visor | McCain |
| LED Modules | GE - Dialight - Duralight |

Table 10: Test Protocol (Task 1: Case 5)

| Wind Speed (mph) | Wind Direction (degrees) | Total Duration (min) |
|-------------------------|---------------------------------|-----------------------------|
| 30 | 0 | 1 |
| 40 | 0 | 1 |
| 55 | 0 | 1 |
| 70 | 0 | 1 |
| 85 | 0 | 1 |
| 100 | 0 | 1 |
| 115 | 0 | 1 |
| 130 | 0 | 1 |
| 140 | 0 | 1 |
| 150 | 0 | 1 |
| TOTAL | | 10 |



Figure 75: Signal assemblies installed on test frame (before testing)



a)



b)

Figure 76: a) Traffic signal set up, b) Cable hanger assembly with reinforced disconnect hanger

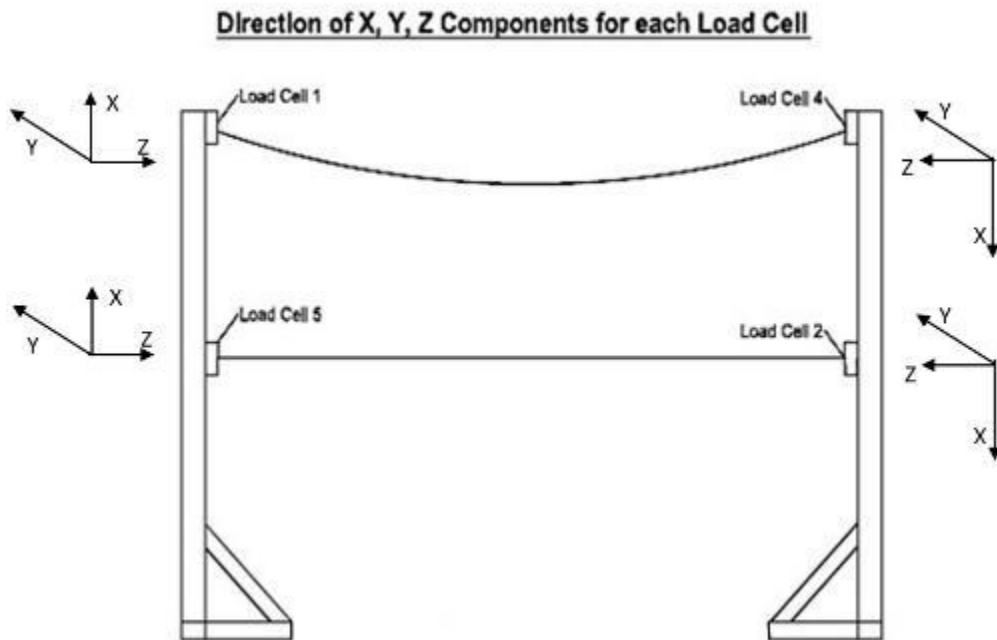

Figure 77: Direction of x, y, z components for each loadcell (direction of each axis shown represents 'positive direction')

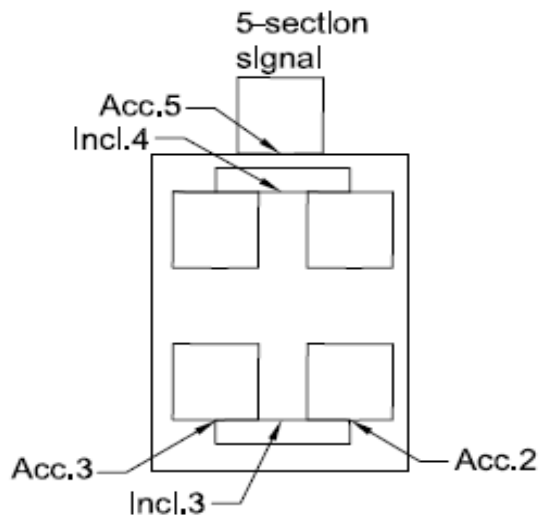

Figure 78: Location of accelerometers and inclinometers in 5-section signal

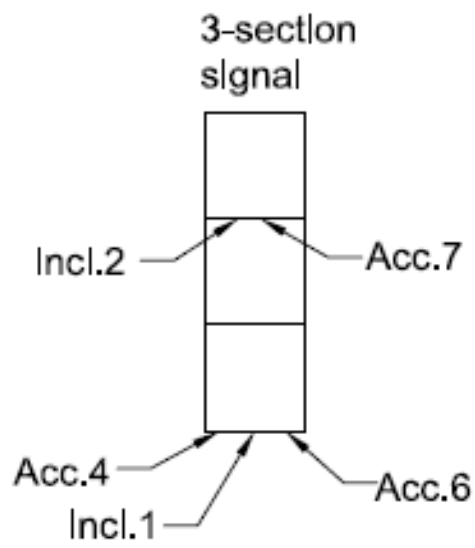

Figure 79: Location of accelerometers and inclinometers in 3-section signal

6.3 Results and discussion

The tests at the WOW were performed in the presence of the representatives from the Florida Department of Transportation (FDOT) Traffic Engineering and Operations Office and Traffic Engineering Research Lab (TERL), representatives of Pelco Products, installation technicians from Horsepower Electric Inc. and members of the WOW technical team. The results in this chapter are presented for 0-degree wind direction.

6.3.1 Wind induced forces

The directions of the forces are shown in Figure 77. The mean and peak forces obtained at various wind speeds are discussed in this section. Figure 80 presents the wind induced mean forces on loadcell 2 (messenger wire) and loadcell 4 (catenary wire) at 0-degree wind direction, for increasing wind speeds. It may be noted that the 'y' and 'z' components of the forces correspond to the 'drag' and 'cable tensions' respectively, while the 'x' component represents the uplift forces.

Data show that Fz on loadcell 2 was only measured at wind speed of 30 mph and 40 mph since the tensions were exceeding the maximum range beyond 40 mph (i.e. 1500lbs without considering the pre-tension applied to the system). Fz on loadcell 4 increased with an increase in wind speed up to 85 mph, beyond which the magnitude of the forces decrease. Fy on loadcells 2 and 4 increased with increasing wind speeds, although for any given wind speed, the magnitude of forces in loadcell 2 (messenger wire) were greater than in loadcell 4 (catenary wire). Fx on loadcells 2 (messenger wire) and 4 (catenary wire) experienced minimal change despite an increase in wind speed. In general, the messenger wire experienced higher magnitudes of tension forces than the catenary wire for any given wind speed.

Similar observations were made for the mean forces on loadcell 5 (messenger) and loadcell 1 (catenary) as shown in Figure 81. For instance, Fz on loadcells 5 increased with increasing wind speed of up to 40 mph, beyond which measurements of the tensions were discontinued due to reasons explained previously. Fz on loadcell 1 increased with increasing wind speed up to 85 mph, beyond which a constant value of about 550 lbs was obtained for increasing wind speeds. Fy on loadcell 5 increased with increasing wind speed, while Fy on loadcell 1 experienced minimal

change despite an increase in wind speed. Negligible changes were observed in F_x on loadcells 1 (catenary wire) and 5 (messenger wire) despite an increase in wind speed. The messenger wire experienced higher cable tensions than the catenary wire for any given wind speed.

Like the mean forces, the peak forces showed similar trends as described in Figure 82. For instance, F_z on loadcell 2 was only recorded up to wind speed of 40 mph due to reasons explained previously. F_z on loadcell 4 increased with increasing wind speed up to 55 mph, beyond which a constant force of about 630 lbs was obtained in the wind speed range of 70-150 mph. F_y on loadcells 2 and 4 increased with increasing wind speed, although the magnitude of the forces on loadcell 2 (messenger) were generally higher than in loadcell 4 (catenary) for any given wind speed higher than 55 mph. F_x in loadcells 2 (messenger wire) and 4 (catenary wire) underwent minimal change despite increasing wind speeds.

Figure 83 presents peak forces for loadcell 5 (messenger) and loadcell 1 (catenary). F_z (cable tensions) on loadcell 5 was found to be 820 lbs at 40 mph. Beyond wind speed of 40 mph, measurement of tension forces on loadcell 5 was not carried out due to the limited range of the loadcell (1500lbs without considering the pre-tension applied to the system). F_z on loadcell 1 increased with an increase in wind speed of up to 70 mph, beyond which a constant force of about 660 lbs was obtained in the wind speed range of 85-150 mph. F_y on loadcell 5 increases with increased wind speed, although minimal change in F_y in loadcell 1 was observed for increasing wind speed. F_x on loadcells 1 (catenary wire) and 5 (messenger wire) experienced minimal change despite an increase in wind speed.

Figure 84 (a) presents the 'total' mean drag and lift forces on the traffic signals. Results show that the drag on the traffic signals increased with an increase in wind speed – highest values of 505 lbs was obtained at 150 mph at 0-degree wind direction. The lift forces increased initially with increase in wind speed, with the highest value of 185 lbs obtained at 150 mph. The peak drag and lift are shown in Figure 84 (b). Like the mean values, the peak drag and lift increased with increasing wind speeds - highest drag of 899 lbs and highest lift of 450 lbs were obtained at 150 mph.

6.3.2 rms of accelerations

The root mean square (rms) of accelerations are presented in Figure 85. Accelerometers 4, 6 and 7 were located on the 3-section signal, while accelerometers 2, 3 and 5 were located on the 5-section signal (see Figure 78 and Figure 79). In general, the rms of accelerations obtained from all the accelerometers increased gradually with an increase in wind speed of up to 115 mph. Due to excessive vibration beyond wind speed of 115 mph, measurement of accelerations was discontinued in order to prevent damage to the accelerometers.

6.3.3 Inclinations of the traffic signals

Figure 86 shows the inclinations (mean and maximum) obtained from inclinometer 1 (3-section) and inclinometer 3 (5-section) at 0-degree wind direction. It may be noted that for inclinometer 1, '1-1' refers to the component of inclination perpendicular to the wind, while '1-2' refers to the component of inclination in the direction of wind. For inclinometers 1 and 3, the mean components '1-2' and '3-2' were found to be 39 and 40 degrees respectively at 70 mph. Similarly, the maximum value of 55 degrees was obtained at a wind speed of 70 mph for the inclinometer component 3-2. The values of inclinations were negligible for 1-1 and 3-1 components in the wind speed range of 0-70 mph. Beyond 70 mph, a galloping movement was observed, resulting in a wide range of inclinations.

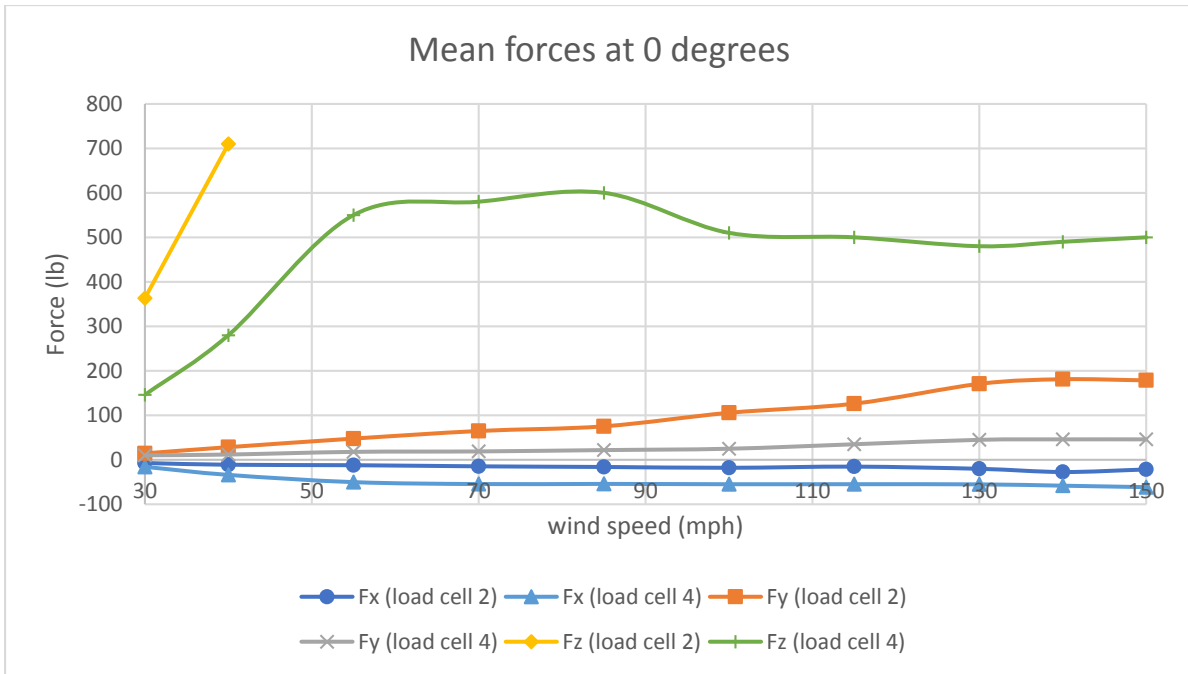

Figure 80: Mean forces on loadcells 2 (messenger wire) and 4 (catenary wire) at 0-degree wind direction

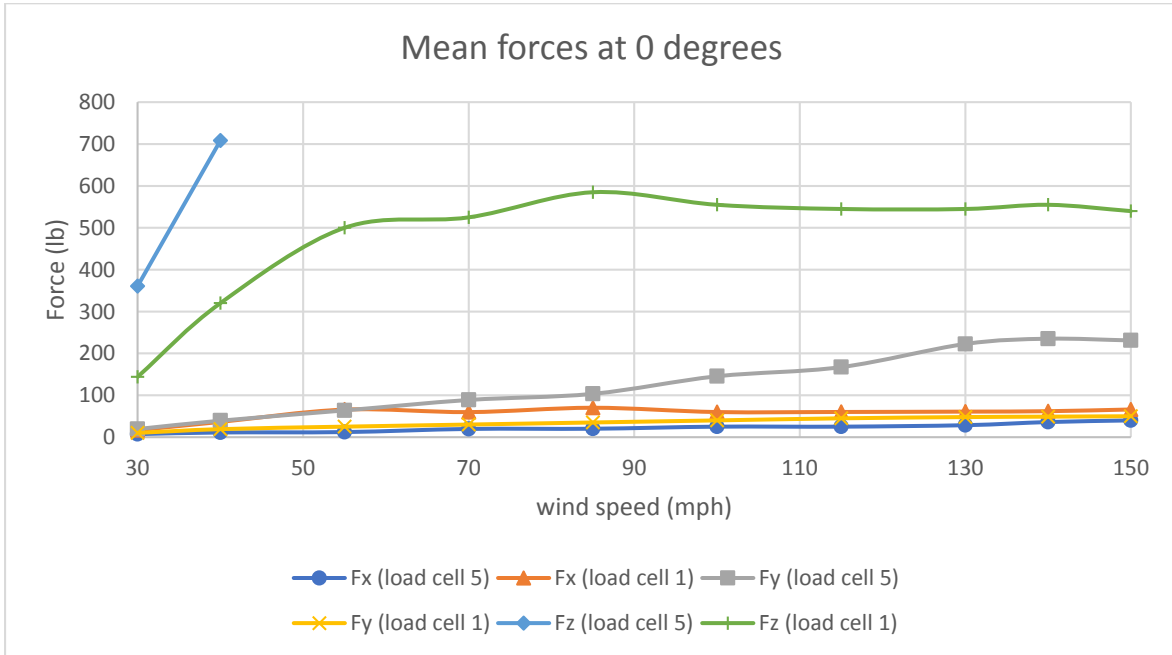

Figure 81: Mean forces on loadcells 1 (catenary wire) and 5 (messenger wire) at 0-degree wind direction

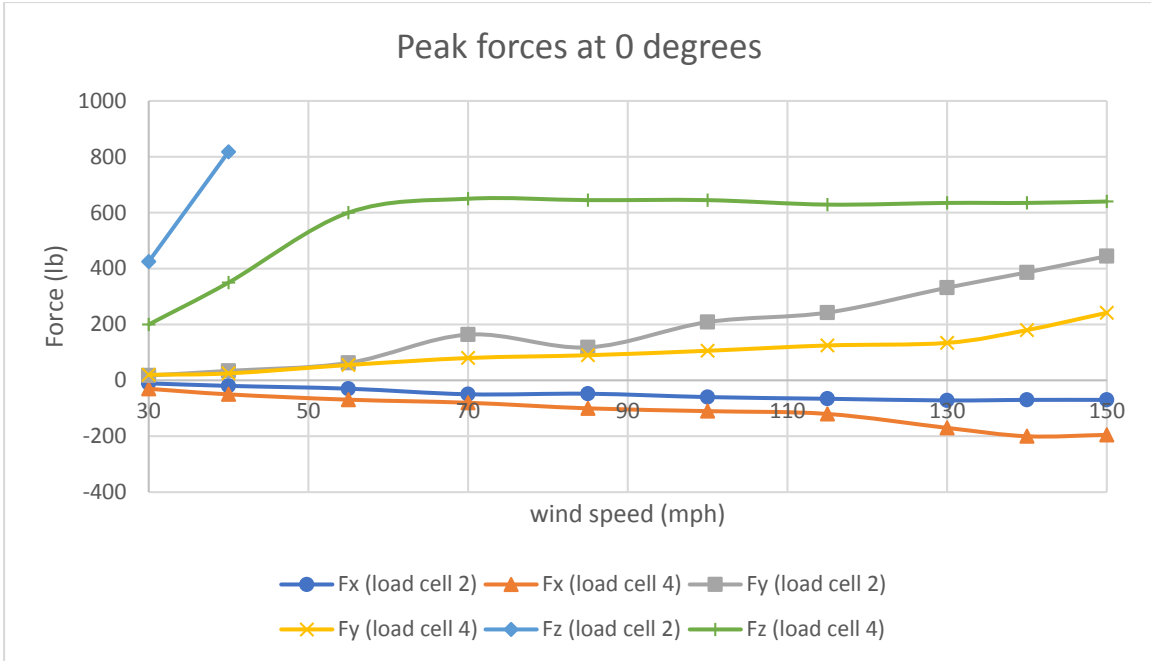

Figure 82: Peak forces at 0-degree wind direction on loadcells 2 (messenger wire) and 4 (catenary wire)

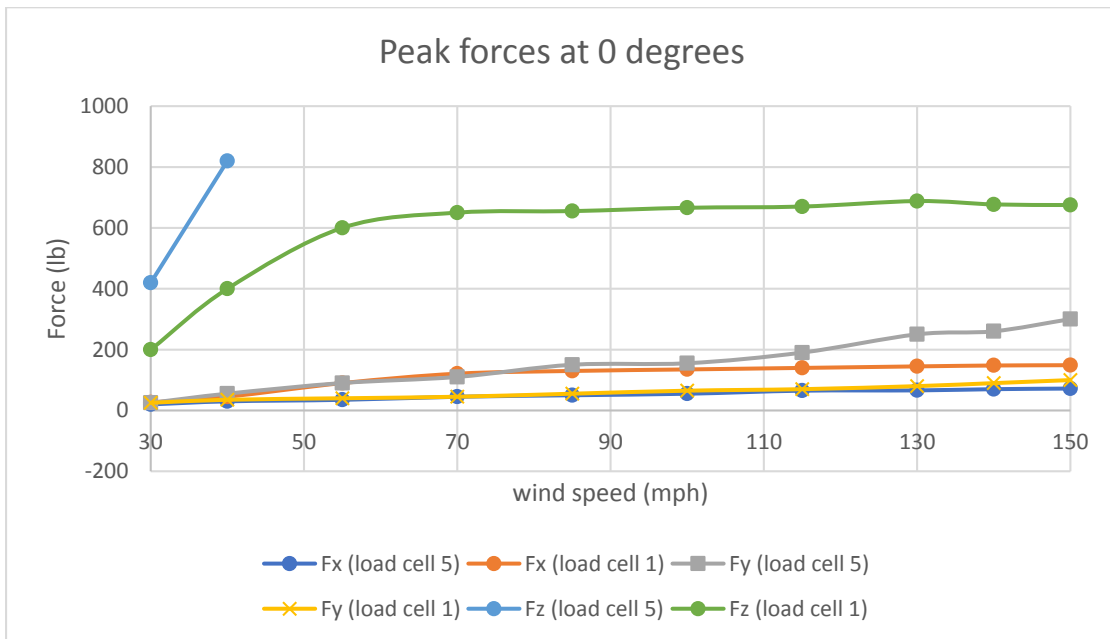
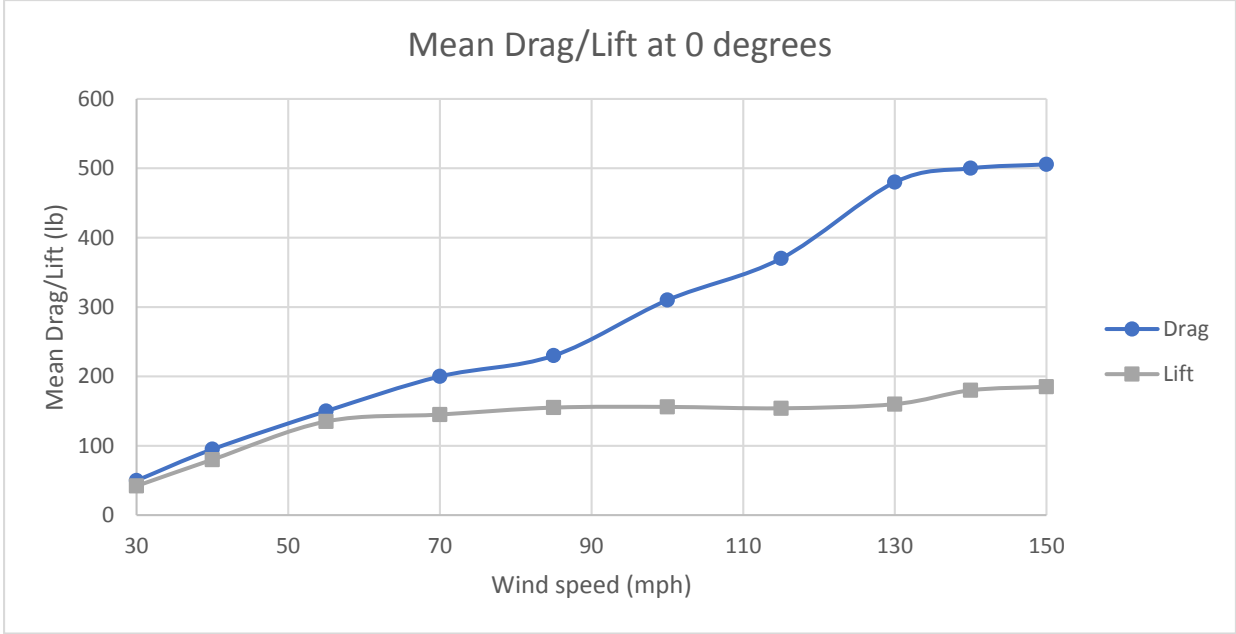
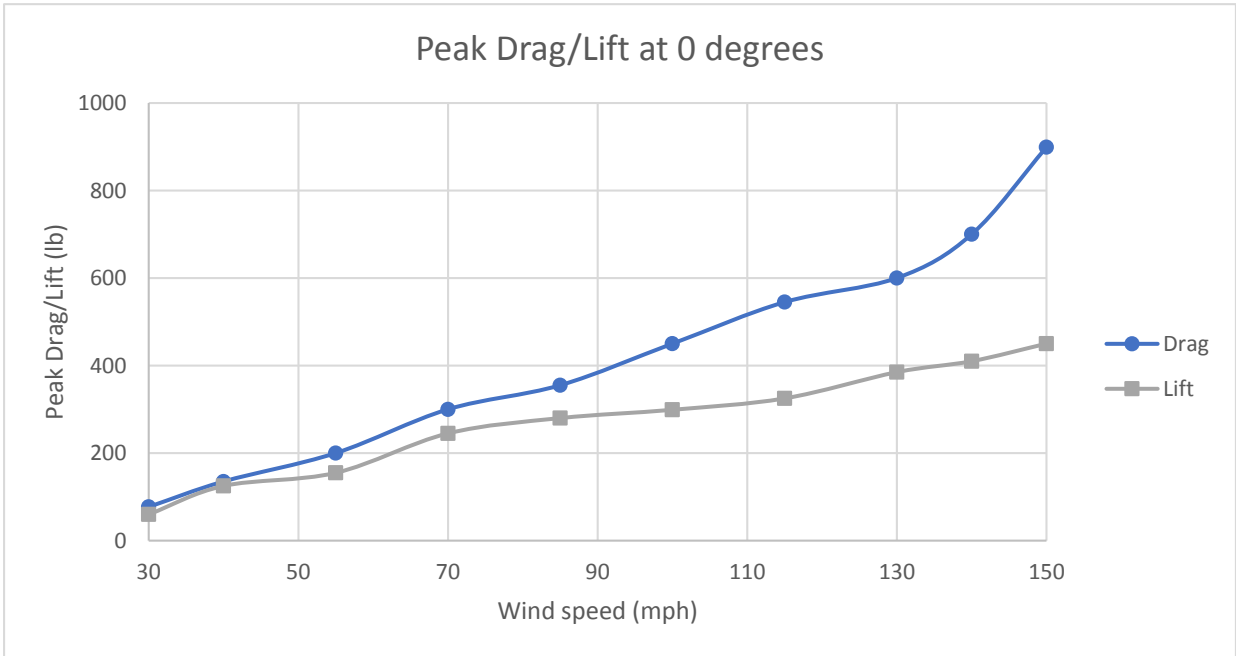

Figure 83: Peak forces at 0-degree wind direction on loadcells 1 (catenary wire) and 5 (messenger wire)



a)



b)

Figure 84: Drag (F_y) and lift (F_x) forces on the traffic signals at 0 degrees: a) Mean; b) Peak

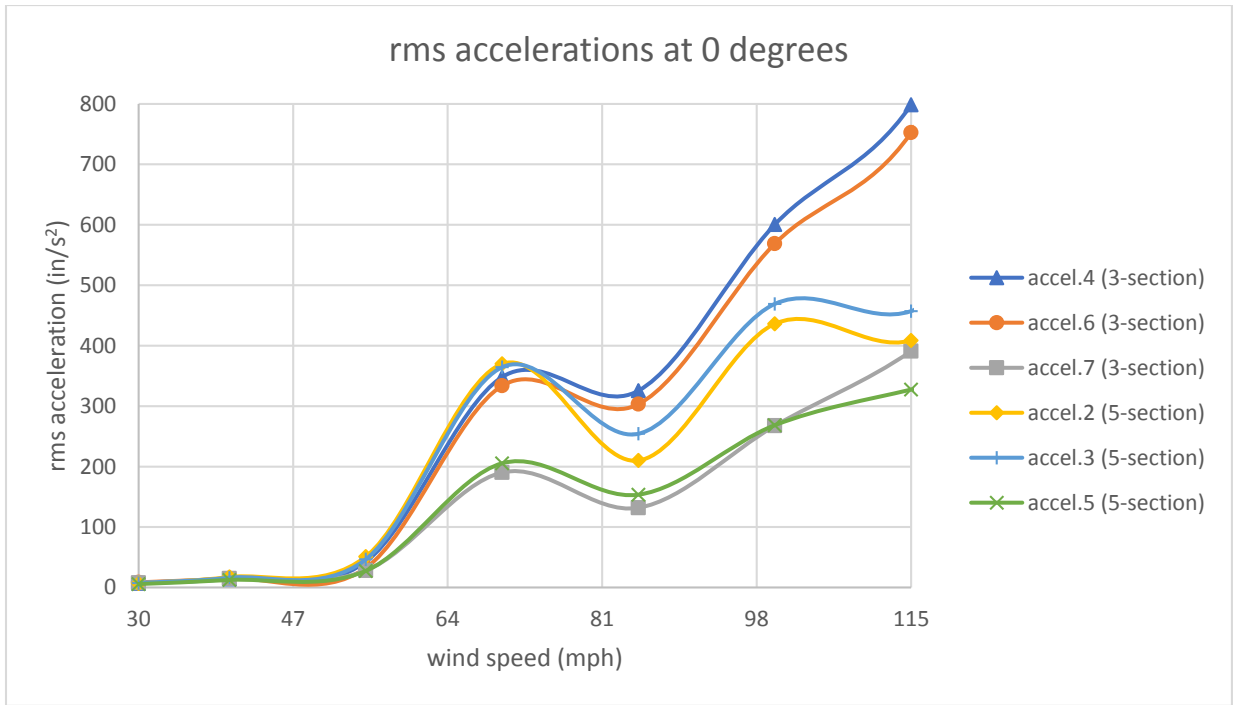

Figure 85: rms of accelerations on the 3-section and 5-section signals at 0 degrees

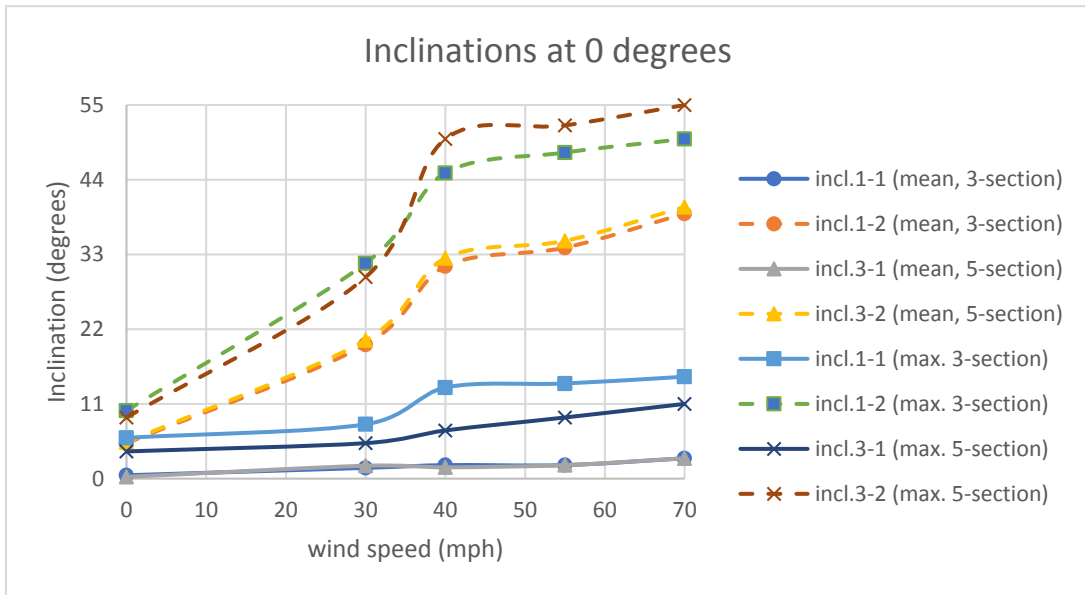

Figure 86: Inclinations (mean and max) obtained at 0 degrees for inclinometers 1 and 3

6.4 Performance of traffic signals during the tests

This test utilized two 3-section and one 5-section aluminum traffic signals installed in span wire configuration connected to the catenary and messenger wires by means of a **“Cable Hanger Assembly with Reinforced Disconnect Hanger with Aluminum Signal Housing” (vendor: Engineered Castings/Pelco Products)**.

From 30 to 40 mph there were no visible damages besides vibration of back plates from 5-section signal. Galloping movement was first noticed at 70 mph and continued throughout the entire testing. Galloping became more severe as the wind speed increased. At 85 mph, right side of back plates from 5-section signal detached from anchorages. When reaching 115 mph back plates that detached from 5-section signal flew away. Continuing to 130 mph, middle visor from center 3-section signal was slightly damaged and the middle visor from the center 3-section signal flew away when speed reached 140 mph. Damaged center 3-section signal is shown in Figure 87.

Back plates from center 3-section signal, middle visor from east 3-section signal and all visors from center 3-section signal detached and flew off. Figure 88 and Figure 89 show the damages produced after completion of the test. A summary of the observed damages is as follows:

- Damage to signal hanger: No permanent visual damage observed.
- Damage to disconnect hanger (box): No permanent visual damage observed.
- Damage to signal housing assembly: Major damage to visors and back plates. No other permanent visual damage observed.

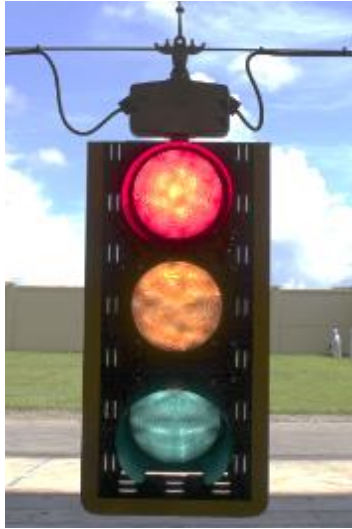

Figure 87: Damaged visor from 3-section signal (center visor missing)



Figure 88: Damage after full range of wind speeds (damage to back plates and visors)



Figure 89: East 3-section signal with sheared off visor screw

6.5 Conclusions

This chapter summarizes the results of a test conducted at WOW at FIU for a 70.5 ft span wire traffic signal assembly consisting of two 3-section and a 5-section traffic signal, connected using a **“Cable Hanger Assembly with Reinforced Disconnect Hanger with Aluminum Signal Housing” (vendor: Engineered Castings/Pelco Products)**. Wind speeds were varied from 30 to 150 mph and wind direction of 0 degrees. The various instruments used for this test included: loadcells to measure forces, accelerometers to measure accelerations and inclinometers to measure the inclinations. This study reports the data for 0-degree wind direction, in terms of: wind induced forces (drag (y-component), lift (x-component) and cable tension (z-component)), rms of accelerations and inclinations. Results indicate that along wind forces (drag) and cable tensions increased in the messenger wire with increase in wind speed. The lift on the messenger wire also increased with increasing wind speeds. The catenary wire experiences only a minor increase of all three components of wind forces with increase in wind speed. At any given wind speed the messenger wire experienced higher tension forces than the catenary wire. The rms of accelerations increased with increasing wind speed from 30 mph to 115 mph. The magnitudes of the peak forces (F_x , F_y and F_z) increased with increasing wind speeds. In the range of 40 to 70 mph for 0-degree wind direction, the mean inclinations in the along wind direction varied from 30 to 40 degrees. Beyond 70 mph, an erratic movement of the signals was observed (galloping). Galloping became more severe as the wind speed increased. Damage was first observed at 85 mph when the right side of back plates from the 5-section signal was detached from the anchorages. The damage to back plates and visors increased considerably as the wind speed was increased to 150 mph.

Chapter 7 - Task 2: LONG SPAN LENGTH FULL SCALE TESTING - Case 1

LONG DURATION TEST - “Tri-stud Adjustable Hanger with Aluminum Housing” (FDOT Base Condition) - Test Date: 09/15/2016

7.1 Introduction

Previous studies at the WOW Research Facility at FIU identified a ‘base’ configuration consisting of two 3-section and one 5-section traffic signals. Considering the knowledge acquired from previous tests that utilized a long span test frame (approx. 80ft), the scope of this research task was to assess the long-term performance of two different signal assemblies. In earlier testing, an aerodynamic instability was observed therefore FDOT requested to perform long duration testing to evaluate the effect of such aerodynamic instabilities on specific traffic signal assemblies. Following FDOT’s recommendations, the existing 70.5 ft test frame was reinforced for this round of tests. The instrumentation that was used consisted of loadcells, accelerometers, and inclinometers.

This chapter presents the results from the tests conducted on the traffic signal assembly with the **“Tri-stud Adjustable Hanger with Aluminum Housing” (also known as FDOT base configuration)** at the WOW.

7.2 Experimental Methodology

7.2.1 Test Setup

The 3-3-5 signal assembly was installed on a reinforced long-span rig (described in chapter 1) by means of a **“Tri-stud Adjustable Hanger with Aluminum Housing” (also known as FDOT base condition)**. Figure 90 and Figure 91 show the traffic signal assembly installed on the rig as well as a close up of the adjustable hanger. The bottom of all signals were at approximately 4.5 ft above the concrete floor. All the signals were made of aluminum and included louvered back plates and visors. The different components used for this round of tests are shown in Table 11. The test protocol is presented in Table 12. The tests were conducted for longer durations, with wind speeds being varied from 65 to 90 mph, for wind direction of 0 degrees.

7.2.2 Instrumentation

The directions of the x, y and z components for each loadcell are shown in Figure 92. Loadcells number 2 and 5 were located at either end of the messenger cable and loadcells number 1 and 4 located at either end of the catenary cable.

Tri-axial accelerometers were installed in the traffic signals to measure accelerations. There was one accelerometer placed on the center top of the signal, Accel5, another placed on the bottom right side, Accel002, and a third placed on the bottom left side, Accel003 for the 5-section signal as shown in Figure 93. Accelerometer Accel007, was installed on the top center, accelerometer Accel004, was installed on the bottom left side and accelerometer Accel006, was installed on the bottom right side of the 3-section signal as shown in Figure 94.

Inclinometers were also installed on each signal to measure the inclination of the signals during wind exposure. The inclinometers measured inclination in two directions, one relative to an axis parallel to the wind direction and another relative to an axis perpendicular to the wind direction. There were inclinometers installed on the top center of the signal, Inc4, and another on the bottom center of the signal, Inc3, for the 5-section signal as shown in Figure 93. Inclinometer, Inc2, was installed on the top center and inclinometer, Inc1, was installed on the bottom center of the of the 3-section signal as shown Figure 94.

7.2.3 Test Method

The test set up was first tested for 'zero wind' conditions, and the values of the various 'quantities' (forces, accelerations and inclinations) obtained were later deducted from quantities obtained for different wind speeds (also known as "zero drift removal" process).

Table 11: Components of signal assembly (Task 2: Case 1)

| Component | Manufacturer |
|-------------------|---------------------------|
| Span wire clamp | Costcast |
| Adjustable hanger | Costcast |
| Extension bar | Pelco (standard) |
| Messenger clamp | Costcast |
| Disconnect Hanger | Pelco (standard) |
| Signal Assembly | McCain |
| Backplate | McCain |
| Visor | McCain |
| LED Modules | GE - Dialight - Duralight |

Table 12: Test Protocol (Task 2: Case 1)

| Wind Speed (mph) | Wind Direction (degrees) | Total Duration (min) |
|-------------------------|---------------------------------|-----------------------------|
| 65 | 0 | 75 |
| 70 | 0 | 15 |
| 75 | 0 | 4.7 |
| 80 | 0 | 3 |
| 85 | 0 | 1.3 |
| 90 | 0 | 0.65 |
| | Total | 99.65 |



Figure 90: Signal assemblies installed on test rig (before testing)



a)



b)

Figure 91: : a) Signal Setup for the test; b) Magnified view of the connection

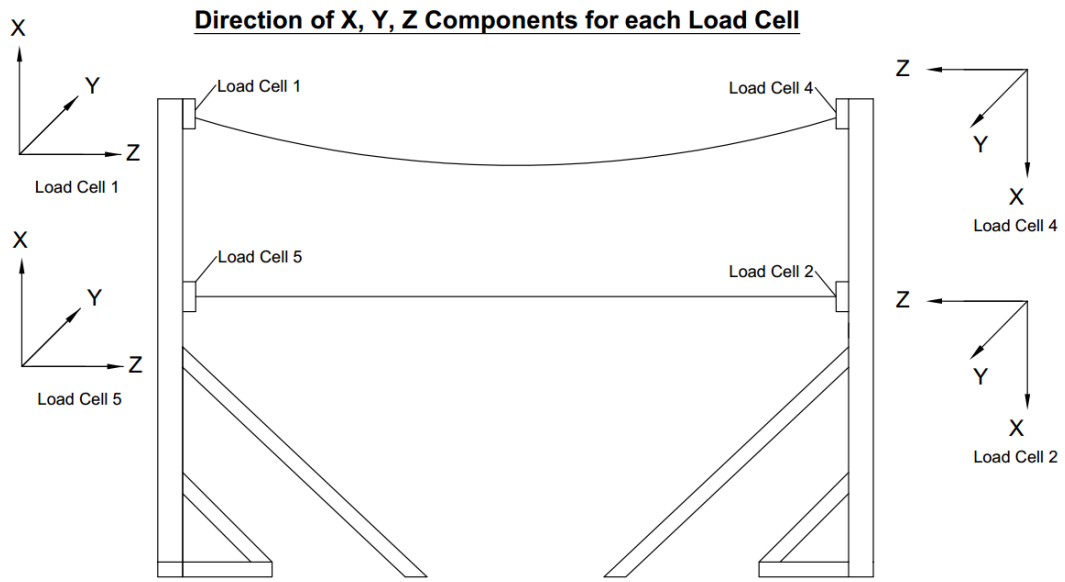

Figure 92: Direction of x, y, z components for each loadcell (direction of each axis shown)

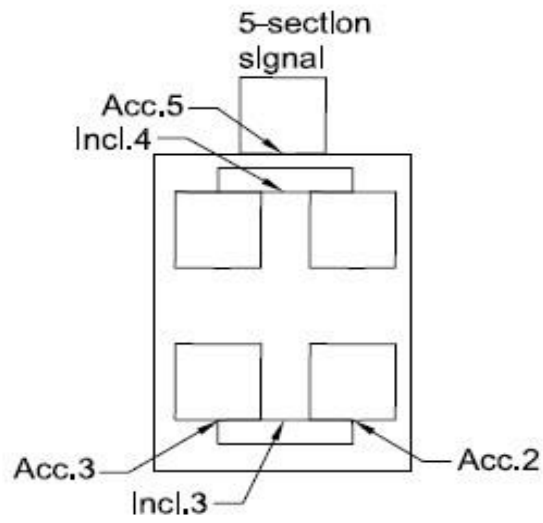

Figure 93: Location of accelerometers and inclinometers in 5-section signal

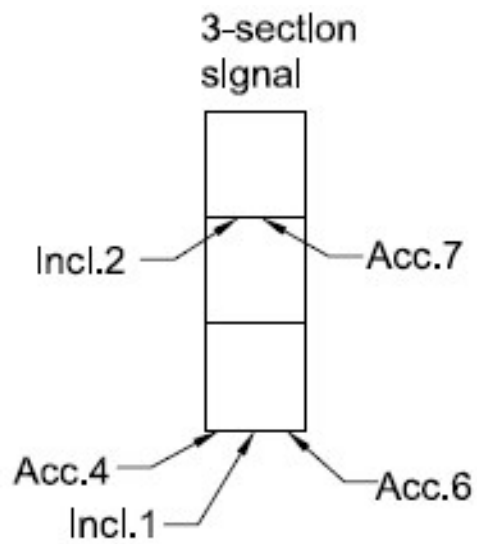

Figure 94: Location of accelerometers and inclinometers in 3-section signal

7.3 Results and Discussion

The tests at the WOW were performed in the presence of the representatives from the Florida Department of Transportation (FDOT) Traffic Engineering and Operations Office and Traffic Engineering Research Lab (TERL), installation technicians from Horsepower Electric Inc. and members of the WOW technical team. Results in this chapter are presented for 0-degree wind direction. The tests were carried out for longer durations (Table 12) for wind speeds varying from 65 mph to 90 mph.

7.3.1 Wind induced forces

The directions of the forces are shown in Figure 92. The mean and peak forces obtained at various wind speeds are discussed in this section. Figure 95 presents the wind induced mean forces on loadcell 2 (messenger wire) and loadcell 4 (catenary wire) at 0-degree wind direction, for increasing wind speeds. It may be noted that the 'y' and 'z' components of the forces correspond to the 'drag' and 'cable tensions' respectively, while the 'x' component represents the uplift forces.

Data show that the mean along wind forces (F_y) in loadcell 4 (catenary) and loadcell 2 (messenger) experienced minimal change despite an increase in wind speed, although the forces in the latter were higher than the former for any given wind speed. The wind induced lift (F_x) in loadcells 2 and 4 experienced minimal increase with increasing wind speed. However, the tensions in the cable (F_z) in loadcell 4 increased with increasing wind speed.

Similar observations were made for the mean forces on loadcell 5 (messenger) and loadcell 1 (catenary) as shown in Figure 96. For instance, F_y (drag) increased marginally with increasing wind speed in loadcell 5 (messenger). The messenger wire experienced higher along wind forces than the catenary at any given wind speed. F_x (lift) on loadcell 1 (catenary) and loadcell 5 (messenger) experienced a minimal increase with increasing wind speeds from 65 to 90 mph. However, F_z (tensions) in loadcell 1 (catenary) increased with increasing wind speed. It needs to be noted that mean forces F_z for loadcells 2 and 5 (messenger wire) were not reported because maximum range of loadcells was reached (1500 lbs without considering the pre-tension applied to the system).

The peak forces at 0-degree wind direction for loadcell 2 and loadcell 4 are shown in Figure 97. The highest magnitude of peak forces is shown, since this is required for the safe wind design of span wire traffic signals. The peak forces F_y (drag) on loadcell 2 (messenger) increased slightly with an increase in wind speed especially from 80-90 mph, while the peak drag forces (F_y) in loadcell 4 (catenary) dropped initially with increasing wind speeds from 65-75 mph. The peak forces F_x (lift) in loadcells 2 experienced a slight increase in forces with increase in wind speed, especially in the wind speed range of 80-90 mph. However, F_z (tension) in loadcell 4 (catenary) did not change markedly despite an increase in wind speed mostly due to the aerodynamic instability after 70 mph. Peak forces F_z for loadcells 2 and 5 (messenger wire) were not reported because maximum range of loadcells was reached, as previously explained.

Figure 98 presents peak forces for loadcell 5 (messenger) and loadcell 1 (catenary). F_z (cable tensions) on loadcell 1 (catenary) did not change markedly despite an increase in wind speed from 65-90mph mostly due to the aerodynamic instability after 70 mph. F_y (drag) on loadcell 5 and loadcell 1 increased marginally with increasing wind speed, although the forces on loadcell 5 (messenger) were higher than in loadcell 1 (catenary) for any given wind speed. F_x on loadcell 5 increased slightly with an increase in wind speed, although F_x on loadcell 1 experienced minimal change despite an increase in wind speed.

It may be noted that the negative sign obtained in mean and peak components of F_z (cable tensions) in the catenary wire (loadcells 4 and 1) is indicative of the wide range of oscillations experienced by the traffic signals which caused the cable tensions to be lower than the initial 'baseline' tension values (at zero wind speed). The mean values of F_z (loadcells 4 and 1) suggest that the tensions in the catenary wire were lower initially in the 65-80 mph range, but beyond 80 mph, the tensions increased slightly. Furthermore, the mean and peak component of F_z (cable tensions) in the messenger wire (loadcells 2 and 5) are not reported since the forces exceeded the maximum capacity of the loadcell.

Figure 99 (a) presents the 'total' mean drag and lift forces on the traffic signals. Results show that the drag on the traffic signals increased with an increase in wind speed – highest drag of 246 lbs was obtained at 90 mph at 0-degree wind direction. The lift forces also increased with increase in wind speed, with the highest value of 195 lbs obtained at 90 mph. The peak drag and lift are

shown in Figure 99 (b). Similar to the mean values, the peak drag and lift increased with increasing wind speeds - highest peak drag of 458 lbs and highest peak lift of 379 lbs were obtained at 90 mph.

7.3.2 rms of accelerations

The root mean square (rms) of accelerations are presented in Figure 100. Accelerometers 4, 6 and 7 were located on the 3-section signal, while accelerometers 2, 3 and 5 were located on the 5-section signal (see Figures 2-8 and 2-9). In general, the rms of accelerations obtained from all the accelerometers increased gradually with an increase in wind speed from 65 mph to 90 mph. Figure 100 suggests that the rms of accelerations increased sharply above wind speed of 70 mph, which is indicative of the high oscillations experienced by the signals.

7.3.3 Inclinations of the traffic signals

Figure 101 shows the inclinations (mean and peak) obtained from various inclinometers. It may be noted that for inclinometer 1, '1-1' refers to the component of inclination perpendicular to the wind, while '1-2' refers to the component of inclination in the direction of wind. The highest mean inclination of 38 degrees and highest peak inclination of 45 degrees was measured at 65 mph in the along wind direction. The values of inclinations were smaller for components of inclination perpendicular to the wind. Instability was observed beyond 70 mph giving a wide range of inclinations therefore no data are reported.

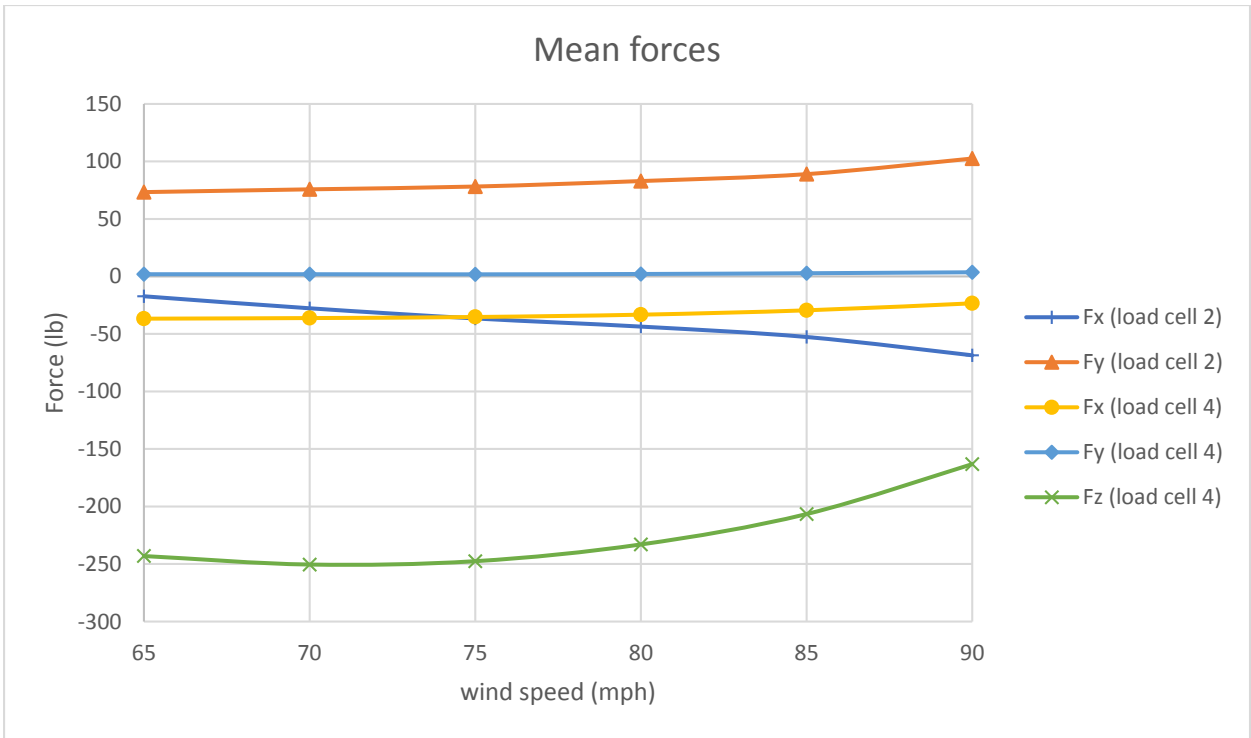

Figure 95: Mean forces on loadcells 2 (messenger wire) and 4 (catenary wire) at 0 degrees wind direction

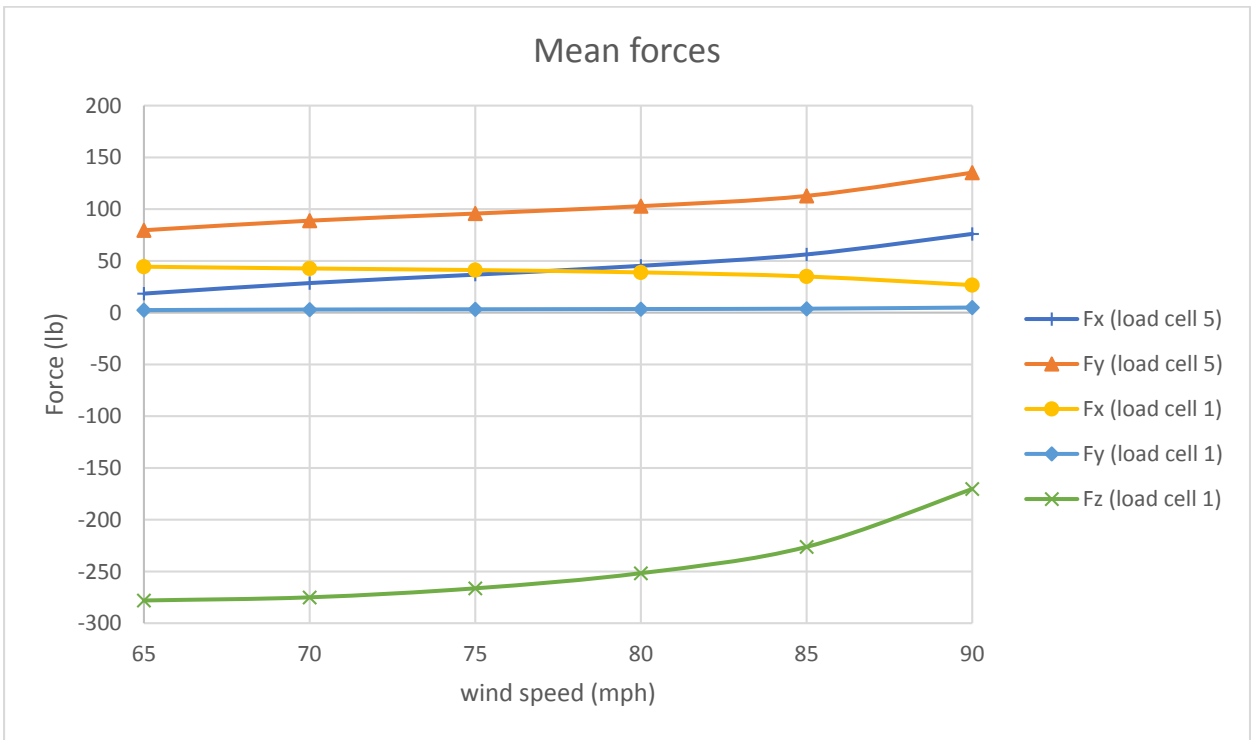

Figure 96: Mean forces on loadcells 1 (catenary wire) and 5 (messenger wire) at 0 degrees wind direction

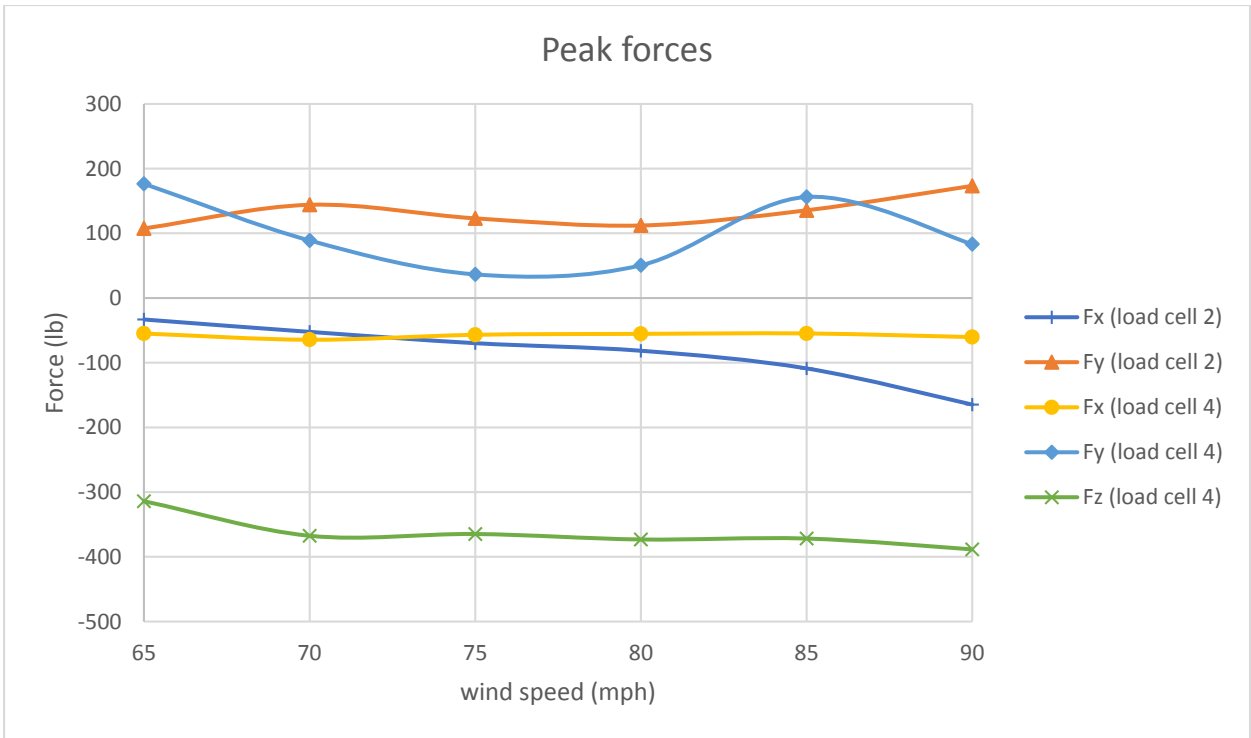

Figure 97: Peak forces at 0 degrees wind direction on loadcells 2 (messenger wire) and 4 (catenary wire)

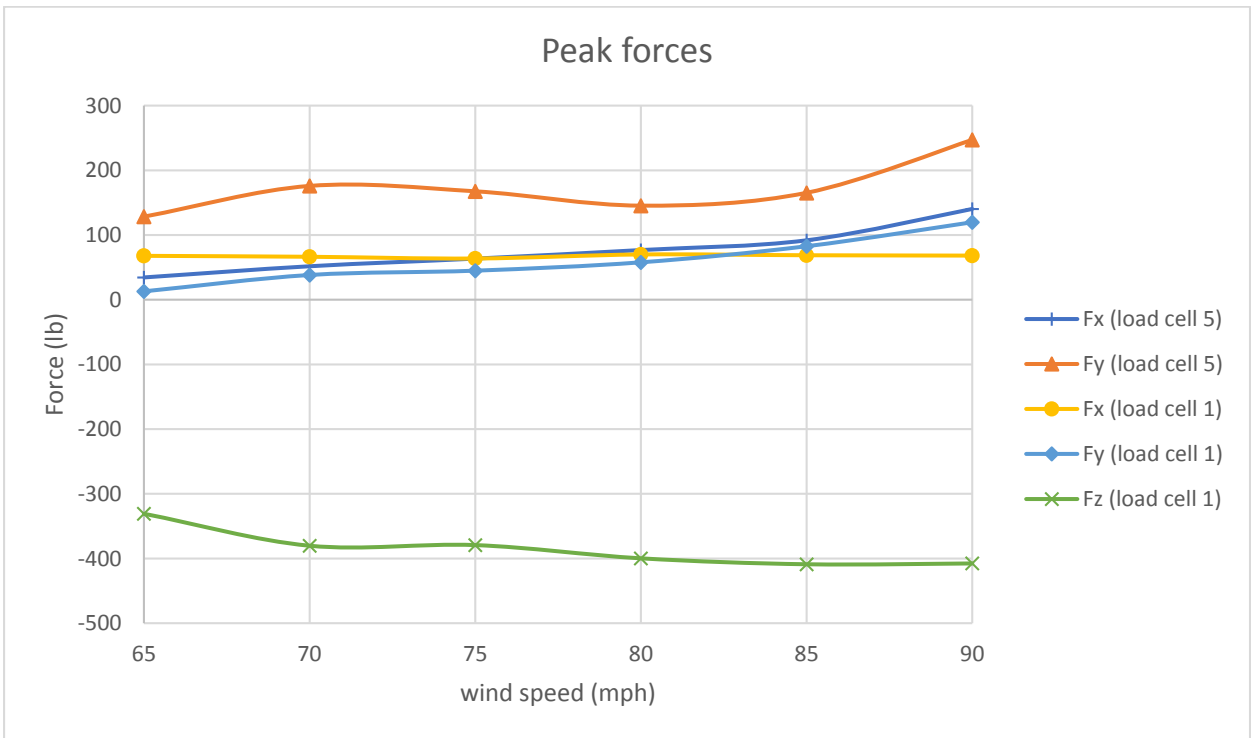
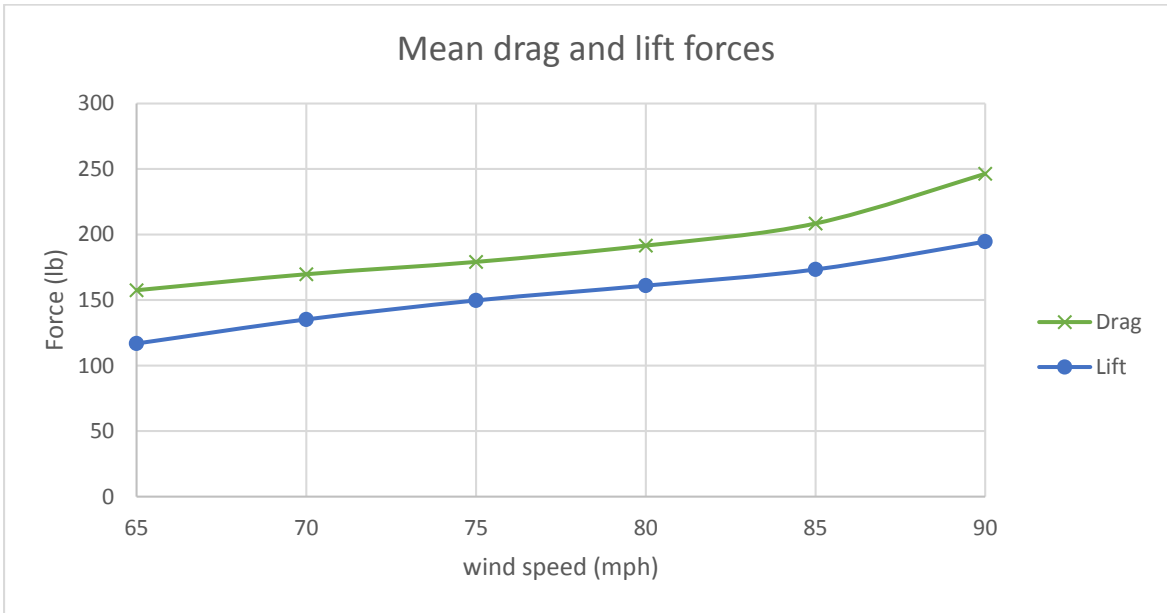
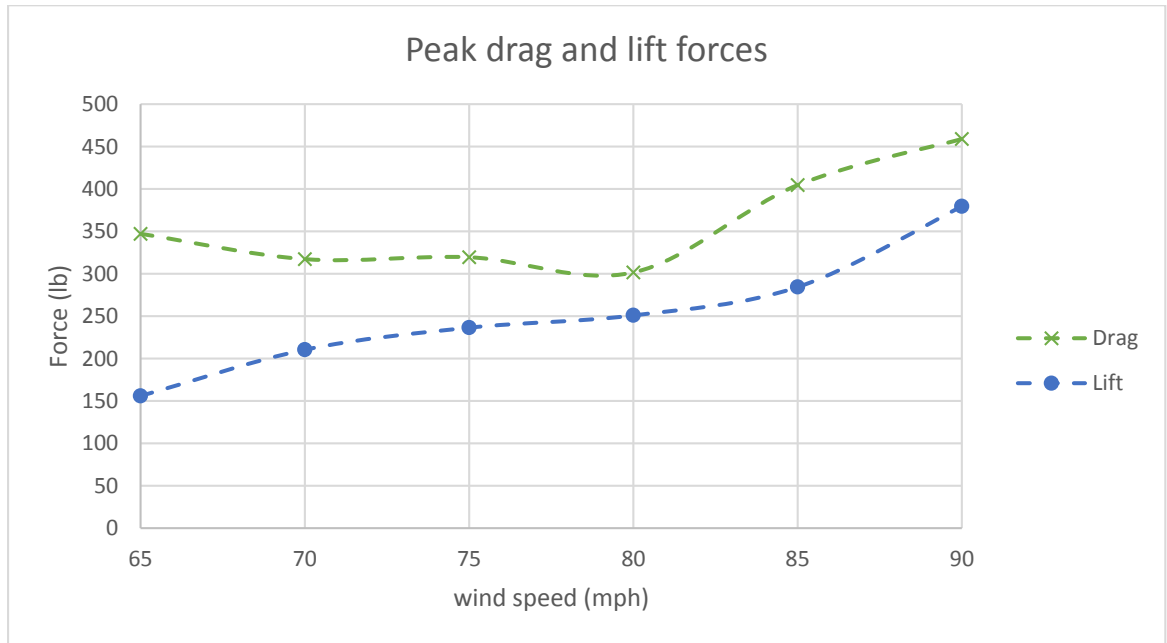

Figure 98: Peak forces at 0 degrees wind direction on loadcells 1 (catenary wire) and 5 (messenger wire)



a)



b)

Figure 99: Drag (F_y) and lift (F_x) forces on the traffic signals at 0 degrees: a) Mean; b) Peak

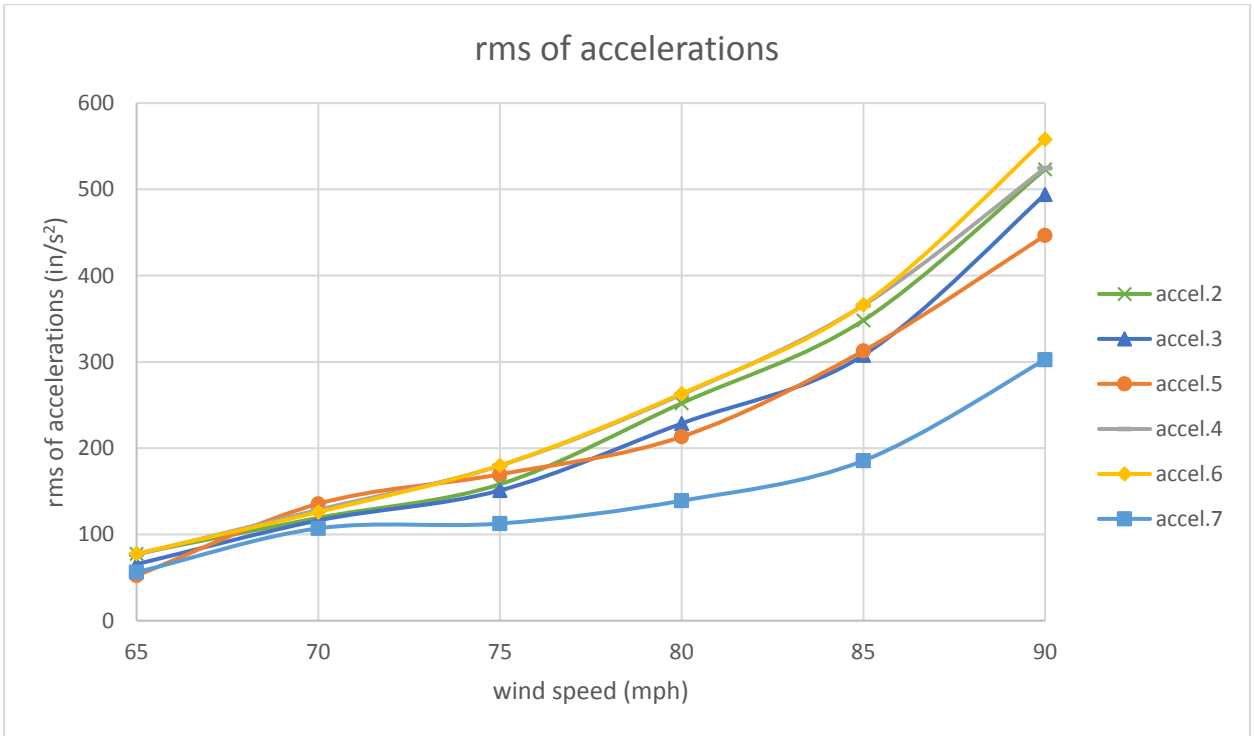
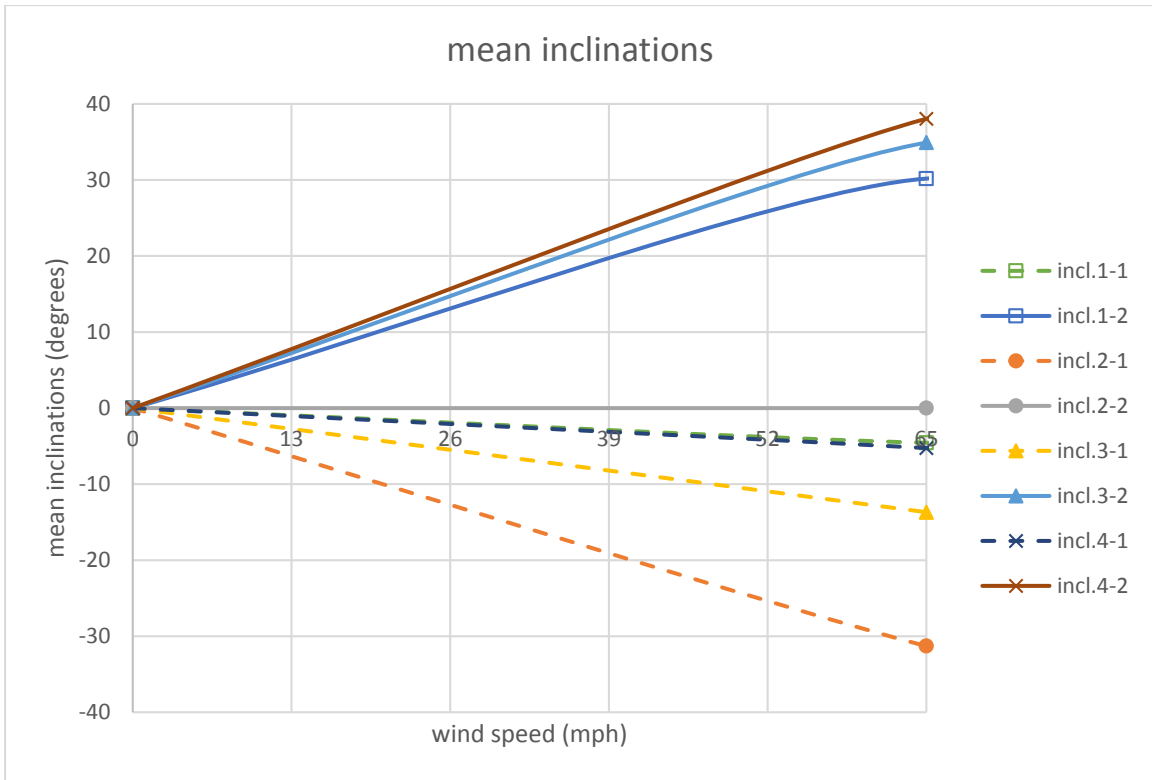
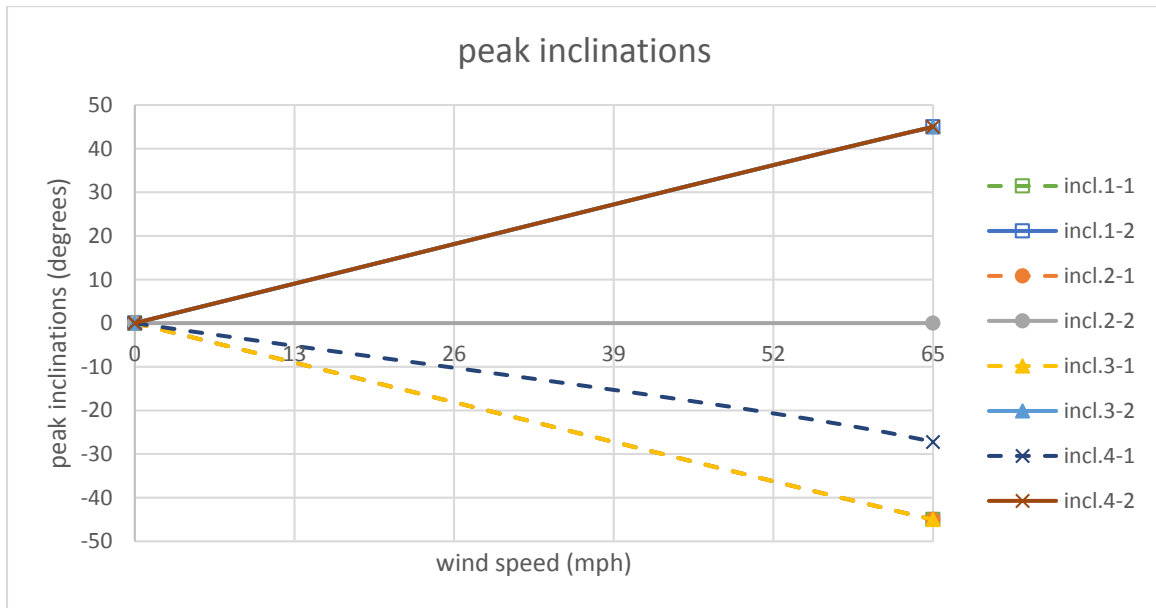

Figure 100: rms of accelerations from various accelerometers at 0 degrees



a)



b)

Figure 101: Inclinations obtained at 0 degrees from inclinometers: a) mean; b) peak

7.4 Performance of traffic signals during the tests

This test utilized two 3-section and one 5-section aluminum traffic signals installed in a reinforced span wire configuration connected to the catenary and messenger wires by means of a “Tri-stud Adjustable Hanger with Aluminum Housing” (also known as FDOT base condition).

Aerodynamic instability was first noticed at 70 mph and continued through all the duration of the test. The galloping movement was noticed to increase in intensity with higher wind speeds. The only damage observed throughout the entire test was bending of the 5-section signal back plates, as shown in Figure 102. Other than that, the traffic assembly remained fully functional with no failure of any of its components besides excessive inclinations due to the aerodynamic instability.



Figure 102: 5-Section signal with damaged back plates

7.5 Conclusions

This chapter summarizes the results of a test conducted at WOW at FIU for a span wire traffic signal assembly consisting of two 3-section and a 5-section traffic signal, connected using a **“Tri-stud Adjustable Hanger with Aluminum Housing” (also known as FDOT base condition)**. The tests were carried out for longer durations, with wind speeds being varied from 65 to 90 mph at wind of 0 degrees. The various instruments used for this test included: loadcells to measure forces, accelerometers to measure accelerations and inclinometers to measure the inclinations. This study reports the data for 0-degree wind direction, in terms of: wind induced forces (drag (y-component), lift (x-component) and cable tension (z-component)), rms of accelerations and inclinations.

Results indicate that the mean and peak values of drag and lift on the traffic signals increased with increasing wind speeds. At any given wind speed, the messenger wire experienced higher tensions and along wind force compared to the catenary wire. The rms of accelerations increased with increasing wind speed from 65 to 90 mph. The highest mean inclination of 38 degrees were measured at 65 mph in the along wind direction. Aerodynamic instability was first noticed at 70 mph and continued through all the duration of the test. The galloping movement was noticed to increase in intensity with higher wind speeds. Throughout the test, the only damage that traffic signal assembly experienced was permanent bending of 5-section signal back plates. Besides that, all components of traffic signal assembly remained fully functional until the end of the test.

Chapter 8 - Task 2: LONG SPAN LENGTH FULL SCALE TESTING - Case 2

LONG DURATION TEST - “Pivotal Adjustable Hanger with Disconnect Hanger Reinforcement Rod and Disconnect Hanger/Signal Head Reinforcement Plates with Aluminum Housing” (vendor: Signal Safe)” - Test Date: 09/16/2016

8.1 Introduction

Previous studies at the WOW Research Facility at FIU identified a ‘base’ configuration consisting of two 3-section and one 5-section traffic signals. Considering the knowledge acquired from previous tests that utilized a long span test frame (approx. 80ft), the scope of this research task was to assess the long-term performance of two different signal assemblies. In earlier testing, an aerodynamic instability was observed therefore FDOT requested to perform long duration testing to evaluate the effect of such aerodynamic instabilities on specific traffic signal assemblies. Following FDOT’s recommendations, the existing 70.5 ft test frame was reinforced for this round of tests. The instrumentation that was used consisted of loadcells, accelerometers, and inclinometers.

This chapter presents the results from the tests conducted on the traffic signal assembly with the **“Pivotal Adjustable Hanger with Disconnect Hanger, Reinforcement Rod and Disconnect Hanger/Signal Head Reinforcement Plates with Aluminum Housing” (vendor: Signal Safe)** at the WOW.

8.2 Experimental Methodology

8.2.1 Test Setup

The 3-3-5 signal assembly was installed on a reinforced long-span rig (described in chapter 1) by means of a **“pivotal adjustable hanger with disconnect hanger reinforcement rod and disconnect hanger/signal head reinforcement plates with aluminum housing” (vendor: Signal Safe)**. Figure 103 and Figure 104 show the traffic signal assembly as well as a close-up of the hanger. The bottom of all signals were at approximately 4.5 ft above the concrete floor. All the

signals were made of aluminum and included louvered back plates and visors. The different components used for the signal assembly of this round of tests are shown in Table 13.

The test protocol is presented in Table 14. The tests were conducted for longer durations, with wind speeds being varied from 65 to 90 mph, for wind direction of 0 degrees. It should be noted that a loss of tension occurred while testing at 65 mph which caused a drop in the cable forces, although the tests continued to run. A detailed discussion on the loss of tension is included in Chapter 8.3.

8.2.2 Instrumentation

The directions of the x, y and z components for each loadcell are shown in Figure 105. Loadcells number 2 and 5 were located at either end of the messenger cable and loadcells number 1 and 4 located at either end of the catenary cable.

Tri-axial accelerometers were installed in the traffic signals to measure accelerations. There was one accelerometer placed on the center top of the signal, Accel5, another placed on the bottom right side, Accel002, and a third placed on the bottom left side, Accel003 for the 5-section signal as shown in Figure 106. Accelerometer Accel007, was installed on the top center, accelerometer Accel004, was installed on the bottom left side and accelerometer Accel006, was installed on the bottom right side of the 3-section signal as shown in Figure 107.

Inclinometers were also installed on each signal to measure the inclination of the signals during wind exposure. The inclinometers measured inclination in two directions, one relative to an axis parallel to the wind direction and another relative to an axis perpendicular to the wind direction. There were inclinometers installed on the top center of the signal, Inc4, and another on the bottom center of the signal, Inc3, for the 5-section signal as shown in Figure 106. Inclinometer, Inc2, was installed on the top center and inclinometer, Inc1, was installed on the bottom center of the of the 3-section signal as shown Figure 107.

8.2.3 Test Method

The test set up was first tested for 'zero wind' conditions, and the values of the various 'quantities' (forces, accelerations and inclinations) obtained were later deducted from quantities obtained for different wind speeds (also known as "zero drift removal" process).

Table 13: Signal assembly components (Task 2: Case 2)

| Component | Manufacturer |
|-------------------|------------------|
| Span wire clamp | Signal Safe |
| Adjustable hanger | Signal Safe |
| Extension bar | Pelco (standard) |
| Messenger clamp | Signal Safe |
| Disconnect Hanger | Pelco (standard) |
| Signal Assembly | Signal Safe |
| Backplate | Signal Safe |
| Visor | Signal Safe |
| LED Modules | Unknown |

Table 14: Test Protocol (Task 2: Case 2)

| Wind Speed (mph) | Wind Direction (degrees) | Total Duration (min) |
|------------------|--------------------------|---|
| 65* | 0 | 75 (8 min-before loss of tension; 67 min-after loss of tension) |
| 70 | 0 | 15 |
| 75 | 0 | 4.5 |
| 80 | 0 | 3 |
| 85 | 0 | 1.25 |
| 90 | 0 | 0.6 |
| | TOTAL | 99.35 |

* The test at 65 mph was carried out for 75 min. However, after about 500 s (8 min), a loss of tension in the messenger wire took place resulting in a drop of cable forces (explained in detail in Chapter 3, Graph 3-1); the effect of the loss of tension lasted for the rest of the test.



Figure 103: Signal assemblies installed on test rig (before testing)



Figure 104: a) Signal Setup for the test; b) Magnified view of the connection

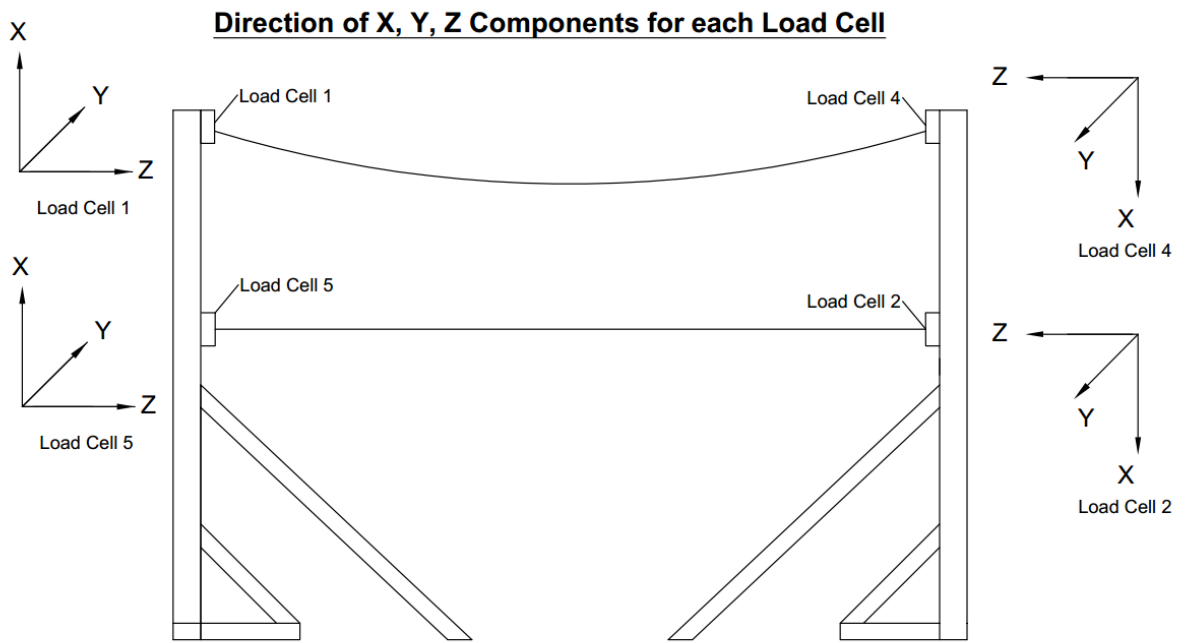

Figure 105: Direction of x, y, z components for each loadcell (direction of each axis shown)

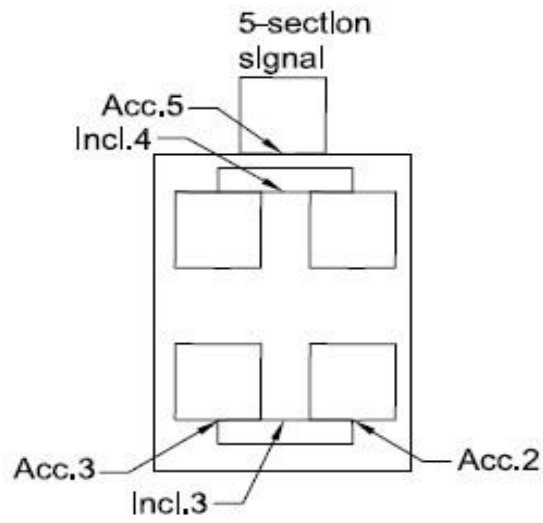

Figure 106: Location of accelerometers and inclinometers in 5-section signal

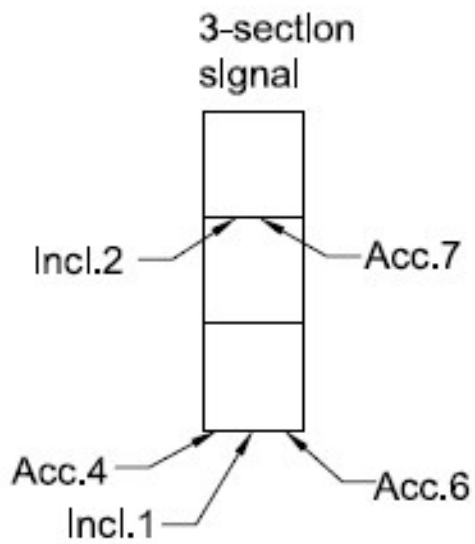

Figure 107: Location of accelerometers and inclinometers in 3-section signal

8.3 Results and Discussion

The tests at the WOW were performed in the presence of the representatives from the Florida Department of Transportation (FDOT) Traffic Engineering and Operations Office and Traffic Engineering Research Lab (TERL), representatives from Signal Safe, installation technicians from Horsepower Electric Inc. and members of the WOW technical team. Results in this chapter are presented for 0-degree wind direction. The tests were carried out for longer durations (Table 14) for wind speeds of 65 mph, 70 mph, 75 mph, 80 mph, 85 mph and 90 mph. Results are presented only for 65 mph and 70 mph, due to a malfunction of the Data Acquisition System.

8.3.1 The effect of drop in cable forces during the tests at 65 mph

According to the specified test protocol, the test started at 65 mph and was run for a total time of 4500 s (approximately 75 minutes). At this speed the system experienced an aerodynamic instability (i.e. galloping) resulting on an erratic motion. However, after approximately 500 s (i.e. 8 min) from the commencement of the test, the messenger wire experienced a drop in tension causing the aerodynamic instability to subside and forces of both cables, catenary and messenger, to drop. This drop in the forces can be seen in the time histories presented in Figure 108 for loadcell 2 (messenger) and for loadcell 4 (catenary). In fact, a similar trend was also observed in the acceleration time histories for accelerometers 6 and 2 as shown in Figure 109. In the following sections, the mean and peak components of the forces, rms of accelerations and inclinations are reported for both the “before loss of tension” and “after loss of tension” situations.

8.3.2 Wind induced forces

The directions of the forces are shown in Figure 105. The mean and peak forces obtained at various wind speeds are discussed in this section. Figure 110 presents the wind induced mean forces on loadcell 2 (messenger wire) and loadcell 4 (catenary wire) at 0-degree wind direction, for wind speed of 65 mph (before loss of tension), 65 mph (after loss of tension) and 70 mph (after loss of tension). It may be noted that the ‘y’ and ‘z’ components of the forces correspond to the ‘drag’ and ‘cable tensions’ respectively, while the ‘x’ component represents the uplift forces.

Data show that there was negligible change in the forces (F_x and F_y) on loadcells 2 and 4 despite an increase in wind speed from 65 mph to 70 mph (after loss of tension). In general, the lift and drag forces experienced by the messenger wire were higher than those experienced by the catenary wire at a given wind speed. Similar observations were made for the mean forces on loadcell 5 (messenger) and loadcell 1 (catenary) as shown in Figure 111. For instance, a negligible increase in F_y (drag) in loadcell 5 (messenger) was observed from 65 mph (after loss of tension) to 70 mph (after loss of tension); at 65 mph (before loss of tension) the mean F_y was slightly lower than at 65 mph (after loss of tension) – similar trends were observed for F_x (lift) in loadcell 1 (catenary). Negligible changes in F_y (drag) in loadcell 1 (catenary) were observed despite an increase from 65 mph to 70 mph (after loss of tension). The tensions (F_z) were not reported due to 1) data exceeding the maximum capacity of the loadcell and 2) the loss of tension altering the baseline values.

The peak forces for loadcell 2 and loadcell 4 are shown in Figure 112. The peak values of F_x (lift) in loadcells 2 and 4 experienced negligible change from wind speed of 65 mph to 70 mph (after loss of tension). However, at 65 mph (before loss of tension), the peak of F_x in loadcells 2 and 4 were higher than those obtained at wind speed of 65 mph (after loss of tension). Similarly, F_y (drag) in loadcell 2 (messenger) experienced minimal change in the peak forces when wind speed increased from 65 mph to 70 mph (after loss of tension). At 65 mph (before loss of tension) peak of F_y on loadcell 2 was higher than the peak at 65 mph (after loss of tension). Figure 113 presents peak forces for loadcell 5 (messenger) and loadcell 1 (catenary). In general, the peak forces F_y (drag) and F_x (lift) on all the loadcells did not change significantly despite an increase in wind speed from 65 mph to 70 mph (after loss of tension). However, at 65 mph (before loss of tension), the peak forces on a given loadcell were higher than the peaks at 65 mph (after loss of tension). The peak drag (F_y) in the messenger wire was generally higher than the catenary wire at any given wind speed. The differences in the peak values before and after the loss of tension is clearly seen due to the presence of the aerodynamic instability, as can be seen also in the time histories of the force data.

Figure 114 (a) presents the ‘total’ mean drag and lift forces on the traffic signals. Results show that the mean drag and the mean lift on the traffic signals increased somewhat with an increase

in wind speed from 65 mph to 70 mph (after loss of tension) - highest drag of 169 lbs and highest lift of 152 lbs were obtained at 70 mph. The peak drag and peak lift are shown in Figure 114 (b). Similar to the mean values, the peak drag and lift experienced negligible changes for a wind speed increase from 65 mph to 70 mph - highest peak drag of 303 lbs and highest peak lift of 202 lbs were obtained at 70 mph. However, a significant difference was observed on the drag force before and after the loss of tension on the messenger wire due to the presence of the aerodynamic instability.

8.3.3 rms of accelerations

The root mean square (rms) of accelerations are presented in Figure 115. Accelerometers 4, 6 and 7 were located on the 3-section signal, while accelerometers 2, 3 and 5 were located on the 5-section signal (see Figure 106 and Figure 107). Overall, the rms of accelerations obtained from all the accelerometers experienced a slight increase from wind speed of 65 mph to 70 mph (after loss of tension). For all accelerometers, the rms values of accelerations at 65 mph (before loss of tension) were found to be significantly higher than those found at 65 mph (after loss of tension).

8.3.4 Inclinations of the traffic signals

Figure 116 shows the inclinations (mean and peak) obtained from various inclinometers. It may be noted that for inclinometer 1, '1-1' refers to the component of inclination perpendicular to the wind, while '1-2' refers to the component of inclination in the direction of wind. In this case, only inclinations (mean and peak values) measured at 65 mph (after loss of tension) are presented. The highest mean inclination of 35.5 degrees and highest peak inclination of 45 degrees was measured at 65 mph in the along wind direction.

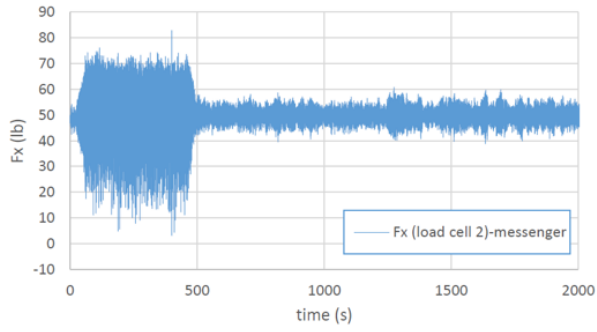

a)

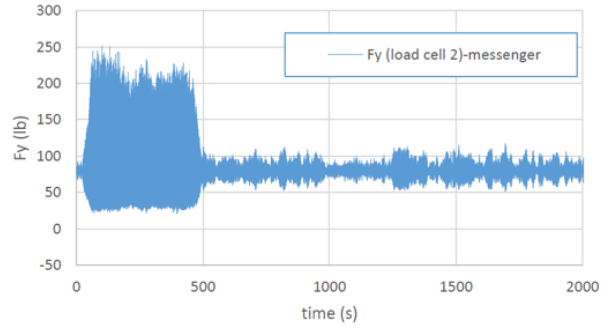

b)

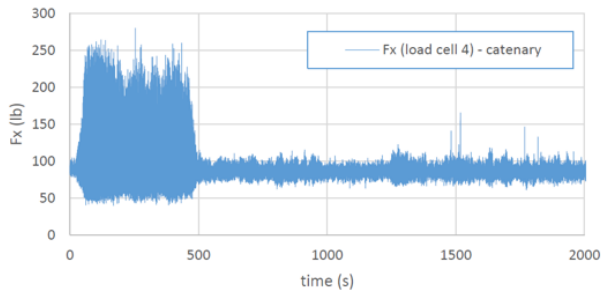

c)

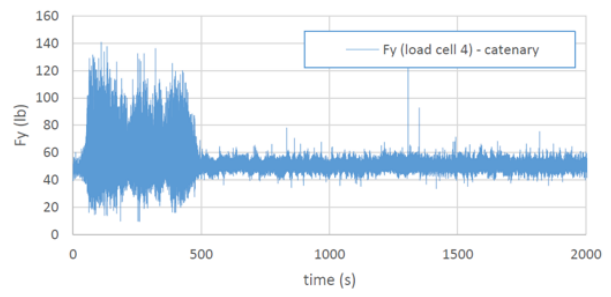

d)

Figure 108: Force time history plots at 65 mph for Fx (lift) and Fy (drag) on loadcell 2 (messenger) and loadcell 4 (catenary)

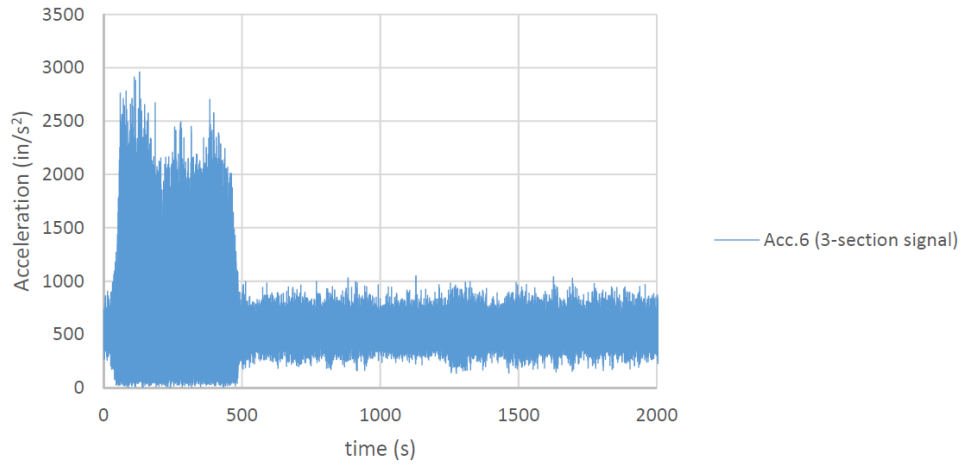

a)

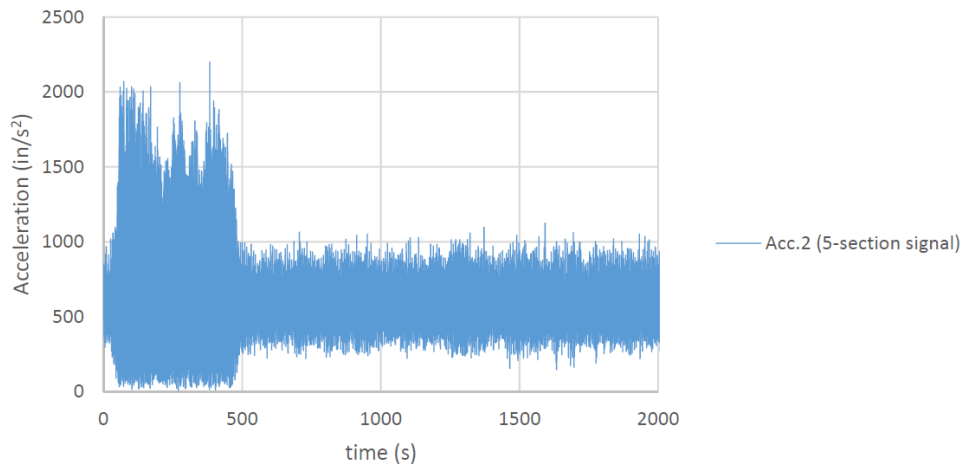

b)

Figure 109: Acceleration time histories at 65 mph: a) Accelerometer 6 (3-section signal); b) Accelerometer 2 (5-section signal) – test duration 33 min

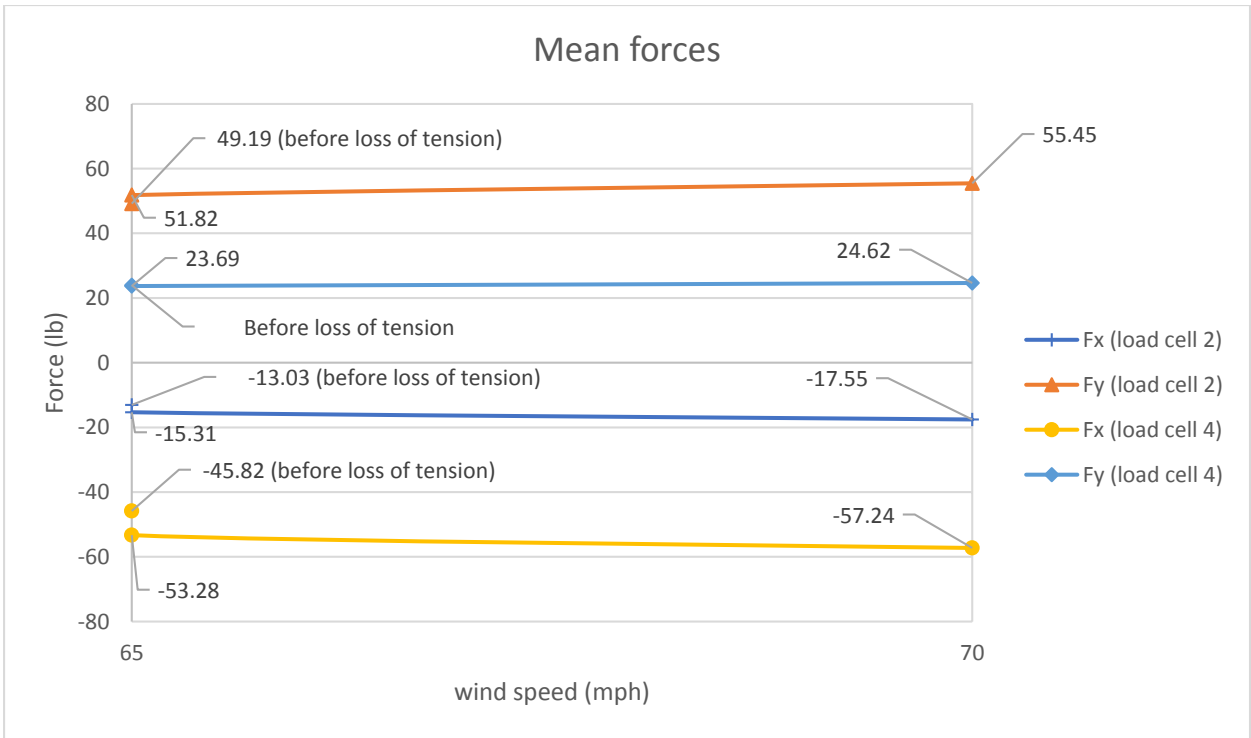

Figure 110: Mean forces on loadcells 2 (messenger wire) and 4 (catenary wire) at 0 degrees wind direction

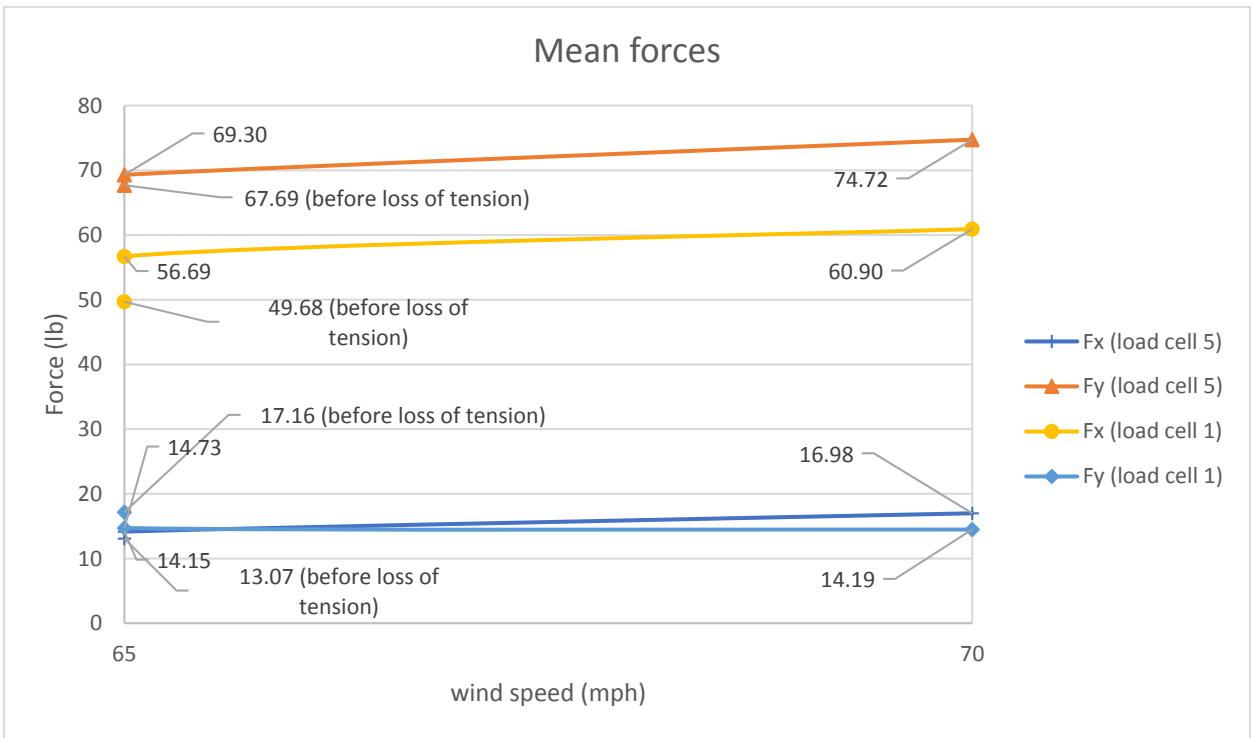

Figure 111: Mean forces on loadcells 1 (catenary wire) and 5 (messenger wire) at 0 degrees wind direction

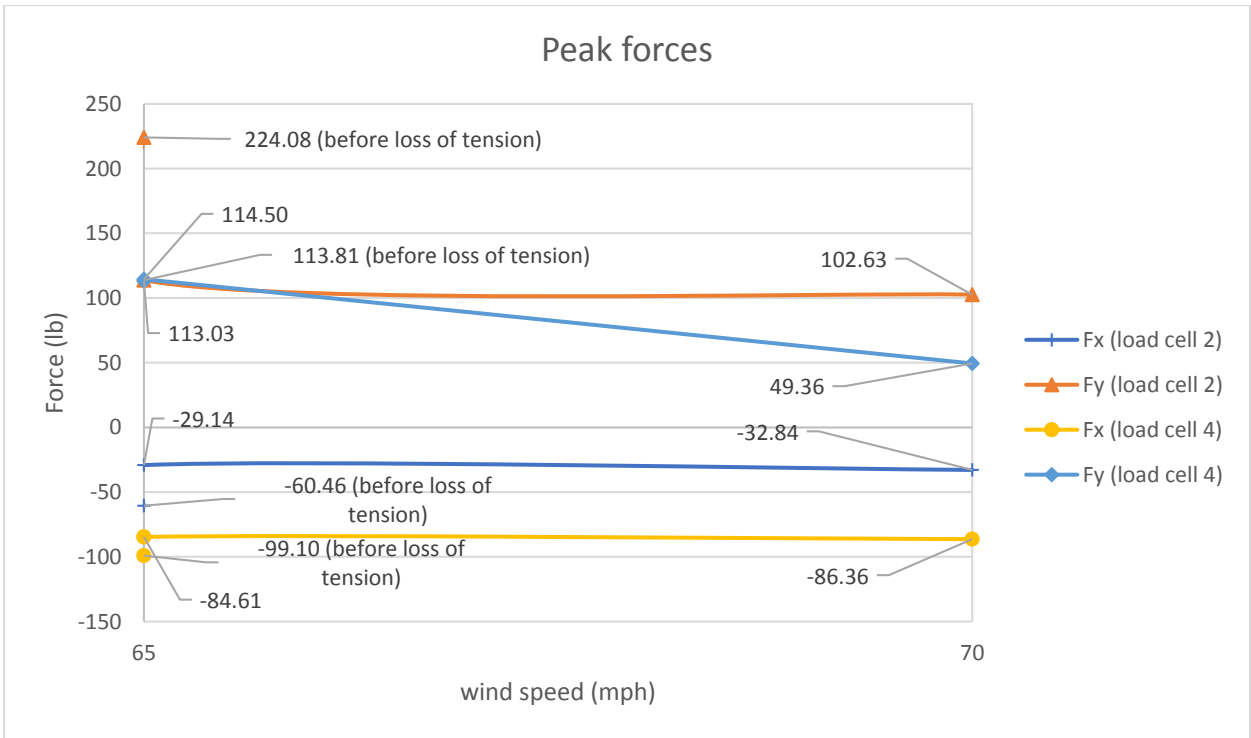

Figure 112: Peak forces at 0 degrees wind direction on loadcells 2 (messenger wire) and 4 (catenary wire)

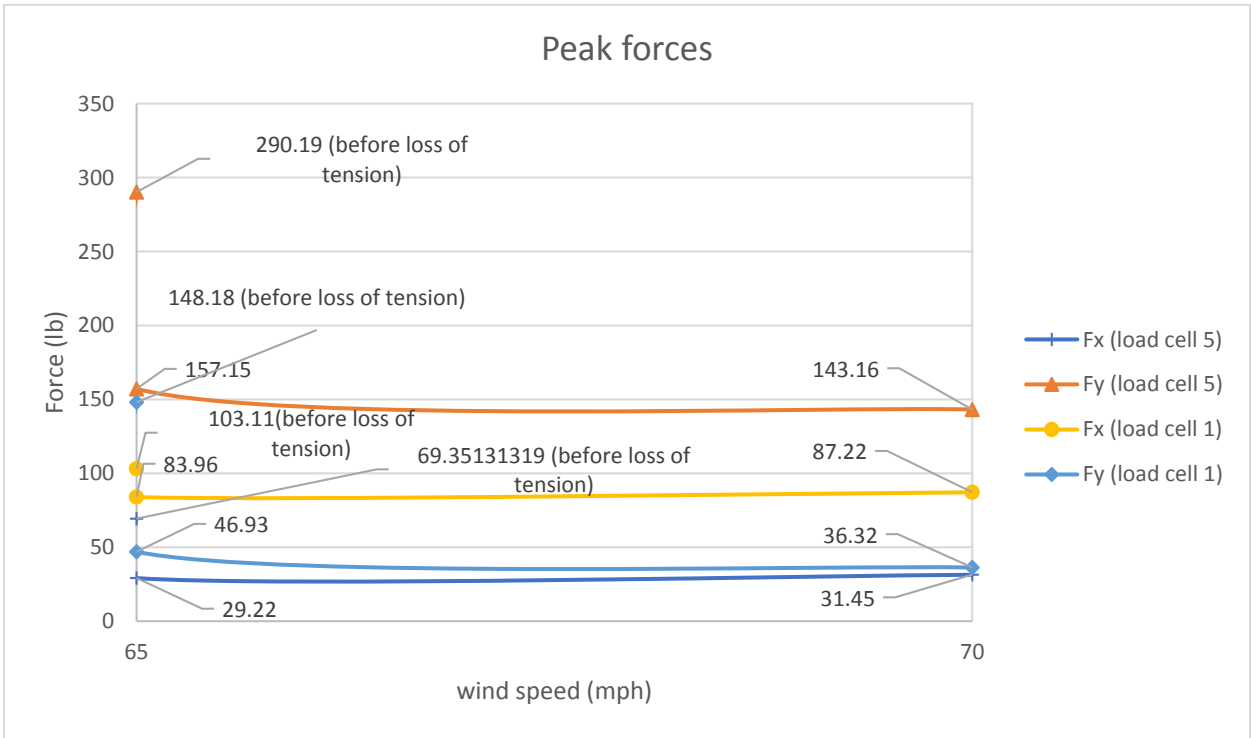
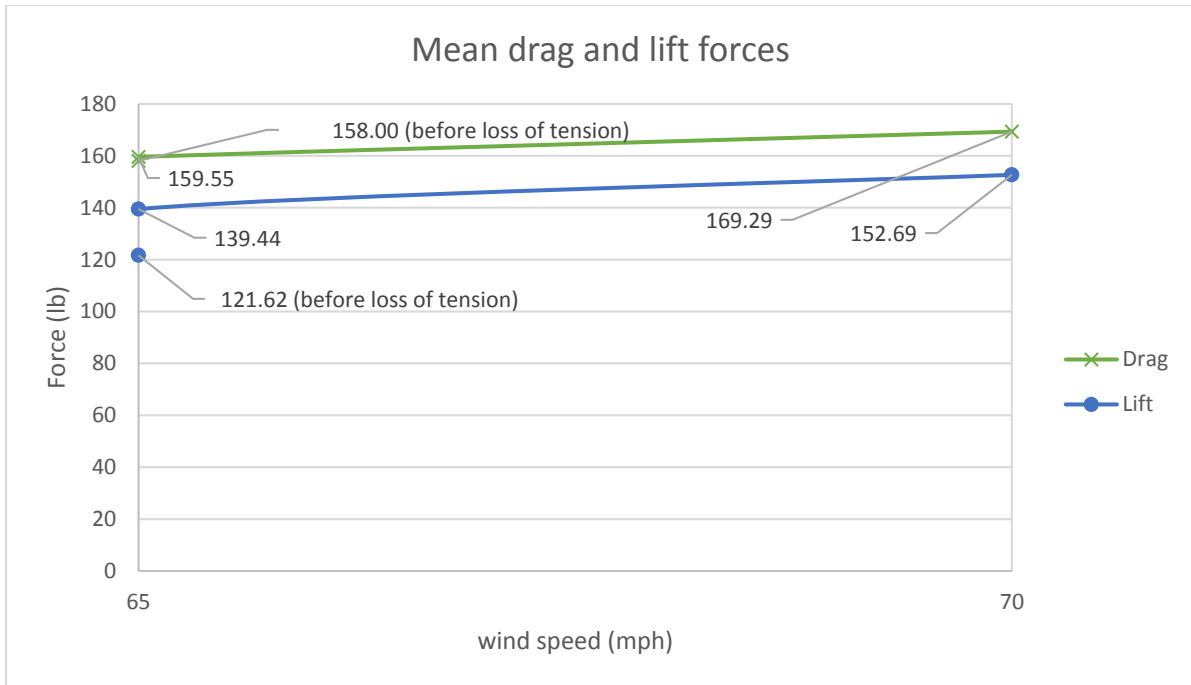
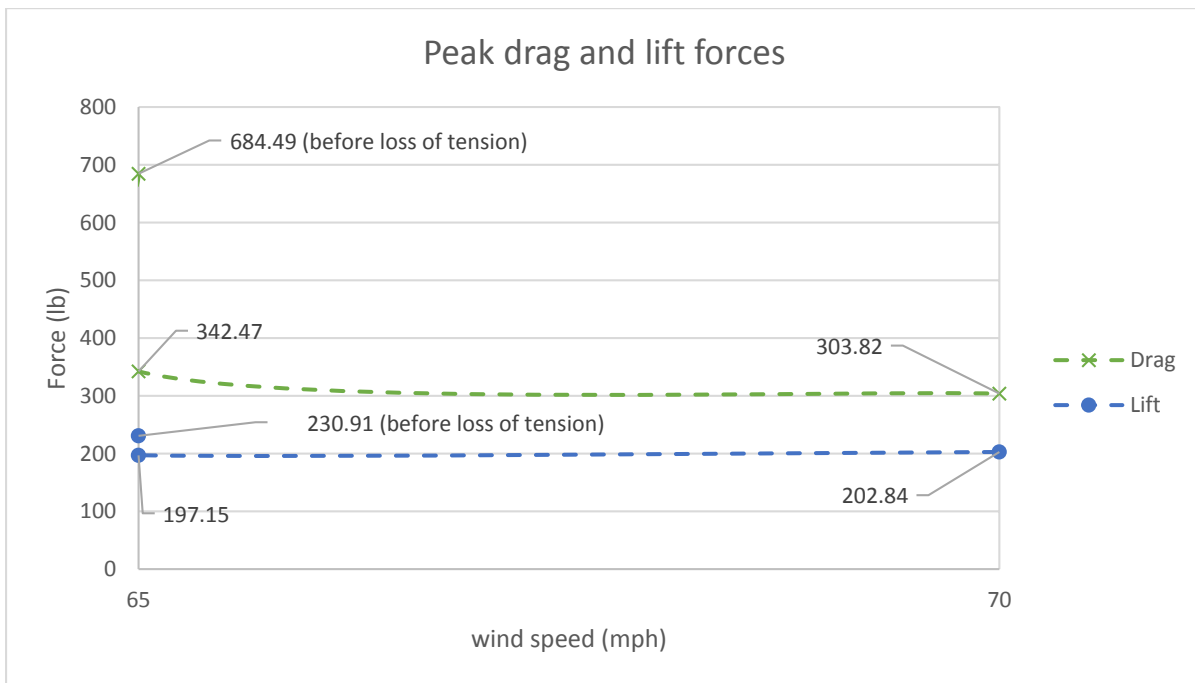

Figure 113: Peak forces at 0 degrees wind direction on loadcells 1 (catenary wire) and 5 (messenger wire)



a)



b)

Figure 114: Drag (F_y) and lift (F_x) forces on the traffic signals at 0 degrees: a) Mean; b) Peak

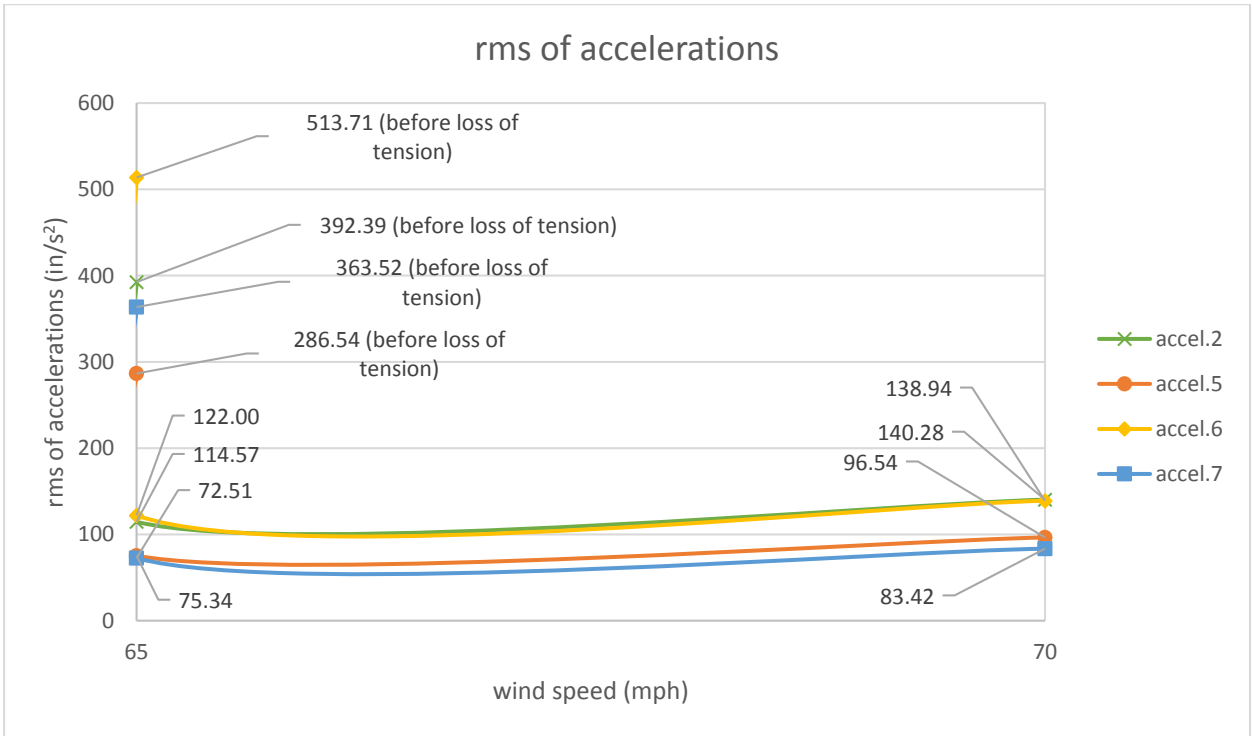
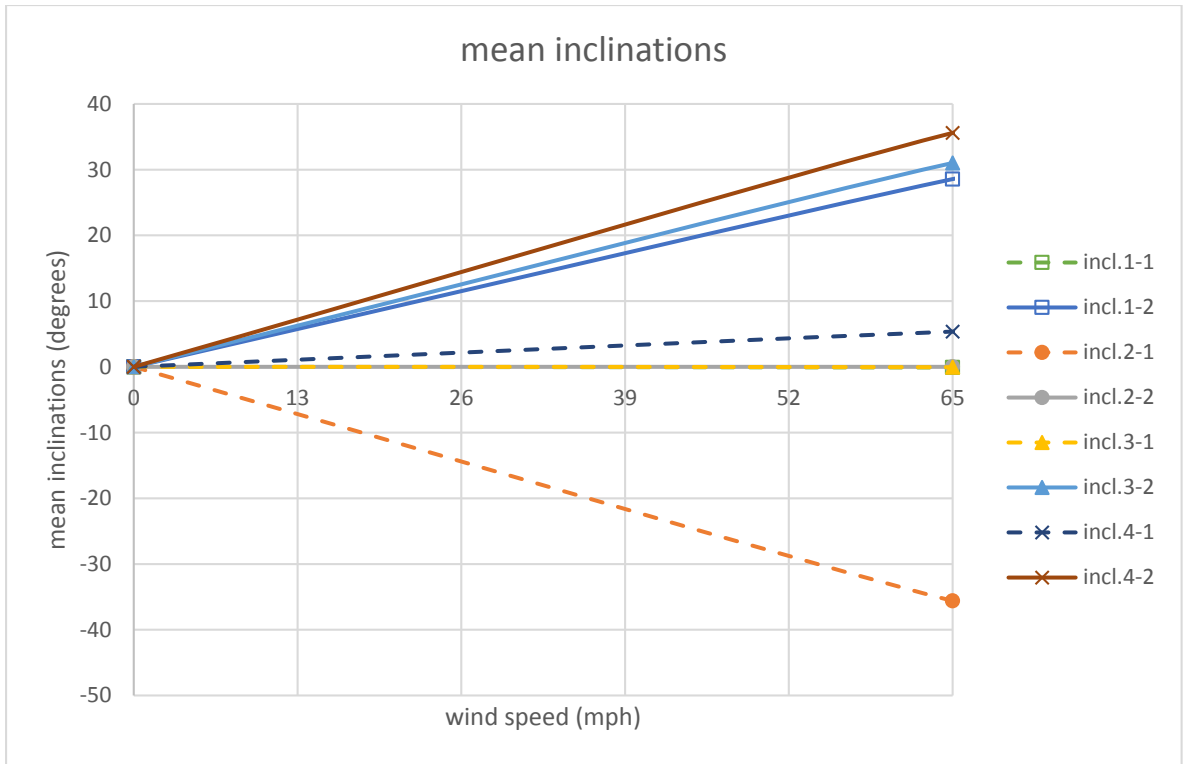

Figure 115: rms of accelerations from various accelerometers at 0 degrees



a)

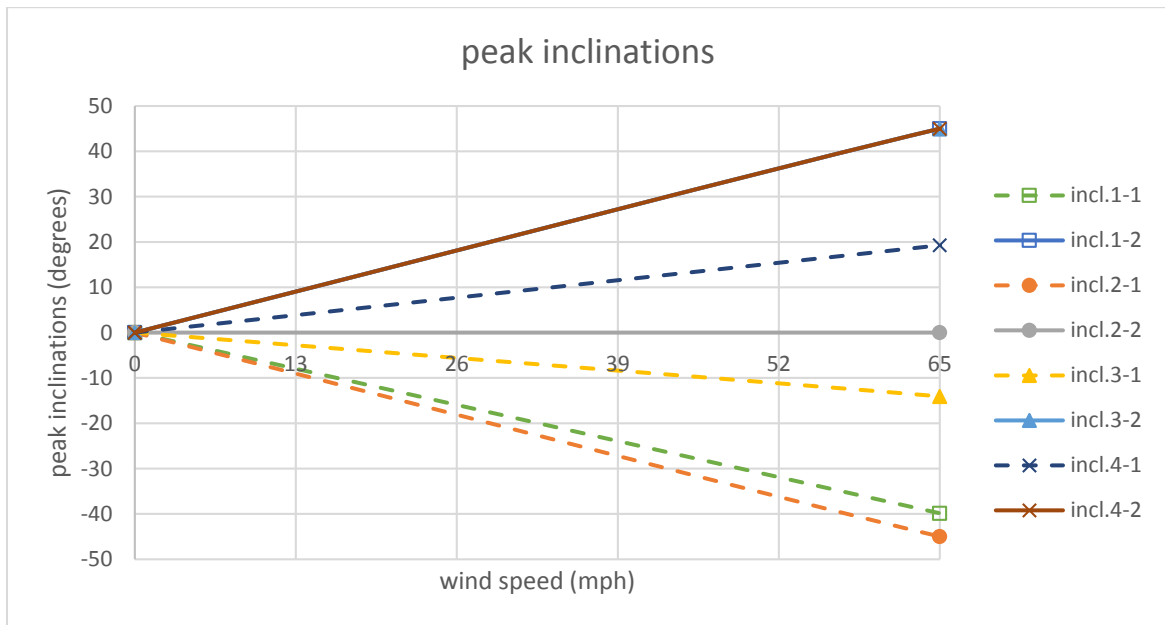

Figure 116: Inclinations obtained at 0 degrees from inclinometers: a) mean; b) peak (wind speed of 65 mph, after loss of tension values reported)

8.4 Performance of traffic signals during the tests

This test utilized two 3-section and one 5-section aluminum traffic signals installed in a reinforced span wire configuration connected to the catenary and messenger wires by means of a “Pivotal Adjustable Hanger with Disconnect Hanger, Reinforcement Rod and Disconnect Hanger/Signal Head Reinforcement Plates with Aluminum Housing” (vendor: Signal Safe).

An aerodynamic instability was observed at the beginning of the test (65 mph). This erratic behavior continued for about 8 minutes until a loss of tension occurred in the messenger cable which then resulted in the subsiding of the galloping. At 80mph, the signals showed occasional galloping. When the wind speed was increased to 85 mph, signals showed galloping movement until the end of the test which intensified at 90 mph.

No damages were observed at the end of the test, however, it was noticed that the messenger wire had a loss of tension 8 minutes after the beginning of the test, which caused the aerodynamic instability, observed at 65 mph, to subside and delayed its appearance to a later wind speed.

8.5 Conclusions

This chapter summarizes the results of a test conducted at WOW at FIU for a span wire traffic signal assembly consisting of two 3-section and a 5-section traffic signal, connected using a **“Pivotal Adjustable Hanger with Disconnect Hanger, Reinforcement Rod and Disconnect Hanger/Signal Head Reinforcement Plates with Aluminum Housing” (vendor: Signal Safe)**. The tests were carried out for longer durations, with wind speeds being varied from 65 to 90 mph at an angle of attack of 0-degree. The various instruments used for this test included: loadcells to measure forces, accelerometers to measure accelerations and inclinometers to measure the inclinations.

A loss of tension occurred at 65 mph causing a drop in the forces in the cables which caused aerodynamic instability, first observed at 65 mph, to subside and appear at a later speed, 80 mph, at a much lesser intensity. Results for 0-degree wind direction indicate that the mean and peak values of the total drag and total lift on the traffic signals experienced a slight increase from 65 mph to 70 mph (after loss of tension). The peak components of total drag and lift forces before

loss of tension at 65 mph were higher than those obtained after loss of tension at 65 mph. The messenger wire experienced higher along wind force compared to the catenary wire. The rms of accelerations experienced a slight increase with increasing wind speed from 65 to 70 mph (after loss of tension). The rms values at 65 mph before loss of tension were found to be higher than those obtained at wind speed of 65 mph after loss of tension. A mean inclination of 35.5 degrees was measured at 65 mph (after loss of tension) in the along wind direction. Throughout the test, there was neither damage nor failure observed and assembly remained fully functional.

Chapter 9 - Task 2: SHORT SPAN LENGTH FULL SCALE TESTING - Case 3

“Adjustable Hanger Assembly with 1-inch Cable Dampener and Reinforced Disconnect Hanger with Aluminum Housing” - Test Date: 04/11/2017

9.1 Introduction

More recent studies involving the FDOT and WOW Research Facility at FIU were able to identify a ‘base’ configuration consisting of a 21.9 ft long section with two 3-section and one 5-section traffic signals (companion project BDV29 TWO 977-20). As a continuation of the study, FDOT tested the span wire traffic signal configurations connected to the catenary and messenger wires via an **“Adjustable Hanger Assembly with 1-inch Cable Dampener and Reinforced Disconnect Hanger with Aluminum Housing”** (vendor: Pelco Products). The tests were carried out at wind directions ranging from 0 to 180 degrees and wind speeds ranging from 40 to 150 mph. The instruments consisted of loadcells to measure forces, accelerometers to measure accelerations, and inclinometers to measure the inclinations of the traffic signals.

This chapter presents the results from the tests conducted on the traffic signal assembly with the **“Adjustable Hanger Assembly with 1-inch Cable Dampener and Reinforced Disconnect Hanger with Aluminum Housing”** (vendor: Pelco products) at the WOW. Additional results are presented in appendix A.

9.2 Experimental Methodology

9.2.1 Test Setup

The 3-3-5 signal assembly was installed on a reinforced short-span rig (described in chapter 1) by means of a **“Adjustable Hanger Assembly with 1-inch Cable Dampener and Reinforced Disconnect Hanger with Aluminum Housing”** (vendor: Pelco Products). Figure 117 to Figure 119 show the traffic signal assembly as well as a close-up of the hanger. The bottom of all signals were at approximately 4.5 ft above the concrete floor. All the signals were made of aluminum and included louvered backplates and visors.

The test protocol is presented in Table 15. The tests were performed from 40 to 150 mph at various angles ranging from 0 to 180 degrees. The different components utilized for this particular test are listed in Table 16.

9.2.2 Instrumentation

The directions of the x, y and z components for each loadcell are shown in Figure 120. Loadcells number 4 and 5 were located at either end of the messenger cable and loadcells number 1 and 2 located at either end of the catenary cable.

Tri-axial accelerometers were installed in the traffic signals to measure accelerations. There was one accelerometer placed on the center top of the signal, Accel5, another placed on the bottom right side, Accel002, and a third placed on the bottom left side, Accel003 for the 5-section signal as shown in Figure 121. Accelerometer Accel007, was installed on the top center, accelerometer Accel004, was installed on the bottom left side and accelerometer Accel006, was installed on the bottom right side of the 3-section signal as shown in Figure 122.

Inclinometers were also installed on each signal to measure the inclination of the signals during wind exposure. The inclinometers measured inclination in two directions, one relative to an axis parallel to the wind direction and another relative to an axis perpendicular to the wind direction. There were inclinometers installed on the top center of the signal, Inc4, and another on the bottom center of the signal, Inc3, for the 5-section signal as shown in Figure 121. Inclinometer, Inc2, was installed on the top center and inclinometer, Inc1, was installed on the bottom center of the of the 3-section signal as shown Figure 122.

9.2.3 Test Method

The test set up was first tested for 'zero wind' conditions, and the values of the various 'quantities' (forces, accelerations and inclinations) obtained were later deducted from quantities obtained for different wind speeds (also known as "zero drift removal" process).

Table 15: Test protocol (Task 2: Case 3)

| Wind Speed (mph) | Wind Direction (degrees) | Total Duration (min) |
|------------------|--------------------------|----------------------|
| 40 | 0, 45, 80, 100, 135, 180 | 3.1 |
| 70 | 0, 45, 80, 100, 135, 180 | 3.1 |
| 100 | 0, 45, 80, 100, 135, 180 | 3.1 |
| 130 | 0, 45, 80, 100, 135, 180 | 3.1 |
| 150 | 0, 45, 80, 100, 135, 180 | 3.1 |
| TOTAL | | 15.5 |

Table 16: - Signal assembly components (Task 2: Case 3)

| Standard Part | Manufacturer |
|---------------------------|---------------------------|
| Span wire clamp | Pelco |
| Adjustable hanger | Pelco |
| Messenger clamp | Pelco |
| Disconnect Hanger | Pelco |
| Signal Assembly | McCain |
| Backplate | TCS |
| Visor | McCain |
| LED Modules | GE - Dialight – Duralight |
| Non-Standard Parts | |
| Cable Dampener Hanger | Pelco |



Figure 117: Test rig



Figure 118: Signal assemblies installed on test rig (before testing)



a)



b)

Figure 119: a) Signal setup for the test; b) Magnified view of the connection

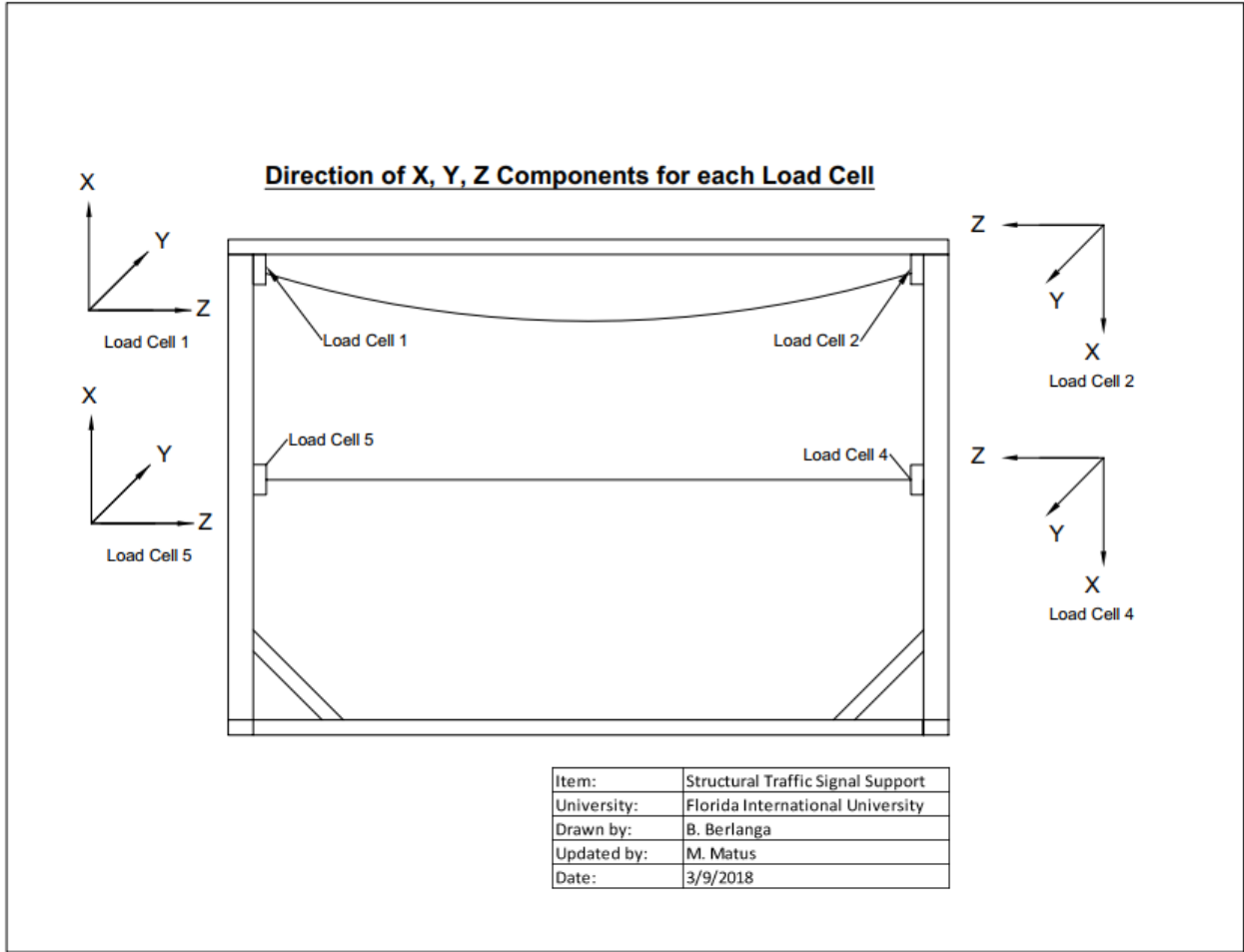

Figure 120: Direction of x,y,z components for each loadcell (direction of each axis shown represents 'positive direction')

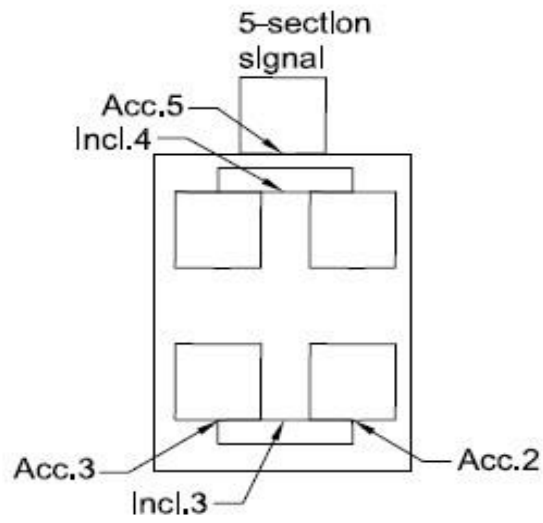

Figure 121: Location of accelerometers and inclinometers in 5-section signal

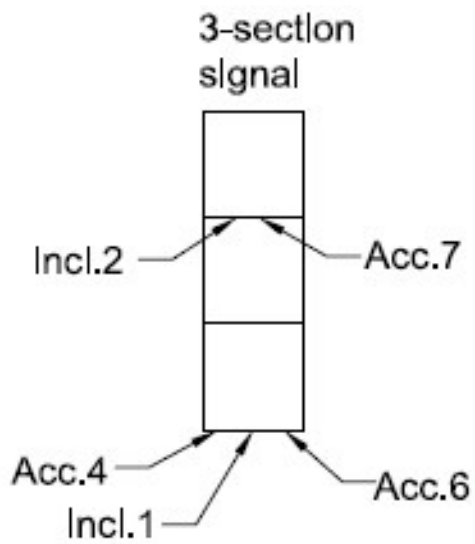

Figure 122: Location of accelerometers and inclinometers in 3-section signal

9.3 Results and Discussion

The tests at the WOW were performed in the presence of the representatives from the Florida Department of Transportation (FDOT) Traffic Engineering and Operations Office and Traffic Engineering Research Lab (TERL), representatives from Pelco Products, installation technicians from Horsepower Electric Inc. and members of the WOW technical team. The results in this chapter are restricted to 0-degree wind direction, with results for additional wind directions presented in appendix A.

9.3.1 Wind induced forces

The directions of the forces are shown in Figure 120. The mean and peak forces obtained at various wind speeds are discussed in this section. Figure 123 presents the wind induced mean forces on loadcell 2 (catenary wire) and loadcell 4 (messenger wire) at 0 degrees wind direction, for increasing wind speeds. It may be noted that the 'y' and 'z' components of the forces correspond to the 'drag' and 'cable tensions' respectively, while the 'x' component represents the uplift forces.

Data show that the along wind forces (F_y) increased with increasing wind speed at loadcell 4 (messenger wire), while F_y at loadcell 2 (catenary wire) experienced minimal change with increasing wind speeds. The highest along wind force of 241 lbs was found at loadcell 4 at 150 mph. Similarly, the tension on loadcell 4 (F_z) increases in magnitude from 159 lbs at 40 mph to 505 lbs at 150 mph. This shows that the messenger wire experienced higher tension and drag than the catenary wire for increasing wind speeds. The uplift forces (F_x) on loadcell 4 (messenger wire) increased in magnitude with increase in wind speed. However negligible change in F_x on loadcell 2 (catenary wire) with increasing wind speed was observed.

Similar observations were made for loadcell 5 (messenger wire) and loadcell 1 (catenary wire) as shown in Figure 124. For instance, F_z (cable tension) and F_y (drag) increase with increasing wind speed on loadcell 5 (messenger wire). F_x on loadcell 5 also increases initially, but remains nearly constant beyond 100 mph. A slight increase in F_y was observed at wind speeds exceeding 130 mph on loadcell 1 (catenary).

The peak forces at 0 degrees wind direction for loadcell 2 (catenary wire) and loadcell 4 (messenger wire) are shown in Figure 125. The peak forces of F_y and F_z increase with increasing wind speeds. The magnitudes of the peaks on loadcell 2 increase marginally for F_x with increasing wind speeds. Figure 126 presents peak results for loadcell 5 (messenger wire) and loadcell 1 (catenary wire). F_z (cable tensions) on loadcells 1 and 5 increase with increasing wind speeds – highest values of 738 lbs on loadcell 5 and 422 lbs on loadcell 1 at wind speed of 150 mph was observed.

The peaks of F_y (drag) on loadcell 5 increases gradually with higher wind speeds, although the magnitudes of the peaks at loadcell 1 do not change markedly for a change in wind speed. Peak of F_x (lift) on loadcell 5 (messenger) and loadcell 1 (catenary) do not change significantly despite a change in wind speed. Results for additional wind directions are presented in appendix A. Figure 127 (a) presents the ‘total’ mean drag and lift forces on the traffic signals. Results show that the drag on the traffic signals increase with an increase in wind speed – highest value of 612 lbs was obtained at 150 mph at 0 degrees wind direction. The peak drag and lift are shown in Figure 127 (b). The peak lift becomes nearly constant beyond 130 mph and attains a value of 453 lbs. However, the peak drag increased initially with increasing wind speed, and attains the highest value of 859 lbs at 150 mph.

It needs to be noted that the sign convention of the x component of all loadcells was configured so that the weight of the signals is a positive reading while a lift force pushing the signals up is a negative reading. With the sign convention, it can be seen that the lift forces increased as wind speed increased.

9.3.2 rms of accelerations

The root mean square (rms) of accelerations are presented in Figure 128. Accelerometers 4, 6 and 7 were located on the 3-section signal, while accelerometers 2, 3 and 5 were located on the 5-section signal (see Figure 121 and Figure 122). Overall, the rms of accelerations obtained from all the accelerometers experienced an increase from wind speed of 40 mph to 100 mph. It needs to be noted that accelerometer 5 results were removed due to malfunction.

9.3.3 Inclinations of the traffic signals

Figure 129 shows the inclinations (mean and peak) obtained from inclinometer 2. It may be noted that for inclinometer 2, '2-1' refers to the component of inclination parallel to the wind, while '2-2' refers to the component of inclination perpendicular to the direction of wind. For inclinometer 2, the mean components '2-1' are generally in the range of 17 to 59 degrees for 40-100 mph wind speed range. Beyond 100 mph, inclinometers were removed to avoid damages due to failure.

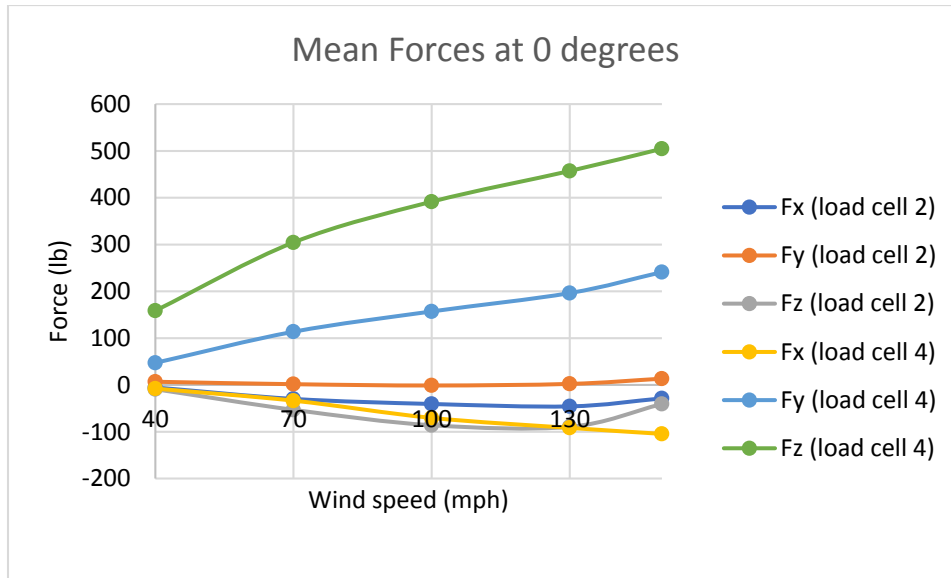

Figure 123: Mean Forces on loadcells 2 (catenary wire) and 4 (messenger wire) at 0 degrees wind direction

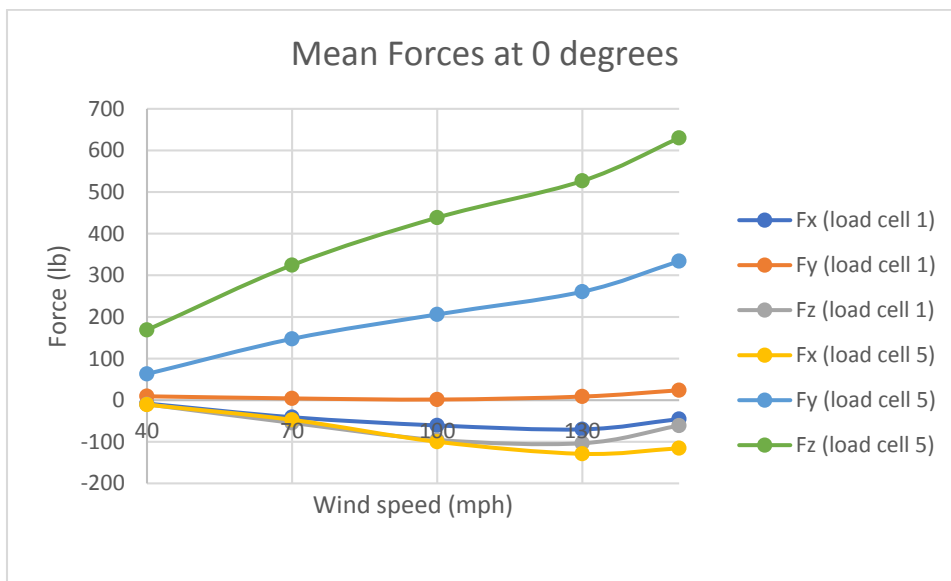

Figure 124: Mean Forces on loadcells 1 (catenary wire) and 5 (messenger wire) at 0 degrees wind direction

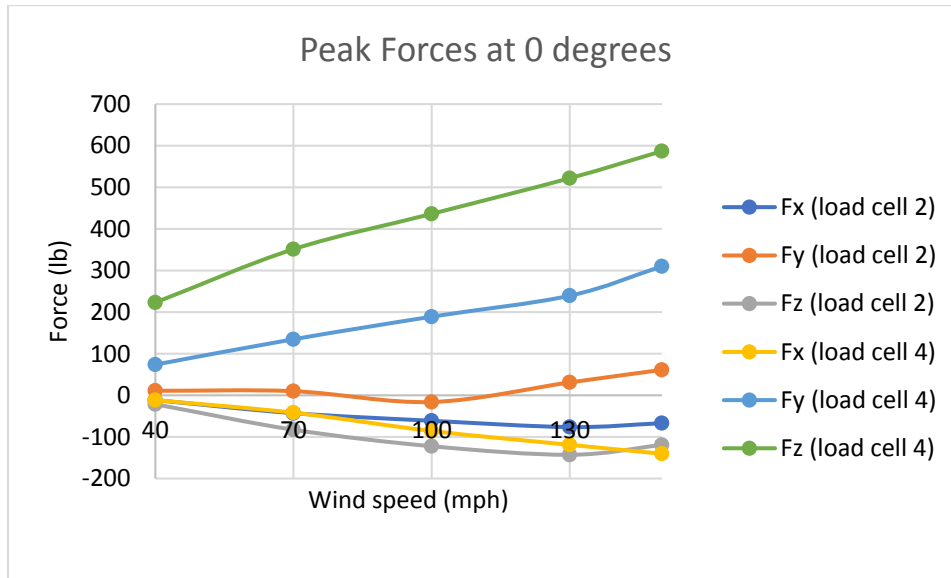

Figure 125: Peak Forces on loadcells 2 (catenary wire) and 4 (messenger wire) at 0 degrees wind direction

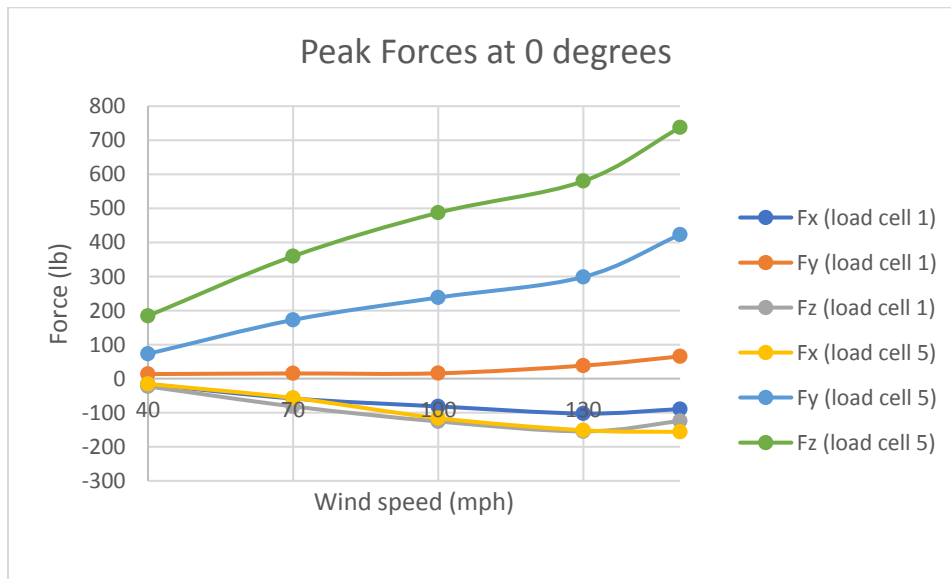
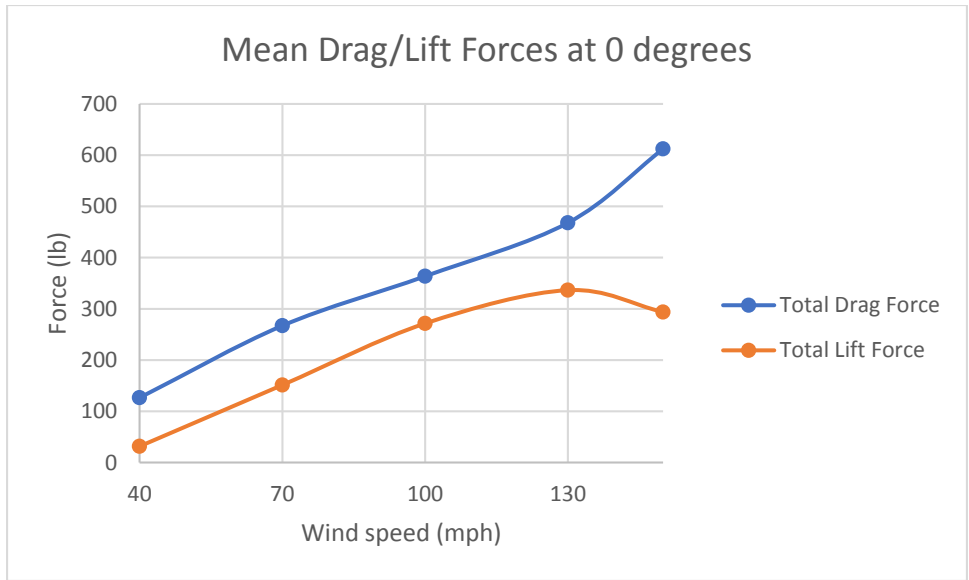
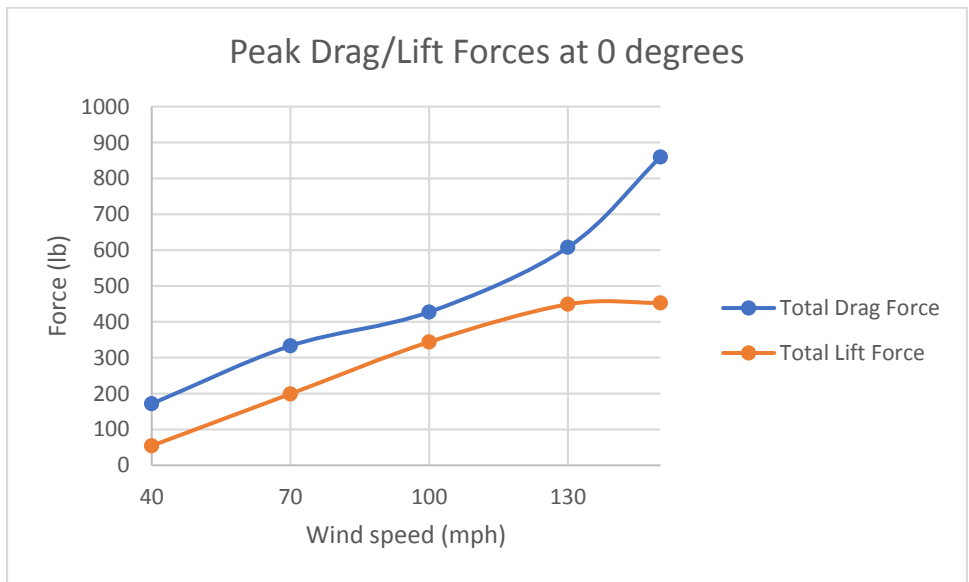

Figure 126: Peak Forces on loadcells 1 (catenary wire) and 5 (messenger wire) at 0 degrees wind direction



a)



b)

Figure 127: Drag (F_y) and lift (F_x) forces on the traffic signal at 0 degrees: a) Mean; b) Peak

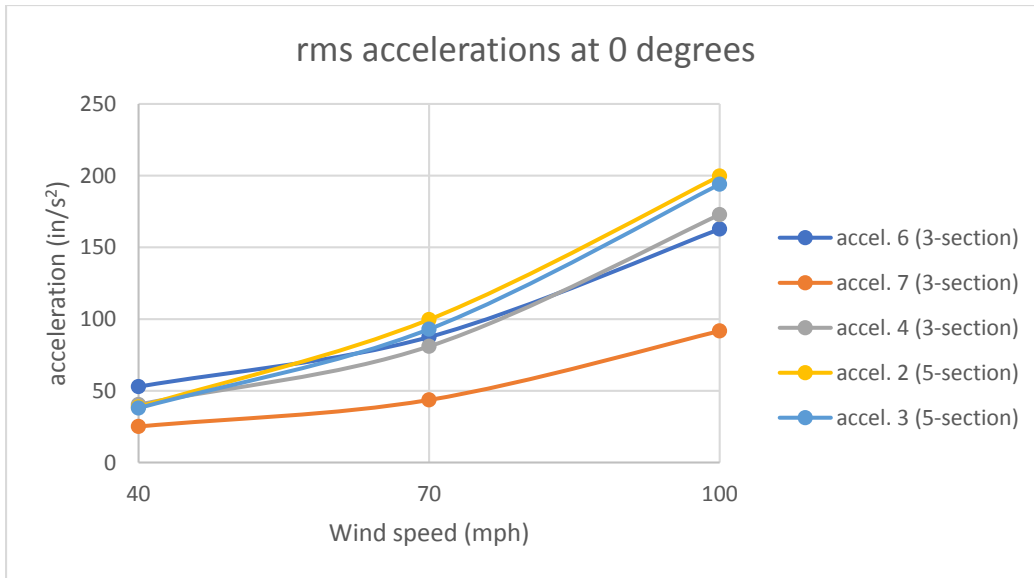

Figure 128: rms of accelerations on the 3-section and 5-section signals at 0 degrees

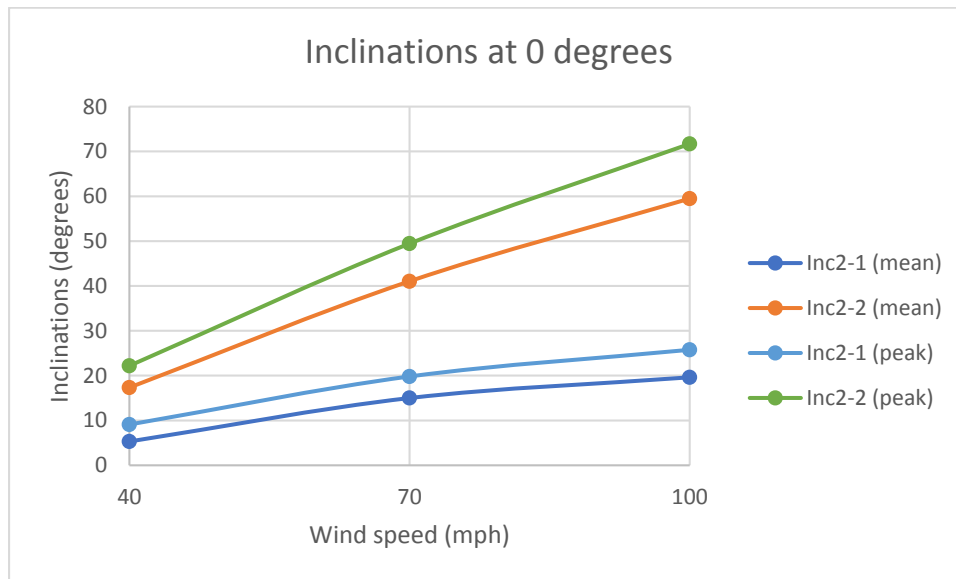

Figure 129: Inclinations (mean and max) obtained at 0 degrees for inclinometer 2

9.4 Performance of traffic signals during the tests

This test utilized two 3-section and one 5-section aluminum traffic signals installed in a test rig span-wire configuration connected to the catenary and messenger wires by means of an **“Adjustable Hanger Assembly with 1-inch Cable Dampener and Reinforced Disconnect Hanger with Aluminum Housing”** (vendor: Pelco Products).

Starting the test at 40 mph and progressing to 70 mph there were no major observations other than minor inclinations. When reaching 100 mph and at 100 degrees, the 5-section signal shows rotation from the top-signal to disconnect-box point. At this same speed, the top visor from the 5-section signal showed damage. Accelerometers, inclinometers and inertia sensors were removed at the end of 100 mph test.

At 130 mph and 80 degrees, the 5-section signal showed erratic motion causing the signal assembly to hit the messenger cable and damage the backplates. At this speed and 100 degrees, a visor from 5-section signal was damaged. At 150 mph the visors from the 3-section signals and 5-section signal were detached and were blown away. At 80 degrees, the 5-section signal showed erratic movement causing the entire assembly to undergo excessive inclinations. This behavior caused the 5-section signal to rotate from the top-signal to 4-bottom-signals connection, as shown in Figure 133. At 135 degrees, the 5-section signal detached and was blown away, as shown in Figure 130. At that moment, the two 3-section signals showed a subtle galloping movement.

After the test, it was found that the 5-section signal disconnect box had become detached due to a failure at the adjustable hanger to disconnect-box connection point and that the serrated teeth of the disconnect box were damaged, as shown in Figure 131 and Figure 132.



Figure 130: Signal assembly after test



Figure 131: Adjustable hanger to disconnect box connection failure (5-section assembly)



Figure 132: 5-Section signal disconnect box with damaged serrated teeth

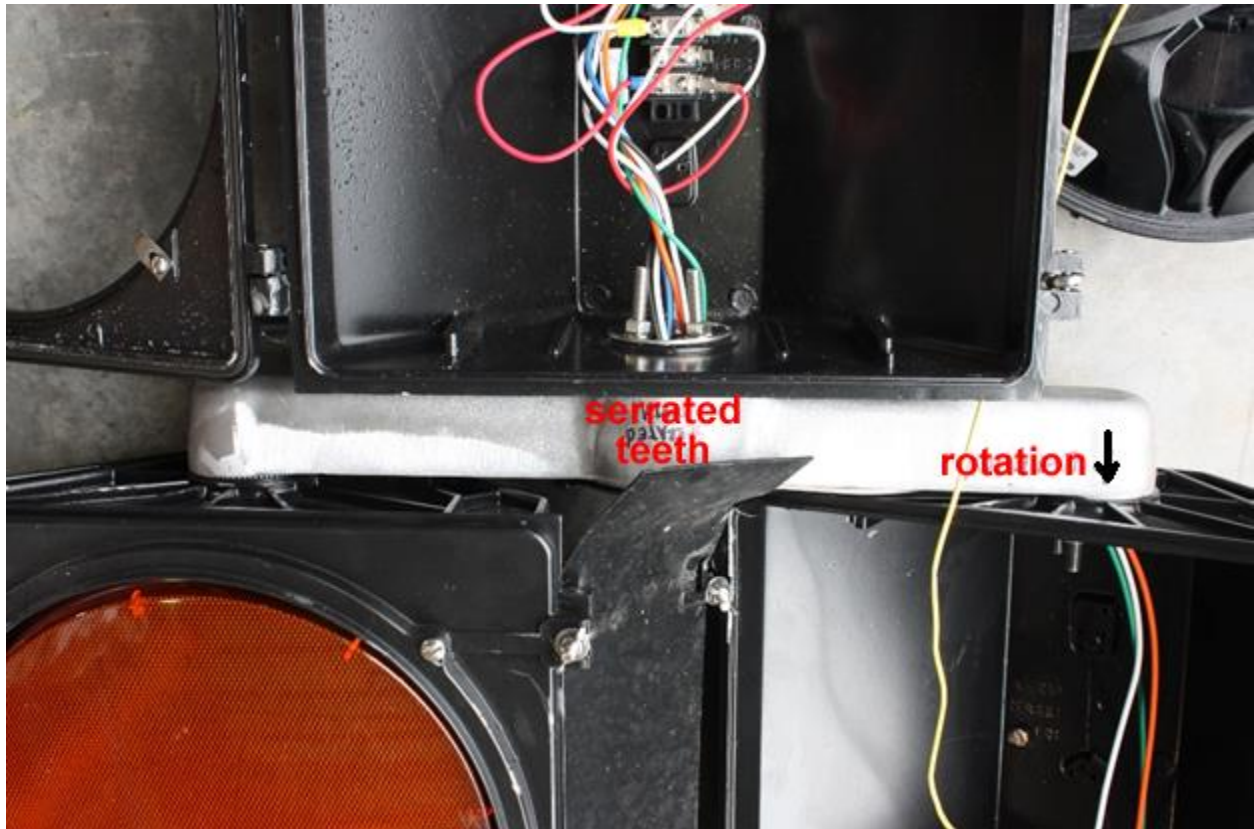

*Figure 133: 5-Section signal with damaged serrated teeth and rotation of bottom signals
(picture inverted)*

9.5 Conclusions

This chapter summarizes the results of a test conducted at WOW at FIU for a span wire traffic signal assembly consisting of two 3-section and a 5-section traffic signal, connected using a **“Adjustable Hanger Assembly with 1-inch Cable Dampener and Reinforced Disconnect Hanger with Aluminum Housing”** (vendor: Pelco Products). The various instruments used for this test included: loadcells to measure forces, accelerometers to measure accelerations and inclinometers to measure the inclinations.

The signal assembly showed no damage during the 40 mph and 70 mph. When wind speed was increased to 100 mph and the traffic signal assembly was exposed to different wind angles, visors and backplates started to detach. At this speed and 100 degrees, the 5-section signal showed erratic motion that caused rotation from the disconnect-box to signal connection, which returned to its original place when exposed to 180 degrees wind angle of attack. It needs to be noted that before starting the next wind speed test (130 mph), the disconnect-box to signal connection point was retightened.

At 130 mph and 80 degrees, the 5-section signal showed erratic motion that caused the entire assembly to experience excessive inclinations but no rotation of disconnect-box to hanger nor rotation of disconnect-box to signal connection was seen.

Considerable failure was observed during 150 mph test and 100 degrees, where the 5-section signal showed rotation of the top-signal to 4-bottom-signals connection. At 135 degrees, the 5-section signal detached and was blown away when the hanger to disconnect-box connection failed and the remaining two 3-section signals started to gallop. The remaining two 3-section signals showed bent backplates and no visors left.

Chapter 10 - Task 2: SHORT SPAN LENGTH FULL SCALE TESTING - Case 4

“Adjustable Hanger Assembly with Gusset Tube and Reinforced Disconnect Hanger with Aluminum Housing” - Test Date: 04/12/2017

10.1 Introduction

More recent studies involving the FDOT and WOW Research Facility at FIU were able to identify a ‘base’ configuration consisting of a 21.9 ft long section with two 3-section and one 5-section traffic signals (companion project BDV29 TWO 977-20). As a continuation of the study, FDOT tested the span wire traffic signal configurations connected to the catenary and messenger wires via an **“Adjustable Hanger Assembly with Gusset Tube and Reinforced Disconnect Hanger with Aluminum Housing”** (vendor: Pelco Products). The tests were carried out at wind directions ranging from 0 to 180 degrees and wind speeds ranging from 40 to 150 mph. The instruments consisted of loadcells to measure forces, accelerometers to measure accelerations, and inclinometers to measure the inclinations of the traffic signals.

This chapter presents the results from the tests conducted on the traffic signal assembly with the **“Adjustable Hanger Assembly with Gusset Tube and Reinforced Disconnect Hanger with Aluminum Housing”** (vendor: Pelco Products) at the WOW. Additional results are presented in appendix B.

10.2 Experimental Methodology

10.2.1 Test Setup

The 3-3-5 signal assembly was installed on a reinforced short-span rig (described in chapter 1) by means of a **“Adjustable Hanger Assembly with Gusset Tube and Reinforced Disconnect Hanger with Aluminum Housing”** (vendor: Pelco Products). Figure 134 to Figure 136 show the traffic signal assembly as well as a close-up of the hanger. The bottom of all signals were at approximately 4.5 ft above the concrete floor. All the signals were made of aluminum and included aluminum louvered backplates and visors.

The test protocol is presented in Table 17. The tests were performed from 40 to 150 mph at various angles ranging from 0 to 180 degrees. The different components utilized for this particular test are shown in Table 18.

10.2.2 Instrumentation

The directions of the x, y and z components for each loadcell are shown in Figure 137. Loadcells number 4 and 5 were located at either end of the messenger cable and loadcells number 1 and 2 located at either end of the catenary cable.

Tri-axial accelerometers were installed in the traffic signals to measure accelerations. There was one accelerometer placed on the center top of the signal, Accel5, another placed on the bottom right side, Accel002, and a third placed on the bottom left side, Accel003 for the 5-section signal as shown in Figure 138. Accelerometer Accel007, was installed on the top center, accelerometer Accel004, was installed on the bottom left side and accelerometer Accel006, was installed on the bottom right side of the 3-section signal as shown in Figure 139.

Inclinometers were also installed on each signal to measure the inclination of the signals during wind exposure. The inclinometers measured inclination in two directions, one relative to an axis parallel to the wind direction and another relative to an axis perpendicular to the wind direction. There were inclinometers installed on the top center of the signal, Inc4, and another on the bottom center of the signal, Inc3, for the 5-section signal as shown in Figure 138. Inclinometer, Inc2, was installed on the top center and inclinometer, Inc1, was installed on the bottom center of the of the 3-section signal as shown Figure 139.

10.2.3 Test Method

The test set up was first tested for 'zero wind' conditions, and the values of the various 'quantities' (forces, accelerations and inclinations) obtained were later deducted from quantities obtained for different wind speeds (also known as "zero drift removal" process).

Table 17: Test protocol (Task 2: Case 4)

| Wind Speed (mph) | Wind Direction (degrees) | Total Duration (min) |
|------------------|--------------------------|----------------------|
| 40 | 0, 45, 80, 100, 135, 180 | 3.1 |
| 70 | 0, 45, 80, 100, 135, 180 | 3.1 |
| 100 | 0, 45, 80, 100, 135, 180 | 3.1 |
| 130 | 0, 45, 80, 100, 135, 180 | 3.1 |
| 150 | 0, 45, 80, 100, 135, 180 | 3.1 |
| | TOTAL | 15.5 |

Table 18: Signal assembly components (Task 2: Case 4)

| Standard Part | Manufacturer |
|---|---------------------------|
| Span wire clamp | Pelco |
| Adjustable hanger | Pelco |
| Extension bar | Pelco |
| Messenger clamp | Pelco |
| Disconnect Hanger | Pelco |
| Signal Assembly | McCain |
| Backplate | TCS |
| Visor | McCain |
| LED Modules | GE - Dialight - Duralight |
| Non-standard Part | |
| Gusseted tube | Pelco |
| Bracket connecting gusseted tube to tri-stud hanger | Pelco |



Figure 134: Test rig



Figure 135: Signal assemblies installed on test rig (before testing)



a)



b)

Figure 136: a) Signal setup for the test; b) Magnified view of the connection

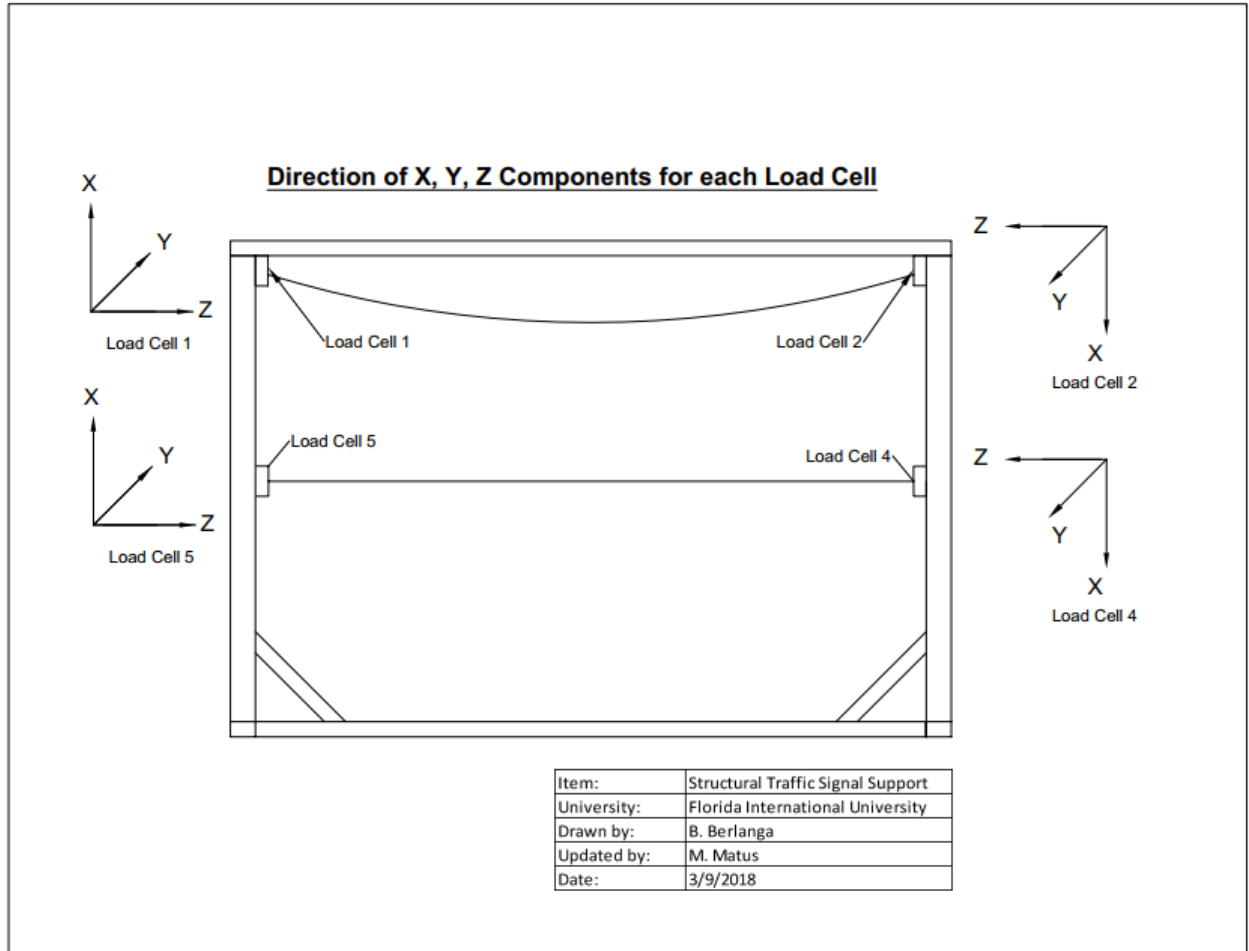

Figure 137: Direction of x,y,z components for each loadcell (direction of each axis shown represents 'positive direction')

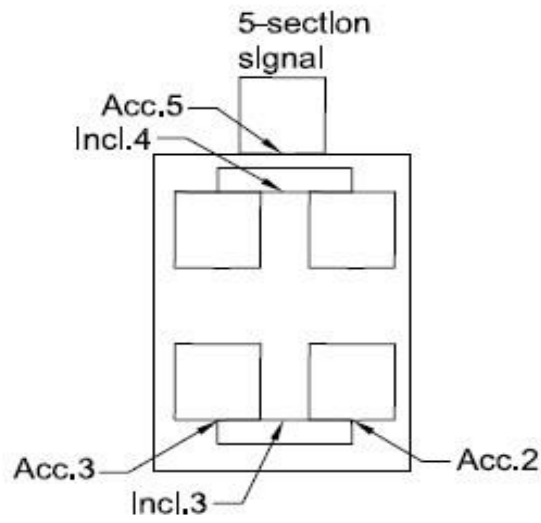

Figure 138: Location of accelerometers and inclinometers in 5-section signal

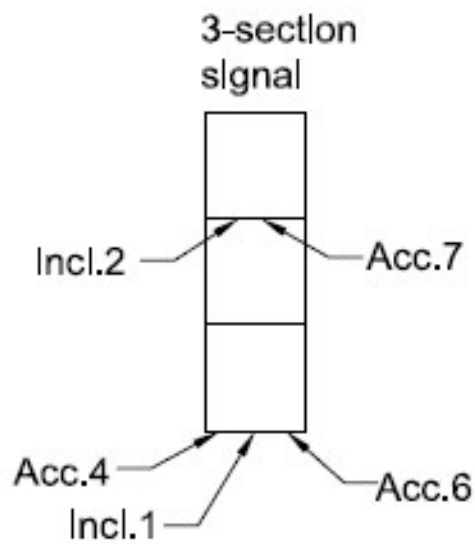

Figure 139: Location of accelerometers and inclinometers in 3-section signal

10.3 Results and Discussion

The tests at the WOW were performed in the presence of the representatives from the Florida Department of Transportation (FDOT) Traffic Engineering and Operations Office and Traffic Engineering Research Lab (TERL), representatives from Pelco Products, installation technicians from Horsepower Electric Inc. and members of the WOW technical team. The results in this chapter are restricted to 0-degree wind direction, with results for additional wind directions presented in appendix B.

10.3.1 Wind induced forces

The directions of the forces are shown in Figure 137. The mean and peak forces obtained at various wind speeds are discussed in this section. Figure 140 presents the wind induced mean forces on loadcell 2 (catenary wire) and loadcell 4 (messenger wire) at 0 degrees wind direction, for increasing wind speeds. It may be noted that the 'y' and 'z' components of the forces correspond to the 'drag' and 'cable tensions' respectively, while the 'x' component represents the uplift forces.

Data show that the along wind forces (F_y) increased with increasing wind speed at loadcell 4 (messenger wire), while F_y at loadcell 2 (catenary wire) experienced minimal change with increasing wind speeds. The highest along wind force of 320 lbs was found at loadcell 4 at 150 mph. Similarly, the tension on loadcell 4 (F_z) increased in magnitude from 163 lbs at 40 mph to 690 lbs at 150 mph. This shows that the messenger wire experienced higher tension and drag than the catenary wire for increasing wind speeds. The uplift forces (F_x) on loadcell 4 (messenger wire) increased in magnitude with increasing wind speed. However negligible change in F_x on loadcell 2 (catenary wire) with increasing wind speed was observed.

Similar observations were made for loadcell 5 (messenger wire) and loadcell 1 (catenary wire) as shown in Figure 141. For instance, F_z (cable tension) and F_y (drag) increased with increasing wind speed on loadcell 5 (messenger wire). F_x on loadcell 4 also increased.

The peak forces at 0 degrees wind direction for loadcell 2 (catenary wire) and loadcell 4 (messenger wire) are shown in Figure 142. The peak forces of F_y and F_z increased with increasing wind speeds. The magnitudes of the peaks on loadcell 2 increased marginally for F_x with

increasing wind speeds. Figure 143 presents peak results for loadcell 5 (messenger wire) and loadcell 1 (catenary wire). F_z (cable tensions) on loadcells 1 and 5 increased with increasing wind speeds – highest values of 966 lbs on loadcell 5 and 151 lbs on loadcell 1 at wind speed of 150 mph was observed.

The peaks of F_y (drag) on loadcell 5 increased gradually with higher wind speeds, although the magnitudes of the peaks at loadcell 1 did not change markedly for a change in wind speed. Peak of F_x (lift) on loadcell 5 (messenger) and loadcell 1 (catenary) did not change significantly despite a change in wind speed. Results for additional wind directions are presented in appendix B. Figure 144 (a) presents the ‘total’ mean drag and lift forces on the traffic signals. Results show that the drag on the traffic signals increased with an increase in wind speed – highest values of 770 lbs was obtained at 150 mph at 0 degrees wind direction. The peak drag and lift are shown in Figure 144 (b). The peak lift also increased with an increase in wind speed and attains a maximum value of 868 lbs. The peak drag increased with increasing wind speeds and reached its highest value of 859 lbs at 150 mph.

It needs to be noted that the sign convention of the x component of all loadcells was configured so that the weight of the signals (downward force) is a positive reading while a lift force pushing the signals up (upward force) is a negative reading. With the sign convention, it can be seen that the lift forces increased as wind speed increased.

10.3.2 rms of accelerations

The root mean square (rms) of accelerations are presented in Figure 145. Accelerometers 4, 6 and 7 were located on the 3-section signal, while accelerometers 2, 3 and 5 were located on the 5-section signal (see Figure 138 and Figure 139). Overall, the rms of accelerations obtained from all the accelerometers increased from wind speed of 40 mph to 100 mph. After 100 mph, instruments were removed to prevent damage to instruments.

10.3.3 Inclinations of the traffic signals

Figure 146 shows the inclinations (mean and peak) obtained from inclinometer 2. It may be noted that for inclinometer 2, ‘2-1’ refers to the component of inclination in the direction of the wind, while ‘2-2’ refers to the component of inclination perpendicular to the direction of wind.

For inclinometer 2, the mean components '2-1' were in the range of 13 to 48 degrees for 40-100 mph wind speed range. Beyond 100 mph, inclinometers were removed to avoid damages due to failure.

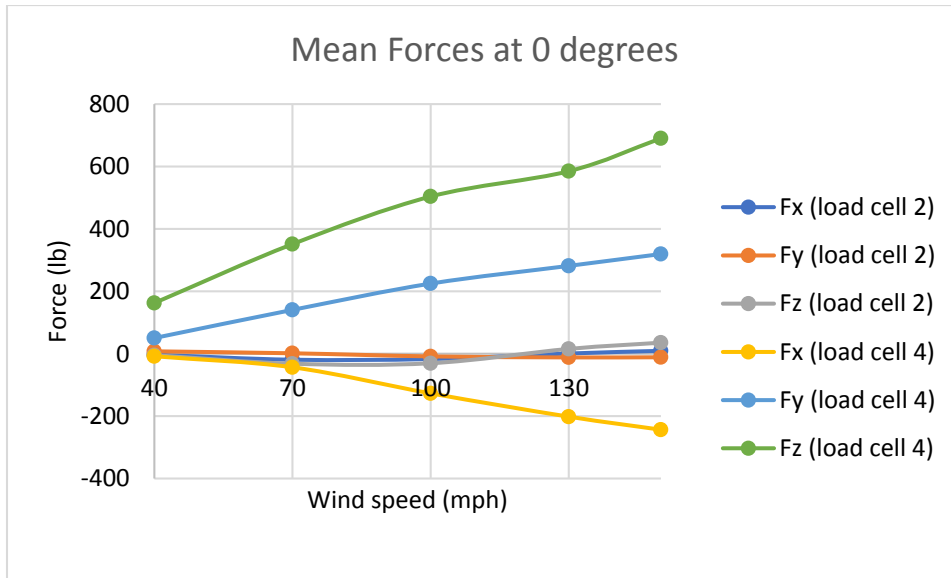

Figure 140: Mean forces on loadcells 2 (catenary wire) and 4 (messenger wire) at 0 degrees wind direction

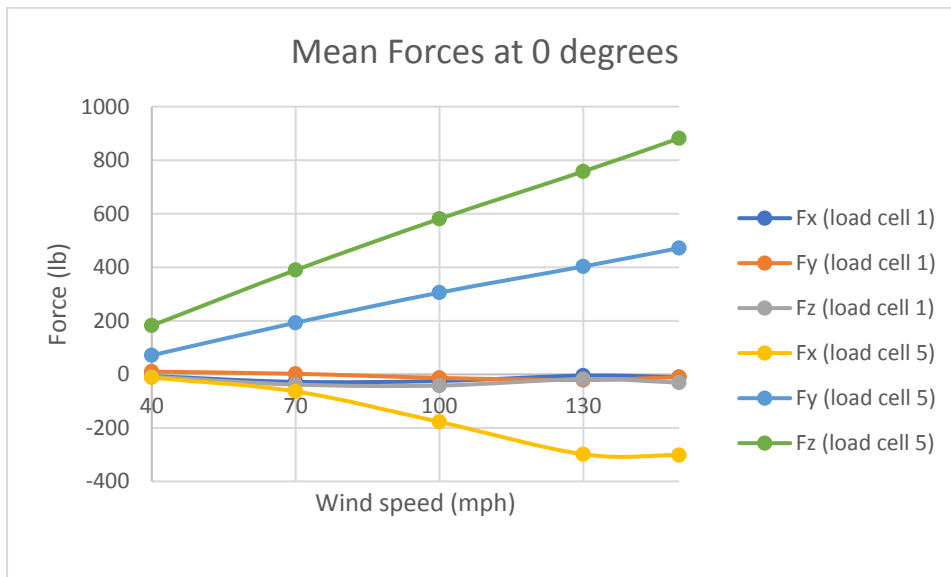

Figure 141: Mean forces on loadcells 1 (catenary wire) and 5 (messenger wire) at 0 degrees wind direction

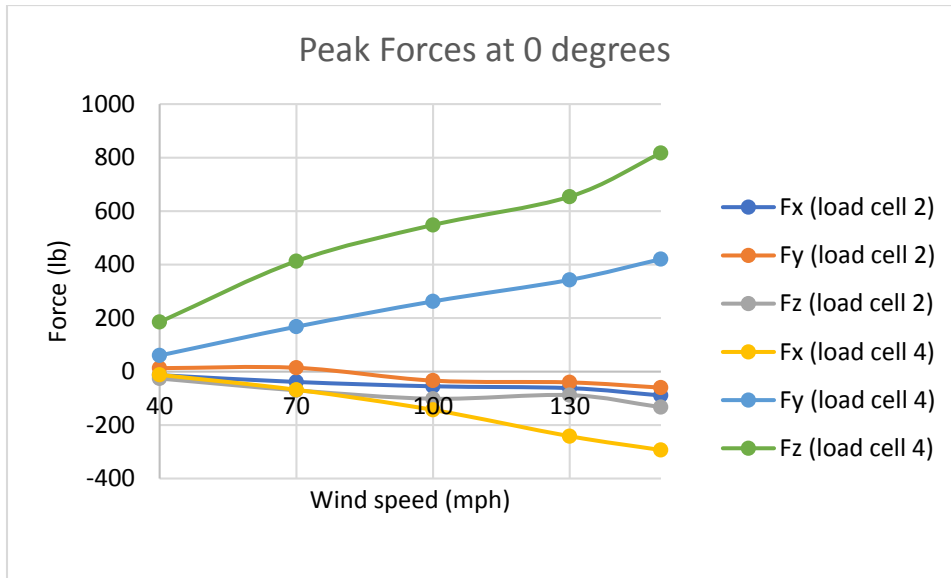

Figure 142: Peak forces on loadcells 2 (catenary wire) and 4 (messenger wire) at 0 degrees wind direction

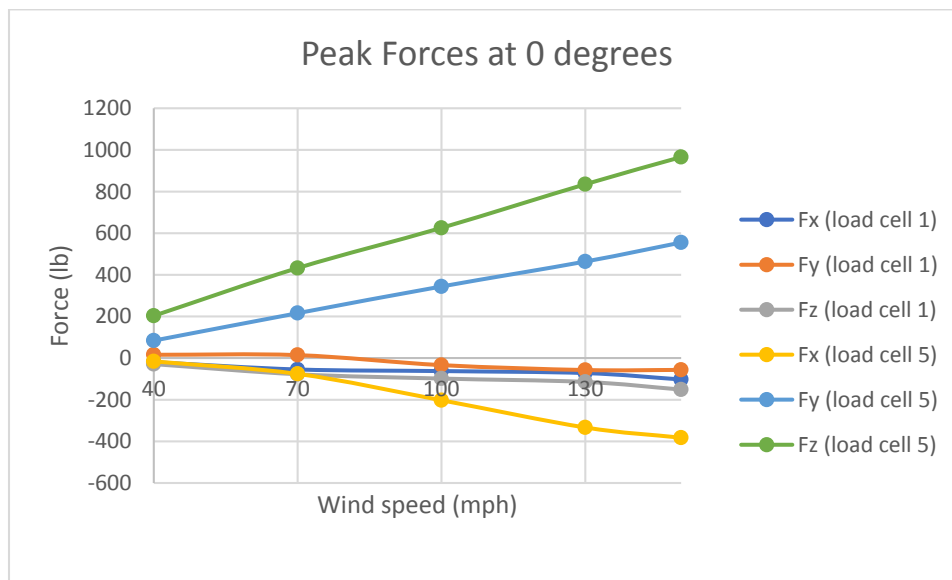
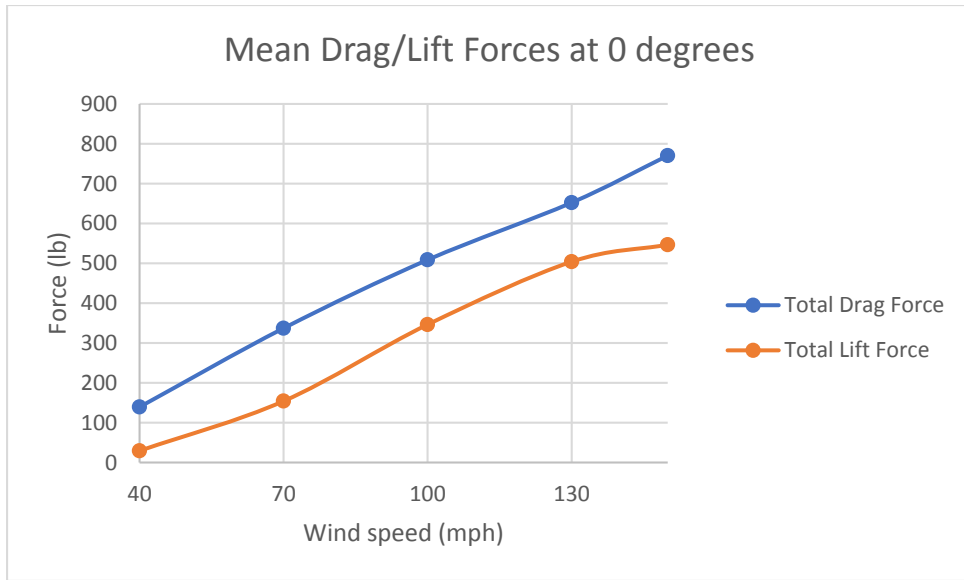
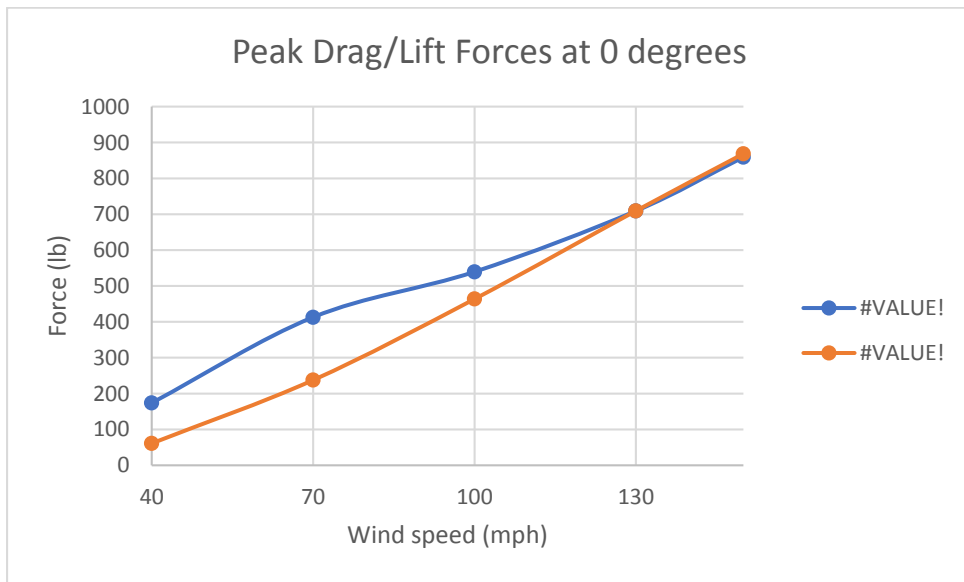

Figure 143: Peak forces on loadcells 1 (catenary wire) and 5 (messenger wire) at 0 degrees wind direction



a)



b)

Figure 144: Drag (F_y) and lift (F_x) forces on the traffic signal at 0 degrees: a) Mean; b) Peak

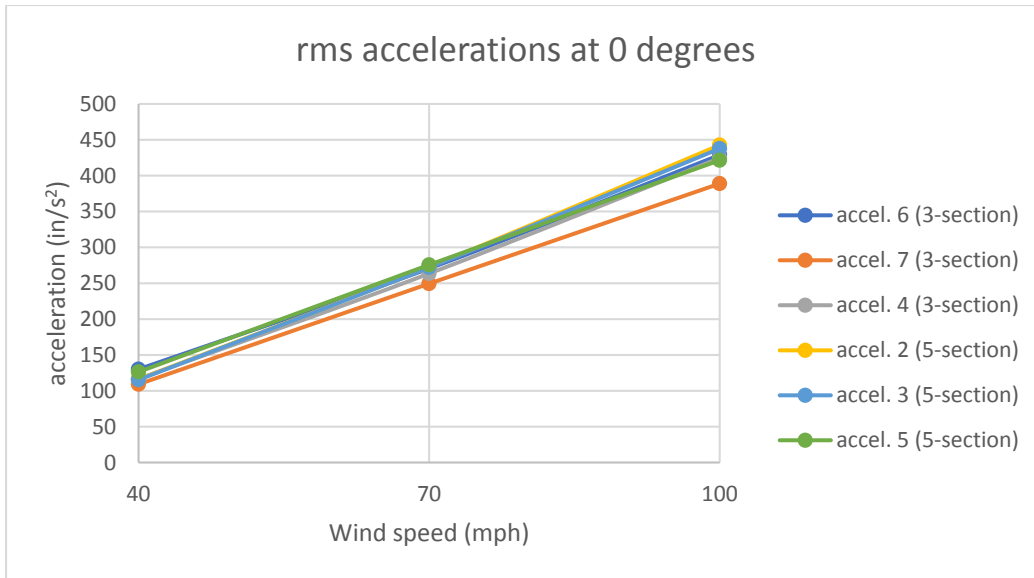

Figure 145: rms of accelerations on the 3-section and 5-section signals at 0 degrees

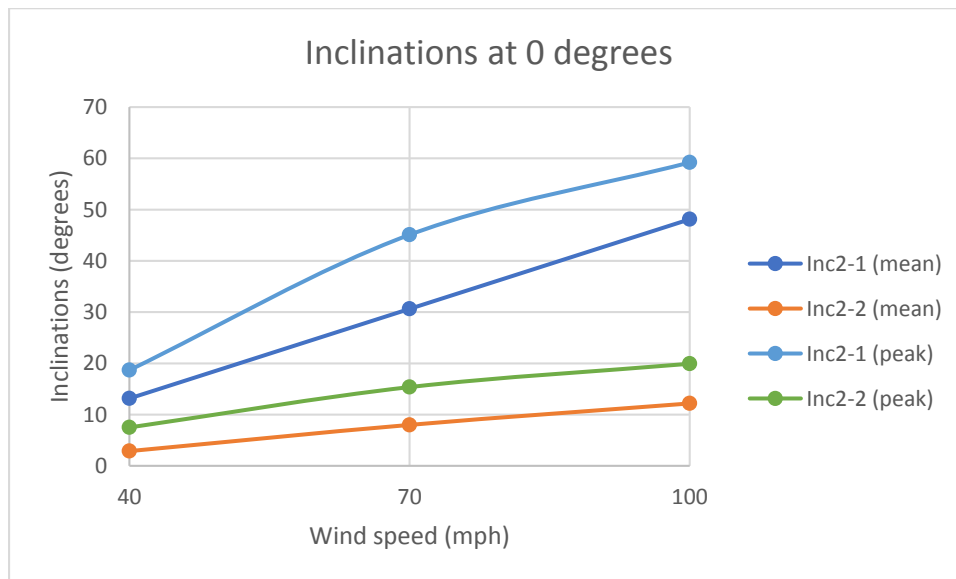

Figure 146: Inclinations (mean and max) obtained at 0 degrees for inclinometer 2

10.4 Performance of traffic signals during the tests

This test utilized two 3-section and one 5-section aluminum traffic signals installed in a test rig span-wire configuration connected to the catenary and messenger wires by means of an **“Adjustable Hanger Assembly with Gusset Tube and Reinforced Disconnect Hanger with Aluminum Housing”** (vendor: Pelco Products).

Starting the test at 40 mph and progressing to 70 mph there were no major observations other than minor inclinations.

When reaching 100 mph and 45 degrees, the center 3-section signal showed a rotational vibration. When changing from wind angle of 80 to 100 degrees, the 5-section signal showed rotation from the hanger to disconnect-box connection, as shown in Figure 147. Accelerometers, inclinometers and inertia sensors were removed at the end of 100 mph test.

At 130 mph and 45 degrees, the signal assemblies showed a rotational vibration. At 80 degrees, the 5-section signal showed erratic motion. Backplates and visors detached and were blow away from east 3-section signal and 5-section signal.

Reaching 150 mph visors from the 3-sections and 5-section signals detached and were blown away. At 80 degrees, the 5-section signal showed erratic movement causing the 5-section signal to rotate from the top-signal to 4-bottom-signals connection, as shown in Figure 148. After the test was finished, it was found that the hold down bar of the 5-section signal disconnect box broke, as shown in Figure 149, and a support bracket from the gusseted tube to tri-stud hanger support broke, as shown in Figure 150.

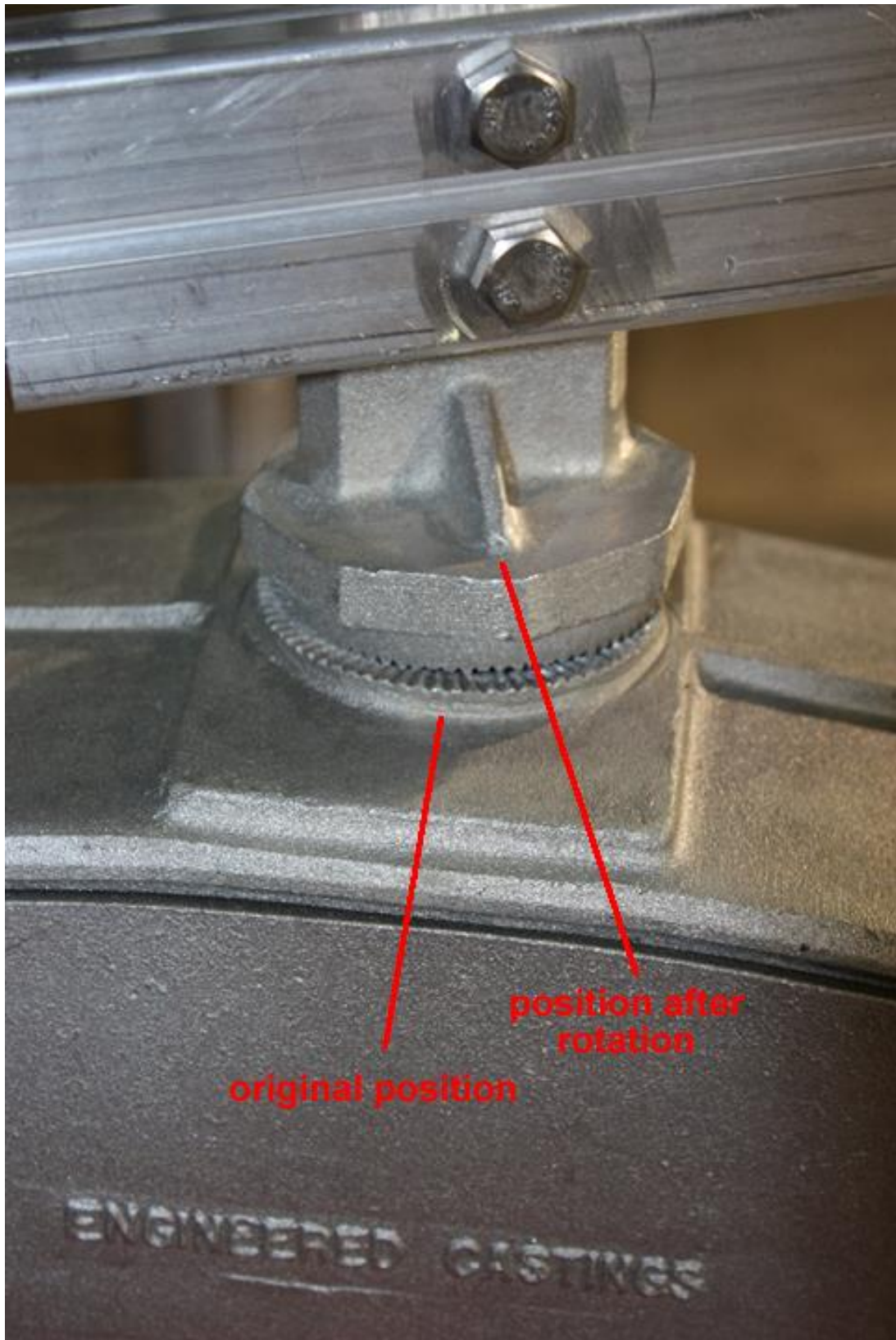

Figure 147: Sheared teeth from hanger to disconnect-box connection

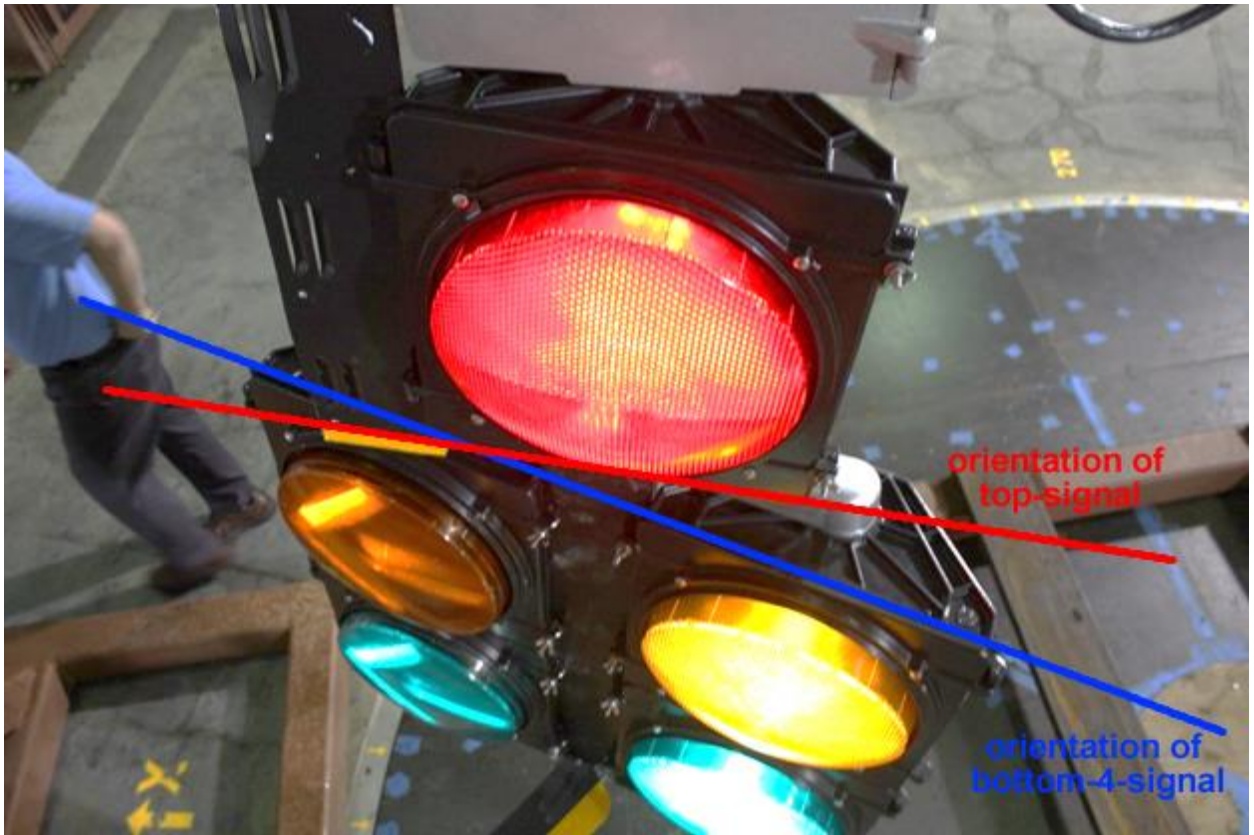

Figure 148: 5-section signal rotation from top-signal to bottom-4-signal connection

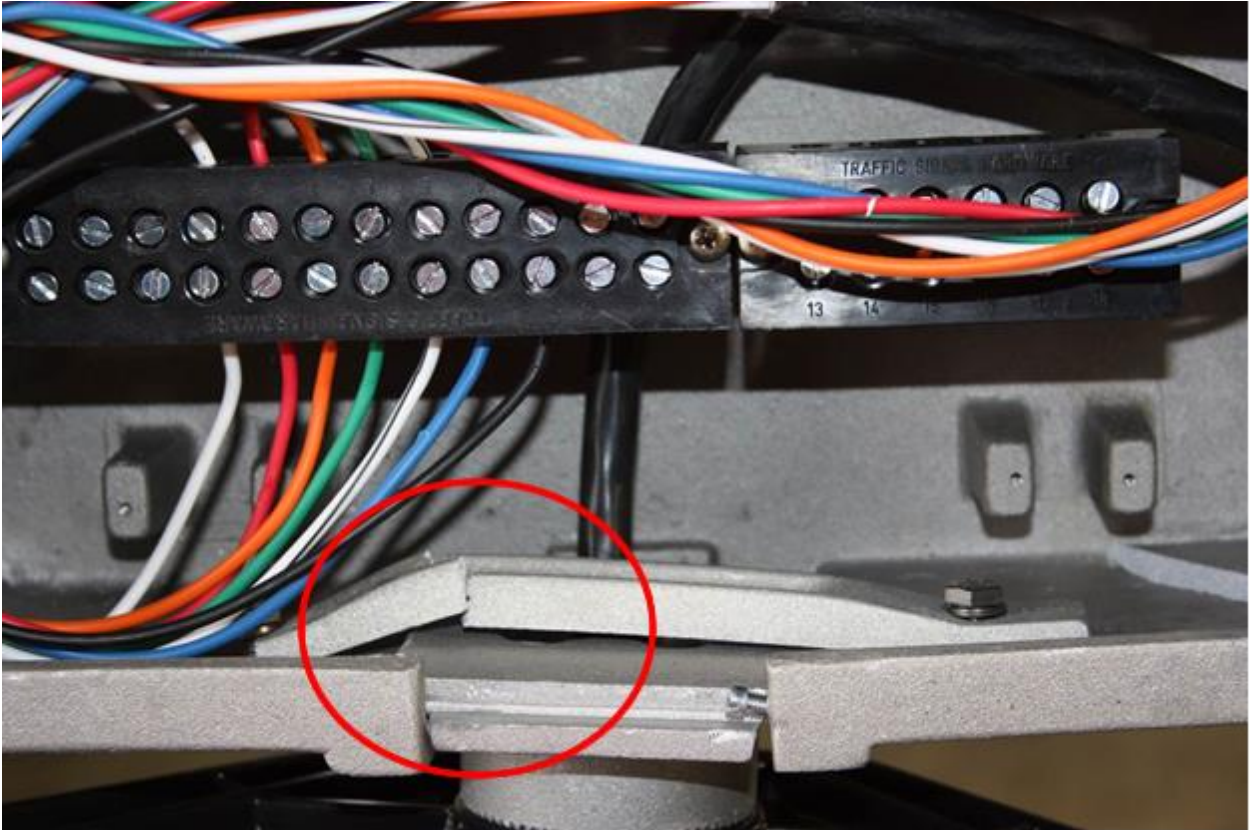

Figure 149: 5-section signal broken hold down bar

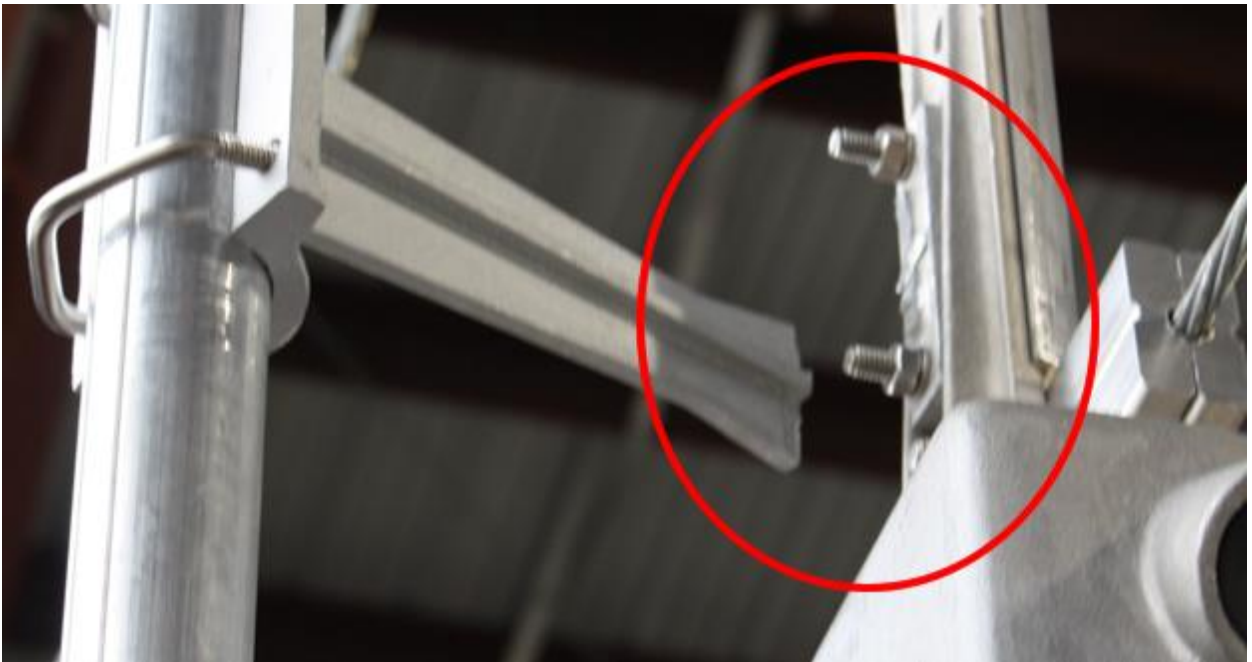

Figure 150: 5-section signal gusseted tube to tri-stud hanger broken bracket

10.5 Conclusions

This chapter summarizes the results of a test conducted at WOW at FIU for a span wire traffic signal assembly consisting of two 3-section and a 5-section traffic signal, connected using a **“Adjustable Hanger Assembly with Gusset Tube and Reinforced Disconnect Hanger with Aluminum Housing”** (vendor: Pelco Products). The various instruments used for this test included: loadcells to measure forces, accelerometers to measure accelerations and inclinometers to measure the inclinations.

The signal assembly showed no damage during the 40 mph and 70 mph. When wind speed was increased to 100 mph and traffic signal assembly was exposed to different angles, visors and backplates started to detach and 5-section signal showed rotation from the disconnect-box to hanger connection. At 130 mph, no major damage was observed other than visors and backplates detaching and being blown away. After the 150-mph test, considerable damage was observed in the 5-section assembly, where the disconnect box hold down bar was cracked, the hanger to disconnect-box connection showed damaged serrated teeth which caused rotation of the signal and the gusset-tube to tri-stud hanger connection bracket was broken.

Chapter 11 - Task 2: SHORT SPAN LENGTH FULL SCALE TESTING - Case 5

“Adjustable Hanger Assembly with Louvered Backplates” - Test Date: 04/10/2017

11.1 Introduction

Recent studies involving the FDOT and WOW Research Facility at FIU were able to identify a ‘base’ configuration consisting of a 21.9 ft long section with two 3-section and one 5-section traffic signals (companion project BDV29 TWO 977-20). As a continuation of the study, FDOT tested the span wire traffic signal with one 3-section with louvered back plates, connected to the catenary and messenger wires via an **“Adjustable Hanger Assembly with louvered Backplates.”** The tests were carried out at wind directions ranging from 0 to 180 degrees and wind speeds ranging from 40 to 100 mph. The instruments consisted of loadcells to measure forces, accelerometers to measure accelerations, and inclinometers to measure the inclinations of the traffic signals.

This chapter presents the results from the tests conducted on the traffic signal assembly with the **“Adjustable Hanger Assembly with Louvered Backplates”** at the WOW. Additional results and a comparison on the performance of traffic signals with “louvered” and “non-louvered” backplates are presented in appendices C and D respectively.

11.2 Experimental Methodology

11.2.1 Test Setup

The 3-section signal assembly was installed on a reinforced short-span rig (described in chapter 1) by means of an **“Adjustable Hanger Assembly with Louvered backplates.”** Figure 151 to Figure 153 show the traffic signal assembly as well as a close-up of the hanger. The bottom of the signal was at approximately 4.5 ft above the concrete floor. The signal housing was made of aluminum and included aluminum louvered back plates and visors.

The test protocol is presented in Table 19. The tests were conducted for longer durations, with wind speeds being varied from 40 to 100 mph, for wind directions of 0-180 degrees. The different components utilized for this particular test are shown in Table 20.

11.2.2 Instrumentation

The directions of the x, y and z components for each loadcell are shown in Figure 154. Loadcells number 4 and 5 were located at either end of the messenger cable and loadcells number 1 and 2 located at either end of the catenary cable.

Tri-axial accelerometers were installed in the traffic signal to measure accelerations. Accelerometer Accel007, was installed on the top center, accelerometer Accel004, was installed on the bottom left side and accelerometer Accel006, was installed on the bottom right side of the 3-section signal as shown in Figure 155.

Inclinometers were also installed on each signal to measure the inclination of the signals during wind exposure. The inclinometers measured inclination in two directions, one relative to an axis parallel to the wind direction and another relative to an axis perpendicular to the wind direction. Inclinometer, Inc2, was installed on the top center and inclinometer, Inc1, was installed on the bottom center of the of the 3-section signal as shown Figure 155.

11.2.3 Test Method

The test set up was first tested for 'no wind' conditions and baselines for the various instruments were acquired (also known as "zero drift removal" process) before each test. The signal assembly was tested at wind speeds ranging from 40 to 100 mph at wind angles of attack ranging from 0 to 180 degrees, as shown in Table 19.

Table 19: Test protocol (Task 2: Case 5)

| Wind Speed (mph) | Wind Direction (degrees) | Total Duration (min) |
|------------------|--------------------------|----------------------|
| 40 | 0, 45, 80, 100, 135, 180 | 3.1 |
| 70 | 0, 45, 80, 100, 135, 180 | 3.1 |
| 100 | 0, 45, 80, 100, 135, 180 | 3.1 |
| | TOTAL | 9.3 |

Table 20: Signal assembly components (Task 2: Case 5)

| Standard Part | Manufacturer |
|-------------------|---------------------------|
| Span wire clamp | Pelco |
| Adjustable hanger | Pelco |
| Extension bar | Pelco |
| Messenger clamp | Pelco |
| Disconnect Hanger | Pelco |
| Signal Assembly | McCain |
| Backplate | TCS |
| Visor | McCain |
| LED Modules | GE - Dialight - Duralight |



Figure 151: Test rig

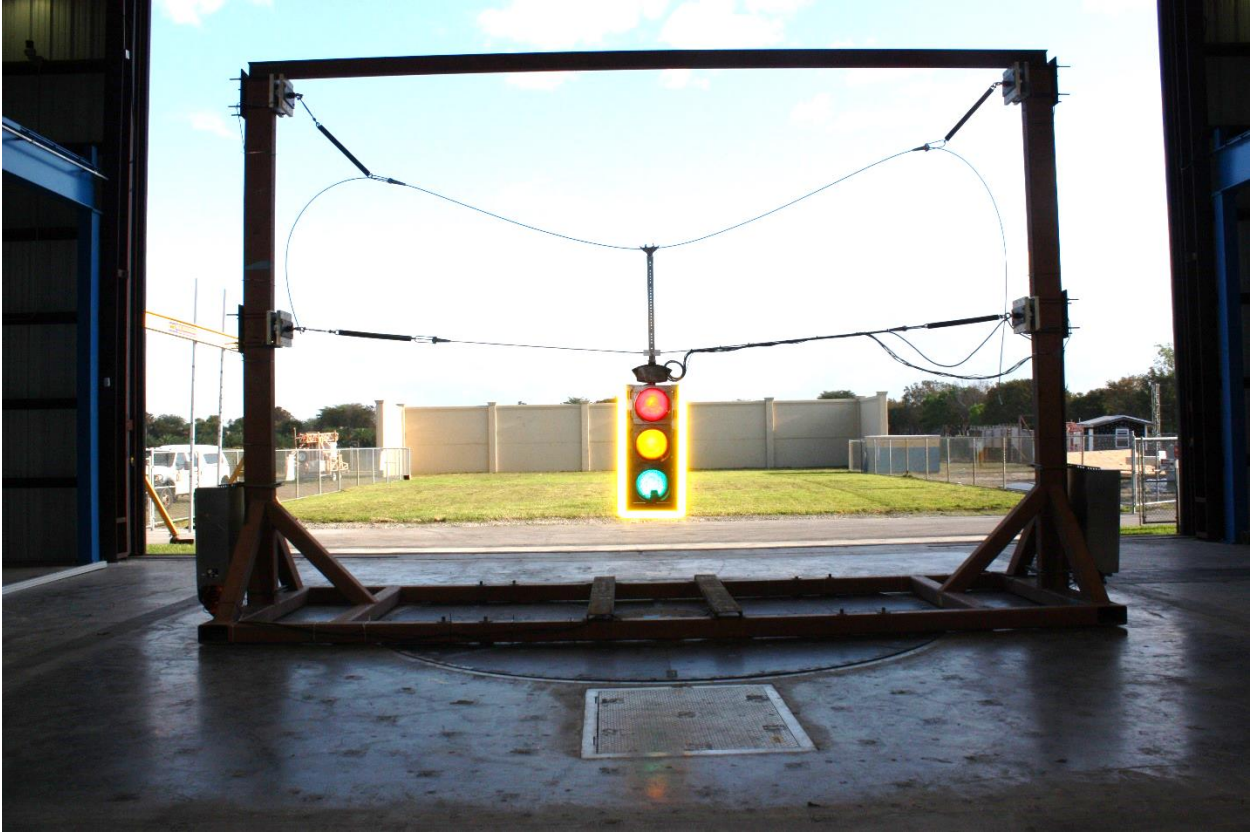

Figure 152: Signal assembly installed on test rig (before testing)



a)



b)

Figure 153: a) Signal Setup for the test; b) Magnified view of the connection

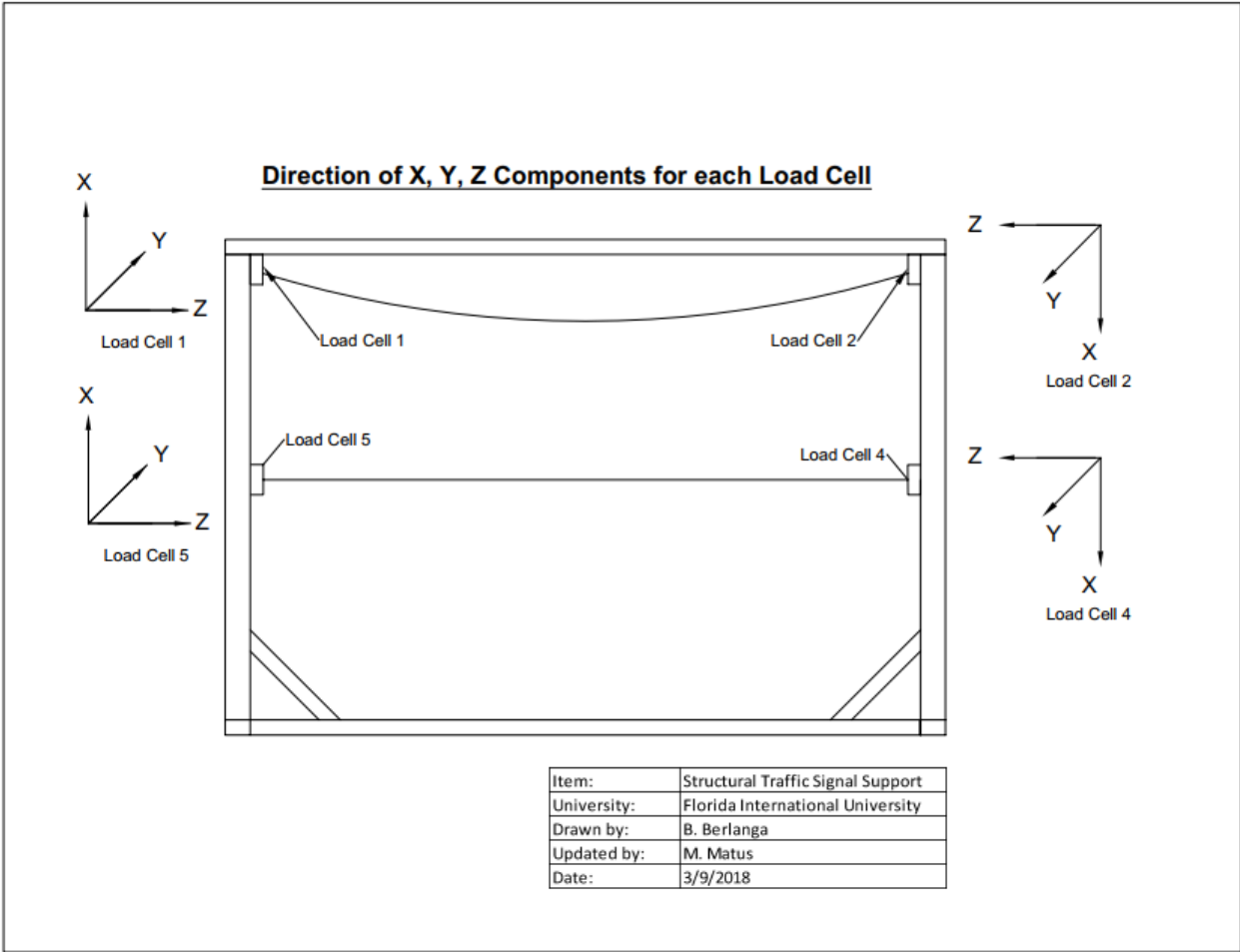

Figure 154: Direction of x,y,z components for each loadcell (direction of each axis shown represents 'positive direction')

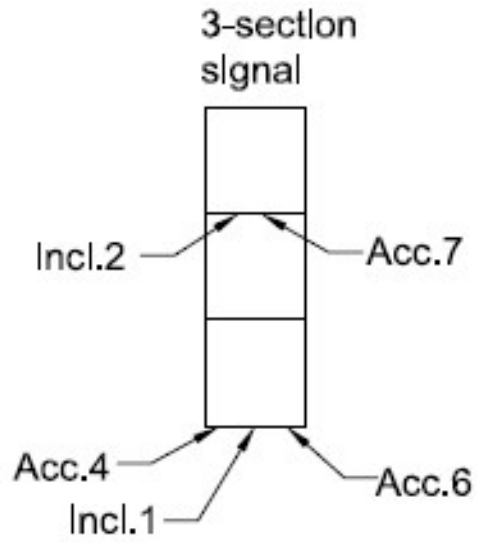

Figure 155: Location of accelerometers and inclinometers in 3-section signal

11.3 Results and Discussion

The tests at the WOW were performed in the presence of the representatives from the Florida Department of Transportation (FDOT) Traffic Engineering and Operations Office and Traffic Engineering Research Lab (TERL) and installation technicians from Horsepower Electric Inc. and members of the WOW technical team. The results in this chapter are restricted to 0-degree wind direction, with results for additional wind directions presented in appendix C.

11.3.1 Wind induced forces

The directions of the forces are shown in Figure 154. The mean and peak forces obtained at various wind speeds are discussed in this section. Figure 156 presents the wind induced mean forces on loadcell 2 (catenary wire) and loadcell 4 (messenger wire) at 0 degrees wind direction, for increasing wind speeds. It may be noted that the 'y' and 'z' components of the forces correspond to the 'drag' and 'cable tensions' respectively, while the 'x' component represents the uplift forces.

Data show that the along wind forces (F_y) increased with increasing wind speed at loadcell 4 (messenger wire), while F_y at loadcell 2 (catenary wire) experienced minimal change with increasing wind speeds. The highest along wind force of 64.7 lbs was found at loadcell 4 at 100 mph. Similarly, the tension on loadcell 4 (F_z) increases in magnitude from 199 lbs at 40 mph to 281 lbs at 100 mph. This shows that the messenger wire experienced higher tension and drag forces than the catenary wire for increasing wind speeds. The uplift forces (F_x) on loadcell 4 (messenger wire) increased in magnitude with increase in wind speed, where at 40 mph a mean lift force of about 25 lbs was observed and it increased in the negative range to -12 lbs. However negligible change in F_x on loadcell 2 (catenary wire) with increasing wind speed was observed. It needs to be noted that the sign convention of the x component of all loadcells was configured so that the weight of the signals gave a positive reading while a lift force pushing the signals up is a negative reading. With the sign convention, the trend of the lift forces of LC 2 and 4 increased in the negative range indicating that as wind speed was increased, the lift forces overcame the weight of the signals and the cable was pushed up resulting in increasing negative measures as wind speed was increased.

Similar observations were made for loadcell 5 (messenger wire) and loadcell 1 (catenary wire) as shown in Figure 157. For instance, Fz (cable tension) and Fy (drag) increased with increasing wind speed on loadcell 5 (messenger wire). Fx on loadcell 5 increased marginally.

The peak forces at 0 degrees wind direction for loadcell 2 (catenary wire) and loadcell 4 (messenger wire) are shown in Figure 158. The peak forces of Fy and Fz increased with increasing wind speeds. The magnitudes of the peaks on loadcell 2 increased marginally for Fx with increasing wind speeds. Figure 159 presents peak results for loadcell 5 (messenger wire) and loadcell 1 (catenary wire). Fz (cable tensions) on loadcells 1 and 5 increased with increasing wind speeds – highest values of 337 lbs on loadcell 5 and 33.6 lbs on loadcell 1 at wind speed of 100 mph was observed.

The peaks of Fy (drag) on loadcell 5 increased gradually with higher wind speeds, although the magnitudes of the peaks at loadcell 1 did not change markedly for a change in wind speed. Peak of Fx (lift) on loadcell 5 (messenger) and loadcell 1 (catenary) did not change significantly despite a change in wind speed. Results for additional wind directions are presented in appendix C. Figure 160 (a) presents the ‘total’ mean drag and lift forces on the traffic signals. Results show that the drag on the traffic signals increased with an increase in wind speed – highest value of 135 lbs was obtained at 100 mph at 0 degree wind direction. The peak drag and lift forces are shown in Figure 160 (b). The peak lift at 100 mph attained a value of 120 lbs. However, the peak drag increased initially with increasing wind speed, and attained the highest value of 301 lbs at 100 mph.

11.3.2 rms of accelerations

The root mean square (rms) of accelerations are presented in Figure 161. Accelerometers 4, 6 and 7 were located on the 3-section signal, as shown in Figure 155. Overall, the rms of accelerations obtained from all the accelerometers experienced an increase from wind speed of 40 mph to 100 mph.

11.3.3 Inclinations of the traffic signals

Figure 162 shows the inclinations (mean and peak) obtained from inclinometer 2. It may be noted that for inclinometer 2, ‘2-1’ refers to the component of inclination parallel to the wind,

while '2-2' refers to the component of inclination perpendicular to the direction of wind. For inclinometer 2, the mean components '2-1' are generally in the range of 23.7 to 63.4 degrees for 40-100 mph wind speed range.

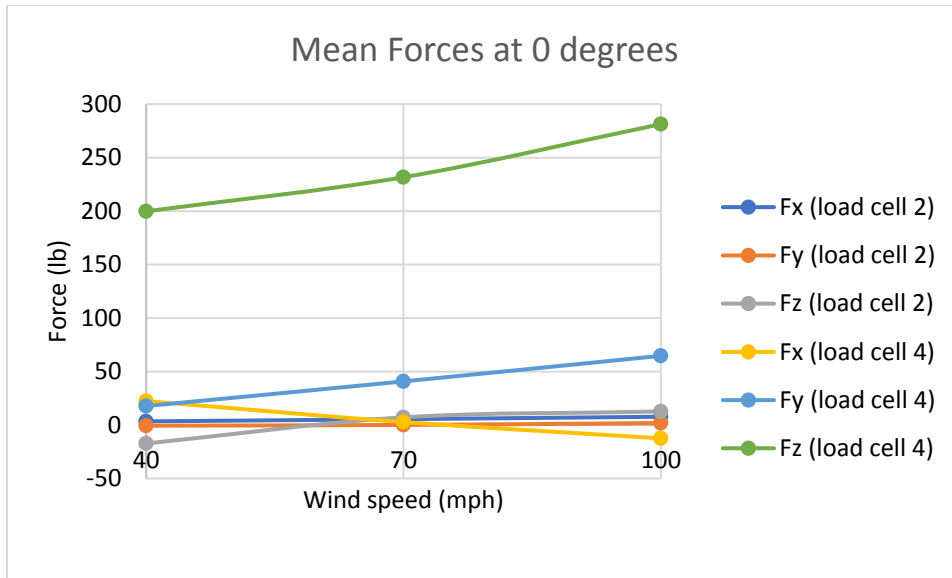

Figure 156: Mean Forces on loadcells 2 (catenary wire) and 4 (messenger wire) at 0 degrees wind direction

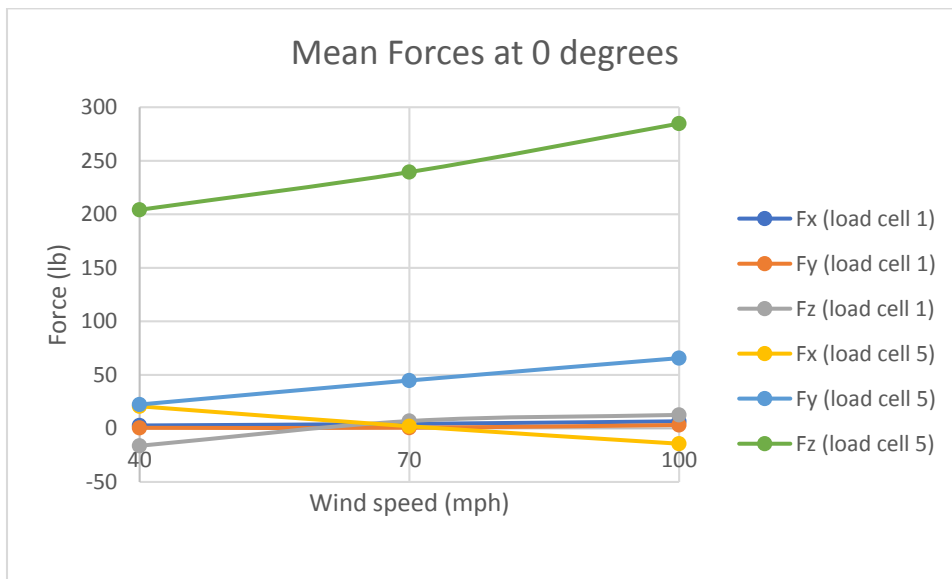

Figure 157: Mean Forces on loadcells 1 (catenary wire) and 5 (messenger wire) at 0 degrees wind direction

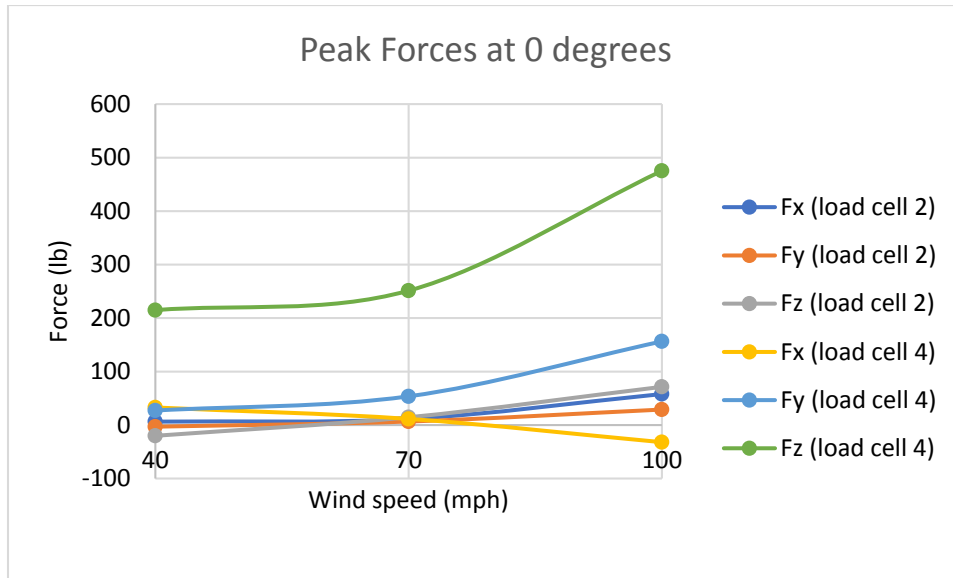

Figure 158: Peak Forces on loadcells 2 (catenary wire) and 4 (messenger wire) at 0 degrees wind direction

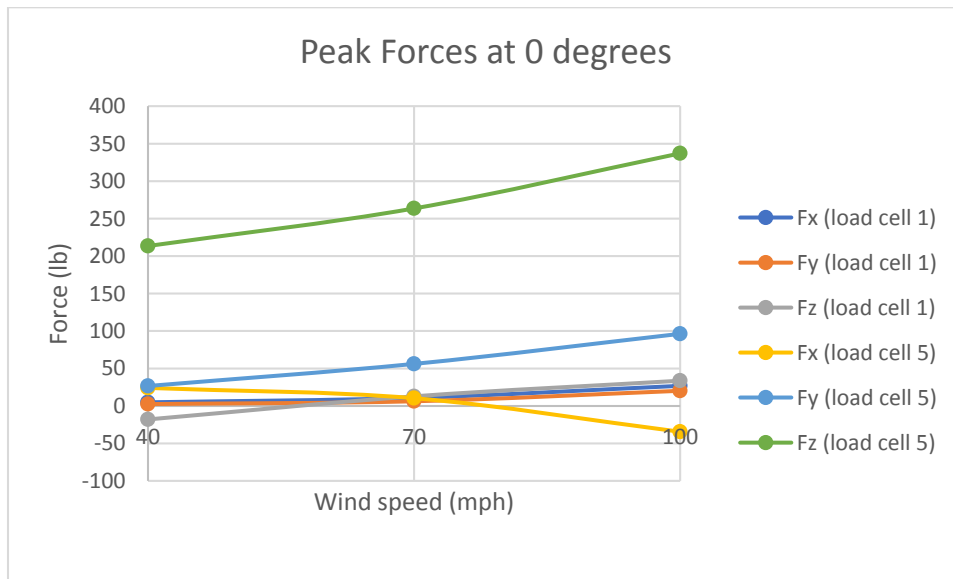
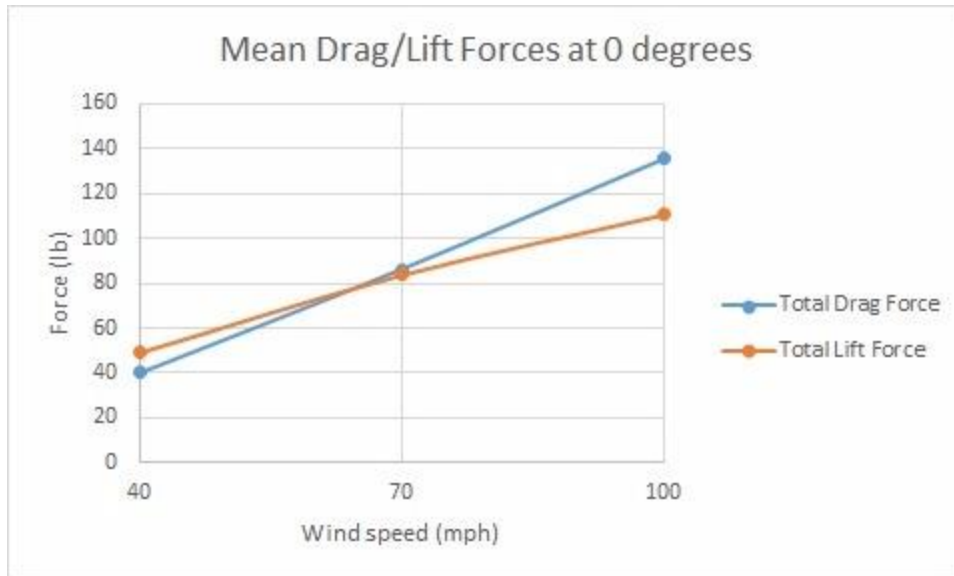

Figure 159: Peak Forces on loadcells 1 (catenary wire) and 5 (messenger wire) at 0 degrees wind direction



a)



b)

Figure 160: Drag (F_y) and lift (F_x) forces on the traffic signal at 0 degrees: a) Mean; b) Peak

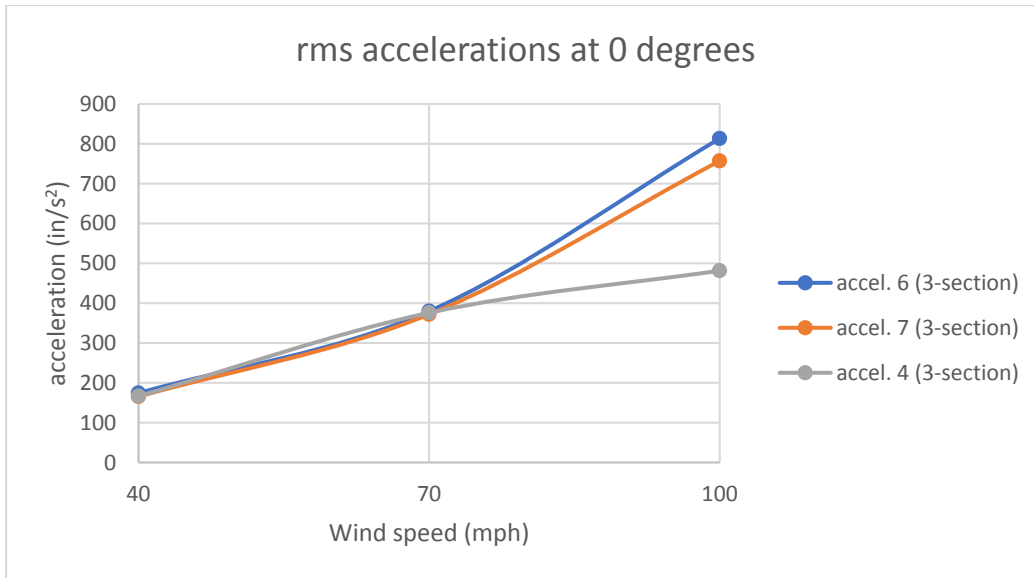

Figure 161: rms of accelerations on the 3-section and 5-section signals at 0 degrees

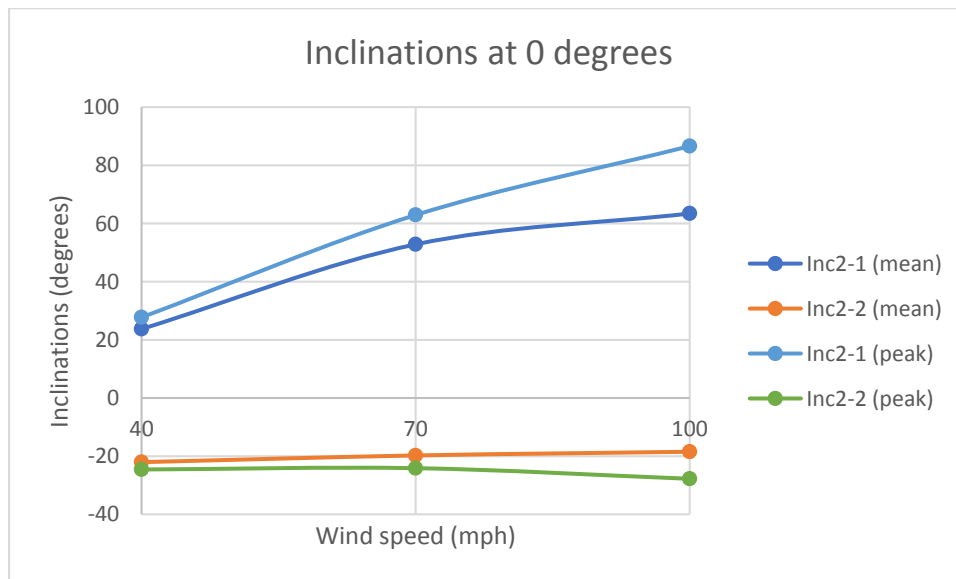

Figure 162: Inclinations (mean and max) obtained at 0 degrees for inclinometer 2

11.4 Performance of traffic signals during the tests

This test utilized a 3-section aluminum traffic signal with aluminum louvered backplates installed in a test rig span-wire configuration connected to the catenary and messenger wires by means of an **“Adjustable Hanger Assembly with Louvered Backplates.”**

Starting the test at 40 mph and progressing to 70 mph there were no major observations other than minor inclinations.

When reaching 100 mph at 0 degrees, an aerodynamic instability was first seen. This slight galloping movement was not present between 45 degrees and 135 degrees. When reaching 100 mph at 180 degrees, an aerodynamic instability was seen again.

After the test was finished, there was no damage to backplates, visors, hanger nor any signal housing component. A picture of the assembly after the test is shown in Figure 163 and a close up of the hanger connection is shown in Figure 164.



Figure 163: Signal assembly after test



Figure 164: Hanger connection after test

11.5 Conclusions

This chapter summarizes the results of a test conducted at WOW at FIU for a span wire traffic signal assembly consisting of a 3-section traffic signal with louvered backplate, connected using a **“Adjustable Hanger Assembly with Louvered Backplates.”** The various instruments used for this test included: loadcells to measure forces, accelerometers to measure accelerations and inclinometers to measure the inclinations.

The signal assembly showed no damage during the 40 mph to 100 mph. A slight galloping movement was seen during the 100-mph test at 0 and 180 degrees. No damage to backplates, visors, hanger, disconnect box nor signal housing was observed at the end of the test. A comparison between the solid (non-louvered) and louvered backplates cases can be found in appendix D.

Chapter 12 - Overview of Conclusions, Findings, and Recommendations

This section summarizes conclusions, findings and recommendations from the current project BDV29 TWO 977-27 and its companion project BDV29 TWO 977-20.

12.1 Full-scale Tests

- The response of the traffic signal system when the long span test frame was used matched reasonably well the response observed using the short span test frame, thus validating the previously adopted testing methodology. The aerodynamic instability was observed in both cases.
- It has been observed that depending on the rigidity of the hanger, the traffic signal assembly is more susceptible to aerodynamic instabilities in the form of galloping. Flexible hangers have a tendency to undergo higher along-wind inclinations at lower wind speeds which would trigger this instability at lower wind speeds (about 70 mph) than a rigid hanger, while for the rigid hanger the instability appears when the extension bars severely bend (about 110 mph).
- The 5-section signal has been found to be susceptible to damage regardless of the type of hanger used. This may be due to its increased weight as well as the increased surface area compared to the 3-section signal. It is recommended to find an alternative section to replace usage of 5-section signal.
- A common failure observed was with the 72-tooth serrated edge connection between the adjustable-hanger and the disconnect-box and also between the disconnect-box to signal-housing point. The failure mode with this connection point was when the serrated edge would shear, allowing the connection to turn. A resilient connection at these points should be considered to enhance the survivability of the signal under wind induced loads. In discussions with FDOT, it was proposed to explore the possibility of using a device that could potentially remove the rotational degree of freedom of the adjustable-hanger to disconnect-box connection. Such component is currently available (i.e. octagon base) but for different types of traffic sign installations and can be connected to the back of the disconnect-box to

restrain the stresses put on the 72-tooth connection. With regards to this issue, modifications should be made to the connection to prevent this failure mode.

- Due to improved performance, the use of maximum overlap at tri-stud adjustable-hanger and extension-bar connection points is recommended (top and bottom portions/connections). At these connection points, use a minimum of 2 bolts per connection. The bolts should be spaced apart with one unused bolt-hole in between.
- Due to its outstanding performance during testing, continue to use aluminum alloy 535 (note that all tri-stud adjustable hangers broken during testing were not made of 535 aluminum alloy).
- Avoid using a thicker extension bar. A thicker bar was tested with the standard adjustable hanger and while it didn't break, it placed more strain on the rest of the assembly.
- Consider installing safety wire between catenary and messenger wire to help hold the system up if hangers or extension bars break.
- Consider a device that would limit the signal from tilting back more than the limit (~60-degrees) at which point aerodynamic instabilities develop. This solution might be carefully assessed before implementation due to the increased force coefficients at higher wind speeds.

References

- [1] State of Florida Department of Transportation (FDOT). (January 2015). Standard Specifications for Road and Bridge Construction, FDOT, Tallahassee, FL.
- [2] Cook, R.A., Masters, F., & Rigdon, J.L. (2012). "Evaluation of Dual Cable Signal Support Systems with Pivotal Hanger Assemblies." FDOT Contract No. BDK75 977-37, University of Florida, Department of Civil and Coastal Engineering, Gainesville, FL.
- [3] Zisis, I., Irwin, P., Berlanga, B., Chowdhury, A.G., Hajra, B. (2016) "Assessing the performance of vehicular traffic signal assemblies during hurricane force winds", Proceedings of the 1st International Conference on Natural Hazards and Infrastructure, June 28-30, Chania, Greece.
- [4] Aly, A. M., Chowdhury, A. G., Bitsuamlak, G. (2011) "Wind profile management and blockage assessment for a new 12-fan Wall of Wind facility at FIU", Wind & Structures, 14(4), 285-300.
- [5] Chowdhury, A.G., Zisis, I., Irwin, P., Bitsuamlak, G.T., Pinelli, J.P., Hajra, B., Moravej, M. (2016) "Large Scale Experimentation using the 12-Fan Wall of Wind to Assess and Mitigate Hurricane Wind and Rain Impacts on Buildings and Infrastructure Systems", Journal of Structural Engineering (ASCE)-Special Issue: Recent advances in assessment and mitigation of multiple hazards for structures and infrastructures, DOI: 10.1061/(ASCE)ST.1943-541X.0001785.
- [6] Zisis, I., Irwin, P., Chowdhury, A. G., Matus, M., BDV29 TWO 977-27 FDOT Interim Report Task 2-Case 10, December 2017.

Appendix A - Task 2: SHORT SPAN LENGTH FULL SCALE TESTING - Case 3

Results for Mean and peak forces, and rms of accelerations for 45 degrees wind direction are presented in Figures A1 to A5

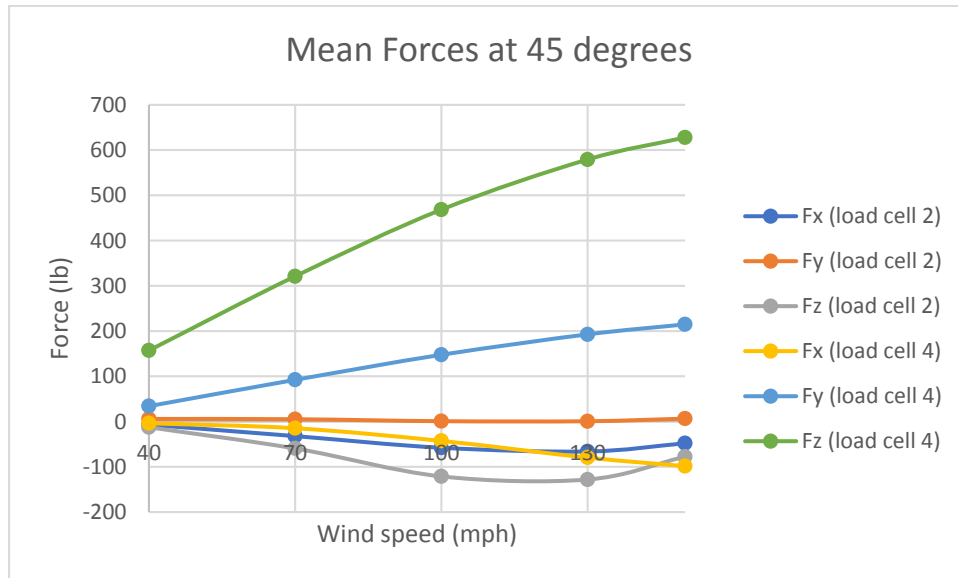

Figure A-1: Mean forces at 45 degrees wind direction on loadcells 2 (catenary wire) and 4 (messenger wire)

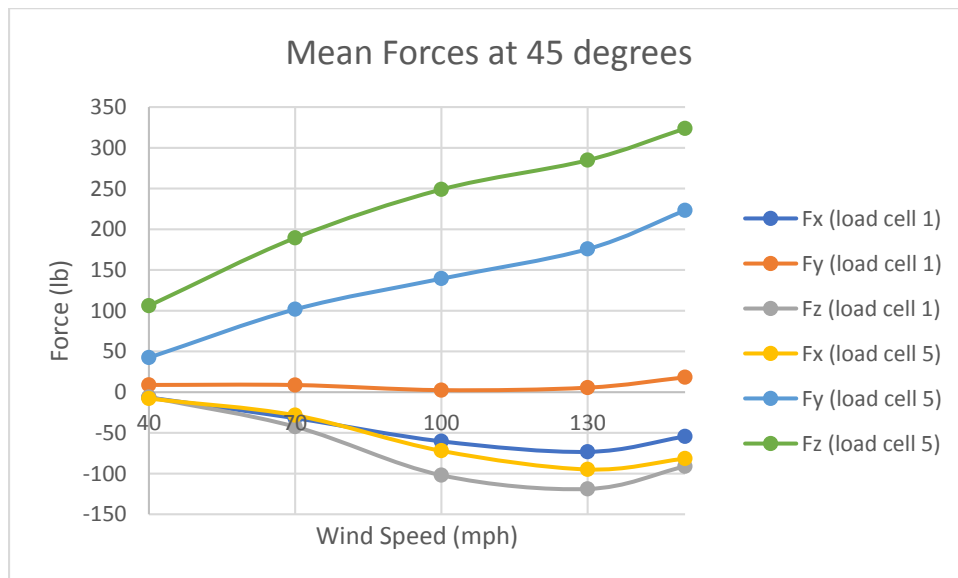

Figure A-2: Mean forces at 45 degrees wind direction on loadcells 1 (catenary wire) and 5 (messenger wire)

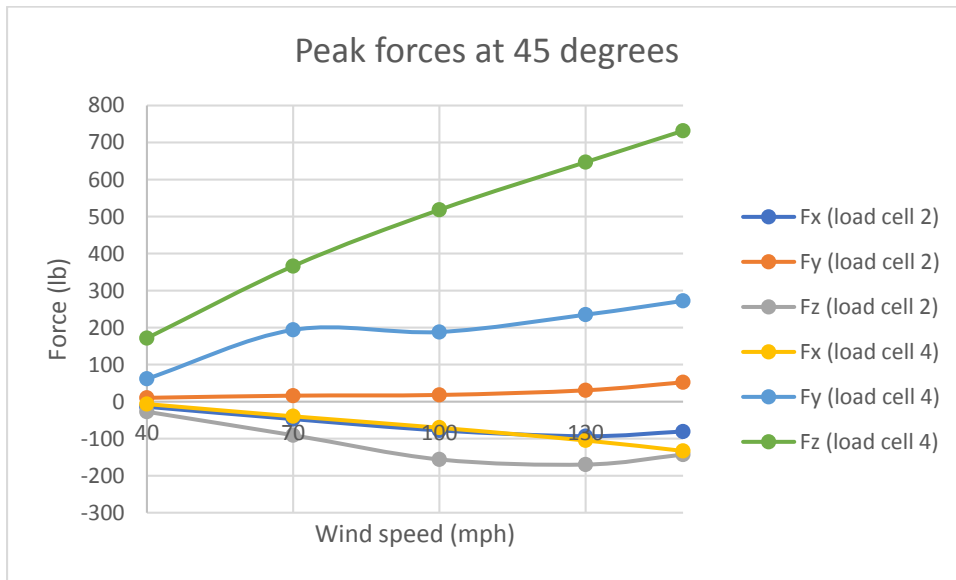

Figure A-3: Peak forces at 45 degrees wind direction on loadcells 2 (catenary wire) and 4 (messenger wire)

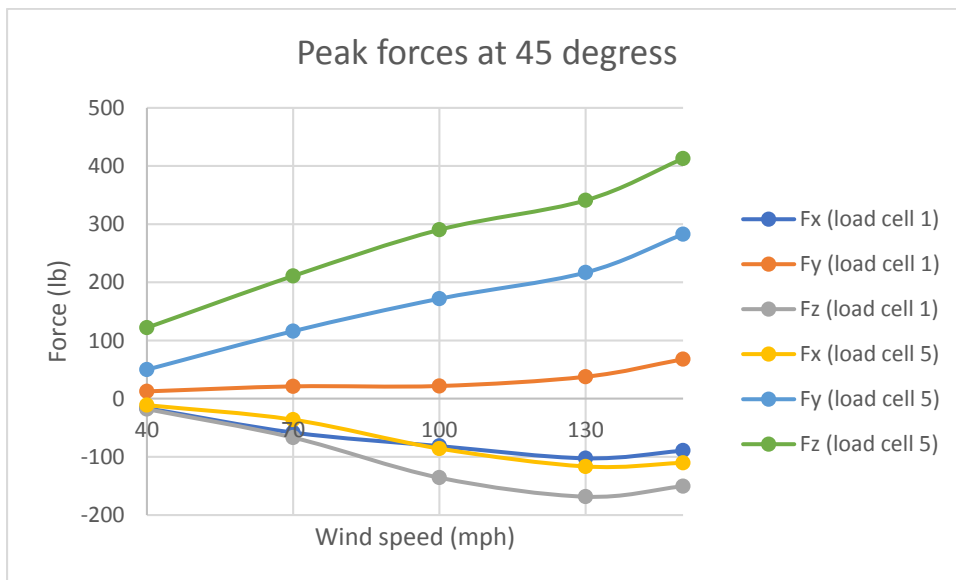

Figure A-4: Peak forces at 45 degrees wind direction on loadcells 1 (catenary wire) and 5 (messenger wire)

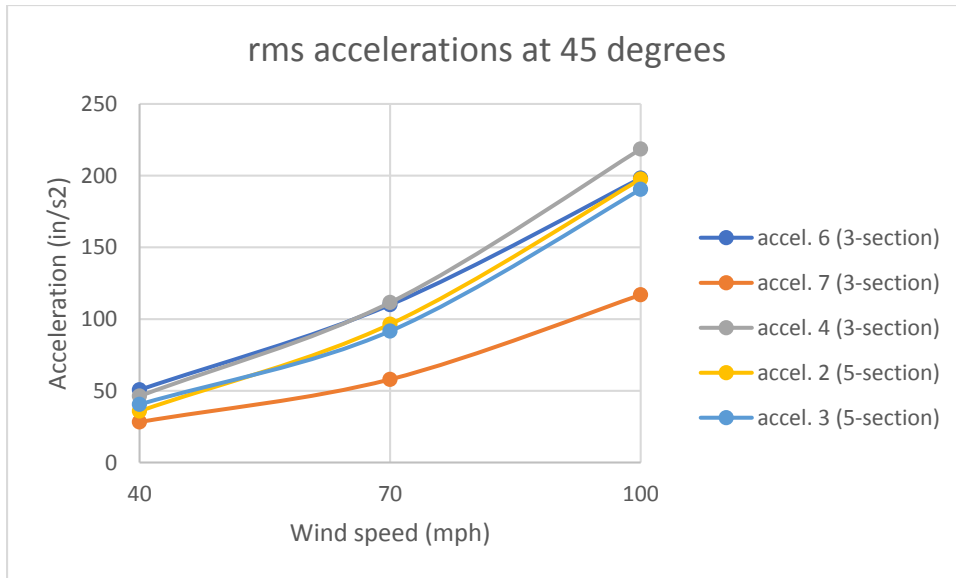

Figure A-5: rms of accelerations at 45 degrees wind direction for various wind speeds

Results for Mean and peak forces, and rms of accelerations for 80 degrees wind direction are presented in Figures A6 to A10

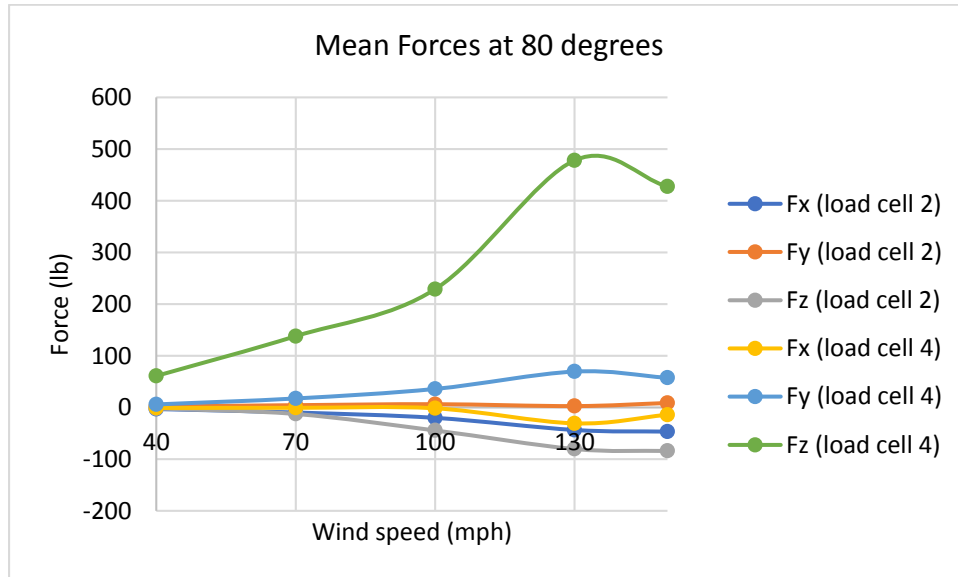

Figure A-6: Mean forces at 80 degrees wind direction on loadcells 2 (catenary wire) and 4 (messenger wire)

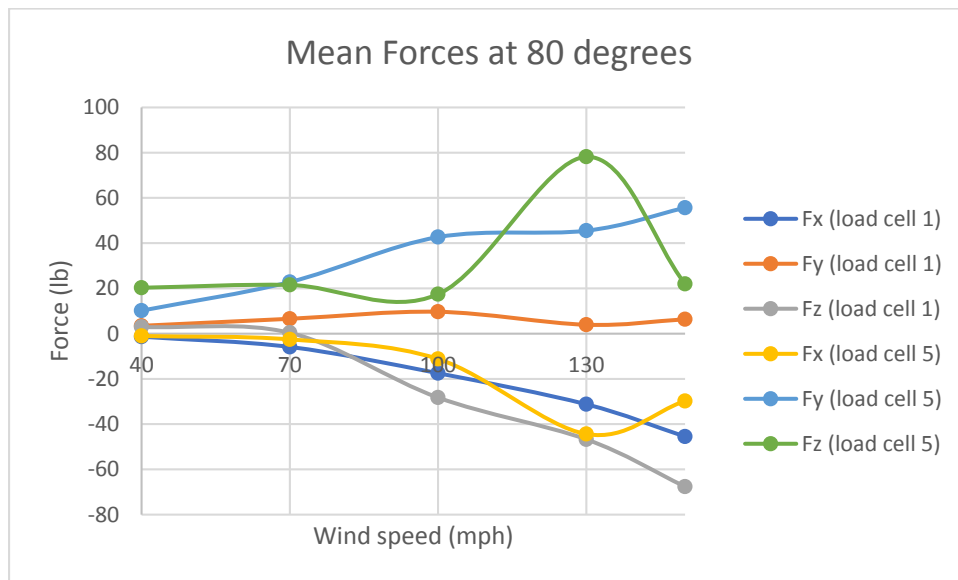

Figure A-7: Mean forces at 80 degrees wind direction on loadcells 1 (catenary wire) and 5 (messenger wire)

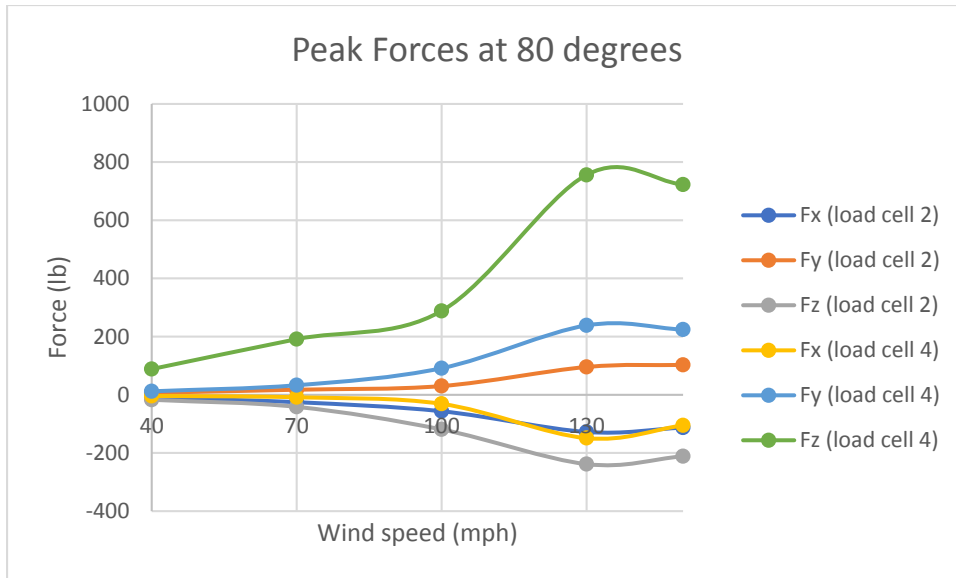

Figure A-8: Peak forces at 80 degrees wind direction on loadcells 2 (catenary wire) and 4 (messenger wire)

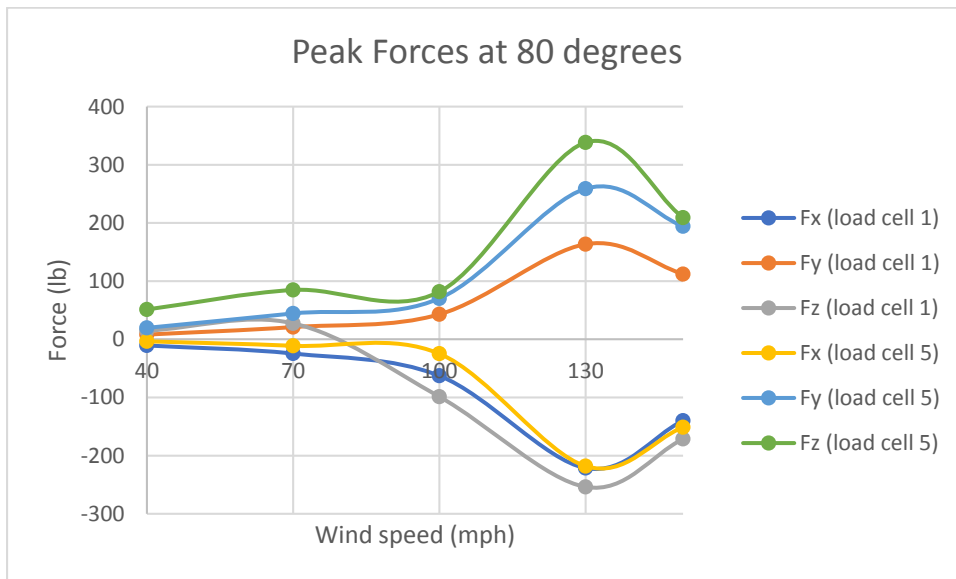

Figure A-9: Peak forces at 80 degrees wind direction on loadcells 1 (catenary wire) and 5 (messenger wire)

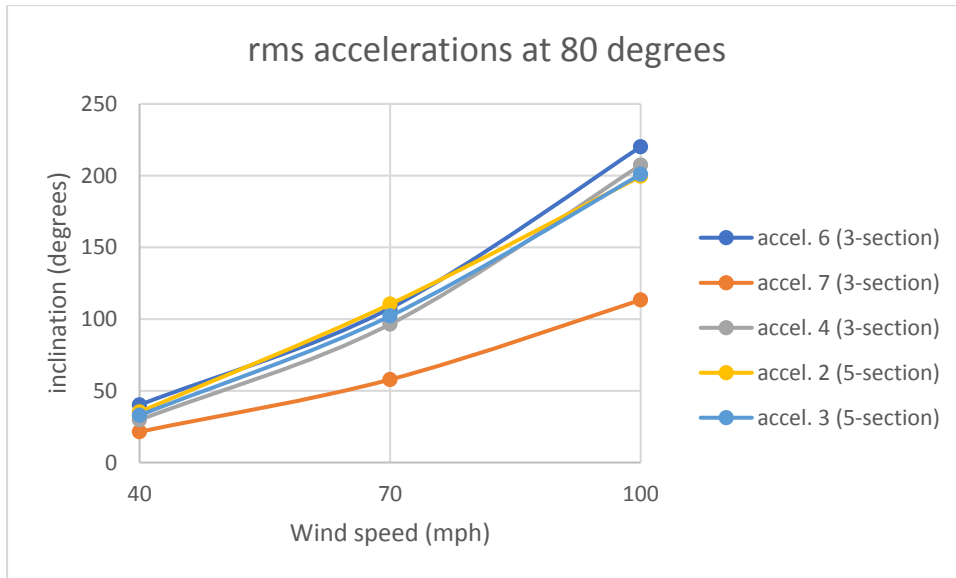

Figure A-10: rms of accelerations at 80 degrees wind direction for various wind speeds

Results for Mean and peak forces, and rms of accelerations for 100 degrees wind direction are presented in Figures A11 to A15

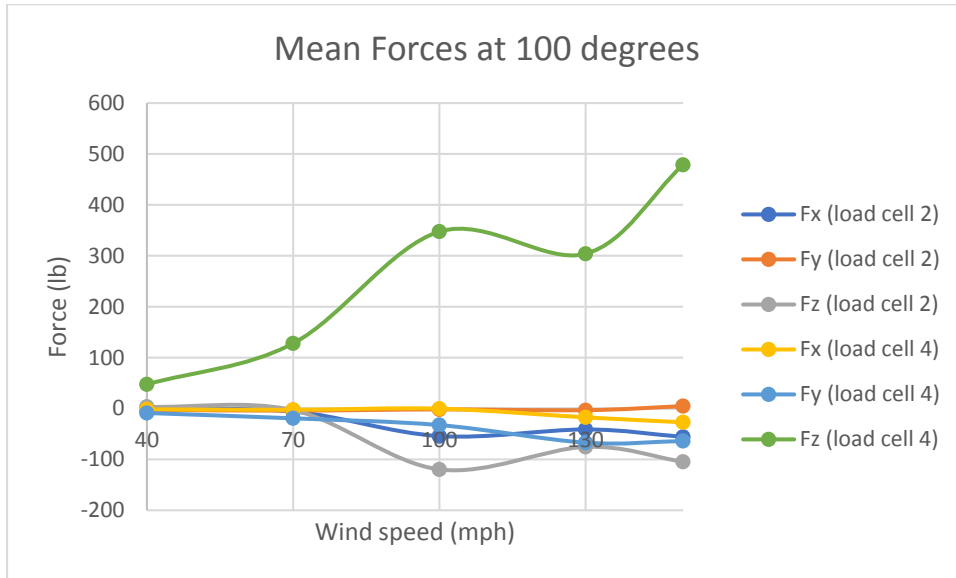

Figure A-11: Mean forces at 100 degrees wind direction on loadcells 2 (catenary wire) and 4 (messenger wire)

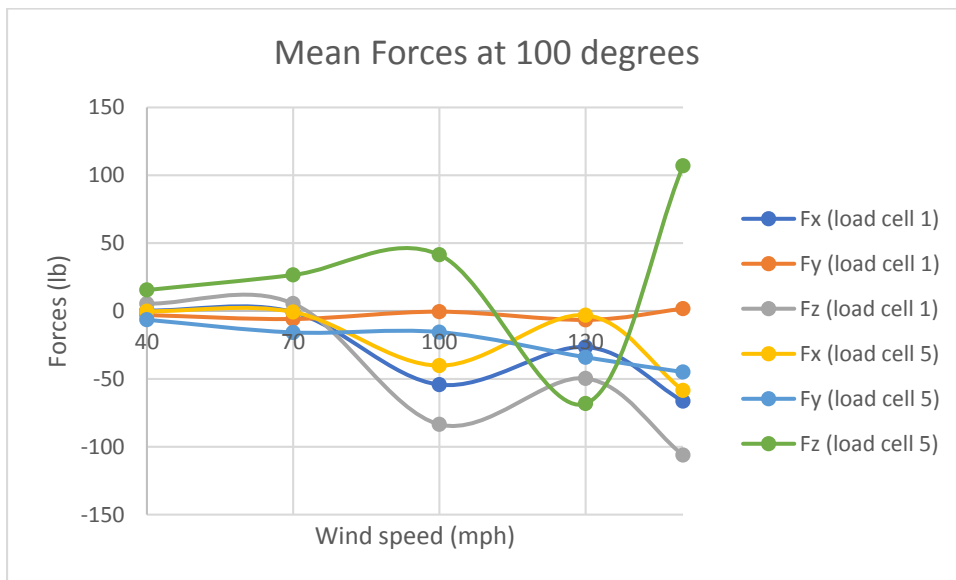

Figure A-12: Mean forces at 100 degrees wind direction on loadcells 1 (catenary wire) and 5 (messenger wire)

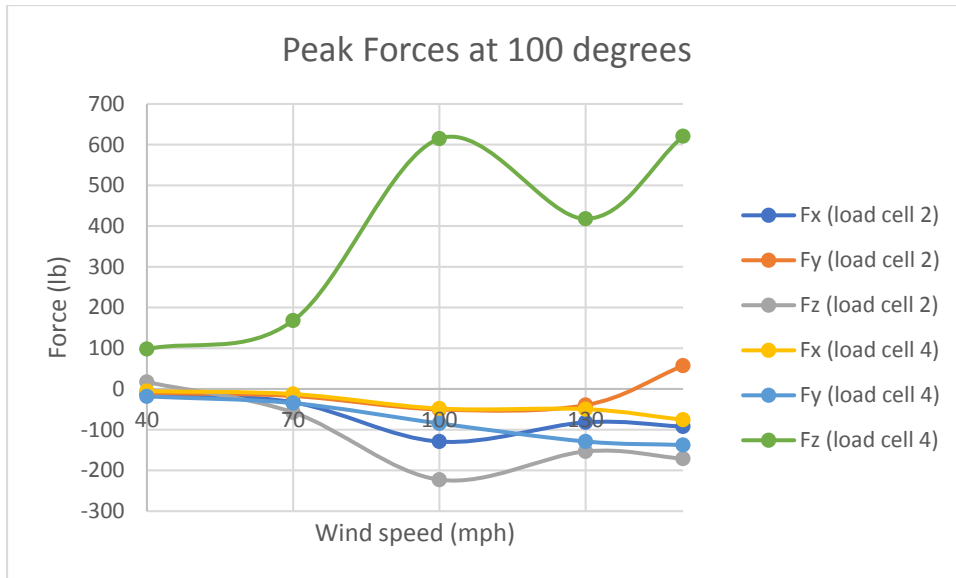

Figure A-13: Peak forces at 100 degrees wind direction on loadcells 2 (catenary wire) and 4 (messenger wire)

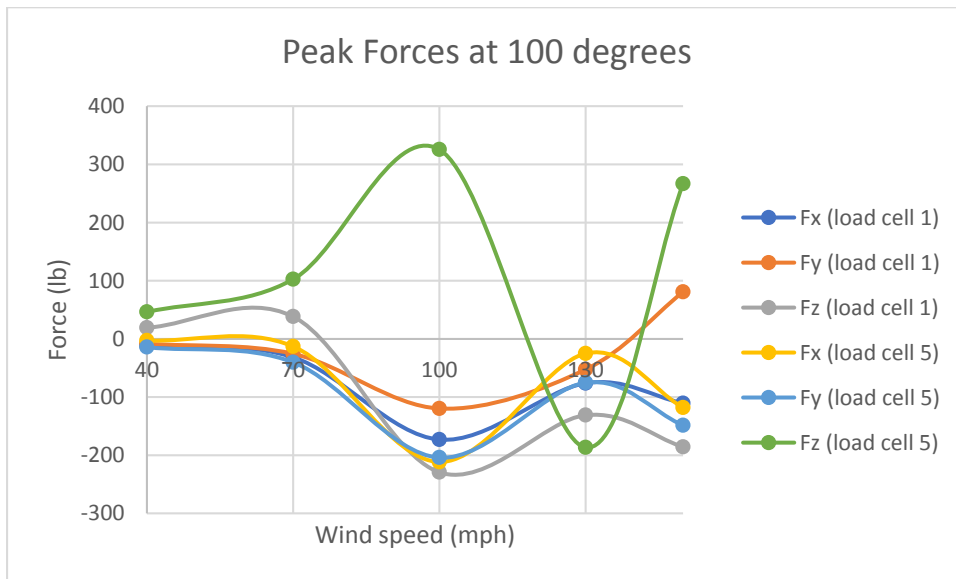

Figure A-14: Peak forces at 100 degrees wind direction on loadcells 1 (catenary wire) and 5 (messenger wire)

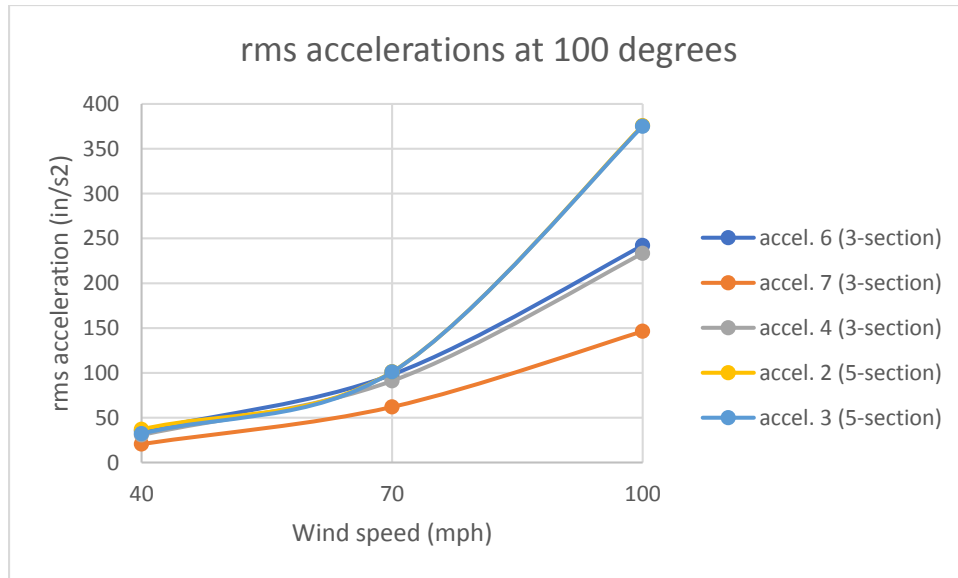

Figure A-15: rms of accelerations at 100 degrees wind direction for various wind speeds

Results for Mean and peak forces, and rms of accelerations for 135 degrees wind direction are presented in Figures A16 to A20

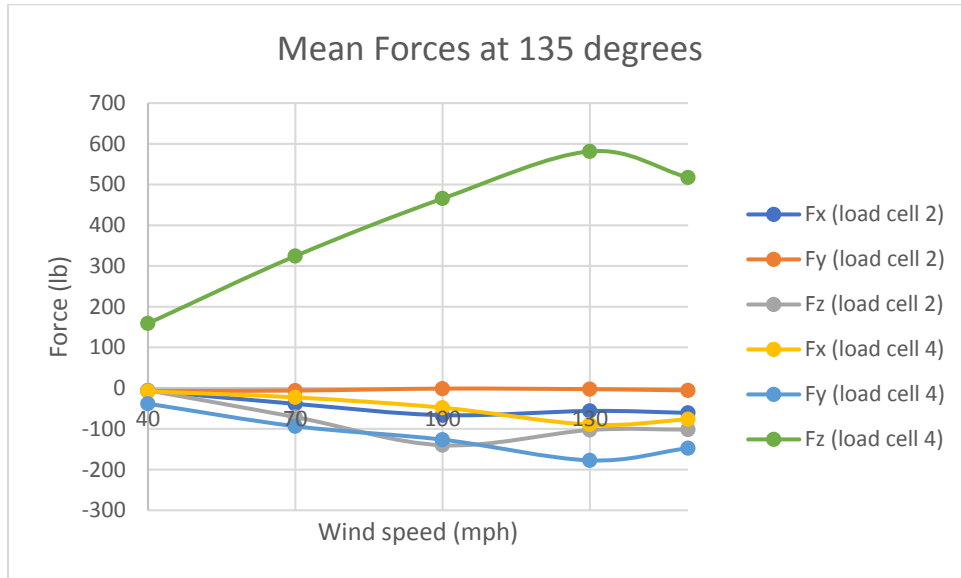

Figure A-16: Mean forces at 135 degrees wind direction on loadcells 2 (catenary wire) and 4 (messenger wire)

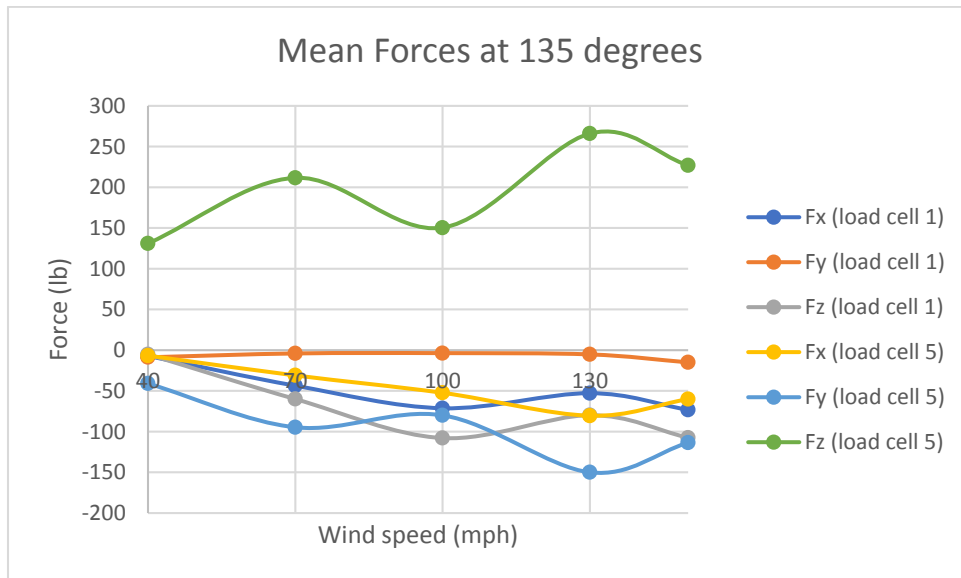

Figure A-17: Mean forces at 135 degrees wind direction on loadcells 1 (catenary wire) and 5 (messenger wire)

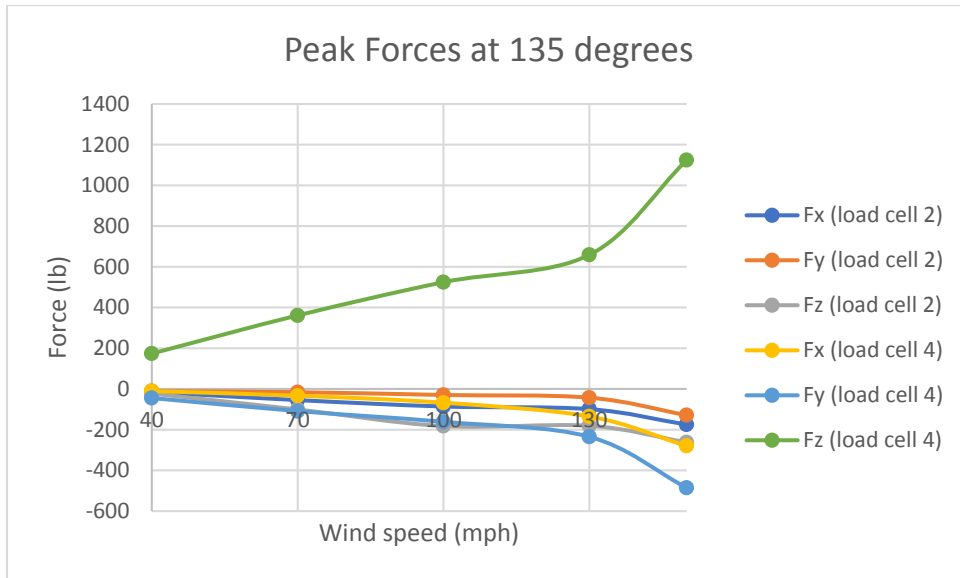

Figure A-18: Peak forces at 135 degrees wind direction on loadcells 2 (catenary wire) and 4 (messenger wire)

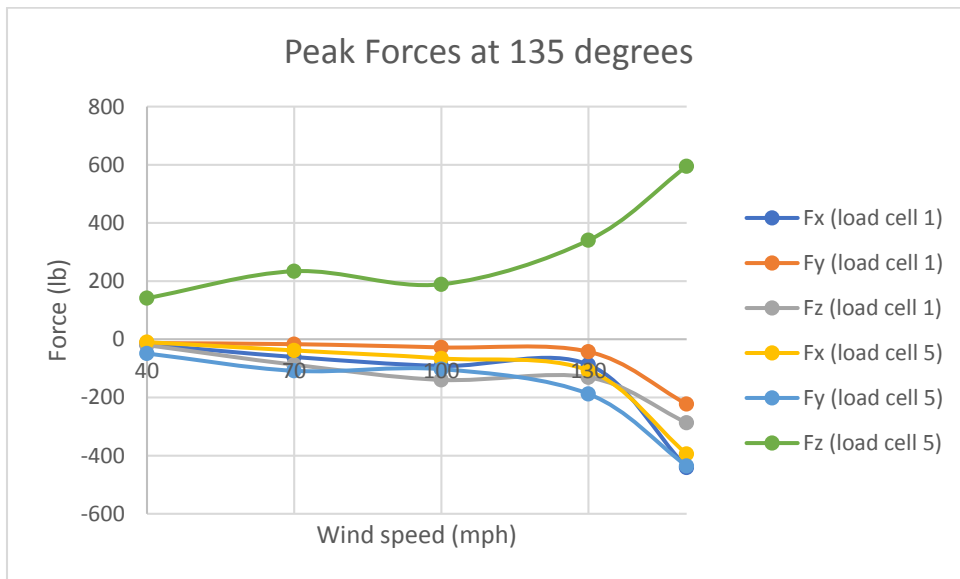

Figure A-19: Peak forces at 135 degrees wind direction on loadcells 1 (catenary wire) and 5 (messenger wire)

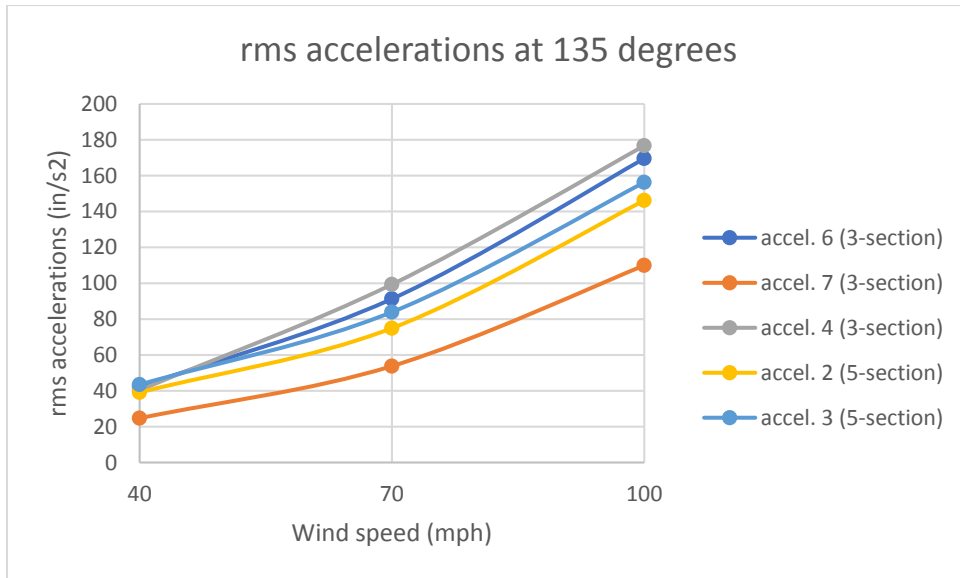

Figure A-20: rms of accelerations at 135 degrees wind direction for various wind speeds

Results for Mean and peak forces, and rms of accelerations for 180 degrees wind direction are presented in Figures A21 to A25

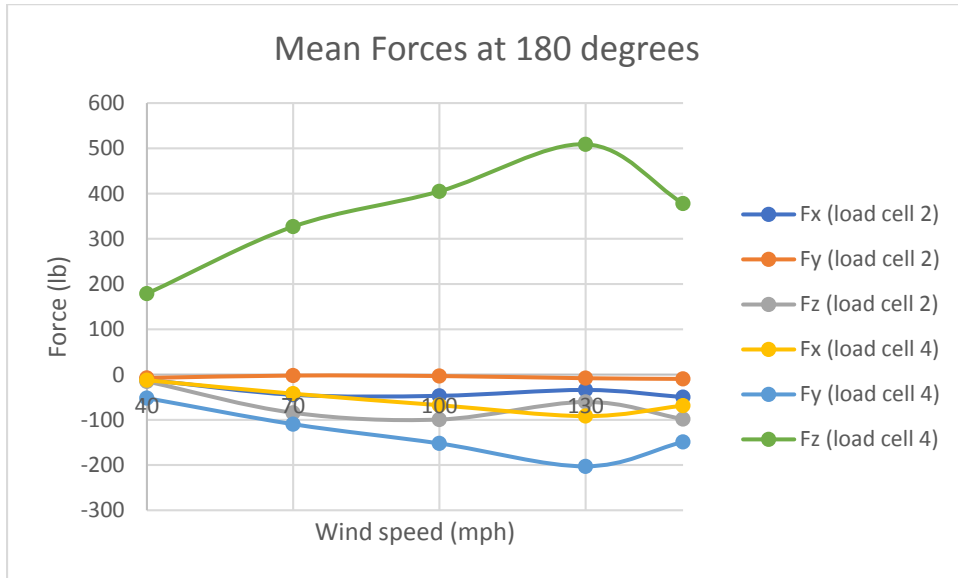

Figure A-21: Mean forces at 180 degrees wind direction on loadcells 2 (catenary wire) and 4 (messenger wire)

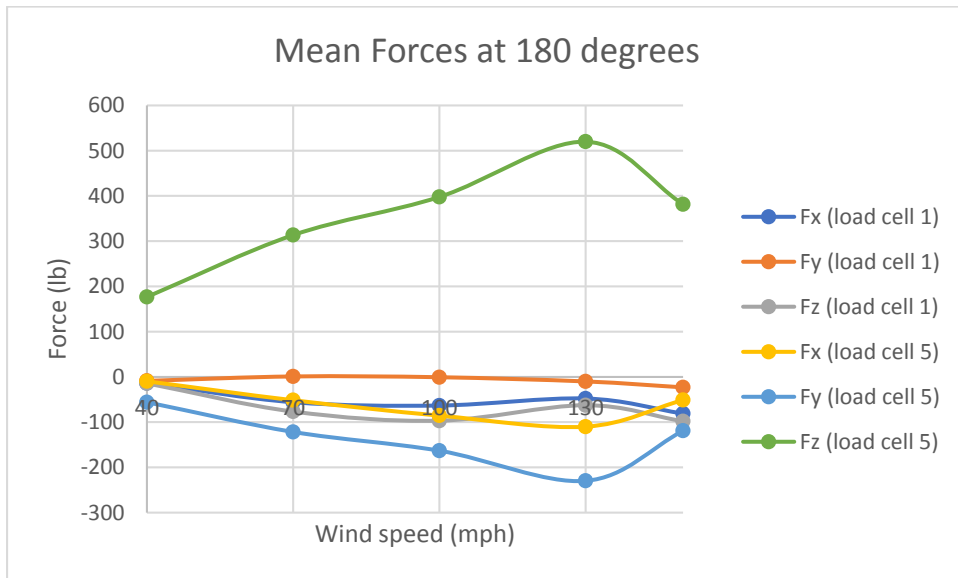

Figure A-22: Mean forces at 180 degrees wind direction on loadcells 1 (catenary wire) and 5 (messenger wire)

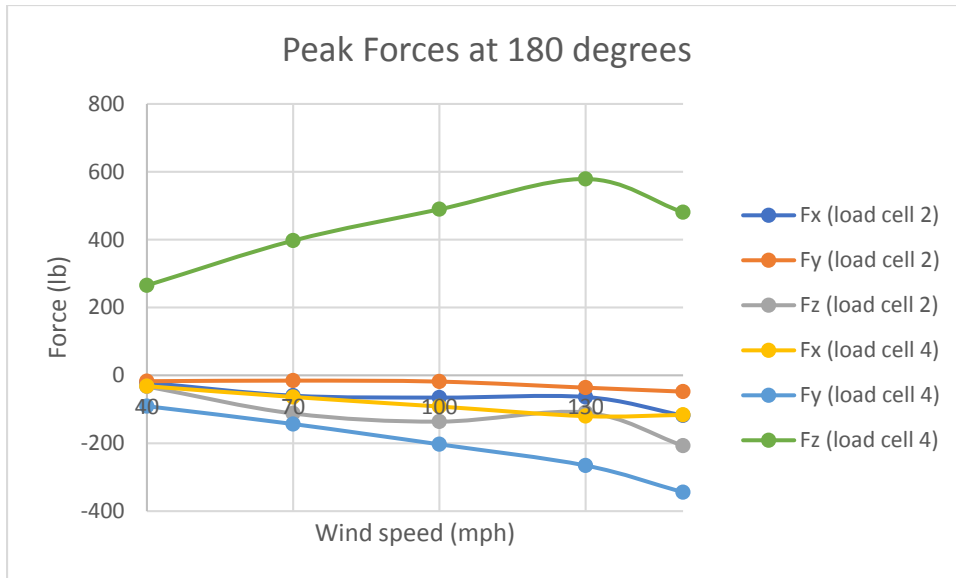

Figure A-23: Peak forces at 180 degrees wind direction on loadcells 2 (catenary wire) and 4 (messenger wire)

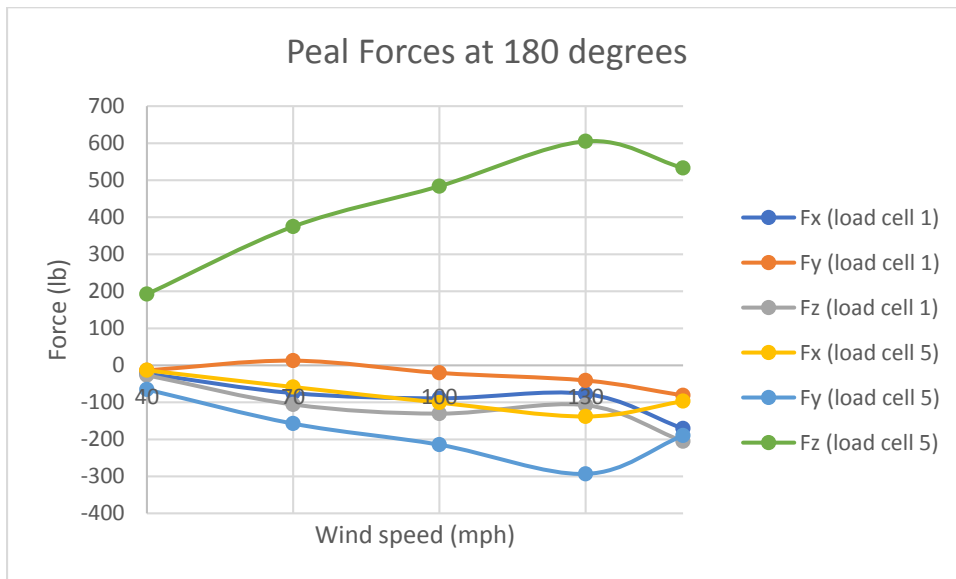

Figure A-24: Peak forces at 180 degrees wind direction on loadcells 1 (catenary wire) and 5 (messenger wire)

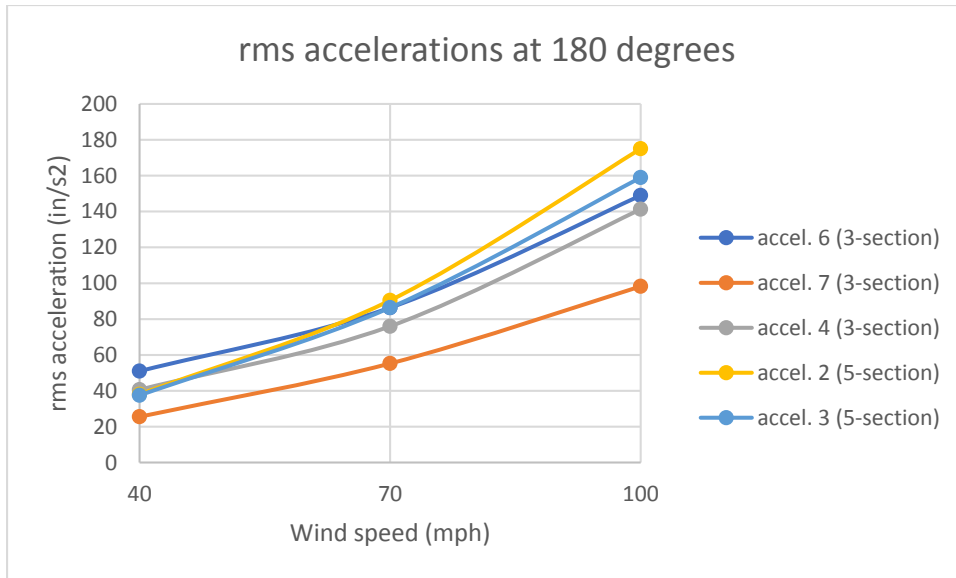

Figure A-25: rms of accelerations at 180 degrees wind direction for various wind speeds

Appendix B - Task 2: SHORT SPAN LENGTH FULL SCALE TESTING - Case 4

Results for Mean and peak forces, and rms of accelerations for 45 degrees wind direction are presented in Figures B1 to B5

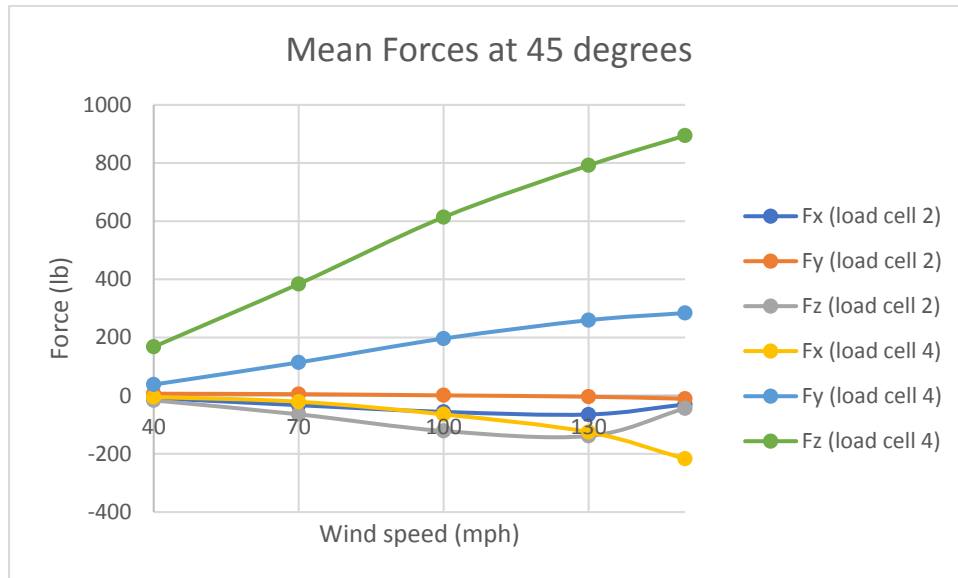

Figure B 1: Mean forces at 45 degrees wind direction on loadcells 2 (catenary wire) and 4 (messenger wire)

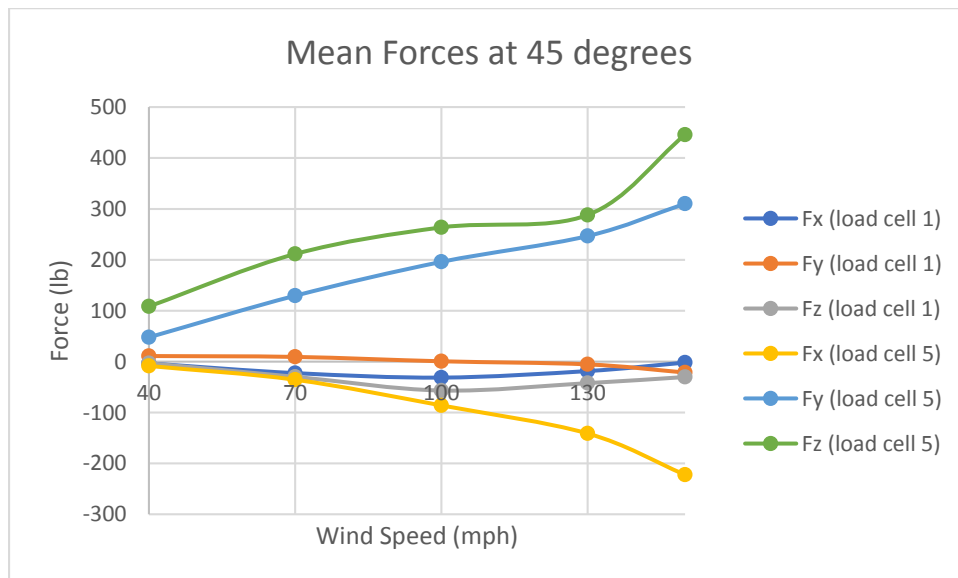

Figure B 2: Mean forces at 45 degrees wind direction on loadcells 1 (catenary wire) and 5 (messenger wire)

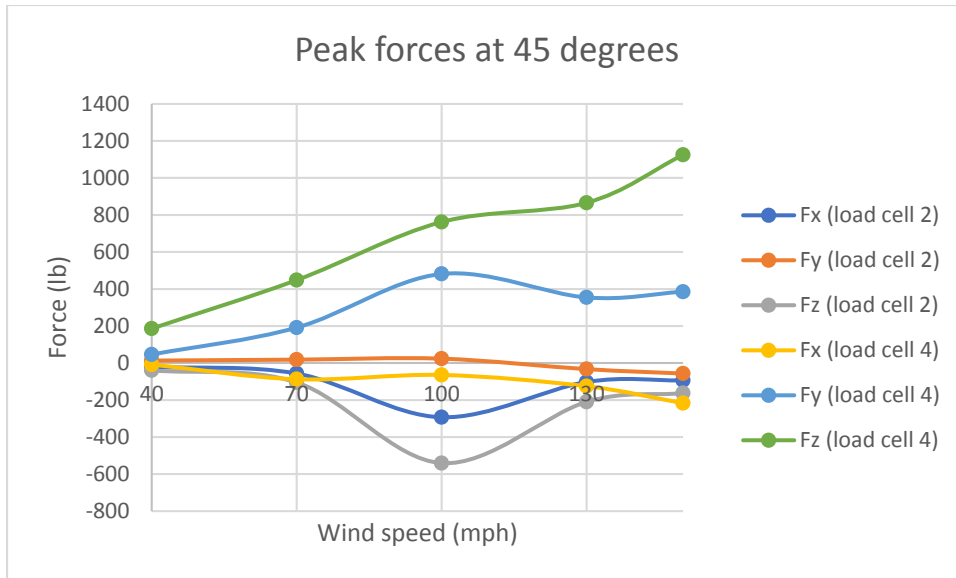

Figure B 3: Peak forces at 45 degrees wind direction on loadcells 2 (catenary wire) and 4 (messenger wire)

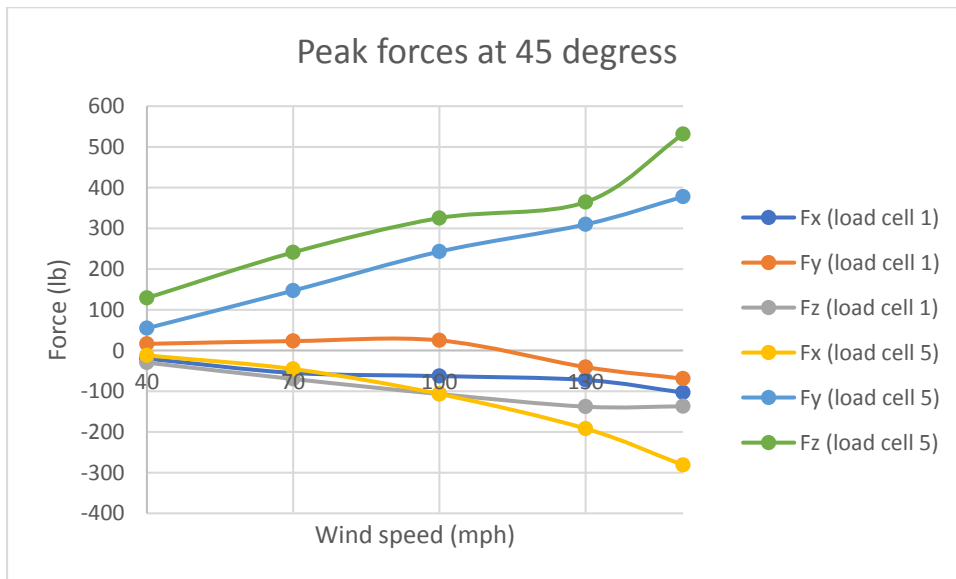

Figure B 4: Peak forces at 45 degrees wind direction on loadcells 1 (catenary wire) and 5 (messenger wire)

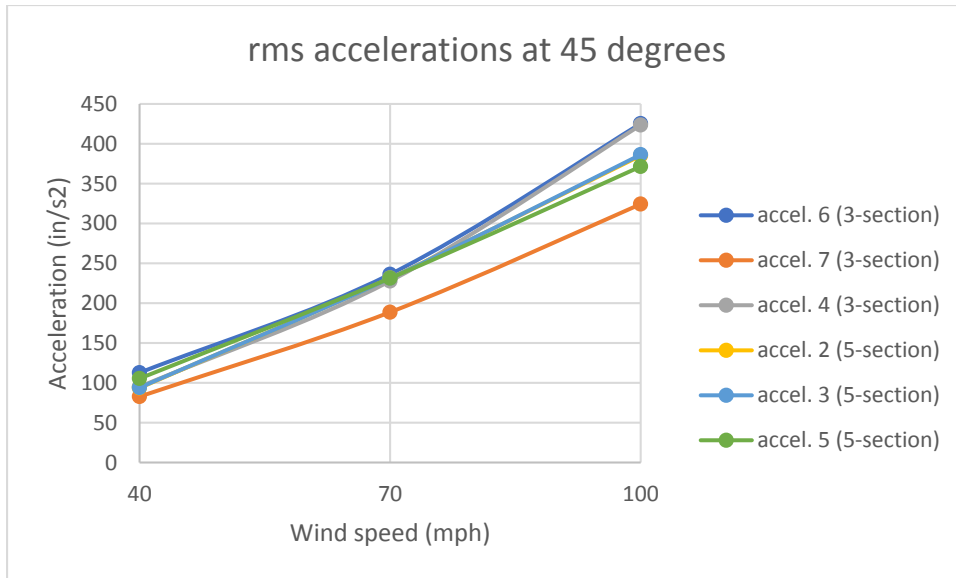

Figure B 5: rms of accelerations at 45 degrees wind direction for various wind speeds

Results for Mean and peak forces, and rms of accelerations for 80 degrees wind direction are presented in Figures B6 to B10

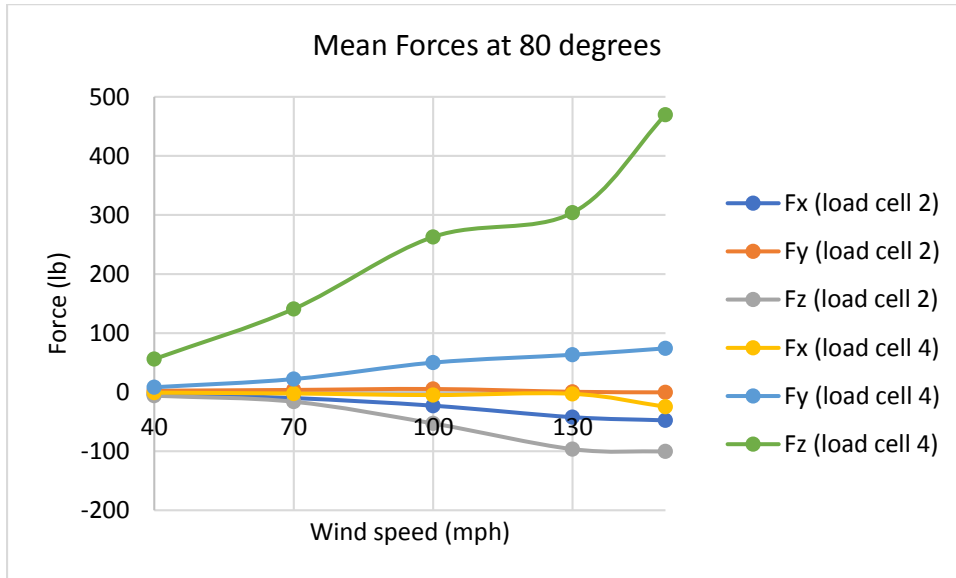

Figure B 6: Mean forces at 80 degrees wind direction on loadcells 2 (catenary wire) and 4 (messenger wire)

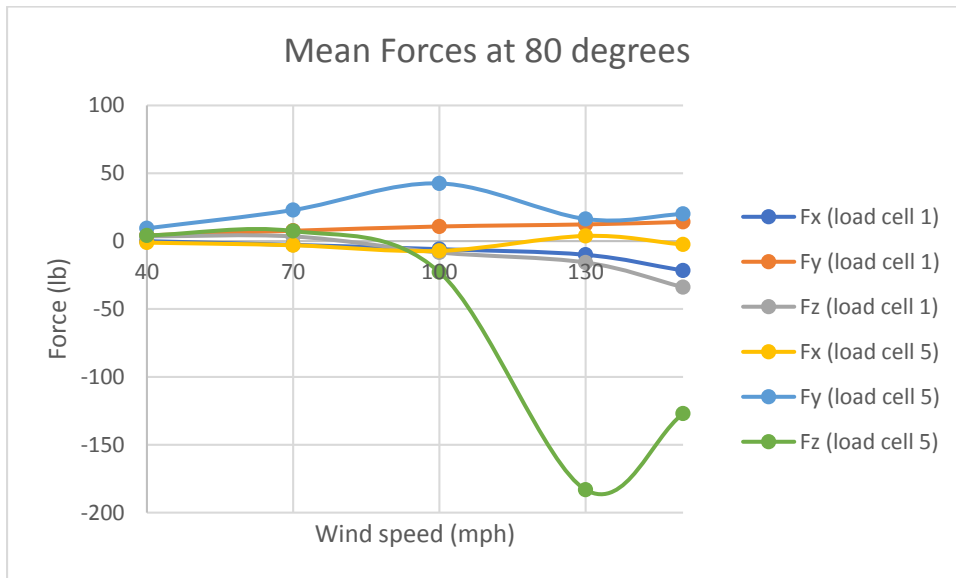

Figure B 7: Mean forces at 80 degrees wind direction on loadcells 1 (catenary wire) and 5 (messenger wire)

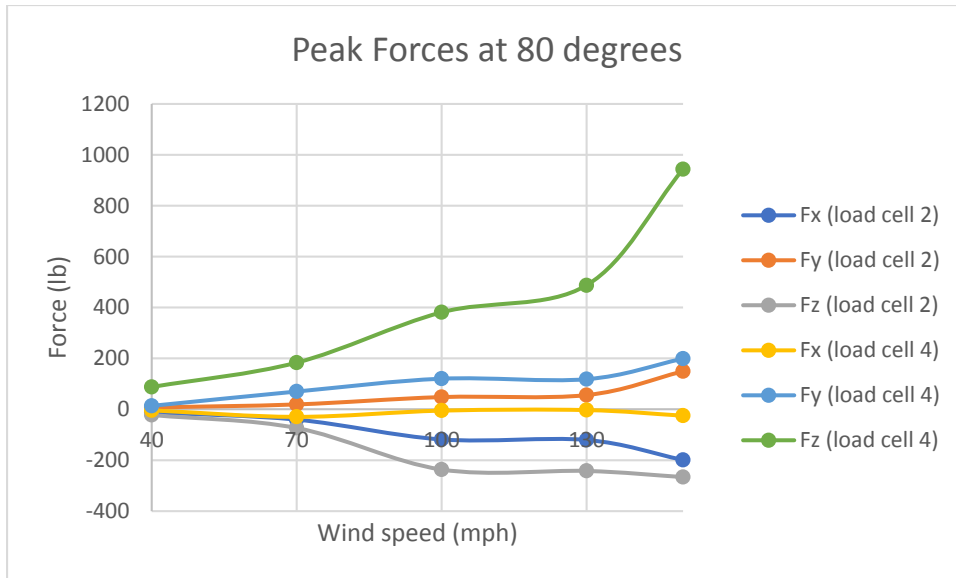

Figure B 8: Peak forces at 80 degrees wind direction on loadcells 2 (catenary wire) and 4 (messenger wire)

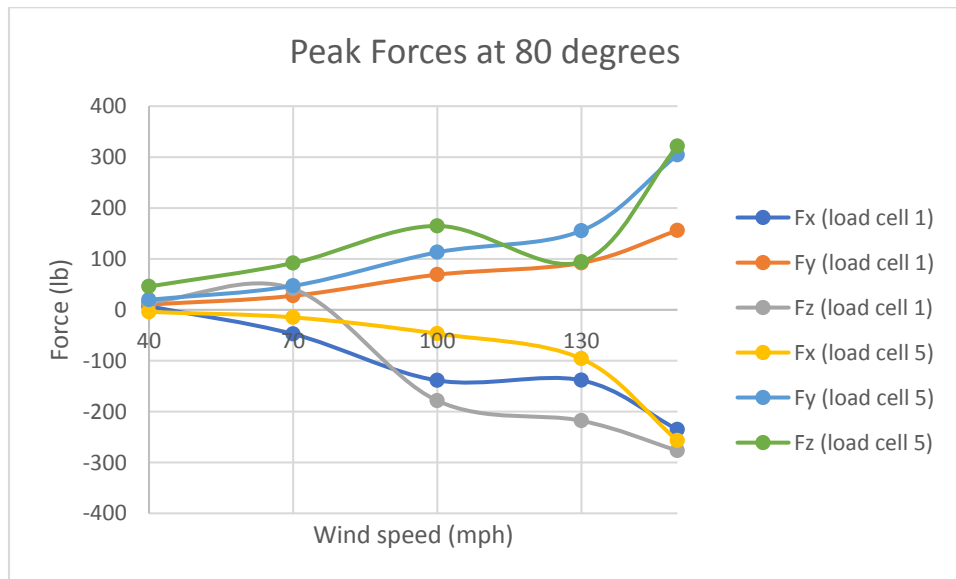

Figure B 9: Peak forces at 80 degrees wind direction on loadcells 1 (catenary wire) and 5 (messenger wire)

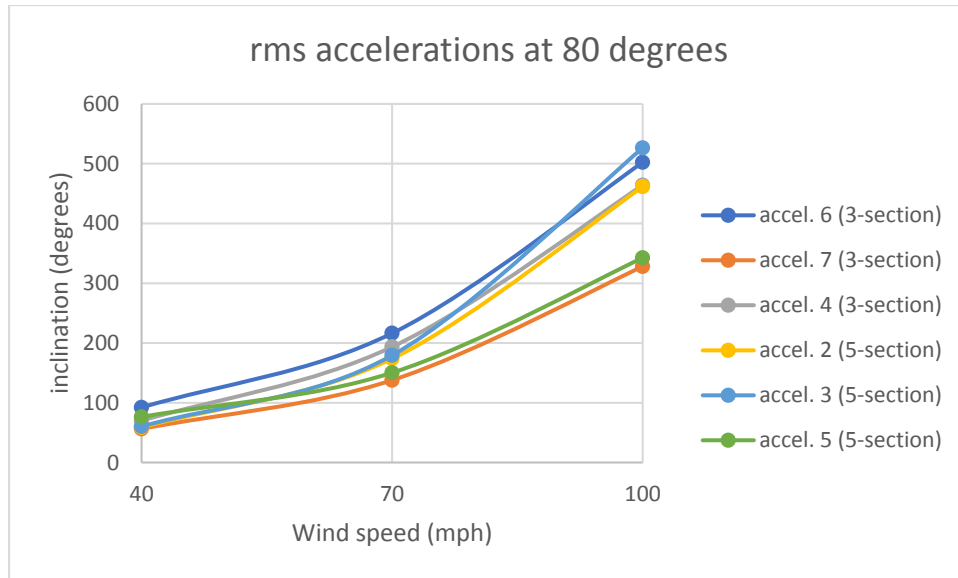

Figure B 10: rms of accelerations at 80 degrees wind direction for various wind speeds

Results for Mean and peak forces, and rms of accelerations for 100 degrees wind direction are presented in Figures B11 to B15

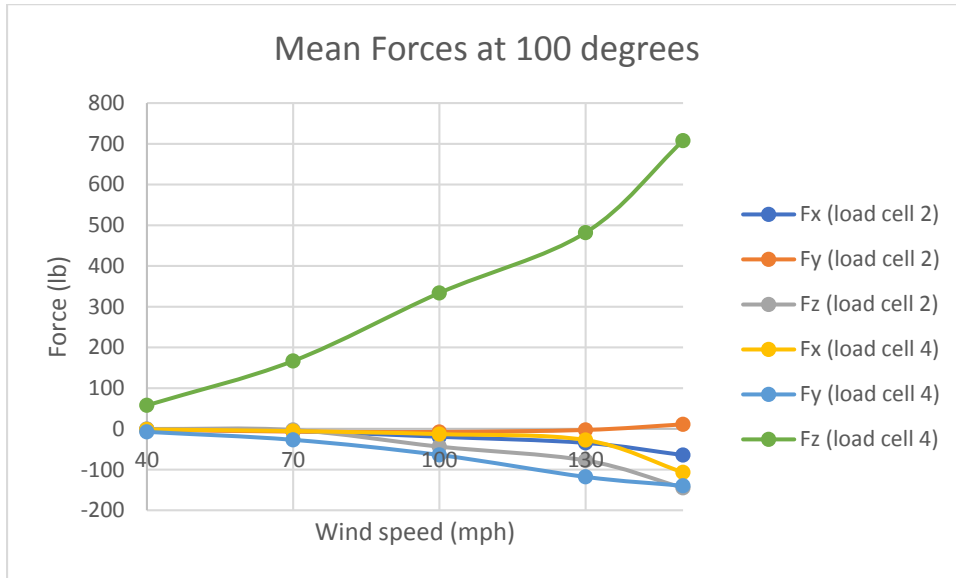

Figure B 11: Mean forces at 100 degrees wind direction on loadcells 2 (catenary wire) and 4 (messenger wire)

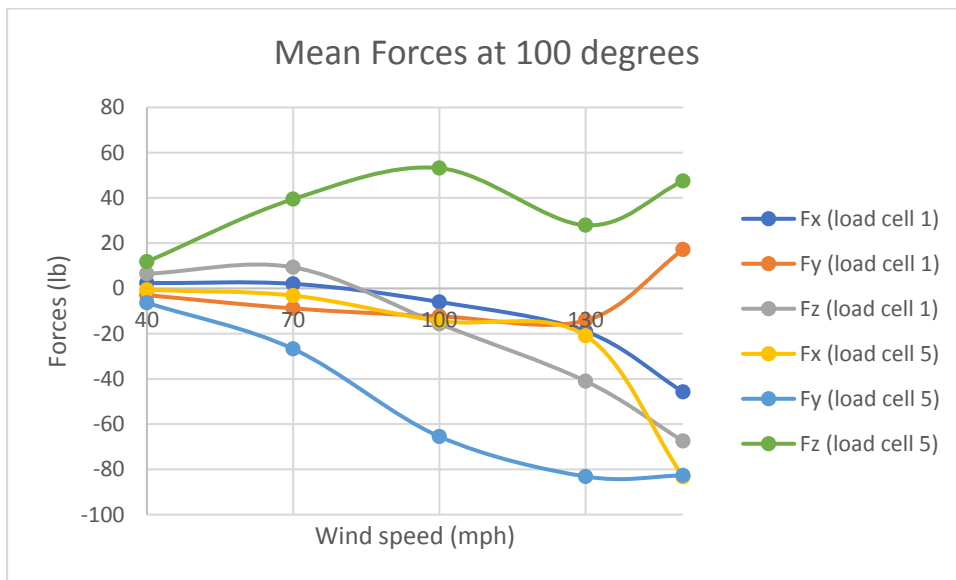

Figure B 12: Mean forces at 100 degrees wind direction on loadcells 1 (catenary wire) and 5 (messenger wire)

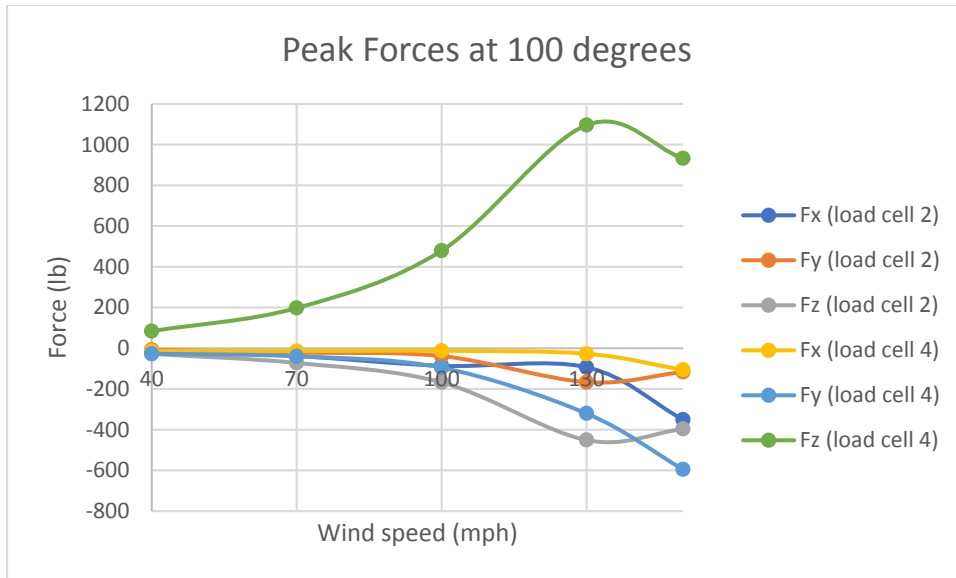

Figure B 13: Peak forces at 100 degrees wind direction on loadcells 2 (catenary wire) and 4 (messenger wire)

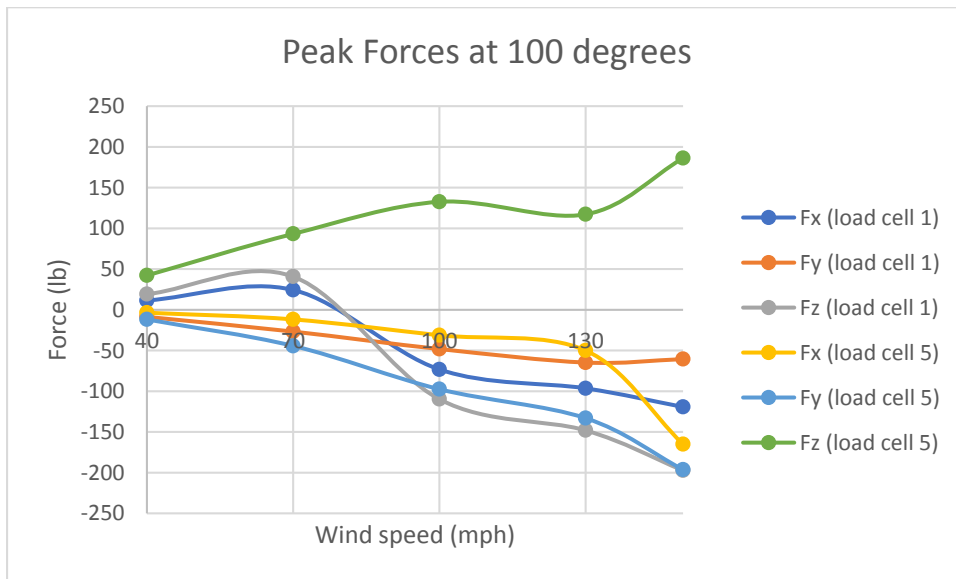

Figure B 14: Peak forces at 100 degrees wind direction on loadcells 1 (catenary wire) and 5 (messenger wire)

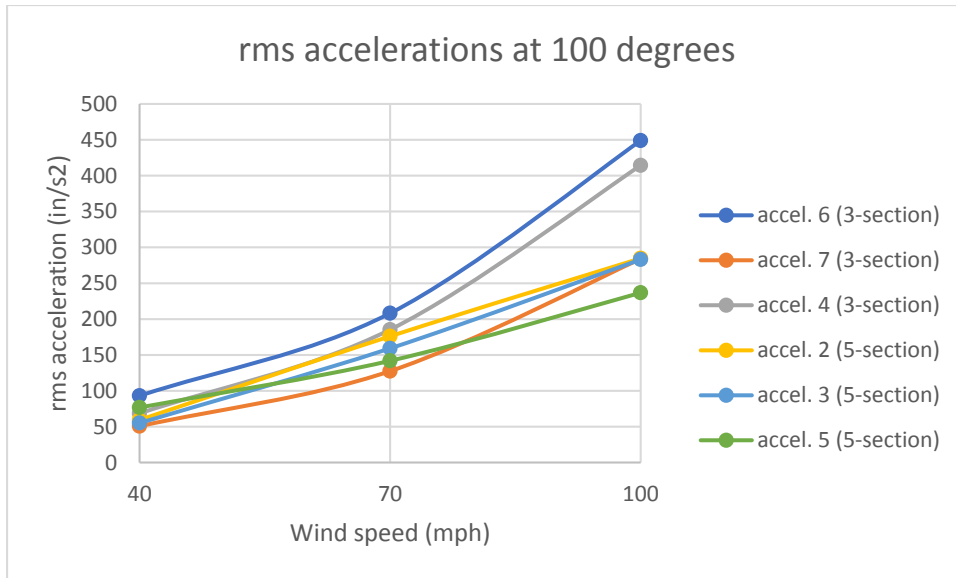

Figure B 15: rms of accelerations at 100 degrees wind direction for various wind speeds

Results for Mean and peak forces, and rms of accelerations for 135 degrees wind direction are presented in Figures B16 to B20

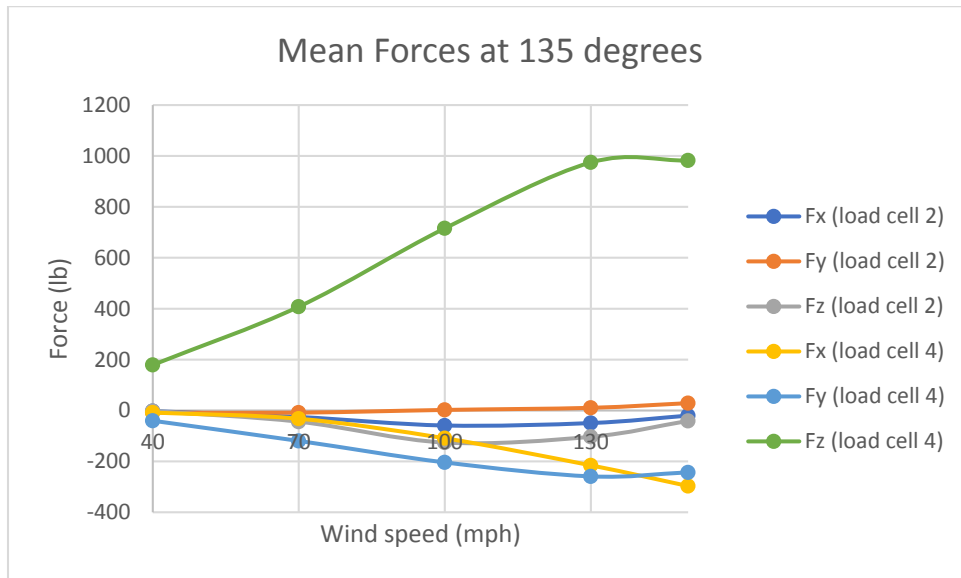

Figure B 16: Mean forces at 135 degrees wind direction on loadcells 2 (catenary wire) and 4 (messenger wire)

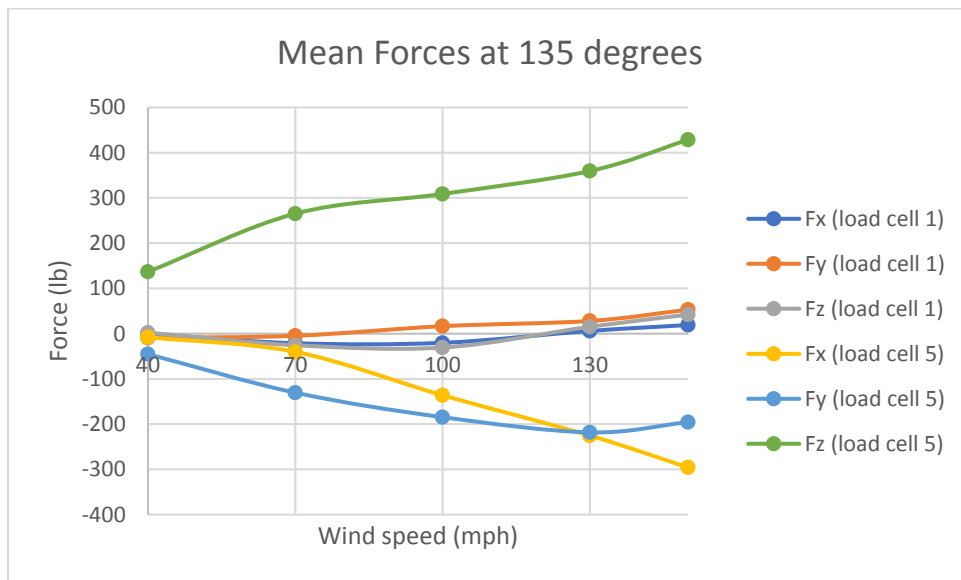

Figure B 17: Mean forces at 135 degrees wind direction on loadcells 1 (catenary wire) and 5 (messenger wire)

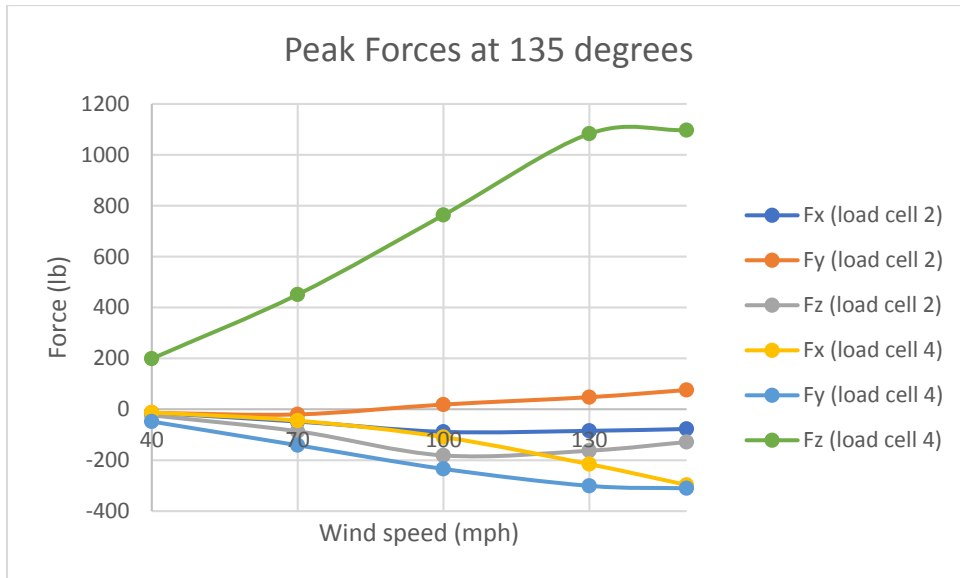

Figure B 18: Peak forces at 135 degrees wind direction on loadcells 2 (catenary wire) and 4 (messenger wire)

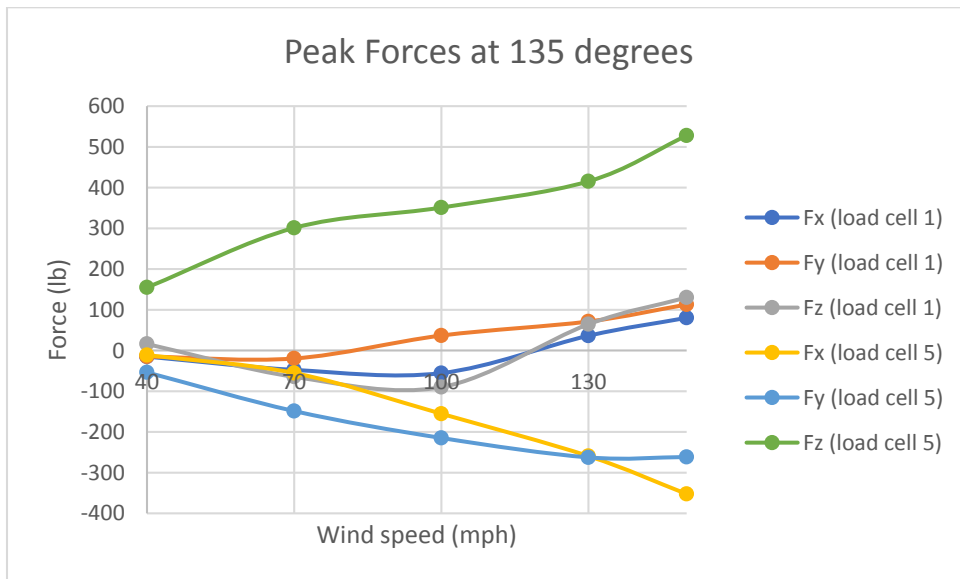

Figure B 19: Peak forces at 135 degrees wind direction on loadcells 1 (catenary wire) and 5 (messenger wire)

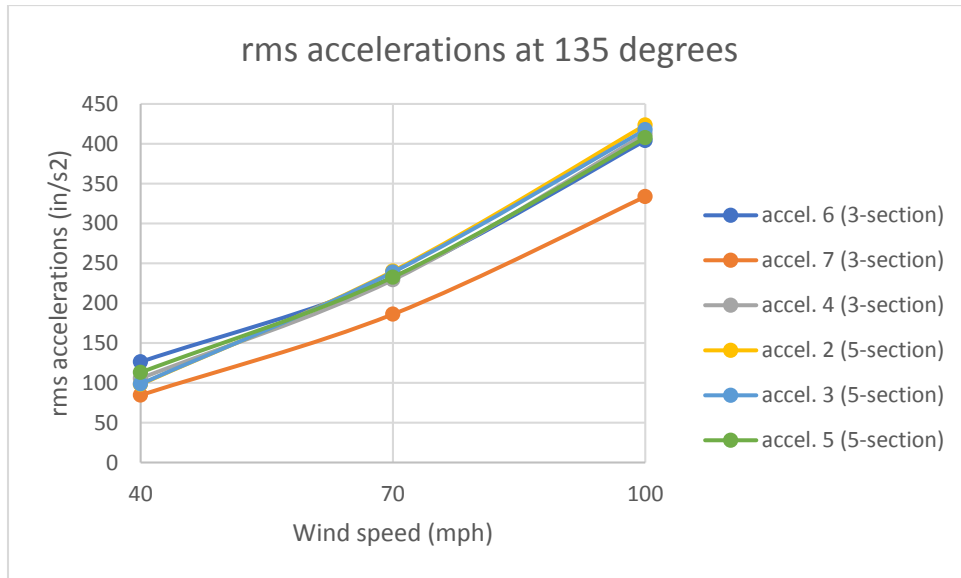

Figure B 20: rms of accelerations at 135 degrees wind direction for various wind speeds

Results for Mean and peak forces, and rms of accelerations for 180 degrees wind direction are presented in Figures B21 to B25

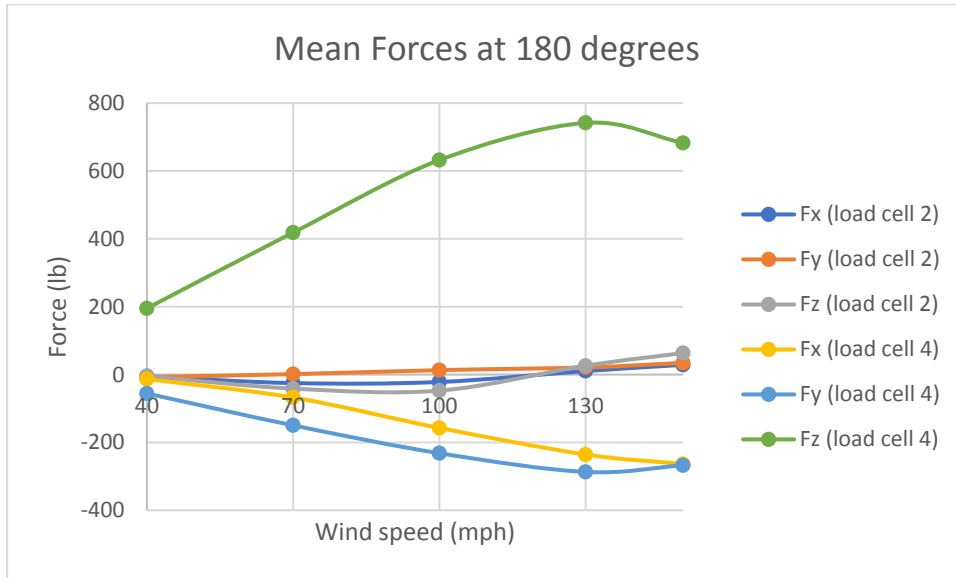

Figure B 21: Mean forces at 180 degrees wind direction on loadcells 2 (catenary wire) and 4 (messenger wire)

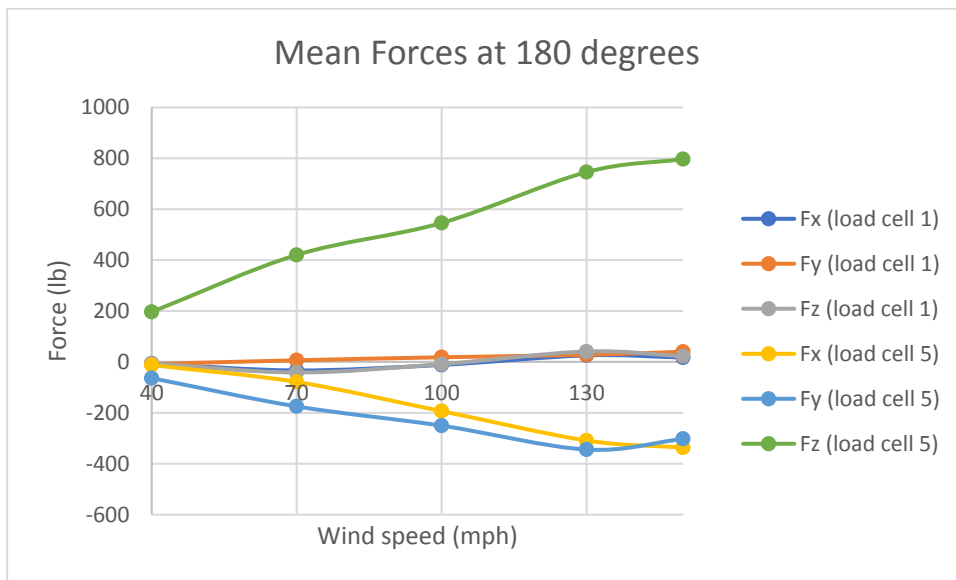

Figure B 22: Mean forces at 180 degrees wind direction on loadcells 1 (catenary wire) and 5 (messenger wire)

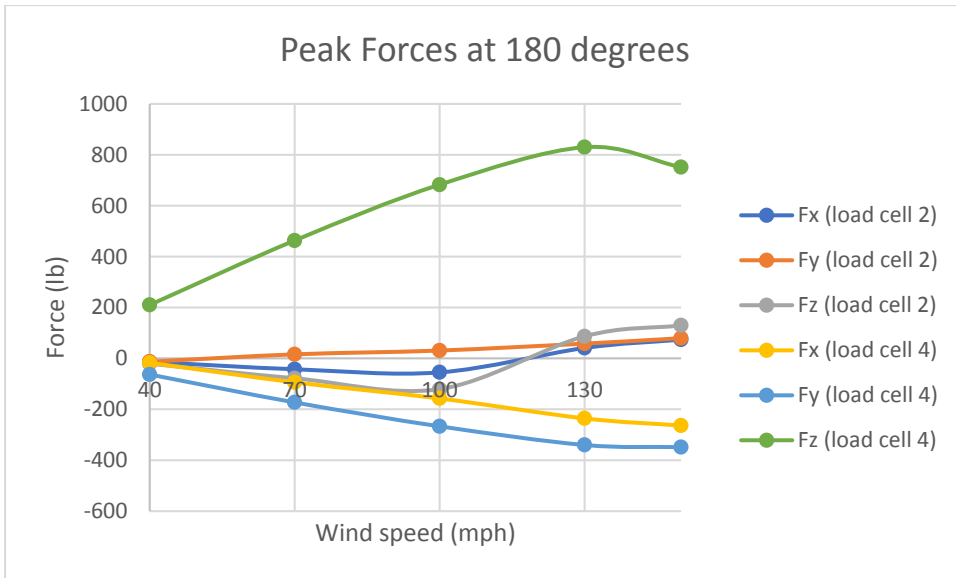

Figure B 23: Peak forces at 180 degrees wind direction on loadcells 2 (catenary wire) and 4 (messenger wire)

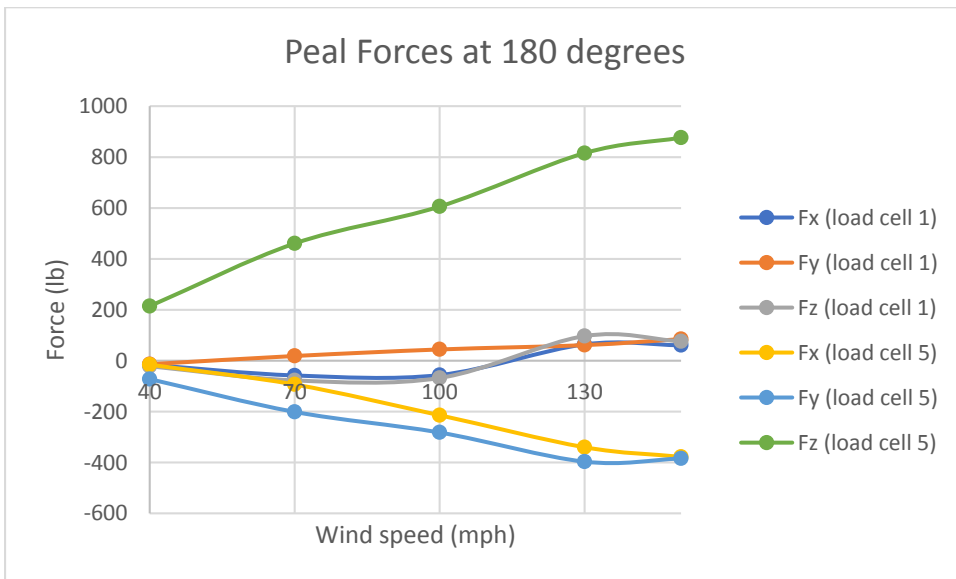

Figure B 24: Peak forces at 180 degrees wind direction on loadcells 1 (catenary wire) and 5 (messenger wire)

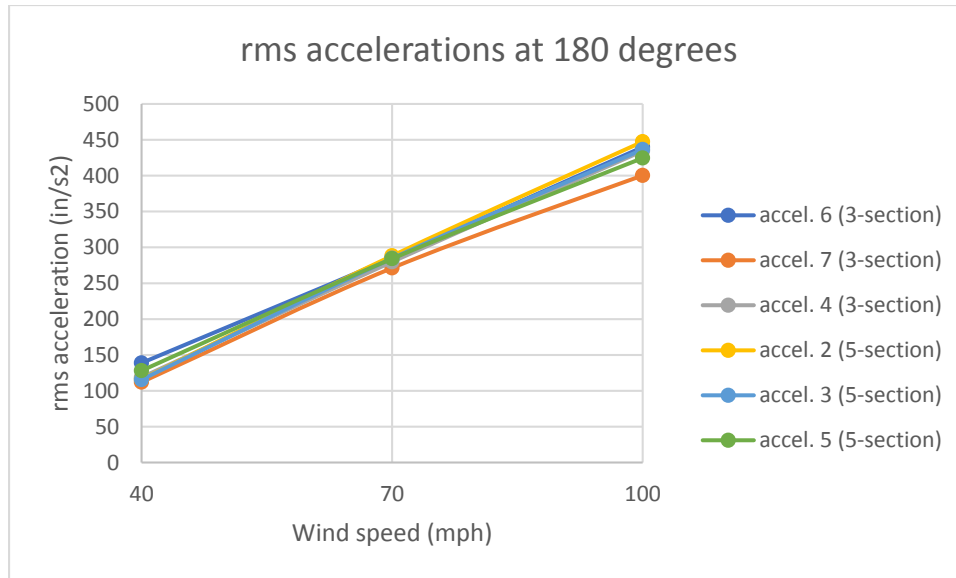

Figure B 25: rms of accelerations at 180 degrees wind direction for various wind speeds

Appendix C - Task 2: SHORT SPAN LENGTH FULL SCALE TESTING – Case 5

Results for Mean and peak forces, and rms of accelerations for 45 degrees wind direction are presented in Figures C1 to C5

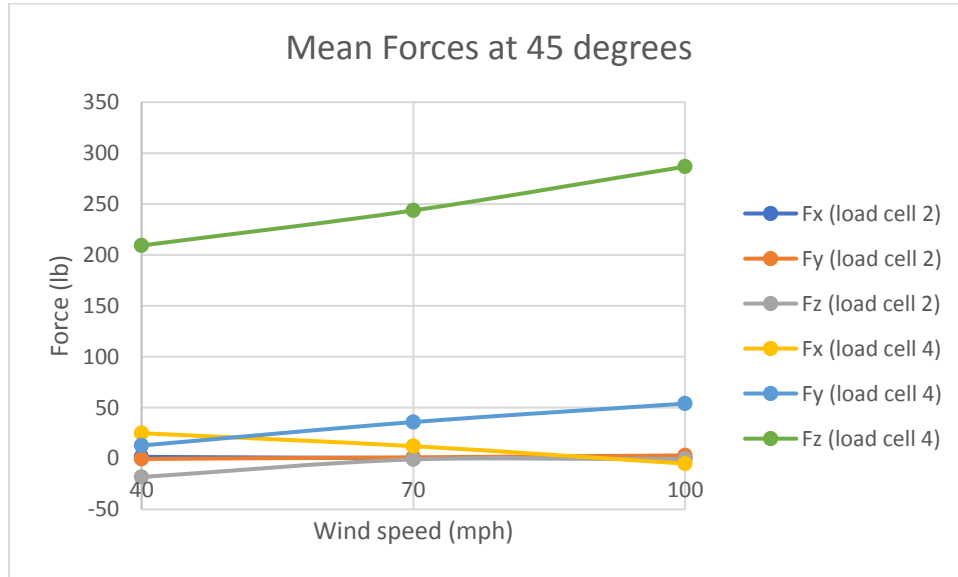

Figure C 1: Mean forces at 45 degrees wind direction on loadcells 2 (catenary wire) and 4 (messenger wire)

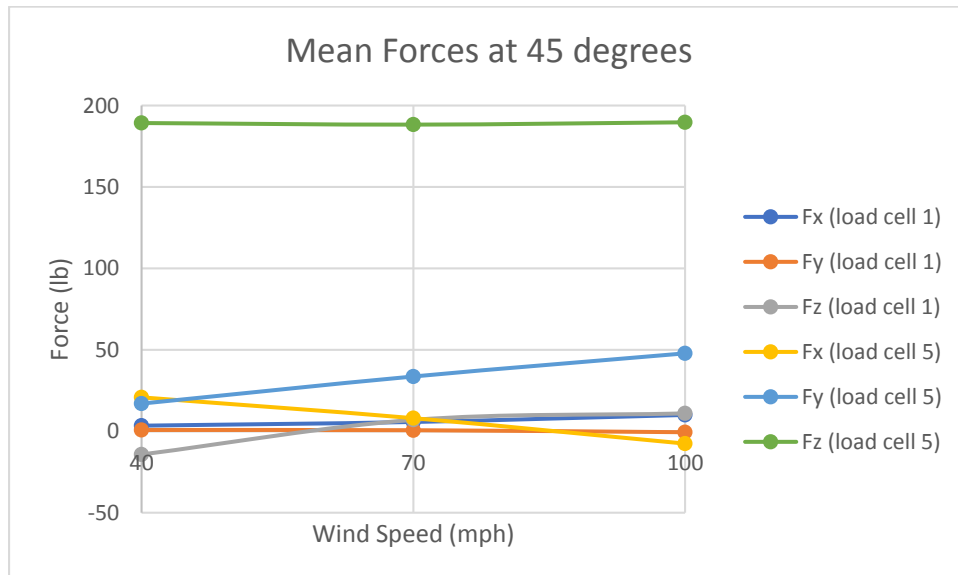

Figure C 2: Mean forces at 45 degrees wind direction on loadcells 1 (catenary wire) and 5 (messenger wire)

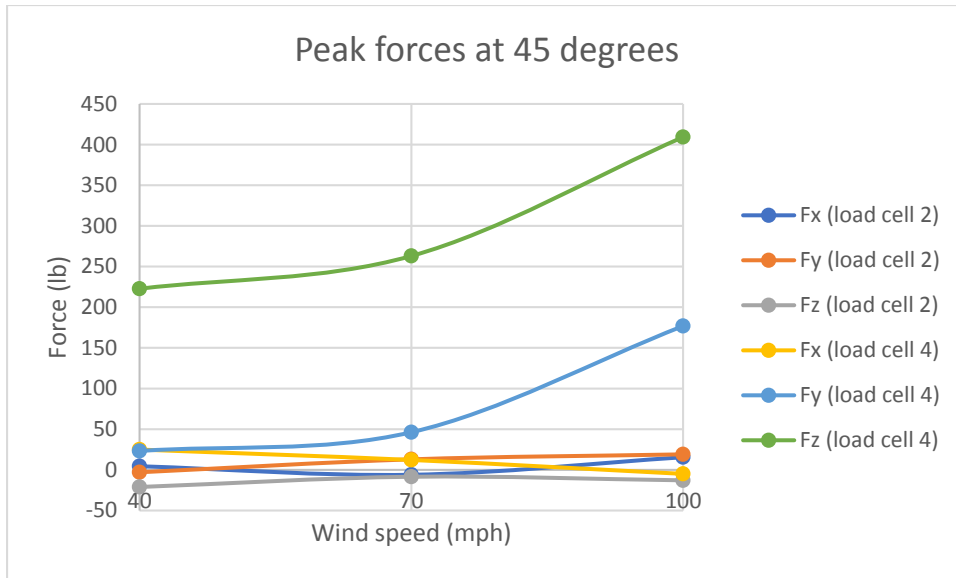

Figure C 3: Peak forces at 45 degrees wind direction on loadcells 2 (catenary wire) and 4 (messenger wire)

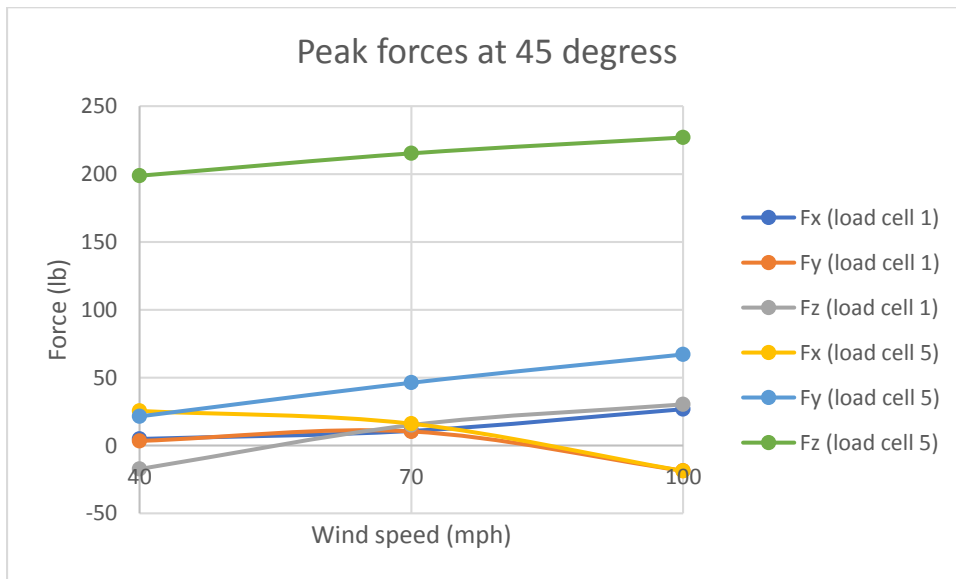

Figure C 4: Peak forces at 45 degrees wind direction on loadcells 1 (catenary wire) and 5 (messenger wire)

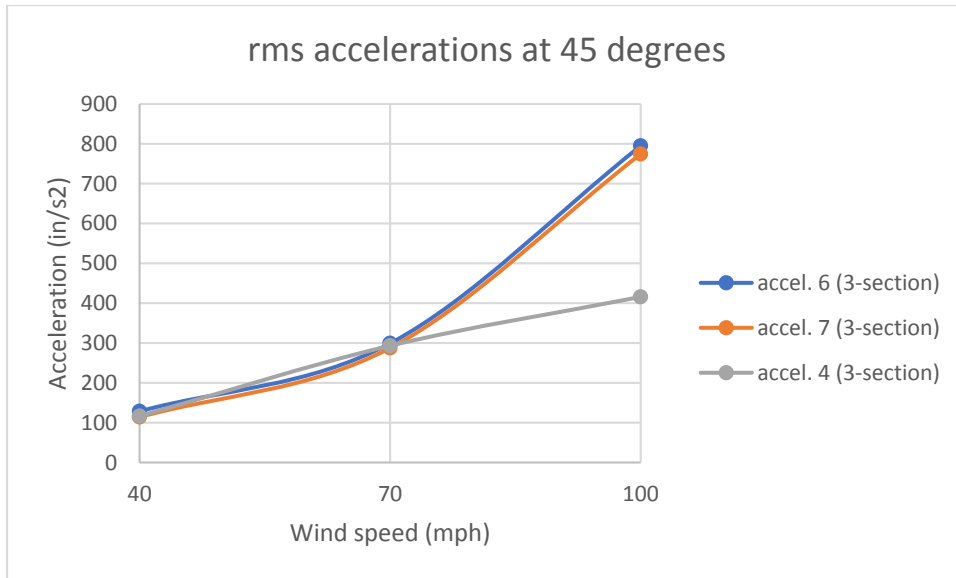

Figure C 5: rms of accelerations at 45 degrees wind direction for various wind speeds

Results for Mean and peak forces, and rms of accelerations for 80 degrees wind direction are presented in Figures C6 to C10

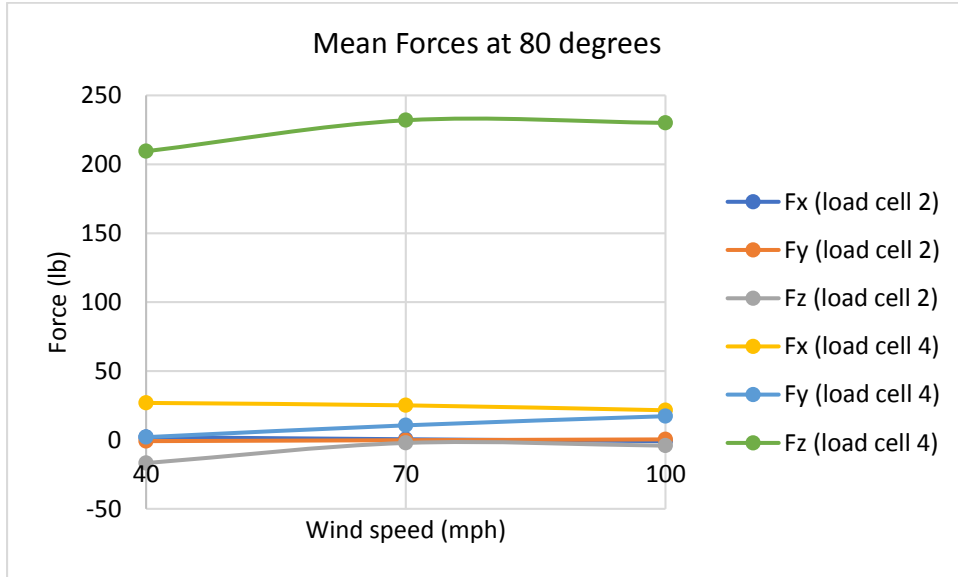

Figure C 6: Mean forces at 80 degrees wind direction on loadcells 2 (catenary wire) and 4 (messenger wire)

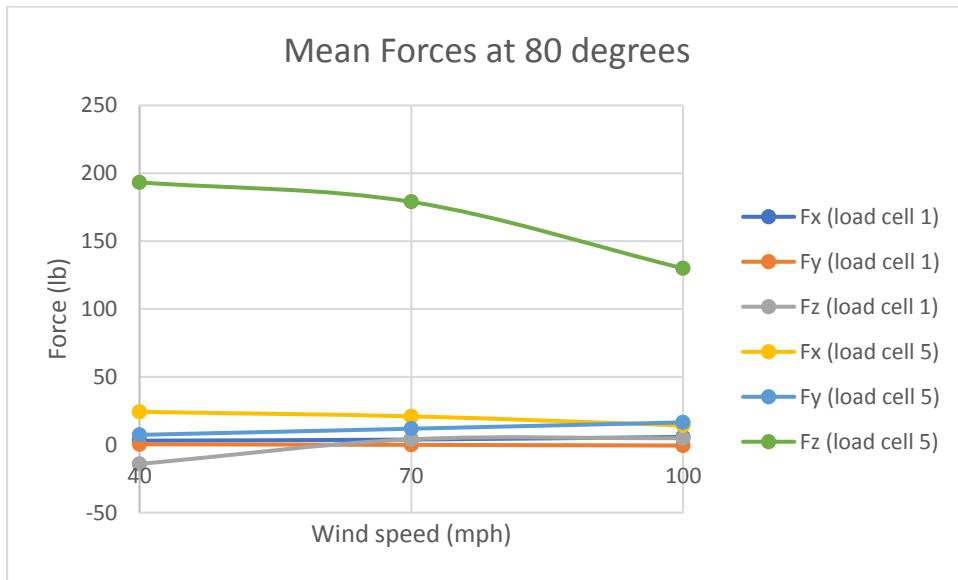

Figure C 7: Mean forces at 80 degrees wind direction on loadcells 1 (catenary wire) and 5 (messenger wire)

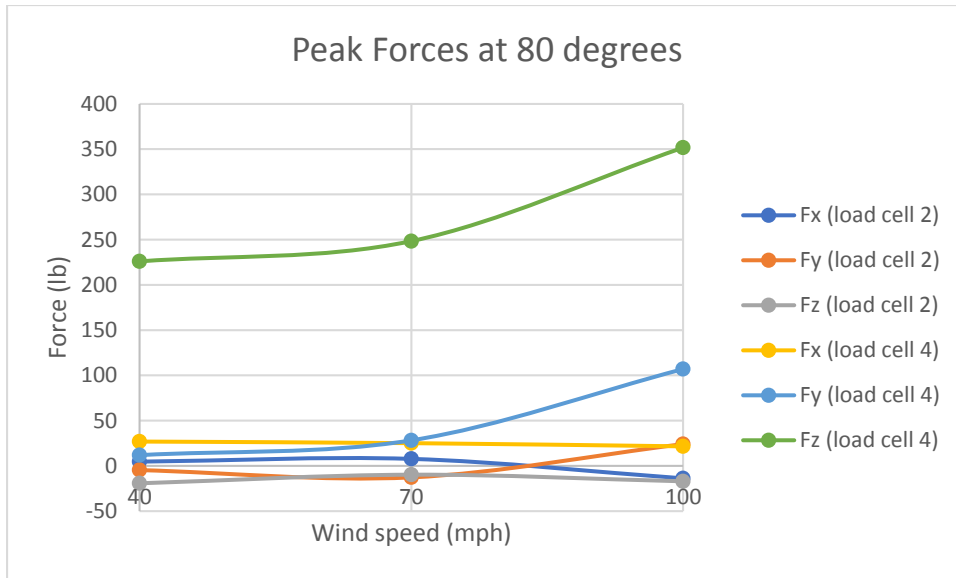

Figure C 8: Peak forces at 80 degrees wind direction on loadcells 2 (catenary wire) and 4 (messenger wire)

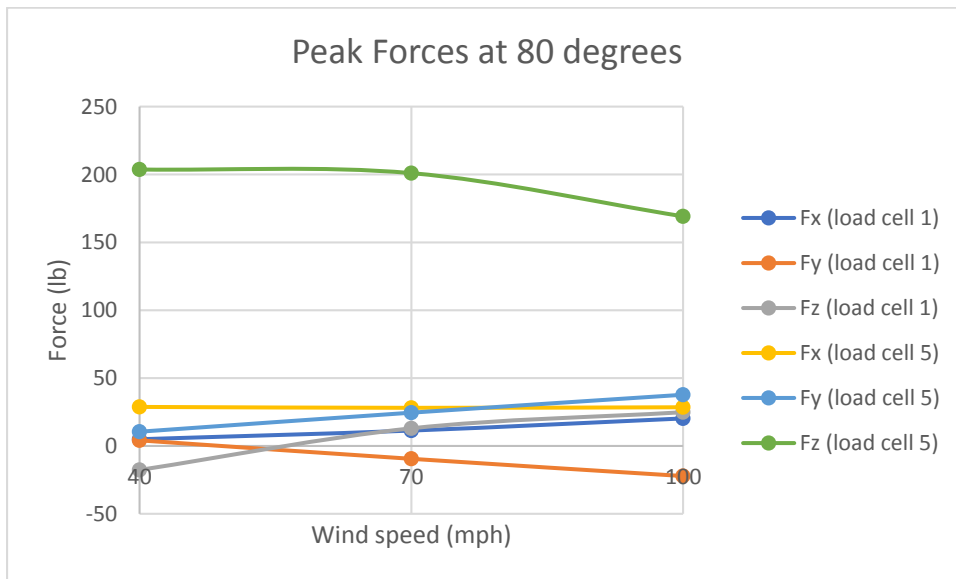

Figure C 9: Peak forces at 80 degrees wind direction on loadcells 1 (catenary wire) and 5 (messenger wire)

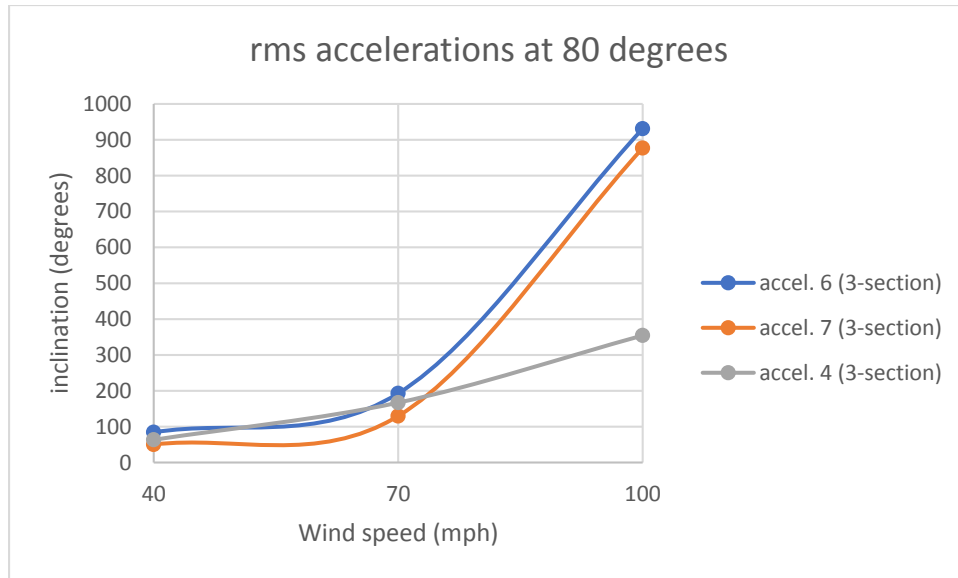

Figure C 10: rms of accelerations at 80 degrees wind direction for various wind speeds

Results for Mean and peak forces, and rms of accelerations for 100 degrees wind direction are presented in Figures C11 to C15

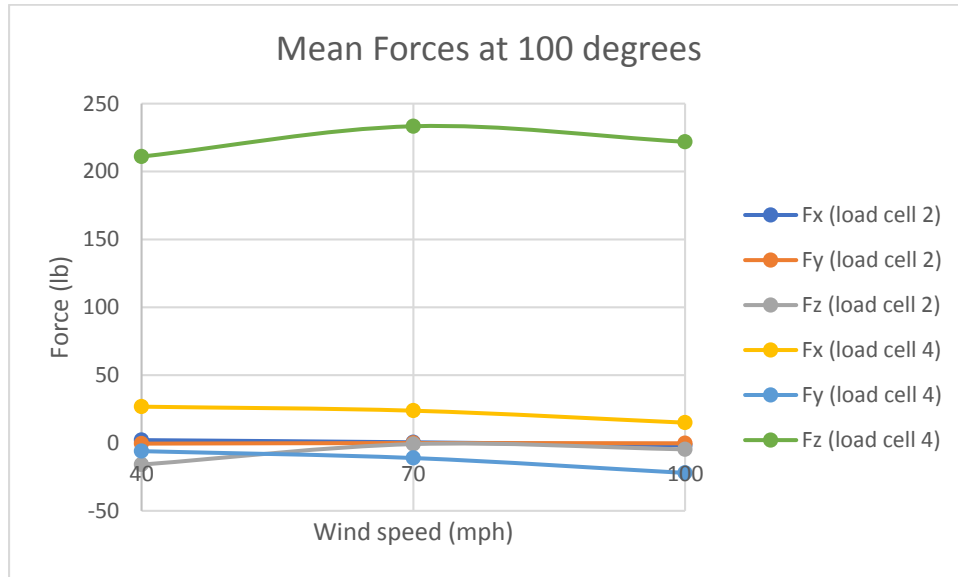

Figure C 11: Mean forces at 100 degrees wind direction on loadcells 2 (catenary wire) and 4 (messenger wire)

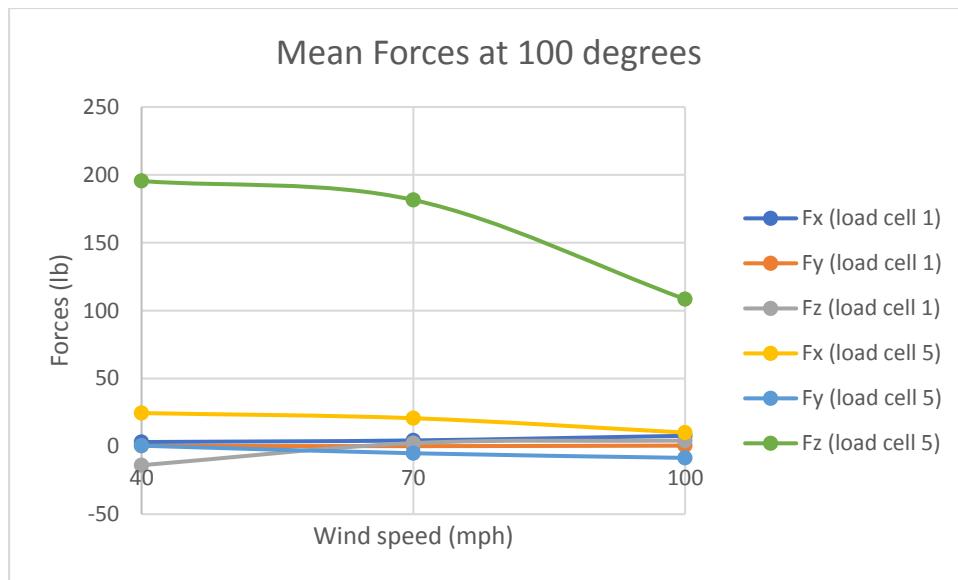

Figure C 12: Mean forces at 100 degrees wind direction on loadcells 1 (catenary wire) and 5 (messenger wire)

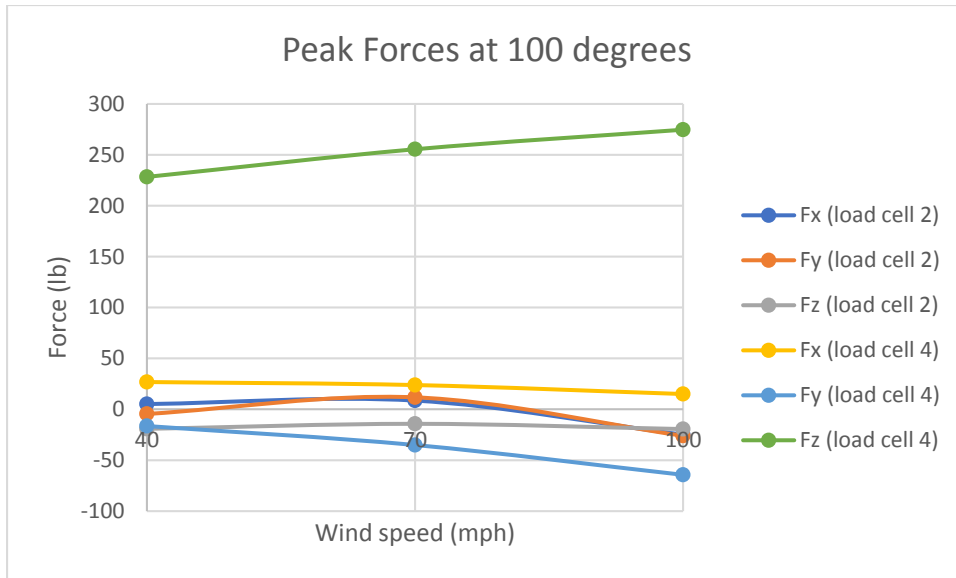

Figure C 13: Peak forces at 100 degrees wind direction on loadcells 2 (catenary wire) and 4 (messenger wire)

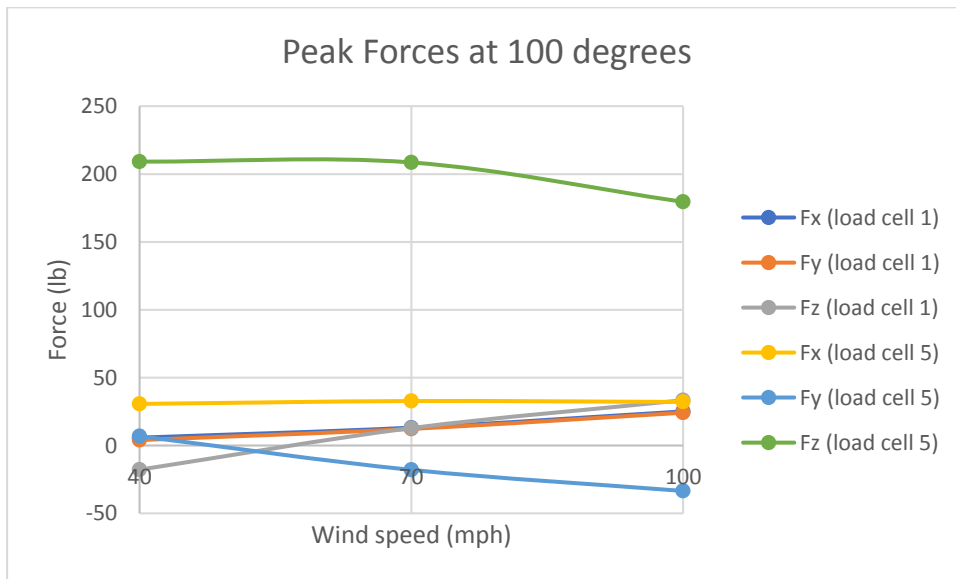

Figure C 14: Peak forces at 100 degrees wind direction on loadcells 1 (catenary wire) and 5 (messenger wire)

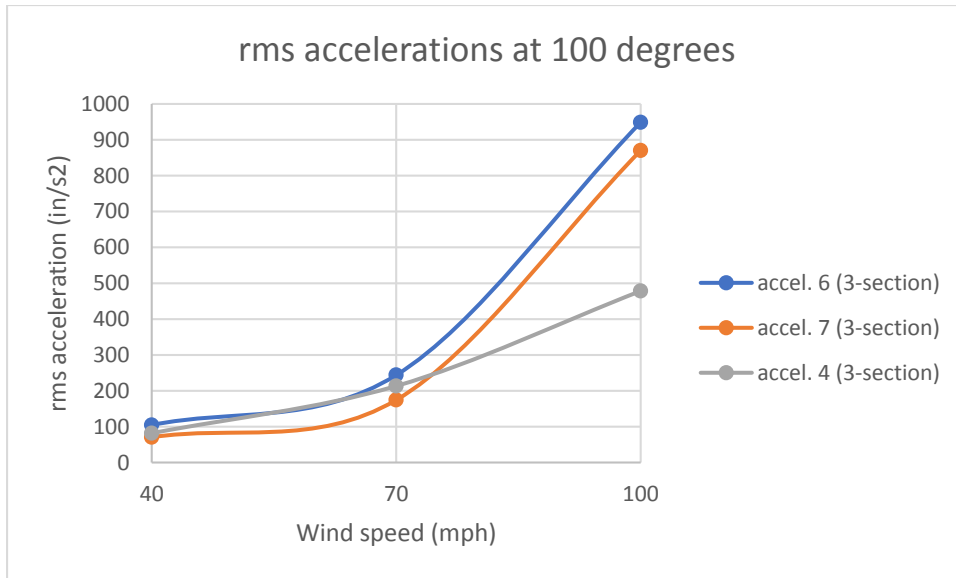

Figure C 15: rms of accelerations at 100 degrees wind direction for various wind speeds

Results for Mean and peak forces, and rms of accelerations for 135 degrees wind direction are presented in Figures C16 to C20

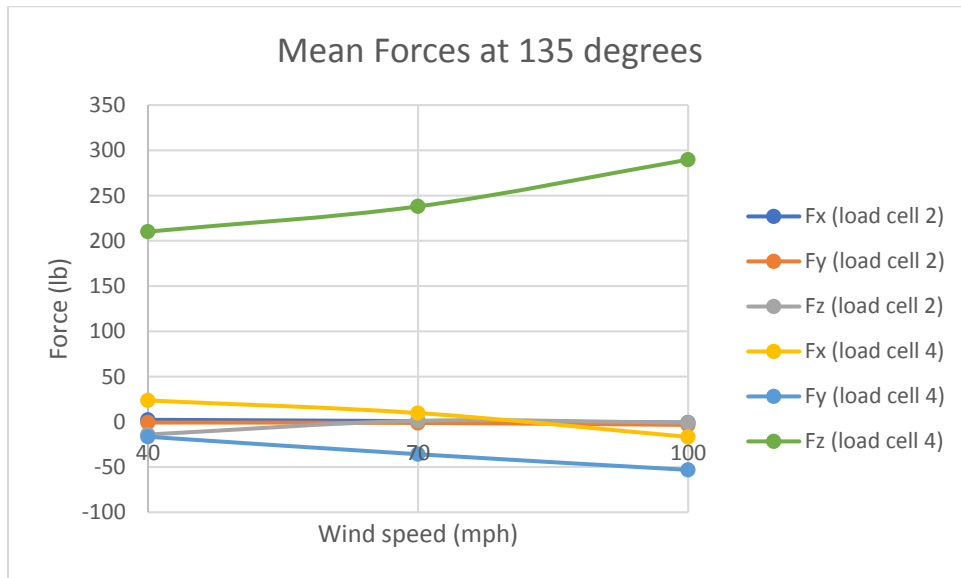

Figure C 16: Mean forces at 135 degrees wind direction on loadcells 2 (catenary wire) and 4 (messenger wire)

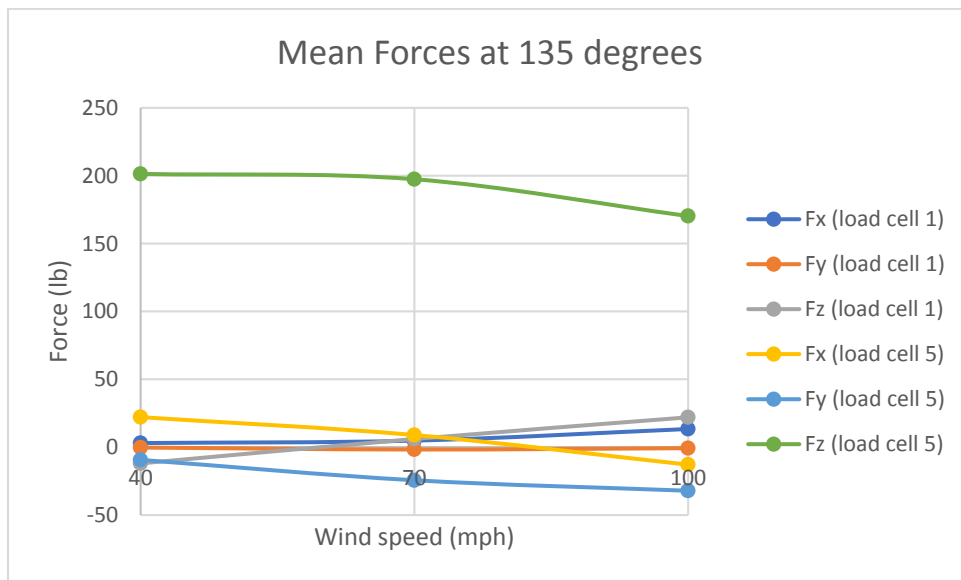

Figure C 17: Mean forces at 135 degrees wind direction on loadcells 1 (catenary wire) and 5 (messenger wire)

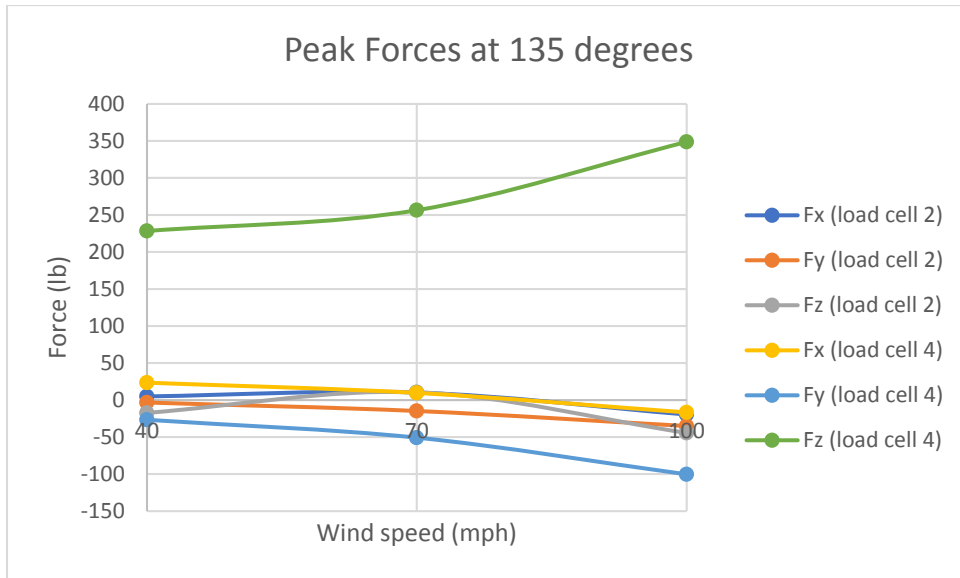

Figure C 18: Peak forces at 135 degrees wind direction on loadcells 2 (catenary wire) and 4 (messenger wire)

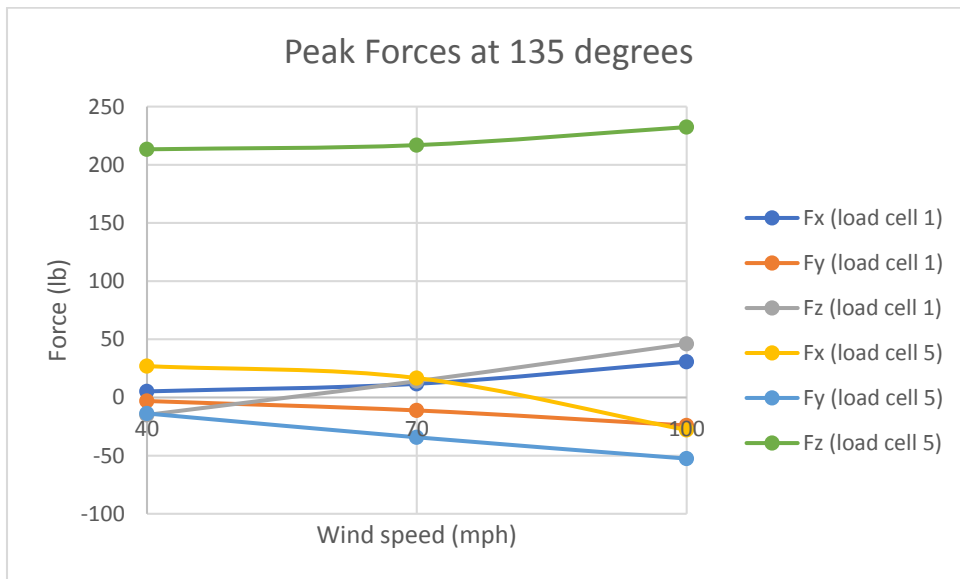

Figure C 19: Peak forces at 135 degrees wind direction on loadcells 1 (catenary wire) and 5 (messenger wire)

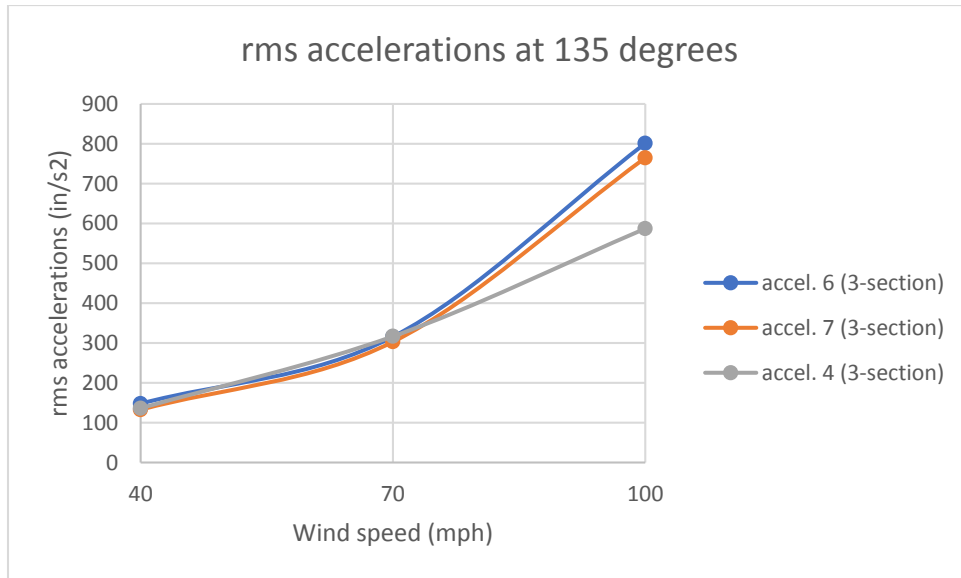

Figure C 20: rms of accelerations at 135 degrees wind direction for various wind speeds

Results for Mean and peak forces, and rms of accelerations for 180 degrees wind direction are presented in Figures C21 to C25

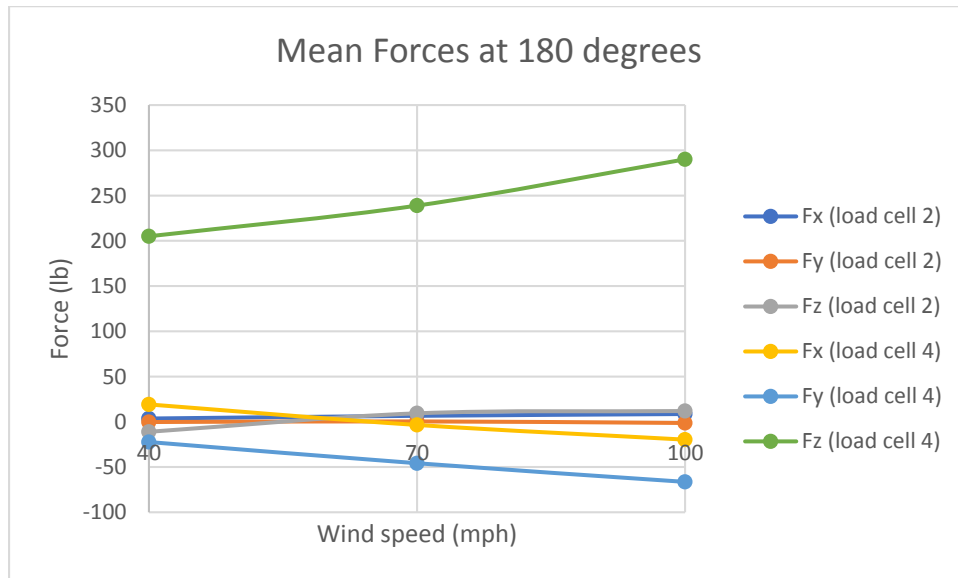

Figure C 21: Mean forces at 180 degrees wind direction on loadcells 2 (catenary wire) and 4 (messenger wire)

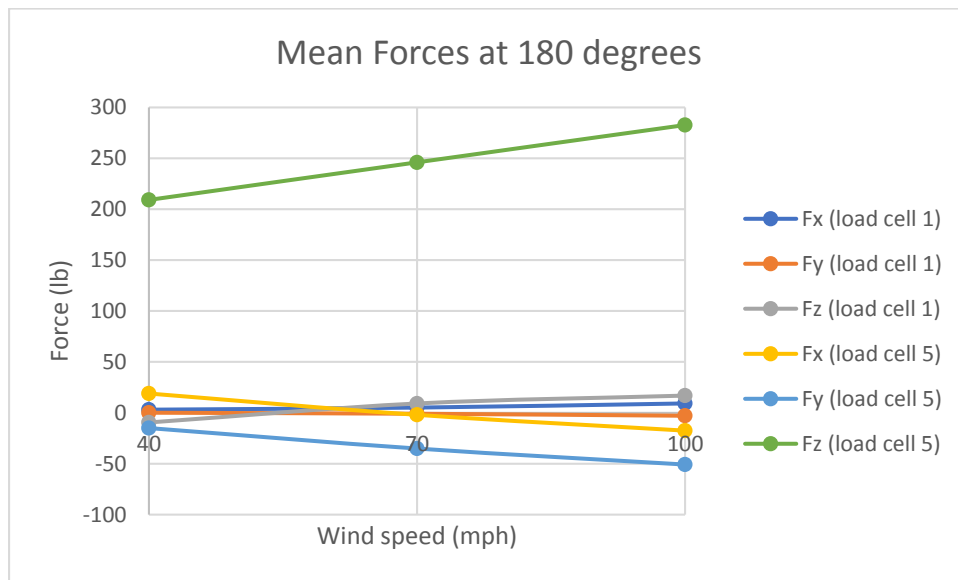

Figure C 22: Mean forces at 180 degrees wind direction on loadcells 1 (catenary wire) and 5 (messenger wire)

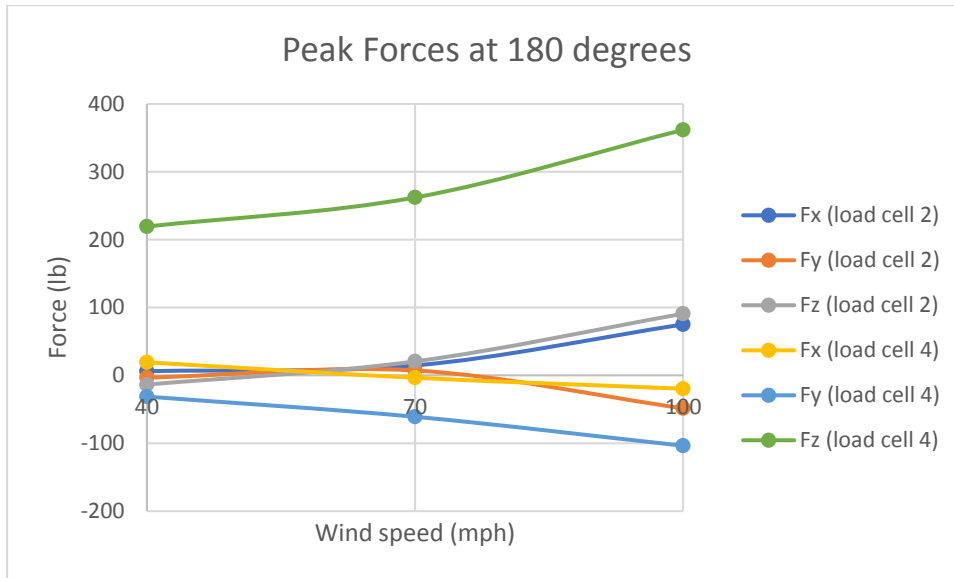

Figure C 23: Peak forces at 180 degrees wind direction on loadcells 2 (catenary wire) and 4 (messenger wire)

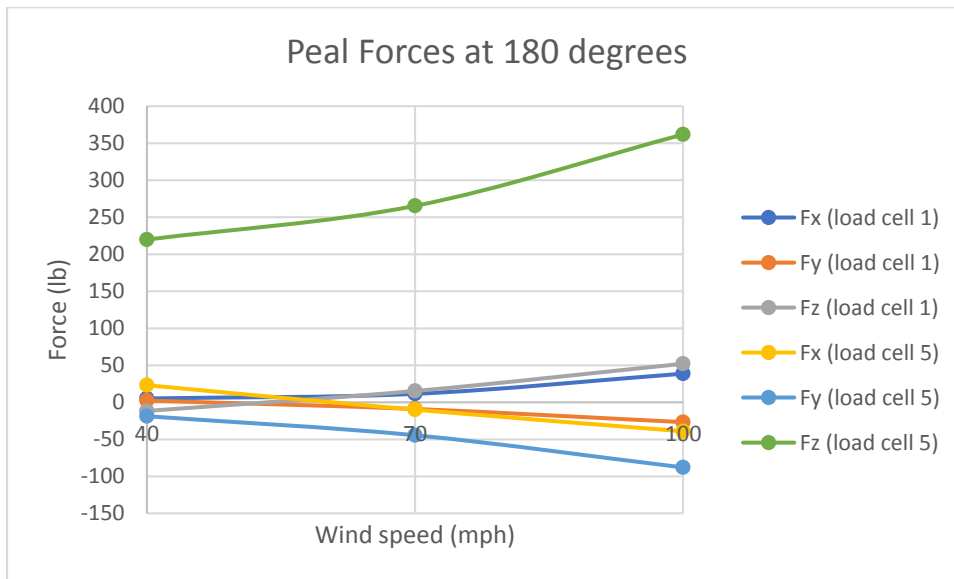

Figure C 24: Peak forces at 180 degrees wind direction on loadcells 1 (catenary wire) and 5 (messenger wire)

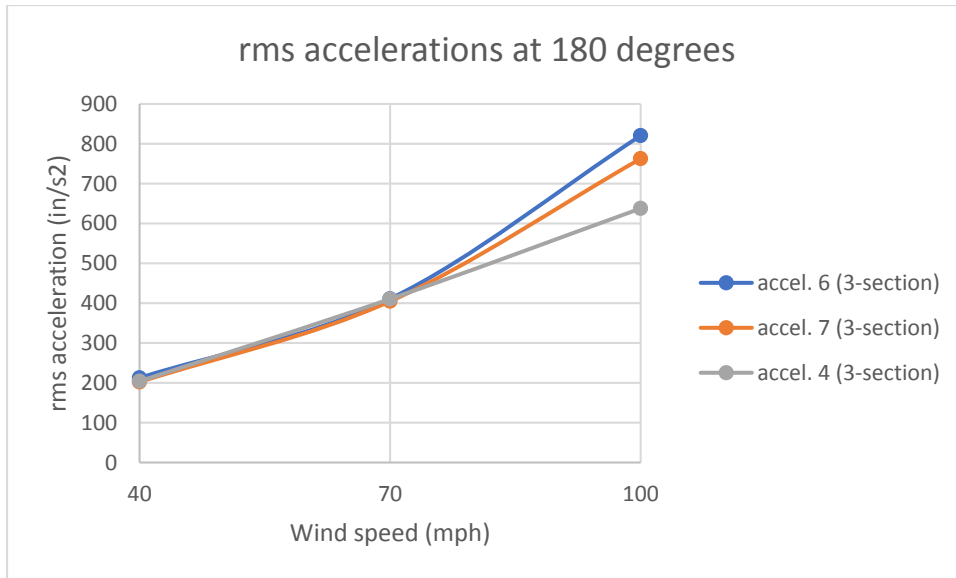

Figure C 25: rms of accelerations at 180 degrees wind direction for various wind speeds

Appendix D - Comparison of solid (non-louvered) backplates and louvered backplates cases

There were two configurations tested with only a 3-section signal. One configuration was assembled with louvered backplates while the other configuration was assembled with solid backplates. The main purpose of these two tests was to assess the overall response of the system with the different backplates and compare them. Results of the Louvered backplate case are presented in this chapter and the results of the Solid backplate case are presented in the report BDV29 TWO 977-27 FDOT Interim Report Task 2-Case 10 [6].

When comparing the results between the solid (non-louvered) and louvered backplates cases, it was found that the solid (non-louvered) backplates case experienced higher mean forces than the louvered backplates, where at 100 mph and at 0 degrees wind direction, the solid (non-louvered) case experienced a maximum mean Fz force of 347 lbs while the louvered backplates case had a maximum mean Fz force of 284.7 lbs, as shown in Figure D-1 and Figure D-2. The overall response of both cases is similar, however, the louvered backplates case experienced less forces than the solid (non-louvered) backplates case while the opposite is seen for inclinations, where the solid (non-louvered) case experienced less mean inclinations than the louvered backplates case, as shown in Figure D-3 and Figure D-4, attaining values of 53 degrees and 63 degrees at 100 mph respectively. When looking at the peak inclinations (along wind), the solid (non-louvered) backplates case experienced a maximum inclination of 70 degrees while the louvered backplates case attained a maximum inclination of 86 degrees, at 100 mph and 0-degree wind direction. It needs to be noted that in the non-louvered backplate case, the clamp attached to the adjustable hanger to hold the messenger wire slipped and the adjustable hanger broke.

Results for Mean forces and inclinations, at 0 degrees wind direction, are presented in Figure D-1 to Figure D-4

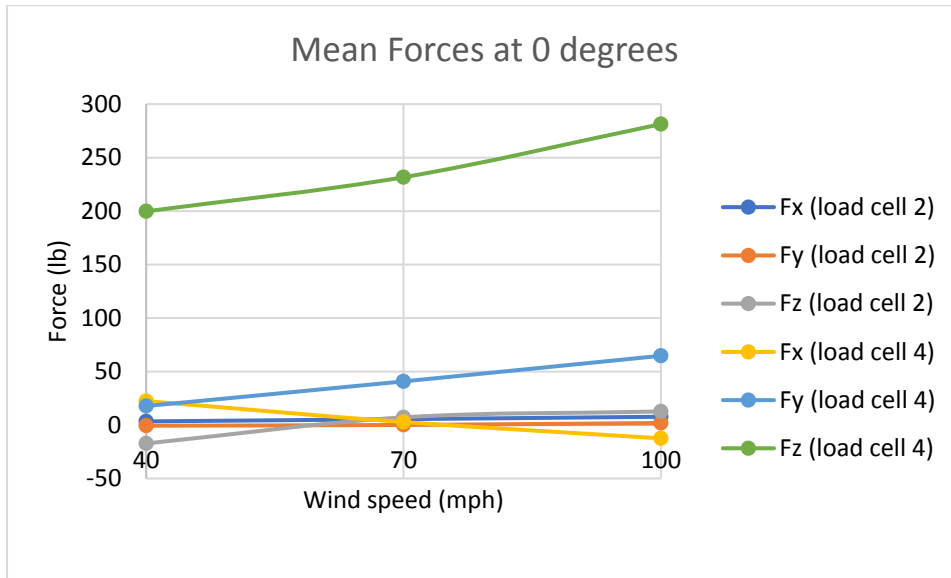

a)

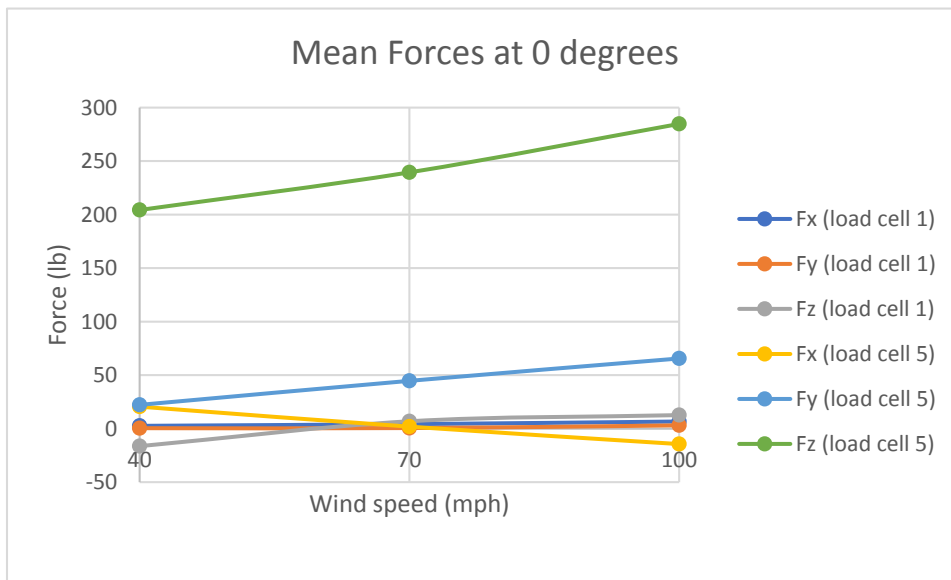

b)

Figure D-1: Mean forces of Louvered backplates case; a) loadcells 1 & 2 catenary wire,) loadcells 4 & 5 messenger wire)

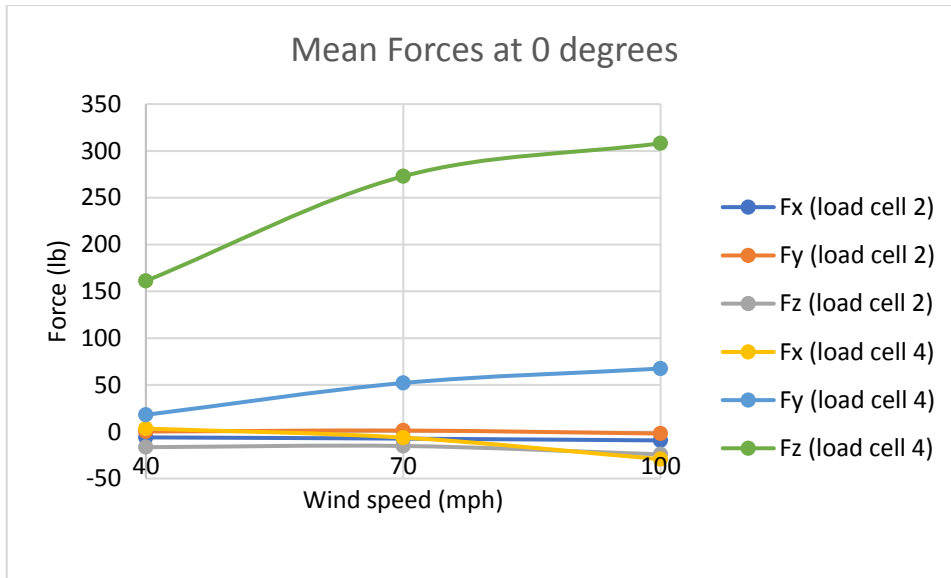

a)

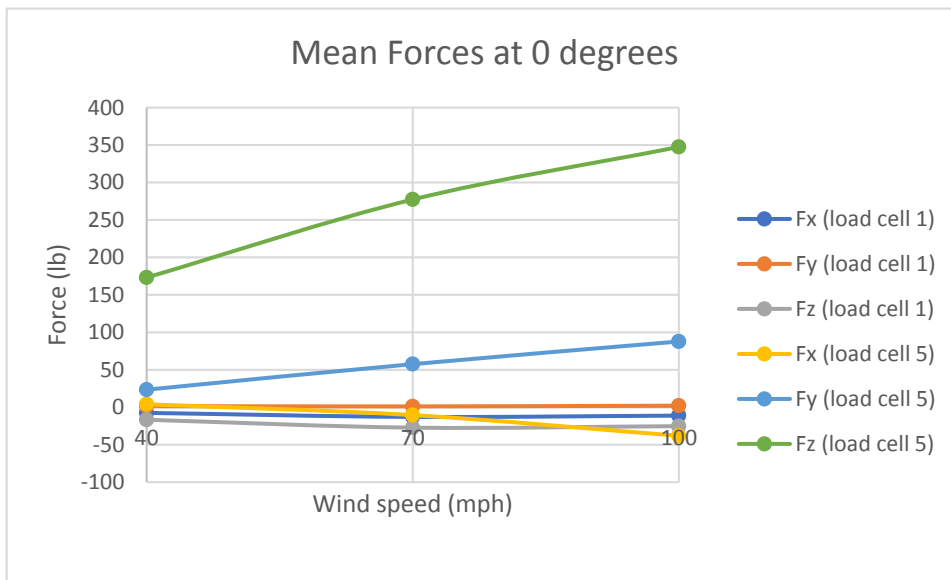

b)

Figure D-2: Mean forces of Solid (non-louvered) backplates case; a) loadcells 1 & 2 catenary wire, b) loadcells 4 & 5 messenger wire)

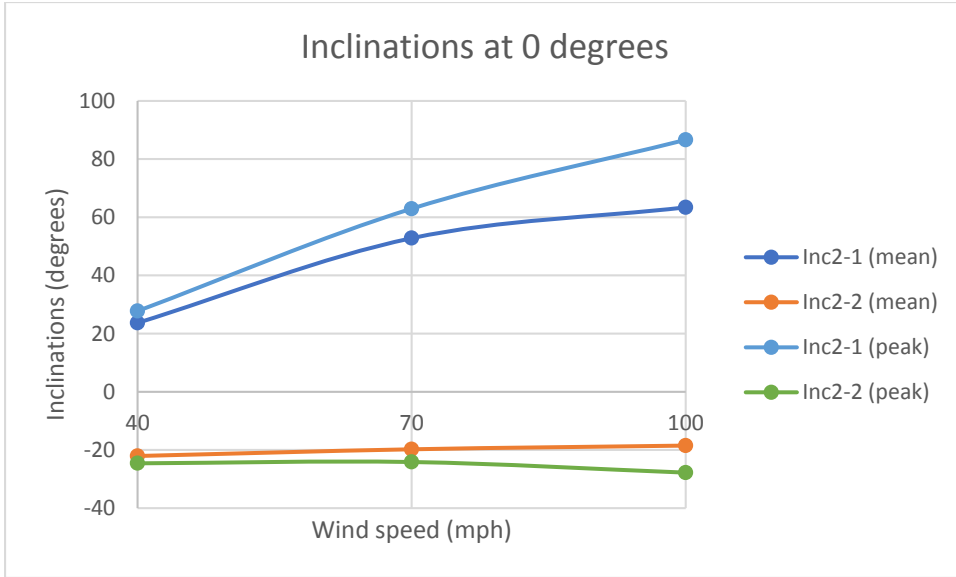

Figure D-3: Mean inclinations of louvered backplates case

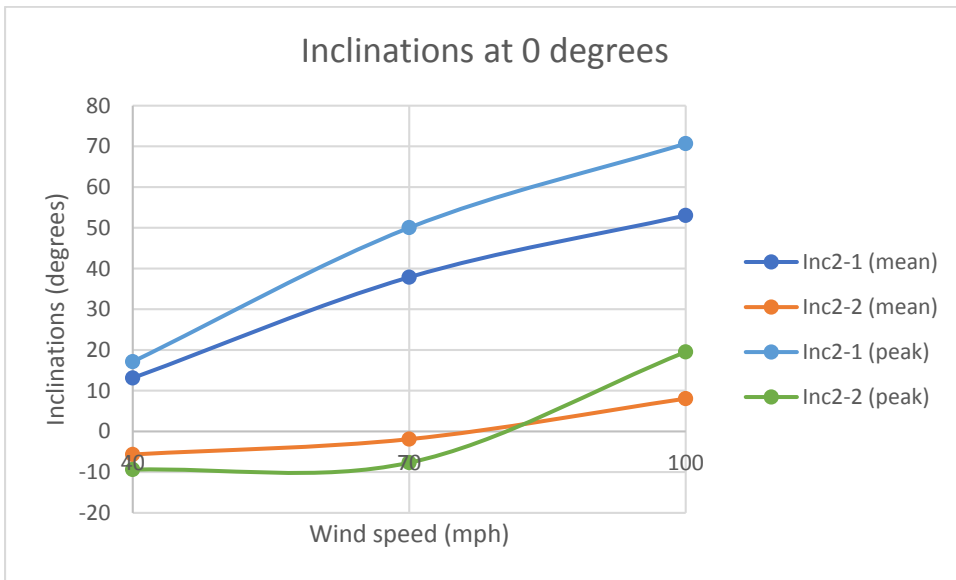

Figure D-4: Mean inclinations of solid (non-louvered) backplates case