



# Federal Lands Highway Field Materials Manual



Federal Highway Administration  
U.S. Department of Transportation



"Commitment to Excellence"

(This page intentionally left blank.)

## INTRODUCTION

This manual has been developed to provide construction project personnel with information and guidance for field activities relating to materials. This manual complements the *Standard specifications for Construction of Roads and Bridges on Federal Highway Projects (FP)*. When the guidelines or directions set forth in this manual conflict with an FLH contract, the contract shall govern.

This manual is intended as general guidance. It sets forth procedures and best practices for testing and verifying materials on a contract. The application of this manual to any particular situation is to be guided by sound engineering principles. This manual does not create enforceable rights. However, a contract may adopt or incorporate by reference any portion of this manual and thereby establish that portion as binding on the parties.

The manual is divided into five chapters and six divisions.

Chapter 1 – Division 100: Acceptance and Verification Procedures and Material Project Requirements

Chapter 2 – Division 200: Earthwork Testing and Evaluation

Chapter 3 – Division 300: Aggregate Base, Subbase, Aggregate-Topsoil, and Base Stabilization

Chapter 4 – Division 400: Asphalt Pavements and Surface Treatments

Chapter 5 – Division 500: Concrete

Chapter 1 processes and procedures are generally applicable to the categories of materials addressed in Chapters 2 through 5. Chapters 2 through 5 set forth the processes needed to address the categories of materials specifically addressed in each particular chapter.

In this manual, the term “Project Engineer” applies to both FHWA Project Engineers and contracted Construction Managers. The Construction Managers role, however, is limited as identified in the specific contract with FHWA and the Delegation of Authority letter.

(This page intentionally left blank.)

**Chapter 1 – DIVISION 100: ACCEPTANCE AND VERIFICATION  
PROCEDURES**

**TABLE OF CONTENTS**

<u>Section</u>	<u>Page</u>
GENERAL GUIDANCE .....	1-1
1.1 ACCEPTANCE .....	1-1
1.1.1 Visual Inspection .....	1-1
1.1.2 Certification .....	1-1
1.1.3 Measured or Tested for Conformance .....	1-3
1.1.4 Statistical Evaluation of Work and Determination of Pay Factor (Value of Work) .....	1-3
1.2 VERIFICATION PROCESSES .....	1-5
1.2.1 Verification of Material Quality .....	1-5
1.2.2 Visual Inspection and Certification .....	1-5
1.2.3 Measured or Tested for Conformance .....	1-5
1.2.4 Statistical Evaluation of Work and Determination of Pay Factor (Value of Work) .....	1-6
1.3 VALIDATION OF TEST RESULTS AND PAY FACTORS.....	1-7
1.3.1 Validation of Contractor Test Results .....	1-7
1.3.1.1 Validation Conditions .....	1-7
1.3.1.2 Test Results Verification .....	1-7
1.3.2 Test Results Review .....	1-9
1.3.3 Dispute Resolution Guidelines .....	1-10
1.4 ACCEPTANCE OF WORK AND VALUE DETERMINATION .....	1-12
1.5 MATERIAL PROJECT REQUIREMENTS.....	1-14
1.5.1 Personnel.....	1-14
1.5.1.1 Qualification Documentation .....	1-14
1.5.1.2 Subcontracted Sampling and Testing.....	1-14
1.5.2 Equipment and Testing Laboratories.....	1-15
1.5.2.1 Contractor-furnished Laboratories.....	1-15
1.5.2.2 Subcontracted Sampling and Testing.....	1-15
1.5.2.3 Equipment Calibration.....	1-16
1.5.2.4 Equipment Calibration Documentation .....	1-17
1.5.3 Sampling.....	1-17
1.5.3.1 Sampling Responsibilities .....	1-18
1.5.3.2 Sampling Procedures.....	1-19
1.5.3.3 Sampling Methodologies.....	1-19
1.5.3.4 Sample Handling.....	1-20
1.5.3.5 Request for Laboratory Testing.....	1-21
1.6 FORM REFERENCES.....	1-22

**LIST OF EXHIBITS**

<b><u>Exhibit</u></b>		<b><u>Page</u></b>
Exhibit 1-1	Common Sample Containers.....	1-21

## Chapter 2 - DIVISION 200: EARTHWORK TESTING AND EVALUATION

### TABLE OF CONTENTS

<u>Section</u>		<u>Page</u>
2.1	SUMMARY AND DESCRIPTION .....	2-1
2.2	MATERIAL PROPERTIES AND TEST METHODS .....	2-2
2.2.1	Classification.....	2-2
2.2.1.1	Particle Size Distribution .....	2-3
2.2.1.2	Consistency and Plasticity (Atterberg Limits).....	2-3
2.2.2	Moisture – Density Relations .....	2-4
2.2.2.1	Moisture content.....	2-4
2.2.2.2	Density .....	2-5
2.2.3	Soil Strength .....	2-6
2.3	IMPORTED SUBGRADE AND BACKFILL MATERIALS .....	2-7
2.4	ROLES AND RESPONSIBILITIES.....	2-10
2.4.1	Contractor’s Responsibilities .....	2-10
2.4.2	Government’s Responsibilities .....	2-10
2.5	MATERIAL CERTIFICATIONS .....	2-12
2.6	FORM REFERENCES .....	2-13

## LIST OF EXHIBITS

<b><u>Exhibit</u></b>	<b><u>Page</u></b>
Exhibit 2-1 Soil Test Methods .....	2-2
Exhibit 2-2 Classification of Soil Material from AASHTO M 145 .....	2-2
Exhibit 2-3 Particle Sizes .....	2-3
Exhibit 2-4 Relationship of Atterberg Limits .....	2-4
Exhibit 2-5 Five Point Moisture Density Curve.....	2-5
Exhibit 2-6 Guidance for Sample Sizes for Transmitting to FLHD Laboratory .....	2-8
Exhibit 2-7 AASHTO Soil Test Procedures .....	2-9
Exhibit 2-8 Materials Certification.....	2-12



**Chapter 3 – DIVISION 300: AGGREGATE BASE, SUBBASE, AGGREGATE  
TOPSOIL AND BASE STABILIZATION**

**TABLE OF CONTENTS**

<u>Section</u>	<u>Page</u>
3.1	SUMMARY AND DESCRIPTION .....3-1
3.2	AGGREGATE BASE PROPERTIES AND TEST METHODS .....3-2
3.2.1	Aggregate Quality Properties.....3-2
3.2.2	Processed Aggregate Properties.....3-3
3.2.2.1	Moisture Density Relationship.....3-4
3.2.3	Aggregate Sampling and Splitting .....3-4
3.2.3.1	Sampling from Stockpiles.....3-5
3.2.3.2	Sampling from Flowing Aggregate Stream .....3-7
3.2.3.3	Sampling from Conveyor Belt .....3-7
3.2.3.4	Sampling from Roadbed or Windrow .....3-9
3.2.3.5	Splitting Samples .....3-10
3.2.4	Typical Aggregate Base Treatments .....3-11
3.2.5	Other Associated Aggregate Products .....3-12
3.2.5.1	Minor Crushed Aggregate .....3-12
3.2.5.2	Recycled Aggregate Base and Road Reconditioning .....3-12
3.2.5.3	Aggregate-Topsoil.....3-12
3.2.5.4	Dust Palliatives and Stabilization Admixtures .....3-12
3.2.6	Field Testing Requirements.....3-13
3.3	ROLES AND RESPONSIBILITIES.....3-15
3.3.1	Contractor’s Responsibilities .....3-15
3.3.2	Government’s Responsibilities .....3-15
3.4	MATERIAL CERTIFICATIONS .....3-17
3.5	FORM REFERENCES .....3-18

**LIST OF EXHIBITS**

<b><u>Exhibit</u></b>	<b><u>Page</u></b>
Exhibit 3-1 Aggregate Quality Test Methods.....	3-2
Exhibit 3-2 Gradation Classification .....	3-3
Exhibit 3-3 Supplemental Aggregate Base Tests.....	3-4
Exhibit 3-4 Proper Sampling of Coarse Aggregate .....	3-5
Exhibit 3-5 Proper Use of Shield for Sampling.....	3-6
Exhibit 3-6 Proper Sampling of Fine Aggregate Stockpile .....	3-6
Exhibit 3-7 Sampling Device Cutting Across Flowing Stream.....	3-7
Exhibit 3-8 Sampling from Conveyor Belt .....	3-8
Exhibit 3-9 Proper Device for Belt Sampling .....	3-8
Exhibit 3-10 Schematic of Belt Sampling Device .....	3-9
Exhibit 3-11 Schematic of Sampling from a Windrow .....	3-10
Exhibit 3-12 Guidance for Sample Sizes for Transmitting to FLHD Laboratory .....	3-11
Exhibit 3-13 AASHTO and ASTM Aggregate Test Procedures .....	3-13
Exhibit 3-14 Materials Certifications.....	3-17

## Chapter 4 – DIVISION 400: ASPHALT PAVEMENTS AND SURFACE TREATMENTS

### TABLE OF CONTENTS

<u>Section</u>		<u>Page</u>
4.1	SUMMARY AND DESCRIPTION .....	4-1
4.2	SUPERPAVE HOT ASPHALT CONCRETE AGGREGATE AND MIX DESIGN ...	4-2
4.2.1	Aggregate Quality and Gradation .....	4-2
4.2.2	Superpave Mix Design Process.....	4-2
4.2.2.1	Hveem and Marshall Mix Design Methods.....	4-4
4.2.3	Asphalt Binder .....	4-4
4.2.4	Additives .....	4-5
4.3	CONSTRUCTION PROCESS .....	4-6
4.3.1	Equipment for Production and Placement .....	4-6
4.3.2	Production Start-Up Procedures.....	4-6
4.3.3	Full Production Operations .....	4-7
4.3.4	Pavement Smoothness.....	4-13
4.3.5	Other Types of Asphalt Mixtures .....	4-13
4.4	SURFACE TREATMENTS .....	4-14
4.4.1	Single or Multiple-Course Surface Treatment.....	4-14
4.4.2	Fog Seal .....	4-16
4.4.3	Slurry Seal and Micro-Surfacing.....	4-17
4.4.4	Prime Coat.....	4-17
4.5	RECYCLING TECHNIQUES .....	4-18
4.5.1	Cold Recycling.....	4-18
4.5.2	Full Depth Reclamation (FDR) Techniques .....	4-18
4.6	ROLES AND RESPONSIBILITIES.....	4-20
4.6.1	Contractor’s Responsibilities .....	4-20
4.6.2	Government’s Responsibilities .....	4-20
4.7	MATERIAL CERTIFICATIONS .....	4-22
4.8	FORM REFERENCES .....	4-23

**LIST OF EXHIBITS**

<b><u>Section</u></b>	<b><u>Page</u></b>
Exhibit 4-1 Superpave Aggregate Quality Test Methods .....	4-2
Exhibit 4-2 Mix Design Test Methods.....	4-3
Exhibit 4-3 Sampling Asphalt Binder.....	4-8
Exhibit 4-4 Placing Separator for Obtaining Mixture Sample .....	4-9
Exhibit 4-5 Obtaining Mixture Sample Prior to Compaction .....	4-9
Exhibit 4-6 Splitting the Uncompacted Mixture Sample .....	4-10
Exhibit 4-7 Quartering the Mixture Sample to Obtain the Proper Split.....	4-10
Exhibit 4-8 Reducing Mixture Sample to Testing Size .....	4-11
Exhibit 4-9 Cutting Core .....	4-12
Exhibit 4-10 Proper Core Removal Device .....	4-12
Exhibit 4-11 Sawing to Separate Pavement Layers.....	4-12
Exhibit 4-12 Chip Seal Aggregate Placement.....	4-14
Exhibit 4-13 Close-up of Placement.....	4-15
Exhibit 4-14 Completed Chip Seal Surface.....	4-15
Exhibit 4-15 Fog Seal Application .....	4-17
Exhibit 4-16 Materials Certifications.....	4-22

## Chapter 5 – DIVISION 500: CONCRETE

### TABLE OF CONTENTS

<u>Section</u>		<u>Page</u>
5.1	SUMMARY AND DESCRIPTION .....	5-1
5.2	CONCRETE MATERIALS SPECIFICATIONS .....	5-2
5.2.1	Hydraulic Cement .....	5-3
5.2.1.1	Portland Cement .....	5-3
5.2.1.2	Blended Cement .....	5-4
5.2.1.3	Hydraulic Cement Constructability Issues.....	5-5
5.2.2	Mineral Admixtures / Pozzolans .....	5-6
5.2.2.1	Fly Ash .....	5-6
5.2.2.2	Ground Granulated Blast-furnace Slag (GGBFS).....	5-8
5.2.2.3	Silica Fume .....	5-9
5.2.2.4	Collective Mineral Admixture Limitation .....	5-10
5.2.3	Water .....	5-11
5.2.4	Concrete Aggregates.....	5-12
5.2.4.1	Concrete Aggregate Gradation .....	5-13
5.2.4.2	Concrete Fine Aggregate .....	5-13
5.2.4.3	Concrete Coarse Aggregate .....	5-14
5.2.4.4	Aggregate Tests Used During Concrete Mixture Proportioning .....	5-15
5.2.5	Chemical Admixtures.....	5-16
5.2.5.1	Air-entraining Admixtures.....	5-17
5.2.5.2	Water-reducing and Set-controlling Admixtures.....	5-17
5.2.5.3	Concrete Coloring Admixtures .....	5-18
5.2.5.4	Miscellaneous Admixtures .....	5-18
5.2.6	Fibers.....	5-18
5.3	CONCRETE MATERIALS ACCEPTANCE REQUIREMENTS .....	5-20
5.3.1	Materials Certification Acceptance .....	5-20
5.3.2	Water Acceptance .....	5-22
5.3.3	Aggregate Acceptance .....	5-22
5.4	CONCRETE MIXTURE PROPORTIONING AND APPROVAL REQUIREMENTS.....	5-25
5.4.1	Concrete Mixture Composition and Proportioning Requirements.....	5-25
5.4.1.1	ACI 211.1 Standard Practice for Selecting Proportions for Normal, Heavyweight and Mass Concrete.....	5-25
5.4.1.2	ACI 211.2 Standard Practice for Selecting Proportions for Structural Lightweight Concrete .....	5-25
5.4.1.3	CI 211.3 Guide for Selecting Proportions for No-Slump Concrete .....	5-26
5.4.1.4	ACI 211.4 Guide for Selecting Proportions for High- Strength Concrete with Portland Cement and Fly Ash .....	5-26

**TABLE OF CONTENTS (Continued)**

<b><u>Section</u></b>	<b><u>Page</u></b>
5.4.2	Concrete Mixture Durability Requirements .....5-27
5.4.2.1	Exposure Category F (Freezing and thawing) .....5-28
5.4.2.2	Exposure Category S (Sulfates) .....5-29
5.4.2.3	Exposure Category C (Corrosion) .....5-30
5.4.2.4	Delayed Ettringite Formation (DEF) .....5-31
5.4.2.5	Alkali—Silica Reactivity (ASR) .....5-31
5.4.3	Concrete Mixture Strength Requirements.....5-35
5.4.3.1	Determine a Sample Standard Deviation from Suitable Test Records .....5-36
5.4.3.2	Determine a Required Average Strength (f'cr).....5-38
5.4.3.3	Select Mixture Proportions .....5-41
5.4.4	Concrete Mix Design Submittal .....5-41
5.4.5	Concrete Mix Design Approval .....5-41
5.5	CONCRETE CONSTRUCTION REQUIREMENTS .....5-42
5.5.1	Aggregate Testing for Uniformity and Water Content Adjustment of Concrete Mixtures.....5-43
5.5.2	Fresh Concrete Properties .....5-44
5.5.2.1	Sampling .....5-45
5.5.2.2	Concrete Slump .....5-45
5.5.2.3	Air Content .....5-46
5.5.2.4	Concrete Temperature .....5-46
5.5.2.5	Concrete Unit Weight .....5-46
5.5.3	Hardened Concrete Properties .....5-46
5.6	SHOTCRETE .....5-49
5.6.1	Shotcrete Materials Specifications.....5-49
5.6.2	Shotcrete Mixture Proportioning and Preconstruction Requirements .....5-50
5.6.2.1	Fresh Shotcrete Properties Sampling and Testing .....5-50
5.6.2.2	Making and Curing Shotcrete Test Panels .....5-50
5.6.2.3	Hardened Shotcrete Properties Testing .....5-51
5.6.3	Shotcrete Mixture Approval Requirements .....5-52
5.6.4	Shotcrete Construction Requirements .....5-53
5.7	DRIVEN PILES.....5-54
5.7.1	Steel H-Piles .....5-54
5.7.2	Concrete-filled Steel Shell Piles .....5-54
5.7.3	Concrete-filled Pip Piles .....5-54
5.7.4	Precast / Prestressed Concrete Piles .....5-55
5.7.5	Sheet Piles .....5-55
5.7.6	Timber Piles .....5-55
5.7.7	Driven Piles Materials Acceptance .....5-55
5.7.8	Driven Pile Material Sampling and Testing .....5-56

**TABLE OF CONTENTS (Continued)**

<b><u>Section</u></b>		<b><u>Page</u></b>
5.8	PAINTING .....	5-57
5.8.1	Coating System Components .....	5-57
5.8.2	Coating Types.....	5-57
5.8.2.1	Alkyd .....	5-57
5.8.2.2	Epoxy .....	5-58
5.8.2.3	Urethane .....	5-58
5.8.2.4	Moisture-cured Urethane .....	5-58
5.8.2.5	Zinc-rich .....	5-58
5.8.2.6	Acrylic Latex.....	5-58
5.8.2.7	Vinyl .....	5-59
5.8.3	Curing .....	5-59
5.8.4	Surface Preparation.....	5-59
5.8.5	Application .....	5-59
5.8.6	Inspection .....	5-60
5.8.7	Safety .....	5-60
5.8.8	Painting Materials Acceptance .....	5-61
5.9	DRILLED SHAFTS .....	5-62
5.9.1	Casings.....	5-62
5.9.2	Mineral Slurry.....	5-62
5.9.3	Integrity Testing .....	5-63
5.9.4	Concrete and Reinforcing Steel for Drilled Shafts .....	5-63
5.9.5	Drilled Shaft Materials Acceptance.....	5-63
5.9.6	Drilled Shaft Materials Sampling and Testing.....	5-63
5.10	ROLES AND RESPONSIBILITIES.....	5-64
5.10.1	Contractor's Responsibilities.....	5-64
5.10.2	Government's Responsibilities .....	5-65
5.11	FORM REFERENCES .....	5-66

---

**LIST OF EXHIBITS**

<b><u>Exhibit</u></b>		<b><u>Page</u></b>
Exhibit 5-1	Concrete Material Specifications .....	5-2
Exhibit 5-2	Portland and Blended Hydraulic Cement Comparison .....	5-5
Exhibit 5-3	Maximum Cementitious Material Requirements .....	5-11
Exhibit 5-4	Water and Mortar Requirements For Questionable Water Source .....	5-12
Exhibit 5-5	Fine Aggregate Source Quality Characteristics .....	5-14
Exhibit 5-6	Coarse Aggregate Source Quality Characteristics .....	5-15
Exhibit 5-7	Aggregate Tests Used During Concrete Mixture Proportioning.....	5-16
Exhibit 5-8	Required Concrete Material Certifications .....	5-20
Exhibit 5-9	Material Sampling Specifications and Sample Sizes.....	5-21
Exhibit 5-10	Concrete freeze-thaw damage (1) on the surface in the form of deicer scaling; (2) throughout the thickness in the form of cracks in paste around aggregate; and (3) at pavement joints in the form of D-cracking.....	5-28
Exhibit 5-11	At the microstructure level, salt deposits (i.e. the formation of ettringite) are shown on a hardened concrete sample as well as cracking in the paste due to the formation and expansion of ettringite. ....	5-30
Exhibit 5-12	At the microstructure level, the characteristic ASR gel is shown within cracks that have formed through and around aggregate and into the surrounding paste. At the macrostructure level, an advanced and characteristic ASR cracking pattern known as map or pattern cracking is shown.....	5-33
Exhibit 5-13	FLH Accepted ASR Testing.....	5-34
Exhibit 5-14	Required Average Compressive Strength with Test Records of 30 or More Consecutive Tests.....	5-38
Exhibit 5-15	Required Average Compressive Strength with Test Records of 15 to 29 Consecutive Tests .....	5-39
Exhibit 5-16	Required Average Compressive Strength with Test Records less than 15 Consecutive Tests .....	5-40
Exhibit 5-17	Example of Concrete Batch Ticket .....	5-39
Exhibit 5-18	The Four Moisture Conditions of an Aggregate Particle.....	5-43
Exhibit 5-19	Fresh Concrete Test Methods .....	5-45



**LIST OF APPENDIX**

<b><u>Appendix</u></b>		<b><u>Page</u></b>
Appendix A	Forms.....	A-1
Appendix B	FLH Test Methods.....	B-1
Appendix C	Sample Quantities .....	C-1
Appendix D	Pre-Paving Meeting Agenda .....	D-1
Appendix E	Examples of Cement Replacement and Fineness Calculations...	E-1
Appendix F	Pre-Concreting Meeting Agenda .....	F-1
Appendix G	Drilled Shaft Meeting Agenda .....	G-1

(This page intentionally left blank.)

# **CHAPTER 1**

## **DIVISION 100: ACCEPTANCE AND VERIFICATION PROCEDURES**

### **GENERAL GUIDANCE**

Quality assurance and quality control (see Construction Manual for details on Contractor Quality Control Plans) as they relate to the construction process, are continuous and ongoing project activities for both the contractor and the Government. Documentation and record keeping are an important part of this process. The process has its beginning with the approval of the contractor's Quality Control Plan; includes the completion and acceptance of the project work, and ends with the signing of the materials certification.

### **1.1 ACCEPTANCE**

Material is to be inspected and/or tested by the Project Engineer before final acceptance of the work. There are four methods for accepting material each having varying degrees of involvement by the Project Engineer; visual inspection, certification, measured or tested for conformance, and statistical evaluation. The contract defines these methods for any particular contract. The contract also defines the primary acceptance procedure applicable to each item of work in the Acceptance Subsection under each Section of work in the FP. Where there is a conflict between the contract and this Manual, the contract will control. A brief discussion of each method follows.

#### **1.1.1 Visual Inspection**

This is the simplest method of acceptance and allows material to be accepted without certification or test results. The Project Engineer accepts or rejects the material based solely on visual inspection of the material. The Project Engineer relies on experience and engineering judgment to determine the acceptability of the material. When accepting material based on visual inspection the Project Engineer should ascertain if the material will perform as intended. Visual acceptance still requires documentation in writing. This can be as simple as a notation in the pay estimate, materials record book, or project files. See Subsection 106.02 of the FP.

#### **1.1.2 Certification**

The next method of acceptance is based on the receipt of a certification. A certification should accompany the material to document that the material meets the specifications. The contractor shall provide a commercial certification for items requiring a certification, unless the acceptance subsection for the item specifically calls for a production certification.

A **commercial certification** is a manufacturer's or Contractor's representation that the material complies with all contract requirements. It typically consists of a supplier's certification indicating the material has been produced to a specific specification and is often accompanied by product catalog data.

Commercial certifications are routinely required for products purchased off the shelf, such as paint, sign hardware, mortar, grout, fencing materials, etc. Only one commercial certification is required for all similar materials.

A **production certification** requires a supplier's certification that the material has been produced to a specific standard, accompanying test data and more. When production certification is required, a production certification is required for each separate shipment of material and must include the following:

- Date and place of manufacture
- Lot number or other means of cross-referencing to the manufacturer's inspection and testing system; and
- Substantiating evidence that the material conforms to the contract quality requirements of FAR 46.105(a)(4). Such evidence includes:
  - Test results on material from the same lot and documentation of the inspection and testing system;
  - A statement of the manufacturer that the material complies with all contract requirements; and
  - Manufacturer's signature or other means of demonstrating accountability for the certification.

A production certification covers materials that are specifically manufactured or fabricated for a specific project. Examples might include culvert pipes, structural elements, bridge hand rails, asphalt binder, etc. The Project Engineer should check the certification prior to allowing the material to be incorporated into the work, although this may not always be possible. The certification should identify the project and reference the appropriate specification requirements (e.g., AASHTO or ASTM standard).

The certification generally must specify that it conforms to "FLH specifications" or specific AASHTO, ASTM or other recognized testing standards. The applicable standards will be stated in the contract.

Sometimes certifications are provided that give test results for individual parameters and do not reference the applicable specification. These are acceptable; however, the Project Engineer needs to verify that the values and individual parameters are those listed in the project specification and that the values are all within acceptable limits. The Project Engineer should discuss the content of certifications with the contractor or supplier ahead of time. Early discussions can help avoid delay in receiving certifications.

Material accepted by certification may be sampled and tested at any time to verify the quality of the materials being supplied. If such material is found not to be in conformance with the contract, it should be rejected whether in place or not.

Certifications should be kept as part of the final documentation for the project and should be included in the project files. See Subsection 106.03 of the FP.

### **1.1.3 Measured or Tested for Conformance**

A third method of acceptance is based on measuring or testing material for conformance to the specifications stated in the contract. The contractor may perform tests on the material and provide the results to the Project Engineer to demonstrate that the product meets the contract requirements. In the event of small quantities, testing may be performed ahead of the actual delivery of the product; however, the contractor may elect to provide these results at the time the material is delivered and/or placed (e.g., structural steel, prefabricated concrete units).

The Project Engineer may accept the results provided by the contractor or arrange for sampling and testing once the material has arrived on-site. Sampling should normally be performed by the contractor and witnessed by Government personnel. Upon the completion of the sampling, the Project Engineer should take possession of the sampled material and arrange for testing. Testing will usually be performed by the FLHD Laboratory; however, with concurrence of the FLH Division Materials Engineer, arrangements may be made for testing by a third party laboratory. The third party laboratory should not be under contract to or otherwise affiliated with the contractor.

If the test results indicate that the material meets the contract requirements, the material will be accepted. If the test results indicate that the material does not conform to the contract specifications, the material should be removed and replaced with conforming material at no cost to the Government. As an alternative to removal and replacement, the contractor may request acceptance at a reduced price or be given permission to correct any deficiencies. A decision to accept material at a reduced price will be made by the Contracting Officer generally after review by either the Division Materials Engineer or Division Materials Quality Assurance Engineer.

Material used in highway construction projects may be fabricated or manufactured at plants or locations off site. Materials fabricated off-site (such as prestressed concrete girders, steel bridge girders, etc.) require inspection, sampling, and testing arrangements. This off-site inspection and testing must be arranged for at least 30 days before fabrication begins. Contact the Division Materials Quality Assurance Engineer for coordination of inspection and testing requirements. See Subsection 106.04 of the FP.

### **1.1.4 Statistical Evaluation of Work and Determination of Pay Factor (Value of Work)**

The fourth and final method of acceptance is based on making an evaluation of the value of the work and is often called "Statistical Acceptance". The Project Engineer determines the random sampling locations using QL-PAY. Typically, the contractor will be sampling and testing the materials and will have a portable testing laboratory on site. The random sampling locations should not be divulged to the contractor until moments before a sample is to be taken. The Project Engineer must witness the actual sampling and splitting of each sample. Once the material is sampled and split, the Project Engineer must take immediate possession of the Government's portion (split).

After obtaining the sample, the Project Engineer will test the material. This means sending the material to the FLHD Laboratory. Upon receiving test results, the Project Engineer should immediately enter all of the test results (those tested by the contractor as well as those tested by the Government) into QL-PAY to determine the value of the work. QL-PAY files should be transmitted to the Division Materials Quality Assurance Engineer at least weekly. If no additional test results are added during the next 7 day reporting period, the current QL-PAY files do not need to be resubmitted.

Where contractor testing is part of the contract, in addition to determining the value of the work, it is necessary to verify the validity of the contractor's results. This is also done within QL-PAY. Only after the contractor's test results are validated may they be used to determine the amount of pay due the contractor. See Subsection 106.05 of the FP.

## **1.2 VERIFICATION PROCESSES**

### **1.2.1 Verification of Material Quality**

Regardless of which acceptance method is used, it is always necessary to verify the quality of materials incorporated into the work. The responsibility for final acceptance of all materials rests with the Contracting Officer. Therefore, the Project Engineer must be confident that the results obtained on which the acceptance decision is based are valid. Using qualified laboratories and qualified technicians facilitates achieving a quality project and having reliable test results on which to base acceptance decisions.

Whenever there are at least three samples tested by both the contractor and the Government, comparison of the results should be performed by entering them into QL-PAY. QL-PAY uses statistical procedures to analyze the data and determine if there are significant differences between the contractor's and Government's results or if the results are within what would be considered normal limits of variability. If the results are within normal variability limits, the contractor's results would be considered valid. If the results are not within normal variability limits, QL-PAY will issue an alert. It is essential that the Division Materials Quality Assurance Engineer be contacted immediately and review the data before any action is taken. A final determination as to the validity of the contractor's results must be made by an individual having a background in both statistical analysis and materials in order to avoid making an incorrect decision.

When there are fewer than three samples tested by either party, the comparison cannot be done in QL-PAY. In those instances, the results of samples should be compared using the multi-laboratory precision limit specified in the applicable test method. This provides an acceptable range for two results obtained from different laboratories by different operators. If the results are within the multi-laboratory precision limit, the contractor's results would be considered valid.

### **1.2.2 Visual Inspection and Certification**

Acceptance verification of material quality may be by visually inspecting the material and verifying the certification. If the Project Engineer has any doubts regarding material quality, he has the right to obtain a sample and have it tested and should do so. Normally, if a sample is desired, it should be obtained by the contractor in the presence of the Project Engineer with the Project Engineer determining the location of the sample. The Project Engineer should take immediate possession of the sample after it is obtained (and split if desired). The sample is usually obtained by using random numbers; however, the Project Engineer may elect to test in a specific location to verify the quality of the material.

### **1.2.3 Measured or Tested for Conformance**

The Project Engineer should normally obtain and test a minimum of three random samples; however, for small quantities fewer samples may be appropriate. In the case where the Project Engineer has suspicions concerning the quality of the material, the Project Engineer may direct the contractor to obtain one or more samples from the suspect area rather than use random samples. The Project Engineer should take immediate possession of the sample after it is obtained (and split if desired) by the contractor.

#### **1.2.4 Statistical Evaluation of Work and Determination of Pay Factor (Value of Work)**

For this type of material acceptance, the contract specifies the sampling frequency and the Project Engineer determines the random location of all the samples. All samples intended for use in the acceptance decision must be obtained by the contractor in the presence of the Project Engineer. The sample location should not be revealed to the contractor until moments before the sample is to be obtained. The Project Engineer should take immediate possession of the sample after it is obtained and split. All comparisons of results should be made in QL-PAY.



## **1.3 VALIDATION OF TEST RESULTS AND PAY FACTORS**

### **1.3.1 Validation of Contractor Test Results**

When a contract provides for contractor testing, the Government has the option of using the contractor's tests results in the acceptance decision. The contractor's results can only be used if the materials quality is verified and the contractor's tests results are validated. This is done by entering the data into QL-PAY. QL-PAY uses various statistical techniques to analyze the test results obtained by the contractor compared to those obtained by the Government.

#### **1.3.1.1 Validation Conditions**

In order to be able to verify the quality of the material and validate the contractor's test results the following conditions must be met:

1. All of the samples must be obtained based on random locations determined by the Project Engineer. Random numbers and locations can be generated within QL-PAY.
2. Sampling locations must not be divulged to the contractor until moments before the sample is to be taken.
3. All samples must be obtained by the contractor in the presence of the Project Engineer.
4. The Project Engineer must take immediate possession of the material after it is sampled and split.
5. The Project Engineer must remain in control of the Government's sample. The contractor is not to handle or have further contact with the sample once the Project Engineer takes possession.
6. The Project Engineer should obtain a split sample of all material and submit the first three to five samples obtained to the FLHD Laboratory for testing. After submitting these samples, a minimum of 10 percent of the remaining split samples should be selected and sent to the FLHD Laboratory for testing. Split samples should be submitted as work progresses. Do not wait until all the work is completed before sending the split samples in for testing.
7. All split samples not submitted for testing must be properly stored until final acceptance of the material. In the event that the contractor's test results are not verified it may become necessary for the Government to test all of the split samples.

#### **1.3.1.2 Test Results Verification**

With the conditions in Section 1.3.1.1 satisfied, the Project Engineer enters all the test results obtained by the contractor and the Government into QL-PAY and determines the appropriate pay factor (value of work). Before the computed pay factor can be used

however, it is necessary to verify the quality of the material and validate the contractor's test result. In order to verify the quality of the material and validate the contractor's results, QL-PAY performs the following functions:

1. Determines the Degree of Normality and Skewness Coefficients for each quality characteristic. These computations determine the appropriateness of running the pay factor computations, which are based on the assumption of normality. If the assumptions are not true, it may still be possible to analyze the data. For example, when data does not approximate a normal distribution, the data can be mathematically transformed to a normal distribution. A warning is issued if the results fall outside acceptable limits and further analysis by the Division Materials Quality Assurance Engineer is required.
2. Determines the pay factor for each quality characteristic and uses the lowest single pay factor to determine the lot pay factor. The program calculates the current pay factor based on available test results and a projected pay factor based on the total number of test results expected, assuming no change in quality level from that calculated for the current number of samples. This provides the contractor with an early indication of what to expect for a pay factor when the work is completed if there is no change in the quality level of the material provided.
3. Performs an F-test for each quality characteristic based on independent data. The F-test compares the sample variance of all the not-paired split sample test results obtained by the contractor to the sample variance of all the Government's test results. For example, 100 samples are obtained and split. The contractor tests all 100 samples. The Government tests 20 split samples. The 80 sample test results obtained by the contractor, which are not paired splits, are compared to the 20 sample test results of the Government. The sample variances should be equal within acceptable limits. A warning is issued if the results fall outside acceptable limits and further analysis by the Division Materials Quality Assurance Engineer is required.
4. Performs an Independent t-test for each quality characteristic. The Independent t-test compares the mean of all the non-paired split sample test results obtained by the contractor to the mean of all Government's test results. For example, 100 samples are obtained and split. The contractor tests all 100 samples. The Government tests 20 split samples. The 80 sample test results obtained by the contractor, which are not paired splits, are compared to the 20 sample test results of the Government. The means should be equal or comparable within acceptable limits. Testing the means of the independent samples verifies the quality of the material. A warning is issued if the results fall outside acceptable limits and further analysis by the Division Materials Quality Assurance Engineer is required.

5. Performs an F-test for each quality characteristic based on paired data. The F-test compares the sample variance of all the matching split samples tested by the contractor to the variance of all Government's test results. For example, 100 samples are obtained and split. The contractor tests all 100 samples.

The Government tests 20 split samples. The 20 sample test results obtained by the contractor that are paired splits are then compared to the 20 sample test results of the Government. The sample variances should be equal within acceptable limits. A warning is issued if the results fall outside acceptable limits and further analysis by the Division Materials Quality Assurance Engineer is required.

6. Performs a Paired t-test for each paired quality characteristic. The Paired t-test compares the mean of all the matching split samples tested by the contractor to the mean of all the Government's test results. For example, 100 samples are obtained and split. The contractor tests all 100 samples. The Government tests 20 split samples. The 20 sample test results obtained by the contractor that are paired splits are compared to the 20 sample test results of the Government. The sample variances should be equal within acceptable limits. This validates the contractor's testing procedures. A warning is issued if the results fall outside acceptable limits and further analysis by the Division Materials Quality Assurance Engineer is required.
7. Plots control charts. Control charts showing the contractor's test results and the Government's test results are plotted for each quality characteristic. This allows the user to perform an analysis of test results, look for bias in test procedures that may not be apparent from the Paired t-test or Independent t-test, and to assist in identifying production problems. Review and analysis of the control charts by the Division Materials Quality Assurance Engineer can provide early identification of production problems.

### **1.3.2 Test Results Review**

All test results should be reviewed and evaluated by the Division Materials Quality Assurance Engineer to confirm the assumptions of normality, verify the quality of the material, and to validate the contractor's testing procedures. All QL-PAY files should be e-mailed to the Division Materials Quality Assurance Engineer. The files should be transmitted at least weekly if additional test results were added during the preceding 7 days.

Sometimes the initial statistical analysis performed by QL-PAY will indicate a problem, which after further analysis is not substantiated. Statistical comparison is only a tool to be used in analysis of the test results. It takes a combined knowledge of material, material variances, and statistics to make a proper analysis of the data and reach an appropriate decision concerning the validity of the data.

It is imperative that consultation regarding the final decision to accept the contractor's test results is made with an individual with a background in both materials and statistics and that sound engineering judgment be applied so as not to affect adversely the contractor or

compromise the Government's position. Although the final decision resides with the Construction Branch, it should be done with the concurrence of the Division Materials Quality Assurance Engineer or Division Materials Engineer.

If the contractor's test results are rejected, the Project Engineer will be requested to submit the Government's entire remaining split samples for that work item to the FLHD Laboratory. In such cases, the Project Engineer should notify the contractor in writing and afford the contractor the opportunity to witness the testing of the remaining split samples. After testing is completed, the Project Engineer should enter all of the results into QL-PAY and e-mail a copy to the Division Materials Quality Assurance Engineer for final analysis.

If the final analysis substantiates the decision to reject the contractor's test results, the final acceptance and pay factor determination will be based on the Government's test results. In such cases, the contractor will be responsible for the cost for all additional Government materials testing. The Division Materials Engineer will provide the Project Engineer with an itemized list of the increased testing costs. The costs should be deducted from the contractor's monthly estimate.

If the final analysis does not substantiate the decision to reject the contractor's test result, the final acceptance and pay factor determination will be based on the contractor's test results, and the Government will absorb the additional costs associated with the increased testing.

### **1.3.3 Dispute Resolution Guidelines**

If the contractor refutes and provides persuasive evidence that Government test results do not accurately reflect the property(s) of material or work tested, and reasonable steps have been taken to resolve disputes, the contractor may request further evaluation of the Government's test results. The request must be in writing and contain a justification for making the request. The contractor should submit for approval a proposed resolution protocol that addresses the following: sampling method, number of samples, sample transport, test procedures, testing laboratory(s), reporting, estimated time and costs, and the validation process (i.e., how results will be used).

If the evaluation requires that additional sampling and/or testing be performed, the Government and contractor must mutually agree on witnessing procedures and the use of a third party laboratory to conduct the sampling and/or testing. The third party laboratory must be accredited by AASHTO for the procedures to be used, except in the case where AASHTO accreditation for the procedure is not offered. The laboratory must not have been used by the contractor or Government in producing the test results in dispute or used as a basis to establish just cause that Government testing does not accurately reflect the property of the material or work.

The Project Engineer should notify the Construction Operations Engineer, the Division Materials Quality Assurance Engineer and the Division Materials Engineer immediately if a contractor submits a request for additional sampling and/or testing. Upon receipt of the proposed resolution protocol, it will be evaluated for merit, accepted if appropriate, modified if necessary, or rejected. At that time, the Project Engineer will be given guidance on how to proceed with the resolution process proposed.

The approved resolution protocol test results will be used to validate disputed testing. Validation will be determined by the Government in accordance with procedures established in the approved resolution protocol. If the Government test results are validated as acceptable, the contractor will be responsible for all costs derived from the additional sampling, testing, and evaluation.

If the Government test results are not validated as acceptable, the Government will be responsible for all costs derived from the additional sampling, testing, and evaluation. If the validity of the Government test results cannot be determined, the contractor and Government will equally share all costs associated with the additional sampling, testing, and evaluation.

## 1.4 ACCEPTANCE OF WORK AND VALUE DETERMINATION

Acceptable work conforming to the contract should be paid for at the contract unit bid price. When material or work fails to meet the established specification, the material or work shall be removed and replaced unless in the public interest the Government consents to accept the work with an appropriate adjustment in price or corrective action. If the contractor requests to have the work accepted at a reduced price or requests permission to perform corrective measures, the request will be evaluated based on the public interest. It is the contractor's responsibility to submit a proposal outlining any action that will be taken in lieu of removal and replacement. The contractor may submit a written request to:

1. Have the work accepted at a reduced price; or
2. Be given permission to perform corrective measures to bring the work into conformity.

A written request must contain supporting rationale and documentation. This would include references or data justifying the proposal based on an evaluation of test results, effect on service life, value of material or work, quality, aesthetics, and other tangible engineering basis.

If the contractor submits a written request, the following process outline provides guidance for addressing the request to accept work at a reduced price:

1. Meet to discuss the non-compliance material or workmanship. The meeting should include the Project Engineer, Construction Operations Engineer, and Technical Services Branch representative with expertise in or responsibility for the area of concern (i.e., bridge, hydraulics, materials).
2. Review test data to determine the significance of non-compliance.
3. Evaluate the degree of deviation from contract requirements. Such evaluation is a subjective process and must take into account the criticality of the material or work, the risk associated with any deviation from the contract requirements, and the degree of deviation from contract requirements.
4. Reduce the contract unit price for the item in question depending on the significance of the noncompliance. The percent reduction in the unit price are based on the following guidelines:

**0 to 5%** Material substantially meets the contract requirements with minor deviations from the specifications.

**6 to 15%** Material fails to meet contract requirements and results in the use of an inferior product. Generally, this material will result in a reduction in the usable life of the item in question.

**16 to 75%** Material fails to meet contract requirements by a significant amount and is clearly and inferior product. Use of this material may meet the intended purpose; however, the quality is well below that specified. The criticality of this material may be low and does not warrant removal or other corrective action.

Likewise, corrective actions need to be evaluated to determine the level of effectiveness. The remedial/corrective work must provide results that are more desirable than reducing item pay amounts. In certain instances, corrective actions may be used in combination with a contract bid price reduction.

When it is determined that the material or work does not meet the intended purpose or results in substantial quality or safety deficiencies, it shall be removed and replaced.

## **1.5 MATERIAL PROJECT REQUIREMENTS**

To ensure a successfully completed construction project, specification compliant materials need to be incorporated into the work. The contractor quality control plan provides, among other items, the system to measure and validate the quality of the materials used. Major components of the plan are 1) personnel, 2) equipment and testing laboratories, and 3) sampling. The contract provides specific requirements for the contractor quality control system. The purpose of this portion of the manual is to provide general guidance regarding elements that may be included as part of the construction project quality control activities.

### **1.5.1 Personnel**

Individuals performing sampling and testing of materials to be used in the construction of FLH projects must be knowledgeable in the sampling and testing procedures and requirements of the contract. In addition to sampling and testing requirements testing personnel must also be familiar with proper use and calibration of equipment required for the testing of materials.

In general, contractor personnel assigned to perform sampling, testing, or inspection functions should have 1 year or more of recent job experience in the type of sampling, testing or inspection required by the contract. Qualifications can also be demonstrated through other certifications or participation in proficiency testing. Examples of these types of qualifications include:

- NICET Level II certification in highway materials, or State Highway Agency (SHA) or industry certification-related sampling and testing equivalent to their contract responsibilities.
- Nationally accepted certification for intended sampling and testing responsibilities, i.e. WAQTC, ACI, NETTCP.
- Current or previous employment by an AASHTO accredited laboratory performing sampling and testing equivalent to their intended responsibilities.
- Demonstrated proficiency or successful testing of one or more proficiency samples (may be substituted for basic qualifications pending verification of test results).

#### **1.5.1.1 Qualification Documentation**

Before the start of the work, the Project Engineer should obtain documentation supporting personnel qualifications. Documentation requirements are listed in the contract.

#### **1.5.1.2 Subcontracted Sampling and Testing**

If sampling, testing or inspection is to be performed by a subcontractor, the Project Engineer should request from the prime contractor detailed information about how the sampling, testing and inspection by the subcontractor will interface with the prime contractor's work and other subcontractors performing work required by the contract.

The contractor is required to have a quality control system that includes the appropriate process control of material. The Project Engineer is responsible to ensure that material being incorporated into the work conforms to the contract requirements as supported by the appropriate inspections, sampling, and testing.



## **1.5.2 Equipment and Testing Laboratories**

Testing of materials used in highway construction projects requires specialized materials testing equipment. Laboratories are essential to assure quality materials are incorporated in the project. Laboratories must be adequately staffed and properly equipped to conduct materials tests required by the contract quality control provisions.

The Project Engineer is responsible for inspecting, verifying, and documenting that field laboratories are properly equipped and staffed prior to the start of the work that requires sampling and testing.

### **1.5.2.1 Contractor-furnished Laboratories**

The contractor may use a commercial laboratory or an on-site contractor furnished laboratory. The commercial or on-site contractor furnished laboratory must be equipped with all the testing equipment and accessories to meet contract sampling and testing requirements.

Laboratory facilities should be kept clean and equipment maintained in proper working condition. Subject to the terms of the contract, the Project Engineer has unrestricted access to the laboratory for inspection and review.

### **1.5.2.2 Government-furnished Laboratories**

A Government-furnished field laboratory trailer may be available for rent. If this is the case, the Government will offer to the contractor a furnished field laboratory with testing equipment. Field laboratory availability and a listing of the testing equipment included in each field laboratory may be obtained by contacting the CO. Due to the wide-range of construction complexity for FLH projects, the laboratory facility may not be equipped with all of the necessary testing equipment required for the project. It is the responsibility of the contractor to review the basic equipment list and provide any specialty or missing testing equipment needed for use on the project.

In general, the laboratory includes testing equipment to conduct process control and project acceptance testing for embankments, crushed aggregate base, asphalt paving materials, and plastic concrete. Other equipment, such as equipment for breaking and curing concrete cylinders, may be included on a specific contract basis. The Sampling and Testing tables located at the end of each Section in the contract will provide references to test methods and procedures that include the equipment requirements.

The laboratory facility should be kept clean and equipment maintained in proper working condition. Subject to the terms of the contract, the Project Engineer has unrestricted access to the laboratory for inspection and review.

#### **1.5.2.2.1 Laboratory Cost**

Field laboratory trailer and testing equipment are offered to the contractor at a cost specified in the contract. The contractor shall replace at their cost or be responsible for the replacement cost of all missing or damaged equipment (other than through reasonable wear and tear).

### 1.5.2.2.2 Laboratory Equipment

The contractor shall determine if the laboratory testing equipment is adequate to perform all testing required by the contract.

In addition, the following apply:

- The equipment has been checked and calibrated to applicable specifications. It is the contractor's responsibility to ensure the equipment is maintained in proper operating condition.
- No nuclear devices will be furnished.
- The contractor is responsible for providing the laboratory trailer with a water supply and adequate 240-volt, 60-cycle, 200 amp single-phase current for all laboratory electrical needs. A minimum of 60 kilowatts of power at the entrance box is required for effective use of electrical equipment. Equip the power supply with a regulator that will limit the voltage of the power furnished to not more than 240 volts and not less than 220 volts.
- The contractor shall accept responsibility for the trailer and equipment upon receipt.
- All equipment provided by the Government and replaced by the contractor shall become the property of the Government.
- The rental rate specified in the contract is in effect for the duration of the contract, excluding periods of seasonal or other work shut downs.
- The laboratory shall be used only for testing materials for a specific contract.

Upon completion of the work, the contractor should clean the equipment and trailer. All equipment should be properly stored and secured for the transport of the trailer to the FLH office. Any damage that occurs prior to the trailer being received at the FLH office will be handled according to the contract.

### 1.5.2.3 Equipment Calibration

Use only equipment that has been calibrated or verified for the specific test and meets the applicable testing requirements of the contract. Equipment will be calibrated or standardized in accordance with national, FLH Standards, State Highway Agency (SHA), industry standard, or Standard Accreditation Programs.

Prior to the beginning of sampling and testing on a project, the Project Engineer should inspect and document the acceptability of the sampling and testing equipment that will be used on the project.

All necessary equipment should be marked with a tag indicating the date of last inspection, inspector, and calibration number. Checking and monitoring of the equipment during the life of the project should be performed and documented by the contractor to ensure equipment is performing properly.

#### **1.5.2.4 Equipment Calibration Documentation**

The Project Engineer should obtain the following documentation supporting the calibration or verification of all necessary equipment prior to actual sampling and testing. The documentation should be on file.

1. Description of the equipment calibrated or verified, including model number, serial number, or other acceptable identification.
2. Identification of the individual performing the calibration or verification.
3. Identification of the calibration or verification procedure used.
4. Current calibration or verification date and the next due date.
5. Detailed report of calibration results of the work performed, i.e. dimension, mass, force, frequency, temperature, time etc.

The Project Engineer may check equipment to verify condition and calibration. If at any time it is suspected that the test equipment is not functioning properly or is not calibrated within specification limits the Project Engineer should contact the FLHD materials staff to determine what corrective action should be taken.

Under no circumstances should test results obtained using faulty equipment be accepted.

#### **1.5.3 Sampling**

The control of material is an important part of any construction project. It can only be accomplished when the material being incorporated into the work is acceptably inspected, properly sampled, and accurately tested. The importance of obtaining a good representative sample cannot be overstated.

Samples obtained or used on construction projects have different purposes. Samples can be obtained to verify proper testing is being performed, to control production processes, or to verify product quality. Here are the general sample types and purposes that are typically used on FLH construction projects:

- **Quality Control (also called process control) Samples.** These samples are obtained by the contractor for the purpose of assessing and making adjustments to a production or construction process. Samples, taken during production, assist the contractor in making appropriate corrections for producing a quality product. Information obtained by testing these samples is used by the contractor to control the level of quality of the furnished end product. The contractor may take a quality control sample at any time. However, when the quality control sample test results are to be utilized in the material acceptance decision, the Government will randomly identify the material to be sampled and tested.

The Government will witness the sampling and splitting procedures and will immediately take possession of the Government's split portion of the sample. The Government must maintain control and custody of the sample at all times to ensure the integrity of the testing and verification process.

- Acceptance Samples. These samples are tested by the Government to determine conformance to contract requirements.
- Verification Samples. These samples are obtained by the contractor; witnessed and tested by the Government or its designated laboratory for the purpose of verifying the results of contractor tested quality control samples. The results are used in a statistical evaluation for the purpose of acceptance and payment. In the event that the contractor's test results are not verified, the Government's test results will be used for acceptance and payment for the material.
- Independent Assurance Samples. Any qualified person from a qualified laboratory, as defined in the contract, which are not associated with the contractor or the FLHD project inspection staff, can take an Independent Assurance (IA) sample. This sample can be taken at any location and at any time within the project. The purpose of this sample is to provide an unbiased and independent evaluation of the sampling and testing procedures used in the acceptance decision. IA samples evaluate the sampling and testing personnel and their associated equipment. The sample cannot be used in the acceptance decision for the material since it is a biased non-random sample used to evaluate testing personnel and equipment. The Division Materials Engineer evaluates the results to determine if any discrepancies exist in the sampling and testing.
- Proficiency Samples. These samples are manufactured by the FLH central laboratory and used as a tool to evaluate the quality of the testing being performed for a project. The results are used in the same manner as the independent assurance samples. The Division Materials Engineer evaluates the results to determine if any discrepancies exist in the testing.

In all cases, it is critical to obtain a representative portion of the manufactured product that will be tested to verify that the material used or the work done conforms to the requirements of the contract. The use of proper sampling procedures and techniques is a vital piece of the verification process for quality highway construction.

### **1.5.3.1 Sampling Responsibilities**

Generally speaking, the contractor is responsible for obtaining all of the samples on a construction project. The sampling process takes place under the supervision or witness of the Project Engineer or Government representative. In addition to acquiring the sample, the contractor is also responsible for splitting the sample, if appropriate, and providing a split portion of the sample to the Government. When results of the contractor testing are to be considered in the acceptance decision, the contractor needs to ensure that a Government representative is present during the sampling and splitting process. Once this has been accomplished, the Government will take immediate control of the sample.

This sample may then be tested and the results used as part of the verification process. It is vitally important for the integrity of the acceptance process that the sampling is witnessed and that the chain of custody for the Government portion of the sample has not been compromised.

The contractor is responsible for following proper sampling and testing methods in accordance with the submitted quality control plan and the contract specifications. This includes monitoring, certifying, or verifying the quality of products manufactured off-site and delivered to the project meet contract specifications. At a minimum the contractor is required to perform all sampling and testing listed in the sampling and testing tables provided in the contract.

The Project Engineer is responsible for verifying that the required sampling is accomplished according to standard procedures and that the material used and work performed on the project, whether produced on the project or manufactured off-site and delivered to the project from an outside source, comply with contract specifications. In addition, the Project Engineer will ensure that all samples used to evaluate work for acceptance are retained until final acceptance.

### **1.5.3.2 Sampling Procedures**

Established sampling methods provide specific guidance regarding the amount of material required for the sample. This amount should not be confused with the amount of material needed to perform the proper testing. The sample obtained needs to be taken in accordance with the appropriate referenced method. Subsequent testing is usually performed on a smaller representative portion of that sample. These smaller testing amounts will be specifically stated in the appropriate test method for the given material.

Project personnel should be knowledgeable in the following sampling criteria that are required by the contract.

- Minimum required sample size. The sampling methods, typically cited as AASHTO or ASTM methods, identify the size sample required for the particular material.
- Sampling frequency. Sufficient samples must be taken to represent the material that is delivered to the project for assurance that it complies with specification requirements. A non-uniform product can require more samples than the minimum specified in the contract for acceptance of its quality. For acceptance purposes, the contract will specify the minimum sampling frequency.
- Sampling methods. Different materials require different sampling methods. The appropriate test methods should be used to ensure a proper sample has been obtained. These methods will be referenced in the contract documents and also in this manual.
- Sample location. Where practicable, samples to be tested for acceptance shall be obtained from the finished product. The contract specifications identify where samples are to be taken for acceptance and at what minimum frequency.

### **1.5.3.3 Sampling Methodologies**

Samples may be obtained at any time and at any location. Specific contract language in subsection 106.01 states that the Government may inspect, sample, or test all work at any time before final acceptance of the project. In general, there are two sampling methodologies.

- Selective sampling. This is a biased non-random procedure in which a sample of material is obtained from a specific location determined by observation. The information obtained from the testing of this sample can be used to determine compliance with the

contract but cannot be included in any statistical evaluation. This methodology may be used at any time.

- Random sampling. This is an unbiased sampling procedure in which a sample of material is chosen in such a manner that any incremental amount of material placed has an equal probability of being selected. For the statistical concepts and comparisons to function properly, the sample used for statistical acceptance must be selected on a random basis. Random sampling locations are selected in advance of the production and placement of the material to be sampled. These locations should be selected using random numbers generated by use of random number tables, the random number function on a calculator, or the random number function in computer software. QL-PAY has a random number generator developed specifically for use with highway construction materials.

#### **1.5.3.4 Sample Handling**

Samples need to be stored and handled appropriately to ensure that the integrity of the material has not been compromised. The samples need to be properly labeled and identified so that all information regarding the sample location and test results can be correlated. If the samples are to be transported, use proper containers to maintain the integrity of the sample throughout the shipping process. Include a Request for Laboratory Tests form, FHWA 1600, for all samples shipped to the central laboratory.

##### **1.5.3.4.1 Sample storage and retention**

Once the Government takes possession of the sample, it should be handled and stored in an appropriate manner. Care should be taken to avoid damage to the sample container, disturbance of the sample, or contamination. The Project Engineer will store, handle, label and date samples in a manner that will preserve the character of the material. Most samples should be stored in a dry environment and kept free from contamination until final acceptance of the project. It is important that all samples be cared for in this manner in the event that complete testing of verification or acceptance samples becomes necessary.

##### **1.5.3.4.2 Sample labeling**

When obtaining the sample, the contractor will need to label the sample container with the appropriate project information. As a minimum, the following information should be included on any sample. Additional information may be required depending on the specific location and/or purpose for the sample:

- Project name;
- Project number;
- Pay item number;
- Pay item description;
- Sample number;
- Lot number;

- Sublot number;
- Date;
- Location of sample.

#### 1.5.3.4.3 Sample transport and shipment

Ship samples in a container of sufficient strength to prevent the loss, contamination or damage of the contents during shipment. Sufficiently identify all samples to facilitate reporting, logging, and tracking of sample information. Exhibit 1-1 provides a brief summary list of containers to be used for common highway materials. If additional guidance is needed for a particular material, contact the Division Materials Engineer.

**Exhibit 1-1 Common Sample Containers**

<b>Material</b>	<b>Appropriate Sample Container</b>
Soil and Aggregate	Clean tight woven canvas sacks 5-gallon plastic buckets with tight lids
Cement, Lime, Fly ash	1-gallon watertight containers
Asphalt binder and cutback asphalts	1-quart cans
Emulsified asphalt	1-gallon large mouth plastic jugs with screw top lids
Asphalt mixture – uncompacted	6" x 12" cylinders 5-gallon plastic or metal buckets Cardboard box of sufficient size
Asphalt mixture – cores	Cushioned container 4" x 8" or 6" x 12" plastic concrete cylinder molds with appropriate packing
Concrete cylinders	Appropriate sized concrete cylinder molds shipped in a sturdy box with insulation and padding

#### 1.5.3.5 Request for Laboratory Testing

All samples shipped to the FLH division laboratory must have a Request for Laboratory Tests form, form FHWA 1600, to provide instruction as to the testing to be performed. The form should be completed by the Project Engineer and attached to the outside of the sample container in a manner that will protect it during shipment. A duplicate copy should be placed inside the shipping container. The form can also be faxed or electronically sent in advance of shipment to alert the lab personnel that a sample will be arriving.

## **1.6 FORM REFERENCES**

Form references for use in the transmittal of samples to the FLH central laboratory.

- Form FHWA 1600C – Request for Laboratory Tests (CFL)
- Form FHWA 1600E – Requests for Laboratory Tests (EFL)
- Form FHWA 1600W – Requests for Laboratory Tests (WFL)



# **CHAPTER 2**

## **DIVISION 200: EARTHWORK TESTING AND EVALUATION**

### **2.1 SUMMARY AND DESCRIPTION**

Typical highway construction involves the use of existing native materials to form the roadbed prior to the placement of the manufactured materials that compose the pavement structure. These native materials, if properly handled and compacted, can be used successfully to construct the roadbed.

Soils are the most abundant material used in highway construction. They form the foundation or supporting surface for roadways, bridges, and other highway structures. Work involved in preparing the foundation and using soils in the construction of a normal highway project can be a major cost of the project. Due to this importance, knowledge of soil properties, condition, and proper construction practice is of utmost importance.

Testing of soil is designed to provide information on the classification, engineering properties and address any unexpected conditions that may be encountered during construction. The project specifications will determine the required testing for the project, however in most cases earth embankment materials will need to be classified to determine proper handling and compaction.

Earthwork construction can also consist of excavating and embanking material, preparing the foundation, bedding, and backfilling for structures. In these instances, materials for construction may be specified. To ensure compliance with the contract, testing will be required to verify the quality of material used.

Imported subgrade materials will typically need to be tested and evaluated prior to use. These materials include unclassified borrow, select borrow, topping, and select topping. In addition, subgrade stabilization techniques, where lime, fly ash, or hydraulic cement is incorporated into the upper layer of the subgrade, will require additional testing to establish the appropriate proportioning for the desired design properties.

Tests listed in Exhibits 2-1, 2-6 and 2-7 function to either evaluate or describe soils and control the manner in which they are to be used. Several different test procedures may be available to analyze the same material property. The tests accomplish the same evaluation but require different equipment or use a slightly different procedure. For instance, there are several tests for determining in-place density and for determining moisture content.

When contract specifications permit options, selection of one test over another is often a matter of personal preference. More often than not, a higher quality of test results is dependent on how carefully a test was performed rather than on the superiority of one piece of equipment or process over another.

## 2.2 MATERIAL PROPERTIES AND TEST METHODS

There are a number of tests to determine properties of soils used in highway construction. Data from tests on the soil will provide useful information to ensure that the desired materials and properties of those materials are incorporated into the construction of the roadbed. Typical soil testing includes tests shown in Exhibit 2-1.

**Exhibit 2-1 Soil Test Methods**

Primary Categories	AASHTO Test Method
Grain size analysis	AASHTO T 11, T 27, & T 88
Moisture content determinations	AASHTO T 265 & T 310
Density standards and density determinations	AASHTO T 99, T 180, T 191, & T 310
Consistency and Plasticity (Atterberg Limits)	AASHTO T 89 & T 90

### 2.2.1 Classification

Classification of the soil material is an important factor in determining handling and placement characteristics. Classification results indicate if the soil is granular (A-1, A-2, A-3) or fine grained silt-clay (A-4, A-5, A-6, A-7). It can also be used to determine the various components of a mixture such as larger sized stone (boulders, cobbles, gravel), sand, silt, or clay. The standard specification system used by FLH and stated in the FP is AASHTO M 145. Two items are needed to classify soil material; particle size distribution and consistency properties (Atterberg limits) of silt-clay materials.

**Exhibit 2-2 Classification of Soil Material from AASHTO M 145**

**Table 1—Classification of Soils and Soil-Aggregate Mixtures**

General Classification Group Classification	Granular Materials (35 Percent or Less Passing 75 $\mu\text{m}$ )			Silt-Clay Materials (More Than 35 Percent Passing 75 $\mu\text{m}$ )			
	A-1	A-3 <sup>a</sup>	A-2	A-4	A-5	A-6	A-7
Sieve analysis, percent passing:							
2.00 mm (No. 10)	—	—	—	—	—	—	—
0.425 mm (No. 40)	50 max	51 min	—	—	—	—	—
75 $\mu\text{m}$ (No. 200)	25 max	10 max	35 max	36 min	36 min	36 min	36 min
Characteristics of fraction passing 0.425 mm (No. 40)							
Liquid limit	—	NP	<sup>b</sup>	40 max	41 min	40 max	41 min
Plasticity index	6 max	—	—	10 max	10 max	11 min	11 min
General rating as subgrade	Excellent to Good			Fair to Poor			

<sup>a</sup> The placing of A-3 before A-2 is necessary in the "left to right elimination process" and does not indicate superiority of A-3 over A-2.

<sup>b</sup> See Table 2 for values.

**Table 2—Classification of Soils and Soil-Aggregate Mixtures**

General Classification Group Classification	Granular Materials (35 Percent or Less Passing 75 $\mu\text{m}$ )							Silt-Clay Materials (More Than 35 Percent Passing 75 $\mu\text{m}$ )			
	A-1		A-3	A-2				A-4	A-5	A-6	A-7
	A-1-a	A-1-b		A-2-4	A-2-5	A-2-6	A-2-7				
Sieve analysis, percent passing:											
2.00 mm (No. 10)	50 max	—	—	—	—	—	—	—	—	—	—
0.425 mm (No. 40)	30 max	50 max	51 min	—	—	—	—	—	—	—	—
75 $\mu\text{m}$ (No. 200)	15 max	25 max	10 max	35 max	35 max	35 max	35 max	36 min	36 min	36 min	36 min
Characteristics of fraction passing 0.425 mm (No. 40)											
Liquid limit	—		—	40 max	41 min	40 max	41 min	40 max	41 min	40 max	41 min
Plasticity index	6 max		NP	10 max	10 max	11 min	11 min	10 max	10 max	11 min	11 min <sup>a</sup>
Usual types of significant constituent materials	Stone fragments, gravel and sand		Fine sand	Silty or clayey gravel and sand				Silty soils		Clayey soils	
General rating as subgrade	Excellent to Good							Fair to Poor			

<sup>a</sup> Plasticity index of A-7-5 subgroup is equal to or less than LL minus 30. Plasticity index of A-7-6 subgroup is greater than LL minus 30. (See Figure 2.)

Exhibit 2-2 demonstrates how particle size distribution and consistency properties are used to determine the soil classification. Granular soils, those with higher percentages of rock and sand, are rated excellent to good for use in subgrade construction. As the amount of silt and clay increases, the rating of the material decreases to being either fair or poor. More detailed information and soil descriptions can be found in AASHTO M 145.

### 2.2.1.1 Particle Size Distribution

AASHTO T 88, Particle Size Analysis of Soils, is used to determine the particle size distribution of soils that consist primarily of sand, silt and clay. The test consists of a sieve analysis, primarily on the granular portion of the soil, and a hydrometer analysis for the fine-grained material. The hydrometer portion of the test is not needed for classification and is typically not performed as part of the quality assurance testing. AASHTO T 11, Materials Finer than No. 200 Sieve in Mineral Aggregates by Washing and AASHTO T 27, Sieve Analysis of Fine and Coarse Aggregates are used to determine the particle size distribution of granular soils that contain a significant portion of gravel size particles. Particle size ranges as defined in AASHTO M 145 are shown in Exhibit 2-3.

**Exhibit 2-3 Particle Sizes**

Soil Constituent	Passing Sieve	Retained on Sieve
Gravel	3 inch (75 mm)	No. 10 (2.00 mm)
Coarse Sand	No. 10 (2.00 mm)	No. 40 (425 $\mu$ m)
Fine Sand	No. 40 (425 $\mu$ m)	No. 200 (75 $\mu$ m)
Silt and Clay	No. 200 (75 $\mu$ m)	—

Granular materials, as defined by AASHTO M 145, contain 35 percent or less material passing the No. 200 (75  $\mu$ m) sieve and silt-clay materials contain more than 35 percent material passing the No. 200 (75  $\mu$ m) sieve. See Exhibit 2-2.

Decisions regarding subsequent tests are made based on information gained from the particle size analysis. Most other soil tests are performed on a specific range of particle sizes that require the soil be separated accordingly.

### 2.2.1.2 Consistency and Plasticity (Atterberg Limits)

Consistency of silt-clay materials varies in proportion to the water content. At higher water contents, silt-clay materials possess properties of a liquid whereas at lower water contents possess properties of a plastic, semisolid or even a solid. The moisture content of a soil at the division between the liquid and plastic phase is defined as the liquid limit. The moisture content of a soil at the division between the plastic and semisolid phase is defined at the plastic limit. The algebraic difference between these two defined limits is known as the plasticity index. The liquid limit is determined from AASHTO T 89 and the plastic limit and plasticity index are determined from AASHTO T 90. The consistency properties (Atterberg limits) and the plasticity index are used to classify soils. They also provide an indication of some engineering properties of the soil. Generally, high liquid limits and high plasticity indices are indicative of potentially troublesome soils. Exhibit 2-4 graphically demonstrates the relationship of these properties.

AASHTO T 89 and T 90 provide for options in the preparation of the soil; the dry preparation method as stated in AASHTO T 87 or the wet preparation method as stated in AASHTO T 146. For the purposes of obtaining consistency and plasticity data for general highway construction, the material should be prepared using the dry preparation method, AASHTO T 87. The wet preparation method would be used only in unique circumstances and would be specifically designated in special contract requirements.

**Exhibit 2-4 Relationship of Atterberg Limits**

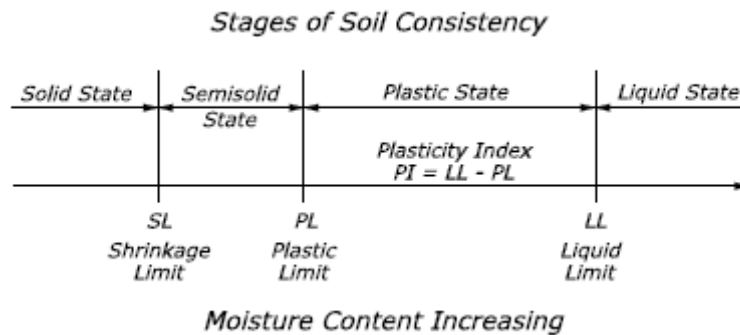

## 2.2.2 Moisture – Density Relations

The relative density of the soil largely influences the behavior of material. The soil type, percentage of moisture, and the compactive effort will determine the density of the in-place material.

### 2.2.2.1 Moisture content

Water can greatly influence engineering properties of soil. Too much or too little water can render some otherwise desirable and stable material virtually useless. Knowledge of the in-place moisture content is necessary for making decisions regarding design and control of material. AASHTO T 265, Laboratory Determination of Moisture Content of Soils, is the method recommended by FLH. In-place field moisture content may also be determined through the use of a nuclear density and moisture gage as provided in AASHTO T 310. The actual moisture content of the soil can be compared with the optimum moisture content to determine if the material is in a suitable condition for compaction. The optimum moisture content of a material will be determined through appropriate proctor testing (typically according to AASHTO T 99 or T 180 depending on the soil classification). A proper proctor test includes five moisture density points to adequately define the relationship. Exhibit 2-5 is an example of a proper proctor test result.

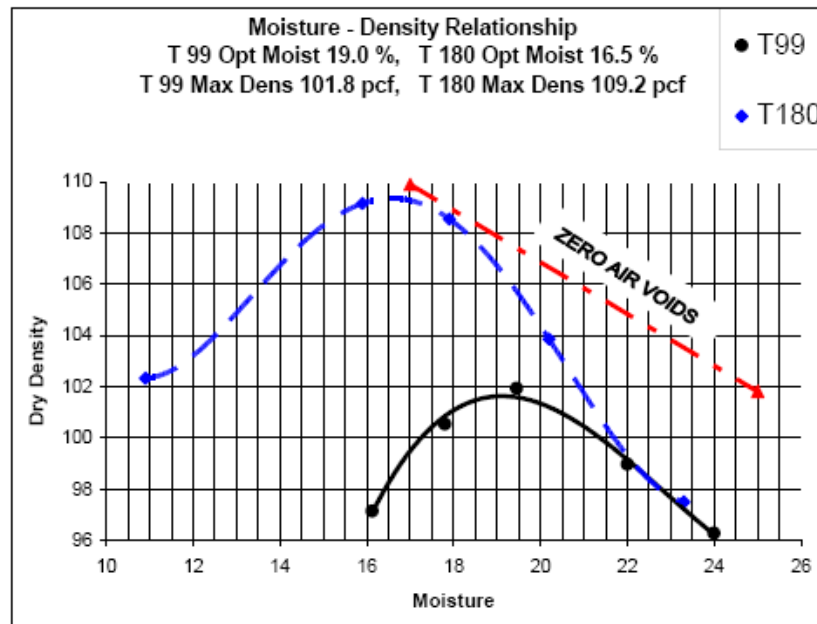
**Exhibit 2-5 Five Point Moisture Density Curve**

\*Note that as the compactive effort increases (T 99 vs. T 180) the maximum dry density increases and the optimum moisture content decreases.

**2.2.2.2 Density**

Density determinations include both the determination of density in the field and the establishment, through standard tests, of reference or standard densities to which the field tests are compared. Results of a field density test cannot be properly evaluated until compared to an appropriate reference density. Tests used to establish density standards are those represented by AASHTO T 99 and T 180, Moisture-Density Relations of Soils. Four alternate methods are provided when using these test procedures. The specific method to be used will be indicated in the contract specifications.

Density determination, of the material placed on a project, using nuclear test methods AASHTO T 310 is the preferred method specified in the FP, however the Sand-Cone Test AASHTO T 191 is also an approved method.

Field density tests are performed on the project site. Each type of density equipment and test procedure is unique. An operator performing a density test should be aware of all special precautions for the equipment and test procedures being used. For example, the sand cone test is extremely sensitive to vibration and nuclear instruments require very careful and uniform surface preparation. Operators must be familiar with the equipment features and test methods.

In working with subgrade material it is common to encounter particles larger than can be tested. When this situation occurs, recognition must be made of the oversize material and a density correction needs to be made. A procedure for making this correction is described in AASHTO T 224. Oversized material is typically defined as particles larger than 0.75 inch (19 mm).

### **2.2.3 Soil Strength**

Soil strength can be determined through various test methods. Most common are the Resistance R-value and the California Bearing Ratio (CBR), however other methods such as triaxial testing and resilient modulus have also been used. More specialized testing can also be performed to determine the shear strength, unconfined compressive strength, or cohesion of a soil. This testing would be performed during the development of a project, typically by the geotechnical engineer. Regardless of the method used, the purpose of the testing is to determine the support that can be provided by the soil. Results of the soil strength tests are used to determine the structural pavement design needed to accommodate traffic loading or the appropriate support needed for a structural member, such as a bridge or retaining wall.

During construction, it may become necessary to verify the subgrade soil strength value. This is often done to compare the strength of the soil that is being compacted during the construction phase of the project to the design values used during the geotechnical investigation and recommendation phase of the project. These verification and testing requirements are typically located in the contract documents. When a question exists regarding this type of testing or the results, consult the Division Materials Engineer for guidance.

Soil strength testing may also be performed as part of a stabilization technique. Based on initial project development sampling and testing, a stabilization technique may be selected. Techniques may include treatment with cement, lime, fly ash, asphalt, or possibly some other chemical treatment. During construction, it may become necessary to validate the original stabilization through the testing of the on-site materials. Again, the contract requirements will address any strength testing that will be needed to verify the original design work. Specific sampling and testing requirements will be included based on the treatment method.

## 2.3 IMPORTED SUBGRADE AND BACKFILL MATERIALS

For some projects, it may become necessary to import materials for the completion of embankments. These materials include:

- Unclassified borrow – granular material that has a maximum size of 24 inches (600 mm ) and used in deep embankment construction;
- Select borrow – granular material with specific gradation requirements and typically used in areas as resistance to frost heave;
- Topping – granular material that has a maximum size of 4 inches; (100 mm )
- Select topping – granular material with specific gradation requirements.

Typically a bid item for the specific material will be listed in the contract documents for the project. Unlike in-situ soils, these materials will need to meet specific requirements as defined in the contract. These materials are described as granular in nature and will be tested for character and quality to ensure compliance with contract requirements. These tests include sieve analysis, Atterberg Limits, and soil classification. Requirements for unclassified borrow are often modified in the special contract requirements for projects in areas where granular materials are not readily available.

Backfill material for structures is also a product that is typically imported for use. These materials include:

- Foundation fill – typically used to replace unsuitable or unstable material for the construction of footings or other structural components
- Bedding material – typically used under culvert pipe
- Backfill material – typically used as backfill material for pipes
- Structural backfill – typically used to provide uniform material for backfill behind structures

These materials are often considered subsidiary to the installation of the structure. Like imported subgrade materials, backfill materials are granular and have specific requirements as indicated in the contract. Testing of these materials is important to ensure compliance with the contract. Sampling and testing requirements that are applicable to the contract may be found in the “Sampling and Testing Requirements” table located at the end of each section in the FP or in the special contract requirements.

Electrochemical requirements may also be included if the backfill will be used in connection with metallic construction elements. These elements include items such as reinforcement for mechanically stabilized earth walls, rock bolts, anchor bolts, gabion mattress material, or pipe elements. The primary use of this testing is to determine the corrosion potential of the soil on metal elements. Soil resistivity measurements supplemented by the soil pH value are used to identify conditions under which the corrosion of the metals in the soil may be sharply accentuated. Sulfate and chloride content are also used in determining the corrosive nature of soil. These tests measure the water-soluble ion content in the soil that would be detrimental to buried metal components.

The quality of the backfill material used is critical to the service life of the constructed retaining structure. If the corrosion potential is a concern, the contract will include sampling and testing requirements to verify the quality of the backfill material. Any questions regarding the specific testing or sampling requirements may be directed to the Division Materials Engineer.

**Exhibit 2-6 Guidance for Sample Sizes for Transmitting to FLHD Laboratory**

<b>Material</b>	<b>Minimum Split Size for Transmitted to FLHD Laboratory</b>	<b>Purpose</b>	<b>Test Method or Specification</b>
Subgrade soil	50 lbs (23 kg)	Classification Moisture - Density	AASHTO M 145 AASHTO T 99 OR T 180
Unclassified Borrow	50 lbs (23 kg)	Classification Moisture - Density	AASHTO M 145 AASHTO T 99 OR T 180
Select Borrow	50 lbs (23 kg)	Gradation Atterberg Limits Moisture - Density	AASHTO T 11 & T 27 AASHTO T 89 & T 90 AASHTO T 99 OR T 180
Topping	50 lbs (23 kg)	Classification Moisture - Density	AASHTO M 145 AASHTO T 99 OR T 180
Select Topping	50 lbs (23 kg)	Gradation Atterberg Limits Moisture - Density	AASHTO T 11 & T 27 AASHTO T 89 & T 90 AASHTO T 99 OR T 180
Foundation fill	50 lbs (23 kg)	Gradation Atterberg Limits Moisture - Density	AASHTO T 11 & T 27 AASHTO T 89 & T 90 AASHTO T 99 OR T 180
Bedding material	50 lbs (23 kg)	Classification Moisture - Density	AASHTO M 145 AASHTO T 99 OR T 180
Backfill material	50 lbs (23 kg)	Classification Moisture - Density	AASHTO M 145 AASHTO T 99 OR T 180
Structural backfill	50 lbs (23 kg)	Gradation Atterberg Limits Moisture - Density	AASHTO T 11 & T 27 AASHTO T 89 & T 90 AASHTO T 99 OR T 180

When field-testing soils, the following are some of the test procedures are to be used as appropriate and as specified in the contract.



**Exhibit 2-7 AASHTO Soil Test Procedures**

<b>Test Number</b>	<b>Test Title</b>
AASHTO T 87	Dry Preparation of Disturbed Soil and Soil Aggregate Samples for Test
AASHTO T 89	Determining the Liquid Limit of Soils
AASHTO T 90	Determining the Plastic Limit and Plasticity Index of Soils
AASHTO T 99	Moisture-Density Relations of Soils Using a 2.5-kg (5.5-lb) Rammer and a 305-mm (12-in.) Drop
AASHTO T 180	Moisture-Density Relations of Soils Using a 4.54-kg (10-lb) Rammer and a 457-mm (18-in.) Drop
AASHTO T 190	Resistance R-Value and Expansion Pressure of Compacted Soils
AASHTO T 191	Density of Soil In-Place by the Sand-Cone Method
AASHTO T 193	The California Bearing Ratio
AASHTO T 224	Correction for Coarse Particles in the Soil Compaction Test
AASHTO T 255	Total Evaporable Moisture Content of Aggregate by Drying
AASHTO T 265	Laboratory Determination of Moisture Content of Soils
AASHTO T 272	Family of Curves - One Point Method
AASHTO T 310	In-Place Density and Moisture Content of Soil and Soil-Aggregate by Nuclear Methods (Shallow Depth)

## **2.4 ROLES AND RESPONSIBILITIES**

### **2.4.1 Contractor's Responsibilities**

The contractor is responsible for excavation and constructing the subgrade and embankments according to the requirements provided in the contract. As part of these requirements, the contractor is to control the quality of the materials provided and also monitor the construction process to ensure compliance. The construction of embankments and the placing of backfill materials require that the material provided meet the specification and be in a suitable condition for compaction. The specific requirements will be established in the contractor quality control plan and contract specifications. In general, the sampling and testing responsibilities of the contractor include:

- Providing subgrade stabilization mix design submittals;
- Sampling material to be tested according to proper sampling methods;
- Providing split samples to the Government when required or requested;
- Testing material for conformance to material requirements; (i.e., classification, gradation, Atterberg Limits, etc.)
- Providing appropriate moisture density curves for a specific material type;
- Testing density of placed material to ensure proper compaction;
- Monitoring the production of any imported material to ensure compliance with the specifications;
- Providing appropriate certifications for material.

The contractor needs to provide information and test results according to the timeframe specified in the contract. Distribution of the test reports and certifications should be according to the contract documents and the quality control plan.

Exhibit 2-6 provides guidance on minimum sample sizes required for given testing.

### **2.4.2 Government's Responsibilities**

The Project Engineer or designated representative will review the test results and certifications for contract compliance. A decision regarding the acceptance of materials and work will be made in accordance with Subsection 106.01.

The Project Engineer or designated representative will also be present to witness all samples taken for the Government and split, when required. Upon completion of splitting, the samples will be secured and should immediately be in the control of the Government. The Project Engineer needs to be aware of the contractor's operations and be available to witness the sampling and splitting activities.

The Project Engineer should review the testing protocols and equipment to ensure compliance with the contract requirements. In regard to subgrade materials, the testing should verify the appropriate material characteristic as listed in the contract requirements. The testing should also verify that the material is suitable for use in the work and may be constructed according to the contract documents.

Visual observations are an important part of the Project Engineer's responsibilities with regard to earthwork operations. Because soils are not a manufactured product, there can be significant variations in the materials being used, especially in areas with many different soil deposits. The Project Engineer should review the Geotechnical and Pavement Design Reports to become familiar with the subsurface conditions and what to expect with on-site materials. It is important to view the contractor's operations to ensure that proper materials are properly placed. The quality control tests should be used by the Project Engineer to confirm field observations. For instance, if tests indicate passing density results but the material is pumping under the weight of construction equipment, an investigation should be conducted to resolve the conflict in test results and field observations. By visually observing earthwork operations, problems can often be identified and addressed early in the construction process and future problems can be eliminated when placing final surfacing.

## 2.5 MATERIAL CERTIFICATIONS

Many of the materials specified and used on a project are manufactured off-site and acceptance is based on materials certification. Certifications need to be in conformance with the contract requirements as provided in Subsection 106.03.

FP specifications reference two types of materials certifications, production and commercial. The Project Engineer needs to determine the appropriate certification for the type of material being provided and obtain the appropriate documentation in accordance with the certification being provided.

Exhibit 2-8 provides guidance for certifications that may be required.

**Exhibit 2-8 Materials Certification**

Section	Description	Material	Frequency	
			Certification	Sample
207	Earthwork geotextiles	Geotextile	1 per shipment	First shipment
213	Subgrade stabilization	Blotter	1 per source	1 per source
		Chemical admixtures	1 per shipment	Upon request
		Fly ash	"	"
		Hydraulic cement	"	"
	Emulsified asphalt	"	"	
251	Grout for riprap	Material for grout	1 per mix	—
253	Gabions and revet mattresses	Material for gabion structures	1 per source	—
254	Crib walls	Material for crib walls	1 per shipment	—
255	MSE walls	Material for MSE walls	1 per shipment	—
256	Ground anchors	Material for ground anchors	1 per shipment	—
258	Reinforced concrete retaining walls	As specified	1 per shipment	—
259	Soil nail retaining walls	As specified	1 per shipment	—
260	Rock bolts	As specified	1 per shipment	—
261	Rock dowels	As specified	1 per shipment	—

## 2.6 FORM REFERENCES

Form references for use in the testing of soils and subgrade materials.

- Form FHWA 1600C – Request for Laboratory Tests (CFL)
- Form FHWA 1600E – Requests for Laboratory Tests (EFL)
- Form FHWA 1600W – Requests for Laboratory Tests (WFL)
- Form FHWA 1616 – Moisture content by microwave method;
- Form FHWA 1618 – In-place nuclear moisture/density worksheet
- Form FHWA 1621 – Coarse and fine aggregate gradation worksheet
- Form FHWA 1624 – Liquid Limit and Plastic Limit worksheet
- Form FHWA 1625 – Moisture density worksheet (T99/T180)
- Form FHWA 1627 – Sieve analysis for fine and coarse aggregate worksheet
- Form FHWA 1636 – Correction for coarse particles in soil compaction worksheet

(This page intentionally left blank.)

# **CHAPTER 3**

## **DIVISION 300: AGGREGATE BASE, SUBBASE, AGGREGATE-TOPSOIL AND BASE STABILIZATION**

### **3.1 SUMMARY AND DESCRIPTION**

Aggregate base and subbase typically provide the first layer of the structural pavement section. These are manufactured aggregate products that may be produced from mining or quarrying naturally occurring rock deposits or as a by-product of other manufacturing processes such as slag. Base aggregates may be combined with a binding agent to form a stronger stabilized base. Cement, lime, fly ash, emulsified asphalts, and other materials have been used to provide additional strength and stability to the aggregate base layer.

Testing of the aggregate for use as base is designed to provide information on the inherent quality properties of the rock to be used. Among these are hardness, soundness, stability, resistance to abrasion and other forms of mechanical breakdown, and resistance to weathering. Once the quality properties of the aggregate are established to meet the intended use, the aggregate will need to be crushed and processed to meet requirements of the finished product. During construction of the base layer, proper compaction is required to provide the proper support as required by the structural pavement design.

Other materials are also used as part of the construction of aggregate base construction. These include aggregate-topsoil courses and dust palliatives. These products serve a unique purpose and are used for specific applications. In general, these uses are limited compared with the more common use of aggregate base.

Tests in Exhibits 3-1, 3-3 and 3-13 function to either evaluate the quality of aggregate, quality of the finished product, or verify proper construction. Base aggregate tests vary throughout the United States. When contract specifications permit options, the selection of one test over another is often a matter of local engineering judgment. Consideration needs to be given to local knowledge and past performance of aggregate bases to determine what testing is appropriate and applicable. The Project Engineer should consult the contract to determine what aggregate tests have been specifically included in the project.

## 3.2 AGGREGATE BASE PROPERTIES AND TEST METHODS

### 3.2.1 Aggregate Quality Properties

Quality of the aggregate material can be determined by testing samples obtained from the source. These samples should be obtained from various locations throughout the source. Sampling techniques used to obtain rock for testing including core samples, rock face grab samples, or crushed processed aggregate stockpiles to name a few. Regardless, the rock or aggregate that is sampled should be representative of the aggregate to be used in the production of the aggregate base. The tests listed in Exhibit 3-1 provide a listing of test methods typically used to determine aggregate quality. The Project Engineer should also review the contract to determine if other quality aggregate tests have been specified based on project location, local conditions, or other engineering judgment.

Resistance of an aggregate to abrasion, impact, and grinding is determined using the Los Angeles Abrasion test. The test measures the degree to which a graded aggregate is reduced in size when subjected to the rolling and pounding of steel spheres inside a rotating steel drum. This is also a measure of aggregate toughness or hardness.

Resistance of an aggregate to breakdown by freezing and thawing is determined using the Soundness test. With the Soundness test, weak porous aggregates often disintegrate from the pressure of the salt that crystallizes in the pores during the performance of the test. This pressure simulates the effect that ice crystals would have in the aggregate when subjected to severe multiple freeze thaw cycles.

The Aggregate Durability test measures resistance of an aggregate to mechanical methods of degradation. In this method, a sample of aggregate is agitated in the presence of water. The amount of fines generated during the test determines the durability index.

The Fractured Faces test is used when aggregate is obtained from a gravel or pit source. In order to provide for aggregate interlock, the round character of the rock needs to be altered by crushing. This test determines the percentage of aggregates that have mechanically fractured faces.

**Exhibit 3-1 Aggregate Quality Test Methods**

<b>Aggregate Test</b>	<b>Test Method</b>	<b>Aggregate Performance Characteristic</b>
L.A. Abrasion	AASHTO T 96	Hardness
Sodium Sulfate Soundness	AASHTO T 104	Freeze / Thaw Resistance
Aggregate Durability	AASHTO T 210	Mechanical Abrasion
Fractured Faces	ASTM D 5821	Aggregate Interlock

A minimum 200-pound (90 kg) representative sample should be obtained in order to perform all of the quality tests listed in Exhibit 3-1. In the event that the contract includes additional quality tests, consult the FLH Division Materials Engineer for additional guidance.



### 3.2.2 Processed Aggregate Properties

Once the quality of the aggregate has been determined to meet the contract requirements, processed aggregate properties will be determined. For any aggregate layer, the gradation of the material and moisture density relationship will be determined. In addition, other properties may be included depending on the use and particular specifications of the project. Certain aggregate base requirements may include a liquid limit or sand equivalent requirement to ensure that the fine portion of the aggregate mixture is granular in nature. A plasticity index requirement may be included when surface course aggregate is used to ensure that the fines exhibit a binding characteristic that would provide a higher quality driving surface. The contract may also include a minimum strength requirement, such as CBR or R-Value, for aggregates.

Gradation or particle size is the one characteristic subject to control by conventional field processing. Gradation is not an inherent geological property of the rock, although to some extent the type of rock does influence the amount and character of coarse and fine materials produced by crushing.

Gradation of the aggregate is determined by means of a sieve analysis, which is the separation of the aggregates into several designated sizes by passing the material through a series of sieves arranged from coarse to fine. The aggregate gradation is determined according to AASHTO T 11 and T 27. Generally aggregates for highways and structures are divided into two gradation classifications.

**Exhibit 3-2 Gradation Classification**

Type of Aggregate	Aggregate Size
Coarse aggregate	Material retained on the #4 (4.75 mm) sieve
Fine aggregate	Material passing the #4 (4.75 mm) sieve

When the #200 (75 µm) sieve is specified as part of the gradation requirements, washing the sample in accordance with AASHTO T 11 is required in conjunction with the sieving process.

The character and relative quality of the fine aggregate can be determined using the liquid limit, plastic index, and sand equivalent test methods. If certain binding characteristics of an aggregate are required, this can be determined using the liquid limit and plasticity index tests. Aggregate material should be prepared using the dry preparation method as stated in AASHTO T 87. For additional discussion on these tests, see Section 2.2.1.2 of this manual. The presence and amount of potentially detrimental clay-like fines in the aggregate can be determined using the sand equivalent test method. These tests may or may not be included in the contract depending on the purpose and function of the aggregate base layer being placed.

**Exhibit 3-3 Supplemental Aggregate Base Tests**

<b>Fine Aggregate Tests</b>	<b>Test Method</b>	<b>Aggregate Characteristic</b>
Liquid Limit	AASHTO T 89	Liquid state of fine aggregate
Plastic Limit	AASHTO T 90	Plastic state of fine aggregate
Sand Equivalent	AASHTOT 176	Proportion of clay in aggregate

**3.2.2.1 Moisture Density Relationship**

The moisture density relationship of an aggregate will be determined through laboratory testing. This testing will establish a reference density that will be used during the construction of the base layer to verify appropriate field compaction has been achieved. The test method most commonly used to establish the moisture density standard is AASHTO T 180 although there are other tests that may also be used. The contract documents will specify the method to be used to establish the target density and moisture content. Aggregates often contain oversized material, particles larger than 0.75 inch (19 mm). The maximum dry density and optimum moisture content of the aggregates containing more than 5 percent of oversized material should be corrected according to AASHTO T 224.

During construction, field density tests are taken and compared to the established standard to verify that the material has been properly compacted. Results of any field density test cannot be properly evaluated until compared to the appropriate reference density and moisture content. There are several acceptable methods that may be used to determine the field density and moisture content of the aggregate. The method most common is AASHTO T 310. This method utilizes a nuclear gage to determine the moisture content and density of the aggregate. Other methods such as the sand-cone method (AASHTO T 191) and the oven-drying moisture method (AASHTO T 265) may still be used however they are becoming less common.

For additional information on moisture density relationship and field density testing, see Section 2.2.2 of this manual.

**3.2.3 Aggregate Sampling and Splitting**

The importance of obtaining a proper sample of aggregate cannot be overemphasized. When obtaining a sample of aggregate, proper methods and technique need to be used to ensure a representative sample has been obtained. A proper sample is vital in order to provide correct information for evaluation purposes. If a proper sample is not obtained, any testing performed on that sample may be of little value.

AASHTO provides a standard practice for sampling of aggregates in AASHTO T 2. This practice provides guidance on obtaining samples from various locations such as stockpiles, flowing aggregate stream, conveyor belts, transportation units, and roadways. Guidance is also provided for the sampling of aggregate for the exploration of potential aggregate sources. The following paragraphs will provide some additional guidance on proper sampling technique.

### 3.2.3.1 Sampling from Stockpiles

As a general rule, sampling from stockpiles should be avoided whenever possible. Because of the potential for segregation to occur during the construction of the stockpile, obtaining a representative sample must be undertaken with great care.

When taking a sample of coarse or mixed coarse and fine aggregate, exercise caution to ensure that only the material from the sampling area is incorporated into the sample. A barrier, such as a wooden board or metal sheet, should be used to restrict the flow of the material down the pile so that the sample may be obtained from the specified area. Power equipment, if available, could also be used to obtain material from various locations in the main pile. These increments would then be combined to compose one field sample. Samples should be made by obtaining material from at least three increments taken from the upper, middle, and lower third of the pile. See Exhibit 3-4 and Exhibit 3-5.

**Exhibit 3-4 Proper Sampling of Coarse Aggregate**

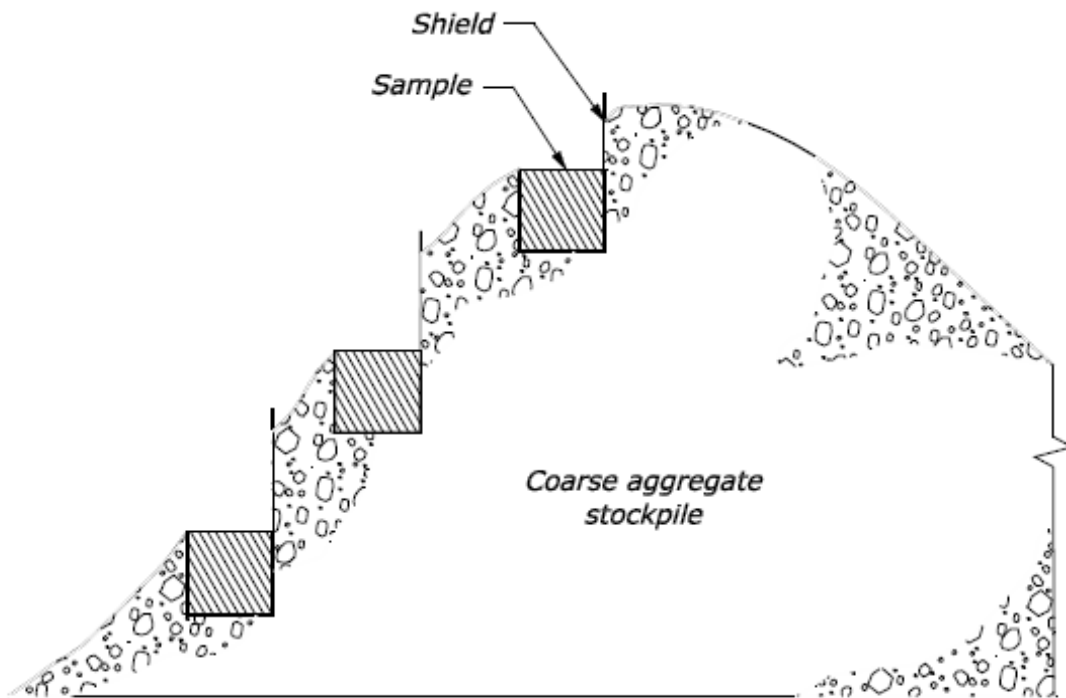

**NOTE:**

*Sample the stockpile near its base, middle, and top as shown. Combine and mix the material obtained to form one sample and then reduce the size of the combined sample by splitting to that required for testing.*

### Exhibit 3-5 Proper Use of Shield for Sampling



A sampling tube may be used to sample stockpiles of fine aggregate. The sampling tube should be inserted into the pile at random locations to extract material. As is the case with coarse or mixed coarse and fine stockpiles, multiple locations through out the pile should be selected to obtain one composite sample. See Exhibit 3-6.

### Exhibit 3-6 Proper Sampling of Fine Aggregate Stockpile

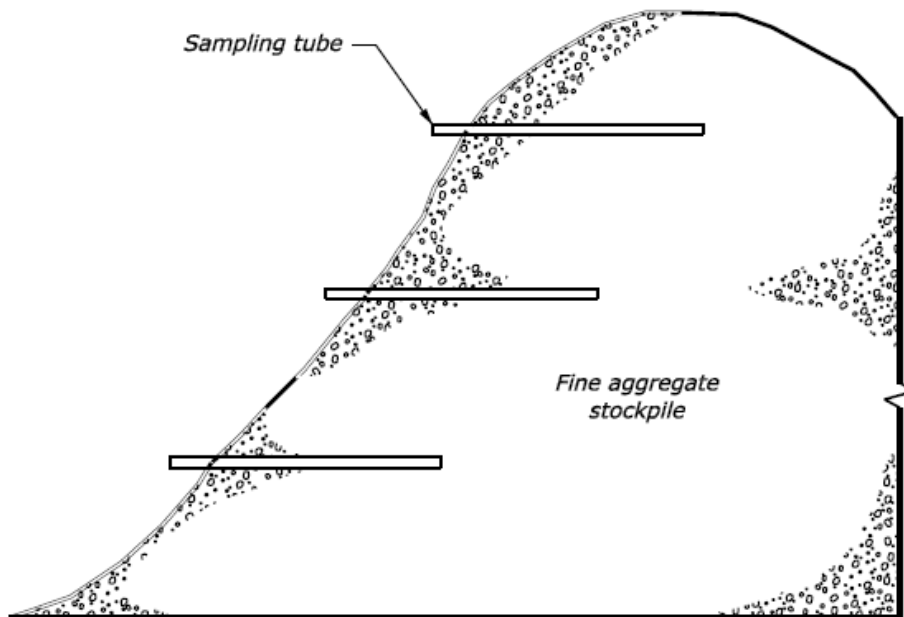

**NOTE:**

*Insert the sampling tube horizontally near the base, middle, and top of the stockpile as shown. Combine and mix the material obtained to form one sample and then reduce the size of the combined sample by splitting to that required for testing.*

### 3.2.3.2 Sampling from Flowing Aggregate Stream

It is recommended to obtain a sample from a flowing aggregate stream by cutting the entire cross section of material as it is being discharged. Another practice is to cut across the flowing material. In either case, special sampling devices are typically fabricated to obtain the sample. Exhibit 3-7 is an example of a fabricated sampling device.

**Exhibit 3-7 Sampling Device Cutting Across Flowing Stream**



### 3.2.3.3 Sampling from Conveyor Belt

In sampling from a conveyor belt, the belt must be stopped in order to obtain the sample. A template should be manufactured that conforms to the shape of the belt. Insert two templates in the aggregate stream and space them appropriately to obtain the recommended amount for the sample. The sample should be obtained for the full width of the belt. Exercise care to ensure that all of the fines are swept off the belt and into the sample container. Exhibits 3-8 and 3-9 show proper sampling technique and devices typically used when obtaining a sample from a conveyor belt. Exhibit 3-10 provides a schematic drawing of a device typically used to obtain conveyor belt samples.

**Exhibit 3-8 Sampling from Conveyor Belt**



**Exhibit 3-9 Proper Device for Belt Sampling**



**Exhibit 3-10 Schematic of Belt Sampling Device**

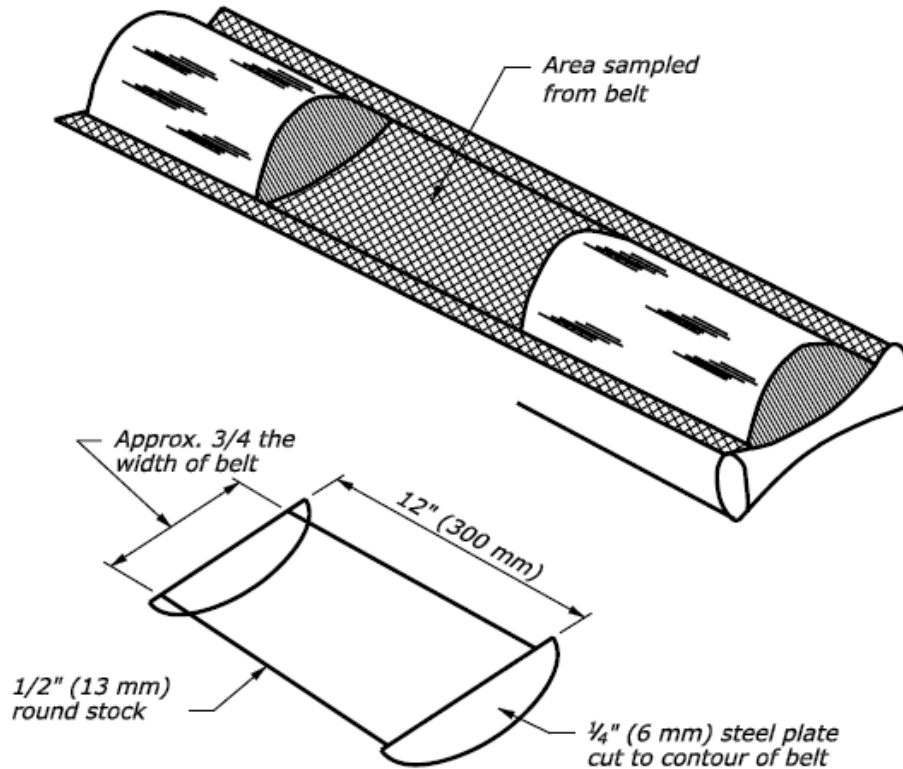

**3.2.3.4 Sampling from Roadbed or Windrow**

Roadbed and windrow sampling is generally used in the acceptance process for aggregate base materials. The sample should be obtained from the windrow or the roadbed after the aggregate has been processed. The typical method of sampling a windrow is to strike off the top of the windrow and sample a minimum of three random locations and combine the material into one sample. Exhibit 3-11 shows a schematic of this type of sampling.

When sampling from the roadbed, all of the material for the sample should be obtained full depth. Care should be exercised when obtaining this sample to ensure that none of the underlying materials are included in this sample. If this does occur, the sample would be considered contaminated and a new sample should be obtained.

### Exhibit 3-11 Schematic of Sampling from a Windrow

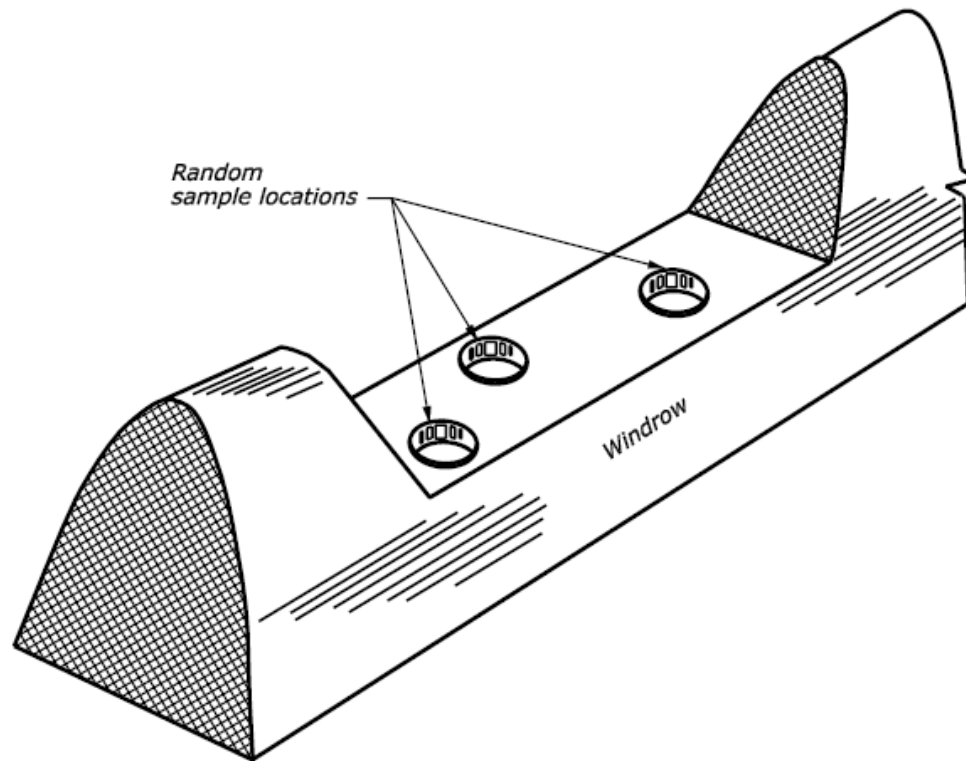

**NOTE:**

*Flatten the windrow to approximately 12 inches (300 mm) in width. Excavate material from at least 3 random locations as shown. Combine and mix the material obtained to form one sample and then reduce the size of the combined sample by splitting to that required for testing.*

The Project Engineer should review the contract documents and identify sample locations or any special sampling or testing requirement that may be specified. The contract will also indicate the point of sampling and sampling frequency for various aggregate products that are included in the contract.

#### **3.2.3.5 Splitting Samples**

Once a field sample has been obtained, it will need to be reduced in size to the proper testing size. AASHTO T 2 provides guidance on the minimum sample sizes of aggregate that constitute an appropriate field sample. From this original field sample, a smaller representative testing sample can be obtained. AASHTO T 248, Reducing Samples of Aggregate to Testing Size, is the method for reducing large field samples to appropriate sizes for testing. Samples are reduced by the use of a quartering blanket or a mechanical splitter. It is important to comply with both the minimum field sample size requirements and the minimum testing size requirements found in the specific test method to have valid test results.

Minimum split sample sizes for general aggregate testing are provided in Exhibit 3-12. If multiple tests are to be performed on a single field sample, consult the FLH Division Materials Engineer for specific guidance on field sample sizes.



**Exhibit 3-12 Guidance for Sample Sizes for Transmitting to FLHD Laboratory**

<b>Material</b>	<b>Minimum Split Size for Transmitting to FLHD Laboratory</b>	<b>Purpose</b>	<b>Test Method or Specification</b>
Subbase, Aggregate Base, and Aggregate Surfacing	50 lbs (23 kg)*	Gradation Atterberg Limits Moisture – Density Sand Equivalent	AASHTO T 11 & T 27 AASHTO T 89 & T 90 AASHTO T 180 AASHTO T 176
Subbase, Aggregate Base, and Aggregate Surfacing	200 lbs (90 kg)	Aggregate Quality Test	AASHTO T 96 AASHTO T 104 AASHTO T 210 ASTM D 5821

\*100 lbs (50 kg) if CBR or R-value testing is required.

**3.2.4 Typical Aggregate Base Treatments**

Aggregate bases and subbases can be treated with various additives to improve the strength and performance characteristic as compared to water-bound (untreated) bases. Laboratory tests are used to determine the amount of additive required to provide the specified mixture requirements. Typically these tests are used to determine the amount of additive required to meet the mixture requirements. Aggregates can be treated as part of the construction of a new aggregate course or in-place aggregates can be stabilized to strengthen an existing base layer.

The additives most commonly used to improve the structural capacity of a base layer are hydraulic cement, lime, or fly ash. It is critical during construction that the proportioning of the components be accurate in order to achieve the desired material properties. Using additional additive will produce a mixture with a higher strength but may also cause undesired side effects such as excessive shrinkage cracking.

The process for determining the proportioning of a treated base is typically established in the contract documents. In general, the contract will specify the requirements for the treated base and the contractor will design a treated aggregate mixture that meets those requirements. As part of the mix design submittal, samples of aggregate and additive may also be obtained for the Government to perform verification testing. Consult your FLH materials staff or the contract for additional guidance.

In some instances, additives may be used to improve handling or alter material characteristics without providing a substantial increase in strength. Emulsified asphalt treated bases are an example of this type of treatment. The additive is used primarily to assist in the binding of the aggregate to provide a water-tight platform for paving and reduce dust generated by traffic.

### **3.2.5 Other Associated Aggregate Products**

#### **3.2.5.1 Minor Crushed Aggregate**

Minor crushed aggregate is a product that is typically specified on projects that have small quantities. The material requirements for this product are for crushed aggregate material normally used and available near the project location. The furnished aggregate should conform to the gradation and quality requirements used by local agencies in the construction of highway projects.

#### **3.2.5.2 Recycled Aggregate Base and Road Reconditioning**

Recycled aggregates and road reconditioning are methods that use existing roadway aggregate as the material for construction. The existing base material is processed on the roadway in the same manner as virgin material. Any organic or deleterious materials are removed during the processing and the material is shaped to provide a uniform surface. The material is compacted according to the methods specified in the contract. Typically for small quantities a method-type specification is used to monitor compaction; whereas for larger quantities compaction is monitored by obtaining a specified percentage of the maximum density determined by a proctor test such as AASHTO T 180.

#### **3.2.5.3 Aggregate-Topsoil**

As the name suggests, aggregate-topsoil is a blended material of crushed aggregate and topsoil that is mixed together. The proportioning is roughly 50/50 by volume and is designed to provide some structural support within a medium that promotes vegetation. This material is typically placed and compacted as a shoulder finishing material. To complete the construction sequence, the completed surface is seeded.

#### **3.2.5.4 Dust Palliatives and Stabilization Admixtures**

There are several reasons to use dust palliatives or stabilizing agents to enhance the performance of aggregate surfacing. Using various additives can improve strength, waterproof, or control dust. The primary purpose of these additives is to provide a bound cohesive material and prevent the loss of fine particulates.

If this is accomplished, the aggregate surfacing will provide improved service and prevent unwanted side effects. Aggregate surface roads will experience some loss of surfacing due to surface abrasion. Use of dust palliatives and stabilization admixtures will help to minimize the loss.

Dust palliatives are utilized to reduce airborne dust particulates and aid in maintaining an aggregate surface. The dust palliatives are applied on a properly constructed prepared surface or are mixed with the aggregate prior to final placement and compaction. Although there are five specific products listed in the FP, there are primarily three categories of dust suppressants. These categories are as follows:

- **Salts.** The primary salts used as dust suppressants are calcium chloride and magnesium chloride. These materials can be incorporated into the aggregate in two forms, dry flakes or as a brine solution. In either case, the material should be mixed into the top few inches of the aggregate to provide maximum benefit. The problems

associated with using salts as dust palliatives include leaching during wet weather, vehicle corrosion potential, and ineffectiveness in dry climates. Multiple applications within a single year may be necessary depending on the local weather and climate conditions. Application rates and construction requirements should be included in the contract if these materials are used.

- Lignosulfonates.** Lignosulfonates are a waste product of the paper pulp industry and are refined and used as dust palliatives. They provide a cementing reaction with the coarse and fine aggregate to provide the dust suppressing action. This material is provided as a liquid and is sprayed on the road surface and allowed to penetrate. Similarly to the salts, lignosulfonates can leach out of the surfacing material during rainy weather and thus may have to be reapplied to provide adequate benefits. However, a distinct benefit of this material is its use in more variable climate conditions.
- Emulsified Asphalts.** Asphalt and other petroleum-based products have been used as prime coats to provide a temporary driving surface. The use of emulsified asphalts as dust palliatives is very similar. When sprayed on the aggregate surface, the emulsified asphalt cements particles together and in doing so, reduces the airborne particulates. The aggregate surfacing must be low in fines content (typically less than 10% passing the #200 (75 µm) sieve) for the application to be successful. The use of this material may also require covering with blotter material to prevent traffic from picking up the newly constructed dust palliative surface.

Other non-traditional stabilizing agents are currently available. These include enzymes, synthetic polymers, and organic non-petroleum derivatives. These products vary in material requirements and use and may be considered on a case-by-case basis. The FP does not currently provide specifications for these types of stabilizing agents.

### 3.2.6 Field Testing Requirements

When field-testing soil-aggregate and aggregate materials, the following test procedures are to be used as appropriate and as specified in the contract.

**Exhibit 3-13 AASHTO and ASTM Aggregate Test Procedures**

Test Number	Test Title
AASHTO T 2	Sampling of Aggregates
AASHTO T 11	Materials Finer Than 75-µm (No. 200) Sieve in Mineral Aggregates by Washing
AASHTO T 27	Sieve Analysis of Fine and Coarse Aggregates
AASHTO T 87	Dry Preparation of Disturbed Soil and Soil Aggregate Samples for Test
AASHTO T 89	Determining the Liquid Limit of Soils
AASHTO T 90	Determining the Plastic Limit and Plasticity Index of Soils

**Exhibit 3-13 AASHTO and ASTM Aggregate Test Procedures (Continued)**

<b>Test Number</b>	<b>Test Title</b>
AASHTO T 96	Resistance to Degradation of Small-Size Coarse Aggregate by Abrasion and Impact in the Los Angeles Machine
AASHTO T 104	Soundness of Aggregate by Use of Sodium Sulfate or Magnesium Sulfate
AASHTO T 176	Plastic Fines in Graded Aggregates and Soils by Use of the Sand Equivalent Test
AASHTO T 180	Moisture-Density Relations of Soils Using a 4.54-kg (10-lb) Rammer and a 457-mm (18-in.) Drop
AASHTO T 190	Resistance R-Value and Expansion Pressure of Compacted Soils
AASHTO T 191	Density of Soil In-Place by the Sand-Cone Method
AASHTO T 193	The California Bearing Ratio
AASHTO T 210	Aggregate Durability Index
AASHTO T 224	Correction for Coarse Particles in the Soil Compaction Test
AASHTO T 248	Reducing Samples of Aggregate to Testing Size
AASHTO T 255	Total Evaporable Moisture Content of Aggregate by Drying
AASHTO T 265	Laboratory Determination of Moisture Content of Soils
AASHTO T 310	In-Place Density and Moisture Content of Soil and Soil-Aggregate by Nuclear Methods (Shallow Depth)
ASTM D 5821	Determining the Percentage of Fractured Particles in Coarse Aggregate

### **3.3 ROLES AND RESPONSIBILITIES**

#### **3.3.1 Contractor's Responsibilities**

The contractor is responsible for constructing the aggregate base layers according to the requirements provided in the contract. As part of these requirements, the contractor is to control the quality of the materials provided and also monitor the construction process to ensure compliance.

Construction of the aggregate base layers and the placing of the aggregate materials require that the material provided meet the specification and that it be in a suitable condition for compaction. Specific requirements for the aggregate will be specified in the contract. The contractor will establish a process to verify that the material and construction requirements are met through a quality control plan. In general, the sampling and testing responsibilities of the contractor include:

- Sampling material to be tested according to proper sampling methods;
- Providing split samples to the Government when required or requested;
- Monitor the production of aggregate to ensure compliance with the specifications;
- Testing material for conformance to material requirements; (i.e., aggregate quality, gradation, Atterberg Limits, etc.)
- Providing appropriate moisture density curves for the aggregate base material;
- Testing density of placed aggregate to ensure proper compaction;
- Providing appropriate certifications for material;
- Submitting a mix design meeting the design parameters as specified in the contract for treated base material.

The contractor needs to provide information and test results according to the timeframe specified in the contract. Distribution of the test reports and certifications should be according to the contract documents and the quality control plan.

Exhibit 3-12 provides guidance on sample sizes required for given testing.

#### **3.3.2 Government's Responsibilities**

The Project Engineer or designated representative will review the test results and certifications for contract compliance. A decision regarding the acceptance of the material will be made in accordance with Subsection 106.01.

The Project Engineer or designated representative will also be present to witness all required split samples taken for the Government. Upon completion of splitting, the samples will be secured and immediately placed in Government control. The Project Engineer needs to be aware of the contractor's operations and be available to witness the sampling and splitting activities.

The Project Engineer should review the testing protocols and equipment to ensure compliance with contract requirements. In regard to aggregate base materials, the testing should verify the appropriate material characteristic as listed in the contract requirements. Testing verifies that the material is suitable for use in the work and may be constructed according to the contract documents.

### 3.4 MATERIAL CERTIFICATIONS

Exhibit 3-14 provides guidance for some of the certifications that may be required. Certifications need to be in conformance with the contract requirements as provided in Subsection 106.03.

**Exhibit 3-14 Materials Certifications**

Section	Description	Material	Frequency	
			Certification	Sample
302	Treated aggregate additives	Emulsified asphalt Hydraulic cement Fly ash Lime	1 per shipment	Upon request
304	Aggregate stabilization	Emulsified asphalt Hydraulic cement Fly ash Lime	1 per shipment	Upon request
305	Aggregate-topsoil mixture	Topsoil Seed	1 per shipment	Upon request
306	Dust palliatives	Dust palliative material	1 per source per manufacturer	Upon request
308	Minor crushed aggregate	Crushed aggregate	1 per source	Upon request
309	Emulsified asphalt treated base	Emulsified asphalt	1 per shipment	Upon request

### **3.5 FORM REFERENCES**

Form references for use in the testing of aggregate base materials.

- Form FHWA 1600C – Request for Laboratory Tests (CFL)
- Form FHWA 1600E – Request for Laboratory Tests (EFL)
- Form FHWA 1600W – Request for Laboratory Tests (WFL)
- Form FHWA 1616 – Moisture content by microwave method
- Form FHWA 1618 – In-place nuclear moisture/density worksheet
- Form FHWA 1621 – Coarse and fine aggregate gradation worksheet
- Form FHWA 1624 – Liquid Limit and Plastic Limit worksheet
- Form FHWA 1625 – Moisture density worksheet (T99/T180)
- Form FHWA 1626 – Sand Equivalent worksheet
- Form FHWA 1627 – Sieve analysis for fine and coarse aggregate worksheet
- Form FHWA 1636 – Correction for coarse particles in soil compaction worksheet



# **CHAPTER 4**

## **DIVISION 400: ASPHALT PAVEMENTS AND SURFACE TREATMENTS**

### **4.1 SUMMARY AND DESCRIPTION**

Asphalt pavements and surface treatments provide the driving surface for the roadway facility. In the case of asphalt pavement, this is the strongest of the structural layers and is also the most expensive in a flexible pavement system. It is critical that various material elements are monitored for quality of product and construction.

Testing of the bituminous mixtures encompasses more facets than for base aggregate materials. The testing process not only verifies quality and gradation of the aggregates used, which is similar to the testing described in Chapter 3, but also verifies properties of the asphalt binder used and the properties of the aggregate/asphalt combination.

## 4.2 SUPERPAVE HOT ASPHALT CONCRETE AGGREGATE AND MIX DESIGN

### 4.2.1 Aggregate Quality and Gradation

Similar to aggregate base material, aggregates for Superpave hot asphalt concrete pavement, Section 401 of the FP, also have quality requirements. Samples need to be obtained from all sources and tested for quality parameters prior to the production of crushed aggregates for use in Superpave hot asphalt concrete pavement. When using a commercial asphalt mixture supplier, samples of the processed crushed coarse and fine aggregate should be sampled and tested for quality aggregate characteristics. Sampling of these aggregates follows the process outlined in Section 3.2.3.

**Exhibit 4-1 Superpave Aggregate Quality Test Methods**

Aggregate Test	Test Method	Aggregate Performance Characteristic
L.A. Abrasion	AASHTO T 96	Hardness
Sodium Sulfate Soundness	AASHTO T 104	Freeze / Thaw Resistance
Fine Aggregate Angularity	AASHTO T 304	Angular Sand
Flat and Elongated Particles	ASTM D 4791	Flat and Elongated Coarse Aggregate
Fractured Faces	ASTM D 5821	Aggregate Interlock
Sand Equivalent	AASHTO T 176	Plastic Fines in Aggregate

A minimum 200-pound (90 kg) representative sample should be obtained in order to perform all of the aggregate quality tests listed in Exhibit 4-1. In the event that the contract includes additional aggregate material requirements, consult the FLH Division Materials Engineer for guidance in obtaining an appropriate sample.

Following in similar manner to the production of aggregates for base materials, the source material, should it meet the quality requirements, will be crushed and processed to meet specific gradation requirements that will be established during the mix design process. Aggregates are processed and stockpiled in multiple piles to allow for recombining during the production of hot asphalt concrete. It is critical to test the gradation of the aggregates as material is produced and stockpiled. The gradation of the material being stockpiled should be tested according to AASHTO T 11 and T 27. The test results will be used to establish the gradation target values for the mix design.

### 4.2.2 Superpave Mix Design Process

The composition of the mix (or job-mix formula) establishes the blend percentages of the aggregate stockpiles, amount of asphalt binder, amount of recycled asphalt pavement (if used), and additives needed to meet the appropriate design parameters that are listed in the contract. The contractor will submit the mix design on form FHWA 1641 with all of the appropriate data included. In addition, samples of all of the materials used in the mix design are also submitted to the FLH Division laboratory for verification purposes.

It is important that the materials submitted to the FLH Division laboratory be split samples of the material that is used by the contractor in establishing the job-mix formula. The quantity of material to be supplied for the verification process is established in the contract.

Once the verification process, as established in contract documents, is complete and the mix design is accepted, a pre-paving meeting will be scheduled. After the pre-paving meeting and successful construction of the test strip (see Section 4.3.2, Production Start-up Procedures), the contractor may begin full mix production.

If a source of material for the production of hot asphalt concrete changes, a new mix design is needed to establish the job-mix formula. The contractor will follow the same submittal and verification process as was done for the original mix design.

The FP contains specific requirements for the mix design submittal and verification process. If the submitted mix design does not meet the contract requirement or fails to be verified by the FLH Division laboratory, it will be rejected. If any questions exist regarding materials used or the mix design process, consult the Division Materials Engineer.

Exhibit 4-2 provides a listing of the test methods used to establish and verify the job-mix formula.

**Exhibit 4-2 Mix Design Test Methods**

Test Number	Test Title
AASHTO R 35	Superpave Volumetric Design for Hot-Mix Asphalt (HMA)
AASHTO T 11	Materials Finer Than 75- $\mu$ m (No. 200) Sieve in Mineral Aggregates by Washing
AASHTO T 27	Sieve Analysis of Fine and Coarse Aggregates
AASHTO T 84	Specific Gravity and Absorption of Fine Aggregate
AASHTO T 85	Specific Gravity and Absorption of Coarse Aggregate
AASHTO T 166	Bulk Specific Gravity of Compacted Hot-Mix Asphalt Using Saturated Surface-Dry Specimens
AASHTO T 209	Theoretical Maximum Specific Gravity And Density of Hot-Mix Asphalt Paving Mixtures
AASHTO T 248	Reducing Samples of Aggregate to Testing Size
AASHTO T 283	Resistance of Compacted Asphalt Mixtures to Moisture-Induced Damage
AASHTO T 312	Preparing and Determining the Density of Hot-Mix Asphalt (HMA) Specimens by Means of the Superpave Gyrotory Compactor

The Asphalt Institute publication “Superpave Mix Design (SP-2)” provides excellent guidance to help understand the various processes involved in establishing proper proportions for a hot asphalt concrete. It provides information on material selection, test methods, calculations, and evaluation of Superpave mix designs.

### **4.2.2.1 Hveem and Marshall Mix Design Methods**

Hveem and Marshall mix design methods have existed for decades and were the primary mix design methods used by DOTs in the United States until Superpave adoption in the late 1990's. These methods have the same objective as the Superpave design method; to establish a job-mix formula for the hot asphalt concrete pavement. The contractor will submit the mix design on form FHWA 1607 (Hveem) or form FHWA 1622 (Marshall) with the appropriate data included. Split samples of materials used in the mix design are submitted to the FLH division laboratory for verification purposes per contract requirements.

Although these methods have unique features and testing apparatuses, both will provide asphalt concrete mixtures that are durable and long-lasting. The Asphalt Institute publication "Mix Design Methods for Asphalt Concrete (MS-2)" provides specific guidance and instruction for the Hveem and Marshall mix design methods. Additionally, the specific mix design test methods are AASHTO T 246 and T 247 for the Hveem method and T 245 for the Marshall method.

### **4.2.3 Asphalt Binder**

The asphalt binder is the "glue" that holds the aggregate together. Asphalt binder is a visco-elastic material meaning that it has characteristics of both a fluid (visco) and solid (elastic) depending on the temperature. At high temperatures, asphalt binder behaves more like a fluid. As the temperature is decreased, the viscosity of the material increases and the material begins to take on characteristics of a solid. AASHTO M 320 is the standard specification used to define the performance characteristics of asphalt binder over a wide range of temperatures.

AASHTO M 320 provides the specification for Performance-Graded (PG) binders. The specification defines the temperatures where the binder will possess appropriate physical properties. For example, a PG 58-28 defines the temperature range for a specific asphalt binder. The first number, 58, is the high temperature designation for the binder. It designates that the binder will possess adequate physical properties up to pavement temperatures of 58 C. Likewise, the second number, -28, is the low temperature designation for the binder. It designates that the binder will possess adequate physical properties down to minus 28 °C.

The larger the difference between these numbers, the higher the temperature range needed for the binder to perform. In cases of large temperature ranges, the asphalt, as produced from the refining of crude petroleum, may need to be modified typically with the addition of an elastomeric additive. The term "polymer modified asphalt" is typically used to describe the asphalt that has been modified in this manner.

The binder for a particular project will be selected based on the climate conditions at the project location. Selection of the binder grade is a critical link in the overall performance of the completed pavement. The contract documents will specify the performance-graded asphalt binder to be used on the project. The asphalt binder supplied as part of the mix design process needs to meet the grade specified and be provided by the same asphalt supplier used during production of hot asphalt concrete pavement.

The Asphalt Institute publication “Superpave Performance Graded Asphalt Binder Specification and Testing (SP-1)” provides a more detailed discussion of the specification and test methods used to evaluate asphalt binder performance.

#### **4.2.4 Additives**

Other additives may be added to obtain the appropriate asphalt mix properties. These include liquid additives, baghouse fines, lime, cement, mineral filler, recycling agents, and recycled asphalt pavement. Any of these additives when used will change the mixture properties. Any proposed additive needs to be included in the mix design process to verify the effect on final mixture properties.

The most common are antistrip additives. These additives are used to improve the long term bonding of the asphalt binder to the aggregate. Antistrip additives come in two forms, as a liquid that is added to the binder and as a mineral additive (lime) that is added to the aggregate prior to the mixing phase. Liquid additives are commercially produced materials and should be used according to the manufacture recommendations.

The percentage of any additive will be established as part of the mix design procedures.

Contract specifications may prohibit the use of some additives. If there is a question regarding any specific additive, consult the Division Materials Engineer for guidance.

## 4.3 CONSTRUCTION PROCESS

### 4.3.1 Equipment for Production and Placement

Once the mix design has been approved, the contractor can begin production and placement of the hot asphalt concrete pavement. The production process has many different components that need to be checked and in good working order to produce a quality product. These components include the mixing plant, the hauling equipment, the paving equipment, and the compaction equipment. In some instances, there is a recognized standard for compliance. In other cases, the specifications will provide general characteristics of properly operating and maintained equipment. AASHTO M 156 is the cited standard that provides the best guidance for the mixing plants and the general operations required for the production of hot mix. This standard provides specific guidance and requirements for mixing operations that include:

- Requirements for mixing plants;
- Requirements for the storage and preparation of mixture components;
- Requirements for controlling gradation;
- Weighing tolerances;
- Adequate and appropriate mixing time;
- Requirements for record keeping.

In addition to the following proper procedures for the production of the hot asphalt concrete, the mixture must also be properly transported, placed, and compacted to provide a quality finished product. The FP provides specific contract requirements for hauling vehicles and pavers. Compaction of the material needs to be accomplished by proper equipment in order to meet the density requirement. Although specific compaction equipment is not listed in the specification, the compaction process will be monitored using nuclear density gauges and verified by testing core samples taken from the completed roadway to verify that appropriate compaction has been obtained.

The successful construction of an asphalt pavement does require knowledge in a number of different areas. The mixture delivery, placement, screed control, joint construction, and compaction are just a few of the many activities that need to be monitored and coordinated for successful asphalt pavement construction. The detailed discussion of these items is beyond the scope of this manual; however, the *Hot-Mix Asphalt Paving Handbook* is an excellent reference to address specific issues relating to asphalt paving. In addition, the publication also provides information for troubleshooting various mat problems.

### 4.3.2 Production Start-Up Procedures

As part of the sequence for full hot asphalt concrete production, a pre-paving conference is held. A general outline for this meeting can be found in Appendix D of this manual. This is designed to ensure that all of the necessary information for full production has been obtained. This meeting alerts all on-site construction personnel of the processes and procedures for producing and placing a quality asphalt concrete pavement. The FP provides general requirements and necessary submittals for the pre-paving conference.

The construction of a control strip is the final process in the start-up procedures for the production of hot asphalt concrete. This requires the contractor to produce and place the mixture following the production and delivery methods described during the pre-paving conference. The production is limited to a short production run to ensure that the quality of the produced, placed, and compacted mixture meets the contract requirements. Samples of the hot asphalt concrete are taken from the mat prior to compaction and tested to ensure compliance with the contract. In addition, core samples are taken from the completed pavement and tested to verify appropriate compaction has been obtained.

Complete evaluation of the control strip is essential to ensure that the produced hot asphalt concrete follows the established job-mix formula. Testing of the asphalt mixture samples verify that the hot plant is producing specification material. Density measurements are used in conjunction with various roller patterns, speeds, and passes to achieve a specified minimum compaction sufficient for a quality pavement. Corresponding mixing and placing temperatures are also measured.

It is also important to use the control strip density results to correlate the nuclear gauge. Prior to cutting the cores, nuclear gauge readings should be taken at the same location as the core samples. It is advantageous to obtain multiple gauge readings at the core location, preferably at right angles to each other, to verify the density value provided by the nuclear device. Once the core density values have been obtained, they can be compared to the nuclear gauge readings and a correlation established. This correlation factor will then be used during production to monitor the actual density being achieved. Nuclear gauges provide density data however without proper correlation this data can be misleading. For example, even though the nuclear gauge data indicates that the proper density has been achieved; in actuality the density values obtained by testing cores may indicate failing results. Since nuclear gauge readings do not always provide accurate density values, it is always necessary to verify their readings with actual density values obtained from pavement cores. Proper use of the nuclear gauge for monitoring density during lay down operations can only be accomplished through correlation to core density.

The contract provides criteria for the acceptance of a control strip. A control strip is required at the beginning of hot asphalt concrete production prior to full production activities, when material is being produced from a different plant or when resuming production after a terminated lot. Once a control strip has been accepted, full production can begin.

### **4.3.3 Full Production Operations**

Placing, finishing and compacting the hot asphalt concrete needs to follow the same process that was established during control strip activities. The mixture should be mixed and placed at the temperature established during the start-up procedures. This needs to be continually monitored to maintain operational and finished product consistency.

Compaction of the mat needs to mimic operations established during start-up. Rollers should follow the same pattern, speed and number of passes used to obtain density of the control strip. The compaction operation needs to be monitored via contractor quality control personnel to maintain operational consistency.

Correlated nuclear density readings established during start-up will be an asset to help monitor density. Should density become difficult to achieve, comparisons between current operational practices and those used during production start-up will be helpful in troubleshooting the problem.

During full production, samples of the mixture and binder will be taken by the contractor at randomly selected times or locations established by the Government in accordance with the frequency and sampling requirements of the contract. A Government representative witnesses sampling and sample splitting and takes possession of the Government's samples. The results of these tests will be used to evaluate the quality of the material provided and determine the acceptance of work in accordance with Section 106. Binder samples are obtained according to AASHTO T 40 and will be sent to the FLH division laboratory for testing. See Exhibit 4-3 for example of asphalt binder sampling. Mixture samples obtained according to AASHTO T 168 will be split and tested by the contractor. The split sample will be provided to the Government for possible verification testing. See Exhibits 4-4, 4-5, 4-6 and 4-7 for a sequencing example of proper mixture sampling and splitting.

#### **Exhibit 4-3 Sampling Asphalt Binder**





**Exhibit 4-4 Placing Separator for Obtaining Mixture Sample**



**Exhibit 4-5 Obtaining Mixture Sample Prior to Compaction**



**Exhibit 4-6 Splitting the Uncompacted Mixture Sample**



**Exhibit 4-7 Quartering the Mixture Sample to Obtain the Proper Split**



The mixture sample is obtained from behind the paver prior to compaction. This sample location is critical in evaluating the quality of the mixture after final placement. Any mishandling or segregation will be discovered based on samples taken at this location.

When obtaining a sample, it is critical to obtain the material throughout the full depth of the lift being paved. Care should be taken to avoid contamination from the underlying material and the loss of any fines that may cling to sampling equipment.

As with the testing of aggregate samples, asphalt mixture samples need to be reduced to the proper testing size. AASHTO T 168 provides guidance on the minimum field sample sizes that constitute an appropriate field mixture sample. From this original field sample, a smaller representative testing sample can be obtained. Asphalt mixture samples should be split and reduced in a manner similar to AASHTO T 248. The size of the testing sample varies according to the test method; each specific test method will list the size of the testing sample required. See Exhibit 4-8 for example of technique in reducing field sample to testing size.

**Exhibit 4-8 Reducing Mixture Sample to Testing Size**



The density of the placed mat will be determined based on 6-inch (150-mm) diameter core samples obtained from the compacted cooled pavement. The core samples will be tested by the contractor and then provided to the Project Engineer. Some of these cores will be sent to the FLH division laboratory for verification testing. When cutting, removing, handling or shipping asphalt cores, extreme care needs to be taken not to damage the core sample. If any damage has occurred, the core should be discarded and a new sample obtained because the damaged core will not be representative of the completed mat. If the core contains more than one pavement layer, it is recommended that the layers be separated by sawing to minimize possible damage prior to testing. See Exhibits 4-9, 4-10 and 4-11 for examples of cutting, removing and sawing asphalt cores.

**Exhibit 4-9 Cutting Core**



**Exhibit 4-10 Proper Core Removal Device**



**Exhibit 4-11 Sawing to Separate Pavement Layers**



#### **4.3.4 Pavement Smoothness**

Once project paving has been completed, the final surface will be measured for smoothness. The smoothness measurement may follow different methods including profile ride index (PRI), international roughness index (IRI) or straight edge measurement. The contract documents will define the method to be used on the project. Typically there will be incentive or disincentive payments associated with the final pavement smoothness measure. If the project is 3-R type project, these pay adjustments may be based on the percent improvement in the smoothness measurements from the original surface condition compared to the final paved surface.

Contract documents will specify any corrective action that may be performed by the contractor to improve defective areas. It is important to note in the contract the definition of a defective area and the allowed methods for correction. Contact the Division Materials Engineer should you have questions regarding smoothness measurement for the specific contract.

#### **4.3.5 Other Types of Asphalt Mixtures**

The most common mixture type used throughout FLH divisions is dense-graded hot asphalt concrete; however other mixture types are sometimes used. Some of these mixtures include:

- Open-graded friction course;
- Open-graded hot mix;
- Open-graded emulsified asphalt mixture;
- Dense-graded emulsified asphalt mixture.

These mixture types do not have the same aggregate or mix design requirements as dense-graded hot asphalt concrete mixtures. Additionally, the mix design methods and requirements have not been formalized into nationally recognized standards. Design methods and requirements for these mixtures can be found in FHWA Technical Advisories, Asphalt Institute publications and State DOT test methods.

The composition and submittal requirements for these materials are very similar to those for dense-graded hot mix. Job-mix formulas need to be submitted prior to production. Along with the job-mix formula, materials used in the mixture should be submitted to the FLH division laboratory for evaluation and verification. In most instances, there is a 21-day evaluation process to review the quality of the materials and verify the job-mix formula submitted. The Project Engineer should review the contract and have an understanding of the processes involved for the use of these materials. If questions arise, contact the Division Materials Engineer for clarification and guidance.

## 4.4 SURFACE TREATMENTS

Surface treatment is a broad term used to describe several types of asphalt and asphalt-aggregate applications placed directly on a finished roadway surface. These applications are relatively thin, typically less than 1 inch (25 mm), and can be applied to paved surfaces or finished granular bases.

### 4.4.1 Single or Multiple-Course Surface Treatment

These surface treatments, often called chip seals, involve spraying an asphalt product directly on the roadway surface immediately followed by a uniform application of aggregate, often referred to as “chips”. When the asphalt cures (breaks), it will develop adhesive strength to hold the aggregate in place. For multiple-course surface treatments, this process is repeated a second or third time with smaller sized aggregates used on successive applications. The completed product will provide an all-weather driving surface, improved skid resistance, moisture barrier and a uniform appearance. Exhibits 4-12, 4-13 and 4-14 show the construction process and completed sealed surface.

**Exhibit 4-12 Chip Seal Aggregate Placement**



**Exhibit 4-13 Close-up of Placement**



**Exhibit 4-14 Completed Chip Seal Surface**



Since the aggregate will be directly exposed to traffic and weather, it is imperative that it meet the quality and gradation requirements. Aggregate quality and gradation test results should be provided by the contractor prior to incorporating the aggregate into the work. The Government may request that split samples be obtained and tested by the FLH division laboratory to verify the aggregate quality. The gradation of the aggregate is critical to performance. The aggregate needs to be uniform (i.e., the majority of the aggregate is all the same size), clean (a minimal amount of material passing the No. 200 (75 µm) sieve), angular (minimal amount of round aggregate) and cubical (a minimal amount of flat and elongated pieces). The aggregate application rate established should provide uniform coverage of the surface at a depth equal to the maximum particle size. If too much aggregate is placed, it will not be embedded in the asphalt and will be wasted. Over application of aggregates may cause embedded aggregate to break loose.

Asphalt for the surface treatment may either use a paving-grade asphalt binder or an asphalt emulsion to adhere the rock to the surface. Regardless of what asphalt product is specified, the product should meet the contract specifications. The application temperature and rate should be established prior to placement operations.

Aggregate and asphalt samples should be submitted to the FLH division laboratory according to the contract. Laboratory testing will verify the quality and gradation of the materials as well as provide information for the initial application rates of aggregate and asphalt.

#### **4.4.2 Fog Seal**

A fog seal is a light application of emulsified asphalt that has been diluted with water and applied directly to an asphalt surface. The application rate depends largely on the texture of the existing pavement; the more open the surface the heavier the application. The FP provides a range of application rates and short test sections should be performed to verify and adjust as necessary the specified application rate. Once allowed to penetrate the surface, cure and break, traffic may be allowed on the surface. In the instance that excess asphalt is not absorbed into the surface, blotter material may be used to cover and prevent tracking due to vehicles.

Contract specifications will provide sampling and testing requirements for the emulsified asphalt. Typically, the material will be accepted by certification under Subsection 106.03; however, in instances where a large quantity is being supplied, the quality of the material will be verified by Government testing. Exhibit 4-15 shows proper application of a fog seal.



### Exhibit 4-15 Fog Seal Application



#### 4.4.3 Slurry Seal and Micro-Surfacing

Slurry seal or micro-surfacing is a mixture of aggregate/sand, emulsified asphalt, fillers, and other additives that is applied as a thin surfacing on an existing pavement. These treatments do not increase the structural strength of the existing pavement section but are used to generally protect and improve the existing driving surface.

Slurry seals and micro-surfacing mixtures follow a mix design process to provide a job-mix formula that meets the contract requirements. Although these design methods are not as complex as for dense-graded hot mix, it is necessary that the mixture conform to these requirements. The contract documents define the methods to follow for the composition of the mix. The contractor must submit the job-mix formula and material components for approval prior to production. The Project Engineer should review the documentation to ensure compliance to the specification. In addition, the material samples should be submitted to the FLH division laboratory to verify compliance to the material specifications. If there are questions regarding material quality or the job-mix formula documentation, the Project Engineer should consult the Division Materials Engineer for guidance.

#### 4.4.4 Prime Coat

Prime coats are constructed similarly to fog seals with the exception that they are placed on an aggregate surface. Emulsified asphalts are typically used in construction these days, however cut-back asphalts were traditionally used in the construction of prime coats. Oftentimes, prime coats are covered with blotter material to minimize damage caused by traffic due to picking of the surface.

Contract specifications will provide sampling and testing requirements for the emulsified asphalt or asphalt cut-back. Typically, the asphalt product and blotter will be accepted by certification under Subsection 106.03.

## **4.5 RECYCLING TECHNIQUES**

### **4.5.1 Cold Recycling**

A cold recycled asphalt base course can be accomplished through two different techniques; in-place recycled or central plant mixed. Both of these methods consist of processing recycled asphalt pavement, recycling agents, emulsified asphalt, and lime into a homogenous material that is placed as a layer. In some instances and usually at central mixing plant operations, reclaimed aggregate or virgin aggregates can be added. Generally speaking, in-place recycling incorporates only recycled asphalt pavement and does not include aggregates as part of the newly mixed material.

A mix design is usually performed to ensure proper proportioning of the ingredients of the cold recycled materials regardless of the technique used to mix and place the final product. Contract requirements will specify the amount of material to be submitted to the FLH division laboratory for testing to be completed. Unlike the verification process for hot asphalt concrete mix design, the FLH division laboratory will perform the mix design and provide the initial application rates for emulsified asphalt, recycling agent, lime or other additives for the mixture. Typically 21 days are allowed to complete the mix design process prior to beginning recycling operations; however consult the specific contract to verify time requirements for the submittals.

The quality of the emulsified asphalt used in the recycling operations is typically the only parameter that is verified through sampling and testing. Contract specifications will provide sampling and testing requirements for this material. Testing is performed by the FLH division laboratory.

### **4.5.2 Full Depth Reclamation (FDR) Techniques**

Full depth reclamation (FDR) is a technique in which the asphalt pavement and underlying materials are pulverized and blended into a homogenous base layer. The underlying material may include base, subbase and subgrade depending on the design. Additional base aggregate can also be incorporated when necessary to improve the existing grade or cross-slope. This technique differs from cold recycling in that the reclamation depth is much greater and is intended to incorporate various layers of the existing pavement structure into the final product.

A broad range of stabilizing additives can be used including cement, lime, emulsified asphalt, hot asphalt binder plus various proprietary products. FDR processes often have different names depending on the additive used. These include:

- Foamed asphalt stabilization;
- Bituminous base stabilization;
- Cement base stabilization;
- Pulverized pavement;
- Recycled aggregate base.

Because the FDR method and additive can vary, it is important to review the contract documents to determine what specific material testing is required. In most instances, some type of mix design will be required prior to beginning production. The Project Engineer needs to review the contract for the submittal, sampling and testing requirements.

## **4.6 ROLES AND RESPONSIBILITIES**

### **4.6.1 Contractor's Responsibilities**

The contractor is responsible for constructing the asphalt pavement layers, surface treatments and recycled layers to meet the requirements provided in the contract. As part of these requirements, the contractor is to control the quality of the materials provided and the construction process to ensure compliance. The contractor's submitted quality control plan should address sampling, testing, and inspection work that will be accomplished to check and validate the quality of material components that will be supplied.

Asphalt pavements and surface treatments require that the material components meet the specifications and that the finished product conforms to contract specifications. For example, the contractor needs to verify that the individual material components produced or supplied meet the material requirements for hot asphalt concrete pavement and that when combined and placed these materials will meet the mixture and finished product requirements. The responsibilities for quality cover three general areas; individual supplied material (i.e., asphalt binder, aggregate, etc.), combined material requirements (i.e., job-mix formula, etc.), and finished product (i.e., density, smoothness, etc.). In general, the sampling and testing responsibilities of the contractor include:

- Sampling material to be tested according to the proper sampling methods;
- Providing split samples to the Government when required or requested;
- Quality control of aggregate production to ensure compliance with specifications;
- Proper submittals for job-mix formulas and mix designs including contractor supplied stockpile gradations, aggregate blends and target values for percent passing each specified sieve size;
- Providing split samples for mix design verifications;
- Monitoring the production of material to ensure compliance with specifications;
- Monitor construction processes as appropriate and have documented test results to verify quality of construction;
- Final in-place testing of finished product according to contract requirements;
- Providing appropriate certifications for materials.

The contractor needs to provide information and test results according to the timeframes stated in the contract. Distribution of the test reports or certifications should be according to the contract documents and the established quality control plan.

### **4.6.2 Government's Responsibilities**

The Project Engineer or designated representative will review the test results and certifications for contract compliance. A decision regarding the acceptance of the material will be made in accordance with Subsection 106.01

The Project Engineer or designated representative will be present to witness all required split samples taken for the Government. This is critical for not only acceptance samples but also for samples submitted for the purpose of mix design verification.

Upon completion of splitting, the samples will be secured and immediately placed in Government control. The Project Engineer needs to be aware of the contractor's operations and be available to witness the sampling and splitting activities.

Many of the material requirements for asphalt pavements and surface treatments require various points of acceptance throughout the construction process. In addition, there are also production start-up procedures that need to be completed prior to beginning full production activities. Some of the general responsibilities of the Project Engineer for these various stages of construction include:

- Reviewing aggregate quality test results and/or obtain Government samples for source approval testing;
- Obtaining proper mix design submittals and provide split samples to the FLH division laboratory for mix design verification;
- Reviewing quality control data to ensure compliance with contract requirements during production;
- Ensuring pre-work conferences occur and are attended by the appropriate people;
- Being aware of the time requirements in the contract for mix design submittals and verifications processes;
- Reviewing contractor's quality control plan to ensure compliance with contract requirements. Verify that the testing technicians are qualified to perform the testing specified in the contract. Request proficiency samples from the Division Materials Engineer as needed to confirm contractor personnel competency and proper functioning equipment.;
- Reviewing test methods, equipment and protocols with contractor testing personnel. Verify that contractor supplied testing equipment has been properly checked, standardized, calibrated and/or verified in accordance with the applicable testing standard;
- Obtaining proper product certifications prior to incorporating material into the work.

The Project Engineer should review and be familiar with the contract requirements for the material used in pavements and surface treatments and the testing required. Testing verifies that the material is suitable for use in the work and may be constructed according to the contract documents. If in doubt regarding material testing or requirements, consult the Division Materials Engineer.

## 4.7 MATERIAL CERTIFICATIONS

Exhibit 4-16 provides guidance for certifications that may be required. Certifications need to be in conformance with the contract requirements as provided in Subsection 106.03.

It should be noted that materials accepted by certification may be either a production or commercial certification according to Subsection 106.03 of the FP. The Project Engineer should review the contract requirements to ensure that the proper certifications have been submitted.

**Exhibit 4-16 Materials Certifications**

Section	Description	Material	Frequency	
			Certification	Sample
401, 402, and 403	Hot asphalt concrete additives	Mineral filler Antistrip additive Recycling agent	1 per source or shipment	Upon request
404	Minor hot asphalt concrete	Hot asphalt concrete	1 per shipment	Upon request
405	Open-graded asphalt friction course additive	Antistrip additive	1 per source	Upon request
408	Cold recycled asphalt base course	Recycling agent Lime Emulsified asphalt	1 per shipment	Upon request
411	Asphalt prime coat	Blotter	1 per source	Upon request
414	Crack and joint sealing	Material for crack and joint sealing	1 per shipment	Upon request
415	Paving Geotextile	Geotextile material	1 per shipment	Upon request
416	Continuous cold recycled asphalt base course	Quicklime Emulsified asphalt	1 per shipment	Upon request
417	Minor cold asphalt mix	Minor cold asphalt mix	1 per shipment	Upon request

## 4.8 FORM REFERENCES

Form references for use in the testing of soils and subgrade materials.

- Form FHWA 1600C – Request for Laboratory Tests (CFL)
- Form FHWA 1600E – Request for Laboratory Tests (EFL)
- Form FHWA 1600W – Request for Laboratory Tests (WFL)
- Form FHWA 1607 – Hveem mix design worksheets
- Form FHWA 1611 – Bulk specific gravity of compacted mixtures worksheet
- Form FHWA 1622 – Marshall mix design worksheets
- Form FHWA 1628 – Maximum specific gravity of asphalt mixtures worksheet (flask)
- Form FHWA 1629 – Maximum specific gravity of asphalt mixtures worksheet (bowl)
- Form FHWA 1639 – Control of asphalt mixtures worksheet
- Form FHWA 1640 – Ignition furnace binder correction factor worksheet
- Form FHWA 1641 – Superpave mix design worksheet
- Form FHWA 1642 – Volumetric properties of Superpave asphalt concrete worksheet

(This page intentionally left blank.)



# CHAPTER 5

## DIVISION 500 – CONCRETE

### 5.1 SUMMARY AND DESCRIPTION

Concrete is one of the most widely used building materials in the world and a primary component of many highway structures. It is used in many highway applications such as roadway surfacing, bridges, retaining walls, head walls, culverts, guardrails, anchors, and posts. American Concrete Institute ACI 116, Cement and Concrete Terminology, defines concrete as a composite material that consists of a binding medium within which are embedded particles or fragments of aggregate, usually a combination of fine and coarse aggregate. In portland cement concrete, the binder is a mixture of portland cement and water, with or without admixtures.

The material presented herein will focus primarily on structural concrete, minor concrete and rigid pavements as denoted in the Standard Specifications for Construction of Roads and Bridges on Federal Highway Projects (FP). Shotcrete and other topics relating to the construction of structures will also be addressed. Generally, structural concrete is specified in a contract when load analysis (i.e. bridges, culverts, wall and foundations) is required and the total concrete mixture quantity is greater than or equal to 50 yd<sup>3</sup> (38 m<sup>3</sup>). Minor concrete is typically specified when load analysis is not required (i.e. headwalls, curb and gutter, sidewalks, waterways) and the total concrete mixture quantity is less than 50 yd<sup>3</sup> (38 m<sup>3</sup>). The FP provides requirements for quality construction and materials that include:

- Material Component Requirements;
- Concrete Composition, Mixture Proportioning and Mix Design Approval;
- Construction and Materials Acceptance.

To facilitate ease of use, the concrete portion of the Field Materials Manual has been organized to mirror the progression of the FP requirements. It therefore consists of the following sections:

- Section 5.2 – Concrete Materials Specifications;
- Section 5.3 – Concrete Materials Acceptance Requirements;
- Section 5.4 – Concrete Mixture Proportioning and Approval Requirements;
- Section 5.5 – Concrete Construction Requirements;
- Section 5.6 – Shotcrete;
- Section 5.7 – Driven Piles;
- Section 5.8 – Painting;
- Section 5.9 – Drilled Shafts;
- Section 5.10 – Roles and Responsibilities;
- Section 5.11 – Form References.

## 5.2 CONCRETE MATERIALS SPECIFICATIONS

Concrete is typically composed of the following basic materials:

- Hydraulic cement;
- Mineral admixtures; (i.e. fly ash, silica fume, ground granulated blast furnace slag)
- Water;
- Aggregates; (coarse and fine)
- Chemical admixtures; (i.e. air entraining, water reducing, set retarding, etc.)
- Fibers.

The standard specifications typically used for each of these basic materials are shown in Exhibit 5-1. Both AASHTO and ASTM standards have been developed for most concrete materials. Exhibit 5-1 shows both the AASHTO and ASTM materials standards. Although both standards have been listed for ready reference and comparative purposes, their individual requirements may differ in some circumstances. It should be noted that contract specifications will state the standards that are applicable for a given construction project and also may provide additional requirements which supplement the AASHTO/ASTM specifications.

**Exhibit 5-1 Concrete Material Specifications**

<b>Material Component</b>	<b>AASHTO Standard</b>	<b>ASTM Standard</b>
<b>Hydraulic Cement:</b> Portland Cement	M 85 Type I, II or V	C 150
Blended Hydraulic Cement	M 240 Type IS, IP, P, I(PM), or I (SM)	C 595
<b>Pozzolans and Mineral Admixtures:</b> Fly Ash	M 295 Class C or F	C 618
Ground granulated blast furnace slag	M 302 Grade 100 or 120	C 989
Silica Fume (microsilica)	M 307	C 1240
<b>Water</b>	M 157	C 94
<b>Aggregates:</b> Coarse Aggregates	M 80 Class A with amendments	C 33
Fine Aggregates	M 6 Class B with amendments	C 33

**Exhibit 5-1 Concrete Material Specifications (Continued)**

<b>Material Components</b>	<b>AASHTO Standard</b>	<b>ASTM Standard</b>
<b>Chemical Admixtures:</b>		
Air-entraining	M 154	C 260
Water-reducing and set-controlling	M 194	C 494
Concrete Coloring	-----	C 979
<b>Fibers</b>		
Fibrillated poly-propylene or deformed steel	-----	C 1116

The basic material types used to proportion a concrete mixture are hereafter discussed on an individual basis in association with their materials standards. The benefits of using each of these material types as well as the potential constructability issues are also addressed.

**5.2.1 Hydraulic Cement**

Hydraulic cement is defined as cement that sets and hardens by chemical interaction with water and is capable of doing so underwater (ACI 116). Both portland cement and blended cement are considered hydraulic cements, however, the physical and chemical properties of each are governed by different materials specifications indicated in Exhibit 5-1.

**5.2.1.1 Portland Cement**

Portland cement is hydraulic cement produced by pulverizing portland-cement clinker, usually in combination with calcium sulfate (ACI 116). It exhibits a specific gravity of about 3.15. The typical material standard used for portland cement is AASHTO M 85. There are eight types of portland cement that are currently specified, namely types I, IA, II, IIA, III, IIIA, IV and V. Typically only types I, II or V are used; however, special contracts requirements may specify others (i.e. type III cement for prestressed concrete applications).

Type I cement is the most common and is known as general use cement. Type II is also general use cement that provides moderate sulfate resistance and moderate heat of hydration. Type V cement provides high sulfate resistance. The “A” suffix after the type designation denotes air-entraining cement so type I cement is non air entraining whereas type IA cement is air entraining. In lieu of utilizing air-entraining cement, a concrete mixture can be air entrained by use of a chemical admixture (i.e. air entraining agent).

AASHTO M 85 details standard chemical composition and physical properties requirements for each cement type as well as the applicable test methods used for evaluation. In addition, allowable optional provisions and their associated chemical and physical requirements are also included. The contract specifications will state any optional provisions that have been included as part of the material requirement. Consult the Division Materials Engineer for additional information.

### 5.2.1.2 Blended Cement

Blended cement is a hydraulic cement consisting essentially of a uniform blend of:

- Granulated blast-furnace slag and hydrated lime;
- Portland cement and granulated blast-furnace slag;
- Portland cement and pozzolan;
- Portland blast-furnace slag cement and pozzolan.

It is produced by:

- Intergrading portland cement clinker with blast furnace slag, fly ash or silica fume;
- Blending portland cement with finely ground blast furnace slag, fly ash or silica fume;
- By a combination of intergrinding and blending (ACI 116).

AASHTO M 240 is the standard specification for blended hydraulic cement. It is used in a fashion similar to portland cement. There are five types of blended hydraulic cements currently available for use. They are:

- Pozzolan-modified portland cement (type I(PM)), containing 0 to 15% pozzolan;
- Portland-pozzolan cement (type IP), containing 15 to 40% pozzolan;
- Portland-pozzolan cement (type P), containing 15 to 40% pozzolan;
- Slag-modified portland cement (type I(SM)), containing 0 to 25% slag;
- Portland-blast furnace slag (type IS), containing 25 to 70% slag.

There is a sixth type of blended cement noted in AASHTO M 240, known as type S, Slag Cement, however, it is not allowed for use in the current FP specifications. Blended cement types I(PM), IP and P may consist of blends of pozzolans with either portland or slag-containing cements. Certain combinations with slag cement will provide resistance to alkali-silica reactions and sulfate attack.

AASHTO M 240 details standard chemical composition and physical properties requirements for each blended cement type as well as the applicable test methods used for evaluation. In addition, allowable optional provisions and their associated chemical and physical requirements are also included. As was the case with portland cement, contract specifications will include references to optional provisions should they apply. Consult the Division Materials Engineer for additional information.

Blended cements can be used as the only cementing material in concrete or they can be used in combination with other supplementary mineral admixtures, which are added at the batch plant. If the blend consists of a proportion of fly ash or slag, blended cements can develop lower early compressive strength, up to 28 days, when compared to an equivalent weight of portland cement alone. If the blend consists of a proportion of silica fume, blended cements can develop higher compressive strengths, up to 28 days, when compared to an equivalent weight of portland cement. A comparison between portland cement types and blended cement types and their associated options is shown in Exhibit 5-2.

**Exhibit 5-2 Portland and Blended Hydraulic Cement Comparison**

Cement Specification	General Use	Moderate Heat of Hydration	High Early Strength	Low Heat of Hydration	Moderate Sulfate Resistance	High Sulfate Resistance	ASR Resistance
AASHTO M85 Portland Cement	I	II	III	IV	II	V	Low Alkali Option
AASHTO M240 Blended Cement	IS IP I(PM) I(SM) P	IS(MH) IP(MH) I(PM)(MH) I(SM)(MH)	-----	P (LH)	IS(MS) IP(MS) P(MS) I(PM)MS I(SM)MS	-----	Low Reactivity Option

**5.2.1.3 Hydraulic Cement Constructability Issues**

When hydraulic cement and water are mixed, a series of chemical reactions begin that result in slump loss, setting, hardening, evolution of the heat of hydration and strength development. This overall process is referred to as cement hydration. The quantity of mixing water required to completely hydrate portland cement is a water-cementitious materials ratio of about 0.40 by weight. When chemical admixtures are used the water-cementitious materials ratio can be halved to as low as about 0.20. Cement fineness and chemical composition are the major characteristics of cement that influence rate of reaction and strength development.

Hydration of cement, however, is a temperature dependent process. When cured at room temperature about 70 °F (21°C), the final set of concrete is typically achieved in about 2 ½ to 4 ½ hours and the specified compressive strength is normally reached in 28 days. Environmental conditions, which affect the temperature of the concrete mixture, therefore influence the behavior of cement. Since the time of set, the strength development and the temperature rise of concrete are all related to the hydration rate, these fresh and hardened concrete properties are influenced by the ambient temperature conditions present at the project site. Hydration rate proceeds very slowly below 40° F (4 °C) but increases rapidly with increasing temperature. As a rule of thumb, the rate of hydration doubles for each 18 °F (10 °C) increase in temperature and, conversely, is halved for each 18 °F (10 °C) decrease. It is of paramount importance that concrete is cured properly at the project site in conjunction with cold or hot weather conditions in order to achieve specified concrete strengths in a timely fashion. In this manner, construction processes which are dependent upon concrete strength (i.e. form removal, etc.) may also proceed.

Premature stiffening in fresh concrete and/or mortar is another issue of concern. Premature stiffening can occur as a result of false set or flash set. False set occurs as a significant loss of plasticity or slump without the generation of heat shortly after mixing. False set is caused by rapid crystallization of excess gypsum from the cement mill. Concrete that has undergone false set can be handled and placed without difficulty. Additional mixing breaks up the crystals and restores workability. It is not necessary or acceptable to add water to the mixture in this process. Flash set occurs as a rapid loss of workability with considerable generation of heat shortly after mixing. The plasticity cannot be regained by further mixing; only with the addition of water. Flash set is caused by a chemical imbalance in the cement.

Concrete experiencing flash set should be rejected and the cement should be tested for conformance to specification requirements. A cement sample should be obtained and the Division Materials Engineer should be contacted for consultation and appropriate testing.

## **5.2.2 Mineral Admixtures / Pozzolans**

Mineral admixtures, otherwise known as pozzolans, are siliceous or siliceous and aluminous materials that in themselves possess little or no cementitious value that will, in finely divided form and in the presence of moisture, chemically react with calcium hydroxide at ordinary temperatures to form compounds possessing cementitious properties (ACI 116). Pozzolans are both artificial and natural. Materials such as fly ash, ground granulated blast furnace slag and silica fume are artificial pozzolans. Raw or calcinated materials that possess pozzolanic properties such as volcanic tuffs or pumicites, opaline cherts, shales and clays are natural pozzolans. These mineral admixtures are finely divided inorganic materials that may be added to concrete to modify its performance and/or cost.

### **5.2.2.1 Fly Ash**

Fly ash is a product from coal burning. It is defined as the finely divided residue that results from the combustion of ground or powdered coal and that is transported by flue gases from the combustion zone to the particle removal zone (ACI 116). It consists of solid and hollow, silt-sized glass spheres that are typically finer than portland cement or lime. Fly ash exhibits a tan to dark gray color and its specific gravity ranges from 1.9 to 2.8.

AASHTO M 295 is the standard specification for fly ash and details standard chemical composition and physical properties requirements for each fly ash type as well as the applicable test methods used for evaluation. Fly ash is categorized into three classes based on its chemical composition as follows:

- Class N is a raw or calcinated pozzolan that is not allowed by FP specifications;
- Class C or high calcium fly ash is derived from sub-bituminous coals. It possesses a free lime (CaO) content in excess of 20 percent and as such has some cementitious (i.e. strength gaining) properties in and of itself;
- Class F or low calcium ash is derived from bituminous and anthracite coals. It possesses less than 10 percent free lime (CaO) and as such has very little cementitious properties in and of itself. Class F fly ash must be mixed with portland cement to serve as a cementing material.

Concrete made with class F fly ash and portland cement will typically gain compressive strength at a slower rate than concrete made with an equivalent weight of portland cement up to 28 days age. However, at later ages, the strength of concrete made with the class F fly ash will be greater. Concrete made with class C fly ash wherein the portland cement is replaced at a proportion of one part fly ash to one part cement typically exhibits a 28 day strength equal to or greater than concrete containing an equivalent weight of portland cement without fly ash. However, concrete made with class C fly ash will likely not show the later age strength gain typical of concrete made with class F fly ash, although strength gain will continue to occur over that of portland cement alone. To compensate for the reduced early age strength trend when using class F fly ash, the FP allows an equivalent weight of portland cement to be replaced at a proportion of 1.5 parts class F fly ash to 1 part cement.

In this manner the expected 28 day strength should be at least equal to concrete made without fly ash. Since this early age strength trend does not exist for class C fly ash, the FP allows for replacement of portland cement at a proportion of one part class C fly ash to one part portland cement.

The FP further limits the weight of portland cement that may be replaced with fly ash. Not more than 20 percent of the minimum weight of portland cement shown for each class of concrete in the FP may be replaced with class F fly ash (at a rate of 1.5 parts fly ash per 1 part portland cement). In addition, not more than 25 percent of the minimum weight of portland cement shown for each class of concrete in the FP may be replaced with class C fly ash (at a rate of 1 part fly ash per 1 part portland cement). An example of portland cement and fly ash weight calculations for one standard FLH mix design at 25 percent class C fly ash replacement (at a rate of 1 to 1) and 20 percent class F fly ash replacement (at a rate of 1.5 to 1) is provided in Appendix E, Example 1.

#### 5.2.2.1.1 Fly Ash Benefits

The benefits of incorporating fly ash into a concrete mixture include:

- Increased workability – Spherical shaped particles act as ball bearings and produce a lubricating effect providing improved pumping, reduced bleeding and enhanced flat work finishing;
- Decreased water demand – Replacement of portland cement with fly ash reduces the water demand. When 20 percent of the cement weight is replaced with fly ash, the water demand is reduced about 10 percent. Reductions of 5 to 10 percent are normal;
- Reduced heat of hydration – Replacing portland cement with fly ash typically reduces the overall temperature rise of concrete and the associated potential for temperature cracking;
- Increased long term strength;
- Reduced permeability and increased corrosion resistance;
- Improved resistance to sulfate attack – Class F fly ash is very effective. Class C ash is less effective;
- Improved resistance to Alkali-Silica Reactivity (ASR) – At least 15 percent of the cementitious material should be fly ash. Lower amounts may increase ASR.

#### 5.2.2.1.2 Fly Ash Constructability Issues

Constructability issues which may arise as a result of using fly ash in a concrete mixture include:

- Lower early compressive strength – Strength gain of concrete containing fly ash is minimal in the colder months. Below 40°F (4° C) strength gain occurs at a very slow rate. Chemical admixtures may be used to partially offset this effect;

- Air entrainment – The use of fly ash in concrete usually requires a higher dose of air entraining agent to meet air requirements if the loss on ignition of the fly ash is greater than 3 percent. Use of Class F fly ash with high loss on ignition can cause difficulty in consistent air entrainment. Additionally, entrained air is lost more rapidly in conjunction with prolonged mixing or agitation. There can also be problems with fly ash compatibility with certain types of chemical admixtures.
- Time of set – Replacement of portland cement with fly ash will usually extend the concrete set time. Longer set times increase the potential for plastic shrinkage cracking and premature finishing (i.e. sealing bleed water under the top surface of the concrete thereby causing a plane of weakness).

### **5.2.2.2 Ground Granulated Blast-furnace Slag (GGBFS)**

Blast-furnace slag is a product from iron and steelmaking. It is defined as the nonmetallic product consisting essentially of silicates and aluminosilicates of calcium and other bases that is developed in molten condition simultaneously with iron in a blast furnace. Ground granulated blast-furnace slag (GGBFS) is granulated blast-furnace slag that has been finely ground and is hydraulic cement (ACI 116). It is lighter in color than conventional concrete and exhibits a specific gravity ranging from 2.85 to 2.95. AASHTO M 302 is the standard specification for ground granulated blast-furnace slag. GGBFS is classified by performance in the slag activity test in three grades including grade 80, grade 100 and grade 120. The slag activity test compares the ratio of the compressive strength of slag and portland-cement mortar samples made with 50-50 weight combinations to equivalent weight samples made with portland cement only. This AASHTO standard details the chemical composition and physical properties requirements for each GGBFS grade as well as the applicable test methods used for evaluation. There are no supplementary optional provisions.

When using a blend of 50 percent GGBFS and 50 percent portland cement by weight, grade 100 GGBFS typically exhibits a 28-day compressive strength equivalent to concrete made with an equivalent weight of portland cement only. Grade 120 GGBFS, however, normally shows reduced strength at early ages but increased strength at later ages (i.e. 7 days and beyond).

The FP allows the use of grades 100 and 120 GGBFS only. It further restricts the amount of GGBFS to no more than 50 percent of the minimum weight of portland cement shown for each class of concrete in the FP to be replaced with GGBFS at a rate of one part slag to one part portland cement. Blends less than 50 percent of the minimum weight of portland cement may be desirable when higher early concrete strengths are required to facilitate quick form removal or when thin sections are placed at low temperatures. However, some of the GGBFS benefits noted below may be sacrificed.

#### **5.2.2.2.1 GGBFS Benefits**

The benefits of incorporating GGBFS into a concrete mixture include:

- Increased workability;
- Decreased water demand – Reductions of 1 to 10 percent are common;
- Reduced permeability and increased corrosion resistance.



- Improved resistance to sulfate attack;
- Improved resistance to Alkali-Silica Reactivity (ASR).

#### 5.2.2.2.2 GGBFS Constructability Issues

Constructability issues which may arise as a result of the using GGBFS in a concrete mixture include:

- Concrete color change - During the second to fourth days after casting, a blue-green surface color may appear which diminishes with age as oxidation occurs.

#### 5.2.2.3 Silica Fume

Silica fume is a product from silicon metal refining. It is defined as very fine noncrystalline silica produced in electric arc furnaces as a byproduct of the production of elemental silicon or alloys containing silicon (ACI 116). Silica fume ranges from light to dark gray in color and generally exhibits a specific gravity ranging from 2.2 to 2.25; although its specific gravity can be as high as 2.5. In raw powdered form, silica fume is a very fine material, on the order of 100 times finer than portland cement. As such, it presents unique handling and safety concerns. Silica fume is therefore available in four different forms, some of which are designed to minimize clogging of batch plant equipment and dust generation. The four forms are as follows:

- As produced silica fume – Available in bulk or bags as collected in raw powder form;
- Slurried silica fume – Available in slurry form, typically in a 50-50 blend of water and silica fume by weight. The water portion of the slurry counts as mixing water and should be compensated for in the water-cementitious materials ratio calculation. The slurry is available with and without chemical admixtures;
- Densified (compacted) silica fume – Available in compacted form where raw powder has been densified by mechanical means or by compressed air. The densified silica fume is available with and without chemical admixtures;
- Pelletized silica fume – Available in pellet form where raw powder has been mixed with a small portion of water. Pellets should not be used as a mineral admixture in concrete because they do not break down sufficiently or disperse properly.

AASHTO M 307 is the standard specification for silica fume. It details standard chemical composition and physical properties requirements as well as the applicable test methods used for evaluation. In the cases of slurried or densified silica fume, tests are performed on the raw material from which these products have been made.

Concrete in which a percentage of the weight of portland cement has been replaced with silica fume will exhibit 28-day compressive strengths higher, sometimes substantially higher, than concrete made with an equivalent weight of portland cement. However, the contribution of silica fume to strength development after 28 days is minimal.

The FP limits the amount of portland cement that may be replaced with silica fume. Not more than 10 percent of the minimum weight of portland cement shown for each class of concrete in the FP may be replaced with silica fume at a rate of 1 part silica fume per 1 part portland cement.

#### 5.2.2.3.1 Silica Fume Benefits

The benefits of incorporating silica fume into a concrete mixture include:

- Substantially increased compressive strength up to 28 days age;
- Improved scaling resistance - At least 5 percent of the cementitious material should be silica fume;
- Excellent abrasion resistance;
- Reduced permeability and increased corrosion resistance;
- Slightly improved resistance to sulfate attack;
- Improved resistance to Alkali-Silica Reactivity. (ASR)
- Reduced heat of hydration.

#### 5.2.2.3.2 Silica Fume Constructability Issues

Constructability issues which may arise as a result of the using silica fume in a concrete mixture include:

- Increased water demand – Water demand increases in proportion to the amount of silica fume used. In order to achieve the desired workability, permeability and strength, silica fume concrete must always be made with chemical admixtures consisting of a water-reducing admixture, a high range water-reducing admixture or both;
- Increased air entrainment admixture dosage requirements – In order to obtain the desired air content, admixture dosages must be increased in proportion to the amount of silica fume used;
- High slump – Due to the use of chemical admixtures, silica fume concrete typically exhibits a much higher slump than conventional concrete. Slumps on the order of 8 inches (200 mm) are common and acceptable;
- Workability loss – Due to the use of chemical admixtures, the slump loss of silica fume concrete will occur much more rapidly than conventional concrete;
- High susceptibility to plastic shrinkage cracking – Bleeding does not occur for silica fume concrete. Therefore, when the surface water evaporates, it is not replenished by bleed water and the silica fume concrete is highly susceptible to plastic shrinkage cracking. The surfaces of freshly placed silica fume concrete must be protected from rapid water evaporation by proper curing as soon as is practicable after placement;
- Color - The color of silica fume concrete will be darker than conventional concrete.

#### 5.2.2.4 Collective Mineral Admixture Limitation

As previously noted, the FP stipulates individual material limits regarding the maximum amount of portland cement that may be replaced with mineral admixtures of fly ash, ground

granulated blast furnace slag and silica fume. In addition, when more than one mineral admixture is used in combination with portland cement, inclusive of blended cements, the collective combination of materials is also limited. These collective material limitations are applicable in very severe circumstances for concrete exposed to freezing and thawing and in continuous contact with moisture and exposed to deicing chemicals.

The FP mineral admixture limitation requirements both individual and collective for structural concrete, rigid pavements and minor concrete are summarized in Exhibit 5-3.

**Exhibit 5-3 Maximum Cementitious Material Requirements**

Supplementary Cementitious Materials	Maximum Total Mix Design Cementitious Materials by Weight(%)*
Class F Fly ash - Replacement rate 1.5 part ash to 1 part cement of minimum cement content	20
Class C Fly ash - Replacement rate 1 part ash to 1 part cement of minimum cement content	25
GGBFS - Replacement rate 1 part slag to 1 part cement of minimum cement content	50
Silica Fume - Replacement rate 1 part silica fume to 1 part cement of minimum cement content	10
Total of fly ash, slag and silica fume	50**
Total of fly ash and silica fume shall constitute no more than 25 percent and 10 percent, respectively	35**
<p>* The total cementitious material includes AASHTO M 85 (Portland Cement) and AASHTO M 240 (Blended Cement). The maximum percentages above are applicable to AASHTO M 240 (Blended Cement) for (1) fly ash present in Type IP or I(PM) blended cement; (2) for slag used in IS or I(SM) blended cement; and (3) silica fume present in blended cement.</p>	
<p>** Maximum cementitious material limitations for concrete designed as exposure class F3.</p>	

### 5.2.3 Water

Mixing water is defined as the water in freshly mixed sand-cement grout, mortar, or concrete, exclusive of any previously absorbed by the aggregate (for example, water considered in the computation of the net water-cement ratio) (ACI 116). Almost any water that is drinkable can be used for mixing concrete. The standard specification for Ready-Mix Concrete is AASHTO M 157. This AASHTO standard listed as part of the requirements in the FP covers mixing and curing water requirements for concrete, irrespective of whether or not it is ready-mix concrete.

Although AASHTO M 157 stipulates that the quality of water to be used in concrete must be tested by AASHTO T 26 for pH and total solids content, the FP allows potable water of known quality to be used without such testing. The definition applied to “potable water that is safe for human consumption” is noted in the FP as being provided by the public health authority having local jurisdiction.

Water of questionable quality can be used for making concrete if it meets established requirements for sulfate content, alkali content, and total solids. In addition, fabricated mortar specimens made with this water must pass tests for compressive strength, time of set, and chloride content.

The water and mortar tests that are used to evaluate these parameters as well as the parameter limitations are provided in AASHTO M 157. The component tested, the test methodology and the limits are summarized in Exhibit 5-4.

**Exhibit 5-4 Water and Mortar Requirements for Questionable Water Source**

Component	Test Method	Limits
Compressive strength	AASHTO T 106*	90% min of control at 7 days
Time of set	AASHTO T 131*	From 1:00 earlier to 1:30 later deviation from control
Chloride as Cl <sup>(-1)</sup>	AASHTO T 260	Prestressed concrete – 0.06% Conventionally reinforced concrete in a moist, chloride exposed environment – 0.10% Conventionally reinforced concrete in a moist environment, but not exposed to chloride – 0.15% Above ground building construction where the concrete will stay dry – no limit
Sulfate as SO <sub>4</sub> **	ASTM D 516	3000 ppm
Alkalis as (Na <sub>2</sub> O+0.658 K <sub>2</sub> O)	ASTM D 4191, ASTM D 4192	600 ppm
Total solids	AASHTO T 26	50,000 ppm
<p>* Comparison shall be based on fixed proportions and the same volume of test water compared to control mix using water or distilled water.</p> <p>** Wash water reused as mixing water in concrete may exceed listed concentrations of sulfate if it can be shown that the concentration calculated in the total mixing water, including mixing water on the aggregate and other sources, does not exceed the stated limits.</p>		

### 5.2.4 Concrete Aggregates

Aggregates are granular materials, such as sand, gravel, crushed stone, crushed hydraulic-cement concrete or iron blast-furnace slag, used with a hydraulic cementing medium to produce either concrete or mortar (ACI 116). Fine and coarse aggregates occupy about 60 to 70 percent of concrete by volume and about 70 to 80 percent by weight.

#### **5.2.4.1 Concrete Aggregate Gradation**

Gradation is a measure of aggregate source quality, uniformity and consistency. The combined gradation from the fine and coarse aggregate is determined by a sieve analysis detailed in AASHTO T 27 and AASHTO T 11. The aggregate particle size is determined by using wire-mesh sieves with square openings. A laboratory sieve shaker is used to perform the analysis. Grading limits are specified to control aggregate proportions as well as cement and water requirements and overall concrete workability, durability and economy. Variations in grading can adversely affect the uniformity and quality of concrete from batch to batch. Very fine sands are often uneconomical in that they require high water contents to sustain mixture workability. Very coarse sands can produce harsh, non-workable mixtures. Aggregates that do not have a large deficiency or excess of any size produce the most satisfactory concrete.

#### **5.2.4.2 Concrete Fine Aggregate**

Concrete fine aggregate generally consists of natural sand or crushed stone (manufactured sand) or a combination of the two with particles smaller than the No. 4 (4.75 mm) sieve. Technically, fine aggregate is defined as almost entirely passing the No. 4 (4.75 mm) sieve while being predominantly retained on the No. 200 (75  $\mu$ m) sieve.

The FP requires fine aggregate source quality verification testing and states that fine aggregate must conform to AASHTO M 6, class B, including the reactive aggregate supplementary requirement as well as additional supplemental FP requirements. AASHTO M 6 is a very comprehensive material standard. It provides requirements for gradation, aggregate quality and uniformity of grading (fineness modulus). To provide guidance in the submittal of fine aggregate quality test data, the requirements for the aggregate are shown on form FHWA 1608. Aggregates not meeting all of the gradation requirements may still be used based on a satisfactory service record. If the gradation criteria are not met, consult the Division Materials Engineer for additional review to determine if acceptable performance can be documented.

The test used to assess the uniformity of the fine aggregate grading is the fineness modulus. The fineness modulus is determined by summing the cumulative percent retained for each sieve size, excluding the No. 200 (75 $\mu$ m) sieve, and dividing the summation by 100. The list of sieves used for this calculation can be found in AASHTO T 27. An example illustrating the calculation of the fineness modulus is shown in Appendix E, Example 2.

The required fine aggregate source quality tests, test methods and aggregate characteristics have been summarized in Exhibit 5-5.

**Exhibit 5-5 Fine Aggregate Source Quality Characteristics**

<b>Aggregate Test</b>	<b>Test Method</b>	<b>Aggregate Characteristic</b>
Clay lumps and friable particles (Deleterious substance)	AASHTO T 112 ASTM C 142	Injurious to workability and durability, may cause pop-outs. Increases water demand
Coal and Lignite (Deleterious substance)	AASHTO T 113 ASTM C 123	Affects durability, may cause stains and pop-outs
Materials finer than No. 200 (75 µm) sieve (Deleterious substance)	AASHTO T 11 ASTM C 117	Injurious to bond, causes large increases in water demand
Organic Impurities (Deleterious substance)	AASHTO T 21 ASTM C 40	Injurious to setting and hardening, may cause deterioration
Sodium Sulfate Soundness, 5-cycles	AASHTO T 104 ASTM C 88	Measure of weathering resistance
Sand Equivalent, Referee Alternate Method 2	AASHTO T 176	Measure of fine dust or clay like materials which affect bond
Alkali-Silica Reactivity (ASR)	ASTM C 1260 ASTM C 1567 ASTM C 1293 ASTM C 295 ASTM C 856	Measure of ASR potential as well as effectiveness of mineral admixtures in ASR mitigation

**5.2.4.3 Concrete Coarse Aggregate**

Concrete coarse aggregate generally consists of gravel, crushed stone, crushed blast-furnace slag, crushed concrete or a combination of any of these materials with particles larger than the No. 4 (4.75 mm) sieve and mostly between 3/8 and 1 1/2 inches (9.5 and 37.5 mm). Technically, coarse aggregate is defined as being predominantly retained on the No. 4 (4.75 mm). The standard specification for coarse aggregate quality is AASHTO M 80 and the gradation requirements can be found in AASHTO M 43. The FP allows all AASHTO M 43 standard sizes except numbers 8, 89, 9 or 10.

The FP requires coarse aggregate source quality verification testing and states that coarse aggregate must conform to AASHTO M 80, class A, including the reactive aggregate supplementary requirement as well as additional supplemental FP requirements. To provide guidance in the submittal of coarse aggregate quality test data, the requirements for the aggregate are shown on form FHWA 1608.

The required coarse aggregate source quality tests, test methods, and aggregate characteristics have been summarized in Exhibit 5-6.

**Exhibit 5-6 Coarse Aggregate Source Quality Characteristics**

<b>Aggregate Test</b>	<b>Test Method</b>	<b>Aggregate Characteristic</b>
Clay lumps and friable particles (Deleterious substance)	AASHTO T 112 ASTM C 142	Injurious to workability and durability, may cause pop-outs. Increases water demand
Chert (lightweight pieces less than 2.4 specific gravity SSD) (Deleterious substance)	AASHTO T 113 ASTM C 123	Injurious to durability, may cause pop-outs
Materials finer than No. 200 (75 µm) sieve (Deleterious substance)	AASHTO T 11 ASTM C 117	Injurious to bond, large increases water demand
Coal and Lignite (Deleterious substance)	AASHTO T 113 ASTM C 123	Affects durability, may cause stains and pop-outs
Los Angeles Abrasion	AASHTO T 96 ASTM C 131	Measure of wear resistance and index of aggregate quality
Sodium Sulfate Soundness, 5-cycles	AASHTO T 104 ASTM C 88	Measure of weathering resistance
Adherent Coating	ASTM D 5711	Measure of coating effects on bond
Mass of Insoluble Residue for Bridge Decks and Surface Courses Only	ASTM D 3042	Measure of wearing resistance of carbonate aggregates
Alkali-Silica Reactivity (ASR)	ASTM C 1260 ASTM C 1567 ASTM C 1293 ASTM C 295 ASTM C 856	Measure of ASR potential as well as effectiveness of mineral admixtures in ASR mitigation

**5.2.4.4 Aggregate Tests Used During Concrete Mixture Proportioning**

In order to meet the water requirement of the approved concrete mixture (i.e. to maintain the water-cementitious materials ratio), the FP requires the amount of water to be adjusted at the mixing plant on an on going basis to account for the existing moisture conditions of the aggregates. The fine and coarse aggregate tests needed to perform mixture proportioning adjustments as well as the definitions of the parameters measured are shown in Exhibit 5-7. Since these tests are performed to gather information for mixture adjustments only, testing limitation requirements are typically not specified.

**Exhibit 5-7 Aggregate Tests Used During Concrete Mixture Proportioning**

<b>Parameter Measured</b>	<b>Test method</b>	<b>Definition</b>
Bulk specific gravity	AASHTO T 19 ASTM C 29	The ratio of the weight of dry aggregate to the weight of water having a volume equal to the volume of the aggregate including both its permeable and impermeable pores.
Dry-rodded unit weight	AASHTO T 19 ASTM C 29	Mass per unit volume of dry aggregate compacted by rodding under standardized conditions. Used to measure density of aggregate including aggregate and voids between aggregate particles.
Absorption	AASHTO T 85 (Coarse) AASHTO T 84 (Fine) ASTM C 127 (Coarse) ASTM C 128 (Fine)	The increase in the weight of aggregate due to water in the pores of the material, but not including water adhering to the outside of the particles, expressed as a percentage of the dry weight.
Bulk SSD specific gravity	AASHTO T 85 (Coarse) AASHTO T 84 (Fine) ASTM C 127 (Coarse) ASTM C 128 (Fine)	The ratio of the weight of aggregate, including the weight of water it contains when its permeable voids are saturated, to the weight of an equal volume of water.
Moisture content	AASHTO T 255 ASTM C 566	The ratio of the weight of water lost in drying to the oven dry weight expressed as a percentage.

**5.2.5 Chemical Admixtures**

An admixture is a material other than water, aggregates, hydraulic cement, and fiber reinforcement, used as an ingredient of a cementitious mixture to modify freshly mixed, setting, or hardened properties and that is added before or during mixing (ACI 116). They are provided in liquid, suspension, or water-soluble solid forms. Chemical admixtures are used to reduce the cost of the concrete mixture, to increase the efficiency of cementitious materials, to achieve desirable fresh and hardened concrete properties, to maintain concrete quality during mixing, transporting, placing and curing and to overcome construction emergencies (i.e. slump loss).

When admixtures are employed in a concrete mix design, it is imperative that trial mixtures be conducted to evaluate their compatibility with one another as well as their compatibility with mixture materials. Admixture effects on fresh and hardened concrete properties should be determined. The trial mixtures should be conducted at temperatures and humidity levels as close as possible to conditions anticipated at the project site. Admixture dosage rates should be within the ranges recommended by the admixture manufacturer and at the optimums determined by trial mixture evaluations.



### **5.2.5.1 Air-entraining Admixtures**

Air-entraining admixtures are used to develop a system of uniformly dispersed microscopic air bubbles in the cement paste. These bubbles serve to improve freeze-thaw and deicer scaling resistance as well as to enhance concrete workability, reduce water demand and minimize segregation and bleeding. AASHTO M 154 is the standard specification for air entraining admixture. It details physical properties requirements as well as applicable test methods used for evaluation. In addition, allowable optional provisions for uniformity are also included. Air-entrainment in a concrete mixture is produced by liquid admixture during mixing, by use of air-entraining cements or by a combination of both methods. Too little air will result in minimal benefits whereas too much air can have detrimental effects on other concrete properties.

### **5.2.5.2 Water-reducing and Set-controlling Admixtures**

AASHTO M 194 is the standard specification for water-reducing, set-controlling, and hydration stabilizing admixtures. It details physical properties requirements as well as applicable test methods used for evaluation. It further defines seven different types of admixtures consisting of the following:

- Type A – water-reducing;
- Type B – set retarding;
- Type C – set accelerating;
- Type D – water-reducing and set retarding;
- Type E – water-reducing and set accelerating;
- Type F – water-reducing, high range;
- Type G – water-reducing, high range, and set retarding.

As the names and types imply, water-reducing and set controlling admixtures reduce the water requirements of a concrete mixture for a given slump and/or modify the time of setting or both. Set retarding admixtures, inclusive of types B, D and G, are used to delay the effects of high ambient temperatures in accelerating concrete set time such that the mixture is kept workable during placement.

Extended set-control admixtures or hydration stabilizers meet the technical requirements for types B and D admixtures although they differ from conventional set-retarding admixtures in that they stop the cement hydration process altogether. Thus, they are specified separately in the FP but will typically meet the requirements of AASHTO M 194. Hydration stabilizers are used to maintain concrete in a stabilized, non-hardened state during long hauls. The stabilizer is added during or immediately after initial batching and is adjusted so that the setting time of the concrete is extended for the duration of the haul. If the concrete remains in a stabilized state after arrival at the job site, an activator can be added to facilitate normal hydration and setting. When hydration stabilizers are used, the FP limits the maximum allowable discharge time to 3 ½ hours. The design discharge limit and associated admixture dosage should be included in the concrete mix design submittal.

Set accelerating admixtures, inclusive of types C and E, are used to accelerate the rate of set and strength development of concrete at an early age. Calcium chloride can be used in this admixture which can cause corrosion of reinforcement steel. For this reason, chloride accelerators are prohibited by the FP. Set accelerating admixtures are also prohibited for use with class P (prestressed) concrete.

Water-reducing admixtures are used to reduce the water to cementitious materials ratio and consequently produce higher strengths at lower cement contents. They are also used to provide workability by increasing slump without increasing water content. Normal water reducing admixtures, inclusive of types A, D and E, typically reduce the water content about 5 to 10 percent. Concrete made with these admixtures commonly exhibits a slump around 4 inches (100 mm) with a slump loss of about 3 inches (75 mm) in 2 hours. High range water reducing admixtures or superplasticizers, inclusive of types F and G, reduce the water content from 10 to 30 percent. Concrete exhibiting slumps of 6 to 7 inches (150 to 175 mm) can be produced with water content reductions ranging from 10 to 15 percent. Flowing concrete, which exhibits a slump greater than 7 ½ inches (190 mm) while remaining self leveling and cohesive, is also typically made with the aid of high range water reducing admixtures. Slump loss of concrete made with these admixtures can be very rapid and occur at a rate of about 3 to 4 inches (75 to 100 mm) per hour. Some admixtures are marketed as midrange water reducing admixtures, although there is no such classification. These admixtures typically meet type A requirements and provide up to 12 percent water reduction without delaying the setting time of concrete.

#### **5.2.5.3 Concrete Coloring Admixtures**

Concrete coloring admixtures are used to color concrete for aesthetic and safety purposes. ASTM C 979 is the standard specification. Coloring pigments should normally not exceed 10 percent by weight of cementitious material. Before a coloring admixture is used on a project, its historical performance should be checked for color fastness in sunlight, chemical stability in cement and non-detrimental effects on concrete properties.

#### **5.2.5.4 Miscellaneous Admixtures**

Many miscellaneous admixtures are available for use in concrete. They include corrosion inhibitors, shrinkage reducers, alkali-silica reactivity inhibitors and pumping aids to name a few. As is the case for all admixtures, they must be compatible with other ingredients of the concrete mixture and pre-approved prior to use.

#### **5.2.6 Fibers**

Fibers are long and slender filaments with lengths typically ranging from ¼ inch to 6 inches (6 to 150 mm) and thicknesses ranging from 0.001 to 0.2 inches (0.025 to 5 mm). Fibers are added to the concrete during mixing to provide resistance to tensile and flexural stresses in the concrete. They do not affect drying shrinkage but increase the resistance to cracking as well as decrease crack width. Fibers are typically added in low volume dosages ranging from less than one to 2 percent. The standard specification covering fiber reinforced concrete is ASTM C 1116. It allows three types of fibers including steel, glass and synthetic.

- Steel fibers may be stainless, alloy, or carbon steel in composition. Steel fibers only slightly affect concrete compressive strength but can dramatically increase tensile and flexural strengths. Steel fibers are used in airport and highway pavements, bridge decks and floors.
- Glass fibers are designed to be alkali-resistant in that they have the potential to react with alkalis in the cement paste when exposed to humid or moist environments. Such a reaction can cause reductions in concrete properties including strength, toughness and impact with age. They have been primarily used in the exterior panels of buildings.
- Synthetic fibers are man-made products such as polyolefins (polypropylene and polyethylene) as well as acrylic, aramid, carbon, nylon and polyester. They are used to reduce plastic shrinkage and subsidence cracking. Polypropylene fibers have been used in bridge decks, pavements, low water crossing and other applications where plastic shrinkage cracking may be a concern.

The use of fibers and the requirements for the mixture will typically be stated in the special contract requirements for a project.

## 5.3 CONCRETE MATERIALS ACCEPTANCE REQUIREMENTS

### 5.3.1 Materials Certification Acceptance

Proper materials certifications pertaining to each applicable material type and source must be obtained by the Project Engineer and retained in project files. As part of the process for approving a Contractor's mix design, representative certifications should be submitted to the Division Materials Engineer for review and recommendation for approval along with the concrete mix design, form FHWA 1608. The FP requires hydraulic cement production certifications for rigid pavements, structural concrete, prestressed concrete and shotcrete. For a discussion and explanation of commercial and production certification requirements, see Division 100, Section 1.1.2. Also, individual materials standards that have been specified in the contract should be referenced. They set forth additional detail pertaining to Contractor submittal of valid manufacturer certifications including required statements, test data and frequency. Certifications must be signed and dated as well as certify that the specified requirements of applicable standards and project specific special contracts requirements have been met. Exhibit 5-8 summarizes individual concrete materials requiring manufacturer certifications as required in the FP in conjunction with the applicable materials standard to which they must be certified.

**Exhibit 5-8 Required Concrete Material Certifications**

Material	AASHTO Standard	ASTM Standard	Frequency
<b>Hydraulic Cement:</b>			
Portland Cement	M 85		1 per shipment
Blended Cement	M 240		1 per shipment
<b>Mineral Admixtures:</b>			
Fly Ash	M 295		1 per shipment
Ground granulated blast-furnace slag	M 302		1 per shipment
Silica Fume (microsilica)	M 307		1 per shipment
<b>Water</b>	M 157		1 for each source
<b>Coloring Agents</b>		C 979	1 per type
<b>Chemical Admixtures:</b>			
Air-entraining	M 154		1 per shipment
Water-reducing, Set-controlling Hydration stabilizing	M 194		1 per shipment per admixture used

The FP further notes that material accepted by certification may be sampled and tested at any time to verify the properties stated as part of the certification. Sampling of concrete materials should be in accordance with the procedures and sample sizes noted in Exhibit 5 - 9.

In general, it is good practice to obtain one sample with each shipment of material. These samples should be retained on the project until final project acceptance or provided to the Division Materials Engineer when required for the purpose of Government testing to verify conformance to the contract specifications.

**Exhibit Error! No text of specified style in document.-9      Material Sampling  
Specifications and Sample Sizes**

<b>Material Component</b>	<b>AASHTO Standard</b>	<b>ASTM Standard</b>	<b>Sample Size</b>
<b>Hydraulic Cement</b>			
Portland Cement	T 127	C 183	Representative of not more than 100 tons (90 Mg): Two grab samples at > 10 lb ( 5 Kg) each
Blended Cement	T 127	C 183	Representative of not more than 100 tons (90 Mg): Two grab samples at > 10 lb (5 Kg) each
<b>Mineral Admixtures:</b>			
Fly Ash	----	C 311	Representative of not more than 400 tons (360 Mg): One grab sample at $\geq$ 4 lb (2 kg) each
Ground granulated blast-furnace slag	M 302	C 989	Representative of not more than 125 tons (115 Mg): Two grab samples at $\geq$ 5 lb (2 kg) each. Remove a 12-in. (300 mm) layer of slag in a hole before sampling.
Silica Fume (microsilica)	M 307	C 1240	Representative of not more than 110 tons (100 Mg): 2 grab samples at $\geq$ 2 lb (1 kg) each.
<b>Water:</b>	M 157	C 94	As required for pertinent tests: liquid grab samples at $\geq$ 1 pt (0.5 L) each.
Compressive strength	T 106 T 131	C 109 C 191	
Time of set	T 260	D 512	
Chloride as Cl	----	D 516	
Sulfate as SO <sub>4</sub>	----	D 4191	
Alkalis		D 4192	
Total Solids	T 26	----	

**Exhibit 5-9 Material Sampling Specifications and Sample Sizes (Continued)**

<b>Material Component</b>	<b>AASHTO Standard</b>	<b>ASTM Standard</b>	<b>Sample Size</b>
<b>Aggregates (Coarse and Fine)</b>	T 2	D 75	Coarse Aggregate: 150 lb (75 kg) Fine Aggregate: 100 lb (50 kg)
Aggregate Sample Splitting	T 248	C 702	Samples are properly split and reduced in size by use of sample splitters or quartering
<b>Chemical Admixtures:</b>			
Air-entraining	M 154	C 260	Representative of not more than 2500 gal (9500 L): 3 liquid grab samples at $\geq$ qt (1 L) each Representative of not more than 2 tons (2 metric tons): 4 non-liquid tube samples at $\geq$ lb (1 kg) each
Water-reducing, Set-controlling	M 194	C 494	Representative of a unit shipment or a single production lot: 3 liquid grab samples at $\geq$ 1 pt (0.5 L) each Representative of not more than 2 tons (2 Mg): 4 non-liquid tube samples at $\geq$ 2 lb (1 kg) each

As always, special contract requirements should be reviewed to ascertain if additional materials certifications and samples are required on a project-specific basis.

As always, special contract requirements should be reviewed to ascertain if additional materials certifications and samples are required on a project-specific basis.

**5.3.2 Water Acceptance**

The FP allows potable water of known quality to be used without testing and certification. Water of questionable quality, however, must be tested in accordance with AASHTO M 157 as summarized in Exhibit 5-4 and certified thereto. The Contractor must submit the certification, including test results, to the Project Engineer. In turn, the Project Engineer must submit the certification to the Division Materials Engineer for approval with the concrete mix design.

**5.3.3 Aggregate Acceptance**

Concrete aggregate acceptance involves a three phase testing process that progresses throughout the life of a project. These phases include testing to:

- assess source suitability;
- evaluate mixture proportioning characteristics;

- verify uniformity of supply and moisture content.

Initial source approval does not constitute acceptance. If an approved aggregate source does not continue to supply acceptable material, further use of the source may be denied and a new concrete mix design may be required.

The first phase entails performing laboratory tests to determine source suitability and acceptability for use as a concrete material. The FP requires that the source quality of fine and coarse aggregates be verified by testing prior to production of concrete. The aggregate samples must be split with the Government taking control of its portion of the split sample. If more than one source is used, split samples must be obtained from each source. Samples should be submitted to the FLH Division Materials Laboratory along with transmittal form FHWA 1600. It is emphasized that aggregate source samples should be submitted far in advance of the submittal of the mix design since some aggregate source quality tests take weeks to perform.

The Contractor should ensure that aggregate samples are submitted as soon as a source is identified. In addition, the Contractor is required to submit test results from each aggregate source and to certify that they meet the specified quality, including the supplemental requirements, established in the contract. Aggregate testing results are generally submitted as part of the proposed mix design on form FHWA 1608. The Government typically tests to verify the Contractor's results and the quality of the aggregate provided. See Exhibits 5-5 and 5-6 for characteristics. Upon source approval, these tests are typically not checked again unless there is reason to question source quality or when there is an unforeseen change in aggregate source(s).

The second phase involves conducting laboratory tests to determine physical properties characteristics necessary for concrete mixture proportioning. These tests are stated in the FP in the Composition (Concrete Mix Design) and Acceptance subsections. Since these tests are performed to gather information for mixture adjustments only, testing limitation requirements are usually not specified. With the exception of aggregate moisture tests, mixture proportioning tests are generally checked one time by the Government on both the fine and coarse aggregate and include measures of parameters shown in Exhibit 5-7. The tests are typically performed by the FLH Division Materials Laboratory on the same samples that are submitted for aggregate source quality verification testing.

The third phase entails performing daily laboratory tests on produced aggregate at the project site during construction to verify the continuous uniformity of the aggregate supply as well as to determine aggregate moisture contents necessary for adjustment of the concrete mixtures water content. The testing and frequency is specified in the FP in the Acceptance subsection. Uniformity of aggregate supply is monitored by gradation and fineness modulus tests. Concrete water content is adjusted in accordance with existing moisture conditions of the fine and coarse aggregate, which fluctuate with environmental and ambient conditions at the mixing plant site. The existing moisture condition of each stockpile is tested and used to adjust batch water contents to maintain the water-cementitious materials ratio of the approved mix design.

During aggregate production, the aggregates should be sampled and tested by the Contractor for gradation, fineness modulus and moisture content at a minimum frequency of one sample per day per stockpile. Split samples should be obtained during the production of the aggregates and tested by the Government to verify the Contractor's gradation and fineness modulus results. The Project Engineer should obtain the Contractor's daily aggregate gradation and moisture test results. As required by the FP under the Composition (Concrete Mix Design) and Acceptance subsections, the Project Engineer must ensure that there is not a change in approved aggregate sources, that the gradations stay within acceptable limits and that the fineness modulus of the fine aggregate does not change by more than 0.20. The Project Engineer must also ensure that the Contractor uses aggregate moisture tests to properly adjust the amount of mix water in concrete batches such that the water-cementitious materials ratio of the approved mix design is maintained. The use of form FHWA 1638 can assist in performing these calculations. The water content of the approved mix design should never be exceeded and concrete must not be re-tempered. These items are discussed in detail in Section 5.5 – Concrete Construction Requirements.



## **5.4 CONCRETE MIXTURE PROPORTIONING AND APPROVAL REQUIREMENTS**

### **5.4.1 Concrete Mixture Composition and Proportioning Requirements**

For structural concrete, the FP denotes mixture composition requirements for various classes of concrete and specifies minimum cement contents, allowable slump ranges, nominal maximum aggregate sizes and minimum air contents. Concrete and/or exposure classes, which dictate mixture proportioning, specified compressive strength and other durability requirements, are usually specified in the plans on contract drawings or in project-specific special contract requirements. Similar requirements are stipulated in the minor concrete and rigid pavements sections of the FP; however, only one mixture composition is specified. For rigid pavements, classes are specified to dictate mixture proportioning, minimum compressive strength and other durability requirements. For minor concrete, one mixture composition is specified in conjunction with a specified concrete compressive strength. Classes are typically not utilized.

The FP requires concrete mixtures to be proportioned in accordance with specific ACI practices and guides as applicable. The ACI practices and guides and the definitions associated thereto are discussed below. Applications and use on FLH projects are also addressed in association with each definition and practice.

#### **5.4.1.1 ACI 211.1 Standard Practice for Selecting Proportions for Normal, Heavyweight and Mass Concrete**

- Normal concrete - Concrete having a density of approximately 150 lb/ft<sup>3</sup> (2400 kg/m<sup>3</sup>) made with normal-density aggregates. Normal concrete is used in the majority of construction applications including typical FLH project applications. (i.e. pavements, bridges, culverts, walls, foundations).
- Heavyweight concrete – Concrete of substantially higher density than that made using normal-density aggregates (i.e. up to 350 lb/ft<sup>3</sup> (5600 kg/m<sup>3</sup>)), usually obtained by use of high-density aggregates. Heavyweight concrete is used in radiation shielding, counter-balancing, ballasting and sound attenuation applications. As such, it has not been employed on FLH projects.
- Mass Concrete - Any volume of concrete with dimensions large enough to require that measures be taken to cope with generation of heat from hydration of the cement and attendant volume change, to minimize cracking. Mass concrete is used in thick-section applications for structures such as dams, mat foundations, pile caps, bridge piers, walls and tunnel linings. It has been used on FLH projects in rare occasions when the size of structural member (i.e. bridge piers) has necessitated measures to prevent temperature-dependent cracking.

#### **5.4.1.2 ACI 211.2 Standard Practice for Selecting Proportions for Structural Lightweight Concrete**

Lightweight concrete - Concrete of substantially lower density than that made using aggregates of normal density. The concrete is made with lightweight aggregates with a

concrete compressive strength exceeding 2500 psi (17 MPa) at 28 days of age and an air dry density not exceeding 115 lb/ft<sup>3</sup> (1840 kg/m<sup>3</sup>). Lightweight concrete is used in applications where normal density aggregates (exhibiting specific gravities from 1.6 to 3.2) are not locally available and light density aggregates are used in whole or in part in the concrete mixture. When compared to normal concrete, proportioning and control procedures for lightweight concrete are modified to account for greater absorptions and rates of absorptions. Lightweight concrete has been used on rare occasions on FLH projects for standard applications such as headwalls or foundations.

#### **5.4.1.3 ACI 211.3 Guide for Selecting Proportions for No-Slump Concrete**

No Slump Concrete - Freshly mixed concrete exhibiting a slump of less than ¼ inch (6 mm). No slump concrete is used in applications where normal workability impairs constructability. These applications have historically included four types of concrete including roller compacted concrete (RCC), roof tiles, concrete masonry units and pervious concrete. Roller compacted concrete has been employed for dams, pavements and horizontal construction. When compared to normal concrete, proportioning and control procedures for no slump concrete are modified in accordance with specific procedures for each concrete type to account for lower water contents and other factors. No slump concrete has been used on rare occasions on FLH projects in applications such as RCC grade control structures within washes for the purposes of dissipating erosion and bridge scour.

#### **5.4.1.4 ACI 211.4 Guide for Selecting Proportions for High-Strength Concrete with Portland Cement and Fly Ash**

- High Strength Concrete - Concrete that has a specified compressive strength for design of 6000 psi (41 Mpa) or greater. High strength concrete is used in applications where superior strength is needed in the design and performance of structural members. Optimization of mixture proportioning and attainment of a low water-cementitious materials ratio is critical to achieving high strength. Select mineral and chemical admixture combinations and aggregate sizes are typically specified in this process. Typical applications for high strength concrete include bridges and pavement overlays although these structures can be designed with normal concrete. Both of these applications have been used on FLH projects on a limited basis.
- High Performance Concrete - Concrete meeting special combinations of performance and uniformity requirements that cannot always be achieved routinely using conventional constituents and normal mixing, placing and curing practices. High performance concrete (HPC) differs from high strength concrete in that superior performance in a particular application is required. The application may or may not require higher compressive strength. In addition to compressive strength, specialized testing and performance requirements are typically specified to address one or more desirable durability characteristics including freeze-thaw, scaling, abrasion, chloride penetration, ASR and sulfate resistance. Testing and performance requirements related to structural integrity may also be specified for rigidity, shrinkage and creep as well as placeability (i.e. flow). As such, examples of HPC when compared to normal concrete include high-ultimate strength, high early

strength, high rigidity, high durability, increased workability, pumpability and finishability and increased placeability in hot and cold weather. HPC has been applied on FLH projects in a fashion similar to high strength concrete. Its use is expected to increase in the future.

A properly proportioned concrete mixture must be designed for strength, durability, workability (i.e., placeability, pumpability, finishability), economy and appearance. The water-cement ratio determines the strength and durability properties. When mineral admixtures are used, the water-cement ratio becomes the water-cementitious materials ratio. In other words, the cementitious materials portion is calculated by summing the weight of the cement plus the weights of the mineral additives (i.e. cement + fly ash + silica fume + ground granulated blast furnace slag). The weight of the water is then divided by the weight of the cementitious materials. The water-cement and water-cementitious ratio are denoted as w/c in the FP.

For structural concrete and rigid pavement, the FP requires the concrete mixture to be proportioned to meet durability requirements for maximum water-cementitious materials ratio, minimum specified compressive strength ( $f'_c$ ) and additional criteria stipulated in ACI 318, Chapter 4 – Durability Requirements. Durability is discussed in Section 5.4.2 below.

For structural concrete and rigid pavement, the FP also requires the concrete mixture to be proportioned to meet the required average compressive strength requirements ( $f'_{cr}$ ) stipulated in ACI 318, Chapter 5 – Concrete Quality Mixing and Placing. These strength requirements are discussed in Section 5.4.3 below.

#### **5.4.2 Concrete Mixture Durability Requirements**

Durability is the ability of concrete to resist weathering action, chemical attack, abrasion and other conditions (ACI 116) while retaining its engineering properties. To provide adequate durability, structural concrete and rigid pavement must be proportioned by the Contractor to meet FP requirements.

Durability requirements pertaining to the maximum water-cementitious materials ratio and minimum compressive strength ( $f'_c$ ) are dependent upon designated exposure categories and classes. ACI 318 defines four different exposure categories and their individual applications as follows:

- Exposure Category F (Freezing and thawing) - applied to exterior concrete that is exposed to moisture and cycles of freezing and thawing with or without deicing chemicals;
- Exposure Category S (Sulfates) - applied to concrete in contact with soil or water containing deleterious amounts of water-soluble sulfate ions;
- Exposure Category P (Permeability) – applied to concrete in contact with water requiring low permeability;

- Exposure Category C (Corrosion) - applied to reinforced and prestressed concrete exposed to conditions that require additional protection against corrosion of reinforcement.

The severity of exposure within each category is further subdivided into exposure classes. Increasing numerical values are used to represent increasingly severe exposure class conditions. A classification of “0” indicates that the exposure severity has negligible effect or does not apply to the structural member.

Specific and applicable exposure classes are assigned to structural members by the Division Materials Engineer on a project-by-project basis in conjunction with the severity of exposure conditions anticipated at the project site. When a structural concrete member is assigned more than one exposure class (i.e. F3, SO, P1 and C2), the concrete mixture must be proportioned by the Contractor to meet the most restrictive requirements for maximum water-cementitious materials ratio and minimum specified compressive strength ( $f'c$ ).

The mixture proportioning durability requirements for maximum water-cementitious materials ratio and minimum specified compressive strength ( $f'c$ ) are specified in the FP and special contract requirements. Other durability requirements are also specified in association with each assigned exposure category and class (with the exception of Exposure Category P (Permeability), which has no additional durability requirements). Exposure class categories F, S and C will be hereafter discussed with respect to the attack method, the corresponding deterioration appearance and specifications pertaining to concrete mix design mitigation measures. Thereafter, other FP durability requirements will be addressed.

#### 5.4.2.1 Exposure Category F (Freezing and thawing)

Freeze-thaw attack occurs in climates of repeated freezing and thawing. When temperatures drop below freezing, ice starts to form in concrete pores. Water increases in volume on freezing. Water confined in pores between freezing bodies is under compression and pores dilate causing the cement paste to rupture or crack. When concrete contains porous aggregate, the aggregate itself is prone to freeze-thaw damage even when the concrete contains air entrainment.

**Exhibit 5-10 Concrete freeze-thaw damage: (1) on the surface in the form of deicer scaling; (2) throughout the thickness in the form of cracks in paste around aggregate; and (3) at pavement joints in the form of D-cracking.**

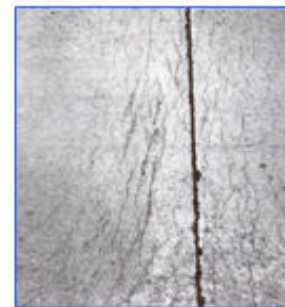
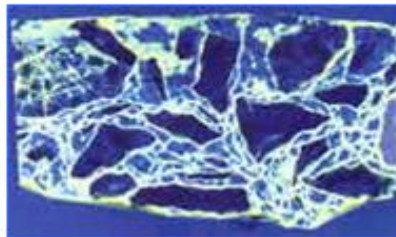

Freeze-thaw deterioration is manifested on the exposed concrete surface by deicer scaling, crumbling and delamination. It is manifested throughout the thickness of the concrete by parallel surface cracks in paste and cracks in paste around aggregate. In pavements, freeze-thaw deterioration sometimes takes the form of D-cracking. D-cracking consists of closely spaced cracks that form parallel to pavement joints and progressively move outward. D-cracks are caused by porous aggregates. As water accumulates under pavements, the porous aggregates become saturated. When freezing and thawing cycles occur, cracking of the concrete typically starts in the saturated aggregate at the bottom of the slab and progresses upward to the wearing surface.

Freeze-thaw damage may be avoided by proper air entrainment of fresh concrete and use of nonporous aggregate. A good air void system provides free space to which water can diffuse and freeze without damaging the concrete. From a microscopic standpoint, air bubbles should be spaced no more than 230  $\mu\text{m}$  apart and 10 to 1000  $\mu\text{m}$  in size. Concrete air content requirements are based on the maximum aggregate size used.

In addition to specifying mixture proportioning requirements for maximum water-cementitious materials ratio and minimum specified compressive strength ( $f'_c$ ) for each freezing and thawing exposure class (F0, F1, F2 or F3), the FP and special contract requirements further mandate allowable air content ranges. To provide protection against freeze-thaw attack, the concrete mixture must be designed by the Contractor to meet air content requirements of the assigned freeze-thaw exposure class. It is noted that too much entrained air will result in detrimental strength loss. As a rule of thumb, the compressive strength loss is about 5 percent for each 1 percent of air content.

It is further noted that the FP limits the maximum total cementitious materials content pertaining to collective combinations of mineral admixtures (i.e. for concrete exposed to freezing and thawing and in continuous contact with moisture and exposed to deicing chemicals or the F3 exposure class). The requirements have been previously discussed and are shown in Exhibit 5 - 3.

#### **5.4.2.2 Exposure Category S (Sulfates)**

Naturally occurring sodium, potassium, calcium or magnesium sulfates found in soil, dissolved in groundwater or from deicing chemicals can enter concrete and attack the cementing materials. Wetting and drying can replenish and concentrate salts on the concrete surface leading to continual attack. Sulfate attack disrupts the cement paste through one of two mechanisms: (1) formation of additional ettringite or (2) formation of additional gypsum. The formation of ettringite results in an increase in solid volume leading to expansion and cracking of paste. The formation of gypsum leads to paste softening and loss of strength. The presence of ettringite and gypsum in concrete, in and of itself, is not an indication of sulfate attack as these components are present in all concrete. In addition to chemical analysis, petrographic examination (ASTM C 856) of hardened concrete samples is necessary to verify sulfate attack.

**Exhibit 5-11 At the microstructure level, salt deposits (i.e. the formation of ettringite) are shown on a hardened concrete sample as well as cracking in the paste due to the formation and expansion of ettringite.**

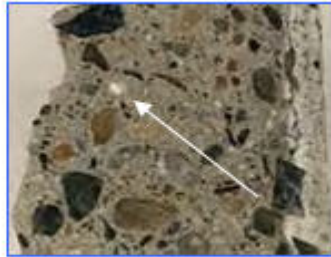

When in-service concrete will be exposed to soil or solutions (groundwater or deicing solutions) containing sulfates, a sulfate condition must be determined and the concrete mixture designed with the appropriate sulfate resisting cementitious materials types. Soil and/or water testing to determine the sulfate condition is accomplished as part of the project development with test results typically being included in Geotechnical reports. Measured test results are used by the Division Materials Engineer to assign an applicable sulfate exposure class which in turn is specified in special contract requirements on a project-by-project basis.

In addition to specifying mixture proportioning requirements for maximum water-cementitious materials ratio and minimum specified compressive strength ( $f'_c$ ) for each sulfate exposure class (S0, S1, S2 and S3), the FP and special contract requirements further mandate the use of sulfate resisting cementitious materials types. To provide protection against sulfate attack, the concrete mixture must be designed by the Contractor to meet the required cementitious materials type of the assigned sulfate exposure class. Alternatively, combinations of cementitious materials proposed for use in the mix design may be tested by mortar bar expansion in a sulfate solution. Mortar bar samples must be fabricated and tested in accordance with the procedure designated in the contract and meet the expansion limitation requirement of the assigned sulfate exposure class. The Contractor is further required to submit valid hydraulic cement materials certifications with the concrete mix design as part of form FHWA 1608. These certifications must include pertinent chemical and physical properties test data, including mortar bar expansion data when applicable, allowing verification of the use of appropriate sulfate resisting cement on the project (See Section 5.3.1).

#### **5.4.2.3 Exposure Category C (Corrosion)**

Concrete protects reinforcing steel because it provides a high pH environment around it. The pH of concrete, including that of the pore solution, is about 12.5. At a pH of 11.5 and higher, a passivating oxide film will form on the steel surface in contact with the concrete which protects the steel from corrosion. As long as the passivating oxide film forms and the high pH environment is maintained, the reinforcing steel will be protected from corrosion.

Reinforcement in concrete corrodes as a result of the failure to establish an initial passivating environment or by loss of an established passivating environment over time. The passivating environment may not initially form if the concrete exhibits excessive voids

throughout its depth and at or near steel reinforcement if the concrete is porous. The passivating environment may be lost over time by concrete carbonation which lowers the pH pore solution near reinforcement steel to about 8.5. All concrete carbonates as a result of exposure to carbon dioxide in the atmosphere. The passivating environment may also be lost over time by ingress of the chloride ion into concrete which destroys the passive oxide film surrounding the steel.

As reinforcement corrodes, it increases substantially in volume resulting in delamination of overlying concrete and further structural deterioration. The effective load carrying area of the reinforcement is also reduced.

In addition to specifying mixture proportioning requirements for maximum water-cementitious materials ratio and minimum specified compressive strength ( $f'_c$ ) for each corrosion exposure class (C0, C1 and C2), the FP and special contract requirements further mandate limitations on the water soluble chloride ion ( $Cl^-$ ) of the concrete mix ingredients when concrete is placed over reinforcing steel. To provide protection against reinforcement corrosion, the concrete mixture must be designed by the Contractor to meet the maximum water soluble chloride ion ( $Cl^-$ ) content by weight of cement for the assigned corrosion exposure class and structural member type. The Contractor is further required to submit water soluble chloride ion ( $Cl^-$ ) data on hardened concrete with the concrete mix design on form FHWA 1608. The data must verify that the maximum water soluble chloride ion ( $Cl^-$ ) content of the mix ingredients has not been exceeded at the designated test age and that the concrete has been tested in accordance with the procedure designated in the contract.

Finally, for proper corrosion protection of the reinforcing steel, it is imperative that minimum concrete cover requirements stipulated by contract drawings be provided. Concrete cover over reinforcing steel should be checked in the field by the Project Engineer. Reinforcement steel cover can best be assessed in the forms prior to concrete placement.

#### **5.4.2.4 Delayed Ettringite Formation (DEF)**

Delayed Ettringite Formation (DEF), also known as internal sulfate attack, results in the formation of ettringite and associated expansion after heat curing at too high of a temperature. Many experiments have shown that pastes, mortars and concretes exposed to excessive temperatures during the hardening process exhibit expansion and cracking when subsequently exposed to moist conditions. The critical temperature for DEF is related to cement alkali content. Cements containing higher alkali contents (i.e. type III cements) exhibit lower critical temperatures. The FP limits elevated curing temperature to a maximum of 149 °F (65 °C).

The temperature of reinforced and prestressed concrete subjected to elevated temperature curing must be monitored by the Contractor and the maximum curing temperature recorded. It must be submitted with the concrete mix design (see FHWA form 1608).

#### **5.4.2.5 Alkali-Silica Reactivity (ASR)**

Alkali aggregate reactivity is the chemical reaction in either mortar or concrete between alkalis (sodium and potassium) from portland cement or other sources and certain

constituents of some aggregates; under certain conditions, deleterious expansion of concrete or mortar may result (ACI 116). ASR is a type of alkali aggregate reactivity which involves reactions of the alkalis in portland cement and certain siliceous rocks or minerals (i.e. opaline, chert, strained quartz, volcanic glass).

In order for ASR to be operative, three components are required including reactive silica, sufficient alkalis and sufficient moisture. Eliminating any one of these components will stop ASR reactivity and subsequent concrete damage.

Reactive silica refers to aggregates that tend to breakdown under exposure to highly alkaline pore solution in concrete and thereafter react with the alkalis to form an expansive ASR gel. Not all siliceous aggregates are reactive. Reactivity depends on aggregate mineralogy, crystalline structure and solubility of silica in the pore solution of concrete.

Sufficient alkalis refer to the alkalis predominately contributed by the sodium and potassium in portland cement but also from other constituent materials and/or external sources. Such alkali sources include supplementary cementitious materials (fly ash, slag and silica fume), aggregates, chemical admixtures, deicing salts, seawater and wash water. The alkalis serve to raise the pH of the pore solution which in turn increases the solubility of the reactive silica.

Sufficient moisture refers to the moisture that is necessary to promote ASR expansion. If the internal relative humidity of the concrete exceeds 80 percent, sufficient moisture is present to allow ASR expansion. Such moisture is typically inherently present within concrete structures that are exposed to the environment or in contact with the ground (i.e. pavements, bridges, canals).

ASR occurs as the alkali and silica react to form a gel reaction product. The gel reaction product absorbs water and subsequently swells. When the volume of the reaction product is greater than the volume of the individual reacted materials, expansive tensile stress are exerted on the concrete and cracking occurs. The only indisputable evidence that ASR has developed in concrete is the detection of ASR reaction products. In the early stages of reactivity or under conditions where only small quantities are produced, ASR gel is virtually undetectable by the unaided eye. Final confirmation of the ASR mechanism must be performed at the microstructure level by a skilled petrographer.

A characteristic and advanced ASR cracking pattern is known as map or pattern cracking. The crack pattern resembles that which develops on dried mud flats. On concrete pavement surfaces, ASR cracks are typically more prominent in the wheel paths in the longitudinal direction. Below the pavement surface, ASR can be manifested by a predominance of vertical cracks in the upper 1 to 2 inches of pavement as well as cracks with sub-horizontal orientation. ASR cracks can extend completely through the pavement thickness.



**Exhibit 5-12** At the microstructure level, the characteristic ASR gel is shown within cracks that have formed through and around aggregate and into the surrounding paste. At the macrostructure level, an advanced and characteristic ASR cracking pattern known as map or pattern cracking is shown.

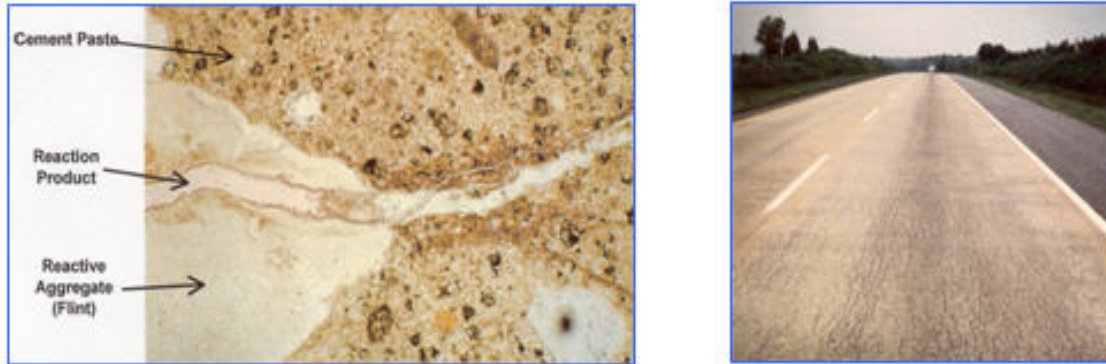

To prevent ASR in new concrete, the concrete mixture is designed to (1) control and limit the availability of alkalis in cement and/or (2) the type and amount of reactive aggregate.

Lowering of alkalis in the concrete mixture is accomplished by specifying the optional low alkali-cement requirement found in portland cement specifications in AASHTO M 85. The low alkali content serves to lower the pH of the concrete pore fluid which in turn decreases the solubility of the reactive silica. The optional low alkali-cement provision may be specified in the special contract requirements as a secondary, but not stand alone, means of ASR mitigation. If the low-alkali option is allowed, the Contractor must submit valid hydraulic cement materials certifications with the concrete mix design which includes pertinent chemical and physical properties test data verifying the use of low-alkali cement on the project (See Section 5.3.1).

Limiting the type and amount of reactive aggregate in the concrete mixture is accomplished by one or more of the following:

- Specifying the optional supplementary reactive aggregate restriction requirements found in AASHTO M 6 for fine aggregate and AASHTO M 80 for coarse aggregate;
- Testing aggregate sources to determine whether or not they contain reactive aggregates;
- Testing reactive sources to determine if the reactivity can be effectively mitigated by use of supplementary cementitious materials (i.e. fly ash, silica fume ground granulated blast furnace slag).

The FP and special contract requirements will specify reactive aggregate supplemental requirements for fine and coarse aggregates. Limiting the type and amount of reactive aggregate is the preferred and primary means of ASR mitigation.

The reactive aggregate supplemental requirements call for the use of non-reactive aggregates in the concrete mixture. Aggregate producers should be able to provide test results demonstrating the reactivity level of their product. The reactive aggregate supplemental requirements do allow for the use of reactive aggregates if supplementary mineral admixtures are added that demonstrably show prevention of harmful expansion by subsequent testing.

The Contractor is required to submit data from aggregate producers for both fine and coarse aggregate which documents aggregate reactivity levels as well as the test methodology used for measurement. If reactive aggregate is proposed for use, then test data must be included which shows that harmful expansion has been effectively mitigated by use of supplementary cementitious materials. However, the proportions of supplementary materials proposed for use in the concrete mix design must be similar to those showing effective mitigation by testing. The mix design proportions must also meet the maximum cementitious material requirements shown in Exhibit 5-3. ASR testing as well as expansion criteria which is accepted by Federal Lands Highway is shown in Exhibit 5-13.

**Exhibit 5-13 FLH Accepted ASR Testing**

<b>Test Name</b>	<b>ASR Test Type and Application</b>	<b>Sample Type and Size</b>	<b>Test Duration</b>	<b>Expansion Criteria</b>
ASTM C 1260	Immersion of mortar bars in NaOH solution at 80° C. (Evaluates aggregates only)	At least 3 mortar bars 1 x 1 x 10- inches long 25 x 25 x 250 mm long)	16 days total – 14 days from zero measurement. Cannot be used to evaluate SCMs or Lithium	0.10% max of 14 days
ASTM C 1293	Concrete prisms stored at 38°C and 100% humidity. (Evaluates aggregate, SCMs* and Lithium)	Three prisms per cement-aggregate combination not less than 3 x 3 x 10- inches long (75 x 75 x 250 mm long)	Measure after 1, 2, 4, 8, 13, 18, 26, 39 and 52 weeks. Every 6 months thereafter as necessary	0.04 % max at one year
ASTM C 1567	Immersion of mortar bars in alkaline solution at 80°C. (Evaluates SCMs*)	At least 3 mortar bars 1 x 1 x 10-inches long (25 x 25 x 250 mm long)	16 days total – 14 days from zero measurement Cannot be used to evaluate Lithium	0.10 % max at 14 days.

**Exhibit 5-13 FLH Accepted ASR Testing (Continued)**

<b>Test Name</b>	<b>ASR Test Type and Application</b>	<b>Sample Type and Size</b>	<b>Test Duration</b>	<b>Expansion Criteria</b>
ASTM C 856	Petrographic examination of hardened concrete	One core specimen 6 inch diameter x 12 inches long (150 mm diameter x 300 mm long) or mortar bar sample	Short term: visual and microscopic to assess reactivity, cracks etc.	Used with ASTM C 1260 or 1293
*SCM stands for supplementary cementitious materials such as fly ash, silica fume or ground granulated last furnace slag or a combination thereof.				

It is emphasized that ASR testing is included as part of the aggregate source quality testing shown in Exhibits 5-5 and 5-6 and discussed in Section 5.3.3. The Contractor should ensure that aggregate samples are submitted to the Government far in advance of the submittal of the concrete mix design in that some aggregate ASR tests take weeks to perform. As a minimum, ASTM C 1260, which is used to ascertain whether or not aggregate is reactive, takes 16 days to perform after receipt and casting of test samples. Additional time will be necessary if supplementary petrographic analysis is required. Also, if reactive aggregate is employed in the concrete mix design, ASTM C 1567, which is used to ascertain whether or not the use of supplementary cementitious materials has been effective in mitigating ASR expansion, takes another 16 days after receipt and casting of test samples. It is important to recognize and plan sufficient time for the Government verification testing for contract compliance with ASR requirements.

### **5.4.3 Concrete Mixture Strength Requirements**

In addition to the durability requirements discussed in Section 5.4.2, the FP also requires structural concrete to be proportioned to meet the required average compressive strength requirements ( $f'_{cr}$ ) stipulated in ACI 318, Chapter 5 – Concrete Quality Mixing and Placing.

Compressive strength is the measured maximum resistance of a concrete specimen to axial compressive loading or the specified resistance used in design calculations (ACI 116). Compressive strength requirement notation is as follows:

- $f'_c$  = specified compressive strength of concrete, psi (MPa);
- $f'_{cr}$  = required average compressive strength of concrete used as the basis for selection of concrete proportions, psi (MPa);
- $s_s$  = sample standard deviation, psi (MPa);
- $k$  = factor used for the increase in standard deviation if the total number of tests is less than 30.

To account for variability that will occur in the field during construction and placement, a suitable concrete mixture must be designed for an average strength ( $f'_{cr}$ ) appreciably higher than the specified compressive strength ( $f'_c$ ). In order for a concrete mix design to be approved, proper strength documentation and calculations must be provided by the Contractor. The data should be supplied as part of the mix design submittal on form FHWA 1608. The process for establishing and documenting a suitable concrete mixture consists of three basic steps:

- Step 1: Determine a sample standard deviation from suitable test records (strength tests).
- Step 2: Determine a required average compressive strength ( $f'_{cr}$ ) from formulas which consider the sample standard deviation or suitable supplemental information documenting average strength potential.
- Step 3: Select mixture proportions that produce an average compressive strength at least as great as the required average compressive strength and also meet durability requirements for the applicable exposure categories noted in Section 5.4.2.

#### **5.4.3.1 Determine a Sample Standard Deviation from Suitable Test Records (Strength Tests)**

Concrete strength is assessed by strength tests. One strength test ( $X_i$ ) is defined as the average of the strengths of at least two 6 by 12-inch (150 by 300 mm) cylinders or three 4 by 8-inch (100 by 200 mm) cylinders made from the same sample of concrete and tested at 28 days, or at the test age designated in the contract, for  $f'_c$ . The average of all the strength tests is calculated and used to determine a sample standard deviation. The sample standard deviation is in turn used to determine the required average compressive strength ( $f'_{cr}$ ).

Suitable test records not more than 12 months old must be used or developed to establish a sample standard deviation. When a concrete production facility is presenting strength test records from which a sample standard deviation is calculated, it is required to represent materials, quality control procedures and conditions similar to those expected on the project. For instance, the same mineral and chemical admixtures should be employed in the concrete mix design as will be used on the project. Changes in materials and proportions within test records are not to be more restricted than those proposed for the work. Additionally, the production facility is required to present test records which represent concrete that meets a specified compressive strength or strengths ( $f'_c$ ) within 1000 psi (7 MPa) of that specified for the proposed work. Where different materials are used for different portions of proposed work (i.e. different classes of concrete), each mix design combination must be evaluated separately by use of strength tests and approved. The Division Materials Engineer can assist in evaluation of the mixtures and recommendation for their use.

The formulas used for the computation of the sample standard deviation are dependent upon the number of suitable test records. There are three different cases of test records.

- Case 1

When a concrete production facility has **one test record of at least 30 consecutive tests** of similar materials and conditions expected, the sample standard deviation ( $s_s$ ) is calculated from those results in accordance with the following formula:

$$s_s = \sqrt{\frac{\sum (X_i - \bar{X})^2}{(n - 1)}}$$

where

$s_s$  = sample standard deviation, psi (MPa)

$X_i$  = individual strength tests

$\bar{X}$  = average of  $n$  strength test results

$n$  = number of consecutive strength tests.

If two groups of consecutive tests or **two test records are used to obtain at least 30 tests**, the sample standard deviation ( $\bar{s}_s$ ) is the statistical average of the values calculated from each test record in accordance with the following formula:

$$\bar{s}_s = \sqrt{\frac{(n_1 - 1)(s_{s1})^2 + (n_2 - 1)(s_{s2})^2}{(n_1 + n_2 - 2)}}$$

where

$\bar{s}_s$  = statistical average standard deviation where two test records are used to estimate the sample standard deviation

$s_{s1}$ ,  $s_{s2}$  = sample standard deviations calculated from two test records, 1 and 2, respectively

$n_1$ ,  $n_2$  = number of tests in each test record, respectively.

- Case 2

When a concrete production facility has **one test record of 15 to 29 consecutive strength tests**, the sample standard deviation is established as the product of the calculated sample standard deviation ( $s_s$ ) above and the  $k$ -modification factor shown in Exhibit 5-15 below. The test record must represent only a single record of consecutive tests that span a period of not less than 45 calendar days.

- Case 3

When less than 15 consecutive strength tests are available, there is insufficient data to establish a sample standard deviation and additional supplemental information must be submitted as discussed in section 5.4.3.2 below in order to document average strength potential and to establish mixture proportions.

### 5.4.3.2 Determine a Required Average Strength ( $f'_{cr}$ )

The determination of the required average strength is hereafter addressed for the same three cases of test records previously discussed in section 5.4.3.1.

- Case 1

When suitable test records from 30 or more consecutive tests are available to establish a standard deviation, the required average compressive strength is determined from the equations shown in Exhibit 5-14. The required average compressive strength ( $f'_{cr}$ ) is based on the specified compressive strength ( $f'_c$ ) which is either (1) less than or equal to 5000 psi (35 MPa) or (2) greater than 5000 psi (35 MPa).

**Exhibit 5-14 Required Average Compressive Strength with Test Records of 30 or More Consecutive Tests**

Specified Compressive Strength, $f'_c$ , psi (MPa)	Required Average Compressive Strength* $f'_{cr}$ , psi (MPa)
$f'_c \leq 5000$ psi (35 MPa)	Use the larger value computed from the following equations: $f'_{cr} = f'_c + 1.34ks_s$ (1) $f'_{cr} = f'_c + 2.33ks_s - 500$ psi (2) $(f'_c + 2.33ks_s - 3.45$ MPa)
Over 5000 psi (35 MPa)	Use the larger value computed from the following equations: $f'_{cr} = f'_c + 1.34ks_s$ (1) $f'_{cr} = 0.90f'_c + 2.33ks_s$ (3)
* k is equal to 1 if the total number of tests are greater than or equal to 30	

In the first instance ( $f'_c \leq 5000$  psi (35 MPa)), two computations are made using equations 1 and 2. In the second instance ( $f'_c > 5000$  psi (35 MPa)), two computations are again made using equations 1 and 3.

Since the total number of tests are greater than or equal to 30, the sample standard deviation does not have to be modified and  $k = 1$  in equations 1, 2 and 3. As was discussed in Section 5.4.3.1 above, either the calculated sample standard deviation,  $s_s$ , for one test record or the calculated statistical average standard deviation,  $\bar{s}_s$ , for

two test records is actually used in the required average compressive strength formula calculations ( $f'_{cr}$ ).

The largest  $f'_{cr}$  value computed from equations 1 and 2 for  $f'_c \leq 5000$  psi (35 MPa) or equations 1 and 3 for  $f'_c > 5000$  psi (35 MPa) in Exhibit 5-14 is ultimately used as the required average compressive strength ( $f'_{cr}$ ).

- **Case 2**

When test records from 15 to 29 consecutive strength tests are available, the sample standard deviation is established as the product of the calculated sample standard deviation ( $s_s$ ) for one test record and the k-modification factor shown in Exhibits 5-14 and 5-15. The procedure results in a more conservative or increased required average compressive strength ( $f'_{cr}$ ) and is statistically equivalent to that of a 30-test record.

**Exhibit 5-15 Required Average Compressive Strength with Test Records of 15 to 29 Consecutive Tests**

<b>Number of Tests*</b>	<b>k-modification Factor for Sample Standard Deviation<sup>†</sup></b>
Less than 15	Use Exhibit 5-16
15	1.16
20	1.08
25	1.03
30 or more	1.00
*Interpolate for intermediate numbers of tests <sup>†</sup> k-modified standard deviation used to determine required average strength $f'_{cr}$ in Exhibit 5-14	

After applying the appropriate k-modification factor, the largest  $f'_{cr}$  value computed from equations 1 and 2 for  $f'_c \leq 5000$  psi (35 MPa) or equations 1 and 3 for  $f'_c > 5000$  psi (35 MPa) in Exhibit 5-14 is ultimately used as the required average compressive strength ( $f'_{cr}$ ).

- **Case 3**

When less than 15 consecutive strength tests are available, there is insufficient data to establish a sample standard deviation. The required average compressive strength is therefore established by a predetermined increase in the specified compressive strength in accordance with Exhibit 5-16 provided suitable supplemental information is submitted documenting average strength potential. Suitable supplemental information includes strength test records and associated trial mixture proportions.

**Exhibit 5-16 Required Average Compressive Strength with Test Records less than 15 Consecutive Tests**

<b>Specified Compressive Strength, <math>f'_c</math>, psi (MPa)</b>	<b>Required Average Compressive Strength <math>f'_{cr}</math>, psi (MPa)</b>
$f'_c < 3000$ psi ( 21 MPa)	$f'_{cr} = f'_c + 1000$ psi (7 MPa)
$3000$ psi (21 MPa) $\leq f'_c \leq 5000$ psi (35 MPa)	$f'_{cr} = f'_c + 1200$ psi (8.5 MPa)
$f'_c > 5000$ psi (35 MPa)	$f'_{cr} = 1.10f'_c + 700$ psi (5 MPa)

When strength test records and associated trial mixture proportions are submitted to document average strength potential, test records consisting of less than 30 but not less than 10 consecutive tests are acceptable provided test records encompass a period of time not less than 45 days. Required concrete proportions may be established by interpolation between the strengths and proportions of two or more test records.

When test records are not available, concrete proportions established from trial mixtures may be used to develop test records for cases 1, 2 or 3. As noted in ACI 318 the trial mixtures must meet the following requirements:

- Materials shall be those for proposed work;
- Trial mixtures with a range of proportions that will produce a range of compressive strengths encompassing  $f'_{cr}$  and meet the durability requirements for applicable exposure categories noted in Section 5.4.2;
- Trial mixtures shall have slumps within the range specified for the proposed work; for air-entrained concrete, air content shall be within the tolerance specified for the proposed work;
- For each trial mixture, at least two 6 by 12 inch (150 by 300 mm) or three 4 by 8 inch (100 by 200 mm) cylinders shall be made and cured in accordance with AASHTO T 126. Cylinders shall be tested at 28 days or at the test age designated for  $f'_c$ ;
- The compressive strength results, at designated test age, from the trial mixtures shall be used to establish the composition of the concrete mixture proposed for the work. The proposed concrete mixture shall achieve an average compressive strength as required in Exhibits 5-14 or 5-16 and meet the durability requirements for applicable exposure categories noted in Section 5.4.2.

When no suitable test records or trial mixture data is available, other experience and information may be submitted and used if approved by the Division Materials Engineer.



### **5.4.3.3 Select Mixture Proportions**

Select mixture proportions that produce an average compressive strength at least as great as the required average compressive strength and also meet durability requirements for the applicable exposure categories in Section 5.4.2. In order for a concrete mix design to be approved, proper strength documentation and calculations must be submitted by the Contractor which demonstrate that the proposed concrete mixture produces an average compressive strength equal to or greater than the required average compressive strength for the applicable case. As noted above, such documentation consists of a field test record, strength test records, trial mixtures or other information approved by the Division Materials Engineer. The data should be supplied as part of the mix design submittal on form FHWA 1608. The Division Materials Engineer may be contacted for assistance and direction in the compressive strength evaluation.

### **5.4.4 Concrete Mix Design Submittal**

The concrete mix design for structural concrete and rigid pavement must be recorded and submitted on form FHWA 1608. The form should be submitted to the Project Engineer at least 36 days before concrete production. All forms require documentation of individual mix constituents, specific gravities, weights, and absolute volumes expressed in the proper units indicated on the form. Mix designs should be reported such that the total volume of mix constituents equals one cubic yard (27 cubic feet) or one cubic meter inclusive of design air contents. However, it is acceptable practice to design a concrete mixture with a total volume that is slightly higher (i.e. a few tenths) to allow for some variation in the as-produced air content. Admixture dosages in fluid ounces per cubic yard or liters per cubic meter must also be recorded. In addition, design fresh and hardened concrete properties and other information must be provided as indicated on the forms.

### **5.4.5 Concrete Mix Design Approval**

The FP requires concrete mix designs be submitted for approval. The Contractor should submit the required forms to the Project Engineer who in turn will submit them to the Division Materials Engineer for review and recommendation for approval. Prior to submitting the forms, the Contractor should review to verify all data and information has been provided according to the contract.

The Division Materials Engineer will review the submitted forms and documentation to ensure compliance with contract requirements.

## 5.5 CONCRETE CONSTRUCTION REQUIREMENTS

Section 5.5 discusses the testing and inspection of concrete during the construction phase once the concrete mix design and materials submittals have been approved.

In addition, the contractor should supply a complete concrete batch ticket with every batch delivered to the project. The Project Engineer should verify that the proportions shown on the ticket match the concrete mix design that was approved for the project. An example of a concrete batch ticket is shown in Exhibit 5-17.

**Exhibit 5-17 Example of Concrete Batch Ticket**

**CONCRETE BATCH TICKET**

KEY NO. \_\_\_\_\_ PROJECT NO. IDPFH-94-1 (1) DATE 10-24-07

CONTRACT ITEM NO. \_\_\_\_\_ SUPPLIER BF Redi-Mix CONCRETE CLASS C-AE

COARSE AGG. SIZE NO. 2B MIX DESIGN NO. 060700 TIME BATCHED: 7:05 AM TRUCK NO. 7 TICKET NO. 27351

STAPLE PRINTOUT HERE	MATERIAL	S.S.D. MIX DESIGN 1 CY	ACTUAL BATCHED MASS (A)	TOTAL MOISTURE % (B)	ABSORPTION MOISTURE % (C)	FREE WATER % (D) (B-C)	FREE WATER (E)
	COARSE AGG 1	1718 LBS	13165 LBS	1.2	0.8	0.4	55 LBS
	COARSE AGG 2	LBS	LBS				LBS
	FINE AGG	1281 LBS	10248 LBS	4.0	1.2	2.8	279 LBS
	FINE AGG	LBS	LBS				LBS
	WATER	263 LBS	1584 LBS		GAL. Convert Gal. to lbs. Factor = 8.34		334 LBS
	CEMENT	658 LBS	5275 LBS	Free water(E) = (A) - (A)			
	FLY ASH	LBS	LBS	1+(D/100)			
	TOTAL MASS (F)	3920 LBS	30864 LBS				LBS

WATER WITHHELD 192 (LB) 23 (GAL) AT THE BATCH PLANT W/C RATIO @ PLANT \_\_\_\_\_ (optional)

BATCH PLANT	AD MIXTURE	BRAND	OZ/BATCH	CEMENT BRAND	FLY ASH
	AIR ENTRAINMENT	<u>MB AE 90</u>	<u>36</u>	<u>Ashgrove</u>	
	WATER REDUCER	<u>322 N</u>	<u>315</u>	TYPE <u>I II</u>	
	SET RETARDER			MIXING REVOLUTIONS (PLANT) <u>30</u>	
	SUPER PLASTICIZER			REMARKS _____	
	OTHER				

BATCH INSPECTOR: HS CHECKED BY: \_\_\_\_\_

CONCRETE PLACED (LOCATION) Dock

TIME EMPTY \_\_\_\_\_ TOTAL TIME \_\_\_\_\_ TODAY'S TOTAL CY \_\_\_\_\_ TOTAL CY TO DATE \_\_\_\_\_

WATER ADDED 10 (GAL) X 8.34 = \_\_\_\_\_ (LB) ADDED TO TOTAL MASS (Q) \_\_\_\_\_ NEW TOTAL MASS (M) \_\_\_\_\_

MIXING REVOLUTIONS (PLANT) \_\_\_\_\_ MIXING REVS. (FIELD) \_\_\_\_\_ TOTAL MIXING/AGITATING REVOLUTIONS \_\_\_\_\_

TESTS: AIR TEMP: 39 CONC TEMP: 62 SLUMP: 2 3/4 AIR%: 5.2 MINUS AGG. CORRECTION FACTOR \_\_\_\_\_

CYLINDERS Set 2 A, B DENSITY: 144.2 lb/cf

CALCULATED ACTUAL CY BATCHED =  $\frac{(Q) \text{TOTAL MASS OF BATCHED MATERIALS}}{(P) \text{TOTAL MASS OF MIX DESIGN}}$  = \_\_\_\_\_ (F) CY ROUNDED TO TENTHS

RELATIVE YIELD:  $\frac{\text{New Total Mass (M)} / (\text{density (lb/cf)} \times 27)}{(F) \text{Actual CY Batched}}$  = \_\_\_\_\_

CEMENT FACTOR:  $\frac{\text{LBS Cement}}{\text{New Total Mass (M)} / (\text{density (lb/cf)} \times 27)}$  = \_\_\_\_\_

ACTUAL WATER/CEMENT RATIO =  $\frac{(S) \text{Total mixing water (LBS)}}{\text{Cement} + \text{Fly Ash (LBS.)}}$  = \_\_\_\_\_

CONVERSION TO METRIC: LB/CF TIMES 16.02 Kg/m<sup>3</sup>

REMARKS: \_\_\_\_\_

PLACING INSPECTOR: [Signature] CHECKED BY: \_\_\_\_\_

As part of the construction phase of the work, a pre-concreting meeting should be held to discuss various aspects of concrete placement. A sample pre-concreting meeting agenda is included in Appendix F of this manual.

### 5.5.1 Aggregate Testing for Uniformity and Water Content Adjustment of Concrete Mixtures

Aggregate source and concrete mix design approval do not constitute final acceptance. If the approved source(s) do not continue to supply acceptable aggregates during the construction process, further use of the source(s) will be denied and a new mix design will be required using another source. For structural concrete and rigid pavements, the FP requires that the concrete as well as the as produced aggregate used in the concrete be sampled, tested and evaluated. Aggregate tests are required to be performed on a daily basis to verify the uniformity of the supply as well as to determine properties necessary for adjustment of the water content of the concrete mixture.

Uniformity of aggregate supply is verified by gradation and fineness modulus tests. A new concrete mix design is required if there is a change in source of material or when the fineness modulus of the fine aggregate changes by more than 0.20.

The water content needs to be monitored and adjusted in accordance with moisture condition of the aggregate, which fluctuates in accordance with environmental conditions at the mixing plant site. The moisture condition is tested on a daily basis and used in conjunction with the aggregate absorption to adjust the batch water amount to meet the water-cementitious materials ratio requirement of the approved mix design. If the water-cementitious materials ratio is not kept constant, the compressive strength, workability and other properties will vary from batch to batch. For example, an increase in the fine aggregate moisture content of one percent will increase the slump of the concrete as much as 1 ½ inches (40 mm) and decrease the compressive strength by as much as 300 psi (2.1 MPa).

In order to adjust batch water contents, it is necessary to understand the moisture conditions of an aggregate particle. Each aggregate particle is made up of internal voids which may or may not contain water. Four potential moisture conditions are depicted in Exhibit 5-18.

**Exhibit 5-18 The Four Moisture Conditions of an Aggregate Particle**

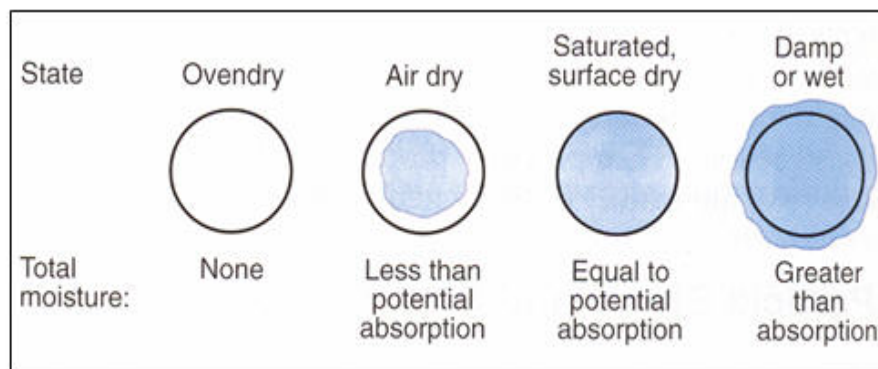

These moisture conditions are defined as follows:

- Oven Dry – Particle is completely dry and fully absorbent;
- Air Dry – Particle is dry at the surface but contains some interior moisture and is still partially absorbent;
- Saturated Surface Dry (SSD) – Particle is fully absorbent and neither absorbs water from nor contributes water to the concrete mixture;
- Damp or wet – Particle contains excess moisture on the surface known as free water.

Concrete mix designs are based on a saturated surface dry aggregate condition. Therefore, the existing moisture condition of the aggregate must be determined to properly apply aggregate moisture corrections. Existing moisture conditions are found by determining absorption and moisture contents. Provided the quality of the aggregate remains the same, the aggregate absorption should remain constant. However, since the moisture content reflects the environmental condition of the stored aggregate and since these conditions continually change as a normal course of the daily temperature and humidity cycles, new moisture contents need to be periodically determined. It is a good idea to conduct moisture contents tests at least two times daily, in the morning and afternoon.

The moisture condition of any aggregate and its effect on the concrete mix water can be found by subtracting the existing moisture content of the aggregate, determined according to AASHTO T 255 from the aggregate absorption determined according to AASHTO T 84 and T 85. If the existing moisture content is less than the absorption, as in the case of air dry aggregate, the result will be negative and the aggregate will absorb some of the mixing water. If the existing moisture content is greater than the absorption, as in the case of the wet aggregate, the result will be positive and the aggregate will provide excess mixing water. In both cases, the amount of water added at the batch plant needs to be adjusted to account for the moisture condition of the aggregates such that the water requirement of the approved mix design can be maintained. Form FHWA 1638, Worksheet for Determining Concrete Batch Moisture/Absorption Corrections, can be used as a means of checking that adjustments have been properly calculated and performed. In this manner, the Project Engineer can verify that water content of the approved mix design has not been exceeded.

### **5.5.2 Fresh Concrete Properties**

For structural concrete, rigid pavements and minor concrete, fresh concrete properties inclusive of slump, air content, unit mass and temperature must be measured and evaluated for acceptance. The specific sampling, testing and properties requirements are included in the contract specifications. They define the frequency, methods for evaluation and allowable tolerances. The importance of proper sampling and testing cannot be over emphasized. Only by following proper procedures for fresh concrete sampling and testing can the quality of the delivered product be evaluated. The Project Engineer should witness fresh concrete properties testing for acceptance and take possession of the Governments portion of the concrete cylinders for future hardened concrete properties testing. Typical fresh concrete testing includes methods shown in Exhibit 5-19.

**Exhibit 5-19 Fresh Concrete Test Methods**

<b>Concrete Test</b>	<b>Test Method</b>	<b>Concrete Characteristics</b>
Sampling Fresh Concrete	AASHTO T 141	Proper method for obtaining fresh concrete sample
Slump	AASHTO T 119	Concrete consistency and uniformity
Air content	AASHTO T 152 AASHTO T 196	Freeze / thaw resistance
Temperature	AASHTO T 309	Temperature of mixture for proper placement
Unit Weight	AASHTO T 121	Yield
Making Test Specimen	AASHTO T 23	Proper method for making, curing and transporting cylinders

The frequency of sampling is established in the contract and is typically one sample per 30 cubic yards (25 cubic meters) but not less than one per day. The truck loads or batches of concrete to be tested must be selected on a random basis by the Project Engineer before commencement of the concrete placement.

**5.5.2.1 Sampling**

Fresh concrete is sampled in accordance with AASHTO T 141. Samples are acquired from the discharge stream at the point of placement. They should be taken between the 10 and 90 percent points of the discharge. Concrete should be collected in two or more portions at regularly spaced intervals throughout the discharge stream. The elapsed time should not exceed 15 minutes between taking the first and final portions of the sample. The samples should be transported to a place where fresh concrete property tests are to be conducted and remixed with a shovel. Slump, temperature and air content tests should be started within five minutes after sampling whereas molding specimens for compressive strength testing should initiate within 15 minutes after sampling.

**5.5.2.2 Concrete Slump**

The slump test is conducted in accordance with AASHTO T 119. It is a measure of concrete consistency or uniformity. The standard slump cone is filled in three layers of approximate equal volume and each layer is rodded 25 times with a standard rod. The top layer of concrete is horizontally struck off to a flat surface and the slump cone is vertically raised to allow the concrete to slump. The slump cone is placed next to the slumped concrete and the slump rod is placed horizontally on top of the slump cone. Concrete slump is measured as the vertical distance from the displaced original center of the top surface of the fresh concrete to the bottom of the rod. Slump is measured to the nearest ¼ inch (5 mm) and recorded.

### **5.5.2.3 Air Content**

Air content can be measured by use of a pressure air meter (AASHTO T 152) or a volumetric air meter (AASHTO T 196). Pressure air meters are calibrated to read air content directly as pressure is applied. Since the measured air content includes air that is trapped in aggregates, a small aggregate correction factor must be subtracted from the pressure meter gauge reading to obtain the correct air content. Pressure type meters cannot be used with porous or lightweight aggregate. Type A pressure meters must be calibrated at the elevation at which they are used since changes in barometric pressure will affect the function of the meter. Volumetric air meters can be used with concrete containing any type of aggregate. They can be used at different elevations and do not require an aggregate correction factor. Volumetric air meters utilize isopropyl alcohol to accelerate air removal and dispel foam. Concrete is placed in the air meter container in three equal layers and rodded in a fashion similar to that of the slump test. After each layer is rodded, the sides of the air meter container are tapped with a rubber or rawhide mallet to close any voids left by the rod and to release any trapped air. Air content is measured to the nearest 0.1 percent and recorded.

### **5.5.2.4 Concrete Temperature**

Concrete temperature is measured in accordance with AASHTO T 309 to assess whether the concrete is too hot or too cold at the time of placement. When performing a temperature measurement, the sensor should be placed within the fresh concrete at a location that allows it to be completely immersed and surrounded by at least three inches (75 mm). The temperature measuring device is left in place and monitored for at least two minutes or until the concrete temperature stabilizes before a reading is acquired. Temperature is measured to the nearest 1°F (0.5°C) and recorded.

### **5.5.2.5 Concrete Unit Weight**

AASHTO T 121 is used to verify batch weights, to determine yield and to measure gravimetric air content. The test requires knowledge of mixture proportions in order to calculate yield and air content. The size of the unit weight container used for measurement varies with the maximum aggregate size of the mixture being tested. The air meter container is typically used to measure unit weight.

## **5.5.3 Hardened Concrete Properties**

Compressive strength is the main hardened concrete property that is tested and evaluated. It is important to fabricate, cure, and handle the specimens appropriately. AASHTO T 22 provides the method for testing concrete specimens for compressive strength. Compressive strength concrete cylinders are made and cured on a construction project in accordance with AASHTO T 23. Cylinder molds must be made of watertight, non-absorbing material that is capable of holding its dimensions and shape under use. Cylinder length must be twice the diameter. Cylinder diameter must be at least three times the nominal maximum size of the coarse aggregate. Standard 6 by 12-inch (150 by 300 mm) cylinders are typically used when the nominal maximum size of the coarse aggregate does not exceed 2-inches (50 mm).

However, AASHTO T 23 does allow the use of 4 by 8-inch (100 by 200 mm) cylinders when the nominal maximum size of the coarse aggregate does not exceed 1-inch (25 mm).

For concrete slumps greater than 1-inch (25 mm), cylinders may be consolidated by rodding or internal vibration. The number of required layers as well as the roddings or vibrator insertions per layer varies in conjunction with the cylinder size. After consolidation, the top surfaces are finished with a wood float or trowel to produce a flat even surface that is level with the mold edge.

Cylinder specimens may be either field cured or standard cured. Field cured cylinders are marked for identification, stored near the point of deposit of the concrete and subjected to the same temperature and environment as the structural work. They are tested in the moisture condition resulting from the specified curing treatment.

Standard cured cylinders are subjected to a twofold process consisting of initial and final curing. During initial curing, cylinders are marked for identification and placed within a level, protected and controlled on-site storage area immediately after molding and finishing. They are initially cured for up to 48 hours in a controlled environment that provides temperatures between 60 to 80°F (16 to 27°C) and prevents moisture loss. For concrete mixtures with a specified strength of 6000 psi (40 MPa) or greater, the initial curing temperatures must be controlled between 68 and 78°F (20 and 26°C).

Cylinders must not be transported for final curing until at least 8 hours after final set. During transportation, cylinders must be protected from moisture loss, freezing and jarring. After arrival at the testing laboratory, the molds are removed. Cylinders are then final cured with free water maintained on their surfaces at all times at a temperature of  $73 \pm 3^\circ\text{F}$  ( $23 \pm 2^\circ\text{C}$ ) using water tanks or moist storing rooms.

Compressive strength testing is conducted in accordance with AASHTO T 22. In order to be tested, specimens must be within the specified tolerances for diameter and the ends must be plane. Specimens may need one or both ends trimmed or ground prior to testing if they do not meet planeness requirements. Immediately prior to testing, cylinders must be capped using bonded or unbonded material. Bonded caps consist of sulfur mortar, high strength gypsum plaster, neat cement paste or other materials. They must meet the requirements of AASHTO T 231. Unbonded caps consist of neoprene pads or other materials that are used in conjunction with capping plates. They must meet the requirements of ASTM C 1231.

AASHTO T 22 provides permissible time tolerances for various test ages (ranging from 12 hours to 90 days) in which test specimens must be broken. The permissible time tolerances for 7 and 28-day test ages are 6 and 20 hours, respectively.

Specimens are tested by compression loading at a constant rate to failure. The type of fracture, maximum load, cross-sectional area and calculated compressive strength are recorded. Length and diameter measurements are also made prior to testing. If the specimen length-to-diameter ratio is 1.75 or less, the length and diameter measurements must also be recorded and the compressive strength corrected by the appropriate correction factor.

The compressive strength of concrete cylinders is dependent upon the moisture condition, curing temperature and specimen size and shape. For these reasons compressive strength data obtained from field cured and standard cured specimens are used for different purposes.

Compressive strength data obtained from field cured specimens (cured with the structure) may be used for the purposes of:

- Determination of whether a structure is capable of being placed into service;
- Comparison with test results of standard cured specimens or with test results from various in-place test methods; (destructive and nondestructive)
- Adequacy of curing and protection of concrete in the structure;
- For falsework or shoring removal time requirements.

Compressive strength data obtained from standard cured specimens (initially cured in the field and final cured in a water storage tank or fog room) may be used for the purposes of:

- Acceptance testing for specified strength;
- Checking the adequacy of mixture proportions for strength;
- Quality control.

For acceptance testing, the FP requires the compressive strength cylinders to be standard cured and tested at 28-days. At least four 6 by 12 inch (150 by 300 mm) or six 4 by 8 inch (100 by 200 mm) cylinders should be molded and cured for each sample taken from the same load. Two 6 by 12 inch (150 by 300 mm) or three 4 by 8 inch (100 by 200 mm) cylinders are typically tested for acceptance at 28-days age with the compressive strength result being the average of the tests. The other cylinders are retained or used for informational purposes such as obtaining 7-day strengths. They may also be used for acceptance testing if specimen(s) that have been previously tested show evidence of improper sampling, molding or testing and have to be discarded.

The Project Engineer should closely monitor the compressive strength of the concrete during the construction process. If low strength test results occur, designers must perform calculations to assure that the load-carrying capacity of the structure is not impaired. If the likelihood of low-strength concrete is confirmed and there is a need for additional investigation, tests of cores drilled from the area in question may be performed. If it is necessary to obtain cores, the specimens will be obtained in accordance with AASHTO T 24. Contact the Division Materials Engineer for specific guidance regarding the sampling and testing of concrete that does not meet the contract compressive strength requirement.



## 5.6 SHOTCRETE

The term shotcrete is used to describe a process where mortar or concrete is pneumatically (by the pressure or exhaustion of air) projected at high velocity onto a surface. The process may be wet mix or dry mix. In the wet-mix process, all of the mix ingredients, including water, are mixed together, sent to the delivery hose and projected through a nozzle into which compressed air is injected. In the dry-mix process, all mix ingredients, except water, are mixed together, carried through the delivery hose by compressed air and projected through a nozzle into which water is injected. Both types of processes are permitted and will typically produce shotcrete suitable for normal construction requirements.

The wet-mix process facilitates more accurate measurement of mix water, assures thorough mixing of water with other ingredients, promotes less dust, results in lower rebound and overspray and provides a higher volume of mix for a given hose size. The dry-mix process provides instantaneous adjustment of the mixing water in accordance with variable field conditions, facilitates transport of materials over longer distances, allows for easier movement of delivery hoses, assures better consistency of mixtures containing lightweight aggregates and provides a lower volume of mix for a given hose size.

On FLH projects conventional shotcrete has been used for walls, shafts, foundation shoring, artificial rock, slope protection, erosion control, structural steel encasement and repair for deteriorated concrete.

### 5.6.1 Shotcrete Material Specifications

Shotcrete is composed of the same basic materials as structural concrete, namely hydraulic cement, mineral admixtures, water, aggregates, chemical admixtures and fibers. As such, the standard specifications for each of these materials, except aggregates, and the pertinent subsections of the FP which reference these material standards are applicable to shotcrete. For additional information, see Section 5.2.

The FP specifies that shotcrete fine and coarse aggregate must conform to AASHTO M 6, class B and AASHTO M 80, class B, respectively, including FP supplemental requirements. The fine and coarse aggregate source quality characteristics are similar to those shown in Exhibits 5-5 and 5-6, although the testing limitation requirements are different for shotcrete coarse aggregate.

Shotcrete aggregate must meet a combined grading requirement. The coarse aggregate amount is limited to less than 30 percent of the total mass. Shotcrete with more than 30 percent coarse aggregate has greater rebound, is more difficult to finish, cannot be used for thin layers and creates voids in the plastic shotcrete when shot at high velocity. The specific combined grading requirement is specified in the FP or by special contract requirements.

Acceptance of shotcrete materials is in the same fashion as acceptance of concrete materials. See Section 5.3 for an applicable discussion pertaining to materials certification acceptance as well as water and aggregate acceptance.

## **5.6.2 Shotcrete Mixture Proportioning and Preconstruction Requirements**

The FP requires shotcrete mixtures to conform to specific ACI practices, specifications and guides including:

- ACI 506 R Guide to Shotcrete;
- ACI 506.1R Committee Report on Fiber Reinforced Shotcrete;
- ACI 506.2 Specification for Shotcrete.

Shotcreting is a process which is highly dependent upon the specific equipment used, the unique placement skills of the nozzle operator and crew and conditions at the job site. Because of these factors, it is not standard practice to conduct laboratory trial mixtures. Instead, proposed shotcrete mix designs are submitted and preconstruction testing is performed in an environment that simulates actual job conditions to assess the quality of shotcrete produced by the crew and equipment that are proposed for use on the job. Shotcrete test panels are shot as a means to approve mix designs and pre-qualify crew and equipment.

### **5.6.2.1 Fresh Shotcrete Properties Sampling and Testing**

Fresh shotcrete properties sampling and testing should be in accordance with ASTM C 1385, which requires composite samples. A composite sample consists of several individual samples which are taken at various times during discharge and then combined into a single sample for testing. The final composite sample size must be large enough to perform the required tests. Sampling is performed as shotcrete material is delivered to the shotcrete machine.

For dry-mix shotcrete, the material is acquired by collecting two or more portions taken at regularly spaced intervals during discharge of the middle of the batch or at two or more random portions from the discharge of continuous mixers. The portions are combined into one sample for testing purposes. Portions should not be acquired from the first or last 15 percent of the discharge.

For wet-mix shotcrete, the sampling procedure is the same as the dry-mix process except the elapsed time between obtaining the first and last portions of the composite sample are as short as possible but no longer than 15 minutes.

Tests for air content by either AASHTO T 152 or AASHTO T 196 and unit mass per AASHTO T 121 must initiate within five minutes after obtaining the last portion of the composite sample. See Section 5.5.2 – Fresh Concrete Properties for discussion of these tests.

### **5.6.2.2 Making and Curing Shotcrete Test Panels**

Test panels are prepared and tested in accordance with ASTM C 1140. Separate test panels are fabricated for:

- Each proposed test mixture representing each admixture type and dosage;
- Each nozzle operator being qualified in association with each shooting position encountered at the jobsite (i.e. horizontal, vertical, overhead).

The test mixture must be of the same materials, admixtures and proportions proposed for use on the project as well as meet the required fresh and hardened concrete properties. The shotcrete must be applied using the same equipment, operating pressures and personnel as those proposed for the project.

Test panels must be constructed of wood or steel that is sufficiently rigid to prevent dislodging of shotcrete through vibration or deformation. To evaluate shotcrete mixture properties, mixture proportion test panels, containing no reinforcement are fabricated to a minimum width and length of 24 inches (600 mm) and a minimum depth of 6 inches (150 mm) with either square or sloped sides. When shotcrete is applied over reinforcement, additional test panels are constructed to evaluate reinforcement encasement by core grading and to determine the water-soluble chloride-ion concentration of the shotcrete mix ingredients. These panels must contain reinforcement of the same size and spacing as that required for the work. They must also be large enough to simulate jobsite conditions and are typically fabricated to a minimum width and length of 30 inches (760 mm) and a minimum depth of 3 inches (75 mm) with either square or sloped sides.

Panels containing no reinforcement are generally used to evaluate mix designs whereas panels containing reinforcement are used to prequalify personnel, equipment and application techniques. In instances where project shotcrete will not be applied over reinforcement, mixture proportioning panels containing no reinforcement are also used for prequalification purposes. Once nozzle operators and equipment have been approved, panels containing reinforcement are no longer constructed or evaluated on a project (i.e. they are needed for preconstruction testing purposes only).

Panels must be cured by tightly wrapping with a sheeting material meeting the requirements of AASHTO M 171 or stored in a moist room meeting the requirements of AASHTO M 201 as soon as is practicable after fabrication.

### **5.6.2.3 Hardened Shotcrete Properties Testing**

Three-inch (75 mm) diameter cores are drilled from test panels to evaluate the compressive strength of the shotcrete mixture, the quality of the shotcrete coating produced by the nozzle operator and the water soluble chloride ion concentration of the mix ingredients. Cores are drilled, moisture conditioned and delivered to the designated laboratory for testing in accordance with contract specifications.

To evaluate compressive strength, at least six strength cores are drilled from mixture proportioning test panels, which contain no reinforcement, in accordance with AASHTO T 24. The 3-inch (75 mm) diameter cores must be acquired from the central 15 by 15 inch (380 by 380 mm) sample area and drilled perpendicular to the surface. Core ends should be sawed to ensure parallel, flat and smooth surfaces. Core specimens with length to diameter ratios equal to or less than 1.75 require corrections to the measured compressive strength. A 28-day compressive strength test result is calculated as the average strength of three individual core specimens taken from the same test panel. The other three cores are used for information purposes such as obtaining 7-day strengths or other tests.

They may also be used for mix design approval testing if specimens that have been previously tested show evidence of improper sampling, coring or testing and have to be discarded.

To evaluate the quality of the shotcrete coating that does not contain reinforcement, at least three samples are obtained in accordance with AASHTO T 24 from each mixture proportioning test panel that has been cured at least seven days. Samples may consist of cores or pieces of cores or test panels that are free from observable cracks, fissures or shattered edges. The samples are tested in accordance with ASTM C 642 for density, boiling absorption and permeable void volume. No individual test may be greater than the maximum permissible boiling absorption and permeable void volume shown in the contract.

To evaluate the quality of the shotcrete coating for reinforcement encasement, at least three cores are obtained in accordance with AASHTO T 24 from nozzle operator and shooting position test panels that have been cured at least seven days. Cut surfaces are visually examined to check the uniformity of the shot material and to provide a basis for core grading and qualifying each nozzle operator in accordance with ACI 506.2. Cores are graded with respect to voids, sand pockets, laminations, complete reinforcement encasement and other inadequacies on a scale ranging from 1 (best) to 5 (worst). Individual shotcrete cores with a grade greater than 3 are unacceptable. Nozzle operators are typically required to achieve a test panel mean core grade less than or equal to 2.5 to qualify for placing job shotcrete. When initial prequalification test panel is rejected by the Project Engineer, a second test panel may be shot. If the nozzle operator's second mean core grade is greater than 2.5, the nozzle operator is not permitted to shoot shotcrete on the project. Core grading is performed during preconstruction testing only.

Additionally, the cores obtained for core grading or others acquired from each test panel containing reinforcement are typically analyzed in accordance with ASTM C 1218 at ages from 28 to 48 days to assess the water-soluble chloride ion concentration of the mix ingredients. No individual test may be greater than the maximum permissible water soluble chloride ion content shown in the contract. Water soluble chloride ion content analysis is performed during preconstruction testing only.

The discussion provided above is generalized to a typical shotcrete process. The FP as supplemented by special contract requirements provides the specific requirements for the preconstruction testing and the nozzle operator approval process for each project. The testing, evaluation and approval must be completed before proceeding to shotcrete construction.

### **5.6.3 Shotcrete Mixture Approval Requirements**

The FP requires shotcrete mix designs be submitted for approval. The submittal must be received at least 36 days before placing shotcrete.

The contractor must submit the required information to the Project Engineer who in turn will submit it to the Division Materials Engineer for approval. The Division Materials Engineer will review the submittal to ensure compliance with the contract requirements. Once the mix design and preconstruction testing has been approved, shotcrete construction may initiate.

#### **5.6.4 Shotcrete Construction Requirements**

The ACI practices, specifications and guides noted in the FP should be consulted regarding industry standards for producing shotcrete of acceptable quality throughout the construction process. The importance of proper sampling and testing cannot be over emphasized.

The FP requires that the as produced aggregate used in the shotcrete be sampled, tested and evaluated during construction. Combined aggregate gradation tests must be conducted to verify the uniformity of the supply. In addition, the Contractor should ensure that the water content of shotcrete mixture is adjusted in accordance with existing moisture conditions of the aggregate, which fluctuate in accordance with environmental conditions at the mixing plant site. Batch water content adjustments have been previously discussed in Section 5.5.1.

The Project Engineer must ensure that the Contractor follows proper procedures for fresh shotcrete sampling and testing as well as witness the associated results for acceptance. The procedures used during construction are the same as for preconstruction. Shotcrete is typically tested and evaluated for air content, unit mass and compressive strength. The sampling and testing table included in the specifications provides guidance and direction on the sampling frequency and acceptance procedures. It is noted that wet mix shotcrete air content values are typically specified and applicable to composite samples that have been acquired from material delivered to the shotcrete machine prior to pumping. It is therefore expected that shotcrete will lose some entrained air during the pumping process and that the in-place air content will be less than the pre-pumped air content. The amount of air loss after pumping should be checked periodically. The final in-place air content should be at least 4 percent.

The compressive strength of the shotcrete is evaluated statistically during construction. A single compressive strength test result is the average result from three cores taken from the same test panel and tested at 28 days. The sampling and testing table included in the specifications will define the frequency for constructing panels to obtain cores for the compressive strength evaluation. The Project Engineer must ensure that the contractor follows proper procedures for making and curing test panels and obtaining compressive strength cores for hardened shotcrete properties acceptance testing.

The compressive strength and quality of the shotcrete coating must be closely monitored by the Project Engineer during the construction process. The shotcrete coating should also meet boiling absorption and permeable void volume requirements. If the compressive strength or quality of the shotcrete coating is unacceptable, corrective action must be taken before continuing shotcrete construction. If low strength test results occur, designers must perform calculations to assure that the load-carrying capacity of the structure is not impaired. If the likelihood of low-strength shotcrete is confirmed and there is a need for additional investigation, tests of cores drilled from the area in question may be performed. If it is necessary to obtain cores, the specimens will be obtained in accordance with AASHTO T 24. Contact the Division Materials Engineer for specific guidance regarding the sampling and testing of shotcrete that does not meet the contract compressive strength or coating quality requirements.

## 5.7 DRIVEN PILES

Materials requirements for driven piles depend on the pile type. Typical piles include:

- Steel H-piles;
- Concrete-filled steel shell piles;
- Concrete-filled pipe piles;
- Precast concrete piles;
- Prestressed concrete piles;
- Sheet piles; and
- Timber piles.

Driven piles are normally required to comply with AASHTO or ASTM materials requirements. Detail materials specifications are provided in Section 715 of the FP.

### 5.7.1 Steel H-piles

The FP requires that steel H-piles be fabricated from structural steel conforming to ASTM A 36. The piles should be of the specified steel grade, length and section/weight. Steel H-piles sometimes require toe attachments (shoes) for hard driving conditions. Shoes fabricated from cast steel conforming to AASHTO M 103 are recommended because of their strength and durability. H-piles are easily spliced either by full penetration groove welding along the web and both flanges or with manufactured splicers. Steel for manufactured splicers should also conform to ASTM A 36.

### 5.7.2 Concrete-filled Steel Shell Piles

The FP requires that steel shell piles be either cylindrical or tapered pile shells of spiral welded, straight-seam welded, or seamless tube steel material. Steel shells can be driven with or without a mandrel, a heavy tubular steel section inserted into the pile to improve drivability. Mandrel driven steel shells are often fabricated from corrugated steel conforming to ASTM A 36. Separate shell sections are usually screw-connected and waterproofed with an o-ring gasket. Steel shells that are driven without a mandrel are typically tapered or step-tapered and are required to be fabricated from no less than 3/16-inch plate stock conforming to ASTM A 36. Separate shells driven without a mandrel may be either spirally welded or longitudinally welded. Concrete and reinforcement steel should comply with Sections 552 and 554.

### 5.7.3 Concrete-filled Pipe Piles

Pipe piles consist of seamless, welded or spiral welded steel pipes. The FP requires ASTM A 252, grade 2 steel pipe piles be used. Pipe piles may be driven either open or closed end. Closed end pipe piles should be closed by welding a flat steel plate meeting ASTM A 36 or a conical point meeting AASHTO M 103. The pipe piles should be of the specified steel grade, length and minimum wall thickness. Typically pipe piles are spliced using full penetration groove welds. Manufacture splices, conforming to ASTM A 36, should only be used if the splice can provide full strength in bending. Open ended piles may be reinforced with a steel cutting shoes meeting AASHTO M 103. Concrete should comply with Section 552.

#### **5.7.4 Precast / Prestressed Concrete Piles**

Precast and prestressed concrete piles are required to be manufactured to the applicable class of concrete specified in the contract. Additionally, they must have reinforcement consisting of a steel cage made up of several longitudinal bars or prestressing steel and lateral or tie steel in the form of individual hoops or a spiral. The piles should be of the specified length and section. Concrete piles should not be moved or transported until they have cured the minimum specified number of days or until concrete cylinders indicate that the concrete has reached the specified compressive strength requirements. Concrete piles delivered to the site should be free of cracks and spalling. They should be stored above ground with adequate blocking to prevent undue bending. Concrete piles can be difficult to splice and extend. The FP requires dowels or other acceptable mechanical means to splice precast and prestressed concrete piles. The contractor must submit drawings of proposed splices for acceptance. A short piece of structural H-section or “stinger” may be cast into or attached to the pile toe to assist in penetration. Concrete and reinforcement steel should comply with Sections 552, 553 and 554.

#### **5.7.5 Sheet Piles**

Sheet piles may be timber, reinforced concrete, vinyl, fiberglass, or plastic, but are most commonly steel. Steel sheet piles need to conform to AASHTO M 202 or ASTM A 572. Timber and reinforced concrete sheet piles should conform to the same material requirements as timber and precast concrete piles. Vinyl, fiberglass and plastic sheet piles should conform to the manufacturers and special contract requirements. Joints between sheet pile sections should be made practically watertight when the piles are in place.

#### **5.7.6 Timber Piles**

Timber piles may be treated or untreated depending on the in-place conditions. Timber piles need to conform to AASHTO M 168 and treated, if required, according to AASHTO M 133, pressure method procedure AWWA Standard C1. Treated timber piles should be imprinted with the name of the treating company and type and year of the treatment according to AWWA Standards M1 and M6. The FP requires that timber piles be fabricated from Douglas fir, Larch, Norway pine, Red oak or Southern yellow pine. Steel straps are required to be placed on timber piles at not more than 10-foot centers. The timber piles should be of the specified species, minimum length, and have the correct pile toe and butt sizes. The twist of spiral grain and the number and distribution of knots should be acceptable and the pile should be acceptably straight. Timber pile splices are difficult and generally undesirable. Cast steel shoes conforming to AASHTO M 103 should be used in hard driving situations.

#### **5.7.7 Driven Piles Materials Acceptance**

Driven pile materials acceptance, as stipulated in the FP, is based on visual inspection and certification. The contractor is required to furnish production certifications with each shipment of concrete piles, sheet piles, steel H-piles, steel shells, steel pipes and treated timber piles.

### **5.7.8 Driven Pile Materials Sampling and Testing**

Concrete for steel shells and pipe piles are required to be sampled and tested according to Section 552.



## 5.8 PAINTING

Protective coating systems are widely used on bridge and highway structures primarily for corrosion control of metals and to protect timber and concrete from deterioration. The coating system protects by isolating the environment from the substrate, by barrier, sacrificial means or a combination. There are many ingredients that constitute a coating material, but they can generally be categorized as non-volatiles and volatiles. The non-volatile component is that which remains on the surface after the volatile component evaporates. Non-volatiles include resins, pigments and additives. The resin or binder is the film-forming component of the coating. It promotes adhesion to the substrate or previous coating layers. Resin systems include acrylic, alkyd, oil, vinyl, epoxy, and urethane. The pigment gives the coating system its color and determines gloss level, but can also be used for corrosion resistance, act as a barrier and to increase the solids content. Additives are used to adjust certain properties of the coating. The volatile component is a solvent or solvent blend. The solvents are used to dissolve the resin in the coating and reduce the viscosity so that it can be applied. The non-volatiles are stated as a percentage of the total volume, known as the “Solids by Volume”. The percentage of solids by volume is used to calculate wet film thickness and coverage rates of the coating.

### 5.8.1 Coating System Components

A coating system includes the surface preparation and the application of a specified number of coats. The coats include a primer, intermediate and top. Each coat requires the application of multiple passes to achieve the specified thickness. Contrasting colors are often used to assist the contractor in assuring coverage. Each coating layer has a specific purpose. The primer provides adhesion to the substrate and can act as a barrier, rust inhibitor or sacrificial layer. The intermediate coat provides additional barrier protection, thickness and forms a tie between the primer and top coat. The top coat is used for aesthetics and corrosion protection. For a successful coating system it is critical to ensure that the specified surface preparation has been achieved and that each coat is applied to the specified thickness.

### 5.8.2 Coating Types

The following generic coating types are specified in the FP:

- Alkyd;
- Epoxy;
- Urethane;
- Moisture cured urethane;
- Zinc-rich; and
- Acrylic latex.

#### 5.8.2.1 Alkyd

Alkyd coatings are relatively inexpensive, flexible, easy to apply and can be modified with other resin systems for enhanced characteristics. An alkyd modified with silicone will provide good ultraviolet resistance and gloss retention. Alkyds cure by oxidation and can be very slow drying. They can also tend to chalk and fade (without silicone modification), have fair to poor acid and alkali resistance and poor solvent resistance.

### **5.8.2.2 Epoxy**

Epoxy coatings exhibit excellent adhesion, acid, alkali and solvent resistance and good flexibility. They offer abrasion, corrosion and chemical resistance. Epoxy coatings cure by cross-link polymerization. If too much time passes before top coating, they may harden to the point where subsequent coats will not adhere. Epoxy coatings are two-component and must be mixed properly to achieve full cure. They have a limited pot life and have poor resistance to sunlight.

### **5.8.2.3 Urethane**

Urethanes are commonly specified as top coats because they have superior gloss and color retention. They also have good adhesion, as well as good acid, alkali, impact and abrasion resistance. Urethane coatings are typically higher priced than other coatings. They are sensitive to moisture during curing and may develop a haze or blush that must be removed prior to top coating and they can cause pinholing in the top coat. Urethanes cure by cross-link polymerization and require careful mixing to achieve full cure. They also have a limited pot life.

### **5.8.2.4 Moisture-cured Urethane**

Moisture-cured urethane coatings cure by a reaction with moisture in the air. They are single component, surface tolerant, easy to apply and some can cure at low temperatures. They also have excellent chemical and solvent resistance and gloss retention. During packaging, a “nitrogen blanket” is floated along the top of the coating prior to sealing the lid. Once opened, the nitrogen dissipates, exposing the content to moist air. The coating may subsequently harden in the container, even if the lid is re-secured. The minimum relative humidity should be 40 percent during application and curing of moisture-cured urethane coatings.

### **5.8.2.5 Zinc-rich**

Zinc-rich coatings are primarily used as primers to provide galvanic protection. There are two categories of zinc-rich coatings: inorganic and organic. The difference is with the binder. Inorganic zinc-rich coatings contain an inorganic binder such as ethyl silicate, while organic zinc-rich coatings contain an organic binder such as, alkyd, vinyl, epoxy and urethane. The inorganic zinc-rich coatings may provide better corrosion protect but are not as easy to apply as the organic zinc-rich coatings. The inorganic zinc-rich coatings are less tolerant of deficient surface preparation and can mudcrack at excessive thickness and are more difficult to topcoat. They are also very porous and can cause pinholes in the top coat.

### **5.8.2.6 Acrylic Latex**

Acrylic latex coatings are relatively easy to apply and clean up. They cure by solvent evaporation and coalescence. Because the solvent system is primarily water, these coatings comply with VOC regulations. Acrylic latex coatings have poor resistance to alkali and solvent, and have moderate abrasion resistance. They must be applied in temperatures above 50 °F.

### **5.8.2.7 Vinyl**

Vinyl top coats were regularly used by highway agencies in the past. However, vinyl coatings are typically 65-70% solvent. Therefore, vinyl coatings are typically not VOC compliant and are no longer used on highway structures.

### **5.8.3 Curing**

There are four basic coating curing mechanisms:

- Solvent evaporation;
- Polymerization;
- Oxidation;
- Moisture cure.

Coatings that cure by solvent evaporation contain a resin and pigment in a solvent blend. The solvent evaporates leaving the resin and pigment behind. Because there is no chemical reaction the resin can be redissolved. Therefore, coating that cure by solvent evaporation cannot be over coated with a coating containing strong solvents, as it will dissolve the underlying layer. Acrylic latex coatings cure by solvent evaporation. Coatings that cure by polymerization are multi-component. The components, once mixed together, react chemically to form a solid, rigid, resistant coating film. Coatings that cure by polymerization include two part epoxies, urethanes and two part organic zincs. Similar to polymerization, oxidation is the reaction of two components to form a single coating layer. However, the coatings are one component and oxygen in the atmosphere is the catalyst. Alkyds cure by oxidation. Moisture cure coatings react to moisture to cure. Moisture cure coatings include inorganic zinc-rich primer and moisture-cure urethane.

### **5.8.4 Surface Preparation**

Surface preparation is the key element in determining the ultimate success or failure of a protective coating system. Prior to surface preparation, structural steel and concrete surfaces may require some amount of repair. For steel surfaces, welding, cutting, grinding or filling of crevices may be required. For concrete surfaces, patching and filling cracks and pores with surfacing compounds may be required. The purpose of surface preparation is to impart a specified level of cleanliness and roughness into the surface. This can in some cases be achieved in one step, however, cleanliness and roughness are two different specification criteria and must be examined independent of one another. There are eleven cleanliness standards provided in the Society for Protective Coatings (SSPC) specifications. The standards typically used for cleaning steel structures include solvent cleaning, hand tool cleaning, power tool cleaning, commercial blast cleaning, and near-white blast cleaning. Contact the Division Materials Engineer for SSPC specifications and visual reference guides for surface preparation.

### **5.8.5 Application**

It is important to review and be familiar with the Manufacturer's product data sheets. They have important information that is critical to a successful application. They should also be reviewed to make sure that they comply with the specifications. There are three primary

methods of transferring the coating material from the can to the surface. These include brush, roller and spray. The contractor will choose the method of application based on the coating type and location of application. Regardless of the application method selected the coating must be applied to provide uniform coverage to the specified thickness.

### **5.8.6 Inspection**

The painting contractor is required to be certified according to SSPC-QP1, “Painting of Complex Industrial Structures” and SSPC-QP2, “Removal of Toxic Coatings form Complex Industrial Structures”. The approved contractor’s quality control plan should identify the personnel responsible for painting inspections and should include a detail list of quality control test to be performed. Inspections should include verifying the removal of weld spatter, grinding of sharp edges and removal of grease, oil, dirt and debris, prior to surface preparation. Measurements should be made and recorded for the weather conditions, including air and wet bulb temperature, relative humidity, dew point temperature, surface temperature and wind velocity. Readings should be taken about every four hours, more often if conditions appear to be changing. Weather conditions should be within the limits of specifications and the coating manufacturer’s data sheets. Cleanliness and surface profile should also be verified prior to applying the coating. If compressed air is used, the cleanliness of the compressed air should be verified. Inspections of the coating materials should be performed to verify that the components are mixed properly, proper thinning procedures are being followed and that materials are discarded once the pot life has expired. At the start of the application, the inspector should verify that good coating application techniques are being used. After the coating is applied the wet and dry film thicknesses need to be measured. Finally, adhesion and gloss retention may also be checked.

It is a good idea to have a pre-painting meeting to identify the role and responsibilities of those involved, and to discuss safety measures, contractual details and inspection and measuring requirements.

### **5.8.7 Safety**

The contractor is required to submit a plan for approval that details the measures to be used for protecting the environment, public, adjacent property and workers. The primary source of information for coatings, thinners and abrasive blasting material is the Material Safety Data Sheets (MSDS). The contractor is responsible for ensuring that MSDSs are available for each chemical used on the jobsite and are readily accessible to employees when they are in the work area. Employees should follow the precautions for safe handling and use personal protective and mechanical equipment if required. In addition all containers must be labeled, marked and tagged. The contractor safety plan should also include information about fall protection/fall prevention. Approved fall protection/fall prevention systems should be used during painting operations.

Toxic metals, including lead and chromium, may be found in paints or coatings already in place on bridges. The contractor must follow all OSHA health standards to protect employees working with toxic metals. The contractor must also follow all applicable federal, state and local environmental regulations for the protection of air, soils and water. Waste must be properly stored and disposed. The generator is always the owner, but the

contractor can be named as a co-generator. The generator will provide an EPA identification number, which is obtained from the state or local EPA office. Waste cannot be transported or disposed of without an EPA identification number. Samples of the waste stream must be randomly selected and analyzed to determine the toxicity. When working with hazardous waste, the contractor must monitor the ambient air levels and conduct pre- and post-job sampling and testing of soil and water/sediment, to ensure compliance with regulations.

### **5.8.8 Painting Materials Acceptance**

Painting materials acceptance, as stipulated in the FP, is based on visual inspection and certification. See Section 1.1.2 for definition and certification requirements.

Should there be a need to sample the paint for verification of the certification provided, contact the Division Materials Engineer for guidance in the proper sample size and method to obtain material for testing.

## 5.9 DRILLED SHAFTS

Materials requirements for drilled shafts depend on the method of installation. There are three primary methods of installation. These include:

- Dry method;
- Casing method;
- Wet method.

The dry method is applicable to soil and rock that are above the water table and that will not cave or slump when the hole is drilled to its full depth. The casing and wet methods are applicable to sites where soil conditions are such that caving or excessive soil or rock deformation can occur when a borehole is excavated. With the casing method, a steel pipe is placed at locations of instability. Slurry is sometimes used to temporarily stabilize the hole until the casing is inserted. The pipe is removed during placement of the concrete or remains permanently in-place. With the wet method, water or mineral slurry is used to keep the borehole stable for the entire depth of the excavation. The water or mineral slurry is displaced from the borehole when the concrete is placed. Detail materials specifications are provided in Section 717 and 725 of the FP.

As part of the construction phase of the drilled shaft work, a meeting should be held to discuss various aspects of drilling, constructing and logging of the drilled shaft. A sample drilled shaft meeting agenda is included in Appendix G of this manual.

### 5.9.1 Casings

The FP requires that steel casing that are smooth, clean and watertight be used. The casings should be of sufficient strength to withstand handling and installation stresses and the concrete and surrounding earth pressures. The outside diameter should be no less than the specified size of the shaft. Steel casings need to conform to AASHTO M 103, grade 70-36.

### 5.9.2 Mineral Slurry

Mineral slurry is a mixture of a clay mineral and potable water. Bentonite is most commonly used; however, attapulgite has been used in place of bentonite, usually in saline ground water conditions. Slurries made from synthetic polymers have been used as an alternative to mineral slurries, however, polymer slurries should be approved prior to use.

The bentonite and water need to be mixed outside the borehole and allowed to hydrate for several hours before using. The contractor should properly design and test the mineral slurry to ensure borehole stability. Because the properties of the mineral slurry change during excavation the FP requires that the contractor test and maintain density, viscosity and pH during excavation and until concrete placement. Chemical additives are sometimes used to control these properties. Because of economic and environmental concerns, slurries are typically circulated, conditioned and reused. To maintain the required properties the slurry usually needs to be decanted to remove sand. The FP limits the slurry sand content to less than 4 percent by volume.

### **5.9.3 Integrity Testing**

Integrity testing is performed on drilled shafts using crosshole sonic logging according to ASTM D 6760. The integrity testing is performed to identify any defective zones along the shaft, such as voids or borehole caving. The integrity testing is performed by lowering crosshole sonic logging probes down 2-inch diameter access tubes to measure and record pulse velocity according to ASTM C 597. The access tubes, black steel pipe per ASTM A 53, are installed with the reinforcement cage prior to placing the concrete. Integrity testing may not be required for relatively small diameter or short drilled shafts.

### **5.9.4 Concrete and Reinforcing Steel for Drilled Shafts**

Concrete and reinforcement steel should comply with Sections 552 and 554.

### **5.9.5 Drilled Shaft Materials Acceptance**

Drilled shaft materials acceptance, as stipulated in the FP, is based on visual inspection, certification and measured or tested conformance. The contractor is required to furnish a commercial certification and test results for the mineral slurry. Concrete and reinforcement steel are evaluated under Sections 552 and 554. The contractor is required to submit a detailed crosshole sonic logging report and test data in ASCII format for all production drilled shafts.

### **5.9.6 Drilled Shaft Materials Sampling and Testing**

The contractor must sample and test the mineral slurry during excavation to ensure that the slurry properties stay within the acceptable ranges. Concrete for drilled shafts are required to be sampled and tested according to Section 552. Integrity testing is to be performed on all production drilled shafts according to ASTM D 6760.

## **5.10 ROLES AND RESPONSIBILITIES**

### **5.10.1 Contractor's Responsibilities**

The contractor is responsible for constructing concrete pavements, structures, and various associated components to the requirements provided in the contract. As part of these requirements, the contractor is to control the quality of the materials provided and the construction process to ensure compliance. The contractor's submitted quality control plan should address sampling, testing, and inspection work that will be accomplished to check and validate the quality of workmanship and material components supplied.

There are various established procedures referenced in the specifications for rigid pavements and structures regarding furnishing products and materials. The contractor needs to follow these procedures to ensure that the material components produced or supplied meet the required specifications; and when combined, the resulting mixture meets the contract specifications. Therefore, the responsibilities for quality cover three general areas; individual supplied material (i.e. cement, aggregate, admixtures, steel, etc.), combined material requirements (i.e. concrete mix design, etc.), and finished product (i.e. placement, curing, strength, etc.). As a general list, the requirements of the contractor include:

- Provide an inspection system for processes and materials quality control;
- Submit and follow the written quality control plan detailing the inspection system;
- Monitor processes to ensure materials provided and work accomplished comply with contract requirements;
- Sample materials to be tested according to the proper sampling method;
- Testing and providing aggregate meeting quality requirements;
- Quality control of aggregate during production to ensure continued compliance with the specifications;
- Proper submittal for mix designs;
- Providing material components and split samples to the Government for verification testing, when requested;
- Monitor construction processes and verify on-site quality and consistency with proper testing;
- Provide appropriate documented test results;
- Provide appropriate certifications (either production or commercial) as established in the contract for supplied material;
- Provide consistent delivery methods for construction. (i.e. shotcrete placement, pile driving, drilled shaft construction, etc.)

The contractor needs to provide information and test results according to the timeframes and formats stated in the contract. Distribution of the test reports or certifications should be according to the contract and quality control plan and contain the appropriate information to verify the quality of the material provided.



### **5.10.2 Government's Responsibilities**

The Project Engineer or designated representative will review the test results and certifications for contract compliance. If clarification or additional expertise is required, the Division Materials Engineer should be contacted.

The Project Engineer or designated representative will also be present to witness all required split samples taken for the Government. In addition, samples that are taken and tested solely by the Government for acceptance, such as concrete strength specimens should be identified in some manner to verify the authenticity. Witnessing and proper sample identification are critical in maintain proper custody of the material samples. Any split samples or samples taken for testing and acceptance by the Government should be secured and immediately be placed in Government control. The Project Engineer needs to be aware of the contractor's operations and be available to witness the sampling, splitting, and testing activities.

As a general list, the responsibilities of the Government include:

- Review the quality control plan for completeness;
- Review aggregate quality test result and/or obtain Government samples for testing;
- Review all material data to ensure compliance with the contract requirements;
- Review and approve submitted mix designs;
- Review test methods, equipment, and protocols with contractor testing personnel;
- Ensure pre-work conferences occur and are attended by appropriate personnel;
- Obtain proper product certifications prior to incorporating material into the work;
- Ensure proper sampling and testing methods are used to evaluate materials and quality during construction;
- Verify proper sampling and testing techniques have been employed at the required frequencies;
- Witness on-site testing of concrete to ensure delivered material is in conformance with the contract;
- Monitor construction processes to ensure material and workmanship conform to contract requirements;
- Review batch tickets to ensure proper mix proportioning;
- Coordinate investigative process for any significant non-compliance issue, in particular low compressive strength concrete.

There are numerous resources available to project personnel to assist in the performance of these tasks. Trade organizations such as ACI, ACPA, and PCA provide excellent technical guidelines and documentation that can help project personnel in the execution of their duties. Additionally, the Division Materials Engineer will provide guidance and assistance to the project should the need arise.

## 5.11 FORM REFERENCES

Form references for use in the testing of concrete and associated materials.

- Form FHWA 1600C – Request for Laboratory Tests (CFL)
- Form FHWA 1600E – Requests for Laboratory Tests (EFL)
- Form FHWA 1600W – Requests for Laboratory Tests (WFL)
- Form FHWA 1606 – Minor portland cement concrete mix design trial batch summary
- Form FHWA 1608 – 552 Structural Concrete Mix Design Submittal
- Form FHWA 1621 – Worksheet for sieve analysis of fine and coarse aggregate
- Form FHWA 1627 – Worksheet for sieve analysis of fine and coarse aggregate
- Form FHWA 1638 – Worksheet for determining concrete batch moisture/absorption corrections

# **APPENDIX A**

## **FORMS**

(This page intentionally left blank.)

**FORMS  
TABLE OF CONTENTS**

1600C	Request for Laboratory Test (CFL)
1600E	Request for Laboratory Test (EFL)
1600W	Request for Laboratory Test (WFL)
1606	Minor Portland Cement Concrete Mix Design Trial Batch Summary
1607	Worksheet for a Hveem Mix Design AASHTO T 246
1608	552 Structural Concrete Mix Design Submittal
1611	Worksheet for Determining Bulk Specific Gravity of Compacted Bituminous Mixtures AASHTO T 166 and AASHTO T 269
1612	Worksheet for Reporting Miscellaneous Tests
1616	Worksheet for Determining Moisture Content of Soil and Aggregates using a Microwave Oven AASHTO T 255
1618	Worksheet for In-Place Nuclear / Moisture Density Testing AASHTO T 310
1621	Worksheet for Sieve Analysis of Fine and Coarse Aggregate AASHTO T 11 and AASHTO T 27
1622	Worksheet for a Marshall Mix Design AASHTO T 245
1624	Worksheet for Determining Liquid Limit and Plastic Limit of Soils AASHTO T 89 and AASHTO T 90
1625	Worksheet for Determining Moisture / Density Relationships AASHTO T 99 and AASHTO T 180
1626	Worksheet for Determining Sand Equivalent AASHTO T 176
1627	Worksheet for Sieve Analysis of Fine and Coarse Aggregate AASHTO T 11 and AASHTO T 27
1628	Worksheet for Determining Maximum Specific Gravity of Bituminous Paving Mixtures AASHTO T 209 (Flask Determination)
1629	Worksheet for Determining Maximum Specific Gravity of Bituminous Paving Mixtures AASHTO 209 (Bowl Determination)
1636	Worksheet for Determining Correction for Coarse Particles in the Soil Compaction Test AASHTO T 224

## APPENDIX A: FORMS

---

1637	Construction Project Material Certification
1638	Worksheet for Determining Concrete Batch Moisture / Absorption Corrections
1639	Worksheet for Control of Asphalt Mixes AASHTO T 30, AASHTO T 176, ASHTO T 308, and ASTM D 5821
1640	Worksheet for Ignition Furnace Binder Correction Factor and Aggregate Gradation Correction Factor T 308
1641	Worksheet for Superpave Asphalt Concrete Mix Design AASHTO R 35
1642	Worksheet for Determining Volumetric Properties of Superpave Asphalt Concrete at $N_{des}$ AASHTO T 209, AASHTO T 166, AASHTO T 269, and AASHTO R 35
1643	Materials Register – Item Summary
1644	Materials Register – Sampling & Testing Summary
1645	Materials Register – Visual Inspection
1646	Asphalt Control Strip Worksheet



**REQUEST FOR LABORATORY TESTS**

State: \_\_\_\_\_ Project No.: \_\_\_\_\_ Project name: \_\_\_\_\_  
 Account No.: \_\_\_\_\_  
 Submitted by: \_\_\_\_\_ Phone Number: \_\_\_\_\_ Fax Number: \_\_\_\_\_  
 Field Sample Number: \_\_\_\_\_ Sampled by: \_\_\_\_\_ Date Sampled: \_\_\_\_\_  
 No. & Type Containers: \_\_\_\_\_ Witnessed by: \_\_\_\_\_ Date Shipped: \_\_\_\_\_  
 Quantity represented: \_\_\_\_\_ Intended Use: \_\_\_\_\_  
 Source Name: \_\_\_\_\_ Source Location: \_\_\_\_\_  
 Material Description: \_\_\_\_\_ Contractor/Owner: \_\_\_\_\_  
 Invoice Number: \_\_\_\_\_ Sample Location: \_\_\_\_\_ Item No.: \_\_\_\_\_ Lot No.: \_\_\_\_\_  
 Station: \_\_\_\_\_ Offset: \_\_\_\_\_ Milepost: \_\_\_\_\_ Hole Number: \_\_\_\_\_ Depth: \_\_\_\_\_

List Numbers (1-25) to be Performed and any Special Instructions:	Project Specifications and Field Test Results				Listing of Tests to be Performed (Circle):
	Sieve Size	Specifications	Test Results	Target Values	
	37.5 mm (1 1/2")				Routine Identification of Soil or Aggregate: 1, 2, 3 Complete Soil Evaluation: 1, 2, 3, 4, 5 or 6 Preliminary Aggregate Source Evaluation: 1, 2, 6, 7, 8, 9, 11, 19 Complete Concrete Aggregate Source Evaluation: 1, 2, 8, 9, 11, 12, 13, 14, 15, 19  1. Sieve Analysis (AASHTO T 11 & T 27) 2. Liquid and Plastic Limit (AASHTO T 89 & T 90) 3. Classification (AASHTO M 145 & ASTM D 2487) 4. R-Value (AASHTO T 190) 5. Compaction (AASHTO T 99, Method C) 6. Compaction (AASHTO T 180, Method D) 7. Fractured Faces (ASTM D 5821) 8. Los Angeles Abrasion (AASHTO T 96) 9. Sodium Sulfate Soundness (AASHTO T 104) 10. Durability Index (AASHTO T 210) 11. Adherent Fines (ASTM D 5711) 12. Specific Gravity, Absorption of Coarse Aggregate (AASHTO T 85) 13. Specific Gravity, Absorption of Fine Aggregate (AASHTO T 84) 14. Organic Impurities (AASHTO T 21) 15. Unit Weight (AASHTO T 19) 16. Resistivity (AASHTO T 288) 17. pH (AASHTO T 289) 18. Asphalt Binder Tests 19. Sand Equivalent (AASHTO T 176) 20. Unconfined Compression of Soil (AASHTO T 208) 21. Concrete Cylinder Compressive Strength (AASHTO T 22) 22. Asphalt Content and Sieve Analysis (AASHTO T 308 & T 30) 23. Asphalt Concrete Core Density (AASHTO T 166) 24. Asphalt Concrete Mix Design 25. Other Testing, Specify at Left Under "Special Instructions"
	25.0 mm (1")				
	19.0 mm (3/4")				
	12.5 mm (1/2")				
	9.5 mm (3/8")				
	4.75 mm (# 4)				
	2.36 mm (# 8)				
	2.00 mm (# 10)				
	1.18 mm (# 16)				
	600 μm (# 30)				
	425 μm (# 40)				
	300 μm (# 50)				
<b>Portland Cement Concrete Data</b>					
Air Content (%):	150 μm (# 100)				
Slump:	75 μm (# 200)				
Break Date:	Liquid Limit				
Age (Days):	Plasticity Index				
<b>Specified Strength</b>					
Min. @ Days	Asphalt Content				

**INSTRUCTIONS FOR SUBMITTING SAMPLE**

1. Fill out the transmittal completely, (use "NK" for not known).
2. Make three copies of the transmittal.
3. Place the first transmittal inside a waterproof envelope and place inside the container.
4. Place a second transmittal in a waterproof envelope and attach to the outside of container.
5. Fax the third transmittal directly to the Laboratory Manager (720-963-3545).
6. Keep the original copy of the transmittal for your records.

(This page intentionally left blank.)





### REQUEST FOR LABORATORY TESTS

Project No.: \_\_\_\_\_ Project name: \_\_\_\_\_  
 Account No.: \_\_\_\_\_ State: \_\_\_\_\_ County: \_\_\_\_\_

Submitted by: \_\_\_\_\_ Address: \_\_\_\_\_  
 Phone Number: \_\_\_\_\_  
 Fax Number: \_\_\_\_\_

Field sample number: \_\_\_\_\_ QL-PAY No.: \_\_\_\_\_ Lot No: \_\_\_\_\_  
 Sampled by: \_\_\_\_\_ Date sampled: \_\_\_\_\_  
 Number & type containers: \_\_\_\_\_ Witnessed by: \_\_\_\_\_ Date shipped: \_\_\_\_\_  
 Quantity represented: \_\_\_\_\_ Intended use: \_\_\_\_\_  
 Sample type (Acceptance, PC, IAS, CVS, etc.): \_\_\_\_\_ Date results needed: \_\_\_\_\_

Source name: \_\_\_\_\_ Source No.: \_\_\_\_\_  
 Source location: \_\_\_\_\_

Item No.: \_\_\_\_\_ Material description: \_\_\_\_\_  
 Sample location: \_\_\_\_\_  
 Station: \_\_\_\_\_ Offset: \_\_\_\_\_ Milepost: \_\_\_\_\_ Depth: \_\_\_\_\_

List Tests To Be Performed: <small>(See Reverse For Tests)</small>	Project Specifications and Field Test Results				Special Instructions: <small>(Continue On Reverse)</small>
	Parameters/Sieves	Target Value Range	Specification Range <sup>1</sup>	Test Result	
	1½ -inch (37.5 mm)				
	1-inch (25.0 mm)				
	¾-inch (19.0 mm)				
	½-inch (12.5 mm)				
	⅜-inch (9.5 mm)				
	No. 4 (4.75 mm)				
	No. 8 (2.36 mm)				
	No. 10 (2.00 mm)				
	No. 16 (1.18 mm)				
	No. 30 (600 µm)				
	No. 40 (425 µm)				
	No. 50 (300 µm)				
	No. 100 (150 µm)				
	No. 200 (75 µm)				
	Moisture-Density				
	Liquid Limit				
	PI				
	Sand Equivalent				
	Fractured Faces				
	Asphalt Content				
	Density				
	Flat & Elongated				
	Concrete Strength				
					<b>Portland Cement Concrete Data</b>
					Air Content (%): _____ Slump: _____
					Break Age In Days (7, 14, 28, other): _____

<sup>1</sup>The specification range may be the allowable deviation (±) from the target value.

## INSTRUCTIONS FOR SUBMITTING SAMPLE

1. Completely fill out the transmittal form (use "NK" for not known) and make three copies.
2. Place one copy in a waterproof envelope, addressed to the Laboratory, and attach to the outside of the container.
3. Place the second copy of the transmittal inside a waterproof envelope and inside the container, if possible.
4. Mail or fax the third copy of the transmittal directly to the Laboratory.
5. Retain the original transmittal form for your records.

### LISTING OF TESTS TO BE PERFORMED (Check tests or list on page 1)

TESTS FOR SOILS	
<input type="checkbox"/> Soil Source Verification	<input type="checkbox"/> Soil Production Verification
<input type="checkbox"/> AASHTO T 88(a) – Particle Size (w/ hydro)	<input type="checkbox"/> AASHTO T 88(b) – Particle Size (w/o hydro)
<input type="checkbox"/> AASHTO T 89 – Liquid Limit	<input type="checkbox"/> AASHTO T 90 – Plastic Limit and Plasticity Index
<input type="checkbox"/> AASHTO T 99 – Standard Proctor	<input type="checkbox"/> AASHTO T 100 – Specific Gravity
<input type="checkbox"/> AASHTO T 180 – Modified Proctor	<input type="checkbox"/> AASHTO T 193 – CBR
<input type="checkbox"/> AASHTO T 265 – Moisture Content	<input type="checkbox"/> AASHTO M 145 – Classification

TESTS FOR AGGREGATE COURSES	
<input type="checkbox"/> Aggregate Course Source Verification	<input type="checkbox"/> Aggregate Course Production Verification
<input type="checkbox"/> AASHTO T 11 – Wash #200	<input type="checkbox"/> AASHTO T 27 – Sieve Analysis
<input type="checkbox"/> AASHTO T 84 – SG and Absorption (Fine)	<input type="checkbox"/> AASHTO T 85 – SG and Absorption (Coarse)
<input type="checkbox"/> AASHTO T 89 – Liquid Limit	<input type="checkbox"/> AASHTO T 90 – Plastic Limit and Plasticity Index
<input type="checkbox"/> AASHTO T 96 – LA Abrasion	<input type="checkbox"/> AASHTO T 99 – Standard Proctor
<input type="checkbox"/> AASHTO T 104 – Soundness by Sodium Sulfate	<input type="checkbox"/> AASHTO T 180 – Modified Proctor
<input type="checkbox"/> AASHTO T 193 – CBR	<input type="checkbox"/> ASTM D 5821 – Fractured Faces

TESTS FOR ASPHALT PAVEMENT AND SURFACE TREATMENTS	
<input type="checkbox"/> Asphalt Pavement Aggregate Source Verification	<input type="checkbox"/> Surface Treatment Aggr. Production Verification
<input type="checkbox"/> Surface Treatment Aggregate Source Verification	<input type="checkbox"/> Superpave HACP Production Verification
<input type="checkbox"/> Superpave HACP Mix Design Verification	<input type="checkbox"/> Marshall HACP Production Verification
<input type="checkbox"/> Marshall HACP Mix Design Verification	<input type="checkbox"/> PG Binder Verification
<input type="checkbox"/> PG Binder Identification	<input type="checkbox"/> Emulsified Asphalt Production Verification
<input type="checkbox"/> Emulsified Asphalt Source Verification	
<input type="checkbox"/> AASHTO T 11 – Wash #200	<input type="checkbox"/> AASHTO T 27 – Sieve Analysis
<input type="checkbox"/> AASHTO T 30 – Sieve Analysis of Extracted Aggr.	<input type="checkbox"/> AASHTO T 84 – SG and Absorption (Fine)
<input type="checkbox"/> AASHTO T 85 – SG and Absorption (Coarse)	<input type="checkbox"/> AASHTO T 96 – LA Abrasion
<input type="checkbox"/> AASHTO T 104 – Soundness by Sodium Sulfate	<input type="checkbox"/> AASHTO T 166 – Bulk Specific Gravity
<input type="checkbox"/> AASHTO T 176 – Sand Equivalent	<input type="checkbox"/> AASHTO T 209 – Max. Specific Gravity
<input type="checkbox"/> AASHTO T 283 – TSR	<input type="checkbox"/> AASHTO T 304 – Uncompacted Void Content
<input type="checkbox"/> AASHTO T 308 – Binder Content	<input type="checkbox"/> ASTM D 4791 – Flat and Elongated Particles
<input type="checkbox"/> ASTM D 5821 – Fractured Faces	

TESTS FOR CONCRETE	
<input type="checkbox"/> Concrete Aggregate Source Verification	<input type="checkbox"/> Concrete Aggregate Production Verification
<input type="checkbox"/> Concrete Mix Design Verification	
<input type="checkbox"/> AASHTO T 11 – Wash #200	<input type="checkbox"/> AASHTO T 19 – Bulk Density
<input type="checkbox"/> AASHTO T 21 – Organic Impurities	<input type="checkbox"/> AASHTO T 27 – Sieve Analysis
<input type="checkbox"/> AASHTO T 22 – Compressive Strength	<input type="checkbox"/> AASHTO T 84 – SG and Absorption (Fine)
<input type="checkbox"/> AASHTO T 85 – SG and Absorption (Coarse)	<input type="checkbox"/> AASHTO T 255 – Moisture Content
<input type="checkbox"/> AASHTO T277 – Chloride Penetration	

Note: For tests not listed, contact the EFLHD Laboratory.

### Special Instructions (continued):



## REQUEST FOR LABORATORY TESTS

Project No.: \_\_\_\_\_ Project name: \_\_\_\_\_  
 Account No.: \_\_\_\_\_ State: \_\_\_\_\_ County: \_\_\_\_\_

Submitted by: \_\_\_\_\_ Address: \_\_\_\_\_  
 Phone Number: \_\_\_\_\_  
 Fax Number: \_\_\_\_\_

Field sample number: \_\_\_\_\_ QL-PAY No.: \_\_\_\_\_ Lot No: \_\_\_\_\_  
 Sampled by: \_\_\_\_\_ Date sampled: \_\_\_\_\_  
 Number & type containers: \_\_\_\_\_ Witnessed by: \_\_\_\_\_ Date shipped: \_\_\_\_\_  
 Quantity represented: \_\_\_\_\_ Intended use: \_\_\_\_\_  
 Sample type (Acceptance, PC, IAS, CVS, etc.): \_\_\_\_\_ Date results needed: \_\_\_\_\_

Source name: \_\_\_\_\_ Source No.: \_\_\_\_\_  
 Source location: \_\_\_\_\_

Item No.: \_\_\_\_\_ Material description: \_\_\_\_\_  
 Sample location: \_\_\_\_\_  
 Station: \_\_\_\_\_ Offset: \_\_\_\_\_ Milepost: \_\_\_\_\_ Depth: \_\_\_\_\_

<b>List Tests To Be Performed:</b> <small>(See Reverse For Tests)</small>	<b>Project Specifications and Field Test Results</b>				<b>Special Instructions:</b> <small>(Continue On Reverse)</small>
	Parameters/Sieves	Target Value Range	Specification Range <sup>1</sup>	Test Result	
	1½ -inch (37.5 mm)				
	1-inch (25.0 mm)				
	¾-inch (19.0 mm)				
	½-inch (12.5 mm)				
	⅜-inch (9.5 mm)				
	No. 4 (4.75 mm)				
	No. 8 (2.36 mm)				
	No. 10 (2.00 mm)				
	No. 16 (1.18 mm)				
	No. 30 (600 µm)				
	No. 40 (425 µm)				
	No. 50 (300 µm)				
	No. 100 (150 µm)				
	No. 200 (75 µm)				
	Moisture-Density				
	Liquid Limit				
	PI				
	Sand Equivalent				
	Fractured Faces				
	Asphalt Content				
	Density				
	Flat & Elongated				
	Concrete Strength				
					<b>Portland Cement Concrete Data</b>
					Air Content (%): _____ Slump: _____
					Break Age In Days (7, 14, 28, other): _____

<sup>1</sup>The specification range may be the allowable deviation (±) from the target value.

## INSTRUCTIONS FOR SUBMITTING SAMPLE

1. Fill out the transmittal completely, (use "NK" for not known).
2. Make three copies of the transmittal.
3. Place the first transmittal inside a waterproof envelope and place inside the container.
4. Place a second transmittal in a waterproof envelope and attach to the outside of container.
5. Address the envelope to the Laboratory.
6. Mail the third transmittal directly to the Laboratory.
7. Keep the original copy of the transmittal for your records.

**NOTE: For tests not listed below, contact the Central laboratory.**

<p><b>TESTS ON SUBBASE, BASE, &amp; SURFACING AGGREGATES:</b></p> <p>AG-PG Complete Preliminary Testing On Gravel. AG-1 to 10, 12 &amp; 13</p> <p>AG-PQ Complete Preliminary Testing On Quarries. AG-4 to 10, 12 &amp; 13</p> <p>AG-EV Base or Subbase Evaluation. AG-1 to 6 &amp; 16</p> <p>AG-1 Sieve Analysis as received. AASHTO T 11 &amp; T 27            AG-2 Plasticity Index as received. AASHTO T 89 &amp; T 90            AG-3 SE as received, Referee Method. AASHTO T 176            AG-4 Durability. AASHTO T 210            AG-5 Apparent Specific Gravity, Fine &amp; Coarse.            AG-6 Los Angeles Abrasion. AASHTO T 96            AG-7 Fine Aggregate Angularity            AG-8 Soundness by Sodium Sulfate. AASHTO T 104            AG-9 Accelerated Weathering, EG &amp; DMSO            AG-10 Immersion Compression. AASHTO T 165            AG-11 Cement Treated Base, Mix Design.            AG-12 Plasticity Index, Lab Manufactured. AASHTO T 89 &amp; T 90            AG-13 SE, Lab Manufactured, Referee Method. AASHTO T 176            AG-14 Specific Gravity, Coarse. AASHTO T 85            AG-15 Specific Gravity, Fine. AASHTO T 84            AG-16 R-Value, 300 PSI Exudation. AASHTO T 190            AG-17 Humphre's Granular Compaction.            AG-18 Fractured Faces. FLH T 507            AG-19 Unit Weight. AASHTO T 19            AG-20 Flat and Elongated Particles</p>	<p><b>TESTS ON SOILS:</b></p> <p>SO-PS Complete Preliminary Testing Soils. SO-1 to 5</p> <p>SO-RI Routine Identification of Soils. SO-1 &amp; 2</p> <p>SO-1 Mechanical Analysis to 0.02 mm. AASHTO T 88            SO-2 Plasticity Index. AASHTO T 89 &amp; T 90            SO-3 Specific Gravity. AASHTO T 100            SO-4 R-Value, 300 PSI Exudation. AASHTO T 190            SO-5 AASHTO Structural Design, Flexible            SO-6 Complete Hydrometer. AASHTO T 88            SO-7 Natural Moisture Content. AASHTO T 265            SO-8 Moisture Density. AASHTO T 99            SO-9 Moisture Density. AASHTO T 180            SO-10 SE, Referee Method. AASHTO T 176            SO-11 Unconfined Compression.            SO-12 Ignition Loss.            SO-13 Triaxial "Q" Test.            SO-14 Triaxial "R" Test.            SO-15 Triaxial "S" Test.            SO-16 Permeability Constant Head.            SO-17 Permeability Variable Head.            SO-18 Shrinkage Limit. AASHTO T 92            SO-19 Consolidation.            SO-20 Additive Stabilization, Specify Type.            SO-21 California Bearing Ratio. AASHTO T 193            SO-22 PH of Soil. AASHTO T 289            SO-23 Zinc Coating, Iron or Steel. AASHTO T 65</p>
<p><b>TESTS ON CONCRETE AGGREGATES AND CONCRETE:</b></p> <p>CO-1 Sieve Analysis. AASHTO T 11 &amp; T 27            CO-2 Sand Equivalent. AASHTO T 176            CO-3 Los Angeles Abrasion. AASHTO T 96            CO-4 Soundness by Sodium Sulfate. AASHTO T 104            CO-5 Specific Gravity, Coarse &amp; Fine. AASHTO T 85 &amp; T 84            CO-6 Unit Weight. AASHTO T 19            CO-7 Organic Impurities. AASHTO T 21            CO-8 Clay Lumps. AASHTO T 112            CO-9 Lightweight Pieces. AASHTO T 113            CO-10 Mortar Strength. AASHTO T 71            CO-11 Compressive Strength, Cylinders. AASHTO T 22</p>	<p><b>TESTS ON BITUMINOUS MATERIALS:</b></p> <p>AC-MD Hot Mix Design, Consult w/ Laboratory.            AC-IC Preliminary Immersion Compression            AB-CC Complete Classification of Liquid Asphalt            AB-VG Verification of Liquid Asphalt Grading            AB-RI Routine Identification of Liquid Asphalt            AB-EA Tests on Emulsified Asphalts</p> <p>AC-1 Dispose of Unneeded Backup Samples            AC-2 Bulk SG &amp; Air Voids. AASHTO T 166            AC-3 Sieve Analysis. AASHTO T 30            AC-4 Immersion Compression. AASHTO T 165            AC-5 Asphalt Content, specify Ignition or            Extraction            AC-6 Resilient Modulus.            AC-7 CKE, Hveem. AASHTO T 270</p>

**Special Instructions (continued):**

## MINOR PORTLAND CEMENT CONCRETE MIX DESIGN TRIAL BATCH SUMMARY

---

Project: \_\_\_\_\_ Date: \_\_\_\_\_  
 Contractor: \_\_\_\_\_ Concrete for: \_\_\_\_\_  
 Concrete producer: \_\_\_\_\_  
 Mix designation: \_\_\_\_\_

---

English      Metric

### MIX PROPERTIES

Compressive strength (28 day) \_\_\_\_\_  
 Slump \_\_\_\_\_  
 Air content \_\_\_\_\_ percent  
 Water/cement ratio<sup>1</sup> \_\_\_\_\_

### PROPORTIONS

Material	Specific Gravity (SSD)	SSD Mass	Absolute Volume	Admixtures	Dosage
Cement	3.15			Air entrainment	
Water	1.00			Water reducer	
Coarse aggregate				Retarder	
Fine aggregate				Color	
Total air				Accelerator	
Other				Other	

Totals: \_\_\_\_\_

<sup>1</sup> The ratio of the mass of water, exclusive only of that absorbed by the aggregate, to the combined mass of cementitious material (i.e. cement, fly ash, silica fume, and ground granulated blast furnace slag (GGBFS)).

(This page intentionally left blank.)

## WORKSHEET FOR A HVEEM MIX DESIGN AASHTO T 246

Project:	Date:
Contractor:	Class & Grading of mixture:
Asphalt supplier:	Grade of asphalt:
Sources for:   Aggregates:	Mineral filler:
Testing laboratory name:	Phone:
Testing performed by:	
Testing reported by:	

English      Metric

### SUMMARY OF THE PROPOSED JOB-MIX-FORMULA

- |  |   |
|--|---|
| <ol style="list-style-type: none"> <li>1. Percent asphalt by mass of total mix<sup>1</sup>, (P<sub>b</sub>)</li> <li>2. Air voids (V<sub>a</sub>)</li> <li>3. Voids in mineral aggregate (VMA)</li> <li>4. Maximum specific gravity (G<sub>mm</sub>)</li> <li>5. Recommended plant mixing temperature,<br/>(Attach Temperature Viscosity Curve)</li> <li>6. Effective specific gravity of aggregate (G<sub>se</sub>)</li> <li>7. Stabilometer value</li> </ol> | <ol style="list-style-type: none"> <li>8. Specific gravity of binder (G<sub>b</sub>)</li> <li>9. Specific gravity of mineral filler</li> <li>10. Dust-to-Binder ratio (DP)</li> <li>11. Moisture susceptibility test results: <sup>2</sup> <ol style="list-style-type: none"> <li>a. Dry strength,</li> <li>b. Wet strength,</li> <li>c. Index of retained strength, %</li> </ol> </li> </ol> |
|--|---|

**Gradation Designation:**

GRADATION TARGET VALUES AND ALLOWABLE DEVIATIONS				SPECIFIC GRAVITY AND ABSORPTION		
Sieve Sizes	Job Mix Formula Target Value <sup>3</sup>	Target Value Specification Range %	Allowable Deviation <sup>4</sup> %	Fine Aggregate (AASHTO T 84)	Coarse Aggregate (AASHTO T 85)	Combined Aggregate
				Bulk SG (G <sub>sb</sub> )		
				Bulk SSD SG		
				Apparent SG (G <sub>sa</sub> )		
				Absorption	%	%

<sup>1</sup> Establish asphalt cement content (percent by mass of mix) to the nearest 0.01 percent.  
<sup>2</sup> See contract for moisture susceptibility test method: AASTHO T 165/T 167 or AASTHO T 283.  
<sup>3</sup> Establish target values to the nearest 0.1 percent as a part of the job mix formula.  
<sup>4</sup> Allowable deviations plus or minus from established target values.

**WORKSHEET FOR A HVEEM MIX DESIGN** (Continued)

Material Stockpile	Stockpile Description	Blend Ratio
A		%
B		%
C		%
D		%
E		%
	<b>Total</b>	%

**Stockpile Gradation**

Sieve Size	Stockpile A %	Stockpile B %	Stockpile C %	Stockpile D %	Stockpile E %	Blended Stockpile Gradation	Job Mix Formula Target Values	Specification Limits

**Aggregate Properties**

Property	Result	Specification	Property	Result	Specification
LA Abrasion, % - Grading AASHTO T 96			Fractured Faces, % - ASTM D 5821		
Sodium Sulfate Soundness, % AASHTO T 104			Sand Equivalent AASHTO T 176, Alt method #2, reference method		
Durability index (Coarse) AASHTO T 210			Other:		
Durability index (Fine) AASHTO T 210			Other:		





# WORKSHEET FOR A HVEEM MIX DESIGN (Continued)

## Design Curves for Proposed Job Mix Formula (JMF)

**AIR VOIDS ( $V_a$ )**

**UNIT MASS**

% Air voids ( $V_a$ )

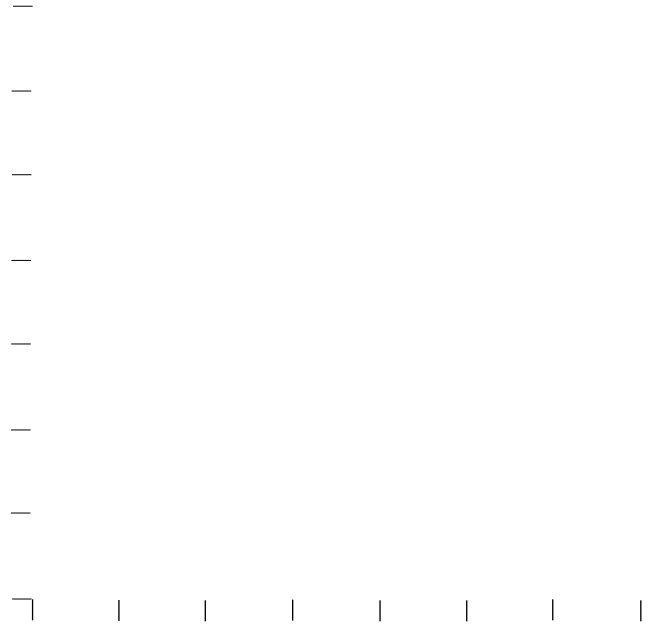
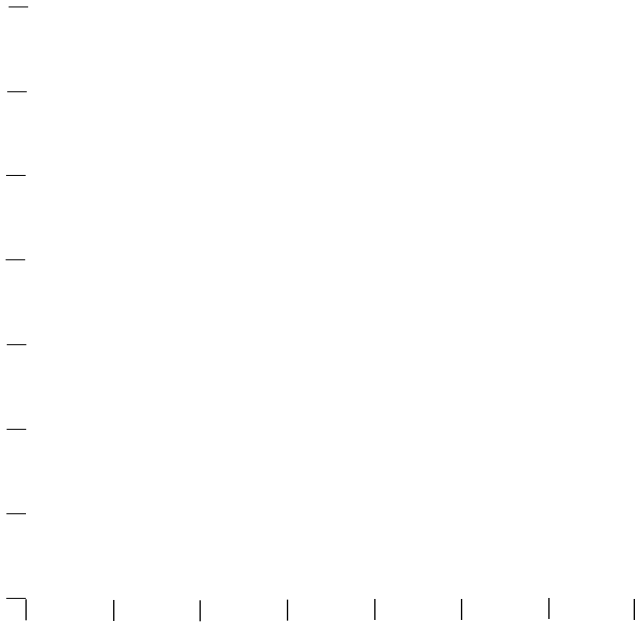

% Asphalt binder ( $P_b$ )

% Asphalt binder ( $P_b$ )

**S-VALUE**

**VMA**

Stabilometer values

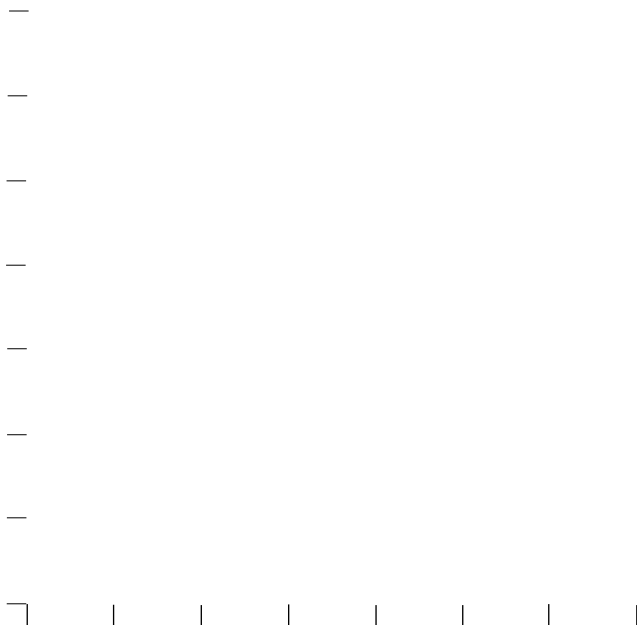

Voids in mineral aggregate

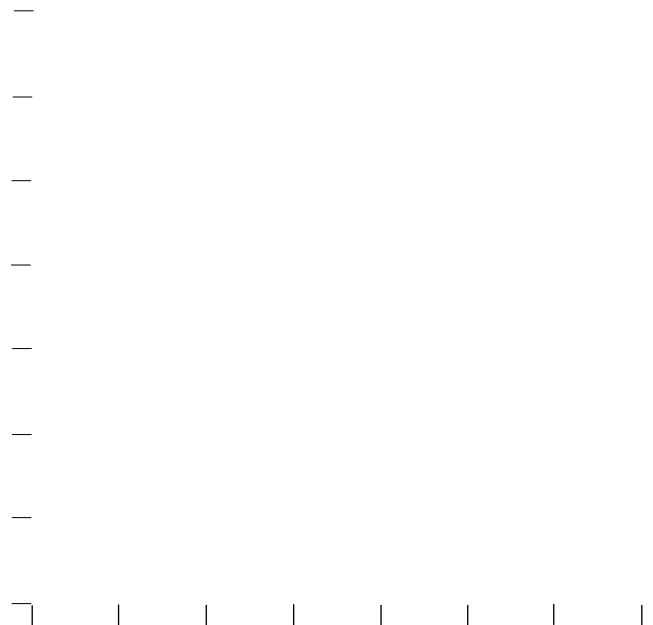

% Asphalt binder ( $P_b$ )

% Asphalt binder ( $P_b$ )

## 552 STRUCTURAL CONCRETE MIX DESIGN SUBMITTAL

---

Project: \_\_\_\_\_ Date: \_\_\_\_\_  
 Contractor: \_\_\_\_\_ Concrete for: \_\_\_\_\_ Concrete producer: \_\_\_\_\_  
 Class of concrete: \_\_\_\_\_ Exposure Class: \_\_\_\_\_ Producer Mix designation: \_\_\_\_\_

---

METRIC     ENGLISH

### SPECIFIED CONCRETE COMPRESSIVE STRENGTH (@ 28 Days)..... (f'c)

Required average concrete compressive strength used for mixture proportion selection<sup>1</sup> (f'cr)

---

### MIXTURE PROPORTIONS

Material	Specific Gravity	Mass	Absolute Volume	Tolerance % (±)	Admixtures	Dosage
Cement (Portland or Blended)				1	Air entraining	
Fly Ash (Class F or C)				1	Type A (Water Reducer -WR)	
Water				1	Type B (Set Retarder - SR)	
Coarse aggregate (SSD)				2	Type C (Set Accelerator - SA)	
Fine aggregate (SSD)				2	Type D (WR & SR)	
Fibers				3	Type E (WR & SA)	
Color Pigments				3	Type F (High Range WR)	
Other					Type G (High Range WR & SR)	
Total air					Hydration Stabilizer (B or D)	
Totals					Other	

### FRESH CONCRETE PROPERTIES

Water/cementitious materials ratio (by mass)<sup>2</sup> \_\_\_\_\_ Theoretical unit mass: \_\_\_\_\_  
 Measured unit mass (AASHTO T 121): \_\_\_\_\_ Measured air content (AASHTO T 152 or T 196): \_\_\_\_\_ %  
 Concrete Temperature (AASHTO T 309): \_\_\_\_\_ Measured slump (AASHTO T 119): \_\_\_\_\_

### HARDENED CONCRETE PROPERTIES

Average 28-day strength designated in specifications, \_\_\_\_\_ : \_\_\_\_\_ Average 7-day strength, \_\_\_\_\_ : \_\_\_\_\_  
 If the concrete is subjected to elevated temperature curing, note the maximum curing temperature: \_\_\_\_\_  
 Water-soluble chloride-ion (Cl<sup>-</sup>) in hardened concrete by weight of cement: \_\_\_\_\_ %<sup>3</sup>

Signature \_\_\_\_\_ Print Name \_\_\_\_\_ Date \_\_\_\_\_

---

<sup>1</sup> Design in accordance with FP and specified ACI standards found in the contract.

<sup>2</sup> The ratio of the mass of water, exclusive only of that absorbed by the aggregate, to the combined mass of cementitious materials (i.e. cement, fly ash, silica fume and ground granulated blast furnace slag (GGBFS)).

<sup>3</sup> Provide for reinforced and prestressed concrete when required in accordance with contract specifications.

**552 STRUCTURAL CONCRETE MIX DESIGN SUBMITTAL (Continued)**

**CEMENT (AASHTO M 85 – TYPES I, IA, II, IIA, III, IIIA or V OR AASHTO M 240 – TYPES I(PM), IP, P, I(SM) or IS) <sup>4</sup>**

Certification attached :  Yes  No

**FLY ASH (AASHTO M 295 – CLASS C or F) <sup>4</sup>**

Certification attached :  Yes  No

**SILICA FUME (AASHTO M 307 – RAW, SLURRIED OR DENSIFIED) <sup>4</sup>**

Certification attached :  Yes  No

**GROUND GRANULATED BLAST FURNACE SLAG (GGBFS) (AASHTO M 302 – GRADE 100 or 120) <sup>4</sup>**

Certification attached :  Yes  No

**WATER (AASHTO M 157 AND AASHTO T 26)**

Reclaimed water or water of questionable quality will be used?  Yes  No

Will water be added at the discharge site?  Yes  No If yes, how much?

**CHEMICAL, COLOR PIGMENTS, FIBERS AND OTHER ADMIXTURES<sup>4</sup>**

<b>Admixture Type <sup>5</sup></b>	<b>Point Admixture Added <sup>6</sup></b>	<b>Certification Attached</b>
Air entraining (AASHTO M 154)		<input type="checkbox"/> Yes <input type="checkbox"/> No
Type A – Water reducing		<input type="checkbox"/> Yes <input type="checkbox"/> No
Type B – Set Retarding (AASHTO M 194)		<input type="checkbox"/> Yes <input type="checkbox"/> No
Type C – Set Accelerating (AASHTO M 194)		<input type="checkbox"/> Yes <input type="checkbox"/> No
Type D – Water Reducing and Set Retarding (AASHTO M 194)		<input type="checkbox"/> Yes <input type="checkbox"/> No
Type E – Water Reducing and Set Accelerating (AASHTO M 194)		<input type="checkbox"/> Yes <input type="checkbox"/> No
Type F – High Range Water Reducing (AASHTO M 194)		<input type="checkbox"/> Yes <input type="checkbox"/> No
Type G – High Range Water Reducing and Set Retarding (AASHTO M 194)		<input type="checkbox"/> Yes <input type="checkbox"/> No
Type B – Hydration Stabilizing (AASHTO M 194)                    hours		<input type="checkbox"/> Yes <input type="checkbox"/> No
Type D – Hydration Stabilizing (AASHTO M 194)                    hours		<input type="checkbox"/> Yes <input type="checkbox"/> No
Color Pigments (ASTM C 979)		<input type="checkbox"/> Yes <input type="checkbox"/> No
Fibers (ASTM C 1116) Type:		<input type="checkbox"/> Yes <input type="checkbox"/> No
Other		<input type="checkbox"/> Yes <input type="checkbox"/> No

<sup>4</sup> Certifications documentation is required prior to approval of a mix design.

<sup>5</sup> Admixtures must be compatible and of the same type as those used in the mixtures from which strength data were obtained. Do not use chloride accelerators. Do not use set accelerating admixtures with Class P (Prestressed Concrete).

<sup>6</sup> Each point where admixture is added must be noted (i.e. concrete batching facilities, project site, etc) as well as the corresponding dosage.

**552 STRUCTURAL CONCRETE MIX DESIGN SUBMITTAL (Continued)**

**FINE AGGREGATE (FP SECTION 703.01 AND AASHTO M 6, CLASS B)**

Name and phone number of fine aggregate supplier/producer:

Location of material source:

Material type: Manufactured sand  % Natural sand  % Blend  %

Sieve Analysis: (AASHTO T 27)			Property	Specification	Specification	Value
Sieve Size	% Passing (P)	Cumulative % Retained (CPR)	(1) Clay lumps and friable particles	AASHTO T 112	3.0% max	
	(Specification)					
	(100)		(2) Coal and lignite	AASHTO T 113	1.0% max	
	(95-100)		(3) Minus	AASHTO T 11	3.0% max	
	(80-100)		(4) Organic Impurities	AASHTO T 21	Color not darker than standard	<input type="checkbox"/> Yes <input type="checkbox"/> No
	(50-85)		(5) Sodium sulfate soundness, 5 cycles	AASHTO T 104	10% max	
	(25-60)		(6) Sand Equivalent. Alt method 2, referee method	AASHTO T 176	75% min	
	(10-30)		(7) Bulk specific gravity	AASHTO T 84		
	(2-10)		(8) Bulk SSD specific gravity	AASHTO T 84		
Fineness modulus ( $\sum \text{CPR}/100$ )			(9) Absorption	AASHTO T 84		
			(10) Alkali Silica Reactivity <sup>7</sup>			

**COARSE AGGREGATE (FP SECTION 703.02 AND AASHTO M 80, CLASS A)**

Name and phone number of coarse aggregate supplier/producer:

Grading number (AASHTO M43)

Location of material source:

Material type:

Sieve Analysis: (AASHTO T 27)			Property	Specification	Specification	Value
Sieve Size	Percent Passing	AASHTO M 43 Specification <sup>4</sup>	(1) Clay lumps and friable particles	AASHTO T 112	2.0% max	
			(2) Deleterious chert	AASHTO T 113	3.0% max	
			(3) $\sum (1) + (2)$	AASHTO T 112 & T 113	3.0% max	
			(4) Minus	AASHTO T 11	1.0 or 1.5% max	
			(5) Coal and lignite	AASHTO T 113	0.5% max	
			(6) LA abrasion Grading _____	AASHTO T 96	40% max	
			(7) Sodium sulfate soundness, 5 cycles	AASHTO T 104	12% max	
			(8) Adherent coating	ASTM D 5711	1.0% max	
			(9) Dry rodded unit mass	AASHTO T 19		
			(10) Mass of insoluble residue (bridge decks or surface courses)	ASTM D 3042	25% min	
			(11) Bulk specific gravity	AASHTO T 85		
			(12) Bulk SSD specific gravity	AASHTO T 85		
			(13) Absorption	AASHTO T 85		
			(14) Alkali Silica Reactivity <sup>7</sup>	<u>A/N</u>		

<sup>7</sup> See specific contract requirements for ASR test methods and limits..

**552 STRUCTURAL CONCRETE MIX DESIGN (Continued)**  
**DATA FOR COMPUTING THE STANDARD DEVIATION**

Cylinder Size: \_\_\_\_\_ or \_\_\_\_\_  
 1 Test Record<sup>8</sup> or 2 Test Records

Consecutive Strength Test	Date Batched <sup>8</sup>	Compressive Strength - at 28 days			
		Cylinder 1	Cylinder 2		Strength Test X <sub>i</sub> <sup>9</sup>
1					
2					
3					
4					
5					
6					
7					
8					
9					
10					
11					
12					
13					
14					
15					
16					
17					
18					
19					
20					
21					
22					
23					
24					
25					
26					
27					
28					
29					
30					

$$\bar{X} = \frac{\sum X_i}{n} = \frac{\quad}{\quad} = \underline{\quad}$$

**For One Test Record:**

$$s_s = \sqrt{\frac{\sum (X_i - \bar{X})^2}{(n - 1)}} = \underline{\quad}$$

**For Two Test Records:**

$$\bar{s}_s = \sqrt{\frac{(n_1 - 1)(s_{s1})^2 + (n_2 - 1)(s_{s2})^2}{(n_1 + n_2 - 2)}} = \underline{\quad}$$

**Where:**

$\bar{X}$  = average of n strength test results    n = number of consecutive strength tests     $s_{s1}, s_{s2}$  = sample standard deviations (1 & 2)  
 $X_i$  = individual strength tests     $s_s$  = sample standard deviation,     $n_1, n_2$  = number of tests in each test record  
 $\bar{s}_s$  = statistical average standard deviation where two test records are used to estimate the sample standard deviation.

<sup>8</sup> The test records must be no more than 12 months old and consist of at least 30 consecutive tests or two groups of consecutive tests totaling at least 30 tests. If 15 to 29 consecutive test records are provided, they must represent a single record of consecutive tests that span a period of not less than 45 calendar days. All test records must also represent materials, quality control procedures and conditions similar to those expected and changes in materials and proportions within the test records must not have been more restricted than those for proposed work. In addition, they must represent concrete produced to meet a specified strength or strengths within \_\_\_\_\_ of f'c.

<sup>9</sup> A strength test shall be the average of at least two 6 by 12-inch cylinders or at least three 4 by 8-inch cylinders made from the same sample of concrete and tested at 28 days or at test age designated in the specification for f'c.

**552 STRUCTURAL CONCRETE MIX DESIGN SUBMITTAL (Continued)**  
**DETERMINATION OF REQUIRED AVERAGE COMPRESSIVE STRENGTH**

**REQUIRED AVERAGE COMPRESSIVE STRENGTH ( $f_{cr}$ )<sup>10</sup>**

**Case 1 – Required Average Compressive Strength with Test Records of 30 or More Consecutive Tests:**

Table 1	
Specified Compressive Strength, $f'_c$ ,	Required Average Compressive Strength* $f'_{cr}$ ,
$f'_c \leq$	<i>Use the larger value computed from the following equations:</i> $f'_{cr} = f'_c + 1.34k_s$ (1) $f'_{cr} = f'_c + 2.33k_s -$ (2)
$f'_c >$	<i>Use the larger value computed from the following equations:</i> $f'_{cr} = f'_c + 1.34k_s$ (1) $f'_{cr} = 0.90f'_c + 2.33k_s$ (3)

\*  $k$  is equal to 1.00 if the total number of tests are greater than or equal to 30

$f'_{cr} =$  \_\_\_\_\_       $\bar{X} =$  \_\_\_\_\_       $\bar{X} \geq f'_{cr}$     Yes    No

**Case 2 – Required Average Compressive Strength with Test Records of 15 to 29 Consecutive Tests:**

Table 2 (k-modification Factor for use in Table 1)	
Number of Tests*	k-modification Factor for Sample Standard Deviation <sup>+</sup>
15	1.16
20	1.08
25	1.03
30 or more	1.00

\*Interpolate for intermediate numbers of tests  
<sup>+</sup>k-modified sample standard deviation used to determine required average strength  $f'_{cr}$  in Table 1

$f'_{cr} =$  \_\_\_\_\_       $\bar{X} =$  \_\_\_\_\_       $\bar{X} \geq f'_{cr}$     Yes    No

**Case 3 – Required Average Compressive Strength with Test Records less than 15 Consecutive Tests:**

Table 3	
	Required Average Compressive Strength
$f'_c <$	$f'_{cr} = f'_c +$
$\leq f'_c \leq$	$f'_{cr} = f'_c +$
$f'_c >$	$f'_{cr} = 1.10f'_c +$

$f'_{cr} =$  \_\_\_\_\_       $\bar{X} =$  \_\_\_\_\_       $\bar{X} \geq f'_{cr}$     Yes    No

<sup>10</sup> Required concrete proportions may be established by interpolation between strengths and proportions of two or more test records. When an acceptable record of field test results is not available, concrete proportions shall be established from trial mixtures or based upon experience or information, if approved by the Materials Engineer. Submit documentation of test records, trial mixtures or information.

(This page intentionally left blank.)





**WORKSHEET FOR DETERMINING BULK SPECIFIC GRAVITY  
 OF COMPACTED BITUMINOUS MIXTURES AASHTO T 166 AND  
 AASHTO T 269**

Project: \_\_\_\_\_ Source: \_\_\_\_\_  
 Where sampled: \_\_\_\_\_ Quantity represented: \_\_\_\_\_  
 Sample of: \_\_\_\_\_ Lot no.: \_\_\_\_\_  
 Sampled by: \_\_\_\_\_ Date: \_\_\_\_\_ Tested by: \_\_\_\_\_ Date: \_\_\_\_\_

(A) Maximum specific gravity, AASHTO T 209 =						
Sample No.						
Station						
Height, inches (mm)						
(B) Dry mass in air, g						
(C) Saturated surface dry mass, g						
(D) Mass in water, g						
(E) Volume (C - D), cm <sup>3</sup>						
(F) Bulk specific gravity (B / E)						
(G) Percent Absorption, (C - B / E) * 100						
(H) Percent compaction (F / A * 100), %						
Air voids (100 - H), %						

**Remarks:**

(This page intentionally left blank.)



---

### WORKSHEET FOR REPORTING MISCELLANEOUS TESTS

---

Project \_\_\_\_\_ Source \_\_\_\_\_

Where sampled \_\_\_\_\_ Quantity represented \_\_\_\_\_

Sample of \_\_\_\_\_ Lot No. \_\_\_\_\_ Sample No. \_\_\_\_\_

Sampled by \_\_\_\_\_ Date \_\_\_\_\_ Tested by \_\_\_\_\_ Date \_\_\_\_\_

---

TEST:  FLH  AASHTO  OTHER \_\_\_\_\_ Test No. \_\_\_\_\_  
(identify)

**Remarks:**

(This page intentionally left blank.)



**WORKSHEET FOR DETERMINING MOISTURE CONTENT  
 OF SOIL AND AGGREGATES USING A MICROWAVE OVEN  
 AASHTO T 255**

Project \_\_\_\_\_ Source \_\_\_\_\_

Where sampled \_\_\_\_\_ Quantity represented \_\_\_\_\_

Sample of \_\_\_\_\_ Lot No. \_\_\_\_\_ Sample No. \_\_\_\_\_

Sampled by \_\_\_\_\_ Date \_\_\_\_\_ Tested by \_\_\_\_\_ Date \_\_\_\_\_

Sample No.				
A. Original mass + dish, g				
B. Dry mass + dish, g				
C. Dish tare mass, g				
D. Loss (A-B), g				
E. Moisture $(D/(B-C)*100)$ , %				

**Remarks:**

(This page intentionally left blank.)



**WORKSHEET FOR IN-PLACE NUCLEAR/MOISTURE DENSITY TESTING  
 AASHTO T 310**

Project: \_\_\_\_\_ Source: \_\_\_\_\_

Quantity represented: \_\_\_\_\_ Item No.: \_\_\_\_\_ Lot No.: \_\_\_\_\_

Gauge No.: \_\_\_\_\_ Tested by: \_\_\_\_\_ Date: \_\_\_\_\_

Test No.						
Station						
Offset						
Elevation/lift						
Mode-depth						
Density count						
(A) Wet density, lb/ft <sup>3</sup> (kg/m <sup>3</sup> )						
Moisture count						
(B) Moisture, lb/ft <sup>3</sup> (kg/m <sup>3</sup> )						
(C) Dry density (A - B)						
% Moisture (100B/C)						
(D) Maximum dry density						
Moisture correction						
% Relative com- paction (100C/D)						
% Optimum moisture						
T 99 / T 180						
Classification						

**Remarks:**

(This page intentionally left blank.)





## WORKSHEET FOR SIEVE ANALYSIS OF FINE AND COARSE AGGREGATE AASHTO T 11 AND AASHTO T 27

Project: \_\_\_\_\_ Source: \_\_\_\_\_ Sample no.: \_\_\_\_\_  
 Sample of: \_\_\_\_\_ Quantity represented: \_\_\_\_\_ Lot no.: \_\_\_\_\_  
 Sampled by: \_\_\_\_\_ Date: \_\_\_\_\_ Tested by: \_\_\_\_\_ Date: \_\_\_\_\_

MOISTURE DETERMINATION			PERCENT PASSING No. 200 (75 μm) SIEVE (P-200) WASH		
Moisture Content	Coarse	Fine	P-200 Content	Coarse	Fine
(A) Mass of wet aggregate			(E) Mass of wet aggregate		
(B) Mass of dry aggregate			(F) Mass of dry aggregate <sup>1</sup>		
(C) Mass of water (A-B)			(G) Mass of washed dry aggregate		
(D) % Moisture (C/B*100)			(H) Mass of No. 200 (75 μm) minus (F-G)		

REMARKS:	Coarse Aggregate Sieve Size	Retained			Total Passing (%)	Spec's
		Mass Wet	Mass Dry	%		
	No. 4 (4.75 mm)					
	No. 4 minus					
	Total sample mass					

<sup>1</sup>Mass of dry aggregate and Total dry mass must agree within 0.3 percent. Total dry mass is used to compute percentages.

Fine Aggregate Sieve Size	WASHED FROM COARSE				DRY No. 4 (4.75 mm) MINUS				Total Passing (%)	Spec's
	Retained		Percent Passing	Adjusted % Passing	Retained		Percent Passing	Adjusted % Passing		
	Mass Dry	%			Mass Dry	%				
No. 4 (4.75 mm)										
Pan										
Mass P-200 (H)										
Total P-200										
Total dry mass <sup>1</sup>										

(This page intentionally left blank.)

## WORKSHEET FOR A MARSHALL MIX DESIGN AASHTO T 245

Project:	Date:
Contractor:	Class & Grading of mixture:
Asphalt supplier:	Grade of asphalt:
Sources for:   Aggregates:	Mineral filler:
Testing laboratory name:	Phone:
Testing performed by:	
Testing reported by:	

English      Metric

### SUMMARY OF THE PROPOSED JOB-MIX-FORMULA

- |  |   |
|--|---|
| <ol style="list-style-type: none"> <li>1. Percent asphalt by mass of total mix<sup>1</sup>, (<math>P_b</math>)</li> <li>2. Air voids (<math>V_a</math>)</li> <li>3. Voids in mineral aggregate (VMA)</li> <li>4. Maximum specific gravity (<math>G_{mm}</math>)</li> <li>5. Recommended plant mixing temperature,<br/>(Attach Temperature Viscosity Curve)</li> <li>6. Effective specific gravity of aggregate (<math>G_{se}</math>)</li> <li>7. Marshall stability,</li> <li>8. Marshall flow,</li> </ol> | <ol style="list-style-type: none"> <li>9. Specific gravity of binder (<math>G_b</math>)</li> <li>10. Specific gravity of mineral filler</li> <li>11. Dust-to-Binder ratio (DP)</li> <li>12. Moisture susceptibility test results: <sup>2</sup> <ol style="list-style-type: none"> <li>a. Dry strength,</li> <li>b. Wet strength,</li> <li>c. Index of retained strength, %</li> </ol> </li> </ol> |
|--|---|

**Gradation Designation:**

GRADATION TARGET VALUES AND ALLOWABLE DEVIATIONS				SPECIFIC GRAVITY AND ABSORPTION		
Sieve Sizes	Job Mix Formula Target Value <sup>3</sup>	Target Value Specification Range %	Allowable Deviation <sup>4</sup> %	Fine Aggregate (AASHTO T 84)	Coarse Aggregate (AASHTO T 85)	Combined Aggregate
				Bulk SG ( $G_{sb}$ )		
				Bulk SSD SG		
				Apparent SG ( $G_{sa}$ )		
				Absorption	%	%

<sup>1</sup> Establish asphalt cement content (percent by mass of mix) to the nearest 0.01 percent.  
<sup>2</sup> See contract for moisture susceptibility test method: AASTHO T 165/T 167 or AASTHO T 283.  
<sup>3</sup> Establish target values to the nearest 0.1 percent as a part of the job mix formula.  
<sup>4</sup> Allowable deviations plus or minus from established target values.

**WORKSHEET FOR A MARSHALL MIX DESIGN (Continued)**

Material Stockpile	Stockpile Description	Blend Ratio
A		%
B		%
C		%
D		%
E		%
<b>Total</b>		%

**Stockpile Gradation**

Sieve Size	Stockpile A %	Stockpile B %	Stockpile C %	Stockpile D %	Stockpile E %	Blended Stockpile Gradation	Job Mix Formula Target Values	Specification Limits

**Aggregate Properties**

Property	Result	Specification	Property	Result	Specification
LA Abrasion, % - Grading AASHTO T 96			Fractured Faces, % - ASTM D 5821		
Sodium Sulfate Soundness, % AASHTO T 104			Sand Equivalent AASHTO T 176, Alt method #2, reference method		
Durability index (Coarse) AASHTO T 210			Other:		
Durability index (Fine) AASHTO T 210			Other:		



**WORKSHEET FOR A HVEEM MIX DESIGN (Continued)**

**Design Curves for Proposed Job Mix Formula (JMF)**

**AIR VOIDS ( $V_a$ )**

**MARSHALL FLOW**

% Air voids ( $V_a$ )

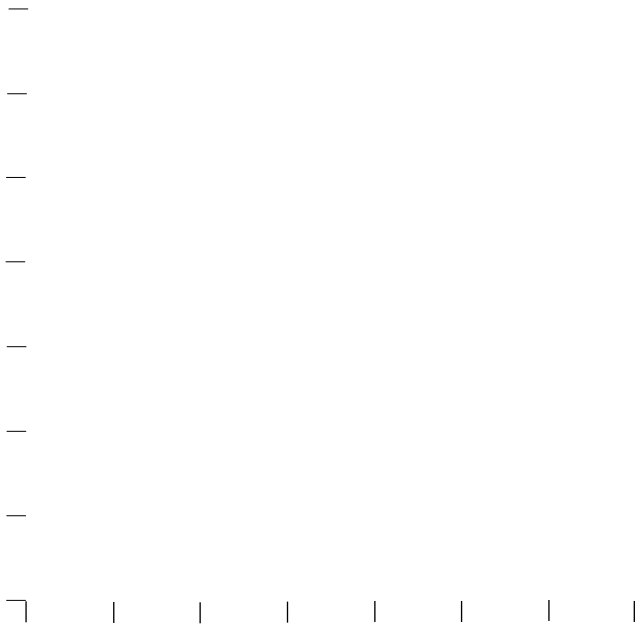

% Asphalt binder ( $P_b$ )

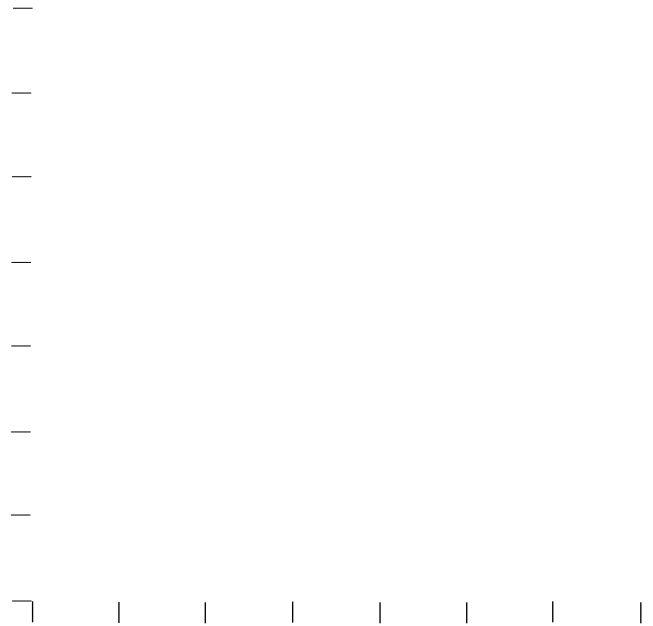

% Asphalt binder ( $P_b$ )

**MARSHALL STABILITY**

**VMA**

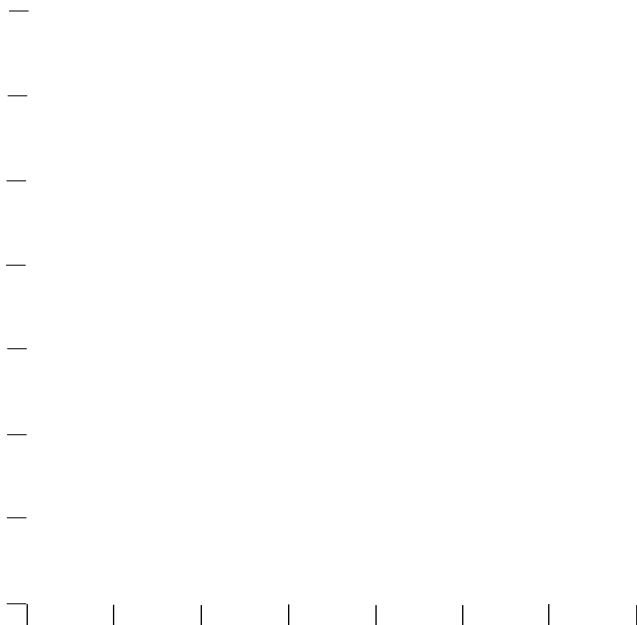

% Asphalt binder ( $P_b$ )

Voids in mineral aggregate

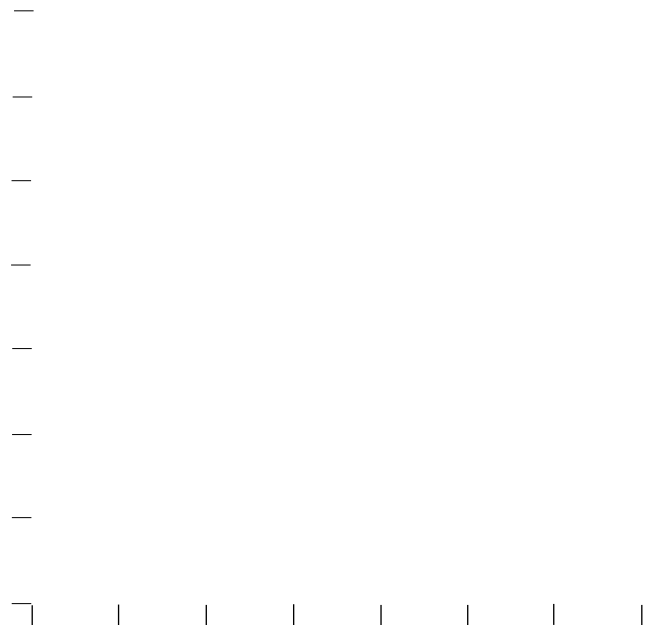

% Asphalt binder ( $P_b$ )



## WORKSHEET FOR DETERMINING LIQUID LIMIT AND PLASTIC LIMIT OF SOILS AASHTO T 89 AND AASHTO T 90

Project: \_\_\_\_\_ Source: \_\_\_\_\_  
 Sample of: \_\_\_\_\_ Quantity represented: \_\_\_\_\_ Lot No. \_\_\_\_\_ Sample No. \_\_\_\_\_  
 Sampled by: \_\_\_\_\_ Date: \_\_\_\_\_ Tested by: \_\_\_\_\_ Date: \_\_\_\_\_

**Method A**

**Method B**

**NP (Non-Plastic)**

<b>Liquid Limit AASHTO T 89</b>			
Determination No.	1	2	3
Number of blows			
Container No.			
(A) Mass of container & wet soil, g			
(B) Mass of container & dry soil, g			
(C) Mass of water (A-B), g			
(D) Mass of container, g			
(E) Mass of dry soil (B-D), g			
(F) Water content (100 * C/E), %			
Liquid limit			
Final liquid limit (LL):			

<b>Plastic Limit AASHTO T 90</b>			
Determination No.	1	2	3
Container No.			
(A) Mass of container & wet soil, g			
(B) Mass of container & dry soil, g			
(C) Mass of water (A-B), g			
(D) Mass of container, g			
(E) Mass of dry soil (B-D), g			
(F) Water content (100 * C/E), %			
Plastic limit			
Final plastic limit (PL):			

**CALCULATIONS:** \_\_\_\_\_ (LL) - \_\_\_\_\_ (PL) = \_\_\_\_\_ Plasticity Index (PI)

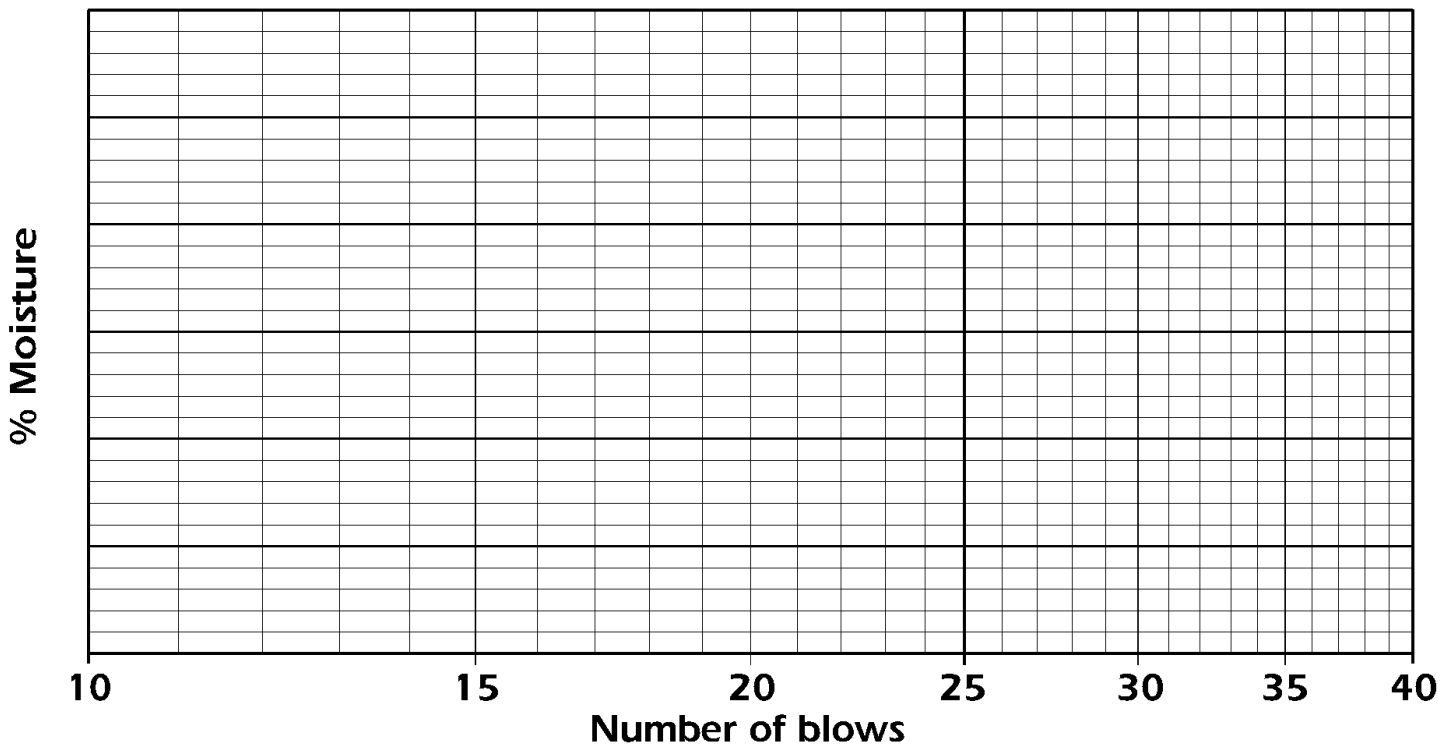

(This page intentionally left blank.)



## WORKSHEET FOR DETERMINING MOISTURE/DENSITY RELATIONSHIPS AASHTO T 99 AND AASHTO T 180

Project: \_\_\_\_\_ Source: \_\_\_\_\_  
 Where sampled: \_\_\_\_\_ Quantity represented: \_\_\_\_\_  
 Sample of: \_\_\_\_\_ Lot No. \_\_\_\_\_ Sample No. \_\_\_\_\_  
 Sampled by: \_\_\_\_\_ Date: \_\_\_\_\_ Tested by: \_\_\_\_\_ Date: \_\_\_\_\_

USC      Metric                      AASHTO T 99      AASHTO T 180                      Method    A    B    C    D

<b>Density Determination</b>	Test No.					
	(a) Wet soil + mold tare	lbs (kg)				
	(b) Mold tare	lbs (kg)				
	(c) Wet mass [a - b]	lbs (kg)				
	(d) Wet density [k * c] <sup>1</sup>	lb/ft <sup>3</sup> (kg/m <sup>3</sup> )				
	Dry density [d/(1+0.01*w)]	lb/ft <sup>3</sup> (kg/m <sup>3</sup> )				
<sup>1</sup> For USC system calculations with molds within tolerance, k = 30 for methods A and C or 13.33 for methods B and D. For metric system calculations with molds within tolerance, k= 1060 for methods A and C or 471 for methods B and D.						
<b>Moisture Determination</b>	Pan No.					
	(r) Wet soil mass + tare	g				
	(s) Dry soil mass + tare	g				
	(t) Tare	g				
	(u) Dry soil mass [s - t]	g				
	(v) Water mass [r - s]	g				
	(w) Moisture [v / u * 100]	%				

Dry Density, lbs/ft<sup>3</sup> (kg/m<sup>3</sup>)

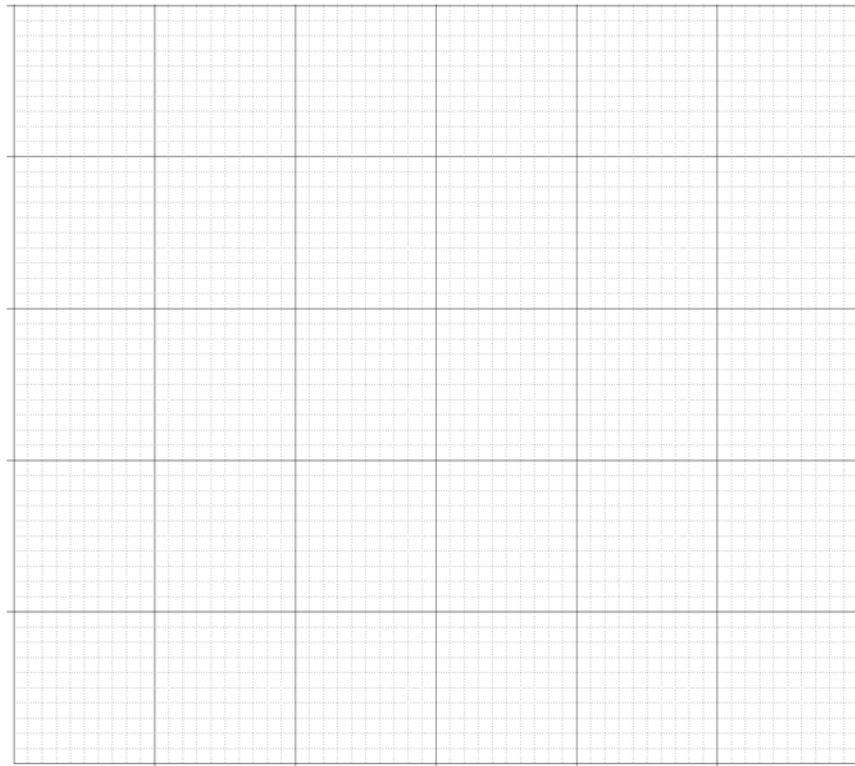

Maximum Dry Density:  
 \_\_\_\_\_ lb/ft<sup>3</sup> (kg/m<sup>3</sup>)

Optimum Moisture:  
 \_\_\_\_\_ %

(This page intentionally left blank.)



## WORKSHEET FOR DETERMINING SAND EQUIVALENT AASHTO T 176

Project: \_\_\_\_\_ Source: \_\_\_\_\_  
 Where sampled: \_\_\_\_\_ Quantity represented: \_\_\_\_\_  
 Sample of: \_\_\_\_\_ Lot No.: \_\_\_\_\_ Sample No.: \_\_\_\_\_  
 Sampled by: \_\_\_\_\_ Date: \_\_\_\_\_ Tested by: \_\_\_\_\_ Date: \_\_\_\_\_

The following method was used to prepare the sample:      Air dry      Pre-wet      Oven Dry

Soaking Time (10 minutes ± 1 minute)				Sedimentation Period ( 20 minutes ± 15 seconds)			
Determination	1	2	3	Determination	1	2	3
Starting time				Starting time			
Finish time				Finish time			
<b>CALCULATIONS:</b> $SE = \frac{\text{Sand Reading}}{\text{Clay Reading}} * 100$				Sand reading			
				Clay reading			
				Sand equivalent (SE) values <sup>1</sup>			

Sand Equivalent (mean) <sup>2</sup> =

**Remarks:**

- <sup>1</sup> If the calculated SE is not a whole number, report it as the next higher whole number.
- <sup>2</sup> If it is desired to average a series of SE values, average the whole number values determined as described above. If the average of these values is not a whole number, raise it to the next higher whole number.

(This page intentionally left blank.)



## WORKSHEET FOR SIEVE ANALYSIS OF FINE AND COARSE AGGREGATE AASHTO T 11 AND AASHTO T 27

Project

Source

Where sampled

Quantity represented

Sample of

Lot No.

Sample No.

Sampled by

Date

Tested by

Date

SIEVE SIZE	MASS RETAINED			COMBINED			TV or Range
	+ No. 4 (4.75 mm) Wash	- No. 4 (4.75 mm) Wash	- No. 4 (4.75 mm) Calculated	Mass Retained	Mass Passing	% Passing	
1-inch (25.0 mm)							
3/4-inch (19.0 mm)							
1/2-inch (12.5 mm)							
3/8-inch (9.5 mm)							
No. 4 (4.75 mm)							
No. 8 (2.36 mm)							
No. 10 (2.00 mm)							
No. 16 (1.18 mm)							
No. 30 (600 µm)							
No. 40 (425 µm)							
No. 50 (300 µm)							
No. 80 (180 µm)							
No. 100 (150 µm)							
No. 200 (75 µm)							
Pan							Difference <math>\leq 0.3\%</math> is Allowed
Wash							
Total							

	+ No. 4 (4.75 mm) Moisture	- No. 4 (4.75 mm) Moisture
Pan No.		
Orig. mass		
Final mass		
Loss		
% Loss		

Total wet mass, + No. 4 (4.75 mm)	
Total dry (corrected), + No. 4 (4.75 mm)	
Total wet mass - No. 4, (4.75 mm)	
Total dry (corrected), - No. 4 (4.75 mm)	
Total dry sample mass	

	+ No. 4 (4.75 mm) Wash	- No. 4 (4.75 mm) Wash
Orig. mass		
Dry mass		
Final mass		
Loss		
% Loss		

**- No. 4 (4.75mm) Wash Test Factor:**

$$\frac{\text{Total Dry Wt. - 4.75 mm}}{\text{Dry Wt. - 4.75 mm Wash}} = \frac{\quad}{\quad} =$$

(This page intentionally left blank.)



**WORKSHEET FOR DETERMINING MAXIMUM SPECIFIC GRAVITY  
 OF BITUMINOUS PAVING MIXTURES  
 AASHTO T 209 (FLASK DETERMINATION)**

Project \_\_\_\_\_ Source \_\_\_\_\_  
 Where sampled \_\_\_\_\_ Quantity represented \_\_\_\_\_  
 Sample of \_\_\_\_\_ Lot No. \_\_\_\_\_ Sample No. \_\_\_\_\_  
 Sampled by \_\_\_\_\_ Date \_\_\_\_\_ Tested by \_\_\_\_\_ Date \_\_\_\_\_

English      Metric

Sample Number						
Location/Station						
Vacuum Absolute Pressure, mm Hg						
(A) % Binder by mass of mix						
(B) Mass of mix and flask, g						
(C) Mass of flask, g						
(D) Mass of mix (B-C), g						
(E) Mass of flask filled with water at _____, g						
(F) Mass of flask filled w/ mix & water at _____, g						
(H) Mass of mix, air dried to constant mass, g						
(J) Mass of water absorbed by aggregate (H-D), g						
(K) Volume of mix (D+E- F+J), mL						
(L) Maximum specific gravity of mixture (D/K)						
(M) Unit Weight,						

(This page intentionally left blank.)





**WORKSHEET FOR DETERMINING MAXIMUM SPECIFIC GRAVITY  
 OF BITUMINOUS PAVING MIXTURES  
 AASHTO T 209 (BOWL DETERMINATION)**

Project

Source

Where sampled

Quantity represented

Sample of

Lot No.

Sample No.

Sampled by

Date

Tested by

Date

English

Metric

Sample Number						
Location/Station						
Vacuum Absolute Pressure, mm Hg						
(A) % Binder by mass of mix						
(B) Mass of mix and bowl, g						
(C) Mass of bowl, g						
(D) Mass of mix (B-C), g						
(E) Mass of bowl and mix in water at _____, g						
(F) Mass of bowl in water at _____, g						
(G) Mass of mix in water at (E-F), g						
(H) Mass of mix, air dried to constant mass, g						
(J) Mass of water absorbed by aggregate (H-D), g						
(K) Volume of mix (D-G+J), mL						
(L) Maximum specific gravity of mixture (D/K)						
(M) Unit Weight,						

(This page intentionally left blank.)



**WORKSHEET FOR DETERMINING CORRECTION FOR COARSE PARTICLES  
 IN THE SOIL COMPACTION TEST  
 AASHTO T 224**

Project: \_\_\_\_\_ Sample of: \_\_\_\_\_  
 Where sampled: \_\_\_\_\_ Quantity represented: \_\_\_\_\_ Lot No. \_\_\_\_\_ Sample No. \_\_\_\_\_  
 Sampled by: \_\_\_\_\_ Date: \_\_\_\_\_ Tested by: \_\_\_\_\_ Date: \_\_\_\_\_

**Identify Laboratory Moisture - Density Relations used:**      **Maximum Dry Density,  $D_F$  =**      **lbs/ft<sup>3</sup> (kg/m<sup>3</sup>)**  
 English      Metric      AASHTO T 99      AASHTO T 180      Method:      A      B      C      D

**Compacted Laboratory-Dry Density Corrected to Field-Dry Density**

*Note: This method is limited to samples containing 40 percent or less material retained on the No. 4 (4.75 mm) for Methods A or B; or 30 percent or less material retained on the 3/4 inch (19.0 mm) for Methods C or D.*

Calculate the dry mass of the fine particles and oversized particles as follows:

$M_{DF} = M_{MF} / (1 + MC_F)$       and  
 $M_{DC} = M_{MC} / (1 + MC_C)$       where:

- $M_{DF}$  = mass of dry material (fine particles), g;
- $M_{DC}$  = mass of dry material (oversized particles), g;
- $M_{MF}$  = mass of moist material (fine particles), g; and       $M_{MF} =$
- $M_{MC}$  = mass of moist material (oversized particles), g; and       $M_{MC} =$
- $MC_F$  = moisture content (T 265, T 217, or T 255) of fines particles,       $MC_F =$   
 expressed as a decimal.
- $MC_C$  = moisture content (T 265, T 217, or T 255) of oversize particles,       $MC_C =$   
 expressed as a decimal. *Note: If  $MC_C$  is unknown use 0.02 (2 percent).*

$M_{DF} = M_{MF} / (1 + MC_F) =$        $/ (1 +$        $) =$

$M_{DC} = M_{MC} / (1 + MC_C) =$        $/ (1 +$        $) =$

Calculate the percentage of the fine particles and oversized particles by dry mass of the total sample as follows:

$P_F = 100M_{DF} / (M_{DF} + M_{DC})$       and  
 $P_C = 100M_{DC} / (M_{DF} + M_{DC})$       where:

- $P_F$  = percent of fine particles of sieve used, by mass, %;
- $P_C$  = percent of oversize particles of sieve used, by mass, %;
- $M_{DF}$  = mass of dry material (fine particles); g; and       $M_{DF} =$
- $M_{DC}$  = mass of dry material (oversize particles), g.       $M_{DC} =$

$$P_F = 100M_{DF} / (M_{DF} + M_{DC}) = 100 ( \quad ) / ( \quad + \quad ) =$$

$$P_C = 100M_{DC} / (M_{DF} + M_{DC}) = 100 ( \quad ) / ( \quad + \quad ) =$$

Calculate the corrected moisture content of the total sample (combined fine and oversized particles) as follows:

$$MC_T = (MC_F P_F + MC_C P_C) / 100 \quad \text{where:}$$

$MC_T$  = corrected moisture content of the combined fine and oversized particles, expressed as a decimal;

$P_F$  = percent of fine particles of sieve used, by mass, %;  $P_F$  =

$P_C$  = percent of oversize particles of sieve used, by mass, %;  $P_C$  =

$MC_F$  = moisture content of the fine particles, expressed as a decimal; and  $MC_F$  =

$MC_C$  = moisture content of the oversize particles, expressed as a decimal,  
*Note: If  $MC_C$  is unknown use 0.02 (2 percent).*  $MC_C$  =

$$MC_T = (MC_F P_F + MC_C P_C) / 100 = [( \quad )( \quad ) + ( \quad )( \quad )] / 100 =$$

Calculate the corrected dry density of the total sample (combined fine and oversized particles) as follows:

$$D_d = 100D_F k / (D_F P_C + k P_F) \quad \text{where:}$$

$D_d$  = corrected total dry density (combined fine and oversize particles), lbs/ft<sup>3</sup> (kg/m<sup>3</sup>);

$D_F$  = dry density of the fine particles, lbs/ft<sup>3</sup> (kg/m<sup>3</sup>);  $D_F$  =

$P_C$  = percent of oversize particles of sieve used, by mass, %;  $P_C$  =

$P_F$  = percent of fine particles of sieve used, by mass, %; and  $P_F$  =

$k$  = 1000 $G_m$  (kg/m<sup>3</sup>) or 62.4 $G_m$  (lbs/ft<sup>3</sup>) where:

$G_m$  = Bulk Specific Gravity (oven-dry basis) of coarse particles (AASHTO T 85).

*Note: If  $G_m$  is unknown use 2.60.*

$$k = ( \quad )( \quad ) =$$

$$D_d = 100D_F k / (D_F P_C + k P_F) =$$

$$100( \quad )( \quad ) / [( \quad )( \quad ) + ( \quad )( \quad )] = \boxed{\phantom{0000}}$$



## CONSTRUCTION PROJECT MATERIAL CERTIFICATION

---

State \_\_\_\_\_ Project No. \_\_\_\_\_

Project name \_\_\_\_\_ Contract No. \_\_\_\_\_

---

### Part I - Field Control

It is certified (1) that all material accepted pursuant to this contract complies with the terms of the contract as documented by the project records in according to Federal Lands standards; or (2) that material not complying with the terms of the contract was accepted according to FAR Clause 52.246-12 based on a technical evaluation of the material documented in the project records.

It is further certified (1) that the results of verification tests taken during construction confirm the validity of acceptance tests according to Federal Lands standards; or (2) that inconsistencies between verification and acceptance tests were responded to according to Federal Lands standards and so documented in the project records.

It is further certified (1) for material accepted by manufacturer's certification of compliance, such certifications and accompanying test result (when required) indicate compliance with the terms of the contract; and (2) that if verification tests of such material were taken, the tests confirmed the validity of the certifications, or the discrepancies were responded to according to Federal Lands standards and so documented in the project records.

Project Engineer \_\_\_\_\_ Date \_\_\_\_\_

Construction Operations Engineer \_\_\_\_\_ Date \_\_\_\_\_

### Part II - Final Review

It is certified (1) that the results of verification tests taken during construction confirm the validity of the job site acceptance testing and/or manufacturer's certificates; or (2) that inconsistencies are appropriately documented together with the technical basis of acceptance of the material.

Materials Engineer \_\_\_\_\_ Date \_\_\_\_\_

It is certified that the records for this project have been reviewed and confirmed that the acceptance and documentation of all materials complied with Federal Lands standards.

Construction Engineer \_\_\_\_\_ Date \_\_\_\_\_

(This page intentionally left blank.)



## WORKSHEET FOR DETERMINING CONCRETE BATCH MOISTURE/ABSORPTION CORRECTIONS

Project:

Date tested:

Concrete for:

Computed by:

English	Metric	Approved Mix Design Information	
(A) Cement content,		(F) Coarse aggregate absorption, %	
(B) Maximum water/cement ratio		(G) Fine aggregate SSD,	
(C) Maximum water,		(H) Fine aggregate, total moisture, % <sup>1</sup>	
(D) Coarse aggregate SSD,		(I) Fine aggregate absorption, %	
(E) Coarse aggregate, total moisture, % <sup>1</sup>		(J) Batch size, /batch	

<sup>1</sup> Calculated from AASHTO T 255 or FLH T 509

### Aggregate / Water / Cement Mass Calculation

(K) Dry mass, coarse aggregate,	[ D / ( 1.0 + ( F / 100 ) ) ]	
(L) Dry mass, fine aggregate,	[ G / ( 1.0 + ( I / 100 ) ) ]	
(M) Coarse aggregate batch mass,	[ K x ( 1.0 + ( E / 100 ) ) ]	
(N) Mass of coarse aggregate per batch, /batch	[ J * M ]	
(O) Fine aggregate batch mass,	[ L x ( 1.0 + ( H / 100 ) ) ]	
(P) Mass of fine aggregate per batch, /batch	[ J * O ]	
(Q) Water batch mass,	[ C - ( ( M - D ) + ( O - G ) ) ]	
(R) Volume of water per batch, /batch	[ J * ( Q / ) ]	
(S) Mass of cement per batch, /batch	[ J * A ]	

### Concrete Batch Masses

Batch Size,	Cement,	Water,	Water,	Coarse Agg.,	Fine Agg.,
0.5					
1.0					
1.5					
2.0					
2.5					
3.0					
3.5					
4.0					
4.5					
5.0					
5.5					
6.0					
6.5					
7.0					
7.5					
8.0					
8.5					
9.0					
9.5					
10.0					

(This page intentionally left blank.)





**WORKSHEET FOR CONTROL OF ASPHALT MIXES  
 AASHTO T 30, AASHTO T 176, AASHTO T 308, AND ASTM D 5821**

Project: \_\_\_\_\_ Source: \_\_\_\_\_  
 Sample of \_\_\_\_\_ Lot No. \_\_\_\_\_ Sample No. \_\_\_\_\_  
 Where sampled: \_\_\_\_\_ Time sampled: \_\_\_\_\_  
 Sampled by: \_\_\_\_\_ Date: \_\_\_\_\_ Tested by: \_\_\_\_\_

**ASPHALT CONTENT BY IGNITION**

**Oven model:** NCAT Troxler Other **Weighing Method:** External Internal

**Reported Ticket Information**

- A. Furnace chamber set point, °C
- B. Total elapsed time, min:sec
- C. Initial sample mass, g
- D. Mass loss during ignition, g
- E. Percent loss, %
- F. Temperature compensation, %
- G. Job mix correction factor<sup>1</sup>, %
- H. Corrected asphalt content, %

**Recorded Data and Calculated Values**

- I. Mass of basket assembly & sample before ignition, g
- J. Basket assembly tare mass, g
- K. Initial sample mass, g [ I - J ]
- L. Mass of basket assembly & residual aggregate, g
- M. Mass of residual aggregate, g [ L - J ]
- N. Mass of residual aggregate after washing, g
- O. Mass lost during washing, No. 200 (75 µm), g [ M - N ]
- P. Final corrected % asphalt by mass of mix

**SIEVE ANALYSIS (AASHTO T 30)**

Sieve Size	Mass <sup>2</sup> Retained	Percent Retained	Percent Passing	Target Values	Allowable Deviation
1-inch (25 mm)					
¾-inch (19.0 mm)					
½-inch (12.5 mm)					
⅜-inch (9.5 mm)					
No. 4 (4.75 mm)					
No. 8 (2.36 mm)					
No. 10 (2.00 mm)					
No. 16 (1.18 mm)					
No. 30 (600 µm)					
No. 40 (425 µm)					
No. 50 (300 µm)					
No. 100 (150 µm)					
No. 200 (75 µm)					
Pan					
Washed [O]					
Total <sup>3</sup>					
Residual mass [M]					

<sup>1</sup> Individual oven aggregate correction (calibration) factor.  
<sup>2</sup> All masses are in grams.  
<sup>3</sup> Total mass should be within 0.2% of the mass of residual aggregate.

**MOISTURE CONTENT (OVEN METHOD)**

- Q. Mass of sample + container, initial
- R. Mass of sample container
- S. Mass of sample, initial [ Q - R ]
- T. Mass of sample + container, dry
- U. Moisture, % [ 100 \* ( Q - T ) / S ]

**SAND EQUIVALENT (AASHTO T 176)**

- Cylinder no.
- Time (20 min)
- Sand reading
- Clay reading
- Sand equivalent
- Average SE value

**FRACTURED FACES (ASTM D 5821)**

- V. Mass of fractured aggregate, g
- W. Mass of non-fractured aggregate, g
- X. % fractured, % [ 100 \* V / ( V + W ) ]

(This page intentionally left blank.)



## WORKSHEET FOR IGNITION FURNACE BINDER CORRECTION FACTOR AND AGGREGATE GRADATION CORRECTION FACTOR T 308

Project:

Date:

Sample No.:

Tested by:

Target binder content, % by mass of Mix:

% by mass of Agg:

Test temperature, (°C):

	Trial No. 1		Trial No. 2
(A) Initial “battered” bowl mass, g			
(B) Final bowl mass <sup>1</sup> , g			
(C) Bowl mass difference, (B – A), g			
(D) Dry aggregate mass, g			
(E) Aggregate & binder mass, g			
(F) Binder mass, (E – D), g			
(G) Corrected binder mass, (F – C), g			
(H) Actual binder content by mixture mass, (G / (D + G) * 100), %			
(I) Sample basket assembly mass, g			
(J) Sample basket assembly & mix mass <sup>2</sup> , g			
(K) Mix mass <sup>3</sup> , (J – I), g			
(L) Ignition furnace binder content, % by mass of mix			
(M) Correction factor, (L – H), %		L1	
(N) Average correction factor <sup>4</sup> , ((L1 + L2) / 2), %		Average	
(O) Difference in correction factor <sup>5</sup> ,  L1 – L2 , %		Difference	

<sup>1</sup> Scrape the bowl until the final mass is within ± 0.5 grams of the initial “battered” mass.

<sup>2</sup> After placing the basket assembly and mix into the ignition furnace verify that the displayed mass and the mass recorded in (J) agree within ± 5 grams.

<sup>3</sup> Be certain to enter (K), the mix mass into the ignition furnace control panel prior to initiating the burn cycle.

<sup>4</sup> If the correction-factor exceeds 1.0%, lower the test temperature to 482 °C and repeat the test. Use the correction factor at 482 °C even if it exceeds 1.0%.

<sup>5</sup> If the difference is greater than ± 0.15 percent, run two more samples and discard the high and low test results.

**Remarks:**



**WORKSHEET FOR IGNITION FURNACE BINDER CORRECTION FACTOR AND  
 AGGREGATE GRADATION CORRECTION FACTOR T 308**

Project:

Date:

Sample No.:

Tested by:

Target binder content, % by mass of Mix:

% by mass of Agg:

Test temperature, (°C):

**AGGREGATE GRADATION CORRECTION FACTOR (% Passing)**

SIEVE SIZE	Trial #1	Trial #2	“blank”	Trial #1 Difference	Trial #2 Difference	Average Difference	Allowable Difference
							±5.0
							±5.0
							±5.0
							±5.0
							±5.0
							±5.0
							±3.0
							±3.0
							±3.0
							±0.5

**Remarks:**

## WORKSHEET FOR SUPERPAVE ASPHALT CONCRETE MIX DESIGN AASHTO R 35

Project:	Date:
Contractor:	Nominal Maximum Aggregate Size, :
Asphalt supplier:	Grade of asphalt:
Sources for: Aggregates:	Mineral filler:
Testing laboratory name:	Phone:
Testing performed by:	
Testing reported by:	

- | English   | Metric | SUMMARY OF THE PROPOSED JOB-MIX-FORMULA   |
|---|--------|---|
| 1. Number of gyrations ( $N_{int}/N_{des}/N_{max}$ )          |        | 10. Specific gravity of binder ( $G_b$ )  |
| 2. Percent binder by mass of total mix ( $P_b$ ) <sup>1</sup> |        | 11. Recommended plant mixing temperature,<br>(Attach Temperature Viscosity Curve) |
| 3. Percent binder by mass of aggregate                        |        | 12. Percent compaction at $N_{max}$   |
| 4. Air voids ( $V_a$ ) at $N_{des}$                           |        | 13. Hveem stabilometer value (If specified)                                       |
| 5. Voids in mineral aggregate (VMA) at $N_{des}$              |        | 14. Moisture Susceptibility:  |
| 6. Voids filled with asphalt (VFA) at $N_{des}$               |        | a. Dry strength,  |
| 7. Maximum unit mass ( $G_{mm}$ )                             |        | b. Wet strength,  |
| 8. Effective specific gravity of aggregate ( $G_{se}$ )       |        | c. Index of Retained Strength, %  |
| 9. Dust-to-Binder Ratio (DP)                                  |        |   |

GRADATION TARGET VALUES AND ALLOWABLE DEVIATIONS			SPECIFIC GRAVITY AND ABSORPTION		
Sieve Sizes	Job Mix Formula Target Value <sup>2</sup>	Allowable Deviation <sup>3</sup> %	Fine Aggregate (AASHTO T 84)	Coarse Aggregate (AASHTO T 85)	Combined Aggregate
			Bulk SG ( $G_{sb}$ )		
			Bulk SSD SG		
			Apparent SG ( $G_{sa}$ )		
			Absorption	%	%

<sup>1</sup> Establish asphalt cement content (percent by mass of mix) to the nearest 0.01 percent.  
<sup>2</sup> Establish target values to the nearest 0.1 percent as a part of the job mix formula.  
<sup>3</sup> Allowable deviations plus or minus from established target values.

**WORKSHEET FOR A SUPERPAVE MIX DESIGN (Continued)**

<b>Material Stockpile</b>	<b>Stockpile Description</b>	<b>Blend Ratio</b>
A		%
B		%
C		%
D		%
E		%
	<b>Total</b>	%

**Stockpile Gradation**

Sieve Size	Stockpile A %	Stockpile B %	Stockpile C %	Stockpile D %	Stockpile E %	Blended Stockpile Gradation	Job Mix Formula Target Values	Specification Limits

**Aggregate Properties**

Property	Result	Specification	Property	Result	Specification
LA Abrasion, % - Grading AASHTO T 96			Fine aggregate angularity, AASHTO T 304 - method A		
Sodium Sulfate Soundness, % AASHTO T 104			Flat and elongated particles, ASTM D 4791 - 1: ratio		
Durability index (Coarse) AASHTO T 210			Sand Equivalent AASHTO T 176, Alt method #2, reference method		
Durability index (Fine) AASHTO T 210			Other:		
Fractured Faces, % - ASTM D 5821			Other:		

**WORKSHEET FOR A SUPERPAVE MIX DESIGN (Continued)**

<b>Trial Number</b>	1		AVG		2		AVG		3		AVG	
% Asphalt by mass of total mix ( $P_b$ )												
Specimen height,												
Effective Binder Content ( $P_{be}$ )												
Bulk specific gravity at $N_{des}$ ( $G_{mb}$ )												
% compaction at $N_{int}$												
% Air voids at $N_{des}$ ( $V_A$ )												
Max. unit mass $G_{mm}$												
Voids in mineral aggregate (VMA) at $N_{des}$												
Voids filled with asphalt (VFA) at $N_{des}$												
Dust-to-Binder Ratio, (DP)												
Hveem Stabilometer value												
<b>Trial Number</b>	4		AVG		5		AVG		6		AVG	
% Asphalt by mass of total mix ( $P_b$ )												
Specimen height,												
Effective Binder Content ( $P_{be}$ )												
Bulk specific gravity at $N_{des}$ ( $G_{mb}$ )												
% compaction at $N_{int}$												
% Air voids at $N_{des}$ ( $V_A$ )												
Max. unit mass $G_{mm}$												
Voids in mineral aggregate (VMA) at $N_{des}$												
Voids filled with asphalt (VFA) at $N_{des}$												
Dust-to-Binder ratio, (DP)												
Hveem Stabilometer value												

**Test Results for Each of the Individual Moisture Susceptibility Test Specimens**

Percent asphalt binder:

AASHTO T 283

Specimen Dia:      6 inch      4 inch

Antistrip, type, amount:

Freeze cycle:      Yes      No

<b>Sample I.D.</b>								<b>Average</b>
Height	<b>Dry</b>							
	<b>Wet</b>							
Bulk Specific Gravity	<b>Dry</b>							
	<b>Wet</b>							
Air Voids	<b>Dry</b>							
	<b>Wet</b>							
Strength	<b>Dry</b>							
	<b>Wet</b>							
<b>Retained Strength, %</b>								

# WORKSHEET FOR A SUPERPAVE MIX DESIGN (Continued)

## Design Curves for Proposed Job Mix Formula (JMF)

**AIR VOIDS ( $V_a$ )**

**UNIT MASS**

% Air voids ( $V_a$ )

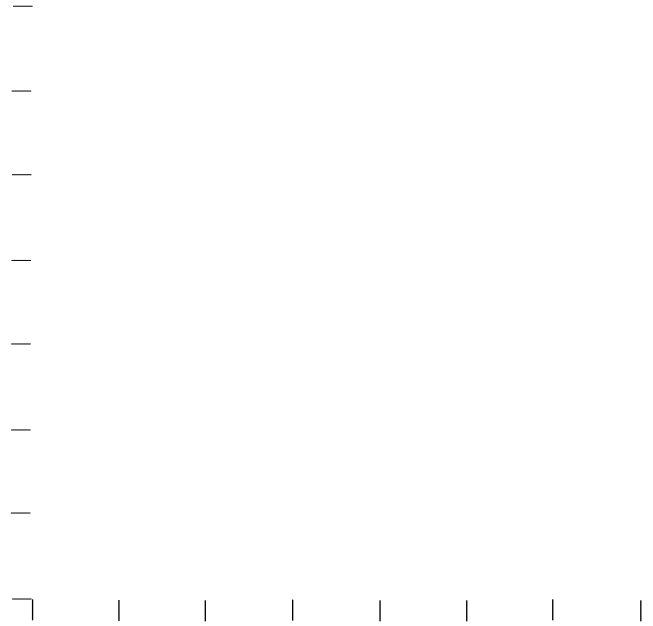
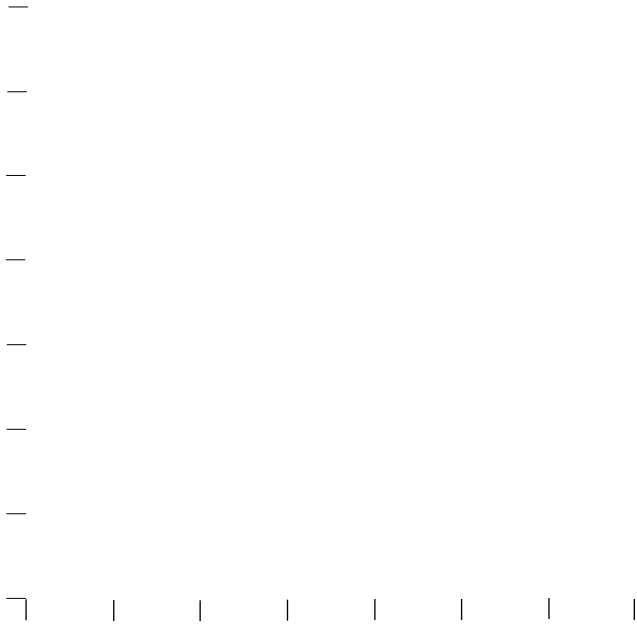

% Asphalt binder ( $P_b$ )

% Asphalt binder ( $P_b$ )

**VFA**

**VMA**

Voids filled with asphalt

Voids in mineral aggregate

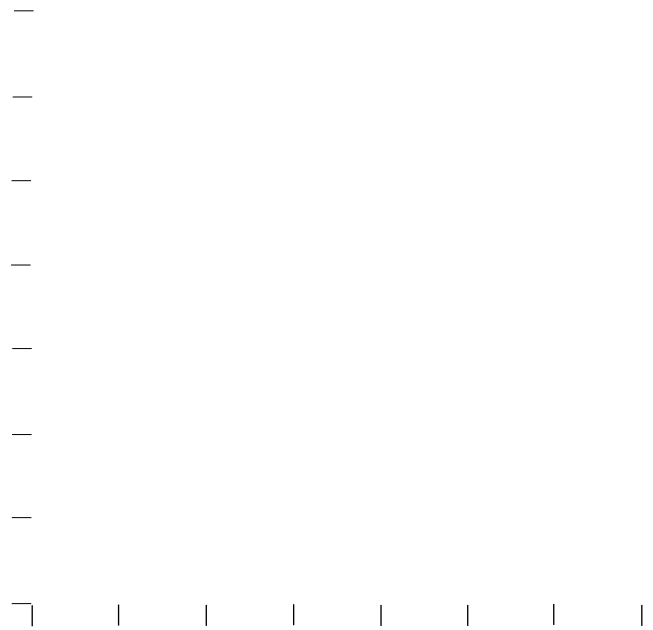
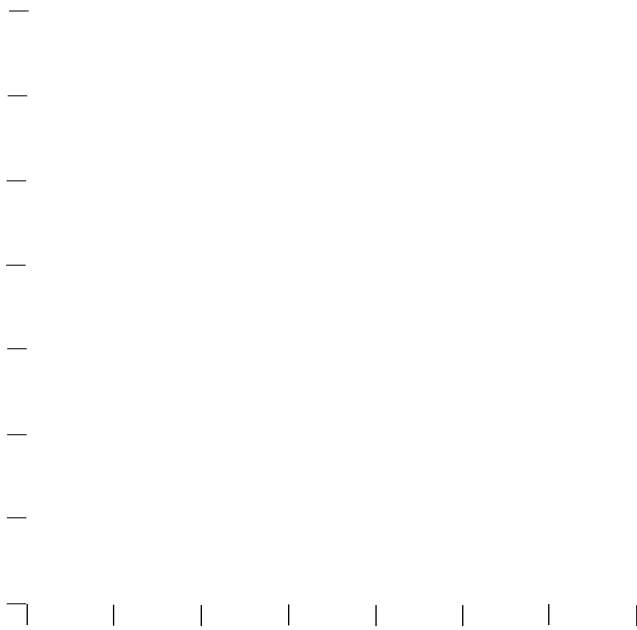

% Asphalt binder ( $P_b$ )

% Asphalt binder ( $P_b$ )





**WORKSHEET FOR DETERMINING VOLUMETRIC  
 PROPERTIES OF SUPERPAVE ASPHALT CONCRETE at  $N_{des}$   
 AASHTO T 209, AASHTO T 166, AASHTO T 269 AND AASHTO R 35**

Project	Source		
Sample of	Lot No.	Sample No.	
Where sampled	Time Sampled:		
Sampled by	Date	Tested by	Date

**GYRATORY COMPACTOR SAMPLE INFORMATION**

English	Metric		
Sample height,		Number of gyrations @ $N_{des}$	
Initial sample weight, g		Binder Content, % by mix (Pb)	

**MAXIMUM SPECIFIC GRAVITY (AASHTO T 209)**

<b>A. MASS OF CALIBRATED PYCNOMETER AT</b>	<b>C. Mass of container filled with sample and water at</b> , g
<b>B. Mass of sample in air, g</b>	<b>D. Maximum Specific Gravity, Gmm, <math>[B/(A+B-C)]</math></b>

**BULK SPECIFIC GRAVITY OF COMPACTED ASPHALT MIX (AASHTO T 166)**

<b>E. Mass of sample in air, g</b>	<b>H. Volume, cc <math>[F-G]</math></b>
<b>F. Mass of SSD sample, g</b>	<b>J. Bulk Specific Gravity, Gmb, <math>[E/H]</math></b>
<b>G. Mass of sample in water</b> , g	<b>K. Unit mass of sample,</b>

**PERCENT AIR VOIDS OF COMPACTED ASPHALT MIX (AASHTO T 269)**

**L. Percent air voids,  $V_a$ , %  $[100*(1-(J/D))]$**

**VOLUMETRIC ANALYSIS FOR COMPACTED ASPHALT MIX (AASHTO R 35)**

<b>M. Bulk specific gravity of combined aggregate, (from mix design), Gsb</b>	<b>O. Voids in the mineral aggregate, VMA, % <math>[100-((J*N)/M)]</math></b>
<b>N. Percent aggregate in sample, <math>P_s</math> <math>(100-P_b)^{(1)}</math></b>	<b>P. Voids filled with asphalt, VFA, % <math>[100*((O-L)/O)]</math></b>

(1)  $P_b$  as determined by AASHTO T 308.

**REMARKS:**

(This page intentionally left blank.)



### MATERIALS REGISTER - ITEM SUMMARY

Project: \_\_\_\_\_ Project engineer: \_\_\_\_\_ Sheet No.: \_\_\_\_\_ of \_\_\_\_\_

Item No.: \_\_\_\_\_ Item description: \_\_\_\_\_ Quantity: \_\_\_\_\_

Material or Product	Type of Acceptance	Material Records Included in Register

**Remarks:** \_\_\_\_\_

(This page intentionally left blank.)



## MATERIALS REGISTER – SAMPLING & TESTING SUMMARY

Project: \_\_\_\_\_ Project engineer: \_\_\_\_\_ Sheet No.: \_\_\_\_\_ of \_\_\_\_\_

Item No.: \_\_\_\_\_ Item description: \_\_\_\_\_ Quantity: \_\_\_\_\_

Material or Product	Characteristic/Test Method	Quantity Represented	Sampling Frequency	Number of Tests		
				Acceptance	Verification	Independent

Remarks: \_\_\_\_\_

(This page intentionally left blank.)



## MATERIALS REGISTER – VISUAL INSPECTION

Project: \_\_\_\_\_ Item No: \_\_\_\_\_

Material or product: \_\_\_\_\_

Quantity represented: \_\_\_\_\_

Reported by: \_\_\_\_\_ Date: \_\_\_\_\_

**The above noted material or product has been evaluated by visual inspection for compliance with the contract and prevailing industry standards.**

**Remarks:** \_\_\_\_\_

\_\_\_\_\_

\_\_\_\_\_

\_\_\_\_\_

\_\_\_\_\_

\_\_\_\_\_

\_\_\_\_\_

\_\_\_\_\_

\_\_\_\_\_

\_\_\_\_\_

\_\_\_\_\_

\_\_\_\_\_

\_\_\_\_\_

\_\_\_\_\_

\_\_\_\_\_

\_\_\_\_\_

\_\_\_\_\_

\_\_\_\_\_

\_\_\_\_\_

\_\_\_\_\_

\_\_\_\_\_

(This page intentionally left blank.)





## Asphalt Control Strip Worksheet

Project: \_\_\_\_\_ Item No: \_\_\_\_\_ Date: \_\_\_\_\_  
 Technician: \_\_\_\_\_ Type of Material: \_\_\_\_\_  
 Beg Station: \_\_\_\_\_ Beg Time: \_\_\_\_\_ Lane Width: \_\_\_\_\_  
 End Station: \_\_\_\_\_ End Time: \_\_\_\_\_ Lane Length: \_\_\_\_\_  
 Lane: \_\_\_\_\_ Weather: \_\_\_\_\_

### Rollers Used

Breakdown (B): \_\_\_\_\_

Intermediate (I): \_\_\_\_\_

Finish (F): \_\_\_\_\_

### Compaction Curve:

Note- Roller Pass is one trip of a roller in one direction over any spot

AASHTO T 209:

English      Metric

Compaction Curve #1				Compaction Curve #2				Compaction Curve #3			
Roller Pass	Roller (B) (F) or (I)	Density	% Comp	Roller Pass	Roller (B) (F) or (I)	Density	% Comp	Roller Pass	Roller (B) (F) or (I)	Density	% Comp
1				1				1			
2				2				2			
3				3				3			
4				4				4			
5				5				5			
6				6				6			
7				7				7			
8				8				8			
9				9				9			
10				10				10			
11				11				11			
12				12				12			
13				13				13			
14				14				14			
15				15				15			

### Core Data:

Core	Station	Dist. From Edge	Gauge Density	Core Density	Core % Comp

Average Core Density: \_\_\_\_\_

Average Core % Comp: \_\_\_\_\_ %

(This page intentionally left blank.)

# **APPENDIX B**

## **FLH TEST METHODS**

(This page intentionally left blank.)

**FLH TEST PROCEDURES**  
**Table of Contents**

T 501	Discontinued
T 502	Discontinued
T 503	Discontinued
T 504 – 08	Determining Longitudinal Surface Smoothness
T 505	Discontinued
T 506	Discontinued
T 507	Discontinued
T 508	Discontinued
T 509	Discontinued
T 510	Discontinued
T 511	Discontinued
T 512	Discontinued
T 513	Discontinued
T 514	Discontinued
T 515	Discontinued
T 516	Discontinued
T 517	Discontinued
T 518	Discontinued
T 519 – 95	Determining Operator Retention Factor for Extraction of Asphalt from Asphalt Paving Mixtures
T 520	Discontinued
T 521 – 08	Determining Riprap Gradation by Wolman Count

(This page intentionally left blank.)

*Standard Method of*  
**Determining Longitudinal Surface Smoothness**  
(California Type Profilograph)  
FLH Designation: T 504-08  
**English**

**I. Collection of Data**

**1. SCOPE**

**1.1** This test method is used to measure the smoothness of a pavement surface in metric units by using a California type profilograph. The profilograph produces a hard copy trace of the surface, from which deviations in the surface are identified and measured.

**2. EQUIPMENT**

**2.1** *Profilograph* - The profilograph shall be a California type profilograph consisting of a metal frame with multiple wheel trucks supporting each end and a center mounted measuring wheel. The unsupported length between the wheel tracks shall be 25 feet. The profilograph shall have steering capability.

NOTE 1 - Insure equipment used is performing properly and is calibrated according to section **3.0 CALIBRATION** of this test procedure or according to the manufacture recommendations.

**2.1.1** The profilograph shall be equipped with a graphic recorder capable of recording the distance of travel and the magnitude of vertical variation. The recorder shall have a horizontal scale of 0.1 inches = 2.5 feet, and a vertical scale of 0.1 inches = 0.1 inches.

**2.2** *Bump Location Template* - The template shall consist of a piece of transparent plastic at least 5.0 inches long by 3.0 inches wide (See Figure A). A line, parallel to the long side, shall be scribed on the template. This line shall be crossed with 2 perpendicularly scribed lines 1.0 inches apart near the center of the template. Construct a straight slot through the template, parallel to the long side and 0.4 inches from the first line scribed. The slot shall extend the distance between the perpendicular lines previously scribed. The 1.0-inch line corresponds to a longitudinal distance of 25 feet on the longitudinal scale of the profilogram. The 0.4 inches distance between the parallel lines represents the maximum allowable bump in 25 feet.

**3.0 CALIBRATION**

**3.1** *Longitudinal (distance) Calibration* - Check the longitudinal calibration before initial use and at such other times as may be required for verification. Verify tire air pressure, as per manufacture recommendations. Operate the profilograph over a measured test section on a reasonably flat and level surface for 528 feet in length. The length of the test section as measured by the graphic recorder shall be within the following tolerance:

$$\text{Longitudinal calibration} \quad L / L_R = 25.1 \pm 0.5$$

Where: L = length of test section in feet, nearest 0.01 feet  
L<sub>R</sub> = recorded length of test section in feet, nearest 0.01 inches

T504-1

**3.2 Vertical calibration** - Check the vertical calibration before initial use and at such other times as may be required for verification. Keep the profilograph stationary. Using pre-measured calibration blocks measured to the nearest 0.001 inches, pull or slide the block(s) under the recording wheel. Measure the vertical trace line from the base line to the peak and return. The trace line must return to the base line. Compare the actual heights of the calibration blocks with the heights of their vertical trace line. These heights should be within  $\pm 0.003$  inches.

NOTE 2 - If the longitudinal and vertical calibration checks are not within the allowable tolerances specified, make the appropriate adjustments or repairs.

## **4.0 PREPARATION**

**4.1** Establish ground controls on the section of roadway to be tested. Controls should include the beginning and end with sufficient intermediate markers to facilitate correlation of areas on the graphic readout to the actual ground locations.

**4.2** Provide for traffic control including appropriate warning signs and flaggers.

**4.3** Assemble the instrument at the work site and perform the calibration procedures to assure that the equipment is operating properly.

## **5.0 TESTING**

**5.1** After determining that the profilograph is operating properly, move to the beginning point. Lower the measurement wheel, and run the test according to manufacture recommendations.

NOTE 3 - Do not back the instrument while the measuring wheel is on the pavement.

**5.2** Profile the center of each lane of the project. Profile continuously from beginning to end of project. Do not break profile at excluded areas.

**5.3** Mark landmarks and excluded areas on the profilogram for documentation purposes. Mark the beginning and ending stations and identify the lane (either left or right) and the direction in which the trace is run (either ahead on line or back on line). Mark the trace by making a spike or strum at least 1 inch long on the upside of the trace.

NOTE 4 - Interrupting the test to add notes to the profilogram will not interfere with the recording. Locations of physical features along the route such as mile markers, cross drains, bridge ends, guard rail terminals, overhead utility crossings, etc. should be noted on the profilogram. This will aid in matching the ground locations with the graphic record. The trace should be marked and the station identified approximately every 500 feet. Do not write on the trace line. Write notes at least 1 inch above or below the line.

**5.4** Operate the profilograph at a speed no greater than a normal walk (1 to 3 miles/h) to eliminate as much bounce as possible.

NOTE 5 - Asphalt materials may tend to be picked up and build-up on the profilograph wheels causing noticeable chatter on the trace. Wheels need to be cleaned off periodically. Materials pickup on the wheels can be minimized or eliminated by spraying the wheels lightly with WD-40.



## II. Profile Trace and Data Reduction

**6.1** Determine the smoothness [Profile Index (PrI)] of each 0.1 mile section or subplot (N) is by using the ProScan Profilogram Scanning System or an approved equal. The ProScan Profilogram Scanning System is available from:

Surface Systems & Instruments  
307 Plymate  
Manhattan, KS 66502  
(800) 662-5656  
<http://www.smoothroad.com/products/proscan/>

**6.2** When using the ProScan Profilogram Scanning System it is necessary to set default values for several parameters. The following default values shall be used:

PRI & Scallop Settings	
Blanking Band:	0.00 Inches
Minimum Height:	0.035 Inches
Minimum Width:	2.00 Feet
Resolution	0.039 Inches
Filter	
Filter Type:	Moving Average
Filter Length:	2.000 Feet
Filter Gain:	1.00
Localized Roughness (Bumps)	
Defect Height	0.400 Inches
Defect Width	25.0000 Feet

**6.3** When using the ProScan Profilogram Scanning System it is necessary to identify and mark the beginning point of the trace. It is also necessary to identify and mark all equations. Mark the trace by drawing a heavy vertical line on the trace at appropriate locations. The vertical line should extend at least 2 inches above and below the trace.

**6.4** Scan the trace between marked beginning and ending points. The scanned trace may consist of only one marked segment or it may consist of several segments. Provide the software with appropriate stationing information at all beginning points. When an equation is encountered, provide the software with the appropriate stationing information. Reposition the trace as necessary after reaching an ending point or equation.

**6.5** After scanning a trace, print a final report.

**6.6** Excluded areas for smoothness and bump determination are:

- 6.6.1** 25 feet from bridges
- 6.6.2** Transverse joints with an existing pavement
- 6.6.3** Cattleguards
- 6.6.4** Horizontal curves with less than 500 foot radii
- 6.6.5** Miscellaneous paved areas such as driveways, parking areas, turning or passing lanes (less than 0.1 mile), and side roads

T504-3

Figure A

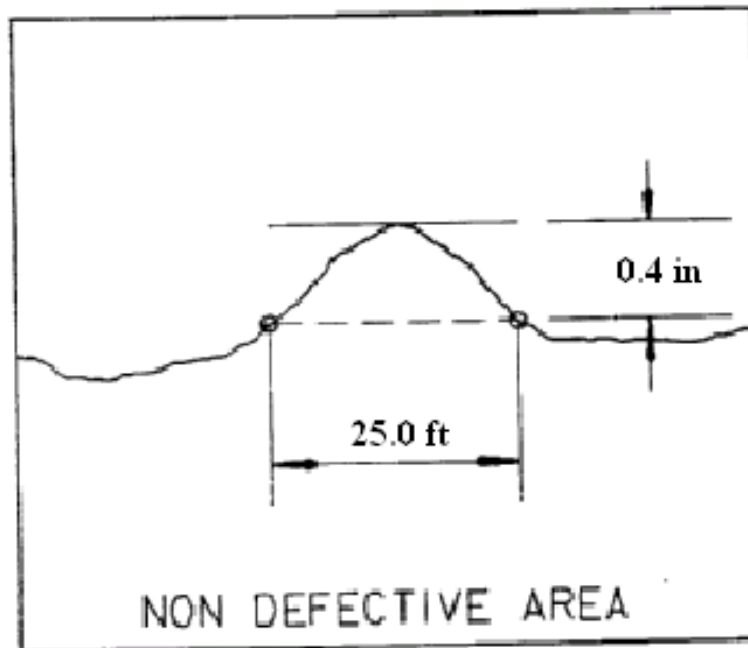
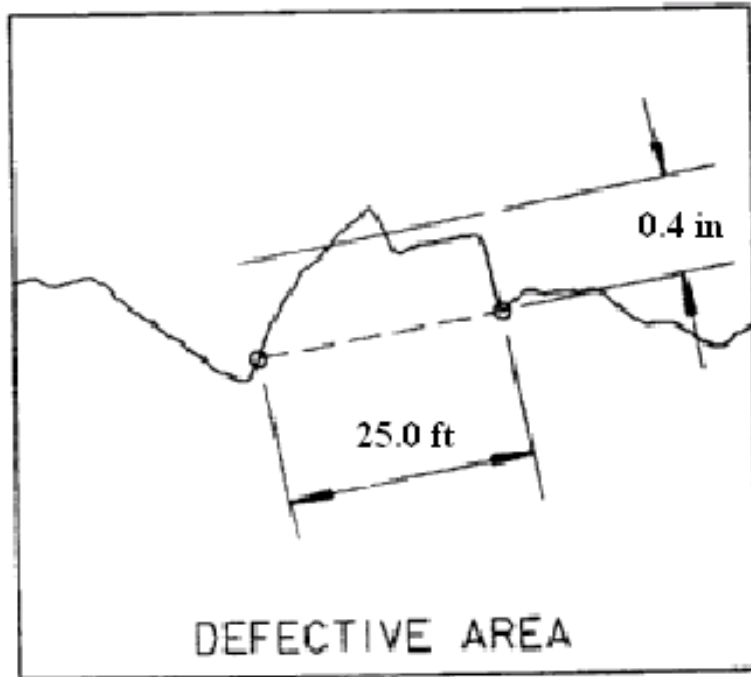

**Scale:**

**Horizontal**    **1.0 in = 25.0 ft**

**Vertical**        **0.4 in = 0.4 in**

T504-4

*Standard Method of*  
**Determining Longitudinal Surface Smoothness**  
(California Type Profilograph)  
FLH Designation: T 504-08  
**Metric**

**I. Collection of Data**

**1. SCOPE**

**1.1** This test method is used to measure the smoothness of a pavement surface in metric units by using a California type profilograph. The profilograph produces a hard copy trace of the surface, from which deviations in the surface are identified and measured.

**2. EQUIPMENT**

**2.1** *Profilograph* - The profilograph shall be a California type profilograph consisting of a metal frame with multiple wheel trucks supporting each end and a center mounted measuring wheel. The unsupported length between the wheel tracks shall be 7.62 meters. The profilograph shall have steering capability.

NOTE 1 - Insure equipment used is performing properly and is calibrated according to section **3.0 CALIBRATION** of this test procedure or according to the manufacture recommendations.

**2.1.1** The profilograph shall be equipped with a graphic recorder capable of recording the distance of travel and the magnitude of vertical variation. The recorder shall have a horizontal scale of 1 millimeter = 0.3 meter, and a vertical scale of 1 millimeter = 1 millimeter.

**2.2** *Bump Location Template* - The template shall consist of a piece of transparent plastic at least 130 millimeter long by 75 millimeters wide (See Figure A). A line, parallel to the long side, shall be scribed on the template. This line shall be crossed with 2 perpendicularly scribed lines 25.4 millimeters apart near the center of the template. Construct a straight slot through the template, parallel to the long side and 10.2 millimeters from the first line scribed. The slot shall extend the distance between the perpendicular lines previously scribed. The 25.4-millimeter line corresponds to a longitudinal distance of 7.62 meters on the longitudinal scale of the profilogram. The 10.2 millimeter distance between the parallel lines represents the maximum allowable bump in 7.62 meters.

**3.0 CALIBRATION**

**3.1** *Longitudinal (distance) Calibration* - Check the longitudinal calibration before initial use and at such other times as may be required for verification. Verify tire air pressure, as per manufacture recommendations. Operate the profilograph over a measured test section on a reasonably flat and level surface for 100 meters in length. The length of the test section as measured by the graphic recorder shall be within the following tolerance:

$$\text{Longitudinal calibration } L / L_R = 0.3 \pm 0.0024$$

Where:     L = length of test section in meters, ( $\pm 10$  mm)  
               $L_R$  = recorded length of test section in millimeters, ( $\pm 1$  mm)

**3.2 Vertical calibration** - Check the vertical calibration before initial use and at such other times as may be required for verification. Keep the profilograph stationary. Using pre-measured calibration blocks measured to the nearest 0.1 millimeter, pull or slide the block(s) under the recording wheel. Measure the vertical trace line from the base line to the peak and return. The trace line must return to the base line. Compare the actual heights of the calibration blocks with the heights of their vertical trace line. These heights should be within  $\pm 1$  millimeter.

NOTE 2 - If the longitudinal and vertical calibration checks are not within the allowable tolerances specified, make the appropriate adjustments or repairs.

## **4.0 PREPARATION**

**4.1** Establish ground controls on the section of roadway to be tested. Controls should include the beginning and end with sufficient intermediate markers to facilitate correlation of areas on the graphic readout to the actual ground locations.

**4.2** Provide for traffic control including appropriate warning signs and flaggers.

**4.3** Assemble the instrument at the work site and perform the calibration procedures to assure that the equipment is operating properly.

## **5.0 TESTING**

**5.1** After determining that the profilograph is operating properly, move to the beginning point. Lower the measurement wheel, and run the test according to manufacture recommendations.

NOTE 3 - Do not back the instrument while the measuring wheel is on the pavement.

**5.2** Profile the center of each lane of the project. Profile continuously from beginning to end of project. Do not break profile at excluded areas.

**5.3** Mark landmarks and excluded areas on the profilogram for documentation purposes. Mark the beginning and ending stations and identify the lane (either left or right) and the direction in which the trace is run (either ahead on line or back on line). Mark the trace by making a spike or strum at least 20 millimeters long on the upside of the trace.

NOTE 4 - Interrupting the test to add notes to the profilogram will not interfere with the recording. Locations of physical features along the route such as mile markers, cross drains, bridge ends, guard rail terminals, overhead utility crossings, etc. should be noted on the profilogram. This will aid in matching the ground locations with the graphic record. The trace should be marked and the station identified approximately every 150 meters. Do not write on the trace line. Write notes at least 20 millimeters above or below the line.

**5.4** Operate the profilograph at a speed no greater than a normal walk (1 to 5 km/h) to eliminate as much bounce as possible.

NOTE 5 - Asphalt materials may tend to be picked up and build-up on the profilograph wheels causing noticeable chatter on the trace. Wheels need to be cleaned off periodically. Materials pickup on the wheels can be minimized or eliminated by spraying the wheels lightly with WD-40.

## II. Profile Trace and Data Reduction

**6.1** Determine the smoothness [Profile Index (PrI)] of each 0.1 kilometer section or subplot (N) is by using the ProScan Profilogram Scanning System or an approved equal. The ProScan Profilogram Scanning System is available from:

Surface Systems & Instruments  
307 Plymate  
Manhattan, KS 66502  
(800) 662-5656  
<http://www.smoothroad.com/products/proscan/>

**6.2** When using the ProScan Profilogram Scanning System it is necessary to set default values for several parameters. The following default values shall be used:

PRI & Scallop Settings	
Blanking Band:	0.00 Millimeters
Minimum Height:	0.900 Millimeters
Minimum Width:	0.61 Meters
Resolution	1.000 Millimeters
Filter	
Filter Type:	Moving Average
Filter Length:	0.610 Meters
Filter Gain:	1.00
Localized Roughness (Bumps)	
Defect Height	10.200 Millimeters
Defect Width	7.6200 Meters

**6.3** When using the ProScan Profilogram Scanning System it is necessary to identify and mark the beginning point of the trace. It is also necessary to identify and mark all equations. Mark the trace by drawing a heavy vertical line on the trace at appropriate locations. The vertical line should extend at least 40 millimeters above and below the trace.

**6.4** Scan the trace between marked beginning and ending points. The scanned trace may consist of only one marked segment or it may consist of several segments. Provide the software with appropriate stationing information at all beginning points. When an equation is encountered, provide the software with the appropriate stationing information. Reposition the trace as necessary after reaching an ending point or equation.

**6.5** After scanning a trace, print a final report.

**6.6** Excluded areas for smoothness and bump determination are:

- 6.6.1 7.62 meters from bridges
- 6.6.2 Transverse joints with an existing pavement
- 6.6.3 Cattleguards
- 6.6.4 Horizontal curves with less than 150 meters radii
- 6.6.5 Miscellaneous paved areas such as driveways, parking areas, turning or passing lanes (less than 0.1 kilometer), and side roads

Figure A

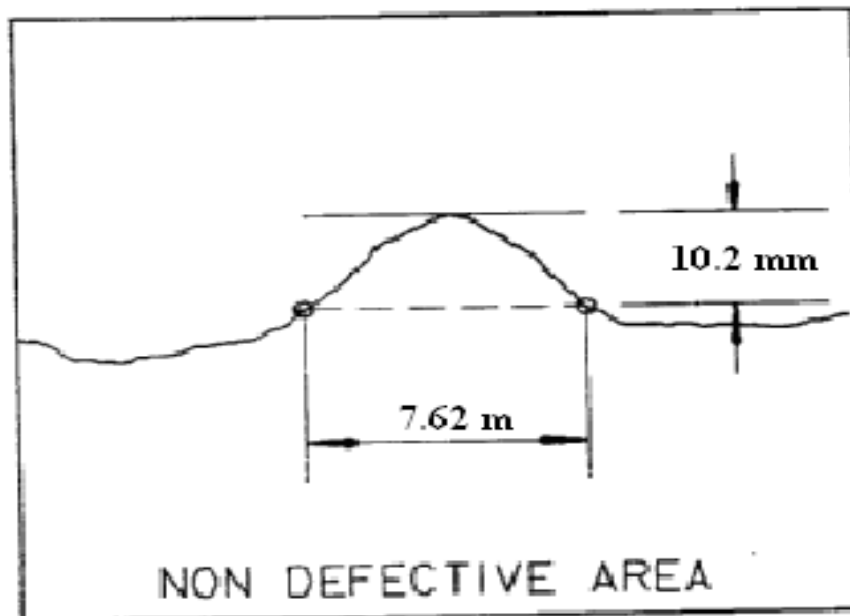
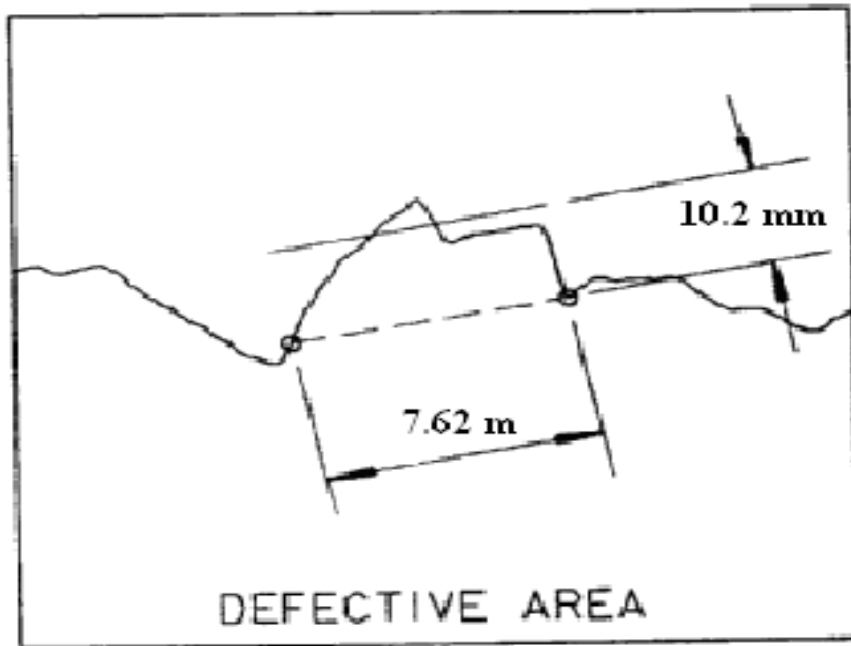

**Scale:**

**Horizontal**    25.4 mm = 7.62 m

**Vertical**        10.2 mm = 10.2 mm

T504-4

FLH T 519-95

*Standard Method of*  
**Determining Operator Retention Factor for  
Extraction of Asphalt from Asphalt Paving Mixtures**

FLH Designation: T 519-95

**1. SCOPE**

**1.1** This method covers the procedure for the determination of an operator asphalt retention factor to be used in conjunction with the quantitative extraction of asphalt from asphalt paving mixtures (AASHTO T 164).

**2. APPLICABLE DOCUMENTS**

- 2.1 AASHTO Test Procedures:  
T 2, Sampling Aggregates  
T 40, Sampling Bituminous Materials  
T 164, Quantitative Extraction of Bitumen from Bituminous Paving Mixtures

**3. SIGNIFICANCE MW USE**

3.1 Before an operator performs the AASHTO T 164 test procedures for extracting asphalt from asphalt paving mixtures for process control or acceptance, a retention factor shall be determined. A retention factor is obtained using samples of fabricated asphalt mixture containing exact quantities of asphalt and aggregate. These samples are prepared by using the asphalt and aggregate actually used on the project.

**4. APPARATUS**

**4.1** In addition to the apparatus listed in AASHTO T 164, the following apparatus is required for determining the retention factor ( $R_F$ ).

**4.1.1** *Oven* -An oven capable of maintaining a temperature of **1500 C**  $\pm$  5°, except when polymer modified asphalts are specified the oven shall be capable of maintaining a temperature of 1700 C  $\pm$  5°.

**4.1.2** *Mixing Bowl* - Mixing bowl of suitable design and shape to allow thorough mixing of the asphalt mixture. A large stainless steel salad, or mixing bowl with a capacity of approximately 8 liters is acceptable.

**4.1.3** *Miscellaneous Apparatus* - Thermometers, spatulas, stirring spoons, gloves, metal pans, and metal pouring containers as necessary.

## 5. TEST MIXTURES

**5.1** Three asphalt concrete mixtures each containing approximately 2.5 kilograms of dried aggregate and the appropriate quantity of asphalt shall be combined into a mixture and the asphalt cement then extracted from the mixture prior to production and/or quality control testing.

**5.1.1** *Preparation of Aggregates* - Obtain a sample of aggregate (at least 10 kilograms) in accordance with AASHTO T 2 from the cold feed conveyor belt or if the plant is not operational, from the stockpiles. Dry, sieve, and separate the aggregate into appropriate sizes. Batch the aggregates for the 3 separate portions to conform to the target values established in the Job Mix Formula. Dry the three portions of aggregate to a constant weight at 150° C ± 5° except when using polymer modified asphalt cements dry the aggregate to a constant weight at 170° C ± 5°. Maintain the temperature for mixing.

*Note: The aggregate for this procedure shall be obtained from the aggregates that have been produced for use in the production of the asphalt concrete mixture for the project work.*

**5.1.2** *Asphalt Cement* - Obtain a sample of the asphalt cement (approximately one liter) in accordance with AASHTO T 40 from the same asphalt cement that will be used in the production of the asphalt concrete mixture. Heat the liquid asphalt in a separate container to the appropriate temperature specified in 5.1.1.

**5.1.3** *Mixing Equipment* - Pre-heat the mixing bowl and spoon to the appropriate temperature as specified in 5.1.1 above.

## 6. PROCEDURE

**6.1** *Preparation of Test Mixes* - Weigh the heated aggregate to the nearest 0.1 gram and record the weight. To obtain the weight of asphalt needed, multiply the weight of the heated aggregate by the percent asphalt (by weight of aggregate) specified in the approved Job Mix Formula.

*Note: % asphalt by weight of aggregate*  $100 \times \frac{\text{\% asphalt by weight of mix}}{100 - \text{\% asphalt by weight of mix}}$

**6.2** Pre-tare the heated mixing bowl and spoon. Place the heated aggregate in the tared mixing bowl, make a small crater in the center of the aggregate, and add the required amount of heated asphalt. Record the weight of asphalt added to the nearest 0.1 gram. Hand mixing using the spoon and bowl has been found to be an acceptable mixing method. Reheating the mixture in the oven may be necessary to completely coat all the aggregate. Use caution not to lose any of the mix (aggregate or asphalt) from the spoon or bowl. After mixing is complete, weigh the mixed sample, the bowl and mixing spoon to the nearest 0.1 gram. The dry original weight of the mixture before extraction is obtained by subtracting the bowl and spoon tare from this weight.

**6.3** Quantitative extraction of the asphalt concrete mixture is then performed according to AASHTO T 164 and the method specified in the contract. Use caution not to leave any material in the bowl or on the spoon. The endpoint of the retention extraction should not differ from the endpoint of a normal extraction test.



**6.4** Repeat the steps set forth in sections 5.1 through 6.3 above for the remaining two separate test mixes. Determine a percent asphalt and calculate a retention factor for each test mixture.

## **7. CALCULATIONS**

**7.1** Calculate the percent of asphalt extracted from each test mix in accordance with the appropriate method in AASHTO T 164. Calculate the actual percent asphalt added to the aggregate for each test mix using the weight of asphalt added and weight of the heated aggregate from section 6.

A retention factor for each test mix is then determined by subtracting the percent asphalt extracted from the actual percent asphalt added to the aggregate.

Report the retention factor to the nearest 0.01 percent.

The overall retention factor for the *same operator*, performing the tests on all asphalt extractions using the same Job Mix Formula (Mix Design), is the mean of three valid tests.

*Note: A new retention factor determination must be made for each Job Mix Formula requiring a new mix design.*

## **8. PRECISION**

**8.1** If the results of any of the three retention factor determinations are not within 0.10 of the mean of the three tests, the tests are considered invalid and must be rerun.

(This page intentionally left blank.)

***Standard Method of***  
**Determining Riprap Gradation by Wolman Count**

FLH Designation: T 521-08

## 1. SCOPE

**1.1** This method describes the procedure that will be used to determine riprap gradation by Wolman count. The method is designed to determine a size distribution of riprap based on a random sampling of individual stones within a matrix.

**1.2** After individual rock particles have been measured, a gradation curve can be developed based on the frequency of the various sizes.

## 2. REFERENCED DOCUMENTS

**2.1** NCHRP Report 568, Riprap Design Criteria, Recommended Specifications, and Quality Control

## 3. TERMINOLOGY

**3.1** *intermediate dimension* - The shortest, straight-line distance across the maximum projected plane of a rock particle. This dimension could be described as the width of the rock particle with the length being the maximum dimension and the thickness being the minimum dimension as shown in Figure 1.

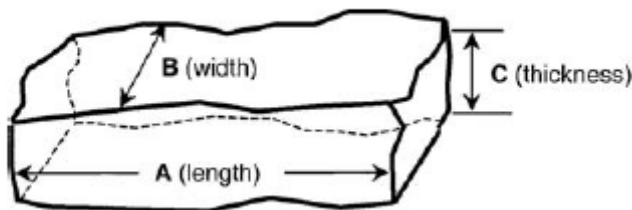

**Figure 1** – Rock particle dimensions

**3.2** *rock particle* – An individual rock or stone piece, regardless of size, that is to be used in the matrix of the riprap placement.

**3.3** *transect* - A single transverse crossing of a riprap pile for the purpose of measuring individual rock particles.

**3.3.1** *discussion* – In order to obtain the minimum number of particles to be measured as stated in the method, multiple transects may need to be performed depending on size and shape of the pile.

#### 4. PROCEDURE

**4.1** Stretch a suitable flexible tape measure across the top and completely over riprap stockpile. Index zero at the base of the stockpile and use as the count starting point.

**4.2** At intervals equal to the maximum specified particle size for the riprap, select the rock particle directly below the interval mark on the tape measure. Measure and record the intermediate dimension of the particle. If the maximum dimension of the rock is larger than the measurement interval, record the measurement twice as if two rock particles are present.

**4.3** Continue across the pile measuring the rock particles at the specified interval until the traverse is completed. This constitutes one transect of the pile.

**4.4** Repeat the procedures in 4.1 to 4.3 for additional transects if necessary until a minimum of 100 particles have been measured. Transects must be evenly spaced.

Note 1 – If rock particles are too large to manipulate by hand to determine the intermediate dimension, power equipment may be needed to assist in manipulation.

**4.5** Once a minimum of 100 particles have been measured, record the particle count for the various size ranges listed in Table 1. The particle count is the number of individual rocks that meet the particle size range listed in the table.

**4.6** Determine the cumulative percent smaller by dividing the cumulative particle count by the total number of particles measured.

**Table 1** – Particle Count and Cumulative Percent Smaller Determination

Particle Size (inches)	Particle Size Range	Particle Count	Cumulative Particle Count	Cumulative Percent Smaller (cum. particle count / total particles)
<b>3.00</b>	$\leq 3.00$			
<b>4.25</b>	$3.00 < x \leq 4.25$			
<b>6.00</b>	$4.25 < x \leq 6.00$			
<b>8.50</b>	$6.00 < x \leq 8.50$			
<b>12.00</b>	$8.50 < x \leq 12.00$			
<b>17.00</b>	$12.00 < x \leq 17.00$			
<b>24.00</b>	$17.00 < x \leq 24.00$			
<b>34.00</b>	$24.00 < x \leq 34.00$			
<b>48.00</b>	$34.00 < x \leq 48.00$			
<b>68.00</b>	$48.00 < x \leq 68.00$			
<b>96.00</b>	$68.00 < x \leq 96.00$			

T521-2

## 5. REPORT

5.1 Report the intermediate dimension for all rock particles measured.

5.2 Plot the cumulative percent smaller versus the particle size on a semi-log graph to produce the representative Wolman count gradation curve as shown in Figure 2.

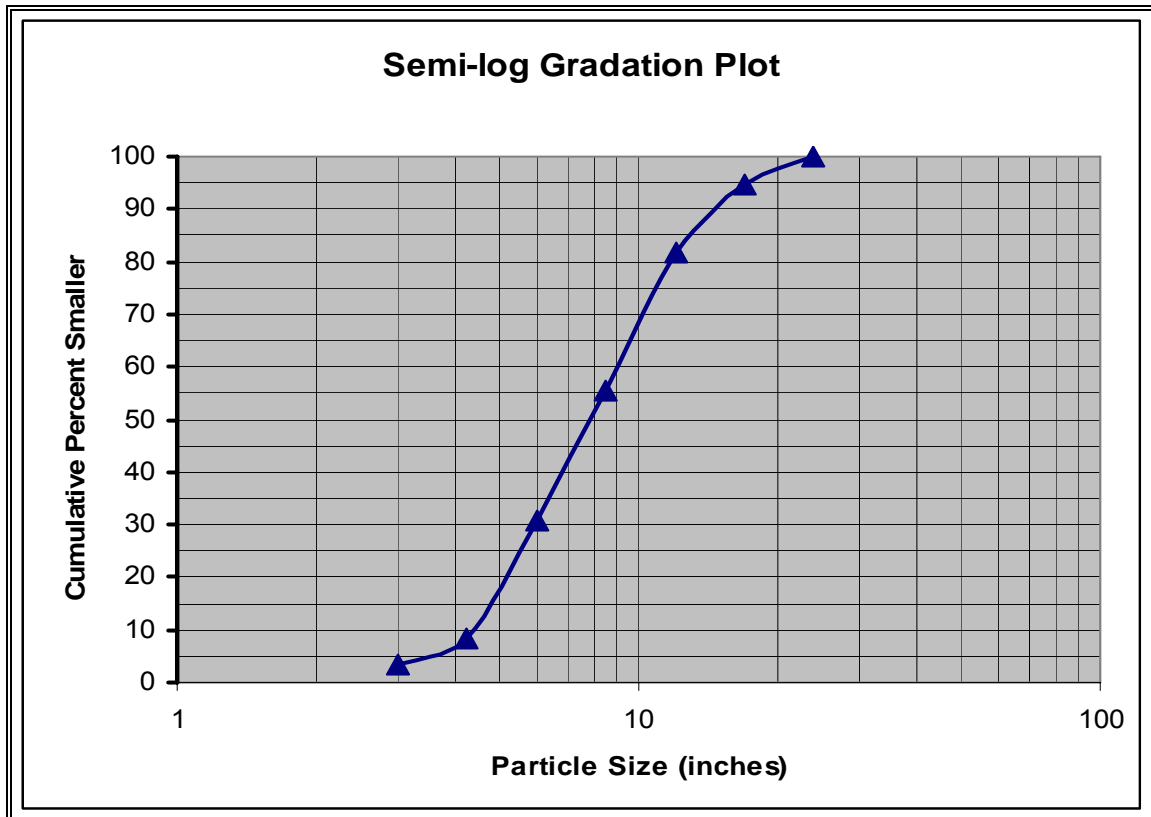

Figure 2 – Example Gradation Plot

**APPENDIX A - EXAMPLE**

FLH T 521-08

Conduct a Wolman count and analysis on the rock produced and stockpiled for use on the project.

Given the configuration of this particular pile, three transects of the pile will be needed in order to obtain a minimum of 100 particle measurements. The three transects were taken at equal intervals along the pile.

## Particle Count Transect No. 1

<b>Rock Count</b>	<b>Intermediate Dimension (inches)</b>	<b>Rock Count</b>	<b>Intermediate Dimension (inches)</b>	<b>Rock Count</b>	<b>Intermediate Dimension (inches)</b>
1	0.6	36		71	
2	4.8	37		72	
3	12	38		73	
4	7.2	39		74	
5	3.6	40		75	
6	9.6	41		76	
7	9.6	42		77	
8	4.8	43		78	
9	6	44		79	
10	8.4	45		80	
11	4.8	46		81	
12	10.8	47		82	
13	8.4	48		83	
14	7.2	49		84	
15	6	50		85	
16	4.8	51		86	
17	15.6	52		87	
18	6	53		88	
19	4.8	54		89	
20	10.8	55		90	
21	8.4	56		91	
22	10.8	57		92	
23	8.4	58		93	
24	18	59		94	
25	12	60		95	
26	9.6	61		96	
27	7.2	62		97	
28	7.2	63		98	
29	6	64		99	
30	8.4	65		100	
31	18	66		101	
32	12	67		102	
33	10.8	68		103	
34	4.8	69		104	
35	15.6	70		105	

T521-4

## Particle Count Transect No. 2

<b>Rock Count</b>	<b>Intermediate Dimension (inches)</b>	<b>Rock Count</b>	<b>Intermediate Dimension (inches)</b>	<b>Rock Count</b>	<b>Intermediate Dimension (inches)</b>
1	12	36	8.4	71	
2	13.2	37	12	72	
3	7.2	38	12	73	
4	9.6	39	13.2	74	
5	3.6	40	8.4	75	
6	7.2	41		76	
7	8.4	42		77	
8	7.2	43		78	
9	2.4	44		79	
10	4.8	45		80	
11	6	46		81	
12	7.2	47		82	
13	4.8	48		83	
14	6	49		84	
15	8.4	50		85	
16	12	51		86	
17	13.2	52		87	
18	8.4	53		88	
19	16.8	54		89	
20	6	55		90	
21	10.8	56		91	
22	18	57		92	
23	7.2	58		93	
24	7.2	59		94	
25	7.2	60		95	
26	14.4	61		96	
27	16.8	62		97	
28	6	63		98	
29	18	64		99	
30	15.6	65		100	
31	10.8	66		101	
32	6	67		102	
33	15.6	68		103	
34	12	69		104	
35	18	70		105	

## Particle Count Transect No. 3

<b>Rock Count</b>	<b>Intermediate Dimension (inches)</b>	<b>Rock Count</b>	<b>Intermediate Dimension (inches)</b>	<b>Rock Count</b>	<b>Intermediate Dimension (inches)</b>
1	18	36		71	
2	12	37		72	
3	10.8	38		73	
4	4.8	39		74	
5	15.6	40		75	
6	6	41		76	
7	8.4	42		77	
8	6	43		78	
9	13.2	44		79	
10	4.8	45		80	
11	6	46		81	
12	7.2	47		82	
13	10.8	48		83	
14	4.8	49		84	
15	8.4	50		85	
16	7.2	51		86	
17	6	52		87	
18	15.6	53		88	
19	12	54		89	
20	6	55		90	
21	10.8	56		91	
22	10.8	57		92	
23	3.6	58		93	
24	12	59		94	
25	2.4	60		95	
26	9.6	61		96	
27	2.4	62		97	
28	8.4	63		98	
29	10.8	64		99	
30	3.6	65		100	
31	12	66		101	
32	13.2	67		102	
33	7.2	68		103	
34	9.6	69		104	
35	3.6	70		105	



From the 110 particles measured, determine the number of particles that fit in the appropriate established particle size ranges. From the particle count, the “Cumulative Particle Count” and the “Cumulative Percent Smaller” can be completed.

**Table 1 – Particle Count and Cumulative Percent Smaller Determination**

Particle Size (inches)	Particle Size Range	Particle Count	Cumulative Particle Count	Cumulative Percent Smaller (cum. particle count / total particles)
3.00	$\leq 3.00$	4	4	3.6
4.25	$3.00 < x \leq 4.25$	5	9	8.2
6.00	$4.25 < x \leq 6.00$	25	34	30.9
8.50	$6.00 < x \leq 8.50$	27	61	55.5
12.00	$8.50 < x \leq 12.00$	29	90	81.8
17.00	$12.00 < x \leq 17.00$	14	104	94.5
24.00	$17.00 < x \leq 24.00$	6	110	100.0
34.00	$24.00 < x \leq 34.00$	0		
48.00	$34.00 < x \leq 48.00$	0		
68.00	$48.00 < x \leq 68.00$	0		
96.00	$68.00 < x \leq 96.00$	0		

To complete the report, plot the cumulative percent smaller versus the particle size on a semi-log graph.

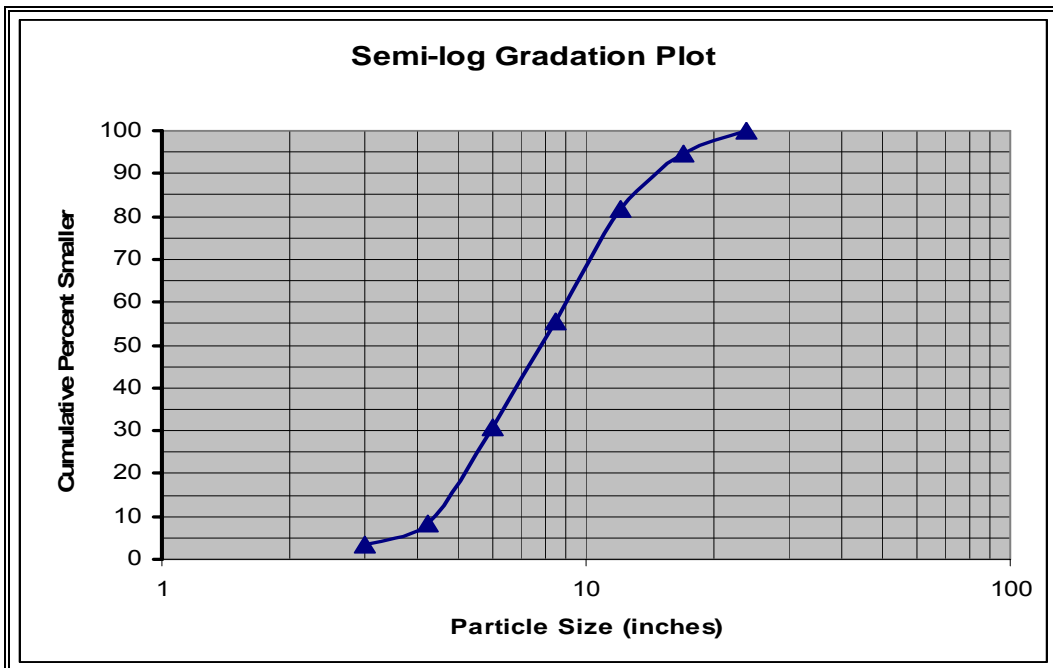

T521-7

(This page intentionally left blank.)

APPENDIX C  
SAMPLE QUANTITIES GUIDE

(This page intentionally left blank.)

Appendix C: Sample Quantities Guide

		Material / Product	Characteristic	Sampling Method	Minimum Field Sample lbs (kg)	Minimum Split Size to FLHD Lab lbs (kg)	
<b>Division 200</b>	<b>Section 204</b>	Topping	Classification	AASHTO T 2			
			2"		220 (100)	44 (20)	
			1"		110 (50)	22 (10)	
			Moisture - Density	AASHTO T 2	330 (150)	50 (23)	
		Select Topping	Classification	AASHTO T 2			
			2"		220 (100)	44 (20)	
			1"		110 (50)	22 (10)	
			Gradation	AASHTO T 2			
			2"		220 (100)	44 (20)	
			1"		110 (50)	22 (10)	
			Liquid Limit/Plasticity Index	AASHTO T 2	12 (5)	12 (5)	
			Moisture-density		330 (150)	50 (23)	
		Unclassified Borrow	Classification	AASHTO T 2			
			2"		220 (100)	44 (20)	
			1"		110 (50)	22 (10)	
	Moisture-density		AASHTO T 2	330 (150)	50 (23)		
	Select Borrow		Classification	AASHTO T 2			
			2"		220 (100)	44 (20)	
			1"		110 (50)	22 (10)	
		Gradation	AASHTO T 2				
		2"		220 (100)	44 (20)		
	1"		110 (50)	22 (10)			
	Liquid Limit/Plasticity Index	AASHTO T 2	12 (5)	12 (5)			
		Moisture-density	AASHTO T 2	330 (150)	50 (23)		
	Earth Embankment	Classification	AASHTO T 2				
		2"		220 (100)	44 (20)		
		1"		110 (50)	22 (10)		
		3/4"		55 (25)	11 (5)		
		1/2"		35 (15)	4 (2)		
		Moisture-density	AASHTO T 2	330 (150)	50 (23)		
<b>Section 208</b>		Foundation Fill	Classification	AASHTO T 2			
	2"			220 (100)	44 (20)		
	1"			110 (50)	22 (10)		
	Gradation		AASHTO T 2				
	2"			220 (100)	44 (20)		
	1"			110 (50)	22 (10)		
	Liquid Limit/Plasticity Index	AASHTO T 2	12 (5)	12 (5)			
		Moisture-density	AASHTO T 2	220 (100)	50 (23)		
	Structural Backfill	Gradation	AASHTO T 2	330 (150)	130 (60)		
		Liquid Limit/Plasticity Index	AASHTO T 2	12 (5)	12 (5)		
Moisture-density		AASHTO T 2	330 (150)	50 (23)			
<b>Section 209</b>	Backfill Material	Gradation	AASHTO T 2				
		3"		330 (150)	130 (60)		
		2"		220 (100)	44 (20)		
		1"		110 (50)	22 (10)		
		Liquid limit	AASHTO T 2	12 (5)	12 (5)		
		Moisture-density	AASHTO T 2	330 (150)	50 (23)		
	Bedding Material	Moisture-density	AASHTO T 2	35 (15)	50 (23)		
	Foundation Fill	Moisture-density	AASHTO T 2	220 (100)	50(23)		
Unclassified Borrow	Classification	AASHTO T 2					
	3"		330 (150)	130 (60)			
	2"		220 (100)	44 (20)			
	1"		110 (50)	22 (10)			

Appendix C: Sample Quantities Guide

		Material / Product	Characteristic	Sampling Method	Minimum Field Sample lbs (kg)	Minimum Split Size to FLHD Lab lbs (kg)	
<b>Division 200</b>	<b>Section 213</b>	Subgrade Stabilization	Mix Design				
			Soil	AASHTO T 2	—	200 (90)	
			Fly Ash	ASTM C 311	—	50 (25)	
			Lime	AASHTO T 218	—	25 (10)	
			Cement	AASHTO T 127	—	25 (10)	
	<b>Section 251</b>	Riprap	Aggregate source quality Apparent specific gravity & absorption, Coarse Durability Index, Sodium Sulfate Soundness, LA Abrasion	AASHTO T 2	—	200 (90)	
	<b>Section 255</b>	Select Granular Backfill	Quality requirements				
			Gradation, Angle of internal friction, Soundness, Plasticity index, Electrochemical	AASHTO T 2			
			3"		330 (150)	130 (60)	
			2"		220 (100)	44 (20)	
1"				110 (50)	22 (10)		
Moisture - Density		AASHTO T 2	330 (150)	50 (23)			
Structural Backfill		Gradation	AASHTO T 2	330 (150)	130 (60)		
	Liquid Limit/Plasticity Index	AASHTO T 2	12 (5)	12 (5)			
	Moisture - Density	AASHTO T 2	330 (150)	50 (23)			
<b>Division 300</b>	<b>Section 301</b>	Aggregate source quality	LA abrasion, Sodium sulfate soundness loss (coarse & fine), Durability Index (coarse & fine), Fractured faces	AASHTO T 2	300 (150)	200 (90)	
			Subbase course, grading A & B	Gradation, Liquid Limit	AASHTO T2	165 (75)	33 (15)
				Moisture - Density	AASHTO T 2	110 (50)	50 (23)
			Base course, grading C, D, & E	Gradation, Liquid Limit	AASHTO T2	110 (50)	22 (10)
				Moisture - Density	AASHTO T 2	110 (50)	50 (23)
	Surface course aggregate	Gradation, Liquid Limit/Plasticity Index, Fractured faces	AASHTO T 2	110 (50)	22 (10)		
		Moisture density (max. density)	AASHTO T 2	110 (50)	50 (23)		
	<b>Section 302</b>	Treated aggregate course (mix design submittal)	Aggregate	AASHTO T 2	—	200 (90)	
			Fly Ash	ASTM C 311	—	50 (23)	
			Lime	AASHTO T 218	—	25 (12)	
			Hydraulic cement	AASHTO T 127	—	25 (12)	
			Retarder / Additives	—	—	5 (2)	
		Aggregate	Gradation, Liquid Limit	AASHTO T 2			
	1 1/2"			165 (75)	33 (15)		
	1"		110 (50)	22 (10)			
	Mixture	Moisture - Density	AASHTO T 2	165 (75)	50 (23)		
	<b>Section 304</b>	Aggregate, Fly ash, Lime, Cement Mixtures (mix design submittal)	Aggregate	AASHTO T 2	—	200 (90)	
			Fly Ash	ASTM C 311	—	50 (23)	
			Lime	AASHTO T 218	—	25 (12)	
			Hydraulic cement	AASHTO T 127	—	25 (12)	
Retarder			—	—	5 (2)		
Aggregate, Fly ash, Lime, Cement Mixtures		Moisture - Density	AASHTO T 2	165 (75)	50 (23)		
Imported aggregate		Gradation, Liquid Limit	AASHTO T2				
		1 1/2"		165 (75)	33 (15)		
1"		110 (50)	22 (10)				
<b>Section 305</b>	Aggregate-Topsoil course	Moisture - Density	AASHTO T 2	110 (50)	50 (23)		

Appendix C: Sample Quantities Guide

		Material / Product	Characteristic	Sampling Method	Minimum Field Sample lbs (kg)	Minimum Split Size to FLHD Lab lbs (kg)
<b>Division 300</b>	<b>Section 308</b>	Crushed aggregate	Moisture - Density	AASHTO T 2	110 (50)	50 (23)
	<b>Section 309</b>	Aggregate source quality	LA abrasion, Sodium sulfate soundness loss (coarse & fine), Durability Index (coarse & fine), Fractured faces	AASHTO T 2	—	200 (90)
		Emulsified asphalt treated base	Gradation, Sand Equivalent	AASHTO T2	110 (50)	22 (10)
Emulsified asphalt treated base (submittal)		Quality, mixture properties	AASHTO T 2	—	300 (150)	
<b>Division 400</b>	<b>Section 401</b>	Aggregate source quality	LA abrasion, Sodium sulfate soundness loss (coarse & fine), Fine aggregate angularity, Flat and elongated particles, Sand equivalent, Fractured faces	AASHTO T 2	—	200 (90)
		Superpave Asphalt Concrete (mix design)	Mix design aggregate	AASHTO T 2	—	800 (375)
			Bag house fines	—	—	20 (10)
			Mineral filler	—	—	20 (10)
			Asphalt binder	AASHTO T 40	—	5 1-gallon samples (5 4-liter samples)
	Asphalt binder	Lime	AASHTO T 218	—	10 (5)	
		Recycled asphalt pavement (RAP)	—	—	200 (100)	
		Quality	AASHTO T 40	—	2 1-quart samples (2 1-liter samples)	
		Hot asphalt concrete pavement (production)	Gradation, Asphalt content, VMA, VFA, Maximum specific gravity	AASHTO T 168	100 (45)	45 (20)
			Core density	ASTM D 5361	6 inch (150 mm) core	6 inch (150 mm) core
	<b>Section 402</b>	Aggregate source quality	LA abrasion, Sodium sulfate soundness loss (coarse & fine), Fractured faces, Sand equivalent	AASHTO T 2	—	200 (90)
		Hveem or Marshall Asphalt Concrete (mix design)	Mix design aggregate	AASHTO T 2	—	800 (375)
			Bag house fines	—	—	20 (10)
			Mineral filler	—	—	20 (10)
			Asphalt binder	AASHTO T 40	—	5 1-gallon samples (5 4-liter samples)
		Lime	AASHTO T 218	—	—	10 (5)
			Recycled asphalt pavement (RAP)	—	—	200 (100)
			Hot asphalt concrete pavement (production)	Gradation, Asphalt content	AASHTO T 168	—
	3/4"			—	32 (14)	16 (7)
	1/2"	—		24 (10)	12 (5)	
	3/8"	—		16 (8)	8 (4)	
	Core density	ASTM D 5361	6 inch (150 mm) core	6 inch (150 mm) core		
	<b>Section 403</b>	Hot asphalt concrete pavement (mix design verification)	Mix design aggregate	AASHTO T 2	—	800 (375)
Bag house fines			—	—	20 (10)	
Mineral filler			—	—	20 (10)	
Asphalt binder			AASHTO T 40	—	5 1-gallon samples (5 4-liter samples)	
Lime			AASHTO T 218	—	10 (5)	
Recycled asphalt pavement (RAP)		—	—	200 (100)		
Hot asphalt concrete pavement (production)		Gradation, Asphalt content	AASHTO T 168	—	—	
		3/4"	—	32 (14)	16 (7)	
		1/2"	—	24 (10)	12 (5)	
		3/8"	—	16 (8)	8 (4)	
Asphalt binder	Quality	AASHTO T 40	—	2 1-quart samples (2 1-liter samples)		
<b>Section 405</b>	Open-graded asphalt friction course	Gradation	AASHTO T 168	8 (4)	8 (4)	
	Asphalt binder	Quality	AASHTO T 40	—	2 1-quart samples (2 1-liter samples)	

Appendix C: Sample Quantities Guide

Division 400		Material / Product	Characteristic	Sampling Method	Minimum Field Sample lbs (kg)	Minimum Split Size to FLHD Lab lbs (kg)
	Section 408	Emulsified asphalt	Quality	AASHTO T 40	—	1-gallon (4-liter) sample
	Section 409	Aggregate surface treatment - source quality	LA abrasion, Sodium sulfate soundness loss (coarse & fine), Durability Index (coarse & fine), Fractured faces, Flat and elongated particles	AASHTO T2	—	200 (90)
		Aggregate surface treatment - produced aggregate	Gradation / Fractured faces	AASHTO T2		
		1"	110 (50)	22 (10)		
		3/4"	55 (25)	11 (5)		
		1/2"	35 (15)	4 (2)		
	3/8"	25 (10)	2 (1)			
	Asphalt binder	Quality	AASHTO T 40	—	2 1-quart samples (2 1-liter samples)	
	Emulsified asphalt	Quality	AASHTO T 40	—	1 gallon (4 liter) sample	
Section 410	Aggregates for slurry seal	LA Abrasion	AASHTO T 2	—	12 (5) Material retained on #4 (4.75 mm) sieve	
		Soundness	AASHTO T 2	—	12 (5)	
		Gradation / Sand equivalent	AASHTO T 2	25 (10)	4 (2)	
Section 411	Emulsified asphalt or Cut-back asphalt	Quality	AASHTO T 40	—	1 gallon (4 liter) sample	
Section 415	Asphalt binder	Quality	AASHTO T 40	—	2 1-quart samples (2 1-liter samples)	
	Emulsified asphalt	Quality	AASHTO T 40	—	1 gallon (4 liter) sample	
Section 416	Recycled base course, Type A (mix design)	Pavement samples		—	10 6-inch (150 mm) cores	
		Emulsified asphalt	AASHTO T 40	—	2 gallons (8 liters)	
		Quicklime	AASHTO T 218	—	2 (1)	
	Emulsified asphalt	Quality	AASHTO T 40	—	1 gallon (4 liter) sample	

Division 500	Section 501	Aggregate source quality	COARSE AGGREGATE: Gradation, LA abrasion, Sodium sulfate soundness, Clay lumps	AASHTO T 2 and AASHTO M 80	—	200 (90)
			FINE AGGREGATE: Gradation, LA abrasion, Sodium sulfate soundness, Clay lumps, Organic impurities	AASHTO T 2 and AASHTO M 6	—	25 (10)
		Structural concrete	Compressive Strength	AASHTO T 141 and AASHTO T 23	—	1 set of cylinders
	Section 502	Aggregate source quality	COARSE AGGREGATE: Gradation, LA abrasion, Sodium sulfate soundness, Clay lumps	AASHTO T 2 and AASHTO M 80	—	200 (90)
			FINE AGGREGATE: Gradation, LA abrasion, Sodium sulfate soundness, Clay lumps, Organic impurities	AASHTO T 2 and AASHTO M 6	—	25 (10)
		Structural concrete	Compressive Strength	AASHTO T 141 and AASHTO T 23	—	1 set of cylinders
	Section 552	Aggregate source quality	COARSE AGGREGATE: Gradation, LA abrasion, Sodium sulfate soundness, Clay lumps	AASHTO T 2 and AASHTO M 80	—	200 (90)
			FINE AGGREGATE: Gradation, LA abrasion, Sodium sulfate soundness, Clay lumps, Organic impurities	AASHTO T 2 and AASHTO M 6	—	25 (10)
		Structural concrete	Compressive Strength	AASHTO T 141 and AASHTO T 23	—	1 set of cylinders
	Section 553	Prestressed concrete	Compressive Strength	AASHTO T 141 and AASHTO T 23	—	1 set of cylinders



Appendix C: Sample Quantities Guide

Division 500	Section 566	Material / Product	Characteristic	Sampling Method	Minimum Field Sample lbs (kg)	Minimum Split Size to FLHD Lab lbs (kg)
		Aggregate source quality	COARSE AGGREGATE: Gradation, LA abrasion, Sodium sulfate soundness, Clay lumps FINE AGGREGATE: Gradation, LA abrasion, Sodium sulfate soundness, Clay lumps, Organic impurities	AASHTO T 2 and AASHTO M 80 AASHTO T 2 and AASHTO M 6	—	200 (90) 25 (10)
Shotcrete	Compressive Strength	AASHTO T 24	—	Cores from production panels		

Division 600	Section 605	Granular backfill	Gradation	AASHTO T2		
			1 1/2"		165 (75)	33 (15)
			1"		110 (50)	22 (10)
			3/4"		55 (25)	11 (5)
			1/2"		35 (15)	4 (2)
		3/8"		25 (10)	2 (1)	
	Section 608	Bed course	Gradation & Liquid Limit	AASHTO T2	25 (10)	4 (2)
		Granular backfill	Gradation	AASHTO T2	25 (10)	4 (2)
	Section 609	Bed course	Gradation & Liquid Limit	AASHTO T2	25 (10)	4 (2)
	Section 615	Bed course	Gradation & Liquid Limit	AASHTO T2	25 (10)	4 (2)
Section 616	Bed course	Gradation & Liquid Limit	AASHTO T2	25 (10)	4 (2)	

(This page intentionally left blank.)

APPENDIX D  
PRE-PAVING MEETING AGENDA

(This page intentionally left blank.)



(This page intentionally left blank.)

**Pre-Paving Meeting Agenda**  
*Superpave – Section 401*

PROJECT: \_\_\_\_\_

DATE: \_\_\_\_\_

- I. Introductions and Titles (please sign sheet)
  - A. Contractor’s Personnel
  - B. Federal Highway Administration Personnel
  - C. Suppliers/subcontractors
  - D. Others
  
- II. Contractor’s Production Schedule
  - A. Begin Paving:
    - When
    - Where (include station and direction)
  - B. Daily production tonnage and # of trucks:
  - C. Projected work hours:
    - Days:
  
- III. Mix Design Information / Plant Operations
  - A. Mixing Temperature - \_\_\_\_\_C ( \_\_\_\_\_ F)
  - B. Target Values & Allowable Deviations

**Superpave Nominal Maximum Aggregate Size \_\_\_\_\_**

SIEVE SIZE	TARGET VALUES	ALLOWABLE DEV. (+/-)
19 mm (3/4")		5
12.5 mm (1/2")		6
4.75 mm (3/8")		7
2.36 mm (#8)		5
600 µm (#30)		4
300 µm (#50)		3
75 µm (#200)		2
AC (%)		0.5

Bin Combinations:

BIN	PERCENT

- C. Lime introduction procedure
  - D. Use of baghouse fines
  - E. Procedure for introducing RAP into the mixture
  - F. Bins and aggregate preparation
- IV. Control (test) Strip, See 401.12
- A. Where (include station and direction)
  - B. Length, width and thickness requirements
  - C. Test strip control sampling requirements
  - D. Process control
  - E. Sample size
  - F. Cores
  - G. Acceptance criteria
  - H. Timely reporting
  - I. Split samples
- V. Construction
- A. Weather limitations, See 401.07
  - B. Surface preparation, See 401.06
  - C. Asphalt preparation, See 401.08
  - D. Aggregate Preparation, See 401.09
  - E. Hauling units
    - (1) Bed condition
    - (2) Tarps / covering
    - (3) Approved release agents
  - F. Laydown Operations
    - (1) Grade control
    - (2) Paver operations
    - (3) Skis – reference and length
    - (4) Paver condition
    - (5) Paving thickness, widths and fore slopes
    - (6) Method(s) for placing material when mechanical spreading and finishing is impractical
    - (7) Joints, trimming and clean-up
  - G. Compaction
    - (1) Rollers – size and type
    - (2) Density requirement
  - H. Weighing procedures and delivery
    - (1) Scale tickets, See 109.03
    - (2) Scale certification, See 109.03
    - (3) Spread person, See 109.04
- VI. Sampling, Acceptance See Section 154 and 401 Sampling and Testing Table
- A. Contractor sampling
    - (1) Location - Behind paver prior to compaction
    - (2) Designated sampler
    - (3) Sampling procedures and device
    - (4) Sampling frequencies
    - (5) Testing procedures



- (a) Ignition method
  - (b) Correction factor
  - (c) Gradation and asphalt content
  - (d) Volumetrics
  - (e) Maximum specific gravity
  - (f) Core density
  - (g) Laboratory equipment
  - (h) Testing forms
  - (6) Project engineer splits samples
  - (7) Binder sampling(between storage and drum, contract frequency)
- VII. Contractor Quality Control, See Section 153
- A. Moisture content
  - B. Gradation, cold feed
  - C. Compaction, on grade-nuclear gauge
  - D. Placement temperature
- VIII. Pavement Smoothness/Roughness, see 401.16
- A. Pavement smoothness/roughness type
  - B. Defective areas
  - C. Measurement and corrective action
  - D. Pay incentives and deducts
- IX. Statistical Acceptance Procedures
- A. Parameters (i.e., density, binder content, volumetrics, etc.) See Table 401 - 6
  - B. Lot definition, See 106.05
  - C. Lot termination and reject, See 106.05
  - D. Incentive/disincentive, See 106.05
- X. Traffic Control
- A. Pilot Car, flaggers, temporary stripping and signing
  - B. Traffic delays
  - C. Work Zone control

(This page intentionally left blank.)

APPENDIX E  
EXAMPLES OF  
CEMENT REPLACEMENT  
AND  
FINENESS MODULUS  
CALCULATIONS

(This page intentionally left blank.)

**Example 1**

Example of portland cement and fly ash weight calculations for a standard FLH mix design at 25 percent class C fly ash replacement (at a rate of 1 to 1) and 20 percent class F fly ash replacement (at a rate of 1.5 to 1)

The FP limits the weight of portland cement that may be replaced with fly ash and other mineral admixtures. Not more than 25 percent of the minimum weight of portland cement shown in the FP for each class of concrete may be replaced with class C fly ash (at a rate of 1 part class C fly ash per 1 part Portland cement). Therefore, if a class A(AE) concrete requiring a minimum cement content of 611 lb/yd<sup>3</sup> was specified, the maximum allowable class C fly ash content would be 153 lb/yd<sup>3</sup> ( $0.25 \times 611 \times 1.0$ ). The corresponding minimum portland cement content for the concrete containing the class C fly ash would be 458 lb/yd<sup>3</sup> ( $611 - (153/1)$ ) with a total cementitious materials content of 611 lb/yd<sup>3</sup> (458 lb/yd<sup>3</sup> cement and 153 lb/yd<sup>3</sup> class C fly ash).

In addition, not more than 20 percent of the minimum weight of portland cement shown in the FP for each class of concrete may be replaced with class F fly ash (at a rate of 1.5 parts class F fly ash per 1 part Portland cement). Therefore, if a class A(AE) concrete requiring a minimum cement content of 611 lb/yd<sup>3</sup> was specified, the maximum allowable class F fly ash content would be 183 lb/yd<sup>3</sup> ( $0.2 \times 611 \times 1.5$ ). The corresponding minimum portland cement content for the concrete containing the class F fly ash would be 489 lb/yd<sup>3</sup> ( $611 - (183/1.5)$ ) with a total cementitious materials content of 672 lb/yd<sup>3</sup> (489 lb/yd<sup>3</sup> cement and 183 lb/yd<sup>3</sup> class F fly ash).

If class A(AE) concrete has been specified and a contractor submits a mix design consisting of a class F fly ash content of 122 lb/yd<sup>3</sup> (wherein class F fly ash has been substituted for 20 percent of the minimum weight of portland cement ( $0.2 \times 611$ )), then the required minimum cement content would be 530 lb/yd<sup>3</sup> ( $611 - (122/1.5)$ ) at the required replacement rate of 1.5 parts class F fly ash per 1 part portland cement. The total cementitious materials content would be 652 lb/yd<sup>3</sup> (530 lb/yd<sup>3</sup> cement and 122 lb/yd<sup>3</sup> class F fly ash).

If a class A (AE) mix design was submitted wherein the cement content exceeded the 611 lb/yd<sup>3</sup> cement content minimum, the maximum allowable class F and class C fly ash contents would still be limited to 183 lb/yd<sup>3</sup> and 153 lb/yd<sup>3</sup>, respectively. Exceptions to these limitations may be considered particularly when fly ash is being incorporated into a mix design to address known durability issues (i.e. to provide resistance to potential sulfate or alkali-silica attack). However, it must be demonstrated that the use of additional fly ash enhances concrete mixture durability.

**Example 2**

Example of calculation of the fineness modulus of fine aggregate.

As shown in Exhibit E-1 below, the arrows within the percent passing and individual percent retained columns, pointing left and down, indicate subtraction of the two connecting values. Arrows pointing to the right within the rows of these same columns indicate the associated subtraction result for each sieve size. After these subtraction calculations have been performed, the fineness modulus is ultimately determined by

summing the cumulative percent retained for each sieve size (except the No. 200 (75  $\mu\text{m}$ )) and dividing the summation by 100. In the exhibit below, the fineness modulus is 2.99. The fineness modulus should range between 2.3 to 3.1 and its uniformity should not vary by more than 0.20 from the base fineness modulus of the aggregate source.

**Exhibit E-1 Fineness Modulus Calculation**

Sieve Size	Individual Percent Retained by Mass	Percent Passing by Mass	Cumulative Percent Retained by Mass
3/8" (9.5 mm)	0	100	0
No. 4 (4.75 mm)	2	98	2
No. 8 (2.36 mm)	8	90	10
No. 16 (1.18 mm)	20	70	30
No. 30 (600 $\mu\text{m}$ )	43	27	73
No. 50 (300 $\mu\text{m}$ )	14	13	87
No. 100 (150 $\mu\text{m}$ )	10	3	97
No. 200 (75 $\mu\text{m}$ )	3	0	-
Total	100	-	299
<b><i>Fineness Modulus = 299 <math>\div</math> 100 = 2.99</i></b>			
<b><i>(Range within 2.3 – 3.1) (Uniformity 0-0.2)</i></b>			

APPENDIX F  
PRE-CONCRETING MEETING  
AGENDA

(This page intentionally left blank.)



## PRE-CONCRETING MEETING AGENDA

PROJECT: \_\_\_\_\_

DATE: \_\_\_\_\_

- I. Introduction and Titles (please sign sheet)
  - A. Contractor's Personnel
  - B. Federal Highway Administration Personnel
  - C. Suppliers/subcontractors
  - D. Other Agencies
  - E. Other
  
- II. Purpose of the meeting  
To discuss standard specification and special contract requirements as they pertain to structural concrete Item 552 and drilled shafts Item 565.
  
- III. Schedule of work
  - A. Proposed schedule for concrete work
  - B. Work hours/days
  
- IV. Review approved concrete mix design/proportioning
  - A. Review/discuss all mix design classes of concrete for structural concrete
  - B. Methods of proportioning, cement, water, aggregates, additives- 552.06,
  - C. Allowable tolerances for proportioning, 552.05
  - D. Calibrated batching equipment, 552.06
  - E. Batch tickets, 552.09
  
- V. Quality Control
  - A. Designated QCS for concrete sampling and testing
  - B. Batch corrected weights, tickets
  - C. Gradations, moisture and FM-CA & FA, --minimum testing requirements
  - D. Truck mixing—revolutions 70 min and 100 max.
  - E. Delivery
    1. Time restriction
    2. Use of set retarders
    3. Retempering
  - F. Slump, air content, unit weight and temperatures—sampling frequency and methods
  - G. Compressive strength:
    1. acceptance—1 set per \_\_\_ cubic yards (meters)
    2. shipping cylinders
  - H. Discuss proper concrete cylinder curing
  - I. Discuss statistical evaluation, 106.05
  - J. Reporting strengths
  - K. Discuss acceptance for incidental items accepted by certification---rebar, cement, additives, steel, etc.,
  
- VI. Placing

- A. False work approval---Section 562
  - B. Cold/hot weather plan---monitor temperatures for aggregates, water, placement, protecting, curing and temperature monitoring, 552.10
  - C. Discuss pumping(loss of air and slump) if applicable, 552.11
  - D. Vibrator/vibrating requirements, 552.11
  - E. Delivery rate
  - F. Maximum drop
  - G. Rebar placement
- VII. Finishing—552.14, 552.16
- A. Striking-off and floating
  - B. Straight edging
  - C. Texturing—552.14
  - D. Deck finishing machine—552.14
- VII. Curing—552.15
- A. Curing times
  - B. Water method
  - C. Form method
  - D. Membrane method
  - E. Deck curing
- IX. Loading
- A. Form Removal, 562.08
  - B. Loads on deck and other members, 552.18

APPENDIX G  
DRILLED SHAFT MEETING AGENDA

(This page intentionally left blank.)

## Drilled Shaft Meeting Agenda

PROJECT: \_\_\_\_\_

DATE: \_\_\_\_\_

- I. Construction requirements, review/discuss drilled shaft installation plan
  - A. Construction Schedule
  - B. Personnel
  - C. Equipment
  
- II. Construction Procedures
  - A. Excavation, dry/wet methods
    - 1. use of casing
    - 2. use of slurry
  - B. Vertical alignment of shaft - tolerances
  - C. Record keeping during shaft excavation
  - D. Cage installation requirements
  
- III. Concrete for Drilled Shafts
  - A. Class of concrete—structural or seal
  - B. Placement procedure—pumped or free fall
  - C. Placement in wet conditions
  
- IV. Cross Hole Sonic Logging
  - A. Access tube placement
  - B. Access tube materials requirements
  - C. CSL integrity testing requirements
  - D. CSL results and reporting requirements
  - E. Interpretation of data
  - F. Correction of defects

(This page intentionally left blank.)