



Data Reference Guide

Version 4.b

Volume II: Biomechanical Tests

May 1999

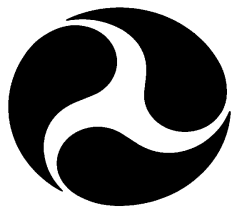

U.S. Department of Transportation

<http://www-nrd.nhtsa.dot.gov/nrd10/software>

[This page intentionally left blank]

TABLE OF CONTENTS

PREFACE	i
RELEASE NOTES	v
INTRODUCTION	vii
CHAPTER 1: GENERAL TEST INFORMATION	1-1
TSTNO - Test Number	1-1
VERNO - Version Number	1-1
TITLE - Contract or Study Title	1-1
TSTOBJ - Test Objectives	1-1
TSTDAT - Test Date	1-1
TSTPRF - Test Performer	1-1
CONNO - Contract Number	1-2
TSTREF - Test Reference Number	1-2
TSTCFN - Test Configuration	1-2
TEMP - Ambient Temperature	1-2
RECTYP - Type of Recorder	1-2
LINK - Data Link to Recorder	1-2
CLSSPD - Closing Speed	1-3
IMPANG - Impact Angle	1-3
TOTCRV - Total Number of Curves	1-3
TSTCOM - Test Commentary	1-3
CHAPTER 2: DUMMY OCCUPANT INFORMATION	2-1
TSTNO - Test Number	2-1
OCCLOC - Occupant Location	2-1
OCCTYP - Occupant Type	2-1
OCCSEX - Occupant Sex	2-1
SEPOSN - Seat Position	2-1
HIC - Head Injury Criterion	2-2
T1 - Lower Boundary of HIC Time Interval	2-2
T2 - Upper Boundary of HIC Time Interval	2-2
CLIP3M - Thorax Region Peak Acceleration Measurement	2-2
LFEM - Left Femur Peak Load Measurement	2-2

CHAPTER 2 (continued)

RFEM - Right Femur Peak Load Measurement	2-2
CSI - Chest Severity Index	2-3
LBELT - Lap Belt Peak Load Measurement	2-3
SBELT - Shoulder Belt Peak Load Measurement	2-3
TTI - Thoracic Trauma Index	2-3
PELVG - Pelvic G's	2-3
MTHCAL - Method of Calibration	2-3
DUMSIZ - Dummy Size Percentile	2-4
DUMMAN - Dummy Manufacturer	2-4
DUMMOD - Dummy Modification	2-4
DUMDSC - Description of the Dummy	2-4
DOCCOM - Occupant Commentary	2-4

CHAPTER 3: BIOLOGICAL SPECIMEN OCCUPANT INFORMATION . . . 3-1

TSTNO - Test Number	3-1
OCCLOC - Occupant Location	3-1
OCCTYP - Occupant Type	3-1
OCCSEX - Occupant Sex	3-1
SEPOSN - Seat Position	3-2
LBELT - Lap Belt Peak Load Measurement	3-2
SBELT - Shoulder Belt Peak Load Measurement	3-2
OCCAGE - Occupant Age	3-2
OCCWT - Occupant Weight	3-2
FRCTRB - Number of Fracture Ribs	3-2
RBFRACT - Number of Rib Fractures	3-3
CADREF - Cadaver Reference Number	3-4
NOTEST - Number of Tests	3-4
DTEDTH - Cadaver Date of Death (DD/MMM/YY)	3-4
CSEDTH - Cadaver Cause of Death	3-4
CADAPP - Cadaver Appearance	3-4
BEDCON - Length of Bed Confinement (days)	3-5
CADAN - Cadaver Anomaly	3-5
AORPRE - Presence of Cardiovascular Pressurization	3-5
CERPRE - Presence of Head Pressurization	3-5
PULPRE - Presence of Pulmonary Pressurization	3-5
RIB1 - First Rib	3-6

CHAPTER 3 (continued)

RIBIN1 - Moment of Inertia for First Rib (millimeters**4)	3-6
NADIS1 - Neutral Axis Distance of the First Rib	3-6
SPLN1 - First Rib Length of Span	3-6
DEFL1 - Deflection of the First Rib	3-6
LOAD1 - Load on the First Rib	3-6
BRKLD1 - Breakload for the First Rib	3-7
ARMAR1 - Area of Bone Marrow of First Rib Segment	3-7
RAREA1 - Total Cross-sectional Area of First Rib	3-8
RIB2 - Second Rib	3-8
RIBIN2 - Moment of Inertia for Second Rib (millimeters**4)	3-8
NADIS2 - Neutral Axis Distance of the Second Rib	3-8
SPLN2 - Second Rib Length of Span	3-8
DEFL2 - Deflection of the Second Rib	3-8
LOAD2 - Load on the Second Rib	3-9
BRKLD2 - Breakload for the Second Rib	3-9
ARMAR2 - Area of Bone Marrow of Second Rib Segment	3-9
RAREA2 - Total Cross-sectional Area of Second Rib	3-9
RIB3 - Third Rib	3-9
RIBIN3 - Moment of Inertia for Third Rib (millimeters**4)	3-9
NADIS3 - Neutral Axis Distance of the Third Rib	3-10
SPLN3 - Third Rib Length of Span	3-10
DEFL3 - Deflection of the Third Rib	3-10
LOAD3 - Load on the Third Rib	3-10
BRKLD3 - Breakload for the Third Rib	3-10
ARMAR3 - Area of Bone Marrow of Third Rib Segment	3-10
RAREA3 - Total Cross-sectional Area of Third Rib	3-11
RIB4 - Fourth Rib	3-11
RIBIN4 - Moment of Inertia for Fourth Rib (millimeters**4)	3-11
NADIS4 - Neutral Axis Distance of the Fourth Rib	3-11
SPLN4 - Fourth Rib Length of Span	3-11
DEFL4 - Deflection of the Fourth Rib	3-11
LOAD4 - Load on the Fourth Rib	3-12
BRKLD4 - Breakload for the Fourth Rib	3-12
ARMAR4 - Area of Bone Marrow of Fourth Rib Segment	3-12
RAREA4 - Total Cross-sectional Area of Fourth Rib	3-12
OCCCOM - Occupant Commentary	3-12

CHAPTER 4: OCCUPANT RESTRAINTS INFORMATION	4-1
TSTNO - Test Number	4-1
RSTNO - Restraint Number	4-1
RSTTYP - Restraint Type	4-1
RSTMNT - Restraint Mount	4-2
DEPLOY - Inflator/Belt Pretensioner Deployment	4-2
RSTCOM - Restraint Commentary	4-2
CHAPTER 5: ANTHROPOMETRIC INFORMATION	5-1
TSTNO - Test Number	5-1
STATUR - Stature	5-1
SHLDHT - Shoulder (Acromial) Height	5-2
VRTSYM - Vertex to Symphision Length	5-2
WASTHT - Waist Height	5-2
SHLDBD - Shoulder (Biacromial) Breadth	5-3
CHSTBD - Chest Breadth	5-3
WASTBD - Waist Breadth	5-3
HIPBD - Hip Breadth	5-4
SHLDEL - Shoulder to Elbow (Acromion to Radiale) Length	5-4
FARMHD - Forearm - Hand Length	5-4
TIBLHT - Tibiale Height	5-5
ANKLHT - Ankle Height	5-5
FOOTBD - Foot Breadth	5-5
FOOTLN - Foot Length	5-6
HDTROC - Head to Trochanterion Distance	5-6
SEATHHT - Seated Height	5-6
KNEEHT - Knee Height, Seated	5-7
HEADLN - Head Length	5-7
HEADBD - Head Breadth	5-8
HEADCH - Head Height (Vertex - Mentum)	5-8
BICPCR - Bicep Circumference	5-8
ELBWCR - Elbow Circumference	5-9
FARMCR - Forearm Circumference	5-9
WRSTCR - Wrist Circumference	5-9
THGHCR - Thigh Circumference Circumference	5-10
LTGHCR - Lower Thigh Circumference	5-10

CHAPTER 5 (continued)	
KNEECR - Knee Circumference	5-11
CALFCR - Calf Circumference Circumference	5-11
ANKLCR - Ankle Circumference	5-12
NECKCR - Neck Circumference	5-12
SCYECR - Scye (Armpit to Shoulder) Circumference	5-12
CHSTCR - Chest Circumference	5-13
WASTCR - Waist Circumference	5-13
BUTTCR - Buttock Circumference	5-13
CHSTDP - Chest (Bust) Depth	5-14
WASTDP - Waist Depth	5-14
BUTTDP - Buttock Depth	5-14
INSCYE - Interscye Distance	5-15
CHAPTER 6: OCCUPANT INJURY INFORMATION	6-1
TSTNO - Test Number	6-1
BODYRG - Body Region	6-1
ASPECT - Body Aspect	6-2
LESION - Injury	6-2
SYSORG - Injured Organ	6-2
AIS - Abbreviated Injury Scale	6-2
INJCOM - Injury Commentary	6-2
CHAPTER 7: INSTRUMENTATION INFORMATION	7-1
TSTNO - Test Number	7-1
CURNO - Curve Number	7-1
SENTYP - Sensor Type	7-1
SENLOC - Sensor Location	7-1
SENATT - Sensor Attachment	7-2
AXIS - Axis Direction of the Sensor	7-2
UNITS - Data Measurement Units	7-2
PREFIL - Prefilter Frequency	7-3
INSMAN - Manufacturer of the Instrument	7-3
CALDAT - Calibration Date	7-3
INSRAT - Instrument Rating	7-3
CHLMAX - Channel Maximum Rating	7-6
INIVEL - Initial Velocity	7-6

CHAPTER 7 (continued)	
NFP - Number of First Point	7-6
NLP - Number of Last Point	7-6
DELTA - Time Increment	7-6
DASTAT - Data Status	7-7
CHSTAT - Channel Status	7-7
INSCOM - Instrumentation Commentary	7-7
CHAPTER 8: CHEST BAND OCCUPANT INFORMATION	8-3
TSTNO - Test Number	8-3
BANDNO - Chest Band Number	8-3
CHSDPT - Chest Depth	8-3
CHSRD - Chest Breadth	8-4
BANLEN - Band Length	8-4
ANTLOC - Anterior Vertical Location	8-5
POSLOC - Posterior Vertical Location	8-8
GAGSTR - Curve Number of the Gauge Relative to the Sternum	8-9
DISSTR - Distance Referenced to the Sternum	8-9
GAGSPN - Curve Number of the Gauge Relative to the Spine	8-9
DISSPN - Distance Referenced to the Spine	8-10
TOTGAG - Total Number of Gauges	8-10
CHBCOM - Chest Band Commentary	8-10
CHAPTER 9: CHEST BAND GAUGE INFORMATION	9-1
TSTNO - Test Number	9-2
BANDNO - Chest Band Number	9-2
GAGENO - Gauge Number	9-3
GAGDIS - Gauge Distance	9-3
CURNO - Curve Number of Specific Gauge	9-4
GAGCOM - Gauge Commentary	9-4
CHEST BAND IMPACT ON INSTRUMENTATION INFORMATION	9-5
SENATT - Sensor Attachment	9-5
SENTYP - Sensor Type	9-5
UNITS - Data Measurement Units	9-5

APPENDICES

APPENDIX A: MEDIA FORMAT	A-1
USING THE “ENTREEW” PROGRAM TO CREATE SPECIFICATION FILES	
Equipment Requirements for ENTREEW	A-1
ENTREEW Conversion Utilities	A-1
ENTREEW Specification File Format Options	A-2
ASCII FORMAT SPECIFICATION FILE	A-2
Omitting Information Group ASCII File	A-3
Record Layout for ASCII Specification File	A-3
LAYOUT FOR MEASUREMENT DATA	A-4
 APPENDIX B: CODES	 B-1
 APPENDIX C: FIELD FORMATS	 C-1
1. TEST INFORMATION	C-1
2. DUMMY OCCUPANT INFORMATION	C-2
3. BIOLOGICAL SPECIMEN OCCUPANT INFORMATION	C-3
4. RESTRAINTS INFORMATION	C-5
5. ANTHROPOMETRY INFORMATION	C-6
6. OCCUPANT INJURY INFORMATION	C-7
7. INSTRUMENTATION INFORMATION	C-8
8. CHEST BAND INFORMATION	C-9
9. CHEST BAND GAUGE INFORMATION	C-9
 APPENDIX D: DATA COORDINATE SYSTEM	 D-1
USING THE COORDINATE SYSTEM CORRECTLY	D-1
Vehicle Coordinate System	D-1
Occupant Global Coordinate System	D-1

LIST OF FIGURES

Figure 1-1 Impact Angle (IMPANG)	1-4
Figure 3-1 Four Fractured Ribs With Six Rib Fractures of the Anterior Thorax	3-3
Figure 3-2 Rib Bending Strength Test Setup	3-7
Figure 7-1 SENATT Codes for Nine Accelerometer Head Array	7-4
Figure 7-2 Body-Based Coordinate System	7-5
Figure 8-1 Anterior Vertical Locations for Cadavers	8-6
Figure 8-2 Anterior Vertical Locations for Hybrid III Dummies	8-7
Figure 8-3 Posterior Vertical Locations for Cadavers	8-8
Figure D-1 Vehicle and Body-based Coordinate Systems	D-2
Figure D-2 Coordinate System for 9-Accelerometer Array	D-3

LIST OF TABLES

Table 7-1 Table of Units	7-8
Table A-1 Sample ASCII Specification File	A-5
Table C-1 Field Format for Test Information	C-1
Table C-2 Field Format for Dummy Occupant Information	C-2
Table C-3 Field Format for Biological Specimen Occupant Information	C-3
Table C-4 Field Format for Restraints Information	C-5
Table C-5 Field Format for Anthropometry Information	C-6
Table C-6 Field Format for Occupant Injury Information	C-7
Table C-7 Field Format for Instrumentation Information	C-8
Table C-8 Field Format for Chest Band Information	C-9
Table C-9 Field Format for Chest Band Gauge Information	C-9
Table D-1 Dummy Manipulations for Checking Recorded Load Cell Polarity Relative to Sign Conventions	D-4

PREFACE

This guide documents the format of media (3.5 inch high density diskettes or CD-ROMs) to be submitted to the National Highway Traffic Safety Administration (NHTSA) for biomechanical tests. This guide is designated Volume II. NHTSA Data Reference Guide (Biomechanical). Three other volumes exist; they correspond to the other NHTSA databases: I. NHTSA Data Reference Guide (Vehicle), III. NHTSA Data Reference Guide (Component), and IV. NHTSA Data Reference Guide (Signal Waveform Generator).

While the four databases are similar, they differ significantly as well. Your data submission will be returned as unacceptable if you submit data in the wrong format for a particular data base.

The first step in creating a data submission is to determine which section of the guide (vehicle crash tests, biomechanics tests, component tests, or signal waveform generator tests) to use. The surest method of determining which section is appropriate for your use is to check with the Contracting Officer's Technical Representative (COTR) who should be able to identify the appropriate data base format. The following guidelines will help to explain the differences between the four data bases.

Information in the vehicle data base relates to the performance and response of vehicles and other structures in impacts.

The biomechanics data base contains information used

- (1) to evaluate human impact response,
- (2) to evaluate prototype dummy designs, or
- (3) to evaluate standard dummy designs in new impact environments.

A component test identifies a specific vehicle component and/or dummy part and summarizes test conditions. Component tests are conducted on various internal or external components of automobiles to provide force deflection or time series data for use in computer simulation models available to NHTSA.

Information in the signal waveform generator data base relates to the evaluation of data acquisition systems at sites performing vehicle crash and biomechanics tests.

A biomechanics test always has exactly one occupant; a vehicle test may have zero occupants or many occupants but normally utilizes dummy (occupant) parts.

Raw data is required unless submission of filtered data is authorized by the Contracting Officer's Technical Representative (COTR).

Several examples may help to illustrate where certain types of tests fit into the data bases:

Tests done as part of the new car assessment program are always vehicle tests.

Pendulum tests to cadavers are always biomechanics tests.

Lateral vehicle-to-vehicle impacts are vehicle tests.

Sled tests with new dummy designs are biomechanics tests.

Calibration tests are component tests.

Tests featuring a car body on a sled designed to evaluate occupant response are biomechanics tests.

Tests using dummy components are always component tests.

Tests (either static or dynamic) measuring deformation impact of a particular interior or exterior component of an automobile by dummy or dummy part art component tests.

Tests evaluating data acquisition systems are signal waveform generator tests.

Tests to record a standard waveform using new car assessment conditioning amplifiers are signal waveform generator tests.

Always check with the COTR in determining which format to use. In all cases where the COTR's advice is contrary to this guide, check with Matt Maltese at (202)366-4717.

When a diskette has been generated according to the appropriate guide, it should be sent via CERTIFIED MAIL to:

The COTR

-or-

Matthew R. Maltese
NHTSA, NRD12, Room 6221
400 Seventh Street, S.W.
Washington, DC 20590

More than one submission may be mailed at one time. The following must be supplied for each mailing:

A cover letter containing a description of each test on each diskette or series of diskettes. This description should contain the data base into which the test should be loaded, the contractor's test reference number, the date of the tests, the test vehicles, component part and the test configuration.

A label on each diskette or CD-ROM listing all tests, along with the contractor's test reference numbers.

A sheet containing a dump of the specification data for each test.

A copy of the plot of each channel of measurement data identifying the curve number and the location and axis of each instrument. These plots do not have to be report quality since they will only be used to verify the test data for each channel.

As soon as possible after each test, a copy of the final test report (if a report has been generated) should be sent to the above address. The COTR should be consulted if different arrangements for the test film and report are required, as would be the case for a test not conducted under DOT auspices.

[this page intentionally left blank]

RELEASE NOTES:

July 1998: Version 4.a. corrects minor typographical errors from original Version 4., which was released in April of 1997.

May 1999: Version 4.b: - includes INJNO (chapter 6) and its definition, excluded in error from earlier iterations.

S PREFIL definition has been clarified (Chapt.7);

S Table A-1 (Appendix A) Sample ASCII Specification File has been expanded.

[This page intentionally left blank]

INTRODUCTION

BACKGROUND

In September of 1966, the National Traffic and Motor Vehicle Safety Act (15 U.S.C. 1381) was signed into law in the United States. The Act specifies that the Secretary of Transportation shall establish appropriate Federal Motor Vehicle Safety Standards that would lead to the reduction of the number of deaths and injuries resulting from motor vehicle accidents. In prescribing standards, the Secretary was to consider: (1) relevant motor vehicle safety data, (2) whether the proposed standard is reasonable, practical, and appropriate for the particular type of motor vehicle equipment for which it is prescribed, and (3) the extent to which such standards contribute to carrying out the purposes of the Act.

In order to meet the above requirements, the National Highway Traffic Safety Administration (NHTSA) has been mandated to develop safety standards. For each proposed regulation, an extensive research program is undertaken to ensure that the proposed standard satisfies the requirements of the Act. An analytical tool that has been utilized to support the research program is the NHTSA crash test data base. For each test conducted for the agency, a formatted magnetic data submission on diskette is generated. The diskette contains specifications about the test as well as the measurement data acquired from the test instrumentation. The specification data is loaded into a data base which has routine data base functions. Analysis techniques are developed for evaluation of the measurement data. This data base was initiated in 1978 and currently contains results from over 3,500 crash tests. An important attribute of this data base is that it provides a standardized format that allows for exchange of data among participating researchers.

This reference guide has been written for two reasons. The first is to document the requirements for the generation of a data diskette. The second is to encourage the adoption of this standardized format so that the exchange of data by the safety research community is readily accomplished and ultimately leads to new and better ways for reducing the fatalities and injuries in motor vehicle accidents.

ORGANIZATION

The guide is divided into two portions: the first consists of the definitions of the data gathered during tests (for use as a reference tool by new users), and the second consists of a series of appendices. In addition to definitions, the definition section includes, for each field, the number of allowable characters, the type of field (integer, text, coded text, and real), and the acceptable units for the entry.

Included in the pocket under the front cover of the guide is a diskette containing the PC-based data entry program, ENTREEW, which may be used to generate the data files described in this document.

The data to be collected during the testing are grouped into six general categories: general test information; vehicle information; barrier information; occupant information; restraint information; and instrumentation information. The organization of the first portion of the guide corresponds to this data grouping scheme, with each chapter comprising one category of data elements:

Chapter 1, **GENERAL TEST INFORMATION**, includes the definitions of data elements identifying the test (type, configuration, date, performing contractor) as well as some elements that identify test conditions (closing speed or impact angle).

Chapter 2, **DUMMY OCCUPANT INFORMATION**, contains information about dummy test subject such as size, type, manufacturer, modifications, and measured injury assessment values.

Chapter 3, **BIOLOGICAL SPECIMEN INFORMATION**, contains information about animal, cadaver or human volunteer test subject such as height, weight, age and sex; for cadavers date of death, appearance, bed confinement, anomaly. In some cases determination of strength of selected ribs--as a result of testing is specified.

Chapter 4, **RESTRAINTS INFORMATION**, lists the restraints used by each of the test occupant and includes information on the type, attachment and deployment status of each restraint.

Chapter 5, **ANTHROPOMETRIC INFORMATION**, details the measurements of the various parts of the body undergoing testing for cadaver and human volunteer test subjects.

Chapter 6, **OCCUPANT INJURY INFORMATION**, defines the injury sustained by the test subject in more detail -- location in the body, severity, physiological system affected, and anomaly. (For tests where the test subjects are animals or cadavers, only.)

Chapter 7, **INSTRUMENTATION INFORMATION**, describes the sensor used in each test by type of instrument, location on the component being tested, attachment points, and other information about how the sensor data is transmitted.

Chapter 8, **CHEST BAND INFORMATION**, describes the relationship between a chest band and the subject to which it is attached. It contains information detailing the location of the band on the subject and the attributes of both the band and the subject at the point of attachment.

Chapter 9, **CHEST BAND GAUGE INFORMATION**, describes the relationships between the active gauges on the chest band and the relationships of those gauges to the curve number that identifies the signal generated by each gauge.

Four appendices appear at the end of this guide:

Appendix A, **MEDIA FORMAT**, gives an explanation for formatting the data and provides a brief description of the data entry program, ENTREEW, which may be used to generate the required data files in either NHTSA's own binary format or in ASCII format.

Appendix B, **CODES**, is a listing of the valid codes for each field.

Appendix C, **FIELD FORMATS**, lists each field, in sequence, the data type, and the maximum field length (for ASCII format data).

Appendix D, **DATA COORDINATE SYSTEM**, explains the rules for determining sign conventions in accordance with SAE recommended practice, Instrumentation for Impact Test -- SAE J211/1 MAR95.

DATA REQUIREMENTS

Data is collected during testing for eventual transmission to diskette. The format is fixed, thus the data must be transcribed with precision so that it can be read by the processing software.

Users are encouraged to utilize the data entry program, ENTREEW, which formats the specification data files automatically and performs validity checks to avoid cross field compatibility and numeric range errors, omissions and miscodings.

ENTREEW output files may be written in one of two ways; either in a special binary format, which NHTSA's in-house processing software loads directly into the NHTSA data bases, or the files may be written in ASCII, for purposes of data exchange outside the agency.

(The format is described in detail in Appendix A: Magnetic Media Format.)

Updates to the ENTREEW program and to this guide may be downloaded from the Internet

<URL <http://www-nrd.nhtsa.dot.gov/nrd10/software>>

Optional Information Groups

Some of the information groups are optional. Groups 1 (Test Information) and 7 (Instrumentation Information) are required for all tests. Each test must have either a Group 2 (Dummy Occupant Information) or Group 3 (Biological Specimen Information) entry, depending on the type of occupant. Groups 4, 5, 6, 8 and 9 are optional. Group 4 (Restraints Information) applies to most sled tests, but may be absent in pendulum and impactor tests. Group 5 (Anthropometric Information) is applicable to cadavers, and human volunteers only, group 6 (Occupant Injury Information) is appropriate for animals and cadavers. If the test occupant is a dummy, skip 3, 5 and 6, and go directly to 7.

Groups 8 and 9 (Chest Band Occupant and Chest Band Gauge Information) apply only to those tests in which chest bands were used.

Optional groups that are not applicable to the test in question should be skipped altogether.

Empty Channels

Instrument channels having no data are not of interest. If channels are bad or empty, an indication of their status should be made in DASTAT (see Appendix B for the allowable codes for DASTAT). Further comments on the status of the data should be made in INSCOM (instrument commentary) -- a code of MN (meaningless) requires an explanation in INSCOM, for example.

CONVENTIONS FOR CODING

Some of the coded fields include NOT APPLICABLE and OTHER codes as options.

NOT APPLICABLE Code Option

Some of the coded fields include NOT APPLICABLE and OTHER codes as options. The NOT APPLICABLE code should be used only if the category is not relevant to the data being collected. For example, in the case of the DEPLOY field, the NOT APPLICABLE code would be used if the restraint used was not an air bag, or air belt. NOT APPLICABLE numeric fields will be left blank. If the data file is written in ASCII rather than the NHTSA ENTREEW binary format, empty fields are delimited by the pipe (|) character. For text fields, a left-justified NOT APPLICABLE will be entered.

OTHER Code Option

The code option, OTHER, should be used if the data element is applicable but none of the codes is appropriate. For DUMSIZ, for example, choosing the OTHER code would be appropriate if the size of the test subject dummy is other than 3-YEAR-OLD CHILD, 50 PERCENTILE, 5 PERCENTILE, 6-YEAR-OLD CHILD, 95 PERCENTILE or NOT APPLICABLE. Anytime the option OTHER is chosen, a brief explanation must be included in the general comment field for that group.

EMPTY FIELDS

Some numeric and free text fields may be left blank if no data is available or the field is not applicable to the test. For example, since TTI (Thoracic Trauma Index) is not calculated for frontal impact tests, the TTI field in section 2, Dummy Occupant Information, may be left blank.

Coded text fields may not be left blank, since there are codes which indicate when a field is either not applicable or no data is available.

MEASUREMENT UNITS

Use metric units only.

For a list of acceptable units and corresponding codes, see Table 1 - 1.

CERTIFICATION REQUIREMENTS

In order to raise and maintain the level of quality of data diskettes being submitted for inclusion in the NHTSA data bases and to insure more efficient processing, a certification process is being instituted effective with this new data format. Each contractor must complete this certification process before we will accept data in the new format. To complete the certification process, contractors will follow the steps listed below:

Submit Media in Appropriate Format

Each contractor will submit data in the new format for certification approval. The diskette or CD-ROM will be submitted in the Biomechanics Database format (or the format for which certification approval is desired). The test written to this diskette may be an old test, a new test submission, or a sample test if an old or new test is not available.

Repeat Submissions Until Certification is Achieved

The diskette will be checked for compliance with the magnetic media processing guidelines. If the data submission is found to be acceptable, a certificate will be sent to the contractor denoting compliance with the current version of the NHTSA media format. If the data submission is not acceptable, the contractor may repeat the submission until an acceptable diskette or CD is produced.

Earn Certification for Each Format

A certificate will be required for each format: vehicle crash test, biomechanics test, component test, or signal waveform generation. A contractor submitting diskettes in more than one format will require a certificate for each. The certificate may be revoked whenever it is evident that a contractor is not maintaining the required level of quality in data submission.

Do Not Submit Diskettes Without Being Certified

Only after a contractor has completed this certification process will data be accepted for inclusion in the OCR data bases.

Submit Certificate with Future Bids

For Research and Development contracts, this certificate will be kept on file in the NHTSA Office of Contracts and Procurement and must be submitted as evidence of compliance when bidding for future contracts. If a proposal on a Research and Development-sponsored RFP is received from a bidder without a valid certificate, the proposal will be rejected as non-responsive

to the solicitation. Each Research and Development RFP requiring the submission of data should contain a statement to this effect.

Incur Costs for Unacceptable Data Submissions

For all NHTSA contracts, including Research and Development contracts, when a data submission is returned to the contractor as unacceptable because of errors, a resubmittal may be validated at a specified cost to the contractor per data resubmission. If required, payment to the Government for this shall be made by offset against the contractor's invoices. Each NHTSA contract which requires the submission of data diskettes will contain a clause to this effect.

RETURN POLICY

If a data diskette cannot be processed or has too many errors flagged by the loading and checkout programs, the submission will be returned to the contractor to be corrected and resubmitted. Two categories of errors lead to the return of a data submission.

MAJOR ERRORS

The first category is major errors. If one major error occurs during the processing of a diskette, the submission will be returned. Examples of major errors are:

Inability to read or load the diskette.

Missing data without which the data submission cannot be processed, such as DELT, IMPANG, NFP, etc.

Omitted data where data fields have been left out. Examples include leaving out an instrument channel, or data shifted as a result of a field delimiter being omitted.

Split channels, which occur when one test is artificially split into two on the diskette with part of the measurement data filed under each.

The rejection of one test on a diskette containing multiple tests.

MINOR ERRORS

The second class of errors is minor errors. If ten or more minor errors occur on a diskette, it will be returned. Examples of minor errors are:

Conversion errors in the measurement data whereby one of the values cannot be read.

Incorrect codings, such as entering a nonvalid sensor attachment code in the SENATT field.

Missing or incorrect information not critical to the processing of the tests such as pretest or post-test measurements.

Anything else not listed here that is flagged by the loading or checkout programs.

1. GENERAL TEST INFORMATION

The data elements defined below constitute the first test group, General Test Information. Appendix B contains a list of valid codes.

TSTNO - Test Number

TSTNO is a preassigned code (0) which is utilized by the data processing software when loading ASCII format input files into the NHTSA Biomechanics database.

Coded text, fixed length, 1 character.

VERNO - Version Number

The number of this version of the NHTSA Data Tape Reference Guide is a preassigned code (B4). This code should be chosen for all vehicle crash tests.

Coded text, fixed length, 2 characters.

TITLE - Contract or Study Title

TITLE is the title of the contract or study.

Free text, variable length, maximum 70 characters.

TSTOBJ - Test Objectives

TSTOBJ is a description of the purpose of the test.

Free text, variable length, maximum 70 characters.

TSTDAT - Test Date (DD/MMM/YY)

TSTDAT is the date the test was performed.

Date text, fixed length, 9 characters.

TSTPRF - Test Performer

TSTPRF is the code for the name of the organization performing the test.

Coded text, fixed length, 3 characters.

CONNO - Contract Number

CONNO is the Department of Transportation contract number (for example, DTNHxx-xx-x-xxxxx in the case of a NHTSA contract or some similar number assigned by the sponsoring organization).

Free text, variable length, 17 character maximum.

TSTREF - Test Reference Number

TSTREF is an alphanumeric code number assigned to the test by the test performer.

Free text, variable length, 10 character maximum.

TSTCFN - Test Configuration

TSTCFN describes the test setup. If a vehicle body is used in a test, describe the make and model of the vehicle (without abbreviations) in TSTCOM.

Coded text, fixed length, 3 characters.

TEMP - Ambient Temperature (degrees Celsius)

TEMP is the temperature at the test location at the time of the test.

Numeric field, integer.

RECTYP - Type of Recorder

RECTYP is the type of data recorder being used in the test.

Coded text, fixed length, 3 characters.

LINK - Data Link to Recorder

LINK is the type of connection from the transducer to the recorder.

Coded text, fixed length, 3 characters.

CLSSPD - Closing Speed (kilometers per hour)

CLSSPD is the total change in velocity of the test subject. The test configuration determines CLSSPD where for a sled test, CLSSPD is the total change in velocity of the sled; for a pendultun test, CLSSPD is the speed of the impactor; and so forth.

Numeric field, real.

IMPANG - Impact Angle (degrees)

IMPANG is the angle of impact in the xy plane, measured clockwise from the x axis. The angle is 0 degrees if the impact is from the front; 90 degrees if the impact is from the right side; 180 degrees if the impact is from the rear; and 270 degrees if the impact is from the left side. Figure 1-1 shows measurement direction in the xy plane.

Numeric field, integer.

TOTCRV - Total Number of Curves

TOTCRV is the total number of recorded instrument channels (curves) in the test.

Numeric field, integer.

TSTCOM - Test Commentary

TSTCOM is the field used to describe other test information for which a coded field does not exist, including anomalies or problems. The reason for coding OTHER or NOT APPLICABLE in the TSTCFN or TSTPRF fields should be recorded in this field as well. If a vehicle body is used in a test, describe the make and model of the vehicle (without abbreviations) in this field. If TSTCFN is coded PEN (an impactor), enter the mass of the impactor in the appropriate units. If no comments are to be made, code the field NO COMMENTS (left justified).

Free text, variable length, maximum 70 characters.

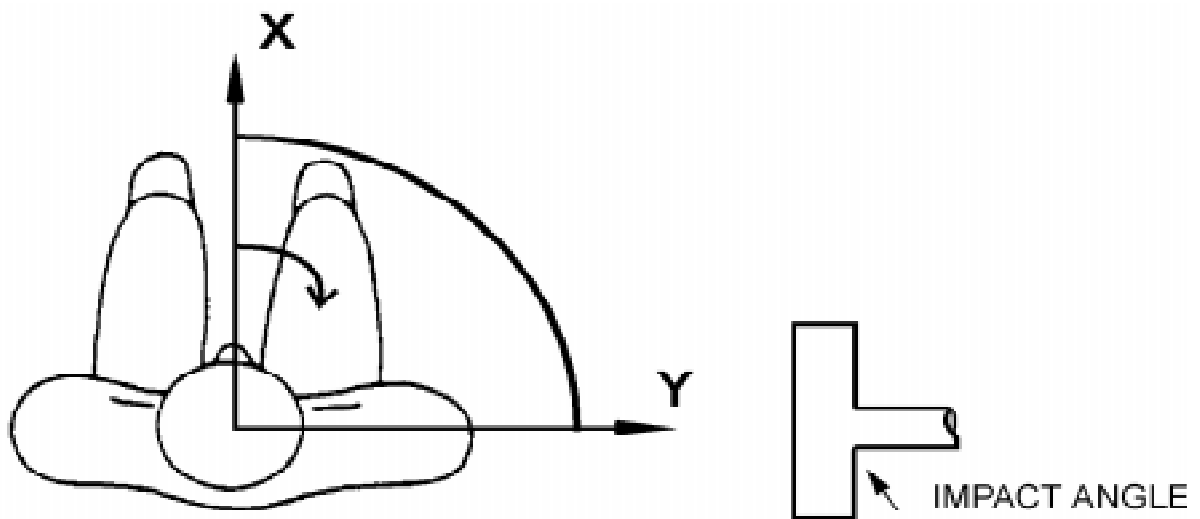

Figure 1-1. Impact Angle (IMPANG)

2. DUMMY OCCUPANT INFORMATION

The data elements defined below comprise the second test group, Dummy Occupant Information. If the test occupant is a cadaver, animal, or human volunteer, this data group is not required.

Appendix B contains a list of valid codes.

TSTNO - Test Number

TSTNO is a preassigned code (0) which is utilized by the data processing software when loading ASCII format input files into the NHTSA Biomechanics database.

Coded text, fixed length, 1 character.

OCCLOC - Occupant Location

OCCLOC is coded OT for all pendulum, drop, pedestrian, and sled tests without a vehicle body. When the test occupant is seated in a vehicle body (such as when a vehicle body is mounted on a sled and the test occupant is sitting in the vehicle), OCCLOC indicates the location of the test occupant (for example, driver, front passenger, and so forth).

Coded text, fixed length, 2 characters.

OCCTYP - Occupant Type

OCCTYP is the type of test occupant, such as the type of dummy, cadaver, animal or human volunteer. A code of SD would be used for an HSRI side impact dummy.

Coded text, fixed length, 2 characters.

OCCSEX - Occupant Sex

OCCSEX is the sex of the test occupant, applicable to all test subjects except child dummies. Code the field N for child dummies.

Coded text, fixed length, 1 character.

SEPOSN - Seat Position

SEPOSN is the position of the seat at the initiation of the test. For pendulum and sled tests without a vehicle body, code the field NO; for drop and pedestrian tests, code the field NA.

Coded text, fixed length, 2 characters.

HIC - Head Injury Criterion

HIC is the computed value of the head injury criterion, based on the resultant acceleration pulse for the head center of gravity. In computing this value, the contractor shall use the HIC algorithm supplied by NHTSA.

Numeric field, integer.

T1 - Lower Boundary of HIC Time Interval (milliseconds)

T1 is the lower boundary of the time interval over which the HIC was computed.

Numeric field, real.

T2 - Upper Boundary of HIC Time Interval (milliseconds)

T2 is the upper boundary of the time interval over which the HIC was computed.

Numeric field, real.

CLIP3M - Thorax Region Peak Acceleration Measurement (g's)

CLIP3M is the maximum 3-millisecond 'clip' value of the chest resultant acceleration, in g's, after filtering with a Class 180 filter (300 Hz Butterworth, low pass, refer to SAE Standard J211 B). In computing the CLIP3M measurement, the contractor shall use the 'clip' algorithm supplied by NHTSA.

Numeric field, real.

LFEM - Left Femur Peak Load Measurement (newtons)

LFEM indicates the maximum compression load for the left femur. Listed as a negative number.

Numeric field, integer.

RFEM - Right Femur Peak Load Measurement (newtons)

RFEM indicates the maximum compression load for the right femur. Listed as a negative number.

Numeric field, integer.

CSI - Chest Severity Index

CSI indicates the computed value of the chest severity index.

Numeric field, integer.

LBELT - Lap Belt Peak Load Measurement (newtons)

LBELT indicates the maximum tension load on the lap belt.

Numeric field, integer.

SBELT - Shoulder Belt Peak Load Measurement (newtons)

SBELT indicates the maximum tension load on the shoulder belt.

Numeric field, integer.

TTI - Thoracic Trauma Index

TTI is the thoracic trauma index value. For a dummy, TTI(d) is computed from the maximum rib and lower spine peak accelerations. In computing this value, the contractor shall use the TTI algorithm supplied by NHTSA.

Numeric field, real.

PELVG - Pelvic G's

PELVG, the pelvis injury criterion, is the peak lateral acceleration on the pelvis. It is obtained after filtering with the FIR100 filtering software supplied by NHTSA.

Numeric field, real.

MTHCAL - Method of Calibration

MTHCAL indicates which method was used to calibrate the test dummy. This field is used for dummy tests only; for other tests, code the field NA,

Coded text, fixed length, 2 characters.

DUMSIZ - Dummy Size Percentile

DUMSIZ indicates the size of the test dummy, measured either as a standard size percentile or by 'age' classification for child dummies.

Coded text, fixed length, 2 characters.

DUMMAN - Dummy Manufacturer and Serial Number

DUMMAN is the serial number as well as the manufacturer of the test dummy. The information should be entered as MFG: (manufacturer's name), S/N (dummy serial number).

Free text, variable length, maximum 70 characters.

DUMMOD - Dummy Modification Description 1

DUMMOD is the description of any modifications to the design of the dummy used in the test. Indicate CONT'D at the end of this field if DUMDSC is to be used to continue this description.

Free text, variable length, maximum 70 characters.

DUMDSC - Dummy Description 2

DUMDSC is a continuation of DUMMOD. DUMDSC should only be used if more space for recording information about the modifications to the test dummy is needed.

Free text, variable length, maximum 70 characters.

DOCCOM - Occupant Commentary

DOCCOM should be used to describe any information that is important about the test occupant that does not appear in any other text field. If no comments are to be made, code the field NO COMMENTS (left justified).

Free text, variable length, maximum 70 characters.

3.

BIOLOGICAL SPECIMEN OCCUPANT INFORMATION

The data elements defined below comprise the third test group, Biological Specimen Occupant Information. If the test occupant is an anthropomorphic dummy this data group is not required.

Appendix B contains a list of valid codes.

TSTNO - Test Number

TSTNO is a preassigned code (0) which is utilized by the data processing software when loading ASCII format input files into the NHTSA Biomechanics database.

Coded text, fixed length, 1 character.

OCCLOC - Occupant Location

OCCLOC is coded OT for all pendulum, drop, pedestrian, and sled tests without a vehicle body. When the test subject is seated in a vehicle body (such as when a vehicle body is mounted on a sled and the test subject is sitting in the vehicle), OCCLOC indicates the location of the test subject (for example, driver, front passenger, and so forth).

Coded text, fixed length, 2 characters.

OCCTYP - Occupant Type

OCCTYP is the type of test occupant, such as the type of cadaver or other occupant including animal or human volunteer.

Coded text, fixed length, 2 characters.

OCCSEX - Occupant Sex

OCCSEX is the sex of the test occupant, applicable to all test occupants except child dummies. Code the field N for child dummies.

Coded text, fixed length, 1 character.

SEPOSN - Seat Position

SEPOSN is the position of the seat at the initiation of the test. For pendulum and sled tests without a vehicle body, code the field NO; for drop and pedestrian tests, code the field NA,.

Coded text, fixed length, 2 characters.

LBELT - Lap Belt Peak Load Measurement (newtons)

LBELT indicates the maximum tension load on the lap belt.

Numeric, integer.

SBELT - Shoulder Belt Peak Load Measurement (newtons)

SBELT indicates the maximum tension load on the shoulder belt.

Numeric, integer.

OCCAGE - Occupant Age

OCCAGE is the age of the test occupant that applied to a cadaver or human volunteer; for animal tests, code the field 99.

Numeric field, integer.

OCCWT - Occupant Weight (kilograms)

OCCWT is the weight of the test occupant.

Numeric field, integer.

FRCTRB - Number of Fractured Ribs

FRCTRB is the number of fractured ribs sustained by the test cadaver or animal. The maximum number of fractured ribs is 24. Figure 3-1 depicts four fractured ribs with six rib fractures. This field is used for animal and cadaver tests only; for human volunteer tests, code the field 99.

Numeric field, integer.

RBFRACT - Number of Rib Fractures

RBFRACT is the number of rib fractures sustained by the test cadaver or animal. Rib fractures will always be greater than or equal to fractured ribs. This field is used for animal and cadaver tests only; for human volunteer tests, code the field 99. Numeric field, integer

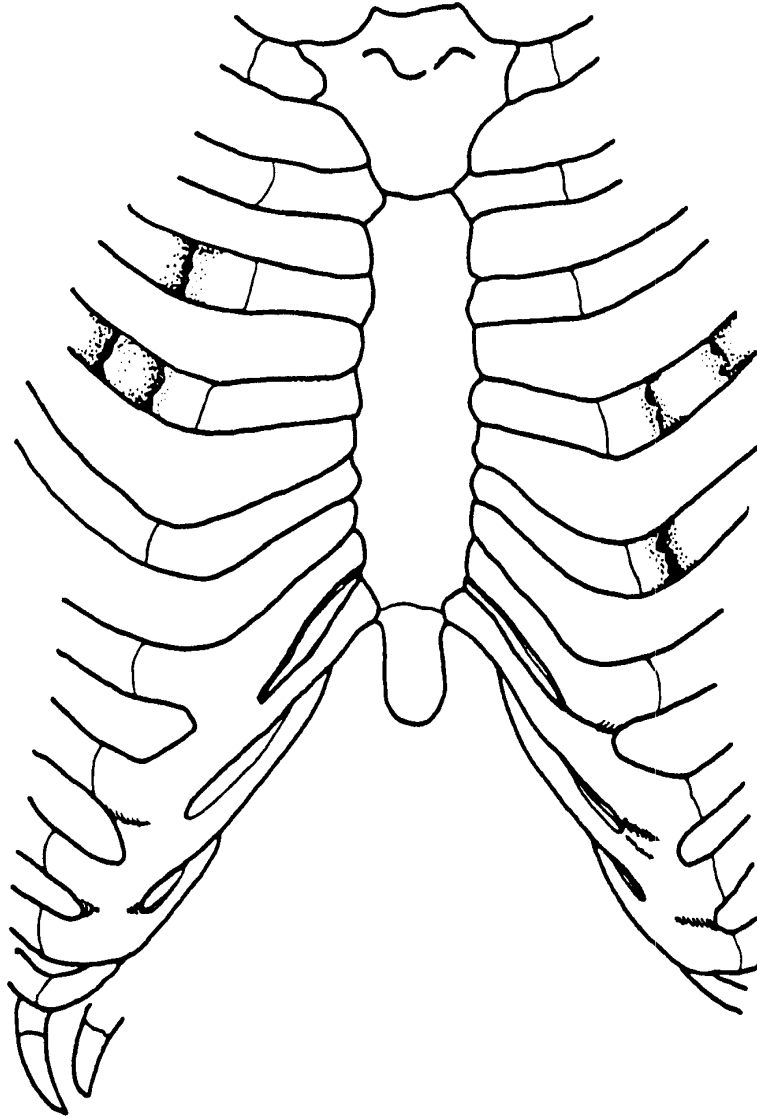

*Figure 3-1:
Four Fractured Ribs With Six Rib Fractures of the Anterior Thorax*

CADAVER TESTS

Fields CADREF through RAREA4 apply to cadavers only. For animal, or human volunteer tests, the remaining fields may be left blank.

CADREF - Cadaver Reference Number

CADREF is the cadaver reference number assigned by the test performer. If multiple tests are performed on a cadaver, each test will have the same CADREF, while each TSTREF (see Section 1) will be different.

Free text, variable length, maximum 10 characters.

NOTEST - Number of Tests

NOTEST indicates the total number of impact tests conducted on the cadaver.

Numeric field, integer.

DTEDTH - Cadaver Date of Death (DD/MMM/YY)

DTEDTH is the date of death of the cadaver.

Date text, fixed length, 9 characters.

CSEDTH - Cadaver Cause of Death

CSEDTH indicates the cause of death of the cadaver.

70-character field (text format).

CADAPP - Cadaver Appearance

CADAPP is the appearance of the cadaver. Anything unusual about the appearance of the cadaver should be noted in this field. If nothing is remarkable about the cadaver, code this field UNREMARKABLE (left justified).

70-character field (text format).

BEDCON - Length of Bed Confinement (days)

BEDCON is the length of bed confinement, in days, of the cadaver immediately prior to death.

3-character field (integer format).

CADAN - Cadaver Anomaly

CADAN is the field in which anything unusual about the cadaver prior to the test should be noted, such as a pretest condition that may affect an injury. If, for example, a cadaver had a broken arm before the test, that characteristic would be noted in this field.

Also included should be an anomalous injury such as one produced by instrumentation rather than the test, e.g. mounting screws for an accelerometer puncture the pericardium.

Free text, variable length, maximum 70 characters.

AORPRE - Presence of Cardiovascular Pressurization

AORPRE indicates whether the cardiovascular system of the thorax and/or abdomen of the test cadaver was pressurized during testing. Code the field YES or NO.

Coded text, fixed length, 3 characters.

CERPRE - Presence of Head Pressurization

CERPRE indicates whether the head vascular system of the test cadaver was pressurized during testing. Code the field YES or NO.

Coded text, fixed length, 3 characters.

PULPRE - Presence of Pulmonary Pressurization

PULPRE indicates whether the pulmonary system of the test cadaver was pressurized during testing. Code the field YES or NO.

3-character field (text format).

RIB1 - First Rib

RIB 1 indicates the position in the rib cage of the first rib undergoing the bending strength test. Left or right side (L or R) is indicated as the first character in the field. The number of the rib (01 for the most superior, 12 for the most inferior) identifies the position of the rib in the skeleton. Figure 3-2 depicts a rib bending strength test setup.

3-character field (text format).

RIBIN1 - Moment of Inertia for First Rib (millimeters4)**

RIBIN1 is the moment of inertia for the cross-section of the first rib being tested.

Numeric field, integer.

NADIS1 - Neutral Axis Distance of the First Rib (millimeters)

NADIS1 is the distance from the neutral axis to the most remote point of the rib cross-section of the first rib being tested.

Numeric field, integer.

SPLEN1 - First Rib Length of Span (millimeters)

SPLEN1 is the length of the span between the two points where the first rib is simply supported.

Numeric field, integer.

DEFL1 - Deflection of the First Rib (millimeters)

DEFL1 represents the deflection of the first rib at the point of loading.

Numeric field, integer.

LOAD1 - Load on the First Rib (newtons)

LOAD1 represents the load on the first rib at the time of DEFL1 where the relationship is linear at a loading rate of 2.54 mm per minute.

Numeric field, integer.

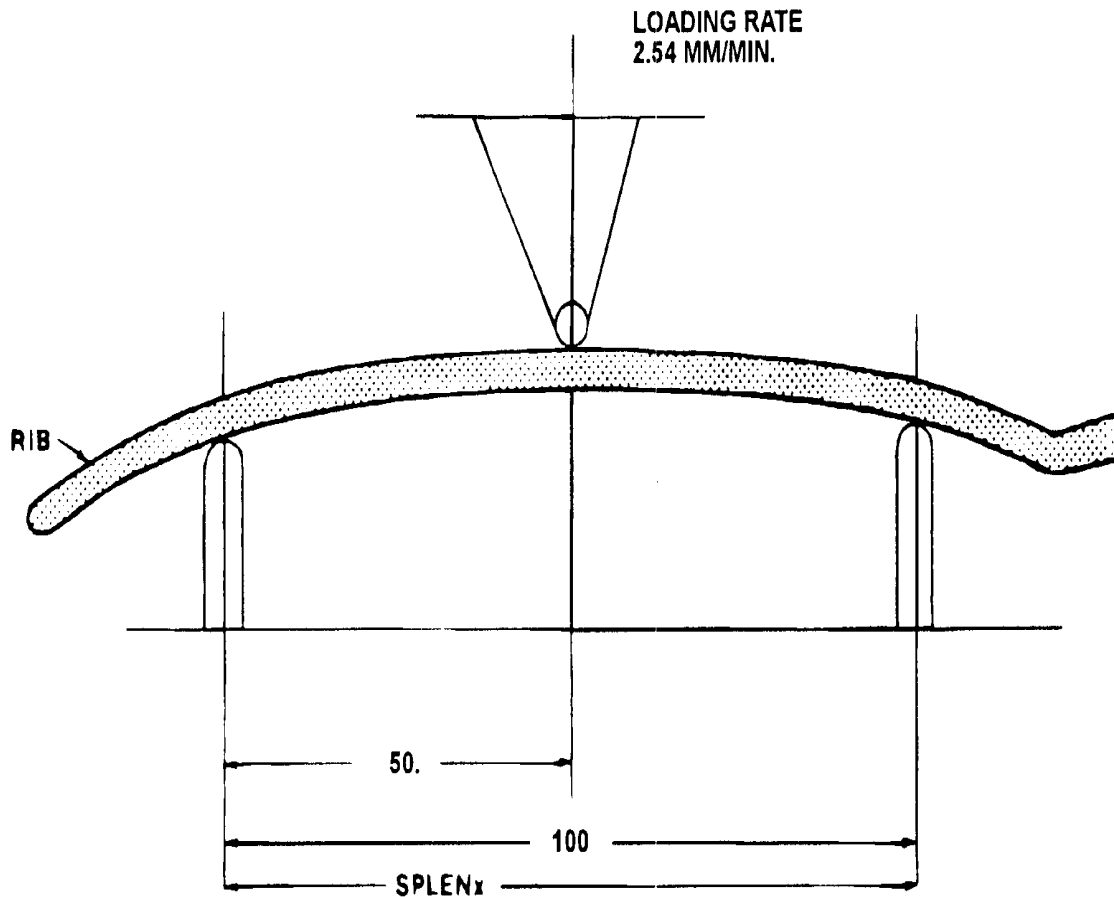

Figure 3-2. Rib Bending Strength Test Setup

BRKLD1 - Breakload for the First Rib (newtons)

BRKLD1 is the load on the first rib at the beginning of the plastic deformation region.

Numeric field, integer.

ARMAR1 - Area of Bone Marrow of First Rib Segment (millimeters2)**

ARMAR1 is the area of the bone marrow, or core, of the first rib segment being tested.

Numeric field, integer.

RAREA1 - Total Cross-sectional Area of First Rib (millimeters2)**

RAREA1 represents the total area of a cross-section of the first rib being tested.

Numeric field, integer.

If only one rib is to be tested, leave the fields pertaining to the second, third, and fourth ribs blank.

RIB2 - Second Rib

RIB2 indicates the position in the rib cage of the second rib undergoing the bending strength test. Left or right side (L or R) is indicated as the first character in the field.

Coded text, fixed length, 3 characters..

RIBIN2 - Moment of Inertia for the Second Rib (millimeters4)**

RIBIN2 is the moment of inertia for the cross-section of the second rib being tested.

Numeric field, integer.

NADIS2 - Neutral Axis Distance of the Second Rib (millimeters)

NADIS2 is the distance from the neutral axis to the most remote point of the rib cross-section of the second rib being tested.

Numeric field, integer.

SPLEN2 - Second Rib Length of Span (millimeters)

SPLEN2 is the length of the span between the two points where the second rib is simply supported.

Numeric field, integer.

DEFL2 - Deflection of the Second Rib (millimeters)

DEFL2 represents the deflection of the second rib at the point of loading.

Numeric field, integer.

LOAD2 - Load on the Second Rib (newtons)

LOAD2 represents the load on the second rib at the time of DEFL2 where the relationship is linear at a loading rate of 2.54 mm per minute.

Numeric field, integer.

BRKLD2 - Breakload for the Second Rib (newtons)

BRKLD2 is the load on the second rib at the beginning of the plastic deformation region.

Numeric field, integer.

ARMAR2 - Area of Bone Marrow of Second Rib Segment (millimeters2)**

ARMAR2 is the area of the bone marrow, or core, of the second rib segment being tested.

Numeric field, integer.

RAREA2 - Total Cross-sectional Area of Second Rib (millimeters2)**

RAREA2 represents the total area of a cross-section of the second rib being tested.

Numeric field, integer.

If only two ribs are to be tested, leave the fields pertaining to the third and fourth ribs blank.

RIB3 - Third Rib

RIB3 indicates the position in the rib cage of the third rib undergoing the bending strength test. Left or right side (L or R) is indicated as the first character in the field.

Coded text, fixed length, 3 characters.

RIBIN3 - Moment of Inertia for the Third Rib (millimeters4)**

RIBIN3 is the moment of inertia for the cross-section of the third rib being tested.

Numeric field, integer.

NADIS3 - Neutral Axis Distance of the Third Rib (millimeters)

NADIS3 is the distance from the neutral axis to the most remote point of the rib cross-section of the third rib being tested.

Numeric field, integer.

SPLEN3 - Third Rib Length of Span (millimeters)

SPLEN3 is the length of the span between the two points where the third rib is simply supported.

Numeric field, integer.

DEFL3 - Deflection of the Third Rib (millimeters)

DEFL3 represents the deflection of the third rib at the point of loading.

Numeric field, integer.

LOAD3 - Load on the Third Rib (newtons)

LOAD3 represents the load on the third rib at the time of DEFL3 where the relationship is linear at a loading rate of 2.54 mm per minute.

Numeric field, integer.

BRKLD3 - Breakload for the Third Rib (newtons)

BRKLD3 is the load on the third rib at the beginning of the plastic deformation region.

Numeric field, integer.

ARMAR3 - Area of Bone Marrow of Third Rib Segment (millimeters2)**

ARMAR3 is the area of the bone marrow, or core, of the third rib segment being tested.

Numeric field, integer.

RAREA3 - Cross-sectional Area of Third Rib (millimeters **2)

RAREA3 represents the total area of a cross-section of the third rib being tested.

Numeric field, integer.

If only three ribs are to be tested, leave the fields pertaining to the fourth rib test blank.

RIB4 - Fourth Rib

RIB4 indicates the position in the rib cage of the fourth rib undergoing the bending strength test. Left or right side (L or R) is indicated as the first character in the field.

Coded text, fixed length, 3 characters.

RIBIN4 - Moment of Inertia for the Fourth Rib (millimeters4)**

RIBIN4 is the moment of inertia for the cross-section of the fourth rib being tested.

Numeric field, integer.

NADIS4 - Axis Distance of the Fourth Rib (millimeters)

NADIS4 is the distance from the neutral axis to the most remote point of the rib cross-section of the fourth rib being tested.

Numeric field, integer.

SPLEN4 - Rib Length of Span (millimeters)

SPLEN4 is the length of the span between the two points where the fourth rib is simply supported.

Numeric field, integer.

DEFL4 - Deflection of the Fourth Rib (millimeters)

DEFL4 represents the deflection of the fourth rib at the point of loading.

Numeric field, integer.

LOAD4 - Load on the Fourth Rib (newtons)

LOAD4 represents the load on the fourth rib at the time of DEFL4 where the relationship is linear at a loading rate of 2.54 mm per minute.

Numeric field, integer.

BRKLD4 - Breakload for the Fourth Rib (newtons)

BRKLD4 is the load on the fourth rib at the belong of the plastic deformation region.

Numeric field, integer.

ARMAR4 - Area of Bone Marrow of Fourth Rib Segment (millimeters **2)

ARMAR4 is the area of the bone marrow, or core, of the fourth rib segment being tested.

Numeric field, integer.

RAREA4 - Total Cross-sectional Area of Fourth Rib (millimeters2)**

RAREA4 represents the total area of a cross-section of the fourth rib being tested.

Numeric field, integer.

OCCCOM - Occupant Commentary

BOCCOM should be used to describe any information that is important about the test occupant that does not appear in any other text field. If no comments are to be made, code the field NO COMMENTS (left justified).

Free text, variable length, maximum 70 characters.

4.

OCCUPANT RESTRAINTS INFORMATION

The data elements defined below comprise the fourth data group, Occupant Restraints Information. Appendix B contains a list of valid codes.

Restraint information is required for each test occupant. For unrestrained occupants, RESTYP = NON. Belts should be coded only if they were used in the test. Inflatable restraints should be coded whether the test resulted in deployment or not. If an occupant is protected by three restraints, e.g. a 3 point belt, and front and side air bags, three restraint records should be generated for that occupant.

TSTNO - Test Number

TSTNO is a preassigned code (0) which is utilized by the data processing software when loading ASCII format input files into the NHTSA Biomechanics database.

Coded text, fixed length, 1 character.

RSTNO - Restraint Number

RSTNO is the sequential number assigned to each restraint system in use for a given occupant at the time of the test. RSTNO = 1 for the first restraint listed for each occupant.

Numeric field, integer.

RSTTYP - Restraint Type

RESTR1 describes the type of restraint or otherwise describes the test apparatus used. An unrestrained test in a vehicle body is NOT coded as NON; rather, dashboard, steering column, or other appropriate vehicle-related component should be coded. Likewise a pendulum test with a steel bar on the face of the impactor is coded as OTH. Use of OTH requires a description in RESTXT such as '25 mm diameter steel bar on impactor face.'

Coded text, fixed length, 3 characters.

RSTMNT - Restraint Mount

RSTMNT indicates the interior component(s) to which the restraint is mounted or from which it originates. For a driver frontal air bag, RSTMNT is the steering wheel hub (SH). Side air bags/air belts could be mounted in the seatback (SB), door (DR), or side header (HS).

Coded text, fixed length, 2 characters.

DEPLOY - Inflator/Belt Pretensioner Deployment

DEPLOY describes the deployment performance of inflatable restraints or the firing of the belt pretensioner during the test.

Coded text, fixed length, 2 characters.

RSTCOM - Restraint Commentary

RSTCOM is used to describe any distinguishing features of the restraint system. If OTHER is used to code the any of the restraint system fields, descriptive information may be added here. If no comments are to be made, enter NO COMMENTS here.

Free text, variable length, maximum 70 characters.

5.

ANTHROPOMETRIC INFORMATION

The data elements defined below comprise the fifth test group, Anthropometric Information. This information group is applicable to cadavers and human volunteers only. If a dummy is the test occupant, this information group should be omitted.

Appendix B contains a list of valid codes.

TSTNO - Test Number

TSTNO is a preassigned code (0) which is utilized by the data processing software when loading ASCII format input files into the NHTSA Biomechanics database.

Coded text, fixed length, 1 character.

STATUR - Stature (millimeters)

STATUR is the stature of the test occupant, measured as the horizontal distance from the headboard of the measuring table to the most distal portion of the heel and taken as an average of the measurement from the left heel and the measurement from the right heel. The measurement is taken with an anthropometer, with the test occupant supine, head in the Frankfort plane and firmly touching the headboard.

Numeric field, integer.



SHLDHT - Shoulder (Acromial) Height (millimeters)

SHLDHT is the shoulder height of the test occupant measured as the horizontal distance from the most distal portion of the heel to the most lateral point of the acromial process of the scapula. The measurement may be obtained by measuring either the distance to both the right and left heels and averaging the two values; or by measuring the distance from the vertex of the head to the acromial process and subtracting the value from STATUR.

Numeric field, integer.

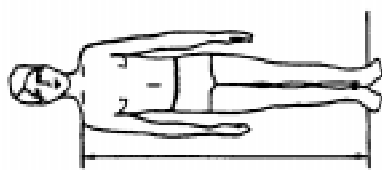
**VRTSYM - Vertex to Symphysis Length (millimeters)**

VRTSYM is the test occupant's vertex-to-symphysis length, measured, using an anthropometer, from the headboard of the measuring table to the symphysis, with the test occupant in a supine position, head oriented in the Frankfort plane and firmly touching the headboard.

Numeric field, integer.

**WASTHT - Waist Height (millimeters)**

WASTHT is the test occupant's waist height, measured as the horizontal distance from the most distal portion of the heel to the anterior superior iliac spine. The measurement may be obtained by measuring either the distance to both the right and left heels and averaging the two values; or by measuring the distance from the vertex of the head to the anterior superior iliac spine and subtracting the value from STATUR.

Numeric field, ral.



SHLDBD - Shoulder (Biacromial) Breadth (millimeters)

SHLDBD is the breadth of the test occupant's shoulder measured as the distance across the body between the lateral edge of the left and right acromions.

Numeric field, integer.

**CHSTBD - Chest Breadth (millimeters)**

CHSTBD is the chest breadth of the test occupant, taken as the average of two measurements of the horizontal breadth of the chest -- one taken at the axilla and the other at the substernale, using a beam caliper.

Numeric field, integer.

**WASTBD - Waist Breadth (millimeters)**

WASTBD is the waist breadth of the test occupant, measured, using a beam caliper, as the horizontal breadth of the body at the level of the anterior superior iliac spine.

Numeric field, integer.



HIPBD - Hip Breadth (millimeters)

HIPBD is the hip breadth of the test occupant, measured, using an anthropometer, between the right and left illocristale landmarks perpendicular to the mid-sagittal plane.

Numeric field, integer.

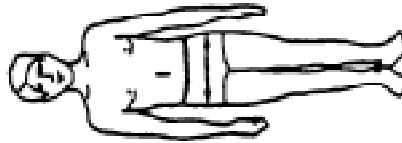

SHLDEL - Shoulder to Elbow (Acromion to Radiale) Length (millimeters)

SHLDEL is the length of the test occupant's arm from shoulder to elbow, measured, with a beam caliper, as the distance from the top of the acromion process to the bottom of the elbow, with the arm flexed 90 degrees.

Numeric field, integer.

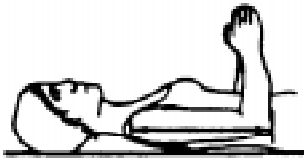

FARMHD- Forearm - Hand Length (millimeters)

FARMHD is the length of the test occupant's forearm, measured, with a beam caliper, from the tip of the elbow to the tip of the longest finger, with the arm flexed 90 degrees.

Numeric field, integer.

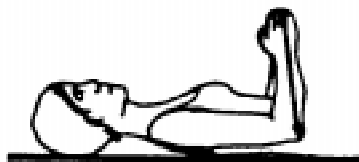

TIBLHT - Tibiale Height (millimeters)

TIBLHT is the knee height of the test occupant, measured from the most distal portion of the heel to the proximal medial margin of the tibia. The measurement may be obtained by measuring either the distance to both the right and left heels and averaging the two values; or by measuring the distance from the vertex of the head to the proximal medial margin of the tibia and subtracting that value from STATUR.

Numeric field, integer.

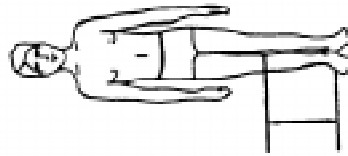
**ANKLHT - Ankle Height (millimeters)**

ANKLHT is the height of the test occupant's ankle as measured, with sliding calipers, from the most distal portion of the heel to the level of the minimum circumference of the ankle (at the level proximal to the malleoli of the tibia and fibula perpendicular to the long axis of the lower leg).



Numeric field, integer.

FOOTBD - Foot Breadth (millimeters)

FOOTBD is the breadth of the test occupant's foot, measured with sliding calipers, at the level of the metatarsal-phalangeal joints along an axis perpendicular to the long axis of the foot. Measure the breadth of both feet and take the average to obtain FOOTBD.

Numeric field, integer.



FOOTLN - Foot Length (millimeters)

FOOTLN is the length of the test occupant's foot, taken as the average of the measurements for both feet. Take the measurements, using a beam caliper, from the dorsal surface of the heel to the tip of the big toe. Measure the length of both feet and take the average to obtain FOOTLN.

Numeric field, integer.

**HDTROC - Head to Trochanterion Distance (millimeters)**

HDTROC is the horizontal distance from the test occupant's head to the Trochanterion measured, using an anthropometer, from the headboard of the measuring table to the Trochanterion, with the test occupant supine, head in the Frankfort plane.

Numeric field, integer.

**SEATHT - Seated Height (millimeters)**

SEATHT is the test occupant's seated height, measured as the vertical distance from the sitting surface to the top of the head. The measurement is taken with the test occupant sitting erect, looking straight ahead. This measurement must be made in all cases where the test occupant is seated during testing.

Numeric field, integer.



KNEEHT - Knee Height, Seated (millimeters)

KNEEHT is the knee height of the test occupant, taken as an average of the vertical distance from the floor to the uppermost point on the knee of both legs. The measurement is taken with the test occupant sitting erect, knees and ankles at right angles. This measurement must be made in all cases where the test occupant is seated during testing.

Numeric field, integer.

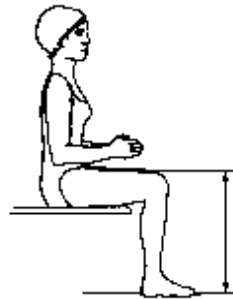
**HEADLN - Head Length (millimeters)**

HEADLN is the head length of the test occupant, measured as the maximum length of the head between the glabella and the occiput in the mid-sagittal plane.

Numeric field, integer.



HEADBD - Head Breadth (millimeters)

HEADBD is the test occupant's head breadth, measured, with spreading calipers, as the maximum horizontal breadth of the skull above the level of the ears, perpendicular to the mid-sagittal plane.

Numeric field, integer.

**HEADCH - Head Height (Vertex - Mentum) (millimeters)**

HEADCH is the test occupant's head height, measured from the highest point on the head to the mentum landmark.

Numeric field, integer.

**BICPCR - Bicep Circumference (millimeters)**

BICPCR is the circumference of the test occupant's bicep, measured, with a tape, as the circumference of the upper arm at the level of the maximum anterior prominence of the biceps brachii, perpendicular to the long axis of the upper arm.

Numeric field, integer.



ELBWCR - Elbow Circumference (millimeters)

ELBWCR is the circumference of the test occupant's elbow, measured with a tape passing over the olecranon process of the ulna and into the crease of the elbow, which is flexed at 125 degrees.

Numeric field, integer.

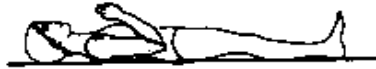

FARMCR - Forearm Circumference (millimeters)

FARMCR is the circumference of the test occupant's forearm, measured at the maximum circumference of the forearm, with a tape perpendicular to the long axis of the forearm.

Numeric field, integer.



WRSTCR - Wrist Circumference (millimeters)

WRSTCR is the wrist circumference of the test occupant, measured at the minimum circumference of the wrist proximal to the radial and ulnar styloid processes, with a tape perpendicular to the long axis of the forearm.

Numeric field, integer.



THGHCR - Thigh Circumference (millimeters)

THGHCR is the circumference of the test occupant's thigh, measured, with a tape, perpendicular to the long axis of the leg and passing just below the lowest point of the gluteal furrow.

Numeric field, integer.

**LTGHCR - Lower Thigh Circumference (millimeters)**

LTGHCR is the circumference of the test occupant's lower thigh, measured, just superior to the patella, with a tape perpendicular to the long axis of the thigh.

Numeric field, integer.



KNEE CR - Knee Circumference (millimeters)

KNEE CR is the circumference of the test occupant's knee, measured either with the leg extended or with the knee flexed 90 degrees. Only one measurement is needed for the test. For tests in which the test occupant is seated with the leg flexed 90 degrees, measure the circumference of the knee across the antecubital crease and the most anterior superior margin of the patella. Measure the circumference of both knees and take the average to obtain KNEE CR.

For all other tests, the test occupant is supine with the leg extended. Measure the circumference of both knees at the level of the mid-patella landmark and take the average to obtain KNEE CR.

Numeric field, integer.

**CALF CR - Calf Circumference (millimeters)**

CALF CR is the circumference of the test occupant's calf, taken as the average measurement of the calf circumferences of both legs. Using a tape perpendicular to the long axis of the lower leg, measure the maximum circumference of the calf for each leg.

Numeric field, integer.



ANKLCR - Ankle Circumference (millimeters)

ANKLCR is the circumference of the test occupant's ankle, measured as the average maximum circumference of the ankle perpendicular to the long axis of the lower leg at the level proximal to the malleoli of the tibia and fibula.

Numeric field, integer.

**NECKCR - Neck Circumference (millimeters)**

NECKCR is the circumference of the test occupant's neck, measured with a tape in a plane perpendicular to the axis of the neck and passing inferior, but tangent, to the laryngeal prominence.

Numeric field, integer.

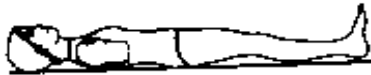
**SCYECR - Scye (Armpit to Shoulder) Circumference (millimeters)**

SCYECR is the test occupant's scye circumference, measured by passing through the axilla over the anterior and posterior vertical scye landmarks and over the acromial landmarks.

Numeric field, integer.



CHSTCR - Chest Circumference (millimeters)

CHSTCR is the test occupant's chest circumference, taken as the average of two measurements, made perpendicular to the long axis of the trunk: one taken as the axilla circumference and the other as the substernale circumference.

Numeric field, integer.



WASTCR - Waist Circumference (millimeters)

WASTCR is the waist circumference of the test occupant, measured with a tape passing over the anterior superior iliac spine and perpendicular to the long axis of the trunk.

Numeric field, integer.



BUTTCR - Buttock Circumference (millimeters)

BUTTCR is the horizontal circumference of the buttocks of the test occupant, measured at the level of the trochanterion surface landmarks.

Numeric field, integer.



CHSTDP - Chest (Bust) Depth (millimeters)

CHSTDP is the test occupant's chest depth, taken as the average of two measurements: with an anthropometer, one is taken from the measuring table to the anterior surface of the body at the axilla and the other at the substernale.

Numeric field, integer

**WASTDP - Waist Depth (millimeters)**

WASTDP is the waist depth of the test occupant, measured as the vertical distance between the measuring table and the anterior surface of the body at the level of the anterior superior iliac spine.

Numeric field, integer.

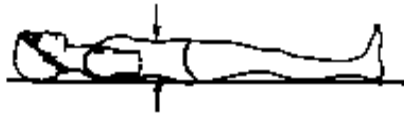
**BUTTDP - Buttock Depth (millimeters)**

BUTTDP is the buttock depth of the test occupant, measured as the anterior-posterior distance on the medial plane projection at the level of the maximum posterior protrusion of the buttocks.

Numeric field, integer.



INSCYE - Interscye Distance (millimeters)

INSCYE is the horizontal distance across the back of the test occupant, measured between the posterior scye point landmarks.

Numeric field, integer.



[This page intentionally left blank]

6.

OCCUPANT INJURY INFORMATION

The data elements that are defined below comprise the sixth test group, Occupant Injury Information. The fields in this information group are used only for animal and cadaver tests. The appropriate information should be recorded in all fields for each injury sustained by the test occupant. If no injuries occur, this section should be omitted.

This section is intended to be a concise, not an exhaustive, report of the occupant injuries, following, in general, the practices of accident investigation teams. Code as many injuries as the test occupant received, one injury per record. Start with the most severe injuries (highest AIS) and continue to the least severe injury.

If an injury is solely the result of instrumentation mounts (e.g. mounting screws lacerating the brain), do not code the injury, but do note this fact in CADAN (3, Biological Specimen Occupant Information). If the cause of the injury cannot be clearly attributed to the test or to instrumentation, note this problem in INJCOM (injury text below). For example, if a skull fracture propagates through an accelerometer mount, code the injury, but note in INJCOM that the fracture propagates through the mount. Appendix B contains a list of valid codes.

TSTNO - Test Number

TSTNO is a preassigned code (0) which is utilized by the data processing software when loading ASCII format input files into the NHTSA Biomechanics database.

Coded text, fixed length, 1 character.

BODYRG - Body Region

BODYRG is the region of the test occupant's body sustaining injury.

Coded text, fixed length, 1 character.

ASPECT - Body Aspect

ASPECT provides a refinement of BODYRG by indicating which portion was injured. If a lesion involves more than one aspect of a body region, determine the predominant aspect and code ASPECT as that aspect. Use W (whole) if ASPECT cannot be determined.

As an example, consider a laceration on the right side of the spleen. The aspect would not be coded right (R) referring to where the laceration is on the spleen. The aspect would be coded left (L), referring to the position of the injury in the body region, abdomen.

Coded text, fixed length, 1 character.

LESION - Injury

LESION is the type of injury sustained by the test occupant. Hemorrhages represent the result of injuries; indicate them as abrasion, contusion, laceration, or strain.

Coded text, fixed length, 1 character.

SYSORG - Injured Organ

SYSORG is the organ or physiological system of the test occupant sustaining injury.

Coded text, fixed length, 1 character.

AIS - Abbreviated Injury Scale

AIS is the abbreviated injury scale, a numerical ranking of the severity of the injury sustained by the test occupant. In AIS, injury is coded on a scale of one to six. The reference volume to be used to determine this injury classification is The Abbreviated Injury Scale (1990 revision), American Association of Automotive Medicine, P.O. Box 222, Morton Grove, Illinois 60053.

Coded text, fixed length, 1 character.

INJCOM - Injury Commentary

INJCOM is the field used to describe the injury. Some examples are: FRACTURES OF RIBS R-7 AND R-8 or LACERATION OF THE LARYNX.

Free text, variable length, maximum 70 characters.

7.

INSTRUMENTATION INFORMATION

The data elements that are defined below make up the seventh test group, Instrumentation Information. Appendix B contains a list of valid codes.

Approximately twenty milliseconds of quiescent data after time zero should come with all measurement data; data shall meet the class 1000 specifications of the SAE J211 recommendation; and all data should be truncated at a common time value to avoid extending the pulse well past the period of significant activity.

The minimum sample rate shall be 8000 Hz. A sample rate shall be chosen such that the DELT value does not have to be rounded off.

TSTNO - Test Number

TSTNO is a preassigned code (0) which is utilized by the data processing software when loading ASCII format input files into the NHTSA Biomechanics database.

Coded text, fixed length, 1 character.

CURNO - Curve Number

CURNO is the sequential number (1,2,3 ...) assigned to a specific sensor and data curve.

Numeric field, integer.

SENTYP - Sensor Type

SENTYP indicates the type of sensor used for collecting the measurements at the time of the test.

Coded text, fixed length, 2 characters.

SENLOC - Sensor Location

SENLOC describes the test occupant's location within a vehicle. SENLOC is relevant to biomechanics tests only when a vehicle body is used. Thus SENLOC is irrelevant for all pendulum tests, drop tests, and pedestrian tests. For most sled tests, SENLOC is also irrelevant.

When SENLOC is irrelevant, code it as NA. In those cases where a vehicle body is on a sled, and the test occupant may be seated within the passenger compartment, (code SENLOC appropriately to describe where the test occupant is seated in the vehicle body. SENLOC should correspond to a previously entered value of OCCLOC.

2-character field (coded text format).

SENATT - Sensor Attachment

SENATT indicates where the sensor is attached.

Figure 7-1 illustrates SENATT codes for a nine accelerometer head array. The distance, *d*, is the length of the arm between HD90 and HD9Y, measured along, the Y arm. The reporting of this value of *d* is described in the INSCOM field. The length of the X arm and the Z arm are reported in the same manner.

Coded text, fixed length, 4 characters.

AXIS - Axis Direction of Sensor

AXIS is the axis direction for sensors measuring vector quantities. For biomechanics tests, AXIS is defined by an anatomically based coordinate system, based on a standing test occupant, where X is positive forward, Y is positive right and Z is positive down. The orientation of this axis system is based on the initial position of the test occupant.

AXIS is always applicable when the measurement is a vector quantity (acceleration, force, velocity, and so forth). Figure 7-2 portrays the body-based coordinate system. All signals from anatomical sensors (RBLU, etc.) are local coordinate systems.

Included in Appendix E are the required sign conventions for various possible measurements. Only these sign conventions are acceptable.

Coded text, fixed length, 2 characters.

UNITS - Data Measurement Units

UNITS indicates the units used to measure the signal of the sensor data. (Refer to Table 7-1 for the only acceptable units.)

Coded text, fixed length, 3 characters.

PREFIL - Prefilter Frequency

PREFIL is the cutoff frequency in Hz of the last low-pass filter (digital or analog) applied to the signal. This frequency is defined as where filter gain equals 70 percent (-3db).

Numeric field, integer.

INSMAN - Manufacturer of the Instrument

INSMAN is the field for the name of the manufacturer of the instrument. The model and serial number should also be included. The format should be: MFG: manufacturer name, S/N: serial number.

Free text, variable length, maximum 70 characters.

CALDAT - Calibration Date (DD/MMM/YY)

CALDAT is the most recent calibration date of the instrument.

Date text, fixed length, 9 characters.

INSRAT - Instrument Rating

INSRAT represents the manufacturer's maximum rated value for the transducer. This value is in the units that the transducer will measure (g's for an accelerometer).

Numeric field, integer.

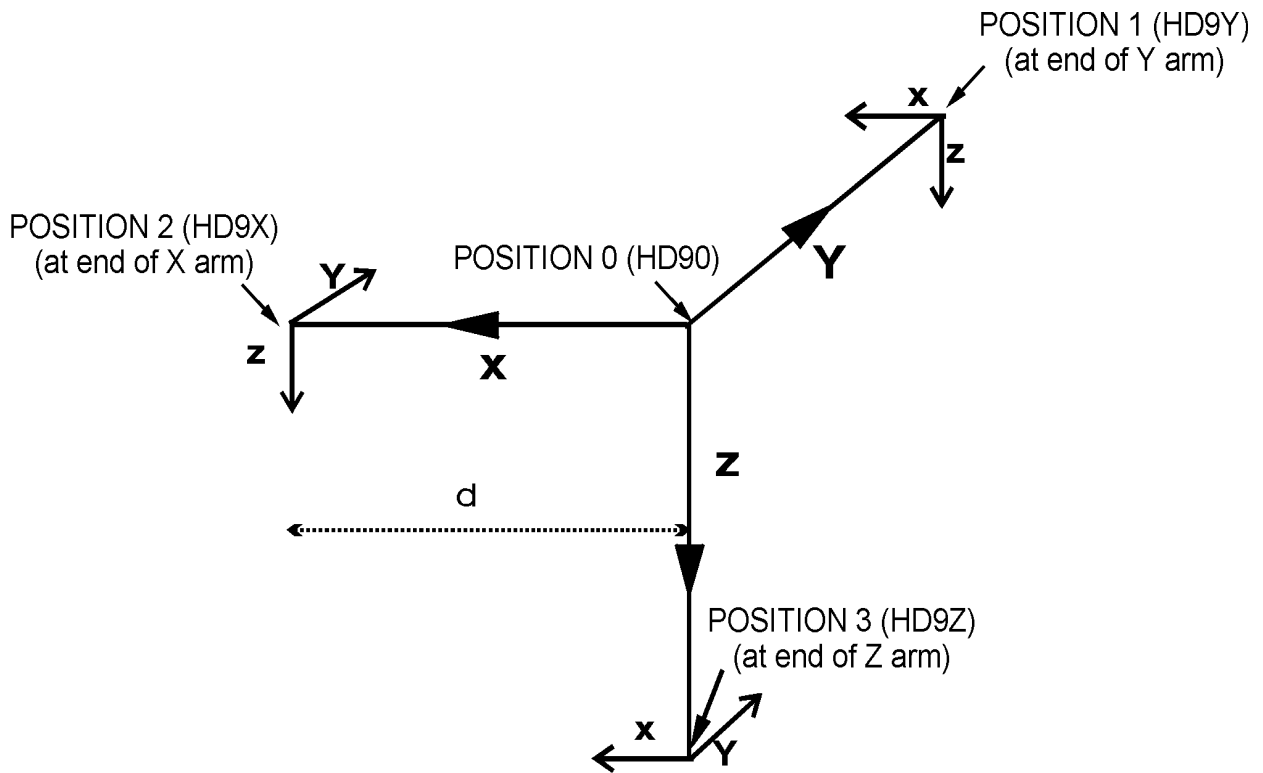

Figure 7-1: SENATT Codes for Nine Accelerometer Head Array

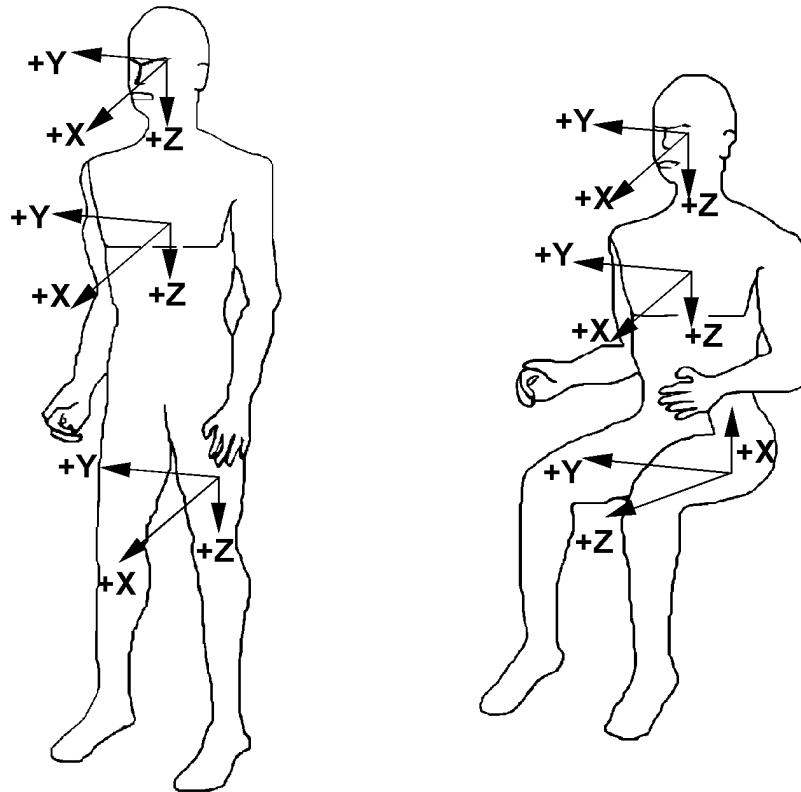

Figure 7-2 Body-Based Coordinate System

CHLMAX - Channel Maximum Rating

CHLMAX represents the full-scale value of the data based upon the actual test setup, including signal conditioning, as a percentage of INSRAT.

Numeric field, integer.

INIVEL - Initial Velocity (kilometers per hour)

INIVEL is the initial (time zero) velocity of the sensor along its axis and applies only to linear accelerometers. Be sure to include the sign if the initial velocity is negative, as it usually is for the impactor in a pendulum test.

Code 0.0 if the sensor is not a linear accelerometer.

Numeric field, real.

NFP - Number of First Point

NFP represents the index number of the first point in the data array (less than or equal to 0). Time zero always has an index number of 0. If no data exists prior to time zero, NFP is equal to 0; if 20 data points exist prior to time zero, NFP is equal to -20. There may never be more than 10,000 points before time zero.

Numeric field, integer.

NLP - Number of Last Point

NLP represents the index number of the last point in the data array. If 1,000 points were digitized, and NFP is equal to -100, then NLP is equal to 899. NLP can never be greater than 99,999.

Numeric field, integer.

DELT - Time Increment

DELT is the time increment in microseconds between each data point. DELT is assumed to be constant for all data points for a given sensor (uniform sampling frequency).

Numeric field, integer.

DASTAT - Data Status

DASTAT indicates the status of the data as it appears on the tape. This field is used to indicate a signal which is invalid (code MN for meaningless) or which becomes questionable or invalid part of the way through a signal (code CF and explain in INSCOM). If a signal is computed, DASTAT is CM. An example of a computed signal would be the resultant acceleration or the rotational acceleration of the head measured with a nine-linear accelerometer array.

Coded text, fixed length, 2 characters.

CHSTAT - Channel Status

CHSTAT indicates whether the data channel is primary or redundant. If, for example, the dummy is instrumented with a backup triaxial accelerometer in the head, the redundant channels should be labeled R. The occupant's HIC value would be calculated using the primary head channels, labeled P.

Coded text, fixed length, 1 character.

INSCOM - Instrumentation Commentary

INSCOM is any further commentary on the instrumentation data, including any unusual conditions affecting the data or a reference to a document that describes problems with a particular curve. The reasons for coding any of the coded fields OTHER (particularly the SENATT field) or for coding the DASTAT field CF should be recorded in this field as well. If no comments are to be made, leave the field blank.

For Head 9 array accelerometers, INSCOM contains dimensions that precisely locate the given instrument. The HD90, X-axis accelerometer, will locate the center of the Head 9 array relative to the head CG; then the entry in INSCOM for HD90 would read: CG; X: 33.2 MM, Y: 2.5 MM, Z: -5.0 MM

The X-axis of HD9Y, HD9X, and HD9Z will contain the distance, d, shown in Figure 7-1, which is the length of the arm. Units must be shown. For example, if the Y arm is 110 mm long, then the entry in INSCOM for HD9Y, X direction would read: Y-ARM: 110 MM

Free text, variable length, maximum 70 characters.

Table 7-1: Table of Units

Measurement Quantity	Unit of Measure	Standard Metric Code*(MET)
Absolute Pressure	Kilopascals	KPA
Acceleration	G's	G'S
Angular Acceleration	Degrees/second**2	DP2
Angular Displacement	Degrees	DEG
Angular Velocity	Degrees/second	DPS
Curvature	Reciprocal millimeters	RMM
+Displacement	Millimeters	MM
Force	Newtons	NWT
Gauge Pressure	Kilopascals	KPG
Impulse	Newton-seconds	NSC
Noise	Decibels	DEC
Strain	Micrometers/meter	MPM
Temperature	Degrees Celsius	CEN
Time	Seconds	SEC
Torque	Newton-meters	NWM
Velocity	Kilometers/hour	KPH
Voltage	Volts	VOL

* Codes used must be in uppercase.

Introduction to 8 - CHEST BAND INFORMATION and 9 - CHEST BAND GAUGE INFORMATION

The data elements that are defined in the following two sections make up the test group, CHEST BAND INFORMATION. The information group consists of Sections 8 and 9, described below.

A chest band is a device that measures deformation. It consists of a number of curvature gauges attached to a band. The band is attached to (encircles) an object, such as a torso, so that the gauges lie on the external surface of the object.

Presently, the chest band is used only on the torso to measure deformation. If, in the future, the chest band should be used to measure deformation of other contours of either the test occupant or restraints, an additional CHEST BAND INFORMATION section describing the relationship between the chest band and the object to which it is attached will be developed.

Because collecting data about deformation using the chest band requires information about the gauges and information about the chest band itself, CHEST BAND INFORMATION is divided into two sections, each with its own group identifier:

Section 8, CHEST BAND OCCUPANT INFORMATION, describes the relationship of a chest band and the occupant to which it is attached. It contains information detailing the location of the band on the occupant and the attributes of both the band and the occupant at the point of attachment.

Section 9, CHEST BAND GAUGE INFORMATION, describes the relationships of the active gauges on the chest band and the relationships of those gauges and the curve number that identifies the signal generated by each gauge.

One Section 8 record will be completed for each chest band used in the test. One Section 9 record will be completed for each gauge on each chest band. Completely fill out all the Section 8 records before proceeding to the Section 9 records.

[This page intentionally left blank]

8.

CHEST BAND OCCUPANT INFORMATION

The appropriate information should be recorded in all fields for each chest band used. For example, if three chest bands are used, the fields TSTNO through CHBCOM will be repeated three times, once for each chest band.

TSTNO - Test Number

TSTNO is a preassigned code (0) which is utilized by the data processing software when loading ASCII format input files into the NHTSA Biomechanics database.

Coded text, fixed length, 1 character.

BANDNO - Chest Band Number

BANDNO is the sequential number assigned to the chest band. Chest band numbering begins at the topmost band, progressing from the superior of the occupant to the inferior of the occupant. (NOTE: BANDNO is NOT equal to INSMAN, the manufacturer's serial number, which is defined in 7, INSTRUMENTATION INFORMATION.)

Numeric field, integer.

CHSDPT - Chest Depth (millimeters)

CHSDPT is the chest depth of the seated test occupant at the location of the specific chest band, indicated by BANDNO. The measurement should be taken after the chest band is put on the occupant, when the occupant is in position for the test. (NOTE: This measurement may differ from CHSTDP, which is a measurement taken on a supine occupant. See Chapter 5, ANTHROPOMETRIC INFORMATION.)

Numeric field, integer.



CHSBRD - Chest Breadth (millimeters)

CHSBRD is the chest breadth of the seated test occupant at the location of the specific chest band, indicated by BANDNO. The measurement should be taken after the chest band is put on the occupant, when the occupant is in position for the test. (NOTE: This measurement may differ from CHSBRD, which is a measurement taken on a supine occupant. (See Chapter 5, ANTHROPOMETRIC INFORMATION.)

Numeric field, integer.

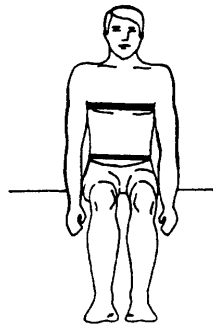
**BANLEN - Chest Band Length (millimeters)**

BANLEN is the total length of the specific chest band referred to in BANDNO. This length is basically the circumference of the chest in the region of the chest band.

Numeric field, integer.

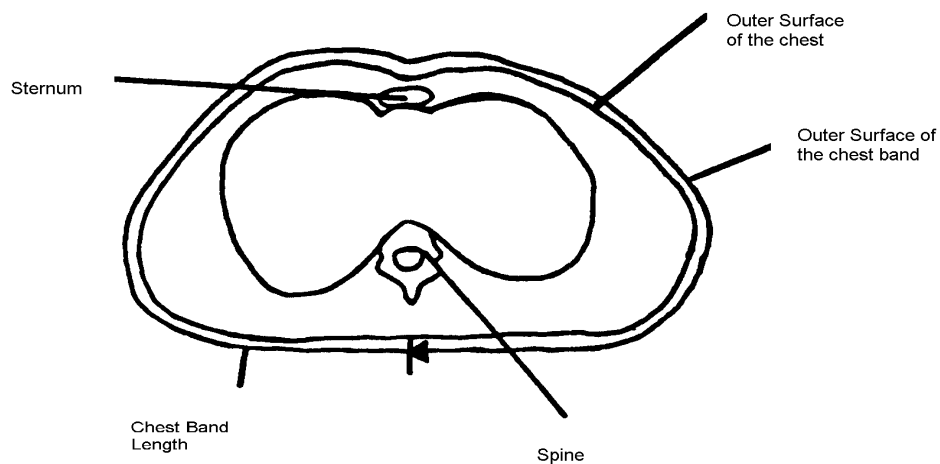

ANTLOC - Anterior Vertical Location

ANTLOC is the vertical position of the top edge of the chest band specified in BANDNO on the anterior of the occupant. To determine the vertical location of the chest band, the torso has been divided into height levels, ranging from 1 to 10. Ten corresponds to the topmost measurement on the torso, and 1 corresponds to the lowest measurement on the torso. Figure 8-1 illustrates these height levels for the cadaver, while Figure 8-2 shows the anterior height levels for the Hybrid III dummy.

For the cadaver, ANTLOC is equal to the height level shown in Figure 8-1 which corresponds to the vertical position of the chest band. The upper limit of the range (ANTLOC = 10) is referenced to the suprasternal notch. The reference for the lower limit (ANTLOC = 1) of the range is the iliac crest. At the xiphisternal junction, ANTLOC = 6.

For the Hybrid III, ANTLOC is equal to the height level shown in Figure 8-2 which corresponds to the vertical position of the top edge of the chest band. The upper limit of the range (ANTLOC = 10) is referenced to the sterno-clavical link. The reference for the lower limit (ANTLOC = 1) is the upper edge of the pelvis. At the bottom of the fourth rib, ANTLOC = 5.

Numeric field, integer.

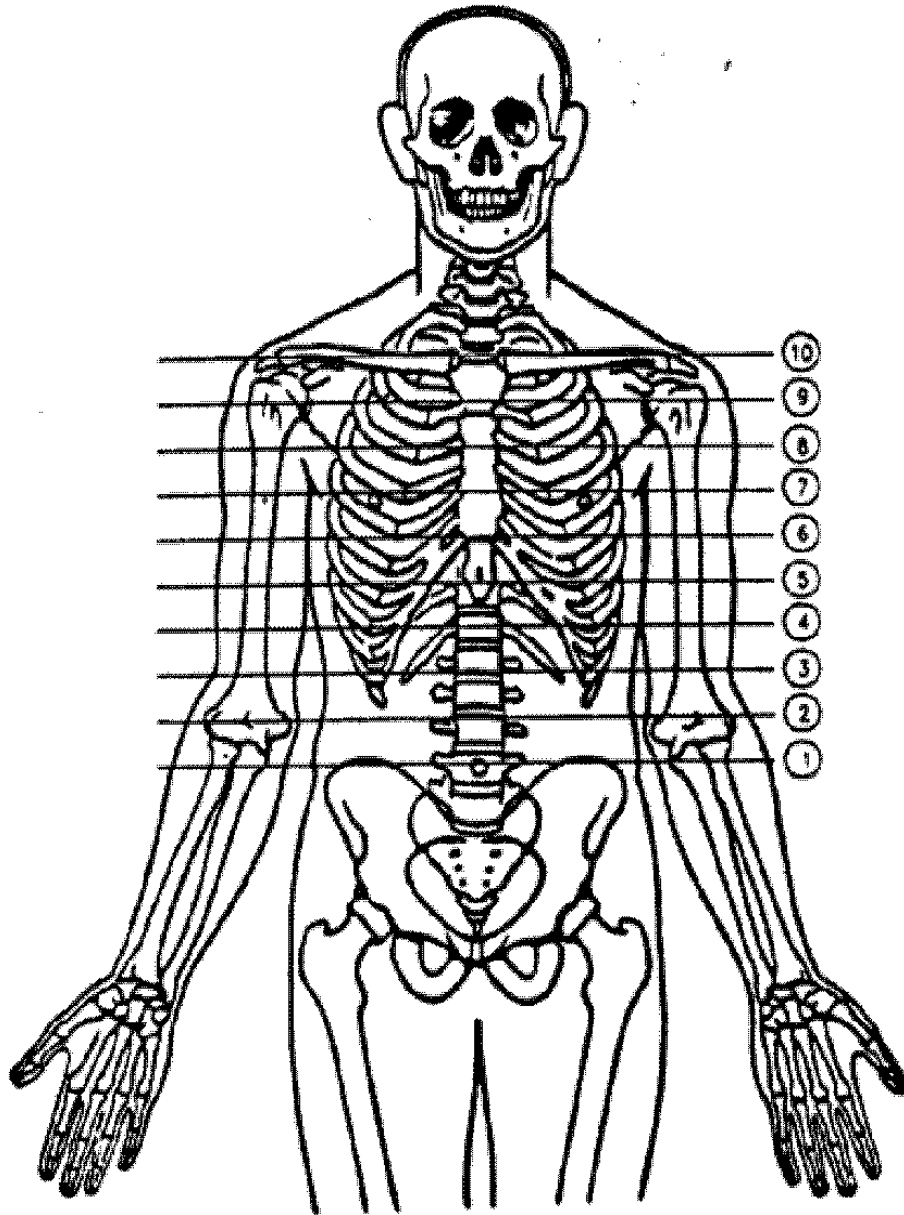

Figure 8-1: Anterior Vertical Locations for Cadavers

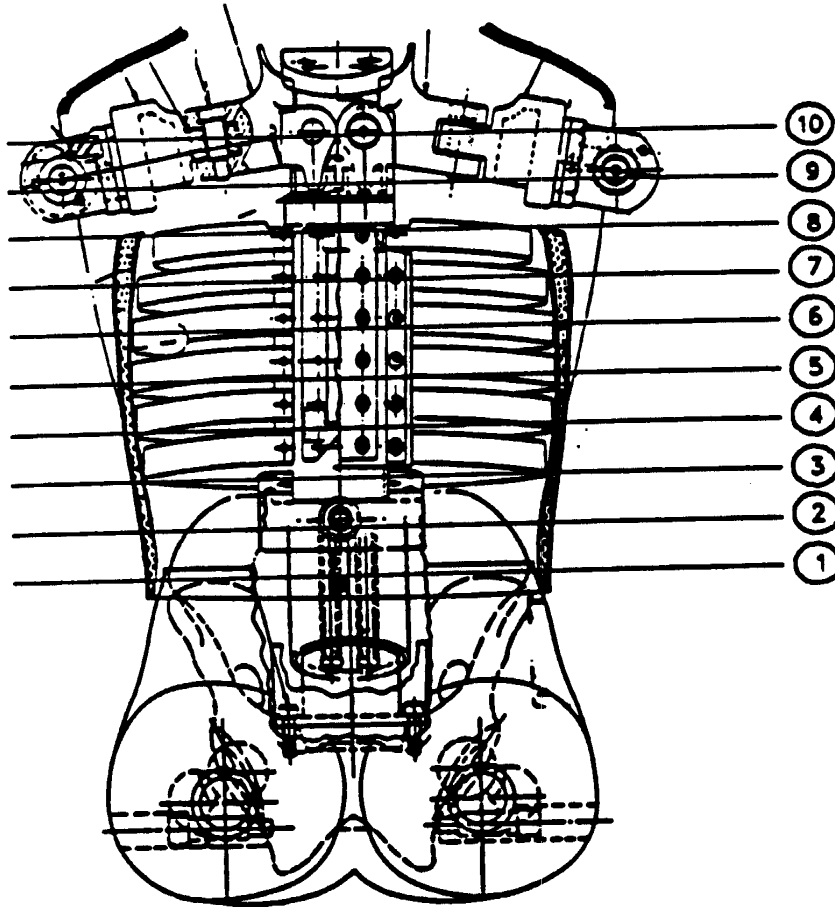

Figure 8-2: Anterior Vertical Locations for Hybrid III Dummies

POSLOC - Posterior Vertical Location

POSLOC is the vertical position of the top edge of the chest band specified in BANDNO on the posterior of the occupant. The same height level designations pertain to this measurement as pertain to ANTLOC. Figure 8-3 shows the posterior height levels.

For the cadaver, POSLOC is equal to the height level in Figure 8-3 which corresponds to the vertical position of the chest band. The upper limit of the range (POSLOC = 10) is referenced to the spinous process of the T02. The reference for the lower limit of the range (POSLOC = 1) is the iliac crest. At the spinous process of T10, POSLOC = 5.

For the Hybrid III, the value of POSLOC should be equal to the value of ANTLOC.

Numeric field, integer.

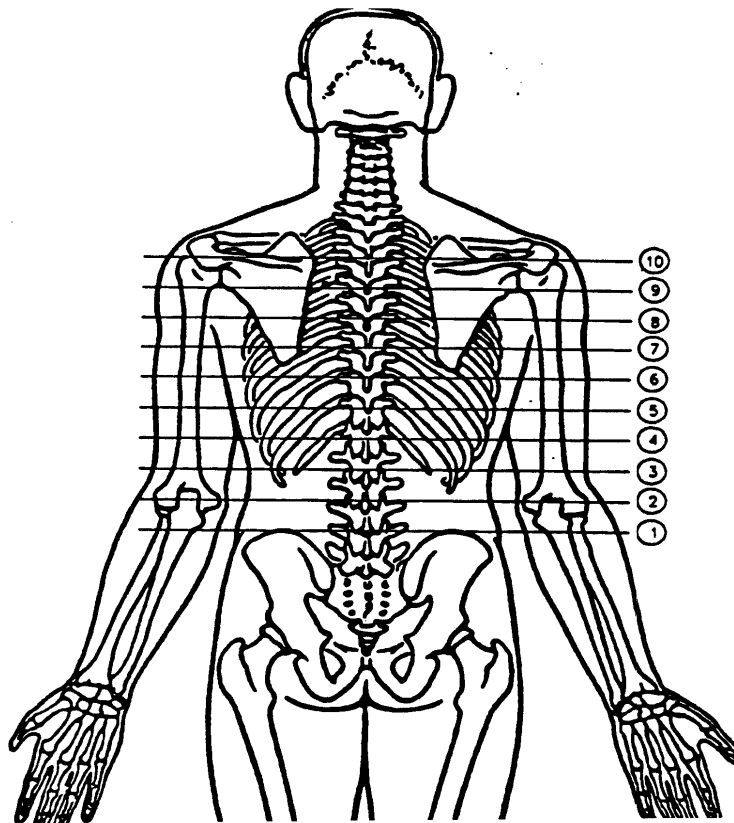

Figure 8-3: Posterior Vertical Locations for Cadavers

GAGSTR - Curve Number of the Gauge Relative to the Sternum

GAGSTR is equal to the curve number, CURNO, of the first active gauge encountered, clockwise, from the center of the sternum. This value defines the location of the sternum relative to the chest band. (CURNO is the sequential number (1,2,3 ...) assigned to a specific sensor and data curve, as defined in 7, INSTRUMENTATION INFORMATION.)

Numeric field, integer.

DISSTR - Distance Referenced to the Sternum (millimeters)

DISSTR is the curvilinear distance from the center of the sternum in a clockwise direction to the specified GAGSTR. This value, in conjunction with GAGSTR, locates the sternum relative to the chest band.

Numeric field, integer.

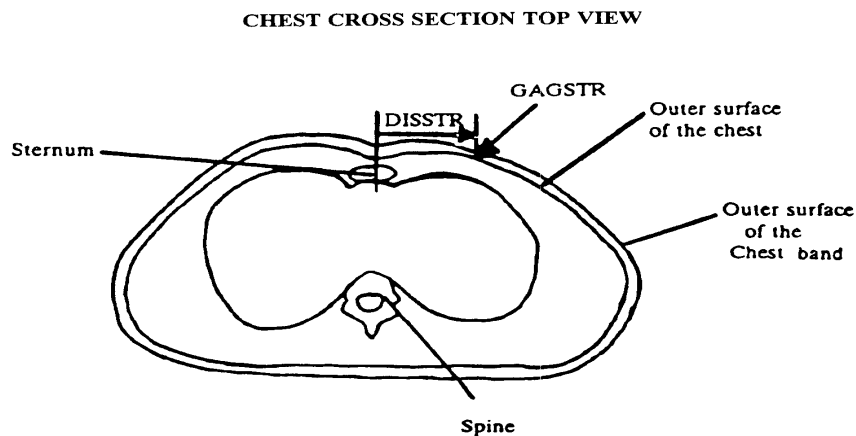
**GAGSPN - Curve Number of the Gauge Relative to the Spine**

GAGSPN is equal to the curve number, CURNO, of the first active gauge encountered when proceeding in a clockwise direction from the center of the spine. This value defines the location of the spine relative to the chest band. (CURNO is the sequential number (1,2,3..) assigned to a specific sensor and data curve, as defined in 7, INSTRUMENTATION INFORMATION.)

Numeric field, integer.

DISSPN - Distance Referenced to the Spine (millimeters)

DISSPN is the curvilinear distance from the spine to the gauge specified by GAGSPN. This value, with GAGSPN, locates the spine relative to the chest band.

Numeric field, integer.

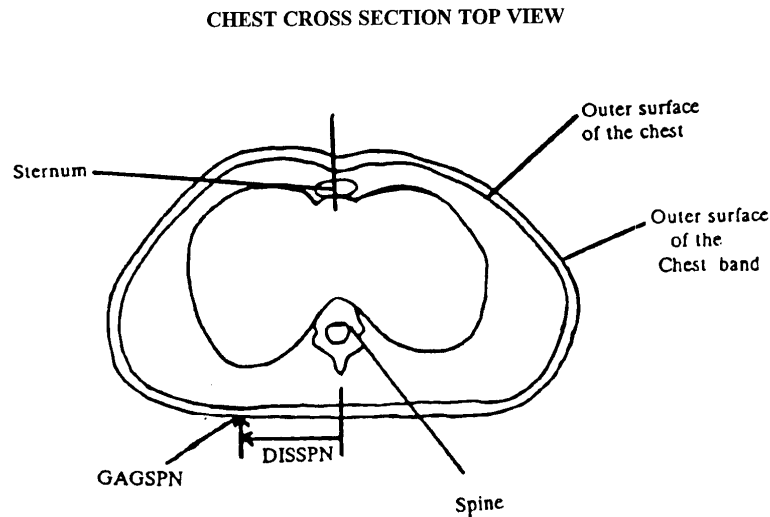
**TOTGAG - Total Number of Gauges**

TOTGAG is the total number of active curvature gauges on the chest band specified by the BANDNO.

2-character field (integer format).

CHBCOM - Chest Band Commentary

CHBCOM should be used to describe any information that is important about the chest band that does not appear in any other field. If no comments are to be made, code the field NO COMMENTS (left justified).

Free text, variable length, maximum 70 characters.

9.

CHEST BAND GAUGE INFORMATION

As mentioned previously, complete the CHEST BAND OCCUPANT INFORMATION section for each chest band used before proceeding to the CHEST BAND GAUGE INFORMATION section.

A 16-gauge chest band is shown below in two positions: lying flat and encircling the test occupant's torso. (A cross section view of the torso is shown, from the perspective of superior to inferior.) As the drawings show, the gauges occur on the band in sequence beginning at the leading edge of the band.

The band should be positioned on the torso so that the gauge numbers are increasing in a clockwise direction. The location of the leading edge of the chest band in reference to the occupant is not restricted and can be placed anywhere along the circumference (surface) of the chest.

CHEST BAND LYING FLAT

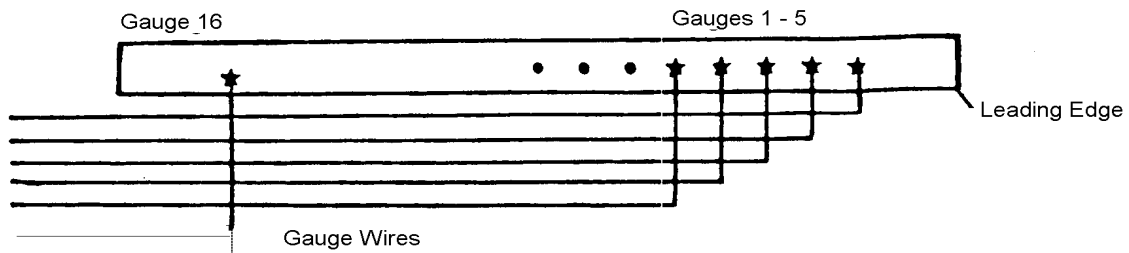

CHEST CROSS SECTION TOP VIEW

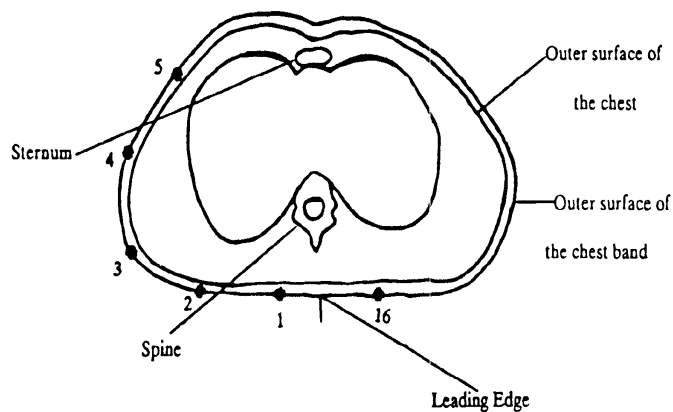

The chest band is described further in a technical article by Rolf H. Eppinger, entitled "The Development of a Measurement System and Its Application toward Developing Mechanically Based Injury Indices" and found in the 33rd Stapp Car Crash Conference Proceedings, October 1989. A detailed Chest Band User's Guide has been written for the experimentalist and can be obtained by contacting the NHTSA technical person working with you.

The fields in Section 9 apply to each active curvature gauge on a chest band. The appropriate information should be recorded in all fields for each sensor (active chest band curvature gauge) associated with the test.

For example, if three chest bands are used, with 16 active gauges per band, the fields TSTNO through GAGCOM will be repeated 48 times. This corresponds to the 48 instrumentation records where SENATT = CHBD. (The SENATT field is described in more detail in 7, INSTRUMENTATION INFORMATION.)

TSTNO - Test Number

TSTNO is a preassigned code (0) which is utilized by the data processing software when loading ASCII format input files into the NHTSA Biomechanics database.

Coded text, fixed length, 1 character.

BANDNO - Chest Band Number

BANDNO is the sequential number (1,2,3 ...) assigned to the chest band in 8, Chest Band Occupant Information. Chest band numbering begins at the superior of the occupant, progressing to the inferior of the occupant. (NOTE: BANDNO is NOT equal to INSMAN, the manufacturer's serial number, which is defined in 7, INSTRUMENTATION INFORMATION.)

Numeric field, integer.

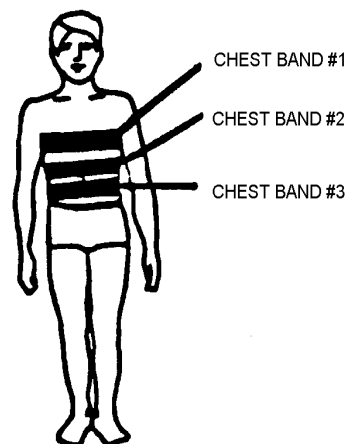

GAGENO - Gauge Number

GAGENO is the number of the active chest band curvature gauge. Active gauges are numbered sequentially from the leading edge of the chest band. Gauges which are not active for the test are ignored. For example, if there are ten active gauges on the chest band, then the value of GAGENO would be 1, 2, 3, 4, 5, 6, 7, 8, 9, or 10, as shown below.

Numeric field, integer.

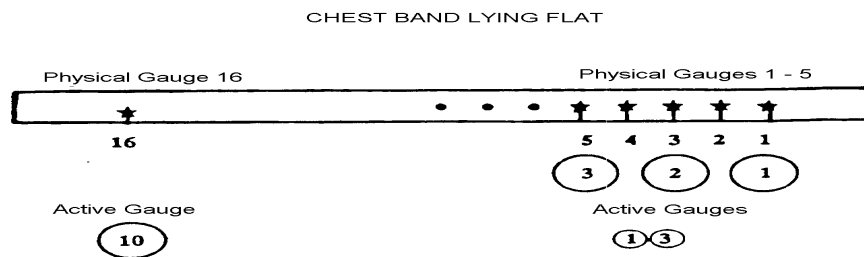
**GAGDIS - Gauge Distance (millimeters)**

GAGDIS is the curvilinear distance from the leading edge of the chest band in a clockwise direction to the GAGENO. There will be one value of GAGDIS that corresponds to each GAGENO (active gauge number). (Recall that the leading edge may be positioned anywhere along the circumference of the torso surface.)

Numeric field, integer.

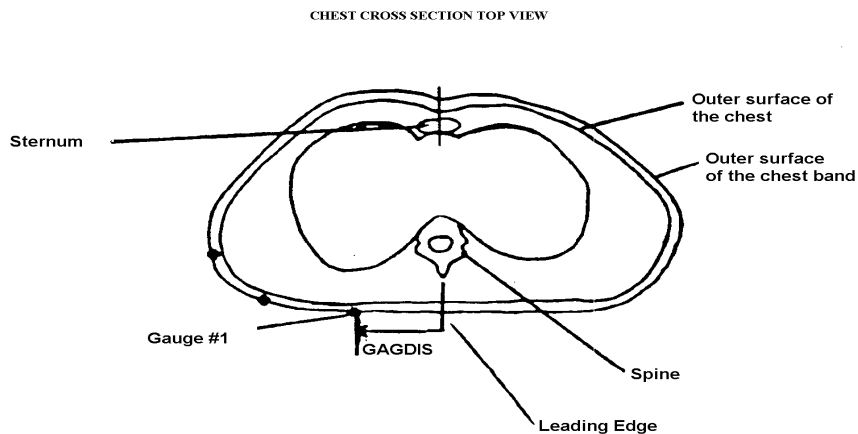

CURNO - Curve Number of a Specific Gauge

CURNO is the sequential number (1,2,3 ...) assigned to a specific sensor and data curve (as defined in Chapter 7, INSTRUMENTATION INFORMATION). CURNO must be equal to the curve number of the active gauge. The total number of CURNOs is equal to the total number of records where SENATT= CHBD in INSTRUMENTATION INFORMATION.

Where CURNOs for other instruments (accelerometers, load cells, for example) have been defined for the same test, CURNOs defined for the gauge numbers will follow in sequence, as the illustration shows.

Numeric field, integer.

Chest Band Number	Physical Gauge	Active Gauge (GAGENO)	Curve Number (CURNO)
1	1 - 16	1 - 10	22 - 31
2	1 - 16	1 - 8	32 - 39
3	1 - 16	1 - 7	40 - 46

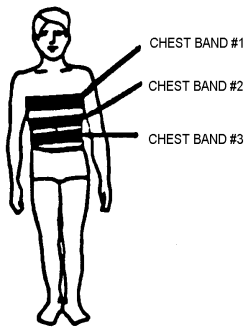

CHESTBAND #2

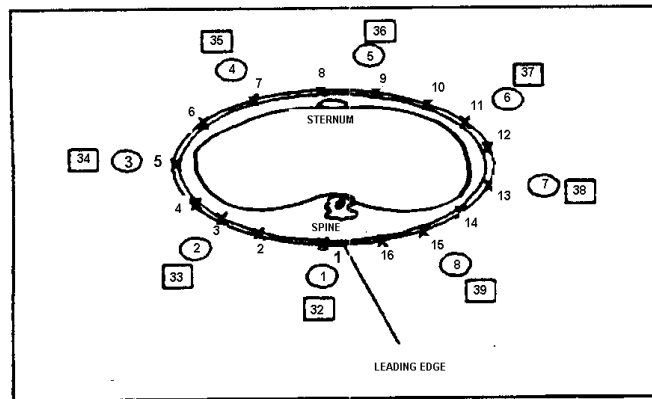

- X = PHYSICAL GAUGE NUMBER
- O = ACTIVE GAUGE NUMBER
- = CURVE NUMBER

GAGCOM - Gage Commentary

GAGCOM should be used to describe any information that is important about the gauge that does not appear in any other field. If no comments are to be made, code the field NO COMMENTS (left justified).

Free text, variable length, maximum 70 characters.

CHEST BAND IMPACT ON INSTRUMENTATION INFORMATION

Section 7, **Instrumentation Information**, includes three fields that indicate

- (1) where the sensor is attached (SENATT),
- (2) the type of sensor used (SENTYP), and
- (3) the units used for the sensor (UNITS).

For each active chest band sensor (strain gauge bridge), special codes are used for these three fields.

SENATT - Sensor Attachment

SENATT indicates where the sensor is attached. For tests in which sensors are attached to a chest band, SENATT = CHBD.

Coded text, fixed length, 4 characters.

SENTYP - Sensor Type

SENTYP indicates the type of sensor used for collecting the measurements at the time of the test. For tests in which chest band gauges are used as sensors, SENTYP = CC.

Coded text, fixed length, 2 characters.

UNITS - Data Measurement Units

UNITS indicates the units used to measure the signal of the sensor data. For tests in which chest band gauges are used, the code RMM (for reciprocal millimeters) should be used to indicate the appropriate data measurement units.

Coded text, fixed length, 3 characters.

These fields also appear in Chapter 7, *Instrumentation Information*.

[This page intentionally left blank]

APPENDIX A: MEDIA FORMAT

Each data submission consists of two types of data: descriptive specification data defined in the previous sections of this Guide, and the measurement data digitized from the test instrumentation signal traces. Several disks may be required to record the specification and measurement files for a test submitted on diskette.

USING THE ENTREEW PROGRAM TO CREATE SPECIFICATION FILES

NHTSA has developed the data entry program, ENTREEW, in order to facilitate preparation of the specification data defined in the previous sections of this Guide. A diskette containing the ENTREEW program, Version 4.0, is included in the front of the Guide. Because ENTREEW contains built-in, on-line checkers for data validation, it is highly recommended that specification data be generated using the ENTREEW program.

Equipment Requirements for ENTREEW

ENTREEW is a Windows-based application which has the following minimum requirements:

- ▶ IBM PC or compatible with 80386 or better processor.
- ▶ 10 Megabytes of disk space.
- ▶ Microsoft Windows 3.1 or later.
- ▶ 8 Megabytes of memory.

ENTREEW should also run properly under Microsoft Windows 95, Windows NT 3.51 or Windows NT 4.0.

ENTREEW Conversion Utilities

The ENTREEW program output file is in NHTSA's own binary format (file extension .ENT). The included EWCONV utility supports the export of binary .ENT files to the ASCII .EV4 format .EV4 files, which is the accepted data format specified under SAE J211. EWCONV also supports the import of .EV4 ASCII data files into the binary .ENT format for editing using ENTREEW.

An optional utility, EWCV32, provides the ability to convert from the older Entree V3 ASCII format to the EV4 format as specified under SAE J211. This utility is not included with the ENTREEW distribution, but is available for download from the Internet at

<URL <http://www-nrd.nhtsa.dot.gov/nrd10/software/entreew>>

EWCV32 requires Microsoft Windows 95, or Microsoft Windows NT 4.0 for proper execution.

ENTREEW Specification File Format Options

ENTREEW output for a given test may be formatted one of two ways: as either a single file in NHTSA's own binary format (<filename>.ENT), or as an ASCII file (<filename>.EV4) for data exchange outside the agency.

The data files should be written to 3.5 inch high density floppies or CD-ROMs.

ASCII FORMAT SPECIFICATION FILE

The ASCII file for a specific test consists of groups of records from each of the categories listed below:

Record Type	Group
TEST	1
DUMMY OCCUPANT	2
BIO OCCUPANT	3
RESTRAINT	4
ANTHROPOMETRY	5
OCCUPANT INJURY	6
INSTRUMENTATION	7
CHEST BAND	8
CHEST BAND GAUGE	9

For example, a Biomechanics test might consist of specification records for TEST, DUMMY OR BIO OCCUPANT, RESTRAINT, ANTHROPOMETRY, OCCUPANT INJURY, INSTRUMENTATION, CHEST BAND and CHEST BAND GAUGE. The EWCONV utility may be used to create the ASCII file automatically from an ENTREEW generated binary file.

Test are limited to one occupant per test. One Test Information file, One Occupant Information file, and one Anthropometry Information file (unless the occupant is a dummy) is required for each test. One Occupant Injury file containing one record for each injury is required if any injury is present. An Instrument Information file should contain one record for each sensor used in the test. If the occupant is instrumented with chest bands, then both Chest Band Occupant file containing one record per band, and Chest Band Gauge file, containing one record per gauge, must also be included.

Omitting Information Groups from the ASCII File

Not all tests require data for all information groups. The optional information groups for the Biomechanics data base are: 5, Anthropometry Information, 6, Occupant Injury Information, 8, Chest Band Information and 9, Chest Band Gauge Information. If the test configuration is no injury occurred during a cadaver test, and no chest band used, for example, then no Occupant Injury, Chest Band and Chest Band Gauge information records would be written to disk.

Record Layout for ASCII Specification File

Appendix C lists the fields and their positions in each of the specification data records. The first line of the ASCII (.EV4) specification file should be the string

“----- EV4 -----”

or

“-----”+space+ “EV4”+space+ “-----”

Each section within an EV4 file should begin with a “key” line indicating the type of records following the key. These keys have the form

“----- KEY -----”

or

“-----”+space+ “KEY”+space+ “-----”

where KEY is appropriate to a particular record type. (KEY equals TEST, BIO OCCUPANT, ANTHROPOMETRY, etc..)

Fields within a record are delimited by the pipe character (|), records are delimited by a line feed. Comment lines may also be included in the file. A comment line should start with the # (pound) sign and end with a line feed.

The ASCII specification file should terminate with the line

“----- END -----”

Fields for which no information is available should contain one blank character. In other words, an empty field begins after the pipe delimiter of the previous field, and consists of a single blank followed by another pipe delimiter. All text should be uppercase.

Table A-1 is an example of an ASCII specification file for a biomechanics test.

LAYOUT FOR MEASUREMENT DATA

Each subsequent file after the specification data files contains unfiltered, digitized data collected from the sensors used in the tests. The order of the measurement files corresponds to the order of the instrumentation records in the instrumentation group specification records. The measurement files are made up of ASCII records of 1 data point each, delimited by a line feed character (ASCII decimal 10, hexadecimal \x0a, octal \012). The point specification will allow for any floating point format, but the preferred format is the C format %12.5E. Thus, each record will be 12 characters long, e.g. +1.23400E-01. The maximum number of points for one channel is 110,000. There cannot be more than 10,000 data points prior to time zero, nor more than 99,999 after time zero.

The name of the ASCII measurement data files should be the same given to the specification file described above (ENTREEW binary file with extension .ENT or ASCII file with extension .EV4). The file extension should be the curve number of the curve contained in the file, and should correspond to the curve number in the instrumentation record in the instrumentation specification group. There should be no leading zeros in the file extensions.

If the specification file is named TSTABC.ENT (binary) or TSTABC.EV4 (ASCII), and there are 35 measurement (curve) files, the curve files should be named TSTABC.1 through TSTABC.35.

Right:	TSTABC.1	TSTABC.12	TSTABC.101
Wrong:	TSTABC.T0	TSTABC.012	TSTABCDAT

Table A-1. Sample ASCII Specification File - continued

```

277337|CC01|CHBD|NA|RM|1650|MFG; R.A. DENTON,INC., S/N: 0823131/JAN/1991|02801-975682480|AMP|GAUGE 12; CHESTBAND 2
277338|CC01|CHBD|NA|RM|1650|MFG; R.A. DENTON,INC., S/N: 0823131/JAN/1991|02401-975682480|AMP|GAUGE 13; CHESTBAND 082
277339|CC01|CHBD|NA|RM|1650|MFG; R.A. DENTON,INC., S/N: 0823131/JAN/1991|01201-975682480|AMP|GAUGE 14; CHESTBAND 082
277340|CC01|CHBD|NA|RM|1650|MFG; R.A. DENTON,INC., S/N: 0823131/JAN/1991|01201-975682480|AMP|GAUGE 15; CHESTBAND 082
277341|CC01|CHBD|NA|RM|1650|MFG; R.A. DENTON,INC., S/N: 0823131/JAN/1991|02201-975682480|AMP|GAUGE 16; CHESTBAND 082
277342|AC|01|SPNU|XL|G|S|1650|MFG; ENDEVCO, S/N: EK25131/JAN/1991|3016310-975682480|AMP|X-Axis; TRIAXIAL ACCELEROMETER MOUNTED TO T1 ON SPINE
277343|AC|01|SPNU|YL|G|S|1650|MFG; ENDEVCO, S/N: EF70131/JAN/1991|3096710-975682480|AMP|Y-Axis; TRIAXIAL ACCELEROMETER MOUNTED TO T1 ON SPINE
277344|AC|01|SPNU|ZL|G|S|1650|MFG; ENDEVCO, S/N: ET360131/JAN/1991|1944510-975682480|AMP|Z-Axis; TRIAXIAL ACCELEROMETER MOUNTED TO T1 ON SPINE
277345|PR|01|CRD|VA|KPG|1650|MFG; DESERET (DISPOSABLE VASCULAR PRESSURE TRANSDUCER)|31/JAN/1991|121010510-975682480|QD|PINTRA-AORTIC PRESSURE; CONNECTOR WENT BAD TOWARD END
OF IMPACT
----- CHEST BAND -----
277311231560952|777015125116|
27732195370939151510431538115|
----- CHEST BAND GAUGE -----
2773111127110|
2773112177111|
2773113241121|
2773114330113|
277311538114|
2773116444115|
2773117495116|
2773118546117|
2773119596118|
2773110647119|
2773111723120|
2773112787121|
2773113838122|
2773114927123|
2773115990124|
27731161041125|
27732112726|
27732177271|
277323241128|
277324330129|
27732538130|
277326444131|
277327495132|
277328596134|
277329647135|
2773210723136|
2773211787137|
2773212838138|
2773213927139|
2773214990140|
27732151041141|
----- END -----

```

APPENDIX B: CODES

AIS

CODE	DESCRIPTION	COMMENT
0	NO INJURY	
1	MINOR INJURY	
2	MODERATE INJURY	
3	SERIOUS INJURY	
4	SEVERE INJURY	
5	CRITICAL INJURY	
6	MAXIMUM INJURY	UNTREATABLE

ASPECT

CODE	DESCRIPTION	COMMENT
A	ANTERIOR	FRONT
B	BILATERAL	
C	CENTRAL	
I	INFERIOR	LOWER
L	LEFT	
P	POSTERIOR	BACK
R	RIGHT	
S	SUPERIOR	UPPER
W	WHOLE REGION	

AXIS

CODE	DESCRIPTION	COMMENT
NA	NOT APPLICABLE	
RS	RESULTANT	
XG	X - GLOBAL	
XL	X - LOCAL	INCLUDES A-P
YG	Y - GLOBAL	
YL	Y - LOCAL	INCLUDES M-L
ZG	Z - GLOBAL	
ZL	Z - LOCAL	INCLUDES I-S
OT	OTHER	

BODYRG

CODE	DESCRIPTION	COMMENT
A	UPPER ARM	THORACO-LUMBAR SPINE
B	BACK	ANTERIOR & POSTERIOR RIBS
C	CHEST	
E	ELBOW	
F	FACE	
H	HEAD/SKULL	
K	KNEE	
L	LOWER LEG	LOWER LEG
M	ABDOMEN	DIAPHRAGM AND BELOW
N	NECK/CERVICAL	SPINE
O	WHOLE BODY	
P	PELVIC/HIP	
Q	ANKLE/FOOT	
R	FOREARM	
S	SHOULDER	
T	THIGH	INCLUDES FEMUR
W	WRIST/HAND	
X	UPPER EXTREMITY	ENTIRE LIMBS
Y	LOWER EXTREMITY	ENTIRE LIMBS

CHSTAT

CODE	DESCRIPTION	COMMENT
P	PRIMARY	
R	REDUNDANT	

DASTAT

CODE	DESCRIPTION	COMMENT
AM	AS MEASURED	NORMAL
CF	CHANNEL FAILED	NOTE CAUSE & TIME OF FAILURE
CM	COMPUTED NORMAL	NOTE TYPE OF COMPUTATION
MN	MEANINGLESS	INVALID DATA
NO	NO DATA	
QD	QUESTIONABLE DATA	NOTE PROBLEM WITH CHANNEL
SC	SCALING FACTOR APPLIED	
SF	SYSTEM FAILED	NOTE CAUSE OF FAILURE

DEPLOY

CODE	DESCRIPTION	COMMENT
DP	DEPLOYED PROPERLY	
NA	NOT APPLICABLE	
ND	NOT DEPLOYED PROPERLY	
UN	UNKNOWN	

DUMSIZ

CODE	DESCRIPTION	COMMENT
05	5 PERCENTILE	
3C	3 YEAR OLD CHILD	
50	50 PERCENTILE	
6C	6 YEAR OLD CHILD	
95	95 PERCENTILE	
NA	NOT APPLICABLE	OCCUPANT NOT A DUMMY
OT	OTHER	DESCRIBE IN DUMMOD

LESION

CODE	DESCRIPTION	COMMENT
A	ABRASION	
B	BURN	
C	CONTUSION	
D	DISLOCATION	
E	SEVERANCE/TRANSECTION	
F	FRACTURE	
G	DETACHMENT/SEPARATION	
K	CONCUSSION	
L	LACERATION	
M	AMPUTATION	
N	CRUSHING	
P	PERFORATION/PUNCTURE	
R	RUPTURE	
S	SPRAIN	
T	STRAIN	
V	AVULSION	
Z	FRACTURE AND DISLOCATION	

LINK

CODE	DESCRIPTION	COMMENT
TEL	TELEMETRY	
UCT	UMBILICAL CABLE AND TELEMETRY	
UMB	UMBILICAL CABLE	
OTH	OTHER	

MTHCAL

CODE	DESCRIPTION	COMMENT
H3	HYBRID III	
HS	SIDE IMPACT DUMMY	DEFINED IN FMVSS
NA	NOT APPLICABLE	OCCUPANT NOT A DUMMY
NO	NONE	NO CALIBRATION
P5	PART 572	
OT	OTHER	DESCRIBE IN DUMMOD

OCCLOC

CODE	DESCRIPTION	COMMENT
01	LEFT FRONT SEAT	
02	RIGHT FRONT SEAT	
03	RIGHT REAR SEAT	
04	LEFT REAR SEAT	
05	CENTER FRONT SEAT	
06	CENTER REAR SEAT	
07	LEFT THIRD SEAT	STATION WAGON/VAN
08	CENTER THIRD SEAT	STATION WAGON/VAN
09	RIGHT THIRD SEAT	STATION WAGON/VAN
NA	NOT APPLICABLE	FOR NON VEHICLE TESTS
OT	OTHER	FOR NON VEHICLE TESTS

OCCSEX

CODE	DESCRIPTION	COMMENT
F	FEMALE	
M	MALE	
N	NOT APPLICABLE	OCCUPANT IS A CHILD DUMMY

OCCTYP

CODE	DESCRIPTION	COMMENT
AN	ANIMAL	
AO	APR OMNI-DIRECTIONAL DUMMY	APROD
AS	APR SIDE IMPACT DUMMY	APR
BS	BIO-SID DUMMY	
CD	CADAVER	
CH	CHILD DUMMY	
ES	EURO-SID DUMMY	
H3	HYBRID III DUMMY	
HP	HUMANOID PEDESTRIAN DUMMY	
HU	HUMAN VOLUNTEER	
P5	PART 572 DUMMY	HYBRID II
SD	NHTSA SIDE IMPACT DUMMY	SID
TD	TAD DUMMY	
TR	TRRL DUMMY	
OT	OTHER	DESCRIBE IN DUMMOD

RECTYP

CODE	DESCRIPTION	COMMENT
DIG	DIGITAL TAPE RECORDER	
FMM	FM MULTIPLEXOR TAPE RECORDER	
FMT	FM TAPE RECORDER	
OSC	OSCILLOGRAPH	
OTH	OTHER	

RSTMNT

CODE	DESCRIPTION	COMMENT
AP	A PILLAR	
BP	B PILLAR	
CH	CHILD SEAT	
AR	ARM REST	
DR	DOOR PANEL	
HR	HEAD REST	
HS	HEADER - SIDE	
HW	HEADER - WINDSHIELD	
DM	DASH PANEL - MID	
DT	DASH PANEL - TOP	
DP	DASH PANEL - UNSPECIFIED	
OT	OTHER	
NA	NOT APPLICABLE	
SB	SEAT BACK	

RSTMNT (continued)

CODE	DESCRIPTION	COMMENT
SP	SIDE PANEL	
SS	SIDE WINDOW SILL	
SW	STEERING WHEEL	

RSTTYP

CODE	DESCRIPTION	COMMENT
3PT	3 POINT BELT LAP & SHOULDER	NOT PASSIVE
ABG	AIR BAG	
ABT	AIR BELT	
APP	APR PADDING	
CHD	CHILD RESTRAINT	
DPL	DASH PANEL	
FHP	FBRGL. HNCB. PADDING	FIBERGLASS HONEYCOMB
KNE	KNEE RESTRAINT	NOTE IF NOT PROVIDED BY MANUFACTURER
LAP	LAP BELT	NO SHOULDER BELT
MCP	MINICARS PADDING	
NON	NONE	UNRESTRAINED
PAD	PADDING	NOT APR, MINICARS, OR HONEYCOMB
PS2	PASSIVE 2 POINT BELT	
PS3	PASSIVE 3 POINT BELT	
RIG	RIGID WALL	
SBK	SEAT BACK	FOR REAR SEAT OCCUPANT
SCE	STR. COLUMN - EA	ENERGY ABSORBING
SCN	STR. COLUMN - NO EA	NOT ENERGY ABSORBING
SWE	STR. WHEEL - EA	ENERGY ABSORBING
SWN	STR. WHEEL - NO EA	NOT ENERGY ABSORBING
UNK	UNKNOWN	
OTH	OTHER	DESCRIBE IN RESTXT

SENATT

CODE	DESCRIPTION	COMMENT
ABD1	ABDOMEN	CONTACT SWITCH 1
ABD2	ABDOMEN	CONTACT SWITCH 2
ABD3	ABDOMEN	CONTACT SWITCH 3
ABDO	ABDOMEN	
ABGM	AIR BAG MANIFOLD	
ABTK	KNEE CONTACT	
ABTM	AIR BELT MANIFOLD	
ANKL	ANKLE - LEFT	
ANKR	ANKLE - RIGHT	
APLL	A PILLAR - LEFT	
APLR	A PILLAR - RIGHT	
BMPF	BUMPER - FRONT	
CHBD	CHEST BAND	
CHLL	CHEST - LEFT LOWER	
CHLU	CHEST - LEFT UPPER	
CHRL	CHEST RIGHT - LOWER	
CHRU	CHEST - RIGHT UPPER	
CHST	CHEST THORAX OR SPINE	IN 208 COMPLIANCE TEST
CLLC	8 STRING POT - CROSS LL	
CLLS	8 STRING POT - STRAIGHT LL	
CLRC	8 STRING POT - CROSS LR	
CLRS	8 STRING POT - STRAIGHT LR	
CRBV	CEREBROVASCULAR SYSTEM	
CRDV	CARDIOVASCULAR SYSTEM	
CULC	8 STRING POT - CROSS UL	
CULS	8 STRING POT - STRAIGHT UL	
CURC	8 STRING POT - CROSS UR	
CURS	8 STRING POT - STRAIGHT UR	
DPLL	DASHBOARD - LEFT	
DPLR	DASHBOARD - RIGHT	
DRLF	DOOR - LEFT FRONT	
DRLR	DOOR - LEFT REAR	
DRRF	DOOR - RIGHT FRONT	
DRRR	DOOR - RIGHT REAR	
EVNT	EVENT TIMES	
FMRL	FEMUR - LEFT	
FMRR	FEMUR - RIGHT	
FOTL	FOOT - LEFT	
FOTR	FOOT - RIGHT	
HD90	HEAD 9 ARRAY - CENTER	
HD9X	HEAD 9 ARRAY - X ARM	FORMERLY HD92, Y & Z AXES ONLY
HD9Y	HEAD 9 ARRAY - Y ARM	FORMERLY HD91, X & Z AXES ONLY
HD9Z	HEAD 9 ARRAY - Z ARM	FORMERLY HD93, X & Y AXES ONLY
HDCG	HEAD CG	USE FOR SINGLE OR TRIAX ON DUMMIES
HDOT	HEAD OTHER	USE FOR OTHER THAN 9-ACCEL ARRAY OR CG

SENATT (continued)

CODE	DESCRIPTION	COMMENT
KNE L	KNEE - LEFT	
KNER	KNEE - RIGHT	
LPBI	LAP BELT - INBOARD	
LPBO	LAP BELT - OUTBOARD	
NEKL	NECK - LOWER	
NEKU	NECK - UPPER	
PEND	PENDULUM	INCLUDES OTHER IMPACTORS
PULM	PULMONARY SYSTEM	
PVCN	PELVIS - CENTER	
PVHP	PELVIS - H-POINT	TROCHANTERION
PVIL	PELVIS - ILIAC	
PVPS	PELVIS PUBIC SYMPHYSIS	
PVSA	PELVIS, SACRUM	
RBLA	RIB, LOWER ABDOMEN	BIOSID
RBLL	RIB - LEFT LOWER	
RBLM	RIB - LEFT MIDDLE	
RBLU	RIB - LEFT UPPER	
RBRL	RIB - RIGHT LOWER	
RBRM	RIB - RIGHT MIDDLE	
RBRU	RIB - RIGHT UPPER	
RBUA	RIB, UPPER ABDOMEN	BIOSID
SHBE	SHOULDER BELT EXTENSION	
SHBT	SHOULDER BELT	
SHLL	SHOULDER - LEFT	
SHLR	SHOULDER - RIGHT	
SLED	SLED	
SNML	STERNUM - LOWER	
SNMU	STERNUM - UPPER	
SPNL	SPINE - LOWER	T12
SPNM	SPINE - MIDDLE	T04
SPNU	SPINE - UPPER	T01
STCL	STEERING COLUMN	
SWHB	STEERING WHEEL HUB	
SWRM	STEERING WHEEL RIM	
TIBL	TIBIA - LEFT	
TIBR	TIBIA - RIGHT	
TBLL	TIBIA - LEFT LOWER	
TBLU	TIBIA - LEFT UPPER	
TBRL	TIBIA - RIGHT LOWER	
TBRU	TIBIA - RIGHT UPPER	
VECG	VEHICLE CG	
OTHR	OTHER	DESCRIBE IN INSCOM

SENLOC

CODE	DESCRIPTION	COMMENT
01	LEFT FRONT SEAT	
02	RIGHT FRONT SEAT	
03	RIGHT REAR SEAT	
04	LEFT REAR SEAT	
05	CENTER FRONT SEAT	
06	CENTER REAR SEAT	
07	LEFT THIRD SEAT	STATION WAGON/VAN
08	CENTER THIRD SEAT	STATION WAGON/VAN
09	RIGHT THIRD SEAT	STATION WAGON/VAN
NA	NOT APPLICABLE	FOR BIOMECHANICS TESTS
OT	OTHER	FOR NONVEHICLE TESTS

SENTYP

CODE	DESCRIPTION	COMMENT
AA	ANGULAR ACCELEROMETER	
AC	ACCELEROMETER	
AD	ANGULAR DISPLACEMENT TRANSDUCER	
AV	ANGULAR VELOCITY TRANSDUCER	
CC	CHESTBAND CURVATURE GAUGE	
DS	DISPLACEMENT TRANSDUCER	
ET	EVENT TIME INDICATOR	
LC	LOAD CELL	
PR	PRESSURE TRANSDUCER	
SG	STRAIN GAUGE	
TB	TIME BASED CHANNEL	
VL	VELOCITY TRANSDUCER	
OT	OTHER	DESCRIBE IN INSCOM

SEPOSN

CODE	DESCRIPTION	COMMENT
CN	CENTER POSITION OF ADJUSTMENT RANGE	
FW	FORWARD OF CENTER POSITION	
NA	NOT APPLICABLE	OCCUPANT NOT SEATED
NO	NONADJUSTABLE SEAT	FOR SLED AND PENDULUM TESTS
RW	REARWARD OF CENTER POSITION	

SYSORG

CODE	DESCRIPTION	COMMENT
A	ARTERIES/VEINS	
B	BRAIN	
C	SPINAL CORD	
D	DIGESTIVE	
E	EAR	
G	UROGENITAL	
H	HEART	
I	INTEGUMENTARY	
J	JOINT	
K	KIDNEY	
L	LIVER	
M	MUSCLE	
N	NERVOUS SYSTEM	
O	EYE	
P	PULMONARY/LUNG	
Q	SPLEEN	
R	RESPIRATORY	LARYNX, TRACHEA, PHARYNX, DIAPHRAGM
S	SKELETAL	
T	ENDOCRINE GLAND	INCLUDES THYROID
V	VERTEBRAE	
W	ALL IN REGION	

TSTCFN

CODE	DESCRIPTION	COMMENT
CAN	CANNON	
DRP	DROP TEST	
OTH	OTHER	
PED	PEDESTRIAN	
PEN	PENDULUM	IMPACTOR TEST
SLB	SLED WITH VEHICLE BODY	DESCRIBE IN TSTCOM
SLN	SLED WITHOUT VEHICLE BODY	
OTH	OTHER	

TSTPRF

CODE	DESCRIPTION	COMMENT
BAT	BATTELLE	
CAL	CALSPAN	
CIR	CALIF. INJURY RES. ASSOC	
HDL	HEIDELBERG	
MCR	MCR TECHNOLOGY	FORMERLY MINICARS
MCW	MEDICAL COLLEGE OF WISCONSIN	

TSTPRF (continued)

CODE	DESCRIPTION	COMMENT
NBL	NAVAL BIODYNAMICS LAB	
ONS	ONSER	
SWR	SWRI	
TRC	TRC OF OHIO	
TRI	UNIV. MICH. TRI	FORMERLY HSRI
UVA	UNIVERSITY OF VIRGINIA	
VRT	VEHICLE RES. TEST CTR	
WSU	WAYNE STATE UNIVERSITY	
OTH	OTHER	DESCRIBE IN INSCOM

UNITS

CODE	DESCRIPTION	COMMENT
DEC	DECIBELS	SOUND
DEG	DEGREES	ANGULAR DISPLACEMENT
DP2	DEGREES/SEC**2	ANGULAR ACCELERATION
DPS	DEGREES/SEC	ANGULAR VELOCITY
G'S	G'S ACCELERATION	
KPA	KILOPASCALS AB	ABSOLUTE PRESSURE
KPG	KILOPASCALS GA	GAUGE PRESSURE
KPH	KILOMETERS/HOUR	VELOCITY
MM	MILLIMETERS	DISPLACEMENT
MPM	MICROMET/MET	STRAIN
NON	DIMENSIONLESS	DIMENSIONLESS
NSC	NEWTON-SECONDS	IMPULSE
NWM	NEWTONS-METERS	TORQUE
NWT	NEWTONS	FORCE
RMM	RECIPROCAL MM	CURVATURE
VOL	VOLTS	VOLTAGE
OTH	OTHER	OTHER - DESCRIBE IN INSCOM

[this page intentionally left blank]

APPENDIX C: FIELD FORMATS

1. TEST INFORMATION

FIELD NAME	DATA TYPE	MAXIMUM FIELD LENGTH/RANGE
TSTNO	predefined text=0	1 char
VERNO	predefined coded text=B4	2 char
TITLE	free text	70 char
TSTOBJ	free text	70 char
TSTDAT	date text (DD/MMM/YYYY)	11 char
TSTPRF	coded text	3 char
CONNO	free text	17 char
TSTREF	free text	10 char
TSTCFN	coded text	3 char
TEMP	integer	-99 to 99
RECTYP	coded text	3 char
LINK	coded text	3 char
CLSSPD	float	0 to 200.00
IMPANG	integer	0 to 359
TOTCRV	integer	1 to 200
TSTCOM	free text	70 char

2. DUMMY OCCUPANT INFORMATION

FIELD NAME	DATA TYPE	MAXIMUM FIELD LENGTH/RANGE
TSTNO	predefined text=0	1 char
OCCLOC	coded text	2 char
OCCTYP	coded text	2 char
OCCSEX	coded text	1 char
MTHCAL	coded text	2 char
DUMSIZ	coded text	2 char
DUMMAN	free text	70 char
DUMMOD	free text	70 char
DUMDSC	free text	70 char
SEPOSN	coded text	2 char
HIC	integer	0 to 9999
T1	float	0 to 999999 (max)
T2	float	0 to 999999 (max)
CLIP3M	float	0 to 99999
LFEM	integer	-99999 to 0
RFEM	integer	-99999 to 0
CSI	integer	0 to 9999
LBELT	integer	0 to 99999
SBELT	integer	0 to 99999
TTI	float	0 to 99999
PELVG	float	0 to 99999
DOCCOM	free text	70 char

3. BIOLOGICAL SPECIMEN OCCUPANT INFORMATION

FIELD NAME	DATA TYPE	MAXIMUM FIELD LENGTH/RANGE
TSTNO	predefined text=0	1 char
OCCLOC	coded text	2 char
OCCTYP	coded text	2 char
OCCAGE	integer	0 to 99
OCCSEX	coded text	1 char
OCCWT	integer	0 to 999
SEPOSN	coded text	2 char
FRCTRB	integer	0 to 99
RBFRACT	integer	0 to 99
CADREF	free text	10 char
NOTEST	integer	0 to 99
DTEDTH	date text (DD/MMM/YYYY)	11char
CSEDTH	free text	70 char
CADAPP	free text	70 char
BEDCON	integer	0 to 999
CADAN	free text	70 char
AORPRE	coded text	3 char
CERPRE	coded text	3 char
PULPRE	coded text	3 char
RIB1	coded text	3 char
RIBIN1	integer	0 to 999999

3. BIOLOGICAL SPECIMEN OCCUPANT INFORMATION (continued)

FIELD NAME	DATA TYPE	MAXIMUM FIELD LENGTH/RANGE
NADIS1	integer	0 to 999999
SPLEN1	integer	0 to 999999
DEFL1	integer	0 to 999999
LOAD1	integer	0 to 99999
BRKLD1	integer	0 to 99999
ARMAR1	integer	0 to 999999
RAREA1	integer	0 to 999999
RIB2	coded text	3 char
RIBIN2	integer	0 to 999999
NADIS2	integer	0 to 999999
SPLEN2	integer	0 to 999999
DEFL2	integer	0 to 999999
LOAD2	integer	0 to 99999
BRKLD2	integer	0 to 99999
ARMAR2	integer	0 to 999999
RAREA2	integer	0 to 999999
RIB3	coded text	3 char
RIBIN3	integer	0 to 999999
NADIS3	integer	0 to 999999
SPLEN3	integer	0 to 999999
DEFL3	integer	0 to 999999
LOAD3	integer	0 to 99999

3. BIOLOGICAL SPECIMEN OCCUPANT INFORMATION (continued)

FIELD NAME	DATA TYPE	MAXIMUM FIELD LENGTH/RANGE
BRKLD3	integer	0 to 99999
ARMAR3	integer	0 to 999999
RAREA3	integer	0 to 999999
RIB4	coded text	3 char
RIBIN4	integer	0 to 999999
NADIS4	integer	0 to 999999
SPLEN4	integer	0 to 999999
DEFL4	integer	0 to 999999
LOAD4	integer	0 to 99999
BRKLD4	integer	0 to 99999
ARMAR4	integer	0 to 999999
RAREA4	integer	0 to 999999
BOCCOM	free text	70 char

4. RESTRAINTS INFORMATION

FIELD NAME	DATA TYPE	MAXIMUM FIELD LENGTH/RANGE
TSTNO	predefined text=0	1char
RSTNO	integer	1 to 9
RSTTYP	coded text	3 char
RSTMNT	coded text	2 char
DEPLOY	coded text	2 char
RSTCOM	free text	70 char

5. ANTHROPOMETRY INFORMATION

FIELD NAME	DATA TYPE	MAXIMUM FIELD LENGTH/RANGE
TSTNO	predefined text=0	1 char
STATUR	integer	0 to 9999
SHLDHT	integer	0 to 9999
VRTSYM	integer	0 to 9999
WASTHT	integer	0 to 9999
SHLDBD	integer	0 to 9999
CHSTBD	integer	0 to 9999
WASTBD	integer	0 to 9999
HIPBD	integer	0 to 9999
SHLDEL	integer	0 to 9999
FARMHD	integer	0 to 9999
TIBLHT	integer	0 to 9999
ANKLHT	integer	0 to 9999
FOOTBD	integer	0 to 9999
FOOTLN	integer	0 to 9999
HDTROC	integer	0 to 9999
SEATHT	integer	0 to 9999
KNEEHT	integer	0 to 9999
HEADLN	integer	0 to 9999
HEADBD	integer	0 to 9999
HEADCH	integer	0 to 9999
BICPCR	integer	0 to 9999
ELBWCR	integer	0 to 9999
FARMCR	integer	0 to 9999
WRSTCR	integer	0 to 999
THGHCR	integer	0 to 9999

5. ANTHROPOMETRY INFORMATION (continued)

FIELD NAME	DATA TYPE	MAXIMUM FIELD LENGTH/RANGE
LTGHCR	integer	0 to 9999
KNEECR	integer	0 to 9999
CALFCR	integer	0 to 9999
ANKLCR	integer	0 to 9999
NECKCR	integer	0 to 9999
SCYECR	integer	0 to 9999
CHSTCR	integer	0 to 9999
WASTCR	integer	0 to 9999
BUTTCR	integer	0 to 9999
CHSTDP	integer	0 to 9999
WASTDP	integer	0 to 9999
BUTTDP	integer	0 to 9999
INSCYE	integer	0 to 9999

6. OCCUPANT INJURY INFORMATION

FIELD NAME	DATA TYPE	MAXIMUM FIELD LENGTH/RANGE
TSTNO	predefined text=0	1 char
INJNO	integer	1 to 99
BODYRG	coded text	1 char
ASPECT	coded text	1 char
LESION	coded text	1 char
SYSORG	coded text	1 char
AIS	coded text	1 char
INJCOM	free text	70 char

7. INSTRUMENTATION INFORMATION

FIELD NAME	DATA TYPE	MAXIMUM FIELD LENGTH/RANGE
TSTNO	predefined text=0	1 char
CURNO	integer	1 to 200
SENTYP	coded text	2 char
SENLOC	coded text	2 char
SENATT	coded text	4 char
AXIS	coded text	2 char
UNITS	coded text	3 char
PREFIL	integer	0 to 99999
INSMAN	free text	70 char
CALDAT	date text (DD/MMM/YYYY)	11 char
INSRAT	integer	-999999 to 999999
CHLMAX	integer	0 to 100
INIVEL	float	-200 to 200
NFP	integer	-10000 to 0
NLP	integer	0 to 99999
DELT	integer	0 to 999999
DASTAT	coded text	2 char
CHSTAT	coded text	1 char
INSCOM	free text	70 char

8. CHEST BAND INFORMATION

FIELD NAME	DATA TYPE	MAXIMUM FIELD LENGTH/RANGE
TSTNO	predefined text=0	1char
BANDNO	integer	1 to 5
CHSDPT	integer	0 to 999
CHSBRD	integer	0 to 999
BANLEN	integer	0 to 999
ANTLOC	coded text	1 to 10
POSLOC	coded text	1 to 10
GAGSTR	integer	1 to 200
DISSTR	integer	0 to 99
GAGSPN	integer	1 to 200
DISSPN	integer	0 to 99
TOTGAG	integer	1 to 40
CHBCOM	free text	70 char

9. CHEST BAND GAUGE INFORMATION

FIELD NAME	DATA TYPE	MAXIMUM FIELD LENGTH/RANGE
TSTNO	predefined text=0	1char
BANDNO	integer	1 to 5
GAGENO	integer	1 to 40
GAGDIS	integer	0 to 999
CURNO	integer	1 to 200
GAGCOM	free text	70 char

[this page intentionally left blank.]

APPENDIX D: DATA COORDINATE SYSTEM

With the introduction of this version (B4) of the NHTSA data format, all submissions will conform to SAE J211/1 MAR95 Instrumentation for Impact Test. Please refer to SAE J211 for a complete description of the coordinate system and signal polarities for vehicle occupants.

USING THE COORDINATE SYSTEM CORRECTLY

The rules for determining the sign conventions described below will enable anyone involved in NHTSA-sponsored testing to determine the proper sign and coordinate axis for any measured quantity.

All coordinate systems are orthogonal, three-dimensional, and right handed. The global coordinate systems for the vehicle and the test occupants are shown in Figure D-1. The coordinate system for the nine accelerometer head array is shown in Figure D-2, along with the proper SENATT codes. Table D-1 lists the polarity of the sensor output from various dummy manipulations when using this coordinate system.

VEHICLE GLOBAL COORDINATE SYSTEM

X is positive forward

Y is positive right (toward the passenger side door)

Z is positive down

OCCUPANT GLOBAL COORDINATE SYSTEM (all occupant types - OCCTYP)

X is positive forward (posterior to anterior)

Y is positive right

Z is positive down

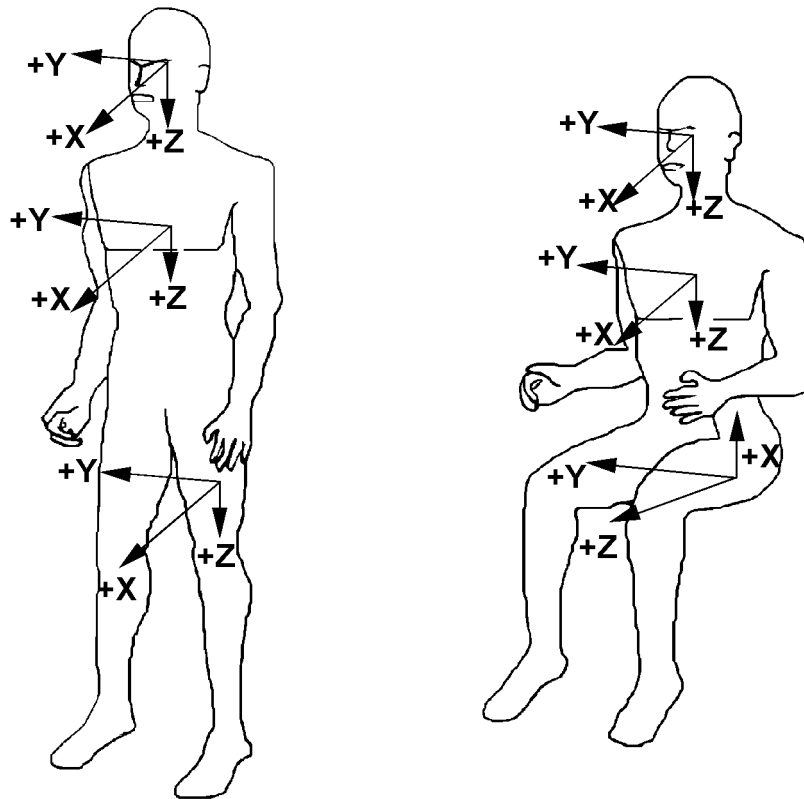
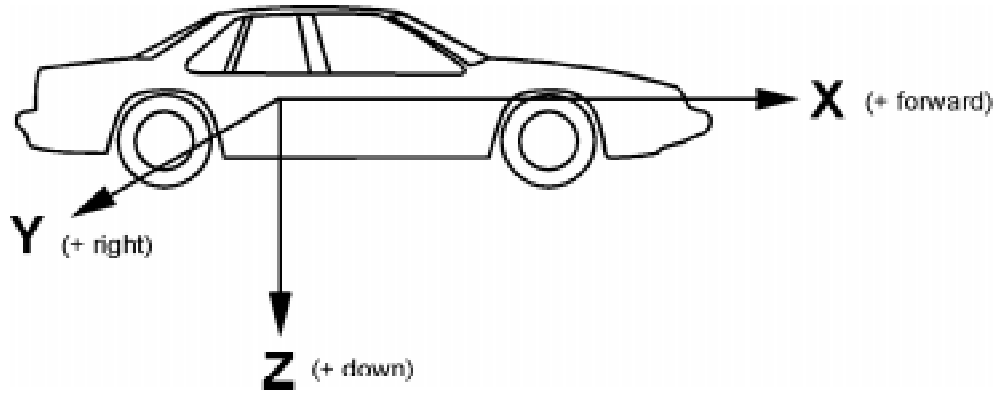

Figure D-1: Vehicle and Body-Based Coordinate Systems

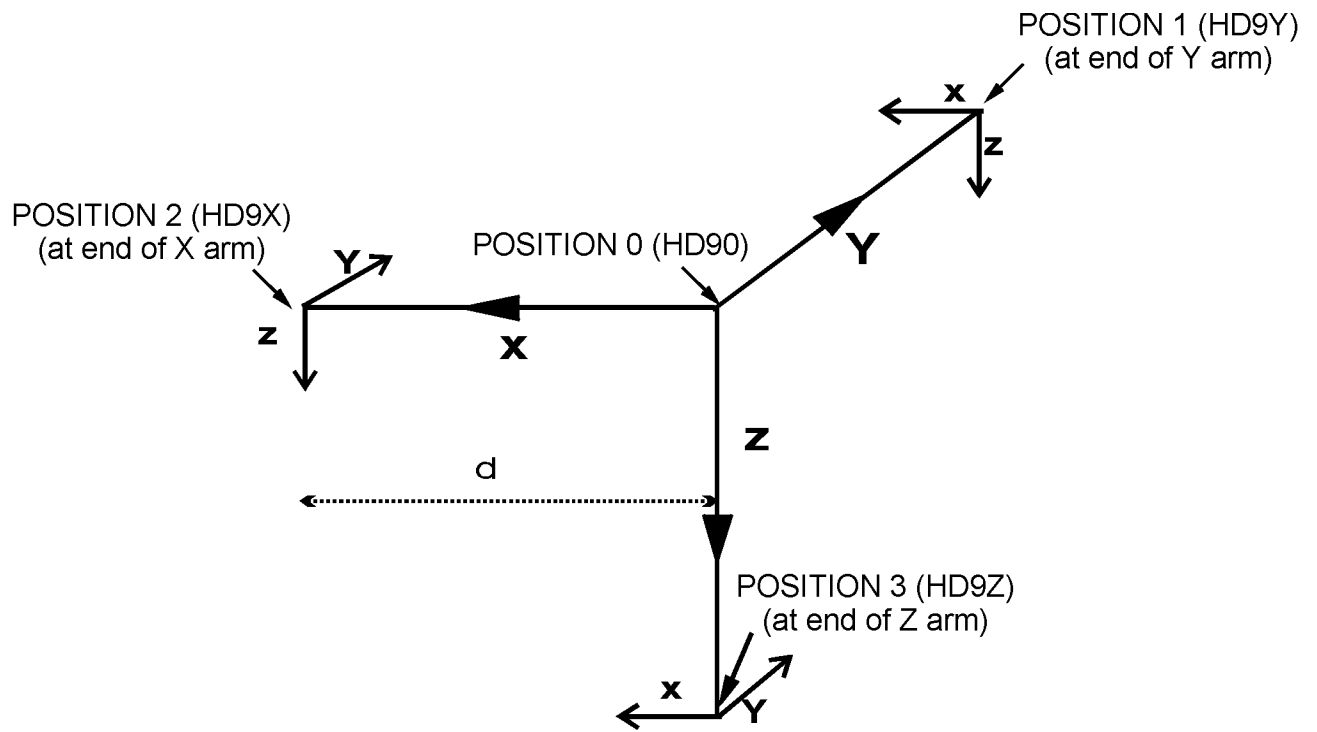

Figure D-2: Coordinate System for 9-Accelerometer Array

TABLE D.1
 Dummy Manipulations for Checking Recorded Load Cell
 Polarity Relative to Sign Convention

Load Cell	Measure	Dummy Manipulations	Polarity
Upper and lower neck loads	Fx	Head rearward, chest forward	+
	Fy	Head leftward, chest rightward	+
	Fz	Head upward, chest downward	+
	Mx	Left ear toward left shoulder	+
	My	Chin toward sternum	+
	Mz	Chin toward left shoulder	+
Left shoulder loads (BIOSID)	Fx	Left shoulder forward, chest rearward	+
	Fy	Left shoulder rightward, chest leftward	+
	Fz	Left shoulder downward, chest upward	+
Right shoulder loads (BIOSID)	Fx	Right shoulder forward, chest rearward	+
	Fy	Right shoulder rightward, chest leftward	+
	Fz	Right shoulder downward, chest upward	+
Clavicle loads	Fx	Shoulder forward, chest rearward	+
	Fz	Shoulder downward, chest rearward	+
Upper and lower lumbar spine	Fx	Chest rearward, Pelvis forward	+
	Fy	Chest leftward, pelvis rightward	+
	Fz	Chest upward, pelvis downward	+
	Mx	Left shoulder toward left hip	+
	My	Sternum toward front of legs	+
	Mz	Right shoulder forward, left shoulder rearward	+
Sacrum load (BIOSID)	Fy	Left H-point pad leftward, chest rightward	+
Left iliac load (BIOSID)	Fy	Left iliac rightward, chest leftward	+

TABLE D.1 (continued)

Load Cell	Measure	Dummy Manipulations	Polarity
Right iliac load (BIOSID)	Fy	Right iliac rightward, chest leftward	+
Pubic load (side impact)	Fy	Right H-point pad leftward, left pad rightward	(-)
Crotch belt loads	Fx	Pubic rearward, pelvis forward	(-)
	Fz	Pubic upward, chest downward	(-)
Iliac lap belt loads	Fx	Upper iliac spine rearward, chest forward	(-)
	My	Upper iliac spine rearward, chest forward	+
Left side abdominal load (Eurosid-1)	Fy	Left side of abdomen rightward, chest leftward	+
Right side abdominal load (Eurosid-1)	Fy	Right side of abdomen leftward, chest rightward	(-)
Femur loads (dummy in seated position, femurs horizontal)	Fx	Knee upward, upper femur downward	+
	Fy	Knee rightward, upper femur leftward	+
	Fz	Knee forward, pelvis rearward	+
	Mx	Knee leftward, hold upper femur in place	+
	My	Knee upward, hold upper femur in place	+
	Mz	Tibia leftward, hold pelvis in place	+
Knee clevis	Fz	Tibia downward, femur upward	+
Upper tibia loads	Fz	Tibia downward, femur upward	+
	Mx	Ankle leftward, hold knee in place	+
	My	Ankle forward, bottom of knee clevis rearward	+
Lower tibia loads	Fx	Ankle forward, knee rearward	+
	Fy	Ankle rightward, knee leftward	+
	Mx	Ankle leftward, hold knee in place	+
	My	Ankle forward, bottom of knee clevis rearward	+

[this page intentionally left blank.]