

# **Interstate Highway Pavement Sampling Final Phase 2 Report**

PUBLICATION NO. FHWA-HIF-20-085

March 2020



U.S. Department  
of Transportation  
**Federal Highway  
Administration**

## **NOTICE**

This document is disseminated under the sponsorship of the U.S. Department of Transportation (USDOT) in the interest of information exchange. The U.S. Government assumes no liability for the use of the information contained in this document.

The U.S. Government does not endorse products or manufacturers. Trademarks or manufacturers' names appear in this report only because they are considered essential to the objective of the document. They are included for informational purposes only and are not intended to reflect a preference, approval, or endorsement of any one product or entity.

## **NON-BINDING CONTENTS**

The contents of this document do not have the force and effect of law and are not meant to bind the public in any way. This document is intended only to provide clarity to the public regarding existing requirements under the law or agency policies. While this is non-binding technical information, you still must comply with the applicable statute or regulation.

## **QUALITY ASSURANCE STATEMENT**

The Federal Highway Administration (FHWA) provides high-quality information to serve Government, industry, and the public in a manner that promotes public understanding. Standards and policies are used to ensure and maximize the quality, objectivity, utility, and integrity of its information. FHWA periodically reviews quality issues and adjusts its programs and processes to ensure continuous quality improvement.

## FOREWORD

The FHWA conducted a Baseline Interstate Condition Study in 2015 to assess whether the Highway Performance Monitoring System (HPMS) was an unbiased representation of pavement condition on the Interstate Highway System (IHS). Approximately 8,500 miles of IHS data were collected using an automated measurement system.

Recently, the FHWA decided to undertake a similar follow-on study to the Baseline Interstate Condition Study, documented in this report, whose objectives were to:

- Collect a follow-up unbiased dataset for a statistically significant sample of the IHS and produce a report indicating condition on IHS nationally and in each State where data were collected.
- Further investigate whether HPMS is an unbiased representation of pavement condition on the IHS.
- Identify possible improvements to HPMS data collection and reporting to either make HPMS unbiased or improve its precision.
- Pursue additional investigations such as performing a temporal analysis of 2015 through 2016 HPMS and Long-Term Pavement Performance (LTPP) data as compared to the data previously collected in 2015 for the Interstate Pavement Condition Sampling project.

## TECHNICAL DOCUMENTATION PAGE

1. Report No. FHWA-HIF-20-085	2. Government Accession No.	3. Recipient's Catalog No.	
4. Title and Subtitle Interstate Highway Pavement Sampling Final Phase 2 Report		5. Report Date June 2019	
		6. Performing Organization Code NONE	
7. Author(s) Amy Simpson, Pedro Serigos, Sareh Kouchaki, Gonzalo Rada, and Jonathan Groeger		8. Performing Organization Report No.	
9. Performing Organization Name and Address Wood Environment & Infrastructure Solutions, Inc. 12000 Indian Creek Court, Suite F Beltsville, MD 20705		10. Work Unit No. (TRAIS)	
		11. Contract or Grant No. DTFH61-13-A-00001-0005	
12. Sponsoring Agency Name and Address U.S. Department of Transportation Federal Highway Administration Office of Preconstruction, Construction, and Pavements 1200 New Jersey Avenue, SE Washington, D.C. 20590		13. Type of Report and Period Covered Final Phase 2 Report; September 2017 – June 2019	
		14. Sponsoring Agency Code	
15. Supplementary Notes The Task Order Contracting Office Representative (TOCOR) was Mr. Thomas Van, P.E., FHWA.			
16. Abstract The Moving Ahead for Progress in the 21st Century Act (MAP-21) and Fixing America's Surface Transportation (FAST) Act required that pavement performance measures be established for the Interstate Highway System (IHS). Because the measures rely on pavement condition data stored in the Highway Performance Monitoring System (HPMS), FHWA undertook a study in 2015 to: (1) collect an unbiased baseline condition of a statistically significant sample of the entire IHS and produce a report indicating the pavement condition on the IHS nationally and in each State where data were collected, (2) determine if HPMS is an unbiased representation of the pavement condition of the IHS, and (3) recommend improvements to HPMS data collection and reporting necessary to make HPMS unbiased or improve its precision. The results provided the outcomes needed at the time. Two years later, FHWA pursued a follow-up study addressing the same objectives plus some additional investigations. Working toward these objectives, a literature review was conducted and presented in this report to identify new developments in the HPMS area. The 2016 HPMS data was reviewed for data completeness and various stratification factors were considered. This review provided the basis for selecting a route to collect a 7,500 mile sample reflecting actual stratification of the entire IHS (based on climate zone, population zone, surface type, and terrain) as observed from the 2016 HPMS. This report addresses the development and execution of the data collection plan, including the data quality management plan (DQMP) that was developed for data collection and data analyses. The report also details the data analyses activities that were performed as part of the study, including the associated conclusions and recommendations.			
17. Key Words Highway Performance Monitoring System, MAP-21, Interstate Highway System, pavement performance measures		18. Distribution Statement No restrictions.	
19. Security Classif. (of this report) Unclassified	20. Security Classif. (of this page) Unclassified	21. No. of Pages 132	22. Price

# SI\* (MODERN METRIC) CONVERSION FACTORS

## APPROXIMATE CONVERSIONS TO SI UNITS

Symbol	When You Know	Multiply By	To Find	Symbol
<b>LENGTH</b>				
in	inches	25.4	millimeters	mm
ft	feet	0.305	meters	m
yd	yards	0.914	meters	m
mi	miles	1.61	kilometers	km
<b>AREA</b>				
in <sup>2</sup>	square inches	645.2	square millimeters	mm <sup>2</sup>
ft <sup>2</sup>	square feet	0.093	square meters	m <sup>2</sup>
yd <sup>2</sup>	square yard	0.836	square meters	m <sup>2</sup>
ac	acres	0.405	hectares	ha
mi <sup>2</sup>	square miles	2.59	square kilometers	km <sup>2</sup>
<b>VOLUME</b>				
fl oz	fluid ounces	29.57	milliliters	mL
gal	gallons	3.785	liters	L
ft <sup>3</sup>	cubic feet	0.028	cubic meters	m <sup>3</sup>
yd <sup>3</sup>	cubic yards	0.765	cubic meters	m <sup>3</sup>
NOTE: volumes greater than 1000 L shall be shown in m <sup>3</sup>				
<b>MASS</b>				
oz	ounces	28.35	grams	g
lb	pounds	0.454	kilograms	kg
T	short tons (2000 lb)	0.907	megagrams (or "metric ton")	Mg (or "t")
<b>TEMPERATURE (exact degrees)</b>				
°F	Fahrenheit	5 (F-32)/9 or (F-32)/1.8	Celsius	°C
<b>ILLUMINATION</b>				
fc	foot-candles	10.76	lux	lx
fl	foot-Lamberts	3.426	candela/m <sup>2</sup>	cd/m <sup>2</sup>
<b>FORCE and PRESSURE or STRESS</b>				
lbf	poundforce	4.45	newtons	N
lbf/in <sup>2</sup>	poundforce per square inch	6.89	kilopascals	kPa

## APPROXIMATE CONVERSIONS FROM SI UNITS

Symbol	When You Know	Multiply By	To Find	Symbol
<b>LENGTH</b>				
mm	millimeters	0.039	inches	in
m	meters	3.28	feet	ft
m	meters	1.09	yards	yd
km	kilometers	0.621	miles	mi
<b>AREA</b>				
mm <sup>2</sup>	square millimeters	0.0016	square inches	in <sup>2</sup>
m <sup>2</sup>	square meters	10.764	square feet	ft <sup>2</sup>
m <sup>2</sup>	square meters	1.195	square yards	yd <sup>2</sup>
ha	hectares	2.47	acres	ac
km <sup>2</sup>	square kilometers	0.386	square miles	mi <sup>2</sup>
<b>VOLUME</b>				
mL	milliliters	0.034	fluid ounces	fl oz
L	liters	0.264	gallons	gal
m <sup>3</sup>	cubic meters	35.314	cubic feet	ft <sup>3</sup>
m <sup>3</sup>	cubic meters	1.307	cubic yards	yd <sup>3</sup>
<b>MASS</b>				
g	grams	0.035	ounces	oz
kg	kilograms	2.202	pounds	lb
Mg (or "t")	megagrams (or "metric ton")	1.103	short tons (2000 lb)	T
<b>TEMPERATURE (exact degrees)</b>				
°C	Celsius	1.8C+32	Fahrenheit	°F
<b>ILLUMINATION</b>				
lx	lux	0.0929	foot-candles	fc
cd/m <sup>2</sup>	candela/m <sup>2</sup>	0.2919	foot-Lamberts	fl
<b>FORCE and PRESSURE or STRESS</b>				
N	newtons	0.225	poundforce	lbf
kPa	kilopascals	0.145	poundforce per square inch	lbf/in <sup>2</sup>

\*SI is the symbol for the International System of Units. Appropriate rounding should be made to comply with Section 4 of ASTM E380.  
(Revised March 2003)

## TABLE OF CONTENTS

<b>CHAPTER 1 - INTRODUCTION.....</b>	<b>1</b>
BACKGROUND .....	1
PROJECT OBJECTIVES AND TASKS.....	2
REPORT ORGANIZATION.....	3
<b>CHAPTER 2 - LITERATURE REVIEW .....</b>	<b>4</b>
BACKGROUND .....	4
FINAL RULE – COMMENTS.....	4
VALIDATION OF PAVEMENT PERFORMANCE MEASURES USING LTPP DATA .....	7
HPMS FIELD MANUAL COMPARISON .....	8
DATA COLLECTION FOR PAVEMENT CONDITION METRICS .....	9
<b>CHAPTER 3 - DATA QUALITY MANAGEMENT PROGRAM .....</b>	<b>12</b>
DATA QUALITY MANAGEMENT PLAN .....	13
DQMP IMPLEMENTATION .....	14
<b>CHAPTER 4 - DATA COLLECTION .....</b>	<b>36</b>
2016 HPMS DATA REVIEW .....	36
COMPARISON OF 2013 AND 2016 HPMS DATA .....	41
DATA COLLECTION ROUTE .....	45
EXECUTION OF DATA COLLECTION PLAN.....	53
<b>CHAPTER 5 - DATA ANALYSIS .....</b>	<b>55</b>
CONDITION OF INTERSTATE PAVEMENT NETWORK .....	55
HPMS PAVEMENT CONDITION DATA ANALYSES.....	71
IMPACT OF STRATIFICATION FACTORS ON PAVEMENT CONDITION DATA.....	81
COMPARISON OF PROJECT AND HPMS PAVEMENT CONDITION DATA.....	86
OTHER COMPARISONS OF PROJECT PAVEMENT CONDITION DATA.....	91
ASSESSMENT OF PAVEMENT CONDITION ERROR SOURCES .....	105
<b>CHAPTER 6 - CONCLUSIONS .....</b>	<b>110</b>
<b>REFERENCES.....</b>	<b>116</b>
<b>APPENDIX A – PROJECT DATABASE DATA DICTIONARY .....</b>	<b>118</b>

## LIST OF FIGURES

Figure 1. Illustration. Flowchart of DQMP implementation activities along with other project activities. ....	15
Figure 2. Picture. Rolling Surface Profiler Reference data collection for Inertial Profiler certification. ....	16
Figure 3. Picture. Example transverse profile used in rut depth validation. ....	18
Figure 4. Picture. Marker for edge of lane. ....	18
Figure 5. Picture. Joints 2 and 3 used in faulting validation. ....	20
Figure 6. Illustration. Location of validation faulting measurements. ....	20
Figure 7. Illustration. Layout of transverse ALPS measurements for faulting validation. ....	21
Figure 8. Illustration. Layout of longitudinal ALPS measurement for faulting validation. ....	21
Figure 9. Picture. Overview of Cell 4 used in percent cracking validation. ....	22
Figure 10. Plot. Rut depth validation data. ....	23
Figure 11. Plot. Faulting validation data. ....	24
Figure 12. Plot. Percent cracking validation data on asphalt pavements. ....	25
Figure 13. Picture. Overview of cell 32 used for percent cracking jointed concrete pavement validation. ....	26
Figure 14. Plot. Percent cracking validation data on jointed concrete pavements and continuously reinforced concrete pavements. ....	27
Figure 15. Picture. Close-up picture of calibration board. ....	31
Figure 16. Picture. Calibration board in use during the LCMS static check in Maryland. ....	31
Figure 17. Image. Screenshot of DCC software with results from LCMS static checks conducted in Texas. ....	32
Figure 18. Illustration. Climate zones used in the HPMS database. ....	37
Figure 19. Graph. Comparison of the distribution of IRI. ....	44
Figure 20. Graph. Comparison of distribution of rut depth. ....	44
Figure 21. Graph. Comparison of distribution of faulting. ....	45
Figure 22. Graph. Comparison of distribution of percent cracking. ....	45
Figure 23. Map. 2018 data collection route. ....	46
Figure 24. Map. 2015 data collection route. ....	47
Figure 25. Comparison of 2015 and 2018 data collection routes: common areas. ....	47
Figure 26. Chart. 2016 HPMS climate zone composition. ....	49
Figure 27. Chart. 2018 Route climate zone composition. ....	49
Figure 28. Chart. 2016 HPMS urban vs. rural composition. ....	50
Figure 29. Chart. 2018 Route urban vs. rural composition. ....	51
Figure 30. Chart. 2016 HPMS pavement surface type composition. ....	51
Figure 31. Chart. 2018 Route pavement surface type composition. ....	52
Figure 32. Plot. Density plots of IRI condition metric for IS1 and IS2 datasets. ....	56
Figure 33. Plot. Density plots of rutting condition metric for IS1 and IS2 datasets. ....	57
Figure 34. Plot. Density plots of cracking condition metric for IS1 and IS2 datasets. ....	57
Figure 35. Plot. Density plots of faulting condition metric for IS1 and IS2 datasets. ....	58
Figure 36. Chart. State level IRI CLES results. ....	61
Figure 37. Chart. State level cracking CLES results. ....	62
Figure 38. Chart. State level rutting CLES results. ....	62
Figure 39. Chart. State level faulting CLES results. ....	62
Figure 40. Chart. Good condition ratings comparison at State level. ....	63

Figure 41. Chart. Fair condition ratings comparison at State level. ....	64
Figure 42. Chart. Poor condition ratings comparison at State level. ....	64
Figure 43. Chart. Comparison between IS1 and IS2 sampled mileage. ....	65
Figure 44. Chart. Comparison of IS1 and IS2 Good IRI condition ratings at route level. ....	66
Figure 45. Chart. Comparison of IS1 and IS2 Poor IRI condition ratings at route level.....	67
Figure 46. Chart. Comparison of IS1 and IS2 Good rutting condition ratings at route level. ....	67
Figure 47. Chart. Comparison of IS1 and IS2 Poor rutting condition ratings at route level. ....	68
Figure 48. Chart. Comparison of IS1 and IS2 Good cracking condition ratings at route level. ....	68
Figure 49. Chart. Comparison of IS1 and IS2 Poor cracking condition ratings at route level. ....	69
Figure 50. Chart. Comparison of IS1 and IS2 Good faulting condition ratings at route level. ....	69
Figure 51. Chart. Comparison of IS1 and IS2 Poor faulting condition ratings at route level.....	70
Figure 52. Plot. Density plots of IRI condition metric for 2015, 2016, and 2017 HPMS datasets.....	73
Figure 53. Plot. Density plots of rutting condition metric for 2015, 2016, and 2017 HPMS datasets.....	73
Figure 54. Plot. Density plots of cracking condition metric for 2015, 2016, and 2017 HPMS datasets.....	74
Figure 55. Plot. Density plots of faulting condition metric for 2015, 2016, and 2017 HPMS datasets.....	74
Figure 56. Chart. Histogram of percent changes in Good condition from 2015 to 2016. ....	77
Figure 57. Chart. Histogram of percent changes in Poor condition from 2015 to 2016.....	77
Figure 58. Chart. Histogram of percent changes in Good condition from 2016 to 2017. ....	78
Figure 59. Chart. Histogram of percent changes in Poor condition from 2016 to 2017.....	78
Figure 60. Equation. Results of multinomial logistic regression.....	83
Figure 61. Equation. Results of multinomial logistic regression.....	83
Figure 62. Chart. CLES results for IS2 and HPMS IRI condition metric. ....	89
Figure 63. Chart. CLES results for IS2 and HPMS rutting condition metric. ....	90
Figure 64. Chart. CLES results for IS2 and HPMS cracking condition metric. ....	90
Figure 65. Chart. CLES results for IS2 and HPMS faulting condition metric. ....	90
Figure 66. Plot. Mean IRI for LTPP test sections.....	93
Figure 67. Plot. IRI COV for LTPP test sections. ....	94
Figure 68. Equation. ‘True’ value of project measured data at time t2. ....	94
Figure 69. Equation. ‘True’ value of LTPP data at time t1. ....	94
Figure 70. Equation. ‘True’ value of LTPP data at time t2. ....	94
Figure 71. Equation. Differences in the LTPP and project true values. ....	95
Figure 72. Equation. Measured project data hypothesis. ....	95
Figure 73. Plot. Project versus LTPP IRI measurements on jointed concrete pavement test sections.....	97
Figure 74. Plot. Project versus LTPP IRI measurements on asphalt pavement test sections. ....	98
Figure 75. Plot. Project versus LTPP cracking measurements on jointed concrete pavement test sections.....	98
Figure 76. Plot. Project versus LTPP cracking measurements on asphalt pavement test sections.....	99
Figure 77. Plot. Project versus LTPP faulting measurements on jointed concrete pavement test sections.....	99
Figure 78. Plot. Project versus LTPP rutting measurements on asphalt pavement test sections. ....	100



Figure 79. Plot. Density plots of IRI condition metric for IS1, IS2, and InfraHealth datasets. ....	102
Figure 80. Plot. Density plots of rutting condition metric for IS1, IS2, and InfraHealth datasets. ....	102
Figure 81. Plot. Density plots of cracking condition metric for IS1, IS2, and InfraHealth datasets. ....	103
Figure 82. Plot. Density plots of faulting condition metric for IS1, IS2, and InfraHealth datasets. ....	103
Figure 83. Equation. Project measured data. ....	106
Figure 84. Equation. HPMS measured data. ....	106
Figure 85. Equation. Measurement error. ....	106
Figure 86. Equation. Expected value of measurement error. ....	106
Figure 87. Equation. Variance of measurement error. ....	106

## LIST OF TABLES

Table 1. Changes in reporting resolution for pavement condition.....	11
Table 2. Statistics for Inertial Profiler certification on asphalt pavement section.....	17
Table 3. Statistics for Inertial Profiler certification on concrete pavement section.....	17
Table 4. Information about weekly validation testing conducted during data collection.....	30
Table 5. Summary reporting and acceptance information of DCC partial data batches.....	34
Table 6. Mileage of Interstate Highway System by climate zone.....	37
Table 7. Mileage of Interstate Highway System by population zone.....	37
Table 8. Mileage of Interstate Highway System by pavement surface type.....	38
Table 9. Mileage of Interstate Highway System by terrain.....	38
Table 10. Data completeness.....	39
Table 11. 2016 HPMS dataset distribution of IRI by pavement surface type.....	39
Table 12. 2016 HPMS dataset distribution of rut depth by surface type.....	40
Table 13. 2016 HPMS dataset distribution of faulting by surface type.....	40
Table 14. 2016 HPMS dataset distribution of percent cracking by surface type.....	41
Table 15. Data mileage comparison by climate zone.....	42
Table 16. Data mileage comparison by population zone.....	42
Table 17. Data mileage comparison by surface type.....	42
Table 18. Data mileage comparison by condition metric.....	43
Table 19. Comparison of 2013 and 2016 condition metric distributions.....	43
Table 20. Data collection route: route, state, direction, and miles.....	48
Table 21. Data collection route: route, state, direction, and miles.....	52
Table 22. IS1 and IS2 condition metric summary statistics.....	56
Table 23. Pavement condition metrics and overall condition ratings for IS1 and IS2 datasets.....	58
Table 24. Comparison of IS1 and IS2 metric condition ratings for common States.....	59
Table 25. Comparison of IS1 and IS2 overall condition ratings and performance measures for common States.....	59
Table 26. Comparison of IS1 and IS2 according to condition metric and surface type.....	60
Table 27. IS2 asphalt pavement percent cracking for different wheelpath widths.....	60
Table 28. States in the “medium” and “large” CLES groups.....	63
Table 29. Sampled mileage details of IS1 and IS2.....	66
Table 30. Comparison of IS1 and IS2 overall condition ratings and performance measures at route level.....	70
Table 31. Sampled mileage of 2017, 2016, and 2015 HPMS datasets.....	71
Table 32. IRI statistics for 2017, 2016, and 2015 HPMS datasets.....	72
Table 33. Rutting statistics for 2017, 2016, and 2015 HPMS datasets.....	72
Table 34. Percent cracking statistics for 2017, 2016, and 2015 HPMS datasets.....	72
Table 35. Faulting statistics for 2017, 2016, and 2015 HPMS datasets.....	72
Table 36. Comparison of HPMS datasets based on IRI condition ratings.....	75
Table 37. Comparison of HPMS datasets based on rutting condition ratings.....	75
Table 38. Comparison of HPMS datasets based on cracking condition ratings.....	75
Table 39. Comparison of HPMS datasets based on faulting condition ratings.....	75
Table 40. Comparison of HPMS datasets based on overall condition ratings and performance measures.....	76
Table 41. IRI statistics for 2017, 2016, and 2015 HPMS datasets based on the common segments.....	79

Table 42. Rutting statistics for 2017, 2016, and 2015 HPMS datasets based on the common segments.....	79
Table 43. Percent cracking statistics for 2017, 2016, and 2015 HPMS datasets based on the common segments.....	79
Table 44. Faulting statistics for 2017, 2016, and 2015 HPMS datasets based on the common segments.....	79
Table 45. Comparison of HPMS IRI condition ratings over time based on common segments. ...	80
Table 46. Comparison of HPMS rutting condition ratings over time based on common segments.....	80
Table 47. Comparison of HPMS cracking condition ratings over time based on common segments.....	80
Table 48. Comparison of HPMS faulting condition ratings over time based on common segments.....	81
Table 49. Comparison HPMS overall condition ratings and performance measures over time for common segments.....	81
Table 50. Pavement condition metrics as a function of climate zone.....	81
Table 51. Pavement condition metrics as a function of terrain.....	82
Table 52. Pavement condition metrics as a function of urban vs. rural locations. ....	82
Table 53. Performance measures for each climate zone.....	82
Table 54. Performance measures for each terrain.....	82
Table 55. Performance measures for urban and rural zones.....	83
Table 56. Results of stepwise regression analysis for IRI, rutting, cracking, and faulting.....	85
Table 57. IRI statistics for the IS1, IS2, and 2017 HPMS datasets. ....	87
Table 58. Rutting statistics for the IS1, IS2, and 2017 HPMS datasets.....	87
Table 59. Cracking statistics for the IS1, IS2, and 2017 HPMS datasets. ....	87
Table 60. Faulting statistics for the IS1, IS2, and 2017 HPMS datasets. ....	87
Table 61. Comparison of IS1, IS2, and 2017 HPMS metric ratings.....	88
Table 62. Comparison of IS1, IS2, and 2017 HPMS overall condition ratings and performance measures.....	88
Table 63. Examples of IS2 and 2017 HPMS overall condition rating and performance measure comparisons at State level.....	89
Table 64. InfraHealth, IS1, and IS2 pavement condition IRI statistics. ....	101
Table 65. InfraHealth, IS1, and IS2 pavement condition rutting statistics. ....	101
Table 66. InfraHealth, IS1, and IS2 pavement condition cracking statistics.....	101
Table 67. InfraHealth, IS1, and IS2 pavement condition faulting statistics. ....	101
Table 68. Comparison of IS1, IS2, and InfraHealth metric condition ratings for I-90 through South Dakota, Minnesota, and Wisconsin. ....	104
Table 69. Comparison of IS1, IS2, and InfraHealth overall condition ratings and performance measures for I-90 through South Dakota, Minnesota, and Wisconsin. ....	105
Table 70. Comparison of IS1, IS2, and InfraHealth overall condition ratings and performance measures at State level.....	105
Table 71. Expected Values of Bias and Random Error for Condition Metrics by Surface Type	107
Table 72. Uncertainty in Performance Measures Resulting from Measurement Error. ....	108
Table 73. Uncertainty in Performance Measures Resulting from Data Sampling.....	108
Table 74. Uncertainty in wrong data definition.....	109
Table 75. Metadata.....	118

Table 76. Hundredth_mile_Crack.....	119
Table 77. Hundredth_mile_Fault.....	120
Table 78. Hundredth_mile_IRI.....	121
Table 79. Hundredth_mile_Rut .....	122
Table 80. Event_Table.....	123
Table 81. Pavement_Change .....	123
Table 82. Tenth_Mile_Data.....	124

## LIST OF ABBREVIATIONS

AASHTO American Association of State Highway and Transportation Officials

AC asphalt concrete

ACP asphalt concrete pavement

ALPS Automated Laser Profile System

ASR Alkali Silica Reactivity

C&P Conditions and Performance

CLES Common Language Effect Size

COV coefficient of variation

CRCP continuously reinforced concrete pavement

DCC data collection contractor

DMI distance measurement instrument

DOT Department of Transportation

DQMP data quality management plan

FAST Fixing America's Surface Transportation

FHWA Federal Highway Administration

GPS global positioning system

HPMS Highway Performance Monitoring System

IA Independent Assurance

IHS Interstate Highway System

IPinertial profiler

IRI International Roughness Index

JCP jointed concrete pavement

JPCP jointed plain concrete pavement

JRCP jointed reinforced concrete pavement

LCMS Laser Cracking Measurement System

LRS Linear Reference System

LTPP Long-Term Pavement Performance

M&R maintenance and rehabilitation

MAP-21 Moving Ahead for Progress in the 21st Century Act

MnDOT Minnesota Department of Transportation

MnROAD Minnesota Road Research Facility

NHS National Highway System

NPRM Notice of Proposed Rulemaking

PCC Portland cement concrete

PSR Present Serviceability Rating

QA quality assurance

QC quality control

TOCOR Task Order Contracting Office Representative

TRB Transportation Research Board

## CHAPTER 1 - INTRODUCTION

### BACKGROUND

In recent surface transportation legislation — Moving Ahead for Progress in the 21<sup>st</sup> Century Act and Fixing America’s Surface Transportation — Congress directed FHWA to establish pavement performance measures for the Interstate Highway System (IHS) and for the National Highway System (NHS).<sup>(1,2)</sup> These measures were subsequently issued as a final rule in 2017.<sup>(3)</sup>

Condition of the pavements is determined based on the following four metrics contained in the Highway Performance Monitoring System (HPMS): (1) International Roughness Index (IRI), (2) percent cracking, (3) rutting, and/or (4) faulting. The HPMS is the official Federal Government source of data on the extent, condition, performance, use, and operating characteristics of the nation’s highways. Data contained in the HPMS are used for assessing and reporting highway system performance under FHWA’s strategic planning process. They also form the basis of analyses that support the Conditions and Performance (C&P) Report to Congress and are the source for a substantial portion of the information in the annual Highway Statistics publication and in other FHWA publications.

Using data contained in the HPMS dataset, the overall condition ratings of the Interstate Highway System and National Highway System pavements is assigned based on condition rating thresholds stipulated in the final rule—these thresholds are detailed in chapter 2. More specifically, the overall condition of the pavement is determined based on the individual metric conditions and thresholds, as follows:

- For asphalt and jointed concrete pavements, the pavement is classified as Good condition if all three metrics are in Good condition. The pavement is classified as Poor condition if two or more of the metrics are in Poor condition. All other combinations of metric conditions classify a pavement as Fair.<sup>(4)</sup>
- For continuously reinforced concrete pavements, if both metrics are in Good condition, the pavement is classified as Good. The pavement is classified as Poor if both metrics are in Poor condition. All other combinations of metric conditions classify the pavement as Fair.<sup>(4)</sup>

In turn, based on the condition ratings, the final rule established four pavement performance measures to assess pavement condition as follows: percentage of pavements on the Interstate Highway System in Good and in Poor condition and percentage of pavements on the National Highway System (excluding Interstate Highway System) in Good and in Poor condition.<sup>(4)</sup>

At the time the performance measures were developed, FHWA and other agencies had performed studies to determine how well the HPMS data reflected actual conditions on the Interstate system using the measurements described in the MAP-21 (see references 4 through 8). The results from these studies along with various discussions with and among the Transportation Research Board (TRB) and American Association of State Highway Transportation Officials (AASHTO) committees raised concerns about the validity and availability of HPMS pavement

data. Because of these concerns, FHWA undertook the initial Interstate Pavement Condition Sampling study in 2015 to ascertain the condition of the IHS and to address HPMS data quality and completeness issues. The primary objectives of the study were to: <sup>(5)</sup>

- Collect an unbiased baseline dataset for a statistically significant sample of the Interstate Highway System and produce a report indicating the condition on the system nationally and in each State where data were collected.
- Determine if HPMS is an unbiased representation of pavement condition on the Interstate Highway System.
- Identify possible improvements to HPMS data collection and reporting to make HPMS unbiased and improve its precision.

The data for this project was collected in 2017 and the relevant findings and conclusions are summarized in chapter 2. These findings and conclusions support ongoing improvements to the HPMS dataset, its completeness, and its data quality. This study and the 2015 FHWA Interstate Pavement Condition Sampling study show significant improvements in the HPMS data submitted to FHWA by the States and evaluate some specific conditions with Interstate pavements.

## **PROJECT OBJECTIVES AND TASKS**

To address issues summarized in the previous section, the FHWA has undertaken this follow-up research effort. The objectives of this project are:

- Collect a follow-up unbiased dataset for a statistically significant sample of the Interstate Highway System and produce a report indicating condition on the system nationally and in each State where data were collected.
- Further investigate whether HPMS is an unbiased representation of pavement condition on the Interstate Highway System.
- Recommend further improvements to HPMS data collection and reporting to either make HPMS unbiased or improve its precision.
- Pursue additional investigations, including:
  - Evaluation of data collected in this project as compared to Long-Term Pavement Performance (LTPP) data.
  - Evaluation of the HPMS with the project-collected data.
  - Analysis of the temporal effects using multiple data sources.

Toward successful accomplishment of the above referenced objectives, the following phases and tasks were conducted:

- PHASE 1: Development of Data Collection and Analysis Plan
  - Task 1.0 – Kick-off Meeting
  - Task 1.1 – Literature Review and Synthesis of Recent Research
  - Task 1.2 – Obtain Latest HPMS Data



- Task 1.3 – Develop a Data Collection and Analysis Plan
- Task 1.4 – Draft Phase 1 Report
- Task 1.5 – Final Phase 1 Report
- Task 1.6 – Teleconferences, Web Conferences and Meetings
- PHASE 2: Implementation of Data Collection and Analysis Plan
  - Task 2.0 – Data Collection
  - Task 2.1 – Data Analysis
  - Task 2.2 – Draft Phase 2 Report
  - Task 2.3 – Final Phase 2 Report and Database
  - Task 2.4 – Teleconferences, Web Conferences and Meetings
  - Task 2.5 – Conference, Webinars and Symposium Presentations
  - Task 2.6 – Preparation of Periodical Articles
- PHASE 3: Additional Data Analysis

## **REPORT ORGANIZATION**

This report documents the entire research effort (Phase 1, Phase 2 and Phase 3), including the approach taken as well as the major findings, conclusions, and recommendations. The report chapters are summarized below:

1. Introduction – provides the project background, project objectives and tasks, and organization of the report.
2. Literature Review – documents the results of the literature review effort, which was intended to identify recent developments in the areas of HPMS data collection and practices.
3. Data Quality Management Program – details the development and implementation of the DQMP, which was specifically tailored to the project.
4. Data Collection – details the data collection effort, from the planning stages to its completion, including data processing and quality review.
5. Data Analysis – details the data analysis effort, from the planning stages to its completion, including quality review of the results and major findings.
6. Conclusions and Recommendations – documents the major conclusions from the effort, and provides recommendations for improving HPMS data collection practices.
7. References – provides a list of the references cited throughout the report.

In addition, Appendix A Project Database Data Dictionary is included after the references to provide the format for the project database that resulted from this study, including appropriate metadata.

## CHAPTER 2 - LITERATURE REVIEW

### BACKGROUND

The objective of the literature review was to identify recent developments related to HPMS data collection, to assess relevant comments from the final rule, and to review data quality elements. The final rule and revision to the HPMS Field Manual made changes to the data collection specifications, reporting accuracy, and determination of pavement condition metrics since the Interstate Condition 2015 Baseline project. <sup>(5)</sup> The literature review was particularly important, as the information contained in this chapter provided the foundation for preparation of the DQMP presented in chapter 3 and the data collection and analysis material presented under chapters 4 and 5.

Although the objective of this literature review was to focus on recent developments, the references included in the literature review during the Interstate Pavement Condition Sampling project are not only still relevant, but are still valid and applicable. Important references from that literature review are acknowledged as: (See references 4,5,6,7,9.)

- Improving FHWA’s Ability to Assess Highway Infrastructure Health.
  - Pilot Study Report.
  - Pilot Study Report Addendum – Rutting Bias Investigation.
  - Development of Next Generation Pavement Performance Measures.
- Increasing Consistency in the Highway Performance Monitoring System for Pavement Reporting, Final Report.
- Practical Guide for Quality Management of Pavement Condition Data Collection.

### FINAL RULE – COMMENTS

This study was conducted using the standards in the final MAP-21 rule that was published on January 18, 2017 and went into effect on May 20, 2017. <sup>(3)</sup> Some of the items in the final rule that are relevant to this project:

- References to AASHTO standards were incorporated within the HPMS Field Guide.
- Data collection on the Interstate Highway System is to be done in “at least one direction” of travel citing the study by Rada et al., \* which showed that the difference in pavement conditions between the two directions was insignificant. <sup>(4)</sup>
- Data is to be collected in nominally 0.1-mile pavement section lengths, but allows for lengths up to 0.11 mile for error corrections.

---

\* The final rule makes reference to Rada et al. This reference is correctly cited as Simpson et al.

- Data is to be collected on the full extent of the Interstate Highway System annually and biennially for the non-Interstate National Highway System.
- When the rightmost lane carries non-representative traffic, or is not readily accessible due to closure, excessive congestion, or other conditions that impact access, the final rule allows an adjacent lane to be measured.
- There are clarifications in the HPMS Field Manual for reporting percent cracking and faulting.
- No more than 5 percent of the data to be measured on the Interstate Highway System can be missing, invalid, or unresolved.
- All data collection efforts are to follow a DQMP containing specific provisions. <sup>(3)</sup>

Conclusions from additional data analyses and evaluations for the 2016 Interstate Pavement Condition Sampling project included the following: <sup>(12)</sup>

- Compare data measured in 2015 to most recently submitted 2015 HPMS data.
  - A straight comparison of the 2014 HPMS data and 2015 HPMS data yields that the datasets in general are quite similar, although a more specific State-by-State review may yield that some States vary significantly between the two datasets.
  - The performance measures observed from the 2015 HPMS data are closer to those obtained from the project data collected in 2015 than the 2014 HPMS data. This observation is also true of the condition measures observed from each of the condition metrics.
- Perform temporal analysis of HPMS datasets from 2013, 2014, and 2015.
  - Overall, the analyses suggest that the time difference between the project data collected in 2015 and the 2014 HPMS data did have some impact on the observed differences in the data.
  - The IRI data in the HPMS datasets follow a Generalized Extreme Value distribution, possibly indicating that high IRI data are important in trying to describe the dataset. This observation is confirmed by a comparison of the mean and median values of the IRI, which indicate that deviation from the mean IRI is more likely caused by one reading being higher than the others than lower.
  - Percent cracking in the HPMS data generally decreased each year, although the proportion of segments with cracking greater than 50 percent is higher in the 2014 HPMS data and the 2015 HPMS data than in the 2013 HPMS data.

- Rutting data in the HPMS datasets generally follow a log normal distribution; however, a smooth distribution function could not be fit to the data because some agencies report values rounded to the nearest 0.1 inch, while others report unrounded data.
- Faulting in the HPMS datasets was observed to decrease over time. Similar to the rutting data, the faulting data appear to be rounded to the nearest tenth of an inch for some agencies and unrounded for others.
- The cumulative distributions of IRI and percent cracking in the HPMS datasets show relatively little change over the three years, while faulting and rutting do exhibit discernible differences. The 2013 HPMS faulting data are significantly different from both the 2014 HPMS and 2015 HPMS faulting data. The rutting data from the 2013 HPMS dataset include a number of unreasonably large rut depths.
- A review of the overall condition measure for each segment in the HPMS data where the segment was identifiable in all three years of HPMS data collection identified that the number of segments within a given condition (Good, Fair, or Poor) remains relatively stable over time. In other words, the expectation is that the performance measures will show very little change from year to year.
- Evaluate whether regional conditions impact Interstate pavement conditions. These analyses were based on the 2015 HPMS dataset.
  - Generally, pavements in Good condition have a longer average segment length than those in Fair condition and segments in Poor condition have a shorter average length than those in Fair condition.
  - The category that has the most significant differences in the performance measures is the urban/rural. In general, pavements in a rural setting have better overall performance measures than those in an urban setting.
  - The largest IRI values were observed on pavements in mountainous terrain, followed by those in an urban setting. The lowest average IRI values were observed on pavement segments in the dry no freeze climate.
  - The climate categories are the best discriminator of cracking condition. The dry freeze and dry no freeze climate categories contain the largest percent cracking on average. The lowest average cracking was observed for pavement segments in the wet freeze climate zone.
  - Climate is also the best discriminator of the rutting condition. The highest average rutting was observed for pavement segments in the dry freeze climate with the lowest average rutting observed in the dry no freeze climate.
  - Terrain and climate zones are the best discriminators of faulting condition. The highest average faulting was observed on pavement segments in the level terrain category and the lowest average faulting was observed on pavement segments in the wet no freeze category.

- Generally, the percentage of Poor pavement segments decreases with increasing traffic although the relationship is not very strong.
- State level comparisons highlight the differences in data collection, reporting, and differences in the factors such as climate zone, urban/rural, and terrain.
- Review data management and quality evaluation performed for the project data, which were collected in 2015.
  - Proper quality control involves checks of equipment and development of processes prior to data collection, monitoring data collection activities, and review of data after data collection. Further data studies to review time series trends and/or comparability to other quality datasets can lead to identification of errors.
  - It is important to maintain a feedback mechanism as part of proper quality assurance techniques to allow for continuous process improvement in data collection, storage, and reporting activities.

## **VALIDATION OF PAVEMENT PERFORMANCE MEASURES USING LTPP DATA**

The overall objective of the Validation of Pavement Performance Measures Using LTPP Data study was to validate the proposed pavement performance measures and demonstrate their use within asset management. Performance and distress data from the LTPP database were translated into the pavement condition metrics used by the performance measures proposed by FHWA. The performance measure validation considered review of the performance measures over time to determine if they followed a logical trend; comparison of performance measures against maintenance and rehabilitation (M&R) activities to demonstrate if the performance measures are impacted by M&R activities; and review of the performance measures against thresholds for logic and reproducibility, temporal analysis, effects of alternate thresholds, and identification of performance measure drivers.

The following bullets summarize the major findings of the review and validation effort: <sup>(13)</sup>

- Changes in IRI, cracking, rutting, and faulting within and between construction events appear rational and logical.
- IRI, cracking, rutting, and faulting provide measures of condition to identify repair needs (i.e., IRI is most important user metric, cracking and faulting show need for M&R, and rutting shows M&R and safety needs).
- Measurement accuracy is important for rutting and faulting.
- It is desirable for faulting measurements to be more accurate than 0.05 inches, but it appears that this may not be possible at high speeds.
- Individual pavement metrics (IRI, cracking, rutting, and faulting) generally increase (worsen) over time between construction events.
- Overall pavement condition ratings tend to follow the expected trend from Good to Fair to Poor 90 percent or more of the time. Overall ratings of jointed concrete pavement tend to follow a similar trend at 83 percent, although the trend is less consistent.

- Individual pavement metrics (IRI, cracking, rutting, and faulting) are generally affected by M&R activities.
- Overall pavement condition is largely unaffected by M&R activities. Overall pavement condition is static and remains constant more than 60 percent of the time and for at least 3.8 years after installation.
- Performance measures for asphalt pavements show benefit from M&R activities as the percentage Good increases and the percentage Poor is reduced.
- Performance measures for jointed concrete pavements did not show a benefit from M&R activities as the percentage Good is reduced and the percentage Poor is increased.
- Performance measures for continuously reinforced concrete pavements generally show benefit from M&R activities as the percentage Good increases but the percentage Poor also increases. This is likely a result of there being few pavements in Poor condition as well as the fact that patching, which is considered an M&R activity, does in fact increase the percent of cracking.
- For the asphalt pavement and continuously reinforced concrete pavements, the alternate thresholds were observed to have an impact at the metric level, but less of an effect on the overall pavement condition and performance measures. A much larger effect was observed at the overall condition and subsequent performance measures on jointed concrete pavements with a 7 percent increase in Good condition. This increase is due to the change in the threshold for the faulting condition metric.
- Overall pavement condition ratings are stable over time, as shown by the temporal analysis. A minimum average time of 4 years from the first survey after construction to the first survey showing a change in condition was determined for asphalt pavements. However, this estimate is conservative, as it does not include the time from construction to the first survey. For example, the average time from construction to the first survey is 1.5 years for the LTPP sections used in this analysis. For jointed concrete pavement and continuously reinforced concrete pavement, the minimum average time to change is significantly higher.
- All metrics were shown to contribute to the overall condition rating.

## **HPMS FIELD MANUAL COMPARISON**

A comparison of the data collection changes between the 2014 and 2016 HPMS Field Manuals is provided in this section. <sup>(14, 15)</sup>

The extent of data collection was changed for several HPMS data items including functional system, urban code, facility type, ownership, speed limit, PSR, surface type, rutting, faulting, percent cracking, and county code. In all instances, the extent to which the items were to be collected per the 2016 Field Manual increased over the earlier edition. For PSR, surface type, rutting, faulting, and percent cracking the collection was increased from a sample to full extent on NHS routes. For all pavement items, the 2016 Field Manual increased the frequency of collection to annually for the Interstate System and biennially for the non-Interstate NHS.

## **DATA COLLECTION FOR PAVEMENT CONDITION METRICS**

There were several changes in the 2016 HPMS Field Manual for the data collection procedures for the specific pavement metrics used for this project:

### **IRI**

In the 2016 HPMS Field Manual, IRI data is collected and reported using the following standards: <sup>(14)</sup>

- AASHTO M 328-14, Standard Equipment Specification for Inertial Profiler
- AASHTO R 56-14, Standard Practice for Certification of Inertial Profiling Systems.
- AASHTO R 57-14, Standard Practice for Operating Inertial Profiling Systems.
- AASHTO R 43-13, Standard Practice for Quantifying Roughness of Pavement.

In the 2014 HPMS Field Manual, IRI data is collected and reported using the following standards: <sup>(13)</sup>

- AASHTO R 43-07, Standard Practice for Quantifying Roughness of Pavement.

The 2014 HPMS Field Manual also provided the following additional standards for information on the collection of IRI data: <sup>(13)</sup>

- ASTM E950 (Standard Test Method for Measuring the Longitudinal Profile of Traveled Surfaces with an Accelerometer Established Inertial Profiling Reference).
- ASTM E1926 (Standard Practice for Computing International Roughness Index of Roads from Longitudinal Profile Measurements).
- AASHTO MP 11-08 (Inertial Profiler).
- Sayers, M. W., Transportation Research Board 1501, Transportation Research Board, Washington, DC 1995.

The 2016 Field Manual specifies that PSR can be reported for sections on the National Highway System where the posted speed limit is less than 40 mph. <sup>(15)</sup>

### **Surface Type**

There is more detail in the 2016 Field Manual for surface type. Pavement groups are specified for asphalt pavement, jointed concrete pavement, and continuously reinforced concrete pavement in the 2016 Field Manual. <sup>(16)</sup> The corresponding surface type numbers are presented: asphalt pavement—2, 6, 7, and 8. continuously reinforced concrete pavement—5. Jointed concrete pavement—3, 4, 9, and 10.

### **Rutting**

The 2014 and 2016 HPMS Field Manuals use the following standards for collection and reporting of rutting values: <sup>(17,18)</sup>

- AASHTO R 48-10, Standard Practice for Determining Rut Depth in Pavements.
- AASHTO PP 70-14, Standard Practice for the Collection the Transverse Pavement Profile
- AASHTO PP 69-14, Standard Practice for Determining Pavement Deformation Parameters and Cross Slope from Collected Transverse Profiles.

The 2014 HPMS Field Manual allowed rutting data to be manually collected and reported following the LTPP protocol. The 2016 HPMS Field Manual does not.

The 2016 HPMS Field Manual specifies the following: <sup>(18)</sup>

- The maximum longitudinal spacing between transverse profiles is 12 inches.
- Transverse profiles are measured with no less than 5 profile points.

### **Faulting**

The 2014 and 2016 HPMS Field Manuals use the following standards for collection and reporting of faulting values: <sup>(19,20)</sup>

- AASHTO R 36-04 (2014) -13 (2016), Standard Practice for Evaluating Faulting of Concrete Pavements

The 2014 HPMS Field Manual allowed faulting data to be manually collected and reported using the LTPP protocols. <sup>(19)</sup> The 2016 HPMS Field Manual identifies that the average absolute value of faulting be reported—the average of the absolute value of faulting at each joint within the section. <sup>(20)</sup> Further, the manual does not recommend the use of manual fault measurements. <sup>(20)</sup> In addition, it specifies method A or method B for automated measurements based on profile data collected for the right wheel path for the calculation of faulting. <sup>(20)</sup> Both methods (method A and method B) assume the use of the inertial profiler (IP) for automated collection of faulting data.

### **Percent Cracking**

For asphalt pavements, the percent cracking is based on the total area exhibiting visible fatigue type cracking in the wheelpaths in the 2016 HPMS Field Manual versus the estimated percent area with fatigue-type cracking in the wheelpaths for the 2014 HPMS Field Manual. <sup>(20,21)</sup> For jointed concrete pavement, percent cracking is calculated based on the number of slabs exhibiting transverse cracking in the 2016 HPMS Field Manual; the 2014 HPMS Manual also included longitudinal cracking in the calculation. <sup>(20,21)</sup>

The 2016 HPMS Field Manual specifies the use of the following standards for collection and reporting of percent cracking:

- AASHTO R 55-10, Quantifying Cracks in Asphalt Pavement Surfaces;
- AASHTO PP 67-14, Quantifying Cracks in Asphalt Pavement Surfaces from Collected Images Utilizing Automated Methods; and



- AASHTO PP 68-14, Collecting Images of Pavement Surfaces for Distress Detection. <sup>(22)</sup>  
The width of the wheelpath is specified as 39 inches. <sup>(22)</sup>

The 2014 HPMS Field Manual also allowed for LTPP protocols to be followed in addition to the standards listed in the 2016 HPMS Field Manual. The 2016 HPMS Field Manual specifies that the percentage of cracking is the total area of the wheelpaths where cracks are detected divided by the total area of the 0.1-mile section. <sup>(22)</sup>

For jointed concrete pavement, the 2016 HPMS Field Manual specifies that the method (manual observations, imaging, or other) used to detect cracks in slabs identify at least 85 percent of the cracks present. <sup>(22)</sup> Only slabs with transverse cracking are included as cracked slabs. Longitudinal cracks, corner breaks, D-Cracking, and Alkali Silica Reactivity (ASR) cracking are excluded from the percent cracked slabs. The percent cracked slabs is calculated as the number of slabs containing one or more transverse cracks extending at least one-half the lane width, divided by the total number of slabs in the section.

For continuously reinforced concrete pavements, the 2016 HPMS Field Manual specifies that the method (manual observations, imaging, or other) used to detect cracks and related distresses identify at least 85 percent of all distresses present. <sup>(22)</sup> The 2016 HPMS Field Manual specifies that the cracked area for longitudinal cracking is determined as the length of the crack multiplied by a 1-foot width. For punchouts, the area is determined by the two transverse cracks and the edge of the pavement or longitudinal joint.

The changes in the reporting resolution between the 2014 and 2016 HPMS Field Manuals are presented in Table 1. <sup>(21,22)</sup>

**Table 1. Changes in reporting resolution for pavement condition.**

Item	2014	2016
Rutting	0.1 inch	0.01 inch
Faulting	0.1 inch	0.01 inch
Percent cracking	5%	1%

Source: FHWA

## CHAPTER 3 - DATA QUALITY MANAGEMENT PROGRAM

Data of known quality is crucial for understanding the impacts of measurement errors on decisions. The final rule for national performance management measure regulations (23 CFR 490.319(c)) requires each State Department of Transportation (DOT) to develop and implement a Data Quality Management Plan (DQMP) for the condition data collected to report pavement metrics for HPMS. A DQMP is key to establishing the minimum level of data quality to be obtained, having procedures in place to assure and control collected data are of acceptable quality throughout the different stages of the data collection process, and provide a systematic approach for resolving potential issues.

The project team developed a DQMP for the data collection of this project under Phase I that aligns with the national performance management measures <sup>(23)</sup>. The developed DQMP was discussed and approved by FHWA for the purposes of this project. Within this document, several terms are used to differentiate between methods to check data and equipment. Specifically, for this study, the following definitions are offered to clarify these terms:

- Calibration – review performed to compare data collected by the equipment against a known standard that is used to adjust the equipment or apply a factor to the collected data to reach an expected level of accuracy. Calibration of equipment is conducted prior to the start of the data collection effort and periodically during the data collection effort.
- Certification—review performed by the project team or an independent third party to evaluate the data collected by the Data Collection Contractor (DCC) equipment or personnel in accordance with a nationally recognized standard or test procedure to check the accuracy and precision of the collected data with respect to reference measurements. Certification of the equipment or personnel is conducted prior to the start of the data collection program.
- Validation—review performed by the project team or an independent third party to evaluate the data collected by the DCC equipment or personnel in comparison with reference measurements under representative conditions. Validation of the equipment or personnel is conducted prior to the start of the data collection program.
- Verification—review of the equipment performed by the DCC at regular intervals throughout the data collection schedule to check that the equipment is functioning as expected. Data collection and verification is conducted by the DCC and independent verification analysis is conducted by the project team.
- Quality Assurance (QA)—actions taken to assure that the data collection processes are being followed and that the resulting data will meet the specified quality standard. QA, as used in this project, refers to the testing performed on the production processes and can be part of the calibration, validation, or verification review.
- Quality Control (QC)—actions taken to measure the quality of the data to identify its compliance with the specified quality standard. QC, as used in this project, refers to the product and can be part of the calibration, validation, or verification review.

## DATA QUALITY MANAGEMENT PLAN

Serigos et al. presented a framework for a DQMP to be used with pavement condition data collection. The framework aligns with components of the DQMP based on the final rule and include: <sup>(23)</sup>

1. Data collection equipment calibration and certification;
2. Certification process for persons performing manual data collection;
3. Data quality control measures conducted both before data collection begins and periodically during the data collection program;
4. Data sampling, review, and checking processes; and
5. Error resolution procedures and data acceptance criteria.

Elements under each component were developed, such as specifying data collection guidelines and standards for automated measurement methods and establishing and documenting procedures for calibration and certification of equipment prior to data collection.

Building on the referenced components and elements and based on discussions between FHWA staff and the project team, sample elements for a DQMP were defined for purposes of the project in question and are summarized below. The key activities, processes, and procedures for ensuring data quality included:

- Deliverables, collection protocols, and quality standards – pavement condition surveys with specified deliverables, protocols, resolution, accuracy, and repeatability.
- Quality Control (QC) for project deliverables (i.e., vehicle configuration, profiler, Distance Measurement System (DMI) pulse counts, Linear Referencing System (LRS), rutting, distress (data reduction and data delivery), include:
  - Quality level for acceptance of data (i.e., standard deviation maximums, repeatability, accuracy, etc.).
  - Activity (e.g., check, certification, validation, etc.).
  - Frequency (e.g., pre-deployment, pre-collection, during data collection, daily checks, etc.).
  - Control sites used for repeatability and reference (often referred to as ground truth) data. These sites provided comparisons for all data collection vehicles and were selected to include the criteria for each pavement condition data deliverable. (e.g. repeatability based on a set number of replicate runs.)
- Independent Assurance (IA) – The IA program is intended to examine the acceptance process established by the DQMP. IA programs included the following: <sup>(26)</sup>
  - Evaluation of the testing equipment and testing personnel;
  - Sampling procedures, testing procedures and testing equipment; and
  - Schedule of frequency for IA evaluation.
- Acceptance –specifying the minimum acceptance criteria.
- Roles and Responsibilities.
- Reporting Plan.

The DQMP emphasized the importance of the data and distress collection following the criteria provided in FHWA's HPMS Field Manual (most current version) and the criteria, definitions, and specifications contained within such as for the equipment to collect the data, measurements of the data, and calculations of the metrics.

The information gathered as part of the literature review and summarized herein is built on the foundation of the previous work conducted and provided direction for development of the DQMP, data collection, and data analysis plans, which are presented in chapters 3, 4, and 5 of this report.

## **DQMP IMPLEMENTATION**

This section documents the work carried out by the project team during the implementation of DQMP activities, including information and results from the different testing locations, and changes to the original DQMP. Figure 1 shows a flowchart with the DQMP implementation activities (white boxes), along with other project activities (grey boxes), conducted by the project team before, during, and after data collection. As described in the project DQMP document, additional DQMP activities were conducted during the different phases of data collection by the DCC, such as calibration of equipment components and the Inertial Profiler's (IP) bounce and block tests.

### **Certification of Inertial Profiler Operators**

The DQMP for the project included operator certification for the Inertial Profiler operation. The process used was identical to that used by the Minnesota Department of Transportation (MnDOT) and included online operator training and an exam. Every operator of the DCC equipment involved in the collection of data using the Inertial Profiler was required to complete the training and pass the exam prior to participation in the project.

### **Certification of Inertial Profiler Equipment**

MNDOT uses the Minnesota Road Research Facility (MnROAD) facility to certify Inertial Profilers used on projects within the State. The State uses one asphalt-surfaced section and one concrete-surfaced section. MNDOT staff performed certification for this project in general accord with AASHTO R 56 "Standard Practice for Certification of Inertial Profiling Systems." The only deviation from the R 56 survey was on the check of the distance measuring instrument (DMI) that was reduced from the standard course length of 1,056 feet to 528 feet due to some facility issues.

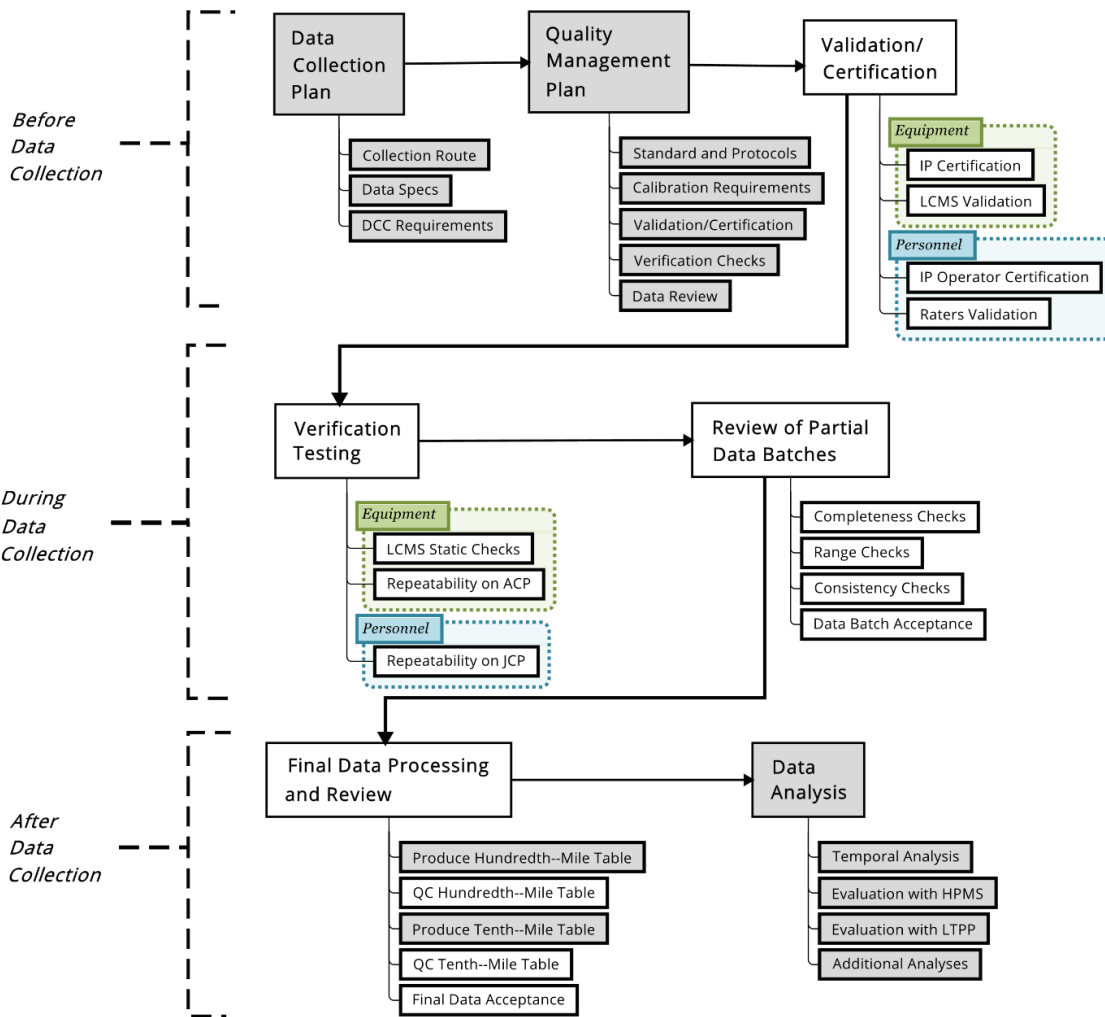

Source: FHWA

**Figure 1. Illustration. Flowchart of DQMP implementation activities along with other project activities.**

### Collection of Certification Roughness Data

A commercial rolling surface profiler reference unit was used for the collection of certification roughness data along a line painted along the surface of the pavement as pictured in Figure 2. The paint line provided a guide for the data collection with both the reference unit and the DCC Inertial Profiler. The reference unit had been calibrated the day prior to data collection and all checks of closure on the data collected were performed and passed.

Prior to data collection, the location of the Inertial Profiler height sensors in the DCC equipment was checked to ensure alignment with the location of the reference unit data collection line. A block check and a bounce test were also performed by the DCC prior to completion of the profile data collection.



Source: FHWA

**Figure 2. Picture. Rolling Surface Profiler Reference data collection for Inertial Profiler certification.**

### **Results from Assessment of DCC Roughness Data**

Data were collected by the DCC at two speeds for the certification—approximately 30 mph and 55 mph. Table 2 presents the results of the certification for the asphalt pavement section and Table 3 presents the results from the certification on the concrete pavement section. The criteria for roughness data is to be within 5 percent of the reference data at a 95 percent confidence interval and that 10 repeat runs are within 5 percent at a 95 percent confidence interval. As shown in these tables, the DCC IP equipment passed all certification checks in the DQMP on both pavement surface types and was authorized to collect project data.

### **Field Validation of LCMS Equipment**

The accuracy and precision of DCC Laser Crack Measurement System (LCMS) equipment measurements were assessed on a field experiment conducted at the MnROAD facility as part of the project DQMP validation testing. The MnROAD facility has multiple sections representing a variety of surface types. The first step in this field testing was the selection of locations for the validation of those DCC LCMS measurements of HPMS metrics collected in a fully-automated way: rutting and percent cracking on asphalt pavement, and faulting on jointed concrete pavement.

**Table 2. Statistics for Inertial Profiler certification on asphalt pavement section.**

<b>Statistic</b>	<b>Repeatability Left</b>	<b>Repeatability Right</b>	<b>Accuracy Left</b>	<b>Accuracy Right</b>
Comparison Count	45	45	10	10
% Passing	100	88.89	100	90
Mean, %	96.56	95.28	95.41	93.04
Minimum, %	92.75	88.63	93.85	88.09
Maximum, %	98.94	98.68	97.01	95.28
Standard Deviation, %	1.5	2.4	0.9	2.0
Grade	Passed	Passed	Passed	Passed

Source: FHWA

**Table 3. Statistics for Inertial Profiler certification on concrete pavement section.**

<b>Statistic</b>	<b>Repeatability Left</b>	<b>Repeatability Right</b>	<b>Accuracy Left</b>	<b>Accuracy Right</b>
Comparison Count	45	45	10	10
% Passing	97.78	97.78	100	90
Mean, %	95.15	94.30	94.24	92.24
Minimum, %	91.82	91.66	91.88	89.38
Maximum, %	98.17	96.38	96.39	94.74
Standard Deviation, %	1.5	1.1	1.2	1.5
Grade	Passed	Passed	Passed	Passed

Source: FHWA

### **Collection of Reference Rutting Data**

Reference rut depth data for the validation testing for this project were produced from transverse profile measurements collected using the MnROAD Automated Laser Profile System (ALPS). A set of 10 transverse profile locations were selected at the facility such as the one shown in Figure 3. The transverse profiles ranged in depth from approximately 0.25 inches to nearly 2 inches. These transverse profile locations were selected at the MnROAD facility to represent a range of surface conditions. The DCC completed 10 repeat measurements at each location.

The ALPS system involves an aluminum beam mounted in front of a utility vehicle. A laser is mounted on rolling plate driven by a servomotor across the beam. The servomotor moves at a speed such that elevation measurements are collected at approximate 0.25-inch intervals across the profile. The beam spans a distance of 12.8 feet and it is equipped with a leveling system to assure that the elevation measurements are obtained from the same reference plane. The ALPS is checked during each spring prior to routine data collection and its accuracy was verified by MnROAD staff prior to this validation testing.



Source: FHWA

**Figure 3. Picture. Example transverse profile used in rut depth validation.**

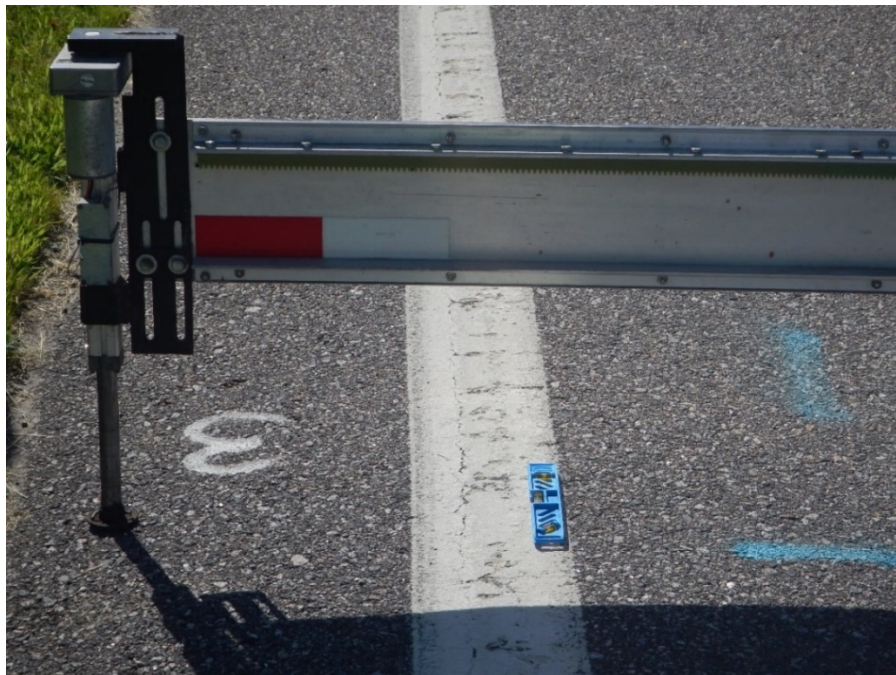

Source: FHWA

**Figure 4. Picture. Marker for edge of lane.**



At each of the 10 transverse profile locations, the beam was lowered and levelled, and data collected across the profile. The beam was then raised, lowered, and re-levelled two more times to provide a set of three repeat transverse profiles for each location. A marker was placed within the profile area as illustrated in Figure 4 to identify the edges of the lane.

The transverse profile data from the ALPS were used to calculate the reference rut depth values for each wheelpath and location in accordance with AASHTO PP69-14. This was done through a custom code written in R programming language by the project team. <sup>(27)</sup> This code produced rut depth values from the transverse profile coordinates in two main steps: first, the locations of the profile lane edges were identified and the segments of the profile located outside of lane edges were deleted from the raw profile; and, second, the procedures outlined in AASHTO PP69-14 for processing the profile and computing the rut depth values were applied to the trimmed profile coordinates. The results from the lane edge identification and the rut depth value calculation steps were visually inspected before these reference data were accepted for use in the validation data analysis.

### **Collection of Reference Faulting Data**

A series of 10 joints were selected at the MnROAD facility for validation of the faulting measurements conducted by the DCC. Average faulting for the selected joints ranged from 0.0 inches to 0.4 inches. Figure 5 illustrates two of the joints used in the validation of faulting measurement.

The DCC was planning on collecting the faulting data using the LCMS sensors. This decision was based on the findings of the 2016 Interstate Pavement Condition Sampling project. <sup>(4)</sup> The approach used for calculating faulting from the LCMS data most closely resembles the approach used for the faultmeter specified in AASHTO R36. Based on discussions with FHWA, the faultmeter was identified as the appropriate measuring device for the collection of reference data. At each joint, the outside wheelpath was identified in accordance with AASHTO Standard R36 “Evaluating Faulting of Concrete Pavements” as being centered at 35 inches from the centerline of the lane. The markings shown in Figure 5 illustrate the locations used by the method to guide the data collection at each joint.

The reference faultmeter was calibrated by MnROAD staff prior to data collection for the validation testing. The calibration involved placement of the faultmeter on a plate and then placing a metal block of known height under one of the feet.

Reference faulting data were collected at the centerline of the outside wheelpath, 4 inches to either side of the centerline of the wheelpath, and 6 inches to either side of the centerline of the wheelpath. For each of these locations the faultmeter was aligned such that its feet were located 1.6 inches prior to the joint and 1.4 inches after the joint, as illustrated in Figure 6. A set of three repeat measurements were performed at each of these locations such that a total of 15 faulting measurements were collected using the faultmeter at each joint. The reference faulting value corresponding to each location and joint used in the validation data analysis was computed as the mean of all faulting measurements taken at the three inner locations (i.e., centerline and 4 inches to either side of the centerline) for all three runs.



Source: FHWA

**Figure 5. Picture. Joints 2 and 3 used in faulting validation.**

In addition to the faultmeter, the ALPS was also used to collect reference measurements on two joints. There was some concern that the feet on the faultmeter did not rest at the same distance from the joint as specified in the R36 standard. R36 identifies that the feet of the faultmeter are to be separated by 11.8 inches. The faultmeter available to the team had a separation of 3 inches. Because of this discrepancy, an additional review of the faulting measurements was performed using data collected by the ALPS.

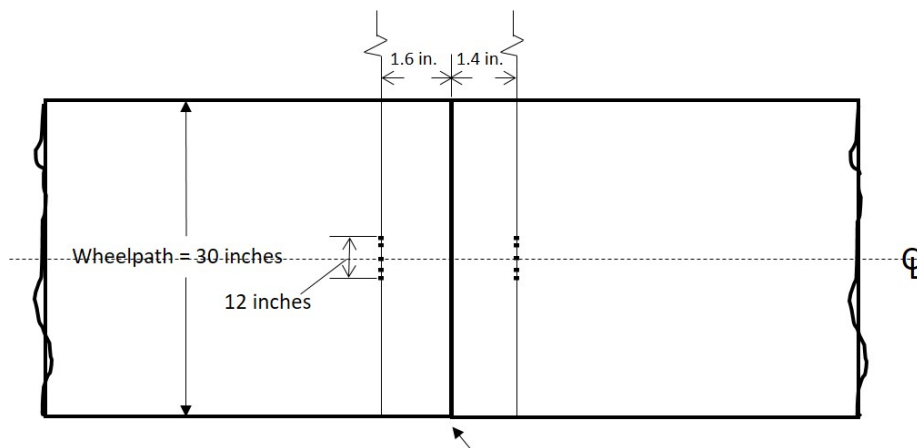

Source: FHWA

**Figure 6. Illustration. Location of validation faulting measurements.**

The ALPS was used to collect transverse profile measurements 6 inches before and 6 inches after the joint. A marker was placed 6 inches to each side of the centerline of the outside wheelpath to identify the location of the data to be used in estimating the faulting at the joint. Figure 7 illustrates the layout used in collection of the transverse profile data by the ALPS for evaluation of the DCC faulting measurements.

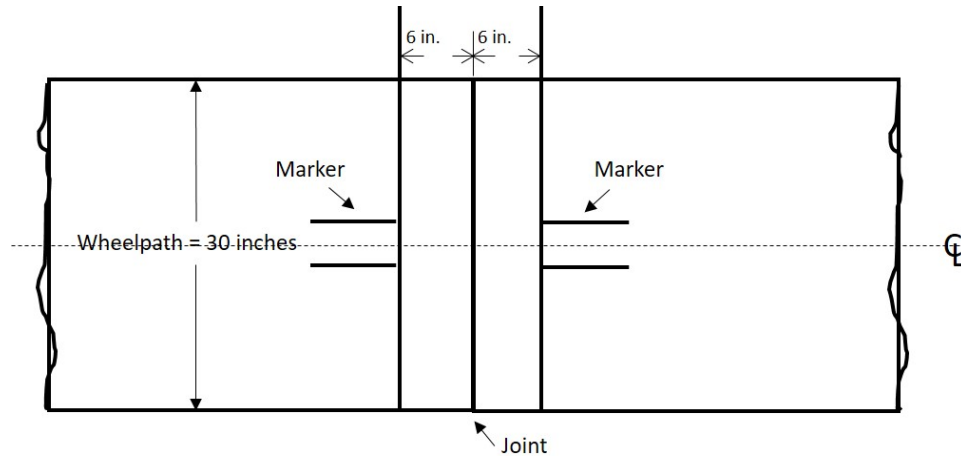

Source: FHWA

**Figure 7. Illustration. Layout of transverse ALPS measurements for faulting validation.**

In addition to the two sets of transverse profile measurements, the ALPS was used to collect a longitudinal profile across a joint at one joint location. For this measurement, the ALPS was aligned along the centerline of the wheelpath. Markers were placed 13.8 inches to either side of the joint and within the measurement of the ALPS device such that they could be used to locate the joint within the data. The layout of this measurement is provided in Figure 8.

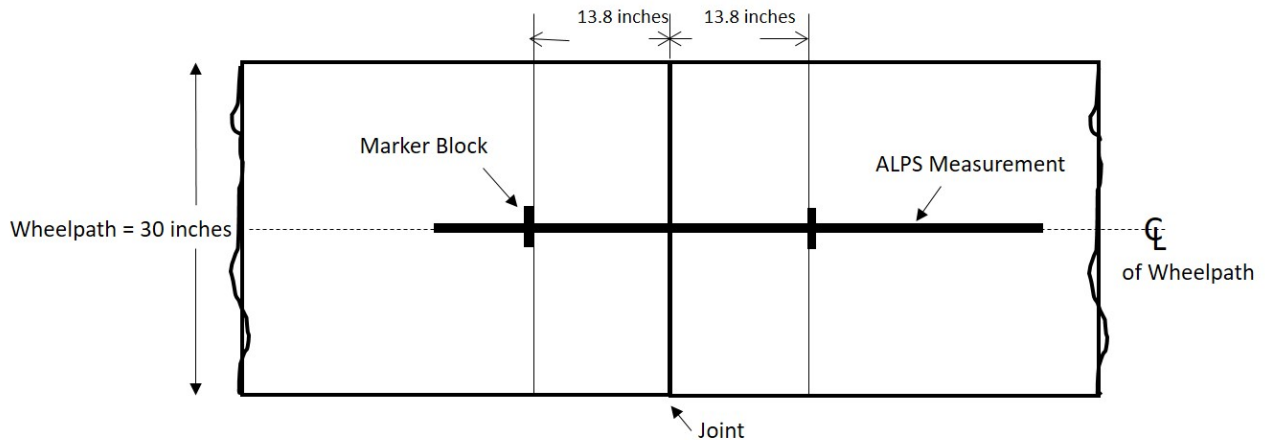

Source: FHWA

**Figure 8. Illustration. Layout of longitudinal ALPS measurement for faulting validation.**

The DCC collected data at each of the joint locations, completing a set of 10 repeat measurements. As noted above, the plan for production data collection was to use the LCMS sensor for collection of faulting data. The approach for calculating faulting from LCMS measurements was to compare the average elevation from transverse profiles located on either side of the joint. With the calculation approach the distance of the transverse profile from the joint face and the width of the transverse profile used may be customized. As part of the review of the faulting data, the DCC calculated faulting using transverse profiles ranging from 3 inches to 6 inches from the face of the joint. The portion of the transverse profile located in the outer wheelpath was used for the calculation and widths of transverse profile use ranged from 0.4 inch to 12 inches. In the end, the decision was made to use the transverse profiles located 6 inches to either side of the joint over a width of 12 inches for production calculations.

### **Collection of Reference Percent Cracking Data on Asphalt Pavements**

Two sections were selected from the MnROAD facility for use in validating the percent cracking on asphalt concrete surfaces by the DCC equipment. Complete cells of the MnROAD facility were selected for use in the evaluation. This approach allowed for simpler identification of the location and cells were identified that were reasonably close to the 0.1-mile length that was to be used in the data collection for the project.

The first site selected was cell 4 of the MnROAD facility. An overview of this section is provided in Figure 9. This section presented approximately 16 percent cracking. This section is 496 feet long and was placed in October 2008 according to MnROAD documentation. The DCC completed 10 runs along this site at approximately 55 mph.



Source: FHWA

**Figure 9. Picture. Overview of Cell 4 used in percent cracking validation.**

The second site selected was a combination of cells 77 and 78. These two cells are short and so were combined for the purposes of the percent cracking validation. Cell 77 is 286 feet long, cell 78 is 365 feet long, and there is a 30-foot gap between the two cells, resulting in a section with a total length of 681 feet. The two cells combined exhibited approximately 5 percent cracking. These sections were placed in October 2007. The DCC completed 10 runs along this site at approximately 50 mph due to the proximity of a curve along the test loop.

The DCC produced percent cracking on the asphalt sections using an automated approach. To validate this process, a consensus survey of reference data was developed by the project team from the surface images produced by the DCC. This effort used software provided by the DCC to mark surface cracking on the images that were reviewed concurrently by two team experts in distress identification. One reference percent cracking value for each of the 2 validation sections was obtained and compared against the 10 values per section produced by the DCC from the automated analysis of the same surface images.

### Results from Validation Checks of LCMS Equipment Data

Data collected by the DCC LCMS equipment at the MnROAD field validation testing were compared against the reference data obtained by the project team to check if their accuracy and precision met the acceptance criteria established in the project DQMP. This part of the section presents the results from the comparative analysis between DCC and reference data for those HPMS metrics collected in a fully-automated approach by the DCC LCMS equipment.

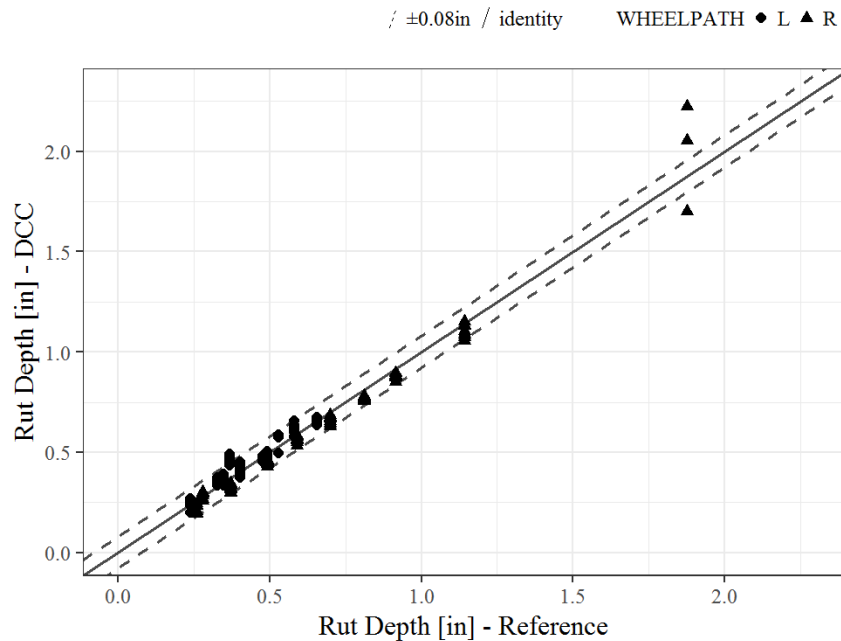

Source: FHWA

**Figure 10. Plot. Rut depth validation data.**

The scatterplot in Figure 10 shows the reference and DCC rut depth values collected at each wheelpath of the 10 selected transverse profiles. The acceptance criteria for rut depth bias was  $\pm 0.08$  inches and precision within  $\pm 0.08$  inches of the mean with a 90 percent confidence level. The estimated bias from data was  $-0.008$  inches, with a 90 percent confidence interval between  $-0.014$  and  $-0.002$  inches. In addition, 90 percent of the observed differences between the measured values and their mean value were within  $-0.027$  and  $0.032$  inches. The DCC LCMS equipment passed the DQMP validation checks for accuracy and precision of rutting data.

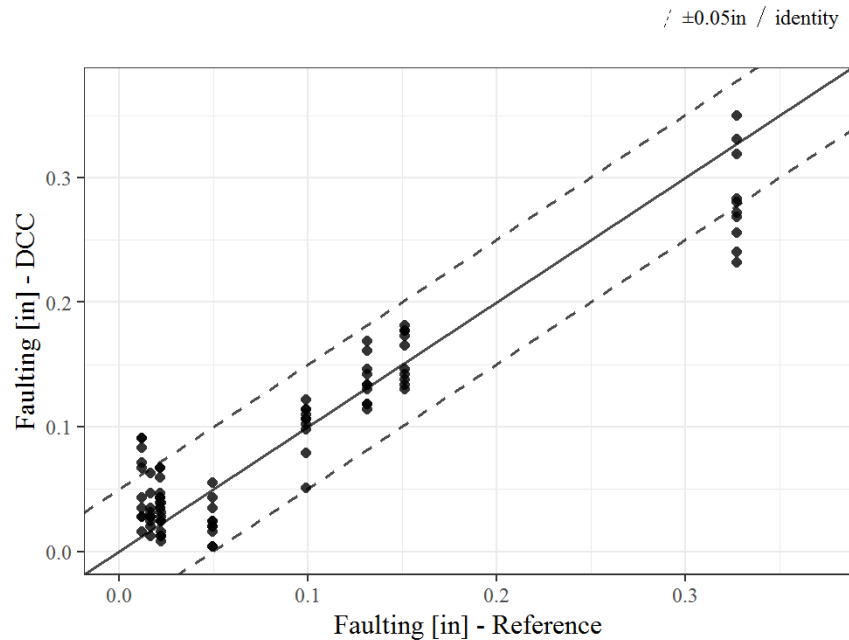

Source: FHWA

**Figure 11. Plot. Faulting validation data.**

The scatterplot in Figure 11 shows the reference and DCC faulting values collected at the 10 selected joint locations. The acceptance criterion for faulting bias was  $\pm 0.05$  inches. The criterion related to precision stated that the standard deviation of DCC repeated values for a joint are less than 15 percent of the mean value if the mean faulting value is greater than 0.1 inches or less than 0.03 inches if the mean faulting value is lower than 0.1 inches. This acceptance criteria for faulting data precision was different than the one in the DQMP—which was based solely on the coefficient of variation (COV). It was implemented to properly account for cases in which low mean faulting values would result in an impractical criterion for standard deviation.

The estimated bias from data was 0.003 inches, with a 90 percent confidence interval between  $-0.012$  and  $0.018$  inches. In addition, all standard deviations were smaller than 10 percent of the mean value for joints with mean faulting values greater than 0.1 inches and all joints had a standard deviation smaller than 0.03 inches for joints with mean faulting values greater than 0.1 inches. The DCC met the DQMP validation checks for accuracy and precision of faulting data.

Figure 12 shows a scatterplot with the reference and DCC percent cracking values collected at the two asphalt pavement sections selected from the MnROAD facility. The acceptance criterion for percent cracking on asphalt pavement was  $\pm 30$  percent or  $\pm 3$  percent cracking, whichever

was higher; the acceptable bias for the two validation sections were 4.86 percent and 3.00 percent, respectively. As shown in Figure 12, all DCC values were within the acceptable bias range (with mean biases of -3.19 percent and -0.40 percent for the two respective validation sections) and the DCC percent cracking values on asphalt pavement surfaces met the DQMP validation check for accuracy.

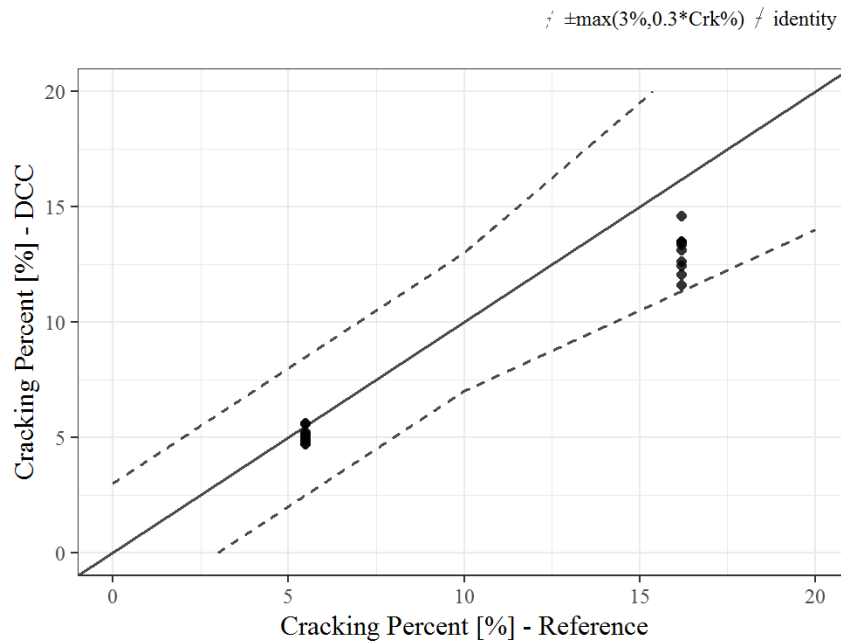

Source: FHWA

**Figure 12. Plot. Percent cracking validation data on asphalt pavement sections.**

The criteria related to the precision of percent cracking on asphalt pavement is that repeated values fall within  $\pm 30$  percent of section mean with a 90 percent confidence level if the section mean is greater than 5 percent, or that the standard deviation of each section be less than 1.5 in all other cases. The DCC repeated values were within 10 percent of the section mean for the section with mean of 12.7 percent, and the standard deviation of repeated values for the section with mean of 4.9 percent was 0.36. The DCC’s percent cracking data on asphalt pavement sections met the DQMP criteria for precision. As noted above, the implemented acceptance criteria for precision of percent cracking on asphalt pavement data was different than the one defined in the DQMP to properly account for cases in which low mean values would result in an impractical criterion for standard deviation.

### Validation of Manual Distress Raters

Percent cracking data on jointed concrete pavement and continuously reinforced concrete pavement pavements were collected by the DCC following a semi-automated approach in which the cracking values are produced by manual raters through visual inspection of pavement surface images collected at highway speeds by the LCMS cameras. All three DCC manual raters involved in the production of project data were validated against reference values developed by

the project team through consensus survey by two experts in distress identification using the same pavement surface images. The three metrics validated from the data produced by the DCC manual raters were percent cracking on jointed concrete pavement sections, number of slabs identified on jointed concrete pavement sections, and percent cracking on continuously reinforced concrete pavement sections.

### **Collection of Reference Percent Cracking Data on Concrete Pavements**

Two sections were selected for validation of percent cracking on jointed concrete pavement. The two sites selected were cell 32 and cell 613 of the MnROAD facility. Cell 32 is 402 feet long; an overview of this section is provided in Figure 13. Approximately 6 percent cracking was observed within this cell as part of the consensus survey. Cell 613 is 528 feet long, with approximately 3 percent cracking observed along it.



Source: FHWA

**Figure 13. Picture. Overview of cell 32 used for percent cracking jointed concrete pavement validation.**

The MnROAD facility does not include any continuously reinforced concrete pavement. For this reason, a set of four 528-foot long continuously reinforced concrete pavement sections were selected from images collected for the Interstate Pavement Condition Sampling project completed in 2015 for FHWA. These images were collected by the same DCC using the same sensor technology. Among the four selected sections, two sections were identified from data collected in Texas, one from South Carolina, and one from South Dakota.

As with the other sections for percent cracking data validation, a consensus survey was conducted by members of the project team for use as reference measurements. The software used to mark the surface cracking detected on the images was provided by the DCC. The two sites in Texas had approximately 12 percent and 1 percent cracking, respectively. The South Carolina site had approximately 10 percent cracking and the South Dakota site had 2 percent cracking.



## Results from Analysis of Manual Raters Validation Data

The acceptance criterion for percent cracking on both jointed concrete pavement and continuously reinforced concrete pavement surfaces was  $\pm 15$  percent or  $\pm 3$ , whichever was higher. In addition, the project DQMP specified that the number of joints identified by the manual raters on jointed concrete pavement sections are within  $\pm 2$  joints for any of the 500-foot long jointed concrete pavement sections. The criterion related to the precision of percent cracking on both jointed concrete pavement and continuously reinforced concrete pavement surfaces stated that the DCC values fall within  $\pm 15$  percent of section mean with a 90 percent confidence level if the section mean was greater than 5 percent, or that the standard deviation of each section be less than 1.5 otherwise. It should be noted that the implemented acceptance criteria for precision was different than the one defined in the DQMP to properly account for cases in which low mean values would result in an impractical criterion for standard deviation.

The initial set of data reported by the DCC showed differences with the reference values of 3 to 4 in the number of joints. The project team analyzed the surface images marked by the DCC raters and found that these differences were explained by discrepancies in start and end locations of the sections. After making the necessary corrections and reprocessing the percent cracking data on jointed concrete pavement sections, the number of joints reported by the DCC were within the acceptable range and met the DQMP criteria.

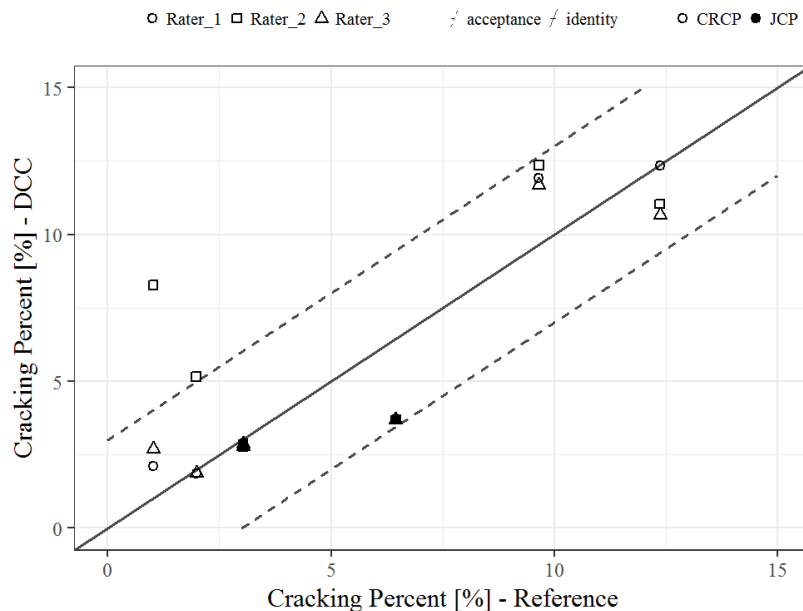

Source: FHWA

**Figure 14. Plot. Percent cracking validation data on jointed concrete pavements and continuously reinforced concrete pavements.**

Figure 14 shows the reference and DCC percent cracking values collected at the jointed concrete pavement and continuously reinforced concrete pavement sections. The DCC reported 10 repeated manual assessments of the percent cracking on the two jointed concrete pavement

sections. The differences between DCC and reference percent cracking values observed for all raters and runs for the jointed concrete pavement validation sections were within the acceptable range, with mean bias values of -2.75 and -0.22 for each section. The standard deviation values observed for each section were smaller than 0.04. The DCC percent cracking values on jointed concrete pavement surfaces met the DQMP validation check for accuracy and precision.

As shown in Figure 14, one of the three DCC manual raters (Rater\_2) produced percent cracking values outside the acceptable range for bias on two of the four continuously reinforced concrete pavement sections. In addition, Rater\_1 and Rater\_3 produced consistent values (all their values were within  $\pm 12$  percent of the section mean) while Rater\_2 values differed by more than 15 percent of the section mean on two of the sections. The values presented in Figure 14 consist of the fourth—and final—set of values reported by the DCC. The three previously submitted sets of percent cracking on continuously reinforced concrete pavement data did not meet the acceptance criteria, and after each data rejection the project team conducted a training session to the DCC raters via web-conference meeting for explaining distress identification and quantification criteria to assess percent cracking on continuously reinforced concrete pavement sections. Only two of the three DCC manual raters met the DQMP criteria for accuracy and precision and were validated for project data collection on jointed concrete pavement and continuously reinforced concrete pavement surfaces.

### **Weekly Verification of Measurement Repeatability**

Repeatability testing was done on a weekly basis by the DCC to verify that the precision level was still within the acceptable range before starting data collection. In each of these tests, the DCC tested using just one site, with one exception. In the sixth week of testing, the DCC tested one jointed concrete pavement-surfaced section and one asphalt pavement-surfaced section for review of data on both surface types. The verification sites were selected by the DCC at locations near the project route among predefined sites where the DCC had previously conducted calibration and quality checks.

Five runs were typically reported by the DCC on each section, although more runs were performed on some sections. The verification sites had variable lengths, ranging from 0.100 miles to 0.265 miles. The hundredth-mile verification data reported for each site were aggregated into tenth-mile subsegments for analysis to test the DCC data on the same section length of the project route, and the measurements reported on the remainder of the validation site were not analyzed.

The DCC reported the repeated runs of all condition metrics for the corresponding surface type—i.e., IRI and percent cracking on any surface type, rut depth on asphalt pavement, and faulting on jointed concrete pavement. Each verification dataset was analyzed by the project team through an automated tool written in R programming language to check if all condition metrics were within the acceptance criteria for data precision. The verification acceptance criteria for percent cracking, rut depth, and faulting were the same implemented for the validation testing. The implemented verification acceptance criteria for IRI called for a COV of repeated IRI values less than or equal to 4.0 percent.

Table 4 shows information about the verification testing conducted during the 13 weeks of data collection from August 1<sup>st</sup> to November 18<sup>th</sup>. As shown in the table, there were two periods of time within these dates on which data collection was suspended due to the DCC survey vehicle being out of service.

Table 4 also shows that the first four weeks passed the check on all metrics but that the verification failed to pass the review in the fifth week for the IRI data. All of the other condition metrics met the prescribed conditions. The project team requested that the DCC review the data for the fifth week and provide additional information about the site and test. As a result of their review, the DCC found that all IRI verification and production data reported up to the fifth data collection week had been produced from LCMS measurements, as opposed to the IP. Therefore, the project team rejected all IRI measurements submitted up to that week and requested the DCC to submit IRI data as collected by the IP.

The project team discussed the implications of the collection with the LCMS as opposed to the IP with the FHWA prior to rejecting the collected data. Both the project team and FHWA acknowledged that the LCMS data collection does not meet the standard set in place by the FHWA for the performance measures. In addition to the system not meeting the AASHTO standard for longitudinal profile data collection, FHWA identified that no LCMS system has passed the bias and precision checks on the equipment. The team in concert with FHWA determined that the data collected by the LCMS were not acceptable for the purposes of this project.

As shown in Table 4, the DCC submitted verification IRI data from LCMS measurements again for the seventh data collection week; however, this error was detected and corrected by the DCC within a few days of submitting the verification dataset and it did not affect the production data.

The reporting dates and check results from the verification datasets with the LCMS IRI values are shown in the last two columns of Table 4 whereas those from the verification datasets with the IP IRI values are reported in the eighth and ninth columns. All reprocessed verification datasets (with the IP IRI values) for collection weeks one to six were reported jointly by the DCC. Two of these reprocessed verification datasets (those for weeks two and four) did not pass the repeatability checks for IRI data: COVs for failing weeks ranged between 4.6 percent and 5.5 percent. The project team requested that the DCC review their data and provide additional information for the failing sites, including the IP longitudinal profiles for all runs, DMI verification results, and daily bounce and block checks results.

The additional data were reviewed in detail. The detailed review included looking at the longitudinal profile graphically to identify whether any significant bumps or dips might exist within the data that would overly influence the repeatability. No such bumps or dips were observed. However, it was noted that the sites involved “routine” levels of roughness such that deviations by the driver from the path could impact the repeatability of the data. The data showed low cross-correlation between some of the longitudinal profiles. Additionally, the daily bounce and block checks were reviewed and showed that these checks met all of the requisite levels. Further, the DMI was successfully verified during each of these checks.

Based on the non-passing IRI COV values and the low cross-correlations for the IP longitudinal profiles from the failing verification testing, the project team decided to flag the production IRI values collected during the affected weeks. Subsequently, the project team met with FHWA staff to discuss resolution of the IRI data flag due to non-passing verification checks. The decision was made to accept the flagged production IRI, and to address the impacts of higher IRI variability on the results of the analysis after reviewing the analysis results. The DCC verification data for all the remaining data collection weeks passed the acceptance criteria.

**Table 4. Information about weekly validation testing conducted during data collection.**

Data Collection Week	From	To	Site Name	Surface Type	Number of Runs	Section Length (miles)	Reported (IP's IRI)	PASS (IP's IRI)	Reported (LCMS's IRI)	PASS (LCMS's IRI)
1	08/01/18	08/08/18	VA1	asphalt pavement	5	0.220	10/01/18	YES	8/7/2018	YES
2	08/08/18	08/15/18	MS1	asphalt pavement	5	0.120	10/01/18	NO	8/10/2018	YES
3	08/15/18	08/22/18	VT3	asphalt pavement	5	0.140	10/01/18	YES	8/16/2018	YES
4	08/22/18	08/29/18	CO244	asphalt pavement	5	0.200	10/01/18	NO	8/31/2018	YES
<i>no data collection</i>	08/29/18	09/17/18	-	-	-	-	-	-	-	-
5	09/17/18	09/24/18	MI2	asphalt pavement	5	0.180	10/01/18	YES	9/21/2018	NO
6	09/24/18	10/01/18	C0078	asphalt pavement	10	0.100	10/01/18	YES		
	09/24/18	10/01/18	MN	jointed concrete pavement	5	0.140	10/01/18	YES		
7	10/01/18	10/08/18	MT1	asphalt pavement	6	0.132	10/22/18	YES	10/10/2018	YES
8	10/08/18	10/15/18	C0229	jointed concrete pavement	7	0.130	10/22/18	YES		
9	10/15/18	10/18/18	C0041	asphalt pavement	5	0.265	10/22/18	YES		
<i>no data collection</i>	10/18/18	10/31/18	-	-	-	-	-	-	-	-
10	10/31/18	11/07/18	C0162	asphalt pavement	6	0.227	11/02/18	YES		
11	11/07/18	11/14/18	OK01	asphalt pavement	5	0.237	11/15/18	YES		
12	11/14/18	11/21/18	C0100	asphalt pavement	5	0.220	11/27/18	YES		
13	11/21/18	11/28/18	C0113	asphalt pavement	5	0.241	11/30/18	YES		

Source: FHWA

## Independent Verification of LCMS Static Checks

The second type of verification testing conducted by the project team consisted of attending and documenting the LCMS static checks performed by the DCC to independently verify that the testing procedure was conducted as described in the documentation submitted by the DCC prior to the start of data collection. This independent verification occurred two times during data collection. The first verification testing took place at the beginning of data collection on August 2, 2018 in Beltsville, Maryland, and the second one took place on November 5, 2018 in Austin, Texas, when 78 percent of the project route mileage had been collected.

The LCMS static checks refer to quality checks routinely conducted by the DCC to verify that the LCMS equipment readings are within the acceptable range and make the necessary adjustments if the equipment fails to pass these checks. The quality checks conducted during this verification testing include height, range, and focus checks using the calibration board shown in Figure 15 and Figure 16—Figure 15 shows a close-up picture of the calibration board while Figure 16 shows the calibration board in use during the LCMS static check in Maryland.

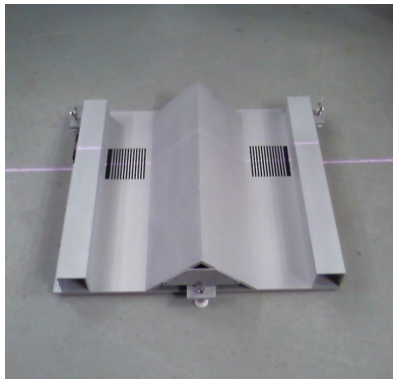

Source: FHWA

**Figure 15. Picture. Close-up picture of calibration board.**



Source: FHWA

**Figure 16. Picture. Calibration board in use during the LCMS static check in Maryland.**

The DCC operator and driver of the survey vehicle conducted these checks guided by a software program that displayed and recorded the results from the quality checks. As an example, Figure 17 shows a screenshot of this software with results from the range and focus checks passing results taken during the testing conducted in Texas.

The first independent verification of LCMS static checks was conducted in the presence of project team staff as well as FHWA staff. The DCC decided to conduct this test indoors (in an office garage)—as opposed to outdoors in a parking lot—as it represented more favorable testing conditions in terms of both climate and pavement surface condition. The office garage surface was considered level by the DCC operators for the purposes of the testing. The LCMS static testing took several iterations for both left and right sensors until both passed the acceptance criteria.

The second independent verification of LCMS static checks was conducted in the presence of project team staff on a parking lot surface (outdoors) considered level by the DCC operators. Conditions during testing were mostly cloudy (but no rain) and windy. As observed during the verification testing in Maryland, it took a number of iterations until both sensors passed the acceptance criteria.

In summary, the procedures observed during the two observed LCMS static testing were carried out in accordance with the established protocols by the DCC and the height, range, and focus results passed the established acceptance criteria and was considered to have successfully passed the LCMS static testing verifications.



© Mandli Communications, Inc.

**Figure 17. Image. Screenshot of DCC software with results from LCMS static checks conducted in Texas.**

## Review of Project Data

This section describes the review of the partial data batches submitted by the DCC throughout data collection, as well as the review of the final project datasets produced by the project team from merging and processing the partial data batches. The review of data involved the implementation of quality checks described in the DQMP. The review of DCC partial data batches was comprised of the completeness, validity, and consistency checks while the review of the final project dataset was comprised of those checks as well as the temporal analysis checks.

### Review of Partial Data Batches Submitted by the DCC

The DCC submitted the production data collected on the project route in 6 partial batches and an additional batch with the data collected on a set of 21 LTPP sections identified by the project team. Each data batch was comprised of two main components:

1. A set of individual data tables with metadata information and hundredth-mile condition measurements in conformance with Table 75 to Table 82 of the “Project Database Data Dictionary” (Appendix A), and
2. A set of images, including front camera images, and LCMS pavement surface images with and without marked distresses.

The first component was delivered via e-mail attachments, while the second component was delivered in hard drives via mail. Each of these partial data batches were subject to the completeness, validity, and consistency checks described in the DQMP through a custom automated tool written in R programming language. Flags identified during the data review were communicated to the DCC along with a decision to either provide additional information about a flag, reprocess and resubmit flagged data, or recollect data for the flagged mileage. The most predominant flags (in terms of affected mileage) detected from the review of the six data batches along with their typical error resolution were the following:

- Percent\_Cracking, Wheelpath\_Length, and Affected\_Wheelpath\_Area fields from the Hundredth-Mile Crack tables not meeting the definitions for the project: The project team provided advised on how to properly process and compute these data and directed the DCC to resubmit the Hundredth-Mile Crack data.
- IRI values lower than 40 in/mile or greater than 250 in/mile on either the left wheelpath or the right wheelpath: This flag was found in all production data batches, affecting between 28 percent and 47 percent of the batch mileage. The majority of the flagged IRI values were between 30 in/mile and 40 in/mile. For each data batch, the DCC reviewed images at locations with the flagged IRI data and communicated via e-mail message that “the images confirm the results found in the data.” Flagged mileage was “virtually driven for verification and this review showed a significant amount of newer pavement justifying the low IRI values.” Following the review, the submitted Hundredth-Mile IRI tables were accepted.
- Difference in IRI between wheelpaths of over 50 in/mile: This flag was found in all production data batches, affecting between 5.0 percent and 8.0 percent of the batch

mileage. As done for the IRI range flags, the DCC reviewed images at locations with the flagged data for each data batch and communicated via e-mail message that “the images confirm the results found in the data.”

- Difference in rut depth between wheelpaths of over 0.25 inches: This flag was found in four of the six production data batches, affecting between 1.3 percent and 2.0 percent of the batch mileage. The DCC reviewed images at locations with the flagged data for each data batch and communicated via e-mail message that “the images confirm the results found in the data.” Ideally, the DCC would have performed some recollection of some small percentage of data to confirm these results and future efforts should consider including this recollection at the time of contracting.
- Survey vehicle speeds in excess of 65 mph: This flag was found in batches 3 to 6 and the flagged values were typically within reasonable levels (below 72 mph). The project team alerted the DCC to safety aspects of collecting data at posted speed limits.
- Other data flags identified during review of partial data batches that resulted in resubmission of one or more data tables included global positioning system (GPS) coordinates with significant errors and a significant proportion of missing values for the Collection\_Time field in the Metadata table (Table 75 in Appendix A).

Table 5 shows summary reporting and acceptance information of the different partial data batches. This table includes the number of submissions until final approval for each data batch as a consequence of having one or more flags requiring reprocessing of data. As shown in the table, the reported 7,543.9 miles of production data were accepted by December 28, 2018 and the data collected on the 21 LTPP sections were accepted on January 11, 2019. The reason of the overlap in time between batches one and two is that the DCC manual raters were not validated to collect production data until October 1, 2018, which caused a delay in the production of data for the concrete pavements (submitted in batch two) on the routes covered in batch one.

**Table 5. Summary reporting and acceptance information of DCC partial data batches.**

Batch Number	Mileage Reported	Percent of Project Route Mileage	Date of Original Submission	Submissions Until Acceptance	Date of Final Acceptance
1	520.8	7%	9/4/2018	4	12/28/2018
2	279.6	4%	10/5/2018	2	12/28/2018
3	1715.8	23%	10/31/2018	3	11/9/2018
4	1278.1	17%	11/14/2018	2	11/20/2018
5	1324.3	18%	11/30/2018	4	12/28/2018
6	2425.4	32%	12/21/2018	1	12/28/2018
LTPP	19.9	-	12/21/2018	2	01/11/2019

Source: FHWA



## Review of Final Project Dataset

Once all partial data batches were accepted by the project team, the next step consisted of processing these data to obtain:

1. Final Hundredth-Mile dataset containing all the accepted individual data tables submitted by the DCC, and
2. Tenth-Mile dataset, in conformance with Table 82 of the “Project Database Data Dictionary” (Appendix A).

The first dataset was developed by the project team from processing and merging the accepted individual data batches. The resulting dataset was subject to the same completeness, validity, and consistency conducted on the individual data batches as well as to additional custom checks (such as comparison of summary statistics against the individual batches) to make sure that the processing and merging were correctly applied. These checks showed that the data in the Hundredth-Mile dataset were consistent with the individual data batches and the final Hundredth-Mile dataset was approved.

The Tenth-Mile dataset was developed by the project team from aggregating and processing the approved version of the final Hundredth-Mile dataset. The aggregation of data from hundredth-mile sections into tenth-mile sections was performed as described in the HPMS Field Manual. For example, the HPMS Field Manual states that each condition metric is aggregated “based on an averaging of values within the limits of the section, weighted by the length of the sub-section for each value.” In addition, some fields were included in the Tenth-Mile dataset due to its potential use in the data analysis part of the project. An example of these fields is the “Percent\_Cracking\_JCPbyNrSlabs” field computed as the weighted average of subsections, weighted by number of slabs of the sub-sections.

The resulting Tenth-Mile dataset was subject to a number of custom quality checks (such as comparison of summary statistics against the Hundredth-Mile dataset) and completeness, validity, and consistency checks, as well as the temporal analysis checks described in the DQMP. These checks showed that the data in the Tenth-Mile dataset were consistent with the Hundredth-Mile dataset. The temporal analysis compared overall statistics and well as statistics by State and route for both performance measures and individual condition metrics between the Tenth-Mile dataset of this project and the one produced for the Interstate Pavement Condition Sampling project completed in 2015 for FHWA. The differences observed from the temporal analysis were considered within the expectation by the project team and the final Tenth-Mile dataset was approved.

## CHAPTER 4 - DATA COLLECTION

As stated in the introductory chapter to this report, the first key objective of the project in question was to collect an unbiased dataset for a statistically significant sample of the Interstate Highway System (IHS). The resulting data would enable preparation of reports indicating pavement condition on the IHS nationally and in each State where data were collected, determination of whether HPMS is an unbiased dataset and, as appropriate, development of recommendations for HPMS improvements.

This chapter presents the planning and execution of the data collection effort. The following factors were considered in selecting the project route, in priority order:

- Route to be a large sample of IHS to allow for conclusive statistical analyses and precise estimates.
- Route to be a consistent representative sample of the HPMS dataset based on a series of stratification factors.
- I-90 through Wisconsin, Minnesota, and South Dakota was to be included (this same corridor was included in the 2013 Infrastructure Health Study and the 2015 Interstate Condition Sampling).
- Sections of Interstate Highways should be included in States that were not part of the 2015 Interstate Condition Sampling data collection route.
- I-10 as sampled in the 2015 Interstate Condition Sampling data collection route should be included.
- Additional routes from the 2015 Interstate Condition Sampling data collection route.
- Series of LTPP sections used for repeat data collection should be included.

### 2016 HPMS DATA REVIEW

Several factors were considered in establishing the data collection route. These factors include the following:

- Climate zones;
- Urban versus rural;
- Mountainous terrain versus plains versus rolling terrain; and
- Pavement/surface types.

A review of the 2016 HPMS data was conducted to estimate the portion of the network falling in each category of these factors.

The contiguous US is divided into four climate zones as indicated in Figure 18. These climate zones are set within the HPMS data based on a standard definition associated with the location. Table 6 provides the mileage of the IHS contained within each of the four climate zones. The table illustrates that the wet freeze climatic zone contains the largest portion of the network mileage and the smallest is in the dry freeze zone. The IRI and percent cracking data are

available for significant portions of the network. The completeness of the faulting and rutting data is difficult to estimate from this table without consideration of the surface type.

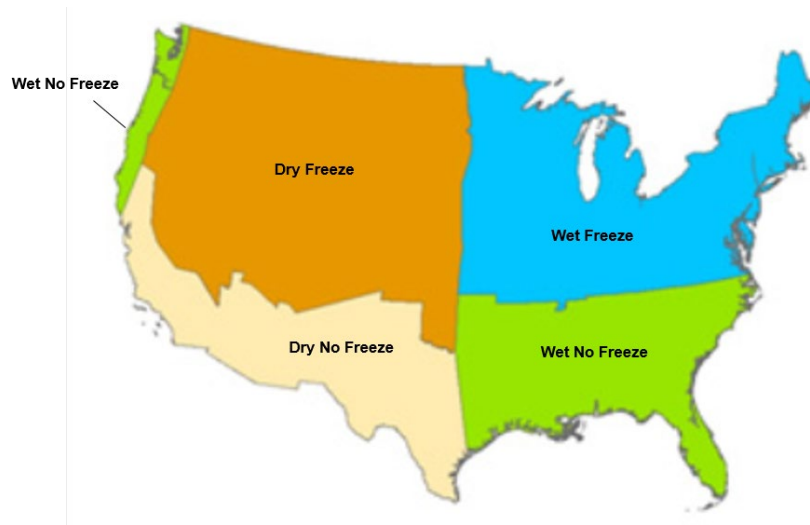

Source: FHWA

**Figure 18. Illustration. Climate zones used in the HPMS database.**

**Table 6. Mileage of Interstate Highway System by climate zone.**

Climate Zone	Mileage	IRI (mi.)	Rutting (mi.)	Faulting (mi.)	Cracking (mi.)
Wet Freeze	19,223	18,596	15,225	9,733	15,588
Wet No Freeze	12,009	11,851	8,320	1,986	9,880
Dry Freeze	9,026	8,971	6,273	3,734	7,508
Dry No Freeze	5,748	5,739	5,079	739	4,062

Source: FHWA

Table 7 presents the mileage by population zone. A section is considered urban if it falls within an area with a population of at least 5,000. The HPMS database identifies which specific urban area the section occupies. These sections are identified as “Urban” in Table 7. If the section does not fall within one of the named areas but is in an area with a population of at least 5,000, it is coded as a “Small Urban” section. The table identifies that most of the network falls into a rural population zone.

**Table 7. Mileage of Interstate Highway System by population zone.**

Population Zone	Mileage	IRI (mi.)	Rutting (mi.)	Faulting (mi.)	Cracking (mi.)
Rural	27,800	27,493	21,607	9,771	22,408
Small Urban	2,740	2,684	2,138	989	2,408
Urban	15,465	14,979	11,171	5,431	12,223

Source: FHWA

The surface type was reviewed and is provided in Table 8. As noted in the table, there are approximately 7,578 miles for which surface type has not been identified. A bituminous surface is the most common surface type across the network. Table 8 also illustrates that rut depth has been provided for some concrete-surfaced segments and faulting has been provided for some asphalt-surfaced sections.

**Table 8. Mileage of Interstate Highway System by pavement surface type.**

Surface Type	Mileage	IRI (mi.)	Rutting (mi.)	Faulting (mi.)	Cracking (mi.)
Asphalt	10,590	10,492	10,282	2,693	9,756
Jointed plain concrete	5,730	5,540	2,617	4,848	5,250
Jointed reinforced concrete	1,359	1,317	528	1,185	1,197
Continuously reinforced concrete pavement	1,808	1,804	944	78	1,154
Asphalt pavement over Asphalt pavement	8,449	8,360	8,335	1,451	7,202
Asphalt pavement over Jointed concrete pavement	8,359	8,223	8,165	4,014	7,176
Asphalt pavement over Continuously reinforced concrete pavement	1,544	1,532	1,460	35	1,529
Unbonded concrete pavement overlay	400	356	14	350	139
Bonded concrete pavement overlay	62	57	20	59	59
Other	127	123	53	83	85
Unidentified	7,578	7,352	2,499	1,394	3,492

Source: FHWA

The final factor considered was the terrain. The mileage by terrain is presented in Table 9. Note that terrain is only reported on the sample panel sections, which accounts for the large mileage of unidentified terrain type. Of the samples identified, level terrain is the most prevalent.

**Table 9. Mileage of Interstate Highway System by terrain.**

Terrain	Mileage	IRI (mi.)	Rutting (mi.)	Faulting (mi.)	Cracking (mi.)
Level	9,517	9,394	7,501	3,280	8,921
Rolling	6,696	6,661	5,815	2,864	6,279
Mountainous	1,654	1,641	1,227	548	1,596
Unidentified	28,138	27,461	20,373	9,499	20,242

Source: FHWA

### Data Completeness

Table 10 presents the quantity of 2016 HPMS data available for each condition metric. The “Total Potential Mileage” column presents the mileage of Interstate Highway System within the HPMS with a surface type specific to that particular distress type. In the instances where no surface was identified, the condition data were reviewed to identify how to classify the section. If

the section contained rutting condition data but not faulting, then the section was assumed to consist of an asphalt surface. If the section contained faulting data, but not rutting, then the section was assumed to consist of a jointed concrete surface. If the section contains both rutting and faulting, the section was excluded from the assessment of data completeness.

**Table 10. Data completeness.**

<b>Distress</b>	<b>Total Potential Mileage</b>	<b>Mileage with Distress</b>	<b>Percent</b>
IRI	46,005	45,156	98%
Rutting	35,125	29,782	85%
Faulting	12,629	6,879	54%
Cracking	46,005	37,038	81%

Source: FHWA

In addition to reviewing the mileage by condition metric, the distribution of each condition metric was reviewed by surface type. In this case, the specific surface type was used to group the data rather than making assumptions about the surface. These distributions are presented separately for each condition metric. Table 11, Table 12, Table 13, and Table 14 provide the distribution of the IRI, rut depth, faulting, and percent cracking respectively for each surface type.

**Table 11. 2016 HPMS dataset distribution of IRI by pavement surface type.**

<b>Surface Type</b>	<b>Mean, in/mile</b>	<b>Minimum, in/mile</b>	<b>Maximum, in/mile</b>	<b>Standard Deviation, in/mile</b>
Asphalt	69	18	700	35.5
Jointed plain concrete	102	18	637	47.3
Jointed reinforced concrete	105	23	702	49.8
Continuously reinforced concrete	102	24	471	41.4
Asphalt pavement over asphalt pavement	66	19	1,011	35.4
Asphalt pavement over jointed concrete pavement	77	15	1,100	43.4
Asphalt pavement over Continuously reinforced concrete pavement	65	30	331	27.6
Unbonded concrete pavement overlay	78	28	297	29.4
Bonded concrete pavement overlay	107	23	333	45.6
Other	99	28	366	48.8
Unidentified	74	19	872	41.8

Source: FHWA

**Table 12. 2016 HPMS dataset distribution of rut depth by surface type.**

Surface Type	Mean, inch	Minimum, inch	Maximum, inch	Standard Deviation, inch
Asphalt	0.14	0	2.25	0.08
Jointed plain concrete	0.07	0	0.67	0.06
Jointed reinforced concrete	0.08	0	0.51	0.06
Continuously reinforced concrete	0.02	0	0.57	0.06
Asphalt pavement over asphalt pavement	0.14	0	0.99	0.10
Asphalt pavement over jointed concrete pavement	0.23	0	99.9	3.26
Asphalt pavement over continuously reinforced concrete pavement	0.13	0	0.68	0.08
Unbonded concrete pavement overlay	0.09	0	0.33	0.07
Bonded concrete pavement overlay	0.02	0	0.20	0.04
Other	0.11	0	0.32	0.04
Unidentified	0.12	0	0.70	0.08

Source: FHWA

**Table 13. 2016 HPMS dataset distribution of faulting by surface type.**

Surface Type	Mean, inch	Minimum, inch	Maximum, inch	Standard Deviation, inch
Asphalt	0.02	0	2.28	0.11
Jointed plain concrete	0.07	0	2.51	0.13
Jointed reinforced concrete	0.06	0	1.58	0.13
Continuously reinforced concrete	0.02	0	0.76	0.08
Asphalt pavement over asphalt pavement	0.01	0	5.32	0.14
Asphalt pavement over Jointed concrete pavement	0.01	0	3.10	0.08
Asphalt pavement over Continuously reinforced concrete pavement	0.00	0	0.10	0.01
Unbonded concrete pavement overlay	0.03	0	1.28	0.11
Bonded concrete pavement overlay	0.01	0	0.13	0.01
Other	0.02	0	0.32	0.04
Unidentified	0.03	0	1.00	0.08

Source: FHWA

**Table 14. 2016 HPMS dataset distribution of percent cracking by surface type.**

Surface Type	Mean, %	Minimum, %	Maximum, %	Standard Deviation, %
Bituminous	3	0	100	7.6
Jointed plain concrete	5	0	100	13.6
Jointed reinforced concrete	10	0	100	23.1
Continuously reinforced concrete	4	0	100	11.0
Asphalt pavement over Asphalt pavement	2	0	100	6.9
Asphalt pavement over Jointed concrete pavement	2	0	100	6.0
Asphalt pavement over Continuously reinforced concrete pavement	0	0	100	2.1
Unbonded concrete pavement overlay	3	0	88	10.2
Bonded concrete pavement overlay	6	0	54	11.6
Other	4	0	100	12.1
Unidentified	3	0	90	6.9

Source: FHWA

The distributions do not demonstrate drastic differences in the data between the various surfaces. Even the distributions of condition metrics for an inappropriate surface type (rutting on concrete surfaces and faulting on asphalt surfaces) are within range of those for the surfaces for which these values are reported. For example, the distribution of the rut depth values for concrete surfaces is not out of range of that for the asphalt surface, although the maximum values are lower than those for the asphalt surfaces. Similarly, the faulting data collected on the asphalt surfaced sections are not substantially different for the faulting reported on concrete surfaces.

Table 12 identifies at least one record with an unreasonable value of rut depth for a surface type of asphalt pavement over jointed concrete pavement. These data are from one State for this particular surface type.

### **COMPARISON OF 2013 AND 2016 HPMS DATA**

A comparison of the 2013 and 2016 data was completed as part of this preliminary analysis effort. This comparison was undertaken to review how the data have changed over time. This review illustrated an improvement in the overall quantity and quality of data contained in the HPMS in 2016 over that from 2013.

#### **Data Completeness**

The first step of the comparison between the 2013 and 2016 HPMS data was to assess data completeness. Table 15, Table 16, Table 17, and Table 18 provide a comparison of the mileage of data by climate zone, population zone, surface type, and condition metric respectively.

Overall, there are 46,460 miles of data from the 2013 HPMS data and 46,006 miles of data from the 2016 HPMS data.

**Table 15. Data mileage comparison by climate zone.**

Climate Zone	2013 Mileage	2016 Mileage
Wet Freeze	18,954	19,223
Wet No Freeze	11,666	12,009
Dry Freeze	9,157	9,026
Dry No Freeze	6,684	5,748

Source: FHWA

**Table 16. Data mileage comparison by population zone.**

Population Zone	2013 Mileage	2016 Mileage
Rural	28,654	27,800
Small Urban	2,669	2,740
Urban	15,105	15,465

Source: FHWA

**Table 17. Data mileage comparison by surface type.**

Surface	2013 Mileage	2016 Mileage
Unpaved	6	0
Asphalt	8,410	10,590
Jointed plain concrete	4,571	5,730
Jointed reinforced concrete	1,103	1,359
Continuously reinforced concrete	989	1,808
Asphalt pavement Over Asphalt pavement	7,265	8,449
Asphalt pavement Over Jointed concrete pavement	5,188	8,359
Asphalt pavement Over Continuously reinforced concrete pavement	903	1,544
Unbonded concrete pavement overlay	351	400
Bonded concrete pavement overlay	69	62
Other	90	127
Unidentified	17,513	7,578

Source: FHWA



**Table 18. Data mileage comparison by condition metric.**

<b>Distress</b>	<b>2013 Mileage</b>	<b>2016 Mileage</b>
IRI	45,900	45,156
Percent Cracking	24,302	37,038
Rutting	25,690	34,915
Faulting	12,673	16,191

Source: FHWA

### **Data Comparison**

The next step in the comparison of the 2013 and 2016 HPMS datasets was a review of the distribution of the metrics. Table 19 provides a comparison of the mean and standard deviation of each condition metric. Figure 19, Figure 20, Figure 21, and Figure 22 provide the cumulative distributions of IRI, rut depth, faulting, and percent cracking respectively.

The cumulative distributions demonstrate that the distribution of IRI data is very similar between the two datasets. These distributions illustrate that the rut depth, faulting, and percent cracking are generally smaller in the 2016 data over the 2013 data. The distributions also demonstrate a trend in the data toward a higher resolution of the 2016 data over those from 2013. In other words, the HPMS data for rutting and faulting present more values rounded to the hundredth of an inch in 2016 as opposed to a tenth of an inch, which was more common in the 2013 data.

The observations from the distributions are consistent with the mean and standard deviations presented in Table 19 with one exception. The standard deviation of the rut depth from 2016 is larger than that observed from the 2013 data due to a few outliers values in the 2016 data. These are all from a single State and a single surface type within that State. When these data are excluded, the next largest value is 2.25 inches and the standard deviation drops from 1.66 inches to 0.09 inches.

Overall, the HPMS data exhibits greater completeness and better-quality data in 2016 over what was seen in 2013.

**Table 19. Comparison of 2013 and 2016 condition metric distributions.**

<b>Condition Metric</b>	<b>2013 Mean</b>	<b>2013 Standard Deviation</b>	<b>2016 Mean</b>	<b>2016 Standard Deviation</b>
IRI	80	43.2	77	42.3
Rut Depth, inch	0.22	0.66	0.15	1.66
Faulting, inch	0.07	0.15	0.03	0.11
Cracking, %	8	17.5	3	9.3

Source: FHWA

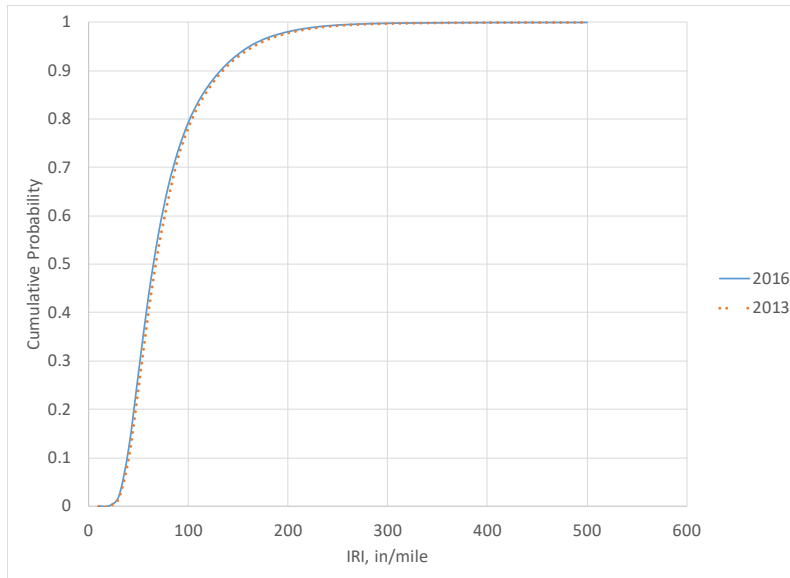

Source: FHWA

**Figure 19. Graph. Comparison of the distribution of IRI.**

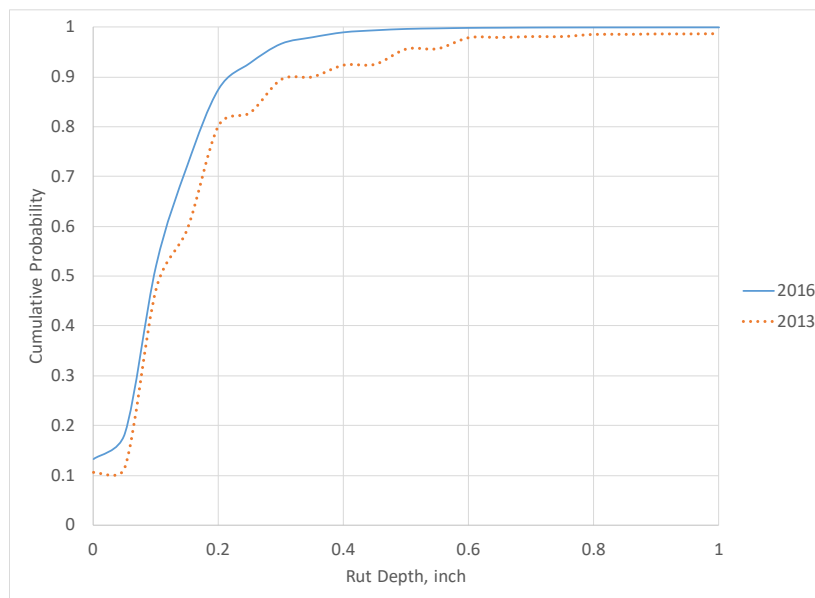

Source: FHWA

**Figure 20. Graph. Comparison of distribution of rut depth.**

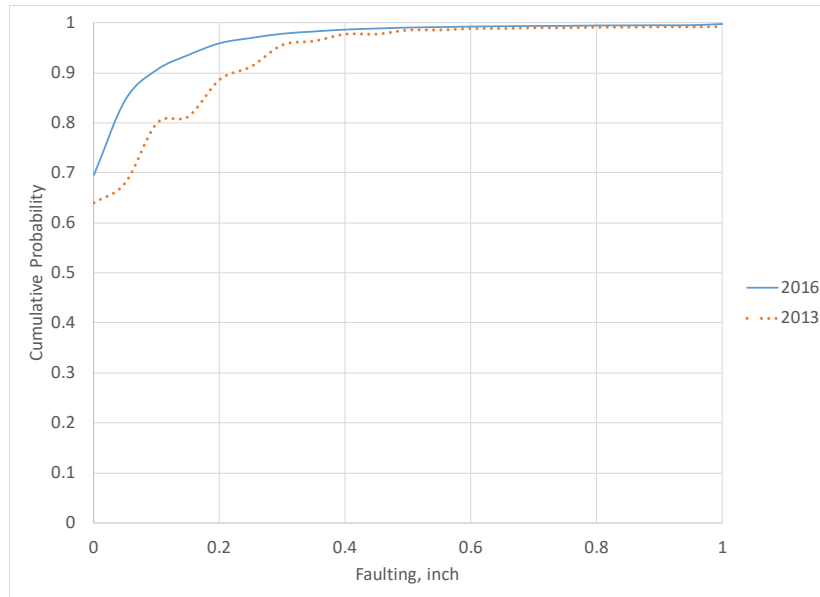

Source: FHWA

**Figure 21. Graph. Comparison of distribution of faulting.**

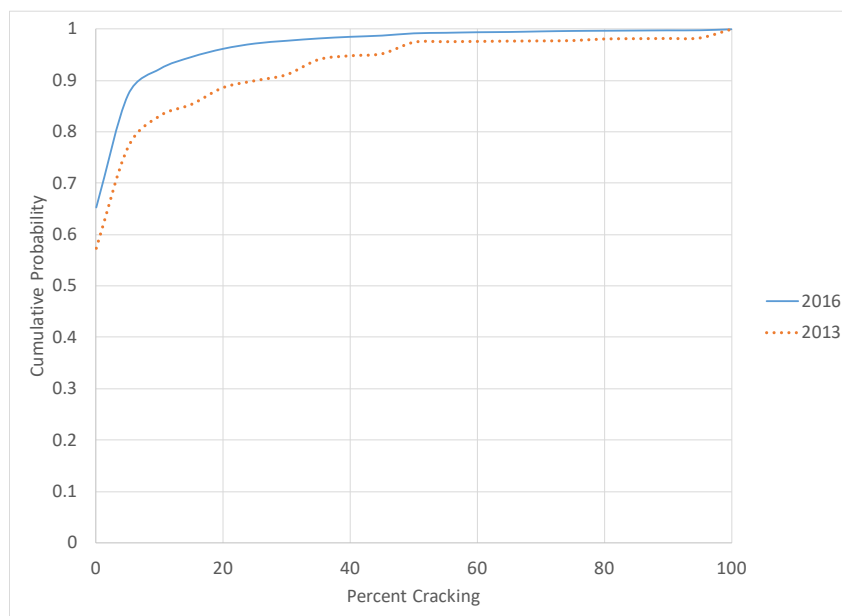

Source: FHWA

**Figure 22. Graph. Comparison of distribution of percent cracking.**

**DATA COLLECTION ROUTE**

The 2018 data collection route is depicted in Figure 23 and incorporated approximately 7,500 miles. This route covered 34 States and included sections from Arkansas, Iowa, Michigan, Nebraska, North Dakota, Ohio, Oklahoma, Oregon, and Vermont that were not part of the prior

data collection effort in 2015. For comparison purposes, Figure 24 depicts the 2015 data collection route, while Figure 25 shows the common areas between the 2015 and 2018 data collection routes. The common areas are:

- I-90 through South Dakota, Minnesota, and Wisconsin.
- I-10 from Los Angeles through Florida.
- I-95 through Virginia, Maryland, Delaware, New Jersey, and New York.

Table 20 provides the details of the Interstate routes included in each State and the estimated mileage.



Source: FHWA

**Figure 23. Map. 2018 data collection route.**

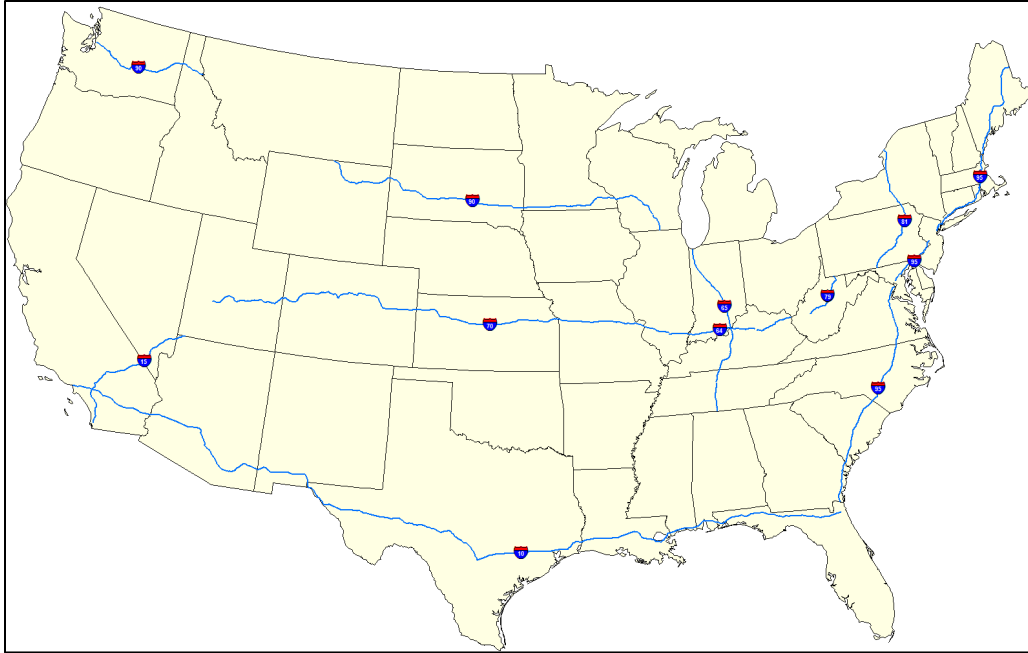

Source: FHWA

**Figure 24. Map. 2015 data collection route.**

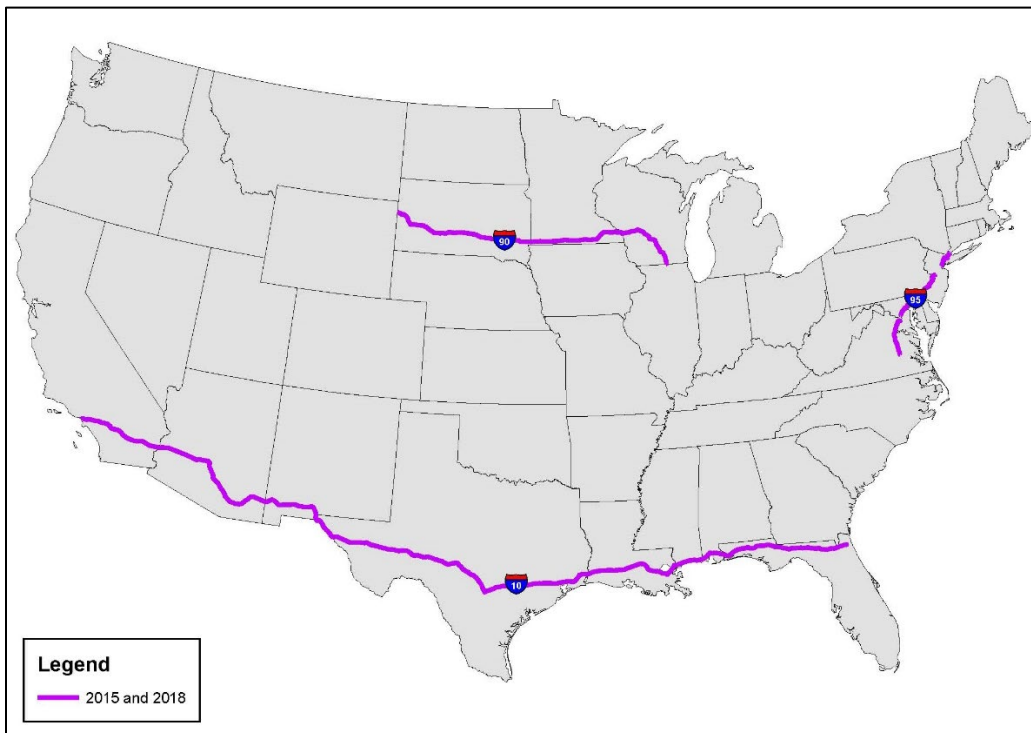

Source: FHWA

**Figure 25. Comparison of 2015 and 2018 data collection routes: common areas.**

**Table 20. Data collection route: route, state, direction, and miles.**

<b>Route</b>	<b>State</b>	<b>Direction</b>	<b>Mileage</b>
I-90	South Dakota	EB	413
	Minnesota	EB	276
	Wisconsin	EB	188
I-5	Oregon	NB	308
	Washington	NB	277
I-10	California	EB	175
	Arizona	EB	392
	New Mexico	EB	164
	Texas	EB	877
	Louisiana	EB	275
	Mississippi	EB	78
	Alabama	EB	66
	Florida	EB	362
I-95	Virginia	NB	110
	Maryland	NB	110
	Delaware	NB	23
	Pennsylvania	NB	51
	New Jersey	NB	98
	New York	NB	23
I-15	Utah	NB	401
	Idaho	NB	196
	Montana	NB	396
I-35	Oklahoma	NB	236
	Kansas	NB	235
	Missouri	NB	110
	Iowa	NB	206
I-75	Tennessee	NB	142
	Kentucky	NB	192
	Ohio	NB	211
	Michigan	NB	340
I-30	Arkansas	EB	143
I-80	Nebraska	EB	103
I-29	North Dakota	NB	217
I-89	Vermont	NB	105

Source: FHWA

### **Stratification Factors**

The route was reviewed to identify how it compares to the full dataset. Figure 26 and Figure 27 provide the comparison of the quantity of the route in each climate zone as compared to the network data. The figures show that the selected route had a smaller percentage in the wet freeze zone than the full dataset.

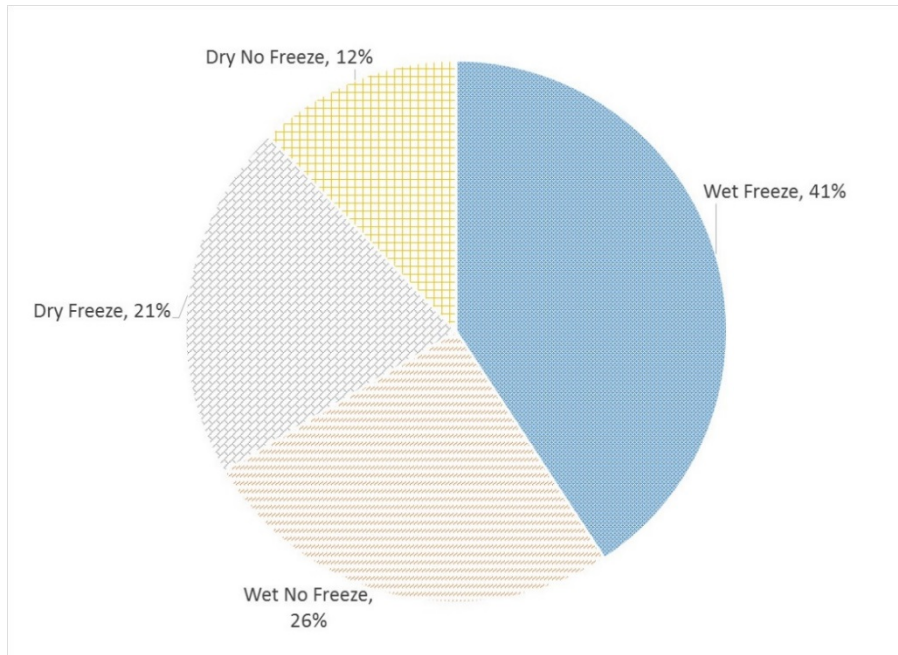

Source: FHWA

**Figure 26. Chart. 2016 HPMS climate zone composition.**

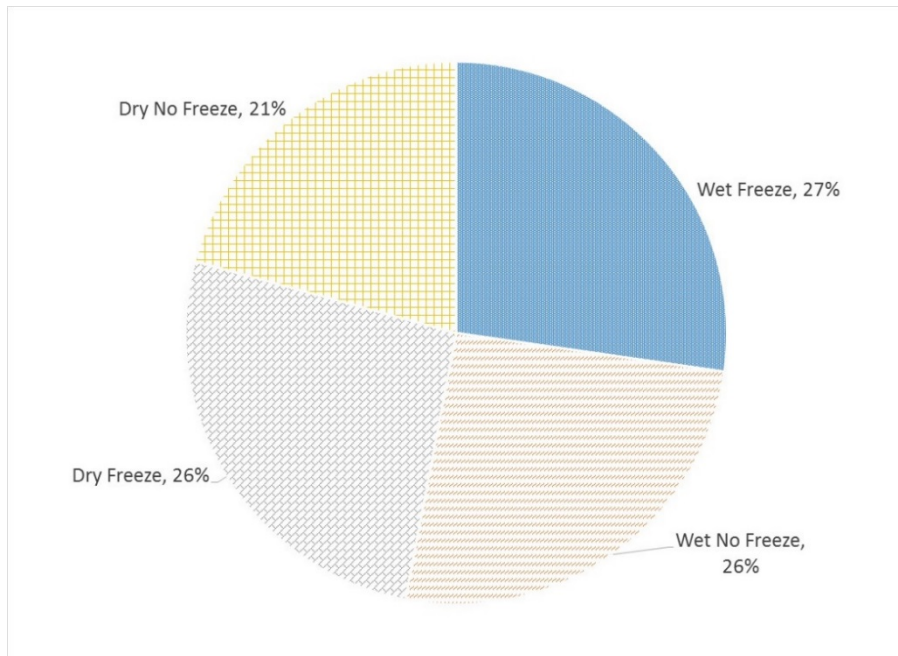

Source: FHWA

**Figure 27. Chart. 2018 Route climate zone composition.**

Figure 28 and Figure 29 illustrate the comparison of the population zone distribution between the 2016 network level data and the data collection route. The selected route had a smaller

percentage of data in an urban population zone than the network; however, the data collection route included mileage along I-95 through New York and I-10 through California, which are the two largest urban areas in the United States. Figure 30 and Figure 31 provide a comparison of the distribution of surface type between the network and the data collection route. These graphs illustrate that the distribution of surface type was similar between the network and the data collection route.

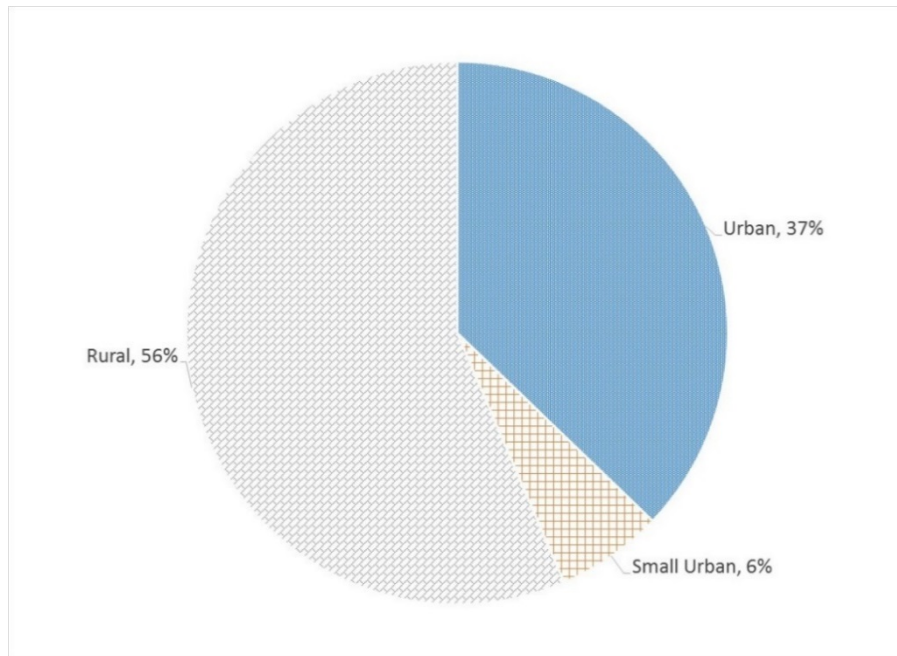

Source: FHWA

**Figure 28. Chart. 2016 HPMS urban vs. rural composition.**



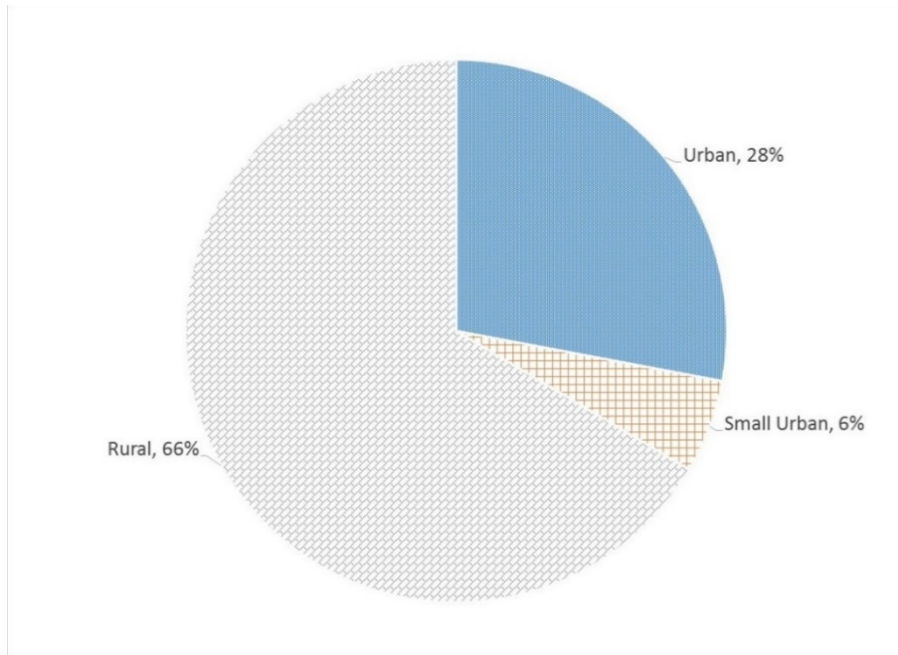

Source: FHWA

**Figure 29. Chart. 2018 Route urban vs. rural composition.**

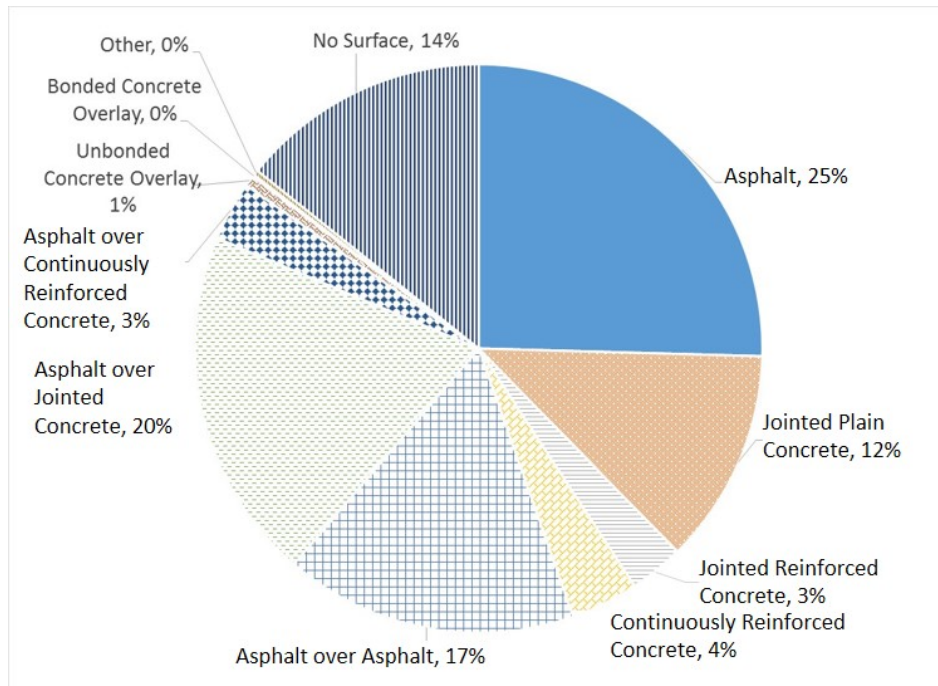

Source: FHWA

**Figure 30. Chart. 2016 HPMS pavement surface type composition.**

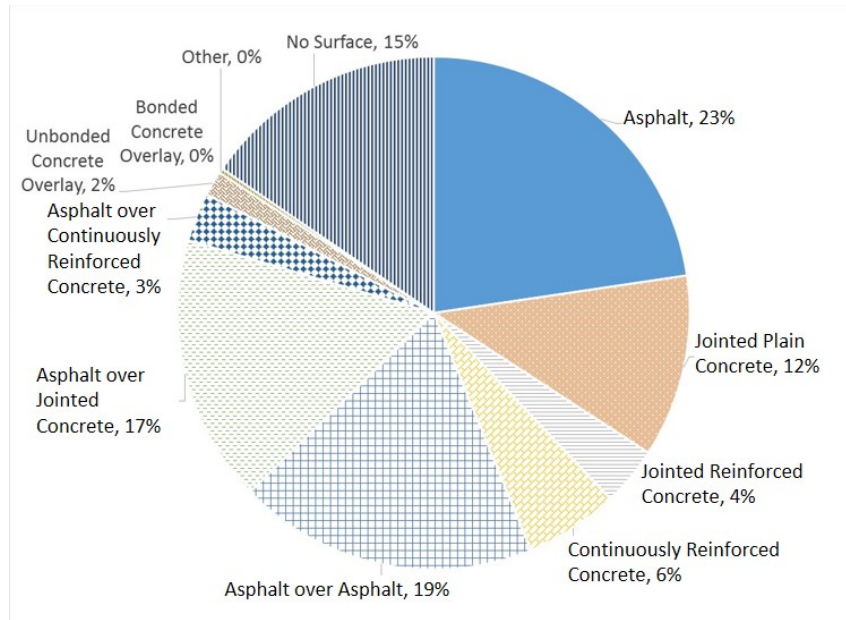

Source: FHWA

**Figure 31. Chart. 2018 Route pavement surface type composition.**

**Table 21. Data collection route: route, state, direction, and miles.**

Route	State	Direction	Mileage	Actual Mileage
I-90	South Dakota	EB	413	412.7
	Minnesota	EB	276	275.5
	Wisconsin	EB	188	187.2
I-5	Oregon	NB	308	308.3
	Washington	NB	277	276.0
I-10	California	EB	175	184.9
	Arizona	EB	392	392.0
	New Mexico	EB	164	164.4
	Texas	EB	877	880.7
	Louisiana	EB	275	273.7
	Mississippi	EB	78	77.2
	Alabama	EB	66	66.3
	Florida	EB	362	362.3
I-95	Virginia	NB	110	109.5
	Maryland	NB	110	108.4
	Delaware	NB	23	23.4
	Pennsylvania	NB	51	51.2
	New Jersey	NB	98	101.1
	New York	NB	23	24.0
I-15	Utah	NB	401	401.1
	Idaho	NB	196	195.8
	Montana	NB	396	395.5
I-35	Oklahoma	NB	236	235.8
	Kansas	NB	235	235.4
	Missouri	NB	110	114.5

Route	State	Direction	Mileage	Actual Mileage
	Iowa	NB	206	218.6
I-75	Tennessee	NB	142	159.1
	Kentucky	NB	192	191.6
	Ohio	NB	211	211.4
	Michigan	NB	340	338.9
I-30	Arkansas	EB	143	142.9
I-80	Nebraska	EB	103	102.5
I-29	North Dakota	NB	217	217.4
I-89	Vermont	NB	105	105.1
TOTAL			7,499	7,544.4

Source: FHWA

## EXECUTION OF DATA COLLECTION PLAN

Data collection commenced in August 2018 and was completed in November 2018. No significant deviations to the route were implemented during data collection. Table 21 provides a comparison of the planned mileage for data collection versus actual. The mileages shown in the table include approximately 566.2 miles of bridges, lane deviations, and construction areas where data were not collected.

Approximately 10 more miles of data were collected in CA than planned. Data collection began in CA at the intersection with I15. The 2016 HPMS data used to plan the data collection includes 175 miles from I10 in CA starting from milepost 0. Detailed review of the HPMS data identifies that there are approximately 66 miles of data between milepost 57.7 (location of intersection with I15) and the eastern edge of I10 within the State. In short, there are approximately 118 miles of data between milepost 57.7 and 241.6 and in combination with the 66 miles of missing HPMS data results in a distance of approximately 184 miles, which is close to the mileage collected.

An additional significant difference was observed for data collected in TN with an added 17 miles over the planned collection. This difference is due to concurrent routes of I75 and I40. It is expected that the HPMS data used to develop the planned collection mileage identified the data in this area as I40 instead of I75.

Over the course of data collection, equipment issues were experienced twice. In both cases, discussions with the DCC identified that the issues were mechanical problems with the van itself. The first instance occurred in late August and was related to a problem with the van transmission. A second mechanical issue, a problem with the radiator, was encountered in late October. Quality checks of the equipment after these mechanical problems were performed as outlined in the prior chapter.

## Data Storage

As described at the end of the prior chapter, the DCC submitted the project data in partial batches during and after the data collection period. Each of these submissions comprised a set of individual data tables in conformance with Table 75 to Table 82 of the “Project Database Data

Dictionary” (Appendix A), and a set of images (front camera images and LCMS pavement surface images with and without marked distresses) stored in hard drives. These data batches included the data collected on the project route mileage, as well as the data collected on the set of LTPP sections selected for the study. Each of the data tables and hard drives with imagery submitted by the DCC were stored on the project team’s network drive.

In addition to the partial data batches submitted by the DCC, the other two project data items are the Hundred-Mile dataset and the Tenth-Mile dataset. These two data items were produced and reviewed by the project team as described in the previous chapter. The Hundred-Mile dataset was produced from processing and merging the accepted individual data batches while the Tenth-Mile dataset was produced from processing the Hundred-Mile dataset in conformance with Table 75 of Appendix A: “Project Database Data Dictionary.” The approved versions of these two data items were stored on the project team’s network drive.

## CHAPTER 5 - DATA ANALYSIS

The data resulting from the collection effort described in the previous chapter served as the source data for the analysis presented in this chapter.

### CONDITION OF INTERSTATE PAVEMENT NETWORK

FHWA undertook the initial Interstate Pavement Condition Sampling study in 2015, which is referred to in this chapter as IS1. In this initial study, data were collected on a sample of approximately 8,500 miles of the Interstate Highway System. The objectives of that initial study were mostly the same as those for the current study (data collected in 2018), which is referred to in this chapter as IS2. This section presents and compares the pavement condition metrics, overall condition ratings, and performance measures for the two datasets at the network, State, and route level.

#### Network-Level Comparisons

Table 22 presents the condition metric summary statistics for the IS1 and IS2 datasets, which reflect the three-year interval between data collection efforts, including their mean, standard deviation, minimum, maximum, and median values. These statistics provide information about the distribution of each dataset and an overview of the condition metrics. As shown, the average IRI value differs by 2 in/mile between the two datasets, the average percent cracking differs by 0.3 percent, and the average rutting and faulting are the same for the two datasets. The ranges in the rut depth, percent cracking, and faulting are larger for the IS1 dataset than for the IS2 data. Also, the IS1 percent cracking data have a significantly larger variance than observed for the IS2 data. For all condition metrics, the mean values are higher than the median values, which indicates that the data are not symmetric and are skewed to the right, further indicating that the data do not follow a truly normal distribution. The percent cracking has a median of zero for the IS1 dataset compared to 0.6 for the IS2 dataset, which indicates there are slightly fewer pavement segments in the IS2 dataset with 0 percent cracking.

The density plots for the four condition metrics are presented in Figure 32, Figure 33, Figure 34, and Figure 35. For each condition metric, the density plot obtained from the IS2 dataset is superimposed on that obtained from the IS1 dataset to compare them on a common scale. As shown, the distributions obtained from the IS1 and IS2 dataset for IRI, rutting, and faulting are nearly identical. For cracking, however, the two datasets have distinct density plots.

**Table 22. IS1 and IS2 condition metric summary statistics**

Element	Mean	Standard Deviation	Min/Max	Median
IS2 – IRI, in/mile	67	35	19 / > 300	59
IS1 – IRI, in/mile	69	35	20 / > 300	60
IS2 – Rutting, inch	0.15	0.09	0.03 / 0.89	0.13
IS1 – Rutting, inch	0.15	0.10	0.03 / 1.54	0.13
IS2 – Cracking, %	3.4	6.6	0 / 73.0	0.6
IS1 – Cracking, %	3.1	9.8	0 / 100.0	0
IS2 – Faulting, inch	0.04	0.03	0 / 0.55	0.03
IS1 – Faulting, inch	0.04	0.04	0 / 0.67	0.03

Source: FHWA

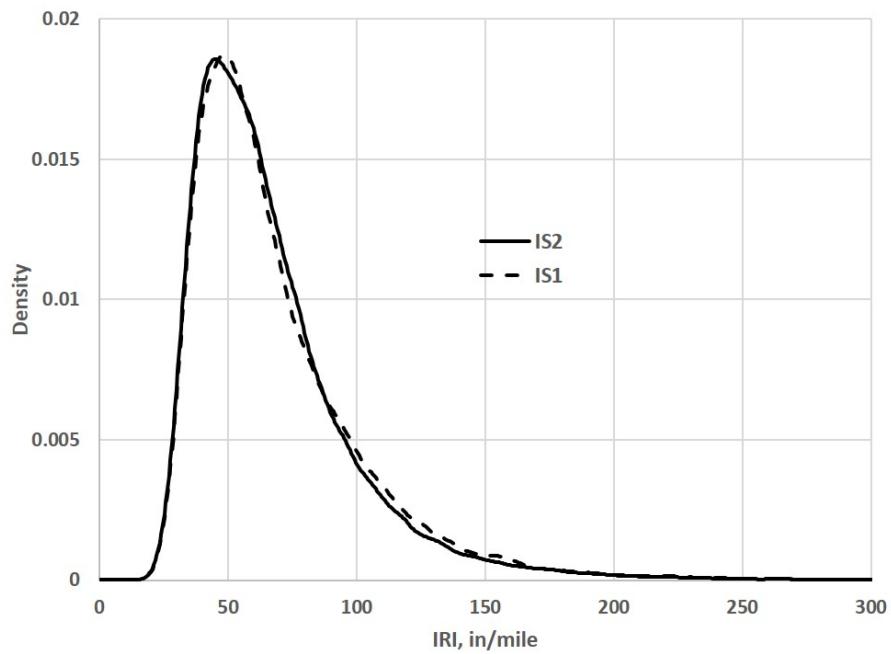

Source: FHWA

**Figure 32. Plot. Density plots of IRI condition metric for IS1 and IS2 datasets.**

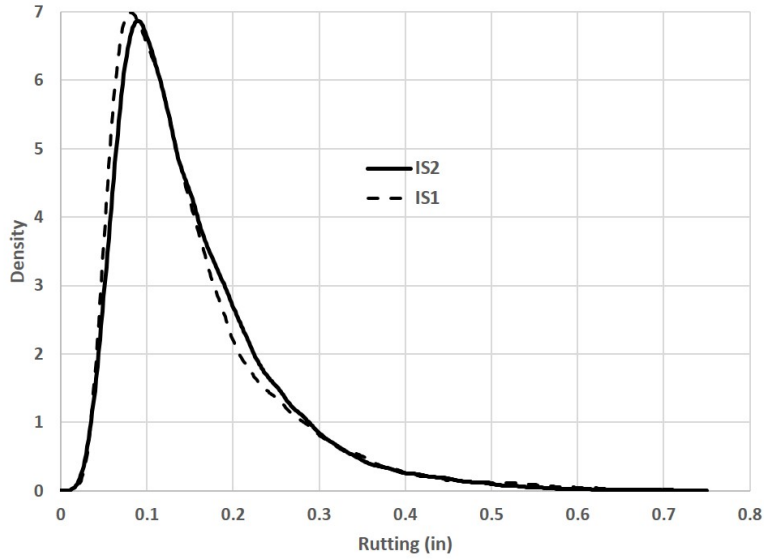

Source: FHWA

**Figure 33. Plot. Density plots of rutting condition metric for IS1 and IS2 datasets.**

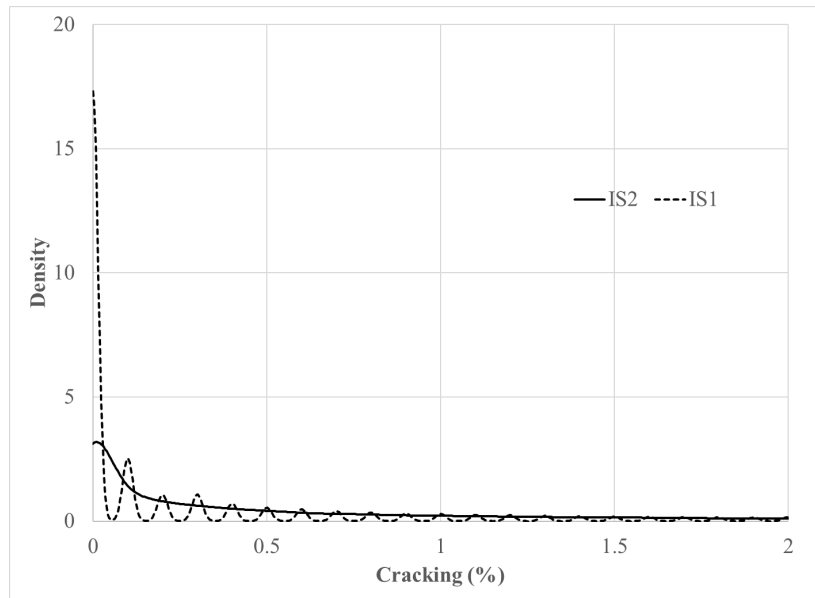

Source: FHWA

**Figure 34. Plot. Density plots of cracking condition metric for IS1 and IS2 datasets.**

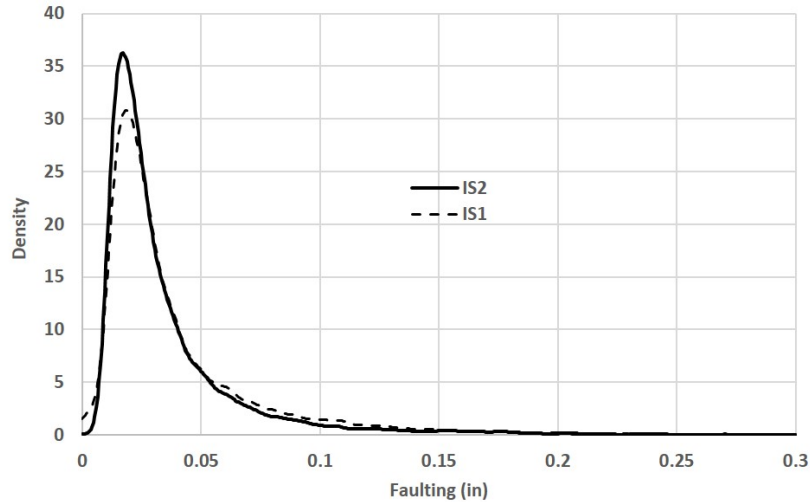

Source: FHWA

**Figure 35. Plot. Density plots of faulting condition metric for IS1 and IS2 datasets.**

Table 23 shows the condition ratings computed for each metric as well as the overall condition ratings (and hence performance measures) for the IS1 and IS2 datasets. The table shows the percentages of pavements in the Good range, in the Fair range, and in the Poor range. As shown, the percentage of pavements in overall Good condition decreased from 63.1 percent in 2015 (IS1) to 61.8 percent in 2018 (IS2), while the percentage of pavements in overall Poor condition decreased from 0.8 percent to 0.7 percent in the same period. The results presented in this table for the individual metrics are consistent with those shown in Table 22. The large changes in percent cracking statistics is also reflected in Table 23, with the percentage of mileage in Fair condition increasing from 5.7 percent to 14.7 percent between datasets. The differences observed in the percent cracking statistics may be due in part to a change in the defined wheelpath width used in these values which changed from 24 inches for IS1 to 39 inches for IS2 data collection. In addition, the variances shown for the individual metrics appear reasonable, especially given the three-year interval between the two data collection efforts.

**Table 23. Pavement condition metrics and overall condition ratings for IS1 and IS2 datasets.**

Metric	% Good	% Fair	% Poor
All IS1	63.1	36.2	0.8
All IS2	61.8	37.6	0.7
IRI IS1	83.5	14.9	1.7
IRI IS2	85.5	13.0	1.5
Rutting IS1	78.1	18.9	3.0
Rutting IS2	76.6	20.9	2.5
Cracking IS1	86.9	5.7	2.4
Cracking IS2	81.5	14.7	3.9
Faulting IS1	93.1	4.5	2.4
Faulting IS2	95.2	2.8	2.1

Source: FHWA



To provide for a more direct comparison between the IS1 and IS2 datasets, the States where data were collected in both 2015 and 2018 were identified and the datasets in question were reduced to only include data from the common States. Table 24 presents the results of the overall condition determined from each metric for IS1 and IS2 datasets. As shown in the table, there are increases in the Good ratings for IRI and faulting and reductions in the Good ratings for cracking and rutting from 2015 to 2018. In addition, for all four condition metrics, reductions are observed in the Poor ratings from 2015 to 2018.

**Table 24. Comparison of IS1 and IS2 metric condition ratings for common States.**

Metric	% Good	% Fair	% Poor
IRI IS1	82.87	15.3	1.8
IRI IS2	84.84	13.7	1.5
Rutting IS1	80.50	17.5	2.0
Rutting IS2	76.78	21.7	1.6
Cracking IS1	87.15	5.3	7.5
Cracking IS2	80.30	15.7	4.0
Faulting IS1	92.41	4.9	2.7
Faulting IS2	94.36	3.1	2.5

Source: FHWA

The overall condition rating and performance measure comparisons between IS1 and IS2 are shown in Table 25. This table shows that the percentage of pavements in Good condition decreased slightly from 2015 to 2018, which is primarily attributed to the reductions in the percentages of pavements in Good condition for cracking and rutting. This table also shows that the IS2 has lower percentage of pavements in Poor condition compared to IS1, which is consistent with the results for the complete datasets (i.e., all States included).

**Table 25. Comparison of IS1 and IS2 overall condition ratings and performance measures for common States.**

Dataset	% Good	% Fair	% Poor
IS1	63.2	35.9	0.9
IS2	60.4	39.0	0.6

Source: FHWA

Using the same datasets (i.e., common IS1 and IS2 States), a comparison of the condition metrics between those two datasets was made as a function of pavement surface type—asphalt pavement, jointed concrete pavement, and continuously reinforced concrete pavement. In this comparison, a t-test was used to determine whether the mean difference between the two datasets for each condition metric was zero—i.e., to test whether a change has occurred in the three-year period between the two data collection events. The results are summarized in Table 26, and show the difference in means for all metrics is statistically significant. In the t-test, even small differences—in engineering terms—between the two distributions means may become statistically significant when testing a large sample size. Because of these issues, it is preferable to use the common language effect size (CLES) statistic. This statistic measures the magnitude of the difference between the mean of two distributions with regard to the sample size and the

standard deviation. The CLES results are also shown in Table 26, and they indicate that the percent cracking metric has the largest differences between the IS1 and IS2 datasets for all pavement types.

**Table 26. Comparison of IS1 and IS2 according to condition metric and surface type.**

Surface Type	IS1 Mileage	IS2 Mileage	Metric	IS1 Mean	IS1 SD	IS2 Mean	IS2 SD	t-test	CLES
asphalt pavement	4583.7	4229.3	IRI, inch/mile	63	31	62	34	Reject	0.03
			Rutting, inch	0.14	0.09	0.15	0.08	Reject	0.10
			Percent Cracking, %	1.9	5.0	3.5	6.0	Reject	0.29
jointed concrete pavement	948.6	798.4	IRI, inch/mile	95	44	90	40	Reject	0.13
			Percent Cracking, %	10.7	22.4	4.3	11.1	Reject	0.36
			Faulting, inch	0.04	0.04	0.04	0.04	Reject	0.06
continuously reinforced concrete pavement	354.5	307.8	IRI, inch/mile	90	30	89	26	Reject	0.05
			Percent Cracking, %	0.1	1.1	0.4	1.35	Reject	0.22

Source: FHWA

The December 2016 HPMS Field Manual defines percent cracking for asphalt pavement as the total area of wheelpath cracking divided by the total lane area. However, in IS1 the width of wheelpath was assumed to be 2 feet versus 3.3 feet in IS2. Accordingly, both 2 feet and 3.3 feet were used in a comparison analysis to determine how the change in width affects percent cracking. The results of this analysis are presented in Table 27. “Cracking\_IS2” represents the 3.3 feet width, while “Cracking\_IS2\*” represents the 2 feet width. As shown in the table, the narrower wheelpath means that the area of cracking is smaller, which in turn results in a lower percent cracking. The studies show that the higher percent cracking value for asphalt pavement pavements in 2018 may be explained by the combination of elapsed time (i.e., 2015 to 2018) and the change in the wheelpath width definition.

In addition, for jointed concrete pavements, the December 2016 HPMS Field Manual defines percent cracking as the percentage of slabs within the segment that exhibits transverse cracking. This definition is different than the one used in the 2015 project, which included both transverse and longitudinal cracks in the definition. This may explain the large reduction in the percent cracking for jointed concrete pavement pavements from 2015 to 2018 as shown in Table 26.

**Table 27. IS2 asphalt pavement percent cracking for different wheelpath widths.**

Metric	Average Percent Cracking, %
Cracking_IS2	3.5
Cracking_IS2*	2.1

Source: FHWA

## State-Level Comparisons

The analysis presented in the previous section compared the IS1 and IS2 datasets at the national network level. In this section, the analyses presented have been performed at the State level. First, the CLES test was performed to compare the condition metrics between the two datasets, i.e., the test results show how the condition metrics are different between IS1 and IS2 at the State level. The histogram of CLES values for all States computed for each of the four condition metrics are provided in Figure 36, Figure 37, Figure 38, and Figure 39. As shown, three ranges were considered for CLES: less than 0.35, between 0.35 and 0.65, and larger than 0.65, representing the “small,” “medium,” and “large” difference size, respectively. The “small” group represents the level for the CLES that is not considered significant. The results for IRI show that most (21) States fall into the medium group. Results for cracking show that no States fall into the “large” group and most States are in the “small” group. Results for rutting show that most States show differences in the “medium” range, while results for faulting show that the States are uniformly distributed amongst the three groups, showing less consistency across States.

For each condition metric, the States that fall in the “medium” and “large” groups were identified and are listed in Table 28. These are the States for which the observed differences between the IS1 and IS2 datasets were considered significant. Some States were identified as having significant differences between the data for more than one condition metric. Further, some States present medium or large CLES values for all condition metrics, such as Idaho and Washington.

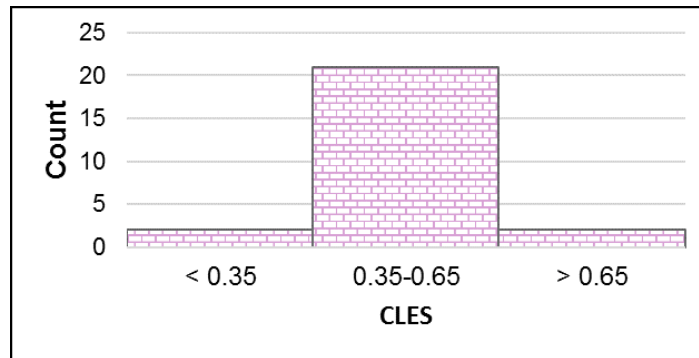

Source: FHWA

**Figure 36. Chart. State level IRI CLES results.**

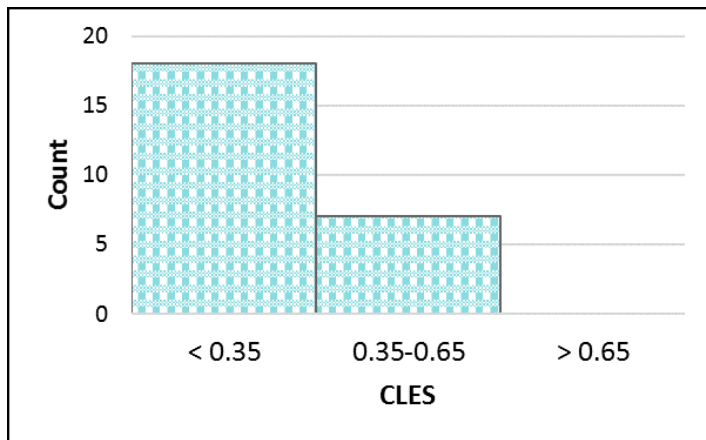

Source: FHWA

**Figure 37. Chart. State level cracking CLES results.**

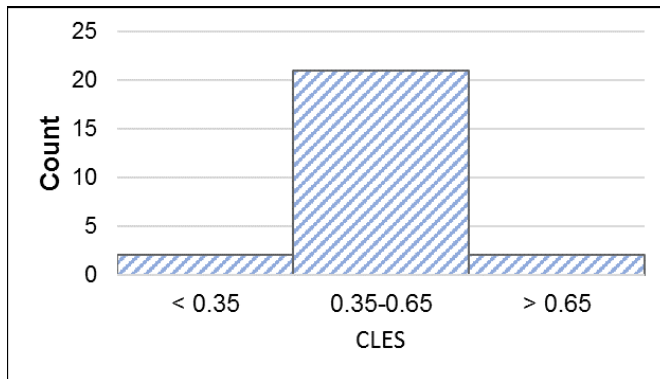

Source: FHWA

**Figure 38. Chart. State level rutting CLES results.**

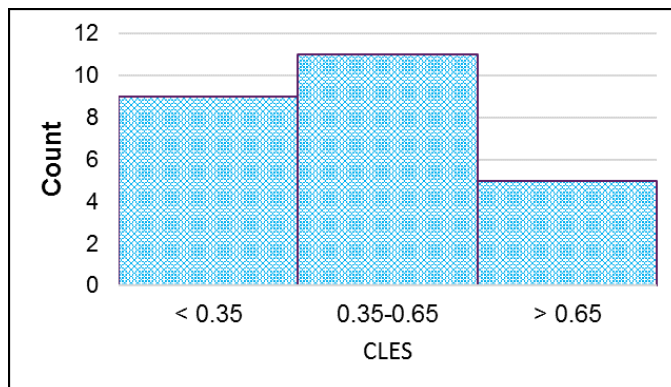

Source: FHWA

**Figure 39. Chart. State level faulting CLES results.**

**Table 28. States in the “medium” and “large” CLES groups.**

Metric	States in the ‘medium’ Group	States in the ‘large’ Group
IRI	AZ, CA, DE, FL, ID, KS, KY, LA, MD, MN, MO, MS, NJ, NM, SD, TN, TX, UT, VA, WA, WI	AL, MT
Cracking	AL, ID, MS, NJ, NM, WA, WI	-
Rutting	AL, AZ, CA, DE, FL, KY, LA, MD, MN, MO, MT, NJ, NM, NY, PA, SD, TN, TX, UT, VA, WI	ID, WA
Faulting	AZ, FL, KS, LA, MN, MO, NY, PA, SD, TX, WA, WI	ID, KY, UT, VA,

Source: FHWA

Next, a comparison of the overall condition ratings (and hence performance measures) was performed between the IS1 and IS2 datasets at the State level. The results of this comparison are provided as bar plots in Figure 40, Figure 41, and Figure 42. For each State, the right bar (in white) represents the IS2 result, while the left bar (in black) shows the IS1 result. As shown, significant differences are observed between the IS1 and IS2 overall condition rating results for California, Idaho, New York, and Washington. To understand the difference in the results, a comparison of the total sampled mileage for each State in IS1 and IS2 datasets was performed.

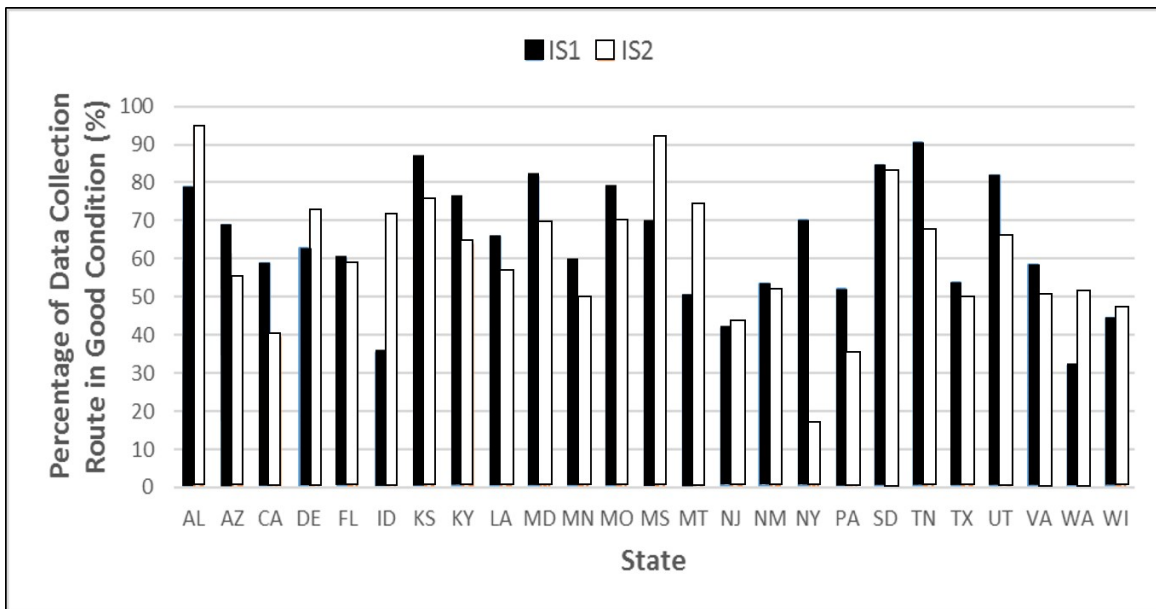

Source: FHWA

**Figure 40. Chart. Good condition ratings comparison at State level.**

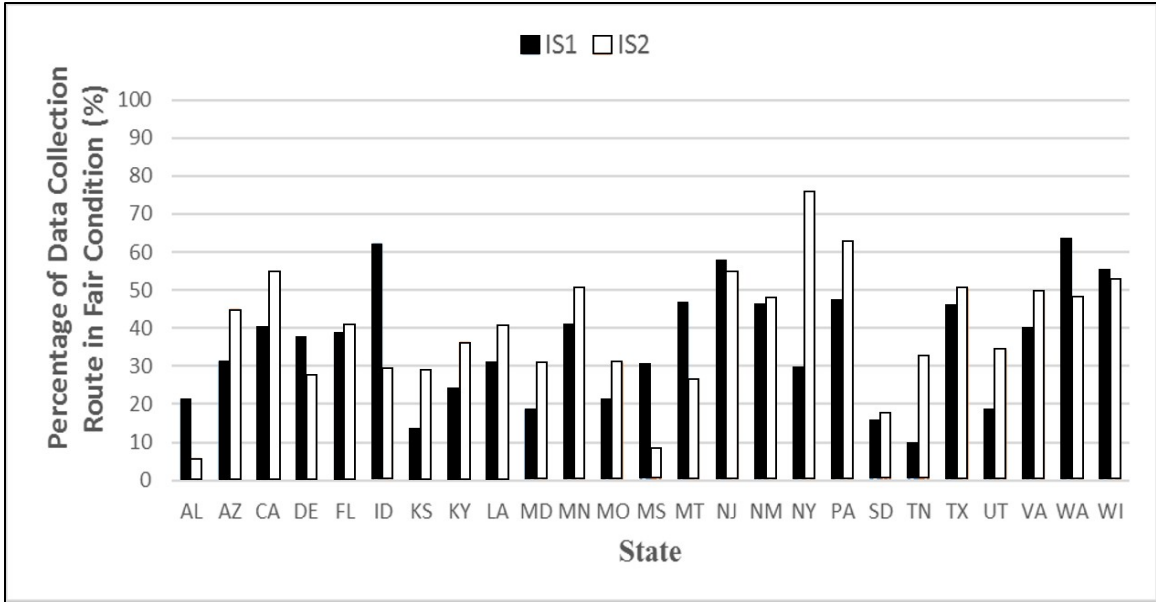

Source: FHWA

**Figure 41. Chart. Fair condition ratings comparison at State level.**

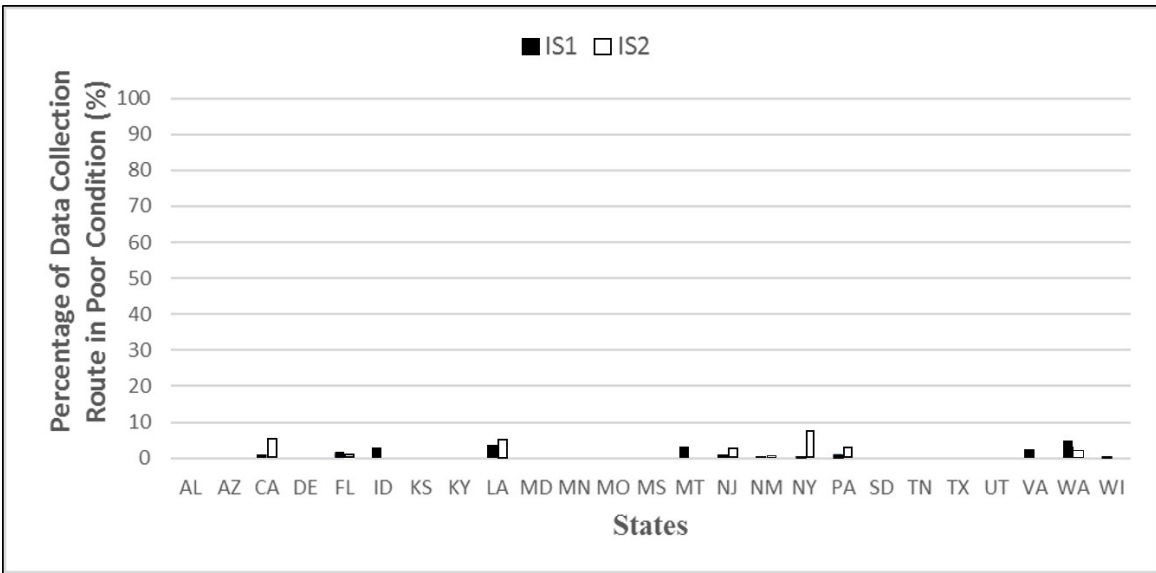

Source: FHWA

**Figure 42. Chart. Poor condition ratings comparison at State level.**

Figure 43 illustrates the results of this comparison. Although significant differences are observed in the total mileage for California, Idaho, and New York, the mileage is the same for Washington. A comparison at the route level was conducted to determine the reason(s) for the differences in the condition ratings. This comparison and the associated results are presented in the next section.

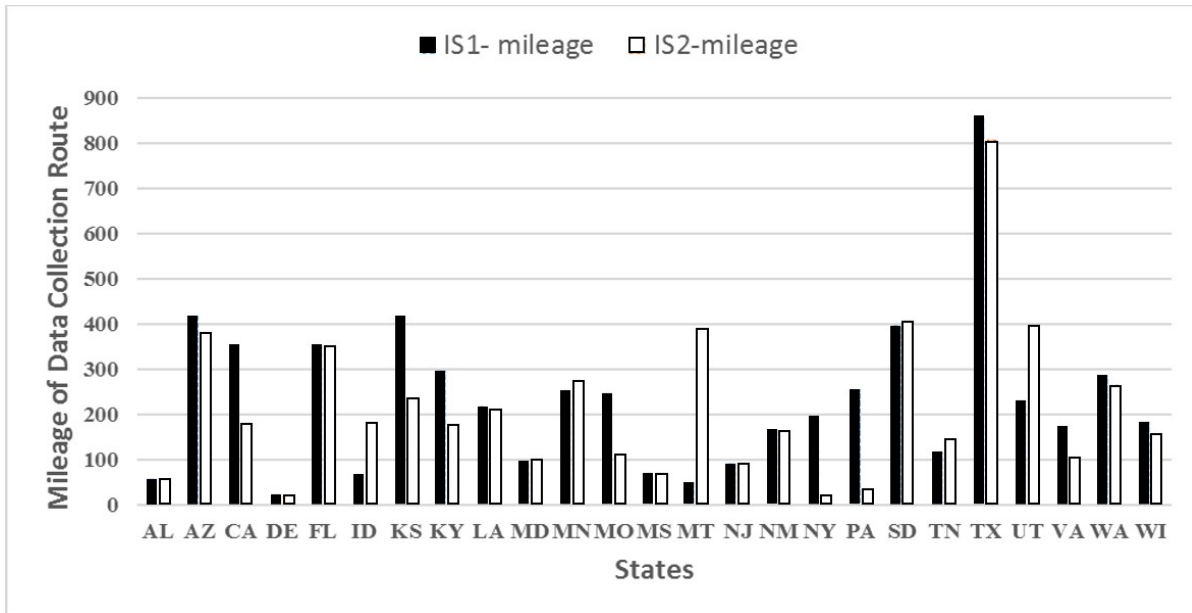

Source: FHWA

**Figure 43. Chart. Comparison between IS1 and IS2 sampled mileage.**

### Route-Level Comparisons

To better understand the differences observed between the IS1 and IS2 performance measures at the State level, comparisons were made between the condition metrics and performance measures at the route level. These comparisons only considered route mileage that was common to both IS1 and IS2—i.e., if a State was common to both IS1 and IS2 but the route collected within that State was not the same, the State was not considered in the comparisons. Table 29 presents the total mileage sampled in each State as part of IS1 and IS2, the common route, and the duplicate mileage on the common routes sampled in IS1 and IS2.

Figure 44, Figure 45, Figure 46, Figure 47, Figure 48, Figure 49, Figure 50, and Figure 51 present the Good and Poor condition ratings for the four metrics at the route level. The comparison of the IS1 and IS2 overall condition ratings and the performance measures at the route level are shown in Table 30. Some of the differences between the two datasets can be attributed to the 3-year time difference between the 2015 and 2018 data collection efforts, but also to variations in the differences for the individual condition metrics. For example, the percentages of segments in Good condition for the Louisiana IRI, faulting, and cracking metrics are greater for IS2 than IS1. Not surprisingly, the percentage of Louisiana segments with a Good rating is also greater for IS2 than for IS1. Alternatively, the percentage of segments in Poor condition for the California IRI, cracking, and faulting metrics are greater for IS2 than IS1, as is the case with the percentage of segments with overall Poor condition ratings.

**Table 29. Sampled mileage details of IS1 and IS2.**

State	IS1 Total Mileage	IS2 Total Mileage	Common Route – Number	Duplicate Mileage
AL	58.04	58.40	I10	58.04
AZ	380.76	417.77	I10	380.76
CA	181.87	355.95	I10	181.87
DE	20.35	22.15	I95	20.35
FL	352.78	355.87	I10	352.78
LA	211.79	217.90	I10	211.79
MS	70.69	70.96	I10	70.69
NM	161.57	164.27	I10	161.57
NY	20.34	197.78	I95	18.19
PA	32.13	254.32	I95	32.13
TX	807.59	862.11	I10	807.59
VA	105.28	174.20	I95	105.28
WI	156.72	184.64	I90	156.72

Source: FHWA

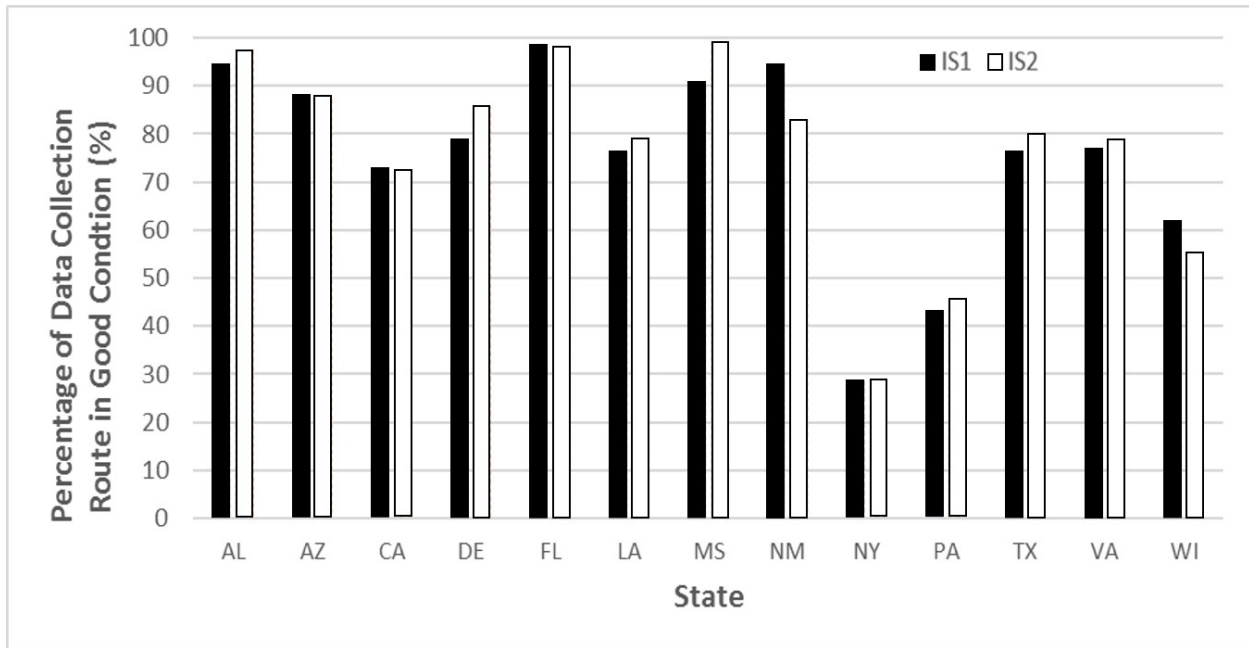

Source: FHWA

**Figure 44. Chart. Comparison of IS1 and IS2 Good IRI condition ratings at route level.**



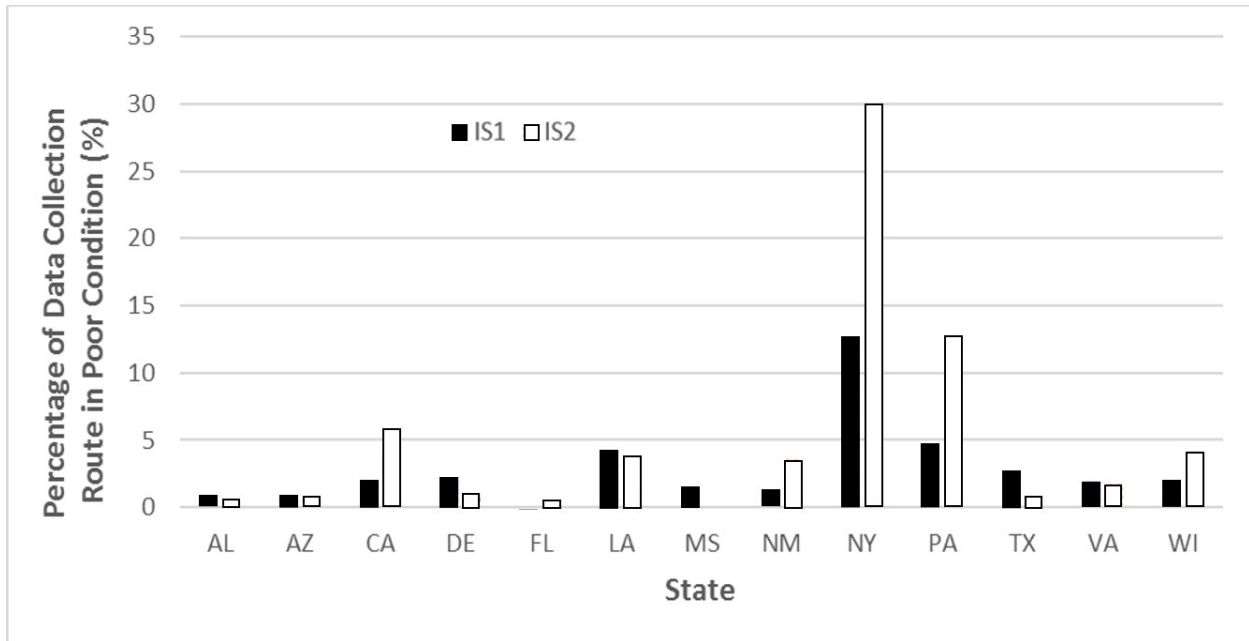

Source: FHWA

**Figure 45. Chart. Comparison of IS1 and IS2 Poor IRI condition ratings at route level.**

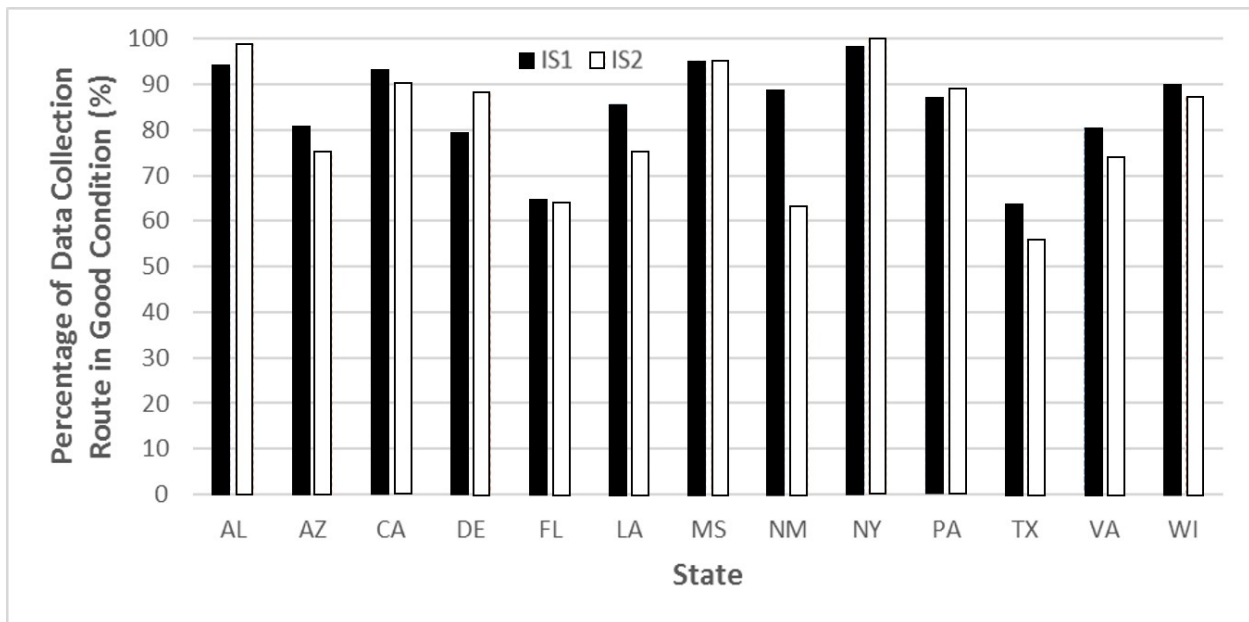

Source: FHWA

**Figure 46. Chart. Comparison of IS1 and IS2 Good rutting condition ratings at route level.**

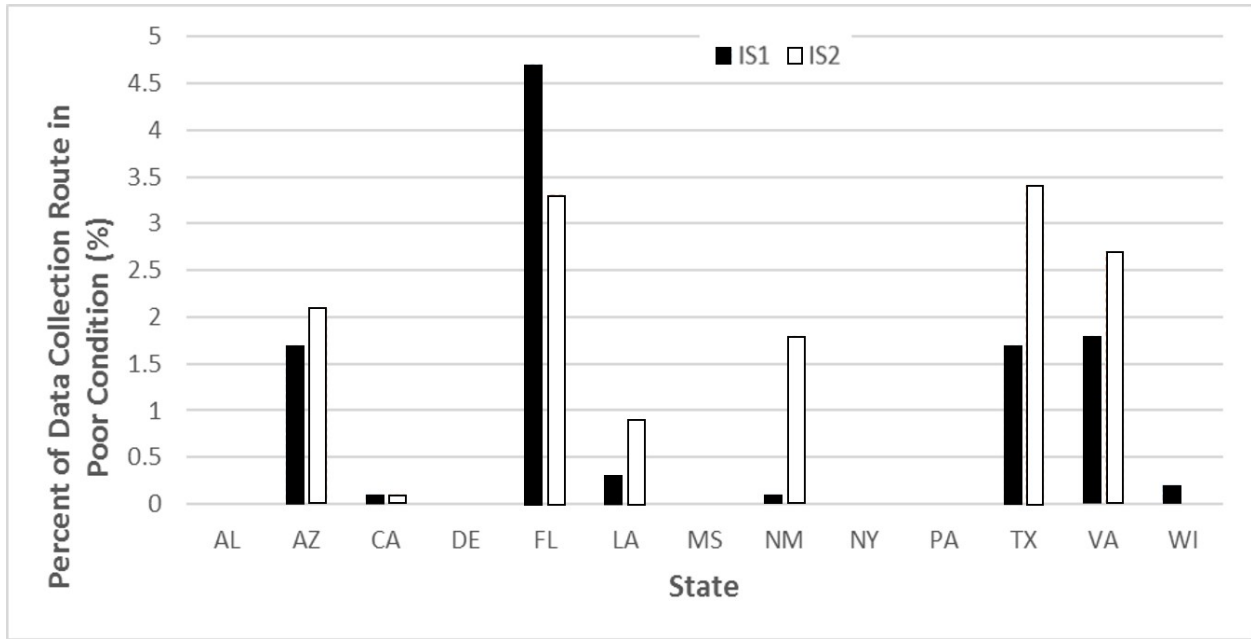

Source: FHWA

**Figure 47. Chart. Comparison of IS1 and IS2 Poor rutting condition ratings at route level.**

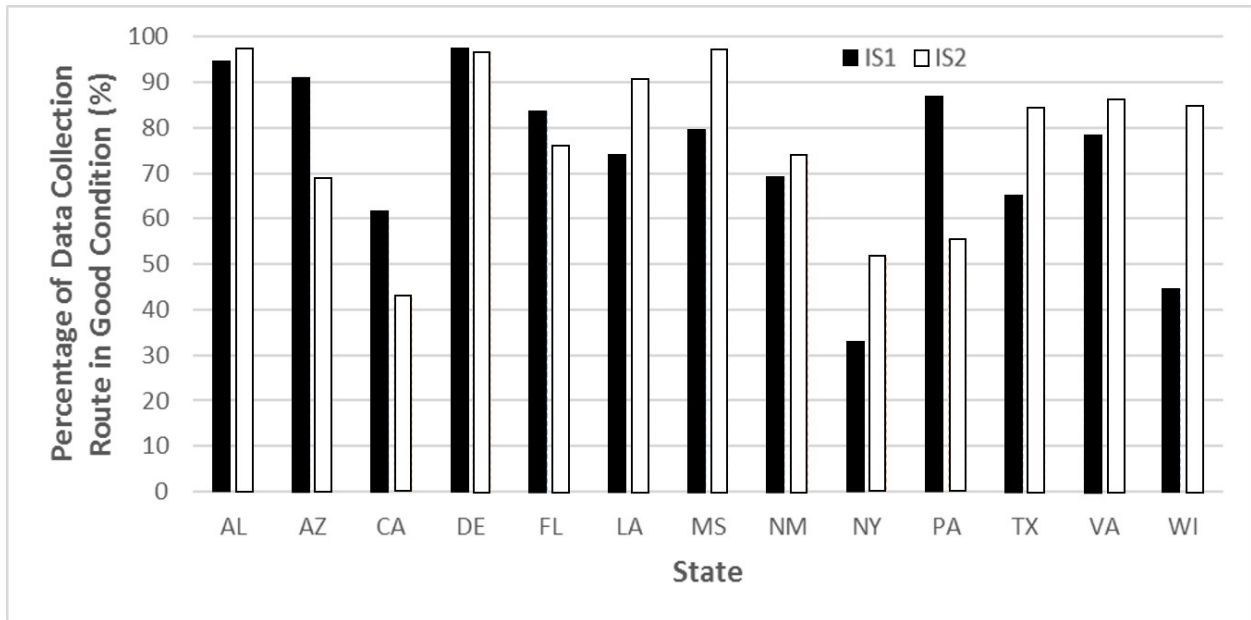

Source: FHWA

**Figure 48. Chart. Comparison of IS1 and IS2 Good cracking condition ratings at route level.**

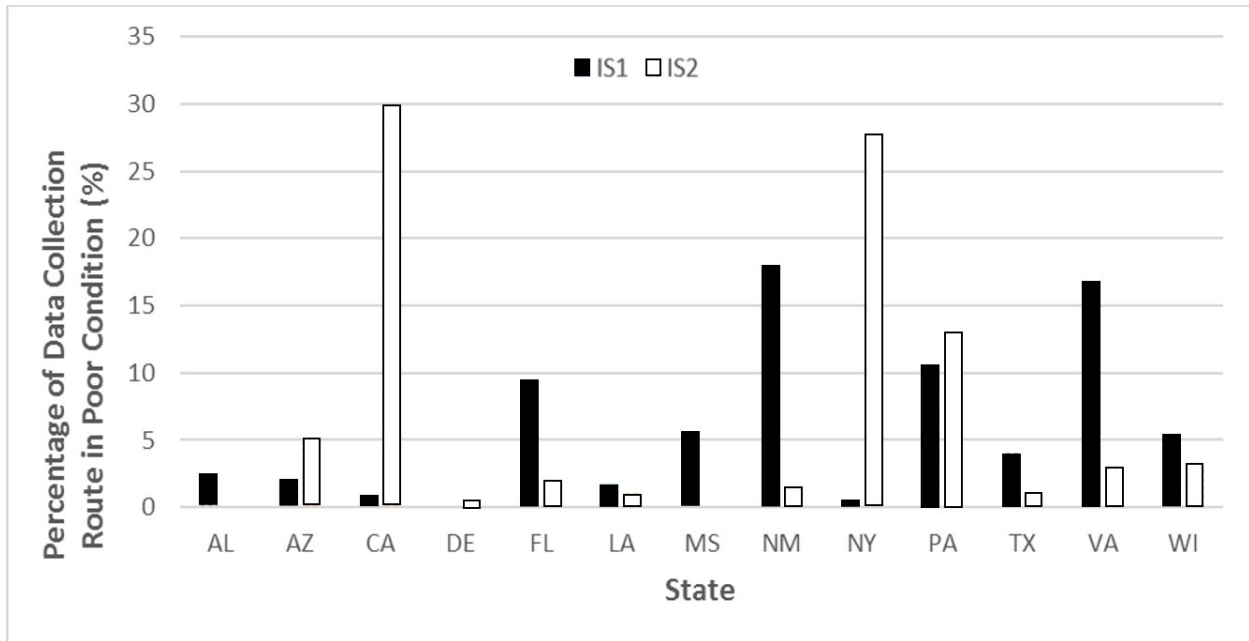

Source: FHWA

**Figure 49. Chart. Comparison of IS1 and IS2 Poor cracking condition ratings at route level.**

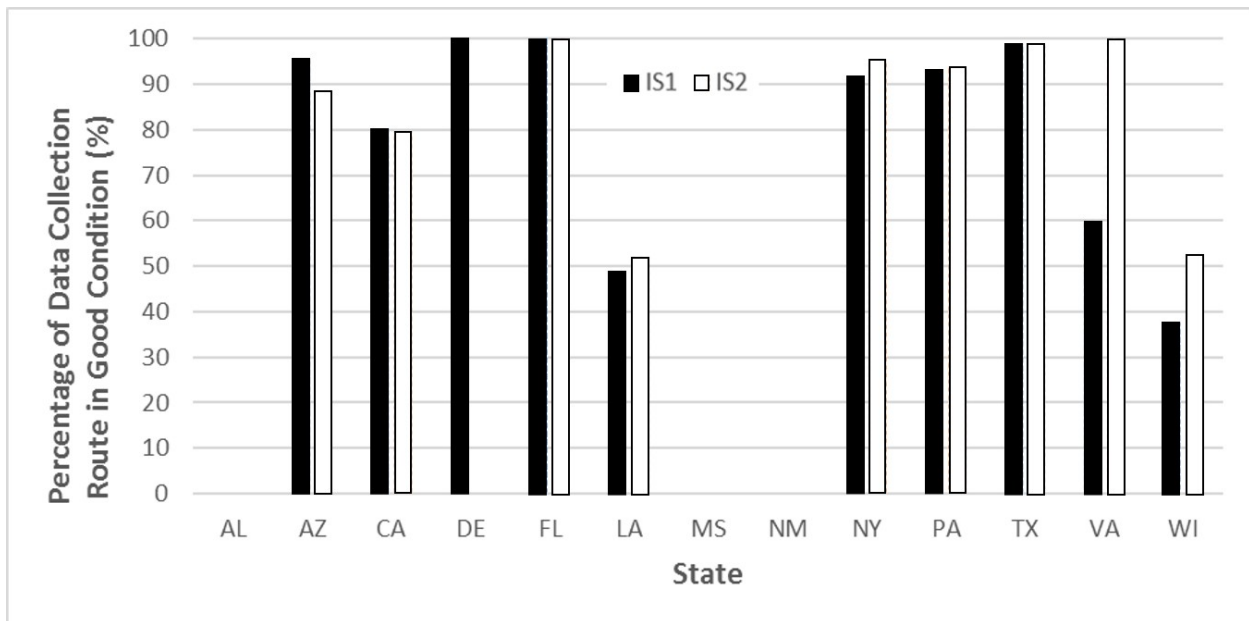

Source: FHWA

**Figure 50. Chart. Comparison of IS1 and IS2 Good faulting condition ratings at route level.**

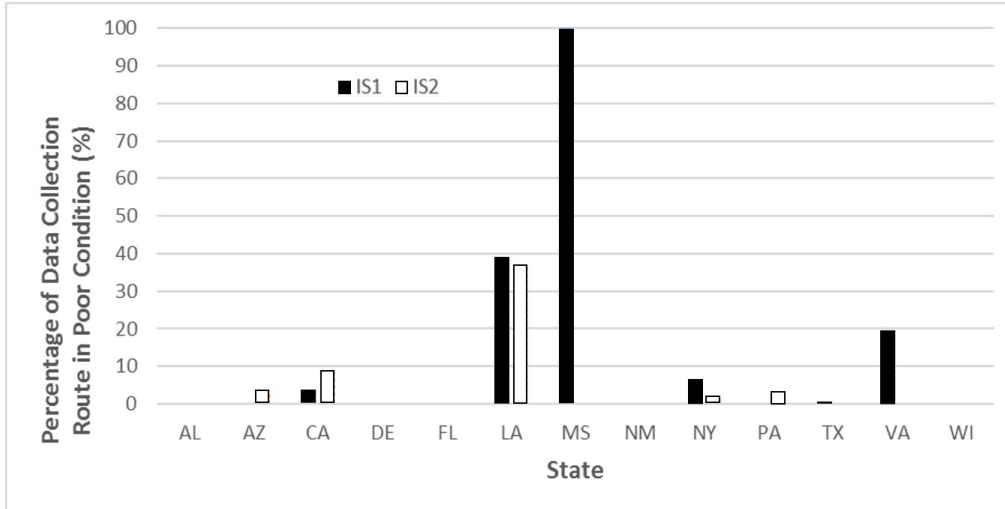

Source: FHWA

**Figure 51. Chart. Comparison of IS1 and IS2 Poor faulting condition ratings at route level.**

**Table 30. Comparison of IS1 and IS2 overall condition ratings and performance measures at route level.**

State Ratings	% Good	% Fair	% Poor
AL IS1	78.8	21.2	0.0
AL IS2	94.5	5.5	0.0
AZ IS1	69.1	30.8	0.1
AZ IS2	54.9	44.8	0.3
CA IS1	52.0	46.0	2.0
CA IS2	39.5	54.8	5.7
DE IS1	62.7	37.3	0.0
DE IS2	72.6	27.4	0.0
FL IS1	60.1	38.4	1.5
FL IS2	58.8	40.6	0.6
LA IS1	65.8	30.9	3.3
LA IS2	56.0	40.4	3.6
MS IS1	69.4	30.3	0.3
MS IS2	91.7	8.3	0.0
NM IS1	53.4	46.1	0.5
NM IS2	51.7	47.6	0.7
NY IS1	23.6	69.8	6.6
NY IS2	16.7	75.6	7.7
PA IS1	35.3	64.4	0.3
PA IS2	34.3	62.5	3.2
TX IS1	53.7	45.9	0.4
TX IS2	49.5	50.4	0.1
VA IS1	58.5	39.7	1.8
VA IS2	50.5	49.4	0.1
WI IS1	44.5	54.9	0.6
WI IS2	47.1	52.6	0.3

Source: FHWA

## HPMS PAVEMENT CONDITION DATA ANALYSES

This section details two sets of analyses that were performed to assess recent HPMS pavement condition data. The first analysis looks at the changes in HPMS pavement condition data over time with data from 2015, 2016, and 2017. This temporal analysis was performed at the network, State, and route levels. The second analysis looks at the impact of stratification factors on the HPMS pavement condition data, including climate, terrain, and traffic factors.

### Temporal Analysis

#### *Network-Level Analysis*

This section looks at the changes in the HPMS pavement condition data at the network level. Data for Arizona, California, Delaware, Oregon, and South Carolina are not included in the analysis because they were not available in the 2017 HPMS dataset; a total of 45 States and the District of Columbia were considered. Also, the 2015 and 2016 HPMS datasets consist of data sampled by the States, while the 2017 HPMS dataset represents the full network. The total mileage associated with each dataset is shown in Table 31.

**Table 31. Sampled mileage of 2017, 2016, and 2015 HPMS datasets.**

Year	2017 HPMS	2016 HPMS	2015 HPMS
Mileage	42,696.6 miles	35,124.1 miles	30,365.4 miles

Source: FHWA

As with the condition analysis presented in the previous section, this analysis starts with the assessment of summary statistics and density plots for each of the four condition metrics and for each of the three HPMS datasets. Table 32 through Table 35 shows the resulting summary statistics, while Figure 52 through Figure 55 show the associated density plots for the combinations of condition metrics and HPMS datasets. As can be observed, the summary statistics and densities show small differences in the 2017 versus the 2016 and 2015 HPMS datasets for most cases. For example, Table 32 shows that the 2017 average IRI value is 80 in/mile, while the value for 2016 and 2015 is 78 in/mile. Similarly, Table 33 shows that the average rutting in 2017 was 0.14 in, while the value in 2016 and 2015 was 0.13 in. Other observations derived from Table 32 through Table 35 include:

- The minimum IRI value in the 2017 HPMS dataset is 1 in/mile, which is significantly smaller than the minimum IRI value for the other two datasets.
- The minimum value of rutting in the 2015 HPMS dataset shows the presence of negative values in that dataset.
- The range of the faulting in the 2016 HPMS dataset is larger than for the other two HPMS datasets.
- Both the means and medians for all condition metrics are less than the Good–Fair thresholds.

**Table 32. IRI statistics for 2017, 2016, and 2015 HPMS datasets.**

<b>Element</b>	<b>Mean</b>	<b>Standard Deviation</b>	<b>Min/Max</b>	<b>Median</b>
2017 HPMS – IRI, inch/mile	80	44	1 / > 300	65
2016 HPMS – IRI, inch/mile	78	43	18 / > 300	66
2015 HPMS – IRI, inch/mile	78	42	14 / > 300	66

Source: FHWA

**Table 33. Rutting statistics for 2017, 2016, and 2015 HPMS datasets.**

<b>Element</b>	<b>Mean</b>	<b>Standard Deviation</b>	<b>Min/Max</b>	<b>Median</b>
2017 HPMS – Rutting, inch	0.14	0.09	0 / 1.50	0.12
2016 HPMS – Rutting, inch	0.13	0.09	0 / 2.25	0.11
2015 HPMS – Rutting, inch	0.13	0.38	-100 / 1.45	0.11

Source: FHWA

**Table 34. Percent cracking statistics for 2017, 2016, and 2015 HPMS datasets.**

<b>Element</b>	<b>Mean</b>	<b>Standard Deviation</b>	<b>Min/Max</b>	<b>Median</b>
2017 HPMS – Percent Cracking, %	3.4	10.1	0 / 100.0	0
2016 HPMS – Percent Cracking, %	3.3	9.6	0 / 100.0	0
2015 HPMS – Percent Cracking, %	3.4	10.5	0 / 100.0	0

Source: FHWA

**Table 35. Faulting statistics for 2017, 2016, and 2015 HPMS datasets.**

<b>Element</b>	<b>Mean</b>	<b>Standard Deviation</b>	<b>Min/Max</b>	<b>Median</b>
2017 HPMS – Faulting, inch	0.03	0.05	0 / 1.11	0.01
2016 HPMS – Faulting, inch	0.03	0.10	0 / 5.32	0
2015 HPMS – Faulting, inch	0.04	0.10	0 / 1.41	0

Source: FHWA

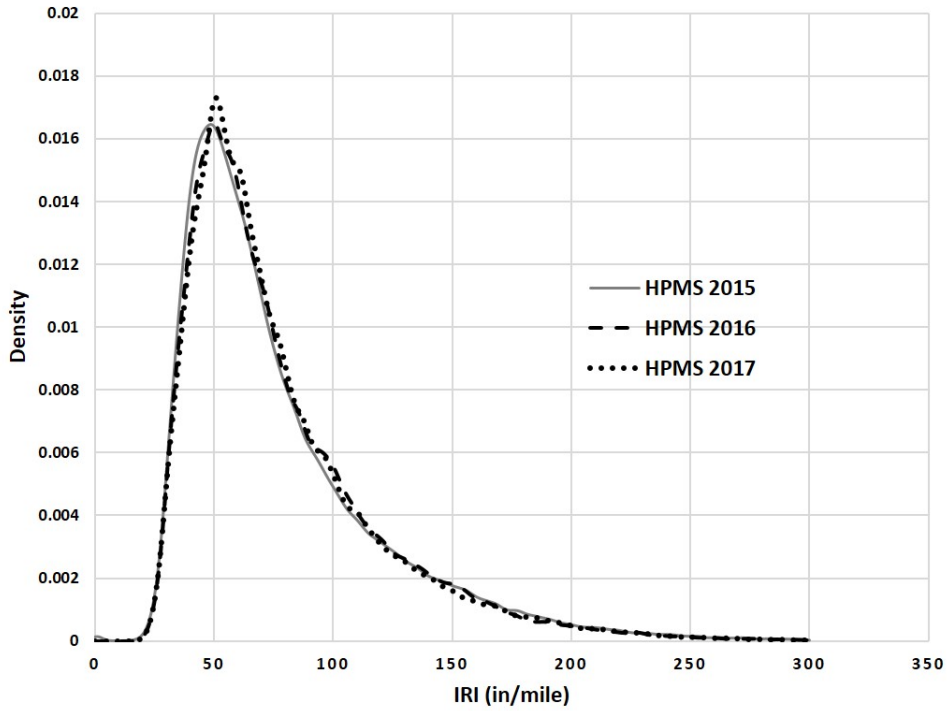

Source: FHWA

**Figure 52. Plot. Density plots of IRI condition metric for 2015, 2016, and 2017 HPMS datasets.**

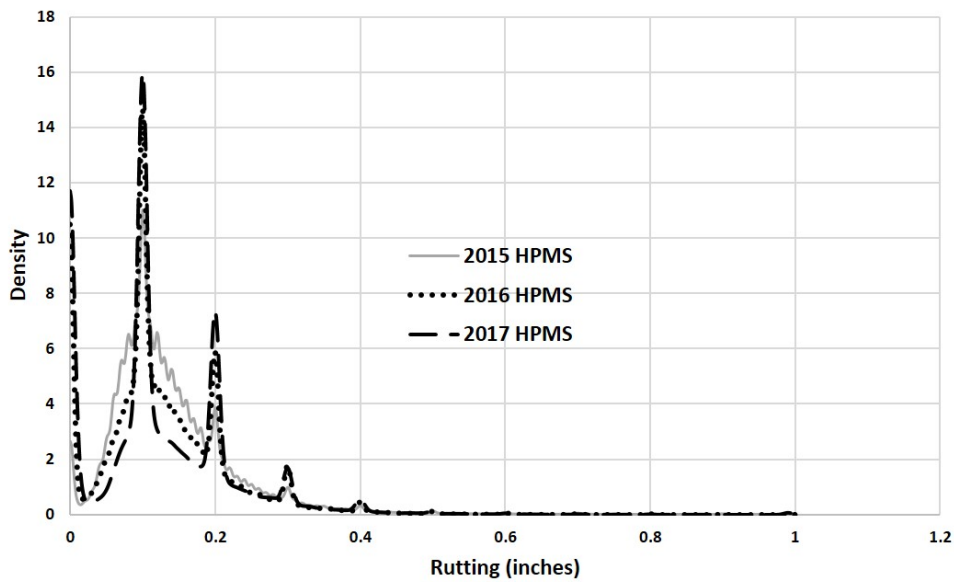

Source: FHWA

**Figure 53. Plot. Density plots of rutting condition metric for 2015, 2016, and 2017 HPMS datasets.**

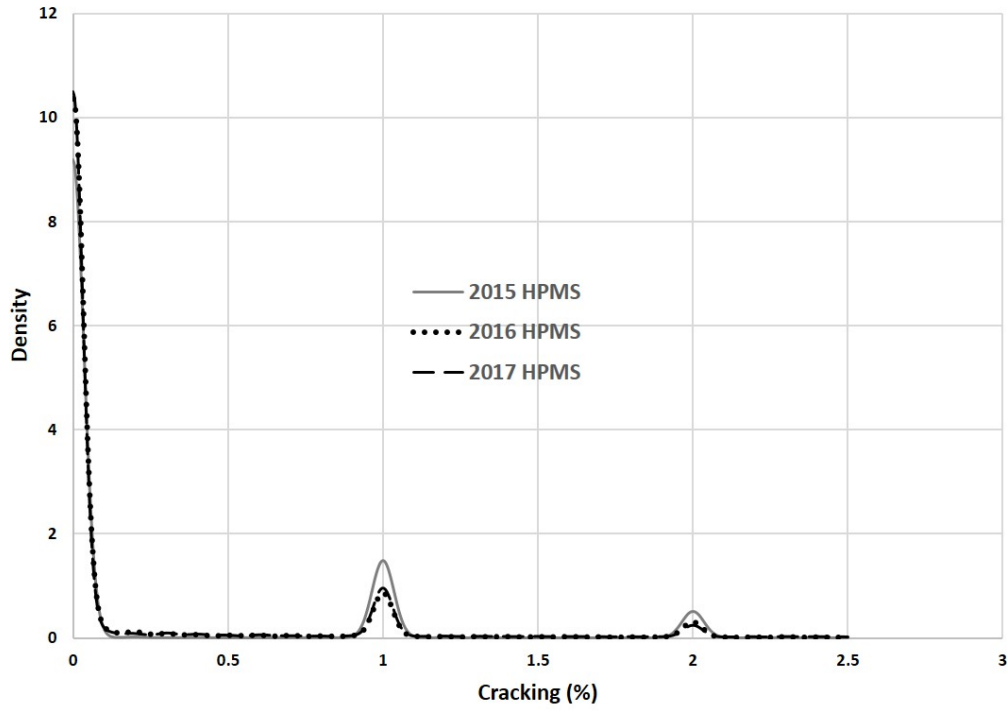

Source: FHWA

**Figure 54. Plot. Density plots of cracking condition metric for 2015, 2016, and 2017 HPMS datasets.**

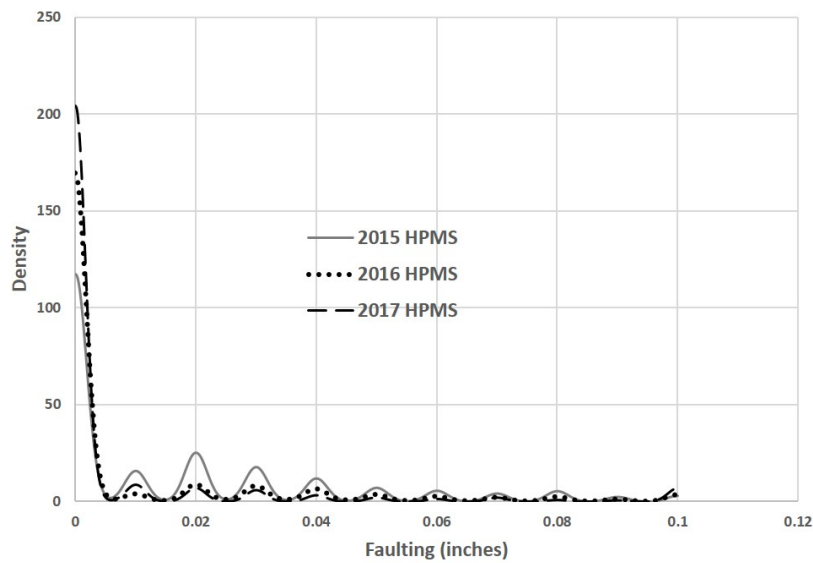

Source: FHWA

**Figure 55. Plot. Density plots of faulting condition metric for 2015, 2016, and 2017 HPMS datasets.**



Table 36, Table 37, Table 38, Table 39, and Table 40 show the percentage of pavement segments in “Good,” “Fair,” and “Poor” condition at the metric and performance measure levels for the three HPMS datasets. These tables show that the 2017 HPMS dataset has the highest percentage of pavement segments in Good condition and the lowest percentage in Poor condition at the performance measure level and for most condition metrics.

**Table 36. Comparison of HPMS datasets based on IRI condition ratings.**

<b>Dataset</b>	<b>% Good IRI</b>	<b>% Fair IRI</b>	<b>% Poor IRI</b>
HPMS - 2017	79.8	17.3	2.8
HPMS - 2016	77.5	19.6	2.9
HPMS - 2015	79.3	18.0	2.7

Source: FHWA

**Table 37. Comparison of HPMS datasets based on rutting condition ratings.**

<b>Dataset</b>	<b>% Good Rutting</b>	<b>% Fair Rutting</b>	<b>% Poor Rutting</b>
HPMS - 2017	80.7	18.0	1.4
HPMS - 2016	78.3	20.4	1.4
HPMS - 2015	75.5	22.4	2.1

Source: FHWA

**Table 38. Comparison of HPMS datasets based on cracking condition ratings.**

<b>Dataset</b>	<b>% Good Cracking</b>	<b>% Fair Cracking</b>	<b>% Poor Cracking</b>
HPMS - 2017	85.0	13.1	2.0
HPMS - 2016	81.4	15.3	3.3
HPMS - 2015	82.1	14.9	3.0

Source: FHWA

**Table 39. Comparison of HPMS datasets based on faulting condition ratings.**

<b>Dataset</b>	<b>% Good Faulting</b>	<b>% Fair Faulting</b>	<b>% Poor Faulting</b>
HPMS - 2017	92.7	4.6	2.7
HPMS - 2016	90.6	4.6	4.8
HPMS - 2015	90.7	3.7	5.6

Source: FHWA

**Table 40. Comparison of HPMS datasets based on overall condition ratings and performance measures.**

<b>Dataset</b>	<b>% Good Overall</b>	<b>% Fair Overall</b>	<b>% Poor Overall</b>
HPMS - 2017	59.9	39.5	0.6
HPMS - 2016	53.9	45.2	1.0
HPMS - 2015	53.6	45.7	0.7

Source: FHWA

***State-Level Analysis***

This section looks at the changes in the HPMS performance measure changes data over time at the State level. The first step involved establishing the performance measures for each State within each of the three HPMS datasets. Next, the changes in the Good and Poor performance measures were determined for each State and HPMS dataset combination. For example, for Alabama, the change in Good condition from 2015 to 2016 was calculated by subtracting the percentage of the network in Good condition in 2015 from the percentage of the network in Good condition in 2016. This showed a positive change in percent of network in Good condition reflects an improvement in overall condition for the State. The same approach was used to determine the change in Good and Poor condition from 2016 and 2017. The histogram of changes in Good and Poor condition are shown in Figure 56, Figure 57, Figure 58, and Figure 59. In terms of Good, the range of the change is divided into four groups: less than -10 percent, between -10 percent to 0 percent, between 0 percent and 10 percent, and greater than 10 percent. In terms of zero change in the percentage Poor condition from 2015 to 2016, four States were observed which had zero percentage in the Poor area in both 2015 and 2016. Likewise, one state was observed with zero change in the percentage Poor condition from 2016 to 2017. Similarly, this State had zero percentage in the Poor area in both 2016 and 2017.

As shown in Figure 56, about 52 percent of the States had an increase (i.e., an improvement) in the percentage of pavement segments in Good condition between 2015 and 2016. Similarly, Figure 58 shows that 59 percent of the States had an increase in the percentage of pavement segments in Good condition between 2016 and 2017. The trends in the performance measures were reviewed further, and States like Arkansas and the District of Columbia were identified as showing improvements in the percentage of pavement segments in Good condition for the three years in question, while States like Illinois and Louisiana were identified as showing worsening conditions—decreasing percentage of pavement segments in Good condition—over the same three-year period. From 2016 to 2017 there was a reduction (i.e., an improvement) in the percentage of pavement segments in Poor condition for over 45 percent of States.

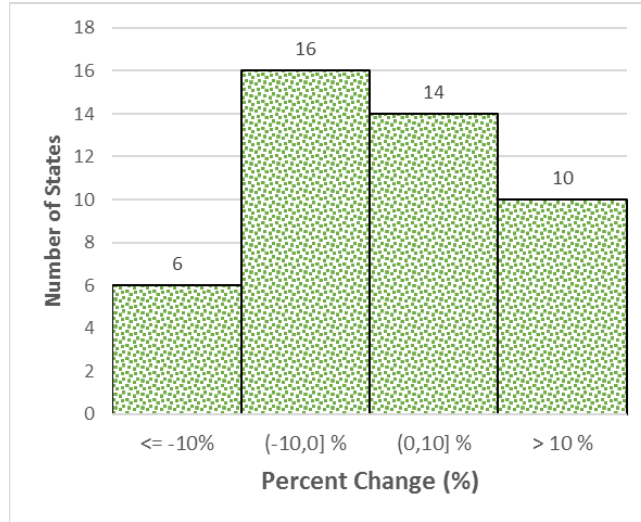

Source: FHWA

**Figure 56. Chart. Histogram of percent changes in Good condition from 2015 to 2016.**

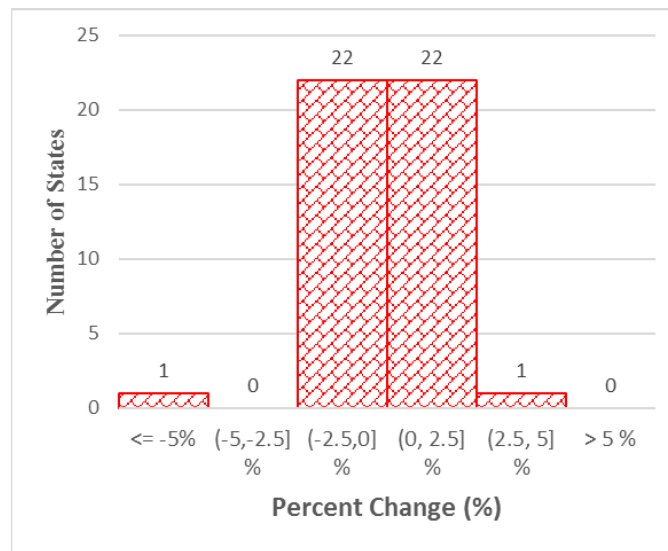

Source: FHWA

**Figure 57. Chart. Histogram of percent changes in Poor condition from 2015 to 2016.**

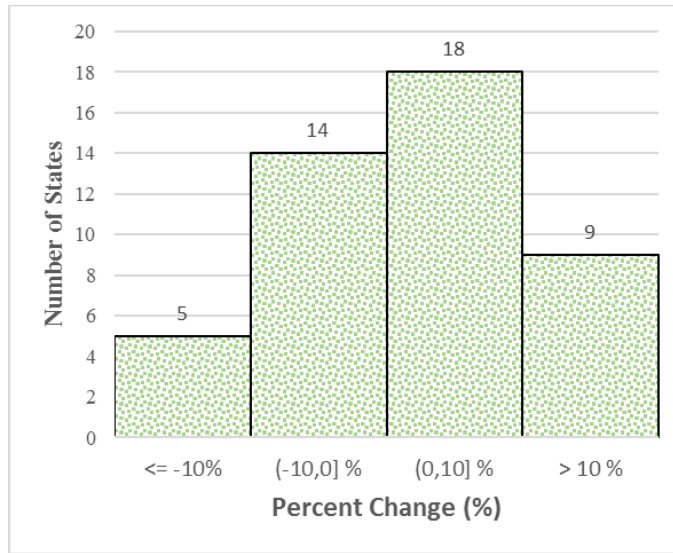

Source: FHWA

**Figure 58. Chart. Histogram of percent changes in Good condition from 2016 to 2017.**

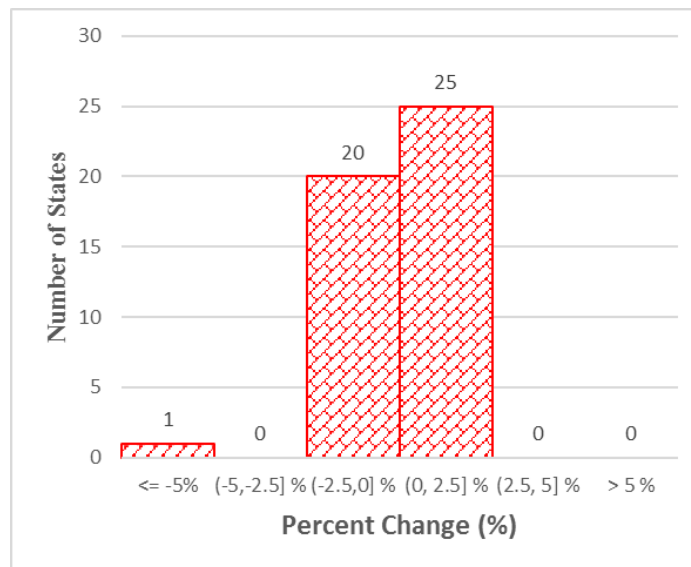

Source: FHWA

**Figure 59. Chart. Histogram of percent changes in Poor condition from 2016 to 2017.**

***Comparison at the Segment Level***

This section presents the results of the temporal analysis performed at the route level. For this analysis, common pavement segments in the three HPMS datasets were identified, and the condition metrics, overall condition ratings, and performance measures for those segments were compared. The total mileage associated with those common pavement segments is 4,908 miles. Table 41, Table 42, Table 43, and Table 44 provide the results of the summary statistics for each

condition metric in 2015, 2016, and 2017. A comparison of the summary statistics shows that the average and median values for the four condition metrics have had little to no change over the three-year period. However, changes are observed in the standard deviation and in the range of the condition metrics. For example, as shown in Table 41, the variability associated with the IRI value in 2017 is higher than that in 2015 or 2016.

**Table 41. IRI statistics for 2017, 2016, and 2015 HPMS datasets based on the common segments.**

Element	Mean	Standard Deviation	Min/Max	Median
2017 HPMS – IRI, inch/mile	73	44	1 / > 300	60
2016 HPMS – IRI, inch/mile	72	39	19 / > 300	60
2015 HPMS – IRI, inch/mile	72	38	19 / > 300	60

Source: FHWA

**Table 42. Rutting statistics for 2017, 2016, and 2015 HPMS datasets based on the common segments.**

Element	Mean	Standard Deviation	Min/Max	Median
2017 HPMS – Rutting, inch	0.14	0.08	0 / 0.90	0.12
2016 HPMS – Rutting, inch	0.14	0.09	0 / 1.70	0.12
2015 HPMS – Rutting, inch	0.14	0.08	0 / 1.45	0.1

Source: FHWA

**Table 43. Percent cracking statistics for 2017, 2016, and 2015 HPMS datasets based on the common segments.**

Element	Mean	Standard Deviation	Min/Max	Median
2017 HPMS – Percent Cracking, %	3	8	0 / 100.0	0
2016 HPMS – Percent Cracking, %	3	7.6	0 / 100.0	0.1
2015 HPMS – Percent Cracking, %	3.3	9.2	0 / 100.0	0

Source: FHWA

**Table 44. Faulting statistics for 2017, 2016, and 2015 HPMS datasets based on the common segments.**

Element	Mean	Standard Deviation	Min/Max	Median
2017 HPMS – Faulting, inch	0.01	0.04	0 / 0.69	0
2016 HPMS – Faulting, inch	0.02	0.07	0 / 0.97	0
2015 HPMS – Faulting, inch	0.01	0.04	0 / 0.69	0

Source: FHWA

The changes in the performance measures for the common set of HPMS pavement segments from 2015 to 2017 are presented in Table 45, Table 46, Table 47, and Table 48. The most significant change is associated with the percentage of pavement segments in Good faulting condition, which dropped by around 6 percent from 2015 to 2016 and then increased by around 6 percent from 2016 to 2017. Similarly, the percentage of common pavement segments with a Poor faulting rating changed from 2.5 percent in 2015 to 5.3 percent in 2016 and then to 1.9 percent in 2017. Overall, these tables show that the common pavement segments are in similar or better condition in 2017 than they were in 2015 and 2016. This can also be observed in the performance measure plots for the common pavement segments shown in Table 49.

**Table 45. Comparison of HPMS IRI condition ratings over time based on common segments.**

<b>Dataset</b>	<b>% Good IRI</b>	<b>% Fair IRI</b>	<b>% Poor IRI</b>
HPMS - 2017	83.2	14.6	2.1
HPMS - 2016	83.7	14.4	1.9
HPMS - 2015	83.4	14.8	1.8

Source: FHWA

**Table 46. Comparison of HPMS rutting condition ratings over time based on common segments.**

<b>Dataset</b>	<b>% Good Rutting</b>	<b>% Fair Rutting</b>	<b>% Poor Rutting</b>
HPMS - 2017	77.3	21.4	1.3
HPMS - 2016	76.2	22.2	1.6
HPMS - 2015	75.1	24.0	0.9

Source: FHWA

**Table 47. Comparison of HPMS cracking condition ratings over time based on common segments.**

<b>Dataset</b>	<b>% Good Cracking</b>	<b>% Fair Cracking</b>	<b>% Poor Cracking</b>
HPMS - 2017	84.4	13.6	2.1
HPMS - 2016	83.9	13.7	2.4
HPMS - 2015	83.0	13.4	3.6

Source: FHWA

**Table 48. Comparison of HPMS faulting condition ratings over time based on common segments.**

Dataset	% Good Faulting	% Fair Faulting	% Poor Faulting
HPMS - 2017	96.0	2.0	1.9
HPMS - 2016	90.6	4.1	5.3
HPMS - 2015	96.4	1.0	2.5

Source: FHWA

**Table 49. Comparison HPMS overall condition ratings and performance measures over time for common segments.**

Dataset	% Good Overall	% Fair Overall	% Poor Overall
HPMS - 2017	57.4	42.2	0.4
HPMS - 2016	57.2	41.8	1.0
HPMS - 2015	57.1	42.4	0.5

Source: FHWA

## IMPACT OF STRATIFICATION FACTORS ON PAVEMENT CONDITION DATA

In this section, the impacts of different stratification factors on the pavement condition metrics are explored using the 2017 HPMS dataset. These factors include climate, terrain, urban/rural, and average annual daily traffic (AADT). As noted in a prior chapter the contiguous US is divided into four climate zones: wet freeze, wet no-freeze, dry freeze, and dry no-freeze. Three terrain categories are defined within the HPMS dataset including level, rolling, and mountainous. In terms of the urban/rural stratification, a pavement segment with an urban code in the HPMS dataset of 99999 or 99998 is considered rural; otherwise, the segment is classified as urban.

Table 50, Table 51, and Table 52 summarize the average pavement condition metrics for each category within the referenced stratification factors. As shown in these three tables, those pavement segments in the dry freeze region have the lowest average IRI value and the largest rutting compared to the other climate regions. The wet freeze region has the highest average percent cracking. The mountainous terrain has the largest average IRI value and the lowest percent cracking among the three terrain categories, although the differences in average values by terrain are generally small. The IRI in rural areas is lower than in urban areas.

**Table 50. Pavement condition metrics as a function of climate zone.**

Climate Zone	IRI (in/mile)	Rutting (in)	Cracking (%)	Faulting (in)
Wet Freeze	82.1	0.13	4.2	0.02
Wet-Non-Freeze	74.5	0.14	1.9	0.04
Dry-Freeze	73.1	0.16	3.8	0.03
Dry-Non-Freeze	77.8	0.13	1.8	0.03

Source: FHWA

**Table 51. Pavement condition metrics as a function of terrain.**

Terrain	IRI (in/mile)	Rutting (in)	Cracking (%)	Faulting (in)
Level	74.2	0.15	3.2	0.03
Rolling	73.7	0.16	2.6	0.02
Mountainous	75.6	0.16	2.4	0.03

Source: FHWA

**Table 52. Pavement condition metrics as a function of urban vs. rural locations.**

Urban/Rural	IRI (in/mile)	Rutting (in)	Cracking (%)	Faulting (in)
Rural	71.6	0.14	3.3	0.02
Urban	89.2	0.13	3.4	0.03

Source: FHWA

The performance measures for the different categories within the three stratification factors is provided in Table 53, Table 54, and Table 55. These tables also provide the mileage for each category-factor combination. Approximately 25,751 miles of the 2017 HPMS dataset do not have terrain information associated with them. The performance measure results presented in Table 53 through Table 55 show that:

- The lowest percentage of pavement segments in Good condition is in the dry freeze zone, which also contains the largest percentage of segments in Poor condition.
- The level terrain has the largest percentage of segments in Good condition, while the mountainous terrain has the largest percentage of segments in Poor condition.
- Rural areas have a larger percentage of segments in Good condition and a smaller percentage of segments in Poor condition as compared to the urban areas.

**Table 53. Performance measures for each climate zone.**

Climate Zone	Mileage	Good (%)	Fair (%)	Poor (%)
Wet Freeze	19,509	60.7	38.7	0.6
Wet-Non-Freeze	13,331	61.2	38.4	0.4
Dry-Freeze	7,369	55.0	44.1	0.9
Dry-Non-Freeze	2,472	61.0	38.6	0.4

Source: FHWA

**Table 54. Performance measures for each terrain.**

Terrain	Mileage	Good (%)	Fair (%)	Poor (%)
Level	8,752	58.6	40.8	0.6
Rolling	6,909	56.9	42.4	0.7
Mountainous	1,268	58.3	40.8	0.9

Source: FHWA



**Table 55. Performance measures for urban and rural zones.**

Urban/Rural	Mileage	Good (%)	Fair (%)	Poor (%)
Rural	28,547	61.9	37.5	0.6
Urban	14,134	56.0	43.2	0.8

Source: FHWA

**Effect of Stratification Factors on Performance Measures**

A regression analysis was performed to determine whether the stratification factors in question have an impact on the performance measures, and if so, to determine the extent of that impact. Regression analysis allows for quantification of the effect of the different stratification factors simultaneously, i.e., the effect of each of the factors holding everything else fixed.

The overall condition rating of a pavement segment is a nominal dependent variable with three possible categories: Good, Fair, and Poor. Hence, a multinomial logistic regression can be used to quantify the effect on factors such as climate zone, terrain, and urban/rural on the condition rating. In this type of regression, the dependent variable is defined as the relative probability of being in one category versus being in another (a reference category). As such, the analysis involves choosing a reference category with which the results will be compared. In this case, the Poor condition rating was used as the reference category. As shown in Figure 60 and Figure 61, the multinomial regression yields two models for estimating the relative probability of being in Good condition instead of being in Poor condition, and being in Fair condition instead of being in Poor condition. In addition, the models provide information about the relative importance of the stratification variables, as defined by the magnitude of the regression coefficients. The independent variables are categorical variables such that the value of each is either 0 or 1, e.g., for a section in the wet non-freeze climate zone, the value for the independent variable for the other climate zones would be 0 while that for wet non-freeze would be 1.

$$\ln\left(\frac{\pi_{Good}}{\pi_{Poor}}\right) = -2.10 + 1.40 \log_{10}(AADT) - 0.58 (wet\ non\ freeze) - 0.31 (dry\ freeze) \\ + 0.14(dry\ no\ freeze) + 0.95 (rural) \\ - 0.11(rolling) - 0.15 (mountainous)$$

**Figure 60. Equation. Results of multinomial logistic regression.**

Source: FHWA

$$\ln\left(\frac{\pi_{Fair}}{\pi_{Poor}}\right) = 0.65 + 0.78 \log_{10}(AADT) - 0.26(wet\ no\ freeze) - 0.21(dry\ freeze) \\ + 0.22(dry\ no\ freeze) + 0.40 (rural) - 0.06(rolling) - 0.15 (mountainous)$$

**Figure 61. Equation. Results of multinomial logistic regression.**

Source: FHWA

The following observations were developed on the basis of the resulting models:

- Figure 60 and Figure 61 show the relationship between the pavement condition level and the chosen stratification factors. The relative strength of each factor is indicated by its regression coefficient. These two models show that the AADT is a strong predictor. If the AADT increases by a factor of 10, the relative probability for a random segment to be in the Good category relative to the Poor and the probability of that segment to be in Fair category relative to the Poor increase by 4.1 and 2.2, respectively.
- Based on further analysis, the probability for a pavement segment being in Fair condition is higher than the probability of it being in Good condition if the AADT values are smaller than 30,000. However, for higher AADT values, the probability of being in Good condition for that pavement segment increases. For example, the probability ratio between Good and Poor categories for a pavement segment in the wet freeze climate, urban area, level terrain type, and an AADT of 10,000 vehicles is 33.1; i.e., a pavement with those conditions is 33.1 times as likely to be in the Good category as in the Poor category. Based on Figure 61, the probability ratio of being in Fair condition versus Poor condition for the same pavement segment as above is 43.4. This indicates that the expected probabilities will be 1 percent of being in the Poor category, 56 percent of being in the Fair category, and 43 percent of being in the Good category. As another example, the expected probabilities for the same pavement segment but an AADT of 100,000 vehicles are 0.5 percent of being in the Poor category, 42.5 percent of being in the Fair category and 60 percent of being in the Good category. More simply, the higher the traffic level of the pavement, the higher the probability of the segment being in Good condition. This increase in probability may be counterintuitive but may be explained by an increased likelihood of stronger pavement sections and more frequent M&R on these more heavily trafficked sections.
- The relative probability for a random segment to be in the Good category relative to the Poor category decreases by 1.60 if the segment is in the wet non-freeze zone as opposed to the wet freeze climate zone.
- The relative probability for a random segment to be in the Good category relative to the Poor category decreases by 1.17 if the segment is in the wet non-freeze climate zone as opposed to the wet freeze zone.
- The relative probability for a random segment to be in the Good category relative to Poor category increases by 2.48 if the segment is in an urban area as opposed to a rural area.
- The relative probability for a random segment to be in the Fair category relative to the Poor category increases by 1.43 if the segment is in an urban area as opposed to a rural area.

## Effect of Stratification Factors on Condition Metrics

For each pavement condition metric, a stepwise linear regression was performed using the metric as the dependent variable and the stratification factors as the independent variables. Stepwise regression analysis fits a model by selecting the subset of best variables in terms of best explanatory power. In addition to the earlier referenced stratification factors, the State identifier was also used as one set of explanatory variables. The inclusion of a State identifier in the model provides an indication of how much the condition metrics vary between States. The data used in the regression was cleaned to include only those pavement segments with no missing data in any of the variables which resulted in 45 States in the regression analysis.

The results of the regression analyses are shown in Table 56. The regression coefficients shown in this table represents the mean change in the dependent variable associated with one unit change in an independent variable holding all other independent variables constant. The p-value for each variable tests the null hypothesis that the coefficient is equal to zero (i.e. there is no effect from that term). A variable with a low p-value is likely to have a statistically significant effect on the condition metric of interest. For example, a pavement with an AADT of 10,000 located on level terrain in a rural area in Colorado has an average IRI value of 99 in/mile. The IRI for a pavement segment with the same AADT located on level terrain in a rural area in Florida is expected to have a value of 55 in/mile. These results show a relationship between condition metrics and State. For some of the States, this relationship is positive while for the others it is negative. The strength of the effect of each State is indicated by the value of the regression coefficient or the p-value results. The results also show that in terms of IRI, rutting, and percent cracking, AADT, urban/rural, terrain level, and State identifiers are the best explanatory variables. To predict percent cracking, all these variables except urban/rural variable have been selected as the best explanatory variables. Those States with no faulting data are shown with a blank cell in the table.

**Table 56. Results of stepwise regression analysis for IRI, rutting, cracking, and faulting.**

Independent Variables	IRI, in/mile	p-Value	Rutting, inches	p-Value	Percent Cracking, %	p-Value	Faulting, inches	p-Value
Intercept	97.3	< 0.0001	0.022	< 0.0001	8.4	< 0.0001	-0.006	0.242
Log10(AADT)	-5.8	< 0.0001	0.029	< 0.0001	-0.8	< 0.0001	-0.005	< 0.0001
Rural	-11.5	< 0.0001	0.006	< 0.0001			-0.002	< 0.0001
Rolling Terrain	-1.8	< 0.0001	-0.004	< 0.0001	-0.5	< 0.0001	0.0005	0.149
Mountainous	-3.3	< 0.0001	-0.008	< 0.0001	-0.4	< 0.0001	-0.005	< 0.0001
Alaska	34.8	< 0.0001	0.134	< 0.0001	4.1	< 0.0001		
Arkansas	15	< 0.0001	-0.031	< 0.0001	-3.9	< 0.0001	0.024	< 0.0001
Colorado	36.5	< 0.0001	0.007	< 0.0001	-2.7	< 0.0001	-0.005	0.242
Connecticut	22.4	< 0.0001	-0.10	0.082	-2.1	< 0.0001		
District of Columbia	134.6	< 0.0001	-0.167	< 0.0001	1.2	0.033	-0.022	< 0.0001
Florida	-7.4	< 0.0001	-0.032	< 0.0001	-2.9	< 0.0001		
Georgia	15.5	< 0.0001	-0.012	< 0.0001	-3.6	< 0.0001	0.059	< 0.0001
Hawaii	69.2	< 0.0001	-0.04	< 0.0001	-2.6	< 0.0001	0.038	< 0.0001
Idaho	7.7	< 0.0001	0.002	0.088	-4.1	< 0.0001	0.009	0.026
Illinois	9.3	< 0.0001	-0.05	< 0.0001	-0.8	< 0.0001	-0.017	0.0001

Independent Variables	IRI, in/mile	p-Value	Rutting, inches	p-Value	Percent Cracking, %	p-Value	Faulting, inches	p-Value
Indiana	15.2	< 0.0001	-0.067	< 0.0001	-4.2	< 0.0001	-0.007	0.101
Iowa	16.2	< 0.0001	-0.008	0.042	-1.5	< 0.0001	-0.005	0.222
Kansas	5.1	< 0.0001	-0.055	< 0.0001	-0.3	0.107	0.007	0.115
Kentucky	3.7	< 0.0001	-0.062	< 0.0001	-0.6	< 0.0001	-0.013	0.002
Louisiana	32.8	< 0.0001	0.107	< 0.0001	-3.7	< 0.0001	0.038	< 0.0001
Maine	7.4	< 0.0001	0.135	< 0.0001	-4.4	< 0.0001		
Maryland	16.9	< 0.0001	0.015	< 0.0001	-3.3	< 0.0001		
Massachusetts	21	< 0.0001	-0.001	0.713	-1.7	< 0.0001		
Michigan	16.1	< 0.0001	-0.053	< 0.0001	2.6	< 0.0001	0.062	< 0.0001
Minnesota	13.5	< 0.0001	0.016	< 0.0001	-3.5	< 0.0001	0.007	0.119
Mississippi	5.4	< 0.0001	-0.052	< 0.0001	-2.4	< 0.0001	-0.014	0.001
Missouri	4.7	< 0.0001	-0.039	< 0.0001	-2	< 0.0001	-0.016	< 0.0001
Montana	3.5	< 0.0001	0.031	< 0.0001	-3.6	< 0.0001		
Nevada	-11.4	< 0.0001	-0.063	< 0.0001	-4.6	< 0.0001	-0.016	< 0.0001
New Hampshire	-9.6	< 0.0001	0.046	< 0.0001	-0.4	0.068	0.036	< 0.0001
New Jersey	23.7	< 0.0001	-0.051	< 0.0001	-0.8	0.0002	0.039	0.071
New Mexico	-0.9	0.162	-0.013	< 0.0001	-1.1	< 0.0001	0.009	0.128
New York	13.7	< 0.0001	-0.013	< 0.0001	-1.9	< 0.0001	0.007	0.003
North Carolina	11	< 0.0001	0.003	0.136	-3.7	< 0.0001	0.013	0.045
North Dakota	0.4	0.634	-0.028	< 0.0001	-5.1	< 0.0001	0.009	< 0.0001
Ohio	14.1	< 0.0001	-0.03	< 0.0001	-3.4	< 0.0001	0.045	0.029
Oklahoma	7.5	< 0.0001	-0.041	< 0.0001	-2.8	< 0.0001	0.01	0.361
Pennsylvania	17.9	< 0.0001	-0.022	< 0.0001	-3.7	< 0.0001	-0.004	< 0.0001
Rhode Island	-2.4	0.424	-0.054	< 0.0001	-1.5	0.010		
South Dakota	12.6	< 0.0001	0.012	< 0.0001	-3.7	< 0.0001	0.008	0.046
Tennessee	-2.2	0.025	-0.041	< 0.0001	-0.1	0.792	0.041	< 0.0001
Texas	7.6	< 0.0001	0.01	< 0.0001	-4.6	< 0.0001	0.014	0.010
Utah	5.4	< 0.0001	0.007	< 0.0001	-2.5	< 0.0001	-0.013	0.001
Vermont	-3	0.001	0.12	< 0.0001	-2.9	< 0.0001		
Virginia	15.3	< 0.0001	-0.001	0.488	-2.5	< 0.0001	0.104	< 0.0001
Washington	27.5	< 0.0001	0.107	< 0.0001	-1.4	< 0.0001	0.034	< 0.0001
West Virginia	14.1	< 0.0001	-0.009	< 0.0001	-3	< 0.0001	-0.007	0.308
Wisconsin	25.6	< 0.0001	-0.077	< 0.0001	-3	< 0.0001	-0.006	0.189
Wyoming	8.6	< 0.0001	0.031	< 0.0001	-2.2	< 0.0001	0.019	< 0.0001

Source: FHWA

## COMPARISON OF PROJECT AND HPMS PAVEMENT CONDITION DATA

In this section, the 2017 HPMS data are compared to those collected as part of IS1 and IS2 to determine if there are significant biases between the datasets. It should be noted that 2018 HPMS data were not available until autumn of 2019 and so were not available for these analyses. Also, as indicated earlier in this chapter, data from Arizona, California, Delaware, Oregon, and South Carolina were missing from the 2017 HPMS dataset, and hence those States were not included in the comparisons. The analysis results presented in this section address the comparisons of condition metrics and performance measures for the three referenced datasets at both the network and State levels.

## Network-Level Comparisons

Table 57, Table 58, Table 59, and Table 60 present summary statistics for each condition metric for the 2017 HPMS, IS1, and IS2 datasets. As shown in Table 57, the mean, median, and standard deviation of the IRI values are larger for the HPMS than those for the IS1 and IS2 datasets. On the other hand, the rutting results presented in Table 58 are similar for the three datasets. Minor differences were observed between the values for percent cracking and faulting, as shown in Table 59 and Table 60, but these differences are small enough to be considered unimportant.

**Table 57. IRI statistics for the IS1, IS2, and 2017 HPMS datasets.**

Element	Mean	Standard Deviation	Min/Max	Median
IS2 – IRI (in/mile)	67	35	19 / > 300	59
IS1 – IRI (in/mile)	69	35	20 / > 300	60
2017 HPMS – IRI (in/mile)	78	44	1 / > 300	65

Source: FHWA

**Table 58. Rutting statistics for the IS1, IS2, and 2017 HPMS datasets.**

Element	Mean	Standard Deviation	Min/Max	Median
IS2 – Rutting (in)	0.15	0.09	0.03 / 0.89	0.13
IS1 – Rutting (in)	0.15	0.10	0.03 / 1.54	0.13
2017 HPMS – Rutting (in)	0.14	0.08	0 / 1.50	0.12

Source: FHWA

**Table 59. Cracking statistics for the IS1, IS2, and 2017 HPMS datasets.**

Element	Mean	Standard Deviation	Min/Max	Median
IS2 – Cracking (%)	3.4	6.6	0 / 73.0	0.6
IS1 – Cracking (%)	3.1	9.8	0 / 100.0	0
2017 HPMS – Cracking (%)	3.3	10.2	0 / 100.0	0

Source: FHWA

**Table 60. Faulting statistics for the IS1, IS2, and 2017 HPMS datasets.**

Element	Mean	Standard Deviation	Min/Max	Median
IS2 – Faulting (in)	0.04	0.03	0 / 0.55	0.03
IS1 – Faulting (in)	0.04	0.04	0 / 0.67	0.03
2017 HPMS Faulting (in)	0.03	0.05	0 / 1.11	0

Source: FHWA

Table 61 shows the metric condition ratings for the three datasets. As shown, the 2017 HPMS dataset has a lower percentage of pavement segments in Good IRI and faulting condition, but a higher percentage of segments in Good rutting and percent cracking condition as compared to the

IS2 dataset. Similarly, the IS1 dataset has a larger percentage of pavement segments in Good cracking and faulting condition as compared to the 2017 HPMS and IS2 datasets.

Table 62 presents the comparison of the performance measures for the three datasets in question. The comparison shows that the percentage of pavement segments in Good condition differs by 1.8 percent between the 2017 HPMS and IS2 datasets and by 3.2 percent between the 2017 HPMS and IS1 datasets. These differences are consistent with the differences observed in the condition metrics for the three datasets.

**Table 61. Comparison of IS1, IS2, and 2017 HPMS metric ratings.**

Percentage of Data Collection Network	% Good	% Fair	% Poor
IRI-IS2	85.5	13.0	1.5
IRI-IS1	83.5	14.9	1.7
IRI-HPMS	78.8	18.1	3.1
Rutting-IS2	76.6	20.9	2.5
Rutting-IS1	78.1	18.9	3.0
Rutting-HPMS	80.5	18.1	1.5
Cracking-IS2	81.5	14.7	3.9
Cracking-IS1	86.9	5.7	7.4
Cracking-HPMS	84.6	13.0	2.4
Faulting-IS2	95.2	2.8	2.1
Faulting-IS1	93.1	4.5	2.4
Faulting-HPMS	92.5	4.9	2.6

Source: FHWA

**Table 62. Comparison of IS1, IS2, and 2017 HPMS overall condition ratings and performance measures.**

Percentage of Data Collection Network	% Good	% Fair	% Poor
Overall-IS2	61.8	37.6	0.6
Overall-IS1	63.1	36.2	0.7
Overall-HPMS	59.9	39.5	0.6

Source: FHWA

### State-Level Comparisons

Although the network-level comparison of the performance measures did not show significant differences between the IS2 and HPMS 2017 datasets, a State-level comparison showed that the performance measures matched well for some States between the 2017 HPMS and IS2 datasets, but not for other States. Table 63 provides examples of two States with lower differences in performance measures between the 2017 HPMS and IS2 datasets (Florida and Kansas) and two States with larger differences in performance measures (Texas and Louisiana).

**Table 63. Examples of IS2 and 2017 HPMS overall condition rating and performance measure comparisons at State level.**

Percentage of Data Collection Network	% Good	% Fair	% Poor
TX-HPMS	67.9	32.0	0.1
TX-IS2	49.5	50.4	0.1
LA-HPMS	13.3	85.0	1.7
LA-IS2	56.9	40.4	2.7
FL-HPMS	65.5	34.5	0.0
FL-IS2	58.8	40.6	0.6
KS-HPMS	66.8	33.1	0.1
KS-IS2	74.5	25.5	0.0

Source: FHWA

In light of the State-level findings, the CLES statistic referenced earlier in this chapter was used to compare the differences between the condition metric distributions for the 2017 HPMS and the IS2 datasets by State (the IS1 dataset was not included in the comparisons). Figure 62, Figure 63, Figure 64, and Figure 65 show the histograms of the calculated CLES values. As shown, the CLES values are presented in terms of three ranges which represent levels of differences. For each condition metric, the States falling in the range of a large CLES value for each condition metric have been identified. For example, Texas shows large differences between the two datasets for the rutting and percent cracking metrics, while Louisiana shows large differences for the rutting and faulting metrics. Florida, on the other hand, shows a large difference for only one condition metric (rutting), while Kansas does not show a significant difference in any of the four condition metrics. It appears that large differences in two or more condition metrics cause a significant difference in the performance measures for a given State while variability in only one condition metric has little to no impact on the performance measures.

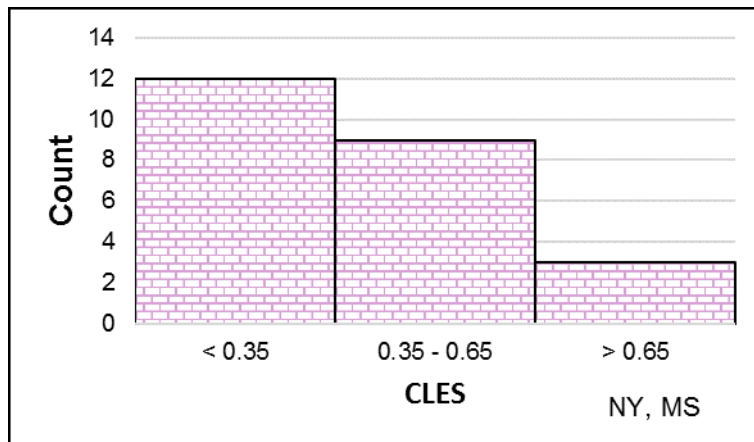

Source: FHWA

**Figure 62. Chart. CLES results for IS2 and HPMS IRI condition metric.**

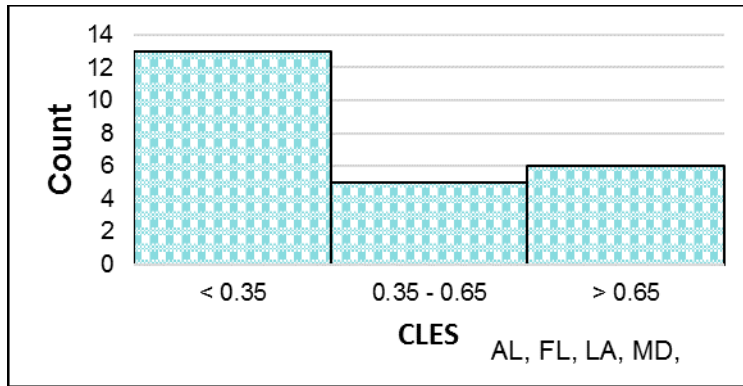

Source: FHWA

**Figure 63. Chart. CLES results for IS2 and HPMS rutting condition metric.**

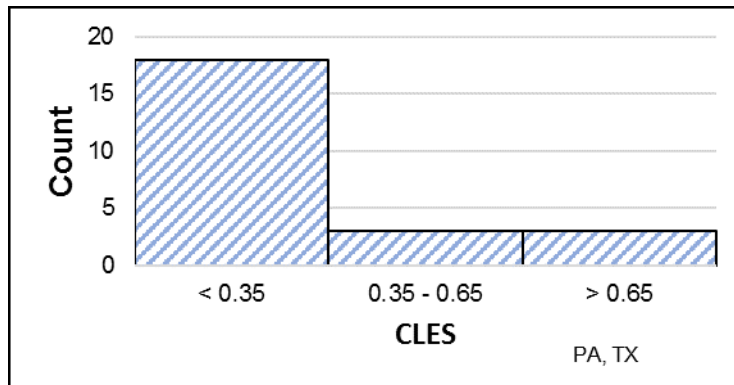

Source: FHWA

**Figure 64. Chart. CLES results for IS2 and HPMS cracking condition metric.**

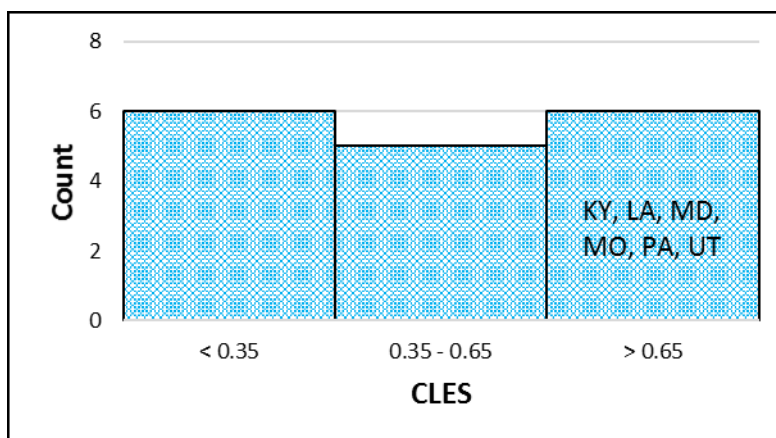

Source: FHWA

**Figure 65. Chart. CLES results for IS2 and HPMS faulting condition metric.**



## OTHER COMPARISONS OF PROJECT PAVEMENT CONDITION DATA

### Comparison to LTPP Program Data

A portion of the project data collection route was selected to pass through 20 LTPP test sections—2 asphalt pavement and 18 jointed concrete pavement test sections—on I-10 in Arizona. Ten sets of repeat pavement condition measurements were collected at each of the 20 LTPP test sections to:

- Assess if the repeatability of the project-collected data was within the project DQMP acceptance criteria.
- Compare project-collected data to data collected as part of the LTPP program on test sections located on the same portions of the IHS network. The comparison was limited to the pavement condition metrics defined in the 2016 HPMS Field Manual.

To assess the repeatability of the project data, summary statistics were computed for each of the four condition metrics. The statistics included the mean, standard deviation, and COV for each metric based on the 10 repeat measurements. The results of the repeatability analyses were compared against the project DQMP acceptance criteria and summarized below for each condition metric:

- The DQMP acceptance criterion for IRI repeatability is  $\pm 5$  percent. The repeatability measurements met this criterion at 12 of the 20 test sections. Seven of the remaining eight sections had a COV higher than the 4 percent but less than 10 percent. The fourth section had a COV of 23 percent, but this COV was similar to that observed by prior LTPP data collection efforts. Further review of other LTPP records illustrates high severity longitudinal cracking near the wheelpath on this section. This cracking would make it difficult to obtain repeatable IRI values for this section.
- The DQMP rutting repeatability criterion for the project states that repeated measurements be within  $\pm 0.08$  inches of the mean with a 90 percent confidence level. For the two asphalt pavement test sections, 90 percent of the observed differences between the measured values and their mean were between -0.0140 inches and 0.0125 inches for one section and between 0.07 inches and 0.037 inches for the second section. The repeatability measurements for both test sections met the DQMP criterion.
- The DQMP criterion for repeatability of percent cracking on asphalt pavement states that repeated values fall within  $\pm 30$  percent of the section mean with a 90 percent confidence level if the section mean is greater than 5 percent cracking, or that the standard deviation of each test section be less than 1.5 percent if the section mean is less than 5 percent cracking. The mean percent cracking for the two asphalt pavement test sections was less than 5 percent and the standard deviation of the repeat measurements was less than 1.5 percent; the measurements for both test sections met the DQMP criterion.
- The DQMP criterion for repeatability of percent cracking on jointed concrete pavement states that repeated values fall within  $\pm 15$  percent of the section mean with a 90 percent

confidence level if the section mean is greater than 5 percent cracking, or that the standard deviation of each section be less than 1.5 percent if the section mean is less than 5 percent cracking. The repeatability measurements at the 18 jointed concrete pavement test sections met the criterion.

- The DQMP faulting criterion for repeatability states that the standard deviation of the repeat measurements for a joint does not exceed 15 percent of the mean value if the mean value is greater than 0.1 inches or that it does not exceed 0.03 inches if the mean faulting value is lower than 0.1 inches. The collected data provided were accumulated to 0.01-mile segments. Based on approximately 33 joints within each test section, the faulting criterion for a section is a maximum value of COV of 0.15 percent for a mean faulting value greater than 0.1 inch. Where the faulting is less than 0.1 inch, the standard deviation should be less than 0.006 inch. Three test sections did not meet these criteria: 040213, 040217, and 040265. As noted above, section 040213 exhibited some high severity longitudinal cracking within the vicinity of the wheelpath which would affect the collection of both the IRI and faulting data.

Next, the quality of the project-collected pavement condition data was assessed by comparing these data to the most recent LTPP data. For the rutting, cracking, and faulting condition metrics, the most recent LTPP data were collected in 2016. For the IRI condition metric, the latest LTPP data were collected in 2018; however, both the 2016 and 2018 LTPP IRI data were used in the assessment. It is also noted that the LTPP IRI dataset included five repeat measurements per test section as compared to the 10 project repeat measurements.

Figure 66 compares the mean IRI values for the project data versus the 2016 and 2018 LTPP data. As can be seen in the figure, except for the two asphalt pavement test sections (260 and 261), the mean IRI values appear to be reasonably close for the three datasets. At the time the 2018 LTPP IRI data were obtained, it did not include values for the two asphalt pavement test sections, and hence the project data were only compared to the 2016 LTPP data. Figure 66 also shows that the mean IRI values for the project on those two asphalt pavement test sections are significantly smaller than those collected in 2016 by the LTPP program. There is a two-year interval between the two data collection efforts, which could help explain the differences, but it appears that there may be other factors involved such as unrecorded M&R activities.

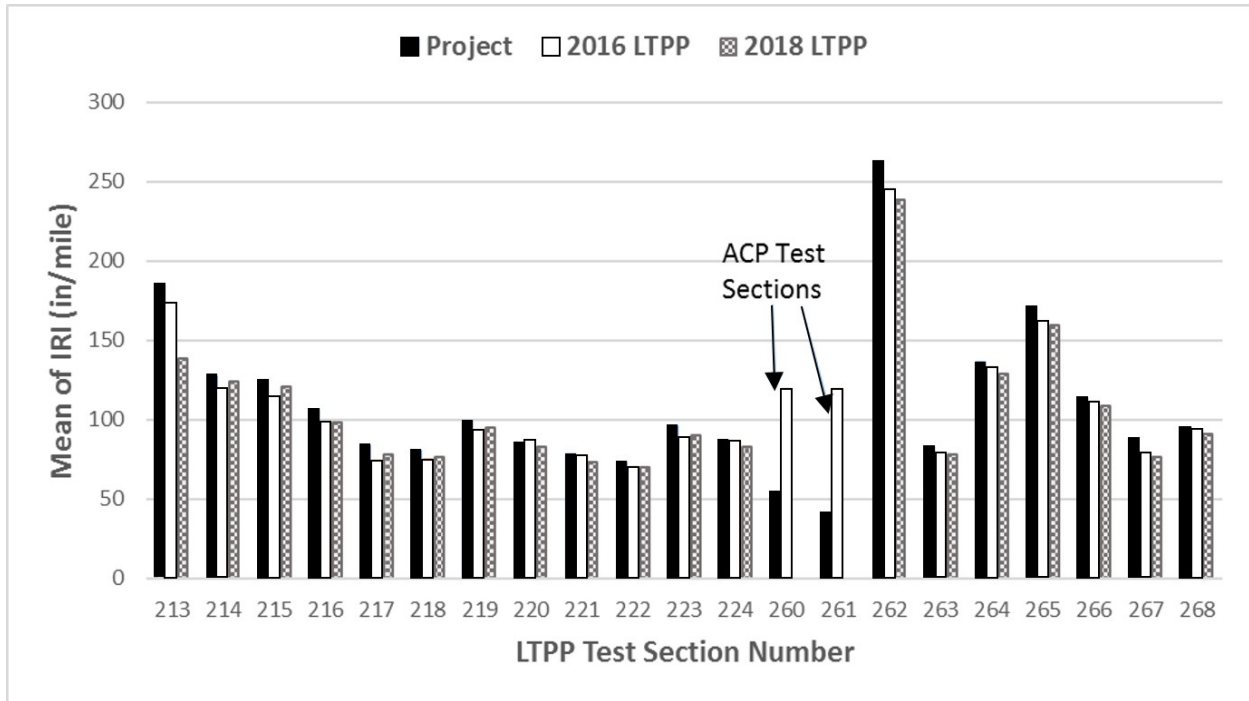

Source: FHWA

**Figure 66. Plot. Mean IRI for LTPP test sections.**

Figure 67 compares the IRI COV values for the three datasets—project, 2016 LTPP, and 2018 LTPP data. The results show that IRI COV for test section 213 does not meet the DQMP criterion regardless of dataset. This section is exhibiting high severity longitudinal cracks as noted by the LTPP program distress survey from 2016. In addition, there have been no recorded M&R activities on that test section since 2016. Both considerations, together with the possibility of vehicle wander during data collection, may explain the high COV values for the project and 2018 LTPP data. COV for the remaining test sections is small and the COV of the project data is typically higher than that from the LTPP datasets. The LTPP program uses the five best of ten runs for storing, which could result in a reduced COV for these datasets.

The mean obtained from repeat project measurements for each condition metric on each test section was compared to the mean from the LTPP data; more specifically, the difference between the project-derived and LTPP-derived means was computed. The measurements for the two datasets consist of two parts: a true value and an error term that includes both bias and random error. Mathematically, this is represented by the equations given by Figure 68, Figure 69, and Figure 70.

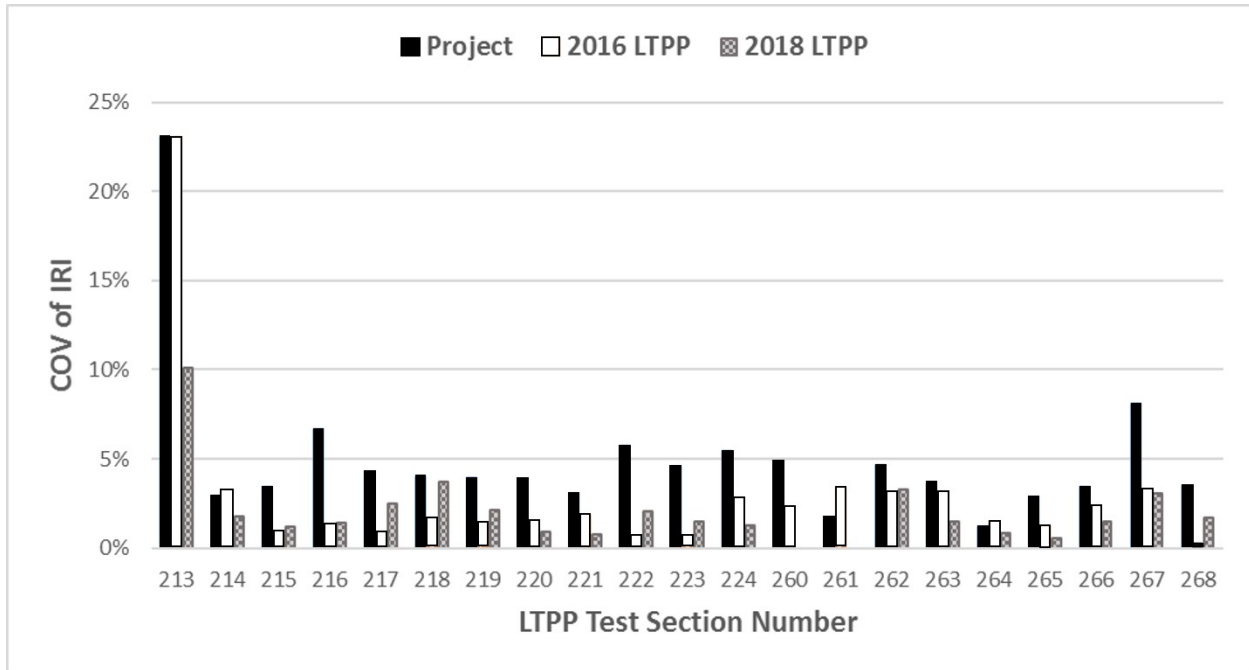

Source: FHWA

Figure 67. Plot. IRI COV for LTPP test sections.

$$pm_{t2} = PM_{t2} + \varepsilon_{t2}$$

Figure 68. Equation. ‘True’ value of project measured data at time t2.

Source: FHWA

$$lm_{t1} = LM_{t1} + \gamma_{t1}$$

Figure 69. Equation. ‘True’ value of LTPP data at time t1.

Source: FHWA

$$LM_{t2} = LM_{t1} + \Delta LM$$

Figure 70. Equation. ‘True’ value of LTPP data at time t2.

Source: FHWA

Where:

$pm_{t2}$ : project condition measurement (e.g. IRI) at time  $t2$

$PM_{t2}$ : true value of the project measurement at time  $t2$  which is not known

$\varepsilon_{t2}$ : errors in measured project data at time equal to  $t2$

$lm_{t1}$ : LTPP measurement at time  $t1$

$LM_{t1}$ : true value of the LTPP measurement at time  $t1$

$\gamma_{t1}$ : errors in measured LTPP data at time equal to  $t1$

$LM_{t2}$ : true value of the LTPP measurement at time  $t2$

$\Delta LM$  = change in the LTPP true measurements between times  $t1$  and  $t2$

The difference between the true LTPP measurement and the true project-collected data for a given pavement test section at time equal to  $t2$  is given by the equation in Figure 71.

$$\begin{aligned} LM_{t2} - PM_{t2} &= lm_{t1} - \gamma_{t1} + \Delta LM - pm_{t2} + \varepsilon_{t2} \\ &= (lm_{t1} - pm_{t2}) + (\varepsilon_{t2} - \gamma_{t1}) + \Delta LM \end{aligned}$$

**Figure 71. Equation. Differences in the LTPP and project true values.**

Source: FHWA

The true measurement values  $LM_{t2}$  and  $PM_{t2}$  correspond to the same measurement time for the same condition metric; the difference in the true measurements is zero. If it is assumed that no bias exists between the two sets of measurements, the expected values of the two error terms cancel each other and the equation in Figure 71 can be re-written as shown in Figure 72.

$$E[pm_{t2}] = E[lm_{t1}] + E[\Delta LM]$$

**Figure 72. Equation. Measured project data hypothesis.**

Source: FHWA

Where:

$E[pm_{t2}]$  = the expected measurement from the project data at time  $t2$

$E[lm_{t1}]$  = the expected measurement from the LTPP data at time  $t1$

$E[\Delta LM]$  = the expected change in LTPP measurements from time  $t1$  to time  $t2$

The likelihood that no bias exists between the two sets of measurements will vary between the condition metrics. For example, IRI is more likely to have a lower difference in measurement bias between the two pieces of equipment used to collect data (project and LTPP) because the two devices use the same technology and the certification process for collection of longitudinal profile is well developed. The data collection methods for the collection of the other metrics were different between the two datasets reducing the chances of equal bias between the two sets of measurements. For example, the faulting for LTPP is collected using a Georgia faultmeter while the project faulting data were collected with the LCMS sensor, as noted previously.

The equation given in Figure 72 was used to assess the difference between the project-collected data and the LTPP data. A linear model was fit to the two sets of pavement condition measurements: LTPP versus project data. If the assumptions of equal bias between datasets were met and the change in true measurements between measurement times (2016 versus 2018) were constant across test sections, then the slope of the resulting model would be one and its intercept would provide an estimate of the change in true measurements over time. The farther the slope is from one, the more likely it is that these assumptions were not met, in which case the intercept would not represent a reliable estimate of the change in true measurements over time.

Figure 73, Figure 74, Figure 75, Figure 76, Figure 77, and Figure 78 show the project-collected and LTPP data as well as the resulting linear models for each condition metric. As shown in these plots the condition metrics measured on asphalt pavement sections had a drastic improvement between 2016 and 2018, which suggests an M&R event has occurred between measurement times even though no such event has been identified within LTPP InfoPave. As such, a comparison between project-collected and LTPP data for these asphalt pavement sections would not be feasible. The changes in condition metrics for the jointed concrete pavement sections did not show improvements in the conditions and were within generally expected changes. The slope values for the linear models corresponding to the jointed concrete pavement sections were all different than one, which suggests that the assumptions were not met. The differences vary between the condition metrics. IRI was the closest to 1 with a slope of 0.93, faulting had a slope of 0.79, and cracking had the largest difference with a slope of 0.69. Again, it should be noted that the approaches for the collection of cracking, rutting, and faulting differ between these two datasets and likely contribute to the differences observed.

The slope value for the case of IRI on jointed concrete pavement sections suggests that the change in IRI over time was nearly constant across sections and its intercept suggests that the IRI decreased by 2 in/mile on average. As IRI is expected to increase over time, the observed decrease in IRI may suggest a bias between datasets; however, these improvements in IRI over time may be explained by other factors such as unrecorded maintenance between the two data collection activities. The observed slope and intercepts for percent cracking and faulting on

jointed concrete pavement sections indicate a possible unequal bias between datasets and/or an inconsistent deterioration rate across test sections. A deterioration rate that is not the same across test sections would make comparisons between project-collected and LTPP data more difficult. However, differences in deterioration rate across sections may be expected with the changes in the pavement structure across the test sections even though they are exposed to the same climate and traffic.

In this project, jointed concrete pavement percent cracking was assessed using a semi-automated approach in which manual raters calculated percent cracking through visual inspection of pavement surface images collected at highway speeds by an LCMS. The number of joints and the number of half-width transverse cracks observed on the images were compared to the manual cracking maps, which were created by raters through visual inspection of the sections and stored in the LTPP 2016 dataset. These comparisons helped in assessing the reliability of the automated method used in the project. Among nineteen jointed concrete pavement sections, only one section showed a difference in the number of observed transverse cracks. Although the statistical analyses indicate potential bias between the two datasets, it appears that the differences in the collected data between the two datasets are unimportant based on a visual review of the images collected. In other words, the observed differences in the cracking data on all but one of the jointed concrete pavement sections were within expected error levels.

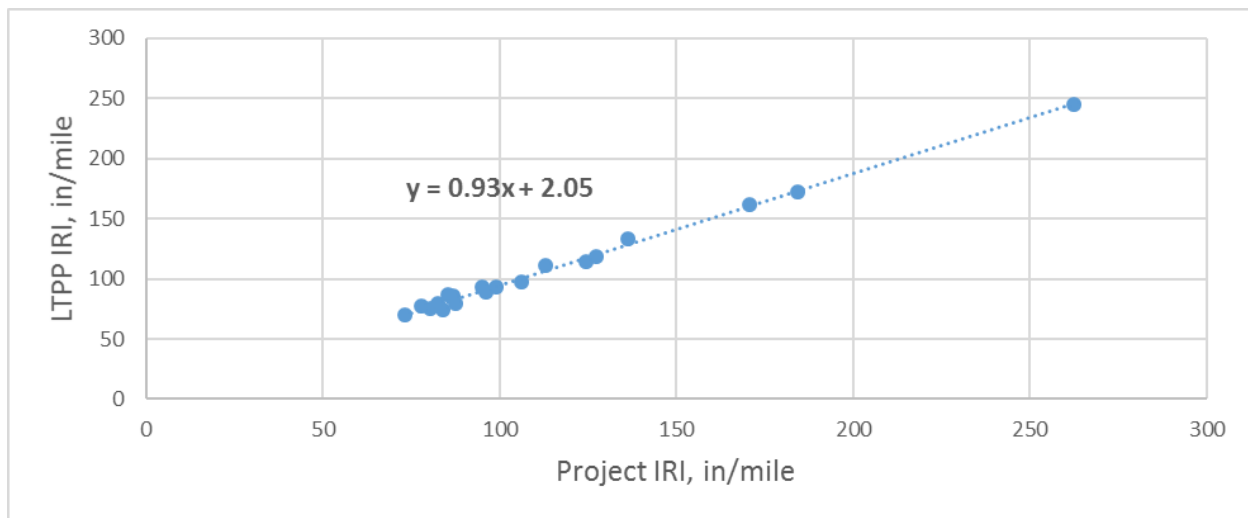

Source: FHWA

**Figure 73. Plot. Project versus LTPP IRI measurements on jointed concrete pavement test sections.**

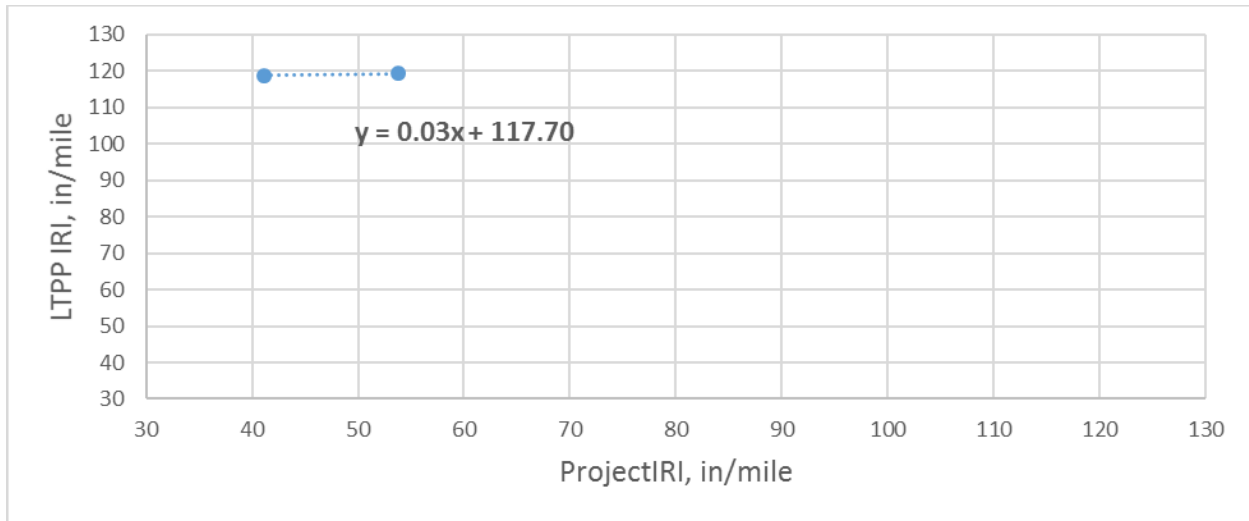

Source: FHWA

**Figure 74. Plot. Project versus LTPP IRI measurements on asphalt pavement test sections.**

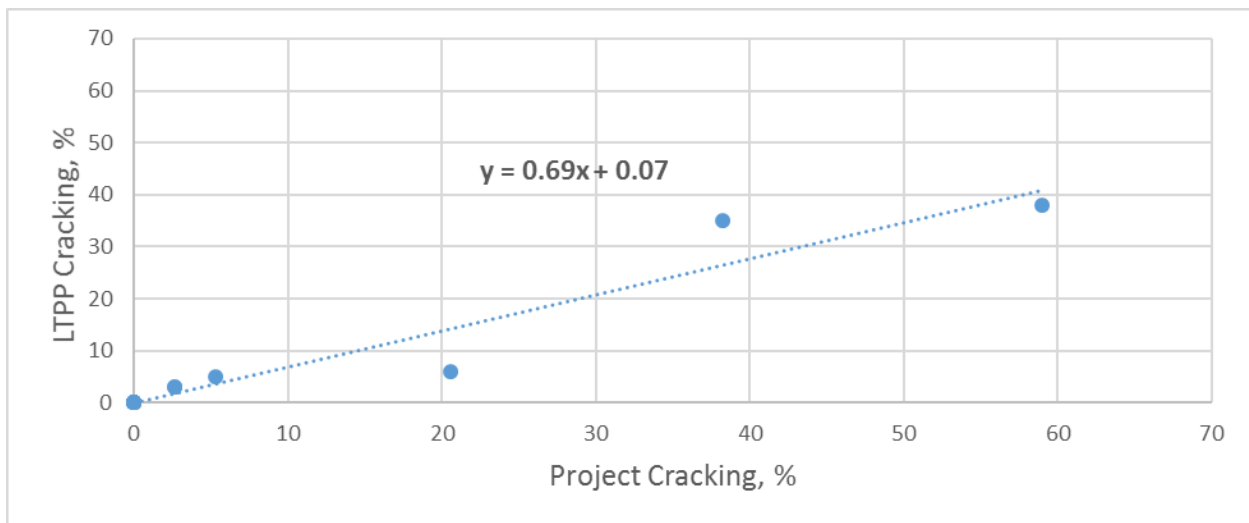

Source: FHWA

**Figure 75. Plot. Project versus LTPP cracking measurements on jointed concrete pavement test sections.**



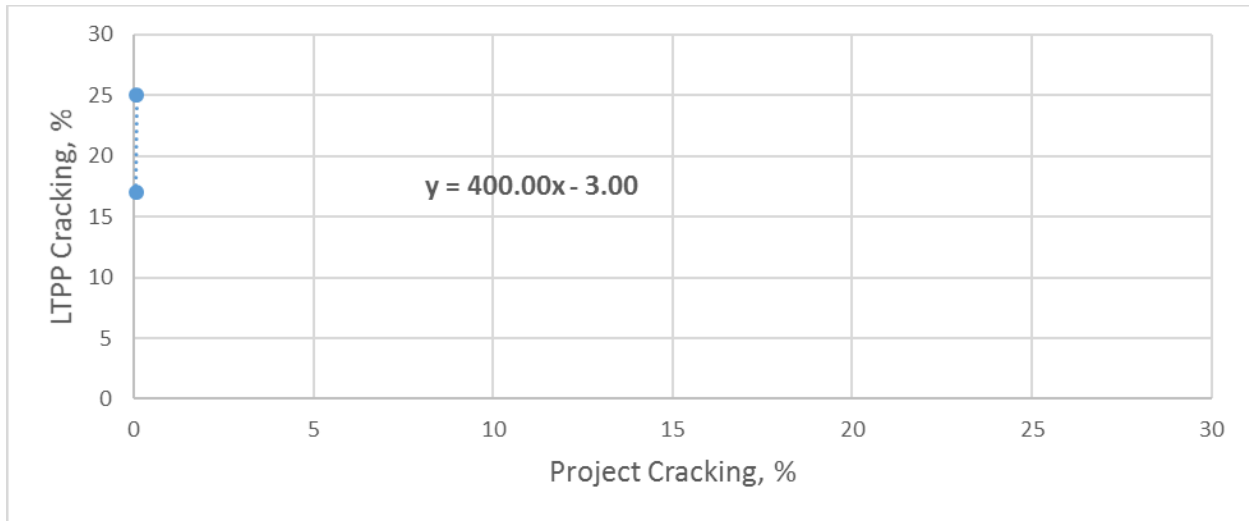

Source: FHWA

**Figure 76. Plot. Project versus LTPP cracking measurements on asphalt pavement test sections.**

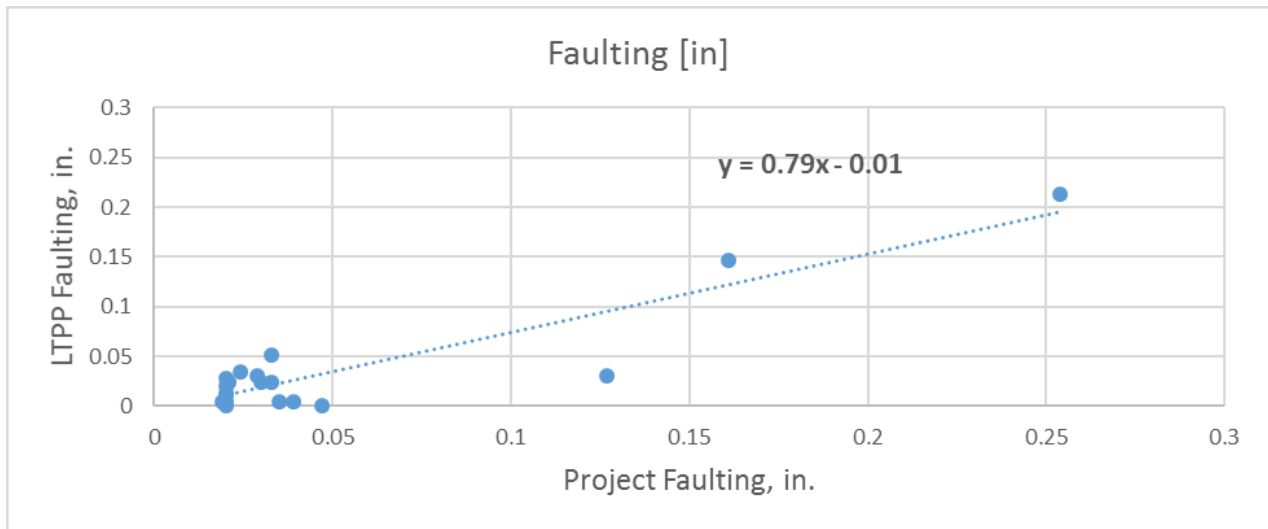

Source: FHWA

**Figure 77. Plot. Project versus LTPP faulting measurements on jointed concrete pavement test sections.**

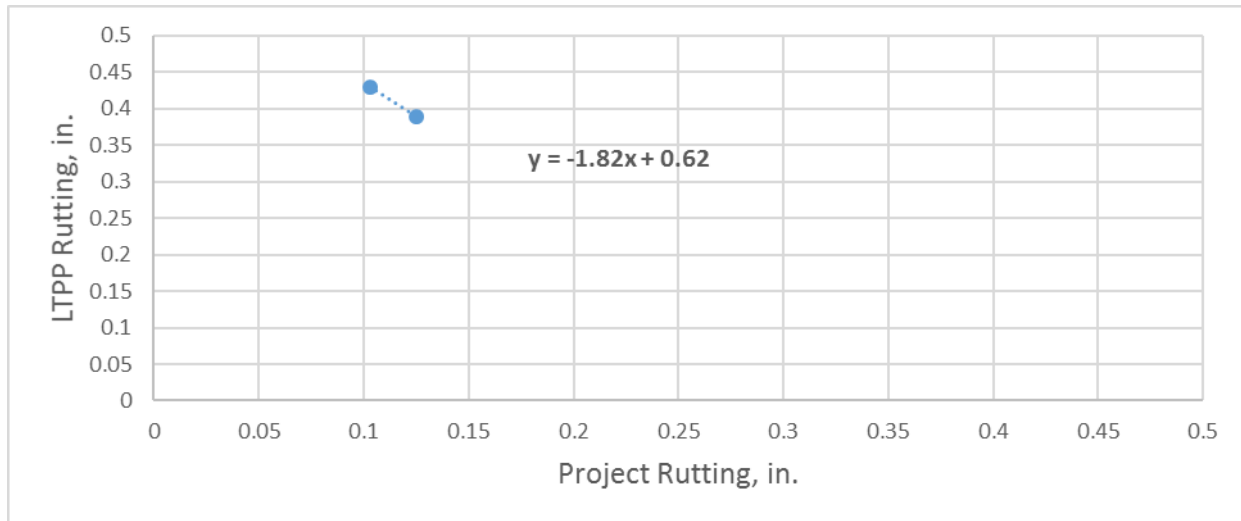

Source: FHWA

**Figure 78. Plot. Project versus LTPP rutting measurements on asphalt pavement test sections.**

### Comparison to FHWA InfraHealth Project Data

This section presents the comparisons of pavement condition results between the IS1 and IS2 studies and those from the 2011 FHWA Infrastructure Health (referred to as InfraHealth) study. The data used in the comparisons were collected along the I-90 corridor through South Dakota, Minnesota, and Wisconsin.

#### *Condition Metrics*

The first comparison entailed the review of the pavement condition metrics. The results of this comparison are summarized in Table 64, Table 65, Table 66, and Table 67. As shown, there are different trends in the condition metrics across the three datasets. For example, as shown in Table 64, the average IRI value is 77 in/mile for InfraHealth, 73 in/mile for IS1, and 75 in/mile for IS2. On the other hand, the average rut depth values presented in Table 65 show an increasing trend from InfraHealth to IS1 to IS2. The median rut depth shows the same trend as the mean. In terms of the percent cracking, Table 66 shows that the InfraHealth has a higher average value with improvements in the IS1 and IS2 datasets. Similarly, the average faulting values presented in Table 67 show an improvement from the InfraHealth project to the IS1 project. The InfraHealth dataset shows a significantly larger standard deviation and range for faulting compared to the other two datasets. Similarly, InfraHealth has a higher average faulting value, standard deviation, and range compared to the other two datasets. Differences may be due in part to differences in data collection equipment between the datasets. Changes have occurred in the definition of percent cracking for these datasets, and the IS1 and IS2 used a different approach for collection of faulting than was used in the InfraHealth study.

**Table 64. InfraHealth, IS1, and IS2 pavement condition IRI statistics.**

Element	Mean	Standard Deviation	Min/Max	Median
InfraHealth – IRI (in/mile)	77	38	0 / 300	71
IS1 – IRI (in/mile)	73	33	23 / 300	64
IS2 – IRI (in/mile)	75	32	22 / 300	66

Source: FHWA

**Table 65. InfraHealth, IS1, and IS2 pavement condition rutting statistics.**

Element	Mean	Standard Deviation	Min/Max	Median
InfraHealth – Rutting (in)	0.10	0.07	0.03 / 0.72	0.08
IS1 – Rutting (in)	0.13	0.08	0.04 / 0.84	0.11
IS2 – Rutting (in)	0.15	0.08	0.03 / 0.55	0.14

Source: FHWA

**Table 66. InfraHealth, IS1, and IS2 pavement condition cracking statistics.**

Element	Mean	Standard Deviation	Min/Max	Median
InfraHealth – Cracking (%)	5.1	14.2	0 / 100.0	0
IS1 – Cracking (%)	2.8	7.9	0 / 83.3	0
IS2 – Cracking (%)	2.8	6.9	0 / 68.4	0.2

Source: FHWA

**Table 67. InfraHealth, IS1, and IS2 pavement condition faulting statistics.**

Element	Mean	Standard Deviation	Min/Max	Median
InfraHealth Faulting (in)	0.08	0.10	0 / 1.12	0
IS1 – Faulting (in)	0.03	0.02	0 / 0.25	0.02
IS2 – Faulting (in)	0.03	0.02	0 / 0.21	0.02

Source: FHWA

Figure 79, Figure 80, Figure 81, and Figure 82 show density plots to simultaneously visualize the three datasets in question. Using these plots, the shape, level of skewness, multimodality, and the maximum value of the datasets were compared. As shown, the IRI and faulting density plots show that the InfraHealth data have a different shape compared to the IS1 and IS2 datasets, while for the rutting and cracking density plots the three datasets have similar shapes. The IS1 and IS2 rutting distributions show a higher dispersion than the InfraHealth distributions.

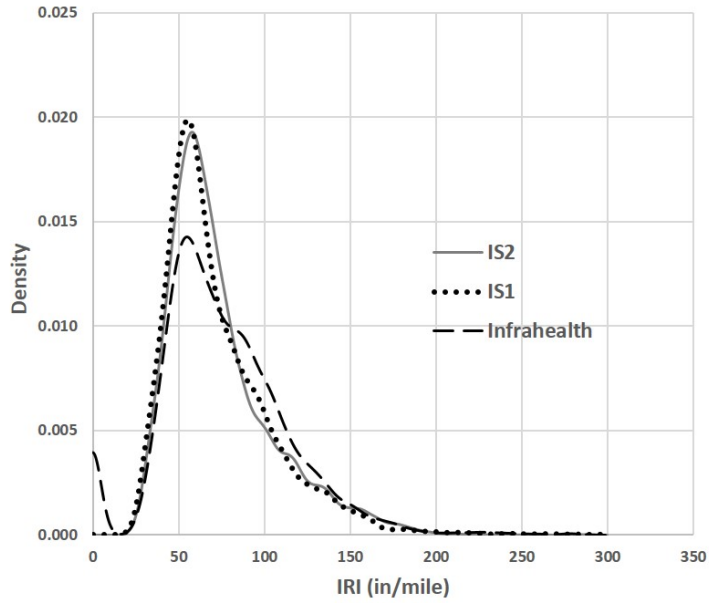

Source: FHWA

**Figure 79. Plot. Density plots of IRI condition metric for IS1, IS2, and InfraHealth datasets.**

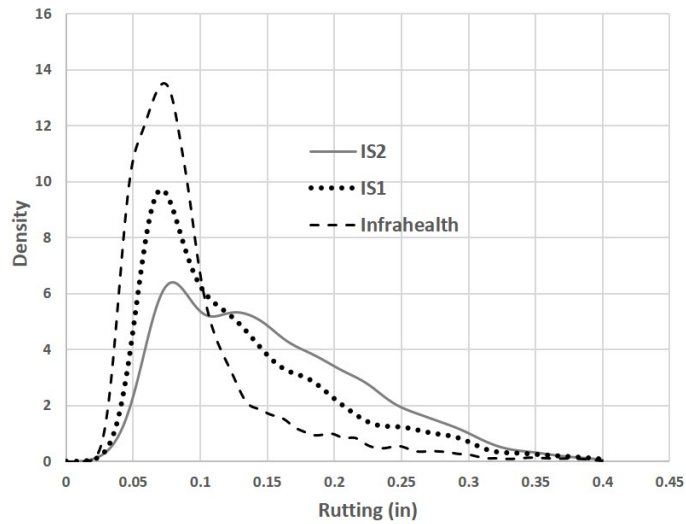

Source: FHWA

**Figure 80. Plot. Density plots of rutting condition metric for IS1, IS2, and InfraHealth datasets.**

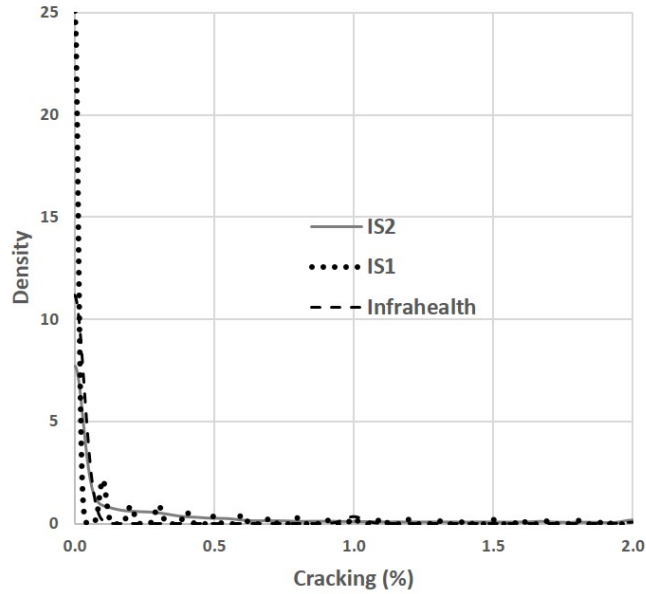

Source: FHWA

**Figure 81. Plot. Density plots of cracking condition metric for IS1, IS2, and InfraHealth datasets.**

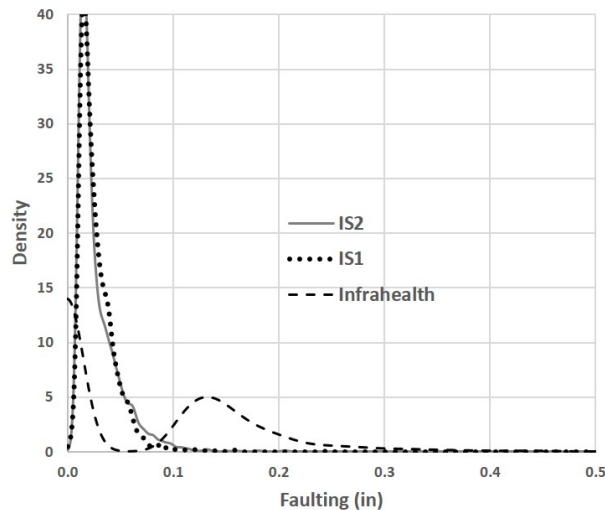

Source: FHWA

**Figure 82. Plot. Density plots of faulting condition metric for IS1, IS2, and InfraHealth datasets.**

Besides changes associated with the deterioration of the pavement with time, the variations in condition metrics between the three datasets are hypothesized to also be the result of factors such as M&R activities, which likely occurred between the data collection events as well as changes and improvements in the data collection procedures. For example, faulting data were collected

using a road surface profiler (RSP) for the InfraHealth study, while an LCMS was used for the IS1 and IS2 studies. It should also be noted that Table 66 shows the same average percent cracking for the IS1 and IS2 datasets. Although the overall average of percent cracking is the same for the IS1 and IS2 datasets, variability was observed between the two datasets when reviewed by surface type. The average asphalt pavement percent cracking is 3.9 percent for IS2 and 1.7 percent for IS1, while the average concrete pavement percent cracking is 1.9 percent for IS2 and 3.9 percent for IS1.

**Overall Pavement Condition Ratings**

Table 68 presents the overall condition ratings for the three datasets. For the IRI condition metric, IS1 has the highest percentage of Good and the lowest percentage of Poor among three datasets. For the rutting metric, InfraHealth has the highest percentage of Good rating. For the cracking metric, the InfraHealth and IS2 datasets have the highest and lowest percent Poor respectively. The faulting results show that the overall condition ratings have changed significantly since the InfraHealth study. In general, it can be postulated that the pavement conditions have improved from 2011 and 2018 and that improvement is likely related to M&R activities performed along I-90 through South Dakota, Minnesota, and Wisconsin. It is also possible that the observed improvement may be related to changes in data collection procedures.

**Table 68. Comparison of IS1, IS2, and InfraHealth metric condition ratings for I-90 through South Dakota, Minnesota, and Wisconsin.**

Percentage of Data Collection Route	% Good	% Fair	% Poor
IRI-InfraHealth	73.1	25.1	1.8
IRI-IS1	80.7	18.2	0.8
IRI-IS2	79.5	19.3	1.2
Rut-InfraHealth	92.7	6.6	0.7
Rut-IS1	84.2	15.0	0.8
Rut-IS2	74.7	24.7	0.6
Crack-InfraHealth	81.9	7.4	10.7
Crack-IS1	90.5	4.9	4.7
Crack-IS2	83.7	12.7	3.6
Fault-InfraHealth	53.0	25.6	21.4
Fault-IS1	99.2	0.7	0.1
Fault-IS2	99.0	0.8	0.2

Source: FHWA

The comparison of overall condition ratings for the three datasets in question is shown in Table 69. As shown, IS1 has 68.0 percent of the pavement segments in Good condition versus IS2 with 65.1 percent and InfraHealth with 60.5 percent. This table also shows that InfraHealth has more segments (5.1 percent) in Poor condition as compared to IS1 (0.1 percent) and IS2 (0.2 percent).

Table 70 illustrates the comparison of the overall condition ratings (hence performance measures) of three datasets for the three States. Generally, these States show increases in the Good rating and reductions in the Poor rating from the InfraHealth project to IS1. From IS1 to IS2, the Good percentage of South Dakota and Minnesota dropped, the Poor percentage of Minnesota increased by 0.3 percent, the Good percentage of Wisconsin improved by approximately 2.5 percent, and the Poor percentage of Wisconsin dropped by 0.3 percent.

**Table 69. Comparison of IS1, IS2, and InfraHealth overall condition ratings and performance measures for I-90 through South Dakota, Minnesota, and Wisconsin.**

Percentage of Data Collection Network	% Good	% Fair	% Poor
IS2	65.1	34.8	0.1
IS1	68.0	31.8	0.2
Infrahealth	60.5	34.5	5.1

Source: FHWA

**Table 70. Comparison of IS1, IS2, and InfraHealth overall condition ratings and performance measures at State level.**

Percentage of Data Collection Route	% Good	% Fair	% Poor
SD-2011	73.1	25.1	1.8
SD-IS1	80.7	18.2	0.8
SD-IS2	79.5	19.3	1.2
MN-2011	92.7	6.6	0.7
MN-IS1	84.2	15.0	0.8
MN-IS2	74.7	24.7	0.6
WI-2011	81.9	7.4	10.7
WI-IS1	90.5	4.9	4.7
WI-IS2	83.7	12.7	3.6

Source: FHWA

## ASSESSMENT OF PAVEMENT CONDITION ERROR SOURCES

An important step toward improving the quality of the HPMS data entails understanding the extent to which the various error sources contribute to the overall uncertainty of the data. When the reported performance measures are calculated from the condition metric measurements, uncertainties in the condition data will propagate through the calculation to uncertainties in the performance measures. Uncertainty in the data may come from uncertainty in the measurements, data sampling, and definition of what is to be measured. In the following, a brief description of each error source is provided along with data illustrating the estimated impact of individual error sources on the overall uncertainty of the performance measures. In each case, a Monte Carlo simulation was used to translate uncertainties in input data to output information, and results are presented in terms of a 95 percent confidence interval of the output.

## Uncertainty in Measurement Data

The measurement error is calculated by evaluating the differences between the HPMS measurement and project measurement. This analysis was addressed similarly as explained in the LTPP analyses. As shown by Figure 83 and Figure 84, each of these measurements consists of three parts: 1) true measurement, 2) systematic error (bias), and 3) random error. The difference between the HPMS measurement and the project measurement for a given pavement section is illustrated by the equation in Figure 85. The difference between the true measurement values  $PTM$  and  $HTM$  is zero if there are no differences in the true values over time. The bias terms in Figure 85 would incorporate this anticipated change in the true value over time. The expected value of the random error terms in Figure 85 would be zero. Figure 86 and Figure 87 present the equations for computing the expected value and the variance of measurement error respectively. Random error is typically identified as noise that occurs within the data collection effort and the expected value of this error is zero, i.e., the arithmetic mean of the error values is expected to be zero. Systematic error (bias) is consistent; its variance is zero.

$$PM = PTM + b_p + re_p$$

**Figure 83. Equation. Project measured data.** Source: FHWA

$$HM = HTM + b_{HPMS} + re_{HPMS}$$

**Figure 84. Equation. HPMS measured data.** Source: FHWA

$$d = PM - HM = (PTM + b_p + re_p) - (HTM + b_{HPMS} + re_{HPMS})$$

**Figure 85. Equation. Measurement error.** Source: FHWA

$$E[d] = (E[b_{proj}] + E[re_p]) - (E[b_{HPMS,st}] + E[re_{HPMS,st}]) = E[b_{proj}] - E[b_{HPMS}]$$

**Figure 86. Equation. Expected value of measurement error.** Source: FHWA

$$V[d] = V[b_{proj}] + V[re_{proj}] + V[b_{HPMS,st}] + V[re_{HPMS,st}] = V[re_{proj}] + V[re_{HPMS}]$$

**Figure 87. Equation. Variance of measurement error.** Source: FHWA

Where:

PM = measured project data

HM = measured HPMS data

PTM = true value of the project measurement

HTM = true value of the HPMS measurement

d = measurement error



$b_p$  = bias in measured project data

$re_p$  = random error in measured project data

$b_{HPMS}$  = bias in measured HPMS data

$re_{HPMS}$  = random error in measured HPMS data

The equations given in Figure 86 and Figure 87 were used to estimate the measurement error on a given pavement section using the paired segments with data from both the project and HPMS 2017 data. This reduced dataset included 2,151 segments of asphalt pavement, 308 segments of jointed concrete pavement, and 34 segments of continuously reinforced concrete pavement. The mean and standard deviation of the differences were used to represent the bias and random errors of the two datasets. The expected values for the bias and standard deviation by pavement type are presented in Table 71. These values show the range of differences between the pavement condition metrics between the two datasets for the paired segments used in this analysis. These differences may occur as a result of the differences in time between the two data collection events, the devices being used for data collection, the operator performing data collection, the quality of data reported, or other characteristics associated with the data collection effort.

Simulations were run using the values presented in Table 71 to represent the distribution of error to be added to each condition metric, with 1,000 runs being incorporated in the analyses. The new condition data were assumed to follow a log-normal distribution with parameters of (*existing condition value* +  $E[d]$ ) and  $v[d]$ . Bias was applied at the State level such that the same value for the bias was used for all of the data within the State. The range of random error also was established at the State level, with the actual random error applied falling within the range established for that State. The new condition metrics were then used to estimate the performance measures.

**Table 71. Expected Values of Bias and Random Error for Condition Metrics by Surface Type**

Condition Metric	Bias/Error	Asphalt pavement	Jointed concrete pavement	Continuously reinforced concrete pavement
IRI, in/mile	Bias	3.94	0.13	6.53
	Random Error	25.7	24.5	8.7
Rutting, inch	Bias	-0.02		
	Random Error	0.05		
Percent Cracking, %	Bias	1.51	-2.02	-1.22
	Random Error	4.23	13.2	2.06
Faulting, inch	Bias		0.006	
	Random Error		0.040	

Source: FHWA

Table 72 provides the original performance measures based upon the HPMS data and a 95 percent confidence interval of the revised performance measures with the applied bias and random error. The values presented in Table 72 are to more significant digits than would

typically be shown to provide the opportunity to see the level of change associated with the confidence intervals provided.

**Table 72. Uncertainty in Performance Measures Resulting from Measurement Error.**

Source	% Good	% Fair	% Poor
HPMS 2017 - Original dataset of paired segments	61.9	37.9	0.2
Measurement Error	[61.8, 61.9]	[37.6, 37.7]	[0.49, 0.51]

Source: FHWA

Table 72 indicate that the bias in the measurement data has a slightly larger impact on the results than that from the random error. Further, it appears that the bias has a slightly larger impact on the percent Poor performance measure than on the percent Good.

### Uncertainty in Data Sampling

In 2017, FHWA began requiring States to submit annual condition data for the Interstate Highway System to HPMS (23CFR 490.309(b)). The uncertainty in data sampling occurs when a State does not submit data for its full network or submits a prior year’s data in place of current data.

The impact of submitting a prior year’s data in place of data collected in the current year was evaluated using the 2016 and 2017 HPMS data. In this simulation, between one and five States were randomly selected. In each case, the simulation replaced the 2017 HPMS data with the 2016 data submitted by that State. The performance measures were then calculated using the revised dataset. This simulation was run 1,000 times to create a sample dataset of potential national performance measures. The 95 percent confidence interval of the performance measures is provided in Table 73. This comparison illustrates an expected decrease in the estimated performance measures if a prior year’s data are submitted in place of the current year.

**Table 73. Uncertainty in Performance Measures Resulting from Data Sampling**

Source	% Good	% Fair	% Poor
HPMS 2017 (Original)	59.9	39.5	0.6
Submitting condition data from prior year	[56.31, 56.44]	[42.72, 42.80]	[0.82,0.83]
Submitting partial condition data	[55.4, 56.5]	[42.8, 43.9]	[0.6, 0.9]

Source: FHWA

Similarly, an analysis was run to investigate the impact of a State submitting only a partial dataset. As with the analysis above, the analysis assumed that between one and five States submitted a partial dataset. A partial dataset was assumed to consist of between 50 to 90 percent of the data from that State. Again, 1,000 runs were performed where the States and the data submittal were randomly selected using the 2017 HPMS data. A 95 percent confidence interval

was developed for the simulated runs and is provided in Table 73. This comparison illustrates an expected decrease in the estimated performance measures if only a partial dataset is submitted.

### Uncertainty in Data Definition

The 2016 HPMS Field Manual provides a complete description of the condition data collection, and the definitions for the pavement distresses. The definitions used for data collection may be expected to evolve over time as improvements are made in data collection and understanding of distress impacts to pavement performance. As an example, the 2016 HPMS Field Manual no longer contains measures of transverse cracking on asphalt pavements. The final rule does not consider the transverse cracking as part of the percent cracking condition metric. Additionally, the wheelpath width percent cracking definition changed from 24 inches to 39 inches in 2016. Because an agency may not recognize the change in a definition in sufficient time to correct their data collection for a particular year, incorrect data may be submitted to the HPMS using these older definitions.

This error in condition metric definition was assessed using the project-collected data. The simulation assumed that between one and five States submitted data using an incorrect wheelpath width for their cracking data. The States were selected randomly in each simulation and their cracking measurements were transformed by multiplying by the ratio of 24/39, which results in a reduction in percent cracking. The performance measures were then calculated for each of the simulated datasets and a 95 percent confidence interval was developed for the results as presented in Table 74. Again, data are shown in the table to a greater precision than is typical to illustrate the differences in the numbers resulting from the analyses. While this particular definition error is expected to improve the performance measures, other errors may be expected to decrease the estimates of the performance measures.

**Table 74. Uncertainty in wrong data definition.**

Source	% Good	% Fair	% Poor
Project Data (Original)	61.75	37.58	0.67
Using incorrect wheelpath width	[61.93, 61.96]	[37.39, 37.41]	[0.659, 0.661]

Source: FHWA

The assessment of potential error sources illustrates that the primary source of this is likely to be due to uncertainty in the measurement data and more specifically, bias within these data that may be anticipated at the State level. Other error sources may have some impact on the individual condition metrics; however, these sources appear to have limited impact on the performance measures at the national level.

## CHAPTER 6 - CONCLUSIONS

This chapter provides the conclusions resulting from the project. The project was conducted to meet the following objectives:

- Collect an unbiased baseline dataset for a statistically significant sample of the Interstate Highway System and produce a report indicating condition on pavement conditions nationally and each in State where data were collected.
- Determine if HPMS is an unbiased representation of pavement condition on the Interstate Highway System.
- Identify improvements to HPMS data collection and reporting to make HPMS unbiased and improve its precision.
- Pursue additional investigations, including:
  - Evaluation of data collected in this project as compared to Long-Term Pavement Performance (LTPP) data.
  - Evaluation of the HPMS with the project-collected data.
  - Analysis of the temporal effects using multiple data sources.

To meet these objectives, approximately 7,500 miles of data were collected on the Interstate Highway System on 11 routes in 34 States. Our comparisons show limited bias at the national level between the pavement performance measures between the data collected and the HPMS. Additional conclusions relative to each of the analyses performed are provided below.

The following statements provide the conclusions observed from this study relative to the data collection activities:

- The Data Quality Management Plan can play an important part in preparing for the data collection effort. In particular, the DQMP identifies the quality standards to be met for the equipment and personnel performing the data collection. These standards are implemented by way of the certification and validation processes for the equipment and personnel, the various methods to review equipment and personnel throughout the data collection process, and the review of the collected data itself.
- Certification procedures are available for use in evaluating the collection of longitudinal profile. Similar procedures are needed for certification of collection of percent cracking, rut depth, and faulting.
- Quality management does not end with certification of equipment. Routine review of equipment operations throughout the data collection process is important to maintaining quality data collection.
- Review of the data as it is being collected is essential for quality data. Simply reviewing data at the end of the data collection is not adequate.
- A complete quality management plan will include processes for reviewing equipment, personnel, and processes to be used during data collection before data collection begins;

processes for reviewing equipment and data collected during the data collection process; and the approaches to be taken if the equipment, personnel, or data fail to meet the accepted standards.

- The HPMS dataset continues to show improvements in data quality and completeness with each passing year.

The resulting Interstate pavement condition and ancillary data were used in multiple analyses, and from those analyses numerous observations and conclusions were derived. From the assessment of the current Interstate Highway condition assessment (i.e., IS2) as well as the comparison of results with those from the 2015 Interstate Pavement Sampling study (i.e., IS1) at the network level, it was found that:

- The condition metrics, overall condition ratings, and performance measures were similar for the two datasets. The average IRI value differs by 2 in/mile, the average percent cracking by 0.3 percent, and the average rutting and faulting are the same. However, the ranges in the rut depth, percent cracking, and faulting are larger for IS1, and the percent cracking variance is also significantly larger variance for the IS1 dataset.
- The IRI, rutting, and faulting distributions for the two datasets are nearly identical, but for cracking they have distinct distributions. More importantly, the percentage of pavements in overall Good condition decreased from 63.1 percent in 2015 (IS1) to 61.8 percent in 2018 (IS2), while the percentage of pavements in overall Poor condition decreased from 0.8 percent to 0.7 percent in the same period.
- When limiting comparison to those States where data were collected in both 2015 and 2018, the results showed increases in the Good ratings for IRI and faulting and reductions in the Good ratings for cracking and rutting. Also, reductions in the Poor ratings were observed for all four condition metrics. In terms of overall rating, the percentage of pavements in both Good and Poor condition decreased slightly.
- At the individual State level, the results showed that the condition metrics are different between IS1 and IS2. In terms of the overall condition ratings, significant differences were observed between the IS1 and IS2 datasets for California, Idaho, New York, and Washington. However, there were significant differences in the total sampled mileage for these three States between 2015 and 2018.
- When limiting the comparisons to the route mileage that was common to 2015 and 2018, some differences between the two datasets were observed. Those differences were attributed to the three-year time difference between data collection efforts as well as to variations in the differences for the individual condition metrics.

Two sets of analyses were performed to assess recent HPMS pavement condition data. The first analysis looked at changes in HPMS pavement condition data over time: 2015 to 2016 to 2017. The second analysis looked at the impact of stratification factors on the HPMS pavement condition data. Significant observations and conclusions include:

- The 2017 versus the 2016 and 2015 HPMS datasets showed small differences for most cases. For example, the 2017 average IRI value is 80 in/mile while the value for 2016 and 2015 is 78 in/mile, and the average rutting in 2017 was 0.14 in while the value in 2016 and 2015 was 0.13 in. Also, the 2017 HPMS dataset has the highest percentage of pavement segments in Good condition and the lowest percentage in Poor condition at the overall condition level and for most condition metrics.
- From the review of changes in the HPMS data over time at the State level, it was found that about 52 percent of the States had an increase in the percentage of pavement segments in Good condition between 2015 and 2016, while 59 percent of the States had an increase in the percentage of pavement segments in Good condition between 2016 and 2017. In addition, from 2016 to 2017 there was a reduction in the percentage of pavement segments in Poor condition for over 45 percent of States.
- At the route level, the comparison results showed that the average and median values for the four condition metrics have had little to no change over the three year period. However, changes were observed in the standard deviation and in the range of the condition metrics.
- In terms of the impacts of different stratification factors on the pavement condition metrics (based on 2017 HPMS dataset), the results showed that those pavements in the dry freeze region have the lowest average IRI value and the largest rutting compared to the other climate regions. The wet freeze region had the highest average percent cracking. The mountainous terrain had the largest average IRI value and the lowest percent cracking among the three terrain categories, although the differences in average values by terrain are generally small. The IRI in rural areas was lower than in urban areas.
- In terms of overall condition ratings, the analysis of stratification factors showed that the lowest percentage of pavement segments in Good condition were in the dry freeze zone, which also contained the largest percentage of segments in Poor condition. The level terrain had the largest percentage of segments in Good condition, while the mountainous terrain had the largest percentage of segments in Poor condition. Rural areas had a larger percentage of pavements in Good condition and a smaller percentage of pavements in Poor condition as compared to the urban areas.

From the comparison of 2017 HPMS data to those collected as part of the Interstate Highway Sampling studies in 2015 (IS1) and 2018 (IS2), the following observations and conclusions were derived:

- A comparison of the performance measures resulting from the three datasets indicate that these values are quite close and indicate that there is limited bias between the data collected and the HPMS data.
- The mean, median, and standard deviation of the IRI values were larger for the HPMS than those for the IS1 and IS2 datasets, while the rutting results were similar for the three datasets, and only minor differences were observed between the values for percent

cracking and faulting. These minor differences were considered to be sufficiently small to be unimportant.

- At the State level, the comparison results showed that the overall condition ratings matched well for some States between the 2017 HPMS and IS2 datasets, but not for other States. It appeared that large differences in two or more condition metrics caused a significant difference in the overall condition ratings for a given State, while variability in only one condition metric has little to no impact on the overall condition rating.
- While no bias is expected in the performance measures at the national level, it appears that there is an inconsistent bias at the State-level data which may be occurring within the HPMS data.

The next set of analyses compared the project data (IS2) with data from 20 LTPP test sections on the Interstate system as well as with those data from the 2011 FHWA InfraHealth project. From the review of ten repeatability runs on LTPP test sections conducted as part of the project, the more significant observations and conclusions include:

- The project DQMP acceptance criterion for IRI repeatability was met at 12 of the 20 test sections, while seven of the remaining test sections had a COV close to the acceptance threshold. The project DQMP rutting, percent cracking, and faulting criteria were met for all LTPP test sections.
- From the comparison of project-collected pavement condition data against the most recent LTPP data, it was determined that the datasets were reasonably close to each other. Similarly, from the comparison of the difference between the project- and LTPP-derived means, the results showed that the condition metrics measured for the asphalt pavement test sections had a drastic improvement between 2016 and 2018, while the jointed concrete pavement test sections did not show improvements in the conditions and were within generally expected changes.

In terms of the comparisons of pavement condition results between the IS1 and IS2 studies and the 2011 FHWA InfraHealth studies, based on data collected along the I-90 corridor through South Dakota, Minnesota, and Wisconsin, the following observations and conclusions were developed:

- Different trends in the condition metrics exist across the three datasets. For example, the average IRI value is 77 in/mile for InfraHealth, 73 in/mile for IS1, and 75 in/mile for IS2. The average and mean rut depths showed an increasing trend from InfraHealth to IS1 to IS2. In terms of percent cracking, InfraHealth had a higher average value with improvements in the IS1 and IS2 datasets. Similarly, the average faulting values show an improvement from the InfraHealth project to the IS1 project.
- Besides changes associated with the deterioration of the pavement with time, the variations in condition metrics between the three datasets are hypothesized to be the result of factors such as M&R activities as well as changes and improvements in the data

collection procedures. For example, faulting data were collected using a road surface profiler (RSP) for the InfraHealth study, while an LCMS was used for the IS1 and IS2 studies.

- For the IRI condition metric, IS1 had the highest percentage of Good and the lowest percentage of Poor among three datasets. For the rutting metric, InfraHealth has the highest percentage of Good rating. For the cracking metric, both the InfraHealth and IS2 datasets have the highest and lowest percent Poor, respectively. The faulting results showed that overall condition ratings have changed significantly since 2011.
- The comparison of overall condition ratings for the three datasets show increases in the Good rating and reductions in the Poor rating from the InfraHealth project to IS1. From IS1 to IS2, the Good percentage of South Dakota and Minnesota dropped, the Poor percentage of Minnesota increased by 0.3 percent, the Good percentage of Wisconsin improved by approximately 2.5 percent, and the Poor percentage of Wisconsin dropped by 0.3 percent.

The final set of analyses reviewed the impacts of possible errors and sources of errors on the resulting performance measures. The following conclusions were drawn from these analyses:

- Uncertainties associated with partial data submittal or with submittal of data from a prior year are generally expected to underestimate the performance of the Interstate Highway System. However, these impacts are generally expected to be small at the national level.
- Errors associated with mistakes in distress definition are also expected to be small. However, these errors may result in either an underestimation or overestimation of the performance of the Interstate Highway System.
- Analysis suggests that the potential bias in the data has a slightly larger impact on the results than random error. Further, the potential bias in the data has the largest impact on the percent Poor observed.
- The error analyses suggest that use of data from a prior year may have the largest impact on the performance measures of the error sources investigated. Regardless, each of the analyses show some impacts to the overall performance measures, suggesting that attention to the quality of the data collected is key in developing appropriate conclusions regarding the current state of the network.

The data collection and analysis efforts documented here demonstrated that quality assurance is the most important aspect of the data collection efforts. The DQMP provides a very important step in achieving quality data collection, but also has resounding impacts in the analysis and interpretation of results from these collected data.

The following recommendations are provided as a result of the data collection and analysis effort documented within this report:



- As noted above, the DQMP documents prepared by each State are of great importance to improving data quality. Maintaining this course of action is imperative to continue to improve upon the quality of data housed in the HPMS. In particular with the DQMP approaches, completing efforts to establish certification procedures similar to those for the IRI for the rutting, faulting, and percent cracking condition metrics is very important.
- The HPMS has exhibited vast improvement over the past three years, particularly in terms of data completeness. Efforts should now be focused on the data quality.
- The error assessment analysis suggested that the primary source of errors is in terms of biases between States. Again, maintaining and improving the DQMP documents and the States' ability to follow those guidelines is expected to continue to improve the quality of the HPMS data, including completion of studies related to certification of equipment and personnel used to collect condition data.

## REFERENCES

1. Moving Ahead for Progress in the 21st Century Act. (2012). Pub. L. 112-141, title 1, Sec. 1507, July 6, 2012, 126 Stat. 405, 565.
2. Fixing America's Surface Transportation Act. (2015). Pub. L. 114-94, div. A, title VI, Sec. 6022, Dec. 4, 2015, 129 Stat. 1312, 1585.
3. "National Performance Management Measures; Assessing Pavement Condition for the National Highway Performance Program and Bridge Condition for the National Highway Performance Program", (Final Rule). 23 CFR 490.111(b)(1)
4. Simpson, A. L., G.R. Rada, B.A. Visintine, and J. L. Groeger. Interstate Pavement Condition Sampling, Report No. FHWA-HIF-17-022, Federal Highway Administration. Washington, D.C. August 2017.
5. NCHRP. 2013. Increasing Consistency in the Highway Performance Monitoring System for Pavement Reporting, Final Report. National Cooperative Highway Research Board (NCHRP). Washington, DC.
6. Guerre, J., J. Groeger, S. Van Hecke, A. Simpson, G. Rada, and B. Visintine. 2012. Improving FHWA's Ability to Assess Highway Infrastructure Health - Pilot Study Report. FHWA-HIF-12-049. Federal Highway Administration, Washington, DC.
7. Simpson, A., G. Rada, B. Visintine, and J. Groeger. 2013a. Improving FHWA's Ability to Assess Highway Infrastructure Health Pilot Study Report Addendum - Rutting Bias Investigation. FHWA-HIF-13-037. Federal Highway Administration, Washington, DC.
8. Simpson, A., G. Rada, B. Visintine, J. Groeger, and J. Guerre. 2013b. Improving FHWA's Ability to Assess Highway Infrastructure Health: Development of Next Generation Pavement Performance Measures. FHWA-HIF-13-042. Federal Highway Administration, Washington, DC.
9. Pierce, L.M., McGovern, G. and Zimmerman, K.A. 2013. Practical Guide for Quality Management of Pavement Condition Data Collection, Draft Report, Federal Highway Administration, Washington, DC.
10. Al-Omari and Darter, Relationships between IRI and PSR, ULIU-ENG-92-2013 (1992).
11. Simpson, A.L., J.M. Bryce, B.A. Visintine, G.R. Rada, and J.L. Groeger. Interstate Pavement Condition Sampling: Report Addendum. Federal Highway Administration. Washington, D.C., 2017.
12. Visintine, B. A., A. L. Simpson, and G.R. Rada. Validation of Pavement Performance Measures Using LTPP Data: Final Report. Report No. FHWA-HRT-17-089. Federal Highway Administration. Washington, D.C. April 2017.
13. Federal Highway Administration. 2014. Highway Performance Monitoring System - Field Manual. <http://www.fhwa.dot.gov/policyinformation/hpms/fieldmanual/>. Federal Highway Administration, Washington, DC. Chapter 4, Item 47 (IRI)
14. Federal Highway Administration. 2016. Highway Performance Monitoring System - Field Manual. <http://www.fhwa.dot.gov/policyinformation/hpms/fieldmanual/>. Federal Highway Administration, Washington, DC. Chapter 4, Item 47 (IRI)
15. Federal Highway Administration. 2014. Highway Performance Monitoring System - Field Manual. <http://www.fhwa.dot.gov/policyinformation/hpms/fieldmanual/>. Federal Highway Administration, Washington, DC. Chapter 4, Item 48 (PSR)
16. Federal Highway Administration. 2016. Highway Performance Monitoring System - Field Manual. <http://www.fhwa.dot.gov/policyinformation/hpms/fieldmanual/>. Federal Highway Administration, Washington, DC. Chapter 4, Item 48 (PSR)

17. Federal Highway Administration. 2014. Highway Performance Monitoring System - Field Manual. <http://www.fhwa.dot.gov/policyinformation/hpms/fieldmanual/>. Federal Highway Administration, Washington, DC. Chapter 4, Item 50 (Rutting)
18. Federal Highway Administration. 2016. Highway Performance Monitoring System - Field Manual. <http://www.fhwa.dot.gov/policyinformation/hpms/fieldmanual/>. Federal Highway Administration, Washington, DC. Chapter 4, Item 50 (Rutting)
19. Federal Highway Administration. 2014. Highway Performance Monitoring System - Field Manual. <http://www.fhwa.dot.gov/policyinformation/hpms/fieldmanual/>. Federal Highway Administration, Washington, DC. Chapter 4, Item 51 (Faulting)
20. Federal Highway Administration. 2016. Highway Performance Monitoring System - Field Manual. <http://www.fhwa.dot.gov/policyinformation/hpms/fieldmanual/>. Federal Highway Administration, Washington, DC. Chapter 4, Item 51 (Faulting)
21. Federal Highway Administration. 2014. Highway Performance Monitoring System - Field Manual. <http://www.fhwa.dot.gov/policyinformation/hpms/fieldmanual/>. Federal Highway Administration, Washington, DC. Chapter 4, Item 52 (Cracking)
22. Federal Highway Administration. 2016. Highway Performance Monitoring System - Field Manual. <http://www.fhwa.dot.gov/policyinformation/hpms/fieldmanual/>. Federal Highway Administration, Washington, DC. Chapter 4, Item 52 (Cracking)
23. "National Performance Management Measures; Assessing Pavement Condition for the National Highway Performance Program and Bridge Condition for the National Highway Performance Program", (Final Rule). 23 CFR 490.319(c)(1) Data Quality Management Plan.
24. Serigos, P.A., B.A. Visintine, A.L. Simpson, G.R. Rada, and J.L. Groeger. "Quality Management Program for Pavement Condition Data Collected on the National Highway System." Presented at the 97th Annual Meeting of the Transportation Research Board, Washington, D.C., 2018.
25. FEDERAL-AID POLICY GUIDE 23 CFR 637B October 5, 1995, Transmittal 14.
26. Interstate Highway Pavement Sampling Quality Management Plan, FHWA-HIF-18-032, A.L. Simpson, G.R. Rada, J.M. Bryce, P. Serigos, B. Visintine, and J.L. Groeger. Federal Highway Administration, Washington, D.C., March 2018.
27. R Core Team. R: A language and environment for statistical computing. R Foundation for Statistical Computing, Vienna, Austria. <https://www.R-project.org/>. 2018
28. InfoPave website, Long-Term Pavement Performance, Federal Highway Administration, US Department of Transportation. <https://infopave.fhwa.dot.gov> (last accessed on 04/19/2019)

## APPENDIX A – PROJECT DATABASE DATA DICTIONARY

The Interstate Highway System pavement condition sampling database consists of eight tables. These tables are detailed here. At the top of each table, the table name (in bold) from the database file is provided, and the table name is followed by a brief description of the table contents. The table then describes each of the data elements within the table, including attribute, data type, description, and notes.

Table 75 is the metadata used to provide the details associated with the data collection stored at 0.01-mile interval.

**Table 75. Metadata**

<b>Attribute</b>	<b>Data Type</b>	<b>Description</b>	<b>Notes</b>
Session_Name	Text 11	Collected file name used by data collection subcontractor	SSRNMP###DL SS – State RN – Route Number ### - Milepost at beginning of the file D – Direction L – Lane
State	Text 2	2 character postal code for State	
Route_Number	Text 3	I for Interstate followed by two-digit route number	
Direction	Text 1	N = North S = South E = East W = West	
Lane	Number 1	1 = Primary Lane	
Begin_Milepost	Number 8,4	Milepost of summary section start	Miles
End_Milepost	Number 8,4	Milepost of summary section end	Miles
Section_Length	Number 8,4	Driven distance in the summary section	Miles
Begin_Latitude	Number 12,8	GPS location of summary section start	Decimal Degrees WGS84
Begin_Longitude	Number 12,8	GPS location of summary section start	Decimal Degrees WGS84
Begin_Elevation	Number 5,2	GPS location of summary section start	Height above Ellipsoid in Feet – WGS84
End_Latitude	Number 12,8	GPS location of summary section end	Decimal Degrees – WGS84
End_Longitude	Number 12,8	GPS location of summary section end	Decimal Degrees – WGS84
End_Elevation	Number 5,2	GPS location of summary section end	High above Ellipsoid in Feet – WGS84
Vehicle_ID	Text 15	ID of collection vehicle	
Driver	Text 3	Initials of driver	
Operator	Text 3	Initials of operator	
Speed	Number 2	Speed of vehicle at summary section start	MPH
Collection_Date	Date	Date of data collection	MM/DD/YYYY
Collection_Time	Time	Time of data collection	HH:MM:SS GMT
Air_Temperature	Number 3	Ambient air temperature	Degrees Fahrenheit

Attribute	Data Type	Description	Notes
Surface_Temperature	Number 3	Temperature of pavement surface	Degrees Fahrenheit
Surface_Type	Text 4	Surface Type of pavement	AC = asphalt concrete CRCP = continuously reinforced concrete pavement JPCP = jointed concrete pavement
Bridge_Flag	Text 5	True = Bridge deck located within the summary section False = No bridge deck within the summary section	
Lane_Deviation_Flag	Text 5	True = Segment contains a lane deviation False = no deviation contained within the segment	
Construction_Flag	Text 5	True = Segment contains construction False = no construction contained within the segment	

Source: FHWA

Table 76 provides the data used to estimate the percent cracking as collected at the 0.01-mile interval.

**Table 76. Hundredth\_mile\_Crack**

Attribute	Data Type	Description	Notes
Session_Name	Text 11	Collected file name used by data collection subcontractor	SSRNMP###DL SS – State RN – Route Number ### - Milepost at beginning of the file D – Direction L – Lane Suffix QC added if QC data
State	Text 2	2 character postal code for State	
Route_Number	Text 3	I for Interstate followed by two-digit route number	
Direction	Text 1	N = North S = South E = East W = West	
Lane	Number 1	1 = Primary Lane 2 = Adjacent Lane	
Begin_Milepost	Number 8,4	Milepost of summary section start	Miles
End_Milepost	Number 8,4	Milepost of summary section end	Miles
Section_Length	Number 8,4	Driven distance in the summary section	Miles

Attribute	Data Type	Description	Notes
Percent_Cracking	Number 3,1	For asphalt pavement, area of affected wheelpath divided by area of lane For jointed concrete pavement, number of transverse cracked slabs divided by total number of slabs For continuously reinforced concrete pavement, area of longitudinal cracking, punchouts, and patches divided by area of lane	%
Length	Number 3,1	Length of segment considered in accumulating traffic data	Feet
Lane_Width	Number 4,2	Average width of lane for the segment of cracking data	Feet
Wheelpath_Length	Number 5,2	Length of wheelpath with either fatigue or longitudinal cracking observed	Feet
Affected_Wheelpath_Area	Number 5	Area of affected wheelpath – using Wheelpath_Length field	Square Feet
Wheelpath_Area	Number 5	Area of wheelpath	Square Feet
Fatigue_Area	Number 5	Area of fatigue present in entire lane	Square Feet
Lane_Area	Number 5	Area of lane in segment	Square Feet
Transverse_Cracked_Slab_Count	Number 3	Total count of transversely cracked slabs in segment	Count
Joint_Count	Number 2	Total count of joints in segment	Count
Punchout_Area	Number 5	Area of all punchouts in segment	Square Feet
Patching_Area	Number 5	Area of all patches in segment	Square Feet
Longitudinal_Crack_Length	Number 5	Length of transverse cracking observed on continuously reinforced concrete pavement	Feet

Source: FHWA

Table 77 is faulting data collected for 0.01-mile segments of jointed concrete surfaces.

**Table 77. Hundredth\_mile\_Fault**

Attribute	Data Type	Description	Notes
Session_Name	Text 11	Collected file name used by data collection subcontractor	SSRNMP###DL SS – State RN – Route Number ### - Milepost at beginning of the file D – Direction L – Lane Suffix QC added if QC data
State	Text 2	2 character postal code for State	

Attribute	Data Type	Description	Notes
Route_Number	Text 3	I for Interstate followed by two-digit route number	
Direction	Text 1	N = North S = South E = East W = West	
Lane	Number 1	1 = Primary Lane	
Begin_Milepost	Number 8,4	Milepost of summary section start	Miles
End_Milepost	Number 8,4	Milepost of summary section end	Miles
Section_Length	Number 8,4	Driven distance in the summary section	Miles
LCMS_Faulting_Average	Number 4,2	Average fault height derived from LCMS adjusted to account for undetected joints	Inches
LCMS_Fault_Count	Number 2	Number of faults detected by LCMS	Count
LCMS_Faulting_Standard_Deviation	Number 4,2	Standard deviation of faults measured with LCMS and added zero values	Inches
LCMS_Faulting_Minimum	Number 4,2	Minimum fault height included in average from LCMS including added zero values	Inches
LCMS_Faulting_Maximum	Number 4,2	Maximum fault height included in average from LCMS	Inches

Source: FHWA

Table 78 is IRI data for the 0.01-mile segment. These data were collected on all surface types.

**Table 78. Hundredth\_mile\_IRI**

Attribute	Data Type	Description	Notes
Session_Name	Text 11	Collected file name used by data collection subcontractor	SSRNMP####DL SS – State RN – Route Number ### - Milepost at beginning of the file D – Direction L – Lane Suffix QC added if QC data
State	Text 2	2 character postal code for State	
Route_Number	Text 3	I for Interstate followed by two-digit route number	
Direction	Text 1	N = North S = South E = East W = West	
Lane	Number 1	1 = Primary Lane	

Attribute	Data Type	Description	Notes
Begin Milepost	Number 8,4	Milepost of summary section start	Miles
End Milepost	Number 8,4	Milepost of summary section end	Miles
Section Length	Number 8,4	Driven distance in the summary section	Miles
IRI_Mean	Number 3	Average of the left and right wheelpath IRI values	in/mile
IRI_Left	Number 3	Left wheelpath IRI	in/mile
IRI_Right	Number 3	Right wheelpath IRI	in/mile

Source: FHWA

Table 79 is rut depth data collected for 0.01-mile segments with asphalt concrete surfaces.

**Table 79. Hundredth\_mile\_Rut**

Attribute	Data Type	Description	Notes
Session_Name	Text 11	Collected file name used by data collection subcontractor	SSRNMP###DL SS – State RN – Route Number ### - Milepost at beginning of the file D – Direction L – Lane Suffix QC added if QC data
State	Text 2	2 character postal code for State	
Route_Number	Text 3	I for Interstate followed by two-digit route number	
Direction	Text 1	N = North S = South E = East W = West	
Lane	Number 1	1 = Primary Lane	
Begin Milepost	Number 8,4	Milepost of summary section start	Miles
End Milepost	Number 8,4	Milepost of summary section end	Miles
Section_Length	Number 8,4	Driven distance in the summary section	Miles
Rutting_Average	Number 4,2	Average of left and right rut depth values	Inches
Rutting_Left	Number 4,2	Left wheelpath rut depth	Inches
Rutting_Right	Number 4,2	Right wheelpath rut depth	Inches

Source: FHWA



Table 80 is location of features impacting data collection.

**Table 80. Event\_Table**

Attribute	Data Type	Description	Notes
Session_Name	Text 11	Collected file name used by data collection subcontractor	SSRNMP###DL SS – State RN – Route Number ### - Milepost at beginning of the file D – Direction L – Lane Suffix QC added if QC data
Route	Text 6	Route description	SSRNDL SS – State RN – Route Number D – Direction L - Lane
Begin Milepost	Number 8,4	Measured distance at start of feature	Miles
End Milepost	Number 8,4	Measured distance at end of feature	Miles
Feature_Type	Text 14	Feature type that exists at referenced location	Bridge Construction Lane Deviation

Source: FHWA

Table 81 is location of changes in pavement type.

**Table 81. Pavement\_Change**

Attribute	Data Type	Description	Notes
Session_Name	Text 11	Collected file name used by data collection subcontractor	SSRNMP###DL SS – State RN – Route Number ### - Milepost at beginning of the file D – Direction L – Lane Suffix QC added if QC data
State	Text 2	2 character postal code for State	
Route_Number	Text 3	I for Interstate followed by two-digit route number	
Direction	Text 1	N = North S = South E = East W = West	
Lane	Number 1	1 = Primary Lane 2 = Adjacent Lane	
Milepost	Number 8,4	Measured distance at pavement change	Miles

Attribute	Data Type	Description	Notes
Surface_Type	Text 4	Pavement type that begins at referenced location	asphalt pavement continuously reinforced concrete pavement JPCP

Source: FHWA

Table 82 is data accumulated to the 0.1-mile segment. Shorter segments are used where a pavement change occurs.

**Table 82. Tenth\_Mile\_Data**

Attribute	Data Type	Description	Notes
Session_Name	Text 14	Collected file name used by data collection subcontractor	SSRNMP###DL SS – State RN – Route Number ### - Milepost at beginning of the file D – Direction L – Lane Suffix QC added if QC data
State	Text 2	2 character postal code for State	
Route_Number	Text 3	I for Interstate followed by two-digit route number	
Direction	Text 1	N = North S = South E = East W = West	
Lane	Number 1	1 = Primary Lane 2 = Adjacent Lane	
Surface_Type	Text 4	Surface Type of pavement	AC = asphalt concrete CRCP = continuously reinforced concrete pavement JPCP = jointed concrete pavement
Begin_Milepost	Number 8,4	Mile point of summary section start	Miles
End_Milepost	Number 8,4	Mile point of summary section end	Miles
Section_Length	Number 8,4	Driven distance in the summary section	Miles
Avg_IRI	Number 4,1	Average IRI for the segment	in/mile
Avg_Rutting	Number 4,3	Average rut depth for the segment	Inches
Avg_Fault	Number 4,3	Average fault for the segment derived from LCMS	Inches

<b>Attribute</b>	<b>Data Type</b>	<b>Description</b>	<b>Notes</b>
Avg_Percent_Cracking	Number 3,1	Average Percent cracking for the segment compatible with 2016 HPMS Field Manual For asphalt pavement, area of affected wheelpath divided by area of lane For jointed concrete pavement, number of transverse cracked slabs divided by total number of slabs For continuously reinforced concrete pavement, area of longitudinal cracking, punchouts, and patches divided by area of lane	%
IRI_Perf	Text 1	Pavement condition based solely on average IRI	Good / Fair / Poor / NA (where value not measured)
Rutting_Perf	Text 1	Pavement condition based solely on average rut depth	Good / Fair / Poor / NA (where value not measured)
Faulting_Perf	Text 1	Pavement condition based solely on average faulting	Good / Fair / Poor / NA (where value not measured)
Percent_Crack_Perf	Text 1	Pavement condition based solely on average Percent Cracking	Good / Fair / Poor / NA (where value not measured)
Performance	Text 1	Pavement performance using Percent_Crack_Perf, Rutting_Perf, Faulting_Perf, and IRI_Perf	Good / Fair / Poor / NA (where segment value not measured)

Source: FHWA