CULVERT ASSESSMENT AND DECISION- MAKING PROCEDURES MANUAL

For Federal Lands Highway

Publication No. FHWA-CFL/TD-10-005

September 2010



U.S. Department
of Transportation
**Federal Highway
Administration**



**Central Federal Lands Highway Division
12300 West Dakota Avenue
Lakewood, CO 80228**

FOREWORD

The Federal Lands Highway (FLH) promotes development and deployment of applied research and technology applicable to solving transportation related issues on Federal Lands. The FLH provides technology delivery, innovative solutions, recommended best practices, and related information and knowledge sharing to Federal agencies, Tribal governments, and other offices within the FHWA.

The objective of this study was to produce project-level guidelines for assessing the condition and performance of existing roadway culverts, and when necessary, select corrective actions to be taken for any deficiencies found as part of specific project development activities.

The content, recommendations and examples provided in this manual are the result of the direct and indirect contribution of many years of combined experience in culvert design and evaluation by multiple agencies and industry consultants. Formulation of the procedure was also influenced by the existing work of others in the realm of culvert assessment and rehabilitation, as researched in the extensive literature review phase of its development.

The contributions and cooperation of the FLH personnel of the Eastern, Central and Western divisions are gratefully acknowledged, as well as interview participants at Caltrans, Minnesota DOT, Ohio DOT and Oregon DOT. Individuals from many other organizations around the country contributed valuable information and insight for this document. Although there are too many to mention by name, their contributions and cooperation are gratefully acknowledged.

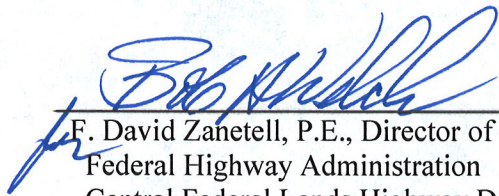

F. David Zanetell, P.E., Director of Project Delivery
Federal Highway Administration
Central Federal Lands Highway Division

Notice

This document is disseminated under the sponsorship of the U.S. Department of Transportation in the interest of information exchange. The U.S. Government assumes no liability for the use of the information contained in this document. This report does not constitute a standard, specification, or regulation.

The U.S. Government does not endorse products or manufacturers. Trademarks or manufacturers' names appear in this report only because they are considered essential to the objective of the document.

Quality Assurance Statement

The Federal Highway Administration (FHWA) provides high-quality information to serve Government, industry, and the public in a manner that promotes public understanding. Standards and policies are used to ensure and maximize the quality, objectivity, utility, and integrity of its information. FHWA periodically reviews quality issues and adjusts its programs and processes to ensure continuous quality improvement.

Technical Report Documentation Page

1. Report No. FHWA-CFL/TD-10-005	2. Government Accession No.	3. Recipient's Catalog No.	
4. Title and Subtitle <i>Culvert Assessment and Decision-Making Procedures Manual For Federal Lands Highway</i>		5. Report Date September 2010	
		6. Performing Organization Code	
7. Author(s) John H. Hunt ⁽¹⁾ , Stephen M. Zerges ⁽¹⁾ , Brian C. Roberts ⁽²⁾ , Bart Bergendahl ⁽³⁾		8. Performing Organization Report No.	
9. Performing Organization Name and Address ⁽¹⁾ Ayres Associates ⁽²⁾ Water Resources Learning Center 3665 JFK Parkway 3918 Prosperity Ave # 100 Bldg 2, Suite 200 Fairfax, VA 22031 Fort Collins, CO 80525		10. Work Unit No. (TRAIS)	
		11. Contract or Grant No. DTFH68-08-C-00024	
12. Sponsoring Agency Name and Address ⁽³⁾ Federal Highway Administration Central Federal Lands Highway Division 12300 W. Dakota Ave Lakewood, CO 80228		13. Type of Report and Period Covered Final Report August 2008 - April 2010	
		14. Sponsoring Agency Code HFTS-16.4	
Supplementary Notes: COTR: Bart Bergendahl, FHWA-FLH. Advisory Panel Members: Eric Brown, FHWA-RC; Scott Hogan, Matthew Demarco and Roger Surdahl, FHWA-CFLHD; Greg Dolson and Richard John Seabrook, FHWA-FLH; Brian Beucler and Jeffrey Johnson, FHWA-EFLHD; Karl Gleason, FHWA-WFLHD; This project was funded under the FHWA Federal Lands Highway Coordinated Technology Implementation Program (CTIP) and the FHWA Resource Center Geotechnical and Hydraulic Program..			
16. Abstract Federal Lands Highway (FLH) Division of FHWA works in cooperation with federal land management agencies to plan, design, construct and rehabilitate highways and bridges on federally owned lands. In support of this mission, FLH has developed project-level guidelines for assessing the condition and performance of existing roadway culverts, and when necessary, selecting corrective action for any deficiencies found as part of specific project development activities. The end-result of this effort is this procedure manual, which consists of a fully integrated culvert assessment tool and culvert decision-making tool that provides guidance for selecting replacement or rehabilitation alternatives. Appendices A through G are included on the attached CD ROM.			
17. Key Words CULVERT ASSESSMENT, CULVERT INSPECTION, HYDRAULIC STRUCTURES, CULVERT DECISION-MAKING, CULVERT REPAIR, CULVERT REPLACEMENT, CULVERT REHABILITATION		18. Distribution Statement No restriction. This document is available to the public from the sponsoring agency at the website http://www.cflhd.gov	
19. Security Classif. (of this report) Unclassified	20. Security Classif. (of this page) Unclassified	21. No. of Pages 222 (92 printed) (130 on CD ROM)	22. Price

SI* (MODERN METRIC) CONVERSION FACTORS

APPROXIMATE CONVERSIONS TO SI UNITS

Symbol	When You Know	Multiply By	To Find	Symbol
LENGTH				
in	inches	25.4	millimeters	mm
ft	feet	0.305	meters	m
yd	yards	0.914	meters	m
mi	miles	1.61	kilometers	km
AREA				
in ²	square inches	645.2	square millimeters	mm ²
ft ²	square feet	0.093	square meters	m ²
yd ²	square yard	0.836	square meters	m ²
ac	acres	0.405	hectares	ha
mi ²	square miles	2.59	square kilometers	km ²
VOLUME				
fl oz	fluid ounces	29.57	milliliters	mL
gal	gallons	3.785	liters	L
ft ³	cubic feet	0.028	cubic meters	m ³
yd ³	cubic yards	0.765	cubic meters	m ³
NOTE: volumes greater than 1000 L shall be shown in m ³				
MASS				
oz	ounces	28.35	grams	g
lb	pounds	0.454	kilograms	kg
T	short tons (2000 lb)	0.907	megagrams (or "metric ton")	Mg (or "t")
TEMPERATURE (exact degrees)				
°F	Fahrenheit	5 (F-32)/9 or (F-32)/1.8	Celsius	°C
ILLUMINATION				
fc	foot-candles	10.76	lux	lx
fl	foot-Lamberts	3.426	candela/m ²	cd/m ²
FORCE and PRESSURE or STRESS				
lbf	poundforce	4.45	newtons	N
lbf/in ²	poundforce per square inch	6.89	kilopascals	kPa

APPROXIMATE CONVERSIONS FROM SI UNITS

Symbol	When You Know	Multiply By	To Find	Symbol
LENGTH				
mm	millimeters	0.039	inches	in
m	meters	3.28	feet	ft
m	meters	1.09	yards	yd
km	kilometers	0.621	miles	mi
AREA				
mm ²	square millimeters	0.0016	square inches	in ²
m ²	square meters	10.764	square feet	ft ²
m ²	square meters	1.195	square yards	yd ²
ha	hectares	2.47	acres	ac
km ²	square kilometers	0.386	square miles	mi ²
VOLUME				
mL	milliliters	0.034	fluid ounces	fl oz
L	liters	0.264	gallons	gal
m ³	cubic meters	35.314	cubic feet	ft ³
m ³	cubic meters	1.307	cubic yards	yd ³
MASS				
g	grams	0.035	ounces	oz
kg	kilograms	2.202	pounds	lb
Mg (or "t")	megagrams (or "metric ton")	1.103	short tons (2000 lb)	T
TEMPERATURE (exact degrees)				
°C	Celsius	1.8C+32	Fahrenheit	°F
ILLUMINATION				
lx	lux	0.0929	foot-candles	fc
cd/m ²	candela/m ²	0.2919	foot-Lamberts	fl
FORCE and PRESSURE or STRESS				
N	newtons	0.225	poundforce	lbf
kPa	kilopascals	0.145	poundforce per square inch	lbf/in ²

*SI is the symbol for the International System of Units. Appropriate rounding should be made to comply with Section 4 of ASTM E380.
(Revised March 2003)

TABLE OF CONTENTS

CHAPTER 1 – INTRODUCTION..... 1

CHAPTER 2 - CULVERT ASSESSMENT TOOL..... 3

 Summary of Assessment Tool..... 3

 Field Assessment Protocol..... 3

 Culvert Entry Diagram..... 7

 Recommended Equipment List..... 9

 Culvert Assessment Form..... 10

 Culvert Assessment Guide..... 11

 Culvert and Channel Performance Indicators..... 19

 Performance Problems Leading to Level 1 Actions..... 19

 Performance Problems Leading to Level 2 Investigations..... 25

CHAPTER 3 - CULVERT DECISION-MAKING TOOL..... 35

 Summary of Decision-Making Tool..... 35

 Culvert Action Flowcharts 37

 Decision-Making Methodology Using Action Flowcharts..... 37

 Repair Liner Selection Matrix..... 50

 Localized Man-Entry Repair Matrix..... 50

 Replacement Matrix..... 50

CHAPTER 4 - CULVERT ASSESSMENT AND DECISION-MAKING EXAMPLES... 51

 Concrete Box Culvert Assessment and Decision-Making Example..... 51

 Corrugated Metal Pipe (CMP) Assessment and Decision-Making Example..... 60

 Plastic Pipe Culvert Assessment and Decision-Making Example..... 73

REFERENCES..... 79

APPENDIX A – FLH CULVERT ENTRY DIAGRAM AND ASSESSMENT FORM (4 Pages)

APPENDIX B – PHOTOGRAPHIC GUIDE FOR CULVERT ASSESSMENT (76 Pages)

APPENDIX C – PHOTOGRAPHIC GUIDE FOR CULVERT REPAIR AND REPLACEMENT TECHNIQUES (18 Pages)

APPENDIX D – CULVERT DECISION-MAKING PROCESS MAP AND FLOWCHARTS (12 Pages)

APPENDIX E – CULVERT DECISION-MAKING MATRICES (8 Pages)

APPENDIX F – FLH BID-BASED COST DATA FOR CULVERT REPAIR AND REPLACEMENT TASKS (4 Pages)

APPENDIX G – BIBLIOGRAPHY (8 Pages)

(Appendices are located on the attached CD ROM)

LIST OF FIGURES

Figure 1. Flowchart. FLH Culvert Entry Diagram..... 8

Figure 2: Form. FLH Culvert Assessment Form (see Appendix A for full size form)..... 10

Figure 3. Photo. Example of severe debris blockage (FHWA/National Highway Institute training materials)..... 20

Figure 4. Photo. Example of severe buoyancy uplift (FHWA/National Highway Institute Training materials)..... 21

Figure 5. Drawing. Idealized example sketch of Poor channel alignment..... 22

Figure 6. Photo. Erosion of downstream embankment slope and shoulder from previous overtopping..... 23

Figure 7. Drawing. Outlet scour: example sketch (taken from FHWA HDS-5)..... 24

Figure 8. Photo. RCP damaged by scour (FHWA/National Highway Institute training materials)..... 24

Figure 9. Photo. Example of piping through embankment (FHWA/NHI Institute training materials)..... 26

Figure 10. Photo. Voids caused by open joints reaching the road surface (FHWA Culvert Inspection Manual)..... 27

Figure 11. Photo. Example of roadway settlement caused by voids around a culvert (taken From MnDOT)..... 27

Figure 12. Photo. Perched culvert outlet due to degradation, with undermining of grouted riprap outlet apron..... 28

Figure 13. Photo. Example of head cut that can be expected to move upstream over time..... 29

Figure 14. Photo. Barrel filled with sediment up to half its rise, due channel aggradation..... 30

Figure 15. Photo. Example of an open-bottom culvert..... 31

Figure 16. Photo. Exposed spread footing condition possible in an open-bottom culvert..... 32

Figure 17. Photo. An aquatic organism passage (AOP) culvert 33

Figure 18. Flowchart. FLH Culvert Decision-Making Process Map..... 36

Figure 19. Flowchart. Starting portion of Culvert Barrel Action Flowchart – Page 1 ALL TYPES..... 37

Figure 20. Flowchart. Maintenance loop at beginning of FLH Culvert Barrel Action Flowchart – Page 1 ALL TYPES..... 38

Figure 21. Flowchart. Treatment of Level 1 fixes, Good and Fair barrel ratings and appurtenances in Page 1 flow..... 39

Figure 22. Flowchart. Treatment of small, shallow pipes in Page 1 – ALL TYPES flowchart... 40

Figure 23. Flowchart. Page 1 treatment of Critical pipe barrels, embankment damage and frequent overtopping..... 41

Figure 24. Flowchart. Page 2 terminators for small concrete and RCP culverts, except Level 2 investigation..... 43

Figure 25. Flowchart. Page 2 treatment of concrete culverts with joint deterioration..... 44

Figure 26. Flowchart. Beginning replacement and scour protection qualifiers for Page 7 Appurtenances Flowchart..... 45

Figure 27. Flowchart. Page 7 qualifiers for appurtenances with Critical or Poor scour countermeasures..... 45

Figure 28. Flowchart. Page 7 qualifiers for appurtenances with undermining, rotation, displacement, or cracks..... 46

Figure 29. Flowchart. Page 7 qualifiers for repair and replacement of appurtenances..... 47

Figure 30. Flowchart. Page 7 qualifiers for Poor or Critical rated aprons with or without aggressive abrasion.....47

Figure 31. Flowchart. Page 7 qualifiers for cracking, spalling and section loss in aprons..... 48

Figure 32. Flowchart. Page 8 qualifiers for no embankment damage, favoring trenchless replacement.....49

Figure 33. Form. Completed Culvert Assessment Form for concrete box culvert example in Yosemite Park..... 52

Figure 34. Flowchart. Annotated Culvert Entry Diagram for concrete box culvert example in Yosemite Park..... 53

Figure 35. Photo. View downstream of concrete box culvert with masonry appurtenances..... 54

Figure 36. Form. Annotated Culvert Assessment Form for concrete box culvert deterioration categories.....54

Figure 37. Photo. Invert abrasion damage with concrete section loss and exposed and corroding rebar.....55

Figure 38. Photo. Vertical crack in culvert wall with exudence.....56

Figure 39. Photo. Diagonal crack near joint and invert with water infiltration 56

Figure 40. Flowchart. Annotated FLH Culvert Barrel Flowchart – Page 1 ALL TYPES for concrete box example.....58

Figure 41. Flowchart. Annotated FLH Culvert Continued Flowchart – Page 2 for concrete box example..... 59

Figure 42. Flowchart. Annotated FLH Culvert Assessment Form for CMP example in Yosemite National Park..... 61

Figure 43. Flowchart. Annotated FLH Culvert Entry Diagram for CMP example in Yosemite National Park..... 62

Figure 44. Form. Annotated Culvert Assessment Form for concrete box culvert deterioration categories..... 63

Figure 45. Photo. Light invert deterioration and minor local scour erosion at outlet of CMP example.....64

Figure 46. Photo. Light invert deterioration at inlet of CMP example in Yosemite Park..... 64

Figure 47. Photo. Stable downstream channel conditions at the outlet of CMP example in Yosemite Park.....65

Figure 48. Photo. Pipe crawler ROV system ready for Level 2 inspection of CMP example in Yosemite Park.....66

Figure 49. Photo. ROV video screenshot of CMP example showing typical corrosion above flow line.....67

Figure 50. Photo. ROV video screenshot of CMP example showing crown deformation and cracking..... 67

Figure 51. Photo. ROV video screenshot of CMP example showing deformation and invert section loss.....68

Figure 52. Photo. ROV video screenshot of CMP example showing complete invert section loss..... 68

Figure 53. Flowchart. Annotated Barrel Action Flowchart – Page 1 for CMP example in Yosemite National Park..... 70

Figure 54. Flowchart. Annotated Continued Decision Process Flowchart – Page 3 for CMP example.....72

Figure 55. Photo. View of inlet of plastic HDPE example in Fountainhead Regional Park, Fairfax, VA..... 73

Figure 56. Photo. View of interior of plastic example in Fountainhead Park showing clogging..... 74

Figure 57. Photo. View of roadway crossing at plastic pipe example in Fountainhead Park.... 74

Figure 58. Form. Annotated Culvert Assessment Form for plastic HDPE example in Fountainhead Park..... 75

Figure 59. Flowchart. Annotated Culvert Entry Diagram for plastic HDPE example in Fountainhead Park..... 76

Figure 60. Form. Annotated deterioration section of the Culvert Assessment Form for plastic example..... 77

Figure 61. Flowchart. Annotated Culvert Barrel Action Flowchart – Page 1 for plastic HDPE example..... 78

LIST OF TABLES

Table 1. Performance Problems Leading to a Level 1 Action..... 19
Table 2. Performance Problems Leading to a Level 2 Action..... 25
Table 3. Other Non-Performance Problems Leading to a Level 2 Action..... 26

LIST OF ABBREVIATIONS AND SYMBOLS

AASHTO	American Association of State Highway and Transportation Officials
C	Celsius
CA	California
Caltrans	California Department of Transportation
CFLHD	Central Federal Lands Highway Division
CIPP	cured-in-place pipe
CIPPL	cured-in-place pipe lining
cm	centimeter
CMP	corrugated metal pipe
DC	District of Columbia
DOT	departments of transportation
EFLHD	Eastern Federal Lands Highway Division
F	Fahrenheit
FHWA	Federal Highway Administration
FLH	Federal Lands Highway
ft	feet
GPS	Global Positioning System
HDPE	high-density polyethylene
in	inches
kPa	kilopascal
L1	Level 1 (investigation)
L2	Level 2 (investigation)
m	meter
MD	Maryland
MN	Minnesota
N/A	not available
NA	not applicable
NCHRP	National Cooperative Highway Research Program
NHI	National Highway Institute
NPS	National Park Service
OH	Ohio
OSHA	Occupational Safety and Health Administration
PE	polyethylene
PLF	price per linear foot
PSF	price per square foot
psig	pounds per square inch, gauge
PP	polypropylene
PVC	poly(vinyl chloride)
TRB	Transportation Research Board
USACE	U.S. Army Corps of Engineers
USFS	U.S. Forest Service
WFLHD	Western Federal Lands Highway Division
WI	Wisconsin
www	World Wide Web

CHAPTER 1 – INTRODUCTION

The Office of Federal Lands Highway (FLH) is part of the US Department of Transportation (USDOT) Federal Highway Administration (FHWA), and works in cooperation with federal land management agencies to plan, design, construct and rehabilitate highways and bridges on federally owned lands. In support of this mission, FLH has developed these project-level guidelines for assessing the condition and performance of existing roadway culverts, and when necessary, selecting corrective actions to be taken for any deficiencies found as part of specific project development activities. This procedures manual is intended to aid users in implementing a fully integrated culvert assessment and decision-making tool that provides guidance for selecting replacement or rehabilitation alternatives.

These guidelines have been prepared for use by FLH engineers and field technicians performing culvert assessments in support of project-level design activities. The full range of environmental regions and structural types that are encompassed by the various FLH divisions across the country are accommodated by the procedure. The modular “toolset” approach to organization of this procedure is intended to efficiently facilitate assessors possessing a potentially wide range of background, training and experience. The core of the procedure offers the minimum necessary tools, including assessment forms, rating guide and decision-making charts, for an engineer-inspector to conduct culvert assessments and make follow-up recommendations quickly and effectively. For those assessors seeking further guidance, modularized content and tools, such as the photographic rating guide or in-depth narrative, can be “grabbed from the shelf” and taken into the field similar to physical inspection tools.

The content, recommendations and examples provided in this manual are the result of the direct and indirect contribution of many years of combined experience in culvert design and evaluation by multiple agencies and industry consultants. Formulation of the procedure was also influenced by the existing work of others in the realm of culvert assessment and rehabilitation, as researched in the extensive literature review phase of its development. Case-study examples included in this manual are a few common scenarios encountered by FLH assessors during an actual culvert investigation effort, and are by no means exhaustive. Future content additions and modifications by FLH are anticipated through further use and evaluation of the procedure.

Although these guidelines are intended for project-level rather than programmatic or inventory-level use (i.e. planning and future budgeting), their development was influenced by existing work and industry practices in the field of culvert inventory and management. Inventory-level use was not a goal in the creation of this manual; however, the manual and its component tools do easily lend themselves to programmatic applications and should function well as a basis for future culvert asset management development efforts by FLH and other users.

This page intentionally left blank.

CHAPTER 2 – CULVERT ASSESSMENT TOOL

SUMMARY OF ASSESSMENT TOOL

The purpose of this assessment tool is to provide FHWA Federal Lands Highway personnel with project-level guidelines for assessing the condition and performance of existing roadway culverts within the extents of a planned roadway project. This procedure applies to culverts with a span of less than 20 feet. The procedure identifies the minimum set of parameters necessary to effectively and efficiently evaluate both existing condition and performance for a broad range of culvert structure types, materials, and applications that may be encountered. The procedure also describes the defining criteria for each parameter, provides a rating system, and suggests methods and tools for measuring and recording the parameters. Safe and efficient assessment practices are outlined in the field inspection protocol and culvert entry guide sections of the procedure.

The culvert assessment tool, herein referred to as a Level 1 assessment, is intended for rapid assessment of a culvert's condition and performance. Culvert condition refers to the level of physical deterioration of the culvert barrel and appurtenances, while performance refers to the functionality of the structure as a water conveyance device, apart from the physical condition of the structures. The Level 1 assessment procedure may identify the need for a more in-depth investigation, termed a Level 2 assessment. Level 2 assessments require the involvement of technical discipline specialists in hydraulic, geotechnical, structural or materials engineering, and may also require special equipment for access and inspection. The Level 1 assessment procedure should lead to one of the following recommendations, for each culvert assessed: (1) the condition and performance appear to be acceptable, and no further action is needed with respect to the project being undertaken; (2) Level 1 maintenance (e.g. cleaning/clearing) is needed to remedy an observed performance problem and/or facilitate completing the Level 1 assessment; (3) Level 1 action is needed to repair or replace the culvert or appurtenances, with assistance from the decision-making tool portion of this procedure; or (4) an in-depth Level 2 assessment is required due to indicators identified by the Level 1 assessment.

FIELD ASSESSMENT PROTOCOL

The following is a recommended field assessment protocol for efficiently conducting Level 1 assessments of culverts. This protocol assumes that the following recommended approach is followed; however, this may not always be the case, depending upon project constraints. The recommended approach is to deploy a two-person assessment team from a motor vehicle staged at regular intervals along the project route, with the team walking from one culvert to the next. This approach allows the assessors to carry the minimum essential inspection and communication gear on their persons, while storing and having intermittent access to specialty and emergency gear that may be required in the vehicle at staging areas. It is also assumed for the purposes of providing this generalized protocol that each culvert is inspected on an individual basis, rather than sampling by groups of similar structures. By following the recommended methodology outlined in this field inspection protocol, the typical Level 1 assessment should take approximately 15 minutes to perform once at the structure, including Tasks B and C below.

Task A: Preparation and Planning

- Step 1: Assure all recommended equipment is mobilized with the inspection vehicle by checking the list of Recommended Equipment for Level 1 Culvert Assessments. Make sure that critical specialty equipment that is not easily replaceable in the field, such as personal air monitors and snake bite kits, are included. Prepare individual tool belts, vests or back packs with the recommended “on-person” equipment, so they are ready to grab and go. Check that there are enough assessment forms for all culverts, plus extras for unanticipated structures and mistakes/lost forms. Assessment forms should be tailored for the specific project as much as possible to maximize efficiency and reduce redundant entries required in the field.
- Step 2: Locate and plan ahead of time the most efficient course of travel to visit each structure within the project limits. Check and plan for the weather.
- Step 3: Consult with environmental and cultural resource specialists to identify possible aquatic organism/fish passage (AOP) or historic structures, and special environmental permitting issues. Check available topographic maps in order to plan for environmental conditions such as remote locations, steep terrain or thick vegetation.
- Step 4: Test electronic equipment, such as the GPS device, digital camera and air monitors, to ensure they are working properly. Charge all batteries as needed.

Task B: Arrival and Site Safety/Access

- Step 1: Upon arrival at the culvert, if GPS positioning is to be used, pause briefly on the approximate centerline of the culvert and acquire and/or record the GPS coordinates. Doing so will enable the team to leave the GPS equipment in the vehicle rather than carrying it through the assessment, and provide a good approximation of location within the typical 3-meter accuracy of the device. Note that newer technology currently in use by FLH personnel integrates GPS mapping and camera capabilities in a compact hand-held device that provides time-stamping and geo-coordinates of photographs, is portable enough to carry on foot throughout the assessment and helpful for navigation.
- Step 2: Stage the vehicle in a safe place on the shoulder or off the roadway, but close enough to be easily reached in an emergency. The distance between staging areas should not exceed twice the distance that either assessor is comfortable with traversing in an emergency, i.e. two miles at the most. Set out safety cones and don safety vests and/or hard hats as needed.
- Step 3: Perform a quick safety assessment of the site for challenging conditions that may require extra gear beyond the on-person standard inspection equipment, or possibly dangerous scenarios that may lead to aborting the assessment. Also be aware of the potential for poisonous vegetation and dangerous animal life.

Step 4: Once it has been determined that the culvert may be approached safely, don the necessary equipment and move to assess the accessibility of the structure. Follow the FLH Culvert Entry Diagram to determine whether the culvert may be entered with no special requirements, accessed in accordance with OSHA confined space entry guidelines, inspected at the ends only, or deferred to a Level 2 assessment due to access restrictions. For safety, it is recommended that the culvert entrant wear a hard hat and personal atmospheric monitoring device, regardless of whether the culvert is classified as a confined space, and the other assessor standby at the end of the culvert.

Task C: Conducting Culvert Assessment

Notes: For efficiency, the lead assessor should direct the sequence of the inspection and fill out the assessment form, while the assistant assessor collects the measurements and data and calls it out to the lead. In steep terrain, location and inspection of the outlet of the pipe can be more time consuming; therefore, it is recommended that the assistant assessor inspect and photograph the outlet while the lead assessor handles the inlet, takes roadway photographs, collects GPS data and fills out the form.

Although the assessment guide occasionally refers to quantitative measurements of characteristics and deterioration levels, effective qualitative descriptions are adequate in most cases.

If the culvert is not entered and an end-only inspection is performed, it is important to use a flashlight and/or mirror to examine as much of the culvert length and circumference as possible and from both ends if accessible. Even though many of the joints may not be observed closely in an end-only inspection, serious problems can be inferred by the appearance of cross-section offsets or the presence of piles of backfill soil that has infiltrated at the joint locations. Additionally, serious joint problems can be detected by the presence of holes or depressions in the road embankment above the culvert. Abrasion problems are often worst in the downstream-most sections of pipe. Assessors can be reasonably confident, therefore, that abrasion conditions are no worse elsewhere in the pipe than at the outlet end.

Step 1: The lead assessor should fill out the Location and Route Information section of the Assessment Form, and begin the Culvert Characteristics section, while the assistant assessor takes any desired site photographs. If basic, inventory-type photographs are to be taken, the following is recommended. Ensure that the time stamp on the digital camera is functioning and accurate. In general, the basic photographs that should be taken include a view of the inlet, outlet, upstream and downstream channel, and roadway surface. For culverts rated Poor or Critical, additional photographs documenting the deterioration are highly suggested. Photographs of small cracks can often be improved by wetting the surface and allowing it to dry while the crack remains wet. Set the photograph size to approximately 240 Kb, as applicable.

Step 2: The assistant assessor should collect the remaining Culvert Characteristics section measurements/data, assign ratings to deterioration and report to the lead assessor who records the information. The lead and assistant assessors should discuss and agree upon the various element condition and performance ratings.

Step 3: The lead and assistant should complete the assessment form at the culvert site before departing. Comments such as access issues, photo logs, and recommendations such as maintenance activities, preliminary repair/replace suggestions, and Level 2 escalations should be recorded. Finally, an overall rating for the culvert should be assigned that is generally dictated by the lowest element ranking, but subject to the assessors' judgment.

Note: Variations of this methodology may increase efficiency, depending upon team members' capabilities, the nature of the culverts and environment, and refinements/modifications adopted by the team in the course of conducting assessments.

Task D: Assessment Follow-Up Activities

Step 1: Upon completing assessments of all culverts within project limits, assessment forms should be reviewed for completeness and edits made as necessary before leaving the project site.

Step 2: A summary report should be written for the engineer/designer that briefly describes the findings and highlights any repair/replace and maintenance actions that are recommended. The summary report may be prepared offsite. Copies of assessments that are to be brought to the engineer/designer's attention, including repair/replace, maintenance, and Level 2 recommendations, should be attached to the report as an Appendix. Photographs of the affected culverts, both baseline and problem-specific, should be effectively labeled and attached to the summary report as an appendix. All photographs should be copied to disk and submitted along with the report.

Step 3: The original assessment forms, digital photographs, and summary report should be provided to the owner and archived in a project file folder. For possible future inventory and research purposes, it is best to electronically scan the forms for archival; however, this is optional since the summary report is likely to be in electronic format and include copies of the culverts assessments of interest. Enter information into the inventory database as applicable.

CULVERT ENTRY DIAGRAM

The FLH culvert entry diagram provides general guidance to the assessor regarding when culvert entry by personnel is permissible, and what alternatives to man-entry are recommended when it is not. OSHA regulations concerning confined space entry, as contained in 29 CFR 1910.146, take precedence over these guidelines, and neither should preclude the exercise of good judgment on the part of the assessor with regard to personal safety. A culvert should not be entered if there is any history, sign, or potential of dangerous conditions in the culvert such as hazardous atmosphere or flash flooding.

Barring site specific dangers that may exist and preclude culvert entry, assessors may generally enter a culvert if the rise exceeds 4 feet, barrel length is less than or equal to 200 feet, both ends are open to entry and exit, flow depth is less than 2 ft and velocity is less than 1 foot per second, slope is less than or equal to 20%, and there are no bends in the culvert that prevent both ends from remaining visible to the assessor at all times. Note that culverts traversing under 4-lane highways are typically 200 feet or less in barrel length, except in cases of very high fills. It is recommended that any culvert entrant wear a personal air monitoring device that has been calibrated and tested successfully within 24 hours of the entry. It is also recommended that only one assessor enter the culvert and the other stand by at the entrance in the event of an emergency.

Culverts larger than 4 feet in rise that do not meet the criteria for safe entry by FLH Level 1 assessor teams should be deferred to special inspection teams equipped and trained to conduct underwater or permit-required confined space entries in potentially adverse conditions. Culverts that are less than or equal to 4 feet in rise, precluding entry of Level 1 assessors, will typically be handled with end-only inspections, provided the condition of the full culvert barrel can be confidently assessed or inferred by the conditions observed at the end. In both cases, maintenance may be called for in order to facilitate completing the Level 1 assessment, as well as specialty inspection equipment such as robotic camera crawlers and Remotely Operated Vehicles (ROV's). The FLH culvert entry diagram is presented in the following Figure 1.

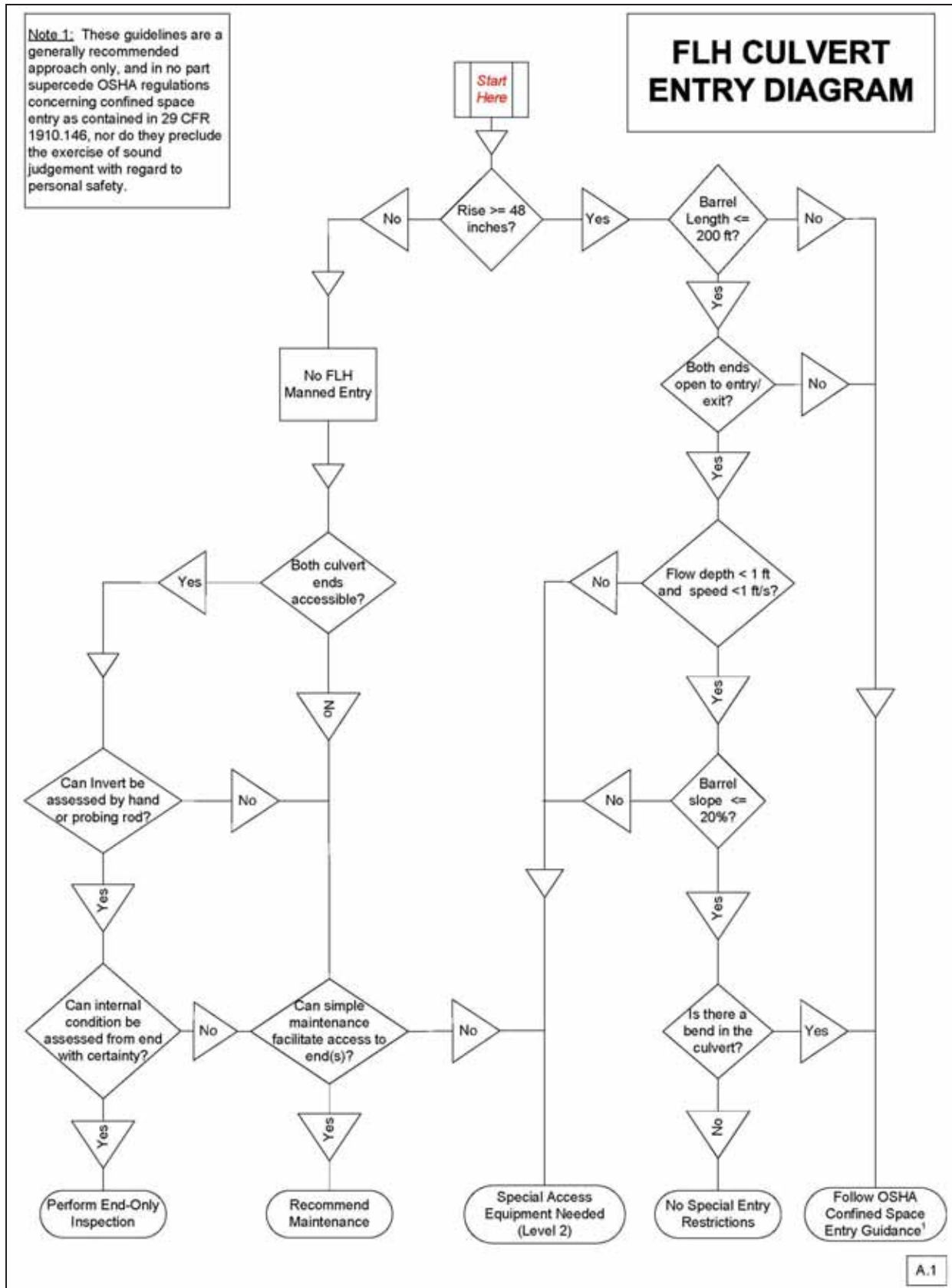

Figure 1. Flowchart. FLH Culvert Entry Diagram (see Appendix A for full size form).

RECOMMENDED EQUIPMENT LIST

The following is a list of recommended field safety and inspection gear to have available for conducting Level 1 assessments of culverts. It is assumed that a two-person assessment team will typically operate out of a motor vehicle; however, this may not always be possible. The experienced assessor(s) should determine the best equipment arrangement that can be efficiently handled by the team in this case. The most commonly used items are noted as “on-person”, while other options are listed as “in-vehicle”.

On-Person Equipment

Assessment Form
Clipboard
Geologist Pick Hammer
25-foot Measuring Tape or Folding Carpenters Ruler
Digital Camera (Shock-resistant and Waterproof)
Flashlight (500k to 1M candle) and/or Head Lamp
Handheld Mirror
Probing Rod (Graduated Survey Rod Section)
Personal Air Monitoring Devices
Traffic Safety Vests and Personal Field Safety Gear
Extra Car Keys
Tool Belts for Hands-Free Carrying of Inspection Equipment
Cell phones and/or Field Radios
CTL Crack Comparator Card

In-Vehicle Equipment

GPS Device
Project Files & Maps
Assessment Guide
Culvert Entry Guide
First Aid Kit w/Snake Bite and Poisonous Vegetation Provisions
OSHA Traffic Cones
Extra Batteries, Bulbs and Storage Cards for Camera, GPS and Lights
Waders and Life Jacket
100-foot Tending Line
Hardhats or Climbing Helmets
Crack Gauge or Calipers
Folding Shovel, Machete and Pry-Bar
Emergency Contact Information and Equipment
100-foot Measuring Tape, Distance Wheel, or Range Finder
Inclinometer

CULVERT ASSESSMENT FORM

The FLH Culvert Assessment Form shown in Figure 2 below and included in Appendix A is the master template for conducting Level 1 assessments. The form is designed to closely correlate with the condition and performance issues related to the array of components of the various culvert material types discussed in the assessment guide. Assessment planners are encouraged to custom tailor the master form to their specific projects, and pre-fill out redundant entry fields as much as possible ahead of time, in order to increase efficiency in the field.

FLH CULVERT ASSESSMENT FORM				Overall Rating			
Notes by: _____		Date: _____	Project: _____		Good Fair Poor Critical Unknown Performance Problems		
Measurements by: _____		Time: _____					
Site Information:							
Facility Location: _____							
Milepost: _____	Project Station: _____	GPS Road CL Waypoint No. _____					
Named waterway: _____ Direction of Flow: _____							
Culvert Information:							
No. of Barrels: _____	Barrel Length (approx): _____	Barrel Slope: Mild / Steep / _____					
Skew (0 degrees = perpendicular to road): _____		Approx Cover: Upstream _____ Downstream _____					
Barrel Shape (circle one)							
		Circular	Box	Elliptical	Pipe Arch	Arch	
Diameter: _____ / Span _____ x Rise _____							
Pipe Material (circle one): Metal - Concrete / RCP - Corrugated Plastic - Smooth Plastic - Timber – Masonry							
Appurtenances (circle one):							
Upstream : Projecting / Mitered / Headwall / Headwall & Wingwalls / Flared End Section / _____							
Downstream : Projecting / Mitered / Headwall / Headwall & Wingwalls / Flared End Section / _____							
Flowing or standing water? N / Y Depth: _____(ft) Est. Flow Velocity: _____(ft/s) Possible AOP/fish passage? Y / N							
Utilities Present (list)? Y / N _____ Possible historic features? Y / N _____ Open Bottom? Y / N _____							
Culvert Condition and Performance (circle / check all that apply and provide appropriate explanations below)							
Category		Rating			Performance Problems Requiring Level 1 Action Debris/Veg Blockage > 1/3 of rise at inlet or outlet <input type="checkbox"/> Sediment Blockage 1/3 to 3/4 of rise at inlet/outlet <input type="checkbox"/> Buoyancy or Crushing-Related Inlet Failure <input type="checkbox"/> Poor Channel Alignment <input type="checkbox"/> Previous and/or Frequent Overtopping <input type="checkbox"/> Local Outlet Scour <input type="checkbox"/> Performance Problems Requiring Level 2 Action Embankment Piping <input type="checkbox"/> Channel Degradation / Headcut (circle one) <input type="checkbox"/> Embankment Slope Instability <input type="checkbox"/> Sediment Blockage > 3/4 Rise at Inlet or Outlet <input type="checkbox"/> Sediment Blockage > 1/3 Rise Throughout Barrel <input type="checkbox"/> Other Problems Requiring Level 2 Action No Access / Ends Totally Buried / Submerged <input type="checkbox"/> Aggressive Abrasion/Corrosion/Chemical (circle) <input type="checkbox"/> Exposed Footing (Open-Bottom Culvert Only) <input type="checkbox"/>		
Invert deterioration	Good	Fair	Poor	Crit		Unk	N/A
Joints & Seams	Good	Fair	Poor	Crit		Unk	N/A
Corrosion / Chemical	Good	Fair	Poor	Crit		Unk	N/A
Cross-Section Deform	Good	Fair	Poor	Crit		Unk	N/A
Cracking	Good	Fair	Poor	Crit		Unk	N/A
Liner / Wall	Good	Fair	Poor	Crit		Unk	N/A
Mortar and Masonry	Good	Fair	Poor	Crit		Unk	N/A
Rot and Marine Borers	Good	Fair	Poor	Crit		Unk	N/A
Headwall/Wingwall	Good	Fair	Poor	Crit		Unk	N/A
Apron	Good	Fair	Poor	Crit	Unk	N/A	
Flared End Section	Good	Fair	Poor	Crit	Unk	N/A	
Pipe End	Good	Fair	Poor	Crit	Unk	N/A	
Scour Protection	Good	Fair	Poor	Crit	Unk	N/A	
Photos (number): ___ Inlet ___ Outlet ___ Roadway (ahead) ___ Roadway (back) ___ View downstream							
___ View upstream Others: _____							
Notes / Recommendations:							

<input type="checkbox"/> Additional notes / Sketches on back of form							

Figure 2. Form. FLH Culvert Assessment Form (see Appendix A for full size form).

General project information that can sometimes be filled out before going into the field appears at the top of the form. The overall rating for the culvert, which is generally governed by the lowest rating of the individual elements, appears in the upper right-hand corner to easily facilitate paging through a group of forms to locate problematic culverts. Specific culvert type and characteristic information such as barrel shape and appurtenance types present is entered in the fields in the middle of the form. Near the bottom of the form are the condition and performance categories and ratings, as well as automatic Level 1 and Level 2 Action triggers. The last fields of the form provide entries for the standard photograph numbers, as well as notes and recommendations. A check box at the footer allows the assessor to indicate if there are additional notes or sketches on the back of the form.

CULVERT ASSESSMENT GUIDE

The culvert assessment guide is a tool to assist assessors in assigning the appropriate condition rating codes to the various culvert material types based on deterioration levels. The guide consists of eleven tables, the first of which describes the five possible rating codes in the left-hand column and their general meanings in the right-hand column. The remaining tables describe each major culvert material type and common appurtenances, with typical modes of deterioration for that material type listed in the left hand column and rating codes appearing in the top row. By cross-referencing the deterioration mode and rating code, the assessor correlates within the body of the Table 1 detailed description for rating each category of deterioration for the culvert.

Important notes for consideration when using the assessment guide appear in the bottom-most row of each table, including special conditions that might trigger in-depth Level 2 investigations above and beyond this initial Level 1 assessment. There is also a reference at the top of each table to the photographic guide for further assistance in assigning rating codes. The Photographic Guide for Culvert Assessment appears as Appendix B of this procedure manual, and provides a sample image of each condition level and appropriate rating code for every deterioration mode and material that is described in this guide and might commonly be encountered in the field.

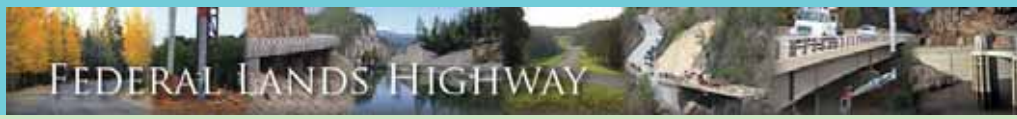

FHWA FLH CULVERT ASSESSMENT GUIDE

CONDITION ASSESSMENT RATING CODES

<p>Good</p>	<p>Like new, with little or no deterioration, structurally sound and functionally adequate.</p>
<p>Fair</p>	<p>Some deterioration, but structurally sound and functionally adequate.</p>
<p>Poor</p>	<p>Significant deterioration and/or functional inadequacy, requiring repair action that should, if possible, be incorporated into the planned roadway project.</p>
<p>Critical</p>	<p>Very poor conditions that indicate possible imminent failure that could threaten public safety, requiring immediate repair action.</p>
<p>Unknown</p>	<p>All or part of the culvert is inaccessible for assessment or a rating cannot be assigned.</p>

Notes:

- In general, the lowest elemental rating for the culvert determines the overall rating.
- Culvert conditions are assigned the above ratings, while failing culvert performance parameters are indicated by a check box if present.
- This guide is used for the rating of culverts with spans less than 20 feet as measured along the centerline of the roadway, as defined by NBIS.⁽¹⁾
- Due to the varied background and experience of the assessors, and variety of structures and deterioration modes, there is some inherent subjectivity to assigning the ratings in this guide.

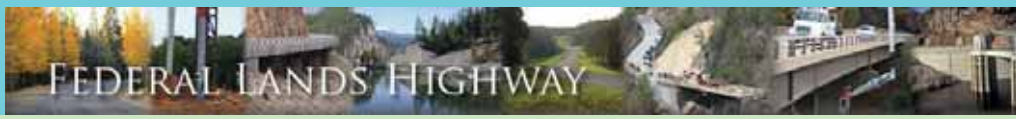

FHWA FLH CULVERT ASSESSMENT GUIDE

CONCRETE & RCP CONDITIONS

Refer to Photographic Guide for further assistance with rating assignments.

	Good	Fair	Poor	Critical
Invert Deterioration	Little or no abrasion, with light scaling and exposed aggregate	Moderate abrasion and scaling with minor aggregate loss but no exposure of steel reinforcement	Heavy abrasion and scaling with exposed steel reinforcement	Holes or section loss with extensive voids beneath and embankment or roadway damage
Joints	Smooth, tight joints with minor chips, cracks	Open or displaced with minor infil/exfil of water and/or soil	Open or displaced with significant infil/exfil of soil and/or water and voids visible	Broken open or separated > 4” gap with extensive voids and embankment or roadway damage
Cross-Section Deformation	None observed	Cracks present, but no perceptible cross-section deformation	Longitudinal cracks in crown, invert and/or haunches, with perceptible cross-section deformation	Deformation and cracking has led to extensive infiltration of backfill soil, structural failure or embankment and/or roadway damage
Cracking	Boxes and Arches: Minor hairline or map cracks due to shrinkage $\leq 1/8$ ” wide at isolated areas, not at the crown or spring lines, with $< 25\%$ cross-section coverage RCP: No cracks	Boxes and Arches: Minor cracks $\leq 1/4$ ” wide, with minor spalls and infil/exfil of water or soil, along crown or haunches, $< 50\%$ cross-section coverage any size RCP: Few hairline cracks, not at crown or haunches	Boxes and Arches: Open cracks $> 1/4$ ” wide with significant infil/exfil and voids, or $> 50\%$ cross-section coverage any size RCP: Cracks $> 1/8$ ” wide, or any along crown or haunches, or $> 25\%$ cross-section coverage any size	Resultant displacement at cracks has led to extensive infiltration of backfill soil, structural failure and/or resultant embankment and/or roadway damage
Corrosion/Chemical	Boxes and Arches: Efflorescence present for boxes & arches RCP: No efflorescence	Boxes and Arches: Rust staining at cracks and spalls RCP: No rust staining	Boxes and Arches: Exposed steel reinforcement RCP: Rust staining or exposed steel reinforcement	Significant section loss of steel reinforcement that causes pipe deformation, holes in pipe walls and embankment and/or roadway damage

Notes:

- If the structure is open-bottomed and the side of a footing is exposed, a Level 2 assessment is required.
- If the structure is open-bottomed and rated in Poor or Critical condition, a Level 2 assessment is required.
- If the structure is known to have deteriorated from New/Good condition to Poor or Critical due to invert abrasion or corrosion/chemical attack in 5 years or less, a Level 2 assessment is required.
- See Level 2 Disciplines Matrix in Decision-Making Tool for guidance on Level 2 assessments.

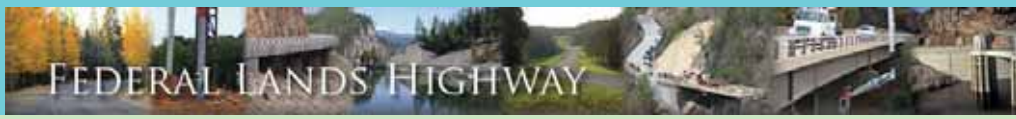

FHWA FLH CULVERT ASSESSMENT GUIDE

CORRUGATED METAL PIPE CONDITIONS

Refer to Photographic Guide for further assistance with rating assignments.

	Good	Fair	Poor	Critical
Corrosion (Above Invert)	<p>Little or no surface rust above the invert</p> <p>Little or no coating loss if coated above the invert</p>	<p>Minor surface rust and limited pitting above the invert</p> <p>Connection hardware corroded but intact</p>	<p>Perforations visible or easily made by hammer test strike above the invert</p> <p>Connection hardware failing</p>	<p>Significant section loss resulting in extensive infiltration of backfill soil, voids and embankment and/or roadway damage</p>
Cross-section Deformation	<p>None</p>	<p>Slight perceptible deformation at worst section, or local bulging</p>	<p>Deformation with accompanying longitudinal cracking or crushing in crown, invert and/or spring lines</p>	<p>Excessive deformation resulting in extensive infiltration of backfill soil, voids and piping with resultant embankment and/or roadway damage</p>
Invert Deterioration	<p>Little or no coating loss, and/or light rust staining, but no metal section loss</p>	<p>General corrosion, scaling or pitting with coating loss, but significant remaining metal section</p>	<p>Perforations visible or easily made by hammer test strike in invert area</p>	<p>Significant section loss in invert beyond perforations resulting in extensive voids beneath invert and/or embankment and/or roadway damage</p>
Joints & Seams	<p>Minor damage with no separation gaps</p>	<p>Open or displaced with minor infil/exfil of water and/or soil</p>	<p>Open or displaced with significant infil/exfil of soil and/or water and voids visible</p>	<p>Open or displaced with significant infiltration of backfill soil, and accompanying embankment and/or roadway damage</p>

Notes:

- If the structure is open-bottomed and the side of a footing is exposed, a Level 2 assessment is required.
- If the structure is open-bottomed and rated in Poor or Critical condition, a Level 2 assessment is required.
- If the structure is known to have deteriorated from New/Good condition to Poor or Critical due to abrasion or corrosion in 5 years or less, a Level 2 assessment is required.
- See Level 2 Disciplines Matrix in Decision-Making Tool for guidance on Level 2 assessments.

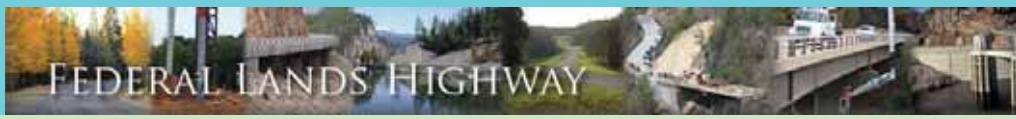

FHWA FLH CULVERT ASSESSMENT GUIDE

PLASTIC PIPE CONDITIONS

Refer to Photographic Guide for further assistance with rating assignments.

	Good	Fair	Poor	Critical
Liner/ Corrugation Wall Condition	Liner is smooth with no signs of re-corrugation (rippling in smooth liner) No splits, tears, cracking or localized bulging	Slight re-corrugation of inner liner or wall buckling Splits, tears, and cracks <=6" long at limited locations	Significant re-corrugation of inner liner or wall buckling Splits, tears and cracks at several locations >6" long	Excessive tears, splits and/or bulges resulting in extensive infiltration of backfill soil, voids and piping with resultant embankment and/or roadway damage
Invert Deterioration	None	Minor wear or abrasion	Significant wear and perforations	Significant section loss in invert through outer wall of pipe resulting in voids beneath invert and/or embankment and/or roadway damage
Joints	Minor damage with no separation gaps	Open or displaced with minor infil/exfil of water and/or soil	Open or displaced with significant infil/exfil of soil and/or water and voids visible	Open or displaced with significant infiltration of backfill soil, and accompanying settlement of, or sinkholes in, embankment and/or roadway damage
Cross-section Deformation	No cross-section deformation	Slight perceptible deformation and/or few bulges	Significant perceptible deformation	Excessive deformation resulting in embankment and/or roadway damage and/or significant loss of conveyance

Notes:

- If the structure is known to have deteriorated from New/Good condition to Poor or Critical due to abrasion in 5 years or less, a Level 2 assessment is required.
- See Level 2 Disciplines Matrix in Decision-Making Tool for guidance on Level 2 assessments.

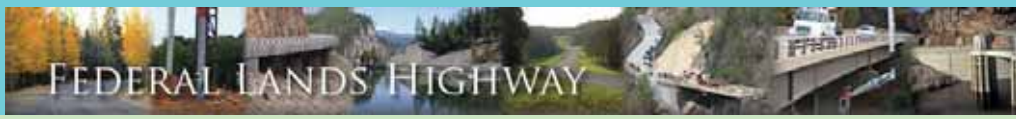

FHWA FLH CULVERT ASSESSMENT GUIDE

TIMBER CONDITIONS

Refer to Photographic Guide for further assistance with rating assignments.

	Good	Fair	Poor	Critical
Invert Deterioration	None	Minor section loss with no perforations	Significant section loss and/or perforations present with accompanying infiltration and voids	Complete loss of section at invert resulting in extensive voids beneath invert and/or embankment and/or roadway damage
Joints & Seams	Minor damage with no separation gaps Surface rusting of connection hardware	Displaced or separated with minor infil/exfil, but no visible voids Connection hardware corroded but intact Perceptible deformation and/or warping, with minor cracks	Displaced or separated with significant infil/exfil and visible voids Connection hardware failing Significant warping and cracking/breaking	Excessive deformation, displacement or separated with accompanying embankment and/or roadway settlement/ sinkholes Connection hardware failure resulting in joint and seam damage and infiltration of backfill soil and roadway damage
Rot and Borer Attack	None	Minor, local damage or section loss	Significant section loss, crushing and/or cracks and holes with significant infil/exfil of soil and water with voids visible	Severe deformation due to section losses and/or crushing, with embankment and/or roadway damage

Notes:

- If the structure is open-bottomed and the side of a footing is exposed, a Level 2 assessment is required.
- If the structure is open-bottomed and rated in Poor or Critical condition, a Level 2 assessment is required.
- If the structure has deteriorated from New/Good condition to Poor or Critical in 5 years or less, a Level 2 assessment is required.
- See Level 2 Disciplines Matrix in Decision-Making Tool for guidance on Level 2 assessments.

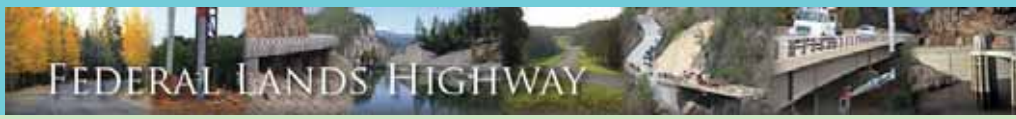

FHWA FLH CULVERT ASSESSMENT GUIDE

MASONRY CONDITIONS

Refer to Photographic Guide for further assistance with rating assignments.

	Good	Fair	Poor	Critical
Cross-section Deformation	None	Minor cracking visible, but no perceptible deformation	Perceptible deformation, and longitudinal cracks in crown, invert and/or spring lines	Holes and gaps have led to extensive infiltration of backfill soil and resultant embankment and/or roadway damage
Invert Deterioration	Minor scaling of joint material or blocks in invert area	Significant scaling with loose mortar and/or blocks in invert area	Displaced mortar and/or blocks, holes in invert area	Significant holes and section loss at invert resulting in extensive voids beneath invert and/or embankment and/or roadway damage
Mortar and Masonry	Isolated, minor mortar deterioration All blocks in place and stable No infil/exfil of soil	Mortar/block crushing and loss, loose blocks Minor infil/exfil of soil	Missing and/or displaced blocks Infiltration and voids	Widespread holes have led to extensive infiltration of backfill soil, voids, and piping with resultant embankment and/or roadway damage

Notes:

- If the structure is open-bottomed and the side of a footing is exposed, a Level 2 assessment is required.
- If the structure is open-bottomed and rated in Poor or Critical condition, a Level 2 assessment is required.
- If the structure has deteriorated from New/Good condition to Poor or Critical in 5 years or less, a Level 2 assessment is required.
- See Level 2 Disciplines Matrix in Decision-Making Tool for further guidance on Level 2 assessments.

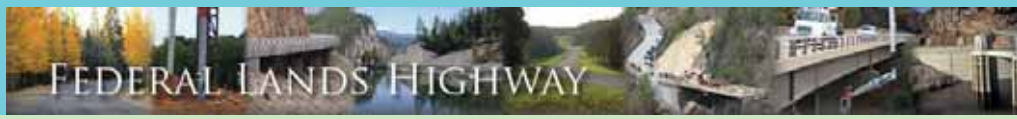

FHWA FLH CULVERT ASSESSMENT GUIDE

APPURTENANCES CONDITIONS

Refer to Photographic Guide for further assistance with rating assignments.

	Good	Fair	Poor	Critical
Headwall/ Wingwall	<p>Little or no cracking, rotation, or displacement</p> <p>Light concrete scaling, timber rot, metal corrosion or other surface deterioration</p> <p>No footing exposed</p>	<p>Minor cracks and spalls in concrete</p> <p>Minor rotation and/or displacement with gap in barrel seam</p> <p>Minor footing exposure</p>	<p>Area affected by cracking and spalling is >50% and/or rebar exposed</p> <p>Significant displacement at cracks or wall rotation causing a gap at the wall-to-barrel interface >4".</p> <p>Footing exposed and undermined</p>	<p>Partially or totally collapsed, with resultant damage to embankment and/or roadway damage</p>
Apron	<p>No cracking, piping or undermining</p>	<p>Minor cracking but no visible piping or undermining</p>	<p>Significant cracking affects >50% of apron</p> <p>Significant piping or undermining</p>	<p>Partially or totally collapsed, significantly effecting performance and/or causing embankment and/or roadway damage</p>
Flared End Section or Pipe End	<p>Little or no visible cracking, deterioration, or deformation</p> <p>No undermining</p>	<p>Minor cracking, deterioration, or deformation</p> <p>Minor undermining</p>	<p>Significant cracks, piping or undermining affects >50% of appurtenance</p> <p>End crushed or separated from barrel</p>	<p>Deterioration is significantly effecting performance and/or causing embankment and/or roadway damage</p>
Scour Protection	<p>Little or no displacement or undermining of individual rip rap or armor units</p> <p>Tight interface with culvert structure</p>	<p>Localized displacement of individual rip rap or armor units, undermining or deterioration</p> <p>Slight separation at culvert interface</p>	<p>Significant displacements, undermining or deterioration effecting the performance of the counter measure and culvert structure</p>	<p>Partially or totally failed, significantly effecting performance and/or causing embankment and/or roadway damage</p>

Notes:

- If the apron has deteriorated from New/Good condition to Poor or Critical in 5 years or less due to aggressive abrasion, a Level 2 assessment is required.
- See Level 2 Disciplines Matrix in Decision-Making Tool for guidance on Level 2 assessments.

CULVERT AND CHANNEL PERFORMANCE INDICATORS

In addition to assessing the condition of each culvert and its appurtenances, the Level 1 assessment includes observations of the performance of the culvert and associated channel. The following pages describe various indicators and potential causes of performance problems. The assessor is expected to indicate whether these problems are present at each culvert. The presence of one or more performance problems may lead to action recommendations such as maintenance, culvert replacement or appurtenance repair, or may indicate the need for a Level 2 investigation. The presence of performance problems would trigger action even in the case of a “Good” or “Fair” condition rating for the structure itself. The relationships between various causes and indicators for level 1 and 2 activities are presented in Tables 1 and 2 at the end of this section. The performance problems are described below. Examples of some common performance problems encountered in the field are included the Appendix A Photographic Guide for Culvert Assessment.

PERFORMANCE PROBLEMS LEADING TO LEVEL 1 ACTIONS

The following Table 1 outlines the Level 1 performance problems that might commonly be encountered by assessors, and the field indicators that are typical of each. The problems listed in the left-hand column coincide with the entry fields on the right-hand side of the FLH Culvert Assessment Form entitled Performance Problems Requiring Level 1 Actions. The field indicators listed on the right-hand side of Table 1 are the most common symptoms of the problems the typical assessor will observe in the field.

Table 1. Performance Problems Leading to a Level 1 Action.

Problem	Field Indicator(s)
Debris/Vegetation Blockage	<ul style="list-style-type: none"> • Debris / Vegetation blocks 1/3 or more of inlet opening
Sediment Blockage at Inlet or Outlet	<ul style="list-style-type: none"> • Sediment blocks 1/3 to 3/4 of rise, localized at the inlet or outlet only
Buoyancy-Related Inlet Failure	<ul style="list-style-type: none"> • Inlet barrel raised above streambed
Poor Channel Alignment	<ul style="list-style-type: none"> • Barrel skewed > 45-degrees to upstream channel with associated damage to embankment or end treatment
Previous and/or Frequent Overtopping	<ul style="list-style-type: none"> • Drift on guardrail • Erosion on downstream side of embankment • Loss of pavement structure • Maintenance history / testimony
Local Scour at Outlet	<ul style="list-style-type: none"> • Undermined culvert, end treatment, or embankment slope

Debris/Vegetation Blockage

The culvert will fail to perform as designed if the entrance is blocked by a combination of vegetation, trash, sediment and other debris, as shown in Figure 3 below. This problem should be noted as present if a significant blockage exists, reducing the opening area by roughly 33% or more. This element is distinct from chronic sediment, explained later in this document. If this problem is present, a Level 1 recommendation for maintenance to clear the culvert is appropriate, considering and combined with any other recommendations arising from the Level 1 condition assessment. If the blockage prevents an adequate Level 1 condition assessment, the assessor should mark the condition parameters as “unknown”, collect what data that can be safely acquired while on-site, and then reattempt the assessment after the required maintenance has occurred.



Figure 3. Photo. Example of severe debris blockage.⁽²⁾

Sediment Blockage at Inlet or Outlet

An accumulation of pure sediment, generally devoid of vegetation debris, that is local to either the inlet or outlet and greater than or equal to 1/3 but less than or equal to 3/4 of the rise of the barrel may be considered a Level 1 maintenance issue. The localized blockage should not extend more than a few feet into the barrel from the culvert end, which would be indicative of greater channel aggradation problems and trigger Level 2 action. In most cases, a minor accumulation is due to minor embankment sloughing around the pipe end, or settling out of sediment loads conveyed by the flow. In cases where the blockage is less than 1/3 of the rise, with sufficient invert slope periodic flows, the culvert will likely blow out the blockage as a self-cleaning mechanism. If the blockage is 1/3 to 3/4 of the rise, self-cleaning may not occur and the culvert should be a candidate for maintenance to clear the sediment.

Buoyancy-Related Inlet Failure

Buoyancy can cause damage to the inlets of a large corrugated metal culvert with a projecting inlet (the pipe projects out from the road embankment). This problem should be noted as present if the projecting segment of a CMP has noticeably lifted above the streambed. The problem should lead to a Level 1 recommendation for repair of the culvert via the decision-making tool (e.g. repair damage and add headwall, slope pavement anchor or terminal end section as appropriate). The following Figure 4 shows an example of extreme buoyancy uplift.



Figure 4. Photo. Example of severe buoyancy uplift (FHWA/NHI training materials).⁽²⁾

Poor Channel Alignment

This problem should be noted as present if the channel approaching the culvert from upstream or exiting the culvert downstream is highly skewed (say more than roughly 45 degrees) from the axis of the culvert barrel, and there is scour at the outside channel bank that is causing damage to the culvert, headwall, wing walls or road embankment. The following Figure 5 is an idealized example sketch of poor channel alignment. If present, this problem should lead to a Level 1 recommendation for remediation.

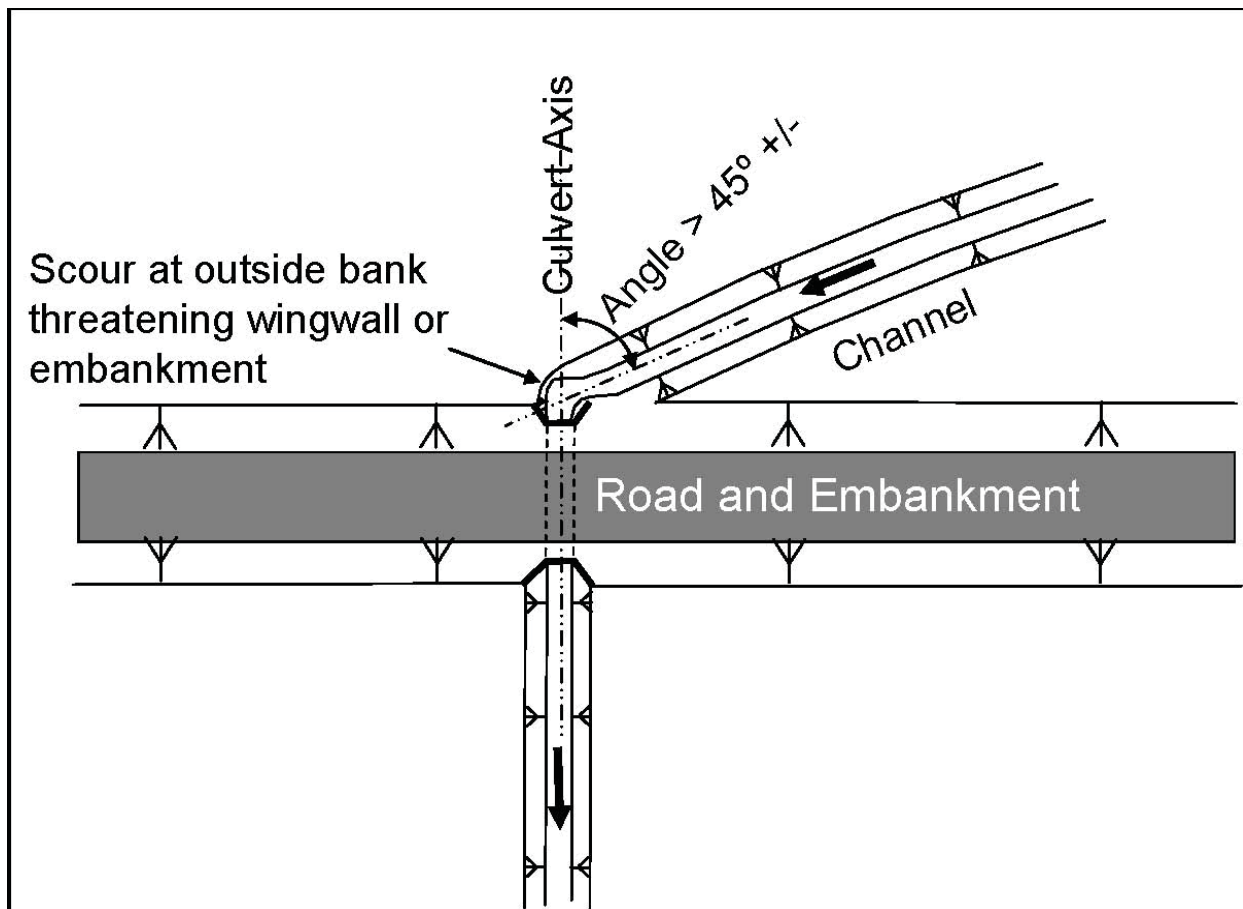

Figure 5. Drawing. Idealized example sketch of Poor channel alignment.

Previous and/or Frequent Overtopping

Embankment damage at the culvert site may be present because of previous overtopping, potentially due to inadequate hydraulic capacity. Indicators of overtopping could include, but are not limited to, drift hanging on guardrail above the culvert, extensive erosion of the downstream embankment, often accompanied by loss of the pavement section along the downstream edge. The most likely location of overtopping is at the low point in the road profile, which may be offset from the culvert crossing location. Overtopping indicators, if present, should lead to a Level 1 recommendation for maintenance (to repair any related erosion damage) and potentially a recommendation to add erosion protection to accommodate future overtopping. If the client reports that overtopping is known to be frequent at the culvert and if the condition rating is poor or critical, then the culvert should be replaced with an adequately sized structure, determined through hydrologic and hydraulic analysis. The following Figure 6 shows an example of erosion damage to the downstream embankment slope and shoulder from previous overtopping.



Figure 6. Photo. Erosion damage to downstream embankment slope and shoulder from previous overtopping.⁽³⁾

Local Scour at Outlet

Most culverts have some degree of scour at the outlet. This problem should be noted as present if a very large and noticeable scour hole is observable at the inlet or outlet, as illustrated in Figures 7 and 8 below, and it is causing damage to the culvert, headwall, wing walls or road embankment. Such problems should lead to a Level 1 recommendation for installation or repair of outlet protection, as determined in the Decision-Making tool (e.g. line existing scour hole with riprap). A local scour hole is different from a head cut in that the scour hole is a localized depression with excavated bed material often mounded not far downstream from the hole, while the stream bed affected by a headcut extends at a generally uniform slope elevation for a significant distance downstream of the headcut.

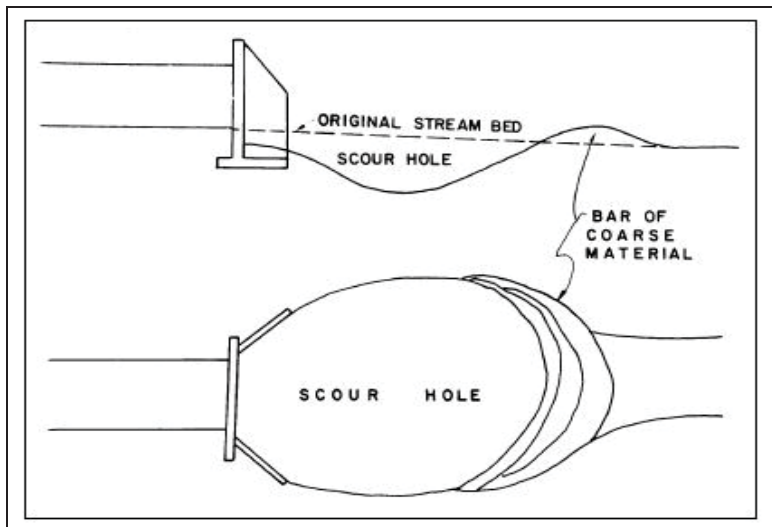

Figure 7. Drawing. Outlet scour: example sketch.⁽⁴⁾



Figure 8. Photo. RCP culvert damaged by scour.⁽²⁾

PERFORMANCE AND OTHER PROBLEMS LEADING TO LEVEL 2 INVESTIGATIONS

The following Table 2 outlines the Level 2 performance problems that might commonly be encountered by assessors, and the field indicators that are typical of each. The problems listed in the left-hand column coincide with the entry fields on the bottom-right corner of the FLH Culvert Assessment Form entitled Performance Problems Requiring Level 2 Actions. The field indicators listed on the right-hand side of Table 2 are the most common symptoms of the problems the typical assessor will observe in the field. Table 3 covers other potential problems that may be encountered which are not performance-related, such as limited access, AOP or historical issues.

Table 2. Performance Problems Leading to a Level 2 Action.

Problem	Field Indicator(s)
Embankment Piping	<ul style="list-style-type: none"> • Settlement or holes in roadway with no significant joint problems identified in culvert • Holes in embankment outside of culvert with no significant joint problems identified in culvert
Channel Degradation	<ul style="list-style-type: none"> • Perched inlet and/or outlet with adjacent channel banks vertical or unstable (sloughing)
Headcut	<ul style="list-style-type: none"> • Unstable channel drop of 2 feet or more within sight of the culvert
Embankment Slope Instability	<ul style="list-style-type: none"> • Failure of upstream embankment with channel approach angle less than 45-degrees to barrel • Failure of downstream embankment beyond that caused by local outlet scour
Sediment Blockage and Channel Aggradation	<ul style="list-style-type: none"> • Full barrel length blocked 1/3 or more of rise with sediment and culvert not an AOP design • Blockage 3/4 or more of rise local to the inlet or outlet only
Aggressive Abrasion, Corrosion and/or Chemical Environment*	<ul style="list-style-type: none"> • Poor or Critical condition reached in 5 years or less
Exposed Footing (Open-Bottom Culvert)*	<ul style="list-style-type: none"> • Side of any footing exposed

* Item also noted in the condition assessment tables

Table 3. Other (Non-Performance) Problems Leading to a Level 2 Action.

Problem	Field Indicator(s)
No Access	<ul style="list-style-type: none"> • Condition cannot be adequately assessed by an end-only inspection • Access precluded by factors not remedied by routine maintenance (e.g. total submergence in water)
Aquatic Organism Passage Culvert	<ul style="list-style-type: none"> • Any performance problem
Historical Culvert or Headwalls	<ul style="list-style-type: none"> • Any performance problem or condition rating of Poor or Critical
Open-Bottom Culvert*	<ul style="list-style-type: none"> • Any condition rating of Poor or Critical

* Item also noted in the condition assessment tables

Embankment Piping

Piping is the condition of water flowing through the embankment outside of, rather than inside the culvert barrel. It leads to holes in the embankment and if left unchecked will cause failure of the embankment and/or culvert. It can be caused by overly porous or poorly compacted culvert backfill, or by exfiltration from the culvert barrel due to open joints. This problem should be noted as present if holes are visible in the embankment outside the culvert barrel at either end of the culvert, as shown in Figure 9 below. Presence of this problem should trigger a Level 2 geotechnical investigation.



Figure 9. Photo. Example of piping through an embankment.⁽²⁾

Holes or settlement visible in the road or embankment can be indicators of embankment piping and damage, as in Figures 10 and 11 below. A Level 2 investigation should be triggered, which may include conducting a full-length culvert investigation (e.g. with an ROV) for infiltration and a geotechnical investigation to determine the extent of the damage to the embankment.

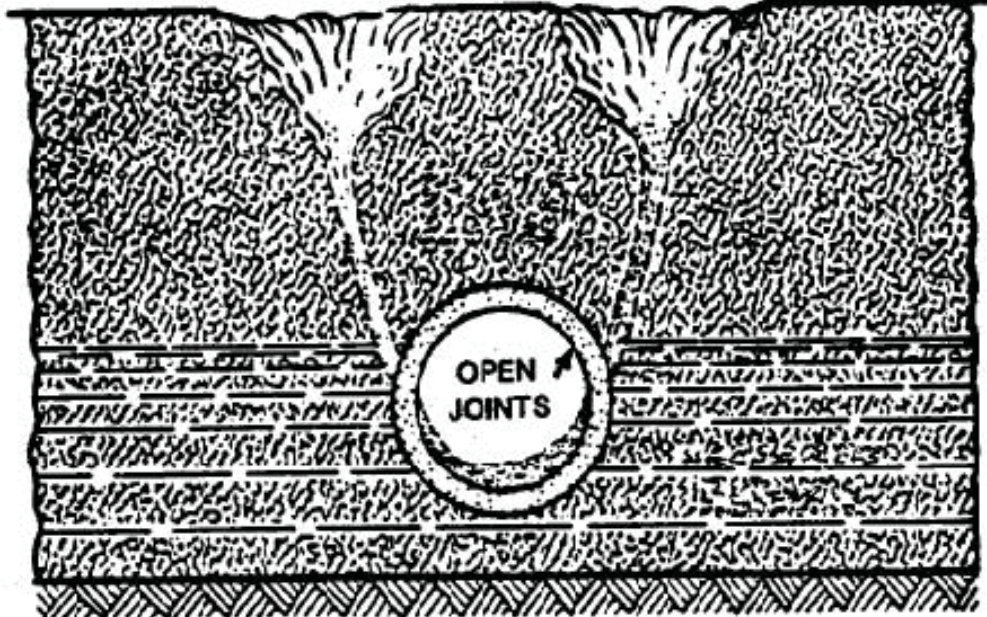

Figure 10. Photo. Voids caused by open joints reaching the road surface.⁽⁵⁾



Figure 11. Photo. Example of roadway settlement caused by voids around a culvert.⁽³⁾

Channel Degradation

A perched culvert inlet or outlet that is not associated with a local scour hole is one of several indicators of channel degradation. Another indicator of degradation is visibly unstable channel banks (e.g. vertical or undercut banks) that are not only local to the culvert structure, but extend much further downstream and/or upstream, as shown in the following Figure 12.



Figure 12. Photo. Unstable channel, evidenced by stream bank erosion and vertical bank.⁽⁶⁾

Head Cut

A head cut is a vertical or steep drop in the stream bed, as shown in Figure 13 below, and is a mechanism of degradation. A head cut is different from a local scour hole in that a stream bed affected by a head cut extends at a generally uniform slope or elevation for a significant distance downstream, while the scour hole is a localized depression with excavated bed material often mounded not far downstream from the hole. If a head cut with a height of two feet or more is observed within sight of the culvert, and if it is not arrested in its current position by bedrock or a structure, its presence should be indicated. It may eventually migrate over time and threaten to undermine the culvert or embankment.



Figure 13. Photo. Example of head cut that can be expected to move upstream over time.⁽⁷⁾

With the exception of a potentially approaching head cut, only channel degradation that is currently affecting the culvert or embankment should be noted in the assessment. The presence of one or more problems with channel degradation should trigger a Level 2 hydraulic investigation.

Embankment Slope Instability

In cases where the road embankment is exceptionally steep, the intermittent ponding and drawdown of water upstream of a culvert inlet can lead to localized slope failure or sloughing of the embankment neat the inlet. If present, this problem should trigger a Level 2 geotechnical investigation.

Sediment Blockage and Channel Aggradation

Unlike a local blockage by debris or sediment, chronic channel sedimentation indicates long-term channel aggradation. Channel aggradation, or excessive sediment accumulation, is a condition that cannot be addressed by maintenance activities at the culvert, especially if it extends downstream of the culvert exit. Mark this problem as present if the culvert barrel has sediment occupying roughly 33% or more of the barrel depth throughout its length, and if the bed sediment continues on that profile downstream of the culvert barrel. Also mark this problem as present if sediment accumulation at the inlet, absent other debris, causes a blockage of greater than 75% of the rise. In culverts that have been designed for AOP/fish passage, this condition may be an intentional design feature (e.g. the culvert was intentionally countersunk into the streambed to provide a natural streambed for aquatic organisms). If this problem is present in a non-AOP culvert, however, it should trigger a Level 2 hydraulic investigation. Figure 14 below shows a culvert barrel filled to approximately half of its rise with aggraded sediment.



Figure 14. Photo. Culvert barrel filled with sediment up to half its rise, possibly due channel aggradation.⁽²⁾

Open-Bottom Culvert

Many culverts have natural streambed sediments at the bottom, either because the bottom of the structure is open, or because the bottom of the culvert structure has been intentionally set below channel grade to promote AOP/fish passage. Open-bottom culverts, an example of which appears as Figure 15 below, often have shallow foundations that can be undermined by scour within the culvert barrel. Open-bottom culverts, if they are to be rehabilitated because of a condition rating of Poor or Critical, should receive a Level 2 hydraulic investigation in order to ensure that the rehabilitation does not increase the risk of undermining the foundations. Note that cattle pathways and farm road underpasses can be confused with flood plain relief culverts and may appear as bottomless culverts, although they are not as much of a concern for undermining and scour. A cattle pathway or farm road underpass in Poor or Critical condition should receive a Level 2 hydraulic investigation, unless it is obvious to the assessor that runoff is not conveyed.



Figure 15. Photo. Example of an open-bottom culvert.

Open-Bottom Culvert with Exposed Footing

If an open-bottom culvert has an exposed footing, there is an enhanced risk of culvert failure by scour undermining the footings. Mark this condition as present if the side of any footing is exposed, as shown in Figure 16 below. The presence of this problem should trigger a Level 2 hydraulic investigation to determine the risk of a scour-related failure. A cattle pathway or farm road underpass with an exposed footing should also receive a Level 2 hydraulic investigation, unless it is obvious to the assessor that runoff is not conveyed and that scour is not the cause of the exposure.



Figure 16. Photo. Exposed spread footing condition possible in an open-bottom culvert.

Regulatory Status for AOP or Historic Structure

If the culvert has been designated with regulatory status requiring passage of fish or other aquatic organisms and rehabilitation or replacement action is required, a Level 2 investigation is conducted before making any decision. If one or both headwalls has an historic structure designation and rehabilitation or replacement action is required, a Level 2 investigation is conducted before making any decision. Figure 17 below shows an example of an AOP culvert.



Figure 17. Photo. An aquatic organism passage (AOP) culvert.⁽⁸⁾

This page intentionally left blank.

CHAPTER 3 – CULVERT DECISION-MAKING TOOL

SUMMARY OF DECISION-MAKING TOOL

The purpose of this decision-making tool is to provide Federal Lands Highway personnel with project-level decision-making guidance for post-assessment actions to be taken for existing roadway culverts. The procedure assists the user in making follow-up recommendations to the culvert assessments, which might include repair, replacement, and Level 1 and 2 activities. Guidance is also provided to users to assist with repair or replacement technique selection, following the assessor's preliminary recommendations. The decision-making tools include a set of flowcharts, presented in the following Culvert Action Flowcharts section and in attached Appendix D, that outlines the possible actions for the various culvert types. The process flow for the decision-making process is described in the FLH Culvert Decision-Making Process Map, shown in the following Figure 18 and in Appendix D.

The decision-making procedure begins after the termination of the culvert assessment procedure, with a rating having been assigned. The procedure then steps through a number of qualifiers intended to guide the user toward the appropriate action path, the options of which are no further action or a recommendation of Level 1 maintenance, Level 2 in-depth investigation, replacement, or repair.

For replacement and repair recommendations, the user is provided a series of action flowcharts for the various culvert materials and site conditions that further develops the best technique to use. A repair liner selection comparison matrix is included, which provides rough cost information, capabilities and limitations for each commonly-used liner option. The tool also includes matrices for considering and comparing culvert man-entry repairs and replacement techniques, as well as culvert-related construction activity options based on the FLH bid history database. Appendix C of this procedure presents photographic guide to culvert rehabilitation, which illustrates some of the more common techniques discussed.

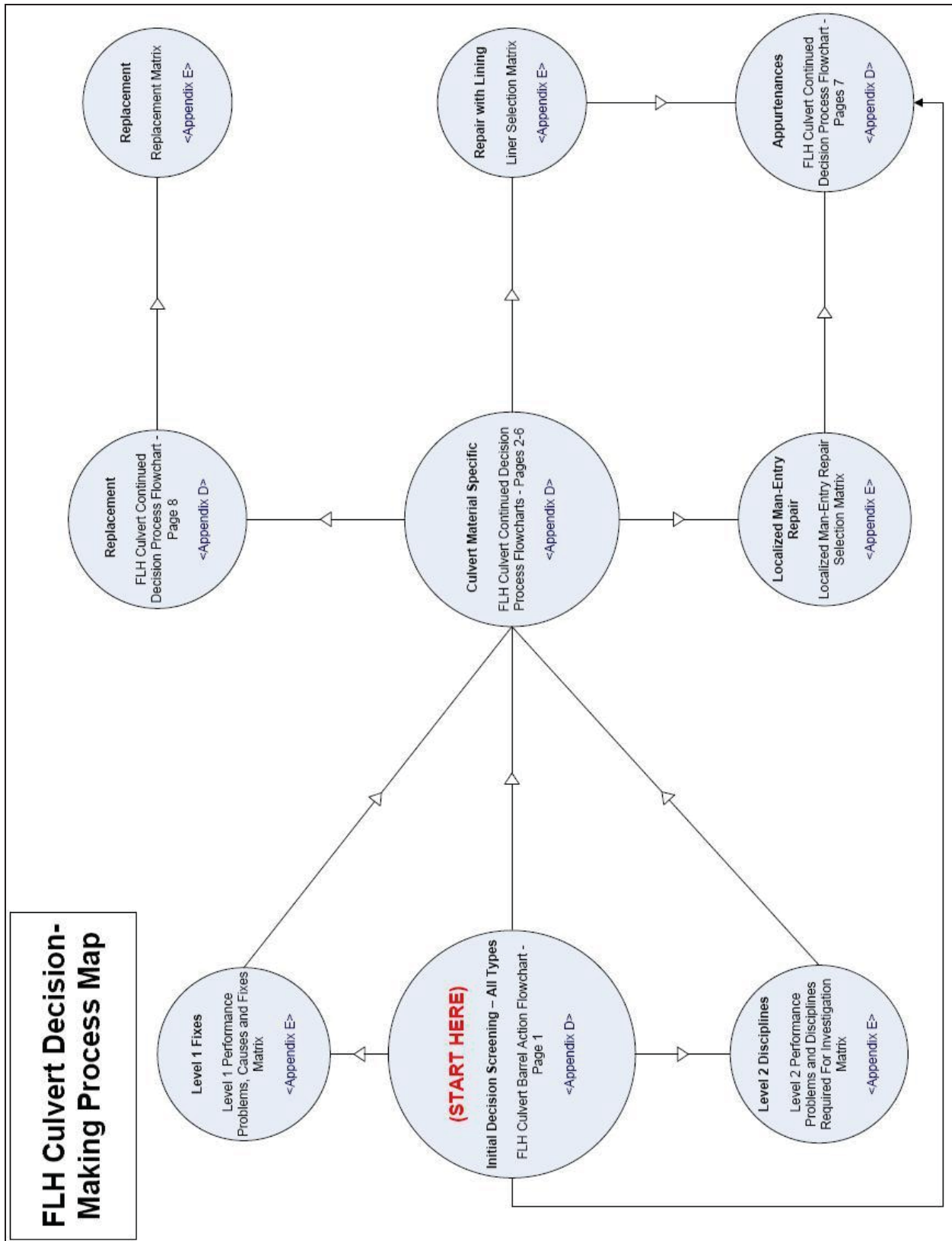

Figure 18. Flowchart. FLH Culvert Decision-Making Process Map.

CULVERT ACTION FLOWCHARTS

The Culvert Action Flowchart set, including Pages 1 through 8, are presented in Appendix D at the end of this manual. The following section steps through the various flowcharts in the set to demonstrate the decision-making methodology employed.

DECISION-MAKING METHODOLOGY USING ACTION FLOWCHARTS

The following is an explanation and example of the decision-making methodology employed in the Culvert Action Flowcharts and Matrices. Decision points, process boxes and terminators are referred to within the following text by name using quotation marks.

Page 1 – All Types Flowchart

To execute the culvert decision-making procedure using the action flowcharts, the user begins on the first page of the set, “FLH Culvert Barrel Action Flowchart – Page 1 All Types”. The Page 1 flowchart addresses site conditions and other general factors that are common to all culvert types. Below is a step-by-step description of each flow path possible on this first action flowchart, shown in Figure 19 below and presented in Appendix D. The user starts at the left-most process box titled “Initial Field Assessment of Culvert Complete”.

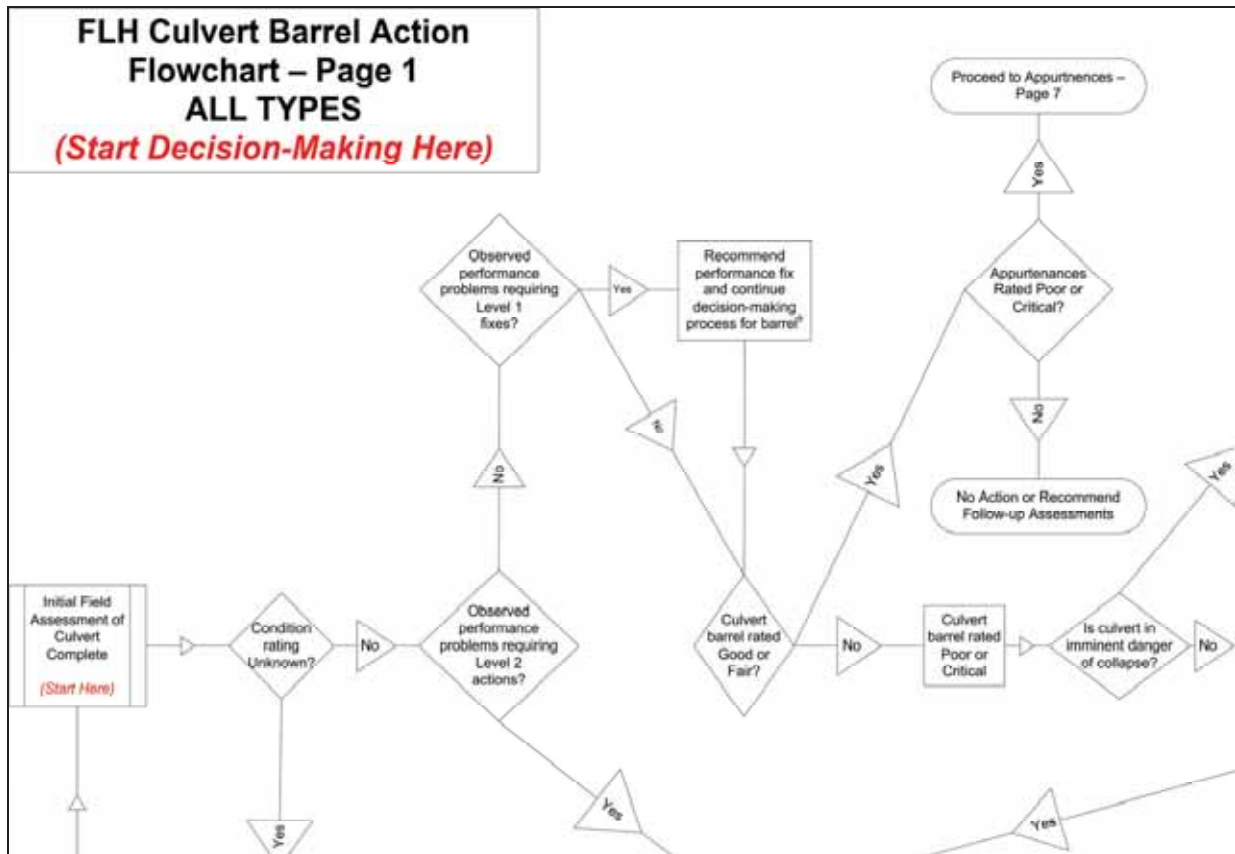

Figure 19. Flowchart. Starting portion of FLH Culvert Barrel Action Flowchart – Page 1 ALL TYPES.

The user is first queried if the culvert was rated Unknown. If the response is Yes, then that pathway is followed to the next query, whether simple maintenance will allow access. As an example, in the case of significant debris accumulation preventing access to the culvert, the user would respond Yes and continue to the process box ‘Request Maintenance, then Re-assess’, after which he/she would reattempt the assessment after the maintenance was completed and access achieved.

On the next attempt at assessment, the answer to the condition rating qualifier will be No and the user will continue down that path rather than around the maintenance loop. If simple maintenance will not allow access, the user answers No and is directed to the ‘Special access equipment or personnel needed’ terminator. Special access might typically include divers, rope access techniques, or a remotely operated vehicle (ROV).

A negative response to the ‘Condition rating Unknown’ prompt leads the user to the ‘Observed performance problems requiring Level 2 actions’ qualifier, which relates to the section of the assessment form entitled “Culvert & Channel Performance Indicators Leading to Level 2 Actions”. If any of the Level 2 indicators on the assessment form are checked as present, the user responds Yes and moves on to the Level 2 investigation directive. Figure 20 below depicts this portion of the Page 1 flowchart.

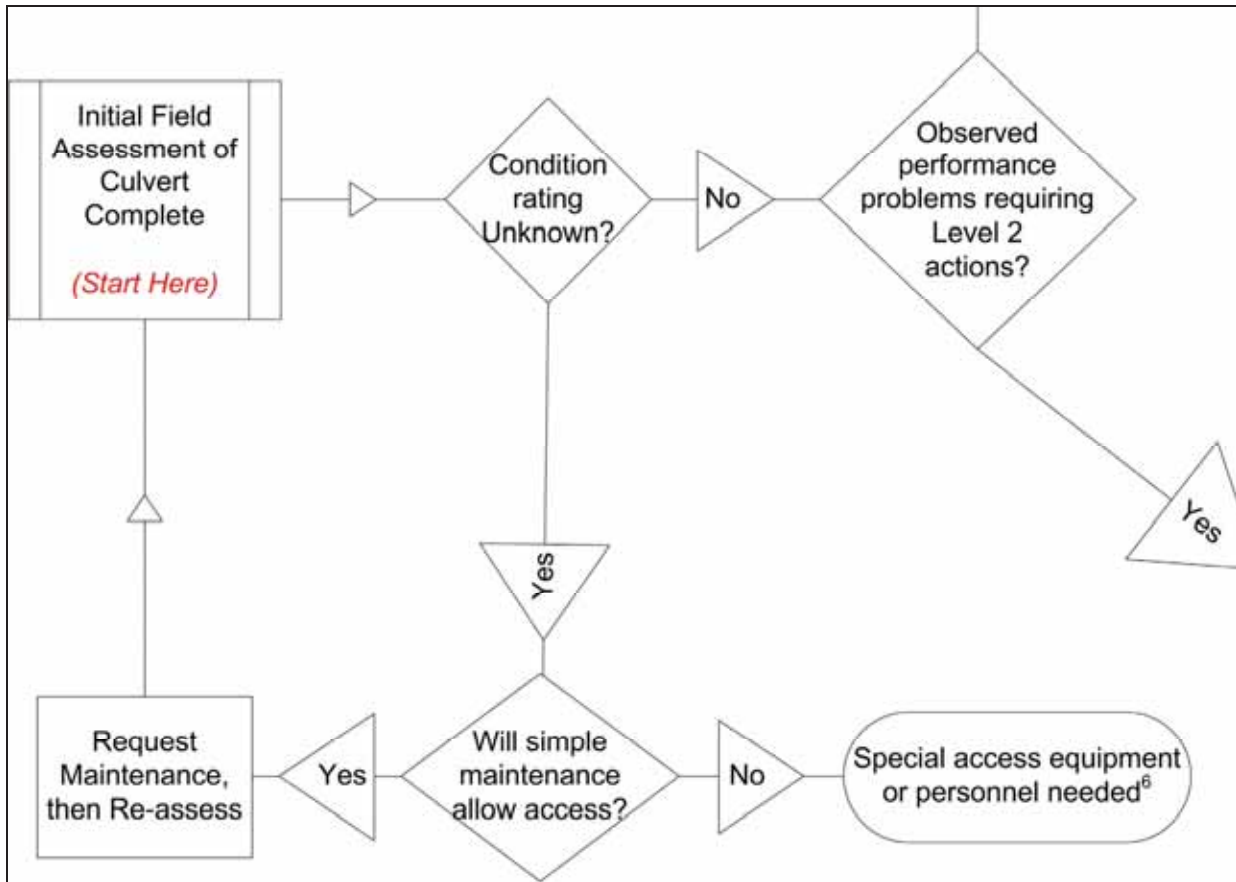

Figure 20. Flowchart. Maintenance loop at start of Culvert Barrel Action Flowchart – Page 1 ALL TYPES.

If there are no observed performance problems requiring Level 2 actions, the user is then queried whether there are observed performance problems requiring Level 1 fixes. If there are Level 1 triggers present, as indicated on the assessment form, the user progresses to the process box ‘Recommend performance fix and continue decision-making process for barrel’. The Level 1 triggers are explained in more detail in the previous Table 1, as well as in the Level 1 Performance Problems – Causes and Fixes matrix in Appendix E. In the event that a Level 1 action recommendation has been made, or there are no Level 1 triggers, the user then moves on to the prompt ‘Culvert barrel rated Good or Fair?’

Answering No to the ‘Culvert barrel rated Good or Fair’ query indicates the culvert barrel was rated Poor or Critical, which carries the user further into the flowchart with the assumption that there are significant problems to be addressed. If the answer is Yes, the culvert barrel is rated Good or Fair, then the next query is whether the ‘Appurtenances were Rated poor or Critical’. If Yes again, the user is directed to proceed to the flowchart “Page 7 – Appurtenances”. A negative answer indicates both the barrel and appurtenances are in Good or Fair condition with no further action or follow-up recommendations necessary, as shown in Figure 21 below.

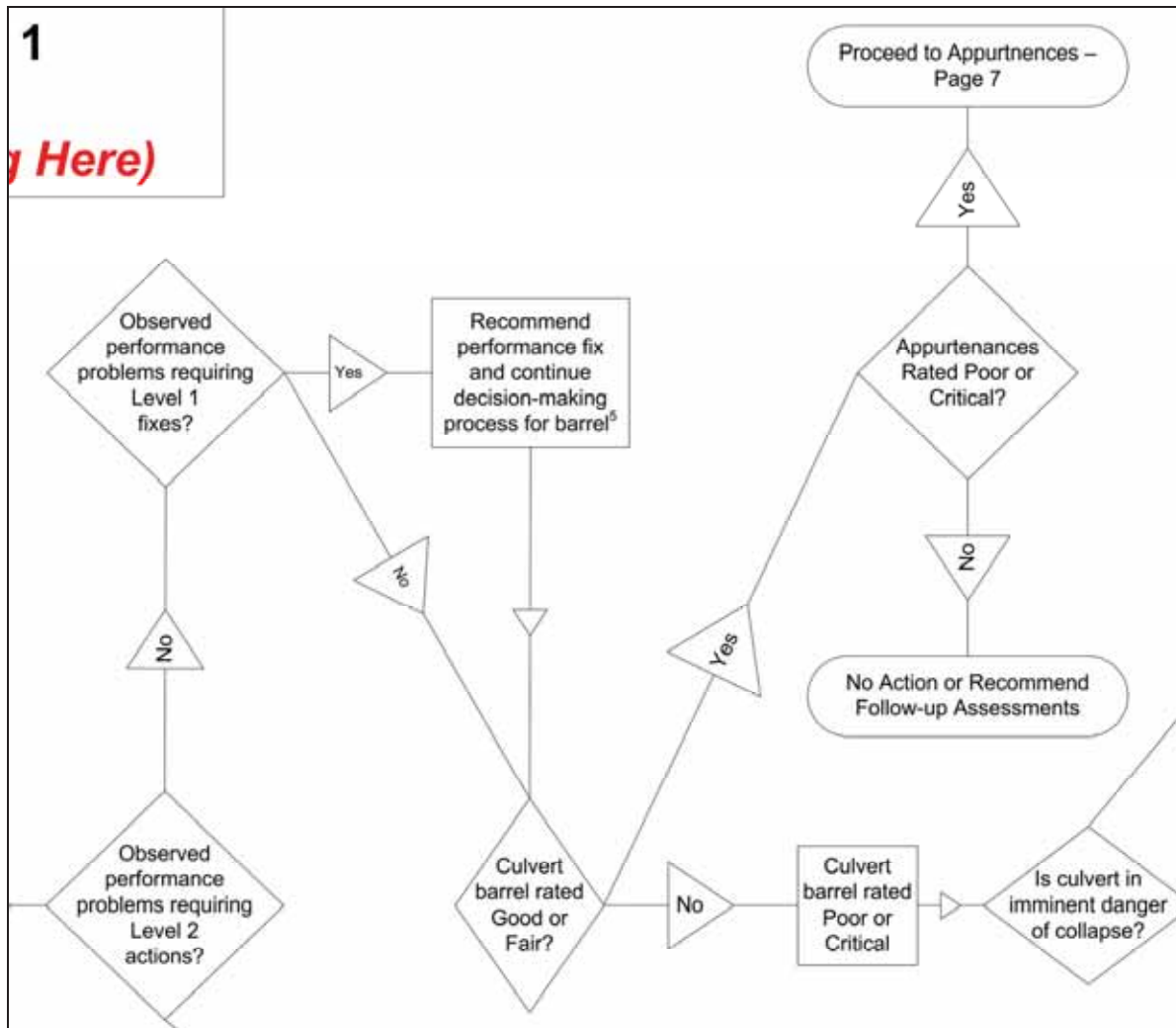

Figure 21. Flowchart. Level 1 fixes, Good and Fair barrel ratings and appurtenances in Page 1 flowchart.

If the culvert barrel is rated Poor or Critical, the next question the user encounters is whether the culvert is in immediate danger of collapse. If there is danger of collapse, temporary structural bracing and road closures recommendations should be considered. If the culvert is not in imminent danger of collapse, or it is and measures have been considered, then the next query is whether the culvert has an open bottom, has been designated as fish passage, aquatic organism passage (AOP) or historic structure. Any positive answer to this query diverts the user to the Level 2 investigation terminator. Note that the fish passage, AOP and historic qualifiers should be designated by environmental and cultural resource specialists. This may be the case for the following qualifier for special environmental permitting issues as well, which provides the user an additional opportunity to recommend a Level 2 investigation of this contingency.

If the culvert is not significant from a fish passage, AOP, cultural, historic or environmental permitting perspective, then it goes to the first major junction in the repair versus replacement pathways, whether the ‘Pipe Rise (diameter) less than or equal to 36 inches’. If the pipe rise is less than or equal to 36 inches, it is a “small” pipe and should be further considered for possible replacement if deemed cost-effective, as shown in Figure 22 below.

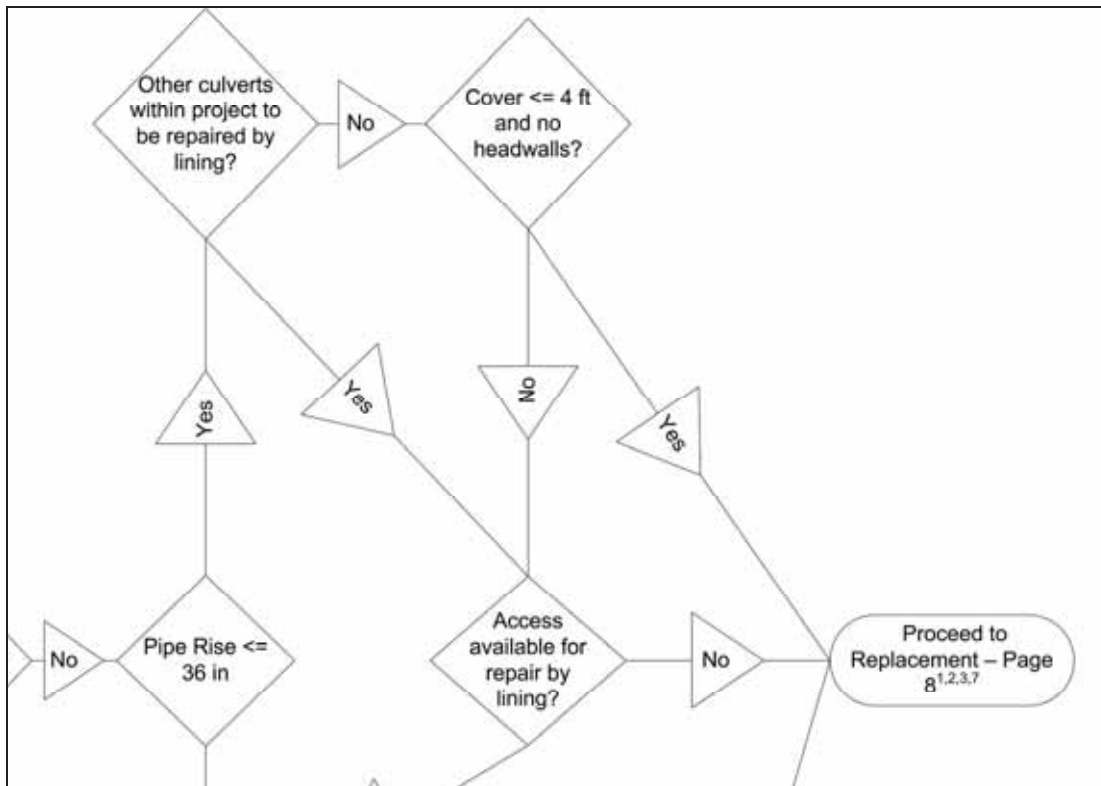

Figure 22. Flowchart. Treatment of small, shallow pipes in Page 1 – ALL TYPES flowchart.

If the pipe ‘Cover is less than or equal to 4 feet, it is a “shallow” pipe. If the small, shallow pipe also has no headwalls, it is assumed to be most cost-effective to address it with open-trench replacement. In this case, the user is directed to ‘Proceed to Replacement – Page 8’. Note that if this replacement terminator is reached, the user must also check the “Appurtenances – Page 7” flowchart, and also consider if other adjacent culverts are to be addressed with in-situ repairs, as described in the related footnotes. If cover is deeper than 4 feet, the user is prompted if there is ‘Access available for repair by lining?’ at the culvert ends.

Access for lining repair refers to available right of way, means of ingress/egress, and work space for the lining equipment, machinery and crew at the ends of the culvert. Responding No directs the user to the ‘Proceed to Replacement – Page 8’ terminator. The recommendation to replace culverts less than 36 inches in rise, under 4 feet of less of cover, with no headwall and favorable traffic conditions is based on limited cost analysis and trench safety guidelines. Specific project conditions, such as the use of trenchless techniques on nearby culverts or availability of cost-effective lining technology, may counter this recommendation.

Responding that the culvert is either greater than 36 inches in rise or has access at the culvert ends for lining repairs will lead the user to the prompt, is the ‘Barrel rated Critical?’ An affirmative response offers the user another opportunity to end up at the replacement terminator by inquiring if there is ‘Extensive Damage to the Embankment?’ In most cases, culverts with Critical ratings are accompanied by extensive roadway and embankment damage, requiring replacement. If this is not the case, the user returns to the previous pathway and the question of if there is ‘Frequent overtopping known (as indicated by client)?’ Answering Yes indicates that the culvert is likely undersized and of insufficient capacity, and the user is directed through the ‘Replace with larger size’ process box to the terminator ‘Proceed to Replacement – Page 8’. If frequent overtopping is not indicated or known to occur, the user is directed through the ‘Repair’ process box to the terminator ‘Continued Decision Process per Type – Pages 2-7’, as shown in Figure 23 below.

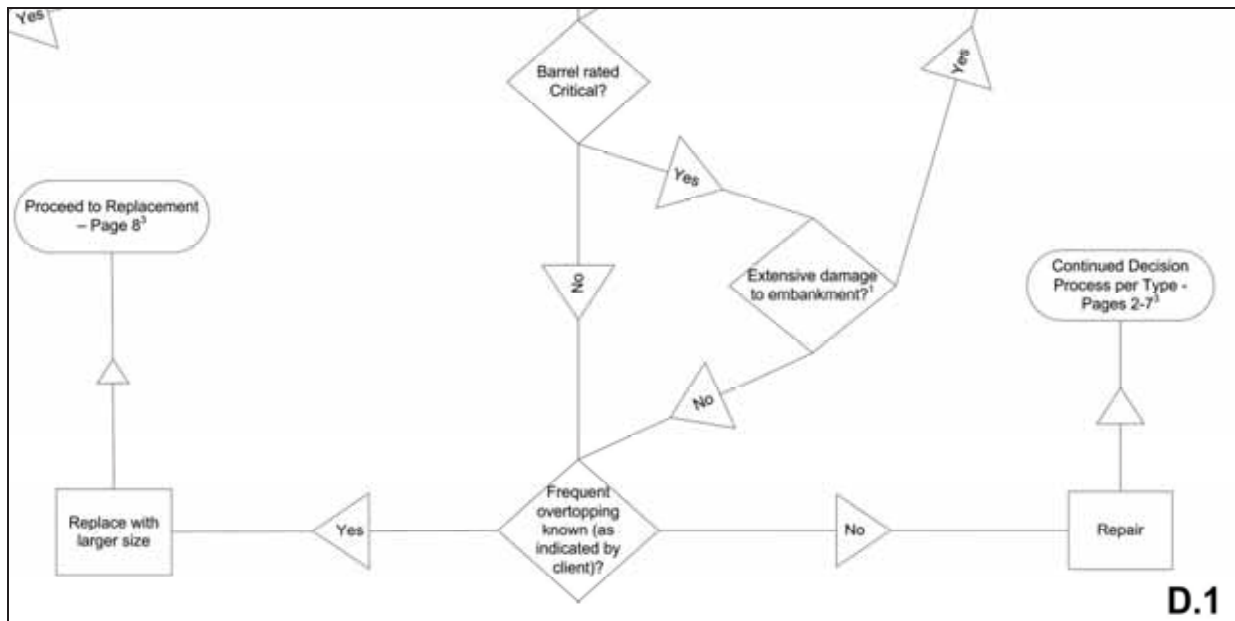

Figure 23. Flowchart. Page 1 Critical barrels, embankment damage and frequent overtopping.

The “Page 1 – All Types” action flowchart ends with the selection of either no action, replacement, repair, or appurtenance terminator. If the Level 2 terminator is reached, the assessment should be continued if possible at the ‘Culvert barrel rated Good or Fair’ qualifier if all Level 2 triggers have been addressed. If a barrel repair is called for, depending on the type of culvert material - concrete/RCP, Metal/CMP, Plastic, Timber, or Masonry – the user moves on to one of the action flowcharts on Pages 2 through 6 of the set. Page 7 provides guidance for actions related to appurtenances, and page 8 provides a replacement decision flowchart for all types of culverts.

Pages 2 through 6 – (Material Specific) Continued Decision Process Flowcharts

In the case of the Page 1 flowchart calling for possible repairs to a culvert, the user moves on to the Continued Decision Process Flowcharts on Pages 2 through 6, depending on the material type. Each of the material-specific continued process flowcharts begins on the left-hand side at the process box titled “Continued Decision Process Needed (From Page 1) (*Start Here*)”.

The flowcharts step through the various possible deterioration modes that led to the Poor or Critical barrel rating, specific to the materials type. The possible terminators the user may reach on these flowcharts typically include Replace, Repair with Lining, Localized Man-Entry Repair, and Level 2 Investigation. The following section steps through the Page 2 flowchart for concrete and RCP culverts, as an example of how the material specific flowcharts on Pages 2 through 6 are used.

Page 2 – Continued Decision Process Flowchart for Concrete & RCP

After reaching a Page 1 terminator for a concrete or RCP culvert, the user moves to ‘FLH Culvert Action Flowchart – Page 2 Concrete & RCP’. The first prompt in this flowchart is if the ‘Cross-section deformation is Poor or Critical’, the assumption being that this type of culvert loses most of its structural integrity when deteriorated to this extent. Concrete and RCP culverts with Poor or Critical cross section deformations immediately go to a replacement terminator and proceed to the Page 8 replacement flowchart.

If the cross-section deformation is not Poor or Critical, the user is queried if ‘Cracking is Poor or Critical?’ If cracking is Critical, then the replacement terminator is again reached, the assumption being that the pipe has lost most of its structural capacity and the condition is not repairable. If the cracking is only Poor, then the alternate path leads to the qualifier is the ‘Rise less than or equal to 48 inches?’ This question stems from the understanding that man-entry repairs should only be considered for pipes greater than 48 inches in size. This means that barrel repairs for smaller pipes would require a lining technique and if lining is not feasible, require replacement. If the size is greater than 48 inches, the next question is whether there is ‘Access available for Repair by Lining?’ If so, the user proceeds to the ‘Repair with Lining and proceed to liner type selection matrix’ terminator and this is his/her preliminary recommendation to complete the procedure. If there is not access for a liner repair, the recommendation and path for a small pipe with Poor cracking becomes replacement, as shown in the following Figure 24.

If the rise of the concrete or RCP pipe is greater than 48 inches, the user is queried if ‘Most of the culvert is affected by Poor/Critical conditions?’, the assumption being that spot repairs on 50 percent or more of a pipe is not cost efficient when compared to lining or replacement. If this is the case, the user is queried about access to the pipe ends for lining repairs, and if not sufficient, replacement should be recommended. In the case where less than half of the pipe is affected by Poor or Critical conditions, the path leads to a ‘Localized Man-Entry Repair’ terminator and recommendation.

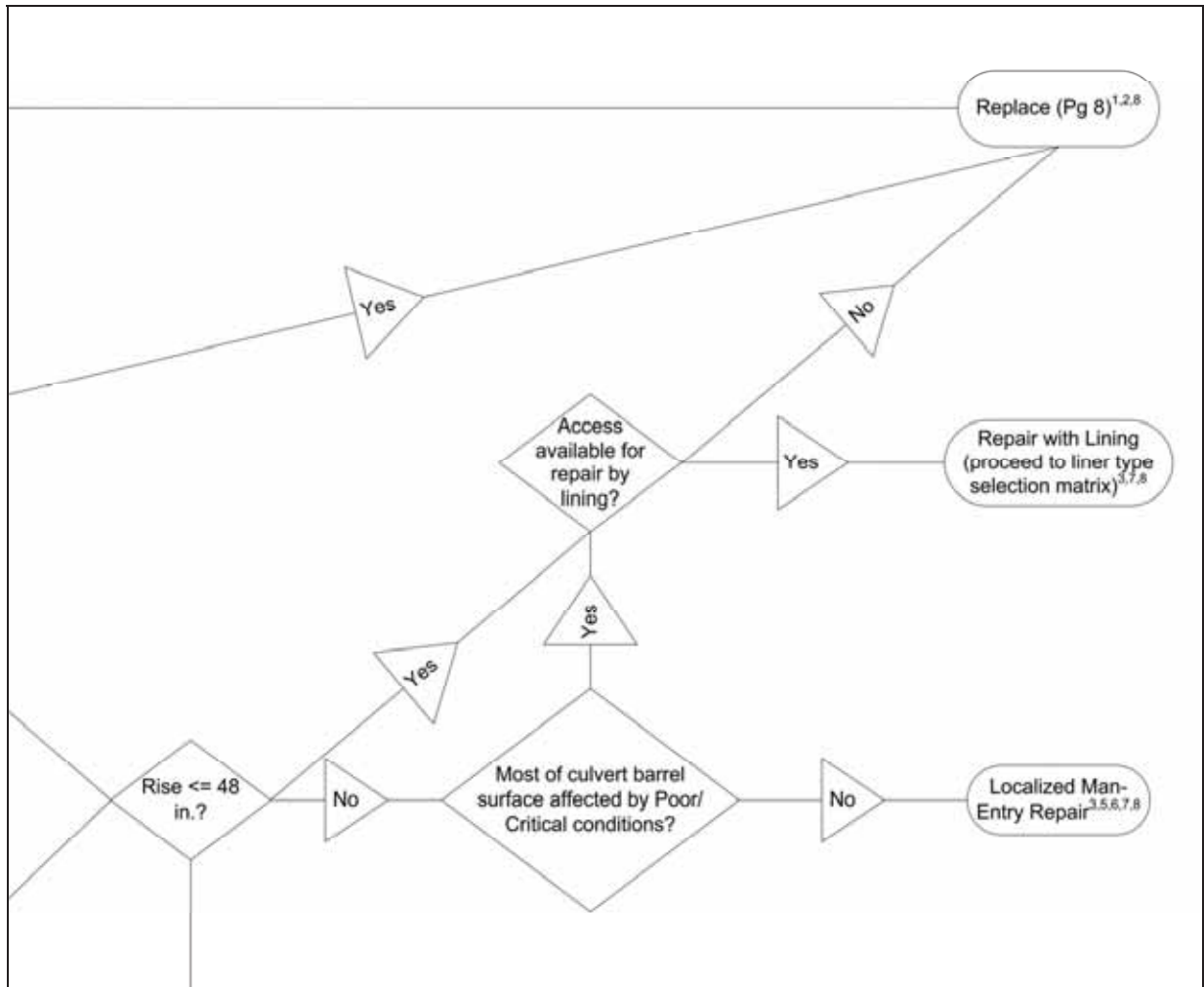

Figure 24. Flowchart. Page 2 terminators for concrete and RCP culverts, except L2 investigation.

Going back to the question of whether ‘Cracking is Poor or Critical’, a No response leads to a prompt for the next mode of deterioration to consider, is ‘Chemical/corrosion Poor or Critical?’ If Yes, the user is asked a Level 2 – Condition qualifier, is it an ‘Aggressively corrosive environment?’. If it is, as indicated on the assessment form, he/she proceeds to the Level 2 investigation terminator. Note that the user may continue the procedure and evaluate the culvert for the remaining modes of deterioration; however, further efforts towards Level 1 recommendations may not be cost-effective if a more-in-depth Level 2 investigation will ensue. If the corrosion/chemical environment is not aggressive, the user proceeds to the prompt if the pipe ‘Rated Critical?’, at which point the repair versus replacement procedure duplicates that for cracking as described above.

If there are no Poor or Critical chemical or corrosion problems, the user progresses to the ‘Invert deterioration and abrasion is Poor or Critical?’ deterioration qualifier, and if Yes, is it in an ‘Aggressive abrasion environment?’. If the environment is aggressively abrasive, the Level 2 investigation recommendation is again reached. If the abrasion environment is not aggressive, the user proceeds to the prompt if the ‘Rise less than or equal to 48 inches?’, at which point the repair versus replacement procedure duplicates that for cracking as described above and shown in the following Figure 25.

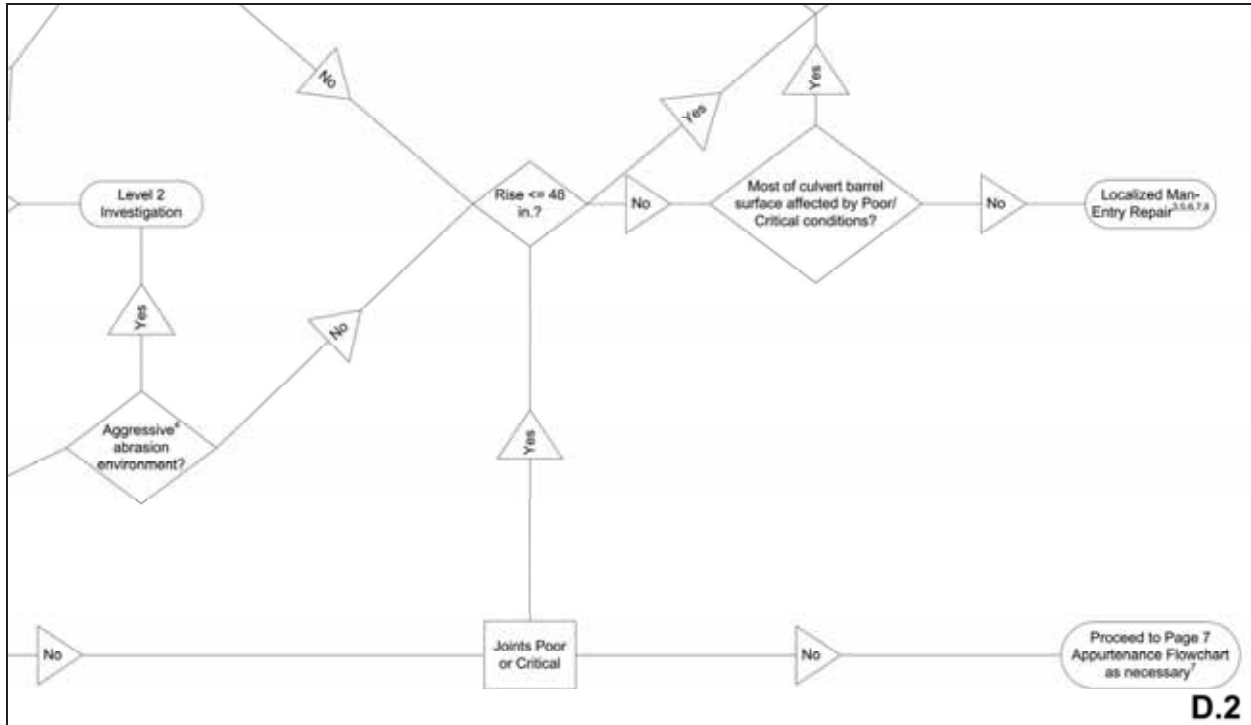

Figure 25. Flowchart. Page 2 treatment of concrete culverts with joint deterioration.

Answering No to the invert deterioration query leaves the user with one remaining mode of deterioration possible, ‘Joints Poor or Critical’. If this is the case, the user moves on to the question regarding if the ‘Rise is less than or equal to 48 inches?’ If the joints were not Poor or Critical, the user is directed to proceed to the appurtenance flowchart as necessary. If the rise is greater than 48 inches, the user proceeds to the prompt is ‘Most of the culvert affected by Poor/Critical conditions?’. Another negative response leads the user to the terminator ‘Localized Man-Entry Repair’ and the end of the procedure. Affirmative answers to either of these two questions regarding rise and coverage will lead the user to the final question is there ‘Access for Repair with Lining?’, at which point this final path diverges to either the ‘Repair with Lining and proceed to liner type selection matrix’ or the ‘Replace (proceed to Page 8)’ terminator. The logic in this region of the flowchart is driven by the concept that joint repair by man-entry is feasible and desirable if the pipe is large enough and the number of joints needing repair is reasonably small; however, if many joints need repair, a liner or replacement may be more cost effective.

Page 7 – Appurtenance Continued Decision Process Flowchart

In the event the culvert barrel is in Good or Fair condition but one or more of the appurtenances is Poor or Critical, the terminator “Proceed to Appurtenances – Page 7” on the top center of the Page 1 flowchart is reached. The user proceeds to the ‘FLH Culvert Continued Decision Process Flowchart - Page 7 Appurtenances’. The first qualifier of the appurtenance flowchart is whether the ‘Culvert barrel is to be replaced?’, in which case the user is directed to the terminator ‘Replace appurtenances as needed’, as shown in the following Figure 26.

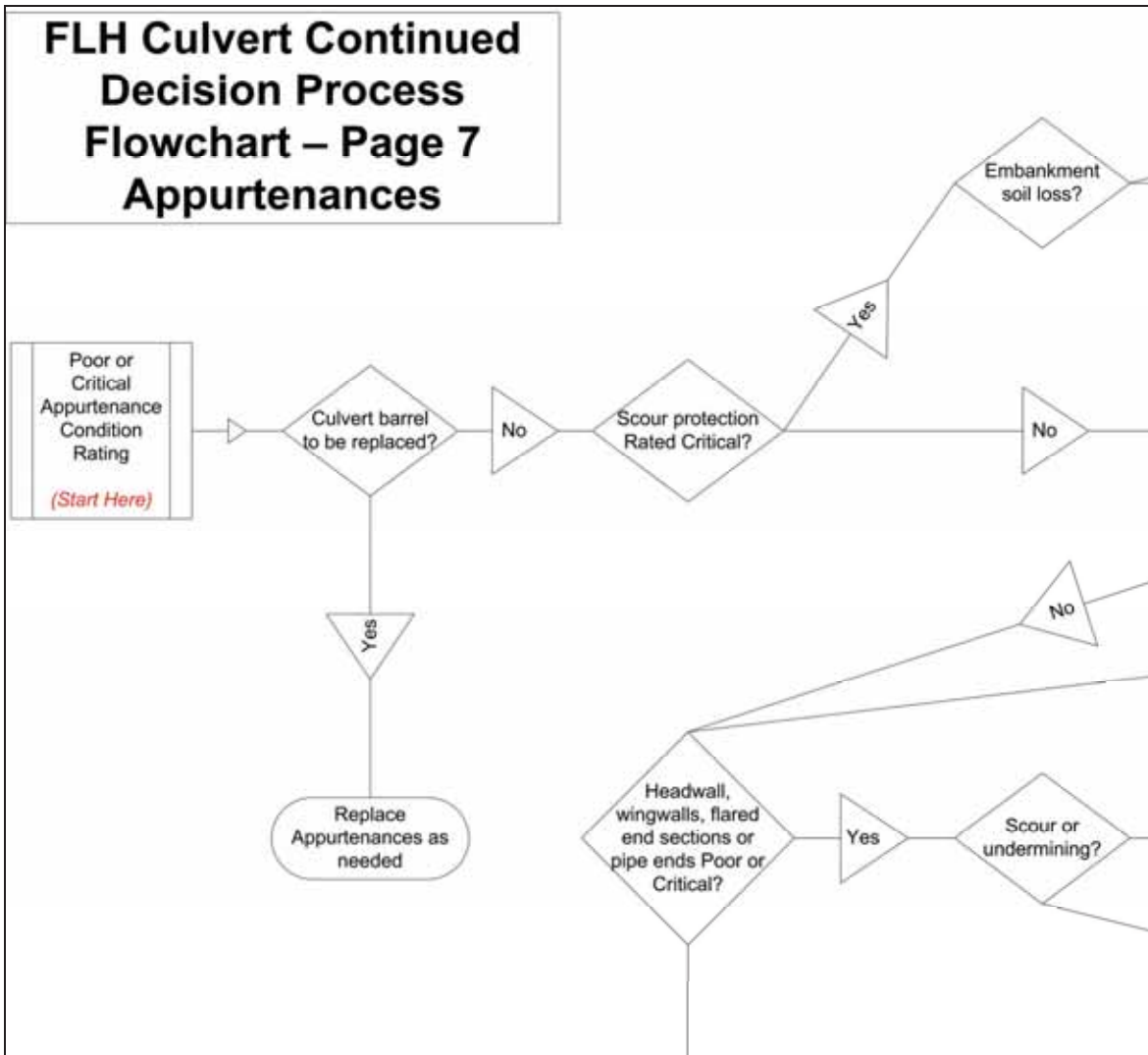

Figure 26. Flowchart. Replacement and scour protection qualifiers for Appurtenances Flowchart.

If the barrel is not to be replaced, the next prompt encountered is the ‘Scour protection is rated Critical?’, in which case the user is queried whether there is ‘Embankment soil loss’ or not. If there is embankment soil loss, the user’s recommendation is ‘Repair soil embankment’ and ‘Replace Scour Protection System’. If there is no embankment loss, the user moves directly to the ‘Replace Scour Protection System’ terminator, as shown in the following Figure 27.

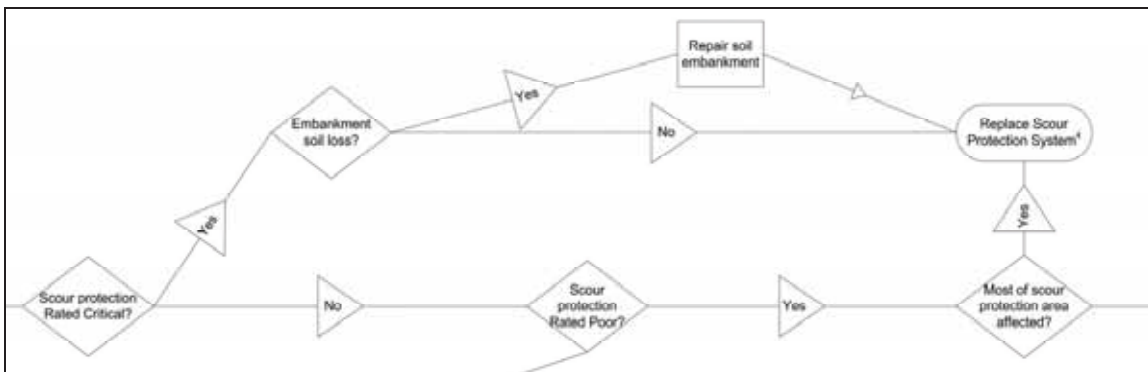

Figure 27. Flowchart. Deteriorated appurtenances with Critical/Poor scour countermeasures.

If the scour countermeasures are not rated Critical, but are Poor, the user is prompted is ‘Most of scour protection area affected?’ If most of the scour protection area is affected by the deterioration, the user again reaches the ‘Replace Scour Protection System’ terminator. If the deterioration does not affect most of the scour protection area, the user recommends a ‘Local Repair of Scour Protection’ and moves on to the next qualifier ‘Headwall, wing walls, flared end sections or pipe ends Poor or Critical?’.

If the answer to the ‘Headwall, wing walls, flared end sections or pipe ends Poor or Critical?’ query is Yes, the next prompt asks whether there is ‘Scour or undermining?’. In the instance there is scour or undermining of the appurtenance, the user recommends ‘Repairing backfill’ and then answers the prompt ‘Appurtenance rotated or displaced?’. If there is rotation or displacement, the user recommends ‘Reposition appurtenance to original state if feasible’. After the recommendation is made, or if there was no rotation or displacement of the appurtenance, the user moves on to the query ‘Cracking/spalling or section loss led to Poor or Critical rating?’, as shown in Figure 28 below.

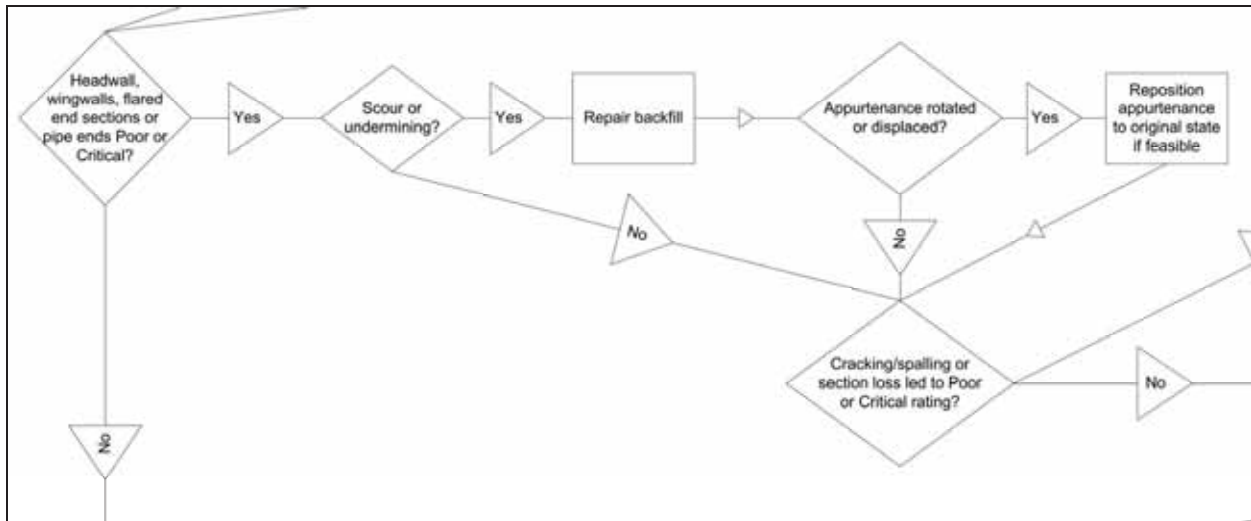

Figure 28. Flowchart. Qualifiers for appurtenances with undermining, rotation, displacement, or cracks/spalls.

Answering affirmative to ‘Cracking/spalling or section loss led to Poor or Critical rating?’ leads the user to the query is ‘Most of appurtenance affected?’. If most of the appurtenance is affected by the deterioration, ‘Replace Appurtenance’ is recommended. If the deterioration does not affect most of the appurtenance, ‘Local Repair of appurtenance’ is recommended, and the user continues on to the next mode of deterioration in the flowchart. If there was no cracking, spalling or section loss leading to a Poor of Critical rating, the user would surmise that ‘Deformation or crushing led to Poor or Critical rating’ and recommend ‘Replace Appurtenance’, as shown in Figure 29 below.

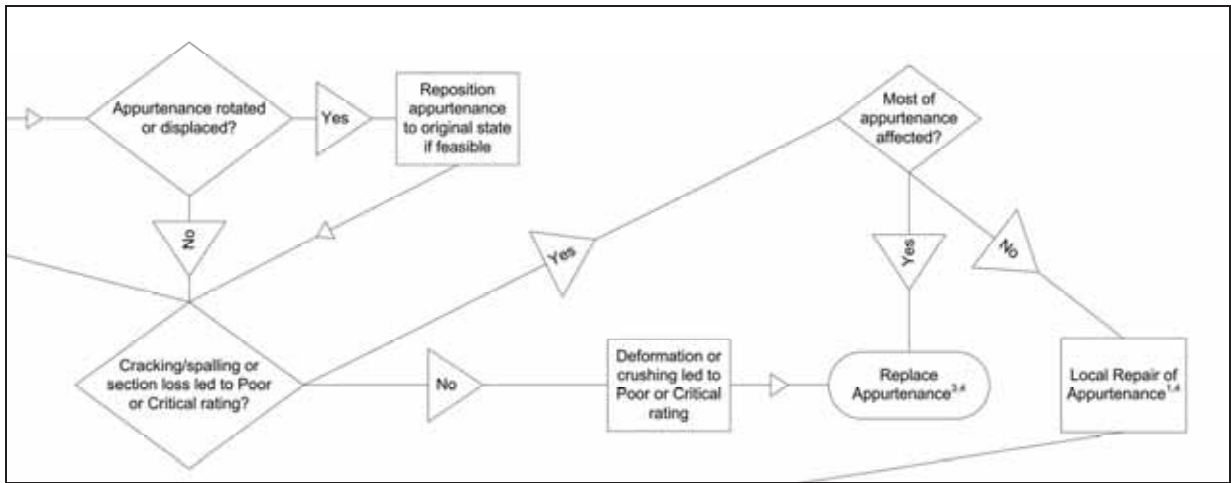

Figure 29. Flowchart. Page 7 qualifiers for repair and replacement of appurtenances.

A negative reply to the qualifier ‘Headwall, wing walls, flared end sections or pipe ends Poor or Critical’ leads to the final appurtenance deterioration mode ‘Apron Poor or Critical’, with the assumption at this point in the decision-making process being that it is. The apron condition prompt is also reached from the ‘Local Repair of Appurtenance’ recommendation discussed above. The user immediately moves to the question is there ‘Aggressive Abrasion?’. If there is aggressive abrasion, the recommendation is to conduct a ‘Level 2 investigation’. If there is no aggressive abrasion, the user moves on to the query is there ‘Scour or undermining?’, as shown in the following Figure 30.

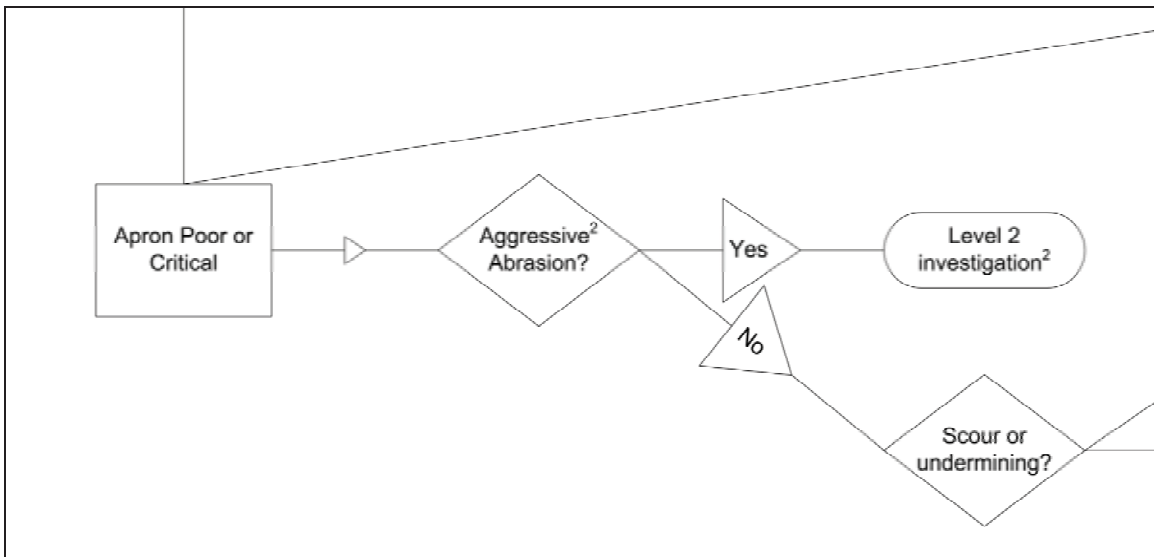
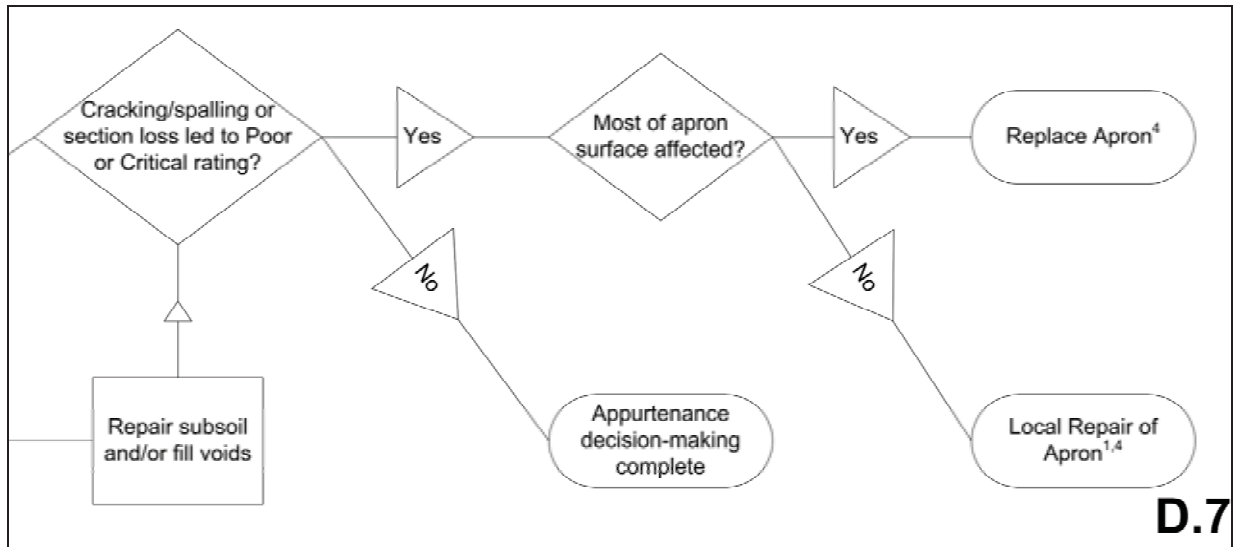

Figure 30. Flowchart. Page 7 qualifiers for Poor/Critical aprons with/without aggressive abrasion.

If scour or undermining of the apron is observed, the user recommends ‘Repair subsoil and/or fill voids’ and proceeds to the final apron query of whether ‘Cracking/spalling or section loss led to Poor or Critical rating?’. If there was no scour or undermining, the user would move directly to this final query. If the answer is Yes, the user is asked if ‘Most of the Apron is affected?’, in which case the recommendation is to ‘Replace Apron’. If most of the apron is not affected, a ‘Local Repair of Apron’ is recommended. If apron deterioration did not lead to a Poor or Critical rating, the user finishes the Page 7 appurtenances flowchart, as shown in the Figure 31.



D.7

Figure 31. Flowchart. Final Page 7 qualifiers for cracking, spalling and section loss in aprons.

Page 8 – Replacement Flowchart

If a replacement was called for on the Page 1 flowchart, the user proceeds to the ‘FLH Culvert Action Flowchart - Page 8 Replacement All Types’. Page 8 can also be reached via references from within the various type-specific Pages 2 through 6. The first qualifier of the replacement flowchart is whether ‘Embankment repairs require surface excavation and repair?’ If such repairs require excavation and rebuilding of the embankment, then the assumption is that culvert should just be dug up and replaced, thereby leading to the ‘Open-trench Replacement’ terminator.

If embankment rebuilding is not necessary, then the user is asked if there is ‘Access and workspace available at culvert ends for trenchless replacement?’ If not, a process follows wherein there is discussion with the client regarding the feasibility and costs of creating access at the culvert ends for trenchless replacement. This process affects and is followed by the question ‘Will client allow temporary road or lane closures?’ The answer to this question will direct the user to either an open-trench or trenchless replacement terminator. Going back to the access prompt, if there is access for trenchless equipment, then the user is asked if ‘Excavation depth is 20 feet or less to the bottom of the pipe?’ If the bottom of the pipe is deeper than 20 feet, the user is queried if there are ‘Adjacent culverts within project limits are being replaced using a trenchless approach?’ If the answer is affirmative, the pathway leads to a terminator and recommendation for trenchless replacement.

In the case where the excavation depth is 20 feet or less, or there are no other culverts being replaced with trenchless methods within the project, the user is directed to the final prompt “Will client allow temporary road or lane closures?” If traffic closures are allowed, the user is directed toward the open-trench recommendation. If closures are not permitted by the client, the remaining replacement option is trenchless replacement. The interview process during the development of the decision-making tool revealed that highway agencies resort to trenchless replacement techniques only in extreme circumstances, because trenchless replacement is typically very expensive. The logic on the Page 8 flowchart therefore reflects an inclination toward open-trench methods when replacement is needed.

If the user answers that either the excavation depth is less than 20 feet, access to culvert ends is insufficient for trenchless replacement, or that there are no other culverts being replaced using trenchless approaches in the project, he/she is directed to a last opportunity qualifier for open-trench replacement. The query is whether the ‘Client will allow temporary road or lane closures?’, with an affirmative answer leading to the Open-trench replacement terminator, as shown in Figure 32 below. If the client is not open to closures, then the recommendation is for a trenchless replacement.

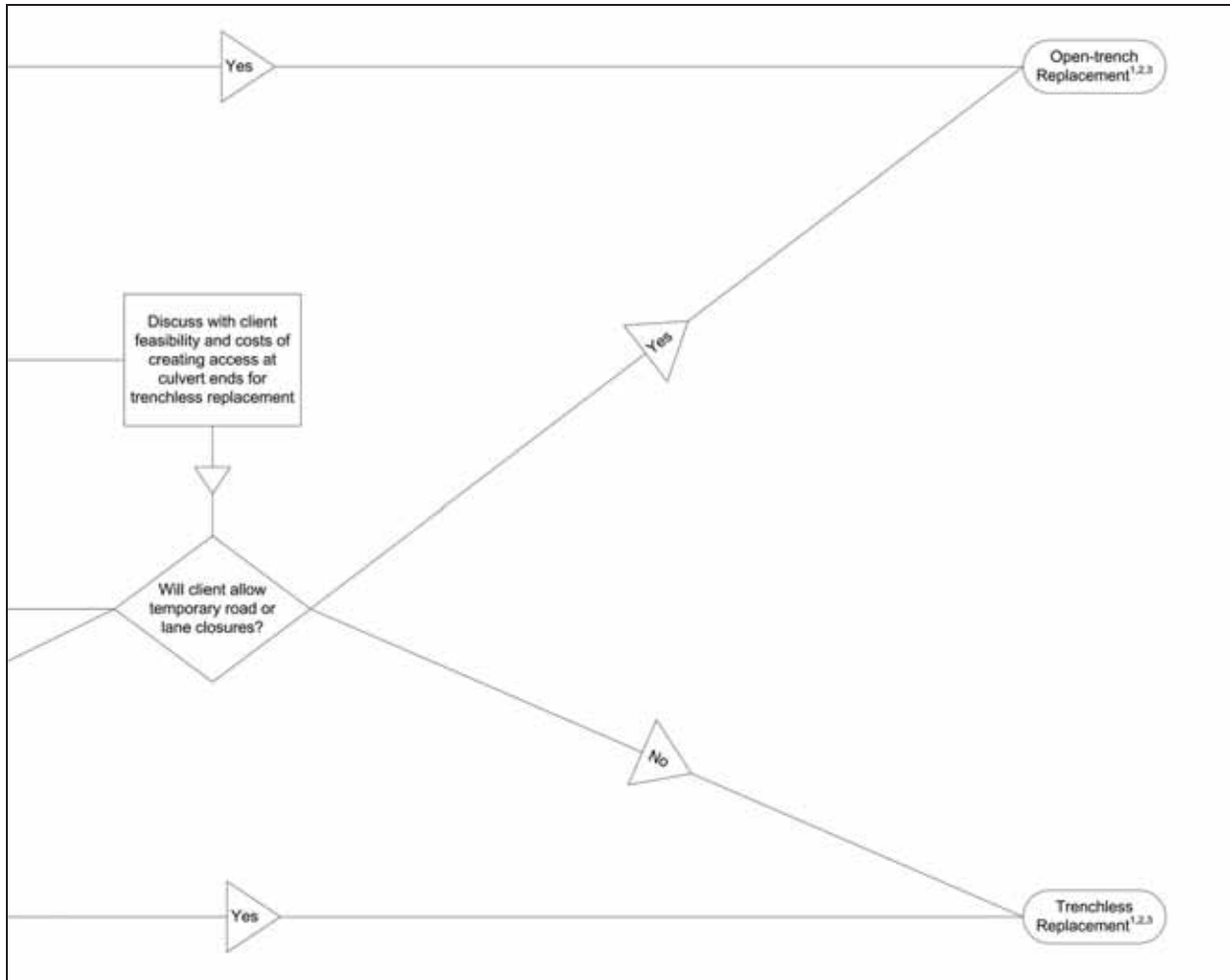

Figure 32. Flowchart. Page 8 qualifiers for no embankment damage, favoring trenchless replacement.

REPAIR LINER SELECTION MATRIX

The one-page culvert Repair Liner Selection Matrix is presented in Appendix E.1 at the end of this manual. This matrix summarizes properties, advantages and disadvantages of some of the liners commonly used in full-length, full-circumference repairs. More options and considerations for liner selection are also presented in the 2005 FLH Culvert Pipe Liner Guide and Specifications, which is listed in the Appendix G – Bibliography of this manual.

LOCALIZED MAN-ENTRY REPAIR MATRIX

The one-page culvert Localized Man-Entry Repair Selection Matrix is presented in Appendix E.2 at the end of this manual. This matrix summarizes properties, advantages and disadvantages of some of the commonly used local repair techniques that require man-entry.

REPLACEMENT MATRIX

The one-page culvert Replacement Matrix is presented in Appendix E.3 at the end of this manual. This matrix summarizes properties, advantages and disadvantages of some of the commonly used open-trench and trenchless replacement techniques.

CHAPTER 4 – CULVERT ASSESSMENT AND DECISION-MAKING EXAMPLES

The following scenarios are three examples of using the assessment and decision-making tools to evaluate in the field and make appropriate recommendations for a concrete box, corrugated metal pipe, and corrugated plastic pipe culvert. The concrete box and CMP culverts were assessed by FLH hydraulics engineers and the consultant team that prepared this manual, as part of a roadway project-specific inspection of culverts on Wawona Road in California’s Yosemite National Park. The corrugated plastic culvert example was developed by the consultant team using an existing culvert within a park in the Washington D.C. region.

Each section is organized as follows: First, a summary of the inspection is presented along with an explanation of the completed Culvert Assessment Form. Next the Decision Making Tools are used to reach a recommended fix or action. The specific sequence steps through the FLH Culvert, Entry Diagram, Assessment Guide, Action Flowchart - Page 1 All Types, Continued Decision Process Flowchart – Pages 2 through 6 (material specific), Continued Decision Process Flowcharts – Pages 7 and 8 (as appropriate), and the repair or replace matrices.

The following culverts are detailed below:

- A 6 foot wide x 9 foot rise Concrete Box, Yosemite National Park, CA
- A 30 inch Corrugated Metal Pipe (CMP) , Yosemite National Park, CA
- An 18 inch High Density Polyethylene Pipe (HDPE), Fountainhead Park, VA

CONCRETE BOX CULVERT ASSESSMENT AND DECISION-MAKING EXAMPLE

The following example is a 6 foot wide x 9 foot rise reinforced concrete box conveying Adler Creek under Wawona Road (Route 14) in Yosemite National Park. The inspection was performed on September 2nd, 2009 by two knowledgeable hydraulic engineers from Central Division of FLH and an experienced consultant inspector, and took approximately 15 minutes. The completed Culvert Inspection Form is shown in the following Figure 33. The culvert received an overall rating of Poor.

Due to the larger culvert size and condition, there were no special entry restrictions, as shown in the following Culvert Entry Diagram in annotated Figure 34. The downstream view of the culvert is shown in the following Figure 35.

CULVERT ASSESSMENT FORM

Overall Rating

Good

Fair

Poor

Critical

Unknown

Performance Problems

Notes by: Bergendahl Date: 9-2-09 Project: **CA YOSE 14(4)**
 Measurements by: Zenger/Hogan Time: 11:15 A **Wawona Road**
FHWA CFLHD

Site Information
 Facility Location: **California, Yosemite National Park, Wawona Road, Route 14 (27 miles)**
 RIP Data Milepost: 10.304 CFL Project Station: 565+80
 GPS Waypoint No. 232 (Near CL of Road) Named waterway: Alder Ck
(C-108)

Culvert Information:
 No. of Barrels: 1 Barrel Length (approx): 120' Barrel Slope (approx): Mod
 Skew to Road (deg -approx): 15 Approx Embankment Height (above upstream invert): 30'/30'
 Barrel Shape (circle one) Circular Box Elliptical Pipe Arch Arch
 Diameter: _____ / Span 6' x Rise 9' Open Bottom / N
 Pipe Material (circle one): Corrugated Metal Reinforced concrete Corrugated plastic - Smooth plastic
 Other (specify) _____ Masonry

End Treatments (circle one): **Upstream** : Projecting / Mitered / Headwall / Headwall & Wingwalls / End Section
Downstream : Projecting / Mitered / Headwall / Headwall & Wingwalls / End Section

Flowing or standing water? N / Y Depth: _____ possible known AOP passage issues? Y / N
 Utilities Present (list)? Y N Possible historic features? Y / N

Culvert Condition (circle / check all that apply and provide appropriate explanations below)

Category	Rating
Invert Abrasion	Good Fair <u>Poor</u> Crit Unk
Corrosion / Chemical <u>NA</u>	Good Fair Poor Crit Unk
Cross section deformation	<u>Good</u> Fair Poor Crit Unk
Invert deterioration	Good Fair <u>Poor</u> Crit Unk
Joints & Seams	Good Fair <u>Poor</u> Crit Unk
Cracking	Good <u>Fair</u> Poor Crit Unk
Liner / Wall <u>NA</u>	Good Fair Poor Crit Unk
Mortar and Masonry <u>NA</u>	Good Fair Poor Crit Unk
Headwall/Wingwall	Good <u>Fair</u> Poor Crit Unk
Apron <u>NA</u>	Good Fair Poor Crit Unk
Terminal End Treatment <u>NA</u>	Good Fair Poor Crit Unk
Scour Protection <u>NA</u>	Good Fair Poor Crit Unk

Performance problems requiring Level 1 Action	
Debris/Vegetation blockage > 1/3 of barrel	<input type="checkbox"/>
Buoyancy related inlet failure	<input type="checkbox"/>
Poor channel alignment	<input type="checkbox"/>
Previous overtopping	<input type="checkbox"/>
Local outlet scour	<input type="checkbox"/>
Performance problems requiring Level 2 Action	
Embankment piping	<input type="checkbox"/>
Channel degradation / Headcut	<input type="checkbox"/>
Sedimentation blockage > 1/3 of barrel	<input type="checkbox"/>
Exposed footing (open bottom)	<input type="checkbox"/>
Embankment slope instability	<input type="checkbox"/>
No access / Buried / Submerged	<input type="checkbox"/>

Photos (check): Inlet Outlet Roadway (ahead) Roadway (back) View downstream
 View upstream 8-11 Inside Barrel

Notes / Recommendations:
Long joint @ Invert & joints need repair.
Scour hole @ inlet. Open joints allowing water infiltration. Diagonal cracking in Wall.

Additional notes / Sketches on back of form

Figure 33. Form. Completed Culvert Assessment Form for concrete box culvert example in Yosemite National Park.

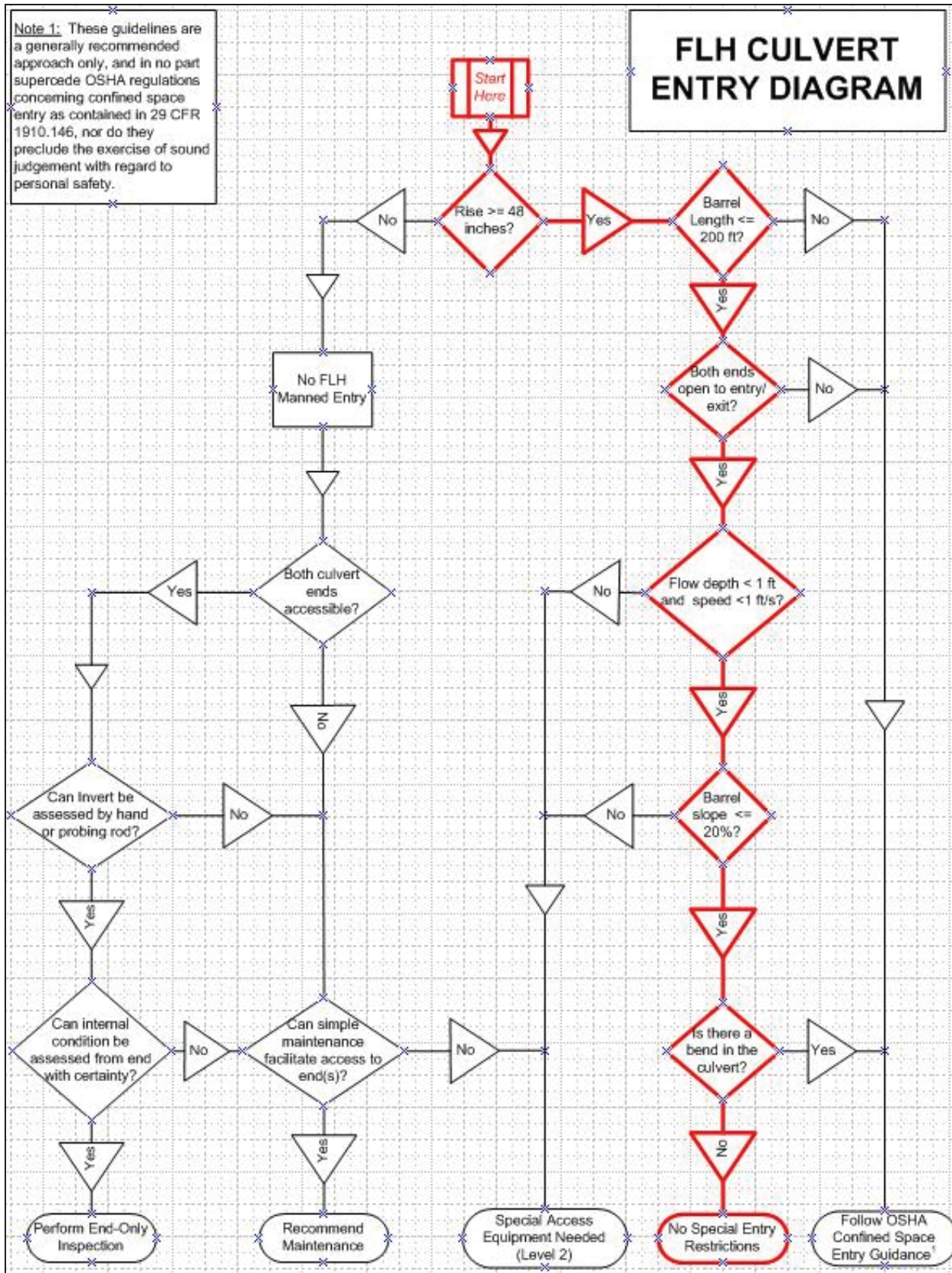

Figure 34. Flowchart. Annotated Culvert Entry Diagram for concrete box culvert example in Yosemite National Park.



Figure 35. Photo. View downstream of concrete box culvert with masonry appurtenances.

The culvert condition ratings by category of deterioration were noted as follows in Figure 36 below, using the Culvert Assessment Guide.

Category	Rating
Invert Abrasion	Good Fair <u>Poor</u> Crit Unk
Corrosion / Chemical <i>NA</i>	Good Fair Poor Crit Unk
Cross section deformation	<u>Good</u> Fair Poor Crit Unk
Invert deterioration	Good Fair <u>Poor</u> Crit Unk
Joints & Seams	Good Fair <u>Poor</u> Crit Unk
Cracking	Good <u>Fair</u> Poor Crit Unk
Liner / Wall <i>NA</i>	Good Fair Poor Crit Unk
Mortar and Masonry <i>NA</i>	Good Fair Poor Crit Unk
Headwall/Wingwall	Good <u>Fair</u> Poor Crit Unk
Apron <i>NA</i>	Good Fair Poor Crit Unk
Terminal End Treatment <i>NA</i>	Good Fair Poor Crit Unk
Scour Protection <i>NA</i>	Good Fair Poor Crit Unk

Figure 36. Form. Annotated Culvert Assessment Form for concrete box culvert deterioration categories.

The Invert Abrasion and Invert Deterioration were rated as Poor due to heavy invert abrasion, section loss, and exposed and corroding rebar, as shown in following Figure 37.



Figure 37. Photo. Invert abrasion damage with concrete section loss and exposed/corroding rebar.

Cracking was rated as Fair due to multiple cracks in the walls up to ¼ inch wide with exudence and minor spalling and infiltration of water, as shown in the following Figure 38 and 39. Joints & Seams were rated as Poor because the joints were spalled and open near the invert in some areas as shown in Figure 39, allowing water to infiltrate. Cracking in close proximity to joints was considered as deterioration to the joint, rather than categorically as cracking.

Headwall/Wingwall was rated Fair due to minor mortar joint deterioration. Due to the Poor ratings and subsequent repairs needed, the culvert was given an overall rating of Poor. There were no performance problems observed at the culvert or indicated on the assessment form.



Figure 38. Photo. Vertical crack in culvert wall with exudence.



Figure 39. Photo. Diagonal crack near joint and invert with water infiltration .

The decision-making part of the process was aided by the FLH Culvert Barrel Action Flowchart - Page 1 All Types, and Continued Decision Process Flowchart - Page 2 – Concrete & RCP, as shown in the following Figures 40 and 41 and described below.

FLH Culvert Barrel Action Flowchart - Page 1 All Types

Initial Field Assessment of Culvert Complete → Condition Rating Unknown? <No> → Observed performance problems requiring Level 2 actions? <No> → Observed performance problems requiring Level 1 fixes? <No> → Culvert barrel rated Good or Fair? <No> → Culvert barrel rated Poor or Critical → Is culvert in imminent danger of collapse? <No> → Open-bottom or possible fish passage/AOP/historical/cultural? (*possibly, but continue assessment in this case*) <No> → Special environmental permitting issues anticipated? <No> → Pipe Rise ≤ 36 in? <No> → Barrel rated Critical? <No> → Frequent overtopping known (as indicated by client)? <No> → Repair → Continue Decision Process per Type – pages 2-7.

FLH Culvert Continued Decision Process Flowchart - Page 2 – Concrete & RCP

Continued Decision Process Needed (From Page 1) → Cross Section Deformation Poor or Critical? <No> → Cracking Poor or Critical? <No> → Chemical Corrosion Poor or Critical? <No> → Invert Deterioration & Abrasion Poor or Critical? <Yes> → Aggressive Abrasion Environment? <No> → Rise ≤ 48" ? <No> → Most of Culvert Barrel Surface Affected by Poor/Critical Conditions? (*all of invert affected, but not barrel surface*) <No> → Localized Man-Entry Repair → (*trace back to*) Joints Poor or Critical <Yes> → Rise ≤ 48" ? <No> → Most of Culvert Barrel Surface Affected by Poor/Critical Conditions? <No> → Localized Man-Entry Repair

Based on the ratings and conditions determined in the Culvert Assessment Guide and material specific flow chart, a localized man-entry type of repair is recommended at this structure. Using the Localized Man-Entry Repair Selection Matrix, the following rehabilitation types would be recommended: Crack Epoxy Injection/Mortar, Crack/Spall Patching and Rebar Coating with Epoxy Grout, and Invert Lining. Note that although cracking was rated Fair, since repairs will be recommended for the Poor joints and invert, it is assumed other observed deterioration such as the Fair cracks will be repaired as well.

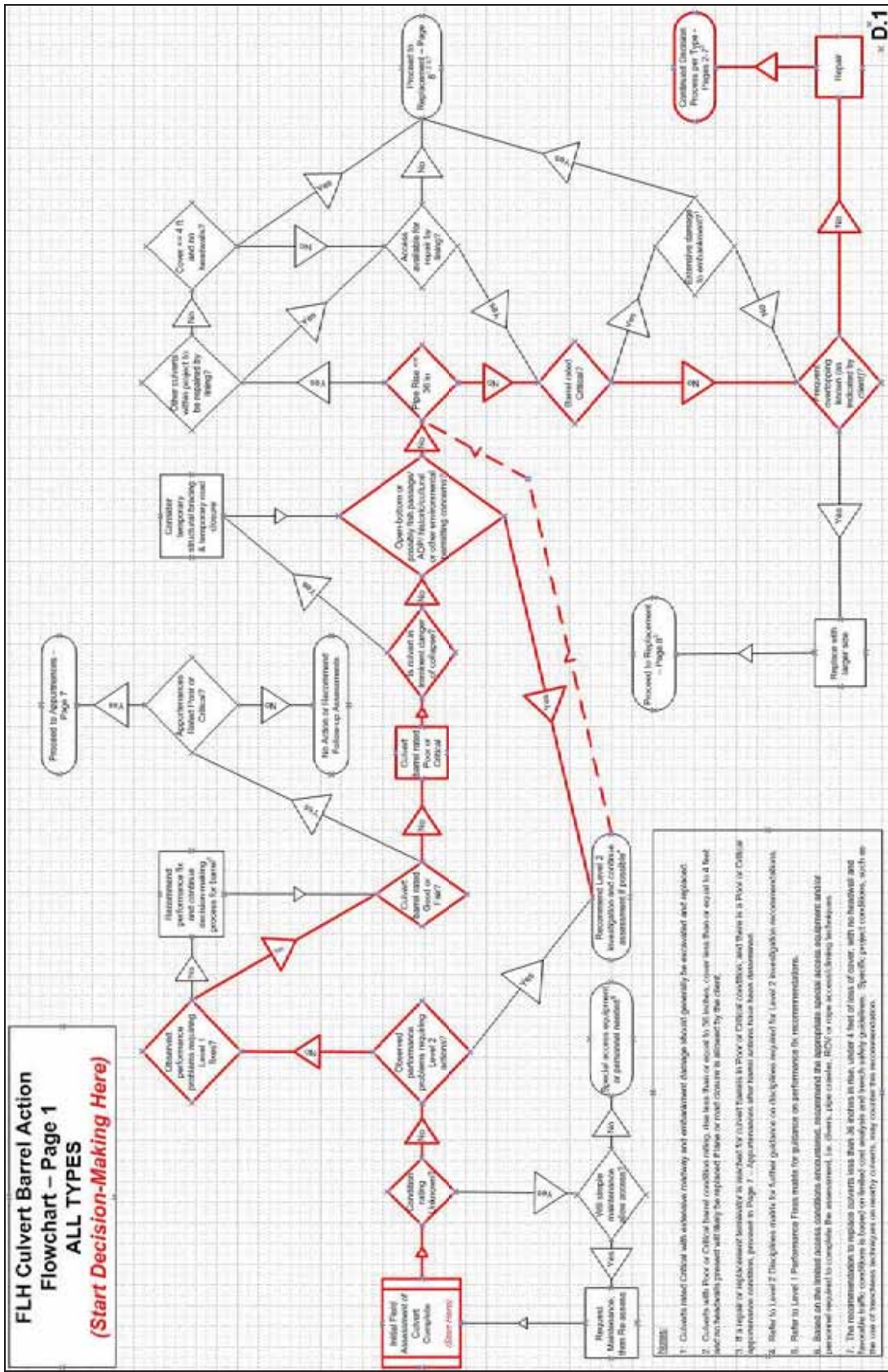

Figure 40. Flowchart. Annotated Culvert Barrel Flowchart – Page 1 ALL TYPES for concrete box example.

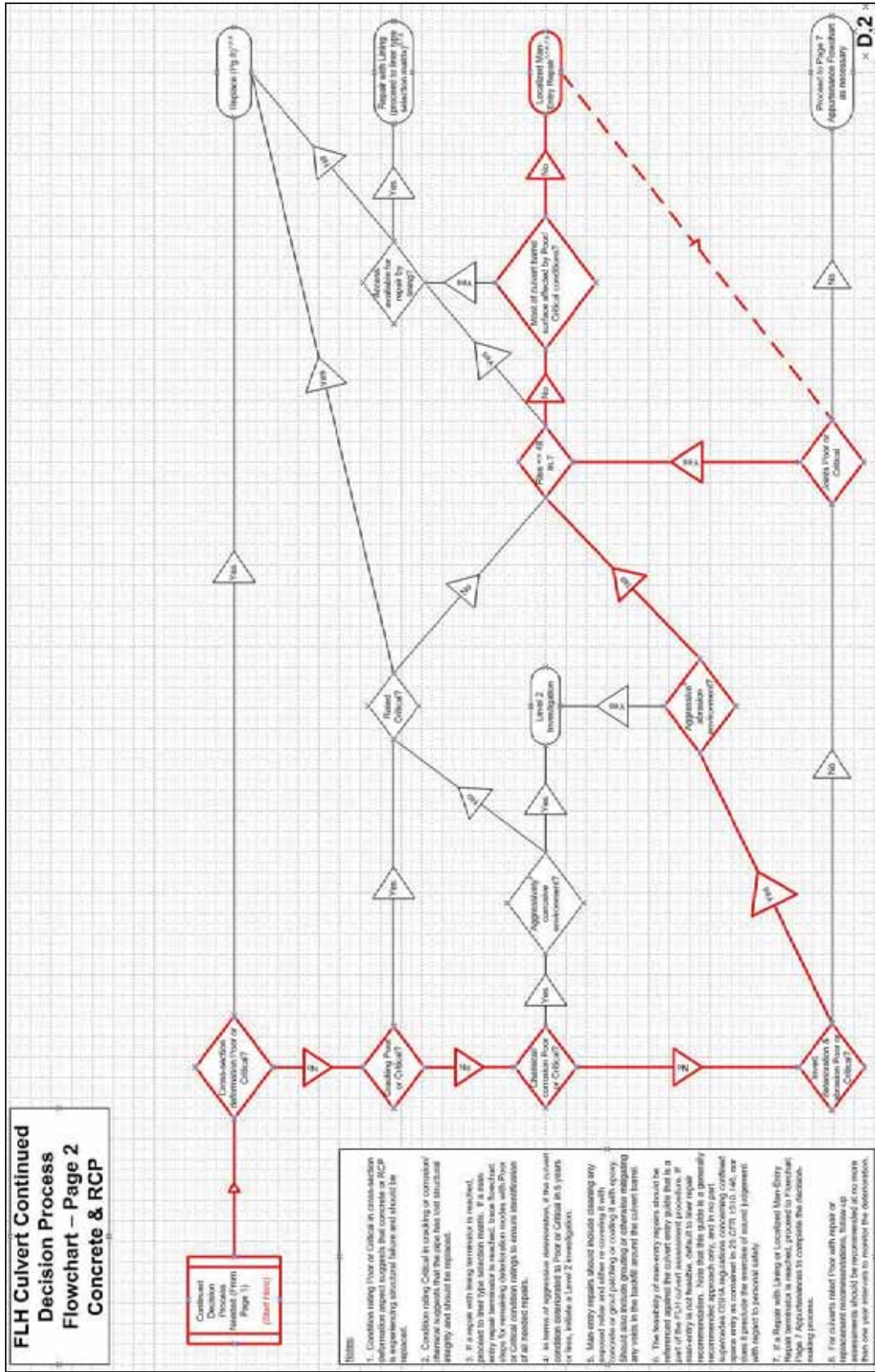

Figure 41. Flowchart. Annotated FLH Culvert Continued Flowchart – Page 2 for concrete box example.

CORRUGATED METAL PIPE (CMP) ASSESSMENT AND DECISION-MAKING EXAMPLE

The following example addresses a 170 foot long, 30 inch diameter CMP located under Wawona Road (Route 14) on Mosquito Creek in Yosemite National Park, California. The initial Level 1 assessment was performed on September 2nd, 2009 by two knowledgeable hydraulic engineers from Central Division of FLH and an experienced consultant inspector, and took approximately 15 minutes. It was noted on the form that the culvert was a potential site for using the ROV. A follow-up Level 2 investigation was conducted two days later using an FLH-owned and operated ROV. The completed and later modified Culvert Inspection Form is shown in the following Figure 42. The culvert initially received an Overall Rating of Fair, which was later changed to Poor following the Level 2 investigation.

CULVERT ASSESSMENT FORM

Notes by: Bugendahl Date: 9-2-09 Project: **CA YOSE 14(4)**
 Measurements by: Zuges/Abgan Time: 10:15A **Wawona Road**
 FHWA CFLHD

Overall Rating

Good

~~Fair~~

Poor

Critical

Unknown

Performance Problems

Site Information
 Facility Location: **California, Yosemite National Park, Wawona Road, Route 14 (27 miles)**
 RIP Data Milepost: 9.897 CFL Project Station: 545+20
 GPS Waypoint No. 227 (Near CL of Road) Named waterway: Mosquito Crk.
(C-103)

Culvert Information:
 No. of Barrels: 1 Barrel Length (approx): 170' Barrel Slope (approx): Mild
 Skew to Road (deg -approx): 0 Approx Embankment Height (above upstream invert): 5/15'
Barrel Shape (circle one) Circular Box Elliptical Pipe Arch Arch
 Diameter: 30" / Span _____ x Rise _____ Open Bottom? Y/N
Pipe Material (circle one): Corrugated Metal - Reinforced concrete - Corrugated plastic - Smooth plastic
 Other (specify) Masonry

End Treatments (circle one): Upstream : Projecting / Mitered / Headwall / Headwall & Wingwalls / End Section
Downstream : Projecting / Mitered / Headwall / Headwall & Wingwalls / End Section

Flowing or standing water? N / Y Depth: 2" Known AOP passage issues? Y / N
 Utilities Present (list)? Y / N Possible historic features? Y / N

Culvert Condition (circle / check all that apply and provide appropriate explanations below)

Category	Rating
Invert Abrasion	Good <input type="checkbox"/> Fair <input type="checkbox"/> Poor <input type="checkbox"/> Crit <input type="checkbox"/> Unk <input type="checkbox"/>
Corrosion / Chemical	Good <input type="checkbox"/> Fair <input type="checkbox"/> Poor <input type="checkbox"/> Crit <input type="checkbox"/> Unk <input type="checkbox"/>
Cross section deformation	Good <input type="checkbox"/> Fair <input type="checkbox"/> <u>Poor</u> <input checked="" type="checkbox"/> Crit <input type="checkbox"/> Unk <input type="checkbox"/>
Invert deterioration	Good <input type="checkbox"/> Fair <input type="checkbox"/> <u>Poor</u> <input checked="" type="checkbox"/> Crit <input type="checkbox"/> Unk <input type="checkbox"/>
Joints & Seams	Good <input type="checkbox"/> Fair <input type="checkbox"/> Poor <input type="checkbox"/> Crit <input type="checkbox"/> Unk <input type="checkbox"/>
Cracking <u>NA</u>	Good <input type="checkbox"/> Fair <input type="checkbox"/> Poor <input type="checkbox"/> Crit <input type="checkbox"/> Unk <input type="checkbox"/>
Liner / Wall <u>NA</u>	Good <input type="checkbox"/> Fair <input type="checkbox"/> Poor <input type="checkbox"/> Crit <input type="checkbox"/> Unk <input type="checkbox"/>
Mortar and Masonry <u>NA</u>	Good <input type="checkbox"/> Fair <input type="checkbox"/> Poor <input type="checkbox"/> Crit <input type="checkbox"/> Unk <input type="checkbox"/>
Headwall/Wingwall	<u>Good</u> <input checked="" type="checkbox"/> Fair <input type="checkbox"/> Poor <input type="checkbox"/> Crit <input type="checkbox"/> Unk <input type="checkbox"/>
Apron <u>NA</u>	Good <input type="checkbox"/> Fair <input type="checkbox"/> Poor <input type="checkbox"/> Crit <input type="checkbox"/> Unk <input type="checkbox"/>
Terminal End Treatment <u>NA</u>	Good <input type="checkbox"/> Fair <input type="checkbox"/> Poor <input type="checkbox"/> Crit <input type="checkbox"/> Unk <input type="checkbox"/>
Scour Protection <u>NA</u>	Good <input type="checkbox"/> Fair <input type="checkbox"/> Poor <input type="checkbox"/> Crit <input type="checkbox"/> Unk <input type="checkbox"/>

Performance problems requiring Level 1 Action	
Debris/Vegetation blockage > 1/3 of barrel	<input type="checkbox"/>
Buoyancy related inlet failure	<input type="checkbox"/>
Poor channel alignment	<input type="checkbox"/>
Previous overtopping	<input type="checkbox"/>
Local outlet scour	<input type="checkbox"/>
Performance problems requiring Level 2 Action	
Embankment piping	<input type="checkbox"/>
Channel degradation / Headcut	<input type="checkbox"/>
Sedimentation blockage > 1/3 of barrel	<input type="checkbox"/>
Exposed footing (open bottom)	<input type="checkbox"/>
Embankment slope instability	<input type="checkbox"/>
No access / Buried / Submerged	<input type="checkbox"/>

Photos (check): Inlet Outlet Roadway (ahead) Roadway (back) View downstream
 View upstream _____ _____ _____

Notes / Recommendations:
5' drop @ Outlet. (Potential Rover)
 Rover inspection showed a badly corroded and perforated invert along much the length - lining may be difficult due to pipe deformation.
 Additional notes / Sketches on back of form

Figure 42. Form. Annotated FLH Culvert Entry Diagram for CMP example in Yosemite National Park.

Due to the smaller barrel size and longer length, an initial “end-only” assessment was made. There was at least one bend in the culvert evident upon initial inspection; therefore, it was concluded that the internal condition could not be assessed with certainty from the end. Per the annotated Culvert Entry Diagram in Figure 43, special access equipment was called for, in this case a pipe-crawler ROV that the FLH team had readily available for the project.

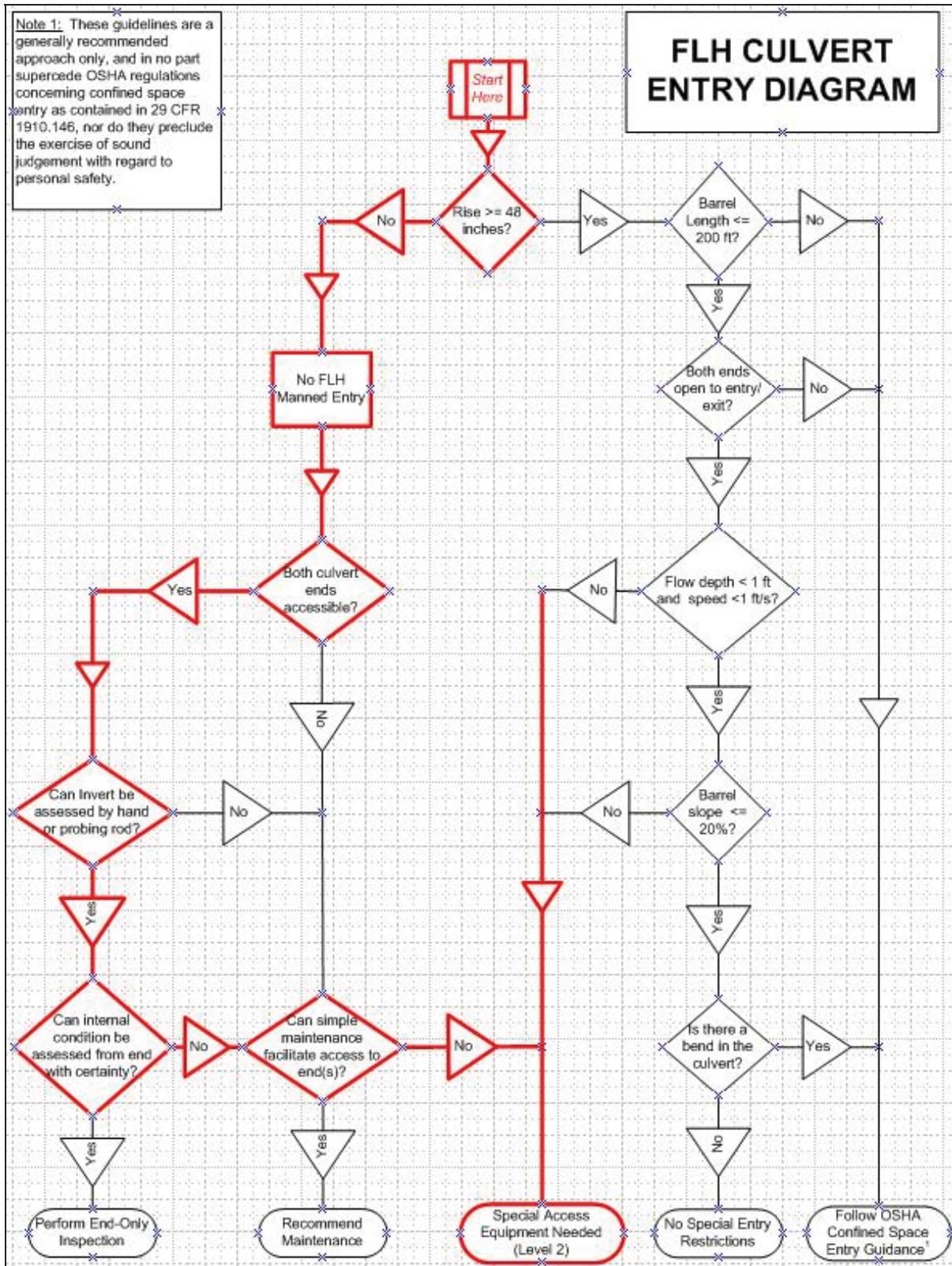

Figure 43. Flowchart. Annotated FLH Culvert Entry Diagram for CMP example in Yosemite National Park.

The culvert condition ratings by category of deterioration were initially noted in the Level 1 end-only assessment as follows in Figure 44, using the Culvert Assessment Guide.

Category	Rating
Invert Abrasion	Good Fair Poor Crit Unk
Corrosion / Chemical	Good Fair Poor Crit Unk
Cross section deformation	Good Fair Poor Crit Unk
Invert deterioration	Good Fair Poor Crit Unk
Joints & Seams	Good Fair Poor Crit Unk
Cracking <i>NA</i>	Good Fair Poor Crit Unk
Liner / Wall <i>NA</i>	Good Fair Poor Crit Unk
Mortar and Masonry <i>NA</i>	Good Fair Poor Crit Unk
Headwall/Wingwall	Good Fair Poor Crit Unk
Apron <i>NA</i>	Good Fair Poor Crit Unk
Terminal End Treatment <i>NA</i>	Good Fair Poor Crit Unk
Scour Protection <i>NA</i>	Good Fair Poor Crit Unk

Figure 44. Form. Annotated Culvert Assessment Form for concrete box culvert deterioration categories.

The cross section deformation was rated as Fair due to minor deformation of the crown at the outlet, as well as possibly inside the barrel near the outlet. Invert deterioration was rated Fair based on the conditions visible at and near the pipe ends, which included general corrosion, staining, coating loss and minor pitting. Very minor surface rust extended above the normal invert and flow line delineation, likely to the high-flow event level; therefore, the corrosion/chemical category was rate as Good based on the end-only observations. The initial overall culvert rating was Fair, based on the limited Level 1 end-only assessment.

A Level 2 investigation was recommended as a follow-up action, based on specialty access equipment needed, with the intent to revise the rating as necessary based on those subsequent findings. Although there was minor scour and end projection noted at the pipe outlet end, there were no significant performance problems observed. The following Figures 45 and 46 show the pipe conditions as observed at the ends during the Level 1 initial assessment.



Figure 45. Photo. Light invert deterioration and minor local scour erosion at outlet of CMP example.



Figure 46. Photo. Light invert deterioration at inlet of CMP example on Mosquito Creek in Yosemite National Park.



Figure 47. Photo. Stable downstream channel conditions at the outlet of CMP example in Yosemite National Park.

The Level 2 investigation using the pipe-crawler ROV revealed significant crown bulging and cross-section deformation under the roadway, section loss and holes at multiple joints above the flow line, suspected water exfiltration below the flow line, structural cracking in the crown of the pipe, and 50 to 100 percent section loss in the invert due to corrosion and abrasion. Heavy corrosion, pitting and section loss was observed at and above the invert throughout the pipe; however, no significant soil or water infiltration was observed. Based on these findings, the overall condition of the culvert was changed to Poor, which initiated the decision-making process for determining repair and replacement recommendations. The following Figures 48 through 52 show the ROV unit and video screenshots of internal pipe deterioration that it observed.



Figure 48. Photo. Pipe crawler ROV system ready for Level 2 inspection of CMP example in Yosemite National Park.

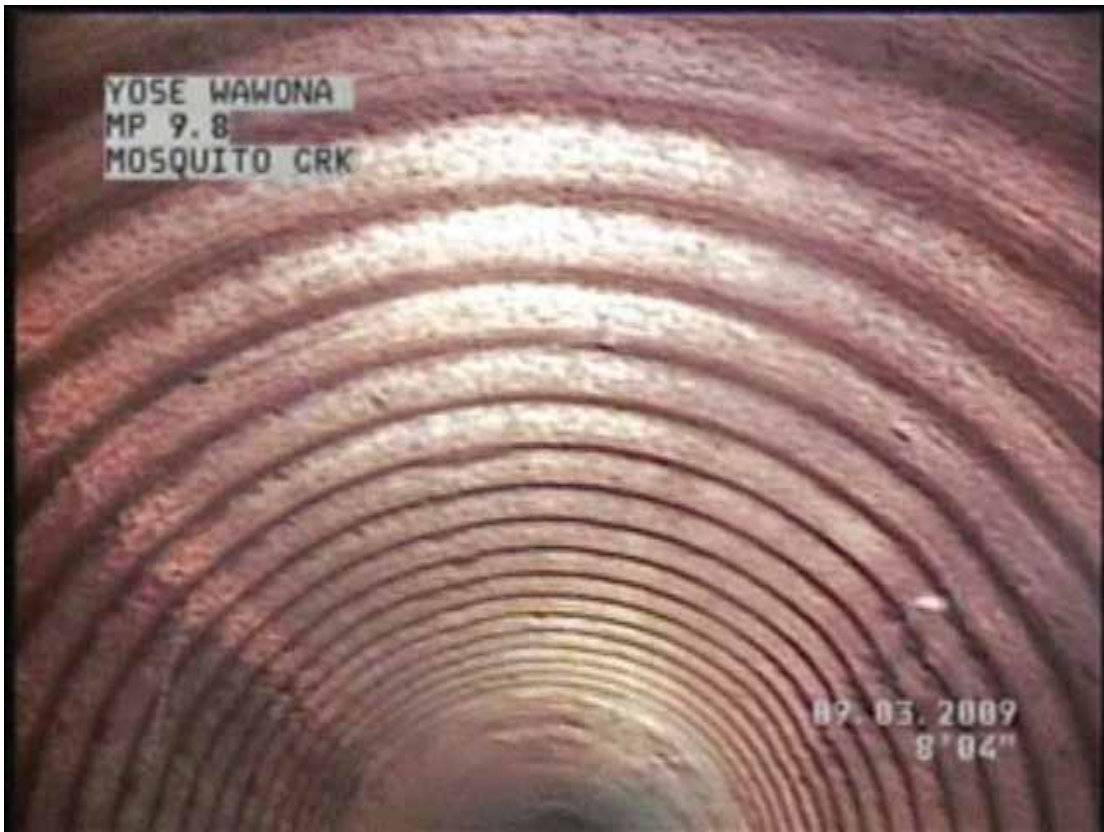

Figure 49. Photo. ROV video of CMP example showing typical corrosion above flow line.



Figure 50. Photo. ROV video of CMP example showing crown deformation and cracking.



Figure 51. Photo. ROV video of CMP example showing deformation and invert section loss.

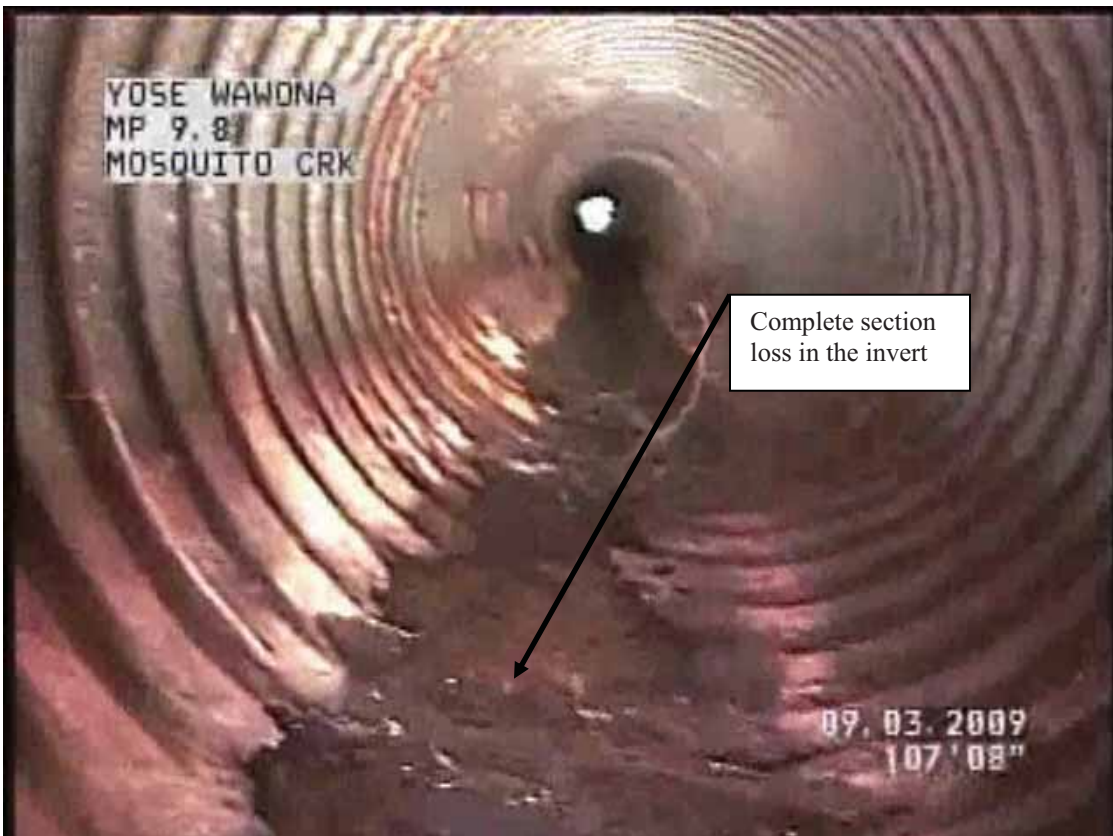

Figure 52. Photo. ROV video of CMP example showing complete invert section loss.

The decision-making part of the process, aided by the FLH Culvert Barrel Action Flowchart - Page 1 All Types, and Continued Decision Process Flowchart - Page 3 – CMP, as shown in the following Figures 53 and 54, was as follows.

FLH Culvert Barrel Action Flowchart - Page 1 All Types

Initial Field Assessment of Culvert Complete → Condition Rating Unknown? <No> → Observed performance problems requiring Level 2 actions? <No> → Observed performance problems requiring Level 1 fixes? <No> → Culvert barrel rated Good or Fair? <No> → Culvert barrel rated Poor or Critical → Is culvert in imminent danger of collapse? <No> → Open-bottom or possible fish passage/AOP/historical/cultural? (*possibly, but continue assessment in this case*) <No> → Special environmental permitting issues anticipated? → <No> → Pipe Rise ≤ 36 in? <Yes> → Other culverts within project to be repaired by lining? <Yes> (*assume possibly for now, to keep options open*) → Cover ≤ 4 ft and no headwalls? <No> → Access available for repair by lining? <Yes> → Barrel Rated Critical <No> → Frequent overtopping known (as indicated by client)? <No> → Repair → Continued Decision Process per Type – Pages 2-7.

The following Figure 53 shows the annotated decision path for the Page 1 flowchart.

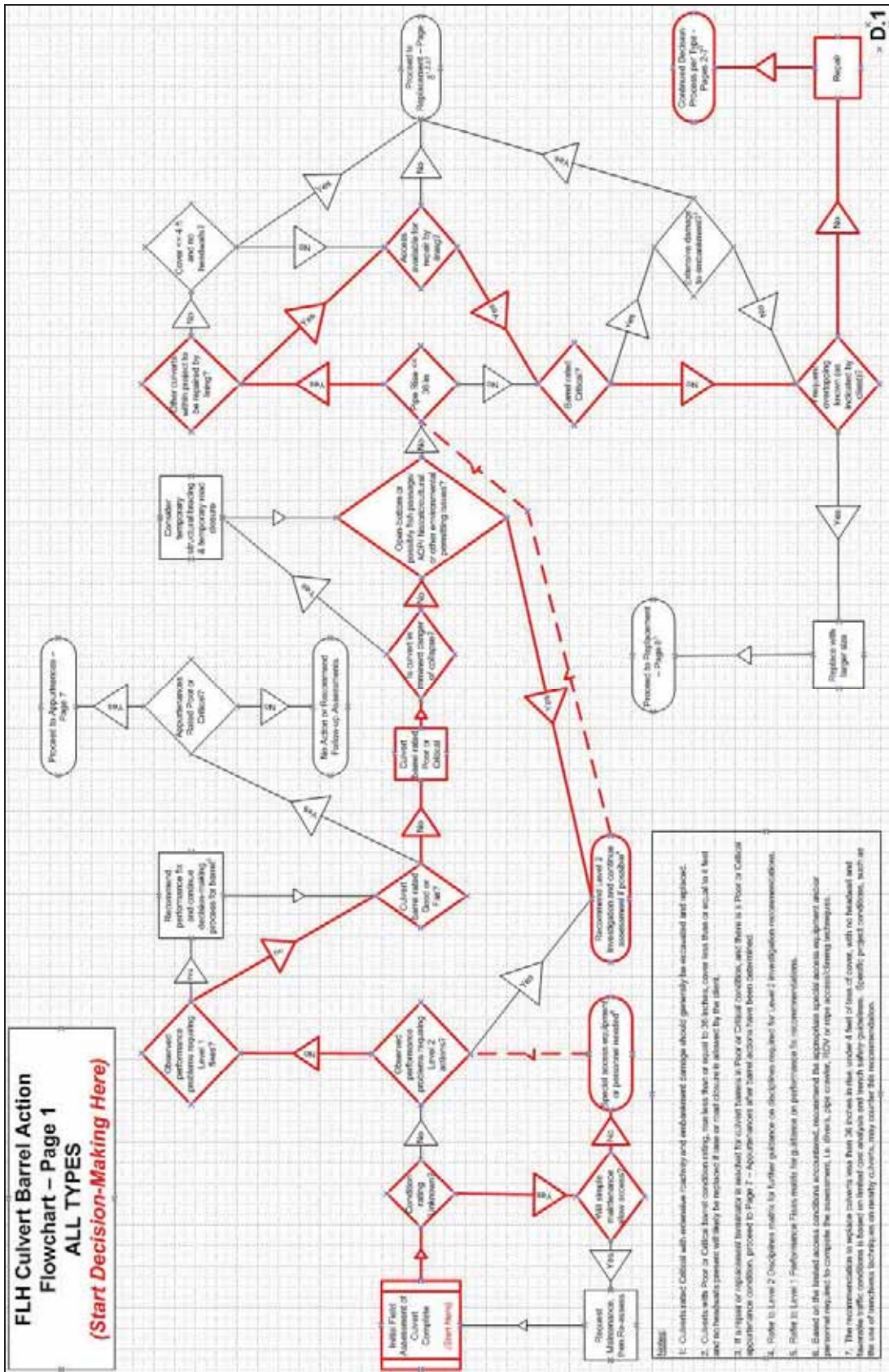

Figure 53. Flowchart. Annotated Barrel Action Flowchart – Page 1 for CMP example in Yosemite National Park.

FLH Culvert Continued Decision Process Flowchart - Page 3 – CMP

Continued Decision Process Needed (From Page 1) → Cross Section Deformation Poor or Critical? <Yes> → Cross Section Deformation Poor? <Yes> → Access available for repair by lining? <Yes> → Repair with Lining (proceed to liner type selection matrix).

Based on the ratings and conditions determined in the Culvert Assessment Guide and material specific flow chart, a liner repair is recommended at this structure, as shown in the following Figure 54. Using the Liner Selection Matrix, with prime consideration given to the localized bulges and cross-section deformations, the Spray-On Cement Mortar or Epoxy Lining types might be recommended; however, additional issues and pipe conditions eventually rule out these methods.

The pipe is rather long, with a bend and low-point in the middle where groundwater infiltration through the lost invert will likely pool water and prevent setup of the mortar. The longer length, bend in the middle, and bulges and deformations present possible issues with pulling the sled through the pipe at the steady rate required to control thickness of application. Lastly, the extent of invert loss may exceed the coating capabilities of this application method, requiring the use of local patches and/or reinforcement that require manned-entry. These added considerations suggest the spray-on liners may not be appropriate for this application. A note at the bottom of the Liner Selection Matrix directs the user to proceed to the Localized Man-Entry Repair or Replacement Matrix as appropriate if no liner can be selected. The combination of small size, long length and location of the worst deterioration at the middle of the run create conditions that may not be conducive to man-entry work. Although the 10 foot depth of cover exceeds the 4 foot delineator described in this procedure, there is room for road excavation equipment and traffic diversion is possible. Referencing the culvert Replacement Flowchart D.8 and the Culvert Replacement Techniques Matrix and comparing cost information, the recommended action is Open-Trench Excavation.

PLASTIC PIPE CULVERT ASSESSMENT AND DECISION-MAKING EXAMPLE

The following example is a 15 inch diameter High Density Polyethylene Pipe (HDPE) pipe is one of two pipes inspected at Fountainhead Regional Park in Fairfax, Virginia, on January 7th, 2010. The assessment was performed by a two-person consultant team in approximately twenty minutes. The culvert and roadway are shown in the following Figures 55 through 57. The completed Culvert Inspection Form is shown in Figure 58. The culvert received an overall rating of Unknown, with additional notes made regarding the clogging throughout the pipe and completely buried outlet, which will lead to constant roadway overtopping and possible damage to the roadway and embankment.



Figure 55. Photo. View of inlet of plastic HDPE example in Fountainhead Regional Park, Fairfax, Virginia.



Figure 56. Photo. View of interior of plastic example in Fountainhead Park showing clogging.



Figure 57. Photo. View of roadway crossing at plastic pipe example in Fountainhead Park.

FLH CULVERT ASSESSMENT FORM

Notes by: Roberts Date: 1-6-10 Project: _____
 Measurements by: Roberts/Trace Time: 1:10-1:30

Site Information:
 Facility Location: Fountainhead Regional Park, Fairfax VA
 Milepost: Marina Project Station: _____ GPS Road CL Waypoint No. _____
 Named waterway: N/A Direction of Flow: _____

Culvert Information:
 No. of Barrels: 1 Barrel Length (approx): 55'? Barrel Slope: Mild / Steep / _____
 Skew (0 degrees = perpendicular to road): N/A Approx Cover: Upstream 12" Downstream unknown
 Barrel Shape (circle one) Circular Box Elliptical Pipe Arch Arch
 Diameter: 15" / Span _____ x Rise _____
 Pipe Material (circle one): Metal - Concrete / RCP - Corrugated Plastic Smooth Plastic - Timber - Masonry
 Appurtenances (circle one):
 Upstream: Projecting / Mitered / Headwall / Headwall & Wingwalls Flared End Section / _____
 Downstream: Projecting / Mitered / Headwall / Headwall & Wingwalls / Flared End Section / unknown
 Flowing or standing water (N) / Y Depth: _____ (ft) Est. Flow Velocity: _____ (ft/s) Possible AOP/fish passage? Y / N
 Utilities Present (list)? Y (N) Possible historic features? Y (N) Open Bottom? Y (N)

Culvert Condition and Performance (circle / check all that apply and provide appropriate explanations below)

Category	Rating				
Invert deterioration	Good	Fair	Poor	Crit	<u>Unk</u> / N/A
Joints & Seams	Good	Fair	Poor	Crit	<u>Unk</u> / N/A
Corrosion / Chemical	Good	Fair	Poor	Crit	<u>Unk</u> / N/A
Cross-Section Deform	Good	Fair	Poor	Crit	<u>Unk</u> / N/A
Cracking	Good	Fair	Poor	Crit	<u>Unk</u> / N/A
Liner / Wall	Good	Fair	Poor	Crit	<u>Unk</u> / N/A
Mortar and Masonry	Good	Fair	Poor	Crit	<u>Unk</u> / N/A
Rot and Marine Borers	Good	Fair	Poor	Crit	<u>Unk</u> / N/A
Headwall/Wingwall	Good	Fair	Poor	Crit	<u>Unk</u> / N/A
Apron	Good	Fair	Poor	Crit	<u>Unk</u> / N/A
Flared End Section	Good	<u>Fair</u>	Poor	Crit	<u>Unk</u> / N/A
Pipe End	Good	<u>Fair</u>	Poor	Crit	<u>Unk</u> / N/A
Scour Protection	Good	Fair	Poor	Crit	<u>Unk</u> / N/A

Performance Problems Requiring Level 1 Action	
Debris/Veg Blockage > 1/3 of rise at inlet or outlet	<input type="checkbox"/>
Sediment Blockage 1/3 to 3/4 of rise at inlet/outlet	<input checked="" type="checkbox"/>
Buoyancy or Crushing-Related Inlet Failure	<input type="checkbox"/>
Poor Channel Alignment	<input type="checkbox"/>
Previous and/or Frequent Overtopping	<input checked="" type="checkbox"/>
Local Outlet Scour	<input type="checkbox"/>

Performance Problems Requiring Level 2 Action	
Embankment Piping	<input type="checkbox"/>
Channel Degradation / Headcut (circle one)	<input type="checkbox"/>
Embankment Slope Instability	<input type="checkbox"/>
Sediment Blockage > 3/4 Rise at Inlet or Outlet	<input type="checkbox"/>
Sediment Blockage > 1/3 Rise Throughout Barrel	<input type="checkbox"/>

Other Problems Requiring Level 2 Action	
No Access / Ends Totally Buried / Submerged	<input type="checkbox"/>
Aggressive Abrasion/Corrosion/Chemical (circle)	<input type="checkbox"/>
Exposed Footing (Open-Bottom Culvert Only)	<input type="checkbox"/>

Photos (number): ___ Inlet ___ Outlet ___ Roadway (ahead) ___ Roadway (back) ___ View downstream
 ___ View upstream Others: _____

Notes / Recommendations:
Pipe is approx 1/2 full of bedload at entrance. Outlet is completely covered with riprap which will lead to frequent overtopping. Structural characteristics could not be evaluated. Recommend Maintenance.
 Additional notes / Sketches on back of form.

Figure 58. Form. Annotated Culvert Assessment Form for plastic example in Fountainhead Park.

Due to the small barrel size and limited access, a maintenance recommendation was selected, as shown in the annotated entry diagram in Figure 59 below. The entrance was the only portion of the structure visible, with the invert substantially buried. The outlet could not be located and was presumed to be completely buried as well. Visibility inside the pipe was restricted due to sediment and debris. The team opted to conduct a partial Level 1 end-only assessment of the culvert to the extent possible from the inlet.

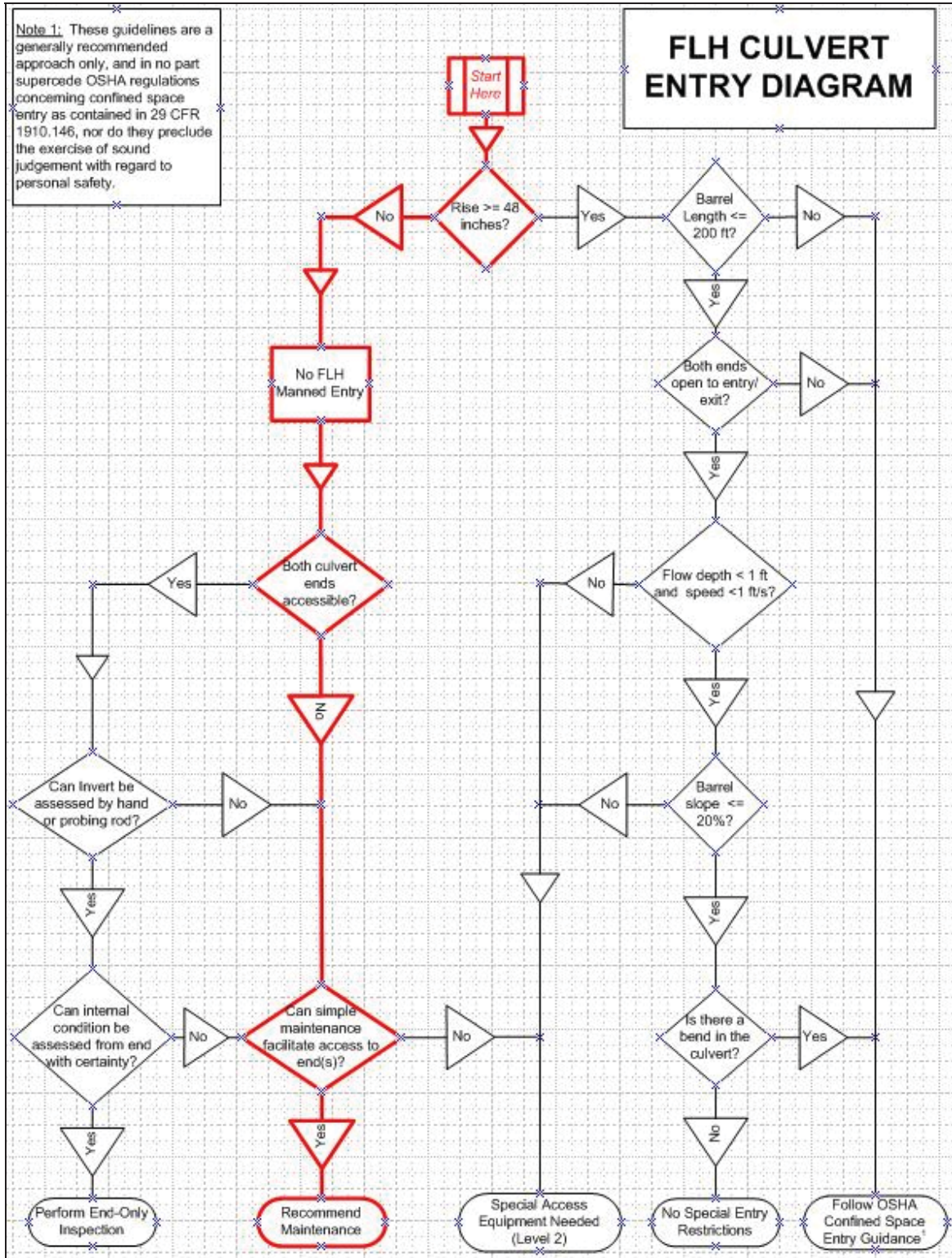

Figure 59. Flowchart. Annotated Culvert Entry Diagram for plastic HDPE example in Fountainhead Park.

The culvert condition categories were rated as shown in Figure 60 below, using the Culvert Assessment Guide. Many of the categories were rated Unknown due to the limited visibility caused by sediment and debris.

Category	Rating					
	Good	Fair	Poor	Crit	Unk	N/A
Invert deterioration					Unk	N/A
Joints & Seams					Unk	N/A
Corrosion / Chemical					Unk	N/A
Cross-Section Deform					Unk	N/A
Cracking					Unk	N/A
Liner / Wall					Unk	N/A
Mortar and Masonry					Unk	N/A
Rot and Marine Borers					Unk	N/A
Headwall/Wingwall					Unk	N/A
Apron					Unk	N/A
Flared End Section		Fair			Unk	N/A
Pipe End		Fair			Unk	N/A
Scour Protection					Unk	N/A

Figure 60. Form. Annotated deterioration section of the Culvert Assessment Form for plastic example.

The decision-making part of the process, aided by the FLH Culvert Barrel Action Flowchart - Page 1 All Types as shown in the following Figure 61, was as follows.

FLH Culvert Barrel Action Flowchart - Page 1 All Types

Initial Field Assessment of Culvert Complete → Condition Rating Unknown? <Yes> → Will simple maintenance allow access? <Yes> → Request Maintenance, then Re-assess.

Based on the results for the partial Level 1 assessment and decision-making process, the recommended action is to immediately uncover the outlet and clean out the pipe to enable a complete Level 1 assessment. It is recommended that the Level 1 maintenance be done immediately to prevent roadway overtopping and possible embankment and roadway damage. Due to the small culvert size and presumably low, cross-drainage nature of the flows conveyed, total failure of the culvert is not anticipated to cause public safety issues; therefore, the culvert was not rated Critical, despite the urgency of the maintenance recommended.

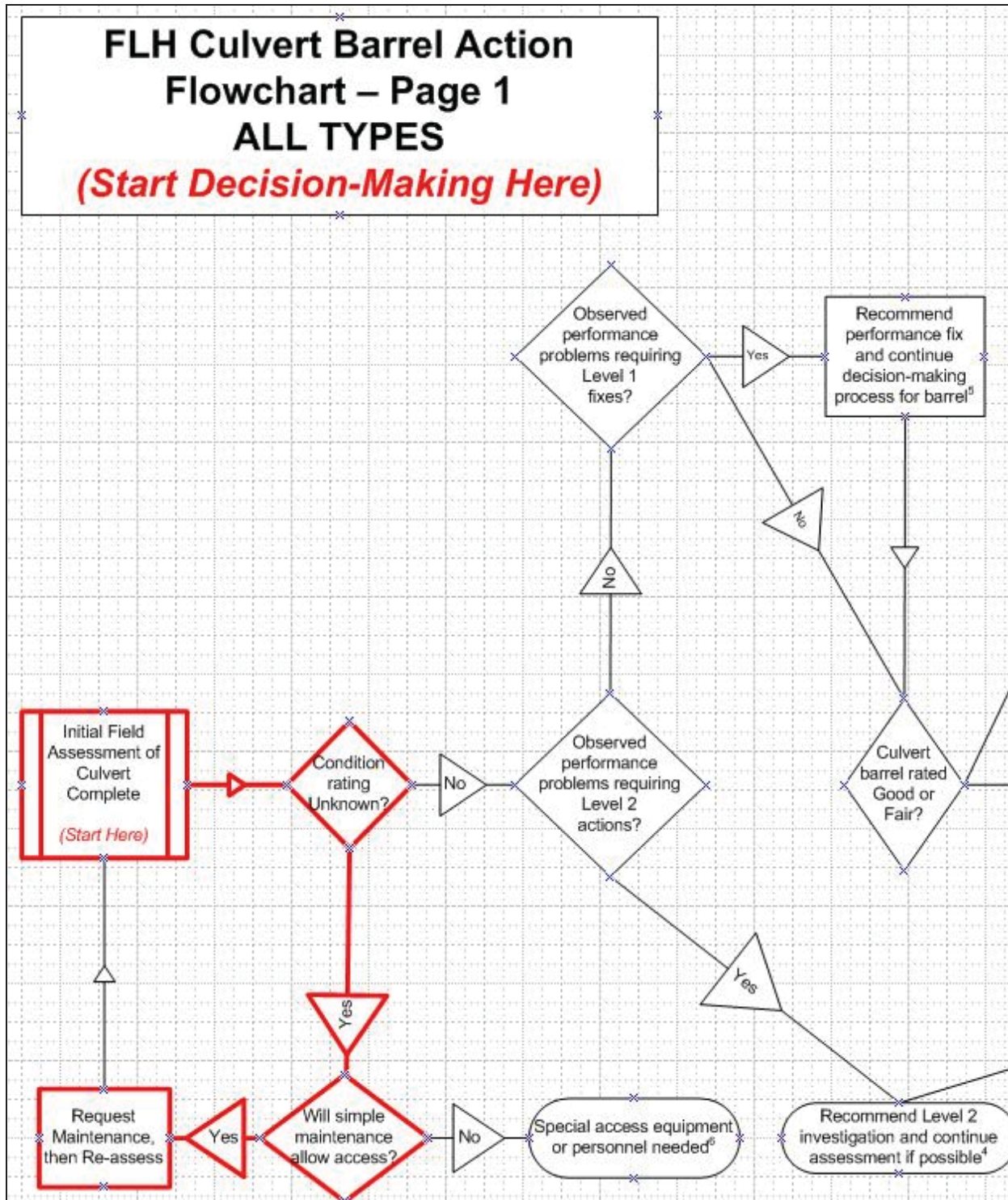

Figure 61. Flowchart. Annotated Culvert Barrel Action Flowchart – Page 1 for plastic HDPE example.

REFERENCES

1. Arnoult, James D. Culvert Inspection Manual – Supplement to the Bridge Inspector’s Training Manual. Report No. FHWA-IP-86-2, USDOT, FHWA. 1986.
2. Federal Highway Administration. Culvert Design. A Training Course on Hydraulic Design Series No. 5. Instructors’ Guide. NHI Course 135056. Publication No. FHWA-NHI-10-053. April 2010.
3. Federal Highway Administration. Hydraulic Design of Highway Culverts, Hydraulic Design Series No. 5 (HDS-5). FHWA-NHI-01-020, Washington, D.C. 2001/2005.
4. Hartle, R., W. Amrhein, K. Wilson, D. Baughman, and J. Tkacs, Bridge Inspector's Training Manual 90. FHWA Report PD-91-015, Federal Highway Administration, Washington, D.C. 1995.
5. Lewis, David J., Tate, Kenneth W., Harper, John M., Price, Julie. Survey Identifies Sediment Sources in North Coast Rangelands. California Agriculture, University of California Davis. July-August, 2001.
6. Minnesota State Department of Transportation. Offices of HYDINFRA Coordinator, Bridge Hydraulics. Phone Interview with Bonnie Peterson, Andrea Hendrickson, and Lisa Taylor. December, 2008.
7. United States Forest Service. FishXing Software for the Evaluation and Design of Culverts for Fish Passage. <http://www.stream.fs.fed.us/fishxing/>.
8. Wyoming Department of Environmental Quality. Abandoned Mine Land Division (AML). Fraser Draw Reclamation Project. <http://deq.state.wy.us/out/aml.fraserdrawproject2006.htm>.

APPENDIX A – FLH CULVERT ENTRY DIAGRAM AND ASSESSMENT FORM
(4 pages)

APPENDIX B – PHOTOGRAPHIC GUIDE FOR CULVERT ASSESSMENT
(76 pages)

**APPENDIX C – PHOTOGRAPHIC GUIDE FOR CULVERT REPAIR
AND REPLACEMENT TECHNIQUES**
(18 pages)

**APPENDIX D – CULVERT DECISION-MAKING PROCESS MAP
AND FLOWCHARTS**
(12 pages)

APPENDIX E – CULVERT DECISION-MAKING MATRICES
(8 pages)

**APPENDIX F – FLH BID-BASED COST DATA FOR CULVERT REPAIR
AND REPLACEMENT**
(4 pages)

APPENDIX G – BIBLIOGRAPHY
(8 pages)

(Appendices are located on the attached CD ROM)

APPENDIX A – FLH CULVERT ENTRY DIAGRAM AND ASSESSMENT FORM

Note 1: These guidelines are a generally recommended approach only, and in no part supercede OSHA regulations concerning confined space entry as contained in 29 CFR 1910.146, nor do they preclude the exercise of sound judgement with regard to personal safety.

FLH CULVERT ENTRY DIAGRAM

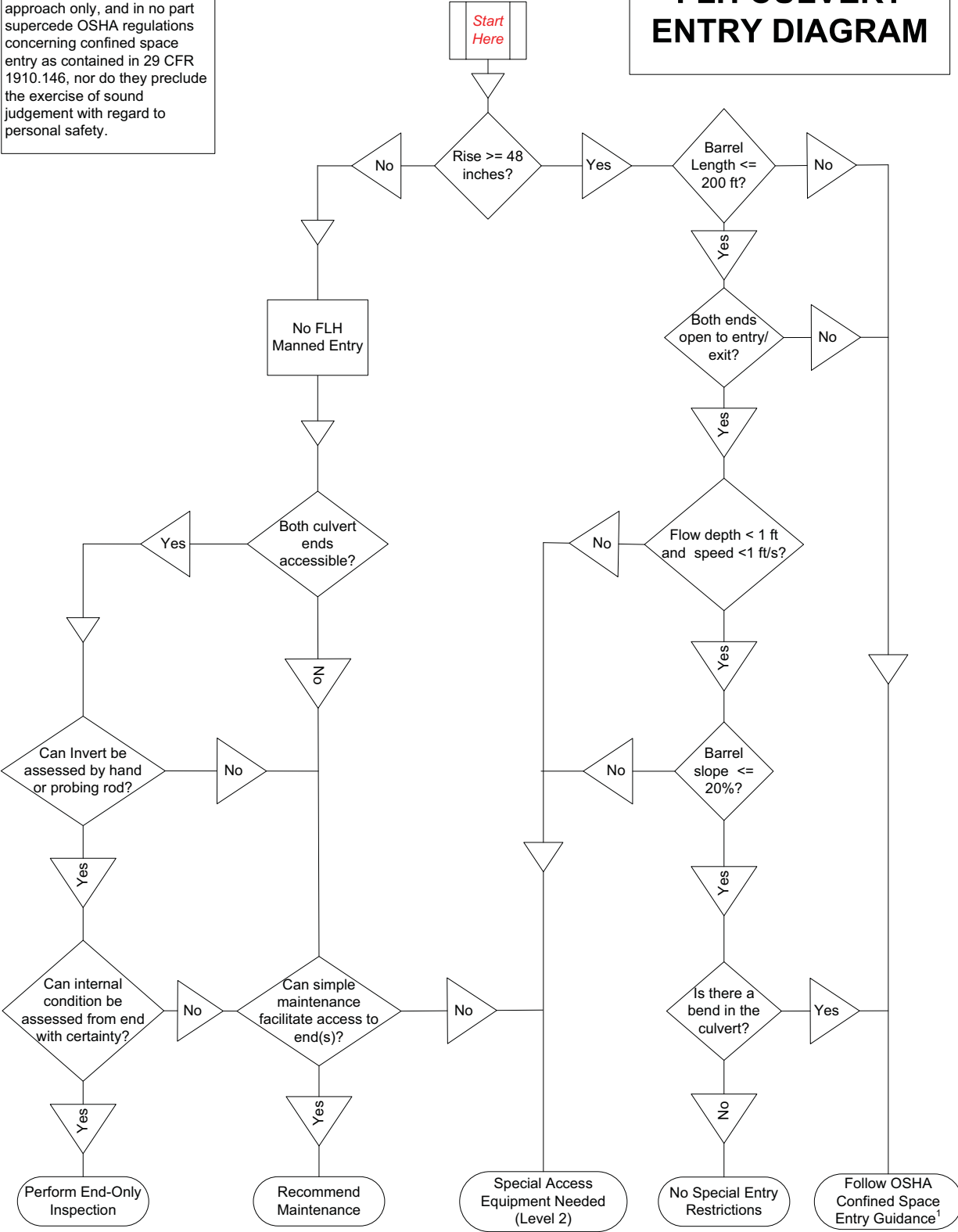

FLH CULVERT ASSESSMENT FORM

Overall Rating
Good
Fair
Poor
Critical
Unknown
Performance Problems

Notes by: _____ Date: _____ Project: _____
 Measurements by: _____ Time: _____

Site Information:

Facility Location: _____ Lat/Long _____
 Milepost: _____ Project Station: _____ GPS Road CL Waypoint No. _____
 Named waterway: _____ Direction of Flow: _____

Culvert Information:

No. of Barrels: _____ Barrel Length (approx): _____ Barrel Slope: Mild / Steep / _____

Skew (0 degrees = perpendicular to road): _____ Approx Cover: Upstream _____ Downstream _____

Barrel Shape (circle one) Circular Box Elliptical Pipe Arch Arch

Diameter: _____ / Span _____ x Rise _____

Pipe Material (circle one): Metal - Concrete / RCP - Corrugated Plastic - Smooth Plastic - Timber – Masonry

Appurtenances (circle one):

Upstream : Projecting / Mitered / Headwall / Headwall & Wingwalls / Flared End Section / _____

Downstream : Projecting / Mitered / Headwall / Headwall & Wingwalls / Flared End Section / _____

Flowing or standing water? N / Y Depth: _____ (ft) Est. Flow Velocity: _____ (ft/s) Possible AOP/fish passage? Y / N

Utilities Present (list)? Y / N _____ Possible historic features? Y / N Open Bottom? Y / N

Culvert Condition and Performance (circle / check all that apply and provide appropriate explanations below)

Category	Rating					
Invert deterioration	Good	Fair	Poor	Crit	Unk	N/A
Joints & Seams	Good	Fair	Poor	Crit	Unk	N/A
Corrosion / Chemical	Good	Fair	Poor	Crit	Unk	N/A
Cross-Section Deform	Good	Fair	Poor	Crit	Unk	N/A
Cracking	Good	Fair	Poor	Crit	Unk	N/A
Liner / Wall	Good	Fair	Poor	Crit	Unk	N/A
Mortar and Masonry	Good	Fair	Poor	Crit	Unk	N/A
Rot and Marine Borers	Good	Fair	Poor	Crit	Unk	N/A
Headwall/Wingwall	Good	Fair	Poor	Crit	Unk	N/A
Apron	Good	Fair	Poor	Crit	Unk	N/A
Flared End Section	Good	Fair	Poor	Crit	Unk	N/A
Pipe End	Good	Fair	Poor	Crit	Unk	N/A
Scour Protection	Good	Fair	Poor	Crit	Unk	N/A

Performance Problems Requiring Level 1 Action	
Debris/Veg Blockage > 1/3 of rise at inlet or outlet	<input type="checkbox"/>
Sediment Blockage 1/3 to 3/4 of rise at inlet/outlet	<input type="checkbox"/>
Buoyancy or Crushing-Related Inlet Failure	<input type="checkbox"/>
Poor Channel Alignment	<input type="checkbox"/>
Previous and/or Frequent Overtopping	<input type="checkbox"/>
Local Outlet Scour	<input type="checkbox"/>
Performance Problems Requiring Level 2 Action	
Embankment Piping	<input type="checkbox"/>
Channel Degradation / Headcut (<i>circle one</i>)	<input type="checkbox"/>
Embankment Slope Instability	<input type="checkbox"/>
Sediment Blockage > 3/4 Rise at Inlet or Outlet	<input type="checkbox"/>
Sediment Blockage > 1/3 Rise Throughout Barrel	<input type="checkbox"/>
Other Problems Requiring Level 2 Action	
No Access / Ends Totally Buried / Submerged	<input type="checkbox"/>
Aggressive Abrasion/Corrosion/Chemical (<i>circle</i>)	<input type="checkbox"/>
Exposed Footing (Open-Bottom Culvert Only)	<input type="checkbox"/>

Photos (number): ___ Inlet ___ Outlet ___ Roadway (ahead) ___ Roadway (back) ___ View downstream
 ___ View upstream Others: _____

Notes / Recommendations:

APPENDIX B – PHOTOGRAPHIC GUIDE FOR CULVERT ASSESSMENT

FHWA FLH Culvert Assessment and Decision-Making
Procedures Manual

Appendix B

Photographic Guide For Culvert Assessment Tool

Box & Arch Concrete – Good

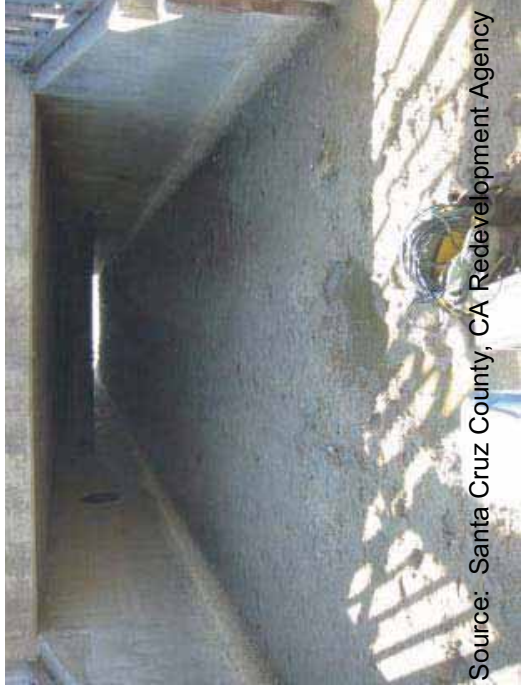

Source: Santa Cruz County, CA Redevelopment Agency



Hairline crack with efflorescence



Source: US Fish & Wildlife Service, Ashland NFWCO

Box & Arch Concrete – Good



Box & Arch Concrete – Fair

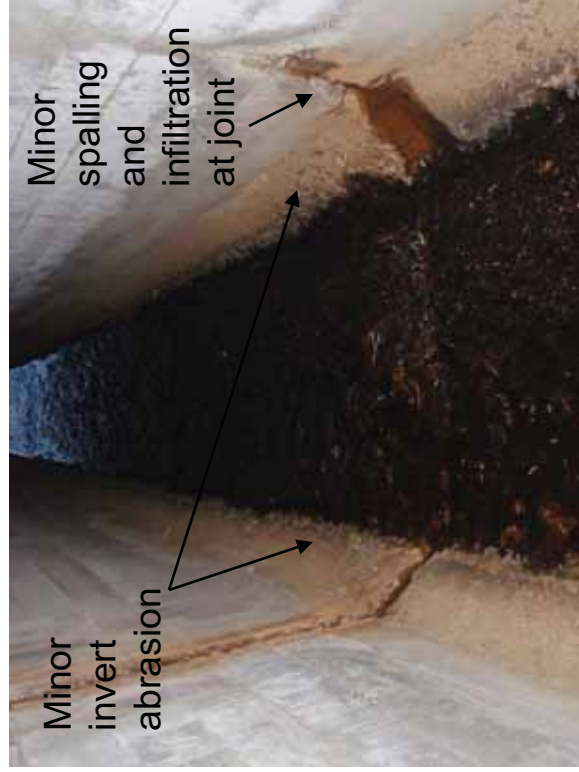
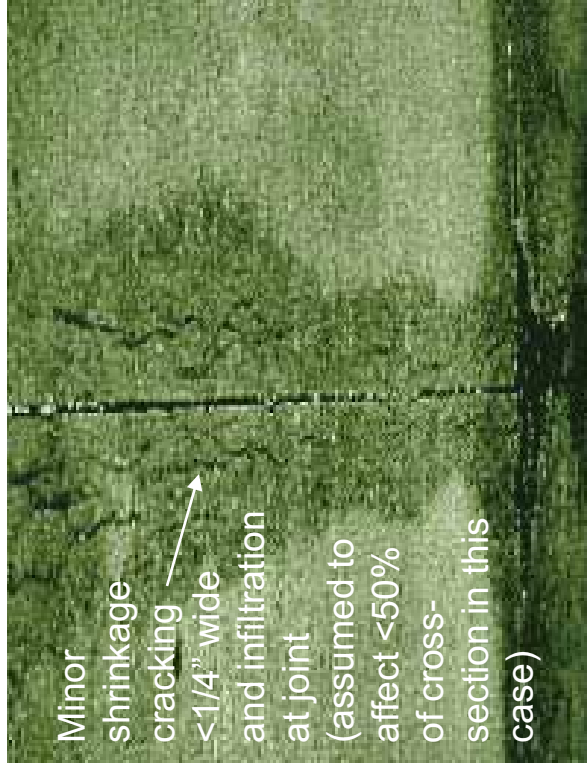
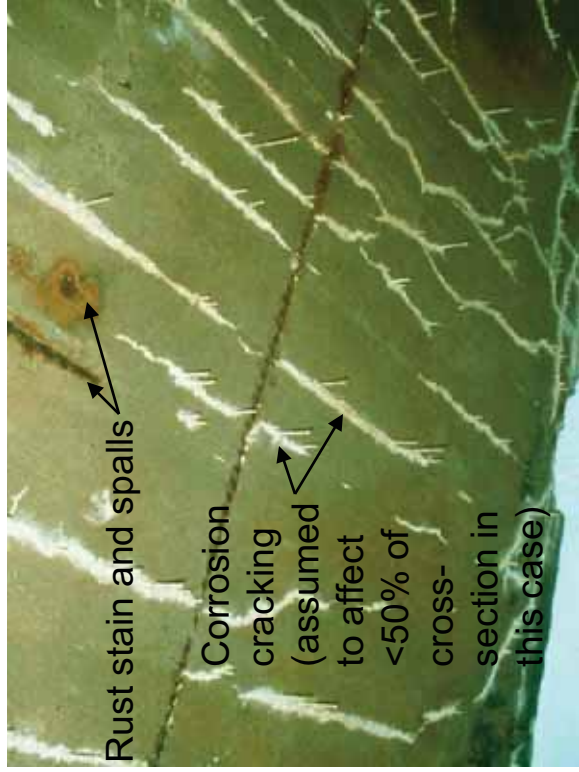

Box & Arch Concrete – Fair

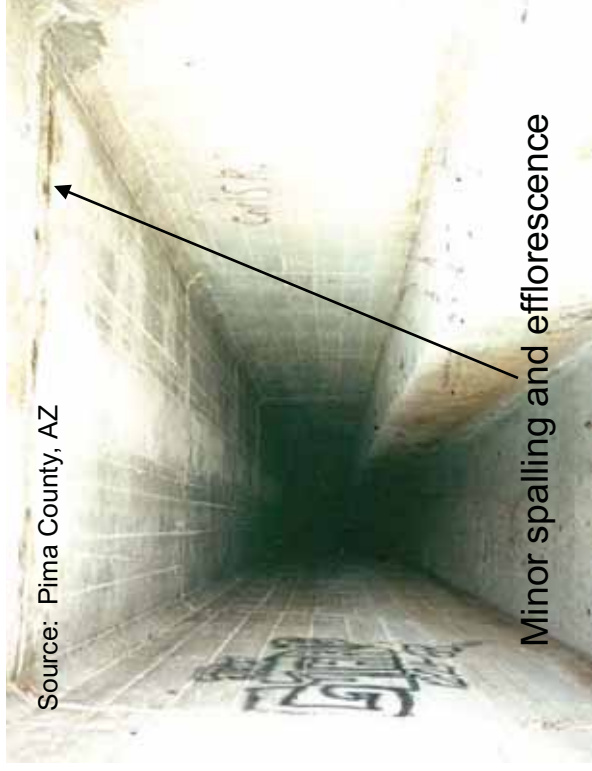

Box & Arch Concrete – Fair

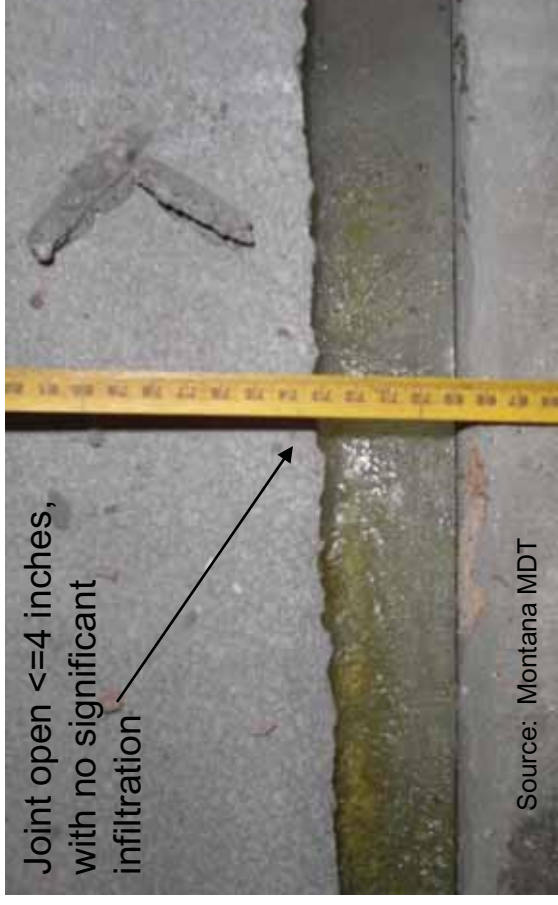

Box & Arch Concrete – Poor

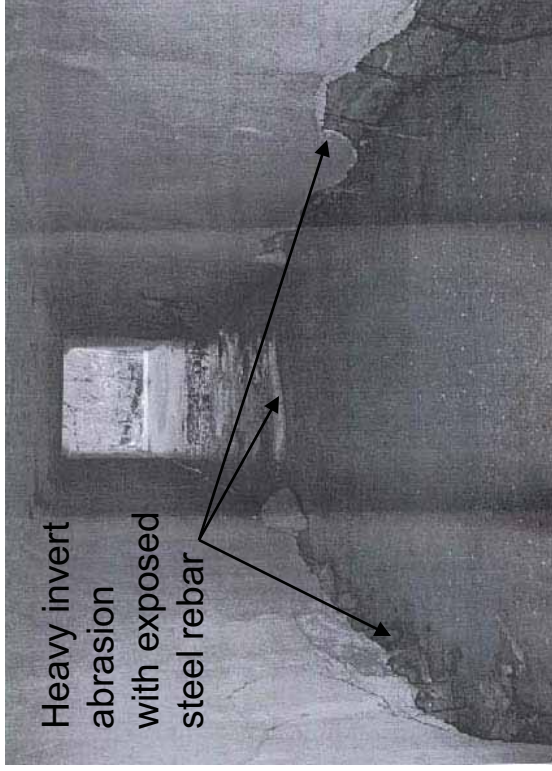
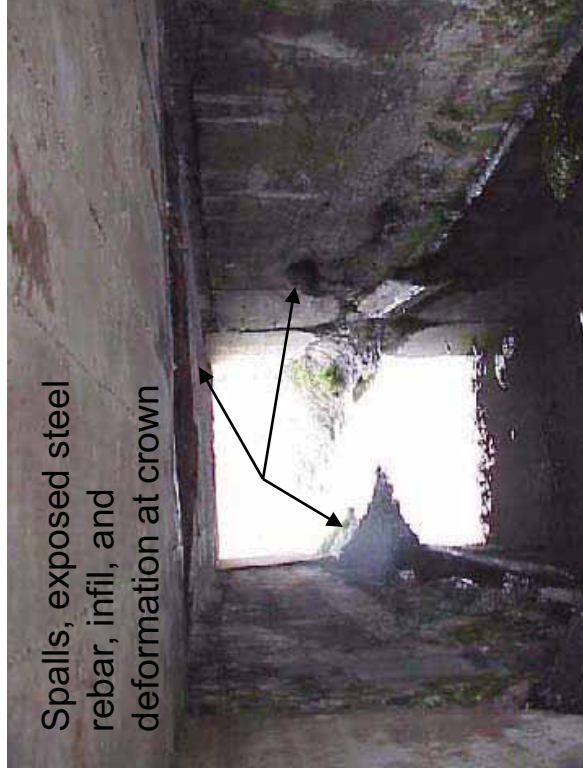

Box & Arch Concrete – Poor



Spalls with exposed and corroding rebar

Box & Arch Concrete – Critical



RCP – Good



RCP – no cracks



Bio-fouling

RCP – Fair

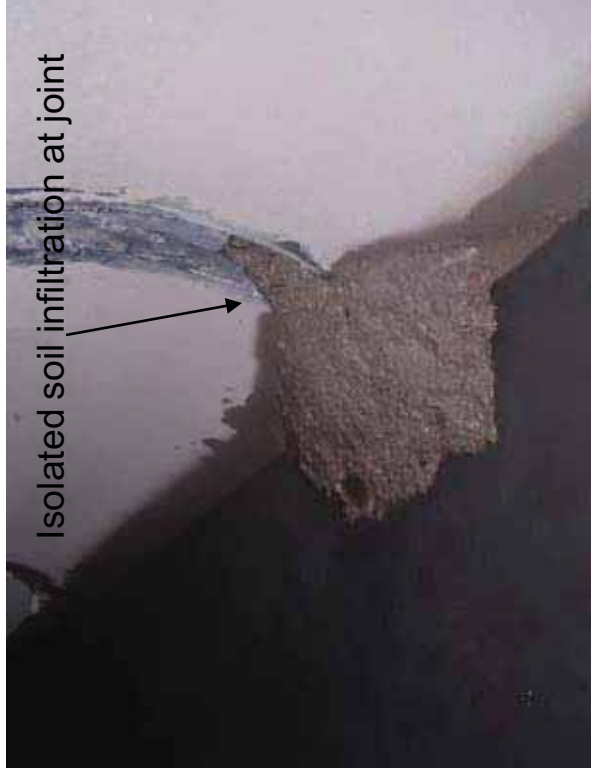
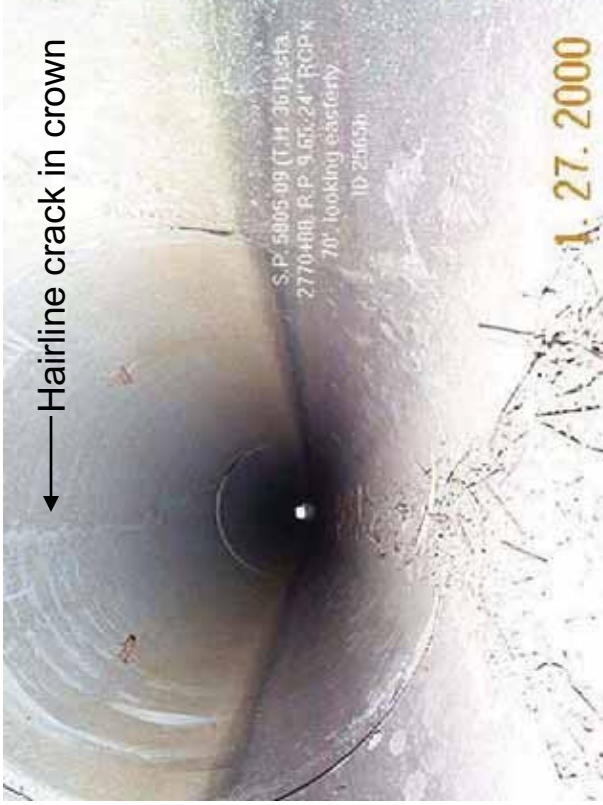

RCP – Fair

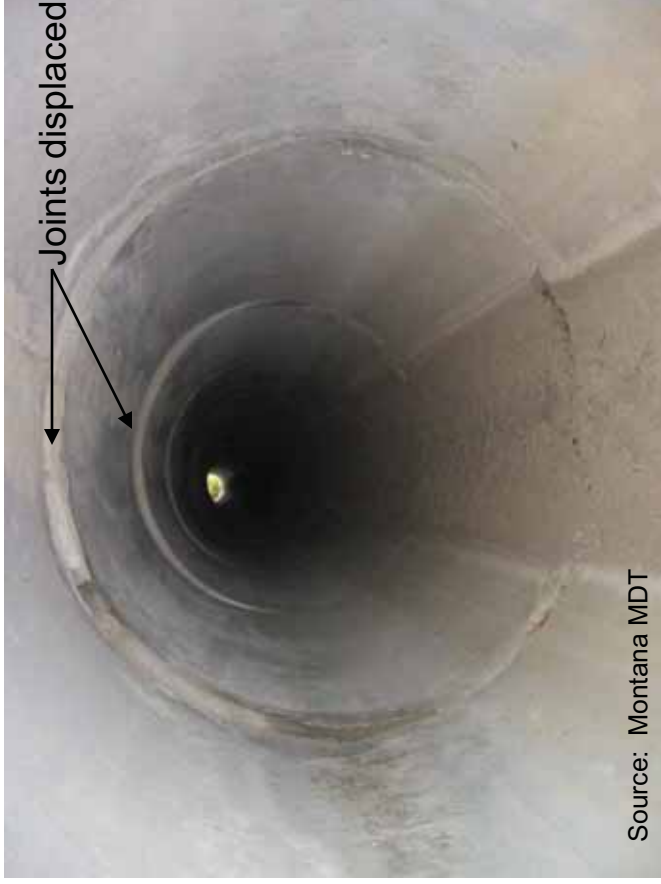

RCP – Poor (Longitudinal and Circumferential > 1/8” Wide Cracks)

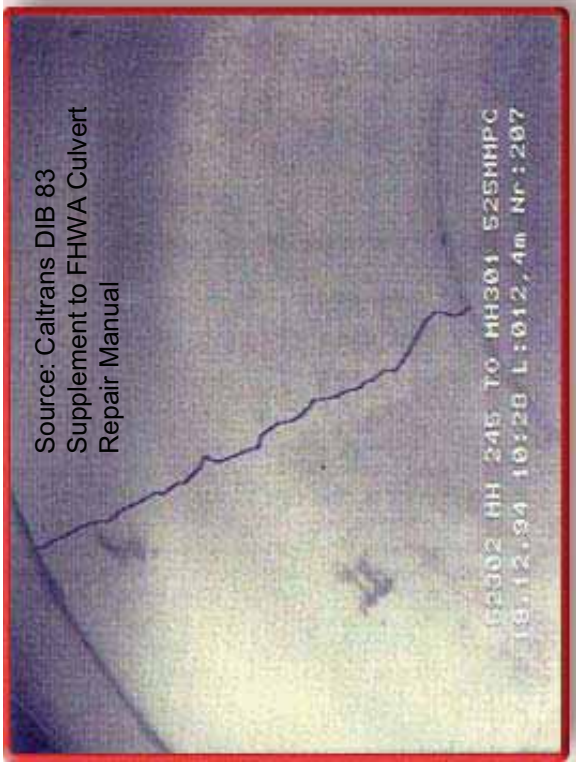
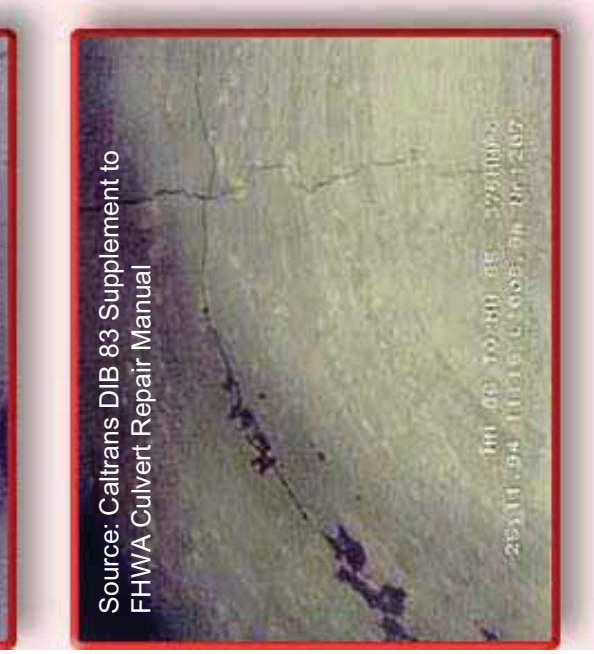
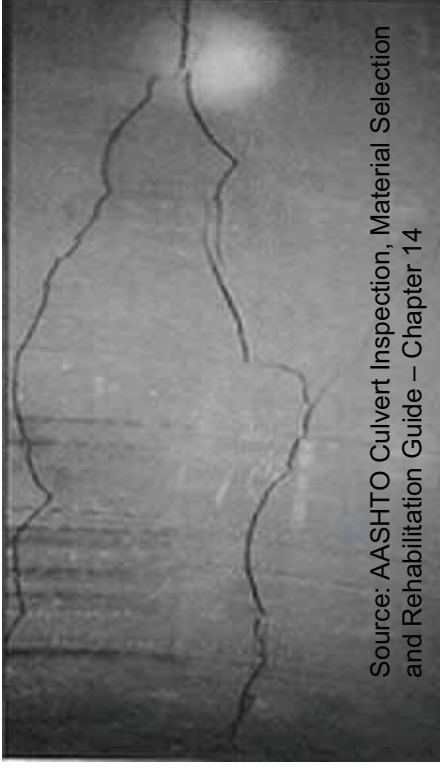

RCP – Poor

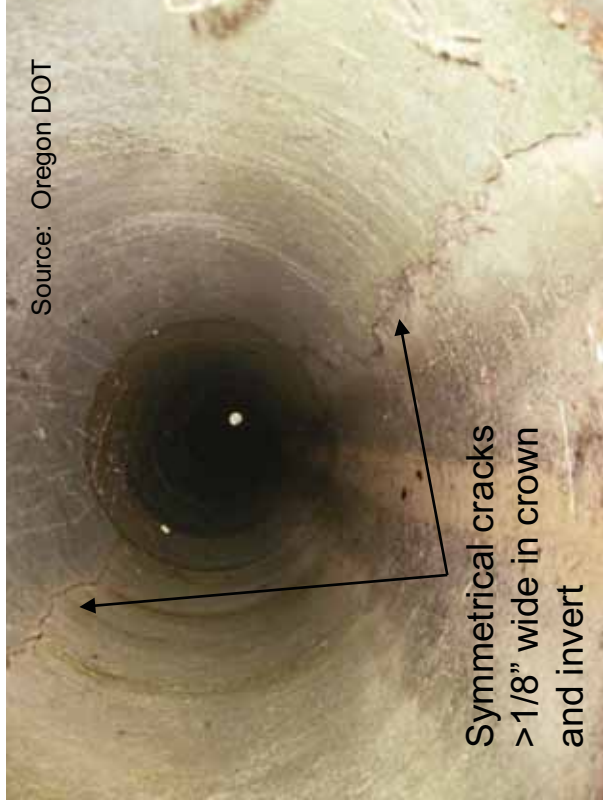
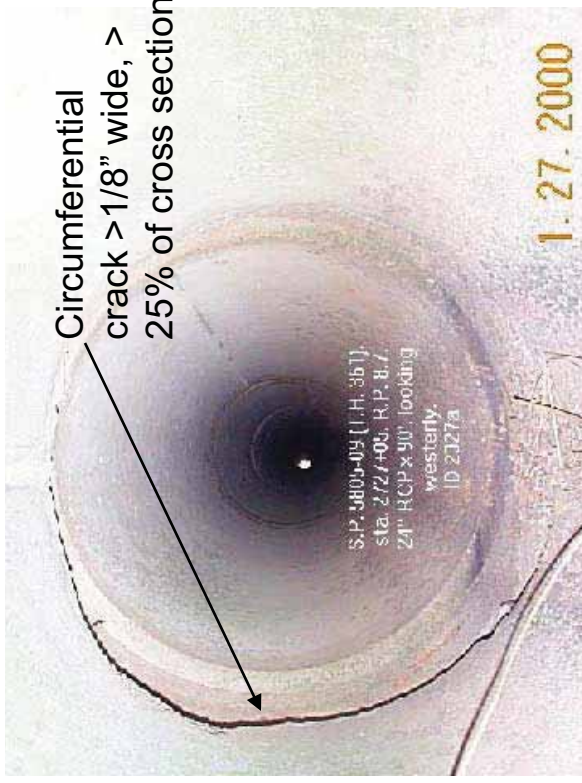

RCP – Poor

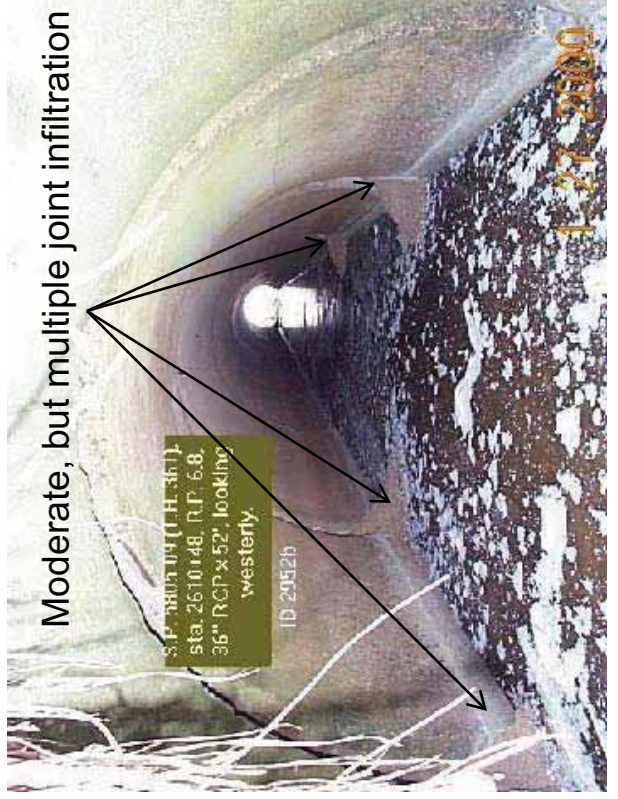
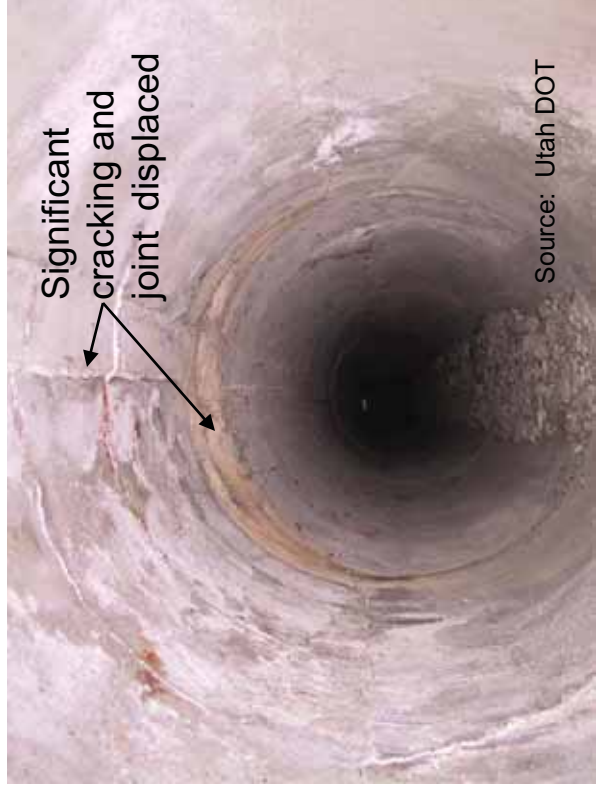
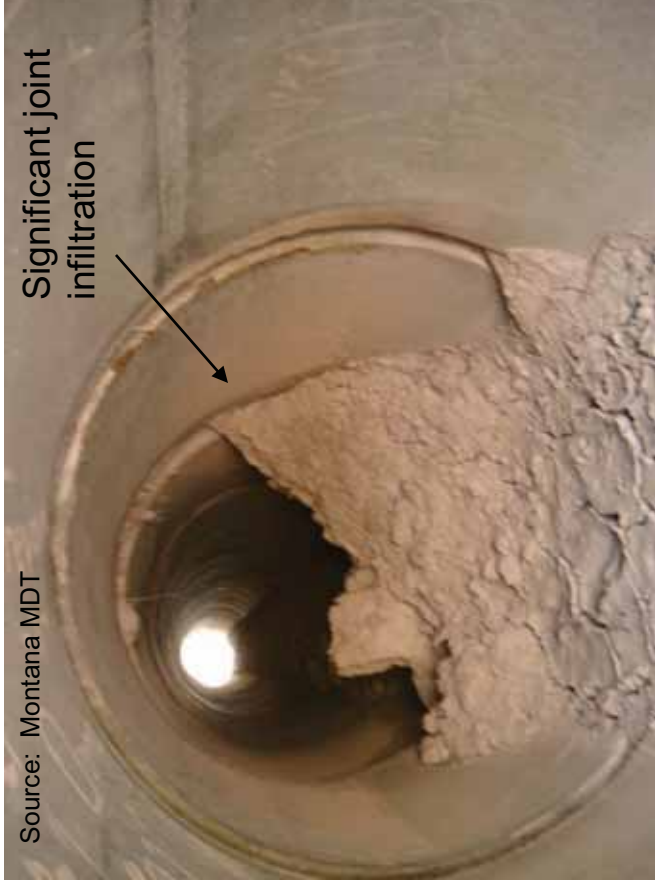

B.15

RCP – Poor

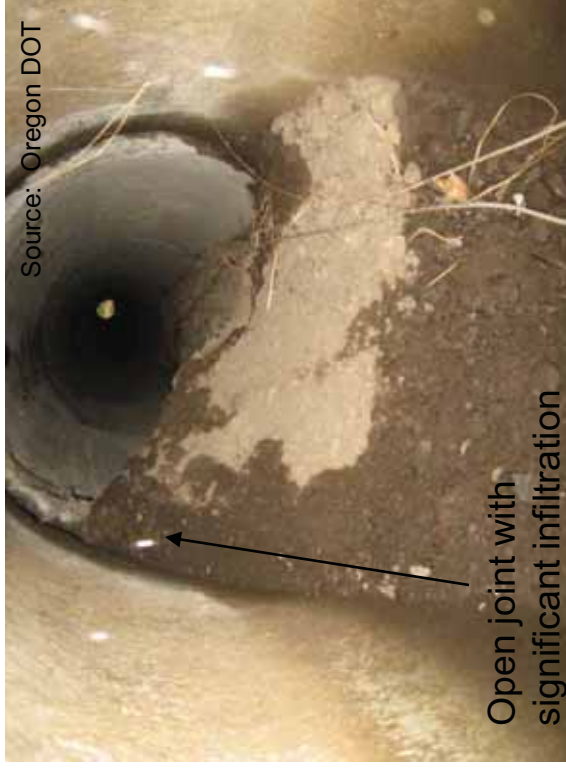
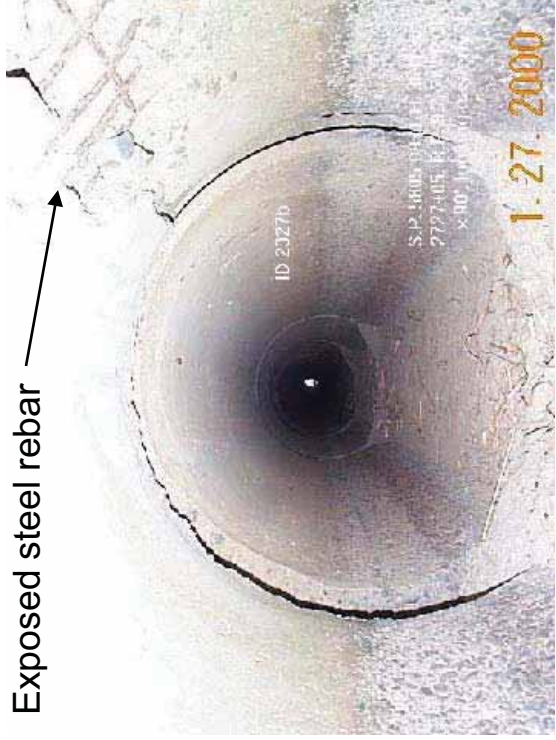

RCP – Critical

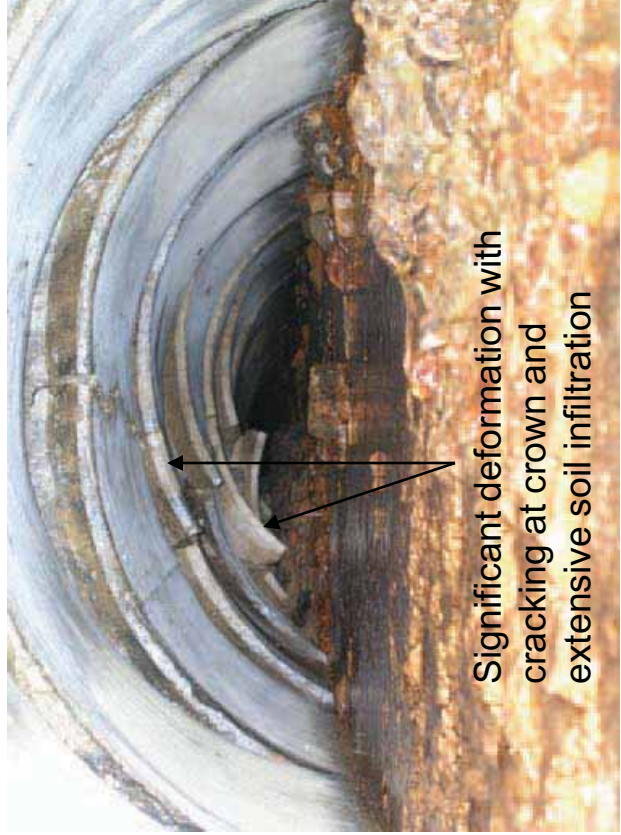
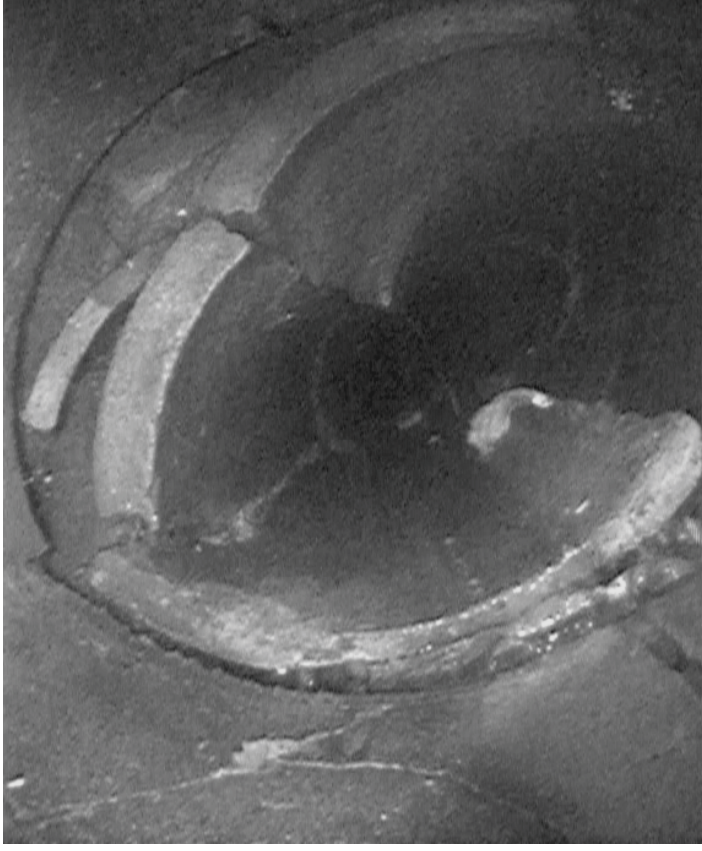
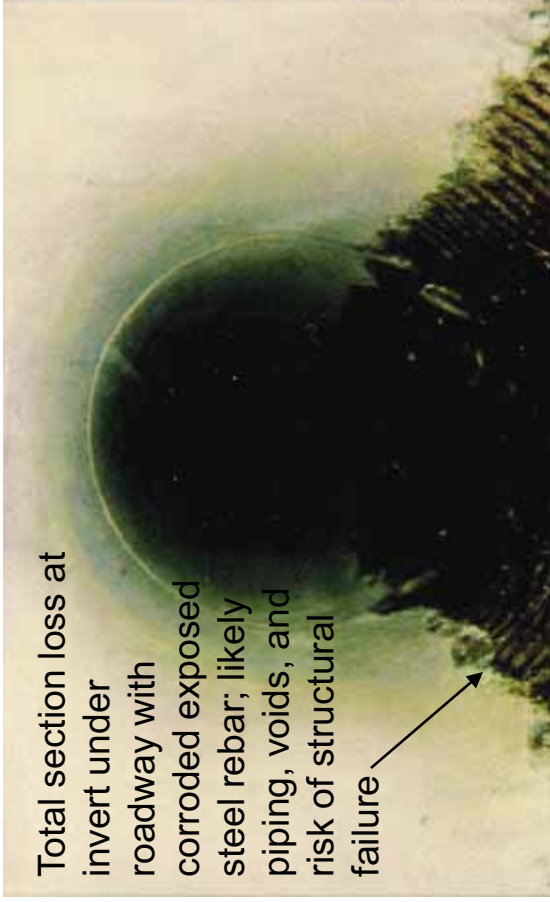

CMP – Good

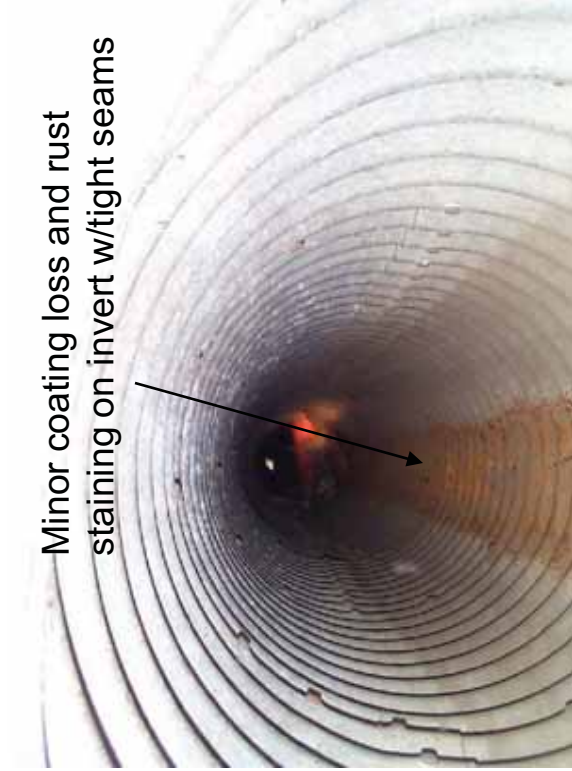

CMP – Good

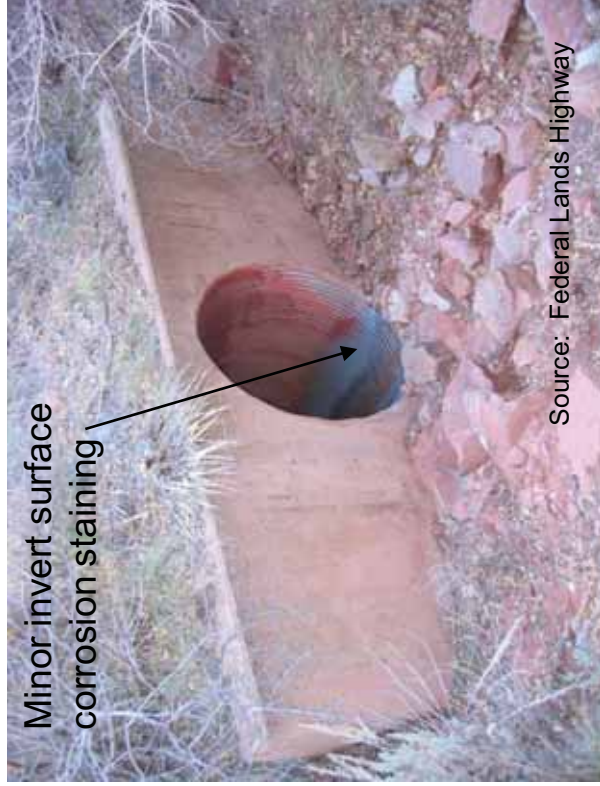
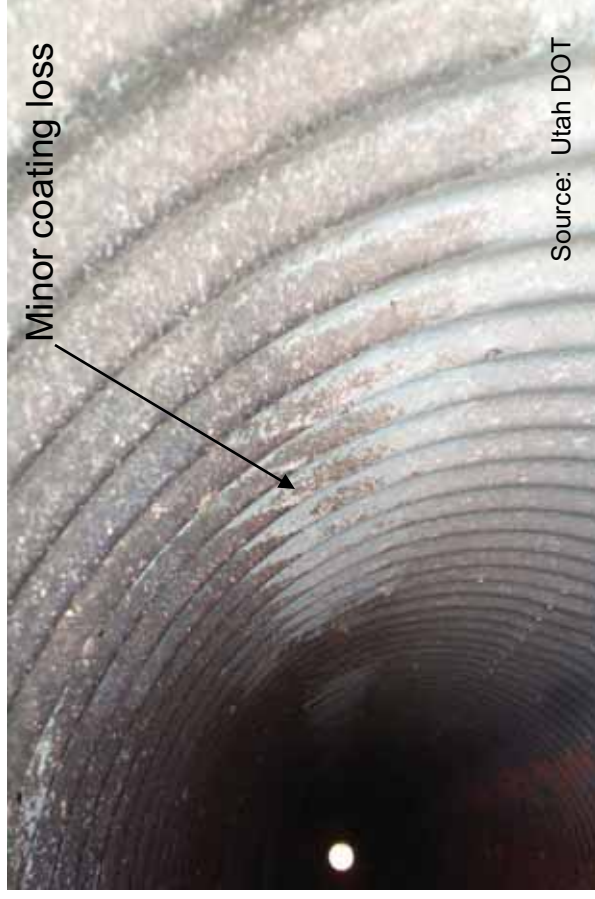

CMP – Fair

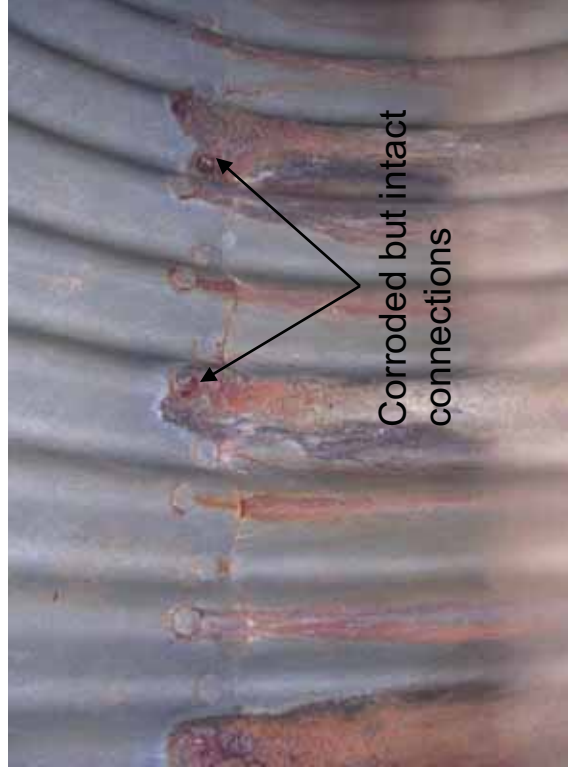

CMP – Fair

(Local corrosion at seam edges and hardware)

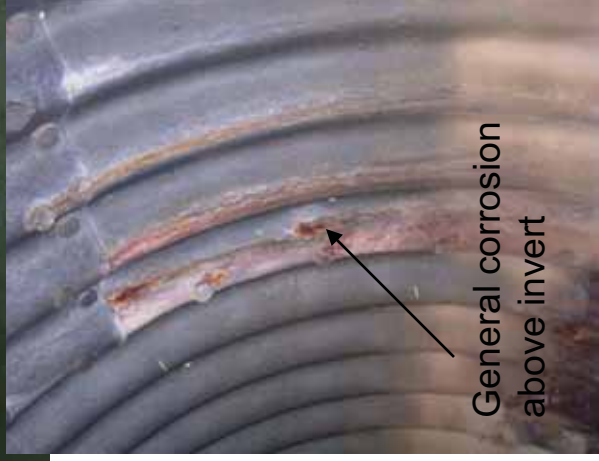
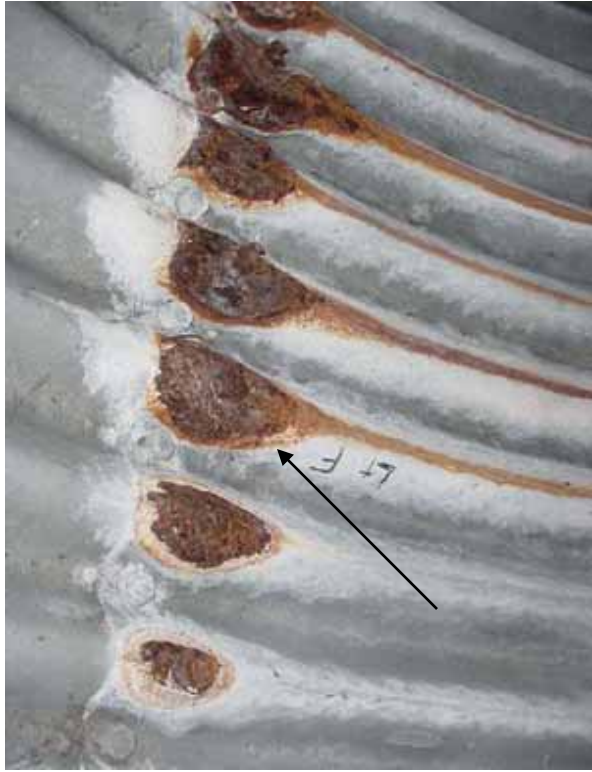

CMP – Fair

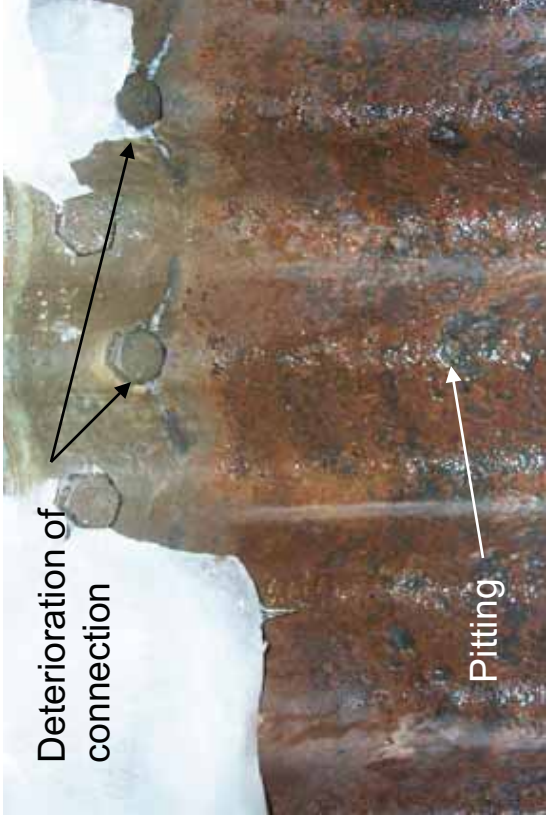

CMP – Fair

(Open joint separation with minor infil/exfil and gasket visible)

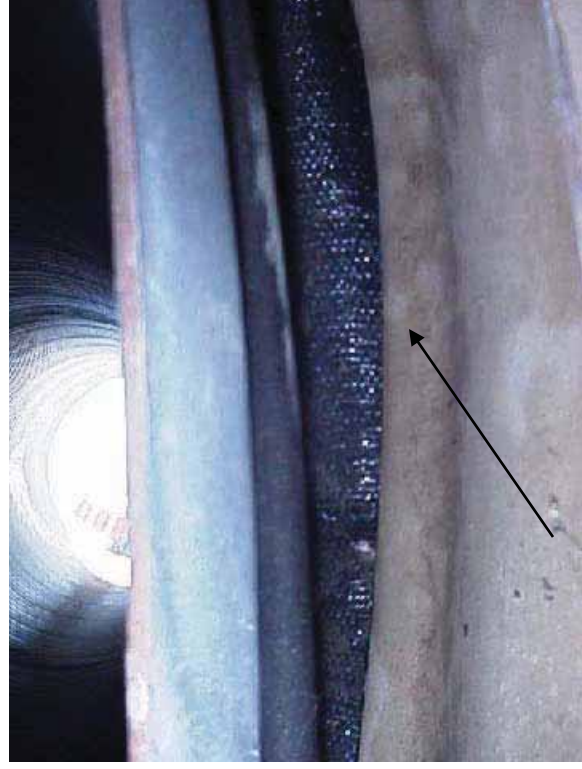

CMP – Fair



CMP – Fair

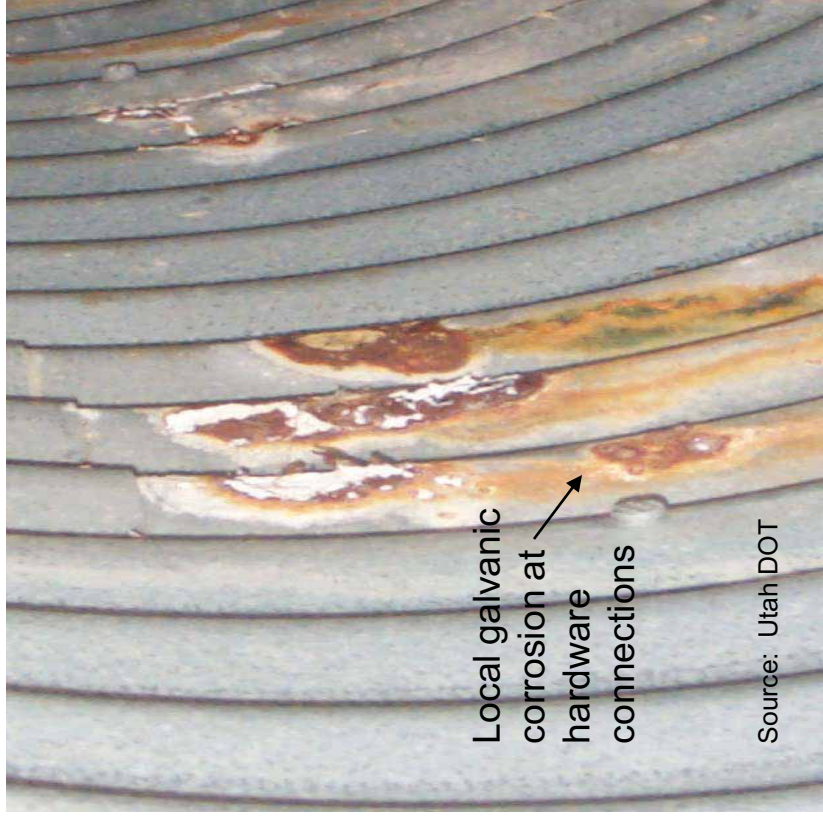
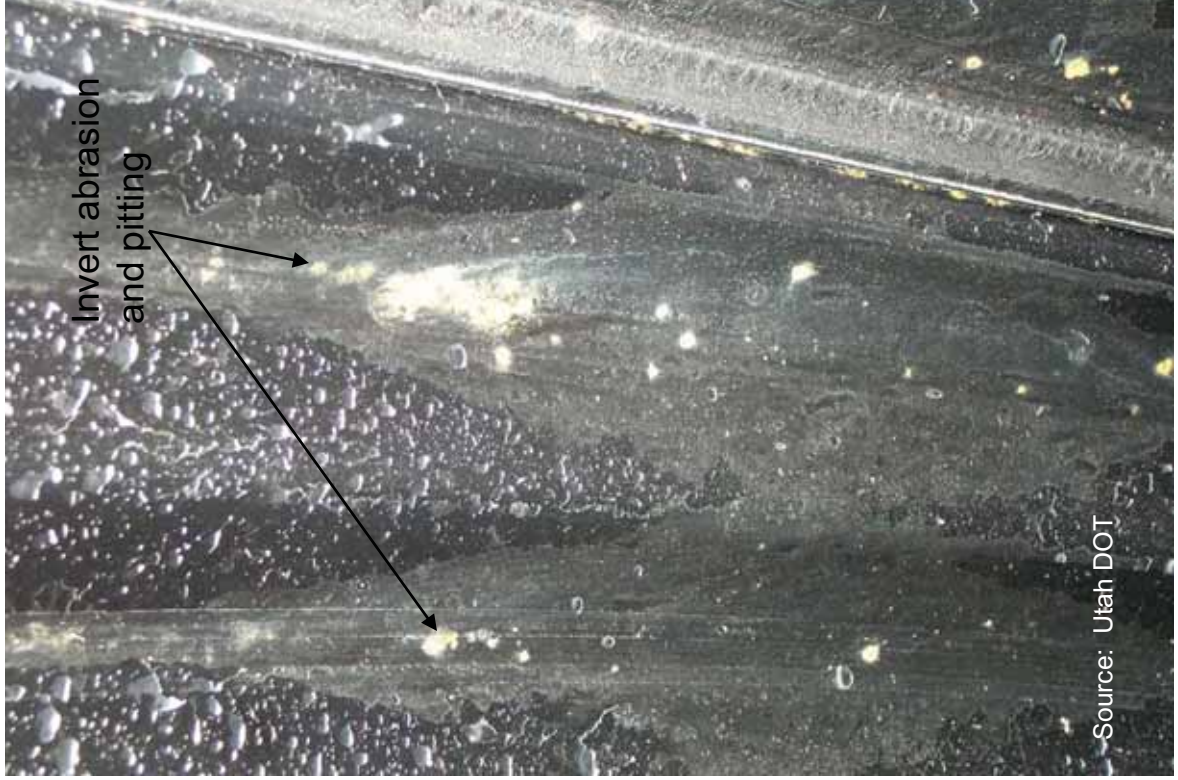

CMP – Fair



CMP – Poor

(Invert deterioration and perforation, and deformation with cracking)

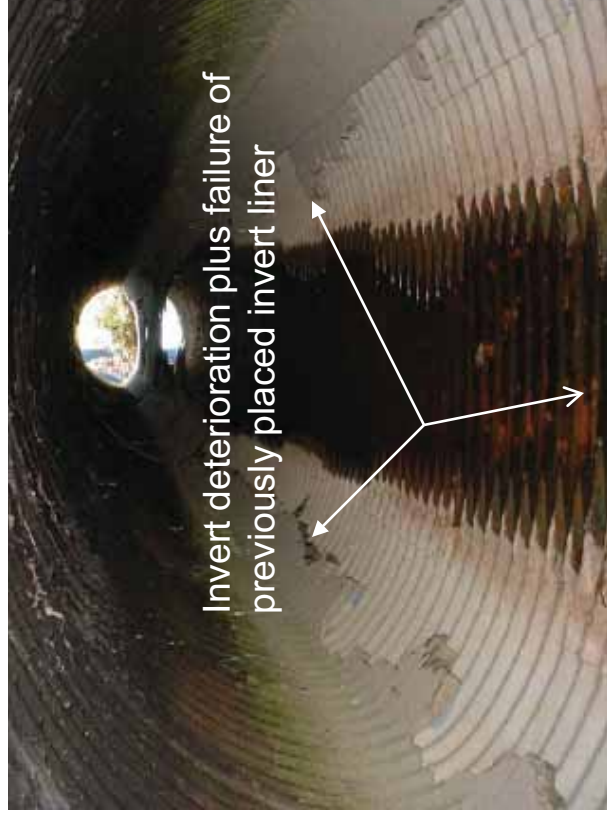
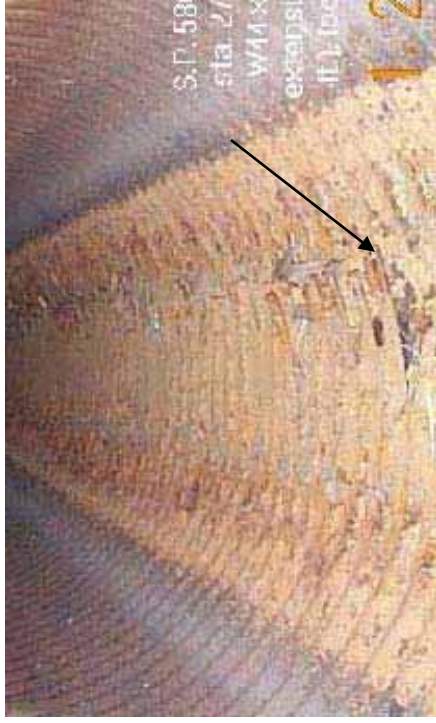

CMP – Poor

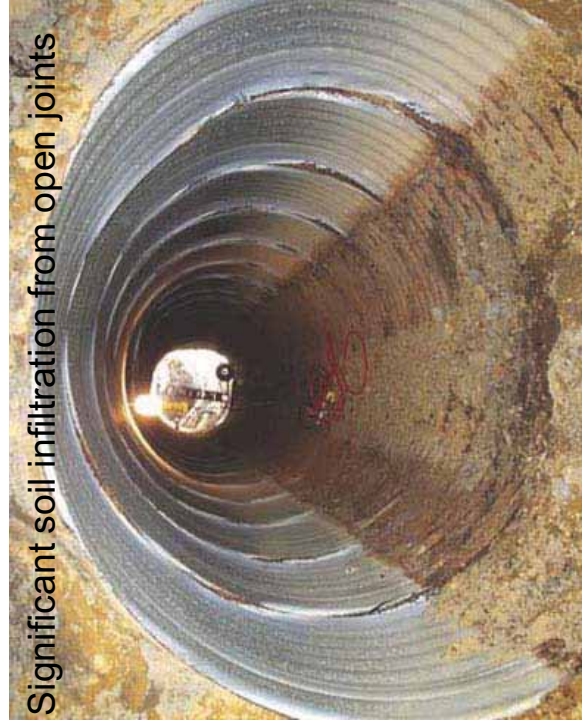

CMP – Critical

(Significant Invert section loss, voids and roadway damage)

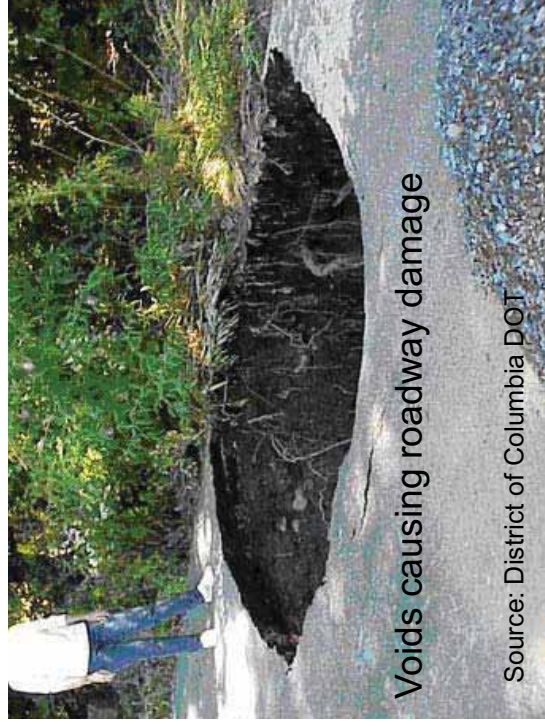
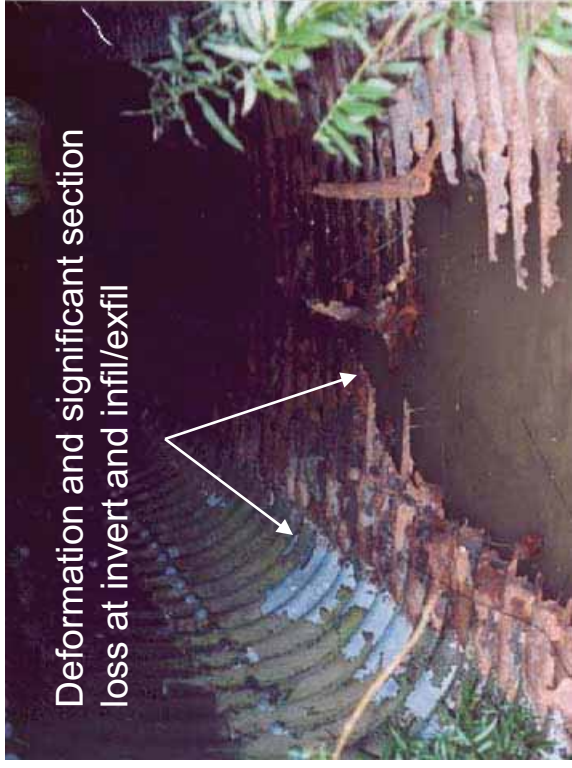

Voids causing roadway damage

Source: District of Columbia DOT

Source: City of Loveland, CO

Deformation, open seam, heavy corrosion and section loss, infiltration of soil

CMP – Critical

(Significant Invert section, soil infiltration and voids)



CMP – Critical



CMP – Critical

(Significant deformation, joint displacement, voids and sinkholes, with risk of embankment and roadway failure)

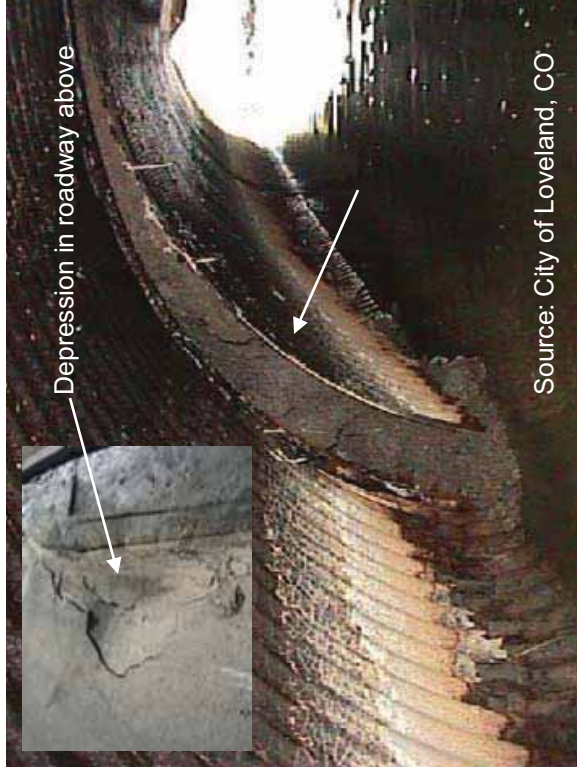

Plastic – Good



Plastic – Fair

(Slight perceptible deformations and bulging)

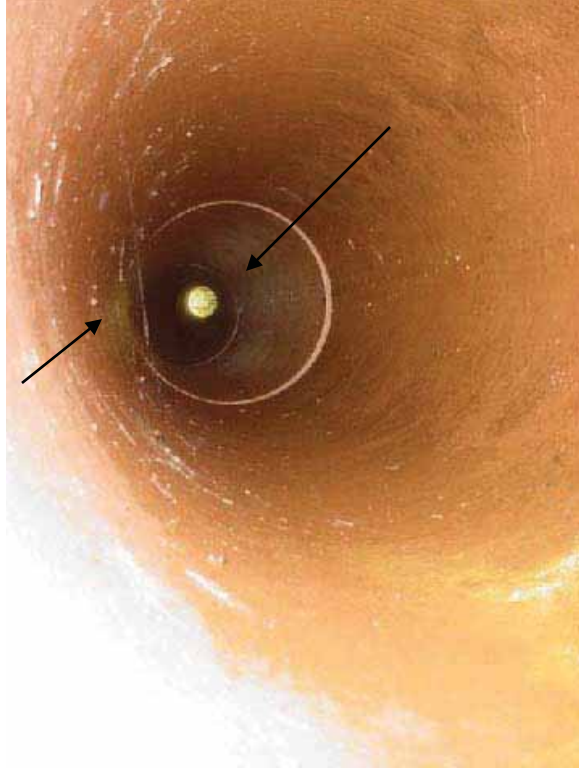
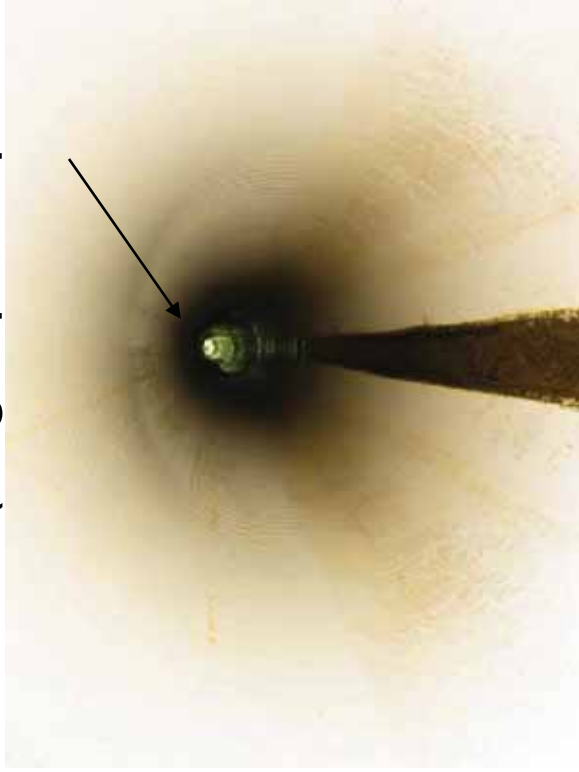

Plastic – Fair

(Joint separations with minor infil/exfil)

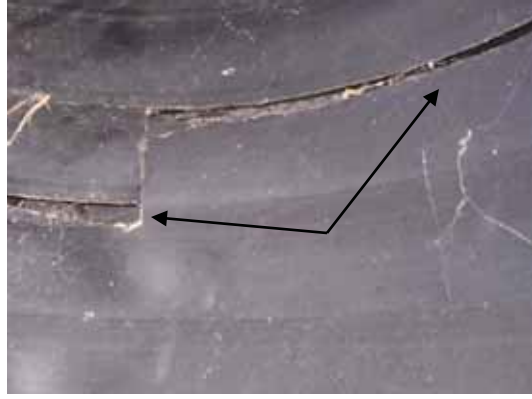

Plastic – Fair

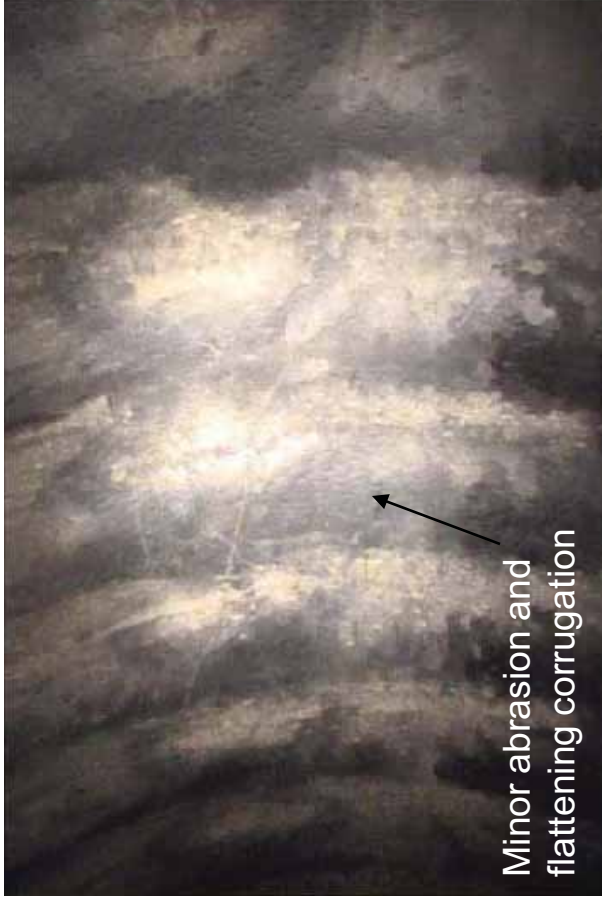

Plastic – Fair

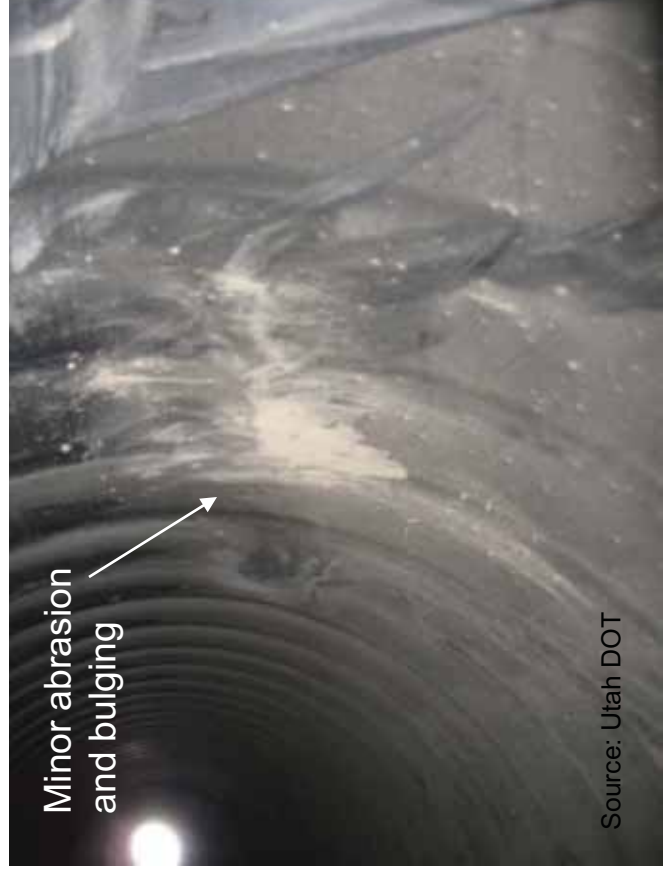

Plastic – Poor

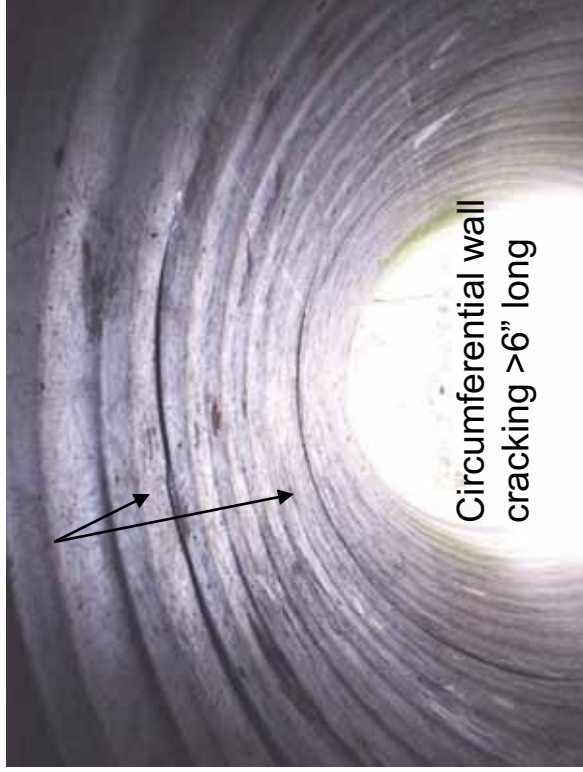
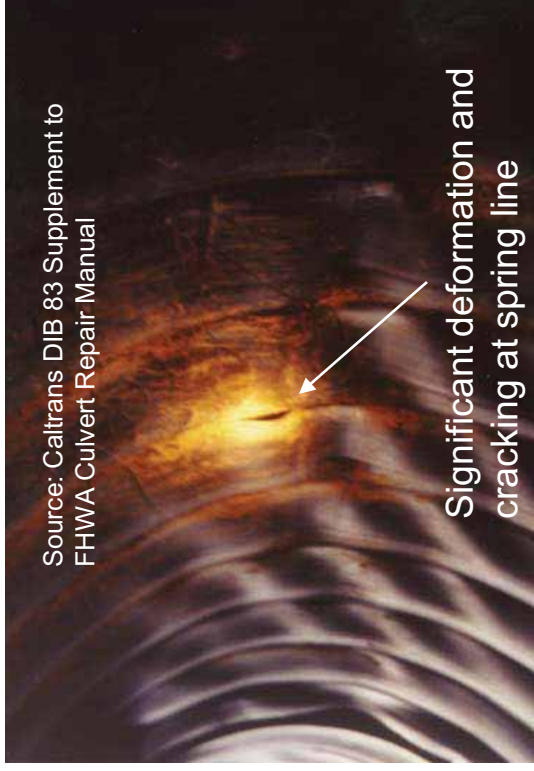
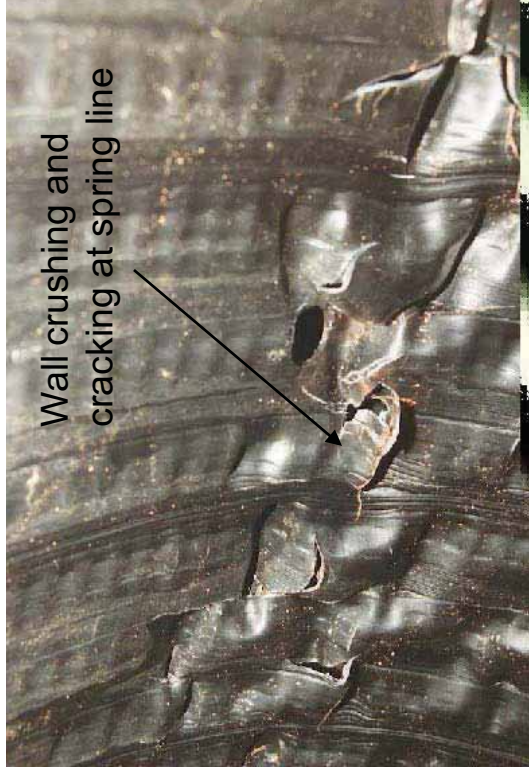

Plastic – Poor

(Excessive cross-sectional deformation and wall damage)

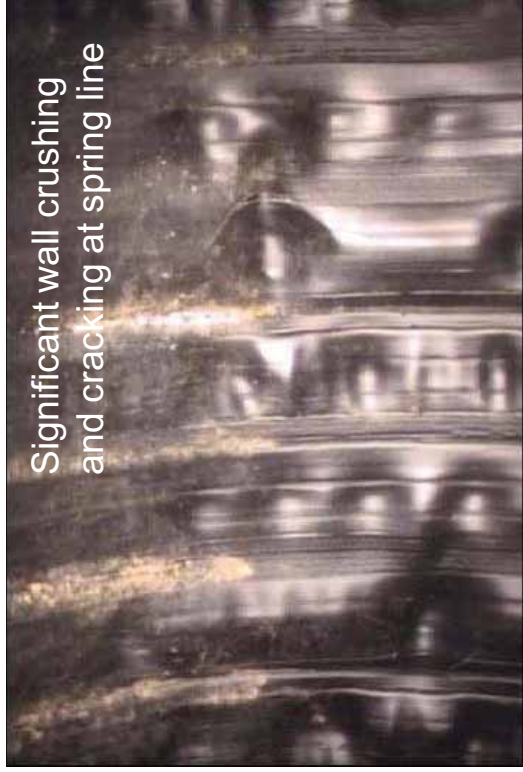

Plastic – Poor



Plastic – Poor

(Fire damage and resultant severe deformations at ends)



Plastic – Critical



Timber – Good

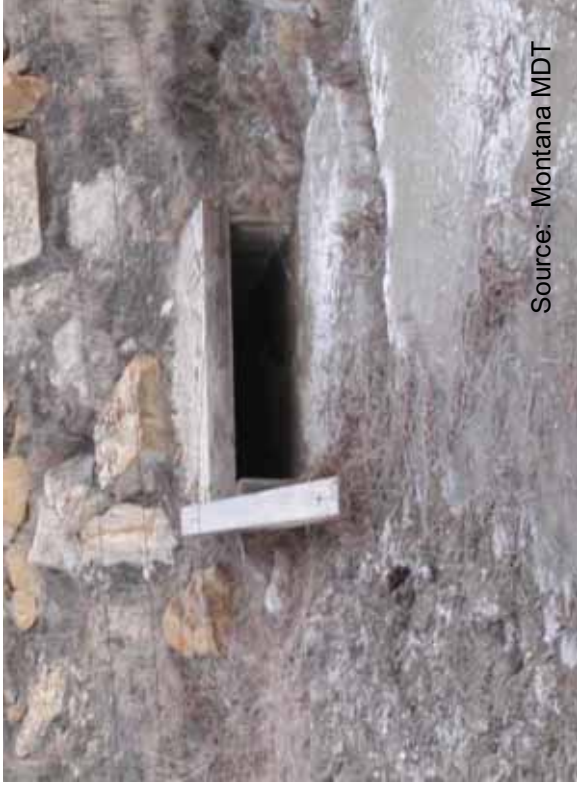

Source: Montana MDT



Source: USFWS Alpeno NFWCO, MI



Source: National Park Service

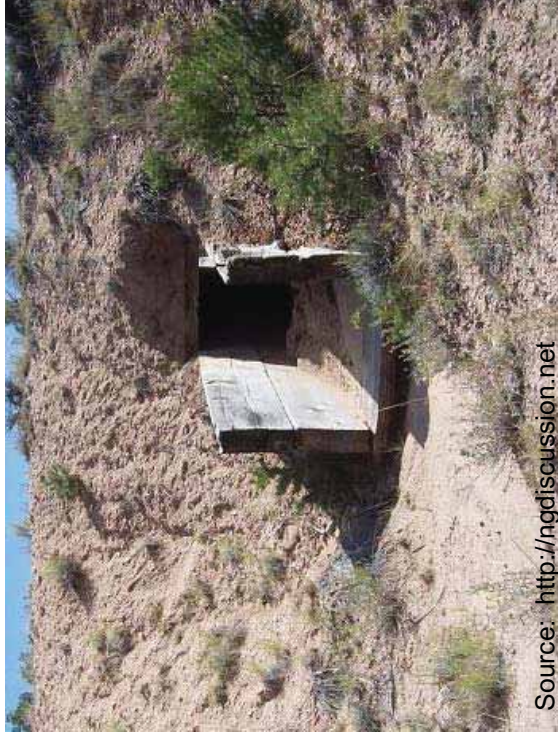

Source: <http://ngdiscussion.net>

Timber – Fair



Source: University of California Berkeley, ITS

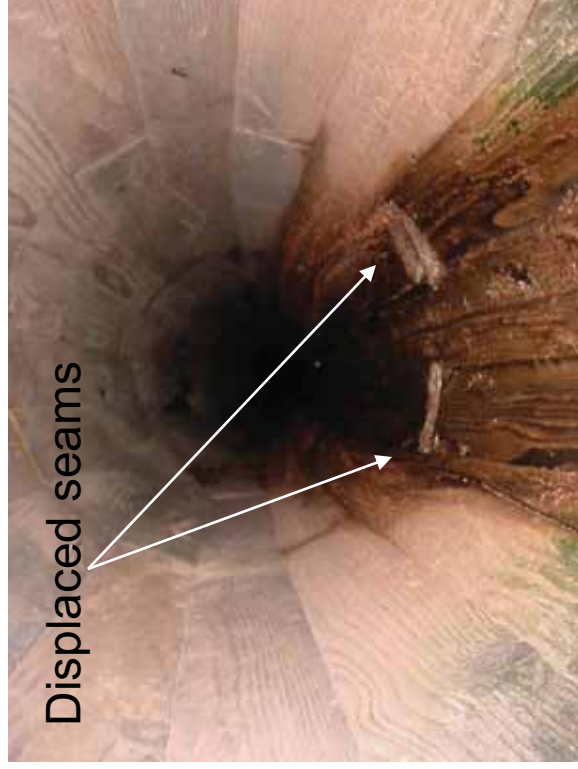

Source: www.fao.org

Timber – Poor



Timber – Critical

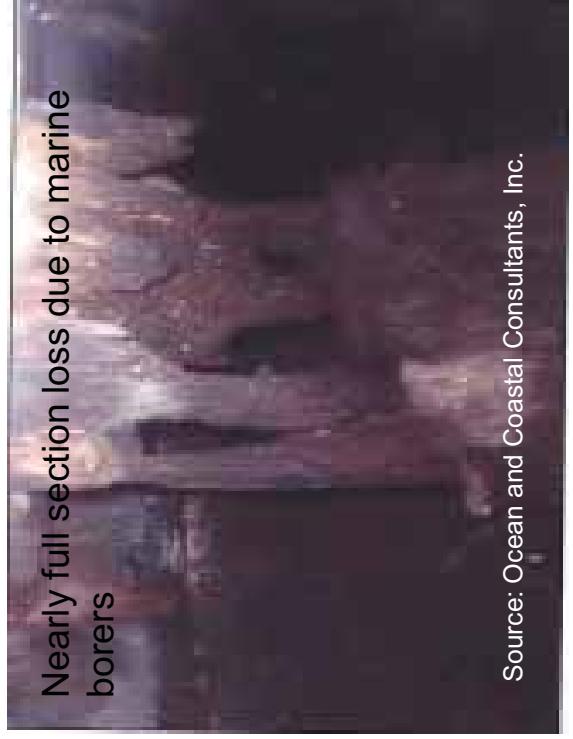

Masonry – Good

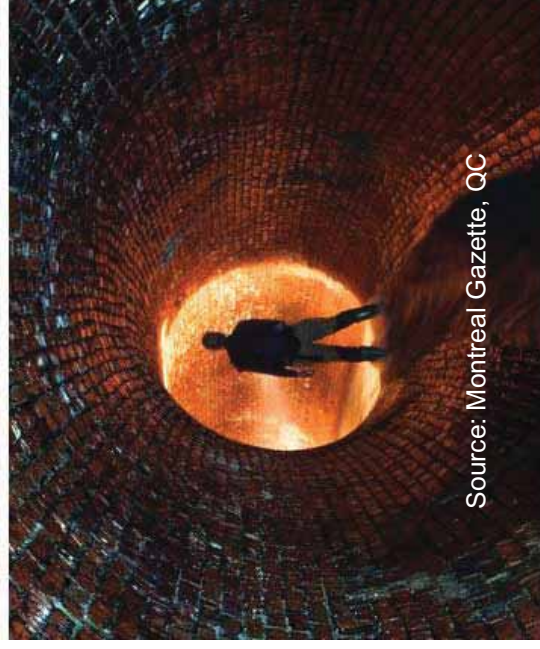
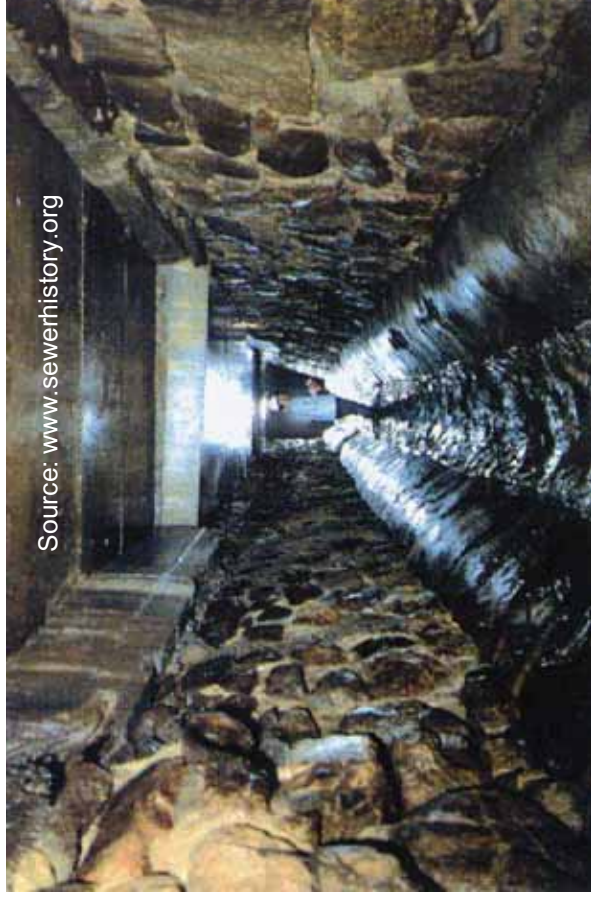

Masonry – Fair

(Minor cracks, mortar/section loss, loose blocks and infill)

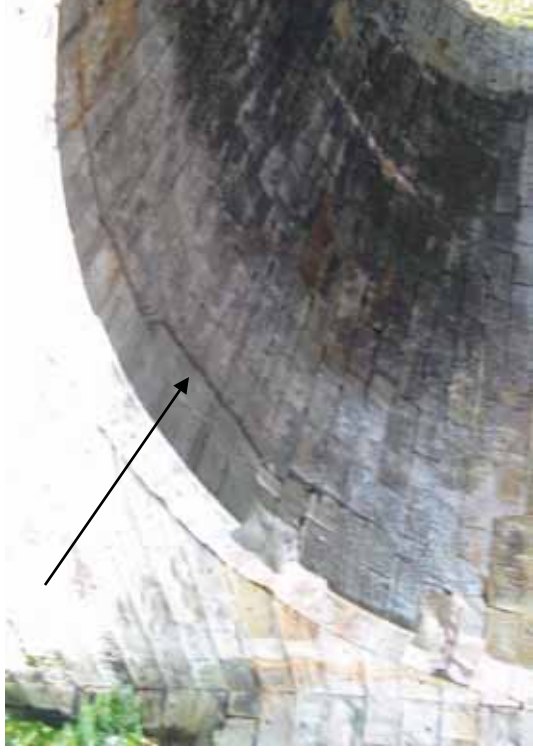
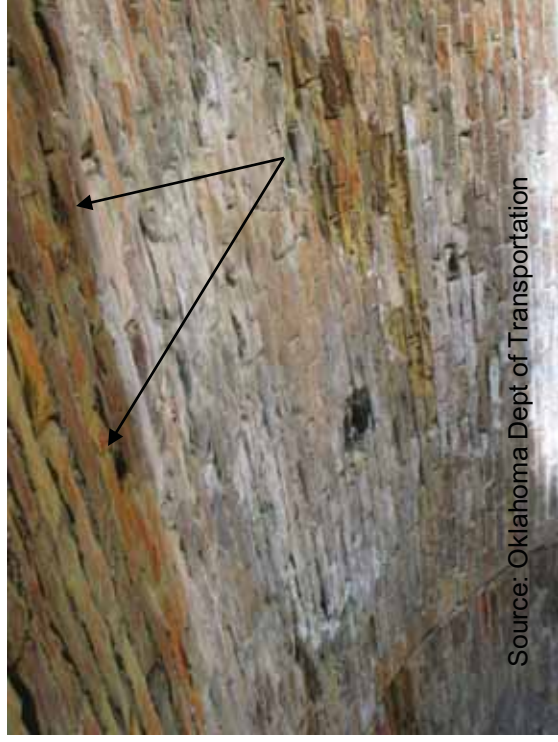

Masonry – Poor

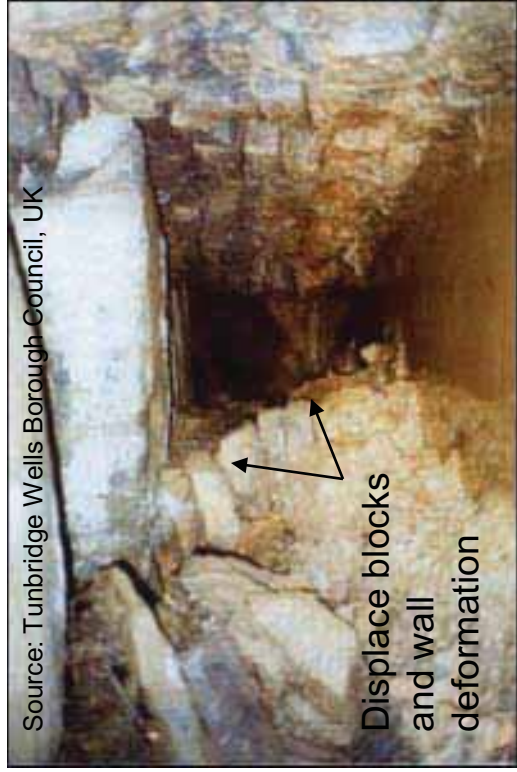
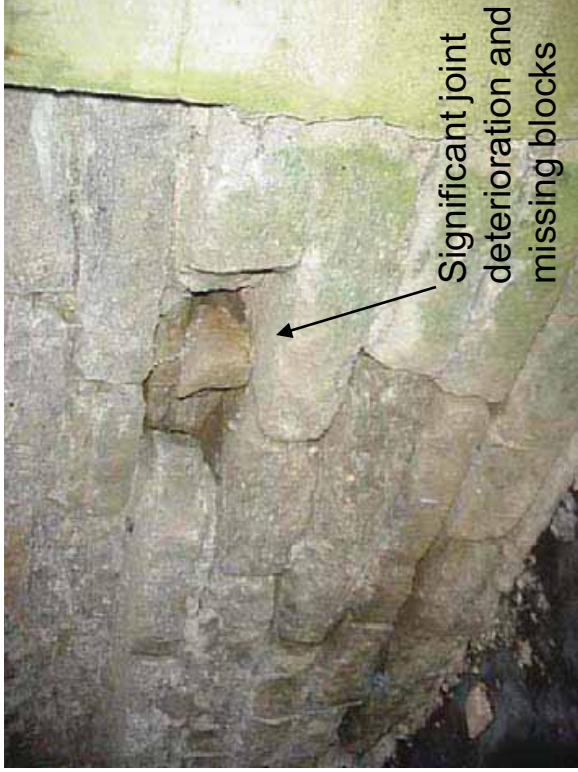

Source: Tunbridge Wells Borough Council, UK



Source: Nova History.org, Manassas, VA

Masonry – Critical



Appurtenances - Good

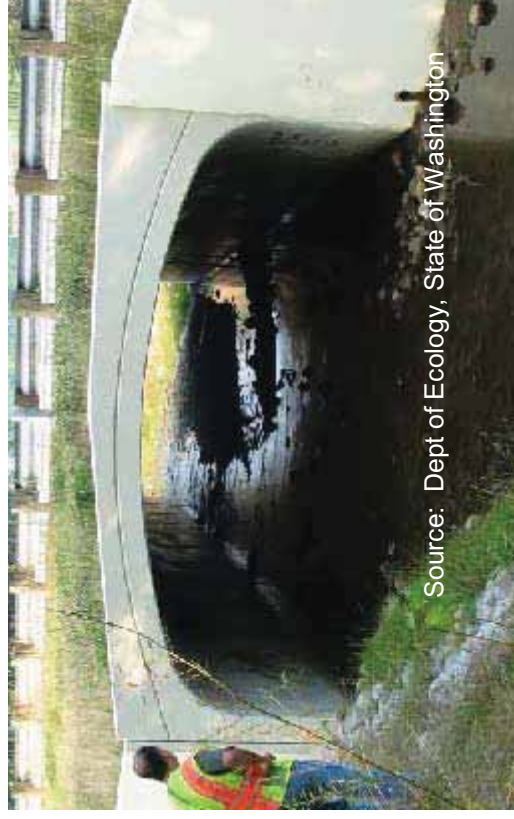
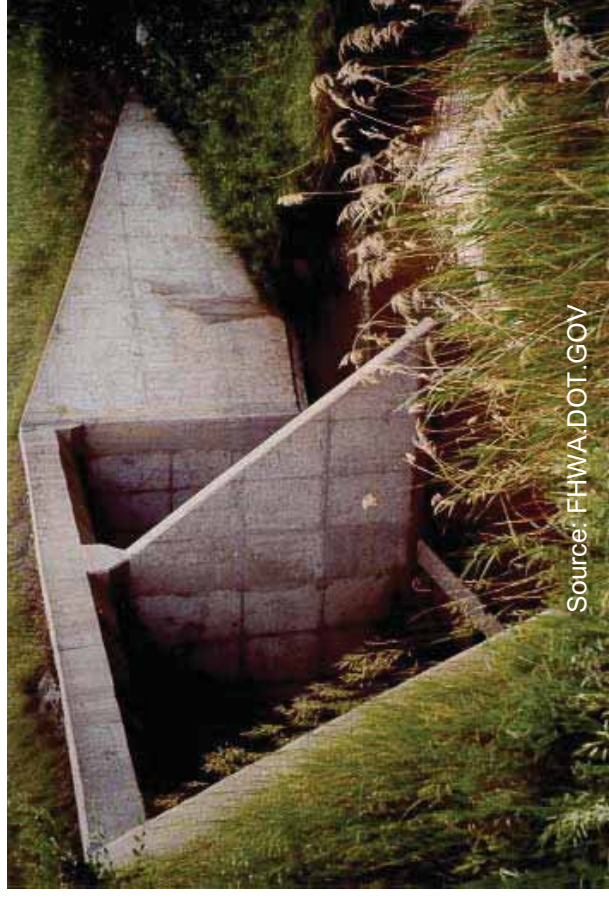

Appurtenances - Good



Source: California State Parks



Appurtenances - Good



Appurtenances - Good

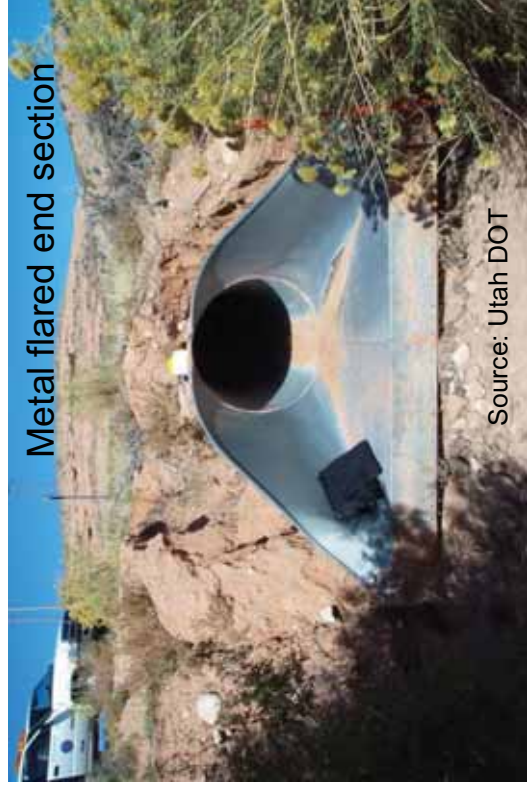
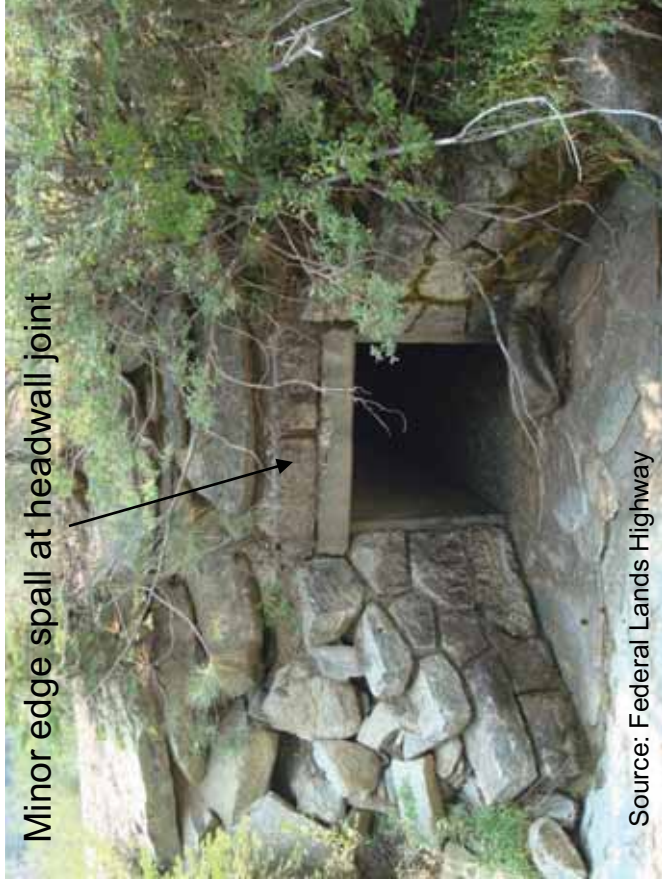

Appurtenances - Fair

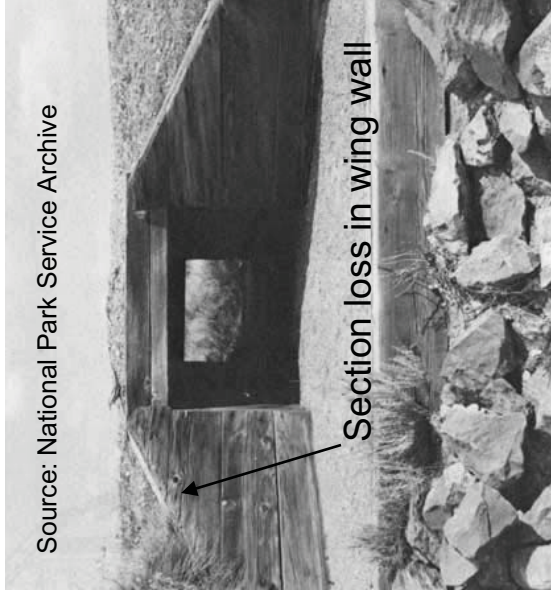

Appurtenances – Fair



Appurtenances - Poor



Appurtenances - Critical



Performance – Perched Outlet



Source: Caltrans DIB
83 Supplement to
FHWA Culvert Repair
Manual



Performance – Outlet Scour or Degradation



Source: Utah DOT

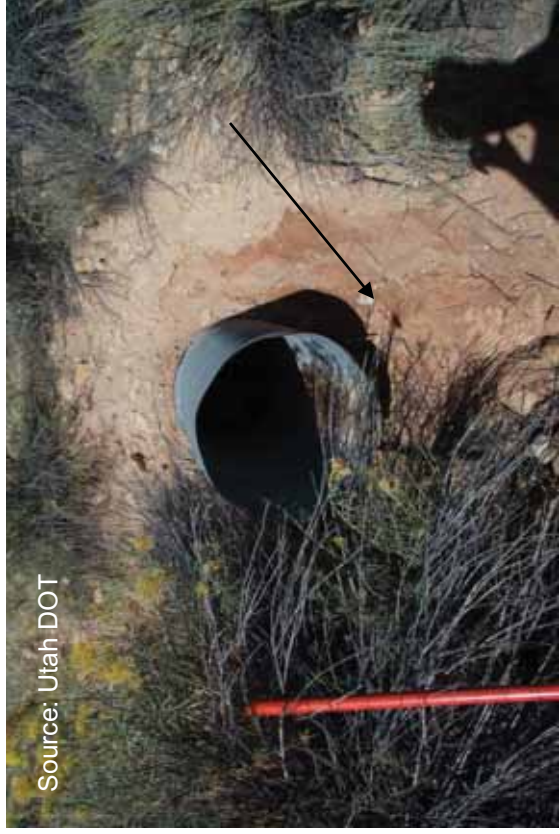

Source: Utah DOT

Performance – Embankment Erosion



Source: Montana MDT



Source: Federal Lands Highway



Performance – Embankment Erosion



Performance – Chronic Sediment

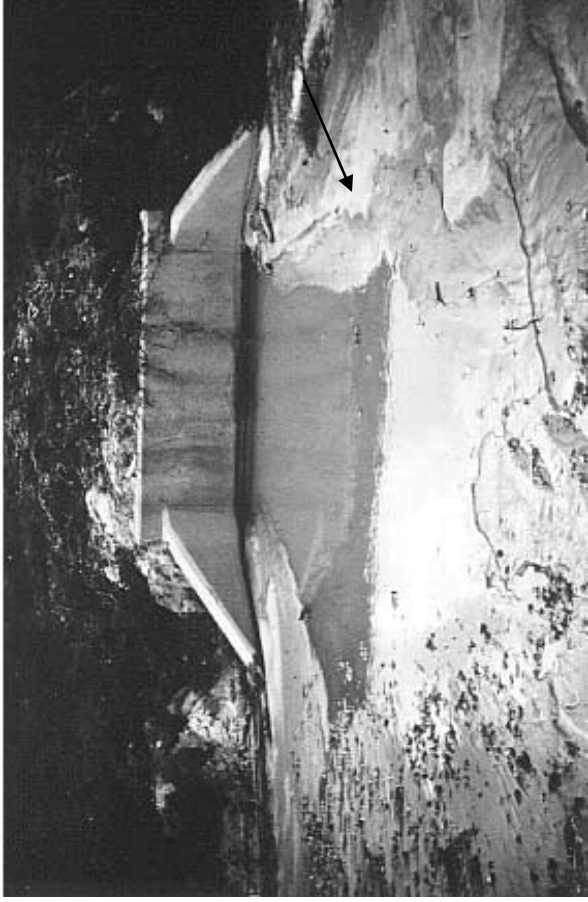

Source: Utah DOT



Source: Utah DOT



Source: Utah DOT

Performance – Debris and Vegetation



Source: US Forest Service



Source: Utah DOT



Source: Utah DOT

Performance – Piping/Settlement/Holes

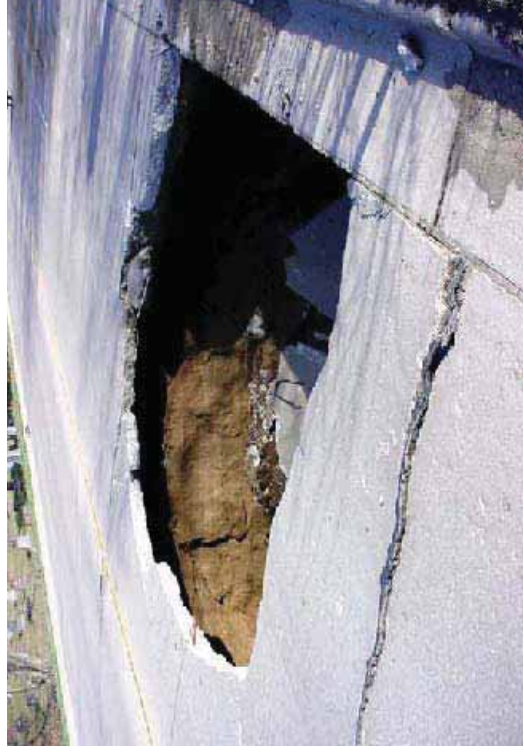

Performance – Piping/Settlement/Holes

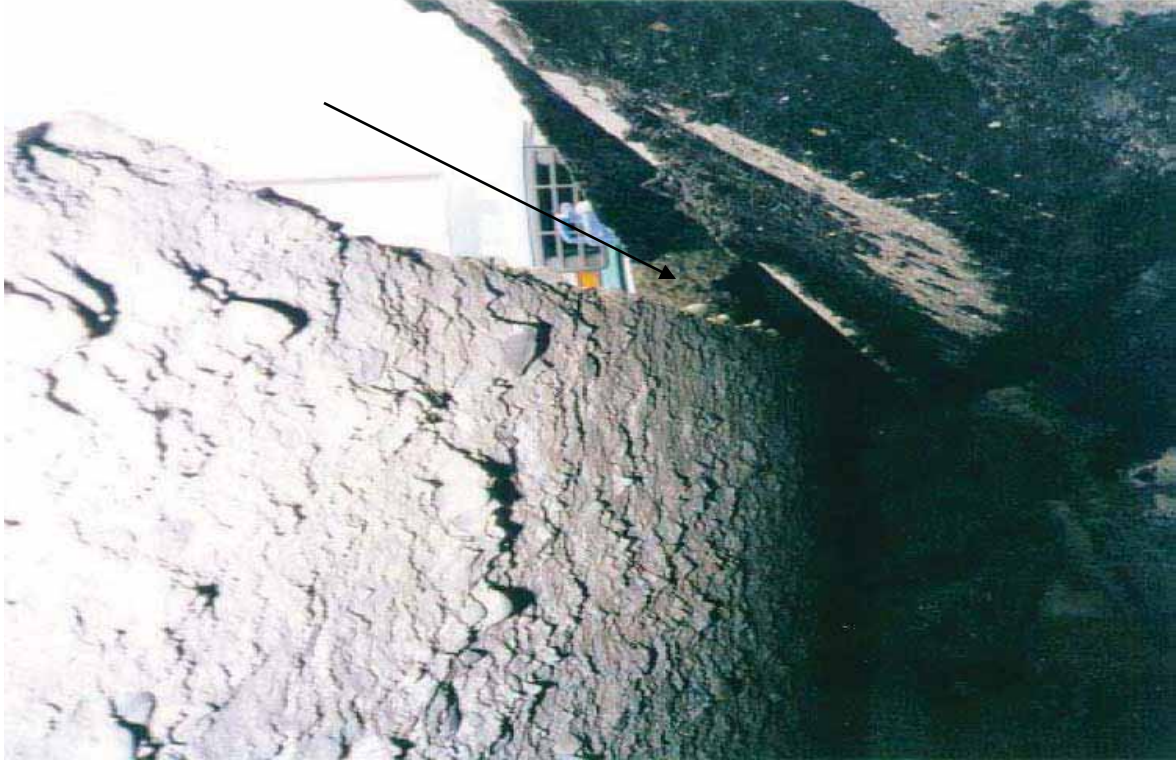

Performance – Piping/Settlement/Holes

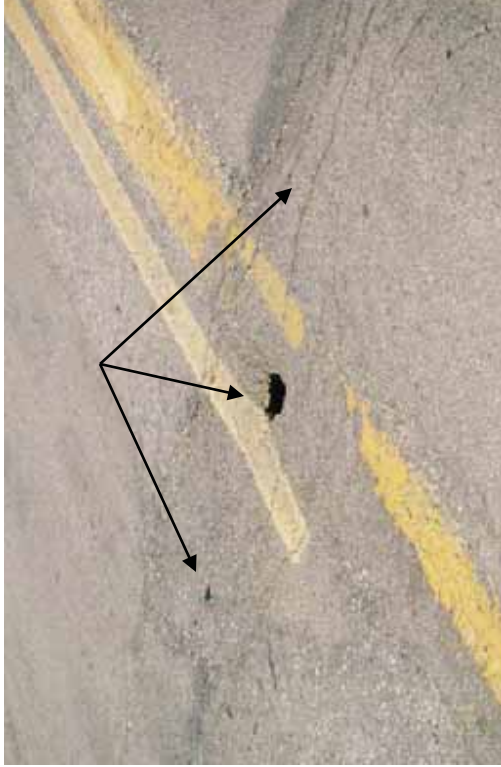

Performance – Piping/Settlement/Holes



Performance – Piping/Settlement/Holes

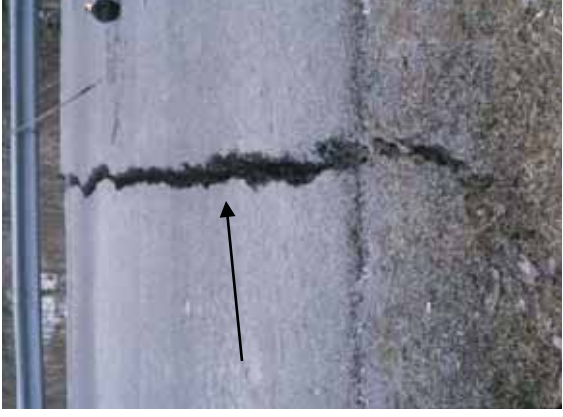

Source: Muskegon Chronicle, MI

Performance – Piping/Invert Buckling



Source: Utah DOT

Performance – Channel Degradation



Performance – Approaching Headcut



Level 2 – No Access or Specialized Equipment Necessary

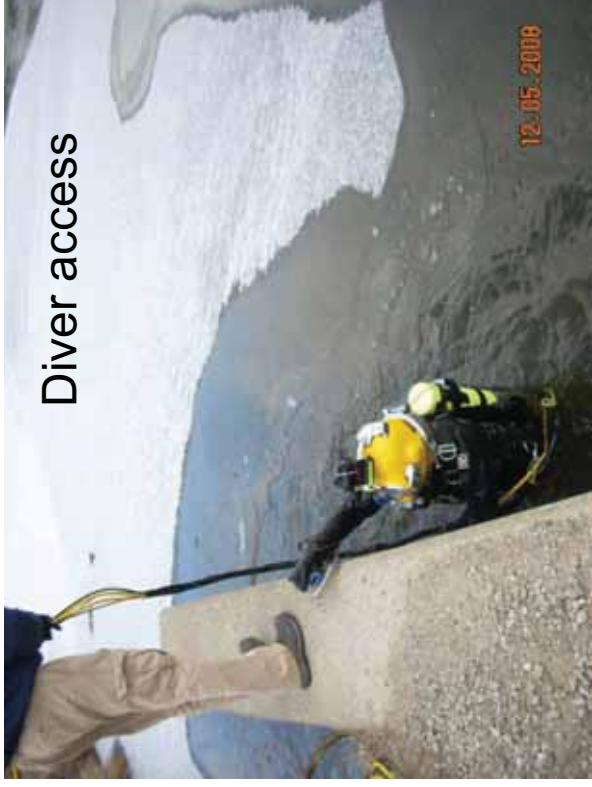

Sources

- AASHTO Culvert Inspection, Material Selection, and Rehabilitation Guideline (Chapter 14); 2007.
- Caltrans Supplement to FHWA Culvert Repair Practices Manual; 2003.
- FHWA FLH Field Photo Archives.
- FHWA HDS5 Hydraulic Design of Highway Culverts; Rev 2005.
- MnDOT HYDINFRA website <http://www.dot.state.mn.us/bridge/Hydraulics/HydInfra.html>
- Ohio/ORITE Risk Assessment and Update of Inspection Procedures for Culverts; 2005.
- USDA Forest Service Summary of Trenchless Technology for Use With USDA Forest Service Culverts; 2005.
- Otherwise noted on the individual photograph.

**APPENDIX C – PHOTOGRAPHIC GUIDE FOR CULVERT REPAIR
AND REPLACEMENT TECHNIQUES**

FHWA FLH Culvert Assessment and Decision-Making
Procedures Manual

Appendix C

Photographic Guide of Culvert Repair and Replacement Techniques

Temporary Bracing



Steel temporary bracing of a concrete culvert

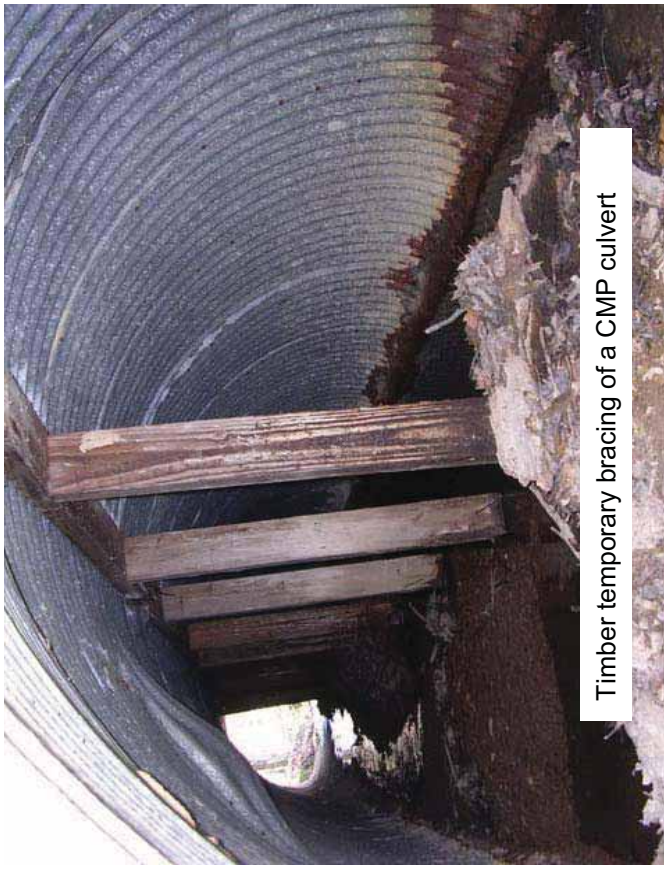

Timber temporary bracing of a CMP culvert

Liner Repairs



Spiral-wound plastic liner with grouted annulus

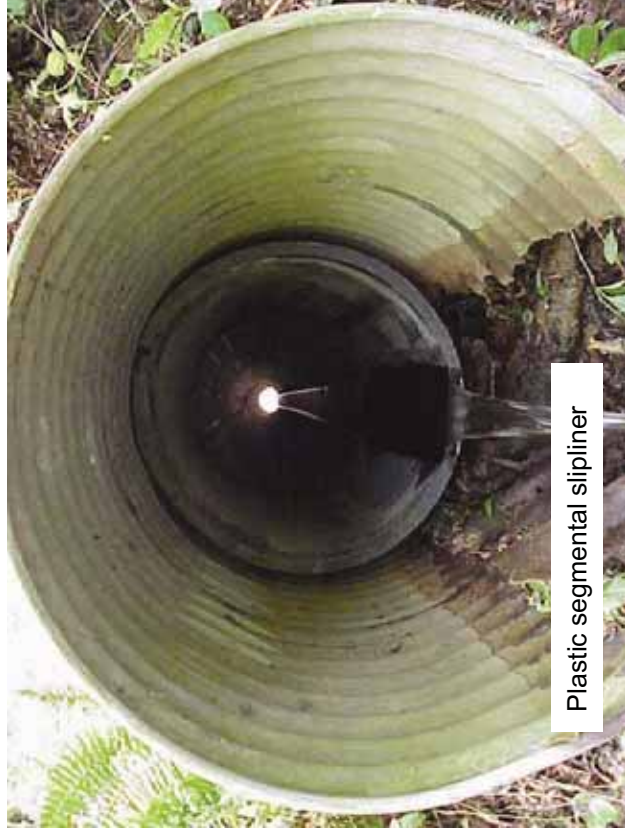

Plastic segmental slipliner

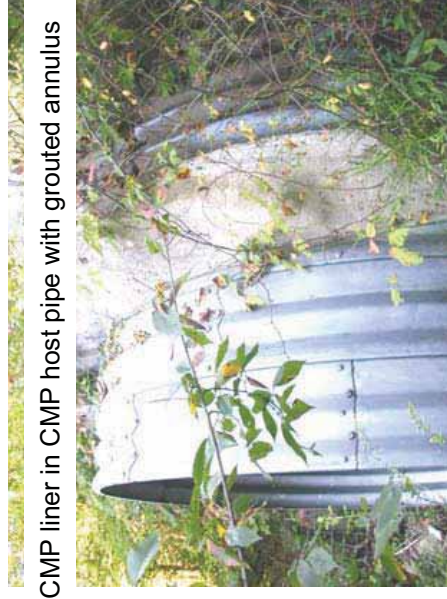

CMP liner in CMP host pipe with grouted annulus

Liner Repairs



PVC liner with annulus grout injection pipes visible



PVC liner with grouted annulus

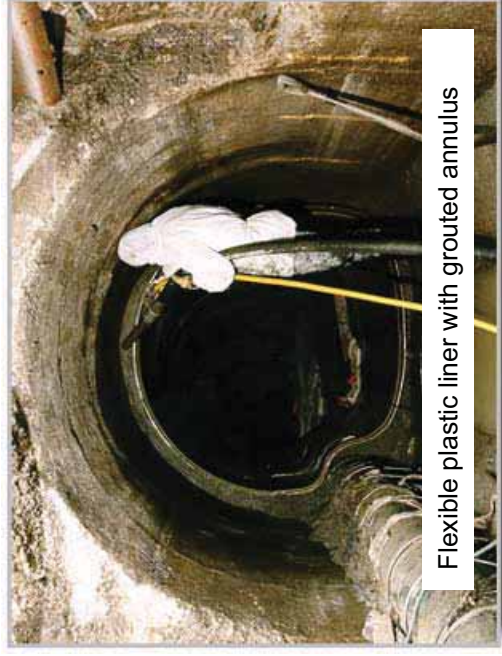

Flexible plastic liner with grouted annulus

Liner Repairs



FRC liner during installation and completed



Push/pull type fusion-welded HDPE pipe slipliner

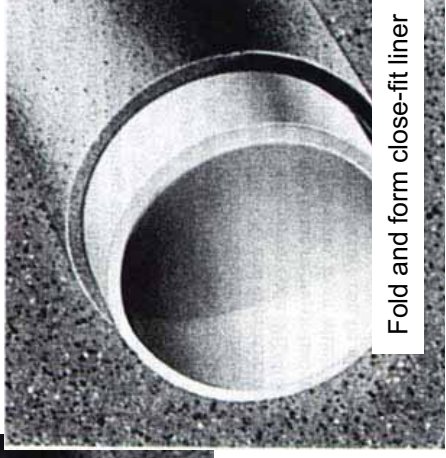

Fold and form close-fit liner

Liner Repairs

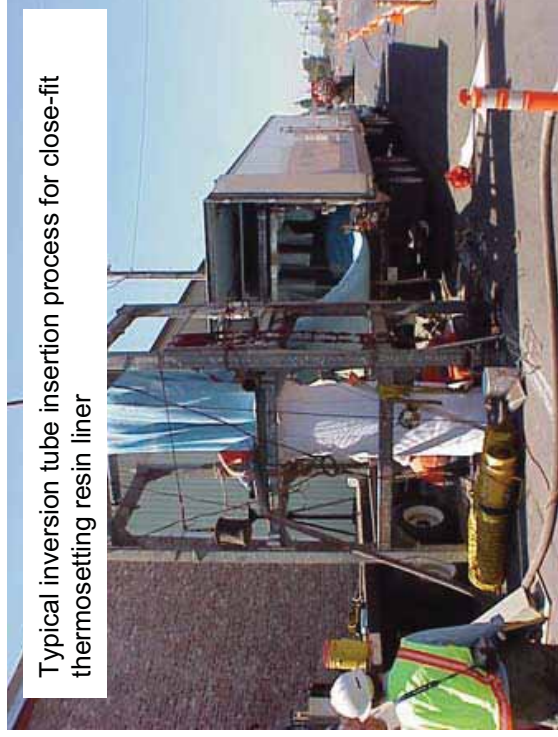
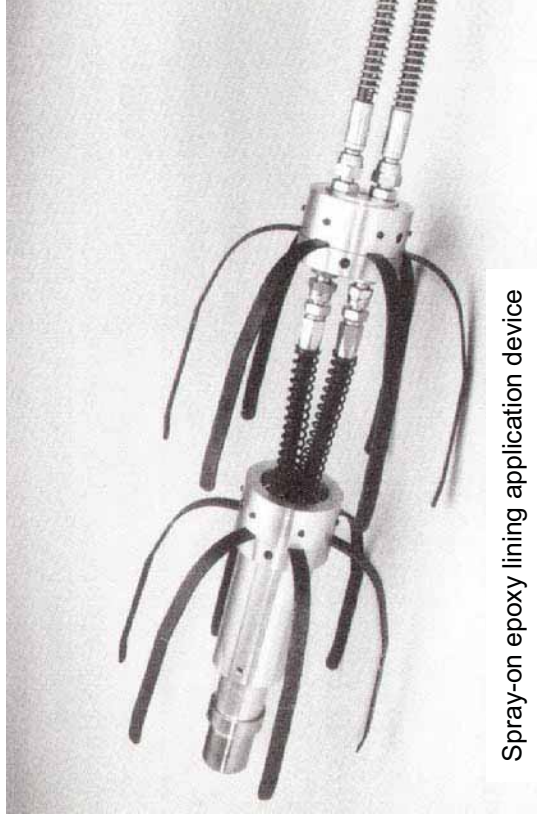
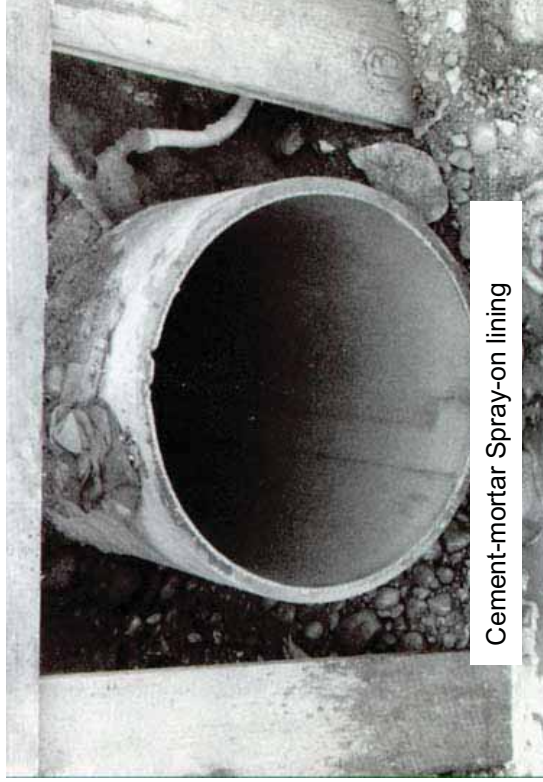

Liner Repairs



Installation of large diameter deformed-reformed HDPE liner



Installation of 18in. diameter deformed-reformed liner through drainage inlet



Spiral wound liner installation in masonry culvert



Spray-on mortar partial lining of CMP via man-entry

Liner Repairs

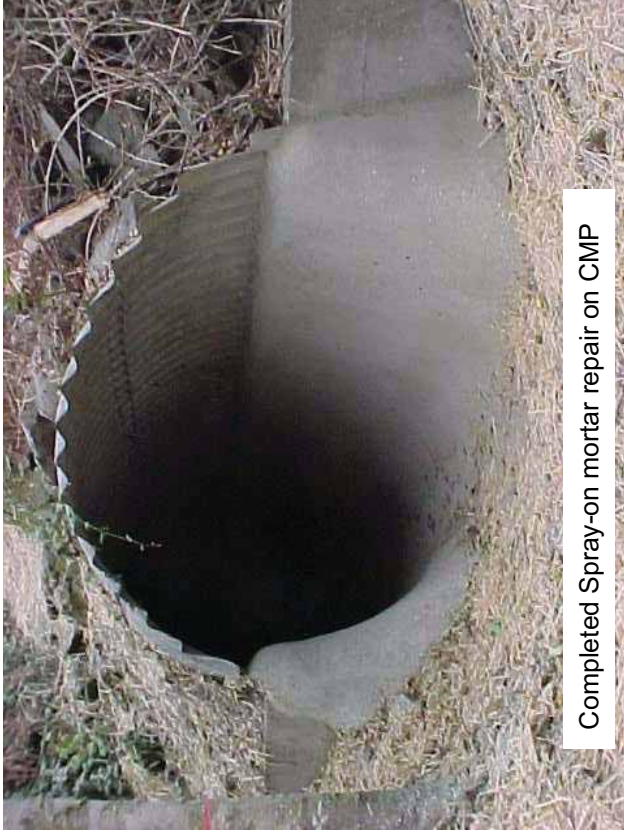

Completed Spray-on mortar repair on CMP



A



B

Cured-in-place Liner installation^B and completed^A

Joint Repairs



Hand-applied epoxy joint patch seal

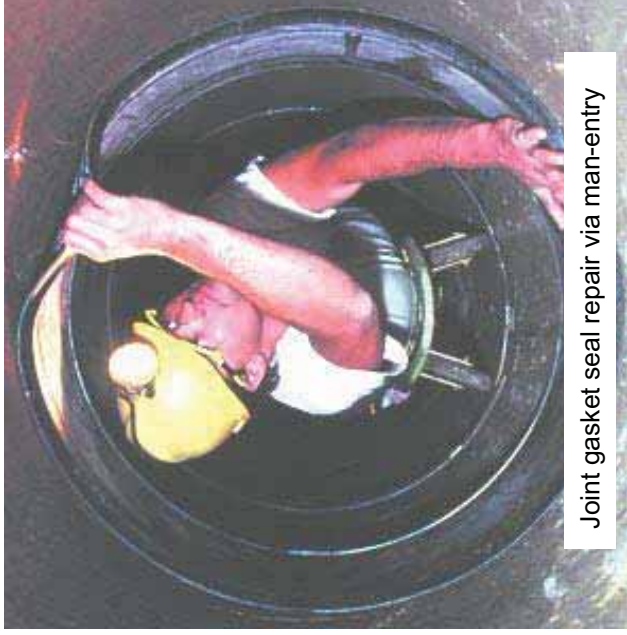

Joint gasket seal repair via man-entry



Joint gasket seal repair via man-entry



Void Repairs

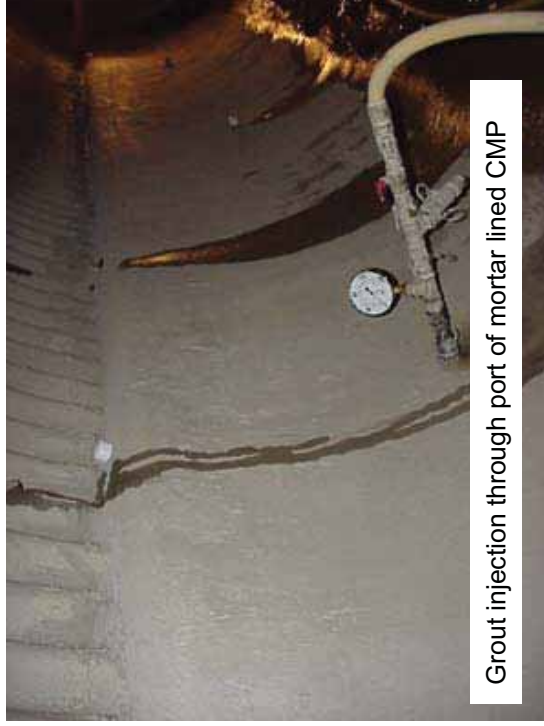

Grout injection through port of mortar lined CMP

Invert Paving and Plating

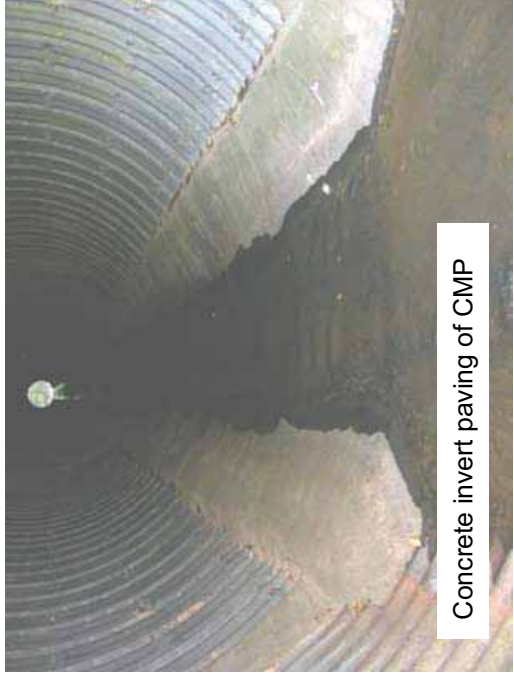
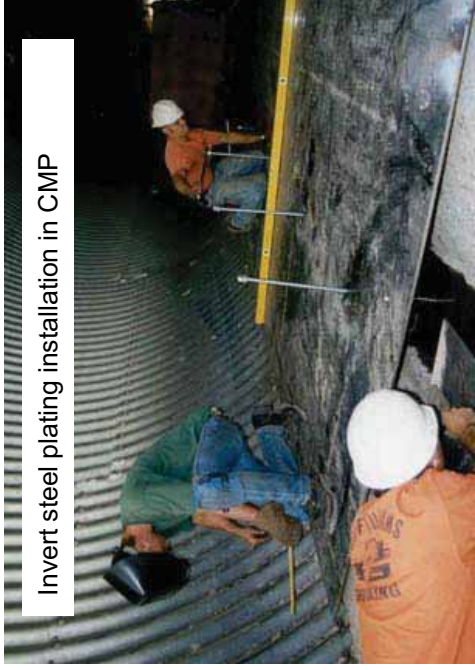
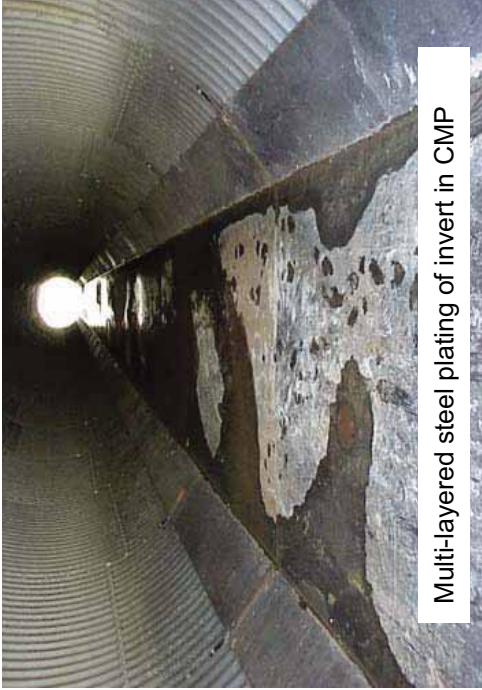

Scour Countermeasures

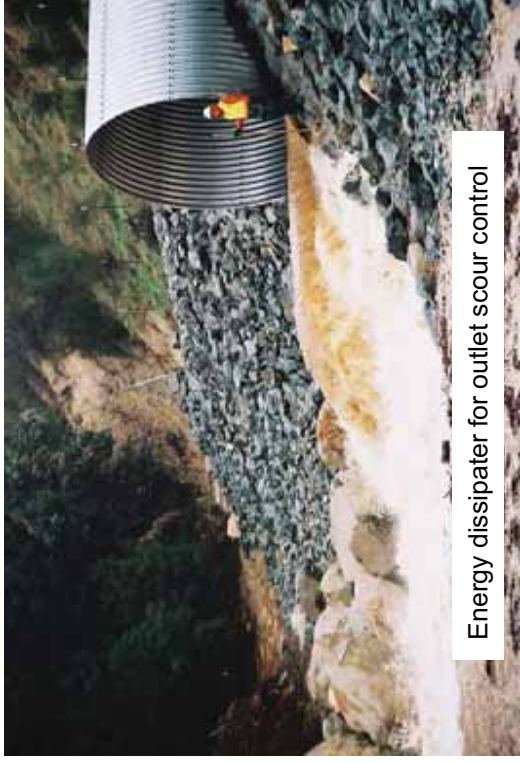
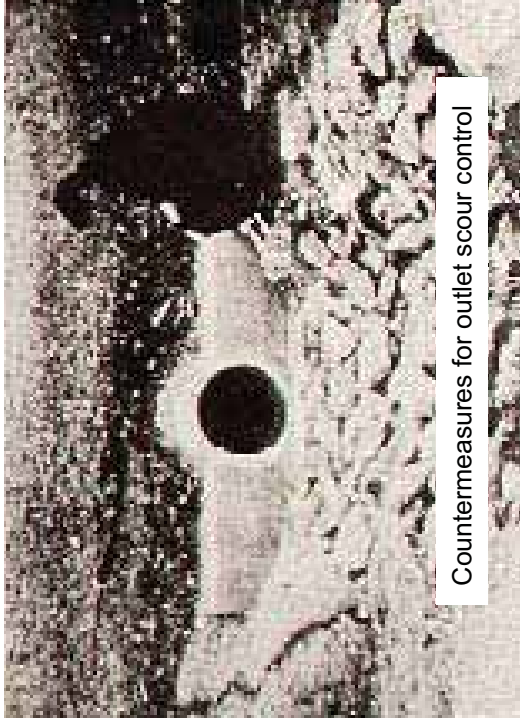

Debris Countermeasures

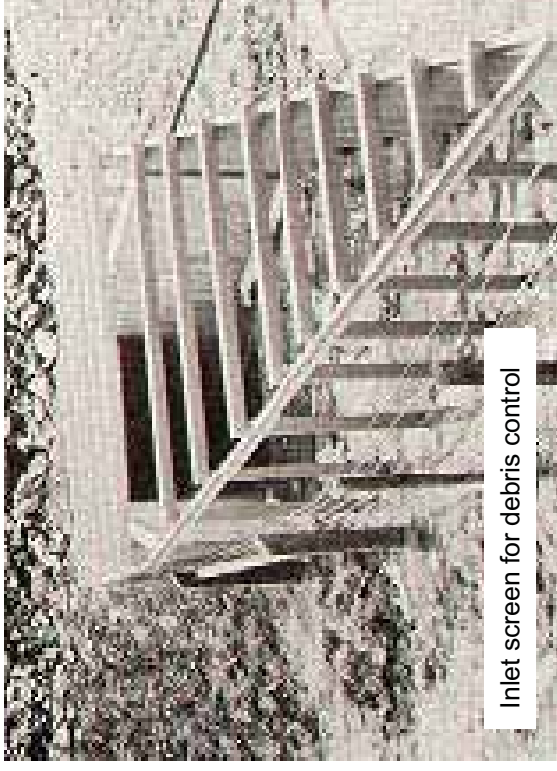

Pipe Jacking/Ramming/Auguring/Replacement



Large scale (10ft. Diameter CMP) ramming operation



Small scale (24in. Diameter CMP) ramming operation



Horizontal auger boring of 24in. CMP



Typical jacking pit

Sources

- Caltrans Supplement to FHWA Culvert Repair practices Manual, DIB No. 83-01; October 2, 2006.
- Culvert Pipe Liner Guide and Specifications; Publication No. FHWA-CFL/TD-05-003; FHWA Central Federal Lands Highway Division; Colorado State University ERC; July 2005.
- FHWA FLH Field Photo Archives.
- Oregon DOT Hydraulics Manual, Chapter 16 – Trenchless Technology; 2005.
- Summary of Trenchless Technology for Use With USDA Forest Service Culverts; USDA Forest Service; Rob Piehl, P.E.; September 2005.
- Understanding the Environmental Implications of Cured-in-Place Pipe Rehabilitation Technology; Virginia Transportation Research Council Research Report VTRC 08-R16; Donaldson and Baker, P.E.; May 2008.
- Otherwise noted on individual photographs.

**APPENDIX D – CULVERT DECISION-MAKING PROCESS MAP
AND FLOWCHARTS**

FLH Culvert Decision-Making Process Map

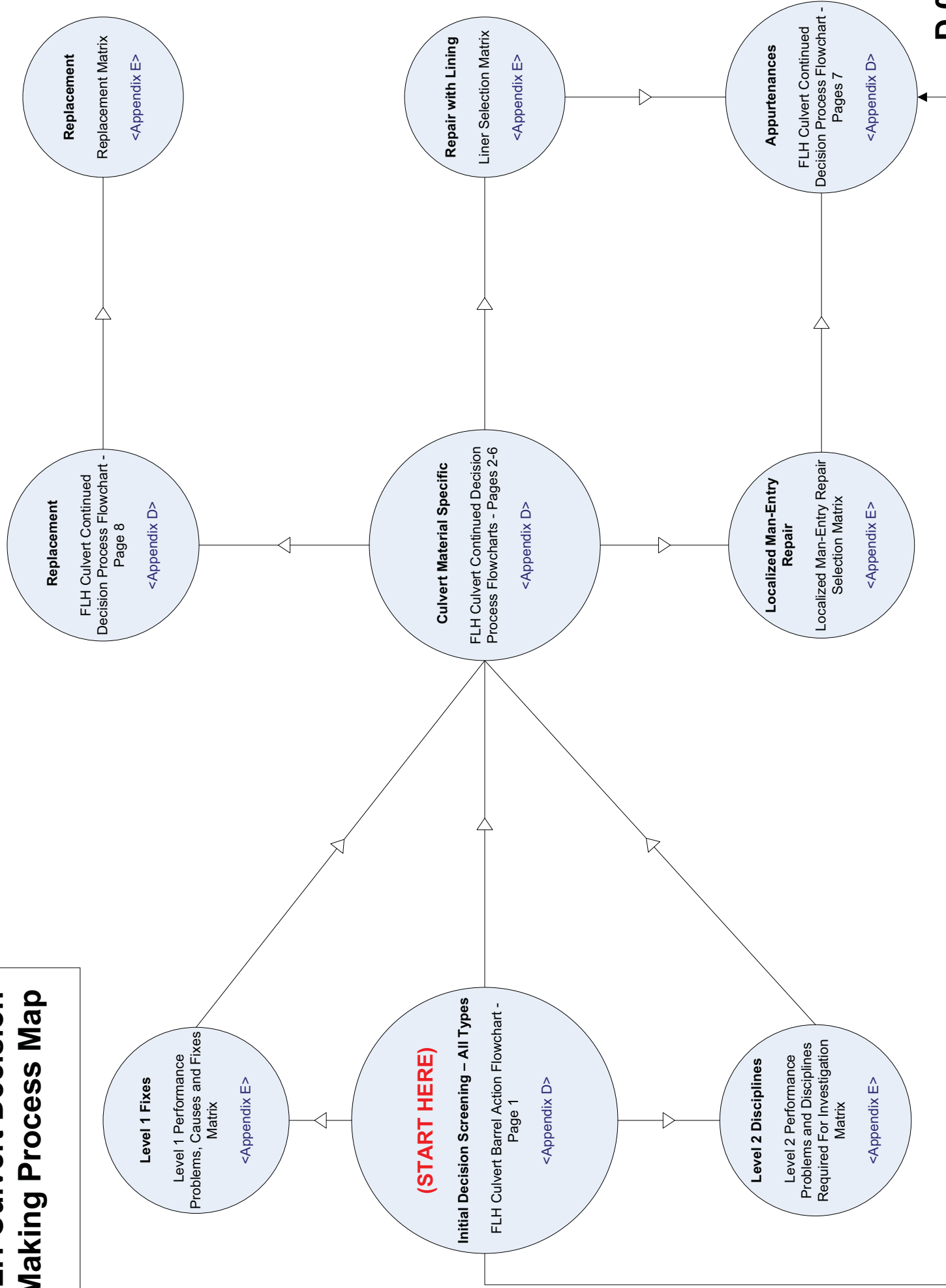

FLH Culvert Barrel Action Flowchart – Page 1 ALL TYPES *(Start Decision-Making Here)*

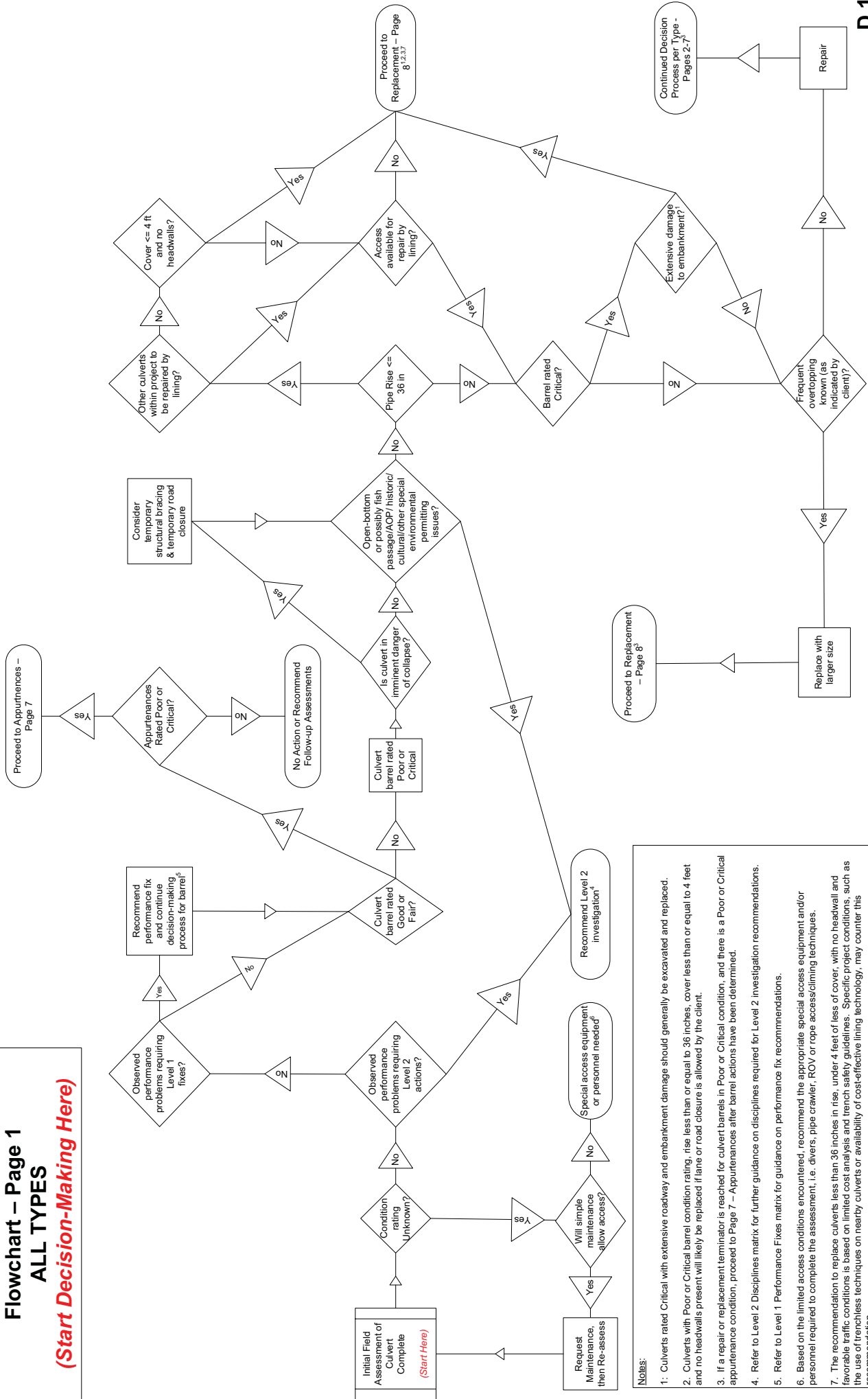

- Notes:**
- 1: Culverts rated Critical with extensive roadway and embankment damage should generally be excavated and replaced.
 - 2: Culverts with Poor or Critical barrel condition rating, rise less than or equal to 36 inches, cover less than or equal to 4 feet and no headwalls present will likely be replaced if lane or road closure is allowed by the client.
 - 3: If a repair or replacement terminator is reached for culvert barrels in Poor or Critical condition, and there is a Poor or Critical appearance condition, proceed to Page 7 – Appurtenances after barrel actions have been determined.
 - 4: Refer to Level 2 Disciplines matrix for further guidance on disciplines required for Level 2 Investigation recommendations.
 - 5: Refer to Level 1 Performance Fixes matrix for guidance on performance fix recommendations.
 - 6: Based on the limited access conditions encountered, recommend the appropriate special access equipment and/or personnel required to complete the assessment, i.e. divers, pipe crawler, ROV or rope access/climbing techniques.
 - 7: The recommendation to replace culverts less than 36 inches in rise, under 4 feet of less of cover, with no headwall and favorable traffic conditions is based on limited cost analysis and trench safety guidelines. Specific project conditions, such as the use of trenchless techniques on nearby culverts or availability of cost-effective lining technology, may counter this recommendation.

FLH Culvert Continued Decision Process Flowchart – Page 2 Concrete & RCP

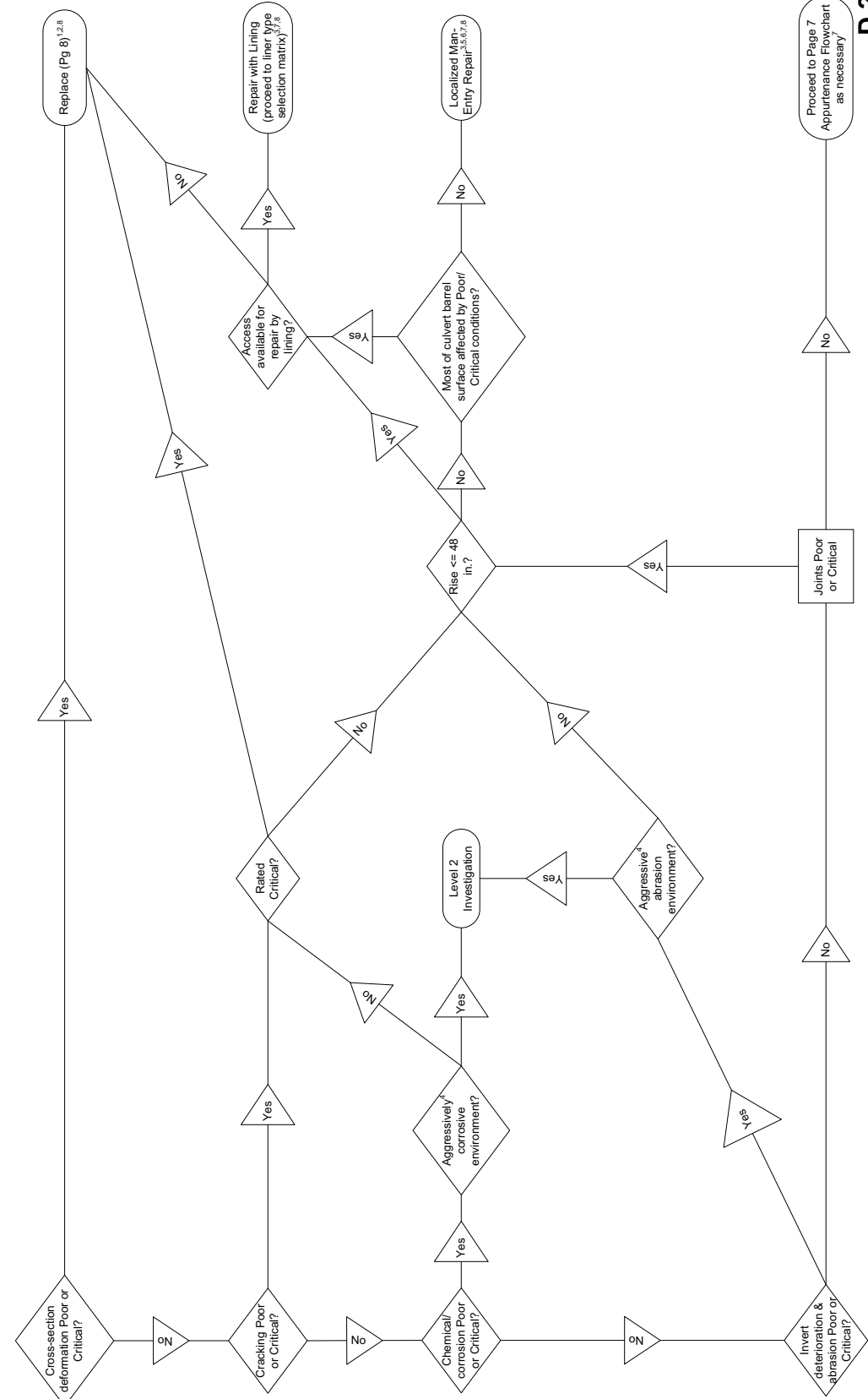

Continued Decision Process Needed (From Page 1) (Start Here)

- Notes:**
1. Condition rating Poor or Critical in cross-section deformation aspect suggests that concrete or RCP is experiencing structural failure and should be replaced.
 2. Condition rating Critical in cracking or corrosion/chemical suggests that the pipe has lost structural integrity and should be replaced.
 3. If a repair with lining terminator is reached, proceed to liner type selection matrix. If a man-entry repair terminator is reached, trace flowchart steps for remaining deterioration modes with Poor or Critical condition ratings to ensure identification of all needed repairs.
 4. In terms of aggressive deterioration, if the culvert condition deteriorated to Poor or Critical in 5 years or less, initiate a Level 2 investigation.
 5. Man-entry repairs should include cleaning any exposed rebar and either re-covering it with concrete or grout patching or coating it with epoxy. Should also include grouting or otherwise mitigating any voids in the backfill around the culvert barrel.
 6. The feasibility of man-entry repairs should be referenced against the culvert entry guide that is a part of the FLH culvert assessment procedure. If man-entry is not feasible, default to liner repair recommendation. Note that this guide is a generally recommended approach only, and in no part supersedes OSHA regulations concerning confined space entry as contained in 29 CFR 1910.146, nor does it preclude the exercise of sound judgement with regard to personal safety.
 7. If a Repair with Lining or Localized Man-Entry Repair terminator is reached, proceed to Flowchart Page 7 Appurtenances to complete the decision-making process.
 8. For culverts rated Poor with repair or replacement recommendations, follow-up assessments should be recommended at no more than one year intervals to monitor the deterioration until the repair/replacement is completed.

FLH Culvert Continued Decision Process Flowchart – Page 3 CMP

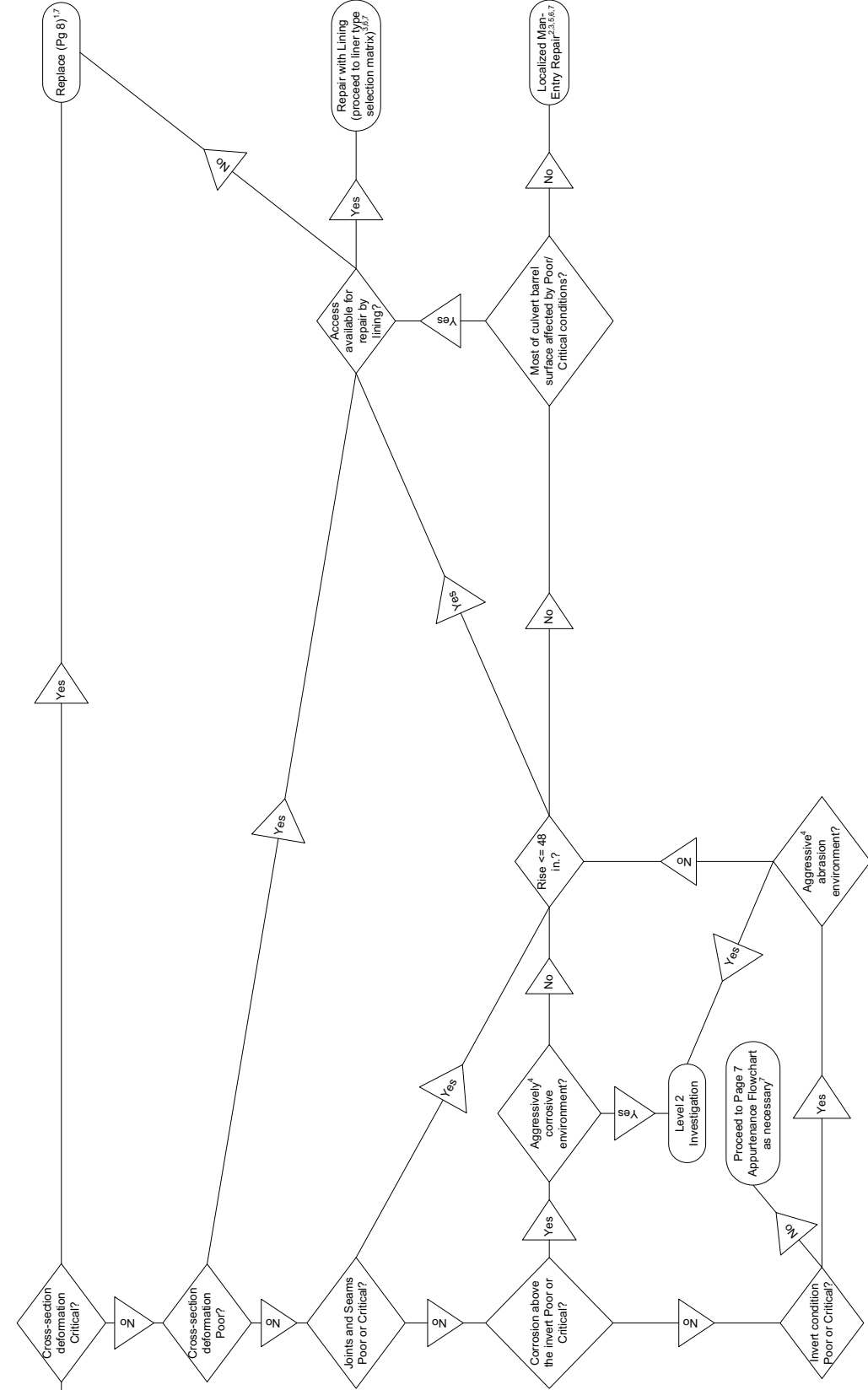

Notes:

1. Condition rating Critical in this aspect suggests that CMP is significantly mishapen and has lost structural integrity. Shape distortion makes lining infeasible.
2. Man-entry repairs should include grouting or otherwise mitigating any voids in the backfill around the culvert barrel.
3. If a repair with lining terminator is reached, proceed to liner type selection matrix. If a man-entry repair terminator is reached, trace flowchart steps for remaining deterioration modes with Poor or Critical condition ratings to ensure identification of all needed repairs.
4. In terms of aggressive deterioration, if the culvert condition deteriorated to Poor or Critical in 5 years or less, initiate a Level 2 investigation.
5. The feasibility of man-entry repairs should be referenced against the culvert entry guide that is a part of the FLH culvert assessment procedure. If man-entry is not feasible, default to liner repair recommendation. Note that this guide is a generally recommended approach only, and in no part supersedes OSHA regulations concerning confined space entry as contained in 29 CFR 1910.146, nor do they preclude the exercise of sound judgement with regard to personal safety.
6. If a Repair with Lining or Localized Man-Entry Repair terminator is reached, proceed to Flowchart Page 7 Appearance to complete the decision-making process.
7. For culverts rated Poor with repair or replacement recommendations, follow-up assessments should be recommended at no more than one year intervals to monitor the deterioration until the repair/replacement is completed.

FLH Culvert Continued Decision Process Flowchart – Page 5 Timber

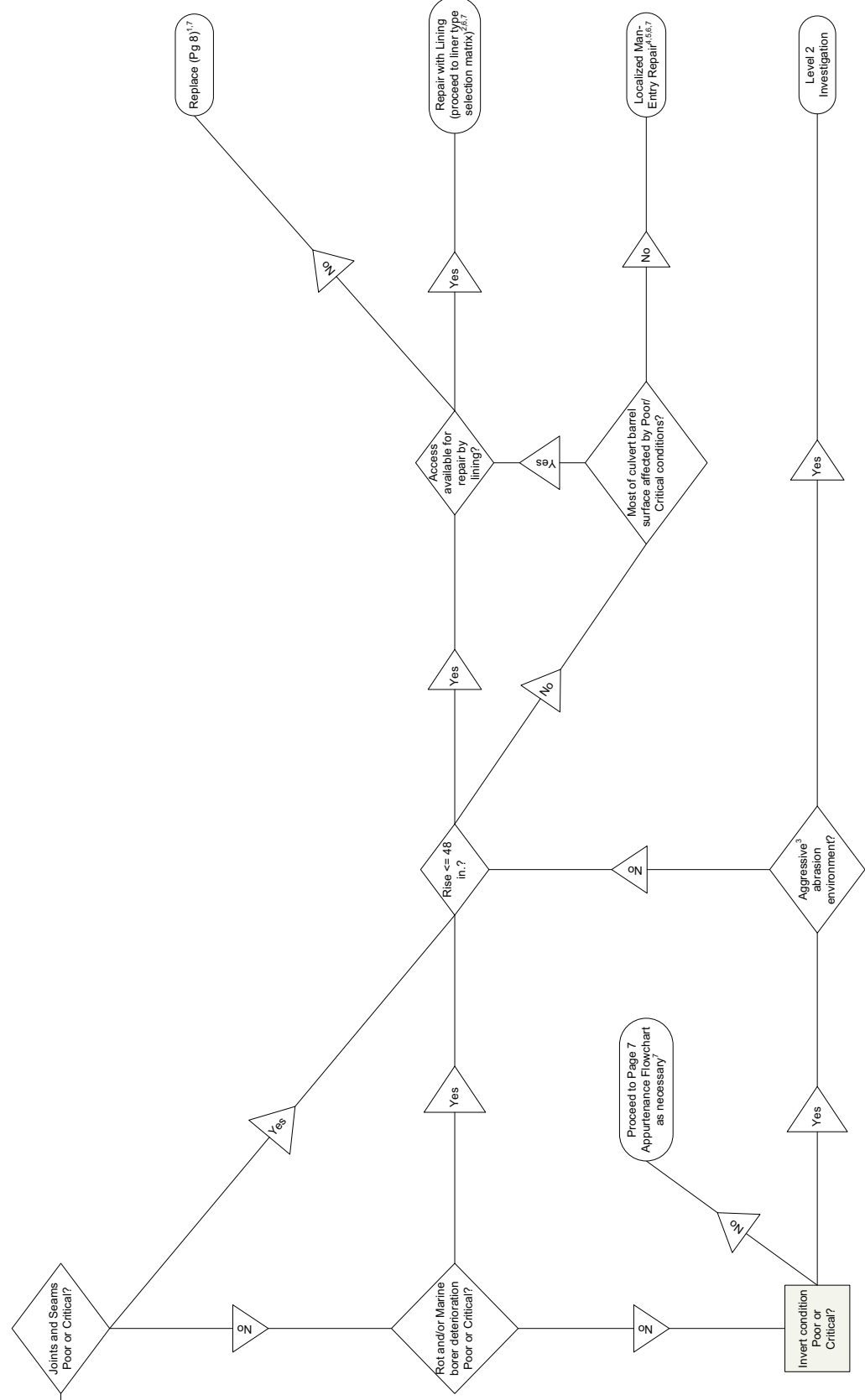

- Notes:**
- 1: Culverts rated Critical with extensive roadway and embankment damage should generally be excavated and replaced.
 - 2: If a repair with lining terminator is reached, proceed to liner type selection matrix. If a man-entry repair terminator is reached, trace flowchart steps for remaining deterioration modes with Poor or Critical condition ratings to ensure identification of all needed repairs.
 - 3: In terms of aggressive deterioration, if the culvert condition deteriorated to Poor or Critical in 5 years or less, initiate a Level 2 investigation.
 - 4: Man-entry repairs should include grouting or otherwise mitigating any voids in the backfill around the culvert barrel.
 - 5: The feasibility of man-entry repairs should be referenced against the culvert entry guide that is a part of the FLH culvert assessment procedure. If man-entry is not feasible, default to liner repair recommendation. Note that this guide is a generally recommended approach only, and in no part supersedes OSHA regulations concerning confined space entry as contained in 29 CFR 1910.146, nor do they preclude the exercise of sound judgement with regard to personal safety.
 - 6: If a Repair with Lining or Localized Man-Entry Repair terminator is reached, proceed to Flowchart Page 7 Appurtenances to complete the decision-making process.
 - 7: For culverts rated Poor with repair or replacement recommendations, follow-up assessments should be recommended at no more than one year intervals to monitor the deterioration until the repair/replacement is completed.

FLH Culvert Continued Decision Process Flowchart – Page 6 Masonry

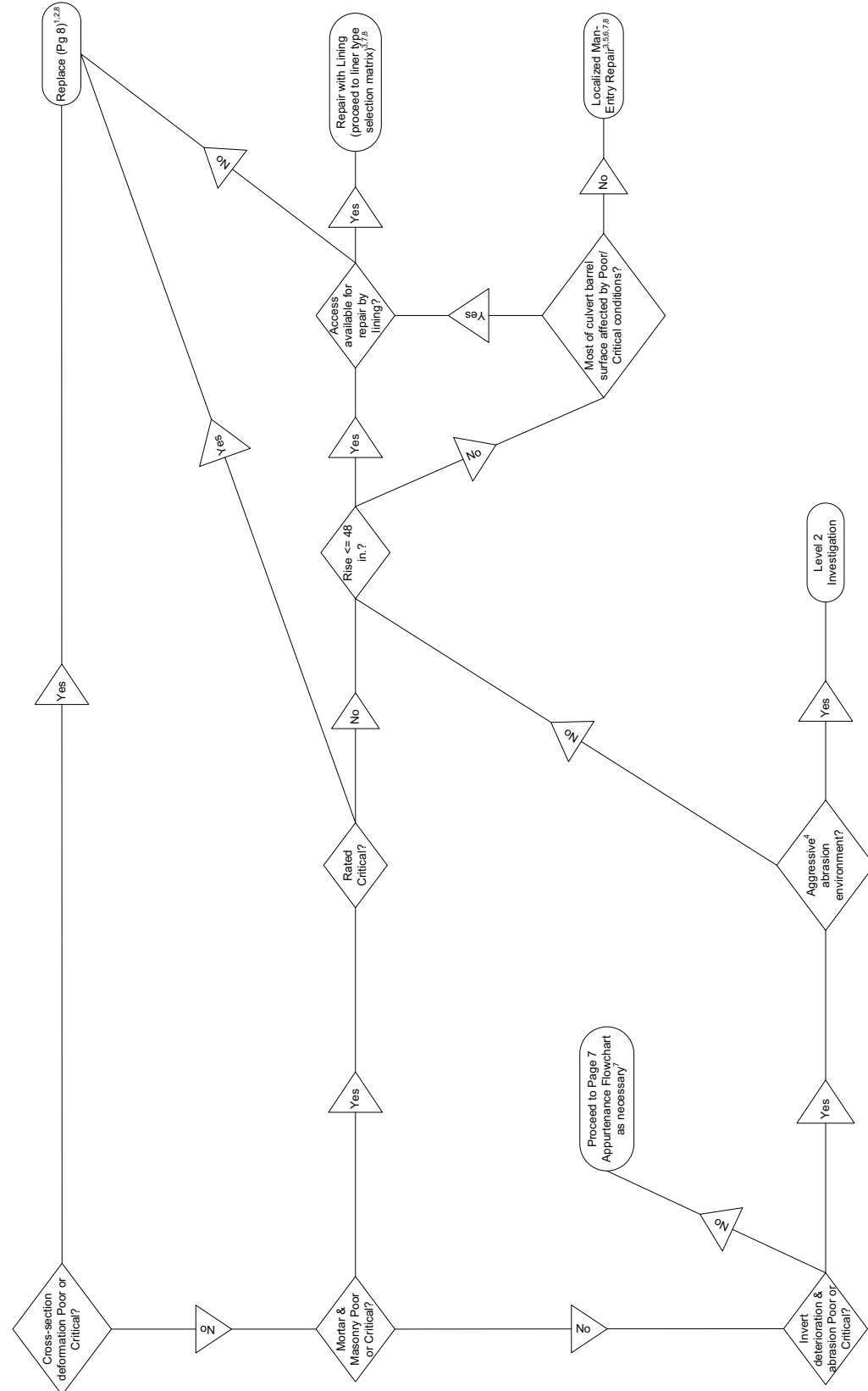

- Notes:**
1. Condition rating Poor or Critical in cross-section deformation aspect suggests that the masonry culvert has lost its structural integrity and should be replaced.
 2. Condition rating Critical in mortar and masonry suggests that restoring the structural integrity through repair is likely infeasible and replacement is appropriate.
 3. If a repair with lining terminator is reached, proceed to liner type selection matrix. If a man-entry repair terminator is reached, trace flowchart steps for remaining deterioration modes with Poor or Critical condition ratings to ensure identification of all needed repairs.
 4. In terms of aggressive deterioration, if the culvert condition deteriorated to Poor or Critical in 5 years or less, initiate a Level 2 investigation.
 5. Man-entry repairs should include cleaning any exposed rebar and either re-covering it with concrete or grout patching or coating it with epoxy. Should also include grouting or otherwise mitigating any voids in the backfill around the culvert barrel.
 6. The feasibility of man-entry repairs should be referenced against the culvert entry guide that is a part of the FLH culvert assessment procedure. If man-entry is not feasible, default to liner repair recommendation. Note that this guide is a generally recommended approach only, and in no part supersedes OSHA regulations concerning confined space entry as contained in 29 CFR 1910.146, nor do they preclude the exercise of sound judgement with regard to personal safety.
 7. If a Repair with Lining or Localized Man-Entry Repair terminator is reached, proceed to Flowchart Page 7 Appurtenances to complete the decision-making process.
 8. For culverts rated Poor with repair or replacement recommendations, follow-up assessments should be recommended at no more than one year intervals to monitor the deterioration until the repair/replacement is completed.

FLH Culvert Continued Decision Process Flowchart – Page 7 Appurtenances

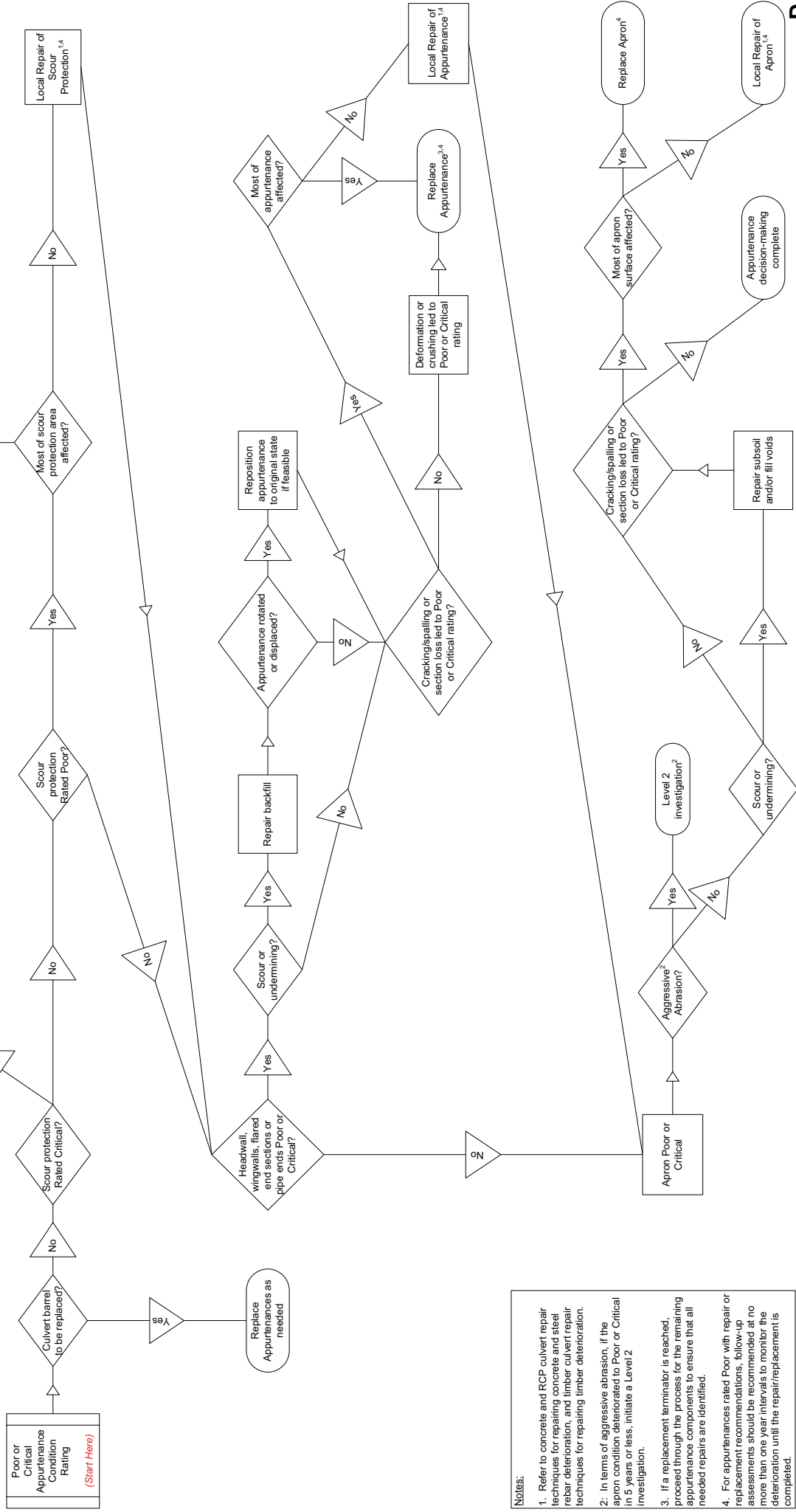

- Notes:**
1. Refer to concrete and RCP culvert repair techniques for repairing concrete and steel rebar deterioration, and timber culvert repair techniques for repairing timber deterioration.
 2. In terms of aggressive abrasion, if the apron condition deteriorated to Poor or Critical in 5 years or less, initiate a Level 2 investigation.
 3. If a replacement terminator is reached, proceed through the process for the remaining appurtenance components to ensure that all needed repairs are identified.
 4. For appurtenances rated Poor with repair or replacement recommendations, follow-up assessments should be recommended at no more than one year intervals to monitor the deterioration until the repair/replacement is completed.

**FLH Culvert Continued
Decision Process Flowchart
– Page 8
REPLACEMENT - ALL TYPES**

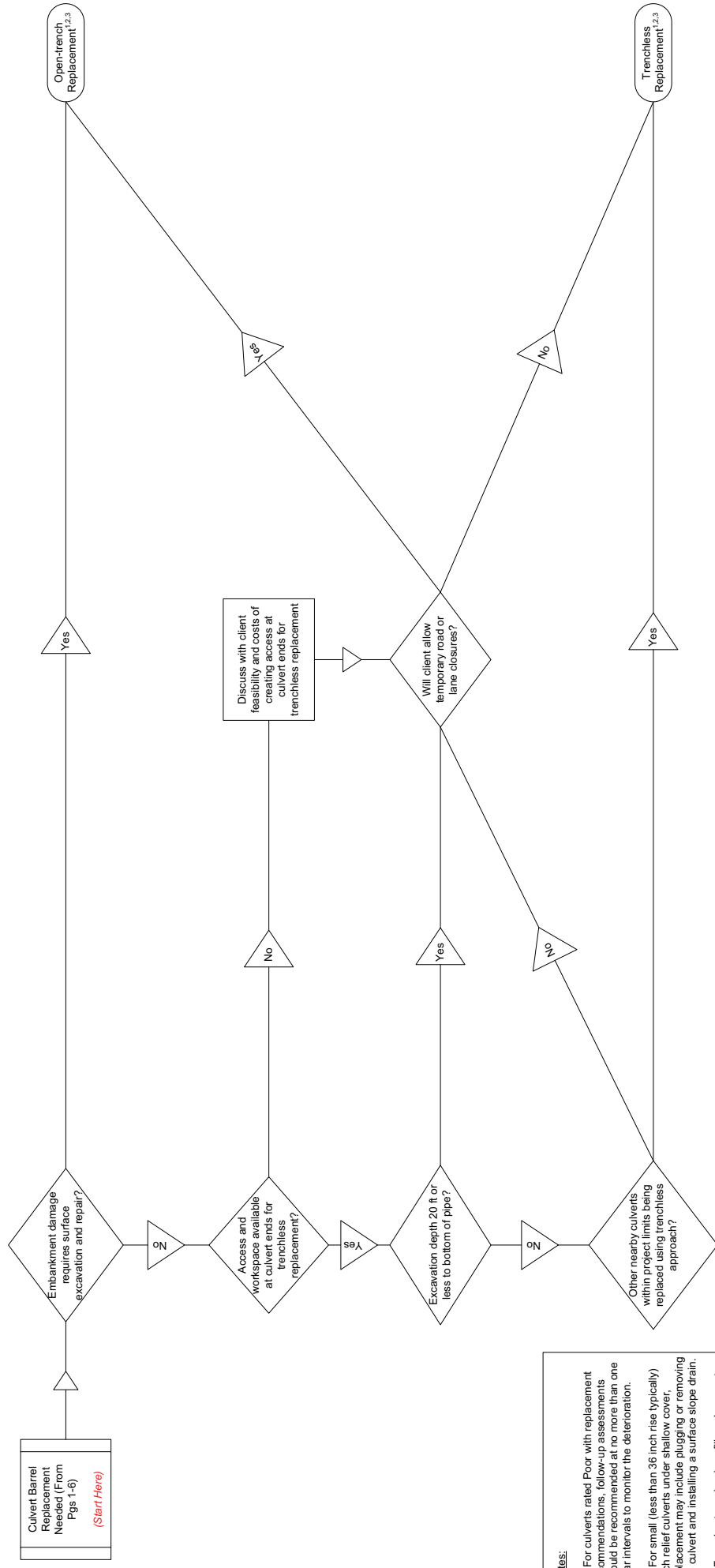

Notes:

- For culverts rated Poor with replacement recommendations, follow-up assessments should be recommended at no more than one year intervals to monitor the deterioration.
- For small (less than 36 inch rise typically) ditch relief culverts under shallow cover, replacement may include plugging or removing the culvert and installing a surface slope drain.
- For culverts under deep fill, replacement may include plugging the deep culvert and installing and shallower culvert.

APPENDIX E – CULVERT DECISION-MAKING MATRICES

Liner Selection Matrix

This matrix summarizes properties, advantages and disadvantages of some of the liners commonly used in full-length, full-circumference repairs. Note that culverts with a slope greater than 1.5% can usually accommodate significant diameter reduction, as long as the diameter is not reduced within four feet of the inlet end. If the slope is greater than 1.5% and a liner will significantly reduce the pipe diameter, it is recommended the liner be terminated short of the pipe end and a new tapered or beveled inlet section be installed. See the sources noted below the table for more detailed discussion. More options and considerations for liner selection are also presented in the FLH Culvert Pipe Liner Guide and Specification, 2005.

Rehabilitation Type	Diameter Limits	Space Requirements for Installation	Shape, Deformation & Joint Discontinuity Tolerance	Structural Restoration	Diameter Reduction	Flow Bypass Required When Flow is Present?	Abrasion and Corrosion Resistance	Rough Comparative Cost	Other Factors and Limitations
Slip Liner - Segmental	Up to 158in. diameter for segmental; up to 72in. common	Small to moderate	Deformations and discontinuities in pipe can be locked in a diameter of the liner; host pipe must be round or semi-round	Depends on liner and annulus composition	Significant	Sometimes	Good	Low to Moderate: \$50/lin.ft. for 18in. Diameter; \$120/lin.ft. for 30in. Diameter; \$400 to \$500 per lin.ft. for 60in. diameter	Low safety concern for installers; Low environmental concern with installation process, in particular with low-density grout
	Slip Liner - Continuous	Moderate to large							
Fold-and-Form PVC or HDPE Liner (close-fit)	Up to 24in. diameter for PVC and 36in. for HDPE; Less than 15in. to 18in. most common; 4in. min.	Small	Deformations, discontinuities and pipe size changes will likely cause problems; host pipe must be round/circular shape	Does not restore structural integrity	Minimal	Usually	Very Good	Moderate to High: \$100 to \$300 per lin.ft.	Moderate safety concern for installers; Moderate environmental concern with installation process; specialized equipment and trained personnel needed.
Spiral-wound Liner	8in. to 120in. diameter, depending on type	Small	Host pipe must be round or semi-round; can tolerate minor discontinuities, deformations and pipe size changes	Depends on liner and annulus composition	Can be significant	Sometimes	Very Good	Moderate to High: \$100/lin.ft. for 18in. Diameter; \$200/lin.ft. for 78in. diameter; up to \$750 per lin.ft. for larger diameters	Moderate safety concern for installers; Low environmental concern with installation process; larger manual systems require man-entry; liners may become brittle in freezing temps; specialized equipment and trained personnel needed.
Cured-in-Place Pipe (CIPP)	12in. to 108in. diameter; 48in. or less most common	Small to moderate	Non-circular shapes, discontinuities and pipe size changes can be accommodated	May restore structural integrity, depending on liner wall thickness	Minimal for non-structural; Moderate for structural	Always	Very Good	High: \$100/lin.ft. for 18in. diameter; up to \$800 per lin.ft. for larger diameters	Moderate safety concern for installers; High environmental concern with installation process, in particular with contaminated water disposal and control of ground water infiltration; some resins may be toxic. Specialized equipment and trained personnel needed.
Spray-On Cement Mortar Lining	12in. to 24in. diameter most common; larger diameter possible	Small	Host pipe must be round or semi-round; can accommodate minor bends; discontinuities and imperfections in host pipe	Restores structural integrity if reinforced	Minimal for non-structural; Moderate for structural	Always	Poor	Low to Moderate: \$100 to \$150/lin.ft. for 24in. diameter; \$250 to \$350 per lin.ft. for 60in. Diameter	Low safety concern for installers; High environmental concern with installation process; specialized equipment and trained personnel needed; cement subject to breakdown if runoff is acidic or contains sulfates; infiltration control required; bends and long lengths can be problematic for pulling sled through pipe at necessary steady rate and verifying application thickness.
	Spray-On Epoxy Lining								

Sources: FLH/BIG History from various departments, 1997 to present; USDA Forest Service Report on Trenchless Technologies; Pehl, 2005; Caltrans Supplement to FHWA Practices Manual Bulletin No. 83-01, 2006; Central FLH Culvert Pipe Liner Guide, 2006; Virginia TRC Research Report No. FHWA/VTRC 06R16.
 Notes: Proceed to Page 7 - Aperturances as necessary to complete the decision-making procedure. Expenses related to road closures and economic disruptions are not included in cost estimates presented here. If no suitable liner repair is available, the user should proceed to the localized man-entry repair or replacement selection matrix depending on circumstances.

Localized Man-Entry Repair Selection Matrix

This matrix presents cost estimates and limitations of some common localized man-entry repairs. See the sources noted below the table for more detailed discussion.

Rehabilitation Type	Cost Estimates Based on FLH Bid History	Rough Cost Estimates from Other Agencies	Maximum Size Limits	Other Limitations
Grouted Repair Sleeves or Short Cured-in-Place Sleeves (CIPP)	No Estimate Available	Low cost; \$2000 to \$5000 per CIPP repair for 18in. diameter	Up to 54in. diameter for CIPP; Up to 54in. for stainless steel; Up to 108 in. for PVC	Mechanical seals work poorly with helical and small diameter CMP; may fail if separated or offset joints present; CIPP available in 36 in. connectible lengths; can be used on deformed flexible pipes
Grouting voids	Medium Cost; \$330/cu.yd.	Low cost; \$10/lin.ft. for small voids; \$100-\$150/cu.yd. for large voids	N/A	Difficult to judge completeness of repair; toxicity with manned-entry
Crack Epoxy Injection/Mortar	No Estimate Available	Low cost	N/A	Toxicity with manned-entry; not recommended for cracks greater than 0.1in. wide
Crack/Spall Patching and Rebar Coating with epoxy grout	High Cost; General repair of concrete \$860/sq.yd. or \$2020/cu.yd.; epoxy coated rebar \$1.30/lb	Low cost	N/A	Toxicity with manned-entry; hand-applied above or underwater via man-entry; repair may only slow deterioration or be cosmetic
Joint Sealing with Expansion Gasket Seal Ring	No Estimate Available	Low cost	Up to 216in. diameter	No more than 10% displacement tolerated; more applicable to RCP than flexible pipe
Invert Lining	No Estimate Available	Medium Cost	N/A	Difficulties tying into host pipe; cement is subject to breakdown if runoff is acidic; modified high-strength concrete mix required; steel plating is best for CMP and RCP, but corrosion is concern
Repoint Masonry	Low Cost; \$55/sq.ft.	No Estimates Available	N/A	N/A

Sources: FLH Bid History from various departments, 1997 to present; USDA Forest Service Report on Trenchless Technologies; Pielh, 2005; Caltrans Supplement to FHWA Practices Manual Bulletin No. 83-01, 2006; Central FLH Culvert Pipe Limer Guide, 2005

Notes: Minimum diameter of 36 inches for man-entry relates to repair industry practices, and is more aggressive than the 48 inch minimum guideline established for FLH assessments by this culvert assessment and decision-making procedures manual. Proceed to Page 7 - Appurtenances as necessary to complete the decision-making procedure. Expenses related to road closures and economic disruptions are not included in cost estimates presented here.

Culvert Replacement Techniques Matrix

Replacement Type	Cost Estimates Based on FLH Bid History	Rough Cost Estimates from Other Agencies	Size Limits	Other Limitations
Pipe Bursting/Splitting	No Estimate Available	\$100 to \$200/lin.ft. for 18" diameter; \$850 per lin.ft. for 48" diameter	Up to 48" diameter possible; up to 24" diameter common	Host pipe must be brittle; access at culvert ends for machinery; CMP can be difficult; existing pipe must be round or semi-round
Plug old pipe and install new via Horizontal-Directional Drilling (HDD)	Plugging an existing culvert \$1600; No estimate available for drilling or augering methods	\$100 to \$300/lin.ft. for 18" diameter; \$300 to \$900 per lin.ft. for 36" diameter; \$50 to \$500/lin.ft. depending on size	Up to 48" diameter	Heavy equipment needed; ample access and space required at culvert ends for machinery and slurry pit, as well as full length of pipe (9' to 25' pit typ.); backstop necessary; boulders can obstruct and non-cohesive soils can collapse after drilling; must be round
Plug old pipe and install new via Horizontal-Auger Boring	No Estimate Available	\$200/lin.ft. for 18" diameter; \$1000 per lin.ft. for 60" diameter; \$3-\$6/in.diam./lin.ft.	Up to 72" diameter	Access and space required at culvert ends for machinery and slurry pit, as well as full length of pipe; backstop necessary; boulders can obstruct and non-cohesive soils can collapse; must be round
Plug old pipe and install new more shallow pipe or surface drain	No Estimate Available	No Estimate Available	Typically 30" diameter or less	Performance limitations typically associated with ditch relief culverts
Pipe Jacking/Ramming	Jacked 36 inch diameter concrete pipe \$1150/lin.ft.	\$260/lin.ft. for 24" diameter; \$5000 to \$6000 per lin.ft. for 10' diameter; ramming \$3-\$6/in.diam./lin.ft.; jacking \$5-\$15/in.diam./lin.ft.	24" to 48" diameter common for jacking (up to 10' diameter possible); 4" to 42" diameter common for ramming	Access and space required at culvert ends for machinery and slurry pit (10'-30' jack pit typ.); bulges and boulders can obstruct
Open-Trench Excavation	Roadway (channel) excavation \$25/cu.yd. and shoulder excavation \$60/cu.yd.; subexcavation \$20/cu.yd.; shoring and bracing \$90/sq.ft.; removing existing culvert \$1200 to \$13,000 (size and type dependent)	\$615/lin.ft. for busy 2-lane road with 15 ft embankment	None	Road or lane closure; run-off and environmental degradation; stream flow bypass necessary

Sources: FLH Bid History from various departments, 1997 to present; USDA Forest Service Report on Trenchless Technologies; Piehl, 2005; Caltrans Supplement to FHWA Practices Manual Bulletin No. 83-01, 2006; Central FLH Culvert Pipe Liner Guide, 2005.

Notes: Expenses related to road closures and economic disruptions are not included in cost estimates presented here

Level 1 Performance Problems - Causes and Fixes

Use this matrix to identify appropriate fixes for Level 1 performance problems identified in the assessment.

Problem	Indicators Seen In Field	Potential Causes	Recommended Fix
Maintenance/Clearing Needed	Debris or vegetation blocks 1/3 or more of rise at inlet	Buildup of debris or vegetation from one or more flow events or ongoing flow conditions	Clearing by client maintenance forces
Previous Overtopping	Drift on guardrail	Debris or vegetation blockage	Clearing by client maintenance forces, repair of any embankment damage
	Erosion on downstream side of embankment	Inlet Failure	Repair inlet as needed, repair any embankment damage as detailed below for inlet failure problem
	Loss of pavement, especially along downstream edge	Sediment blockage through barrel < 1/3 of rise Local sediment blockage @ inlet or outlet 1/3 to 3/4 rise	Clearing by client maintenance forces, repair of any embankment damage
Frequent Overtopping	Known maintenance history, report from client	Causes listed above for "previous overtopping"	See corresponding recommended fix above
Inlet Failure	Mitered inlet edge curled inward	Undersized culvert (if potential causes listed above are absent)	Perform hydrologic/hydraulic analysis to determine appropriate culvert size, replace if necessary
	Inlet barrel raised above streambed	Inadequate edge strength to resist soil pressure of embankment	Repair inlet as needed (unless culvert is to be replaced), add lateral support via headwall or slope paving
	Undermined culvert, apron, flared end section, or embankment slope	Unbalanced buoyancy uplift	Repair inlet as needed (unless culvert is to be replaced), add headwall for counterweight Repair damage, provide appropriate scour protection
Local Scour at Outlet		Scour protection needed but never provided Scour protection provided but failed	Repair or replace scour protection, see Decision Flowchart, Page 7, Appurtenances
Poor Channel Alignment	Damage to embankment and/or apron, wingwalls, or flared end section, and barrel axis skewed to channel by 45 degrees or more	Scour caused by poor angle of attack not adequately mitigated	Repair damage as needed, provide scour protection covering areas previously damaged, including embankment adjacent to end treatment and channel banks in vicinity of culvert/embankment

Level 2 Performance and Other Problems - Disciplines Required for Investigation

Use this table to determine the appropriate discipline(s) needed to conduct Level 2 investigations where needed.

Problem	Indicators Seen in Field	Disciplines Required for Investigation
Embankment Piping	Settlement or holes in roadway or embankment with no significant culvert barrel condition problems	Geotechnical
Channel Degradation	Perched inlet and/or outlet with adjacent channel banks vertical or unstable (sloughing)	Hydraulics
Headcut	Unstable channel drop of 2 feet height or more within sight of culvert	Hydraulics
Embankment Slope Instability	Failure of upstream embankment with channel skew angle less than 45 degrees to barrel axis or failure of downstream embankment not explained by overtopping or outlet scour	Geotechnical
Sediment Blockage and Channel Aggradation	Local sediment blockage > 3/4 rise at inlet or outlet	Hydraulics
	Full barrel length blocked 1/3 or more with sediment and culvert not designed intentionally for AOP	Hydraulics
No Access	Condition cannot be adequately assess by an end-only Level 1 inspection. Access is prevented by factors not remedied by routine maintenance.	Underwater or Climbing Inspector or other specialist and equipment
Aggressive Abrasion, Corrosion and/or Chemical Environment*	Poor or Critical condition reached in 5 years or less	Materials, Hydraulics, Geotechnical
AOP Culvert with Poor or Critical Condition Rating or with Performance Problem	Any action required due to performance problems or condition ratings	Environmental Resource Specialists and Hydraulics
Historical culvert with Poor or Critical Condition Rating or with a Performance Problem	Any action required due to performance problems or condition ratings	Cultural Resource Specialists and Hydraulics
Structural Cracking	Significant cracking that is suspected to compromise the structural integrity of the culvert and diminish load carrying capacity	Structural
Open-bottom culvert*	More than 10 feet of side of footing exposed. Any open-bottom culvert requiring action due to Poor or Critical condition ratings	Hydraulics, Geotechnical

* Item also noted in the condition assessment tables

E.5

**APPENDIX F – FLH BID-BASED COST DATA FOR CULVERT REPAIR
AND REPLACEMENT**

FLH Bid History Cost Estimates for Culvert Repair and Replacement Tasks

Sources: FLH Bid History from various departments, 1997 to present.

Notes: Average of low bids, up to four maximum, taken from the FLH Bid History from 1997-present for each line entry.

Average of all line entries for each item then taken. Note these are bid prices, not actual costs as-built. Expenses related to road closures and economic disruptions are not included in cost estimates presented here.

Average Cost	Units	Item Description
\$ 60.68	LNFT	12-INCH PIPE CULVERT
\$ 78.73	LNFT	15-INCH EQUIVALENT DIAMETER ARCH OR ELLIPTICAL PIPE
\$ 82.23	LNFT	18-INCH EQUIVALENT DIAMETER ARCH OR ELLIPTICAL PIPE
\$ 79.27	LNFT	18-INCH PIPE CULVERT
\$ 388.75	LNFT	18-INCH PIPE CULVERT (CORRUGATED METAL PIPE)
\$ 159.69	LNFT	21-INCH PIPE CULVERT
\$ 105.16	LNFT	24-INCH EQUIVALENT DIAMETER ARCH OR ELLIPTICAL PIPE
\$ 94.16	LNFT	24-INCH PIPE CULVERT
\$ 360.75	LNFT	24-INCH PIPE CULVERT (CORRUGATED METAL PIPE)
\$ 146.22	LNFT	24-INCH PIPE CULVERT (CONCRETE)
\$ 98.68	LNFT	30-INCH EQUIVALENT DIAMETER ARCH OR ELLIPTICAL PIPE
\$ 101.81	LNFT	30-INCH PIPE CULVERT
\$ 231.25	LNFT	30-INCH PIPE CULVERT (CORRUGATED METAL PIPE)
\$ 130.67	LNFT	30-INCH PIPE CULVERT (CONCRETE)
\$ 90.90	LNFT	36-INCH EQUIVALENT DIAMETER ARCH OR ELLIPTICAL PIPE
\$ 119.36	LNFT	36-INCH PIPE CULVERT
\$ 240.00	LNFT	36-INCH PIPE CULVERT (CORRUGATED METAL PIPE)
\$ 9,797.69	EACH	36-INCH PIPE CULVERT
\$ 101.28	LNFT	42-INCH EQUIVALENT DIAMETER ARCH OR ELLIPTICAL PIPE
\$ 135.90	LNFT	42-INCH PIPE CULVERT
\$ 7,700.00	EACH	42-INCH PIPE CULVERT
\$ 189.96	LNFT	48-INCH EQUIVALENT DIAMETER ARCH OR ELLIPTICAL PIPE
\$ 141.66	LNFT	48-INCH PIPE CULVERT
\$ 226.67	LNFT	48-INCH PIPE CULVERT (CONCRETE)
\$ 279.25	LNFT	48-INCH PIPE CULVERT (CORRUGATED METAL PIPE)
\$ 10,224.33	EACH	48-INCH PIPE CULVERT
\$ 121.92	LNFT	54-INCH EQUIVALENT DIAMETER ARCH OR ELLIPTICAL PIPE
\$ 209.95	LNFT	54-INCH PIPE CULVERT
\$ 158.56	LNFT	60-INCH PIPE CULVERT
\$ 12,398.00	EACH	60-INCH PIPE CULVERT
\$ 936.97	LNFT	66-INCH EQUIVALENT DIAMETER ARCH OR ELLIPTICAL PIPE
\$ 218.76	LNFT	66-INCH PIPE CULVERT
\$ 12,682.67	EACH	66-INCH PIPE CULVERT
\$ 326.71	LNFT	72-INCH EQUIVALENT DIAMETER ARCH OR ELLIPTICAL PIPE
\$ 206.06	LNFT	72-INCH PIPE CULVERT
\$ 13,365.17	EACH	72-INCH PIPE CULVERT
\$ 264.63	LNFT	78-INCH EQUIVALENT DIAMETER ARCH OR ELLIPTICAL PIPE
\$ 87.59	LNFT	78-INCH PIPE CULVERT
\$ 515.20	LNFT	84-INCH PIPE CULVERT
\$ 603.29	LNFT	144-INCH PIPE CULVERT
\$ 1,650.30	EACH	CLEANING CULVERT IN PLACE
\$ 4.01	SOYD	CLEARING AND GRUBBING
\$ 18,823.13	EACH	CONCRETE, HEADWALL (36-INCH PIPE CULVERT)
\$ 17,839.13	EACH	CONCRETE, HEADWALL (QUADRUPLE PIPE CULVERT)
\$ 4,825.00	EACH	CONCRETE, HEADWALL FOR 15-INCH PIPE CULVERT
\$ 7,286.05	EACH	CONCRETE, HEADWALL FOR 18-INCH PIPE CULVERT
\$ 4,127.22	EACH	CONCRETE, HEADWALL FOR 24-INCH PIPE CULVERT
\$ 3,686.03	EACH	CONCRETE, HEADWALL FOR 30-INCH PIPE CULVERT
\$ 5,044.18	EACH	CONCRETE, HEADWALL FOR 36-INCH PIPE CULVERT
\$ 3,800.00	EACH	CONCRETE, HEADWALL FOR 42-INCH PIPE CULVERT
\$ 7,922.81	EACH	CONCRETE, HEADWALL FOR 48-INCH PIPE CULVERT
\$ 11,298.33	EACH	CONCRETE, HEADWALL FOR 54-INCH PIPE CULVERT
\$ 8,881.04	EACH	CONCRETE, HEADWALL FOR 60-INCH PIPE CULVERT
\$ 45,991.50	EACH	CONCRETE, HEADWALL FOR 78-INCH PIPE CULVERT
\$ 31,700.00	EACH	CONCRETE, HEADWALL FOR 84-INCH
\$ 12,403.05	EACH	CONCRETE, HEADWALL FOR DOUBLE 30-INCH PIPE CULVERT
\$ 6,736.36	EACH	CONCRETE, HEADWALL FOR DOUBLE 24-INCH PIPE CULVERT
\$ 217.18	LNFT	CORING/PRESSURE GROUTING
\$ 6,452.87	EACH	DEBRIS RACK
\$ 13.21	LNFT	DITCH, EXCAVATION
\$ 14.71	CUYD	DITCH, EXCAVATION
\$ 3.54	LNFT	DITCH, EXCAVATION, FURROW
\$ 23.52	CUYD	EMBANKMENT CONSTRUCTION
\$ 396.66	EACH	END SECTION FOR 12-INCH PIPE CULVERT
\$ 437.72	EACH	END SECTION FOR 18-INCH PIPE CULVERT
\$ 684.99	EACH	END SECTION FOR 21-INCH PIPE CULVERT
\$ 636.26	EACH	END SECTION FOR 24-INCH EQUIVALENT DIAMETER ARCH OR ELLIPTICAL PIPE CULVERT
\$ 485.09	EACH	END SECTION FOR 24-INCH PIPE CULVERT
\$ 761.93	EACH	END SECTION FOR 24-INCH PIPE CULVERT
\$ 750.00	EACH	END SECTION FOR 24-INCH CULVERT , ASPHALT COATED
\$ 1,500.00	EACH	END SECTION FOR 24-INCH PIPE CULVERT (CORRUGATED METAL PIPE)
\$ 878.25	EACH	END SECTION FOR 24-INCH PIPE CULVERT (CONCRETE)
\$ 496.94	EACH	END SECTION FOR 30-INCH EQUIVALENT DIAMETER ARCH OR ELLIPTICAL PIPE CULVERT
\$ 658.54	EACH	END SECTION FOR 30-INCH PIPE CULVERT
\$ 524.92	EACH	END SECTION FOR 36-INCH EQUIVALENT DIAMETER ARCH OR ELLIPTICAL PIPE CULVERT
\$ 758.51	EACH	END SECTION FOR 36-INCH PIPE CULVERT
\$ 2,182.00	EACH	END SECTION FOR 42-INCH EQUIVALENT DIAMETER ARCH OR ELLIPTICAL PIPE CULVERT
\$ 1,404.17	EACH	END SECTION FOR 48-INCH EQUIVALENT DIAMETER ARCH OR ELLIPTICAL PIPE CULVERT
\$ 1,221.65	EACH	END SECTION FOR 48-INCH PIPE CULVERT
\$ 1,883.33	EACH	END SECTION FOR 48-INCH PIPE CULVERT (CONCRETE)
\$ 2,154.50	EACH	END SECTION FOR 54-INCH PIPE CULVERT
\$ 1,377.06	EACH	END SECTION FOR 60-INCH PIPE CULVERT
\$ 3,969.50	EACH	END SECTION FOR 72-INCH PIPE CULVERT
\$ 426.67	EACH	EQUIVALENT DIAMETER ARCH OR ELLIPTICAL PIPE CULVERT
\$ 444.30	EACH	EQUIVALENT DIAMETER ARCH OR ELLIPTICAL PIPE CULVERT
\$ 200.73	CUYD	GABIONS, GALVANIZED OR ALUMINIZED COATED
\$ 286.70	CUYD	GABIONS, POLYVINYL CHLORIDE COATED
\$ 326.02	CUYD	GROUT
\$ 132.68	LNFT	GROUT PIPE
\$ 152.92	CUYD	GROUTED RIPRAP, CLASS 1
\$ 294.42	CUYD	GROUTED RIPRAP, CLASS 2
\$ 508.98	CUYD	GROUTED RIPRAP, CLASS 3
\$ 176.37	CUYD	GROUTED RIPRAP, CLASS 4
\$ 146.88	CUYD	GROUTED RIPRAP, CLASS 5
\$ 700.00	CUYD	GROUTED RIPRAP, CLASS 6
\$ 4,602.88	EACH	INLET
\$ 1,293.96	EACH	INLET ADJUSTMENT
\$ 3,550.00	EACH	Inlet Caltrans type ODI
\$ 2,041.88	EACH	INLET MODIFICATION
\$ 736.34	EACH	INLET TOP, METAL FRAME AND GRATE TYPE A
\$ 1,166.32	EACH	INLET TOP, METAL FRAME AND GRATE TYPE B
\$ 2,483.56	EACH	INLET, CALTRANS
\$ 4,729.17	EACH	INLET, CALTRANS (TYPE G0)
\$ 4,141.50	EACH	INLET, CALTRANS (TYPE G1, W/GRANITE COPING STONE)
\$ 3,030.19	EACH	INLET, TYPE 1

FLH Bid History Cost Estimates for Culvert Repair and Replacement Tasks

Sources: FLH Bid History from various departments, 1997 to present.

Notes: Average of low bids, up to four maximum, taken from the FLH Bid History from 1997-present for each line entry.

Average of all line entries for each item then taken. Note these are bid prices, not actual costs as-built. Expenses related to

Average Cost Estimate	Units	Item Description
\$ 3,459.00	EACH	INLET, TYPE 2
\$ 3,116.25	EACH	INLET, TYPE 2, DOUBLE GRATE
\$ 2,325.00	EACH	INLET, TYPE 2A
\$ 3,239.00	EACH	INLET, TYPE 6A MODIFIED
\$ 2,069.85	EACH	INLET, TYPE 6B
\$ 3,402.19	EACH	INLET, TYPE 6B
\$ 2,497.50	EACH	INLET, TYPE GOL-2.1
\$ 1,150.00	LNFT	JACKED CONCRETE 36-INCH PIPE CULVERT
\$ 408.75	LNFT	LINING 24-INCH PIPE CULVERT (CEMENT-MORTAR SPRAY-ON)
\$ 361.25	LNFT	LINING 18-INCH PIPE CULVERT (CEMENT-MORTAR SPRAY-ON)
\$ 460.00	LNFT	LINING 30-INCH PIPE CULVERT (CEMENT-MORTAR SPRAY-ON)
\$ 139.23	LNFT	LINING 18-INCH PIPE CULVERT
\$ 168.63	LNFT	LINING 24-INCH PIPE CULVERT
\$ 150.35	LNFT	LINING 30-INCH PIPE CULVERT
\$ 125.33	LNFT	LINING 36-INCH PIPE CULVERT
\$ 125.73	LNFT	LINING 48-INCH PIPE CULVERT
\$ 207.88	LNFT	LINING 60-INCH PIPE CULVERT
\$ 6,600.45	EACH	OUTLET STRUCTURE
\$ 4.98	SOYD	PAVING GEOTEXTILE
\$ 106.92	CUYD	PLACED RIPRAP, CLASS 1
\$ 123.27	CUYD	PLACED RIPRAP, CLASS 2
\$ 113.38	CUYD	PLACED RIPRAP, CLASS 3
\$ 92.35	CUYD	PLACED RIPRAP, CLASS 4
\$ 62.74	CUYD	PLACED RIPRAP, CLASS 5
\$ 58.97	TON	PLACED RIPRAP, CLASS 6
\$ 66.90	CUYD	PLACED RIPRAP, CLASS 6
\$ 117.81	CUYD	PLACED RIPRAP, CLASS 7
\$ 1,567.95	EACH	PLUG, EXISTING PIPE
\$ 19.58	LNFT/SQFT	PRECAST REINFORCED CONCRETE BOX CULVERT
\$ 53.33	LNFT/SQFT	REINFORCED CONCRETE BOX CULVERT, DOUBLE BARREL
\$ 50.79	LNFT/SQFT	REINFORCED CONCRETE BOX CULVERT, TRIPLE BARREL
\$ 172.53	SQFT	REINFORCED CONCRETE RETAINING WALL, 4 FEET
\$ 180.19	SQFT	REINFORCED CONCRETE RETAINING WALL, 6 FEET
\$ 140.58	SQFT	REINFORCED CONCRETE RETAINING WALL, 8 FEET
\$ 142.04	SQFT	REINFORCED CONCRETE RETAINING WALL, 10 FEET
\$ 149.42	SQFT	REINFORCED CONCRETE RETAINING WALL, 12 FEET
\$ 162.55	SQFT	REINFORCED CONCRETE RETAINING WALL, 14 FEET
\$ 110.90	SQFT	REINFORCED CONCRETE RETAINING WALL, 15 FEET
\$ 237.00	SQFT	REINFORCED CONCRETE RETAINING WALL
\$ 272.50	SQFT	REINFORCED CONCRETE RETAINING WALL (GRANITE VENEER)
\$ 220.17	SOYD	REINFORCED SHOTCRETE, 12-INCH DEPTH
\$ 1.28	LB	REINFORCING STEEL, EPOXY COATED
\$ 233.06	EACH	REMOVAL OF BOULDER
\$ 12,964.80	EACH	REMOVAL OF BOX CULVERT
\$ 1,666.16	EACH	REMOVAL OF HEADWALL
\$ 943.30	REMOVAL OF IN	REMOVAL OF INLET
\$ 1,161.80	EACH	REMOVAL OF PIPE CULVERT
\$ 285.43	EACH	REMOVAL OF PIPE END SECTION
\$ 83.61	SOYD	REMOVAL OF WALL
\$ 219.25	SOYD	REMOVAL OF WALL (MSE)
\$ 5,000.00	LPSM	REMOVAL OF WINGWALL CONCRETE
\$ 2,473.58	CUYD	REMOVE AND RESET STONE MASONRY HEADWALL
\$ 4,465.45	EACH	REMOVE AND RESET STONE MASONRY HEADWALL
\$ 2,743.33	EACH	REMOVE AND RESET, TERMINAL SECTION
\$ 154.24	LNFT	REMOVING, CLEANING, AND RELAYING CULVERT
\$ 857.03	SOYD	REPAIR CONCRETE
\$ 2,017.46	CUYD	REPAIR CONCRETE
\$ 53.88	SQFT	REPOINT STONE MASONRY
\$ 126.11	SOYD	REVEAT MATTRESS, GALVANIZED OR ALUMINIZED COATED
\$ 99.20	SOYD	REVEAT MATTRESS, POLYVINYL CHLORIDE COATED
\$ 9.82	LNFT	RIPRAP DITCH, CLASS 1
\$ 32.04	LNFT	RIPRAP DITCH, CLASS 2
\$ 26.44	LNFT	RIPRAP DITCH, CLASS 3
\$ 24.74	CUYD	ROADWAY EXCAVATION (CHANNEL EXCAVATION)
\$ 808.49	CUYD	RUBBLE MASONRY, COURSE POINTED FINISH
\$ 1,176.65	CUYD	RUBBLE MASONRY, ROCK FACE FINISH
\$ 89.97	SQFT	SHORING AND BRACING
\$ 282.90	CUYD	SHOTCRETE
\$ 250.00	SOYD	SHOTCRETE (SCULPTED FACE FINISH)
\$ 4.22	LNFT	SHOULDER, EXCAVATION
\$ 58.40	CUYD	SHOULDER, EXCAVATION
\$ 1,100.00	SOYD	SLOPE PAVING, STONE
\$ 3,763.35	EACH	STONE MASONRY HEADWALL FOR 18-INCH PIPE CULVERT (WITH CUTOFF WALL)
\$ 4,810.40	EACH	STONE MASONRY HEADWALL FOR 24-INCH PIPE CULVERT
\$ 8,950.00	EACH	STONE MASONRY HEADWALL FOR 30-INCH PIPE CULVERT (WITH CUTOFF WALL)
\$ 6,184.63	EACH	STONE MASONRY HEADWALL FOR 36-INCH PIPE CULVERT
\$ 1,587.27	LNFT	STRUCTURAL PLATE BOX
\$ 1,234.46	LNFT	STRUCTURAL PLATE PIPE-ARCH
\$ 19.69	CUYD	SUBEXCAVATION
\$ 3,885.55	EACH	TERMINAL END, TYPE FLARED END
\$ 842.14	EACH	TERMINAL END, TYPE ROUND END
\$ 2,888.25	EACH	TERMINAL SECTION TYPE TANGENT
\$ 3,246.83	EACH	TERMINAL SECTION, TYPE 1
\$ 27,500.00	EACH	TERMINAL SECTION, TYPE BAT
\$ 3,799.19	EACH	TERMINAL SECTION, TYPE BET
\$ 4,788.52	EACH	TERMINAL SECTION, TYPE FAT-30
\$ 2,461.78	EACH	TERMINAL SECTION, TYPE FLARED
\$ 3,000.74	EACH	TERMINAL SECTION, TYPE G4-BAT
\$ 2,016.25	EACH	TERMINAL SECTION, TYPE G4-CRT
\$ 9,825.00	EACH	TERMINAL SECTION, TYPE SBT-BAT
\$ 6,625.00	EACH	TERMINAL SECTION, TYPE SBT-FAT
\$ 33.01	LNFT	UTILITY TRENCH TYPE A (WATER)
\$ 58.91	LNFT	UTILITY TRENCH TYPE B (COMMON)
\$ 56.67	LNFT	UTILITY TRENCH TYPE C (POWER)
\$ 59.14	LNFT	UTILITY TRENCH TYPE D (SANITARY)
\$ 62.48	LNFT	UTILITY TRENCH TYPE E
\$ 58.09	LNFT	UTILITY TRENCH TYPE F

APPENDIX G – BIBLIOGRAPHY

Appendix G - Bibliography for FHWA FLH Culvert Assessment and Decision-Making Procedure Manual

1. American Association of State Highway and Transportation Officials (AASHTO). "Highway Drainage Guidelines: Volume XIV, Culvert Inspection Material Selection and Rehabilitation." 1999.
2. Arnoult, James D. "Culvert Inspection Manual – Supplement to the Bridge Inspector's Training Manual." Report No. FHWA-IP-86-2, USDOT, FHWA, 1986.
3. Ballinger, C.A. and Drake, P.G. "Culvert Repair Practices Manual: Volumes I and II." Federal Highway Administration Report No. FHWA-RD-94-096, Washington D.C., 1995.
4. Beaver, J.L., McGrath, T.J. "Management of Utah Highway Culverts." Transportation Research Board Journal, Volume 1904, 2005.
5. Cahoon, J. E., Baker, D., and Carson, J., "Factors for Rating Conditions of Culverts for Repair or Replacement Needs." Transportation Research Record: Journal of Transportation Research Board, Vol. 1814, National Research Council, Washington, D. C., 2002, Pg. 197-202.
6. California Department of Transportation. Office of Culvert Program Manager – Statewide Coordinator. Phone Interview with Manual Morales, November 14, 2008.
7. California Department of Transportation. Office of State Highway Drainage Design. "Caltrans Supplement to FHWA Culvert Repair Practices Manual." State of California Design Information Bulletin No.83-01, 2006.
8. California Department of Transportation. Office of Highway Drainage Design. "Evaluation of Abrasion Resistance of Pipe and Pipe Lining Materials", 2007.
9. Childs, K.M. "Underwater Investigations Standards Practice Manual." American Society of Civil Engineers Manuals and Reports on Engineering Practice No. 101, 2001.
10. Donaldson, B.M. and Baker, A.J. "Understanding the Environmental Implications of Cured-in-Place Pipe Rehabilitation Technology." Federal Highway Administration Report No. FHWA/VTRC 08-R16. Washington D.C., 2008.
11. Federal Highway Administration. "Culvert Design. A Training Course on Hydraulic Design Series No. 5. Instructors' Guide." NHI Course 135056. Publication No. FHWA-NHI-10-053. April 2010.
12. Federal Highway Administration. "Hydraulic Design of Highway Culverts, Hydraulic Design Series No. 5 (HDS-5)." FHWA-NHI-01-020, Washington, D.C., 2001/2005.

Appendix G - Bibliography for FHWA FLH Culvert Assessment and Decision-Making Procedure Manual

13. Federal Highway Administration, Central Division of Federal Lands Highway. Phone and Written Interviews with Bart Bergendahl, Mathew DeMarco, Scott Hogan, Bob Johnson, Heidi Hirsbrunner, Pat Flynn, Mark Taylor and Mark Meng. November, 2008.
14. Federal Highway Administration, Eastern Division of Federal Lands Highway. Phone and Written Interviews with Brian Beucler, Greg Dolson, Jeff Slater, John Seabrook, Jeff Johnson, Kevin Rose, David Dajc, Mark Miller, Nelson Clark, Brian Lawrence and Abbie Ginsberg. December, 2008.
15. Federal Highway Administration, Western Division of Federal Lands Highway. Phone and Written Interviews with Karl Gleason, Grant Lindsey, Chuck Mikkola and Sven Leon. January, 2009.
16. Gassman, Schroeder and Ray. "Performance Evaluation of High-Density Polyethylene Culvert Pipe." TRR 1814, 2002.
17. Haeffner, Brian. Missouri Department of Transportation. "Alternate Pipe Materials – Responses from State DOT Hydraulic Contacts". June 9, 2003.
18. Hartle, R., W. Amrhein, K. Wilson, D. Baughman, and J. Tkacs, "Bridge Inspector's Training Manual 90." FHWA Report PD-91-015, Federal Highway Administration, Washington, D.C., 1995.
19. Joseph, P. Jr., and Dwivedi, R. "A Need for Culvert Asset Management." Transportation Research Record: Journal of the Transportation Research Board, No. 1957, 2005, Pg 8-15.
20. Kelly, S.W. "Underwater Inspection Criteria." Naval Facilities Engineering Service Center, 1999.
21. Hotchkiss, Rollins H., and Frei, Chistopher M., Office of Infrastructure Research and Development, Federal Highway Administration. "Design for Fish Passage at Roadway-Stream Crossings: Synthesis Report". Prepared by Washington State University and Brigham Young University, June, 2007.
22. Lewis, David J., Tate, Kenneth W., Harper, John M., Price, Julie. "Survey Identifies Sediment Sources in North Coast Rangelands". California Agriculture, University of California Davis, July-August, 2001.
23. Meegoda, J.N., Juliano, T.M., Tang, Chi. "Culvert Information Management System." Transportation Research Board, Record 2108, 2009.

Appendix G - Bibliography for FHWA FLH Culvert Assessment and Decision-Making Procedure Manual

24. Meegoda, J.N., Juliano, T.M., Ratnaweera, P., Abdel-Malek, L. "Framework for Inspection, Maintenance, and Replacement of Corrugated Steel Culvert Pipes." Transportation Research Board, Volume 1911, 2005.
25. Midwest Regional University Transportation Center, College of Engineering, Department of Civil and Environmental Engineering, University of Wisconsin. "Use of Trenchless Technologies for Comprehensive Asset management of Culverts and Drainage Structures, Project 07-15." Prepared by Principal Authors Dr. Sam Salem (University of Cincinnati) and Dr. Mohammad Najafi (University of Texas), August, 2008.
26. Minnesota State Department of Transportation. Offices of HYDINFRA Coordinator, Bridge Hydraulics. Phone Interview with Bonnie Peterson, Andrea Hendrickson, and Lisa Taylor, December, 2008.
27. Minnesota State Department of Transportation. Bridge Office/Hydraulics Automation Unit. "HYDINFRA Condition Rating Guide, Version 5.1.", <http://dot.state.mn.us/bridge/Hydraulics/HydInfra.html>, December 10, 2007.
28. Missouri Department of Transportation. "Effectiveness of Metal and Concrete Pipe Currently Installed in Missouri – Phase 2". Final Report RI07-058, 2008.
29. Missouri Department of Transportation. "Installation and Initial Performance of 60 Inch ADS N-12HC® HDPE Pipes".
30. Mitchell, G., Masada, T., Sargand, S., Tarawneh, B., Stewart, K., Mapel, S., and Roberts, J. "Risk Assessment and Update of Inspection Procedures for Culverts." Ohio Research Institute for Transportation and the Environment (ORITE), Russ College of Engineering and Technology, Ohio University, 2005.
31. National Cooperative Highway Research Program (NCHRP) Synthesis Report No. 254, "Service Life of Drainage Pipe", Transportation Research Board, National Research Council, Washington, D.C., 1998.
32. National Corrugated Steel Pipe Association (NCSPA), "Evaluation Methodology for CSP Coating/Invert Treatments", Final Report, March 1996.
33. National Corrugated Steel Pipe Association (NCSPA), "Invert Abrasion Testing of CSP Coatings", March 2002.
34. National Corrugated Steel Pipe Association (NCSPA), "Field Performance Evaluation of Polymer Coated CSP Structures in New York", March 2002.

Appendix G - Bibliography for FHWA FLH Culvert Assessment and Decision-Making Procedure Manual

35. New York City Economic Development Corporation Waterfront Facilities Maintenance Management System. "Inspection Guidelines Manual." Prepared by Han Padron, October, 1999.
36. New York Department of Transportation, "Bridge Inspection Manual", 1997.
37. New York State Department of Transportation. "Standard Specifications Section 600: Incidental Construction subsection 602-Rehabilitation of Culvert and Storm Drain Pipe." May 1, 2008.
38. Ohio Department of Transportation (ODOT). "Culvert Management Manual," Columbus, OH, 2005.
39. Ohio Department of Transportation. Office of Structural Engineering. Phone Interview with David Riley, Rebecca Humphreys, and John Stains, November, 2008.
40. Oregon State Department of Transportation. Offices of Unit Manager for Asset Management and Geo Env Division Tech Service. Phone Interview with Paul Wirfs and Rob Travis, December, 2008.
41. Oregon State Department of Transportation Engineering and Asset Management, Unit Geo-Environmental Section. "Hydraulics Manual (Part 2/Chapter 16)." 2005.
42. Pennsylvania Department of Transportation, "Drainage Condition Survey Field Manual." Publication 73, Harrisburg, 1999.
43. Perrin, Joseph Jr. and Dwivedi, Rajesh. "Need for Culvert Asset Management." TRB Record No. 1957. Prepared by University of Utah Civil and Environmental Engineering Management, 2006.
44. Piehl, Rob. "Summary of Trenchless Technology for Use with USDA Forest Service Culverts." Department of Agriculture, Forest Service, San Dimas Technology and Development Center, San Dimas, CA, U.S, 2005.
45. Public Works Canada – Design and Construction, Transport Canada – Harbours and Ports, "Guidelines for Inspection and Maintenance of Marine Facilities." 1985.
46. Ryan, T.W., Hartle, R.A., Mann, J.E. and Danovich, L.J. "Bridge Inspector's Reference Manual (BIRM)." Report No. FHWA NHI 03-001, Federal Highway Administration, Washington, DC, 2002/2006.
47. State of Florida Department of Transportation, Culvert Service Life Estimator Software

Appendix G - Bibliography for FHWA FLH Culvert Assessment and Decision-Making Procedure Manual

48. State of Florida Department of Transportation. Office of Design, Drainage Section. "Culvert Design Handbook". Tallahassee: State of Florida, 2004.
49. Thornton, C.I., Robeson, M.D., Girard, L.G. and Smith, B. A. "Culvert Pipe Liner Guide and Specifications." Federal Highway Administration Report No. FHWA-CFL/TD-05-003, 2005.
50. United States Army Corps of Engineers (USACE). "Engineering and Design: Conduits, Culverts, and Pipes Engineering Manual." 1110-2-2902, 2004.
51. United States Forest Service. "FishXing Software for the Evaluation and Design of Culverts for Fish Passage". <http://www.stream.fs.fed.us/fishxing/>.
52. Vermont Agency of Transportation. "Environmental Field Handbook for Vermont Agency of Transportation Culvert & Ditch Procedures." June 2002.
53. Virginia Transportation Research Council (VTRC). "Research Report No. FHWA/VTRC 08-R16: Understanding the Environmental Implications of Cured-in-Place Rehabilitation Technology." May 2008.
54. Washington State Department of Fish and Wildlife. "Design of Road Culverts for Fish Passage". 2003.
55. Washington State Department of Transportation. "Levels of Culvert Inspections". Drainage Facilities Inspection Program. <http://www.wsdot.wa.gov/mapsdata/tdo/PDF_and_ZIP_Files/Culvert_Inspection_Levels.pdf>, October 22, 2008.
56. Wisconsin Department of Transportation. "Bridge Inspection Pocket Manual". August, 2003.
57. Wissink, K., McKee, M., Houghtalen, R., Sutterer, K. "Simple Rating System for Identification of Failure-Critical Culverts and Small Structures." Transportation Research Record: Journal of the Transportation Research Board, No. 1928, 2005, Pg 226-229.
58. Wyant, D.C. "NCHRP Synthesis 303, Assessment and Rehabilitation of Existing Culverts." Transportation Research Board, National Research Council, Washington, D.C., 2002.
59. Wyoming Department of Environmental Quality. Abandoned Mine Land Division (AML). Fraser Draw Reclamation Project. <http://deq.state.wy.us/out/aml.fraserdrawproject2006.htm>.

