

SNAP (SOIL NAIL ANALYSIS PROGRAM) User's Manual

Publication No. FHWA-CFL/TD-10-004

September 2010

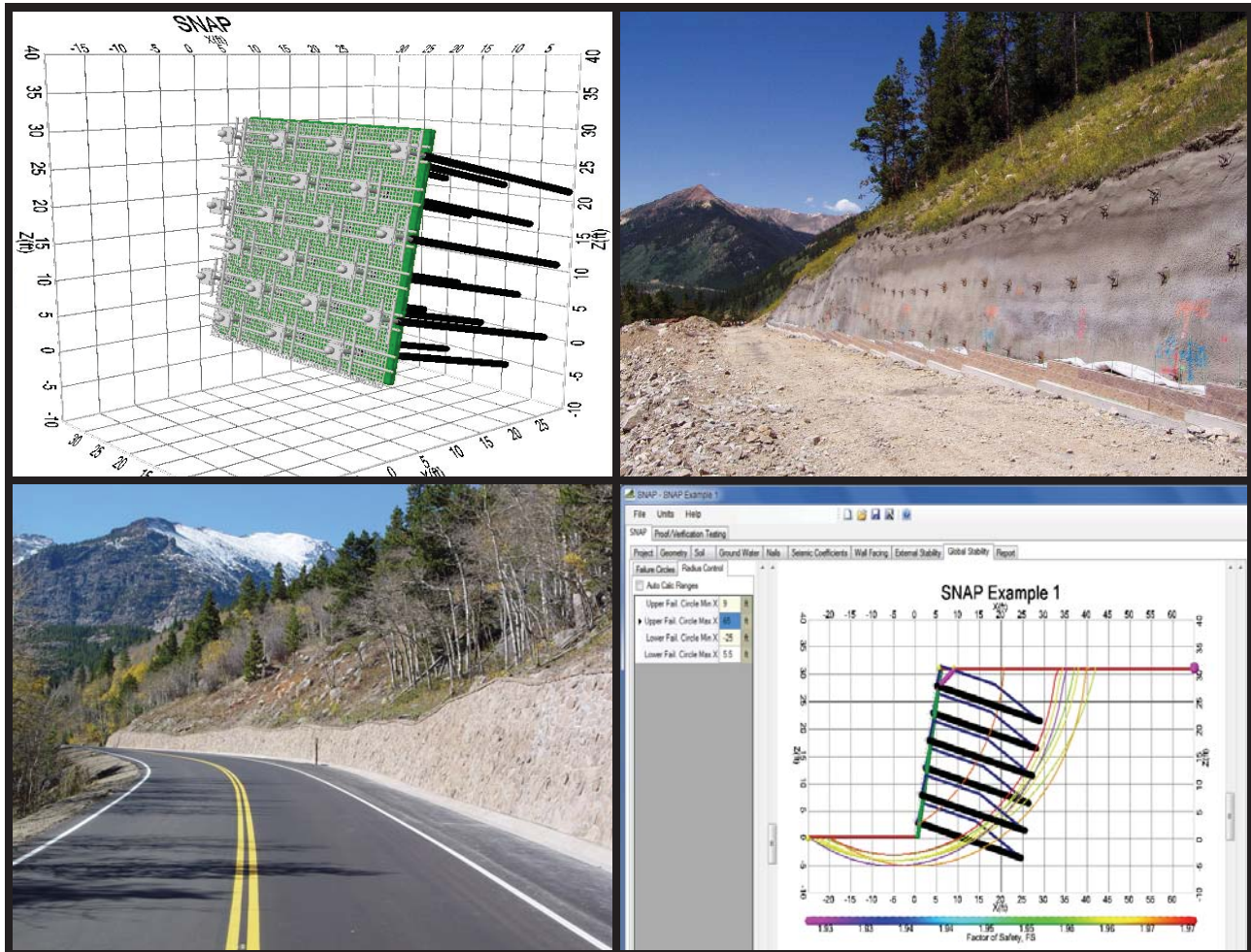

U.S. Department
of Transportation
**Federal Highway
Administration**



Central Federal Lands Highway Division
12300 West Dakota Avenue
Lakewood, CO 80228

FOREWORD

The Office of Federal Lands Highway (FLH) of the Federal Highway Administration (FHWA) promotes development and deployment of applied research and technology applicable to solving transportation related issues on Federal Lands. The FLH provides technology delivery, innovative solutions, recommended best practices, related information, and knowledge sharing to Federal agencies, Tribal governments, and other offices within the FHWA.

The current design process for soil nail earth retention systems is inefficient because multiple tools are needed for facing, internal, external, and global design. These tools do not communicate with one another, and are often used by different staff members. The main objective of this work was to develop a single State-of-Practice computer program for designing the entire soil nail earth retaining structure, including nail elements, facing elements, global stability, and evaluation of internal and external wall stability based on the current AASHTO design standards. By combining all these assessment tools into one package, we take another step towards assuring high quality and efficient designs and accelerating project delivery.

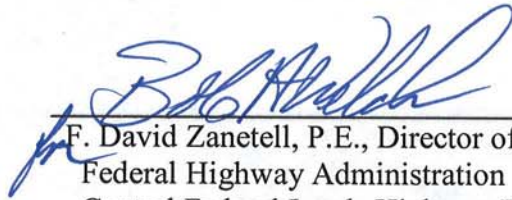

F. David Zanetell, P.E., Director of Project Delivery
Federal Highway Administration
Central Federal Lands Highway Division

Notice

This document is disseminated under the sponsorship of the U.S. Department of Transportation in the interest of information exchange. The U.S. Government assumes no liability for the use of the information contained in this document.

The U.S. Government does not endorse products or manufacturers. Trademark or manufacturers' name appear in the document only because they are considered essential to the objective of the document.

Quality Assurance Statement

The FHWA provides high-quality information to serve Government, industry, and the public in a manner that promotes public understanding. Standards and policies are used to ensure and maximize the quality, objectivity, utility, and integrity of its information. The FHWA periodically reviews quality issues and adjusts its program and processes to ensure continuous quality improvement.

Technical Report Documentation Page

1. Report No. FHWA-CFL/TD-10-004		2. Government Accession No.		3. Recipient's Catalog No.	
4. Title and Subtitle <i>SNAP (Soil Nail Analysis Program) User's Manual</i>				5. Report Date September 2010	
				6. Performing Organization Code J2009-05	
7. Author(s) Rick Andrew, Howard Hume, Sara Hansen, Ben Arndt, and Paul Macklin (Yeh and Associates, Inc.), Alan Rock (Summit Peak Technologies, LLC.), Runing Zhang (Metropolitan State College of Denver)				8. Performing Organization Report No.	
9. Performing Organization Name and Address Yeh and Associates, Inc. 5700 E. Evans Avenue Denver, CO 80222				10. Work Unit No. (TRAVIS)	
				11. Contract or Grant No. DTFH68-07-D-00001	
12. Sponsoring Agency Name and Address Federal Highway Administration Central Federal Lands Highway Division 12300 W. Dakota Avenue, Suite 210 Lakewood, CO 80228				13. Type of Report and Period Covered Final Report April 2008 – September 2010	
				14. Sponsoring Agency Code HFTS-16.4	
15. Supplementary Notes COTR: Khamis Haramy, FHWA-CFLHD. Advisory Panel Members: Roger Surdahl, FHWA-CFLHD; Barry Siel, FHWA-RC; Khalid Mohamed and Rich Barrows, FHWA-WFLHD. This project was funded under the FHWA Federal Lands Highway Coordinated Technology Implementation Program (CTIP).					
16. Abstract <p>Soil nail walls are internally stabilized earth-retaining structures. Soil nail walls use a top-down construction with in situ reinforcement to support temporary or permanent excavations. In certain conditions, soil nailing is a viable alternative to other ground anchor systems, considering technical feasibility, cost, and construction duration.</p> <p>Although the use of soil nail walls for highway applications has increased dramatically in the past decade, computer programs for the design of soil nail walls are not up to date. The main objective of this work is to develop a state-of-the-practice computer program (<u>Soil Nail Analysis Program</u>) for designing all components of soil nail retaining structures, including nail and facing elements. The program will evaluate the internal and external wall stability (including limit-equilibrium global slope stability) based on the current standards in the ASD method. In addition, the program may be used to evaluate verification and proof field test results. All design and evaluation procedures are according to the FHWA guidelines presented in 1) The Manual for Design and Construction of Soil Nail Walls, Report No. FHWA-SA-96-069R, and 2) Geotechnical Engineering Circular No. 7 - Soil Nail Walls, Report No. FHWA-IF-03-017.</p> <p>This user's manual discusses the theoretical basis for the computer program, gives a comparison of available soil nail wall design guidelines, discusses program execution including inputs and outputs, and includes two worked examples to demonstrate use of the program.</p>					
17. Key Words SOIL NAIL, COMPUTER PROGRAM, GLOBAL STABILITY, EXTERNAL STABILITY, INTERNAL STABILITY				18. Distribution Statement No restriction. This document is available to the public from the sponsoring agency at the website http://www.cflhd.gov .	
19. Security Classif. (of this report) Unclassified		20. Security Classif. (of this page) Unclassified		21. No. of Pages 118	22. Price

SI* (MODERN METRIC) CONVERSION FACTORS

APPROXIMATE CONVERSIONS TO SI UNITS

Symbol	When You Know	Multiply By	To Find	Symbol
LENGTH				
in	inches	25.4	millimeters	mm
ft	feet	0.305	meters	m
yd	yards	0.914	meters	m
mi	miles	1.61	kilometers	km
AREA				
in ²	square inches	645.2	square millimeters	mm ²
ft ²	square feet	0.093	square meters	m ²
yd ²	square yard	0.836	square meters	m ²
ac	acres	0.405	hectares	ha
mi ²	square miles	2.59	square kilometers	km ²
VOLUME				
fl oz	fluid ounces	29.57	milliliters	mL
gal	gallons	3.785	liters	L
ft ³	cubic feet	0.028	cubic meters	m ³
yd ³	cubic yards	0.765	cubic meters	m ³
NOTE: volumes greater than 1000 L shall be shown in m ³				
MASS				
oz	ounces	28.35	grams	g
lb	pounds	0.454	kilograms	kg
T	short tons (2000 lb)	0.907	megagrams (or "metric ton")	Mg (or "t")
TEMPERATURE (exact degrees)				
°F	Fahrenheit	5 (F-32)/9 or (F-32)/1.8	Celsius	°C
ILLUMINATION				
fc	foot-candles	10.76	lux	lx
fl	foot-Lamberts	3.426	candela/m ²	cd/m ²
FORCE and PRESSURE or STRESS				
lbf	poundforce	4.45	newtons	N
lbf/in ²	poundforce per square inch	6.89	kilopascals	kPa

APPROXIMATE CONVERSIONS FROM SI UNITS

Symbol	When You Know	Multiply By	To Find	Symbol
LENGTH				
mm	millimeters	0.039	inches	in
m	meters	3.28	feet	ft
m	meters	1.09	yards	yd
km	kilometers	0.621	miles	mi
AREA				
mm ²	square millimeters	0.0016	square inches	in ²
m ²	square meters	10.764	square feet	ft ²
m ²	square meters	1.195	square yards	yd ²
ha	hectares	2.47	acres	ac
km ²	square kilometers	0.386	square miles	mi ²
VOLUME				
mL	milliliters	0.034	fluid ounces	fl oz
L	liters	0.264	gallons	gal
m ³	cubic meters	35.314	cubic feet	ft ³
m ³	cubic meters	1.307	cubic yards	yd ³
MASS				
g	grams	0.035	ounces	oz
kg	kilograms	2.202	pounds	lb
Mg (or "t")	megagrams (or "metric ton")	1.103	short tons (2000 lb)	T
TEMPERATURE (exact degrees)				
°C	Celsius	1.8C+32	Fahrenheit	°F
ILLUMINATION				
lx	lux	0.0929	foot-candles	fc
cd/m ²	candela/m ²	0.2919	foot-Lamberts	fl
FORCE and PRESSURE or STRESS				
N	newtons	0.225	poundforce	lbf
kPa	kilopascals	0.145	poundforce per square inch	lbf/in ²

*SI is the symbol for the International System of Units. Appropriate rounding should be made to comply with Section 4 of ASTM E380. (Revised March 2003)

TABLE OF CONTENTS

CHAPTER 1 – METHODOLOGY OF THE MODEL.....	1
INTRODUCTION	1
PURPOSE AND SCOPE OF THE PROGRAM	2
LIMITATIONS.....	2
SYSTEM REQUIREMENTS.....	2
INSTALLATION	2
CD Installation.....	3
Internet Installation.....	3
BASIC THEORY.....	3
Wall Facing Analysis.....	3
Internal Stability Analysis.....	4
External Stability Analysis	5
Global Stability Analysis	8
Groundwater	10
CHAPTER 2 – SNAP INPUT PARAMETERS.....	13
PROGRAM CONVENTIONS	13
SNAP Main Menus.....	13
Toolbar.....	15
Tabs and Option Selection.....	16
Problem Geometry	17
Additional Navigation Information.....	18
PROGRAM EXECUTION.....	20
Quick Introduction.....	20
Create a New Project	22
GRAPHICS.....	24
Summary of Graphical Presentation	24
INPUT TABS.....	27
Project.....	27
Soil Layers	31
Groundwater Data.....	32
Nail Data.....	32
Seismic Data	38
Facing Data.....	39
CHAPTER 3 – SNAP OUTPUT.....	45
RESULT SCREENS.....	45
Wall Facing Design and Serviceability Checks.....	45
External Stability Analysis	47
Global Stability Analysis (Simplified Bishop Method for circular failure surfaces)	48
REPORT GENERATION	51
CHAPTER 4 – EXAMPLE PROBLEMS	55
EXAMPLE 1.....	55
Geometry.....	55
Soil.....	57

SNAP USER'S MANUAL – TABLE OF CONTENTS

Nails	58
Wall Facing.....	60
External Stability	64
Global Stability	65
Report.....	66
EXAMPLE 2.....	67
Geometry.....	67
Soil	68
Groundwater	69
Nails	70
Seismic Effects.....	72
Wall Facing.....	73
External Stability	75
Global Stability	76
Report.....	79
CHAPTER 5 – PROOF/VERIFICATION TESTING	81
DESIGN TEST LOAD	81
TEST LOADING DATA.....	82
PROOF/VERIFICATION TESTING REPORT.....	83
REFERENCES.....	85
APPENDIX A – SOIL NAIL DESIGN COMPARISON	87
ACTIVE EARTH LOAD FOR INTERNAL STABILITY AND FACING DESIGN.....	87
OVERALL (GLOBAL) STABILITY	87
EXTERNAL STABILITY ANALYSES.....	88
APPENDIX A REFERENCES.....	102

LIST OF FIGURES

Figure 1. Photo. Installation of a permanent pre-cast concrete facing over a structural shotcrete soil wall. 4

Figure 2. Schematic. Nail Support Diagram used in SNAP, reproduced from publication FHWA-SA-96-069R. 5

Figure 3. Schematic. Wall base length, B, used for external stability calculations. 7

Figure 4. Schematic. SNAP generates slip circles (green) using a grid of center points and a range of radii. (Only the pink portion of the circle is actually relevant to FS calculations.) 9

Figure 5. Schematic. Method of pore pressure calculation in SNAP (from Abramson et al., 1996). 11

Figure 6. Screen Shot. SNAP main menus. 13

Figure 7. Screen Shot. File menu items. 13

Figure 8. Screen Shot. Units menu items. 14

Figure 9. Screen Shot. Help menu items. 14

Figure 10. Screen Shot. Show/hide the Help frame. 15

Figure 11. Screen Shot. Toolbar. 15

Figure 12. Screen Shot. Selecting tabs, radio buttons, and sub-tabs. 16

Figure 13. Schematic. Problem geometry in SNAP. 17

Figure 14. Screen Shot. Hovering over a variable will show its description. 18

Figure 15. Screen Shot. Blue icons display additional information. 18

Figure 16. Screen Shot. Yellow icons display warnings for Factors of Safety or serviceability. 19

Figure 17. Screen Shot. Splash screen shown on startup. 20

Figure 18. Screen Shot. Select “Example 1” to see how the program works using sample data. 21

Figure 19. Screen Shot. Generate a sample report by clicking on the “Report” tab. 21

Figure 20. Screen Shot. Create a new project file from scratch. 22

Figure 21. Screen Shot. Select “Make New Folder” to create a new project. 22

Figure 22. Screen Shot. A new project folder, ready to be renamed. 23

Figure 23. Screen Shot. Type a new name for your new project. 23

Figure 24. Screen Shot. Six scroll bars surrounding the display control the zoom, pan, tilt, and spin. 24

Figure 25. Screen Shot. Zoom in to see the problem geometry more easily. 25

Figure 26. Screen Shot. Tilt will show the ground surface above the wall, or the view from below the wall. 26

Figure 27. Screen Shot. You can “spin” the image to see the wall facing or view the stability analysis from left to right. 27

Figure 28. Screen Shot. Enter basic information about your problem on the Project tab. 28

Figure 29. Screen Shot. Hold the mouse pointer over a variable to see its description. 28

Figure 30. Screen Shot. The problem geometry can be entered using X,Z coordinates or a horizontal distance and angle from horizontal. 29

Figure 31. Screen Shot. You can also click and drag on the pink circles to adjust the problem geometry. 29

Figure 32. Screen Shot. Surcharge loading on the top of the wall is shown by yellow arrows. 30

Figure 33. Screen Shot. Enter soil strength information, including pullout strength, on the Soil tab.....	31
Figure 34. Screen Shot. Enter phreatic surface information on the Groundwater tab.....	32
Figure 35. Screen Shot. Change uniform nail lengths by clicking and dragging the top nail around the display area.....	33
Figure 36. Screen Shot. The “Uniform Nail Settings” tab displays nail heights above the toe of the wall and support load diagrams.....	34
Figure 37. Screen Shot. The “Non-Uniform Nail Settings” tab displays nail lengths, heights, and inclinations, as well as support load diagrams.	35
Figure 38. Schematic. SNAP uses the nail handicapping procedure outlined in FHWA-SA-96-069R.	37
Figure 39. Screen Shot. Un-check this box to do a normal analysis without seismic effects.....	38
Figure 40. Screen Shot. You can enter two types of seismic coefficients: K_h or Peak Ground Acceleration.	38
Figure 41. Screen Shot. An “Offset” nail installation pattern is selected on the Wall Facing tab.	39
Figure 42. Screen Shot. A “Square” nail installation pattern is selected on the Wall Facing tab.	40
Figure 43. Screen Shot. The nominal nail head strength, T_{FN} , and allowable nail head load, T_F are displayed at the bottom of the list for a shotcrete facing.....	41
Figure 44. Screen Shot. Design checks for the shotcrete facing are viewed by holding the mouse over the blue icons.....	42
Figure 45. Screen Shot. The nominal nail head strength, T_{FN} , and allowable nail head load, T_F are displayed at the bottom of the list for a cast-in-place facing.....	43
Figure 46. Screen Shot. Design checks for the cast-in-place facing are viewed by holding the mouse over the blue icons.....	44
Figure 47. Screen Shot. The nominal nail head strength and allowable nail head load are shown under the Wall Facing tab, on the Nail Head Strength sub-tab.....	45
Figure 48. Screen Shot. Design and serviceability checks are shown on the Design Checks sub-tab for the appropriate facing type.	46
Figure 49. Screen Shot. External stability output results are shown on the External Stability tab.	47
Figure 50. Screen Shot. The 10 lowest Factors of Safety, and their associated slip circles, are shown under the Global Stability tab.	48
Figure 51. Screen Shot. Display the nail support diagram for each nail by checking the “Show Nail T Force” box.....	49
Figure 52. Screen Shot. The user has some control over how the program searches for slip circles.	50
Figure 53. Screen Shot. Select the “Report” tab to generate, view, and print all input and output information in a format that is also easier to copy into another program.	51
Figure 54. Screen Shot. Warning messages and other information are highlighted in the report.	52
Figure 55. Screen Shot. Standard print functions such as Page Setup and Print Preview are available.	53
Figure 56. Screen Shot. Select “Print” to print the entire Report.	54
Figure 57. Screen Shot. Example 1, the Geometry tab.....	55

SNAP USER'S MANUAL – TABLE OF CONTENTS

Figure 58. Screen Shot. Example 1, the display area.....	56
Figure 59. Screen Shot. Example 1, the Soil tab.	57
Figure 60. Screen Shot. Example 1, the Nail Properties tab.....	58
Figure 61. Screen Shot. Example 1, the Uniform Nail Settings tab.	59
Figure 62. Screen Shot. Example 1, Wall Facing tab, Nail Head Strength for the shotcrete facing.....	60
Figure 63. Screen Shot. Example 1, the Shotcrete Design Checks tab.....	61
Figure 64. Screen Shot. Example 1, the Cast-in-Place Nail Head Strength tab.	62
Figure 65. Screen Shot. Example 1, Cast-in-Place facing Design Checks tab.	63
Figure 66. Screen Shot. Example 1, External Stability analysis results.	64
Figure 67. Screen Shot. Example 1, Global Stability tab.	65
Figure 68. Screen Shot. Example 1, Report generation tab.....	66
Figure 69. Screen Shot. Example 2, the Geometry tab.....	67
Figure 70. Screen Shot. Example 2, the display area.....	68
Figure 71. Screen Shot. Example 2, the Soil tab.	68
Figure 72. Screen Shot. Example 2, the Groundwater tab.....	69
Figure 73. Screen Shot. Example 2, the Nail Properties tab.....	70
Figure 74. Screen Shot. Example 2, the Uniform Nail Settings tab.	71
Figure 75. Screen Shot. Example 2, Seismic Coefficients tab.....	72
Figure 76. Screen Shot. Example 2, Wall Facing tab, Nail Head Strength for the shotcrete facing.....	74
Figure 77. Screen Shot. Example 2, the Shotcrete Design Checks tab.....	75
Figure 78. Screen Shot. Example 2, External Stability tab showing (a) the results for seismic loading conditions and (b) the results for static loading conditions.....	75
Figure 79. Screen Shot. Example 2, Global Stability tab for seismic (pseudo-static) conditions ($k_h = 0.18$).....	76
Figure 80. Screen Shot. Example 2, Global Stability tab for static loading conditions.....	77
Figure 81. Screen Shot. Example 2, the Radius Control tab.....	78
Figure 82. Screen Shot. Example 2, Report tab.....	79
Figure 83. Screen Shot. Proof/Verification Testing, Design Test Load calculation tab.....	81
Figure 84. Screen Shot. Proof/Verification Testing, Test Loading Data tab.....	82
Figure 85. Screen Shot. Proof/Verification Testing Report.....	83
Figure 86. Schematic. Estimating the Deformation and Extent of Influence. [REF1].	98
Figure 87. Schematic. Deformation Estimate at Top of Wall and Extent of Influence. [REF2]99	
Figure 88. Schematic. Illustration of Distributed Nail Tensile Loads (T_o , T_{max} , etc.) and the Limiting Nail Capacities (Tensile, Facing, & Pullout). [REF1]	100
Figure 89. Schematic. Illustration showing the Distributed Nail Capacities. [REF2].....	101

LIST OF TABLES

Table 1. Soil Nail Retaining Wall Design Comparison Summary.89
Table 2. Factors of Safety Comparison for [REF1] and [REF2].97

LIST OF SYMBOLS AND ABBREVIATIONS

A	Peak ground acceleration due to seismic loading
AASHTO	American Association of State Highway and Transportation Officials
ASD	Allowable Stress Design
B	Wall base length
CalTrans	California Department of Transportation
CFLHD	Central Federal Lands Highway Division
CIP	Cast-in-place
COTR	Contracting Officer's Technical Representative
DOS	Disk Operating System
FHWA	Federal Highway Administration
FLH	Federal Lands Highway
ft	foot (feet)
ft ²	square feet
ft ³	cubic feet
FS	Factor of Safety
in	inches
in ²	square inches
K _a	Active earth pressure coefficient
k _h	Horizontal seismic coefficient
kip	kilo pound (1000 pounds)
kN	kilo Newton(s), SI unit of force
kPa	kilo Pascal
k _v	Vertical seismic coefficient
lb	pounds of mass
lbf	pounds of force
L _{BV}	Maximum bond length to avoid overstressing the nail during a verification or proof field test
LRFD	Load Resistance Factor Design

m	meter
m ²	square meters
m ³	cubic meters
MSE	Mechanically Stabilized Earth
N _c	Bearing capacity factor
N _q	Bearing capacity factor
N _γ	Bearing capacity factor
NCHRP	National Cooperative Highway Research Program
P _{AE}	Dynamic horizontal thrust force due to seismic loading
psi	pounds per square inch
Q	Allowable pullout resistance between grout and soil, e.g., pounds/foot (or kN/m)
Q _u	Ultimate pullout resistance per unit of nail length (grout-ground bond)
SI units	International System of units (e.g. m, N, kPa, etc.)
SNAP	Soil Nail Analysis Program
T _F	Allowable nail head load, e.g., kips (or kN)
T _N	Allowable nail tendon load, e.g., kips (or kN)
T _{FN}	Controlling nominal nail head load
US units	United States customary units (e.g., ft, lbf, psi, etc.)
φ	Internal friction angle of a soil

ACKNOWLEDGMENTS

The Yeh and Associates authors would like to acknowledge several individuals who contributed their time and knowledge to this work. The guidance of Khamis Haramy, in the role of FHWA-CFLHD's Contracting Officer's Technical Representative (COTR) is noted and appreciated. Alan Rock, of Summit Peak Technologies LLC., is respected for his effort in developing the unique code for this program. The effort of Dr. Runing Zhang of the Metropolitan State College of Denver, was invaluable in assisting with the development of the analytical model. Dr. John Turner of the University of Wyoming is also identified in appreciation for his high-quality contribution to the final analysis of the package. And finally, the review and cooperation of the Federal Highway Administration's advisory panel, Khamis Haramy, Roger Surdahl, Barry Siel, Khalid Mohamed, and Rich Barrows is gratefully acknowledged.

CHAPTER 1 – METHODOLOGY OF THE MODEL

INTRODUCTION

Soil nail walls are internally stabilized earth-retaining structures. The use of these structures has substantially increased in the United States in the last decade. Soil nail walls use a top-down construction method with installed reinforcing elements to support temporary or permanent excavations. In certain soil conditions, soil nail walls can be more feasible and cost-effective alternatives to conventional retaining structures. Soil nailing has been extensively used for highway applications as excavation support and for permanent retaining wall systems where top-down construction is advantageous. Soil nailing consists of installing closely spaced epoxy-coated steel bars (nails) which are subsequently encased in grout. As construction proceeds from top of cut to bottom, shotcrete is applied to the excavated face to provide stability. In certain conditions, soil nailing is a viable alternative to other ground anchor systems, considering technical feasibility, cost, and construction duration.

Although the use of soil nailing for highway applications has increased dramatically, computer programs for designing soil nail walls have not kept pace with the industry. Currently two computer programs are available for determining the length and specifications of the nail components. SNAIL (DOS-based, developed by CalTrans, 1991) and GOLDNAIL (Windows-based, developed by Golder and Associates, 1993) are the primary programs available for the designer. Both programs have limited use and are mainly designed for checking the soil nail wall stability by varying nail types and sizes, spacing and bond strengths. Neither program is capable of designing wall facing elements or shotcrete; global stability evaluation in both programs is done by limiting slip surfaces to those that pass through the toe of the wall, and cannot evaluate a system with a complex slope profile above or below the wall. These programs also are used primarily with the Allowable Stress Design (ASD) method and older Load and Resistance Factor Design (LRFD) methods which may or may not be applicable to more recent guidelines.

Because of the advantages of soil nail walls, the Federal Highway Administration (FHWA) has sponsored and coordinated the development of several technical reports and research on soil nail wall projects since the early 1990s, including a comprehensive design and construction manual for soil nail walls (Manual for Design and Construction of Soil Nail Walls, Report No. FHWA-SA-96-069R), guidelines for analyzing, design, construction and monitoring of soil nail walls (Geotechnical Engineering Circular No. 7 - Soil Nail Walls, Report No. FHWA-IF-03-017), and a research project underway for developing LRFD Soil-Nailing Design and Construction Factors and Specifications (NCHRP Project 24-21). These technical reports, specifications, and research, together with engineering practice, provide highway engineers and contractors with a better understanding of the mechanisms, structural principles, and guidelines for soil nail retaining wall design and construction.

PURPOSE AND SCOPE OF THE PROGRAM

The objective of this work is to develop a computer program that follows the current State-of-Practice for designing the entire soil nail earth retaining structure. This includes the design of all soil nail system components such as 1) nail elements, 2) facing elements, 3) external stability, and 4) global stability for more complex slope geometries. All design and evaluation procedures were developed in general accordance with the FHWA guidelines presented in 1) The Manual for Design and Construction of Soil Nail Walls, Report No. FHWA-SA-96-069R, and 2) Geotechnical Engineering Circular No. 7 - Soil Nail Walls, Report No. FHWA-IF-03-017.

The computer program analysis follows the current service load design guidelines including internal and external stability evaluation for static and seismic loading. External failure modes include global stability, sliding, and bearing capacity analysis. Internal failure modes include nail pullout and nail tensile failure analysis, along with nail head and facing element analysis for temporary and permanent conditions.

LIMITATIONS

This program has been tested and is believed to be a reliable engineering tool. No responsibility is assumed by the authors, Yeh & Associates, Summit Peak Technologies LLC, FHWA, or any employees of the above for any errors, mistakes or misrepresentations that may occur from any use of this program.

SYSTEM REQUIREMENTS

Minimum System Requirements:

2.0 GHz or faster processor

Intel Pentium 4, Penium M, Pentium D processor or better, or AMD K-8 (Athlon) or better

4 GB internal RAM

Windows 7, Windows Vista, Windows XP Professional or Windows XP Home

NVIDIA GeForce FX 5200, ATI Radeon 9600, or better graphics card

Recommended Requirements:

2.5 GHz or faster processor

Core 2 Duo or Athlon X2.

8 GB internal RAM

Windows 7, Windows Vista

NVIDIA GeForce 8000, ATI Radeon 9600, or better graphics card with 512 MB dedicated RAM

INSTALLATION

The SNAP (Soil Nail Analysis Program) can be installed from the accompanying CD ROM disk, or installed from an internet web link. Either way, some files will be copied to your location during the installation process. Before installing SNAP, ensure that you have at least a minimum recommended free space of 300 MB.

CD Installation

From your CD drive, select and double click the file named "*SNAP 1.0 Self Extracting Executable.exe*". A window will open asking to where you wish to extract the executable files. A suggestion would be C:\SNAP. This will download all the files to a folder called SNAP on the root directory of your C drive. To run the SNAP program, click on "*SNAP.exe*" in C:\SNAP or whatever directory you chose. For convenience you can create a desktop shortcut to SNAP.

Internet Installation

This public version of SNAP 1.0 can be found at www.cflhd.gov/programs/techDevelopment. Navigate to "*Completed Projects*" under the "*FHWA CFLHD Technology Development*" website. From under the "*Geotechnical*" section, select "*SNAP (Soil Nail Analysis Program) - 2010.*" Click on "*Self-Extracting Executable Program – SNAP (Soil Nail Analysis Program)*" and "*save*" it onto your hard drive. Once downloaded, follow the *CD Installation* directions shown above.

BASIC THEORY

SNAP (Soil Nail Analysis Program) evaluates the internal (facing and nail) components of a soil nail wall, external stability, and global stability. The calculations are based primarily on two FHWA publications: 1) The Manual for Design and Construction of Soil Nail Walls, Report No. FHWA-SA-96-069R, and 2) Geotechnical Engineering Circular No. 7 - Soil Nail Walls, Report No. FHWA-IF-03-017. The differences and similarities between these two manuals are diverse. The primary differences include methods for calculating the active earth load for internal stability and facing design, overall (global) stability, and external stability failure modes. Further discussion related to the two publications can be found in Appendix A.

The following sections discuss how each component including groundwater is treated.

Wall Facing Analysis

SNAP (Soil Nail Analysis Program) evaluates the internal stability of a soil nail wall for both a shotcrete-only facing type and a permanent cast-in-place (CIP) concrete facing type. Calculations are based on FHWA Report No. FHWA-SA-96-069R, "The Manual for Design and Construction of Soil Nail Walls," and on AASHTO Standard Specifications for Highway Bridges, 17th Edition.

For a shotcrete-only facing, the program determines the nominal nail head strength by evaluating "Flexure" and "Punching Shear" failure modes, based on input from the user. SNAP will calculate the nominal nail head strength for both failure modes, and use the appropriate (controlling) value in subsequent global stability calculations. Input parameters include information on the wire mesh, horizontal waler bars, vertical bearing bars, bearing plate, and shotcrete. Permanent applications of shotcrete facing can be troweled to an acceptable façade or faced with pre-cast panels (Figure 1).

For a cast-in-place (CIP) facing type, typically soil nail walls are constructed with a temporary shotcrete facing only, then the permanent CIP concrete facing is installed and connected after completion of the wall. When a CIP concrete facing is evaluated in SNAP, the strength of the shotcrete facing is neglected under the assumption that the shotcrete is a temporary facing only and its long-term strength cannot be relied upon. In addition to flexure and punching shear failure modes, headed stud tension failure is also evaluated for a permanent cast-in-place facing type. The program will calculate the nominal nail head strength for all three failure modes in the permanent facing, and use the appropriate value in subsequent global stability calculations. Input parameters include information on cast-in-place concrete, horizontal and vertical reinforcement bars, and the headed-stud connection system.

In addition to determining the nail head strength, SNAP performs required design and serviceability checks for both shotcrete and CIP facings as outlined in FHWA Report No. FHWA-SA-96-069R and AASHTO Standard Specifications for Highway Bridges, 17th Edition.



Figure 1. Photo. Installation of a permanent pre-cast concrete facing over a structural shotcrete soil wall.

Internal Stability Analysis

SNAP evaluates maximum nail loading along the length of each nail using methods outlined in FHWA-SA-96-069R. This method is based on applying the Coulomb active earth load uniformly at the back of the wall facing. The program uses the nail head strength determined from the facing analysis, the nail tendon strength entered by the user, the grout-ground pullout

strength entered by the user, and the reduction factors entered by the user to generate a nail support diagram for each nail (Figure 2). The reduction factors should be selected by the user based on Tables 4.4 and 4.5 in FHWA-SA-96-069R.

SNAP then uses the nail support diagram for each nail in the global stability calculations. For each slip circle evaluated for global stability, the program determines the nail loads at the locations where the slip circle intersects each nail, according to each nail's support diagram. These loads are applied as “resisting forces” to their respective slices in the global Factor of Safety calculations for each slip circle.

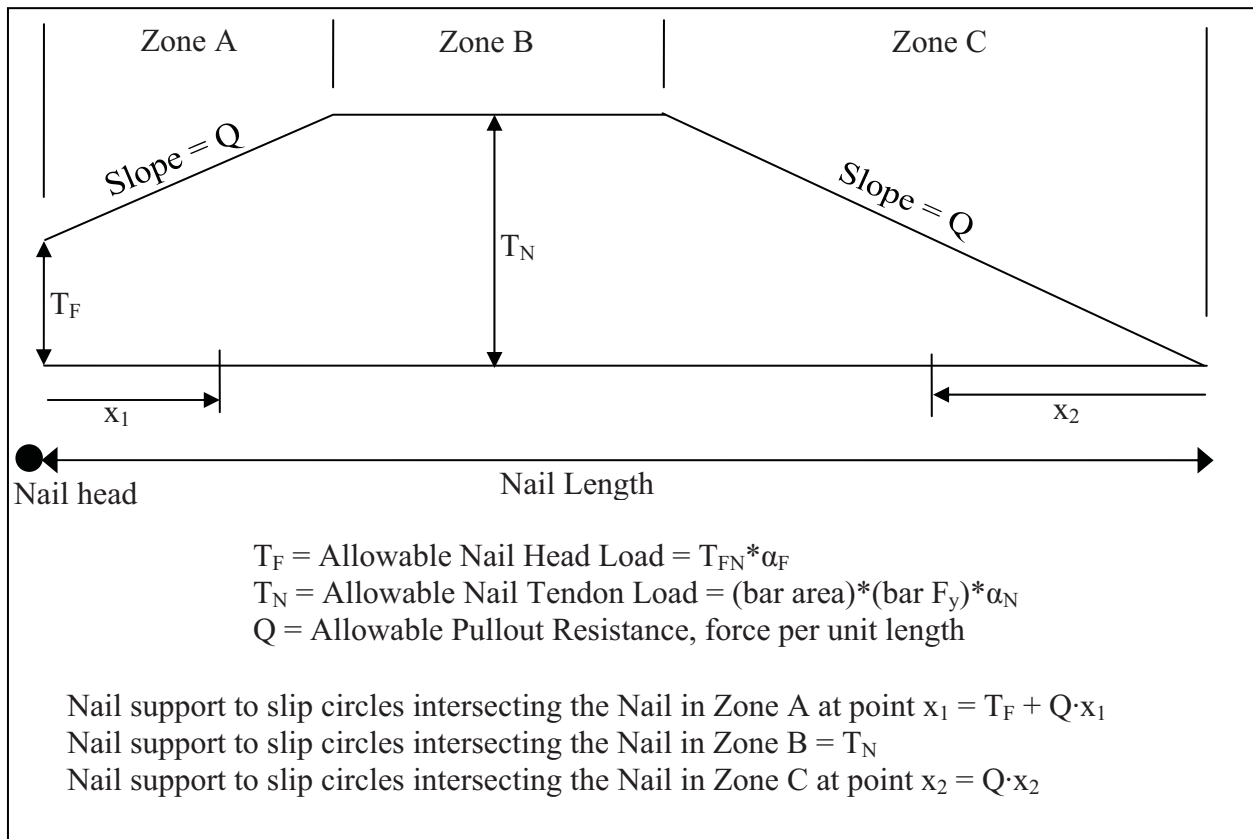

Figure 2. Schematic. Nail Support Diagram used in SNAP, reproduced from publication FHWA-SA-96-069R.

External Stability Analysis

External stability of a retaining structure refers to the potential failure or deformation modes which are typically associated with conventional gravity or cantilever retaining structures. These failure modes include horizontal sliding of the retaining wall along its base, and foundation bearing failure of the retaining wall associated with overturning. FHWA Report No. FHWA-SA-96-069R recommends use of the “slip surface” limiting equilibrium technique, which does not entail separate evaluation for sliding stability or overturning stability about the toe of the

wall; these failure modes are accounted for in the general slip surface evaluation, which also includes global stability analysis. Foundation bearing failure is evaluated separately, but a complete evaluation as per AASHTO Section 4.4.7.1 is not required for all soil conditions.

SNAP performs a complete bearing capacity evaluation for all cases, rather than the rough initial check outlined in FHWA-SA-96-069R. Sliding failure along the base of the wall and overturning about the toe of the wall are also evaluated, based on guidelines for Mechanically Stabilized Earth (MSE) walls given in the AASHTO Standard Specifications for Highway Bridges, 17th Edition. These failure modes are highly unlikely to control stability of a soil nail wall, and are provided primarily for the designer's own information and conformance with the AASHTO. For bearing capacity evaluation, FHWA publication No. FHWA-SA-96-069R points the designer to AASHTO 15th Edition, which is more than 15 years old; the more recent 17th Edition was used for the purposes of this program to evaluate bearing capacity as well as sliding and overturning failure modes.

The user may choose to include the effects of seismic forces in external stability calculations. Seismic forces are taken into account by including, in addition to the static forces, a horizontal inertial force and a dynamic horizontal thrust force, as outlined by AASHTO 17th Edition, Section 5.8.9.1. The dynamic horizontal thrust force (shown in SNAP as P_{AE}) is calculated with the use of the Mononobe-Okabe method (Mononobe, 1929; Okabe, 1926), rather than the equation given in AASHTO. This method is applicable to all values of the friction angle, ϕ , and introduces an additional angle into the calculations for the active earth pressure coefficient, K_a , based on the horizontal and vertical seismic coefficients. The user input for seismic loading can either be the peak ground acceleration, A , or the horizontal seismic coefficient, k_h . For conservative calculations, SNAP always assumes that the vertical seismic coefficient, k_v , is zero, for both external and global stability calculations. This is common for pseudo-static analysis, and is done because the vertical component of seismic forces is generally significantly smaller than the horizontal component, and may act upwards on the nailed soil mass. This would decrease the loads on the wall and result in a less conservative analysis.

For all external stability calculations, the active earth pressure behind the nailed soil mass is calculated using Coulomb's earth pressure coefficient, K_a . The wall-soil interface friction angle is taken to be 2/3 of the friction angle, ϕ . The surface on which active earth pressure acts (the back surface of the wall) is always assumed to be vertical. SNAP evaluates external stability for the long-term drained case rather than the short-term undrained case; therefore, saturated unit weight of the reinforced soil and groundwater uplift forces are not incorporated into the external stability calculations.

Sliding stability is evaluated along the base of the nailed soil mass. Since SNAP has the capability to evaluate both uniform and non-uniform soil nail lengths and vertical spacings, the base width of the wall is taken as the horizontal distance between the toe of the wall and the average end of nail, as shown in Figure 3. This method allows the calculation to be consistent whether the user selects uniform or non-uniform nail geometry. The cohesive strength of the foundation soil is included in the resisting forces, but not the shear strength of any nails that may extend below the base of the wall.

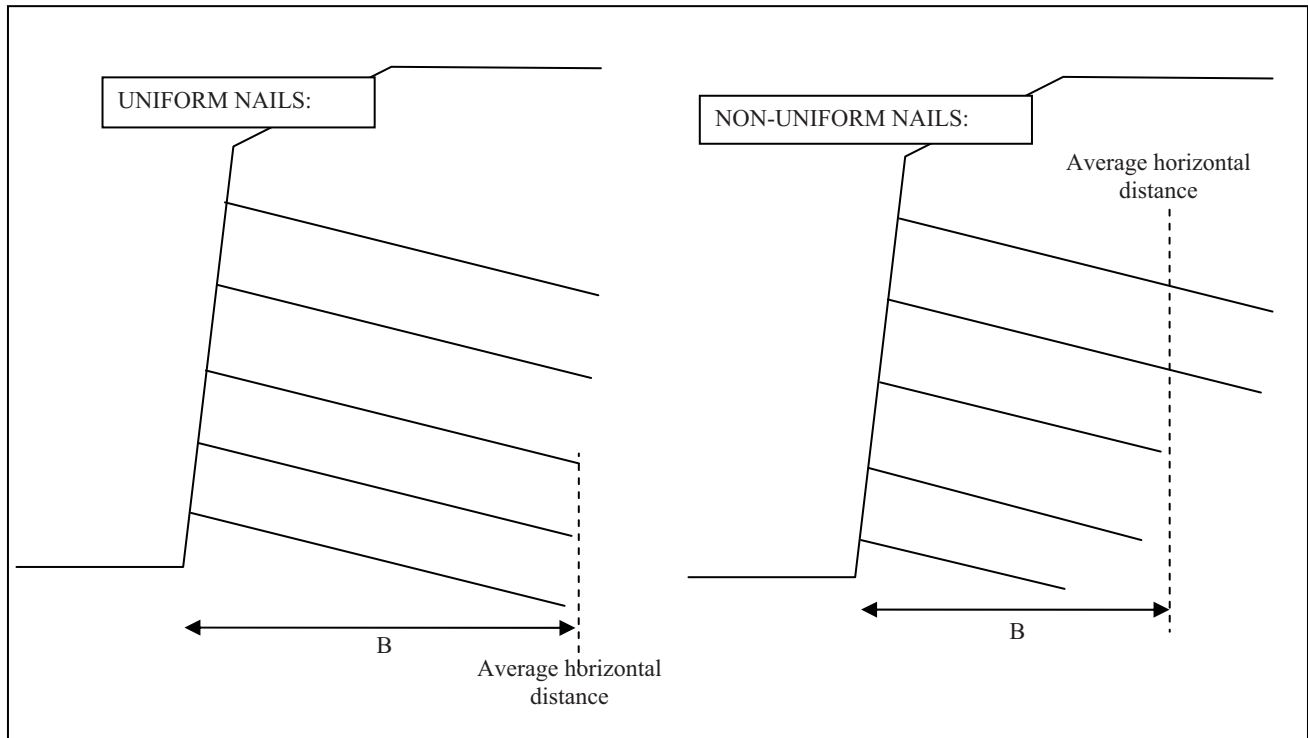

Figure 3. Schematic. Wall base length, B , used for external stability calculations.

Overturing (moment) stability is evaluated about the toe of the wall, at the ground surface. Although this is not generally considered for soil nail walls, it has been included for the wall designer's information and conformance with AASHTO. This failure mode is highly unlikely to control stability of a soil nail wall.

Bearing capacity is evaluated using the method outlined in AASHTO Standard Specifications for Highway Bridges, 17th Edition, Section 4.4.7.1. The user must enter bearing capacity factors N_c , N_γ , and N_q , on the Soil input tab. This allows the user to adjust the bearing capacity calculation to account for sloping ground in front of the wall. At this time, groundwater below the base of the wall is not accounted for in the ultimate bearing capacity calculations; if groundwater is anticipated below the soil nail wall, SNAP accounts for this condition in the global stability evaluation.

Global Stability Analysis

SNAP evaluates limit-equilibrium global stability using Bishop's Simplified (Modified) Method (Bishop, 1955). This method accounts for interslice normal forces but ignores interslice shear forces, and satisfies vertical force equilibrium for each slice and overall moment equilibrium about the center of the slip circle. SNAP evaluates circular-shaped failure surfaces only. The soil mass is divided into approximately 100 vertical slices, and stability is assessed for an average of 5,000 slip circles to find the 100 most critical failure surfaces and Factors of Safety (FS). SNAP can evaluate stability under seismic loading conditions using a pseudo-static analysis. This is done by multiplying the mass of each slice by the horizontal seismic coefficient and modeling this as an applied horizontal force at the centroid of each slice.

The slip circles for which SNAP calculates a Factor of Safety (FS) are generated automatically by the program, with some minimal user control of the search limits. Slip circle centers are located inside a pre-defined grid area, which is located above the top nail and to the left of the wall face at the top of wall, as shown in Figure 4 below. Circle center points have equal horizontal and vertical grid spacing. The spacing is scaled according to the height of the wall. For this reason, the number of total center points varies for different walls. Slip circles are generated when SNAP selects various *radius values, in 1-foot increments*, for each center point. The radius range for each center point can *either* be automatically limited to the slope geometry entered *or* the user can control the search by choosing a permissible X-coordinate range for the top and bottom of each failure circle. When *the radius range is automatically calculated*, the *minimum radius* for each center point must pass *only* through the top nail of the wall, and the *maximum radius* passes through the point on the ground surface furthest from the center point which will still result in the circle passing through both the toe slope and the backslope of the wall (Figure 4).

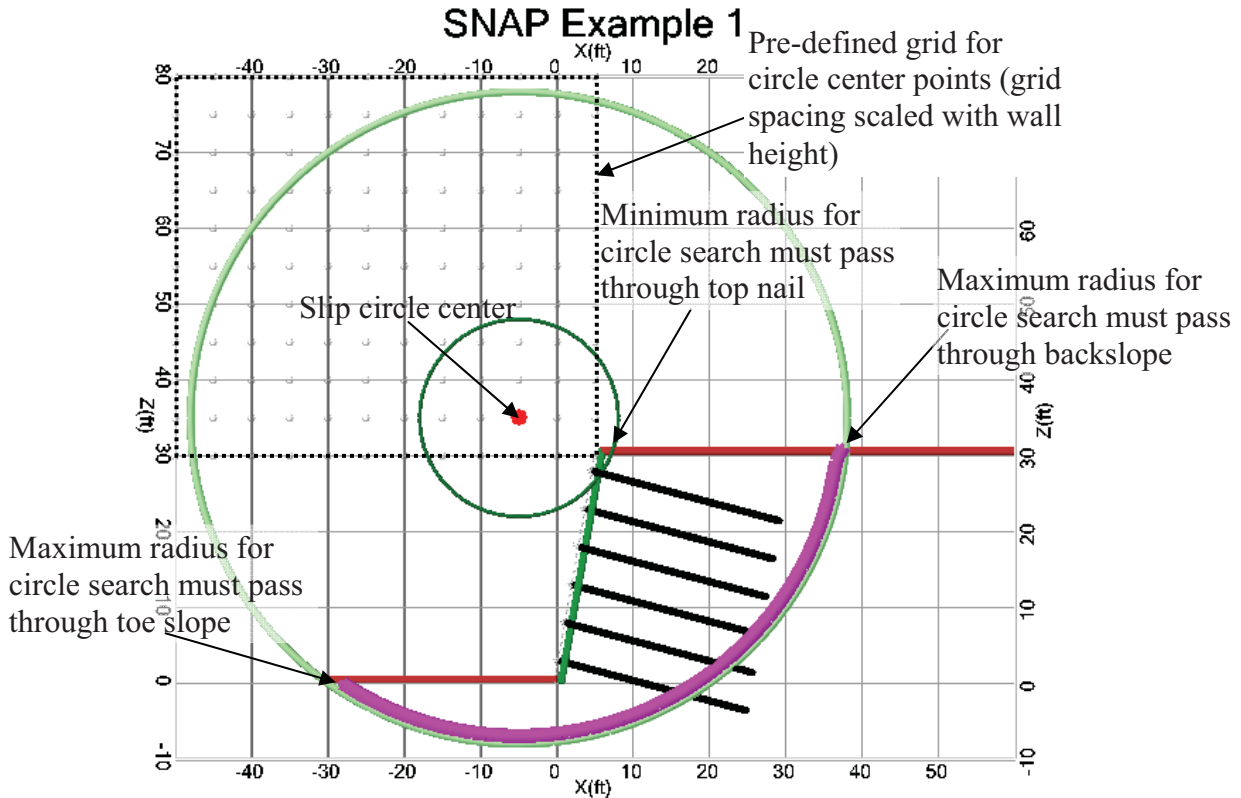

Figure 4. Schematic. SNAP generates slip circles (green) using a grid of center points and a range of radii. (Only the pink portion of the circle is actually relevant to FS calculations.)

SNAP calculates a FS using Bishop’s Simplified Method for all radii at all center points generated in this manner.

For Bishop’s Simplified Method, and the interslice force assumptions, each FS calculation is iterative; SNAP chooses an initial “guess” FS of 1.0 for each slip circle evaluated. The global stability calculation includes surcharge loading, nail support loads, pseudo-static seismic loads (if selected), and uplift force at the base of each slice due to groundwater.

SNAP uses the Nail Support Diagram discussed above to determine how the nails contribute to global stability of the wall. For each slip circle, the program determines where along each nail the circle and nail intersect, and in which slice the circle and nail intersect. Then the program pulls the corresponding nail support load for each nail from its nail support diagram, and applies that force as a resisting force to the appropriate slice, oriented in the direction of the nail inclination. In this way, the global stability calculation incorporates a resisting force based on the allowable nail bar tensile strength where circles intersect the nail closer to the facing, but for nails that are intersected near the back end of the nail, the calculation will reduce the resisting force according to the allowable pullout strength. The effects of lengthening particular nails can thus be seen directly in the program display.

Groundwater

SNAP uses a phreatic surface (water table) groundwater model (as opposed to a piezometric model). The pore pressure from any point is computed from the difference in head between that point and the phreatic surface. Figure 5 illustrates a phreatic pore pressure calculation. SNAP only uses pore water pressure for calculating global stability. Global stability calculations use the buoyant unit weight (saturated unit weight - water uplift force) for soil below the phreatic surface. SNAP can only accommodate an unconfined aquifer groundwater model. *Groundwater is not accounted for in facing, internal, or external stability calculations, including bearing capacity.*

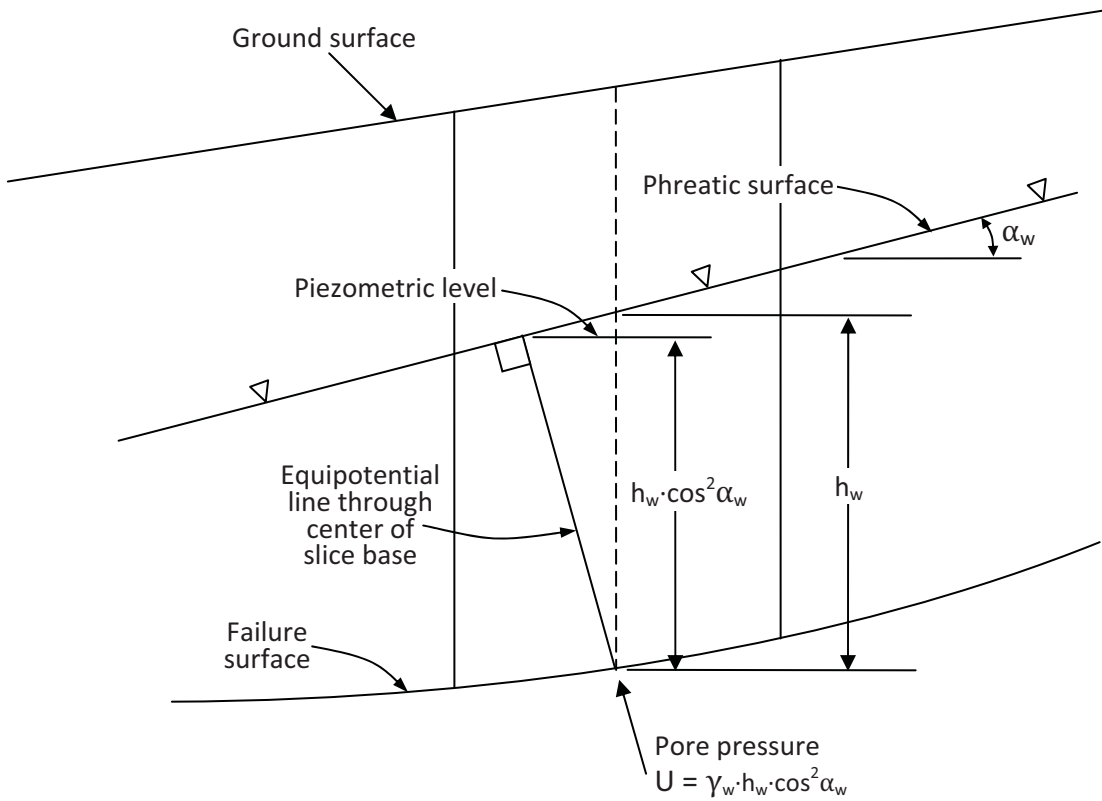

Figure 5. Schematic. Method of pore pressure calculation in SNAP (from Abramson et al., 1996)

CHAPTER 2 – SNAP INPUT PARAMETERS

PROGRAM CONVENTIONS

SNAP Main Menus

The menu in SNAP consists of 4 options: *File*, *Units*, and *Help* (Figure 6.)

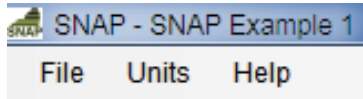

Figure 6. Screen Shot. SNAP main menus.

File Menu Items

The File menu contains standard operations found in other Windows-based computer programs: *New*, *Open*, *Save...*, *Save As...*, and *Exit* (Figure 7). The *Rename* operation allows the user to rename the current file, by right-clicking on the folder name. The *Clear Data* operation will erase all the inputs in the current file so the user can start over. The *Default Data* operation fills data fields with values for Example 1 (the complete Example work-through can be found in Chapter 4).

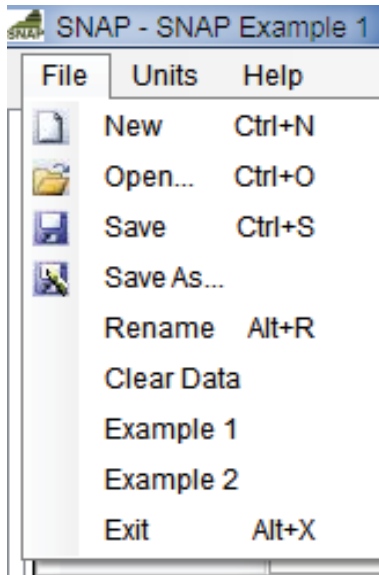

Figure 7. Screen Shot. File menu items.

Units Menu Items

The *Units* menu allows the user to enter project data in either Customary US units (i.e. ft, lbf, psi, etc.) or SI units (i.e. m, N, kPa, etc.) (Figure 8). The default setting for a new project is Customary US units. If the user has input data in SI units and accidentally enters those values while the units are set to US units, then the user can simply select *SI* from the units menu. The input values will remain the same, but the program will perform calculations in SI units.

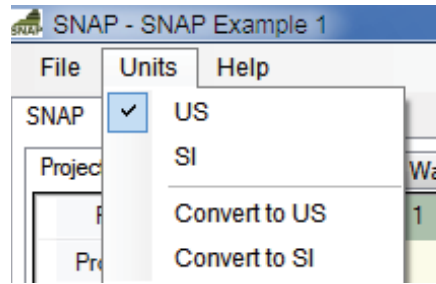

Figure 8. Screen Shot. Units menu items.

Convert to US and Convert to SI are used when the user has entered data in US units and now wants to see the equivalent problem in SI units. For example, after entering a unit weight of 110 lb/ft^3 , when the user selects Convert to SI, this will be converted to 17.28 kN/m^3 . The SI units designation in the top part of the menu will then be automatically checked. Please be aware that repeatedly converting back and forth between US and SI units will result in slight round-off errors.

Help Menu Items

On the *Help* menu, select *Topics* to open the Help file's *Table of Contents*.

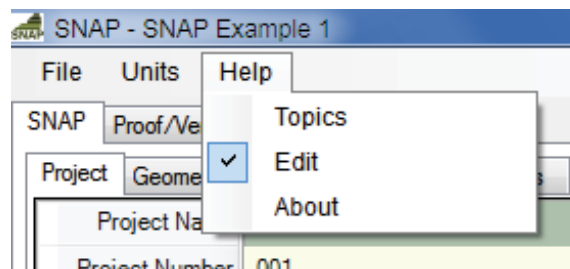

Figure 9. Screen Shot. Help menu items.

The *Help* function is navigated by clicking on links in the *Table of Contents* listing, and clicking on *Return to Table of Contents* and other links within each Help section. No Search function is currently available. To hide *Help*, drag the frame all the way to the right side of your screen (Figure 10)

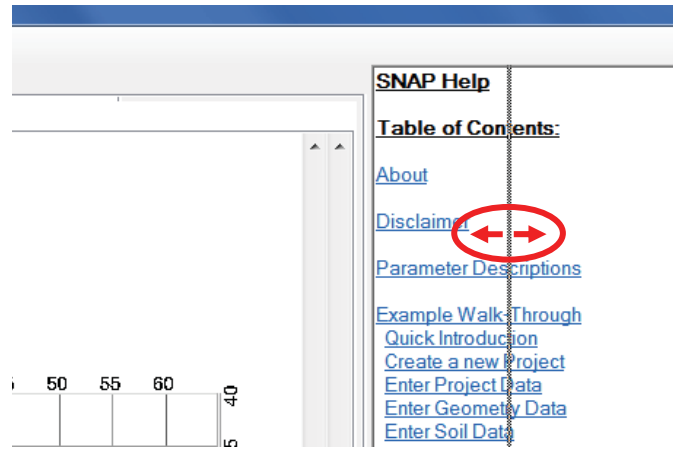

Figure 10. Screen Shot. Show/hide the Help frame.

At any time, selecting *Help* → *About* from the main menu provides version information.

Toolbar

The toolbar at the top of the screen (Figure 11) gives access to common menu commands, including:

- File → New Input File
- File → Open
- File → Save
- File → Save As
- Help → Help Topics



Figure 11. Screen Shot. Toolbar.

Tabs and Option Selection

Input parameters and output results in SNAP are organized into a series of tabs and sub-tabs. These tabs are used for organizing inputs and outputs (*outputs are shown shaded in green*). In addition to the tabs, some options can be changed by selecting radio buttons within the tabs (Figure 12). For example, under the *Wall Facing* tab, the user must select either *Shotcrete* or *Cast-in-Place* facing type. When *Shotcrete* is selected, two sub-tabs appear listing the inputs and outputs for that facing type. When *Cast-in-Place* is selected, two sub-tabs appear listing the inputs and outputs for the cast-in-place concrete and for the headed stud connection system.

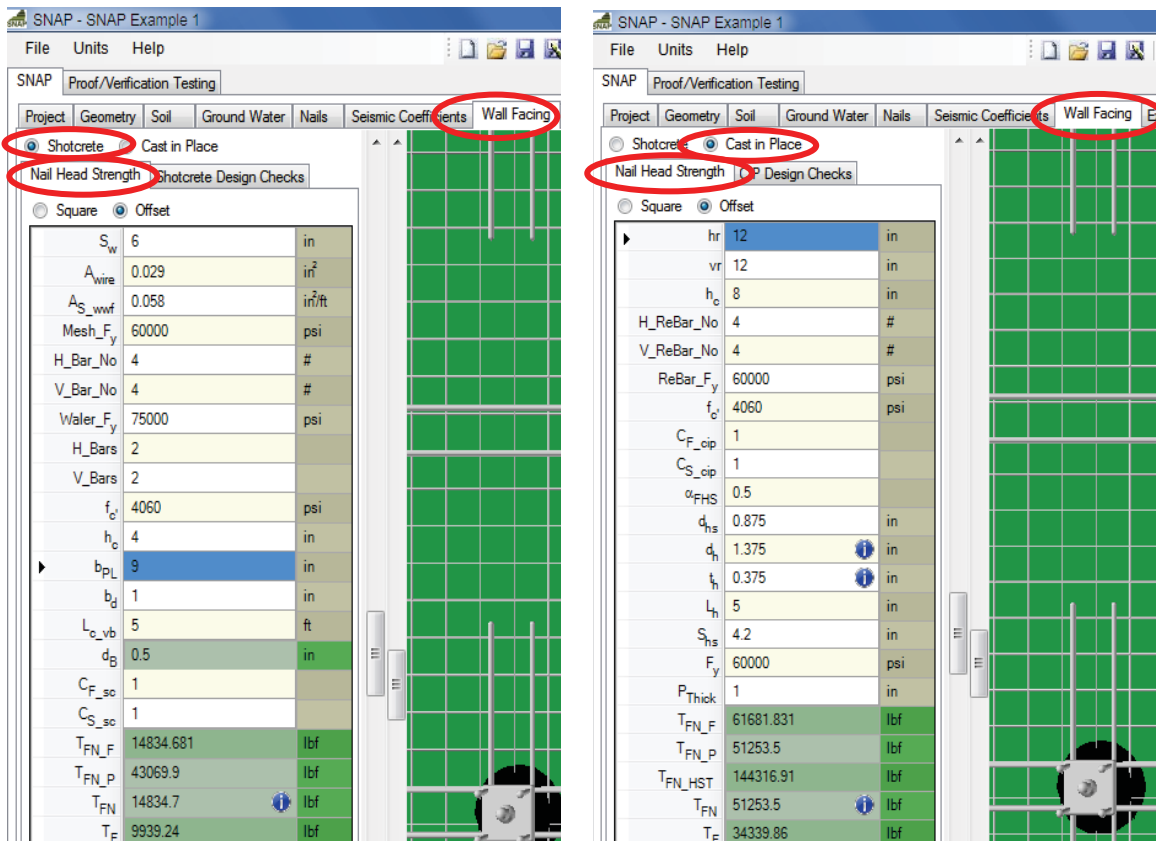

Figure 12. Screen Shot. Selecting tabs, radio buttons, and sub-tabs.

Problem Geometry

In SNAP, the soil nail wall face is on the left, with the global failure occurring from right to left on the screen. The coordinate system in SNAP is 3-dimensional so the user can view 3D graphics. However, a 2D view is always available by tilting or spinning the graphical wall representation until it returns to its original position on the screen. In 2D, the X-axis is along the bottom of the wall, and the Z axis is the vertical axis (Figure 13). The toe of the wall (at the ground surface) is always located at the origin point, $(X, Z) = (0,0)$. Problem geometry is therefore entered in X,Z coordinates. The Y-axis forms the base of the wall in the 3D view; no problem geometry is entered for the Y-axis. See the Graphics section on page 24 for more information.

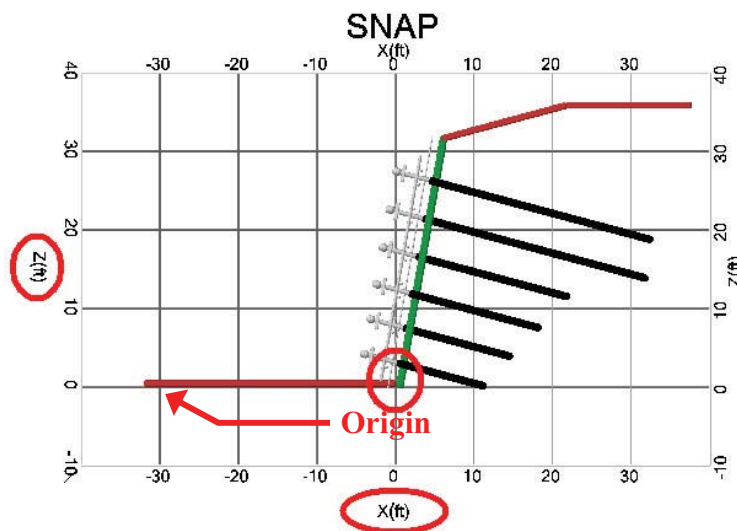

Figure 13. Schematic. Problem geometry in SNAP.

Additional Navigation Information

Many input parameters in SNAP are shown with a mathematical variable in the left column. When the mouse is placed over the box with the variable, a more detailed description of what the variable stands for will appear after a few seconds:

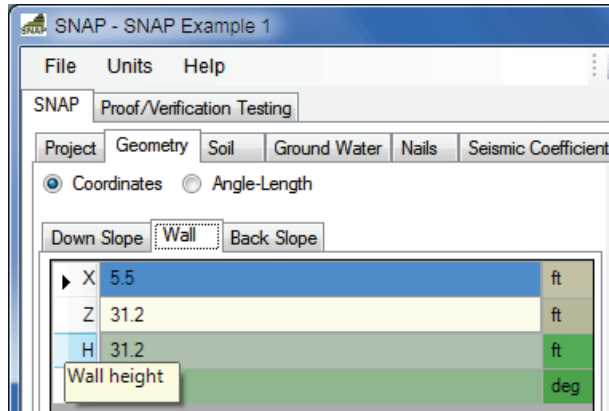

Figure 14. Screen Shot. Hovering over a variable will show its description.

Additionally there is a *complete list of parameter descriptions* used in SNAP under *Parameter Descriptions* in the Help section.

When more information is available about one of the output results, or a serviceability check does not pass minimum FHWA criteria, an icon will appear to the right of that result. This icon may be a blue “information” bubble or a yellow “caution” icon:

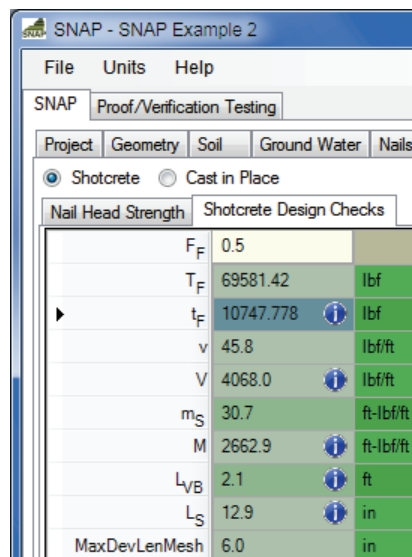

Figure 15. Screen Shot. Blue icons display additional information.

Project	Geometry	Soil	Ground Water
B	26.9		ft
▶ ecc	4.7		
σ_v	5472.6		psf
FS_{SL}	2.0		
FS_{OT}	2.9		
q_{ult}	67605		psf
q_{allow}	27042		psf
FS_{BC}	12.4		

Figure 16. Screen Shot. Yellow icons display warnings for Factors of Safety or serviceability.

PROGRAM EXECUTION

Quick Introduction

Click on the desktop icon to start SNAP. The program will take several minutes to start up. A “splash screen” is displayed during program initialization each time the program runs; a “Loading” progress indicator is shown at the bottom:



Figure 17. Screen Shot. Splash screen shown on startup.

The program loads showing the *Project tab*. For an immediate example of how the program looks and works, select “Example 1” from the File menu for a sample data set like that shown in 8. This example is discussed in further detail in Chapter 4.

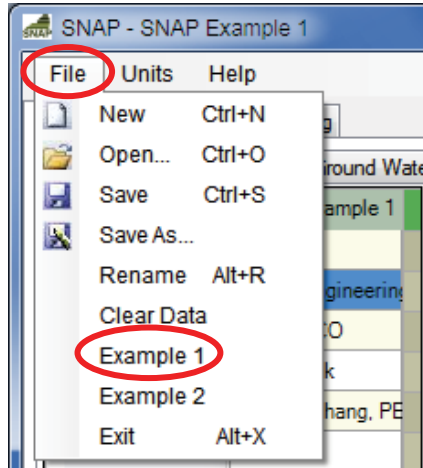

Figure 18. Screen Shot. Select “Example 1” to see how the program works using sample data.

You can now go through each tab to see what typical inputs and outputs might be. Select the *Report tab* to generate a sample report (Figure 19). Please wait until the report generation is complete. This may require up to a minute. A progress indicator will be displayed at the bottom of the screen. After clicking a different tab and then clicking the *Report tab* again, the program will re-generate the report, assuming some inputs or outputs may have changed.

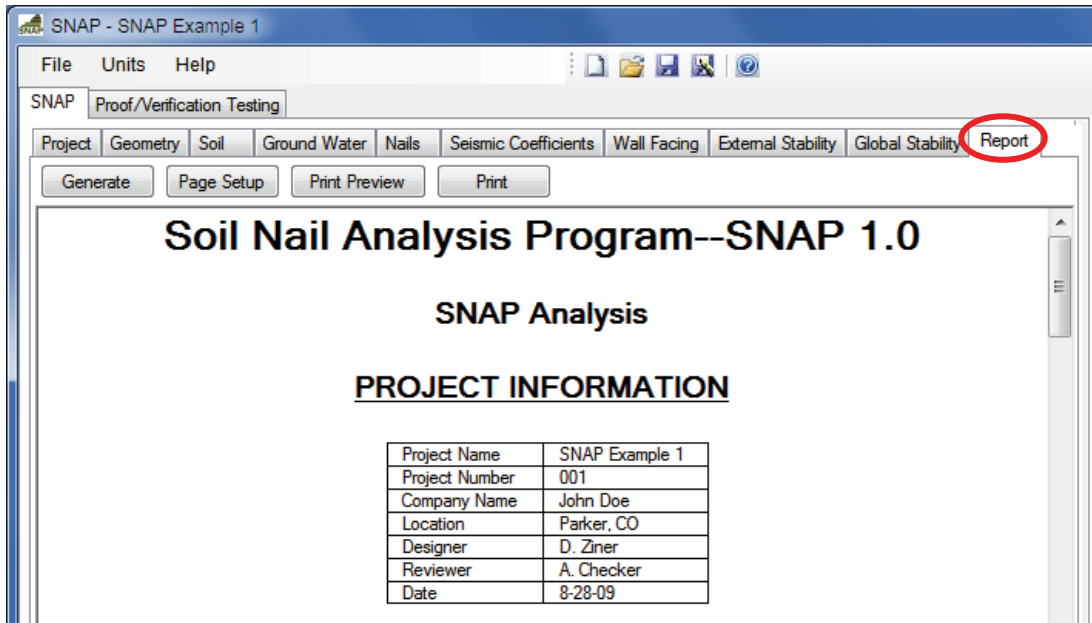

Figure 19. Screen Shot. Generate a sample report by clicking on the “Report” tab.

Create a New Project

To start from scratch and create a new project file, Select *File* → *New*:

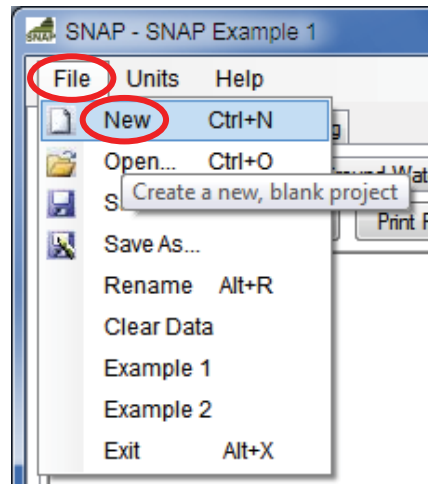

Figure 20. Screen Shot. Create a new project file from scratch.

You can browse to the location where you would like your new project to be stored, or just click on the default SNAP folder (located where you installed SNAP), and select *Make New Folder* to create a new project.

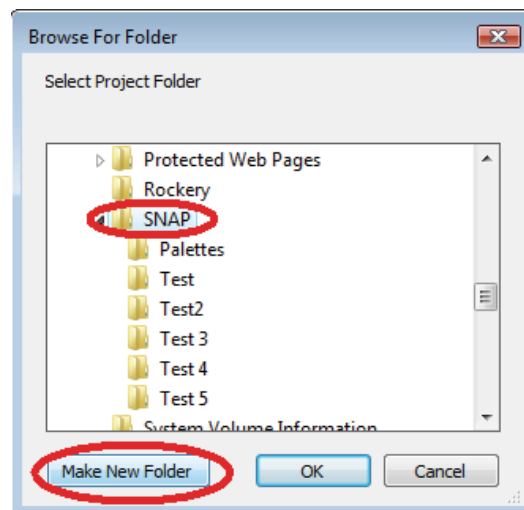

Figure 21. Screen Shot. Select “Make New Folder” to create a new project.

A new folder will appear:

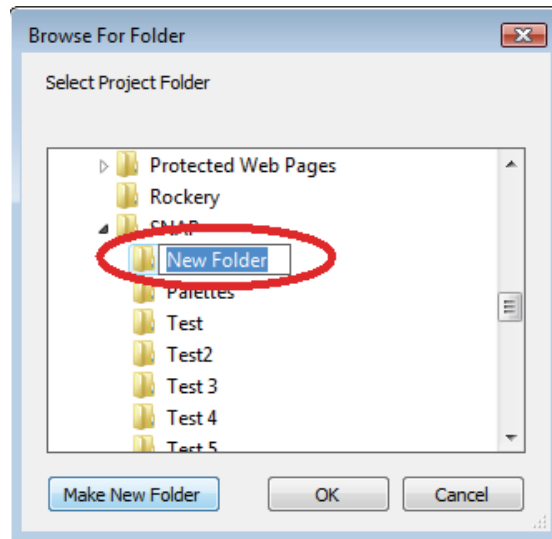

Figure 22. Screen Shot. A new project folder, ready to be renamed.

Type in a new project name, such as Rocky Mountain National Park, and click OK:

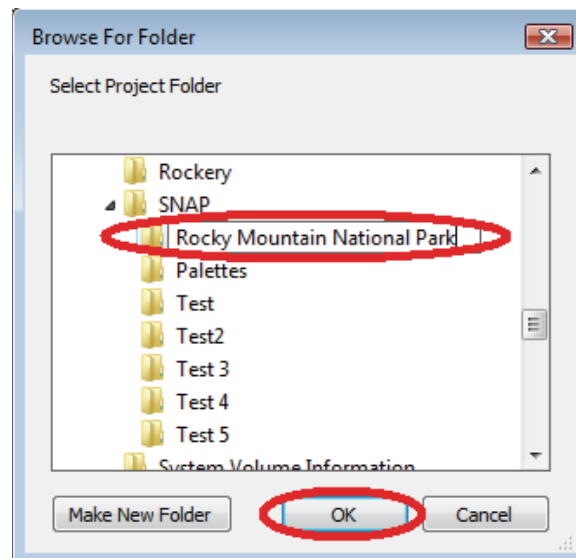

Figure 23. Screen Shot. Type a new name for your new project.

Now you can begin filling in the input data for your new project.

GRAPHICS

Summary of Graphical Presentation

SNAP displays the soil nail wall in three dimensions, but all analyses are done in two dimensions. Display capabilities can be useful for producing reports and presentations. Figure 24 summarizes how the various scroll bars surrounding the display area can be used to manipulate the image and see all aspects of a soil nail wall. The axes will automatically adjust as the image is manipulated. You can always go back to a 2D display by moving the Tilt and Spin scroll bars back to their original positions in the center.

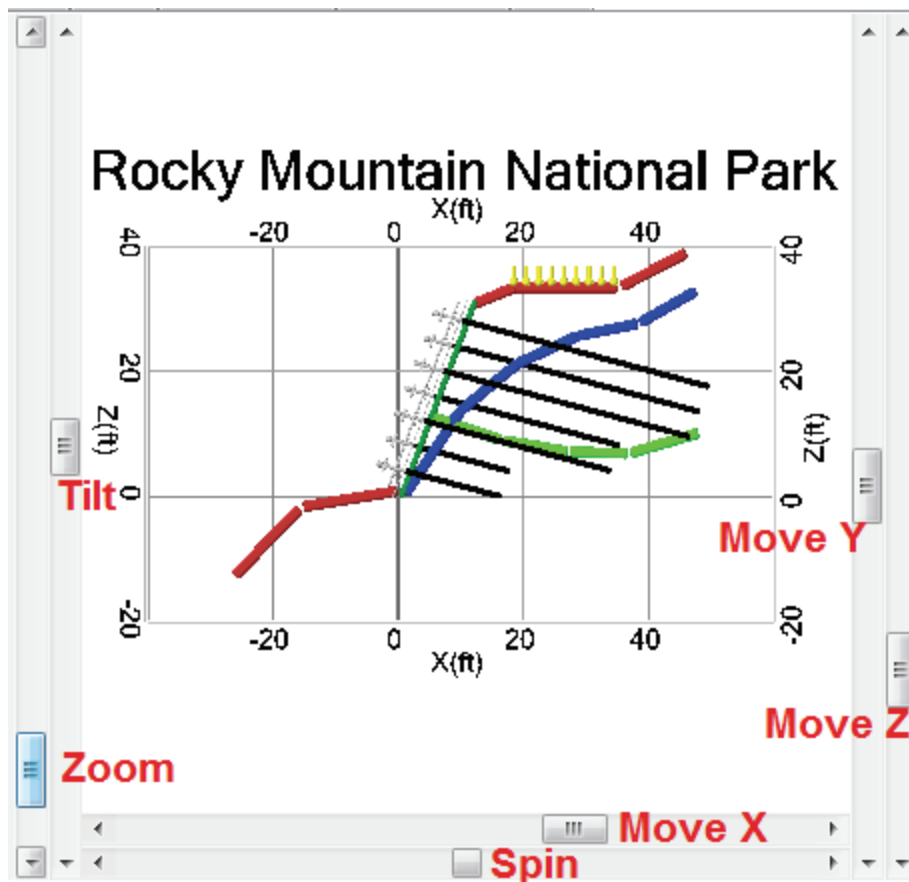

Figure 24. Screen Shot. Six scroll bars surrounding the display control the zoom, pan, tilt, and spin.

Zoom enlarges the image on your screen:

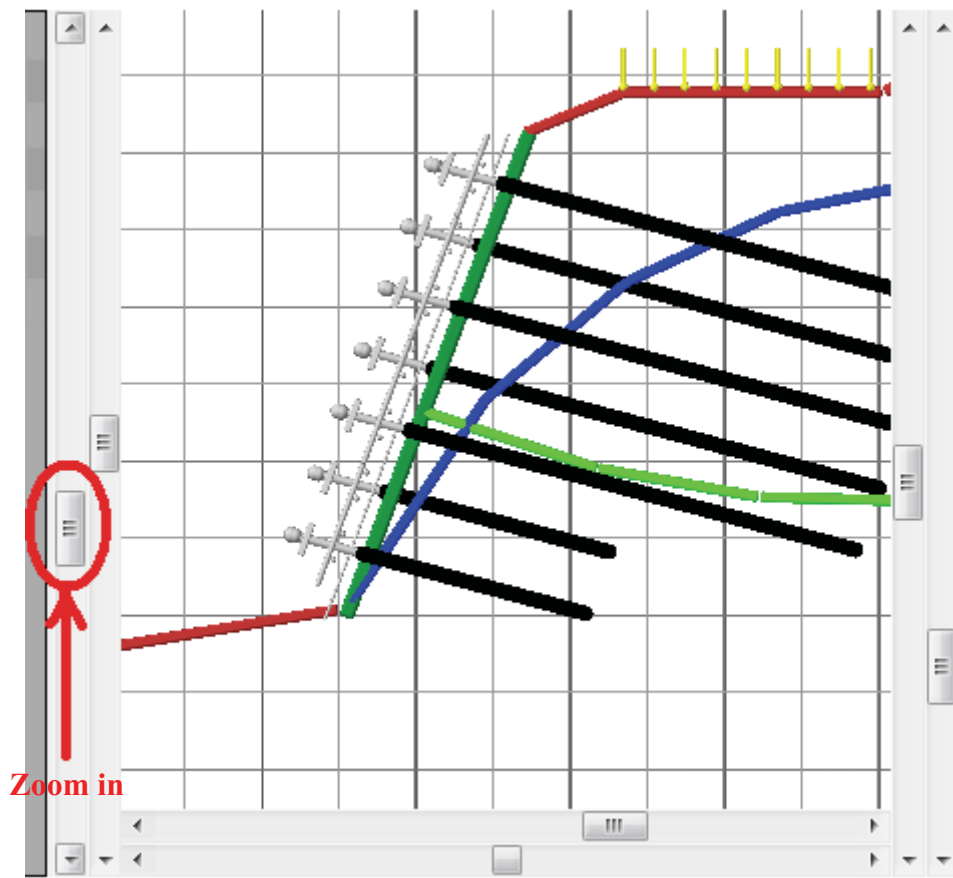

Figure 25. Screen Shot. Zoom in to see the problem geometry more easily.

Tilt rotates the image about the X-Axis:

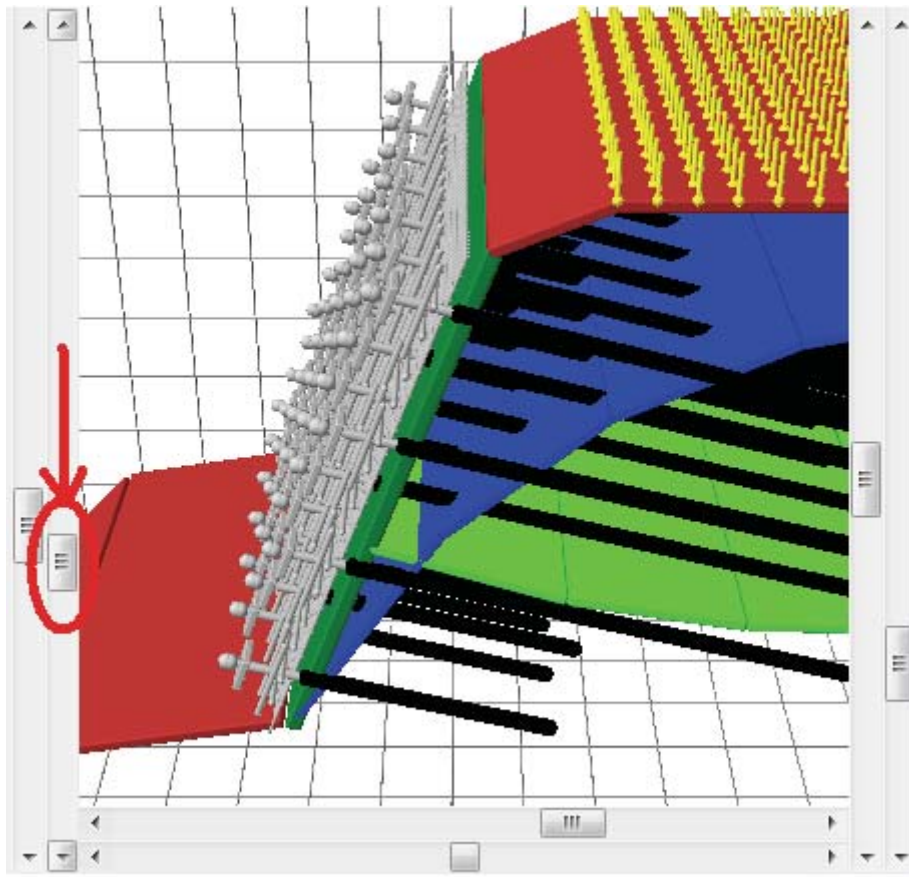

Figure 26. Screen Shot. Tilt will show the ground surface above the wall, or the view from below the wall.

Spin rotates the image about the Z-Axis:

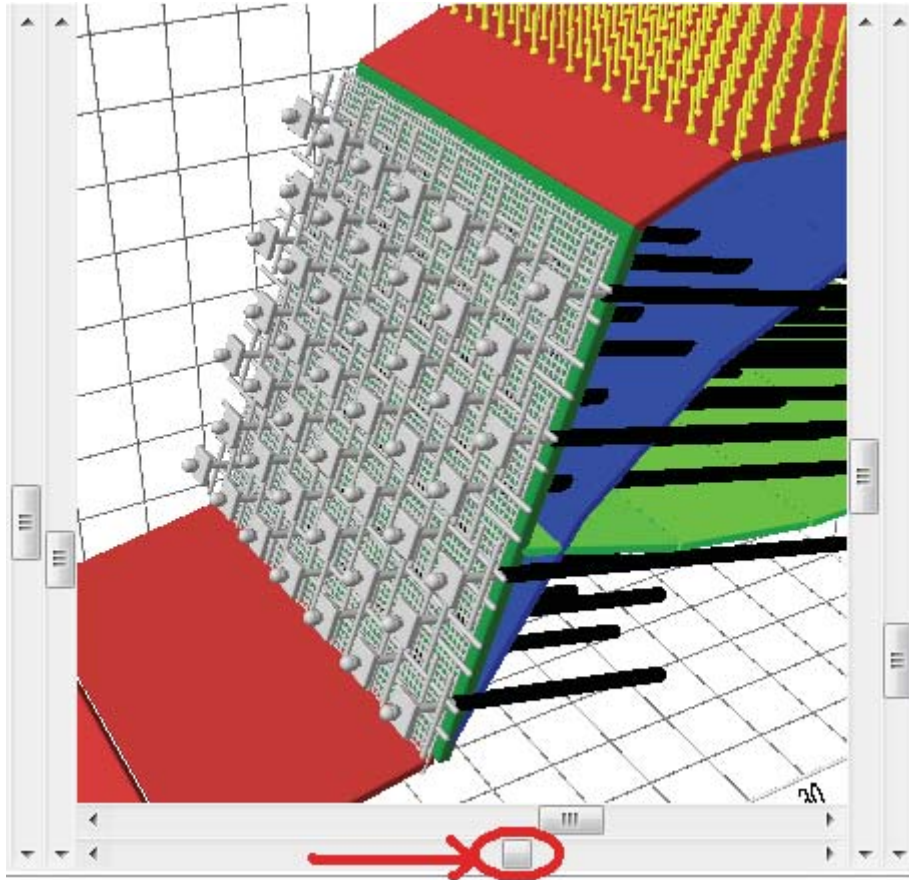

Figure 27. Screen Shot. You can “spin” the image to see the wall facing or view the stability analysis from left to right.

“Move X,” “Move Y,” and “Move Z” translate the image along the corresponding axis, without tilting, zooming, or spinning. This is similar to Pan commands in other programs (e.g. AutoCAD).

INPUT TABS

Project

The *Project tab* contains basic information about the project you are working on, such as the Name, Number, and Location. When the Report is generated, this information will be displayed on every page.

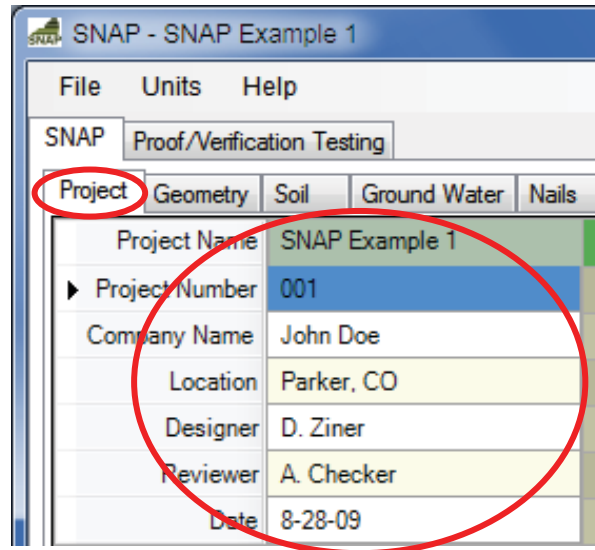

Figure 28. Screen Shot. Enter basic information about your problem on the Project tab.

Select the *Geometry* tab to enter data for the wall and backslope. Hold the mouse over any variable to see a description of that input parameter, such as *Wall height* for H (there is also a list of parameter descriptions used in SNAP under *Parameter Descriptions* in the Help section).

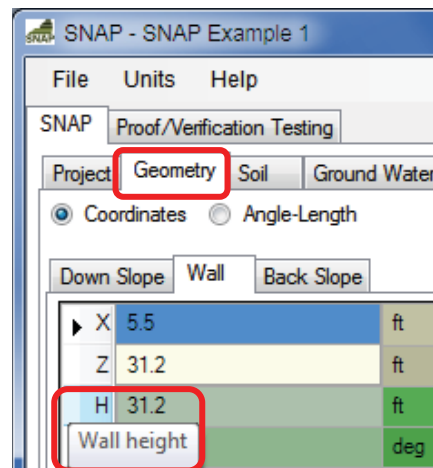

Figure 29. Screen Shot. Hold the mouse pointer over a variable to see its description.

The *Geometry* tab includes three sub-tabs: *Down Slope*, *Wall*, and *Back Slope*. For each of these geometry segments, the user must select one of two data entry methods: point-by-point using X,Z coordinates (*Coordinates* radio button) or by entering the horizontal distance and angle from horizontal for each segment (*Angle-Length* radio button (Figure 31)). When *Coordinates* are chosen, the program will automatically fill in the *Angle-Length* numbers, and vice-versa. For any geometry segment, points may also be added by clicking in the display area at the location a point is desired, or deleted by right-clicking on the yellow dot at that point. Points may also be moved by clicking and dragging them around the display area.

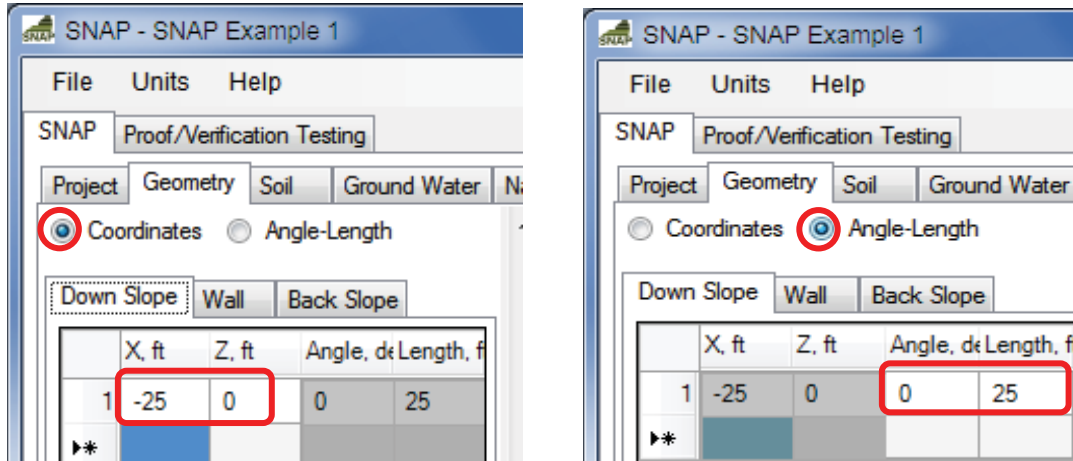

Figure 30. Screen Shot. The problem geometry can be entered using X,Z coordinates or a horizontal distance and angle from horizontal.

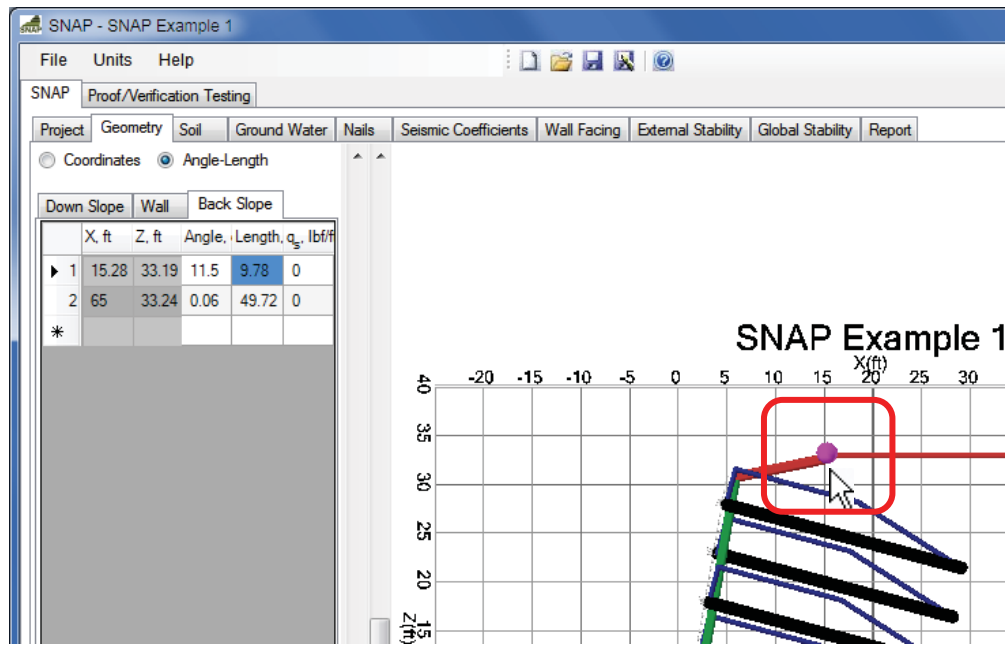

Figure 31. Screen Shot. You can also click and drag on the pink circles to adjust the problem geometry.

Complex slope geometry may be added in this way; however, only single-tier walls are available.

The program also allows a surcharge load to be specified for any ground segment behind the wall (in the back slope). The surcharge is displayed graphically by yellow arrows:

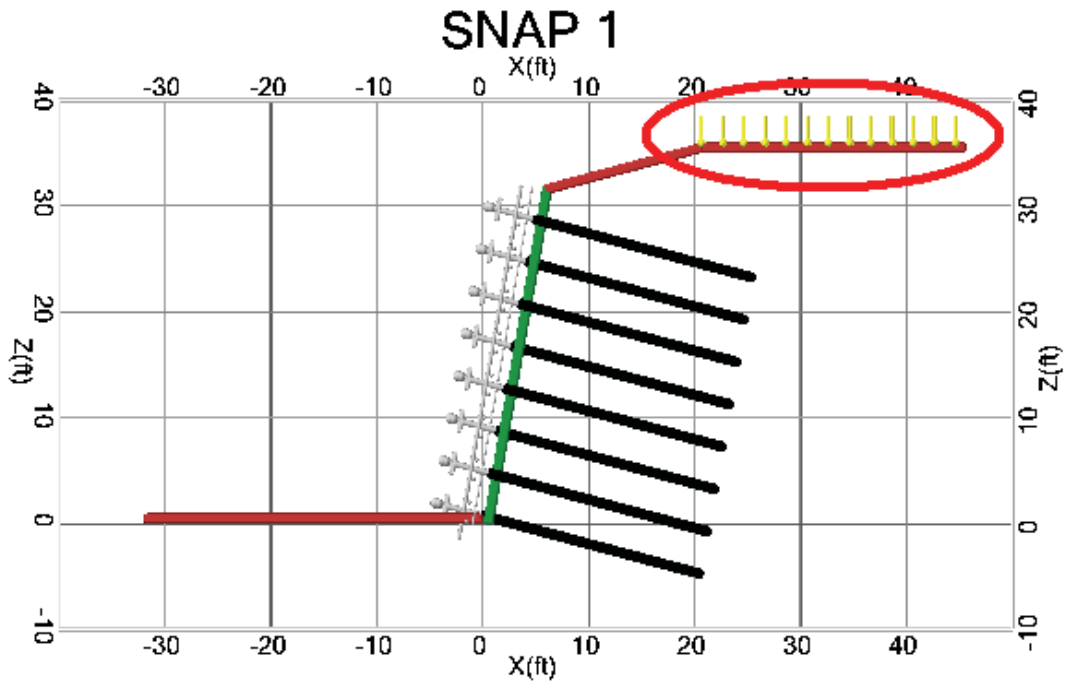

Figure 32. Screen Shot. Surcharge loading on the top of the wall is shown by yellow arrows.

Soil Layers

Select the *Soil tab* to enter soil strength data, pullout resistance (grout-ground bond) data, and bearing capacity factors.

Project	Geometry	Soil	Ground Water
▶ γ	114.5		pcf
ϕ	34		deg
c	104		psf
q_u	15		psi
Q_u	4524		lbf/ft
N_c	42.2		
N_γ	41.1		
N_q	29.4		

Figure 33. Screen Shot. Enter soil strength information, including pullout strength, on the Soil tab.

The ability to model *only one soil layer* is provided in this version of the program. Bearing capacity factors are entered by the user to allow for reductions due to an inclined toe slope, if required. Q_u is the ultimate pullout resistance *per unit of nail length*, and is calculated *based on the hole diameter entered on the Nails tab*.

Groundwater Data

Points specifying a phreatic surface may be entered by selecting the *Groundwater tab*:

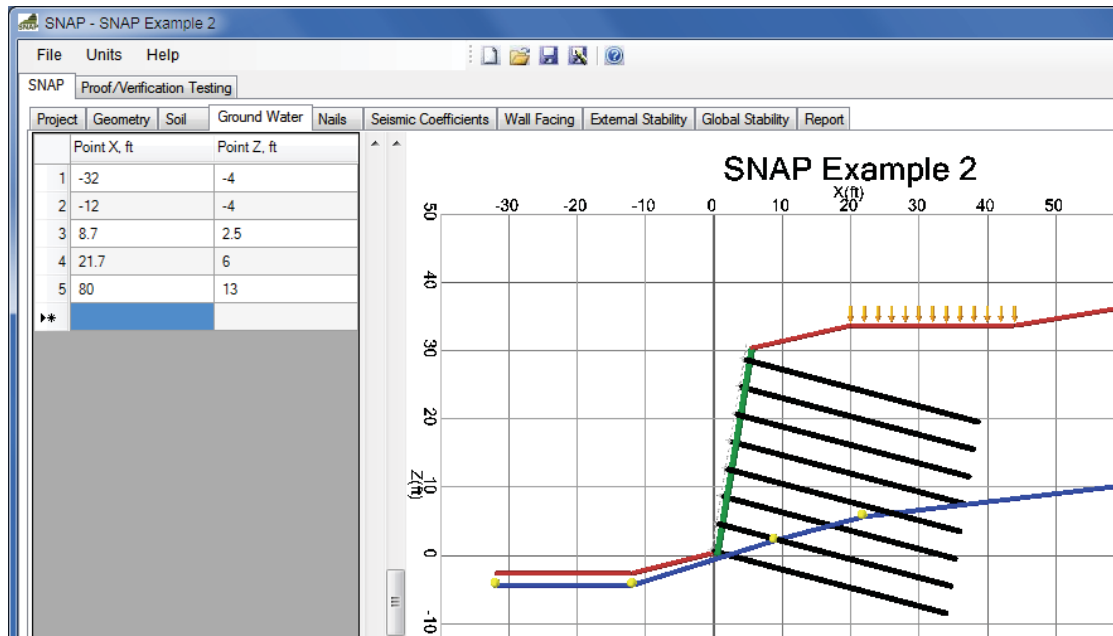

Figure 34. Screen Shot. Enter phreatic surface information on the Groundwater tab.

Points on the phreatic surface may be added either by entering X, Z coordinates into the table, or by clicking within the display area. Groundwater is not used in external stability or facing (internal) stability; it is used only in global stability.

Nail Data

Nail geometry and strength information is entered on the *Nails tab*. Nail lengths and vertical spacing can be either uniform or non-uniform, by selecting the radio button next to *Uniform* or *Non-Uniform*. When *Non-Uniform* is selected, only the nail lengths and vertical spacing can be non-uniform; other nail properties will still be uniform throughout the wall.

For both uniform and non-uniform nail geometries, a *Properties tab* allows the user to enter general data about the nails. This includes the nail length (for uniform nails only), horizontal nail spacing, vertical nail spacing (for uniform nails only), nail inclination, drill hole diameter, nail bar size, nail bar yield strength, nail bar shear strength, cantilever distance between the top of the wall and the top nail, and the strength factors for nail pullout, tendon tensile failure, and head strength. Both nail bar cross-sectional area and diameter must be entered, which *allows for the use of hollow-bar nails* in all subsequent calculations.

Please note: nail length in SNAP is defined from the back of the shotcrete facing to the end of the steel nail tendon, for both shotcrete and cast-in-place facing types. Nail length is measured in the direction of the nail inclination.

In the display area, the variation of allowable nail bar load along the length of the nail is shown as a blue line just above each nail (similar to Figure 2 in Chapter 1). Depending on the location, this line may correspond to the allowable nail head strength, the allowable nail bar tensile strength, or a reduction of the tensile strength based on the allowable pullout strength between the grout and the soil. This line is essentially a small graph, based on the nail and soil properties entered on the *Soil*, *Nail*, and *Wall Facing* tabs. (The nail head strength will be zero until wall facing information is entered on the Wall Facing tab.) When SNAP calculates global stability for the wall, these graphs are used to determine the resisting forces contributed by each nail.

For uniform nail geometry, the user may change the length or inclination of a nail by entering values into the Properties tab, or using the mouse to drag the end point of the top nail (displayed in bright purple) around the display area. The lengths and inclinations of all of the nails will automatically change.

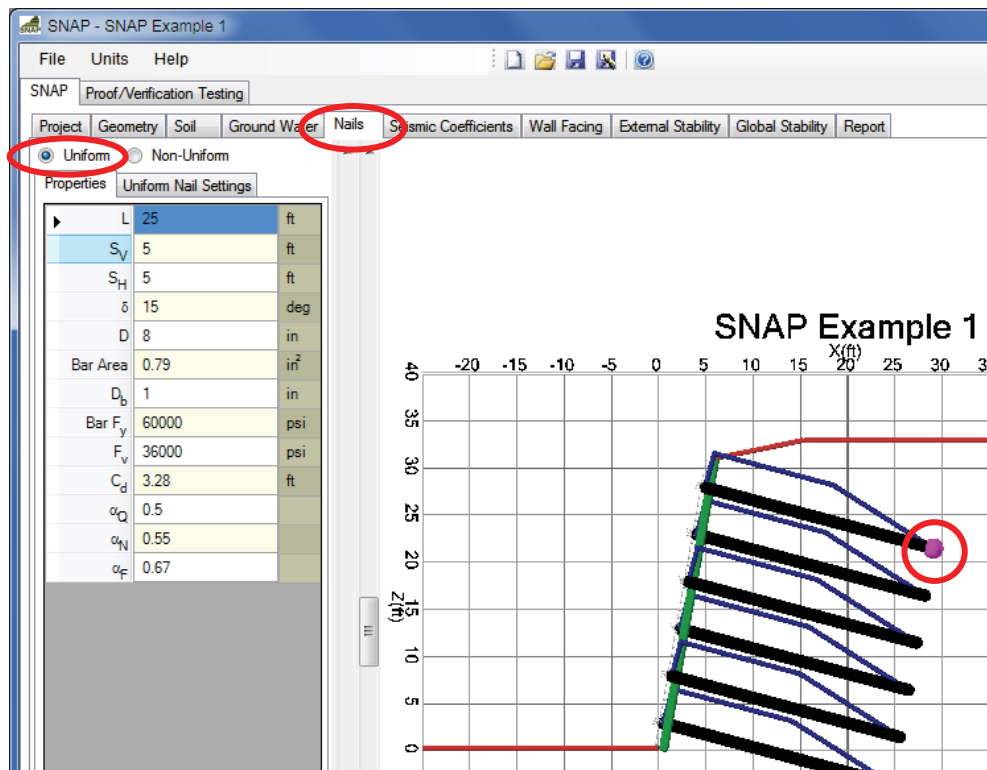

Figure 35. Screen Shot. Change uniform nail lengths by clicking and dragging the top nail around the display area.

For uniform nail geometry, the *Uniform Nail Settings* tab displays the height of each nail above the toe of the wall (the toe of the wall is by default $Z = 0$). When the user selects a nail in the table on the left, the allowable nail support load variation is summarized in a table in the lower portion of the frame. The nail support load diagrams are also shown in the display area, along the length of each nail.

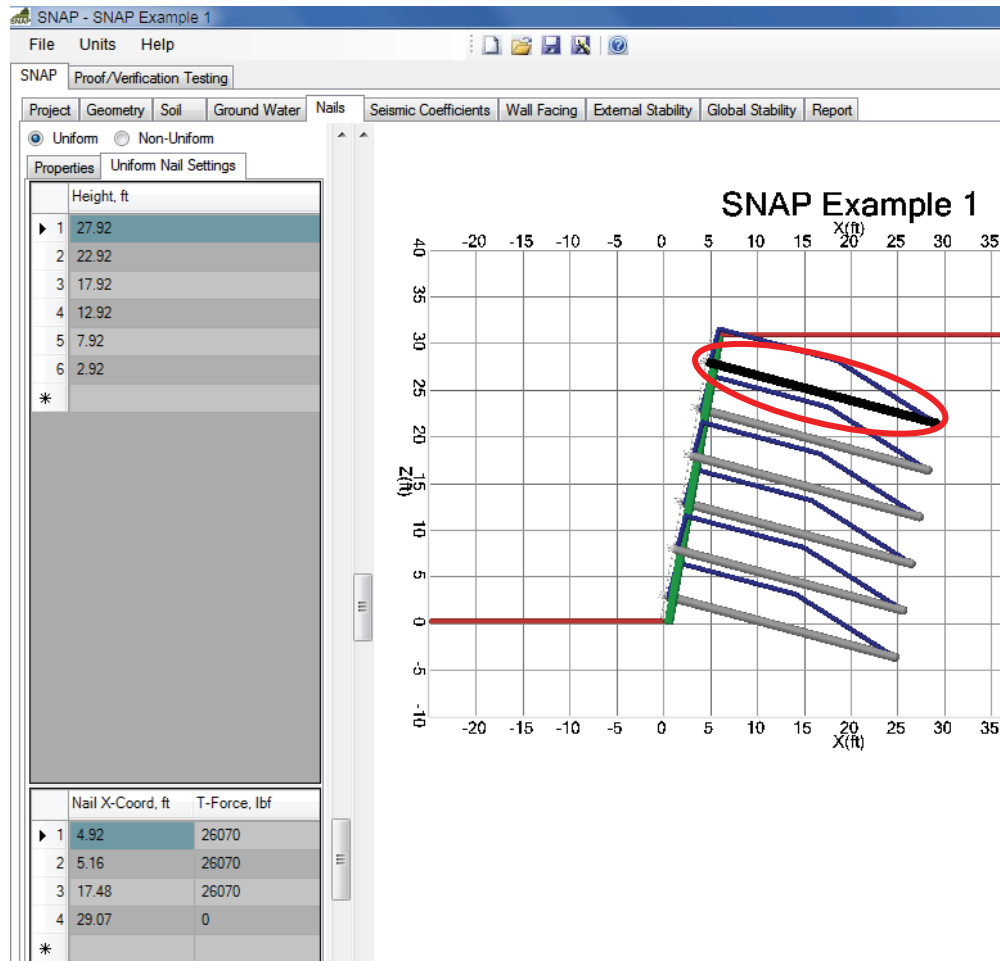

Figure 36. Screen Shot. The “Uniform Nail Settings” tab displays nail heights above the toe of the wall and support load diagrams.

For *non-uniform nail geometry*, the *Nail Settings tab* allows the user to change the length and height above the toe of the wall for each nail (the toe of the wall is by default $Z = 0$). Individual nail inclination may also be adjusted if a different orientation is required for any row of nails (e.g. in the case of an underground utility in conflict with wall construction). The overall nail inclination value on the Properties tab will show the minimum inclination value from the Nail Settings tab.

All settings values may be entered into the table or the user may click in the display area where the end point of a new nail should go, and a nail will be added. When a nail is selected in the table or when the user hovers over a nail in the display area with the mouse, the nail support load diagram for that nail is summarized in a table in the lower portion of the left frame. The nail support load diagrams are also shown in the display area along each nail.

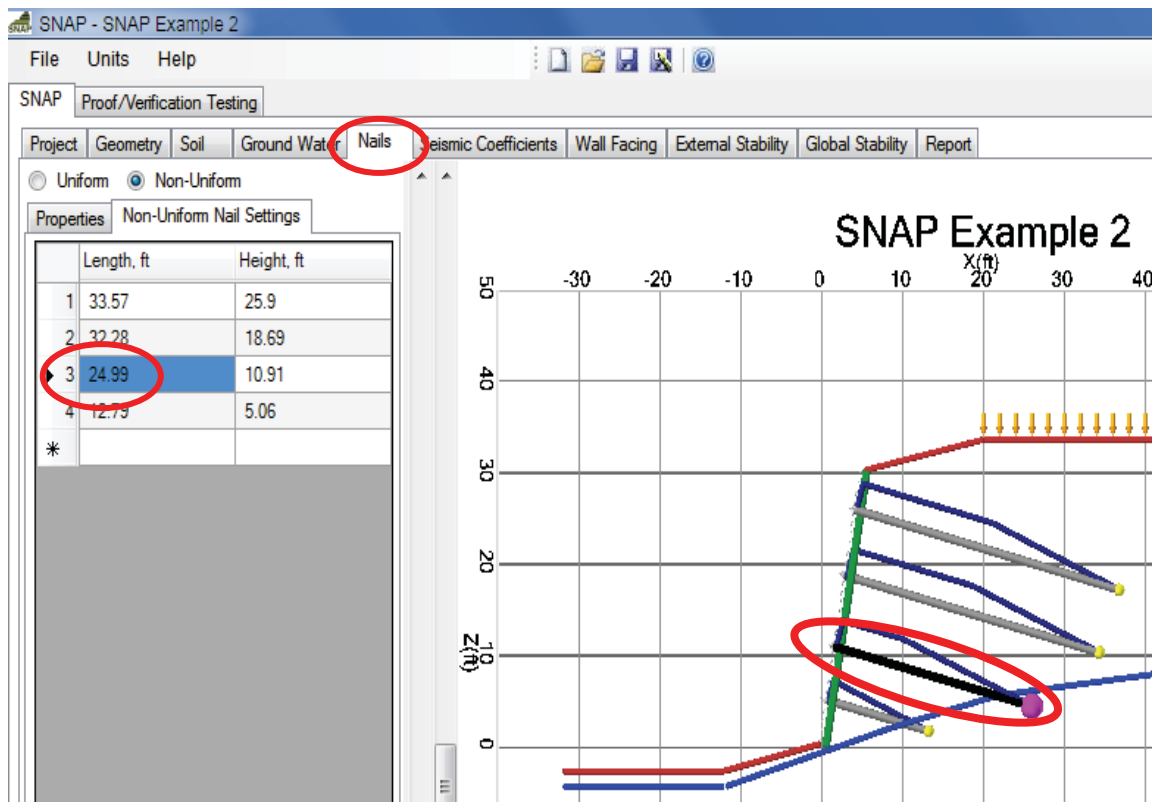

Figure 37. Screen Shot. The “Non-Uniform Nail Settings” tab displays nail lengths, heights, and inclinations, as well as support load diagrams.

Additional Information on Nail Support Load Diagrams

FHWA Publication No. FHWA-SA-96-069R includes a helpful example of a nail support load diagram, reproduced as Figure 2 on page 5 above. This diagram is used to visualize how a soil nail’s contribution to global stability varies along the length of the nail. Where a potential slip circle intersects the nail along the nail’s length determines how much additional strength will be

available to resist failure. The closer the intersection is to the front or the back, the more likely the nail is to fail in pullout. If the nail is long enough, then the nail's tendon tensile strength may be the contributing force at locations near the center of the nail tendon, rather than the pullout strength between the soil and the grout around the nail. The nail head also contributes some strength near the front of the nail.

Nail Length Handicapping in SNAP

FHWA-SA-96-069R outlines a procedure for “handicapping” or “shorting” soil nails near the bottom of a wall during design, in order to ensure that adequate nail reinforcement is installed in the upper portion of the wall. Performance monitoring of several instrumented soil nail walls has demonstrated that the top-down construction method of soil nail walls generally results in the nails in the upper part of the wall being more critical than the nails in the lower part of the wall in developing resisting loads and controlling wall deformation. If stability calculations overstate the contribution from the lower nails, then this can erroneously specify shorter nails or smaller tendon sizes should be used in the upper part of the wall. This is detrimental and could result in poor wall performance. The procedure given by FHWA (in Section 4.7.1) is summarized in Figure 38 below.

In SNAP, this can be done manually by the user, by using the Non-Uniform Nails feature in the Nails tab. The user can select appropriate lengths to analyze global stability based on artificially shortened nails.

Please note that this design procedure is only for use in designing the wall; it does not indicate that the installed nail pattern should correspond to this pattern. Soil nail walls are normally constructed with uniform nail lengths to simplify cost estimation and construction, although it is possible to install shorter nails in the lower part of the wall if external and global stability requirements are met.

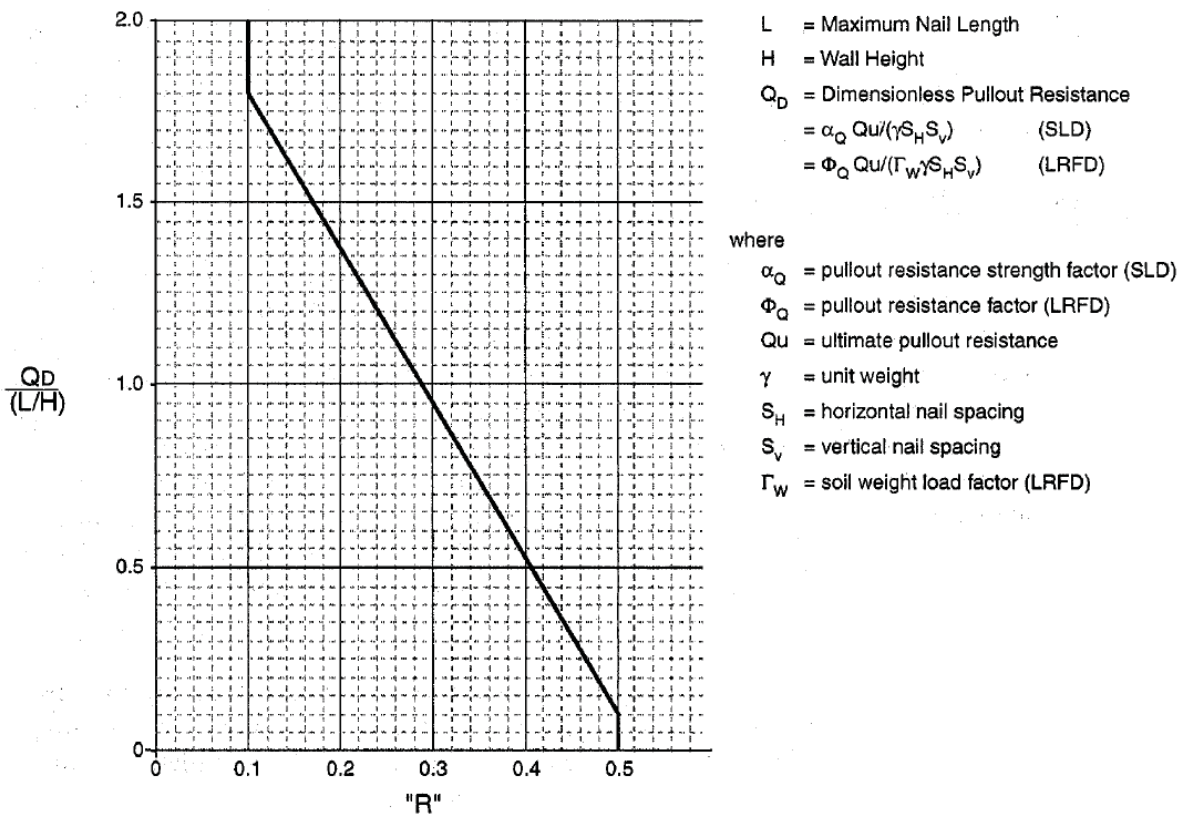
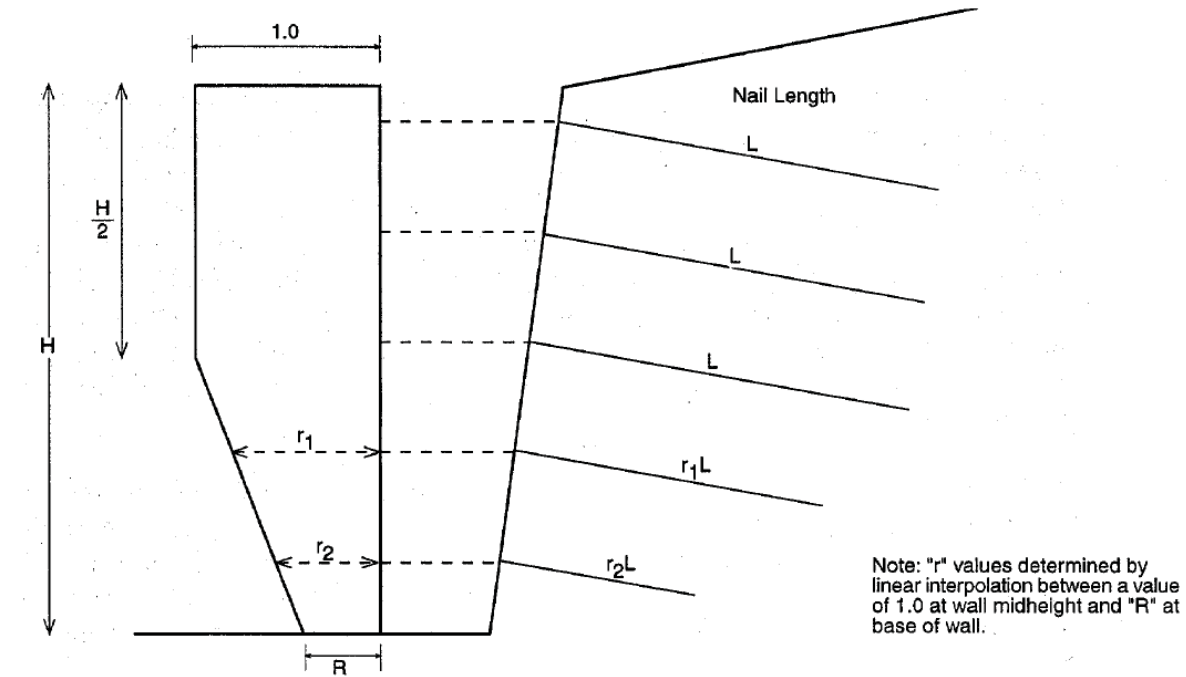

Figure 38. Schematic. SNAP uses the nail handicapping procedure outlined in FHWA-SA-96-069R.

Seismic Data

Seismic effects are ignored when “Include Seismic Loading in Analysis” on the *Seismic Coefficients* tab is not checked:

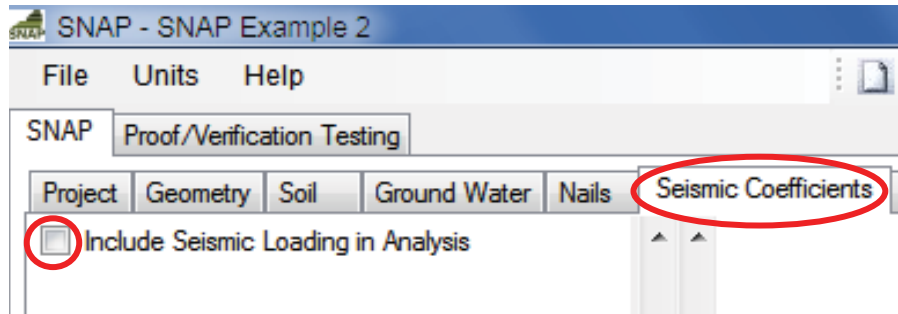

Figure 39. Screen Shot. Un-check this box to do a normal analysis without seismic effects.

To include seismic effects, check the box next to *Include Seismic Loading in Analysis*. Enter a value for the horizontal seismic coefficient K_h , or enter the peak ground acceleration, A , and obtain K_h from the *Calc K_h from A* button.

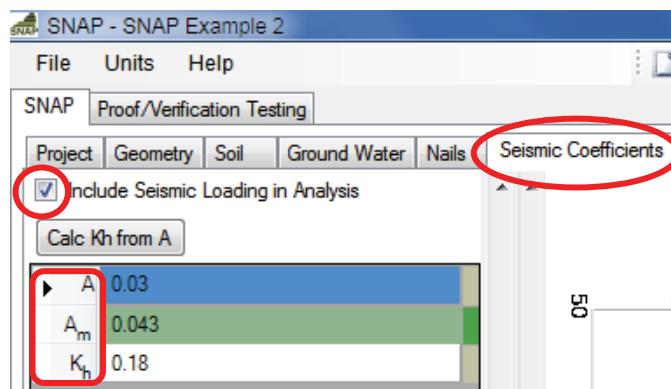

Figure 40. Screen Shot. You can enter two types of seismic coefficients: K_h or Peak Ground Acceleration.

This calculation is based on a tolerable seismically-induced lateral wall movement, as outlined by FHWA-IF-03-017, Section 5.4.5.3. Including seismic loading will affect results for external stability and global stability. For conservative calculations, SNAP always assumes that the vertical seismic coefficient, k_v , is zero, for both external and global stability calculations.

Facing Data

The *Wall Facing* tab provides the user with two options for facing types: Shotcrete and Cast-in-Place. When Cast-in-Place is selected, the strength of any shotcrete facing that would be constructed behind the cast-in-place facing is neglected. FHWA guidelines recommend this since a shotcrete facing is often only designed for a temporary loading condition.

Two common nail spacing patterns can be selected: Offset and Square. This *does not affect any calculations*, and is for display purposes only. Both nail patterns may be selected for either Shotcrete or Cast in Place facing types. An offset pattern is shown in Figure 41.

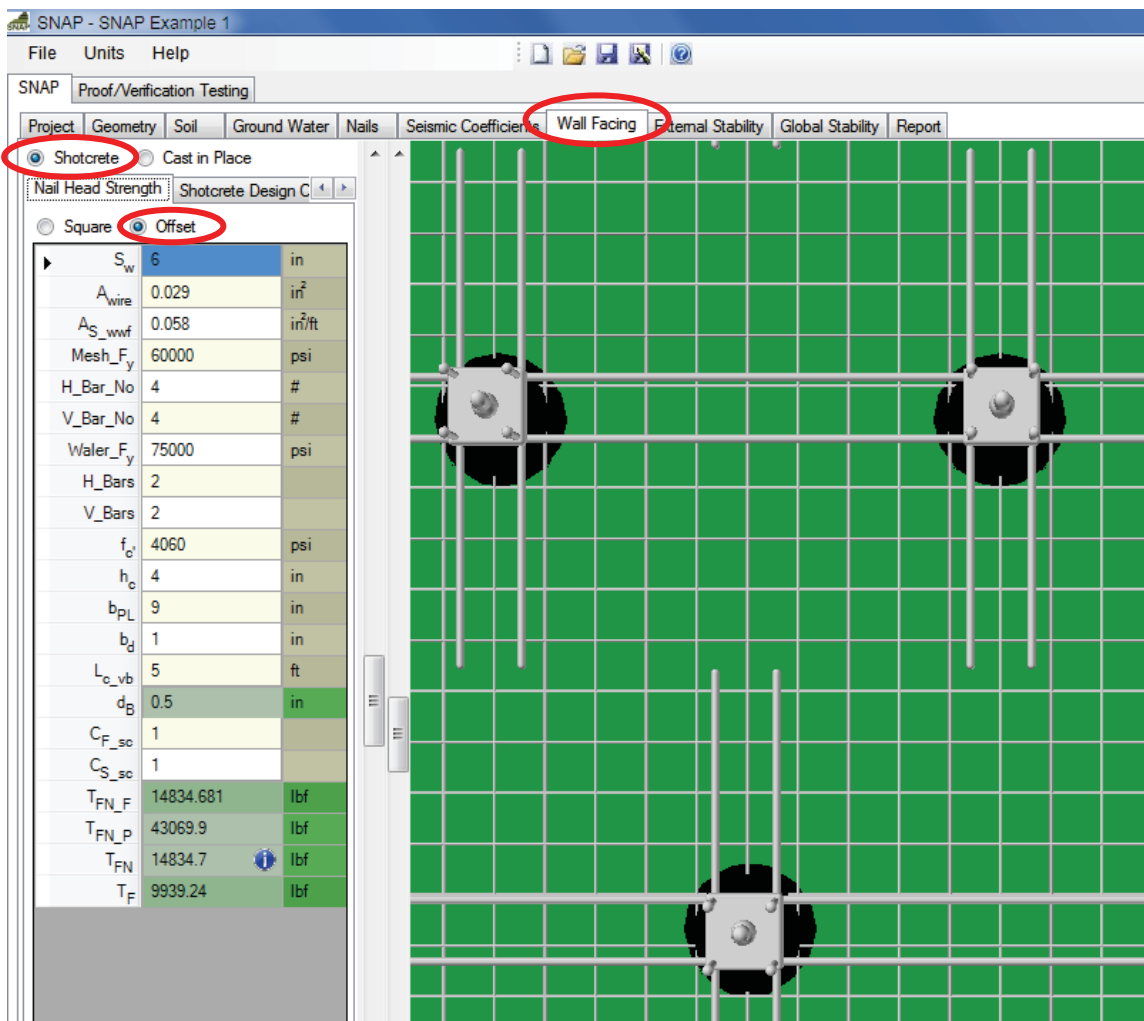

Figure 41. Screen Shot. An “Offset” nail installation pattern is selected on the Wall Facing tab.

Selecting a square pattern results in the following:

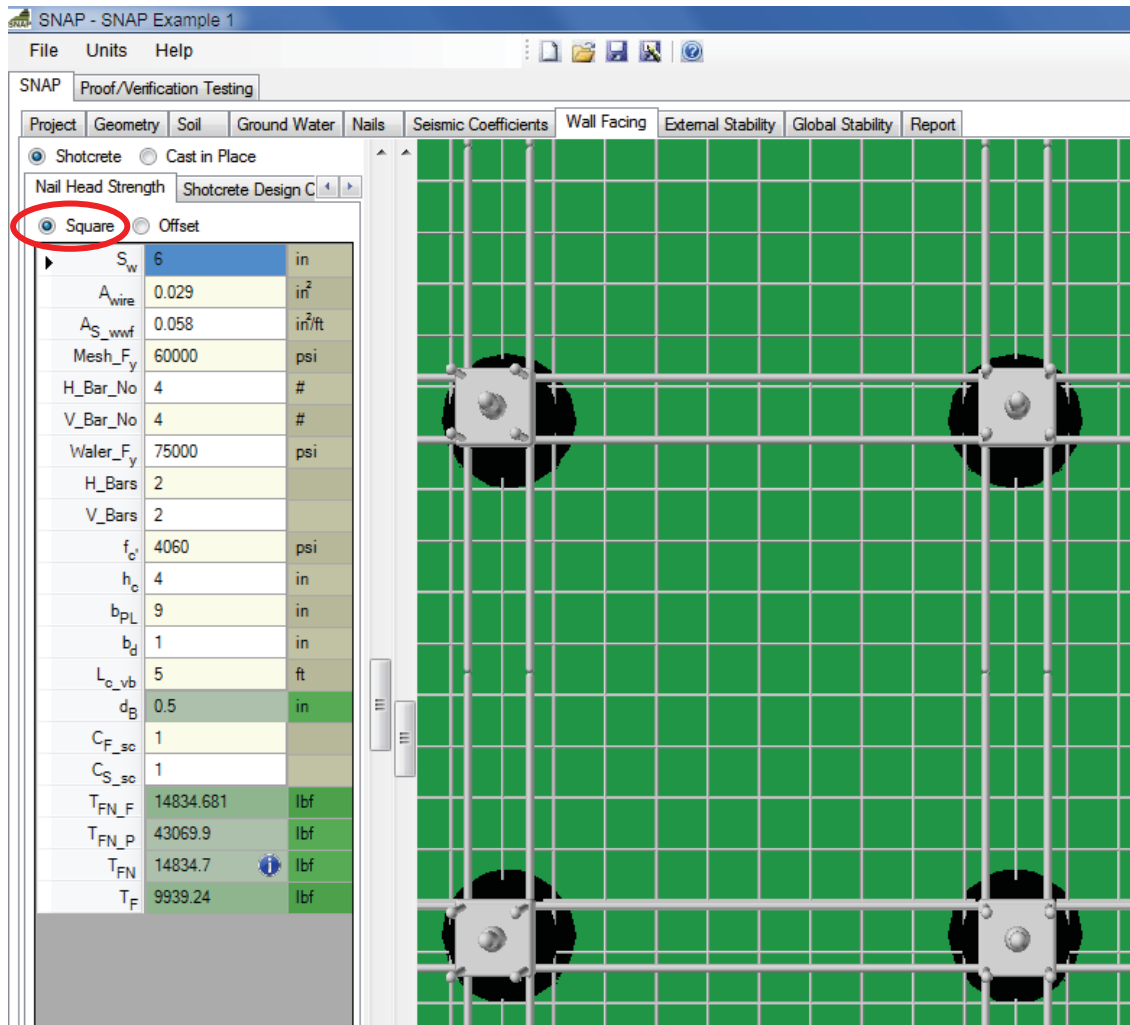

Figure 42. Screen Shot. A “Square” nail installation pattern is selected on the Wall Facing tab.

For a shotcrete facing, the user enters input information about the wire mesh, horizontal waler bars, vertical bearing bars, shotcrete, and bearing plate. SNAP calculates the nominal nail head strength for both punching and flexure, selects the controlling mode, and calculates the allowable nail head load based on this value. All of these are displayed at the bottom of the list.

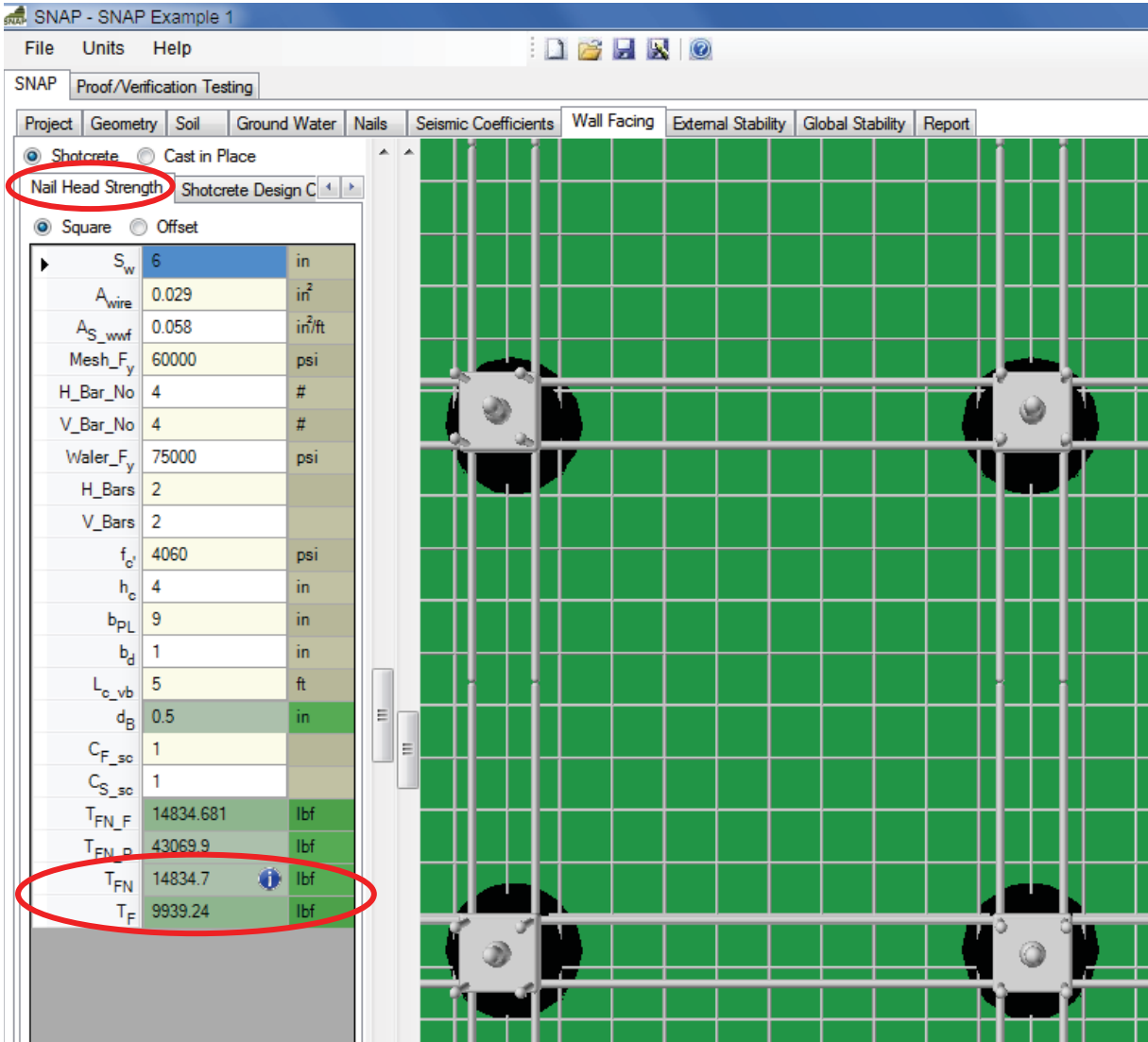

Figure 43. Screen Shot. The nominal nail head strength, T_{FN} , and allowable nail head load, T_F are displayed at the bottom of the list for a shotcrete facing.

Design checks for the shotcrete facing are included in a separate *Shotcrete Design Checks* tab, in the rows with small blue “information” icons. These can be viewed by holding the mouse over the icon for a few seconds:

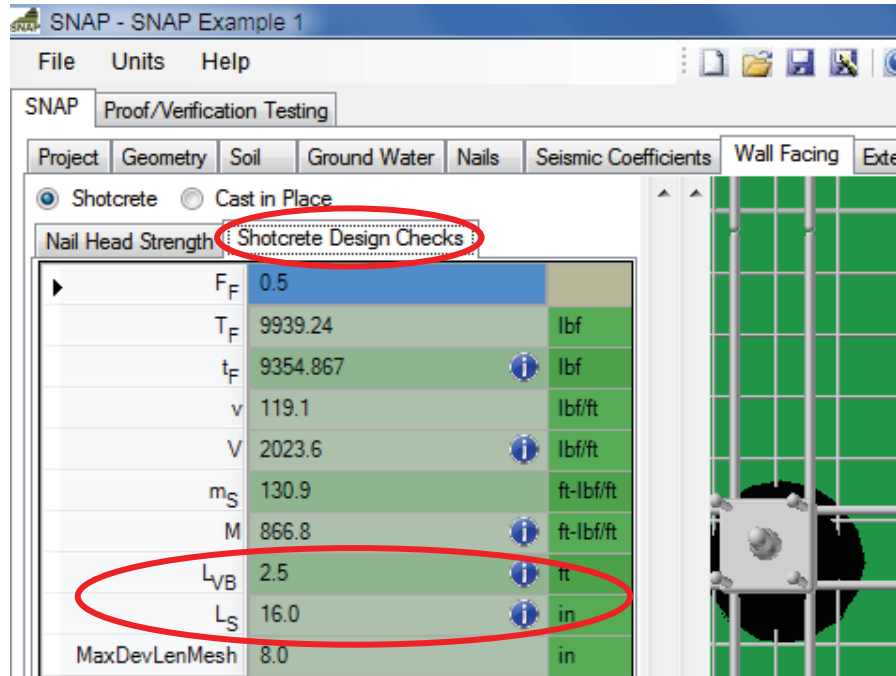

Figure 44. Screen Shot. Design checks for the shotcrete facing are viewed by holding the mouse over the blue icons.

For a cast-in-place concrete facing, the user enters input information about the horizontal and vertical concrete reinforcement, the concrete itself, and the headed-stud connection system between the concrete facing and the shotcrete facing. SNAP calculates the nominal and allowable nail head load and displays it at the bottom of the list under the *Cast-in-Place* tab.

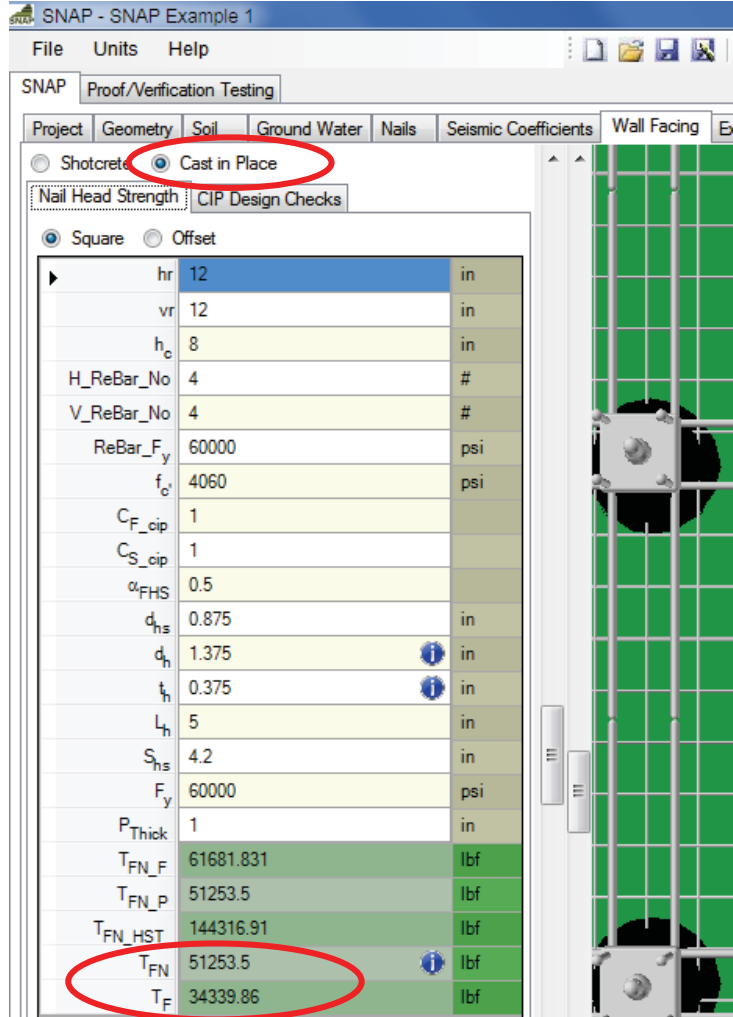

Figure 45. Screen Shot. The nominal nail head strength, T_{FN} , and allowable nail head load, T_F are displayed at the bottom of the list for a cast-in-place facing.

Design checks for a cast-in-place concrete facing are included in a separate *CIP design checks* tab, in the rows with small blue “information” icons. These can be viewed by holding the mouse over the icon for a few seconds:

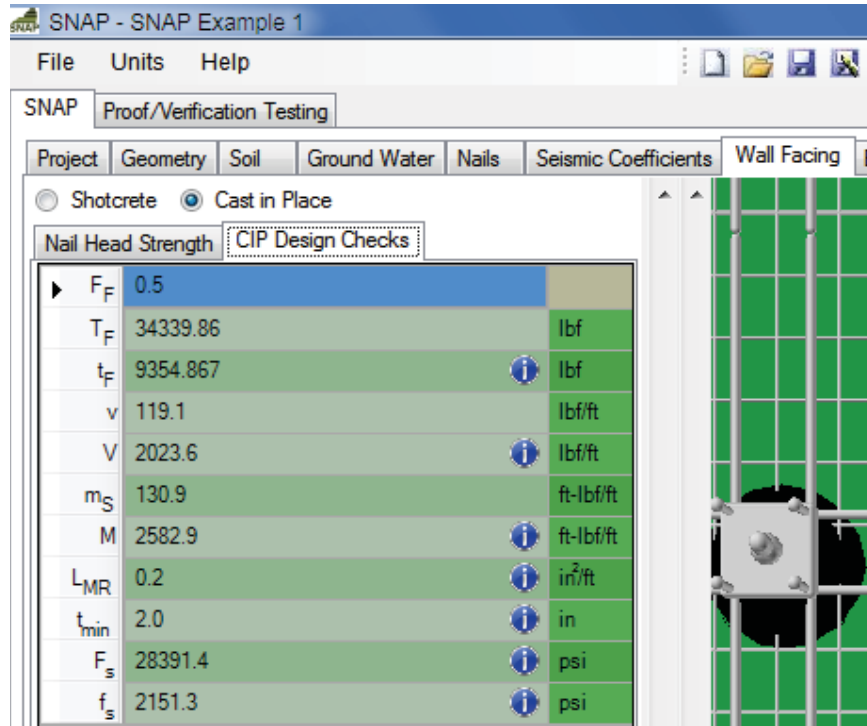

Figure 46. Screen Shot. Design checks for the cast-in-place facing are viewed by holding the mouse over the blue icons

CHAPTER 3 – SNAP OUTPUT

RESULT SCREENS

Wall Facing Design and Serviceability Checks

As mentioned above, SNAP calculates the nominal nail head strength for all applicable facing failure modes for both shotcrete and cast-in-place concrete facing types, then selects the controlling value for the nominal strength (T_{FN}) and calculates the allowable nail head load (T_F). All of these values are shown in the program under the *Nail Head Strength tabs* for both shotcrete and CIP facing types. When a Cast-in-Place facing is chosen, the strength of the shotcrete facing is neglected, as recommended by FHWA.

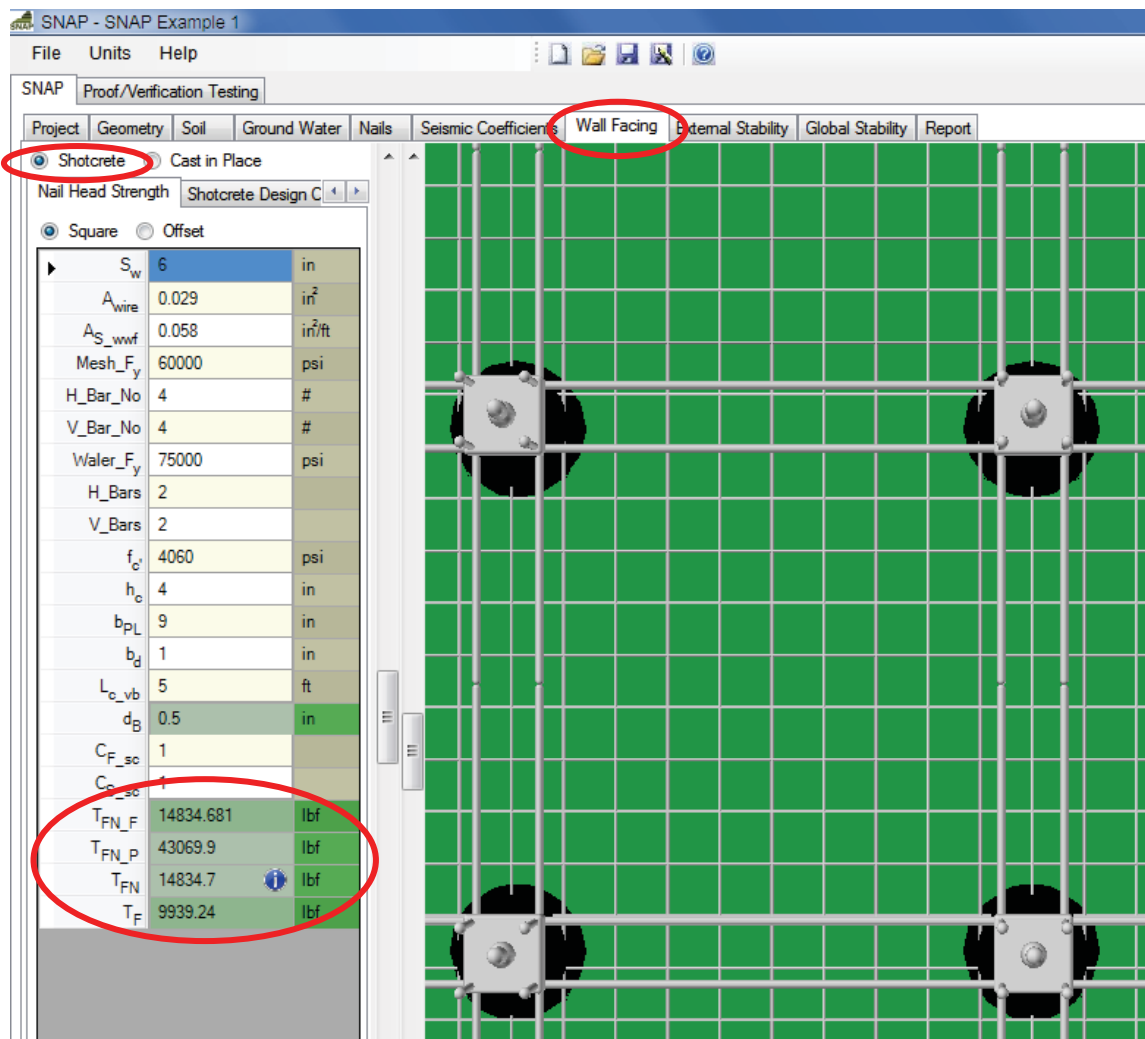

Figure 47. Screen Shot. The nominal nail head strength and allowable nail head load are shown under the Wall Facing tab, on the Nail Head Strength sub-tab.

Design and serviceability checks appear in the *Wall Facing* tab, on the *Shotcrete Design Checks* or *CIP Design Checks* sub-tabs, with small icons to the right of the values. Hold the mouse over the icon for a few seconds to view messages:

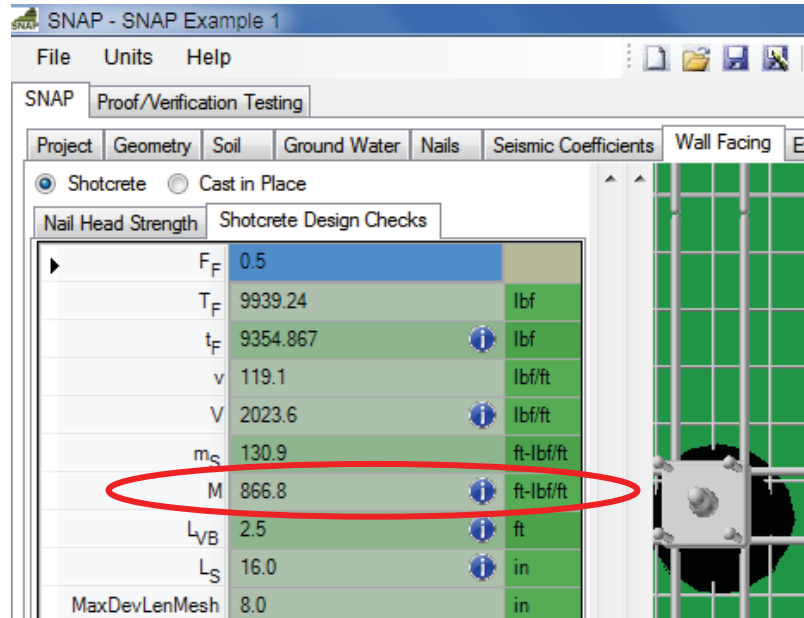

Figure 48. Screen Shot. Design and serviceability checks are shown on the Design Checks sub-tab for the appropriate facing type.

External Stability Analysis

External stability results, including sliding, overturning, and bearing capacity, can be reviewed on the *External Stability tab*. Some intermediate calculation values are shown in the table. Safety factors for external stability failure modes are given, as well as the eccentricity, vertical effective stress at the base of the wall, and ultimate and allowable bearing capacity values for the wall. Certain results have icons to the right of the numbers, indicating whether AASHTO minimum factor of safety requirements are being met (The program will change these minimum FS values depending on whether seismic coefficients are being used). Hold the mouse over the information or warning icons for a few seconds to read what they say:

Project	Geometry	Soil	Ground Water	Nails	Seismic Coefficients	Wall Facing	External Stability
B	26.9						ft
▶ ecc	4.7						⚠
c_v	5472.4						psf
FS_{SL}	2.0						ℹ
FS_{OT}	2.9						ℹ
q_{ult}	67606						psf
q_{allow}	27043						psf
FS_{BC}	12.4						ℹ

Figure 49. Screen Shot. External stability output results are shown on the External Stability tab.

These results are provided for the designer's reference, even though overturning and sliding failure are very unlikely to control stability of a soil nail wall.

Global Stability Analysis (Simplified Bishop Method for circular failure surfaces)

The *Global Stability* tab is divided into two sub-tabs: *Failure Circles* and *Radius Control*. The *Failure Circles* tab is an output-only tab, which provides the lowest 10 Simplified Bishop factors of safety (FS), along with information on the location and radius of each slip circle associated with these factors of safety. The slip circles for the lowest 10 FS values are also shown in the display area, with the color of each circle corresponding to its calculated FS, according to the legend bar at the bottom of the display area. Select a specific circle by clicking anywhere in that row to see the selected circle highlighted in the table, and in the display (the circle will be displayed as a much thicker line):

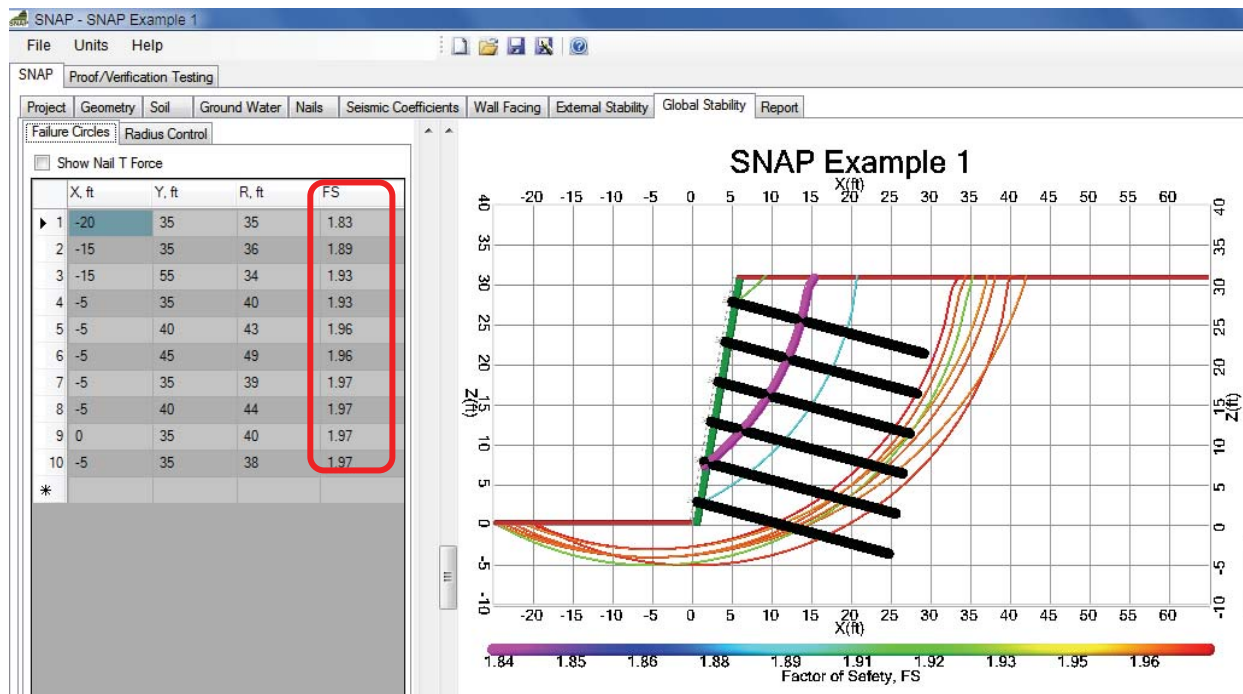

Figure 50. Screen Shot. The 10 lowest Factors of Safety, and their associated slip circles, are shown under the Global Stability tab.

When the Show Nail T Force box is checked, the variation in tensile force along the length of each nail will be shown in the display area as blue lines above the nails. This is a graphical representation of how the tensile force in each nail increases or decreases with distance from the wall face, similar to Figure 2 in Chapter 1. This gives the user the ability to determine how each nail is contributing to global stability, or whether the nails are failing in pullout.

These forces are numerically summarized under the *Nails tab* (See Chapter 1 and the Nail Data section in Chapter 2 for more information.)

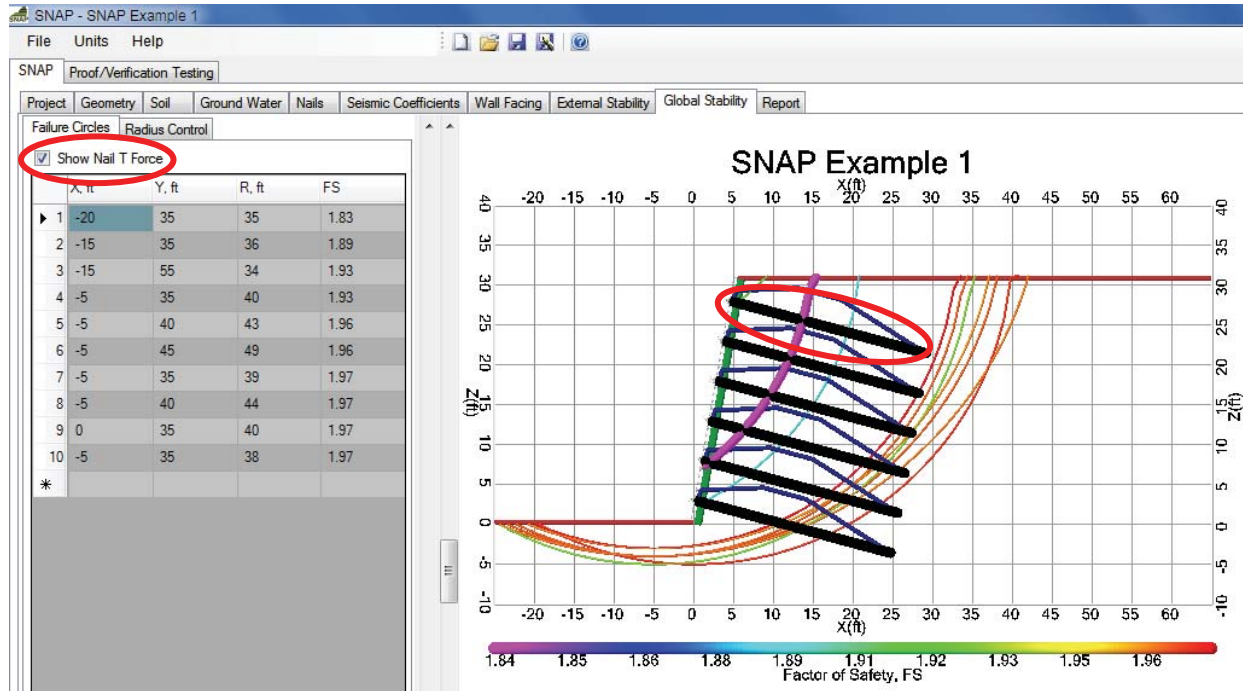

Figure 51. Screen Shot. Display the nail support diagram for each nail by checking the “Show Nail T Force” box.

The program analyzes slip circles with centers in a certain range and radii within a certain range (see Chapter 1 for a discussion). The *Radius Control* tab allows the user to change the limits of where slip circles can intersect the entire zone (down slope, wall, or back slope). This allows the exclusion of slip circles that only intersect the top nail, or slip circles that are too far away from the wall, for instance. *Upper Fail. Circle Min* and *Max* indicate a user-defined acceptable range of failure circle intersections with respect to the upper part of the slope given in terms of X coordinates. Likewise *Lower Fail. Circle Min* and *Max* indicate a user-defined acceptable range of failure circle intersections with the lower part of the slope given in terms of X coordinates

To have manual control over this aspect of the program, uncheck the box next to *Auto Calc Ranges*. The limits can be changed either by typing the values into the table, or by clicking and dragging the left and right points (shown in bright purple). These limits will be automatically selected if the Auto Calc Ranges checkbox is checked (See Chapter 1 for how this is done).

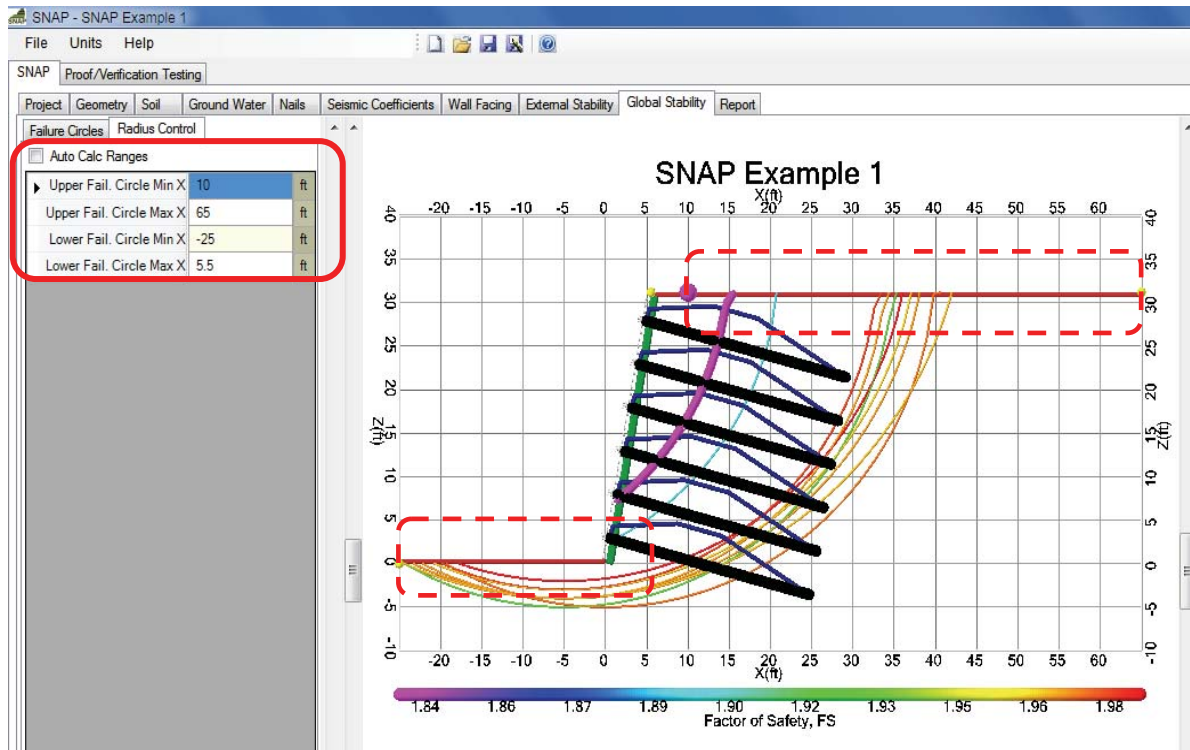

Figure 52. Screen Shot. The user has some control over how the program searches for slip circles.

REPORT GENERATION

On the *Report tab*, click on *Generate* to generate and view the report. This may take up to a few minutes to generate. The report includes all of the input information, as well as all of the output results, in a format that is easier to print or copy into another program. Tables and text can be copied and pasted into other programs for use in documents, presentations, etc.

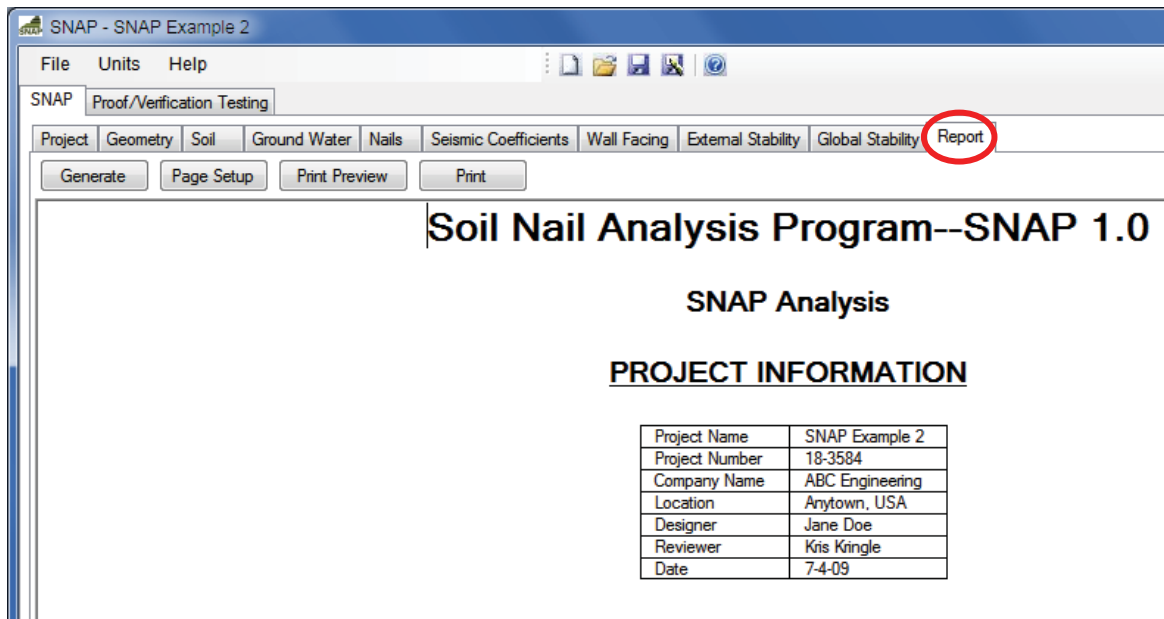

Figure 53. Screen Shot. Select the “Report” tab to generate, view, and print all input and output information in a format that is also easier to copy into another program.

Within the report, information or warning messages will appear in text below tables, with yellow or red backgrounds:

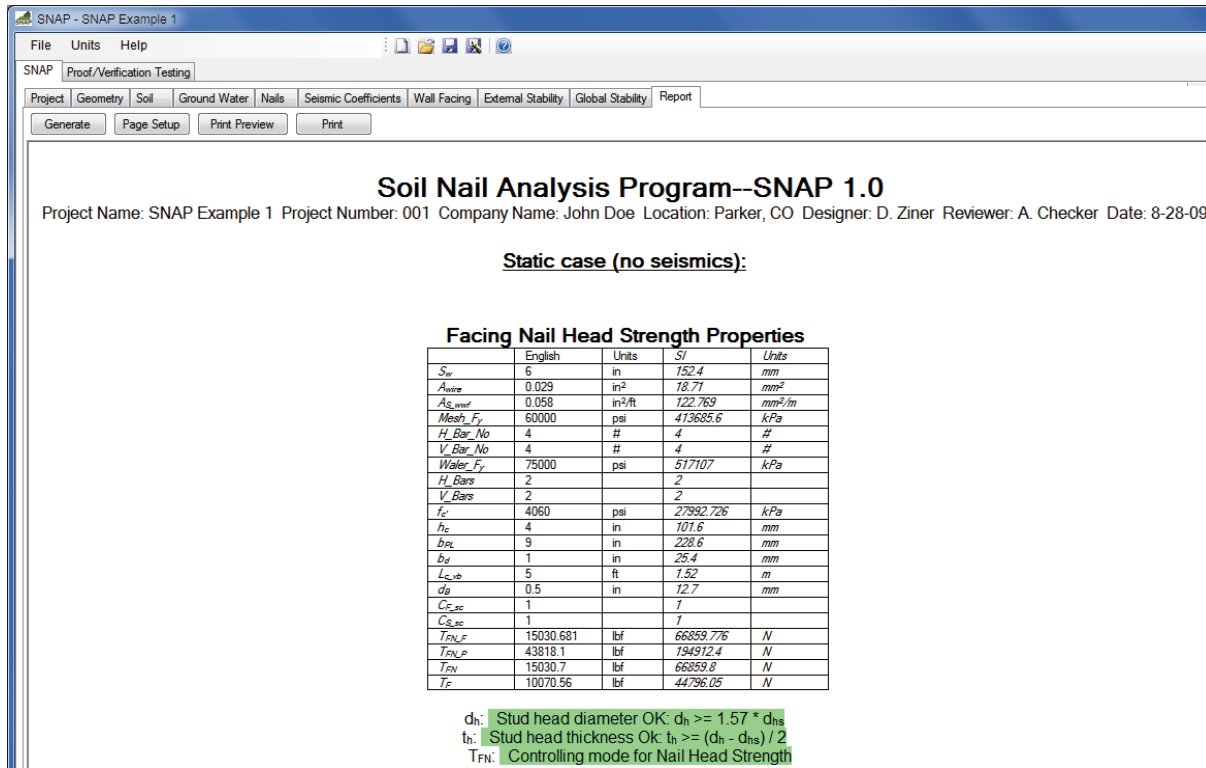

Figure 54. Screen Shot. Warning messages and other information are highlighted in the report.

While viewing the report, standard printing functions are available, such as Page Setup, Print Preview, and Print.

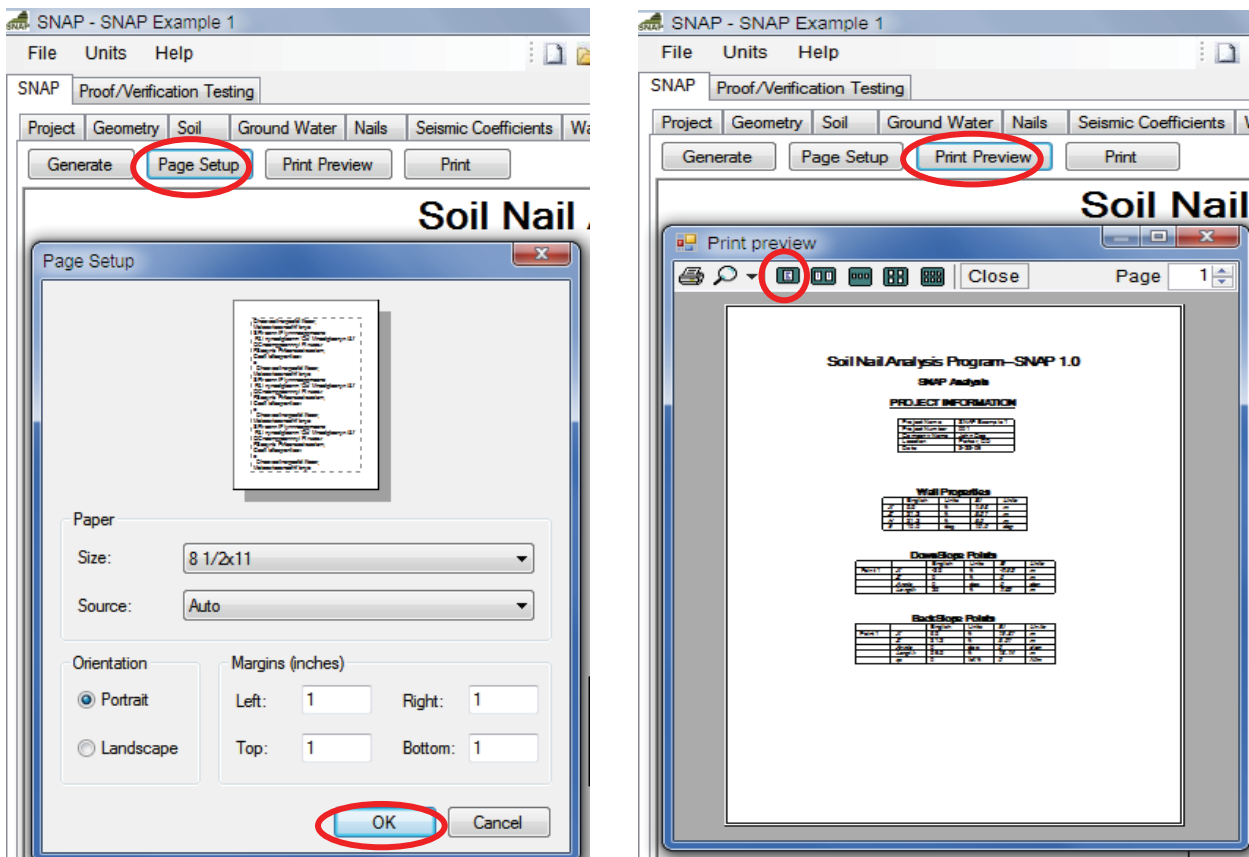

Figure 55. Screen Shot. Standard print functions such as Page Setup and Print Preview are available.

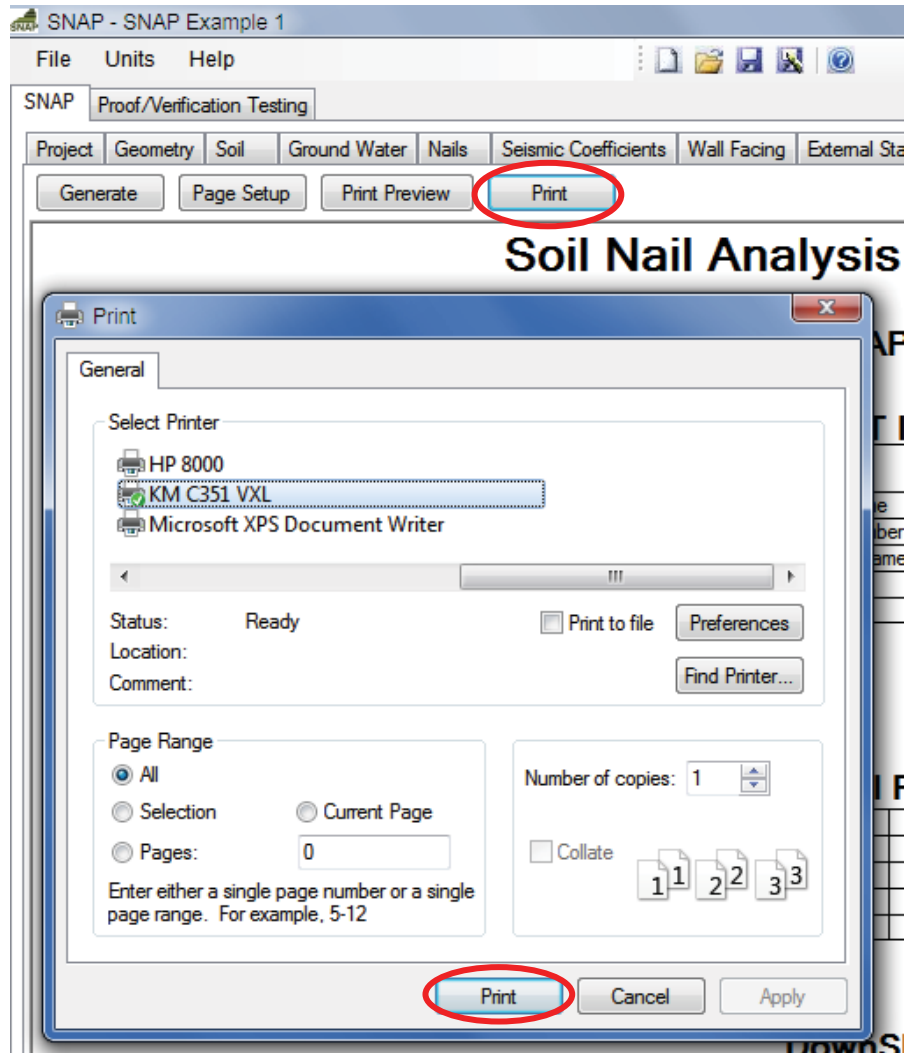

Figure 56. Screen Shot. Select “Print” to print the entire Report.

CHAPTER 4 – EXAMPLE PROBLEMS

EXAMPLE 1

The following is a demonstration of the application of SNAP for design of a soil nail wall support for a 31.2 foot high cut. This Example can be loaded in SNAP by selecting File → Example 1.

Geometry

The slope in front of the wall will be horizontal and 25 feet long. The wall will be battered at an angle of 10 degrees from vertical, and will be 31.2 feet high. The *Geometry tab* shown below indicates that the backslope angle directly behind the top of the wall is chosen to be horizontal, and that the slope behind the wall will extend for 59.5 horizontal feet and remain flat.

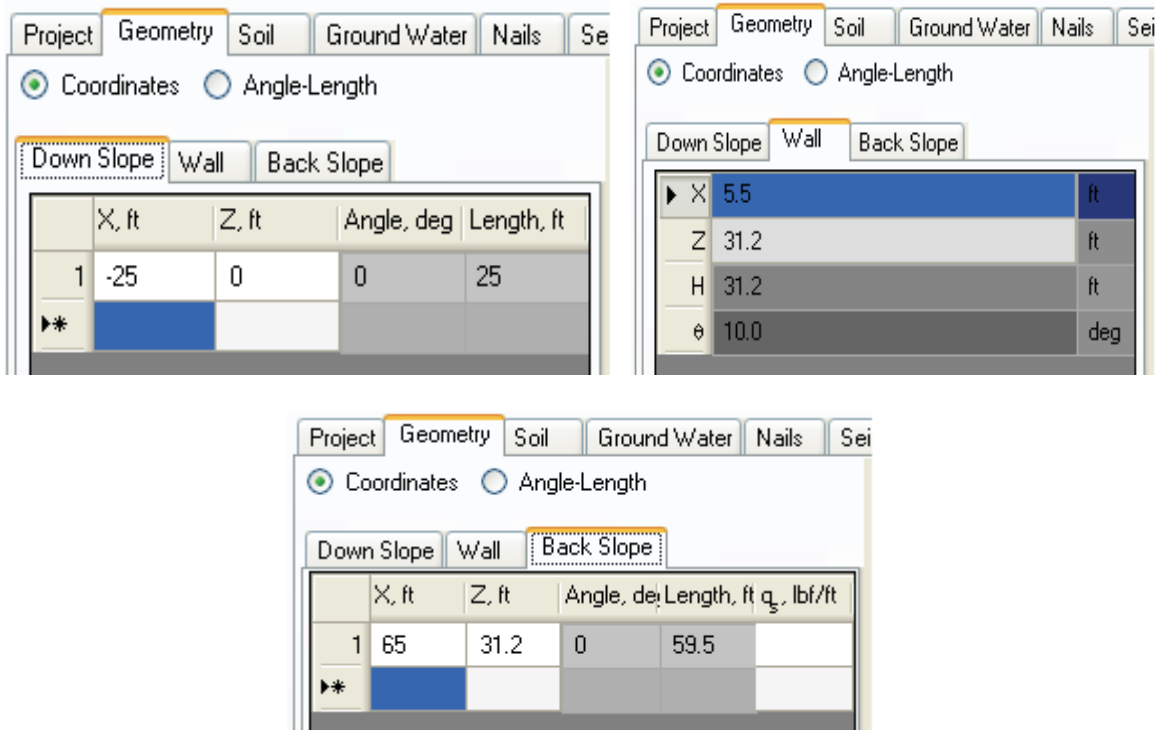

Figure 57. Screen Shot. Example 1, the Geometry tab.

The display area shown on-screen should look like this:

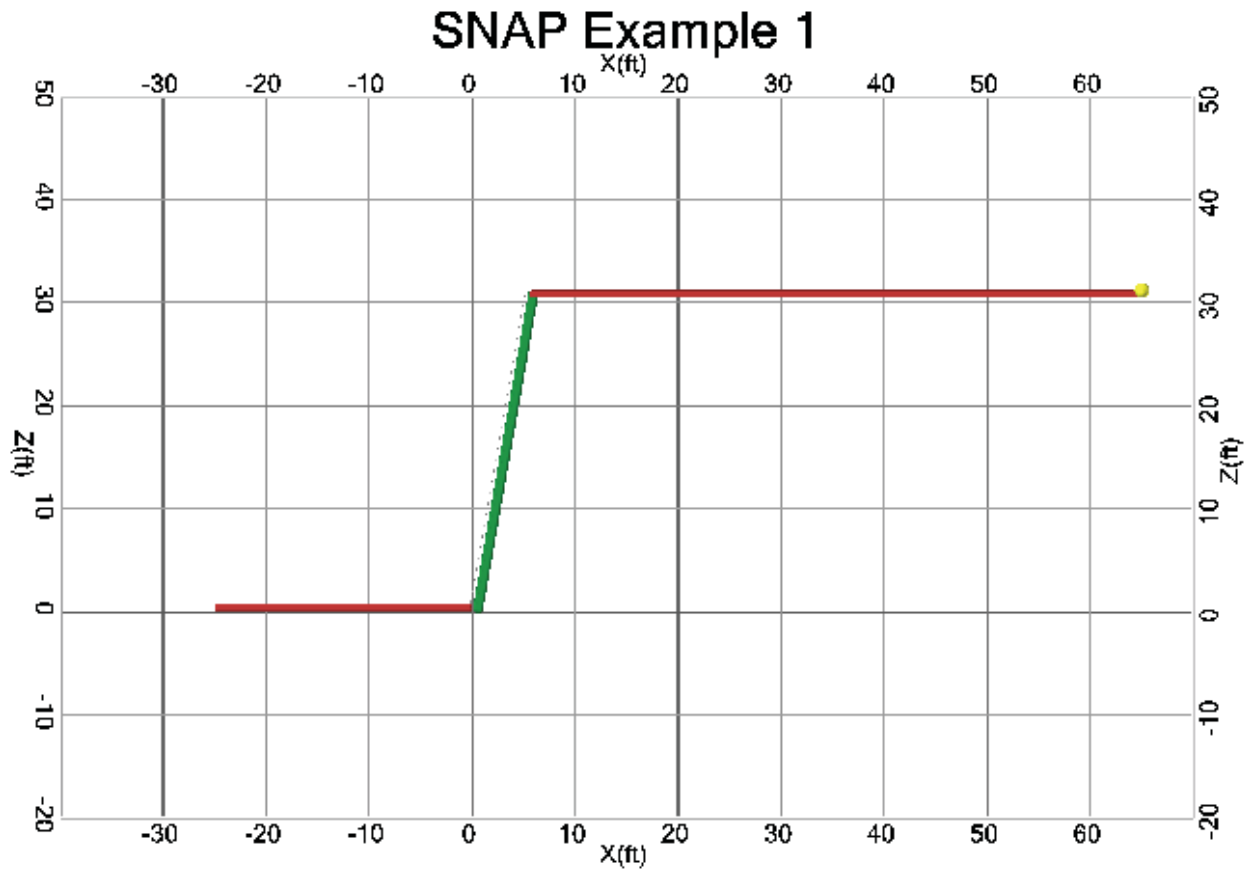

Figure 58. Screen Shot. Example 1, the display area.

(Note: when you start a problem from scratch, the display area won't show any nails until you have entered information on the Nails tab.)

Soil

As shown on the Soil tab below, the soil behind this wall has a moist unit weight of 114.5 lbf/ft³, a friction angle of 34 degrees, and an ultimate cohesion of 104 lbf/ft². The ultimate grout-ground pullout resistance is 15 lbf/in², and the bearing capacity factors are $N_c = 42.2$, $N_\gamma = 41.1$, and $N_q = 29.4$. SNAP uses the drill hole diameter entered on the Nails tab to calculate the ultimate pullout resistance per foot of nail to be 4524 lbf/ft (when you start a problem from scratch, Q_u won't be displayed until the drill hole diameter is entered on the Nails tab).

Property	Value	Unit
γ	114.5	pcf
ϕ	34	deg
C_u	104	psf
q_u	15	psi
Q_u	4524	lbf/ft
N_c	42.2	
N_γ	41.1	
N_q	29.4	

Figure 59. Screen Shot. Example 1, the Soil tab.

Nails

Groundwater is not used in this example, so let's skip to the *Nails tab*. A *trial* nail pattern is input on the Nails tab. Trial nail lengths, vertical spacing, and nail inclination are Uniform, and selected to be 25 feet, 5 feet, and 15 degrees, respectively. The horizontal nail spacing is selected to be 5 feet as well. The drill hole diameter is selected to be 8.0 inches. A bar diameter of 1 in and a cross-sectional area of 0.79 in^2 is chosen, which corresponds to a solid #8 bar (Both area and diameter must be entered to allow for the use of hollow nail bars under certain circumstances). Bar yield strength of 60 kip/in^2 and shear strength of 36 kip/in^2 are chosen. An upper cantilever distance of 3.28 feet (1 meter) is chosen, and the standard recommended resistance factors of 0.50, 0.55, and 0.67 for nail pullout, nail tendon strength, and nail head strength, respectively, are used.

The screenshot shows the SNAP software interface with the 'Nails' tab selected. Under 'Uniform Nail Settings', the following parameters are listed:

L	25	ft
S_v	5	ft
S_H	5	ft
δ	15	deg
D	8	in
Bar Area	0.79	in^2
D_b	1	in
Bar F_y	60000	psi
F_v	36000	psi
C_d	3.28	ft
α_Q	0.5	
α_N	0.55	
α_F	0.67	

Figure 60. Screen Shot. Example 1, the Nail Properties tab.

The *Uniform Nail Settings sub-tab* displays the nail heights (vertical distance from the bottom of the wall to the nail) and summarizes the nail support diagram for each nail in table form. For example, nail number three has a nail head x-coordinate of 3.16 ft.

	Height, ft
1	27.92
2	22.92
▶ 3	17.92
4	12.92
5	7.92
6	2.92
*	

	Nail X-Coord, ft	T-Force, lbf
▶ 1	3.16	10070.56
2	10.4	26070
3	15.72	26070
4	27.31	0
*		

Figure 61. Screen Shot. Example 1, the Uniform Nail Settings tab.

Wall Facing

Seismic coefficients are not used in this example, so let's skip to the *Wall Facing tab*. This example includes inputs for both a temporary shotcrete facing and a permanent cast-in-place concrete facing. Beginning with the Shotcrete facing type, select the *Shotcrete* button at the top of the Wall Facing tab. The *Shotcrete sub-tab* includes 2 options for the nail installation pattern: Offset and Square. An offset pattern is chosen for this Example.

Shotcrete facing inputs are selected for the wall. The welded wire mesh is 6 in. by 6 in., with a wire cross-sectional area of 0.029 in^2 , a reinforcement area of 0.058 in^2 per vertical foot of mesh, and an ultimate yield strength of 60 kip/in^2 . Horizontal waler bars and vertical bearing bars are chosen to be #4 bars, with an ultimate yield strength of 75 kip/in^2 and two of each type of bar. The program looks up the vertical bearing bar diameter from the bar number, which is 0.5 inch for a #4 bar. 60-inch long vertical bearing bars are chosen. The shotcrete is specified with a compressive strength of 4060 lbf/in^2 , and a shotcrete thickness of 3.95 inches is chosen. In reality it is difficult to control the thickness of shotcrete during construction to better than about half an inch but 3.95 inches (rounds to 4) has been chosen purely for the purposes of illustration. The bearing plate is chosen to be 9 inches on each side, and 1 inch thick. The standard recommended pressure factors of 1.0 and 1.0 for flexure and shear, respectively, are used.

Parameter	Value	Unit
S_w	6	in
A_{wire}	0.029	in^2
A_{S_wvf}	0.058	in^2/ft
Mesh_ F_y	60000	psi
H_Bar_No	4	#
V_Bar_No	4	#
Waler_ F_y	75000	psi
H_Bars	2	
V_Bars	2	
f_c	4060	psi
h_c	4	in
b_{pL}	9	in
b_d	1	in
L_{c_vb}	5	ft
d_B	0.5	in
C_{F_sc}	1	
C_{S_sc}	1	
T_{FN_F}	14834.681	lbf
T_{FN_P}	43069.9	lbf
T_{FN}	14834.7	lbf
T_F	9939.24	lbf

Figure 62. Screen Shot. Example 1, Wall Facing tab, Nail Head Strength for the shotcrete facing.

SNAP calculates the nominal nail head strength and the allowable nail head load for the shotcrete facing on the same tab as all of the inputs. The nominal nail head strength with respect to facing flexure is calculated to be 14834 lbf, and the nominal nail head strength with respect to facing punching shear is calculated to be 43070 lbf. Facing flexure controls, so the maximum nominal nail head load is 14834 lbf. Based on the Nail Head Strength Reduction Factor of 0.67 entered on the Nails tab, the maximum allowable nail head load is 9939 lbf.

On the *Shotcrete Design Checks* tab, the program calculates a predicted nail head service load, using the input nail head service load factor, F_F , entered by the user. This is usually selected to be 0.5. The remainder of this tab includes design and serviceability checks for the shotcrete facing. These indicate that the allowable nail head load is acceptable based on the estimated nail head service load (as outlined in FHWA-SA-96-069R), the one-way unit shear and flexure in the upper cantilever section are acceptable, vertical bearing bars meet minimum length and embedment requirements, and that minimum horizontal waler splice length requirements are met.

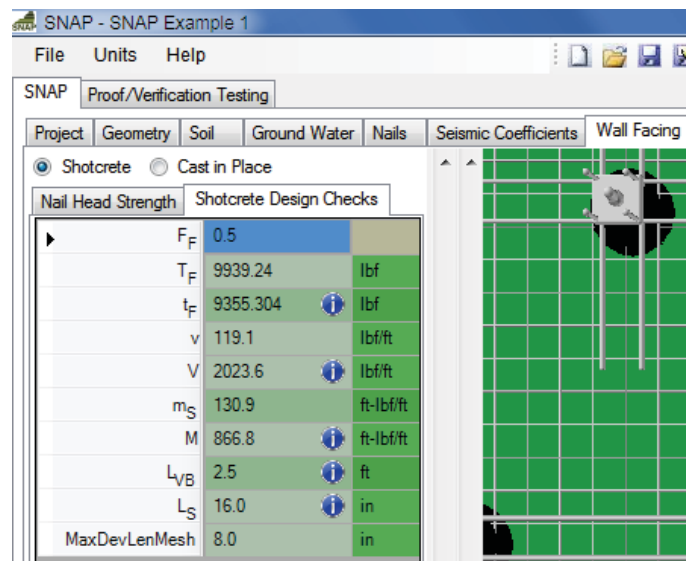

Figure 63. Screen Shot. Example 1, the Shotcrete Design Checks tab.

This example also includes an evaluation of a permanent cast-in-place concrete facing constructed in front of the shotcrete facing for this wall. These inputs are entered by selecting the *Cast-in-Place* button at the top of the *Wall Facing* tab. Now the *Nail Head Strength* sub-tab includes data on the cast-in-place concrete, reinforcement components, and the headed-stud connection system for this facing type. The *CIP Design Checks* tab includes design and serviceability checks relevant to a CIP wall facing, which are similar to those for the shotcrete facing.

On the Nail Head Strength sub-tab, the concrete reinforcement spacing in Example 1 will be 12 inches both horizontally and vertically, and #4 bar with a yield strength of 60,000 psi is chosen for the reinforcements. A CIP facing thickness of 8 inches and a concrete compressive strength of 4060 psi are chosen. The standard recommended pressure factors of 1.0 and 1.0 for flexure

and shear, respectively, are chosen. The headed-stud tensile failure factor is chosen to be 0.50, as is recommended.

For the headed-stud connection system, the stud body diameter is chosen to be 0.875 ($\frac{7}{8}$) inches, and the stud head diameter is chosen to be 1.375 ($1\frac{3}{8}$) inches. The stud head thickness is 0.375 ($\frac{3}{8}$) inches. The stud length is 5 inches, and the stud spacing is 4.2 inches. Grade 60 steel is chosen for the studs. The plate thickness is 1 inch.

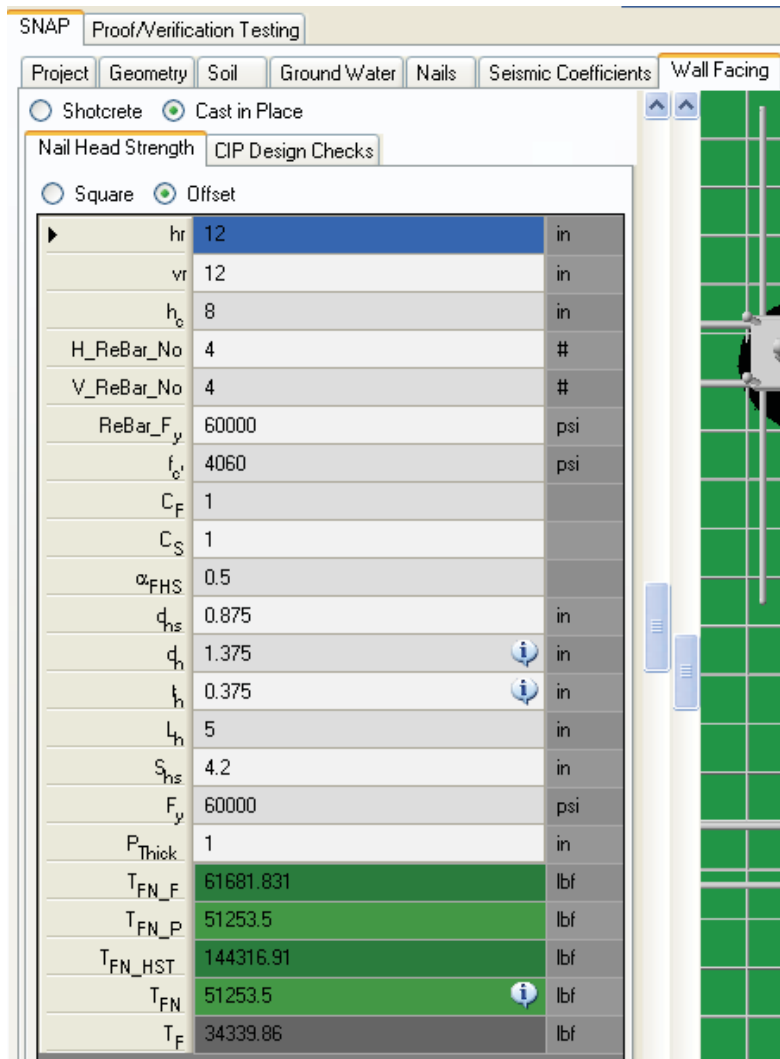

Figure 64. Screen Shot. Example 1, the Cast-in-Place Nail Head Strength tab.

Output information for the cast-in-place concrete facing is displayed in a similar manner to the shotcrete facing. The nominal nail head strength for flexure, punching, and headed-stud tension are calculated and displayed on the Nail Head Strength tab. For Example 1, these are calculated to be 61682 lbf, 51253 lbf, and 144317 lbf, respectively. SNAP selects the lowest of these to use for calculating the allowable nail head load: in this case, the controlling failure mode is punching shear failure at 51253 lbf. Based on the Nail Head Strength Reduction Factor of 0.67 entered on the Nails tab, the maximum allowable nail head load is 34,340 lbf.

Design and serviceability checks, shown on the CIP Design Checks tab, indicate that the allowable nail head load is acceptable based on the estimated nail head service load (as outlined in FHWA-SA-96-069R), the one-way unit shear and flexure in the upper cantilever section are acceptable, that the facing meets minimum reinforcement ratio and minimum reinforcement cover requirements, and that reinforcement distribution in the upper cantilever is satisfactory.

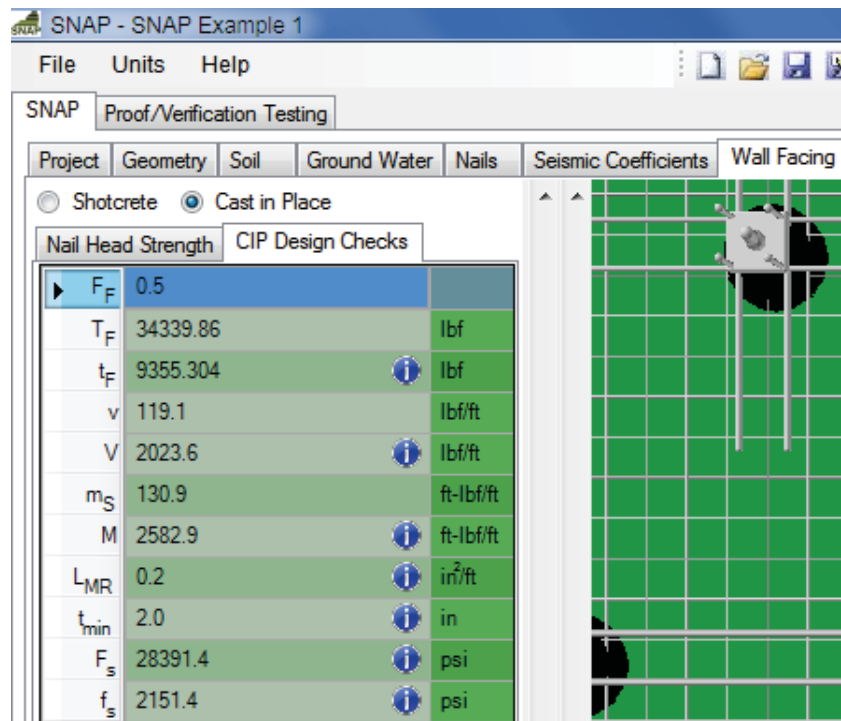

Figure 65. Screen Shot. Example 1, Cast-in-Place facing Design Checks tab.

External Stability

The next tab is the *External Stability tab*. This is only an output tab, and it provides Factors of Safety on sliding, overturning, and bearing capacity, as well as the eccentricity used in the bearing capacity calculation, the effective stress at the base of the wall, and the ultimate and allowable bearing capacity values. Small icons to the right of certain values indicate whether these values meet AASHTO minimum criteria.

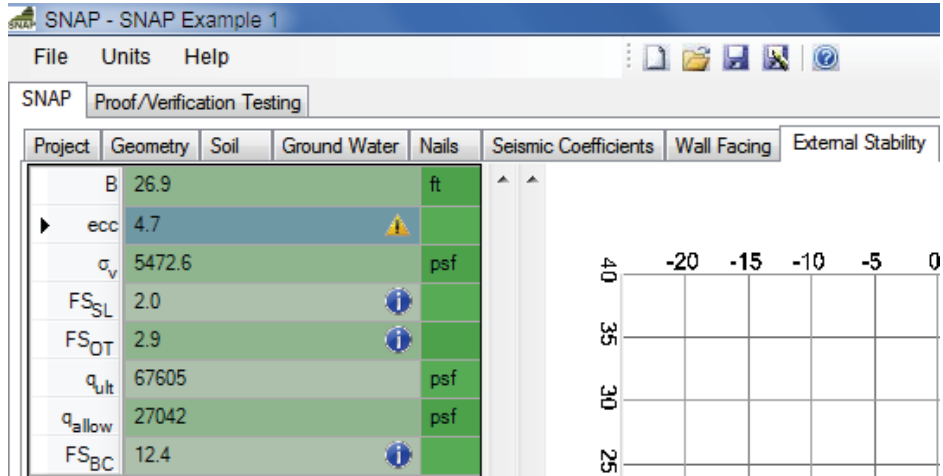

Figure 66. Screen Shot. Example 1, External Stability analysis results.

Global Stability

The *Global Stability* tab (uses the Simplified Bishop Method - circular surfaces only) includes results for global stability, organized into *two sub-tabs: Failure Circles and Radius Control*. For this Example, using the *Auto Calc Ranges* feature for selecting the search limits for circular failure surfaces *does not* provide realistic results, showing all 10 lowest FS values on slip circles in the slope above the top nail. By unchecking *Auto Calc Ranges* on the Radius Control tab, and increasing *Upper Fail. Circle Min X* to 9.0, all of the 10 lowest FS circles will pass near the base of the wall.

After making this change, the *Failure Circles* tab indicates that the minimum FS for our example problem is 1.93. The slip circles are shown in the display area, with the selected circle displayed as a much thicker line.

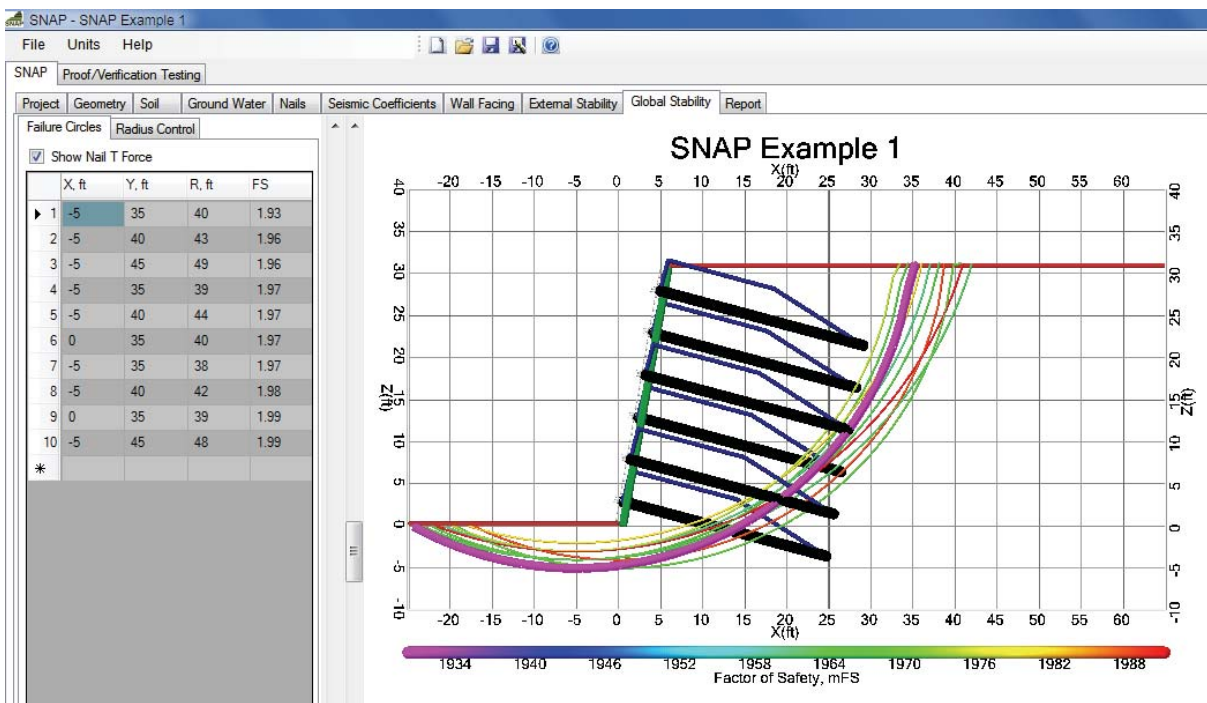

Figure 67. Screen Shot. Example 1, Global Stability tab.

Further adjustment of the values on the *Radius Control* tab will change the minimum FS calculated on the *Failure Circles* tab. Try adjusting these values, and observe how the minimum FS changes.

Report

On the *Report tab*, click *Generate* to create and view the report. It usually takes several seconds to a minute to generate the report; text at the bottom of the screen indicates the progress of report generation. The report will be approximately 13 pages long for this Example problem. The project information from the first tab is displayed on every page, and the report includes all of the input parameters and output results discussed above, as well as graphics from the problem. The last five pages give complete definitions for all the input parameters and output results in the program.

SNAP Analysis

PROJECT INFORMATION

Project Name	SNAP Example 1
Project Number	001
Company Name	John Doe
Location	Parker, CO
Designer	D. Zner
Reviewer	A. Checker
Date	8-28-09

Wall Properties

	English	Units	SI	Units
<i>X</i>	5.5	ft	1.68	m
<i>Z</i>	31.2	ft	9.51	m
<i>H</i>	31.2	ft	9.5	m
θ	10.0	deg	10.0	deg

DownSlope Points

		English	Units	SI	Units
Point 1	<i>X</i>	-25	ft	-7.62	m
	<i>Z</i>	0	ft	0	m
	<i>Angle</i>	0	deg	0	deg
	<i>Length</i>	25	ft	7.62	m

BackSlope Points

		English	Units	SI	Units
Point 1	<i>X</i>	65	ft	19.81	m
	<i>Z</i>	31.2	ft	9.51	m
	<i>Angle</i>	0	deg	0	deg
	<i>Length</i>	59.5	ft	18.14	m
	q_x	0	lb/ft	0	N/m

Figure 68. Screen Shot. Example 1, Report generation tab.

EXAMPLE 2

The following is a demonstration of the application of SNAP for design of a different soil nail wall support, for a cut approximately 31 feet high. This example also includes groundwater and seismic loading, but is designed with only a shotcrete facing. It can be loaded into the program by selecting *File* → *Example 2*.

Geometry

The ground surface in front of the wall first slopes down, and then becomes flat, extending a total of 32 feet in front of the wall. The wall will be battered at an angle of 9.5 degrees from vertical, and will be 30.6 feet high. The *Geometry* tab shown below indicates that the backslope angle directly behind the top of the wall is chosen to be 12.88 degrees from horizontal, or a slope of about 4.4:1, extending 14.87 horizontal feet. Above this inclined portion, the slope behind the wall is flat, 24 feet long, and supports a surcharge of 250 psf. After that, the ground slopes upward again at an angle of 9.46 degrees for 36 horizontal feet.

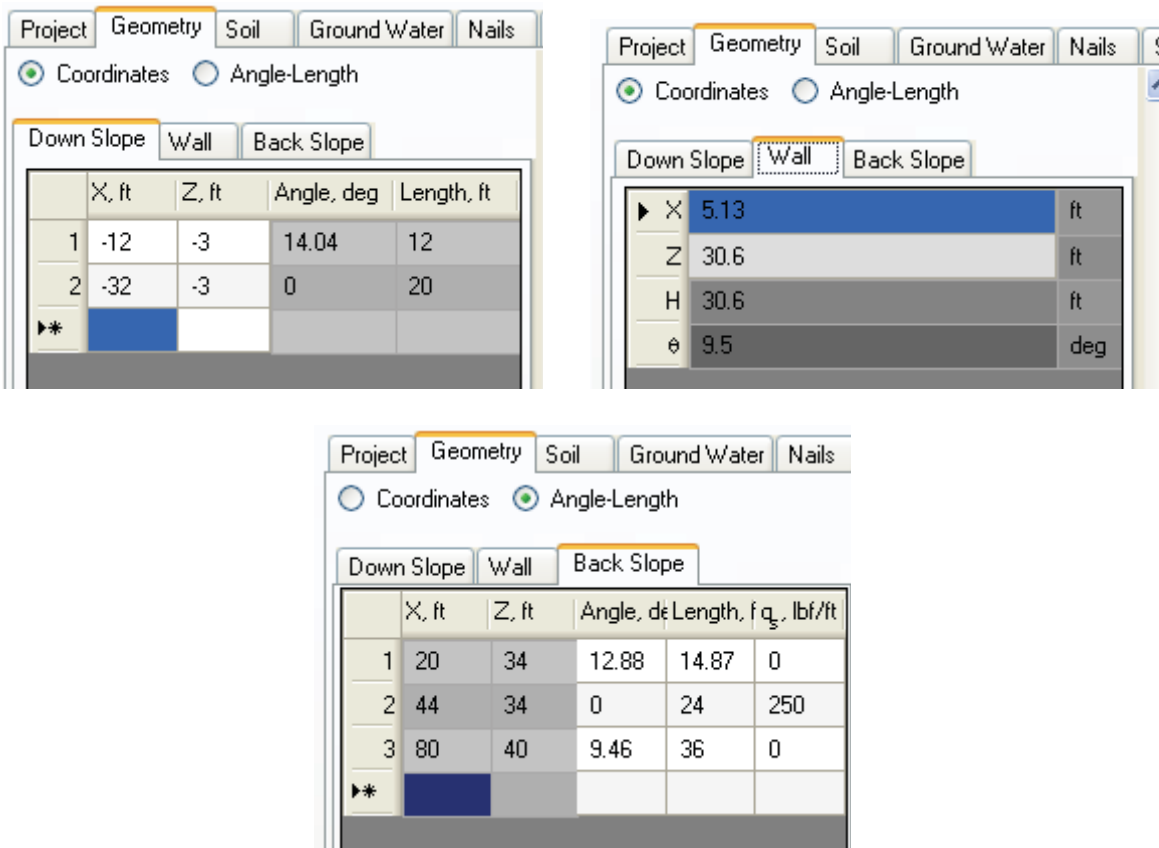

Figure 69. Screen Shot. Example 2, the Geometry tab.

The display area shown on-screen should look like this:

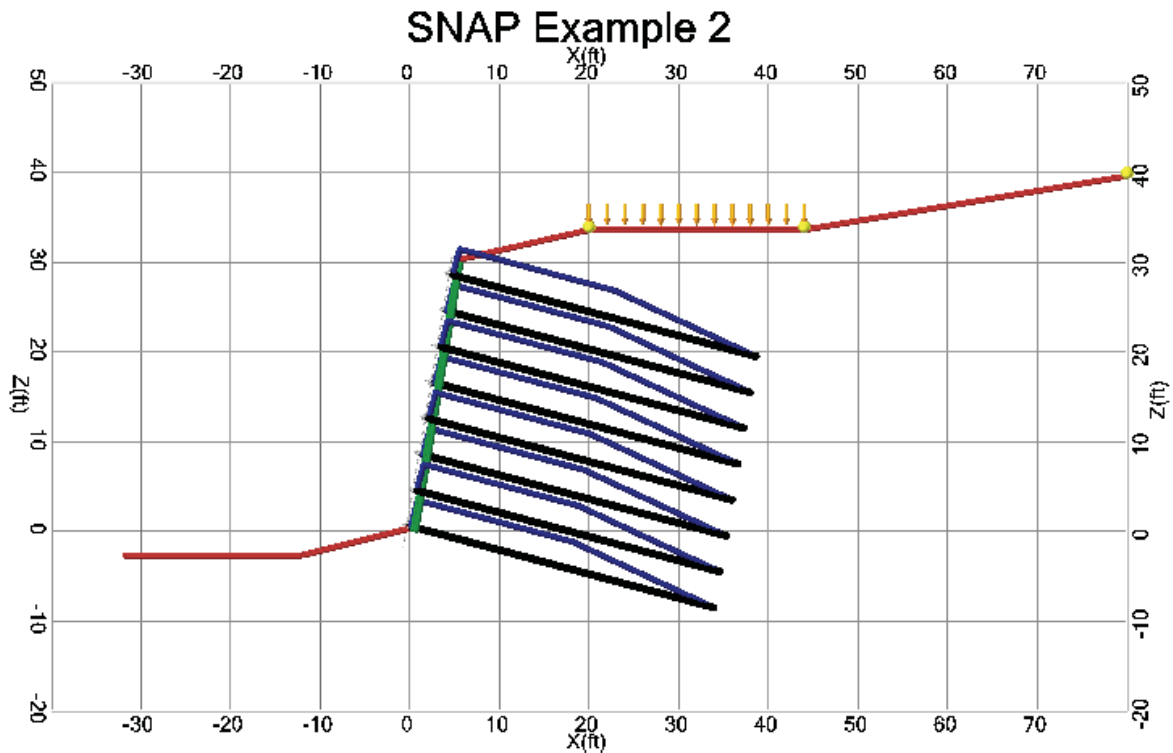

Figure 70. Screen Shot. Example 2, the display area.

Soil

As shown on the *Soil tab* below, the soil behind this wall has a moist unit weight of 125 lbf/ft³, a friction angle of 36 degrees, and an ultimate cohesion of 150 lbf/ft². The ultimate grout-ground pullout resistance is 20 lbf/in², and the bearing capacity factors are $N_c = 50.6$, $N_\gamma = 56.3$, and $N_q = 37.8$. SNAP uses the drill hole diameter entered on the *Nails tab* to calculate the ultimate pullout resistance per foot of nail to be 3958 lbf/ft.

SNAP Proof/Verification Testing		
Project	Geometry	Soil
γ	125	pcf
φ	36	deg
C _U	150	psf
q _u	20	psi
Q _u	3958	lbf/ft
N _c	50.6	
N _γ	56.3	
N _q	37.8	

Figure 71. Screen Shot. Example 2, the Soil tab.

Groundwater

This Example problem includes groundwater. The phreatic surface information entered on the *Groundwater tab* indicates that the groundwater surface is shallow at the toe of the wall, and becomes higher within the reinforced/retained soil mass.

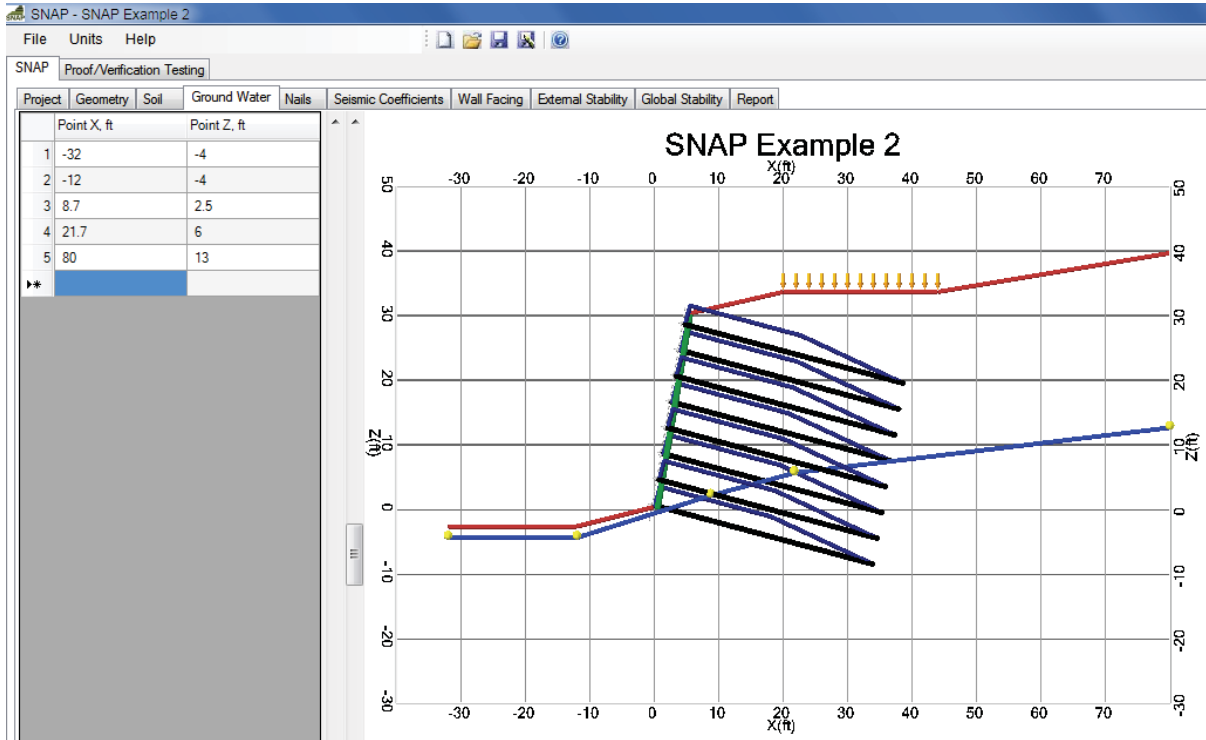

Figure 72. Screen Shot. Example 2, the Groundwater tab.

Nails

A trial nail pattern is input on the *Nails tab*. Trial nail lengths, vertical spacing, and nail inclination are Uniform, and selected to be 35 feet, 4 feet, and 15 degrees, respectively. The horizontal nail spacing is selected to be 7 feet. The drill hole diameter is selected to be 5.25 inches. A 1-inch diameter bar with a cross sectional area of 0.79 in² is chosen, which corresponds to a solid #8 bar. Bar yield strength of 75 ksi and shear strength of 36 ksi are chosen. An upper cantilever distance of 2.0 feet is selected. The standard recommended resistance factors of 0.50, 0.55, and 0.67 for nail pullout, nail tendon strength, and nail head strength, respectively, are used.

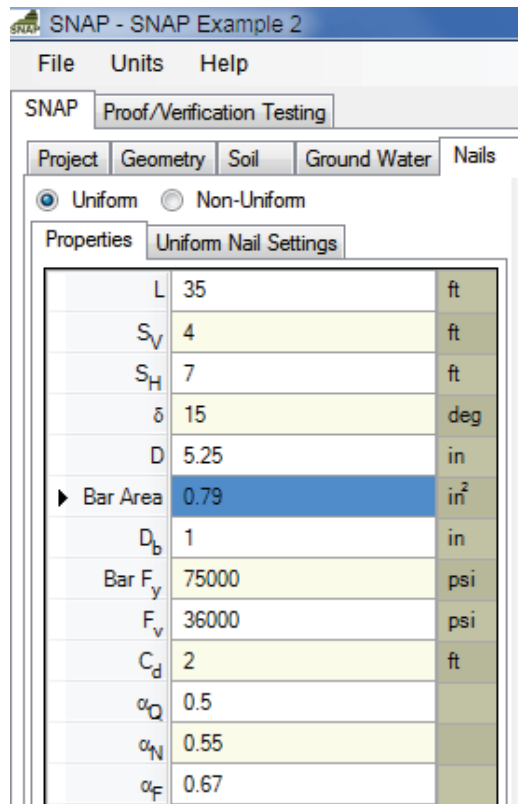

Figure 73. Screen Shot. Example 2, the Nail Properties tab.

The *Uniform Nail Settings sub-tab* displays the nail heights (vertical distance from the bottom of the wall to the nail) and summarizes the nail support diagram for each nail in table form. For Example 2, the allowable nail tendon tensile load (T_N) is smaller than the allowable nail head load (T_F), so the program reports T_N as equal to T_F .

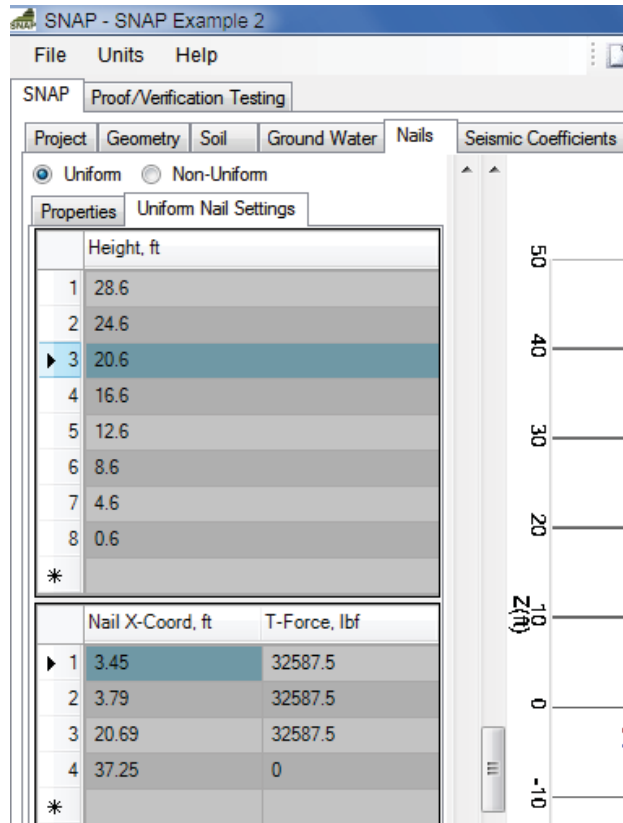

Figure 74. Screen Shot. Example 2, the Uniform Nail Settings tab.

Note that when you create a new file from scratch and go through the data entry, the Nail T-force diagram and corresponding values will not be correct until information about the wall facing is entered.

Seismic Effects

Example 2 demonstrates the use of seismic coefficients in SNAP. A horizontal seismic coefficient (K_h) of 0.18 is entered directly on the *Seismic Coefficients* tab, indicating that a horizontal seismic acceleration equal to 18% of gravity may act on this wall. The Factors of Safety for External Stability and Global Stability will be displayed with the effects of seismic loading as long as the checkbox on the Seismic Coefficients tab is checked. To view the static loading FS, you must return to the Seismic Coefficients tab and uncheck the checkbox.

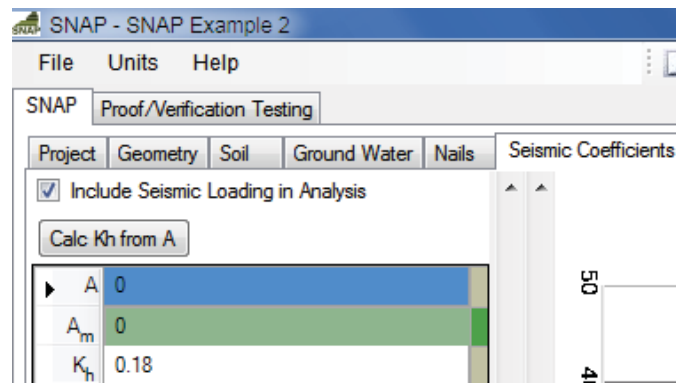

Figure 75. Screen Shot. Example 2, Seismic Coefficients tab.

Wall Facing

This example includes inputs for only a shotcrete facing. The *Shotcrete* button at the top of the *Wall Facing* tab is selected. The *Shotcrete* sub-tab includes 2 options for the nail installation pattern: *Offset* and *Square*. An offset pattern is chosen for this Example.

Example 2 demonstrates how to design a facing using 2 layers of welded wire mesh simultaneously in the shotcrete facing. In this example, one layer of 4x4 inch, W4.0 x W4.0 mesh is selected, along with one layer of 6x6 inch, W2.9 x W2.9 mesh. To enter these in SNAP, the wire spacing is entered as 4 in., with a cross-sectional area of 0.04 in², a reinforcement area of 0.178 in² per vertical foot of mesh, and an ultimate yield strength of 60000 lb/in² i.e. the 2 layers are:

- (1) 4x4 W4.0 x W4.0 Area = 0.120 in²/ft
- (2) 6x6 W2.9 x W2.9 Area = 0.058 in²/ft

The opening size input to SNAP is the smaller of the two (4 inches). The wire cross-sectional area input to SNAP is that of the W4.0 (0.04 in²). The total cross-sectional area of reinforcement per unit of width is the sum of the areas of the two layers = 0.120 + 0.058 = 0.178 in²/ft.

Horizontal waler bars and vertical bearing bars are chosen to be #4 bars, with an ultimate yield strength of 60 kip/in². Two horizontal waler bars and one vertical bearing bar are used. The program looks up the vertical bearing bar diameter from the bar number, which is 0.5 inch for a #4 bar. A 60-inch long vertical bearing bar is chosen. The shotcrete is specified with a compressive strength of 4000 lbf/in², and a shotcrete thickness of 8.0 inches is chosen. The bearing plate is chosen to be 8 inches on each side, and 1 inch thick. The standard recommended pressure factors for an 8-inch shotcrete thickness are used: 1.0 for flexure and 1.0 for shear.

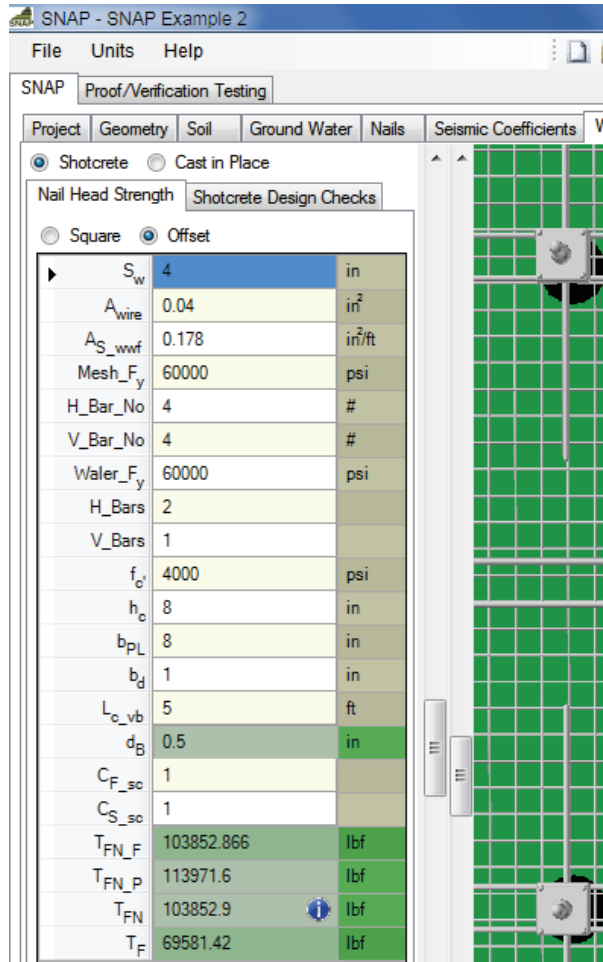

Figure 76. Screen Shot. Example 2, Wall Facing tab, Nail Head Strength for the shotcrete facing.

SNAP calculates the nominal nail head strength and the allowable nail head load for the shotcrete facing on the same tab as all of the inputs. The nominal nail head strength with respect to facing flexure is calculated to be 103853 lbf, and the nominal nail head strength with respect to facing punching shear is calculated to be 113972 lbf. Facing flexure controls, so the maximum nominal nail head strength is 103853 lbf. Based on the Nail Head Strength Reduction Factor of 0.67 entered on the Nails tab, the maximum allowable nail head load is 69581 lbf.

The design and serviceability checks for the shotcrete facing are shown on the *Shotcrete Design Checks* tab. These indicate that the allowable nail head load is acceptable based on the estimated nail head service load (as outlined in FHWA-SA-96-069R), the one-way unit shear and flexure in the upper cantilever section are acceptable, vertical bearing bars meet minimum length and embedment requirements, and that minimum horizontal waler splice length requirements are met.

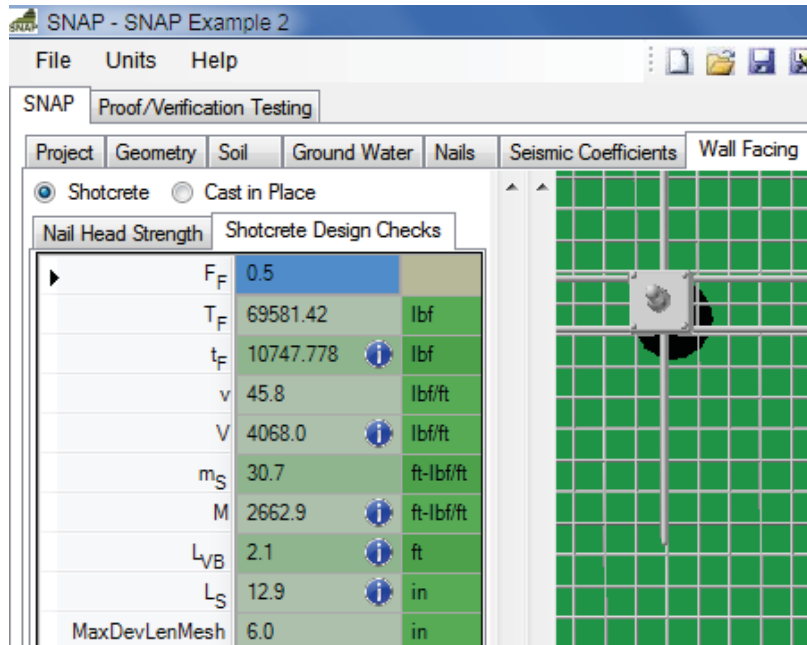

Figure 77. Screen Shot. Example 2, the Shotcrete Design Checks tab.

External Stability

The next tab is the *External Stability tab*. This is only an output tab, and it provides Factors of Safety on sliding, overturning, and bearing capacity, as well as the eccentricity used in the bearing capacity calculation, the effective stress at the base of the wall, and the ultimate and allowable bearing capacity values. To see the results for when seismic loading is included, make sure the *checkbox* on the Seismic Coefficients tab is checked. To see the static FS results, make sure this box remains unchecked. Small icons to the right of certain values indicate whether these values meet AASHTO minimum criteria. These criteria change depending on whether seismic loading is included.

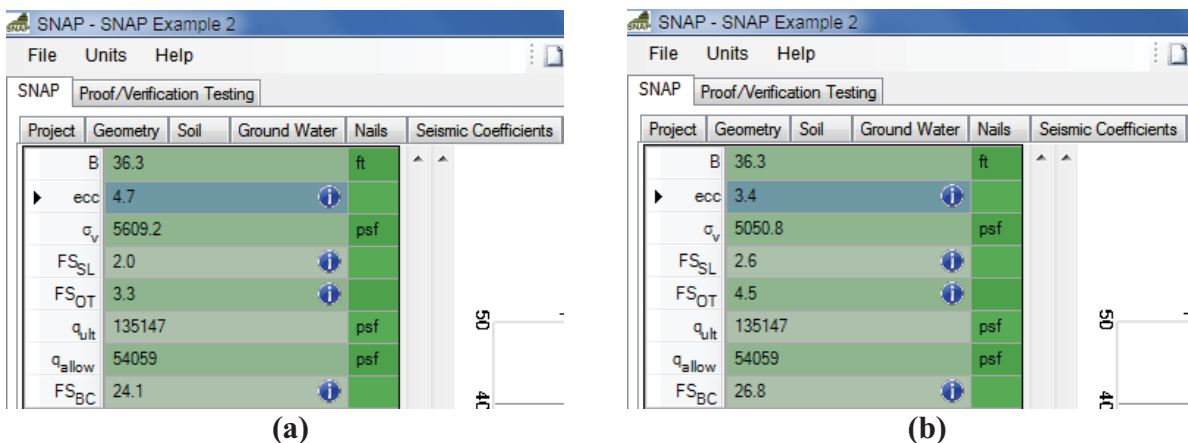

Figure 78. Screen Shot. Example 2, External Stability tab showing (a) the results for seismic loading conditions and (b) the results for static loading conditions.

Global Stability

The *Global Stability* tab applies the Simplified Bishop Method of Slices to obtain results for global stability, organized into two sub-tabs: *Failure Circles* and *Radius Control*. The Failure Circles tab indicates that the minimum FS for our example problem is 0.77 for seismic loading, with the lowest 10 FS all less than or equal to 0.81. The minimum FS for static loading is 0.80, with the lowest 10 FS all less than or equal to 0.83. The slip circles are shown in the display area, with the selected circle shown as a much thicker line. Note that the Auto Calc Ranges option was used for this stability calculation.

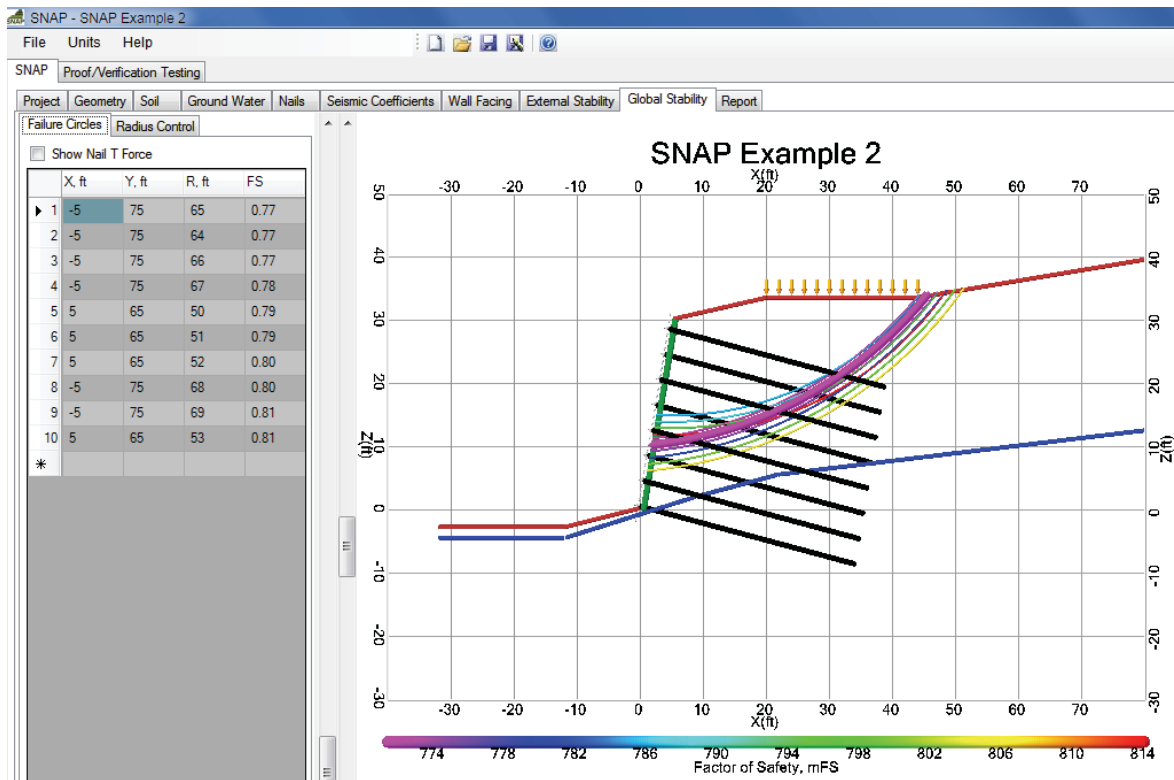

Figure 79. Screen Shot. Example 2, Global Stability tab for seismic (pseudo-static) conditions ($k_h=0.18$).

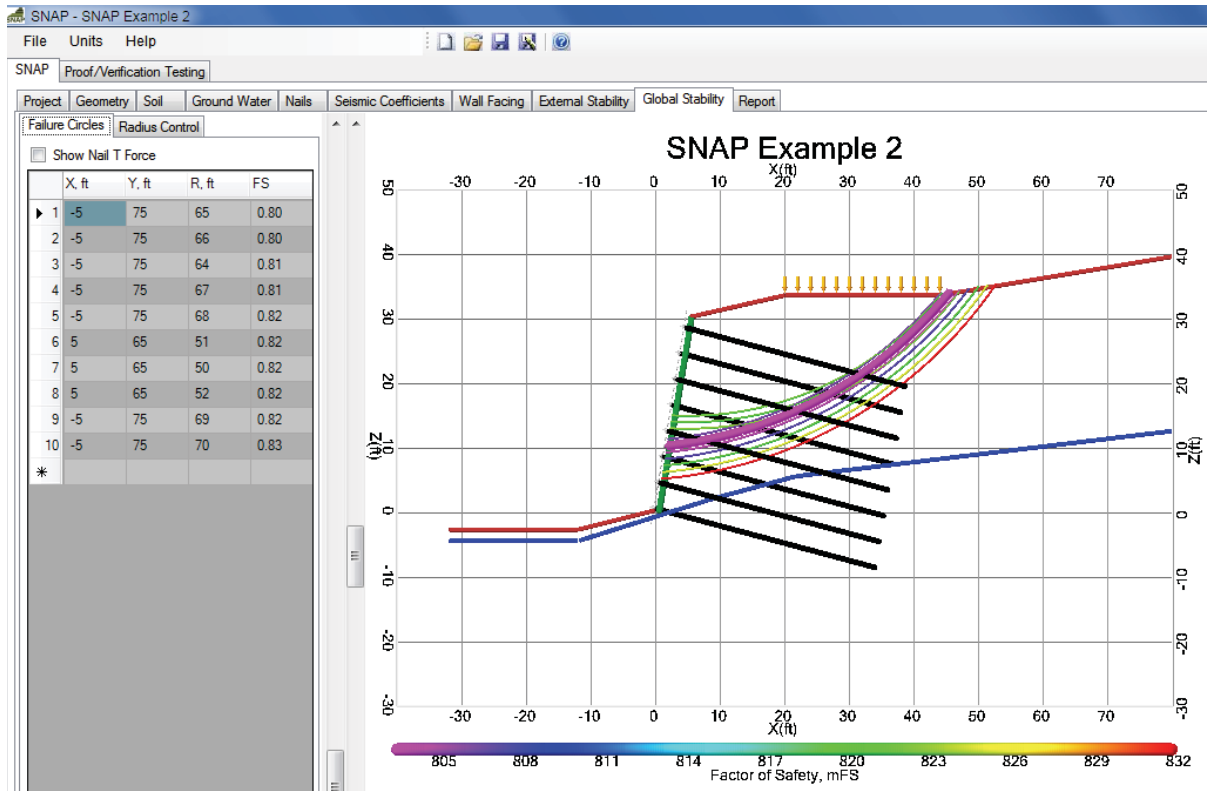

Figure 80. Screen Shot. Example 2, Global Stability tab for static loading conditions.

The *Radius Control* tab allows the user to adjust the range of radius values the program will search within. See Chapter 1 for more information on how SNAP searches for circular failure planes. Adjusting these values will change the minimum FS calculated on the Failure Circles tab. Try adjusting these values, and observe how the minimum FS changes. For this example problem, selecting “Auto Calc Ranges” gives good results.

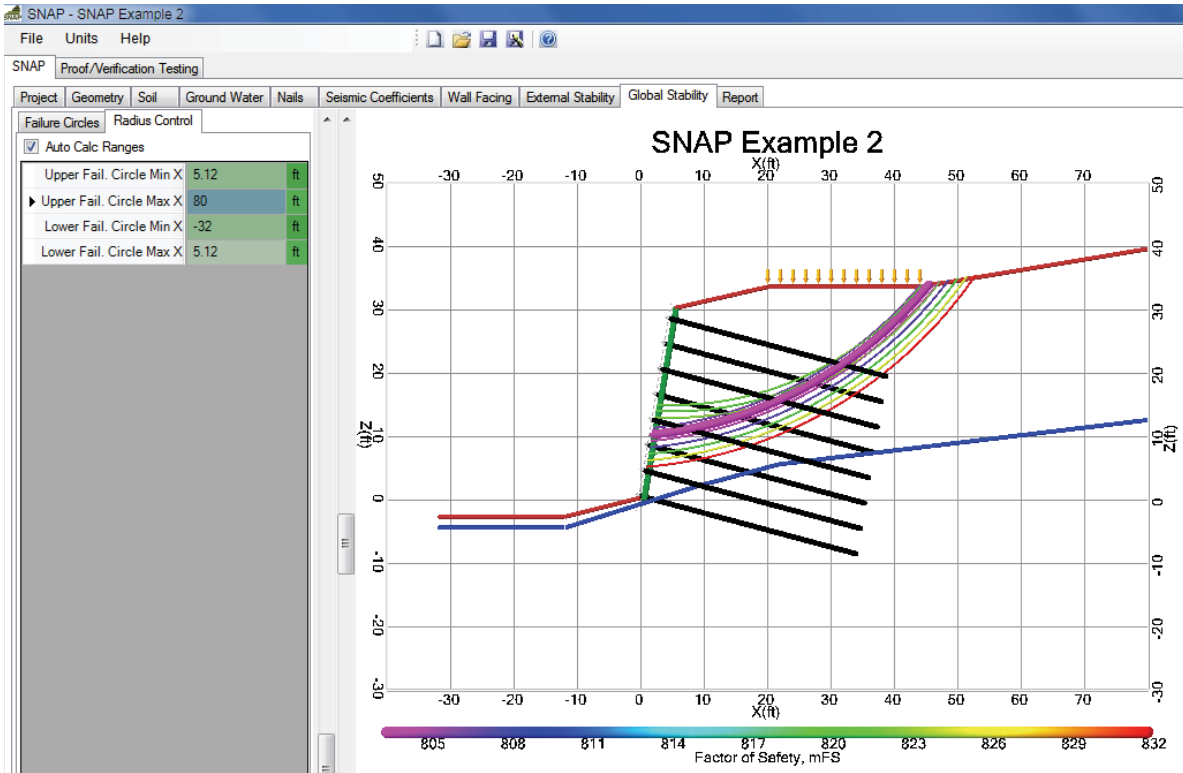

Figure 81. Screen Shot. Example 2, the Radius Control tab.

Report

On the *Report tab*, click *Generate* to create and view the report. It usually takes several seconds to a minute to generate the report; text at the bottom of the screen indicates the progress of report generation. The report will be approximately 21 pages long for this Example problem. The project information from the first tab is displayed on every page, and the report includes all of the input parameters and output results discussed above, as well as graphics from the problem. The last five pages give complete definitions for all the input parameters and output results in the program. When seismic loading is evaluated, such as in this Example, the Report will include output results for both the static and seismic cases.

Soil Nail Analysis Program--SNAP 1.0

Project Name: SNAP Example 2 Project Number: 18-3584 Company Name: ABC Engineering Location: Anytown, USA Designer: Jane Doe
Reviewer: Kris Kringle Date: 7-4-09

Static case (no seismics):

Facing Nail Head Strength Properties

	English	Units	SI	Units
S_w	4	in	101.6	mm
A_{wire}	0.04	in ²	25.806	mm ²
A_{s_wref}	0.178	in ² /ft	376.773	mm ² /m
$Mesh_F_y$	60000	psi	413685.6	kPa
H_Bar_No	4	#	4	#
V_Bar_No	4	#	4	#
$Water_F_y$	60000	psi	413685.6	kPa
H_Bars	2		2	
V_Bars	1		1	
f_c	4000	psi	27579.04	kPa
h_c	8	in	203.2	mm
b_{PL}	8	in	203.2	mm
b_d	1	in	25.4	mm
$L_{c,vb}$	5	ft	1.52	m
d_B	0.5	in	12.7	mm
$C_{F,sc}$	1		1	
$C_{S,sc}$	1		1	
$T_{FN,F}$	103852.866	lbf	461960.394	N
$T_{FN,P}$	113971.6	lbf	506970.7	N
T_{FN}	103852.9	lbf	461960.4	N
T_F	69581.42	lbf	309513.46	N

dh: **WARNING**, Stud head diameter not OK: $d_h < 1.57 * d_{hs}$
 t_h : Stud head thickness OK: $t_h \geq (d_h - d_{hs}) / 2$
 T_{FN} : Controlling mode for Nail Head Strength

Note: D_H is stud diameter and D_{HS} is stud body (reversed from document FHWA-SA-96-069R)

Figure 82. Screen Shot. Example 2, Report tab.

CHAPTER 5 – PROOF/VERIFICATION TESTING

SNAP can assist a wall designer or engineer with verification and proof testing of soil nails during construction. The *Proof/Verification Testing* tab at the top of the screen (the same level as the main SNAP tab) is divided up into three sub-tabs: *Design Test Load*, *Test Loading Data*, and *Report*.

DESIGN TEST LOAD

The *Design Test Load* tab will determine the appropriate design test load for proof testing or for verification testing. The user must select *Verification Test* or *Proof Test* at the top of the tab by selecting one of the radio buttons. The user must enter the grout/ground pullout strength, the drill hole diameter, the appropriate pullout bond strength factor of safety, the nail tendon yield strength, the cross-sectional area of the nail tendon, and the actual nail bond length for the nail being tested. None of this information is taken from the other tabs of the SNAP program, since field testing is often done completely independent of the wall design process.

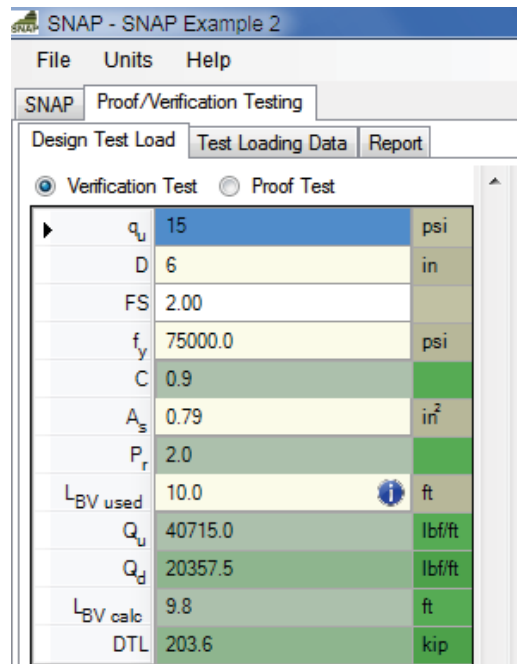

Figure 83. Screen Shot. Proof/Verification Testing, Design Test Load calculation tab.

The program will select the appropriate nail yield strength factor, C, based on the user-entered nail bar yield strength (0.8 for yield strength less than 75,000 psi or 0.9 for a yield strength greater than 75,000 psi). The program also selects the appropriate pullout resistance factor, P_r , based on whether a Verification Test or a Proof Test is chosen. The ultimate and allowable pullout resistance per foot of nail length are calculated and shown as Q_u and Q_d , respectively. The maximum test bond length to avoid overstressing the nail, $L_{BV\ calc}$, is calculated, and checked

against the user-input actual as-built bond length, L_{BVused} . The design test load for the current test is calculated based on the actual as-built bond length, L_{BVused} .

TEST LOADING DATA

On the *Test Loading Data* tab, the user may enter actual test data from a proof or verification test. The design test load from the *Design Test Load* tab is used, and the user must enter the bond length of the nail, the unbonded (free) length of the nail, the cross-sectional area of the nail bar, and the elastic modulus of the nail bar steel. The user then enters all of the test load and average dial gage data, and the program will produce a graph and determine if the nail passes creep and total movement acceptance criteria, which are calculated and shown in the upper left frame.

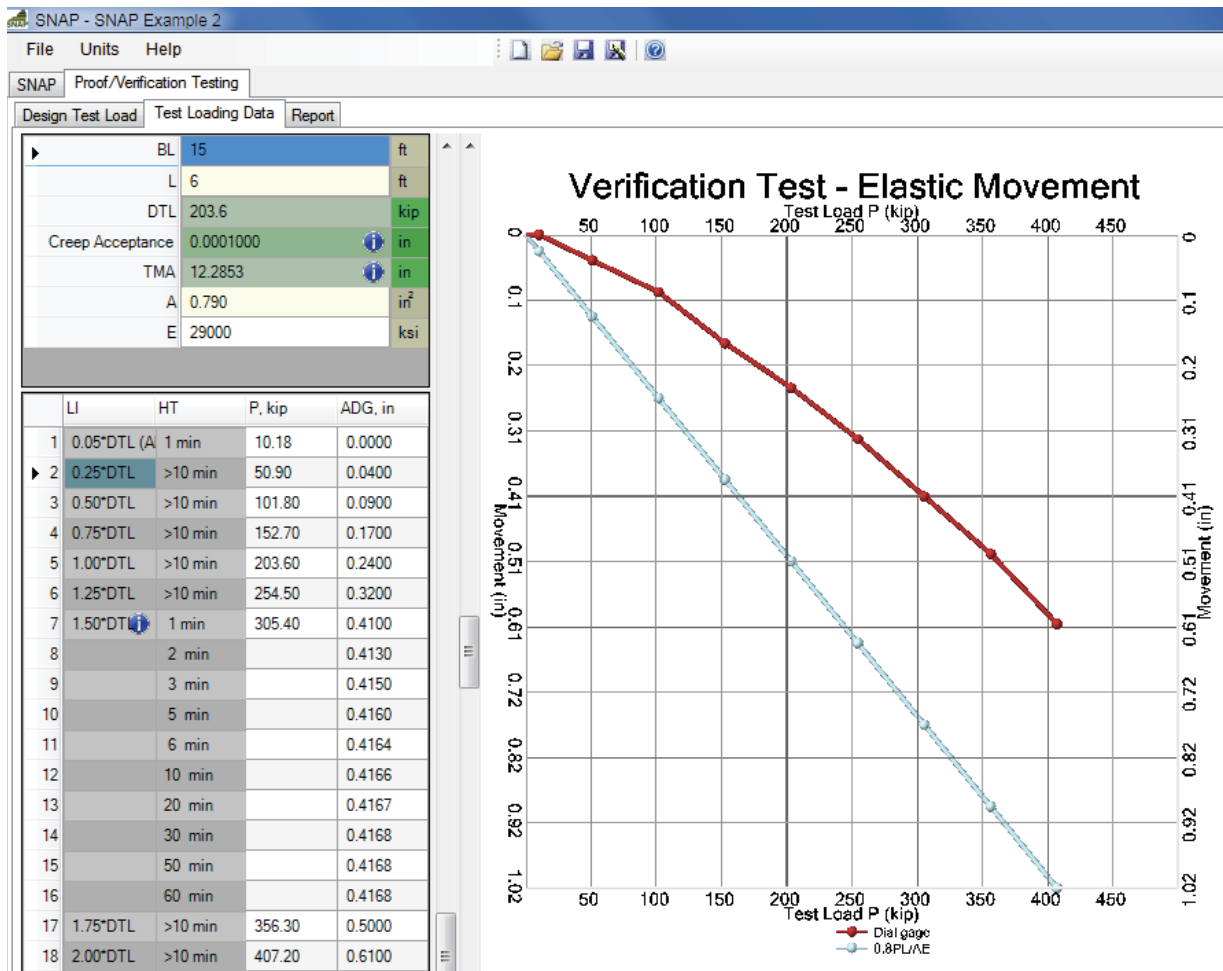

Figure 84. Screen Shot. Proof/Verification Testing, Test Loading Data tab.

PROOF/VERIFICATION TESTING REPORT

Clicking *Generate* on the *Report tab* under the *Proof/Verification Testing tab* will generate a report for the single test currently entered on the first two tabs. The report will be approximately 4 pages long which can be sent directly to a printer, or the information in the report can be copied and pasted into another program for presentation purposes.

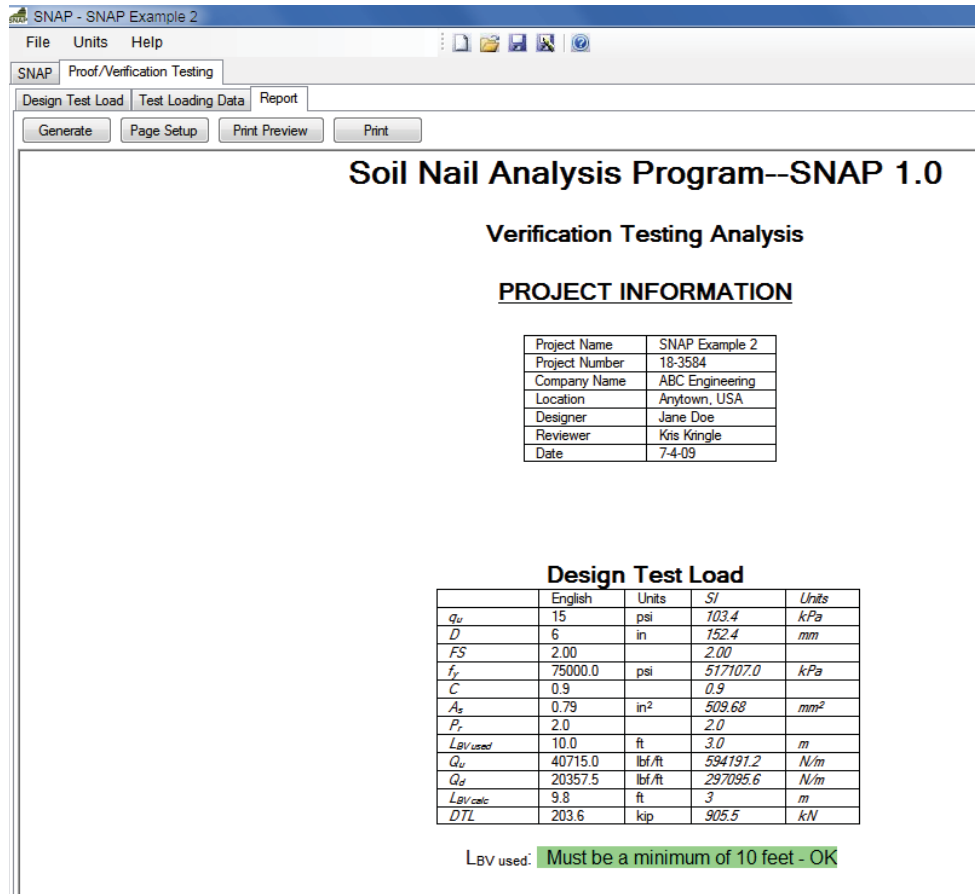

Figure 85. Screen Shot. Proof/Verification Testing Report.

REFERENCES

- Abramson, L.W., Lee, T.S., Sharma, S., and Boyce, G.M. (1996). "Slope Stability and Stabilization Methods." New York: John Wiley and Sons, Inc.
- Bishop, A.W. (1955). "The Use of the Slip Circle in the Stability Analysis of Slopes," *Geotechnique*, Vol. 10, No. 1, pp. 129-150.
- Byrne, R.J., Cotton, D., Porterfield, J., Wolschlag, C. and Ueblacker, G. (1998). "Manual for Design and Construction Monitoring of Soil Nail Wall," Report No. FHWA SA-96-069R, Federal Highway Administration, Washington D.C.
- CALTRANS (Undated). "Manual of Instructions for SNAILZ, Version 3.10," California Department of Transportation, Engineering Service Center, Division of Materials and Foundations, Office of Roadway Geotechnical Engineering, Sacramento, California.
- Golder Associates (1996). "GoldNail: A Stability Analysis Computer Program for Soil Nail Wall Design, Reference Manual, Version 3.11."
- Lazarte, C.A., Elias, V., Espinoza, R.D. and Sabatini, P.J. (2003). "Geotechnical Circular No. 7 – Soil Nail Walls," Report No. FHWA IF-02-017, Federal Highway Administration, Washington, D.C.

APPENDIX A – SOIL NAIL DESIGN COMPARISON

The reports FHWA-IF-03-017 (Lazarte et. al., 2003) and FHWA-SA-96-069R (Byrne et al., 1998), hereafter referred to as [REF1] and [REF2], respectively, contain specific recommendations pertaining to the analysis and design of soil nail walls with a reinforced concrete facing (shotcrete and cast-in-place concrete). The comparison was limited to those sections of each manual providing specific design recommendations that influence or otherwise direct the efforts of engineers engaged in the prescriptive practice of designing and analyzing soil nail walls. Likewise opinions or corrections to the manuals are beyond the scope of the comparison. The design items considered are listed in Table 1 and include external, internal and facing calculations. Where convenient, equations are sometimes shown in Table 1 as a means to illustrate the similarity or difference of the recommendations in the respective manuals; however, the reader is referred to the appropriate report for a complete list of the variables, their definitions and specific discussions on the guidance or limitations of the listed equations. Based on the review of the design methods, a discussion of the main differences between the two manuals is provided.

ACTIVE EARTH LOAD FOR INTERNAL STABILITY AND FACING DESIGN

For estimating the “internal” active earth load resisted by the nails, [REF1] recommends using the slope stability software, SNAIL (CALTRANS, undated). SNAIL is capable of estimating the available nail resistance intersecting a given slip surface based on the controlling condition of grout-soil pullout, facing punching shear or nail tensile yield. The analysis determines the internal “maximum average nail load” that provides a factor of safety of 1.0 (active failure condition). Once the “maximum average nail load” has been determined, the active earth load occurring at the back of the shotcrete is empirically derived using an equation, based on earth pressure measurements at the shotcrete-soil interface done on walls in Germany and France using total stress cells (Clouterre, 1993). The maximum average active earth load applied to the head of the nails may vary from approximately 60% to 100% of the “maximum average nail load” depending on nail spacing.

In contrast, [REF2] applies the full coulomb active earth loading uniformly behind the shotcrete facing. In complex terrain or layered soils, a slope stability analyses can be conducted to determine the magnitude of an external load against the facing. The external load that provides a factor of safety of 1.0 (active condition) is then distributed uniformly along the back of the shotcrete. [REF2] does not rely on any particular software package to complete these calculations.

OVERALL (GLOBAL) STABILITY

Both manuals emphasize the use of global stability analysis to design soil nail walls. [REF1] relies heavily on the software program SNAIL to determine both active earth pressure loading applied to the wall facing (Factor of Safety equal to 1.0) and a search for the critical slip surface producing a minimum factor of safety for a given nail layout (spacing, orientation and lengths). [REF2] has a design procedure that reduces the lengths of the nails towards at the middle and lower elevations in the wall to account for “top down”

loading of the soil nails. [REF2] is concerned that after construction of a soil nail wall the nails in the upper part of the wall are more heavily loaded than the middle to lower nails. This is the necessary result of the staged, top-down nature of soil nail wall construction. In order to adjust the engineering calculations to account for this condition, [REF2] has a procedure to reduce the lengths of the nails in the middle to lower portion of the soil nail walls thereby reducing their contribution to slope stability. This procedure is not demonstrated in [REF1].

EXTERNAL STABILITY ANALYSES

Both methods use earth pressure type equations to estimate the factors of safety for external modes of failure (bearing capacity, etc.). However [REF1] considers bearing capacity and sliding, while [REF2] considers bearing capacity and eccentricity of the soil reaction (overturning). Also the pseudo-static seismic coefficient is much larger using [REF2] than [REF1].

Table 1. Soil Nail Retaining Wall Design Comparison Summary.

(equations provided for visual comparison – see referenced section in the appropriate design manual for variable identification and additional information)

Design Categories	Analyses Consideration	[REF1] FHWA IF-03-017 Geotechnical Circular No. 7	[REF2] FHWA-SA-96-069R Manual for Design and Construction Monitoring of Soil Nail Wall	Comments
General	UNITS	English, SI	SI	Equations in Summary Table use English Units for Illustration.
	DESIGN METHODOLOGY	ASD	ASD & LRFD	Currently ASD is the preferred methodology
	SHORT AND LONG TERM FACTORS OF SAFETY	See Table 2 below		Same or similar general discussion in both manuals
External Design	GLOBAL STABILITY	Section 5.4.2 Uses slope stability limiting equilibrium calculation with consideration for tensile forces in the nail controlled by either facing, tensile or pullout capacity. Discusses SNAIL and GOLDNAIL as two popular software programs capable of managing the soil shear strength with the multiple potential failure modes of the soil nails. Relies on SNAIL to determine “maximum average nail loading” (see internal design below).	Section 4.3.2 Uses slope stability limiting equilibrium calculation with consideration for tensile forces in the nail controlled by either facing, tensile or pullout capacity. Does not rely on any specific software program.	[REF1] relies on SNAIL software to complete analyses. [REF2] does not rely on any specific software package.
	BEARING	Section 5.4.4	Section 4.2.4 & 4.7.1	Both design manuals

APPENDIX A – SOIL NAIL DESIGN COMPARISON

Design Categories	Analyses Consideration	[REF1] FHWA IF-03-017 Geotechnical Circular No. 7	[REF2] FHWA-SA-96-069R Manual for Design and Construction Monitoring of Soil Nail Wall	Comments
	CAPACITY	Check for Basal heave of fine grained soil at base of excavation.	General Bearing Capacity Evaluation and Check for Basal Heave	provide for a separate, earth pressure type, bearing capacity calculation. [REF1] emphasizes basal heave for fine grained soils.
External Design	SLIDING	Section 5.4.3 Conducts separate earth pressure type sliding calculation	Section 4.2.4 The discussion suggests that no separate earth pressure calculation for sliding is necessary as thorough global stability analyses will capture this mode of failure.	Separate earth pressure type sliding calculation is considered in [REF1] but not in [REF2]
	OVERTURNING	Does not promote a separate calculation for overturning.	Section 4.2.4 Check that the eccentric soil reaction is within middle third of foundation	[REF1] does not provide a separate earth pressure type overturning calculation. [REF2] checks whether the eccentric soil reaction is located within the middle third of the foundation.

APPENDIX A – SOIL NAIL DESIGN COMPARISON

Design Categories	Analyses Consideration	[REF1] FHWA IF-03-017 Geotechnical Circular No. 7	[REF2] FHWA-SA-96-069R Manual for Design and Construction Monitoring of Soil Nail Wall	Comments
	SEISMIC	<p>Section 5.4.5 Uses pseudo static seismic coefficient applied to global stability analyses. Uses Mononobe-Okabe method for sliding check</p>	<p>Section 4.7, Chapter 5 and Appendix G Uses pseudo static seismic coefficient applied to global stability analyses. The discussion recommends a different coefficient for “internal” slip surfaces than for “external or mixed” slip surfaces. Uses Mononobe-Okabe method for bearing capacity and eccentricity check</p>	<p>For slip surfaces that are “external or mixed” the global stability analyses is the same for both manuals. [REF2] uses a higher pseudo static seismic coefficient for “internal” slip surfaces. Both manuals apply the M-O method for external stability checks; however, each manual checks different modes of external failure.</p>
SERVICE/ DEFORMATION		<p>Section 5.7 See Figure 86 below</p>	<p>Section 2.8 See Figure 87 below</p>	<p>The estimated vertical and horizontal deformations are identical. The extent of the estimated influence zones behind the wall face is different.</p>

APPENDIX A – SOIL NAIL DESIGN COMPARISON

Design Categories	Analyses Consideration	[REF1] FHWA IF-03-017 Geotechnical Circular No. 7 Section 5.6.2 Uses Charts or SNAIL Program (FS=1.0) to Estimate “Maximum Average Nail Loading.”	[REF2] FHWA-SA-96-069R Manual for Design and Construction Monitoring of Soil Nail Wall Section 2.4.4 & 4.7 Determines coulomb active earth load and applies uniformly to nails with consideration of nail spacing.	Comments
Internal Design	MAXIMUM NAIL LOADING (SEE FIGURE 87 BELOW)			The estimate for maximum nail loading is more involved for [REF1] than for [REF2]. [REF1] uses the slope stability program SNAIL, searching for “internal” slip surfaces with consideration for available nail resistances (controlled by facing, tensile yield or pullout) to determine the maximum average nail loading at a FS=1.0 (active state). [REF2] calculates the coulomb active earth load and uniformly distributes the load to the nails with consideration of nail spacing (tributary area).
	GROUT-SOIL PULLOUT	Section 5.5.2 $Q_u := \pi \cdot D_h \cdot L_p \cdot q_u$	Section 4.2.2 $Q_u := \pi \cdot D_h \cdot L_p \cdot q_u$	Same or similar general discussion in both manuals.
	NAIL-GROUT	Section 5.5.1	Section 4.2.2	Same or similar general

APPENDIX A – SOIL NAIL DESIGN COMPARISON

Design Categories	Analyses Consideration	[REF1] FHWA IF-03-017 Geotechnical Circular No. 7	[REF2] FHWA-SA-96-069R Manual for Design and Construction Monitoring of Soil Nail Wall	Comments
PULLOUT	Recommends use of deformed or threaded bar.	Section 5.5.4 $R_T := A_t \cdot f_y$	Promotes use of deformed bars to provide mechanical interlock. Not typically a design concern for soil nails	discussion in both manuals.
NAIL TENSILE	Section 5.5.1	The influence of nail shear and bending on stability is conservatively ignored.	Section 4.2.2 $T_{NN} := A_b \cdot F_y$	Same or similar general discussion in both manuals
NAIL BENDING	Section 5.5.1	The influence of nail shear and bending on stability is conservatively ignored.	Section 2.4.7 Design does not use nail bending resistance.	Same or similar general discussion in both manuals

Design Categories	Analyses Consideration	[REF1] FHWA IF-03-017 Geotechnical Circular No. 7	[REF2] FHWA-SA-96-069R Manual for Design and Construction Monitoring of Soil Nail Wall	Comments
Wall Facing Design	FACE LOADING	<p>Section 5.6.2</p> <p>Uses Charts or SNAIL Program (FS=1.0) to Estimate Maximum Nail Loading. Face loading varies from approximately 60% of maximum nail loading for closely spaced nails to full maximum nail loading (FS=1.0).</p>	<p>Section 2.4.5 & Section 4.7.1</p> $t_{F,F} := \frac{2 \cdot F_{F,a} \cdot P_a \cdot S_h \cdot S_v}{H}$ <p>where $F_{F,F} := 0.5$ P_a = Coulomb Active Earth Load</p>	<p>[REF1] uses SNAIL software to conduct a global stability analysis, interacting with available nail resistances (whether pullout, facing or tensile control) to determine the maximum average nail load. Depending on nail spacing this load may be reduced using an empirical formula to arrive at the applied earth load at the nail head. [REF2] applies the full coulomb active earth load distributed uniformly behind the facing.</p>

Design Categories	Analyses Consideration	[REF1] FHWA IF-03-017 Geotechnical Circular No. 7	[REF2] FHWA-SA-96-069R Manual for Design and Construction Monitoring of Soil Nail Wall	Comments
	FLEXURAL STRENGTH (EQUATIONS SHOWN REPRESENT VERTICAL DIRECTION)	Section 5.6.3 $R_{FF} := 3.8 \cdot C_F \cdot (a_{vm} + a_{vm}) \cdot \frac{S_{h,h}}{S_v} \cdot f_y$	Section 4.5.2 & Appendix F $T_{FN} := C_F \cdot (m_{v, pos} + m_{v, neg}) \cdot \left(\frac{8 \cdot S_{h,h}}{S_v} \right)$ where: $m := \frac{A_s \cdot F_y}{b} \cdot \left(d - \frac{A_s \cdot F_y}{1.7 \cdot f_c \cdot b} \right)$	Equations are different; however, they result in similar nominal flexure resistance
	PUNCHING SHEAR STRENGTH – BEARING PLATE	Section 5.6.4 $R_{FP} := C_P \cdot V_F$ where: $V_F (\text{kip}) := 0.58 \cdot \sqrt{f_c} (\text{psi}) \cdot \pi \cdot D_c (\text{ft}) \cdot h_c (\text{ft})$	Section 4.5.3 & Appendix F $T_{FP} := \frac{V_N}{1 - \left[\frac{C_s \cdot (A_c - A_{gc})}{S_v \cdot S_{h,h} - A_{gc}} \right]}$ where: $V_N := 4 \cdot \sqrt{f_c} \cdot \text{psi} \cdot \pi \cdot D_c \cdot h_c \cdot \text{pl}$	Results are identical for nominal punching shear resistance
Wall Facing Design	HEADED STUD CONNECTION	Section 5.6.5 $R_{HT} := N_H \cdot A_{SH} \cdot f_y$	Section 4.5.3 (b), Section 4.5.4 & Appendix F Punching Shear calculated the same as for bearing plate. Only the perimeter area is different where D_C is based on the stud spacing. Check for Stud Tensile Capacity $T_{FN} := 4 \cdot A_{HS} \cdot F_u$	For tension check the capacity is based on yield strength [REF1] and ultimate strength for [REF2]. The maximum compression force exerted on the concrete behind the head of the studs is evaluated differently.
	STEEL REINFORCEMENT CHECKS	Section 5.6.3 & Appendix D Reinforcement Ratio (min and max) Minimum Cover Appropriate Development & Splices	Section 4.7 Waler Reinforcement Minimum Reinforcement Ratios Minimum Cover	Same or similar result using either manual

APPENDIX A – SOIL NAIL DESIGN COMPARISON

Design Categories	Analyses Consideration	[REF1] FHWA IF-03-017 Geotechnical Circular No. 7	[REF2] FHWA-SA-96-069R Manual for Design and Construction Monitoring of Soil Nail Wall	Comments
		Water Bars	Reinforcement Development and Splices	
Other	UPPER/LOWER CANTILEVER CHECK	Not a Separate Design Step	Section 4.7 Check for Flexure and One Way Shear at Cantilever	[REF1] does not check upper cantilever for shear or flexure.
Other	SPECIAL DESIGN CONSIDERATIONS	Section 5.11, 5.12 & Chapter 6 Drainage Frost External Loads Strut Nails Tiered Walls Composite (Hybrid) Structures Varying Nail Inclinations Varying Nail Orientations Varying Nail Lengths	Section 4.10 Heterogeneous Soil Profiles Surcharge Loading Bridge Abutments Tiered Walls Composite (Hybrid) Wall Types Variable Nail Lengths Variable Nail Inclinations Variable Nail Orientations Ground Water Seepage Water Table Close to Base of Wall Infinite Slope Condition Performance Under Seismic Loading Frost Protection Expansive Soils Residual Soils Structures with Externally Loaded Wall Facing Strut Nails for Facing Support End of Wall Transitions CIP Concrete Form Connection to Shotcrete Facing	

Table 2. Factors of Safety Comparison for [REF1] and [REF2].

		Minimum Factor of Safety							
		[REF1]				[REF2]			
		Resisting Component		Static Loads		Seismic Loads		Static Loads	
Failure Mode		Temporary Structure	Permanent Structure	Temporary Structure	Permanent Structure	Temporary Structure	Permanent Structure	Temporary Structure	Permanent Structure
External	Global Stability (long-term)	1.35	1.5	1.1	1.35 (1.50)	1.01 (1.13)			
	Global Stability (construction staging)	1.2-1.3	1.5	NA	1.20 (1.35)	NA			
	Sliding	1.3	1.5	1.1	NA	NA			
	Eccentricity Check for Overturning, e	2.5	3.0	2.3	?±B/6	?±B/6			
	Bearing Capacity	2.0	3.0	2.3	2.5	1.88			
Internal	Pullout Resistance	1.8	1.5	1.5	2	1.5			
	Nail Bar Tensile Strength	1.35	1.35	1.35	1.8	1.35			
Facing Strength	Flexure	1.35	1.5	1.1	1.5	1.12			
	Punching Shear	1.35	1.5	1.1	1.5	1.12			
	Stud Tensile (A307 Bolt)	1.8	2.0	1.5	2	1.5			
	Stud Tensile (A325 Bolt)	1.5	1.7	1.3	1.7	1.27			

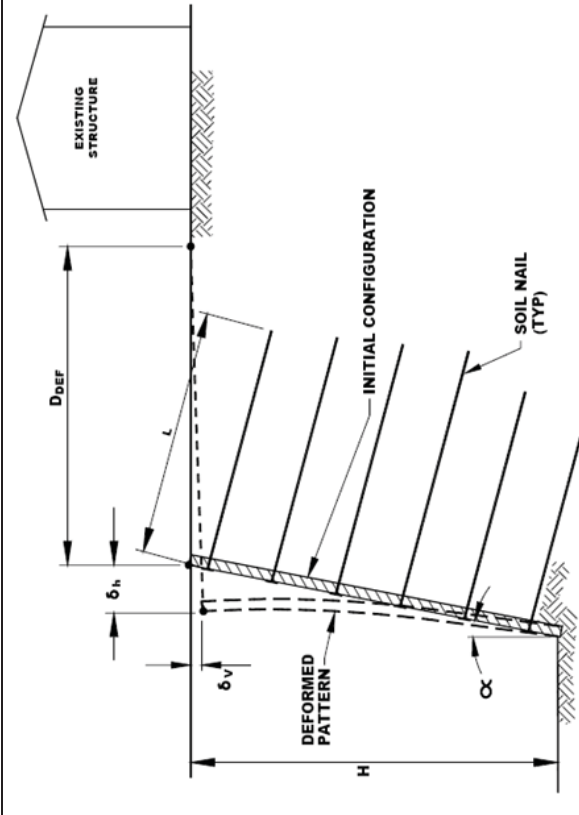

Empirical data show that for soil walls with typical L/H between 0.7 and 1.0, negligible surcharge loading, and typical global factors of safety (FS_G) values of 1.5, the maximum long-term horizontal and vertical wall displacements at the top of the wall, δ_h and δ_v , respectively, can be estimated as follows:

$$\delta_h = \left(\frac{\delta_h}{H} \right)_i \times H$$

where:

$(\delta_h/H)_i$ = a ratio dependant on the soil conditions "i" indicated in the table below; and
 H = wall height.

The size of the zone of influence is defined by a horizontal distance behind the soil nail wall (D_{DEF}) and can be estimated with the following expression:

$$\frac{D_{DEF}}{H} = C (1 - \tan \alpha)$$

where α : is the wall batter angle; and C coefficient

Values of (δ_h/H) , and C as Functions of Soil Conditions.

Variable	Weathered Rock and Stiff Soil	Sandy Soil	Fine-Grained Soil
δ_h/H and δ_v/H	1/1,000	1/500	1/333
C	1.25	0.8	0.7

Figure 86. Schematic. Estimating the Deformation and Extent of Influence. [REF1].

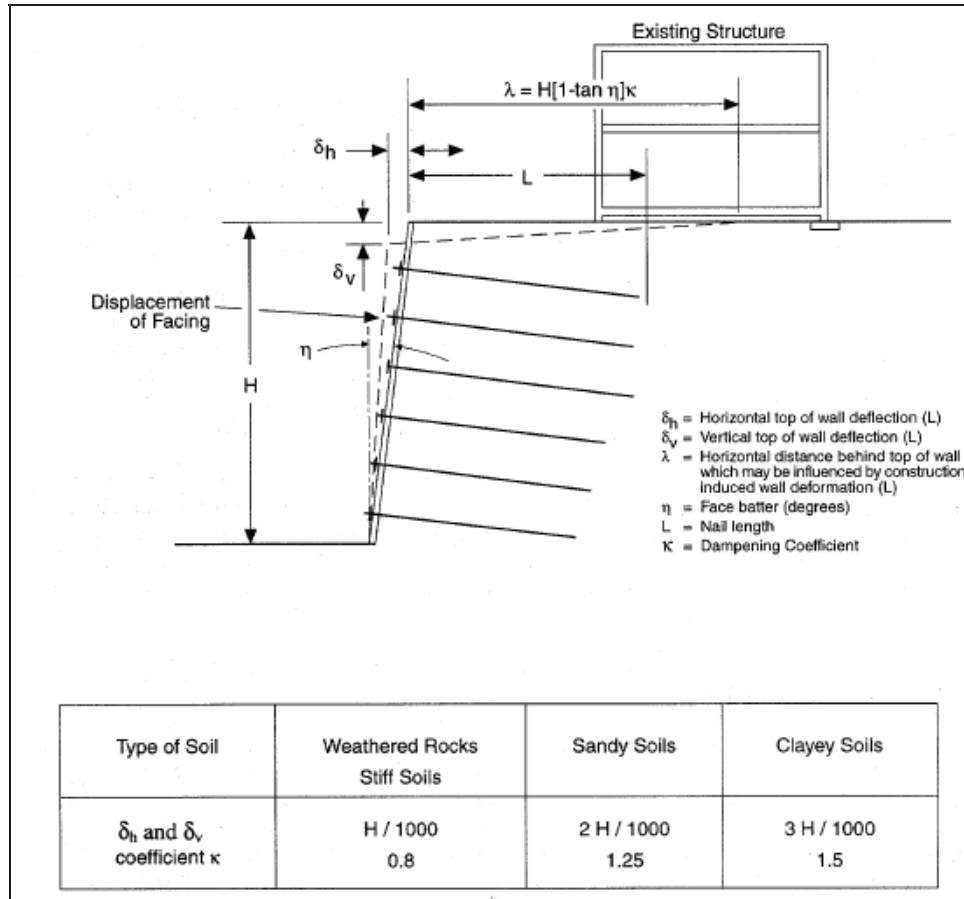

Figure 87. Schematic. Deformation Estimate at Top of Wall and Extent of Influence. [REF2]

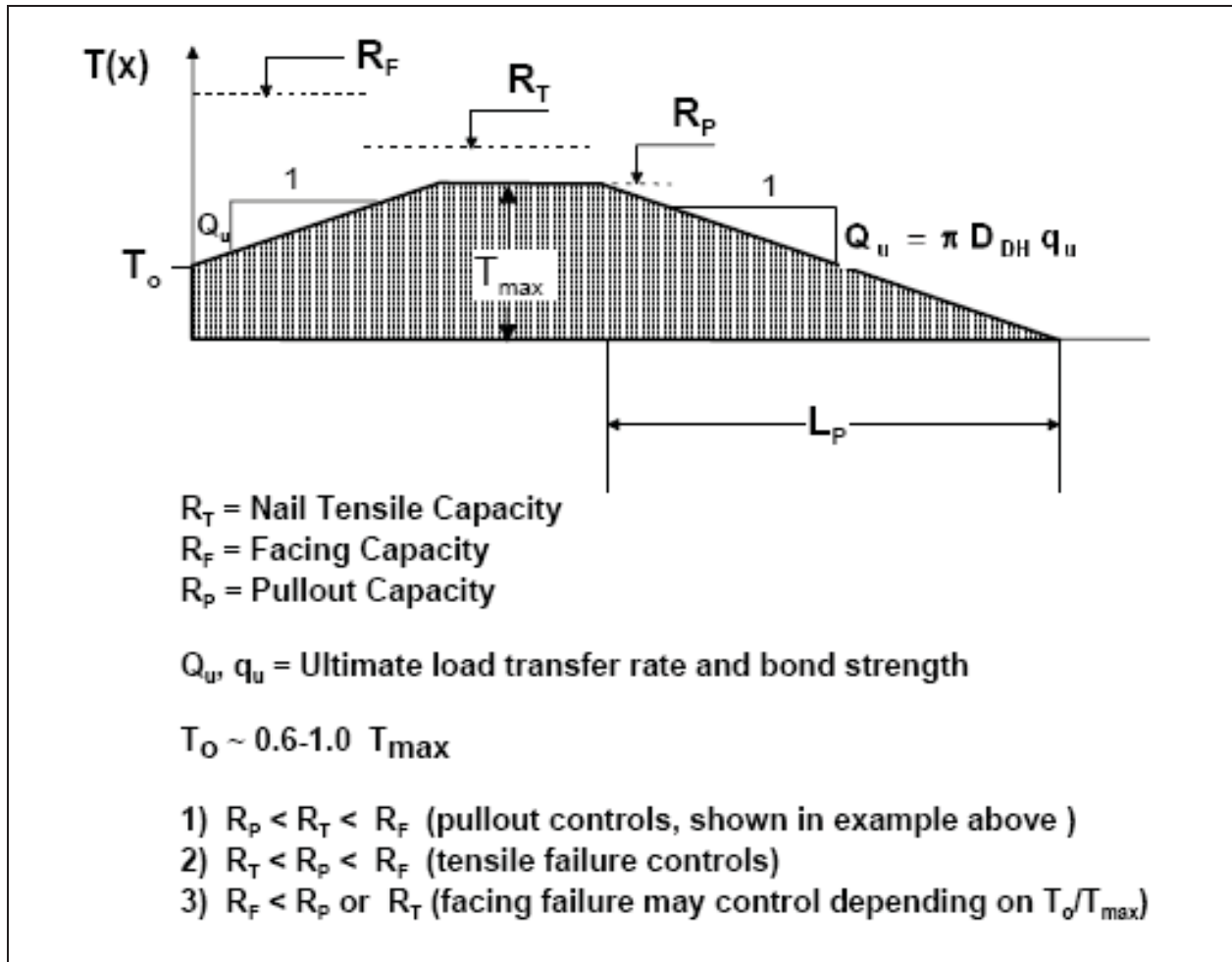

Figure 88. Schematic. Illustration of Distributed Nail Tensile Loads (T_0 , T_{max} , etc.) and the Limiting Nail Capacities (Tensile, Facing, & Pullout). [REF1]

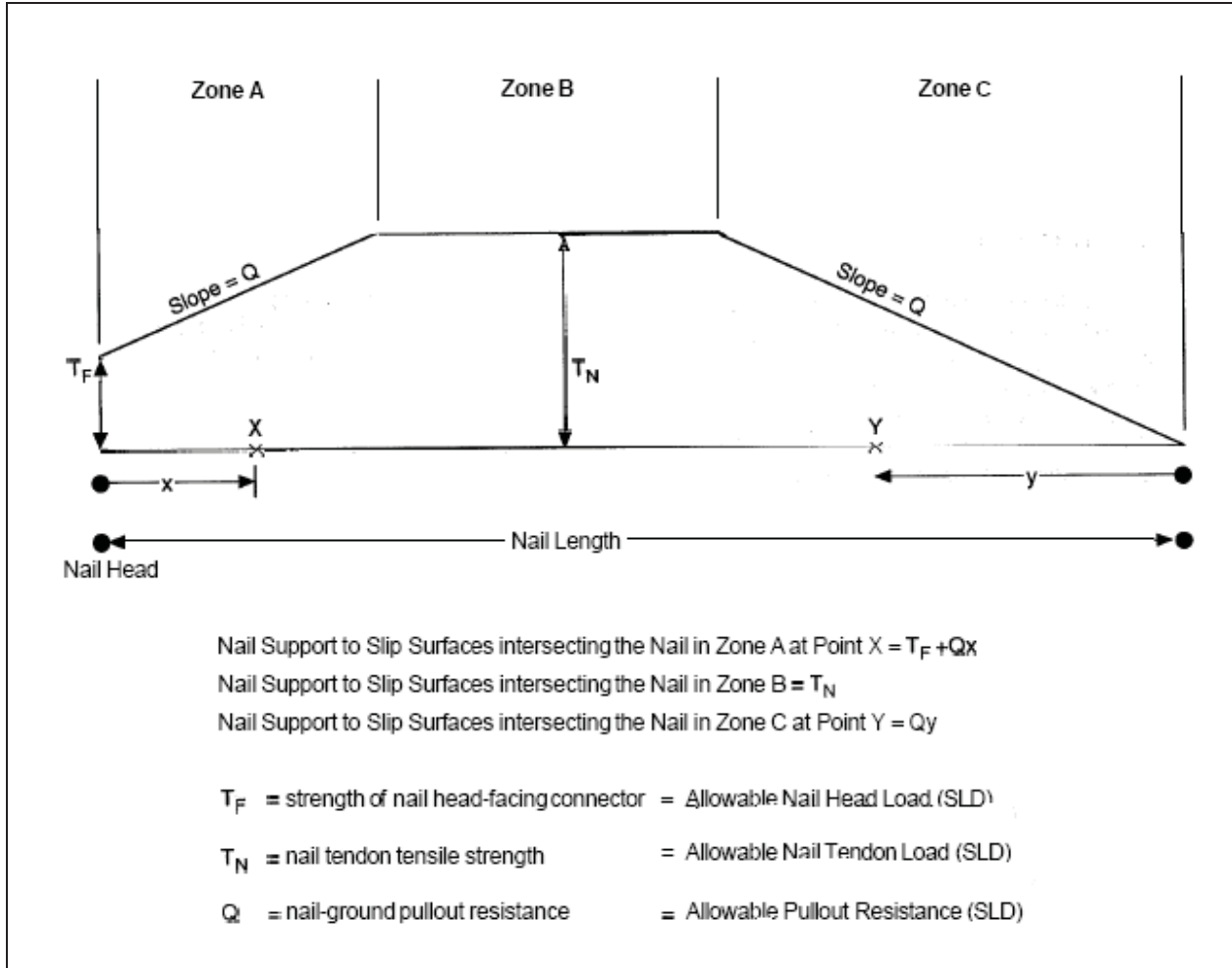

Figure 89. Schematic. Illustration showing the Distributed Nail Capacities. [REF2]

APPENDIX A REFERENCES

- Lazarte, C.A., Elias, V., Espinoza, R.D. and Sabatini, P.J. (2003). “Geotechnical Circular No. 7 – Soil Nail Walls,” Report No. FHWA IF-02-017, Federal Highway Administration, Washington, D.C.
- Byrne, R.J., Cotton, D., Porterfield, J., Wolschlag, C. and Ueblacker, G. (1998). “Manual for Design and Construction Monitoring of Soil Nail Wall,” Report No. FHWA SA-96-069R, Federal Highway Administration, Washington D.C.
- CALTRANS (Undated). “Manual of Instructions for SNAILZ, Version 3.10,” California Department of Transportation, Engineering Service Center, Division of Materials and Foundations, Office of Roadway Geotechnical Engineering, Sacramento, California.
- Clouterre (1993). “Recommendations CLOUTERRE 1991 – Soil Nailing Recommendations 1991,” English Translation, Presses de l’Ecole Nationale des Ponts et Chaussées, Paris, France.