

DISTRIBUTION STATEMENT A

Approved for public release
Distribution Unlimited

19980309 094

1991-1992 Europe & Asia in Space

PLEASE RETURN TO:

BMD TECHNICAL INFORMATION CENTER
BALLISTIC MISSILE DEFENSE ORGANIZATION
7100 DEFENSE PENTAGON
WASHINGTON D.C. 20301-7100

US AIR FORCE
PHILLIPS LABO

46084
ICES
N

DTIC QUALITY INSPECTED 4

Front Cover: The Russian Gals communications satellite was undergoing development testing at the Applied Mechanics Scientific Production Association in Siberia during 1991-1992 (Photograph courtesy of Ed O'Grady).

Back Cover: In 1991-1992 the Mir space station expanded its international activities with visits by cosmonauts from Russia, Ukraine, Kazakhstan, Austria, France, Germany, and the United Kingdom (Photograph courtesy of Alexander Chernyavskiy).

Accession Number: 6084

Publication Date: Jan 01, 1991

Title: Europe and Asia in Space, 1991-1992

Personal Author: Johnson, N.L.; Rodvold, D.M.

Corporate Author Or Publisher: Kaman Sciences Corp., 1500 Garden of the Gods Rd., Colorado Springs, CO 80907 Report Number: DC-TR-2191.103-1

Report Prepared for: USAF Phillips Laboratory, Kirtland AFB, NM 87117

Abstract: This book describes the space activities of countries other than the United States. Only the ten principal sponsors of space endeavors in Europe and Asia which have broad interest and influence in space activities have been selected.

Descriptors, Keywords: Europe Asia Space USSR/CIS France Germany India Israel Italy Japan China UK

Pages: 313

Cataloged Date: Oct 02, 1996

Copyrighted or Not: ~~Yes~~

No

Document Type: HC

Number of Copies In Library: 000001

Record ID: 42417

EUROPE AND ASIA IN SPACE

1991-1992

PLEASE RETURN TO:
BMD TECHNICAL INFORMATION CENTER

Nicholas L. Johnson
Senior Scientist

David M. Rodvold
Research Scientist

Prepared by

Kaman Sciences Corporation
1500 Garden of the Gods Road
Colorado Springs, Colorado 80907

Prepared for

USAF Phillips Laboratory
Kirtland AFB, NM 87117

U6084

FOREWORD

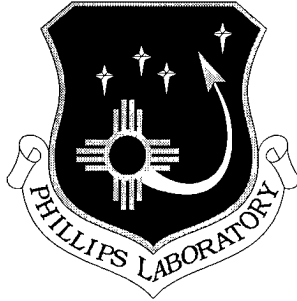

Phillips Laboratory is proud to present this book describing the space activities of countries other than the United States. This book was prepared by KAMAN Sciences Corporation under the direction of the Studies and Analysis Division of the Phillips Laboratory. The KAMAN principal investigator was Mr. Nicholas Johnson.

For 10 years Nick Johnson authored *The Soviet Year in Space* series. This book represents Phillips Laboratory effort to continue the publication of this useful series and increase its scope to other countries. Nick Johnson has documented his sources, all of which are in the open literature or have been provided by the owner of the spacecraft.

As the U.S. Air Force's premier space and missile systems laboratory we hope that this document will prove to be useful to you and we would like to hear your comments. Your comments will be used to determine if we should continue this effort and what changes we should consider in the content and format of the material presented. Please send your comments to:

Phillips Laboratory/XPF
Attn: Europe and Asia in Space Project
3550 Aberdeen Ave SE
Kirtland AFB, NM 87117-5776

A handwritten signature in black ink, appearing to read "Richard W. Davis".

Richard W. Davis, Col USAF
Commander

TABLE OF CONTENTS

Section	Page
FOREWORD	i
1.0 PRINCIPAL SPACE ORGANIZATIONS AND INFRASTRUCTURE	1
1.1 USSR/CIS	1
1.2 European Space Agency	5
1.3 France	7
1.4 Germany	7
1.5 India	9
1.6 Israel	10
1.7 Italy	10
1.8 Japan	11
1.9 People's Republic of China	12
1.10 United Kingdom	12
References	14
2.0 SPACE TRANSPORTATION SYSTEMS AND LAUNCH FACILITIES	17
2.1 USSR/CIS	17
2.2 European Space Agency	29
2.3 Germany	33
2.4 India	33
2.5 Israel	36
2.6 Italy	36
2.7 Japan	37
2.8 People's Republic of China	40
2.9 Spain	43
2.10 United Kingdom	43
References	45
3.0 MANNED AND MAN-RELATED SPACE PROGRAMS	57
3.1 USSR/CIS	57
3.1.1 1991 Operations	60
3.1.2 1992 Operations	70
3.2 European Space Agency	78
3.3 France	79
3.4 Germany	80
3.5 Japan	81
3.6 People's Republic of China	82
3.7 United Kingdom	82
References	83
4.0 EARTH APPLICATIONS PROGRAMS	91
4.1 Communications	91
4.1.1 USSR/CIS	91
4.1.2 European Space Agency	107
4.1.3 EUTELSAT	108
4.1.4 France	109
4.1.5 Germany	110

TABLE OF CONTENTS (Continued)

Section	Page
4.1.6 Hong Kong	111
4.1.7 India.....	112
4.1.8 Indonesia	113
4.1.9 INMARSAT.....	114
4.1.10 Israel.....	115
4.1.11 Italy.....	115
4.1.12 Japan.....	115
4.1.13 Luxemburg	118
4.1.14 Pakistan.....	119
4.1.15 People's Republic of China	119
4.1.16 Saudi Arabia.....	120
4.1.17 Spain.....	121
4.1.18 Sweden.....	121
4.1.19 United Kingdom	121
 4.2 Navigation and Geodesy	 123
4.2.1 USSR/CIS.....	123
4.2.2 France	128
4.2.3 Italy.....	129
4.2.4 Japan.....	129
4.2.5 People's Republic of China	129
 4.3 Earth Observation and Remote Sensing	 131
4.3.1 USSR/CIS.....	131
4.3.2 European Space Agency.....	156
4.3.3 France	159
4.3.4 Germany	160
4.3.5 India.....	161
4.3.6 Israel.....	162
4.3.7 Italy.....	162
4.3.8 Japan.....	163
4.3.9 Pakistan.....	166
4.3.10 People's Republic of China	166
4.3.11 South Korea.....	168
 4.4 Materials Science.....	 169
4.4.1 USSR/CIS.....	169
4.4.2 European Space Agency.....	173
4.4.3 France	176
4.4.4 Germany	176
4.4.5 Italy.....	177
4.4.6 Japan.....	177
4.4.7 People's Republic of China	178
 References.....	 179
 5.0 SPACE SCIENCE AND EXPLORATION PROGRAMS.....	 193
 5.1 Life Sciences	 193
5.1.1 USSR/CIS.....	193
5.1.2 European Space Agency.....	195
5.1.3 France	196
5.1.4 Germany	197

TABLE OF CONTENTS (Continued)

Section	Page
5.1.5 Japan.....	198
5.1.6 People's Republic of China	199
5.2 Geophysics.....	200
5.2.1 USSR/CIS.....	200
5.2.2 Czechoslovakia	202
5.2.3 European Space Agency.....	203
5.2.4 Italy.....	203
5.2.5 Japan.....	204
5.2.6 Sweden.....	205
5.3 Solar System Investigations.....	206
5.3.1 USSR/CIS.....	206
5.3.2 European Space Agency.....	209
5.3.3 France	212
5.3.4 Japan.....	212
5.4 Extra-Solar System Observations.....	214
5.4.1 USSR/CIS.....	214
5.4.2 European Space Agency.....	219
5.4.3 Germany	222
5.4.4 India.....	222
5.4.5 Italy.....	223
5.4.6 Japan.....	223
5.4.7 Spain.....	224
References.....	225
6.0 NATIONAL SECURITY PROGRAMS	233
6.1 Imaging Reconnaissance	233
6.1.1 USSR/CIS.....	234
6.1.2 France	239
6.1.3 People's Republic of China	239
6.1.4 Western European Union.....	240
6.2 Electronic Intelligence.....	241
6.2.1 USSR/CIS.....	241
6.2.2 France	244
6.3 Ballistic Missile Launch Detection.....	246
6.3.1 USSR/CIS.....	246
6.4 Space Defense	249
6.4.1 USSR/CIS.....	249
6.5 National Security Support Systems.....	252
6.5.1 USSR/CIS.....	252
References.....	254

TABLE OF CONTENTS (Concluded)

Section	Page
7.0 1991-1992 SPACE LAUNCHES	257
7.1 USSR/CIS	257
7.2 European Space Agency	266
7.3 India	268
7.4 Japan	269
7.5 People's Republic of China	270
 8.0 APPENDICES	
Appendix 1: Frequencies Used by European and Chinese Satellites in 1991 and 1992 as Monitored by the Kettering Group	271
Appendix 2: CIS Agreement on Joint Activity in Space Research and Exploitation	274
Appendix 3: Decree Establishing the Russian Space Agency	277
Appendix 4: Agreement Between the Republic of Kazakhstan and the Russian Federation on Procedure for the Use of the Baikonur Cosmodrome	278
Appendix 5: Agreement Between the United States of America and the Russian Federation Concerning Cooperation in the Exploration and Use of Outer Space for Peaceful Purposes	281
Appendix 6: Statute of the Russian Space Agency of the Government of the Russian Federation	283
Appendix 7: Resolution on the European Long-Term Space Plan 1992-2005 and Programs	286
Appendix 8: Resolution on Programs for Observation of the Earth and Its Environment	291
Appendix 9: Resolution on the Implementation of the European Long-Term Space Plan and Programs	295
Appendix 10: ESA Resolution of International Cooperation	304
Appendix 11: ESA Resolution on Space Cooperation with the Russian Federation	305
9.0 ACKNOWLEDGMENTS AND CREDITS	307
10.0 SPACECRAFT CLASS INDEX	309

1.0 PRINCIPAL SPACE ORGANIZATIONS AND INFRASTRUCTURE

The high technology requirements associated with space activity, including satellite and launch vehicle design, manufacture, and operations, dictate a comprehensive and well defined organization involving both government and industry whether the program is of a national or commercial nature. This section highlights the major agencies and support functions which are necessary for the realization of the spacecraft and the space transportation system described herein. Only the ten principal sponsors of space endeavors in Europe and Asia which have broad interest and influence in space activities have been selected.

1.1 USSR/CIS

Since the mid-1960's the USSR has been the most prolific builder and launcher of artificial satellites in the world, accounting for more than two-thirds of the nearly 3,500 international space missions conducted between 1957 and 1992. The sheer magnitude of this 35-year effort led to a highly structured, albeit Byzantine, system of space program development, funding, and implementation. While the historic transformation of the Union of Soviet Socialist Republics into the Commonwealth of Independent States at the end of 1991 brought profound political changes, the fabric of the former Soviet space industry remained essentially intact below the government ministerial and state committee level. Although the year 1992 witnessed significant economic disruptions and project down-scalings in the space program, the near-term effects have not yet altered the identity of the majority of individuals and agencies responsible for producing space-related hardware.

Under the Soviet bureaucracy of 1991 numerous Ministries and State Committees played major roles in the management of civilian and military space programs as directed by the Council of Ministers through its various committees. Whereas the heart of the space industry was located within the Ministry of General Machine Building, other important organizations were affiliated with the Ministry of Defense, Ministry of Aviation Industry, Ministry of Electrical Equipment Industry, the State Committee on Hydrometeorology, the State

Committee on Education, and the Main Administration for Geodesy and Cartography. The USSR Academy of Sciences through its many, widely dispersed institutes, directed a few special scientific programs as well as supported a variety of other applications projects with both civilian and military objectives.

The space industry itself was largely divided into scientific production associations (NPO's), institutes (local or "All-Union"), and design bureaus. Most of these organizations have retained their identity under the CIS, although all are undergoing internal realignments (Table 1.1). Today, the USSR Ministry of General Machine Building has essentially been replaced by the Russian Ministry of Industry which contains the Department of General Machine Building. Non-Russian organizations are directed by their respective governments via bi-lateral or multi-lateral agreements with Moscow, e.g., under the auspices of the CIS, or work with Russian industry under commercial contracts.

The mutual benefit of an integrated commonwealth space program for economic and defense requirements was so apparent that this issue was addressed in a separate agreement signed at the Minsk meeting in December, 1991, which established the CIS (Appendix 2). Even though most heavy industry was Russian, the republics of Azerbaijan, Belorussia, Georgia, Kazakhstan, Kyrgystan, Ukraine, and Uzbekistan contained vital design bureaus, manufacturing plants, and facilities for space launches, space surveillance, and satellite control.

After only one year, the mechanism for this cooperation and coordination in space endeavors was still being defined. Officially, the CIS Joint Armed Forces (CIS OVS) encompassed the former activities of the Soviet Space Units of the Ministry of Defense, including the space surveillance system, the missile early warning network, the spacecraft control network, and space launch complexes. Consequently, the Russian space program has become virtually synonymous with the CIS space program. Near the end of 1992 Ukraine indicated that it might decline joining a formal CIS Space Agency (References 1-6).

To represent their national interests, many of the newly independent republics quickly formed

Table 1.1. Primary USSR Aerospace Industries, 1991.

Organization	Principal Facility	Major Emphasis
Central Specialized Design Bureau	Samara, Russia	Launch Vehicles; Recoverable Unmanned Spacecraft
Energiya NPO	Moscow Region, Russia	Launch Vehicles; Manned and Man-related Spacecraft
Energomash NPO	Moscow Region, Russia	Launch Vehicle Engines
Experimentalnoe Mashinostroeniye (Experimental Machine Building) NPO, Salyut Design Bureau	Moscow Region, Russia	Launch Vehicles; Space Station Modules
Khimavtomatika (Chemical Automation) Design Bureau	Voronezh, Russia	Launch Vehicle and Spacecraft Engines
Krunichev Machine Building Plant	Moscow Region, Russia	Launch Vehicles; Space Station Modules
Kometa (Comet) TsNPO	Moscow Region, Russia	Military Spacecraft
Lavochkin NPO, Babakin Engineering and Research Center	Moscow Region, Russia	Military and Scientific Spacecraft
Machinostroeniye (Machine Building) NPO	Moscow Region, Russia	Remote Sensing and Military Spacecraft
Molniya (Lightning) NPO	Moscow Region, Russia	Reusable Manned Spacecraft
Polet (Flight) PO	Omsk, Russia	Launch Vehicles; Communications and Navigation Spacecraft
Precision Instruments NPO	Moscow Region, Russia	Spacecraft Sub-systems
Prikadnoi Mekaniki (Applied Mechanics) NPO	Krasnoyarsk, Russia	Communications, Navigation, and Geodetic Spacecraft
Soyuz NPO, Isayev Design Bureau	Moscow Region, Russia	Launch Vehicle and Spacecraft Engines
Space Instrument Building NPO	Moscow Region, Russia	Spacecraft Sub-systems
VNIIEM (All-Union Research Institute for Electro-Mechanics)	Moscow Region, Russia	Meteorological and Remote Sensing Spacecraft
Yuzhnoye (Southern) NPO	Dnepropetrovsk, Ukraine	Launch Vehicles; Military, Remote Sensing, and Scientific Spacecraft
Zvezda (Star) NPO	Moscow Region, Russia	Life Support and Man-related Systems

their own space agencies. Azerbaijan established the National Air and Space Agency (headed by General Director Arif Shafayatovich Mekhtiyev) on 21 February 1992, followed four days later by the creation of the Russian Space Agency (headed by General Director Yuri Nikolayevich Koptev) (Appendix 3) and on 2 March by the formation of the National Space Agency of Ukraine. Kazakhstan moved a little more slowly, laying the groundwork for the Space Research Agency to be established in early 1993 and led by former cosmonaut Major General Tokhtar Ongarbayevich Aubakirov.

The principal Russian organizations and their areas of responsibility, as outlined by the Russian Space Agency (RSA) in September, 1992, are depicted in Figure 1.1. An early goal of a 150-member Russian Space Agency had already been exceeded by Fall of 1992: ~200 people belonged to the organization which included (1) a First Deputy General Director responsible for the office of Federal Space Programs Planning and the office of Federal Space Programs Realization, (2) a Deputy General Director overseeing the office of Manned Spacecraft and Transport Systems and the Office of Space Infrastructure, (3) a Deputy General Director for the office of Space Science and Applications, and (4) a Deputy General Director to manage international cooperation, including relations with the other CIS republics. The head of RSA, Yuri Koptev, was once an engineer at the Lavochkin NPO and later a Deputy Minister in the USSR Ministry of General Machine Building.

Whereas Figure 1.1 indicates a significant role for the CIS OVS in military affairs and support services, the Russian Armed Forces were established on 7 May 1992, followed by the formation of the Russian Military Space Forces. In effect the Russian Military Space Forces are jointly serving Russian national interests and CIS requirements much like a service command functions within a US unified command (References 7-9). The Russian Ministry of Defense is also responsible for the management of the Gagarin Cosmonaut Training Center (TsPK), the Aviation Search and Rescue Service which handles spacecraft recoveries, and the Mozhayskiy Military Space Engineering Institute in St. Petersburg which trains all the officers for the Russian Military Space Forces and the CIS Space Units.

Russian and CIS satellites are still handled via the Space Command, Control, and Tracking System (KIK) which operates the Main Center for Spacecraft Tests and Control at Golitsyno-2 near Moscow as well as 14 other sites in Russia, Ukraine, Kazakhstan, and Uzbekistan. In the Fall of 1992, Golitsyno-2 was reportedly supporting 190 active spacecraft. Seven of these facilities (at Yevpatoriya, Tbilisi, Dzhuzaly, Kolpashevo, Ulan Ude, Ussuriysk, and Petropavlovsk) also serve as the primary support network for the Mir space station through the Flight Control Center (TsUP) at Kaliningrad outside Moscow. However, at least two of the sites in Ukraine are no longer participating in KIK on a routine basis (References 10 and 11).

The Russian (former USSR) Academy of Sciences possesses a fleet of Space Event Support Ships (SESS) which historically have assisted manned and deep space missions. From a fleet of 11 vessels, ranging in tonnage from 6,100 metric tons to 45,000 metric tons in 1988, the SESS navy was reduced to six ships in 1990 with 3-4 on deployment at any given time. During 1991-1992 the on-station times of the SESS (normally in the North and South Atlantic Ocean) were significantly curtailed, apparently due to a lack of hard currency. A simultaneous degradation of the Luch geostationary data relay system led to a marked reduction in communications opportunities with the Mir space station.

A special network of large diameter antennas makeup the Long-Range Space Communications System (TsDKC) for control of scientific spacecraft in high Earth orbits or on interplanetary flights. The network consists of 10 primary antennas (22-70 m diameter) at seven locations: Yevpatoriya, Simeiz, Pushchino, Medvezhi Ozero, Ulan Ude, Ussuriysk, and the Suffa Plateau (the last under construction). For example, current plans call for linking the RT-32 and RT-70 radiotelescopes at Yevpatoriya and Ussuriysk and the RT-64 radiotelescope at Medvezhi Ozero to form the primary tracking and telecommunications system for the Mars-94 mission (References 12-15).

Equally important as the KIK is the CIS network of large ground-based radars which comprise the System for Monitoring Outer Space (SKKP) and the terrestrial element of the System for Warning of Missile Attacks (SPRN).

MANAGEMENT STRUCTURE OF THE SPACE ACTIVITIES IN RUSSIA

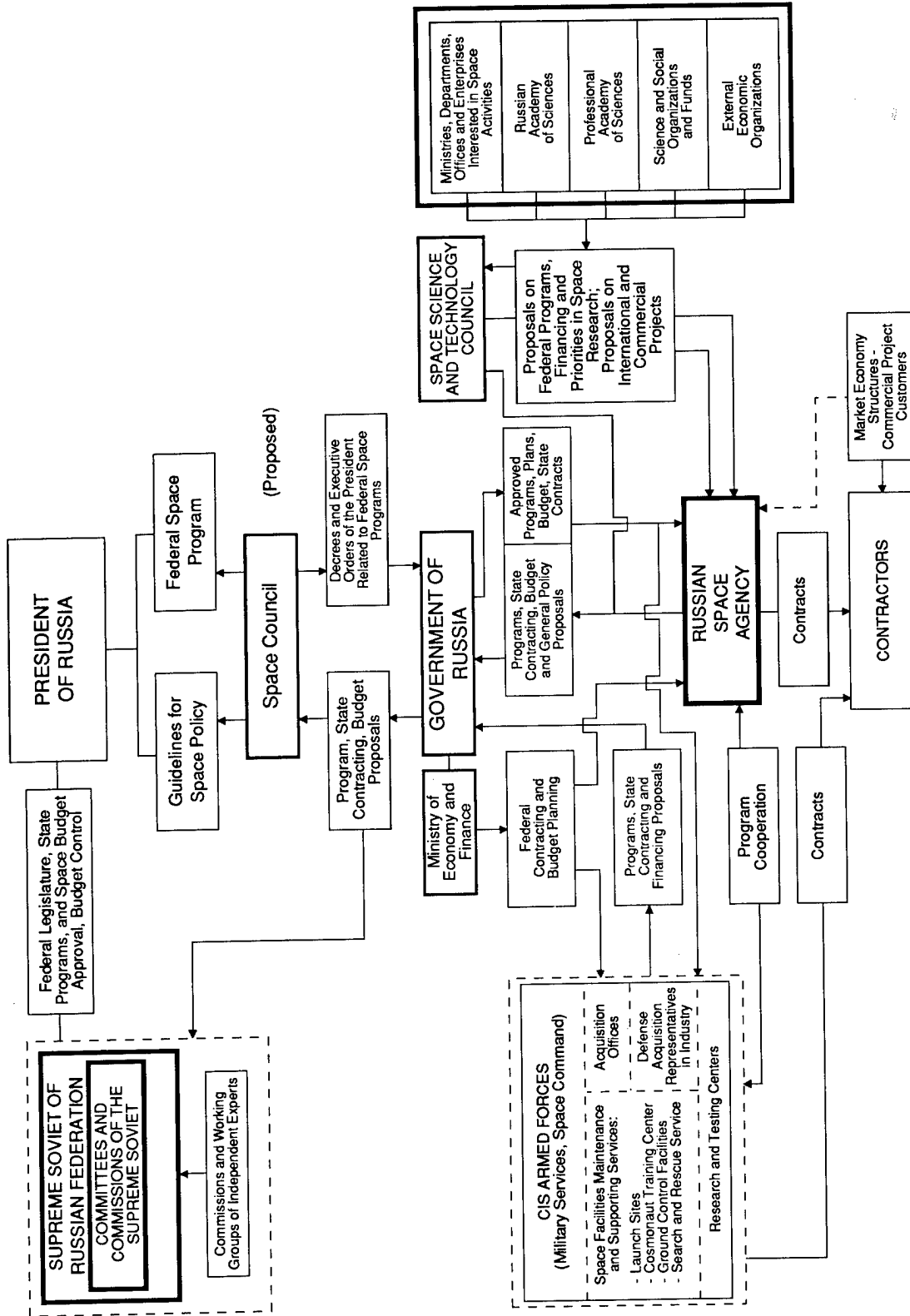

Prepared by the Russian Space Agency

Figure 1.1. Russian Space Agency's View of Russian Space Program Architecture.

Space surveillance tasks are primarily performed by HEN HOUSE and Large Phased Array Radars (LPARs) developed in the 1960's and 1980's respectively (Figure 1.2). Eight facilities are currently operational: in Russia at Irkutsk, Murmansk, and Pechora; in Ukraine at Sevastopol and Uzhgorod; in Kazakhstan at Balkhash; in Azerbaijan at Mingeçhaur; and in Latvia at Riga. A ninth sensor for the SKKP is an ABM radar near Moscow. To augment the radar facilities which operate primarily at 150 MHz and 400 MHz, the SKKP receives information from twelve optical and electro-optical sites: 7 optical sensors located in Russia, Kazakhstan, Tadjikistan, and Ukraine and 5 electro-optical sensors located in Russia, Georgia, Armenia, Ukraine, and Turkmenia (Reference 16).

1.2 European Space Agency

Since its official establishment in 1975, the European Space Agency (ESA) not only has become the most prominent force in the commercial space launch services market but also has invested substantial resources in developing and operating scientific and applications (Earth observation, communications, meteorology, and materials processing) space systems. Although ESA's ambitious plans to perform manned space operations were set back during 1991-1992, a long term commitment remains. For a decade ESA has been the third most active space-faring organization in the world behind the USSR/CIS and the US.

From an initial membership of 11 nations, ESA now includes 13 full members (Austria, Belgium, Denmark, France, Germany, Iceland, Italy, The Netherlands, Norway, Spain, Sweden, Switzerland, and the United Kingdom), one associate member (Finland), and one co-operating state (Canada). The purpose of ESA is to "provide for and to promote, for exclusively peaceful purposes, co-operation among European States in space research and technology and their space applications, with a view to their being used for operational space applications systems" (Reference 17). Although cooperation with other national and international space organizations has been encouraged, one of the tenets of ESA policy has been European independence in virtually all matters of space exploration and exploitation.

The ESA organizational structure includes a Council for policy decisions and approval of long-range plans and a much larger operations arm for handling the day-to-day affairs of the agency. The Council, led in 1992 by Chairman Francesco Carassa of Italy, is divided into Program Boards and Committees staffed by national delegations. Whereas the Council normally meets once each quarter, full ministerial-level meetings are held only once a year or less as dictated by events. As a result of significant world political changes and economic factors, ministerial-level meetings were held in both 1991 and 1992 (Appendices 7-11).

ESA operations are managed by the General Director, Jean-Marie Luton of France, and his principal staff which includes five major technical directorates: Science, Telecommunications, Observation of the Earth and Its Environment, Space Station and Microgravity, and Space Transportation Systems. With headquarters in Paris and liaison offices in Washington, DC; Kourou, French Guiana; and Toulouse, France, ESA runs four major facilities with a staff of just over 2,000 permanent employees (Reference 18).

The European Space Operations Center (ESOC) celebrated its 25th anniversary in 1992 as the primary satellite control facility for ESA spacecraft. Located in Darmstadt, Germany, and headed by Director Felix Garcia-Costaner, ESOC operates detachments in French Guiana, Belgium, Germany, and Spain and receives additional assistance from national ground stations in the Canary Islands, Sweden, Italy, Kenya, Australia, and Japan. In 1992 ESOC cooperated with the US ground station at Wallops Island in conjunction with the operation of Meteosat 3 and with the US Jet Propulsion Laboratory to support the Ulysses deep space mission.

The European Space Research and Technology Center (ESTEC) in Noordwijk, Norway, houses more than half of all ESA personnel in its role as the satellite environmental testing facility. Two smaller ESA facilities with 100 personnel or less are the European Space Research Institute (ESRIN) in Frascati, Italy, and the newly created European Astronauts Center (EAC) in Cologne, Germany. Plans for rapid expansion of the latter have been delayed due to the restructuring of the Hermes space plane program, but training for joint missions

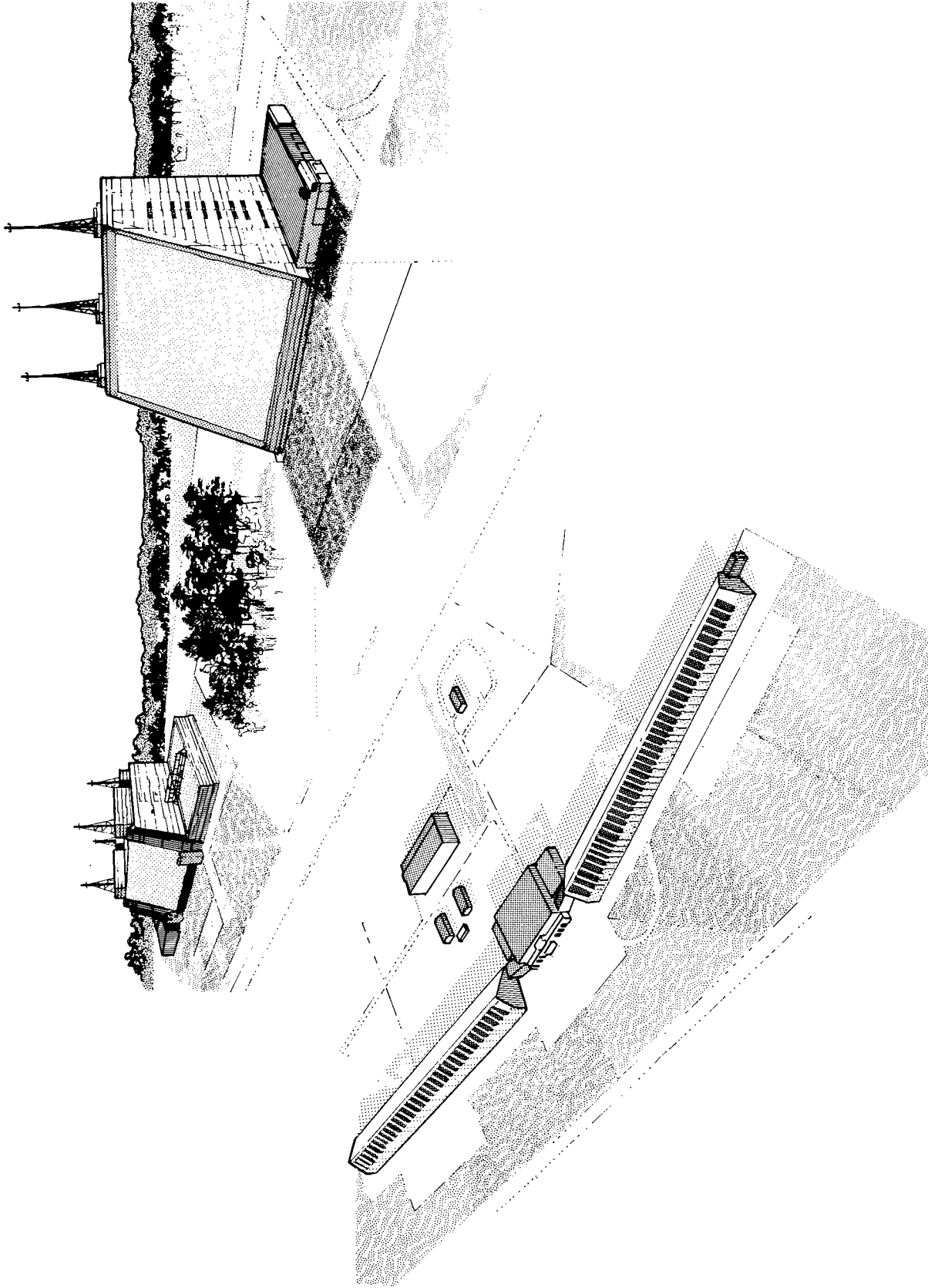

Figure 1.2. HEN HOUSE (lower left) and LPAR Space Surveillance and Early Warning Radars.

with the US and CIS continues.

ESA does not maintain its own aerospace industry but instead contracts with the specialized companies of its member states to procure ESA satellites and launch vehicles. Annual contributions to ESA by each nation are based upon the respective gross national products. ESA then returns funds in the form of contracts to the national aerospace industries in direct proportion to the amount of their government's contributions. States may elect to concentrate their support on specific programs. For example, the UK which places great emphasis on Earth observation programs has agreed to finance up to 25% of the Envisat-1 satellite but will support the Data Relay Satellite program at a level of only one percent.

1.3 France

In addition to being the principal contributor to ESA, France finances the largest national space program in Europe. During the past ten years (1983–1992), total French investment in space rose more than 260% to an annual budget of more than 10 billion Francs. France continues to pursue a broad selection of national, bi-lateral, and ESA-sponsored programs and is taking the lead in Europe in developing military space systems.

The French space program is managed by the Centre National D'Etudes Spatiales (CNES), which was established in 1962. The principal objectives of CNES are four-fold: "(1) orienting the French space program by preparing Government decisions, (2) designing, managing, and conducting the actual programs in an industrial context, (3) furthering the know-how of France's space industry, and (4) consolidating research programs with the scientific community." CNES resides within the Ministry for Research and Space but maintains close ties with the Ministry of Defense and the Ministry of Transport (Reference 19).

With a contingent of 2,400 personnel, CNES' staff outnumbers all of ESA. Led by President Jacques Louis Lions, CNES was managed by Director General Jean-Daniel Levi in 1992. Previous CNES Director Generals have moved on to assume top positions within the French government, including the Minister for Research and Space and Chief of the Delegation General pour l'Armement of the Ministry of Defense, as

well as the head of ESA, e.g., Jean-Marie Luton. Reporting to the Director General are three principal directorates for Space Transportation Systems; Research and Applications; and Strategy, Planning, International and Industrial Affairs.

Analogous to ESA, CNES operates four major centers. The largest by far is the Toulouse Space Center, home to approximately 1,650 personnel. Operations centers for SPOT, TDF, and Telecom are located at Toulouse, which also directs tracking, telemetry, and communications control centers at Issus Aussaquel, France; Kourou, French Guiana; Hartebeesthoek, South Africa, and Kerguelen Island. The Guiana Center for Space at Kourou, French Guiana, provides full launch support services for all ESA Ariane space launches, while the Evry Center for Space is the headquarters for Arianespace, the CNES subsidiary responsible for managing much of the Ariane program. A fourth CNES center is in charge of atmospheric balloon launchings.

In its role as promoter of the French aerospace industry, CNES has established a number of subsidiaries and special organizations called GIEs (Groupements d'Interet Economiques). The best known subsidiaries include Arianespace, SPOT Image, Intespace, and Novespace. Space research laboratories are closely associated with CNES (Table 1.2). The principal aerospace industries in France include Aerospatiale (spacecraft, subsystems, and materials), Alcatel Espace (communications, subsystems, and TT&C), Arianespace (launch vehicles), Dassault Aviation (manned aerospace vehicles), Intespace (environmental testing), Matra Marconi (spacecraft, subsystems, and ground stations), SEP (launch vehicle and spacecraft propulsion), and Thomson-CSF (communications, space technology, and ground support).

1.4 Germany

Under a major governmental restructuring in 1989–1990, a new German space agency, DARA (Deutsche Agentur fur Raumfahrtangelegenheiten) GmbH, was created and seven national space goals were established:

- increase scientific knowledge of the universe, our solar system, the Earth and the conditions for life on our planet and to

Table 1.2. French Space Research Laboratories.

Organization	Major Emphasis
Service d'Aeronomie (SA)	Study of Earth's atmosphere in correlation with solar and geophysical phenomena
Institut d'Astrophysique Spatiale (IAS)	Study and evolution of the Galaxy and surrounding galaxies
Laboratoire de Meteorologie Dynamique (LMD)	Study of dynamic climatology and fundamental and applied geophysical turbulence
Laboratoire de Recherche Spatiale de l'Observatoire de Paris-Meudon (DESPA)	Radio-astronomy investigation of the atmosphere of planets and comets
Service d'Astrophysique due Departement de Physique Generale (SAP)	Study of nucleosynthesis phenomena in relation with the origins of the solar system and chemical evolution of the Galaxy
Laboratoire d'Astronomie Spatiale (LAS)	Observation in the far ultraviolet spectrum using space vehicles
Centre de Recherche en Physique de l'Environnement terrestre et planetaire (CRPE)	Applications of physics and chemistry in the mechanisms playing a role in the evolution of the neutral or ionized atmosphere of planets
Centre d'Etude Spatiale des Rayonnements (CESR)	Physical laws of the magnetosphere, high-energy astrophysics, remote sensing of natural resources, IR astrometry
Groupe de Recherches de Geodesie Spatiale (GRGS)	Study of the morphology, kinematics and dynamics of the stars, Earth-Moon system and solar system
Laboratoire de Physique et Chimie de l'Environnement (LPCE)	Research of the ionosphere and magnetosphere using space vehicles
Laboratoire d'Etude de la Solidification	Fabrication of materials and crystal growth in space
Laboratoire de Physiologie Neurosensorielle	Study of physiological conditions governing human life in space
Laboratoire de Biophysique Medicale	Study of the cardiovascular system of astronauts
Institut de Physique du Globe (IPG)	Use of altimetry satellites for studying global ocean circulation

- enlarge the possibilities for research;
- contribute to solving environmental problems by means of Earth observation satellites and promote further world climate research;
- improve public and commercial infrastructure and services by means of spacebound telecommunications, positioning and navigation;
- stimulate technological progress and thereby contribute to improving the competitiveness of the German economy;
- make access to space and its utilization safer and more economic;
- promote international cooperation especially in the field of science and technology and improve the possibilities of extending aid to developing countries;
- realize the verification and control of treaties covering disarmament, crisis management and Earth observation for environmental purposes alongside our European partners."

DARA, which has assumed and consolidated the activities of the former West German and East German organizations, is headed by Director General Wolfgang Wild and is staffed by a group of only about 250 personnel. National long-range planning and oversight of DARA is achieved by the Cabinet Committee and the State Secretary's Committee formed by representatives of seven ministries and the Federal Chancellery. Internally, DARA is divided into three main directorates: space infrastructure, space utilization, and administration. With its limited resources, DARA is largely restricted to policy and top level management tasks (Reference 20).

Technical and scientific research in the areas of aeronautics, astronautics, and energy technology is directed and coordinated by the German Aerospace Research Establishment (DLR, Deutsche Forschungsanstalt für Luft und Raumfahrt) with approximately 4,500 personnel. The chairman of DLR, Walter Kroll, is assisted by six directors in charge of Flight Mechanics and Guidance and Control, Fluid Mechanics, Materials and Structures, Energetics, Telecommunications Technology and Remote Sensing, and Scientific-Technical Facilities (Reference 21).

DLR operates major research centers in

Braunschweig, Cologne-Porz, Göttingen, Oberpfaffenhofen, and Stuttgart. Oberpfaffenhofen is the home of the German Space Operations Center which has supported numerous national, ESA, and bi-lateral space missions for more than 20 years. Nearby are DLR's Manned Space Laboratories Control Center, User Data Center, and Automation in Orbit Center. The Crew Training Complex and the Microgravity User Support Center are located in Cologne-Porz.

Germany is the only European country to possess a credible, albeit limited, space surveillance capability. The German Defense Research Organization (FGAN, Forschungsgesellschaft für Angewandte Naturwissenschaften) operates the High Power Radar System consisting of a 34-m diameter dish antenna, an L-band tracking radar, and a Ku-band imaging radar. Located at Wachtbeg-Werthoven outside Bonn and housed within a 49-m diameter radome, this system can perform selected observations on objects in Earth orbit (Reference 22).

The nature of the German aerospace industry changed significantly at the beginning of the decade when the formation of Deutsche Aerospace (DASA) brought together some of the most influential space manufacturing firms. DASA's four subsidiaries are now Dornier (unmanned and manned space systems), Messerschmitt-Bölkow-Blohm (MBB; spacecraft, subsystems, and ground support equipment), Motoren- und Turbinen-Union (MTU; propulsion), and Telefunken Systemtechnik (subsystems, materials). Other important aerospace companies include ANT Nachrichtentechnik GmbH (communications spacecraft, subsystems), MAN Technologie (space vehicle engineering), and Siemens (communications, subsystems).

Germany is also the site of two of ESA's four major space centers: the European Space Operations Center in Darmstadt and the new European Astronauts Center in Cologne.

1.5 India

Despite its limited resources, India has and is continuing to develop a broad-based space program with indigenous launch vehicles, satellites, control facilities, and data processing. Since its first satellite was orbited by the USSR in 1975 and its first domestic space launch was

conducted in 1980, India has become a true space-faring nation and an example to other Eurasian countries wishing to move into the space age. Today's Indian remote sensing, communications, and meteorological satellites are comparable to many similar space systems operated by more affluent countries, and by the end of the decade India may be one of only a half dozen countries/organizations with a geostationary launch capability.

The Indian Space Research Organization (ISRO) was established in 1969 and is currently under the Department of Space. An inter-ministerial Space Commission coordinates space-related issues at the highest government levels for policy-making and implementation through the Department of Space and ISRO. Along with ISRO in the Department of Space are the National Remote Sensing Agency, the National Natural Resources Management System, the National Satellite Space Segment Project, and the Physical Research Laboratory. The Chairman of ISRO since 1984 and Secretary of the Department of Space is Prof. U. R. Rao. With headquarters at Bangalore, ISRO now boasts of a workforce of more than 16,000 (References 23-25).

ISRO overseas five major centers and various units. The largest facility is the Vikram Sarabhai Space Center at Trivandrum, near the southern tip of India, where emphasis is placed on propulsion and launch vehicle technology as well as spacecraft subsystems. The ISRO Satellite Center in Bangalore is the lead center for all satellite development. All Indian space launches originate from the Sriharikota High Altitude Range (SHAR) Center on Sriharikota Island in the Bay of Bengal. The Liquid Propulsion Systems Center is actually distributed among facilities at Bangalore, Mahendragiri, and Trivandrum. Finally, the Space Applications Center at Ahmedabad has the responsibility to ensure that practical applications of space technology are realized.

Unlike European countries, India's aerospace industry is largely contained within the national space agency itself. Facilities construction and development are provided by a separate Civil Engineering Division of the Department of Space.

1.6 Israel

The newest member of the so-called space club is Israel which has conducted only two successful space launches, the first in 1988 and the other in 1990. Following in the footsteps of India, Israel is first concentrating on the development of relatively simple launch vehicles with low payload capacity and of satellites based on proven technologies. Future activities may be biased toward the deployment of more sophisticated space systems (via domestic and commercial foreign launch services) than a significant advance in booster capability.

The Israeli Space Agency (ISA) was created in 1983 under the Ministry of Science and Technology and is chaired by Prof. Yuval Ne'eman, who is also the Minister of Science and Technology. The Director of ISA, Prof. Akiva Bar-Nun, manages the agency in its duties to run the nation's space program, to coordinate research and space studies, and to promote the "development of space-related products by the private sector" (References 26 and 27). Cooperating with ISA to exploit Israel's fledgling capabilities in space are the Interdisciplinary Center for Technological Analysis and Forecasting of Tel Aviv University and the National Committee for Space Research of the Israeli Academy of Sciences and Humanities.

To date Israel's industrial base for launch vehicle and satellite development is narrow. Israel Aircraft Industries Ltd (IAI) was the principal designer and manufacturer of the Shavit solid-propellant booster and the Ofeq experimental spacecraft and is developing the Amos geostationary communications satellite. Rafael, Israel Armament Development Authority, was responsible for the AUS-51 which has served as the third stage motor of Shavit launch vehicle.

1.7 Italy

Italy was one of the first European nations to operate its own Earth satellite (1964) and since 1967 has been conducting space launches with assistance from the US. About half of Italy's national expenditures on space are contributed to ESA, where Italy is the third largest member and the leading participant in the Data Relay Satellite project. Italy's primary interests are in

the fields of geophysics, astrophysics, and Earth applications. ESA's European Space Research Institute is located in Frascati, Italy.

A governmental reorganization in 1988 established the Italian Space Agency (ASI, Agenzia Spaziale Italiana) under the Ministry for Coordination of Scientific Research and Technology (MURST) and its Undersecretary of Space. In 1992 Rossela Artioli was named the new Undersecretary of Space. With assistance from ASI the Italian government adopts 5-year space plans to establish national goals and for long-range budgeting purposes.

ASI is a relatively small organization with a staff of little more than 100 personnel. Headquartered in Rome, ASI is led by President Luciano Guerriero and Director General Carlo Buongiorno. The agency's Board of Directors is advised by two 12-person committees: the Scientific Committee and the Technical Committee. To implement the national space program ASI works closely with the University of Rome and the National Research Council. The former, through its Aerospace Research Center run by Director Luigi Broglio, manages the San Marco space launch facility in the Indian Ocean near Kenya. However, relations between ASI and the University of Rome became strained in 1991-1992 over different views concerning the means of improving Italy's space launch capability. The National Research Council, through its CNUCE institute, supports ASI in areas of mission analysis, mission design, and data handling, and works with Italian aerospace industries.

The principal Italian corporation involved in space activities is Alenia Spazio which was formed in 1990 with the merger of Aeritalia and Selenia. The new firm is broad-based, supporting both Italian and European programs with spacecraft, subsystems, ground stations, and related software. BPD Difesa E Spazio is Italy's leading company for launch vehicle and spacecraft propulsion.

1.8 Japan

Japan is unique among the Eurasian space nations with two, relatively independent national space organizations: one for applications and one for science. Both not only fund and manage satellite programs but also develop families of launch vehicles to place the satellites

in orbit. The government structure is further complicated by the various ministries and agencies which support these organizations. The Space Activities Commission (SAC) annually reviews Japan's Space Development Program to coordinate national space activities and to draft departmental budgets. The chairman of SAC is the Minister of State for Science and Technology. Since the first domestic launch of a Japanese satellite in 1970, the country has become a major space power, perhaps surpassed in all Europe and Asia by only the CIS and the multi-national ESA (References 28-30).

The National Space Development Agency of Japan (NASDA) currently receives about 75% of the national space budget primarily via the Science and Technology Agency of the Prime Minister's Office, the Ministry of Transport, and the Ministry of Posts and Telecommunications. NASDA is responsible for the development of Japanese communications, meteorological, and Earth observation satellites as well as the large H-class launch vehicles. NASDA also oversees Japan's participation in the international Freedom Space Station and is behind the proposed HOPE space plane. The President of NASDA in 1992 was Masato Yamano. NASDA operates several large space centers including the Tanegashima Space Center for space launches, the Kakuda Propulsion Center for the development of launch vehicle propulsion systems, the Tsukuba Space Center for satellite tracking and control, and the Earth Observation Center for data processing of remote sensing information (References 28 and 31).

Working under the Ministry of Education, the Institute of Space and Aeronautical Science (ISAS) is devoted to space science research and the development of satellite and launch vehicle technologies needed to support this objective. Until 1981 ISAS was a part of the University of Tokyo. The Director General of ISAS, Ryojiro Akiba (since February, 1992), heads 11 technical divisions and is advised by a Board of counselors and an Advisory Council for Research and Management. ISAS' primary facilities include the Kagoshima Space Center for space launches, the Noshiro Testing Center for launch vehicle propulsion system development, and the Usuda Deep Space Center with a 64-m diameter antenna for satellite tracking and control (References 28, 32-34).

Japan benefits from a strong interest in

space activities by the giants of industry. Moreover, these firms invest considerable private resources to conceive long-term projects which may not be realized for a decade or more. Mitsubishi Heavy Industries and Nissan Motor Company are the major launch vehicle manufacturers for NASDA and ISAS, respectively. Mitsubishi Electric Corporation, Nippon Electric Corporation, and Toshiba Corporation all have credentials as satellite prime contractors.

1.9 People's Republic of China

The PRC's first domestic space launch took place just two months after Japan's first mission in 1970, and since then the paths of these two Asian countries have been remarkably similar. Like Japan, the PRC averages only a few missions each year and has developed the means to reach both LEO (including sun-synchronous missions) and GEO. However, the PRC has launched relatively few scientific satellites and has accumulated extensive experience with recoverable spacecraft.

The internal organization of the Chinese space program is somewhat obscure, but many of the principal players and their areas of responsibility are known. The national space program is focused at the government level in the Ministry of Aerospace Industry, whose predecessor was formed in 1982. In the late 1980's a new State Astronautics Committee was established with the PRC Premier as its head to guide space planning (References 35-40).

The most visible entity within the Ministry of Aerospace Industry is the China Great Wall Industry Corporation (CGWIC) which was created in 1980 but did not assume the responsibility for marketing commercial launch services until 1985. CGWIC now coordinates all foreign contracts within the Chinese space industry. Actual launch operations at the three launch sites are conducted under the auspices of China Satellite Launch and TT&C General which is a part of the Commission for Science, Technology and Industry for National Defense.

The satellite and launch vehicle manufacturing base is concentrated in three lead organizations. The Chinese Academy of Space Technology (CAST) has designed and produced the majority of PRC satellites since 1970. Located in Beijing, CAST also plays a central

role in the recoverable satellite payloads. Meteorological satellites originate at the Shanghai Institute of Satellite Engineering. The largest launch vehicle manufacturer, responsible for the CZ-2 and CZ-3 lines of boosters, is the Beijing Wan Yuan Industry Corporation which includes more than a dozen research institutes and six factories. The firm also performs mission analysis and handles interface coordination issues. The Shanghai Bureau of Astronautics with its 10 research institutes and 12 factories serves as a subcontractor to the Beijing Wan Yuan Industry Corporation for CZ-2 and CZ-3 components and is the prime contractor for the CZ-4 launch vehicle. Solid propellant retro motors and apogee kick motors have been developed by the Northwest Chemistry Dynamics Corporation and spacecraft thrusters are built by the Beijing Institute of Control Engineering and the Lanzhou Institute of Physics.

1.10 United Kingdom

During the 1960's the UK was an early and active participant in space activities, fielding its first national satellite in 1962 and conducting its first (and only) space launch in 1971. However, for a variety of reasons, support for space programs in the UK has waned steadily for the past two decades, and current funding is concentrated on Earth observation science and data processing. Even though ESA contributions now represent approximately two-thirds of the national space budget, the UK has fallen to fourth place in ESA, well below its desired, GNP-linked level.

The British National Space Center (BNSC) was established in 1985 as a coordinating agency among government departments and research councils to help formulate and manage national space policy. The BNSC works directly with the Cabinet Office, the Ministry of Defense, the Meteorological Office, the Department of Trade and Industry, the Department of the Environment, the Foreign and Commonwealth Office, and the Department of Education and Science to this end. More than 80% of the national space budget is funded through the Department of Trade and Industry and the Science and Engineering Research Council of the Department of Education and Science. BNSC with its staff of less than 250 personnel is

led by Arthur Pryor, the Director General. The agency is divided into four main directorates: Space Applications, Science and Microgravity, Earth Observations, and Policy and Finance (References 41-44).

BNSC claims five technical centers, although four actually belong to other government organizations. The Royal Aerospace Establishment (RAE) and the Royal Signals and Radar Establishment (RSRE) are elements of the Ministry of Defense's Defense Research Agency. The Space Department of RAE is renown for its spacecraft systems and remote sensing technology mission analysis, orbital dynamics and ground facilities, while the RSRE specializes in telecommunications. Two other centers fall under the Department of Education and Science's Science and Engineering Research Council (SERC) and National

Environment Research Council (NERC). SERC's Rutherford Appleton Laboratory provides support for university groups working in space research. NERC's Remote Sensing Applications Development Unit and the independent Earth Observation Data Center's (EODC) National Remote Sensing Center lead the UK's Processing and Archiving Facility, one of four facilities supporting ESA's European Remote Sensing (ERS) satellite program.

In the industrial sector, the two largest aerospace firms are British Aerospace (scientific spacecraft, communications, subsystems) and Matra Marconi (spacecraft, subsystems, ground stations). A relative newcomer is Surrey Satellite Technology Limited of the University of Surrey which has already acquired an international reputation for the manufacture of miniature (<50 kg) satellites.

References - Section 1.0

1. V. Kiernan, "Ukraine May Forego Participation in CIS Space Agency," Space News, 23–29 November 1992, p. 9.
2. Interfax, Moscow, 8 January 1992.
3. Krasnaya Zvezda, Moscow, 27 February 1992, p. 4; 5 March 1992, p. 4; and 4 June 1992.
4. Turkmenskaya Iskra, 30 May 1992, p. 3.
5. ITAR-TASS, Moscow, 22 April 1992.
6. Nezavisimaya Gazeta, 4 August 1992, p. 6.
7. Krasnaya Zvezda, Moscow, 10 October 1992, p. 3.
8. Argumenty I Fakty, Moscow, April, 1993, p. 5.
9. Russia TV, Moscow, 19 January 1993.
10. Argumenty I Fakty, Moscow, October, 1992, p. 4.
11. Krasnaya Zvezda, Moscow, 21 April 1992, p. 2 and 22 April 1992, p. 2.
12. R. S. Kremnev *et al.*, "Organization of the Flight Control Centre in Evpatoria, Basic Principles," Paper IAF-92-549, 43rd Congress of the International Astronautical Federation, August–September, 1992.
13. Zemlya I Vselennaya, Moscow, July–August, 1990, pp. 26–31 and May–June, 1990, pp. 27–32.
14. Aviatsiya I Kosmonavtika, Moscow, June, 1988, pp. 42–43.
15. Krasnaya Zvezda, Moscow, 22 March 1990, p. 4.
16. G. Batyr *et al.*, "The Current State of Russian Space Surveillance System and Its Capability in Surveying Space Debris," April, 1993.
17. ESA Convention, entered into force in 1980.
18. Annual Report '92, ESA, Paris, 1993.
19. A Lightning Tour Through CNES, CNES, Paris, 1992.
20. DARA Information 1991, DARA, Bonn, June, 1991.
21. A Look At the Future, DLR, Cologne-Porz, April, 1991.
22. D. Mehrholz, "Space Object Observation with Radar," Paper B.8-M.1.03, World Space Congress, August–September, 1992.
23. S. F. von Welck, "India's Space Policy," Space Policy, November, 1987, pp. 326–334.
24. "Rendezvous with Rao," Satellite Technology, October, 1985, pp. 16–19.
25. Annual Report 1988–89, Department of Space, Bangalore, 1989.
26. S. Fisher, "Israel Joins Up," Space, January–February, 1991, pp. 12–14.
27. J. Simpson *et al.*, "The Israeli Satellite Launch," Space Policy, May, 1989, pp. 117–128.
28. Space in Japan 1988–89, Science and Technology Agency, Tokyo, 1988.

29. S. Saito, "Japan's Space Policy," Space Policy, August, 1989, pp. 193-200.
30. S. Kurachi, "Update on Japan's Space Policy," Space Policy, May, 1991, pp. 95-102.
31. NASDA, NASDA, Tokyo, 1987 and 1991.
32. M. Oda and Y. Tanaka, "Japan's Blossoming Space Science," Sky and Telescope, January, 1987, pp. 7-11.
33. "Newsmaker Forum," Space News, 27 July-9 August 1992, p. 30.
34. N. W. Davis, "Japan's ISAS Pursues 'Independent' Agenda," Aerospace America, July, 1993, pp. 13-15.
35. Y. Chen, "China's Space Policy - A Historical Review," Space Policy, May 1991, pp. 116-128.
36. Liu Ji-yuan and Min Gui-rong, "The Progress of China's Astronautics," US Space Foundation Symposium, January, 1987.
37. China Great Wall Industry Corporation, brochure, Beijing, ~1989.
38. Space in China. Launch Services and Space Technology, China Great Wall Industry Corporation, Beijing, 1988, 1989.
39. G. Lynwood May, "China Advances in Space," Spaceflight, November, 1988, pp. 428-433.
40. G. Pike, "Chinese Launch Services," Space Policy, May, 1991, pp. 103-115.
41. Lord Reay, "UK Space Policy," Space Policy, November, 1991, pp. 307-315.
42. I. Parker, "Britain Looks To Orbit," Space, March, 1993, pp. 12-15.
43. UK Space Activities 1990/91, British National Space Center, London, 1991.
44. BNSC. British National Space Centre, information package, BNSC, London, 1991.

2.0 SPACE TRANSPORTATION SYSTEMS AND LAUNCH FACILITIES

During 1991–1992 75% of all world-wide space missions were performed by the European and Asian space powers. Of the 14 active launching grounds around the globe, 11 are operated by Eurasian nations to support 14 families of launch vehicles available in as many as 24 major variants to meet specific mission needs. By the year 2000 the number of operational launch vehicle types is likely to grow, providing commercial flight opportunities for payloads as small as a few hundred kilograms or as large as tens of metric tons.

In all, 137 missions originating from the USSR/CIS, ESA, India, Japan, or the PRC reached Earth orbit in the period 1991–1992 from eight different sites (Figures 2.1 and 2.2). Only three launches (CIS) are known to have failed to reach orbit, although two payloads intended for GEO were stranded in lower altitude orbits (PRC). To support these activities, a considerable infrastructure has been established by each organization to design, manufacture, launch, and track the vehicles on every flight.

2.1 USSR/CIS

Despite the continued decline in space launch activity, the USSR/CIS during 1991–1992 conducted 116 known launches with only three failures compared with 24 missions with two

launch failures for the rest of Eurasia. Averaging a launch every six days, the USSR/CIS overcame severe political and economic difficulties to maintain a constellation of more than 150 active spacecraft. This feat was accomplished by employing nine of the ten operational space launch systems from the Baikonur and Plesetsk Cosmodromes (Figure 2.3).

The oldest booster family consists of the SL-3 (Vostok), SL-4 (Soyuz), and the SL-6 (Molniya) launch vehicles which are direct descendants of the SL-1 which placed Sputnik 1 into orbit on 4 October 1957. All three variants are produced under the direction of the Central Specialized Design Bureau of Samara (formerly Kuybyshev). Each vehicle employs the same basic lower stage consisting of a core stage powered by the RD-108 engine and four strap-on boosters powered by the RD-107 engine. Both engines burn liquid oxygen and kerosene and were developed by Glushko's GDL-OKB, now the Energomash NPO (References 1–14).

Since 1983 the SL-3 has only been flown from the Baikonur Cosmodrome on four missions into sun-synchronous orbits. The SL-3 uses a short, liquid oxygen/kerosene upper stage with a RD-448 engine designed by the Kosberg Design Bureau, now the Khimavtomatika Design Bureau in Voronezh. The demonstrated payload capacity to a 630

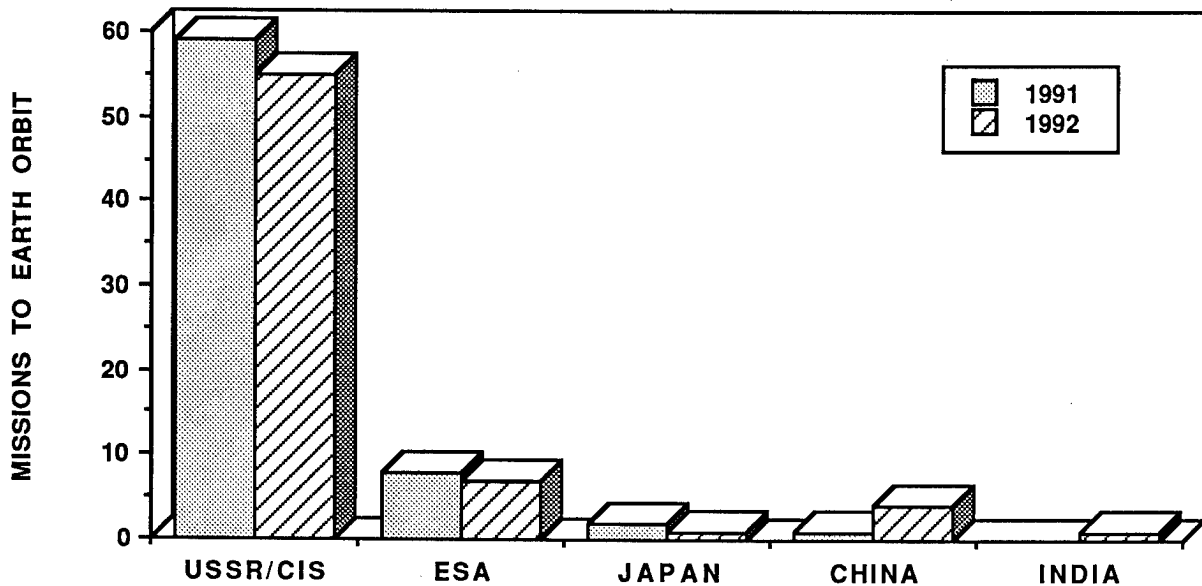

Figure 2.1. Eurasian Space Launch History, 1991–1992.

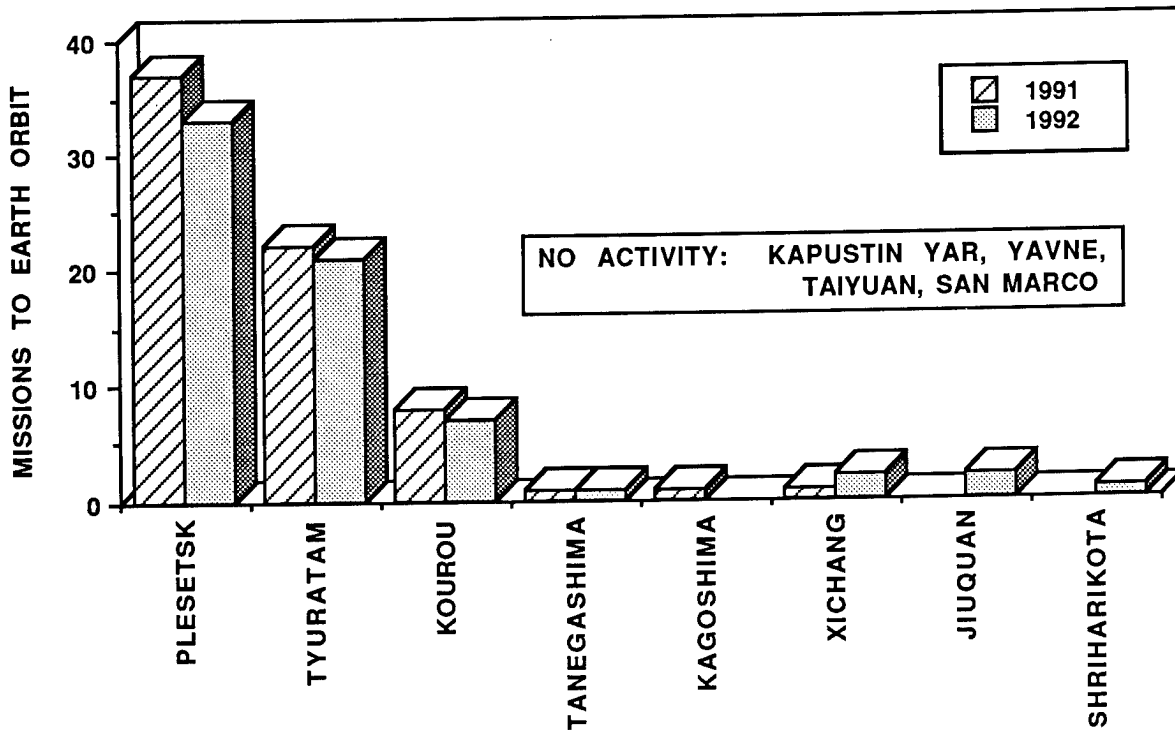

Figure 2.2 Eurasian Space Launch Activity, 1991–1992.

km, 98° orbit is 1,840 kg. The only SL-3 mission flown during 1991–1992 was the commercial launching of the Indian IRS-1B on 29 August 1991. IRS-1C will be launched by the SL-3 in 1994 or 1995. For such sun-synchronous missions, the booster follows a southwesterly trajectory from Baikonur (References 1–7).

Replacing the SL-3 upper stage with a longer stage powered by a Kosberg RD-461 liquid oxygen/kerosene engine yields the more powerful SL-4 booster which currently supports all CIS manned space flights and unmanned military photographic reconnaissance, Photon, Bion, Resurs-F, and Progress M missions (Reference 8). The booster has a demonstrated LEO capacity 7,320 kg to an orbit of 200 km at 51.6° inclination and was successfully flown 24 times in each of 1991 and 1992. During both years 13 missions were conducted from Plesetsk and 11 missions originated from Baikonur. A variety of shrouds are available for the SL-4 to accommodate oversized payloads and to support the emergency rescue system required on Soyuz TM missions (References 1-4, 8-9).

The SL-6 launch vehicle consists of the SL-4 plus another small upper stage burning liquid oxygen and kerosene. Originally developed for lunar and planetary missions, the SL-6 is now

used to place payloads of 1.6-1.8 metric tons into highly elliptical (~400 km by 40,000 km) Earth orbits inclined 63° to the equator. The upper stage and the payloads (a Molniya communications or Kosmos early warning satellite) are encased within the launch shroud and placed into a low altitude parking orbit by the first three stages. About half a revolution of the Earth later, the upper stage is ignited for transfer into the elliptical orbit. Five SL-6 missions were flown in 1991 and eight in 1992: all from the Plesetsk Cosmodrome (References 1–4, 10). In 1991 a group of US scientists and engineers considered the SL-6 to launch a small satellite, Lunar Prospector, to the Moon (Reference 11).

Beginning in 1991 Russia revealed plans for modifying and upgrading the SL-3/SL-4/SL-6 family of launch vehicles. The original concept involved replacing the final stages of the SL-3 and SL-6 with a new stage called Fregat, developed by the Lavochkin NPO and derived from the lower stage of the Phobos spacecraft. The improved launch vehicles were dubbed Vostok-A and Molniya-A and both were offered for sun-synchronous missions with payload capacities of 2,500–3,000 kg and 4,000 kg respectively. By late 1992 the modernization project envi-

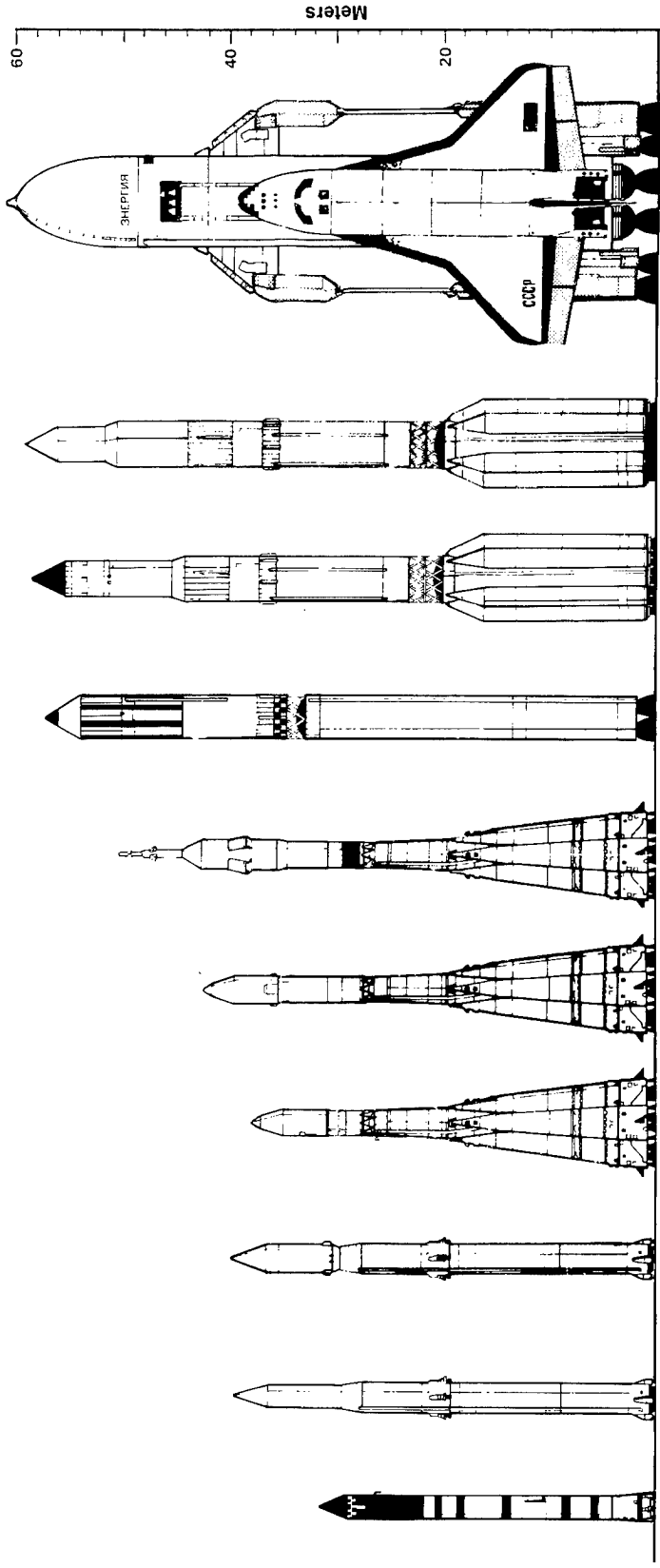

Designator	SL-8	SL-11	SL-14	SL-3	SL-6	SL-4	SL-16	SL-12	SL-13	SL-17
Name	Kosmos	Tsyklon-M	Tsyklon	Vostok	Molniya	Soyuz	Zenit	Proton	Proton	Energija/Buran
First Flight	1964	1966	1977	1959	1961	1963	1985	1967	1968	1988
1991 Missions	12*	1	8	1	5	24	1*	8	1	0
1992 Missions	7	0	5	0	8	24	3*	8	0	0
Current Launch Sites	PL	TT	PL	TT	PL	TT, PL	TT	TT	TT	TT
Principal Manufacturer	Russia	Ukraine	Ukraine	Russia	Russia	Russia	Ukraine	Russia	Russia	Russia/Ukraine

*Includes one known launch failure

Figure 2.3 Operational CIS Launch Vehicles.

sioned more substantial modifications in all three launch vehicles under the Rus program. One of the primary objectives was to increase the lift capacity of the SL-4 by as much as 800 kg to permit the launch of Soyuz-TM spacecraft from Plesetsk into 65° inclination orbits (References 12-14).

The smallest launch vehicle still in use by the USSR/CIS is the SL-8 (Kosmos) booster, derived from the SS-5 (Skean) medium range ballistic missile. Originally designed by the Yangel Design Bureau in Ukraine (now the Yuzhnoye NPO), primary manufacturing responsibilities are currently held by the Polet PO in Omsk, Russia. Between 1964 and 1992, a total of 389 SL-8 missions reached Earth orbit. The two stage booster burns Unsymmetrical Dimethylhydrazine (UDMH) as a fuel and either nitric acid or nitrogen tetroxide as the oxidizer. Used only for LEO missions, the SL-8 has a demonstrated payload capacity of 1,500 kg to a low altitude, 51° parking orbit, although most payloads are substantially smaller and are placed at moderate altitudes between 500 and 1,500 km. The only known launch failure of the SL-8 during 1991-1992 occurred on 25 June 1991 when the second stage failed to reignite and the payload immediately fell back to Earth before reaching orbit (References 1-4, 15-16). However, the SL-8 second stage used for the Kosmos 2125-2132 mission (12 February 1991) fragmented repeatedly during its first five weeks in orbit, creating more than 70 trackable debris.

The third family of launch vehicles operated by the USSR/CIS includes the SL-11 (Tsyklon-M) and the SL-14 (Tsyklon) boosters built in Ukraine. Based on the SS-9 (Scarp) ICBM developed by Yangel, the SL-11 launch vehicle is a 2-stage booster flown only from Baikonur and used only for high value military payloads, e.g., the co-orbital ASAT, EORSAT, and RORSAT. In the case of the last two missions, the payload is required to complete insertion into the desired operational orbit because the second stage is sub-orbital (RORSAT) or remains in a very short-lived transfer orbit (EORSAT). Since 1988 the SL-11 has been employed by only EORSATs of which one was flown in the 1991-1992 time period. Both stages burn UDMH and nitrogen tetroxide. Like all USSR/CIS launch vehicles, the SL-11 is transported to the pad horizontally for final pre-

paration and fueling. However, the SL-11 reportedly has the shortest pad stay time and can be launched within a few hours (References 1-4, 17-18).

The SL-14 consists of the 2-stage SL-11 plus a small hypergolic stage sitting inside the payload shroud, much like the SL-6. This vehicle debuted in 1977, has a reported 4,000 kg capacity to LEO, and to date has only been flown from Plesetsk, operationally at inclinations of 73.6° and 82.6°. The SL-14 has assumed all the posigrade military (ELINT) and Earth observation (Meteor, Okean) missions formerly serviced by the SL-3 and has taken away several SL-8 missions as well, including multiple communications satellites, geodetic spacecraft, and national security support systems. Eight SL-14 missions were conducted in 1991 and five in 1992, and the last known failure occurred in June, 1989, when the third stage failed to reignite (Reference 17).

The largest USSR/CIS launch vehicles in regular use are the SL-12 and SL-13 (Proton) booster. (Since 1967 these vehicles have been technically designated Proton-K.) The first three stages of the SL-12 and SL-13 are identical, a product of the Chelomei Design Bureau in the 1960's. Today design responsibilities lie with the Salyut Design Bureau of the Experimental Machine Building NPO, while manufacturing is performed by the Khrunichev Machine Building Plant. All three stages burn UDMH and nitrogen tetroxide. The first stage is powered by six RD-253 engines, the second stage by three RD-465 and one RD-468 engines, and the third stage by one RD-473 engine. Glushko was the chief designer of the RD-253, whereas Kosberg was the developer of the second and third stage engines (References 1-4, 19).

The 3-stage SL-13 is used infrequently when large payloads of about 20 metric tons are slated for insertion into LEO. All Soviet space stations and space station modules have been launched by the SL-13 as have the Almaz remote sensing platforms. The only SL-13 mission of 1991-1992 was the launch of Almaz 1 on 31 March 1991. This marked only the 22nd orbital mission of the SL-13 since flights started in 1968. The last launch failure was in 1986.

The more common Proton configuration mates a fourth stage, Block D/DM, with the SL-

13 to make the SL-12. The Block D (for deep space missions) and Block DM (for geosynchronous and circular, semi-synchronous missions) are produced by the Energiya NPO and burn liquid oxygen and kerosene or similar hydrocarbon fuel. The single 58M engine was originally designed by Melnikov of the Korolev Design Bureau for use by the N-1 heavy-lift launch vehicle. It was first transferred to the SL-13 to support the Zond circumlunar program. The lift capacity of the SL-12 to GEO is about 2.5 metric tons, to the Moon is 5.7 metric tons, to Venus is 5.3 metric tons, and to Mars is 4.6 metric tons. Eight SL-12 missions were successfully flown in both 1991 and 1992 (References 1-4, 20-25). The last known launch failure of the SL-12 occurred on 10 August 1990. The SL-12 has been selected to launch an INMARSAT-3 satellite in 1995 and three sets of seven Iridium satellites.

To accommodate larger payloads, particularly those designed for GEO, the SL-12 and SL-13 launch vehicles are undergoing a modernization process. The new Proton-KM vehicles will by 1994-1995 be able to place up to 23.7 metric tons into LEO and 4.5 metric tons into GEO. With a standard Block DM fourth stage the GEO capacity will be 3 metric tons, but a new liquid oxygen/liquid hydrogen fourth stage will permit the heavier 4.5 metric ton GEO satellites. Likewise a new shroud with 120 m³ volume will replace the current standard shrouds with 50 m³ or 70 m³. An alternative design calls for adding a Fregat upper stage to a standard SL-12 to increase GEO capacity to 3.5 metric tons. Authorization for construction of Proton launch pads at Plesetsk was announced in late 1992 (References 12, 26-29).

The first brand new launch vehicle to be developed in the USSR in 20 years debuted in 1985 as the SL-16 (Zenit). A medium-lift, 2-stage booster in its own right, the SL-16 was primarily made possible by the need to develop the first stage as a strap-on booster for the heavy-lift SL-17 (Energiya) launch vehicle. As a secondary objective, the SL-16 was designed to off-load several satellite programs from the SL-4, particularly those which were approaching the lift capacity limit of SL-4 due to normal evolutionary growth.

Both stages of the SL-16 employ liquid oxygen and kerosene as propellants for their Energomash NPO engines: the RD-170/171 for

the first stage and the RD-120 for the second stage. Overall responsibility for the SL-16, which has a low altitude payload capacity of 13.7 metric tons, rests with the Yuzhnoye NPO in Ukraine. Due to satellite program redirections, the need for the SL-16 has to date been far below the level anticipated in the early 1980's. Currently, the SL-16 supports only a single satellite program - the newest generation military ELINT - although other uses are expected within the next few years. However, plans to employ the SL-16 as the principal launch vehicle at Cape York, Australia, have been severely curtailed due to problems in establishing the launch facility (References 4, 30-34).

The first twelve orbital missions of the SL-16 (1985-1990) were largely successful with only one failure in late 1985 when the second stage failed to reignite. Then, the booster was struck with three devastating failures in a row. The first accident occurred on 4 October 1990 within seconds of lift-off, causing the vehicle to fall back to Earth, destroying not only itself and its payload, but the launch pad as well. The next attempt to launch the SL-16 took place in late July, 1991, but the countdown was terminated shortly before launch. The subsequent launch on 30 August 1991 failed when the second stage malfunctioned. The next launch on 5 February 1992 was also unsuccessful due to a second stage breakdown (References 35-38).

The SL-16 finally returned to service on 17 November 1992 with a successful mission, followed by an identical mission on 25 December. Although the December military payload was placed in the desired orbit, the second stage of the SL-16 exploded two days later into more than 200 fragments. Future improvements for the SL-16 include new launch pads at Plesetsk and a third stage to provide a high altitude, e.g., GEO, capability. The latter modification was first chosen in conjunction with the Cape York project, since the three-stage Zenit will still have less lift capacity than the SL-12. The third stage was to be an adaptation of the SL-12 Block DM, but the failure of Energiya NPO and Yuzhnoye NPO to agree on integration issues led the Ukrainian firm to begin designing its own upper stage (References 39 and 40).

When Glushko was designated head of the Korolev Design Bureau (now Energiya NPO) in

the mid-1970's, his first major act was to terminate the N-1 heavy-lift launch vehicle program and substitute in its place the development of the Energiya-Buran space transportation system. In 1987 the SL-17 (Energiya) booster made its maiden flight with an unmanned payload called Polyus. Although the spacecraft failed to reach orbit due to an attitude control malfunction, the SL-17 apparently performed flawlessly (Reference 41). Launch facilities are only available at the Baikonur Cosmodrome.

The SL-17 is comprised of a central stage powered by four liquid oxygen/liquid hydrogen RD-0120 engines developed by the Khimavtomatika Design Bureau surrounded by four strap-on boosters (essentially equivalent to the SL-16 first stage) with Energomash RD-170/171 liquid oxygen/kerosene engines. The lift-off payload capacity is cited as about 102 metric tons, but the maximum low altitude orbital payload mass is only 88 metric tons due to the fact that the SL-17 is a sub-orbital system and the "payload" must carry its own propulsion system for orbital insertion. On the two SL-17 missions flown by the end of 1992, such a propulsion unit was an integral part of the payload, i.e., Polyus and Buran (References 42-45).

To provide the SL-17 with direct LEO, GEO, and deep space capabilities, two auxiliary stages were designed. The smallest is a modification of the SL-12 Block D with overall dimensions of 3.7 m by 5.5 m. Named the Retro and Correction Stage (RCS), this unit could deliver an 88 metric ton payload to an altitude of 200 km or an 81.5 metric ton payload to 600 km. For higher orbit destinations, an Upper Stage, measuring 5.7 m by 16.5 m and burning liquid oxygen/liquid hydrogen, is being developed. This larger stage could place a 19 metric ton

payload into GEO or insert a 21.5-23 metric ton spacecraft into lunar orbit. Using both the RCS and the Upper Stage, the SL-17 is capable of sending a 10 metric ton payload to the surface of Mars while leaving a 3 metric ton spacecraft in Mars orbit (Reference 46).

To accommodate these auxiliary stages and their payloads, a payload carrier is needed for the SL-17's required side-mounting. This container has a maximum diameter of 6.7 m, a length of 42 m, and a payload volume dependent upon the combination of auxiliary stages selected. The maximum payload dimensions (with the RCS) are 5.5 m diameter and 35 m length. To date none of the auxiliary stages or the payload carrier have been flight tested.

The principal payload designed for the SL-17 is the Buran space shuttle. This vehicle (Figure 2.4) is analogous to the US Space Shuttle and completed a single, unmanned space flight in November, 1988. The overall length of Buran is 36.4 m with a wing-span of 24 m. The basic orbiter has a mass of 75 metric tons and can accommodate a payload of 30 metric tons inside the 4.7 m by 19 m cargo bay. Unlike the US Space Shuttle, Buran does not carry large main engines which are employed during lift-off, since this function is performed by the SL-17 central stage.

The Buran program in the late 1980's envisioned a fleet of three orbiters. The first flight of the second spacecraft, which includes life support systems absence from the original Buran, has been delayed repeatedly since 1990. The mission profile called for an unmanned launch, a rendezvous and docking with the Mir space station, a check-out by Mir cosmonauts, and an automated landing at Baikonur. During 1992 the Buran program was

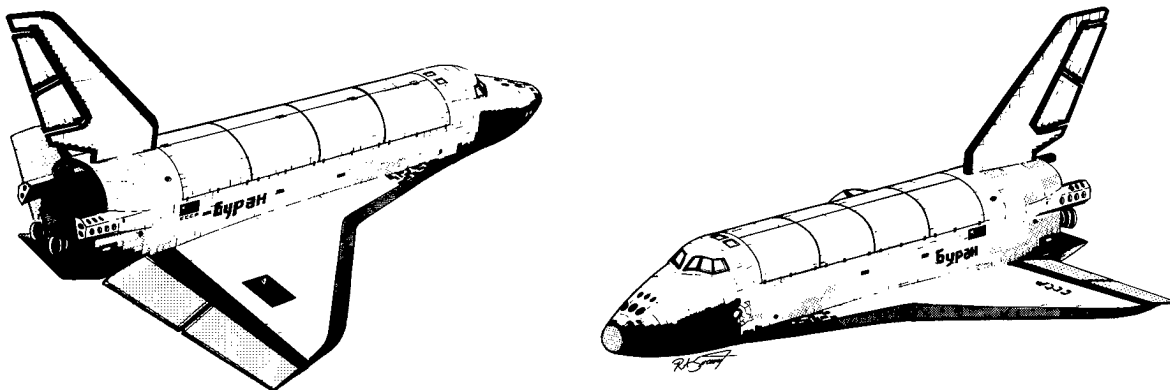

Figure 2.4. Buran Space Shuttle.

repeatedly and "officially" declared both dead and alive. The earliest possible launch of a Buran is now 1994, and the prospects for regular Buran missions seems poor (References 45-57).

Originally conceived as a large family of space transportation carriers, the entire Energiya system is currently under considerable political pressure due to its high cost and a current lack of payloads. The delay and restructuring of the Buran, the Mir 2, planetary exploration, and national security programs have had a negative impact on Energiya. Early plans for implementing recoverable reusable strap-on boosters and for varying the number of strap-ons (2-8) to match payload requirements have been stalled indefinitely. The only near-term use of Energiya is the launch of heavy (18-19 metric ton) communications payloads to GEO being heavily promoted by the Energiya NPO (Section 4.1.1). Such a launch could come as early as 1994.

Another Energiya variant, known as Energiya-M, perhaps has a brighter future. Energiya-M employs two standard SL-17 strap-on boosters and a shorter central stage with only one RD-0120 engine (Figure 2.5). Upper stages and payloads are stacked above the central stage within a large shroud. Three upper stages - the N12R, N14R, and N15DV - may be used to provide GEO capabilities of 3, 5.5, and 6.5 metric tons, respectively. The payload space allocated is 5.1 m by 15 m for the N12R and the N14R and 5.1 m by 12 m for the N15DV. The maiden flight of the Energiya-M is possible in the 1994-1996 timeframe (References 58-62).

A farther term potential for the Energiya space transportation system is a completely reusable vehicle integrating Buran technology directly with Energiya. A preliminary concept employs four strap-on boosters modified to become gliders after release from the central stage for a controlled runway landing. The central stage would be an unmanned shuttle with three main engines designed for the delivery of payloads to low altitude parking orbits (Figure 2.6). A simpler design would add wings to the current SL-17 central stage and use a parachute system for the strap-on boosters (References 63-66).

Another reusable space transportation system currently being evaluated is a small space plane, originally referred to as Molniya and now

known as MAKS, the Multi-purpose Aerospace System. Taking advantage of 30 years of developing small and large space planes under the Spiral, EPOS, BOR, and Buran programs, MAKS would be a 27-metric-ton-class spacecraft capable of manned (with a crew of two and an 8.3 metric ton payload) or automated (with a 9.5 metric ton payload) flight.

MAKS is being developed jointly by the Molniya NPO and the Central Aerohydrodynamic Institute and could be launched either atop the An-225 aircraft or by the Energiya-M launch vehicle. In the air-launched mode, the space plane and a large propellant tank would separate from the An-225 at an altitude near 10 km, and the space plane, using two tri-propellant (liquid oxygen/liquid hydrogen/kerosene) RD-701 engines, would fly into a low altitude orbit. The overall dimensions of the space plane, which could be operational by the end of the decade with proper funding, are 19.3 m in length and 12.5 m wing-span (References 67-73).

Whereas MAKS represents a multi-stage space transportation system, a single-stage-to-

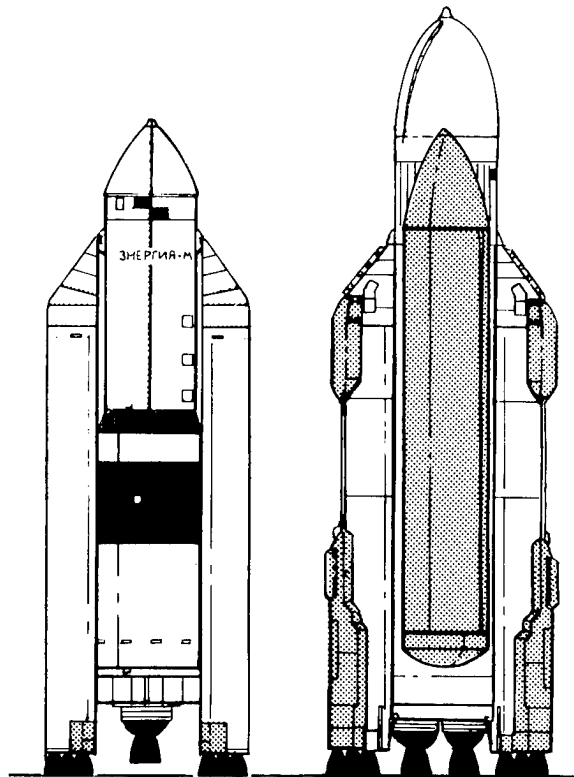

Figure 2.5. Energiya-M (left) and Energiya Launch Vehicles.

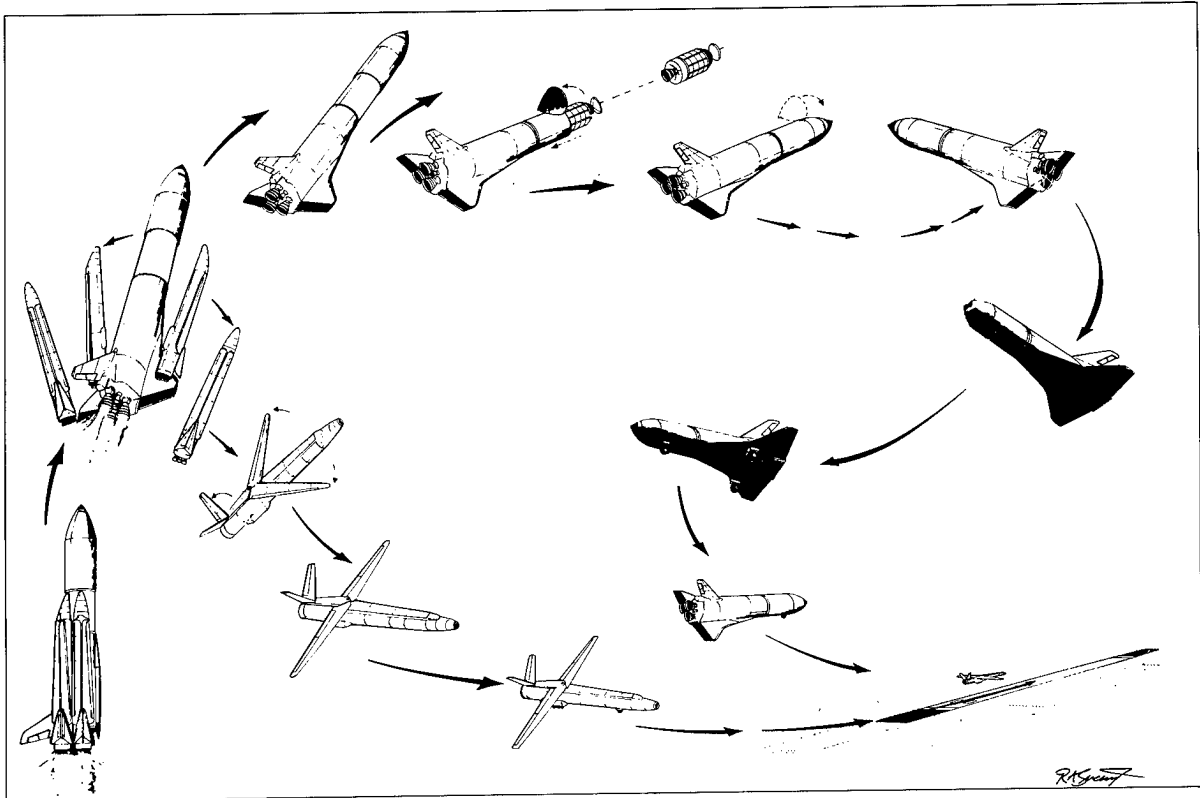

Figure 2.6. Fully Reusable Energiya Concept.

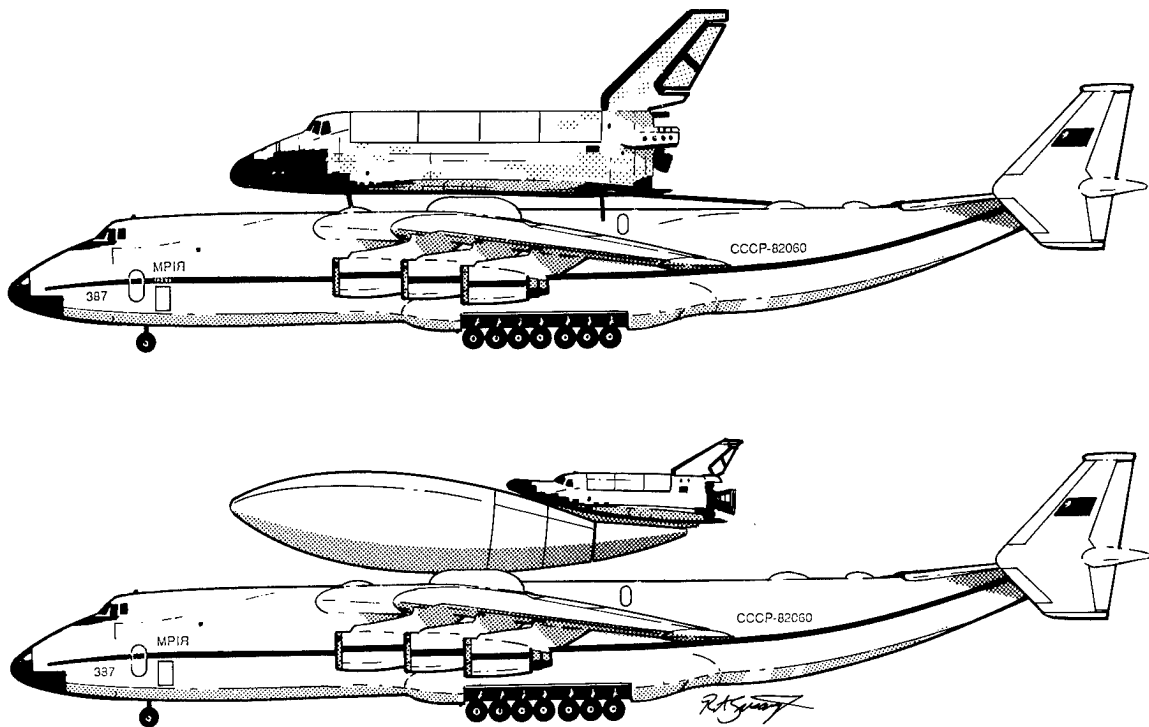

Figure 2.7. An-225 with Buran and MAKS Payloads.

orbit aerospace plane is viewed as the ultimate goal to reduce drastically the cost of delivering material to Earth orbit as well as to evolve into a more routine method of access to space. For several years USSR/CIS aerospace engineers have been evaluating different designs of aerospace planes which are analogous to the US NASP and the UK HOTOL. An integral part of the project, sometimes refer to as the Tu-2000, is the development of a supersonic/ hypersonic ramjet/scramjet engine for powered flight within the atmosphere.

A prototype engine model, developed by the Turayev Soyuz Machine Design Bureau, was tested 28 November 1991 when the rocket-mounted engine was launched from Kazakhstan on a 130-second flight. Supersonic combustion was achieved in the range of Mach 5-6. A second test was conducted 17 November 1992 in cooperation with France. A separate aerospace plane project, named Ayaks, is centered in St. Petersburg and relies on disposable boosters supplied by the Polet PO in Omsk. The CIS is soliciting international participation in the development of an aerospace plane, which will not be fully tested until after the turn of the century (References 74-88).

Despite the wealth of space launch vehicles already available and the future systems described above, CIS industries are eagerly promoting many new booster systems - primarily for small satellite payloads - derived from former ballistic missiles. The relatively low cost of the vehicles, together with a wide variety of launching options (ground-based fixed and mobile, sea-based, and air-based) and rapid availability, represent attractive features for the emerging "small sat" market. While the CIS government is encouraging former missile manufacturers to find new civilian applications for their decommissioned boosters, direct government support has not been forthcoming. The missiles proposed for conversion range from small SLBMs to the largest ICBM (References 89-94). Unlike the European arms control agreement which prohibited the use of banned missiles for space launch purposes, the START Treaty explicitly permits such conversions with modest restrictions (Reference 95).

One of the first Soviet missiles to be considered for space launch support in 1989 was the SS-20 (Soviet designator RSD-10) mobile

IRBM, under the name START. However, this was forbidden under international agreements, and the concept was later changed on the basis of the SS-25 (Soviet designator RS-12M) ICBM, under the name Start-1. The SS-25, a 3-stage solid propellant missile, is closely related to the less powerful SS-20. To create an orbital launch vehicle a fourth stage was added to the SS-25 producing a 1.8 m diameter, 21.6 m tall booster. The lift capacity of Start-1 is cited as 550 kg to a low Earth orbit or 300 kg to an altitude of 1,000 km with inclinations of zero degrees. The first launch of Start-1 was delayed from late 1992 to early 1993. An improved Start-1 vehicle with a maximum LEO capacity of 850 kg and more than five times the payload volume is possible during 1993-1994. The principal supporters of the program are the Kompleks Scientific and Technical Center, the Moscow Institute of Thermal Engineering, and the IVK Joint-Stock Company. The First commercial customer of Start-1 will be the Kuryer

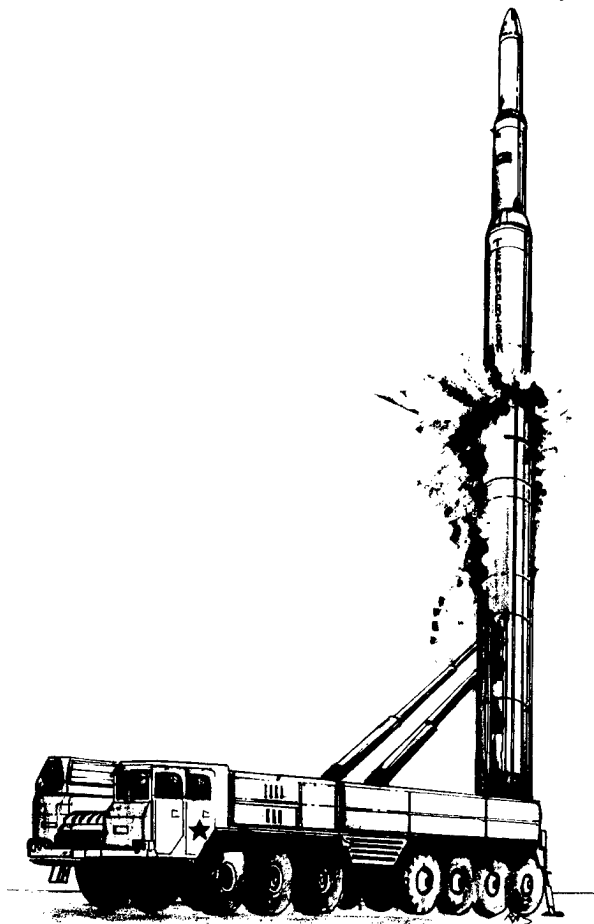

Figure 2.8. Start-1 Launch Vehicle.

communications satellite system (References 96–100).

The largest ICBM in the CIS inventory is the SS-18 (Soviet designator RS-20), and under the terms of the START Treaty more than 150 of the missiles must be removed from strategic duties. Consequently, the designers and manufacturers of the 2-stage, liquid propellant (UDMH and nitrogen tetroxide) rocket – the Yuzhnoye NPO of Dnepropetrovsk, Ukraine – have developed a space launch variant with a lift capacity of 4.4 metric tons to a 65°-inclined, 200 km orbit. To achieve orbital velocity a small third stage has been added, and two payload fairings (one 5 m tall and one 8 m tall) have been designed. Referred to as the SS-18K, this new space launch vehicle has a diameter of 3 m and a height of up to 37.3 m and has specifically been recommended for materials science experiments (orbital and ballistic) and for support to an emergency rescue service named VITA (References 31, 101–103).

The Salyut Design Bureau, creators of the SL-12 and SL-13 Proton boosters, was also responsible for developing the 2-stage SS-19 ICBM (Soviet designator RS-18), of which 300 were deployed at the time of the signing of the START Treaty. By adding a third stage named Breaz, the SS-19 has been converted into a space launch vehicle named Rokot with a low altitude payload capacity of two metric tons into an orbit inclined 65° to the equator. All three stages burn UDMH and nitrogen tetroxide, and the overall dimensions of the vehicle are 2.5 m diameter and 24.6 m height. Two payload shrouds provide a useful satellite cavity of up to 1.7 m in diameter and 3.1 m in height. Two ballistic test missions have been flown (20 November 1990 and 20 December 1991), and the first orbital flight is scheduled for late 1993. Although the principal launch facilities will be silos at Plesetsk, a floating sea-based platform has also been considered (References 104–108).

Another Yuzhnoye NPO product is the rail-mobile and silo-based SS-24 (Soviet designator RS-22) ICBM. Ukraine is proposing to develop this 3-stage, solid propellant missile into an air-dropped space launch vehicle called the Space Clipper. The booster would be carried aloft inside an An-124 cargo plane and then pushed out the rear cargo door at an altitude of 10–11 km (Figure 2.9). A small parachute

would briefly stabilize the vehicle prior to first stage ignition (References 31, 109–111).

Originally advertised in two variants, Space Clipper 1 and Space Clipper 1A, the program now foresees six or more variations based on five solid rocket stages (thrust in vacuum from 2 metric tons to 210 metric tons) in 3- or 4-stage configurations. The most powerful versions could place a 1.75 metric ton payload into an orbit of 200 km at 90° inclination or 800 kg into a geostationary transfer orbit (GTO) of 150 km by 36,000 km at 0° inclination. The ability of the An-124 to fly to lower latitudes for GTO or low inclination missions greatly increases the efficiency of the system. A 0.95 flight reliability has been designed.

Although submarine-launched satellites have been considered since the 1960's, political more than practical limitations have prevented such operations. In 1990 the US firm Space Commerce Corporation began marketing three Soviet SLBMs developed by the Makeyev Design Bureau of Mechanical Engineering in the Urals capable of placing small satellites into LEO. The Vysota is based on the SS-N-8 (Soviet designator RSM-40) SLBM and would be launched from a Delta-I submarine (Figure 2.10). This 2-stage, liquid-propellant launch vehicle has a payload capacity of 130 kg to an altitude of 200 km with 0° inclination. The Volna is derived from the SS-N-18 (Soviet designator RSM-50) SLBM and would be launched from a Delta-III submarine. Its payload capacity is similar to that of the Vysota, but a small third stage could be added for heavier payloads or high altitude/inclination requirements. A third system named Shetal (or Shtil) is based on the SS-N-23 (Soviet designator RSM-54) SLBM, launched from Delta-IV submarines. The orbital capacity is said to be 550 kg to an 800 km, 0° inclination orbit (Reference 112).

Two other SLBMs may be combined to form yet another small satellite launcher. A US-Russian joint venture is examining the potential of a hybrid SS-N-20/SS-N-23 (Soviet designators RSM-52 and RSM-54) launch vehicle called Surf. Launched from a floating platform (but not a submarine), Surf will consist of the SS-N-20 solid propellant first stage and a complete liquid propellant, 4-stage SS-N-23. The SS-N-20 is currently deployed on Typhoon submarines and is also a creation of the Makeyev Design Bureau of Mechanical

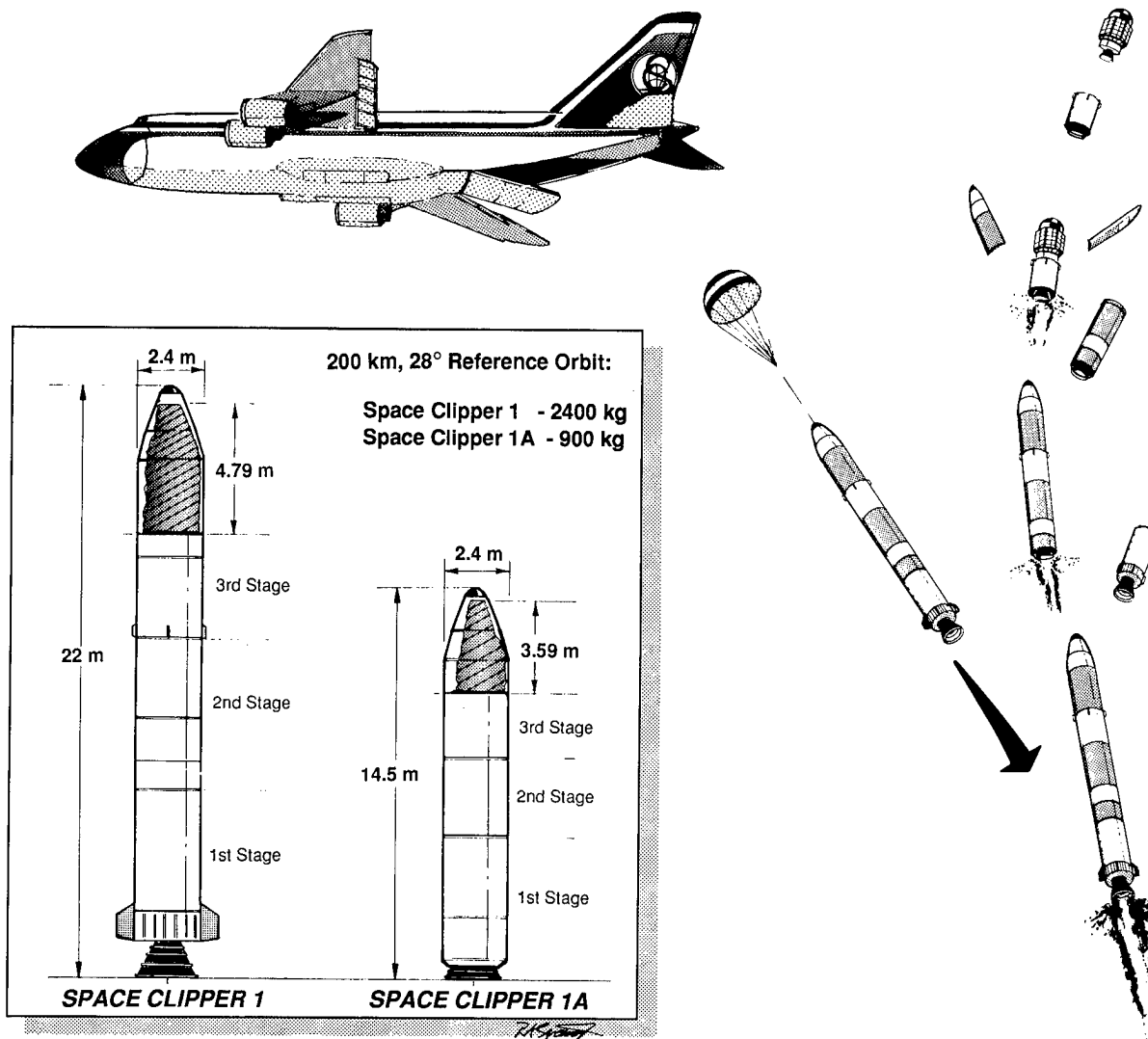

Figure 2.9. Original Space Clipper Concept.

Engineering. Surf is calculated to have a 2.4 metric ton payload capacity into a 200 km, 0° orbit. A test flight of the composite launch vehicle is possible in 1994 (References 113–115).

In 1991 the Raduga Machine Building Design Bureau of Moscow announced plans to offer the Burlak air-launched space launch vehicle. Much smaller than the Space Clipper, Burlak would be carried under the wing of an aircraft such as the Tu-160 much like the US Pegasus launcher (Figure 2.11). Initial designs provided a 700 kg payload capacity to a low altitude, equatorial orbit, but later refinements increased the payload to 1,100 kg for the same orbit. Flights could begin in 1995 (References 116–118).

Finally, the USSR/CIS has studied the problem of designing nuclear-powered space

propulsion for more than 30 years. Most concepts have involved the heating of a working fluid (e.g., liquid hydrogen) by a fission or fusion nuclear reactor. Although complex to build and operate, such nuclear-powered engines attain very high specific impulses (up to 950 seconds or more) and are considered an attractive means to send men on interplanetary voyages. The principal organizations in the CIS conducting research in this area are the Kurchatov Institute of Atomic Energy, the Research Institute for Thermal Processes, Moscow Physical-Technical Institute, and the Luch NPO. Testing of nuclear engine designs was performed for many years at the Semipalatinsk proving grounds (References 119–127).

From 1966 to 1987 the USSR operated three launch sites: Baikonur in Kazakhstan and

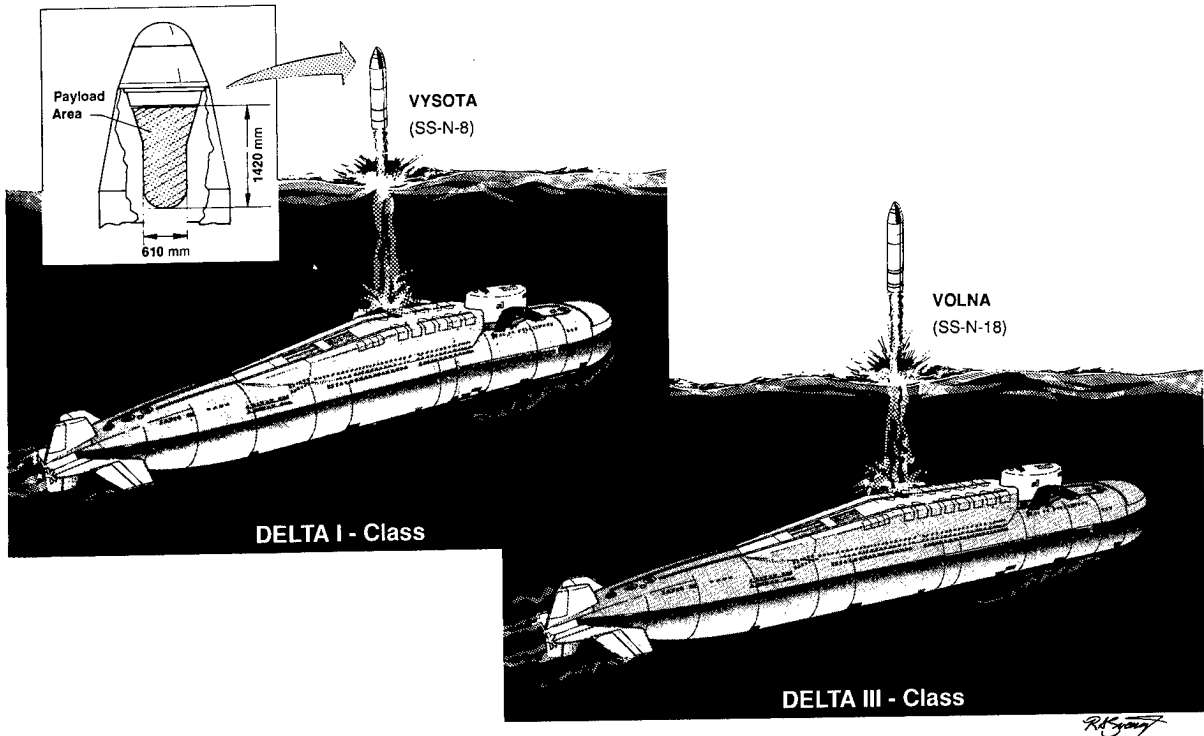

Figure 2.10. Vysota and Volna Space Launch Systems.

Plesetsk and Kapustin Yar in Russia. The last facility, which only launched the smallest space boosters, has been inactive since 1987 and is no longer a part of the Russian Military Space Forces which manages all launch activities. The other two sites remain quite active and both have performed more space launchings than any other facilities in the world.

The Baikonur Cosmodrome (also known as Tyuratam) is the oldest space launch facility in the world and by the end of 1992 had conducted more than 900 orbital missions. In 1991 and 1992 the number of launches to reach Earth orbit were 22 and 21, respectively. Baikonur also supports the largest assortment of launch vehicles including the SL-3, SL-4, SL-6, SL-11, SL-12, SL-13, SL-16, and SL-17. More importantly, the heaviest USSR/CIS boosters, Zenit, Proton, and Energiya, can only be flown from Baikonur. The cosmodrome is the origin of all manned and man-related (e.g., space stations, resupply ships), lunar, interplanetary, high altitude navigation, and geosynchronous missions.

In late 1991 when the Soviet Union was dissolved and the CIS was formed, the importance of commonwealth space coordination – and in particular the status of Baikonur – was the subject of special agreements (Appendix 2). In

fact, on 31 August 1991 soon after the attempted coup, the President of Kazakhstan signed a decree asserting jurisdiction over Baikonur. By May, 1992, the first of several bi-lateral accords between Russia and Kazakhstan were signed (Appendix 2). Despite sometimes heated rhetoric between the two nations, the continued maintenance and operation of the Baikonur Cosmodrome is clearly in the best interests of both parties. Ukraine and Kazakhstan have also been engaged in discussions concerning the launches of SL-11 and SL-16 boosters produced by Ukraine. In late 1992 the President of Kazakhstan appointed Major General Aleksii A. Shumilin as the new commander of Baikonur (References 128–130).

Conditions at Baikonur and the adjacent support town of Leninsk have always been described as harsh due to the extreme climates in winter and summer and due to the absence

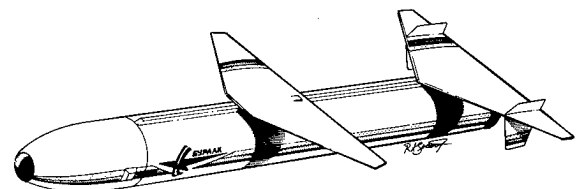

Figure 2.11. Burlak Satellite Launcher.

of many amenities. The organizational and economic difficulties arising after the fall of the USSR only aggravated the situation, increasing tensions between the civilian and military populations and between the Russians and the Kazakhs. The most extreme example of this strife occurred during 23–25 February 1992 when riots started by a military construction unit left three dead, many injured, and a substantial loss of property, including destroyed barracks, warehouses, and food storage facilities (References 131–137).

Plesetsk in northwestern Russia is the world's busiest cosmodrome, averaging one mission per week during the past ten years (1983–1992). By the end of 1992 the site had conducted 1,369 orbital launches – more than a third of all world missions since 1957. Although the annual flight rate at Plesetsk fell to 33 in 1992 (the lowest since 1968), the site outperformed every other space launch facility around the globe.

Currently, Plesetsk has launch pads for the SL-4, SL-6, SL-8, and SL-14 boosters. Technically, SL-3 vehicles could be launched from Plesetsk but the last such mission occurred in 1983, and future missions here are unlikely. Pads are reportedly under construction for the SL-16, and SL-12/SL-13 complexes have at least been authorized, if not funded. In 1993 plans call for the first launches of the Start-1 and Rokot vehicles from Plesetsk.

From its location near the Arctic Circle, by far the most northerly launch facility in the world, Plesetsk can support only missions with initial inclinations of 62.8° or greater. In practice, due largely to range safety restrictions, flights from Plesetsk now exhibit inclinations of 62.8°, 73–74°, and 82–83°. The prime reason behind the consideration of placing the Mir 2 space station into a 63–65° inclination is to permit manned and logistical flights to originate from Plesetsk as well as (or instead of) Baikonur. These missions will also require the SL-4 upgrade (Rus) for Soyuz TM and Progress M flights and possibly the installation of SL-12/SL-13 pads for large space station module launches. However, during a visit to Plesetsk in April, 1992, Russian President Yeltsin cautioned that a major shift of missions from Baikonur to Plesetsk in the near-term was unlikely due to the tremendous financial investment needed (References 26, 40, 138–141).

Unlike many space launch facilities in the world, both Baikonur and Plesetsk are not directly situated on or near a coast. Consequently, the lower, sub-orbital stages of USSR/CIS boosters normally fall back on former Soviet territory. This situation limits the permissible launch azimuths to avoid impacts near populated or foreign regions, e.g., due east launches (the most advantageous) from Baikonur are forbidden since lower rocket stages would fall on Chinese territory. For those launch corridors which are used, tens of thousands of tons of spent boosters, many with toxic residual propellants still on board, now litter the countryside. Local residents have complained about this situation, which makes some land unproductive, for many years, and the calls for remedial action as well as lawsuits did not subside in 1991–1992 (References 142–147).

2.2 European Space Agency

ESA introduced the European-built Ariane launch vehicle in 1979, and by the end of 1992 had conducted 55 missions with an overall success record of 91% (Figure 2.12). The original Ariane 1 vehicle was joined in 1984 by Ariane 2/3 and in 1988 by Ariane 4. Since 1989 all ESA orbital flights have used a variant of the Ariane 4 booster. In 27 launches Ariane 4 has suffered only one failure for a 96.3% reliability mark.

The basic Ariane 4, also known as the Ariane 40 variant, is a three-stage, liquid propellant booster with a 1.9 metric tons payload capacity to a 7°-inclined GTO or 2.7 metric tons to a 800-km, sun-synchronous orbit. The first stage (L220) is powered by four Viking V engines burning nitrogen tetroxide and a combination of UDMH plus hydrazine hydrate called UH25. The second stage (L33) employs the same propellants with a single, higher thrust Viking IV engine. The third stage (H10) burns liquid oxygen and liquid hydrogen through an HM7 engine (References 148–151).

The Ariane 4 program is managed and launch services are marketed by Arianespace, while the French space agency CNES is responsible for overall design and serves as general contractor. The primary industrial agent and integration contractor for stages one and three is Aerospatiale. Main engines are provid-

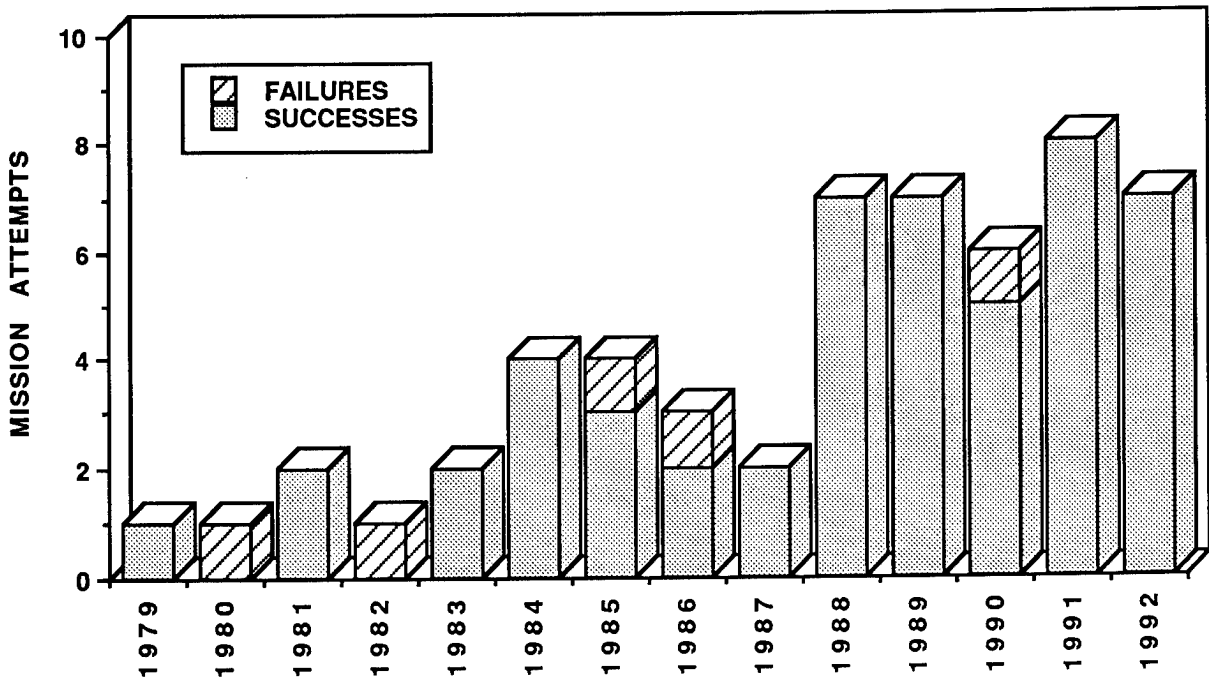

Figure 2.12. Ariane Launch Vehicle Flight Record.

ed by SEP. In all, more than three dozen European companies provide significant services in the design, manufacture, and operation of Ariane 4.

The Ariane 40 variant has actually only flown twice to place payloads into low altitude, sun-synchronous orbits (1990 and 1991). Since the principal mission of Ariane 4 is to insert commercial satellites into GTO, five other booster variants are available depending upon the mass of the payload and whether one or two main satellites are to be carried. The five variants are distinguished by the number and type (liquid propellant or solid propellant) of the small boosters attached to the first stage. The payload capacity ranges from 2.6 metric tons for two solid boosters (PAP) to 4.2 metric tons for four liquid boosters (PAL) (Figure 2.13). The most widely used variant is the most powerful Ariane 44L, and by the end of 1992 all but the Ariane 42L had flown at least once. The major contractor for the PAL, which employs the same propellants as the first two stages and a Viking VI engine, is MBB-ERNO, whereas SNIA-BPD is in charge of the PAP.

To permit the launching of two large, independent spacecraft on a single booster, one satellite is encased in a special housing (SYLDA or SPELDA) while the second satellite is mounted on top of the housing. Both the

housing and the upper satellite are then covered by the payload shroud which is jettisoned at an altitude of about 115 km. Once the Ariane third stage reaches GTO, the upper satellite is released, followed by separation of the top portion of the SYLDA or SPELDA and release of the second satellite. Injection into GEO is the responsibility of the individual satellites. For the infrequent LEO missions, a multiple payload platform called ASAP can carry up to six small (less than 50 kg) piggyback satellites without interfering with the primary payload.

During 1991–1992 15 Ariane missions were flown (all successful) including 13 GTO flights and 2 LEO flights with a total of 27 satellite payloads. Of all these payloads, only two were produced under the auspices of ESA; the rest belonged to a variety of countries and international organizations (Section 7).

In April, 1992, the 50th Ariane mission (22nd Ariane 4) introduced a new third stage called H10 Plus, which was lengthened by 0.3 m to accommodate an additional 340 kg of propellant for a 100 kg payload capacity increase. By the end of 1994 a new propellant management technique will add another 120 kg increase in payload capacity, bringing the Ariane 44L up to 4.46 metric tons for GTO. Also introduced in 1992 was a new flight profile which utilizes a

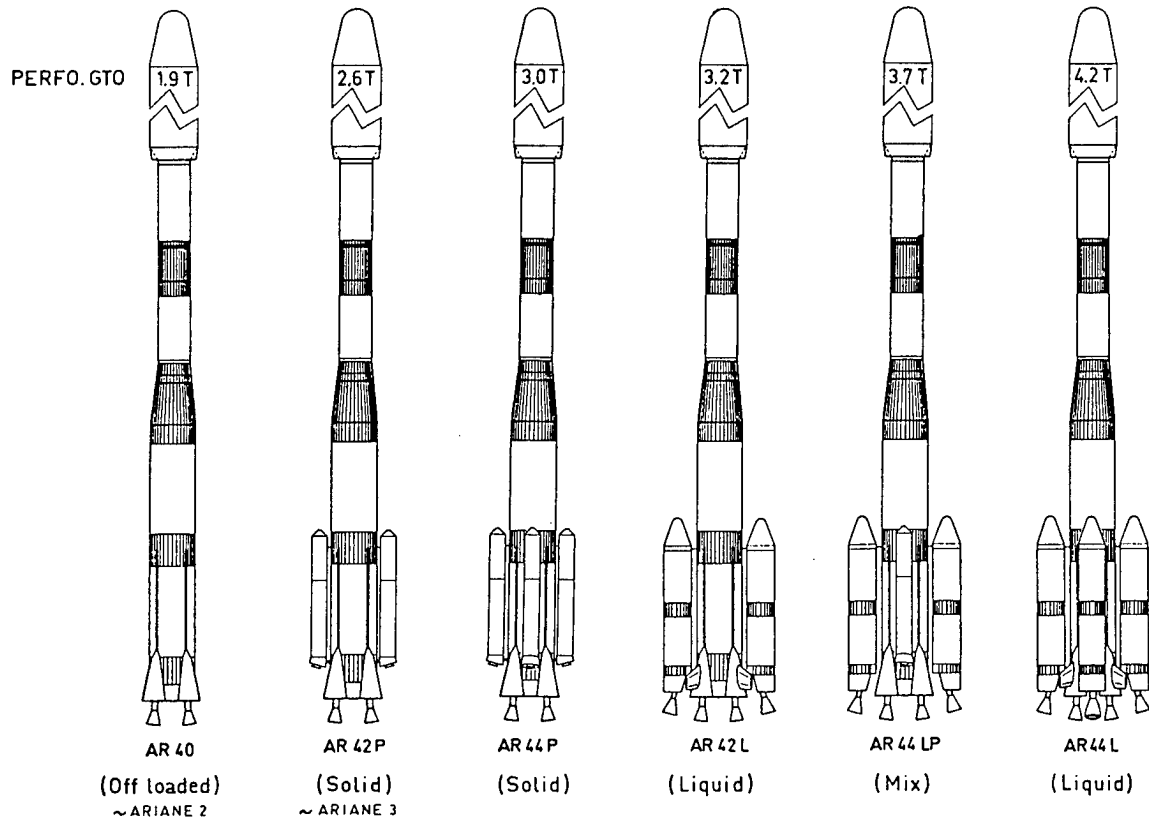

Figure 2.13. Ariane 4 Variants and Payload Capacities.

lower than normal perigee to provide a net gain for satellites slightly heavier than the cited vehicle capacity (References 152–154).

Ariane 4 will continue its current flight rate of about seven missions per year through 1996 when a gradual reduction is planned for eventual phase-out in 1999 (Reference 155). To take its place will be the more capable Ariane 5, scheduled for a maiden flight in 1995 and operational missions in 1996. Ariane 5 represents a significant departure from Arianes 1–4 and will support a much wider range of heavier spacecraft. From the start Ariane 5 was designed as a critical node in ESA's autonomous man-in-space program.

Ariane 5 will be somewhat shorter but much broader than its predecessor (Figure 2.14). The basic launch vehicle consists of a large, liquid-propellant central stage surrounded by two large, solid propellant boosters. The central stage (H155) will be powered by a single HM-60 Vulcain engine developed by SEP and burning liquid oxygen/liquid hydrogen. The booster stages (P230) are analogous to the boosters used by the US STS and are designed to be

recovered from the Atlantic Ocean and refurbished. This configuration was sized to place the 22-metric-ton Hermes space plane into a low altitude transfer orbit: 100 km by 460 km, 28.5° inclination (References 149, 156–158).

For GTO or other LEO missions, a small upper stage (L7) burning nitrogen tetroxide and monomethylhydrazine through a single engine will be employed. Payload capacity for this type of mission varies from 5.1 to 6.9 metric tons depending upon the number of payloads carried. Multiple payload housing systems called SPETRA and SPILMA can accommodate two or three major satellites. The L7 stage was also designed to place the unmanned Columbus module into LEO.

The principal contractors for Ariane 5 are Aerospatiale (central stage), SEP (Vulcain engine), Europropulsion and Aerospatiale (booster stage and engine), and MBB-ERNO (upper stage). The ambitious program has remained essentially on track for the last several years, and the first full-scale firing of a booster stage was scheduled for early 1993 after slight difficulties. The first full-duration

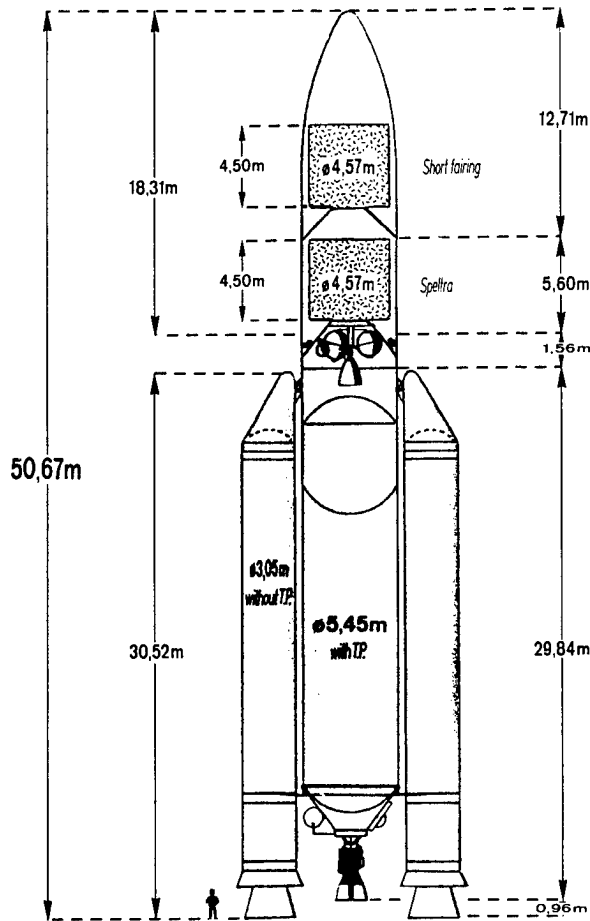

Figure 2.14. Ariane 5 Design.

firings of the HM-60 commenced in 1992, and initial tests of the central stage propellant tanks occurred in the same year (References 159–164).

Although Ariane 5 will not be operational for at least three years, ESA is already looking into the future for needed Ariane 5 derivatives. An improved HM-60 main engine and a change in propellant ratio and mass represent a near-term improvement which could increase the booster payload capacity to LEO by two metric tons. By combining the new main engine with two additional strap-on boosters, the LEO capacity could be increased by more than seven metric tons. This concept would employ two P130 boosters which are shortened versions of the standard P230 rockets and which would be ignited at altitude to avoid costly pad modifications. Another option includes replacing the small L7 upper stage with a more capable unit. To effect a much greater lift capability, preliminary designs

envision a significant increase in the size of the central stage which would be equipped with five improved HM-60 engines and would be surrounded by four P230 boosters. At the other end of the spectrum, ESA is evaluating the need for smaller launch vehicles which would be derived from Ariane 5 components. One example sees a launch vehicle employing a P230 booster as the main stage with a small solid-propellant second stage to place 5-metric-ton payloads into LEO (References 165–168).

Perhaps the most important – and stressing – influence on the design of Ariane 5 has been the requirement to launch ESA's Hermes space plane (see also Section 3.2). The manned Hermes spacecraft was officially adopted as a major ESA development program in 1987 after many years of preliminary study by France. During its nearly 10 year conceptualization, the configuration and specifications of Hermes changed many times. In the latest design, Hermes is seen as possessing a mass of just over 24 metric tons at transfer orbit injection with a three-man crew and a useful payload of one metric ton. To regain the desired 3-ton payload capacity, Ariane 5 must be upgraded (References 169–174).

Hermes is divided into two primary components: the orbiter and the Module de Ressources Hermes (MRH), an aft compartment serving as the Hermes-Ariane adapter and propulsion and docking module. The MRH is discarded prior to reentry. The overall length of Hermes is approximately 19 m with a wing-span of 9.4 m. Electrical power is provided by fuel cells, and propulsion is furnished by 12 hypergolic thrusters. An ejectable crew cabin was dropped in favor of individual ejection seats for the crew members. Hermes will also carry EVA suits as mission plans dictate.

During 1991–1992 ESA's Hermes program came under intense pressure, primarily due to the cost of the effort. In late 1991 Norway indicated its intention to withdraw from the project, and soon thereafter ESA seriously considered canceling Hermes entirely or down-scaling the program to a sub-orbital demonstrator ready for flight in the year 2000. At the end of 1992, ESA's space plane project was drastically revamped, concentrating in the near-term on technology development in close cooperation with Russia. A manned space transportation system has been postponed well into the next

century (References 175–179).

All Ariane launches are conducted at ESA facilities located on the French Centre Spatial Guyanais grounds in Kourou, French Guiana. Kourou was the site of eight launches of the French Diamant B/BP boosters during 1970–1975 before the maiden flight of Ariane 1 in 1979. Currently, only one launch pad, ELA-2, is operational for all Ariane 4 missions. Another pad, ELA-3, is under construction for the larger Ariane 5. Both pads are designed for rapid refurbishment in case of a major launch vehicle accident. Launches are conducted essentially eastward for GTO missions and to the northeast or northwest for LEO posigrade and retrograde orbits, respectively. Kourou was also to be the site of one of the principal runways for Hermes.

2.3 Germany

Following the lead of France with its Hermes space plane, Germany and the major German aerospace industries are investing considerable resources in the preliminary design and technology development of an advanced transportation system with hopes that ESA will adopt the program for full-scale development and operation. Named in honor of the German engineer whose pioneering work in the first half of the 20th century fostered the present-day concept, the Sanger project is based on a two-stage, fully reusable aerospace plane which would take-off and land horizontally like conventional aircraft.

The first stage is a large (>80 m long, >40 m wing-span), unmanned hypersonic aircraft powered by hybrid, air-breathing turbo-ramjets to carry a smaller Hypersonic Orbital Reusable Upper Stage (HORUS) to an altitude of approximately 40 km. HORUS would then separate at a speed of more than Mach 6 and ignite conventional liquid oxygen/liquid hydrogen engines to reach LEO. With a 4-man crew, HORUS would be capable of delivering up to three metric tons to the baseline Freedom Space Station orbit. An unmanned version of HORUS, HORUS-C, could deliver up to 6 metric tons of cargo and return a like amount to Earth.

Currently sponsored by the Federal Ministry of Research and Technology, Sanger requires international cooperation to move into Phase 2 which would develop a hypersonic flight demonstrator by about the year 2000. An operational

Sanger vehicle probably would not be available until the second decade of the next century. The recent de-scoping of ESA's Hermes program may have an adverse effect on Sanger's long-term prospects. Meanwhile, Germany is continuing state-of-the-art technology development of turbo-ramjet engines (References 180–183). MBB is the leading aerospace company investigating the Sanger concept.

2.4 India

India's modest, yet steady, indigenous space launch program scored a major victory in 1992 with the first successful launch of the Augmented Satellite Launch Vehicle (ASLV). Derived from the successful SLV-3 booster (three orbital missions in four attempts during 1979–1983), the ASLV is itself a transition program for the Polar Satellite Launch Vehicle (PSLV) scheduled for an inaugural flight in 1993. Simultaneously, India is developing the much more ambitious Geosynchronous Satellite Launch Vehicle (GSLV) to assure its independence from foreign launch providers.

The SLV-3 launch vehicle was a four-stage, solid-propellant booster with a LEO payload capacity of less than 50 kg into an orbit with a mean altitude of 600 km at an inclination of 47°.

Following an initial failure, the SLV-3 successfully orbited three Rohini Satellites in 1980, 1981, and 1983, respectively (Reference 184). The ASLV was created by adding two additional boosters modified from the SLV-3's first stage and by making other general improvements to the basic SLV-3 4-stage stack (Figure 2.15). The ASLV is actually a five-stage vehicle since the core first stage does not ignite until just before the booster rockets burn out. The payload capacity of the ASLV is approximately 150 kg to an orbit of 400 km with a 47° inclination (Reference 185).

The first launch of the ASLV on 24 March 1987 failed when the bottom stage of the core vehicle failed to ignite after booster burn-out. The second attempt ended with the Rohini payload falling into the Bay of Bengal on 13 July 1988 when the vehicle became unstable and broke up soon after release of the booster rockets. Finally, on 20 May 1992 the SROSS 3 (Stretched Rohini Satellite Series) was inserted into LEO by the third ASLV. However, instead of obtaining a circular orbit near 400 km, the

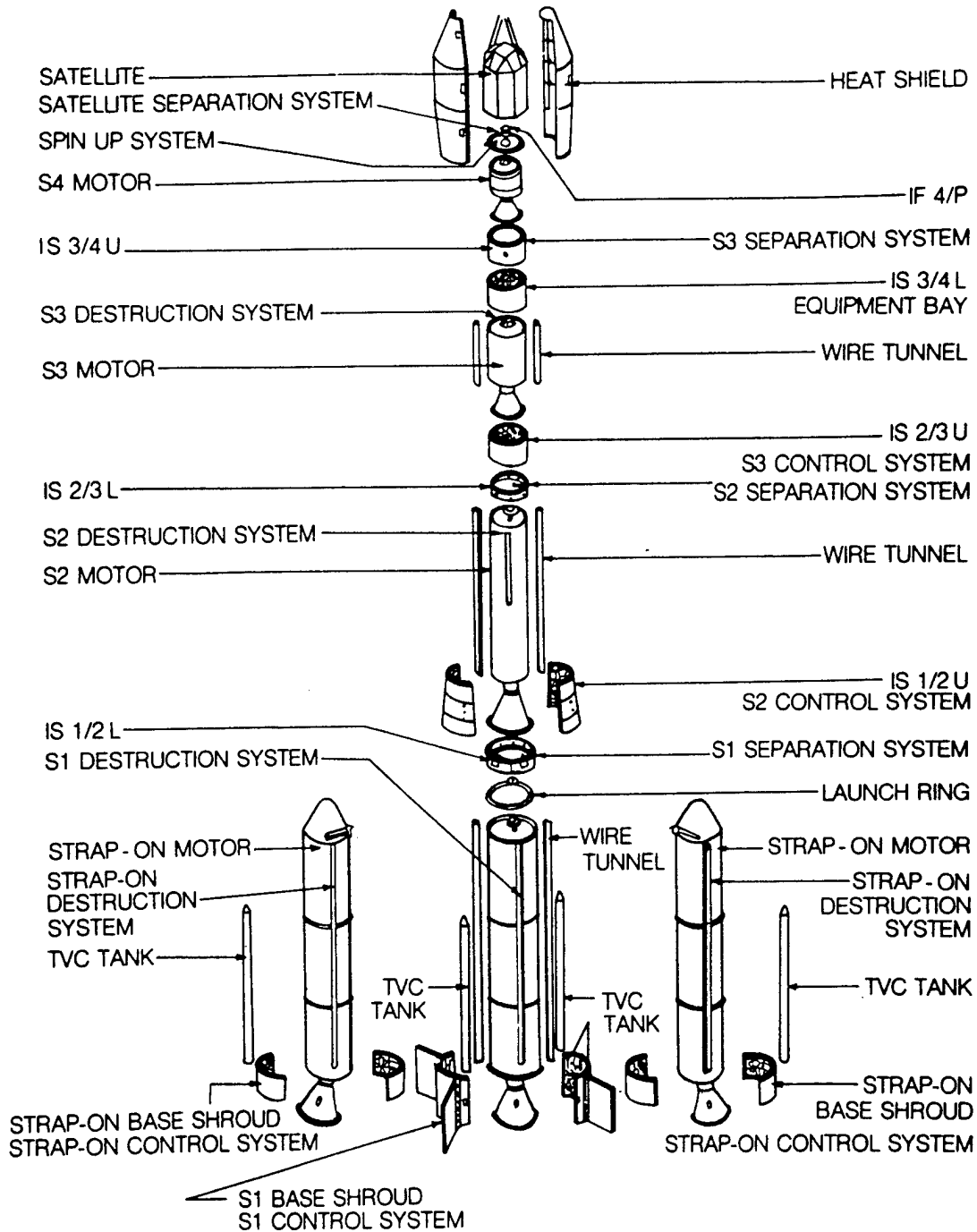

SALIENT FEATURES	
PAY LOAD	: 150 KG IN 400 KM CIRCULAR ORBIT
LIFT-OFF WEIGHT	: 39 TONNES
HEIGHT	: 23.5 METRES
MAX. DIA	: 1.00 METRE

Figure 2.15. ASLV Launch Vehicle Components.

ASLV only achieved a short-lived orbit of 256 km by 435 km, not unlike the degraded performance of the SLV-3 launch of 31 May 1981 (Reference 186).

The PSLV is being developed to permit India to launch its own IRS-class satellites into sun-synchronous orbits, a service until now procured commercially via the USSR/CIS. The design orbital capacity for the PSLV is one metric ton into a 900 km, 99° inclination orbit. This significant increase in lift will be achieved using a 5-stage design similar to the ASLV: a 4-stage core vehicle surrounded by six strap-on boosters of the type developed for the ASLV. At lift-off only two of the strap-ons and the bottom stage of the core vehicle are ignited. The other four boosters are fired at an altitude of 3 km.

The core vehicle possesses an unusual design consisting of two solid-propellant stages (1 and 3) and two liquid, hypergolic stages (2 and 4). The first stage also carries two cylindrical tanks which are part of the Secondary Injection Thrust Vector Control System (SITVC). The large liquid engine of the second stage is designated Vikas and is essentially an Indian-manufactured Viking engine used by ESA's Ariane. During 1992 all four stages were certified for flight in 1993, and full vehicle integration tests were performed (Reference 185).

In the 1980's India began designing the GSLV with an objective of placing 2.5 metric ton payloads into GTO. Drawing heavily on the PSLV, early concepts for the GSLV would borrow the six strap-on boosters and first two stages of the PSLV's core vehicles. A later design suggested replacing the solid strap-on boosters with four liquid units similar to the second stage of the core vehicle. The third stage was to incorporate an indigenous liquid oxygen/liquid hydrogen engine with a thrust of approximately 12 metric tons. Component development for this engine was already underway in the late 1980's, and subscale development was still on-going in 1992 (References 185, 187-188).

However, in an attempt to maintain the GSLV development schedule which now calls for a first flight in 1995, India in 1992 contracted with Russia to buy a liquid oxygen/liquid hydrogen engine (KVD-1) developed in the 1970's for the heavy-lift N-1 launch vehicle. The plan, which had been in negotiations since 1988 came

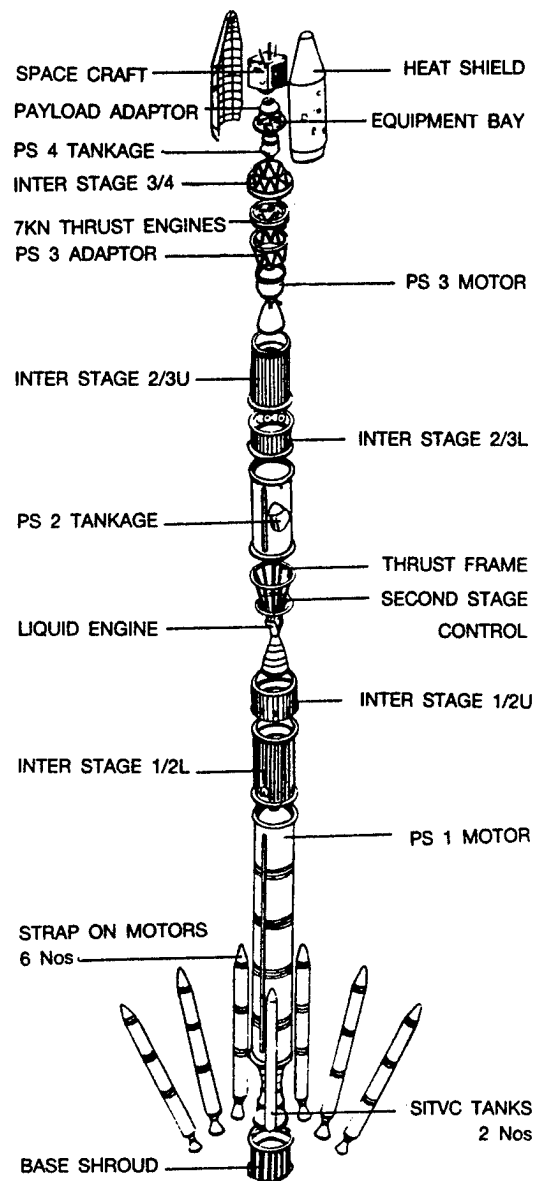

Figure 2.16. PSLV Booster.

under fire from the US which considered the transfer of such technology a violation of the Missile Technology Control Regime. Despite sanctions by the US against ISRO and GLAVKOSMOS, the engine sale agreement was still in effect at the end of the year. Under the contract terms, the first two engines would be assembled in Russia, but later engines would be built jointly (References 189-195).

In October, 1992, India conducted sub-orbital tests of model air-breathing rocket engines mounted on small conventional launch vehicles. The development program was initiated in the

late 1980's and is said to be applicable to the creation of future hypersonic boosters. Although few details have been released, both flights were described as successful (References 196 and 197).

All Indian space launches are conducted from the Sriharikota High Altitude Range (SHAR) on Sriharikota Island off the east coast of India in the Bay of Bengal. The original SLV-3 launch complex was converted to support the ASLV. Two new complexes to the south are being readied for the PSLV and GSLV. The Vikran Sarabhai Space Center at the southern tip of India is the site of most launch vehicle stage development.

2.5 Israel

Israel's Shavit (Comet) launch vehicle has flown only twice – 19 September 1988 and 3 April 1990 – to place the Ofeq 1 and Ofeq 2 engineering technology satellites into LEO. Shavit is a small, 3-stage, solid-propellant booster based on the 2-stage Jericho 2 ballistic missile and developed under the general management of Israeli Aircraft Industries and in particular its MBT Systems and Space Technology subsidiary. The demonstrated payload capacity is 160 kg into an elliptical orbit of 207 km by 1587 km with a highly retrograde inclination of 143.2°. Shavit was proposed to launch an American commercial recoverable spacecraft (COMET) which would have required a payload of 800 kg or more inserted into a low altitude orbit (References 198–200).

The upper stage of the Shavit is designated AUS-51 (Advanced Upper Stage) and since September, 1992, has been offered commercially under a cooperative venture by the Israeli firm Rafael, which developed and manufactures the AUS-51, and the American Atlantic Research Corporation. A much more capable upper stage is under development by Israeli Aircraft Industries for much larger launch vehicles with a GEO objective. Called the Cryogenic Transfer Module (CTM), the stage burns liquid oxygen and liquid hydrogen to produce a thrust of approximately one metric ton. CTM is designed to lift a 2.1 metric ton satellite from a 200 km, 28° parking orbit to GEO and was scheduled to be ready for flight by the end of 1992 (References 201 and 202).

Shavit boosters are launched from an undis-

closed site near the Palmachim Air Force Base on the coast of Israel south of Tel Aviv. The facility is also sometimes referred to as Yavne. To prevent over flight of foreign territory, Shavits have been launched on a north-westerly trajectory over the Mediterranean Sea, passing over the Straits of Gibraltar at the west end of the Mediterranean. This procedure significantly reduces the payload capacity of the launch vehicle and severely limits potential operational orbits.

2.6 Italy

Although nine space launches were conducted by Italy during 1967–1988, all employed variants of the US-built Scout booster to orbit small scientific satellites prepared by Italy, the UK, or the US. The vehicles are completed in the US prior to shipping to the Italian launch facility for final testing and launch. However, this arrangement has provided Italy with valuable launch operations experience.

The Italian firm BPD Difesa E Spazio is the prime contractor for the Ariane 4 solid-propellant strap-on boosters and is a principal developer of the larger Ariane 5 solid-propellant booster. Meanwhile, Alenia Spazio in cooperation with BPD has developed the solid-propellant Italian Research Interim Stage (IRIS) for use by a variety of international launch vehicles. Its first mission was the successful transfer of Italy's LAGEOS 2 satellite from a US Space Shuttle to a high altitude operational orbit in October, 1992.

Italy's desire to acquire a more capable and more independent space launch capability ran into trouble in 1992 when competing designs from the Italian Space Agency and the University of Rome became embroiled in a legal dispute. Since 1988 the Italian Space Agency has been examining the possibility of developing a Scout 2 launch vehicle based on the first three stages of the current US Scout G-1. Italy would add two large, solid-propellant, strap-on boosters and possibly a new fourth stage. The strap-on boosters would be derived from BPD's Ariane 4 boosters. The University of Rome, which operates the current Scout launch facility, has supported this program which would increase Italy's LEO payload capacity to 500 kg.

However, in recent years the Italian Space Agency has preferred a more radical design

employing a greater degree of national space technology and less dependence on the US. In March, 1992, the experimental Zefiro rocket, which would serve as the new launch vehicle's first stage with two strap-on boosters was flown for the first time – albeit with mixed success. Unwilling to support two, essentially redundant Scout upgrade programs, the Italian Space Agency began withholding development funds from the University of Rome, prompting the latter to file suit. The initial court rulings have been in favor of the University of Rome, leaving Italy with two relatively independent launch vehicle programs to produce an improved Scout-class vehicle by 1995 (References 203–208).

Although the 1992 test launch of the sub-orbital Zefiro was conducted from the island of Sardinia, all Italian space launches to date have originated from the San Marco launch platform off the coast of Kenya in Formosa Bay. With a latitude less than three degrees from the equator, San Marco offers nearly optimum payload capacity for satellite missions with low inclination. However, much larger launch vehicles would be required to support the more popular GTO/GEO missions. A second sea-based platform near San Marco supports the necessary launch control facilities.

2.7 Japan

Japan operates two independent space transportation systems: a small launch vehicle for modest scientific payloads under the Institute of Space and Astronautical Science (ISAS) and a medium-lift booster for applications and technology spacecraft managed by the National Space Development Agency of Japan (NASDA). Both organizations expect to be flying new more capable launch vehicles in the mid-1990's. By the end of the decade the boosters may be conducting commercial flights – an aspect of space activity as yet untapped by Japan.

ISAS's present M-3SII launch vehicle has been in operation since 1985, has performed flawlessly on all six missions by the end of 1992 and is a descendent of the M-4S first flown in 1970. The only flight during 1991–1992 occurred on 30 August 1991 when the 420-kg Solar-A (later renamed Yohkoh) X-ray observatory was sent into an orbit of 523 km by 792 km with an inclination of 31.3°. The maximum lift capacity for the M-3SII is approximately 800 kg

into a 250 km, 31° orbit (References 209 and 210).

The M-3SII is a 3-stage, all solid-propellant launch vehicle with two strap-on boosters and a family of optional fourth stages which are tailor-made for specific mission profiles. All four stages as well as the strap-on boosters are manufactured by the Nissan Motor Company. In addition to LEO missions, the M-3SII has placed spacecraft on Earth escape trajectories (Sakigake and Suisei in 1985) and into extremely high altitude orbits with apogees beyond lunar distances (Muses-A in 1990). Following another scientific mission in 1993 similar to Solar-A, the M-3SII is scheduled to support the German-Japanese Express microgravity recoverable satellite program in 1994 (Section 4.4.4).

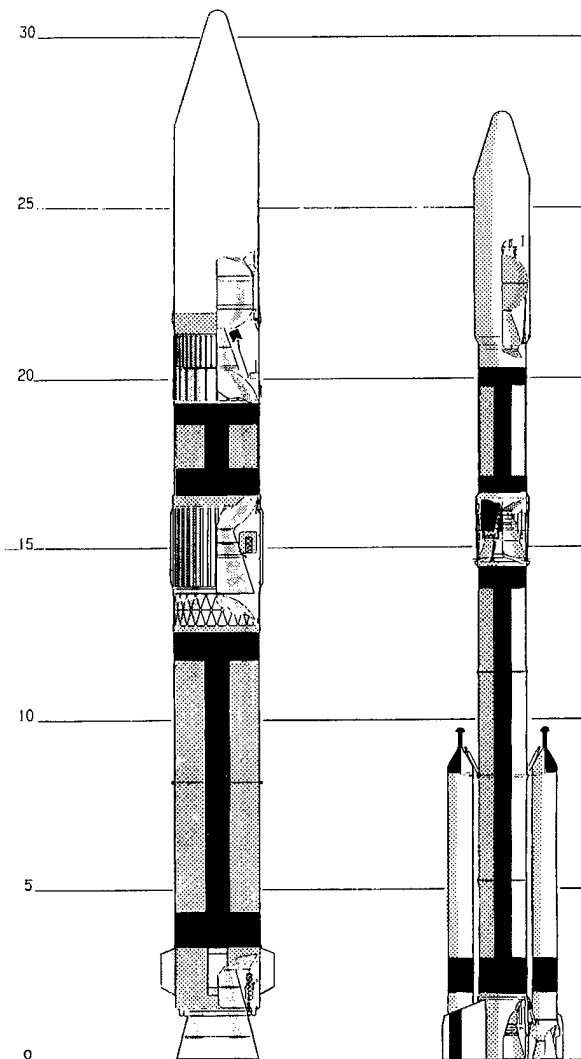

Figure 2.17. M-5 and M-3SII Launch Vehicles.

The following year, 1995, may witness the maiden flight of the M-5 launch vehicle, a 3-stage, solid-propellant system capable of lifting 1.8 metric tons into a LEO of 250 km. Both the second and third stages will employ extendable motor nozzles. Again produced by Nissan, the M-5 will permit ISAS to undertake more ambitious scientific missions, particularly beyond Earth orbit, e.g., a Mars mission in 1996 and a lunar mission in 1997. A one-year delay in the first launch has already been introduced due to funding and technological difficulties (References 211–213).

Since 1975 NASDA has been conducting a parallel program of launching Japanese satellites for space technology and applications purposes using liquid-propellant vehicles. The original N-series (N-1 and N-2) launch vehicles were developed under license from the US and were closely related to the Delta launchers. Flown during 1975–1987, the N-series was replaced by the H-1 launch vehicle (first flight in 1986), a hybrid US-Japanese design. The first stage of the H-1 is essentially the same as that of the N-2 with a liquid oxygen/kerosene main engine and 6–9 small solid-propellant strap-on boosters. The second stage is of Japanese origin, built by Mitsubishi Heavy Industries, and burns liquid oxygen and liquid hydrogen. A small solid-propellant third stage designed by Nissan is employed on GEO missions to place the payload into GTO (References 209 and 214).

During 1991–1992 the eighth and ninth missions maintained the perfect success record of the H-1. On 25 August 1991 an H-1 inserted the BS-3B communications satellite into GTO, and on 11 February 1992 a 2-stage H-1 placed the JERS-1 remote sensing satellite into a retrograde LEO. The latter mission marked the last of the H-1 line and represented the heaviest payload with a mass of 1.4 metric tons.

To provide greater payload capacity and to permit unencumbered commercial offerings (the Delta licensing agreement restricted the use of the H-1 for commercial flights), Japan is completing the development of the H-2 launch vehicle based on all-Japanese propulsion systems. The H-2 will be able to lift payloads four times heavier than the H-1 into LEO and GTO and will open the door to NASDA spacecraft designed to explore the Moon and planets (References 209, 214–217).

Dwarfing its predecessors, the H-2 consists of a 2-stage core vehicle, burning liquid oxygen and liquid hydrogen in both stages, with two large solid-propellant strap-on boosters. Nissan is producing the 4-segmented strap-on boosters which are considerably larger than the main

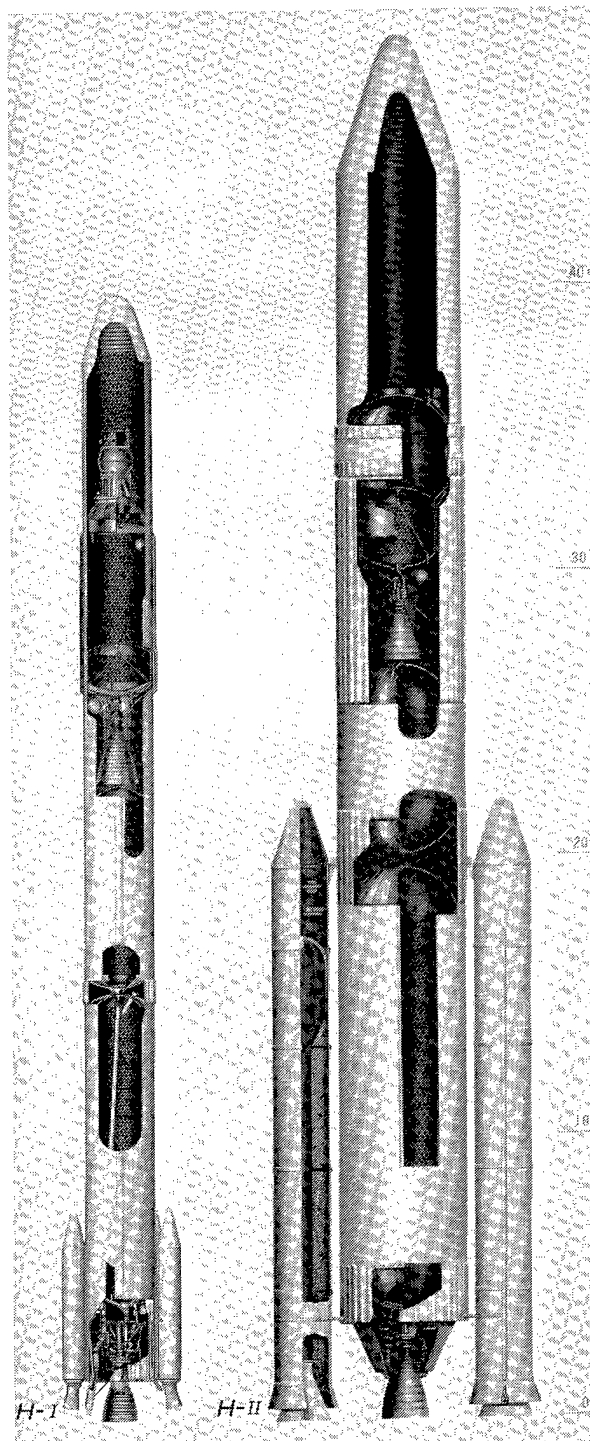

Figure 2.18. H-Class Launch Vehicles.

stages of ISAS' M-3 and M-5 series vehicles. Development began in 1984, and the first full-scale, complete-duration test occurred 15 April 1988. The fourth and final test of the booster was conducted on 29 May 1991 for 95 seconds certifying the design for serial production (References 218–220).

While the development of the second stage, which uses an upgraded LE-5 engine from the H-1, has moved smoothly, the new 86-metric-ton thrust (sea level) LE-7 first-stage main engine has been the source of extensive problems. Following test fires in both 1989 and 1990 which had already led to a year's delay in the inaugural mission from 1992 to 1993, difficulties continued to plague the program in 1991–1992. Two explosions occurred during tests in 1991 on 16 May and 9 August, respectively, with the latter resulting in the death of a Japanese engineer. The next year fared little better with numerous test failures in April and a fire during a test on 18 June. At the end of 1992 most problems appeared to have been resolved and a first flight was scheduled for early 1994 (References 221–229). A major program mile-

stone was accomplished in 1992 when the full-scale H-2 ground-test model was rolled out to the brand new H-2 launch pad for compatibility checks (Reference 230).

A third new launch vehicle concept emerged during 1991–1992. Called J-1, the new booster would serve the small satellite community with a one metric ton payload capacity to LEO in its basic configuration. After some evolution the J-1 design has solidified around a 3-stage, solid-propellant vehicle using a modified H-2 strap-on booster for the first stage and the second and third stages of the current M-3SII. Growth options include adding two or more small strap-on boosters or augmenting the first stage with two additional H-2 class strap-ons. The project, which may result in a sub-orbital, 2-stage test flight by 1995–1996, is being sponsored by NASDA with cooperation from ISAS (References 231–233). The first orbital mission is scheduled for 1997.

In addition to lofting larger GEO satellites, the H-2 has been designed specifically to accommodate the proposed HOPE (H-2 Orbiting Plane) spacecraft (see also Section 3.5). In its

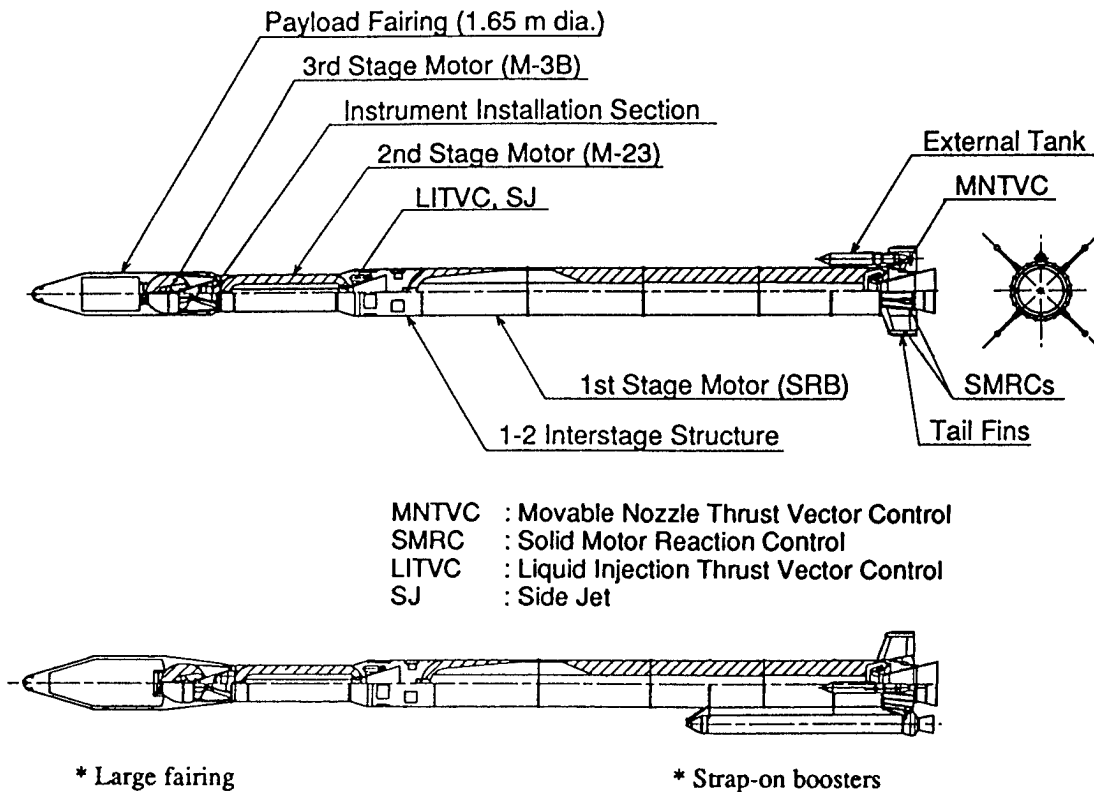

Figure 2.19. J-1 Launch Vehicle Design.

current configuration HOPE will have a launch mass of approximately 10 metric tons, a length of 11.5 m, and a wing-span of 8.6 m. Originally viewed as a major logistical vehicle for the Japanese Experiment Module of the Freedom Space Station, NASDA's HOPE has not received adequate funding to meet the desired end-of-decade maiden flight, and its payload capacity has been reduced to only one metric ton. HOPE would initially fly in an automated mode, but the addition of a crew is seen as a long-term goal. A typical flight time of only four days is planned with an automatic landing on a 3,000 m runway. At the end of 1992, the HOPE project was in limbo with uncertain government support for 1993; however, an early H-2 mission is still planned to test thermal protection materials for HOPE under the Orbiting Re-entry Experiment (OREX) program (References 209, 214, 234–236).

A 20-metric-ton version of HOPE with a 3–3.5 metric ton payload capacity has also been considered. Such a vehicle would be 16 m long with a wing-span of 12.3 m. To support the larger HOPE, the H-2 launch vehicle would require additional strap-on boosters (up to six solid boosters or a combination of solids or liquids). However, preliminary engineering analyses suggest that the new H-2D would still not be able to insert the larger HOPE directly into orbit, requiring HOPE to burn up to four metric tons of propellants to enter LEO (Reference 237).

ISAS and NASDA conduct their space launch activities at two separate sites. The oldest facility is known as the Kagoshima Space Center and is maintained by ISAS on Kyushu Island. All M-3SII missions are launched from Kagoshima which will also support future M-5 flights. NASDA operates the Tanegashima Space Center on the island of Tanegashima south of Kagoshima for all H-class vehicle launches. The H-1 launch pad is currently being modified to support the new J-1 vehicle. A new facility about 1 km away is being readied for the first H-2 flight in 1994. Due to strict fishing industry requirements, all Japanese launches from both Kagoshima and Tanegashima are limited to two 2-month periods each year: January–February and August–September. Consequently, the current maximum flight rate each year is two M-class and two H-class launch vehicles.

2.8 People's Republic of China

Since 1970 the PRC has conducted nearly 40 space launches, although its failure rate of more than 20% is substantially higher than its primary Eurasian competitors: CIS, ESA, and Japan. Despite a relatively low domestic launch demand – typically 2–3 satellites annually – the PRC has developed and is expanding, in part for commercial reasons, a diverse arsenal of launch vehicles to support both LEO and GEO missions. In 1992 a new Long March (CZ) booster variant was introduced, bringing to five the number of vehicles currently available among three broad families: CZ-2, CZ-3, and CZ-4. Principal responsibility for the design and production of CZ launch vehicles appears to lie with the Beijing Wan Yuan Industry Corporation with major contributions by the Shanghai Bureau of Astronautics.

The oldest operational Chinese launch vehicle is the CZ-2C which debuted in 1975 as the carrier of the FSW-class of recoverable low altitude satellites. Averaging one mission per year for the past decade, the CZ-2C has a high reported reliability and a payload capacity of three metric tons to LEO. The CZ-2C is derived from the CSS-4 ballistic missile and consists of two stages burning UDMH and nitrogen tetroxide. The single CZ-2C mission during 1991–1992 was launched on 6 October 1992 with a FSW-1 13 primary payload and the Swedish Freja scientific satellite (Section 5.2.6) as a secondary payload (References 238–247). In the second half of the 1990's, the CZ-2C may be mated with a small, solid-propellant perigee kick stage to provide the vehicle with a modest GTO capability.

In 1990 the CZ-2E variant was introduced to give the CZ-2 series of launch vehicles a GTO capability which was specially designed to accommodate Western GEO satellites. The booster consists of a 2-stage core vehicle with four strap-on stages, all employing UDMH and nitrogen tetroxide. The strap-on stages each use a single YF-20B engine which is an improved version of the main engine design used on the first stage of the CZ-2C. Four YF-20B engines are combined to make the YF-21B which powers the first stage of the core vehicle, which is more than three meters longer than the CZ-2C first stage. The CZ-2E second stage is also based on its CZ-2C counterpart with an up-

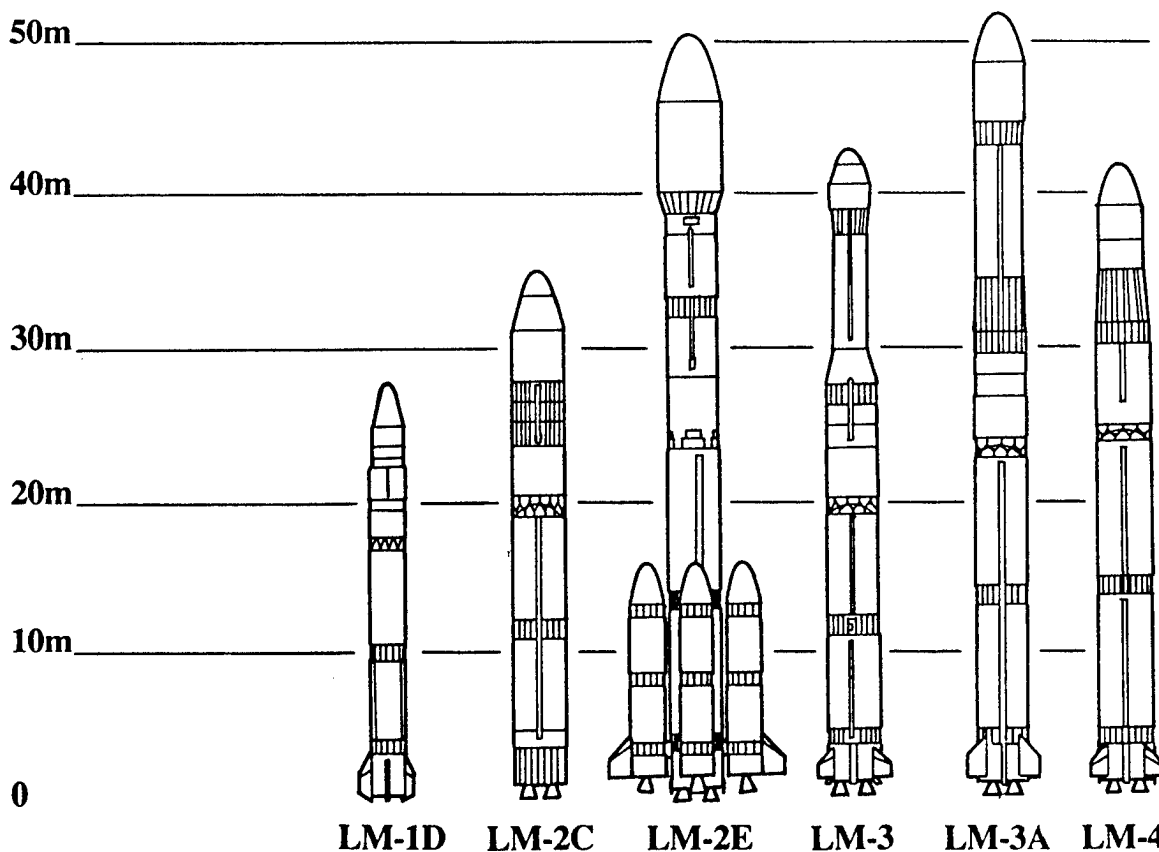

Figure 2.20. Long March Family of Launch Vehicles.

rated main engine (YF-22B) and larger propellant tanks carrying more than twice the load of the CZ-2C second stages. Finally, a small perigee kick stage is available for payload transfer from a LEO parking orbit to GTO (References 239, 242, 243, 246–250). The CZ-2E has a 9.2 metric ton LEO capacity and a 3.1–3.4 metric ton capacity to GTO depending upon the perigee kick stage selected.

The first test of the CZ-2E on 16 July 1990 successfully reached the desired LEO parking orbit with the small (50 kg) Pakistani Badr piggyback satellite, but an attempt to test the new Chinese perigee kick stage attached to a dummy payload failed. The next mission carried the Australian Optus B1 satellite into orbit on 13 August 1992 after an initial pad launch abort on 22 March of that year. The next flight on 21 December 1992 failed when a malfunction of the payload or shroud occurred less than one minute into the ascent. Despite the violent nature of the failure, which left a large portion of the payload scattered down range, the CZ-2E

second stage continued to function and reached a nominal LEO parking orbit (References 251–259).

A third CZ-2 variant, the CZ-2D, appeared with little forewarning on 9 August 1992 in conjunction with the maiden flight of the FSW-2 satellite. To lift the heavier FSW-2 (as compared with the FSW-1), the CZ-2D replaced the first stage of the CZ-2C with the more capable first stage of the CZ-2E without the strap-on boosters. The overall dimensions of the new launch vehicle suggest that the CZ-2C second stage is also used by the CZ-2D. Payload capacity data for the CZ-2D were not available at the end of 1992 (Reference 247).

The CZ-3 launch vehicle was introduced in 1984 to provide the PRC with its initial GEO mission capability. The vehicle also marked the first use of a high technology upper stage and led to China's entry into the commercial space launch services market. The CZ-3 is a 3-stage launch vehicle with the first two stages essentially identical to the CZ-2C. The third stage

utilizes a restartable, liquid oxygen/liquid hydrogen engine designated YF-73. The GTO capacity of the CZ-3 is 1.5 metric tons (References 239, 244, 260–264).

Although the inaugural flight of the CZ-3 on 29 January 1984 failed when the third stage did not restart to maneuver from a LEO parking orbit to GTO, the next six missions (April, 1984–April, 1990) were successful. Only one CZ-3 mission was attempted during 1991–1992, and this resulted in the stranding of a domestic PRC communications satellite in the wrong orbit. Lift-off occurred on 28 December 1991 (the only PRC space flight of the year), and orbital insertion into the planned LEO was accomplished. However, when the third stage was re-ignited, a propellant pressurization malfunction caused a premature shut-down, leaving the payload with an apogee of only 2,450 km instead of nearly 36,000 km as required (Reference 265).

With its limited payload capacity and the continued growth of GEO satellites, the CZ-3 is scheduled to be upgraded in the near-term. The CZ-3A, which could fly as soon as late 1993, will incorporate a lengthened first stage, a pair of more powerful YF-75 engines in the third stage, and an improved, light-weight flight control system. The LEO payload capacity will increase from 5.5 metric tons to 6.5 metric tons, and the GTO payload capacity will increase from 1.5 metric tons to 2.5 metric tons. The CZ-3B, also known as the CZ-2E/HO, will be formed by essentially adding the new CZ-3A third stage to the CZ-2E, thereby creating the most powerful PRC booster with a 12 metric ton LEO capacity and a 4.8 metric ton GTO capacity (References 239 and 267). By removing two of the four strap-on boosters from the CZ-3B, the CZ-3C will be formed.

The third currently operational series in the CZ family is the CZ-4 (also referred to as the CZ-4A) which to date has been employed only twice for inserting payloads into sun-synchronous orbits. Both flights in September of 1988 and 1990, respectively, lofted the PRC's first domestic meteorological satellite Feng Yun-1. The CZ-4 is a 3-stage launch vehicle carrying UDMH and nitrogen tetroxide for all stages. The CZ-4 uses first and second stages very similarly to those of the CZ-2E first stage and the CZ-2C second stage. The CZ-4 third stage is a short stage powered by the YF-40 main

engine. One month after the first CZ-4 mission, the third stage exploded into more than 70 trackable pieces, apparently as a result of residual propellants. The payload capacity of the CZ-4 into a sun-synchronous orbit is cited as 2.5 metric tons (References 239, 268–269).

To satisfy the need for launching small satellites into LEO, the PRC is offering to make available the CZ-1D launch vehicle about 1995. The CZ-1 was the PRC's first space launch vehicle with missions in 1970 and 1971. Derived from the CSS-3 ballistic missile, the CZ-1 was quickly replaced by the more capable CZ-2 and its cousin the FB-1. The CZ-1D design consists of a 2-stage vehicle with the first stage burning UDMH and nitric acid whereas the second stage utilizes UDMH and nitrogen tetroxide. The payload capacity of the CZ-1D will be 900 kg to LEO and 300 kg to a sun-synchronous orbit (References 239–241, 270–271).

In the long-term the PRC has expressed the need to develop a much larger LEO payload capacity: on the order of 25 metric tons. Such a capability is consistent with future plans for manned space systems, including a potential space station (Section 3.6). Even further into the future is the development of a fully reusable, two-stage-to-orbit space transportation system similar to the German Sanger concept. The PRC has been conducting detailed engineering studies in this area for more than a decade, but available resources have not permitted a commitment to begin development (References 239, 272–273).

Presently, the PRC operates three widely separated space launch centers to meet the needs of the entire CZ family of vehicles. Since these facilities are not located on the coast of China, each site is limited in the launch azimuths permitted which has led to separate centers for typical LEO, sun-synchronous, and GEO missions.

The oldest site which is used for low altitude posigrade missions with inclinations of 40° or more is called the Jiuquan Satellite Launch Center (sometimes referred to in the West as Shuang Cheng-Tzu) and is situated in the Gobi Desert in north central China. All CZ-2C and CZ-2D launches originate at Jiuquan. The second PRC space facility is the Xichang Satellite Launch Center which supports all GEO missions from its location in southern China.

Separate launch pads support CZ-3 and CZ-2E operations. The Taiyuan Satellite Launch Center was commissioned for sun-synchronous missions and thus supports all CZ-4 launches. Taiyuan is located southwest of Beijing (References 274 and 275).

2.9 Spain

In 1992 Spain's National Institute for Aerospace Technology (INTA) announced plans to develop a small orbital launch vehicle with a payload capacity of up to 100 kg into 600 km polar orbits. Named Capricornio, the launch vehicle is still in the preliminary design stage, although an initial flight in the mid-1990's is desired. To facilitate the development effort, INTA will produce the solid-propellant second-stage and purchase a foreign-made solid-propellant first stage. The third stage may be either foreign or domestic, liquid- or solid-fueled. The initial launch site may be El Aranosillo near Portugal to be followed by a more capable launch facility in the Canary Islands (References 276 and 277).

2.10 United Kingdom

During the 1960's and early 1970's the UK embarked on a national space launch program which culminated in the launch of the Prospero scientific satellite by a Black Arrow launch vehicle on 28 October 1971. However, for many years further UK interests in launch vehicle development were transferred to ELDO and ESA programs. Finally, in 1982 British Aerospace engineers originated a concept for a single-stage, horizontal take-off and landing (HOTOL) space transportation system. For the next several years the design was refined and eventually presented to ESA for consideration; meanwhile a 2-year proof-of-concept study was initiated in 1985 among the UK government, British Aerospace, and Rolls Royce.

Firm support for HOTOL never materialized from the UK government or ESA, but the project has managed to survive at a very low level of effort. The baseline HOTOL design in the late 1980's called for a 250 metric ton unmanned vehicle which could deliver a payload of up to seven metric tons to LEO on a typical mission

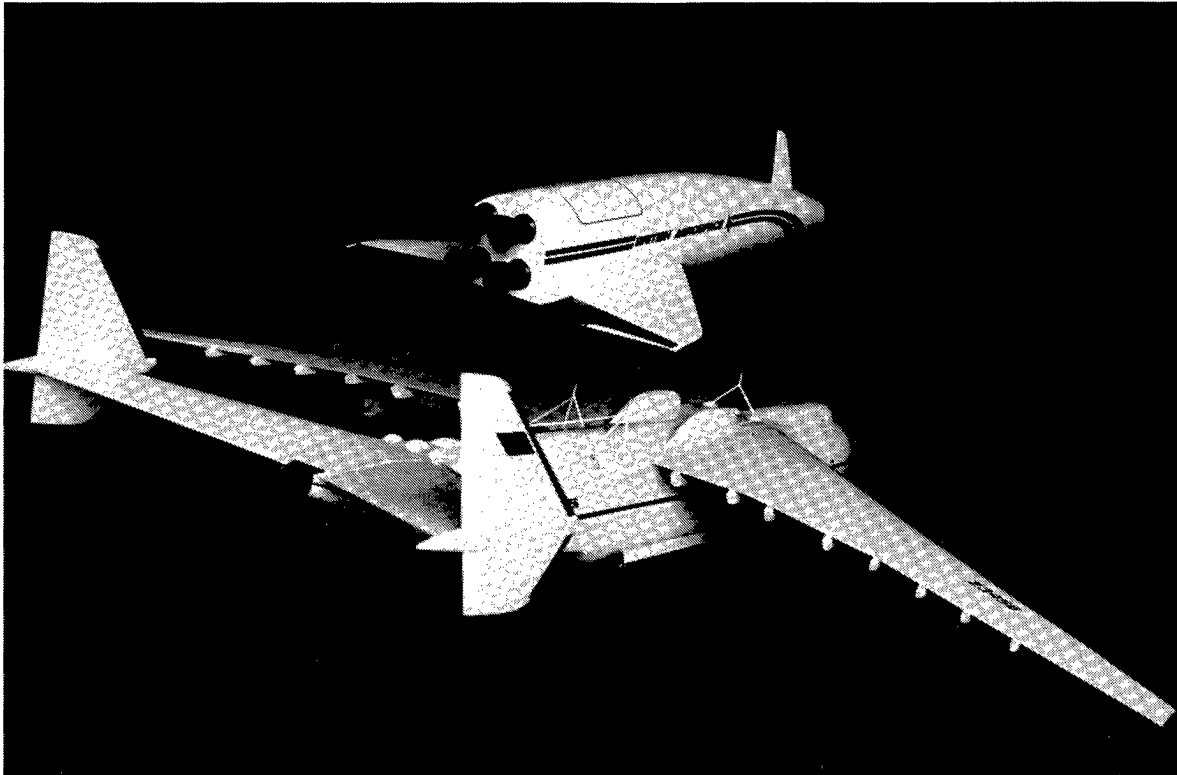

Figure 2.21. Interim-HOTOL on Top of Modified An-225.

lasting 50 hours. The vehicle would be similar in size to the Concorde supersonic aircraft with an overall length of 62 m and wing-span of 28 m. Propulsion would be provided by four RB545 dual-mode engines which would operate in an air-breathing mode up to an altitude of 26 km where a conversion would be made to a liquid oxygen/liquid hydrogen rocket propulsion mode. A 14-year development program was recommended before HOTOL would become operational (Reference 278).

In 1991 British Aerospace joined with the USSR's Antonov Design Bureau to consider the possibility of developing a smaller version of HOTOL, dubbed Interim HOTOL, which could

be air-launched by a modified An-225 aircraft. Interim HOTOL would be released at an altitude of about nine kilometers and would then use four Russian RD-0120, liquid oxygen/liquid hydrogen engines to carry a payload of 7–8 metric tons into LEO. Wind tunnel testing of the Interim HOTOL and 8-engine Antonov carrier has been accomplished. The dimensions of Interim HOTOL are approximately 36 m length and 22 m wing-span. Despite considerable interest in the program, no full development plan has been approved and funded. The concept is still being evaluated following the restructuring of the Hermes space plane program (References 279–286).

References - Section 2

1. V. P. Glushko, Rocket Engines GDL-OKB, Novosti Press Agency Publishing House, Moscow, 1975,
2. V. P. Glushko, Razvitiye Raketostroi niya I Kosmonavika B CCCP, Mashinostroenie Press, Moscow, 1981 and 1987 editions.
3. V. P. Glushko, Kosmonavtika Encyclopedia, Sovetskaya Encyclopedia, Moscow, 1985.
4. Yu. Semenov *et al*, Soviet Space 1990, Mashinostroenie Press, Moscow and Matson Press, Huntsville, 1991.
5. Specifications on Application of the Vostok-Type Carrier Rocket, GLAVKOSMOS, Moscow, 1987.
6. Vostok -IRS, GLAVKOSMOS and Licensintorg, Moscow, 1988.
7. Krasnaya Zvezda, Moscow, 30 August 1991, p. 4.
8. Actually, the SL-4 nomenclature covers several variants of this three-stage launch vehicle. See Reference 4 in particular.
9. Specifications on Application of the Soyuz Carrier Rocket, GLAVKOSMOS, Moscow, 1987.
10. Specifications on Application of the Molniya Carrier Rocket, GLAVKOSMOS, Moscow, 1987.
11. A. Lawler, "Houston Group Draws Corporate Funding for Lunar Mission," Space News, 25 February-3 March 1991, p. 21.
12. Fregat Upper Stage, fact sheet distributed by ARKOS Innovation Company, Khimki, 1992.
13. "KB Photon To Build Soyuz Successor," Space News, 23-29 November 1992, p. 2.
14. Krasnaya Zvezda, Moscow, 27 March 1993 and Izvestiya, Moscow, 24 March 1993, p. 5.
15. Specifications on Application of the Kosmos Carrier Rocket, GLAVKOSMOS, Moscow, 1987.
16. Krasnaya Zvezda, Moscow, 10 July 1991, p. 5.
17. Specifications on Application of the Tsyklon Carrier Rocket, GLAVKOSMOS, Moscow, 1987.
18. The Soviet Space Challenge, Department of Defense, U.S. Government Printing Office, November, 1987, p. 11.
19. B. V. Cherinatiev *et al*, "Identification and Resolution of an Orbital Debris Problem with the Proton Launch Vehicle," First European Conference on Space Debris, Darmstadt, April, 1993.
20. Proton Soviet Launcher, technical brochure distributed by GLAVKOSMOS, Moscow, 1986.
21. Soviet Launch Vehicle "Proton" For Injecting Satellite in Geostationary Orbit, Moscow, circa. 1987.
22. Soviet Launcher Proton, Licensintorg, Moscow, 1986.
23. G. Maksimov, "Proton Launch Vehicle," Aviatsiya I Kosmonavtika, Moscow, August, 1988, pp. 40-41.
24. S. Chenard, "Moscow's Proton Factory," Space Markets, No. 1., 1990, pp. 10-14.
25. F. A. Beswick, "Proton Launcher at Baikonur," Spaceflight, September, 1992, pp. 298-301.
26. ITAR-TASS, Moscow, 21 December 1992.
27. Pravda Ukrainy, 16 January 1991, p. 3.

28. Technical brochures provided by Salyut Design Bureau, Moscow, 1991.
29. D. Haeseler, "Soviets to Modify Proton Launcher," Spaceflight, July, 1991, pp. 248-249.
30. The Multi-Purpose Space Rocket Complex "Zenit," GLAVKOSMOS, Moscow, 1989.
31. Y. A. Smetanin, "Rocket Space Transportation Systems Produced by 'Yuzhnoye' Rocket-Space Association," Paper IAF-92-862, 43rd Congress of the International Astronautical Federation, 1992.
32. Y. A. Smetanin, "GLAVKOSMOS Operational Space Transportation Systems," GLAVKOSMOS, Moscow, 1989.
33. Zenit, brochure distributed by Cape York Space Agency and GLAVKOSMOS, 1990.
34. V. K. Tchvanov, "Oxygen-Kerosene Liquid Rocket Engines with Postburning Generator Gas and High Pressure in Combination Chamber," Symposium on Launcher Propulsion Towards the Year 2010, Bordeaux, June, 1991.
35. Krasnaya Zvezda, Moscow, 12 October, p. 3. and 25 October 1990, p. 4.
36. Ekonomika i Zhizn, Moscow, October, 1991, p. 11.
37. Krasnaya Zvezda, Moscow, 30 July 1991, p. 4. and 31 August 1991, p. 2.
38. "News Breaks," Aviation Week and Space Technology, 6 April 1992, p. 15.
39. Rabochaya Tribuna, Moscow, 2 June 1992, p. 2.
40. C. Covault, "Plesetsk Cosmodrome Gearing for New Heavy Booster Role," Aviation Week and Space Technology, 16 September 1991, pp. 46-51.
41. Zemlya i Vselennaya, Moscow, July-August 1992, pp. 18-23.
42. B. I. Gubanov, "Energiya - New Soviet Launch Vehicle," Paper IAF-88-172, 39th Congress of the International Astronautical Federation, October, 1988.
43. B. I. Gubanov, "New Versatile Rocket-Space Transportation System," Paper IAF-89-202, 40th Congress of the International Astronautical Federation, October, 1989.
44. B. I. Gubanov, "The Energiya Launch Vehicle Capabilities in Space Research," Energiya NPO, Moscow, 1989.
45. S. P. Aksjonov et al, "Experience of the Chemical Automatics Design Bureau in Creation of RD-0120 LOX/H₂ Liquid Rocket Engine with Thrust of 2 MN for 'Energiya' Launcher," Symposium on Launcher Propulsion Towards the Year 2010, Bordeaux, June, 1991.
46. B. I. Gubanov, "The Space Vehicle For Today and Tomorrow," Soviet Technical Paper No. SSI BIG-2, Space Studies Institute, 1990.
47. Krasnaya Zvezda, Moscow, 26 December 1991, p. 4 and 19 November 1992, p. 4.
48. Radio Moscow World Source, Moscow, 20 November 1991, 12 June 1992, and 17 January 1993.
49. G. Lozino-Lozinsky, " 'Buran,' Its Creation and Prospects of Its Usage," 40th Congress of the International Astronautical Federation, October, 1989. See also V. V. Ryumin, "The 'Buran' Orbiter Flight Control and Preparation" at the same conference.
50. Nezavisimaya Gazeta, Moscow, 12 August 1992, p. 6.
51. Kuranty, Moscow, 21 December 1991, p. 8.
52. Moskovskaya Pravda, Moscow, 25 March 1991, p. 3.

53. Izvestiya, Moscow, 29 April 1991, p. 8.
54. "Improvements to Third Soviet Shuttle," Spaceflight, May, 1990, p. 147.
55. Trud, Moscow, 26 January 1990, p. 3.
56. J. M. Lenorovitz, "Soviets' Second Buran Orbiter Undergoes Launch Pad Tests," Aviation Week and Space Technology, 12 August 1991, pp. 38-40.
57. "Assembly of Second Orbiter Completed at Cosmodrome," Aviation Week and Space Technology, 10 June 1991, p. 49.
58. Technical materials distributed by Energiya NPO, Moscow, 1991.
59. "Soviets Developing Smaller Version of Energia Heavy-Lift Booster," Aviation Week and Space Technology, 24 December 1990, p. 79.
60. "Energia M Launcher, Designed to Carry Smaller Payloads Than Standard Version," Aviation Week and Space Technology, 10 June 1991, p. 48.
61. J. M. Lenorovitz, "Stockholding Company Proposed To Raise Funds for Energia M," Aviation Week and Space Technology, 29 June 1991, p. 66.
62. Yu. Semenov, presentation to the 42nd Congress of the International Astronautical Federation, Montreal, October, 1991.
63. B. I. Gubanov, "The Immediate Prospect of the Reusable Space Transport Systems," Soviet Technical Paper No. SSI BIG-1, Space Studies Institute, 1990.
64. Moscow World Service, Moscow, 28 January 1989.
65. Moscow Radio, Moscow, 2 February 1989.
66. N. L. Johnson, The Soviet Year in Space 1989, Teledyne Brown Engineering, Colorado Springs, 1990, pp. 18 and 19.
67. G. E. Lozino-Lozinsky et al., "Reusable Aerospace System with Horizontal Take-Off," Paper IAF-90-176, 41st Congress of the International Astronautical Federation, Dresden, October, 1990.
68. G. E. Lozino-Lozinsky et al., "Multi-Purposed Aerospace System MAKS and Its Outlook," Paper IAF-92-851, 43rd Congress of the International Astronautical Federation, Washington, August-September, 1992.
69. Izvestiya, Moscow, 26 September 1992, p. 2, and 10 January 1993, p. 6.
70. M. Hemsell and B. Parkinson, "MAKS - Eastern Promise?," Spaceflight, March, 1993, pp. 79-83.
71. Zemlya I Vseennaya, Moscow, May-June 1991, pp. 19-26.
72. Pravda, Moscow, 1 September 1990, pp. 1 and 2.
73. D. Hughes, "Russian Liquid Rocket Bureau Designing Three-Fuel Engine," Aviation Week and Space Technology, 30 March 1992, p. 23.
74. V. P. Plokhikh, "Sensitivity Analysis of Single-Stage-To-Object Reusable Vehicle Parameters," Paper IAF-89-223, 40th Congress of the International Astronautical Federation, October, 1989.
75. O. K. Yugov et al., "Optimum Control Programs For Airbreathing Propulsion System of the Single-Stage-To-Orbit Vehicles," Paper IAF-89-308, 40th Congress of the International Astronautical Federation, October, 1989.
76. Moskovskaya Pravda, Moscow, 20 May 1990, p. 2.

77. Pravda, Moscow, 4 July 1991, p. 6.
78. Vozdushnyy Transport, Moscow, February, 1993, p. 11.
79. Space FAX Daily, 22 January 1993, p. 1.
80. Izvestiya, Moscow, 12 February 1992, p. 1 and 6 April 1992, p. 2.
81. Poisk, Moscow, 2–8 May 1992, p. 13.
82. P. B. de Selding, "Russia Claims First Scramjet Flight," Space News, 3–9 February 1992, p. 3.
83. S. W. Kandebo, "Russians Want U.S. to Join Scramjet Tests," Aviation Week and Space Technology, 30 March 1992, pp. 18–20.
84. "Russian Ramjet/Scramjet Operates Successfully," Aviation Week and Space Technology, 31 August 1992, p. 24.
85. S. W. Kandebo, "Franco-Russian Tests May Spur New Projects," Aviation Week and Space Technology, 14/21 December 1992, pp. 70–71.
86. Komsomolskaya Pravda, Moscow, 11 October 1991, p. 2.
87. Sant-Peterburgskiy Vedomosti, 9 December 1992, pp. 2–3.
88. L. M. Shkadov *et al.*, "Comparative Analysis of Various Concepts For Reusable Aerospace Systems," Paper IAF-92-865, 43rd Congress of the International Astronautical Federation, Washington, August–September, 1992.
89. Krasnaya Zvezda, Moscow, 5 June 1991, p. 2.
90. Izvestiya, Moscow, 1 August 1991, p. 1 and 15 April 1992, p. 1.
91. Komsomolskaya Pravda, Moscow, 16 August 1991, p. 2 and 25 July, 1992, p. 3.
92. ITAR-TASS, Moscow, 27 October 1992.
93. P. B. de Selding, "Russian Missiles to Go on Sale," Space News, 23–29 November 1992, p. 4.
94. P. B. de Selding, "Russians Leave Missile Conversion to Private Sector," Space News, 10–16 May 1993, p. 6.
95. Treaty with the Union of Soviet Socialist Republics on the Reduction and Limitation of Strategic Offensive Arms (The START Treaty), Treaty Document 102–20, US Senate, 25 November 1991.
96. Novosti Kosmonavtiki, Moscow, 15–28 March 1993, pp. 12–14.
97. Krasnaya Zvezda, Moscow, 2 December 1992, p. 4 and 28 January, 1993, p. 2, and 27 March 1993, p. 1.
98. Moskovskaya Pravda, Moscow, 27 May 1992, p. 5 and 5 June 1992, p. 4.
99. Delovoy Mir, Moscow, 4 June 1992, p. 3.
100. Izvestiya, Moscow, 29 May 1992, p. 2.
101. Pravda, Moscow, 29 April 1989, p. 4.
102. Technical brochure distributed by the Yuzhnoye NPO, Dnepropetrovsk, 1991.
103. Delovoy Mir, Moscow, 9 May 1992, p. 5.

104. Rocket Launch Vehicle, technical brochure distributed by Salyut Design Bureau, Moscow, 1993.
105. Krasnaya Zvezda, Moscow, 23 January 1992, p. 4.
106. Nezavisimaya Gazeta, 22 January 1992, p. 3.
107. Izvestiya, Moscow, 21 January 1992.
108. Komsomolskaya Pravda, Moscow, 3 April 1993, pp. 1, 6.
109. Space Clipper Commercial Space Launch System, technical brochure distributed by Yuzhnoye NPO, Dnepropetrovsk, 1991.
110. P. B. de Selding, "Soviets Seek Partner For Launch Business With Refitted SS-24s," Space News, 23-29 September 1991, p. 4.
111. "Soviets Eye Air-Launch ICBM To Put Civil Satellites in Orbit," Aviation Week and Space Technology, 14 October 1991, pp. 72-73.
112. Technical material prepared by GLAVKOSMOS and made available by Space Commerce Corporation, 1990-1991.
113. Izvestiya, Moscow, 28 February 1992, p. 1; 29 February 1992, p. 3; and 2 March 1992, p. 3.
114. J. M. Lenorovitz, "US Entrepreneurs Seek Russian SLBMs," Aviation Week and Space Technology, 19 April 1993, pp. 22-23.
115. J. M. Lenorovitz, "U.S. - Russian SLBM Venture Plans Initial Test for 1994," Aviation Week and Space Technology, 3 May 1993, pp. 60-61.
116. "Burlak" Aviation Complex, technical brochure distributed by Raduga Machine Building Design Bureau and Aviaexport, Moscow, 1991.
117. Krasnaya Zvezda, Moscow, 21 July 1992, p. 2.
118. "Russians Improve Planned Payload of Air-Launched Booster," Aviation Week and Space Technology, 24 August 1992, p. 65.
119. Rabochaya Tribuna, Moscow, 28 December 1991, p.4
120. Kazakhstanskaya Pravda, 3 April 1992, p. 1.
121. Krasnaya Zvezda, Moscow, 5 March 1989, p. 4.
122. Pravda, Moscow, 11 February 1992, p. 1.
123. Pravda Vostoka, 7 August 1991, p. 3.
124. Transactions of the Anniversary Specialist Conference on Nuclear Power Engineering in Space, Parts I and II, Obninsk, 15-19 May 1990.
125. See the papers of the annual Symposium on Space Nuclear Power Systems, Institute for Space Nuclear Power Studies, Albuquerque, since 1989. In particular, see V.I. Brukhty et al., "Electric Propulsion for Space Research," 1990; V.A. Pavshoock et al., "Criterion for the Selection of Power Propulsion Complex for Manned Interplanetary Missions," 1990; and M.S. Belyakov et al., "The Problems of the Brayton Cycle Application in a Biomodal Nuclear Power Propulsion System," 1990.
126. V. Kiernan, "Russians: Site Tested Rockets, Not Beam Weapon," Space News, 12-18 October 1992, p. 1.

127. L. David, " Soviets Reveal Work In Advanced Nuclear Rockets, Seek to Share," Space News, 16–22 September 1991, p. 18.
128. Krasnaya Zvezda, Moscow, 5 September 1992.
129. Kazakhstanskaya Pravda, Moscow, 1 August 1992, p. 1.
130. Komsomolskaya Pravda, Moscow, 28 December 1991, p. 2.
131. Pravda, Moscow, 28 December 1990, p. 3.
132. Kazakhstanskaya Pravda, 27 February 1992, p. 1; 5 March 1992, p. 1.; 7 March 1992, p. 2; and 14 March 1992, pp. 1, 6.
133. Krasnaya Zvezda, Moscow, 20 November 1991, p. 4; 1 May 1991, p. 4; 27 February 1992, p. 3; and 12 March 1992, p. 2.
134. Pravda, Moscow, 28 February 1992, p. 2.
135. Gudok, Moscow, 8 August 1992, p. 3
136. Ogonek, Moscow, March, 1991, pp. 16–17.
137. Izvestiya, 3 October 1991, p. 4.
138. Pravda Vostoka, 28 May 1992, p. 1.
139. Nezavisimaya Gazeta, 29 April 1992, p. 6. and 30 April 1992, p. 1.
140. ITAR-TASS World Service, Moscow, 22 April 1992.
141. Krasnaya Zvezda, Moscow, 29 April 1992, p. 1.
142. Izvestiya, Moscow, 7 January 1991, p. 1.
143. Moscow Central Television, Moscow, 14 January 1991.
144. Pravda, Moscow, 30 January 1991, p. 8 and 28 October 1991, p. 6.
145. TASS, Moscow, 19 September 1991.
146. Trud, Moscow, 13 October 1992, p. 2.
147. Moskovskiy Komsomolets, 11 October 1991, p. 2.
148. Ariane 4, Arianespace, Evry, October, 1983.
149. Reaching For The Skies, BR-42, ESA, Paris, 1988.
150. Ariane, "Space Special" by MBB Deutsche Aerospace, Bremen, May, 1991.
151. Ariane, Arianespace, Evry, May, 1990.
152. "50th Ariane the First of a New Batch," Spaceflight, June, 1992, p. 184.
153. P. B. de Selding, " Bigot Announces More Modifications for Ariane Launcher," Space News, 18–24 January 1993, p. 8.
154. "New Mission Procedure Proposed To Increase Ariane Performance," Aviation Week and Space Technology, 29 June 1992, p. 47.

155. Personal communication from Philippe Rasse, Arianespace, 4 December 1992.
156. Ariane 5 Programme, CNES, Evry, and ESA, Paris, November, 1990.
157. Ariane 5. Next Generation of Launchers, ESA, Paris, undated.
158. P. Donaldson, "Boosting Ariane 5," Space, May, 1993, pp. 26–27.
159. J. M. Lenorovitz, "Propellant Mixer Delay Could Stall Ariane 5 Program," Aviation Week and Space Technology, 26 June 1989, p. 35.
160. P. B. de Selding, "Glitch in Ariane 5 Delays Test Firing," Space News, 19–25 October 1992, pp. 1, 20.
161. J. M. Lenorovitz, "Europe Begins Extended Firings of Vulcain Main Engine for Ariane 5," Aviation Week and Space Technology, 15 July 1991, pp. 56–57.
162. "Ariane V: Combining Economy and Safety," Aerospace America, July, 1992, p. 46.
163. P. B. de Selding, "Europe To Keep Ariane 5 On Track," Space News, 2–8 November 1992, p. 6.
164. R. Riccitiello, "European Fuel Tank Passes First Tests," Space News, 16–22 December 1991, p. 17.
165. I. Parker, "Growing Ariane 5," Space, August–September, 1992, pp. 42–43.
166. "France Studies Ariane 5 Derivatives Comprising Family of Launch Vehicles," Aviation Week and Space Technology, 16/23 December 1991, p. 62.
167. "Ariane 5 Studied for Lunar Return," Aviation Week and Space Technology, 17 May 1993, p. 35.
168. P. B. de Selding, "French Signal Interest in Polar Orbit Launcher," Space News, 9–15 September 1991, p. 26.
169. Hermes, ESA/CNES Hermes Team, Paris, 1991.
170. Hermes European Spaceplane, EuroHermespace, 1992.
171. J. M. Lenorovitz, "Hermes Definition Program Begins; First Manned Mission Set for 1998," Aviation Week and Space Technology, 11 April 1988, pp. 51–52.
172. S. Chenard and A. Wilson, "Hermes Changes Shape Again," Space Markets, No. 1, 1989, pp. 18–23.
173. "A New Look For Hermes," Spaceflight, October, 1989, pp. 352–353.
174. "Aerospatiale Researches Space Transfer and Utility Vehicles," Aviation Week and Space Technology, 9 June 1986, pp. 65–75.
175. P. B. de Selding, "Norway Plans to Bail Out of ESA Hermes Space Plane," Space News, 4–10 November 1991, p. 7.
176. P. B. de Selding, "ESA Mulls Drastic Alternatives to Hermes," Space News, 25–31 May 1992, p. 4.
177. "Hermes Demonstrator Proposed For Suborbital Flight in 2000," Aviation Week and Space Technology, 8 June 1992, p. 23.
178. P. B. de Selding, "ESA Proposes End To Costly Hermes Effort," Space News, 7–13 September 1992, pp. 1, 20 and P. B. de Selding, "Hermes' End Draws Outbursts in Parliament," Space News, 23–29 November 1992, p. 6.
179. B. Deloffre, "Designing Europe's Spaceplane," Space Technology International, 1990, pp. 91–95.

180. Reusable Space Transportation Systems. Reference Concept Sanger, MBB/Deutsche Aerospace, August, 1992.
181. DARA Information 1991. Space Research for a Global Perspective, DARA, Bonn, June, 1991.
182. A Look at the Future, DLR, Koln-Porz, April, 1991.
183. E. Hogenauer, "Hot Off the Runway," Space Technology International, 1989, pp. 114-115.
184. N. Kidger, "India's SLV-3 Launch Vehicle," Spaceflight, February, 1982, pp. 72-73.
185. Annual Report, ISRO Headquarters, Department of Space, Government of India, Bangalore, 1989 and previous years.
186. "Indian Launch Vehicle Accident Inquiry Focuses on Initiat Stage Burn Sequence," Aviation Week and Space Technology, 24 October 1988, p. 47.
187. T. Pirard, "India Develops Cryogenic Engine," Spaceflight, February, 1988, p. 54.
188. All-India Radio, 31 August 1992.
189. "GLAVKOSMOS Sternly Rebukes U.S. Allegations As Protectionist," European Space Report, 16 June 1992, pp. 1-2.
190. A. Lawler, "India's Plan To Buy Russian Stage Draws U.S. Protests," Space News, 27 April-3 May 1992, p. 36.
191. Krasnaya Zvezda, Moscow, 16 June 1992, p. 2.
192. Izvestiya, Moscow, 21 April 1992, p. 5.
193. "Russian Sale of Rocket Engine To India," U.S. Department of State public release, 11 May 1992.
194. ITAR-TASS, Moscow, 25 June 1992.
195. V. Raghuvanshi, "Yeltsin: Cryogenic Rocket Deal Is Irrevocable," Space News, 1-7 February 1993, p. 6.
196. All-India Radio, 25 January 1993.
197. V. Raghuvanshi, "Indians Test Air-Breathing Engine," Space News 22-28 February 1993, p. 7.
198. J. Simpson et al, "The Israeli Satellite Launch," Space Policy, May, 1989, pp. 117-128.
199. C. Covault, "Israeli Rocket Proposed to NASA For U.S. Commercial Booster Project," Aviation Week and Space Technology, 1 October 1990, pp. 100-101.
200. S. Fisher, "Israel Joins Up," Space, January-February 1991, pp. 12-14.
201. "Atlantic Research Corporation and Rafael in Israel Announce Cooperative Effort on AUS-51," news release by ARC and Rafael, Virginia, 2 September 1992.
202. "IAI Space Activity Accelerates," Israel Space Research and Technology Information Bulletin, Vol. 7, No. 1, pp. 4-5.
203. "Italy Bets on Bantamweight Carina," Space News, 9-15 July 1990, p. 2.
204. S. Coleden, "Upgraded Scout Booster Readied To Begin Tests Again," Space News, 22 June-5 July 1992, p. 24.
205. R. Riccitiello, "Italian Lawsuit Centers On Scout," Space News, 2-8 November 1992, p. 3.
206. A. Lawler, "Export Licenses May Be Too Late for U.S. Firms," Space News, 11-17 January 1993, p. 4.

207. R. Riccitiello, "Court Ruling Leaves Italy With Two Scout Programs," Space News, 18–24 January 1993, pp. 3, 21.
208. R. Riccitiello, "ASI Pays First Installment, Scout's Future Still Uncertain," Space News, 8–14 March 1993, p. 9.
209. Space In Japan 1988–89, Research and Development Bureau, Science and Technology Agency, Tokyo, 1988.
210. M. Oda and Y. Tanaka, "Japan's Blossoming Space Science," Sky and Telescope, January, 1987, pp. 7–11.
211. C. Covault, "Japan Designing Atlas-Class Rocket To Launch Lunar, Planetary Missions," Aviation Week and Space Technology, 20 August 1990, pp. 63–68.
212. K. P. Dawson, "Japanese M-5 Faces Delay to '95 Start," Space News, 15–21 June 1992, p. 4.
213. "Japan Presses on With M-5 Project Despite Motor Casing Problems," Aviation Week and Space Technology, 10 August 1992, pp. 48–49.
214. NASDA. National Space Agency of Japan, NASDA, 1987.
215. NASDA Report, NASDA, beginning with No. 1, August, 1988.
216. H-II Launch Vehicle, technical brochure distributed by NASDA, Tokyo, 1992.
217. H-II Rocket, NASDA, Tokyo, undated.
218. "Nissan Preparing to Develop First H-2 Solid Rocket Boosters," Aviation Week and Space Technology, 4 August 1986, pp. 80–84.
219. NASDA Report, No. 1, NASDA, Tokyo, August, 1988, pp. 11–12.
220. "Final Testing of H-2 Solid Rocket Booster a Winner," Space News, 3–9 June 1991, p. 13.
221. P. B. de Selding, "Japanese Expect H-2 Delays in Wake of Fire," Space News, 15-21 October 1990, 14.
222. "Leak Causes Blast at LE-7 Test Site," Space News, 20–26 May 1991, p. 2.
223. K. P. Dawson, "Explosion Mars LE-7 Work," Space News, 19–25 August 1991, pp. 1, 21.
224. K. P. Dawson, "NASDA Pins August Engine Explosion on Cracked Well," Space News, 28 October–3 November 1991, p. 30.
225. "LE-7 Failures Threaten Further Japanese H-2 Rocket Launch Delays," Aviation Week and Space Technology, 27 April 1992, p. 15.
226. K. P. Dawson, "Japan Scrambles To Fix LE-7 Problem," Space News, 11–17 May 1992, p. 4.
227. K. P. Dawson, "Fire Threatens Japan's H-2 Rocket Schedule," Space News, 22 June–5 July 1992, p. 1, 28.
228. K. P. Dawson, "LE-7 Test Failure Delays Launch,," Space News, 20–26 July 1992, p. 9.
229. Kyodo News Service, Tokyo, 18 June and 7 July 1992.
230. "Japan's H-2 Tested At Tanegashima," Aviation Week and Space Technology, 8 June 1992, p. 25.
231. "New Japanese Booster," Aviation Week and Space Technology, 19 August 1991, p. 11.

232. K. P. Dawson, "NASDA Seeks To Fund New Launcher in 1992 Request," Space News, 9–15 September 1991, p. 21.
233. P. Proctor, "Japan To Offer J-1 Solid Rocket For Launch of Small Payloads," Aviation Week and Space Technology, 10 August 1992, pp. 47–48.
234. H-II Orbiting Plane (HOPE), technical brochure issued by NASDA, Tokyo, 1991.
235. K. P. Dawson, "Japan's Space Plane Faces Termination or Shrinking," Space News, 23–29 November 1992, pp. 3, 20.
236. S. W. Kandebo, "Japanese Refining Unmanned HOPE Orbiter for Planned 1996 Launch," Aviation Week and Space Technology, 3 April 1989, pp. 57–58.
237. "Space Agency Considers Doubling Size of HOPE Unmanned Space Vehicle," Aviation Week and Space Technology, 13 August 1990, pp. 65–68.
238. LM-2C Launch Vehicle, specification sheet distributed by China Great Wall Industry Corp., Beijing, 1992.
239. Zhao Bing, "A System Analysis of the Launch Vehicle Technology in China," Paper 92-824, 43rd Congress of the International Astronautical Federation, August–September, 1992.
240. China In Space, China Great Wall Industry Corp., Beijing, 1988.
241. Space in China Launch Services and Space Technology, China Great Wall Industry Corp., Beijing, 1989.
242. Xu Jian, "Progress in Carrier Rocket Technology," Beijing Review, Beijing, 3–9 September 1990, pp. 27–30.
243. G. Pike, "Chinese Launch Services, A User's Guide," Space Policy, May, 1991, pp. 103–115.
244. Long March Launch System, Ministry of Astronautics, Beijing, 1985.
245. P. S. Clark, "Chinese Launch Vehicles - Chang Zheng 2," Jane's Intelligence Review, May, 1992, pp. 231–234.
246. P. S. Clark, "Chinese Launch Vehicles - The Rest of the Story," Jane's Intelligence Review, October, 1990, pp. 469–473.
247. P. S. Clark, "Chinese Launch Vehicles - Further Details," Jane's Intelligence Review, June, 1993, pp. 274–275.
248. LM-2E Launch Vehicle, specification sheet distributed by China Great Wall Industry Corp., Beijing, 1992.
249. Long March-2E, specification sheet distributed by China Great Wall Industry Corp., Beijing, 1991.
250. Zhongguo Xinwen She News Agency, Beijing, 23 December 1992.
251. Xinhua News Agency, 21, 22, and 24 December 1992.
252. Wen Wei Po, Hong Kong, 27 December 1992.
253. Guangming Ribao, Beijing, 2 February 1993, p. 1.
254. Zhongguo Xinwen She News Agency, Beijing, 23 March 1993.
255. P. Proctor, "U.S., China Examine Failed Launcher Parts," Aviation Week and Space Technology, 11 January 1993, pp. 60, 63.
256. C. Covault, "Chinese Rocket Shroud Breakup Caused Long March Failure," Aviation Week and Space Technology, 18 January 1993, p. 28.

257. "Restrictions Slow Long March Probe," Aviation Week and Space Technology, 8 February 1993, p. 25.
258. P. B. de Selding and P. Seitz, "Investigators Fail To Find Cause of Optus Loss," Space News, 8-14 February 1993, pp. 3, 20.
259. "Hughes Clears Optus Satellite in Long March Accident Probe," Aviation Week and Space Technology, 12 April 1993, p. 60.
260. LM-3 Launch Vehicle, specification sheet distributed by China Great Wall Industry Corp., 1992.
261. Long March-3, specification sheet distributed by China Great Wall Industry Corp., 1991.
262. Long March 3 User's Manual, Ministry of Astronautics, Beijing, May, 1985.
263. P. S. Clark, "Chinese Launch Vehicles - Chang Zheng 3," Jane's Intelligence Review, August, 1992, pp. 372-376.
264. Wang Zhiren and Gu Mingchu, "Oxygen/Hydrogen Rocket Engine For CZ-3," Paper IAF-89-299, 40th Congress of the Astronautical Federation, October, 1989.
265. Xinhua News Agency, Beijing, 7 January 1992.
266. "Chinese Satellite Ends Up in Wrong Orbit," Spaceflight, February, 1992, p. 38.
267. Zhongguo Xinwen She News Agency, Beijing, 23 December 1992.
268. LM-4 Launch Vehicle, specification sheet distributed by China Great Wall Industry Corp., 1992.
269. Long March-4, specification sheet distributed by China Great Wall Industry Corp., 1991.
270. P. S. Clark, "Chinese Launch Vehicles - Feng Bao 1," Jane's Intelligence Review, April, 1992, pp. 188-191.
271. P. S. Clark, "Chinese Launch Vehicles - Chang Zheng 1," Jane's Intelligence Review, November, 1991, pp. 508-511.
272. Z. Huang, "Fully Reusable Launch Vehicle with Airbreathing Booster," Paper IAF-83-376, 34th Congress of the International Astronautical Federation, October, 1983.
273. "Chinese Studying TSTO-Based Space Transportation System," Aviation Week and Space Technology, 9 December 1991, p. 70.
274. China Jinquan Satellite Launch Center, brochure, undated.
275. China Xichang Satellite Launch Center, brochure, undated.
276. P. B. de Selding, "Spain Boosts Space Spending, Plans New Launch Vehicle," Space News, 15-21 June 1992, p. 6.
277. "Spanish Orbital Rocket," Spaceflight, August, 1992, p. 249.
278. HOTOL, brochure published by British Aerospace and Rolls Royce, undated.
279. C. A. Shifrin, "British Aerospace, Soviets to Study Launching HOTOL from AN-225," Aviation Week and Space Technology, 10 September, 1992, p. 23.
280. S. Young, "Soviet Cooperation Gives Hotol a New Lease of Life," Spaceflight, October, 1990, pp. 326-327.
281. P. B. de Selding, "Antonov-Hotol Project Passes Test," Space News, 6-12 May 1991, p. 26.
282. "Antonov Launched Hotol Moves Forward," Spaceflight, August, 1991, p. 259.

283. Izvestiya, Moscow, 21 June 1991, p. 8.
284. J. M. Lenorovitz, "New Hotel Version Emerges Following British/Soviet Study," Aviation Week and Space Technology, 9 September 1991, pp. 68-69.
285. S. W. Kandebo, "Soviets to Conduct Wind Tunnel Separation Tests on Hotel Launch System," Aviation Week and Space Technology, 6 January 1992, p. 58.
286. R. Parkinson, "Project 'Interim Hotel' Update," Space Technology International, 1992, pp. 127-128.

3.0 MANNED AND MAN-RELATED SPACE PROGRAMS

Since Yuri Gagarin first paved the way for manned space flight, citizens of 25 nations (21 countries in Europe and Asia) have ventured into the hostile near-Earth environment. However, 32 years after that historic mission only the US and the USSR had developed the technological base and spacecraft necessary to carry man into space and to return him home safely to Earth. Although ESA, Japan, and the PRC have seriously considered building manned spacecraft, all three programs are on indefinite suspension with no flights possible until after the year 2000. Hence, for the remainder of this decade European and Asian astronauts must continue their reliance on American and Russian spaceships.

Despite this lack of national space transportation capability, formal man-in-space programs are developing rapidly in the Eastern Hemisphere. ESA and Japan are major partners in the international Freedom Space Station program, contributing habitable modules to the large complex, and have consequently established official astronaut training programs. In addition to its activities with ESA, France has undertaken a long-term bi-lateral agreement with USSR/CIS to gain manned space flight experiences. PRC's on-again/off-again manned space program appears dormant at the present, but the country remains capable of conducting an indigenous man-in-space project or entering international endeavors. Austria and the UK both sponsored short duration missions to the Mir space station in 1991 but support no ongoing national manned space programs. Consequently, these two flights are addressed under the CIS Mir section. Likewise, Belgium's and Italy's first astronauts flew in 1992 aboard the US Space Shuttle, but no major manned activities are planned for the near future by these countries.

3.1 USSR/CIS

The year 1991 marked the 30th anniversary of USSR/CIS manned space flight and the 20th anniversary of the Soviet Earth orbital space station program. During these two decades more than 120 spacecraft, including ten space stations, with an aggregate mass of over 1,000 metric tons were launched. Figure 3.1 clearly indicates that the Salyut and Mir platforms

represent a continuing evolution with major improvements being incorporated into successive vehicles. Likewise, the Mir 2 facility planned for the latter part of this decade will benefit from more than 24 man-years of space station operations, including uninterrupted activities on Mir since 1989.

The Mir core module has been in Earth orbit since February, 1986, and by the end of 1992 had met its original design life. The vehicle is 13.1 m long with a maximum diameter of 4.2 m and an initial mass of 20.4 metric tons. The habitable volume is approximately 90 m³, and the two main solar arrays were augmented in 1987 with a third, deployed array for a total power capacity of 10.1 kW. The basic outward configuration of Mir was similar to that of Salyut 6 and Salyut 7, but the forward transfer compartment of the Salyuts was replaced with a 5-port docking module on Mir. Internally, many design changes and system improvements were incorporated.

Space station logistical and upgrade requirements have been met with three classes of spacecraft: crew ferries (Soyuz, Soyuz T, and Soyuz TM), unmanned cargo ships (Progress and Progress M), and large specialized modules (Kosmos, Kvant, and Kristall). The Soyuz series spacecraft flew the first manned mission in 1967 (Figure 3.2) and by the end of 1992 had launched 65 crews into Earth orbit. The current Soyuz TM model (Figure 3.3) closely resembles its predecessors, but many of the support systems have been greatly modernized.

Designed and manufactured by Energiya NPO, the Soyuz TM is capable of carrying three cosmonauts and has a gross weight of just over seven metric tons, a length of seven meters, and a maximum diameter of 2.7 m. The spacecraft consists of three main sections: the orbital module, the command and reentry module, and the service module. Two solar arrays (10.6 m span) provide electrical power for the typical 50-hour journey to Mir and can be interconnected with the space station's electrical system to furnish an additional 1.3 kW. The nominal flight time for a Soyuz TM spaceship is 5–6 months (References 1–3).

Since the cargo capacity of a manned Soyuz TM is limited to only a few hundred kilograms, a

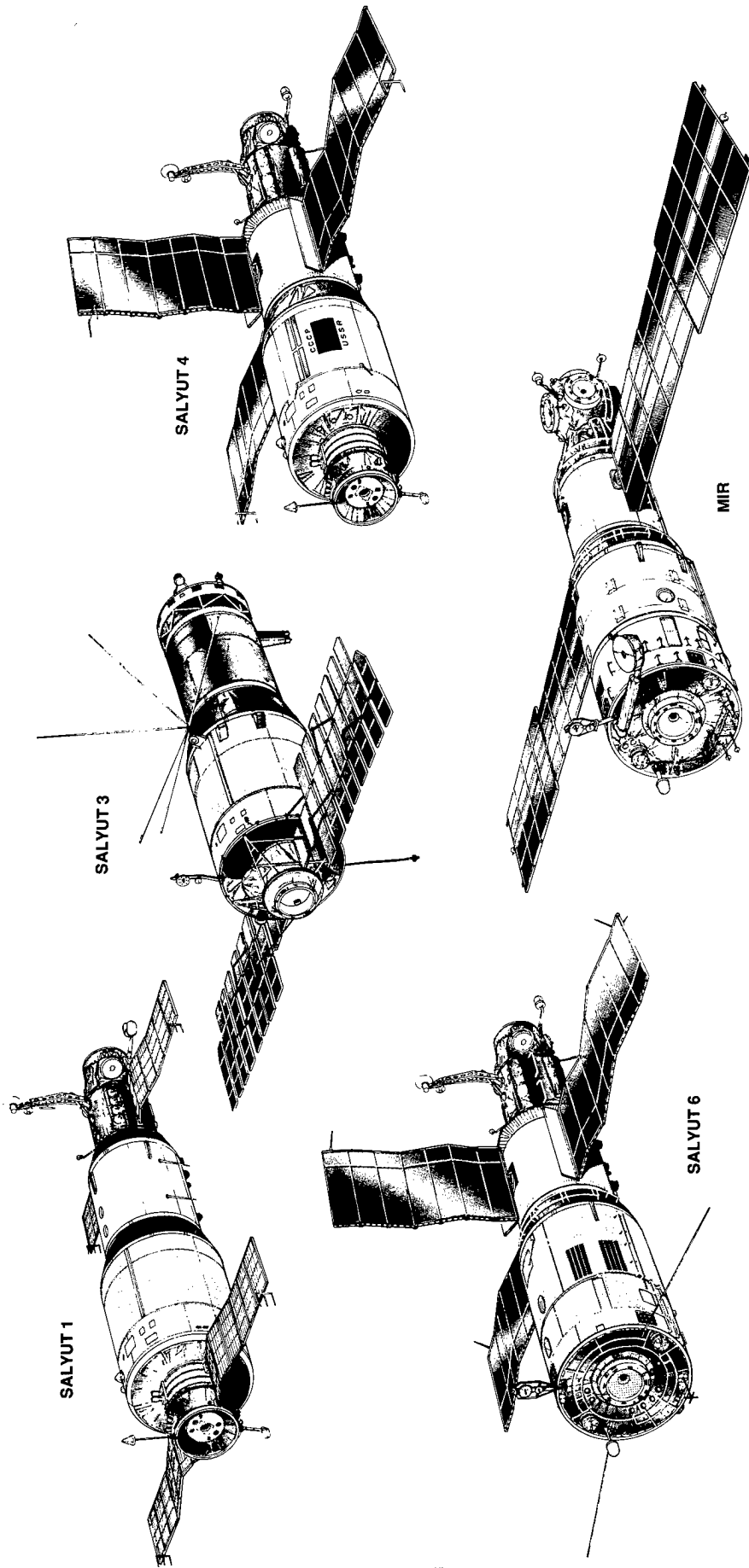

Figure 3.1. Evolution of USSR Space Stations.

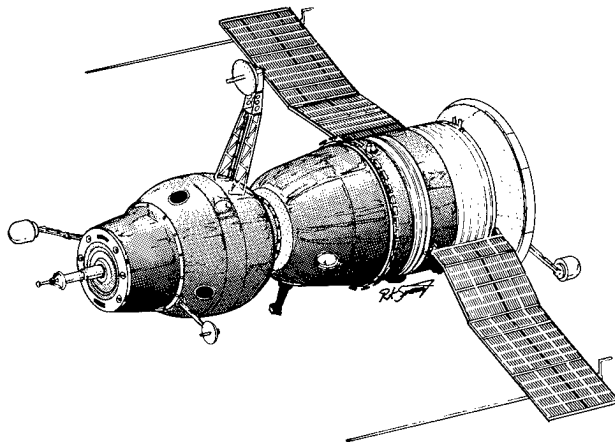

Figure 3.2. Original Soyuz Spacecraft.

more efficient logistics vehicle was designed for support operations to Mir. Progress M (maiden flight in August, 1989) is a "modernized" version of the original Progress cargo freighter (1978–1990) which flew 43 times (including Kosmos 1669) without a docking failure. Derived from Soyuz TM, Progress M has a launch mass of approximately 7.3 metric tons and a length of 8.2 m.

Whereas the service module is essentially the same as the one used by Soyuz TM, the central module is designed for carrying propellants, air, and water, while dry cargo is stored in the forward, nearly spherical compartment (Figure 3.4). Continual improvements to the spacecraft have increased

the total payload cargo to 2.7 metric tons, averaging more than 2.6 metric tons on five missions in 1991. Progress M is rated for 30 days independent flight and up to 180 days attached to Mir. Although Progress M spacecraft are destroyed during reentry, beginning in 1990 (Progress M-5) a small recoverable capsule (payload capacity of 150 kg) has been used on about every other mission (References 2, 4–8).

Since 1977 large, 20-metric-ton class spacecraft have been tested and used to support the USSR/CIS space station program. Kosmos 929, the first of the series (Figure 3.5), was designed to serve as a combination cargo carrier, space tug, and temporary space station module. The conical reentry vehicle at the forward end was originally conceived as a manned return capsule but has only been used in an unmanned mode. Kosmos 929, flown on a solo shakedown mission, was followed by Kosmos 1267 and Kosmos 1443 which docked with the Salyut 6 and Salyut 7 space stations, respectively. Kosmos 1686 was a variant of this series without the reentry vehicle.

With the advent of the Mir space station in 1986, a new requirement for permanent expansion of the orbital complex was set. In 1987 Kvant 1, a specialized module left over from the Salyut 7 program, was attached to Mir not only to provide a complex set of scientific equipment (the international Roentgen X-ray

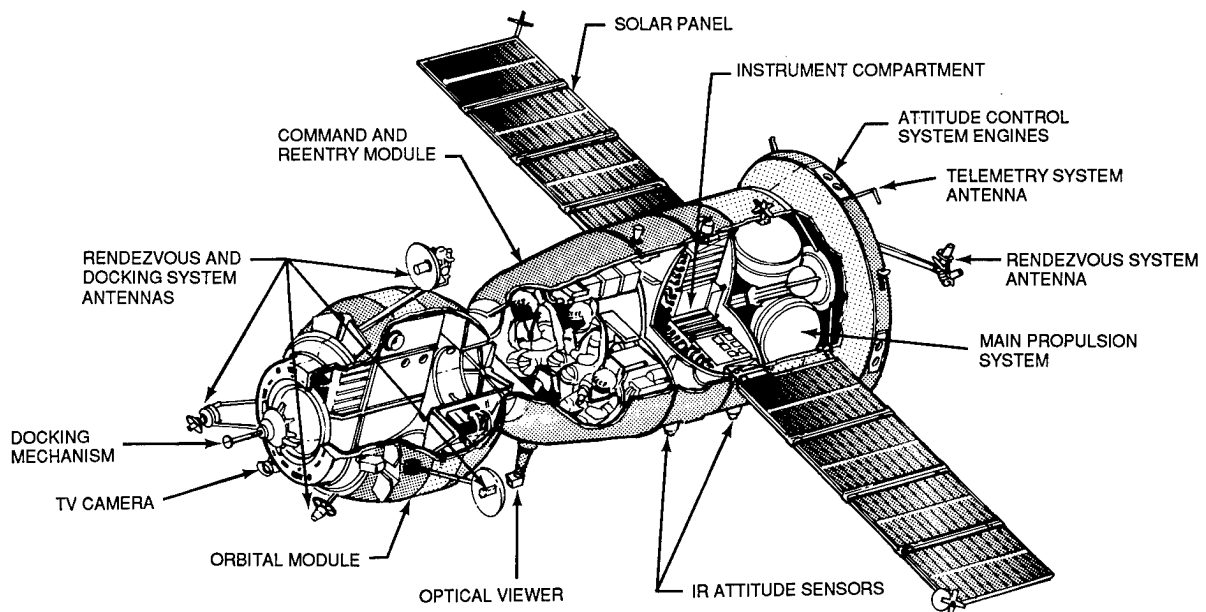

Figure 3.3. Current Soyuz-TM Spacecraft.

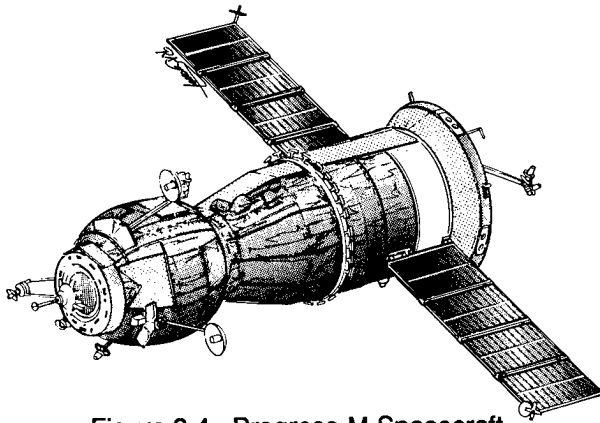

Figure 3.4. Progress-M Spacecraft.

Observatory consisting of the HEXE, Pulsar X-1, Sirene-2, and TTM instruments; the Glasar UV telescope; and the Svetlana electrophoresis unit) but also to enhance space station support systems, in particular attitude control via six large gyrodynes. When attached to the aft docking port of Mir, Kvant 1 (Figure 3.6) measured 5.8 m in length and 4.2 m in diameter with an initial mass of 11 metric tons (References 2, 9–10).

The four forward radial ports were reserved for full-size Kosmos 929-class modules of about 19.6 metric tons each. However, the multi-role missions of the former spacecraft were abandoned in favor of one-of-a-kind, highly specialized modules built at the Khrunichev Machine Building plant for the Energiya NPO. Kvant 2, which was attached in 1989, was also known as the additional equipment module in accordance with its wide variety of new systems. Perhaps the most important feature of the new module was the unique air-lock chamber with an enlarged (1 m diameter) exit hatch. In addition, the 12.4 m long, 4.4 m diameter Kvant 2 housed the following major equipment:

- Six gyrodynes
- MKF-6MA multi-spectral camera system
- ITS-7D infrared spectrometer
- MKS-M2 optical spectrometer
- KAP-350 Topographic camera
- ARIS X-ray sensor
- Inkubator 2 hatchery
- Rodnik water system
- Elektron and Vika electrolysis units
- ASP-G-M exterior instrument platform.

Less exotic but equally important are Kvant 2's two solar arrays with a capacity of 6.7 kW at beginning of life (References 2, 11–16).

Six months after the arrival of Kvant 2, the Kristall module became the newest component of the Mir complex. Kristall (Figure 3.7) possessed the same mass and diameter as Kvant 2 but was a little shorter at 11.9 m. In place of the Kvant 2 air-lock chamber, Kristall was equipped with a new multiple docking adapter employing two APAS-89 androgynous ports for mating with the Buran space shuttle and a new model of Soyuz TM. The primary scientific payload was devoted to microgravity research and is described in more detail in Section 4.4.1. Kristall also carried the Priroda 5 high resolution camera and the Svet greenhouse for botanical research. The two solar arrays on Kristall were of a new design with a total 8.4 kW capacity, variable deployment positioning, and the ability to be removed and relocated to another part of the space station (References 2, 17–20).

By the end of 1990 the Mir space station's normal configuration consisted of six linked spacecraft: Mir, Kvant 1, Kvant 2, Kristall, a Soyuz TM, and a Progress M. Together they boasted a total mass of about 90 metric tons and a habitable volume of 270 m³. During its nearly seven years of operations (1986–1992), the Mir space station program has involved 53 spacecraft with an aggregate of more than 400 metric tons. Twelve primary expeditions have been undertaken with a maximum duration of 366 days.

3.1.1 1991 Operations

As 1991 began, Soviet and international attention was temporarily drawn away from activities on Mir to the impending destruction of its predecessor. Salyut 7, the heart of the USSR man-in-space program during 1982–1985, was losing altitude at an exponential rate and was expected to fall back to Earth in February. With only a tiny amount of fuel left in its propellant tanks, Salyut 7 was virtually uncontrollable and could not follow the tradition

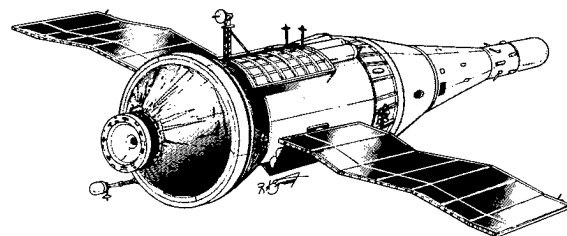

Figure 3.5. Kosmos 929-class Spacecraft.

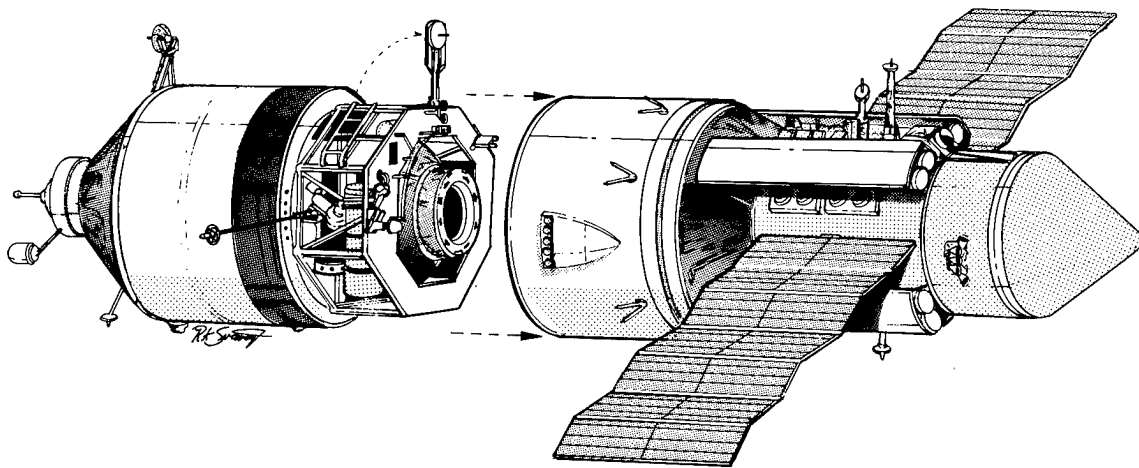

Figure 3.6. Kvant 1 Module (left) with Delivery Unit.

of being intentionally ditched over the Pacific Ocean.

During its four-year service as a manned orbital laboratory (May, 1982–June, 1986), Salyut 7 had been the site of numerous world records and daring exploits. In all, 25 spacecraft (10 Soyuz T manned ferries, 13 Progress-class resupply ships, and two heavy cargo modules) docked with the station which hosted 21 different cosmonauts, including two foreign visitors. Over 2,000 man-days were spent on-board Salyut-7: 30% more than Salyut 6's mark. Five main expeditions toiled on the space station, setting new world records of 211 days in 1982 (Soyuz T-5) and 237 days in 1984 (Soyuz T-10B).

Despite these significant achievements, Salyut 7 seemed to attract more than its share of bad luck. The planned second expedition in April, 1983, was aborted after only two days when a rendezvous system malfunction prevented docking with the space station. Five months later another expedition never got off the ground when their SL-4 booster caught fire and exploded on the launch pad. Within days of the launch pad accident, Salyut 7 – in a completely unrelated failure – suffered a potentially crippling rupture of its propulsion unit's primary oxidizer line. A year and six EVA's later the journeymen team of Kizim and Solovyev had performed unprecedented repairs to mitigate the damage and to allow continued operations on the station.

Scarcely had the propulsion unit repairs been effected when an even more devastating malfunction appeared to end Salyut 7's mission prematurely. During a brief period after the Kizim-Solovyev mission when Salyut 7 was left

unattended, a series of cascading failures left the station without electrical power, heat, and communications with Earth. A heroic mission by veteran cosmonauts Dzhanibekov and Savinykh in early 1985 literally brought the frozen spacecraft back to life. However, amid concerns about Salyut 7's safety and after the accelerated launch of its successor, Mir, cosmonauts vacated Salyut for the last time on 25 June 1986. Two months later the Kosmos 1686–Salyut 7 complex was sent into a storage orbit 475 km above the Earth (Reference 21).

From this altitude USSR officials announced that the complex would not decay for eight years, i.e., until 1994, by which time a Buran space shuttle mission was expected to visit the station, examine the effects of more than 10 years in the harsh space environment, and either reboost the vehicles or de-orbit them over the Pacific Ocean. Fate, however, was not yet through with the hard-luck Salyut 7 (Reference 22).

First, technical and budgeting problems beset the Buran program, repeatedly pushing back its initial manned mission. Meanwhile, the

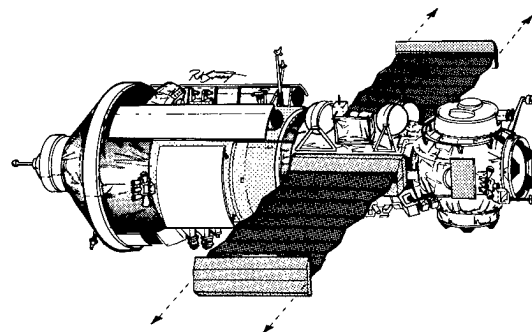

Figure 3.7. Kristall Module.

anticipated increase in solar activity predicted for the early 1990's came far sooner and with greater intensity than expected. The resultant increases in atmospheric density around Kosmos 1686-Salyut 7 hastened their fall back to Earth. By the end of 1990 Salyut 7 had dropped to a mean altitude of only 288 km, and the USSR Flight Control Center in Kaliningrad was projecting a reentry by February, 1991 (References 23 and 24).

While mission control personnel were confident that they could influence the complex's reentry point by expending the remaining propellant on its final orbit (Kosmos 1686 had failed about a year earlier but Salyut 7 was still active) and thereby avoid any populated region, spacecraft engineers tried to estimate the number and the masses of fragments which might reach the surface of the Earth. In the process, details of the nature of Kosmos 1686 – held secret for more than five years – were finally released. In part, this secrecy was derived from Kosmos 1686's heritage with the Soviet military Salyut space program (Salyut 2, Salyut 3, and Salyut 5) run by Chelomei in parallel (and to an extent in competition) with Mishin's and Glushko's civilian Salyut platforms.

Prior to 1991 no clear photo or drawing of Kosmos 1686 had appeared in the West, although the TASS launch announcement stated that Kosmos 1686 was "similar in design to the artificial Earth satellites Kosmos 1267 and Kosmos 1443." In an article in Pravda about a week after launch, Kosmos 1686 was credited with delivery of about five metric tons of dry cargo to Salyut 7 but specifically was not outfitted with a Gemini-type return craft like those of its predecessors (References 25 and 26).

Although a Soviet drawing of Kosmos 1686 released in 1991 confirmed the absence of the large return module, new conflicting statements by officials about a reentry capsule with a diameter of 3 meters and a mass of 2.5 metric tons or more clouded the issue further. One series of articles claimed that the capsule was to have been undocked in January, 1986, by the Soyuz T-14 crew but this plan was abandoned when Cosmonaut Vasyutin fell ill, and his mission was abruptly terminated in November, 1985. Reportedly, the undocking could have been performed only manually, unlike the Kosmos 1267 and Kosmos 1443 return craft. However, the USSR repeatedly asserted that an actual

return to Earth was not envisioned and the solid-fuel retro motors were not loaded with propellant (References 27–31).

Due to the design of Salyut 7 and Kosmos 1686, including the mysterious reentry capsule, an estimated 250 fragments were expected to reach the surface of the Earth. The end finally came on 7 February after the complex passed over the southern Pacific Ocean and broke apart, scattering some debris over Chili and Argentina. A final attitude control maneuver with perhaps 70 kg of fuel was executed and was credited with shifting the debris reentry zone farther away from populated regions. The USSR acknowledged liability for damage caused by falling debris, although no significant strikes were reported. The two largest fragments reported found were 4 and 8 kg, respectively (References 28, 32–36).

The 1991 mission plan for Mir was ambitious: conducting as many as four manned missions, including two foreign visitors traveling on a commercial basis; launching a third, semi-permanent module; testing the new universal docking system with a Buran shuttle and a new Soyuz TM variant; and performing a record number of extra-vehicular activities (EVA's) to repair and to reconfigure the space station. At year's end most of these objectives were left unfulfilled and postponed to 1993 or even later. However, the Mir program did weather the tumultuous storm of upheaval which had disrupted much of Soviet terrestrial affairs, culminating in the dissolution of the Union on the eve of 1992.

On New Year's Day, 1991, Soyuz TM-11 cosmonauts Viktor Afanasyev and Musa Manarov were completing the first month of their mission and looking to as many as four ventures outside the cramped confines of Mir. The first EVA was scheduled for 7 January to repair the troublesome Kvant 2 EVA air-lock hatch, which had been damaged inadvertently by the Soyuz TM-9 crew in July, 1990, and which had resisted earlier efforts by the Soyuz TM-10 team to repair it in October.

On the evening of 7 January (Moscow time) Afanasyev and Manarov donned their EVA suits, sealed themselves in the Kvant 2 air-lock, and then depressurized the compartment to begin their primary task. If the hatch could not be satisfactorily repaired, the 1991 mission plan for Mir might suffer a serious setback. After

experiencing some difficulty in removing the damaged hatch hinge, the two cosmonauts were able to install a new device without incident. After verifying the operation of the hatch, Afanasyev and Manarov transferred outside the station equipment needed for the next series of EVA's, removed a malfunctioning camera, and retrieved a cartridge of material samples which had been exposed to the space environment to evaluate long-term effects on proposed spacecraft structures (References 37-38).

A week after the EVA the first unmanned cargo ship of the year was launched. Progress M-6 arrived at the Mir complex two days later on 16 January and successfully docked at the Kvant 1 aft port, vacant since the departure of Soyuz TM-10 on 10 December 1990. During the next week Afanasyev and Manarov began unloading Progress M-6 and preparing for a pair of EVA's while attending to routine house-keeping and medical chores.

The spacewalks conducted on 23 and 26 January were primarily designed to affix and to test a crane (Strela) on the Mir core module. The arm, which could be extended up to 14 m in length, would permit the transfer of the 500-kg Kristall solar panels to new sites on the Kvant 1 module as well as assist other EVA operations. The first EVA lasted just over five and a half hours, almost two hours longer than planned, but the crane was completely installed and checked-out with Manarov receiving a ride on the end of the crane as Afanasyev operated the device. Before the EVA was terminated another tray of sample materials (Ferritt) was retrieved from Kvant 2's hull and replaced with a new experiment (Sprut-5) designed to measure particle flows near the station (References 39-45).

With the Strela crane now operational, the two cosmonauts were tasked to prepare the Kvant 1 module to receive the Kristall solar panels. Their third EVA involved mounting two support structures on Kvant 1 (one on either side) in line with the main Mir solar panels. Actual transfer of the Kristall panels was not scheduled for this outing; however, laser reflectors were attached to the Mir complex before the 6 hour 20 minute EVA was over (References 41-42).

For the next month the pace of activity on board Mir slackened somewhat and a more routine regime was established. The cosmonaut's typical activities included strenuous exer-

cise periods, medical examinations, house-keeping and maintenance chores, and specific scientific investigations, e.g., in the fields of astrophysics, remote sensing, and materials science. The Kristall module was the site of several materials processing operations including the production of large gallium arsenide crystals in the Gallar furnace and other semiconductor materials in the Optizon crucibleless melting device. Afanasyev and Manarov also conducted remote sensing observations, including the consequences of the conflict in the Persian Gulf. At the end of January the Mir complex was passing over the region during mid-morning and early evening (local time), but within a week the space station's orbit had precessed, offering early-morning and mid-afternoon observation opportunities (Reference 46).

Although the entire month of February passed uneventfully for the crew, their busy daily schedules did not allow boredom to gain a foothold. Late in the month, the two men began concentrating on the completion of the Progress M-6 mission. The cargo ship was used to boost the orbital complex to a higher altitude on 27 February and again on 4 March. After refueling operations with Mir had been accomplished and station refuse had been loaded into Progress M-6, the unmanned spacecraft was undocked from Kvant 1 on 15 March and then sent to a destructive reentry into the Earth's atmosphere (Reference 47).

Four days after the departure of Progress M-6, its successor was launched by SL-4 from the Baikonur Cosmodrome. The Progress M-7 launch announcement issued by TASS indicated that the cargo ship carried the new recoverable capsule for the second time. Docking of Progress M-7 at the Kvant 1 aft port was scheduled for 1428 GMT on 21 March, almost 50 hours after lift-off. The rendezvous proceeded smoothly until Progress M-7 closed to within 500 m of the space station. At this point the Progress M-7 Kurs rendezvous and docking system computer failed to receive the anticipated guidance data and automatically terminated the operation (References 48-49).

The situation with the automated spacecraft was viewed seriously by mission control personnel but not with alarm. Although Progress M-7 was the first of 50 Progress-class vehicles to experience a problem of this nature, all three of the Mir modules (Kvant 1, Kvant 2, and Kristall)

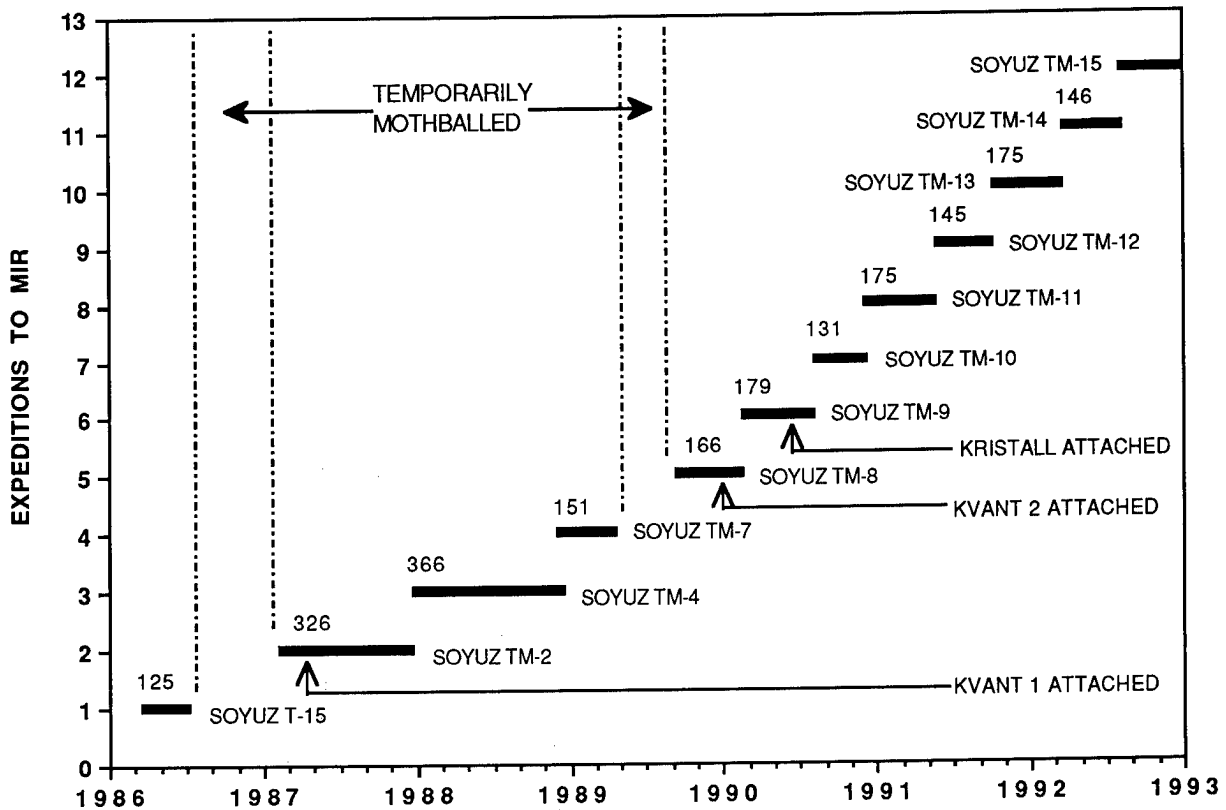

Figure 3.8 History of Expeditions to the Mir Space Station.

had failed on their first attempt to dock. With guarded optimism Progress M-7 was maneuvered back toward Mir on 23 March. In a virtual replay of the mishap two days earlier, the robot vehicle again faltered as the two spacecraft drew close. Progress M-7 veered away but missed the space station by a narrow margin, variously reported as within 5–12 m (References 51–55).

Analysis of telemetry from Progress M-7 suggested that the problem might reside on the Kvant 1 module. To verify this suspicion Afanasyev and Manarov were directed to reactivate their Soyuz TM-11 spacecraft, undock from Mir's forward port, and attempt an automatic redocking with Kvant 1. On 26 March with Progress M-7 being maintained in an orbit close to the space station, the two cosmonauts separated from Mir and brought their Soyuz TM-11 ferry in line with Kvant 1's aft port. Again, the automatic rendezvous and docking system failed, but this time the docking could be achieved manually (Reference 56).

Even through the Kvant 1 auto docking system remained inoperable, the immediate situation was resolved by commanding Progress M-

7 to dock with the now vacant port at the forward end of Mir. This was finally accomplished without further incident on 28 March, one week after the first docking attempt. Had a similar scenario developed prior to the introduction of the Progress M spacecraft in 1989, an older Progress would probably have been lost without the extra electrical power and integrated propulsion system of Progress M (References 51, 57).

Initial reports from the Mir cosmonauts indicated that the Kvant 1 Kurs antenna was "dislocated." Apparently, Afanasyev and Manarov had inadvertently bumped the antenna while installing the laser reflectors on their last EVA of 26 January. A new EVA was tentatively scheduled for late April to inspect the site and to ascertain the degree of damage inflicted.

Another consequence of the three procedures and the 9-day independent flight of Progress M-7 was the extensive consumption of propellants which would have been used to raise the space station to a slightly higher orbit and to replenish the propellant tanks feeding Mir's attitude control system. Mir's own primary propulsion system had been disabled since the

docking of Kvant 1 in 1987. By 11 April the Mir complex had fallen to its lowest mean altitude of the year (369 km), and a decision was made to transfer propellants from Mir to Progress M-7, which then could push the space station into a higher orbit. This operation was performed successfully with a series of burns by Progress M-7 during 12–13 April, lifting the complex approximately 7 km (Reference 58).

Two weeks later Afanasyev and Manarov were given the opportunity to perform a final EVA. In addition to their inspection of Kvant 1, the men were to engage in a number of activities: reinstall the camera removed from Kvant 2's mobile platform during their 7 January EVA, retrieve a boom made of carbon-reinforced plastic for structural tests, deploy and return a sample specimen associated with the Sofora girder experiment planned for the summer, and place "highway markers" along the Mir complex to assist future cosmonauts working outside the space station.

The EVA was conducted over a span of about three and one-half hours during the evening of 25 April and was largely successful. Manarov examined the antennas of Kvant 1 while Afanasyev remained at Kvant 2 to mount the aforementioned camera. This breach of the buddy policy earned the cosmonauts a mild rebuke. Manarov discovered that the antenna dish, approximately 23 cm in diameter, was completely missing. Purportedly, it had been knocked-off by the boot of one of the cosmonauts in January. Manarov took careful note of the present condition of the antenna to permit support personnel to fabricate a repair kit for the next Mir crew (References 59–60).

With the successful completion of their fourth EVA, Afanasyev and Manarov entered the final days of their mission. The difficulties encountered with the rendezvous and docking system, particularly the delay in docking Progress M-7, led to a slip in the launch schedule of the next Mir crew from 12 May to 18 May. Meanwhile, operations with Progress M-7 had to be finished, including the loading of the return capsule with the fruits of months of materials science and remote sensing activities.

The robot spacecraft was undocked late on 6 May (early 7 May, Moscow time) and prepared for reentry by personnel at the Kaliningrad Flight Control Center outside Moscow. The de-orbit burn commenced at

1624 GMT on 7 May as the spacecraft passed over the south Pacific Ocean, west of South America. The maneuver appears to have been successful, but the return capsule was never recovered. Although hope remained for several months that the approximately 380-kg capsule had survived reentry and would be found, by year's end the precious cargo had not been located (References 61–63).

Preparations for the launch of Soyuz TM-12 drew world-wide attention not for the objectives of the 5-month mission but for the composition of its crew. Commanding the flight was Anatoli Artsebarskiy, a Lieutenant Colonel in the Soviet Air Force and a native of the Ukrainian Republic, making his first flight into space. The Flight Engineer assignment was awarded to Sergei Krikalev, a Russian national and member of the Energiya NPO which manages the Mir space station program. Krikalev was a veteran of the 151-day Soyuz TM-7 mission in 1988–1989.

The third member of the Soyuz TM-12 crew was clearly the center of the attention: Helen Sharman, a 27-year-old research technologist from Great Britain. Dubbed the Juno mission, the joint Soviet-British space flight emerged from a commercial venture announced in 1989. Against a backdrop of severe financial difficulties, which eventually led the Moscow Narodny Bank (a Soviet-owned British bank) to underwrite the 16-million-pound-sterling mission, Sharman along with Major Timothy Mace were selected in November, 1989, and began their indoctrination at the Yuri Gagarin Cosmonaut Training center immediately. On 22 February 1991, Sharman was named the primary candidate. This selection was not officially confirmed until 17 May, the day before launch (Reference 64).

A comprehensive, scientific program had been proposed for Sharman and her Soviet colleagues during her six-day stay on board the Mir complex. Twenty-six experiments in the fields of botany, biology, materials science, and physiology proposed by British researchers were replaced by 16 Soviet experiments in these same fields in addition to Earth observations after the collapse of British financing efforts. Some of the equipment needed for these experiments was delivered by the Progress M-7 spacecraft in March.

The launch of Soyuz TM-12 on 18 May occurred precisely on schedule, and the subse-

Table 3.1 Mir Space Station Logistical Summary, 1991-1992.

Spacecraft	Docking Date	Undocking Date	Space Station Port	Total Stay	Comment
Soyuz TM-11	4 Dec 90 26 Mar 91	26 Mar 91 26 May 91	Mir, forward Kvant 1, aft	173 days	Brought crew of Afanasyev, Manarov, Akiyama; Returned with crew of Afanasyev, Manarov, Sharman
Progress M-6	16 Jan 91	15 Mar 91	Kvant 1, aft	58 days	
Progress M-7	28 Mar 91	6 May 91	Mir, forward	39 days	Failed 21 and 23 Mar to dock at Kvant 1 aft port; capsule was lost during reentry on 7 May 91
Soyuz TM-12	20 May 91 28 May 91	28 May 91 10 Oct 91	Mir, forward Kvant 1, aft	142 days	Brought crew of Artsebarskiy, Krikalev, Sharman; Returned with crew of Artsebarskiy, Aubakirov, Viehboeck
Progress M-8	1 Jun 91	15 Aug 91	Mir, forward	76 days	Brought MAK-1 satellite which was released 17 June 91
Progress M-9	23 Aug 91	30 Sep 91	Mir, forward	38 days	Capsule was recovered 30 Sep 91
Soyuz TM-13	4 Oct 91 15 Oct 91 14 Mar 92 14 Mar 92	15 Oct 91 14 Mar 92 25 Mar 92	Mir, forward Kvant 1, aft Mir, forward	173 days	Brought crew of Volkov, Aubakirov, Viehboeck; Returned with crew of Vokov, Krikalev, Flade
Progress M-10	21 Oct 91	20 Jan 92	Mir, forward	81 days	Failed 19 Oct to dock at Mir forward port; capsule was recovered 20 Jan 92
Progress M-11	27 Jan 92	13 Mar 92	Mir, forward	46 days	
Soyuz TM-14	19 Mar 92	9 Aug 92	Kvant 1, aft	143 days	Brought crew of Viktorenko, Kaleri, Flade; returned with crew of Viktorenko, Kaleri, Tognini
Progress M-12	21 Apr 92	27 Jun 92	Mir, forward	67 days	
Progress M-13	4 Jul 92	24 Jul 92	Mir, forward	19 days	Failed 2 Jul to dock at forward port
Soyuz TM-15	29 Jul 92	1 Feb 93	Mir, forward	187 days	Brought crew of Solovyev, Audeyev, Tognini; Returned with crew of Solovyev, Audeyev
Progress M-14	18 Aug 92	21 Oct 92	Kvant1, aft	65 days	Capsule was recovered 22 Oct 92
Progress M-15	29 Oct 92	4 Feb 93	Kvant 1, aft	97 days	Brought MAK-2 which was released 20 Nov 92 and the Banner experiment which was deployed 5 Feb 93

quent two-day rendezvous proceeded without incident. In the process Sharman became only the third woman to fly on a Soviet spacecraft (after Valentina Tereshkova in 1963 and Svetlana Savitskaya in 1982 and 1984) and the first woman sent to the Mir space Station. During the final approach to Mir, the automatic docking procedure was aborted when the Kurs system (Mir forward end) failed to provide complete relative motion data. However, Artsebarskiy and Krikalev quickly assumed control of Soyuz TM-12 and docked manually at the scheduled time (References 65-66).

While Sharman concentrated on fulfilling her assigned tasks, with occasional assistance from crew members, Artsebarskiy and Krikalev spent the majority of their time conferring with Afanasyev and Manarov about the status of the complex and the transfer of command to the newcomers, the ninth Mir expedition in more than five years. Afanasyev and Manarov would return to Earth with Sharman in the Soyuz TM-11 spacecraft, leaving Artsebarskiy and Krikalev on board until their own relief crew arrived in October. On 24 and 25 May the Soyuz TM-11 vehicle was re-activated, tested, and loaded with materials from a large number of experiments. Also during these final days, Afanasyev and Manarov had to set aside time wearing the Chibis apparatus which facilitates the body's readaption to 1-g environment by promoting blood circulation in the lower extremities.

Like the launch eight days earlier, the return to Earth of Afanasyev, Manarov, and Sharman proceeded smoothly. A gentle touchdown occurred in Kazakhstan, northeast of the Baikonur Cosmodrome where the Juno mission had originated. In addition to the numerous records established by Sharman in accordance with her sex and nationality, Musa Manarov shattered the previous world record for total time in space (nearly 431 days by Yuri Romanenko during three missions) with an accumulated flight time of 541 days on two missions (Reference 67).

The departure of Soyuz TM-11 left the Kvant 1 aft port vacant. However, since the Kurs rendezvous system at this port was still inoperable, Progress M cargo ships were still prevented from mooring there. To receive new supplies, Artsebarskiy and Krikalev needed to repeat the actions of their predecessors, i. e., move their Soyuz TM transport from the Mir

forward port and dock manually at the Kvant 1 aft port. This maneuver was accomplished on 28 May. Two days later Progress M-8 was launched, arriving at Mir on 1 June (References 68-70).

The program for the Soyuz TM-12 cosmonauts during June and July was exceptionally intensive, and its success would directly dictate the course of future expeditions. One of the first orders of business was to employ the Progress M-8 propulsion system for a series of orbit adjustments which would compensate for the loss of propellant on the Progress M-7 mission. Between 6 and 19 June, the orbit of the Mir complex was raised more than a half-dozen times, adding a full 30 km to the station and boosting it to a mean altitude of approximately 395 km.

On 17 June, prior to the last minor orbital adjustment, the MAK-1 upper atmospheric scientific satellite, developed by the Moscow Aviation Institute, was ejected from the Mir space station. (Two small satellites, Iskra 2 and Iskra 3 had been launched in a similar manner from one of the experiment/waste air-locks of Salyut 7 in 1982.) Identified in the popular press as the first satellite to be launched from Mir, MAK-1 was actually the 114th satellite from the space station tracked and cataloged by the US Space Surveillance Network. The previous objects, including 10 released just the week before, are believed to be debris originating from intentional dumpings or created during EVAs. For example, a total of 15 new objects were found after the four EVAs conducted in January and April, 1991.

The MAK-1 satellite received the international designator 1986-17 DV and the US satellite number 21425. Unfortunately, communications with the satellite were never established, and it reentered the Earth's atmosphere on 18 October without completely fulfilling its mission. A second MAK satellite launch scheduled for the Soyuz TM-12 crew was postponed for 17 months (References 71-73).

A week after the launch of MAK-1 from Mir, Artsebarskiy and Krikalev ventured outside the space station on the first of six EVAs to be conducted over the course of a little more than one month. The first spacewalk during the night of 24-25 June was primarily concerned with the repair of the Kvant 1 Kurs antenna. With an array of specially designed tools, the two men

completed the complex task, replacing the damaged appendage with a new one delivered by Progress M-8. However, revised mission plans prevented an operational test of the Kurs system to verify the success of the repair until the fourth quarter of the year (References 74–75).

A second objective of the 6-hr EVA, one which would greatly affect planned July activities as well as the future operation of the Mir complex, was the testing of a new thermo-mechanical joint designed for use in the assembly of large space structures. An experimental model of a girder using those joints was deployed and temporarily attached to the exterior of the space station.

Four days after the first EVA, the two cosmonauts were ready for their next chores in open space. This time the goals were more modest. An experiment provided by the University of California and delivered by the Progress M-8 cargo ship was installed outside the complex to detect and to characterize cosmic rays of particularly heavy nuclei. A new television camera was attached to one of the space station's solar panels, and the thermo-mechanical joints tested on the previous EVA were retrieved for closer inspection inside Mir. In all, Artsebarskiy and Krikalev spent less than three and one-half hours on this second EVA (Reference 76).

After a two-week respite the two cosmonauts began preparing for an arduous job of space construction which would require nearly 24 hours outside the safe confines of Mir. Their goal was to assemble and to erect a 14.5-m-tall, 0.5 m wide girder under a project named Sofora. The girder would be comprised of 20 cubical units relying on titanium-nickel fasteners with "thermal shape memory." Attached to Kvant 1, the tower was to later support a new attitude control engine designed to improve the stability of the station along the roll axis. The construction activity was reminiscent of an experimental girder built on the Salyut 7 space station in 1986, but the technique to be employed on Mir was new. If Sofora withstood the rigors of the harsh space environment for one year without detrimental effects, plans for mounting the attitude control engine could proceed (References 77–80).

The work began on 15 July when Artsebarskiy and Krikalev prepared the site on top of the Kvant 1 module. The Strela crane

was used to transport the equipment easily from the Kvant 2 air-lock to the aft end of the space station. The men first affixed two ladders along the surface of Kvant 1 to aid their footing. Next, the platform for the girder was unfolded and securely fastened to Kvant 1. Four "installation and heating" devices were then connected to the Mir electrical power grid in preparation to apply the thermo-mechanical couplers. All these tasks were completed and the cosmonauts had returned inside Mir in just under six hours (Reference 81).

Between each of their EVA's Artsebarskiy and Krikalev were allowed four days to rest, to recharge and ventilate their space suits (the latest Orlan-DMA model rated for 10 EVAs), and to review the tasks for the next outing. During the second EVA on 19 July the men installed an assembly unit on Kvant 1 with which to build the cubical segments of the girder. A pre-assembled section was completed, and two more sections were built in the five and a half hour EVA (References 82–84).

The third and fourth EVAs were conducted on schedule on 23 and 27 July. With the experience gained on EVA number two, Artsebarskiy and Krikalev increased their efficiency, completing 11 more segments on the third EVA and easily finishing all 20 on the last. The completed girder, including a USSR flag attached on the initiative of the cosmonauts, was then raised into a nearly vertical (79°) position. Toward the end of the last EVA, Artsebarskiy's visor became fogged due to his exertion and a taxing of the space suit's ventilation system, and Krikalev had to assist his comrade back to the air-lock. The EVA lasted 6 hours and 49 minutes, the longest space walk of 1991–1992. In total, the four EVAs had taken 23 hours and 47 minutes, but all objectives had been met (References 85–86).

In the midst of this extraordinary operation, the USSR announced a significant change in the Mir program schedule for the remainder of the year. Originally, the next mission (Soyuz TM-13) was to carry two Soviets to relieve the Soyuz TM-12 crew and a visiting Austrian cosmonaut. That mission was to be followed by Soyuz TM-14 with two regular members of the cosmonaut corps and a Kazakh cosmonaut. For a variety of reasons the two missions were integrated to produce a Soyuz TM-13 crew consisting of the Austrian and the Kazakh on an

8-day mission and a Soviet mission commander on a 6-month tour of duty. This meant that while Artsebarskiy could be relieved, Krikalev had to stay on Mir until Soyuz TM-14 was launched in early 1992 (references 87-89).

In the wake of the revised mission plan and the world-shaking events in Moscow during August, little notice was given to the cancellation of two additional EVAs scheduled for the Soyuz TM-12 crew to transfer the large solar panels on Kristall to Kvant 1. With virtually no explanation this important restructuring of the space station, already postponed from the beginning of the year, was eventually delayed until 1993.

By 15 August the mission of Progress M-8 had been completed except for one final experiment. As the cargo ship was undocked, an inflatable balloon was released in the first of many promised experiments. Unfortunately, the integrity of the balloon failed, and full inflation did not occur. The limp satellite decayed quickly and reentered the Earth's atmosphere two weeks later (References 90-92).

Four days after Progress M-8 was intentionally reentered over the Pacific Ocean on 16 August, Progress M-9 was launched, arriving at Mir shortly after midnight on 23 August. Among its cargo were a new ballistic return capsule and two space-age cans of Coca-Cola. (The first test of a Coke in space had occurred on a US Space Shuttle in July, 1985). The unmanned freighter also brought equipment to be used during the Austrian mission in October (References 93-95).

The remainder of August and September passed with little fanfare as Artsebarskiy and Krikalev performed a variety of astronomical, materials science, remote sensing, and other scientific work in addition to their routine chores. During 27 August-14 September Progress-9 was used to raise the space station several times, finally reaching an altitude just over 400 km. On the last day of September Progress M-9 was undocked to clear the way for the arrival of Soyuz TM-13. This time the reentry capsule was successfully recovered in the USSR (Reference 96).

Soyuz TM-13 was launched from the Baikonur Cosmodrome on 2 October for a docking at Mir on 4 October, the 34th anniversary of Sputnik 1 and the beginning of the space age. Commanding the spacecraft was Colonel

Alexander Volkov, a veteran of the Soyuz T-14 (1985) and Soyuz TM-7 (1988-1989) with a total of 216 days experience in space. The normal Flight Engineer's position was omitted to accommodate two visiting researchers, Toktar Aubakirov of Kazakhstan and Franz Viehboeck of Austria. Aubakirov was assigned to the Soyuz TM-13 mission after his scheduled flight on Soyuz TM-14 on 21 November was canceled in July. Although Aubakirov was not the first Kazakh native to fly in space, his presence represented a new official program to establish an identity for Kazakh aerospace endeavors. Viehboeck's participation grew out of a 1988 commercial agreement sponsored by the Austrian Government for a reported 19 million dollars, including a direct payment of 7 million dollars to the USSR (References 97-100).

An hour and a half after docking the Soyuz TM-13 crew was able to join their hosts on-board Mir and to begin the two research programs: Kazakhstan-Kosmos for Aubakirov and Austromir for Viehboeck. Both programs included a large number of biomedical experiments as well as materials science activities and Earth observations. Meanwhile, Volkov conferred with Artsebarskiy and Krikalev on matters regarding the partial crew rotation. Two days before the end of these joint operations the Soyuz TM-12 spacecraft was rechecked to ensure its proper working condition (References 101-104).

On 10 October Artsebarskiy, Aubakirov, and Viehboeck returned safely to Earth a little more than three hours after undocking from Mir. Along with the cosmonauts were the results of the American-sponsored experiment to measure radiation levels outside the Mir space station to assist in spacecraft design and the development of protection for future cosmonauts (Reference 105). The departure of Soyuz TM-12 left the Kvant 1 docking port open for future Progress M resupply missions since the Kurs antenna had been repaired in June. However, Volkov and Krikalev were instructed to undock the Soyuz TM-13 spaceship from the Mir forward port and redock with Kvant 1 in a final test of the automatic rendezvous and docking system. This operation was successfully carried out on 15 October on a short fly-around lasting 1 hour 44 minutes.

Two days later Progress M-10 was launched carrying another reentry capsule in the wake of the successful Progress M-9 capsule recovery.

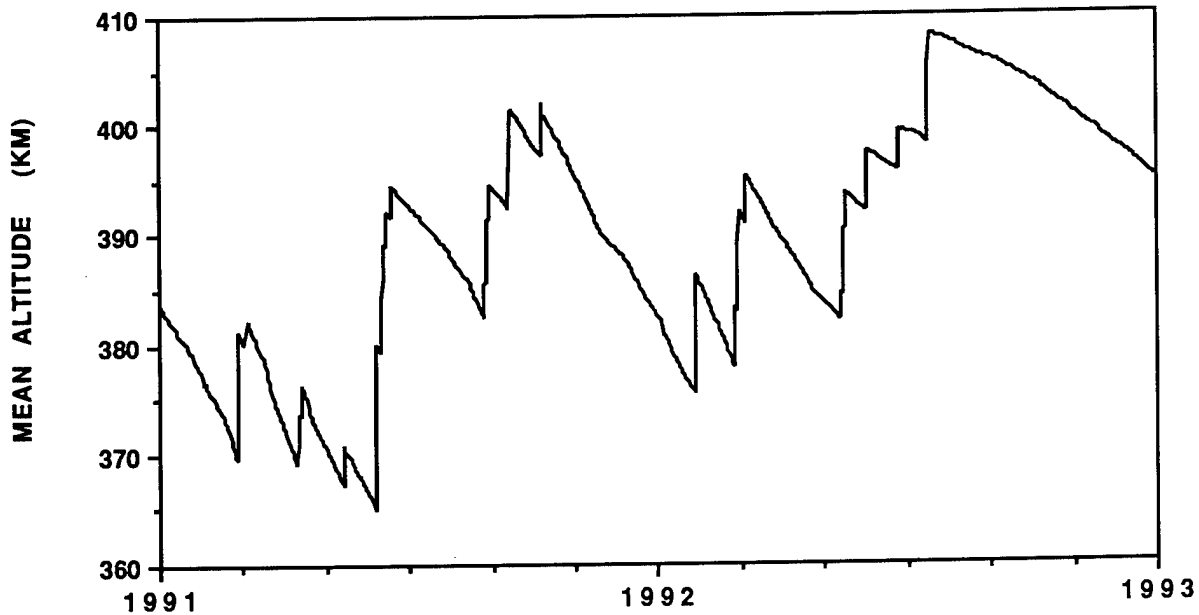

Figure 3.9. 1991-1992 Orbital History of the Mir Space Station.

What should have been a routine rendezvous and docking on the morning of 19 October failed to materialize. At a distance of 150 m the computer on board Progress M-10 abruptly terminated the approach and the docking was temporarily canceled. Two days later a second attempt succeeded without incident, and Progress M-10 became the latest spacecraft to join the Mir orbital complex. In fact, no further dockings or undockings occurred until after the new year (References 104–106).

The remainder of 1991 was anti-climatic with Volkov and Krikalev engaged in numerous materials science and Earth observation experiments. No further comments were made concerning the EVAs which apparently had been planned for the duo to move the Kristall solar panels to Kvant 1. Tests were made with the Volna-2 equipment to examine new techniques for transferring propellants under microgravity conditions, and instruments left over from the Austrian mission were employed for biomedical studies. Maintenance chores, including replacing Mir storage batteries with new units brought by Progress M-10, continued to consume much of the cosmonauts' time. Progress M-10 refueled Mir, but no orbital corrections were performed (Reference 107).

In November and December, the imminent transfiguration of the USSR into the CIS was proceeded by political and bureaucratic changes of significant importance to Volkov,

Krikalev, and the entire Mir space program. On 5 November the Russian Council of Ministers decreed that the Mir orbital complex was the property of the Energiya NPO. Ten days later the Russian Ministry of Industry was put in charge of Energiya NPO's fixed assets, including those at the Baikonur Cosmodrome. (On 31 August, shortly after the attempted coup, Kazakhstan unilaterally assumed jurisdiction of most of the Baikonur Cosmodrome from the USSR.) To help offset the rapidly growing rate of inflation, a government resolution was adopted on 6 December restructuring the pay scales and benefits for the various levels of cosmonauts (References 108–109).

3.1.2 1992 Operations

Despite the historic changes and accompanying social upheaval surrounding the rebirth of the USSR as the CIS, the Mir space station program in 1992 was able to persevere amid hardships and to maintain a business-as-usual facade. Although still not complete, the nearly 6-year-old Mir continued to function without major problems. With the launch of the remaining two modules (Priroda and Spektr) delayed yet again until 1993 or later, the principal tasks for the year included the repair or replacement of attitude control gyroscopes (5 of 12 were inoperable), transfer of the Kristall solar arrays to Kvant 1 (total available power was down to 10 kW from a theoretical 28 kW), and the installa-

tion of a roll control engine on the top of the Sofora girder. Three manned missions (including two with foreign guests) to Mir were also planned for 1992 as were 5–6 automated resupply flights (References 110–112).

Logistical activity began soon after the start of the new year. During the first half of January operations with Progress M-10 were brought to an end, and its ballistic capsule was loaded with the products of months of research. The scheduled 18 January undocking of the vehicle was delayed two days due to attitude control problems. However, Progress M-10 was separated without difficulty on 20 January, and the ballistic capsule survived reentry and was recovered in Kazakhstan. Back on Mir, Volkov and Krikalev repaired a wiring problem in the attitude control system in preparation for future spacecraft.

Five days later the first mission of the year lifted-off from the Baikonur Cosmodrome in the form of Progress M-11. Unlike its predecessor, the new spacecraft docked easily at Mir's forward port less than 50 hours after launch. The only excitement surrounding the mission were rumors of a possible strike at the Kaliningrad Flight Control Center prior to docking. Fortunately, the labor unrest did not transform into a work stoppage. In Progress M-11's forward cargo hold was a 5 kg protein crystallization device belonging to the American firm of Payload Systems, Incorporated. A total 96 individual experiments prepared by international scientists were to be conducted during a 55-day period before the package was returned to Earth inside Soyuz TM-13. Also included in the total 2,576 kg of supplies were equipment needed for the upcoming Russian-German mission in March (References 115–117).

The next major event occurred on the evening of 20 February when Volkov and Krikalev undertook the only EVA of the Soyuz TM-13 expedition. Plans to reposition the Kristall solar panels were once again postponed, and the duo were asked to perform an assortment of minor chores, including the cleaning of an exterior video camera, the dismantlement of auxiliary equipment used in the construction of the Sofora girder, the retrieval of an experimental section of solar cells which had been deployed during another EVA almost exactly four years earlier, and the installation of trays outside Kvant 2 to evaluate the effects of the space environment on a variety of material

samples. The EVA encountered difficulties immediately due to a faulty thermal control system in Volkov's space suit. While Volkov remained near the Kvant 2 air-lock, Krikalev made his way along the length of the complex to Kvant 1 and accomplished all the assigned tasks somewhat to the chagrin of mission managers who were concerned about Krikalev working without a backup. The spacewalk lasted a total of 4 hours 12 minutes, three minutes shorter than planned despite Volkov's problems (References 118–122).

Three weeks later final preparations were made to receive the first manned mission of 1992. On 13 March Progress M-11 was separated after a stay of 46 days and was sent on a destructive reentry into the Earth's atmosphere the same day. In a surprising move, the next day Volkov and Krikalev moved their Soyuz TM-13 ferry back to Mir's forward port where Progress M-11 had been berthed. This meant that after Soyuz TM-13 had finally returned to Earth, the new Soyuz TM-14 crew would begin receiving resupply ships at the Mir port rather than the Kvant 1 port. Less than 72 hours after this latest round of cosmic musical chairs, Soyuz TM-14 was launched from Baikonur.

Commanding Soyuz TM-14 was Col. Alexander Viktorenko, a veteran of Soyuz TM-3 (8 days) and Soyuz TM-8 (116 days), looking forward to this third visit to Mir and his second long-duration stay. Assisting him as Flight Engineer was Energiya NPO's Alexander Kaleri, making his first space flight to become the USSR/CIS's 73rd cosmonaut. The third seat in the Soyuz TM capsule was filled by German citizen Klaus-Dietrich Flade, a military pilot who had begun training at Star City for this flight in November, 1990. The 38-million-DM German project, dubbed Mir-92, included up to 15 experiments with a total mass of 100 kg and a 10-kg allowance for the return of materials to Earth (References 123–128).

After performing a series of orbital maneuvers devised by mission control, the Soyuz TM-14 crew approached the Mir complex on 19 March. The rendezvous and docking was to be performed automatically in a further re-certification test of the repaired Kurs antenna, particularly from long range. The procedure was accomplished without incident with docking coming less than 50 hours after launch. For the next 140 hours Flade labored to fulfill as many of the

Mir-92 objectives as possible, concentrating primarily on biomedical and materials science experiments. On 25 March Flade returned to Earth in Soyuz TM-13 with cosmonauts Volkov and Krikalev, the latter adding 312 days to his space flight experience for a total of more than 463 days. Despite initial reports to the contrary, Krikalev apparently suffered no serious effects from his long-term mission. Accompanying the three men in the Soyuz TM-13 command module were the results of the American Payload Systems, Inc., materials science package brought to Mir by Progress M-11 with experiments from Canada, Europe, Japan, and the US (References 129–133).

With the departure of Soyuz TM-13, Viktorenko and Kaleri began their 5-month-long expedition in earnest, concentrating scientific duties in the fields of astrophysics, biomedicine,

and materials science. No EVA's were planned for this mission, but the two crewmen were prepared to undertake such activities if required – a necessity which eventually came to pass. The first resupply ship for the pair, Progress M-12, was not launched until 19 April, followed by a routine docking at Mir's forward port late on 21 April (Reference 134).

In mid-May Viktorenko and Kaleri performed the first of several maneuvers with Progress M-12 which by mid-July would raise the orbital complex to its highest altitude of the 1991-1992 period (Figure 3.9). After a stay of 67 days the cargo ship was released and almost immediately sent on a destructive reentry into the atmosphere on 27 June. Less than three days later Progress M-13 was launched to continue necessary logistical operations. In a disturbingly familiar scenario, the first attempt to rendez-

Table 3.2. Mir Extra-Vehicular Activities, 1991-1992.

Date	Crew Members	Duration	Activities
7 Jan 91	Afanasyev, Manarov	5 hr 18 min	Repaired Kvant 2 airlock hatch
23 Jan 91	Afanasyev, Manarov	5 hr 33 min	Assembled exterior crane on Mir
26 Jan 91	Afanasyev, Manarov	6 hr 20 min	Installed solar panel supports on Kvant 2
25 Apr 91	Afanasyev, Manarov	3 hr 34 min	Inspected Kvant 1 Kurs antenna
24 Jun 91	Artsebarskiy, Krikalev	4 hr 58 min	Repaired Kvant 1 Kurs antenna
28 Jun 91	Artsebarskiy, Krikalev	3 hr 24 min	Deployed US-USSR experiment and performed miscellaneous chores
15 Jul 91	Artsebarskiy, Krikalev	5 hr 56 min	Started construction of Sofora girder
19 Jul 91	Artsebarskiy, Krikalev	5 hr 28 min	Continued construction of Sofora girder
23 Jul 91	Artsebarskiy, Krikalev	5 hr 34 min	Continued construction of Sofora girder
27 Jul 91	Artsebarskiy, Krikalev	6 hr 49 min	Completed construction of Sofora girder
20 Feb 92	Volkov, Krikalev	4 hr 12 min	Performed miscellaneous chores
8 Jul 92	Viktorenko, Kaleri	2 hr 3 min	Performed maintenance on Kvant 2 gyrodynes
3 Sep 92	Solovyev, Avdeyev	3 hr 56 min	Began VDU installation on Sofora
7 Sep 92	Solovyev, Avdeyev	5 hr 8 min	Continued VDU installation on Sofora
11 Sep 92	Solovyev, Avdeyev	5 hr 44 min	Completed VDU installation on Sofora
15 Sep 92	Solovyev, Avdeyev	3 hr 33 min	Performed miscellaneous chores and realigned Kristall Kurs antenna
	Total	77 hr 30 min	(155 man-hrs)

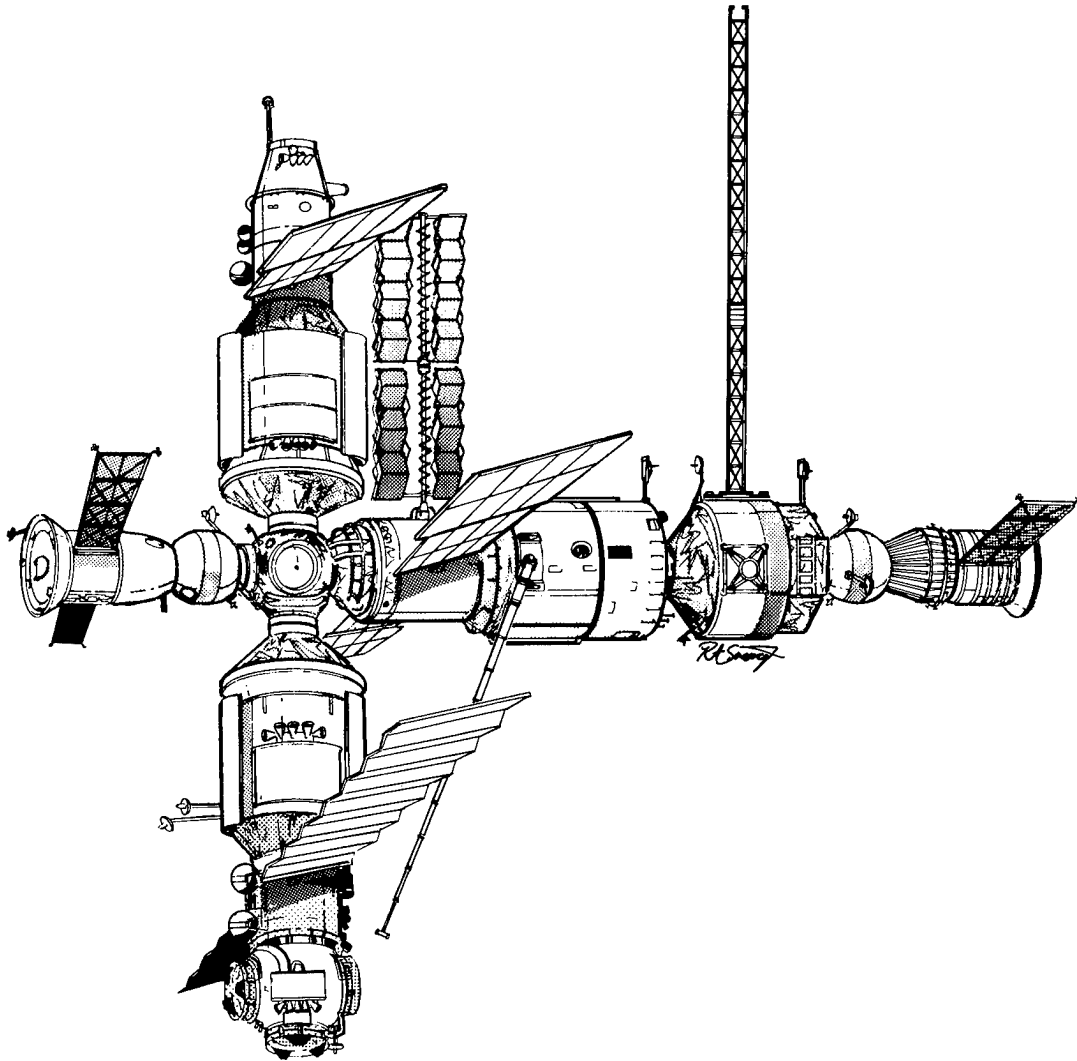

Figure 3.10. The Mir Space Station Complex in August, 1992.

vous and dock with the orbital station on 2 July failed due to an attitude control problem. However, a second try on 4 July was successful (Reference 135).

Before the Soyuz TM-14 cosmonauts could begin serious unloading operations, they had to prepare for a short spacewalk aimed at investigating the difficulty of repairing and replacing gyrodyne stabilization control units. Four of the six devices on Kvant 2 were already inoperative while one of the Kvant 1 gyrodynes was also out of service. On 8 July, Viktorenko and Kaleri ventured outside the Mir space station to examine the gyrodynes installed on the exterior of Kvant 2 just below the air-lock chamber. The spacewalk, which lasted only two hours and three minutes, was reported to be a prelude for

extensive gyrodyne maintenance planned for 1993 or 1994 (References 136–137).

The next major event on the space station was the arrival of the twelfth expedition, Soyuz TM-15, scheduled to dock in late July. To prepare for the new spacecraft, Progress M-13 was cast-off on 24 July and de-orbited later that day. On 27 July Soyuz TM-15 was launched from the Baikonur Cosmodrome with a Russian-French crew. Commanding the mission was Col. Anotoli Solovyev, a veteran of Soyuz TM-5 in 1988 (10 days) and Soyuz TM-9 in 1990 (179 days). His flight engineer was rookie cosmonaut Sergei Avdeyev, a member of the Energiya NPO. Representing France on the 73 million Franc Antares mission, the third flight of a French national to a USSR/CIS space station,

was Michel Tognini, a colonel in the French Air Force, who had previously trained for the 1988 Aragatz mission (Soyuz TM-7). The docking of Soyuz TM-15 and Mir took place on 29 July but only after the crew intervened when the automatic system malfunctioned (References 138–141).

From 29 July until 9 August the Mir space station was home to five men. While Tognini conducted his primary program of six biomedical, two fluids and materials, and two technological experiments with 300 kg of specialized equipment, the Mir resident crew was busy handing over control of the complex to its replacement. Undocking of Soyuz TM-14 with Viktorenko, Kaleri, and Tognini occurred late on 9 August, followed by a successful landing in Kazakhstan early on 10 August (References 142 and 143).

One week after the departure of Soyuz TM-14, Progress M-14 arrived at the station, the first unmanned docking at the Kvant 1 aft port since January, 1991 (Figure 3.10). The cargo ship, with 2.5 metric tons of materials including a return capsule, was specially modified to carry a 700 kg attitude control engine unit (VDU) to be installed on the top of the Sofora tower. To accommodate the VDU and to facilitate its attachment to Mir, Progress M-14's central section was redesigned and the normal propellant tanks were removed. Under commands from mission control, the VDU was automatically unloaded from Progress M-14 on 2 September in preparation for its transfer to Sofora (References 144–146).

Following the pattern set the previous year, four EVAs were planned at four-day intervals. The first EVA, which lasted nearly four hours, occurred on 3 September and was devoted to moving the VDU to the planned assembly site and to affixing a locking device on Sofora to secure the girder during future operations. During the next spacewalk on 7 September Solovyev and Avdeyev laid a control cable along the Sofora girder for remote control of the VDU. This operation was made easier by collapsing Sofora at its hinge about one-third up the mast, allowing the top of the mast to be brought down toward the main complex.

Also at this time the metal frame which had held the USSR flag erected the previous year was removed. The flag itself was literally gone, having been shredded by natural and artificial debris. A potentially serious communications

problem developed during the EVA when direct contact to Kaliningrad via a data relay satellite was lost and the Ukrainian ground control center failed to assist the cosmonauts (References 147–149).

The VDU installation operations were completed on 11 September with a nearly 6-hour-long EVA. The engine unit was firmly fastened to the top of the Sofora girder, and the girder was then raised into its full upright position. The total time spent outside Mir on the three EVAs was slightly less than 15 hours. The final spacewalk on 15 September lasted only three and a half hours and was devoted to retrieval of a section of experimental solar cells and special material samples and to repositioning the Kurs antenna on the Kristall module in preparation for the Soyuz TM-16 mission in early 1993 (References 149–151).

The remainder of 1992 passed relatively uneventfully for Solovyev and Avdeyev. On 21 October the mission of Progress M-14 came to an end, and its return capsule safely landed in Kazakhstan just after midnight GMT on 22 October. Five days later Progress M-15 was launched, arriving at Mir on 29 October. Of the many equipment on board were two Canadian devices, code-named Kondor, designed to measure radiation levels which might affect the Mir cosmonauts. Actual operation of the monitors began on 17 November and continued through December.

In November two noteworthy events involved other satellites. On 8 November Kosmos 1508, a small Soviet calibration satellite, passed within 300 m of the space station with a relative velocity of 12.7 km/s. The probability of collision (due to trajectory uncertainties) was only 2.1×10^{-5} . Twelve days later Solovyev and Avdeyev launched their own satellite from Mir. Named MAK-2, the small vehicle was similar to MAK-1 (released in June, 1991) which failed to operate properly. MAK-2 decayed on 1 April 1993.

At the end of 1992, Solovyev and Avdeyev were looking forward to being relieved by the next expedition in late January, 1993. Soyuz TM-16 was slated to carry only a two-man crew but would test the new APAS-89 docking unit on the Kristall module. This spacecraft had originally been scheduled to fly to Mir in conjunction with a test of the second Buran space shuttle in 1991–1992. After that mission was postponed several times, a decision was made to fly the

modified Soyuz TM on a regular expedition.

Two additional manned missions were scheduled in 1993: Soyuz TM-17, carrying a French cosmonaut on a short duration visit in July, and Soyuz TM-18 with an all-CIS crew in November. The latter mission might initiate an attempt to set a new long duration record of 16–18 months for at least one of the crew. Although five Progress M flights were manifested for 1993, the large Spektr and Priroda modules (Section 4.3.1) were tentatively rescheduled for 1994–1995, and the prospect of a Mir-Buran linkup remained very much in doubt.

Despite earlier optimistic forecasts for international missions to Mir in the mid-1990's, few firm arrangements have been reached. France plans to continue its joint activities with Russian-French missions in 1996, 1998, and 2000, and an American astronaut will fly to Mir (Soyuz TM-

21) in early 1995 to be retrieved during the US Space Shuttle-Mir docking mission a few months later. (In late 1993 a Russian cosmonaut will be a member on a US STS mission.) NASA has also considered conducting a Space Shuttle rendezvous with Mir in 1994 but not docking the two vehicles. ESA astronauts may be included on missions in 1994 (Soyuz TM-20) and 1995 (Soyuz TM-22), and a joint Russian-Canadian flight is possible in 1994 (Soyuz TM-19). Discussions with other countries in Europe and Asia, particularly Israel, have failed to produce firm commitments. Also, lacking significant support were proposals for an all-Ukrainian mission and the flight of a Russian journalist to Mir.

At the start of 1993 the course of the Mir space program was still in doubt. Under one scenario the complex would be completed by 1995 (Figure 3.11) and then maintained through

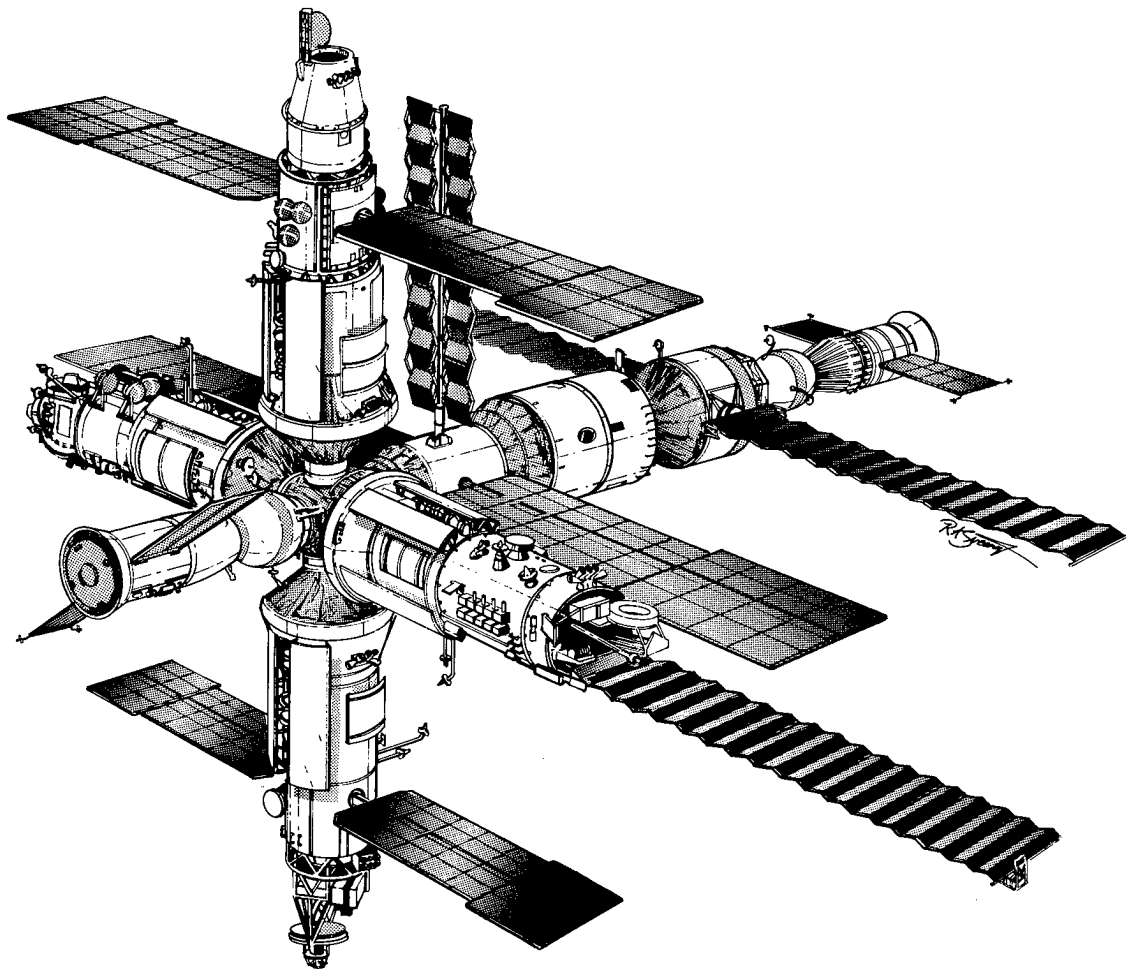

Figure 3.11. Basic Configuration of Completed Mir Space Station.

the end of the decade. An earlier plan to replace the Mir core module in the mid-1990's with Buran and recycle the large specialized modules appeared to be dead. The configuration of a potential Mir 2 complex was in a high state of flux with a variety of designs employing Proton, Energiya, and/or Buran logistical flights for on-orbit assembly. Also undecided was whether to increase the orbital inclination of Mir 2 to 63–65° to permit new launches from Plesetsk rather than Baikonur. Upgrades to the SL-4 launch vehicle would compensate for the loss of payload capacity at the more northerly facility.

Several new logistical spacecraft are also under consideration. A crew rescue vehicle, for use by any international space station, with a capacity of 7–8 persons and launched by either a space shuttle or the SL-16 (Zenit) booster has been designed (Figure 3.12). The 10–12 metric spacecraft could be maintained in orbit on a 1-hour standby for up to two years. A more radical approach to a 6-man ferry craft has been derived from preliminary studies of potential interplanetary manned vehicles (Figure 3.13).

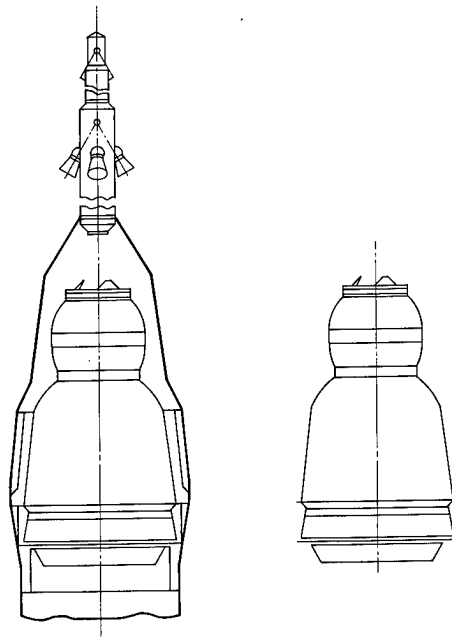
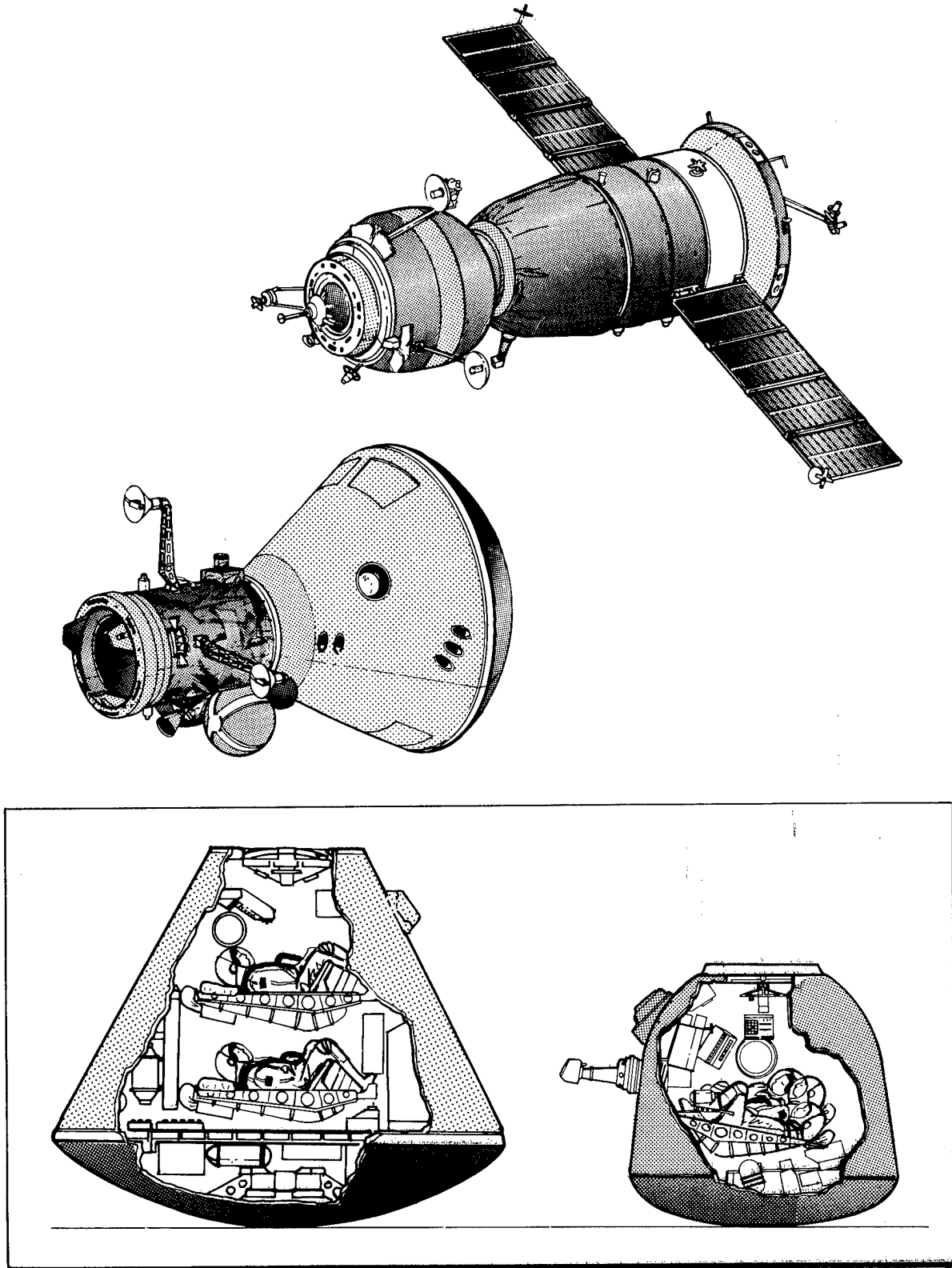

Figure 3.12. Proposed Crew Rescue Vehicle.

Unmanned space station logistical spacecraft with masses of 12-18 metric tons are also being investigated.



RD Spang

Figure 3.13. Comparison of Future CIS Spacecraft with Soyuz-TM.

3.2 European Space Agency

The stage was set for ESA's entry into manned spaceflight in December, 1972, with a European commitment to involve ESRO in the US Space Shuttle program and in 1973 with the signing of an agreement with the US to develop the Spacelab scientific facility for the US Space Transportation System. During 1992 two European astronauts representing ESA flew on board US Space Shuttles: one in conjunction with a Spacelab mission and one to deploy ESA's EURECA satellite. ESA's participation in the international Freedom Space Station program will ensure an expanding role for ESA in manned space flight activities, despite the recent reversals in the Columbus free-flyer and the Hermes space plane projects. In 1992 ESA conducted its second astronaut candidate selection to form the ESA Astronaut Corps which will train at the newly established European Astronauts Center (EAC) in Cologne, Germany.

Spacelab, which had flown on 10 STS missions by the end of 1992, is actually a modular system which is custom configured and out-fitted for each specialized mission (Figure 3.14). The principal components employed to date are the Long Module habitable pressurized compartment (approximately 8 metric tons, 4 m diameter, and 7 m length), the exposed equipment Pallet (725 kg base mass, 4 m diameter, and 3 m length), and the pressurized equipment Igloo (640 kg base mass, 1.1 m diameter, and 2.4 m height). On manned Spacelab missions the Long Module can be flown with up to two Pallets (only non-Pallet and 1-Pallet missions have been conducted), and on unmanned flights the Long Module is replaced by an Igloo and as many as five Pallets (only 2- and 3- Pallet mis-

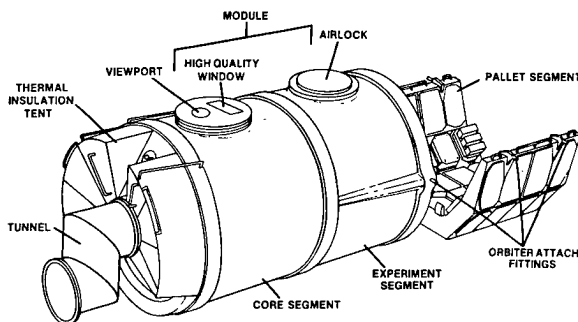

Figure 3.14. Basic Spacelab Configuration.

sions have been conducted). A short Module configuration (length approximately 4.3 m) was part of the original Spacelab design but has not been implemented (Reference 154).

Spacelab missions may be sponsored by ESA, the US, or individual countries or organizations. ESA astronauts have been part of the Spacelab 1 (1983), the Spacelab D1 (1985), and the International Microgravity Laboratory (1992). On the last, which was part of STS-42, ESA's Ulf Merbold (a German) made his second space flight during 22–30 January. The International Microgravity Laboratory carried ESA's Biorack and Critical Point Facility (Sections 4.4.2 and 5.1.2). At the end of the mission, Merbold had accumulated more than 18 days experience in space.

ESA's third astronaut, Claude Nicollier of Switzerland, was part of the STS-46 mission (31 July–8 August 1992) and was the first ESA astronaut qualified as a mission specialist. His primary responsibility was the deployment of the EURECA satellite (Section 4.4.2). A Belgian member of ESTEC, Dirk Frimout, was also a member of the Atlas-1 mission flown on STS-45 (24 March–2 April 1992). Six new ESA candidates were selected in May, 1992: Maurizio Cheli (Italy), Jean-Francois Clervoy (France), Pedro Duque (Spain), Christer Fuglesang (Sweden), Marianne Merchez (Belgium), and Thomas Reiter (Germany). This group will probably furnish the candidates for ESA-sponsored missions to the Mir space station in 1994 and 1995 (Reference 156).

Under the international Freedom Space Station program, ESA has committed to providing the Columbus attached laboratory, a 4.5 m diameter, 12 m long, 17-23 metric ton scientific module (Figure 3.15). The principal areas of research initially envisioned for the laboratory are materials science and life science studies. The project is being managed via the EuroColumbus consortium with principal members Alenia Spazio, DASA, and Matra Marconi. Barring a major redesign of the Freedom Space Station, the Columbus laboratory will be the center of ESA manned space flight activity until after the turn of the century. Plans to operate a man-tended Columbus free-flyer have been postponed indefinitely (References 156–161).

When ESA decided to develop the Ariane 5 launch vehicle, the French space agency,

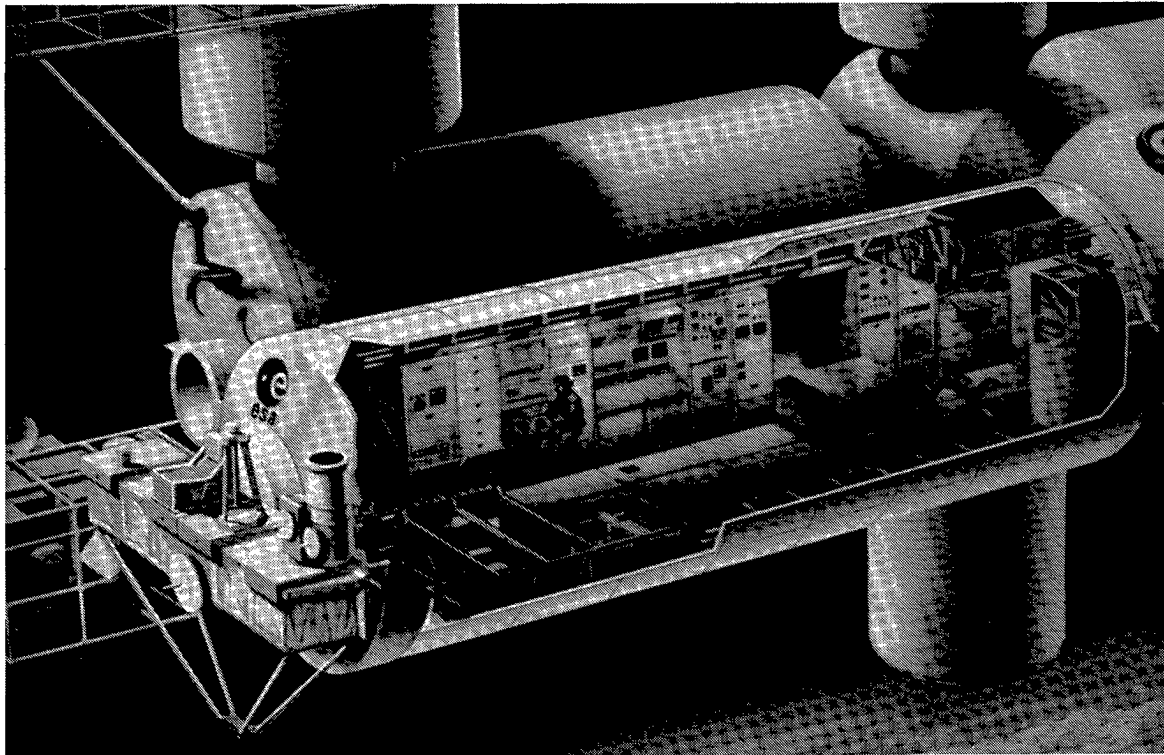

Figure 3.15. Columbus Attached Laboratory.

CNES, began serious design studies of the Hermes manned space plane which could only be launched by an Ariane 5-class booster. After an extensive review of the Hermes concept, ESA formally adopted the project at the ministerial meeting in November, 1987, as an integral part of the ESA's long-range manned space activities. An inaugural unmanned flight was tentatively set for 1998, followed by the first manned mission the next year. However, in 1991 ESA essentially stretched the program for another four years, and then in November, 1992, the effort was drastically revised, becoming a near-term technology program while investigating a cooperative space plane program with Russia (see Appendices).

The design of Hermes evolved greatly during the past 10 years, finally culminating in a 3-man, 24-metric-ton spacecraft by 1992. With an overall length of 14 m and a width of 9.5 m, Hermes was designed to carry a payload of up to 3 metric tons into space and to return with 1.5 metric tons of materials. Originally seen as a critical node in the Columbus Free-flyer program, Hermes missions to the Mir space station were also contemplated. Since 1990 the four principal companies responsible for Hermes design and development – Aerospatiale, Alenia,

Dassault Aviation, and Deutsche Aerospac – have worked within a consortium called EurorHermespace (References 162–167).

3.3 France

As noted in the previous section, since the late 1970's France has become increasingly

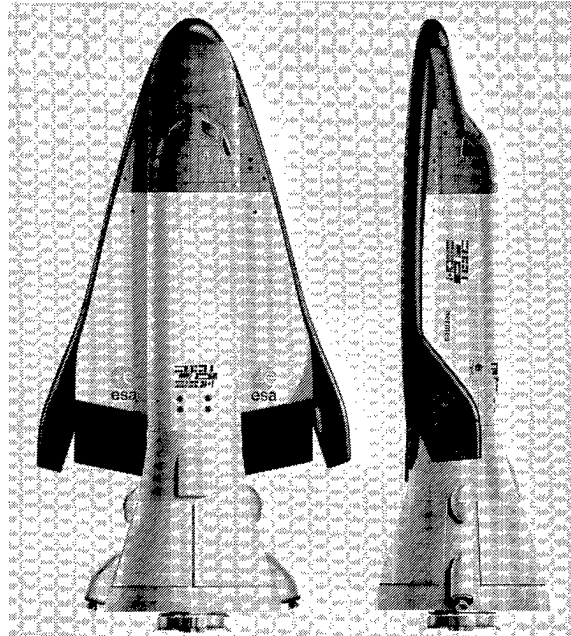

Figure 3.16. Hermes Space Plane.

interested in expanding its space expertise to manned activities. In addition to fathering the Hermes space plane project which was eventually adopted by ESA, France financed four manned missions during the period 1982–1992, including three flights to USSR/CIS space stations and one flight on the US Space Shuttle. At least four more flights are anticipated during the remainder of this decade under a new French-Russian agreement.

France's first astronaut, Jean-Loop Chretien, visited the Soviet Salyut 7 space station in June, 1982, on an 8-day mission and then worked on board Mir for 23 days during November–December, 1988. On the latter mission Chretien became the first non-American/non-Soviet astronaut to perform an EVA. During July–August, 1992, Michel Tognini spent nearly two weeks on board Mir under the Antares program (Section 3.1.2).

In 1993 Jean-Pierre Haignere is scheduled to become the third Frenchman to reach the Mir space station where he will work for three weeks. A memorandum of agreement for three additional French-Russian manned missions in 1996, 1998, and 2000, respectively, was signed on 29 July 1992. With the re-scoping of the ESA Hermes program, France is expected to strengthen its ties to Russia in manned space activities and the development of future reusable manned spacecraft.

3.4 Germany

Germany's experience with manned space flight dates back to 1978 when East German

cosmonaut Sigmund Jahn became the third foreign national to visit a Soviet space station (Salyut 6). By the end of 1992 four other Germans (one as a representative of ESA) had flown in space: three on board STS Spacelab missions (Spacelab 1 in 1983 and Spacelab D1 in 1985) and one to the Mir space station in 1992. The last mission is summarized in Section 3.1.2 under Mir operations.

A strong supporter of ESA's Spacelab program, Germany is the only ESA member to underwrite a dedicated Spacelab flight. The Challenger accident which occurred only a few months after the successful Spacelab D1 of October–November, 1985, with two German astronauts, delayed the continuation of such missions until 1993 when Spacelab D2 was scheduled to earn two more Germans their astronaut wings. The multi-disciplined Spacelab D2 mission will carry approximately 6.5 metric tons of payload to conduct nearly 100 experiments in the fields of materials science, life science, Earth observation, geophysics, and space technology (References 168). A third German-sponsored Spacelab mission is possible in the mid-1990's.

While France was refining its design for the Hermes space plane and convincing ESA to assume responsibility for the project, Germany was creating plans for a next-generation, reusable manned transportation system. Named Sanger in honor of Prof. Eugen Sanger (1905–1964), the system would consist of a two-staged winged vehicle which would take-off and land from European airfields. The first stage

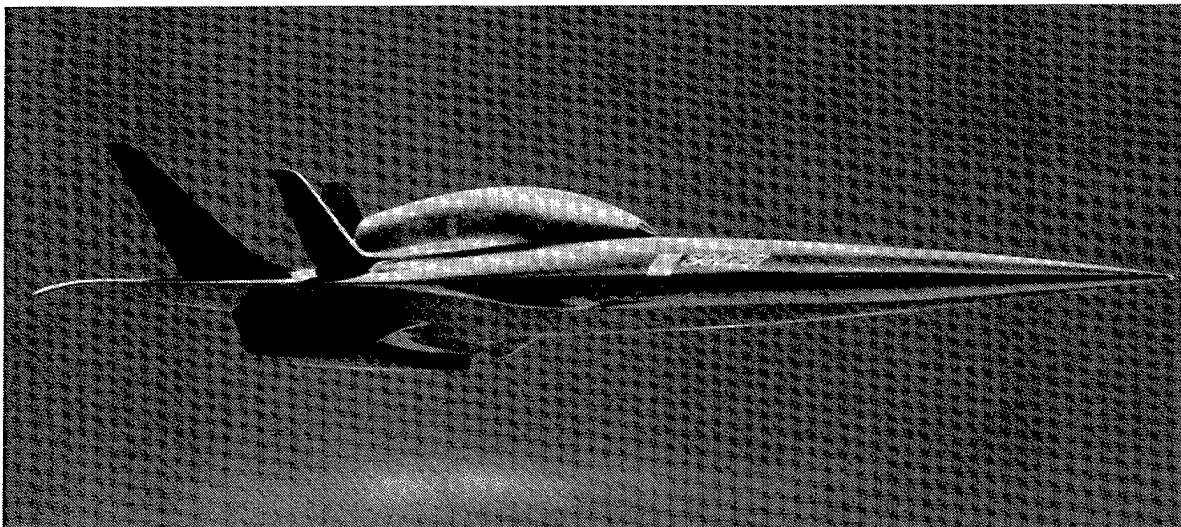

Figure 3.17. Sanger Reusable Space Transportation System.

would rely on liquid hydrogen turbo/ramjet engines to carry the HORUS (Hypersonic Orbital Reusable Upper Stage) space plane to an altitude of 40 km and a velocity of more than 6.5 Mach. HORUS, outwardly and functionally similar to Hermes, may carry a crew of three and a payload of up to three metric tons into low Earth orbit using more conventional liquid oxygen/liquid hydrogen rocket engines. An unmanned version capable of lifting a seven metric ton payload is also being evaluated. Sanger became an official technology program in 1988 under the German Federal Ministry for Research and Technology (BMFT), but ESA support is considered essential for an operational system by the year 2010 (Reference 169–171).

3.5 Japan

Although somewhat behind France and Germany, Japan's entrance into manned space flight is following a very similar road: initial missions on foreign spacecraft and the development of a small reusable space plane. Japan has also committed to supplying one of the major scientific modules for the international Freedom Space Station. However, to date national support in Japan for manned activities has not yet matched that of its European allies.

Although the first Japanese astronaut flew a mission to the Mir space station in late 1990 (Soyuz TM-11), this was a purely commercial venture like the UK mission five months later and did not enjoy government backing. The first sanctioned Japanese manned space flight occurred in September, 1992, on the US STS under the Spacelab J program, analogous to the German Spacelab D flights. The 8-day Spacelab J mission was primarily devoted to

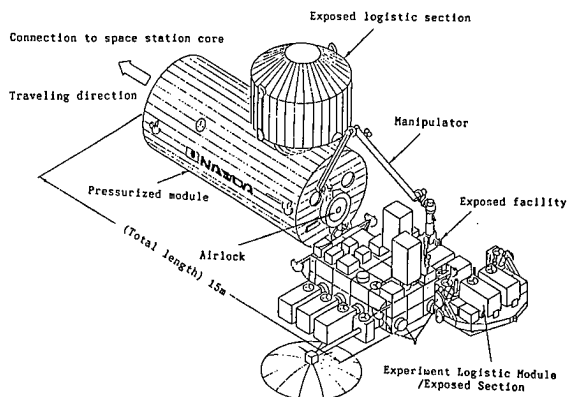

Figure 3.18. Japanese Experiment Module.

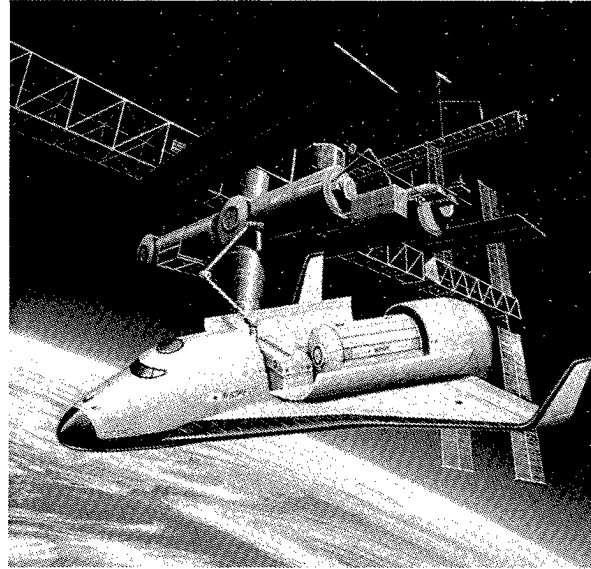

Figure 3.19. HOPE Space Plane.

conducting material sciences and life sciences experiments (Sections 4.4.6 and 5.1.5). Japan also played a major role in organizing the International Microgravity Laboratory program which first flew on the US STS in 1992 and is scheduled for a re-flight in 1994 (References 172–176).

The Japanese Experiment Module (JEM) was designed to serve as one of the four primary sections of the international Freedom Space Station. JEM is actually a complex facility consisting of a Pressurized Module, Experiment Logistics Modules (Pressurized Section and Exposed Section), an Exposed Facilities platform, an air-lock, and a remote manipulator arm. The Experiment Logistics Modules and the Exposed Facilities are specifically designed to be replaced periodically to allow a diverse and evolutionary scientific experimentation program. Under current plans JEM will be delivered to Freedom Space Station in parts beginning in 1998. When fully assembled, the module will probably possess a mass in excess of 20 metric tons. The engineering model of JEM was already under construction by the end of 1992. NASDA is managing the JEM program with the assistance of prime contractor Mitsubishi Heavy Industries (References 176–181).

In conjunction with the JEM project, NASDA has been studying the feasibility of developing a small reusable space plane named HOPE (H-2 Orbiting Plane). Launched by the forthcoming H-

2 booster, HOPE would perform the primary servicing for JEM, both delivering new equipment to the space station and returning the fruits of scientific experiments. Although the initial 10-metric-ton HOPE variant will be an unmanned spacecraft, options for modifying the vehicle to carry a small crew have been part of the overall design from the beginning. A 20-metric-ton version of HOPE which would need the H-2D booster, is also under serious consideration. However, delays in the H-2 program as well as general economic pressures have slowed the HOPE program which has not yet received approval to enter Phase B development (References 182-187). A farther term single-stage-to-orbit aerospace plane is also being considered (Section 2.8).

3.6 People's Republic of China

Since the late 1970's the PRC has seriously planned for the eventual flight of Chinese astronauts, but shifting program priorities have resulted in only preliminary work in the areas of spacecraft design and space medicine. Small teams of Chinese have undergone some astronaut training, and designs for manned spacecraft ranging from simple capsules to space shuttles to space stations have all been drawn up. The 1984 prospect of a Chinese astronaut flying on the US Space Shuttle never materialized.

A 1978 decision to embark on a Chinese manned space program was short-lived, although astronaut training and space suit design were initiated (References 188-192). By the mid-1980's PRC began to talk about building

a manned Chinese space station in apparent competition with the US and the USSR programs (References 193-198). Although discussions of sophisticated space shuttles were offered, the near-term goal appeared to be a Gemini-class capsule launched by an expendable booster with a crew of 2-4 astronauts. A tentative schedule envisioned a first flight near the turn of the century. In recent years Chinese officials have referred to the development of both manned space capsules and space shuttles, although neither is believed to be available until late in this decade at the earliest (References 199-200). Plans for a Sanger-class, two-stage manned space shuttle have been under development since at least the early 1980's.

3.7 United Kingdom

Although the UK's first astronaut, Helen Sharman, conducted a successful mission on board the Mir space station in 1991 (Section 3.1.1), no national man-in-space program currently exists. Since 1982 the UK, principally through British Aerospace, Rolls Royce, and the UK government, have conducted extensive design studies of a Horizontal Take-Off and Landing (HOTOL) space transportation system (Section 2.10). Although principally an unmanned spacecraft, long-range plans to man-rate HOTOL are under consideration. In the near-term, a smaller scale Interim HOTOL, which could be air-launched from the back of a CIS An-225, is being evaluated as a technology development phase for a future single-stage-to-orbit HOTOL.

References - Section 3

1. The "Soyuz" Transportation Spacecraft, descriptive brochure issued by Energiya NPO, Moscow, 1991.
2. V. A. Pivnyuk, Space Station Handbook, Matson Press, 1992.
3. Yu. Semenov and V. Timchenko, "The Family of 'Soyuzes'," Pravda, Moscow, 5 August 1987, p. 3.
4. Progress M, technical specification sheet distributed by Energiya NPO, Moscow, 1991.
5. Recoverable Ballistic Capsule, technical specification sheet distributed by Energiya NPO, Moscow, 1990.
6. Krasnaya Zvezda, Moscow, 23 August 1989, p. 3.
7. Gudok, Moscow, 26 August 1989, p. 4.
8. Sovetskaya Rossiya, Moscow, 26 August 1989, p. 1.
9. I. Pochkayev, et al, Aviatsiya I Kosmonavtika, Moscow, September, 1987, pp. 44-45.
10. J. K. Beatty, "The High-Flying Kvant Module," Sky and Telescope, December, 1987, pp. 599-601.
11. "77 KSD, Extension Module," technical specifications brochure distributed by Khrunichev Machine Building Plant, 1989.
12. M. M. Lemelev, Zemlya I Vselennaya, Moscow, May-June, 1990, pp. 3-11.
13. G. Glabay, Aviatsiya I Kosmonavtika, Moscow, February, 1991, pp. 46-47.
14. G. Lomanov, Sotsialisticheskaya Industriya, Moscow, 2 August 1989, p. 4.
15. Krasnaya Zvezda, Moscow, 2 December 1989, p. 5.
16. Pravda, Moscow, 27 November 1989, p. 1.
17. "77 KST, Docking Support Module," technical specifications brochure distributed by Khrunichev Machine Building Plant, 1989.
18. G. Sergeyev, Aviatsiya I Kosmonavtika, Moscow, March, 1991, pp. 46-47.
19. Krasnaya Zvezda, Moscow, 4 April 1990, p. 3.
20. Pravda, Moscow, 1 June 1990, p. 3.
21. For a history of Salyut 7 operations see:
N. L. Johnson, Soviet Space Programs 1980-1985, Volume 66, Science and Technology Series, American Astronautical Society, 1987, and
N. L. Johnson, The Soviet Year in Space 1986, Teledyne Brown Engineering, 1987.
22. Pravda, Moscow, 30 September 1986, p. 7.
23. Pravda, Moscow, 30 December 1990, p. 2.
24. Sovetskaya Rossiya, Moscow, 5 January 1991, p. 2.
25. Pravda, Moscow, 6 October 1985, p. 6.
26. V. Sergeyev, "Heavy Space Technology Development: Prospects and Promises," Advances of Science and Technology, Moscow, 5 December 1985, pp. 1-3.
27. Izvestiya, Moscow, 18 January 1991, p. 8.

28. Pravda, Moscow, 4 February 1991, p. 6.
29. Izvestiya, Moscow, 5 February 1991, p. 2.
30. Trud, Moscow, 23 January 1991, p. 4.
31. Gudok, Moscow, 1 February 1991, p. 3.
32. Rabochaya Tribuna, Moscow, 30 January 1991, p. 3.
33. Pravda, Moscow, 31 January 1991, pp. 1, 6.
34. Izvestiya, Moscow, 7 January 1991, p. 6.
35. TASS, Moscow, 5, 7, and 11 February 1991.
36. The Reentry of Salyut 7-Kosmos 1686, ESA SP-345, ESA, Paris, 1991.
37. TASS, Moscow, 6 January 1991.
38. TASS International Service, Moscow, 8 January 1991.
39. TASS, Moscow, 23 January 1991.
40. TASS International Service, Moscow, 23 January 1991.
41. TASS, Moscow, 26 January 1991.
42. Moscow Central Television, Moscow, 26 January 1991.
43. "Cosmonauts Ride 'Space Crane'," Spaceflight, June 1991, p. 189.
44. "New Crane-like Arm on Mir to Aid Solar Panel Relocation," Aviation Week and Space Technology, 15 October 1990, p. 30.
45. Pravda, Moscow, 30 January 1991, p. 4.
46. TASS, Moscow, 8, 12, 15, 22, and 28 February 1991.
47. TASS, Moscow, 15 March 1991.
48. TASS, Moscow, 19 and 21 March 1991.
49. Moscow Radio, Moscow, 21 March 1991.
50. "Soviets Abort Docking of Progress Spacecraft to Mir station," Aerospace Daily, 25 March 1991.
51. Krasnaya Zvezda, Moscow, 29 March 1991, p. 3.
52. Moscow Radio, Moscow, 23 March 1991.
53. Moscow Central Television, Moscow, 28 March 1991.
54. "Soviet Resupply Ship Again Fails to Dock with Mir," Aerospace Daily, 27 March 1991, pp. 511-512.
55. "Soviet Cargo Spacecraft Nearly Collides with Mir Space Station," Aerospace Daily, 2 April 1991, p. 15.
56. TASS, Moscow, 26 March 1991.
57. TASS, Moscow, 28 March 1991.

58. TASS, Moscow, 10 April 1991.
59. TASS, Moscow, 26 April 1991.
60. N. Kidger, "Progress M-7 – Catastrophe Avoided," Spaceflight, June 1991, pp. 192–193.
61. TASS, Moscow, 7 May 1991.
62. TASS International Service, Moscow, 8 May 1991.
63. Moscow Radio, Moscow, 26 May 1991, and Krasnaya Zvezda, Moscow, 28 May 1991, p. 3.
64. For background on the Juno mission see Media Information Pack, The Juno Mission, 18–26 May 1991, distributed by Partners in PR, London, 1991, and Spaceflight: August, 1989, pp. 258–259; September, 1989, pp. 303–305; October, 1989, pp. 334–339; November, 1989, p. 367; December, 1989, p. 401; January, 1990, pp. 18–20; February, 1990, pp. 38–40; March, 1990, pp. 102–103; May, 1990, p. 159; February, 1991, pp. 44–45; April, 1991, pp. 138–139; May 1991, pp. 154–155; July, 1991, pp. 226–231; August, 1991, pp. 268–269; and P. Collins, "Juno and the Business-Space Gap," Space Policy, August, 1990, pp. 184–186.
65. "News Breaks," Aviation Week and Space Technology, 27 May 1991, p. 17.
66. TASS, Moscow, 20 May 1991.
67. TASS, Moscow, 26 May 1991.
68. TASS, Moscow, 28 May 1991.
69. TASS International Service, Moscow, 30 May 1991.
70. TASS, Moscow, 1 June 1991.
71. Krasnaya Zvezda, Moscow, 18 June 1991, p. 1.
72. V. Kiernan, "Mag 1 Failure, Spacewalks Highlight Mir Activity," Space News, 15–28 July 1991, p. 8.
73. Trud, Moscow, 24 April 1991, p. 3.
74. TASS, Moscow, 24 and 25 June 1991.
75. Izvestiya, Moscow, 26 June 1991, p. 1.
76. TASS, Moscow, 29 June 1991.
77. Pravda, Moscow, 11 July 1991, p. 6.
78. Pravda, Moscow, 17 July 1991, p. 2.
79. Izvestiya, Moscow, 22 July 1991, p. 1.
80. Pravda, Moscow, 29 July 1991, p. 2.
81. Krasnaya Zvezda, Moscow, 17 July 1991, p. 1.
82. G. I. Severin, et al. "EVA Space Suit. General Concepts of Design and Arrangements," ESA SP-300, Proceedings of the Workshop on Crew Safety and Rescue in Space, 7 June 1989, pp. 13–17.
83. TASS, Moscow, 19 July 1991.
84. Moscow Central Television, Moscow, 20 July 1991.

85. Pravda, Moscow, 29 July 1991, p. 2.
86. Moscow Central Television, Moscow, 27 July 1991.
87. Moscow Radio, Moscow, 16 and 18 July and 5 August 1991.
88. TASS, Moscow, 14 August 1991.
89. V. Kiernan, "Soviets Cancel Fall Flight to Mir Station," Space News, 29 July–4 August 1991, pp. 3, 21.
90. The R.A.E. Table of Earth Satellites, Defense Research Agency, Farnborough, monthly update, 6 September 1991, p. 1071b.
91. N. Kidger, "Cosmonauts Chalk-up More than Thirty Hours of Spacewalks," Spaceflight, October, 1991, pp. 359-360.
92. Moscow Central Television, Moscow, 16 August 1991.
93. TASS, Moscow, 23 August 1991.
94. UPI, Atlanta, 26 August 1991.
95. Krasnaya Zvezda, Moscow, 28 September 1991, p. 1.
96. TASS, Moscow, 30 September 1991.
97. Izvestiya, Moscow, 2 October 1991, p.1.
98. Izvestiya, Moscow, 4 October 1991, p.7.
99. J. M. Fritzer and N. Kidger, "Soviet-Austrian Space Flight Details," Spaceflight, August, 1989, p. 256.
100. The Austromir Project, public relations documents issued by the Institute for Applied Systems Technology and Joanneum Research, 1991.
101. Trud, Moscow, 3 October 1991, p. 1.
102. Pravda, Moscow, 5 October 1991, p.3.
103. N. Kidger, "Austrian Mission Follows Failed Coup," Spaceflight, January, 1992, pp. 12–17.
104. TASS World Service, Moscow, 5–8 October 1991.
105. V. Kiernan, "Mir Data To Assist in Designing Extended Orbit Spacecraft," Space News, 9–15 December 1991, p. 10.
106. TASS, Moscow, 19 October 1991.
107. TASS World Service, Moscow, 15, 19, 22, 26 and 29 November and 4, 5, 24, 27, and 29 December 1991.
108. Komsomolskaya Pravda, Moscow, 28 December 1991, p.2.
109. Pravitelstvennyy Vestnik, December, 1991, p. 2.
110. Kuranty, 1 February 1992, p. 6.
111. Nezavisimaya Gazeta, 11 April 1992, p. 6.
112. J. M. Lenorovitz, "Russians to Keep Mir Manned This Year," Aviation Week and Space Technology, 13 January 1992, p. 22.

113. TASS, Moscow, 14 and 20 January 1992.
114. "News Breaks," Aviation Week and Space Technology, 27 January 1992, p. 29.
115. Sovetskaya Rossiya, Moscow, 28 January 1992, p.1.
116. "Payload Systems Inc Sends Second Package To Mir 1," Space FAX Daily, 22 January 1992, p. 1.
117. Komsomolskaya Pravda, Moscow, 28 January 1992, p. 1.
118. ITAR-TASS, Moscow, 21 February 1992.
119. N. Kidger, "Mir Cosmonauts Continue Work," Spaceflight, April, 1992, pp. 117-120.
120. Nezavisimaya Gazeta, 22 February 1992, p. 1.
121. Izvestiya, Moscow, 20 February 1992, p. 1.
122. Izvestiya, Moscow, 21 February 1992, p. 2.
123. ITAR-TASS World Service, Moscow, 7 March 1992.
124. Krasnaya Zvezda, Moscow, 10 March 1992, p. 1.
125. Krasnaya Zvezda, Moscow, 17 March 1992, p. 1.
126. Izvestiya, Moscow, 18 March 1992, p. 2.
127. P. B. de Selding, "Training Ends for German Astronaut Destined for Mir," Space News, 9-15 March 1992, p. 11.
128. DARA Information 1991, DARA, Bonn, June 1991, p. 20.
129. Krasnaya Zvezda, Moscow, 18 March 1992, p. 3.
130. Krasnaya Zvezda, Moscow, 20 March 1992, p. 1.
131. Izvestiya, Moscow, 4 April 1992, p. 7.
132. L. David, "Payload Systems Awaiting Recovery of Mir Package," Space News, 23-29 March 1992, p. 12.
133. A. Salmon and N. Kidger, "German 'Mir-92' Experiments," Spaceflight, August, 1992, p. 269.
134. Nezavisimaya Gazeta, 25 March 1992, p. 6.
135. "Russian Progress Aborts Mir Rendezvous; Missile Warning Satellite System Bolstered," Aviation Week and Space Technology, 27 July 1992, p. 21.
136. Nezavisimaya Gazeta, 11 April 1992.
137. ITAR-TASS, Moscow, 8 July 1992.
138. Antares Press Kit, CNES, Paris, and Energiya NPO, Moscow, July, 1992.
139. Krasnaya Zvezda, Moscow, 15 July 1992, p. 4.
140. Ostankino Channel 1 TV, Moscow, 29 July 1992.
141. Sovetskaya Rossiya, Moscow, 28 July 1992, p. 2.
142. ITAR-TASS, Moscow, 2-8 August 1992.

143. V. Kiernan, "Soyuz TM-14 Turns Turtle on Landing," Space News, 17–23 August 1992, p. 4.
144. Nezavisimay Gazeta, 21 July 1992, p. 6.
145. J. M. Lenorovitz, "Russia to Upgrade Mir 1 Space Station, Prepares for New Orbital Facility," Aviation Week and Space Technology, 4 May 1992, pp. 84–85.
146. ITAR-TASS World Service, Moscow, 3 September 1992.
147. ITAR-TASS, Moscow, 7 September 1992.
148. C. Covault, "Russians Perform Complex EVAs; Ukraine Disrupts Radio Link," Aviation Week and Space Technology, 12 October 1992, p. 59.
149. ITAR-TASS World Service, Moscow, 11 and 15 September 1992.
150. V. Kiernan, "Russian Cosmonauts Place Thruster on Mir, Prepare It for Shuttle," Space News, 21–27 September 1992, p. 12.
151. ITAR-TASS, Moscow, 22 and 27 October and 17 November 1992.
152. "Canadian Space Radiation Tests Ready for Mir Flight," Space News, 26 October–1 November 1992, p. 15.
153. Spacelab Data Book, ESA BR-14, ESA, Paris, September, 1983.
154. C. Covault, "International Shuttle/Spacelab Mission to Conduct Life Sciences, Materials Tests," Aviation Week and Space Technology, 20 January 1992, pp. 55–56.
155. All About the European Space Agency, ESA, Paris, March, 1993, p. 7.
156. Columbus. A User's Introduction, ESA BR-62, ESA, Paris, September, 1989.
157. J. M. Lenorovitz, "European Industry Submits Proposal For Space Station Design/Development," Aviation Week and Space Technology, 16 October 1989, p. 22.
158. "Columbus Contractors Revising Space Station Industrial Package," Aviation Week and Space Technology, 9 July 1990, p. 23.
159. J. M. Lenorovitz, "Italian, German Companies Agree on Columbus Program Management," Aviation Week and Space Technology, 20 January 1992, p. 26.
160. P.B. de Selding, "Matra Marconi Buys Portion of Euro-Columbus Consortium," Space News, 9–15 November 1992, p. 8.
161. "France Proposes Minishuttle Spacecraft," Aviation Week and Space Technology, 8 August 1983, p. 17.
162. "Ten ESA Member Nations Join Hermes Spaceplane Program," Aviation Week and Space Technology, 8 December 1986, p. 27.
163. J. M. Lenorovitz, "Hermes Definition Program Begins; First Manned Mission Set for 1998," Aviation Week and Space Technology, 11 April 1988, pp. 51–52.
164. S. Chenard and A. Wilson, "Hermes Changes Shape, Again," Space Markets, No. 1, 1989, pp. 18–23.
165. J. M. Lenorovitz, "Europeans to Reorganize Hermes Management Setup," Aviation Week and Space Technology, 9 July 1990, pp. 21–22, and J. M. Lenorovitz, "Company Formed to Manage Next Phase of Europe's Hermes Spaceplane Program," Aviation Week and Space Technology, 12 November 1990, pp. 76–77.
166. Hermes, ESA/CNES Hermes Team, Paris, May, 1991.
- 167.

168. Experiments in Space. The Second German Spacelab Mission D-2, DLR, Cologne-Porz, March, 1992.
169. Reusable Space Transportation Systems. Reference Concept Sanger, MBB/Deutsche Aerospace, August, 1992.
170. DARA. German Space Agency, DARA, Bonn, February, 1990.
171. DARA Information 1991. Space Research for a Global Perspective, DARA, Bonn, June, 1991.
172. S. Kurachi, "Update on Japan's Space Policy," Space Policy, May, 1991, pp. 95-102.
173. C. Covault, "First Japanese Shuttle Astronaut Set for 1991 Spacelab J Flight," Aviation Week and Space Technology, 27 August 1990, pp. 72-75.
174. J.R. Asker, "U.S., Japan Ready Spacelab Flight," Aviation Week and Space Technology, 7 September 1992, p. 39.
175. "Japanese Spacelab Mission Extended for More Science," Aviation Week and Space Technology, 21 September 1992, pp. 24-25.
176. NASDA. National Space Development Agency of Japan, NASDA, Japan, 1987.
177. "Japan Begins \$2.5-Billion Effort To Develop Freedom Station Module," Aviation Week and Space Technology, 20 August 1990, pp. 79, 82.
178. L. David, "Japan's Space Station Contribution Enters Critical Stage," Space News, 24-30 September 1990, pp. 10, 12.
179. K. P. Dawson, "Japan's Station Program Nears Start of Key Design Review," Space News, 25 November-1 December 1991, p. 18.
180. K. P. Dawson, "Japan Begins Building Station Module Model," Space News, 16-22 November 1992, p. 23.
181. E. Sekigawa, "Japan Committed to Space Station," Aviation Week and Space Technology, 5 April 1993, p. 59.
182. "Japanese Panel Recommends Spaceplane Development," Aviation Week and Space Technology, 6 July 1987, p. 31.
183. "Japanese Showcases Maturing Space Program Manufacturing Capabilities," Aviation Week and Space Technology, 19 June 1989, pp. 66-70.
184. S.W. Kandebo, "Japanese Refining Unmanned HOPE Orbiter for Planned 1996 Launch," Aviation Week and Space Technology, 3 April 1989, pp. 57-58.
185. "Space Agency Considers Doubling Size of HOPE Unmanned Space Vehicle," Aviation Week and Space Technology, 13 August 1990, pp. 65-67.
186. Y. Yamamoto, "HOPE looks to CFD for help," Aerospace America, February, 1992, pp. 39-41.
187. K. P. Dawson, "Japan's Space Plane Faces Termination or Shrinking," Space News, 23-29 November 1992, p. 3.
188. Orlando Sentinel Star, Orlando, 21 January 1979, p. 4-D.
189. "China Beginning Manned Space Effort," Aviation Week and Space Technology, 28 May 1979, pp. 26-27.
190. L. Mathews, "China Trains Its First Astronauts," Los Angeles Times, 13 January 1980, p. 18.
191. "Astronaut Candidates Training in China for Future Missions," Aviation Week and Space Technology, 4 February 1980, p. 57.

192. "Chinese Astronauts Train in Simulators," Aviation Week and Space Technology, 26 January 1981, pp. 62-63.
193. "Chinese Space Station, As 'Head of a Dragon', Would Boost Economy," Aerospace Daily, 10 December 1985, pp. 198-199.
194. Liu Ji-yuan and Min Gui-rong, "The Progress of China's Astronautics," U.S. Space Foundation Symposium, Colorado Springs, 22 January 1987.
195. "China Plans Space Station/Cargo Vehicle," Defense Daily, 11 June 1987, p. 239.
196. C. Covault, "China Developing Technology for Future Manned Space Flight," Aviation Week and Space Technology, 29 June 1987, pp. 22-23.
197. "Chinese Studies on Space Station Begin," Defense Daily, 28 September 1987, p. 159.
198. Y. Chen, "China's Space Police - A Historical Review," Space Policy, May, 1991, pp. 116-128.
199. "China Eyes Manned Space Capsule," Aviation Week and Space Technology, 10 December 1990, p. 24.
200. Zhongguo Tongxun She News Agency, Hong Kong, 31 October 1992.
201. Z. Huang, "Fully Reusable Launch Vehicle with Airbreathing Booster," IAF-83-376, 34th Congress of the International Astronautical Federation, 10-15 October 1983.
202. Lord Reay, "UK Space Policy," Space Policy, November, 1991, pp. 307-315.

4.0 EARTH APPLICATIONS PROGRAMS

The overwhelming majority of operational satellites are devoted to Earth applications programs in the fields of communications, navigation, geodesy, Earth observation and remote sensing, and materials science. By their very nature, these missions may be sponsored by civil, military, or government agencies or may support multiple users. Earth applications spacecraft may range in mass from 50 kg to nearly 20,000 kg and may be short-lived in orbits as low as 150 km or may be operational for ten years or more in orbits as high as 36,000 km. Perhaps more importantly, Earth applications satellites are operated by more nations and international organizations than any other class of spacecraft.

4.1 Communications

Space-based communications systems continue to represent the major area of satellite applications for all European and Asian countries. Globally, more than half of all operational satellites are devoted to telecommunications. In the USSR/CIS during 1991-1992 a quarter of all space launches carried communications satellites, which, due to the use of multiple payload missions, represented more than 40% of all new spacecraft during the period. Each of the 15 ESA launches during the same period placed a communication satellite into Earth orbit either as a primary or a secondary payload. Likewise, three of China's five missions were communications-related, while the ratio for Japan was one out of three. For many non-launching countries, communications satellites constitute their only national space systems.

4.1.1 USSR/CIS

Although historically the number of annual recoverable photographic reconnaissance missions has outpaced the launch of communications satellites, approximately 100 communications satellites are currently operational, accounting for nearly two-thirds of the entire CIS satellite constellation. Since 1980, an average of 16-17 missions each year have been successfully launched into one of three regimes: (1) low Earth orbits, (2) highly elliptical, semi-synchronous orbits, or (3) geosynchronous orbits.

During 1991-1992, launches into each regime averaged around five per year. Prior to the breakup of the USSR, the nation's Telecommunications Administration comprised a workforce of more than 1.8 million and a variety of institutes, technical schools, and colleges with a combined enrollment of 80,000 (Reference 1). With its immense geographical expanse, the USSR in the 1960's and 1970's concluded that space-based telecommunications networks would be considerably more efficient, in terms of both cost and development time, than comparable terrestrial systems.

Despite the extensive satellite telecommunications infrastructure developed since the first experimental communications satellite was launched in 1964, the CIS today is still struggling to meet national and international demands. The network is characterized by numerous satellites of limited throughput, short lifetimes, and dated technology. In addition, the advantages of numerous systems are mitigated by interoperability issues, including the restricted use of some military systems. However, economic pressures are forcing a reevaluation of converting some military communications assets to civilian use.

In early 1992 Col. Yuri Pigasov, a former satellite communications center director, indicated that not more than 30% of the capacity (1,600 telephone and 1,000 telegraph channels) of ten military geosynchronous and highly elliptical orbit satellites is normally in continuous use (Reference 2). Government and military communications are now overseen by the Russian Federal Agency for Government Communications and Information, whose USSR predecessor was part of the State Security Committee or KGB (References 3 and 4). The civilian Russian Ministry of Communications has proposed developing a new national communications systems under the Rossiya program which would rely heavily on the next generation of geosynchronous communications satellites. Implementation of the program probably will not occur before the year 2000 at an estimated cost of more than 10 billion (1992) rubles (Reference 5).

The lowest level of the three-tier communications satellite constellation is populated with three distinct systems devoted to military and government communications. All systems are assessed to be simple store-dump repeaters

which are particularly useful in relaying non-essential traffic between the CIS and overseas stations or forces.

The first system debuted in 1970 and consists of 750–1,000 kg satellites deployed at mean altitudes of 800 km in three orbital planes inclined 74° to the equator and spaced 120° apart. Spacecraft are launched separately by the SL-8 launch vehicle from the Plesetsk Cosmodome into each orbital plane at intervals of 22–36 months in recent years. The activity of satellites can be monitored via a characteristic CW beacon emitted on a frequency of 153.660 MHz. A single launch into this constellation was conducted in each of 1991 and 1992. Kosmos 2150 was orbited on 11 June 1991 into the orbital plane of Kosmos 1954 which was almost exactly three years old at the time. On 12 August 1992 Kosmos 2208 apparently replenished the orbital plane of the 31-month-old Kosmos 2056. At the beginning of 1993, the principal members of the constellation were Kosmos 2112, Kosmos 2150, and Kosmos 2208.

Also, debuting in 1970 was a communications system of small (~50 kg, 0.8 m by 1.0 m) relay satellites launched from Plesetsk by the SL-8 in groups of eight. Although the mean altitude of this constellation is near 1500 km, each set of eight satellites are normally dispersed into slightly elliptical orbits with mean altitudes between 1430 km 1490 km. The intentional orbital period differences of about 0.15 min ensure that the satellites will become randomly spaced about the orbital plane shortly after launch. Unlike the lower altitude constellation, this network relies on a single orbital plane with an inclination of 74° which is replenished on the average once each year. Assuming an operational requirement of 16–24 active satellites, the mean lifetime of a typical satellite should be 2-3 years.

The most recent missions in this system are Kosmos 2064–2071 (6 April 1990), Kosmos 2125–2132 (12 February 1991), and Kosmos 2187–2194 (3 June 1992). The 1991 mission was noteworthy for the peculiar behavior of its rocket body for a period of two months after launch. As many as ten fragmentation events were traced to the 2.4 m by 5 m, 1.5 metric ton SL-8 second stage. A major event generated more than 50 trackable debris on 5 March, and in all more than 70 fragments were detected by

the U.S. Space Surveillance Network (References 6 and 7).

In 1985 a new store-dump communications system began deployment with some characteristics of both the earlier networks. To date the new system has augmented rather than replaced its predecessors. Launched by the more capable SL-14 from Plesetsk into orbits near 1,400 km at inclinations of 82.6° , the new constellation is comprised of multiple satellites, launched six at a time, in two orbital planes spaced 90° apart. Each plane is believed to contain 10-12 operational spacecraft and is replenished with a new sextet once a year. During 1991 Kosmos 2157–2162 (28 September) and Kosmos 2165–2170 (12 November) were inserted into separate orbital planes. They were joined in 1992 by Kosmos 2211–2216 (20 October) and Kosmos 2197–2002 (15 July), respectively.

The nature of this new system was partially revealed in 1990 when the principal spacecraft developers (the Applied Mechanics Scientific

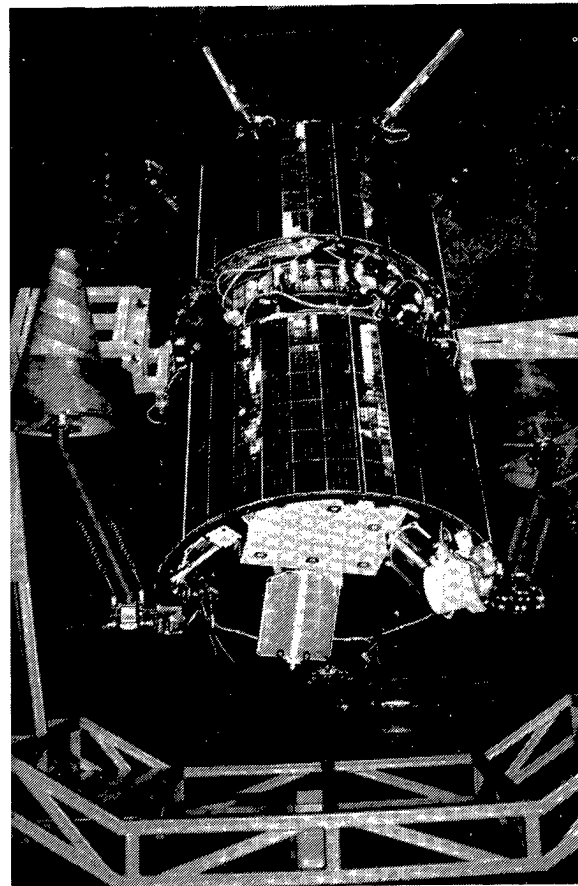

Figure 4.1. Gonets Satellite in Assembly.

Production Association and the Precision Instruments Scientific Production Association) began to market a slightly modified satellite as a commercial communications relay. Through the SMOLSAT Consortium in Moscow, which also includes the Soyuzmedinform Scientific Production Association and an American partner (COSSCASP, now known as Network Services International), the spacecraft have been offered to support international health organizations to meet their global communications needs, e.g., the transfer of medical data and records to remote sites.

In the commercial variant, the satellites, known as Gonets (Messenger), are capable of store/dump communications on 2–3 channels in the 200–400 MHz band with a transmitter output power of 10 W. The 230-kg Gonets are expected to be deployed at altitudes and inclinations similar to the military sextet satellites but distributed among 5–6 orbital planes for a total constellation of 30–36 spacecraft. This infrastruc-

ture should ensure a mean communication waiting time of less than 20 minutes with more than 80% probability. Attitude control is achieved through gravity-gradient stabilization. The electrical power system, provided by solar cells and nickel-hydrogen batteries, provides an average 40 W for the payload which is designed to operate for five years.

Data transmission rates available include 2.4 kbits/s, 9.6 kbit/s, and 64 kbit/s with an on-board storage capacity of 8 Mbytes. A hand-held user terminal (UT-P) resembles a cellular phone and weighs only 1–3 kg. Two demonstration Gonets (Gonets D) satellites were included in the Kosmos 2197–2202 mission (specifically, Kosmos 2199 and Kosmos 2201) and were tested successfully during 1992. Three additional Gonets D spacecraft are scheduled for launch in 1993. The first generation Gonets system may be operational by 1995 and may be followed in 1997 by an advanced Gonets design equipped with satellite-to-satellite links

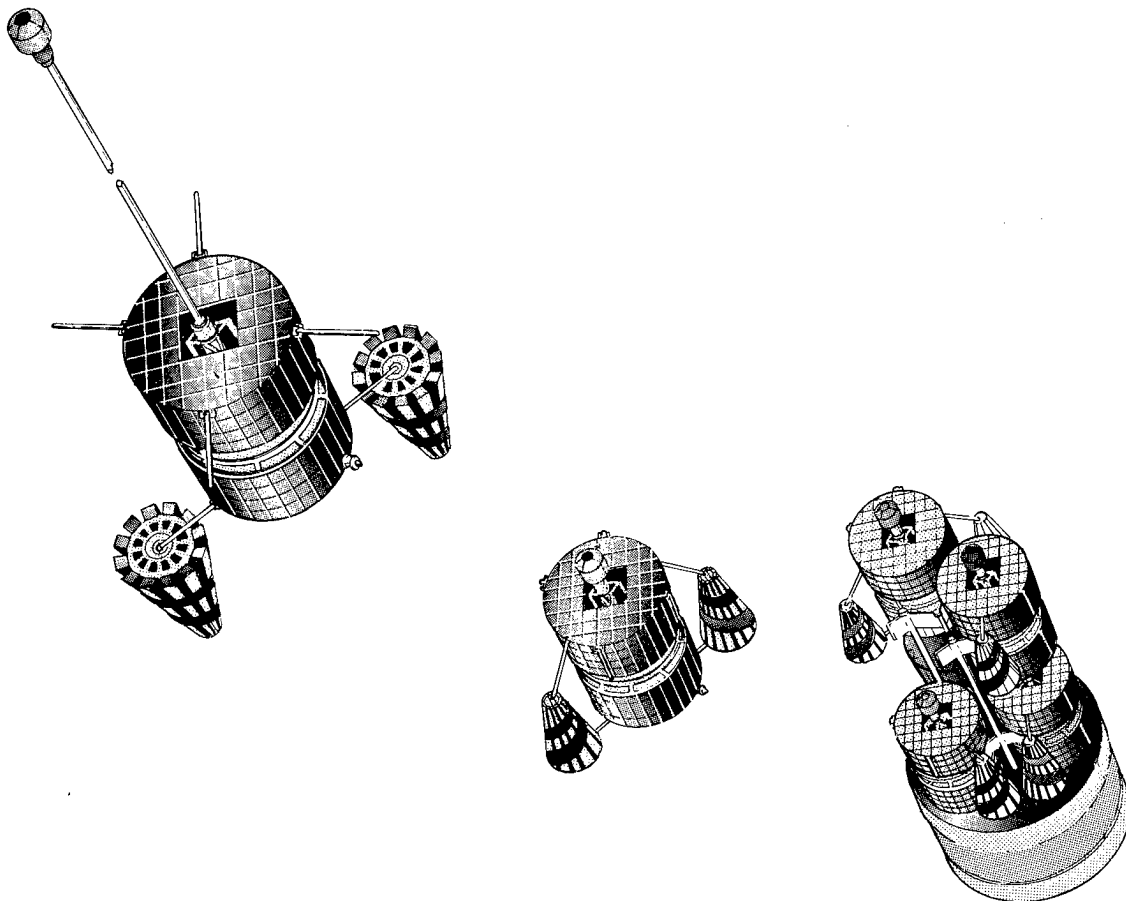

Figure 4.2. Deployment of Gonets-Class Satellites.

(References 8-11).

Several other LEO satellite communications systems have been proposed by CIS organizations. On 29 January 1991 a prototype satellite for the Koskon (Space Conversion) Global Space Communication System was launched from the Plesetsk Cosmodome by the SL-8 launch vehicle. Designated Informator 1, the 600-kg satellite was inserted into an orbit of 960 km by 1,010 km at a inclination of 83° under the sponsorship of the Ministry of Geology Informator 1 was developed by the Polet Production Association and the Elas Scientific Production Association and is cylindrical in nature (diameter 1.8 m, height of 4 m) with two solar panels designed to produce 1 kW average power. Like Gonets, Informator 1 relies on gravity gradient stabilization and is projected to have an operational lifetime of 5 years or more.

Informator 1 also carried the Soviet RS 14 and the German RUDAK 2 amateur satellite transponders as piggy-back payloads. Exactly one week after the launch of these amsat transponders, two more, RS12 and RS13, were placed in a virtually identical orbit as secondary payloads to the Kosmos 2123 navigation satellite. Several such amsat transponders were developed at the Kaluga Electromechanical Plant under the direction of Aleksander Papkov and were launched by the USSR during 1978-1991 (Reference 12).

The operational Koskon system will consist of 32 satellites (Figure 4.3) with eight satellites

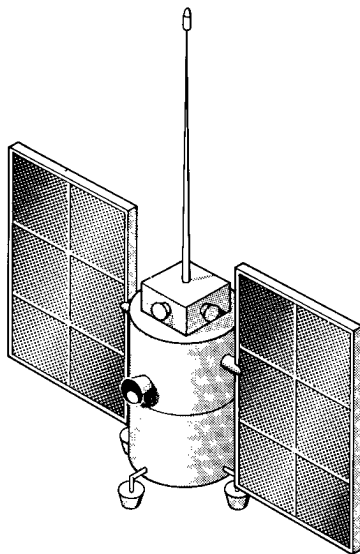

Figure 4.3. Koskon Satellite.

in each of four orbital planes. Although replacement spacecraft may continue to be launched by the SL-8, the initial groups of eight spacecraft are to be deployed using the SL-16 booster. The first operational spacecraft may be launched as early as 1993 with deployments completed by 1995-1996. Uplink (1.656-1.660 GHz) and downlink (1.555-1.559 GHz) communications will be at a rate of 4-5 MBaud, while cross-link communications at 2.0-2.1 GHz and 0.5-1 MBaud are also advertised. The two primary control centers will be located in the Moscow and Omsk regions (References 13-15).

The Polet PO and the Elas NPO are also cooperating with the Lavochkin NPO, the Applied Mechanics NPO, and several other organizations to develop the Kuryer communications system of LEO satellites. A total network of 24-60 Convert satellites (Figure 4.4) are envisioned, operating with either L-band phased-array antennas or UHF helical antennas as well as optical crosslinks. Elas will be responsible for the primary payload while Lavochkin will manufacture the antennas. The small spacecraft will be powered by two long, narrow solar arrays and will reject heat via a liquid radiator. The first launch of a Convert satellite may occur in 1993 (References 16 and 17).

In 1990 the Lavochkin NPO announced plans to create a LEO communications network of 4-8 satellites operating in the UHF band (400-480 Mhz) by 1994 (Reference 18). However, in 1992 the Bankir project had evolved into a geosynchronous satellite system employing new Coupon satellites. This concept is described below with other future GEO systems. The Russian-Ukrainian company Ariadne announced in late 1992 its intention to field a 25-member LEO satellite communications system launched by the Yuzhnoye-produced SL-14 booster (Reference 19).

The second stratum of the CIS space-based communications system consists of 16 Molniya-class spacecraft in highly elliptical, inclined (63°) semi-synchronous orbits. With initial perigees between 450 and 600 km fixed deep in the Southern Hemisphere and apogees near 40,000 km in the Northern Hemisphere, Molniya satellites are synchronized with the Earth's rotation, making two complete revolutions each day (orbital period of 718 minutes). The laws of orbital mechanics dictate that the spacecraft

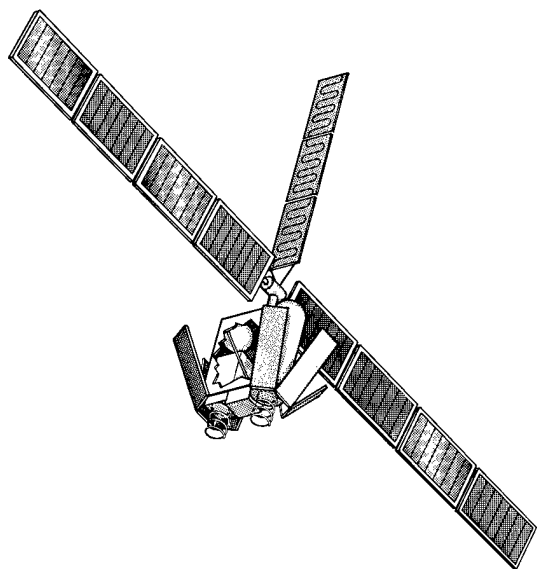

Figure 4.4. Convert Satellite.

orbital velocity is greatly reduced near apogee, allowing broad visibility of the Northern Hemisphere for periods up to eight hours at a time. By carefully spacing 3–4 Molniya spacecraft, continuous communications can be maintained. This type of orbit was pioneered by the USSR and is particularly suited to high latitude regions which are difficult or impossible to service with geostationary satellites.

The first prototype Molniya satellite was launched in 1964 and to date nearly 150 have been deployed. Primarily produced by the Applied Mechanics NPO in Krasnoyarsk, Molniya satellites weigh approximately 1.6 metric tons at launch and stand 4.4 m tall with a base diameter of 1.4 m. Electrical energy is provided by six windmill-type solar panels producing up to 1 kW of power (Figure 4.5). A liquid propellant attitude control and orbital correction system maintains spacecraft stability and performs orbital maneuvers, although the latter usage is rarely needed. Sun and Earth sensors are used to determine proper spacecraft attitude and antenna pointing.

The 16 operational Molniya satellites are divided into two types and four distinct groups. Eight Molniya 1 satellites are divided into two constellations of four vehicles each. Both constellations consist of four orbital planes spaced 90° apart, but the ascending node of one constellation is shifted 90° from the other, i.e., the Eastern Hemisphere ascending nodes are

approximately 65° and 155° E, respectively. Although the network supports the CIS Orbita Television network, a principal function is to service government and military communications traffic via a single 40 W, 1.0/0.8 GHz transponder. Since Molniya 1-75 in 1989, all Molniya 1 spacecraft have been launched from the Plesetsk Cosmodome by the SL-6.

Through 1990 all eight Molniya 1 satellites shared a common groundtrack with an ascending node near 65° E. However, the first Molniya 1 launch of 1991, Molniya 1-80 on 15 February, was stabilized with an ascending node near 155° E. Then, during 21–27 March three resident Molniya 1 spacecraft (Molniyas 1-75, 1-77, and 1-79) were maneuvered, causing their ascending nodes to drift. All three satellites were re-stabilized with 155° E ascending nodes during 28–30 May, and the Molniya 1 network restructure was completed.

In all, five Molniya 1 spacecraft were orbited in 1991–1992. During 1991 Molniya 1-80 replaced Molniya 1-73, Molniya 1-81 replaced Molniya 1-74, and Molniya 1-82 replaced Molniya 1-76. The following year Molniya 1-83 replaced Molniya 1-75 and Molniya 1-84 replaced Molniya 1-72. The average age of the replaced satellites was 35 months.

The first Molniya 3 spacecraft appeared in 1974, primarily to support civil communications (domestic and international), with a slightly enhanced electrical power system and a com-

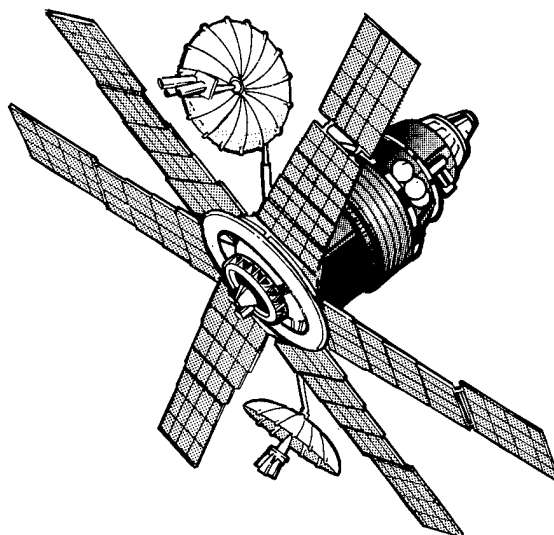

Figure 4.5. Original Molniya 1 Satellite.

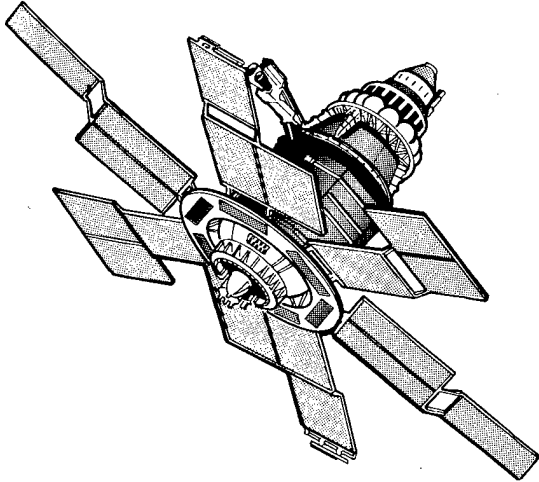

Figure 4.6. Molniya 3 Satellite.

munications payload of three 6/4 GHz transponders with power outputs of 40 W or 80 W. Although the launch requirements are the same for Molniya 1 and Molniya 3 and although Molniya 1 satellites have been launched from either Plesetsk or Tyuratam, Molniya 3 spacecraft have only originated from Plesetsk. Until 1983 the Molniya 3 constellation consisted of only four satellites which were essentially collocated with four Molniya 1 satellites. When the Molniya 3 system was expanded to eight vehicles in 1983–1985, the new additions inaugurated the 155° E ascending node geometry. After the restructuring of the Molniya 1 constellations in 1991, the Molniya 1 and Molniya 3 systems are essentially the same from a deployment perspective and to some extent provide an inherent backup capability. While Molniya 1 and Molniya 3 replenishments are normally independent, the Molniya 1-80 and Molniya 3-40 missions of early 1991 entered the same constellation position just five weeks apart.

Two Molniya 3 satellites (Figures 4.6 and 4.9) were launched in each of 1991 and 1992. Molniya 3-40 replaced Molniya 3-33 and Molniya 3-41 replaced Molniya 3-32 in 1991, whereas Molniya 3-42 replaced Molniya 3-35 and Molniya 3-43 replaced Molniya 3-34 in 1992. The average age of the replaced satellites was 40 months, slightly older than the replaced Molniya 1 spacecraft.

In 1990 the Applied Mechanics NPO announced that it was developing a successor to the Molniya series of spacecraft. The new Mayak satellite closely resembles the current

Molniya 1 and has approximately the same weight (1.7 metric tons) and the same electrical power (950 W). Mayak (Figure 4.10) will retain the standard 6/4 GHz retransmission capability and will add the INMARSAT standard 1.6/1.5 GHz system for mobile platforms. Mayak is designed for a 5-year operational lifetime. The inaugural flight of Mayak was scheduled for 1992, but the mission did not appear. An experimental Mayak transmitter, developed by Bulgaria, Czechoslovakia, Germany, and the USSR was carried by the geosynchronous Gorizont 20 in 1990 (References 20–22).

The Lavochkin NPO has proposed the 3-axis stabilized NORD spacecraft with a mass of 2,300 kg for a 4-satellite communications network in Molniya-type orbits. A modified SL-6 launch vehicle would be used for the maiden flight in 1994–1995.

The Soviet use of geosynchronous satellites for telecommunications purposes did not begin until the mid-1970's. By the end of 1992 nearly 90 communications and data relay spacecraft had been placed in geosynchronous orbits with 29 still operational near 21 positions along the geostationary ring. During 1991–1992 a total of ten GEO, communications spacecraft were deployed under four program names: Raduga, Gorizont, Ekran, and Kosmos.

USSR/CIS GEO spacecraft differ from most other GEO satellites by their greater mass (approximately two metric tons in GEO), their lesser communications capacity, and their lack of north–south station-keeping ability. The last characteristic is evident in the continual variation of orbital inclinations (typically between 0–5 degrees) of USSR/CIS GEO satellites during their operational lifetimes. To minimize this effect, new satellites are launched with initial GEO orbital inclinations of 1–2 degrees under strict conditions which take advantage of solar–lunar perturbations to first reduce the inclination to zero over a period of one to two years before it increases. East–West station-keeping is accomplished with liquid propulsion or ion thrusters.

To date, the development of all USSR/CIS GEO satellites has been directed by the Applied Mechanics NPO under the leadership of Mikhail Reshetnev. The Radio NPO and the Institute of Space Device Engineering are the primary communications payload developers, and the Astra NPO is the principal supplier of ground

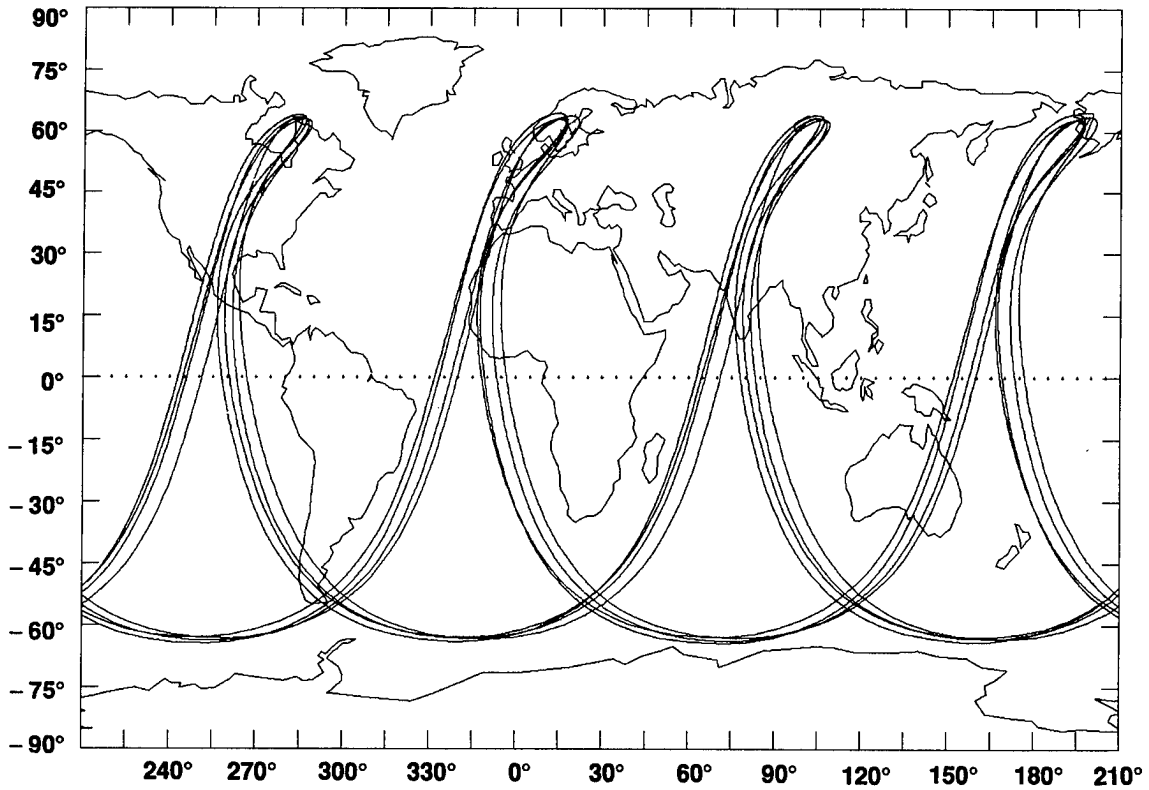

Figure 4.7. Molniya 1 Groundtracks, December, 1992.

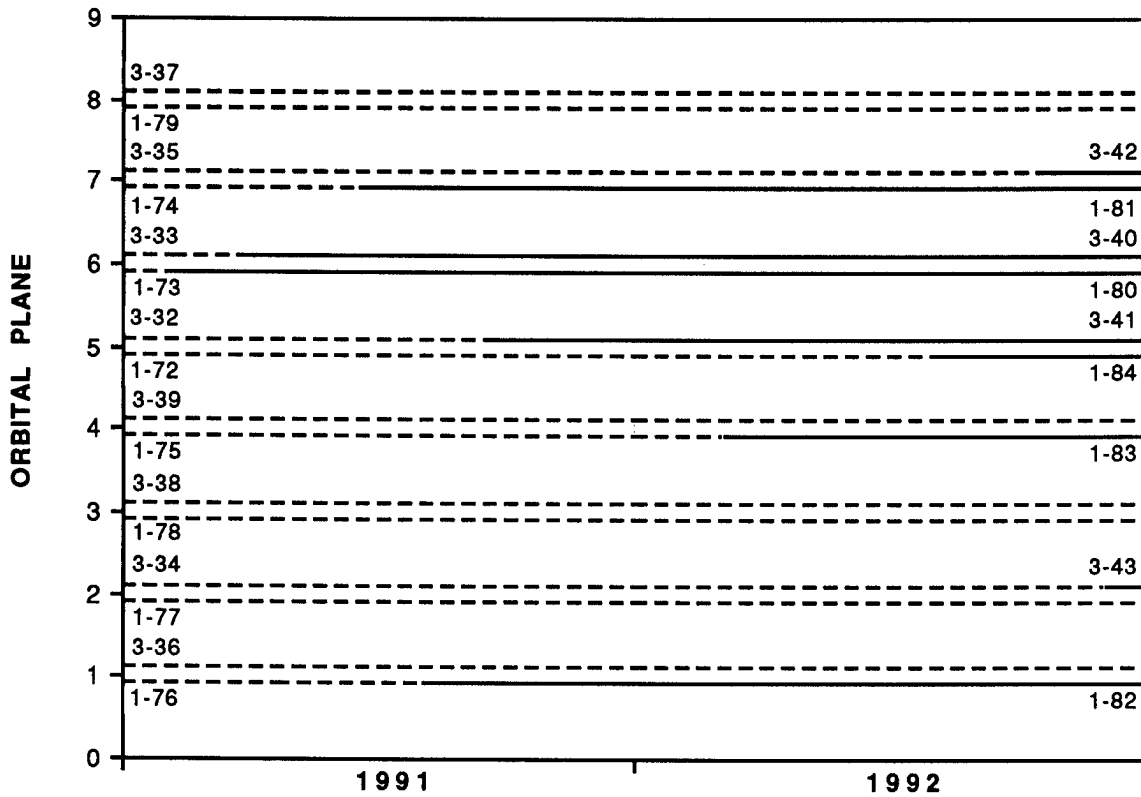

Figure 4.8. Replacement History of Molniya Satellites, 1991-1992.

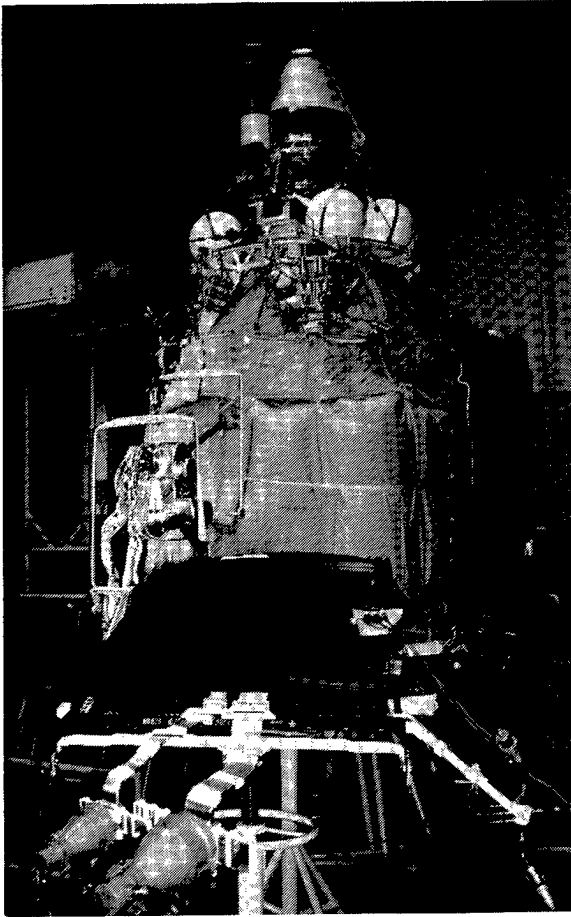

Figure 4.9. Molniya 3 Satellite in Checkout.

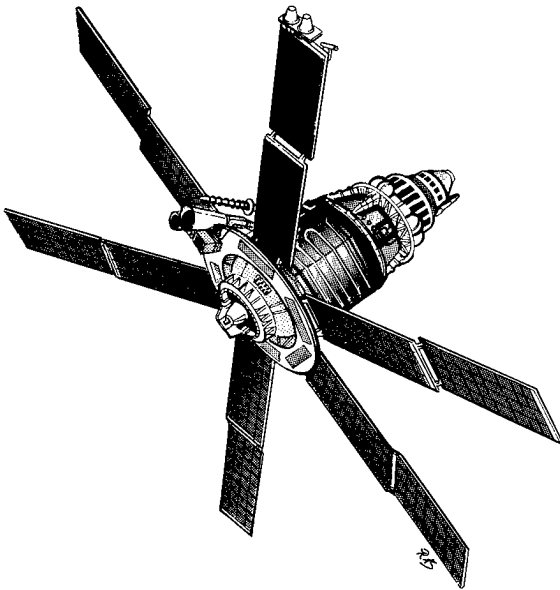

Figure 4.10. Mayak Satellite.

stations and receivers. Although USSR/CIS satellites are often characterized by short lifetimes in comparison to analogous Western satellites, these Siberian-made spacecraft exhibit normal mission lives of 5–10 years. All GEO satellites are transported to Tyuratam for launch by the SL-12. With rare exceptions the spacecraft are inserted into GEO near 90° E and allowed to drift east or west to their intended stations.

The first USSR/CIS GEO series spacecraft were the Raduga military and government communications satellites which appeared in 1975. Since then the Raduga constellation has expanded to 12 spacecraft distributed among 9 locations for global coverage. The general configuration of Raduga spacecraft is unknown, but the launch mass is approximately 2.0 metric tons. Up to six 6/4 GHz transponders are carried on each satellite. In addition, Raduga spacecraft may host Gals (8/7 GHz), Luch P (14/11 GHz), and Volna (1.6/1.5 GHz) transponders. A new series of Raduga spacecraft, designated Raduga 1, debuted in 1989. An agreement by the Astra NPO and the Italian firm Telespazio in 1991 led to the first commercial use of a Raduga satellite for international communications in early 1992 (References 23 and 24). In 1993 another resident Raduga satellite may be moved to 134° E to support on a temporary basis Pacific region communications for the newly formed Western Rimsat organization (Reference 25).

In 1991 two new Raduga satellites were placed in GEO as two aging spacecraft were retired. Raduga 27 (28 February) was positioned at 128° E where Raduga 21 was already on station. After a brief checkout period for the new satellite, Raduga 21 was moved during April–May to 190° E next to Raduga 18, which in turn was retired and placed in a graveyard orbit in late 1991 after a mission life of nearly six years. The other new Raduga in 1991 was Raduga 28 (19 December) which joined Raduga 19 and Raduga 22 at 35° E. Raduga 19 had been transferred from its prior spot at 45° E to 35° E in August. At about the same time, Raduga 17 was moved from 85° E to 49° E. The last major activity in the Raduga constellation occurred in December when Raduga 20 was shutdown and placed in a graveyard orbit after five years of service.

No new Raduga satellites were orbited in

Table 4.1. CIS GEO Communications Network, 1 January 1993.

EQUATORIAL POSITION (E)	COMMUNICATIONS SYSTEMS	HOST SPACECRAFT			
		RADUGA	GORIZONT	KOSMOS	EKRAN
12	GALS, VOLNA	RADUGA 22			
35	GALS, VOLNA	RADUGA 19 RADUGA 28			
40	LUCH		GORIZONT 22		
45	GALS, LUCH P, VOLNA	RADUGA 24			
49	GALS, VOLNA	RADUGA 1-2			
53	LUCH, VOLNA		GORIZONT 17 GORIZONT 27		
70	GALS, VOLNA	RADUGA 25 RADUGA 1-1			
80	LUCH, POTOK		GORIZONT 24	KOSMOS 1961 KOSMOS 2085	
85	GALS, LUCH P, VOLNA	RADUGA 26			
90	LUCH, VOLNA		GORIZONT 21		
96.5	LUCH		GORIZONT 19		
99	EKRAN				EKRAN 19 EKRAN 20
103	LUCH		GORIZONT 25		
128	GALS, VOLNA	RADUGA 27			
140	LUCH, VOLNA		GORIZONT 18		
190	GALS, LUCH P, VOLNA	RADUGA 21			
335	GALS, LUCH P, VOLNA	RADUGA 23			
344	SDRN			KOSMOS 2054	
346	LUCH, VOLNA		GORIZONT 20		
346.5	POTOK			KOSMOS 1888 KOSMOS 2172	
349	LUCH		GORIZONT 26		

1992, but two resident spacecraft were shuffled about the geostationary ring. During February–March Raduga 22 was shifted from 35° E to 12° E, and Raduga 1-1 left 49° E to share operations with Raduga 25 at 70° E. The movement of Raduga 22 was noteworthy by its effect of expanding the Raduga constellation from eight locations to nine. Finally, in December Raduga 17 left its position at 49° E, apparently terminating its mission after seven years.

The second most populous USSR/CIS satellites in GEO are called Gorizont and are primarily used for domestic and international telecommunications. In use since 1979, by the end of 1992 the Gorizont constellation had grown to

ten operational spacecraft located at nine different positions in a 154° arc from 14° W to 140° E. A tenth position at 145° E may be added in the near term.

The Gorizont spacecraft (Figure 4.11) possesses an initial mass in excess of 2.1 metric tons and has demonstrated a lifetime of nearly 10 years, although a 5-year service life is more common. The 3-axis stabilized satellite is approximately 2 m in diameter and 5 m long with two large solar arrays capable of generating 1.3 kW of electrical power for the first three years. Seven separate transmission antennas permit a variety of reception patterns for both broad and localized terrestrial regions.

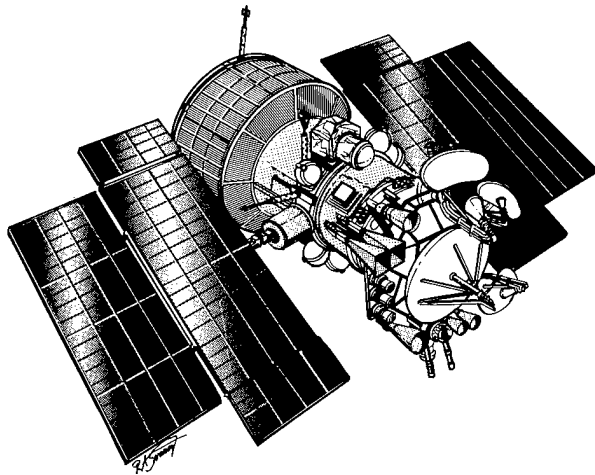

Figure 4.11. Gorizont Satellite.

A typical Gorizont communications payload includes six general purpose (TV, audio, facsimile) 6/4 GHz transponders (five 12.5 W and one 60 W), one 60 W, one Luch 14/11 GHz transponder (15 W), and one Volna 1.6/1.5 GHz transponder (20 W). The Volna transponders are INMARSAT-compatible and are extensively used by the USSR/CIS merchant marine fleet via the primary control center in the Tomilino suburb of Moscow and the Odessa and Nakhodka ground stations (Reference 26). Gorizont is the primary GEO television rebroadcasting system, supporting all five commonwealth time zones: Zone 1 from 140° E, Zone 2 from 90° E, Zone 3 from 80° E, Zone 4 from 53° E, and Zone 5 from 14° W. These transmissions are handled by Orbita (12 m receiving antenna) and Moskva (2.5 m receiving antenna) ground stations in the 6/4 GHz band. The Moskva Globalnaya system was inaugurated in 1989 using 4 m receiving antennas and serviced by Gorizonts at 96.5° E and 11° W. In 1991 Kazakhstan announced its plan for the Zharyk direct broadcasting system via an experimental channel on Gorizont satellites (Reference 27).

While Gorizont satellites have long supported the Intersputnik communications network, in recent years these spacecraft have increasingly been linked to Western communications grids (Reference 28). Major ground stations are now deployed in sixteen countries in Europe, Asia, Africa, and the Western Hemisphere. At the Intersputnik 20th anniversary meeting held in Alma-Ata in October, 1991 (where Syria became the 16th member), the organization

discussed the challenges presented by the recent dissolution of the Eastern-bloc council for Mutual Economic Aid and the need to work more closely with the international community, in particular INTELSAT (Reference 29). In July, 1991, the USSR became the 121st member of INTELSAT (at a 0.05% share), making Gorizont available to this system (Reference 30). Rimsat, Ltd, selected Gorizont satellites in 1992 as the principal GEO assets for its fledgling Pacific region communications network until a more advanced, follow-on satellite is available. The first Gorizont launches specifically for Rimsat are scheduled for November, 1993, and March, 1994 (References 25, 31, 32). Since 1990 the UK-based Brightstar Communications firm has leased a transponder on 14° W Gorizont satellites to provide a link from Moscow to London and Europe (Reference 33), and during the 1991 Persian Gulf War the U.S. leased Gorizont transponders to handle the dramatically increased communications traffic in the middle-East (Reference 34).

Prior to the breakup of the USSR, the Russian Federation decided to establish its own independent communications system by commercially procuring Gorizont spacecraft and launch services. The first such spacecraft was Gorizont 22, launched in November, 1990, and stationed at 40° E. When the resident USSR satellite at that location (Gorizont 12) was retired in 1991, Gorizont 22 assumed the additional USSR international obligations of its predecessor (Reference 36). Although the Russian Federation possesses more than 7,000 ground receivers for satellite transmissions, three million citizens still live in regions with no access to television broadcasts. In 1992 the joint-stock company Kosmos-S offered to provide business communications services via Gorizont satellites using a new Yenisey-M ground station developed by the Krasnoyarsk Radio Equipment Plant (Reference 35).

The overall Gorizont constellation decreased by one during 1991 as two new spacecraft were launched but three ended their missions. Gorizont 23 was successfully launched on 1 July after an aborted attempt three days earlier. The spacecraft was the second Russian-owned vehicle and was stationed at 103° E next to Gorizont 14 (Reference 36). Gorizont 24, launched 23 October 1991, took up duties near 80° E alongside Gorizont 16, which was subse-

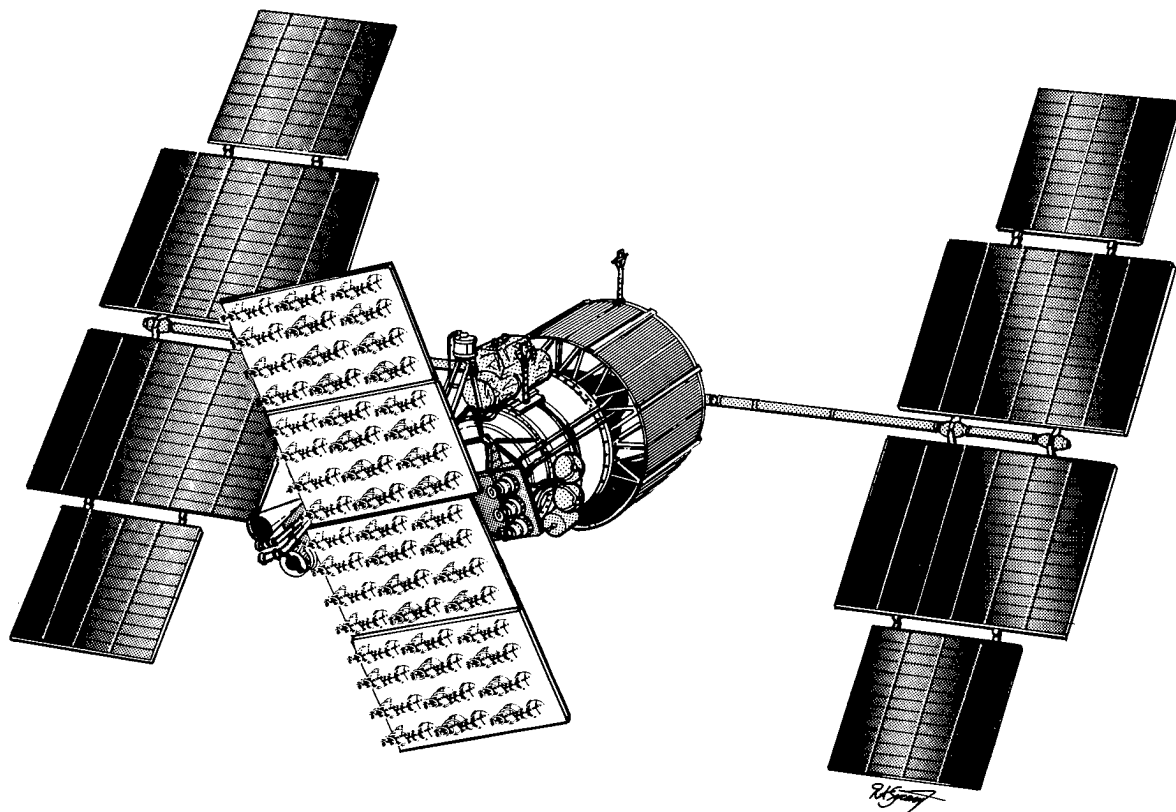

Figure 4.12. Ekran-M Satellite.

quently placed in a higher non-synchronous orbit in mid-December. Other constellation actions included the apparent demise of the 5-year old Gorizont 12 (see above) in January when the spacecraft began to drift off-station. In April Gorizont 13 was moved out of the geostationary ring at the end of a 4.5 year service period, and Gorizont 15 was moved from 346° E to 349° E to assist the aging Gorizont 11.

In 1992 three new Gorizonts were added to the network, but four satellites were removed. Gorizont 25 was launched on 2 April and was soon stabilized at 103° E. The launch itself was noteworthy since it occurred three hours later than expected, prompting the SL-12 launch vehicle to perform an unusual plane change maneuver to compensate. Even more surprising was the apparent termination in July of both Gorizont 15 and Gorizont 23 co-located at 103° E. The two spacecraft were lost by the U.S. Space Surveillance Network at that time but found months later in higher altitude graveyard orbits. Whereas Gorizont 15 was several years old, Gorizont 23 had just celebrated its first anniversary in space when its mission ended.

Gorizont 26 was orbited in July, 1992, and moved directly to 349° E, the first satellite to operate there immediately after launch. Historically, aging Gorizonts were transferred to 349° E after being relieved of duties at other locations. When Gorizont 26 arrived, the two residents, Gorizont 11 and Gorizont 15, were nearing the ends of their missions. The former gradually drifted off-station in the Fall and Winter, while the latter was placed in a graveyard orbit in September. Gorizont 27 was launched 27 November 1992 and entered the GEO regime near 90° E with a westward drift of approximately 9° per day. The spacecraft was stabilized near 53° E next to Gorizont 17.

A third USSR/CIS system, Ekran-M provides unique direct television broadcasting service to the central CIS region (Zone 3). The original Ekran spacecraft debuted in 1976 and were upgraded to the Ekran-M model in the second half of the 1980's. All spacecraft in the series have been positioned near 99° E and transmit directly to simple individual or communal receivers at 0.7 GHz with a powerful 200 W transponder. The new Ekran-M spacecraft (Figure 4.12)

weigh approximately two metric tons and carry two transponders. The solar arrays have been augmented to provide 1.8 kW of power.

Although the original Ekran spacecraft were exceptionally short-lived, the new Ekran-M are markedly surpassing the cited 3-year design life. No Ekran-M spacecraft were launched during 1989–1991 as Ekran 17 and Ekran 19 continued to operate. Ekran 18's mission ceased in late 1990 just short of its 3-year goal. Finally, on 30 October 1992, Ekran 20 was launched and soon joined Ekran 17 and Ekran 19. At the end of the year Ekran 17 had drifted off-station, leaving Ekrans 19 and 20 as the sole Ekran-M relays.

Two other USSR/CIS telecommunications systems have been operating in GEO for many years aboard Kosmos spacecraft. Beginning with Kosmos 1366 in 1982, the Potok data relay system has primarily supported military and government users. Potok transponders are hosted on Geyser satellites and utilize a unique, hexagonal phased-array antenna. The principal ground stations for the Potok system are located at Nakhodka and in the Moscow region at Konakovo. From Geyser spacecraft positioned at 80° E and 13.5° W, the Potok system is designed for document and digital data transmissions in the 4.4/3.2 GHz band. A third GEO slot at 168° W has not yet been opened. Mobile and stationary transmitter/receiver stations are used with antenna diameters of 2.6–3 m. In 1992 the CIS offered the Geyser-Potok system for commercial international use under the name Sokol (References 37–39).

The only launch of a Geyser satellite during 1991–1992 occurred on 22 November 1991 under the name Kosmos 2172. The brief launch announcement identified the on-board equipment simply as "intended for relaying telegraph and telephone information in the microwave range" (Reference 40). Kosmos 2172 was located at 13.5° W next to Kosmos 1888 and Kosmos 1961. Then, at the beginning of March, 1992, Kosmos 1961 began an unusual six-week-long transfer to the second Potok position at 80° E. The shift was marked by numerous maneuvers which first lowered both apogee and perigee and then raised them again as the spacecraft neared its destination. The transfer was completed in mid-April when Kosmos 1961 joined Kosmos 2085. All four Geyser spacecraft were apparently operational at the end of 1992.

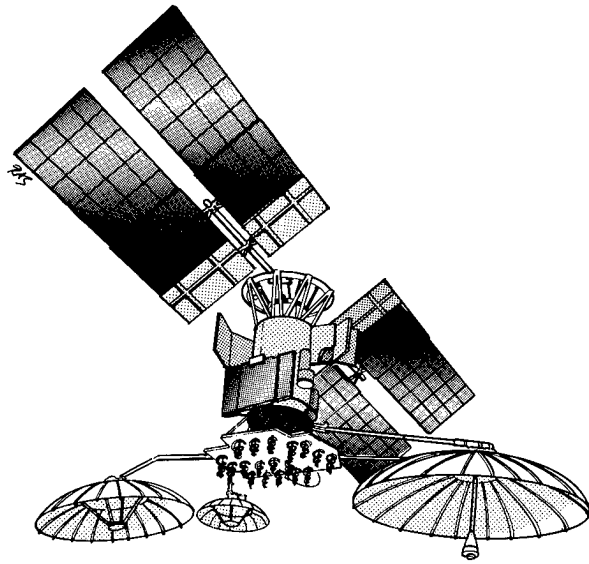

Figure 4.13. Luch Satellite.

A second GEO telecommunications system hidden within the Kosmos program is the Satellite Data Relay Network (SDRN) which is analogous to the U.S. Tracking and Data Relay Satellite System (TDRSS). Three Luch spacecraft (not to be confused with the Luch transponder system on Gorizont spacecraft) have been launched since 1985. Although three locations have been registered with the International Telecommunications Union (16° W, 95° E, and 160° W), only the first two have been employed to date.

Each Luch spacecraft (also referred to as Altair satellites) has a mass of 2.4 metric tons and two extended solar arrays capable of supplying 1.8 kW (Figure 4.13). Three large antennas and numerous, small helical antennas permit data relays in the 15/14, 15/11, and 0.9/0.7 GHz bands. Terrestrial stations may employ simple 0.8–2 m antennas. The system is especially well suited for space-to-space communications, including the Mir space station and the Buran space shuttle. The Luch spacecraft has a design lifetime of 5 years.

Throughout 1991 two Luch satellites were operational: Kosmos 1897 at 95° E and Kosmos 2054 at 16° W. The Western Hemisphere spacecraft was employed in 1991 for a Moscow–Washington television conference link established, in part by Soyuzmedinform NPO, to discuss the international exchange of medical information (Reference 41). In January, 1992, Kosmos 1897 began to drift off-station, and by the beginning of March had slipped to 90° E.

However, during the month a small maneuver caused the spacecraft to drift back toward 95° E, which was reached by the end of April. Kosmos 1897 remained in this vicinity for several months before natural perturbations began pulling it westward once again. By December 1992, the spacecraft had drifted to 77° E with no attempt to retard its movements, suggesting that the vehicle was now inoperable.

An additional geosynchronous data relay satellite was launched in 1991 under the Kosmos program, but the specific identity of its payload is uncertain. Launched on 13 September, Kosmos 2155 became only the second USSR satellite to remain in a LEO parking orbit for four orbits before maneuvering into a GTO. This procedure enabled Kosmos 2155 to enter the GEO ring in the Western Hemisphere in a manner identical to that of Kosmos 1940 in 1988. Kosmos 2155 was stabilized soon after launch near 335-336° E.

The launch announcement for Kosmos 2155 referred only to a payload with "equipment to relay telegraph and telephone information on centimeter frequencies" (Reference 42). This region had previously been occupied by four other Kosmos spacecraft in the missile early warning program: Kosmos 1546, Kosmos 1629, Kosmos 1894, and Kosmos 1940. (The last of these apparently ceased functioning in January 1992.) No further announcements were made concerning the objectives of Kosmos 2155, and after only nine months in orbit the spacecraft apparently malfunctioned. A small maneuver in mid-June, 1992, induced a slow eastward drift that was never corrected by the end of the year.

As many as half a dozen or more types of new generation CIS GEO communications satellites could debut during the remainder of the decade under the names Arcos, Bankir, Express, Gals, Gelikon, Globis, and Granit. In addition, two joint ventures, one with Canada (SovCanStar) and one with Germany (Romantis), to develop specialized GEO communications satellites have also begun. These programs were all initiated prior to the fall of the USSR, and the organizational and financial instability of the current CIS suggest that not all systems will be deployed. However, the first new spacecraft could appear as early as 1993.

The Applied Mechanics NPO is already far along in the development of four of the new spacecraft. The Express satellite program is

being managed via the Informcosmos association with members including the Applied Mechanics NPO, Radio NPO, Space Instrument Building NPO, and Space Communications PO as well as the Vostok bank for financial services and Intersputnik. Express will replace the widely used Gorizont system and support Intersputnik by providing greater flexibility, capacity, longevity, and overall technology. The 2.5 metric ton Express spacecraft will be deployed at up to 10 GEO locations (the initial positions may be at 40° E, 103° E, and 145° E) and will employ both east-west and north-south station-keeping. Two large solar arrays (total power = 2.4 kW) will power 12 transponders: ten in the 6/4 GHz and two in the 14/11 GHz bands. On station the spacecraft bus will measure 3.6 m by 6.1 m with a solar array span of 21 m. (References 43-47).

The Gals television broadcasting satellite closely resembles Express but will be used at only two GEO locations: 23° E and 44° E. Each spacecraft will carry three transponders operating at 18/12 GHz, which will support professional broadcasting firms (receiving antenna 2.5 m in diameter), communal associations (receiving antenna 1.5 m), and individuals (receiving antenna 0.6-0.9 m). Gals spacecraft will use a solar array identical to that of Express, but the overall dimensions of the former's bus will be slightly larger at 4.1 m by 6.6 m. Predicted operational life, like Express, is 5-7 years. Spacecraft testing was being completed in 1992 with a projected launch late that year deferred to 1993 (References 47-50). The maiden launch was originally slated for December, 1990.

To provide television broadcasting service to the entire commonwealth, replacing both Gorizont and Ekran spacecraft, Gelikon satellites will be deployed at five GEO positions (one for each of the major broadcast time zones): 23° E, 44° E, 74° E, 110° E, and 140° E. Although the launch mass of Gelikon will be the same as Gals and Express (2.5 metric tons), Gelikon will carry augmented solar arrays (span of 26.9 m) which will provide up to 5.2 kW for the expected ten year lifetime. Instead of the three transponders on Gals, the Gelikon payload will include twelve 18/12 GHz units which will also work with the variety of receiving stations identified above for Gals. The Gelikon spacecraft bus differs in appearance from that of Gals and Express with overall dimensions of 6.2 m by 6.8 m. The first launch of Gelikon is presently set for

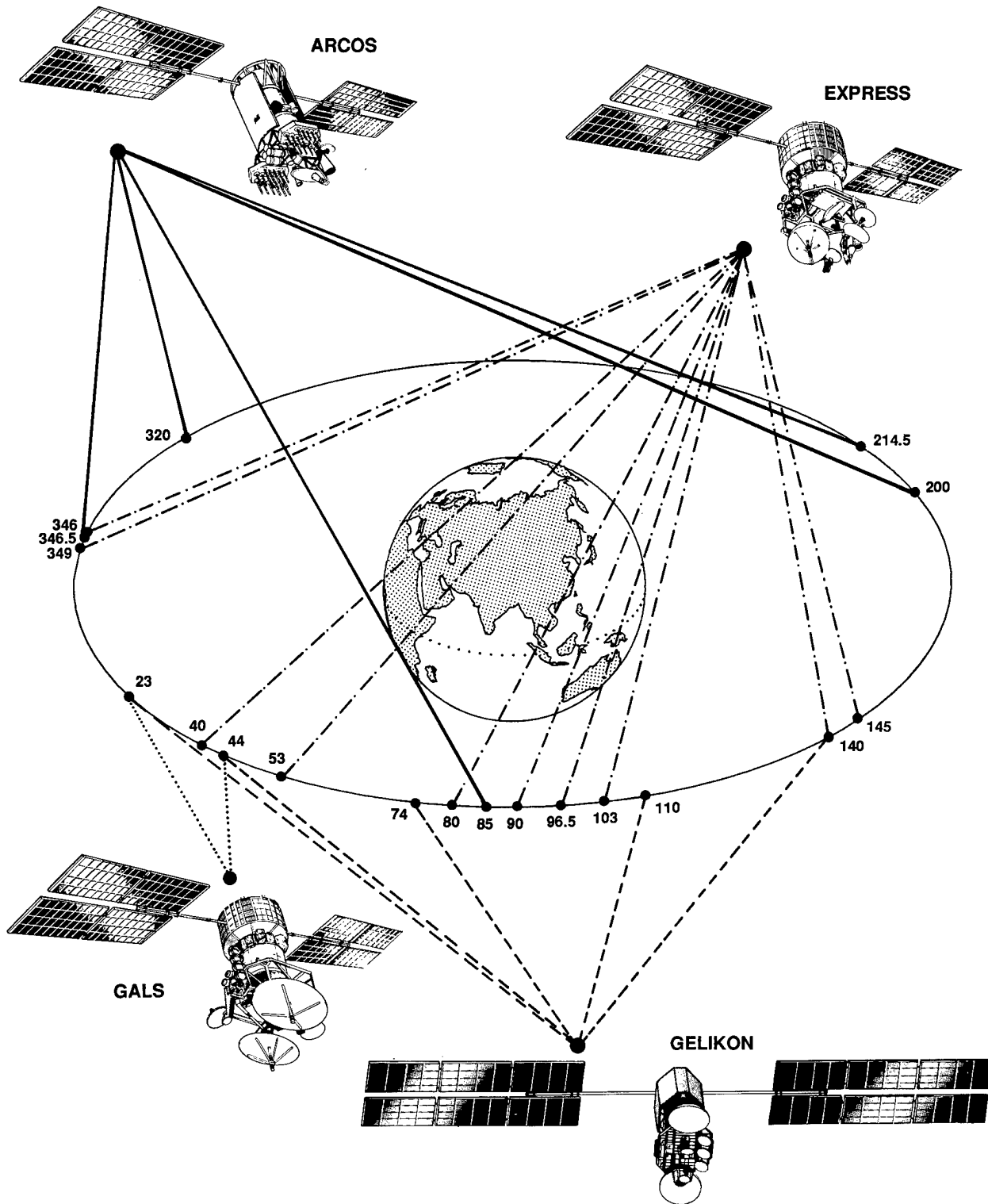

Figure 4.14. The Next Generation CIS GEO Communications Satellites.

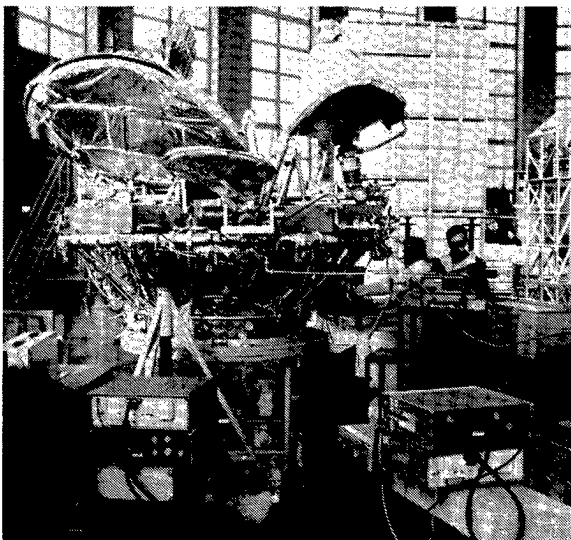

Figure 4.15. Gals Satellite in Development.

approximately 1995 (Reference 51).

The fourth Applied Mechanics NPO product will be the Arcos spacecraft, specifically designed to service mobile (air, land, and sea) and remote users. The Arcos design evolved during 1990–1992 and now relies more heavily on the Express and Gals spacecraft bus and solar arrays. The overall dimensions of the 2.5 metric ton Arcos are 5.0 m by 5.3 m by 21 m. Each spacecraft will be equipped with two transponders (one 6/4 GHz and one 1.6/1.5 GHz) with a capacity of 250–300 telephone channels. With spacecraft at five locations (85° E, 200° E, 214.5° E, 320° E, and 346.5° E), the Arcos network will have full global coverage at low- and mid-latitudes. Four types of terminals have been designed for principal anticipated Arcos users: Quark-B terminal for aircraft, the Kolibri terminal for trains, the Volna-S and Aysberg terminals for ships, and the Zvezda-A for automobiles. Originally scheduled to debut 1993, the first launch may be delayed until 1994 (References 47–52).

In 1989 the USSR was involved in design studies with the U.S. firm of Space Commerce Corporation for a new geostationary communications satellite, tentatively named Granit. With up to 21 transponders operating at 1.6/1.5 GHz, 6/4 GHz, and 14/11 GHz, Granit was designed to appeal specifically to Western users. A design option would also permit the use of a 30/20 GHz transponders if required. No immediate plans apparently exist for offering Granit on the commercial market in the near

future (References 53 and 54).

As noted above, the Lavochkin NPO proposed in 1990 the creation of a LEO store/dump communications network called Bankir. However, 1992 documents from Lavochkin NPO indicate the Bankir name is now used in reference to a geostationary communications system comprised of Coupon satellites. The Bankir network may begin operations in 1993 using existing CIS assets but will transition to Coupon satellites as early as 1994. By 1996 a constellation of three Coupon spacecraft is envisioned at locations above the eastern Atlantic (8° W) and the eastern and western Indian Ocean (55° E and 120° E).

Each 2.5 metric ton Coupon will carry 16 transponders and employ sophisticated phased-array antennas for tailored transmission footprints to user specifications. The first two spacecraft will carry 16 14/11 GHz transponders, but the third satellite will offer an equal mix of 6/4 GHz and 14/11 GHz units. The Coupon spacecraft bus is derived from the newest generation missile detection satellites. The Bankir network is being organized by the newly established Russian firm of Global Information Systems, Inc. The Elas NPO will provide the transponders and the ground stations (References 55–57). In 1995 Lavochkin NPO may introduce the 3.1 metric ton Zerkalo satellite with 10 Ku-band (13/11 GHz) transponders and six mechanical antennas.

Clearly the most ambitious GEO satellite

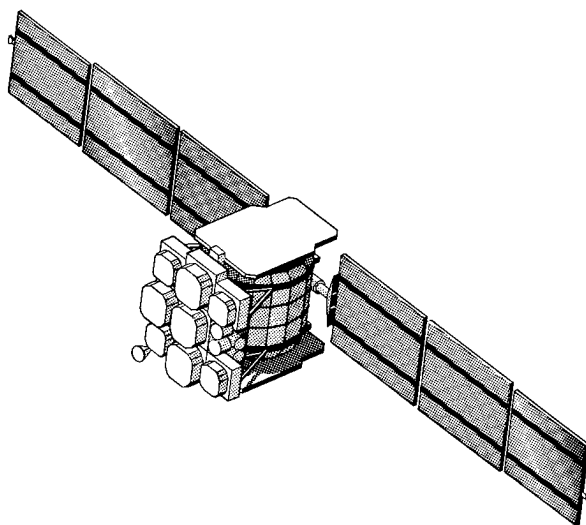

Figure 4.16. Bankir's Coupon Satellite.

project in the CIS is led by the Energiya NPO and calls for the launch of enormous telecommunications platforms with a mass in GEO of up to 20 metric tons. First proposed in 1989 as a means of coordinating and consolidating numerous national communications systems, the idea of a high-cost, high-capacity GEO satellite was received with muted enthusiasm (Reference 58). While providing one solution to the problem of overcrowding in the GEO ring (reportedly, three platforms could replace 32 conventional GEO satellites), the concern about a launch failure of the SL-17 or of an on-board support system (e.g., attitude control) which would cause the loss of the entire spacecraft was difficult to overcome.

In July, 1992, work on the project was said to be near a standstill since government funding had ceased in the Fall of 1991 (Reference 59). Under the original Energiya NPO and Energiya-Marathon Association proposal, a Phase 1 system (1994–1997) would include three 17.8 metric ton platforms to meet USSR internal communications needs as well as communications with Europe and Asia. The 7.6 metric ton payload would draw 12 kW from the total 16 kW on-board power supply to operate a host of transponders at 1.6/1.5 GHz, 6/4 GHz, 14/11 GHz, and 18/12 GHz through antennas ranging from 1 to 8.5 m in diameter. The design lifetime was rated at 10 years.

If successful, a Phase 2 system (1997–2000)

might be deployed with 4–5 even larger satellites to form a Global Space System. A total platform mass of 20 metric tons could support a 9 metric payload package and a 24 kW electrical power supply system. Antenna dimensions would grow to up to 20 m in diameter, while transponder frequencies would increase to 60/50 GHz. To increase the payload capacity of the SL-17, a two-stage liquid oxygen/hydrocarbon upper stage would be replaced with a single liquid oxygen/liquid hydrogen upper stage (References 60–62).

The Energiya NPO reported in the second half of 1992 that the firm had secured a 4 billion ruble loan to continue design and test activities on an experimental, 20-metric-ton-class GEO satellite (Reference 63). Then, in late 1992 the Energiya NPO and the Vypel interstate joint-stock company agreed to develop the Globis global space communications system with the former responsible for developing the spacecraft and the latter tasked with developing the terrestrial communications infrastructure. The plan which foresaw the launch of the first spacecraft in 1996 would follow closely the outline of the Phase 1 Marathon program (References 64 and 65).

Despite the volatile financial environment in the CIS, a joint venture with a Canadian consortium is proceeding with the objective of launching the first Russian–Canadian satellite SovCanStar by 1995. The spacecraft will be

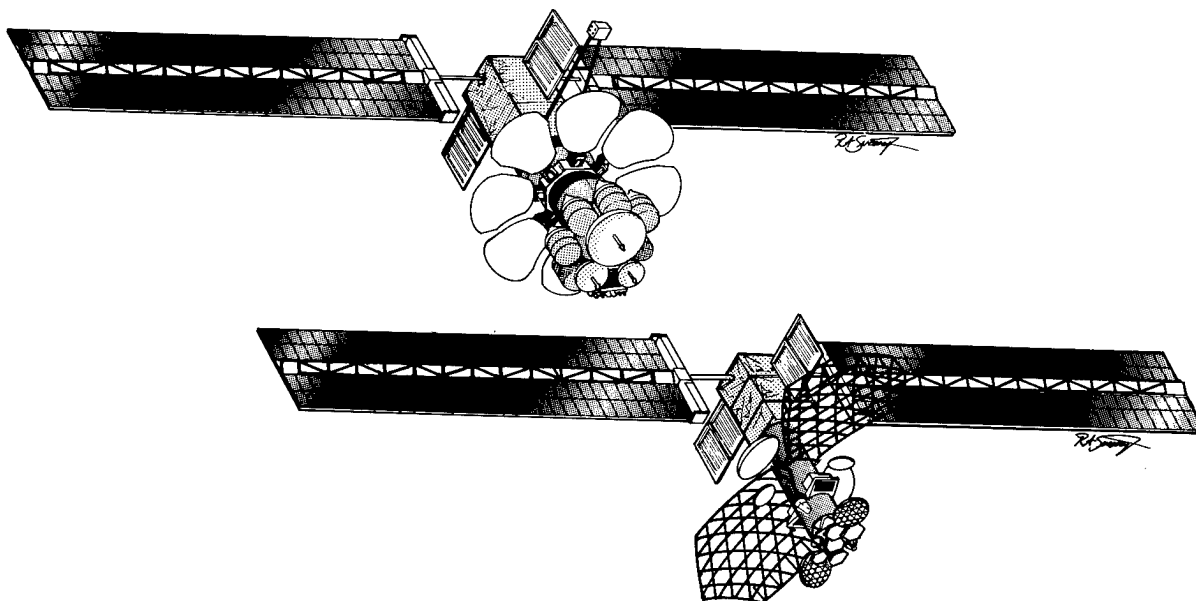

Figure 4.17. Proposed Configurations for CIS Heavy GEO Satellites.

manufactured by the Applied Mechanics NPO, and the satellite will be launched by the SL-12 from Tyuratam. The Canadian association of Com Dev Ltd, Canadian Satellite Communications, Inc., and General Discovery will provide the communications payload. After spacecraft are deployed over the Atlantic and Pacific Oceans for international links, additional satellites could be launched to satisfy CIS domestic requirements (References 66–69).

A similar project between Russia and Germany was significantly altered in 1992. Known as Romantis, the original plan envisioned a German consortium providing the communications payloads for Russian-built-and-launched satellites. Later, German industry assumed responsibility for the complete development of the spacecraft. Then, in late 1992 the scope of the project was reduced with the German team now focusing on the manufacture of ground stations and the lease of INTELSAT links between the CIS and Europe (References 70–73).

4.1.2 European Space Agency

Telecommunications not only was the subject of ESA's first Earth applications satellite program but also has remained a high priority of the organization. Although only five ESA GEO communications satellites were operational during 1991–1992, the influence of ESA has been far greater due to the transfer of spacecraft to the fledging EUTELSAT and INMARSAT programs. Throughout its history ESA has focused on communications technology development rather than network operations. One of the agency's three major satellite engineering programs is the Data Relay Satellite (DRS) scheduled for launch near the end of this decade.

The Orbital Test Satellite (OTS) program was inherited by ESA in 1975 from its predecessor the European Space Research Organization (ESRO). Two of the experimental spacecraft were built, but the first vehicle was lost during a Delta launch failure in 1977. The following year OTS-2 became one of the first GEO communications satellite to carry six Ku-band (14/11 GHz) transponders and was capable of handling 7,200 telephone circuits. With a mass of approximately 445 kg on station, the OTS-2 bus was hexagonal with overall dimensions of 2.4 m by 2.1 m. Two solar panels with a span of 9.3 m

provided 0.6 kW of electrical power. British Aerospace was the prime contractor from the European MESH consortium which developed the OTS vehicle. OTS-2 completed its primary mission in 1984 after which the spacecraft was involved in a 6-year program of experiments, including the testing of a new attitude control technique taking advantage of solar wind forces. In January, 1991, OTS-2 was moved out of the geostationary ring and into a graveyard orbit (Reference 73).

Based on the OTS experience, ESA developed and launched the European Communications Satellite (ECS) and the Maritime ECS (MARECS) in the early 1980's. These assets were later transferred to the EUTELSAT and INMARSAT organizations, respectively, and are described in the appropriate sections below. In all, six satellites of this class were successfully launched under sponsorship of ESA during the period 1981–1988, and at the end of 1992 all were still in active or reserve status.

ESA's current communications technology test bed is Olympus (formerly known as L-Sat), launched by an Ariane 3 in July, 1989, and stationed near 19° W. The on-station mass of Olympus is 1.5 metric tons with a payload of 360 kg, including two 18/12 GHz, 230 W transponders; three 30/20 GHz, 30 W transponders, and four 14/12 GHz, 30 W transponders. The spacecraft bus is approximately 2.6 m by 2.1 m by 1.8 m with two 27.5 m solar arrays capable of a minimum of 3.6 kW at end of life. The prime contractor was British Aerospace with major

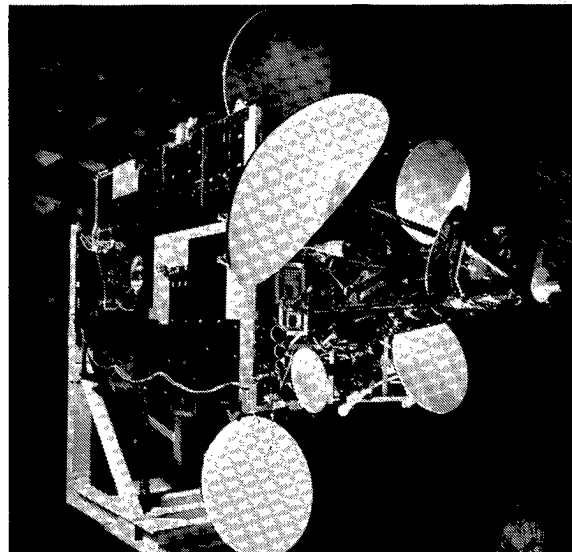

Figure 4.18. Olympus Satellite.

contributions from Alenia Spazio, Fokker, Matra Marconi, and Spar Aerospace Ltd. The principal ESA participants in the Olympus program are Austria, Belgium, Canada, Denmark, Italy, Netherlands, Spain, and the United Kingdom.

Olympus (Figure 4.18) suffered several setbacks in 1991 but was eventually able to recover. In late January one of the two solar arrays lost its ability to track the sun. Then, four months later, an attitude control upset was compounded by improper commands from the Fucino ground station, causing failures in the electrical, propulsion, and thermal control systems. The spacecraft drifted in GEO for two months before the vehicle could be brought under control. Olympus was maneuvered back to 19° W by mid-August, 1991, and the individual payloads were reactivated during September–November (References 74–79).

The next major telecommunications satellite to be developed by ESA will be ARTEMIS (Advanced Relay Technology Mission), which has been modified to serve in a pathfinder role for DRS. ARTEMIS will be similar in mass (total and payload) and configuration to Olympus but is being derived from prime contractor Alenia Spazio's ITALSAT platform. Among the payloads will be the Silex (Semiconductor Intersatellite Link Experiment) optical terminal which will demonstrate space-to-space links with the French SPOT 4 satellite, a L-band land-mobile communications system, and a prototype of the DRS S/Ka-band relay system. ARTEMIS, scheduled for a mid-1990's launch on the first flight of Ariane 5, will test two independent ion thruster systems for orbit maintenance over a potential 10-year life span.

Alenia Spazio is also the prime contractor for the DRS which was reaffirmed at the November, 1991, ESA ministerial meeting at Granada. Originally, DRS was to play a major role in the Hermes, Columbus, and Polar Platform programs. However, despite the downscaling and delays associated with the aforementioned programs, ESA has elected to proceed with DRS essentially on schedule for a maiden launch in 1999. DRS will carry a 450 kg payload similar to that now designed for ARTEMIS and will be deployed at 59° E and 316° E. After fulfilling its test program, ARTEMIS will join DRS for routine operations, which will be compatible with U.S. and Japanese data relay systems (References 79–83).

Under the ESA Payload and Spacecraft Demonstration and Experimentation Program (PSDE), development of a European Mobile Services (EMS) system is underway for a test flight as an auxiliary payload of ITALSAT F2, now scheduled for launch in 1995. The Advanced Orbital Test Satellite System (AOTS) will introduce ESA's first communications satellite in a highly elliptical, inclined orbit. Named Archimedes, the new system will be designed primarily for portable receivers at high latitudes. First launch of up to six spacecraft is tentatively set for 1998 (References 74, 84, and 85).

4.1.3 EUTELSAT

The European Telecommunications Satellite Organization (EUTELSAT) has been servicing the European community since 1977, being formally established by a multi-lateral agreement in 1985. By 1991, a total of 28 European nations had joined EUTELSAT with France, Germany, Spain, and the United Kingdom accounting for more than 70% of the shares. In 1979 ESA agreed to design, build, and launch five ECS spacecraft to be assumed by EUTELSAT after passing initial on-orbiting testing. At that time the name of each spacecraft was changed to EUTELSAT 1-F1, EUTELSAT 1-F2, etc. Of the five ECS spacecraft, four were successfully launched (1983, 1984, 1987, and 1988) and transferred to EUTELSAT. ECS 3 was lost in an Ariane launch accident in 1985.

As noted previously, the ECS spacecraft was derived from the OTS vehicle but with an initial

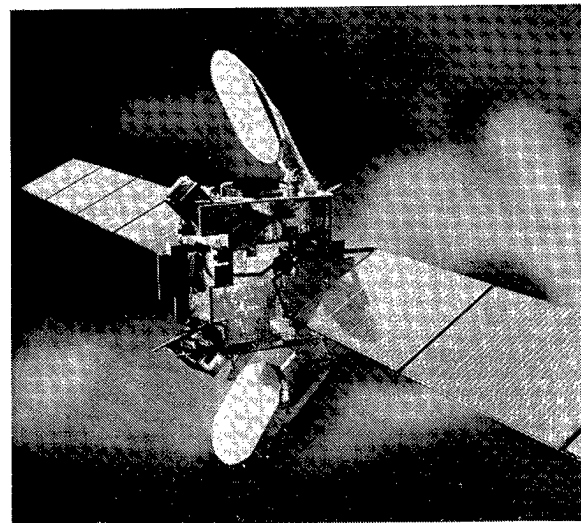

Figure 4.19. EUTELSAT 2 Satellite.

mass on station of approximately 700 kg. The payload included twelve (including two spares) 14/11 GHz transponders with 20 W output power for a capacity of 12,000 telephone circuits or 10 television channels. Two solar arrays with a span of 13.8 m provided 1 kW of electrical power to the 2.2 m by 2.4 spacecraft bus. With an anticipated working life of up to seven years, at the end of 1992 all four ECS/EUTELSAT 1 spacecraft were still operational at 2° E, 7° E, 21.5° E, and 26° E.

In 1990 EUTELSAT began the deployment of the second generation EUTELSAT spacecraft procured directly from Aerospatiale and based on the Spacebus-100 design. Each EUTELSAT 2 spacecraft supports 16 transponders (with eight spares) operating at 14/11 GHz and 50 W output power. In orbit the spacecraft spans 22.4 m across the two rectangular solar arrays which generate up to 3.5 kW. Although similar in appearance to EUTELSAT 1, EUTELSAT 2 employs two, 1.6 m diameter multifeed reflectors, one on each side of the spacecraft bus. The second, third, and fourth EUTELSAT 2 spacecraft were successfully launched during 1991-1992 on 15 January 1991, 7 December 1991, and 9 July 1992, respectively. A fifth mission is planned for 1994 at the earliest. At the end of 1992 EUTELSAT 2-F1 was stationed at 13° E, EUTELSAT 2-F2 at 10° E, and EUTELSAT 2-F4 at 7° E. EUTELSAT 2-F3 was near 16° E and drifting slowly to the west.

EUTELSAT had planned to create a new generation of direct broadcast satellites, called Europesat, for operations beginning in the mid-1990's. However, in late 1992 the program was in doubt due to a lack of financial support. If deployed, Europesat would carry high power (125 W) 18/12 GHz transponders capable of servicing high definition television transmissions (References 86 and 87).

4.1.4 France

France presently operates two national communications systems in GEO, Telecom and TDF, to ensure domestic and international telephone and television service. The launching of the first two vehicles of the second generation Telecom spacecraft during 1991-1992 coincided with the retirement of France's first GEO communications satellite. A small prototype communications spacecraft was also inserted into LEO for the first time during the period.

The initial French experience with GEO telecommunications began in 1967 when a joint venture was signed by France and Germany to develop two experimental Symphonie satellites. The small (230 kg) spacecraft with 3-axis stabilization and two 6/4 GHz transponders were launched by the U.S. in 1974 and 1975. The Symphonie system was highly successful in providing telecommunications links throughout Europe and to other continents. Both spacecraft far exceeded the 5-year design life and were transferred to graveyard orbits in 1983 and 1985, respectively.

Shortly before the retirement of Symphonie 2, the first Telecom spacecraft, Telecom 1A, was launched by an Ariane booster on 4 August 1984. Operated by France Telecom under government sponsorship, Telecom satellites service both civilian and military users through twelve active and five reserve transponders operating at 6/4 GHz (four transponders), 14/12 GHz (six transponders), and 8/7 GHz (two transponders). The last units provide the Syracuse (Système de Radio Communications Utilisant un Satellite) secure military channels for the French Ministry of Defense (References 88 and 89).

Telecom 1 satellites were designed and manufactured by Matra with the communications package supplied by Alcatel Espace. At the start of its 7-year design life, each Telecom 1 had a mass of approximately 700 kg and an initial electrical power capacity of 1.2 kW, supplied by two narrow solar arrays with a total span of 16 m. The spacecraft bus was derived from the earlier ECS program (Section 4.1.3) in which Matra was a subcontractor to British Aerospace. A total of three Telecom 1 satellites were launched (1984, 1985, 1988). Telecom 1A was placed in a graveyard orbit in September, 1992. Only Telecom 1C remained operational at the end of 1992 and was stationed at 3° E after being moved from 5° W in the Fall of 1992.

The second generation Telecom spacecraft debuted on 16 December 1991 as Telecom 2A and was followed on 15 April 1992 by Telecom 2B. This new series of more capable spacecraft was designed and manufactured jointly by Matra Marconi Space and Alcatel Espace and is based on the Matra-British Aerospace Eurostar 2000 2.0 x 2.1 x 2.0 m satellite bus. On-orbit mass of Telecom 2 is 1380 kg with a payload mass of 400 kg. The twin solar panels span 22 m and provide an excess of 3.6 kW with 2.5 kW

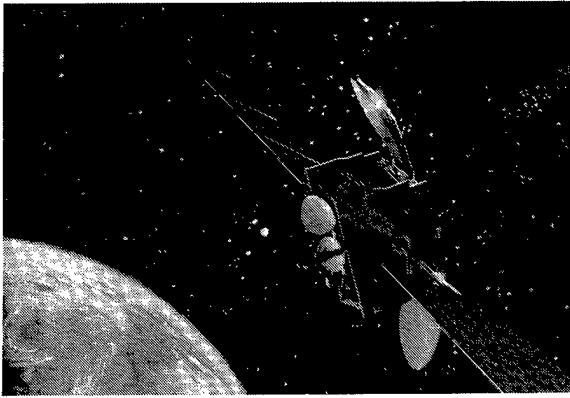

Figure 4.20. Telecom 2 Satellite.

available for the payload. The design life is 10.25 years.

The Telecom 2 communications package includes ten 6/4 GHz transponders with four spares for telephone and television relays, six 8/7 GHz transponders with three spares for the military Syracuse II payload, and 11 14/12 GHz transponders with four spares for television, data transmission, and teleconference. When completed the Telecom 2 constellation will be deployed at 8° W, 5° W, and 3° E. At the end of 1992 Telecom 2A and 2B were stationed at 8° W and 5° W, respectively. The launch of a third Telecom 2 satellite has not yet been manifested (Reference 90).

A 1980 France-German agreement to develop compatible direct broadcast satellite systems led to the creation of the French TDF (Telediffusion de France) series of satellites which were launched in 1988 and 1990 (Reference 91). Based on Aerospatiale's Spacebus 300 platform, TDF spacecraft are about 1.3 metric tons on station with bus dimensions of 1.6 m by 2.4 m by 7.1 m and a payload mass of 250 kg. The solar arrays span 19.3 m and provide 4.3 kW at start of life. Both spacecraft carry five, high power (230 W) 18/12 GHz transponders and are located at 19° W. A decision to delete a third spacecraft from the program was based, in part, on the assumption that Europesat would be available in the late 1990's (Section 4.1.3).

Matra Marconi Space's S80/T microsatellite, based on the UK UoSAT bus, was placed into a nearly circular orbit of 1,315 km at an inclination of 66.1° as a piggyback payload on the Topex/Poseidon mission in August, 1992. Sponsored by CNES, the 50 kg S80/T satellite with a

7 kg payload developed by Dassault Electronique was gravity gradient stabilized with a 25 W power supply. The primary objectives were "analysis of the VHF frequency band between 148 and 149.9 MHz and transmission of data to prepare the future operational S80 system, a constellation of small satellites in low, inclined orbits providing positioning and short message services" (Reference 92).

4.1.5 Germany

German experience with GEO telecommunications has mirrored that of France. As noted in the previous section, Germany was an equal partner with France in the Symphonie program. After gaining space communications relay experience, Germany developed a pair of TV-Sat spacecraft in conjunction with France's TDF program. This was followed by the DFS (Deutscher Fernmeldesatellit) Kopernikus series of communications satellites.

Like the French TDF, TV-Sat satellites are based on the Aerospatiale Spacebus 300 platform and were created by the Eurosatellite consortium of Aerospatiale and Messerschmitt-Boelkow-Blohm (MBB). The technical specifications of TV-Sat are also virtually identical with those of TDF, and both satellites share the same geostationary slot. MBB was responsible for the attitude and orbit control systems on both TDF and TV-Sat using the S400 and S10 engines.

TV-Sat 1 was launched on 21 November 1987 but the failure of one solar panel to deploy severely curtailed operations, and the

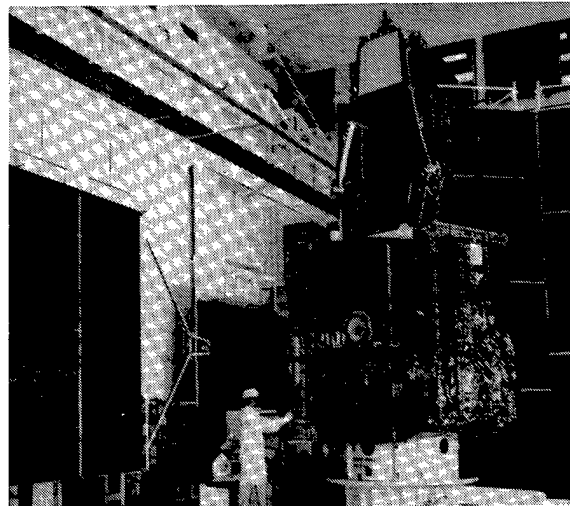

Figure 4.21. TDF Satellite.

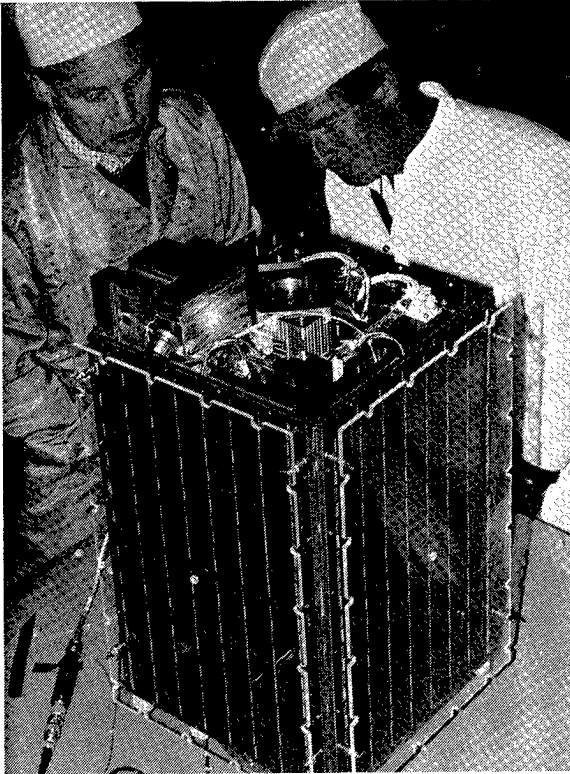

Figure 4.22. S80/T Satellite in Testing.

spacecraft was placed in a graveyard orbit in 1989. TV-Sat 2 followed on 8 August 1989 and is currently on station near 19° W.

The DFS series of satellites debuted in 1989 with the third being launched in 1992. Produced by the GESAT consortium of MBB (flight segment prime contractor), Siemens (overall prime contractor), ANT Nachrichtentechnik (payload), Standard Elektrik Lorenz (digital switching equipment), and Dornier Systems (ground control system), DFS spacecraft are smaller than TV-Sat: on-station mass of DFS is

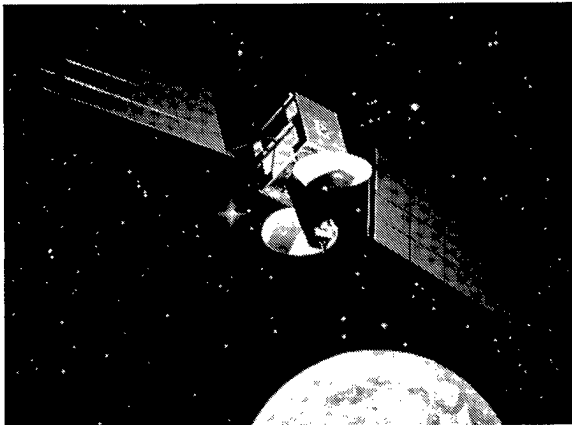

Figure 4.23. TV-SAT Satellite.

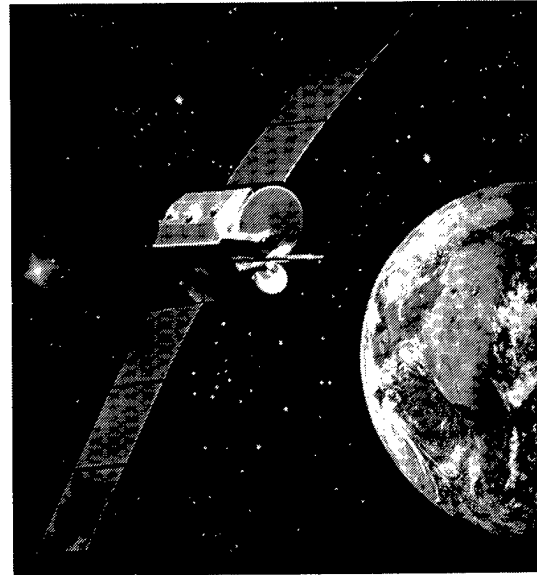

Figure 4.24. DFS (Kopemikus) Satellite.

850 kg with a 15.4 m solar array span providing up to 1.5 kW of electrical power.

The communications payload includes ten 14/11-12 GHz transponders with five spares and one experimental 30/20 GHz transponder with one spare. DFS-3 launched on 12 October 1992, was initially positioned near DFS-2 at 28.5° E, then moved to 33.5° E. DFS-1 remains operational at 23.5° E (Reference 93).

In 1991 The Technical University of Berlin's microsat Tubsat A was carried into a sun-synchronous orbit of approximately 775 km at an inclination of 98.5° during ESA's ERS-1 flight. The 30 kg, 0.4 m cube satellite was designed to test a 1.6/1.5 GHz data relay system for Antarctic platforms. An octagonal Tubsat B with slightly greater dimensions (0.5 m) and power (25 W) is scheduled for launch in 1993.

4.1.6 Hong Kong

A Hong Kong-based consortium, Asia Satellite Telecommunications Company, including United Kingdom and Chinese partners, entered the commercial telecommunications market in 1990 with the launch of Asiasat 1. Based on Hughes' HS-376 platform, Asiasat 1 had been flown in 1984 as Westar 6, but a perigee kick motor malfunction allowed it to be retrieved by the U.S. Shuttle, refurbished, and reflown (see also Indonesia's Palapa B2R). Asiasat 1 marked China's first commercial space launch when a CZ-3 booster placed the

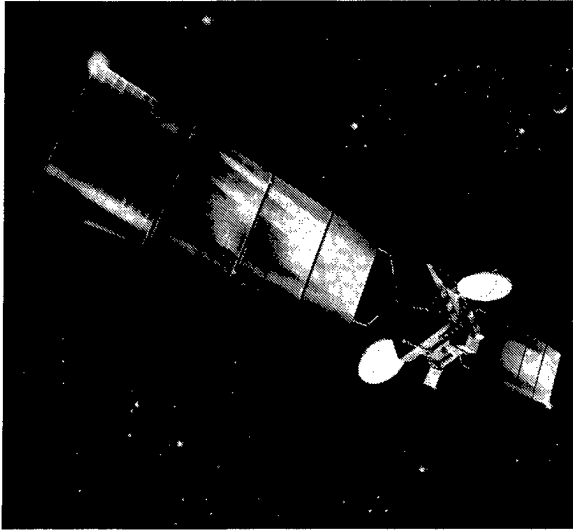

Figure 4.25. Asiasat 2 Satellite.

spacecraft in a geostationary transfer orbit on 7 April 1990.

Asiasat 1 carries 30 6/4 GHz transponders of which as many as 24 are active. The on-orbit mass of the satellite at 105.5° E is just over 600 kg. A more capable Asiasat 2 is expected to be launched in 1995 and will be based on a Martin-Marietta 7000 spacecraft bus. Asiasat 2 will be 3-axis stabilized with an initial launch mass of 3.5 metric tons and will carry a payload of 24 6/4 GHz and 9 14/12 GHz transponders (Figure 4.25).

4.1.7 India

India first experimented with geosynchronous telecommunications relays in 1981 and now has three active spacecraft in GEO. Moreover, the launch of INSAT 2A in July, 1992, marked the debut of India's first domestically built operational GEO spacecraft. In a departure from most nations, India's GEO platforms combine a communications mission with that of Earth observation.

India's first experimental GEO communications satellite, Apple (Ariane Passenger Payload Experiment), was launched on the third test flight of the Ariane launch vehicle in June, 1981. For 27 months (until attitude control fuel depletion) the 350 kg Apple successfully served as a testbed for the entire Indian telecommunications space relay infrastructure despite the failure of one solar panel to deploy. The spacecraft bus was cylindrical with a diameter of 1.2 m and a height of 1.2 m. The communications payload

consisted of two 6/4 GHz transponders connected to a 0.9 m diameter parabolic antenna.

Between 1982 and 1990 four U.S.-built INSAT 1 satellites were launched to support Indian domestic communications and Earth observation requirements as a joint venture among the Indian Department of Space, the Department of Telecommunications, the Meteorological Department, All-India Radio, and All-India Doorarshan Television. The Ford Aerospace spacecraft had a mass of 650 kg on station and carried twelve 6/4 GHz transponders with an output power of 4.5 W and three (two active plus one backup) 6/2.5 GHz transponders. Both INSAT 1A (April, 1982) and INSAT 1C (July, 1988) were lost due to malfunctions within 18 months of launch. At the end of 1992 INSAT 1B (August, 1983) was stationed at 93.5° E and INSAT 1D (June, 1990) was operational at 83° E.

The INSAT 2 program was underway in 1983 to develop an indigenous multi-purpose GEO spacecraft that relied heavily on the previous Ford Aerospace design. In 1985 the basic spacecraft configuration was adopted, calling for an on-station mass of 875 kg. The

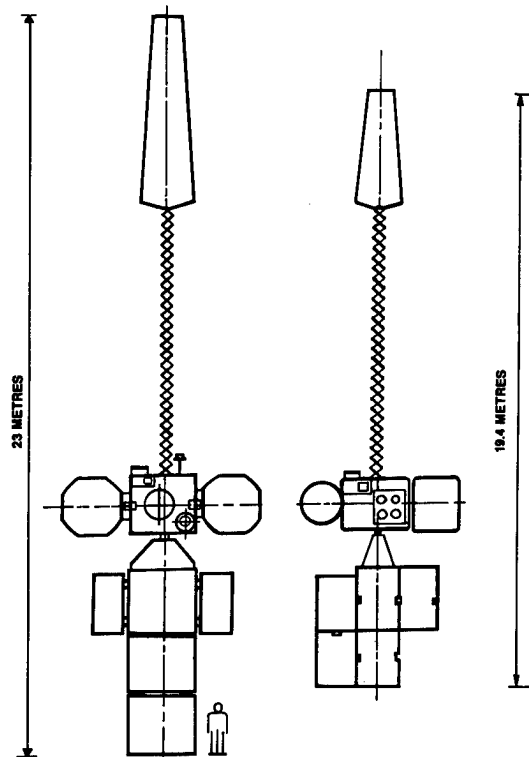

Figure 4.26. INSAT 2 (left), INSAT 1.

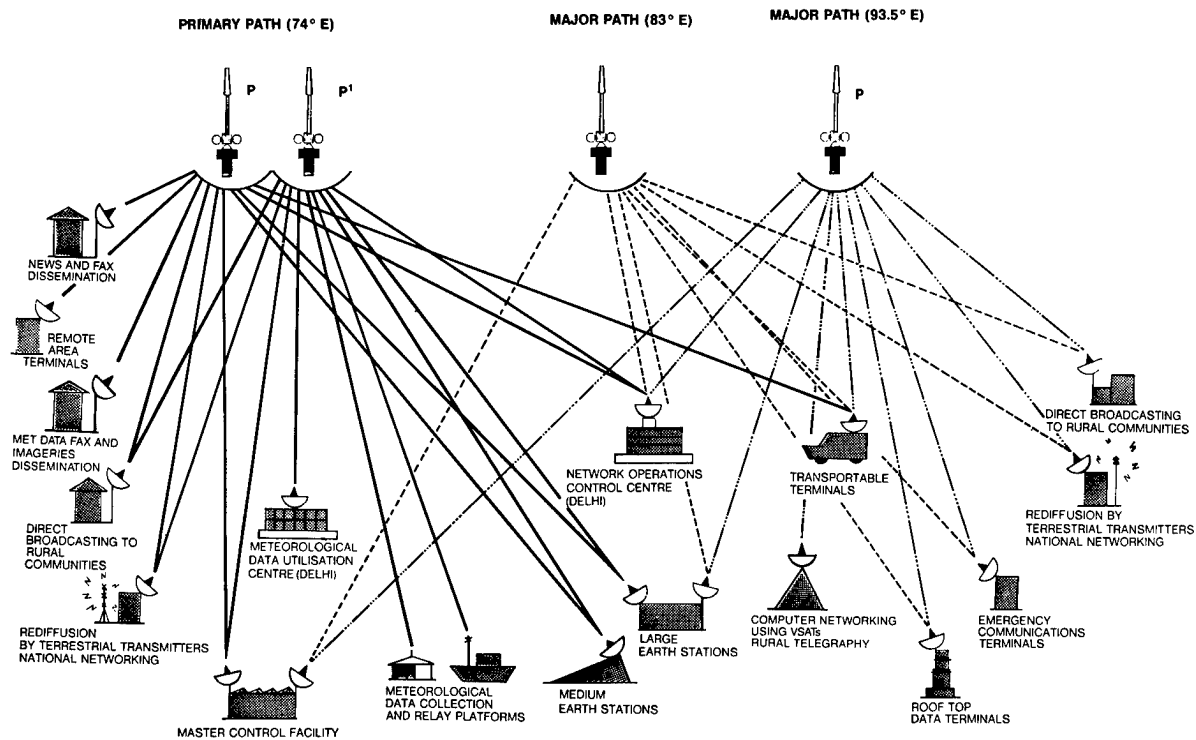

Figure 4.27. INSAT 2 Space Segment Concept.

communications payload was increased with six additional 7/5 GHz transponders for a total of 180 kg. The spacecraft bus is rectangular with side dimensions of 1.6 m by 1.7 m by 1.9 m. The asymmetric, accordion type solar panel produces 1.4 kW at beginning of life and is offset on the other side of the bus by an extendible solar sail (References 94–96).

INSAT 2A was finally launched on 9 July 1992 by an Ariane booster, about three years behind schedule. The spacecraft was positioned at the primary INSAT location of 74° E, which was vacated by INSAT 2B in April, 1992. INSAT 2B is slated for launch in 1993 again by Ariane. INSATs 2C and 2D may be launched by India's own GSLV in the latter part of this decade.

4.1.8 Indonesia

Since 1976 Indonesia has operated a national GEO telecommunications network based on U.S.-made Hughes, spin-stabilized spacecraft. Today the Palapa constellation consists of three HS-376 class spacecraft located at 108° E (Palapa B2R, launched 13 April, 1990), 113° E (Palapa B2P, launched 29 March, 1987), and 118° E (Palapa B4), launched 14 May 1992). These second generation of Palapa spacecraft

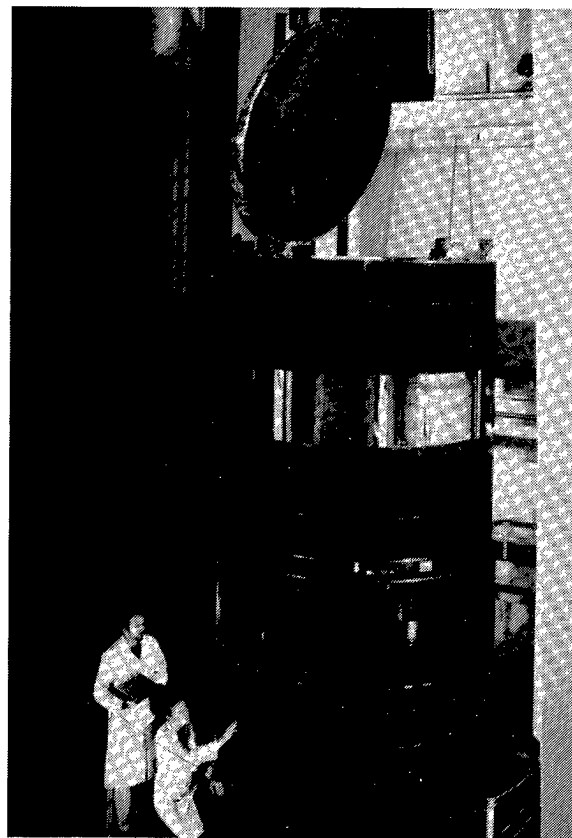

Figure 4.28. Palapa B Satellite.

have an on-station mass of 630 kg and have all been launched by Delta boosters. (Palapa B2R was originally launched as Palapa B2 by the U.S. Space Shuttle in February, 1984, but its perigee motor malfunctioned, leading to a Shuttle retrieval in November, 1984. The spacecraft was then refurbished and relaunched as Palapa B2R.)

The Palapa B series of satellites carry 30 6/4 GHz transponders (including six spares) to support telecommunications services throughout southeast Asia. The design lifetime of the spacecraft is eight years, and a third generation vehicle, Palapa C, may debut as early as 1995. In 1991 the aging Palapa B1 satellite (June, 1983) was sold to Pasifik Satelit Nusantara for a new mission over the Pacific. Palapa B1 was moved to its new location near 134° E during March–May, 1992.

4.1.9 INMARSAT

The International Maritime Satellite Organization (INMARSAT) is the principal global provider of communications services to mobile (land, air, and sea) users. Based in London and with 67 member countries, INMARSAT was formed in 1979 and began operations in 1982 with leases of three American Marisat spacecraft launched in 1976. In the mid-1980's INMARSAT expanded operations through ESA's MARECS spacecraft, which represented a specialized variation of the ECS/EUTELSAT satellites manufactured by the MESH consortium with British Aerospace as the prime contractor. The MARECS program evolved from the original Marots program (1973–1978) (Reference 78).

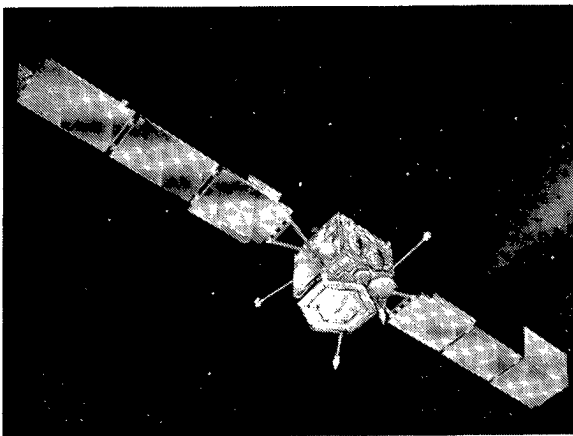

Figure 4.29. INMARSAT 2 Satellite.

MARECS spacecraft are roughly 0.55 metric tons on-station and have a design life of 7 years, although both deployed MARECS vehicles have exceeded that goal. The primary payload consists of 6/4 GHz and 1.6/1.5 GHz transponders for fixed and mobile users, respectively. Only three MARECS spacecraft were built, and the second, MARECS B1 was lost in a launch accident in 1982.

At the end of 1992 MARECS A was no longer in service but was the subject of testing near 22° E. MARECS B2 was moved from 55.5° W (Atlantic Ocean West region) in the summer of 1992 to near 15.2° W (Atlantic Ocean East region), where it remained at the end of the year.

To replace the MARISAT and MARECS satellites, INMARSAT commissioned the development of the INMARSAT 2 series of spacecraft. Based on the Eurostar 1000 spacecraft bus created by British Aerospace and Matra, INMARSAT 2 satellites have an initial on-station mass of approximately 800 kg of which 130 kg is allocated to the payload. Electrical power capacity of the twin solar arrays (total span = 15.2 m) is 1.2 kW. Overall dimensions of the rectangular bus are 1.5 m by 1.6 m. The total communications package includes four active and two reserve 1.6/1.5 GHz transponders and one active and one reserve 6/4 GHz transponders.

The first two INMARSAT 2 spacecraft (Figure 4.29) were launched by American Deltas (October, 1990, and March, 1991). INMARSATs 2 F3 and 2 F4 followed on 16 December 1991 and 15 April 1992 via Ariane launch vehicles. At the beginning of 1993, these four spacecraft were serving as the primary nodes in the INMARSAT network at 64.5° E (2 F1), 178° E (2 F3), 344.5° E (2 F2), and 305° E (2 F4). Selected INTELSAT and MARISAT satellites are also employed as needed in the INMARSAT network.

The third generation INMARSAT satellites are currently being manufactured by a team led by Matra Marconi Space (payload) and GE Astro Space (spacecraft, Satcom 4000 bus). Four of the 1.1 metric ton (on-station) spacecraft are tentatively scheduled for launch in 1994–1995: the first two by Atlas, the third by Ariane, the fourth by Proton (SL-12). The approximately 200 kg payload will retain the same 1.6/1.5 GHz and 6/4 GHz communica-

tions links and will add a navigation package. Design lifetime will be 13 years for INMARSAT 3 compared to 10 years for INMARSAT 2 (References 97 and 98).

4.1.10 Israel

By the end of 1992 Israel had launched only two small experimental LEO satellites. However, a civil GEO communications system is being developed for deployment as early as 1995 by Ariane. Israel Aircraft Industries is the prime contractor for the first two 600 kg-class Amos satellites which will carry 6–7 14/11 GHz transponders each. The Amos spacecraft will be three-axis stabilized with a mostly rectangular spacecraft bus and two short solar panels providing up to 1.1 kW of power. An operational lifetime of ten years is anticipated (References 99–102).

A university-produced LEO microsat named Techsat is being proposed for launch as a piggyback payload on Ariane or another launch vehicle. The 60 kg, multi-discipline vehicle will include a store/dump message handling system for amateur radio operators. The Israeli Space Agency along with Israeli aerospace industries are sponsoring the project at the Technion Institute of Technology in Haifa (Reference 103).

4.1.11 Italy

Italy began its national space-based telecommunications program with the experimental Sirio spacecraft developed in the 1970's. These relatively small (approximately 220 kg on-station in GEO), spin-stabilized spacecraft were constructed by an Italian aerospace consortium to test the characteristics of 18/12 GHz transmissions. The drum-shaped spacecraft had a diameter of 1.4 m and a height of 1 m and was covered with solar cells which produced a maximum of 150 W. Sirio 1 was launched in 1977 and functioned well past its 2-year design life before being retired in 1992.

Italy's first operational communications satellite was launched 15 January 1991 by an Ariane booster. Developed by a contractor team led by Alenia Spazio, ITALSAT carries ten active transponders plus five spares for 30/20 GHz and 50/40 GHz links with a capacity of 12,000 telephone circuits. The 900 kg (on-station) spacecraft consists of a rectangular bus 2.3 m by 2.7 m by 3.5 m and two solar panels with a total

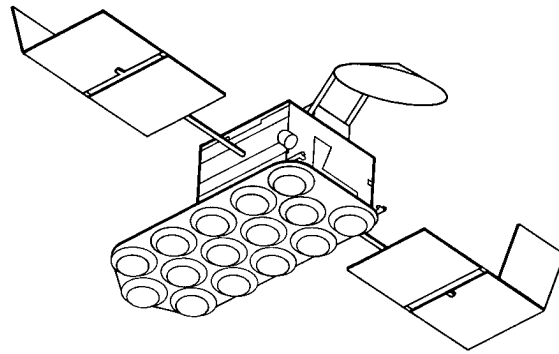

Figure 4.30. Amos Satellite.

span of 21.8 m and more than 1.5 kW power. The design life for the first test vehicle is only five years, while ITALSAT 2 is not scheduled for launch until late 1994 or beyond when it will also carry ESA's first European Mobile Services payload. ITALSAT 1 is stationed at 13.2° E (Reference 104).

Two new systems are under construction by Italy for deployment by the end of the decade. SARIT (Satellite di Radiodiffusione Italiana) could provide direct broadcast television service currently handled by ESA's Olympus Satellite and may be based on the ITALSAT design. Also being designed is the SICRAL (Sistema Italiana de Comunicazione Riservate Allarmi) military communications systems with satellites positioned at 16° and 22° E. The multi-purpose spacecraft would include transponders for 8/7 GHz and 14/11 GHz communications.

4.1.12 Japan

By the end of 1992 Japan had deployed 17 GEO communications satellites from five series and was maintaining a constellation of nine operational satellites at seven locations in the geostationary ring from 110° E to 162° E. Japan's extensive satellite-based communications program is 15 years old and has been promoted by both the national space agency NASDA and by the commercial sector. Since the program's inception, Japan has employed a mix of domestic and foreign spacecraft and launch services.

Japan's Engineering Test Satellite (ETS) series began in 1975, and two years later NASDA's first GEO platform ETS II (also known as Kiku-2) was launched by an N-1 booster and stationed at 130° E. This mission not only validated the GEO launch technique but also tested

spacecraft control systems vital to future communications satellites. Experimental communications at 1.7 GHz, 11.5 GHz, and 34.5 GHz were tested. The 130 kg, spin-stabilized ETS II was finally retired in 1991.

The first ETS series spacecraft to have a specific communications objective was ETS V (Kiku-5), launched on 27 August 1987 by an H-1 booster and stationed at 150° E. ETS V was Japan's first 3-axis stabilized GEO satellite with an on-station mass of 550 kg. The spacecraft carried two 1.6/1.5 GHz transponders to test an INMARSAT compatible mobile communications system. The spacecraft bus measured 1.4 m by 1.7 m with a twin solar panel span of 9.7 m. At the end of 1992, ETS V was still positioned near 150° E.

Two future ETS missions are planned for the 1990's after the new H-2 launch vehicle debuts. ETS VI is scheduled for the second H-2 flight in 1994 and the first demonstration of the H-2's ability to deliver a two metric ton payload to GEO. ETS VI's 670 kg payload will include numerous transponder systems, primarily at higher frequencies of 30/20 GHz and above.

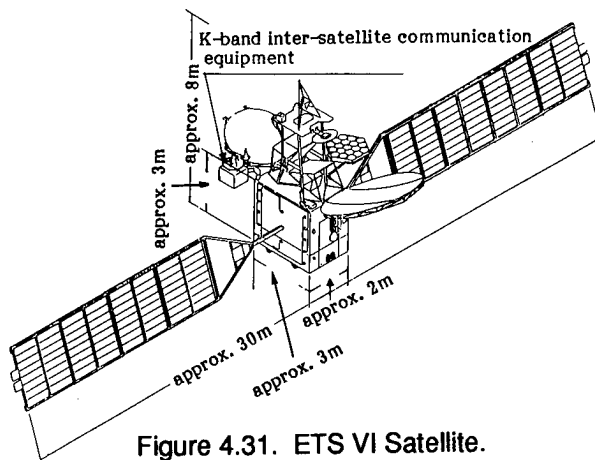

Figure 4.31. ETS VI Satellite.

The vehicle will also test an inter-satellite communications system utilizing a 23 GHz forward link and a 32 GHz return link. The primary contractors for ETS VI are Toshiba and Mitsubishi. The spacecraft bus will measure 2 m by 2.8 m by 3 m and will support two solar panels (total power = 4.2 kW) with a span of approximately 30 m (References 105-107).

With a successful demonstration of technologies required for a Data Relay and Tracking Satellite (DRTS) by ETS VI, a 1997 mission of

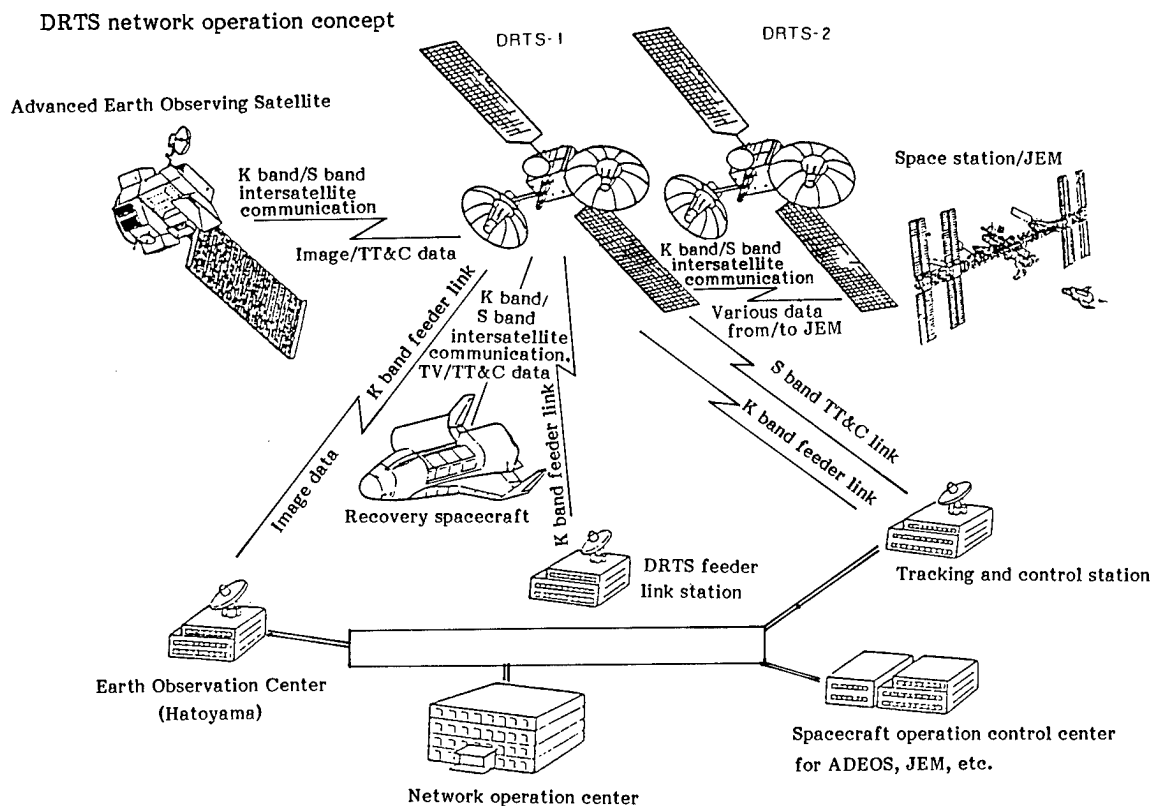

Figure 4.32. DRTS Network Operation Concept.

ETS VII or COMETS (Communications and Broadcasting ETS) is anticipated. A two-satellite DRTS constellation (Figure 4.32) is eventually envisioned with full compatibility with its American and European counterparts, TDRS and DRS (References 106 and 108).

The Japanese CS (Communications Satellite) series has been highly successful since its debut 15 years ago. The prototype satellite CS (also known as Sakura) was operational from 1977 to 1985. The second generation, operational spacecraft, CS-2a and CS-2b were launched in 1983 and continued to function until 1991 and 1990, respectively.

The current constellation is comprised of CS-3a and CS-3b (launched in 1988) and stationed at 132° E and 136° E. These spin-stabilized, drum-shaped (diameter of 0.2 m and height of 0.3 m) spacecraft (Figure 4.33) possess an on-orbit mass of 550 kg (compared to the 350 kg CS-2 satellites) and are based on U.S. Ford Aerospace designs. The communications payload consists of 10 active plus five spare 30/20 GHz transponders and two active plus one spare 6/4 GHz transponders. The primary contractors are Mitsubishi and NEC Corporation (References 109 and 110).

By the time the design lives of CS-3a and CS-3b are reached in 1995, the next generation of satellites in the series are scheduled to be launched. Known as CS-4 or N-Star, the new spacecraft will be procured by the Nikon Telegraph and Telephone company from the U.S. and will be based on Loral's FS-1300 platform. The N-Star payload will consist of eight 14/11 GHz, eleven 30/20 GHz, and five 6/4 GHz transponders and should be operational for ten years.

A year after the first CS-class satellites were launched, the BS (Broadcasting Satellite) program was inaugurated with the flight of BSE (Experimental) also known as Yuri. As the name implies, BS satellites are designed for television broadcasting and were initially developed for the Japanese Ministry of Posts and Telecommunications and for the Japan Broadcasting Corporation (NHK). All BS satellites have been located at 110° E and have been of the same basic configuration: 3-axis stabilization of a rectangular spacecraft bus with two elongated solar arrays.

The 350-kg BSE was followed in 1984 and 1986 by the operational and essentially identical

BS-2a and BS-2b, respectively. Each spacecraft carried two active and one spare 100 W, 14/12 GHz transponders. Built by Toshiba with assistance from General Electric, the BS-2 series were designed for five years of operations. BS-2a was moved to a graveyard orbit in 1989, followed by BS-2b in 1992.

After losing two BS spacecraft in launch accidents (Ariane in February, 1990, and Atlas-Centaur in April, 1991), the BS constellation now consists of BS-3a (August, 1990) and BS-3b (August, 1991). The BS-3 class satellites (Figure 4.34) have an initial on-station mass of 550 kg and are based on the GE Astro Space 3000 bus. The 15-m span solar arrays provide slightly less than 1.5 kW at beginning of life. The payload includes three active and three backup 14/12 GHz transponders and a single 14/13 GHz unit. A third BS-3 satellite has been procured from GE Astro Space for launch in 1994. An as yet undefined, next generation spacecraft, BS-4, is scheduled for its maiden flight by 1997 (Reference 111).

During 1979–1980 Japan launched two Experimental Communications Satellites (ECS, also known as Ayame) on N-1 boosters from Tanegashima. However, both satellites were lost shortly after launch during the firing of their apogee kick motors. These small, 130 kg, spin-

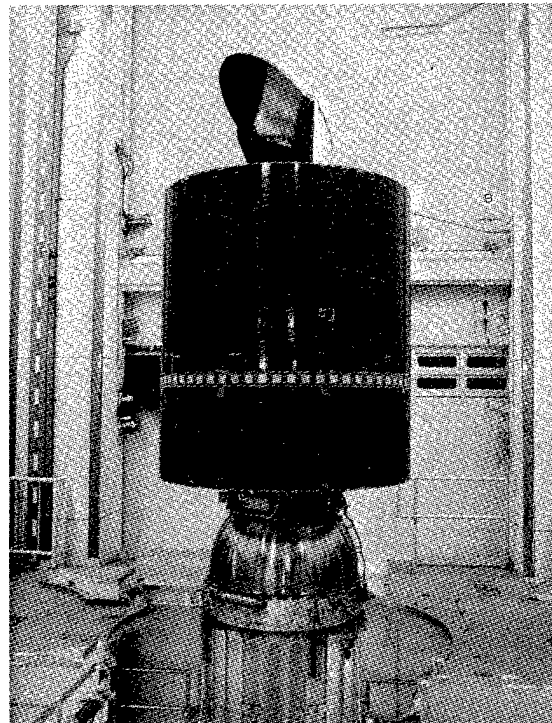

Figure 4.33. CS-3a Satellite.

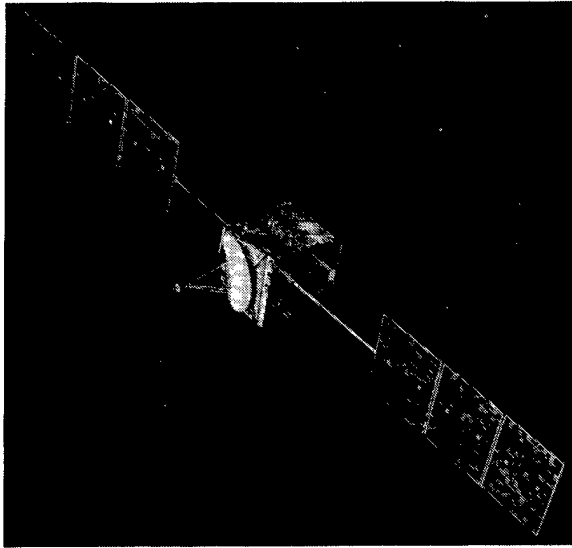

Figure 4.34. BS-3 Satellite.

stabilized satellites were not replaced and the Japanese ECS program was terminated.

In 1989 two, purely commercial Japanese communications networks were started, both relying on U.S.-made spacecraft. In 1985 the Japanese Communications Satellite Company was created by Hughes, Mitsui, and C Itoh as a commercial alternative to the Government controlled CS and BS satellites for the full range of telecommunications services. In March, 1989, and January, 1990, JCSAT 1 and JCSAT 2 were launched by Ariane and Titan 3 boosters, respectively. Both spacecraft are identical and based on the Hughes HS-393 platform. These 1.4 metric ton spin-stabilized spacecraft are 3.7 m in diameter and 10 m tall when the solar array skirt is extended. The communications payload consists of 40 14/12 GHz transponders (including eight spares), working through a single 2.4 m diameter antenna. The JCSAT spacecraft are deployed at 150° E (next to ETS V) and 154° E and are designed to operate for at least ten years (References 112 and 113).

The Space Communications Corporation of Japan (SCC) was formed a month before JCSAT in 1985 but did not launch its first satellite until three months after its competitor. SCC's Superbird spacecraft are based on Loral's (formerly Ford Aerospace) FS-1300 bus, which has also been selected for the N-Star replacement of the CS-3 satellites. The 1.5 metric ton Superbird spacecraft carry a total of 26 transponders: 23 (with 8 spares) at 14/12 GHz and 3 at 29/19 GHz.

Superbird A was launched in June, 1989, by Ariane (as have been all Superbird satellites) and was stationed at 158° E. A second satellite Superbird B, was lost in the Ariane accident of February, 1990. Before a replacement could be lost, Superbird A malfunctioned, necessitating its transfer to a graveyard orbit in 1991. The constellation of two spacecraft (Figure 4.35) at 158° E and 162° E was finally established in 1992 with Superbird A1 (1 December 1992) and Superbird B1 (26 February 1992).

A third entry into the Japanese commercial communications satellite market is expected in 1994 when the Satellite Japan Corporation plans to acquire two Hughes HS-601 spacecraft (Reference 114).

In 1986 and then again in 1990 Japan launched small amateur radio satellites under the OSCAR program. The two 50-kg spacecraft, Fuji 1 (Oscar 12) and Fuji 2 (Oscar 20), were constructed by the Japan Amateur Radio League and were roughly 0.4 m by 0.4 m by 0.5 m. Fuji 1 was inserted into a nearly circular orbit of about 1,500 km at an inclination of 50° along with a primary geodetic payload, and Fuji 2 accompanied a maritime observation satellite into space, reaching an orbit of 910 km by 1,750 km at an inclination of 99°.

A future Japanese LEO satellite may test a laser-based optical communications system for inter-satellite relays. The 50-kg class spacecraft may be launched in the latter part of this decade.

4.1.13 Luxemburg

The Luxemburg-based European Society of Satellites provides telecommunications services

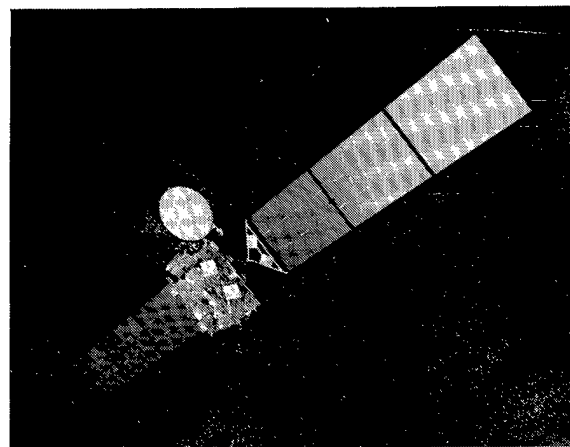

Figure 4.35. Superbird Satellite.

to most of Europe via American-manufactured satellites. The Astra network consists of two spacecraft, Astra 1A (launched 11 December 1988) and Astra 1B (launched 2 March 1991), both orbited by Ariane launch vehicles. Together they provide 32 active 14/11 GHz transponders co-located at 19.2° E (References 91 and 115).

Astra 1A and Astra 1B are both based on GE Astro Space spacecraft buses, although the former is a 1.0 metric ton GE 4000 series platform and the latter is a 1.5 metric ton GE 5000 series platform. Astra 1A measures 1.5 m by 1.7 m by 2.1 m with a solar panel span of 19.3 m and 2.8 kW capacity. Meanwhile, Astra 1B has overall dimensions of 2.2 m by 2.2 m by 2.8 m with a solar panel span of 24.3 m and 4.9 kW.

Astra 1C is scheduled for launch by Ariane in 1993 and will be followed in 1994 by Astra 1D. These new satellites will be based on the Hughes HS-601 platform and will each carry 18 active transponders (plus six spares) working in the 14/11 GHz regime.

4.1.14 Pakistan

Although Pakistan has expressed an interest to develop a GEO communications system, the country is still several years away from deploying the first satellite. In the meantime, Pakistan is experimenting with basic store/dump communications relays in LEO. A 50 kg Badr-1 satellite was launched as a secondary payload on the Chinese CZ-2E mission of 16 July 1990.

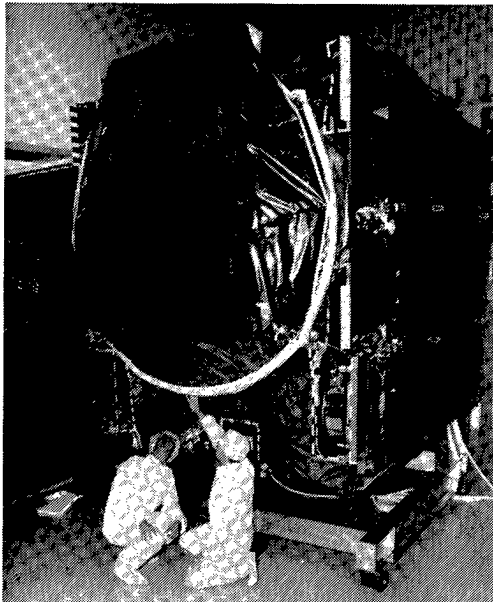

Figure 4.36. Astra 1B Satellite.

Originally designed for a nearly circular orbit of 400–500 km, Badr-1 was inserted into an orbit of 205 km by 990 km which led to a natural decay after only 145 days, although contact with the vehicle ceased on 20 August. However, during its short mission, the satellite successfully completed store/dump message tests using 144–146 and 435–436 MHz frequencies.

The Pakistan GEO constellation is being designed with a capacity of 4,800 long distance telephone channels, 2,400 rural circuits, and two direct broadcast television channels in the 14/11 GHz band. PAKSAT GEO locations near 38° E and 41° E are planned (References 116 and 117).

4.1.15 People's Republic of China

The PRC currently operates a constellation of three Dongfanghong-2 (DFH-2) communications satellites in GEO for domestic needs. Designed, manufactured, and launched by indigenous means, the modest DFH-2 spacecraft are analogous to 1960's era Western GEO vehicles, although slightly heavier. A new, more sophisticated and more capable DFH-3 series of satellites may debut as early as 1994.

After an initial CZ-3 launch failure in January, 1984, the first Chinese GEO satellites were deployed in April, 1984, and February, 1986, to 125° E and 103° E, respectively. Both satellites apparently continued to operate until 1990–1991, by which time they had been replaced by the operational DFH-2 series. With an on-orbit mass of 441 kg (compared to 433 kg for the earlier satellites), DFH-2 spacecraft were successfully placed in GEO in March, 1988, December, 1988, and February, 1990, and positioned at 87.5° E, 110.5° E, and 98° E, respectively. All three satellites remained on station at the end of 1992. A fourth DFH-2 was lost on 28 December 1991 when its CZ-3 upper stage failed to reignite.

The DFH-2 is a spin-stabilized, drum-shaped satellite with a diameter of 2.1 m and a height of 3.1 m (Figure 4.37). The communications payload consists of only two 6/4 GHz transponders with an output power of 10 W. The total electrical power capacity is assessed to be about 300 W (the first two experimental satellites were rated at 284 W) (References 118–122).

The DFH-3 generation spacecraft will be much larger, will utilize 3-axis stabilization, and

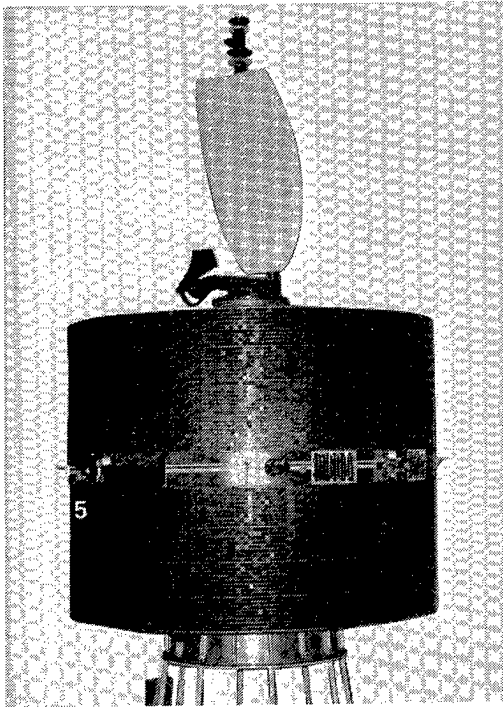

Figure 4.37. DFH-2 Satellite.

will bear a resemblance to the GE Astro Space 5000 series spacecraft. More importantly, the communications payload will consist of up to 24 6/4 GHz transponders for both telephone and television transmissions. The design life of the DFH-3 will be double that of DHF-2, i.e., eight years compared to four years.

4.1.16 Saudi Arabia

Saudi Arabia is the headquarters of the Arab Satellite Communications Organization which has operated the Arabsat GEO telecommunication system since 1985. With more than 20 member countries, the organization fills a vital role of communications in North Africa and the Middle East for many nations which do not need nor can afford dedicated satellite networks. By the end of 1992, the Arabsat system had been reduced to only one spacecraft, but a new generation of satellites is expected in the mid-1990's.

The three Arabsat 1 spacecraft are based on the Aerospatiale and MBB Spacebus 100 platform which was also employed for the EUTELSAT 2 series. Ranging from nearly 600 kg to almost 800 kg at the start of life in GEO, the spacecraft measure 1.5 m by 1.6 m by 2.3 m with a solar array span of about 21 m for 1.4 kW

of electrical power. The primary communications payload consists of two 6/2.5 GHz transponders and 25 6/4 GHz transponders. The nominal design life was seven years.

Arabsat 1A was launched by Ariane on 8 February 1985 but immediately suffered a solar panel extension malfunction. Other failures quickly relegated the spacecraft to backup status until late 1991 when the vehicle was abandoned. Arabsat 1B was launched by the U.S. Space Shuttle and was operated near 26° E from June, 1985, until the summer of 1992 when it, too, no longer continued station-keeping operations. Arabsat 1C was launched by Ariane on 26 February 1992 and was on station near 31° E at the end of the year. The Arabsat 2 series is scheduled to debut about 1995 with a similar communications capacity, although a few 14/11 GHz transponders may be added.

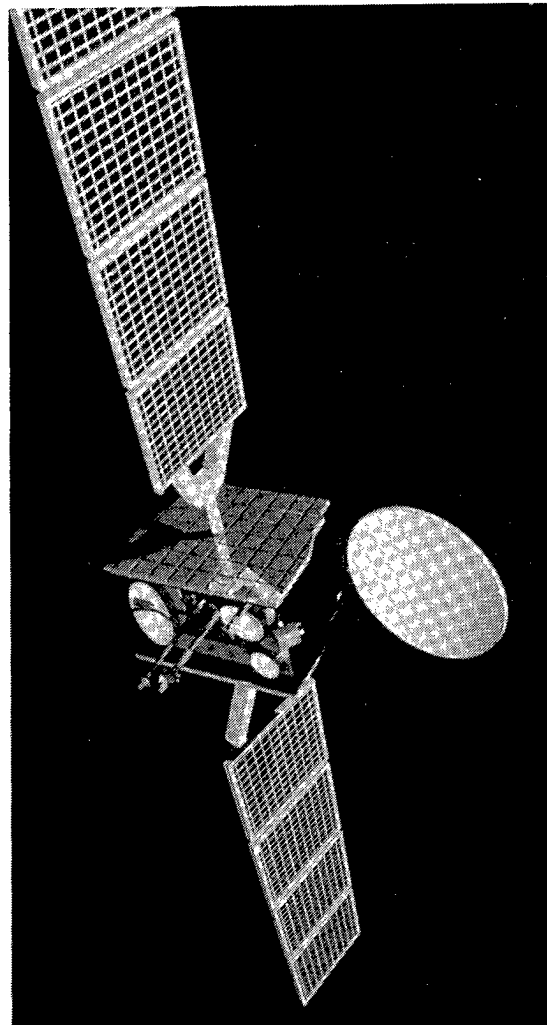

Figure 4.38. Hispasat 1 Satellite.

4.1.17 Spain

Spain's first GEO communications satellite was launched by Ariane on 10 September 1992 as Hispasat 1A (Figure 4.38) and positioned at 31° W. The launch of a sister satellite, Hispasat 1B, was planned for 1993. Based on the Eurostar spacecraft bus developed by British Aerospace and Matra Marconi, Hispasat is designed to support civil, military, and government communications requirements through an array of multi-frequency transponders.

With an on-orbit mass of 1.1 metric tons, the government-owned Hispasat 1A carries 15 active transponders: three 8/7 GHz with one spare, ten 14/12 GHz with five spares, and three 17/12 GHz with one spare. The Hispasat bus measures 1.7 m by 1.9 m by 2.1 m with a solar array span of 22 m and an initial power capacity of 3.2 kW. The spacecraft design life is ten years. From its position over the Atlantic Ocean, Hispasat is capable of servicing not only Europe but also North and South America (References 123 and 124).

4.1.18 Sweden

Originally conceived as the birth of a Scandanavian telecommunications network, including Denmark, Finland, Iceland, Norway, and Sweden, Tele-X now represents a national Swedish asset with greatly reduced objectives and prospects. Launched on 2 April 1989 by Ariane, the Tele-X spacecraft (Figure 4.39) is located at 5° E with tailored coverage primarily for Finland, Norway, and Sweden. A follow-on to Tele-X at the end of its expected life in the second half of the 1990's is uncertain.

Based on the Aerospatiale and MBB

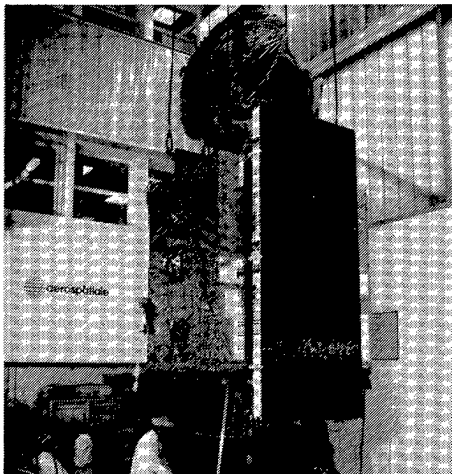

Figure 4.39. Tele-X Satellite.

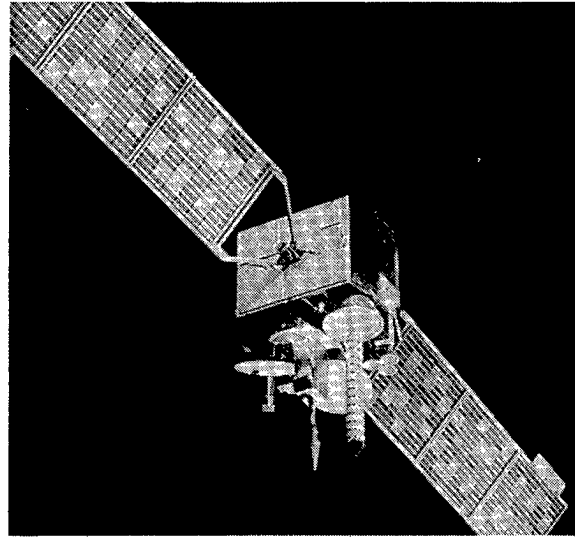

Figure 4.40. Skynet 4 Satellite.

Spacebus 300, Tele-X has an on-orbit mass of 1.3 metric tons and a design life of up to eight years. The 3-axis stabilized vehicle measures 1.7 m by 2.4 m by 2.4 m with a solar array span of 19 m and a electrical capacity in excess of 3 kW. The communications payload consists of two 14/13 GHz transponders and two 18/12 GHz transponders with one spare for each type.

4.1.19 United Kingdom

The United Kingdom was the third entity to operate a telecommunications satellite in GEO, after the United States and INTELSAT. Its Skynet military communications network has been operational since 1974 following abortive starts in 1969 and 1970. A civilian direct broadcasting system, known as Marcopolo or BSB, debuted in 1989 and currently operates two spacecraft in GEO.

The first attempt of the UK to establish an independent and secure space-based communications systems faltered in 1969–1970 when Skynet 1A failed prematurely and Skynet 1B was lost in a launch malfunction. Whereas the Skynet 1 spacecraft were American-made, the Skynet 2 series which appeared in 1974 were designed and manufactured by the British firm of Marconi Space and Defense Systems with assistance from Philco-Ford. Skynet 2A was also lost in an unsuccessful launch attempt in January, 1974. However, the spin-stabilized, 240 kg Skynet 2B was orbited in November, 1974, and provided regular service for more than 16 years.

Although the follow-on Skynet 3 system never materialized, the current Skynet 4 series of spacecraft was successfully deployed during 1988–1990. Built under the direction of British Aerospace and derived from its earlier OTS and ECS satellites, Skynet 4 satellites are 3-axis stabilized with an initial on-orbit mass of slightly less than 800 kg. The spacecraft bus dimensions are 1.4m by 1.9 m by 2.1 m with a 1.2 kW solar array span of 16 m. The communications payload includes three 8/7 GHz transponders and two 0.3/0.25 GHz transponders.

The current Skynet 4 constellation consists of three spacecraft: Skynet 4A (launched 1 January 1990) located near 35° W, Skynet 4B (launched 11 December 1988) located near 53° E, and Skynet 4C (launched 30 August 1990) located near 1° W. Skynets 4B and 4C were launched by Ariane, whereas Skynet 4A was launched by the U.S. Titan 3. With a design life of only seven years, the present Skynet 4 vehicles are expected to be replaced in the second half of this decade. A variant of the Skynet 4 spacecraft has also been flown under the NATO 4 series.

In 1986 the British Satellite Broadcasting firm won approval to initiate direct broadcasting services to the UK. Two Hughes HS-376 series spacecraft were chosen to serve as the GEO relays. Marcopolo 1 (also known as BSB R-1) was launched on 27 August 1989 by a U.S.

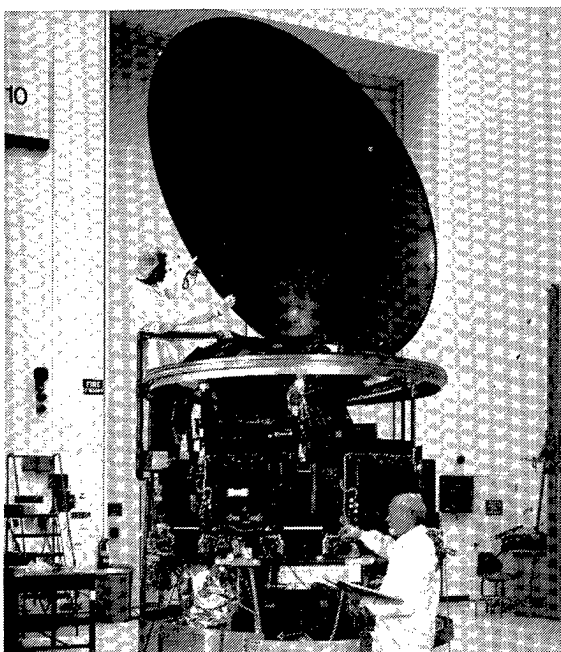

Figure 4.41. BSB (Marcopolo) Satellite.

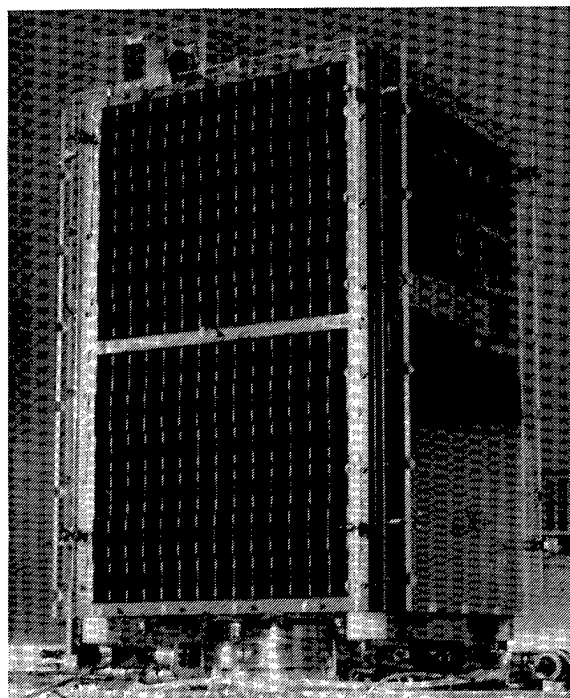

Figure 4.42. UoSAT 5 Satellite.

Delta and was followed on 18 August 1990 by Marcopolo 2 (BSB R-2) atop another Delta. Each spacecraft is drum-shaped (2.2 m diameter and a deployed height of 7.2 m) and has an initial on-orbit mass of approximately 660 kg. The spin-stabilized satellite produces 1.1 kW of electrical power at beginning of life. The communications payload includes five 18/12 GHz transponders. Both satellites were positioned near 31° W until November, 1992, when BSB R-2 was sold to Norwegian Telecom and moved to 1° W. The satellite was renamed Thor and was expected to resume service in 1993.

Since 1981 the University of Surrey has been successfully deploying 60 kg-class miniature satellites for LEO store/dump communications, primarily for use by the amateur radio community. Designated UoSAT, the first of these satellites was launched as a piggyback with the U.S. Solar Mesospheric Explorer in October, 1981. UoSAT 2 accompanied the U.S. Landsat 5, while UoSAT 3 and 4 hitched a ride on the SPOT 2 mission. UoSAT 5 was launched along with ESA's ERS-1 on 17 July 1991 and was a repeat of the UoSAT 4 vehicle which had malfunctioned almost immediately after launch. UoSATs 2, 3, and 5 were all still operational during 1992.

4.2 Navigation and Geodesy

One of the first practical applications of artificial satellites was to aid in terrestrial navigation. Although only the US and the USSR/CIS have deployed operational navigation satellite systems, these networks are available to users everywhere on land, at sea, or in the air. Increased accuracies, nearly instantaneous information, and the development of international standards have prompted an explosive growth in the use of satellite navigation aids. The PRC has acknowledged its intent to enter this field during the 1990's, while INMARSAT will add navigation to its current communications services with the introduction of the INMARSAT 3 generation spacecraft in 1994-1995.

Although even the earliest satellites provided new, valuable data on the nature and shape of the Earth, dedicated geodetic satellites now support specific civil, scientific, and military requirements. CIS, French, Italian, and Japanese geodetic spacecraft are already in Earth orbit, while numerous other satellites carry laser reflectors, which can be used for geodetic studies, as a matter of course.

4.2.1 USSR/CIS

The year 1992 marked the 25th anniversary of the launching of the USSR's prototype navigation satellite, Kosmos 192 (23 November 1967). In all, 146 missions with 186 navigation spacecraft reached Earth orbit during the quarter-century period. Today, the CIS navigation network consists of 24 principal spacecraft in three distinct constellations to service both fixed and mobile subscribers.

The first generation navigation satellites are launched one at a time by SL-8 (Kosmos) boosters from the Plesetsk Cosmodrome into orbits of approximately 960 km by 1,015 km with an inclination of 83°. Each spacecraft has a diameter of 2 m, a height of approximately 2.1 m and a mass of 800 kg. An internally pressurized compartment housing the primary payload (approximately 0.86 m in diameter, 0.55 m in height, mass of 200 kg) and support systems is surrounded by solar cells affixed to a cylindrical sheet. Electrical power available to the payload is limited to about 200 W average daily (Reference 25). Attitude control is achieved with a gravity-gradient boom extend-

ing from the top of the spacecraft, while payload and telemetry antennas are attached to the bottom, Earth-facing end (Figure 4.43).

Navigation information is derived from Doppler-shifted VHF transmissions (approximately 150 and 400 MHz) of satellite position and orbital data (References 126 and 127). By acquiring fixes from several satellites, a user's location can be calculated with an accuracy of 100 m (Reference 128). The time needed to ascertain one's position is dependent upon the user's latitude and the number of operational spacecraft in orbit. Normally, ten first-generation CIS satellites are transmitting navigational signals, permitting accurate location determination within 1-2 hours.

These ten spacecraft are deployed in two complementary constellations. The older constellation (first launch in 1974 with Kosmos 700) consists of six satellites distributed in orbital planes spaced 30° apart. This network is never explicitly referred to by the CIS and is primarily dedicated to the support of military forces. A

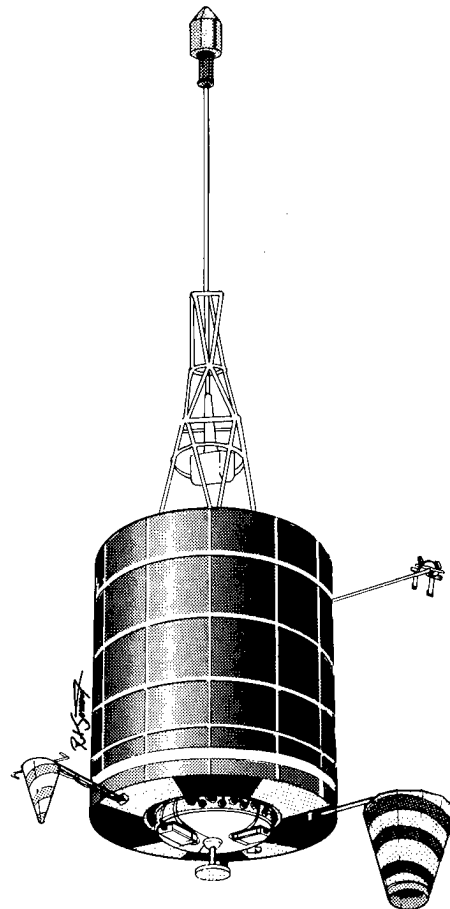

Figure 4.43. Nadezhda Satellite.

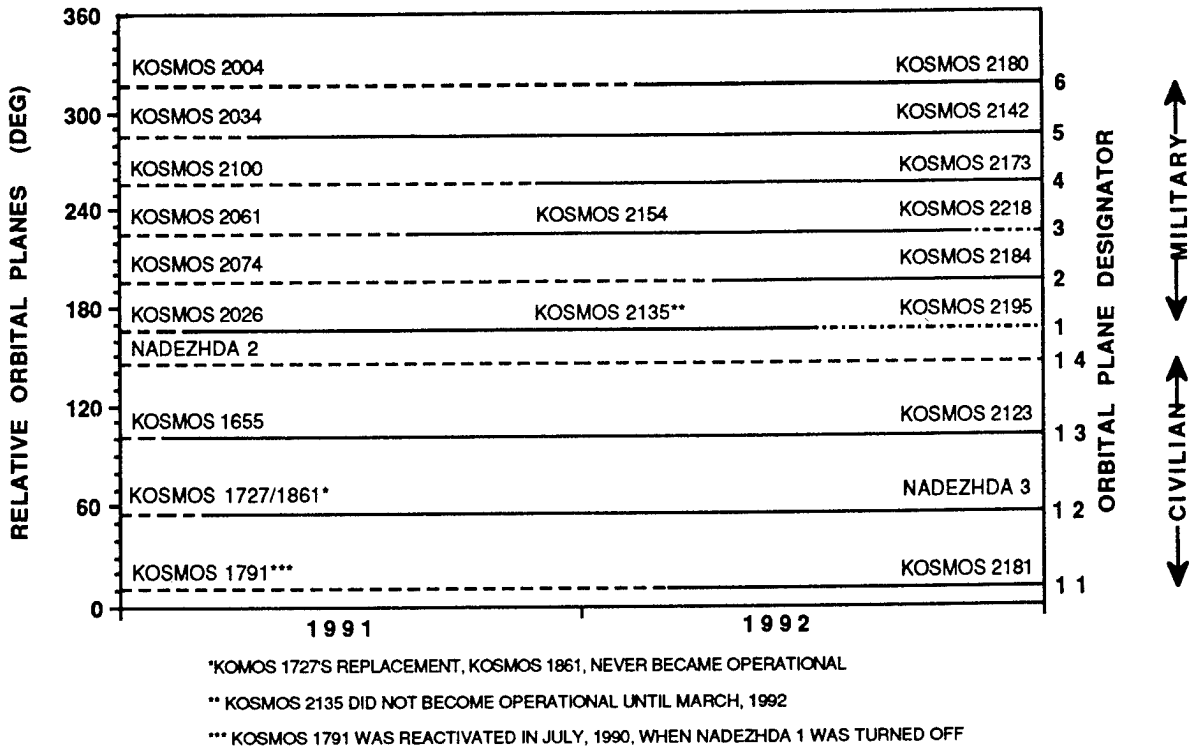

Figure 4.44. USSR/CIS LEO Navigation Satellite Constellation.

virtually identical civilian navigation network, called Tsikada, began deployments in 1976 with Kosmos 883 and employs four orbital planes separated by 45°. Moreover, the Tsikada orbital planes are carefully offset from the military satellites to maximize consolidated system effectiveness, i.e., minimize the mean time between satellite sightings (Figure 4.44). The Tsikada system is widely used by the CIS merchant marine which is equipped with Shkhuna receiving equipment which automatically computes the vessel's position. Originally, designed and manufactured by the Applied Mechanics NPO in Krasnoyarsk, both type of navigation satellites are now largely produced by the Polet PO in Omsk, where an annual production rate of ten spacecraft has been achieved. The navigational payloads were developed, in part, by the Institute of Space Device Engineering. By the end of 1992 more than 125 first generation satellites had been launched — an average of five per year since 1967.

Despite their obvious similarities, the military navigation satellites are replaced at a much faster rate than their Tsikada cousins: currently on the average of every 20 months versus 48 months for Tsikada. During 1991–1992, eight

military spacecraft were launched, completely replenishing the entire constellation, including two replacement satellites for two orbital planes (Figure 4.44). The launch of Kosmos 2135 (26 February 1991) was particularly interesting since it was not made part of the operational network for thirteen months when its predecessor, Kosmos 2026 was finally shutdown (Reference 129). Kosmos 2135 was then replaced by Kosmos 2195 four months later. Kosmos 2135 was also noteworthy since its SL-8 launch vehicle left the spacecraft with a perigee approximately 35 km lower than normal. The next spacecraft to be launched into the military navigation system, Kosmos 2142 (16 April 1991), was inserted into an orbital plane near Kosmos 2034, but signals monitoring by the Kettering Group revealed that Kosmos 2142 did not takeover from the older spacecraft for slightly more than two months (Reference 130).

The Tsikada navigation satellites periodically carry small communications transponders as secondary payloads. The most common package is the COSPAS search and rescue transponder, which represents the major USSR/CIS contribution to the international

COSPAS-SARSAT system. Established in principle by the USSR, US, Canada, and France in 1979, COSPAS-SARSAT is designed to relay distress signals from the site of aircraft and ship accidents or other emergency situations to special Local User Terminals (LUTs) which in turn notify the appropriate search and rescue teams (Figure 4.45). Distress signals are transmitted on either 121.5 MHz (15 km location accuracy) or 406 MHz (2 km location accuracy) and rebroadcast on 1544.5 MHz to LUTs. Over 500,000 beacons are deployed worldwide, saving more than 2,000 lives since the system began operations via Kosmos 1383 in September, 1982. Since 1989, Tsikada satellites carrying COSPAS transponders have been called Nadezhda (Russian for "hope") rather than assigned a Kosmos designation.

The Ukrainian Musson Corporation of Sevastopol has been the primary supplier of COSPAS distress beacons for the USSR/CIS. The ARB (Emergency Locator Beacon) - 121 system employs the 2.2 kg Poisk-B emergency

locator beacon and the 1.8 kg Poisk-R emergency distress signal transmitters for the COSPAS lower band, while the more popular 4.5 kg ARB-406 emits the higher frequency distress signal every 50 seconds for up to 48 hours with a power of 5 W (Reference 131). Veteran cosmonaut G. S. Titov is now President of a new Russian firm called Kosmoflot which will also manufacture navigational equipment and COSPAS beacons. The primary Russian LUTs are located at Arkhangelsk, Moscow, Novosibirsk, and Vladivostok. The CIS has also proposed the creation of a rocket-borne rescue system called VITA which would employ converted SS-18 or SS-19 ICBM's to send rescue equipment to the site of an accident identified by the COSPAS-SARSAT system (Section 2.1).

Of the three Tsikada satellites launched during 1991-1992, two carried secondary payloads in addition to the primary navigation system. Kosmos 2123 (5 February 1991) housed the amateur radio transponders RS12 and RS13 described in Section 4.1.1. The other

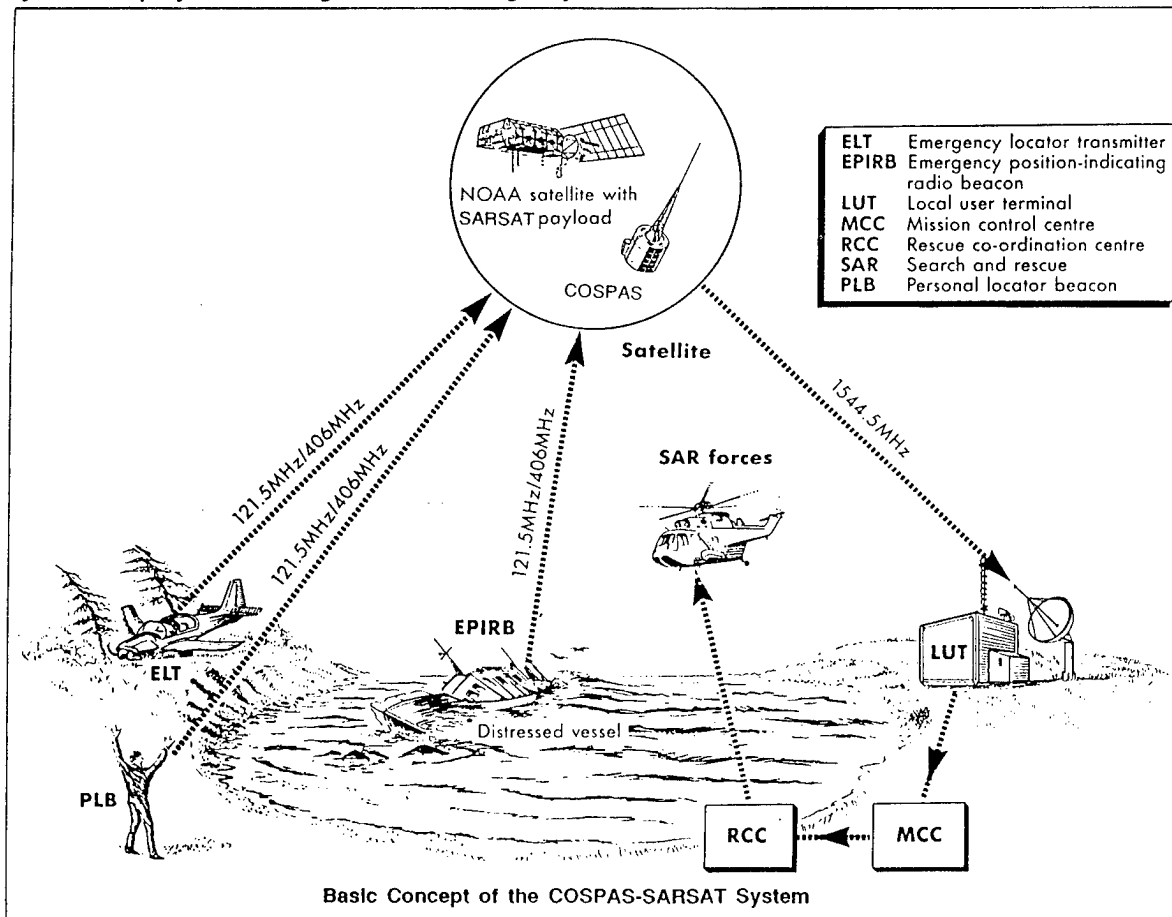

Figure 4.45. International COSPAS/SARSAT System.

1991 mission was Nadezhda 3 (12 March), the sixth USSR satellite to carry a COSPAS transponder. (For comparison, the US deployed comparable SRSAT transponders on four NOAA satellites launched during 1983–1988.) Nadezhda 3 replaced the six-year old Kosmos 1727, which had been retained in service when its successor, Kosmos 1891, encountered interference between the navigation payload and the RS10 and RS11 piggyback payloads (Reference 132). The 20th satellite in the Tsikada series was launched as Kosmos 2181 (9 March 1992) as a replacement for Kosmos 1791. Analysis by the renown Kettering Group identified the reactivation of Kosmos 1791 in July 1990, when its successor, Nadezhda 1, was turned off.

Whereas the Soviet low altitude navigation systems were patterned after the American Transit network, a Soviet counterpart to the US Global Positioning System first appeared in 1982, four years after the launch of the first Navstar GPS satellite. The USSR/CIS Global Navigation Satellite System (GLONASS) is designed to provide instantaneous, high precision location and speed information to users throughout most of the world. Deployed in nearly circular orbits at an altitude of 19,100 km, each GLONASS satellite emits navigational signals in a 38° degree cone near 1250 MHz (L₂). GLONASS positional accuracies (95% confidence) are claimed to be 100 m on the surface of the Earth, 150 m in altitude, and 15 cm/s in velocity.

The 1,400 kg GLONASS satellites are produced by the Applied Mechanics NPO with the

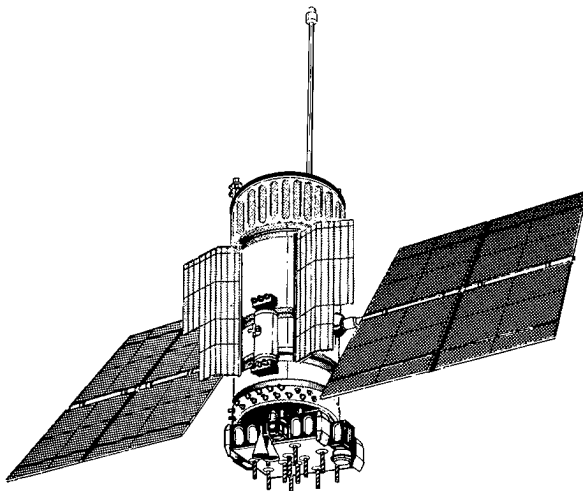

Figure 4.46. GLONASS Satellites.

assistance of the Institute of Space Device Engineering for the payload and the Polet PO for the spacecraft bus (Figure 4.46). Electrical power is provided by two rectangular solar arrays, and stabilization is performed by both active and passive (gravity gradient) means. Each satellite also possesses a limited propulsion system to permit relocation and to maintain interplane phasings.

The Phase I GLONASS system was completed in 1991 with seven active satellites in each of two orbital planes separated by 120°. (The official Phase I goal was six satellites in each of two planes.) Within each plane the spacecraft are spaced 45° apart with a 15° phase shift between planes. The Phase II requirement for seven active and one spare satellite in each of three orbital planes separated by 120° is scheduled to be met by 1995.

The two principal USSR/CIS GLONASS receivers are the SNS-85 for airborne platforms and the Shkiper for naval vessels. The former unit has a mass of only 13.5 kg and dimensions of 201 x 259 x 364 mm, while the latter is somewhat larger at 21.5 kg and 263 x 425 x 426 mm.

However, the Shkiper provides a more accurate velocity determination: 15 cm/s compared to 50 cm/s for the SNS-85 (Reference 134). The similarity of the GLONASS and GPS frequencies and techniques permits the creation of single, dual-use receivers when the slightly different geodetic (SGS-85 versus WGS-84, respectfully) and time reference frames are taken into account. Such a dual-use receiver has been developed by the Institute of Space Device Engineering (Reference 135). Several concepts have been proposed for integrating the GLONASS and GPS networks, particularly for international civil aviation (Reference 136).

GLONASS satellites are launched in groups of three by the SL-12 (Proton) launch vehicle. By the end of 1990, 17 missions had orbited 51 GLONASS spacecraft, although six satellites were lost due to launch vehicle malfunctions (Kosmos 1838–1840 in 1987 and Kosmos 1917–1919 in 1988). At the beginning of 1991, eleven GLONASS satellites were operational: seven in plane 1 and four in plane 3 (Reference 138). The sole GLONASS launch of 1991, Kosmos 2139–2141 (4 April) deposited three additional satellites into plane 3, filling three of the four vacant slots in that plane.

Six more GLONASS satellites were launched

in 1992 to maintain a constellation of 12–14 active spacecraft. Kosmos 2177–2179 (29 January) replenished plane 1, replacing Kosmos 1988, Kosmos 1946, and Kosmos 1948, respectively. The year's second mission of Kosmos 2204–2206 (30 July) entered plane 3, replacing Kosmos 2141, Kosmos 1972, and Kosmos 2139, respectively.

Within a few years of the debut of GLONASS satellites, the world scientific community, in particular radio astronomers, discovered a harmful side-effect of the system. The heart of the GLONASS L₁ band coincides with the weak natural emissions of extra-solar hydroxyl molecules. Consequently, some spacecraft transmissions were interfering with radio astronomy surveys. As the number of operational GLONASS spacecraft increased, the problem became severe and was further accentuated by the fact that the high altitude satellites remain above the horizon for extended periods. However, having been made aware of the problem, the GLONASS program is incorporating measures to minimize the interferences (References 138–141).

Dedicated geodetic satellites have been in use by the USSR/CIS since 1968. Extremely precise knowledge of the topography and gravitational field of the Earth is of great importance to the civilian as well as to the military community. However, only since 1989 have specific details of the USSR/CIS programs been made available. Today, two different satellite networks, one low altitude and one high altitude, are available for geodetic studies.

The current LEO geodetic system, known as GEO-IK, is a second generation design which debuted in 1981 and has averaged one new launch each year. With normally one or two satellites operational, the GEO-IK network can assist the user in

- “• creating of regional geodetic nets, including:
 - islands geodetic fixation
 - basis for topographic survey of large building objects
 - geodetic basis for working onto shelf of the World Ocean
- working by request of coordinate fixation of the points in required coordinate system
- working to research the topography of the World Ocean” (Reference 142).

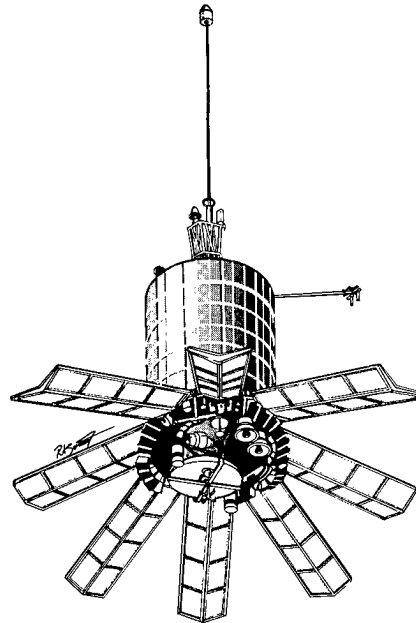

Figure 4.47. GEO-IK Satellite.

GEO-IK satellites are deployed in nearly circular orbits with a mean altitude of 1,500 km at inclinations of 73.6° or 82.6°. (Since 1986 only the former inclination has been utilized.) Each spacecraft is launched by the SL-14 (Tsiklon) booster from the Plesetsk Cosmodrome. The Applied Mechanics NPO of Krasnoyarsk is the principal designer and manufacturer of the less than 2-metric-ton GEO-IK. The satellite bus is similar in appearance to the Tsikada navigation satellites, i.e., primarily a right cylinder with a gravity-gradient stabilization system at the top and payload antennas, etc., attached to the bottom (Figure 4.47). However, ten panels extend like petals from the bottom of the spacecraft to provide additional electrical power in conjunction with nickel-hydrogen storage cells. Also like Tsikada, payload and support systems are primarily contained within a pressurized, temperature-controlled container located inside the cylindrical, solar-cell array.

Geodetic analyses can be performed with any one of five payload systems. A 9.4 GHz radar provides altitude determination above the sea surface with an accuracy of 3–5 m. A two-frequency (150 MHz and 400 MHz) doppler system (1–3 cm/s accuracy) operates up to 12 hours per day, and a 5.7/3.4 GHz transponder is also available on demand to provide ranging data to within 3–5 m. Laser corner reflectors with a total area of 0.024 m² are installed on the spacecraft permitting range determinations to

within 1.5 m. Finally, a light signaling system producing a series of nine high intensity (800–1200 J) flashes at a rate of 1/3 Hz can be used in conjunction with ground-based observatories to determine the satellite's position against the star background to with 1.5 arc seconds. The light signaling system can be activated up to 55 times per day (References 142–144).

Normally, GEO-IK geodetic measurements are performed five days per week, permitting two days of mission planning and satellite position forecast preparation. Typical spacecraft lifetimes are only 1–2 years. The principal civilian processor of and clearinghouse for geodetic data is now the Russian Ministry of Ecology and National Resources (which absorbed the former Soviet Main Administration for Geodesy and Cartography), working in conjunction with the Russian Academy of Sciences, in particular the Institute of Terrestrial Magnetism, Ionosphere, and Radio-wave Propagation (IZMIRAN).

During 1991 no new GEO-IK satellites were deployed, the first year since the program began in 1981 without a launch. However, the last two spacecraft, Kosmos 2037 (1989) and Kosmos 2088 (1990), were still active during 1991–1992 according to signal intercepts by the Kettering Group. At the end of 1992, Kosmos 2226 (22 December) was launched and inserted into an orbital plane roughly 60° away from Kosmos 2088 and 120° away from Kosmos 2037. A more advanced geodetic satellite system with accuracies of less than 1 m may begin operations by 1995–1997 (Reference 145).

In contrast to GEO-IK, the USSR/CIS Etalon satellites reside in high altitude (19,100 km) orbits and are completely passive in nature. Each 1,415-kg satellite is a 1.294 m diameter sphere covered with 306 antenna arrays which in turn each contain 14 corner cubes for laser interrogation and reflecting (Figure 4.48). A small number of reflectors are made of germanium for "future infrared interferometric measurements" (Reference 146). To date only two Etalon satellites have been orbited, Kosmos 1989 (10 January 1989) and Kosmos 2024 (31 May 1989), and each accompanied a pair of GLONASS satellites on SL-12 (Proton) launch vehicles.

The higher altitude of the Etalon satellites, when compared to similar laser-reflecting geo-

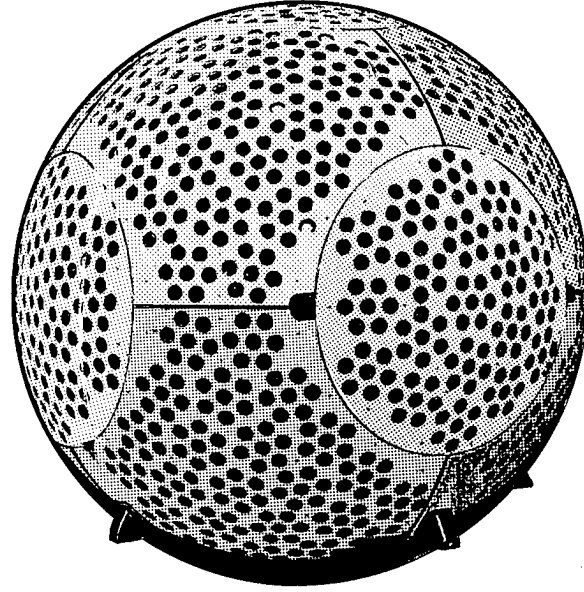

Figure 4.48. Etalon Satellite.

dedic satellites of other nations, was selected to enhance several specific goals: "(1) the development of a high-accuracy global reference coordinate system and determination of the Earth's rotation parameters, (2) determination of lengths of long baselines, (3) improvement of the Earth's gravitational field parameters, and (4) improvement of the selenocentric gravitational constant" (Reference 146). The effect of non-gravitational forces on the orbits of the Etalon satellites was reported in late 1990 (Reference 147).

4.2.2 France

To date France has not deployed a satellite navigation network, and plans to establish the Locstar system of two geostationary satellites for position-determination services were abandoned in July, 1991, when sufficient funds could not be raised (References 148). The system would have combined navigation aids with a data and message service but would have been limited to a restricted operational region between Europe and North Africa.

France is one of the four founding nations of the COSPAS-SARSAT search and rescue system and operates a LUT at Toulouse. However, no COSPAS-SARSAT transponders are currently carried aboard French spacecraft. Since 1988 the CNES subsidiary CLS (Collected Localization Satellites) in conjunction with NASA and NOAA has operated a satellite-

based location system under the Argos World Service network. Argos transponders attached to NOAA spacecraft can provide users equipped with a Platform Transmitter Terminal (PTT) position information accurate to about 350 m.

The French Starlette satellite (6 February 1975) was the first of a series of international geodetic satellites based on relatively simple spherical platforms embedded with laser reflectors and was followed by Lageos (US-1976), EGP (Japan-1986), Etalon (USSR-1989), and Lageos 2 (Italy-1992). The 47-kg Starlette is 26 cm in diameter, circles the Earth in an orbit of 800 km by 1,100 km at an inclination of 49.8°, and carries 60 laser reflectors evenly distributed about its surface. In 1993 Starlette will be joined by the French Stella satellite of similar design. Stella will accompany the SPOT 3 satellite into a 820-km, 98.7°-inclination orbit where it will enable geodetic measurements to be expanded into the polar regions. The Stella program is being managed by CNES and ONERA (Office National D'Etudes et de Recherches Aérospatiales).

During 1966–1975 France launched five other satellites with dedicated or auxiliary geodetic missions. Diapason (1966) was an active, 19-kg satellite with 149.70 and 399.92 MHz transmitters to permit geodetic measurements based on doppler techniques and is no longer operational. Diademe 1 and Diademe 2 were launched one week apart in February, 1967, into elliptical orbits (currently, 550 km by 1,100 km and 600 km by 1,700 km, respectively) at an inclination of 40°. In addition to dual-frequency transmitters like Diapason, the 22.6 kg Diademe spacecraft were also covered with numerous laser reflectors. Two other spacecraft also carried laser reflectors, Peole (1970) and Castor (1975), but both have since decayed.

4.2.3 Italy

Europe's newest geodetic satellite was launched in 1992, marking Italy's first entry in this scientific field. Lageos 2, built by Aeritalia Space Systems Group, is a twin to the US' Lageos satellite launched in May, 1976, with a mass of 405 kg, a diameter of 60 cm, and a total of 426 laser reflectors. Deployed from the US Space Shuttle Columbia (STS-52) on 23 October, Lageos 2 was boosted into an orbit of approximately 5,615 km by 5,950 km at an inclination of 52.7° by an Italian-made IRIS upper

stage.

The orbit altitude is almost identical to that of Lageos, but the lower inclination of Lageos 2 compared with Lageos (52.7° versus 109.9°) will permit better understanding of the Earth's gravitational field and will enhance observations from European latitudes. Together, the two satellites will provide data capable of detecting tectonic movements on the order of 2 cm per year (References 150–151). The launch of Lageos 2 was delayed several years due to the US Challenger accident.

4.2.4 Japan

The success of the US and French geodetic satellites launched in the mid-1970's influenced Japan's national space agency, NASDA, to sponsor a similar, yet complementary, geodetic satellite. Under the auspices of the Hydrography Department of the Maritime Safety Agency and the Geographical Survey Institute of the Ministry of Construction, the objectives of the Experimental Geodetic Payload (EGP, also known as Ajisa) are to:

- correct the geodetic triangulation nets in the country,
- determine the location of isolated islands (improve the marine geodetic network) and
- establish Japan's geodetic datum" (Reference 152).

EGP was launched 12 August 1986 on the inaugural mission of the H-1 launch vehicle. The 685 kg satellite is spherical with a diameter of 2.15 m, but unlike other geodetic satellites of its class EGP was covered with both laser reflector assemblies (120 with 1436 corner cubes) and solar reflecting mirrors (318). The mean altitude of EGP is slightly less than 1,500 km with an orbital inclination of 50.0°.

4.2.5 People's Republic of China

Although the PRC has yet to establish a navigation satellite network, research for such a system has been underway for many years, and a future space-based navigation capability is an acknowledged goal. A prototype navigation satellite was built by the early 1980's but was never launched. In appearance the spacecraft resembles the Shi Jian 2 scientific satellite launched on 19 September 1987. This spacecraft bus is octagonal with a diameter of 1.2 m

and a height of 1 m with a mass of about 250 kg, including the payload. The navigation system was possibly of the US Transit and USSR/CIS Tsikada class (References 153–154). More recent writings have indicated a desire to deploy navigation satellites by the end

of the decade (References 155–157). A hand-held receiver compatible with US GPS satellites, the VT 900, has already been developed by the Chinese Carrier Rocket Technology Institute (Reference 158).

4.3 Earth Observation and Remote Sensing

Although unmanned observations of the Earth from artificial satellites have been conducted for more than three decades, the growing international concern about the global environment has led to a renewed emphasis on the monitoring of the planet's land masses and oceans as well as the atmosphere. Moreover, recent satellite systems and those now in development possess a much wider variety of more sophisticated instruments. Whereas national Earth observation programs have historically concentrated on atmospheric and meteorological data collection, today both passive and active techniques are employed to keep watch over virtually all aspects of the environment. An unprecedented degree of international cooperation and standardization, particularly in data transmission, permits a free exchange of information and at times even asset sharing. The principal European and Asian sponsors of Earth observation and remote sensing systems are the CIS, ESA, France, India, Japan, and the PRC.

4.3.1 USSR/CIS

During 1991–1992 the USSR/CIS managed ten major Earth observation and remote sensing space systems operating at wavelengths from less than one micron to 100,000 microns and at altitudes from 200 km to nearly 36,000 km. Data collection techniques range from simple optical and infrared sensors and cameras to real and synthetic aperture radars capable of penetrating cloud cover and even the surface of the Earth itself. For convenience these systems are divided into the general categories of meteorology, oceanography, and multi-purpose.

Since the inception of the Soviet meteorological program in 1964 and the official debut of the Meteor 1 spacecraft in 1969, the USSR/CIS has operated a single, integrated space-based network designed to meet all civilian, military, and governmental requirements. In 1992 the responsibility for program management of the meteorological program transitioned from the USSR State Committee on Hydrometeorology (GOSKOMHYDROMET) to the newly established Committee on Hydrometeorology of the Russian Ministry of Ecology and Natural Resources. Similarly, the All-Union Research

Institute for Electromechanics (VNIIEM), which has produced Meteor spacecraft for a quarter century, was renamed the All-Russian Electromechanical Scientific Research Institute under General Director and General Designer Vladimir I. Adasko (References 159–160).

CIS Meteor satellites make possible the creation of atmospheric temperature and humidity profiles, penetrating radiation profiles, sea-surface temperature readings, sea-ice condition charts, snow-cover limit charts, cloud and surface images in the visible and infrared, and cloud-top height charts. The well-known visible images have been transmitted according to the international automatic picture transmission (APT) format since 1971 and are available on carrier frequencies of 137.300 MHz, 137.400 MHz, and 137.850 MHz (FM, ± 50 KHz bandwidth, two lines per second).

Between 1975 and 1990 twenty Meteor 2 spacecraft (not including the apparent Meteor 2 failure designated Kosmos 1066) served as the USSR's primary space-based meteorological network. Originally launched by the SL-3 into nominal orbits of 850 km by 900 km at an inclination of 81.3°, during 1982–1984 the Meteor 2 satellites were transferred to the SL-14 booster and a new orbital regime of 940 km by 960 km with an inclination of 82.5°. The approximately 1,300 kg spacecraft carried a modest array of scanning telephotometers, scanning IR radiometers, and a radiation measurement complex. Two spacecraft in the series were launched in 1990 (Meteor 2-19 on 27 June and Meteor 2-20 on 28 September) and operated until the summer of 1992. A 60° separation in orbital planes allowed the two vehicles to alternate their operations as lighting conditions varied due to orbital plane precession. Both spacecraft transmitted on 137.850 MHz during this period (Reference 161).

The Meteor 3 program began with the launch of Meteor 3-1 in 1985 after the prototype spacecraft (Kosmos 1612) was lost due to a launch vehicle failure the previous year. According to documents filed with the World Meteorological Organization, the objectives of the Meteor 3 program are as follows:

- to obtain, on a regular basis, global data on the distribution of cloud, snow, and ice cover and surface radiation temperatures once or twice daily at times close to the synoptic

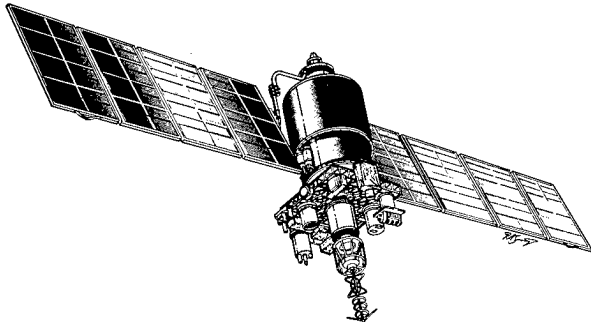

Figure 4.49. Meteor 3 Satellite.

- times;
- to obtain, on a regular basis, regional data on the distribution of cloud, snow, and ice cover;
 - to obtain, during each communication session, global data on the vertical temperature and humidity distributions in the atmosphere;
 - to observe, on a regular basis, information on radiation conditions in near-Earth space globally once or twice a day, and for each orbit in storm conditions.”

To eliminate low latitude coverage gaps, the altitude of Meteor 3 satellites was increased

250 km in comparison with the Meteor 2 network, i.e., approximately 1,200 km circular orbits with an inclination of 82.5°. The higher altitude provides a wider ground swath for the same instrument angular field-of-view. All Meteor 3 spacecraft are launched by the SL-14 booster from the Plesetek Cosmodrome.

Although very similar to its predecessor, the Meteor 3 satellite incorporates several new improvements and capabilities. Total spacecraft mass is approximately 2,150 kg with a payload of 500–700 kg in a volume of 0.7 m³. The spacecraft (Figure 4.49) is essentially a vertically oriented cylinder with a maximum diameter of slightly more than 1 m and a height of about 1.5 m which supports a payload equipment truss at the bottom, a gravity gradient stabilization system on top, and two movable solar arrays (~1.5 m tall by 3.5 m wide). The spacecraft bus is maintained at standard temperatures and pressures and is fed a total output power from the solar arrays of not less than 500 W. The design lifetime is two years.

The payload truss is an innovation over the Meteor 2 satellite design which facilitates the addition of new and experimental instruments. Table 4.2 details a typical Meteor 3 satellite

Table 4.2. Typical Meteor 3 Instrument Suite.

INSTRUMENT	NUMBER OF SPECTRAL BANDS	BAND WAVELENGTHS, μM	GROUND SWATH, KM	GROUND RESOLUTION, KM	TRANSMISSION MODE
Scanning Telephotometer	1	0.5-0.7	2600	1.0 x 2.0	Direct
Scanning Telephotometer	1	0.5-0.7	3100	0.7 X 1.4	Store/Dump
Scanning IR-Radiometer	1	10.5-12.5	3100	3 x 3	Direct
Scanning IR-Radiometer	10	9.4-19.68	1000	42	Store/Dump
UV-Spectrometer	8	0.25-0.38	200	3-5 in altitude	Store/Dump
Multi-Channel UV-Spectrometer (Ozon-M)	4	0.25-0.29 0.37-0.39 0.60-0.64 0.99-1.03	---	2 in altitude	Store/Dump
Radiation Measurement Complex (PMK)	Registration of Flow Density:			0.15-3.1 MeV (Electrons) 1-600 MeV (Protons)	Store/Dump

payload suite. The principal telephotometer produces an image size of 195 mm by 290 mm which is scanned at 3.8 lines per mm with at least 12 gray levels. Similarly, the IR radiometer image of 148 mm by 290 mm is scanned at 1 line per mm with at least 9 gray levels. The 10-channel spectrometer includes one band for water vapor, six bands for carbon dioxide, one band for ozone, and two bands about 11 μm . The experimental Ozon-M spectrometer is

designed to measure total ozone content and vertical ozone distribution in individual regions (References 162–164). In addition to 137–138 MHz direct transmissions, data is also beamed to Earth at 466.5 MHz (FM, ± 120 KHz bandwidth, 10 W output power) in a “store and forward” mode. The primary ground stations are located at Moscow/Obninsk, Novosibirsk, and Khabarovsk.

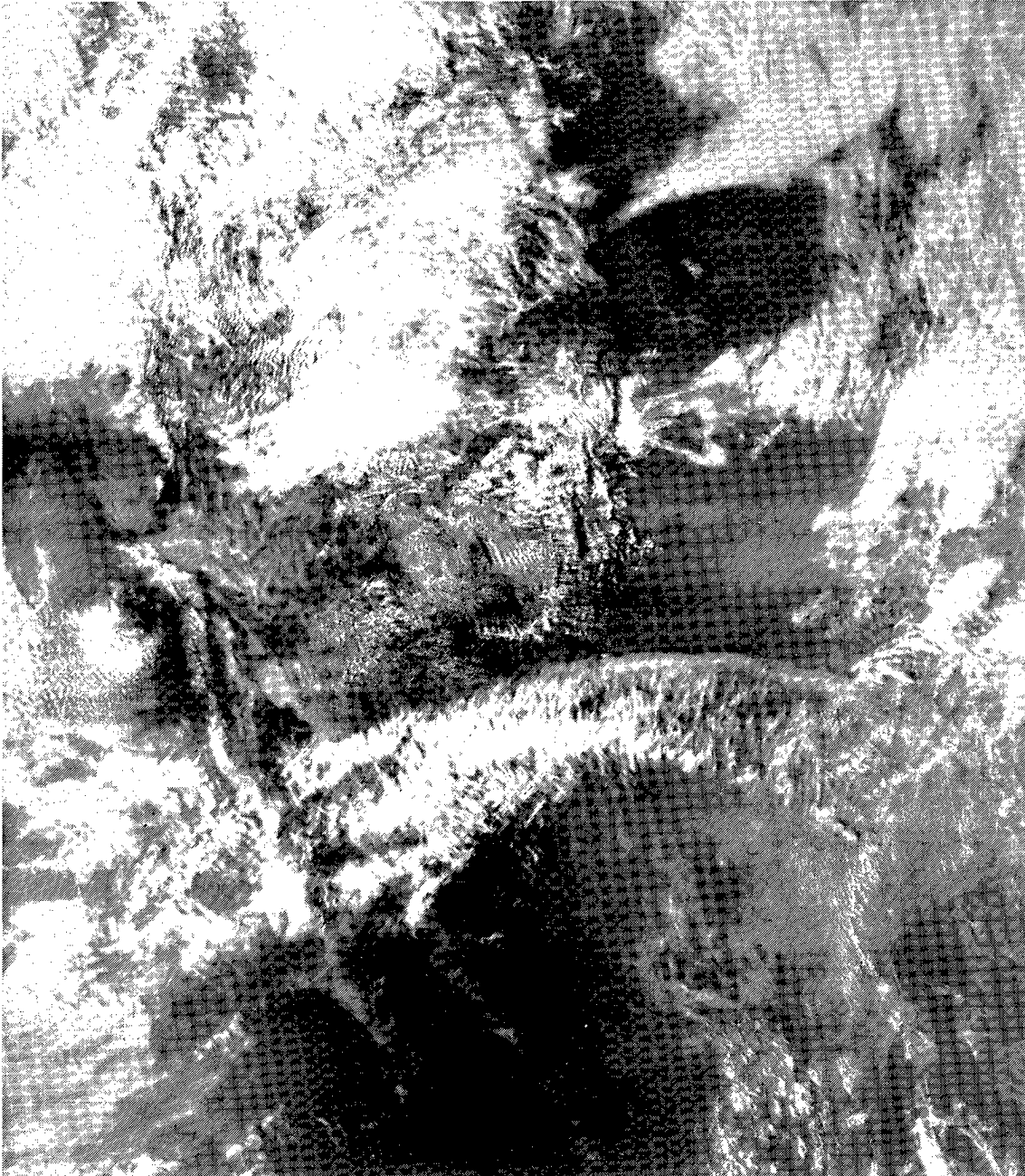

Figure 4.50. Meteor 3–5 View of the US and Mexico.

Two Meteor 3 spacecraft were launched in 1991 (Meteor 3-4 on 24 April and Meteor 3-5 on 15 August) joining the still operational Meteor 3-3 (24 October 1989). Meteor 3-4 was inserted into an orbital plane about 90° away from Meteor 3-3 with an auxiliary objective of testing new systems required to support the US Total Ozone Mapping Spectrometer (TOMS) scheduled to be carried by Meteor 3-5. Meteor 3-3 and Meteor 3-4 initially shared the 137.300 MHz direct transmission frequency until the older spacecraft was temporarily shutdown in August, 1991 (References 161 and 165). Meteor 3-4 remained operational on this frequency through the end of 1992, ceasing transmissions periodically when lighting conditions were inadequate or during small maneuvers with its ion engines (e.g., September, 1991). Figure 4.50 is a sample image returned by Meteor 3-5 on 24 October 1991 as received by Grant Zehr.

The launch of Meteor 3-5 was accompanied with a great deal of unusual attention due to the presence of the 30-kg US TOMS instrument (References 166–169). An American delegation, headed by NASA Associate Deputy Administrator Samuel Keller, witnessed the launch from Plesetsk, which occurred just a few days before the attempted coup against Soviet President Gorbachev. Meteor 3-5 was placed into an orbital plane 60° away from that of Meteor 3-4. The new spacecraft transmitted APT at 137.300 MHz until late November when it ceased imagery transmissions for almost a year. As Meteors 2-19 and 2-20 neared the end of their lives, Meteor 3-3 was reactivated in May, 1992 on a frequency of 137.400 MHz where it remained until December, 1992, when the spacecraft switched to the higher frequency 137.850 MHz band. During a brief period in October–November, 1992, Meteor 3-5 resumed APT signals at 137.850 MHz. While Meteor 3-5 was relatively inactive in APT, the US TOMS instrument was operating as planned, returning high quality data (Reference 170).

Despite the organizational turmoil in the CIS and the extreme budgeting pressures, the meteorological program retains considerable support. A Meteor 3 spacecraft to be launched in 1993 will carry a French payload called SCARAB (Scanner for Radiation Budget). The radiometer will study the Earth's radiation budget over an extended period of time and will measure the effect of clouds on the greenhouse phenome-

non (References 171–172). A second Meteor/SCARAB mission may be launched in 1996.

In 1993 the Meteor 3 satellite may be replaced with a new Meteor 3M variant. The overall mass of the spacecraft will be increased to 2,500 kg, including a larger payload of up to 900 kg. In addition, the average daily power available will nearly double to 1 kW, and the spacecraft stabilization accuracy will be improved by an order of magnitude. Pointing accuracy will also be improved, as well as satellite design lifetime which will reach three years. The store and forward transmission mode will be converted from the current 466.5 MHz analog to 1.69–1.71 GHz digital. The 1.4 m diameter, 2.2 m long spacecraft bus will carry a payload truss (like Meteor 3) with dimensions of 1,8000 mm by 1,600 mm by 270 mm. High temperature ammonia thrusters (0.147 N) will be used for adjustments of the basic 900 km by 950 km orbit with an inclination of 82.5° (References 163 and 173).

The year 1993 should witness the long-awaited debut of Geostationary Operational Meteorological Satellite (GOMS) system of Electro spacecraft. Originally proposed for a maiden flight in 1978–1979, GOMS has suffered both technical and budgetary problems. The objectives of the program, as stated in 1991, are as follows:

- to acquire, in real time, television images of the Earth surface and cloud within a radius of 60° centered at the sub-satellite point in the visible and IR regions of the spectrum;
- to measure temperature profiles of the Earth surface (land and ocean) as well as cloud

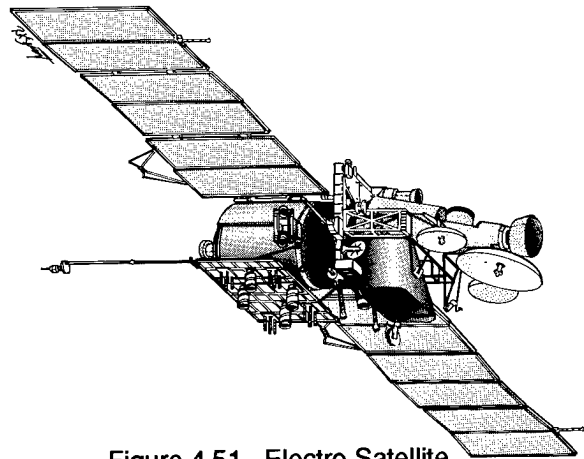

Figure 4.51. Electro Satellite.

- cover;
- to measure radiation state and magnetic field of the space environment at the geostationary orbital altitude;
- to transmit via digital radio channels television images, temperature and radiation and magnetometric information to the Main and regional data receiving and processing centers;
- to acquire the information from Soviet and international data collection platforms (DCPs), located in the GOMS radio visibility, and to transmit the obtained information to the main and regional data and processing centers;
- to retransmit the processed meteorological data in the form of facsimile or alphanumeric information from the receiving and processing centers to the independent receiving stations via satellites;
- to provide the exchange of high-speed digital data (retransmissions via the satellite) between the Main and regional centers of

the USSR State Committee for Hydrometeorology;

- to call for the data collection platforms to transmit the information to the satellite.” (Reference 174)

The GOMS network will eventually consist of three spacecraft spaced 90° apart in the geostationary ring: at 14° W, 76° E, and 166° E. Each 2.4 metric ton spacecraft will have a payload capacity of 650–800 kg with an estimated operational lifetime of at least three years. The satellites will be 3-axis-stabilized and receive a maximum of 1.5 kW (900 W for the payload) produced by two rectangular solar arrays (Figure 4.51). Twelve communications channels will link the spacecraft to the receiving and processing centers, the independent data receiving center, and the data collection platforms. The main data receiving and processing center is in the Moscow region while two regional centers are located at Tashkent and Khabarovsk (Figure 4.52).

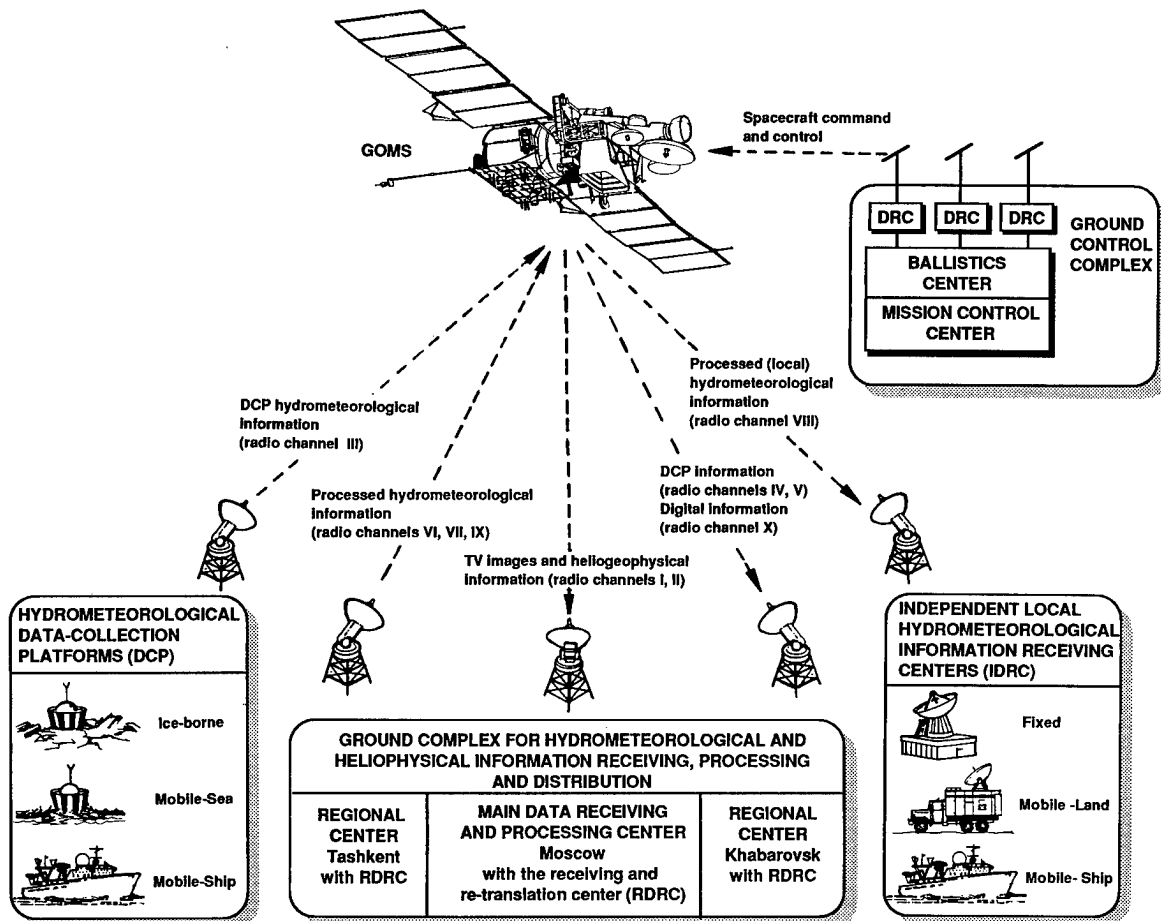

Figure 4.52. GOMS Meteorological Network.

Table 4.3. Planned Electro Instrument Suite.

INSTRUMENT	NUMBER OF SPECTRAL BANDS	BAND WAVELENGTHS, μM	GROUND RESOLUTION, KM	SCAN LINES PER FRAME
Scanning Telephotometer	1	0.4-0.7	1.25	8000
Scanning IR-Radiometer	1	10.5-12.5	6.5	1400
Scanning IR-Radiometer	1	6-7	6.5	1400
Radiation Measurement Complex (PMK)	Registration of Flow Density:		0.04-1.7 MeV (Electrons) 0.5-90 MeV (Protons) 5-12 MeV (Alpha) > 600 MeV (Cosmic Radiation)	

The proposed Electro spacecraft instrument suite is summarized in Table 4.3, although the 6-7 μm scanning radiometer might not appear until the second mission. The telephotometer is limited to a total of 24 frames per day (each framing session lasts 30 minutes of which 15-20 minutes is imaging time), and only 4-5 frames can be successively taken at the 30 minute per-frame imaging rate. This high frame rate will normally be employed around 0000 and 1200 GMT, in part, to permit the calculation of wind speed and direction data. DCP information will be collected and transmitted at three-hour intervals each day, i.e., 0300 GMT, 0600 GMT, etc. (References 174-176).

In the late 1970's the USSR began testing a series of new instruments which would complement the standard meteorological payloads while at the same time would provide specific data on ocean and ice conditions. The heavy reliance of the USSR on its merchant marine fleet for both domestic and international commerce, particularly in the northern latitudes which are subject to extreme environmental conditions, prompted the State Committee on Hydrometeorology to develop specialized spacecraft capable of providing direct operational assistance to ships at sea as well as to a host of other government agencies and civilian and military organizations (Figure 4.53).

After testing various equipment on four spacecraft (Kosmos 1076, Kosmos 1151, Interkosmos 20, and Interkosmos 21) launched

during 1979-1981, the first prototype Okean satellite (Okean-OE) was orbited in 1983 as Kosmos 1500 and was followed by Kosmos 1602 (1984), Kosmos 1766 (1986), and Kosmos 1869 (1987). The first operational spacecraft (Okean-O) was launched in 1988 as Okean 1 and was joined in 1990 by Okean 2. This Okean-O program is designed

- to estimate the potential reserves of the energy of tides and the accumulated energy of solar radiation;
- to study the World Ocean as a global damper and regulator of heat and moisture content of the atmosphere;
- to detect zones of upwelling and higher bioproductivity;
- to study subsurface circular eddies and their effect on the formation of destructive cyclones and typhoons;
- to ensure the safety of navigation and control of the ice situation in the Arctic and Antarctic;
- to study the dynamics of sea currents, and the processes of self-purification of sea water and cleansing of river effluents; and
- to control the intensity of pollution of the oceans with oil and oil product discharges."

Designed by the Yuzhnoye NPO of Dnepropetrovsk, Ukraine, each Okean spacecraft has a mass of a little more than 1,900 kg, with a payload capacity of 550 kg and is

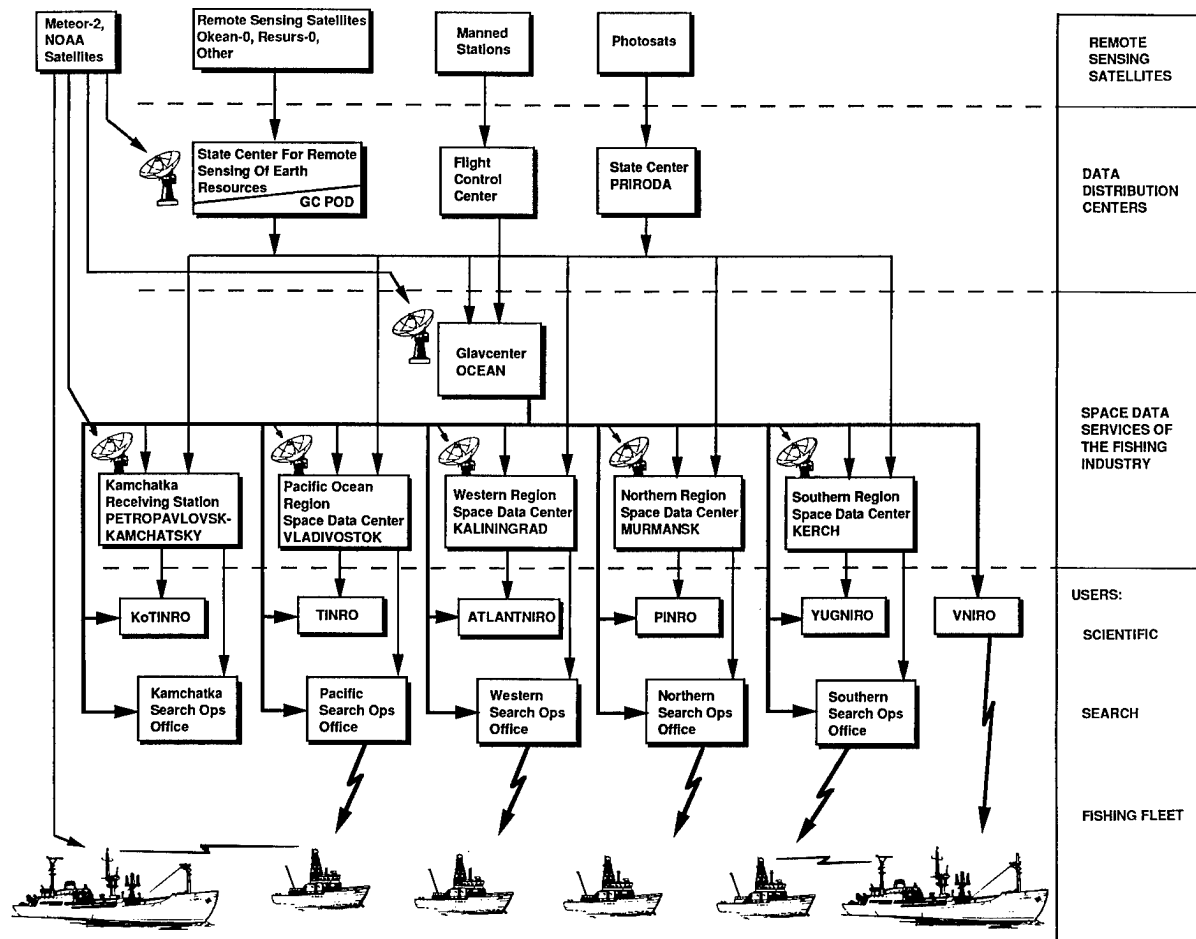

Figure 4.53. Former Soviet Oceanographic Support System.

launched from the Plesetsk Cosmodrome by the SL-14 (Tsyklon) booster, also made by Yuzhnoye NPO. The spacecraft bus is a three-segmented, vertically oriented cylinder, three meters tall with a base diameter of 1.4 m and an upper diameter of 0.8 m. Like Meteor 3, Okean's primary structure is pressurized and maintained at normal temperatures to protect the support system and payload electronics housed within. Two small, rotatable solar arrays (1.6 m wide and 2.0 m tall) provide a modest 110–270 W average daily power to the payload. Stabilization is partially provided by a gravity-gradient boom extended from the top of the satellite. At the bottom, four large panels (1.0 m wide and 2.9 m long), attached at 90° intervals, support a number of payload receivers and transmitters. A narrow, 11-m-long radar antenna is fixed to the base of one panel (Figure 4.54).

Okean spacecraft transmit data in real time on 137.400 MHz using APT formats similar to

that employed by Meteor satellites with a scan rate of 4 lines per second. Data is also stored and retransmitted on 466.5 MHz to the three principal data reception and processing centers at Moscow, Novosibirsk, and Khabarovsk. Table 4.4 indicates the typical set of instruments on board an Okean satellite, their characteristics, and the potential transmission modes. The APT images may be sent in one of four formats: (1) one low resolution scanner, (2) side-looking radar and microwave scanning radiometer, (3) side-looking radar alone, and (4) a combination of radar, microwave, and visible images. Figure 4.55 from the Kosmos 1500 Okean-OE depicts radar (left) and visible (right) images of the Middle East region. The original image size is 195 mm by 290 mm with a scanning density of 7.6 lines per mm and at least 12 gray level (References 177–182).

The major Okean payload with no counterpart on Meteor satellites is the real-aperture, side-looking RLS-BO radar operating with a

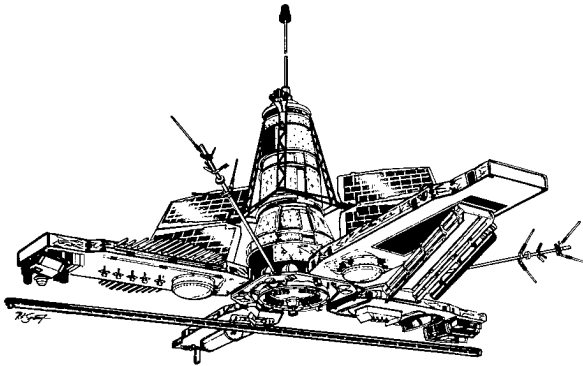

Figure 4.54. Okean Satellite.

vertically polarized 9.5 GHz frequency. This instrument, developed by the Radio Engineering and Electronics Institute (IRE) in Kharkov, provides not only surface characteristics of land, sea, and ice but also near-surface wind speeds and sub-surface features. The last has proved to be exceptionally effective in determining ice thickness in the polar regions as an aid to naval navigation.

From its orbital altitude of 635 km by 665 km at an inclination of 82.5°, an Okean satellite employs both nadir-centered and off-nadir swaths. The MSU-M and MSU-S sweeps are centered about the sub-satellite point, but the RLS-BO and RM-08 swaths are displaced to the left of the ground track. The boresight of the MSU-M can be shifted up to 30° along the direc-

tion of the flight path. In part, due to power limitations, the MSU-M and RM-08 cannot be operated for more than 30 minutes at a time, and the RLS-BO is restricted to 10-minute sessions.

Okean satellites also serve as the central node in the Condor system which collects environmental data from small, remote stations on land, water, or ice. These stations, designated Condor-1, are interrogated by Okean satellites at 460.03 MHz and then transmit their data at 1553.4 MHz during a 4–12 second contact. Okean, also known as the Condor-2 node, then relays the data to special Condor-3 processing stations at 460.03 MHz. Okean satellites can interrogate Condor-1 stations within 800 km and can store up to 64 kbits of data for subsequent relay to a Condor-3 site.

Although Okean spacecraft have an official design life of only six months, actual lifetimes have significantly exceeded this value. Okean 3 was launched 4 June 1991 and was placed in an orbital plane approximately 90° away from that of Okean 2. No further launches were conducted in this program in 1992.

As early as 1993 Okean may be replaced by an improved Okean-M satellite. The slightly larger spacecraft (Figure 4.56) will carry a significantly greater payload (1,200 kg versus 550 kg) and may operate at higher altitudes (up to 900

Table 4.4. Typical Okean Instrument Suite.

INSTRUMENT	NUMBER OF SPECTRAL BANDS	BAND WAVELENGTHS	GROUND SWATH, KM	GROUND RESOLUTION, KM	TRANSMISSION MODE
Multi-Spectral Scanner (MSU-M)	4	0.5-0.6 μm 0.6-0.7 μm 0.7-0.8 μm 0.8-1.1 μm	1930	1.0 x 1.7	Direct, Store/Dump
Multi-Spectral Scanner (MSU-S)	2	0.5-0.7 μm 0.7-0.9 μm	1380	0.35	Store/Dump
Real Aperture Side-Looking Radar (RLS-BO)	1	3.15 cm	450	1.8 x 2.2	Direct, Store/Dump
Scanning Microwave Radiometer (RM-08)	1	0.8 cm (Horizontal Polarization)	550	15 x 15	Direct, Store/Dump
Optical Spectrometer - Experimental (Trasser)	2 x 50	0.4-0.8 μm	--	45	Store/Dump



Figure 4.55. Okean Dual Visible and Radar Image of the Middle East.

km) at inclinations between 73° and 99° . The basic dimensions of the spacecraft bus will increase to 1.6 m diameter and nearly 4.5 m height. Likewise, the four instrument panels will be enlarged to 1.3 m by 3.4 m as will the solar arrays which will be one-third larger. Solar cells will also be attached to the main body for a total average daily power available to the payload of 420 W. Angular stability will be improved markedly, and the design life will be extended to two years.

Okean-M's new instrument suite will feature the RLS-BO D model with both left and right scanning antennas, an improved MSU-SK (original MSU-SK flown on Resurs-O1 satellites described below), and advanced UV and microwave detectors (Table 4.5). Equally important, the data transmission links will become digital at 1.7 and 8.2 GHz for greater capacity. The preliminary 5.5 Gbit storage of the 8.2 GHz system may later be expanded to 61.44 Gbits.

A second-generation class of oceanographic satellites has been designed and a prototype satellite has been built. Currently designated simply as Platform B (Okean and Okean-M rep-

resent Platform A types), the new spacecraft is much larger than Okean and will use the SL-16 (Zenit) launch vehicle to place it in a sun-synchronous orbit of 650 km and 98° inclination. The overall dimensions of the horizontally oriented Platform B are 3.6 m diameter and a length of 10.7 m, excluding the side-looking radar antenna (Figure 4.57). The spacecraft will have a three-axis attitude control system with a pointing accuracy of 8 arc minutes.

The spacecraft bus will be a pressurized cylinder 1.9 m in diameter and 6.6 m long. A single solar array deployed above the spacecraft will deliver an average daily power of 800 W to the payload. The instrument suite (Table 4.6) will be much more comprehensive than that envisioned for Okean-M and will utilize both analog APT (137.4 MHz) and high capacity digital (8.2 GHz) data links. Platform B with a one-year design life will also carry the Condor-2 data relay system. A maiden flight could come as early as 1993. A modified Platform B, possible by 1995, is being designed for a higher operating altitude (900 km), greater power (1.5–2.2 kW), longer life (2 years), more sophisticated sensors (including synthetic aperture radars; see Table 4.7), and more capable data handling systems.

In addition to the meteorological and oceanographic satellites described above, the CIS has operated seven different types of spacecraft since 1991 to perform a wide variety of global remote sensing observations. More advanced spacecraft are already in the design and development phase for possible missions later in this decade. However, together the satellites represent a level of redundancy which suggests that, in the difficult financial conditions now present in the CIS, not all spacecraft classes will continue to be supported.

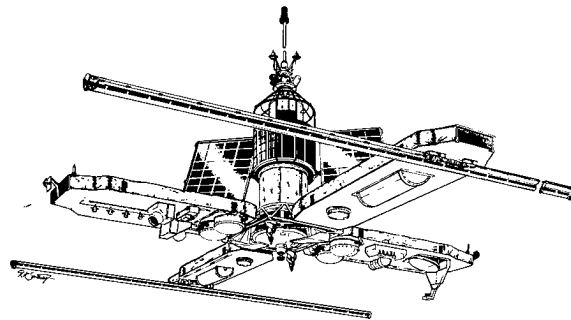

Figure 4.56. Okean-M Satellite.

Table 4.5. Projected Okean-M Instrument Suite.

INSTRUMENT	NUMBER OF SPECTRAL BANDS	BAND WAVELENGTHS	GROUND SWATH, KM	GROUND RESOLUTION, KM
Multi-Spectral Scanner (MSU-SK[M])	6	0.41-0.46 μm 0.52-0.57 μm 0.64-0.69 μm 3.5-4.0 μm 10.3-11.3 μm 11.4-12.4 μm	600	0.2 0.2 0.2 0.2 0.6 0.6
UV-Scanner (OZONE)	2 x 8 (From 2 x 1024)	0.25-0.40 μm	1300	20
Real Aperture Side-Looking Radar (RLS-BO D)	1	3.15 cm	2 x 700	1.5 x 2.0
Scanning Microwave Radiometer (Delta 2)	4	0.8 cm 1.35 cm 2.25 cm 4.3 cm (Horizontal, Vertical Polarization)	900	16 x 21 27 x 35 47 x 62 87 x 115

The Resurs-O program, which is analogous to the US Landsat program, became operational in 1985 after more than ten years of on-orbit testing. Designed and manufactured by the All-Union Research Institute for Electromechanics, the Resurs-O1 spacecraft, not surprisingly, closely resemble the Meteor series of satellites from which they were derived. In fact, the Resurs-O development program utilized two Meteor satellites (Meteor 1-18 and Meteor 1-25) and five Meteor-Priroda vehicles (1977-1983) to perfect the instruments and techniques finally adapted for Resurs-O1. The Meteor-Priroda satellites also marked the first use of sun-synchronous orbits by the USSR.

Program management for the Resurs-O effort was originally the responsibility of the

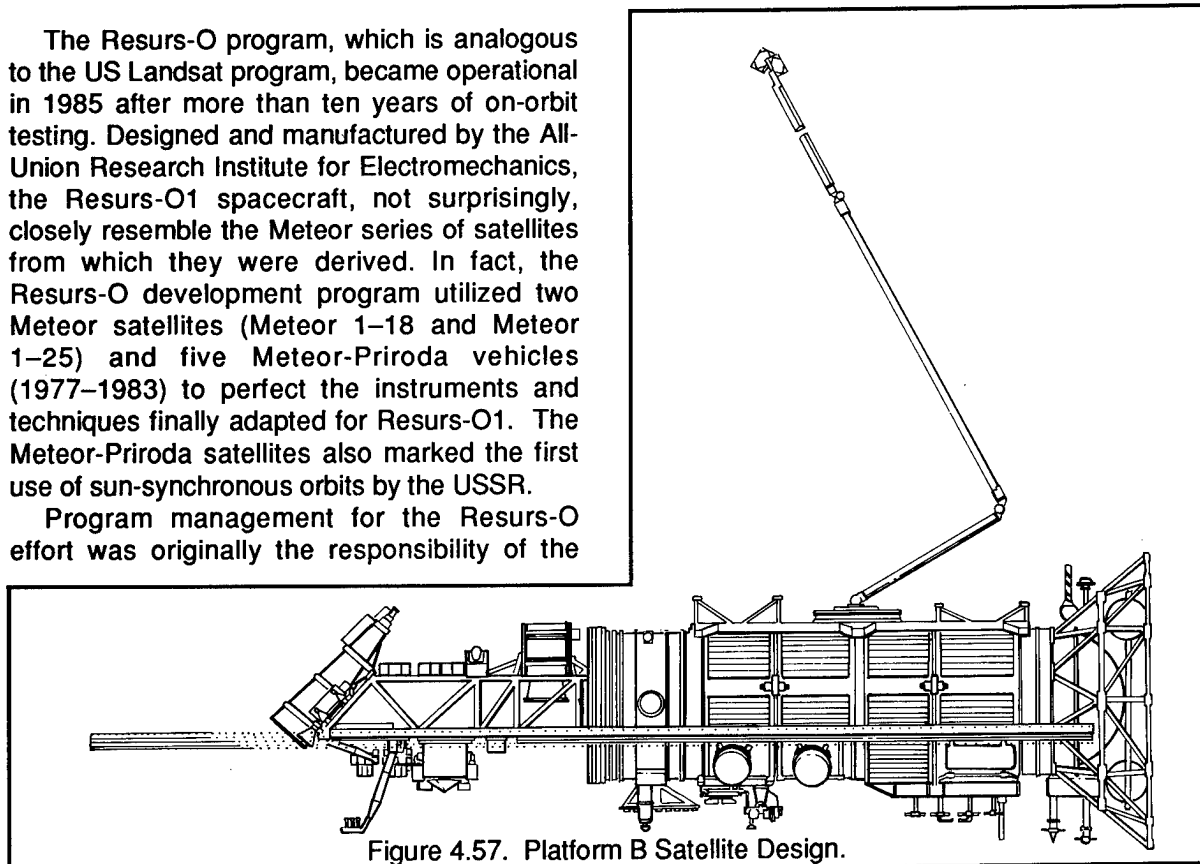

Figure 4.57. Platform B Satellite Design.

Table 4.6. Projected Platform B Instrument Suite.

INSTRUMENT	NUMBER OF SPECTRAL BANDS	BAND WAVELENGTHS	GROUND SWATH, KM	GROUND RESOLUTION, KM
Multi-Spectral Scanner (MSU-M)	4	0.5-0.6 μm 0.6-0.7 μm 0.7-0.8 μm 0.8-1.1 μm	1930	1.0 x 1.7
Multi-Spectral Scanner (MSU-SK)	5	0.53-0.59 μm 0.61-0.69 μm 0.7-0.8 μm 0.9- 1.0 μm 10.4-12.6 μm	600	.175 x .245 .175 x .245 .175 x .245 .175 x .245 .590 x .820
Multi-Spectral Scanner (MSU-V)	8	0.45-0.52 μm 0.52-0.62 μm 0.62-0.74 μm 0.76-0.9 μm 0.9-1.1 μm 1.55-1.75 μm 2.1-2.35 μm 10.0-12.0 μm	180	.050 x .050 .050 x .050 .050 x .050 .050 x .050 .050 x .050 .10 x .10 .25 x .25 .10 x .10
Multi-Spectral Scanner (MSU-E)	3	0.5-0.6 μm 0.6-0.7 μm 0.8-0.9 μm	45 (\pm 300 km off nadir)	.025 x .035
Real Aperture Side-Looking Radar (RLS-BO D)	1	3.15 cm	2 x 700	1.5 x 2.0
Optical Spectrometer (VIDEO)	2 x 6 (From 2 x 256)	0.4-0.8 μm	740	1.0
Scanning Microwave Radiometer (Delta 2)	4	0.8 cm 1.35 cm 2.25 cm 4.3 cm (Horizontal, Vertical Polarization)	900	16 x 21 27 x 35 47 x 62 87 x 115

State Committee on Hydrometeorology. In 1989 the Planeta NPO was formed under this organization to consolidate the meteorological and remote sensing satellite systems of the USSR. Subsequently, the Planeta NPO, the All-Union Research Institute of Electromechanics, and the Space Instrument Building NPO, which was responsible for many of the payload instruments, formed the Soviet Association for Earth Remote Sensing (SOVZOND) to promote Resurs-O products on a commercial basis.

To date Resurs-O spacecraft have been

launched by the SL-3 (Vostok) booster into nominal orbits of 630 km altitude and an inclination of 98°. Each mission is conducted to ensure that the spacecraft's descending node will occur between 10:00 and 10:30 a.m. local sun time, thereby providing excellent lighting conditions for the complex sensor suite. The objectives of the Resurs-O program are as follows:

- to obtain in both real-time and store-and-forward modes multispectral sensor information with medium and high resolution in

Table 4.7. Oceanographic Instruments Under Development.

INSTRUMENT	NUMBER OF SPECTRAL BANDS	BAND WAVELENGTHS	GROUND SWATH, KM	GROUND RESOLUTION, KM
Multi-Spectral Scanner (MSU-V2)	8	0.45-0.49 μm 0.53-0.59 μm 0.65-0.69 μm 0.70-0.74 μm 0.83-0.87 μm 1.55-1.75 μm 2.1-2.35 μm 10.5-12.5 μm	200	.015 x .015 .015 x .015 .015 x .015 .015 x .015 .015 x .015 .015 x .015 .045 x .045 .045 x .045
Synthetic Aperture Radar (SAR-9)	1	9 cm	60-200	.050-.150
Synthetic Aperture Radar (SAR-DM)	1	23 cm	5 x 100	.100
Vertical Atmospheric Scanner (Zond)	2 x 8 (From 2 x 1024)	.5 - .8 μm	90° FOV	5
Multi-Channel Microwave Radiometer	4	0.8 cm 1.35 cm 2.2 cm 5.5 cm (Horizontal, Vertical Polarization)	1200	7 x 8 11 x 13 18 x 20 50 x 55

- visible and IR bands to provide data for land and ocean states in any region of the globe;
- to obtain in the same modes the all-weather relay images of the land ocean with medium resolution;
- to process the obtained data and images, and to perform their radiometric, geometric and geographical correction;
- to represent and distribute the obtained data in the form of single-spectral and synthesized

- multispectral images on the photos, negatives, and digital recordings on the various media (tapes, diskettes); and
- to obtain and disseminate thematic maps and charts concerning various aspects of Earth natural resources exploration, environmental control and ecological monitoring" (Reference 183).

The Resurs-O1 spacecraft bus is almost identical to that of the Meteor 3 vehicle with a total mass of approximately 1,840 kg, including a payload of up to 600 kg (Figure 4.58). The payload support structure at the base of the spacecraft is tailored for each mission to accommodate the specific instruments to be carried. For example, of the three primary instruments available (Table 4.8), the first Resurs-O1 (Kosmos 1689) was out-fitted with two MSU-E, one MSU-SK, and one MSU-S devices, while the second Resurs-O1 (Kosmos 1939) omitted the MSU-S and carried two MSU-E and two MSU-SK. The 30-kg MSU-E employs an electro-

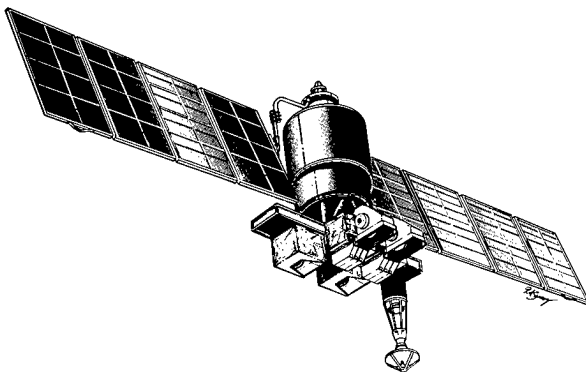

Figure 4.58. Resurs-O1 Satellite.

Table 4.8. Resurs-O1 Instruments Available.

INSTRUMENT	NUMBER OF SPECTRAL BANDS	BAND WAVELENGTHS, μM	GROUND SWATH, KM	GROUND RESOLUTION, M
MSU-SK	5	0.5-0.6 0.6-0.7 0.7-0.8 0.8-1.1 10.4-12.6	600	170 170 170 170 600
MSU-E	3	0.5-0.6 0.6-0.7 0.8-0.9	45 (\pm 350 km from nadir)	45
MSU-S	2	0.58-0.7 0.7-1.0	1380	240

optical CCD scanner for high resolution and can be used in pairs to provide a continuous 80 km wide swath. On the other hand, the mechanical MSU-SK scanner weighs 60 kg and combines a lower resolution capability with a much wider swath. (References 183–192).

The primary data collection and processing stations for Resurs-O are the same as for Okean: Moscow, Novosibirsk, and Khabarovsk. The principal data transmission link is also similar at 466.5 MHz. A standardized small receiving station, utilizing a 2.5 m diameter antenna and the Spektr-DK01 system, has been designed for use with both Okean and Resurs-O spacecraft when the data links are upgraded to the new 8.2 GHz system (Reference 193).

The unexpected longevity of Kosmos 1939 led to the postponement of the launch of the third (and possibly final) Resurs-O1 satellite during 1991–1992. Originally scheduled to replace Resurs-O1 in late 1992, Resurs-O2 represents an evolutionary improvement of the Resurs-O system which adds both a synthetic aperture radar and a microwave radiometer capability (Figure 4.59 and Table 4.9). Resurs-O2 not only will be heavier (2,400 kg with a payload of 900 kg) but also will be placed in a higher, 830 km orbit to increase its coverage potential. The SL-16 (Zenit) launch vehicle will be called on to orbit Resurs-O2.

The Resurs-O2 payload will be able to draw up to 800 W daily with a peak power of 2 kW. The data transmission system will operate at 8.2 GHz to the main receiving and data processing center at Moscow and the regional centers at

Novosibirsk, Tashkent, and Khabarovsk as well as with smaller, local stations (Figure 4.60). On-board data storage capacity will also be increased markedly.

The new synthetic aperture, side-looking radar is similar to the SAR-DM envisioned for the modified Platform B oceanographic spacecraft and has a mass of about 265 kg. Likewise, the Delta-2P microwave radiometer is a variant of the Delta 2 instrument proposed for the original Platform B. The mass of the Delta-2P is 60 kg. The total Resurs-O2 instrument suite is designed to match the 3-year spacecraft lifetime.

While the first synthetic aperture radars (SAR) have yet to fly on Platform B or Resurs-O2, the USSR/CIS has already gained experi-

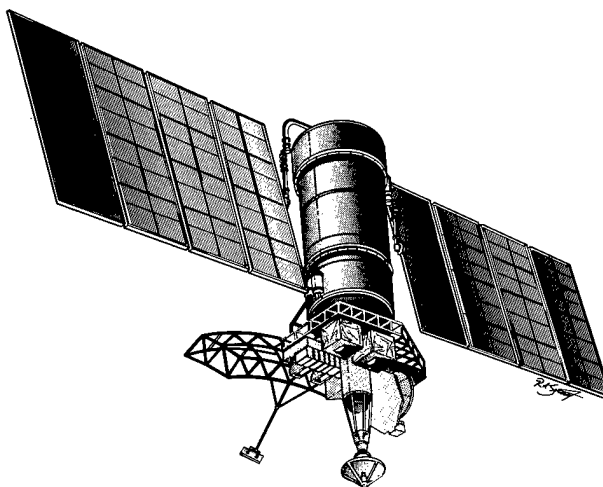

Figure 4.59. Resurs-O2 Satellite.

Table 4.9. Proposed Resurs-O2 Instrument Suite.

INSTRUMENT	NUMBER OF SPECTRAL BANDS	BAND WAVELENGTHS	GROUND SWATH, KM *	GROUND RESOLUTION *
MSU-SK2	5	0.5-0.6 μm 0.6-0.7 μm 0.7-0.8 μm 0.8-1.1 μm 10.4-12.6 μm	600	170 m 170 m 170 m 170 m 600 m
MSU-E2	3	0.5-0.6 μm 0.6-0.7 μm 0.8-0.9 μm	45 (\pm 350 km from nadir)	27 m
RLS-BO Synthetic Aperature Radar	1	23 cm	100	200 x 200 m (on-board processing) 50 x 200 m (ground processing)
Delta-2P Multi-Channel Microwave Radiometer	4	0.8 cm 1.35 cm 2.2 cm 4.5 cm	1200	17 km 30 km 45 km 90 km

* These values dependent on operational altitude.

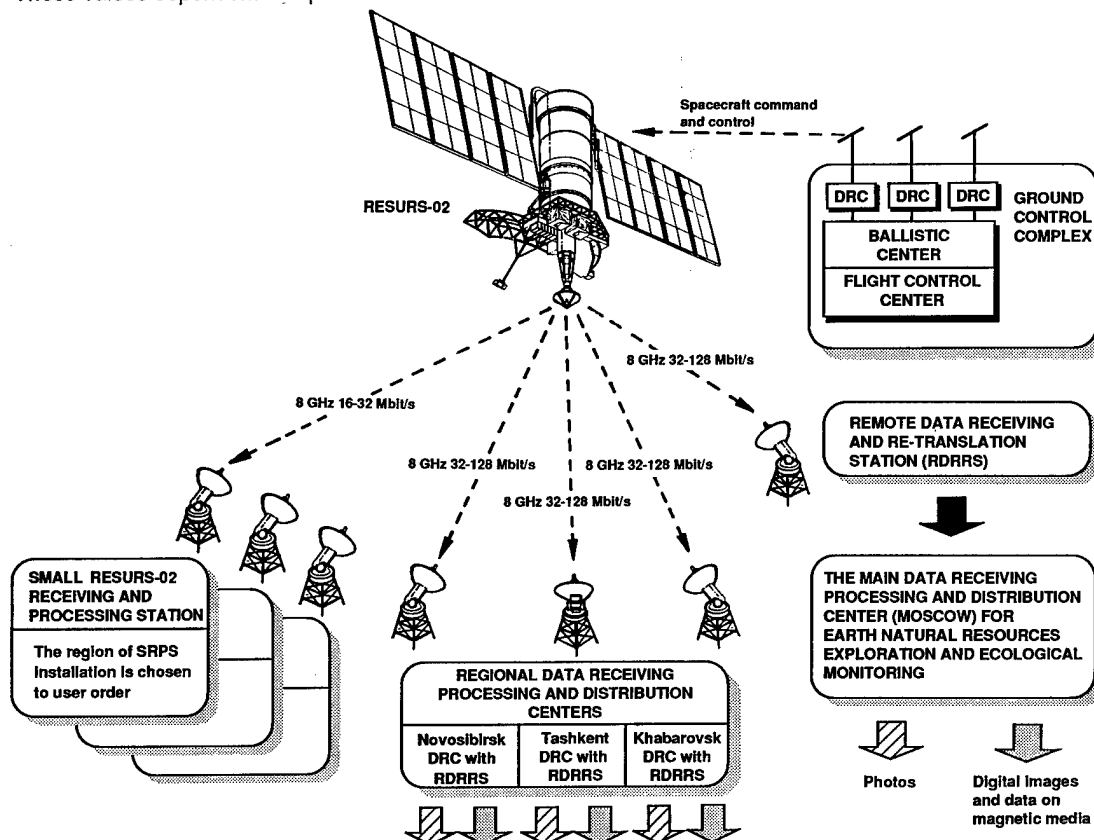

Figure 4.60. Resurs-O2 Data Collection and Distribution Network.

ence with this advanced technology under the Almaz program. The basic Almaz spacecraft was first designed in the 1960's under Chief Designer Vladimir Chelomei as a military manned space station. Almaz was flown three times during the 1970's (Salyut 2 in 1973, Salyut 3 in 1974, and Salyut 5 in 1976) and its civilian derivative was used for the remaining Salyut missions. The fourth Almaz vehicle was the first to be equipped with a large, high resolution SAR and was scheduled for launch in 1981. However, a dispute between Chelomei and Minister of Defense Ustinov led to a grounding of the spacecraft until 1986 when it was finally launched but failed to reach orbit due to a failure of its SL-13 (Proton) booster. A duplicate satellite was later flown during 1987-1989 as Kosmos 1870 (Reference 194).

An improved Almaz, officially designated Almaz 1, was launched on 31 March 1991 (eight months after its target date) into an initial operational orbit of approximately 270 km with an inclination of 72.7°, slightly higher than the 71.9° inclination of Kosmos 1870. The primary manufacturer and integrator of Almaz 1 was the Machine Building NPO using the former Chelomei facilities in the Moscow suburb of Reutov. The principal radar payload was contributed by the Vega NPO. The observation program was prepared with the assistance of the State Committee on Hydrometeorology, the State Geodesy Committee, the Ministry of Nature Management, and the USSR Academy of Sciences.

The initial on-orbit mass of Almaz 1 was 18,500 kg with sufficient propellants to maintain the vehicle at a low altitude for up to two years and to provide for a controlled reentry over a broad ocean area at the end of mission. The spacecraft core consisted of two joined cylinders with a length of 12 m and a maximum diameter of the larger cylinder of 4.2 m. This basic space station structure (similar to Salyut and Mir) has an interior volume of 90 m³ which is maintained at standard temperatures and pressures.

Attached to the spacecraft bus were two solar panels capable of generating a mean power of 2.4 kW and a peak power of 7.5-10 kW and two 3-piece SAR antennas (1.5 m by 15 m) along either side of the spacecraft. At the forward end of Almaz 1 between the two SAR antennas were two phased-array antennas to

permit real time data transfers via a geosynchronous relay satellite. Two small dish command and control and data transmission antennas were located at the aft end of Almaz 1, and a separate data transmission antenna extended upward from the spacecraft's mid-section (Figures 4.61 and 4.62).

Almaz spacecraft can carry a payload of 4-6.5 metric tons. On Almaz 1 this was divided between the SAR and a multi-channel microwave radiometer operating at 6-37.5 GHz with a swath of 600 km and a resolution of 10-30 km. The SAR transmitted at a frequency of 3 GHz with an average power of 80 W and a peak power of 190 kW. A typical radar image covered a region 20-45 km wide and 20-240 km long with a resolution of 15-30 m. However, Almaz 1 could aim its coverage over a swath at least 350 km wide. Unfortunately, the failure of one of the SAR antennas to deploy fully rendered that side inoperable. The main data reception center was located in Moscow region, although designs for data processing stations outside the USSR/CIS with a VAX-11/785, two MicroVAX II's, and four IBM PS/2-80's have been created (References 195-198).

Despite the antenna problem difficulties, Almaz 1 operated successfully until 17 October 1992 when it was deorbited over the Pacific Ocean. Figure 4.63 indicates the orbital history of the spacecraft and its gradual increase in altitude before maneuvers ceased. A sample SAR image of the Philippines' Mount Pinatubo is presented in Figure 4.64.

Originally, a second Almaz 1-type spacecraft was to be launched in 1993 on a two-year mission, but funding problems are likely to delay — if not ultimately cancel — those plans despite appeals to the international community to participate in the program, including the addition of foreign remote sensing instruments to the spacecraft. Even more ambitious plans have been revealed for an Almaz 2 satellite in 1995 and Almaz 3 in 1998. Both spacecraft would represent major extensions to the Almaz 1 capabilities. Tentative plans call for operations at an altitude of 600 km and an inclination of 73°. Aft rendezvous and docking systems would leave open the possibility of automatic refueling by a Progress-M spacecraft or man-tending by a Soyuz TM crew. (Figures 4.61 and 4.65). A payload mass of 6.5 metric tons would be powered by solar arrays with a maximum begin-

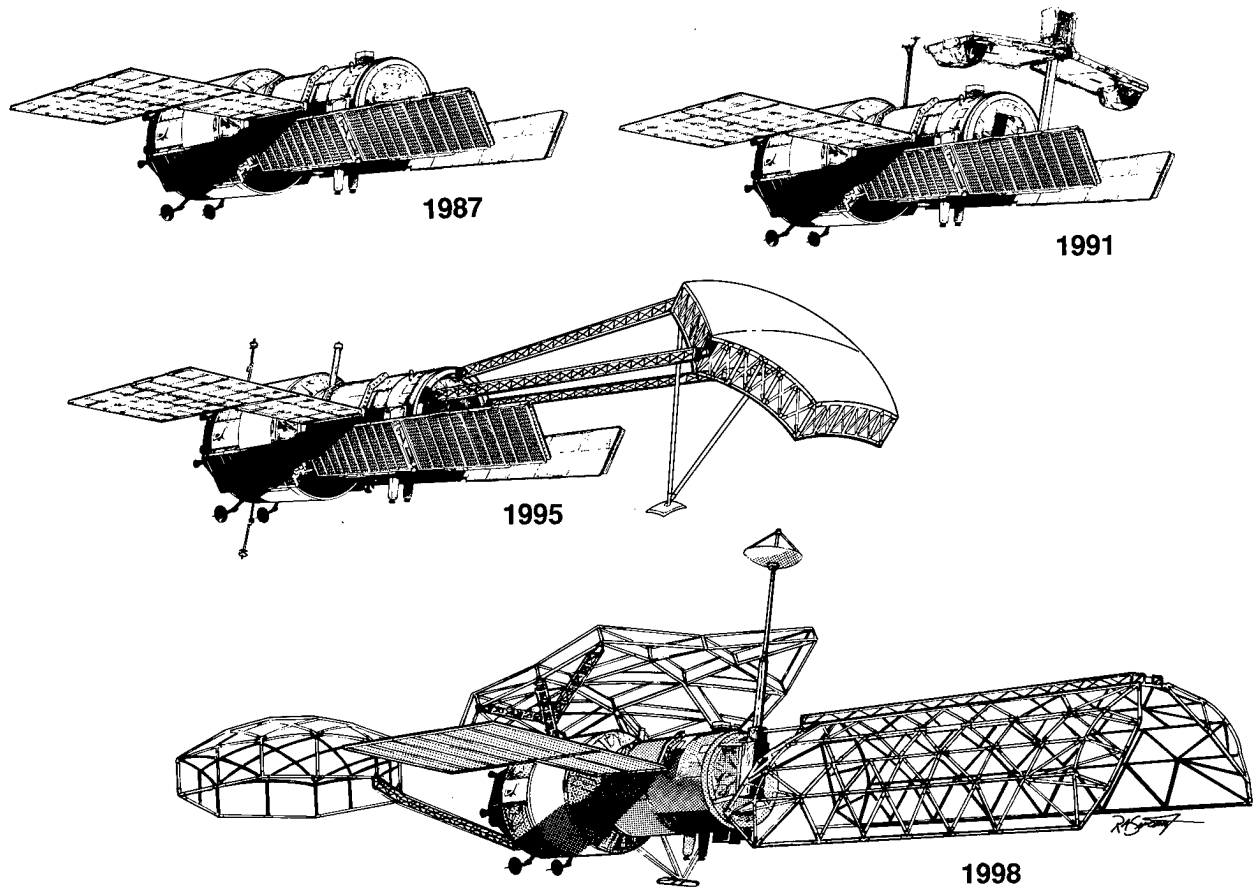

Figure 4.61. Past and Future Almaz-class Satellites.

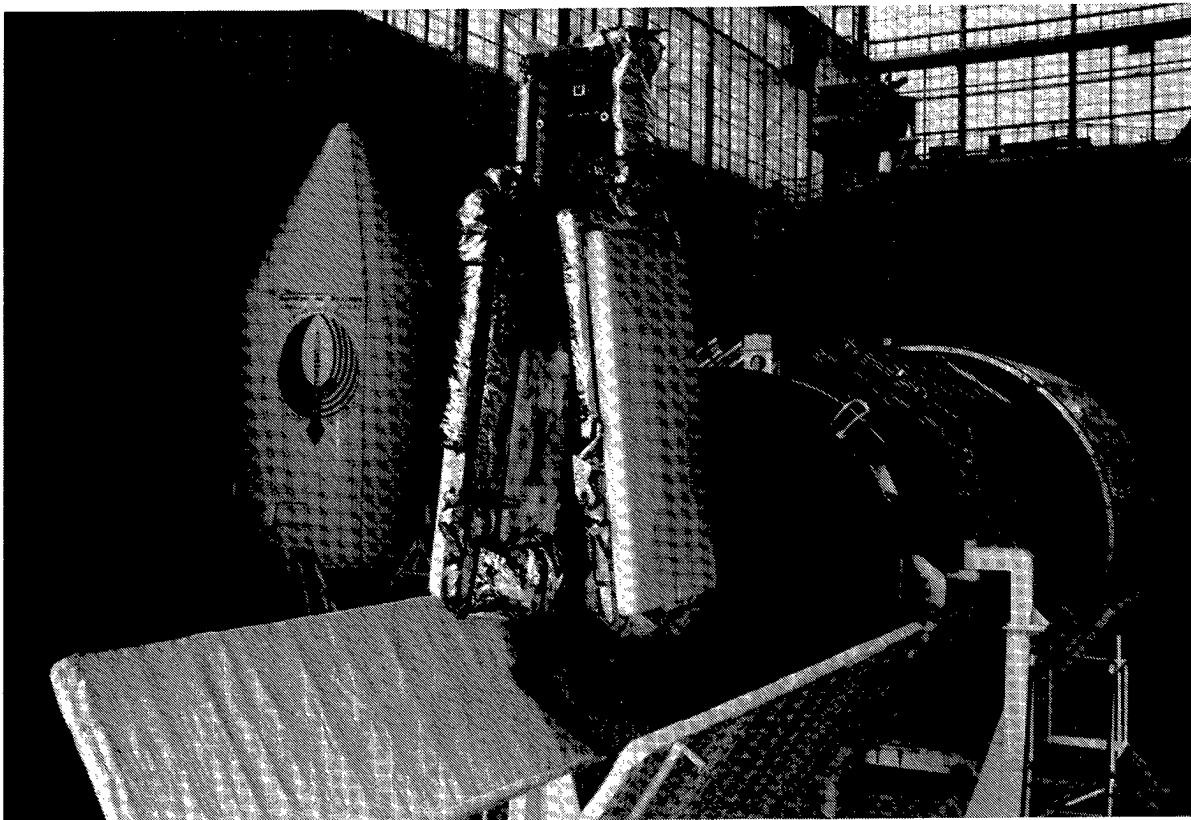

Figure 4.62. Almaz 1 Prior to Launch.

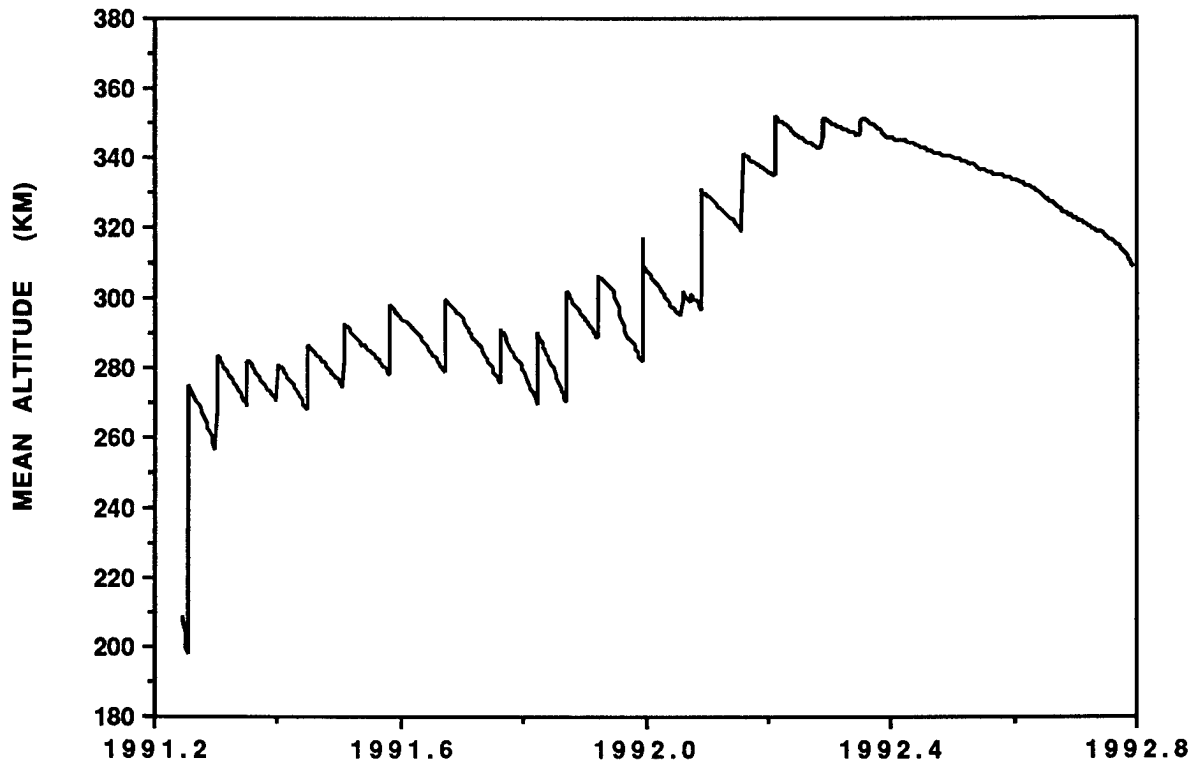

Figure 4.63. Almaz 1 Orbital History.

ning of life average power rating of 3.8 kW. More than three metric tons of propellants would be available for a mission duration of up to five years.

One of the oldest and still highly capable methods of performing space-based Earth observations is basic photography in one or more spectral bands with return of the film to Earth for development and analysis. This technique was first perfected in the USSR in 1962 but was not officially converted into a civil-oriented system until 1979. Currently, two similar types of 3rd generation spacecraft, Resurs-F1 and Resurs-F2, are flown several times a year for the Russian Ministry of Ecology and Natural Resources. One of the 1992 missions was specifically tasked with "discovering and inventorying natural resources (including soil, plant and water resources); engineering-geological surveying; monitoring of water consumption, land use, the consequences and effectiveness of land-reclamation measures and the state of the environment; and evaluating the ecological consequences of human economic activities" (Reference 199).

Since 1979 approximately 50 Resurs-F1

spacecraft have flown on missions of up to 23 days, although prior to 1989 they were given simple Kosmos designators. Based on the Vostok spacecraft developed in the late 1950's, Resurs-F1 spacecraft are designed and manufactured at the Samara (formerly Kuybyshev) Photon Design Bureau and the Progress Plant both of the Central Specialized Design Bureau. The Resurs-F1 vehicle, launched by the SL-4 booster from Plesetsk, is 7 m long with a maximum diameter of 2.4 m and a mass of 6,300 kg and is comprised of three major modules (Figures 4.66 and 4.67).

The central portion of the spacecraft is a sphere of 2.3 m diameter and a mass of about 2.4 metric tons containing the photographic apparatus, electronic control equipment, and the recovery system. This section is secured to a 3 m long, 2.4 m wide service and reentry propulsion module with four straps which are released after retrofire. On the opposite end of the recoverable capsule is a 1.9 m by 1 m propulsion unit used for minor orbital adjustments. The propulsion unit is also jettisoned prior to reentry and may carry additional, releasable payloads (up to 75 cm by 90 cm) for secondary missions. Secondary payloads up to 30 kg or

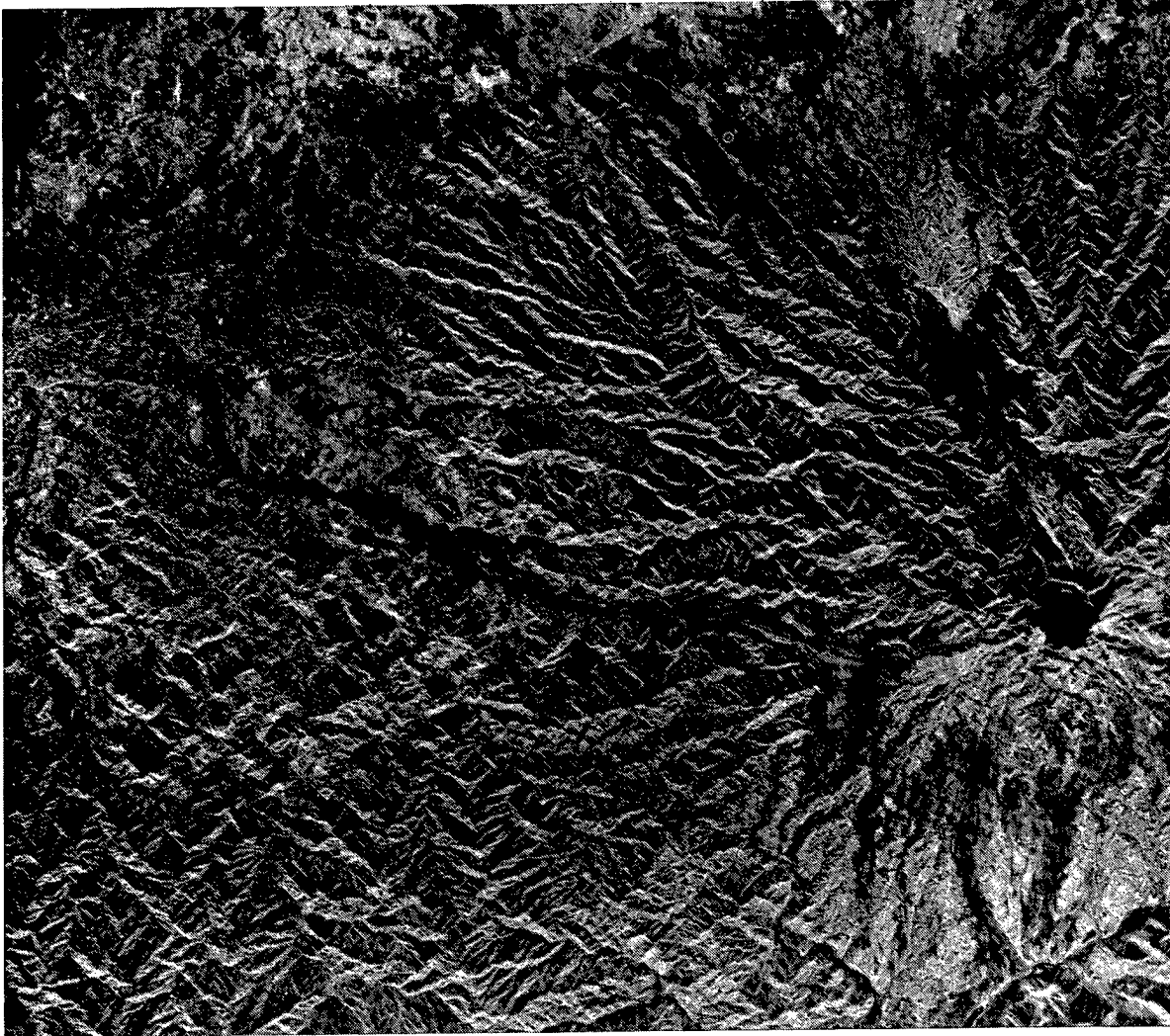

Figure 4.64. Almaz 1 Radar Image of Mount Pinatubo.

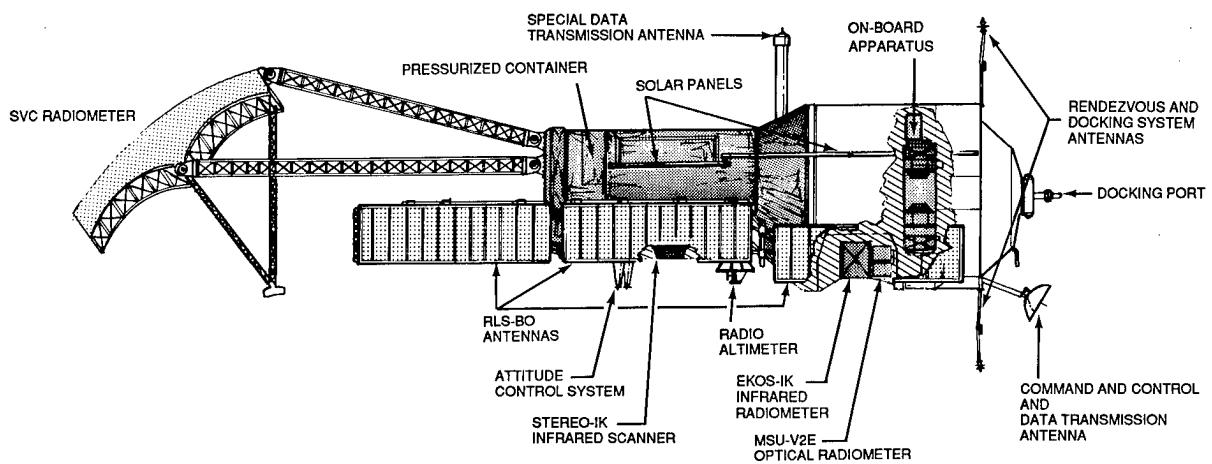

Figure 4.65. Proposed Almaz 2 Type Satellite.

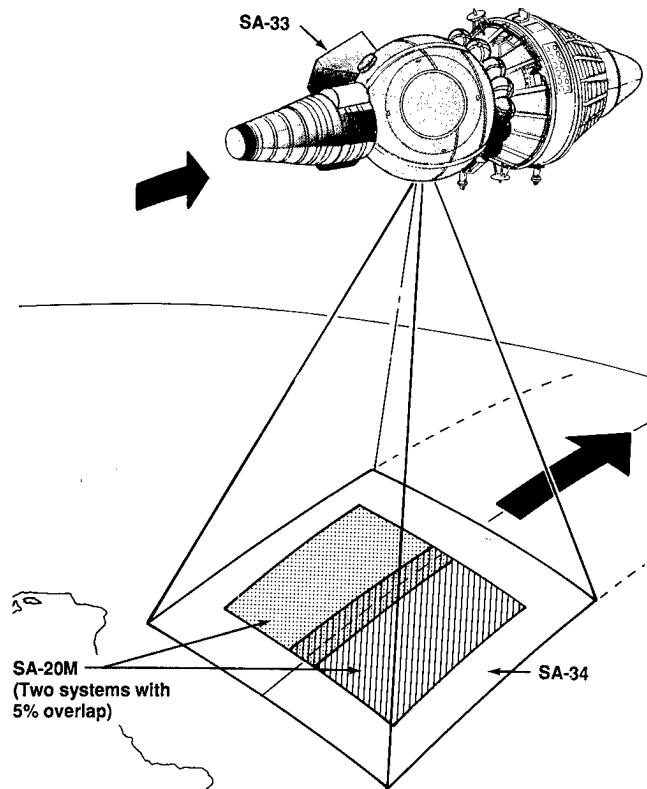

Figure 4.66. Resurs-F1 Satellite.

more can also be carried inside or outside the recoverable capsule for return to Earth.

Two photographic systems are normally available on Resurs-F1 missions: the SA-20M with a KFA-1000 camera and the SA-34 with its KATE-200 camera. The former operates in two spectral bands (570–680 nm and 680–810 nm) with a ground swath of 80 km and a resolution of 5–8 m. Up to 1,800 frames measuring 300 mm by 300 mm may be taken on each mission. The SA-34 operates in three spectral bands (510–600 nm, 600–700 nm, and 700–850 nm) with a ground swath of 225 km and a resolution of 15–30 m. The SA-34 has a capacity of 1,200 frames, each 180 mm by 180 mm. All film frames of both systems are etched with codes to identify vital camera parameters, including camera and frame number, film number, focal length, and timing codes (References 200–202).

Each Resurs-F1 spacecraft carries multiple camera systems. The Priroda 4 payload configuration includes two SA-20M and three SA-34 devices. One of the SA-34's is linked to a SA-33 stellar camera to provide simultaneous star backgrounds for precise geographical location determination. The SA-34 survey regions are aligned with common axes, but the SA-20M

cameras are each oriented 8° off nadir for a total separation of 16° between the camera axes, permitting a 5% image overlap when both systems are operated simultaneously. Six modes of operation are possible with 2–5 camera systems operating at one time. Although the maximum spacecraft lifetime is 25 days, the electrical system fed only by storage batteries limits active operations to no more than 14 days.

During 1991–1992 two Resurs-F1 missions were flown each year during the summer months. Resurs-F 11 and Resurs-F 12, launched on 28 June and 23 July 1991, respectively, followed standard flight profiles with altitudes normally between 260 km and 275 km at inclinations of about 82°. Resurs-F 11 remained aloft for 23 days, whereas Resurs-F 12 returned to Earth after a more typical 16-day mission. The two 1992 flights, Resurs-F 15 and Resurs-F 16, both lasted only 16 days, but more importantly the spacecraft adopted a lower altitude profile similar to the one introduced by the Resurs-F2 spacecraft the previous year. Resurs-F 16 also carried two PION satellites for atmospheric density studies (Section 5.2.1).

In 1987 a more capable version of the Resurs-F1, called Resurs-F2, began operations. The most significant improvement was the addition of two small solar arrays attached to the base of the orbital propulsion unit which permitted active missions for up to a full month (Figure 4.68). The first mission in late 1987 by Kosmos 1906 was not entirely successful, and the spacecraft was intentionally destroyed in orbit. Four more missions were conducted during 1988–1990, followed by three flights in 1991–1992.

The Resurs-F2 photographic system differs from that of its predecessor. The SA-M system with its MK-4 camera combines the high resolution of the SA-20M with the multi-spectral capability of the SA-34. Resurs-F2 offers a ground swath of 150 km with a resolution of 5–8 m in six spectral bands from 400 nm to 860 nm. As many as 2,700 photographs with image motion compensation and frames 180 mm by 180 mm can be shot on a single mission. The SA-M is also linked to the SA-3R stellar camera which serves the same purpose as the Resurs-F1's SA-33 (References 200–202).

Prior to 1991, Resurs-F2 spacecraft would

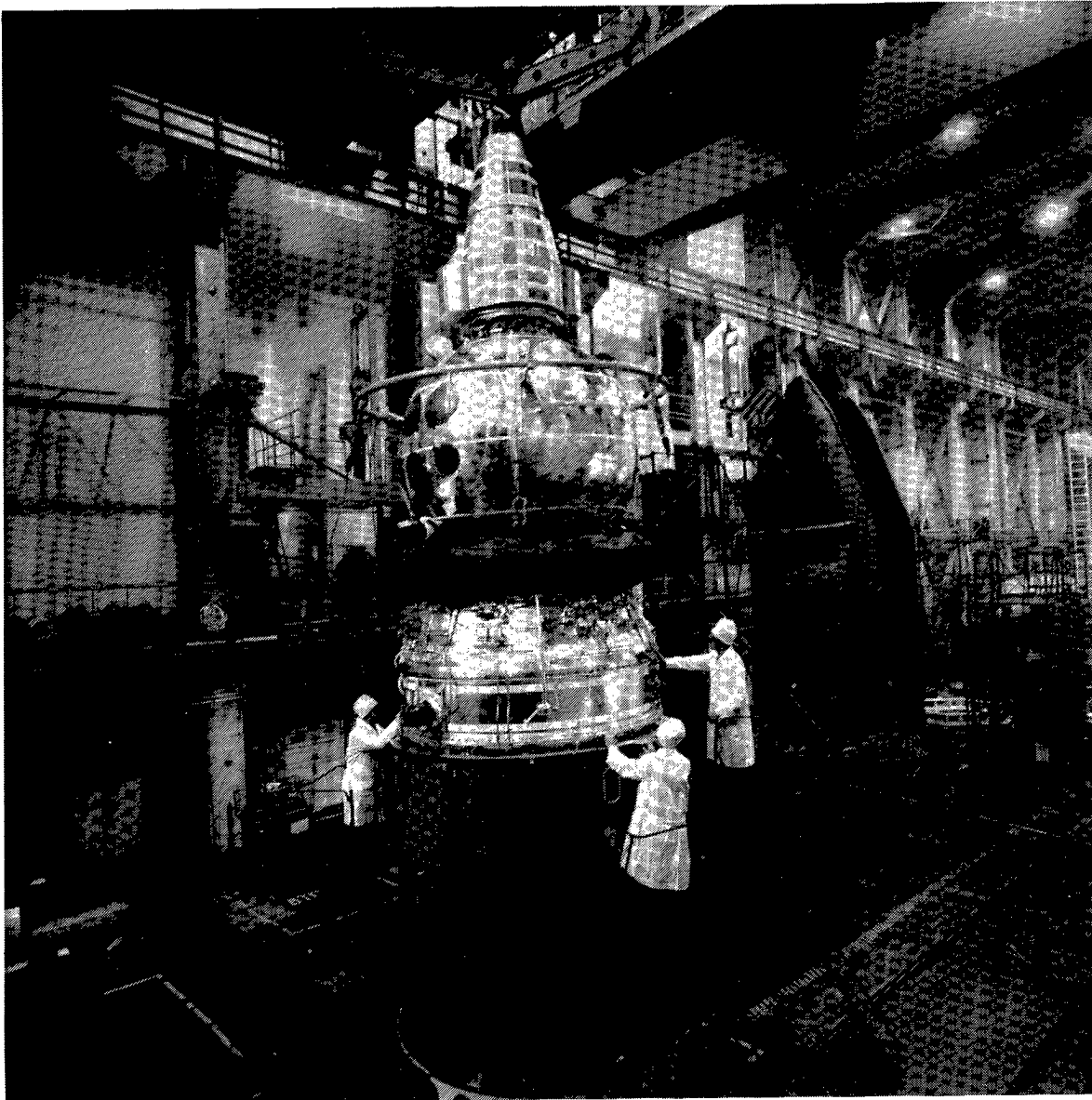

Figure 4.67. Resurs-F1 Being Prepared For Launch.

normally maintain a mean altitude of between 260 km and 270 km, requiring only two orbital maneuvers per 30-day mission. Beginning with Resurs-F 10 (21 May 1991), a new profile was chosen with mean altitudes between 225 km and 235 km but with a corresponding requirement to perform orbital adjustments more frequently, e.g., six times per mission. This pattern had previously been used primarily by the 4th generation, topographic mapping satellites which debuted in 1981 and are flown at inclinations of 65° and 70°. The subsequent Resurs-F2 flights, Resurs-F 13 (21 August 1991) and Resurs-F 14 (29 April 1992), were virtually iden-

tical to Resurs-F 10, both in character and duration.

During 1992 the CIS made available to the commercial market Earth observation photography acquired by military photographic reconnaissance satellites. In particular, two types of analog optical images taken by the more modern 4th generation satellites were made available. Ten-meter resolution stereo photographs taken by the TK-350 camera, which is a product of the Belorussia Optical Camera Company, cover a region of 180 km by 270 km with 256 gray values. Higher resolution, two-meter photographs provide similar gray-level

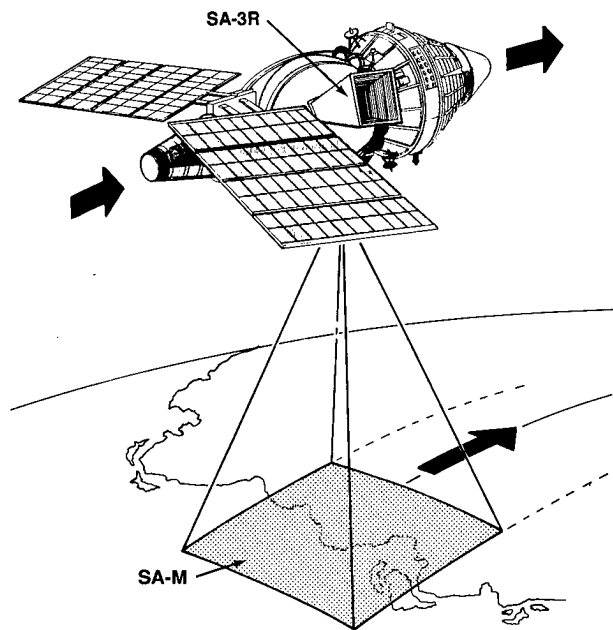

Figure 4.68. Resurs-F2 Satellites.

sensitivity but over a much smaller area of 40 km by 40 km (Reference 203). Since these missions remain primarily of a military nature, they are described more fully in Section 6.1.1. The CIS has also indicated that future civil Earth observation satellites may employ digital electronic transmission techniques in real-time or near real-time like the current 5th generation military photographic reconnaissance satellites (Reference 204).

An extensive suite of Earth observation instruments is currently operational on the Mir space station. Although only a pair of devices were carried aboard Mir at its launch in 1986, sixteen major systems have been deployed to the Mir core module or the Kvant 2 and Kristall auxiliary modules:

Mir Core Module:

- EFO-1 electronic photometer for studies of atmospheric aerosols and dust
- Haselblad camera
- KATE-140 topographic camera (50 m resolution)
- MKS-M multi-band spectrometer (0.4– 0.9 μm)
- PCN spectrometer
- Sever topographic camera (used in conjunction with KATE-140)

- Skif spectrometer (0.4–1.1 μm)
- Spektr-256 multi-band spectrometer (256 channels in visible and IR)
- Terra impulse photometer for the study of atmospheric optical emissions

Kvant 2 Module:

- AFM-2 for study of the atmosphere and pollutants
- Gamma 2 video spectropolarimeter
- ITS-7D spectrometer
- KAP-350 topographic camera
- MKF-6MA multi-spectral camera (0.5–0.9 μm , 10–15 m resolution)
- MKS-M2 multi-band spectrometer

Kristall Module:

- Priroda 5 multi-purpose high resolution (5 m) camera

Existing plans call for the launch in late 1993 or 1994 of the Priroda (Nature) auxiliary module to augment substantially the Earth observation capabilities of the Mir space station complex. With a basic structure mass of 19.7 metric tons, a volume of more than 66 m^3 , a length of approximately 12 m (without solar panel deployment) and a maximum diameter of 4.35 m, Priroda is the most sophisticated and complex Earth observation spacecraft undertaken by the USSR/CIS (Figure 4.69). The overall mission objectives of the Priroda module are the:

- determination of the atmospheric–ocean system characteristics;
- measurements of the land local characteristics;
- measurement of optical characteristics of the atmosphere;
- investigation of the sea surface roughness state;
- comparison of radiation and reflection characteristics of the sea surface in the microwave range; and
- measurements of the concentrations of trace gases in the atmosphere.”

The principal Earth observation instruments to be carried by the Priroda are described in Table 4.10. The Delta-2P and Ikar-N radiometers and the Travers synthetic aperture radar have been designed by the Moscow Energy Institute, while the Russian Academy of Sciences’ Institute of Space Research is responsible for the Obzor spectrometer. The

Moscow Energy Institute has also developed the 2.25 cm wavelength Greben radar altimeter which will provide precise altitude data with an accuracy of 0.1 m for correlation with the Earth observation systems. The MSU-E and MSU-SK multi-spectral scanners are being provided by the Space Instrument Building NPO, and the Istok-1 spectrometer is a product of the Academy's Institute of Physics.

The module will be powered by a 35 m² array with a generating capacity of 4.2 kW but

an average daily power availability of only 0.5–1.0 kW. Peak loads of up to 7 kW will be possible. Finally, the Centaur data acquisition system, similar to the Okean Condor system, will be operated for the collection of environmental information from various terrestrial sites. The Centaur system was created by the Moscow Energy Institute (References 205–207).

The other major module yet to be attached to the Mir space station is known as Spektr. Of

Table 4.10. Priroda Module Earth Observation Instruments.

INSTRUMENT	NUMBER OF SPECTRAL BANDS	BAND WAVELENGTHS	GROUND SWATH	GROUND RESOLUTION
IKAR-D Scanning Radiometer	4	0.3 cm 0.8 cm 1.35 cm 4.0 cm	400 km	5 km 8 km 15 km 30 km
IKAR-N Staring Radiometer	5	0.3 cm 0.8 cm 1.35 cm 2.25 cm 6.0 cm	60 km	60 km 60 km 60 km 60 km 60 km
IKAR-P Panoramic Radiometer	2	2.25 cm 6.0 cm	750 km	75 km 75 km
ISTOK-1 IR Spectrometer	64	4.0-16.0 μm	7 km	0.7 x 2.8 km
MOZ-OBZOR Multi-Spectral Spectrometer	17	0.415-1.03 μm	60 km	600 m
MSU-E Multi-Spectral Scanner	3	0.5-0.6 μm 0.6-0.7 μm 0.8-0.9 μm	27 km	25 m 25 m 25 m
MSU-SK Multi-Spectral Scanner	5	0.53-0.59 μm 0.61-0.69 μm 0.7-0.8 μm 0.9-1.0 μm 10.4-12.6 μm	350 km	120 m 120 m 120 m 120 m 400 m (?)
OZON-M Spectrometer	UNK	0.26-1.02 μm	-	1 km (in height)
Travers SAR	2	9.2 cm 23.0 cm	80 km	100 m 100 m
ALISA Aerosol Lidar (France)	1	.532 μm	-	-

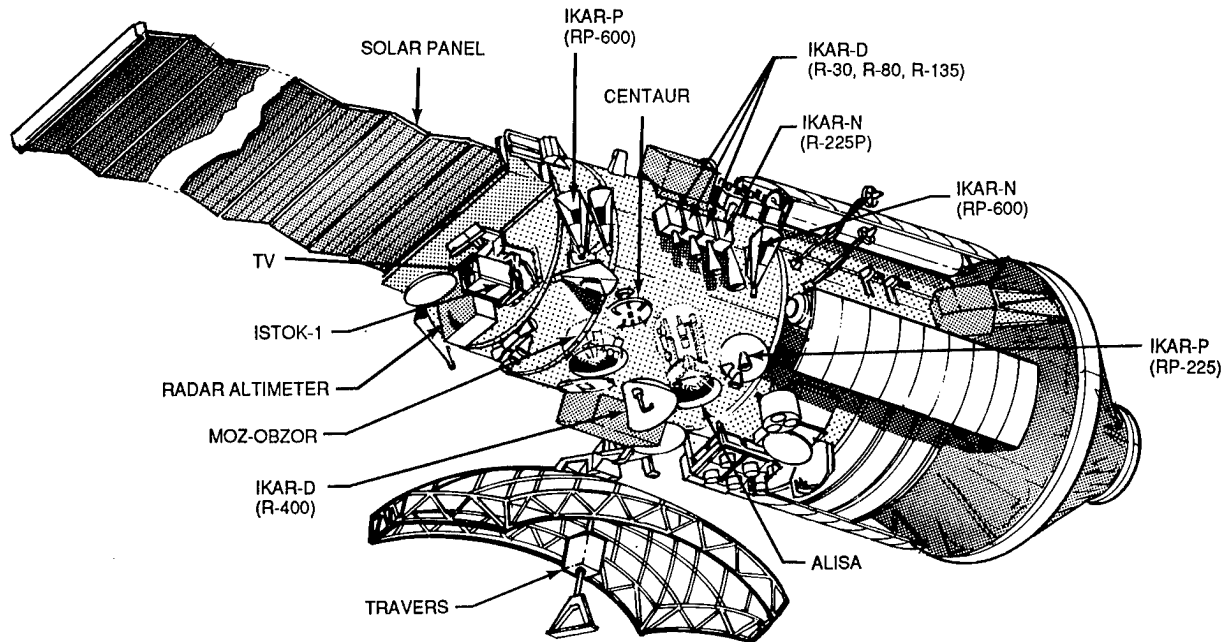

Figure 4.69. Priroda Module For The Mir Space Station.

similar size and mass as Priroda, Spektr (Figure 4.70) will be used to conduct a wide assortment of studies, including "investigations of the surface-atmosphere system and studies of the Earth's natural resources." Specific Earth observations instruments earmarked for Spektr are the Oktava optical system developed by the USSR/Russian Academy of Sciences, the Kometa TsNPO, and the Kazan Optical-Mechanical Works for investigations of the surface-atmosphere system via the Pion-K, Lira, and the Buton devices; the Balkan 1 apparatus developed by the Siberian branch of the USSR/Russian Academy of Sciences for lower atmosphere measurements; the Faza and Feniks instruments produced by the Estonian Academy of Sciences and the Integral design office of the Leningrad State University for spectral analysis of the Earth's surface; and the Astra 2 sensor from the State Committee on Hydrometeorology to measure gas and ionization levels in the upper atmosphere (Reference 208).

Numerous USSR/CIS proposals have been made for both relatively simple and extremely sophisticated ecological monitoring systems which could be fielded before the decade is out. In 1990 the Institute of Space Research suggested the EKOS program of relatively small LEO satellites with a maiden mission possible by 1996 (Reference 209). An international

effort, managed by the USSR Academy of Sciences, evolved into the EKOS-A and EKOS-D projects. The former would utilize a Regatta-class satellite (Section 5.2.1) in a halo orbit 1.7 million km above the Earth and a Resurs-EKOS satellite in a 900 km, sun-synchronous orbit. The objectives of EKOS-A would be to understand the effects of solar activity, the ozone layer, atmospheric pollutants, large scale atmospheric eddies, and overall climate on the biosphere. EKOS-D would examine and forecast local natural resources and ecological processes with large spacecraft, including space stations.

The Lavochkin NPO has designed a variety

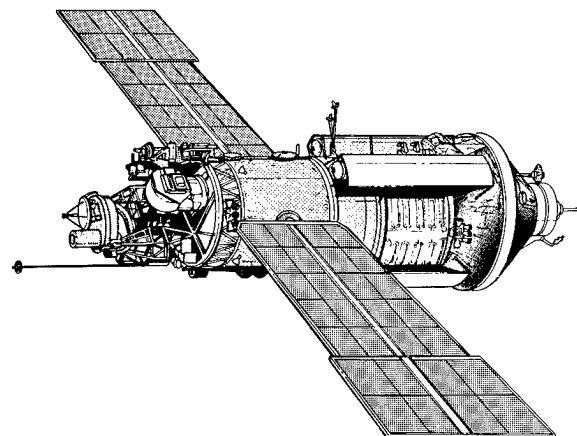

Figure 4.70. Spektr Module for Mir.

of remote sensing spacecraft based on a new 3.5 metric ton, 4 kW satellite bus named Freight which could be launched from the Baikonur Cosmodrome on converted SS-18 ICBM's. The two principal remote sensing versions of Freight (other variants can support technological, materials science, and biological science experiments) are EKOL and Ozone. The configuration of the 5.2 metric ton EKOL (Figure 4.71) has varied with potential SAR (30–100 m resolutions) and multi-spectral (0.4–10.3 microns with 5–10 m resolution) instruments. Ozone would carry a lidar (0.8 m diameter mirror) at altitudes of 600–900 km to study ozone concentrations as part of its 5 metric ton mass. Another Lavochkin project called Monitor envisions a small, 600 kg spacecraft launched by a SL-8 (Kosmos) booster for moderate resolution Earth observations in the 0.4–12.5 micron band (Reference 210).

The Salyut Design Bureau of the Experimental Machine Building NPO, with its long history of development of large spacecraft,

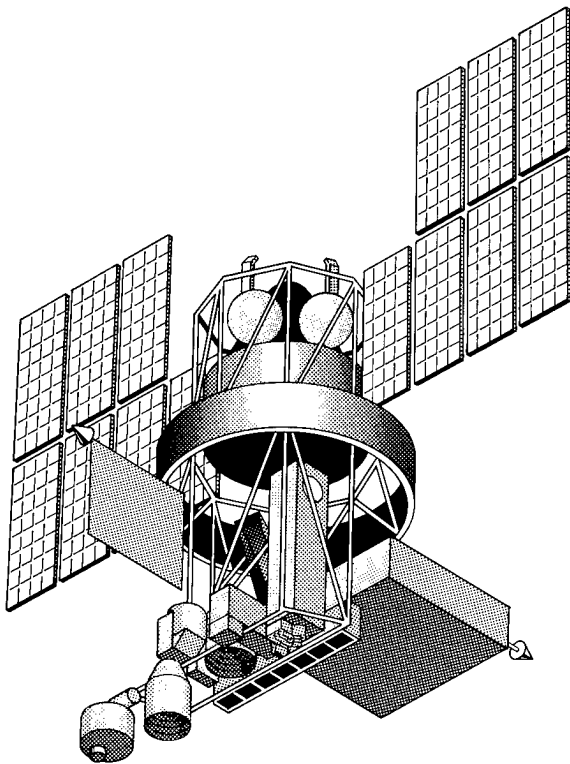

Figure 4.71. EKOL Satellite.

proposed in 1991 an unmanned, free-flying space station named Tellura-EKO. Based on the current series of augmentation modules designed for the Mir space station, Tellura-EKO (Figure 4.72) would have a total mass of approximately 20 metric tons, half of which would be available for the remote sensing payload. With a basic maximum diameter maximum diameter of 4.4 m and a length of 12 m, the vehicle would use two large solar arrays to generate up to 5 kW of electrical power.

The Tellura-EKO program would consist of:

- Accommodation on its board and placing into orbit home and foreign made scientific and special purpose equipment, including:
 - a) unified multi-frequency lidar complex;
 - b) TV-complex;
 - c) radio and spectrometry complexes;
 - d) detachable container with synthetic substances (clouds) sources.
- Recording and transmitting to Earth hydrometeorological, geophysical and ecological information stipulated for by a potential partner, i.e.:
 - size, structure and concentration of atmospheric aerosol stratification layers, velocity and direction of their displacement;
 - atmospheric concentration of poisonous sulphurous, ammonia, and nitric gaseous combinations;
 - ozone concentration vertical distribution with 1 km altitude resolution in the range of 10 to 80 km;
 - wind altitude and spatial parameters measurement with 1 km resolution in the range of altitudes from 3–50 km;
 - cloud top altitude measurement with 10 to 100 m accuracy;
 - cloud cross-section with 300 to 1200 m

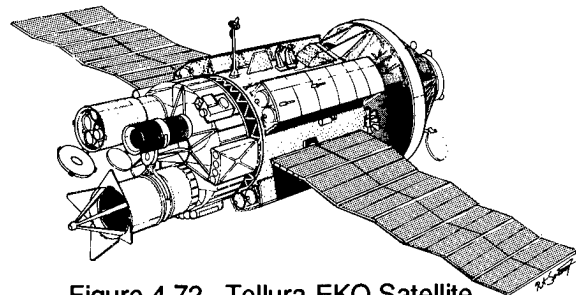

Figure 4.72. Tellura-EKO Satellite.

- cloud cross-section with 300 to 1200 m spacing and fleecy clouds registering with 150 m altitude and 1–5 km horizontal accuracy;
- tropospheric and stratospheric aerosol distribution with 300 to 2400 m altitude and 1000 to 1500 m horizontal spacing;
- atmospheric temperature and density in the altitude range 30 to 100 km with respective accuracy of 2 to 8° K and 2 to 4%;
- slight sodium, potassium, lithium, as well as potassium, magnesium and fermium ion and mixtures at the altitude of 80 to 100 km with 20 to 60% accuracy;
- ionosphere and magnetosphere condition, solar activity, etc.
- Processing the accumulated information and delivering it to the user in a generalized form – photographs, photomontage, positives, duplicate negatives, digital information, tape-recorded information through communication links, topical maps and charts, etc.” (Reference 211).

The 1991 description of Tellura-EKO predicted a first flight as early as 1994 with Western participation. A development investment of 90 million dollars was estimated but operational costs for the period of 1995–1998 were predicted to be only 8 million dollars. The total lifetime of the spacecraft could be up to five years at an altitude of 400–450 km and inclinations of 52–72°.

Almost simultaneous with the Tellura-EKO proposal came the Salyut Design Bureau's concept of a slightly less sophisticated spacecraft known as Ecologia (Figure 4.73). With roughly the same physical characteristics (mass of 21 metric tons, payload of 8–9 metric tons, average power of 3 kW), Ecologia was designed to operate at altitudes of 350–450 km for 3–5 years. Orbital inclinations of 51°, 65°, or 73° are possible. The original Ecologia prospectus indicated that a launch by 1993 was possible, however, without foreign investment the program is unlikely to be fulfilled (Reference 212).

Finally, the Energiya NPO has also designed two platforms – one LEO and one GEO – to serve remote sensing and ecological monitoring

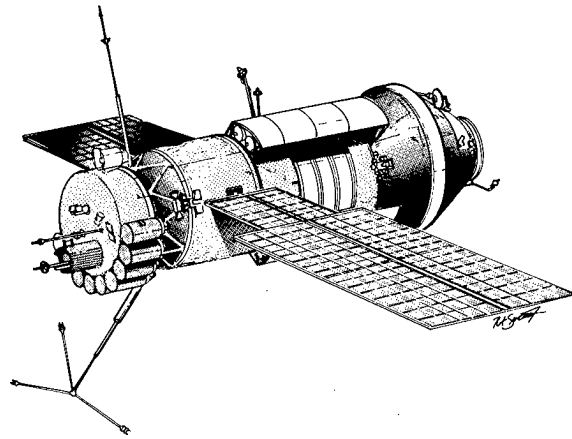

Figure 4.73. Ecologia Satellite.

missions. Calling on their experience with the Progress-M and Gamma spacecraft, Energiya NPO engineers have conceived a new, nearly 10 metric ton, sun-synchronous satellite with a variety of Earth observation sensors, including a side-looking radar, a television camera, a video-spectrometer, and a scanning radiometer (Figure 4.74). The scientific payload could reach a mass of 1.4 metric tons with an available power of 2 kW. From an operating altitude of 400–800 km, the spacecraft would be able to return data directly or via a relay satellite for a period of 3–5 years. If approved, launch by the SL-16 (Zenit) booster would not come until 1996 or later.

As part of its effort promoting the use of very heavy geostationary platforms, the Energiya NPO has recommended the creation of an

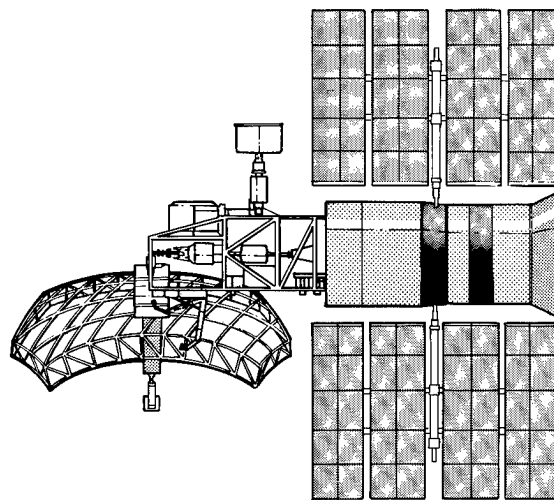

Figure 4.74. Energiya NPO LEO Earth Observation Satellite Design.

Ecological Information Acquisition and Transmission System. One to three 18 metric ton satellites would provide connectivity between more than 100,000 data collection stations, and regional and national ecological centers for routine as well as emergency activities, e.g., in case of flood, earthquakes, fire, and nuclear accidents (Figure 4.75). As a secondary mission, the satellite could host Earth observation sensors for direct monitoring of

specified regions. This proposed program, which could begin deployments in the latter part of this decade, is dependent upon the viability of both the Energiya launch system and the heavy geostationary platform development effort.

4.3.2 European Space Agency

With its emphasis on commercial and scientific space activities, ESA has historically not

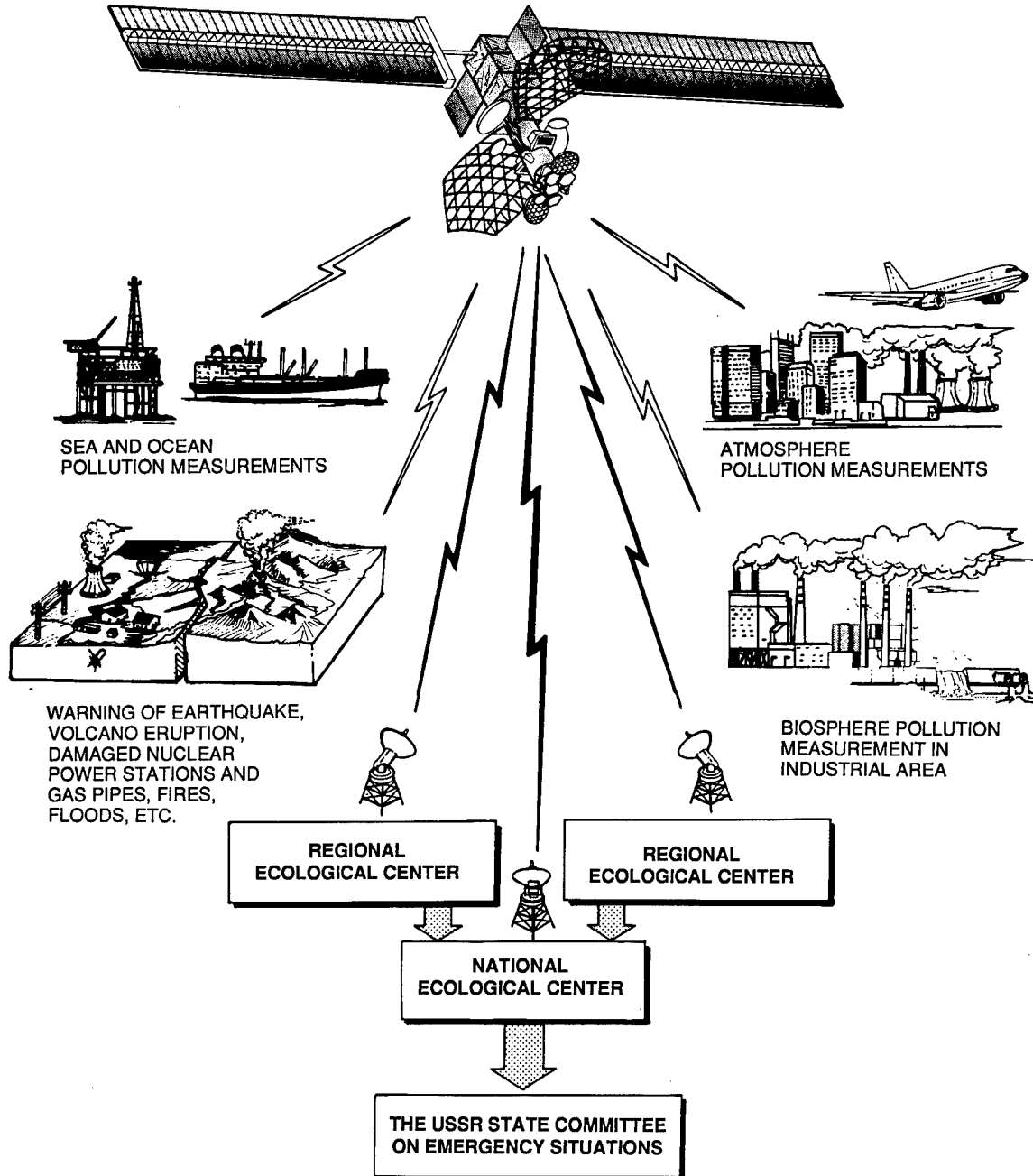

Figure 4.75. Energiya NPO Proposed GEO Network.

devoted major resources to satellite applications programs. The principal exceptions to this rule have been the geostationary Meteosat (since 1977) and the sun-synchronous European Remote Sensing (ERS, since 1991) satellite programs. In part due to the impressive successes of these programs, ESA at its 1991 and 1992 ministerial meetings elevated the organization's commitment to Earth observation networks. Consequently, both current systems will be upgraded or superseded in the second half of this decade with yet more capable spacecraft.

In conjunction with the Global Atmospheric Research Program (GARP), ESA developed and maintains two geostationary meteorological satellites of the Meteosat series. Three pre-operational spacecraft were launched in 1977, 1981, and 1988, respectively, before the Meteosat Operational Program (MOP) was initiated with the orbiting of Meteosat 4 in 1989. Although ESA originated and continues to control the Meteosat network, the 16-member European Organization for Meteorological Satellites (EUMETSAT), created during 1981–1986, is now responsible for the system. Beginning with Meteosat 4, EUMETSAT is the legal owner of the series satellites.

Meteosat satellites closely resemble their American and Japanese counterparts. Each spacecraft has a mass of about 320 kg on station in the form of a 2.1-m-wide, 3-m-tall, spin-stabilized (100 rpm) stepped cylinder (Figure 4.76). Solar cells cover the majority of the spacecraft surface providing a minimum of 200 W of electrical power. The satellite design life is three years with consumable supplies for at least five years. The prime contractor for Meteosat is the French firm Aerospatiale with major subcontractors DASA/MBB (Germany), Matra Marconi Space (UK), and Alenia (Italy).

The primary Meteosat payload is a 40-cm diameter, 3-band, imaging radiometer sensitive to visible light (0.5–0.9 μm). Resolution for the visible band is 2.5 km, while that for the other two bands is 5 km. A single image requires a scan time of 25 minutes with a limit of 48 images per day. Meteosat also carries a 66-channel capacity data collection service package similar to those described in the previous section for Okean and GOMS. Data collection platform reports from 4000 sites are forwarded by Meteosat to the primary control

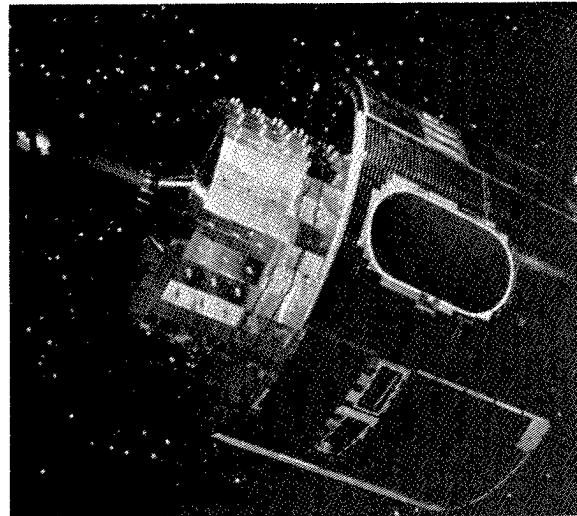

Figure 4.76. Meteosat Satellite.

center at Odenwald, near Darmstadt, Germany, for further distribution (References 213–216).

At the beginning of 1991, three Meteosat satellites were operational: Meteosat 2, Meteosat 3 (known as Meteosat P2), and Meteosat 4 (known as MOP 1). Meteosat 5 (MOP 2) was launched on 2 March 1991 to replace Meteosat 4, which had developed problems in late 1989, as the prime satellite at 0° E. However, Meteosat 5 experienced unexpected imaging problems which have left it in a standby mode at 356° E until remedial actions can be implemented. Due to the difficulties in the US GOES program, Meteosat 3 was moved to 310° E in the summer of 1991 when the Atlantic Data Coverage program was inaugurated. This service will continue until at least late 1994 when a new GOES satellite can be launched and checked out.

In December, 1991, the 10-year-old Meteosat 2 was finally retired and placed into a super-synchronous disposal orbit. Meteosat 6 (MOP 3) is scheduled for launch in late 1993. Two additional satellites are being procured under the Meteosat Transition Program to provide continued service until the second generation Meteosat satellites are available at the turn of the century.

The only satellite launched by ESA during 1991–1992 to belong completely to the agency was ERS-1, marking ESA's first entry into high resolution Earth observations. The culmination of a 10-year development project led by Germany, ERS-1 hosts a suite of precision instruments tailored for a comprehensive envi-

ronmental monitoring program with objectives including:

- a much more accurate representation of the interactions between ocean and atmosphere in climatic models,
- a major advance in our knowledge of ocean circulation, its variability and the associated energy transfers,
- better monitoring of polar regions, in particular the Arctic and Antarctic ice sheets and sea-ice-covered areas,
- a more comprehensive understanding of coastal processes and surface pollution, including erosion, sedimentation, coastal currents, estuarine fronts and circulation,
- the regular monitoring of land-surface processes on a global scale, and in particular the vegetation cover,
- the monitoring of changing land-use patterns,
- offering a unique all-weather sensing capability for disaster observation and assessment, and
- enhancing the data available for operational meteorology, in particular observation of winds near the sea surface, sea-state, sea-surface temperature measurements, cloud fields, atmospheric water content, and sea-ice distribution."

The 2,384 kg ERS-1 satellite employs a spacecraft bus derived from the French SPOT satellite, measuring 1.8 m by 1.9 m by 3.1 m (Figure 4.77). The two primary appendages are a solar array with two 2.4 m by 5.8 m segments providing more than 2 kW of electrical power and a combination radar antenna for the Active Microwave Instrument. Placed into a sun-synchronous orbit near 780 km with an inclination of 98.5° on 17 July 1991, ERS-1 carried 300 kg of hydrazine for a mission expected to last three years. The spacecraft's orbit is maintained with a very high degree of accuracy, resulting in a 35-day groundtrack pattern which is controlled within ± 1 km (Reference 218).

The five principal scientific instruments include:

- (1) Active Microwave Instrument (AMI) consisting of a side-locking synthetic aperture radar and a scatterometer, both operating at 3.5 GHz. The former returns high reso-

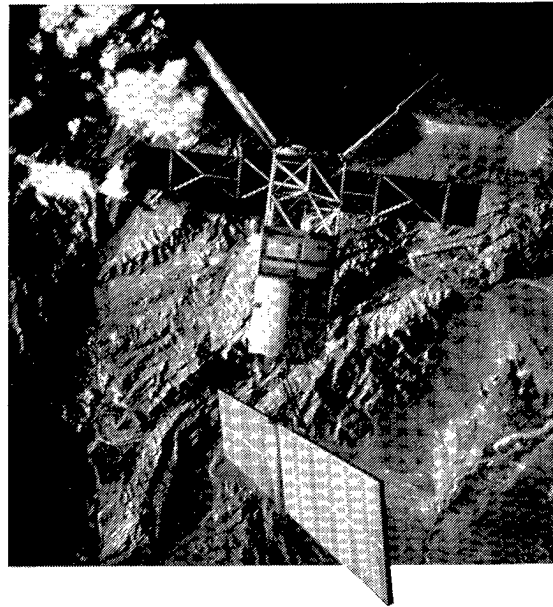

Figure 4.77. ESA's ERS-1.

lution photographs with a 100 km ground swath in the image mode or 5 km by 5 km snapshots in the wave mode. With the use of three antennas with 45° separation angles, the scatterometer sweeps a 500 km swath to provide surface wind measurements;

- (2) Radar Altimeter (RA) with separate "ocean" and "ice" modes operating at 13.8 GHz;
- (3) Along-Track Scanning Radiometer and Microwave Sounder (ATSR-M) consisting of an Infrared Radiometer and a Microwave Radiometer to measure the global sea-surface temperature and the atmospheric integrated water content, respectively. The Infrared Radiometer operates at the 1.6, 3.7, 11, and 12 μm bands, while the Microwave Radiometer is tuned to 23.8 and 36.5 GHz;
- (4) Laser Retro-Reflector (LRR) assembly of corner cubes mounted on the side of the spacecraft bus is used as a target by ground-based laser ranging stations;
- (5) Precise Range and Range-rate Equipment (PRARE) utilizes 2.2 GHz and 8.5 GHz transmissions for ionospheric corrections and orbit determination, respectively.

Despite some early data distribution difficul-

ties, ERS-1 has performed remarkably well, averaging the return of 700 images per day during its first three months in orbit. In particular, AMI images of ocean areas have been of higher quality than anticipated. The most serious setback of the mission was the failure of PRARE less than a month after launch. ERS-2, with an improved ATSR-M and a new ozone measurement instrument, is currently scheduled for launch in late 1994. However, the potential longevity of ERS-1 could lead to a decision to delay ERS-2 for a year or more. Alternatively, plans for simultaneous operations of ERS-1 and ERS-2 are being evaluated (References 219–222).

The November, 1992, ESA ministerial meeting reaffirmed the organization's intention to follow the ERS program with the ambitious Polar-Orbiting Earth Observation Mission (POEM). POEM will utilize a new 8 metric ton Polar Platform to conduct two missions late in this decade. Envisat-1, planned for a 1998 launch, will be "mainly dedicated to understanding and monitoring the environment and to providing radar data as a continuation of the data provided by ERS-2" (Appendix 9). With a spacecraft bus measuring 3 m in diameter and 10 m long, Envisat-1 will carry a useful payload of about 2,000 kg, including five ESA-funded instruments: an advanced synthetic aperture radar, an advanced radar altimeter, a medium resolution imaging spectrometer, a Michelson interferometer for passive atmospheric sounding, and a global ozone monitor (Figure 4.78). National sensors expected to be carried by Envisat-2 include a French radiometer (SCARAB), a German imaging spectrometer (SCIAMACHY), and a British radiometer (AATSR). The spacecraft's orbit will be essentially the same as used in the ERS program, and the 6.5 kW electrical system will provide nearly 2 kW to the instrument suite (Reference 223). France and the UK will each fund about one-fourth of the Envisat-1 mission with other ESA members pooling resources for the remaining half.

Tentatively scheduled for launch in the year 2000, Metop-1 will represent the second application of the Polar Platform in a program coordinated with EUMETSAT to provide operational meteorological and other environmental data. France and Germany will be the leading nations for Metop-1 which is expected to be approved

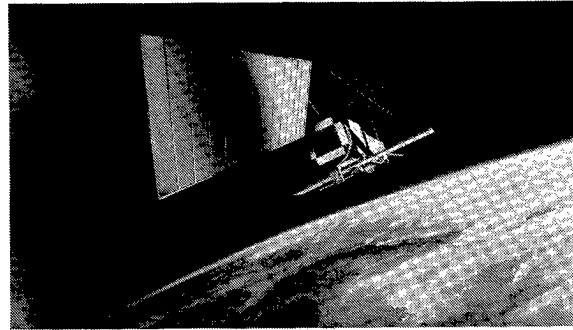

Figure 4.78. Early Polar Platform Concept.

for full development by late 1994. Contingency plans for an Envisat-2 and a Metop-2 are also being prepared.

4.3.3 France

Since 1986 France has operated the highly regarded SPOT (Satellite Pour l'Observation de la Terre) high resolution imaging satellite system. Operated by CNES, SPOT is managed on a commercial basis by SPOT Image with multi-national shareholders, which hope to be free of all government subsidies by the late 1990's (Reference 224). Experience gained by the French through the SPOT program is being applied to a series of space endeavors including ESA's Polar Platform and French national security satellites.

SPOT satellites orbit the Earth at an altitude near 825 km and an inclination of 98.7° to produce a 26-day repeating groundtrack pattern with sun-synchronous conditions. SPOT 1 (February, 1986) and SPOT 2 (January, 1990) are virtually identical spacecraft operating in nearly co-planar orbits. SPOT 2, the present primary spacecraft, is about 40 kg heavier than its predecessor with a launch mass of 1,870 kg. The spacecraft bus is 2 m by 2 m by 3.5 m with a hydrazine-controlled 3-axis stabilization system (Figure 4.79). A 15.6 m long solar array produces nearly 1.4 kW of electrical power at start of life.

The heart of SPOT is a pair of high resolution visible CCD scanners with both multi-spectral (0.50–0.59 μm , 0.61–0.68 μm , and 0.79–0.89 μm) and panchromatic (0.51–0.73 μm) features. The former mode returns images with a ground resolution of 20 m, while the latter is capable of 10 m resolution. The swath of each scanner is 60 km, but the pair can be operated simultaneously to produce a 117 km swath with a small (3 km) overlap region. Off-

nadir viewing is also possible with the aid of a tilting mirror extending the swath to 80 km for each scanner at an angle of 27° from nadir. Images can be transmitted in real time directly to a world-wide network of ground stations or may be stored on board the spacecraft for later downlinking via two Odetics tape recorders (Reference 225).

Developed by a team led by Matra Marconi Space and Aerospatiale, SPOT 1 was initially retired at the end of 1990, nearly two years past its design life of three years. However, the spacecraft was recalled to service during March–October, 1992, to help meet imaging demands during the principal Northern Hemisphere growing season, although both its tape recorders had failed. SPOT 2, with only one working tape recorder was nearing the end of its official design life at the end of 1992 with an excellent prognosis for extended service. As a result, the launch of SPOT 3 was delayed until the fall of 1993. Whereas SPOT 2 added the Doppler Orbitography and Radio-positioning Integrated by Satellite (DORIS) system for high precision orbit determination, SPOT 3 will test the Polar Ozone and Aerosol Measurement (POAM) sensor as an auxiliary payload. SPOT 3 will also carry improved (longer duration) tape recorders (References 226–227).

Whereas the 2,500 kg SPOT 4, scheduled for launch in 1996, will possess several significant improvements over its predecessors (in particular, greater power availability, longer life, and additional mid-IR band of 1.58–1.75 μm), SPOT 5 in about 1999 will represent the second generation SPOT spacecraft. The imaging instruments will be modified to permit 5-m resolution in each of two bands (panchromatic and

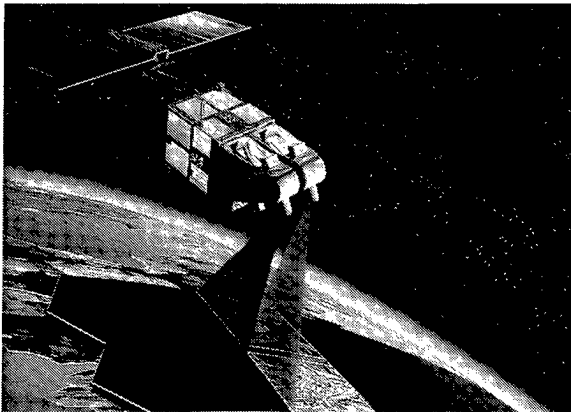

Figure 4.79. France's SPOT Satellite.

near-IR) while the multi-spectral capability will be improved to 10-m resolution. Greater use of stereo imaging will also be possible (References 228–229).

A military reconnaissance satellite derived from SPOT is anticipated as soon as 1994 and is described in Section 6.1.2. Meanwhile, studies are also underway for a SPOT variant hosting a synthetic aperture radar not unlike ERS (References 230). Another French proposal named BEST would carry even more sophisticated radar and lidar sensors for environmental studies (Reference 231). Meanwhile, French Earth observations are operational on the multinational Topex/Poseidon (DORIS and radar altimeter) and UARS (Wind Imaging Interferometer). In 1993–1994 the French Alissa lidar and SCARAB radiometer will be flown on CIS Priroda and Meteor 3 spacecraft, respectively, and in 1996 the French POLDER instrument will be carried by the Japanese ADEOS spacecraft (Section 4.3.8)

4.3.4 Germany

Earth observation pursuits by Germany have to date been restricted to the development of domestic remote sensing instruments for flight opportunities on foreign spacecraft, most notably those of ESA and the US. During 1989–1991 studies were undertaken for the design of a dedicated German satellite, Atmos, which would have concentrated investigations on the Earth's atmosphere. From a 775 km, sun-synchronous orbit, Atmos was to have been launched in the mid-1990's with four major Earth observation systems: the Advanced Millimeter Wave Atmospheric Sounder (AMAS), the Michelson Interferometer for Passive Sounding (MIPAS), the Scanning Imaging Absorption Spectrometer for Atmospheric Cartography (SCIAMACHY), and the Reflective Optics Imaging Spectrometer (RODIS). The first three devices were designed to analyze atmospheric chemistry, whereas the objective of RODIS was to return moderate and high resolution, multi-spectral photographs of the Earth's surface (Reference 232). The Atmos program has been reoriented to provide some or all of the above mentioned instruments to ESA's Envisat satellite scheduled for launch in 1998 (Section 4.3.2).

In addition to its contributions to the ESA ERS (led by Germany with a 24% contribution)

and the ESA/EUMETSAT Meteosat programs, German interest in Earth observation studies is reflected in the X-SAR payload to be flown on several US Shuttle missions and, to a lesser extent, the STS-Spacelab D2 mission of April–May, 1993. The X-SAR (X-band Synthetic Aperture Radar) was developed jointly by Germany (Dornier) and Italy (Alenia) and will use a 3.3 kW peak power beam to scan a swath of 15–45 km with resolutions as low as 10 m. Although the Spacelab D2 program is principally devoted to material and biological sciences, photogrammetry and thematic mapping activities are included in the mission objectives (References 232 and 233). Finally, Germany is preparing a Modular Optical Multispectral Scanner (MOMS) for integration into the Priroda Earth observation module for the Mir space station.

4.3.5 India

Despite the modest extent of the Indian space program, Earth observations have played a prominent role in most (14 of 17) Indian satellites launched to the end of 1992. The three Indian satellites launched during 1991–1992 (one by India, one by the USSR, and one by ESA) all possessed Earth observation payloads. The scientific secretary of the Indian Space Research Organization, M. G. Chandrasekhar, is also the Director for Earth Observations programs.

Following the successful demonstrator flights of Bhaskara 1 and Bhaskara 2 launched in 1979 and 1981, respectively, India began development of an indigenous Indian Remote Sensing Satellite (IRS) program to support the national economy in the areas of "agriculture, water resources, forestry and ecology, geology, water, sheds, marine fisheries and coastal management" (Reference 234). To date two IRS spacecraft have been launched – IRS 1A, 17 March 1988, and IRS 1B, 29 August 1991 – both by Soviet SL-3 (Vostok) vehicles from the Baikonur Cosmodrome, and both were still operational in 1992.

From their 22-day repeating orbits of 905 km mean altitude and 99° inclination, the two identical IRS spacecraft host a trio of Linear Imaging Self-Scanning (LISS) remote sensing CCD instruments working in four spectral bands: 0.45–0.52 μm , 0.52–0.59 μm , 0.62–0.68 μm , and 0.77–0.86 μm . The 38.5 kg LISS-I images

a swath of 148 km with a resolution of 72.5 m, while the 80.5 kg LISS-IIA and LISS-IIB exhibit a narrower field-of-view (74 km swath) but are aligned to provide a composite 145 km swath with a 3 km overlap and a resolution of 36.25 m.

Each IRS spacecraft is 975 kg at launch with a design life of 2.5–3 years. The 3-axis stabilized spacecraft is essentially rectangular (1.1 m by 1.5 m by 1.6 m) with two narrow solar arrays producing less than 1 kW electrical power (Figure 4.80). The Spacecraft Control Center at Bangalore oversees all spacecraft operations, but the principal data reception station for the remote sensing payload is located at Shadnagar. Spacecraft data transmissions are effected via X-band and S-band antennas at the base of spacecraft.

The next IRS mission, designated IRS 1E, is scheduled for 1993 with the modified IRS-1A engineering model carrying the LISS I and a German Monocular Electro-optical Stereo Scanner (MEOSS). The next year, IRS P2 will host an LISS-II package along with a second MEOSS and a scientific payload. Both missions will be launched from India by the new PSLV booster. Improved versions of IRS will incorporate the LISS-III with greater image resolution (10 m panchromatic, 20 m visible/near IR, and 70 m SWIR) and greater pointing accuracy and will be launched by the CIS (IRS 1C in 1994) and by India (IRS 1D in 1996 or later) (References 235–237).

After two launch failures (1987 and 1988), the Indian-made Augmented Space Launch Vehicle (ASLV) successfully placed its SROSS 3 payload (Stretched Rohini Satellite Series) into an orbit at 256 km by 435 km with an inclination of 46° on 20 May 1992. The 106 kg spacecraft was octagonal (~0.9 m diameter) with a height of slightly more than 1 m and eight solar panels radiating from the base. The lower than intended orbit caused SROSS 3 to reenter prematurely on 14 July 1992, limiting data from the Retarding Potential Analyzer on plasma depletion and ionospheric anomalies.

As noted in the section on communications satellites, India's INSAT series of geostationary spacecraft perform the dual missions of communications and meteorology. INSAT 1-class satellites carry a Very High Resolution Radiometer (VHRR) working in the visible (0.55–0.75 μm) and IR (10.5–12.5 μm) bands with resolutions of 2.75 km and 11 km, respectively. Like many

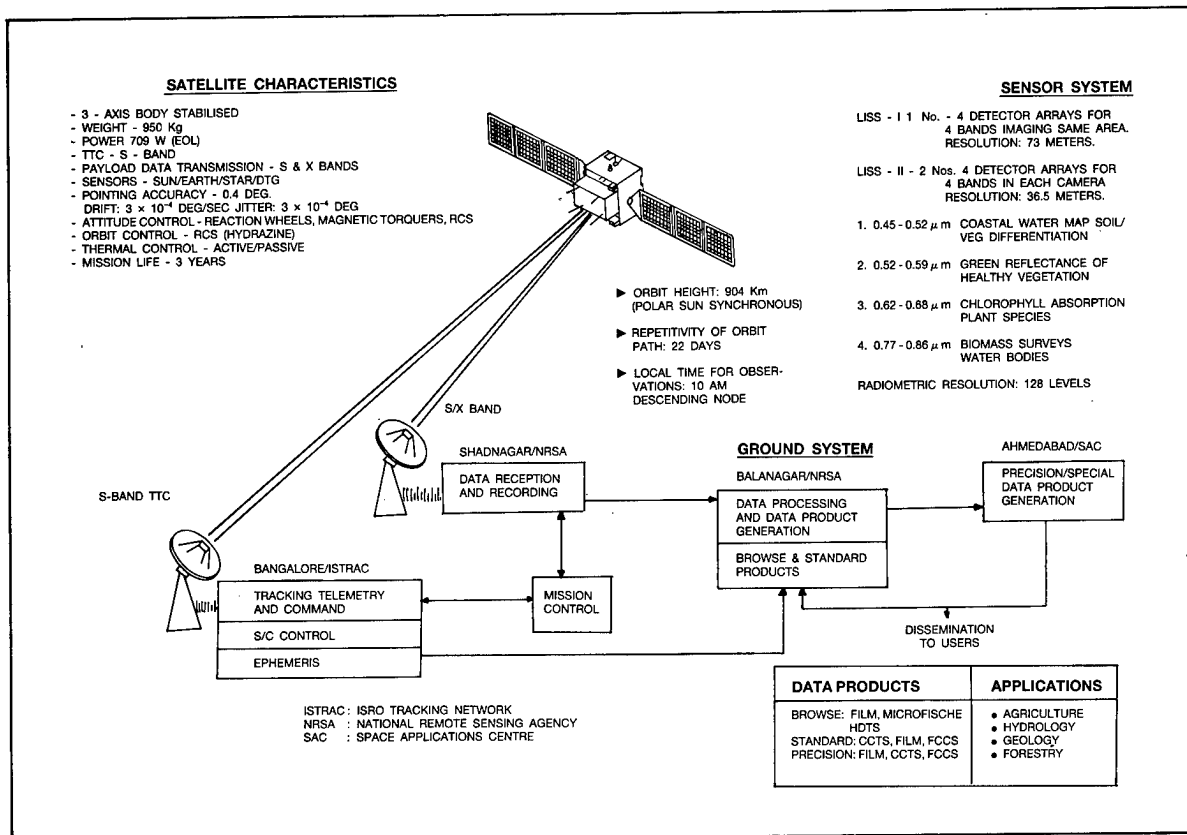

Figure 4.80. India's IRS Earth Observation System.

GEO meteorological satellites, INSAT 1 spacecraft require 30 minutes to complete a full Earth scan. Each vehicle is also capable of receiving (on 402.75 MHz) meteorological, hydrological, and oceanographic data from remote data collection platforms for relay to central Indian processing centers.

The INSAT 2 program was inaugurated in 1992 with the launch of INSAT 2A. The spacecraft characteristics and communications payload are described in Section 4.1.7. For Earth observations, the VHRR was improved with 2 km resolution in the visible band and 8 km resolution in the IR band. In addition to full Earth images, the VHRR can be commanded to scan very limited regions for more rapid return of time-critical data, e.g., during the approach of cyclones to the sub-continent. INSAT 2 satellites also carry the Data Relay Transponder system for collection and retransmission of data from DCPs. Four additional INSAT 2 satellites are expected to maintain this GEO Earth observation capability into the next century.

4.3.6 Israel

Israel's fledgling space program has to date produced only two, short duration, LEO satellites of a primarily engineering nature. However, in 1994 a small (50 kg, 43 cm by 46 cm) multi-purpose satellite will be placed into a sun-synchronous orbit as a secondary payload on an Ariane 4 mission. Named Techsat and designed and built by the Israel Space Agency, Haifa's Technion Institute, and others, the spacecraft will carry a simple television system for Earth observation purposes.

4.3.7 Italy

During 1991-1992 Italy earmarked 8% of its space budget for Earth observation activities. The San Marco series of small LEO satellites (1964-1988) were largely devoted to upper atmospheric studies and geophysics. Italy is currently sponsoring the X-SAR experiment in a joint venture with Germany (Section 4.3.4). Although the nation has no firm plans for a national Earth observation satellite system, two

Italian firms are studying such options. Telespazio is designing a small spacecraft capable of detecting sources of sulphur dioxide, while Alenia Spazio is looking at a larger, almost 900 kg, vehicle equipped with radar and optical sensors for more comprehensive monitoring of the Earth. Italy also contributed to ESA's ERS program at a level of slightly more than 10%.

4.3.8 Japan

Japan currently operates three types of Earth observation systems: one for meteorology, one for oceanography, and one for general remote sensing. The last, known as the Japan Earth Resources Satellite (JERS), represents the only such mission to be launched during the 1991-1992 period. With the advent of the H2 launch vehicle in 1994, Japan will be able to transition its environmental program to much larger multi-purpose platforms operating in sun-synchronous orbits.

Japan's Geostationary Meteorological Satellite (GMS) system was originally developed by NASDA relying heavily on the US GOES design and is now jointly run by NASDA and the Japan Meteorological Agency. The American firm of Hughes is the prime contractor, working for Japan's NEC Corporation. Four GMS spacecraft have been launched since 1977, the last in September, 1989. GMS-3 (August, 1984) is available for backup operations at 120° E, while GMS-4 is located in the primary position at 140° E. As with all national satellites, GMS spacecraft are also known by a specific Japanese name, in this case, Himawari, meaning "sunflower." GMS-5, the final satellite in the series, is scheduled for launch by the H2 booster in 1995.

GMS-4 is a spin-stabilized (100 rpm) spacecraft with an on-orbit mass of approximately 325 kg, a diameter of 2.1 m and a height (after apogee kick motor separation) of 3.4 m (Figure 4.81). Solar cells applied to the exterior of the spacecraft bus generate up to 300 W, and the overall design life is five years. Hydrazine thrusters maintain the desired geostationary position and counteract perturbations attempting to alter the vehicle's inclination.

The major Earth-oriented instrument is the Visible and Infrared Spin Scan Radiometer (VISSR), "used to obtain visible and infrared spectrum mappings of the Earth and its cloud cover with a specially designed optical tele-

scope and detector system" (Reference 238). Visible images are collected in the 0.50–0.75 μm band with a resolution of 1.25 km, and the infrared signatures are taken in the 10.5–12.5 μm band with a 5.0 km resolution. Thirty minutes are required to obtain a full Earth image consisting of 2500 narrow strips. A separate payload, called the Space Environment Monitor (SEM), measures the flux of solar protons, alpha particles, and electrons.

While outwardly almost identical to GMS-4, GMS-5 will host a more sophisticated VISSR with one visible band (0.55–0.9 μm) and three IR bands (10.5–11.5 μm , 11.5–12.5 μm , and 6.5–7.0 μm). The relative visible and IR resolution will remain unchanged. The height of the spacecraft will increase slightly to 3.5 m as will the on-orbit mass of 338 kg. In place of the SEM, an experimental COSPAS-SARSAT transponder will be carried (Reference 239).

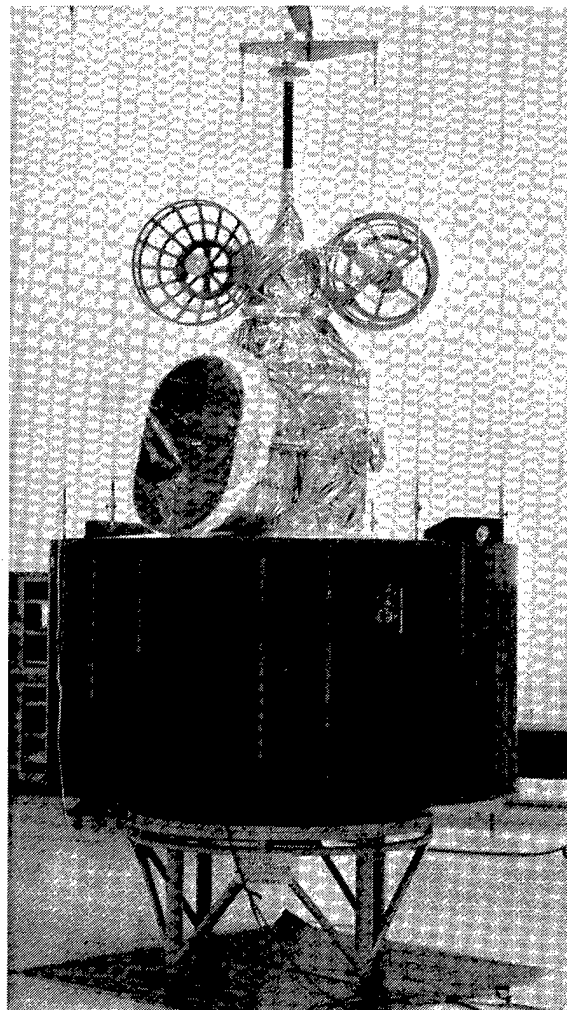

Figure 4.81. Japan's GMS Satellite.

Space-based oceanography is conducted in Japan by two Marine Observation Satellites (MOS) placed in sun-synchronous orbits of approximately 910 km with an inclination of 99.1°. After 10 years of development MOS 1 (aka Momo 1 or "peach tree") was launched in February, 1987, and was followed by MOS 1b (Momo 1b) in February, 1990, into an orbital plane only a few degrees away from MOS 1. The program objectives include:

- Development of observation sensors; verification of their functions and performances, and experimental observation of the Earth (in particular the oceans) using such sensors;
- Basic experiments on a data collection system (DCS);
- Establishment of fundamental technologies for Earth observation satellites" (Reference 240).

Funded and managed by NASDA, the MOS program selected NEC Corporation as the prime contractor with significant assistance by Mitsubishi Electric, Toshiba, and Fujitsu. Each 740-kg, 3-axis-stabilized spacecraft (Figure 4.82) consists of a box-shape bus (1.3 m by 1.5 m by 2.4 m) with a single solar array (2.0 m by 4.5 m). The selected orbit permits a repeating groundtrack with a period of 17 days.

The MOS payload consists of four primary classes of instruments. Two 70-kg Multi-spectral Electronic Self-Scanning Radio-meters (MESSR) return images in four bands (0.51–0.59 μm , 0.61–0.69 μm , 0.72–0.80 μm , and 0.80–1.1 μm) with a ground resolution of 50 m and a swath of 100 km. The fields-of-view of the two MESSR sensors are slightly overlapped (15 km) to provide stereo viewing. The 25-kg Visible and Thermal Infrared Radiometer (VTIR) operates in one visible and three IR bands: 0.5–0.7 μm , 6–7 μm , 10.5–11.5 μm , and 11.5–12.5 μm with ground resolutions of 900 m (visible) and 2,700 m (IR) and a swath of 1,500 km. The 54-kg Microwave Scanning Radiometer (MSR) is tuned to two frequencies: 23.8 GHz and 31.4 GHz. The swath is 317 km with respective resolutions of 23 km and 32 km.

Finally, the Data Collection System Transponder (DCST) collects data from DCP's transmitting in the 400 MHz band and relays the information to data acquisition and processing

facilities at a frequency of 1.7 GHz. MESSR and VTIR data are transmitted at 1.7 GHz and 8 GHz, while MSR data are downlinked at 2 GHz (References 240 and 241). MOS 1 and MOS 1b are expected to remain operational until about 1997 and 2001–2002, respectively (Reference 242).

The final launch of the H-1 booster took place on 11 February, 1992, when JERS-1 (aka Fuyo 1) was placed into a low altitude sun-synchronous orbit of 446 km by 561 km with an inclination of 97.7°. The altitude was soon adjusted to 571 km by 574 km. The 12-year effort to field the moderate resolution SAR and multi-spectral payload was a joint venture by NASDA, which was responsible for the spacecraft, by the Ministry of International Trade and Industry, which developed the payload instruments, and by the Science and Technology Agency. Mitsubishi Electric was the prime contractor aided by Toshiba, Nippon Electric, and the Japanese Resources Observation Systems Organization.

The 1,340 kg JERS-1 (Figure 4.83) consists of a flat rectangular bus (0.9 m by 1.8 m by 3.2 m) with a single 2-kW solar array (3.5 m by 7.0 m) and an eight-segmented SAR antenna (2.4 m by 11.9 m when deployed). The spacecraft is 3-axis stabilized with a payload of nearly 500 kg

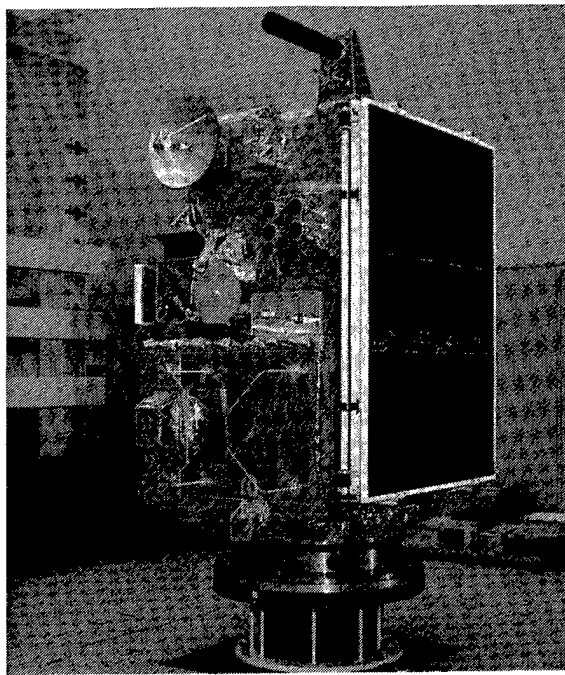

Figure 4.82. MOS 1 Satellite.

and a design life of two years. Frequent orbital adjustments are required to maintain the 44-day repeating groundtrack.

The spacecraft carries two closely matched Earth observation sensors: the SAR and the OPS multi-spectral imager. The SAR operates at a frequency of 1.275 GHz with a peak power of 1.3 kW, a 75 km swath, and a 18 m resolution. The SAR mission was placed in jeopardy for two months when the large radar antenna failed to deploy fully. On 4 April the spacecraft signaled that the first stage of deployment was finally accomplished, and by 9 April the full antenna array was in position. Images returned by the SAR in late April lived up to expectations, although some minor interference problems appeared later in the year (References 243–246).

The OPS system is comprised of a 3-band, CCD Visible and Near-IR Radiometer (VNIR) using 0.52–0.60 μm , 0.63–0.69 μm , and 0.76–0.86 μm regimes and a 4-band, CCD Short Wavelength IR Radiometer (SWIR) sensitive to 1.60–1.71 μm , 2.01–2.12 μm , 2.13–2.25 μm , and 2.27–2.40 μm . The resolution of the OPS is matched to that of the SAR at 18 m. A mission data recorder is available to store images until downlinked by the mission data transmitter at 8.15 GHz and 8.35 GHz.

Japan's next major remote sensing satellite undertaking is the Advanced Earth Observation Satellite (ADEOS), slated for launch in 1996 by the H-2 booster. The three primary objectives of the program are to "develop advanced Earth observation sensors, develop a modular satellite that is the prototype of the future platform, and

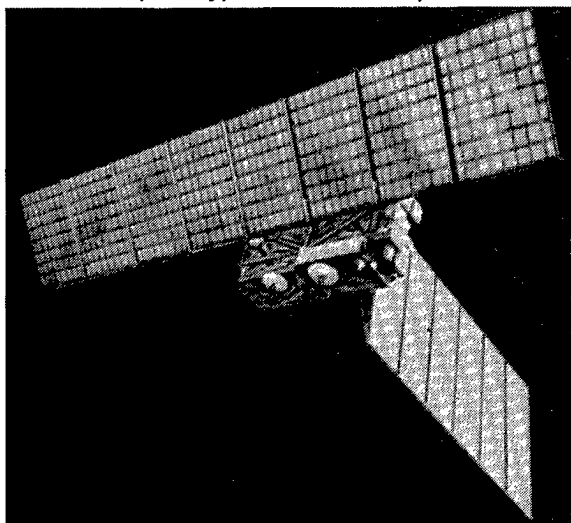

Figure 4.83. JERS-1 Satellite.

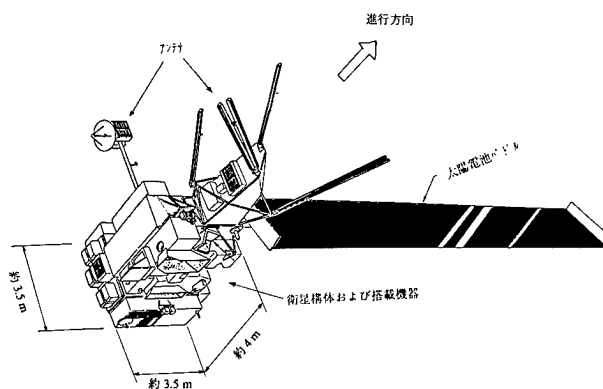

Figure 4.84. ADEOS Satellite.

conduct experiments on Earth observation data relay using data relay satellites to form a global observation network" (Reference 241).

The 3.2 metric ton ADEOS will operate in an 800 km orbit with an inclination of 98.6°. Developed jointly by Mitsubishi Electric, Toshiba, and Nippon Electric, the ADEOS configuration employs an irregularly shaped bus (3.5 m by 3.5 m by 4 m) with a single solar array (3 m by 13 m) capable of generating a minimum of 4.5 kW during the anticipated 3-year lifetime of the satellite. Hydrazine thrusters will maintain a precise 41-day repeating groundtrack.

An extensive, complex payload consisting of Japanese, American, and French remote sensing instruments is planned for ADEOS. NADSA will directly contribute an Advanced Visible and Near-IR Radiometer (5 bands, 8m and 16 m resolution, 80 km swath) and the Ocean Color and Temperature Scanner (12 bands, 700 m resolution, 1,400 km swath). The Japanese Environment Agency will provide the Improved Limb Atmospheric Spectrometer and the Retroreflector in Space, while the Ministry of International Trade and Industry supplies the Interferometric Monitor for Greenhouse Gases. The three foreign instruments to be hosted by ADEOS are the Total Ozone Mapping Spectrometer (NASA), the Scatterometer (NASA), and the French POLDER (Polarization and Directionality of the Earth's Reflectance). A follow-on ADEOS mission is tentatively scheduled for 1999 under the name JPOPS-1 (Japanese Polar-orbiting Earth Observation Platform) (References 242, 247–249).

Japan is also a principal participant in the international Tropical Rainfall Measuring Mission (TRMM) scheduled to begin in 1997. Japan will launch the 3.5 metric ton satellite built by NASA into a 350 km orbit with a low inclina-

tion of 35°. Accompanying four NASA instruments will be the Japanese Precipitation Radar, operating at 13.8 GHz and sponsored by NASDA with Toshiba as the prime contractor.

4.3.9 Pakistan

Although Pakistan has only operated one small satellite in LEO (Badr-A, 16 July–20 August 1990, orbited as a secondary payload by a Chinese booster), the country's modest space program has long been oriented toward remote sensing applications. A data processing infrastructure has been established to exploit Earth observation data transmitted by Landsat, NOAA, and SPOT satellites. As a next step, the Space and Upper Atmosphere Research Commission (SUPARCO) is preparing for the commercial launch of a simple Pakistani satellite with Earth imaging capabilities.

The 50-kg Badr-B now in final development will be a cube with side dimensions of 45 cm and a gravity-gradient stabilization system. The project plan envisions a 2-3 year mission for a CCD camera in a sun-synchronous orbit. Final launch arrangements are still being negotiated with the goal of a 1994 lift-off (References 250–251).

4.3.10 People's Republic of China

The PRC has been actively pursuing Earth observation space systems for more than twenty years and in 1975 became only the third country in the world to retrieve high resolution photographs of the planet shot from space. Today, two models of LEO recoverable Earth observation satellites are in use and a sun-synchronous meteorological satellite system has been tested. In the near-term a geostationary meteorological satellite network will be deployed.

Designed to support both military and civilian Earth observation needs, the FSW-1 program began in 1966 with an initial launch failure in 1974. During the period 1975–1992, thirteen FSW-1 missions, lasting up to 8 days, were conducted with a 100% recovery rate, although FSW-1 8 (October, 1986) made an unplanned splashdown in a lake. Launched by the CZ-2C booster from Jiuquan, the FSW-1 (Figure 4.85) has a blunt conical shape with a length of 3.14 m, and a maximum diameter of 2.2 m, and a mass of 1.8–2.0 metric tons. The vehicle is divided into two major sections: the equipment

and retro module (1.6 m long) and the reentry module (1.5 m long). The 3-axis-stabilized FSW-1 is powered by batteries and is controlled from the Xian Satellite Control Center (References 253–254).

FSW-1 satellites have carried imaging payloads with high resolution (10–15 m) cameras for film development on Earth and with CCD (50 m resolution) camera systems for near-realtime images. The latter system can also be used in directing the operation of the former system, thereby minimizing the wastage of film supplies if environmental conditions are unfavorable, e.g., cloud-covered (References 255–257). The maximum recoverable payload is 150 kg.

The only FSW-1 mission conducted during 1991–1992 occurred 6–13 October 1992. FSW-1 13 was inserted into an initial orbit of 214 km by 312 km with an inclination of 63.0°. (Sweden's Freja geophysical satellite was launched as a piggy-back payload on the same CZ-2C booster.) After a flight of nearly seven days, the recoverable capsule was deorbited and landed in Sichuan Province. In addition to the Earth observation payload, a small biological facility was installed in the capsule (References 258 and 259).

Two months before the flight of FSW-1 13, the improved FSW-2 spacecraft made its debut.

Launched by the maiden flight of the CZ-2D booster from Jiuquan on 9 August, FSW-2 entered an initial orbit of 172 km by 330 km at an inclination of 63.1°. The heavier (2,400 kg) FSW-2 resembled the FSW-1 with an additional cylindrical module 2.2 m in diameter and 1.5 m long. The major advantages of the newer model are an increased recoverable payload (up to 300 kg) and a longer mission duration (16 days or more). Although the flight plan called for a mission of 15 days, the spacecraft was not de-orbited until 25 August due to poor weather in the recovery region. Like FSW-1 13, FSW-2 1 carried a dual payload for remote sensing and microgravity research; but unlike its smaller cousin, the FSW-2 1 performed three small maneuvers on days 3, 6, and 9 of the mission (References 253, 254, and 260–262).

A general reference was made in a 1989 scientific paper about the development of a second generation of recoverable satellites which would be "much larger, heavier, and more advanced than FSW-2" (Reference 253). The new spacecraft would also incorporate more

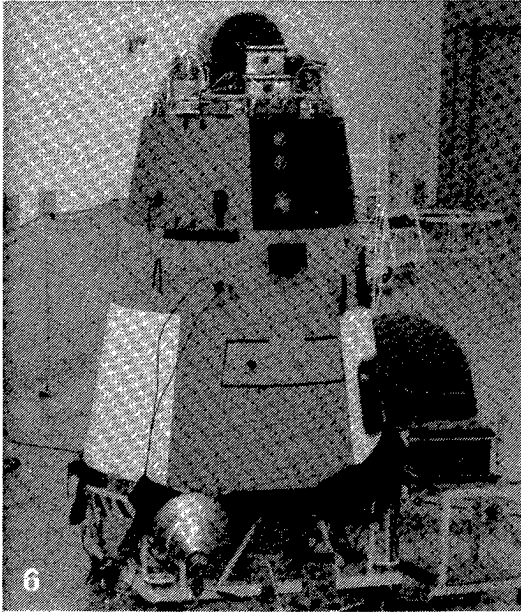

Figure 4.85. FSW-1 Satellite.

sophisticated reentry lift techniques to improve landing precision and to lessen deceleration forces, which are currently as high as 20 g's for FSW capsules.

In 1988 and again in 1990 the PRC launched Feng Yun 1 meteorological satellites into approximately 900 km, 99° inclination orbits by CZ-4A boosters from Taiyuan. The spacecraft were designed to be comparable to existing international LEO meteorological and remote sensing systems, including APT transmissions in the 137 MHz band. The satellite structure and support systems were created by the Shanghai Satellite Engineering and Research Center of the China Space Technology Institute, whereas the payload was developed by the Shanghai Technical Physics Institute of the Chinese Academy of Sciences.

Both satellites were experimental to test systems prior to the launch of operational Feng Yun 1 spacecraft and were similar in design, although technical characteristics differed. The height of the cubical spacecraft bus (1.4 m by 1.4 m base) of Feng Yun 1A was apparently increased from 1.2 m to nearly 1.8 m for Feng Yun 1B. Likewise, total spacecraft mass increased from 750 kg to about 880 kg. Both satellites were powered by two solar arrays (about 3.5 m long each) with a combined rating of more than 800 W. Nickel-cadmium batteries were used for electrical power storage. Attitude control was maintained by a combination of

nitrogen cold gas thrusters and reaction wheels, although both spacecraft suffered serious malfunctions in this system. Feng Yun 1A was lost after only 38 days, but Feng Yun 1B operated for more than a year (References 263–265).

The Feng Yun 1 primary payload consisted of two Very High Resolution Scanning Radiometers (VHRSR) with a combined mass of 95 kg. These optical-mechanical scanners operated at 360 rpm with a 20 cm diameter primary mirror. The five spectral bands used were 0.58–0.68 μm , 0.725–1.1 μm , 0.48–0.53 μm , 0.53–0.58 μm , and 10.5–12.5 μm . The system swath was 2,860 km with a 1.08 km resolution in the High Resolution Picture Transmission (HRPT) mode and 4 km resolution in the Automatic Picture Transmission (APT) mode.

Several projects are underway to improve the Feng Yun 1 series of spacecraft, to deploy the first Feng Yun 2 GEO meteorological satellites, and to investigate other instrument and system alternatives (Reference 266). Feng Yun 2 may be launched as early as 1993 (Reference 267) and will resemble in configuration and performance current American, ESA, and Japanese GEO meteorological satellites. In 1994 the joint China-Brazil Earth Resources Satellites (CBERS) will be launched by a CZ-4A

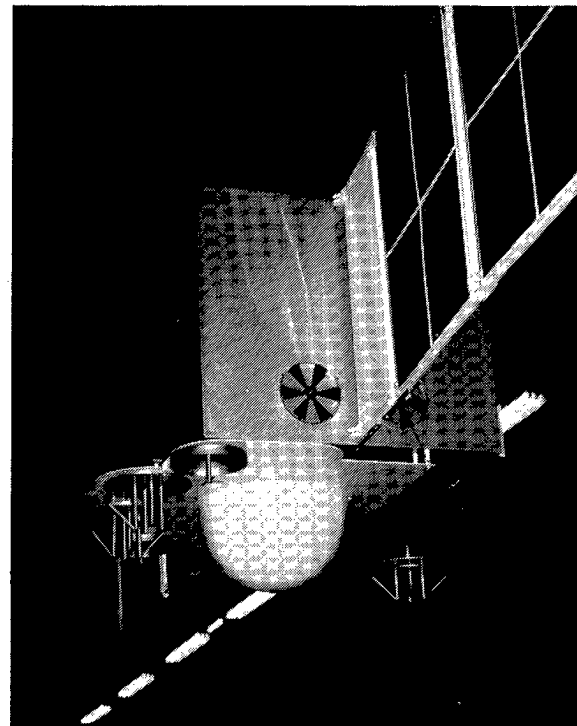

Figure 4.86. Feng Yun-1 Satellite.

booster into a planned orbit of 778 km at an inclination of 98.5°. The 1.4 metric ton spacecraft will have overall dimensions of 2 m by 3.3 m by 8.3 m with a 1.1 kW capacity, single solar array. The Earth observation payload will include:

- CCD Camera: Five bands (0.51–0.73 μm , 0.45–0.52 μm , 0.52–0.59 μm , 0.63–0.69 μm , and 0.77–0.89 μm); 20 m resolution; 120 km swath;
- IR Multi-Spectral Scanner: Four bands (0.50–1.10 μm , 1.55–1.75 μm , 2.08–2.35 μm , and 10.40–12.50 μm); 80–160 m resolution; 120 km swath;
- Wide-Field Imager: Two bands (0.63–0.69 μm and 0.76–0.90 μm); 260 m resolution; 900 km swath.

The selected orbit will permit a 26-day repeating groundtrack pattern. The CBERS will also carry a Data Collection System and a

Space Environment Monitor (Reference 268).

4.3.11 South Korea

In August, 1992, South Korea's first satellite was launched as a piggy-back payload on the Topex/Poseidon mission. The 50 kg minisat is known variously as Kitsat A, Oscar 23, and Uribyol 1 (Our Star). Along with a communications payload, Kitsat A carries two CCD cameras for Earth photography in a 1,300 by 1,400 km orbit inclined 66° to the equator. The principal national organizations participating in the program are the Korea Advanced Institute of Science and Technology and the Korea Research Institute of Standards and Science. The satellite was created with the help of the University of Surrey, England, which specializes in microsatellite technology. A second Kitsat is scheduled for launch in 1993, possibly followed by an "environment-monitoring" satellite in 1995 with a mass of up to 250 kg (References 269–270).

4.4 Materials Science

The microgravity conditions available in Earth orbit have given rise to an entirely new branch of materials science. Whether the objective is to grow high quality semi-conductor crystals, to prepare purer medicines via electrophoresis, or to develop practical techniques for welding, soldering, or metallic coatings, manned and unmanned satellites offer unique opportunities not only for pioneering experiments but also for commercial production. Although the slow development of this scientific discipline has not yet met many expectations, interest in space-based materials science investigations continues to grow in Europe and Asia.

To date only the CIS and PRC have the capability to launch and to retrieve materials science payloads. In addition to supporting their own national programs, these materials science platforms are made available on a commercial basis to other nations. With the help of the US, ESA and Japan are expanding their materials science programs, while a joint German-Japanese venture is creating a new recoverable spacecraft designed specially for microgravity research.

4.4.1 USSR/CIS

The materials science program in the USSR/CIS dates back to the first electron-beam welding experiments conducted on board Soyuz 6 in 1969. However, the experimental and pilot production activities have been underway in earnest since the launching of the Salyut 5 space station in 1976. Today, the Mir space station is the focal point of such operations with a wide assortment of electric furnaces and other devices and with the added benefit of crew participation. One of the primary objectives of the Kristall module, attached to Mir in 1990, was to support microgravity experiments.

Despite the fact that microgravity conditions are typically 10–100 times worse on a manned versus an unmanned spacecraft, man-tended experiments on Soviet-built space stations, some lasting more than a week, have proved to be quite successful. The other principal drawback of materials science research on Mir – the extremely limited capability of returning samples to Earth – was reduced in late November, 1990, when the Progress M recoverable capsule was successfully tested for the first time. This

system is now used twice each year, returning up to 150 kg of cargo (including the product of materials science research) per mission.

Whereas specific details of Mir operations are covered in Section 3.1, a list of major materials science devices delivered to the station are included here for completeness. In 1987 three electric furnaces were delivered to Mir: Korund-1M, Kristallizator, and Mirror-Beam. These were augmented or superseded in 1990 by the five new furnaces installed on the Kristall module: Krater V, Kristallizator, Optizon, Zona 2, and Zona 3. Other Mir materials science devices have been used for electrophoresis (Aynur-Kristall, EFU Robot, Ruchey, and Svetlana), protein crystallization (Aynur-Mir), and miscellaneous experiments (Biostoykost, Svetoblok, and Yantar).

Since 1985 the USSR/CIS has conducted one annual unmanned space mission dedicated to materials science research. The Photon spacecraft used for these flights is a derivative of the 1960's era Vostok/Voskhod manned spacecraft and the Zenit military reconnaissance satellites and is very similar to the currently operational Bion and Resurs-F satellites. Prototype Photon satellites were launched during 1985–1987 as Kosmos 1645, Kosmos 1744, and Kosmos 1841. Beginning in 1988, the spacecraft have been officially designated as Photon.

The 6,200 kg spacecraft is 6.2 m in length with a maximum diameter of 2.5 m and is divided into three major sections: The service/retro module, the payload capsule, and an equipment block (Figure 4.87). The 2.3 m diameter recoverable capsule can handle a payload of up to 700 kg and a volume of 4.7 m³. Electrical power is supplied entirely by storage batteries with 400 W average per day allocated to the payload (up to 700 W for 90 minutes each

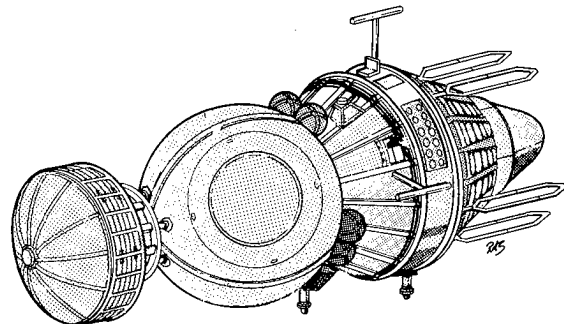

Figure 4.87. Photon Satellite.

day). Mission durations for the eight Photon flights to the end of 1992 have been 13–16 days (References 271–274).

To minimize perturbation forces, thereby maximizing microgravity conditions (as low as 10^{-5} g), Photon spacecraft are placed in a mildly eccentric orbit at 62.8° inclination and are not maneuvered during the mission. The initial orbits for Photon 4 (4–20 October 1991) and Photon 5 (8–24 October 1992) were 215 km by 359 km, respectively. Prior to 1991 the annual Photon missions had always been launched in April or May. Launches are performed by the SL-4 (Soyuz) booster from Plesetsk, and recoveries are made in Kazakhstan in the primary manned recovery region northeast of the Baikonur Cosmodrome.

The early Photon materials science payloads consisted of the Zona 1 and Splav 2 electric furnaces and the Kashtan electrophoresis unit. More recently the Zona 4, Splav 2, and the Konstanta 2 electric furnaces have been the principal equipment employed. Since 1989 Photon missions have also carried small foreign materials science payloads on a commercial basis. Photon 4 (also known as Photon 7 in recognition of the three pre-operational flights) carried the German Cosima 4, the French Sedex, and the joint German-Soviet LZZ experiments. German experiments were again carried on Photon 5, including the new Biopan package mounted on the exterior of the capsule (References 275–277).

The French firm Carra is developing a new interface module for Photon called Spacepack which will facilitate the integration of foreign microgravity experiments on the Russian spacecraft. Meanwhile, the German company Kayser-Threde is working with the Photon Design Bureau to develop a new spacecraft (Eurokosmos) with specific features of Photon, Bion, and Resurs-F which will permit missions of up to 30 days with greater data processing and recording capabilities. Finally, Kayser-Threde is also designing a tether experiment to be flown on a Photon spacecraft in 1995 (References 276, 278–279).

When Soviet officials decided to make the Photon spacecraft available to foreign commercial users, the similar Resurs-F1 Earth observation spacecraft was also offered for payloads of 15–30 kg. Working through the Kayser-Threde firm (Figure 4.88), several European sponsors



Figure 4.88. Installing Microgravity Experiments in Resurs-F1 Return Capsule.

have taken advantage of these more frequent flight opportunities: Cosima 2 on Resurs-F 5 (September, 1989), Cosima 3 on Resurs-F 6 (May, 1990), and Casimir on Resurs-F 9 (September, 1990). Although mission durations can be increased to 25 days as compared to the 16-day flights of Photon, Resurs-F1 spacecraft are subject to attitude control adjustments and orbital maneuvers which may have a deleterious effect on microgravity experiments (References 273–274, 280–282).

By 1995 the Photon Design Bureau anticipates testing a much more capable microgravity spacecraft as a follow-on to the successful Photon program. Designated Nika-T, the new vehicle will retain the spherical reentry capsule of Photon but will possess significantly improved support systems. The 9 metric ton Nika-T will be capable of returning payloads of up to 1,200 kg after missions of 3–4 months. Early Nika-T concepts envisioned a maximum spacecraft diameter of 2.7 m and a length of 9.3 m, but more recent diagrams suggest that the length has been reduced slightly. Two solar arrays will generate 6 kW of which 4.5 kW will be available for the microgravity payload (Figure 4.89). A third array is part of the thermal control system's heat rejection loop (References 272–274, 283).

Nika-T will be launched by the SL-16 (Zenit) launch vehicle into sun-synchronous orbits of 300–500 km at inclinations of $96\text{--}98^\circ$. To

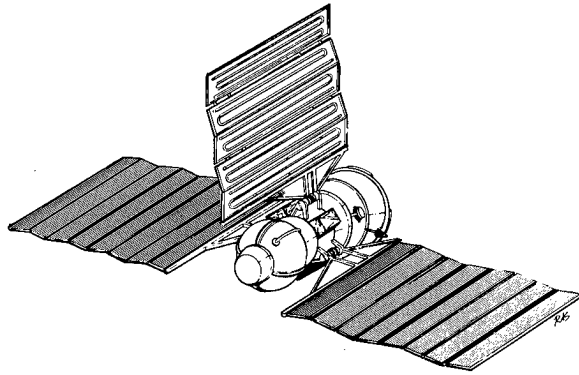

Figure 4.89. Nika-T Satellite.

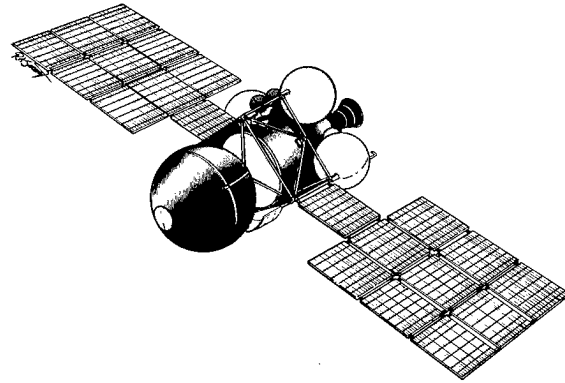

Figure 4.91. Tekos Satellite.

protect the fragile materials sciences samples, the landing velocity of the capsule will be reduced to only 5 m/s. At least two new materials science instruments are being developed for Nika-T: the Zona 8 and the Konstanta 4 furnaces. The former will be capable of accepting sample cartridges of 40 mm diameter and 200 mm length, whereas the latter will possess a 85 mm diameter and 400 mm length capacity.

In 1990 the Lavochkin NPO announced plans to enter the microgravity services market with its own spacecraft, generally referred to as Lavochkin or Mercury. The original prospectus indicated a spacecraft (Figure 4.90) mass of 5,600 kg and a payload mass of 500 kg. The descent module which was conical in shape had a mass of 2,900 kg. Electrical power was to be supplied by two solar panels with a 4.5 kW capacity. Mission durations of up to two years in orbits of 500 km and 97.7° inclinations were anticipated by 1993-94 with the aid of a modified SS-18 ICBM launch vehicle (References 284-286).

By 1991 the project had matured to include a

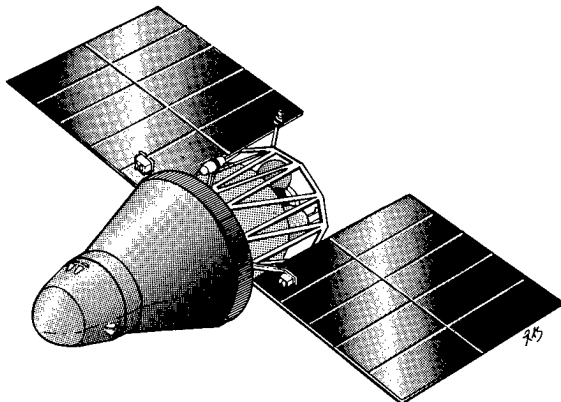

Figure 4.90. Lavochkin NPO Materials Science Satellite (early design).

new spacecraft design and a host of available materials science equipment. The current design calls for a spacecraft, called Lavochkin or Tekos, with a mass of 5,500 kg with a spherical 2.2 m diameter reentry capsule (based on the Venera reentry module) of 2 metric tons and a payload mass of 900 kg and volume of 4-4.5 m³ (Figure 4.91). Solar-generated electrical power capacity will remain at 4.5 kW. Also unchanged was a goal of flight duration up to two years in a 500 km, 98° orbit, launched by a modified SS-18. The maiden flight of the spacecraft was set for 1994. Expected microgravity conditions were 10⁻⁴-10⁻⁵ g (References 287-290).

To sweeten the commercial package, Lavochkin NPO has teamed with specialists in the CIS materials science community to provide specific semi-conductor and pharmaceutical microgravity devices for Lavochkin/Tekos. Three electrophoresis instruments are being prepared (Potok, Meduza, and Shtamm) along with the Biocryst facility for the production of biocrystals. The Krater-AG furnace will have the capacity of handling sample cartridges 76 mm in diameter and 200 mm in length at temperatures of up to 1,270° C and total operations of 5,000 hours. Lavochkin NPO has estimated that 100 kg of gallium arsenide and 20 kg of other semi-conductor materials could be produced on a single mission.

Not to be outdone by its longtime competitors (Photon Design Bureau and Lavochkin NPO), the Salyut Design Bureau of Proton launch vehicle and Mir space station fame has proposed no less than four new concepts for materials science research with spacecraft of 1.2 metric tons to more than 100 metric tons. However, to date none of these designs appear

to have secured project funding.

At the least ambitious end of the spectrum is the Space Biotechnological Complex, "intended for experimental production of exclusively pure biologically active substances possessing unique properties (unthought of gaining in the terrestrial conditions) and its manufacturing process improvement" (Reference 291). The 1,200 kg spacecraft (Figure 4.92) measures only 1.50 m in height and 1.45 m in diameter at the base. The core of the spacecraft is a recoverable module, similar to that introduced with Progress M spacecraft in 1990, surrounded by electrical and thermal control systems. Total recoverable payload mass is 100 kg with a diameter of 53 cm and a length of 100 cm. Designed for launch by a "light-weight launch vehicle," possibly the SS-19-derived ROKOT (also created by the Salyut Design Bureau), the Space Biotechnological Complex may remain in its reference 400 km, 65° inclination orbit for only five hours. A 1991 description of the project indicated that operations could start in 1993.

The second materials science spacecraft innovation being offered by the Salyut Design Bureau is called *Technologiya* and is based on a new spacecraft bus called the Unified Space Platform (USP). The USP is designed to handle payloads of up to 10 metric tons with stowed dimensions of 4.1 m diameter and 6.7 m length. The USP will supply electrical power up to 12 kW, attitude control with a precision of 10' to 1°, orbital maneuver capability, and other support functions. Mission durations of as long as five years are possible in orbits up to 500 km

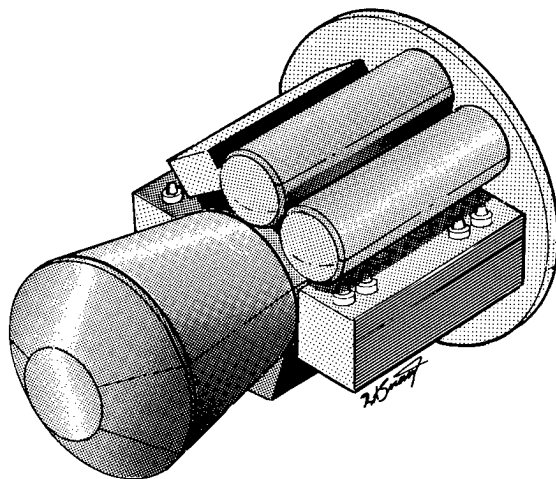

Figure 4.92. Space Biotechnological Complex

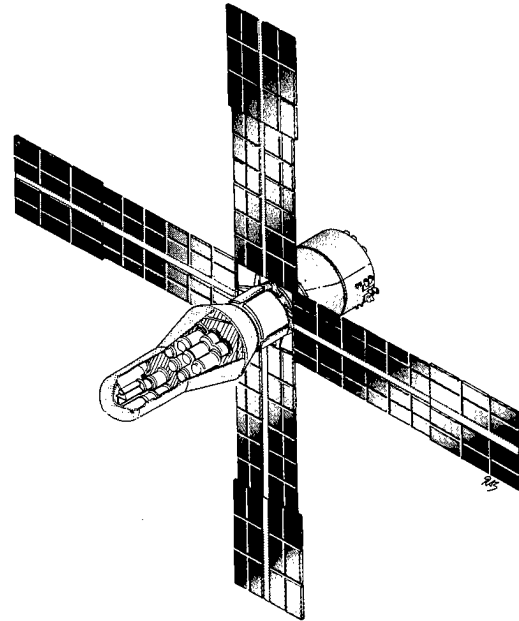

Figure 4.93. Technologiya Satellite.

with inclinations of 51.6°, 65°, or 72°. Launches would be provided by the SL-13 (Proton) within 3–4 years of contract agreement (Reference 292).

Under the *Technologiya* program, the Salyut Design Bureau has already designed a customized microgravity payload unit for the USP (Figure 4.93). The 20 metric ton vehicle will be capable of carrying 4–5 metric tons of processing equipment for the manufacture of semiconductor materials, optical glasses, and biological preparations in a volume of up to 30 m³. A maximum mission duration of three years at a 400–450 km altitude is possible. Products and processing equipment will be returned to Earth in a large recoverable module (Reference 293).

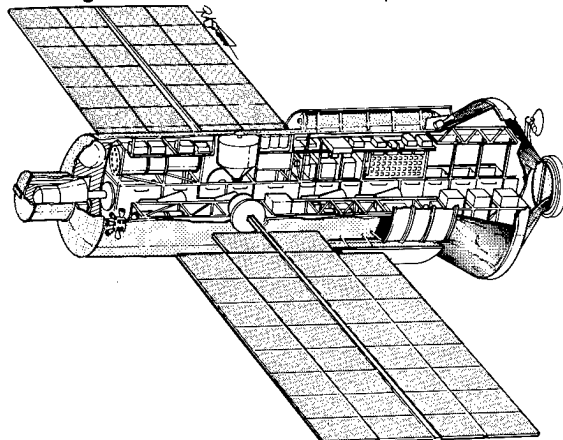

Figure 4.94. Biotechnologiya Satellite.

The third Salyut Design Bureau proposal is based on a derivative of the class of spacecraft which serve as the heavy add-on modules for the Mir space station, e.g., Kvant 2 and Kristall. Named the Biotechnologiya Space Vehicle, this proposed materials science spacecraft (Figure 4.94) has a launch mass of 21 metric tons of which 8–9 metric tons represent the payload. The maximum diameter is 4.3 m and the length is approximately 12 m. Two solar array generate up to 3 kW average power and 10 kW for peak loads. Microgravity conditions of 10^{-4} g are possible for year-long missions at altitudes of 350–450 km (References 211 and 294).

A unique aspect of the Biotechnologiya Space Vehicle is its ability to return materials in small recoverable modules periodically throughout the mission. Ballistic capsules (5 or more) with a capacity of 120 kg and a volume of 120 liters are loaded separately, then ejected from the main spacecraft for the return to Earth. Since the basic spacecraft systems have already been developed and tested in space, the preparation period for this specialized vehicle may be only 2–3 years.

In support of the first SL-17 (Energiya) mission in 1987, the Salyut Design Bureau constructed a 100-ton class spacecraft called Polyus. Although the vehicle never reached orbit due to an attitude control problem, its designers have expanded upon the original concept to propose the heavy Space Processing Module (SPM), also known as the Engineering Production Module (TMP) (References 294–297). With a 102 metric ton launch mass, the SPM possesses an on-station (350–400 km, 51.6° inclination) mass of a mere 88 metric tons. In typical Russian style, the Salyut Design Bureau engineers adapted well-known hardware to create the SPM. The heart of the facility (the Laboratory Compartment), where the materials processing equipment is installed, is based on the main core cylinder of the Proton launch vehicle's first stage. Above it is a heavy Kosmos module (the Instrument-Cargo Compartment) of the Kvant 2, Kristall, or Biotechnologiya class.

In orbit the SPM is approximately 35 m long with a main diameter of just over 4 m (Figure 4.95). In addition to the two sizable solar arrays extending from the Instrument-Cargo Compartment, the SPM has two very large arrays attached to the Laboratory Compartment

– total span = 60.4 m. Together, they can produce more than 60 kW for a mission exceeding five years. Total payload mass of up to 25 metric tons is possible with microgravity conditions of 10^{-5} – 10^{-6} g.

Expanding upon the idea of multiple return capsules proposed for the Biotechnologiya Space Vehicle, the SPM designers have included a similar capability using 361 kg ballistic capsules with a payload mass of 141 kg and a payload volume of 92.5 liters. Robotics are used to remove a ballistic capsule from storage, load it, and then transfer it to a small air-lock for ejection. This operation cycle would occur every 1–3 months. Nine types of processing units have been proposed for the SPM for a total of 45 individual installations for an annual production capacity of more than one metric ton per year.

A novel element of the SPM program is the option for man-tended operations. Docking ports at both the aft and forward end of the SPM would be compatible with a Soyuz TM spacecraft or the proposed MAKS space plane. The latter could be launched either by the Energiya-M launch vehicle or from an air-based platform like the An-225. A maintenance or resupply crew could spend up to 10 days on the SPM unloading supply ships and repairing equipment. Unmanned resupply missions using Progress M or heavy Kosmos spacecraft are also envisioned. The advent of MAKS would also increase the opportunities (and therefore mass) for returning processed materials to Earth. Complete design of the SPM will require two years, followed by four years of building and testing the flight module before launch.

4.4.2 European Space Agency

Under ESA's charter participation in microgravity research programs, which were formally established in 1982, is optional for member states. Significant activities did not begin until the flight of Spacelab 1 on the US STS in 1983. To date the majority of ESA materials science programs remain linked to STS, including ESA's free-flying EURECA satellite which is designed for deployment and retrieval by STS. The recent elimination of the Columbus independent platform and the rescoping of the Hermes space plane program will limit future ESA experiments in this field until the international Freedom Space Station is operational.

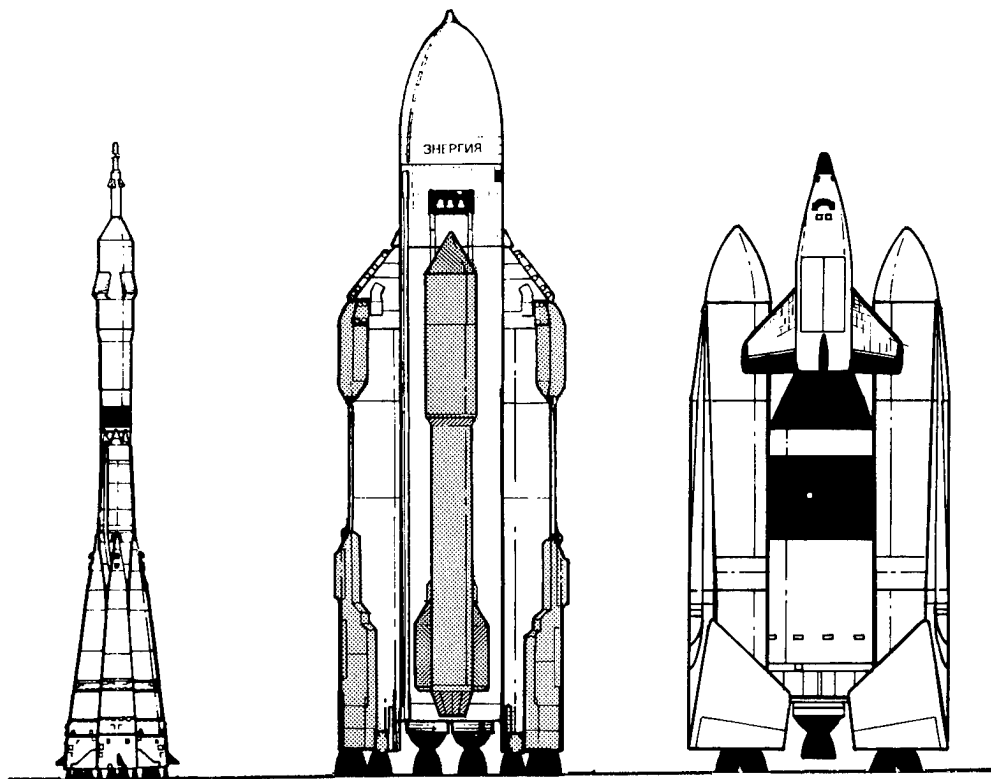
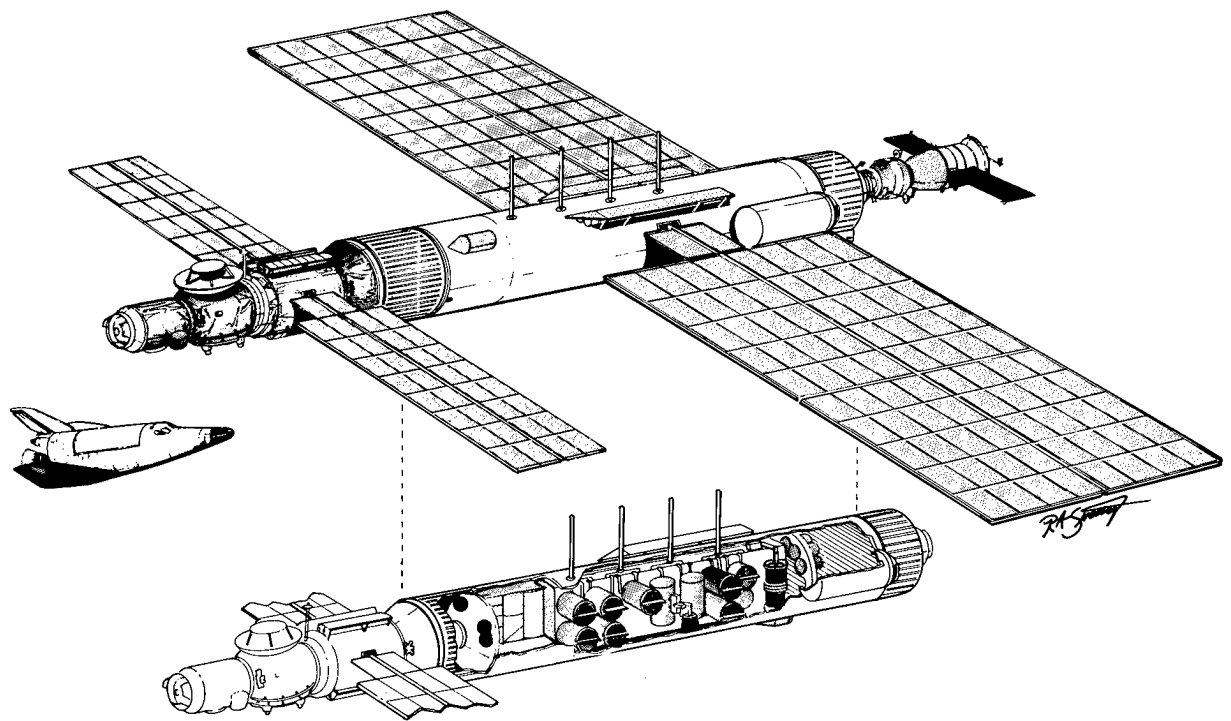

Figure 4.95. The Proposed Space Processing Module Infrastructure, Including Soyuz TM and MAKS Space Plane Logistics Vehicles.

Following the ESA Ministerial Meeting at The Hague in November, 1987, the long-term, 4-phase microgravity program was revised taking into account the effects of the Challenger accident of 1986. Phase 1 (1982–1985) had already been completed with the first flights of Spacelab. Phase 2 (1986–1992) and its extension included additional Spacelab missions and the first flight of EURECA. Phase 3 (1989–1997), termed the pre-Columbus phase, envisioned continued operations of Spacelab and EURECA while developing the Man-Tended Free-Flyer. Phase 4 (1998–2000) was called the Columbus Utilization Period, during which the volume and sophistication of materials research would be greatly expanded (Reference 298). Although the pace of the program has not met expectations, a strong commitment for materials science research remains within ESA.

Spacelab, in its many possible configurations, represents a major ESA development effort tailor-made for integration into the US STS program. With a mass of up to 14.5 metric tons, Spacelab is actually a modular system which can be assembled in a variety of forms using a Pressurized Module (short or long) and payload pallets. The long Pressurized Module, in which crew-tended materials science experiments can be performed is approximately 4 m in diameter with a length of 7 m and a total mass in excess of 8 metric tons. The Pressurized Module is connected to the Orbiter crew cabin via a 1.3 m diameter tunnel. One to five 2.9 m long equipment pallets can also be part of a Spacelab configuration depending upon flight needs and the presence of a short or long Pressurized Module. A "typical" Spacelab mission includes a long Pressurized Module and one or two pallets. Principal contractors for Spacelab included Matra (France) for command and data management, Dornier (Germany) for environmental control and life support systems, AEG-Telefunken (Germany) for electrical power distribution, Aeritalia (Italy) for the Pressurized Module, Fokker (The Netherlands) for the airlock, and British Aerospace (UK) for the pallets (References 299–300). Together, France, Germany, Italy, and the UK contributed more than 85% of the funding for Spacelab.

Although Spacelab (Figure 4.96) had flown on ten STS missions by the end of 1992, only a few have supported major ESA materials science research: Spacelab 1 (1983), Spacelab

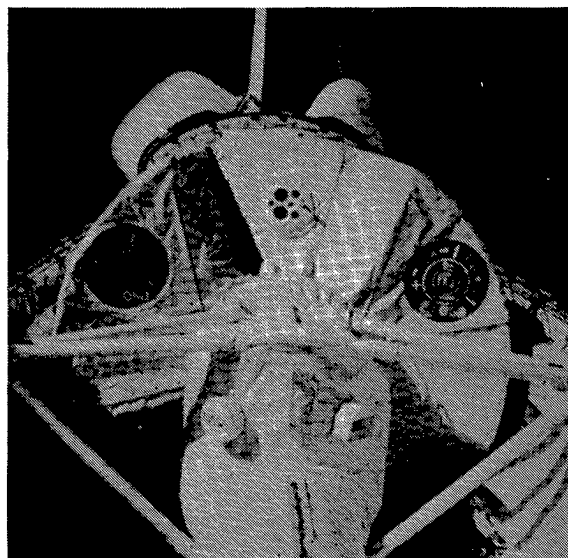

Figure 4.96. Spacelab In Orbit.

D1 (1985), and International Microgravity Laboratory (1992). The principal ESA materials science facilities developed and now available for Spacelab missions are the Advanced Fluid Physics Double Rack and the Materials Science Double Rack. Several additional flights of Spacelab are scheduled through the mid-1990's, including the Spacelab D2 mission in 1993 and the second International Microgravity Laboratory in 1994.

In 1982 ESA formally approved the development of a free-flying satellite dedicated to microgravity research during missions lasting six months or longer (Reference 301). The first European Retrievable Carrier (EURECA) was finally launched 31 July 1992 on board the Atlantis Space Shuttle and deployed two days later. The 4.5 metric ton spacecraft with a 1 metric ton payload used its own propulsion system to maneuver into an operational orbit of approximately 500 km at an inclination of 28.5° (Figure 4.97). The two solar arrays can generate up to 5 kW with 1 kW average power available to the payload.

The prime contractor for EURECA is MBB/ERNO of Germany, assisted by major subcontractors Matra, Fokker, Aeritalia, AEG, and SNIA/BPD. On its first flight EURECA was expected to achieve microgravity conditions of 5×10^{-7} g and carried five Microgravity Multi-User Facilities: Automatic Monoellipsoid Mirror Furnace (AMF), the Exobiology and Radiation Assembly (ERA), the Multi-Furnace Assembly

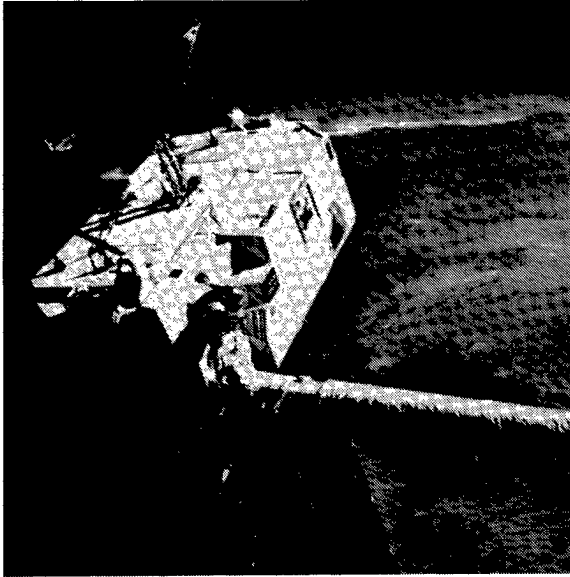

Figure 4.97. EURECA Satellite.

(MFA), the Protein Crystallization Facility (PCF), and the Solution Growth Facility (SGF). Also on board were the High Precision Thermostat (HPT) and the Surface Forces Adhesion (SFA) materials science experiments. The Endeavor Space Shuttle was manifested to retrieve EURECA in the spring of 1993. Not only are additional EURECA-class vehicles now unlikely to be manufactured for commercial microgravity missions, but also re-flights of EURECA are in jeopardy due to budgeting pressures (References 302–304).

Under the original Columbus program, a free-flying man-tended laboratory, based on the Freedom Space Station attached module, would be flown with a major emphasis on microgravity research. Launched in the late 1990's by the Ariane 5 booster, the 18 metric ton laboratory was to be serviced by Hermes space plane crews once or twice each year. However, a redirection of the Columbus and Hermes programs in 1992 left the free-flyer mission in limbo with little likelihood of development in the near-term.

4.4.3 France

Although France has no current plans to operate dedicated microgravity research satellites, this nation has taken advantage of flight opportunities on European, US, and USSR/CIS spacecraft to conduct materials science experiments. French equipment has flown on Spacelab missions as well as EURECA. The

1990 USSR Photon mission carried the Crocodile crystallization facility, followed by the Sedex enzyme synthesis experiment on the 1991 Photon spacecraft. In 1993 a Photon spacecraft is scheduled to carry the Gezon investigation in the effects of magnetic fields on the crystallization process and may re-fly the Crocodile apparatus. As noted in Section 4.4.1, the French firm Carrar is developing the Spacepack materials science experiment carrier for future Photon missions.

The Casimir experiment to study the growth of zeolites with a French furnace was conducted on the Resurs-F 9 vehicle in 1990. Two major materials science experiments were performed on the Mir space station in 1992 during the French Antares mission: Alice to study the transport and phase change phenomena in the neighborhood of critical points and Supraconducteur to investigate the crystallization of a high critical temperature superconductor under zero-g conditions. A separate experiment studied the effects of heavy ions on electronic components in the space station. On the second International Microgravity Laboratory mission, a French electrophoresis apparatus will be tested under the Ramses program. (References 305 and 306).

4.4.4 Germany

For many years several German organizations, e.g., Intospace GmbH, Kayser-Threde GmbH, MBB/ERNO, OHB-System GmbH, and DLR's Microgravity User Support Center, have been involved in numerous European microgravity experiments on such foreign orbital platforms as EURECA, FSW-1, Mir, Photon, Resurs-F, and Spacelab. The German mission to the Mir space station in 1992 and the 1993 flight of Spacelab D2 on the US STS represent the latest man-tended materials research efforts undertaken. However, the German national space agency has recently approved a project to develop a new unmanned microgravity spacecraft for short duration missions (References 232, 307–309).

Named Express, the 760 kg spacecraft (including a 160 kg payload) will be launched by a Japanese M-3SII booster from Kagoshima as early as 1994. Designed and built by MBB/ERNO, Express will orbit the Earth at altitudes below 400 km for missions of less than one week before being de-orbited for recovery

in the Australian desert. The simple spacecraft will rely on batteries to deliver an average 100 W for the payload. The capsule measures 1.4 m in diameter and 2 m in length. A potential competitor is the Space Courier recoverable space system being studied by a German consortium, including Dornier, Kayser-Threde, MBB/ERNO, OHB-System, and ZARM, with a goal of flying a 400 kg payload for up to seven days (Reference 308-309).

4.4.5 Italy

In concert with its goal to develop the Scout 2 launch vehicle, Italy is investigating potential payloads for the modest capacity booster. One of the leading concepts for a long-term program is the Carina (Capsula di Rientro Non Abitata) microgravity spacecraft. With a total mass of 450-500 kg, Carina could carry a 100-150 kg materials science payload into a 300 km, low inclination orbit for operations of up to five days.

Current designs call for a spacecraft with a diameter of 1.2 m and a height of 1.7 m at launch, including the 1.0 m diameter, 1.2 m tall reentry capsule. The payload volume would be restricted to 0.3 m³, and power would be supplied from lithium batteries. Launches would be conducted from the San Marco platform in the Indian Ocean with water recoveries nearby. Originally scheduled for a maiden flight as early as 1993, Carina may not appear until 1995 or later in an upgraded configuration capable of handling 200-300 kg payloads for missions lasting as long as three weeks. However, the status of the program is probably dependent upon a decision to continue the Scout 2 development effort.

4.4.6 Japan

As indicated in Section 4.4.4 above, Japan will play a vital role in the Express microgravity program underway with Germany by providing the necessary launch services with its M-3SII booster. If the Express program is successful, the M-3SII could be replaced by the forthcoming M-5 or J-1 boosters later in the decade.

Until 1992, Japan's opportunities for microgravity research were largely restricted to small sounding rocket flights. However, interest in orbital materials research is growing rapidly, and a late start in this field may be overcome through a variety of programs slated for the remainder of this decade.

The flight of Spacelab J in September, 1992, included 24 materials science experiments as part of the FMPT (First Materials Processing Test) program. Specific equipment tested during Spacelab J by astronaut Mamoru Mohri and his American colleagues included the Acoustic Levitation Furnace (ALF), the Continuous Heating Furnace (CHF), the Crystal Growth Experiment Facility (CGF), the Gradient Heating Furnace (GHF), the Image Furnace (IMF), the Large Isothermal Furnace (LIF), the Liquid Drop Experiment Facility (LDF), the Gas Evaporation Experiment Facility (GEF), the Organic Crystal Growth Experiment (OCF), the Bubble Behavior Experiment Unit (BBU), the Free Flow Electrophoresis Unit (FFEU), and the Marangoni Convection Experiment Unit (MCU). Japanese materials science experiments will be continued on the second International Microgravity Laboratory (References 313-314).

The first domestic microgravity spacecraft is now scheduled for launch by the H-2 booster in early 1995. Called the Space Flyer Unit (SFU), the reusable satellite is analogous to ESA's EURECA, i.e., SFU will be operated in LEO for 6-9 months conducting a variety of materials processing experiments before it is retrieved and returned to Earth by a US Space Shuttle. Also like EURECA, SFU will possess an initial mass of approximately four metric tons, including one metric ton of payload.

Mitsubishi is the prime contractor for SFU, which is being funded by the Ministry of International Trade and Industry through ISAS and NASDA in cooperation with the newly established Institute for Free Flyer Unmanned Space Experiments (USEF).

SFU consists primarily of an octagonal bus (4.6 m diameter, 2.8 m tall) and two large solar arrays (2 m by 9.6 m each) with a capacity of 2.7 kW. The solar arrays are retractable and will be stowed and redeployed several times during the mission as warranted by special experiments. The spacecraft will utilize a 3-axis stabilization system and will be equipped with a propulsion unit capable of maneuvering the vehicle to an operating altitude of nearly 500 km and returning to a lower retrieval altitude for STS (Reference 315).

The objectives for SFU are actually multi-purpose to include materials science, life science, astrophysics, and space technology experiments. The platform will also serve to test

equipment slated for use on the Japanese Experiment Module (JEM) being built for the Freedom Space Station (below). Three materials science experiments are manifested for the first SFU mission: a gradient heating furnace (1,350° C capacity), an image heating furnace (1,600° C capacity), and a mirror heating furnace (1,700° C capacity). The frequency of SFU missions will, in part, be determined by the US STS schedule.

Still in the concept development phase are two proposed space planes with primary or secondary microgravity research objectives. ISAS is studying a Highly Maneuverable Experiment Space (HIMES) vehicle which initially would be limited to sub-orbital missions of approximately 30 minutes in duration. In its current design, HIMES is a 14-metric ton class space plane with a wing span of less than 10 m and a length of nearly 14 m.

Concurrently, NASDA continues to refine the design and objectives of the H-2 Orbiting Plane (HOPE). Since its beginning in 1987, the HOPE program, which was originally linked to servicing the international Freedom Space Station, has been beset by budgeting and political difficulties. Delays and the growing costs in the H-2 development program have affected government commitments to the HOPE project (References 316-320). Both 10-metric-ton and 20-metric-ton versions of HOPE have been proposed in manned and unmanned modes of operation (Section 2.8). If eventually deployed about the turn of the century, a 10-metric-ton, unmanned HOPE could become a major element in Japan's materials science program.

A nearer term option for man-tended microgravity research will be on board JEM, which is tentatively scheduled for launch in about 1998. This space station module is described in more detail in Section 3.4. At the present, JEM is being designed to support a wide variety of scientific and technology programs, including materials science investigations. Although the majority of such experiments will probably be conducted in the Pressure Module (PM), the unique concept of replaceable Experiment Logistics Modules (ELMs) may also benefit microgravity research.

4.4.7 People's Republic of China

As noted previously, since 1987 the PRC has utilized its FSW-1 Earth observation recoverable capsule for both small materials science and life science experiments (Reference 321). The FSW-2 spacecraft which was first introduced in 1992 is also being offered to support microgravity research and with its greater capacity will probably succeed the FSW-1 as the principal carrier of such equipment. The PRC has no announced plans for developing a larger, dedicated microgravity satellite, although a second generation, multi-purpose recoverable vehicle is under consideration.

Overall technical details of the FSW-1 and FSW-2 are provided in Section 4.3.10. Specific microgravity experiment limitations for the FSW-1 are 20 kg recoverable for piggyback payloads and 150 kg recoverable/150 kg non-recoverable for a dedicated mission. Similarly, the FSW-2 offers a 300 kg recoverable payload capacity in addition to another non-recoverable 400-500 kg. Maximum flight time is approximately eight days for FSW-1 and 15 days for FSW-2.

Two drawbacks of the current FSW-1 design are the high reentry loads (up to 11 g's) and the moderate landing velocity (13-14 m/s). The European COSIMA payload flown in 1988 experienced fractures of a significant portion of the crystals grown in space. The FSW-2 will feature less stressing impact loads. On-orbit microgravity conditions are on the order of 10^{-4} - 10^{-5} g.

The domestic Chinese materials science research program appears to be still in its infancy. The first acknowledged payload for national interests was flown on FSW-1 9 which carried the first commercial payload for Matra of France. A general description of the Chinese experiments referred to smelting and recrystallization of alloys and semi-conductor materials. Specifically, the Lanzhou Physics Institute is said to have performed work with yttrium-barium-copper superconductor samples. The FSW-1 10 mission the following month (September, 1987) also carried "technological" experiments. Subsequent FSW-1 missions have been associated with biological payloads rather than materials science experiments.

References - Section 4

1. Materials presented by the Soviet delegation at the Telecom 91 Conference, Geneva, 7-15 October 1991.
2. Izvestiya, Moscow, 5 February 1992.
3. Krasnaya Zvezda, Moscow, 23 May 1992, p. 5.
4. Trud, Moscow, 14 August 1991, p. 4.
5. Izvestiya, Moscow, 15 June 1992, p. 2.
6. N. L. Johnson, "A Preliminary Analysis of the Fragmentations of the Kosmos 2125-2132 Rocket Body," Teledyne Brown Engineering Technical Report CS91-TR-JSC-007, April, 1991.
7. E. L. Jenkins and R. E. Farmer, "Cosmos 2125-2132 Rocket Body (U), Fragmentation and Breakup Report (U)," Naval Space Surveillance Center, April, 1991.
8. Izvestiya, Moscow, 31 May 1991, p. 6.
9. Izvestiya, Moscow, 21 December 1991, p. 9.
10. Network Services International, Inc., Warwick, NY, press release, 17 July 1992.
11. Gonets technical brochures issued by Applied Mechanics NPO and Precision Instruments NPO, 1991-1992.
12. Sovetskiy Patriot, Moscow, March, 1991, p. 15.
13. Global Space Communication System Coscon, brochure issued by International Innovatory Joint Venture COSCON, Moscow-Omsk, 1990.
14. Trud, Moscow, 30 May 1991, p. 2.
15. Zenit, Astro Info Service, England, March, 1991, p. 13 and April, 1991, p. 16.
16. Vozdushnyy Transport, Moscow, April 1992, p. 8.
17. Technical drawings issued by Elas NPO, 1992.
18. P. Langereux, "Project Bankir," Air and Cosmos, 6 October 1990, p. 33.
19. Ukrainian Radio, Kiev, 25 September 1992.
20. Technical brochures distributed by the Applied Mechanics NPO, Krasnoyarsk, 1990.
21. Pravda, Moscow, 23 June 1990, p. 6.
22. Sovetskaya Rossiya, Moscow, 23 June 1990, p. 12.
23. P. B. de Selding, "Soviets, Italians Plan Joint Venture," Space News, 23-28 September 1991, p. 34.
24. R. Riccitiello, "Firm Starts Russia-Italy Phone Link," Space News, 24 February-1 March 1992, p. 4.
25. Presentation by M.A. Sternberg, Chief Operating Officer of Rimsat, Ltd., Washington, 17 November 1992.
26. Pravitelstvennyy Vestnik, Moscow, May 1991, p. 12.
27. Krasnaya Zvezda, Moscow, 26 February 1991, p. 2.
28. R. Riccitiello, "Intersputnik Links East to West," Space News, 5-11 October 1992, p. 1, 21.

29. Krasnaya Zvezda, Moscow, 22 October 1991, p. 4.
30. Pravda, Moscow, 20 July 1991, p. 5.
31. D. J. Marcus, "Firms See Lucrative Pacific Business," Space News, 18-24 January 1993, p. 1, 20.
32. L. Tucci, "Rimsat To Use Gorizont for Pacific Coverage," Space News, 25-31 January 1993, p. 6.
33. "Newsmaker Forum," Space News, 20-26 April 1992, p. 22.
34. "Soviets Had Desert Storm Role," Signal, July 1991, p. 9.
35. Ekonomika I Zhizn, Moscow, May 1992, p. 5.
36. Rossiyskaya Gazeta, Moscow, 28 June 1991, p. 3.
37. Technical materials provided by Elas NPO and Applied Mechanics NPO, 1992.
38. R. Saunders "Despite Poor Economy, Satellite Business Offers New Opportunities," Space News, 9-15 March 1992, p. 4.
39. V. Kiernan, "New System to Connect Russia, U.S.," Space News, 22 June-5 July 1992, p. 12.
40. Sovetskaya Rossiya, Moscow, 26 November 1991, p. 1.
41. Izvestiya, Moscow, 20 December 1991, p. 9.
42. TASS, Moscow, 16 and 18 September 1991.
43. Express technical brochures distributed by Applied Mechanics NPO, 1990-1992.
44. Krasnaya Zvezda, Moscow, 21 June 1991, p. 4.
45. Krasnaya Zvezda, Moscow, 15 December 1990, p. 6.
46. Nezavisimaya Gazeta, Moscow, 13 May 1992, p. 6.
47. Izvestiya, Moscow, 16 June 1992.
48. Gals technical brochures distributed by Applied Mechanics NPO, 1990-1992.
49. V. Kiernan, "Soviets To Increase Satellite TV Broadcast Capacity," Space News, 6-12 May 1991, p. 24.
50. ITAR-TASS, Moscow, 25 November 1992.
51. Gelikon technical brochures distributed by Applied Mechanics NPO, 1990-1992.
52. Arcos technical brochures distributed by Applied Mechanics NPO, 1990-1992.
53. Granit technical papers, Space Commerce Corporation, 1989.
54. "Soviets Consider Developing C/Ku-Band Commercial Satellite," Aviation Week and Space Technology, 12 June 1989, p. 67.
55. Fact Sheets for Global Information Systems, Inc., and Globostar by GIS, Inc., Moscow, 1992.
56. C. Lee, "Joint Venture to Sell Russia Satellites," South China Morning Post, 10 December 1992, p. Business 4.
57. "Another Satellite Venture Aims for Asian Market," Space News, 14-20 December 1992, p. 18.

58. Komsomolskaya Pravda, Moscow, 15 February 1991, p. 2.
59. Delovoy Mir, Moscow, 4 July 1992, p. 7.
60. Integrated Satellite Information System, Energiya NPO and Energiya-Marathon Association, 1991.
61. Global Space System Based on Theory Space Platforms Utilization, Energiya NPO, 1991.
62. Sotsialisticheskaya Industriya, Moscow, 30 May 1989, p. 4.
63. P. B. de Selding, "Energiya to Build Hugh Satellite," Space News, 10-16 August 1992, p. 17. See also, Izvestiya, Moscow, 28 December 1992, p. 3.
64. Kommersant Daily, Moscow, 6 November 1992.
65. V. Kiernan, "Russians Develop, Big, Heavy, Cheap Communications Satellite," Space News, 30 November-6 December 1992, p. 26.
66. B. Knapp, "Com Dev Buys Into Soviet Satellite Venture," Space News, 14-20 October 1991, p. 10.
67. Radio Canada International, 19 June 1992.
68. "Russians, Sov Can Star Formalize Joint Venture," Space News, 6-19 July 1992, p. 14.
69. D. Hughes, "Soviet-Canadian Joint Venture to Design, Launch Satellites," Aviation Week and Space Technology, 12 November 1990, p. 77-78.
70. P. Langereux, "Soviet Union and Germany Prepare Romantis," Air and Cosmos, 6 October 1990, p. 36-37.
71. P. B. de Selding, "Germans May Barter Satellites for Troop Withdrawal," Space News, 14-20 October 1991, p. 10.
72. P. B. de Selding, "Germans Test Scaled-Down Romantis Plan," Space News, 14-20 December 1990, p. 6.
73. "Telecommunications: The OTS legacy," Spaceflight, January, 1989, p. 22-23.
74. "ESA and Telecommunications," All About the European Space Agency, ESA, August, 1992.
75. European Space—On Course for the 21st Century, ESA, BR-39, 1987.
76. "The Telecommunications Programme," ESA f-05, March, 1989.
77. D. Smith, "Olympus, A Giant Amongst Satellites," Spaceflight, November, 1989, p. 386-387.
78. Europe in Space, ESA, January, 1983.
79. ESA Annual Report 1991, ESA, 1992.
80. R. Riccitiello, "ESA Works to Improve Telecommunications," Space News, 27 April-3 May 1992, p. 6, 8.
81. "Future ESA Space Plan Agreed," Spaceflight, December, 1992, p. 376.
82. R. Riccitiello, "ESA Goes Ahead With Data Relay Satellite Plans," Space News, 12-18 October 1992, p. 1, 28.
83. C. Covault, "Europe Sets \$26-Billion Space Program for 1990's," Aviation Week and Space Technology, 16 November 1992, p. 23-25.
84. R. Riccitiello, "Alenia Wins ESA Contract for Communications System," Space News, 5-11 October 1992, p. 10.

85. R. Riccitiello, "ESA Archimedes Project to Use Elliptical Orbits," Space News, 18–24 May 1992, p. 10.
86. P. B. de Selding, "French, Swiss Reluctance May Stall Europesat," Space News, 28 October–1 November 1992, p. 12.
87. A. Wilson, Interavia Space Directory 1992–1993, Jane's Information Group, 1992, p. 366-368.
88. CNES Annual Report 1990, CNES, 1991.
89. A Lightning Tour Through CNES, CNES, 1992.
90. Telecom 2 technical brochure, Matra Marconi Space, 1992.
91. T. Pirard, "DBS to Begin in Europe," Spaceflight, January, 1988, p. 24–25.
92. S80T Micro-Satellite, specification and program sheet, Matra Marconi Space, 1992.
93. "German Consortium to Compete for Third World Satellite Market," Aviation Week and Space Technology, 9 June 1986, p. 117.
94. Annual Report, Department of Space, India, 1983–1984, 1984–1985, 1985–1986, 1986–1987, 1988–1989. See also, U. R. Rao, *et al.*, "The Indian National Satellite System–INSAT," Space Communication and Broadcasting, 1987, p. 339–358.
95. J. M. Lenorovitz, "India Seeks Larger Role in Commercial Satellite Market," Aviation Week and Space Technology, 27 July 1992, p. 57.
96. U. R. Rao, "Space Helps India Develop," Part 2, Space, November–December, 1988, p. 15, 17–18.
97. Inmarsat-3, Mobile Satcoms Payload, technical brochure distributed by Matra Marconi Space, 1992.
98. C. Simpson, "Inmarsat-3, A Satellite Ahead of its Time," Spaceflight, January, 1993, p. 18-19.
99. S. Fisher, "Israel Joins Up," Space, January –February, 1991, p. 12–14.
100. S. Parnes, "Funds Sought for Amos Project," Space News, 20–26 April 1992, p. 18.
101. "Ministers Approve 1993 Launch of IAI's Amos Satellite," Aerospace Daily, 9 June 1989, p. 410.
102. "Israeli Satellite Advances," Signal, December, 1989, p. 10.
103. S. Parnes, "Israeli Students Begin Work on Techsat 1 Satellite," Space News, 31 August–6 September 1992, p. 34.
104. R. Riccitiello, "Italsat Launch to Improve Telecommunications," Space News, 16–22 March 1992, p. 8.
105. Space in Japan 1988–89, Federation of Economic Organizations, 1988.
106. N. W. Davis, "Japan Expands Research on Communications Satellites," Aerospace America, August, 1992, p. 22–24.
107. NASDA Report No. 5, August, 1989, p. 12–14.
108. NASDA Report No. 2, November, 1988, p. 4–5.
109. NASDA Report No. 1, August, 1988, p. 2–3.
110. NASDA, 1987, p. 20.
111. D. J. Marcus, "G.E. Maintains Foothold in Key Japanese Market," Space News, 14–20 September 1992, p. 4.

112. K. P. Dawson, "Satellite Use Doubles Japanese TV Channels," Space News, 27 July–9 August 1992, p. 6, 10.
 113. K. P. Dawson, "Communications Satellite Binge Begins to Slow," Space News, 27 July–9 August 1992, p. 6, 10.
 114. "Losing Bidders Criticize Hughes Satellite Award," Aviation Week and Space Technology, 8 June 1992, p. 69.
 115. R. Riccitiello, "Thor Slow to Steal Astra's Thunder," Space News, 1–7 February 1993, p. 16.
 116. S. Mehmud, "Pakistan's Space Programme," Space Policy, August, 1989, p. 217–226.
 117. P. Proctor, "Pakistan's Space Agency Building Second Experimental Satellite," Aviation Week and Space Technology, 10 August 1992, p. 46.
 118. Liu Ji-yuan and Min Gui-rong, "The Progress of China's Astronautics," U.S. Space Foundation Space Symposium, January, 1987.
 119. Min Gui-rong, "China's long march catching up in space," Space Technology International 1992, p. 91–92.
 120. Wu Guoxiang, "China's space communications goals," Space Policy, February, 1988, p. 41–45.
 121. G. L. May, "China Advances in Space," Spaceflight, November, 1988, p. 428–433.
 122. Liu Lin-hui, "Development and Flight Performances of China's Satellite Power Systems," Space Power, 1988, p. 261–265.
 123. R. Riccitiello, "Hispasat Up; Future of Satellite Unclear," Space News, 14–20 September, p. 12.
 124. R. Riccitiello, "Spain, Matra Near Major Milestone," Space News, 7–13 September 1992, p. 8.
 125. Polyot. Omsk. Russia, advertising brochure distributed by the Polet PO, 1990–1991.
 126. P. Daly and G. E. Perry, "Recent Developments with the Soviet Union's VHF Satellite Navigation System," Space Communication and Broadcasting, Vol. 4, 1986, p. 51–61.
 127. P. Daly and G. E. Perry, "Update on the Behavior of the Soviet Union's VHF Satellite Navigation System," Space Communication and Broadcasting, Vol. 5, 1987, p. 379–384.
 128. The USSR in Outer Space. The Year 2005., Glavkosmos, Moscow, 1989.
 129. The RAE Table of Earth Satellites, monthly supplement dated 2 April 1992, p. 1085 b.
 130. G. E. Perry, "A Kettering Miscellany," Proceedings of the 6th AMSAT-UK Colloquium, 25–28 July 1991, Reference 11, p. 56.
 131. Yu. Kravtsov, "The Space Program Serving Science and the Economy, Search and Rescue System," Aviatsiya I Kosmonavtika, October, 1988, p. 44–45.
 132. "Soviets Launch Nadezhda Navigation Satellite," Aerospace Daily, 15 March 1991, p. 444.
 133. For a more detailed description of how the GLONASS system operates, see G. I. Moskin and V. A. Sorochinsky, "Navigational Aspects of GLONASS," GPS World, January–February, 1990, p. 50–54.
- P. Daly, "NAVSTAR GPS and GLONASS – Global Satellite Navigation Systems," Paper IAF-89-396, 40th Congress of the International Astronautical Federation, 7–12 October 1989, Malaga, Spain.
- P. Raby, S. Riley, and P. Daly, "Initial Results of Integrity Monitoring Tests on GPS/GLONASS," Department of Electronic and Electrical Engineering, University of Leeds, UK, November, 1991.

- T. G. Anodina, "The GLONASS System Technical Characteristics and Performance," Working Paper FANS/4-WP/75, International Civil Aviation Organization, 6 May 1988, Montreal, Canada.
134. Navigation Satellite "GLONASS", technical specifications distributed by the Applied Mechanics NPO, Krasnoyorsk, 1991.
 135. N. Ivanov and V. Salischev, "GLONASS System – Overview," Institute of Space Device Engineering, November, 1991. See Also B. D. Nordwall, "Flight Tests Highlight New GPS Uses, Emphasize Need for GPS/Glonass System," Aviation Week and Space Technology, 2 December 1991, p. 71–73, and R. Saunders, "Airline Tests Navigation Satellite Link," Space News, 6–12 May 1991, p. 22–23.
 136. For example, see Vodnyy Transport, Moscow, 12 September 1991, p. 2.

P. J. Klass, "Inmarsat Decision Pushes GPS to Forefront of Civil Navsat Field," Aviation Week and Space Technology, Moscow 14 January 1991, p. 34–35.

D. Hughes, "U.S. and Soviets Offer Civil Aviation Free Access to Satellite Navigation Signals," Aviation Week and Space Technology, 9 September 1991, p. 38.

D. Hughes, "ICAO Delegates Back FANS Concept, Set Stage for Global Satellite Systems," Aviation Week and Space Technology, 14 October 1991, p. 36, 43.
 137. G. E. Perry, *ibid.*, p. 40.
 138. V. Pankonin, Interference to Radio Astronomy from GLONASS Transmissions in the Frequency Band 1600–1615 MHz, National Science Foundation, August, 1985.
 139. R. J. Cohen, "The Threat to Radio Astronomy from Radio Pollution," Space Policy, May, 1989, p. 91–93.
 140. V. Kiernan, "Noise Pollution or Navigation?," Space News, 25 February–3 March 1991, p. 4, 29.
 141. P. V. Bout, "Protect Radio Astronomers from Noisy Satellites," Space News, 16–22 December 1991, p. 15.
 142. Geodetic Satellite GEO-1K, technical specifications distributed by the Applied Mechanics NPO, Krasnoyarsk, 1991.
 143. V. S. Avduyevsky and G. R. Uspensky, Scientific and Economy-Oriented Space Systems, Mir Publishers, Moscow, 1988, p. 212–260.
 144. S. K. Tatevian, "The Space Geodetic Complex 'GEO-1K'," CSTG Bulletin, No. 11, International Coordination of Space Techniques for Geodesy and Geodynamics, 1989, p. 9–11.
 145. Izvestiya, Moscow, 23 July 1990, p. 2.
 146. S. K. Tatevian and A. N. Zakharov, "The Geodynamical Satellite 'Etalon'," CSTG Bulletin, No 11, International Coordination of Space Techniques for Geodesy and Geodynamics, 1989, p. 3–8.
 147. V. P. Bass and S. K. Tatevian, Astronomicheskiv Zhurnal, November–December, 1990, p. 1315–1325.
 148. "News Breaks," Aviation Week and Space Technology, 15 July 1991, p. 17.
 149. CNES Annual Report 1990, CNES, Paris, 1991, p. 30–31.
 150. "Laser Reflectors on New Italian Satellite," Spaceflight, September, 1988, p. 348.
 151. "ASI: Lageos Operational Weeks Ahead of Schedule," Space News, 9–15 November 1992, p. 11.
 152. Space in Japan, 1988–89, Research and Development Bureau, Science and Technology Agency, 1988, p. 16.

153. Great Wall Industry Corporation brochure, China, circa 1985, p. 19.
154. G. L. May, "China Advances in Space," Spaceflight, November, 1988, p. 432,
155. Liu Ji-Yuan and Min Gui-rong, "The Progress of China's Astronautics," presented at the U.S. Space Foundation Symposium, Colorado Springs, Colorado, 22 January 1987, p. 6.
156. Min Gui-rong, "China's Long March Catching Up in Space," Space Technology International, 1992, p. 92.
157. Xinhua News Agency, Beijing, 13 February 1993.
158. Xinhua News Agency, Beijing, 9 December 1992.
159. Pravda, Moscow, 3 February 1992, p. 3
160. Izvestiya, Moscow, 17 September 1992.
161. Signal Transmissions were monitored regularly by the international Kettering Group and by Grant Zehr in the United States.
162. Information on Meteorological and other Environmental Satellites, Second Edition, WMO-No. 411, World Meteorological Organization, 1989, p. V-10-V-16.
163. "Meteor-3" Space Station for Hydrometeorological Observation, Soviet Association for Earth Remote Sensing and the All-Union Research Institute of Electromechanics, Moscow, 1991.
164. Automatic Spacecraft "Meteor-3", V/O Sovelectro, Moscow, 1989.
165. "Soviets to Test-Fly a Meteor 3 Before August TOMS Launch," Aerospace Daily, 24 January 1991, p. 134.
166. Pravda, Moscow, 15 August 1991, p. 3 and 17 August 1991, p. 2.
167. Izvestiya, Moscow, 16 August 1991, p. 1-2; 19 August 1991, p. 3; and, 16 September 1991, p. 2.
168. D. Isbell, "Soviets To Launch U.S. Ozone Mapper," Space News, 5-18 August 1991, p. 14.
169. C. Covault, "Soviets Open Plesetsk to U.S. Group for Joint Satellite Mission Launch," Aviation Week and Space Technology, 19 August 1991, p. 30.
170. "TOMS Working Properly, Cooperation Progressing," Space News, 2-8 December 1991, p. 20.
171. Izvestiya, Moscow, 17 September and 29 December 1992.
172. Study of Our Planet: The French Space Effort, CNES, Paris, 1992, p. 14-17.
173. Spacecraft "Meteor-3M" Reference Book, USSR State Committee for Hydrometeorology, Ministry of the Electrotechnical Industry, Moscow, 1990.
174. Space System with Geostationary Meteorological Satellite (GOMS), Soviet Association for the Earth Remote Sensing, Moscow, 1991.
175. Information on Meteorological and Other Environmental Satellites, op-cit., p. V-26-V-28.
176. "Russians Plan 1993 Launch of GOMS Weather/Telecom Satellite," Aviation Week and Space Technology, 1 June 1992, p. 70-71.
177. Y. Andreotti, Advances of Science and Technology, No. 21, 5 November 1985, p. 1-5.
178. Information on Meteorological and other Environmental Satellites, op cit., p. V-17-V-22.

179. A. I. Kalmykov, et al., Determination of Oceanic Surface Structure with "Cosmos-1500" Satellite Side Looking Radar, Intercosmos Council, Moscow, 1984.
180. M. V. Bukharov, et al., Issledovaniye Zemli Iz Kosmosa, May-June 1991, p. 26-32.
181. A. I. Kalmykov, "Space-based Prediction of Catastrophes," NTR: Problemy I Resheniya, Moscow, 1989, p. 3.
182. The "Yuzhnoye" Scientific-Production Association (NPO), Rocket-Space Research and Test Centre, Dnepropetrovsk, 1989.
183. Resours-O Space System for Ecological Monitoring, Soviet Association for the Earth Remote Sensing, Moscow, 1991.
184. Multispectral Space Imaging of the Earth. Space Remote Sensing System "Resource-O1." two versions, GLAVKOSMOS, Moscow, 1991.
185. State-of-the-Art and Prospects for Earth Resources and Hydrometeorological Satellite System Development, USSR State Committee for Hydrometeorology, State Research Center for Earth Resources Exploration, Moscow, 1988, p. 31-36.
186. Y. Israel, et al., "The Space Ecological Monitoring of Cities and Suburban Areas with the Use of 'Resource-O1' Satellite," Paper IAF-89-143, 40th Congress of the International Astronautical Federation, 7-12 October 1989.
187. Preliminary Technical Description of Commercial Remote Sensing Capability, GLAVKOSMOS and Space Commerce Corporation, 1989.
188. Y. Novikov and A. Dula, "Ecological Monitoring from Space," 1991.
189. Y. Trifonov, "Commercial Spacecraft for the Exploration of the Earth's Natural Resources," All-Union Science Research Institute of Electromechanics, Moscow, 1989.
190. A. S. Selivanov, et al., "Basic Parameters of Terrestrial Reception Facilities and Recording Systems of 'Resource'," 1989.
191. Information from the "Resurs-O1 No. 2 Satellite, 1989.
192. Information on Meteorological and Other Environmental Satellites op-cit. p. V-23-V-25.
193. Small Stations for Reception of Information from Spacecraft of "Resurs" System Used for Exploration of Natural Resources, GLAVKOSMOS, Moscow, 1990.
194. I. B. Afanasyev, "Unknown Spacecraft," Izdatelstvo Znaniye, Moscow, December, 1991.
195. H. A. Yefremov and W. B. Wirin, "Almaz Satellites," Paper IAF-91-153, 42nd Congress of the International Astronautical Federation, 1991.
196. D. Massonnet, et al., "Advanced Use of Almaz Radar Data," Paper IAF-92-108, 43rd Congress of the International Astronautical Federation, 1992.
197. Almaz. Radar Remote Sensing Satellite. Buyer's Guide, Space Commerce Corporation, Houston, 1990.
198. Radar Data Processing Center Structure Technical Proposal, Special Design Section, Moscow Energy Institute, 1989.
199. S. Omelchenko, Vozdushnyy Transport, Moscow, May, 1992, p. 8-9.
200. V. F. Pankin, Soviet Satellite Cameras, Soyuzkarta, Moscow, 1989.
201. "Description of the Information Obtained from Resource-F Earth Observation Spacecraft," Soyuzkarta, Moscow, 1989.

202. G. P. Anshakov, *et al.*, "Earth Resources and Research Automated Spacecraft," Photon Design Bureau, Kuybyshev, 1989.
203. "Satellite Optical Products," advertising brochure issued by Wirin and Associates, Palm Springs, 1992.
204. Sotsialisticheskaya Industriya, Moscow, 17 September 1989, p. 4.
205. N. A. Armand and B. G. Kutuza, "International Space Project of the Earth Remote Sensing 'Priroda'," Paper IAF-90-103, 41st Congress of the International Astronautical Federation, 1990.
206. "77 KSI Research Module, Purpose and Description," M. V. Khrunichev Machine Building Plant, Fili, 1989.
207. B. Z. Petrenko and S. V. Sokolovskiy, Issledovaniye Zemli Iz Kosmosa, Moscow, March-April, 1989, p. 123.
208. "77 KSO Optical Research Module, Purpose and Description," M. V. Khrunichev Machine Building Plant, Fili, 1989.
209. A. Lawler, "Environmental Satellite Plan Unveiled by Soviets," Space News, 22-28 October 1990, p. 27.
210. C. Lardier, "Les Nouveaux Projets de Lavotchkine," Air and Cosmos, 25 October 1992, p. 49-50.
211. "'Tellura-EKO' Space Station," Salyut Design Bureau, Experimental Machine Building NPO, Moscow, 1991.
212. "'Salyut' Design Bureau of Experimental Engineering Industry NPO," undated prospectus for the Proton launch vehicle and three conceptual spacecraft.
213. EUMETSAT, brochure of Meteosat system description, EUMETSAT, 1992.
214. MOP 2, ESA C-6, ESA and EUMETSAT, January, 1991.
215. METEOSAT, Aerospatiale, 1992.
216. EUMETSAT Annual Report 1991, EUM AR 04, EUMETSAT, 1991.
217. Bright Eyes, ESA C-7 ESA, April, 1991.
218. M. Rosengren, "ERS-1 - An Earth Observer That Exactly Follows its Chosen Path," ESA Bulletin, No. 72, November 1992, p. 76-82.
219. "Radar Imager on ERS-1 Taking 700 Images Daily," Space News, 19-25 October 1992, p.12.
220. R. Riccitiello, "ERS-1 Ocean Imaging Exceeds Initial Expectations," Space News, 8-14 June 1992, p. 8.
221. M. Mecham, "Europeans Prepare to Build on Early ERS Satellite Success," Aviation Week and Space Technology, 13 July 1992, p. 68-69.
222. P. B. de Selding, "Dual ERS Operations Sought for '95," Space News, 8-14 March 1993, p. 6.
223. C. A. Shifrin, "Polar Platform To Offer Constant Earth Observation," Aviation Week and Space Technology, 29 March 1993, p. 25-26.
224. R. Saunders, "SPOT Chooses Mid-1998 For Self-Sufficiency," Space News, 21 January-3 February 1991, p. 33.
225. G. Brachet, "The French SPOT Programme," The Cambridge Encyclopedia of Space, 1990, p. 238-241.
226. R. Riccitiello, "Retired SPOT 1 May Return to Active Duty in 1993," Space News, 23-29 November 1992, p. 16.

227. R. Riccitiello, "Odetics Upgrade Tape Recorders on SPOT 3," Space News, 30 November–6 December 1992, p. 12.
228. J. M. Lenorovitz, "Spot Image Plans Better Resolution on Next Generation of Satellites," Aviation Week and Space Technology, 15 June 1992, p. 94–97.
229. R. Riccitiello, "France, SPOT Plan New Satellite Design Before 2000," Space News, 25–31 January 1993, p. 18.
230. "France Defines Satellite to Complement Spot Series," Aviation Week and Space Technology, 23 October 1989, p. 48.
231. Study of Our Planet: The French Space Effort, CNES, 1991, p. 25.
232. DARA Information 1991. Space Research for a Global Perspective, DARA, Bonn, June, 1991.
233. Experiments in Space. The Second German Spacelab Mission D-2, DLR, Cologne–Porz, March, 1992.
234. Annual Report 1988–89, Department of Space, Government of India, Bombay, 1989.
235. A. Lawler, "India's IRS-1C Satellite To Offer Sharper Images," Space News, 25–31 May 1992, p. 11.
236. "India Building Follow-On Remote Sensing Spacecraft," Space Fax Daily, 23 November 1992, p. 1.
237. V. Raghuvanshi, "Germany to Supply Part for India's IRS-P2," Space News, 8–14 February 1993, p. 20.
238. Geostationary Meteorological Satellite-4 [HIMAWARI-4], technical brochure distributed by NASDA, Tokyo, 1991.
239. Geostationary Meteorological Satellite-5 [HIMAWARI-5], technical brochure distributed by NASDA, Tokyo, 1991.
240. "Japan's New Space Bid," Spaceflight, April, 1987, p. 138–141.
241. Space in Japan 1988–89, Research and Development Bureau, Science and Technology Agency, Tokyo, 1989.
242. N. W. Davis, "Japan Stresses Multisatellite Remote Sensing," Aerospace America, March, 1993, p. 28.
243. K. P. Dawson, "Balky Radar Antenna Threatens JERS-1 Mission," Space News, 17–23 February 1992, p. 3, 21.
244. "Controllers Struggle With Radar Antenna on JERS-1 Satellite," Aviation Week and Space Technology, 17 February 1992, p. 21.
245. "Japanese Relief as JERS-1 Antenna Finally Deploys," Spaceflight, June, 1992, p. 188.
246. K. P. Dawson, "JERS Producing Flawed Imagery," Space News, 14–20 December 1992, p. 22.
247. P. Proctor, "Japan Plans New Generation of Remote Sensing Satellites," Aviation Week and Space Technology, 13 July 1992, p. 66–67.
248. D. J. Marcus, "Japan Plans Missions for Earth Observation," Space News, 18–24 March 1991, p. 23.
249. "Japanese Earth Satellites Spawn Multiple User Groups," Aviation Week and Space Technology, 13 August 1990, p. 70–72.
250. S. Mehmud, "Pakistan's Space Programme," Space Policy, August, 1989, p. 217–226.
251. P. Proctor, "Pakistan's Space Agency Building Second Experimental Satellite," Aviation Week and Space Technology, 10 August 1992, p. 46.

252. Radio Pakistan, 27 February 1993.
253. Lin Hua-bao and Min Gui-rong, "The Chinese Recoverable Satellite Program," Paper IAF-89-426, 40th Congress of the International Astronautical Federation, October, 1989.
254. Recoverable Satellite FSW. Microgravity Test Platform, Chinese Academy of Space Technology, Beijing, 1987.
255. J. Zhaogian and G. Lynwood-May, "China's Developing Space Program," Signal, February 1986, p. 27.
256. H. Changchui, "The Development of Remote Sensing in China," Space Policy, February, 1989, p. 65-74.
257. Liu Ji-yuan and Min Gui-rong, "The Progress of China's Astronautics," U.S. Space Foundation Symposium, Colorado Springs, 1987.
258. Xinhua News Agency, Beijing, 6 January 1993.
259. Xinhua News Agency, Beijing, 13 October 1992.
260. Xinhua News Agency, Beijing, 25 August 1992.
261. Xinhua News Agency, Beijing, 3 September 1992.
262. Space in China. Launch Services and Space Technology, China Great Wall Industry Corporation, Beijing, 1989.
263. Chuijun Weng, et al, "Remote Sensor on the FY-1 Satellite," Paper IAF-92-099, 43rd Congress of the International Astronautical Federation, August-September, 1992.
264. C. Covault, "Chinese Seek U.S. Assistance in Weather Satellite Program," Aviation Week and Space Technology, 5 August 1985, p. 79-81.
265. Min Gui-rong, "China's Long March Catching Up in Space," Space Technology International, 1992, p. 91-92.
266. Chen Fang-yun, et al, "Earth Environment Observing Satellite System and International Cooperation," Paper IAF-92-138, 43rd Congress of the International Astronautical Federation, August-September, 1992.
267. Xinhua News Agency, Beijing, 13 January 1993.
268. China-Brazil Resources Satellite-CBERS, technical brochure, Instituto Nacional de Pesquisas Espaciais, 1992.
269. Yonhop News Agency, Seoul, 10 August 1992.
270. A. Lawler, "South Korea Plans To Build, Launch Satellites," Space News, 28 May-3 June 1990, p. 1, 20.
271. Principal Technical Characteristics of the Space Vehicle "Photon" and Specifications of its Scientific Instrumentation, GLAVKOSMOS, Moscow, 1987.
272. G. P. Anshakov, et al, "Earth Resources and Research Automated Spacecraft," Photon Design Bureau, 1989.
273. Spacecrafts for the Production of Materials and Microgravity Experiments, Photon Design Bureau, GLAVKOSMOS, 1990.
274. Wide Experience in Developing of Space Technology, Photon Design Bureau, 1990.
275. TASS World Service, Moscow, 27 September 1991.

276. P. Hoffman, *et al.*, "Crystal Growth Experiments on Russian Unmanned Spacecraft," Paper IAF-92-934, 43rd Congress of the International Astronautical Federation, August–September, 1992.
277. "Russian Capsule Returns German Firm's Experiment," Space News, 2–8 November 1992.
278. P. B. de Selding, "French to Adapt Soviet Capsule for Western Clients," Space News, 11–18 November 1991, p. 17.
279. "Germans Plan Automated Tether Test," Space News, 31 August–6 September 1992, p. 2.
280. J. M. Lenorovitz, "Soviets Book New Commercial Payloads Grant Greater Access to Space Facilities," Aviation Week and Space Technology, 9 October 1989, p. 121–123.
281. P. B. de Selding, "Intospace Discloses Failure on Latest Microgravity Flight," Space News, 6–12 August 1990, p. 1, 38.
282. "Intospace Launches New Experiment, Pinpoints Cause of Earlier Failure," Aviation Week and Space Technology, 24 September 1990, p. 43.
283. "The Nika-T," GLAVKOSMOS, Moscow, 1989.
284. Lavochkin, prospectus distributed by Lavochkin NPO, Moscow region, 1990.
285. Space Apparatus "Mercury", prospectus distributed by Lavochkin NPO, Moscow region, 1991.
286. P. Longereux, "Premier Satellite 'Lavochkine' en 1993," Air and Cosmos, 6 October 1990, p. 32.
287. Lavochkin Spacecraft, prospectus distributed by Lavochkin NPO, Moscow region, 1991.
288. C. Lardier, "Les Nouveaux Projets de Lavotchkine," Air and Cosmos, 25 October 1992, p. 49–50.
289. Izvestiya, Moscow, 29 May 1992, p. 2.
290. Moskovskiye Novosti, Moscow, 15 November 1992, p. 6.
291. Space Biotechnological Complex for Light Weight Spacecrafts, technical specifications distributed by Salyut Design Bureau, Moscow, 1991.
292. Unified Space Platform, technical specifications brochure, Salyut Design Bureau, Moscow, 1991.
293. Technologiya Spacecraft, technical specifications brochure, Salyut Design Bureau, Moscow, 1991.
294. Pravda, Moscow, 17 May 1990, p. 3.
295. Orbital Plant. Unique Materials and Preparations Production in Space Environment, Salyut Design Bureau, Moscow, 1991.
296. Zemlya i Vselennaya, Moscow, March–April 1992, p. 18–25.
297. Moscow Radio, Moscow, 7 August 1990.
298. European Space – On Course or the 21st Century, ESA BR-39, ESA, Paris, 1987.
299. Spacelab Data Book, ESA BR-14, ESA, Paris, 1983.
300. D. J. Shapland, "Spacelab and the Space Shuttle," The Cambridge Encyclopedia of Space, Cambridge, 1990, p. 278–283.
301. EURECA, ESA BR-16, ESA, Paris, 1983.
302. J. R. Asker, "Eureca Will Offer New Capabilities for Extended Microgravity Experiments," Aviation Week and Space Technology, 20 July 1992, p. 46–47.

303. R. Riccitiello, "ESA Budget May Exclude Eureka," Space News, 24–30 August 1992, p. 10.
304. P. B. de Selding, "Eureka Platform May Be Retired After Retrieval," Space News, 1–7 March 1993, p. 4.
305. "Information File," CNES, May 1992.
306. "Antares Press Kit," CNES, July 1992.
307. Experiments in Space. The Second German Spacelab Mission D-2, DLR, Cologne-Porz, March, 1992.
308. "Japan and Germany Plan Launch," Aviation Week and Space Technology, 18 January 1993, p. 13.
309. A. Wilson, Interavia Space Directory 1992–93, Jane's Information Group, London, 1992, p. 516–517.
310. "Italy Bets on Bantonweight Carina," Space News, 9–15 July 1990, p. 2.
311. R. DeMeis, "Alenia," Aerospace America, November, 1992, p. 10–11, 39.
312. A. Wilson, op-cit., p. 518.
313. C. Covault, "First Japanese Shuttle Astronaut Set for 1991 Spacelab J Flight," Aviation Week and Space Technology, 27 August 1990, p. 72–75.
314. J. R. Asker, "U.S., Japan Ready Spacelab Flight," Aviation Week and Space Technology, 7 September 1992, p. 39.
315. "First Japan Reusable Spacecraft to Carry Science, Technology Payload," Aviation Week and Space Technology, 20 August 1990, p. 70-74.
316. "Japanese Panel Recommends Spaceplane Development," Aviation Week and Space Technology, 6 July 1987, p. 31.
317. "Japan Showcases Maturing Space Program, Manufacturing Capabilities," Aviation Week and Space Technology, 19 June 1989, p. 66–70.
318. S. W. Kandebo, "Japanese Refining Unmanned HOPE Orbiter for Planned 1996 Launch," Aviation Week and Space Technology, 3 April 1989, p. 57–58.
319. "Space Agency Considers Doubling Size of HOPE Unmanned Space Vehicle," Aviation Week and Space Technology, 13 August 1990, p. 65–68.
320. K. P. Dawson, "Japan's Space Plane Faces Termination or Shrinking," Space News, 23–29 November 1992, p. 3.
321. "China Would Lease Payload Space on Its Recoverable Satellites," Aerospace Daily, 25 February 1987, p. 286–287.

5.0 SPACE SCIENCE AND EXPLORATION PROGRAMS

Whereas the applications satellites described in the previous section provide essential support services with direct economic impact on national and international markets, space science and exploration programs, in particular those dedicated to life sciences, geophysics, astrophysics, and solar system exploration, enjoy greater notoriety. On the whole, science missions also represent the most costly undertakings with the exception of manned space flight. Consequently, in recent years a significant portion of such missions involves widespread international participation. This section focuses on unmanned, near-Earth and deep space probes, with brief descriptions of manned space science activities included with appropriate references to related summaries appearing in Section 3.

5.1 Life Sciences

The study of the effects of space travel on living organisms predated the launch of Sputnik 1 in 1957 through extensive high altitude ballistic flights conducted by the US and the USSR beginning shortly after World War II. Once orbital flights were possible, the range of life sciences experiments on all levels of biology and botany, from simple cells to man himself, quickly expanded. For more than 30 years the short-term and long-term effects of microgravity and radiation on the maintenance and reproduction of life in space have been the subject of intense scientific investigations by researchers around the world. To date, citizens from more than two dozen nations have flown in space, and numerous European and Asian countries are currently pursuing significant life sciences space programs.

5.1.1 USSR/CIS

The USSR was the first space-faring power, and, not surprisingly, orbited the world's first biosatellite. Sputnik 2, launched less than a month after its world-shocking predecessor, contained a female dog named Laika in an instrumented and pressurized chamber. Launched 3 November 1957, Sputnik 2 returned biological, movement, and sound data on Laika until her oxygen supply was depleted after seven days. Fourteen dogs and one rabbit had

previously been launched during Soviet vertical rocket tests, and numerous dogs and other small animals and insects were later orbited during the early years of the Soviet space program (Reference 1).

The largest effort in the life sciences on the part of the CIS is the Bion, or Biokosmos, program, managed by the Institute of Biomedical Problems in Moscow. Bion is an ongoing program that has orbited ten satellites over twenty years. Unlike Sputnik 2, all Bion satellites have been recovered after reentry, though some minor casualties have occurred in the program. Participation in Bion is truly international, with countries other than CIS participating in all but the first mission and with the US participating in the eight missions since 1975.

All Bion missions have used a modified Vostok recoverable capsule as shown in Figure 5.1. This vehicle is a derivative of the spacecraft used by Yuri Gagarin on his historic orbital flight in 1961. Similar Vostok-derived craft still in use include the Photon microgravity/materials research satellites and the Resurs-F Earth environment/resource monitoring systems, produced by the Samara Specialized Design Bureau led by Dmitri Ilyitch Kozlov. The Bion experiment (reentry) chamber is a 2.3 m diameter sphere with two 1.2 m access hatches. The scientific payload is about 1,000 kg, while the overall spacecraft mass is about six metric tons. All Bion missions have been launched by SL-4 launch vehicles from Plesetsk (Reference 2).

Throughout the history of the Bion program, several notable and sometimes humorous incidents have occurred. The mission of Bion 3 (Kosmos 782) was cut short because of threatening snowstorms in the intended satellite recovery area. Soviet scientists reported "wintry" conditions during recovery and were forced to erect shelters at the landing site. Yerosha, one of the monkeys on Bion 8 (Kosmos 1887) partially freed himself and explored his orbital cage, much to mission controllers' dismay and the popular media's delight. On reentry, Bion 8 then missed its intended touchdown point by about 3,000 km, causing the demise of several fish in frigid weather. Bion 9 (Kosmos 2044) experienced temperature control problems three days before reentry, killing some ants and earthworms that were part

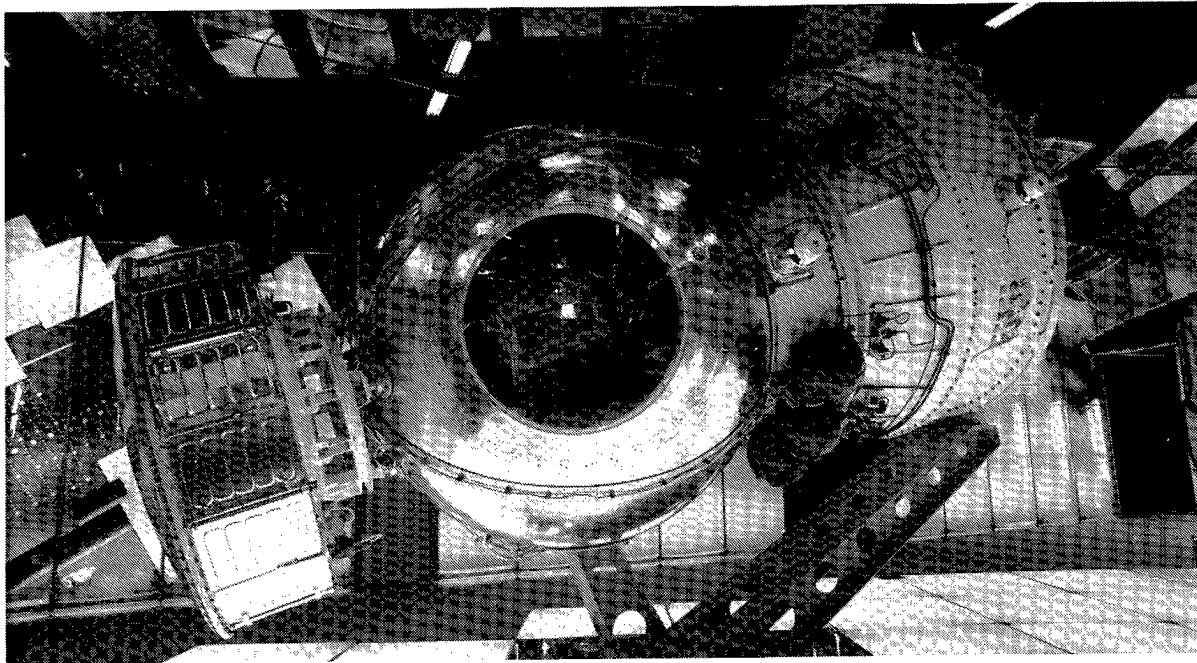

Figure 5.1. Bion Spacecraft

Table 5.1 Bion Missions.

Name	Launch Date, Flight Duration	Altitude, Inclination	Primary Payload	Participants
Bion 1 Kosmos 605	31 October 73 22 days	213-403 km 62.8°	Tortoises, rats, insects, fungi	USSR
Bion 2 Kosmos 690	22 October 74 21 days	215-364 km 62.8°	Tortoises, rats, insects, fungi	Czechoslovakia, Romania, USSR
Bion 3 Kosmos 782	25 November 75 20 days	218-384 km 62.8°	Tortoises, rats, insects, plants	Czechoslovakia, France, Hungary, Poland, Romania, USA, USSR
Bion 4 Kosmos 936	3 August 77 19 days	219-396 km 62.8°	Rats, insects, plants	Bulgaria, Czechoslovakia, East Germany, France, Hungary, Poland, Romania, USA, USSR
Bion 5 Kosmos 1129	25 September 79 19 days	218-377 km 62.8°	Rats, insects, plants, mold, quail eggs	Bulgaria, Czechoslovakia, East Germany, France, Hungary, Poland, Romania, USA, USSR
Bion 6 Kosmos 1514	14 December 83 5 days	214-259 km 82.3°	Monkeys, rats, plants, insects, fish	Bulgaria, Czechoslovakia, East Germany, France, Hungary, Poland, Romania, USA, USSR
Bion 7 Kosmos 1667	10 July 85 7 days	211-270 km 82.4°	Monkeys, rats, plants, insects, fish, newts	Bulgaria, Czechoslovakia, East Germany, France, Hungary, Poland, Romania, USA, USSR
Bion 8 Kosmos 1887	29 September 87 13 days	216-384 km 62.8°	Monkeys, rats, plants, insects, fish, frogs	Czechoslovakia, East Germany, ESA, France, Hungary, Poland, Romania, USA, USSR
Bion 9 Kosmos 2044	15 September 89 14 days	207-267 km 82.3°	Monkeys, cells, insects, newts, fish, seeds	Canada, Czechoslovakia, East Germany, ESA, France, Hungary, Poland, Romania, USA, USSR
Bion 10 Kosmos 2229	29 December 92 12 days	218-375 km 82.3°	Monkeys, cells, frogs, insects, plants, seeds	Austria, Canada, China, CIS, Czechoslovakia, ESA, France, Germany, Lithuania, USA

of a school project. As discussed below, Bion 10 experienced similar thermal control problems. Table 5.1 outlines the history of the Bion program (References 3–7).

Aside from activities on Mir, the only major life sciences space activity for the USSR/CIS during the 1991–1992 timeframe was the Bion 10 satellite, Kosmos 2229, launched 29 December 1992. Bion 10 was scheduled to orbit for 14 days before reentry and recovery, but thermal control problems sent onboard temperatures to unacceptable levels, and the craft was deorbited two days early on 10 January 1993. This forced Russian officials to land the spacecraft near the Kazakh town of Karaganda, rather than the planned location near Kustanay. The high on-board temperatures are suspected of killing seven of the fifteen tadpoles. Additionally, one of the two monkeys on board went without food for three days, suffering measurable weight loss. After treatment for dehydration, both monkeys (Krosh and Ivasha) were declared healthy. Yevgeniy Ilyin, a scientist at the Institute of Biomedical Problems, declared that, in spite of the equipment problems, the experiments were "generally successful" (References 8–11).

Findings from each Bion mission often take years to determine and document. Preliminary results of the 1989 flight of Bion 9 now indicate that insects incubating in microgravity exhibit severe hatching and growth problems. Stick insect eggs, particularly in early stages of development, hatched at only half the normal rate. Fruit flies showed similar hatching rates (for eggs actually laid in space), pupal development took about a week longer, and the resultant adult flies were less active and had a reduced life span. Scientists from both ESA and CIS are continuing research on the results (Reference 12).

Future CIS biosatellite missions may abandon the Vostok-derived Bion platform for the new Nika-series spacecraft. Scheduled for first flight in the 1995 timeframe, the Nika will offer longer mission durations, increased recoverable payload (up to 1,200 kg), and greater power generation capabilities. The Photon Design Bureau-developed biosatellite may be referred to as Nika-B, to distinguish it from the proposed Nika-T technology platform (References 2, 13, 14).

An integral part of the USSR/CIS program to

investigate the effects of long-term spaceflights on human crews is actually terrestrially based. Details of the long-secret BIOS project in Krasnoyarsk have emerged gradually in recent years. The program, managed by the Institute of Biophysics of the Academy of Sciences' Siberian Branch, entails humans living in an enclosed, self-contained environment for extended periods. Air and water regeneration using the chlorella algae, as well as crop production, are the major foci of the project, which is intended to study techniques for sustaining long-term, unreplenished space missions. The primary near-term applications for such technologies are a lunar base or manned mission to Mars. The initial phase of the program, BIOS 1, was undertaken in the late 1960s, with a contained volume of only 12 m³. The current experiment, BIOS 3, has successfully housed persons for several-month periods in its underground, 300 m³ volume. NASA researchers have begun a cooperative effort with CIS on this topic, and Japanese scientists are considering joining the experiments at Krasnoyarsk in preparation for a year 2010 Moon base. Internal (CIS) funding for the program is reported to be decreasing dramatically, though, and the facilities at Krasnoyarsk are now reported to be in a state of disrepair (References 15–17).

5.1.2 European Space Agency

ESA has sponsored a variety of life sciences activities since its first such mission in 1985. These endeavors have been both in concert with other agencies, namely USSR/CIS and NASA, and as strictly European initiatives. Those missions entirely administered by ESA often have one member country or more as the principal participant or lead state. In some cases, the distinction between international and national programs may be somewhat blurred.

For example, the first major ESA life sciences experiments were the Biorack, Anthrorack, and Vestibular Sled flown on Spacelab D1, which was primarily funded by Germany. Of the three European astronauts who flew on that mission, two were German and one was Dutch. While Germany is a strong participant in ESA, its two astronauts were official representatives of DARA on Spacelab D1. The Dutch astronaut was a representative for ESA (Section 5.1.4).

ESA has also been involved with the three

most recent USSR/CIS Bion flights: Bion 8 in 1987, Bion 9 in 1989, and Bion 10 in 1992–3. Analysis of data from the Bion 8 and 9 missions was performed during 1991–2, with significant results reported pertaining to the retarded development of germinating seeds and other botanical developmental processes. Bion 10, launched in late 1992, included the maiden flight of ESA's Biobox, a general-purpose incubator with a programmable temperature profile (References 18 and 19).

Another major life sciences project for ESA was Spacelab IML-1. ESA astronaut Ulf Merbold, along with one Canadian and five American astronauts, manned the International Microgravity Laboratory during 22–30 January 1992. ESA provided two main life sciences facilities for the mission: Biorack and the Vestibular Sled. Both platforms had been used previously on Spacelab D1. Biorack, shown in Figure 5.2, is a general purpose facility for the study of cellular and developmental processes in plants and animals. Aboard IML-1, 17 life sciences experiments were fielded, including insects, bacteria, animal tissue, frog eggs, molds, yeasts, and several plants. The Vestibular Sled is a track-mounted chair that is used to test human nervous system responses to a variety of accelerations in weightlessness (References 20 and 21).

The most recent ESA life sciences project was carried aboard the European Retrievable Carrier (EURECA). Launched 31 July 1992, EURECA operated at an altitude of 500 km with an orbital inclination of 28.5° and was designed for longer-duration experiments than are available with Spacelab. After eleven months in orbit, the US STS retrieved EURECA in June, 1993. Used for both materials and life sciences, EURECA's first mission included the Exobiology and Radiation Assembly as one of the five major components of the payload. EURECA-1 utilized about seventy percent of the maximum 1,000 kg payload capacity (Figure 5.3). Optimal microgravity conditions are about 5×10^{-7} g (an order of magnitude better than is achievable aboard Spacelab), while the guaranteed worst conditions are 10^{-5} g (similar to Spacelab). Originally planned for five flights, future missions of EURECA are uncertain (References 18, 19, 22).

Several life sciences projects are pending at ESA. Support for Spacelab D2 (the second

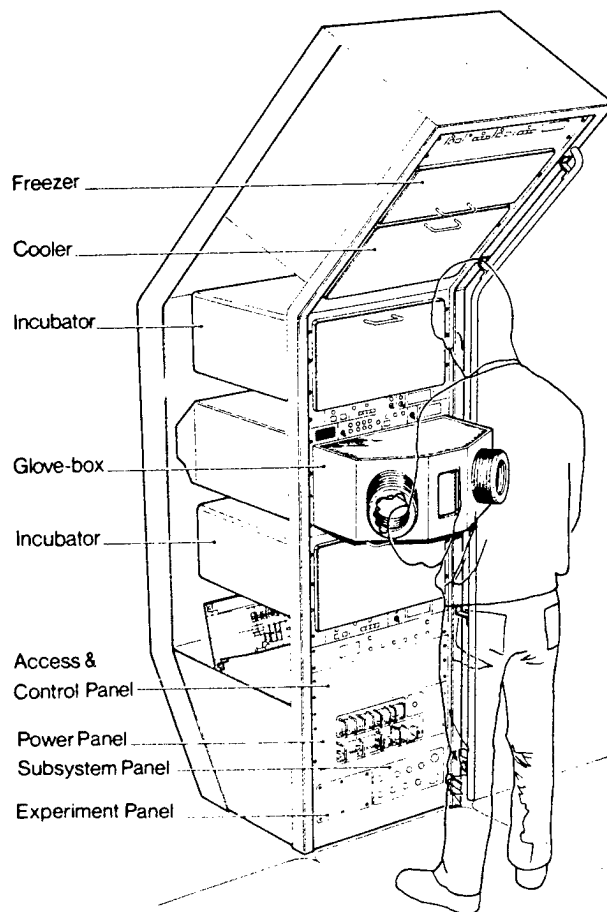

Figure 5.2. ESA's Biorack.

German Spacelab mission), Spacelab IML-2, possible future CIS Bion missions, and planning for future flights of EURECA are all in progress. The most ambitious upcoming life sciences experiment is the construction and launch of the Columbus Attached Laboratory for space station Freedom. Existing ESA assets (such as Biorack) as well as new modules still under development will be used on Columbus, with life sciences facilities being a major part of the overall effort (Reference 19).

5.1.3 France

The French firm Matra employed a Chinese vehicle to carry a biological package in 1987. The payload was piggybacked on a Chinese FSW-1 mapping satellite launched by a CZ-2C booster on 5 August 1987 from Jiuquan. Orbital characteristics were an altitude range of 173–400 km at a 63.0° inclination. The payload, which included algae, cyanophyta, and protozoa, was recovered 10 August 1987 and the sealed capsule was handed over to Matra

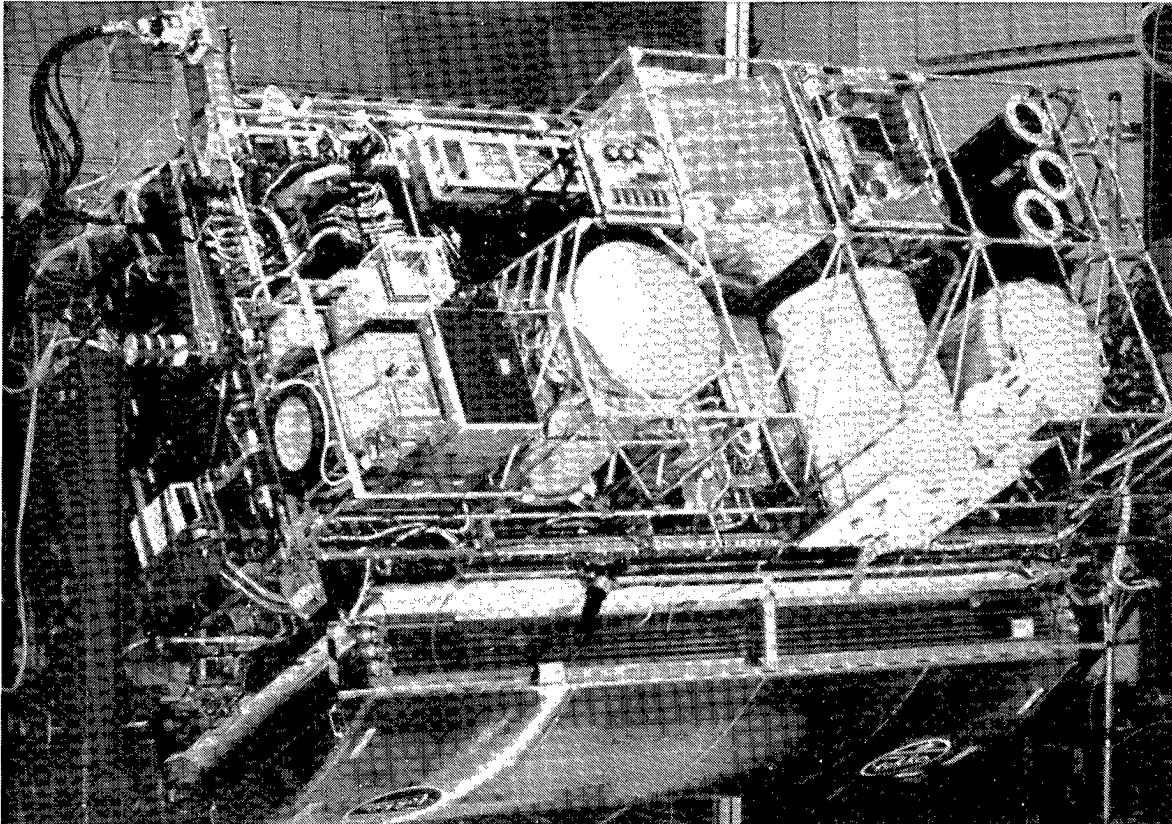

Figure 5.3. EURECA Being Prepared For Flight.

representative Frederic Bard on 12 August (References 23 and 24).

More recent CNES efforts have been in conjunction with other agencies. France has participated in numerous Bion missions (Section 5.1.1) and has supplied the Anthrorack and Biorack testbeds for ESA/NASA Spacelab missions (Section 5.1.2). CNES is also planning to work directly with NASA on the upcoming Rhesus mission on Spacelab SLS-3 in 1995.

A recent major series of life sciences experiment was performed by French astronaut Michel Tognini aboard the Mir space station from 27 July to 10 August 1992. The 43-year-old Colonel in the French army journeyed to the Russian orbital laboratory aboard Soyuz TM-15 with cosmonauts Anatoliy Solovyev and Sergei Advyev. As a major part of the Antares mission, the trio carried out research on human responses to weightlessness. The experiment was performed in three stages. Pre-launch tests of Tognini were made to establish a biological benchmark. In space, more measurements were made to establish physiological changes and adaptation rates. Upon return to Earth, final tests were run to complete the data-gathering

stage of the experiment. The primary foci of Antares were the effects of space flight on the human cardio-vascular system, blood composition changes, immunological responses to weightlessness, and the psychological and physiological condition of space travelers during adaptation to weightlessness. Antares was deemed successful, completing nine of ten intended experiments. On landing in Kazakhstan, the reentry module capsized, leaving the cosmonauts inverted for a short time. The French space agency CNES paid between 12 and 14 million dollars for the mission, which was coordinated by the Energiya Scientific Production Association (References 25-29).

5.1.4 Germany

Like France and most other European countries, much of Germany's space program is in conjunction with and performed under the auspices of the European Space Agency. However, the German Space Agency DARA has conducted some significant orbital life sciences work in cooperation with NASA via the Spacelab program and has plans for additional

joint studies in the future. A German astronaut also conducted life sciences experiments on board the Mir space station in 1992 (Sections 3.1 and 3.4).

Germany's first Spacelab mission was D1, a seven-day mission launched 30 October 1985. This mission marked the first time the scientific and technical control of the Spacelab was performed outside the US. The German Space Operations Center (GSOC) in Oberpfaffenhofen planned, prepared, and controlled D1. Two German payload specialists, Ernst Messerschmid and Reinhard Furrer, worked in shifts with NASA and one Dutch astronaut to provide nearly 24 hours per day access to the scientific payload. The manifest of German life sciences experiments included cellular biological, botanical, and medical experiments, utilizing ESA's Biorack, Anthrorack, and Vestibular Sled facilities (References 30 and 31).

The most recent major orbital life sciences project with German participation was Spacelab IML-1, the International Microgravity Laboratory. German ESA astronaut Ulf Merbold (who was part of the ground support and control for Spacelab D1) was launched with NASA and Canadian astronauts on 22 January 1992 for an eight-day mission. European participation in Spacelab IML-1 was largely coordinated and funded by ESA, but Germany did field some distinct experiments. In particular, the Cryostat enzyme growth experiment/facility was utilized, as were four experiments in ESA's Biorack (References 20, 32).

Planned for 1993 is another German-sponsored shuttle flight, Spacelab D2. As with the flight of D1, other agencies will be involved with the project, but Germany will be the principal coordinator and funding agency. Two German astronauts will be aboard the shuttle for this mission. Major life sciences experiments on D2 will involve biological cellular electrofusion, cellular function in weightlessness, behavioral physiology, cardiovascular, endocrinological, and metabolic functions, and radiational exposure tests. A German payload control team will operate Spacelab D2 from GSOC (Reference 33).

5.1.5 Japan

The first Japanese life sciences experiment in space took place in late 1990, when Toyohiro Akiyama, a journalist from the Tokyo

Broadcasting System, boarded the Mir space station. This was the result of a private Japanese company negotiating with GLAVKOSMOS and Energiya NPO and had no official sponsorship by the Japanese government or space agency. While on Mir, Akiyama performed several experiments on six Japanese Tree Frogs, gauging their adaptation to weightlessness (Reference 34).

Japan's space agency NASDA recently fielded its first major orbital life sciences experiment. Spacelab J, launched 12 September 1992 for an eight-day mission, included NASDA payload specialist Mamoru Mohri, NASDA's first astronaut. The Japanese experiment docket was also known as FMPT, First Materials Processing Test. The mission, which also hosted several materials science experiments, included biological investigations with live insects, frogs, chicken embryos, and fish. Biologists were encouraged by the first successful effort to fertilize frog eggs in weightlessness (References 35, 36).

A reusable free-flying platform called the Space Flier Unit (SFU) has been scheduled to be launched aboard the third flight of Japan's new H-2 launch vehicle, but development problems with the new booster have pushed the launch of the SFU into 1995 at the earliest. SFU-1 is intended primarily for advanced technology and materials processing, but some biological experiments are expected to be fielded, including one dealing with the growth of newts from egg to adult. After about three months in space, the SFU is to be retrieved by the US Space Shuttle. The SFU is a 3,500 kg craft with a 4.6 m diameter and two 9.6 m solar arrays. The effort is a joint project of NASDA, the Institute of Space and Astronautical Science (ISAS) and the Ministry of International Trade and Industry (MITI) (References 37-39).

Japan had some involvement in the numerous life sciences experiments aboard the 1992 Spacelab IML-1. Japan's major contribution to IML-1 was the Organic Crystal Growth Facility. NASDA intends to be heavily involved in future IML experiments, possibly supplying payload specialists (Reference 38).

By far the largest orbital life sciences project underway in Japan is the major module for the Freedom Space Station, JEM (Japan Experiment Module). A consortium of 14 Japanese companies have formed Japan

Manned Systems Corporation to coordinate construction of the shuttle-deployed module. JEM will be configured to allow a broad range of materials, observational, and life sciences studies. Construction of a working prototype of JEM was begun in 1992 for configuration testing and training. The entire JEM cost is expected to be about 2.5 billion dollars. JEM will be one of four large modules scheduled for early deployment on the space station (References 40, 41).

The proposed layout of JEM consists of three main modules (Section 3.5). The Pressurized Module (10 m long, 4 m diameter, 10,250 kg) contains numerous experiment racks and controls for JEM. The Experiments Logistics Module (4 m high, 4 m diameter, 2,450 kg), which is located above the Pressurized Module, is largely a storage and transport module for replenishing perishable items used for JEM. An exposed rack can be mounted on the Experiments Logistics Module to facilitate equipment and resupply cargo shuffling. The Exposed Facility consists of two external pallets (each 2.5 m high, 1.4 m wide, 4 m long) with a total mass of 2.8 metric tons and a manipulator arm for servicing the exposed experiments without EVA. Expected power requirements are 6 to 9 kW, depending on mission parameters (Reference 37).

5.1.6 People's Republic of China

Similar to early experiments by the USSR, China launched animals, including dogs and mice, on suborbital flights in the mid 1960s. Early Chinese efforts focused mainly on unmanned military and civilian space applications, thus life sciences experiments were few. In the 1980's the Great Wall Industries Corporation began promoting commercial appli-

cations of the Chinese space program, including the opportunity to fly small life sciences payloads on board the FSW-1 recoverable spacecraft which had been developed as an observation platform (Section 4.3.6). The first Western payload was launched 5 August 1987 for the French aerospace company Matra and was a biological microgravity experiment (Section 5.1.4) (References 23, 42, 43).

A recent Chinese biosatellite was China 33, launched 5 October 1990 from Jiuquan. Sixty animals and plants were included on the mission, including rats and guinea pigs. Primary studies focused on the effects of weightlessness on metabolism, food requirements, and excretion. The experiments and biosystems were developed by the Astronautical Engineering Institute of the State Commission of Science, Technology, and Industry for National Defense. The recoverable FSW-1 capsule was returned to Earth eight days after launch. The mission initial altitude was 208–311 km at an inclination of 57.0° (References 44–47).

China's Institute of Hydrobiology fielded a group of experiments on a recoverable FSW-1 launched from Jiuquan 6 October 1992. The biosatellite payload included algae, microorganism, rotifers, and a small aquatic creature. Dr. Liu Yongding, Institute Deputy Director, said that the algae experiments were particularly successful, with one new form of blue algae produced. The Chinese are considering algae as a potential food source for astronauts on long space missions. The FSW-1 was deployed in an orbit at 213–309 km altitude with an inclination of 63.0° (Reference 48). Future Chinese life sciences experiments may be flown on the more capable FSW-2 which was introduced in 1992.

5.2 Geophysics

The missions discussed in this section detail Eurasian efforts to characterize the Earth's geomagnetic environment in terms of radiation belts and interactions with the solar wind. In recent years, a loose international alliance of scientists has been formed to share and distribute the results of myriad independent missions. The International Solar Terrestrial Physics (ISTP) program is a multinational effort whose 1977 origin was prompted by the Inter-Agency Consultative Group (IACG). ISTP now consists of over 100 entities (mostly universities and other research facilities) in sixteen countries.

5.2.1 USSR/CIS

The USSR/CIS has had an active program for geophysics research since its Elektron satellites were launched in 1964 for study of the Van Allen radiation belts. Interkosmos 24, the Aktivnyy (Active) experiment, was launched 28 September 1989 from the Plesetsk Cosmodrome via SL-14 (Tsyklon) launcher. With an 82.6°, 511 km by 2,497 km orbit, Aktivnyy

actively disturbed the geomagnetic plasma sheath. A second satellite deployed from the transmitting orbiter, the Czech Magion-2, contained sensors to gauge the induced disturbances from a variety of distances. The two spacecraft separated 3 October, 1989, but problems prevented operation until January, 1990. Data collection continued until November, 1990, and much work was done in 1991–2 interpreting the data. Results are now being published detailing the outcome of the experiments, with preliminary results reporting electron density inhomogeneities in the Earth's auroral zones. The pair of satellites is shown in Figure 5.4, with the small Magion satellite visible at the top of the larger module. The Aktivnyy experiment was coordinated by the USSR Academy of Sciences' Institute of Space Research (IKI), with additional sponsorship from the Academy's Institute of Terrestrial Magnetism, Ionosphere and Propagation of Radio Waves (References 49–56).

A follow-on to the Aktivnyy mission is the APEKS (Active Plasma Experiment) project. The experiment, also designated Interkosmos

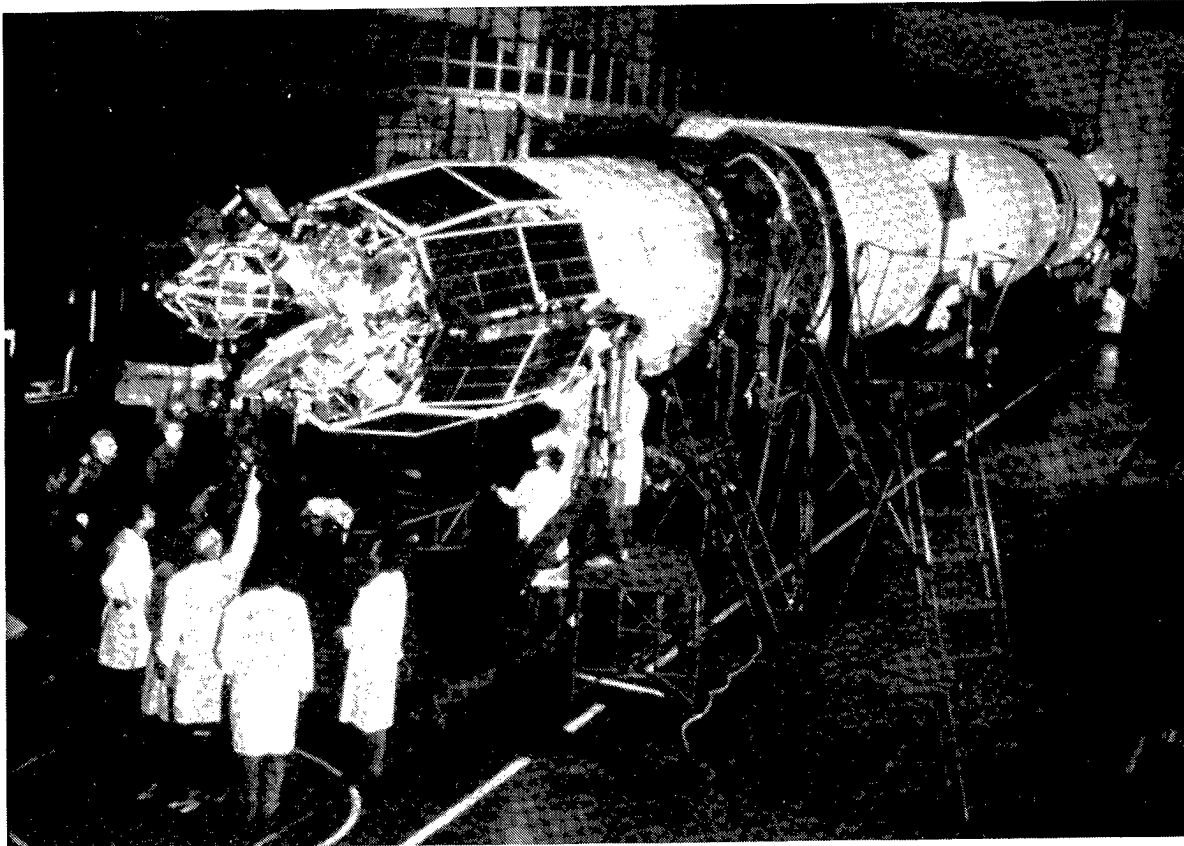

Figure 5.4. Interkosmos 24 (Aktivnyy) Being Mated to Launch Vehicle.

25, was launched 18 December 1991 from the Plesetsk Cosmodrome via SL-14 launcher. APEKS was placed in an 82.6° , 435 km by 3,053 km orbit. Using a concept very similar to Aktivnyy, the Czech Magion-3 is a companion to the mother satellite. The mother craft injects electron and Xenon ion beams into the magnetosphere, and the Magion-3 records the effects from a distance. The orbital measurements are augmented by observations at several ground stations. The distance between the two satellites varies from a few meters to over 1,000 km and is adjusted by a Soviet Pulsar engine aboard the Magion. The primary coordinating agency for APEKS was the USSR/Russian Academy of Sciences' Institute of Terrestrial Magnetism, Ionosphere and Propagation of Radio Waves (References 57–59).

The Pion series of upper atmospheric research satellites was continued in 1992. Pion 5 and Pion 6 were launched from Plesetsk with Resurs-F 16 on 19 August 1992 and were released from the host satellite on 1 and 2 September, respectively. The two satellites, both with a diameter of 0.33 m, possessed masses of 49.466 kg (Pion 5) and 49.434 kg (Pion 6). The internal configuration of the two spheres was identical, with three mutually orthogonal lead disks embedded in plastic. The sphere coatings were different, with Pion 5 coated with a radar reflective material, and Pion 6 covered with a material transparent to radar. Thus in addition to the atmospheric research, radar calibration was performed. The two satellites were injected into 221 km by 226 km orbits and their decay was monitored closely with CIS, European, and US sensors. As the orbits evolved, the higher atmospheric drag of Pion 6 caused it to decay faster and thus eventually 'pass' the earlier-deployed Pion 5. Both satellites reentered on 24 September 1992, Pion 6 about 10.5 hours before Pion 5 (References 60 and 61).

The CIS has several projects underway or being considered for potential deployment in the 1990s. These projects, all parts of international efforts, include the Interbol and Regatta programs within ISTP, and the System of Aeronomical Satellites (SAS) project as a part of the International Geosphere-Biosphere Program. Interbol, which was developed as an Interkosmos effort, will retain international participants from several former Interkosmos members as well as ESA and several other

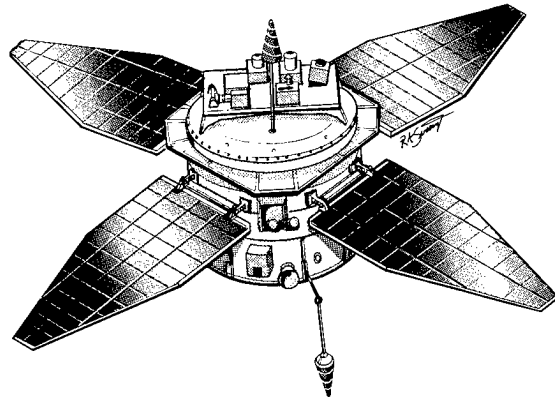

Figure 5.5 Prognoz-M Satellite.

nations. Interbol will continue the parent-child paradigm of Aktivnyy and APEKS, using Prognoz-M (Figure 5.5) and Magion vehicles. Two Interbol pairs are planned: Auroral probe with an apogee of about 20,000 km and Tail Probe with a maximum altitude of over 200,000 km.

In 1993 the Relikt-2 mission to examine the uniformity of the universal 2.7° K black-body background radiation is scheduled to be launched (Section 5.4.1). As a secondary objective the Prognoz-class satellite will also monitor the geotail plasma. Relikt-2 will be the first USSR/CIS satellite placed into a halo orbit around the L_2 libration point 1,500,00 km from the Earth on the side opposite the Sun (References 62–64).

An even more complex mission to understand better "solar activity, the mechanisms for the transmission of solar effects through the interplanetary medium, and the reactions of near-planet space to solar disturbances" is the subject of the proposed multi-spacecraft Regatta-Plasma mission. The Regatta class of spacecraft represents a dramatic move toward reducing the size, complexity, and hence cost of scientific satellites while still returning valuable data. Conceived by the Institute of Space Research, Regatta satellites are 500–600 kg platforms with 40–50% of the mass devoted to the scientific payload. A unique aspect of the Regatta configuration (Figure 5.6) is the use of coated solar rudders to control the spin of the spacecraft and a large, immovable solar sail which is aligned with the Sun and acts as a general stabilizer.

The Regatta-Plasma mission calls for a

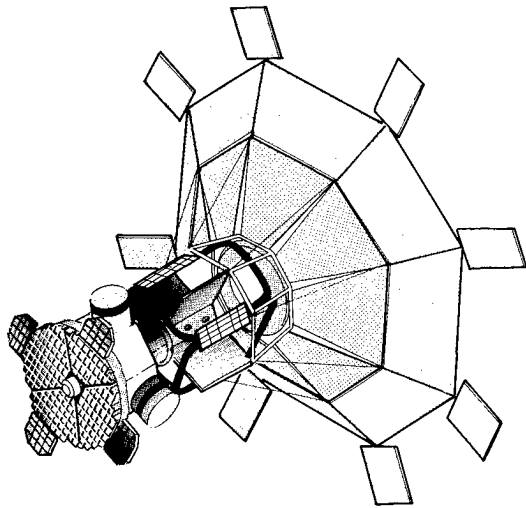

Figure 5.6. Regatta-Plasma Satellite.

constellation of five spacecraft in widely dispersed orbits. Regatta-Ye would conduct research within the Earth's radiation belts in an orbit of 500 km by 25,000 km with an inclination of 62.5°. Regatta-A would orbit the Earth in a manner similar to ESA's cluster satellites (Section 5.2.3), i.e., perigee of 4 R_E , apogee of 22 R_E , and an inclination of 90°. Regatta-D would follow a complicated path with periodic fly-by's of the Moon. The last spacecraft, Regatta-V and Regatta-S, would be inserted into halo orbits around the L_1 and L_2 libration points, respectively. This multi-dimensional, time-sensitive network would provide a comprehensive look at the response of the near-Earth environment to solar activity. Initially proposed for operation during 1994–1997, the Regatta-Plasma mission is now likely to be delayed at least several years due, in part, to restructuring of the Russian and CIS space program (Reference 65).

The System of Aeronomical Satellites (SAS) was originally planned for deployment in the 1992–1993 timeframe as an Interkosmos project, but the status of SAS and possible follow-ons is currently uncertain. If the mission is eventually deployed, it will likely be 1995 or later. SAS is planned to consist of three satellites, termed A1, A2, and A3. Satellite A1, which would be the main instrumentation platform, would sense the lower thermosphere

and ionosphere from a roughly 500 km circular polar orbit. The A2 platform, based on the Czech Magion satellite outfitted with microaccelerometers, would be deployed into a 300 km by 1,300 km polar orbit. Satellite A3 would have orbital parameters similar to A1 but would carry a mass spectrometer to augment its observations (References 63 and 66).

5.2.2 Czechoslovakia

While most of the Interkosmos member countries' activities are contained implicitly in the USSR/CIS Section (Section 5.2.1), significant Czech contributions are noteworthy. In particular, the Magion series of sensor subsatellites are of Czechoslovak design and manufacture (though the last two have utilized Soviet Pulsar engines for maneuvering). Three Magion spacecraft have been successfully deployed since the first in 1978 with Interkosmos 18. The second and third in the series were companions

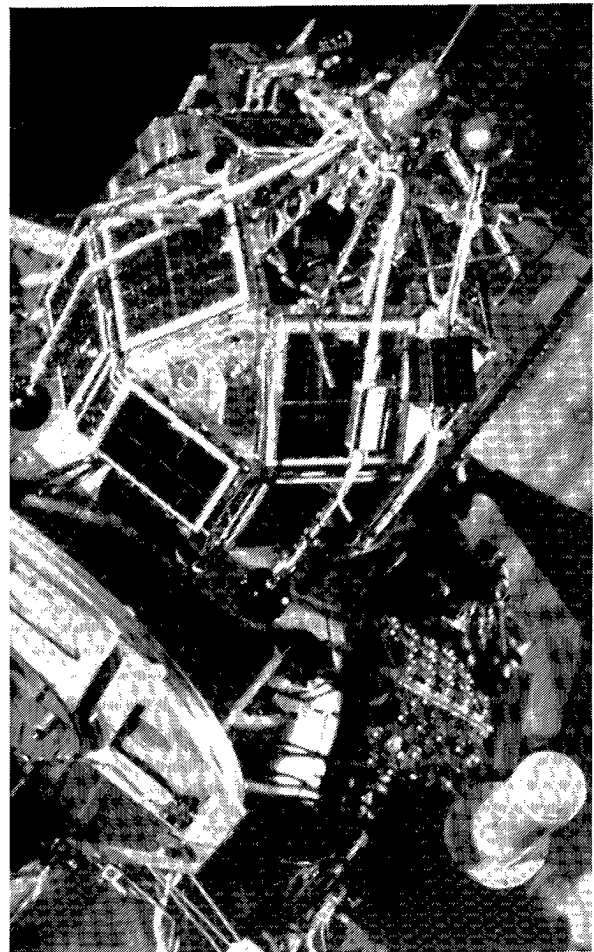

Figure 5.7. Magion-2 Sub-Satellite.

to the Soviet Aktivnyy and APEKS projects (Section 5.2.1). Dimensions of the Magion subsatellite are 56 cm high, 1.7 m diameter (with antenna unfolded), and 52 kg. Magion-2, which was deployed from Aktivnyy, is shown in Figure 5.7. The Magion program is under the auspices of the Czechoslovak Academy of Sciences' Geophysics Institute in Prague (References 67–69).

5.2.3 ESA

Although ESA did not field any new orbital geophysics experiments during the 1991–1992 timeframe, significant work was performed in pursuit of the Cluster mission. Cluster will be a set of four identical satellites operating in concert from similar orbits, varying in dispersment up to a few Earth radii, depending on mission tasks (Figure 5.8). A part of ISTP, Cluster is being planned in close coordination with the CIS Regatta project (Section 5.2.1). Cluster is scheduled for launch by an Ariane 5 in 1996. The 1,200 kg satellites will be deployed into near-polar, highly eccentric orbits. Each satellite will be identically outfitted with

sensors to investigate boundary region physics, plasma acceleration in the geomagnetic tail, plasma sheet turbulence, vortices and eddies, bow shock structure, and plasma and field microstructure. The Cluster satellites will be gradually moved among various altitudes to investigate diverse areas of the geomagnetosphere. Dornier is acting as the prime contractor for the project (References 70 and 71).

5.2.4 Italy

Although Italy's primary involvement in geophysics experiments is via ESA, one major experiment in 1992 was, in part, involved in geomagnetic analysis, namely, the Tethered Satellite System (TSS). Carried aboard the Shuttle Atlantis (STS-49), the experiment was to have unwound up to 20 km of 2.5 mm Kevlar tether to a 520 kg satellite, gather scientific data on the upper atmosphere and geomagnetic fields, and be rewound and returned to Earth. There were major problems with the deployment mechanism, and the satellite achieved a separation of only about 256 m from the orbiter. As the

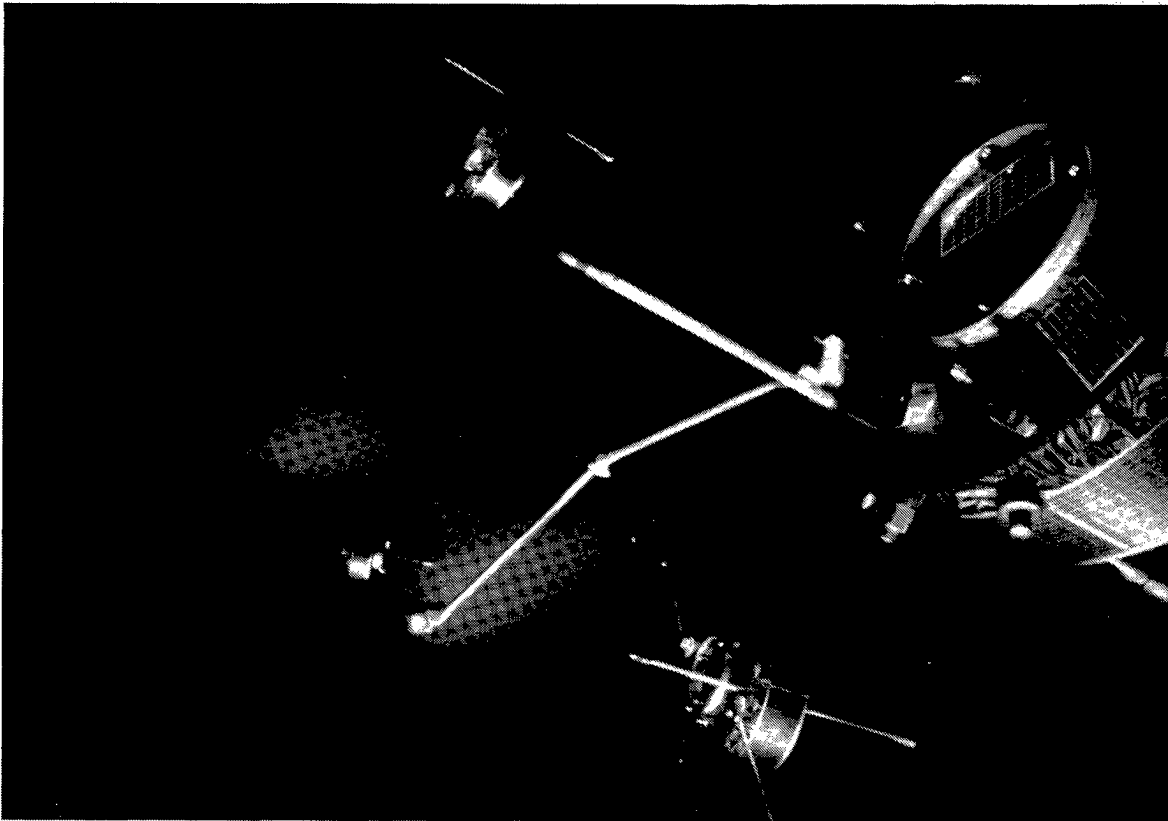

Figure 5.8. Quartet of Cluster Satellites.

tether passed through the fields, up to 5,000 volts were expected to be produced. However, with the limited deployment, only about 40 volts were generated. The satellite, manufactured by Alenia, seemed to be controllable via shuttle maneuvers, and considerable data were gathered on the flight dynamics of the tandem. Post-flight examination revealed that the winding mechanism was halted by a protruding bolt that was added relatively late in the design process. Martin Marietta was the prime contractor for the deployment mechanism, under contract to NASA. At this time, it is not known if follow-up missions will be flown (References 72–74).

5.2.5 Japan

The Japanese conducted three primary geophysics activities during the 1991–1992 timeframe. The first two, Sakigake (Pioneer) and Muses-A, are actually earlier missions with recent activity, whereas the Geotail satellite is a more recent mission began in 1992. Sakigake, which was originally launched in 1985 into a heliocentric orbit to study Halley's comet, was maneuvered through the tail of the Earth's

geomagnetic field. Closest approach to Earth was about 90,000 km on 8 January 1992. Sakigake, which was the first payload launched on Nissan's M-3SII booster, is a project of Japan's Institute of Space and Astronautical Science (References 75 and 76).

Muses-A, also referred to as Hiten, was a research vehicle to test flight dynamics and data communication capabilities for the following Geotail mission. Muses-A (Figure 5.9), which was launched 24 January 1990, demonstrated a complex set of orbital maneuvers that eventually resulted in a lunar orbit and, ultimately, lunar impact. For most of its orbital life, it was deployed in highly elliptical orbits which included multiple lunar swingbys. During one such swingby, Muses-A ejected a small subsatellite (Hagoromo) into lunar orbit, but a beacon malfunction resulted in uncertainty about its orbital parameters. On 12 March 1991, Muses-A demonstrated aerobraking in the Earth's upper atmosphere. Slowing by 1.8 m/s, a 10,000 km reduction in apogee was achieved. After entering lunar orbit in February, 1992, Muses-A eventually impacted the Moon in April, 1993. ISAS, which operated the satellite, successfully dem-

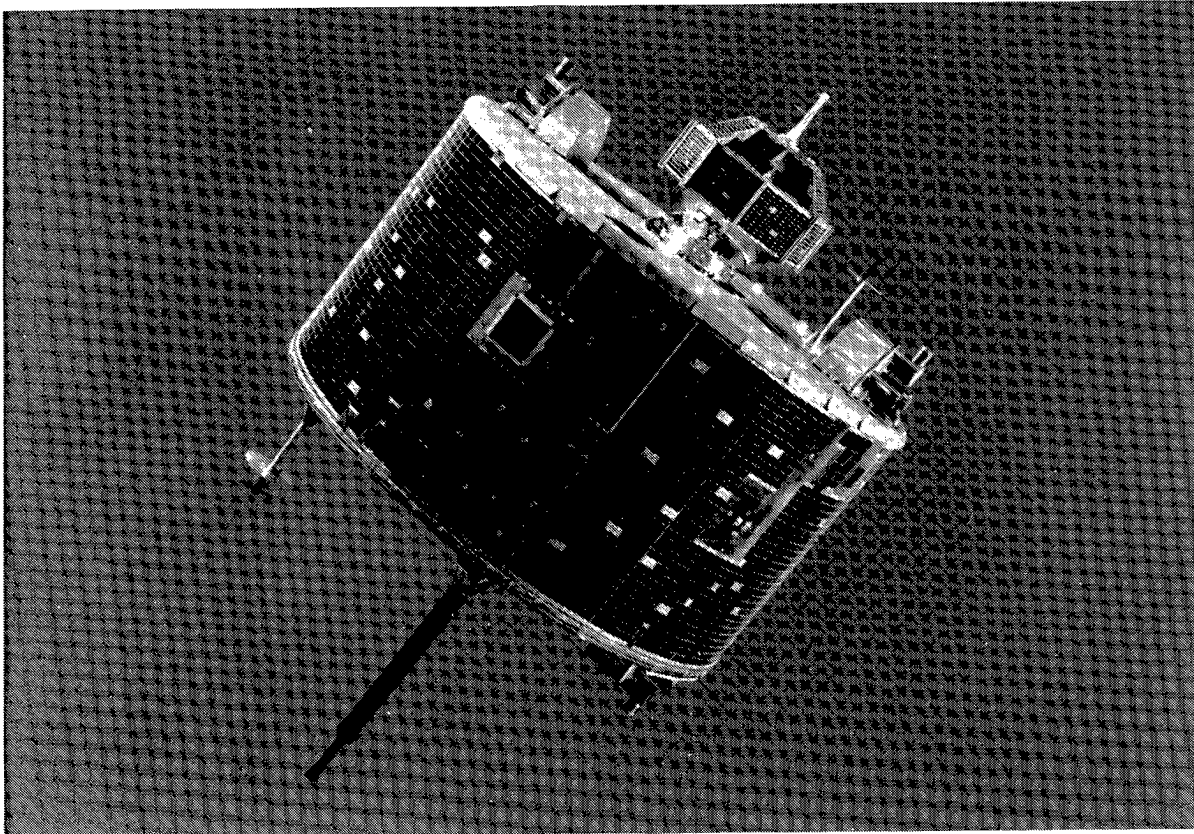

Figure 5.9. Muses-A (Hiten) with Hagoromo Lunar Orbiter Attached (top).

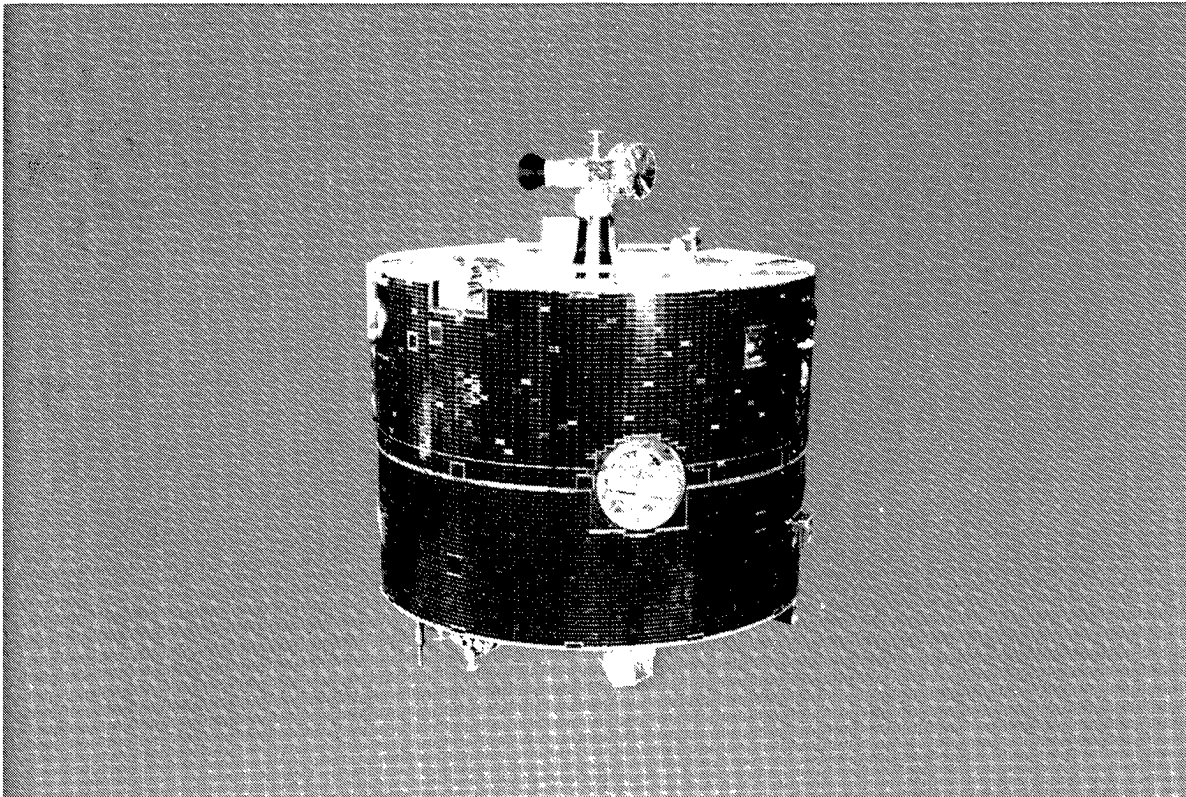

Figure 5.10. Geotail Spacecraft with Sensors Stowed.

onstrated low-fuel, gravity aided-maneuvers that will be used by Geotail and other spacecraft. ISAS worked with NASA to develop some of the orbital manipulation (References 77–81).

Geotail was launched during a tight five minute launch window on 20 July 1992 via a McDonnell Douglas Delta 2 booster from Cape Canaveral. Geotail's planned orbits were perfected with experience gained in the Muses-A program and included two lunar swingbys resulting in a 51,000 km by 1,400,000 km elliptical orbit with 7.5° inclination. The apogee will be eventually dropped to about 190,000 km. A part of ISTP, the nearly 1,000 kg Geotail (Figure 5.10) was built by Nippon Electric for ISAS and contains seven sensors (three Japanese, two American, and two joint) for probing the Earth's geomagnetic tail, in particular magnetic and electric fields, plasma, and energetic particles. Geotail is a 1.6 m long cylinder with a 2.2 m diameter but with its antennas deployed spans about 100 m. The satellite is scheduled to operate until early 1996 (References 82 and 83).

5.2.6 Sweden

The launch of Sweden's Freja (a goddess from Norse mythology) satellite by China as a piggyback payload on 6 October 1992 marked the nation's second geophysics satellite. In 1986, Sweden launched (piggyback with SPOT-1) the Viking geophysics satellite, which operated for over 14 months. The focus of both missions was observation of the aurora. The Freja project is managed by the Swedish National Space Board and controlled from Swedish Space Corporation's Esrange ground station. Swedish Space Corporation acted as prime contractor for Freja, while the Max Planck Institute's Institute for Extraterrestrial Physics in Garching, Germany, served as a scientific partner on the project. The eight sensors on Freja (three Swedish, two German, two Canadian, and one American) detect electric and magnetic fields, hot and cold plasmas, waves and particles, and aurora. The 214 kg, 2.2 m diameter, dish-shaped Freja operates in a 601 km by 1,756 km orbit with 63° inclination. Planned operational life for Freja is about two years (Reference 84).

5.3 Solar System Investigations

This section presents solar system exploration programs, both in terms of planetary probes and solar research, i.e., geocentric and heliocentric satellites. Some of the missions described below are coordinated through the International Solar Terrestrial Physics (ISTP) program described in Section 5.2. That section details the missions that are largely Earth-based, chiefly investigating geomagnetospheric effects, while the programs discussed here focus on the properties and characteristics of other members of the solar system.

5.3.1 USS/RCIS

The USSR was the first nation to launch probes to extraterrestrial bodies with its Luna series initiated in 1958. Luna 1 performed the first lunar flyby in January, 1959, and Luna 2 was the first lunar impact in September, 1959. The Luna program continued until the mid-1970's, included unmanned projects which retrieved lunar soil samples, and used two remotely-piloted lunar rovers that transmitted about 100,000 televised pictures to Earth in 1970 and 1973. Other historical planetary projects include missions to Mars and Venus. The Mars and Phobos series projects produced only marginal results, due to a variety of technical failures and Martian weather problems. The Venusian missions performed by the Venera and VEGA spacecraft met with considerably better success, providing the first high-quality

images and mapping of Venus' surface and atmosphere. The VEGA carrier vehicles went on to become the first satellites to rendezvous with Halley's comet in March, 1986, providing tracking data for the ESA Giotto probe (Section 5.3.2) (References 85-87).

As early as 1978, plans for a Soviet Lunar Polar Orbiter were being drafted. The purpose of such a mission would be to conduct numerous geological and morphological studies in support of manned lunar base planning. A long-term plan in 1988 called for a 1993 launch, but in 1989 the schedule was accelerated for a 1992 launch with the designation Luna-92. However, by 1990, references to the project were conspicuously absent. It now appears that the project is on indefinite hold and that funding priority will be given to the Mars missions described below. The proposed spacecraft is shown in Figure 5.11 (References 86, 88-90).

Clearly, the largest active CIS planetary exploration programs are the upcoming Mars exploration launches, Mars-94 and Mars-96. Once planned for a single 1994 mission, funding and time constraints have dictated a two-window approach. The first mission, scheduled for launch in October or November, 1994, will consist of one orbiter (with experimental and data relay functions), two surface penetration probes, and two surface landers. The program has evolved over the past two years into a broad international effort as a result of budgetary constraints. Several nations and agencies have joined the effort, including France (the

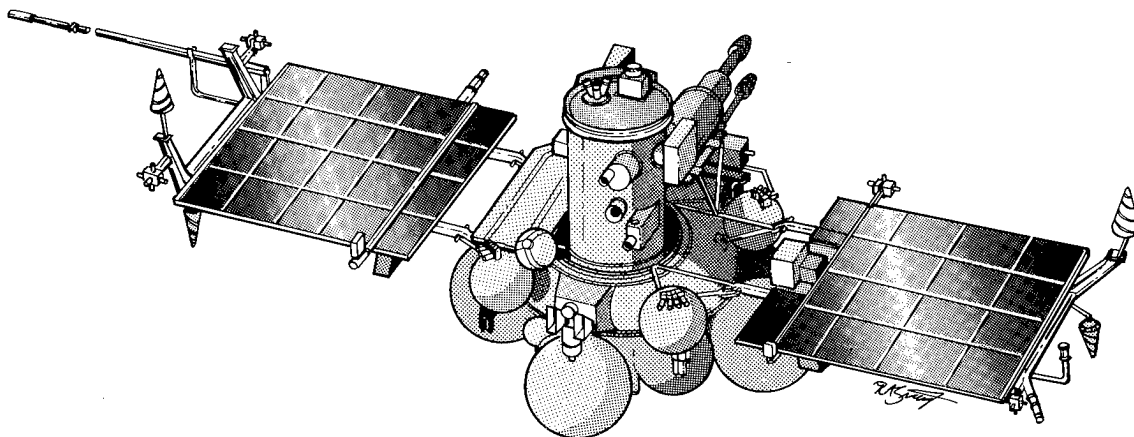
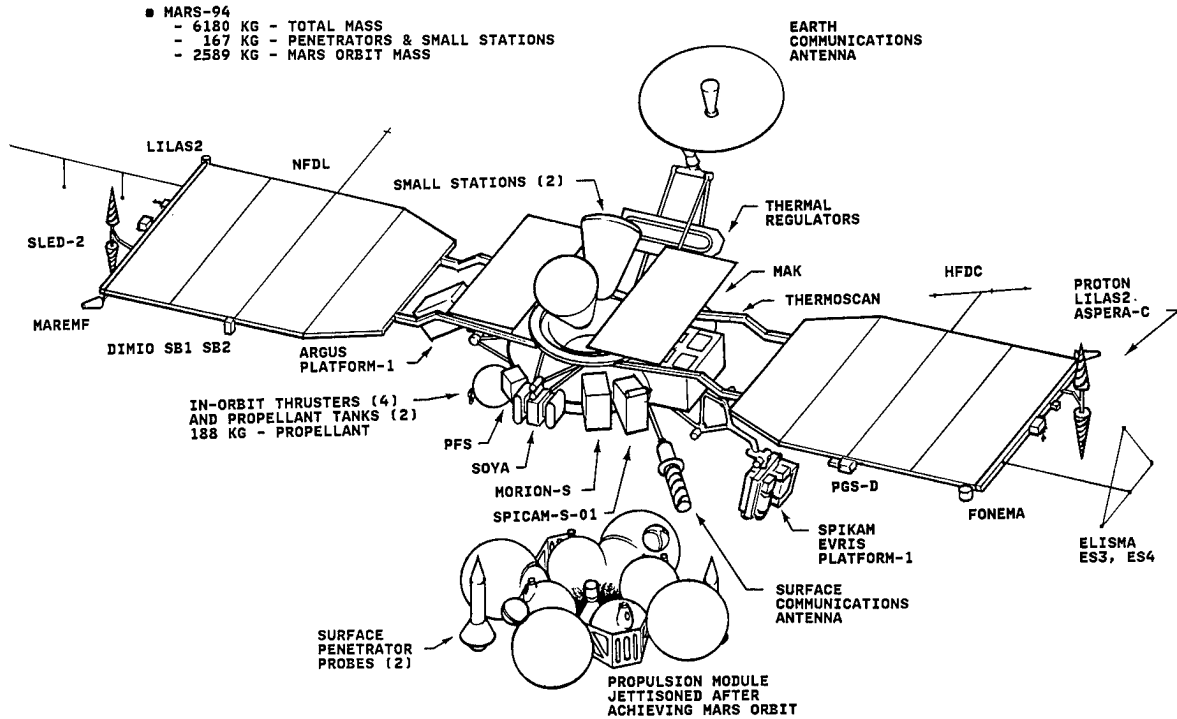
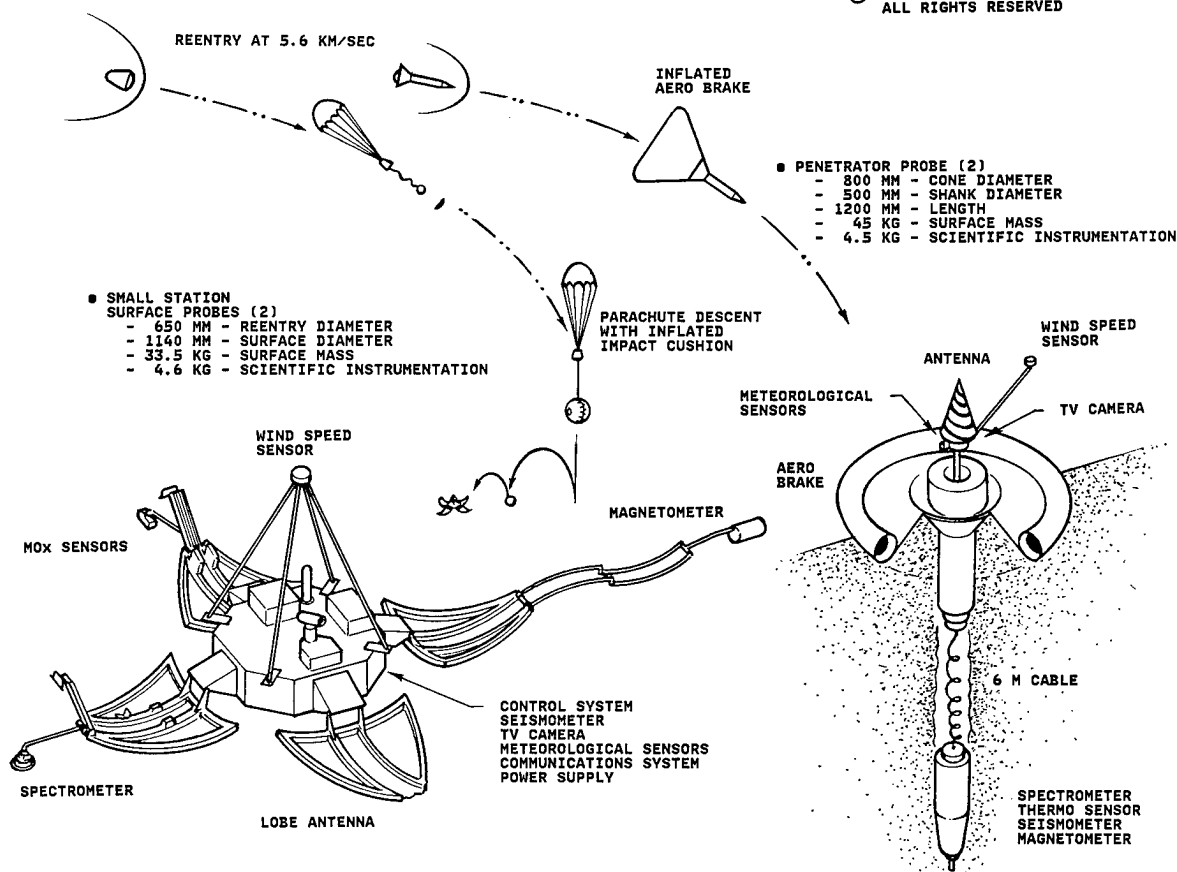

Figure 5.11. Proposed CIS Lunar Polar Orbiter.



© D.R.WOODS 1993
ALL RIGHTS RESERVED



© D.R.WOODS 1993
ALL RIGHTS RESERVED

Figure 5.12. Mars-94 Orbiter and Landing Probes.

major partner), Germany, USA, and other European countries to a lesser extent.

Figure 5.12 illustrates the components of the Mars-94 mission. The cruise spacecraft is shown with the surface experiments on-board for the journey to the red planet. Upon arrival and attaining Mars orbit, the four reentry vehicles will be deployed to the planet for surface experiments as shown in the figure, with the parent craft remaining on-orbit for its own studies and Earth transmission responsibilities. The elliptical orbit used by the orbiter will be varied over several weeks to accommodate the diverse on-board experiments. As is shown in the figure, the project includes an impressive variety of sensors and experiments. The project is being coordinated through the Russian Academy of Sciences' Institute of Space Research in Moscow and the Babakin Engineering and Research Center of the Lavochkin Scientific Production Association in Khimki (References 91-94).

The second mission, Mars-96, will consist of two primary experiment vehicles: a surface rover and an atmospheric balloon. Tests are already underway to fine-tune the concepts before deployment to Mars. The "Marsokhod" rover has been tested in Death Valley, California, and on the Kamchatka peninsula by IKI, Babakin Center, St. Petersburg's Mobile Vehicle Engineering Institute (VNIITransmash), and McDonnell Douglas engineers. Extensive cooperation between the US and Russia on both Mars-94 and -96 is being sponsored by The Planetary Society. The Mars Aerostat balloon being proposed for Mars-96 will be helium-filled with an instrumented gondola. Trailing from the gondola will be a sensor cluster on a cable. During daylight hours, the balloon will travel aloft, propelled by the Martian wind. During darkness, the balloon will descend close to the surface and drag the instrument cable along the ground. Testing of the balloon concept has already been performed by CNES with some success. Mission plans call for traversal of thousands of kilometers with one or more Aerostats (References 95 and 96).

The USSR/CIS has also studied manned missions to Mars for many years. The overall spacecraft fleet proposed for the mission consists of three attached craft: a Mars Orbital Vehicle (which would also serve as the chief interplanetary travel vehicle), a Mars Landing

Vehicle (which would eventually return to the orbiter) and an Earth Return Vehicle (for final transport back to Earth's surface). The proposed mission would be manned by a crew of four, with two likely visiting the Mars surface.

While the final configuration of the project is far from fixed, the leading candidate design would seem to be an electric rocket propulsion system powered by a solar photovoltaic power plant, with an aerobraking, relatively unsteerable Mars lander. This option seems to have gained recent favor over a powered, maneuverable biconic lander which was the earlier choice. The Earth return vehicle would be reminiscent of a Soyuz craft, with certain updates for weight reduction and specialized docking with the Mars orbiter. No funding plans for such a mission are currently under serious consideration, and any such project would not come to fruition until well into the twenty-first century (References 97 and 98).

As recently as five years ago, the USSR had scheduled a very ambitious program of solar system exploration that included no fewer than eleven deep space probes deployed by 2002. This included missions to the Sun, Moon, Mars, Phobos, Jupiter, Saturn, Titan, the asteroid belt, and a comet. Recent events, along with the corresponding fiscal realities, have prompted the complete overhaul of this plan (Reference 99).

Work is also continuing on CIS solar research missions. Two Koronas satellites are currently planned: Koronas-I which is a near-term project that will likely launch in 1993 or 1994, and Koronas-F which is planned for a couple of years later. The focus of Koronas-I will be on solar neutrino emissions (studied via helioseismology) and the structure of the high temperature regions of the solar atmosphere. One sensor used on Koronas-I will be the Czech TEREK-C multichannel imaging telescope, similar to the device fielded on the Phobos-1 spacecraft which launched in July, 1988. Koronas-I is being coordinated by the Institute of Earth Magnetism, the Ionosphere and the Propagation of Radio Waves (IZMIRAN). The Koronas satellites will be deployed in geocentric orbits, varying from highly elliptical to circular. These satellites will mark the first use of the new AUOS-SM platform (Figure 5.13) from the Ukrainian Yuzhnoye Design Office. The Koronas program receives

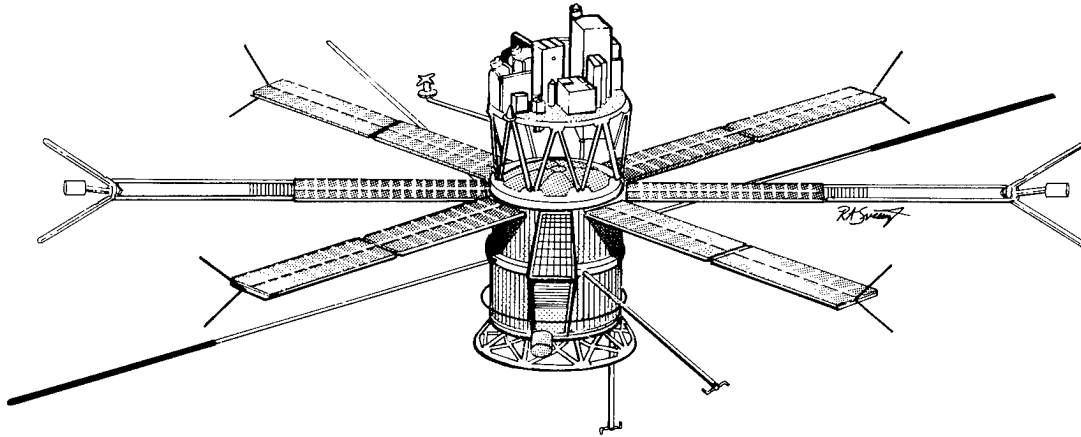

Figure 5-13. AUOS-SM Platform for Koronas Missions.

significant support (technical and financial) from the recently formed Ukrainian Space Agency (References 100-102).

Another much more ambitious solar research mission is also in planning. The Tsiolkovsky mission, named for cosmonautic research pioneer K.E. Tsiolkovsky, will be a solar probe approaching within about 4,000,000 km of the Sun. After analysis of several potential planetary gravity-assist trajectories, an Earth-Jupiter-Sun route is currently favored. This approach was chosen as a compromise between necessary delta-V, flight time, and multi-planet aerobraking complexity. Estimated flight time is about five years, with a necessary on-board delta-V of about 8 km/s. The Jupiter flyby will swing the craft 'north' out of the plane of the solar system, for a polar solar approach. Launched from Earth via Proton, the Phobos autonomous propulsion system would provide the interplanetary transport. Maximum overall spacecraft weight for this mission configuration is about 1,300 kg.

The Tsiolkovsky craft itself is modular in design, maximizing use of available components for low cost and technical risk. On-board power is to be supplied via radioisotope thermoelectric generators (RTGs). Figure 5.14 shows a possible configuration of the spacecraft. The propulsion system and bus appear to be near final configuration, but the solar probe itself, which is the disk at the top in the figure, has multiple candidate layouts, the primary alternative being a toroidal biconic with instruments in the center.

Extensive on-board processing capabilities are envisioned, since mission parameters

dictate difficult command and control operation. For relatively long periods of flight, the spacecraft will be either out of contact with Earth or in a position to only transmit on a real-time basis. Autonomous decision making and mission execution algorithms are being developed to allow for this eventuality. Although considerable research has been accomplished toward the eventual Tsiolkovsky deployment, actual project status is uncertain. The mission has not yet been funded beyond the research phase, though the principals claim that Tsiolkovsky can be ready to fly as early as 1997 (References 103 and 104).

5.3.2 European Space Agency

ESA currently has two long-term solar system probes active. The cometary explorer Giotto was launched by Ariane 1 on 2 July 1985. The cylindrical 1.8 m diameter by 1.6 m

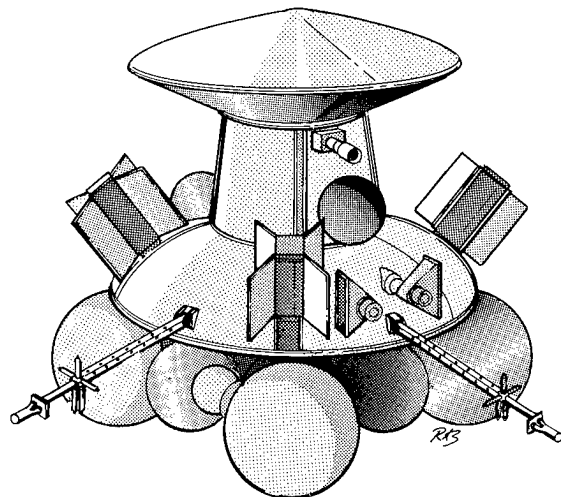

Figure 5.14. Tsiolkovsky Probe

satellite, shown in Figure 5.15, had its first encounter with Halley's Comet in March, 1986, and returned the most detailed data ever on the structure of the comet nucleus and the dust/ice ejection mechanisms involved. After spending the intervening years in hibernation, Giotto was reactivated for a July, 1992, encounter with Comet Grigg-Skjellerup. During the Halley encounter, Giotto sustained major damage from a dust strike, which completely disabled three of the eleven sensors on-board and damaged others. Unfortunately, one of the destroyed sensors was the multicolor camera which had returned closeup photos of Halley's nucleus. Giotto broke its own record for comet proximity, passing an estimated 200 km from Grigg-Skjellerup on 10 July 1992, besting the 600 km mark it set with Halley. A wealth of data on Grigg-Skjellerup's coma and bow shock were collected and transmitted during and after the encounter. Although much smaller and more quiescent than Halley, dust jets from the recent comet again were felt by Giotto in the flyby; however, no new damage was detected. Shortly after the encounter, ESOC controllers used most of the remaining propellant to vector Giotto for another Earth flyby in July, 1999, and then placed the probe back in hibernation. Scientists are currently considering a third target

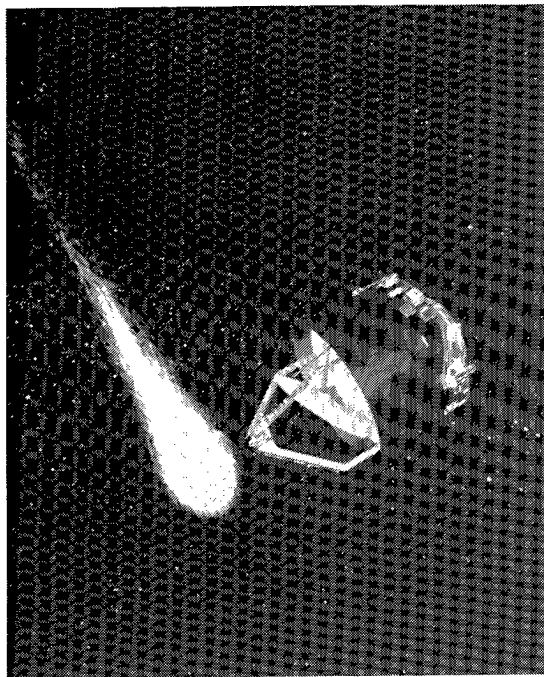

Figure 5.15. Giotto Encounter with Comet Grigg-Skjellerup.

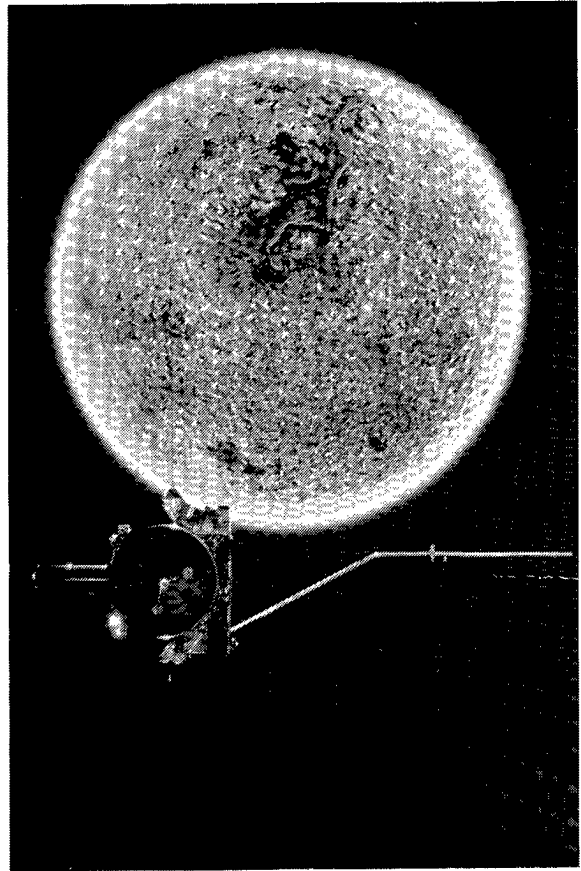

Figure 5.16. Ulysses at the Sun.

for the probe to investigate with the remaining fuel (Reference 105).

The second probe extant is the Ulysses satellite, which swung by Jupiter en-route to a polar flyby (south first, then north) of the Sun. Ulysses was originally scheduled for a May, 1986 launch aboard the Space Shuttle, but the Challenger accident caused an extensive delay. After storage, refurbishment, and testing, the probe was finally launched over four years later in July, 1990. The 367 kg spacecraft is shown in Figure 5.16. During the Jupiter flyby in February, 1992, Ulysses explored the Jovian magnetosphere, which even at interplanetary speeds took twelve days to traverse. After a gravity-assisted turn at Jupiter, Ulysses headed 'south' of the solar ecliptic and back towards the Sun. It is scheduled for a June through November, 1994, south polar (i.e., greater than 70° heliographic south latitude) solar pass and a June through September, 1995 north polar solar pass. ESA researchers have not ruled out a second solar pass in 2001 (Reference 106).

SOHO (Solar Heliospheric Observatory), scheduled for launch in 1995, will be placed in a halo orbit about the L_1 libration point of the Earth-Sun system. Although SOHO's primary mission will be solar observation, it will augment ISTP sensors investigating the interaction of the solar wind and geomagnetic fields by carefully tracking the exogeomagnetic environment. SOHO (Figure 5.17) is designed for a two year mission with reserves available for up to four additional years of observation. Matra Marconi is the prime contractor for SOHO and reports that all aspects of the program are on or ahead of schedule (References 107 and 108).

October, 1997, should bring the launch of a ground-breaking satellite from ESA. NASA/JPL's Cassini probe will be launched in a circuitous Earth-Venus-Venus-Earth-Jupiter-Saturn gravity assist trajectory which will arrive at Saturn in June, 2004. ESA's Huygens probe is to be carried aboard Cassini and deployed to Titan, Saturn's largest Moon, in October, 2004, for atmospheric entry in November. During its

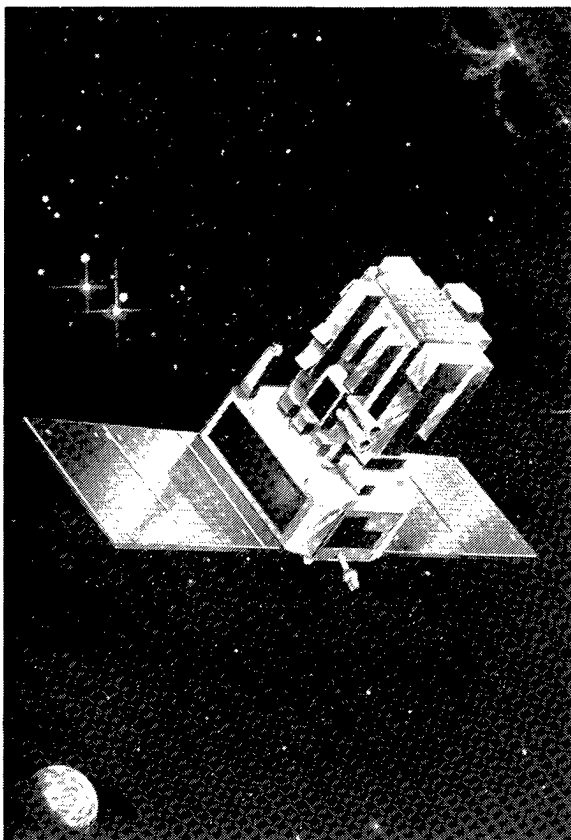

Figure 5.17. SOHO Observatory.

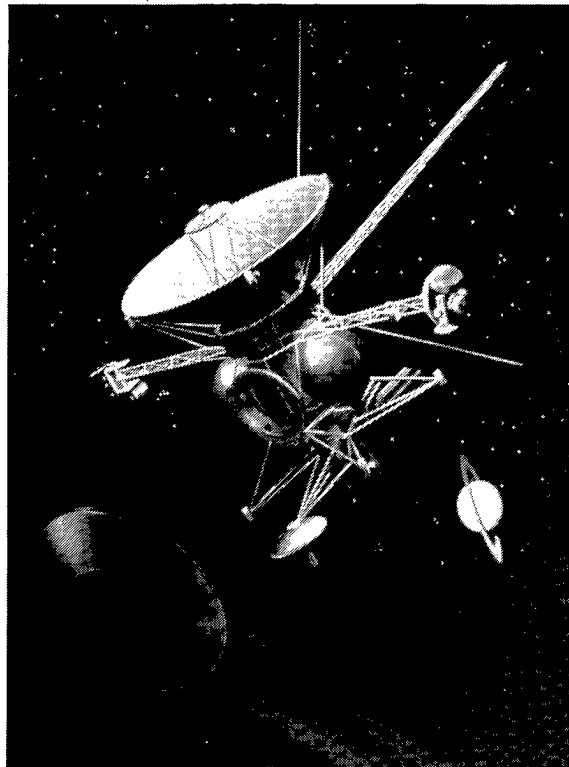

Figure 5.18. Cassini and Huygens Probe.

parachute-slowed descent, Huygens will chart the chemical composition, density, winds, and temperature down to the surface. It is hoped that the probe will survive impact and continue to transmit from the surface. Due to fiscal constraints, NASA was forced to reconfigure Cassini in 1992, and ESA had to respond by adapting the Huygens probe accordingly. Cassini/Huygens is shown in Figure 5.18 (References 109 and 110).

One of the most aggressive unmanned projects under consideration by ESA or any other agency is the joint NASA/ESA Rosetta mission. The primary goal of the mission was proposed as matching trajectories with an inbound comet, approaching, landing on it, taking material samples, and returning to Earth. The plans for the program have suffered several budget cut-backs over the past few years (primarily on the US side), leading to major program redefinitions and scale-downs. According to ESA's 1992 annual report, ESA has now abandoned hope for a landing on a comet, instead proposing to achieve more modest goals via remote sensing. Final program status has yet to be determined for both NASA and ESA, but fundamental ESA

policy changes have emerged as a result of this and other US-modified joint programs. ESA Science Director Roger Bonnet recently stated, "We will now study missions in the context of a European framework to be sure we can handle them in ESA, then define cooperation afterward." ESA's new European Rosetta program has not yet identified a target comet or launch date (References 110 and 111).

5.3.3 France

Aside from its considerable involvement with the ESA programs (Section 5.3.2), France also launched a modest Jupiter research mission on 17 July 1991. The SARA (Amateur Radio Astronomy Satellite) spacecraft, designed by college students at the Ecole Superieure d'Ingenieur en Electrotechnique et Electronique in Noisy le Grand, was fielded with support from CNES and French aerospace companies. The mission of the microsatellite is to monitor the Jovian atmosphere for radio emissions in pursuit of a better understanding of the giant planet's magnetosphere. The 19 kg, 0.4 m per edge, cubic SARA, which was deployed from an Ariane 4 ASAP (Ariane Structure for Auxiliary Payloads) platform, resides in a 770 km by 777 km, 98.54° inclination orbit (Reference 112).

5.3.4 Japan

Japan has a growing portfolio of solar system investigations, and planned future missions will further expand Japan's position via direct solar system exploration. To date ISAS, rather than NASDA, has been the primary agency involved with such missions. Starting in 1971 with the Shinei (New Star) satellite, ISAS has fielded four 'pure' solar research experiments, culminat-

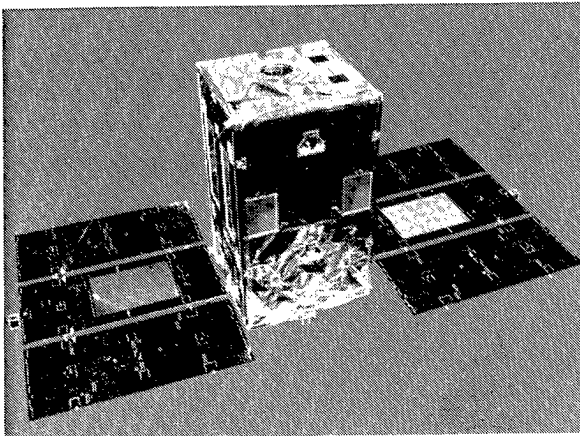

Figure 5.19. Solar-A (Yohkoh).

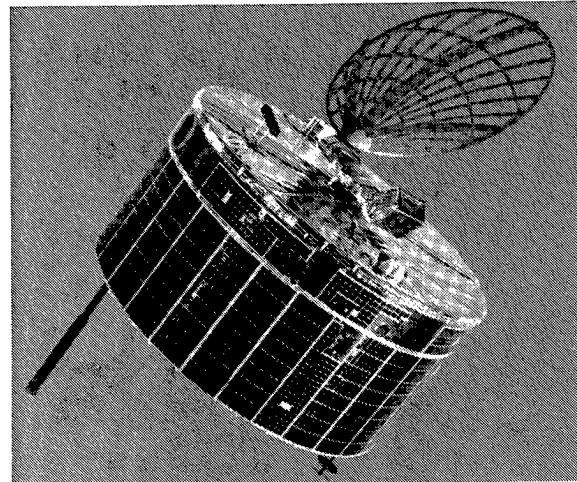

Figure 5.20. MS-T5 (Sakigake).

ing with the Yohkoh (Sunbeam) probe, also known as Solar-A (Figure 5.19), on 30 August 1991 from the Kagoshima Space Center. The 390 kg, 2 m by 1 m by 1 m box-shaped satellite resides in low-Earth orbit with four solar sensors: hard and soft X-ray telescopes, a Bragg crystal spectrometer and a wide-band spectrometer. Yohkoh is the first satellite to provide continuous 'video' of events in the X-ray and gamma-ray spectra and has already inundated solar researchers with hundreds of thousands of high-quality images. The particular bands chosen yield data on the activity of high-temperature gases and high-energy phenomena on the Sun's surface. The project also involved researchers in the US and UK (References 113-115).

Japan launched two deep space probes in 1985 as part of the international fleet to study Halley's comet. The Sakigake (Pioneer) and Suisei (Comet) probes were more distant observers than ESA's Giotto but returned much valuable information on the Halley-induced space environment. Sakigake (Figure 5.20) was later vectored back toward Earth for geophysical research (Section 5.2.5) (Reference 37).

ISAS has two major solar system exploration projects in planning at this time. A lunar mission due for launch in 1997, currently referred to as Lunar-A (Figure 5.21), will have two primary scientific missions: mapping from an orbital craft and thermo/seismological studies from subsurface lunar sensors. The orbiter will deploy three probes to the Moon over a one month period. The 0.12 m diameter by 0.83 m

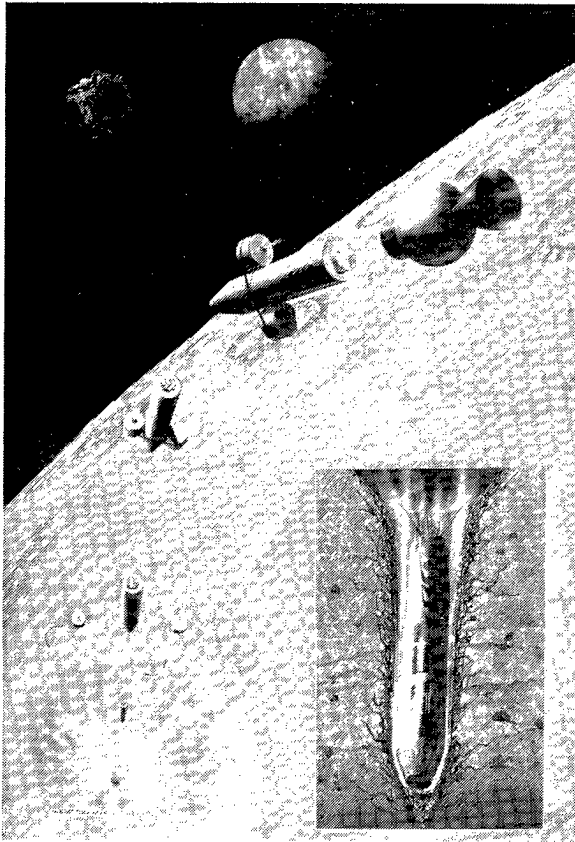

Figure 5.21. Lunar-A Mission.

instrumented spikes will impact the lunar surface at about 300 m/s and will return heat loss information and seismic data on moonquakes in an attempt to determine the core state of the Moon, which has puzzled researchers for decades. The 2.2 m diameter by 2 m high, 550 kg orbiter will then assume a low altitude (100 km) lunar mapping orbit, probably with a CCD camera. Imagery detail should be about 20 m. The data from both studies should aid in mission definition and planning for future manned lunar visits and/or bases. Lunar-A will draw on the experience in lunar transfer orbits

and subsatellite deployment gained with the Hiten/Hagomoro mission in 1990-1991 (Section 5.2.5) (References 116 and 117).

The second pending interplanetary ISAS mission is Planet-B (Figure 5.22), a Mars orbital mission due for deployment in 1996. The primary goal of the 300 kg payload will be to study the interaction of the solar wind with Mars' atmosphere. Mars has a very weak magnetic field as compared with Earth and all other planets except Venus, thus it is suspected that the unobstructed solar wind strips away much of the Martian atmosphere. The probe will carry about ten sensors, including an ultraviolet camera. Other instruments are still being considered. Planet-B's two year mission will be performed from a 150 km by 30,000 km elliptical orbit. Nippon Electric is the prime contractor of Planet-B, though a \$3.7 M contract to the Canadian Space Agency has been let to build a thermal plasma analyzer for the mission (References 118-120).

Japan's larger space agency, NASDA, is also planning two deep space missions before the turn of the century. A 1997 lunar polar orbiter and a 1999 Mars orbiter are planned, though details are sketchy at this time. Several large Japanese industrial companies are also working on plans for an eventual manned lunar base.

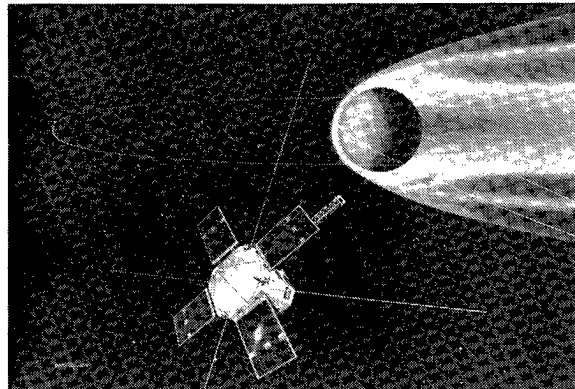

Figure 5.22. Planet-B Mars Orbiter.

5.4 Extra-Solar System Observations

The use of man-made satellites to perform surveys of the Universe beyond our small Solar System has revolutionized the field of astrophysics in the second half of the 20th century. Not only have orbital platforms made possible the collection of electromagnetic spectra normally screened by the Earth's atmosphere, but these satellites can operate beyond the influence of other geophysical perturbations and can permit the establishment of very long baselines (greater than the diameter of the Earth) necessary for some radio astronomy investigations.

Due to their complex, often state-of-the-art nature and to their often one-of-a-kind status, modern deep space astrophysical observatories may require strong governmental support. In Europe and Asia, the USSR/CIS, ESA, and Japan have been the leaders in this field while India strives to increase its contribution. However, the growing international cooperation in space science missions has in large measure eroded previous national distinctions. Despite severe economic pressures facing virtually all national space programs, a large number of significant extra-Solar System observation missions are planned for the remainder of this decade.

5.4.1 USSR/CIS

At the beginning of 1991 the USSR was operating two impressive satellite observatories aimed at improving man's knowledge of the X-ray and gamma-ray Universe. Whereas the dramatic changes occurring in the USSR/CIS during 1991–1992 had little direct effect on the Gamma and Granat spacecraft, the outlook for future missions remains hazy. Most major programs slated for the mid-1990's remain intact albeit delayed. Complicating matters is the demise of the Interkosmos organization which acted as a coordinating body for many missions.

The Gamma spacecraft, launched in July, 1990, was designed to conduct basic research in the field of gamma astronomy from a low altitude Earth orbit. Based in part on systems proven with the Progress cargo ships for the Mir space station, the Gamma satellite possessed an initial mass of 7.3 metric tons and measured 7.7 m in length and 2.7 m in diameter, excluding the two solar arrays capable of generating 3.5 kW of electrical power (Figure 5.23). The pro-

pulsion system contained 780 kg of propellant to maintain attitude and altitude control for at least the minimum 1-year design life (References 121–124).

The heart of Gamma was its 1.7 metric ton scientific payload consisting of the Gamma-1, Disk-M, and the Pulsar X-2 telescopes. The Gamma-1 telescope, by far the largest of the three primary instruments, was the result of the collaborative effort of several Soviet (including the Institute of Space Research, the Energiya NPO, the Lebedev Physics Institute, and the Leningrad Physical-Technical Institute) and French (Center for Nuclear Research, Center for Research of Cosmic Radiation, and CNES) institutions. The high energy gamma telescope was sensitive to energies of 50 MeV to 5 GeV and worked in conjunction with the Polish Telezvezda star tracker with a 6° by 6° field-of-view and an angular resolution of 2'.

The 78 kg Disk-M telescope was designed to capture soft gamma radiation in the range 20 keV to 5 MeV and was developed by the Physical-Technical Institute in Leningrad. The 50 kg Pulsar X-2 telescope complemented the Disk-M device by detecting lower energy radiation in the 2–25 keV band. The Pulsar X-2 was the product of the Soviet Institute of Space Research and the French Center for Research of Cosmic Radiation. All three primary instruments were mounted coaxially to permit simultaneous observations at specified locations on the

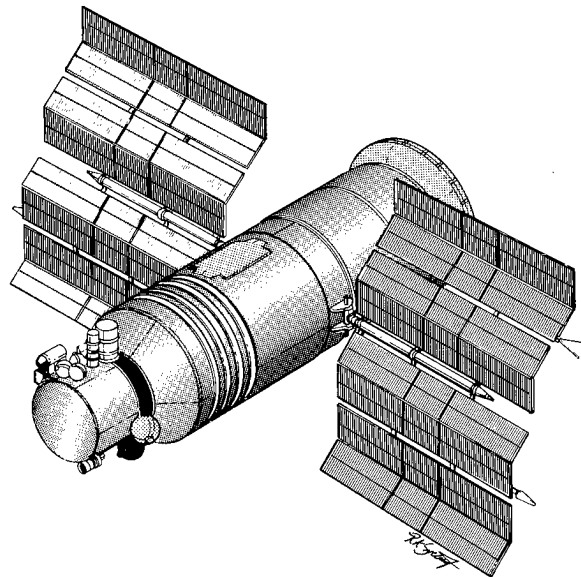

Figure 5.23. Gamma Satellite.

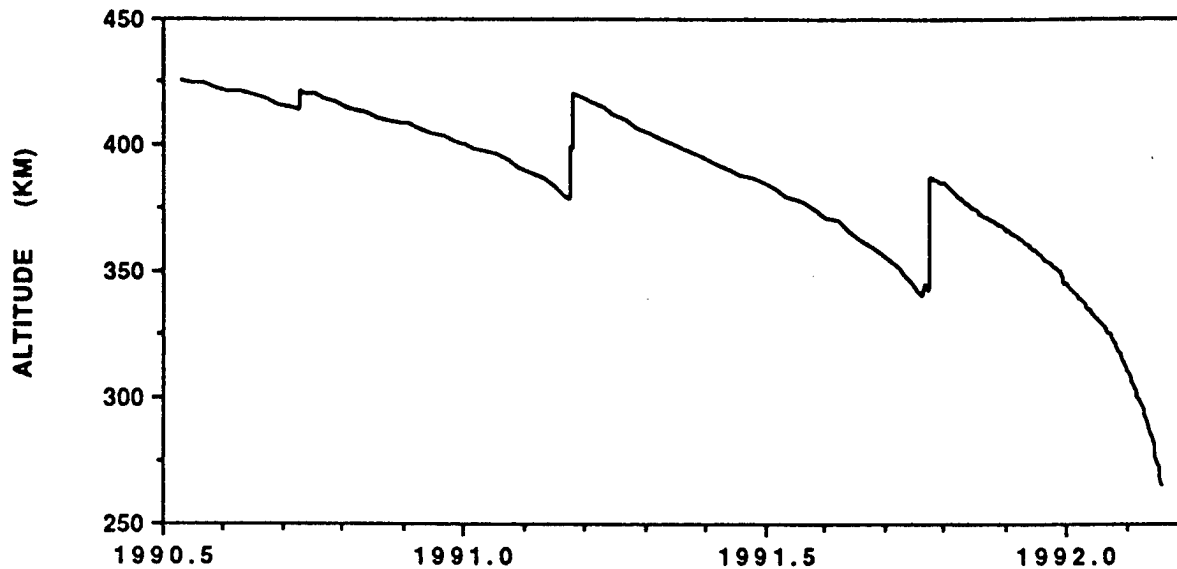

Figure 5.24. Orbital History of Gamma Satellite,

celestial sphere.

After reaching its initial operational altitude near 425 km, the Gamma spacecraft underwent a thorough check-out. Immediately, spacecraft controllers detected a short-circuit in the broad-gap spark chambers of the Gamma-1 telescope, leading to a decision to refocus the scientific program toward the study of gamma-ray pulsars. Less than a year into the mission, the Disk-M telescope ceased functioning. Lower than expected propellant usage allowed Gamma to remain in orbit for almost 20 months before the vehicle was intentionally de-orbited on 28 February 1992 (Figure 5.24). In the first year alone Gamma returned more than 2,000 hours of valuable observations (References 121, 125–130).

While Gamma orbited the Earth in a low altitude circular orbit, the Granat observatory was conducting its own X-ray and gamma ray studies in an extremely elliptical orbit (10,000 km by 193,000 km in early 1991) requiring four days to complete a full circuit. Granat was the last of the Venera-class spacecraft produced by the Lavochkin NPO and was similar to the Astron observatory (1983–1989). The 4.4 metric ton Granat carried a scientific payload of almost 2.3 metric tons and stood 6.5 m tall with a total span across its two solar arrays of 8.5 m (Figure 5.25).

The major instrument on Granat was the French-built, one-metric-ton Sigma gamma-ray telescope designed to detect energy in the 30

keV to 2 MeV band with a 7° by 7° field-of-view. Adjacent to Sigma on one side were four Soviet ART-P imaging X-ray telescopes created by the Institute of Space Research and in particular its Frunze Special Design Bureau. The ART-P telescope covered the energy range of 3–100 keV with a narrow 1.8° by 1.8° field-of-view. On the other side of Sigma were four ART-S spectral X-ray telescopes designed by the same team which built the ART-P and covering the same energy regime with a 2° by 2° field-of-view. The Frunze Special Design Bureau also provided the Podsolnukh installation consisting of an X-ray telescope (2–25 keV, 2.5° by 2.5° FOV) mounted on a rapidly moving platform which is aimed after being cued by the Konus-B all-sky, gamma-ray burst detector provided by the Leningrad Physical-Technical Institute. Rounding out the deep space payload suite were the French Phoebus spectrometer (200 keV–40 MeV) and the Danish Watch X-ray burst detector (5–150 keV), both of which were all-sky instruments (References 131–134).

Launched on 2 December 1989, the Granat observatory had completed the first phase of its mission by the end of 1990 but remained active throughout 1991–1992. Figure 5.26 indicates the natural perturbations of Granat's orbit during its first two years in space (December, 1989–December, 1991) when its orbital inclination increased from 54.8° to 82.3° while its eccentricity decreased. The disruption in the USSR in late 1991 led to France providing direct

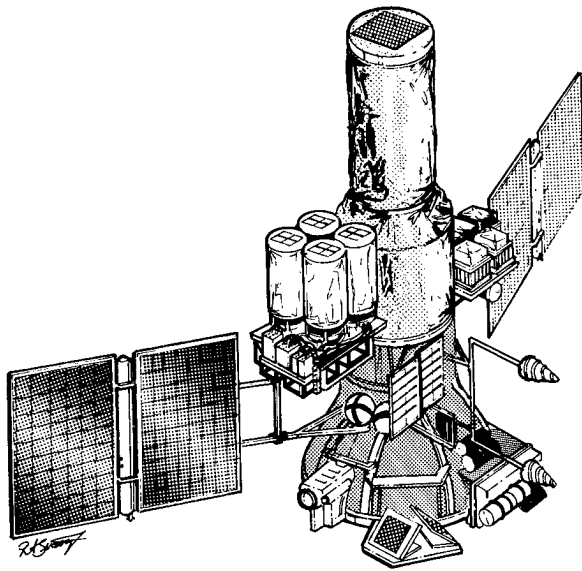

Figure 5.25. Granat Observatory.

funds to maintain the Yevpatoriya ground station with its 70-m diameter dish antenna in the Ukraine's Crimea region serving as the primary data collection and spacecraft control

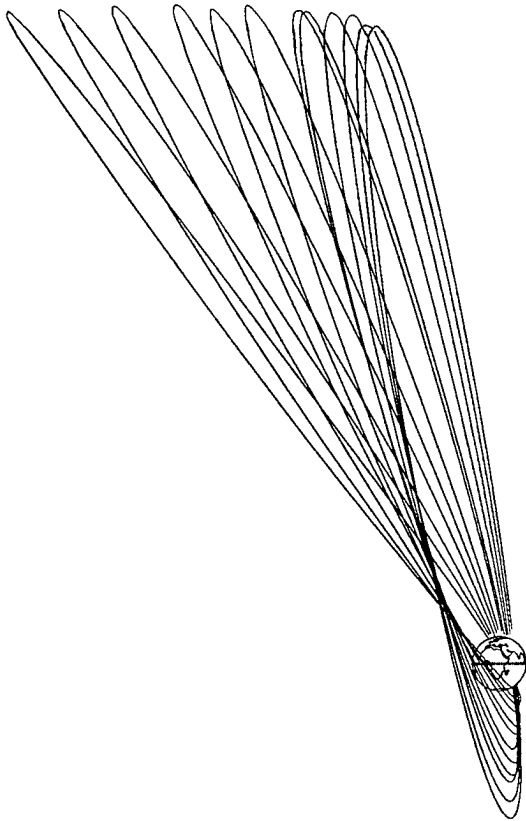

Figure 5.26. Granat Orbit Perturbation.

node (References 135–139).

Replacing the Venera-class platform used by Granat will be the new Spektr-class series of high altitude astrophysical observatories. Built by the Lavochkin NPO, the Spektr spacecraft bus will support up to four major missions in the 1990's beginning about 1995: Spektr-X γ for X-ray and gamma-ray astronomy, Spektr-R for radio astronomy, Spektr-UVT for ultra-violet observations, and Spektr-IR for infrared investigations. The 3.5 metric-ton, 3-axis-stabilized Spektr bus will measure more than 18 m across its solar arrays which provide 3 kW of electrical power at beginning of life including up to 0.8 kW for the scientific payload. The attitude control system is designed for an operational pointing accuracy of not worse than 4 arc minutes, and the spacecraft projected lifetime is three years. The maximum scientific payload for Spektr will be approximately 2.5 metric tons for a total 6 metric ton spacecraft mass (References 140 and 141).

One of the first Spektr satellites to be launched will be Spektr-X γ currently scheduled for 1995 or 1996 (Figure 5.27). The SL-12 (Proton) launch vehicle will insert the spacecraft into a highly elliptical orbit with a perigee near 2,000 km and an apogee of 200,000 km, resulting in a 4-day orbital period similar to that of Granat. Originally conceived and sponsored by the USSR/CIS Institute of Space Research, Spektr-X γ now boasts wide cooperation from 20 international participants, including the former Czechoslovakia, Denmark, ESA, Finland, Germany, Italy, Japan, the UK, and the US.

The principal scientific instrument will be the SODART grazing incidence X-ray telescope assembly with two parallel telescopes operating

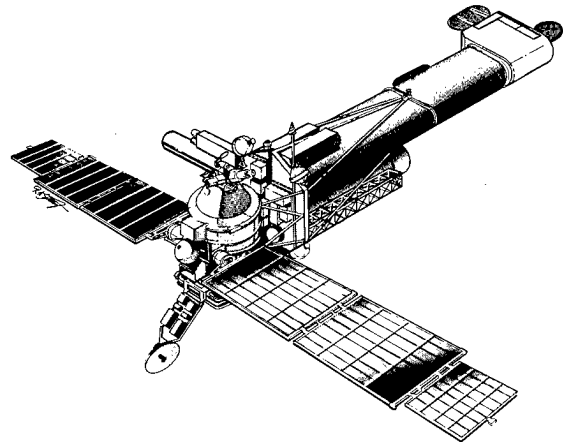

Figure 5.27. Spektr-X γ Satellite.

in the 0.3–20 keV regime. The approximately 1.5 metric ton unit offers nine focal instruments, including a polarimeter, a gas scintillation proportional counter, a spectrometer, and four (two per telescope) XSPECT position-sensitive proportional counters. Also part of the scientific package will be the JET-X X-ray telescope (0.1–10 keV), the MART X-ray telescope (4–100 keV), the EUVITA UV telescope (0.07 keV), the MOXE X-ray burst detector (3–12 keV), and the SPIN gamma-ray burst detector (10 keV–MeV) (References 142–146).

Scheduled for launch at about the same time as Spektr-Xy is Spektr-R, also known as Radioastron, with an objective of establishing a Very Long Baseline Interferometer (VLBI) between the spacecraft and large radio telescopes on Earth. Spektr-R will carry a 10-m diameter radio telescope tuned to receive frequencies of 0.3, 1.6, 5.0, and 22 GHz (Figure 5.28) in a highly elliptical, 28-hr Earth orbit. The Yevpatoriya Deep Space Tracking Center with its 70-m diameter radio telescope will serve as the primary spacecraft control facility, while smaller 25-m and 32-m CIS antennas will assist with spacecraft communications and 70-m antennas at Ussuriysk and in Uzbekistan will become part of the VLBI. The US Deep Space Network will also play a major role in satellite tracking and data collection.

The scientific payload mass will amount to about 1.5 metric tons, including the 700 kg deployable antenna. Early plans for a more ambitious Radioastron program involving six spacecraft over a period of 15 years have at

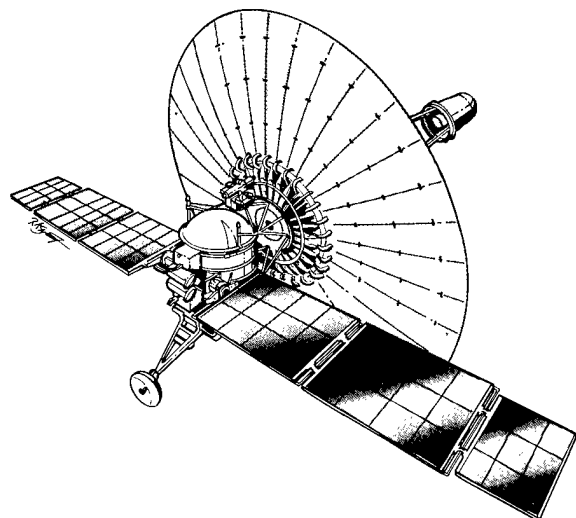

Figure 5.28. Spektr-IR Satellite.

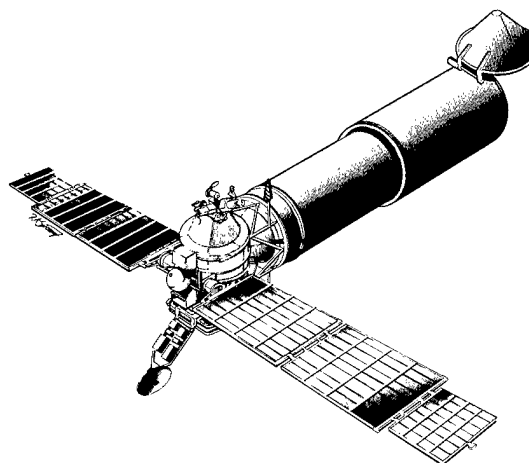

Figure 5.29. Spektr-UVT Satellite.

least temporarily been shelved. The launch of Spektr-R, once envisioned as early as 1991, is now tentatively set for 1995 (References 147–154).

In the second half of 1997 the Spektr-UVT spacecraft is tentatively scheduled for launch into a 500 km by 300,000 km orbit with an inclination of 51.5°. However, within eight months the perigee will be raised to 40,000 km for the remainder of the 3-year mission. The principal participants in the project are now Canada, Germany, Italy, Russia, and Ukraine with Russia's Institute of Astronomy assuming a lead position. The purpose of the mission is to perform UV (including EUV and XUV) observations with a higher fidelity than those of Astron.

The centerpiece instrument for Spektr-UVT will be the T-170 Ritchey-Chretien telescope (912–3,600Å) consisting of a 170 cm (light) diameter primary mirror and a 49 cm (light) diameter mirror in a main housing more than 8 m in length and 2 m in diameter (Figure 5.29). The three major focal plane devices are (1) a high resolution dual Echelle spectrograph (1150–3600Å), (2) a medium and low resolution (912–1,200Å and 1,150–3600Å, respectively) Rowland spectrograph, and (3) a direct imaging camera (912–3600Å). Under consideration is the addition of two T-50 (50 cm diameter) and four T-20 (20 cm diameter) EUV/XUV telescopes. One T-50 (T-50I) would be used for direct imaging (400–800Å), whereas the other T-50 (T-50S) would be equipped with a low resolution spectrograph (400–1,200Å). The T-20 telescopes would permit narrow band imaging within the range of 100–300Å (Reference 141).

The fourth and least mature proposed Spektr

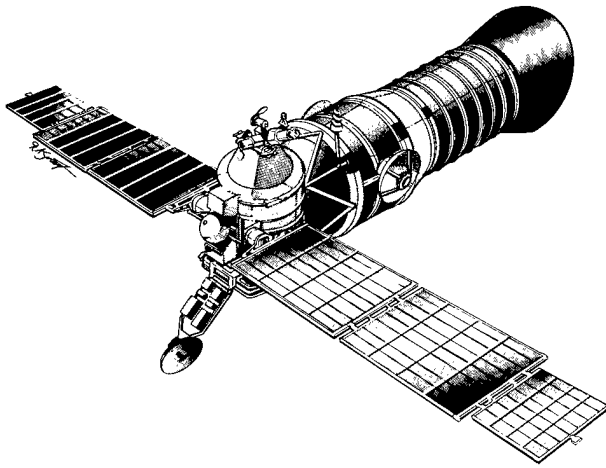

Figure 5.30. Spektr-IR Satellite.

mission is Spektr-IR, which may not be flown until after the end of the decade (Figure 5.30). Seriously examined since 1986 (originally under the name Aelita), this infrared observatory would carry a 1-m diameter, cryogenically-cooled telescope operating in the 0.15–2 mm band for studies of interstellar and intergalactic dust and molecular clouds as well as the general background environment. Liquid neon and super fluid helium may be used to lower the temperature of the telescope to 27° K and of the photometer to 1.8° K, respectively (References 155–156).

Of special interest to astrophysicists is the precise nature, including anisotropy, of the universal background radiation (~2.7° K) at 37 GHz. In 1983–1984 the Prognoz 9 spacecraft carried out the Relikt experiment from a unique Earth orbit of 400 km by 720,000 km in an attempt to characterize the uniformity of emissions around the celestial sphere. However, despite the spacecraft's extreme apogee (twice the distance to the Moon), interference from the Earth and Moon as well as spacecraft systems degraded the quality of the observations.

While data from Prognoz 9 was still being reduced nearly 10 years later, final preparations were underway for the Relikt-2 experiment. In addition to employing instruments with significantly greater sensitivity than the first mission, Relikt-2 will be performed far away from the Earth-Moon system around the L_2 libration point about 1.5 million km from the Earth on the side opposite the Sun. The Relikt-2 satellite, which will be based on the Prognoz-M2 spacecraft bus, is scheduled for launch in the Fall of 1993

after which it will conduct a close fly-by of the Moon on its third revolution in an extremely elliptical Earth orbit for a gravitational assist toward L_2 . Once the vehicle reaches its destination, a halo orbit around L_2 will be established with an orbital period of 180 days (References 156–161).

Under serious development since 1986 in the Institute of Space Research, the Relikt-2 instrument suite now includes five separate radiometers operating at a wavelength of 1.5 mm, 3.0 mm, 5.0 mm, 8.0 mm, and 13.5 mm, respectively. Each radiometer will operate through two perpendicular antennas with a 7° beam width: one pointed away from the Sun and the other perpendicular to the spacecraft's spin axis.

One of the oldest problems in astronomy has been the inaccuracy of positional data for the hundreds of thousands of cataloged stars used in cosmological as well as geophysical research. Although star maps have improved considerably during the 20th Century, the inherent limitations of surface-based observations can be overcome from a high altitude space platform. Since 1989 the Sternberg State Astronomical Institute of Moscow University in conjunction with the Lavochkin NPO, the Vavilov State Optics Institute, and the All-Union Television Scientific Research Institute, has been promoting the Lomonosov astrometric project with its goal of creating an ultra-high precision star catalog (References 162–165).

The program's objectives include observations of all stars of 10th magnitude and brighter (~400,000), of selected stars between 10th and 13th magnitude (~8,000), of 30 of the brightest sources of extra-galactic radiation, and of 40 natural bodies of the solar system (major and minor planets). These observations would be carried out from an orbit about the Earth of 1,500 km by 120,000 km, yielding a 48-hour period of revolution. Actual measurements would be performed during a 32-hour period when the spacecraft is more than 80,000 km above the Earth. The principal data reception facility would be at Medvezhi Ozero in the Moscow region with reserve sites at Yevpatoriya and Ussuriysk.

Based loosely on the Venera-class spacecraft but with improvements developed for the new Spektr-class satellites, Lomonosov is envisioned as a 5.8 metric ton, 9 m tall vehicle with a 1,000 kg scientific payload (Figure 5.31). A

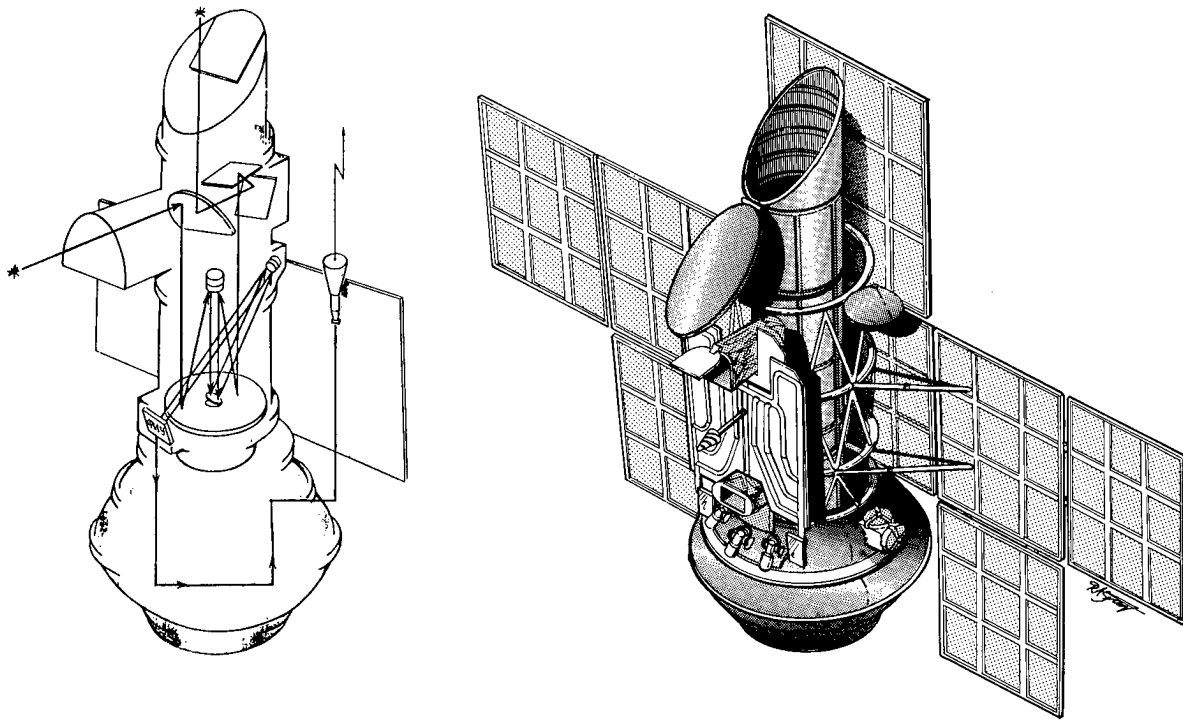

Figure 5.31. Lomonosov Stellar Mapping Satellite.

complex solar array could produce up to 3 kW of electrical power. The primary instrument is a Cassegrain telescope with a 1 m diameter main mirror with an equivalent focal length of 50 m. The focal plane detector will be a CCD matrix of 800 x 800 elements. Originally planned for a launch in 1995–1996, this project appears to be no longer funded.

A much more modest alternative to Lomonosov has been proposed under the Regatta-Astro program. As noted in Section 5.2.1, the Regatta series of small spacecraft (<230 kg payloads) are being developed by the Institute of Space Research to perform a variety of space science investigations. The Regatta-Astro mission is specifically designed to conduct astrometric and radiometric observations of stars and other celestial bodies. Unlike Lomonosov, Regatta-Astro would forsake the relative stability of a L_2 halo orbit for a quasi-satellite orbit with a inclination of 10° to the ecliptic and varying ranges from Earth of 2–10 million kilometers. In orbit the approximately 575 kg Regatta spacecraft would exhibit a height of 2.75–3 m and a diameter across the solar sail and solar rudders of 6–9 m (References 166–168).

In early 1991 an operational period for Regatta-Astro of 1994–1997 was proposed, but

the current status of the project is unclear. If successful, a second Regatta-Astro could be flown with more precise observational instrumentation. Plans for similar Regatta missions concentrating on thermal IR (2–7 μm) with a spatial resolution of six minutes and on radiometric mapping in the 1.0, 1.5, and 3.0 mm wavebands with a spatial resolution of at least 0.5 minutes have also been devised. These latter missions would also employ quasi-satellite orbits like Regatta-Astro.

5.4.2 European Space Agency

Since the establishment of ESA, space science, including extra-solar system observations, has been considered one of the foundations of the multi-national organization. (ESA's predecessor, ESRO, fielded numerous scientific satellites, including its first spacecraft in 1968 with cosmic ray detectors.) From its initial cooperation with the US and UK on the International Ultraviolet Explorer (launched 1978), ESA undertook a program of autonomous missions, beginning with the European X-ray Observatory Satellite (EXOSAT), while continuing its participation with other countries, e.g., the Hubble Space Telescope. During 1991–1992 ESA's long-range astrophysics program continued one major satellite mission, prepared for the start of

two more ambitious flights later in the decade, and evaluated proposals for additional projects soon after the turn of the century.

ESA was a significant participant in the Hubble Space Telescope project, providing the solar arrays (British Aerospace) and the Faint Object Camera (Dornier). While the latter has performed well, albeit at reduced fidelity due to the primary mirror problem, soon after launch in April, 1990, the solar arrays were found to be susceptible to thermal effects when crossing the terminator, in turn upsetting the stability of the telescope. During 1991–1992 design modifications were made and a new pair of solar arrays prepared for the Hubble repair mission in December, 1993.

In 1989 ESA launched the High Precision Parallax Collecting Satellite (HIPPARCOS) for the purpose of compiling an accurate catalog of stellar positions in a manner similar to the CIS' proposed Lomonosov and Regatta-Astro missions described above (Section 5.4.1). Although a launch malfunction left the 1.14 metric ton satellite stranded in GTO instead of the intended GEO, ESA engineers and space scientists have been able to salvage much of the program's objectives despite the less than optimum conditions. By 1992, precise astrometric measurements of 120,000 stars had been made with the desired accuracy of two milli-

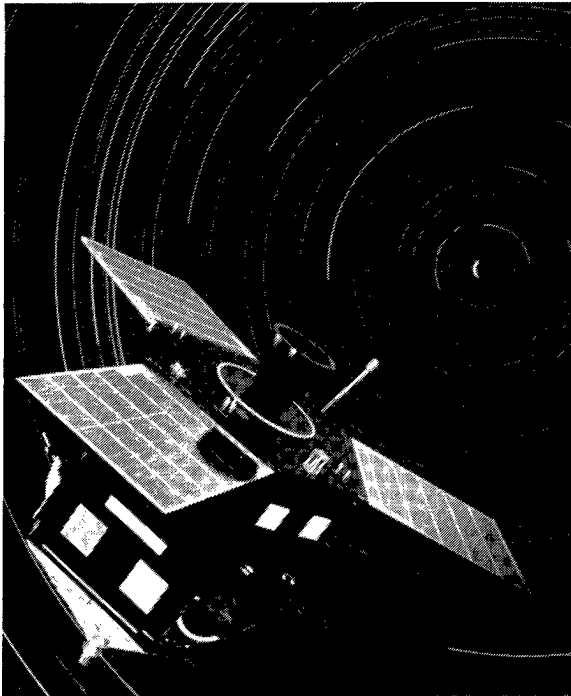

Figure 5.32. HIPPARCOS Satellite.

arcseconds under the Main Experiment, and a mission extension had been granted to continue operations to mid-1994. A secondary objective, code-named the Tycho Experiment, calls for obtaining positional data (30 milli-arcsecond accuracy) and two-color photometric properties of 400,000 additional stars (References 169–171).

The HIPPARCOS satellite's basic structure is a hexagonal box with three rectangular solar panels extending from the base (Figure 5.32). The spacecraft maintains a very slow spin rate (\sim one revolution every two hours) to facilitate its all-sky mapping mission. At the end of 1992 the orbital parameters of HIPPARCOS were about 520 km by 35,850 km at an inclination of 7.2° . Matra was the prime contractor for the satellite with significant contributions from the major European aerospace industries, including Dornier, Fokker, ERNO, and British Aerospace.

The next major astrophysical mission of ESA is the Infrared Space Observatory (ISO), now scheduled for launch in late 1995. Selected in 1983, ISO will expand upon the work of the pioneering US-UK-Netherlands Infrared Astronomical Satellite (IRAS), launched in 1983. However, "compared with IRAS, ISO will have a longer operational lifetime, wider wavelength coverage, better angular resolution, more sophisticated instruments, and, through a combination of detector improvements and longer integration times, a sensitivity gain of several orders of magnitude" (Reference 170). Whereas IRAS was designed to map the IR celestial sphere, ISO will make more detailed observations of selected objects.

ISO will have an initial mass of 2.4 metric tons in a compact structure 5.3 m in length and 3.5 m in width (Figure 5.33). The precision attitude control system will provide a pointing accuracy of 2.7 arcseconds. Electrical power will be furnished by solar cells mounted on the exterior of the Sun shield. ISO's operational orbit will be 1,000 km for perigee and 70,500 km for apogee at a low inclination, and the spacecraft will be controlled from ESA's Villafranca ground station in Spain (References 170, 172, and 173).

The heart of ISO is a cryogenically-cooled Ritchey-Chretien telescope with an effective aperture of 60 cm. Approximately 2,300 liters of superfluid helium will be carried to cool the infrared detectors and scientific equipment to

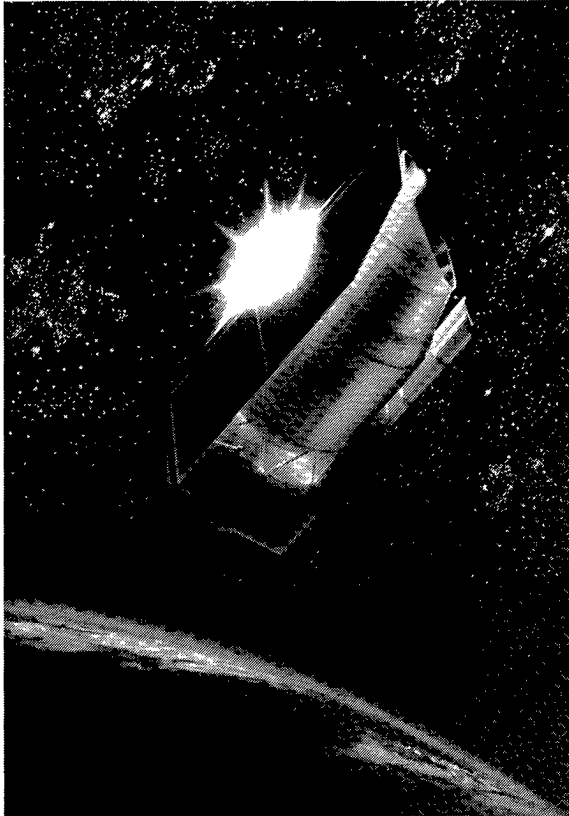

Figure 5.33. ISO Satellite.

2–3° K for a period of at least 18 months. The principal instruments are (1) ISOCAM camera and polarimeter operating at 2.5–17 μm , (2) ISOPHOT imaging photopolarimeter operating at 2.5–200 μm , (3) SWS short-wavelength spectrometer operating at 2.4–45 μm , (4) LWS long-wavelength spectrometer operating at 45–180 μm .

ISO's prime contractor is Aerospatiale with a team of about 35 subcontractors, including Fokker, MBB, and Dornier. Difficulties with the cryogenic cooling system have been the principal reason for the more than two year delay encountered thus far in the project. In addition, the flight model telescope was rejected due to excessive contamination and blemishes on the primary mirror. The mirror was replaced, and the telescope rebuilt.

In 1985 ESA set forth its Horizon 2000 program for space science investigations with four "cornerstone" missions. The first cornerstone is STSP (Section 5.3.2), scheduled to begin solar studies with SOHO and Cluster in 1995. The second cornerstone mission, now slated for launch in 1999, is the High-

Throughput X-ray Spectroscopy Mission known as the X-ray Multi-Mirror (XMM) observatory. The objective of the program is to collect "high-quality spectral measurements of faint sources down to 2×10^{-15} erg/cm²/s together with fast low- and medium-resolution spectroscopy of brighter objects" (Reference 174) as a follow-on to ESA's earlier EXOSAT mission.

The XMM spacecraft will be 2.4–2.5 metric tons at launch and will be inserted into an elliptical 24-hr orbit like that of ISO but with a higher inclination of 60°. The spacecraft definition has not been set since Phase B activities are not anticipated to commence until early 1994 (Figure 5.34). Current project emphasis is on perfecting the manufacturing process of the required three mirror modules sensitive to 1–50 Å waves and made-up of 58 nested mirror shells. Three primary instruments have been identified: (1) Prime Focus Camera for each mirror module to provide broadband spectrophotometry with CCD arrays, (2) Secondary Focus Spectrometer for two mirror modules to provide medium resolution spectroscopy using reflection gratings, and (3) Optical Monitor consisting of a 30 cm diameter Cassegrain telescope for simultaneous optical coverage of the X-ray telescope field (References 169–170, 175).

Another Horizon 2000 cornerstone mission still in the conceptual phase is the Far-Infrared and Submillimeter Space Telescope (FIRST) with a tentative launch date soon after the turn of the century, probably the year 2003 or later. The objective of the mission is to acquire high precision imaging in the 50 μm –1 mm portion of the electromagnetic spectrum to study the physics of the interstellar medium, star formation, and cosmology. The original design called for a primary telescope of 4–8 m diameter, but in 1992 budget pressures led to a down-sizing of the diameter to only 3 m. In turn this leads to an emphasis on the 200–600 μm region with heterodyne spectroscopy – a technique which eliminates the need for liquid helium cryogenic cooling. Further payload and spacecraft redefinition are likely during the next few years (References 169–170, 176).

In early 1993 ESA was expected to select the second Medium Mission (M2) under the Horizon 2000 program. M1 is the Huygens Titan probe discussed in Section 5.3.2. From 22 proposals submitted by late 1989, four final candidates were being evaluated in 1992:

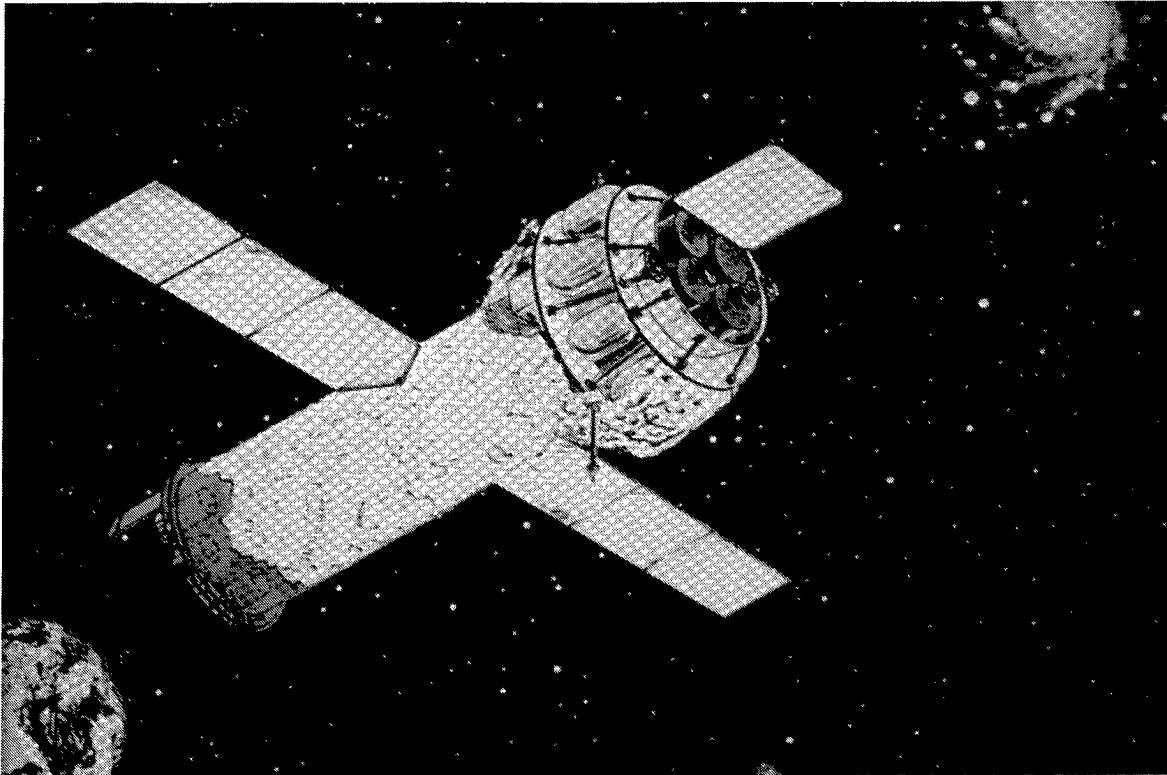

Figure 5.34. Preliminary Concept of XMM Observatory.

- INTEGRAL (International Gamma-Ray Laboratory)
- MARSNET
- PRISMA (Probing Rotation and Interior of Stars; Microvariability and Activity)
- STEP (Satellite Test of the Equivalence Principle).

Only the first and third suggested missions would fall within the extra-solar system observation category. Of the four missions the selection committee gave the highest marks to INTEGRAL. Regardless of which mission is selected, the flight will not occur until after the decade is over (References 169–170, 177–178).

5.4.3 Germany

In addition to its support of ESA astrophysics missions, Germany took the lead in the ROSAT (Roentgensatellit) X-ray imaging telescope program which was a cooperative effort among Germany, the UK, and the US. Under prime contractor Dornier, Germany was responsible

for the spacecraft as well as the principal 0.8 m diameter X-ray (6–120 Å) telescope. The UK provided a Wide Field Camera for extreme UV observations in the 60–300 Å band, while the US furnished the High Resolution Imager for the X-ray telescope and launch and spacecraft control services.

ROSAT is a 2.4-metric-ton, 3-axis-stabilized satellite with a length of 4.3 m (Figure 5.35). Designed for an operational life of only 18 months from its June, 1990, launch date, ROSAT was still operational at the end of 1992 and was expected to continue returning valuable scientific data into 1994. ROSAT's orbit has a mean altitude of 550 km at an inclination of 53° (References 179–180).

5.4.4 India

India's successful launch of SROSS-3 on 20 May 1992 provided the nation with its first astrophysical observatory, albeit temporarily. The primary purpose of the flight was to test the ASLV launch vehicle which had failed on the two previous attempts (Section 2.4). The SROSS-3 was a payload of opportunity which carried a geophysics package and a gamma-ray

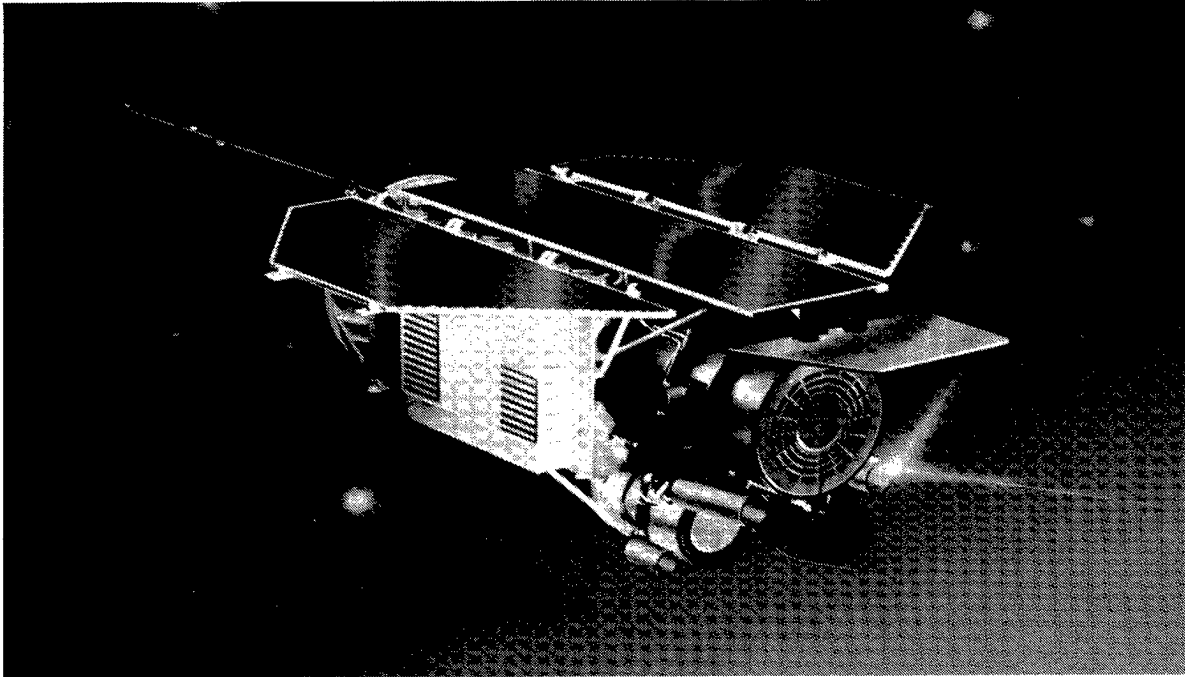

Figure 5.35. Germany's ROSAT X-ray Observatory.

burst detector. The latter was tuned to the energy range of 20 keV–3 MeV and consisted of high voltage scintillation detectors. The observational program was concentrated on the southern celestial sky. Unfortunately, the 106 kg spacecraft decayed after only 55 days instead of an anticipated one year due to the less-than-nominal performance of the launch vehicle: an orbit of only 256 km by 435 km was achieved (References 181–183).

5.4.5 Italy

Like Germany, Italy is heading an international effort to field a complex X-ray observatory designed to characterize a variety of stellar and galactic objects. The Satellite Astronomic raggi-X (SAX) program represents a bilateral agreement between Italy and the Netherlands for the launch of a 1.4 metric spacecraft by an American commercial Atlas 1 launch vehicle. SAX and Germany's ROSAT were originally conceived as US Space Shuttle payloads, but restructuring of the STS program in the wake of Challenger accident forced both satellites to expendable vehicles.

Sponsored by the Italian Space Agency and the Dutch Space Research Organization, SAX is being prepared under the prime contractorship of Alenia Spazio with assistance from

Fokker. The spacecraft is designed to operate in a 600 km high orbit with a nearly equatorial inclination. A suite of Italian X-ray telescopes and detectors and Dutch Wide Field Cameras will span an energy range of 0.1–200 keV, concentrating on long-term variable sources. During 1992 the program came under attack for both rising costs and technical difficulties. A planned early 1994 launch date could be postponed nearly a year (References 184 and 185).

5.4.6 Japan

To date all Japanese astrophysics spacecraft have been developed under the auspices of the Institute of Space and Aeronautical Science and consequently have been modest in size in order to be accommodated by the M-3 class of launch vehicles (Section 2.7). However, the three principal spacecraft, all devoted to X-ray astronomy, have been eminently successful: Corsica-B (Hakucho) in 1979, Astro-B (Tenma) in 1983, and Astro-C (Ginga) in 1987. The Astro-C mission was completed in November, 1991. This tradition is expected to be maintained with Astro-D (Asuka) in 1993 and the radio astronomy mission of Muses-B in 1995.

Astro-D will be a 420 kg spacecraft operating in LEO at a mean altitude of less than 600 km for a period of 5–6 years. With a 1.3 m dia-

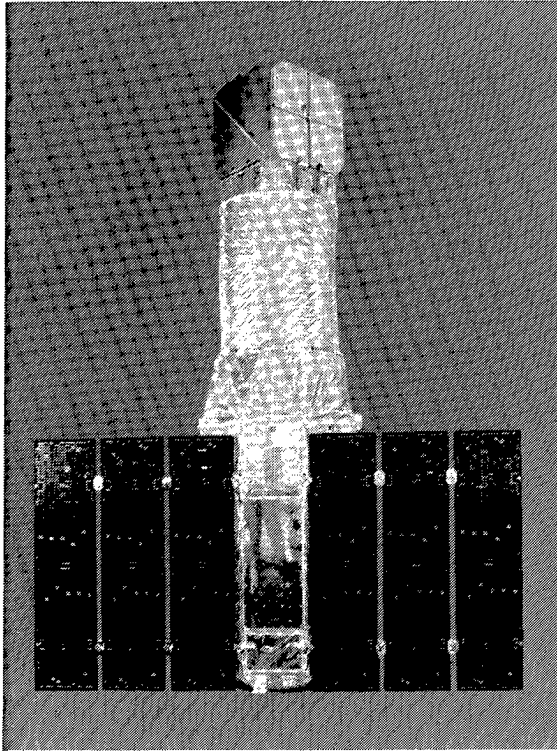

Figure 5.36. Astro-D Observatory.

meter and a 4.7 m length (after telescope extension in orbit), Astro-D (Figure 5.36) will be an order of magnitude more sensitive than its predecessor and will scan the electromagnetic spectrum from 1 to 12 keV. The principal instruments will be an American-supplied X-ray telescope with a CCD camera and a Japanese imaging gas scintillation proportional counter. The mission was scheduled to begin in early 1993 (References 186–191).

In 1995 with the help of ISAS' new M-5 launch vehicle, the institute plans to expand its astrophysical studies into the radio spectrum with the Muses-B spacecraft. The objective of the new VLBI Space Observatory Program (VSOP) is to obtain quality images of both highly energetic and weak radio sources at frequencies of 1.7, 5, and 22 GHz. The 800 kg spacecraft (Figure 5.37) will deploy a 10 m diameter, gold-plated mesh antenna once it reaches an operational orbit of 1,000 km by 20,000 km. The primary contractors developing Muses-B are Mitsubishi Electric Company and Heavy Industries, Nippon Electric Company, Sumitomo Heavy Industries, and Toshiba Corporation (Reference 184).

5.4.7 Spain

Spain has recently decided to develop a small indigenous satellite capable of performing a variety of scientific and applications missions. Sponsored by the National Institute for Aerospace Technology, the satellite is simply called Minisat and will possess a mass of about 300 kg. Despite its small size (~1 m x 2 m) the vehicle will be 3-axis stabilized, will carry deployable solar arrays, and will operate for up to three years. The first mission for Minisat is scheduled for about 1995 on a yet-to-be chosen foreign launch vehicle. Eventually Minisats may be boosted by an upgraded Capricornio launch vehicle also currently under development by Spain. One of the payloads for the maiden Minisat mission is an extreme ultra-violet telescope for astrophysical studies. Other mini-observatories are being considered for subsequent flights (References 192 and 193).

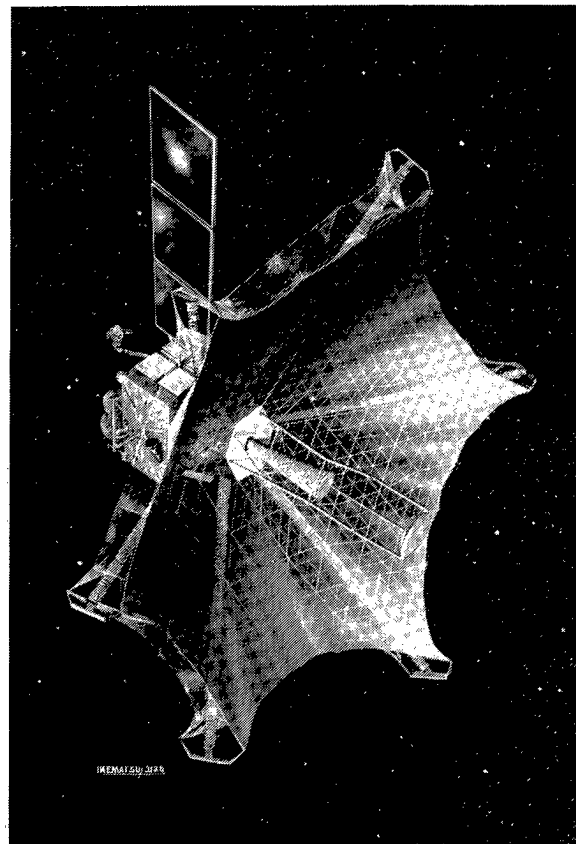

Figure 5.37. Muses-B Spacecraft.

References - Section 5.0

1. G. E. Wukelic, ed, Handbook of Soviet Space Science Research, Gordon and Breach Science Publishers, New York, 1968.
2. G. P. Anshakov et al, "Earth Resources and Research Automated Spacecraft," Photon Design Bureau, 1989.
3. Sotsialisticheskaya Industriya, Moscow, 8 February 1976.
4. Soviet Space Programs. 1971-1975. Volume 1. Overview. Facilities and Hardware. Manned and Unmanned Flight Programs. Bioastronautics. Civil and Military Applications. Projections of Future Plans. Committee on Aeronautical and Space Sciences, United States Senate, 30 August 1976, p. 222.
5. R. Spangenburg and D. Moser, "An Astronautical Ark," Ad Astra, September 1989, p. 35.
6. Craig Covault, "Soviet Biological Satellite Misses Target by 2,000 Miles," Aviation Week and Space Technology, 19 October, 1987, p. 32.
7. Sotsialisticheskaya Industriya, Moscow, 19 November 1989, p. 4.
8. P. B. de Selding, "Bion-10 Tests Effects of Weightlessness, Radiation," Space News, 4-10 January 1993, p. 4.
9. P. B. de Selding, "Bion-10 Forced to Land When Temperatures Skyrocket," Space News, 25-31 January 1993, p. 12.
10. Komsomolskaya Pravda, Moscow, 21 January 1993, p.2.
11. ITAR-TASS, Moscow, 18 January 1993.
12. "Biokosmos-9 - The First Results," Spaceflight, December 1990, p. 380.
13. "Soviets Developing Advanced Materials Processing Satellite," Aerospace Daily, 19 May 1989, p. 294.
14. The Nika-T, Glavkosmos, 1986.
15. Sovetskaya Kirgiziya, 19 May 1990, p. 3.
16. Rabochaya Tribuna, Moscow, 6 July 1991, p. 4.
17. Komsomolskaya Pravda, Moscow, 15 January 1992, p. 4.
18. ESA Annual Report '90, European Space Agency, 1991.
19. ESA Annual Report '91, European Space Agency, 1992.
20. C. Covault, "International Shuttle/Spacelab Mission to Conduct Life Sciences, Materials Tests," Aviation Week and Space Technology, 20 January 1992, p. 55.
21. "Space Shuttle IML Samples Undergoing Study Around the World," Aviation Week and Space Technology, 3 February 1992, p.61.
22. J. R. Asker, "Eureca Will Offer New Capabilities for Extended Microgravity Experiments," Aviation Week and Space Technology, 20 July 1992, p. 46.
23. Lin Hua-bao and Min Gui-rong, "The Chinese Recoverable Satellite Program," Paper IAF-89-426, 40th Congress of the International Astronautical Federation, October, 1989.
24. P. S. Clark, Chinese Space Activity, 1987-1988, Astro Info Service Publications, London, 1989.
25. ITAR-TASS, Moscow, 27 July 1992.

26. Sovetskaya Rossiya, Moscow, 28 July 1992, p. 2.
27. Izvestiya, Moscow, 10 August 1992, p. 1.
28. J. M. Lenorovitz, "French Technical Aid to Russians to Bolster Long-Term Space Plan," Aviation Week and Space Technology, 17 August 1992, p. 47.
29. V. Kiernan, "Soyuz TM-14 Turns Turtle on Landing," Space News, 17-23 August 1992, p. 4.
30. J. M. Lenorovitz, "Europeans Show Mission Control Capabilities with Spacelab D1," Aviation Week and Space Technology, 4 November 1985, p. 19.
31. J. M. Lenorovitz, "Spacelab Mission Coordination Achieves Experiment Goals," Aviation Week and Space Technology, 18 November 1985, p. 55.
32. J. M. Lenorovitz "Spacelab Mission Proves Concept of International Payload Control," Aviation Week and Space Technology, 11 November 1985, p. 24.
33. Experiments in Space: The Second German Spacelab Mission D-2, DLR, March 1992.
34. Tokyo Broadcasting System, Tokyo, 15 March 1990.
35. "Japanese Spacelab Mission Extended for More Science," Aviation Week and Space Technology, 21 September 1992, p. 24.
36. "Spacelab Mission Ends," Aviation Week and Space Technology, 28 September 1992, p. 30.
37. Space in Japan: 1988-89, Research and Development Bureau, Science and Technology Agency, Tokyo, 1988.
38. T. Siencko, "Microgravity and Japan," Space, November-December 1990, p. 36.
39. "First Japanese Reusable Spacecraft to Carry Science, Technology Payload," Aviation Week and Space Technology, 20 August 1990, p.70.
40. "Japan Begins \$2.5-Billion Effort to Develop Freedom Station Module," Aviation Week and Space Technology, 20 August 1990, p. 79.
41. K. P. Dawson, "Japan Begins Building Station Module Model," Space News, 16-22 November 1992, p. 23.
42. "Flying into Outer Space," Beijing Guangming Ribad, 20 September 1984.
43. A. Dupas, "Asia in Space: The Awakening of China and Japan," Space Policy, February 1988, p. 31.
44. Aviation Week and Space Technology, 15 October 1990, p. 13.
45. Beijing Television Service, 6 October, 1990.
46. Beijing Television Service 14 October, 1990.
47. Xinhua Domestic Service, Beijing.
48. Xinhua News Service, , Beijing, 6 January 1993.
49. Soviet Solar Experiments," Space Policy, February, 1989, p. 84.
50. "Soviets Launch Four Satellites, Recover Biosat," Aerospace Daily, 4 October 1989, p. 26.
51. Pravda, Moscow, 29 September 1989, p. 4.

52. TASS, Moscow, 3 October 1989.
53. "Soviet Intercosmos-24 Spacecraft to Study Earth's Magnetosphere," Aviation Week and Space Technology, 30 October 1989, p. 23.
54. Izvestiya, Moscow, 22 May 1990, p. 3.
55. "Soviet Space Program Policy in Flux After Social and Economic Upheaval," Aviation Week and Space Technology, 29 October 1990, p. 68.
56. M. Fester, et al., "Mid-Scale Wavelike Inhomogeneities of Electron Concentration in Outer Ionosphere from Aktivnyy Satellite Data (Preliminary Report)," Geomagnetizm I Aeronomiya, Moscow, January-February, 1992, p. 169.
57. "Projects to Study Magnetosphere, Ionosphere," Aviatsiya I Kosmonavtika, Moscow, July, 1989, p. 38.
58. TASS, Moscow, 5 December 1989.
59. Krasnaya Zvezda, Moscow, 19 December 1991, p. 2.
60. Izvestiya, Moscow, 21 August 1992.
61. R. Jehn, et al., "European Involvement in the 1992 Pion Experiment," Proceedings of the First European Conference on Space Debris, Darmstadt, Germany, 5-7 April 1993.
62. "Canadian Experiment for Soviet Mission," Spaceflight, February, 1988, p. 53.
63. Ts.P. Dacheb, et al., "Description of the Intercosmos Project: System of Aeronomical Satellites and its Place in International Geosphere-Biosphere Program," Paper IAF-89-188, 40th Congress of the International Astronautical Federation, Malaga, Spain, October, 1989.
64. M.L. Lidov, et al., "Earth-Moon-Halo-Orbit Transfer Trajectories in Vicinity of L_2 of Earth-Sun System," Kosmicheskiye Issledovaniya, Moscow, July-August, 1992, p. 435.
65. "Small Solar Sail Spacecraft for Regatta Project," Zemlya I Vseleennaya, Moscow, January-February 1991, p. 3.
66. S.K. Tatevian, "System of Aeronomical Satellites - SAS Mission - Intercosmos Project," CSTG Bulletin No. 11, International Coordination of Space Techniques for Geodesy and Geodynamics, 1989, p. 87.
67. Pravda, Moscow, 20 March 1990, p. 5.
68. TASS, Moscow, 5 December 1991.
69. Mlada Fronta Dnes, Prague, 20 December 1991.
70. ESA's Report to the 28th COSPAR Meeting, SP-1124, ESA, Paris, June, 1990, p. 61.
71. All About the European Space Agency, ESA, Paris, March, 1993, p. 5.
72. J. R. Asker, "Atlantis to Evaluate Characteristics of Tethered Satellite," Aviation Week and Space Technology, 20 July 1992, p. 40.
73. J. R. Asker, "NASA/Martin Marietta to Prove Failure of Atlantis Tethered Satellite Deployer," Aviation Week and Space Technology, 10 August 1992, p. 60.
74. "Inadequate Tests Cause Tether Woes," Aviation Week and Space Technology, 16 November 1992, p. 65.
75. C. Covault, "Japanese Weighing Missions to Venus, Far Side of Moon," Aviation Week and Space Technology, 4 August 1986, p. 70.

76. "Japanese Satellite Studies Earth's Magnetic Field," Space News, 3-9 February 1992, p. 16.
77. "Japan Launches Muses-A Lunar Probe After One-Day Delay," Aerospace Daily, 25 January 1990, p. 141.
78. "Japan Lunar Mission Uses Goddard-Developed Trajectory," Aerospace Daily, 29 January 1990, p. 161.
79. "ISAS Can't Confirm that Hagoromo Moon Probe Achieved Lunar Orbit," Aerospace Daily, 26 April 1990, p. 156.
80. Aviation Week and Space Technology, 25 March 1991 p. 17.
81. "Muses-A Ends Three-Year Mission, Crashes on Moon," Space News, 19-25 April 1993, p. 17.
82. "New Japanese Spacecraft to Study Solar Flares, Effects of Sun on Earth," Aviation Week and Space Technology, 27 August 1990, p. 76.
83. J.R. Asker, "Japan/U.S. Geotail Mission Set for NASA's First Commercial Launch," Aviation Week and Space Technology, 20 July 1992, p. 65.
84. I. Parker, "Freja Images Aurora," Space, April, 1993.
85. Krasnaya Zvezda, Moscow, 13 January 1990, p. 4.
86. N. L. Johnson, The Soviet Year in Space 1990, Teledyne Brown Engineering, Colorado Springs, 1991, p. 123.
87. V. M. Kovtunenko, "Multi-Purpose Mission Intended for Space, Mars, Phobos, and Sun Exploration - Mission Profile and Phobos Rendezvous - Design Approach," Paper IAF-86-316, 37th Congress of the International Astronautical Federation, October 1986.
88. Yu.I. Zaytsev, On The Frontier of the Millennium, Izdatelstvo Znaniye, Moscow, 1989.
89. "Soviets Discussing Lunar Base Plans," Soviet Aerospace, 18 September 1989, p. 8.
90. D. Burnham, "Return to the Moon?," Spaceflight, November, 1991, p. 370.
91. "Soviets Pop Mars Balloon Date," Space News, 27 May - 2 June 1991, p. 2.
92. Sankt-Peterburgskiye Vedomosti, 24 December 1992, p. 2.
93. "Russians Commit to Mars 1994 Mission", Aviation Week and Space Technology, 8 February 1993, p. 51.
94. Signal, June, 1993.
95. "Norwegian Space Center Launches Successful Space Balloon Experiment," Spacewatch, November, 1991, p. 13.
96. L. David, "McDonnell Douglas, Russia Team on Rover," Space News, 18-24 January 1993, p. 6.
97. Mars Manned Mission: Scientific/Technical Report, NPO Energiya, 1991.
98. R. Ju. Zhitz, "Elaboration Configuration of Martian Manned Excursion Module," 43rd Congress of the International Astronautical Federation, Washington, D.C., August, 1992.
99. N. L. Johnson, The Soviet Year in Space 1987, Teledyne Brown Engineering, Colorado Springs, 1988, p. 103.
100. Pravda, Moscow, 22 October 1990, p. 6.
101. Izvestiya, Moscow, 30 May 1992, p. 1.
102. I. Sobelman, et al. Koronas Information - No. 5, DARA, 1992.

103. Y. N. Coptev, et al, "Unified Automatic Spacecraft for Exploration of the Remote Solar System Planets, Interplanetary Medium and Sun (Tsiolkovsky Mission)," Paper IAF-89-478, 40th Congress of the International Astronautical Federation, Malaga, Spain, October, 1989.
104. Yu. A. Ryzhov, et al, "Tsiolkovsky Space Complex for Exploration of the Sun and the Outer Planets of Solar System," Paper IAF-92-0767, 43rd Congress of the International Astronautical Federation, Washington, D.C., August, 1992.
105. M. Mecham, "Giotto's Second Mission 'Brings' Scientists Within 200 Km of Comet," Aviation Week and Space Technology, 20 July 1992, p. 66.
106. N. Longdon, "European Rendezvous," Spaceflight, November, 1992, p. 366.
107. ESA Bulletin No. 72, Noorwidjk, November, 1992, p. 117.
108. All About the European Space Agency, ESA, Paris, March, 1993, p. 4.
109. "Cassini's Progress," Spaceflight, October, 1992, p. 389.
110. ESA Annual Report '92, European Space Agency, 1993.
111. C. Covault, "European Scientists Wary of U.S. Cooperation," Aviation Week and Space Technology, 22 March 1993, p. 22.
112. "Ariane V44 Launches Microsatellites from Four Western Nations into Orbit," Aviation Week and Space Technology, 5 August 1991, p. 61.
113. DPA, 30 August 1991.
114. "Japan's Yohkoh Observation Returns Data on Characteristics, Behavior of Sun," Aviation Week and Space Technology, 16/23 December 1991, p. 63.
115. K. P. Dawson, "Sun-Watchers Praise Early Solar-A Results," Space News, 16-22 December 1991, p. 6.
116. D. Burnham, "Japan Approves New Moon Mission - Probes to Study Lunar Surface," Spaceflight, July, 1991, p. 225.
117. "Japan's ISAS Pursues 'Independent' Agenda," Aerospace America, July, 1993, p. 13.
118. K. P. Dawson, "Japan to Begin Design Work for Mars Exploration Satellite," Space News, 10-16 February 1992, p. 26.
119. "Japanese Mars Mission at Science Milestone," Aviation Week and Space Technology, 12 October 1992, p. 58.
120. "Lowering the Boom on Mars," Signal, June, 1993, p. 15.
121. P. N. Polezhayev and V. P. Poluektov, "The Space Program: Space-Based 'Gamma' Observatory," Zemlya I Vselennaya, May-June, 1991, pp. 2-9.
122. Pravda, Moscow, 13 July 1990, p. 8.
123. V. G. Kirillov-Ugryumov and Yu. P. Semenov, "The Orbital Space Observatory," Zemlya I Vselennaya, September-October, 1988, pp. 5-13.
124. Space Observatory Gamma, project description, Moscow, undated.
125. Zarya Vostoka, 23 October 1990, p. 1.
126. Sovetskaya Rossiya, Moscow, 12 July 1991, p. 1.

127. Pravda, Moscow, 16 January 1991, p. 8.
128. Izvestiya, Moscow, 9 April 1991, p. 8.
129. Pisma V Astronomicheskii Zhurnal, Moscow, February, 1992, pp. 167–172; April, 1992, pp. 315–321; and July, 1992, pp. 579–582; and June, 1991, pp. 501–504.
130. Sovetskaya Moldova, 12 July 1991, p. 1.
131. Granat, project description and specification sheet distributed by GLAVKOSMOS, Moscow, 1989.
132. Sovetskaya Kirgiziya, 19 April 1989, p. 1; 30 January 1990, p. 2; and 9 February 1991, p. 10.
133. Sotsialisticheskaya Industriya, Moscow, 12 April 1989, p. 4.
134. Pravda, Moscow, 3 December 1989, p. 6.
135. P. B. de Selding, "France May Pay To Save Russian Ground Station," Space News, 9–15 December 1991, pp. 1, 21.
136. P. B. de Selding, "France Cash Sustains Operation of Granat Observatory," Space News, 7–13 December 1992, pp. 1, 23.
137. P. B. de Selding, "CNES Funds on Slow Path to Russia; Debts Piling Up," Space News, 29 March–4 April 1993, p. 7.
138. Pisma V Astronomicheskii Zhurnal, Moscow, February, 1991, pp. 99–125 and 135–140; December, 1991, pp. 1059–1081; January, 1992, pp. 3–45; March, 1992, pp. 217–227; April, 1992, pp. 291–314; and July, 1992, pp. 570–578.
139. Pravda, Moscow, 15 January 1991, p. 1 and 5 December 1991, p. 3.
140. V. M. Kovtunenکو et al, "Spectrum: Unified Spacecraft for Astrophysical Observations," Paper IAF-88-001, 39th Congress of the Astronautical Federation, October, 1988.
141. A. A. Boyarchuck and E. G. Tanzi, "The Spectrum-UV Project," Workshop on Space Projects to Probe the Internal Structure of the Sun and Sun-like Stars," November, 1991.
142. V. M. Kovtunenکو et al, "Spectrum-X-Gamma Spacecraft," Paper IAF-89-461, 40th Congress of the International Astronautical Federation, October, 1989.
143. Flight International, 4–10 July 1990, p. 35.
144. Moskovskaya Pravda, Moscow, 10 June 1987, p. 3.
145. ITAR-TASS World Service, Moscow, 4 and 25 February 1993.
146. Yu. Zaytsev, " 'Spectrum-Roentgen-Gamma' – A New Space Project," Advances of Science and Technology, November, 1988, pp. 1–3.
147. Pravda Vostoka, 5 November 1991, p. 1.
148. V. I. Altunin and K. H. Robinett, "Mission Operations System for Russian Space Very-long-Baseline Interferometry Mission," Paper IAF-92-547, 43rd Congress of the International Astronautical Federation, August–September, 1992.
149. N. Layevich, "Time Trouble For 'Radioastron'," NTR Tribuna, Moscow, January, 1990, p. 3.
150. V. V. Andreyanov, " 'Radioastron' Details the Universe," Zemlya I Vseleennaya, Moscow, January–February, 1989, pp. 13–17.
151. Izvestiya, Moscow, 10 April 1988, p. 2.

152. Radioastron, Space Research Institute, Moscow, 1987.
153. A. Lawler, "U.S., Soviet Astronomy Cooperation Expanded," Space News, 12–18 March 1990, pp. 1, 21.
154. I. Fejes, "Orbit Determination Accuracy Improvement By Space-VLBI Observables as Tracking Data," IAG General Meeting, Edinburgh, August, 1989.
155. G. B. Sholomitskiy, "A Cooled Submillimeter Telescope," Soviet Astronautics, September–October, 1986, pp. 867–873.
156. V. S. Avduyevskiy et al., "Soviet Cosmonautics: Achievements and Prospects," Zemlya I Vselennaya, Moscow, July–August, 1990, pp. 8–16.
157. Pisma V Astronomicheskiiy, Moscow, May, 1992, pp. 387–395.
158. Kosmicheskkiye Issledovaniya, Moscow, July–August, 1992, pp. 435–454; March–April, 1987, pp. 163–185; and January–February, 1987, pp. 152–154.
159. Krasnaya Zvezda, Moscow, 19 December 1986, p. 4.
160. J. M. Lenorovitz, "Multinational Cometary Watch Group Plans New Ventures," Aviation Week and Space Technology, 10 November 1986, pp. 28–29.
161. I. A. Strukov, "Reliet-2 Project: Scientific Program and Structure," Paper IAF-90-421, 41st Congress of the International Astronautical Federation, October, 1990.
162. Project Lomonosov, Astrometric Space Experiment, project description produced jointly by the four participants, Moscow, 1989.
163. V. M. Kovtunenکو et al., "Lomonosov Space Astrometric Mission," Paper IAF-90-422, 41st Congress of the International Astronautical Federation, October, 1990.
164. V. V. Nesterov, "The 'Lomonosov' Astrometric Space Project," Zemlya I Vselennaya, Moscow, March–April 1990, pp. 10–16.
165. TASS International Service, Moscow, 29 December 1989.
166. G. A. Avanesov et al., "Small Space Lab – The Regatta Project Spacecraft," Paper IAF-90-431, 41st Congress of the International Astronautical Federation, October, 1990.
167. "Regatta Ready To Sail," Spaceflight, June, 1991, p. 191.
168. A. Yu. Kogan, "Quasi-Satellite Orbits and Their Applications," Paper IAF-90-307, 41st Congress of the International Astronautical Federation, October, 1990.
169. Annual Report '92, ESA, Paris, 1993.
170. ESA's Report to the 28th COSPAR Meeting, SP-1124, ESA, Paris, 1990.
171. M.A.C. Perryman et al., The Hipparcos Mission, SP-1111, ESA, Paris, 1989.
172. J. M. Lenorovitz, "ESA, Soviets Plan Joint Space Research," Aviation Week and Space Technology, 9 May 1983, pp. 59–60.
173. ISO, Infrared Space Observatory, ESA project brochure, undated.
174. All About the European Space Agency, ESA, Paris, March, 1993.
175. European Space – On Course for the 21st Century, BR-39, ESA, Paris, 1987.
176. First, Far Infrared and Submillimeter Space Telescope, BR-69, ESA, Paris, July, 1990.

177. R. M. Bonnet, "Towards the Selection of ESA's Next Medium-Size Scientific Project (M2)," ESA Bulletin, May, 1991, pp. 37–52.
178. N. Longdon, "European Rendezvous," Spaceflight, November, 1992, pp. 366–367.
179. DARA Information 1991, DARA, Bonn, June, 1991.
180. "Germans Estimate Rosat Will Keep Working Until '94," Space News, 8–14 March 1993, p. 12.
181. All-India Radio, New Delhi, 28 May 1992.
182. Press Trust of India, Bangalore, 8 July 1992.
183. A. Lawler, "India Succeeds With Third ASLV Launch Attempt," Space News, 25–31 May 1992, p. 6.
184. R. Riccitiello, "Development Snags Push Back SAX Plans," Space News, 1–7 March 1993, pp. 3, 20.
185. R. Riccitiello, "Committee Probes SAX Funding," Space News, 22 June–5 July 1992, p. 24.
186. Space in Japan 1988–89, Research and Development Bureau, Science and Technology Agency, Tokyo, 1988.
187. "Japan Developing Advanced Spacecraft For Deep Space X-Ray, Radio Astronomy," Aviation Week and Space Technology, 27 August 1990, pp. 80–81.
188. M. Mecham, "Launch of X-ray Satellite Will Aid Big Bang Studies," Aviation Week and Space Technology, 1 March 1993, p. 21.
189. Kyodo News Service, Tokyo, 20 February 1993.
190. N. W. Davis, "Japan's ISAS Pursues 'Independent' Agenda," Aerospace America, July, 1993, pp. 13–15.
191. M. Oda and Y. Tanaka, "Japan's Blossoming Space Science," Sky and Telescope, January, 1987, pp. 7–11.
192. P. B. de Selding, "Spain Boosts Space Spending, Plans New Launch Vehicle," Space News, 15–21 June 1992, p. 6.
193. "Spanish Satellite Project Matures," Aviation Week and Space Technology, 21 June 1993, p. 26.

6.0 NATIONAL SECURITY PROGRAMS

Many space systems described in Sections 3–5 contribute to national security either directly or indirectly and on a dedicated, dual use, or ad hoc basis. However, specific national security satellite networks are those which are funded and operated by the armed forces for the primary purpose of performing intelligence gathering, attack warning, direct defensive/offensive space activities, or special functions supporting these missions. Unlike communications, navigation, or meteorological satellites which can serve a wide range of users, national security spacecraft normally have little applicability to civilian needs. Even a great deal of military photographic reconnaissance is of limited utility for many Earth observation studies due to the narrow field-of-view employed.

To date, of all the European and Asian satellite operators, only the USSR/CIS has deployed significant national security space systems due to technological as well as economic and political reasons. More than one-fourth of all USSR/CIS new space missions undertaken during 1991–1992 fell within this category. The PRC is believed to use its FSW photographic satellites for military reconnaissance, and France is developing its first dedicated military satellites for both reconnaissance and electronic intelligence. Israel and India may follow suit with their own national security systems, and the Western European Union is evaluating the need for a shared system of spy satellites. Discussions about a common European ballistic missile defense system may lead to a future constellation of missile launch detection satellites.

Contrary to popular opinion, the end of the Cold War has not diminished the need or importance of national security space systems. In fact, with reduced military budgets and forces, many nations are placing an even higher premium on intelligence information obtained via space-based platforms. Moreover, the Persian Gulf War of 1991 reinforced the value of specialized satellites in even localized, conventional conflicts. This realization may prompt nations not only to field new national security space systems but also to develop the means of negating such systems of their opponents.

6.1 Imaging Reconnaissance

Photographic reconnaissance (photo recon) satellites represented the first operational use of spacecraft to perform dedicated military support missions. Such systems have become extremely valuable in both peacetime and war. Photo recon satellites have been legitimized in their role of monitoring international arms control treaties and are essential for general intelligence gathering, including the assessment of foreign forces and early indications of the development of future weapon systems. During war, photo recons contribute to order of battle assessments, engagement planning, and battle damage assessments. Although photo recons can currently fly with relative impunity over battlefield areas, they are normally restricted to only 1–2 short-duration, overflights per day and are susceptible to cloud cover, lighting conditions, and battlefield obscurants. Recent technological advances have permitted many of these deficiencies to be overcome with the use of moderate resolution synthetic aperture radars.

The early generation photo recons relied on classical photographic techniques with the physical return of the exposed film to Earth (sometimes a week or more after the photographs of interest were taken) for processing, analysis, and distribution. The moderate-to-high resolutions available via this technique were partially offset by the delay in receiving the desired information. With advances in electronic imaging and data transmission systems, real-time or near-realtime return of reconnaissance data is now possible directly from the photo recon or through a geostationary relay satellite. An added advantage of this more sophisticated method is that it lends itself more readily to rapid computer processing techniques.

Historically, photo recon products have been categorized as low-, medium-, or high-resolution, indicating the relative limitations of distinguishing objects of specific sizes. Moreover, the degree of resolution is normally inversely proportional to the field-of-view, e.g., a high resolution system will typically image a very limited region of the Earth measured in tens of kilometers on a side while a low resolution system will cover a wide area

hundreds of kilometers on a side in a single image. Together, they provide complementary data of national security significance.

6.1.1 USSR/CIS

By the end of 1992 the USSR/CIS had orbited over 850 photo recon satellites, representing more than one-third of all USSR/CIS space missions conducted since 1957. The vast majority of satellites were dedicated military flights with primary photographic objectives outside the territory of the USSR/CIS. During 1991–1992 a total of 23 such missions were flown, accounting for 20% of all USSR/CIS space launches in the period. Declassified photographs with resolutions of 2–30 m can now be purchased commercially, while resolutions on the order of one-third meter have been acknowledged. On average, two photo recons were in orbit conducting military observations for approximately 780 mission days each year (Figure 6.1).

Since the first Soviet photo recon mission in 1962, a variety of specialized spacecraft have been developed. Today three basic classes or

generations of 6-metric-ton photo recons are operational (Figure 6.2), and all are launched by the SL-4. The so-called third and fourth generation vehicles are relatively short-lived (2–8 weeks) and employ standard photographic systems which return film payloads to Earth on demand. The fifth generation spacecraft have operated for as long as 11 months and return their intelligence data electronically.

Unlike most satellites designed to photograph the Earth, USSR/CIS photo recons fly in posigrade (normally 63°–83°) orbits rather than sun-synchronous trajectories. Consequently, when altitude restoration maneuvers are made approximately every 7–10 days, the satellite's argument of perigee is normally adjusted to keep perigee phased to acceptable lighting conditions. For example, during a typical 2-month mission, the argument of perigee will be rotated progressively from ascending passes (first-month) to descending passes (second-month). Fifth generation satellites are an exception with nearly stable arguments of perigee between 80° and 110°.

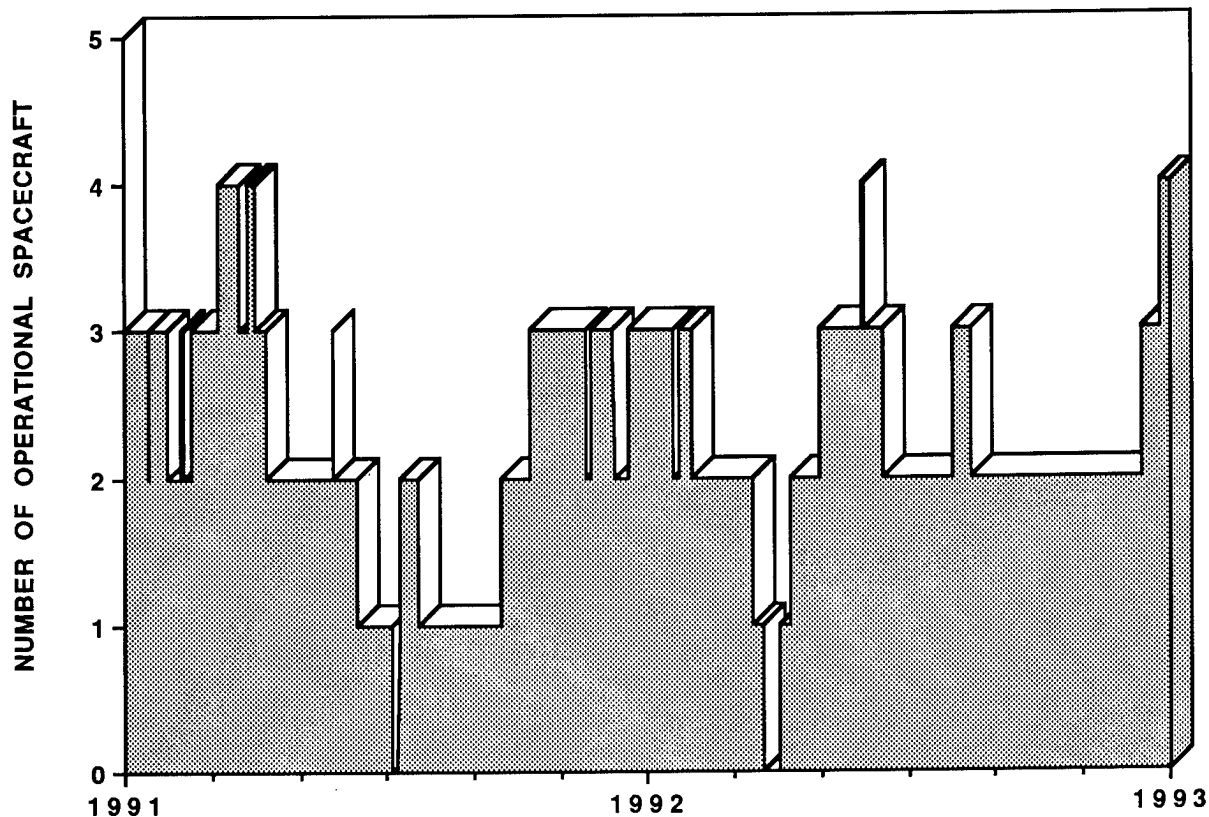

Figure 6.1. USSR/CIS Military Reconnaissance Activity.

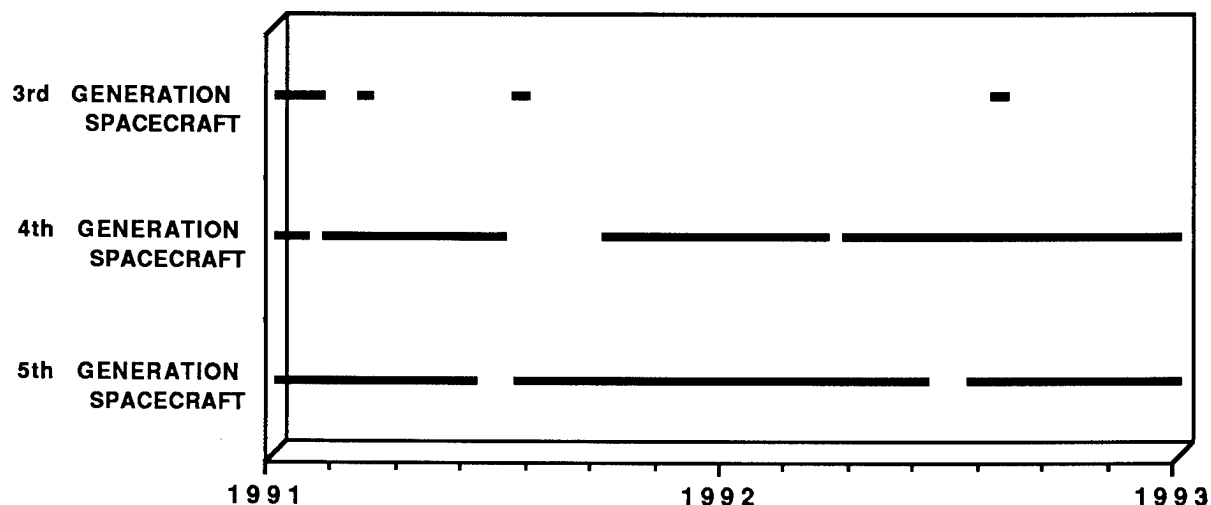

Figure 6.2. USSR/CIS Reconnaissance Periods by Spacecraft Type.

The 3rd generation photo recons, called Zenit by the USSR/CIS, are derived from the original Vostok spacecraft and are very similarly to the Resurs-F1 spacecraft. In recent years the number of these satellites flown annually without a cited Earth resources objective has dropped precipitously: 12 in 1989, 8 in 1990, 3 in 1991, and 1 in 1992. This apparent phasing out of 3rd generation photo recons for military missions may be linked with the operational status of the 5th generation spacecraft which are believed to possess comparable moderate resolution capabilities.

For the past few years 3rd generation photo recons have been launched only from the Plesetsk Cosmodrome into low Earth orbits with perigees about 235–245 km and inclinations of 62.9° or 82.3–82.6°. Mission durations are normally only 2–3 weeks with recoveries occurring as the spacecraft passes northbound over the standard USSR/CIS satellite landing zone in Kazakhstan. In addition to their orbital profiles, 3rd generation photo recons are distinguished by the debris left in orbit just prior to reentry.

At the start of 1991 a single 3rd generation photo recon was in orbit: Kosmos 2120 (launched 26 December 1990). As tensions increased in the Persian Gulf region in mid-January, 1991, Kosmos 2120 maneuvered into a lower orbit to stabilize its groundtrack over Kuwait and Iraq. From 12 to 16 January the satellite passed directly over southern Iraq and Kuwait as the allied air war commenced, before returning to Earth early on 17 January.

The three 3rd generation photo recons launched during 1991 all appeared to conduct global reconnaissance activities during the first two-thirds to three-fourths of their missions before maneuvering into relatively stabilized orbits for special observations. Kosmos 2121, launched about five hours after Kosmos 2120 was recovered, spent its first 18 days in space with a normal, drifting groundtrack, performing a standard orbital adjustment on day 11. For the last six days of its 24-day flight, Kosmos 2121 lowered its mean altitude, providing an opportunity for repeated observations of the Persian Gulf region until its return to Earth on 10 February.

The next satellite in this class was launched on 6 March and was inserted into an orbit with an inclination of 62.8°. During 13–14 March Kosmos 2136 maneuvered into a lower orbit, setting up a nearly repeating pattern of groundtracks over the Persian Gulf region on early morning descending passes. The spacecraft was de-orbited on 20 March after a two-week mission. The final 3rd generation photo recon mission of the year took place during 9–23 July under the name Kosmos 2152. Not until 20 July did the satellite synchronize its 82.3° inclination orbit for repeated passage over selected areas, including Iraq.

In 1992 the solitary 3rd generation photo recon flight was conducted during 30 July–13 August by Kosmos 2207. Once again employing the 82.3° inclination orbit, the photo recon remained in its global reconnaissance pattern

for its entire 14-day mission.

In 1975 the 4th generation photo recon satellites debuted for the purpose of taking over the high resolution reconnaissance duties of their predecessors. By flying elliptical orbits with perigees typically near 170 km, 4th generation spacecraft can enhance the resolution of their imaging systems. Principal improvements of the original 4th generation satellites included an extended orbital lifetime (initially 30 days; now 60 days) and the capability to return small film capsules during the course of the mission without de-orbiting the entire spacecraft.

The 4th generation photo recon class now apparently consists of three major variants: one for high resolution photographs, one for topographic mapping, and a new model with a yet-to-be-defined mission. The basic vehicle is larger than the 3rd generation satellites and is widely believed to incorporate many systems from the Soyuz-class of recoverable satellites. Optical observations strongly suggest the use of solar panels for electrical power generation.

The use of 4th generation photo recons has remained steady during the last five years with an annual launch rate of eight: six high resolution, one topographic mapper, and one of the latest type. The two-month missions of the high resolution satellites are often timed to minimize both the amount of operational overlap and the lapse of coverage. For example, the last three such missions in 1992 were launched on the same day that their predecessors were returned to Earth. During 1991–1992 high resolution 4th generation missions only originated from Plesetsk, while the topographic mapping and special variants were launched from Tyuratam.

As with the 3rd generation photo recons, at the start of 1991 a single high resolution 4th generation satellite, Kosmos 2108, was in orbit. When the allied air campaign started in the Persian Gulf, Kosmos 2108 was in a normal global reconnaissance mode. By 20 January its groundtrack had naturally drifted toward the region, and the spacecraft was commanded to lower its orbit to retard further shifting. For the period 22–28 January Kosmos 2108 passed directly over the conflict area once each day on a descending pass. The spacecraft was de-orbited late on 28 January after a flight of 55 days.

Ten days later on 7 February, Kosmos 2124 was launched to continue observations of the

volatile region. By 10 February, the spacecraft had dropped its mean altitude to prolong ascending passes over Iraq through 14 February. After a series of maneuvers, Kosmos 2124 returned to the Persian Gulf during the period 23–28 February and ending on the morning of 1 March. The rest of Kosmos 2124's mission was standard global reconnaissance until the last week of flight when two maneuvers kept the groundtrack once again aligned with the Persian Gulf on descending passes.

Before Kosmos 2124 had finished its mission, Kosmos 2138 was launched (26 March) into a slightly higher inclination of 67.1° to take its place. Kosmos 2138 remained in orbit for 59 days and was succeeded by Kosmos 2149 on the day of its return to Earth, 24 May. The new satellite lasted only 40 days (the shortest such mission of 1991–1992) before it was unexpectedly brought down from orbit. Equally surprising was the lapse of 11 weeks before another 4th generation high resolution satellite reached Earth orbit.

Kosmos 2156 (19 September) was on station for only a few days when a new crisis involving UN nuclear weapons inspection teams arose in Iraq. On 23 September Iraq detained a group of inspectors in an abortive attempt to redefine the conditions of the cease-fire agreements. As tensions mounted, Kosmos 2156 was maneuvered on 27 September to maximize ascending observation opportunities over the region. The following day the UN inspectors were released, and Kosmos 2156 resumed its global reconnaissance on 3 October. Kosmos 2156 completed a 59-day mission on 17 November and was replaced by Kosmos 2171 three days later.

USSR/CIS high resolution photo recon activity returned to a more normal state in 1992 with six missions: Kosmos 2175, Kosmos 2182, Kosmos 2186, Kosmos 2203, Kosmos 2210, and Kosmos 2220. All satellites remained in orbit for 57–60 days, and the longest gap in coverage was 12 days at the end of March. Only occasional deviations from standard global reconnaissance missions were undertaken. An attempt to test the tight secrecy which surrounds these missions failed in January, 1992, when a Russian reporter found that under the new CIS the old USSR restrictions still applied (Reference 1).

Special topographic mapping missions using basic 4th generation photo recon spacecraft

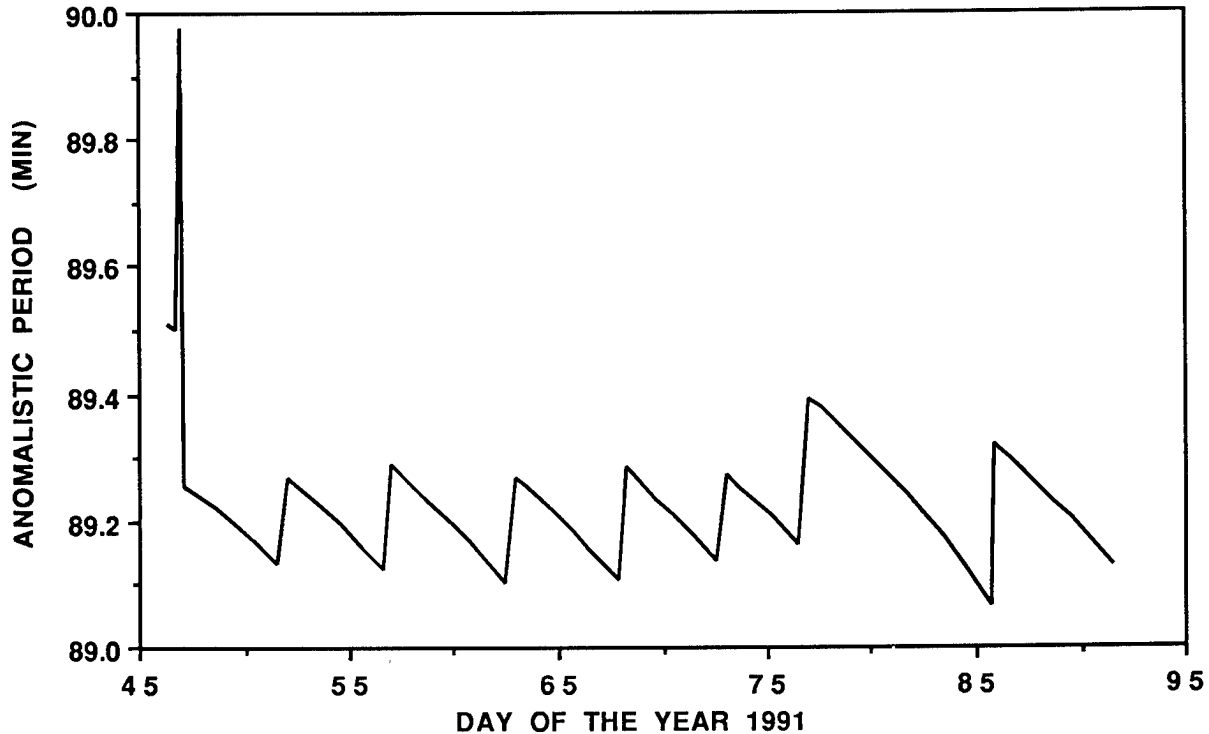

Figure 6.3. Kosmos 2134, Topographic Mapper, Orbital History.

began in 1981 with Kosmos 1246. These flights, partially acknowledged by the USSR in 1988, are distinguished by their orbital profiles (Figure 6.3), the mission duration (normally 44 days), and their geodetic-type signals at 150.3 MHz which are regularly detected by the Kettering Group (Appendix 1). These missions are always launched from Tyuratam into inclinations of approximately 65° or 70° at a rate of one or two per year.

Three such missions were performed in 1991–1992: Kosmos 2134, Kosmos 2174, and Kosmos 2185. The first two missions were flown at an inclination of slightly less than 65° , the most common orbit for such missions. As noted in Section 4.3.1, in late 1992 the CIS offered for commercial use new 2-m and 10-m space-based photography apparently taken by satellites in 65° orbits. The descriptions of the photographic products were also consistent with a topographic mapping mission.

In July, 1989, the USSR conducted what appears to have been the first flight of a third variant of the 4th generation class of photo recon. The mission of Kosmos 2031 was immediately unusual due to the selection of an inclina-

tion of 50.5° , an orbit used by SL-4 boosters from Tyuratam only rarely and since the 1970's primarily for testing new spacecraft. (The last such mission was the inaugural flight of the 5th generation photo recons in December, 1982.) During the next six weeks Kosmos 2031 performed five major maneuvers indicative of a photo recon. However, the perigee was maintained near 230 km with a widely varying apogee up to 380 km unlike either the high resolution or topographic mapping missions. Then, on 31 August 1989 Kosmos 2031 was destroyed in orbit (Reference 2).

On 9 October 1991 Kosmos 2163 was launched and then moved into an operational orbit of 214 km by 360 km with an inclination of 64.8° . Although the inclination was normal for a 4th generation satellite from Tyuratam the orbital behavior was reminiscent of Kosmos 2031. This time the mission lasted 58 days before the spacecraft exploded.

A little more than a year after the demise of Kosmos 2163, Kosmos 2225 (22 December 1992) was placed into an initial operational orbit of 214 km by 309 km at an inclination of 64.9° . Its orbital characteristics were very similar to

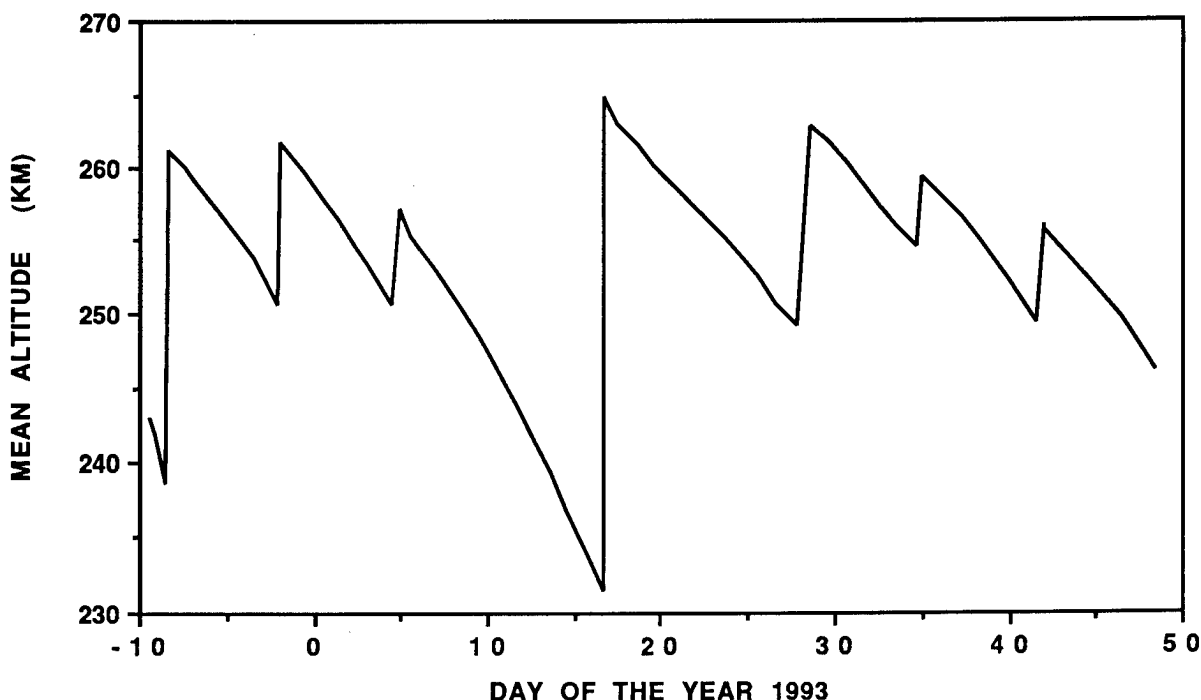

Figure 6.4. Kosmos 2225 Orbital History.

Kosmos 2031 and Kosmos 2163 and distinctly different from other 4th generation photo recons (Figure 6.4). Again, on day 58 of the mission the satellite was destroyed in orbit, leaving a cloud of debris which decayed rapidly into the Earth's atmosphere. The nature of this special class of 4th generation satellites is still unclear, but the three missions cited appear to be closely related.

Between 1982 and 1990 thirteen advanced 5th generation photo recon satellites were flown on missions lasting 67 days (the first) to a record 259 days (Kosmos 1810 in 1986-1987). Although these long duration spacecraft normally flew alone, short periods of overlapping operations were not uncommon, and specific orbital phasings were repeated on such occasions. The longevity of the spacecraft suggested that film return was probably not employed, and eventually statements by both US and USSR/CIS officials indicated that the satellites were conducting electronic imaging (References 3-6). Not only were the intelligence data being returned much more rapidly, but also the satellite's mission was no longer restricted to a limited number of photographs.

Apart from their longevity, 5th generation photo recons are known for their regular pat-

terns of decay and boost, narrowly maintained regimes of argument of perigee, and relative high perigee altitudes. The last lessens atmospheric drag, thereby increasing lifetime, but at a cost of degraded resolution. Satellites of this class are rarely used for short-term, specific region observations, instead maintaining very routine global reconnaissance activities.

However, when the Persian Gulf War began in mid-January, 1991, the sole 5th generation photo recon in orbit at that time, Kosmos 2113, was quickly tasked to increase total USSR space-based observations of the conflict. To accelerate the alignment of Kosmos 2113's groundtrack over the Kuwait-Iraqi war zone, the satellite was first maneuvered into a higher orbit on 17 January and then dropped to a ground-track-stabilized orbit on 20 January. Kosmos 2113 remained in that low altitude until 24 January when it resumed normal operations. The mission was finally terminated on 11 June 1991 after 172 days.

About a month after the deorbiting of Kosmos 2113, Kosmos 2153 was launched (10 July) to take its place. The new flight continued for 247 days without incident. Again, one month later a replacement satellite was launched, this time designated Kosmos 2183 (8 April 1992).

While on its way to setting an all-time USSR/CIS photo recon endurance record (mission ended on 16 February 1993 after 314 days), Kosmos 2183 was joined on 9 December 1992 by Kosmos 2223. Both satellites were active at the end of 1992 as were Kosmos 2220 (high resolution 4th generation) and Kosmos 2225 (special 4th generation).

In the 1980's a large synthetic aperture radar reconnaissance system was developed under the then military Almaz program. This system lost support from the Ministry of Defense and was eventually converted into a quasi-commercial Earth observation program (Section 4.3.1) with flights in 1987 and 1991. No comparable SAR system is now known to be under development by the CIS for dedicated national security applications.

6.1.2 France

As early as 1978 France proposed an international monitoring agency employing satellites under the auspices of the United Nations. Failing to win support from either the US or the USSR, by 1981 France was studying the feasibility of deploying a national reconnaissance spacecraft called SAMRO and derived in large measures from the SPOT Earth observation satellite. The studies evolved into the present Helios program now looking for a maiden flight in 1994 (References 7–10).

Funded primarily by the French Delegation Generale pour l' Armement (DGA) via the Direction des Engins (DEN), Helios is also being financially sponsored by Italy and Spain at a level of approximately 20%. Responsibility for the overall space system architecture has been delegated to CNES with Matra serving as the prime contractor. Major subcontractors include Aerospatiale, Alcatel Espace, Alenia, SEP, and Sodern (References 11–13).

Helios will have a mass of about 2.5 metric tons and will operate in a sun-synchronous orbit at an altitude of 850 km and an inclination of 99°. Outwardly, the spacecraft will closely resemble SPOT 4 with a box-like bus and a five-segmented solar array capable of generating 2.5 kW of electrical power. A 3-axis stabilization system and precision pointing accuracy will support the primary multi-spectral CCD imaging system with a resolution of one meter. Operational lifetime is now estimated at four years or more.

The present program plan envisions Helios 1 being launched in 1994 by an Ariane booster, followed by Helios 2 in 1996 for joint operations. A second generation Helios satellite with additional IR capability is possible later in the decade with a third generation, radar-equipped model debuting in 2001 or later under the name Osiris. Data from Helios will be used for arms control verification as well as for direct military support and crisis monitoring. European interest in Helios has increased significantly in the aftermath of the Persian Gulf War, and Helios images will be made available to the members of the Western European Union (WEU) (References 13–19).

6.1.3 People's Republic of China

As noted in Section 4.3.10, the PRC has operated a recoverable photographic reconnaissance satellite system since 1975. Thirteen missions of the FSW-1 satellite were conducted by the end of 1992, and the new FSW-2 was flight-tested for the first time in August, 1992. The former satellites are limited to eight days in orbit, whereas the latter model has demonstrated a lifetime twice that long.

Although the PRC primarily mentions the civil Earth observation and microgravity capabilities of the FSW series of satellites, a military reconnaissance objective is not only possible but was probably the original incentive for the development program. FSW satellites are normally flown only once each year (the only exceptions being 1987 and 1992 when two missions were undertaken). Moreover, since 1982 launches have been restricted to the August-October period.

Prior to September, 1987, FSW-1 initial orbital parameters were characterized by perigees near 170 km and apogees of 380–480 km at inclinations of 57–68°. The last four missions (FSW-1 10 in September, 1987; FSW-1 11 in August, 1988; FSW-1 12 in October, 1990; FSW-1 13 in October, 1992) have employed more circular orbits of 210 km by 310 km at inclinations of 63° (three missions) and 57° (one mission). Unlike USSR/CIS photo recon satellites, PRC FSW-1 spacecraft do not perform orbital maneuvers to adjust groundtracks for prolonged observations over areas of high interest. This implies that the FSW-1 payload possesses a wide field-of-view and a low resolution. When the return capsule is released, the space-

craft bus remains in orbit and decays naturally. The flight of FSW-2 1 in August, 1992, marked changes to the FSW program beyond simple payload capacity and longevity. The initial orbit of the satellite was 172 km by 330 km with an inclination of 63.1°. More important than the return to orbits with lower perigees and greater eccentricities was the demonstration of an orbital maneuver capability. On three occasions at three day intervals (12, 15, and 18 August) the FSW-2 1 satellite slightly raised its apogee by 7–25 km. The total ΔV expended was less than 15 m/s. Further flights may shed greater light on FSW-2 maneuver capacity and intentions to employ this new capability for ground-track shifting (Reference 20).

6.1.4 Western European Union

Since 1988 the Western European Union

(then consisting of Belgium, France, Italy, Luxemburg, the Netherlands, Portugal, Spain, West Germany, and the United Kingdom) has been considering the formation of a WEU space agency with a primary objective of performing national security reconnaissance from space. After postponing a decision of integrating WEU requirements and funding with the French-Italian-Spanish Helios program, the WEU in 1992 committed to establishing an image processing center which will initially work with data from SPOT, Helios, and other commercial sources. Experimental activities should begin in 1993 in readying for the anticipated Helios data in 1994. The concept of operating an independent WEU satellite system, perhaps consuming the follow-on Helios program, near the end of the decade with multi-spectral and radar capabilities is gaining momentum (References 21–23).

6.2 Electronic Intelligence

Electronic intelligence (ELINT) satellites, which use active or passive techniques to detect specific targets, complement the data returned by imaging reconnaissance satellites to provide a more complete picture of an adversary's forces or intentions. The most common ELINT satellites are designed to pickup radio and radar emanations of ships at sea, mobile air defense radars, fixed strategic early warning radars, and other vital military components for the purpose of identification, location, and signals analysis.

The data can then be used for weapons targeting, offensive and defensive engagement planning, and even countermeasure development. In a conflict, the electronic order of battle (EOB) provided by space-based ELINT systems may be even more valuable than conventional photographic reconnaissance. Unlike photo recon satellites, ELINT spacecraft can fly at much higher altitudes without significant impact on sensitivity (the ELINT counterpart to photo recon resolution). Consequently, ELINT satellites can exploit very wide fields-of-view and thereby broaden coverage of terrestrial regions considerably. Since ELINT satellites operate independently of lighting conditions, small constellations of satellites can provide regular, frequent interception opportunities.

6.2.1 USSR/CIS

The CIS is the only member of the European-Asian space community known to operate ELINT satellite systems. Since 1967 nearly 200 spacecraft have been orbited by the USSR/CIS for dedicated ELINT missions. Additional spacecraft may have carried ELINT packages as secondary payloads. Although during 1991-1992 six satellites representing three different types of ELINT spacecraft were launched, the on-orbit constellation of operational ELINT satellites was apparently reduced by more than one half (from a maximum of 15) by the end of the period due to launch failures and temporary program reductions.

Two of the three ELINT networks established and maintained by the USSR/CIS are believed to be global in nature, i.e., they are designed to detect land-based as well as sea-based electronic signals. The principal mode of operations is for each satellite to record the type of signal received and to determine the direction

of the transmitter from the satellite's position. These data are then stored and forwarded to special receiving stations or are relayed in near-realtime via data relay satellites. Analysts on the ground can then combine the data from several satellites to pinpoint the location of the receiver and to determine the type of the emitter. For mobile targets, the frequency of ELINT overflights is crucial to maintaining an accurate knowledge of the target's position.

Historically, ELINT systems have played a major role in Soviet military doctrine. With the dramatic increase of radio and radar emitters on the battlefield during the past 30 years, the value of ELINT satellites has also risen. In the former Soviet Union, the Chief Intelligence Directorate of the Soviet General Staff (GRU) was tasked with the primary responsibility for global ELINT satellite systems. Collection activities were managed by the Satellite Intelligence Directorate, while the data analysis function was performed by the Decrypting Service (References 24-26).

At the beginning of 1991 the USSR global ELINT satellite capability was distributed between a well-established second generation system and a more advanced model striving to reach full operational capability (FOC). The former was represented by a constellation of six satellites placed in evenly spaced orbital planes at altitudes of 635-665 km with inclinations of 82.5°. The constellation was established during 1981-1983 when the satellite was transferred from the SL-3 launch vehicle to the SL-14. (The Meteor meteorological satellites were likewise shifted from the SL-3 to the SL-14 at the same time.)

The SL-14 ELINT satellites are estimated to have a mass of about two metric tons. The similarity of their orbits to Okean satellites, their similar radar cross-sections, and their lack of maneuverability, suggest that the ELINT satellites may be gravity-gradient stabilized. Furthermore, the recent revelation that the Yuzhnoye NPO is responsible for the latest generation ELINT satellites suggests that Yuzhnoye NPO, the designer of Okean satellites, may have created the SL-14 ELINT satellites as well. A report in 1985, citing a classified GAO study, estimated that these ELINT satellites could determine the location of pulsed emitters with an accuracy of about 10 km (Reference 27).

The principal planes of the SL-14 ELINT constellation were staffed during early 1991 by Kosmos' 1842, 1908, 1933, 1953, 1975, and 2058. The one and only replenishment launch of the year occurred on 13 June when Kosmos 2151 appeared to replace Kosmos 1908. An indication of the status of each satellite is possible via a CW beacon operating at about 153 MHz. Monitoring by the Kettering Group during 1991 revealed signals from four satellites: Kosmos' 1953, 1975, 2058, and 2151 (Appendix 1). In 1992 two more replenishment launches were conducted: Kosmos 2221 (24 November) to replace Kosmos 1842 and Kosmos 2228 (25 December) to replace Kosmos 2058).

A possible successor system for the SL-14 ELINT network began flight testing in 1984. After two experimental missions using the SL-12 booster, the new SL-16 (Zenit) launch vehicle was introduced in 1985. The advanced ELINTs, which have been assessed to be capable of near-realtime downlinks (Reference 28), operate from nearly circular orbits at 850 km with inclinations of 71°. The complete constellation consists of four satellites in orbital planes spaced 45° apart. The higher altitude and lower inclination actually increase the frequency of detection in the temperate zones without sacrificing polar coverage. The Yuzhnoye NPO is responsible for both the launch vehicle and the spacecraft (Reference 29).

After nine launches in the program by October, 1990, a full constellation of four satellites in the principal orbital planes was almost at hand. Launches during 1988 and 1990 (Kosmos 1943, Kosmos 1980, and Kosmos 2082) were conducted with the desired 45° phasing between planes. The fourth and final slot was to be filled on 4 October 1990, but a major malfunction just three seconds into the flight caused the RD-170 main engine to shut-down. Consequently, the vehicle fell back onto the pad, destroying not only the booster and its payload, but also the pad as well. Unfortunately, this was only the first in a series of accidents which would set the program back more than two years.

A second SL-16 launch pad at Tyuratam was not yet operational, so the advanced ELINT program was delayed until the accident investigation report was completed, remedial actions taken, and the new pad commissioned. By late July, 1991, another launch vehicle and

payload were readied, but the launch was halted just moments before ignition due to an electrical problem. However, a report in Red Star about the incident noted that the payload would "verify the fulfillment of disarmament treaty commitments" (References 30 and 31).

One month later the advanced ELINT was once again prepared for launch. On 30 August the countdown proceeded smoothly and lift-off occurred at a time set to fill the remaining constellation plane. Although the first stage performed well, the second stage failed almost immediately, and the vehicle never reached orbit (References 32-34). This was the third time in nine attempts that the SL-16 failed on an advanced ELINT mission. A payload was stranded in a transfer orbit in December, 1985, when the second stage refused to restart.

Shortly after the new year, yet another booster/payload combination was erected on a pad at Tyuratam. The launch on 5 February 1992 failed again during the second stage phase, and the payload was lost (Reference 35). More than nine months passed before Kosmos 2219 joined the ELINT constellation on 17 November. However, instead of being inserted into the empty orbital plane, Kosmos 2219 replaced the oldest of the resident trio, Kosmos 1943. Five weeks later the long-awaited fourth member of the network was successfully launched with the designation of Kosmos 2227. Whereas the deployment of Kosmos 2227 was nominal, on the day after launch the SL-16 second stage unexpectedly exploded into more than 200 trackable fragments.

While the USSR/CIS valiantly tried to build up its newest ELINT network, its high value naval reconnaissance system was steadily declining. Initiated in late 1974, the ELINT Ocean Reconnaissance Satellite (EORSAT) flight program had involved 36 spacecraft by the end of 1990. The objectives of the EORSAT system are to detect, identify, and track Western shipping, particularly naval task forces which might threaten the CIS or are engaged in a conflict elsewhere in the world, e.g., the Persian Gulf. More importantly EORSATs are designed to provide direct tactical support to CIS forces in the form of weapons targeting data via the near-realtime transmission of its intelligence information (References 28, 36-38). Such data can be beamed directly to CIS ships equipped

with Punch Bowl antennas or sent to Moscow for relay via Molniya and Raduga satellites to CIS vessels carrying Big Ball communications antennas (References 39–41).

Since naval vessels may be in transit at high speeds, several sightings in a short period of time are desired to determine location, heading, and speed. To accomplish this the EORSAT constellation normally consists of multiple satellites in two orbital planes. A complete EORSAT constellation might consist of six satellites with three satellites evenly spaced in each of two orbital planes separated by approximately 145°. This arrangement ensures a flurry of over-flights for specific regions, increasing the probability of detection and the accuracy of position and movement data (Figure 6.5). EORSATs are believed to be capable of estimating naval positions to within two kilometers (Reference 27).

The current operational orbit for EORSATs is 404 km by 417 km at an inclination of 65°. This altitude regime is rigidly maintained (± 1 km) with frequent orbital maneuvers as are the relative spacings of EORSATs to adhere to a

strict groundtrack pattern which repeats every three days (46 revolutions). All operational EORSATs possess the same set of 46 ascending nodes and are primarily phased in time. A geometric analysis suggests that this phasing is linked to the field-of-view of the satellites for their selected altitude (Reference 42).

Like the global ELINTs, EORSATs are subservient to the GRU, although they are operated by the Department for Satellite Intelligence of the Naval Intelligence Directorate of the Main Navy Staff, Naval Headquarters. The designing organization for EORSATs is believed to be the Kometa Central Scientific Production Association, headed by General Director and General Designer Academician Anatoli I. Savin. The Kometa TsNPO is known to be responsible for the sister Radar Ocean Reconnaissance Satellite (RORSAT) as well as other high value tactical and strategic space systems.

At the start of 1991 five EORSATs were operational: Kosmos 2046, Kosmos 2060, and Kosmos 2096 in one orbital plane and Kosmos 2103 and 2107 in the other. However, on 2

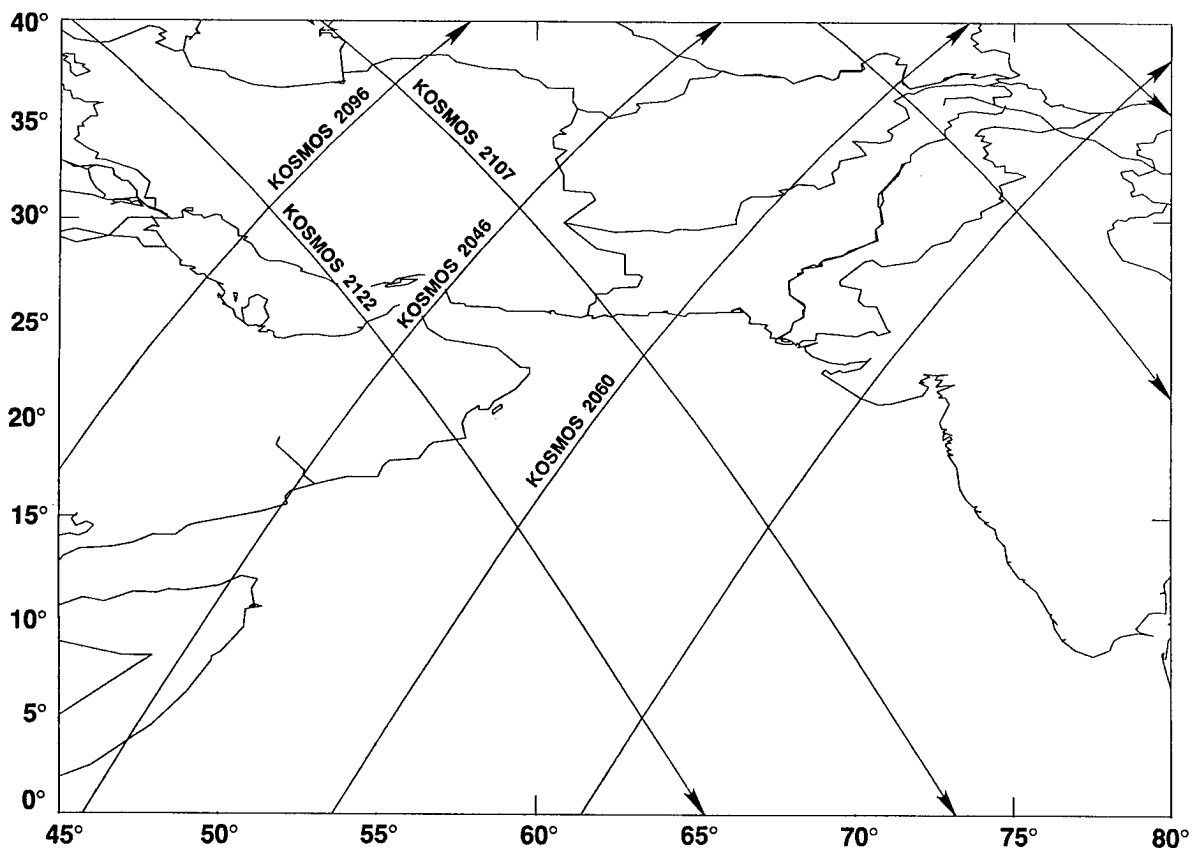

Figure 6.5. EORSAT Coverage of the Persian Gulf War Region.

January Kosmos 2103 apparently failed unexpectedly. The spacecraft was only 49 days old, representing the shortest EORSAT mission since Kosmos 1625 in January, 1985, which failed immediately upon reaching orbit. The suddenness of the demise of Kosmos 2103 was illustrated by the USSR's inability to command the spacecraft to reenter. Instead, natural decay set in and the satellite fell back into the Earth's atmosphere on 3 April 1991. Due to a severe propulsion system problem during 1975–1987 which resulted in the breakup of as many as 16 satellites, the present practice is to lower perigee as far as possible with the remaining propellants at the end of the spacecraft's functional life. In the case of Kosmos 2103, the satellite could easily have been de-orbited as was done with the short-lived Kosmos 1737 in 1986.

Just 16 days after control of Kosmos 2103 was lost, a replacement satellite, Kosmos 2122, was launched from Tyuratam by the SL-11 booster. Kosmos 2122 filled the exact spot in the EORSAT constellation left vacant by Kosmos 2103. In a side note, the upper stage of Kosmos 2122's launch vehicle reentered the atmosphere less than 24 hours after launch (as is normal) but did so over the Middle East at

night triggering false reports of another Iraqi Scud attack in the midst of actual raids on Israel.

Surprisingly, Kosmos 2122 was the only EORSAT to be launched during 1991–1992. After a considerable effort in 1989–1991 to triple the size of the constellation, requiring a record number of four launches in 1990, the network was allowed to atrophy as individual satellites reached their end of life (Figure 6.6). By the end of 1991 the constellation had been reduced to only three satellites with the loss of Kosmos 2046 on 11 April and Kosmos 2060 on 23 August. Two more satellites were terminated in 1992: Kosmos 2107 on 10 March and Kosmos 2096 on 2 August. The latter set an EORSAT longevity record by remaining on station for 710 days. The average lifetime for the previous 15 missions had been just over 400 days.

6.2.2 France

While no European or Asian country other than the CIS currently operates ELINT satellites, France will deploy its first satellite of this type in 1994 under the Cerise program. A much more capable satellite named Zenon is under development for launch sometime about the turn of the century. The Cerise satellite is

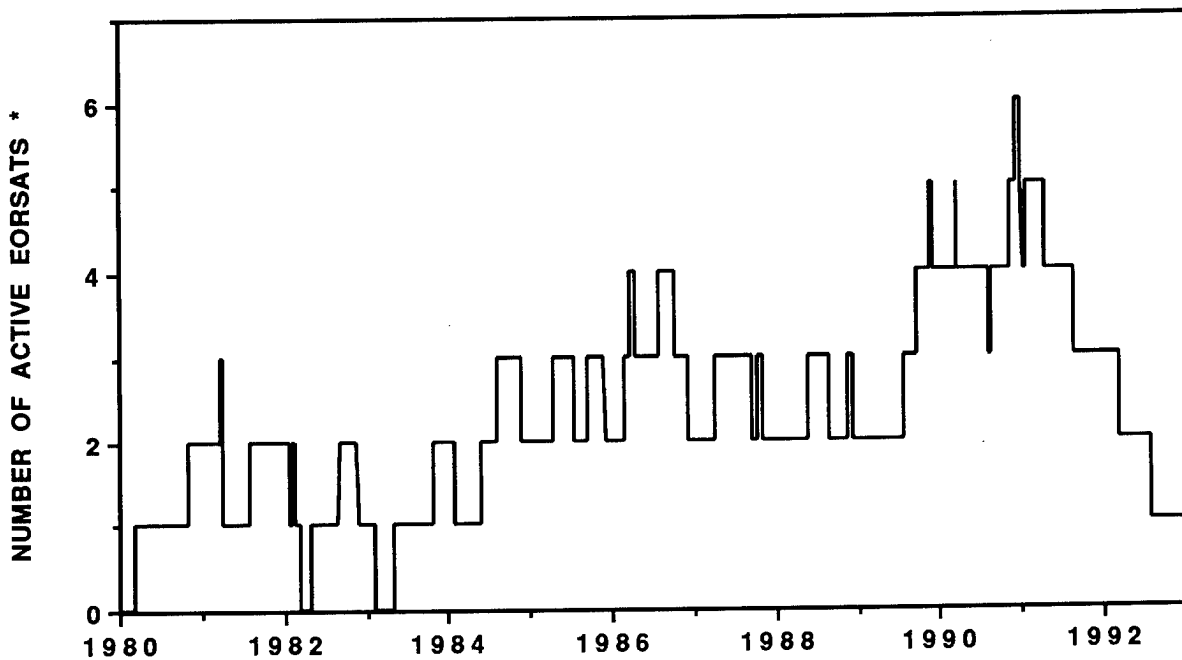

* ACTIVE = PERFORMING PERIODIC ORBITAL ADJUSTMENTS

Figure 6.6. EORSAT Constellation History.

actually a 50 kg mini-satellite which will be carried piggyback with the Helios military reconnaissance satellite (Section 6.1.2). Based on the UK's UoSAT spacecraft bus, Cerise is being designed and manufactured by Alcatel Espace. The project is viewed as largely experimental, and Cerise will have the capability of detecting a limited portion of the electromagnetic spectrum.

Anticipating practical results, the French government in 1992 began studying the feasibility of deploying and operating the large, dedicated Zenon ELINT satellite. The space architecture of a potential Zenon network is still in a formative stage. The program may concentrate on studying the emissions of foreign tactical and strategic radars (References 17, 43-44).

6.3 Ballistic Missile Launch Detection

In the early 1960's the US and USSR began deploying large ground-based radars to detect the approach of nuclear warheads launched by ICBM's. However, these radars were normally restricted to observing the threat objects relatively late in their trajectories, allowing little time to respond. A space-based surveillance system would have the advantage of detecting an ICBM (and later SLBMs) much earlier, in the powered flight regime. Equally important, launch detection satellites would observe the missiles as a consequence of their IR emissions, permitting a dual phenomenology (radar and IR) warning system necessary to eliminate false alarms.

For more than 20 years, only the US and the USSR/CIS have operated space-based ballistic missile launch detection satellites. On the other hand, due to the proliferation of ballistic missile technology in the Third World and due to advancements in IR detectors and computer processors, other nations, e.g., France, are now studying the feasibility of national or multi-national launch detection networks.

6.3.1 USSR/CIS

The USSR's prototype early warning (EW) satellite was launched in 1972 as Kosmos 520. Since a geostationary launch capability had not yet been tested, Kosmos 520 was inserted into a highly elliptical orbit with a period of approximately 12 hours and an inclination near 63°. This orbit, although superficially similar to that employed by Molniya communications satellites, was distinguished by its argument of perigee of 319° (in contrast to 280° or 288° for Molniya satellites). The seemingly minor difference significantly affected the shape of the satellite's groundtrack in the Northern Hemisphere. The stabilized ascending nodes were also distinct from those employed by Molniya satellites.

After a 4-year, 4-satellite test program, the pre-operational EW network began in 1976 with the launch of Kosmos 862. Four years later the transition to a full operational capability with nine satellites in evenly spaced planes was initiated. The EW network comprised the first echelon of the Missile Attack Warning System (SPRN), which was operated by the Air Defense Forces of the Ministry of Defense. According to Soviet officials the EW satellite could detect missile launches within 20 seconds of lift-off "by

means of a heat direction finder responding to the infrared radiation emanating from the flame of the ICBM's engine unit" (References 45 and 46). Responsibility for the development of USSR/CIS EW satellites rests with Academician Savin's Kometa TsNPO, while the Lavochkin NPO provides the spacecraft bus (Figure 6.7).

During the pre-operational phase and early in the full operational phase of the EW satellite program, the 1.6 metric ton spacecraft were susceptible to sudden fragmentations. The first such event was observed with Kosmos 862 in 1977 and had affected as many as 15 satellites through 1986. In 1992 the breakups were explained as originating with a loss of spacecraft attitude which in turn activated a pre-programmed self-destruct device.

Although using orbits very similar to those of Molniya satellites, EW spacecraft are more affected by gravitational perturbations due to their higher argument of perigee and, therefore, perform periodic station-keeping maneuvers to maintain an acceptable groundtrack. In addition, the argument of perigee migrates slightly over time (due to inclination variations), causing an alteration in the shape of the groundtrack. Instead of expending additional propellant to prevent the argument of perigee shift, USSR/CIS spacecraft controllers alter the satellite's ascending node (Figure 6.8). This has the effect of "stabilizing" the apogee point about which surveillance operations are performed. This practice is consistent with a recent report that USSR/CIS EW satellites concentrate their observations near the Earth's limb above expected launch points rather than staring directly at the warm planet.

After six replenishment launches (including one launch failure) in 1990, the USSR did not

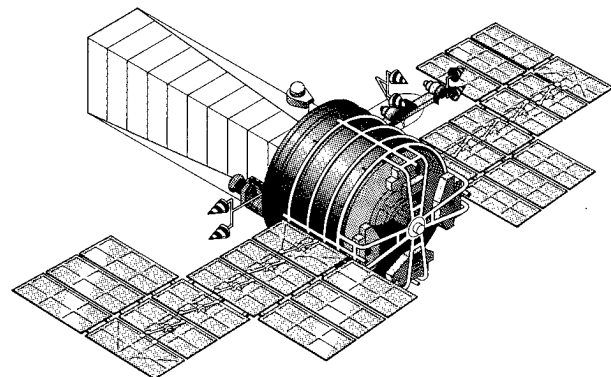

Figure 6.7. CIS Missile Detection Satellite.

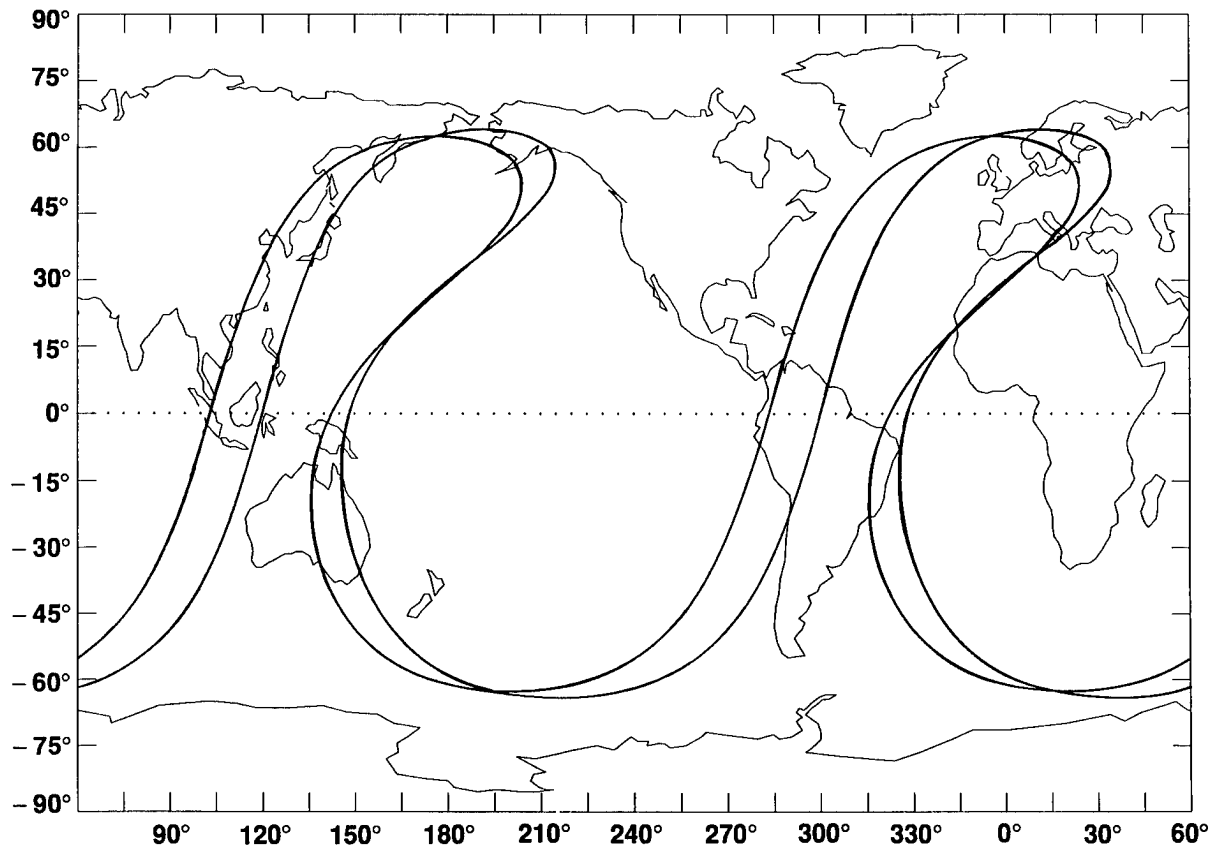

Figure 6.8. CIS Early Warning Satellite Groundtrack Extremes.

orbit another EW satellite the following year, despite the fact that one of the constellation planes was missing an operational spacecraft (Figure 6.9). However, four new missions in 1992 rectified this situation in addition to replacing three other resident satellites. All EW satellites are launched from the Plesetsk Cosmodrome by the SL-6 (Molniya) booster. The age of the three retired satellites varied from 18 to 58 months.

In addition to the established EW constellation, one other EW satellite was operational during all of 1991–1992 in a highly elliptical orbit. Kosmos 2105 (launched 20 November 1990) was placed into an orbital plane 15° away from the nearest constellation slot. Moreover, the satellite's groundtrack was stabilized 30° to the west of the standard ascending node for its argument of perigee. The location coincided with the groundtracks of very early EW satellites. Kosmos 2105 remained in this solitary position for an as yet undetermined reason.

In 1975 Kosmos 775 was placed in a

geostationary orbit at 25° W on an assessed EW test mission. Although an identified GEO EW system was not forthcoming, several reports suggested that GEO testing has continued with an objective of developing a detection system for SLBM's. A back-up GEO EW network was confirmed in 1992. The first generation system apparently consisted of Kosmos 1546, Kosmos 1629, Kosmos 1894, and Kosmos 2209, all stationed near 24° W. The launch announcements of the first three missions were missing the standard reference to communications or data relay objective. Kosmos 2209 was the third in a new series of Prognoz (Forecast) satellites with official objectives of monitoring the world's oceans and natural resources and studying atmospheric processes. Kosmos 2133 and Kosmos 2224 were also linked to the Prognoz program but may represent a second generation GEO EW satellite. Kosmos 2133 was particularly interesting due to its movement from one Prognoz location to another: 80° E (Feb–Oct 91), 35° E (Nov–Dec 91), 12° E (Jan–Feb 92), 24° W (Mar

92–Dec 92). At the end of 1992 Kosmos' 2133, 2209, and 2224 were all operational near 24° W (first two) or 12° E (last one). Kosmos 1940 was not explicitly called a Prognoz satellite, but

its mission description and orbital locations suggest it may have been a second generation prototype (References 47 and 48).

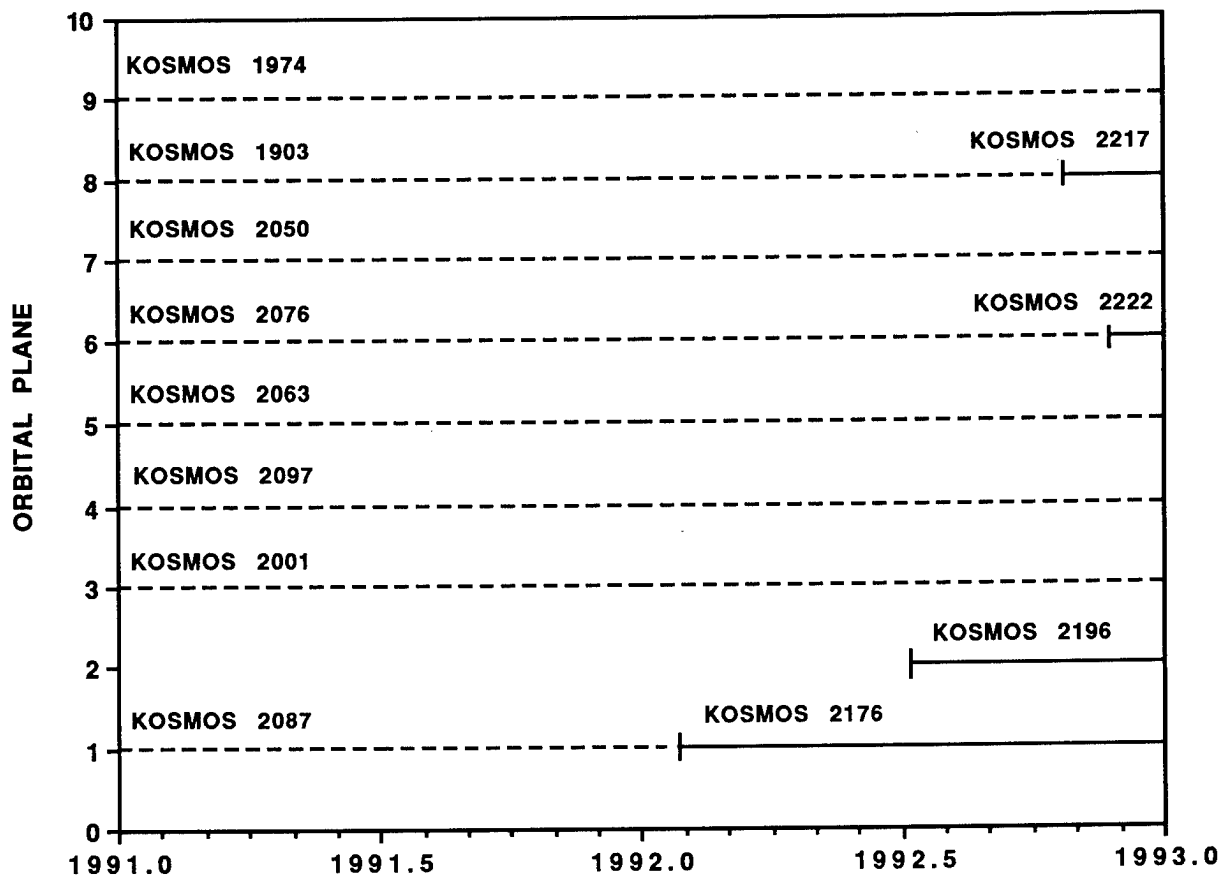

Figure 6.9. CIS Early Warning Satellites Constellation and Replacements

6.4 Space Defense

6.4.1 USSR/CIS

Space defense is an integral part of the broader concept of space control, which asserts one's ability to act freely in space while denying the same privilege to one's enemy. Space control is analogous to air superiority and sea control in the terrestrial environment. In 1963–1964 the Soviet Troops of Air Defense (PVO) established two new commands: PRO and PKO. PRO, meaning anti-missile defense, was charged with detecting, intercepting, and destroying enemy ballistic rockets, while the PKO, meaning anti-space defense, was responsible for "destroying the enemy's cosmic means of fighting" (Reference 49). In 1992 the USSR Space Units which include PRO and PKO were essentially transferred to the CIS United Armed Forces. However, on 7 May 1992 the armed forces of the Russian Federation were established with specific air and space defense missions.

To implement a space control regime and to fulfill its space defense obligation, the PKO

began developing anti-satellite (ASAT) capabilities. Today, the USSR/CIS is commonly believed to have acquired four basic ASAT systems with varying degrees of effectiveness. However, the operational status of these systems is a topic of considerable debate.

The principal and only dedicated ASAT system is referred to as the Co-orbital ASAT in reference to its engagement profile. Developed by the Kometa TsNPO under Academician Savin, the Co-orbital ASAT is based on the SL-11 booster and was tested 20 times in space during the period October, 1968–June, 1982. For each test a dedicated target vehicle was first placed into a low Earth orbit (the first two by the SL-11 from Tyuratam and later targets by the SL-8 from Plesetsk). The Co-orbital ASAT would then be launched from Tyuratam on either a 1-revolution or a 2-revolution intercept.

The co-orbital plane requirement meant that launch opportunities occurred as the orbital plane of the target satellite passed through the Tyuratam launch site twice each day. In practice, only one opportunity per day was acceptable to prevent launches toward the PRC. From



Figure 6.10. CIS Co-Orbital ASAT Flight Profile and Engagement.

an initial, low altitude parking orbit the Co-orbital ASAT would quickly maneuver into a transfer orbit with a greater or lesser orbital period than the target to permit an intercept over Europe after one or two complete circuits about the Earth, i.e., approximately 90–200 minutes after launch (Figure 6.10). Within minutes of the actual attack, the Co-orbital ASAT would maneuver a final time to establish the required end-game conditions. A conventional warhead would then be detonated to effect the negation.

The initial test phase of the Co-orbital ASAT program was conducted during 1968–1971 with an assessed five successes out of seven attempts. In all but one case, a cloud of debris caused by the breakup of the Co-orbital ASAT at the time of warhead detonation was left in LEO. This series of tests validated the operational envelope of the weapon from as low as 230 km to a height of 1,000 km.

Between 1976 and 1982 13 more tests were conducted, primarily to perfect a more rapid intercept profile and to evaluate a new acquisition sensor. Whereas the first seven tests had all required two revolutions, tests 8 and 9 attempted single-revolution attacks as did tests 12 and 13. In both cases the first attempt was judged a failure and the second attempt a success. The last of these tests demonstrated a reach to an altitude of nearly 1,600 km.

Several of the other missions in the Phase 2 test program reportedly employed an optical or IR sensor for target acquisition rather than the standard radar seeker. All attempts with the new sensor are believed to have failed. However, a radar-equipped Co-orbital ASAT was flown on a 2-revolution profile in 1977 to prove that a target at an altitude as low as 159 km in an elliptical orbit could be successfully negated.

All missions after 1970 were flown at inclinations near 65.8° to satisfy range safety restrictions at both Plesetsk (target) and Tyuratam (Co-orbital ASAT). The lack of testing for more than 10 years has raised some questions about the current operational status of the Co-orbital ASAT, although the SL-11 has been flown frequently in support of ocean reconnaissance programs and in August, 1989 the US Secretary of Defense claimed "conclusive evidence" existed that the system was "in a constant state of readiness." Nearly three years later a Russian publication appeared to confirm its

operational status (Reference 50). Two launch pads are available at Tyuratam, each capable of supporting several ASAT missions per day (Reference 51). Although the Co-orbital ASAT has never been launched from Plesetsk, the assumed commonality of SL-11 and SL-14 launch pads should make such operations feasible.

A second ASAT capability is actually older than the Co-orbital ASAT but also much more limited in range. Since 1964 the USSR/CIS has operated a limited ABM system around Moscow. Originally, employing the Galosh nuclear-tipped interceptor, the system now possesses the Gazelle and the Gorgon missiles for endo- and exo-atmospheric engagements, respectively (Reference 52). The silo-launched Gorgon is probably capable of intercepting very low altitude (only a few hundred kilometers) satellites which pass above the Moscow region. This substantially limits the number of satellites potentially vulnerable to the Gorgon, which would be guided to its target by the new Pill Box phased-array radar. Moreover, the use of a nuclear warhead at a low altitude above Moscow would result in collateral damage due to the effects of electromagnetic pulse (EMP). Additional Gorgon interceptors may be operational at the Sary Shagan ABM test range in Kazakhstan (References 53 and 54).

Whereas the Co-orbital ASAT and the Gorgon ABM interceptor are limited in their ability to negate only satellites in LEO, electronic warfare techniques, known as Radio Electronic Combat (REC) in the USSR/CIS, are potentially effective at all altitudes, including GEO. In recent years Soviet officials openly acknowledged not only the possibility of employing REC against enemy satellites but also the USSR's interest and ability in such methods (References 55–56). REC is a basic tenet of USSR/CIS terrestrial war-fighting doctrine, but its application to satellites may leave the attacker with considerable uncertainty as to the outcome of the engagement.

For more than 10 years beginning in the late 1970's, the USSR was involved in an extensive, multi-faceted program to develop high-powered, ground-based lasers. The centers of this activity, with potential ASAT applications, were at Sary Shagan and at Troitsk near Moscow. At least two major facilities were constructed at Sary Shagan: one a 0.7 μm ruby laser and one

a 10.6 μm pulsed CO_2 laser. Both lasers shared a common one-meter diameter beam director. Although Soviet officials admitted the facilities had been used to track satellites prior to 1988, no lethal capability was said to exist (References 55–59). A 1 MW gas laser was built at Troitsk outside Moscow in the late 1970's for military purposes, but a purported ASAT role was not realized (References 60–63).

The level of damage inflicted by a laser on a satellite may range from hard kill (including fragmentation) to general component damage to special component damage. Hard kill normally requires very high energy deposition which is currently possible only at relatively low altitudes of a few hundred kilometers. General component damage may extend above 1,000 km, and special component damage (e.g., sensitive payload optics or attitude control sensors) may be possible as high as GEO. However, the magnitude of the last two levels of damage may be difficult to determine by the attacker, reducing the operational utility of the technique as an ASAT weapon.

By moving the laser platform into Earth orbit some difficulties can be overcome, in particular atmospheric attenuation of the laser's energy can be eliminated. If the space-based laser (SBL) is maneuverable, the range to the target can be reduced, increasing the energy deposition and possibly enhancing the probability of a hard kill. In addition, the SBL could serve an ABM as well as an ASAT role. On the other hand, SBLs are much more limited in the amount of lasing medium and power available and are essentially unserviceable.

Following the attempted coup in the USSR in 1991, a number of reports began to emerge about an effort to deploy SBLs in conjunction with a strategic defense program. The Polyus vehicle carried on the first SL-17 mission in 1987 included the Skif-DM payload, which was "intended for perfecting the design and on-board systems of a future military space complex with laser weaponing" (References 64–66). Whereas Polyus was primarily a product of the Salyut Design Bureau and the Khrunichev Machine Building Plant, Skif-DM was designed by the Institute of Thermal Processes, well-known for its work with nuclear energy. Polyus/Skif-DM failed to reach orbit due to an attitude control problem and fell into the Pacific Ocean after separating from the SL-17 booster. No further launches have been attempted.

A more conventional ASAT program was also underway in the late 1980's and early 1990's. A specially configured MiG-31 was designed to carry an air-launched missile equipped with a satellite-homing, kinetic-kill warhead (Reference 67). Very similar to the US F-15 air-launched ASAT, successfully tested against a satellite in September, 1985, the USSR/CIS miniature ASAT would have been restricted to satellites in LEO, but it would have considerably greater flexibility for engaging enemy satellites than the Co-orbital ASAT. Perhaps more important would be its ability to attack with virtually no warning, unlike the Co-orbital ASAT. The status of the USSR/CIS air-launched ASAT today is unclear, but Russian officials in 1992 indicated that future space tests were possible.

6.5 National Security Support Systems

To perform the early warning, space defense, and general space surveillance functions, a nation must regularly calibrate its large ground-based radars and update its upper atmospheric (<2,000 km altitude) models. In part, these activities are carried out with the aid of a variety of relatively small satellites, often referred to as minor military spacecraft. As the only European-Asian country engaged in the above functions, the USSR/CIS is also the only member to undertake an extensive program of this nature.

6.5.1 USSR/CIS

During 1964–1992 the USSR/CIS orbited 160 spacecraft believed to be associated with the support of national security systems. At least three launches were conducted in 1991, although one spacecraft failed to reach orbit due to a booster malfunction. In 1992 no new satellites appeared in this program, the first such annual lapse since the program began 28 years earlier.

Until 1986 these minor military satellites were launched by the SL-7 (retired in 1977) and the SL-8. Although the majority of missions continue to be launched by the SL-8, the SL-14 and SL-16 have also been employed by the program. In general, satellites are inserted in low, nearly circular orbits (350–550 km) or in moderately eccentric orbits between 200 km and 2,600 km. The primary inclinations used are 50.7°, 65.8°, 74° and 82.9°. The first inclination has not been used since 1987 when the last space mission was flown from the Kapustin Yar Cosmodrome.

Through the years the specific techniques and the orbital profiles have evolved, but the satellites have fallen into two basic categories: those which release multiple objects during their missions and those which do not. The former class of satellites have been linked to the calibration and testing of USSR/CIS radars, in particular ABM radars, while the latter group probably perform a variety of functions.

A total of 20 spacecraft with sub-satellite release capabilities were orbited during 1980–1990 with demonstrated capacities of 8–37 sub-satellites. The ejection events may occur at anytime during the life of the satellites

and may involve only a few or many objects, although almost always in even numbers. For example, Kosmos 2053 was launched on 27 December 1989 and by the end of 1992 had released a total of 37 objects during nine operations spanning 18 months. The smallest number released at one time was two and the largest number was eight. In contrast, Kosmos 1494 waited five months before ejecting its full complement of 25 sub-satellites in a week's time.

Two satellites, Kosmos 2053 and Kosmos 2106, were engaged in this type of activity during 1991 with events occurring in January, March, May, July, and October. Figure 6.11 indicates not only the irregular intervals involved between events but also the significantly higher area-to-mass ratios of the sub-satellites as compared to their parent spacecraft. The sub-satellites exhibit typical radar cross-sections of only 0.1 m², consistent with their 30 cm diameters. In addition, many of the sub-satellites appear to be ejected in opposite pairs from the parent satellite.

In many cases the release of a batch of new sub-satellites is closely tied to the decay of an earlier set (Reference 68). While a link between the sub-satellites and testing ABM radars dates back to at least 1981 (Reference 69), a recent analysis by G. E. Perry of the Kettering Group strongly suggests that this is still a principal objective. His work showed a close correlation between ejection events and immediate passes over the Moscow area (Reference 70).

In 1992 sub-satellite release activity was limited to two short periods. During the first half of February, Kosmos 2075 released at least seven objects, which was noteworthy because Kosmos 2075 had been "dormant" since August, 1990, and because the spacecraft was only two weeks away from natural reentry. A launch failure on 25 June 1991 of a SL-8 from Plesetsk may have been designed to carry on the mission of Kosmos 2075 (Reference 71). In June, 1992, Kosmos 2106 released nine additional sub-satellites, increasing its total number of sub-satellites to 28.

The two successful launches of national security support satellites occurred on 19 March 1991 (Kosmos 2137) and 10 October 1991 (Kosmos 2164). Both missions were of the non-ejecting variety and were launched by the SL-8 from Plesetsk. Kosmos 2137 was similar to

Kosmos 1615 and Kosmos 1427 with initial orbits of approximately 450 km by 500 km at an inclination of 65.8°. Kosmos 1427 has been described by the USSR/CIS as a spherical object used in determining variations in atmospheric density, which in turn is a critical parameter in the estimations of satellite orbit lifetime (Reference 72). The same satellites are equally valuable in calibrating the sensitivity of ground-based radars. The diameter of Kosmos 1427 is believed to be 2 meters.

Similar spherical satellites are placed in more eccentric orbits. Kosmos 2164 repeated the mission of Kosmos 1868 (1987–1989) with an initial orbit of 286 km by 708 km at an inclination of 74.0°. The spacecraft decayed naturally on 12 December 1992. Even more eccentric missions with low perigees have been flown recently by Kosmos 1786 (1986), Kosmos 2002 (1989), and Kosmos 2059 (1990) with perigees

of 190 km and apogees of 2,280–2,560 km. Kosmos 1786 was the only launch in the minor military program to be performed by the SL-16, and German radar analysis of the spacecraft confirmed it to be a sphere of two meter diameter and a calculated mass of 500 kg.

A third orbital regime for spherical calibration satellites utilizes slightly less eccentric orbits of 400 km by 2,00 km and 300 km by 1,550–1,650 km. Six such satellites were still in orbit at the end of 1992. Kosmos 1179 an early member of the group (May, 1980) has been explicitly acknowledged by the USSR/CIS as a spherical satellite used in atmospheric modeling (Reference 72) with a likely diameter of two meters. Another member of this group, Kosmos 1508, gained notoriety in late 1992 when it passed within 300 meters of the Mir space station (Section 3.1).

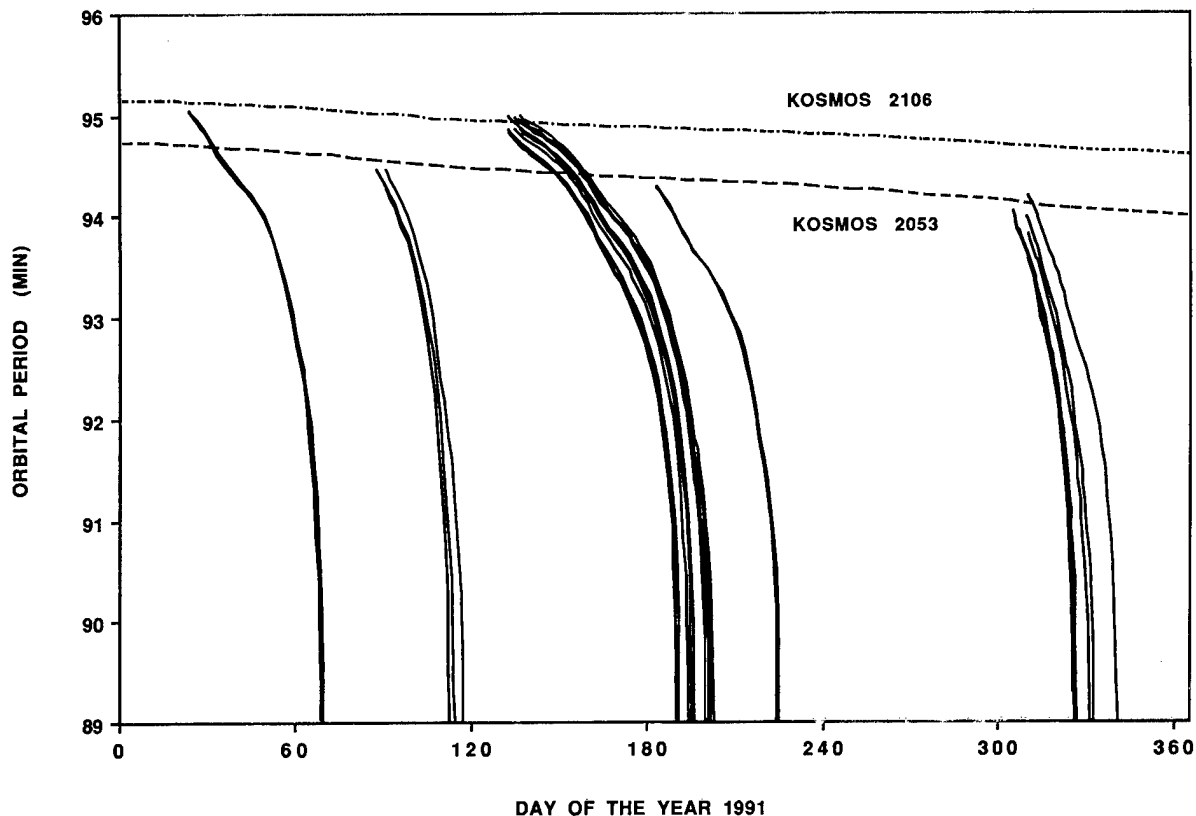

Figure 6.11. Calibration Sub-satellite Activity During 1991.

References - Section 6

1. Rabochaya Tribuna, Moscow, 24 January 1992, p. 2.
2. N. L. Johnson, Fragmentation of Kosmos 2031, Technical Report CS89-TR-JSC-003, Teledyne Brown Engineering, September, 1989.
3. DoD Authorization for FY 1987, House Armed Services Committee, US House of Representatives, 1986, p. 916, Testimony of General Randolph.
4. "USSR Boosts Reconnaissance Capabilities," Aviation Week and Space Technology, 21 January 1985, p. 15.
5. "Statement of Rear Admiral Thomas A. Brooks, U.S. Navy Director of Naval Intelligence," before the Seapower, Strategic, and Critical Materials Subcommittee of the House Armed Services Committee on Intelligence Issues, House of Representatives, 22 February 1989, p. 25.
6. D. Fulghum, "Experts Report Advances in Capability of Soviet Reconnaissance Satellites," Defense News, 14 November 1988, p. 14.
7. C. Covault, "Soviets Endorse French Proposal for Space Reconnaissance Agency," Aviation Week and Space Technology, 24 October 1988, p. 23.
8. "France Studies Reconnaissance Version of Spot Spacecraft," Aviation Week and Space Technology, 10 August 1981, p. 58.
9. "France To Build 'Third Great' Force in Space," Military Space, 14 April 1986, pp. 4-5.
10. "France Approves Military Recon and Communications Satellites," Defense Daily, 5 February 1987, p. 196.
11. "French Milspace," Military Space, 27 April 1987, p. 8.
12. "France Approves Launch by Ariane of Helios Reconnaissance Satellite," Aviation Week and Space Technology, 4 June 1990, p. 20.
13. P. B. de Selding, "France Steps Up Its Military, Space Activity, Spending," Space News, 2-8 November 1992, p. 21.
14. P. B. de Selding, "Gulf War Spurs Call for European Spy Satellites," Space News, 11-17 March 1991, p. 3.
15. "Matra Marconi Space Proposes Expanded Program for Helios Reconnaissance Satellite," Aviation Week and Space Technology, 20 May 1991, p. 63.
16. P. B. de Selding, "Joxe: France To Share Helios Images with WEU," Space News, 10-16 June 1991, p. 22.
17. P. B. de Selding, "France Confirms Work on New Spy Satellite Systems," Space News, 6-19 July 1992, p. 1.
18. P. B. de Selding, "French Begin Military Radar Satellite," Space News, 4-10 November 1991, pp. 1, 20.
19. P. B. de Selding, "French To Provide Imagery To WEU," Space News, 3-9 May 1993, p. 9.
20. For a concise analytical summary of the orbital behavior of FSW-2 1 see P.S. Clark, "Report on the First Flight of the Chinese Fanhui Shi Wexixing-2 Class Satellite," Molniya Space Consultancy, London, 1992.
21. G. de Briganti, "Europeans Push for Independent Treaty-Verification Satellite Net," Space News, 18 September 1989, p. 22.
22. P. B. de Selding "WEU Contract Squabble Ends, Contract Awarded," Space News, 11-17 January 1993, p. 6.

23. G. de Briganti, "WES Study Group Envisions Spy Satellite Program," Space News, 1-7 February 1993, pp. 3, 21.
24. D. Ball and R. Windrem, Soviet Signals Intelligence (SIGINT): Organization and Management, Reference Paper No. 168, Strategic and Defence Studies Centre, The Australian National University, Canberra, September, 1989.
25. D. Ball, Soviet Signals Intelligence (SIGINT), Canberra Papers on Strategy and Defence No. 47, Strategic and Defence Studies Centre, The Australian National University, Canberra, 1989.
26. C. Andrew and O. Gordievsky, KGB. The Inside Story, Harper Collins, Publisher, 1990, p. 609.
27. J. Anderson, "GAO Audits Soviet Spy Satellites," Washington Post, 11 February 1985, p. C12.
28. 1989 Joint Military Net Assessment, Joint Chiefs of Staff, US Government, 1989, pp. 11-12.
29. Pravda Ukrainy, 10 April 1993, p. 1.
30. Krasnaya Zvezda, Moscow, 30 July 1991, p. 4.
31. Krasnaya Zvezda, Moscow, 31 August 1991, p. 2.
32. "Soviet Booster Explodes," Aviation Week and Space Technology, 9 September 1991, p. 19.
33. M. Arkhipov, Ekonomika I Zhizn, Moscow, October, 1991, p. 11.
34. H.-W. Luttmann, "Setback for the Commercial Soviet Space Programme: Zenit Launcher Remains Grounded," Flug Revue, January, 1992, pp. 7-8.
35. "News Breaks," Aviation Week and Space Technology, 6 April 1992, p. 15.
36. Soviet Military Power 1985, Department of Defense, US Government Printing Office, April, 1985, p. 53.
37. Soviet Military Power 1988, Department of Defense, US Government Printing Office, April, 1988, p. 63.
38. G. C. Wilson, "Antisatellite Effort Needed, Senate Is Told," Washington Post, 24 April 1987.
39. R. S. Cooper, Director, Defense Advanced Research Projects Agency, in testimony before a Subcommittee of the Committee on Appropriations, US House of Representatives, 23 March 1983.
40. J. Bussert, "Wartime Needs Give Direction to Soviet C³I Technology," Defense Electronics, May, 1985, p. 155.
41. "Analysis of Changes to the Baku," Jane's Defense Weekly, 6 August 1988, p. 225.
42. N. L. Johnson, The Soviet Year in Space 1990, Teledyne Brown Engineering, 1991, p. 90.
43. "France's Recon Satellite Will Conduct Elint Missions," Defense Daily, 31 March 1987, p. 169.
44. P. B. de Selding, "France To Launch Eavesdropping Satellite in '94," Space News, 3-9 February 1992, pp. 1, 28.
45. Pravda, Moscow, 15 April 1991, p. 8.
46. Krasnaya Zvezda, Moscow, 14 March 1991, p. 4.
47. "Industry Observer," Aviation Week and Space Technology, 19 October 1987, p. 13, and "Industry Observer," Aviation Week and Space Technology, 5 January 1976, p. 9.
48. Novosti Kosmonavtiki, Moscow, 1-17 January 1993, pp. 19-20.

49. For a more in-depth discussion of this topic and the history of Soviet space defense capabilities see N. L. Johnson, Soviet Military Strategy in Space, Jane's Publishing Company, London, 1987.
50. Nezavisimaya Gazeta, Moscow, 21 November 1991, p. 5.
51. The Soviet Space Challenge, Department of Defense, US Government Printing Office, November, 1987, p. 11.
52. Military Forces in Transition 1991, Department of Defense, US Government Printing Office, 1991, p. 37.
53. Krasnaya Zvezda, Moscow, 5 October 1990, p. 2.
54. Sovetskaya Rossiya, Moscow, 5 August 1990, p. 4.
55. Der Spiegel, Hamburg, 8 February 1988, pp. 130–138.
56. Komsomolskaya Pravda, Moscow, 24 October 1989, p. 1.
57. "Sary Shagan and Kyshtym, A Visit to Soviet Nuclear Facilities," Science and Global Security, Vol. 1, No.'s 1–2, pp. 165–170.
58. "Soviets Display Laser Facility at Sary Shagan," Aviation Week and Space Technology, 17 July 1989, p. 27.
59. Rep. R. Carr, "Soviets Taking Wraps Off Secrecy," Defense News, 28 August 1989, p. 30.
60. "Soviet Union Developing Laser Antisatellite Weapon," Aviation Week and Space Technology, 16 June 1980, pp. 60–61.
61. "Heflin Says Soviets Have Operational Anti-Satellite Laser," Defense Daily, 28 July 1981, p. 146.
62. Krasnaya Zvezda, Moscow, 17 August 1989, p. 3.
63. Sovetskaya Litviya, 8 September 1989, p. 3.
64. Izvestiya, Moscow, 13 December 1991, p. 3.
65. Nezavisimaya Gazeta, Moscow, 26 February 1992, p. 2.
66. Nezavisimaya Gazeta, Moscow, 25 September 1991, p. 6.
67. "Russians Alter MiG-31 for ASAT Carrier Role," Aviation Week and Space Technology, 17 August 1992, p. 63.
68. For example, see N. L. Johnson, The Soviet Year in Space 1989, Teledyne Brown Engineering, 1990, p. 88.
69. "Soviets Orbit ABM Test Satellite," Defense Daily, 29 October 1981, p. 284.
70. G. E. Perry, "A Possible Mission for the Sub-Set of Cosmos Satellites Which Produce Additional Objects During Their Active Phase," First European Conference on Space Debris, April, 1993.
71. Krasnaya Zvezda, Moscow, 10 July 1991, p. 5.
72. A. I. Nazarenko, et al, "The Space-Temporal Variations of the Upper Atmospheric Density Derived From Satellite Drag Data," Advances in Space Research, Vol. 11, No. 6, 1991, pp. 155–160.

7.0 1991-1992 SPACE LAUNCHES

7.1 USSR/CIS

USSR LAUNCH HISTORY, 1991

DATE	SATELLITE	SATELLITE NUMBER	INTERNATIONAL DESIGNATOR	LAUNCH VEHICLE	LAUNCH SITE	PERGEE (KM)	APOGEE (KM)	INCLINATION (DEG)	PERIOD (MIN)	MISSION TYPE	NOTES
14.82 JAN	PROGRESS M-6	21053	1991-02A	SL-04	TT	363	398	51.61	92.16	MIR RESUPPLY	DOCKED 16 JAN; UNDOCKED 15 MAR
17.44 JAN	KOSMOS 2121	21059	1991-04A	SL-04	PL	235	306	82.59	89.92	PHOTO RECON	3RD GENERATION; RETURNED 10 FEB
18.48 JAN	KOSMOS 2122	21065	1991-05A	SL-11	TT	404	417	65.02	92.78	EORSAT	REPLACED KOSMOS 2103; MISSION TERMINATED 4 MAR 93; RECORD DURATION
29.50 JAN	INFORMATOR 1	21087	1991-06A	SL-08	PL	959	1009	82.95	104.78	COMMUNICATIONS	PROTOTYPE KOSKON SATELLITE FOR MINISTRY OF GEOLOGY; ALSO RADIO M-1 TRANSPONDER
05.11 FEB	KOSMOS 2123	21089	1991-07A	SL-08	PL	965	1007	82.92	104.81	NAVIGATION	REPLACED KOSMOS 1655; ALSO CARRIED RS12 AND RS13 TRANSPONDERS
07.76 FEB	KOSMOS 2124	21092	1991-08A	SL-04	PL	182	289	62.84	89.21	PHOTO RECON	4TH GENERATION; RETURNED 7 APR
12.12 FEB	KOSMOS 2125 KOSMOS 2126 KOSMOS 2127 KOSMOS 2128 KOSMOS 2129 KOSMOS 2130 KOSMOS 2131 KOSMOS 2132	21100 21101 21102 21103 21104 21105 21106 21107	1991-09A 1991-09B 1991-09C 1991-09D 1991-09E 1991-09F 1991-09G 1991-09H	SL-08	PL	1458 1466 1467 1468 1469 1470 1471 1472	1473 1474 1475 1476 1477 1478 1479 1480	74.03 74.03 74.03 74.03 74.03 74.03 74.03 74.03	115.22 115.58 115.39 115.04 114.88 114.56 114.40 114.72	COMMUNICATIONS COMMUNICATIONS COMMUNICATIONS COMMUNICATIONS COMMUNICATIONS COMMUNICATIONS COMMUNICATIONS COMMUNICATIONS	ROCKET BODY EXPERIENCED NUMEROUS FRAGMENTATIONS AFTER SUCCESSFUL PAYLOAD DELIVERY
14.36 FEB	KOSMOS 2133	21111	1991-10A	SL-12	TT	35760	35812	2.30	1436.08	EARLY WARNING	POSITIONED AT 80 E (FEB/OCT), 35 E (NOV-DEC); 12 E (JAN 92-FEB 92), 356 E (MAR 92); ALL ARE REGISTERED PROGNOSIS LOCATIONS
15.40 FEB	KOSMOS 2134	21116	1991-11A	SL-04	TT	212	262	64.73	89.24	PHOTO RECON	4TH GENERATION; TOPOGRAPHIC MAPPING; RETURNED 1 APR
15.63 FEB	MOLNIYA 1-80	21118	1991-12A	SL-06	PL	421	39943	62.79	717.96	COMMUNICATIONS	REPLACED MOL 1-79; ON STATION 21 FEB; INITIATED CONSTELLATION RESTRUCTURE
26.21 FEB	KOSMOS 2135	21130	1991-13A	SL-08	PL	925	1020	82.82	104.53	NAVIGATION	DID NOT REPLACE KOSMOS 2026 UNTIL MAR 92
28.23 FEB	RADUGA 27	21132	1991-14A	SL-12	TT	35782	35798	1.49	1436.27	COMMUNICATIONS	POSITIONED AT 128 E
08.64 MAR	KOSMOS 2136	21143	1991-16A	SL-04	PL	249	294	62.85	89.93	PHOTO RECON	3RD GENERATION; RETURNED 20 MAR
12.81 MAR	NADEZHDA 3	21152	1991-19A	SL-08	PL	958	1018	82.93	104.86	NAVIGATION	REPLACED KOSMOS 1727; ALSO CARRIED COSPAS TRANSPONDER

USSR LAUNCH HISTORY, 1991

DATE	SATELLITE	SATELLITE NUMBER	INTERNATIONAL DESIGNATOR	LAUNCH VEHICLE	LAUNCH SITE	PERGEE (KM)	APOGEE (KM)	INCLINATION (DEG)	PERIOD (MIN)	MISSION TYPE	NOTES
19.55 MAR	PROGRESS M7	21188	1991-20A	SL-04	TT	363	384	51.61	92.02	MIR RESUPPLY	DOCKED AFTER THIRD ATTEMPT 28 MAR; UNDOCKED 6 MAY
19.61 MAR	KOSMOS 2137	21190	1991-21A	SL-08	PL	449	496	65.85	94.04	MINOR MILITARY	SIMILAR TO KOSMOS 1615
22.51 MAR	MOLNIYA 3-40	21196	1991-22A	SL-06	PL	432	39885	62.84	717.02	COMMUNICATIONS	REPLACED MOL 3-33; ON STATION 27 MAR
26.57 MAR	KOSMOS 2138	21203	1991-23A	SL-04	PL	163	345	67.14	89.59	PHOTO RECON	4TH GENERATION; RETURNED 24 MAY
31.63 MAR	ALMAZ 1	21213	1991-24A	SL-13	TT	268	280	72.70	90.00	REMOTE SENSING	KOSMOS 1870 CLASS; DEORBITED 17 OCT 92
04.45 APR	KOSMOS 2139 KOSMOS 2140 KOSMOS 2141	21216 21217 21218	1991-25A 1991-25B 1991-25C	SL-12	TT	19111 19105 19107	19148 19155 19152	64.81 64.80 64.79	675.73 675.73 675.71	NAVIGATION NAVIGATION NAVIGATION	KOSMOS 2139-2141 EXPANDED EXISTING CONSTELLATION
16.31 APR	KOSMOS 2142	21230	1991-29A	SL-08	PL	964	1019	82.96	104.93	NAVIGATION	REPLACED KOSMOS 2034
24.07 APR	METEOR 3-4	21232	1991-30A	SL-14	PL	1187	1213	82.54	109.46	METEOROLOGY	
16.90 MAY	KOSMOS 2143 KOSMOS 2144 KOSMOS 2145 KOSMOS 2146 KOSMOS 2147 KOSMOS 2148	21299 21300 21301 21302 31303 21304	1991-33A 1991-33B 1991-33C 1991-33D 1991-33E 1991-33F	SL-14	PL	1400 1413 1406 1395 1390 1384	1416 1416 1416 1416 1416 1416	82.57 82.58 82.57 82.58 82.57 82.57	113.96 114.10 114.03 113.90 113.85 113.78	COMMUNICATIONS COMMUNICATIONS COMMUNICATIONS COMMUNICATIONS COMMUNICATIONS COMMUNICATIONS	COPLANAR WITH KOSMOS 2090-2095
18.53 MAY	SOYUZ TM-12	21311	1991-34A	SL-04	TT	366	373	51.61	91.94	MANNED	DOCKED AT MIR 20 MAY; UNDOCKED 10 OCT
21.38 MAY	RESURS-F 10	21313	1991-35A	SL-04	PL	230	235	82.32	89.15	PHOTO RECON	3RD GENERATION; EARTH RESOURCES; RETURNED 20 JUN
24.65 MAY	KOSMOS 2149	21315	1991-36A	SL-04	PL	165	352	67.14	89.68	PHOTO RECON	4TH GENERATION; RETURNED 4 JUL
30.34 MAY	PROGRESS M8	21395	1991-38A	SL-04	TT	363	370	51.61	91.88	MIR RESUPPLY	DOCKED 1 JUN; UNDOCKED 15 AUG
04.34 JUN	OKEAN 3	21397	1991-39A	SL-14	PL	634	665	82.53	97.72	OCEANOGRAPHY	PHASED WITH OKEAN 2
11.24 JUN	KOSMOS 2150	21418	1991-41A	SL-08	PL	783	809	74.04	100.79	COMMUNICATIONS	COPLANAR WITH KOSMOS 1954
13.65 JUN	KOSMOS 2151	21422	1991-42A	SL-14	PL	637	663	82.51	97.72	ELINT	REPLACED KOSMOS 1908

USSR LAUNCH HISTORY, 1991

DATE	SATELLITE	SATELLITE NUMBER	INTERNATIONAL DESIGNATOR	LAUNCH VEHICLE	LAUNCH SITE	PERGEE (KM)	APOGEE (KM)	INCLINATION (DEG)	PERIOD (MIN)	MISSION TYPE	NOTES
17.12 JUN	MAK-1	21425	1986-17DV	.	MR	383	394	51.61	92.32	SCIENTFC	RELEASED FROM MIR SPACE STATION; DELIVERED TO MIR BY PROGRESS M-8; NEVER OPERATIONAL
18.38 JUN	MOLNIYA 1-81	21426	1991-43A	SL-06	PL	447	39902	62.88	717.68	COMMUNICATIONS	REPLACED MOL 1-74; ON STATION 23 JUN
25.56 JUN	KOSMOS.....	NONE	NONE	SL-08	PL	***	***	****	****	MINOR MILITARY	SECOND STAGE OF SL-08 FAILED TO REIGNITE; PLANNED ORBIT SIMILAR TO KOSMOS 2075
28.34 JUN	RESURSF11	21524	1991-44A	SL-04	PL	259	273	82.34	89.82	PHOTO RECON	3RD GENERATION; EARTH RESOURCES; RETURNED 21 JUL
01.95 JUL	GORIZONT 23	21533	1991-46A	SL-12	TT	35884	35080	1.47	1435.95	COMMUNICATIONS	POSITIONED AT 103 E; 2ND RUSSIAN GORIZONT
09.40 JUL	KOSMOS 2152	21558	1991-48A	SL-04	PL	236	351	82.35	90.38	PHOTO RECON	3RD GENERATION; RETURNED 23 JUL
10.59 JUL	KOSMOS 2153	21560	1991-49A	SL-04	TT	241	282	64.87	89.74	PHOTO RECON	5TH GENERATION; RETURNED 13 MAR 92
23.38 JUL	RESURSF12	21611	1991-52A	SL-04	PL	256	272	82.34	89.81	PHOTO RECON	3RD GENERATION; EARTH RESOURCES; RETURNED 8 AUG
01.49 AUG	MOLNIYA 1-82	21630	1991-53A	SL-06	PL	622	39739	62.85	717.90	COMMUNICATIONS	REPLACED MOL 1-76; ON STATION 16 AUG
15.39 AUG	METEOR 3-5	21655	1991-56A	SL-14	PL	1188	1206	82.56	109.36	METEOROLOGY	CARRIED U.S. TOMS PAYLOAD
15.93 AUG	NONE	21661	1986-17FJ	.	MR	385	386	51.61	92.27	SCIENTFC	BALLOON DEPLOYED DURING UNDOCKING OF PROGRESS M-8 FAILED TO INFLATE; DECAYED 29 AUG
20.95 AUG	PROGRESS M-9	21662	1991-57A	SL-04	TT	382	384	51.60	92.22	MIR RESUPPLY	DOCKED 23 AUG; UNDOCKED 30 SEP
21.45 AUG	RESURSF13	21664	1991-58A	SL-04	PL	231	234	82.31	89.15	PHOTO RECON	3RD GENERATION; EARTH RESOURCES; RETURNED 20 SEP
22.53 AUG	KOSMOS 2154	21666	1991-59A	SL-08	PL	973	1008	82.91	104.91	NAVIGATION	REPLACED KOSMOS 2061
29.28 AUG	IPS-1B	21688	1991-61A	SL-03	TT	857	919	99.25	102.73	COMMERCIAL	LAUNCH FOR INDIA
30.37 AUG	KOSMOS.....	NONE	NONE	SL-16	TT	***	***	****	****	ELINT	SECOND STAGE OF SL-16 FAILED AT IGNITION; PLANNED ORBIT SIMILAR TO KOSMOS 2082

USSR LAUNCH HISTORY, 1991

DATE	SATELLITE	SATELLITE NUMBER	INTERNATIONAL DESIGNATOR	LAUNCH VEHICLE	LAUNCH SITE	PERGEE (KM)	APOGEE (KM)	INCLINATION (DEG)	PERIOD (MIN)	MISSION TYPE	NOTES
13.74 SEP	KOSMOS 2155	21702	1991-64A	SL-12	TT	35762	35809	1.31	1436.05	COMMUNICATIONS	POSITIONED AT 335 E
17.83 SEP	MOLNIYA 3-41	21706	1991-65A	SL-06	PL	453	39911	62.85	717.96	COMMUNICATIONS	REPLACED MOL 3-32; ON STATION 22 SEP
19.68 SEP	KOSMOS 2156	21713	1991-66A	SL-04	PL	163	348	67.11	89.61	PHOTO RECON	4TH GENERATION; RETURNED 17 NOV
28.30 SEP	KOSMOS 2157	21728	1991-68A	SL-14	PL	1407	1415	82.58	114.02	COMMUNICATIONS	COPLANAR WITH KOSMOS 2143-2148
	KOSMOS 2158	21729	1991-68B			1404	1411	82.58	113.95	COMMUNICATIONS	
	KOSMOS 2159	21730	1991-68C			1389	1410	82.58	113.77	COMMUNICATIONS	
	KOSMOS 2160	21731	1991-68D			1400	1410	82.56	113.89	COMMUNICATIONS	
	KOSMOS 2161	21732	1991-68E			1395	1410	82.58	113.84	COMMUNICATIONS	
	KOSMOS 2162	21733	1991-68F			1408	1420	82.59	114.09	COMMUNICATIONS	
02.25 OCT	SOYUZ TM-13	21735	1991-69A	SL-04	TT	392	403	51.60	92.51	MANNED	DOCKED AT MIR 4 OCT; UNDOCKED 25 MAR 92
04.75 OCT	PHOTON 4	21737	1991-70A	SL-04	PL	215	397	62.81	90.63	MATERIALS SCIENCE	RETURNED 20 OCT
09.55 OCT	KOSMOS 2163	21741	1991-71A	SL-04	TT	214	360	64.78	90.25	PHOTO RECON	SPECIAL 4TH GENERATION; DESTROYED IN ORBIT 6 DEC
10.59 OCT	KOSMOS 2164	21743	1991-72A	SL-06	PL	286	708	73.99	94.55	MINOR MILITARY	SIMILAR TO KOSMOS 1868; DECAYED 12 DEC 92
17.00 OCT	PROGRESS M-10	21746	1991-73A	SL-04	TT	395	401	51.60	92.52	MIR SUPPLY	DOCKED 21 OCT; UNDOCKED 20 JAN 92
23.64 OCT	GORIZONT 24	21759	1991-74A	SL-12	TT	35776	35793	1.46	1436.01	COMMUNICATIONS	POSITIONED AT 80 E
12.84 NOV	KOSMOS 2165	21779	1991-77A	SL-14	PL	1395	1413	82.61	113.87	COMMUNICATIONS	COPLANAR WITH KOSMOS 2114-2119
	KOSMOS 2166	21780	1991-77B			1407	1413	82.60	114.00	COMMUNICATIONS	
	KOSMOS 2167	21781	1991-77C			1400	1413	82.61	113.93	COMMUNICATIONS	
	KOSMOS 2168	21782	1991-77D			1390	1413	82.60	113.82	COMMUNICATIONS	
	KOSMOS 2169	21783	1991-77E			1383	1413	82.61	113.74	COMMUNICATIONS	
	KOSMOS 2170	21784	1991-77F			1412	1415	82.61	114.08	COMMUNICATIONS	
20.80 NOV	KOSMOS 2171	21787	1991-78A	SL-04	PL	189	322	62.82	89.62	PHOTO RECON	4TH GENERATION; RETURNED 17 JAN 92
22.56 NOV	KOSMOS 2172	21789	1991-79A	SL-12	TT	35779	35794	1.37	1436.09	COMMUNICATIONS	POSITIONED AT 346.5 E
27.15 NOV	KOSMOS 2173	21796	1991-81A	SL-08	PL	947	1019	82.95	104.75	NAVIGATION	REPLACED KOSMOS 2100
17.46 DEC	KOSMOS 2174	21816	1991-85A	SL-04	TT	209	266	64.86	89.26	PHOTO RECON	4TH GENERATION; TOPOGRAPHIC MAPPING; RETURNED 30 JAN 92

USSR LAUNCH HISTORY, 1991

DATE	SATELLITE	SATELLITE NUMBER	INTERNATIONAL DESIGNATOR	LAUNCH VEHICLE	LAUNCH SITE	PERGEE (KM)	APOGEE (KM)	INCLINATION (DEG)	PERIOD (MIN)	MISSION TYPE	NOTES
18.16 DEC	INTERKOSMOS 25 MAGION 3	21819	1991-86A	SL-14	PL	438	3072	82.56	121.66	SCIENTIFIC SCIENTIFIC	INTERKOSMOS APEXS PROJECT SUB-SATELLITE RELEASED ON 28 DEC
		21835	1991-86E			437	3071	82.56	121.64		
19.49 DEC	RADUGA 28	21821	1991-87A	SL-12	TT	35761	35831	1.45	1436.60	COMMUNICATIONS	POSITIONED AT 35 E

CIS LAUNCH HISTORY, 1992

DATE	SATELLITE	SATELLITE NUMBER	INTERNATIONAL DESIGNATOR	LAUNCH VEHICLE	LAUNCH SITE	PERGEE (KM)	APOGEE (KM)	INCLINATION (DEG)	PERIOD (MIN)	MISSION TYPE	NOTES
21.63 JAN	KOSMOS 2175	21844	1992-01A	SL-04	PL	163	346	67.14	89.60	PHOTO RECON	4TH GENERATION; RETURNED 20 MAR
24.05 JAN	KOSMOS 2176	21847	1992-03A	SL-06	PL	604	39746	62.80	717.69	EARLY WARNING	REPLACED KOSMOS 2087; ON STATION 27 JAN
25.33 JAN	PROGRESS M-11	21851	1992-04A	SL-04	TT	374	377	51.60	92.06	MIR RESUPPLY	DOCKED 27 JAN; UNDOCKED 13 MAR
29.93 JAN	KOSMOS 2177	21853	1992-05A	SL-12	TT	19114	19149	64.76	675.79	NAVIGATION	REPLACED KOSMOS 1988
	KOSMOS 2178	21854	1992-05B			19088	19170	64.80	675.71	NAVIGATION	REPLACED KOSMOS 1946
	KOSMOS 2179	21855	1992-05C			19111	19149	64.79	675.73	NAVIGATION	REPLACED KOSMOS 1948
05.76 FEB	KOSMOS	NONE	NONE	SL-16	TT	***	***	****	****	ELINT	SECOND STAGE OF SL-16 FAILED AT IGNITION; PLANNED ORBIT SIMILAR TO KOSMOS 2082; THIRD CONSECUTIVE SL-16 LAUNCH FAILURE
17.92 FEB	KOSMOS 2180	21875	1992-08A	SL-08	PL	962	1015	82.93	104.88	NAVIGATION	REPLACED KOSMOS 2004
04.18 MAR	MOLNIYA 1-83	21897	1992-11A	SL-06	PL	613	39737	62.81	717.70	COMMUNICATIONS	REPLACED MOL. 1-75; ON STATION 10 MAR
09.94 MAR	KOSMOS 2181	21902	1992-12A	SL-08	PL	973	1013	82.95	104.97	NAVIGATION	REPLACED KOSMOS 1791
17.45 MAR	SOYUZ TM-14	21908	1992-14A	SL-04	TT	381	403	51.60	92.40	MANNED	DOCKED AT MIR 19 MAR; UNDOCKED 10 AUG
01.60 APR	KOSMOS 2182	21920	1992-16A	SL-04	PL	162	291	67.16	89.03	PHOTO RECON	4TH GENERATION; RETURNED 30 MAY
02.08 APR	GORIZONT 25	21922	1992-17A	SL-12	TT	35770	35794	1.43	1435.85	COMMUNICATIONS	RUSSIAN SPACECRAFT; POSITIONED AT 103 E
08.52 APR	KOSMOS 2183	21928	1992-18A	SL-04	TT	240	294	64.87	89.85	PHOTO RECON	5TH GENERATION; RETURNED 16 FEB 93
15.30 APR	KOSMOS 2184	21937	1992-20A	SL-08	PL	967	1014	82.94	104.92	NAVIGATION	REPLACED KOSMOS 2074
19.90 APR	PROGRESS M-12	21946	1992-22A	SL-04	TT	375	396	51.60	92.26	MIR RESUPPLY	DOCKED 21 APR; UNDOCKED 27 JUN
29.38 APR	RESURF-14	21951	1992-24A	SL-04	PL	231	235	82.08	89.16	PHOTO RECON	3RD GENERATION; EARTH RESOURCES; RETURNED 29 MAY
29.43 APR	KOSMOS 2185	21953	1992-25A	SL-04	TT	212	279	69.97	89.41	PHOTO RECON	4TH GENERATION; TOPOGRAPHIC MAPPING; RETURNED 11 JUN
28.79 MAY	KOSMOS 2186	21973	1992-29A	SL-04	PL	182	352	62.85	89.85	PHOTO RECON	4TH GENERATION; RETURNED 24 JUL

CIS LAUNCH HISTORY, 1992

DATE	SATELLITE	SATELLITE NUMBER	INTERNATIONAL DESIGNATOR	LAUNCH VEHICLE	LAUNCH SITE	PERGEE (KM)	APOGEE (KM)	INCLINATION (DEG)	PERIOD (MIN)	MISSION TYPE	NOTES
03.04 JUN	KOSMOS 2187	21976	1992-30A	SL-08	PL	1402	1480	74.01	114.69	COMMUNICATIONS	
	KOSMOS 2188	21977	1992-30B			1389	1479	74.00	114.53	COMMUNICATIONS	
	KOSMOS 2189	21978	1992-30C			1418	1479	74.00	114.85	COMMUNICATIONS	
	KOSMOS 2190	21979	1992-30D			1431	1480	74.00	115.01	COMMUNICATIONS	
	KOSMOS 2191	21980	1992-30E			1473	1503	74.01	115.72	COMMUNICATIONS	
	KOSMOS 2192	21981	1992-30F			1472	1486	74.00	115.52	COMMUNICATIONS	
	KOSMOS 2193	21982	1992-30G			1447	1480	74.01	115.17	COMMUNICATIONS	
	KOSMOS 2194	21983	1992-30H			1459	1485	74.00	115.36	COMMUNICATIONS	
23.33 JUN	RESURS F-15	21998	1992-33A	SL-04	PL	226	233	82.32	89.09	PHOTO RECON	3RD GENERATION; EARTH RESOURCES; RETURNED 9 JUL
30.70 JUN	PROGRESS M-13	22004	1992-35A	SL-04	TT	388	410	51.60	92.54	MIR RESUPPLY	DOCKED 4 JUL; UNDOCKED 24 JUL
01.84 JUL	KOSMOS 2195	22006	1992-36A	SL-08	PL	958	1011	82.93	104.79	NAVIGATION	REPLACED KOSMOS 2195
08.41 JUL	KOSMOS 2196	22017	1992-40A	SL-06	PL	595	39779	62.98	718.17	EARLY WARNING	REPLACED KOSMOS 1922; ON STATION 13 JUL
13.74 JUL	KOSMOS 2197	22034	1992-42A	SL-14	PL	1397	1416	82.59	113.93	COMMUNICATIONS	COPLANAR WITH KOSMOS 2165-2170
	KOSMOS 2198	22035	1992-42B			1410	1416	82.59	114.07	COMMUNICATIONS	
	KOSMOS 2199	22036	1992-42C			1414	1426	82.60	114.22	COMMUNICATIONS	GONETS D (DEMONSTRATION) SPACECRAFT
	KOSMOS 2200	22037	1992-42D			1405	1416	82.58	114.02	COMMUNICATIONS	
	KOSMOS 2201	22038	1992-42E			1413	1421	82.59	114.15	COMMUNICATIONS	GONETS D (DEMONSTRATION) SPACECRAFT
	KOSMOS 2202	22039	1992-42F			1409	1417	82.59	114.07	COMMUNICATIONS	
14.92 JUL	GORIZONT 26	22041	1992-43A	SL-12	TT	35765	35801	1.44	1435.90	COMMUNICATIONS	POSITIONED AT 349 E
24.82 JUL	KOSMOS 2203	22052	1992-45A	SL-04	PL	191	313	62.80	89.54	PHOTO RECON	4TH GENERATION; RETURNED 22 SEP
27.26 JUL	SOYUZ TM-15	22054	1992-46A	SL-04	TT	406	410	51.62	92.72	MANNED	DOCKED AT MIR 29 JUL; UNDOCKED 1 FEB 93
30.08 JUL	KOSMOS 2204	22056	1992-47A	SL-12	TT	19121	19139	64.84	675.74	NAVIGATION	REPLACED KOSMOS 2141
	KOSMOS 2205	22057	1992-47B			19120	19139	64.86	675.73	NAVIGATION	REPLACED KOSMOS 1972
	KOSMOS 2206	22058	1992-47C			19102	19158	64.85	675.74	NAVIGATION	REPLACED KOSMOS 2139
30.46 JUL	KOSMOS 2207	22062	1992-48A	SL-04	PL	232	317	82.33	90.00	PHOTO RECON	3RD GENERATION; RETURNED 13 AUG
06.81 AUG	MOLNIYA 1-84	22068	1992-50A	SL-06	PL	638	39716	62.85	717.77	COMMUNICATIONS	REPLACED MOL 1-72; ON STATION 19 AUG
12.24 AUG	KOSMOS 2208	22080	1992-53A	SL-08	PL	788	807	74.04	100.82	COMMUNICATIONS	REPLACED KOSMOS 2066
15.93 AUG	PROGRESS M-14	22090	1992-55A	SL-04	TT	404	409	51.63	92.69	MIR RESUPPLY	DOCKED 18 AUG; UNDOCKED 21 OCT

CIS LAUNCH HISTORY, 1992

DATE	SATELLITE	SATELLITE NUMBER	INTERNATIONAL DESIGNATOR	LAUNCH VEHICLE	LAUNCH SITE	PERGEE (KM)	APOGEE (KM)	INCLINATION (DEG)	PERIOD (MIN)	MISSION TYPE	NOTES
19.43 AUG	RESURS F-16	22093	1992-56A	SL-04	PL	221	239	82.57	89.10	PHOTO RECON	3RD GENERATION; EARTH RESOURCES; RETURNED 4 SEP
	PION 5	22099	1992-56C			223	233	82.56	89.06	SCIENTIFIC	RELEASED 1 SEP; DECAVED 25 SEP
	PION 6	22100	1992-56D			222	233	82.57	89.05	SCIENTIFIC	RELEASED 2 SEP; DECAVED 24 SEP
10.75 SEP	KOSMOS 2209	22112	1992-59A	SL-12	TT	35764	35807	1.33	1436.05	EARLY WARNING	POSITIONED AT 336 E
22.87 SEP	KOSMOS 2210	22133	1992-62A	SL-04	PL	163	356	67.16	89.69	PHOTO RECON	4TH GENERATION; RETURNED 20 NOV
08.79 OCT	PHOTON 5	22173	1992-65A	SL-04	PL	221	359	62.81	90.32	MATERIALS SCIENCE	RETURNED 24 OCT
14.83 OCT	MOLNIYA 3-42	22178	1992-67A	SL-06	PL	464	39890	62.83	717.77	COMMUNICATIONS	REPLACED MOL 3-35; ON STATION 23 OCT
20.54 OCT	KOSMOS 2211	22182	1992-68A	SL-14	PL	1400	1415	82.59	113.94	COMMUNICATIONS	COPLANAR WITH KOSMOS 2157-2162
	KOSMOS 2212	22183	1992-68B			1408	1414	82.59	114.03	COMMUNICATIONS	
	KOSMOS 2213	22184	1992-68C			1411	1416	82.59	114.08	COMMUNICATIONS	
	KOSMOS 2214	22185	1992-68D			1414	1422	82.59	114.17	COMMUNICATIONS	
	KOSMOS 2215	22186	1992-68E			1413	1428	82.60	114.23	COMMUNICATIONS	
	KOSMOS 2216	22187	1992-68F			1413	1414	82.59	114.08	COMMUNICATIONS	
21.43 OCT	KOSMOS 2217	22189	1992-69A	SL-06	PL	599	39757	62.95	717.8	EARLY WARNING	REPLACED KOSMOS 1903; ON STATION 23 OCT
27.72 OCT	PROGRESS M-15	22203	1992-71A	SL-04	TT	400	403	51.62	92.59	MIRRESUPPLY	DOCKED 29 OCT; UNDOCKED 4 FEB 93
29.45 OCT	KOSMOS 2218	22207	1992-73A	SL-08	PL	969	1015	82.92	104.94	NAVIGATION	REPLACED KOSMOS 2154
30.62 OCT	EKRAN 20	22210	1992-74A	SL-12	TT	35761	35800	1.48	1435.79	COMMUNICATIONS	POSITIONED AT 98 E
15.91 NOV	RESURS 500	22217	1992-75A	SL-04	PL	182	242	82.58	88.74	COMMERCIAL	RECOVERED 22 NOV IN PACIFIC NEAR WASHINGTON STATE AND RETURNED TO SEATTLE
17.33 NOV	KOSMOS 2219	22219	1992-76A	SL-16	TT	849	855	71.01	101.97	ELINT	FIRST SUCCESSFUL FLIGHT OF SL-16 AFTER THREE FAILURES; REPLACED KOSMOS 1943
20.38 NOV	MAK 2	22225	1986-17GX	-	MR	394	398	51.63	92.48	SCIENTIFIC	RELEASED FROM MIR SPACE STATION; DELIVERED TO MIR BY PROGRESS M-15
20.65 NOV	KOSMOS 2220	22226	1992-77A	SL-04	PL	167	343	67.14	89.60	PHOTO RECON	4TH GENERATION; RETURNED 18 JAN 93
24.18 NOV	KOSMOS 2221	22236	1992-80A	SL-14	PL	636	665	82.51	97.74	ELINT	REPLACED KOSMOS 1842

CIS LAUNCH HISTORY, 1992

DATE	SATELLITE	SATELLITE NUMBER	INTERNATIONAL DESIGNATOR	LAUNCH VEHICLE	LAUNCH SITE	PERGEE (KM)	APOGEE (KM)	INCLINATION (DEG)	PERIOD (MIN)	MISSION TYPE	NOTES
25.51 NOV	KOSMOS 2222	22238	1992-81A	SL-06	PL	597	39759	62.91	717.81	EARLY WARNING	REPLACED KOSMOS 2076; ON STATION 28 NOV
27.55 NOV	GORIZONT Z7	22245	1992-82A	SL-12	TT	35775	35793	1.30	1435.98	COMMUNICATIONS	POSITIONED AT 53 E
02.08 DEC	MOLNIYA 3-43	22255	1992-85A	SL-06	PL	418	39920	62.83	717.43	COMMUNICATIONS	REPLACED MOLNIYA 3-34; ON STATION 7 DEC
09.48 DEC	KOSMOS 2223	22260	1992-87A	SL-04	TT	241	293	64.66	89.85	PHOTO RECON	5TH GENERATION; STILL IN ORBIT 1993
17.53 DEC	KOSMOS 2224	22269	1992-88A	SL-12	TT	35704	35874	2.18	1436.22	EARLY WARNING	POSITIONED AT 12 E
22.50 DEC	KOSMOS 2225	22280	1992-91A	SL-04	TT	214	309	64.90	89.73	PHOTO RECON	SPECIAL 4TH GENERATION; DESTROYED IN ORBIT 18 FEB 93
22.53 DEC	KOSMOS 2226	22282	1992-92A	SL-14	PL	1478	1526	73.63	116.03	GEODESY	PHASED WITH KOSMOS 2088
25.26 DEC	KOSMOS 2227	22284	1992-93A	SL-16	TT	849	854	71.02	101.96	ELINT	ESTABLISHED 4TH PLANE OF CONSTELLATION
25.84 DEC	KOSMOS 2228	22286	1992-94A	SL-14	PL	633	669	82.53	97.75	ELINT	REPLACED KOSMOS 2058
29.56 DEC	KOSMOS 2229	22300	1992-95A	SL-04	PL	218	375	62.81	90.45	SCIENTIFIC	10TH BION MISSION; RETURNED 10 JAN 93

7.2 European Space Agency

ESA LAUNCH HISTORY, 1991

DATE	SATELLITE	SATELLITE NUMBER	INTERNATIONAL DESIGNATOR	LAUNCH VEHICLE	LAUNCH SITE	PERIGEE (KM)	APOGEE (KM)	INCLINATION (DEG)	PERIOD (MIN)	MISSION TYPE	NOTES
15.97 JAN	ITALSAT 1 EUTELSAT 2 F2	21055 21056	1991-03A 1991-03B	ARIANE 44L	KOU	35728 35780	35848 35797	0.09 0.09	1436.17 1436.21	COMMERCIAL COMMERCIAL	ITALIAN PAYLOAD POSITIONED AT 132 E EUTELSAT PAYLOAD POSITIONED AT 10 E
02.98 MAR	ASTRA 1B MOP 2	21139 21140	1991-15A 1991-15B	ARIANE 44LP	KOU	35784 35771	35791 35791	0.14 1.16	1436.15 1435.79	COMMERCIAL METEOROLOGY	LUXEMBURG PAYLOAD POSITIONED AT 192 E ESA/EUMETSAT PAYLOAD POSITIONED AT 356E
04.98 APR	ANIK E 2	21222	1991-26A	ARIANE 44P	KOU	35761	35811	0.03	1436.06	COMMERCIAL	CANADIAN PAYLOAD
17.07 JUL	ERS-1 UCSAT-5 CFECCOMAX TUBSAT SARA	21574 21575 21576 21577 21578	1991-50A 1991-50B 1991-50C 1991-50D 1991-50E	ARIANE 40	KOU	776 766 772 768 770	778 776 777 777 777	98.54 98.54 98.54 98.54 98.54	100.38 100.27 100.33 100.29 100.31	REMOTE SENSING COMMERCIAL COMMERCIAL COMMERCIAL COMMERCIAL	ESA PAYLOAD UK PAYLOAD US PAYLOAD GERMAN PAYLOAD FRENCH PAYLOAD
14.97 AUG	INTELSAT 6 F5	21653	1991-55A	ARIANE 44L	KOU	35756	35820	0.05	1436.18	COMMERCIAL	INTELSAT PAYLOAD
26.99 SEP	ANIK E 1	21726	1991-67A	ARIANE 44P	KOU	35776	35795	0.01	1436.05	COMMERCIAL	CANADIAN PAYLOAD
29.96 OCT	INTELSAT 6 F1	21765	1991-75A	ARIANE 44L	KOU	35674	35900	0.05	1436.12	COMMERCIAL	INTELSAT PAYLOAD
16.97 DEC	TELECOM 2A INMARSAT 2 F3	21813 21814	1991-84A 1991-84B	ARIANE 44L	KOU	35768 35743	35800 35825	0.05 2.67	1436.14 1435.96	COMMERCIAL COMMERCIAL	FRENCH PAYLOAD POSITIONED AT 352 E INMARSAT PAYLOAD POSITIONED AT 178 E

ESA LAUNCH HISTORY, 1992

DATE	SATELLITE	SATELLITE NUMBER	INTERNATIONAL DESIGNATOR	LAUNCH VEHICLE	LAUNCH SITE	PERGEE (KM)	APOGEE (KM)	INCLINATION (DEG)	PERIOD (MIN)	MISSION TYPE	NOTES
26.999 FEB	SUPERBIRD B1 ARABSAT 1C	21893	1992-10A	ARIANE 44L	KOU	35767	35806	0.10	1436.09	COMMERCIAL	JAPANESE PAYLOAD POSITIONED AT 162 E SAUDI ARABIAN PAYLOAD POSITIONED AT 31 E
		21894	1992-10B			35776	35797	0.07	1436.10		
15.98 APR	TELECOM 2B INMARSAT 2 F4	21939	1992-21A	ARIANE 44L	KOU	35771	35799	0.05	1436.03	COMMERCIAL	FRENCH PAYLOAD POSITIONED AT 365 E INMARSAT PAYLOAD POSITIONED AT 305 E
		21940	1992-21B			35766	35806	1.95	1436.14		
09.95 JUL	INSAT 2A EUTELSAT 2 F4	22027	1992-41A	ARIANE 44L	KOU	35770	35803	0.18	1436.09	COMMERCIAL	INDIAN PAYLOAD POSITIONED AT 74 E EUTELSAT PAYLOAD POSITIONED AT 7 E
		22028	1992-41B			35786	35791	0.07	1436.14		
10.96 AUG	TOPEXPOSEIDON KITSAT A/OSCAR 23 S80/T	22076	1992-52A	ARIANE 42P	KOU	1317	1331	66.08	112.12	COMMERCIAL	US-FRENCH PAYLOAD SOUTH KOREAN PAYLOAD FRENCH PAYLOAD
		22077	1992-52B			1301	1402	66.07	112.72		
		22078	1992-52C			1302	1328	66.08	111.93		
10.96 SEP	HISPASAT 1A	22116	1992-60A	ARIANE 44L	KOU	35783	35800	0.03	1436.34	COMMERCIAL	SPANISH PAYLOAD POSITIONED AT 329 E
28.01 OCT	GALAXY 7	22205	1992-72A	ARIANE 42P	KOU	35783	35790	0.10	1436.09	COMMERCIAL	US PAYLOAD
01.95 DEC	SUPERBIRD A1	22253	1992-84A	ARIANE 42P	KOU	35773	35801	0.05	1436.10	COMMERCIAL	JAPANESE PAYLOAD POSITIONED AT 158 E

7.3 India

INDIAN LAUNCH HISTORY, 1991-1992

DATE	SATELLITE	SATELLITE NUMBER	INTERNATIONAL DESIGNATOR	LAUNCH VEHICLE	LAUNCH SITE	PERIGEE (KM)	APOGEE (KM)	INCLINATION (DEG)	PERIOD (MIN)	MISSION TYPE	NOTES
20.02 MAY	SROSS3	21967	1992-28A	ASLV	SFI	256	435	46.03	91.45	LV TEST, SCIENTIFIC	FIRST SUCCESSFUL FLIGHT OF ASLV; PERIGEE HEIGHT BELOW NOMINAL GOAL; ASTROPHYSICS AND GEOPHYSICS PAYLOAD

7.4 Japan

JAPANESE LAUNCH HISTORY, 1991-1992

DATE	SATELLITE	SATELLITE NUMBER	INTERNATIONAL DESIGNATOR	LAUNCH VEHICLE	LAUNCH SITE	PERIGEE (KM)	APOGEE (KM)	INCLINATION (DEG)	PERIOD (MIN)	MISSION TYPE	NOTES
1991											
25.36 AUG	BS-3B	21668	1991-60A	H-1	TAN	35775	35799	0.19	1436.11	COMMUNICATIONS	POSITIONED AT 110 E
30.10 AUG	SOLARA	21694	1991-62A	M-3SII	KAG	523	792	31.34	97.88	SCIENTIFIC	
1992											
11.08 FEB	JERS-1	21867	1992-07A	H-1	TAN	571	574	97.71	96.11	REMOTE SENSING	SYNTHETIC APERTURE RADAR PRIMARY PAYLOAD; MANEUVERED INTO OPERATIONAL ORBIT 27-29 FEB

7.5 People's Republic of China

CHINESE LAUNCH HISTORY, 1991-1992

DATE	SATELLITE	SATELLITE NUMBER	INTERNATIONAL DESIGNATOR	LAUNCH VEHICLE	LAUNCH SITE	PERGEE (KM)	APOGEE (KM)	INCLINATION (DEG)	PERIOD (MIN)	MISSION TYPE	NOTES
1991											
28.50 DEC	DFH-24	21833	1991-86A	CZ-3	XC	219	2451	31.06	112.35	COMMUNICATIONS	PARTIAL LAUNCH FAILURE; FAILED TO REACH GEO
1992											
9.33 AUG	FSW-21	22072	1992-51A	CZ-2D	JQ	172	330	63.07	89.52	PHOTO RECON	FIRST OF NEW GENERATION RECOVERABLE SPACECRAFT; CAPSULE RETURNED 25 AUG
13.96 AUG	OPTUS B1	22087	1992-54A	CZ-2E	XC	35656	35901	0.34	1435.7	COMMERCIAL	AUSTRALIAN PAYLOAD
6.26 OCT	FREJA FSW-113	22161 22162	1992-64A 1992-64B	CZ-2C	JQ	596 214	1763 312	63.00 63.01	108.97 89.76	COMMERCIAL PHOTO RECON	SWEDISH SCIENTIFIC SATELLITE CAPSULE RETURNED 13 OCT
21.47 DEC	OPTUS B2	22278	1992-90A	CZ-2E	XC	208	1032	28.14	97.11	COMMERCIAL	AUSTRALIAN PAYLOAD; PARTIAL LAUNCH FAILURE; FAILED TO REACH GEO

8.0 APPENDICES

Appendix 1

Frequencies Used by European and Chinese Satellites in 1991 and 1992 as Monitored by the Kettering Group

FREQUENCY (MHz)	DESCRIPTION	USE
19.989	FSK. Note 1	RECONNAISSANCE KOSMOS SATELLITES: 2102, 2121, 2136
121.75	FM VOICE	SOYUZ TM-13, TM-14, TM-15
130.167	FM VOICE	MIR
137.150	TELEMETRY	INTERKOSMOS 25-MAGION 3
137.300	2 LINES/SEC APT	METEOR 3-3, 3-4, 3-5
137.400	4 LINES/SEC APT. Note 2	OKEAN 2, 3
137.400	2 LINES/SEC APT	METEOR 3-3, 3-5
137.400	TELEMETRY	SROSS-C
137.425	TELEMETRY	ARYABHATA
137.450	TELEMETRY	INTERKOSMOS 24-AKTIVNY
137.795	4 LINES/SEC APT	FENGYUN 1-2
137.845	TELEMETRY	KOSMOS 1809
137.850	2 LINES/SEC APT + 20 LINES/MIN IR	METEOR 2-19, 2-20
137.850	2 LINES/SEC APT	METEOR 3-5
143.625	FM VOICE	MIR
145.550	AMATEUR RADIO PACKET + VOICE	MIR
145.822	TELEMETRY	INFORMATOR 1
145.825	AMATEUR RADIO	UoSAT 2
149.910	#2 MILITARY NAVSAT. Note 3	KOSMOS 2074, 2184
149.940	#3 MILITARY NAVSAT #6 MILITARY NAVSAT. Note 3	KOSMOS 2061, 2154, 2218 KOSMOS 2004, 2180
149.970	#1 MILITARY NAVSAT #4 MILITARY NAVSAT. Note 3	KOSMOS 2026, 2135, 2195 KOSMOS 2100, 2173

**Appendix 1
Frequencies Used by European and Chinese Satellites in 1991 and 1992 as Monitored by
the Kettering Group (Continued)**

FREQUENCY (MHz)	DESCRIPTION	USE
150.000	#11 CIVIL NAVSAT #12 CIVIL NAVSAT #13 CIVIL NAVSAT #14 CIVIL NAVSAT. Note 3	KOSMOS 1791, 2181 KOSMOS 1727, NADEZHDA 3 KOSMOS 1655, 2123 NADEZHDA 2
150.030	#5 MILITARY NAVSAT. Note 3	KOSMOS 2034, 2142
150.300	300 kHz WIDE FM/PCM TELEMETRY WITH 1 SEC FRAME	TOPOGRAPHICAL KOSMOS SATELLITE: 2134, 2174, 2185
150.300	300 kHz WIDE FM/PCM TELEMETRY WITH 2 SEC FRAME	GEODETTIC KOSMOS SATELLITES: 2037, 2088
153.420	CW BEACON, <1 WATT	HEAVY ELINT KOSMOS: 1975, 2058
153.480	CW BEACON, <1 WATT	HEAVY ELINT KOSMOS: 1953, 2151
153.600	CW BEACON, <1 WATT	STORE DUMP KOSMOS: 1954
153.720	CW BEACON, <1 WATT	STORE DUMP KOSMOS: 1992, 2050
166.0	FM TELEMETRY. Note 4	PROGRESS M-6, M-7, M-8, M-11, M-12, M-13 SOYUZ TM-14, TM-15
166.0	FM TELEMETRY. Note 4 PLUS TONE SIGNALS WITH 3.7 SEC FRAME	GAMMA
179.985	TELEMETRY	CHINA 38
180.005	NARROWBAND FM TELEMETRY 1 SEC FRAME	FENGYUN 1-2
180.130	TELEMETRY	ALMAZ
231.5	FM TELEMETRY. Note 4	RECONNAISSANCE KOSMOS SATELLITES: 2102, 2121, 2136
400.550	SLOW RATE TELEMETRY	FREJA
400.800	CW BEACON	COHERENT WITH SIGNAL ON 150.3 MHz FROM GEODETTIC KOSMOS 2088
480.025	TELEMETRY	FENGYUN 1-2
922.75	TELEMETRY	PROGRESS M-11, SOYUZ TM-12, TM-14, TM-15
926.07	TELEMETRY	PROGRESS M-11

NOTE 1

Frequency-shift keying back and forth between two adjacent frequencies approximately 1000 Hz apart. Each frequency is transmitted for equal durations so that there is no information content in the signal. The time for one complete cycle varies between 1.4 and 1.8 seconds. Variations in cycle-duration can be used to distinguish between different satellites in orbit simultaneously.

NOTE 2

APT similar to that from the sun-synchronous Meteor 30 but imagery can show visible, microwave sounder, and radar swaths contiguously.

NOTE 3

Fifty bits/second modulation is employed. The data to be transmitted select a low frequency and the resulting sequence amplitude modulates the VHF carrier. The frequency spectrum is shown in figure below. The data to be transmitted select either 3.5 or 7 KHz producing side-bands a, b, c after modulating the carrier. Only the 3 and 5 KHz convey the binary information. Transitional encoding is employed, binary 1 being represented by a change from 3 to 5 KHz or vice versa. Binary 0 produces no frequency shift. The 7 KHz provides time synchronization every second.

The numbers marked by # indicate the Soviet orbital plane number assigned to each satellite and transmitted as part of its telemetry. Planes #1-6 are spaced 30 degrees apart covering one hemisphere (180 degrees) and #11-14 are spaced 45 degrees apart to cover the remaining hemisphere.

NOTE 4

This telemetry signal consists of an approximately 250 KHz wide FM spectrum with most of the energy concentrated at the edges of the signal bandwidth, indicating a high modulation index. The modulating signal is probably an amplitude-modulated pulse train, PAM. The normal frame length is 10 milliseconds. The normal number of words per frame is 32. The frequency given in the table indicates the center frequency of the FM spectrum. This frequency is determined as the average of the frequencies of the lower and upper peaks of the FM spectrum. These frequencies can be accurately determined by tuning a frequency-synthesized receiver across them.

Appendix 2

CIS Agreement on Joint Activity in Space Research and Exploitation

The state-participants of the present agreement, noting the great significance of space science and technology for the development of the Commonwealth state-participants; recognizing the need to combine efforts for effective space research and exploitation in the interests of the national economy and science, and also defense capability and ensuring the collective security of Commonwealth state-participants; confirming the need for the rigorous observation of international agreements and obligations in the sphere of space research and exploitation earlier taken upon itself by the USSR; feeling that the adoption of an agreement on joint activity in space research and exploitation will serve the interests of the states signing it, have agreed on the following:

Article 1

Joint activity in space research and exploitation is effected by state-participants of the present agreement on the basis of interstate programs.

Article 2

The implementation of interstate programs of space research and exploitation is coordinated by an interstate space council, which is being formed from empowered representatives of the state-participants of the present agreement. The statute on the council is ratified by a decision of the heads of government.

State-participants of the present agreement may have independent programs for space research and exploitation.

Article 3

The fulfillment of interstate programs of space research and exploitation in the area of military and dual purpose (military and civilian) space facilities is ensured by the joint strategic armed forces.

Article 4

Interstate programs for space research and exploitation are financed by means of proportionate contributions by the states participating in the present agreement, and are implemented on the basis of existing space complexes and space infrastructure facilities and of those being set up (the Baikonur and Plesetsk cosmodromes, technical, launching and landing complexes, areas where separating fragments of rocket-carriers fall to ground, space flight control centers, the cosmonaut training center, coordinating and computing complexes, data reception and processing centers, arsenals and other facilities).

The use of the aforementioned infrastructure for conducting the independent programs of the states participating in the present agreement is determined by separate agreements by the interested parties.

Article 5

Expenditures on the exploitation of existing and the setting up of new space systems for economic, scientific, and military purposes and the maintenance of the unique testing base, as well as profit gained from space projects and the launch of space apparatus carried out on a commercial basis, are distributed in accordance with the proportionate participation of the states taking part in the present agreement.

The states participating in the present agreement bear responsibility for their activity in space research and exploitation in accordance with the terms and procedure defined by a special agreement.

Article 6

The states participating in the present agreement undertake to develop their activity in space research and exploitation in accordance with existing international legal norms, and to coordinate their efforts aimed at setting international legal problems of space research and exploitation.

Article 7

The states taking part in the present agreement pledge to make mutually agreed decisions determining the procedure for assigning proportional financing for interstate programs of space research and exploitation; for the provision of facilities, territory and material and energy resources; and for compensation for damages associated with the use of space equipment and also the procedure for the dissolution of the present agreement by one or all of the states taking part.

Article 8

The states taking part in the present agreement pledge to provide the persons and facilities involved in the execution of interstate space research and exploitation programs with the necessary material and technical resources, to make payments under the system of state regulation and taxation, and also to deal with the issues of social support and protection.

They pledge to make provision for the allocation of the necessary funds for the implementation of interstate programs when compiling the state budgets, beginning 1992.

Article 9

The states taking part in the present agreement pledge to target the training of qualified specialists in higher education, the scientific research establishments, and the Academy of Sciences into providing facilities in the space infrastructure with professional staff.

Article 10

The states taking part in the present agreement are not to make decisions or carry out actions which entail the cessation (impediment) of the normal functioning of space centers and facilities in the space infrastructure sited on their territories.

They pledge to retain and develop the existing scientific and technological and industrial potential for the design , construction, testing, and development of space rocket technology within the framework of the adopted interstate programs.

Article 11

Other states can join the present agreement with the consent of the participating states.

Article 12

The agreement comes into force on signing.

Concluded in the City of Minsk on 30 December 1991 in one original copy in the state languages of the states participating in the present agreement.

The original copy is kept in the archives of the Government of the Republic of Belarus, which will send the states participating in the present agreement a signed copy.

Signed for the Republic of Azerbaijan, A. Mutalibov
 the Republic of Armenia, L. Ter-Petrosyan
 the Republic of Belarus, S. Shuskevich
 the Republic of Kazakhstan, N. Nazarbayev
 the Republic of Kyrgyzstan, A. Akayev
 the Russian Federation, B. Yeltsin
 the Republic of Tajikistan, R. Nabiyev
 Turkmenistan, S. Niyarov
 the Republic of Uzbekistan, I. Karimov

Appendix 3

Decree Establishing the Russian Space Agency

In order to make efficient use of Russia's space-rocket complex in the interests of the Russian Federation's socio-economic development, security and international cooperation, I decree:

1. The Russian Space Agency is to be formed under the Russian Federation government.

The Russian Space Agency is to be entrusted with:

implementing state policy in the sphere of space research and utilization;

drawing up jointly with the Russian Academy of Sciences and interested ministries, departments and organizations and submitting to the Russian Federation government a draft state space program of the Russian Federation in the sphere of space systems, complexes and facilities for scientific, national economic and defense purposes;

exercising the functions of a general contractor for space systems, complexes and facilities for scientific, national economic and defense purposes being developed in accordance with the state space program of the Russian Federation;

participating in the creation and utilization of space systems, complexes and facilities of dual (military and civilian) purpose being developed under defense orders in accordance with the state space program;

coordinating commercial space projects and assisting in their implementation;

developing the scientific research and test base of cosmonautics jointly with organizations and enterprises in industry and creating the scientific-technical and technological groundwork for improving space-rocket equipment;

cooperating with corresponding bodies of the CIS member states and foreign countries in the sphere of space research and utilization, as well as the ground installations of the space infrastructure within its competence.

2. Yuriy Nikolayevich Koptev is to be appointed general director of the Russian Space Agency under the Russian Federation.

The general director of the Russian Space Agency is to submit to the Russian Federation government within two weeks a draft statute on the Russian Space Agency for approval.

3. Consent is to be given to the proposal of the Russian Academy of Sciences and the Russian Federation Ministry of Science, Higher Education and Technical Policy to set up the Interdepartmental Expert Commission on Space, which will provide expert advice and select plans for space systems, complexes and facilities for scientific and national economic purposes.

The Russian Federation Ministry of Science, Higher Education and Technical Policy and the Russian Space Agency, jointly with the Russian Academy of Sciences and interested ministries and departments, are to submit to the Russian Federation government within two months a statute on the Interdepartmental Expert Commission on Space and its personnel for approval.

B. Yeltsin, President of the Russian Federation
Moscow, The Kremlin, 25 February 1992

Appendix 4
Agreement Between the Republic of Kazakhstan and the Russian Federation on Procedure for the Use of the Baikonur Cosmodrome

The States party to this agreement,

guided by the provisions of the agreement concluded on 30 December 1991 between the CIS member states on joint activity in space research and the use of space, the 20 March 1992 agreement on principles for supplying the Armed Forces of the CIS member states with weapons, military, equipment, and other materiel and the organization of scientific research and testing and design work, the 30 December 1991 agreement between CIS member states on strategic forces, the 15 May 1992 agreement on procedure for maintaining and using the facilities of the space infrastructure in the interests of the Republic of Kazakhstan and the Russian Federation on creating the armed forces on these states,

recognizing the need to maintain and develop the Baikonur cosmodrome for space research and the use of space in the interests of the national economy, science, international cooperation, and ensuring the security of the Commonwealth,

giving consideration to the importance of the cosmodrome in the realization of interstate and independent programs,

proceeding from legislative enactments passed by the States party to this agreement,

have agreed as follows:

Article 1

The Baikonur cosmodrome is an integral part of the space infrastructure and its includes technical, launch, and landing facilities and the regions in which separated fragments of space rockets and ballistic missiles fall.

The subject of this agreement is procedure for making use of those facilities of the Baikonur cosmodrome located on the territory of the Republic of Kazakhstan and the Russian Federation, and also matters pertaining to their maintenance and funding.

The boundaries of areas into which separated fragments of space rockets and ballistic missiles fall, the landing sites for descent vehicles and capsules, and procedure and conditions for use of the land are defined with the agreement of the local organs of power in accordance with existing legislation of the States party to this agreement.

Article 2

Facilities of the Baikonur cosmodrome located on the territory of the Republic of Kazakhstan are its property.

The Republic of Kazakhstan and the Russian Federation assign the right of use of real estate and the use and ownership of movable property at the Baikonur cosmodrome on their territories to the strategic forces of the CIS (UNKS). Assignment of particular facilities to other interested organizations is permitted with the agreement of the parties.

The composition of the facilities assigned and the conditions for their use, including facilities in the social sphere, is determined by special agreement between the Republic of Kazakhstan Ministry of Defense, the Republic of Kazakhstan Space Research Agency, and the head of the Leninsk administration, on the one hand, and the UNKS and the Russian Space Agency on the other.

In the event that the activity of the strategic forces of the CIS is terminated, the status of the military formation at the Baikonur cosmodrome is determined by agreement between the Republic of Kazakhstan Ministry of Defense and the Russian Federation Ministry of Defense.

Article 3

Coordination of scientific-production activity in the preparation and implementation of space programs, and also the use of space technologies in the interests of science and the national economy, is done by the Republic of Kazakhstan Space Research Agency and the Russian Space Agency.

Use and further development of the scientific and technical potential of the Baikonur cosmodrome are done by the agencies on an agreed basis giving due consideration to the creation of a state center at the cosmodrome for new and space technologies of the Republic of Kazakhstan.

Article 4

The Republic of Kazakhstan is setting up a special body at the Baikonur cosmodrome to resolve in accordance with its existing legislation all matters pertaining to property and management stemming from Article 2 of this agreement.

Article 5

Proposals on financing for the cost of maintaining and operating facilities at the Baikonur cosmodrome, the social sphere, and the production infrastructure are drawn up by the cosmodrome command jointly with the local organs of power, and are submitted for approval in accordance with established procedure.

The proportionate participation of the Republic of Kazakhstan in financing joint spending to maintain and operate the Baikonur cosmodrome shall not exceed six percent of the volume of financing allocated by the Russian Federation for this purpose.

The States party to this agreement pledge themselves to provide the necessary material-technical resources for the operation of the cosmodrome and the development of its social sphere.

Article 6

Compensation for damages connected with violation of environmental standards as a result of the operation of facilities at the Baikonur cosmodrome, and also with disruption of the normal function of objects and installations of the space infrastructure and implementation of space programs, is paid by whoever was to blame for the damages in accordance with procedure and in amounts specified by an interstate commission. The parties to the agreement pledge themselves to take steps to eliminate the environmental consequences of operations at the Baikonur cosmodrome gradually through the period to the year 2000.

Article 7

Commercial projects at the Baikonur cosmodrome are conducted jointly by the Republic of Kazakhstan and the Russian Federation on an agreed basis.

Distribution of profits from commercial activity is determined by separate agreements. At least 15 percent of the commercial profit made will be used to develop the social sphere at the Baikonur cosmodrome and in Leninsk city.

Article 8

The UNKS jointly with the Russian Space Agency will promptly submit to the Governments of the Republic of Kazakhstan and the Russian Federation plans for launches of space vehicles and test launches of ballistic missiles for the next year. The government of the Republic of Kazakhstan has the right at its own discretion to introduce classifications and changes to the launch (firing) plans submitted before approving them.

The UNKS will notify appropriate state organs about each planned launch (firing) five days in advance, with subsequent submission of information on the results.

The appropriate organs will be notified at least 10 days in advance about all changes in the annual launch (firing) plan.

Article 9

The UNKS submits to the appropriate organs of state management in the Republic of Kazakhstan and the Russian Federation plans for drafting enlisted servicemen and assigning them and warrant officers and officers to the Baikonur cosmodrome.

The Republic of Kazakhstan and the Russian Federation pledge themselves to allocate the necessary number of draftees and officers in the interests of efficient use of the Baikonur cosmodrome.

Article 10

The import into, export from, and transfer across the territory of the Republic of Kazakhstan of technical and technological equipment, weapons, military equipment, and other material resources ensuring the function of the Baikonur cosmodrome, and also the arrivals and departures of officials, industrial experts, and servicemen (and their families) living in Leninsk city or recruited in accordance with established procedure to work at the cosmodrome, are done without hindrance and without imposition of custom duties, and also without customs inspections of the means of transport.

During the implementation of space programs within the framework of interstate cooperation, in the event that citizens or freight arrive in Leninsk city from other states, customs, border, and other kinds of control envisaged by international standards and the laws of the Republic of Kazakhstan are carried out.

Article 11

The parties pledge themselves to exchange in an agreed volume essential military, scientific and technical, commercial, and other kinds of information of mutual interest, and not to allow leaks of such information.

Ensuring the safekeeping of information is done in accordance with the principles adopted for the strategic forces and concretized by additional agreements between the interested parties.

Article 12

General coordinating activity to implement this agreement is done by the UNKS, the Republic of Kazakhstan Space Research Agency, and the Russian Space Agency.

Done in the city of Moscow on 25 May 1992 in four copies, two each in Russian and Kazakhstan languages.

(signed) for the Republic of Kazakhstan, N. Nazarbayev

(signed) for the Russian Federation, B. Yeltsin

Appendix 5
Agreement Between the United States of America and the Russian Federation Concerning Cooperation in the Exploration and Use of Outer Space for Peaceful Purposes

The United States of America and the Russian Federation, hereinafter referred to as the Parties;

considering the role of the two States in the exploration and use of outer space for peaceful purposes;

desiring to make the results of the exploration and use of outer space available for the benefit of the peoples of the two States and of all peoples of the world;

considering the respective interest of the Parties in the potential for commercial applications of space technologies for the general benefit;

taking into consideration the provisions of the Treaty on Principles Governing the Activities of States in the Exploration and Use of Outer Space, including the Moon and other Celestial Bodies, and other multilateral agreements regarding the exploration and use of outer space to which both States are Parties;

expressing their satisfaction with cooperative accomplishments in the fields of astronomy and astrophysics, earth sciences, space biology and medicine, solar system exploration and solar terrestrial physics, as well as their desire to continue and enhance cooperation in these and other fields;

have agreed as follows:

Article I

The Parties, through their implementing agencies, shall carry out civil space cooperation in the fields of space science, space exploration, space applications and space technology on the basis of equality, reciprocity and mutual benefit.

Cooperation may include human and robotic flight projects, ground-based operations and experiments and other activities in such areas as:

- Monitoring the global environment from space;
- Space Shuttle and Mir Space Station missions involving the participation of U.S. astronauts and Russian cosmonauts;
- Safety of space flight activities;
- Space biology and medicine; and,
- Examining the possibilities of working together in other areas, such as the exploration of Mars.

Article II

For the purposes of developing and carrying out the cooperation envisaged in Article I of this Agreement, the Parties hereby designate, respectively, as their principal implementing agencies the National Aeronautics and Space Administration for the United States and the Russian Space Agency for the Russian Federation.

The Parties may designate additional implementing agencies as they deem necessary to facilitate the conduct of specific cooperative activities in the fields enumerated in Article I of this Agreement.

Each of the cooperative projects may be the subject of a specific written agreement between the designated implementing agencies that defines the nature and scope of the project, the individual and joint responsibilities of the designated implementing agencies related to the project, financial arrangements, if any, and the protection of intellectual property consistent with the provisions of this Agreement.

Article III

Cooperative activities under this Agreement shall be conducted in accordance with national laws and regulations of each Party, and shall be within the limits of available funds.

Article IV

The Parties shall hold annual consultations on civil space cooperation in order to provide a mechanism for government-level review of ongoing bilateral cooperation under this Agreement and to exchange views on such various space matters. These consultations could also provide the principal means for presenting proposals for new activities falling within the scope of this Agreement.

Article V

This Agreement shall be without prejudice to the cooperation of either Party with other states and international organizations.

Article VI

The Parties shall ensure adequate and effective protection of intellectual property created or furnished under this Agreement and relevant agreements concluded pursuant to Article II of this Agreement. Where allocation of rights to intellectual property is provided for in such agreements, the allocation shall be made in accordance with the Annex attached hereto which is an integral part of this Agreement. To the extent that it is necessary and appropriate, such agreements may contain different provisions for protection and allocation of intellectual property.

Article VII

This Agreement shall enter into force upon signature by the Parties and shall remain in force for five years. It may be extended for further five-year periods by an exchange of diplomatic notes. This Agreement may be terminated by either Party on six months written notice, through the diplomatic channel, to the other Party.

Done at Washington, in duplicate, this seventeenth day of June, 1992, in the English and Russian languages, both texts being equally authentic.

Appendix 6

Statute of the Russian Space Agency of the Government of the Russian Federation

1. The Russian Space Agency of the Government of the Russian Federation (RSA) is a State administrative body which formulates and implements State policy on the exploration and use of outer space.

2. The main tasks of RSA are:

To implement State policy on the exploration and use of outer space;

To formulate, in conjunction with the Russian Academy of Sciences, the Unified Armed Forces of the Commonwealth of Independent States, and the ministries, departments and organizations concerned, and to submit to the Government of the Russian Federation the draft State space program of the Russian Federation, specifying the financial and other resources require, and also the dates for the completion of activities;

To carry out general procurement for the development of space systems, complexes and scientific and industrial facilities envisaged under the State space program;

To participate in the development and use of dual-purpose (military and civilian) space systems, complexes and resources developed under defense contracts in accordance with the State space program, and also in the preparation and launching of space complexes for scientific and national economic purposes;

To develop in conjunction with industrial organizations and enterprises, a scientific research and testing base for space activities, and to establish scientific and technical stocks for the development of rocket and space technology;

To cooperate with the relevant bodies of member States of the Commonwealth of Independent States and of foreign countries in the exploration and use of outer space, and also in the use of ground-based space facilities, within the limits of its competence;

To coordinate work on commercial space projects and promote their implementation;

To coordinate work on the preparation and conduct of manned space flights and the protection of the safety of cosmonauts.

3. The Russian Space Agency shall, in accordance with the tasks entrusted to it:

Organize, in conjunction with the ministries, departments and organizations concerned, systems research to support the main areas of the development of space technology for scientific and industrial purposes and to determine the tactical and technical characteristics of space complexes;

Prepare on the basis of the State space program and submit to the Government of the Russian Federation proposals on the Agency's budget for the following year;

Formulate in conjunction with the Russian Academy of Sciences and the ministries, departments and organizations concerned, on the basis of the State space program and in accordance with its budget, and submit to the Government of the Russian Federation a draft program of work in the Russian Federation for the following year;

Participate in the organization and conduct of scientific research, experimental and design and construction work on the development and use of dual-purpose space technology, and also of work to maintain and develop ground-based space facilities infrastructure;

Carry out scientific research, experimental and design and construction work on space technology for scientific and industrial purposes, procure supplies and organize the use of individual types of this technology in accordance with the Russian Federation's space technology work program for the following year (space vehicles developed for the purposes of the Ministry of Communications of the Russian Federation and the Ministry of Ecology and Natural Resources of the Russian Federation shall, as a rule, be procured and operated by these ministries);

Ensure the continuing development of new technologies, materials and scientific and technical stocks in order to develop promising types of space technology;

Maintain and develop the experimental and testing base needed to develop space technology under ground conditions;

Carry out research, scientific and technical monitoring and organization of work on the use, as a means for launching various space devices, of strategic missile systems which are scheduled for reduction or elimination;

Cooperate with the corresponding organs of the member States of the Commonwealth and the Unified Armed Forces of the Commonwealth of Independent States in aspects of the conduct of joint space activities, the use of ground-based space facilities and the implementation of the other provisions of the inter-State agreement on joint activities in the study and utilization of outer space;

Ensure, in conjunction with the ministries and departments concerned, compliance with the international obligations of the Russian Federation in the field of space activities and the development of mutually advantageous cooperation with government and commercial organizations of foreign countries;

Conduct, in conjunction with the Ministry of Foreign Affairs of the Russian Federation and the other ministries and departments concerned, discussions on the conclusion of international agreements for the exploration and use of outer space;

Conclude, within the limits of its competence, international agreements with the corresponding organizations of foreign States;

Maintain a register of space objects of the Russian Federation and submit information to the United Nations on space objects launched by the Russian Federation;

Conduct, in accordance with established procedures, the issue of licenses for all types of activity in the exploration and use of outer space and the provision of space services in the Russian Federation, and keep a record of those licenses;

Participate in the preparation of standards relating to the manufacture and use of space technology;

Participate in monitoring compliance with safety requirements, standards and regulatory documents in the manufacture, testing and use of civilian space technology;

Organize information services for the public, and take part in exhibitions of rocket and space technology and in the preparation and publication of scientific and technical literature on space activities;

Elaborate, in conjunction with the ministries and departments concerned, draft legislative and other regulatory acts governing activities in the exploration and use of outer space.

4. The Russian Space Agency shall have the right:

To acquire, lease, install, reconstruct and operate space and other forms of technology (including space vehicles and carrier-rockets), buildings and installations and other property and to acquire patents, licenses and know-how;

To conclude, on the basis of the space technology program of the Russian Federation for the given year and in accordance with the regime established by the legislation of the Russian Federation, contracts for the conduct of basic, experimental and design studies, scientific research and work on the application and enterprises operating in the territory of the Russian Federation and of other States and to use extra budgetary resources for the financing of such studies;

To be represented, in accordance with its competence, in international organizations active in the exploration and use of outer space;

To engage the services of experts on a contractual basis for the purpose of consultations or the preparation and consideration of relevant issues, and to set up temporary task forces and working groups;

To engage in foreign economic activity in accordance with the established legal procedures;

To send, in accordance with established procedures, employees of the Agency on official visits to foreign countries and to receive foreign specialists at the Agency to deal with issues connected with the Agency's work;

To arrange the admission of foreign specialists, to launching sites and other ground-based space facilities, by agreement with the Office of the Chief of Space Resources of the Unified Armed Forces of the Commonwealth of Independent States and the corresponding organs of the member States of the Commonwealth;

To engage, in accordance with established procedures, in international telephone, telex and facsimile communications.

5. The Russian Space Agency shall be headed by a General Director, who shall be appointed and dismissed by the President of the Russian Federation.
6. The General Director of the Russian Space Agency shall have deputies, appointed on his recommendation by the Government of the Russian Federation.
7. The Russian Space Agency shall operate settlement, current and budget accounts in banks, including foreign currency accounts.
8. The Russian Space Agency shall be a juridical person and shall have a seal depicting the state emblem of the Russian Federation and its own name, as well as the emblem (logo) of the agency.

Appendix 7
Resolution on the European Long-Term Space Plan 1992-2005 and Programs
adopted on 20 November 1991

The Council Meeting at Ministerial Level

RECALLING Resolution ESA/C-M/LXVII/Res. 1 (Final) on the European long-term space plan adopted on 31 January 1985 and Resolution ESA/C-M/LXXX/Res. 1 (Final) on the European long-term space plan and programs adopted on 10 November 1987,

CONSCIOUS of the need for a careful ongoing analysis of the changing geopolitical context in order to assess its impact on European space activities,

RECOGNIZING the need to achieve the best possible relationship between cost and effectiveness requirements, in particular through a widened and strengthened cooperation with States that have already developed advanced space technologies, while keeping European efforts within an acceptable financial framework,

RECALLING the mission of the Agency to formulate and implement a long-term European space policy as part of the European drive to develop high technology and to further space activities for the benefit of science and applications,

CONSCIOUS of the need to ensure synergy between the Agency and the European Communities and between the Agency and other European organizations concerned while taking due account of their respective memberships and areas of responsibility,

RECOGNIZING the successful development of cooperation with the United States of America on the International Space Station,

WELCOMING the renewal of the Association Agreement with Finland and Finland's stated intention to become a full member of the Agency on 1 January 1995,

WELCOMING the continuation of cooperation with Canada on the basis of the renewed close cooperation Agreement,

CONSIDERING that the European science program has yielded remarkable results over a number of years and that Resolution ESA/C/XCIII/Res. 2 (Final) of 13 December 1990 has confirmed the increase in the level of resources allocated to that program while proposing that measures be taken to increase the purchasing power of its annual budgets,

RECOGNIZING that exploitation of the elements developed under the programs making up the in-orbit infrastructure will give Europe mastery of the basic technologies for crewed space flight and provide exceptional resources with a view to multidisciplinary scientific use,

NOTING that the implementation of the Agency's Earth-observation program contributes to the formulation of a European long-term policy in this field,

WELCOMING the launch and operation since the 1987 Meeting in The Hague of Olympus, Giotto, Hipparcos, Meteosat, the Space Telescope, Ulysses and ERS-1,

NOTING with satisfaction the continuing success of the Ariane-4 operational launches following successful qualification tests and the progress made on Ariane-5 development, while RECOGNIZING the need for a European launcher system, for continuing support to the corresponding production programs and for preferential use of this system by European user programs,

EXPRESSING its satisfaction at the outcome of the work done by the Council Working Group on the preparation of this Ministerial Meeting, in particular the draft Resolutions, which it regards as the basis for further progress in optimizing the Agency's programs,

HAVING REGARD to the level of resources adopted for the period 1990 - 1995 (ESA/C/XCIII/Res. 3 (Final) of 13 December 1990),

HAVING REGARD to the Director General's proposal for a European long-term space program (ESA/C-M(91)2) and the European long-term space plan 1992 - 2005 (ESA/C(91)38),

CHAPTER I Objectives

1. REAFFIRMS in the entirety the agreed objectives referred to in Chapter 1 of Resolution ESA/C-M/LXXX/Res. 1 (Final) of 10 November 1987, which are reproduced for reference in the Annex to this Resolution, stressing that those objectives were designed to further the principles contained in the Convention and represented a comprehensive undertaking touching upon all fields of space activity pursued by the Agency.
2. RECOGNIZES that the extensive and valuable experience gained in carrying out the programs undertaken since 1987 has confirmed the relevance of the objectives referred to above, and has provided sound and reasonable guidelines of those programs, as well as a suitable basis for their better evaluation.
3. REAFFIRMS the need to intensify international cooperation, both among the Member States and with other European and non-European partners, with a view to achieving fully the objectives of the European long-term space plan with the best possible relationship between the cost and effectiveness requirements, while optimizing the use of European space resources available within the Agency and the Member States.
4. INVITES the Director General to continue to improve the balance between the infrastructure, scientific research and applications programs, such as telecommunications and Earth observation, that will match the expectations of the Member States, while ensuring a proper relationship between technology, research and development, exploitation and utilization activities.

CHAPTER II European Long-Term Space Plan 1992-2005

1. WELCOMES the Director General's proposal for a European long-term space program and the European long-term space plan 1992-2005 referred to in the preamble.
2. ACCEPTS the European long-term space plan 1992 - 2005 as a strategic framework for the Agency's planning, activities and programs, and RECOGNIZES that the Director General's proposal mentioned above provides the guidance needed for satisfactory implementation of this plan.
3. CONSIDERING the strategic importance for Europe of the above mentioned plan and the duration of the corresponding commitments, AGREES in principle to meet each year at Ministerial Level, on the next occasion before the end of 1992; and INTENDS, at those meetings, to evaluate the progress made by the programs under way, to consider the impact on these programs of changes in the world political context, to evaluate the possibilities for widened international cooperation with other space powers, in the first instance in Europe, and to consider the future direction to be taken by the programs.
4. RECOGNIZES that the said plan allows the Member States concerned to take part in other programs such as the GSTP (General Support Technology Program), for which the Director General is invited to submit an enabling Resolution, as well as in any further programs that he may propose with a view to complete achievement of the objectives of the plan.

CHAPTER III In-Orbit Infrastructure Programs

1. CONSIDERING the progress made since the Council meeting at Ministerial Level in The Hague in 1987 in defining the technical, timetable and cost element objectives of the Hermes, Columbus and Data-Relay System (DRS) in-orbit infrastructure development programs,

RECOGNIZING nonetheless that the pursuit of activities relating to these programs must take account of changes since that meeting in factors that are likely to affect their execution, such as the changes that have taken place in the overall political environment in Europe and the new financial constraints within the Member States,

CONSIDERING, without prejudice to the evaluation provided for in Chapter IV of this Resolution, the need to maintain the objectives of the overall coherence of these programs and in particular the dates for launching their respective elements,

WELCOMING the will shown by the States participating in the said programs to continue with their execution within the framework of the Director General's proposal for a European long-term space program and of the European long-term space plan 1992-2005 referred to in the preamble,

1. AGREES that, bearing in mind the evaluation provided for in Chapter IV of this Resolution, the Agency shall carry out these programs in 1992 within an overall budgetary envelope reduced by 120 MAU in contributions from the amount proposed by the Director General (2427 MAU), to give revised contributions totaling 2307 MAU (at 1990 economic conditions), and REQUESTS the Director General to allocate the reduced budgets in accordance with program needs and to distribute the work to be performed in 1992 in an equitable manner, taking due account of those firms that are not assuming prime contractorship responsibilities for those programs.
2. AGREES to continue work in 1992 under the Hermes and Columbus development programs and the Data-Relay System program element within the framework of the proposals for those programs and the European long-term space plan 1992-2005 referred to in the preamble, taking into account the evaluation due to take place in late 1992, and to do so in accordance with the respective contribution percentages agreed to by the States participating in those programs and with the new levels of contribution to the Data-Relay System program element declared by France and Germany at this Meeting;

NOTES further that the work to be undertaken under the programs referred to in this paragraph shall be organized in such a way as to ensure continuity of activities and adherence to the development timetables.

3. INVITES the States participating in these programs to adopt the corresponding draft budgets by the end of 1991 and AGREES that the present Resolutions shall constitute the legal basis for their adoption and execution.
4. INVITES the Director General to present the terms of a proposal for an optional program of Columbus precursor flights in order to prepare for utilization of the Columbus in-orbit infrastructure, seeking a balance between the infrastructure and utilization programs, and INVITES the States concerned to draw up the legal instruments that will enable these activities to be started before mid-1992.
5. AGREES to assess the situation of those in-orbit infrastructure programs in the light of the report drawn up by the Director General in accordance with the provisions of Chapter IV below.
6. INVITES the Director General to further pursue, in time for the Council Meeting at Ministerial Level in late 1992, optimization of the costs of the validation and exploitation of the in-orbit infrastructure programs and submit proposals for the sharing of these costs among the Member States.
7. NOTES the proposals made on the decentralized ground infrastructure given in ESA/C-WG(91)WP/49 Rev. 1 which is an Annex to the European long-term space plan and which was submitted by the Council Working Group to Council for Adoption (ESA/C(91)95).

CHAPTER IV Evaluation and Confirmation of the In-Orbit Infrastructure and Earth-Observation Programs

1. INVITES the Director General to submit, in time for the Council Meeting at Ministerial Level in late 1992, a report on the situation of the in-orbit infrastructure and Earth-observation programs being carried out within the Agency. The said report shall show in particular the impact on the Agency's objectives and programs as a whole of the possibilities for international cooperation, in the first instance in Europe, with a view to improving the overall cost-effectiveness of the Agency's activities. Finally, the report shall describe the status of the various programs in terms of their final development objectives, their technical and time-scheduling coherence, and their estimated cost-at-completion.

STRESSES its intention to set up, at a subsequent meeting at delegate level, a working group to consider on an ad hoc basis the international aspects of such cooperation and to report to Council so that the Director General can take its findings into account in his report referred to in this paragraph.

2. INVITES the Director General to formulate such proposals for adjustment of those programs as may be judged necessary in order to ensure their proper execution and an equitable industrial involvement, while keeping the balance between development and user programs.
3. INVITES the States participating in the in-orbit infrastructure and Earth-observation programs to take, in the light of the report and of any adjustment proposals as referred to above, such decisions as are necessary to permit their continuation, in accordance with the relevant provisions of Annex III to the convention; and

AGREES that the decisions in question shall be taken at the Meeting of Council at Ministerial Level due to be held in late 1992.

CHAPTER V Industrial Policy

1. RECALLS that the objectives of the Agency's industrial policy defined in Article VII of the Convention and Annex V thereto determine the rules and procedures for implementing that policy.
2. REAFFIRMS the objective, when distributing contracts, of achieving a return coefficient as near as possible to the ideal value of 1 for all countries and that this must be achieved on the basis of all the Agency's programs as provided for in Article IV paragraph 3 of Annex V to the Convention.
3. TAKES NOTE of the results of the formal review of the geographical distribution of contracts and associated return coefficients for the period 1988 - 1990 that was held in January 1991 and RECALLS that, pursuant to Article IV paragraph 5 and Article V of Annex V to the Convention, such a formal review must take place every three years.
4. DECIDES as a measure of conservation that the lower limit referred to in Article IV paragraph 6 of Annex V to the Convention, below which special measures are to be taken, shall be kept at 0.95 for the present three-year period (1991-1993);

AGREES to consider, at the Meeting of Council at Ministerial Level scheduled for late 1992, increasing the said limit to 0.96 with retroactive effect over the period 1991 - 1993 and applying it also to the following three-year period (1994-1996); and

DECIDES that, in addition to this limit, the ratio between the deficit observed at the end of each period covered by the formal review and the annual contributions for the last year of that period shall be taken into account in determining whether special measures are to be taken.

5. CONFIRMS the guidelines and measures concerning the Agency's industrial policy which were decided upon by the Council Meeting at Ministerial Level at The Hague and are described in Chapter IV of Resolution ESA/C-M/LXXX/Res. 1 (Final), including the guarantee for all participating States of a return coefficient above 0.9 at the end of each optional program.
6. ACCEPTS that special measures be applied in favor of Italy, in accordance with the procedures in force, for an amount corresponding to the figure that would have been necessary to bring its return coefficient to 0.95 at the end of September 1991, on the understanding that the said measures shall be applied progressively within the framework of implementation of the long-term plan in the period 1992-1995.
7. INVITES the Director General to provide in future, in addition to the information relating to the geographical distribution of contracts already provided, a predicted overall return coefficient with the aim of assessing the trend in the industrial return situation of each country more accurately.
8. RECOMMENDS that all necessary measures be taken in accordance with Article VII of the Convention to improve the competitiveness of European space industry and increase its share of the world market.
9. CONSIDERS that the involvement of the private sector in the use of available capacities, and in financing and operating responsibilities, should be encouraged.

ANNEX
Council Resolution on the European Long-Term Space Plan and Programs (ESA/C-M/LXXX/Res.1 (Final)) adopted on 10 November 1987 in The Hague
Chapter I

1. REAFFIRMS the agreed objectives as described in Chapter 1 of the Resolution ESA/C-M/LXVII/Res. 1 (Final) adopted on 31 January 1985, these being in particular:
 - to pursue a European space program as a coherent whole, with the spending on the tools needed for space activities and on the activities themselves;
 - to expand the horizons of space research and exploitation in Europe;
 - to enable the European scientific community, via an expansion of the scientific program, to remain in the vanguard of space research;
 - to develop further the potential of space in the areas of telecommunications and meteorology;
 - to prepare a substantial contribution of space and ground techniques to Earth observation sciences and applications and, if so required, prepare for the setting-up of operational systems and of user-oriented organizations to operate them;
 - To improve the competitiveness of European industry in applications areas by means of advanced developmental of space systems and technology;
 - To promote, via a substantial microgravity research program (e.g. materials sciences, life sciences and fluid physics) practical applications in space;
 - to strengthen the European space transportation capability, meeting foreseeable future user requirements both inside and outside Europe, and remaining competitive with space transportation systems that exist or are planned elsewhere;
 - to prepare autonomous European facilities for the support of man in space, for the transport of equipment and crews and for making use of low Earth orbits;
 - to enhance international cooperation and in particular aim at a partnership with the United States through a significant participation in an international space station.
2. NOTES the advent of new space capabilities and new techniques and the emergence of further promising applications.
3. CONSIDERS that an additional effort is needed to ensure that Europe keeps up with other space powers beyond the year 2000 and to ensure that Europe is capable of all space applications.
4. APPROVES the objective of reinforcing the current European capability in order to achieve as far as possible by the end of this century the capability needed for access to and return from space for manned missions and for servicing payloads, and in order to provide for men living and working in space; NOTES the importance of continuing studies and technology programs concerning future European space transportation systems which will take into account studies carried out in Member States nationally and concerning the expansion of the European in-orbit infrastructure in order to render it fully autonomous.
5. SEES it as important for Europe to be able to respond to new scientific and applications prospects of space, to acquire new scientific and high-technology knowledge and to be able to remain competitive in new markets and to increase its ability as a valuable partner in international cooperation in exploring and making use of space.
6. SEES these efforts as a source of new opportunities offered to the private sector, which should be encouraged to make use of the available capacity, participate in the investment and take over operating responsibilities. WELCOMES the fact that the Director General is actively pursuing in particular the studies on the possibility of the private sector taking part in the funding of the Data-Relay Satellite.

Appendix 8
Resolution on Programs for Observation of the Earth and Its Environment
adopted on 20 November 1991

The Council meeting at Ministerial Level

WHEREAS by Resolution ESA/C-M/LXXX/Res. 1 (Final), approved on 10 November 1987, it welcomed and endorsed pursuance of the Agency's activities and programs in the field of Earth observation,

EXPRESSING satisfaction at the successful launch and operation of the ERS-1 satellite, and the approval of the ERS-2 Program; and NOTING that such missions will make a major contribution to the understanding of the global environment and a significant European contribution to International Space Year,

HAVING REGARD to the successful cooperation between the Agency and Eumetsat in developing and operating the geostationary Meteosat satellites,

WELCOMING the continuation of research and development work within the Agency on new generations of space systems such as future missions in polar orbit designed to study the Earth and its environment, as part of the European long-term space policy entrusted to the Agency,

HAVING REGARD to the preparatory program for the first Earth-observation mission in polar orbit (POEM-1) and to the Director General's proposal for a POEM-1 program (ESA/PB-EO(91)68) and a preparatory program for follow-on POEM missions (ESA/PB-EO(91)69), and to the Aristoteles program proposal (ESA/PB-EO(91)1, Rev. 1),

CONSIDERING that these activities and programs of the Agency foster the successful implementation of a coherent and effective European long-term Earth observation policy, as well as forming part of the international action being taken on studying the Earth and its environment and laying the foundation for independent operational systems in the future,

HAVING REGARD to the Resolution on the European long-term space plan 1992-2005 and programs (ESA/C-M/MCVII/Res. 1 (Final) of 20 November 1991,

HAVING REGARD to Articles V.1(b) and XI.5(c) of the ESA Convention, and Annex III thereto.

CHAPTER I
International Dimension of Earth Observation

1. RECOGNIZES the growing awareness of the need to protect the environment and the various initiatives being taken in this area and the crucial role for satellite observations in understanding, monitoring and managing the Earth's resources.
2. NOTES that satellite measurements are essential monitoring and research programs, including the World Climate Research Program, the International Geosphere Biosphere Program and the proposal for a Global Climate Observing System,
3. NOTES that the crucial importance of Earth-observation programs, with guaranteed continuity, for understanding and systematically observing the climate system was emphasized by the Second World Climate Conference in Geneva in November 1990, by the Intergovernmental Panel on Climate Change in its First Assessment Report in 1990, and again during the ongoing negotiations under the auspices of the United Nations on a future Climate Convention,
4. NOTES that the importance of monitoring and understanding the environment through Earth-observation programs will be considered at the United Nations Conference on Environment and Development in June 1992,
5. RECOGNIZES the importance of remote-sensing data from space for socioeconomic development in Member States and throughout the World including the Developing Countries, and the need for the Agency to contribute to the development of user communities in close coordination with other European organizations.

6. **RECOMMENDS** all Member States actively to pursue consistent implementation of the objectives of a European long-term Earth-observation policy in the framework of other international organizations and institutions, and to establish an effective European contribution to an international program of long-term climate monitoring.
7. **INVITES** the Director General to establish fruitful cooperation with Eumetsat with the European Communities and their Environmental Agency, as well as with other European organizations, and to seek appropriate international arrangements for involving such organizations in the development of the future European Earth-observation systems.
8. **UNDERLINES** that the programs referred to in this Resolution constitute a significant European contribution to international efforts to develop space-based observation of the Earth's resources, and to an international Earth-observation system.

CHAPTER II

The European Earth-Observation Policy

1. **RECOGNIZES** that the Agency has successfully developed and run Earth-observation systems in the course of its activities and programs and has thereby demonstrated the knowledge and expertise needed for cooperation among European States in research and development work on future space systems intended for scientific and operational purposes.
2. **CONSIDERS** that the Agency's activities and the programs in the field of observation of the Earth and its environment should be given high priority for the successful implementation of a coherent and effective European Earth-observation policy.
3. **ENDORSES** the Agency's contribution to the development of a European Earth-observation policy aimed at increasing Europe's capability to monitor both regional and global environment phenomena and at furthering the understanding of such matters as global warming, climate change and ozone depletion.
4. **STRESSES** that the Agency's Earth-observation programs will address the requirements of the user communities, which call for a European segment of a global environmental data network.

STRESSES further that this policy should be closely coordinated with the appropriate national and European bodies such as the Commission of the European Communities, and be such as to encourage private commercial users' enterprises and to ensure the widest availability, in the proper formats, of remote-sensing data from space from all sources for the various user entities, with particular regard to the environmental needs of regional, national and European entities.

5. **RECOGNIZES** that the experience already gained by means of the Earthnet system can be regarded as a foundation on which such a network can be built, and **INVITES** the Director General, at the appropriate time, to propose an optional Earthnet program to ensure the continuity of existing activities to meet this expanding requirement in accordance with the Agency's long-term space plan.
6. **RECOGNIZES** the maturity of the ARISTOTELES program proposal and notes the intention to fly a package of instruments selected for precise mapping of the Earth's gravitational and magnetic fields under cooperative ESA/NASA arrangements. **ENCOURAGES** the Director General to explore further the possibilities of continuing ongoing activities with a view to ultimately presenting the program proposal to Member States for their consideration on a timescale consistent with scientific requirements.
7. **RECOGNIZES** the successful cooperation with Eumetsat and **INVITES** the Director General to continue this cooperation in the context of the future use of the First Polar Platform; **INVITES** the Director General to continue to cooperate closely with Eumetsat on the further definition and development of the second-generation Meteosat system, taking into due account the Resolution of the Eumetsat Council of 30 October 1991; and further **INVITES** the Director General to present in due time to Council a program proposal within the financial provisions of the European Long-Term Space Plan and consistent with the continuing operational responsibilities of Eumetsat.
8. **SEEKS** the Director General's guidance in exploring the possibility of adding the science and research part of the Earth-observation programs to the mandatory activities of the Agency.

9. INVITES all Member States and Associate States to participate in the activities and programs designed to implement and further develop a coherent European Earth-observation policy.

CHAPTER III
POEM-1 Program

1. APPROVES execution of the first Polar-Orbiting Earth Observation Mission (POEM-1) program within the framework of the Agency, on the basis of the Director General's proposal referred to above, using the Columbus Polar Platform as a technical basis, and exploiting the Data-Relay System (DRS), in order to acquire global data coverage. This program will be carried out in two phases in accordance with Annex III to the Convention.
2. NOTES that this first mission has the following primary objectives:
 - (a) to provide for continuity of the observations started with the ERS satellites, including those obtained from radar-based observations;
 - (b) to extend the range of parameters observed to meet the need to increase knowledge of the factors determining the environment;
 - (c) to provide a demonstration flight opportunity for a polar operational meteorological payload package provided by Eumetsat; and further NOTES that those will be achieved by developing
 - (d) a package of instruments selected via the ongoing POEM-1 preparatory program, aimed at meeting the need to observe the Earth and its atmosphere from space in synergetic fashion, addressing such matters as global warming, climate change, operational meteorology, ozone depletion and ocean and ice monitoring;
 - (e) a ground segment including a mission management and planning center, an operation control center and a reception, archiving, cataloging and user access system taking also into account the model of the present ESA ground infrastructure serving inter alia ERS-1.
3. AGREES that the first phase will run until end 1992. The decision to move to Phase 2 will be taken in the light of the report drawn up by the Director General in accordance with the provisions of Chapter IV of the resolution on the European long-term space plan 1992-2005 and programs adopted on 20 November 1991. This report will include the proposal of the Director General for the final platform decision taking into account aspects of international cooperation and the most effective means to meet the mission objectives.
4. NOTES that the cost of the POEM-1 program, including its exploitation and the associated ground segment, is estimated at 929 MAU (at 1990 economic conditions), assuming inclusion in the payload of a SAR/AMI instrument. However, if it is technically feasible in the light of studies under the POEM-1 Preparatory Program to include an advanced SAR in the payload of POEM-1 while maintaining the schedule of the mission, the Director General will present a technical and financial proposal for such an inclusion;

RECORDS the statements on intended participation contained in the Annex to this Resolution.

5. INVITES Eumetsat to confirm within six months its commitment to provide at no cost to the Agency the operational meteorological instruments, the associated communications package and the related ground segment for processing, disseminating and archiving the data. The Agency will then take responsibility for integrating the instruments and communication package onto the Polar Platform.
6. INVITES interested Member States to expedite finalization of the corresponding Declaration and Implementing Rules and take all other steps needed for the POEM-1 program to start as early as possible so as to ensure continuity with the POEM-1 Preparatory Program.

CHAPTER IV
Preparatory Program for Follow-on Polar-Orbiting Earth Observation Missions

1. INVITES the Director General to prepare a program proposal for a preparatory program for the development of the necessary technologies in order to provide for flight continuity beyond POEM-1 and to present it in due time to Member States for their consideration before the end of 1992.
2. NOTES in particular that this Preparatory Program for the follow-on Polar-Orbiting Earth-Observation Missions is planned to include:
 - (a) studies to define the mission objectives and implementation alternatives;
 - (b) technological investigations and critical hardware developments to support the candidate instruments, including future advanced imaging radar options, such as ASAR (if not flown on POEM-1), a multi-frequency SAR, and others;
 - (c) assessment of the options for the flight of Announcement of Opportunity Instruments including Earth- and space-science instruments;
 - (d) procurement of long-lead items for the follow-on missions.
3. NOTES that this program is also planned to include, in cooperation with Eumestat, studies to determine the optimum long-term solution for the flight of operational meteorological instruments in polar orbit. These should explore the potential for synergy between such operational instruments and instrumentation required for long-term climate monitoring.

ANNEX

The Delegations declare their intention to participate in the POEM-1 program and to subscribe to the corresponding program Declaration as follows:

Scale of contributions of the POEM-1 Program:	
Participating State	Scale (%)
Austria	1
Belgium	2.72
Denmark	1
France	0-20
Germany	22
Italy	16
Netherlands	2-3
Norway	1-1.5
Spain	0-12
Sweden	up to 6
Switzerland	4
United Kingdom	up to 25
Finland	0-1.6
Canada	2.6

Appendix 9

Resolution on the Implementation of the European Long-Term Space Plan and Programs adopted on 10 November 1992

The Council Meeting at Ministerial Level,

HAVING REGARD to ESA/C-M/XCVII/Res. 1 (Final) on the European Long-Term Space Plan 1992–2005 and programs, adopted in Munich on 20 November 1991,

HAVING REGARD to ESA/C-M/XCVII/Res. 2 (Final) on programs for observation of the Earth and its environment, adopted in Munich on 20 November 1991,

HAVING REGARD to the Director General's proposal for the Agency's policy and programs (ESA/C-M(92)3), submitted in response to the instruction given by Council meeting at Ministerial Level in Munich on 19 and 20 November 1991 to achieve the best possible relationship between the requirements of cost and effectiveness, in particular through a widened and strengthened cooperation with States that have already developed advanced space technologies,

NOTING the work already done in the Agency's delegate bodies to prepare or adapt the legal instruments relating to the programs on which decisions were called for in the above-mentioned Resolutions of Council meeting at Ministerial Level,

CHAPTER I Long-Term Space Plan

1. ENDORSES the director General's proposal for the Agency's policy and programs referred to in the preamble, as a revision of the European Long-Term Space Plan 1992–2005 which constitutes the strategic framework for the Agency's activities, planning and programs.
2. ENDORSES the introduction in the planning of the Agency's major optional programs of a stepped approach aimed at reconciling the need to maintain continuity in the Agency's programs and activities with the ability to respond, when needed, to the changes taking place in the overall political, financial, scientific and technological environment. This approach allows the taking of immediate decisions on developing certain program elements and on reorientation activities over the period 1993–95, with a view to preparing for necessary complementary decisions in 1995.
3. RECOGNIZES that the Director General's proposal ensures the continuity of European space policy while allowing for a gradual widening of international cooperation to the benefit of the Agency's programs.

CHAPTER II Decisions on Programs called for in Resolution of Council Meeting at Ministerial Level of 20 November 1991

ENDORSES the decisions taken by the States participating in the various programs referred to in this Chapter, which are made in accordance with the Director General's proposal for the Agency's policy and program (ESA/C-M(92)3) and permit the continuation and satisfactory execution of those programs in accordance with the Resolutions of Council Meeting at Ministerial Level of 20 November 1991 referred to in the preamble.

WELCOMES the decisions taken at this Ministerial Meeting by the States participating in the programs referred to in this Chapter, which constitute the agreed basis for amending the Declaration applicable to each of the said programs.

A. Programs for Observation of the Earth and Its Environment

1. NOTES the decision of the States participating in the POEM-1 program that the work undertaken in 1992 pursuant to the decision taken on 20 November 1991 by Council meeting at Ministerial Level entails completion of Phase 1 of the POEM-1 program on 31 December 1992;

2. NOTES that the POEM-1 program will comprise as of 1 January 1993 the two elements described below and that, in accordance with the Director General's proposal referred to in the preamble which fulfills the requirement for a report contained in Chapter III of Resolution ESA/C-M/XCVII/Res.2 (Final), both elements will use the Polar Platform developed under the Columbus program and use the Data Relay System (DRS) for data transmission, telemetry and command:
 - (1) the Envisat-1 mission planned for launch in 1998, which will be mainly dedicated to understanding and monitoring the environment and to providing radar data as a continuation of the data provided by ERS-2 through inclusion of the instruments referred to in the Director General's proposal;
 - (2) the Metop-1 mission planned for launch in 2000, which will provide operational meteorological observations, to be carried out taking into account the requirements expressed by the Eumetsat Council and in accordance with the terms of an Agreement to be concluded with Eumetsat.
3. NOTES the decision of the States participating in the POEM-1 program to execute the Envisat-1 mission with an allocated financial envelope estimated at 1134.5 MAU at mid-1991 economic conditions and the preparatory activities for the Metop-1 mission with an allocated financial envelope estimated at 40 MAU at the same economic conditions, it being understood that the corresponding envelopes will be financed in accordance with the contribution scales in Table 1 attached hereto, giving a total of 1174.5 MAU.
4. INVITES the States participating in the POEM-1 program to decide before the end of 1994 to develop the Metop-1 mission on the basis of a proposal from the Director General, accompanied by a cooperation Agreement negotiated with Eumetsat; and NOTES that, on current assumptions, the Agency's contribution to Metop-1 development is estimated at 625 MAU at mid-1991 economic conditions, which includes the costs of the DRS terminal.
5. WELCOMES the Resolution adopted by the Eumetsat Council at its meeting of 22-23 September 1992 confirming Eumetsat's intention to cooperate with ESA in developing a second generation of Meteosat satellites and to contribute to the Metop-1 mission. The preparatory activities for the Metop-1 mission take due account of the above resolution. The relevant parallel decisions by the Eumetsat Council on financing Eumetsat's own preparatory activities will be needed by mid-1993. Such decisions by the Eumetsat Council are required in order for the Agency to decide whether the Metop-1 mission will be continued unchanged beyond 1993 or will be modified.
6. NOTES that, in accordance with the Director General's proposal referred to in the preamble, and in particular Annex 8 thereto, Envisat-1 ground segment will have recourse to both the Agency's and national facilities developed for ERS-1 and ERS-2, will take account of the ongoing Phase B studies and will be further designed to provide efficient linkage with the systems being developed worldwide, and in particular in the environmental science community.
7. RECOGNIZES that the Agency's activities and programs in the field of observation of the Earth and its environment play an important role in providing suitable means for monitoring ice, oceans and the atmosphere; and RECOGNIZES further that these activities and programs contribute to a coherent and effective European Earth-observation policy, which among other things, takes into account the uses that developing countries can make of observation data.
8. INVITES the Director General to take the initiative of consulting with European entities active in the field, in particular the Commission of the European Communities, Eumetsat, appropriate national bodies and the user communities, with a view to acquiring a solid basis for the formulation and strengthening of a European Earth-observation policy as an element of a worldwide strategy.

B. The DRS Element of the DRTM Program

1. NOTES the decision taken by the States participating in the DRS element of the DRTM program that the work undertaken so far, pursuant to the decision taken on 20 November 1991 by Council meeting at Ministerial Level and including tasks within the Data-Relay Preparatory Program, the Technology Mission and Phase 1 of the DRS Program Element, entails the completion of definition activities and constitutes a satisfactory basis for initiating the development of the Data-Relay System.
2. NOTES that the DRS Program Element will comprise as of 1 January 1993 the full development of the first DRS satellite for launch in 1999 in order to meet the requirements of the Earth observation and other programs; and INVITES the participating States to take a complementary decision in February 1995 with regard to the integration and launch of the second flight unit.

3. NOTES the decision of the States participating in the DRS element of the DRTM program to execute the full development of the DRS system with an overall corresponding financial envelope estimated at 945 MAU at mid-1991 economic conditions (of which 199.4 MAU are the subject of the complementary decision mentioned in paragraph (2), it being understood that the corresponding envelope will be financed in accordance with the contribution scale in Table 1 attached hereto.

C. The Columbus Program

1. NOTES the decision taken by the States participating in the Columbus Program that the work undertaken in 1992 pursuant to the decision taken on 20 November 1991 by Council meeting at Ministerial Level entails completion of Phase 1 of the Columbus Program on 31 December 1992.
2. NOTES that the Columbus Program will comprise as of 1 January 1993 the four elements described below:
 - (1) development and launch of the Columbus Attached Laboratory, including the development of the ground segment and the conduct of operational and utilization activities up to the launch planned for 1999;
 - (2) development and launch, which is planned for 1998, and initial operations of the Columbus Polar Platform, including the ground segment necessary for its control;
 - (3) execution of the Columbus precursor-flight activities to prepare for exploitation of the Columbus Attached Laboratory and to provide intermediate flight opportunities for the user community;
 - (4) execution over the period 1993-95 of system studies and definition activities involving international cooperation on a future crewed in-orbit infrastructure, in order to prepare for activities to be carried out in the second planning step.
3. NOTES the decision of the States participating in the Columbus Program to execute development of the Columbus Attached Laboratory with an allocated financial envelope estimated at 2516.8 MAU at mid-1991 economic conditions, of which 350.0 MAU are allocated to the preparation for utilization and operation are subject to a complementary decision to be taken by a double two-thirds majority vote of the participating States in February 1995 as indicated in Chapter III, and development of the Polar Platform with an allocated financial envelope estimated at 694.0 MAU at the same economic conditions, to proceed with execution of Columbus precursor flights, including MIR flights, with an allocated financial envelope estimated at 315.9 MAU at the same economic conditions, and the execution of studies on a future crewed in-orbit infrastructure, with an allocated financial envelope estimated at 30.0 MAU at the same economic conditions; it is further understood in that decision that the corresponding envelopes, amounting to 3556.7 MAU, will be financed with regard to activities undertaken as of 1 January 1993 in accordance with the contribution scales in Table 1 attached hereto.
4. INVITES the Director General to take the appropriate measures, possibly including prolongation of the development of the Columbus Attached Laboratory by a maximum of one year, so as to reconcile the requirements of the program with the financial resources made available by the participating States, as indicated in Table 1 attached hereto.
5. TAKES due account of the preliminary information, provided in the Director General's proposal referred to in the preamble, on the envisaged costs and principles for sharing the costs of the exploitation program for the Columbus Attached Laboratory and INVITES the Director General to formulate a final proposal in this regard so that a decision on the said exploitation program can be taken in due time.
6. INVITES the States participating in the Columbus Program to monitor closely the evolution of development of the International Space Station and to take decisions as appropriate to provide for the necessary adjustment of the program.
7. RECOGNIZES the Agency's responsibilities with regard to the selection and training of astronauts; RECALLS that the European Astronauts Center was created with the specific responsibility of fulfilling those functions; NOTES that the costs corresponding to the Columbus Program's requirements in this respect are covered by the said program; and NOTES further that the role and funding of the Center will be reviewed in 1995 in line with the complementary decisions to be taken by the end of 1995 with

D. The Hermes Program

1. NOTES the decision taken by the States participating in the Hermes Program that the work undertaken in 1992 pursuant to the decision taken on 20 November 1991 by Council meeting at Ministerial Level entails completion of Phase 1 of the Hermes Program on 31 December 1992.
2. NOTES that the Hermes Program, as defined in the Director General's proposal referred to in the preamble, introduces a reorientation period of three years from 1 January 1993 for the purpose of studying the following three strategic options for implementation of a future crewed transportation system:
 - cooperation with Russia
 - cooperation with the United States
 - an autonomous European scenario

and comprises the following activities:

- (1) system studies, primarily directed towards definition of an ESA-Russian Hermes crew transportation vehicle, and development of critical technologies based on the Hermes definition, for an estimated amount of 338 MAU at mid-1991 economic conditions;
 - (2) a detailed definition study for the ESA Assured Crew Return Vehicle (ACRV), as an element of cooperation with the United States relating to the International Space Station, for an estimated amount of 45 MAU at mid-1991 economic conditions;
 - (3) detailed definition studies and pre-development of servicing elements, for an estimated amount of 94 MAU at mid-1991 economic conditions.
3. NOTES the decision of the States participating in the Hermes Program to execute the program reorientation activities with an overall corresponding financial envelope estimated at 567 MAU at mid-1991 economic conditions, including 90 MAU for commitments made during Phase 1 of the program, it being understood that the corresponding envelope will be financed with regard to activities undertaken as of 1 January 1993 in accordance with the overall contribution scale in Table 1 attached hereto and that the Participating States' contributions will be called up in accordance with the separate contribution scales corresponding to the activities described under Section 2 above.
 4. INVITES the States participating in the Hermes Program to include in the corresponding Declaration suitable provisions for the decisions to be taken on the development of the crewed transport system and the servicing elements selected in the course of the three-year reorientation period from 1993 to 1995, and INVITES the Director General to prepare a final proposal as a basis for the required complementary decisions in 1995.

CHAPTER III

Review of the In-Orbit Infrastructure Programs: Columbus Attached Laboratory, DRS, Hermes

1. AGREES to proceed in February 1995 to a review of the infrastructure program referred to in Chapter II above, on the basis of a report of the Director General concerning the status of their execution and the results of the negotiations he will have conducted with international partners.
2. HAVING REGARD to the Intergovernmental Agreement and the Memorandum of Understanding concluded on the International Space Station, INVITES the Director General to negotiate with NASA the terms of an agreement on the allocation of the exploitation costs of the International Space Station which will satisfy the following requirements:
 - a commitment by NASA that the Agency contribution to the Space Station annual common system operations costs will remain under a firm fixed financial ceiling;
 - a commitment by NASA to the effect that a significant portion of the said Agency's contribution shall be made through the provision of goods and service in kind, such as the Assured Crew Return Vehicle (ACRV), the Automated Transfer Vehicle (ATV) using the Ariane launcher and the Data Relay System (DRS), so as to minimize the exchange of funds.
3. INVITES the States participating in the Columbus Attached Laboratory element of the Columbus Program to decide, by a two-thirds majority representing at least two-thirds of the contributions to the program, the unblocking of the amount of 350 MAU, earmarked for preparation of utilization and operations, referred to in Section 3 of Chapter IIC.

4. INVITES the Member States to agree, on the basis of a proposal of the Director General, principles for the financing of the exploitation costs of the Columbus Attached Laboratory.
5. INVITES the Director General to negotiate with Russia the terms of an agreement on the joint development of a crewed space transportation system and to report on the status of these negotiations to the Participating States concerned in time for the review referred to in Section 1 above.
6. INVITES the States participating in the Hermes Program to determine, on the basis of this report, if the terms and conditions negotiated respectively with Russia and the United States permit the decision to be made on the options identified in Section 2 of Chapter IID.
7. INVITES the States participating in the DRS Program Element to decide, by a two-thirds majority representing at least two-thirds of the contributions to the program, the integration of the second flight unit, and to decide the launch of the said unit by a unanimous vote, as referred to in Section 2 of Chapter IIB

CHAPTER IV Other Programs

STRESSING the need to explore with Member States ways in which the development and launching of small satellites could contribute to fulfillment of the objectives outlined in the Long-Term Space Plan with regard to all the sectors of space activities referred to in this chapter.

CONSIDERING that the private sector involvement in the utilization of available resources, and in financing and operating responsibilities, is to be encouraged.

A. Science Program

REAFFIRMS its support for the Science Program and for full and timely implementation of the Horizon 2000 Program, in accordance with the provisions of Resolution ESA/C/XCIII/Res.2 (Final) of 13 December 1990 and RECOGNIZES that the Horizon 2000 program, by furthering understanding of the Universe through space astronomy and in-situ exploration of the solar system, is the key element in implementing European space science policy; and INVITES the Director General to submit in 1995, taking account of scientific, technical and political developments and after consultation with the scientific community, a plan for the continuing implementation of European space science policy.

B. Earth-Observation Programs

1. RECOGNIZES the need to start the Meteosat Second Generation Program in 1993 on the basis of the Director General's program proposal, taking into account the terms of the agreement to be concluded concerning Eumetsat's participation, and INVITES interested Member States to establish the necessary legal instruments.
2. INVITES the Director General to submit in 1993 to Member States a program proposal concerning an Earth observation data user program.
3. RECALLS the interest expressed by the scientific community in the Aristoteles program as described in the Long-Term Space Plan and RECOGNIZES the need to continue minimum activities to allow for execution of the said program.

C. Microgravity Program

1. AGREES that the States participating in the Microgravity Program shall proceed with the reorganization of the said program to include the following two elements:
 - (a) a basic microgravity research program (EMIR) dedicated to scientific use of the microgravity environment.
 - (b) a program to develop the facilities required for microgravity experiments to be carried out in the Columbus Attached Laboratory.

D. Telecommunications Program

1. AGREES the principle of continuing the activities previously undertaken within the Payload and Spacecraft Development and Experiments (PSDE) Program and the Advanced Systems and Technology Program (ASTP); NOTES the findings of the Agency's working group on satellite telecommunications policy, which stress the far-reaching implications for European industry of the European Commission's plan for deregulation in this economic sector; and CALLS for close consultation with operators, regulatory authorities and industry in order to implement a consistent policy for improving the competitiveness of the European telecommunications industry.
2. NOTES the strategy described in the Director General's proposal referred to in the preamble, which seeks to achieve greater coherence in the Agency's telecommunications activities and to merge as far as possible programs and activities referred to in Paragraph 1 within a unified program on Advanced Research in Telecommunications Systems (ARTES); INVITES the interested States to establish the necessary legal instruments and to indicate as soon as possible their level of participation.

E. Launcher Programs

1. RECOGNIZES the need for continuous research and technology accompaniment activities during the operational lifetime of the Ariane launchers, so as to ensure their technical reliability and performance, as a responsibility shared between the design authority and industry, and WELCOMES the Director General's proposals in this respect; and AGREES in principle to set up before the end of 1995 the programs necessary for ensuring an orderly transition from Ariane-4 to Ariane-5, as well as those which are required to permit further evolution of the Ariane 5 launcher's capabilities.
2. RECOGNIZES that the Guiana Space Center (CSG) is an essential element in the Agency's strategy and EXPRESSES its willingness to continue to build on the experience gained from exploitation of the CSG for the benefit of the Agency's programs; RECALLING the report presented to Council by the Director General on 8 November 1992 on the present status of the discussions held with CNES on the execution of the CSG activities beyond 1992, INVITES the Directors General of the Agency and of CNES to finalize the terms of an agreement on the continued funding of the CSG beyond 1992 and submit it to the Agency's relevant bodies with a view to early approval by Council at Delegate Level.
3. INVITES the Member States to pursue their efforts to define the Future European Space Transportation Investigation Program (FESTIP) so that a decision on its start-up can be taken as soon as possible.

F. Technology

WELCOMES the approval by Council at its 103rd Meeting of the Resolution on the General Support Technology Program (GSTP), ESA/C/CIII/Res. 1 (Final), and INVITES Member States to subscribe expeditiously to the corresponding program Declaration.

CHAPTER V European Launcher Policy

WHEREAS the Ariane launcher developed by the Agency is a strategic asset providing Europe with autonomous access to space and must be preserved as a vital component of European space policy and of the Long-Term Space Plan

1. REAFFIRMS the principles of European space launcher policy laid down in Resolution ESA/C/CIII/Res. 2 (Final), adopted on 23 October 1992.
2. INVITES the Member States to implement the principle of granting preference to the Ariane launcher for their own missions and those of European and international bodies in which they participate in accordance with the provisions of the Declaration on the production phase renewed on 21 May 1992 and to encourage the satellite operators, which they entrusted with the task of meeting the needs of the general public in fields such as telecommunications, also to grant preference to the Ariane launcher.
3. INVITES the Director General to submit proposals designed to further the principle of European preferential use of the Ariane launchers.

4. INVITES the Director General to contribute in close cooperation with both the Member States and the competent bodies of European Communities, to the conclusion of an agreement, or other form of terms and conditions, with the governments of other space-faring nations to ensure fair conditions in the launcher market.

CHAPTER VI Industrial Policy

RECALLING the objectives of the Agency's industrial policy as set out in Article VII of the Convention, namely to meet the requirements of the European space program in a cost-effective manner, to improve the worldwide competitiveness of European industry, to ensure that all Member States participate in an equitable manner in implementing the European space program, and to exploit the advantages of free competitive bidding,

1. CONSIDERING the industrial impact of the reorientation called for in the Director General's proposal, DECIDES that the lower limit for the cumulative return coefficient referred to in Article IV.6 of Annex V to the Convention, below which special measures are to be taken in accordance with Article V of that Annex, be maintained at 0.95 for the present three-year period (1991-93) and be fixed at 0.96 for the following period (1994-96), it being understood that the objective continues to be to achieve an overall return coefficient as near as possible to the ideal value of 1 for all countries.
2. REAFFIRMS the guidelines and measures concerning the Agency's industrial policy which were decided upon by Council meeting at Ministerial Level in The Hague in 1987 and in Munich in 1991, INVITES the Director General, in consultation with Member States, to further evaluate and formulate proposals in this respect, in particular proposals to minimize the overall surplus and deficit situations, in order to allow the Industrial Policy Committee and Council to take the appropriate decisions and STRESSES that, when establishing and implementing procedures for fulfilling industrial policy objectives, the particular situation of each Member State's industrial infrastructure shall be given due consideration.
3. INVITES States participating in the Columbus and Hermes Program to insert in the relevant program Declarations provisions allowing for the application of the appropriate measures to correct imbalances recorded in the programs at the end of 1992, bearing in mind the provisions of Section 1 above with regard to the cumulative return coefficient, and ensuring that all participating States have a guaranteed return coefficient of 0.9 at program completion.

CHAPTER VII General Provisions

NOTING with satisfaction the statements made by Delegations at the present Council Meeting regarding their participation in the programs referred to in Chapter II, together with the scales of contributions in Table 1 attached hereto,

WHEREAS it is essential to take measures at an early date that will ensure programmatic and financial continuity in the execution of the Agency's programs,

RECALLING that the present Resolution introduces a reorientation period for the purpose of evaluating new opportunities for international cooperation and preparing for the adoption, before the end of 1995, of complementary decisions that will be needed to ensure satisfactory execution of a number of the Agency's optional programs,

A. Transitional Measures

1. URGES the States participating in the programs referred to in Chapter II to adopt, by the end of 1992, the corresponding 1993 budgets on the basis of the present Resolution, which shall thus constitute the legal basis for their adoption and execution until adoption of the corresponding amended program Declarations, using the financial envelopes and scales of contributions contained in this Resolution.
2. INVITES the States participating in the programs concerned to complete their revision of the corresponding Declarations by 31 March 1993 at the latest on the basis of this Resolution so as to ensure the necessary continuity of the said programs.

3. AUTHORIZES the Director General to take without delay the action needed to begin implementation of each of the programs concerned, while taking care not to commit the Agency beyond 1993 budgets as long as the corresponding Declaration referred to in Section 2 above is not finalized and entered into force.

B. Other General Provisions

1. INVITES the Director General to implement the provisions of his proposal referred to in the preamble pertaining to the Agency's ground infrastructure and to pursue the definition of that infrastructure, making the best use of existing facilities and available services of the Agency and of Member States as a first priority, and of those of the Associate Member and Cooperating States in accordance with the applicable arrangements, and further INVITES the Director General to formulate proposals in due course with a view to establishing the basis for any decisions that may be required in this respect, including the complementary decisions to be taken by the end of 1995.
2. RECOGNIZES that the size and importance of the major optional programs together with the budgetary constraints experienced by Member States call for further efforts in improving the management of these programs; DECIDES to set up a Council Working Group to examine proposals for improving the supply of information to Participating States concerning the execution of the said programs and for handling any structural deficits that may arise in their financial coverage; the working group shall also examine proposals aiming at reconciling the budgetary planning of Member States with the efficient and timely execution of these programs with a view, in particular, to accommodating those Member States that need to contain their annual contributions within predetermined financial limits; REQUESTS the working group to submit its findings to Council before 28 February 1993; INVITES the States participating in the programs concerned to incorporate in the corresponding Declarations the measures adopted by Council, taking into account the specific features of each program; AGREES that the process described above shall not prejudice the finalization and entry into force of the said Declarations pursuant to Section A2 above.
3. RECOGNIZES that the existing system of the Agency to adjust contributions for variations in conversion rates should be modified in order to cope with monetary fluctuations more effectively; AGREES to decide at its next session at delegate level in December 1992 on interim measures to address the effects in 1992 and 1993 of the recent monetary fluctuations until a fully modified system and its adoption procedures have been agreed upon; and INVITES the Director General to make a proposal to the said Council session, taking due note of the views expressed during this session, and which shall be based in particular on the following alternative solutions already described, among others, in document ESA/C(92)92:
 - in the first instance, to apply the retroactive adjustment to a State's contributions only to the extent that amounts are not actually spent in the State concerned.
 - to apply a 50% abatement on adjustments of contributions both on the payments to the Agency as well as on reimbursement by the Agency;

DECIDES to set up a Council Working Group in order to report before the end of 1993 with a view to proposing a reform of the Agency's adjustments mechanism towards a more complete and equitable system.

4. INVITES the Director General to assist the scientific community active in the field of Earth observation in the definition of its priorities and to explore in due course, in consultation with Member States and Finland, the possibility of incorporating the science and research parts of the Earth-Observation Program in the Agency's mandatory activities, and to make proposals to Council to that effect; and further INVITES the Director General to pursue similar actions as appropriate with regard to the field of microgravity.
5. DECIDES to consider the complementary decisions required for the program referred to in Chapter II of this Resolution at a meeting at Ministerial Level to be held in 1995.

Table 1.

The Delegations declare that their respective States will participate as follows in the programs referred to in Chapter II of this Resolution and will ensure the continuation of the said programs on the basis of the corresponding amended Declarations, it being that full financial coverage for the Agency's programs is essential for their orderly execution:

A. The POEM-1 Program

Participant	Envisat-1 Mission %	Metop-1 Preparation %
Austria	1.00	1.00
Belgium	4.00	4.00
Denmark	0.5-1.00	0.5-1.00
France	25.00	25.00
Germany	17.40	18-22.00
Italy	12.00	16.00
Netherlands	2.14	4.60
Norway	1.30	1.50
Spain	7.00—8.00	7.00-8.00
Sweden	5.10	3.35
Switzerland	4.00	4.00
United Kingdom	21-25.00	14.60
Canada	2.7-5.00	—
Finland	1.20	—
TOTAL	104.34—112.14	99.55—105.05

B. The DRS Element of the DRTM Program

Participant	Scale, %
Austria	1.50
Belgium	4.00
France	[20.00]
Germany	12.00
Italy	45.00
Netherlands	2.00
Spain	up to 4.00
Sweden	1.80
Switzerland	0.10*
United Kingdom	1.00
Finland	0.40
TOTAL	up to 91.80

- This figure corresponds to the Swiss contribution of 2% to the former Phase 1 of the DRS Program Element of the DRTM Program.

Appendix 10
ESA Resolution of International Cooperation
adopted on 10 November 1992

The Council Meeting at Ministerial Level,

HAVING REGARD to Resolution ESA/C-M/XCVII/Res. 1 (Final) on the European Long-Term Space Plan and programs, adopted in Munich on 20 November 1991, which reaffirmed the need to intensify international cooperation, taking into account the evolution of the geopolitical context, with a view to achieving fully the objectives of the European Long-Term Space Plan with best possible relationship between the requirements of cost and effectiveness, while optimizing the use of European space resources available within the Agency and the Member States,

HAVING REGARD to Resolutions ESA/C-M/CIV/Res. 1 (Final) on the implementation of the European Long-Term Space Plan and programs and ESA/C-M/CIV/Res.3 (Final) on space cooperation with the Russian Federation, both adopted this day,

RECALLING the conclusions of the Report on the prospects for widening international space cooperation (ESA/C(92)74) from the Council Working Group on international cooperation set up on 12 December 1991,

HAVING REGARD to Articles II and XIV of the ESA Convention,

1. INVITES the Director General and the Member States to strengthen the coherence and coordination of their activities and programs in the space field, and to make optimum use, in implementing these programs, of existing resources and expertise within the Agency and the Member States.
2. INVITES the Director General to pursue his efforts to achieve synergy between the Agency's activities and those of the European Communities in areas where those activities complement each other, in particular in the area of observation of the Earth and its environment.
3. EXPRESSES THE WISH that the results of the Agency's programs be put to the best possible use by other European space organizations such as Eutelsat and Eumetsat, under arrangements for making these available to be determined together with these organizations, in order in particular to avoid the duplication of research and development work.
4. INVITES the Director General to seek, together with those responsible for cooperation in the Member States concerned and with the appropriate international bodies, ways of making available to the developing countries, on mutually acceptable terms, appropriate data obtained through the Agency's programs that can be of use to them, in accordance with the provisions of the Agency's Rules on information and data; and INVITES the Director General to prepare a report on the aforementioned cooperation with developing countries so as to enable Council to discuss the Agency's policy in that area.
5. EXPRESSES SATISFACTION at the extensive cooperation engaged in with Canada and Finland.
6. RECOGNIZES that the execution of the Agency's programs during the years ahead in line with the Director General's proposal on the Agency's policy and programs (ESA/C-M(92)/3) will promote a deepening of the long-standing cooperation with the United States, will make it possible to carry out joint activities with Russia, and will allow the foundations to be laid for closer cooperation with Japan.
7. NOTES with interest the achievements of many countries, in particular those in central and eastern Europe, in areas of space research and development and EXPRESSES THE WISH that the Agency continue to maintain and develop relations with those countries.

Appendix 11
ESA Resolution on Space Cooperation with the Russian Federation
adopted on 10 November 1992

The Council Meeting at Ministerial Level,

WHEREAS ESA/C-M/XCVII/Res. 1 (Final) on the European Long-Term Space Plan and programs, adopted in Munich on 20 November 1991, reaffirmed the need to intensify international cooperation, with a view to achieving fully the objectives of the European Long-Term Space Plan with the best possible relationship between the requirements of cost and effectiveness, while optimizing the use of European space resources available within the Agency and the Member States,

HAVING REGARD to ESA/C-M/XCIV/Res. 1 (Final) on the implementation of the European Long-Term Space Plan and programs and ESA/C-M/CIV/Res. 2 (Final) on international cooperation, both adopted this day,

TAKING NOTE of the diplomatic note dated 28 April 1992 by which the Russian Federation explicitly declared its wish to exercise the rights and fulfill the obligation stemming from the Agreement concerning cooperation in the field of the exploration and use of outer space for peaceful purposes, signed by the Agency and the Government of the Union of Soviet Socialist Republics on 25 April 1990,

WISHING to increase the existing cooperation between the Agency and Russia and extend it not only in all the areas already referred to in the aforementioned Agreement, but also in the areas of manned in-orbit infrastructure, crew transport and the associated communication facilities,

HAVING REGARD to the joint statement signed on 12 October 1992 by the Director General of the European Space Agency and the Director General of the Russian Space Agency (RKA),

HAVING REGARD to Article XIV.1 of the Convention,

- I. EXPRESSES SATISFACTION at the results obtained so far in the framework of the cooperation activities undertaken in the fields of space science, space biology and medicine, microgravity research, Earth observation and crewed space transport systems; and WELCOMES the prospects for intensifying cooperation between the Agency and the Russian Federation.
- II. ENDORSES the Director General's proposals, as described in his Proposal for the Agency's policy and programs (ESA/C-M(92)3), to widen and strengthen such active cooperation with the space institutes of the Russian Federation during the period 1993-95, in the following main areas:
 - (a) in-orbit infrastructure
 - (b) crew transport facilities
 - (c) communication facilities associated with the in-orbit infrastructure
 - (d) missions onboard the Mir station, including the flight and accommodation of astronauts and payloads, to prepare the Agency for the use of inhabited space infrastructures.
- III. AGREES that all the cooperation referred to in Section II above shall be reviewed by Council by the end of 1993, on the basis of reports by the Director General.
- IV. INVITES the Director General to negotiate and submit to it as soon as possible the practical procedures for the cooperation activities identified in this Resolution for the period 1993-95, which shall be laid down in implementing arrangements within the meaning of Article 6 of the Agreement referred to above, and to be concluded between ESA and the Russian Space Agency (RKA), as well as in contracts with Russian industrial or research centers more specifically concerned with each of the cooperation themes selected, all the legal instruments concerned to be approved by the appropriate Agency bodies.
- V. STRESSES that space cooperation of this kind between the Agency and the Russian Federation must safeguard the interests of the space history of the Member States, including in the launch services sector.
- VI. INVITES the Director General to make sure that such cooperation over the period 1993-95 proceeds in accordance with the objectives of the European Long-Term Space Plan, to report periodically on progress made in the corresponding work, and to propose any changes or reorientation which he may consider necessary.

VII. AGREES to undertake, in due course, a review of the main results of the cooperation activities conducted pursuant to Section II, so that the complementary decisions referred to in Chapters II and VII of ESA/C-M/CIV/Res. 1 (Final), adopted this day, can be taken by the end of 1995, and INVITES the Director General to take the measures needed to make it possible for cooperation between the Agency and the Russian Federation to continue beyond 1995, if so desired, under the terms of a new Agreement.

9.0 ACKNOWLEDGMENTS AND CREDITS

The authors would like to express their appreciation to the following individuals and organizations which contributed technical information and other assistance of significant value to this project: Phillip S. Clark, Molniya Space Consultancy; Art Dula, Space Commerce Corporation; Sven Grahn and Geoffrey Perry, Kettering Group; Rex Hall; Merle McKenzie, Jet Propulsion Laboratory; Jane Mellors, European Space Agency; Ed O'Grady, DYJ Technologies; Vern Riportella, Network Services International; Marcia Smith, Library of Congress; Bill Wirin, Almaz Corporation; Grant Zehr.

Under a special arrangement with Teledyne Brown Engineering, Robert Sweeney's renown artwork of Soviet spacecraft and launch vehicles, most created for Teledyne Brown Engineering's The Soviet Year in Space series (1982-1991), have been included throughout this report. Specifically, these drawings, which remain under the copyright of Teledyne Brown Engineering, are found in:

Section 1: Figure 2

Section 2: Figures 3-11

Section 3: Figures 1-7, 10, 11, 13

Section 4: Figures 2, 5, 6, 10-14, 17, 43, 46-49, 51, 54, 56-59, 61, 66, 68, 70, 72-74, 87, 89-95

Section 5: Figures 5, 6, 11, 13, 14, 23, 25, 27-31

Section 6: Figure 10.

Gratitude is also extended to the following who supplied the cited illustrations:

Almaz Corporation: Section 4, Figures 62 and 64.

Asia Satellite Telecommunications Company: Section 4, Figure 25.

British Aerospace: Section 2, Figure 21.

CNES: Section 4, Figure 79.

DARA: Section 3, Figure 17 and Section 5, Figure 35.

EUMETSAT: Section 4, Figure 76.

EUTELSAT: Section 4, Figure 19.

European Space Agency: Section 2, Figures 13 and 14; Section 3, Figures 14-16; Section 4, Figures 18, 77, 78, 96, and 97; Section 5, Figures 2, 3, 8, 15-18, and 32-34.

GWIC: Section 2, Figure 20 and Section 4, Figures 37 and 85.

Hughes Aircraft Company, Space and Communications Group: Section 4, Figure 41.

INMARSAT: Section 4, Figure 29.

ISAS: Section 2, Figure 17; Section 5, Figures 9, 10, 19-22, and 36-37.

ISRO: Section 2, Figures 15 and 16 and Section 4, Figures 26, 27, and 80.

Jet Propulsion Laboratory: Section 4, Figures 52, 53, 60, 65, 69, 75 and Tables 2-10.

Kayser-Threde GmbH: Section 4, Figures 67 and 88.

Matra Marconi Space: Section 4, Figures 19, 20.

NASDA: Section 2, Figures 18 and 19; Section 3, Figures 18 and 19; and Section 4, Figures 31-34 and Figures 81-84.

Ed O'Grady: Cover and Section 4, Figures 1, 9, and 15.

Space Commerce Corporation: Section 4, Figure 55 and Section 5, Figures 4 and 7.

Space Communications Corporation of Japan: Section 4, Figure 35.

Telekom: Section 4, Figures 23, 24.

Grahman Turnill: Section 5, Figure 1.

Andrew Wilson: Section 4, Figures 21, 28, 36, 39, 42.

David Woods: Section 5, Figure 12.

Grant Zehr: Section 4, Figure 50.

10. SPACECRAFT CLASS INDEX

ADEOS (Advanced Earth Observation Satellite): 160, 165
Aelita (aka Spektr-IR): 216, 218
Ajisa (aka EGP): 129
Aktivny: 200-201
Almaz 1: 20, 145-148
Almaz 2: 145-146, 148
Almaz 3: 145-146
Altair: 102
Amos (Afro-Mediterranean Orbital System): 10, 115
APEKS (Active Plasma Experiment): 200-201
Apple (Ariane Passenger Payload Experiment): 112
Arabsat: 120
Archimedes: 108
Arcos: 103-105
ARTEMIS (Advanced Relay Technology Mission): 108
Asiasat: 111-112
Astra 1: 119
Astro-B (aka Tenma): 223
Astro-C (aka Ginga): 223
Astro-D (aka Asuka): 223-224
Astron: 215
Asuka (aka Astro-D): 223-224
Atmos: 160
AUOS-SM (Automatic Universal Orbital Station): 208-209
Ayame (aka ECS-Japan): 117-118
Badr: 41, 119, 166
Bankir: 94, 103, 105
BEST: 160
Bion: 18, 169, 193-197
Biotehnologiya: 172-173
BOR: 23
BS (Broadcasting Satellite, aka Yuri): 38, 117-118
BSB (aka Marcopolo): 121-122
Buran: 22-23, 74, 76, 102
Carina (Capsula di Rientro Non Abitata): 177
Cassini: 211
Castor: 129
CBERS (China-Brazil Earth Resources Satellite): 167-168
Cerise: 244-245
Cluster: 203, 221
Columbus: 78-79, 108, 173, 175-176, 196
COMETS (Communications and Broadcasting Engineering Test Satellite): 117
Convert: 94
Corsa-B (aka Hakucho): 223
Coupon: 94, 105
Co-orbital ASAT: 20, 249-251
CS (Communications Satellite, aka Sakura): 117-118
DFH-2 (Dong Fang Hong): 119-120
DFH-3 (Dong Fang Hong): 119-120
DFS (Deutscher Fernmeldesatellit, aka Kopernikus): 110-111
Diademe: 129
Diapason: 129
DRS (Data Relay Satellite): 7, 10, 107-108, 117
DRTS (Data Relay and Tracking Satellite): 116-117
Ecologia: 155
ECS (European Communications Satellite-ESA): 108-109, 114, 122

ECS (Experimental Communications Satellite-Japan, aka Ayame): 117-118
 EGP (Experimental Geodetic Payload, aka Ajisa): 129
 Ekran-M: 99, 101-103
 EKOL: 154
 EKOS: 153
 Electro: 134-136
 Envisat: 7, 159
 EORSAT (ELINT Ocean Reconnaissance Satellite): 20, 242-244
 EPOS (Experimental Manned Orbital Airplane): 23
 ERS (European Remote Sensing Satellite): 111, 157-159, 163
 Etalon: 128
 ETS (Engineering Test Satellite, aka Kiku): 115-117
 EURECA (European Retrievable Carrier): 78, 173, 175-177, 196-197
 Europesat: 109-110
 EUTELSAT (European Telecommunications Satellite): 107-109, 120
 EXOSAT (European X-ray Observatory Satellite): 219
 Express: 103-105, 176-177
 Feng Yun 1: 42, 167
 Feng Yun 2: 167
 FIRST (Far-infrared and Submillimeter Space Telescope): 221
 Freja: 40, 205
 FSW-1 (Fanhui Shi Weixing): 40-41, 166-167, 176, 178, 196, 199, 233, 239
 FSW-2 (Fanhui Shi Weixing): 41, 166, 178, 199, 233, 239-240
 Fuji: 118
 Fuyo (aka JERS): 163-165
 Gals: front cover, ii, 103-105
 Gamma: 155, 214-215
 Gelikon: 103-105
 Geysler: 102
 GEO-IK: 127-128
 Geotail: 204-205
 Ginga (aka Astro-C): 223
 Giotto: 209-210, 212
 Globis: 103, 106
 GLONASS (Global Navigation Satellite System): 126-127
 GMS (Geostationary Meteorological Satellite): 163
 GOMS (Geostationary Operational Meteorological Satellite, aka Electro): 134-136, 157
 Gonets: 92-93
 Gorizont: 96, 99-101, 103
 Granat: 214-216
 Granit: 103, 105
 Hagaromo: 204, 213
 Hakucho (aka Corsa-B): 223
 Helios: 239-240
 Hermes: 5, 31-33, 44, 78-80, 108, 173, 176
 HIPPARCOS (High Precision Parallax Collecting Satellite): 220
 Hispasat: 120-121
 Hiten (aka Muses-A): 37, 204-205, 213
 HOPE (H-2 Orbiting Plane): 11, 39-40, 81-82, 178
 HORUS (Hypersonic Orbital Reusable Upper Stage): 33, 81
 HOTOL (Horizontal Take-Off and Landing): 25, 43-44, 82
 Hubble Space Telescope: 219-220
 Huygens: 211, 221
 INMARSAT (International Maritime Satellite): 21, 96, 100, 107, 114-116, 123
 INSAT 1 (Indian Satellite): 112, 161-162
 INSAT 2 (Indian Satellite): 112-113, 162
 INTEGRAL (International Gamma-Ray Laboratory): 222
 Interbol: 201

IRAS (Infra-Red Astronomical Satellite): 220
 IRS (Indian Remote Sensing Satellite): 18, 35, 161-162
 Iskra: 67
 ISO (Infrared Space Observatory): 220-221
 ITALSAT (Italian Satellite): 108, 115
 IUE (International Ultraviolet Explorer): 219
 JCSAT (Japanese Communications Satellite): 118
 JEM (Japanese Experiment Module): 81, 178, 198-199
 JERS (Japan Earth Resources Satellite, aka Fuyo): 38, 163-165
 JPOPS (Japanese Polar-Orbiting Observation Platform System): 165
 Kiku (aka ETS): 115-117
 Kitsat (aka Uribyol): 168
 Kopernikus (aka DFS): 110-111
 Koronas: 208-209
 Koskon: 94
 Kristall: 57-75, 151, 173
 Kuryer: 94
 Kvant 1: 57-75
 Kvant 2: 57-75, 151, 173
 LAGEOS 2 (Laser Geodynamics Satellite): 36, 129
 Lavochkin (aka Mercury): 171
 Locstar: 128
 Lomonosov: 218-220
 Luch: 102-103
 Luna: 206
 Lunar Polar Orbiter: 206
 Lunar-A: 212-213
 Magion: 200-203
 MAK: 67, 74
 MAKs (Multi-purpose Aerospace System): 23-24, 173-174
 Marcopolo (aka BSB): 121-122
 MARECS (Maritime European Communications Satellite): 114
 Mars: 206
 Mars-94: 206-208
 MARSNET: 222
 Mayak: 96, 98
 Mercury (aka Lavochkin): 171
 Meteor 1: 131
 Meteor 2: 131-132
 Meteor 3: 131-134, 160
 Meteor 3M: 134
 Meteosat: 5, 157
 Metop: 159
 Minisat: 224
 Mir: back cover, 57-76, 78, 80-82, 151-152, 161, 169, 171, 173, 176, 197-198
 Molniya 1: 94-95, 97
 Molniya 3: 95-98
 Momo (aka MOS): 164
 Monitor: 154
 MOP (Meteosat Operational Program): 157
 MOS (Marine Observation Satellite, aka Momo): 164
 Muses-A (aka Hiten): 37, 204-205, 213
 Muses-B: 224
 Nadezhda: 123-126
 Nika-B: 195
 Nika-T: 170-171, 195
 NORD: 96
 N-Star: 117-118

Ofeq: 10, 36
 Okean-M: 138-139
 Okean-O: 20, 136-139, 143, 157
 Okean-OE: 136-137
 Olympus: 107-108, 115
 OREX (Orbiting Reentry Experiment): 40
 Osiris: 239
 OTS (Orbital Test Satellite): 107, 122
 Ozone: 154
 PAKSAT (Pakistan Satellite): 119
 Palapa: 113-114
 Peole: 129
 Phobos: 18, 206
 Photon: 18, 169-170, 176, 193
 Pion: 201
 Planet-B: 213
 Platform B: 139-141, 143
 POEM (Polar-Orbiting earth Observation Mission): 108, 159
 Polyus: 22, 173, 251
 Priroda: 70, 75, 151-153, 160-161
 PRISMA (Probing Rotation and Interior of Stars; Microvariability and Activity): 222
 Prognoz (missile detection): 246-248
 Prognoz 9 (Relikt): 201, 218
 Prognoz-M: 201, 218
 Progress M: 18, 29, 57-75, 155, 169, 173
 Radioastron (aka Spektr-R): 216-217
 Raduga: 96, 98-99
 Raduga-1: 98-99
 Regatta-Astro: 219-220
 Regatta-Plasma: 201-202
 Relikt (aka Prognoz 9): 20, 218
 Relikt 2: 201, 218
 Resurs-EKOS: 153
 Resurs-F1: 147, 149-150, 169-170, 193, 201, 235
 Resurs-F2: 147, 149-151
 Resurs-O1: 139-143
 Resurs-O2: 143-144
 Rohini: 33
 Romantis: 103, 107
 RORSAT (Radar Ocean Reconnaissance Satellite): 20
 ROSAT (Roentgensatellit): 222-223
 Rosetta: 211-212
 S80/T: 110-111
 Sakigake: 37, 204, 212
 Salyut: 57-58, 60-62, 169
 San Marco: 162
 SARA (Satellite for Amateur Radio Astronomy): 212
 Sakura (aka CS): 117-118
 SAMRO: 239
 SARIT (Satellite di Radiodiffusione Italiana): 115
 SAS (System of Aeronomical Satellites): 202
 SAX (Satellite Astronomic raggi-X): 223
 Shi Jian: 129
 Shinei: 212
 SICRAL (Sistema Italiana de Comunicazione Riservente Allarmi): 115
 Skynet: 121-122
 SOHO (Solar Heliospheric Observatory): 211, 221
 Solar-A (aka Yohkoh): 37, 212

SovCanStar: 103, 106-107
 Soyuz TM: 20, 29, 57-77, 173-174, 197
 Space Biotechnological Complex: 172
 Space Flyer Unit: 177-178, 198
 Spacelab: 78, 80-81, 161, 173, 175-177, 195-198
 Spektr (Mir Module): 70, 75, 152-153
 Spektr-IR (aka Aelita): 216, 218
 Spektr-R (aka Radioastron): 216-217
 Spektr-UVT: 216-217
 Spektr-Xγ: 216-217
 Spiral: 23
 SPM (Space Processing Module, aka TMP): 173-174
 SPOT (Satellite Pour l'Observation de la Terre): 7, 108, 129, 158-160, 166, 2505, 239
 Sputnik: 193
 SROSS (Stretched Rohini Satellite Series): 33, 161, 222
 Starlette: 129
 Stella: 129
 STEP (Satellite Test of Equivalence Principle): 222
 Superbird: 118
 Suisei: 37, 212
 Symphonie: 109-110
 TDF (Telediffusion de France): 7, 109-110
 Techsat: 115, 162
 Technologiya: 172
 Tekos: 171
 Tele-X: 121
 Telecom 2: 7, 109-110
 Tellura-EKO: 154-155
 TMP (Engineering Production Module, aka SPM): 173-174
 Tenma (aka Astro-B): 223
 Topex/Poseidon: 110, 160, 168
 TRMM (Tropical Rainfall Measuring Mission): 165-166
 Tsikada: 124-127, 130
 Tsiolkovsky: 209
 TSS (Tethered Satellite System): 203-204
 Tubsat: 111
 TV-Sat: 110-111
 UARS (Upper Atmosphere Research Satellite): 160
 Uribyol (aka Kitsat): 168
 UoSAT (University of Surrey Satellite): 110, 122, 245
 VEGA (Venus-Halley Comet): 206
 Venera: 206
 Viking: 205
 VITA: 125
 Voskhod: 169
 Vostok: 169, 193, 235
 VSOP (VLBI Space Observatory Program): 224
 XMM (X-ray Multi-Mirror Satellite): 221-222
 Yohkoh (aka Solar-A): 37, 212
 Yuri (aka BS): 117-118
 Zerkalo: 105
 Zenit: 169, 235
 Zenon: 244-245