

U.S. Department of Transportation
Federal Highway Administration

Steel Bridge Design Handbook

Bridge Deck Design

Publication No. FHWA-IF-12-052 - Vol. 17

November 2012



Notice

This document is disseminated under the sponsorship of the U.S. Department of Transportation in the interest of information exchange. The U.S. Government assumes no liability for use of the information contained in this document. This report does not constitute a standard, specification, or regulation.

Quality Assurance Statement

The Federal Highway Administration provides high-quality information to serve Government, industry, and the public in a manner that promotes public understanding. Standards and policies are used to ensure and maximize the quality, objectivity, utility, and integrity of its information. FHWA periodically reviews quality issues and adjusts its programs and processes to ensure continuous quality improvement.

Steel Bridge Design Handbook: Bridge Deck Design

Publication No. FHWA-IF-12-052 – Vol. 17

November 2012

Technical Report Documentation Page

| | | | |
|--|--|--|-----------|
| 1. Report No. FHWA-IF-12-052 – Vol. 17 | 2. Government Accession No. | 3. Recipient's Catalog No. | |
| 4. Title and Subtitle Steel Bridge Design Handbook: Bridge Deck Design | | 5. Report Date November 2012 | |
| | | 6. Performing Organization Code | |
| 7. Author(s) Brandon Chavel, Ph.D, PE | | 8. Performing Organization Report No. | |
| 9. Performing Organization Name and Address HDR Engineering, Inc. 11 Stanwix Street Suite 800 Pittsburgh, PA 15222 | | 10. Work Unit No. | |
| | | 11. Contract or Grant No. | |
| 12. Sponsoring Agency Name and Address Office of Bridge Technology Federal Highway Administration 1200 New Jersey Avenue, SE Washington, D.C. 20590 | | 13. Type of Report and Period Covered Technical Report March 2011 – November 2012 | |
| | | 14. Sponsoring Agency Code | |
| 15. Supplementary Notes | | | |
| <p>16. Abstract</p> <p>The primary function of a bridge deck is to support the vehicular vertical loads and distribute these loads to the steel superstructure. This module provides practical information regarding the decking options and design considerations for steel bridges, presenting deck types such as concrete deck slabs, metal grid decks, orthotropic steel decks, wood decks, and several others. The choice of the particular deck type to use can depend on several factors, which may include the specific application, initial cost, life cycle cost, durability, weight, or owner requirements. For the deck types discussed herein, a brief description of the particular deck type is given, in addition to general design and detail considerations.</p> | | | |
| 17. Key Words Steel Bridge, Deck Design, Concrete Deck, Precast Concrete Deck, Wood Deck, Metal Grid Deck, Orthotropic Deck | | 18. Distribution Statement No restrictions. This document is available to the public through the National Technical Information Service, Springfield, VA 22161. | |
| 19. Security Classif. (of this report) Unclassified | 20. Security Classif. (of this page) Unclassified | 21. No of Pages | 22. Price |

Steel Bridge Design Handbook: Bridge Deck Design

Table of Contents

| | |
|--|----|
| FOREWORD | 1 |
| 1.0 INTRODUCTION | 3 |
| 2.0 CONCRETE DECK SLABS | 4 |
| 2.1 General..... | 4 |
| 2.2 Traditional Design Method (Equivalent Strip Method)..... | 4 |
| 2.3 Empirical Design Method..... | 6 |
| 2.4 Other Methods of Analysis and Design..... | 6 |
| 2.5 Bridge Deck Overhang (Cantilever Slab) and Barriers (Railings) | 7 |
| 2.6 Precast Deck Slabs..... | 7 |
| 2.6.1 Full-depth precast concrete deck panels | 8 |
| 2.6.2 Partial-depth precast concrete deck panels | 10 |
| 2.7 Post Tensioning of Cast-in-Place Deck Slabs..... | 12 |
| 2.8 Edge Support..... | 12 |
| 2.9 Formwork..... | 13 |
| 2.9.1 Stay-in-place formwork | 13 |
| 2.9.2 Temporary formwork..... | 14 |
| 2.9.3 Deck Overhang Brackets | 15 |
| 2.10 Serviceability | 16 |
| 2.11 Minimum Negative Flexure Concrete Deck Reinforcement | 16 |
| 2.12 Detailing Considerations..... | 17 |
| 2.12.1 Skewed Bridges | 17 |
| 2.12.2 Future Deck Replacement..... | 18 |
| 2.12.3 Haunches..... | 18 |
| 2.12.4 Cast-in-place Deck Placement Sequence..... | 19 |
| 2.12.5 Concrete Deck Reinforcement..... | 19 |

| | | |
|-------|--|----|
| 3.0 | METAL GRID DECKS | 21 |
| 3.1 | General | 21 |
| 3.2 | Open Metal Grid Deck | 22 |
| 3.3 | Filled and Partially Filled Metal Grid Deck | 23 |
| 3.4 | Unfilled Metal Grid Deck Composite with Reinforced Concrete Slab | 24 |
| 3.5 | Design and Detailing Considerations | 25 |
| 3.5.1 | Analysis and Determination of Force Effects | 25 |
| 3.5.2 | Typical Applications | 26 |
| 3.5.3 | Composite Action | 26 |
| 3.5.4 | Cast-In-Place and Precast Construction Methods | 26 |
| 3.5.5 | Deck Overhang | 27 |
| 4.0 | ORTHOTROPIC STEEL DECKS | 28 |
| 4.1 | Typical Deck Sections and Applications | 29 |
| 4.2 | Design and Detailing Considerations | 31 |
| 4.3 | Wearing Surfaces | 31 |
| 5.0 | WOOD DECKS | 33 |
| 5.1 | Types of Wood Decks | 33 |
| 5.1.1 | Glued Laminated Deck | 33 |
| 5.1.2 | Stress Laminated Deck | 33 |
| 5.1.3 | Spike Laminated Deck | 34 |
| 5.1.4 | Plank Decks | 34 |
| 5.2 | Wearing Surfaces | 35 |
| 6.0 | OTHER DECK SYSTEMS | 36 |
| 6.1 | Fiber Reinforced Polymer (FRP) Bridge Decks | 36 |
| 6.2 | Aluminum Decks | 37 |
| 6.3 | Sandwich Deck Panels | 38 |
| 7.0 | SUMMARY | 40 |
| 8.0 | REFERENCES | 41 |

List of Figures

| | |
|---|----|
| Figure 1 Bridge deck being constructed with full depth precast concrete deck panels (courtesy Iowa DOT)..... | 8 |
| Figure 2 Construction workers adjusting the elevation of the full depth precast concrete deck panels by adjusting leveling bolts (courtesy Iowa DOT)..... | 9 |
| Figure 3 Detail sketch of a female-to-female type shear key transverse joint..... | 10 |
| Figure 4 Partial-depth precast concrete deck panel..... | 11 |
| Figure 5 Photo showing permanent steel stay-in-place deck formwork installed on a steel plate I-girder bridge..... | 14 |
| Figure 6 Photo showing temporary wood formwork installed on a steel plate I-girder bridge ... | 14 |
| Figure 7 Photo showing deck overhang brackets supporting cantilever slab construction on a steel plate I-girder bridge..... | 15 |
| Figure 8 Inadequate reinforcement provided in acute corner of concrete deck slab (8)..... | 17 |
| Figure 9 Breakback detailing to eliminate skew effects associated with detailing acute corners at ends of skewed deck slab (8)..... | 18 |
| Figure 10 Open Steel Grid Deck (courtesy of BGFMA (11))..... | 22 |
| Figure 11 Filled Steel Grid Deck (courtesy of BGFMA (11))..... | 23 |
| Figure 12 Partially Filled Steel Grid Deck (courtesy of BGFMA (11))..... | 24 |
| Figure 13 Unfilled Metal Grid Deck Composite with Reinforced Concrete Slab..... | 25 |
| Figure 14 Orthotropic Steel Deck Integral with Plate Girder (taken from AISC (16))..... | 28 |
| Figure 15 Common Rib Types for Orthotropic Steel Decks..... | 30 |
| Figure 16 Cross section sketch of stress laminated wood deck (21)..... | 34 |
| Figure 17 Photo showing the installation of an FRP deck panel for deck replacement project in New York State (courtesy NYSDOT and FHWA)..... | 36 |
| Figure 18 Typical aluminum rib extrusion cross section for use in an aluminum bridge deck panel (23)..... | 37 |
| Figure 19 Example of an aluminum deck panel created by welding rib extrusions together at the top and bottom flanges of the extrusion (24)..... | 38 |
| Figure 20 Example of sandwich deck panel (25)..... | 38 |

List of Tables

| | |
|--|----|
| Table 1 Typical components, span lengths, weight ranges, and total thickness for various metal grid decks (11) | 26 |
|--|----|

FOREWORD

It took an act of Congress to provide funding for the development of this comprehensive handbook in steel bridge design. This handbook covers a full range of topics and design examples to provide bridge engineers with the information needed to make knowledgeable decisions regarding the selection, design, fabrication, and construction of steel bridges. The handbook is based on the Fifth Edition, including the 2010 Interims, of the AASHTO LRFD Bridge Design Specifications. The hard work of the National Steel Bridge Alliance (NSBA) and prime consultant, HDR Engineering and their sub-consultants in producing this handbook is gratefully acknowledged. This is the culmination of seven years of effort beginning in 2005.

The new *Steel Bridge Design Handbook* is divided into several topics and design examples as follows:

- Bridge Steels and Their Properties
- Bridge Fabrication
- Steel Bridge Shop Drawings
- Structural Behavior
- Selecting the Right Bridge Type
- Stringer Bridges
- Loads and Combinations
- Structural Analysis
- Redundancy
- Limit States
- Design for Constructibility
- Design for Fatigue
- Bracing System Design
- Splice Design
- Bearings
- Substructure Design
- Deck Design
- Load Rating
- Corrosion Protection of Bridges
- Design Example: Three-span Continuous Straight I-Girder Bridge
- Design Example: Two-span Continuous Straight I-Girder Bridge
- Design Example: Two-span Continuous Straight Wide-Flange Beam Bridge
- Design Example: Three-span Continuous Straight Tub-Girder Bridge
- Design Example: Three-span Continuous Curved I-Girder Beam Bridge
- Design Example: Three-span Continuous Curved Tub-Girder Bridge

These topics and design examples are published separately for ease of use, and available for free download at the NSBA and FHWA websites: <http://www.steelbridges.org>, and <http://www.fhwa.dot.gov/bridge>, respectively.

The contributions and constructive review comments during the preparation of the handbook from many engineering professionals are very much appreciated. The readers are encouraged to submit ideas and suggestions for enhancements of future edition of the handbook to Myint Lwin at the following address: Federal Highway Administration, 1200 New Jersey Avenue, S.E., Washington, DC 20590.



M. Myint Lwin, Director
Office of Bridge Technology

1.0 INTRODUCTION

This module provides practical information regarding the decking options and design considerations for steel bridges, presenting deck types such as concrete deck slabs, metal grid decks, orthotropic steel decks, wood decks, and several others. The choice of the particular deck type to use can depend on several factors, which may include the specific application, initial cost, life cycle cost, durability, weight, or owner requirements. For the deck types discussed herein, a brief description of the particular deck type is given, in addition to general design and detail considerations. Reference should be made to the *AASHTO LRFD Bridge Design Specifications (5th Edition, 2010)*, Section 9: Decks and Deck Systems (1), for specific design requirements associated with the various deck types.

The primary function of a bridge deck is to support the vehicular vertical loads and distribute these loads to the steel superstructure. The deck is typically continuous along the span of the bridge and continuous across the width of the span. In most applications, the bridge deck is made composite with the steel superstructure through positive attachment to the girders, such as using shear connectors to attach the concrete deck slabs to steel girders. In such cases, the deck serves as part of the top flange in the composite section and can be utilized for strength and stiffness. The deck is subjected to local flexural bending of the slab spanning over the girders in the transverse direction caused by the vehicle wheel loads. When the deck is made composite, it is also subjected to longitudinal stresses caused by flexure along the span. The deck, when positively attached to the girders, provides continuous bracing of the top flange in the finished structure, and provides stability to the overall bridge system. The deck will also act as a horizontal diaphragm that is capable of transferring lateral loads, such as wind or seismic loads, to the supports.

2.0 CONCRETE DECK SLABS

Generally, reinforced concrete deck slabs are the most often used type of deck for steel bridges. Concrete deck slabs can be constructed with cast-in-place or precast methods, and typically include mild steel reinforcement in the longitudinal and transverse directions. Although not common to typical steel bridges, concrete decks can utilize post-tensioning steel in addition to the mild steel reinforcement in an effort to provide additional strength and durability.

2.1 General

Reinforced concrete deck slabs must not only be designed for dead and live loads at the service and strength limit states, the *AASHTO LRFD (5th Edition, 2010)* requires that the deck also be designed for a vehicular collision with the railing system at the extreme event limit state (Article 9.5.5). The fatigue limit state does not need to be investigated for concrete deck slabs used in multi-girder bridges.

The *AASHTO LRFD (5th Edition, 2010)* provides two methods for deck design: The Traditional Design Method and the Empirical Design Method. The traditional design method can typically be employed in any situation, while the empirical design method has limitations based on deck geometry and bridge behavior. Additionally, a bridge owner may explicitly specify which design method shall be used by the designer.

The *AASHTO LRFD (5th Edition, 2010)* requires that the minimum thickness of concrete deck, excluding any provisions for grinding, grooving, or sacrificial wearing surface, should not be less than 7 inches. Thinner decks may be acceptable, only if approved by the bridge owner. For concrete deck slabs with a thickness less than 1/20 of the design span, consideration should be given to the use of prestressing steel in the direction of that span in order to control cracking (see Article C9.7.1.1).

2.2 Traditional Design Method (Equivalent Strip Method)

The Traditional Design Method, typically referred to as the Equivalent Strip Method, is based on flexure of the deck in the transverse direction. The equivalent strip method applies to concrete deck slabs that are at least 7 inches thick, have sufficient concrete cover, and have four layers of steel reinforcement, with longitudinal and transverse layers at both the top and bottom of the deck slab. In a typical girder bridge the longitudinal direction of the deck is parallel to the main supporting girder, and the transverse direction is perpendicular to the main supporting girder. If the deck is only supported by the main supporting girders, then the deck is typically designed for primary reinforcement in the transverse direction, and that primary reinforcement is perpendicular to the direction of traffic.

The equivalent strip method assumes a transverse strip of deck supports the truck axle loads. The transverse strip is to be treated as a continuous beam, or simply supported beam as appropriate, assuming pinned supports at the centerline of each girder web. The deflection of the beam is assumed to be zero for this design procedure. The width of the strip is determined in accordance with *AASHTO LRFD (5th Edition, 2010)* Article 4.6.2.1. As shown in Table

4.6.2.1.3-1, a different equivalent width is used for the overhang, and for positive and negative moment regions of the deck.

To determine live load effects, the strip can be analyzed with classical beam theory, moving truck axle wheel loads laterally, along the transverse strip, to produce moment envelopes. Multiple presence factors and the dynamic load allowance (impact) should also be included. Article 4.6.2.1.6 of the *AASHTO LRFD (5th Edition, 2010)* allows the axle wheel loads to be considered as concentrated loads, or as patch loads whose length along the span is taken as the length of the tire contact area plus the depth of the deck. The tire contact area should be computed in accordance with *AASHTO LRFD (5th Edition, 2010)* Article 3.6.1.2.5.

The primary reinforcement, along the transverse strip is designed using conventional principles of reinforced concrete design, similar to a one-way slab. The design location for maximum positive moment is at the location of the maximum positive moment. However for negative moment design, the design location for a typical steel girder bridge can be taken at a point that is located at one-quarter of the flange width, measured from the centerline of the support, in accordance with Article 4.6.2.1.6. In bridges where the flange width varies, to be conservative, designers will typically use the smallest flange width to determine the negative moment design location.

In lieu of more precise calculations, unfactored design live load moments for many practical concrete deck slabs spans can be found in Table A4-1 of the *AASHTO LRFD (5th Edition, 2010)*. In this table, the design live load moments are provided as a function of girder spacing (S). Multiple presence factors and the dynamic load allowance (impact) are included in the tabulated values shown in Table A4-1. Interpolation is permitted between the girder spacings and design sections provided in the table. The tabulated values are not to be used for the design of the deck overhang.

The use of the equivalent strip method also requires that distribution reinforcement be placed in the secondary direction in the bottom of the slab, per Article 9.7.3.2. The amount of distribution reinforcement is based on a percentage of the primary reinforcement required to resist the positive moment in the primary direction, along the transverse strip. For primary reinforcement placed perpendicular to traffic, this secondary reinforcement in the bottom of the slab shall be taken as a percentage of the primary reinforcement equal to $220/S^{0.5}$, but does not need to be greater than 67%, where S is the effective span length and is equal to the effective length specified in Article 9.7.2.3.

The amount of reinforcement in the secondary direction in the top of the deck slab depends on whether the deck slab is in an area in which the main supporting girders are subjected to negative or positive flexure. If the deck slab is in an area of positive flexure, nominal reinforcement such as #4 bars spaced at 12 inches may be required. However, if the deck slab is in an area of negative flexure, additional steel reinforcement is required per Article 6.10.1.7, as discussed later within this section. This additional steel reinforcement may affect both the top and bottom reinforcement in the secondary direction.

2.3 Empirical Design Method

The Empirical Design Method is based on experimental research of reinforced concrete deck slabs, and employs the notion that the deck behaves more like a membrane as opposed to a series of continuous beams (transverse strips). Experimental research indicates that the primary structural action by which concrete slabs resist concentrated wheel loads is not flexure, but a complex internal membrane stress state referred to as internal arching that distributes the live loads from the deck to the supporting girders. This internal arching occurs due to the cracking of the concrete in the bottom of the slab, in the positive moment region of the design slab, and the resulting upward shift of the neutral axis in that section of the slab. Membrane compressive stresses develop which transmit the vertical live load from the deck to the girders, relying on the lateral confinement at the girder that occurs with the use of a composite design and ties between girders, such as those provided by cross frames with top struts or top flange lateral bracing.

The internal arching can be thought of as an internal compressive dome. Failure usually only will occur when there is overstraining around the perimeter of the wheel footprint, and will be in the form of a punching shear. The internal arching action of the concrete alone cannot resist the full wheel load, but a small amount of isotropic reinforcement is more than adequate to resist this small flexural component. The isotropic reinforcement also creates a global confinement, which is required to produce the internal arching effects.

Per Article 9.7.2.4 of the *AASHTO LRFD (5th Edition, 2010)*, the empirical design method can only be used if several limitations related to the geometric configuration of the concrete deck slab are satisfied. The empirical design method does not necessarily employ any design procedures, as the minimum reinforcement required is specified. The minimum amount of reinforcement is 0.27 in.²/ft of steel for the bottom layer in each direction and 0.18 in.²/ft of steel for the top layer in each direction. The steel reinforcement ratios correspond to a 7.5 in. thick deck slab, and may need to be adjusted if a thicker deck slab is used. Also, spacing of the steel reinforcement can not exceed 18 inches, and the steel reinforcement must have a yield strength of 60 ksi or greater. The empirical method can not be applied to cantilever portions of the deck slab.

2.4 Other Methods of Analysis and Design

Article 9.6.1 of the *AASHTO LRFD (5th Edition, 2010)* allows for the use of refined methods of analysis for deck slabs as specified in Article 4.6.3.2. Refined methods can include finite element analysis, grillage analyses, or orthotropic plate theory. A finite element analysis may consist of a mesh of shell or brick-type elements representing the concrete deck alone, and can be used to determine the local transverse bending moments in the concrete slab. A grillage analysis using beam elements to represent the deck can also be used to determine the transverse bending moments in the concrete slab.

Local moments in the deck slab due to wheel loads can also be calculated through the use of Pucher Influence Charts, a practice somewhat common in Europe. The Pucher charts are a series of contour plots of influence surfaces for various plate and loading geometries, which can be used for deck design.

2.5 Bridge Deck Overhang (Cantilever Slab) and Barriers (Railings)

The cantilever portion of the deck slab (deck overhang) must be designed for dead and live load moments for the strength and service limit states, where the moments are based on traditional beam theory. However, the deck overhang design must also consider a vehicular collision load with the railing system at the extreme event limit state. Article A13.4 of the *AASHTO LRFD (5th Edition, 2010)* provides the design procedures associated with the vehicular collision load. In accordance with Article A13.4.1, bridge deck overhangs should be designed for the following three design cases:

- Design Case 1: Transverse and longitudinal forces specified in Article A13.2 for the Extreme Event Load Combination II limit state;
- Design Case 2: Vertical forces specified in Article A13.2 for the Extreme Event Load Combination II limit state;
- Design Case 3: The loads specified in Article 3.6.1 that occupy the overhang for the Load Combination Strength I limit state.

Although not explicitly stated in the above three design cases, the design of the bridge deck overhang should also consider serviceability requirements with regard to crack control and minimum steel reinforcement required for shrinkage and temperature effects.

Additionally, the bridge barriers (or railings) must be designed to withstand a predetermined level of crashworthiness, typically specified by the bridge owner or governing agency. The combination of the deck overhang and the bridge barrier must be capable of resisting a horizontal vehicular collision force. Bridge barriers (or railings) used on the National Highway System must be crash tested, and the crash test specimen should include the barrier and deck overhang. In accordance with Article 13.7.3.1 of the *AASHTO LRFD (5th Edition, 2010)*, “a railing system and its connection to the deck shall be approved only after they have been shown through crash testing to be satisfactory for the desired test level.” Most States have typical barrier designs that have been tested and meet the specified levels of crashworthiness.

To develop a preliminary design of a barrier and overhang the Engineer should reference Section 13 of the *AASHTO LRFD (5th Edition, 2010)*, which provides design guidelines and specifications. Most often, concrete barriers (railings) are employed, and Article A13.3.1 provides a methodology for the design of the barrier based on an application of the yield line theory. For further information, design examples demonstrating the application of the yield line theory, in accordance with Article A13.3.1 have been previously published by the Federal Highway Administration (FHWA), see references (2) and (3).

2.6 Precast Deck Slabs

Precast concrete deck panels can be used as an alternative to cast-in-place concrete decks, as they may reduce construction times associated with placing the deck in new bridge construction and deck reconstruction. Precast concrete deck panels are typically fabricated offsite, at a precasting plant that can provide optimal casting and curing conditions. As such, precast concrete deck panels are often more durable and more uniformly constructed than their cast-in-place

counterparts because of the controlled fabrication environment and quality control offered at a precasting plant. Also, precast concrete deck panels have little or no shrinkage cracking since they are allowed to shrink and cure in an unrestrained condition. Precast concrete deck panels can be either full-depth or partial depth.

The use of both reinforced and prestressed precast concrete slab panels is permitted by Article 9.7.5 of the *AASHTO LRFD (5th Edition, 2010)*. The depth of the slab, excluding any provisions for grinding, grooving, and sacrificial surface shall not be less than 7.0 inches.

2.6.1 Full-depth precast concrete deck panels

Full-depth precast concrete panels typically span the width of a bridge and are placed longitudinally adjacent to one another. The transverse joints between adjacent panels are often grouted, and post-tensioning may also be used to keep the transverse joint in compression. The deck panels are made composite with the steel girders through the use of shear studs. Block-outs in the panels are provided to allow for the placement of shear studs onto the top flange of the steel girder. Composite action between the deck and the girders is provided by shear studs that extend out of the girder and into the block-outs in the panels, once the block-outs are filled with grout. Figure 1 shows a bridge deck being constructed with full depth precast concrete deck panels, where the block-outs for the shear studs can be seen above the steel girders. Also shown in Figure 1 are block-outs for connecting the post-tensioning strands. The block-outs for the post-tensioning strands are at the panel joints, transversely across the width of the bridge.



Figure 1 Bridge deck being constructed with full depth precast concrete deck panels (courtesy Iowa DOT).

After the precast deck panel is installed, it is set to the correct elevation with the use of leveling bolts that bear on the girder top flange, as shown in Figure 2. The transverse joints are then filled with grout. Once the grout reaches the required compressive strength the longitudinal post-tensioning strands are tightened (if post-tensioning is used in the design of the deck system). The shear studs are then welded to the girder top flange in the block-outs provided. The shear

stud block-out, the haunch between the girder top flange and deck panel, and the post-tensioning ducts are filled with grout. A wearing surface or overlay is typically installed on top of the deck panel after all installation is complete, providing the necessary riding surface.



Figure 2 Construction workers adjusting the elevation of the full depth precast concrete deck panels by adjusting leveling bolts (courtesy Iowa DOT).

Two particular design issues require due consideration by the engineer specifying the use of full depth precast concrete deck panels. One issue is related to the grout used in the shear stud block-outs. Given that the block-outs are located in areas of negative moment in the transverse direction of the deck, the grouted block-outs are susceptible to cracking. One method to reduce the potential for cracking is to use block-outs with rounded corners to prevent stress concentrations. Additionally, Article 9.7.5.3 of the *AASHTO LRFD (5th Edition, 2010)* states that upon completion of the post-tensioning, the block-outs should be filled with grout having a minimum compressive strength of 5.0 ksi at 24 hours. The designer should check to ensure that specified grout is capable of resisting the tensile stress caused by negative moment in the transverse direction of the deck.

The transverse joints between adjacent panels must be able to transfer wheel load shear forces and deck axial forces from flexure of the bridge. The transverse joint must also prevent the flow of water and corrosion causing materials through the deck. In practice, non-grouted and grouted transverse joints have been used. Non-grouted joints are typically match-cast at a precast concrete plant, and use a male-to-female shear key type joint with a thin neoprene sheet in between, and sealed with a polyurethane sealant. In some cases it has been found that even though the panels are match-cast, it is difficult to achieve a perfect fit in the field due to construction tolerances and elevation adjustments of the panels (5). This detail is used in conjunction with post-tensioning, in order to close the joint.

However, most joints used in practice are female-to-female shear key type joints that are filled with grout prior to post-tensioning taking place. Unlike joints that have male-to-female shear keys, the female-to-female joints allow for some adjustment related construction tolerances in

the field, as the joint is not interlocking. A sketch of a typical female-to-female joint is shown in Figure 3. The full depth of the female-to-female joint should be filled with grout, as placing grout only in the top portion of the joint can cause poor performance of the joint because of the reduced bearing area (6). Grout used in the transverse joint should be of high quality and have a high early strength, high bond capability, and low shrinkage. In fact, Article 9.7.5.3 of the *AASHTO LRFD (5th Edition, 2010)* states that the transverse joints are to be filled with a nonshrink grout having a minimum compressive strength of 5.0 ksi at 24 hours. Once the joint is grouted, longitudinal post tensioning can be tightened. Per Article 9.7.5.3 of the *AASHTO LRFD (5th Edition, 2010)*, the minimum average effective prestress from the post-tensioning should not be less than 250 psi. The effective prestress is typically interpreted as the net prestress under loading. The post-tensioning places the joint in compression, which can help to prevent cracking due to applied loads and shrinkage, help prevent leakage of corrosive materials through the joint, and helps to keep the panels in compression under loading. In continuous span designs, the designer may elect to increase the post-tensioning to achieve the 250 psi effective stress under all loading conditions.

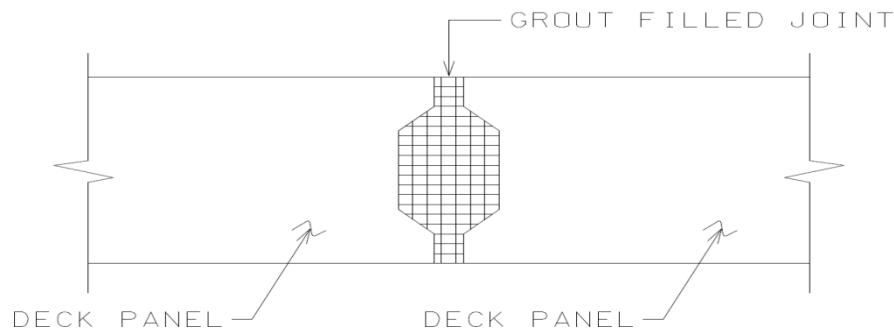

Figure 3 Detail sketch of a female-to-female type shear key transverse joint.

2.6.2 Partial-depth precast concrete deck panels

Partial-depth precast concrete panels span between girders and act as stay-in-place forms for cast-in-place concrete that is placed on top of the panels and act as the bottom reinforcing for the deck, creating a composite full-depth deck. Since partial-depth panels span between the girders, the overhangs must still be constructed with conventional cast-in-place concrete. The partial-depth panels are typically prestressed with strands located at the mid-depth, orientated in the bridge's transverse direction which is in the direction of the deck design span. The prestressing serves as the bottom layer of reinforcing steel in the deck. The panels are placed adjacent to each other along the length of the bridge. The panels are not connected to one another at the transverse joints above the girder, as shown in Figure 4. The top layer of steel in the completed deck is placed after the panels are placed, and before the cast-in-place concrete that is placed on top of the panel. Shear studs are placed on the girder flanges, and composite action is obtained by placing the cast-in-place concrete in this region, as shown in Figure 4. In general, the precast deck panels are 3.5 inches thick, and the cast-in-place concrete layer is 4.5 inches thick.

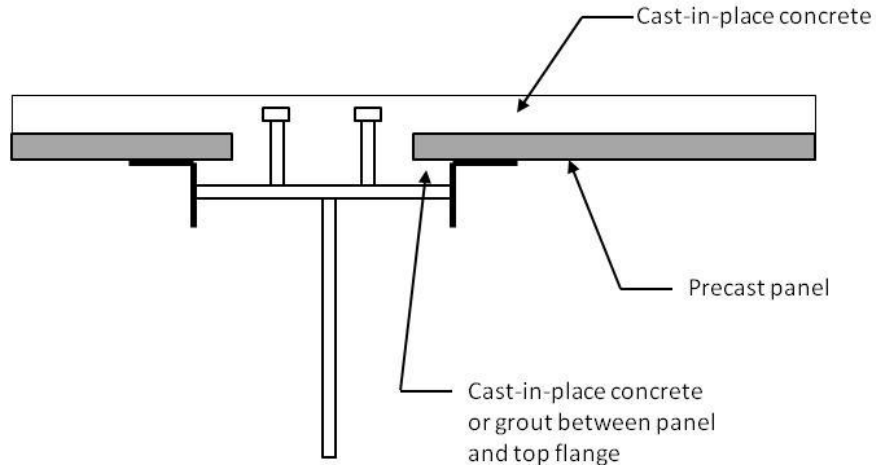

Figure 4 Partial-depth precast concrete deck panel.

Partial-depth precast concrete deck panels are typically considered as concrete stay-in-place formwork. Per Article 9.7.4.3 of the *AASHTO LRFD (5th Edition, 2010)*, the depth of the stay-in-place concrete should neither exceed 55 percent of the depth of the finished deck slab nor be less than 3.5 inches. For the cast-in-place slab placed above the precast deck panel, Article 9.7.4.3.2 allows the bottom distribution reinforcement, when used, to be placed directly on top of the precast panel. Splices in the top primary reinforcement in the cast-in-place portion of the deck slab are not to be located at the panel joints. Furthermore, the concrete cover below the prestressing strands should not be less than 0.75 inches.

The partial-depth precast concrete panels are typically fabricated in one of two ways. One long continuous panel is fabricated, and then cut into shorter panels so that the ends of the prestressing strands are flush with the edges of the panels. Alternatively, panels are fabricated by creating one longer panel but with forms between adjacent deck panels, and once the prestressing strands are cut, small lengths of prestressing strand extend beyond the edge of the panel. The effectiveness of prestressing strand extensions and the performance of partial-depth precast panels is an area that requires further research. Article 9.7.4.3.2 of the *AASHTO LRFD (5th Edition, 2010)* states that prestressing strands and/or reinforcing bars in the precast panels need not extend into the cast-in-place concrete above the beams. However, the commentary to this Article notes that the lack of extended reinforcement may affect the transverse load distribution because there is a lack of continuity over the beams, which could result in cracking where the panels rest on the girders.

The bearing of the partial-depth panels on the supporting girders is an issue that must be properly addressed. A solid, uniform bearing between the partial-depth panels and the girders should be provided. Using soft bearing materials, such as fiber board, has caused problems as the panel lacks a uniform bearing area, causing cracks to develop in the cast-in-place concrete. Other problems have also been noted: the bridge deck may behave like simple spans between the girders instead of continuous spans over the girders; the ends of panels may delaminate from the cast-in-place concrete near the joints, forcing the cast-in-place concrete to carry the entire live load shear; and cracking may occur over the joints (7). In accordance with Article 9.7.4.3.4, current designs typically require that the panels be firmly bedded in grout on the supporting

girder, such that the grout completely fills the voids between the panels and the girder flanges and is allowed to reach the required strength before placement of the cast-in-place concrete.

In accordance with Article 9.7.4.3.3, the upper surface of the precast partial-depth panels is to be intentionally roughened in such a manner to ensure composite action with the cast-in-place concrete. The partial-depth panels and the cast-in-place concrete must be capable of developing sufficient composite action, as the panel and the cast-in-place concrete act together to create the total thickness of the slab, and the panel's reinforcing steel resists the positive flexural moment in the transverse direction of the deck.

2.7 Post Tensioning of Cast-in-Place Deck Slabs

In some cases, transverses post-tensioning can be used in cast-in-place concrete bridge decks. For example, transverse post-tensioning may be specified when wider girder spacings are used, and mild reinforcement will not provided sufficient flexural capacity. Depending on the particular situation, a thicker deck may result with the use of post-tensioning and wider girder spacings, and may offset any steel cost and weight savings realized from using fewer longitudinal girders.

Another consideration regarding the use of transverse post-tensioning is whether or not there is sufficient access to the edges on the concrete deck slab. The anchorage for the post-tensioning tendons will be located at the transverse edges of the deck. Sufficient access must be provided to allow for stressing of the post-tensioning tendons with the necessary equipment and personnel. Furthermore, since transversely post-tensioned concrete bridge decks are not all that common, the skilled labor required to cast the deck and properly install the post-tensioning tendons may not be readily available. The labor and construction time associated with transversely post-tensioned cast-in-place decks may also prove to be more costly than the costs associated with a conventional reinforced cast-in-place concrete bridge deck.

Cast-in-place deck slabs using transverse post-tensioning should be designed in accordance with the applicable provisions of Section 5 and Section 9 of the *AASHTO LRFD (5th Edition, 2010)*.

2.8 Edge Support

The transverse free edges of the concrete deck slab may need to be strengthened or supported by means of a beam or other component. This mainly occurs at abutments, where the transverse free edge of the deck will interface with some type of expansion device, approach slab, or abutment backwall. At these transverse edges, the deck is usually thickened for a certain width so that it behaves like a concrete beam, or the deck is supported by the end diaphragm. If a cross frame is used at this location, the top member of the cross frame will usually need to be a channel or a W-shape than can provide support to the deck. If a beam used to support this free edge is made composite with the concrete deck slab, Article 9.7.1.4 of the *AASHTO LRFD (5th Edition, 2010)* allows the beam to be designed with an effective width as specified in Article 4.6.2.1.4.

2.9 Formwork

Permanent or temporary formwork can be used to construct cast-in-place concrete bridge deck slabs. Permanent formwork, also referred to as stay-in-place formwork, can either be constructed from steel or concrete components. Temporary formwork typically consists of wood elements. States typically specify whether or not it is acceptable to use stay-in-place formwork. The forming of the cantilever portion of the deck slab at the exterior of the bridge is typically supplemented with deck overhang brackets.

2.9.1 Stay-in-place formwork

Stay-in-place formwork can consist of concrete or steel components. Partial-depth precast concrete panels are structural components that also act as stay-in-place concrete formwork. The partial depth precast panels become an integral part of the full-depth deck slab. When concrete formwork is specified by the bridge designer, the designer is typically responsible for the design of the formwork as it is made composite with the bridge system. Article 9.7.4 of the *AASHTO LRFD (5th Edition, 2010)* specifies the design requirements of partial-depth concrete deck panels. Partial-depth precast concrete panels are discussed earlier in this Deck Design module, and are not elaborated further herein.

Steel stay-in-place forms are not to be considered composite with the concrete slab, per Article 9.7.4.2. Figure 5 shows a photo of stay-in-place formwork installed on a steel I-girder bridge, prior to the placement of the deck slab steel reinforcement. The bridge designer is typically not responsible for the design of the steel stay-in-place formwork, and is instead the responsibility of the contractor or steel stay-in-place formwork provider. However, the designer must consider the additional weight caused by the use of steel stay-in-place formwork in the design of the bridge. A customary allowance of 0.015 ksf is often used by designers, which accounts for the weight of the steel formwork and the additional concrete in the “valleys” of the stay-in-place forms. The weight of formwork is typically provided in the contract documents, and if the allowance is exceeded by the contractor’s choice, the contractor is responsible for showing that the effects of on the bridge are acceptable or providing additional strengthening as needed at no cost to the Owner. Additionally, the steel stay-in-place formwork should not be welded to the top flanges of the girders subject to tensile stresses. Welding is permissible in area where the top flange always in compression. The stay-in-place steel deck forms are often attached to an angle that is attached to the girder top flange by welding or via mechanical attachment, such as a hanger or strap over the top flange of the girder. In regions where the top flange is subject to tension, welding the stay-in-place forms or supporting components directly to the girder can result in a fatigue detail not considered during the design of the steel superstructure. Therefore, in order to facilitate installation of steel stay-in-place forms, the designer should indicate the top flange tension and compression zones on the contract plans (this may be done by showing the CVN testing limits as well.)



Figure 5 Photo showing permanent steel stay-in-place deck formwork installed on a steel plate I-girder bridge

2.9.2 Temporary formwork

Temporary formwork is often constructed from wood components, and is removed once the cast-in-place concrete deck has hardened. Figure 6 shows a photo of temporary wood formwork constructed in between the girder top flanges of a steel I-girder bridge. The use of temporary formwork should be specified in the contract documents. However, the bridge designer should consider an appropriate loading for the temporary formwork when investigating the girder constructibility provisions associated with the deck placement sequence. The load allowance considered by the bridge designer may also be placed in the contract documents. In most cases, the contractor is responsible for the design of the temporary formwork. A benefit to the use of temporary wood formwork is the bottom of the concrete deck slab is visible, and any signs of distress can be noted during routine bridge inspections. A disadvantage to the use of temporary formwork is the fact it will take additional construction time to remove the forms



Figure 6 Photo showing temporary wood formwork installed on a steel plate I-girder bridge

2.9.3 Deck Overhang Brackets

Deck overhang brackets, such as those shown in Figure 7, are typically required to construct the cantilever portion of the deck slab that extends beyond the exterior girders. The deck overhang brackets always support the overhang formwork and wet concrete, and will typically support a construction walkway and the concrete paving machine when the rails are installed above the bracket. The deck overhang brackets are typically selected from manufacturer catalogues and prefabricated components. The contractor is responsible for selecting the proper deck overhang bracket and spacing, as well as the design of any addition formwork. In some States, the contractor is required to submit computations sealed by a Professional Engineer, verifying the selection and spacing of the deck overhang brackets to be used to construct the concrete deck slab.



Figure 7 Photo showing deck overhang brackets supporting cantilever slab construction on a steel plate I-girder bridge

The bridge designer should consider the loads imparted on the exterior girders as part of the girder constructibility checks, as the eccentricity of the deck weight and other loads acting on the overhang brackets creates applied torsional moments on the exterior girder. The overhang bracket also imparts a lateral load on the girder top flange and bottom flange or web, depending on the bearing location of the bottom portion on the bracket. In most cases, deck overhang brackets are typically spaced at 3.0 or 4.0 feet along the exterior girders. Article C6.10.3.4 provides equations that can be used, in lieu of a refined analysis, to estimate the maximum flange lateral bending moments due to the eccentric loading caused by the deck overhang brackets.

Also where practical, the deck overhang brackets should be carried to the intersection of the bottom flange and web. The brackets may bear on the girder webs if temporary bracing is provided to ensure that the web is not damaged and that the associated deformations permit proper placement of the concrete deck slab. Alternatively, the out-of-plane bending of the web could be checked using refined analysis techniques in order to ensure that the lateral load imparted by the deck overhang bracket does not cause damage to the web or interfere with construction of the concrete deck slab. When required, notes should be included in the contract

plans or specifications stating the need for a contractor to submit computations, sealed by a Professional Engineer, that verify the deck overhang bracket does not cause damage to the web.

2.10 Serviceability

The spacing of mild steel reinforcement in decks designed in accordance with the equivalent strip method must also satisfy crack control criteria per Article 5.7.3.4 of the *AASHTO LRFD (5th Edition, 2010)*. This crack control criteria does not apply to deck slabs designed in accordance with the empirical design method. However, no matter which design method is used, the cantilever portion of the deck slab must also satisfy the requirements of Article 5.7.3.4.

Also, reinforcement for shrinkage and temperature stresses should be provided near the surfaces of concrete exposed to daily temperature changes. Therefore, the reinforcement at each surface, in at least one direction of the deck, should meet the requirements of Article 5.10.8 of the *AASHTO LRFD (5th Edition, 2010)*.

2.11 Minimum Negative Flexure Concrete Deck Reinforcement

In composite steel girder construction, minimum requirements associated with the longitudinal reinforcement in the concrete deck slab in negative moment regions must be satisfied in accordance with Article 6.10.1.7 of the *AASHTO LRFD (5th Edition, 2010)*. Wherever the longitudinal tensile stress in the concrete deck slab due to either factored construction loads or the Service II load combination exceeds $0.9f_r$, the total cross-sectional area of the longitudinal reinforcement should not be less than 1% of the total cross-sectional area of the concrete deck slab. For normal-weight concrete, the modulus of rupture, f_r , is computed as: $f_r = 0.24\sqrt{f'_c}$.

The reinforcement used to satisfy the requirements of Article 6.10.1.7 should not have a yield strength less than 60 ksi, a bar diameter not exceeding 0.75 in. (No. 6 bar), nor a spacing exceeding 12 in. The longitudinal reinforcement should be placed in two layers uniformly distributed across the deck slab width, and two-thirds of the total longitudinal should be placed in the top layer. It should be noted that if longitudinal post tensioning is used in the deck, in precast deck panels for example, the longitudinal post-tensioning can be designed to provide the minimum negative flexural reinforcement required by Article 6.10.1.7.

In previous specifications, the requirement for 1% was limited to regions of negative flexure, which was typically interpreted by designers as the regions between points of dead load contraflexure. In continuous composite steel bridges, the deck can be exposed to significant tensile stresses beyond the points of dead load contraflexure due to moving live loads, and in particular in long span bridges or when the supports are skewed. Placement of the concrete deck in stages can also produce tensile stresses greater than the rupture strength of the concrete in regions where the concrete deck was previously placed. Thermal and shrinkage strains may also cause increased tensile stresses in the concrete deck slab. The 1% longitudinal steel requirement is intended to address these tensile stress issues and provide sufficient crack control. The 1% requirement of past specifications has proven to be reasonably satisfactory for crack control. In the current specification, this requirement is simply extended to locations where the concrete tensile stress exceeds $0.9f_r$ in an effort to further limit cracking of the concrete deck slab.

2.12 Detailing Considerations

2.12.1 Skewed Bridges

Support skew can affect the detailing of the reinforcement in the concrete deck slab. For support skew, it may be acceptable to orient the deck transverse reinforcement parallel to the skew. However, the deck design calculations must account for a reduction in the effective steel area due to the skewed reinforcement and thus a reduction in the concrete deck slabs flexural resistance. Per Article 9.7.1.3 of the *AASHTO LRFD (5th Edition, 2010)*, the primary reinforcement may be orientated along the skew for skew angles that do not exceed 25 degrees, where the skew angle is measured from a line that is perpendicular to the centerline of the bridge to the centerline of the support.

The acute corners of a skewed concrete deck slab are often difficult to adequately reinforce (8). As the angle of skew increases, large portions of the deck can be unreinforced and therefore subject to spalling and chipping, as shown in Figure 8. Because the orthogonal bars are too short to develop, it is typically necessary to detail diagonal bars that extend into the deck over the girders, to carry the deck overhang loads. Similarly, acute corners in concrete barriers are also difficult to reinforce, and require special consideration.

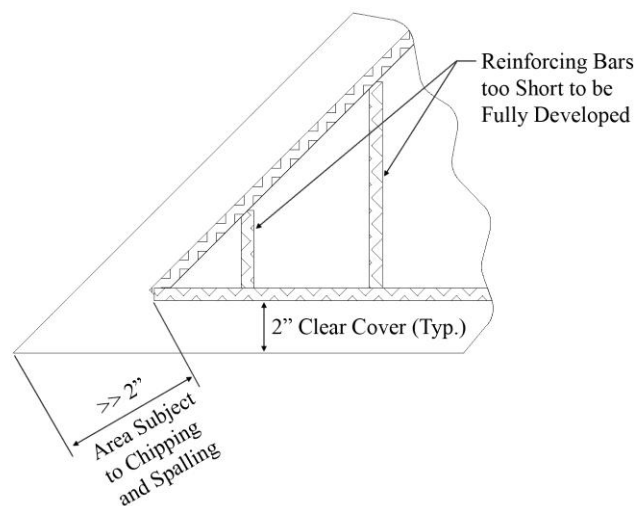

Figure 8 Inadequate reinforcement provided in acute corner of concrete deck slab (8)

A possible technique to combat the skew effects related to the detailing of the reinforcement in the concrete deck and barriers is a detailing method commonly referred to as breakback detailing. Breakback detailing is where the ends of the skewed deck are turned so that the end is normal to the longitudinal edge of the deck, as shown in Figure 9. This breakback detailing effectively eliminates the acute and obtuse corners of the concrete deck and barriers. Various owner agencies may include guidelines for breakback detailing in their design manuals, policy memos, or standard drawing details (8). These guidelines typically address the degree of skew at which breakback options should be considered.

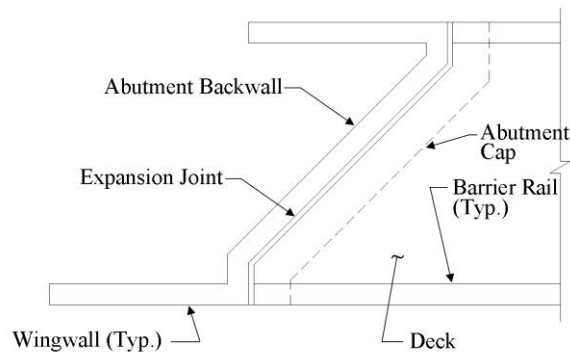

Figure 9 Breakback detailing to eliminate skew effects associated with detailing acute corners at ends of skewed deck slab (8)

2.12.2 Future Deck Replacement

A complete replacement of a reinforced concrete deck slab may be required during the life span of a composite steel bridge. Forethought during the initial design of the bridge could provide the details and requirements necessary for a future deck replacement at the initial design and construction stage, as opposed to costly modifications at the time of deck replacement. The initial bridge layout and design may consider a specific future deck replacement sequence to be shown on the contract plans, and analyzed as part of the bridge design. A section of deck designed for positive moment between adjacent girders may become a cantilevered slab due to the future deck slab removal and replacement sequence. A future deck replacement sequence such as this could be facilitated by considering this cantilever condition during the initial bridge and deck slab design. Additional mild reinforcement to compensate for the negative moment resulting from the temporary cantilever condition could be added during initial design and construction. Alternatively, a staged overhang may be supported with a temporary framing bracket (knee-brace) installed at the time of deck replacement.

2.12.3 Haunches

The haunch in a steel girder bridge is typically referred to as the distance from the top of the steel girder web to the bottom of the concrete deck slab. Alternatively, some agencies refer to this area as the fillet, but where the fillet is the distance from the top of the top flange to the bottom of the concrete deck slab. The main difference between the haunch and the fillet is that the haunch will theoretically remain constant along the length of the girder, while the fillet dimension will vary due to top flange thickness changes along the length of the girder. However, both dimensions may need to be adjusted in the field due to girder fabrication and erection tolerances. The detailing of this concrete haunch (or fillet) needs to be considered by the bridge designer.

The haunch width is typically set as the same width as the top flange. The deck forming method will affect the haunch width. For example, where steel stay-in-place deck forms are used, they typically employ clip angles with are attached to the top flange, requiring the haunch to be the same width as the flange.

The haunch depth is usually set to accommodate all variations in top flange thickness, along with consideration of the deck cross slope and deck forming method. The thickness of splice plates must also be considered. Typically, the thickness of concrete above the flange (the fillet), is allowed to be no less than 0.75 inches at any point across the top flange width, and considering the thickness of the top flange splice plates. The haunch depth at the centerline of the girder web is typically shown on the contract plans, and depth must consider the cross slope and superelevation of the deck slab.

Shear reinforcement in the concrete haunch is often required when the depth of concrete measured from the top of the top flange to the bottom of the concrete deck exceeds a certain thickness (agencies specify the minimum thickness anywhere from 3.0 to 6.0 inches). Shear reinforcement is also typically required if the shear connectors (studs) do not penetrate a minimum of 2.0 inches into the deck slab. In this case the haunch must be reinforced to contain the shear stud connector and develop its load in the deck (Article 6.10.1.1.4).

2.12.4 Cast-in-place Deck Placement Sequence

The cast-in-place deck placement sequence considered by the bridge designer must be provided in the contract plans, and must be taken into account as part of the girder constructability checks. Common practice when placing the deck in continuous span bridges is to place the cast-in-place deck slab in the positive moment regions first and then place the cast-in-place deck slab in the negative moment regions over the supports. A strategy such as this is typically adopted in order to minimize the potential for cracking at the top of the deck slab in regions that are subjected to negative moment. It should be noted that when concrete is placed in a span adjacent to a span that already has a hardened concrete deck, negative moments in the span with the hardened concrete will often result. These negative moments will cause tensile stresses in the hardened concrete that could result in transverse deck cracking. The concrete deck stresses during deck placement should be checked in accordance with Article 6.10.3.2.4 of the *AASHTO LRFD (5th Edition, 2010)*.

2.12.5 Concrete Deck Reinforcement

Concrete bridge deck slabs, parapets, and sidewalks are often reinforced with mild steel reinforcement bars. In most cases, the reinforcing bars in the concrete bridge deck should conform to the requirements of ASTM A615 or ASTM A706, both with a yield strength of 60 ksi, and modulus of elasticity equal to 29,000 ksi. These deck reinforcement bars are often protected from corrosive materials through the use of an epoxy coating applied to the bars. Alternatively, some agencies require that the deck reinforcement bars be galvanized in an effort to protect the bars from corrosion. Furthermore, some agencies allow the use of uncoated bars in the bridge deck, but provide increased cover to the reinforcement. The choice of corrosion protection is dependent on the environment in which the bridge is located, and the likelihood of corrosive materials being applied to the bridge deck. The designer should refer to standard specifications and design manuals for the particular deck reinforcement and corrosion protection method required by bridge owner.

However, since corrosion of mild steel reinforcement is a main cause of deterioration of concrete bridge decks, other viable reinforcement options have been investigated and used in practice. The use of fiber-reinforced polymer (FRP) reinforcement bars and stainless steel reinforcement bars in concrete bridge decks has increased in recent years, and research using each is currently on-going. Currently, the *AASHTO LRFD (5th Edition, 2010)* does not explicitly address either reinforcement option.

In addition to superior corrosion resistance, FRP reinforcement bars offer a high strength and light weight alternative to typical steel reinforcement in concrete bridge decks. In the absence of AASHTO or bridge owner specifications, ACI 440.1 R-06 provides design guidance for the design and construction of structural concrete reinforced with FRP bars (9). A recent study discussing the use of a bridge deck reinforced with glass FRP bars built in Vermont offers another resource for designers, as a field investigation is described along with design and construction procedures (10). A higher cost is associated with the use of FRP or stainless steel reinforcement bars in bridge decks, as compared to the use mild steel reinforcement. However, these initial high costs may be offset by the possible savings in maintenance and repairs over the life of the bridge.

Stainless steel reinforcement bars are manufactured according to ASTM A995, and have enhanced corrosion resistance as compared to conventional reinforcement. The entire reinforcement bar is comprised of a corrosion resistant combination of metals, with a large percentage of chromium and nickel. Stainless steel has a high chloride threshold and a slower corrosion rate than conventional reinforcement. Stainless steel reinforcement is available for yield strengths of 40, 60, and 75 ksi, and the sizes of stainless steel bars are the same as conventional steel reinforcement bars. The use of stainless steel bars may be warranted in a highly corrosive environment, such as a project site in an oceanic location. Like FRP reinforcement, stainless steel has higher initial costs than conventional reinforcement which may be offset by future maintenance savings.

3.0 METAL GRID DECKS

A metal grid deck consists of primary (main) members that span between adjacent beams, stringers, or cross beams and secondary members (often referred to as distribution bars or cross bars) that interconnect and span between the primary members. The primary and secondary members of the grid deck typically form a rectangular pattern, although diagonal patterns can also be used. The primary and secondary members must be securely joined together. Metal grid decks are typically comprised of steel members forming the grid, and can be open, filled and partially filled with reinforced concrete, or unfilled and composite with a reinforced concrete slab. These types of metal grid decks are further explained within this section.

3.1 General

Metal grid decks, both open and filled with reinforced concrete, have been used in bridge construction since the 1930's. These deck systems can be considered for both new construction and bridge rehabilitation projects, where weight reduction and/or speed of construction are important considerations. Metal grid decks, filled or unfilled, are typically lighter in weight than a conventional reinforced concrete deck slab with similar flexural capacity. Weight savings can be especially important in movable bridges as well as rehabilitated structures in which a lighter weight deck may reduce the need to strengthen a structure for increased live load capacity. In many cases, filled grid decks have proven to be quite durable. Filled grid decks on bridges such as the South 10th Street Bridge in Pittsburgh, the Walt Whitman Bridge in Philadelphia, and the Mackinac Bridge in Michigan have all provided a service life of 50 years or more.

Metal grid decks typically consist of several panels that are connected together as the system is installed on the bridge. As such, filled grid decks are modular, and may be able to be installed quicker than typical cast in place reinforced concrete deck slabs. In cast-in-place filled grid decks, the grid panels serve as the formwork, leaving little forming to be done in the field. The concrete in the grid deck can also be precast into the grid panels, and the deck set into place as a precast unit, only requiring closure pours between the panels.

The initial installation and construction of a filled metal grid deck is typically more expensive than conventional reinforced concrete deck slabs. However, a filled metal grid deck can prove to be a viable option when life cycle costs are considered, as a filled metal grid deck may not need to be replaced at the same intervals as those required by a conventional reinforced concrete deck slab, or when dead load reduction or speed of construction are important drivers.

The Bridge Grid Flooring Manufacturers Association (BGFMA) is an industry group comprised of companies who fabricate and supply metal grid deck systems for bridges (11). The BGFMA focuses on the use and design of steel grid decks through data collection, research, development, and education. Several technical documents concerning metal grid deck systems are available at the BGFMA's website (www.bgfma.org).

3.2 Open Metal Grid Deck

An open grid deck consists of the primary and secondary steel members only, as the system does not include any reinforced concrete. Figure 10 shows a section of an open steel grid deck. In this figure, the primary supporting bars are I-shaped, while the secondary members are simple rectangular bars that are perpendicular but interlock with the primary members. Additional simple rectangular members interlock with the secondary members, and run parallel to the primary members. These members help to provide the ride surface of the open metal grid deck. With open grid decks, serrations are typically provided on the top of the grid members to enhance vehicle traction.

Per Article 9.8.2.2 of the *AASHTO LRFD (5th Edition, 2010)*, open metal grid decks must be connected to the supporting components (girders, stringers, cross beams, etc.) by welds or mechanically fasteners at each primary member of the grid deck system. Using shear studs and a narrow, full depth concrete pour over the supports is another method of connecting open grids, if the minimal additional weight is permitted. Furthermore, welding within the open grid decks should typically be considered as a Category E detail.

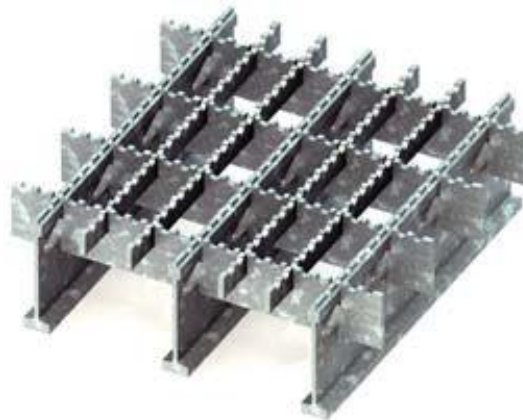

Figure 10 Open Steel Grid Deck (courtesy of BGFMA (11))

An advantage of the open steel grid deck is that it is lightweight, as compared to a conventional reinforced concrete deck slabs or filled metal grid decks. However, it has several disadvantages as compared to conventional reinforced concrete deck slabs or filled metal grid decks. These include perceived unpleasant ride quality, additional noise, or possible safety issues when wet, and they allow debris, road salts, and water through the deck and onto the feature below the bridge. Also, open metal grid decks are prone to fatigue issues, both internally and in their connections to girders or stringers. Open grid decks are rarely specified on new construction projects, and are typically only used for in-kind replacements. The use of open metal grid decks is typically limited to situations in which weight savings is the main driver, so as to increase the live load carrying capacity of the structure, or where these systems were installed many years ago. Older truss bridges and movable bridges are examples of where one may see these systems employed.

3.3 Filled and Partially Filled Metal Grid Deck

A filled metal grid deck is a deck in which the entire depth of the grid system is completely filled with concrete, as shown in Figure 11. Filled grid systems were first introduced in the 1930's as a method to increase speed of construction on large scale bridge projects. Filled grid decks can utilize precast or cast-in-place methods for the reinforced concrete. Mild reinforcement is required to satisfy concrete serviceability and durability requirements, and is typically located perpendicular to the main supporting bars. Thin gage sheet metal rests between the bottom flanges to support the full depth concrete.

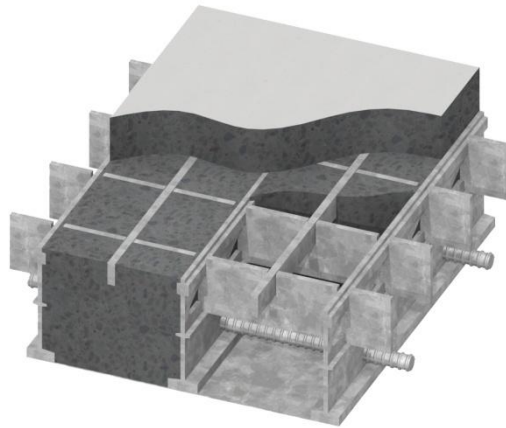

Figure 11 Filled Steel Grid Deck (courtesy of BGFMA (11))

A partially filled metal grid deck is a deck in which only a portion of the depth of the grid system is filled with concrete, as shown in Figure 12. Partially filled grid systems were first introduced in the 1950's as a method to further reduce weight by eliminating concrete from the bottom of the deck which is in tension in simple span applications. Partially filled grid decks can utilize precast or cast-in-place methods for the reinforced concrete. Mild reinforcement may be used to satisfy concrete serviceability and durability requirements, and is typically located parallel to and in between the main supporting bars. A rib, located near the mid depth of the primary I-beam in the deck system is used to support thin gage sheet metal. The thin gage sheet metal supports the wet concrete, creating a partially filled system.

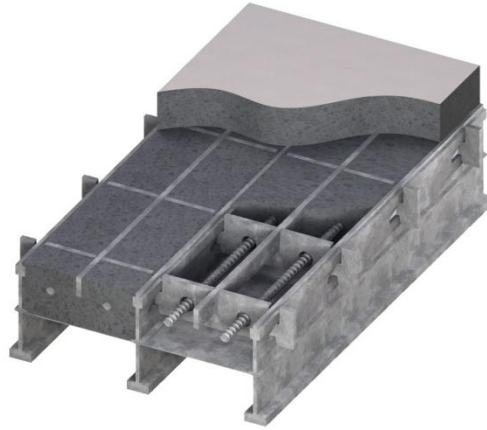

Figure 12 Partially Filled Steel Grid Deck (courtesy of BGFMA (11))

Per Article 9.8.2.3.1 of the *AASHTO LRFD (5th Edition, 2010)*, a 1.75 inch thick structural overfill should be provided when possible on filled and partially filled metal grid decks, although a 2 inch overfill is more common. Overfill is taken as the concrete thickness above the metal portion of the grid deck. The concrete overfill provides protection for the steel portion of the grid deck from chloride ion attack. The steel grid deck should also be galvanized or painted to further protect the deck system. The overfill and galvanizing (or painting) limits the corrosion in the grid deck steel. Heavy corrosion of the grid deck can lead to a phenomenon often called “grid growth,” which impacts the performance of the grid deck.

Filled and partially filled grid decks can be attached to the supporting components (girders, stringers, cross beams, etc.) by welding, or more commonly by shear stud connectors, to transfer the shear between the deck and the supporting component. If shear studs are employed on the supporting components, a haunch should be provided so that the shear studs are completely encased in concrete. The shear studs should extend into the grid deck similar to a conventional reinforced concrete deck slab, but typically do not need to extend into the overfill.

3.4 Unfilled Metal Grid Deck Composite with Reinforced Concrete Slab

An unfilled metal grid deck composite with reinforced concrete slab consists of a reinforced concrete slab that is cast on top of an unfilled grid deck, and is made to be composite with the unfilled grid deck. An ExodermicTM deck, shown in Figure 13, is a specific manufactured type of unfilled metal grid deck which is composite with a reinforced concrete slab. In this type of deck, WT sections are used as the primary members, spanning from the supporting components (girders, stringers, cross beams, etc.). Secondary members are perpendicular to and interlock with the WT sections. The secondary members support thin gage sheet metal, which in turn supports the wet concrete of the reinforced slab. Negative flexural capacity is provided by the mild reinforcement located within the concrete deck slab.

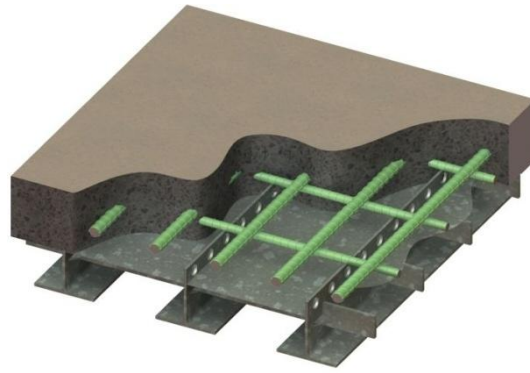

**Figure 13 Unfilled Metal Grid Deck Composite with Reinforced Concrete Slab
(Exodermic™ Deck courtesy of BGFMA (11))**

Composite action between the unfilled grid deck and the concrete slab must be provided by shear connectors or other means capable of resisting horizontal and vertical components of interface shears. Article 9.8.2.4.2 of the *AASHTO LRFD (5th Edition, 2010)* states that acceptable methods of shear connection include tertiary bars to which 0.5 inch diameter reinforcement or round studs have been welded, or the punching of holes at least 0.75 inch in size in the top portion of the main bars of the grid which are embedded in the reinforced concrete slab by a minimum of 1 inch. The steel decking should also be galvanized or painted to protect the steel members from corrosion.

These types of decks are often attached to the main supporting components by shear stud connectors. Shear studs are welded to the main supporting components and a haunch is provided so that the shear studs are completely encased in concrete.

This type of grid deck can be used where the distance between supports is greater than 10 feet. On rehabilitation projects, the use of this deck type may permit the removal of stringers between floor beams.

3.5 Design and Detailing Considerations

3.5.1 Analysis and Determination of Force Effects

Per Article 9.8.2.1 of the *AASHTO LRFD (5th Edition, 2010)*, the force effects in open, filled, and partially filled grid decks, and grid decks composite with a reinforced concrete slab can be determined using one of the following methods:

- Approximate analysis methods specified in Article 4.6.2.1, as applicable;
- Orthotropic plate theory;
- Equivalent Grillage;
- Design aids provided by the deck manufacturer, if the performance of the deck is documented and supported by sufficient technical evidence.

Live load effects for open grid decks, per Article 4.6.2.1, can be determined using the equivalent strip method, similar to conventional reinforced concrete deck slabs. Filled and partially filled

grid decks, and grid decks composite with a reinforced concrete slab must be designed for live load force effects computed in accordance with Article 4.6.2.1.8, as the equivalent strip method is not applicable. Additional information regarding the development of the equations provided in Article 4.6.2.1.8 and the determination of live load effects can be found in references (12), (13), and (14).

3.5.2 Typical Applications

Table 1 highlights the typical span length applications, components, weights, and total thicknesses associated with filled and partially filled grid decks, and grid decks composite with a reinforced concrete slab (11). The typical weight range and thickness consider a 2 inch overfill.

Table 1 Typical components, span lengths, weight ranges, and total thickness for various metal grid decks (11)

| | Partial Depth | Full Depth | Unfilled and Composite Slab |
|---------------------------------|----------------------|----------------------|------------------------------------|
| Primary Member Component | Rolled I-shape | Rolled I-shape or WT | *WT4, WT5, or WT6 |
| Maximum Span Length | Up to 10 ft | Up to 10 ft | Greater than 10 ft |
| Weight Range (psf) | 65 to 75 | 70 to 110 | 60 to 70 |
| Total Thickness (in.) | 7.25 | 5.00 to 7.25 | 6.50 to 9.50 |

* These are the most common sizes; however larger WT shapes can be used for large spans.

3.5.3 Composite Action

Filled and partially filled grid decks, and grid decks composite with a reinforced concrete slab can be made composite with steel superstructures by welding shear studs to the supporting structural components and embedding the shear studs in a haunch area with full depth concrete. This haunch area is placed at the same time as the reinforced concrete is placed when the concrete is cast-in-place, or separately when the reinforced concrete is precast. In order to assume composite action between the supporting components and the metal grid deck, the shear studs must be designed and placed in accordance with Article 6.10.10 of the *AASHTO LRFD (5th Edition, 2010)*. If these deck types are considered to be composite with the main supporting components, an effective width of slab can be assumed for the design of the main supporting components. The slab effective width is to be computed in accordance with Article 4.6.2.6.1 of the *AASHTO LRFD (5th Edition, 2010)*. For the design of the main supporting components, the section properties should be computed omitting any effect of the concrete slab in tension.

3.5.4 Cast-In-Place and Precast Construction Methods

As mentioned previously, filled and partially filled grid decks, and grid decks composite with a reinforced concrete slab can have the concrete slab portion installed with cast-in-place or precast construction methods. With cast-in-place construction, the unfilled steel grid deck is placed on

the supporting components, such as the top flanges of the girders. Since the grid deck is divided into multiple panels longitudinally and transversely, adjacent panels are typically spliced together with mechanical fasteners, shear reinforcement (transverse only), or other methods. The unfilled grid deck is set to the required elevation using leveling bolts that are built into the grid deck panels. Shear stud connectors are placed through the grid deck and welded to the top flange of the supporting component. Haunches are formed at the supporting components, usually with galvanized thin gage steel sheets, structural angles, or timber. Mild steel reinforcement, if not already incorporated into the grid deck, is then installed, and concrete is then placed in a conventional fashion, filling the haunches full depth and the specified depth and overfill of the grid deck.

Alternatively, the concrete for the grid deck panels can be precast off site, and the panels with concrete installed delivered to the work site. When the concrete is precast, forms or blockouts are used to prevent the placement of concrete in panel areas that will eventually be located over supporting components in the final structural configuration, in deck panel connection areas, and in areas where cast-in-place barriers will be placed. However, when precast methods are used, the panels must be properly handled and stored to reduce the possibility of concrete cracking. In general, the installation of the precast panels, shear stud connectors, and haunch formwork are similar to cast-in-place construction. Once all components are installed, rapid setting concrete is used to make the full depth closure pours in the haunch and deck panel connection areas. Rapid setting concrete provides the high early strength that is typically required, while also limiting the potential for shrinkage cracking.

In both methods of construction, a maximum coarse aggregate size of 0.375 in. is typically specified, and pencil type vibrators are recommended as the concrete is placed. Also, after concrete placement is complete, and any grinding or finishing has occurred, a sealant or overlay is typically installed. Overlays are more commonly used with precast concrete decks. The sealant or overlay should be compatible with conventional reinforced concrete deck slabs.

3.5.5 Deck Overhang

Similar to a conventional reinforced concrete deck slab, the design of a deck overhang of a grid deck needs to be considered a vehicular crash loading applied to the barrier. Although Section 13 of the *AASHTO LRFD (5th Edition, 2010)* is developed for conventional reinforced concrete deck slabs, the provisions are applicable to grid decks. The design of the overhang of a metal grid deck with reinforced concrete must consider the three design cases provided in Article A13.4.1. Furthermore, the connection of the barrier to the deck must be given special attention by the designer, to ensure that the crashworthiness of the system is sufficient.

4.0 ORTHOTROPIC STEEL DECKS

Orthotropic steel decks have been employed worldwide, particularly in Europe, Asia, the Far East, and South America. However the use of orthotropic steel decks in the United States has been fairly limited, such that their use represents a very small percentage of the bridge inventory. The modern orthotropic welded deck bridge construction was developed by German engineers in the 1930's, and the first such deck was constructed in 1936.

In general, an orthotropic steel deck consists of a flat, thin steel plate which is stiffened by a series of closely spaced longitudinal ribs that run parallel to traffic, placed orthogonal to transverse floor beams. The deck stiffness is considerably different in the longitudinal and transverse direction, hence orthotropic steel decks are structurally anisotropic. According to Troitsky (15), the name orthotropic comes from the fact that the ribs and floor beams are orthogonal, and the elastic section properties are different, or anisotropic, in both directions; thus the system became known as orthogonal-anisotropic, which shortens to orthotropic. Typically, an orthotropic steel deck is made integral with the supporting superstructure component, such as the top flanges of girders or floor beams. Figure 14 shows general sketches of an orthotropic steel deck integral with a plate girder.

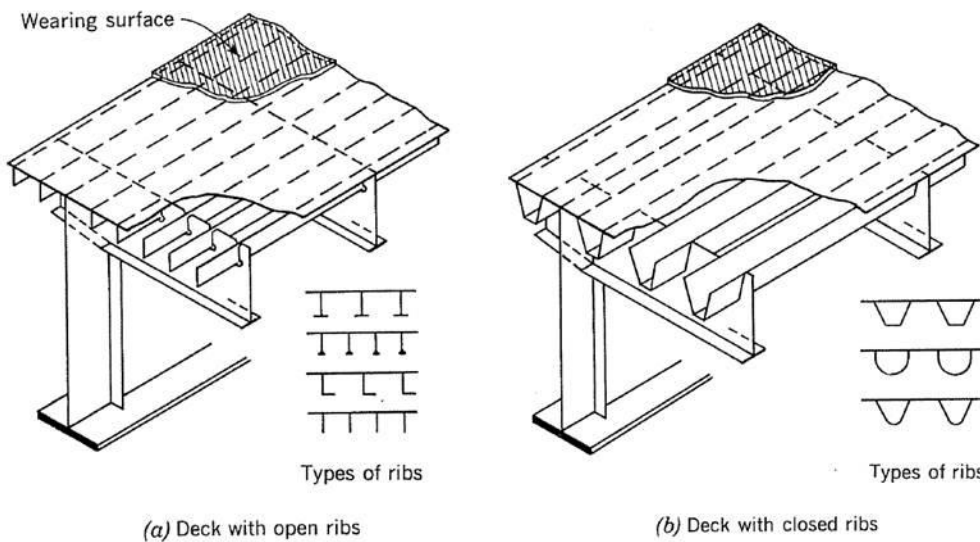

Figure 14 Orthotropic Steel Deck Integral with Plate Girder (taken from AISC (16))

In an orthotropic steel deck system, live loads are transferred through the wearing surface and top steel deck plate, to the longitudinal ribs, and then to the transverse floor beams. The load in the floor beam is then transferred to the main load carrying system, such as a longitudinal plate girder. Per Article 9.8.3.1 of the *AASHTO LRFD (5th Edition, 2010)*, the deck plate is to act as a common flange of the ribs, the floor beams, and the main longitudinal components of the bridge. With proper maintenance, experience has shown that a steel superstructure system that employs the use of an orthotropic steel deck can have a long service life.

The use of orthotropic steel decks has been limited in the United States for a variety of reasons, but mainly due to issues related to the complex design and fabrication associated with them, as

opposed to the use of a conventional reinforced concrete deck slab. Orthotropic steel decks also require a different set of inspection and maintenance techniques. Orthotropic steel decks have had problems related to fatigue cracking and performance of wearing surfaces in the past, which have made bridge owners wary of specifying the use of these decks. Many of these problems are related to limitations of design and analytical methods used in the past, as well as reliance on trial and error with regard to detailing and fabrication.

The construction and fabrication techniques employed are very important to the successful use of orthotropic steel bridge decks. Orthotropic steel decks typically require detailed construction specifications and special quality control procedures during fabrication. Current designs typically are not standardized, and thus repetition does not currently help to improve construction and fabrication techniques.

Orthotropic steel decks can be constructed more rapidly and provide a significantly longer service life than conventional concrete deck slabs. Construction tends to be more rapid, since most of the components are assembled in the fabrication shop. Future deck replacement is typically not required for orthotropic steel decks, but based on past experience, the wearing surface typically requires replacement every 20 to 30 years.

Article 9.8.3 of the *AASHTO LRFD (5th Edition, 2010)* provides guidance on design and detailing for orthotropic steel decks that should currently be followed by bridge designers. However, it should be noted that the Federal Highway Administration (FHWA) funded a project to develop a new manual focused on the design, fabrication, and construction of orthotropic steel deck bridges (17). The *Manual for Design, Construction, and Maintenance of Orthotropic Steel Bridge Decks* (18) covers relevant issues related to orthotropic steel deck bridges, including analysis, design, detailing, fabrication, testing, inspection, evaluation, and repair. Based on extensive recent research efforts, this manual addresses the limited guidance currently provided with regard to fatigue design. This manual also addresses issues related to the quality control of both construction and fabrication, as well as establishes sound detailing concepts based on current experience in order to help develop standardized details.

4.1 Typical Deck Sections and Applications

Orthotropic steel decks are typically classified as either open-rib or closed-rib systems. In either case, the ribs are arranged in the longitudinal direction of the bridge and distribute wheel loads to the intermediate floor beams, while also providing increased flexural stiffness to the primary structural component. The ribs are rarely orientated in the transverse direction, as this orientation can cause problems with the durability of the wearing surface (19). The longitudinal ribs are typically made continuous through openings in the web plates of the floor beams. Closed-ribs are typically used in orthotropic steel decks that are subjected to direct wheel loads.

As shown in Figure 15, open-ribs are usually made from flat bars, bulb shapes, inverted tee-sections, or angles. Open-ribs are not necessarily ideal for use in decks subjected to wheel loads. Open-ribs do not have the torsional stiffness to efficiently distribute transverse loads to adjacent ribs, resulting in more ribs and closer floor beam spacing as compared to a closed-rib system. Open-ribs are more often used to stiffen box girder webs and bottom flanges.

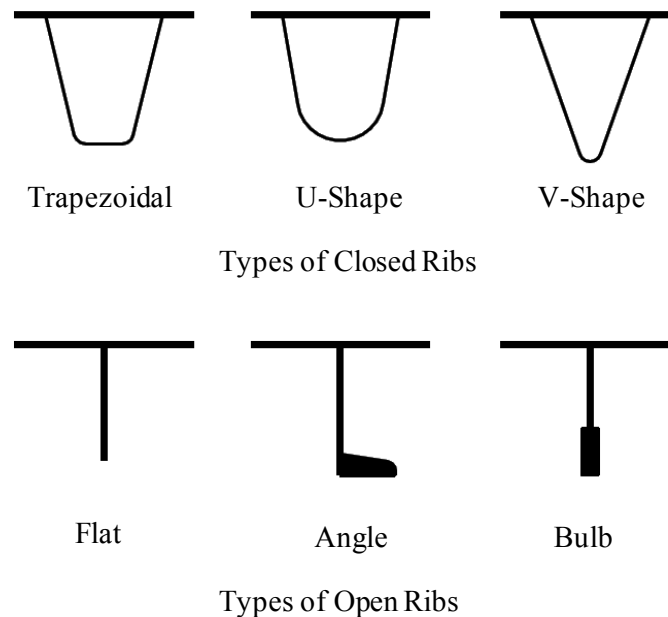

Figure 15 Common Rib Types for Orthotropic Steel Decks

Closed-ribs are typically made from trapezoidal, U-shaped, or V-shaped sections, as shown in Figure 15. Trapezoidal rib sections are the most common specified in orthotropic steel decks. Closed-ribs have a much higher torsional stiffness than open-ribs, and thus closed-ribs better distribute transverse loads to adjacent ribs. The closed-rib system is complicated by the partial penetration weld on the outside of the closed-rib where it attaches to the deck plate, and is a fatigue sensitive detail that requires care to execute with consistent quality. Furthermore, due to the torsional rigidity of the closed-rib, decks using closed ribs are subjected to secondary deformations and stresses that must be addressed in design.

Advantages of orthotropic steel decks are realized in long span bridges because the deck is lightweight (typically 60% of comparable concrete) and can be made composite with the main longitudinal girders. As such, orthotropic bridge cross sections are good candidates for suspended span bridges such as suspension, cable-stayed, and tied arch bridges, minimizing the dead load on the entire bridge system. Cross sections have included plate girders with orthotropic steel decks, as well as multi-cell box girders, single-cell box girders, and combinations of stiffening trusses and floor beams.

Orthotropic steel decks are also effective in movable bridges because of their reduced weight as compared to conventional reinforced concrete deck slabs. The reduced weight of the deck also results in a reduction in the size of the counterweights required. Also, a movable bridge with an orthotropic steel deck requires less power from moving devices, and reduces the internal forces in the trunnions.

I-girder bridges in the short to medium span range can also utilize orthotropic steel decks, because of their internal redundancy and possibly eliminating the potential for complete future deck replacement. Orthotropic construction is often found in box girder sections, as slender plate

components requiring stiffening. Steel box girders utilizing an orthotropic deck result in a lighter superstructure, which allows for modular construction techniques.

4.2 Design and Detailing Considerations

In accordance with Articles 9.8.3.4 and 9.8.3.5, refined methods or approximate methods of analysis are acceptable to determine force effects in orthotropic steel decks. Approximate methods of analysis for both open rib and closed rib decks may be based on the Pelikan-Esslinger method, per Articles C9.8.3.5.2 and 9.8.3.5.3 of the *AASHTO LRFD (5th Edition, 2010)*.

Per Article 9.8.3.6.2, orthotropic steel decks are to be designed for the service, strength, and fatigue limit states. Strength design should consider the design of the deck related to rib flexure and shear, floor beam flexure and shear, and axial compression of the deck. Deflection limits should be satisfied for the Service I limit state, so as to prevent premature deterioration of the wearing surface. The Service II limit state is required for the slip critical design of any bolted connections. Fatigue in orthotropic steel decks requires careful consideration as orthotropic steel decks experience numerous stress cycles.

Fatigue cracking has been observed in orthotropic steel decks, resulting from vintage weld details and desire to minimize weight. Early analytical tools and procedures were limited in their ability to quantify the stress states at these details and the early experimental fatigue database was limited (17). Detailing and fabrication practices also relied on experience gained through trial and error. The design of critical details in orthotropic steel decks is typically controlled by cyclic live load and the fatigue limit state. Many of these details that have experienced cracking are due to fatigue, and can be sensitive to the fabrication process. In particular, cracking has been experienced at rib to deck welds, rib to floor beam welds, and at welded deck splice plates. However, it should be noted that an orthotropic steel deck systems is a highly redundant system, and cracking related to fatigue most often does not have a serious threat to the strength or integrity of the structure as a whole (17). Furthermore, the FHWA manual, previously discussed, provides further guidance regarding the analysis, design and physical testing related to fatigue in orthotropic steel decks.

Detailing requirements are provided in Article 9.8.3.7 of the *AASHTO LRFD (5th Edition, 2010)*. The minimum deck plate thickness shall not be less than 9/16 in. or four percent of the larger spacing of the rib webs. The thickness of closed ribs should not be less than 3/16 in. while also satisfying the cross sectional requirements of Equation 9.8.3.7.2-1. Furthermore, the interiors of closed ribs are to be sealed by welds in order to prevent the ingress of moisture and air into the closed rib. The *AASHTO LRFD (5th Edition, 2010)* permits eighty percent partial penetration welds between the webs of a closed rib and the deck plate. Additional guidance regarding the deck and rib details is provided in Article 9.8.3.7.4.

4.3 Wearing Surfaces

The wearing surface on an orthotropic steel deck plays an important role in improving skid resistance, distributing wheel loads, and protecting the deck against corrosion. The wearing

surface should have sufficient ductility and strength to accommodate expansion, contraction, and deformations without cracking or debonding. The wearing surface should also have sufficient fatigue strength to withstand flexural stresses due to composite action of the wearing surface with the deck plate, resulting from local flexure. Furthermore, the wearing surface should be durable enough to resist rutting and wearing from traffic; impervious to water and vehicular fuels and oils; and resistant to deicing salts and deterioration due to solar radiation.

Problems related to the performance of the wearing surface have been experienced in past applications, and have generally been attributed to inadequate construction control, degradation of the materials, or flexible design of the steel decking. Recent research and design improvements, such as the minimum deck plate thickness currently required by the *AASHTO LRFD (5th Edition, 2010)*, have addressed many of these previous failures. Many current design concepts utilized in modern orthotropic steel deck bridges have shown to be successful.

There are two main categories for surfacing materials that are typically used on orthotropic steel decks. One is a bituminous surfacing system that can consist of mastic asphalts, latex-modified asphalts, or reinforced asphalt systems. Bituminous systems are generally 2.0 inches or greater in thickness. The other surfacing system is a polymer system, which include epoxy resins, methacrylates, or polyurethanes, all usually having a thickness of 0.75 in. or less. In most cases climate dictates the chosen surfacing system as bituminous surfaces are more sensitive to thermal changes. However, when specified and installed correctly, and with regular maintenance, both wearing surfaces have demonstrated service lives in excess of 30 years.

5.0 WOOD DECKS

Article 9.9 of the *AASHTO LRFD (5th Edition, 2010)* addresses design requirements of wood decks and wood deck systems. The use of wood deck systems on steel girders is typically limited to structures in special environments (forests, bike trails, etc.), or structures with severe weight restrictions. The United States Department of Agriculture, Forest Service, has developed Standard Plans for Timber Bridge Superstructures (20) that design engineers can reference for the various types of wood decks that can be used with steel girder bridges.

To determine the load distribution and force effects for structures with wood decks, Article 9.9.3.1 allows the bridge designer to use one of the following methods: Approximate methods specified in Article 4.6.2.1, orthotropic plate theory, or equivalent grillage modeling. The live load flexural moment and shear for beams with transverse wood decks can be determined using the approximate methods provided in Article 4.6.2.2a for interior beams, and Article 4.6.2.2.3b for exterior beams. The distribution factors for interior beams are based on girder spacing and type of wood deck, and the distribution factors for exterior beams are to be determined using the lever rule.

If the girder spacing is less than 36 inches, or 6 times the nominal depth of the deck or the deck system including the girders, the deck should be modeled as an orthotropic plate or equivalent grillage. For wood decks with closely spaced supporting components, the assumption of infinitely rigid supports upon which the approximate methods are based, is not valid. Therefore, two dimensional methods such as orthotropic plate theory or equivalent grillage models are recommended to obtain force effects with reasonable accuracy.

5.1 Types of Wood Decks

5.1.1 Glued Laminated Deck

Glue laminated (Glulam) timber deck panels typically consist of a series of panels, prefabricated with water-resistant adhesives that are tightly abutted along their edges. Glulam deck panels typically span transversely across the full width of the bridges, spanning over the longitudinal steel girders. The joints of adjacent panels are typically sealed with a bituminous sealer that provides a watertight deck surface (21). In accordance with Article 9.9.4.2 of the *AASHTO LRFD (5th Edition, 2010)*, the panels should be attached to steel girders with metal clips that extend over the girder flange and are bolted through the wood deck.

5.1.2 Stress Laminated Deck

Stress laminated timber decks are typically constructed by compressing a series of wood laminations, placed edgewise, and compressing them together with post-tensioning bars, normal to the direction of the laminations. The post-tensioning bars are placed through holes in the laminations that must be predrilled. The diameters of the holes in the laminations for the post-tensioning bars must not be greater than 20 percent of the laminations depth, and the spacing of the holes shall not be less than 15 times the hole diameter nor less than 2.5 times the depth of the

laminations (Article 9.9.5.4). A sketch of a stress laminated deck cross section is shown in Figure 16.

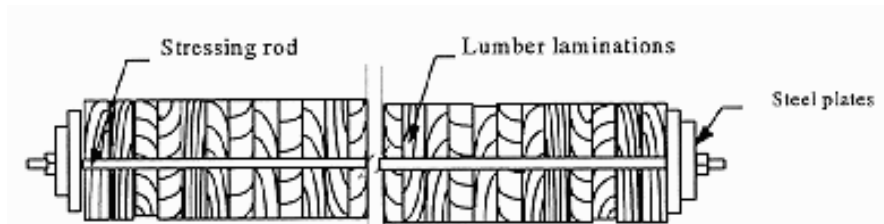

Figure 16 Cross section sketch of stress laminated wood deck (21)

The compression created by the post-tensioning develops friction and load distribution between the laminations so that they act together as a large orthotropic plate (21). Per Article C9.9.5.6.3, the post-tensioning force per bar is based on a uniform compressive stress of 0.1 ksi between the laminations. Article 9.9.5.6.3 provides additional design requirements for stress laminated decks.

Stress laminated decks must be tied down at every girder with bolts or lag-screws to ensure proper contact of the deck with the top flanges of the girders. Stress laminated decks have a tendency to develop curvature perpendicular to the laminates when transversely stressed by post-tensioning. Furthermore, past research work and field experience has shown that it is necessary to re-stress a stress laminated deck system after initial stressing in order to offset long-term relaxation effects.

5.1.3 Spike Laminated Deck

A spike laminated timber deck consists of a series of timber laminations that are placed edgewise spanning transversely over the supports (longitudinal steel girders) and spiked together on their wide face with deformed spikes of sufficient length to fully penetrate four laminations. Per Article 9.9.6.1, the spikes are to be placed in pilot holes that are bored through pairs of laminations at each end at intervals not greater than 12 inches in an alternating pattern near the top and bottom of the laminations. The panels should be attached to steel girders with metal clips that extend over the girder flange and are bolted through the wood deck.

5.1.4 Plank Decks

Wood plank decks consist of a series of timber planks placed flat-wise and transversely across the width of the bridge, and over the supporting steel girders. Per Article 9.9.7.2, the planks are to be bolted to the steel girders or nailed to wood nailing strips that are secured to the top flange of the girder with a minimum of 0.625 inch diameter A307 bolts, spaced no more than 4 feet apart and no more than 1.5 feet from the ends of the nail strip. Wood plank decks are fairly uncommon, and should be limited to roads that carry few or no heavy vehicles, and where the running surface is constantly monitored and appropriately maintained.

5.2 Wearing Surfaces

In accordance with Article 9.9.8 of the *AASHTO LRFD (5th Edition, 2010)*, wearing surfaces on wood decks are to be of a continuous nature, and bituminous wearing surfaces are recommended. The surface of the wood deck should be free of surface oils to encourage adhesion, and there should be no bleeding of the preservative wood treatment. Excessive bleeding of the preservative treatment can seriously reduce adhesion with the wearing surface. The contract plans and specifications should clearly state that the deck material be treated using the empty cell process, followed by an expansion bath or steaming.

Due to the smooth surface of individual lamination and glued laminated decks, it is beneficial to provide a positive connection with the wearing surface, in order to ensure proper performance. A tack coat should be applied to wood decks prior to the application of an asphalt wearing surface, which typically improves the adhesion of the asphalt wearing surface to the deck. In lieu of a tack coat, a geotextile fabric may be used, depending on manufacturer recommendations. In any case, the asphalt surface should have a minimum compacted thickness of 2.0 inches.

In practice, cracking of the wearing surfaces on glue laminated wood decks has been observed. The cracks in the wearing surface often develop at joints between panels, and are typically caused by insufficient load distribution between panels. Designers may be able to reduce the potential for cracking by means of a steel channel bolted to the underside of the wood deck panels.

6.0 OTHER DECK SYSTEMS

6.1 Fiber Reinforced Polymer (FRP) Bridge Decks

Fiber reinforced polymer (FRP) composite bridge decks are pre-engineered and prefabricated in a manufacturer's shop, and then assembled and installed at the bridge site. A wearing surface or overlay is typically installed after all the FRP deck panels are installed. FRP deck panels are engineered materials with their strength dependent on several factors, including fiber type, percent of fiber volume, fiber orientation, resin type, manufacturing methods, and bonding materials used in the final assembly. FRP bridge decks are typically fabricated with vinyl ester or polyester resin reinforced with E-glass fiber (22).

FRP deck panels weight much less than a comparable reinforced concrete bridge deck. A typical FRP deck with a wearing surface or overlay may weigh between 25 to 70 pounds per square foot of deck, as compared to a conventional 9.5 inch thick reinforced concrete deck that weighs 120 pounds per square foot of deck. Figure 17 shows the installation of an FRP deck panel using a forklift type vehicle. FRP deck panels are also more resistant to deicing salts and other materials that can result in degradation of a conventional reinforced concrete deck. FRP deck panels can be installed faster than a conventional reinforced deck, making FRP deck panels advantageous in rehabilitation projects where bridge closure time is of concern.



Figure 17 Photo showing the installation of an FRP deck panel for deck replacement project in New York State (courtesy NYSDOT and FHWA)

However, FRP deck panels have a higher initial cost as compared to conventional reinforced concrete decks. The design of FRP decks is also proprietary and there are currently no standard manufacturing processes. FRP decks are also subject to degradation resulting from the overexposure to ultraviolet radiation, and there is reluctance to use FRP bridge decks due to the lack of long term performance data. Since FRP decks are prefabricated, they have little tolerance for existing conditions when used in bridge rehabilitation projects, and can not be adjusted as easily for existing conditions as a conventional reinforced concrete deck.

Currently, there are several active research projects that may further the use of FRP bridge decks. The Federal Highway Administration (FHWA) has contracted studies that may evolve into AASHTO guidelines for the design and construction of FRP bridge decks, as well as material standards (22).

Per an advisory published by the FHWA (22), a designer may specify an FRP deck system if it appears on the purchasing agency's (bridge owner) approved list of materials or meets nationally accepted testing standards. Design calculations certified by a professional engineer, an installation procedure and working drawings are required to be submitted by the FRP deck supplier for review by bridge owner. Wearing surface materials are also to be selected from an approved list if not listed specifically as part of the preapproved deck system. Suppliers are responsible for the certification of the finished product as well as quality control during the manufacturing process. Though not mandatory, the designer may want to consider specifying that FRP deck is load tested prior to placing the bridge in service. This will serve to verify theoretical finite element models of FRP bridge decks and design computations.

For more information regarding the advantages and disadvantages of FRP decks, construction methods, considerations for the use of FRP decks, and general design criteria, the reader should refer to the FHWA advisory titled *Current Practices in FRP Composite Technology FRP Bridge Decks and Superstructures* (22).

6.2 Aluminum Decks

Aluminum deck panels are briefly discussed in Article 9.8.4 of the *AASHTO LRFD (5th Edition, 2010)*, as orthotropic aluminum deck panels. These deck panels consist of a deck plate stiffened and supported by rib extrusions, where the ribs are either parallel or perpendicular to the direction of traffic. An example of a rib extrusion is shown in Figure 18. The aluminum deck panel can be fabricated by shop welding individual extrusion together at the top and bottom flanges of the extrusions, as shown in Figure 19. A thin epoxy-type wearing surface is typically installed over the deck panel, but is not to be considered part of the structural deck system. The chosen wearing surface must be capable of providing sufficient skid resistance. The reader can refer to analytical and experimental investigations of aluminum deck panels that have been reported on in the literature, see references (23) and (24).

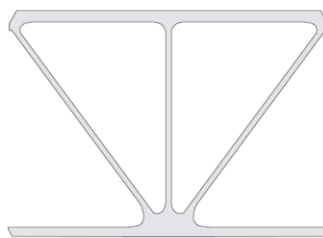

Figure 18 Typical aluminum rib extrusion cross section for use in an aluminum bridge deck panel (23)

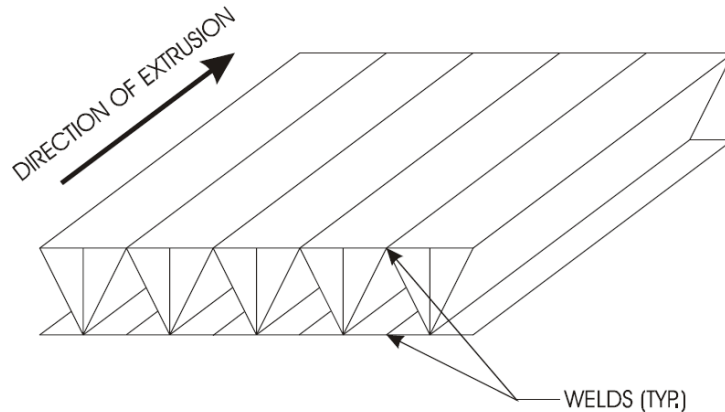

Figure 19 Example of an aluminum deck panel created by welding rib extrusions together at the top and bottom flanges of the extrusion (24)

Aluminum deck panels are to be designed to meet the requirements of Section 7 of the *AASHTO LRFD (5th Edition, 2010)* which pertains to aluminum structures. All applicable limits states should be considered in the design of the aluminum deck panels. Particular attention should be given to the fatigue limit state, and details should satisfy the provisions of Article 7.6, as well as the connection requirements associated with dissimilar materials if applicable. Furthermore, the longitudinal ribs, including the effective width of deck plate should be investigated for stability as individual beam columns assumes as simply support at transverse beams.

Similar to FRP deck panels, aluminum deck panels offer a lightweight alternative to conventional reinforced concrete bridge decks, making them ideal candidates for consideration in deck replacement projects where the live load carrying capacity may be an issue. However, much like FRP deck panels, the use of aluminum deck panels is limited due to high initial costs and unfamiliarity with the deck system.

6.3 Sandwich Deck Panels

Sandwich deck panels are a relatively new bridge deck system that could be used for new bridge construction and bridge rehabilitation projects. A sandwich deck panel typically consists of upper and lower steel plates bonded to a core material that can consist of small I-shapes, pressed corrugated plates, or another type of material. A special case is shown in Figure 20, where a sandwich deck panel consists of steel plates bonded to a rigid polyurethane core.

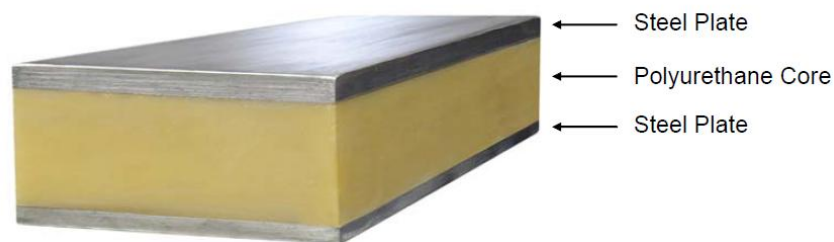

Figure 20 Example of sandwich deck panel (25)

The sandwich deck panel is analogous to an I-beam subjected to flexure, where the steel plates act as the flanges, and the core acts as the web (25). The entire deck is typically constructed from a series of deck panels, spanning transversely across the width of the bridge. A sandwich deck panel is similar to a conventional orthotropic plate deck, but without the required intermediate stiffeners, as the core serves the same purpose as intermediate stiffeners by providing sufficient support to the steel plates. If the core is continuous, the local buckling effect resulting from discretely spaced stiffeners is eliminated (25). The lack of intermediate stiffeners eliminates fatigue sensitive details that are inherent in orthotropic steel decks. Currently, the use of sandwich deck panel systems is very limited, with few known applications in North America. As such, there are no standards or guidelines available for the design of bridges using these deck systems.

7.0 SUMMARY

This module on bridge decks has provided practical information regarding the decking options and design considerations for steel bridges, presenting deck types such as concrete deck slabs, metal grid decks, orthotropic steel decks, wood decks, and several others. The choice of the particular deck type to use can depend on several factors, which may include the specific application, initial cost, life cycle cost, durability, weight, or owner requirements. While most bridge decks are constructed from concrete, there are other viable options available that should be considered by bridge designers and bridge owners. Decking options other than concrete are often lighter and may be less time consuming to install. These other options may be advantageous and competitive for use in deck replacement and bridge rehabilitation projects, where construction time and/or load rating capacity are a concern.

8.0 REFERENCES

1. AASHTO, (2010). AASHTO LRFD Bridge Design Specifications, 5th Edition, American Association of State Highway and Transportation Officials, Washington, DC.
2. Hartle, R., Wilson, K., Amrhein, W., Zang, S., Bouscher, J., and Volle, L, (2003). "LRFD Design Example for Steel Girder Bridge Superstructure Bridge with Commentary," Report No. FHWA-NHI-04-041, www.fhwa.dot.gov/bridge/lrfd/examples.htm.
3. Wassef, W., Smith, C., Clancy, C., and Smith, M., (2003). "Comprehensive Design Example for Prestressed Concrete (PSC) Girder Superstructure Bridge with Commentary," Report No. FHWA-NHI-04-043, www.fhwa.dot.gov/bridge/lrfd/examples.htm.
4. Tadros, M.K. and Baishya, M.C., (1998). "Rapid Replacement of Bridge Decks," National Cooperative Highway Research Program, NCHRP Report 407, Washington D.C.
5. Badie, S. S. and Tadros, M.K., (2008). "Full-Depth Precast Concrete Bridge Deck Panel Systems," National Cooperative Highway Research Program, NCHRP Report 584, Washington D.C.
6. Issa, M.A., Idriss, A., Kaspar, I.I., and Khayyat, S.Y., (1995). "Full Depth Precast and Precast, Prestressed Concrete bridge Deck Panels," PCI Journal, V. 40, No. 1, pp. 59-80.
7. Hieber, D., Wacker, J., Eberhard, M., and Stanton, J., (2005). "State-of-the-Art Report on Precast Concrete Systems for Rapid Construction of Bridges – Final technical Report," Washington State Transportation Center, University of Washington, Seattle Washington.
8. Coletti, D., Chavel, B., and Gatti, W. (2009). "The Problems of Skew," Proceedings, World Steel Bridge Symposium, National Steel Bridge Alliance, San Antonio, Texas.
9. American Concrete Institute (ACI), (2006). *ACI 440.1 R-06: Guide for the Design and Constriction of Structural Concrete with Reinforced FRP Bars*, ACI Committee 440.
10. Benmokrane, B., El-Salakawy, E., El-Ragaby, A., and Lackey, T., (2006). "Designing and Testing of Concrete Bridge Decks Reinforced with Glass FRP Bars," *Journal of Bridge Engineering*, ASCE, Vol. 11, No. 2. pp. 217-229.
11. Bridge Grid Flooring Manufacturers Association (BGFMA), www.bgfma.org.
12. Higgins, C. (2003), "LRFD Orthotropic Plate Model for Determining Live Load Moments in Concrete Filled Bridge Decks," *Journal of Bridge Engineering*, ASCE, Vol. 8, No. 1, pp. 20-28.
13. Higgins, C. (2003), "Orthotropic Plate Model for Estimating Deflections Filled Bridge Decks," *Journal of Bridge Engineering*, ASCE, Vol. 9, No. 6, pp. 599-605.

14. Higgins, C. and Turan, O. T., (2009), "Calibration of AASHTO-LRFD Section 4.6.2.1.8 with Historical Performance of Filled, Partially Filled, Unfilled and Composite Grid Decks – Final Report," School of Civil and Construction Engineering, Oregon State University, Corvallis, Oregon.
15. Troitsky, M.S. (1987), *Orthotropic Bridges Theory and Design*. 2nd Ed. The James F. Lincoln Arc Welding Foundation. Cleveland, OH.
16. AISC (1963), *Design Manual for Orthotropic Steel Plate Deck Bridges*, American Institute of Steel Construction. Chicago, IL.
17. Kozy, B., Connor, R., Paterson, D., Mertz, D. (TBD), "Proposed Revisions to the AASHTO LRFD Bridge Design Specifications for Orthotropic Steel Deck Bridges," *Journal of Bridge Engineering*, ASCE, (posted ahead of print Dec. 30, 2010, available at www.asce.org).
18. Connor, R., Fisher, J. Gatti, W., Gopalaratnam, V., Kozy, B., Leshko, B., McQuaid, D., Medlock, R., Mertz, D., Murphy, T., Paterson, D., Sorenson, O., Yadlosky, J. (2012), *Manual for Design, Construction, Inspection, and Maintenance of Orthotropic Steel Deck Bridges*, Report No. FHWA-IF-12-027.
19. Sadleck, G., (1992). "Orthotropic Plate Deck Bridges," *Construction Steel Design – An International Guide*, Chapter 2.10, edited by Dowling, P., Harding, J. and Bjorhovde, R., Elsevier Science Publishers LTD, Essex, England.
20. United States Department of Agriculture, Forest Service, (2001). "Standard Plans for Timber Bridge Superstructures," Gen. Tech Rep FPL-GTR-125, USDA, Forest Service, Forest Product Laboratory.
21. Duwadi, S. and Ritter, M., (1997). "Timber Bridges in the United States," *Public Roads*, Vol. 60, No. 3, www.fhwa.dot.gov/publications/publicroads/97winter/p97wi32.cfm.
22. Federal Highway Administration (FHWA), (2011). "Current Practices in FRP Composites Technology FRP Bridge Decks and Superstructures," available at <http://www.fhwa.dot.gov/bridge/frp/deckprac.cfm>.
23. Dobmeier, J., Barton, F., Gomez, J., Massarelli, P., and McKeel, W., (1999). "Analytical and Experimental Evaluation of an Aluminum Bridge Deck Panel," Report No. VTRC 00-R5, Virginia Transportation Research Council.
24. Misch, P., Barton, F., Gomez, J., Massarelli, P., and McKeel, W., (1999). "Experimental and Analytical Evaluation of an Aluminum Deck Bridge," Report No. VTRC 00-R10, Virginia Transportation Research Council.
25. Cousins, T., Murray, T., and Harris, D., (2009), "Use of a Sandwich Plate System in a Virginia Bridge," FHWA/VTRC 09-CR12, Virginia Transportation Research Council.