

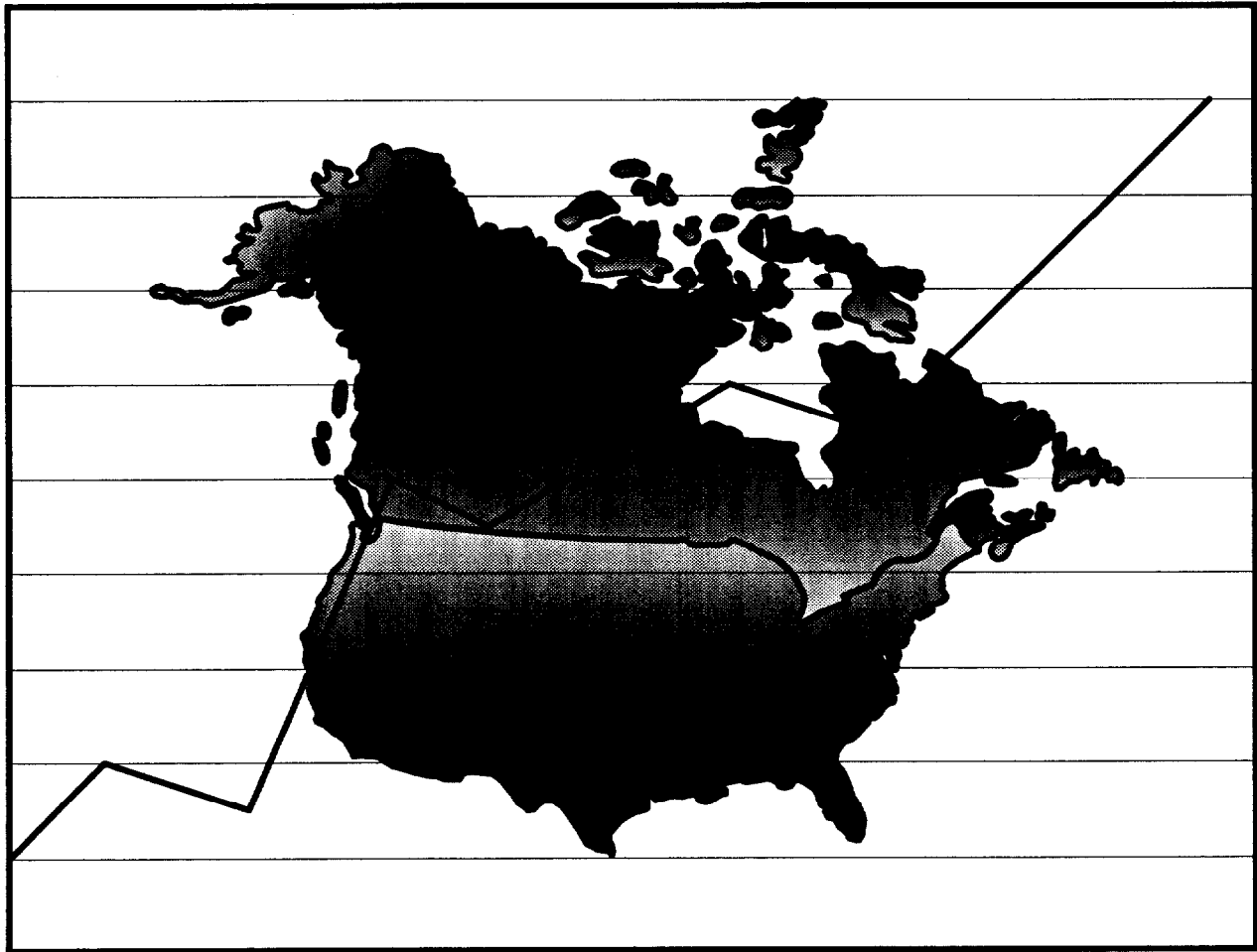

U.S. Department
of Transportation
**Maritime
Administration**

U.S. Exports & Imports Transshipped via Canadian Ports - 1993



Office of Statistical and Economic Analysis

530
814

U.S. Exports & Imports Transshipped via Canadian Ports - 1993

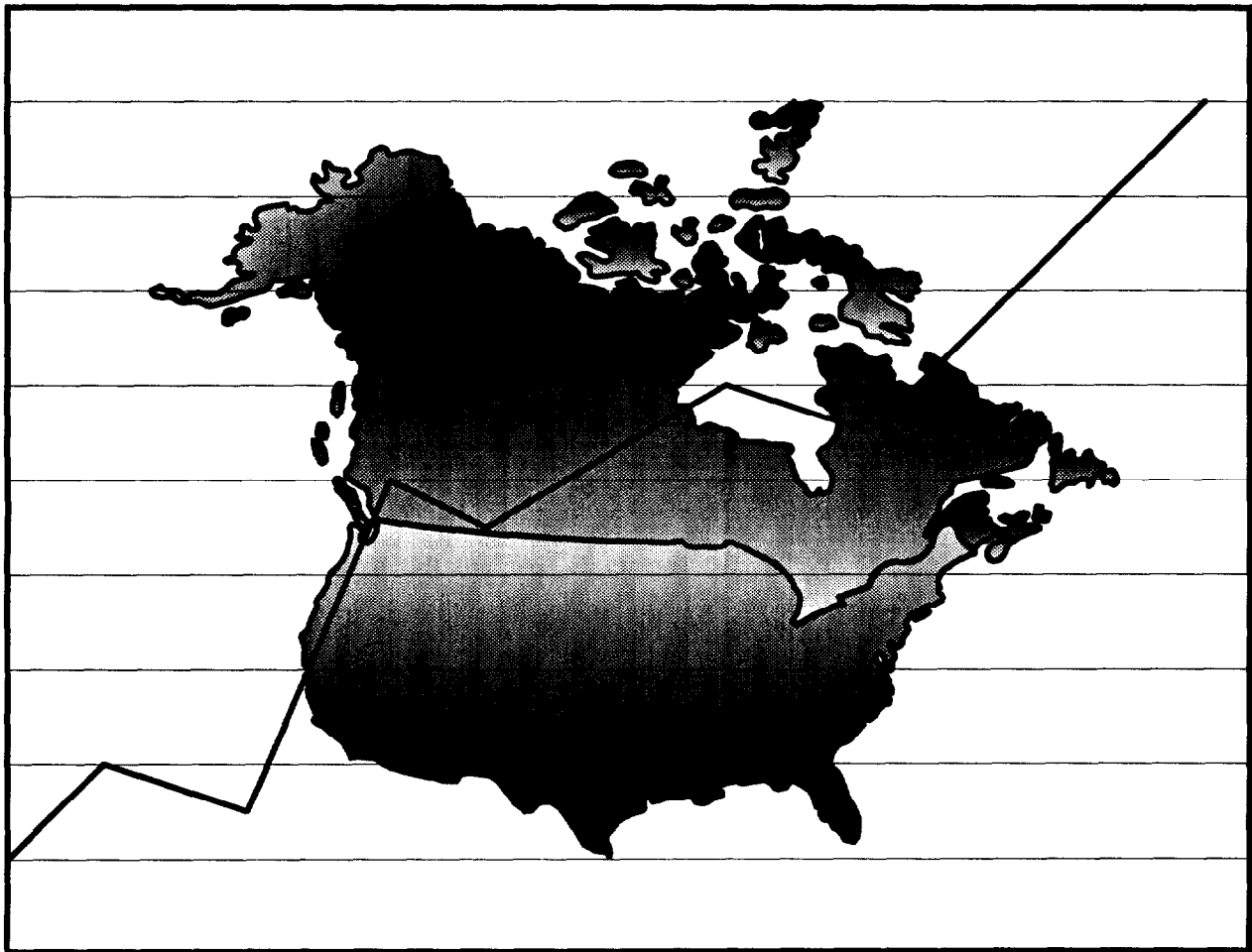

Office of Statistical and Economic Analysis

ACKNOWLEDGMENT

This report has been prepared by the Port Department of the Port Authority of New York and New Jersey (PANYNJ) under the direction of Avis Pauga. This report is the result of a joint project with the PANYNJ and the Department of Transportation's Maritime Administration (MARAD) with the funding support of the Bureau of Transportation Statistics.

In addition to this printed report, the data is available in computerized dBase format in 4-digit or 6-digit Harmonized Commodity Code detail. Requests for this data should be addressed to Robert G. Christensen, Data Coordination and Evaluation Group, Office of Statistical and Economic Analysis, MAR-450, Room 8107, Maritime Administration, 400 Seventh Street SW, Washington, DC 20590.

INTRODUCTION

This report summarizes U.S. cargo which moved via Canada in 1993. Summaries are provided showing transshipped cargo through Canada in historical perspective, by customs district, by country, and by leading Harmonized 4-digit commodity code. Appendixes E-1 and I-1 are summaries of trade by country within customs district. Appendixes E-2 and I-2 contain computer printouts of leading 4-digit Harmonized commodity movements by U.S. customs district. Please note that the data is now in metric tons, as opposed to long tons utilized in previous reports. A brief description of the methodology used in deriving the transshipped cargo is provided in a section following the summary tables and charts. In addition to the report, this data is available in computerized dBase format in digit or 6-digit Harmonized Code detail upon request from the Maritime Administration.

SUMMARY

In 1993 the total U.S. trade transshipped through Canada was \$13.98 billion and 4,303,697 estimated metric tons. Exports amounted to \$5.83 billion and 2,091,355 estimated metric tons. Imports were \$8.15 billion and 2,212,342 estimated metric tons.

Exports were up 6.8% on a value basis and 12.8% on a weight basis compared to 1992. Imports were up 16.9% on a value basis and 21.5% on a weight basis.

In 1993 the value of total U.S. cargo transshipped via Canada was 4.1% of U.S. liner cargo. On a weight basis, the transshipped cargo amounted to 3.9% of the total.

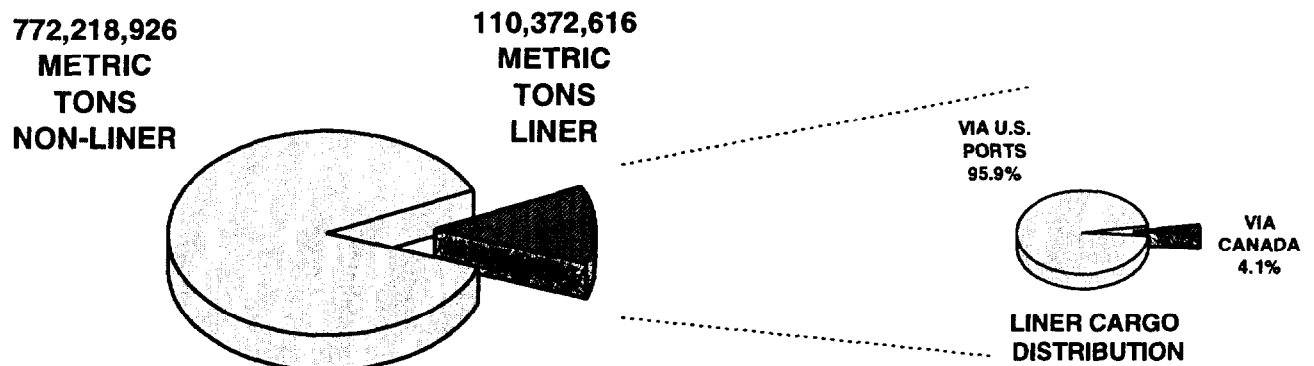

**TOTAL U.S. OCEANBORNE TRADE FOR 1993
IN METRIC TONS**

HISTORICAL SUMMARY OF U.S. IN-TRANSIT TRADE VIA CANADA- EXPORTS

Table 1E displays a summary of the value and estimated metric tons of U.S. cargo transhipped via Canada to foreign destinations during the period 1976 through 1993. For 1993 the export value was \$5.83 billion, up 6.8% from 1992, while the weight was estimated at 2,091,335 metric tons, up 12.8%.

**TABLE 1 - E
HISTORICAL COMPARISON OF U.S. EXPORTS VIA CANADA
1976 - 1993 IN DOLLAR VALUE AND METRIC TONS**

YEAR	\$1,000's	% CHNG PRIOR YEAR	ESTIMATED METRIC TONS	% CHNG PRIOR YEAR
1976	496,715		597,429	
1977	987,255	98.8	856,517	43.4
1978	978,845	-0.9	881,398	2.9
1979	1,311,553	34.0	900,684	2.2
1980	2,099,115	60.0	1,198,228	33.0
1981	2,428,199	15.7	1,081,140	-9.8
1982	1,976,532	-18.6	1,214,385	12.3
1983	2,072,998	4.9	1,133,483	-6.7
1984	2,989,409	44.2	1,382,974	22.0
1985	2,723,706	-8.9	1,315,838	-4.9
1986	3,207,921	17.8	1,758,108	33.6
1987	3,928,869	22.5	1,821,101	3.6
1988	5,119,955	30.3	2,346,414	28.8
1989	4,890,666	-4.5	2,763,261	17.8
1990	5,696,968	16.5	2,284,088	-17.3
1991	5,952,746	4.5	2,274,254	-0.4
1992	5,458,471	-8.3	1,853,273	-18.5
1993	5,828,323	6.8	2,091,355	12.8

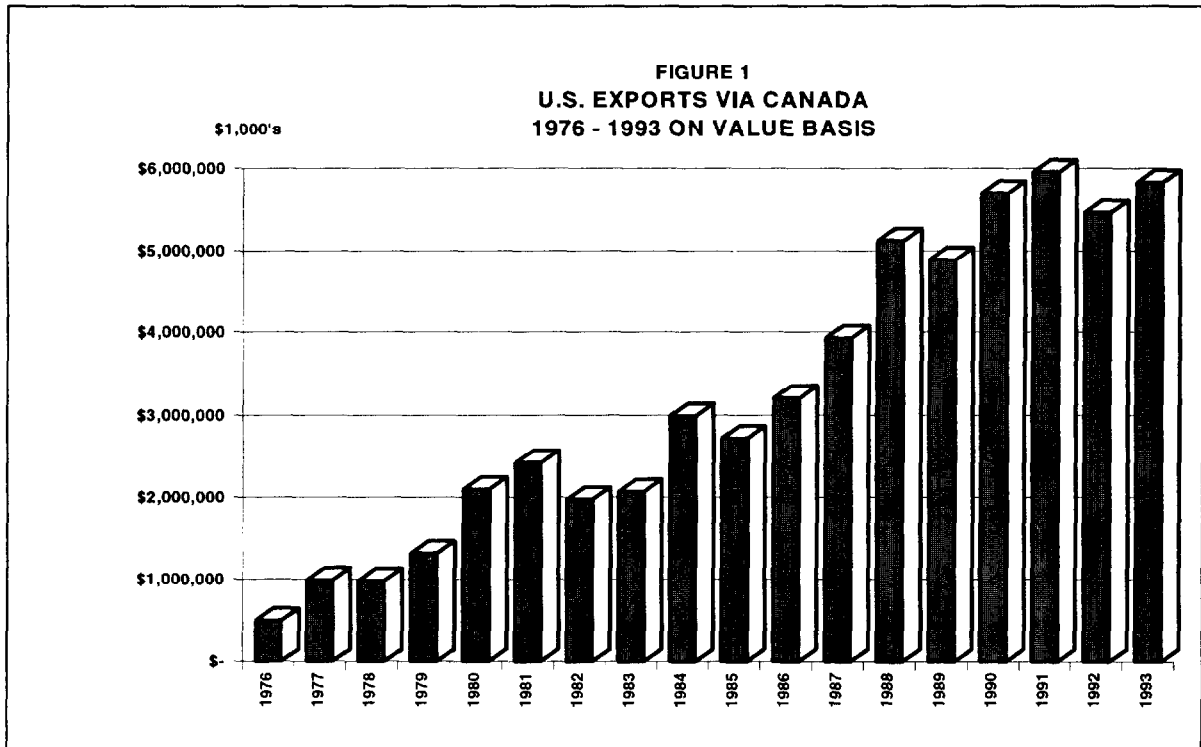

HISTORICAL SUMMARY OF U.S. IN-TRANSIT TRADE VIA CANADA- IMPORTS

Table 1-I displays a summary of the value and estimated metric tons of U.S. cargo transshipped via Canada from foreign origins during the period 1976 through 1993. For 1993 the import value was \$8.15 billion, up 16.9% from 1992, while the weight was estimated to be 2,212,342 metric tons, up 21.5%.

**TABLE 1 - I
HISTORICAL COMPARISON OF U.S. IMPORTS VIA CANADA
1976 - 1993 IN DOLLAR VALUE AND METRIC TONS**

YEAR	\$1,000's	% CHNG PRIOR YEAR	ESTIMATED METRIC TONS	% CHNG PRIOR YEAR
1976	757,885		828,844	
1977	1,083,698	43.0	1,039,151	25.4
1978	1,696,173	56.5	1,159,256	11.6
1979	2,088,288	23.1	1,245,456	7.4
1980	2,180,200	4.4	997,615	-19.9
1981	2,598,231	19.2	1,294,002	29.7
1982	2,279,984	-12.2	1,075,701	-16.9
1983	3,004,681	31.8	1,245,717	15.8
1984	3,922,893	30.6	1,766,267	41.8
1985	3,699,505	-5.7	1,761,856	-0.2
1986	3,924,967	6.1	1,624,238	-7.8
1987	5,343,304	36.1	2,224,876	37.0
1988	6,298,867	17.9	2,493,763	12.1
1989	6,212,419	-1.4	2,466,700	-1.1
1990	6,159,186	-0.9	1,770,948	-28.2
1991	6,301,064	2.3	1,667,216	-5.9
1992	6,976,513	10.7	1,820,728	9.2
1993	8,153,114	16.9	2,212,342	21.5

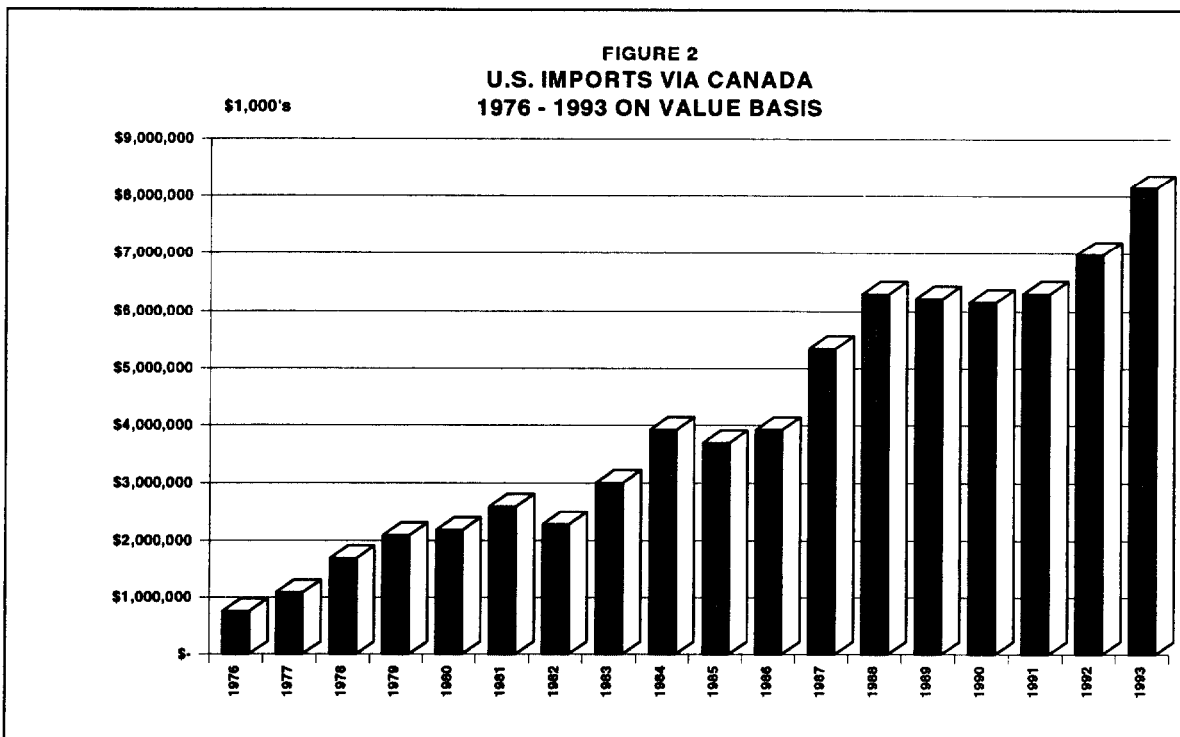

TRANSSHIPMENTS BY CUSTOMS DISTRICT - EXPORTS IN DOLLAR VALUE

Table 2-E displays transshipments in dollar value by customs district. The value of exports transshipped via Canada rose by 6.8% to \$5.83 billion. The customs district of Ogdensburg, N.Y. more than doubled its dollar volume, compared to 1992, increasing by 106.4%. St. Albans, Vt. also exhibited significant growth, up 26.6%

Figure 3 displays the distribution of export value by customs district. Detroit remained by far the largest customs district for transshipment of exports. It had 69% of the total value, even though its volume grew a modest 2.2%. The next largest customs district was Seattle (15%), followed by St. Albans, Vt. (6%), and Ogdensburg, N.Y.(6%).

**TABLE 2 - E
U.S. EXPORTS IN-TRANSIT VIA CANADA
TOP U.S. CUSTOMS DISTRICTS BASED ON 1993 VALUE**

CD# CUSTOMS DISTRICT	\$1000's		% CHNG
	1992	1993	
38 DETROIT, MICH.	3,912,676	3,998,292	2.2
30 SEATTLE, WASH.	842,208	855,892	1.6
2 ST. ALBANS, VT.	295,483	373,945	26.6
7 OGDENSBURG, N.Y.	176,000	363,178	106.4
9 BUFFALO-NIAGRA FALLS	153,912	171,820	11.6
1 PORTLAND, ME.	58,166	53,195	-8.5
36 DULUTH, MINN.	37	6,080	N.A.
34 PEMBINA, N. DAK.	15,560	4,198	-73.0
33 GREAT FALLS, MONT.	1,275	838	-34.3
41 CLEVELAND, OHIO	2,247	682	-69.6
35 MINNEAPOLIS/ST. PAUL	907	203	-77.6
TOTAL	5,458,471	5,828,323	6.8

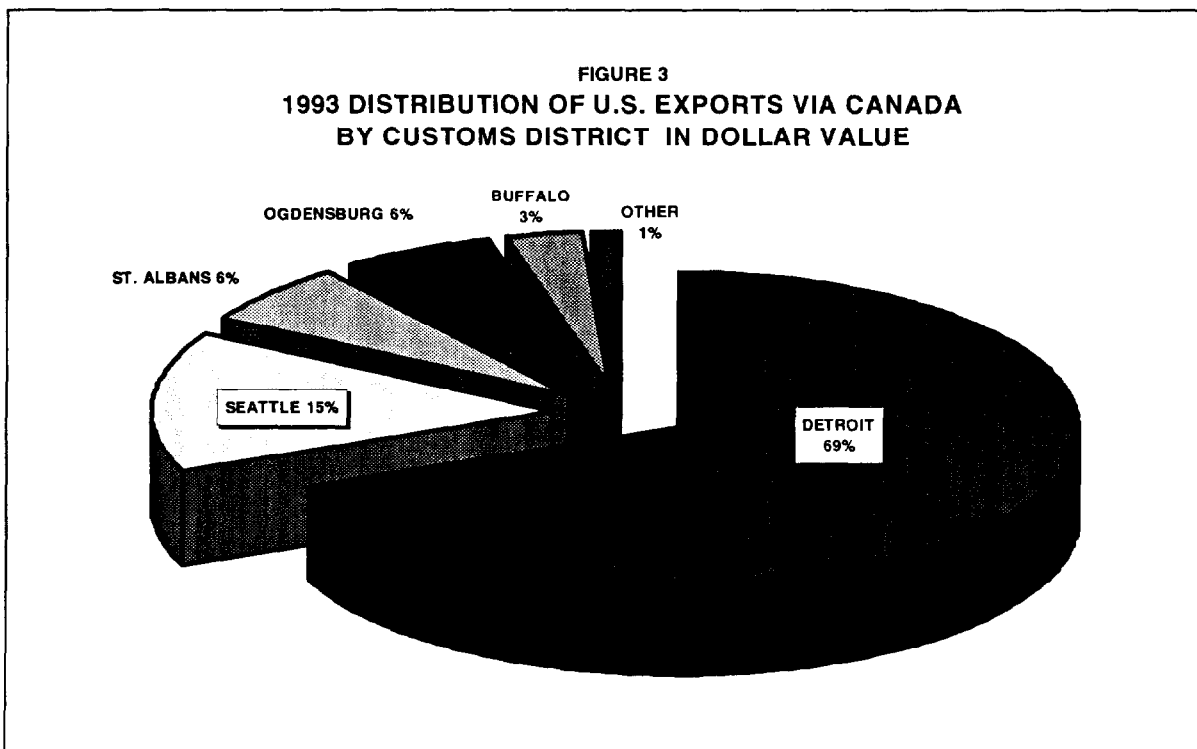

TRANSSHIPMENTS BY CUSTOMS DISTRICT - EXPORTS IN METRIC TONS

Table 3-E displays transshipments in metric tons by customs district compared to 1992. The volume of transshipments via Canada rose by 12.8% to 2,091,356 metric tons. The largest percentage increases, compared to 1992, were for Ogdensburg, N.Y. (up 95.3%), St. Albans, N.Y. (up 30.0%), and Seattle, Wa. (up 12.0%).

Figure 4 shows the distribution of exports by customs district. Detroit has by far the largest share, with 73% of the total. Its volume grew by 10.2%, less than the average. Other districts with significant volume are Seattle, Wa. (9%), Ogdensburg, N.Y. (8%), and St. Albans, Vt. (5%).

**TABLE 3 - E
U.S. EXPORTS TRANSSHIPPED VIA CANADA
TOP U.S. CUSTOMS DISTRICTS BASED ON 1993 METRIC TONS**

CD# CUSTOMS DISTRICT	METRIC TONS		% CHNG
	1992	1993	
38 DETROIT, MICH.	1,389,907	1,531,448	10.2
30 SEATTLE, WASH.	173,758	194,625	12.0
7 OGDENSBURG, N.Y.	83,492	163,065	95.3
2 ST. ALBANS, N.Y.	74,768	97,201	30.0
9 BUFFALO-NIAGARA FALLS	65,083	56,287	-13.5
1 PORTLAND, ME.	53,425	41,024	-23.2
33 GREAT FALLS, MONT.	2,451	2,991	22.0
34 PEMBINA, N. DAK.	9,386	2,492	-73.5
36 DULUTH, MINN.	12	1,524	N.A.
35 MINNEAPOLIS/ST. PAUL	412	513	24.7
41 CLEVELAND, OHIO	579	186	-67.9
TOTAL	1,853,273	2,091,356	12.8

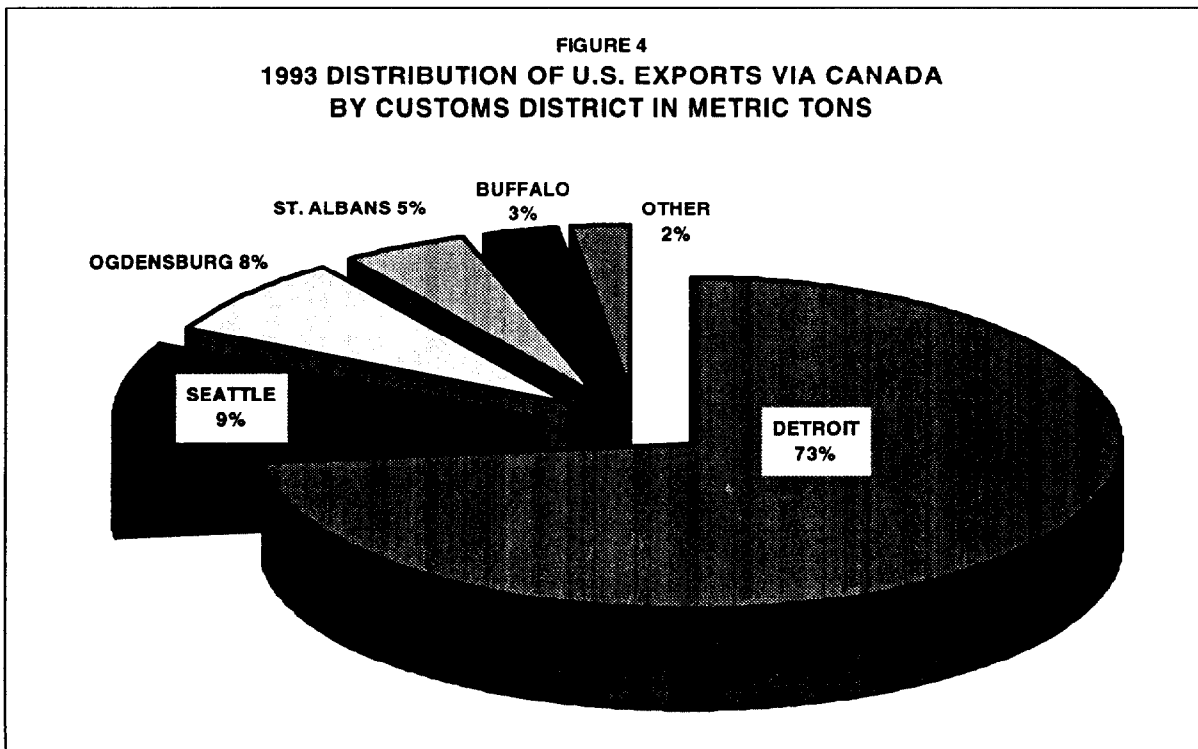

TRANSSHIPMENTS BY CUSTOMS DISTRICT - IMPORTS IN DOLLAR VALUE

Table 2-1 displays import transshipments in dollar value by customs district. The value of imports transhipped via Canada jumped by 16.9% to \$8.15 billion in 1993, compared to 1992. Of the districts with meaningful volume, significant growth occurred in Chicago (up 24.1%), St. Albans, Vt. (up 27.1%), and Detroit (up 17.2%). Declines occurred for New York and Boston.

Figure 5 shows the distribution of imports by customs district. Together, Chicago and Detroit account for 45% of all transhipped imports. They are followed by Ogdensburg, N.Y. (10%), St. Albans, Vt. (6%), and Cleveland, Ohio (6%).

**TABLE 2-1
U.S. IMPORTS IN-TRANSIT VIA CANADA
TOP U.S. CUSTOMS DISTRICTS BASED ON VALUE**

CD# CUSTOMS DISTRICT	\$1,000's 1992	\$1,000's 1993	% CHNG
39 CHICAGO, ILL.	1,615,702	2,005,675	24.1
38 DETROIT, MICH.	1,437,041	1,684,615	17.2
9 BUFFALO-NIAGRA FALLS	874,921	977,677	11.7
7 OGDENSBURG, N.Y.	684,716	789,025	15.2
2 ST. ALBANS, VT.	405,543	515,544	27.1
41 CLEVELAND, OHIO	421,875	474,218	12.4
37 MILWAUKEE, WIS.	315,218	349,671	10.9
35 MINNEAPOLIS/ST. PAUL	202,895	292,473	44.1
30 SEATTLE, WASH.	179,098	221,575	23.7
10 NEW YORK N.Y.	274,853	197,471	-28.2
45 ST. LOUIS, MO.	147,545	175,360	18.9
34 PEMBINA, N. DAK.	109,463	125,189	14.4
4 BOSTON, MASS.	111,459	95,628	-14.2
ALL OTHER	196,184	248,993	26.9
TOTAL	6,976,513	8,153,114	16.9

**FIGURE 5
DISTRIBUTION OF U.S. IMPORTS VIA CANADA
FOR 1993 BY VALUE**

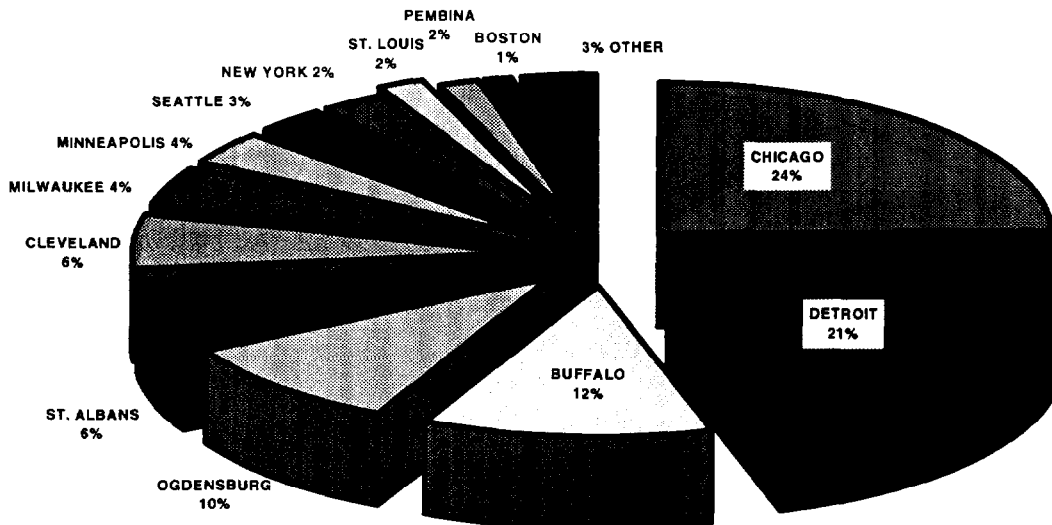

TRANSSHIPMENTS BY CUSTOMS DISTRICT - IMPORTS IN METRIC TONS

Table 3-I displays import transshipments in metric tons by customs district. The volume of imports transshipped via Canada jumped by 21.5% to 2,212,344 metric tons in 1993, compared to 1992. Of the districts with significant tonnage, Buffalo-Niagara Falls grew by 37.7%, Ogdensburg, N.Y. by 30.2%, Chicago by 26.9%, and Detroit by 23.3%.

Table 6 shows the distribution of import volume by customs district. Together, Detroit and Chicago account for 47% of imports. They are followed by Buffalo (10%), Ogdensburg, N.Y. (9%), and Cleveland, Ohio (7%).

**TABLE 3-I
U.S. IMPORTS TRANSSHIPPED VIA CANADA
TOP U.S. CUSTOMS DISTRICTS BASED ON METRIC TONS**

CD# CUSTOMS DISTRICT	METRIC TONS		%CHNG
	1992	1993	
39 CHICAGO, ILL.	469,756	596,213	26.9
38 DETROIT, MICH.	367,233	452,971	23.3
9 BUFFALO-NIAGARA FALLS	160,351	220,835	37.7
7 OGDENSBURG, N.Y.	149,376	194,506	30.2
41 CLEVELAND, OHIO	138,898	145,303	4.6
37 MILWAUKEE, WIS.	90,165	120,351	33.5
2 ST. ALBANS, VT.	84,889	119,245	40.5
35 MINNEAP/ST. PAUL	44,860	80,880	80.3
30 SEATTLE, WASH.	150,112	77,740	-48.2
1 PORTLAND, ME.	38,204	52,537	37.5
45 ST. LOUIS, MO.	38,022	47,550	25.1
10 NEW YORK N.Y.	31,802	38,148	20.0
4 BOSTON, MASS.	21,885	19,270	-11.9
OTHER	35,175	46,793	33.0
TOTAL	1,820,728	2,212,344	21.5

**FIGURE 6
U.S. IMPORTS IN-TRANSIT VIA CANADA
BY CUSTOMS DISTRICT IN METRIC TONS**

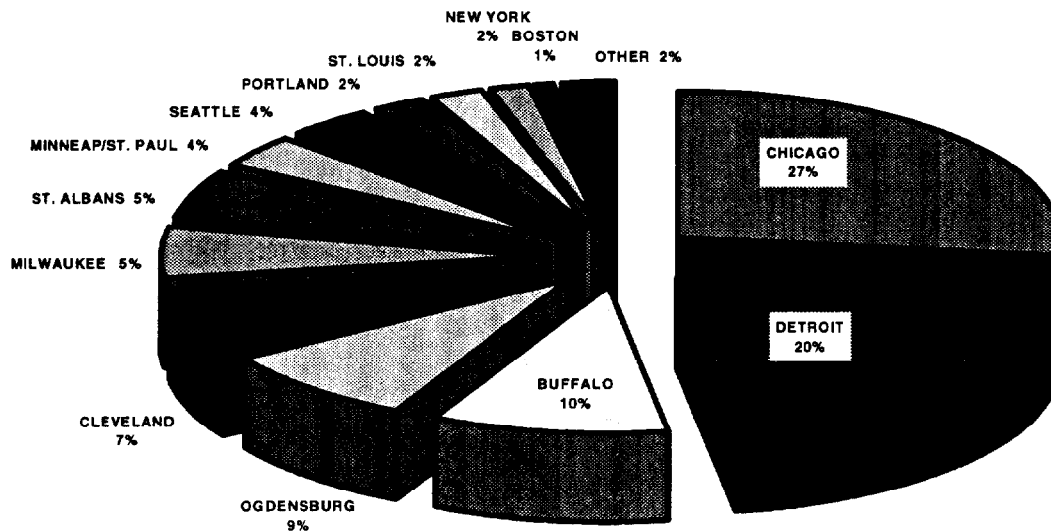

TRANSSHIPMENTS BY DESTINATION COUNTRY - EXPORTS IN DOLLAR VALUE

Table 4-E displays 1993 transshipments in dollar value by country of destination compared to 1992. Figure 7 illustrates the growth in graphic form. The top five countries of destination represented 70.2% of the total value of exports. Of these, the largest growth in value was for exports to Belgium/Luxembourg and the United Kingdom. The largest percentage growth in value occurred to the Far East countries of Taiwan and Hong Kong, as well as to Russia/Ukraine and Austria.

**TABLE 4-E
U.S. EXPORTS TRANSSHIPPED VIA CANADA
TOP TWENTY COUNTRIES OF DESTINATION BASED ON VALUE**

COUNTRY	\$1000's		% CHNG
	1992	1993	
UNITED KINGDOM	1,237,330	1,330,819	7.6
GERMANY	1,076,987	1,099,937	2.1
FRANCE	548,216	587,585	7.3
NETHERLANDS	652,493	564,939	-13.5
BELG/LUX	381,500	512,350	34.3
ITALY	287,054	300,849	4.8
SINGAPORE	109,662	137,799	25.7
SWITZ/LIECHT	110,344	120,858	9.6
IRELAND	129,403	112,548	-13.0
SPAIN	102,559	109,391	6.7
JAPAN	85,257	84,355	-3.1
AUSTRIA	53,408	78,223	46.5
HONG KONG	36,580	60,443	65.2
TAIWAN	22,634	59,696	163.7
SWEDEN	80,002	55,992	-30.0
DENMARK	66,490	50,496	-24.3
RUSSIA&UKR	30,330	49,759	64.1
S KOREA	38,995	46,706	19.8
SOUTH AFRICA	41,325	46,294	12.0
AUSTRAL+ISL	73,105	35,516	-51.4
OTHER	294,797	383,768	30.2
TOTAL	5,458,471	5,828,323	6.8

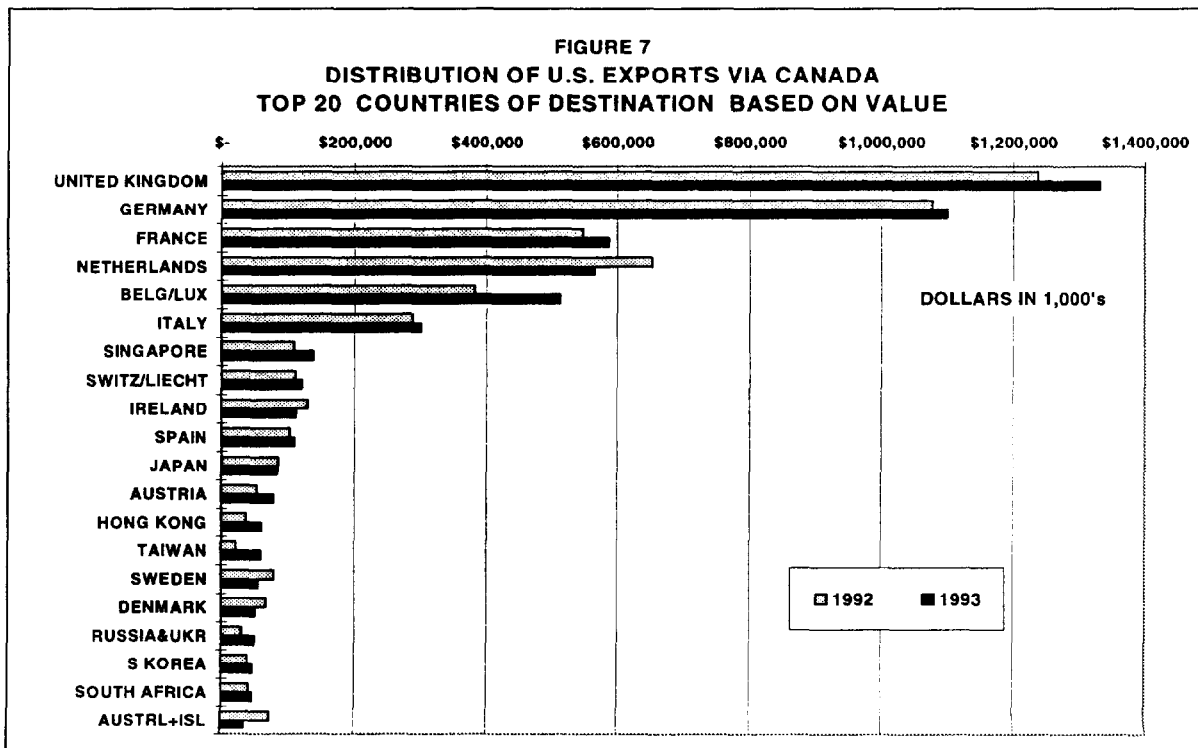

TRANSSHIPMENTS BY DESTINATION COUNTRY - EXPORTS IN METRIC TONS

Table 5-E displays 1993 transshipments in metric tons by country of destination compared to 1992. Figure 8 illustrates the growth in graphic form. The top five countries of destination represented 62.3% of the total volume of exports in metric tons. Of these, the largest growth in metric tons was to the United Kingdom, Belgium/Luxembourg, Japan, and Spain. In addition, Taiwan, Hong Kong, and Ireland displayed significant percentage increases.

**FIGURE 5-E
U.S. EXPORTS TRANSSHIPPED VIA CANADA
TOP TWENTY COUNTRIES OF DESTINATION BASED ON METRIC TONS**

COUNTRY	METRIC TONS		% CHNG
	1992	1993	
UNITED KINGDOM	376,523	424,297	12.7
GERMANY	318,473	309,737	-2.7
NETHERLANDS	181,333	207,098	14.2
ITALY	166,711	183,134	9.9
BELG/LUX	138,512	180,673	30.4
FRANCE	183,869	162,369	-11.7
SPAIN	72,211	105,302	45.8
IRELAND	44,185	72,456	64.0
JAPAN	26,865	67,524	151.3
SWITZ/LIECHT	36,718	36,527	-0.5
DENMARK	31,230	28,634	-8.3
SWEDEN	34,345	28,344	-17.5
RUSSIA&UKR	26,195	26,686	1.9
AUSTRIA	17,294	25,997	50.3
SOUTH AFRICA	18,057	17,049	-5.6
S KOREA	11,874	14,966	26.0
AUSTR+ISL	17,789	14,419	-18.9
TAIWAN	6,970	12,972	86.1
SINGAPORE	9,267	12,712	37.2
HONG KONG	6,696	12,042	79.8
OTHER	128,156	148,418	15.8
TOTAL	1,853,273	2,091,355	12.8

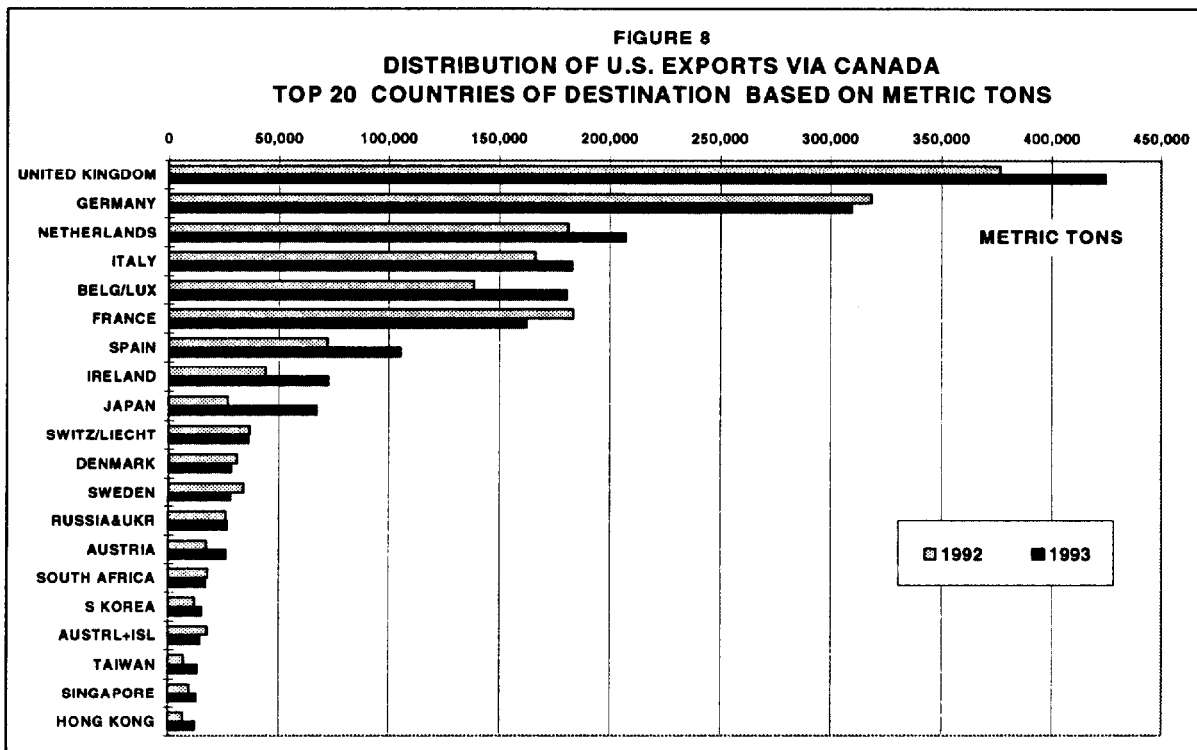

TRANSSHIPMENTS BY ORIGIN COUNTRY - IMPORTS IN DOLLAR VALUE

Table 4-1 displays 1993 transshipments in dollar value by country of origin compared to 1992. Figure 9 illustrates the growth in graphic form. The top five countries of origin represented 65.0% of the total value of imports. Of these, the largest growth in value of transshipped imports was from Germany, followed by Italy and the United Kingdom. The largest percentage increases were from Russia/Ukraine, Finland, Austria, and Denmark.

**TABLE 4-1
U.S. IMPORTS IN-TRANSIT VIA CANADA
TOP TWENTY COUNTRIES OF ORIGIN BASED ON VALUE**

COUNTRY	\$1000's		% CHNG
	1992	1993	
GERMANY	1,809,700	2,081,808	15.0
UNITED KINGDOM	1,007,303	1,161,135	15.3
FRANCE	803,133	869,931	8.3
ITALY	494,330	660,167	33.5
JAPAN	478,763	526,399	9.9
SWITZ/LIECHT	219,136	282,961	29.1
NETHERLANDS	280,538	279,233	-0.5
BELG/LUX	283,529	246,501	-13.1
TAIWAN	165,633	190,069	14.8
SPAIN	151,405	176,218	16.4
IRELAND	137,994	172,732	25.2
SWEDEN	128,801	170,162	32.1
AUSTRIA	105,756	166,550	57.5
CHINA	106,954	141,156	32.0
DENMARK	97,339	137,616	41.4
S KOREA	83,117	115,207	38.6
FINLAND	51,919	89,905	73.2
RUSSIA&UKR	20,819	86,860	317.2
AUSTR+ISL	41,156	44,454	8.0
SINGAPORE	32,535	43,893	34.9
OTHER	476,653	510,157	7.0
TOTAL	6,976,513	8,153,114	16.9

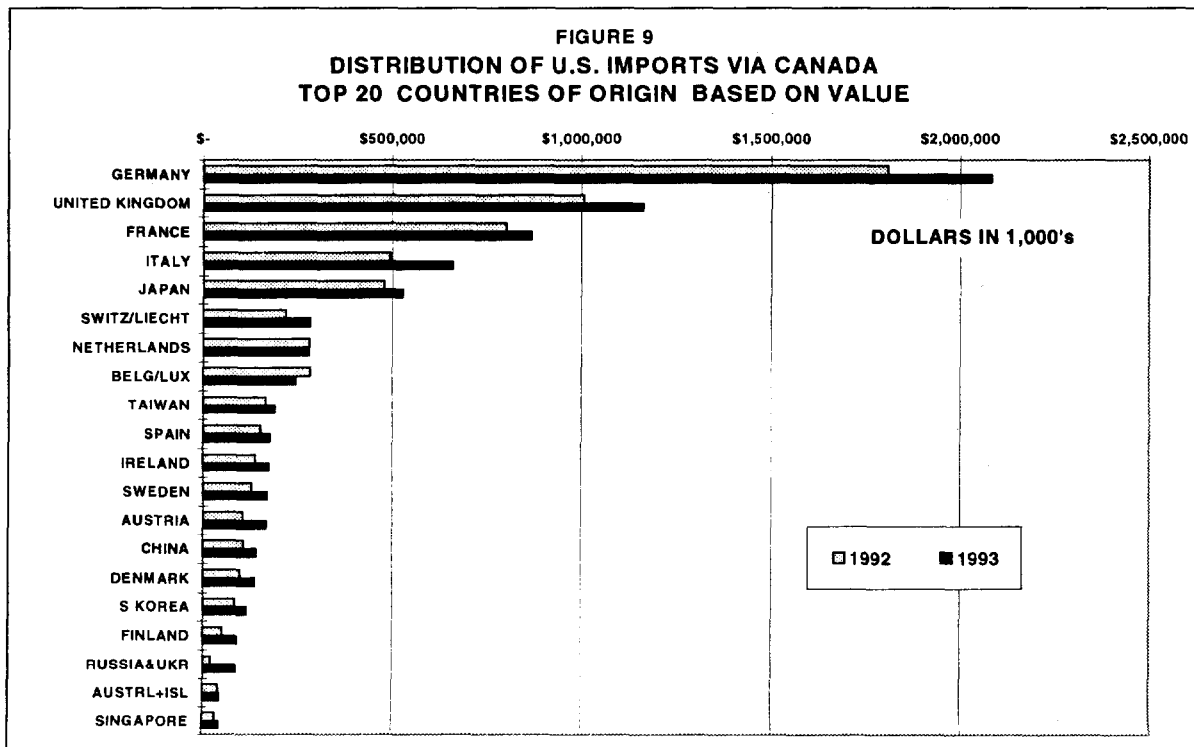

TRANSSHIPMENTS BY ORIGIN COUNTRY - IMPORTS IN METRIC TONS

Table 5-1 displays 1993 transshipments in metric tons by country of origin compared to 1992. Figure 10 illustrates the growth in graphic form. The top five countries of origin represented 60.9% of the total volume of imports in metric tons. Of these, the largest growth in metric tons was from Germany, followed by the United Kingdom and Italy. Significant increases in percentage growth occurred from Russia/Ukraine, Finland, China, and South Korea.

**TABLE 5-1
U.S. IMPORTS IN TRANSIT VIA CANADA
TOP TWENTY COUNTRIES OF ORIGIN BASED ON METRIC TONS**

COUNTRY	\$1000's		1993 %CHNG
	1992	1993	
GERMANY	386,938	462,030	19.4
UNITED KINGDOM	247,021	313,739	27.0
FRANCE	202,926	242,106	19.3
ITALY	133,861	191,888	43.3
NETHERLANDS	124,554	138,540	11.2
BELG/LUX	76,324	109,742	43.8
SPAIN	49,832	72,576	45.6
JAPAN	64,832	62,469	-3.6
AUSTRIA	39,940	56,317	41.0
SWEDEN	39,602	48,655	22.9
RUSSIA&UKR	11,395	45,626	300.4
FINLAND	13,361	43,817	228.0
SWITZ/LIECHT	44,602	43,383	-2.7
CHINA	23,769	39,090	64.5
IRELAND	26,081	36,676	40.6
DENMARK	24,734	31,596	27.7
TAIWAN	28,396	28,862	1.6
S KOREA	11,652	18,012	54.6
HUNGARY	15,481	13,143	-15.1
SINGAPORE	3,063	2,677	-12.6
OTHER	252,366	211,400	-16.2
TOTAL	1,820,728	2,212,344	21.5

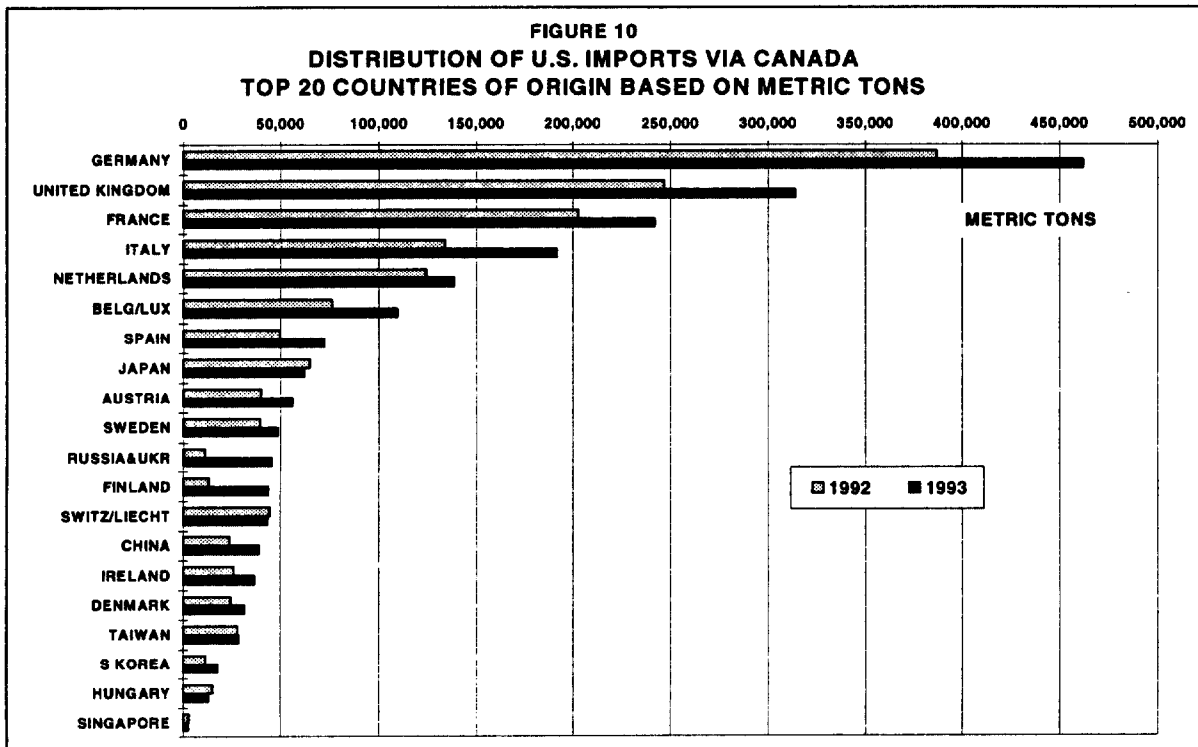

TRANSSHIPMENTS BY COMMODITY - EXPORTS IN DOLLAR VALUE

Table 6-E displays 1993 exports transshipped via Canada in dollar value by 4-digit Harmonized commodity code, compared to 1992. Figure 11 illustrates the commodities in graphic form. The top twenty commodities accounted for 34.7% of the total value of transshipped exports. By far the greatest increase in dollar value was for Parts & Accessories for Motor Vehicles, which jumped \$165 million or by 51.9%. Other commodities exhibiting strong growth were Photo Film in Rolls, Parts of Aircraft & Spacecraft, Malt Extracts-Food Preps of Flour, Spark-Ignition, Reciprocating or Rotary Engines, and Heterocyclic Compounds.

**TABLE 6-E
U.S. EXPORTS TRANSSHIPPED VIA CANADA
TOP TWENTY 1993 COMMODITIES BASED ON VALUE**

HARM4 HARMONIZED COMMODITY	\$1000's		% CHNG	% TOTAL 1993
	1992	1993		
8708 PARTS & ACCESS FOR MOTOR VEHICL	318,902	484,461	51.9	8.3
8471 AUTOMATIC DATA PROCESS MACHIN	323,294	209,216	-35.3	3.6
8803 PARTS OF AIRCRAFT, SPACECRAFT	85,586	137,622	60.8	2.4
8473 PARTS FOR TYPEWR OTH OFF MACH	125,718	112,593	-10.4	1.9
9018 MEDICAL, SURGI, DENTL OR VET INST	89,353	95,428	6.8	1.6
1604 PREP OR PRES FISH, CAVIAR & SUBST	68,205	84,855	24.4	1.5
8409 PARTS FOR ENGINES, HEADNG 8407-8	54,493	78,469	44.0	1.3
8479 MACHINES HAVNG INDIVIDUAL FUNC	55,201	69,809	26.5	1.2
1901 MALT EXT, FOOD PREP OF FLOUR ETC	27,443	69,806	154.4	1.2
9504 ARTCLS FR ARCADE, TBLE PARL GAM	67,558	69,790	3.3	1.2
8413 PUMPS FOR LIQDS, LIQD ELEVAT PRTS	90,422	68,257	-24.5	1.2
3920 PLATES, SHEETS, FILM ETC	49,718	66,683	34.1	1.1
8407 SPRK-IGNIT RECIP OR ROTRY ENGINES	30,267	66,630	120.1	1.1
3702 PHOTO FILM IN ROLLS SENSITIZED	287	63,803	N.A.	1.1
8431 PARTS FOR MACHY , HEADNG 8425-30	49,505	61,087	23.4	1.0
9030 OSCILLOSCOPES, SPECTRUM ANALYZ	87,496	60,124	-31.3	1.0
713 LEGUMINOUS VEGETABLES	55,122	59,522	8.0	1.0
7112 WASTE & SCRAP OF PREC METALS	30,832	57,312	85.9	1.0
2933 HETEROCYCLIC COMP, NUCLEIC ACID	25,868	55,310	113.8	0.9
9506 ARTICLES & EQUIP FOR SPORTS ETC	43,824	53,655	22.4	0.9
9999 ALL OTHER COMMODITIES	3,779,377	3,803,891	0.6	65.3
TOTAL	5,458,471	5,828,323	6.8	

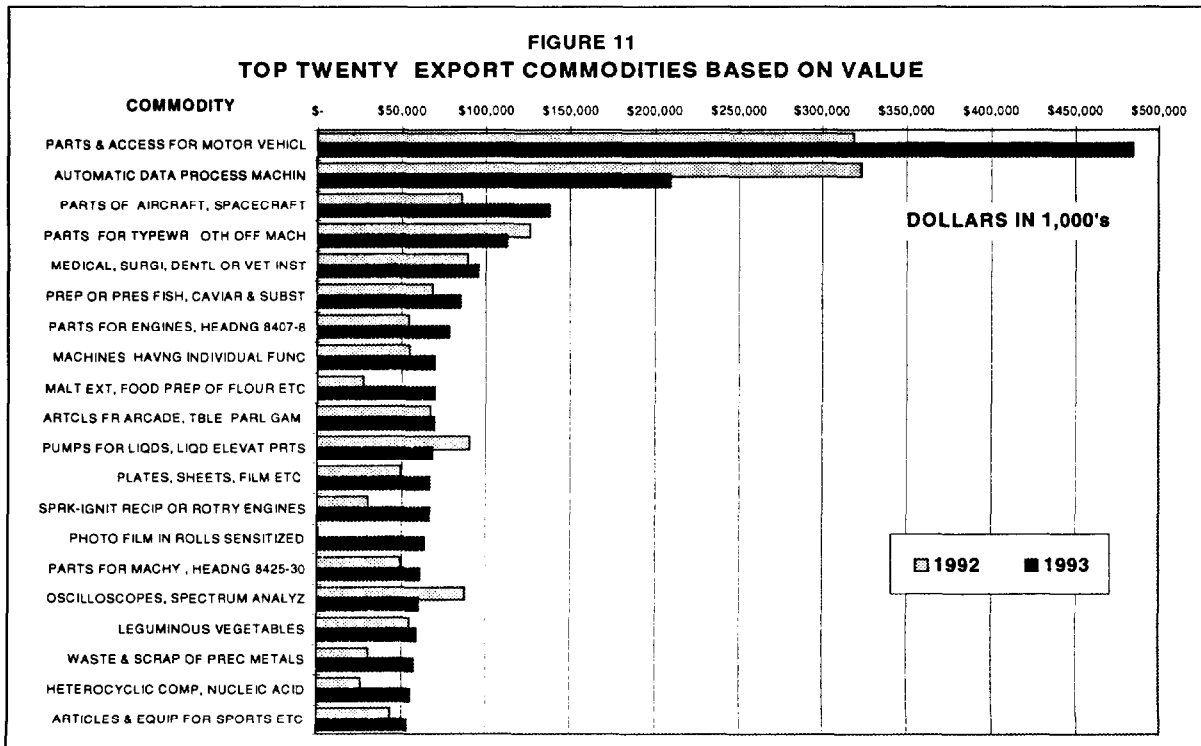

TRANSSHIPMENTS BY COMMODITY - EXPORTS IN METRIC TONS

Table 7-E displays 1993 transshipment exports via Canada in metric tons by 4-digit Harmonized commodity code, compared to 1992. Figure 12 illustrates the commodities in graphic form. The top twenty commodities accounted for 43.6% of the estimated transshipped weight. The largest increases occurred for Corn (Maize), Malt, Zinc Ores, Preparations Used in Animal Feed, Parts & Accessories for Motor Vehicles, Refractory Bricks, Oxygen-Function Amino-Compounds, and Residues of Starch, Sugar Manufacture.

**TABLE 7-E
1993 U.S. EXPORTS TRANSSHIPPED VIA CANADA
TOP TWENTY COMMODITIES BASED ON METRIC TONS**

HARM4 HARMONIZED COMMODITY	ESTIMATED METRIC TONS		% CHNG	% TOTAL 1993
	1992	1993		
1005 CORN (MAIZE)	114,523	144,945	26.6	6.9
713 LEGUMINOUS VEGETABLES	71,442	87,017	21.8	4.2
2005 VEGETABLES NESOI PREPARED ETC	63,293	68,802	8.7	3.3
2309 PREPARATIONS USED IN ANIMAL FEED	41,209	62,420	51.5	3.0
8708 PARTS & ACCESS FOR MOTOR VEHICL	36,073	61,398	70.2	2.9
4407 WOOD SAWN OR CHIPPED	56,991	53,185	-6.7	2.5
1107 MALT, WHETHER OR NOT ROASTED	23,682	48,134	103.3	2.3
1206 SUNFLOWER SEEDS	52,521	47,608	-9.4	2.3
1201 SOYBEANS, WHETHER OR NOT BRKN	46,686	43,582	-6.6	2.1
2303 RESIDUES OF STARCH ,SUGAR MANUF	27,753	41,949	51.2	2.0
2521 LIMESTONE FLUX, LMSTN & OTH CAL	21,262	37,468	76.2	1.8
2608 ZINC ORES AND CONCENTRATES	0	30,272	N.A.	1.4
2922 OXYGEN-FUNCTION AMINO-COMPND S	5,401	29,935	454.2	1.4
1702 SUGARS NESOI, INC CHEM PURE LACT	12,586	28,858	129.3	1.4
2713 PETROLEUM COKE, BITUMEN, OT RES	200	25,271	N.A.	1.2
1604 PREP OR PRES FISH, CAVIAR & SUBSTIT	19,976	22,660	13.4	1.1
2516 GRANITE, PORPHYRY, BASALT ETC.	11,536	21,929	90.1	1.0
6902 REFRACTORY BRICKS & OT RFR CERA	1,471	21,299	1347.7	1.0
1901 MALT EXT, FOOD PREP OF FLOUR ,ETC.	8,948	18,161	103.0	0.9
4408 VENEER SHEETS ETC, NOT OVER 6MM	18,379	17,769	-3.3	0.8
9999 ALL OTHER COMMODITIES	1,219,341	1,178,693	-3.3	56.4
TOTAL	1,853,273	2,091,355	12.8	

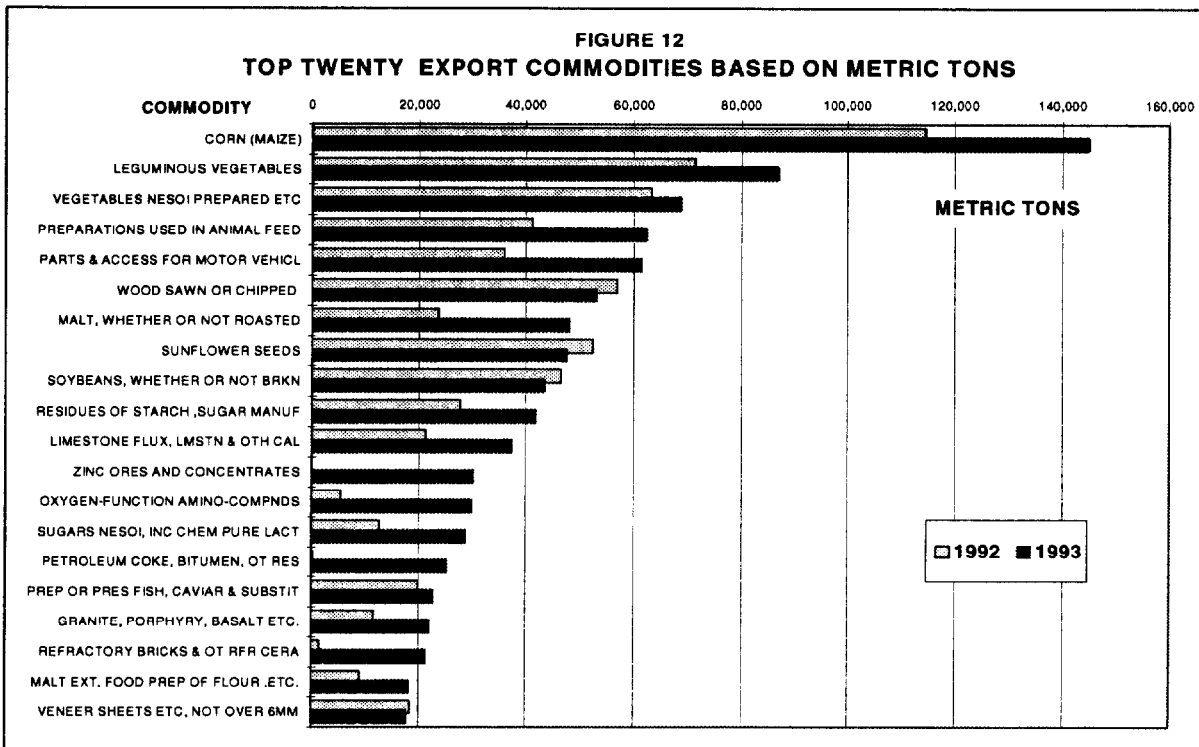

TRANSSHIPMENTS BY COMMODITY - IMPORTS IN DOLLAR VALUE

Table 6-1 displays 1993 imports transhipped via Canada in dollar value by 4-digit Harmonized commodity code, compared to 1992. Figure 13 illustrates the commodities in graphic form. The top twenty import commodities accounted for 33.1% of the value of transshipped imports. By far the largest import commodity was Parts and Accessories for Motor Vehicles, which accounted for 7.6% of the total value. Large increases were also exhibited by Automatic Data Processing Machinery, Transmission Shafts & Bearings, Compression-Ignition Internal Combustion Engines, and Synthetic Organic Coloring Matter & Preparations. A decline was observed for Motor Cars & Vehicles.

**TABLE 6-1
U.S. IMPORTS TRANSSHIPPED VIA CANADA
TOP TWENTY 1993 COMMODITIES BASED ON VALUE**

HARM4 HARMONIZED COMMODITY	\$1000's		% CHNG	% TOTAL 1993
	1992	1993		
8708 PARTS & ACCESS FOR MOTOR VEHCL	565,144	618,692	9.5	7.6
8471 AUTOMATIC DATA PROCESS MACHIN	150,146	208,632	39	2.6
8483 TRANSMISSION SHAFTS, BEARINGS	148,219	204,007	37.6	2.5
3501 CASEIN, CASEINATES & OTH DERIV	131,188	142,690	8.8	1.8
8473 PARTS FOR TYPEWR OTH OFF MACH	158,732	127,720	-19.5	1.6
8542 ELECTRONIC INTEGRATED CIRCUITS	118,095	126,064	6.7	1.5
8431 PARTS FOR MACY HEADNG 8425-30	89,136	123,990	39.1	1.5
8407 SPRK-IGNIT RECI OR ROTRY ENGINES	105,810	118,787	12.3	1.5
8481 TAPS, COCKS, VALVES FOR PIPES	95,079	118,776	24.9	1.5
8409 PARTS FOR ENGINES HEADING 8707-8	85,145	110,545	29.8	1.4
8413 PUMPS FOR LIQDS, LIQD ELEVAT PRTS	103,967	109,719	5.5	1.3
9506 ARTICLS EQUIP FOR SPORTS, POOLS	65,364	101,926	55.9	1.3
8414 AIR OR VAC PUMPS, COMPR & FANS	85,006	98,844	16.3	1.2
8703 MOTOR CARS & VEHICLES FOR TRAN	160,512	90,776	-43.4	1.1
8408 COMPRESSN-IGNIT INTRNL COMB ENG	31,354	73,470	134.3	0.9
8501 ELECTRIC MOTORS AND GENERATORS	73,499	73,009	-0.7	0.9
8479 MACHNS HAVING INDIVIDUAL FUNCT	51,149	72,350	41.4	0.9
3204 SYN ORG COLORING MATTER & PREP	16,399	61,415	274.5	0.8
3926 ARTICLES OF PLASTIC INC POLYMERS	48,743	58,842	20.7	0.7
9009 PHOTOCOPY, THERMCOPI APPAR	39,862	58,328	46.3	0.7
9999 ALL OTHER COMMODITIES	4,653,964	5,454,532	17.2	66.9
TOTAL	6,976,513	8,153,114	16.9	

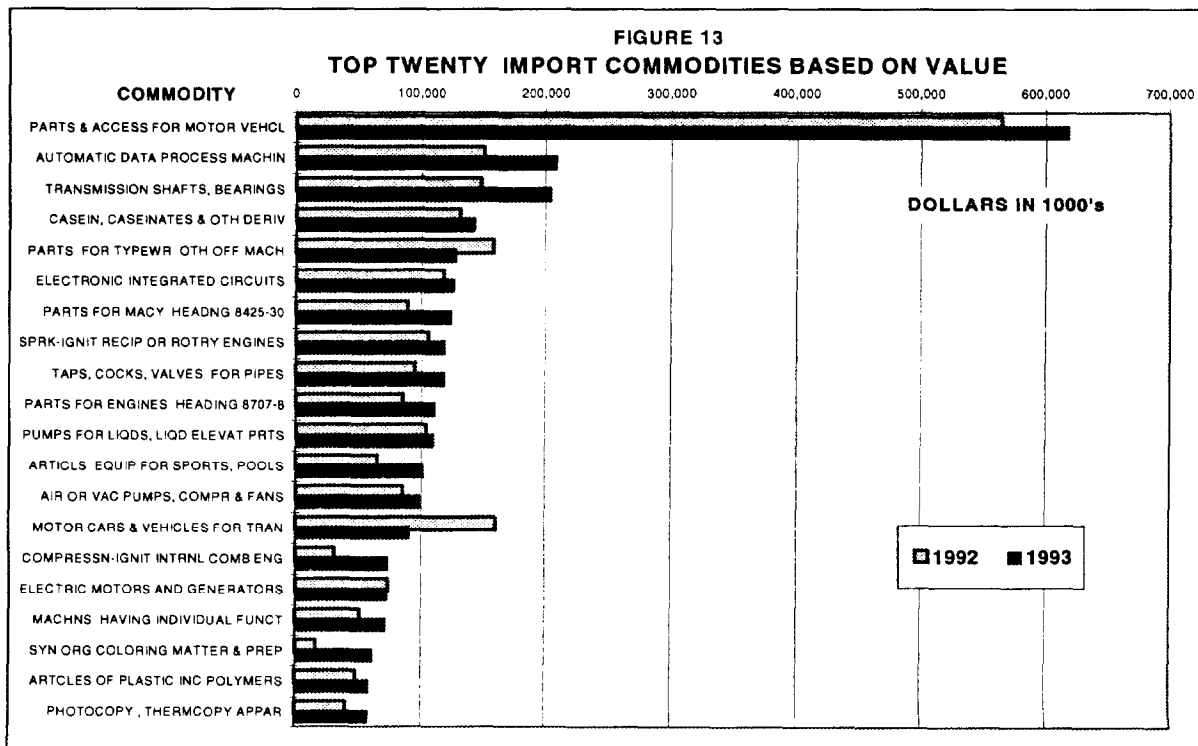

TRANSSHIPMENTS BY COMMODITY - IMPORTS IN METRIC TONS

Table 7-1 displays 1993 imports transshipped via Canada in metric tons by 4-digit Harmonized commodity code, compared to 1992. Figure 14 illustrates the commodities in graphic form. The top twenty import commodities accounted for 30.2% of the transshipped imports by weight. The largest commodity was Parts & Accessories for Motor Vehicles, followed by Paper & Paperboard Coated With Kaolin. Large increases were exhibited by Paper & Paperboard Coated With Kaolin, Bars & Rods of Iron and Steel, Paper, Uncoated, for Writing, and Carbonates. However, Aluminum Oxide dropped by 65.3%.

**TABLE 7-1
U.S. IMPORTS TRANSSHIPPED VIA CANADA
TOP TWENTY 1993 COMMODITIES BASED ON METRIC TONS**

HARM4 HARMONIZED COMMODITY	ESTIMATED METRIC TONS			% CHNG	% TOTAL 1993
	1992	1993			
8708 PARTS & ACCESS FOR MOTOR VEHCL	115,476	125,674	8.8	5.7	
4810 PAPER & PAPERBRD, CTD W/ KAOLIN	24,381	66,337	172.1	3.0	
6908 GLZD CRMC FLGS & PVNG, HRTH TILES	32,302	43,440	34.5	2.0	
2818 ALUMINUM OXIDE (INCL ART CORUN	113,981	39,571	-65.3	1.8	
7217 WIRE OF IRON & NONALLOY STEEL	33,135	36,379	9.8	1.6	
7215 BARS & RODS, IRON & NA STEELN	14,782	35,516	140.3	1.6	
3501 CASEIN, CASEINATES & OTHR DERIV	30,807	34,046	10.5	1.5	
8431 PARTS FOR MACHY HEADING 8425-30	17,746	30,559	72.2	1.4	
7202 FERROALLOYS	18,658	30,291	62.4	1.4	
2918 CARBOXYLIC ACID, ADDED OXYGEN	23,714	28,146	18.7	1.3	
3102 MINERAL OR CHEMICAL FERTILIZER	17,375	24,559	41.3	1.1	
4802 PAPER, UNCOAT, FOR WRITING ETC	2,375	21,361	799.4	1.0	
8483 TRANSMISSION SHAFTS, BEARINGS	18,080	20,770	14.9	0.9	
3206 COLORING MATTER, COLORING PREP	11,213	19,348	72.5	0.9	
7606 ALUM PLTS, SHTS & STRIP OVR .2MM	15,652	19,079	21.9	0.9	
7219 FL-RL STAINLESS STEEL PRODUCTS	12,178	19,019	56.2	0.9	
2836 CARBONATES, PEROXOCARBONATES,	8,204	18,931	130.8	0.9	
3505 DXTRINS ETC, GLUES BSD ON STARCH	12,464	18,715	50.2	0.8	
6902 REFRACTORY BRICKS & OTHER REFR	13,464	18,114	34.5	0.8	
4002 SYN RUBBER & FACTICE, INC NAT-SYN	14,803	17,912	21.0	0.8	
9999 ALL OTHER COMMODITIES	1,269,936	1,544,579	21.6	69.8	
TOTAL	1,820,728	2,212,343	21.5		

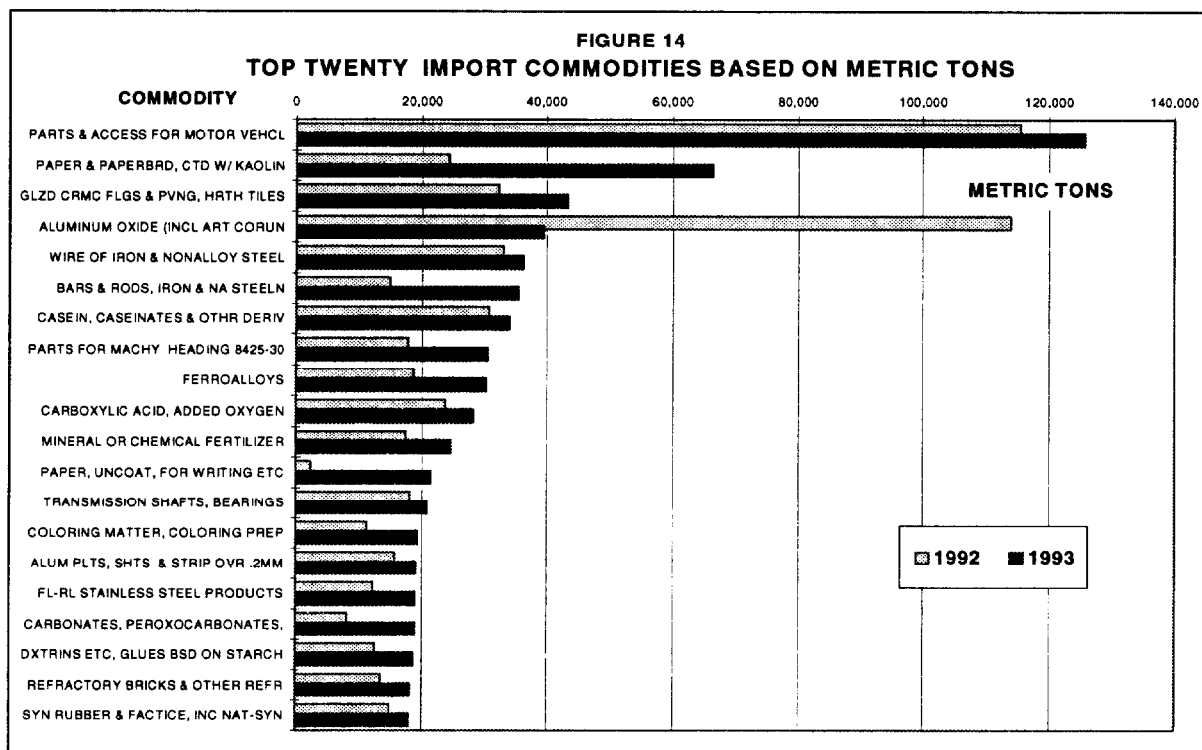

METHODOLOGY

Data Source

The source for export data is the monthly U. S. Department of Commerce All Methods EM-522 data tape, and for imports it is the IM-145 tape. These data tapes provide U.S. trade by customs district by country of origin/destination in terms of value and weight. They contain the total value and net quantity from all methods of transportation, the dollar value and weight of waterborne and airborne shipping weight separately. The monthly tapes were processed and consolidated into quarterly data, from which the annual 1993 data is derived.

Procedure

The derivation of the U.S. cargo transshipped via Canada is based on the presumption that for those customs districts which are along the Canadian border, or in close proximity to it, the difference between the total value of U.S. exports or imports for a particular commodity to or from a country, less the sum of waterborne and airborne cargo for that commodity, is the cargo which must have moved via the Canadian Gateway. For example, cargo moving to the United Kingdom exported from Detroit, but not exiting the U.S. by water or air, is assumed to have moved via Canadian ports. A similar procedure applies for imports, though the set of customs districts is broadened to include additional districts to which the cargo may have moved in-bond.

Weight is estimated by taking the derived value figure for a particular 6-digit HS commodity in a given month, and dividing it by a dollar per metric ton factor. This factor is derived from the value per ton relationship of waterborne cargo for that particular 6-digit Harmonized commodity moving to or from a given country via U.S. ports. Monthly data is used to reduce errors due to price and currency exchange fluctuations.

The data was further refined and adjusted for reasonableness of the dollar per ton conversion factors. Also, to minimize errors, certain commodities such as self-propelled aircraft, repairs, imported gold, diamonds and gemstones, low value shipments, and certain products known to have been re-exported were excluded.

Beginning with 1990 data, more accurate procedures were used to estimate weight, and the data was more closely scrutinized to reduce data errors. Consequently, comparisons with data prior to 1990 may show some discontinuity.

1993 U.S. IMPORTS TRANSSHIPPED VIA CANADA ABOVE \$5,000,000
 BY CUSTOMS DISTRICT BY TOP COUNTRIES IN \$1000'S ESTIMATED WEIGHT IN METRIC TONS

CD#	CUSTOMS DISTRICT	COUNTRY	\$1000S	EST. M.TONS
-----	-----	-----	-----	-----
1	PORTLAND, ME.	RUSSIA&UKR	26,760.	13,933.
		FRANCE	12,007.	2,187.
		GERMANY	6,866.	874.
		BELOW MIN.	24,537.	35,543.
*SUB-TOTAL CUSTOMS DIST. # 1			70,170.	52,537.
2	ST. ALBANS, VT.	GERMANY	103,530.	21,645.
		UNITED KINGD	63,056.	15,178.
		ITALY	47,128.	7,474.
		FRANCE	46,302.	9,711.
		PHILIPPINES	29,970.	967.
		AUSTRIA	25,977.	1,658.
		TAIWAN	21,797.	2,363.
		S KOREA	21,280.	2,500.
		JAPAN	16,102.	1,446.
		BELG/LUX	14,241.	8,917.
		SWITZ/LIECHT	13,297.	4,043.
		CHINA-MAINLA	12,852.	5,853.
		MALAYSIA	9,876.	331.
		IRELAND	9,256.	1,296.
		SWEDEN	8,357.	1,790.
		NETHERLANDS/	8,036.	10,715.
		SPAIN	7,583.	1,637.
		PORTUGAL	7,461.	488.
		HUNGARY	5,868.	1,074.
		FORMR YUGOSL	5,614.	347.
		BELOW MIN.	37,961.	19,813.
*SUB-TOTAL CUSTOMS DIST. # 2			515,544.	119,245.
4	BOSTON, MASS.	GERMANY	33,660.	5,630.
		FRANCE	17,739.	5,160.
		IRELAND	6,629.	277.
		BELOW MIN.	37,600.	8,203.
*SUB-TOTAL CUSTOMS DIST. # 4			95,628.	19,270.
5	PROVIDENCE, R.I.	BELOW MIN.	640.	296.
7	OGDENSBURG, N.Y.	GERMANY	208,853.	45,247.
		FRANCE	111,564.	28,835.
		UNITED KINGD	80,466.	22,407.
		TAIWAN	49,398.	5,489.
		SWITZ/LIECHT	42,908.	2,518.
		JAPAN	41,776.	3,195.
		BELG/LUX	29,797.	9,395.
		CHINA-MAINLA	24,617.	5,994.

1993 U.S. IMPORTS TRANSSHIPPED VIA CANADA ABOVE \$5,000,000
 BY CUSTOMS DISTRICT BY TOP COUNTRIES IN \$1000'S ESTIMATED WEIGHT IN METRIC TONS

CD#	CUSTOMS DISTRICT	COUNTRY	\$1000S	EST. M.TONS
---	-----	-----	-----	-----
7	OGDENSBURG, N.Y.	ITALY	22,627.	9,275.
		AUSTRIA	21,379.	9,390.
		NETHERLANDS/	16,278.	12,144.
		IRELAND	11,998.	4,188.
		SINGAPORE	11,622.	963.
		SWEDEN	10,616.	4,924.
		FINLAND	10,489.	2,148.
		SPAIN	9,124.	6,042.
		SOUTH AFRICA	7,802.	4,117.
		S KOREA	7,187.	1,019.
		ZAIRE	6,258.	252.
		MADAGASCAR	5,847.	94.
		BELOW MIN.	58,419.	16,869.
*SUB-TOTAL CUSTOMS DIST. # 7			789,025.	194,506.
9	BUFFALO-NIAGRA FALLS	UNITED KINGD	174,127.	30,099.
		GERMANY	118,387.	31,720.
		JAPAN	117,526.	11,791.
		ITALY	88,170.	16,333.
		TAIWAN	74,837.	12,506.
		FRANCE	64,884.	11,781.
		CHINA-MAINLA	51,059.	10,764.
		FINLAND	39,918.	27,892.
		S KOREA	38,507.	3,350.
		NETHERLANDS/	25,172.	8,157.
		THAILAND	22,998.	3,153.
		SWITZ/LIECHT	17,721.	2,271.
		AUSTRIA	13,755.	4,566.
		BELG/LUX	11,882.	3,592.
		SPAIN	10,812.	3,965.
		HONG KONG	10,200.	1,367.
		SWEDEN	9,883.	3,022.
		SOUTH AFRICA	9,775.	2,420.
		BRAZIL	8,227.	3,437.
		SINGAPORE	8,021.	534.
		RUSSIA&UKR	7,411.	2,392.
		DENMARK	5,963.	1,873.
		MALAYSIA	5,184.	638.
		BELOW MIN.	43,258.	23,214.
*SUB-TOTAL CUSTOMS DIST. # 9			977,677.	220,835.
10	NEW YORK N.Y.	GERMANY	66,318.	6,616.
		JAPAN	18,637.	1,035.
		IRELAND	17,804.	2,118.
		FRANCE	14,785.	3,066.
		UNITED KINGD	12,909.	3,123.

1993 U.S. IMPORTS TRANSSHIPPED VIA CANADA ABOVE \$5,000,000
 BY CUSTOMS DISTRICT BY TOP COUNTRIES IN \$1000'S ESTIMATED WEIGHT IN METRIC TONS

CD#	CUSTOMS DISTRICT	COUNTRY	\$1000S	EST. M.TONS
----	-----	-----	-----	-----
10	NEW YORK N.Y.	DOMINICAN RE	6,498.	1,118.
		CHINA-MAINLA	5,050.	610.
		BELOW MIN.	55,470.	20,463.
*SUB-TOTAL CUSTOMS DIST. # 10			197,471.	38,148.
11	PHILADELPHIA, PA.	BELG/LUX	19,187.	2,093.
		GERMANY	15,835.	2,074.
		FRANCE	7,689.	816.
		UNITED KINGD	5,319.	1,158.
		BELOW MIN.	7,683.	2,445.
*SUB-TOTAL CUSTOMS DIST. # 11			55,713.	8,586.
13	BALTIMORE, MD.	BELOW MIN.	11,557.	2,534.
14	NORFOLK, VA.	BELOW MIN.	12,261.	8,651.
28	SAN FRANCISCO, CALIF	JAPAN	16,772.	796.
		S KOREA	6,750.	217.
		SINGAPORE	5,356.	71.
		FRANCE	5,283.	572.
		BELOW MIN.	11,043.	1,808.
*SUB-TOTAL CUSTOMS DIST. # 28			45,204.	3,464.
29	PORTLAND, OREGON	JAPAN	6,686.	128.
		BELOW MIN.	13,268.	2,492.
*SUB-TOTAL CUSTOMS DIST. # 29			19,954.	2,619.
30	SEATTLE, WASH.	JAPAN	54,557.	11,884.
		ITALY	15,468.	3,745.
		CHINA-MAINLA	14,648.	5,074.
		GERMANY	14,060.	3,329.
		UNITED KINGD	13,199.	2,834.
		AUSTR+ISL	12,284.	8,154.
		TAIWAN	12,233.	2,297.
		FRANCE	10,514.	1,911.
		COLOMBIA	8,464.	4,746.
		SINGAPORE	8,146.	508.
		S KOREA	6,677.	5,506.
		INDONESIA	5,916.	5,763.
		BELOW MIN.	45,409.	21,991.
*SUB-TOTAL CUSTOMS DIST. # 30			221,575.	77,740.
33	GREAT FALLS, MONT.	BELOW MIN.	25,111.	4,988.

1993 U.S. IMPORTS TRANSSHIPPED VIA CANADA ABOVE \$5,000,000
 BY CUSTOMS DISTRICT BY TOP COUNTRIES IN \$1000'S ESTIMATED WEIGHT IN METRIC TONS

CD#	CUSTOMS DISTRICT	COUNTRY	\$1000S	EST. M.TONS
---	-----	-----	-----	-----
34	PEMBINA, N. DAK.	JAPAN	105,687.	9,673.
		GERMANY	5,094.	613.
		BELOW MIN.	14,408.	4,202.
*SUB-TOTAL CUSTOMS DIST. # 34			125,189.	14,488.
35	MINNEAP/ST. PAUL	GERMANY	74,594.	20,142.
		ITALY	58,139.	15,522.
		UNITED KINGD	49,678.	10,751.
		IRELAND	20,628.	4,773.
		AUSTRIA	12,651.	3,069.
		FINLAND	10,375.	2,351.
		SWITZ/LIECHT	10,049.	907.
		DENMARK	9,434.	1,301.
		FRANCE	9,150.	5,303.
		BELG/LUX	6,959.	4,768.
		NETHERLANDS/ BELOW MIN.	6,652. 24,164.	3,546. 8,447.
*SUB-TOTAL CUSTOMS DIST. # 35			292,473.	80,880.
36	DULUTH, MINN.	BELOW MIN.	1,647.	558.
37	MILWAUKEE, WIS.	GERMANY	112,028.	39,175.
		ITALY	33,274.	9,475.
		IRELAND	32,892.	8,245.
		FRANCE	31,247.	10,887.
		UNITED KINGD	28,873.	9,067.
		DENMARK	26,641.	3,428.
		NETHERLANDS/	14,885.	11,636.
		SWEDEN	13,482.	3,912.
		PORTUGAL	10,517.	3,489.
		SWITZ/LIECHT	10,091.	2,344.
		SPAIN	9,583.	3,197.
BELG/LUX	6,499.	5,959.		
JAPAN	5,257.	1,475.		
BELOW MIN.	14,602.	8,064.		
*SUB-TOTAL CUSTOMS DIST. # 37			349,671.	120,351.
38	DETROIT, MICH.	GERMANY	468,886.	105,865.
		UNITED KINGD	257,420.	77,668.
		FRANCE	220,666.	55,364.
		ITALY	100,403.	29,508.
		SWITZ/LIECHT	93,203.	18,834.
		SPAIN	86,581.	31,455.
		JAPAN	86,175.	11,832.
BELG/LUX	67,425.	23,037.		

1993 U.S. IMPORTS TRANSSHIPPED VIA CANADA ABOVE \$5,000,000
 BY CUSTOMS DISTRICT BY TOP COUNTRIES IN \$1000'S ESTIMATED WEIGHT IN METRIC TONS

CD#	CUSTOMS DISTRICT	COUNTRY	\$1000S	EST. M.TONS
38	DETROIT, MICH.	NETHERLANDS/	55,269.	26,387.
		SWEDEN	46,296.	8,314.
		AUSTRIA	34,869.	9,416.
		S KOREA	27,563.	4,270.
		RUSSIA&UKR	17,226.	13,796.
		DENMARK	14,724.	4,577.
		TAIWAN	14,270.	3,113.
		CHINA-MAINLA	14,027.	3,753.
		AUSTR+ISL	8,645.	1,487.
		FINLAND	7,283.	2,663.
		SINGAPORE	6,572.	390.
		IRELAND	5,838.	1,095.
		BELOW MIN.	51,274.	20,147.
*SUB-TOTAL CUSTOMS DIST. # 38			1,684,615.	452,971.
39	CHICAGO, ILL.	GERMANY	639,068.	129,866.
		UNITED KINGD	332,797.	104,381.
		FRANCE	248,408.	82,924.
		ITALY	199,781.	71,672.
		BELG/LUX	86,649.	32,482.
		NETHERLANDS/	85,202.	42,442.
		SWEDEN	58,856.	19,539.
		SWITZ/LIECHT	58,697.	7,134.
		DENMARK	53,749.	12,576.
		IRELAND	48,012.	9,987.
		AUSTRIA	32,355.	18,233.
		JAPAN	28,322.	2,540.
		SPAIN	27,351.	14,920.
		HUNGARY	16,333.	5,633.
		POLAND	12,538.	3,090.
		NORWAY	11,443.	14,650.
		CZECH/SLOV	11,072.	2,243.
		FINLAND	9,690.	3,824.
		RUSSIA&UKR	5,896.	2,777.
		FORMR YUGOSL	5,127.	2,194.
		BELOW MIN.	34,329.	13,107.
*SUB-TOTAL CUSTOMS DIST. # 39			2,005,675.	596,213.
41	CLEVELAND, OHIO	GERMANY	170,953.	38,509.
		UNITED KINGD	77,854.	24,308.
		ITALY	55,842.	19,776.
		FRANCE	44,761.	18,072.
		BELG/LUX	26,484.	10,327.
		NETHERLANDS/	18,194.	6,291.
		RUSSIA&UKR	10,924.	2,970.
		SWITZ/LIECHT	9,829.	2,100.

1993 U.S. IMPORTS TRANSSHIPPED VIA CANADA ABOVE \$5,000,000
 BY CUSTOMS DISTRICT BY TOP COUNTRIES IN \$1000'S ESTIMATED WEIGHT IN METRIC TONS

CD#	CUSTOMS DISTRICT	COUNTRY	\$1000S	EST. M.TONS
---	-----	-----	-----	-----
41	CLEVELAND, OHIO	IRELAND	9,812.	3,234.
		SWEDEN	8,687.	1,265.
		JAPAN	7,333.	2,879.
		HUNGARY	7,265.	790.
		AUSTRIA	6,998.	4,680.
		DENMARK	5,026.	1,071.
		BELOW MIN.	14,256.	9,032.
*SUB-TOTAL CUSTOMS DIST. # 41			474,218.	145,303.
45	ST. LOUIS, MO.	UNITED KINGD	46,765.	8,550.
		GERMANY	33,084.	9,767.
		ITALY	23,491.	5,434.
		FRANCE	15,529.	4,296.
		SWITZ/LIECHT	11,176.	1,137.
		BELG/LUX	7,596.	6,511.
		SPAIN	7,328.	4,276.
		NETHERLANDS/	6,912.	2,677.
		AUSTRIA	6,058.	705.
		BELOW MIN.	17,421.	4,197.
*SUB-TOTAL CUSTOMS DIST. # 45			175,360.	47,550.
54	WASHINGTON, D.C.	BELOW MIN.	6,736.	610.
TOTAL			8,153,114.	2,212,343.

1993 U.S. EXPORTS TRANSSHIPPED VIA CANADA ABOVE \$5,000,000
 BY CUSTOMS DISTRICT BY TOP COUNTRIES IN \$1000'S ESTIMATED WEIGHT IN METRIC TONS

CD#	CUSTOMS DISTRICT	COUNTRY	\$1000S	EST. M.TONS
---	-----	-----	-----	-----
1	PORTLAND, ME.	RUSSIA&UKR	10,561.	1,886.
		GERMANY	9,631.	6,271.
		BELOW MIN.	33,003.	32,867.
*SUB-TOTAL CUSTOMS DIST. # 1			53,195.	41,024.
2	ST. ALBANS, VT.	UNITED KINGD	66,553.	14,533.
		BELG/LUX	50,017.	10,577.
		GERMANY	35,636.	11,340.
		ITALY	35,155.	19,467.
		TAIWAN	32,492.	6,076.
		SWITZ/LIECHT	30,733.	1,944.
		FRANCE	27,676.	8,613.
		NETHERLANDS/	21,265.	6,813.
		QATAR	16,800.	460.
		THAILAND	11,589.	2,369.
		S KOREA	8,993.	237.
		HONG KONG	6,278.	1,743.
		BELOW MIN.	30,758.	13,030.
*SUB-TOTAL CUSTOMS DIST. # 2			373,945.	97,201.
7	OGDENSBURG, N.Y.	FRANCE	96,954.	11,546.
		UNITED KINGD	81,525.	17,706.
		GERMANY	56,029.	18,318.
		ITALY	26,100.	12,528.
		NETHERLANDS/	20,608.	5,584.
		BELG/LUX	14,510.	20,758.
		RUSSIA&UKR	9,460.	14,389.
		IRELAND	6,106.	23,684.
		SPAIN	5,434.	6,982.
		SINGAPORE	5,165.	84.
		BELOW MIN.	41,287.	31,486.
*SUB-TOTAL CUSTOMS DIST. # 7			363,178.	163,065.
9	BUFFALO-NIAGRA FALLS	UNITED KINGD	41,885.	7,989.
		JAPAN	16,813.	4,890.
		FRANCE	15,147.	7,134.
		TAIWAN	13,450.	2,322.
		GERMANY	12,679.	5,761.
		BELG/LUX	11,949.	5,828.
		NETHERLANDS/	8,094.	1,818.
		ITALY	6,300.	3,826.
		S KOREA	5,476.	1,452.
		IRAN	5,000.	629.
		BELOW MIN.	35,027.	14,638.
*SUB-TOTAL CUSTOMS DIST. # 9			171,820.	56,286.

1993 U.S. EXPORTS TRANSSHIPPED VIA CANADA ABOVE \$5,000,000
 BY CUSTOMS DISTRICT BY TOP COUNTRIES IN \$1000'S ESTIMATED WEIGHT IN METRIC TONS

CD#	CUSTOMS DISTRICT	COUNTRY	\$1000S	EST. M.TONS
---	-----	-----	-----	-----
30	SEATTLE, WASH.	UNITED KINGD	203,536.	41,190.
		SINGAPORE	126,372.	10,926.
		GERMANY	107,599.	16,401.
		NETHERLANDS/	69,028.	10,315.
		JAPAN	55,452.	52,144.
		HONG KONG	39,346.	5,320.
		FRANCE	37,300.	9,139.
		S KOREA	27,778.	5,812.
		MALAYSIA	24,001.	2,310.
		AUSTR+ISL	20,931.	7,514.
		BELG/LUX	17,694.	8,171.
		TAIWAN	11,366.	2,014.
		INDONESIA	9,515.	728.
		ITALY	8,516.	2,359.
		AUSTRIA	8,223.	599.
		CHINA-MAINLA	8,172.	1,208.
		SWITZ/LIECHT	6,651.	2,594.
		IRELAND	6,304.	948.
		RUSSIA&UKR	6,248.	354.
		THAILAND	5,731.	1,229.
		BELOW MIN.	56,129.	13,351.
*SUB-TOTAL CUSTOMS DIST. # 30			855,892.	194,625.
33	GREAT FALLS, MONT.	BELOW MIN.	838.	2,991.
34	PEMBINA, N. DAK.	BELOW MIN.	4,198.	2,492.
35	MINNEAP/ST. PAUL	BELOW MIN.	203.	513.
36	DULUTH, MINN.	BELOW MIN.	6,080.	1,524.
38	DETROIT, MICH.	UNITED KINGD	932,688.	339,978.
		GERMANY	875,178.	248,202.
		NETHERLANDS/	442,993.	180,406.
		BELG/LUX	412,900.	130,867.
		FRANCE	405,444.	121,606.
		ITALY	222,882.	143,330.
		SPAIN	95,268.	94,327.
		IRELAND	94,306.	45,251.
		SWITZ/LIECHT	79,775.	30,557.
		AUSTRIA	65,569.	23,889.
		SWEDEN	44,430.	24,675.
		DENMARK	39,775.	22,605.
		SOUTH AFRICA	37,789.	14,001.
		FINLAND	22,259.	10,320.
		RUSSIA&UKR	19,047.	8,420.
		NORWAY	18,790.	10,969.

1993 U.S. EXPORTS TRANSSHIPPED VIA CANADA ABOVE \$5,000,000
 BY CUSTOMS DISTRICT BY TOP COUNTRIES IN \$1000'S ESTIMATED WEIGHT IN METRIC TONS

CD#	CUSTOMS DISTRICT	COUNTRY	\$1000S	EST. M.TONS
---	-----	-----	-----	-----
38	DETROIT, MICH.	HUNGARY	17,525.	5,570.
		PORTUGAL	16,017.	8,076.
		SAUDI ARABIA	14,487.	5,796.
		TURKEY	12,943.	4,935.
		POLAND	10,896.	15,094.
		CZECH/SLOV	9,052.	2,404.
		JAPAN	8,822.	1,654.
		FORMR YUGOSL	8,505.	3,377.
		IRAN	8,347.	1,612.
		GREECE	7,473.	4,640.
		HONG KONG	7,294.	1,244.
		ROMANIA	6,487.	3,946.
		BRAZIL	5,978.	2,856.
		BELOW MIN.	55,373.	20,837.
*SUB-TOTAL CUSTOMS DIST. # 38			3,998,292.	1,531,448.
41	CLEVELAND, OHIO	BELOW MIN.	682.	186.
TOTAL			5,828,323.	2,091,355.

1993 U.S. IMPORTS TRANSSHIPPED VIA CANADA ABOVE \$200,000
 BY CUSTOMS DISTRICT BY DESCEND. VALUE IN \$1000'S ESTIM. WEIGHT IN METRIC TONS

CD#	CUSTOMS DISTRICT	CODE	HARMONIZED COMMODITY DESCRIPTION	\$1000S	EST. M.TONS
1	PORTLAND, ME.	304	FISH FILLETS & OTH FISH MEAT, FRESH, CHILL OR FROZ	28,198.	14,543.
		7326	ARTICLES OF IRON OR STEEL, NESOI	5,645.	1,365.
		8411	TURBOJETS, TURBOPROPELLERS & OTH GAS TURBINES, PTS	5,036.	534.
		8406	STEAM TURBINES & OTHER VAPOR TURBINES, PARTS	2,607.	278.
		1302	VEG SAPS & EXTRACTS, PECTATES ETC, AGAR-AGAR ETC.	2,487.	608.
		8702	PUBLIC-TRANSPORT TYPE PASSENGER MOTOR VEHICLES	2,166.	138.
		1806	CHOCOLATE & OTHER FOOD PRODUCTS CONTAINING COCOA	1,604.	395.
		8429	SELF-PROPELLED BULLDOZERS, GRADERS, SCRAPERS ETC	1,420.	309.
		1703	MOLASSES FROM THE EXTRACTION OR REFINING OF SUGAR	1,273.	15,621.
		8907	FLOATING STRUCTURES NESOI, RAFTS, TANKS, BUOYS ETC	1,269.	224.
		8421	CENTRIFUGES, FILTER ETC MACH FOR LIQ OR GASES, PT	1,246.	79.
		3102	MINERAL OR CHEMICAL FERTILIZERS, NITROGENOUS	1,206.	11,658.
		8436	AGRI ETC & POULTRY ETC EQUIP, INC INCUBATORS, PTS	945.	65.
		303	FISH, FROZEN (NO FISH FILLETS OR OTHER FISH MEAT)	943.	540.
		7213	BARs & RODS, IRON & NA STEEL, H-R IRREG COILS	802.	1,672.
		7308	STRUCTURES NESOI & PARTS THEREOF, OF IRON OR STEEL	722.	197.
		6110	SWEATERS, PULLOVERS, VESTS ETC, KNIT OR CROCHETED	692.	20.
		8701	TRACTORS (OTHER THAN WORKS TRUCKS OF HEADING 8709)	654.	122.
		8477	MACHINERY FOR WORKING RUBBER & PLAST ETC NESOI, P	594.	46.
		8433	HARVEST ETC MACHINES, CLEANING EGGS ETC NESOI, PT	572.	59.
		2929	NITROGEN FUNCTION COMPOUNDS NESOI	516.	117.
		8502	ELECTRIC GENERATING SETS AND ROTARY CONVERTERS	484.	24.
		306	CRUSTACEANS, LIVE, FRESH ETC, AND COOKED ETC.	414.	56.
		8708	PARTS & ACCESS FOR MOTOR VEHICLES (HEAD 8701-8705)	382.	86.
		8503	PARTS OF ELECTRIC MOTORS, GENERATORS & SETS	319.	46.
		7312	STRANDED WIRE, ROPES ETC, NO ELEC INS, IR OR STEEL	317.	125.
		8419	MACHINERY ETC FOR TEMP CHANG TREAT MAT, W HEAT, P	279.	43.
		8448	AUXILIARY MACHINERY FOR USE WITH TEXTILE MACHINES	277.	9.
		302	FISH, FRESH OR CHILLED (NO FILLETS OR OTHER MEAT)	270.	48.
		7325	CAST ARTICLES NESOI, OF IRON OR STEEL	260.	60.
		8443	PRINTING MACHINERY, MACHINES ANCIL TO PRINTING, P	237.	10.
		4001	NATURAL RUBBER, BALATA, CHICLE ETC, PRIM FORM ETC	235.	340.
		8704	MOTOR VEHICLES FOR TRANSPORT OF GOODS	230.	23.
		8463	MACHINE TOOLS FOR WORKING METAL, NESOI	228.	11.
		9999	BELOW MINIMUM	5,641.	3,067.
			*SUB-TOTAL CUSTOMS DIST. # 1	70,170.	52,537.
2	ST. ALBANS, VT.	9506	ARTICLES & EQUIP FOR SPORTS ETC NESOI, POOLS, PTS	66,278.	5,768.
		8542	ELECTRONIC INTEGRATED CIRCUITS & MICROASSEMBL, PT	44,586.	1,502.
		8708	PARTS & ACCESS FOR MOTOR VEHICLES (HEAD 8701-8705)	25,677.	2,675.
		6402	FOOTWEAR, OUTER SOLE & UPPER RUBBER OR PLAST NESOI	23,865.	1,776.
		6403	FOOTWEAR, OUTER SOLE RUB, PLAST OR LEA & UPPER LEA	14,706.	893.
		8481	TAPS, COCKS, VALVES ETC FOR PIPES, TANKS ETC, PTS	14,353.	2,607.
		8443	PRINTING MACHINERY, MACHINES ANCIL TO PRINTING, P	10,882.	454.
		3701	PHOTO PLATES & FILM, FLAT, SENSITIZED, UNEXPOSED	9,041.	362.
		8541	SEMICONDUCTOR DEVICES, LIGHT-EMIT DIODES ETC, PTS	8,325.	257.
		7112	WASTE & SCRAP OF PREC METAL OR METAL CL W PREC MT	8,079.	1,689.

1993 U.S. IMPORTS TRANSSHIPPED VIA CANADA ABOVE \$200,000
 BY CUSTOMS DISTRICT BY DESCEND. VALUE IN \$1000'S ESTIM. WEIGHT IN METRIC TONS

CD#	CUSTOMS DISTRICT	CODE	HARMONIZED COMMODITY DESCRIPTION	\$1000S	EST. M.TONS
----	-----	----	-----	-----	-----
2	ST. ALBANS, VT.	7606	ALUMINUM PLATES, SHEETS & STRIP OVER .2MM THICK	7,827.	1,996.
		9301	MILITARY WEAPONS EX REVOLVERS PISTOLS LANCES ETC	7,201.	698.
		6204	WOMEN''S OR GIRLS'' SUITS, ENSEMB ETC, NOT KNIT ET	6,245.	393.
		8471	AUTOMATIC DATA PROCESS MACHINES, MAGN READER ETC	6,176.	652.
		203	MEAT OF SWINE (PORK), FRESH, CHILLED OR FROZEN	5,301.	2,643.
		6804	MILLSTONES ETC FOR GRINDING ETC, VARIOUS MATERIALS	5,161.	821.
		9302	REVOLVERS & PISTOLS, DESIGNED TO FIRE LIVE AMMO	5,055.	201.
		7607	ALUMINUM FOIL (BACK OR NOT) NOV .2MM TH (EX BACK)	5,019.	2,035.
		2818	ALUMINUM OXIDE (INCL ART CORUNDUM), ALUM HYDROXIDE	4,620.	2,753.
		3204	SYN ORG COLORING MATTER & PREP, SYN ORG BRIT AGENT	4,543.	354.
		6203	MEN''S OR BOYS'' SUITS, ENSEMBLES ETC, NOT KNIT ET	4,436.	394.
		4811	PAPER, PAPERBOARD, WAD ETC, COAT ETC NESOI, RL ET	4,152.	1,364.
		8518	MICROPHONES, LOUDSPEAKERS, SOUND AMPLIFIER ETC, P	4,149.	455.
		6404	FOOTWEAR, OUTER SOLE RUB, PLAST OR LEA & UPPER TEX	4,027.	342.
		5603	NONWOVENS, WHETHER OR NOT IMPREGNATED, COATED ETC	4,026.	886.
		6216	GLOVES, MITTENS AND MITTS, NOT KNIT OR CROCHETED	3,890.	370.
		3920	PLATES, SHEETS, FILM ETC NO AD, NON-CEL ETC, PLAS	3,760.	1,447.
		8508	ELECTROMECHANICAL TOOLS, WORKING IN HAND, PARTS	3,690.	151.
		4814	WALLPAPER ETC., WINDOW TRANSPARENCIES OF PAPER	3,474.	781.
		2204	WINE OF FRESH GRAPES, GRAPE MUST NESOI	3,458.	1,176.
		7409	COPPER PLATES, SHEETS & STRIP, OVER 0.15MM THICK	3,360.	1,281.
		7013	GLASSWARE FOR TABLE, KITCHEN, TOILET ETC USE NESOI	3,354.	296.
		3921	PLATES, SHEETS, FILM, FOIL & STRIP NESOI, PLASTIC	3,222.	454.
		4810	PAPER & PAPERBOARD, COATED WITH KAOLIN ETC, RL ET	3,193.	4,755.
		1806	CHOCOLATE & OTHER FOOD PRODUCTS CONTAINING COCOA	3,180.	1,129.
		4202	TRAVEL GOODS, HANDBAGS, WALLETS, JEWELRY CASES ETC	3,165.	335.
		9006	PHOTOGRAPHIC STILL CAMERAS, FLASH APPARATUS ETC	3,155.	58.
		4203	ARTICLES OF APPAREL & ACCESS, LEATH & COMP LEATHER	3,008.	152.
		3926	ARTICLES OF PLASTICS (INC POLYMERS & RESINS) NESO	2,947.	285.
		3505	DEXTRINS ETC, GLUES BASED ON STARCHES, DEXTRIN ETC	2,841.	3,554.
		9306	BOMBS, GRENADES ETC, CARTRIDGES ETC AND PARTS	2,823.	900.
		6814	WORKED MICA & ARTICLES SUPPORT ON PAPER ETC OR NOT	2,797.	543.
		4901	BOOKS, BROCHURES & SIMILAR PRINTED MATTER	2,775.	425.
		7321	STOVES, RANGES ETC, NONEL DOMEST & PTS, IR & STEE	2,669.	708.
		2902	CYCLIC HYDROCARBONS	2,619.	2,444.
		9403	FURNITURE NESOI AND PARTS THEREOF	2,493.	873.
		9010	APPARATUS ETC FOR PHOTO LABS ETC NESOI, PARTS ETC	2,446.	105.
		6909	CERAMIC LAB ETC WARES, AGR TUBS ETC & PACKING ART	2,414.	334.
		8477	MACHINERY FOR WORKING RUBBER & PLAST ETC NESOI, P	2,360.	205.
		8458	LATHES FOR REMOVING METAL	2,313.	835.
		8474	MACHINERY FOR SORTING SCREENING ETC MINERALS, PTS	2,140.	725.
		7226	FL-RL ALLOY STEEL NESOI UN 600MM WIDE	2,109.	2,224.
		8516	ELEC WATER, SPACE & SOIL HEATERS, HAIR ETC DRY, P	1,984.	154.
		6110	SWEATERS, PULLOVERS, VESTS ETC, KNIT OR CROCHETED	1,983.	88.
		8504	ELECTRIC TRANSFORM, STATIC CONVERTERS & INDUCT, PT	1,969.	68.
		7005	FLOAT GLASS & SURF GROUND OR POLISHED SHEETS ETC	1,962.	904.
		7004	DRAWN & BLOWN GLASS, IN SHEETS ETC	1,917.	1,493.
		6201	MEN''S OR BOYS'' OVERCOATS, CLOAKS ETC, NOT KNIT E	1,823.	105.

1993 U.S. IMPORTS TRANSSHIPPED VIA CANADA ABOVE \$200,000
 BY CUSTOMS DISTRICT BY DESCEND. VALUE IN \$1000'S ESTIM. WEIGHT IN METRIC TONS

CD#	CUSTOMS DISTRICT	CODE	HARMONIZED COMMODITY DESCRIPTION	\$1000S	EST. M.TONS
2	ST. ALBANS, VT.	2516	GRANITE, PORPHYRY, BASALT ETC., CRUDE OR CUT ETC.	1,815.	5,693.
		4802	PAPER, UNCOAT, FOR WRITING ETC, ROLLS, HNDMD PAPER	1,815.	1,417.
		3909	AMINO-RESINS, PHENOLICS & POLYURETHANES, PRIM FORM	1,774.	1,278.
		7217	WIRE OF IRON & NONALLOY STEEL	1,718.	1,484.
		2933	HETEROCYCLIC COMP, NIT HETERO-ATOM, NUCLEIC ACIDS	1,716.	237.
		8419	MACHINERY ETC FOR TEMP CHANG TREAT MAT, W HEAT, P	1,651.	239.
		9305	PARTS & ACCESSORIES OF ARMS OF HEAD 9301 TO 9304	1,523.	269.
		1302	VEG SAPS & EXTRACTS, PECTATES ETC, AGAR-AGAR ETC.	1,500.	129.
		3923	CONTAINERS (BOXES, BAGS ETC), CLOSURERS ETC, PLAS	1,456.	202.
		5407	WOVEN FAB OF SYN FIL YN, INCL MONOFIL 67 DEC ETC	1,439.	112.
		4011	NEW PNEUMATIC TIRES, OF RUBBER	1,432.	440.
		9031	MACHINES, NESOI IN CHAPTER 90, PROFILE PROJECT, P	1,378.	37.
		5903	TEXTILE FABRICS (NOT TIRE CORD) COAT ETC, PLASTICS	1,369.	130.
		8409	PARTS FOR ENGINES OF HEADING 8407 OR 8408	1,369.	76.
		7215	BARS & RODS, IRON & NA STEEL NESOI	1,364.	2,082.
		6210	GARMENTS, OF FELT ETC, OR FABRIC IMPREGNATED ETC	1,280.	40.
		7406	COPPER POWDERS AND FLAKES	1,270.	110.
		3206	COLORING MATTER NESOI, COLORING PREP NESOI, ETC.	1,250.	523.
		6302	BED LINEN, TABLE LINEN, TOILET LINEN & KITCH LINEN	1,223.	129.
		9009	PHOTOCOPY APPARATUS & THERMOCOPY APPARATUS, PTS	1,219.	47.
		8403	CENTRAL HEAT BOILERS NESOI, AND PARTS	1,215.	345.
		4002	SYNTH RUBBER & FACTICE, INC NAT-SYN MIX, PR FM ETC	1,206.	652.
		4806	VEG PARCHMENT, GREASEPROOF PAPERS ETC, ROLLS ETC	1,188.	705.
		3005	BANDAGES ETC COATED ETC OR IN RETAIL MEDIC ETC FM	1,150.	479.
		2825	HYDRAZINE ETC, OTH INORG BASES, METAL OXIDES ETC	1,134.	299.
		8483	TRANSMISSION SHAFTS, BEARINGS, GEARS ETC, PARTS	1,097.	138.
		8422	MACHINES, DISHWASH, CLEAN ETC CONT & FILL, PAK ET	1,092.	33.
		8203	FILES, RASPS, PLIERS, METALCUT SHEARS ETC, B MT PT	1,085.	81.
		8701	TRACTORS (OTHER THAN WORKS TRUCKS OF HEADING 8709)	1,069.	194.
		3501	CASEIN, CASEINATES AND OTHER CASEIN DERIVATIVES	1,063.	222.
		6211	TRACK SUITS, SKI-SUITS & SWIMWEAR, NOT KNIT ETC	1,054.	56.
		7326	ARTICLES OF IRON OR STEEL, NESOI	1,042.	283.
		7225	FL-RL ALLOY STEEL NESOI NUN 600MM WIDE	1,037.	1,426.
		8438	MACH NESOI, IND PREP OF FOOD OR DRINK ETC, PARTS	1,037.	66.
		6401	WATERPROOF FOOTWEAR, RUBBER OR PLASTICS, BOND SOLE	1,021.	118.
		8430	MACH NESOI, MOVING, GRAD ETC, PILE-DR, SNOPLow ET	1,007.	60.
		6913	STATUETTES AND OTHER ORNAMENTAL CERAMIC ARTICLES	997.	406.
		4008	PLATES, SHEETS, PROFILE SHAPES ETC, SOFT VULC RUBR	995.	443.
		8514	INDUSTRIAL OR LAB ELEC FURNACES ETC, PARTS	978.	78.
		6202	WOMEN'S OR GIRLS' OVERCOATS ETC, NOT KNIT OR CRO	944.	49.
		2620	ASH & RESIDUES (NOT FR IRON ETC MFR) W METAL CONT	942.	29.
		3707	PHOTOGRAPHIC CHEMICALS, UNMIXED PROD RETAIL PACKED	928.	168.
		6506	HEADGEAR NESOI, WHETHER OR NOT LINED OR TRIMMED	918.	58.
		4104	BOVINE OR EQUINE LEATHER, NO HAIR NESOI	897.	54.
		2930	ORGANO-SULFUR COMPOUNDS	864.	134.
		8448	AUXILIARY MACHINERY FOR USE WITH TEXTILE MACHINES	848.	33.
		8472	OFFICE MACHINES NESOI (HECTOGRAPH, ADDRESSING ETC	827.	21.
		8510	ELECTRIC SHAVERS & HAIR CLIPPERS, PARTS	820.	84.

1993 U.S. IMPORTS TRANSSHIPPED VIA CANADA ABOVE \$200,000
 BY CUSTOMS DISTRICT BY DESCEND. VALUE IN \$1000'S ESTIM. WEIGHT IN METRIC TONS

CD#	CUSTOMS DISTRICT	CODE	HARMONIZED COMMODITY DESCRIPTION	\$1000S	EST. M.TONS
2	ST. ALBANS, VT.	7017	GLASSWARE FOR LAB, HYGIENIC OR PHARMACEUTICAL USE	785.	144.
		8421	CENTRIFUGES, FILTER ETC MACH FOR LIQ OR GASES, PT	778.	49.
		9303	SPORT SHOTGUNS & RIFLES ETC, VERY PISTOLS ETC	770.	58.
		7503	NICKEL WASTE AND SCRAP	769.	450.
		6111	BABIES'' GARMENTS & ACCESSORIES, KNIT OR CROCHETED	767.	47.
		6912	CERAMIC TABLEWARE, KITCHENWARE ETC, EARTHENWARE ETC	749.	321.
		8413	PUMPS FOR LIQUIDS, LIQUID ELEVATORS, PARTS THEREO	726.	35.
		2820	MANGANESE OXIDES	724.	480.
		8411	TURBOJETS, TURBOPROPELLERS & OTH GAS TURBINES, PTS	707.	11.
		8302	HARDWARE, FIXTURES, CASTORS ETC & PARTS, BASE METL	701.	95.
		8465	MACHINE TOOLS FOR WORKING WOOD, CORK, BONE ETC	701.	51.
		5911	TEXTILE PRODUCTS ETC. FOR SPECIFIC TECH USES NESOI	687.	16.
		7227	BAR & RODS ALLOY STEEL NESOI, H-R IRREG COILS	687.	775.
		9027	INST ETC FOR PHYSICAL ETC ANAL ETC, MICROTOME, PT	660.	22.
		6102	WOMEN''S OR GIRLS'' OVERCOATS ETC, KNIT OR CROCHET	655.	65.
		7019	GLASS FIBERS & ARTICLES THEREOF (YARN ETC.)	650.	199.
		3102	MINERAL OR CHEMICAL FERTILIZERS, NITROGENOUS	646.	5,288.
		3213	ARTIST COLORS ETC IN TABLETS, TUBES, JARS ETC.	638.	70.
		8515	ELECTRIC, LASER OR OTH LIGHT OR PHOTON BEAM ETC	614.	10.
		6406	PARTS OF FOOTWEAR, INSOLES ETC, GAITORS ETC, PARTS	613.	133.
		8451	MACHINERY (NOT LAUNDRY) FOR CLEANING, DRYING ETC	613.	27.
		3202	SYN ORG & INORG TANNING SUBST, TAN PREP, ENZ PREP	607.	251.
		6104	WOMEN''S OR GIRLS'' SUITS, ENSEMB ETC, KNIT OR CRO	596.	50.
		7315	CHAIN & PARTS, OF IRON OR STEEL	579.	198.
		2849	CARBIDES	576.	262.
		4805	PAPER & PAPERBOARD, UNCOAT, NESOI, ROLLS OR SHEETS	567.	201.
		8482	BALL OR ROLLER BEARINGS AND PARTS	565.	67.
		8512	ELECTRIC LIGHT ETC EQUIP, WINDSH WIPERS ETC, PART	561.	30.
		2841	SALTS OF OXOMETALLIC OR PEROXOMETALLIC ACIDS	549.	203.
		7223	WIRE OF STAINLESS STEEL	547.	125.
		9401	SEATS (EXCEPT BARBER, DENTAL, ETC), AND PARTS	547.	143.
		2009	FRUIT JUICES (& GRAPE MUST) & VEG JUICE, NO SPIRIT	541.	480.
		4102	RAW SKINS OF SHEEP OR LAMBS NESOI	541.	219.
		8453	MACHINERY FOR WORK LEATHER ETC & FOOTWEAR ETC, PT	540.	69.
		8533	ELECTRICAL RESISTORS EXCEPT HEATING RESISTORS, PT	528.	27.
		8414	AIR OR VAC PUMPS, COMPR & FANS, HOODS & FANS, PTS	522.	47.
		4016	ARTICLES NESOI OF UNHARDED VULCANIZED RUBBER	521.	57.
		8428	LIFTING, HANDLING, LOADING & UNLOAD MACHINES NESO	483.	29.
		8439	MACHINERY FOR MAKING PULP & MAKING ETC PAPER, PTS	482.	57.
		6206	WOMEN''S OR GIRLS'' BLOUSES, SHIRTS ETC NOT KNIT E	477.	24.
		9032	AUTOMATIC REGULATING OR CONTROL INSTRUMENTS, PART	474.	34.
		8501	ELECTRIC MOTORS AND GENERATORS (NO SETS)	471.	76.
		8536	ELECTRICAL APPARATUS FOR SWITCHING ETC, NOV 1000	471.	30.
		8433	HARVEST ETC MACHINES, CLEANING EGGS ETC NESOI, PT	452.	79.
		8544	INSULATED WIRE, CABLE ETC, OPT SHEATH FIB CABLES	450.	33.
		9405	LAMPS & LIGHTING FITTINGS & PARTS ETC NESOI	445.	68.
		3812	PREPARED RUBBER ACCELERATORS, COM PLASTICIZERS ET	439.	193.
		7318	SCREWS, BOLTS, NUTS, WASHERS ETC, IRON OR STEEL	439.	255.

1993 U.S. IMPORTS TRANSSHIPPED VIA CANADA ABOVE \$200,000
 BY CUSTOMS DISTRICT BY DESCEND. VALUE IN \$1000'S ESTIM. WEIGHT IN METRIC TONS

CD#	CUSTOMS DISTRICT	CODE	HARMONIZED COMMODITY DESCRIPTION	\$1000S	EST. M.TONS
2	ST. ALBANS, VT.	2921	AMINE-FUNCTION COMPOUNDS	422.	99.
		8423	WEIGHING MACHINES & WEIGHING MACHINE WEIGHTS, PTS	422.	36.
		5107	YARN OF COMBED WOOL, NOT PUT UP FOR RETAIL SALE	419.	32.
		2927	DIAZO-, AZO-, OR AZOXY-COMPOUNDS	412.	100.
		9014	DIRECTION FINDING COMPASSES & NAVIG INST ETC, PTS	406.	10.
		8108	TITANIUM & ARTICLES THEREOF, INCLUD WASTE & SCRAP	396.	104.
		3402	ORGANIC SURF-ACT AGENTS, PREPS & CLEANING PREPS	393.	163.
		8479	MACHINES ETC HAVING INDIVIDUAL FUNCTIONS NESOI, P	391.	31.
		9307	SWORDS, CUTLASSES, BAYONETS, & SIML ARMS & PARTS	379.	70.
		7010	GLASS CONTAINERS FOR PACKING ETC & GLASS CLOSURES	372.	209.
		6802	WORKED MONUMENT ETC STONE & ART NESOI, GRANULE ETC	370.	678.
		5401	SEWING THREAD OF MANMADE FILAMENTS, RETAIL OR NOT	363.	10.
		8429	SELF-PROPELLED BULLDOZERS, GRADERS, SCRAPERS ETC	362.	83.
		4819	CARTONS ETC PAPER, OFFICE BOX FILES ETC, PAPER ET	360.	263.
		2509	CHALK	357.	710.
		202	MEAT OF BOVINE ANIMALS, FROZEN	352.	169.
		9607	SLIDE FASTENERS AND PARTS THEREOF	352.	131.
		2922	OXYGEN-FUNCTION AMINO-COMPOUNDS	335.	41.
		8476	AUTOMATIC GOODS-VENDING MACHINES, PARTS	330.	10.
		8001	TIN, UNWROUGHT	320.	62.
		8464	MACHINE TOOLS FOR WORKING STONE, ETC & GLASS	315.	15.
		8432	AGRICULT ETC MACH FOR SOIL ETC, LAWN ROLLERS, PTS	311.	69.
		7309	TANKS ETC, OVER 300 LITER CAPACITY, IRON OR STEEL	306.	270.
		9026	INST ETC MEASURE OR CHECK FLOW, LEVEL ETC, PTS ET	306.	16.
		6805	ABRASIVE POWDER ETC ON A BASE TEXT MATERIAL ETC	304.	43.
		2916	UNSAT ACYCLIC & CYCLIC MONOCARBOX ACID & ANHYD ET	301.	145.
		304	FISH FILLETS & OTH FISH MEAT, FRESH, CHILL OR FROZ	294.	113.
		8607	PARTS OF RAILWAY OR TRAMWAY LOCOMOTIVES OR R STOCK	290.	31.
		3401	SOAP, ORGANIC SURF-ACT PREP FOR SOAP USE, BARS ETC	288.	225.
		9609	PENCILS (LEAD ENCASED), CRAYONS, LEADS, CHALKS ETC	288.	23.
		3904	POLYMERS OF VINYL CHLORIDE ETC., IN PRIMARY FORMS	286.	181.
		4101	RAW HIDES & SKINS OF BOVINE OR EQUINE ANIMALS	284.	182.
		1804	COCOA BUTTER, FAT AND OIL	264.	97.
		2519	MAGNESITE, FUSED MAGNESIA, D-B MAGN, M OXIDE NESOI	260.	3,587.
		2530	MINERAL SUBSTANCES NESOI	257.	1,951.
		2208	ETHYL ALCOHOL, UNDENAT, UND80% ALC, SPIRIT BEV ETC	256.	84.
		9017	DRAWING, MATH, MEASURING INST ETC NESOI, PARTS	256.	8.
		8420	CALENDERING MACHINES ETC NESOI & CYLINDERS, PARTS	253.	20.
		6209	BABIES'' GARMENTS & ACCESSORIES, NOT KNIT OR CROCH	242.	13.
		504	ANIMAL (NOT FISH) GUTS, BLADDERS, STOMACHS & PARTS	240.	49.
		8207	INTERCHANGE TOOLS FOR HAND- OR MACHINE-TOOLS, BMPT	240.	8.
		2935	SULFONAMIDES	238.	87.
		9209	PARTS ETC OF MUSICAL INSTR, METRONONES, T FORK ETC	238.	31.
		7211	FL-RL IRON & NA STEEL UN 600MM WD, NOT CLAD ETC	236.	446.
		3215	INK, PRINTING, WRITING, DRAWING ETC, CONCEN OR NO	229.	13.
		8447	MACHINES, KNITTING, STITCH-BOND, LACE, NET ETC.	219.	12.
		3307	PERSONAL TOILET ETC PREP NESOI, SHAVING, BATH ETC.	217.	59.
		8407	SPARK-IGNITION RECIP OR ROTARY INT COMB PISTON ENG	217.	50.

1993 U.S. IMPORTS TRANSSHIPPED VIA CANADA ABOVE \$200,000
 BY CUSTOMS DISTRICT BY DESCEND. VALUE IN \$1000'S ESTIM. WEIGHT IN METRIC TONS

CD#	CUSTOMS DISTRICT	CODE	HARMONIZED COMMODITY DESCRIPTION	\$1000S	EST. M.TONS
2	ST. ALBANS, VT.	8525	TRANS APPAR FOR RADIOTELEPHONY ETC, TV CAMERAS	216.	9.
		8450	WASHING MACHINES, HOUSEHOLD- OR LAUNDRY-TYPE, PTS	213.	32.
		2821	IRON OXIDES & HYDROXIDES, EARTH COLORS NUN 70% IR	209.	358.
		2835	PHOSPHINATES, PHOSPHONATES, PHOSPHATES & POLYPHOSP	209.	163.
		9013	LIQUID CRYSTAL DEVICES NESOI, LASERS, OPT APPL, P	208.	4.
		7603	ALUMINUM POWDERS AND FLAKES	205.	60.
		7411	COPPER TUBES AND PIPES	203.	43.
		9999	BELOW MINIMUM	17,484.	11,376.
			*SUB-TOTAL CUSTOMS DIST. # 2	515,544.	119,245.
4	BOSTON, MASS.	2826	FLUORIDES, FLUROSILICATES, FLUROALUMINATES ETC	12,400.	3,196.
		8516	ELEC WATER, SPACE & SOIL HEATERS, HAIR ETC DRY, P	10,349.	617.
		8471	AUTOMATIC DATA PROCESS MACHINES, MAGN READER ETC	9,986.	242.
		6913	STATUETTES AND OTHER ORNAMENTAL CERAMIC ARTICLES	7,412.	1,553.
		3920	PLATES, SHEETS, FILM ETC NO AD, NON-CEL ETC, PLAS	5,636.	1,828.
		5501	SYNTHETIC FILAMENT TOW	3,250.	1,169.
		2204	WINE OF FRESH GRAPES, GRAPE MUST NESOI	3,045.	1,043.
		6403	FOOTWEAR, OUTER SOLE RUB, PLAST OR LEA & UPPER LEA	2,979.	152.
		8421	CENTRIFUGES, FILTER ETC MACH FOR LIQ OR GASES, PT	2,466.	244.
		8473	PARTS ETC FOR TYPEWRITERS & OTHER OFFICE MACHINES	2,322.	218.
		3921	PLATES, SHEETS, FILM, FOIL & STRIP NESOI, PLASTIC	1,666.	294.
		2208	ETHYL ALCOHOL, UNDENAT, UNDB0% ALC, SPIRIT BEV ETC	1,473.	588.
		7013	GLASSWARE FOR TABLE, KITCHEN, TOILET ETC USE NESOI	1,069.	453.
		5702	CARPETS & OTH TEXT FLOOR COVER, WOVEN, NO TUFT ETC	1,011.	277.
		8481	TAPS, COCKS, VALVES ETC FOR PIPES, TANKS ETC, PTS	952.	185.
		9018	MEDICAL, SURGICAL, DENTAL OR VET INST, NO ELEC, P	926.	56.
		3215	INK, PRINTING, WRITING, DRAWING ETC, CONCEN OR NO	915.	164.
		8518	MICROPHONES, LOUDSPEAKERS, SOUND AMPLIFIER ETC, P	878.	46.
		3213	ARTIST COLORS ETC IN TABLETS, TUBES, JARS ETC.	849.	304.
		4016	ARTICLES NESOI OF UNHARDED VULCANIZED RUBBER	836.	39.
		9017	DRAWING, MATH, MEASURING INST ETC NESOI, PARTS	773.	49.
		2005	VEGETABLES NESOI PREPARED ETC NESOI, NOT FROZEN	738.	692.
		8543	ELECTRICAL MACH ETC, WITH IND FUNCTIONS NESOI, PT	718.	35.
		9019	MECH-THER, MASSAGE, PSYCH TEST, OZONE APP ETC, PT	710.	24.
		8451	MACHINERY (NOT LAUNDRY) FOR CLEANING, DRYING ETC	661.	33.
		3926	ARTICLES OF PLASTICS (INC POLYMERS & RESINS) NESO	654.	125.
		8103	TANTALUM & ARTICLES THEREOF, INCLUD WASTE & SCRAP	643.	5.
		1604	PREP OR PRES FISH, CAVIAR & CAVIAR SUBSTITUTES	613.	247.
		9609	PENCILS (LEAD ENCASED), CRAYONS, LEADS, CHALKS ETC	583.	21.
		3707	PHOTOGRAPHIC CHEMICALS, UNMIXED PROD RETAIL PACKED	551.	323.
		8413	PUMPS FOR LIQUIDS, LIQUID ELEVATORS, PARTS THEREO	527.	29.
		8465	MACHINE TOOLS FOR WORKING WOOD, CORK, BONE ETC	525.	92.
		4823	PAPER, PAPERBOARD, CELLUL WAD TO SIZE & ARTS NESO	519.	95.
		306	CRUSTACEANS, LIVE, FRESH ETC, AND COOKED ETC.	506.	64.
		2933	HETEROCYCLIC COMP, NIT HETERO-ATOM, NUCLEIC ACIDS	490.	1.
		4901	BOOKS, BROCHURES & SIMILAR PRINTED MATTER	465.	93.
		8708	PARTS & ACCESS FOR MOTOR VEHICLES (HEAD 8701-8705)	452.	88.

1993 U.S. IMPORTS TRANSSHIPPED VIA CANADA ABOVE \$200,000
 BY CUSTOMS DISTRICT BY DESCEND. VALUE IN \$1000'S ESTIM. WEIGHT IN METRIC TONS

APPENDIX I-2 PAGE: 7

CD#	CUSTOMS DISTRICT	CODE	HARMONIZED COMMODITY DESCRIPTION	\$1000S	EST. M.TONS
4	BOSTON, MASS.	7310	TANKS ETC, NOV 300 LITER CAPACITY, IRON OR STEEL	451.	128.
		5603	NONWOVENS, WHETHER OR NOT IMPREGNATED, COATED ETC	415.	150.
		8509	ELECTROMECH DOMESTIC APPLIANCES, PARTS	396.	21.
		304	FISH FILLETS & OTH FISH MEAT, FRESH, CHILL OR FROZ	377.	138.
		9208	MUSICAL BOXES, FAIRGROUND ORGANS ETC, WHISTLES ETC	368.	38.
		6406	PARTS OF FOOTWEAR, INSOLES ETC, GAITORS ETC, PARTS	360.	28.
		9506	ARTICLES & EQUIP FOR SPORTS ETC NESOI, POOLS, PTS	360.	37.
		9403	FURNITURE NESOI AND PARTS THEREOF	349.	133.
		3922	BATHS, WASHBASINS, LAVATORY SEATS ETC OF PLASTICS	347.	40.
		8531	ELECTRIC SOUND OR VISUAL SIGNALING APPARATUS, PTS	323.	8.
		8479	MACHINES ETC HAVING INDIVIDUAL FUNCTIONS NESOI, P	322.	27.
		4421	ARTICLES OF WOOD, NESOI	302.	50.
		9505	FESTIVE, CARNIVAL OR OTHER ENTERTAINMENT ART, PTS	294.	47.
		6912	CERAMIC TABLEWRE, KITCHNWRE ETC, EARTHENWARE ETC	266.	105.
		7118	COIN	265.	18.
		9401	SEATS (EXCEPT BARBER, DENTAL, ETC), AND PARTS	223.	76.
		3307	PERSONAL TOILET ETC PREP NESOI, SHAVING, BATH ETC.	219.	11.
		208	MEAT & EDIBLE OFFAL NESOI, FRESH, CHILLD OR FROZEN	214.	76.
		1905	BREAD, PASTRY, CAKES ETC, COMM WAFRS, EMP CAPS ETC	212.	70.
		8453	MACHINERY FOR WORK LEATHER ETC & FOOTWEAR ETC, PT	212.	40.
		6402	FOOTWEAR, OUTER SOLE & UPPER RUBBER OR PLAST NESOI	211.	20.
		5107	YARN OF COMBED WOOL, NOT PUT UP FOR RETAIL SALE	208.	27.
		7326	ARTICLES OF IRON OR STEEL, NESOI	208.	78.
		9999	BELOW MINIMUM	8,178.	3,222.
			*SUB-TOTAL CUSTOMS DIST. # 4	95,628.	19,270.
5	PROVIDENCE, R.I.	9999	BELOW MINIMUM	640.	296.
			*SUB-TOTAL CUSTOMS DIST. # 5	640.	296.
7	OGDENSBURG, N.Y.	8542	ELECTRONIC INTEGRATED CIRCUITS & MICROASSEMBL, PT	52,351.	2,372.
		8471	AUTOMATIC DATA PROCESS MACHINES, MAGN READER ETC	47,932.	2,680.
		8523	PREPARED UNRECORDED MEDIA (NO FILM) FOR SOUND ETC	39,644.	4,827.
		2934	HETEROCYCLIC COMPOUNDS NESOI	35,511.	1,155.
		3204	SYN ORG COLORING MATTER & PREP, SYN ORG BRIT AGENT	30,823.	1,995.
		8473	PARTS ETC FOR TYPEWRITERS & OTHER OFFICE MACHINES	22,242.	746.
		7217	WIRE OF IRON & NONALLOY STEEL	12,515.	12,423.
		8482	BALL OR ROLLER BEARINGS AND PARTS	12,234.	867.
		1806	CHOCOLATE & OTHER FOOD PRODUCTS CONTAINING COCOA	11,789.	5,018.
		3701	PHOTO PLATES & FILM, FLAT, SENSITIZED, UNEXPOSED	10,628.	547.
		8411	TURBOJETS, TURBOPROPELLERS & OTH GAS TURBINES, PTS	10,591.	853.
		9405	LAMPS & LIGHTING FITTINGS & PARTS ETC NESOI	10,298.	1,244.
		9503	TOYS NESOI, SCALE MODELS ETC, PUZZLES, PARTS ETC	10,220.	1,660.
		8517	ELECTRIC APPARATUS FOR LINE TELEPHONY ETC, PARTS	9,166.	303.
		3702	PHOTO FILM IN ROLLS SENSITIZED, UNEXPOSED	8,779.	413.
		2918	CARBOXYLIC ACID, ADDED OXYGEN & ANHY ETC, HAL ETC	8,644.	5,831.
		6201	MEN'S OR BOYS' OVERCOATS, CLOAKS ETC, NOT KNIT E	8,559.	550.

1993 U.S. IMPORTS TRANSSHIPPED VIA CANADA ABOVE \$200,000
 BY CUSTOMS DISTRICT BY DESCEND. VALUE IN \$1000'S ESTIM. WEIGHT IN METRIC TONS

CD#	CUSTOMS DISTRICT	CODE	HARMONIZED COMMODITY DESCRIPTION	\$1000S	EST. M.TONS
----	-----	----	-----	-----	-----
7	OGDENSBURG, N.Y.	4011	NEW PNEUMATIC TIRES, OF RUBBER	7,972.	2,486.
		6912	CERAMIC TABLEWARE, KITCHENWARE ETC, EARTHENWARE ETC	7,916.	3,168.
		4901	BOOKS, BROCHURES & SIMILAR PRINTED MATTER	7,552.	1,082.
		8409	PARTS FOR ENGINES OF HEADING 8407 OR 8408	7,516.	679.
		2922	OXYGEN-FUNCTION AMINO-COMPOUNDS	7,347.	674.
		2208	ETHYL ALCOHOL, UNDENAT, UN80% ALC, SPIRIT BEV ETC	7,055.	1,950.
		8105	COBALT MATTES ETC, COBALT & ART, INC WASTE & SCRAP	7,001.	278.
		7607	ALUMINUM FOIL (BACK OR NOT) NOV .2MM TH (EX BACK)	6,645.	2,708.
		3206	COLORING MATTER NESOI, COLORING PREP NESOI, ETC.	6,551.	2,460.
		3926	ARTICLES OF PLASTICS (INC POLYMERS & RESINS) NESO	5,964.	1,223.
		2933	HETEROCYCLIC COMP, NIT HETERO-ATOM, NUCLEIC ACIDS	5,951.	428.
		905	VANILLA BEANS	5,839.	81.
		8481	TAPS, COCKS, VALVES ETC FOR PIPES, TANKS ETC, PTS	5,674.	605.
		2818	ALUMINUM OXIDE (INCL ART CORUNDUM), ALUM HYDROXIDE	5,597.	5,639.
		4810	PAPER & PAPERBOARD, COATED WITH KAOLIN ETC, RL ET	4,802.	6,294.
		3503	GELATIN & DERIV, ISINGLASS, GLUES, ANIMAL OR NESOI	4,559.	880.
		9506	ARTICLES & EQUIP FOR SPORTS ETC NESOI, POOLS, PTS	4,014.	682.
		8701	TRACTORS (OTHER THAN WORKS TRUCKS OF HEADING 8709)	4,000.	741.
		8708	PARTS & ACCESS FOR MOTOR VEHICLES (HEAD 8701-8705)	3,968.	534.
		8803	PARTS OF BALLOONS ETC, AIRCRAFT, SPACECRAFT ETC	3,929.	47.
		7315	CHAIN & PARTS, OF IRON OR STEEL	3,897.	663.
		8211	KNIVES WITH BLADES & BLADES FOR KNIVES NESOI, BMP	3,737.	164.
		8501	ELECTRIC MOTORS AND GENERATORS (NO SETS)	3,735.	1,995.
		7409	COPPER PLATES, SHEETS & STRIP, OVER 0.15MM THICK	3,684.	1,348.
		3703	PHOTO PAPER, PAPERBOARD & TEXTILES, SENS, UNEXPOS	3,540.	261.
		2005	VEGETABLES NESOI PREPARED ETC NESOI, NOT FROZEN	3,385.	3,192.
		7118	COIN	3,368.	315.
		8503	PARTS OF ELECTRIC MOTORS, GENERATORS & SETS	3,360.	412.
		3913	NATURAL (INC MODIFIED) POLYMERS NESOI, PRIMARY FM	3,331.	402.
		4002	SYNTH RUBBER & FACTICE, INC NAT-SYN MIX, PR FM ETC	3,301.	1,760.
		2914	KETONES & QUINONES & HALOGENATD, SULFONATD DER ET	3,287.	346.
		8534	PRINTED CIRCUITS	3,193.	67.
		5603	NONWOVENS, WHETHER OR NOT IMPREGNATED, COATED ETC	3,176.	686.
		8479	MACHINES ETC HAVING INDIVIDUAL FUNCTIONS NESOI, P	3,156.	341.
		2925	CARBOXYIMIDE-FUNCTION COMP, IMINE-FUNCTION COM ET	3,113.	178.
		8406	STEAM TURBINES & OTHER VAPOR TURBINES, PARTS	3,071.	704.
		8443	PRINTING MACHINERY, MACHINES ANCIL TO PRINTING, P	3,041.	167.
		8607	PARTS OF RAILWAY OR TRAMWAY LOCOMOTIVES OR R STOCK	3,010.	752.
		6403	FOOTWEAR, OUTER SOLE RUB, PLAST OR LEA & UPPER LEA	3,006.	199.
		9018	MEDICAL, SURGICAL, DENTAL OR VET INST, NO ELEC, P	2,999.	103.
		8410	HYDRAULIC TURBINES, WATER WHEELS & REGULATORS, PTS	2,973.	843.
		8433	HARVEST ETC MACHINES, CLEANING EGGS ETC NESOI, PT	2,962.	375.
		9703	ORIGINAL SCULPTURES AND STATUARY, IN ANY MATERIAL	2,921.	945.
		6211	TRACK SUITS, SKI-SUITS & SWIMWEAR, NOT KNIT ETC	2,903.	171.
		8483	TRANSMISSION SHAFTS, BEARINGS, GEARS ETC, PARTS	2,798.	475.
		8430	MACH NESOI, MOVING, GRAD ETC, PILE-DR, SNOPLow ET	2,789.	342.
		8439	MACHINERY FOR MAKING PULP & MAKING ETC PAPER, PTS	2,748.	385.
		3822	COMPOSITE DIAGNOSTIC/LAB REAGENTS, EXC PHARMACEUT	2,709.	503.

1993 U.S. IMPORTS TRANSSHIPPED VIA CANADA ABOVE \$200,000
 BY CUSTOMS DISTRICT BY DESCEND. VALUE IN \$1000'S ESTIM. WEIGHT IN METRIC TONS

CD#	CUSTOMS DISTRICT	CODE	HARMONIZED COMMODITY DESCRIPTION	\$1000S	EST. M.TONS
7	OGDENSBURG, N.Y.	8508	ELECTROMECHANICAL TOOLS, WORKING IN HAND, PARTS	2,697.	146.
		8516	ELEC WATER, SPACE & SOIL HEATERS, HAIR ETC DRY, P	2,695.	392.
		9403	FURNITURE NESOI AND PARTS THEREOF	2,648.	1,026.
		304	FISH FILLETS & OTH FISH MEAT, FRESH, CHILL OR FROZ	2,621.	512.
		7326	ARTICLES OF IRON OR STEEL, NESOI	2,546.	872.
		8431	PARTS FOR MACHINERY OF HEADINGS 8425 TO 8430	2,521.	576.
		4203	ARTICLES OF APPAREL & ACCESS, LEATH & COMP LEATHER	2,472.	91.
		4303	ARTICLES OF APPAREL ETC. OF FURSKIN	2,420.	103.
		3920	PLATES, SHEETS, FILM ETC NO AD, NON-CEL ETC, PLAS	2,348.	861.
		8714	PARTS & ACCESS FOR CYCLES & INVALID CARRIAGES	2,283.	500.
		8429	SELF-PROPELLED BULLDOZERS, GRADERS, SCRAPERS ETC	2,275.	491.
		7601	ALUMINUM, UNWROUGHT	2,249.	1,857.
		8422	MACHINES, DISHWASH, CLEAN ETC CONT & FILL, PAK ET	2,228.	231.
		4802	PAPER, UNCOAT, FOR WRITING ETC, ROLLS, HNDMD PAPER	2,200.	2,697.
		2204	WINE OF FRESH GRAPES, GRAPE MUST NESOI	2,075.	996.
		7202	FERROALLOYS	2,067.	1,894.
		9401	SEATS (EXCEPT BARBER, DENTAL, ETC), AND PARTS	2,056.	585.
		8441	MACH FOR MAKING UP PULP & PAPER, INC CUTTERS, PTS	1,892.	92.
		8421	CENTRIFUGES, FILTER ETC MACH FOR LIQ OR GASES, PT	1,870.	173.
		2932	HETEROCYCLIC COMPOUNDS, OXYGEN HETERO-ATOM(S) ONL	1,867.	243.
		2835	PHOSPHINATES, PHOSPHONATES, PHOSPHATES & POLYPHOSP	1,856.	1,673.
		9014	DIRECTION FINDING COMPASSES & NAVIG INST ETC, PTS	1,818.	39.
		3905	POLYMERS OF VINYL ACETATE & OTH VINYL POLYM, PR FM	1,816.	435.
		2921	AMINE-FUNCTION COMPOUNDS	1,797.	512.
		3823	BINDERS FOR FOUND MOLDS, CHEMICAL PROD ETC NESOI	1,742.	715.
		7503	NICKEL WASTE AND SCRAP	1,735.	2,248.
		3911	PETRO RESINS, POLYSULFIDES ETC NESOI, PRIMARY FOR	1,614.	515.
		9603	BROOMS, BRUSHES, MOPS, FEATHER DUSTERS ETC	1,606.	357.
		3921	PLATES, SHEETS, FILM, FOIL & STRIP NESOI, PLASTIC	1,590.	276.
		8302	HARDWARE, FIXTURES, CASTORS ETC & PARTS, BASE METL	1,584.	520.
		8524	RECORDS, TAPES & OTHER RECORDED SOUND MEDIA ETC	1,561.	60.
		4202	TRAVEL GOODS, HANDBAGS, WALLETS, JEWELRY CASES ETC	1,558.	167.
		2811	INORGANIC ACIDS & INORGANIC OXY NONMET COMP NESOI	1,553.	732.
		7408	COPPER WIRE	1,549.	420.
		1602	PREPARED OR PRESERV MEAT, MEAT OFFAL & BLOOD NESOI	1,529.	559.
		6506	HEADGEAR NESOI, WHETHER OR NOT LINED OR TRIMMED	1,526.	65.
		7212	FL-RL IRON & NA STEEL UN 600MM WD, CLAD ETC	1,524.	1,136.
		3603	SAFETY FUSES, DETONATING FUSE, PERCUSSION CAPS ETC	1,508.	170.
		8507	ELECTRIC STORAGE BATTERIES, INCL SEPARATORS, PARTS	1,491.	347.
		9009	PHOTOCOPY APPARATUS & THERMOCOPY APPARATUS, PTS	1,459.	65.
		6202	WOMEN'S OR GIRLS' OVERCOATS ETC, NOT KNIT OR CRO	1,456.	77.
		8465	MACHINE TOOLS FOR WORKING WOOD, CORK, BONE ETC	1,446.	135.
		7013	GLASSWARE FOR TABLE, KITCHEN, TOILET ETC USE NESOI	1,445.	326.
		7307	TUBE OR PIPE FITTINGS, OF IRON OR STEEL	1,443.	499.
		7205	PIG IRON, SPIEGEL, IRON OR STEEL GRANULES & POWDER	1,427.	194.
		3909	AMINO-RESINS, PHENOLICS & POLYURETHANES, PRIM FORM	1,403.	683.
		4102	RAW SKINS OF SHEEP OR LAMBS NESOI	1,400.	419.
		3925	BUILDERS' WARE OF PLASTICS, NESOI	1,372.	346.

1993 U.S. IMPORTS TRANSSHIPPED VIA CANADA ABOVE \$200,000
 BY CUSTOMS DISTRICT BY DESCEND. VALUE IN \$1000'S ESTIM. WEIGHT IN METRIC TONS

CD#	CUSTOMS DISTRICT	CODE	HARMONIZED COMMODITY DESCRIPTION	\$1000S	EST. M.TONS
7	OGDENSBURG, N.Y.	2917	POLYCARBOXYLIC ACIDS & ANHYD ETC, HALOG, SULF ETC	1,358.	548.
		5407	WOVEN FAB OF SYN FIL YN, INCL MONOFIL 67 DEC ETC	1,355.	178.
		6913	STATUETTES AND OTHER ORNAMENTAL CERAMIC ARTICLES	1,349.	96.
		8419	MACHINERY ETC FOR TEMP CHANG TREAT MAT, W HEAT, P	1,335.	136.
		1905	BREAD, PASTRY, CAKES ETC, COMM WAFRS, EMP CAPS ETC	1,329.	316.
		2002	TOMATOES PREPARED OR PRESERVED NESOI	1,325.	4,096.
		2804	HYDROGEN, RARE GASES AND OTHER NONMETALS	1,321.	894.
		3923	CONTAINERS (BOXES, BAGS ETC), CLOSURERS ETC, PLAS	1,306.	352.
		2826	FLUORIDES, FLUROSILICATES, FLUOROALUMINATES ETC	1,303.	1,372.
		8205	HANDTOOLS NESOI, BLOW TORCHES ETC, ANVILS ETC	1,287.	209.
		4902	NEWSPAPERS, JOURNALS & PERIODICALS	1,268.	479.
		8703	MOTOR CARS & VEHICLES FOR TRANSPORTING PERSONS	1,262.	111.
		3401	SOAP, ORGANIC SURF-ACT PREP FOR SOAP USE, BARS ETC	1,237.	314.
		8504	ELECTRIC TRANSFORM, STATIC CONVERTERS & INDUCT, PT	1,234.	150.
		5501	SYNTHETIC FILAMENT TOW	1,220.	424.
		4823	PAPER, PAPERBOARD, CELLUL WAD TO SIZE & ARTS NESO	1,212.	187.
		5510	YARN (NO SEW THREAD), ART STAPLE FIB, NOT RETAIL	1,181.	387.
		8545	CARBON ELECTRODES & BRUSHES, LAMP CARBONS ETC	1,163.	612.
		3005	BANDAGES ETC COATED ETC OR IN RETAIL MEDIC ETC FM	1,149.	345.
		902	TEA	1,146.	678.
		8447	MACHINES, KNITTING, STITCH-BOND, LACE, NET ETC.	1,138.	121.
		4814	WALLPAPER ETC., WINDOW TRANSPARENCIES OF PAPER	1,135.	263.
		3801	ARTIFICIAL GRAPHITE, COLLODIAL GRAPHITE & PREP ETC	1,100.	375.
		2936	PROVITAMINS AND VITAMINS & DERIVATIVES & INTERMIX	1,093.	41.
		6110	SWEATERS, PULLOVERS, VESTS ETC, KNIT OR CROCHETED	1,077.	86.
		2009	FRUIT JUICES (& GRAPE MUST) & VEG JUICE, NO SPIRIT	1,075.	853.
		4104	BOVINE OR EQUINE LEATHER, NO HAIR NESOI	1,051.	75.
		6902	REFRACTORY BRICKS & OTHER REFR CER CONST ART NESOI	1,036.	949.
		6911	CERAMIC TABLEWARE ETC. OF PORCELAIN OR CHINA	1,023.	152.
		8512	ELECTRIC LIGHT ETC EQUIP, WINDSH WIPERS ETC, PART	1,009.	46.
		3707	PHOTOGRAPHIC CHEMICALS, UNMIXED PROD RETAIL PACKED	991.	119.
		7226	FL-RL ALLOY STEEL NESOI UN 600MM WIDE	989.	365.
		3924	TABLEWARE & OTHER HOUSEHOLD ARTICLES ETC, PLASTIC	985.	235.
		303	FISH, FROZEN (NO FISH FILLETS OR OTHER FISH MEAT)	984.	345.
		3914	ION-EXCHANGERS BASD ON PLASTICS, IN PRIMARY FORMS	959.	405.
		3602	PREPARED EXPLOSIVES OTHER THAN PROPELLENT POWDERS	955.	107.
		7211	FL-RL IRON & NA STEEL UN 600MM WD, NOT CLAD ETC	953.	857.
		6402	FOOTWEAR, OUTER SOLE & UPPER RUBBER OR PLAST NESOI	945.	70.
		6109	T-SHIRTS, SINGLETs, TANK TOPS ETC, KNIT OR CROCHET	943.	91.
		8506	PRIMARY CELLS & BATTERIES, PARTS	933.	81.
		7325	CAST ARTICLES NESOI, OF IRON OR STEEL	931.	329.
		2402	CIGARS, CIGARETTES ETC., OF TOBACCO OR SUBSTITUTES	919.	70.
		6205	MEN'S OR BOYS' SHIRTS, NOT KNITTED OR CROCHETED	904.	50.
		6203	MEN'S OR BOYS' SUITS, ENSEMBLES ETC, NOT KNIT ET	888.	66.
		7606	ALUMINUM PLATES, SHEETS & STRIP OVER .2MM THICK	887.	296.
		8201	HANDTOOLS & TOOLS USED IN AGRICULT ETC, B MET PTS	883.	525.
		6206	WOMEN'S OR GIRLS' BLOUSES, SHIRTS ETC NOT KNIT E	880.	40.
		9025	HYDROMETERS, THERMOMETERS, PYROMETERS ETC, PTS ET	879.	33.

1993 U.S. IMPORTS TRANSSHIPPED VIA CANADA ABOVE \$200,000
 BY CUSTOMS DISTRICT BY DESCEND. VALUE IN \$1000'S ESTIM. WEIGHT IN METRIC TONS

CD#	CUSTOMS DISTRICT	CODE	HARMONIZED COMMODITY DESCRIPTION	\$1000S	EST. M.TONS
---	-----	---	-----	---	-----
7	OGDENSBURG, N.Y.	2836	CARBONATES, PEROXOCARBONATES, COMM AMM CARBONATE	874.	1,417.
		9030	OSCILLOSCOPES, SPECTRUM ANALYZERS ETC, PARTS ETC	872.	35.
		3506	PREPARED GLUES & ADHESIVES NESOI, GLUE RETAIL PACK	851.	176.
		2518	DOLOMITE, CALCINED OR NOT, ROUGHLY TRIMMED ETC.	830.	1,582.
		7602	ALUMINUM WASTE AND SCRAP	809.	859.
		3906	ACRYLIC POLYMERS IN PRIMARY FORMS	807.	353.
		7404	COPPER WASTE AND SCRAP	807.	1,207.
		3601	PROPELLANT POWDERS	795.	98.
		2905	ACYCLIC ALCOHOLS & HALOGENAT, SULFONATD ETC DERIVS	794.	333.
		8414	AIR OR VAC PUMPS, COMPR & FANS, HOODS & FANS, PTS	794.	119.
		3908	POLYAMIDES IN PRIMARY FORMS	793.	206.
		7010	GLASS CONTAINERS FOR PACKING ETC & GLASS CLOSURES	790.	621.
		3307	PERSONAL TOILET ETC PREP NESOI, SHAVING, BATH ETC.	789.	198.
		7615	HOUSEHOLD ART ETC, POT SCOUR ETC, SAN WR, ALUMINUM	775.	113.
		8424	MECH APPL TO DISPERSE LIQ ETC, SAND ETC BLAST MAC	759.	68.
		8536	ELECTRICAL APPARATUS FOR SWITCHING ETC, NOV 1000	750.	53.
		8805	AIRCRAFT LAUNCH GEAR, DECK-ARREST, GR FL TRAIN, PT	750.	35.
		7112	WASTE & SCRAP OF PREC METAL OR METAL CL W PREC MT	748.	321.
		3202	SYN ORG & INORG TANNING SUBST, TAN PREP, ENZ PREP	741.	508.
		8452	SEWING MACHINES (NOT BOOK-SEW), COVER ETC, NEEDLE	737.	53.
		3604	FIREWORKS, SIGNALLING FLARES, RAIN ROCKETS ETC.	731.	104.
		3214	GLAZIERS PUTTY, RESIN CEMENTS, CAULKING COMPS ETC	726.	711.
		6404	FOOTWEAR, OUTER SOLE RUB, PLAST OR LEA & UPPER TEX	712.	73.
		2923	QUATERNARY AMMONIUM SALTS ETC, LECITHINS ETC.	708.	129.
		2926	NITRILE-FUNCTION COMPOUNDS	685.	67.
		3402	ORGANIC SURF-ACT AGENTS, PREPS & CLEANING PREPS	677.	290.
		8529	PARTS FOR TELEVISION, RADIO AND RADAR APPARATUS	672.	24.
		7318	SCREWS, BOLTS, NUTS, WASHERS ETC, IRON OR STEEL	668.	470.
		8518	MICROPHONES, LOUDSPEAKERS, SOUND AMPLIFIER ETC, P	651.	67.
		3821	PREPARED CULTURE MEDIA FOR DEVEL OF MICROORGANISM	650.	74.
		1109	WHEAT GLUTEN, WHETHER OR NOT DRIED	612.	548.
		8001	TIN, UNWROUGHT	607.	172.
		2821	IRON OXIDES & HYDROXIDES, EARTH COLORS NUN 70% IR	602.	700.
		8509	ELECTROMECH DOMESTIC APPLIANCES, PARTS	601.	53.
		3812	PREPARED RUBBER ACCELERATORS, COM PLASTICIZERS ET	597.	421.
		8106	BISMUTH AN ARTLS, INCLD WASTE AND SCRAP	583.	41.
		9032	AUTOMATIC REGULATING OR CONTROL INSTRUMENTS, PART	581.	41.
		3903	POLYMERS OF STYRENE, IN PRIMARY FORMS	576.	282.
		7220	FL-RL STAINLESS STEEL PRODUCTS, UNDER 600MM WIDE	563.	197.
		8403	CENTRAL HEAT BOILERS NESOI, AND PARTS	562.	86.
		9504	ARTICLES FOR ARCADE, TABLE OR PARLOR GAMES, PARTS	557.	54.
		2903	HALOGENATED DERIVATIVES OF HYDROCARBONS	546.	822.
		8445	MACHINES FOR PREPARING TEXTILE FIBERS & YARNS	541.	55.
		504	ANIMAL (NOT FISH) GUTS, BLADDERS, STOMACHS & PARTS	531.	395.
		8413	PUMPS FOR LIQUIDS, LIQUID ELEVATORS, PARTS THEREO	529.	43.
		2930	ORGANO-SULFUR COMPOUNDS	526.	128.
		4819	CARTONS ETC PAPER, OFFICE BOX FILES ETC, PAPER ET	524.	196.
		9022	X-RAY ETC APPARATUS, TUBES, PANELS, SCREEN ETC, P	521.	29.

1993 U.S. IMPORTS TRANSSHIPPED VIA CANADA ABOVE \$200,000
 BY CUSTOMS DISTRICT BY DESCEND. VALUE IN \$1000'S ESTIM. WEIGHT IN METRIC TONS

CD#	CUSTOMS DISTRICT	CODE	HARMONIZED COMMODITY DESCRIPTION	\$1000S	EST. M.TONS
7	OGDENSBURG, N.Y.	2825	HYDRAZINE ETC, OTH INORG BASES, METAL OXIDES ETC	518.	146.
		6307	MADE-UP ARTICLES OF TEXTILE MATERIALS NESOI	515.	75.
		3102	MINERAL OR CHEMICAL FERTILIZERS, NITROGENOUS	502.	3,547.
		4012	RETREAD OR USED PNEU TIRES, SOLID TIRES ETC, RUBB	502.	228.
		4706	PULPS OF FIBEROUS CELLULOSIC MATERIAL NESOI	499.	427.
		3201	TANNING EXT OF VEG ORIGIN, TANNINS & ITS SALTS ETC	495.	585.
		7407	COPPER BARS, RODS AND PROFILES	495.	239.
		6908	GLAZED CERAMIC FLAGS & PAVING, HEARTH TILES, ETC	494.	961.
		3808	INSECTICIDES, RODENTICIDES, FUNGICIDES ETC, RETAIL	487.	133.
		1108	STARCHES, INULIN	480.	858.
		8462	MACHINE TOOLS FOR FORGING, BENDING, STAMPING ETC	478.	33.
		4911	PRINTED MATTER NESOI, INCL PRINT PICTURES & PHOTOS	475.	52.
		8438	MACH NESOI, IND PREP OF FOOD OR DRINK ETC, PARTS	475.	17.
		2924	CARBOXYAMIDE-FUNCTION COMP, AMIDE-FUNCTION COM ET	473.	205.
		2915	SAT ACYCLIC NONOCARBOX ACID & ANHYD, HALOGON ETC	472.	417.
		6803	SLATE, WORKED AND ARTICLES, ARTICLS OF AGGLOM SLT	469.	858.
		5911	TEXTILE PRODUCTS ETC. FOR SPECIFIC TECH USES NESOI	465.	8.
		8544	INSULATED WIRE, CABLE ETC, OPT SHEATH FIB CABLES	462.	53.
		306	CRUSTACEANS, LIVE, FRESH ETC, AND COOKED ETC.	456.	66.
		8541	SEMICONDUCTOR DEVICES, LIGHT-EMIT DIODES ETC, PTS	456.	170.
		8716	TRAILERS ETC, OTHER VEHICLES, NOT MECH PROPELD, P	456.	512.
		6210	GARMENTS, OF FELT ETC, OR FABRIC IMPREGNATED ETC	452.	21.
		8214	ARTICLES OF CUTLERY NESOI, MANICURE SETS ETC, BMP	452.	36.
		8434	MILKING MACHINES & DAIRY MACHINERY & PARTS	448.	34.
		2842	SALTS OF INORGANIC ACIDS OR PEROXOACIDS NESOI	447.	193.
		3406	CANDLES, TAPERS AND THE LIKE	436.	270.
		3505	DEXTRINS ETC, GLUES BASED ON STARCHES, DEXTRIN ETC	433.	582.
		3205	COLOR LAKES, PREPARATIONS BASED ON COLOR LAKES	428.	37.
		6214	SHAWLS, SCARVES, MUFFLERS, MANTILLAS, VEILS ETC.	425.	13.
		7223	WIRE OF STAINLESS STEEL	421.	100.
		9013	LIQUID CRYSTAL DEVICES NESOI, LASERS, OPT APPL, P	420.	7.
		8101	TUNGSTEN (WOLFRAM) & ARTICLES, INCL WASTE & SCRAP	415.	123.
		8448	AUXILIARY MACHINERY FOR USE WITH TEXTILE MACHINES	406.	20.
		2907	PHENOLS, PHENOL-ALCOHOLS	403.	85.
		2906	CYCLIC ALCOHOLS & HALOGENATD, SULFONATD ETC DERIVS	400.	78.
		3907	POLYETHERS, EXPOXIDES & POLYESTERS, PRIMARY FORMS	399.	84.
		7210	FL-RL IRON & NA STEEL NUN600MM WD, CLAD ETC	390.	487.
		7403	REFINED COPPER & ALLOYS (NO MAST ALLOY), UNWROUGHT	382.	193.
		8451	MACHINERY (NOT LAUNDRY) FOR CLEANING, DRYING ETC	370.	25.
		8474	MACHINERY FOR SORTING SCREENING ETC MINERALS, PTS	370.	248.
		9023	INST, APPTS&MODELS, FOR DEMONSTRATIONAL USE& PARTS	370.	30.
		8527	RECEPTION APPARATUS FOR RADIOTELEPHONY ETC	369.	21.
		9608	PENS (BALL POINT, S TIP ETC), MECH PENCILS ETC, PT	369.	63.
		2935	SULFONAMIDES	368.	25.
		9010	APPARATUS ETC FOR PHOTO LABS ETC NESOI, PARTS ETC	364.	21.
		7002	GLASS IN BALLS (NOT MICROS), RODS OR TUBES, UNWORK	357.	398.
		8476	AUTOMATIC GOODS-VENDING MACHINES, PARTS	357.	14.
		7502	NICKLE, UNWROUGHT	356.	43.

1993 U.S. IMPORTS TRANSSHIPPED VIA CANADA ABOVE \$200,000
 BY CUSTOMS DISTRICT BY DESCEND. VALUE IN \$1000'S ESTIM. WEIGHT IN METRIC TONS

CD#	CUSTOMS DISTRICT	CODE	HARMONIZED COMMODITY DESCRIPTION	\$1000S	EST. M.TONS
7	OGDENSBURG, N.Y.	6302	BED LINEN, TABLE LINEN, TOILET LINEN & KITCH LINEN	349.	50.
		9306	BOMBS, GRENADES ETC, CARTRIDGES ETC AND PARTS	345.	122.
		8428	LIFTING, HANDLING, LOADING & UNLOAD MACHINES NESO	344.	47.
		2931	ORGANO-INORGANIC COMPOUNDS NESOI	339.	84.
		5509	YARN (NO SEW THREAD), SYN STAPLE FIB, NOT RETAIL	335.	85.
		8112	BERYLLIUM, CHROM, GERM, VANAD, GALLIUM, HAFNM, ETC	334.	59.
		2904	HYDROCARBON DERIVATIVES, SULFONATED, NITRATED ETC	333.	119.
		203	MEAT OF SWINE (PORK), FRESH, CHILLED OR FROZEN	326.	158.
		9609	PENCILS (LEAD ENCASED), CRAYONS, LEADS, CHALKS ETC	324.	42.
		6204	WOMEN'S OR GIRLS' SUITS, ENSEMB ETC, NOT KNIT ET	323.	21.
		4811	PAPER, PAPERBOARD, WAD ETC, COAT ETC NESOI, RL ET	319.	117.
		6903	REFRACTORY CERAMIC GOODS, RETORTS, TUBES ETC NESOI	316.	86.
		8453	MACHINERY FOR WORK LEATHER ETC & FOOTWEAR ETC, PT	314.	32.
		7405	MASTER ALLOYS OF COPPER	312.	187.
		8715	BABY CARRIAGES (INC STROLLERS) AND PARTS THEREOF	311.	42.
		6102	WOMEN'S OR GIRLS' OVERCOATS ETC, KNIT OR CROCHET	310.	12.
		5205	COTTON YARN (NOT SEWING THREAD) NU85% COT NO RETAIL	309.	119.
		2833	SULFATES, ALUMS, PEROXOSULFATES (PERSULFATES)	308.	458.
		5516	WOVEN FABRICS OF ARTIFICIAL STAPLE FIBERS	306.	28.
		8463	MACHINE TOOLS FOR WORKING METAL, NESOI	306.	23.
		4004	WASTE OF RUB, EXC HD RUB, & POWDER OBTAIN THEREOF	304.	1,032.
		7323	HOUSEHOLD ART & PTS, IR & ST, IR OR STEEL WOOL ET	302.	73.
		8432	AGRICULT ETC MACH FOR SOIL ETC, LAWN ROLLERS, PTS	300.	80.
		3912	CELLULOSE AND CHEMICAL DERIV NESOI, PRIMARY FORMS	296.	183.
		901	COFFEE, COFFEE HUSKS ETC, SUBSTITUTES WITH COFFEE	294.	255.
		3919	SELF-ADHESIVE PLATES, SHEETS, FILM ETC OF PLASTIC	290.	96.
		8213	SCSSRS, TLRS A SMLR SHRS, BLDS A OTH BS MTL PTS	289.	20.
		7310	TANKS ETC, NOV 300 LITER CAPACITY, IRON OR STEEL	288.	258.
		4101	RAW HIDES & SKINS OF BOVINE OR EQUINE ANIMALS	287.	141.
		1804	COCOA BUTTER, FAT AND OIL	286.	111.
		9031	MACHINES, NESOI IN CHAPTER 90, PROFILE PROJECT, P	284.	18.
		3304	BEAUTY, MAKE-UP & SKIN-CARE PREP, MANICURE ETC PRP	282.	22.
		8705	SPECIAL PURPOSE MOTOR VEHICLES NESOI	281.	25.
		3902	POLYMERS OF PROPYLENE OR OTHER OLEFINS, PRIM FORMS	280.	196.
		5607	TWINE, CORDAGE, ROPE & CABLES, COATED ETC OR NOT	279.	439.
		2916	UNSAT ACYCLIC & CYCLIC MONOCARBOX ACID & ANHYD ET	274.	170.
		3407	MODELING PASTES FOR CHILD ETC, DENTA IMPR CP ETC	274.	15.
		5904	LINOLEUM, FLOOR COVER WITH COAT ETC ON A TEXT BASE	272.	112.
		7411	COPPER TUBES AND PIPES	272.	88.
		2927	DIAZO-, AZO-, OR AZOXY-COMPOUNDS	268.	52.
		8458	LATHES FOR REMOVING METAL	267.	39.
		2805	ALKALI METALS ETC, RARE-EARTH METALS ETC, MERCURY	259.	100.
		8456	MACHINE TOOLS FOR MATERIAL REMOVAL BY LASER ETC	257.	34.
		8502	ELECTRIC GENERATING SETS AND ROTARY CONVERTERS	257.	20.
		8427	FORK-LIFT TRUCKS, OTH WORKS TRUCKS WITH LIFTS ETC	255.	73.
		3213	ARTIST COLORS ETC IN TABLETS, TUBES, JARS ETC.	254.	42.
		3818	CHEM ELEM DOPED, USED IN ELECTRON, DISCS WAFERS E	252.	152.
		1504	FATS & OILS, THEIR FRACTIONS, FISH & MARINE MAMMAL	251.	71.

1993 U.S. IMPORTS TRANSSHIPPED VIA CANADA ABOVE \$200,000
 BY CUSTOMS DISTRICT BY DESCEND. VALUE IN \$1000'S ESTIM. WEIGHT IN METRIC TONS

CD#	CUSTOMS DISTRICT	CODE	HARMONIZED COMMODITY DESCRIPTION	\$1000S	EST. M.TONS
----	-----	----	-----	-----	-----
7	OGDENSBURG, N.Y.	202	MEAT OF BOVINE ANIMALS, FROZEN	250.	117.
		6802	WORKED MONUMENT ETC STONE & ART NESOI, GRANULE ETC	249.	316.
		2909	ETHERS, ETHER-ALCOHOLS, ALCOHOL PEROXIDES ETC.	248.	216.
		2827	CHLORIDES ETC, BROMIDES ETC, IODIDES ETC.	246.	284.
		1605	CRUSTACEANS, MOLLUSCS ETC. PREPARED OR PRESERVED	245.	40.
		8207	INTERCHANGE TOOLS FOR HAND- OR MACHINE-TOOLS, BMPT	242.	44.
		9027	INST ETC FOR PHYSICAL ETC ANAL ETC, MICROTOME, PT	239.	7.
		5402	SYNTHETIC FILAMENT YARN (NO SEW THREAD), NO RETAIL	237.	67.
		7007	SAFETY GLASS, OF TEMPERED OR LAMINATED GLASS	237.	49.
		4707	WASTE AND SCRAP OF PAPER OR PAPERBOARD	236.	143.
		4602	BASKETWORK, WICKERWORK OF PLAITS ETC, LOOFA ARTICL	232.	106.
		5208	WOVEN COTTON FABRICS, NU 85% COT, WT NOV 200 G/M2	227.	30.
		8477	MACHINERY FOR WORKING RUBBER & PLAST ETC NESOI, P	227.	12.
		3215	INK, PRINTING, WRITING, DRAWING ETC, CONCEN OR NO	225.	16.
		8466	PARTS ETC FOR MACHINE TOOLS OF HEAD 8456 TO 8465	224.	30.
		9502	DOLLS, REPRESENTING ONLY HUMAN BEINGS, & PARTS ETC	223.	36.
		5209	WOVEN COTTON FABRICS, NU 85% COT, WT OV 200 G/M2	221.	78.
		8459	MACHINE TOOLS FOR DRILLING, BORING, MILLING ETC	220.	36.
		7219	FL-RL STAINLESS STEEL PRODUCTS, NOT UND 600MM WID	219.	97.
		710	VEGETABLES (RAW OR COOKED BY STEAM ETC), FROZEN	218.	432.
		2526	NATURAL STEATITE, ROUGHLY TRIMMED ETC, TALC	218.	859.
		7312	STRANDED WIRE, ROPES ETC, NO ELEC INS, IR OR STEEL	217.	98.
		4016	ARTICLES NESOI OF UNHARDED VULCANIZED RUBBER	213.	31.
		2102	YEASTS, DEAD SING-CELL MICRO-ORG NESOI, BAK POWDER	207.	67.
		1901	MALT EXT, FOOD PREP OF FLOUR ETC UN 50% COCOA ETC	204.	93.
		4111	COMPOSITION LEA, LEA FIBER IN SLABS, SHEETS, STRIP	201.	41.
		9999	BELOW MINIMUM	21,354.	16,730.
		*SUB-TOTAL CUSTOMS DIST. # 7		789,025.	194,506.
9	BUFFALO-NIAGRA FALLS	8473	PARTS ETC FOR TYPEWRITERS & OTHER OFFICE MACHINES	69,241.	4,176.
		8471	AUTOMATIC DATA PROCESS MACHINES, MAGN READER ETC	52,556.	1,903.
		9009	PHOTOCOPY APPARATUS & THERMOCOPY APPARATUS, PTS	45,456.	2,448.
		8414	AIR OR VAC PUMPS, COMPR & FANS, HOODS & FANS, PTS	35,832.	2,930.
		8708	PARTS & ACCESS FOR MOTOR VEHICLES (HEAD 8701-8705)	28,982.	4,735.
		3702	PHOTO FILM IN ROLLS SENSITIZED, UNEXPOSED	23,914.	1,160.
		8409	PARTS FOR ENGINES OF HEADING 8407 OR 8408	23,735.	1,553.
		8105	COBALT MATTES ETC, COBALT & ART, INC WASTE & SCRAP	20,823.	1,405.
		7502	NICKLE, UNWROUGHT	17,340.	3,923.
		9006	PHOTOGRAPHIC STILL CAMERAS, FLASH APPARATUS ETC	16,862.	535.
		8525	TRANS APPAR FOR RADIOTELEPHONY ETC, TV CAMERAS	14,780.	634.
		306	CRUSTACEANS, LIVE, FRESH ETC, AND COOKED ETC.	12,858.	1,963.
		8518	MICROPHONES, LOUDSPEAKERS, SOUND AMPLIFIER ETC, P	10,005.	846.
		4814	WALLPAPER ETC., WINDOW TRANSPARENCIES OF PAPER	9,662.	2,196.
		6403	FOOTWEAR, OUTER SOLE RUB, PLAST OR LEA & UPPER LEA	9,543.	748.
		3701	PHOTO PLATES & FILM, FLAT, SENSITIZED, UNEXPOSED	9,498.	375.
		3926	ARTICLES OF PLASTICS (INC POLYMERS & RESINS) NESO	8,766.	2,527.
		2836	CARBONATES, PEROXOCARBONATES, COMM AMM CARBONATE	8,690.	10,788.

1993 U.S. IMPORTS TRANSSHIPPED VIA CANADA ABOVE \$200,000
 BY CUSTOMS DISTRICT BY DESCEND. VALUE IN \$1000'S ESTIM. WEIGHT IN METRIC TONS

CD#	CUSTOMS DISTRICT	CODE	HARMONIZED COMMODITY DESCRIPTION	\$1000S	EST. M.TONS
9	BUFFALO-NIAGRA FALLS	8479	MACHINES ETC HAVING INDIVIDUAL FUNCTIONS NESOI, P	8,594.	569.
		8215	TABLEWARE ETC OF BASE METAL, & BASE METAL PARTS	8,447.	1,272.
		7312	STRANDED WIRE, ROPES ETC, NO ELEC INS, IR OR STEEL	8,372.	3,731.
		8477	MACHINERY FOR WORKING RUBBER & PLAST ETC NESOI, P	7,894.	516.
		7202	FERROALLOYS	7,884.	9,381.
		8443	PRINTING MACHINERY, MACHINES ANCIL TO PRINTING, P	7,841.	425.
		3204	SYN ORG COLORING MATTER & PREP, SYN ORG BRIT AGENT	7,541.	565.
		8501	ELECTRIC MOTORS AND GENERATORS (NO SETS)	7,302.	2,687.
		8211	KNIVES WITH BLADES & BLADES FOR KNIVES NESOI, BMP	7,203.	999.
		8542	ELECTRONIC INTEGRATED CIRCUITS & MICROASSEMBL, PT	7,136.	191.
		9503	TOYS NESOI, SCALE MODELS ETC, PUZZLES, PARTS ETC	6,936.	947.
		2933	HETEROCYCLIC COMP, NIT HETERO-ATOM, NUCLEIC ACIDS	6,819.	206.
		9403	FURNITURE NESOI AND PARTS THEREOF	6,357.	2,232.
		8481	TAPS, COCKS, VALVES ETC FOR PIPES, TANKS ETC, PTS	6,355.	648.
		2833	SULFATES, ALUMS, PEROXOSULFATES (PERSULFATES)	6,294.	9,819.
		2822	COBALT OXIDE & HYDROXIDE, COMMERCIAL COBALT OXIDES	6,183.	3,385.
		4104	BOVINE OR EQUINE LEATHER, NO HAIR NESOI	6,109.	332.
		8302	HARDWARE, FIXTURES, CASTORS ETC & PARTS, BASE METL	6,059.	1,722.
		8483	TRANSMISSION SHAFTS, BEARINGS, GEARS ETC, PARTS	5,867.	617.
		7323	HOUSEHOLD ART & PTS, IR & ST, IR OR STEEL WOOL ET	5,751.	1,078.
		4011	NEW PNEUMATIC TIRES, OF RUBBER	5,579.	1,538.
		4902	NEWSPAPERS, JOURNALS & PERIODICALS	5,502.	1,921.
		9020	BREATHING APPLIANCES & GAS MASKS NESOI, PARTS ETC	5,139.	75.
		7326	ARTICLES OF IRON OR STEEL, NESOI	5,096.	1,743.
		8422	MACHINES, DISHWASH, CLEAN ETC CONT & FILL, PAK ET	5,020.	339.
		8205	HANDTOOLS NESOI, BLOW TORCHES ETC, ANVILS ETC	4,664.	738.
		3920	PLATES, SHEETS, FILM ETC NO AD, NON-CEL ETC, PLAS	4,300.	1,158.
		8108	TITANIUM & ARTICLES THEREOF, INCLUD WASTE & SCRAP	4,146.	926.
		3703	PHOTO PAPER, PAPERBOARD & TEXTILES, SENS, UNEXPOS	4,104.	456.
		7013	GLASSWARE FOR TABLE, KITCHEN, TOILET ETC USE NESOI	4,104.	679.
		4901	BOOKS, BROCHURES & SIMILAR PRINTED MATTER	3,955.	629.
		8803	PARTS OF BALLOONS ETC, AIRCRAFT, SPACECRAFT ETC	3,922.	144.
		2849	CARBIDES	3,875.	1,445.
		8504	ELECTRIC TRANSFORM, STATIC CONVERTERS & INDUCT, PT	3,857.	402.
		2818	ALUMINUM OXIDE (INCL ART CORUNDUM), ALUM HYDROXIDE	3,845.	3,379.
		8466	PARTS ETC FOR MACHINE TOOLS OF HEAD 8456 TO 8465	3,680.	409.
		2009	FRUIT JUICES (& GRAPE MUST) & VEG JUICE, NO SPIRIT	3,625.	3,078.
		8429	SELF-PROPELLED BULLDOZERS, GRADERS, SCRAPERS ETC	3,538.	821.
		6911	CERAMIC TABLEWARE ETC. OF PORCELAIN OR CHINA	3,473.	381.
		8431	PARTS FOR MACHINERY OF HEADINGS 8425 TO 8430	3,453.	813.
		8202	HANDSAWS & MET PTS, SAW BLADES, BASE MTL SAW PARTS	3,428.	67.
		9506	ARTICLES & EQUIP FOR SPORTS ETC NESOI, POOLS, PTS	3,412.	768.
		6805	ABRASIVE POWDER ETC ON A BASE TEXT MATERIAL ETC	3,379.	437.
		4414	WOODEN FRAMES PAINTINGS, PHOTOGRAPHS, MIRRORS, ET	3,316.	561.
		9303	SPORT SHOTGUNS & RIFLES ETC, VERY PISTOLS ETC	3,253.	124.
		7215	BARS & RODS, IRON & NA STEEL NESOI	3,250.	5,328.
		8517	ELECTRIC APPARATUS FOR LINE TELEPHONY ETC, PARTS	3,250.	112.
		9018	MEDICAL, SURGICAL, DENTAL OR VET INST, NO ELEC, P	3,149.	306.

1993 U.S. IMPORTS TRANSSHIPPED VIA CANADA ABOVE \$200,000
 BY CUSTOMS DISTRICT BY DESCEND. VALUE IN \$1000'S ESTIM. WEIGHT IN METRIC TONS

CD#	CUSTOMS DISTRICT	CODE	HARMONIZED COMMODITY DESCRIPTION	\$1000S	EST. M.TONS
-----	-----	-----	-----	-----	-----
9	BUFFALO-NIAGRA FALLS	8462	MACHINE TOOLS FOR FORGING, BENDING, STAMPING ETC	3,144.	1,274.
		2825	HYDRAZINE ETC, OTH INORG BASES, METAL OXIDES ETC	3,125.	949.
		8421	CENTRIFUGES, FILTER ETC MACH FOR LIQ OR GASES, PT	3,093.	270.
		5702	CARPETS & OTH TEXT FLOOR COVER, WOVEN, NO TUFT ETC	3,065.	671.
		8465	MACHINE TOOLS FOR WORKING WOOD, CORK, BONE ETC	3,045.	297.
		8419	MACHINERY ETC FOR TEMP CHANG TREAT MAT, W HEAT, P	3,005.	372.
		3503	GELATIN & DERIV, ISINGLASS, GLUES, ANIMAL OR NESOI	2,976.	483.
		3303	PERFUMES AND TOILET WATERS	2,923.	179.
		8516	ELEC WATER, SPACE & SOIL HEATERS, HAIR ETC DRY, P	2,905.	335.
		8527	RECEPTION APPARATUS FOR RADIOTELEPHONY ETC	2,901.	168.
		8438	MACH NESOI, IND PREP OF FOOD OR DRINK ETC, PARTS	2,893.	211.
		3823	BINDERS FOR FOUND MOLDS, CHEMICAL PROD ETC NESOI	2,721.	555.
		7019	GLASS FIBERS & ARTICLES THEREOF (YARN ETC.)	2,704.	262.
		8426	DERRICKS, CRANES, MOBILE LIFTING FRAMES ETC	2,689.	715.
		8536	ELECTRICAL APPARATUS FOR SWITCHING ETC, NOV 1000	2,641.	148.
		4421	ARTICLES OF WOOD, NESOI	2,639.	404.
		1109	WHEAT GLUTEN, WHETHER OR NOT DRIED	2,621.	2,530.
		9405	LAMPS & LIGHTING FITTINGS & PARTS ETC NESOI	2,603.	368.
		7325	CAST ARTICLES NESOI, OF IRON OR STEEL	2,584.	789.
		3924	TABLEWARE & OTHER HOUSEHOLD ARTICLES ETC, PLASTIC	2,551.	748.
		6902	REFRACTORY BRICKS & OTHER REFR CER CONST ART NESOI	2,494.	2,883.
		9603	BROOMS, BRUSHES, MOPS, FEATHER DUSTERS ETC	2,447.	213.
		8412	ENGINES AND MOTORS NESOI, AND PARTS THEREOF	2,446.	156.
		4016	ARTICLES NESOI OF UNHARDED VULCANIZED RUBBER	2,443.	325.
		9031	MACHINES, NESOI IN CHAPTER 90, PROFILE PROJECT, P	2,409.	110.
		9032	AUTOMATIC REGULATING OR CONTROL INSTRUMENTS, PART	2,407.	108.
		8701	TRACTORS (OTHER THAN WORKS TRUCKS OF HEADING 8709)	2,398.	536.
		8538	PARTS FOR ELEC APPAR ETC OF HEAD 8535, 8536 & 853	2,282.	226.
		8413	PUMPS FOR LIQUIDS, LIQUID ELEVATORS, PARTS THEREO	2,184.	134.
		3507	ENZYMES, PREPARED ENZYMES NESOI	2,141.	156.
		8485	MACHINERY PTS, NO ELECT CONNECTORS ETC NESOI	2,105.	157.
		2909	ETHERS, ETHER-ALCOHOLS, ALCOHOL PEROXIDES ETC.	2,089.	351.
		3002	HUMAN BLOOD, ANIMAL BLOOD, ANTISERA, VACCINES ETC	2,075.	635.
		8505	ELECTROMAGNETS, PERMANENT MAGNETS ETC & PARTS	2,052.	265.
		8207	INTERCHANGE TOOLS FOR HAND- OR MACHINE-TOOLS, BMPT	2,042.	169.
		7217	WIRE OF IRON & NONALLOY STEEL	2,016.	1,698.
		8537	BOARDS, PANELS ETC WITH ELEC SWITCH APPAR ETC.	2,008.	98.
		8703	MOTOR CARS & VEHICLES FOR TRANSPORTING PERSONS	1,998.	122.
		3304	BEAUTY, MAKE-UP & SKIN-CARE PREP, MANICURE ETC PRP	1,980.	142.
		7503	NICKEL WASTE AND SCRAP	1,952.	472.
		2811	INORGANIC ACIDS & INORGANIC OXY NONMET COMP NESOI	1,937.	1,775.
		8424	MECH APPL TO DISPERSE LIQ ETC, SAND ETC BLAST MAC	1,932.	377.
		2936	PROVITAMINS AND VITAMINS & DERIVATIVES & INTERMIX	1,922.	208.
		7220	FL-RL STAINLESS STEEL PRODUCTS, UNDER 600MM WIDE	1,922.	683.
		2841	SALTS OF OXOMETALLIC OR PEROXOMETALLIC ACIDS	1,900.	854.
		9026	INST ETC MEASURE OR CHECK FLOW, LEVEL ETC, PTS ET	1,874.	134.
		4202	TRAVEL GOODS, HANDBAGS, WALLETS, JEWELRY CASES ETC	1,855.	290.
		9010	APPARATUS ETC FOR PHOTO LABS ETC NESOI, PARTS ETC	1,854.	55.

1993 U.S. IMPORTS TRANSSHIPPED VIA CANADA ABOVE \$200,000
 BY CUSTOMS DISTRICT BY DESCEND. VALUE IN \$1000'S ESTIM. WEIGHT IN METRIC TONS

CD#	CUSTOMS DISTRICT	CODE	HARMONIZED COMMODITY DESCRIPTION	\$1000S	EST. M.TONS
9	BUFFALO-NIAGRA FALLS	9401	SEATS (EXCEPT BARBER, DENTAL, ETC), AND PARTS	1,814.	1,185.
		2920	ESTERS OF INORG ACIDS & SALTS, THEIR HALOG ETC DE	1,799.	472.
		3923	CONTAINERS (BOXES, BAGS ETC), CLOSURERS ETC, PLAS	1,792.	549.
		2826	FLUORIDES, FLUROSILICATES, FLUOROALUMINATES ETC	1,765.	1,283.
		8509	ELECTROMECH DOMESTIC APPLIANCES, PARTS	1,764.	118.
		8511	ELECTRIC IGNITION ETC EQUIP, GENERATORS, PARTS	1,756.	244.
		7318	SCREWS, BOLTS, NUTS, WASHERS ETC, IRON OR STEEL	1,752.	1,148.
		2941	ANTIBIOTICS	1,702.	46.
		8539	ELECTRIC FILAMENT OR DISCHARGE LAMPS, PARTS	1,688.	171.
		8523	PREPARED UNRECORDED MEDIA (NO FILM) FOR SOUND ETC	1,680.	128.
		9502	DOLLS, REPRESENTING ONLY HUMAN BEINGS, & PARTS ETC	1,657.	157.
		9504	ARTICLES FOR ARCADE, TABLE OR PARLOR GAMES, PARTS	1,653.	291.
		4203	ARTICLES OF APPAREL & ACCESS, LEATH & COMP LEATHER	1,652.	59.
		8480	MOLDING BOXES FOR METAL FOUNDRY, MOLD BASES ETC	1,644.	96.
		3906	ACRYLIC POLYMERS IN PRIMARY FORMS	1,606.	711.
		7219	FL-RL STAINLESS STEEL PRODUCTS, NOT UND 600MM WID	1,586.	962.
		3816	REFRACTORY CEMENTS, MORTARS, CONCRETES, ETC. NESO	1,582.	1,889.
		3907	POLYETHERS, EXPOXIDES & POLYESTERS, PRIMARY FORMS	1,552.	443.
		8430	MACH NESOI, MOVING, GRAD ETC, PILE-DR, SNOFLOW ET	1,539.	648.
		3801	ARTIFICIAL GRAPHITE, COLLODIAL GRAPHITE & PREP ETC	1,535.	353.
		8543	ELECTRICAL MACH ETC, WITH IND FUNCTIONS NESOI, PT	1,533.	47.
		8433	HARVEST ETC MACHINES, CLEANING EGGS ETC NESOI, PT	1,531.	338.
		8514	INDUSTRIAL OR LAB ELEC FURNACES ETC, PARTS	1,531.	162.
		8411	TURBOJETS, TURBOPROPELLERS & OTH GAS TURBINES, PTS	1,521.	93.
		3707	PHOTOGRAPHIC CHEMICALS, UNMIXED PROD RETAIL PACKED	1,508.	136.
		2924	CARBOXYAMIDE-FUNCTION COMP, AMIDE-FUNCTION COM ET	1,499.	48.
		5402	SYNTHETIC FILAMENT YARN (NO SEW THREAD), NO RETAIL	1,481.	305.
		8428	LIFTING, HANDLING, LOADING & UNLOAD MACHINES NESO	1,448.	226.
		6908	GLAZED CERAMIC FLAGS & PAVING, HEARTH TILES, ETC	1,404.	3,081.
		7322	RADIATORS, AIR HEATERS ETC, NONEL & PT, IR & STEE	1,392.	594.
		2915	SAT ACYCLIC NONOCARBOX ACID & ANHYD, HALOGON ETC	1,380.	797.
		8519	TURNTABLES, RECORD & CASSETTE PLAYERS ETC.	1,375.	62.
		8540	THERMIONIC, COLD CATHODE OR PHOTOCATHODE TUBES, P	1,361.	93.
		2903	HALOGENATED DERIVATIVES OF HYDROCARBONS	1,330.	408.
		4002	SYNTH RUBBER & FACTICE, INC NAT-SYN MIX, PR FM ETC	1,330.	1,124.
		8508	ELECTROMECHANICAL TOOLS, WORKING IN HAND, PARTS	1,327.	88.
		6215	TIES, BOW TIES & CRAVATS, NOT KNITTED OR CROCHETE	1,278.	19.
		8545	CARBON ELECTRODES & BRUSHES, LAMP CARBONS ETC	1,256.	761.
		3919	SELF-ADHESIVE PLATES, SHEETS, FILM ETC OF PLASTIC	1,226.	263.
		8716	TRAILERS ETC, OTHER VEHICLES, NOT MECH PROPELD, P	1,224.	722.
		3810	PICKLING PREPS FOR METAL, SOLDERING ETC POWDER ET	1,208.	357.
		2402	CIGARS, CIGARETTES ETC., OF TOBACCO OR SUBSTITUTES	1,199.	92.
		6903	REFRACTORY CERAMIC GOODS, RETORTS, TUBES ETC NESOI	1,195.	573.
		7223	WIRE OF STAINLESS STEEL	1,178.	231.
		9008	IMAGE PROJECTORS, STILL, ENLARGERS ETC, STILL, PTS	1,171.	55.
		9002	OPTICAL ELEMENTS, MOUNTED, PARTS & ACCESSORIES	1,170.	9.
		4911	PRINTED MATTER NESOI, INCL PRINT PICTURES & PHOTOS	1,146.	199.
		2827	CHLORIDES ETC, BROMIDES ETC, IODIDES ETC.	1,142.	1,636.

1993 U.S. IMPORTS TRANSSHIPPED VIA CANADA ABOVE \$200,000
 BY CUSTOMS DISTRICT BY DESCEND. VALUE IN \$1000'S ESTIM. WEIGHT IN METRIC TONS

CD#	CUSTOMS DISTRICT	CODE	HARMONIZED COMMODITY DESCRIPTION	\$1000S	EST. M.TONS
9	BUFFALO-NIAGRA FALLS	6913	STATUETTES AND OTHER ORNAMENTAL CERAMIC ARTICLES	1,104.	128.
		8482	BALL OR ROLLER BEARINGS AND PARTS	1,103.	101.
		8521	VIDEO RECORDING OR REPRODUCING APPARATUS	1,096.	36.
		9011	COMPOUND OPTICAL MICROSCOPES, PARTS & ACCESSORIES	1,086.	25.
		7606	ALUMINUM PLATES, SHEETS & STRIP OVER .2MM THICK	1,084.	534.
		2930	ORGANO-SULFUR COMPOUNDS	1,063.	859.
		5107	YARN OF COMBED WOOL, NOT PUT UP FOR RETAIL SALE	1,055.	98.
		3305	PREPARATIONS FOR USE ON THE HAIR	1,024.	154.
		8454	CONVERTERS, LADLES, INGOT MOLDS & CASTING MACH, P	1,019.	290.
		4819	CARTONS ETC PAPER, OFFICE BOX FILES ETC, PAPER ET	1,016.	267.
		8533	ELECTRICAL RESISTORS EXCEPT HEATING RESISTORS, PT	995.	22.
		2615	NIOBIUM, TANTALUM, VANADIUM & ZIRCONIUM ORE & CONC	992.	4,872.
		8474	MACHINERY FOR SORTING SCREENING ETC MINERALS, PTS	988.	128.
		6912	CERAMIC TABLEWARE, KITCHENWARE ETC, EARTHENWARE ETC	986.	536.
		3006	PHARMACEUTICAL GOODS (SPECIFIED STERILE PROD ETC.)	970.	22.
		8475	MACHINES FOR ASSEMB ELEC TUBES ETC & GLASS MFR, P	958.	108.
		8531	ELECTRIC SOUND OR VISUAL SIGNALING APPARATUS, PTS	955.	78.
		3915	WASTE, PARINGS AND SCRAP, OF PLASTICS	940.	1,141.
		9001	OPT FIBERS & BUND ETC, POL SHEETS, UNMOUN OPT ELEM	937.	12.
		2935	SULFONAMIDES	932.	95.
		8442	MACH ETC NESOI FOR TYPESET, MAKING PR PLATES ETC	926.	53.
		8416	FURNACE BURNERS, MECHANICAL STOKERS ETC, PARTS	884.	63.
		2620	ASH & RESIDUES (NOT FR IRON ETC MFR) W METAL CONT	881.	840.
		8459	MACHINE TOOLS FOR DRILLING, BORING, MILLING ETC	865.	182.
		6404	FOOTWEAR, OUTER SOLE RUB, PLAST OR LEA & UPPER TEX	845.	65.
		9019	MECH-THER, MASSAGE, PSYCH TEST, OZONE APP ETC, PT	825.	50.
		8544	INSULATED WIRE, CABLE ETC, OPT SHEATH FIB CABLES	816.	100.
		9021	ORTHOPEDIC APPL, ARTIF BODY PTS, HEAR AID, PTS ET	816.	97.
		6402	FOOTWEAR, OUTER SOLE & UPPER RUBBER OR PLAST NESOI	810.	82.
		3821	PREPARED CULTURE MEDIA FOR DEVEL OF MICROORGANISM	796.	112.
		4909	PRINTED OR ILLUSTR POST CARDS, GREETING CARDS, ETC.	775.	163.
		8458	LATHES FOR REMOVING METAL	767.	90.
		304	FISH FILLETS & OTH FISH MEAT, FRESH, CHILL OR FROZ	755.	162.
		8432	AGRICULT ETC MACH FOR SOIL ETC, LAWN ROLLERS, PTS	746.	173.
		9004	SPECTACLES, GOGGLES ETC, CORRECT, PROTECT ETC	745.	35.
		8461	MACHINE TOOLS FOR SHAPING, SLOTTING, GEAR CUT ETC	734.	76.
		2917	POLYCARBOXYLIC ACIDS & ANHYD ETC, HALOG, SULF ETC	728.	490.
		5911	TEXTILE PRODUCTS ETC. FOR SPECIFIC TECH USES NESOI	728.	26.
		7321	STOVES, RANGES ETC, NONEL DOMEST & PTS, IR & STEE	724.	165.
		8524	RECORDS, TAPES & OTHER RECORDED SOUND MEDIA ETC	714.	41.
		7117	IMITATION JEWELRY	710.	48.
		3307	PERSONAL TOILET ETC PREP NESOI, SHAVING, BATH ETC.	687.	101.
		7607	ALUMINUM FOIL (BACK OR NOT) NOV .2MM TH (EX BACK)	685.	87.
		9027	INST ETC FOR PHYSICAL ETC ANAL ETC, MICROTOME, PT	685.	33.
		8311	WIRE, RODS ETC FOR SOLDERING ETC & MET SPRAY, BMPT	668.	371.
		2204	WINE OF FRESH GRAPES, GRAPE MUST NESOI	664.	335.
		801	COCONUTS, BRAZIL NUTS & CASHEW NUTS, FRESH OR DRY	663.	354.
		8467	TOOLS FOR WORKING IN THE HAND, PNEUMATIC ETC, PTS	646.	56.

1993 U.S. IMPORTS TRANSSHIPPED VIA CANADA ABOVE \$200,000
 BY CUSTOMS DISTRICT BY DESCEND. VALUE IN \$1000'S ESTIM. WEIGHT IN METRIC TONS

CD#	CUSTOMS DISTRICT	CODE	HARMONIZED COMMODITY DESCRIPTION	\$1000S	EST. M.TONS
----	-----	----	-----	-----	-----
9	BUFFALO-NIAGRA FALLS	8503	PARTS OF ELECTRIC MOTORS, GENERATORS & SETS	633.	81.
		2834	NITRITES, NITRATES	629.	2,208.
		3003	MEDICAMENTS NESOI OF MIXTURES, NOT DOSAGE ETC FORM	625.	32.
		4008	PLATES, SHEETS, PROFILE SHAPES ETC, SOFT VULC RUBR	623.	179.
		905	VANILLA BEANS	620.	9.
		3909	AMINO-RESINS, PHENOLICS & POLYURETHANES, PRIM FORM	613.	263.
		901	COFFEE, COFFEE HUSKS ETC, SUBSTITUTES WITH COFFEE	610.	396.
		8528	TELEVISION RECEIVERS (INCL MONITORS & PROJ RECEIV	608.	37.
		7205	PIG IRON, SPIEGEL, IRON OR STEEL GRANULES & POWDER	606.	434.
		7419	ARTICLES OF COPPER NESOI	605.	66.
		8415	AIR CONDITIONING MACHINES (TEMP & HUM CHANGE), PT	598.	67.
		2504	NATURAL GRAPHITE	596.	977.
		9014	DIRECTION FINDING COMPASSES & NAVIG INST ETC, PTS	593.	23.
		7315	CHAIN & PARTS, OF IRON OR STEEL	592.	263.
		7307	TUBE OR PIPE FITTINGS, OF IRON OR STEEL	588.	309.
		9023	INST, APPTS&MODELS, FOR DEMONSTRATIONAL USE& PARTS	586.	33.
		710	VEGETABLES (RAW OR COOKED BY STEAM ETC), FROZEN	580.	637.
		7212	FL-RL IRON & NA STEEL UN 600MM WD, CLAD ETC	573.	362.
		2106	FOOD PREPARATIONS NESOI	565.	167.
		7214	BARS & RODS, IRON & NA STEEL NESOI, H-R ETC	564.	1,041.
		6802	WORKED MONUMENT ETC STONE & ART NESOI, GRANULE ETC	555.	672.
		2208	ETHYL ALCOHOL, UNDENAT, UNDR80% ALC, SPIRIT BEV ETC	545.	179.
		5903	TEXTILE FABRICS (NOT TIRE CORD) COAT ETC, PLASTICS	545.	118.
		4811	PAPER, PAPERBOARD, WAD ETC, COAT ETC NESOI, RL ET	539.	248.
		8522	PARTS & ACCESS OF RECORD PLAY, MAG TAPE RECORD ET	534.	16.
		9102	WATCHES, WRIST, POCKET ETC, CASE NOT PREC NOR CLAD	533.	19.
		8463	MACHINE TOOLS FOR WORKING METAL, NESOI	528.	23.
		7308	STRUCTURES NESOI & PARTS THEREOF, OF IRON OR STEEL	510.	135.
		8439	MACHINERY FOR MAKING PULP & MAKING ETC PAPER, PTS	502.	108.
		8515	ELECTRIC, LASER OR OTH LIGHT OR PHOTON BEAM ETC	499.	13.
		8541	SEMICONDUCTOR DEVICES, LIGHT-EMIT DIODES ETC, PTS	497.	87.
		8301	PADLOCKS, LOCKS & KEYS & PARTS, OF BASE METAL	495.	66.
		6204	WOMEN'S OR GIRLS' SUITS, ENSEMB ETC, NOT KNIT ET	491.	37.
		7604	ALUMINUM BARS, RODS AND PROFILES	488.	139.
		8507	ELECTRIC STORAGE BATTERIES, INCL SEPARATORS, PARTS	484.	52.
		7009	GLASS MIRRORS, FRAMED OR NOT, INC REARVIEW MIRRORS	477.	214.
		9305	PARTS & ACCESSORIES OF ARMS OF HEAD 9301 TO 9304	475.	39.
		3921	PLATES, SHEETS, FILM, FOIL & STRIP NESOI, PLASTIC	472.	110.
		5602	FELT, IMPREGNATED, COATED, ETC. OR NOT	468.	48.
		8407	SPARK-IGNITION RECIP OR ROTARY INT COMB PISTON ENG	463.	54.
		1302	VEG SAPS & EXTRACTS, PECTATES ETC, AGAR-AGAR ETC.	462.	117.
		8529	PARTS FOR TELEVISION, RADIO AND RADAR APPARATUS	462.	26.
		8453	MACHINERY FOR WORK LEATHER ETC & FOOTWEAR ETC, PT	456.	52.
		6505	HATS & HEADGEAR, KNIT ETC, LACE, ETC IN PC, HR NET	447.	25.
		4810	PAPER & PAPERBOARD, COATED WITH KAOLIN ETC, RL ET	438.	560.
		8714	PARTS & ACCESS FOR CYCLES & INVALID CARRIAGES	436.	42.
		3925	BUILDERS' WARE OF PLASTICS, NESOI	435.	236.
		8423	WEIGHING MACHINES & WEIGHING MACHINE WEIGHTS, PTS	435.	62.

1993 U.S. IMPORTS TRANSSHIPPED VIA CANADA ABOVE \$200,000
 BY CUSTOMS DISTRICT BY DESCEND. VALUE IN \$1000'S ESTIM. WEIGHT IN METRIC TONS

CD#	CUSTOMS DISTRICT	CODE	HARMONIZED COMMODITY DESCRIPTION	\$1000S	EST. M.TONS
9	BUFFALO-NIAGRA FALLS	9030	OSCILLOSCOPES, SPECTRUM ANALYZERS ETC, PARTS ETC	434.	27.
		9703	ORIGINAL SCULPTURES AND STATUARY, IN ANY MATERIAL	434.	207.
		2918	CARBOXYLIC ACID, ADDED OXYGEN & ANHY ETC, HAL ETC	433.	75.
		8546	ELECTRICAL INSULATORS OF ANY MATERIAL	430.	75.
		9609	PENCILS (LEAD ENCASED), CRAYONS, LEADS, CHALKS ETC	429.	90.
		2835	PHOSPHINATES, PHOSPHONATES, PHOSPHATES & POLYPHOSP	427.	380.
		6110	SWEATERS, PULLOVERS, VESTS ETC, KNIT OR CROCHETED	426.	21.
		7222	BARS & RODS, ST STEEL NESOI, ANGLES ETC, ST STEEL	424.	180.
		9505	FESTIVE, CARNIVAL OR OTHER ENTERTAINMENT ART, PTS	422.	73.
		4823	PAPER, PAPERBOARD, CELLUL WAD TO SIZE & ARTS NESO	419.	138.
		8460	MACHINE TOOLS FOR HONING OR FINISHING METAL ETC	419.	29.
		8452	SEWING MACHINES (NOT BOOK-SEW), COVER ETC, NEEDLE	417.	28.
		9022	X-RAY ETC APPARATUS, TUBES, PANELS, SCREEN ETC, P	417.	8.
		4820	REGISTERS, NOTEBOOKS, BINDERS, BUS FORMS ETC, PAP	414.	93.
		1209	SEEDS, FRUIT AND SPORES, FOR SOWING	404.	246.
		9107	TIME SWITCHES W CLK/WTCH MOVEMNT/SYNCHRONOUS MOTOR	401.	11.
		8001	TIN, UNWROUGHT	397.	162.
		9105	CLOCKS, WITH CLOCK MVTS OTH THAN INST PANEL ETC	393.	46.
		1905	BREAD, PASTRY, CAKES ETC, COMM WAFRS, EMP CAPS ETC	384.	121.
		7208	FL-RL IRON & NA STEEL NUN600MM WD HOT-RL, NOT CLAD	380.	1,170.
		8470	CALCULATING & ACCOUNT MACHINES, CASH REGISTERS ET	373.	21.
		9029	REVOLUTION & PRODUCTION COUNT, TAXIMETERS ETC, PT	371.	22.
		7225	FL-RL ALLOY STEEL NESOI NUN 600MM WIDE	351.	484.
		7616	ARTICLES OF ALUMINUM NESOI	349.	51.
		7615	HOUSEHOLD ART ETC, POT SCOUR ETC, SAN WR, ALUMINUM	348.	71.
		8510	ELECTRIC SHAVERS & HAIR CLIPPERS, PARTS	348.	17.
		704	CABBAGES, CAULIFLOWER, KALE ETC, FRESH OR CHILLED	347.	2,239.
		8440	BOOKBINDING MACHINERY, INCL BOOK-SEWING, PARTS	347.	28.
		6806	MINERAL WOOLS, EXPANDED MINERAL MATERIAL & MIXTURE	346.	157.
		7304	TUBES, PIPES ETC, SEAMLESS, IRON NESOI & STEEL	346.	150.
		8106	BISMUTH AN ARTLS, INCLD WASTE AND SCRAP	339.	37.
		8532	ELECTRIC CAPACITORS, FIXED, VAR OR ADJ (PRESET) P	339.	66.
		3911	PETRO RESINS, POLYSULFIDES ETC NESOI, PRIMARY FOR	337.	311.
		8425	PULLEY TACKLE & HOISTS (EXC SKIP), WINCH ETC, JAK	334.	73.
		2916	UNSAT ACYCLIC & CYCLIC MONOCARBOX ACID & ANHYD ET	331.	266.
		5007	WOVEN FABRICS OF SILK OR SILK WASTE	331.	10.
		4502	NATURAL CORK DEBACK/RGH SQD IN BLKS/SHEETS/STRIPS	330.	225.
		6207	MEN''S OR BOYS'' UNDERSHIRTS ETC, NOT KNIT OR CROC	330.	5.
		7504	NICKEL POWDERS AND FLAKES	326.	38.
		3912	CELLULOSE AND CHEMICAL DERIV NESOI, PRIMARY FORMS	325.	139.
		3102	MINERAL OR CHEMICAL FERTILIZERS, NITROGENOUS	323.	2,581.
		4009	TUBES, PIPES & HOSES OF UNHARD VULCANIZED RUBBER	323.	36.
		802	NUTS NESOI, FRESH OR DRIED	320.	92.
		4802	PAPER, UNCOAT, FOR WRITING ETC, ROLLS, HNDMD PAPER	319.	206.
		8418	REFRIGERATORS, FREEZERS ETC, HEAT PUMPS NESOI, PT	313.	68.
		3206	COLORING MATTER NESOI, COLORING PREP NESOI, ETC.	308.	203.
		3215	INK, PRINTING, WRITING, DRAWING ETC, CONCEN OR NO	306.	48.
		2201	WATERS, NATURAL ETC, NOT SWEETENED ETC, ICE & SNOW	304.	965.

1993 U.S. IMPORTS TRANSSHIPPED VIA CANADA ABOVE \$200,000
 BY CUSTOMS DISTRICT BY DESCEND. VALUE IN \$1000'S ESTIM. WEIGHT IN METRIC TONS

CD#	CUSTOMS DISTRICT	CODE	HARMONIZED COMMODITY DESCRIPTION	\$1000S	EST. M.TONS
9	BUFFALO-NIAGRA FALLS	8472	OFFICE MACHINES NESOI (HECTOGRAPH, ADDRESSING ETC	302.	17.
		7403	REFINED COPPER & ALLOYS (NO MAST ALLOY), UNWROUGHT	300.	148.
		1509	OLIVE OIL & ITS FRACTIONS, NOT CHEMICALLY MODIFIED	299.	183.
		6211	TRACK SUITS, SKI-SUITS & SWIMWEAR, NOT KNIT ETC	299.	15.
		3918	FLOOR COVER (ROLLS & TILES) & WALL COVER, PLASTIC	298.	103.
		6815	ARTICLES OF STONE OR OTHER MINERAL SUBSTANCE NESOI	297.	18.
		2804	HYDROGEN, RARE GASES AND OTHER NONMETALS	291.	266.
		5801	WOVEN PILE & CHENILLE FABRICS NESOI (NO TERRY ETC)	285.	34.
		8506	PRIMARY CELLS & BATTERIES, PARTS	282.	42.
		8203	FILES, RASPS, PLIERS, METALCUT SHEARS ETC, B MT PT	279.	25.
		8534	PRINTED CIRCUITS	275.	7.
		8520	MAGNETIC TAPE & OTHER SOUND RECORDERS	273.	9.
		4503	ARTICLES OF NATURAL CORK	271.	15.
		4201	LEATHER ART, SADDLERY ETC, HANDBAGS ETC, GUT ART	270.	24.
		8436	AGRI ETC & POULTRY ETC EQUIP, INC INCUBATORS, PTS	270.	93.
		303	FISH, FROZEN (NO FISH FILLETS OR OTHER FISH MEAT)	267.	97.
		6914	CERAMIC ARTICLES NESOI	267.	85.
		7418	HOUSEHOLD ART & PTS, COP, POT SCOURERS ETC, COPPE	267.	39.
		8441	MACH FOR MAKING UP PULP & PAPER, INC CUTTERS, PTS	263.	12.
		2803	CARBON, NESOI (INCLUDING CARBON BLACK)	261.	141.
		6810	ARTICLES OF CEMENT, CONCRETE OR ARTIFICIAL STONE	260.	437.
		8111	MANGANESE AND ARTICLES THEREOF, INC WASTE AND SCRAP	258.	119.
		9608	PENS (BALL POINT, S TIP ETC), MECH PENCILS ETC, PT	257.	28.
		8512	ELECTRIC LIGHT ETC EQUIP, WINDSH WIPERS ETC, PART	256.	26.
		2805	ALKALI METALS ETC, RARE-EARTH METALS ETC, MERCURY	255.	56.
		2921	AMINE-FUNCTION COMPOUNDS	252.	47.
		4101	RAW HIDES & SKINS OF BOVINE OR EQUINE ANIMALS	252.	136.
		5603	NONWOVENS, WHETHER OR NOT IMPREGNATED, COATED ETC	250.	34.
		4301	RAW FURSKINS NESOI (INCL PCS FOR FUR USE)	247.	91.
		8408	COMPRESSION-IGNITION INTERNAL COMB PISTON ENGINES	247.	36.
		2513	PUMICE, EMERY, NATURAL CORUNDUM AND GARNET ETC	245.	337.
		7601	ALUMINUM, UNWROUGHT	243.	210.
		1704	SUGAR CONFECTION (INCL WHITE CHOCOLATE), NO COCOA	241.	95.
		2202	WATERS, SWEETENED ETC & OTH NONALC BEVERAGES NESOI	237.	450.
		4012	RETREAD OR USED PNEU TIRES, SOLID TIRES ETC, RUBB	236.	166.
		6702	ARTIFICIAL FLOWERS, FOLIAGE & FRUIT, PTS & ARTICLS	234.	39.
		3004	MEDICAMENTS NESOI, MIXED OR NOT, IN DOSAGE ETC FM	230.	42.
		8704	MOTOR VEHICLES FOR TRANSPORT OF GOODS	230.	20.
		8101	TUNGSTEN (WOLFRAM) & ARTICLES, INCL WASTE & SCRAP	229.	77.
		6401	WATERPROOF FOOTWEAR, RUBBER OR PLASTICS, BOND SOLE	228.	106.
		8306	BELLS ETC (NONELEC), ORNAMENTS, PH FRAMES ETC BMPT	227.	62.
		8451	MACHINERY (NOT LAUNDRY) FOR CLEANING, DRYING ETC	227.	29.
		902	TEA	226.	72.
		2008	FRUIT, NUTS ETC PREPARED OR PRESERVED NESOI	222.	215.
		7216	ANGLES, SHAPES & SECTIONS OF IRON & NONALLOY STEE	217.	437.
		7014	SIGNAL GLASSWARE & GLASS OPTIC ELEM NESOI NOT WRK	216.	12.
		8457	MACHINING CENTERS, UNIT CONST MACH ETC WORK METAL	214.	7.
		8437	MACH FOR CLEANING SEED ETC & WORK CEREAL ETC, PTS	213.	23.

1993 U.S. IMPORTS TRANSSHIPPED VIA CANADA ABOVE \$200,000
 BY CUSTOMS DISTRICT BY DESCEND. VALUE IN \$1000'S ESTIM. WEIGHT IN METRIC TONS

CD#	CUSTOMS DISTRICT	CODE	HARMONIZED COMMODITY DESCRIPTION	\$1000S	EST. M.TONS
9	BUFFALO-NIAGRA FALLS	5112	WOVEN FABRICS OF COMBED WOOL OR FINE ANIMAL HAIR	212.	5.
		8427	FORK-LIFT TRUCKS, OTH WORKS TRUCKS WITH LIFTS ETC	209.	72.
		6303	CURTAINS & INTERIOR BLINDS, CURTAIN & BED VALANCES	206.	17.
		8464	MACHINE TOOLS FOR WORKING STONE, ETC & GLASS	203.	10.
		1806	CHOCOLATE & OTHER FOOD PRODUCTS CONTAINING COCOA	202.	58.
		9005	OPTICAL TELESCOPES & MOUNT, ASTRO INST & MOUNT, PT	201.	6.
		9999	BELOW MINIMUM	21,587.	15,596.
			*SUB-TOTAL CUSTOMS DIST. # 9	977,677.	220,835.
10	NEW YORK N.Y.	8703	MOTOR CARS & VEHICLES FOR TRANSPORTING PERSONS	53,104.	3,636.
		8207	INTERCHANGE TOOLS FOR HAND- OR MACHINE-TOOLS, BMPT	14,075.	604.
		2208	ETHYL ALCOHOL, UNDENAT, UND80% ALC, SPIRIT BEV ETC	6,614.	3,099.
		306	CRUSTACEANS, LIVE, FRESH ETC, AND COOKED ETC.	5,698.	927.
		7112	WASTE & SCRAP OF PREC METAL OR METAL CL W PREC MT	5,189.	1,053.
		9702	ORIGINAL ENGRAVINGS, PRINTS & LITHOGRAPHS	4,460.	707.
		7118	COIN	4,303.	471.
		3204	SYN ORG COLORING MATTER & PREP, SYN ORG BRIT AGENT	4,250.	307.
		8471	AUTOMATIC DATA PROCESS MACHINES, MAGN READER ETC	4,031.	58.
		9506	ARTICLES & EQUIP FOR SPORTS ETC NESOI, POOLS, PTS	4,024.	190.
		8542	ELECTRONIC INTEGRATED CIRCUITS & MICROASSEMBL, PT	3,671.	112.
		4303	ARTICLES OF APPAREL ETC. OF FURSKIN	3,611.	144.
		3303	PERFUMES AND TOILET WATERS	3,302.	160.
		6403	FOOTWEAR, OUTER SOLE RUB, PLAST OR LEA & UPPER LEA	2,904.	170.
		2204	WINE OF FRESH GRAPES, GRAPE MUST NESOI	2,595.	956.
		8473	PARTS ETC FOR TYPEWRITERS & OTHER OFFICE MACHINES	2,443.	93.
		8521	VIDEO RECORDING OR REPRODUCING APPARATUS	2,148.	53.
		2909	ETHERS, ETHER-ALCOHOLS, ALCOHOL PEROXIDES ETC.	2,034.	945.
		9009	PHOTOCOPY APPARATUS & THERMOCOPY APPARATUS, PTS	1,930.	90.
		2101	EXTRACTS ETC OF COFFEE, TEA OR MATE, ROAST CHICORY	1,863.	1,745.
		7606	ALUMINUM PLATES, SHEETS & STRIP OVER .2MM THICK	1,832.	1,391.
		8411	TURBOJETS, TURBOPROPELLERS & OTH GAS TURBINES, PTS	1,728.	121.
		3004	MEDICAMENTS NESOI, MIXED OR NOT, IN DOSAGE ETC FM	1,588.	100.
		2936	PROVITAMINS AND VITAMINS & DERIVATIVES & INTERMIX	1,530.	258.
		6912	CERAMIC TABLEWARE, KITCHNWARE ETC, EARTHENWARE ETC	1,471.	581.
		1701	CANE OR BEET SUGAR & CHEM PURE SUCROSE, SOLID FORM	1,404.	3,776.
		2850	HYDRIDES, NITRIDES, AZIDES, SILICIDES & BORIDES	1,288.	1,310.
		2009	FRUIT JUICES (& GRAPE MUST) & VEG JUICE, NO SPIRIT	1,275.	1,775.
		4911	PRINTED MATTER NESOI, INCL PRINT PICTURES & PHOTOS	1,256.	108.
		6110	SWEATERS, PULLOVERS, VESTS ETC, KNIT OR CROCHETED	1,217.	95.
		6204	WOMEN'S OR GIRLS' SUITS, ENSEMB ETC, NOT KNIT ET	1,193.	69.
		6302	BED LINEN, TABLE LINEN, TOILET LINEN & KITCH LINEN	1,074.	168.
		2937	HORMONES, DERIVATIVES & STERIODS USED AS HORMONES	977.	35.
		9705	COLLECTORS ITEMS OF BOTANIC, HISTOR ETC INTEREST	950.	23.
		2846	RARE-EARTH METAL COMPOUNDS OF YTTRIUM OR SCANDIUM	919.	443.
		4901	BOOKS, BROCHURES & SIMILAR PRINTED MATTER	908.	128.
		8516	ELEC WATER, SPACE & SOIL HEATERS, HAIR ETC DRY, P	902.	54.
		8481	TAPS, COCKS, VALVES ETC FOR PIPES, TANKS ETC, PTS	888.	209.

1993 U.S. IMPORTS TRANSSHIPPED VIA CANADA ABOVE \$200,000
 BY CUSTOMS DISTRICT BY DESCEND. VALUE IN \$1000'S ESTIM. WEIGHT IN METRIC TONS

CD#	CUSTOMS DISTRICT	CODE	HARMONIZED COMMODITY DESCRIPTION	\$1000S	EST. M.TONS
-----	-----	-----	-----	-----	-----
10	NEW YORK N.Y.	6206	WOMEN''S OR GIRLS'' BLOUSES, SHIRTS ETC NOT KNIT E	880.	29.
		8527	RECEPTION APPARATUS FOR RADIOTELEPHONY ETC	871.	53.
		3905	POLYMERS OF VINYL ACETATE & OTH VINYL POLYM, PR FM	865.	114.
		9102	WATCHES, WRIST, POCKET ETC, CASE NOT PREC NOR CLAD	841.	76.
		2930	ORGANO-SULFUR COMPOUNDS	783.	194.
		9703	ORIGINAL SCULPTURES AND STATUARY, IN ANY MATERIAL	780.	123.
		3206	COLORING MATTER NESOI, COLORING PREP NESOI, ETC.	775.	160.
		2905	ACYCLIC ALCOHOLS & HALOGENAT, SULFONATD ETC DERIVS	736.	221.
		2906	CYCLIC ALCOHOLS & HALOGENATD, SULFONATD ETC DERIVS	716.	185.
		2921	AMINE-FUNCTION COMPOUNDS	685.	219.
		6203	MEN''S OR BOYS'' SUITS, ENSEMBLES ETC, NOT KNIT ET	682.	47.
		2005	VEGETABLES NESOI PREPARED ETC NESOI, NOT FROZEN	669.	624.
		2933	HETEROCYCLIC COMP, NIT HETERO-ATOM, NUCLEIC ACIDS	626.	46.
		8447	MACHINES, KNITTING, STITCH-BOND, LACE, NET ETC.	611.	19.
		1604	PREP OR PRES FISH, CAVIAR & CAVIAR SUBSTITUTES	608.	105.
		3402	ORGANIC SURF-ACT AGENTS, PREPS & CLEANING PREPS	606.	405.
		7205	PIG IRON, SPIEGEL, IRON OR STEEL GRANULES & POWDER	603.	69.
		3304	BEAUTY, MAKE-UP & SKIN-CARE PREP, MANICURE ETC PRP	577.	44.
		4104	BOVINE OR EQUINE LEATHER, NO HAIR NESOI	573.	34.
		1702	SUGARS NESOI, INCL CHEM PURE LACTOSE ETC, CARAMEL	568.	652.
		1905	BREAD, PASTRY, CAKES ETC, COMM WAFRS, EMP CAPS ETC	560.	220.
		9113	WATCH STRAPS, WATCH BANDS AND WATCH BRACELETS, PT	558.	47.
		3301	ESSENT OILS, RESINOIDS, TERPENIC BY-PRODUCTS ETC	555.	51.
		3911	PETRO RESINS, POLYSULFIDES ETC NESOI, PRIMARY FOR	538.	128.
		8525	TRANS APPAR FOR RADIOTELEPHONY ETC, TV CAMERAS	506.	10.
		9018	MEDICAL, SURGICAL, DENTAL OR VET INST, NO ELEC, P	497.	46.
		9502	DOLLS, REPRESENTING ONLY HUMAN BEINGS, & PARTS ETC	477.	77.
		6913	STATUETTES AND OTHER ORNAMENTAL CERAMIC ARTICLES	473.	63.
		8442	MACH ETC NESOI FOR TYPESET, MAKING PR PLATES ETC	470.	9.
		6104	WOMEN''S OR GIRLS'' SUITS, ENSEMB ETC, KNIT OR CRO	454.	41.
		6205	MEN''S OR BOYS'' SHIRTS, NOT KNITTED OR CROCHETED	451.	31.
		9504	ARTICLES FOR ARCADE, TABLE OR PARLOR GAMES, PARTS	450.	40.
		9101	WATCHES, WRIST, POCKET ETC, PREC METAL OR CLD CASE	416.	87.
		9704	POSTAGE OR REVENUE STAMPS, FIRSTDAY COVERS	409.	14.
		9503	TOYS NESOI, SCALE MODELS ETC, PUZZLES, PARTS ETC	385.	59.
		1509	OLIVE OIL & ITS FRACTIONS, NOT CHEMICALLY MODIFIED	380.	211.
		2912	ALDEHYDES, ITS CYCLIC POLYMERS, PARAFORMALDEHYDE	375.	71.
		8517	ELECTRIC APPARATUS FOR LINE TELEPHONY ETC, PARTS	369.	10.
		8511	ELECTRIC IGNITION ETC EQUIP, GENERATORS, PARTS	349.	44.
		6201	MEN''S OR BOYS'' OVERCOATS, CLOAKS ETC, NOT KNIT E	343.	27.
		3906	ACRYLIC POLYMERS IN PRIMARY FORMS	335.	192.
		8903	YACHTS & OTHER VESSELS FOR PLEAS ETC, ROW BOAT ETC	333.	9.
		1806	CHOCOLATE & OTHER FOOD PRODUCTS CONTAINING COCOA	326.	107.
		9609	PENCILS (LEAD ENCASED), CRAYONS, LEADS, CHALKS ETC	313.	30.
		2922	OXYGEN-FUNCTION AMINO-COMPOUNDS	292.	28.
		7019	GLASS FIBERS & ARTICLES THEREOF (YARN ETC.)	288.	49.
		3908	POLYAMIDES IN PRIMARY FORMS	287.	66.
		8470	CALCULATING & ACCOUNT MACHINES, CASH REGISTERS ET	279.	13.

1993 U.S. IMPORTS TRANSSHIPPED VIA CANADA ABOVE \$200,000
 BY CUSTOMS DISTRICT BY DESCEND. VALUE IN \$1000'S ESTIM. WEIGHT IN METRIC TONS

CD#	CUSTOMS DISTRICT	CODE	HARMONIZED COMMODITY DESCRIPTION	\$1000S	EST. M.TONS
10	NEW YORK N.Y.	2001	VEG, FRUIT, NUTS ETC, PREP OR PRES BY VINEGAR ETC	268.	221.
		2925	CARBOXYIMIDE-FUNCTION COMP, IMINE-FUNCTION COM ET	260.	28.
		7117	IMITATION JEWELRY	256.	29.
		2821	IRON OXIDES & HYDROXIDES, EARTH COLORS NUN 70% IR	248.	269.
		4202	TRAVEL GOODS, HANDBAGS, WALLETS, JEWELRY CASES ETC	235.	20.
		2919	PHOSPHORIC ESTERS & SALTS, LACTOPHOSPHATES ETC.	229.	145.
		6202	WOMEN''S OR GIRLS'' OVERCOATS ETC, NOT KNIT OR CRO	228.	10.
		8472	OFFICE MACHINES NESOI (HECTOGRAPH, ADDRESSING ETC	226.	6.
		2915	SAT ACYCLIC NONOCARBOX ACID & ANHYD, HALOGON ETC	211.	213.
		8103	TANTALUM & ARTICLES THEREOF, INCLUD WASTE & SCRAP	211.	9.
		8712	BICYCLES & OTH CYCLES (INC DEL TRICYCLE) NO MOTOR	210.	46.
		2924	CARBOXYAMIDE-FUNCTION COMP, AMIDE-FUNCTION COM ET	206.	66.
		8528	TELEVISION RECEIVERS (INCL MONITORS & PROJ RECEIV	203.	9.
		5701	CARPETS & OTHER TEXTILE FLOOR COVERINGS, KNOTTED	202.	15.
		9999	BELOW MINIMUM	14,106.	5,702.
		*SUB-TOTAL CUSTOMS DIST. # 10		197,471.	38,148.
11	PHILADELPHIA, PA.	3701	PHOTO PLATES & FILM, FLAT, SENSITIZED, UNEXPOSED	13,218.	1,401.
		8414	AIR OR VAC PUMPS, COMPR & FANS, HOODS & FANS, PTS	11,384.	764.
		3702	PHOTO FILM IN ROLLS SENSITIZED, UNEXPOSED	8,935.	803.
		3703	PHOTO PAPER, PAPERBOARD & TEXTILES, SENS, UNEXPOS	2,478.	231.
		3707	PHOTOGRAPHIC CHEMICALS, UNMIXED PROD RETAIL PACKED	2,383.	343.
		7601	ALUMINUM, UNWROUGHT	1,077.	925.
		8479	MACHINES ETC HAVING INDIVIDUAL FUNCTIONS NESOI, P	975.	165.
		8527	RECEPTION APPARATUS FOR RADIOTELEPHONY ETC	945.	53.
		5910	TRANSMSN/CONVYR BELTS,TEX MATRL,WHTHR/NOT REINFRCD	818.	49.
		4010	CONVEYOR OR TRANSMISS BELTS OF VULCANIZED RUBBER	797.	184.
		5903	TEXTILE FABRICS (NOT TIRE CORD) COAT ETC, PLASTICS	739.	33.
		8418	REFRIGERATORS, FREEZERS ETC, HEAT PUMPS NESOI, PT	669.	138.
		8419	MACHINERY ETC FOR TEMP CHANG TREAT MAT, W HEAT, P	562.	14.
		9102	WATCHES, WRIST, POCKET ETC, CASE NOT PREC NOR CLAD	539.	9.
		8483	TRANSMISSION SHAFTS, BEARINGS, GEARS ETC, PARTS	520.	33.
		8481	TAPS, COCKS, VALVES ETC FOR PIPES, TANKS ETC, PTS	466.	48.
		3920	PLATES, SHEETS, FILM ETC NO AD, NON-CEL ETC, PLAS	432.	171.
		8307	FLEXIBLE TUBING OF BASE METAL	397.	42.
		9403	FURNITURE NESOI AND PARTS THEREOF	356.	186.
		3004	MEDICAMENTS NESOI, MIXED OR NOT, IN DOSAGE ETC FM	338.	32.
		2005	VEGETABLES NESOI PREPARED ETC NESOI, NOT FROZEN	328.	294.
		8537	BOARDS, PANELS ETC WITH ELEC SWITCH APPAR ETC.	326.	5.
		8482	BALL OR ROLLER BEARINGS AND PARTS	293.	17.
		4811	PAPER, PAPERBOARD, WAD ETC, COAT ETC NESOI, RL ET	259.	24.
		5407	WOVEN FAB OF SYN FIL YN, INCL MONOFIL 67 DEC ETC	253.	14.
		3914	ION-EXCHANGERS BASD ON PLASTICS, IN PRIMARY FORMS	252.	170.
		8421	CENTRIFUGES, FILTER ETC MACH FOR LIQ OR GASES, PT	240.	27.
		8433	HARVEST ETC MACHINES, CLEANING EGGS ETC NESOI, PT	225.	54.
		8477	MACHINERY FOR WORKING RUBBER & PLAST ETC NESOI, P	223.	16.
		6909	CERAMIC LAB ETC WARES, AGR TUBS ETC & PACKING ART	213.	21.

1993 U.S. IMPORTS TRANSSHIPPED VIA CANADA ABOVE \$200,000
 BY CUSTOMS DISTRICT BY DESCEND. VALUE IN \$1000'S ESTIM. WEIGHT IN METRIC TONS

CD#	CUSTOMS DISTRICT	CODE	HARMONIZED COMMODITY DESCRIPTION	\$1000S	EST. M.TONS
11	PHILADELPHIA, PA.	7307	TUBE OR PIPE FITTINGS, OF IRON OR STEEL	202.	142.
		9999	BELOW MINIMUM	4,871.	2,180.
*SUB-TOTAL CUSTOMS DIST. # 11				55,713.	8,586.
13	BALTIMORE, MD.	8703	MOTOR CARS & VEHICLES FOR TRANSPORTING PERSONS	3,579.	403.
		3303	PERFUMES AND TOILET WATERS	2,063.	83.
		2208	ETHYL ALCOHOL, UNDENAT, UNDB80% ALC, SPIRIT BEV ETC	1,056.	370.
		8701	TRACTORS (OTHER THAN WORKS TRUCKS OF HEADING 8709)	798.	114.
		3304	BEAUTY, MAKE-UP & SKIN-CARE PREP, MANICURE ETC PRP	700.	49.
		7606	ALUMINUM PLATES, SHEETS & STRIP OVER .2MM THICK	658.	499.
		8462	MACHINE TOOLS FOR FORGING, BENDING, STAMPING ETC	361.	25.
		3707	PHOTOGRAPHIC CHEMICALS, UNMIXED PROD RETAIL PACKED	342.	43.
		2003	MUSHROOMS AND TRUFFLES PREPARED OR PRESERVED NESOI	237.	279.
		8704	MOTOR VEHICLES FOR TRANSPORT OF GOODS	210.	37.
		8443	PRINTING MACHINERY, MACHINES ANCIL TO PRINTING, P	204.	8.
		9999	BELOW MINIMUM	1,349.	625.
*SUB-TOTAL CUSTOMS DIST. # 13				11,557.	2,533.
14	NORFOLK, VA.	2401	TOBACCO, UNMANUFACTURED, TOBACCO REFUSE	9,964.	8,332.
		2402	CIGARS, CIGARETTES ETC., OF TOBACCO OR SUBSTITUTES	628.	43.
		8408	COMPRESSION-IGNITION INTERNAL COMB PISTON ENGINES	503.	52.
		8471	AUTOMATIC DATA PROCESS MACHINES, MAGN READER ETC	209.	7.
		9999	BELOW MINIMUM	957.	217.
*SUB-TOTAL CUSTOMS DIST. # 14				12,261.	8,651.
28	SAN FRANCISCO, CALIF	8471	AUTOMATIC DATA PROCESS MACHINES, MAGN READER ETC	13,357.	320.
		8542	ELECTRONIC INTEGRATED CIRCUITS & MICROASSEMBL, PT	10,615.	348.
		8703	MOTOR CARS & VEHICLES FOR TRANSPORTING PERSONS	4,133.	400.
		2208	ETHYL ALCOHOL, UNDENAT, UNDB80% ALC, SPIRIT BEV ETC	3,590.	914.
		8473	PARTS ETC FOR TYPEWRITERS & OTHER OFFICE MACHINES	3,207.	134.
		3303	PERFUMES AND TOILET WATERS	1,863.	73.
		3304	BEAUTY, MAKE-UP & SKIN-CARE PREP, MANICURE ETC PRP	1,537.	112.
		8479	MACHINES ETC HAVING INDIVIDUAL FUNCTIONS NESOI, P	710.	18.
		9018	MEDICAL, SURGICAL, DENTAL OR VET INST, NO ELEC, P	546.	12.
		8803	PARTS OF BALLOONS ETC, AIRCRAFT, SPACECRAFT ETC	454.	8.
		9703	ORIGINAL SCULPTURES AND STATUARY, IN ANY MATERIAL	331.	5.
		2204	WINE OF FRESH GRAPES, GRAPE MUST NESOI	280.	154.
		9027	INST ETC FOR PHYSICAL ETC ANAL ETC, MICROTOME, PT	277.	3.
		8704	MOTOR VEHICLES FOR TRANSPORT OF GOODS	268.	42.
		3002	HUMAN BLOOD, ANIMAL BLOOD, ANTISERA, VACCINES ETC	247.	100.
		8507	ELECTRIC STORAGE BATTERIES, INCL SEPARATORS, PARTS	216.	8.
		9999	BELOW MINIMUM	3,573.	814.
*SUB-TOTAL CUSTOMS DIST. # 28				45,204.	3,464.

1993 U.S. IMPORTS TRANSSHIPPED VIA CANADA ABOVE \$200,000
 BY CUSTOMS DISTRICT BY DESCEND. VALUE IN \$1000'S ESTIM. WEIGHT IN METRIC TONS

CD#	CUSTOMS DISTRICT	CODE	HARMONIZED COMMODITY DESCRIPTION	\$1000S	EST. M.TONS
---	-----	----	-----	-----	-----
29	PORTLAND, OREGON	8471	AUTOMATIC DATA PROCESS MACHINES, MAGN READER ETC	6,485.	91.
		8542	ELECTRONIC INTEGRATED CIRCUITS & MICROASSEMBL, PT	2,088.	36.
		8534	PRINTED CIRCUITS	1,528.	32.
		3823	BINDERS FOR FOUND MOLDS, CHEMICAL PROD ETC NESOI	1,283.	599.
		6403	FOOTWEAR, OUTER SOLE RUB, PLAST OR LEA & UPPER LEA	760.	61.
		8108	TITANIUM & ARTICLES THEREOF, INCLUD WASTE & SCRAP	397.	107.
		6215	TIES, BOW TIES & CRAVATS, NOT KNITTED OR CROCHETE	383.	4.
		9027	INST ETC FOR PHYSICAL ETC ANAL ETC, MICROTOME, PT	375.	4.
		8524	RECORDS, TAPES & OTHER RECORDED SOUND MEDIA ETC	370.	9.
		8518	MICROPHONES, LOUDSPEAKERS, SOUND AMPLIFIER ETC, P	343.	75.
		6110	SWEATERS, PULLOVERS, VESTS ETC, KNIT OR CROCHETED	288.	8.
		8541	SEMICONDUCTOR DEVICES, LIGHT-EMIT DIODES ETC, PTS	255.	23.
		6201	MEN''S OR BOYS'' OVERCOATS, CLOAKS ETC, NOT KNIT E	238.	15.
		9999	BELOW MINIMUM	5,161.	1,555.
			*SUB-TOTAL CUSTOMS DIST. # 29	19,954.	2,619.
30	SEATTLE, WASH.	8471	AUTOMATIC DATA PROCESS MACHINES, MAGN READER ETC	25,386.	924.
		901	COFFEE, COFFEE HUSKS ETC, SUBSTITUTES WITH COFFEE	12,047.	6,596.
		2818	ALUMINUM OXIDE (INCL ART CORUNDUM), ALUM HYDROXIDE	11,241.	6,661.
		8473	PARTS ETC FOR TYPEWRITERS & OTHER OFFICE MACHINES	9,898.	547.
		8525	TRANS APPAR FOR RADIOTELEPHONY ETC, TV CAMERAS	7,269.	213.
		8429	SELF-PROPELLED BULLDOZERS, GRADERS, SCRAPERS ETC	6,420.	1,441.
		9506	ARTICLES & EQUIP FOR SPORTS ETC NESOI, POOLS, PTS	5,461.	500.
		8411	TURBOJETS, TURBOPROPELLERS & OTH GAS TURBINES, PTS	5,236.	580.
		4412	PLYWOOD, VENEERED PANELS & SIMILAR LAMINATED WOOD	4,656.	5,610.
		2826	FLUORIDES, FLUROSILICATES, FLUOROALUMINATES ETC	4,431.	5,951.
		9403	FURNITURE NESOI AND PARTS THEREOF	4,153.	1,260.
		8803	PARTS OF BALLOONS ETC, AIRCRAFT, SPACECRAFT ETC	3,867.	62.
		8708	PARTS & ACCESS FOR MOTOR VEHICLES (HEAD 8701-8705)	3,507.	1,066.
		9504	ARTICLES FOR ARCADE, TABLE OR PARLOR GAMES, PARTS	3,391.	116.
		8703	MOTOR CARS & VEHICLES FOR TRANSPORTING PERSONS	2,890.	221.
		8712	BICYCLES & OTH CYCLES (INC DEL TRICYCLE) NO MOTOR	2,598.	523.
		306	CRUSTACEANS, LIVE, FRESH ETC, AND COOKED ETC.	2,466.	269.
		304	FISH FILLETS & OTH FISH MEAT, FRESH, CHILL OR FROZ	2,396.	1,395.
		8443	PRINTING MACHINERY, MACHINES ANCIL TO PRINTING, P	2,263.	124.
		8504	ELECTRIC TRANSFORM, STATIC CONVERTERS & INDUCT, PT	2,114.	315.
		8431	PARTS FOR MACHINERY OF HEADINGS 8425 TO 8430	2,109.	494.
		7225	FL-RL ALLOY STEEL NESOI NUN 600MM WIDE	2,092.	3,492.
		8413	PUMPS FOR LIQUIDS, LIQUID ELEVATORS, PARTS THEREO	2,090.	186.
		8701	TRACTORS (OTHER THAN WORKS TRUCKS OF HEADING 8709)	2,082.	370.
		6205	MEN''S OR BOYS'' SHIRTS, NOT KNITTED OR CROCHETED	1,940.	170.
		8524	RECORDS, TAPES & OTHER RECORDED SOUND MEDIA ETC	1,815.	72.
		6403	FOOTWEAR, OUTER SOLE RUB, PLAST OR LEA & UPPER LEA	1,733.	102.
		8477	MACHINERY FOR WORKING RUBBER & PLAST ETC NESOI, P	1,728.	152.
		3823	BINDERS FOR FOUND MOLDS, CHEMICAL PROD ETC NESOI	1,719.	516.
		4011	NEW PNEUMATIC TIRES, OF RUBBER	1,709.	662.
		8483	TRANSMISSION SHAFTS, BEARINGS, GEARS ETC, PARTS	1,575.	155.

1993 U.S. IMPORTS TRANSSHIPPED VIA CANADA ABOVE \$200,000
 BY CUSTOMS DISTRICT BY DESCEND. VALUE IN \$1000'S ESTIM. WEIGHT IN METRIC TONS

CD#	CUSTOMS DISTRICT	CODE	HARMONIZED COMMODITY DESCRIPTION	\$1000S	EST. M.TONS
30	SEATTLE, WASH.	8428	LIFTING, HANDLING, LOADING & UNLOAD MACHINES NESO	1,477.	330.
		8528	TELEVISION RECEIVERS (INCL MONITORS & PROJ RECEIV	1,359.	56.
		4901	BOOKS, BROCHURES & SIMILAR PRINTED MATTER	1,281.	198.
		802	NUTS NESOI, FRESH OR DRIED	1,232.	383.
		8537	BOARDS, PANELS ETC WITH ELEC SWITCH APPAR ETC.	1,220.	37.
		8713	INVALID CARRIAGES, MECHANICALLY PROPELLED OR NOT	1,200.	130.
		7306	TUBES, PIPES & HOLLOW PROFILES NESOI, IRON & STEEL	1,189.	2,906.
		9018	MEDICAL, SURGICAL, DENTAL OR VET INST, NO ELEC, P	1,163.	12.
		6110	SWEATERS, PULLOVERS, VESTS ETC, KNIT OR CROCHETED	1,148.	68.
		8432	AGRICULT ETC MACH FOR SOIL ETC, LAWN ROLLERS, PTS	1,089.	278.
		8419	MACHINERY ETC FOR TEMP CHANG TREAT MAT, W HEAT, P	1,068.	51.
		8430	MACH NESOI, MOVING, GRAD ETC, PILE-DR, SNOFLOW ET	990.	122.
		9401	SEATS (EXCEPT BARBER, DENTAL, ETC), AND PARTS	979.	178.
		5608	KNOTTED NET OF TWINE ETC, FISH NET ETC OF TEXTILES	946.	83.
		9503	TOYS NESOI, SCALE MODELS ETC, PUZZLES, PARTS ETC	941.	169.
		8479	MACHINES ETC HAVING INDIVIDUAL FUNCTIONS NESOI, P	922.	71.
		8460	MACHINE TOOLS FOR HONING OR FINISHING METAL ETC	872.	49.
		7304	TUBES, PIPES ETC, SEAMLESS, IRON NESOI & STEEL	866.	1,460.
		8433	HARVEST ETC MACHINES, CLEANING EGGS ETC NESOI, PT	839.	161.
		6206	WOMEN''S OR GIRLS'' BLOUSES, SHIRTS ETC NOT KNIT E	823.	43.
		8481	TAPS, COCKS, VALVES ETC FOR PIPES, TANKS ETC, PTS	806.	126.
		8517	ELECTRIC APPARATUS FOR LINE TELEPHONY ETC, PARTS	806.	32.
		6105	MEN''S OR BOYS'' SHIRTS, KNITTED OR CROCHETED	805.	57.
		7208	FL-RL IRON & NA STEEL NUN600MM WD HOT-RL, NOT CLAD	805.	2,367.
		4418	BUILDERS'' JOINERY AND CARPENTRY OF WOOD	756.	498.
		9014	DIRECTION FINDING COMPASSES & NAVIG INST ETC, PTS	746.	29.
		8903	YACHTS & OTHER VESSELS FOR PLEAS ETC, ROW BOAT ETC	737.	35.
		7315	CHAIN & PARTS, OF IRON OR STEEL	720.	460.
		6201	MEN''S OR BOYS'' OVERCOATS, CLOAKS ETC, NOT KNIT E	664.	41.
		8436	AGRI ETC & POULTRY ETC EQUIP, INC INCUBATORS, PTS	658.	108.
		8505	ELECTROMAGNETS, PERMANENT MAGNETS ETC & PARTS	620.	538.
		8459	MACHINE TOOLS FOR DRILLING, BORING, MILLING ETC	597.	474.
		8536	ELECTRICAL APPARATUS FOR SWITCHING ETC, NOV 1000	588.	55.
		8704	MOTOR VEHICLES FOR TRANSPORT OF GOODS	584.	70.
		7312	STRANDED WIRE, ROPES ETC, NO ELEC INS, IR OR STEEL	572.	461.
		3926	ARTICLES OF PLASTICS (INC POLYMERS & RESINS) NESO	559.	149.
		8101	TUNGSTEN (WOLFRAM) & ARTICLES, INCL WASTE & SCRAP	555.	120.
		8414	AIR OR VAC PUMPS, COMPR & FANS, HOODS & FANS, PTS	554.	140.
		8458	LATHES FOR REMOVING METAL	545.	40.
		8438	MACH NESOI, IND PREP OF FOOD OR DRINK ETC, PARTS	527.	32.
		2519	MAGNESITE, FUSED MAGNESIA, D-B MAGN, M OXIDE NESOI	518.	1,316.
		8482	BALL OR ROLLER BEARINGS AND PARTS	518.	58.
		8465	MACHINE TOOLS FOR WORKING WOOD, CORK, BONE ETC	507.	80.
		6702	ARTIFICIAL FLOWERS, FOLIAGE & FRUIT, PTS & ARTICLS	497.	78.
		9507	FISHING RODS & TACKLE, NETS, DECOYS ETC, PARTS ETC	482.	44.
		3920	PLATES, SHEETS, FILM ETC NO AD, NON-CEL ETC, PLAS	459.	87.
		6210	GARMENTS, OF FELT ETC, OR FABRIC IMPREGNATED ETC	454.	36.
		8427	FORK-LIFT TRUCKS; OTH WORKS TRUCKS WITH LIFTS ETC	453.	109.

1993 U.S. IMPORTS TRANSSHIPPED VIA CANADA ABOVE \$200,000
 BY CUSTOMS DISTRICT BY DESCEND. VALUE IN \$1000'S ESTIM. WEIGHT IN METRIC TONS

CD#	CUSTOMS DISTRICT	CODE	HARMONIZED COMMODITY DESCRIPTION	\$1000S	EST. M.TONS
---	-----	----	-----	-----	-----
30	SEATTLE, WASH.	8526	RADAR APPARATUS, RADIO NAVIG AID & REMOTE CONT AP	452.	5.
		7305	TUBES & PIPES NESOI, EXT DIA OV406-4MM, IR & STEEL	451.	997.
		9405	LAMPS & LIGHTING FITTINGS & PARTS ETC NESOI	445.	94.
		9022	X-RAY ETC APPARATUS, TUBES, PANELS, SCREEN ETC, P	441.	4.
		8519	TURNTABLES, RECORD & CASSETTE PLAYERS ETC.	437.	19.
		8716	TRAILERS ETC, OTHER VEHICLES, NOT MECH PROPELD, P	433.	118.
		6203	MEN''S OR BOYS'' SUITS, ENSEMBLES ETC, NOT KNIT ET	430.	27.
		7307	TUBE OR PIPE FITTINGS, OF IRON OR STEEL	427.	83.
		7302	RAILWAY ETC TRACK CONSTRUCT MATERIAL, IRON & STEEL	425.	694.
		9010	APPARATUS ETC FOR PHOTO LABS ETC NESOI, PARTS ETC	419.	10.
		8506	PRIMARY CELLS & BATTERIES, PARTS	408.	153.
		8521	VIDEO RECORDING OR REPRODUCING APPARATUS	405.	10.
		9030	OSCILLOSCOPES, SPECTRUM ANALYZERS ETC, PARTS ETC	391.	23.
		505	BIRD SKINS & OTHER FEATHERED PARTS AND DOWN	386.	25.
		7317	AILS, TACKS, DRAWING PINS ETC OF IRON OR STEEL	384.	534.
		8523	PREPARED UNRECORDED MEDIA (NO FILM) FOR SOUND ETC	380.	29.
		4407	WOOD SAWN OR CHIPPED LENGTH, SLICED ETC, OV6MM TH	376.	533.
		7318	SCREWS, BOLTS, NUTS, WASHERS ETC, IRON OR STEEL	375.	284.
		6910	CERAMIC SINKS, WASHBASINS, WATER CLOSET BOWLS ETC	356.	187.
		6211	TRACK SUITS, SKI-SUITS & SWIMWEAR, NOT KNIT ETC	355.	11.
		6902	REFRACTORY BRICKS & OTHER REFR CER CONST ART NESOI	347.	606.
		8407	SPARK-IGNITION RECIP OR ROTARY INT COMB PISTON ENG	347.	33.
		8516	ELEC WATER, SPACE & SOIL HEATERS, HAIR ETC DRY, P	347.	38.
		2007	JAMS, FRUIT JELLIES, MARMALADES ETC, COOKED	340.	317.
		8714	PARTS & ACCESS FOR CYCLES & INVALID CARRIAGES	338.	48.
		2204	WINE OF FRESH GRAPES, GRAPE MUST NESOI	335.	236.
		5407	WOVEN FAB OF SYN FIL YN, INCL MONOFIL 67 DEC ETC	332.	42.
		2918	CARBOXYLIC ACID, ADDED OXYGEN & ANHY ETC, HAL ETC	328.	295.
		8466	PARTS ETC FOR MACHINE TOOLS OF HEAD 8456 TO 8465	327.	41.
		4301	RAW FURSKINS NESOI (INCL PCS FOR FUR USE)	324.	86.
		6802	WORKED MONUMENT ETC STONE & ART NESOI, GRANULE ETC	324.	814.
		8203	FILES, RASPS, PLIERS, METALCUT SHEARS ETC, B MT PT	323.	60.
		8457	MACHINING CENTERS, UNIT CONST MACH ETC WORK METAL	323.	22.
		7207	SEMIFINISHED PRODUCTS OF IRON OR NONALLOY STEEL	322.	1,589.
		8409	PARTS FOR ENGINES OF HEADING 8407 OR 8408	318.	37.
		7606	ALUMINUM PLATES, SHEETS & STRIP OVER .2MM THICK	314.	94.
		5702	CARPETS & OTH TEXT FLOOR COVER, WOVEN, NO TUFT ETC	311.	35.
		9017	DRAWING, MATH, MEASURING INST ETC NESOI, PARTS	310.	39.
		6908	GLAZED CERAMIC FLAGS & PAVING, HEARTH TILES, ETC	298.	540.
		9502	DOLLS, REPRESENTING ONLY HUMAN BEINGS, & PARTS ETC	298.	46.
		6202	WOMEN''S OR GIRLS'' OVERCOATS ETC, NOT KNIT OR CRO	295.	16.
		4016	ARTICLES NESOI OF UNHARDED VULCANIZED RUBBER	291.	20.
		6204	WOMEN''S OR GIRLS'' SUITS, ENSEMB ETC, NOT KNIT ET	285.	12.
		7321	STOVES, RANGES ETC, NONEL DOMEST & PTS, IR & STEE	278.	46.
		1806	CHOCOLATE & OTHER FOOD PRODUCTS CONTAINING COCOA	276.	90.
		2936	PROVITAMINS AND VITAMINS & DERIVATIVES & INTERMIX	276.	26.
		8474	MACHINERY FOR SORTING SCREENING ETC MINERALS, PTS	275.	91.
		2208	ETHYL ALCOHOL, UNDENAT, UNDBOX ALC, SPIRIT BEV ETC	274.	75.

1993 U.S. IMPORTS TRANSSHIPPED VIA CANADA ABOVE \$200,000
 BY CUSTOMS DISTRICT BY DESCEND. VALUE IN \$1000'S ESTIM. WEIGHT IN METRIC TONS

CD#	CUSTOMS DISTRICT	CODE	HARMONIZED COMMODITY DESCRIPTION	\$1000S	EST. M.TONS
30	SEATTLE, WASH.	8412	ENGINES AND MOTORS NESOI, AND PARTS THEREOF	271.	19.
		8109	ZIRCONIUM & ARTICLES THEREOF, INCLUD WASTE & SCRAP	269.	9.
		4012	RETREAD OR USED PNEU TIRES, SOLID TIRES ETC, RUBB	266.	302.
		8439	MACHINERY FOR MAKING PULP & MAKING ETC PAPER, PTS	264.	18.
		9031	MACHINES, NESOI IN CHAPTER 90, PROFILE PROJECT, P	258.	11.
		3906	ACRYLIC POLYMERS IN PRIMARY FORMS	244.	51.
		8542	ELECTRONIC INTEGRATED CIRCUITS & MICROASSEMBL, PT	244.	12.
		4411	FIBERBOARD OF WOOD OR OTHER LIGNEOUS MATERIALS	243.	636.
		7308	STRUCTURES NESOI & PARTS THEREOF, OF IRON OR STEEL	241.	183.
		3912	CELLULOSE AND CHEMICAL DERIV NESOI, PRIMARY FORMS	240.	49.
		3303	PERFUMES AND TOILET WATERS	238.	9.
		6913	STATUETTES AND OTHER ORNAMENTAL CERAMIC ARTICLES	238.	101.
		1108	STARCHES, INULIN	234.	721.
		3921	PLATES, SHEETS, FILM, FOIL & STRIP NESOI, PLASTIC	229.	37.
		8302	HARDWARE, FIXTURES, CASTORS ETC & PARTS, BASE METL	223.	73.
		2804	HYDROGEN, RARE GASES AND OTHER NONMETALS	220.	103.
		1704	SUGAR CONFECTION (INCL WHITE CHOCOLATE), NO COCOA	214.	71.
		2834	NITRITES, NITRATES	214.	705.
		6912	CERAMIC TABLEWRE, KITCHNWRE ETC, EARTHENWARE ETC	214.	140.
		8207	INTERCHANGE TOOLS FOR HAND- OR MACHINE-TOOLS, BMPT	211.	27.
		4602	BASKETWORK, WICKERWORK OF PLAITS ETC, LOOFA ARTICL	209.	102.
		7117	IMITATION JEWELRY	209.	14.
		7219	FL-RL STAINLESS STEEL PRODUCTS, NOT UND 600MM WID	209.	81.
		7228	AL STEEL NESOI BARS, ANG ETC, HOL DR ST BARS ETC	207.	254.
		305	FISH, DRIED, SALTED ETC, SMOKED ETC, ED FISH MEAL	200.	27.
		9999	BELOW MINIMUM	17,856.	9,585.
			*SUB-TOTAL CUSTOMS DIST. # 30	221,575.	77,740.
33	GREAT FALLS, MONT.	9506	ARTICLES & EQUIP FOR SPORTS ETC NESOI, POOLS, PTS	4,931.	642.
		8429	SELF-PROPELLED BULLDOZERS, GRADERS, SCRAPERS ETC	2,495.	466.
		8481	TAPS, COCKS, VALVES ETC FOR PIPES, TANKS ETC, PTS	1,683.	195.
		8701	TRACTORS (OTHER THAN WORKS TRUCKS OF HEADING 8709)	1,545.	290.
		202	MEAT OF BOVINE ANIMALS, FROZEN	1,059.	514.
		8479	MACHINES ETC HAVING INDIVIDUAL FUNCTIONS NESOI, P	940.	59.
		8430	MACH NESOI, MOVING, GRAD ETC, PILE-DR, SNOPLow ET	769.	62.
		8507	ELECTRIC STORAGE BATTERIES, INCL SEPARATORS, PARTS	706.	14.
		6402	FOOTWEAR, OUTER SOLE & UPPER RUBBER OR PLAST NESOI	687.	49.
		8431	PARTS FOR MACHINERY OF HEADINGS 8425 TO 8430	511.	140.
		8525	TRANS APPAR FOR RADIOTELEPHONY ETC, TV CAMERAS	477.	12.
		8207	INTERCHANGE TOOLS FOR HAND- OR MACHINE-TOOLS, BMPT	466.	28.
		8511	ELECTRIC IGNITION ETC EQUIP, GENERATORS, PARTS	447.	27.
		9015	SURVEY, HYDROGR, METEORO ETC INST, RANGEF ETC, PT	409.	28.
		8471	AUTOMATIC DATA PROCESS MACHINES, MAGN READER ETC	361.	12.
		7308	STRUCTURES NESOI & PARTS THEREOF, OF IRON OR STEEL	358.	139.
		8515	ELECTRIC, LASER OR OTH LIGHT OR PHOTON BEAM ETC	316.	13.
		7315	CHAIN & PARTS, OF IRON OR STEEL	294.	68.
		3808	INSECTICIDES, RODENTICIDES, FUNGICIDES ETC, RETAIL	264.	53.

1993 U.S. IMPORTS TRANSSHIPPED VIA CANADA ABOVE \$200,000
 BY CUSTOMS DISTRICT BY DESCEND. VALUE IN \$1000'S ESTIM. WEIGHT IN METRIC TONS

CD#	CUSTOMS DISTRICT	CODE	HARMONIZED COMMODITY DESCRIPTION	\$1000S	EST. M.TONS
---	-----	---	-----	-----	-----
33	GREAT FALLS, MONT.	8473	PARTS ETC FOR TYPEWRITERS & OTHER OFFICE MACHINES	263.	11.
		8703	MOTOR CARS & VEHICLES FOR TRANSPORTING PERSONS	256.	21.
		6911	CERAMIC TABLEWARE ETC. OF PORCELAIN OR CHINA	244.	247.
		8438	MACH NESOI, IND PREP OF FOOD OR DRINK ETC, PARTS	230.	42.
		9006	PHOTOGRAPHIC STILL CAMERAS, FLASH APPARATUS ETC	201.	10.
		9999	BELOW MINIMUM	5,199.	1,845.
		*SUB-TOTAL CUSTOMS DIST. # 33		25,111.	4,988.
34	PEMBINA, N. DAK.	8407	SPARK-IGNITION RECIP OR ROTARY INT COMB PISTON ENG	88,435.	7,421.
		8409	PARTS FOR ENGINES OF HEADING 8407 OR 8408	4,940.	425.
		8473	PARTS ETC FOR TYPEWRITERS & OTHER OFFICE MACHINES	4,160.	118.
		8708	PARTS & ACCESS FOR MOTOR VEHICLES (HEAD 8701-8705)	2,780.	626.
		8413	PUMPS FOR LIQUIDS, LIQUID ELEVATORS, PARTS THEREO	1,634.	117.
		2934	HETEROCYCLIC COMPOUNDS NESOI	1,535.	237.
		8429	SELF-PROPELLED BULLDOZERS, GRADERS, SCRAPERS ETC	1,498.	287.
		8701	TRACTORS (OTHER THAN WORKS TRUCKS OF HEADING 8709)	1,453.	277.
		8471	AUTOMATIC DATA PROCESS MACHINES, MAGN READER ETC	1,188.	18.
		3604	FIREWORKS, SIGNALLING FLARES, RAIN ROCKETS ETC.	1,164.	639.
		9403	FURNITURE NESOI AND PARTS THEREOF	1,128.	458.
		8608	RAILWAY FIXTURES, MECH SIGNALING, SAFETY, ETC, EQ	1,069.	185.
		8707	BODIES (INCLUDING CABS), FOR SPECIF MOTOR VEHICLES	718.	165.
		9401	SEATS (EXCEPT BARBER, DENTAL, ETC), AND PARTS	683.	151.
		8431	PARTS FOR MACHINERY OF HEADINGS 8425 TO 8430	675.	129.
		8430	MACH NESOI, MOVING, GRAD ETC, PILE-DR, SNOFLOW ET	672.	60.
		8433	HARVEST ETC MACHINES, CLEANING EGGS ETC NESOI, PT	614.	124.
		5503	SYNTHETIC STAPLE FIBERS, NOT CARDED, COMBED ETC.	546.	483.
		4811	PAPER, PAPERBOARD, WAD ETC, COAT ETC NESOI, RL ET	478.	121.
		8803	PARTS OF BALLOONS ETC, AIRCRAFT, SPACECRAFT ETC	379.	7.
		8436	AGRI ETC & POULTRY ETC EQUIP, INC INCUBATORS, PTS	316.	398.
		8483	TRANSMISSION SHAFTS, BEARINGS, GEARS ETC, PARTS	310.	34.
		4104	BOVINE OR EQUINE LEATHER, NO HAIR NESOI	289.	16.
		8512	ELECTRIC LIGHT ETC EQUIP, WINDSH WIPERS ETC, PART	284.	23.
		8525	TRANS APPAR FOR RADIOTELEPHONY ETC, TV CAMERAS	272.	1.
		8518	MICROPHONES, LOUDSPEAKERS, SOUND AMPLIFIER ETC, P	263.	40.
		8443	PRINTING MACHINERY, MACHINES ANCIL TO PRINTING, P	238.	10.
		8302	HARDWARE, FIXTURES, CASTORS ETC & PARTS, BASE METL	221.	54.
		9999	BELOW MINIMUM	7,247.	1,864.
		*SUB-TOTAL CUSTOMS DIST. # 34		125,189.	14,488.
35	MINNEAP/ST. PAUL	8413	PUMPS FOR LIQUIDS, LIQUID ELEVATORS, PARTS THEREO	25,532.	2,311.
		3501	CASEIN, CASEINATES AND OTHER CASEIN DERIVATIVES	13,731.	3,309.
		8408	COMPRESSION-IGNITION INTERNAL COMB PISTON ENGINES	13,724.	1,568.
		9507	FISHING RODS & TACKLE, NETS, DECOYS ETC, PARTS ETC	10,426.	3,052.
		8501	ELECTRIC MOTORS AND GENERATORS (NO SETS)	8,264.	753.
		6805	ABRASIVE POWDER ETC ON A BASE TEXT MATERIAL ETC	8,074.	2,608.
		8479	MACHINES ETC HAVING INDIVIDUAL FUNCTIONS NESOI, P	7,937.	581.

1993 U.S. IMPORTS TRANSSHIPPED VIA CANADA ABOVE \$200,000
 BY CUSTOMS DISTRICT BY DESCEND. VALUE IN \$1000'S ESTIM. WEIGHT IN METRIC TONS

CD#	CUSTOMS DISTRICT	CODE	HARMONIZED COMMODITY DESCRIPTION	\$1000S	EST. M.TONS
35	MINNEAP/ST. PAUL	4810	PAPER & PAPERBOARD, COATED WITH KAOLIN ETC, RL ET	5,870.	8,051.
		8422	MACHINES, DISHWASH, CLEAN ETC CONT & FILL, PAK ET	5,409.	196.
		8424	MECH APPL TO DISPERSE LIQ ETC, SAND ETC BLAST MAC	5,330.	1,415.
		6402	FOOTWEAR, OUTER SOLE & UPPER RUBBER OR PLAST NESOI	4,954.	505.
		9021	ORTHOPEDIC APPL, ARTIF BODY PTS, HEAR AID, PTS ET	4,889.	312.
		3823	BINDERS FOR FOUND MOLDS, CHEMICAL PROD ETC NESOI	4,726.	2,569.
		7607	ALUMINUM FOIL (BACK OR NOT) NOV .2MM TH (EX BACK)	4,163.	1,590.
		2818	ALUMINUM OXIDE (INCL ART CORUNDUM), ALUM HYDROXIDE	3,928.	3,266.
		8481	TAPS, COCKS, VALVES ETC FOR PIPES, TANKS ETC, PTS	3,908.	408.
		3920	PLATES, SHEETS, FILM ETC NO AD, NON-CEL ETC, PLAS	3,890.	1,290.
		8412	ENGINES AND MOTORS NESOI, AND PARTS THEREOF	3,866.	276.
		8708	PARTS & ACCESS FOR MOTOR VEHICLES (HEAD 8701-8705)	3,682.	818.
		9010	APPARATUS ETC FOR PHOTO LABS ETC NESOI, PARTS ETC	3,433.	121.
		9006	PHOTOGRAPHIC STILL CAMERAS, FLASH APPARATUS ETC	3,387.	116.
		3926	ARTICLES OF PLASTICS (INC POLYMERS & RESINS) NESO	3,308.	539.
		4811	PAPER, PAPERBOARD, WAD ETC, COAT ETC NESOI, RL ET	3,177.	1,587.
		8302	HARDWARE, FIXTURES, CASTORS ETC & PARTS, BASE METL	3,175.	428.
		7606	ALUMINUM PLATES, SHEETS & STRIP OVER .2MM THICK	3,055.	1,570.
		6908	GLAZED CERAMIC FLAGS & PAVING, HEARTH TILES, ETC	3,003.	5,457.
		2208	ETHYL ALCOHOL, UNDENAT, UNDR80% ALC, SPIRIT BEV ETC	2,963.	1,124.
		8483	TRANSMISSION SHAFTS, BEARINGS, GEARS ETC, PARTS	2,958.	221.
		3815	REACTION INITIATORS & ACCELER & CATALYT PREP NESO	2,942.	208.
		2936	PROVITAMINS AND VITAMINS & DERIVATIVES & INTERMIX	2,803.	368.
		3921	PLATES, SHEETS, FILM, FOIL & STRIP NESOI, PLASTIC	2,616.	522.
		4901	BOOKS, BROCHURES & SIMILAR PRINTED MATTER	2,466.	373.
		8477	MACHINERY FOR WORKING RUBBER & PLAST ETC NESOI, P	2,449.	128.
		9506	ARTICLES & EQUIP FOR SPORTS ETC NESOI, POOLS, PTS	2,356.	350.
		5906	RUBBERIZED TEXTILE FABRICS, OTHER THAN TIRE CORD	2,306.	254.
		7217	WIRE OF IRON & NONALLOY STEEL	2,042.	1,709.
		8414	AIR OR VAC PUMPS, COMPR & FANS, HOODS & FANS, PTS	2,026.	253.
		9505	FESTIVE, CARNIVAL OR OTHER ENTERTAINMENT ART, PTS	1,990.	245.
		8471	AUTOMATIC DATA PROCESS MACHINES, MAGN READER ETC	1,973.	33.
		4823	PAPER, PAPERBOARD, CELLUL WAD TO SIZE & ARTS NESO	1,967.	374.
		9502	DOLLS, REPRESENTING ONLY HUMAN BEINGS, & PARTS ETC	1,912.	104.
		3808	INSECTICIDES, RODENTICIDES, FUNGICIDES ETC, RETAIL	1,822.	632.
		3503	GELATIN & DERIV, ISINGLASS, GLUES, ANIMAL OR NESOI	1,726.	304.
		8433	HARVEST ETC MACHINES, CLEANING EGGS ETC NESOI, PT	1,662.	191.
		2204	WINE OF FRESH GRAPES, GRAPE MUST NESOI	1,653.	804.
		8431	PARTS FOR MACHINERY OF HEADINGS 8425 TO 8430	1,647.	389.
		8211	KNIVES WITH BLADES & BLADES FOR KNIVES NESOI, BMP	1,474.	291.
		8437	MACH FOR CLEANING SEED ETC & WORK CEREAL ETC, PTS	1,468.	303.
		8465	MACHINE TOOLS FOR WORKING WOOD, CORK, BONE ETC	1,418.	154.
		8538	PARTS FOR ELEC APPAR ETC OF HEAD 8535, 8536 & 853	1,403.	99.
		3506	PREPARED GLUES & ADHESIVES NESOI, GLUE RETAIL PACK	1,313.	113.
		8407	SPARK-IGNITION RECIP OR ROTARY INT COMB PISTON ENG	1,295.	254.
		8443	PRINTING MACHINERY, MACHINES ANCIL TO PRINTING, P	1,281.	62.
		3912	CELLULOSE AND CHEMICAL DERIV NESOI, PRIMARY FORMS	1,239.	1,047.
		8482	BALL OR ROLLER BEARINGS AND PARTS	1,224.	120.

1993 U.S. IMPORTS TRANSSHIPPED VIA CANADA ABOVE \$200,000
 BY CUSTOMS DISTRICT BY DESCEND. VALUE IN \$1000'S ESTIM. WEIGHT IN METRIC TONS

CD#	CUSTOMS DISTRICT	CODE	HARMONIZED COMMODITY DESCRIPTION	\$1000S	EST. M.TONS
---	-----	---	-----	-----	-----
35	MINNEAP/ST. PAUL	402	MILK AND CREAM, CONCENTRATED OR SWEETENED	1,196.	965.
		6912	CERAMIC TABLEWARE, KITCHENWARE ETC, EARTHENWARE ETC	1,188.	357.
		3919	SELF-ADHESIVE PLATES, SHEETS, FILM ETC OF PLASTIC	1,153.	186.
		8428	LIFTING, HANDLING, LOADING & UNLOAD MACHINES NESO	1,107.	136.
		9503	TOYS NESOI, SCALE MODELS ETC, PUZZLES, PARTS ETC	1,100.	185.
		1704	SUGAR CONFECTION (INCL WHITE CHOCOLATE), NO COCOA	1,095.	503.
		8480	MOLDING BOXES FOR METAL FOUNDRY, MOLD BASES ETC	1,083.	127.
		8518	MICROPHONES, LOUDSPEAKERS, SOUND AMPLIFIER ETC, P	1,072.	35.
		8438	MACH NESOI, IND PREP OF FOOD OR DRINK ETC, PARTS	1,069.	38.
		3923	CONTAINERS (BOXES, BAGS ETC), CLOSURES ETC, PLAS	1,061.	222.
		1109	WHEAT GLUTEN, WHETHER OR NOT DRIED	1,044.	888.
		8508	ELECTROMECHANICAL TOOLS, WORKING IN HAND, PARTS	1,026.	48.
		6802	WORKED MONUMENT ETC STONE & ART NESOI, GRANULE ETC	1,023.	988.
		2924	CARBOXYAMIDE-FUNCTION COMP, AMIDE-FUNCTION COM ET	979.	79.
		7318	SCREWS, BOLTS, NUTS, WASHERS ETC, IRON OR STEEL	933.	430.
		8460	MACHINE TOOLS FOR HONING OR FINISHING METAL ETC	927.	92.
		8436	AGRI ETC & POULTRY ETC EQUIP, INC INCUBATORS, PTS	918.	176.
		7215	BARS & RODS, IRON & NA STEEL NESOI	909.	1,372.
		5911	TEXTILE PRODUCTS ETC. FOR SPECIFIC TECH USES NESOI	900.	33.
		4016	ARTICLES NESOI OF UNHARDED VULCANIZED RUBBER	889.	188.
		8426	DERRICKS, CRANES, MOBILE LIFTING FRAMES ETC	859.	178.
		5603	NONWOVENS, WHETHER OR NOT IMPREGNATED, COATED ETC	841.	76.
		9009	PHOTOCOPY APPARATUS & THERMOCOPY APPARATUS, PTS	836.	33.
		8421	CENTRIFUGES, FILTER ETC MACH FOR LIQ OR GASES, PT	834.	71.
		2915	SAT ACYCLIC NONOCARBOX ACID & ANHYD, HALOGON ETC	833.	1,185.
		8467	TOOLS FOR WORKING IN THE HAND, PNEUMATIC ETC, PTS	831.	29.
		8425	PULLEY TACKLE & HOISTS (EXC SKIP), WINCH ETC, JAK	816.	297.
		8444	MACHINES EXTRUDING, DRAWING ETC MANMADE TEXTILES	789.	42.
		8432	AGRICULT ETC MACH FOR SOIL ETC, LAWN ROLLERS, PTS	745.	153.
		6913	STATUETTES AND OTHER ORNAMENTAL CERAMIC ARTICLES	731.	155.
		4011	NEW PNEUMATIC TIRES, OF RUBBER	719.	232.
		7410	COPPER FOIL (BACKED OR NOT) NOV .15MM TH (EX BACK)	705.	146.
		8516	ELEC WATER, SPACE & SOIL HEATERS, HAIR ETC DRY, P	701.	125.
		7307	TUBE OR PIPE FITTINGS, OF IRON OR STEEL	689.	235.
		3406	CANDLES, TAPERS AND THE LIKE	665.	211.
		9032	AUTOMATIC REGULATING OR CONTROL INSTRUMENTS, PART	661.	31.
		8474	MACHINERY FOR SORTING SCREENING ETC MINERALS, PTS	654.	61.
		8462	MACHINE TOOLS FOR FORGING, BENDING, STAMPING ETC	648.	78.
		8417	INDUSTRIAL OR LAB FURNACES & OVENS, NONELECT, PTS	646.	66.
		6002	KNITTED OR CROCHETED FABRICS, NESOI	622.	84.
		8473	PARTS ETC FOR TYPEWRITERS & OTHER OFFICE MACHINES	618.	17.
		9403	FURNITURE NESOI AND PARTS THEREOF	608.	259.
		2203	BEER MADE FROM MALT	598.	909.
		7013	GLASSWARE FOR TABLE, KITCHEN, TOILET ETC USE NESOI	598.	189.
		7326	ARTICLES OF IRON OR STEEL, NESOI	598.	130.
		3403	LUBRICATING PREPS, ANTIRUST & TREATING TEXTILES ETC	570.	177.
		7616	ARTICLES OF ALUMINUM NESOI	569.	68.
		8419	MACHINERY ETC FOR TEMP CHANG TREAT MAT, W HEAT, P	516.	39.

1993 U.S. IMPORTS TRANSSHIPPED VIA CANADA ABOVE \$200,000
 BY CUSTOMS DISTRICT BY DESCEND. VALUE IN \$1000'S ESTIM. WEIGHT IN METRIC TONS

CD#	CUSTOMS DISTRICT	CODE	HARMONIZED COMMODITY DESCRIPTION	\$1000S	EST. M.TONS
35	MINNEAP/ST. PAUL	8511	ELECTRIC IGNITION ETC EQUIP, GENERATORS, PARTS	514.	82.
		8485	MACHINERY PTS, NO ELECT CONNECTORS ETC NESOI	510.	29.
		8202	HANDSAWS & MET PTS, SAW BLADES, BASE MTL SAW PARTS	508.	259.
		305	FISH, DRIED, SALTED ETC, SMOKED ETC, ED FISH MEAL	489.	51.
		8466	PARTS ETC FOR MACHINE TOOLS OF HEAD 8456 TO 8465	489.	58.
		8201	HANDTOOLS & TOOLS USED IN AGRICULT ETC, B MET PTS	472.	190.
		9401	SEATS (EXCEPT BARBER, DENTAL, ETC), AND PARTS	471.	66.
		2005	VEGETABLES NESOI PREPARED ETC NESOI, NOT FROZEN	461.	433.
		6907	UNGLAZED CERAMIC FLAGS & PAVING, HEARTH TILES ETC	451.	819.
		8505	ELECTROMAGNETS, PERMANENT MAGNETS ETC & PARTS	451.	339.
		1902	PASTA, PREPARED OR NOT, COUSCOUS, PREPARED OR NOT	450.	222.
		7315	CHAIN & PARTS, OF IRON OR STEEL	433.	89.
		9405	LAMPS & LIGHTING FITTINGS & PARTS ETC NESOI	431.	54.
		3402	ORGANIC SURF-ACT AGENTS, PREPS & CLEANING PREPS	428.	240.
		3906	ACRYLIC POLYMERS IN PRIMARY FORMS	424.	125.
		8409	PARTS FOR ENGINES OF HEADING 8407 OR 8408	424.	24.
		6803	SLATE, WORKED AND ARTICLES, ARTICLS OF AGGLOM SLT	420.	609.
		7310	TANKS ETC, NOV 300 LITER CAPACITY, IRON OR STEEL	415.	231.
		1901	MALT EXT, FOOD PREP OF FLOUR ETC UN 50% COCOA ETC	406.	281.
		4420	WOOD MARQUETRY ETC, JEWEL CASE ETC & WD FURN NESO	405.	52.
		8453	MACHINERY FOR WORK LEATHER ETC & FOOTWEAR ETC, PT	404.	53.
		1209	SEEDS, FRUIT AND SPORES, FOR SOWING	394.	218.
		8309	STOPPERS, CAPS & LIDS, SEALS ETC & PTS, BASE METAL	394.	72.
		2918	CARBOXYLIC ACID, ADDED OXYGEN & ANHY ETC, HAL ETC	384.	311.
		8503	PARTS OF ELECTRIC MOTORS, GENERATORS & SETS	381.	43.
		9008	IMAGE PROJECTORS, STILL, ENLARGERS ETC, STILL, PTS	376.	48.
		3924	TABLEWARE & OTHER HOUSEHOLD ARTICLES ETC, PLASTIC	373.	102.
		1806	CHOCOLATE & OTHER FOOD PRODUCTS CONTAINING COCOA	368.	117.
		7018	GLASS BEADS ETC & ARTICLES NESOI, LW GLASS ORN ET	351.	32.
		9014	DIRECTION FINDING COMPASSES & NAVIG INST ETC, PTS	350.	16.
		9406	PREFABRICATED BUILDINGS	348.	514.
		2201	WATERS, NATURAL ETC, NOT SWEETENED ETC, ICE & SNOW	347.	1,070.
		3304	BEAUTY, MAKE-UP & SKIN-CARE PREP, MANICURE ETC PRP	345.	33.
		4202	TRAVEL GOODS, HANDBAGS, WALLETS, JEWELRY CASES ETC	338.	26.
		9603	BROOMS, BRUSHES, MOPS, FEATHER DUSTERS ETC	332.	65.
		8461	MACHINE TOOLS FOR SHAPING, SLOTTING, GEAR CUT ETC	326.	15.
		8441	MACH FOR MAKING UP PULP & PAPER, INC CUTTERS, PTS	319.	15.
		8468	MACHINES, SOLDER ETC, GAS SURF TEMPER MACHINES, P	306.	22.
		8213	SCSSRS,TLRS A SMLR SHRS, BLDS A OTH BS MTL PTS	294.	23.
		6804	MILLSTONES ETC FOR GRINDING ETC, VARIOUS MATERIALS	291.	61.
		2930	ORGANO-SULFUR COMPOUNDS	285.	149.
		6506	HEADGEAR NESOI, WHETHER OR NOT LINED OR TRIMMED	281.	7.
		7323	HOUSEHOLD ART & PTS, IR & ST, IR OR STEEL WOOL ET	280.	74.
		8446	WEAVING MACHINES (LOOMS)	264.	11.
		4911	PRINTED MATTER NESOI, INCL PRINT PICTURES & PHOTOS	257.	43.
		404	WHEY & MILK PRODUCTS NESOI, FLAVORED ETC. OR NOT	256.	302.
		9026	INST ETC MEASURE OR CHECK FLOW, LEVEL ETC, PTS ET	251.	12.
		3703	PHOTO PAPER, PAPERBOARD & TEXTILES, SENS, UNEXPOS	241.	26.

1993 U.S. IMPORTS TRANSSHIPPED VIA CANADA ABOVE \$200,000
 BY CUSTOMS DISTRICT BY DESCEND. VALUE IN \$1000'S ESTIM. WEIGHT IN METRIC TONS

CD#	CUSTOMS DISTRICT	CODE	HARMONIZED COMMODITY DESCRIPTION	\$1000S	EST. M.TONS
35	MINNEAP/ST. PAUL	6214	SHAWLS, SCARVES, MUFFLERS, MANTILLAS, VEILS ETC.	241.	5.
		8541	SEMICONDUCTOR DEVICES, LIGHT-EMIT DIODES ETC, PTS	241.	18.
		8536	ELECTRICAL APPARATUS FOR SWITCHING ETC, NOV 1000	235.	7.
		7211	FL-RL IRON & NA STEEL UN 600MM WD, NOT CLAD ETC	234.	197.
		8543	ELECTRICAL MACH ETC, WITH IND FUNCTIONS NESOI, PT	234.	8.
		8454	CONVERTERS, LADLES, INGOT MOLDS & CASTING MACH, P	232.	39.
		3907	POLYETHERS, EXPOXIDES & POLYESTERS, PRIMARY FORMS	226.	59.
		8415	AIR CONDITIONING MACHINES (TEMP & HUM CHANGE), PT	225.	12.
		7219	FL-RL STAINLESS STEEL PRODUCTS, NOT UND 600MM WID	210.	102.
		8307	FLEXIBLE TUBING OF BASE METAL	207.	23.
		7019	GLASS FIBERS & ARTICLES THEREOF (YARN ETC.)	200.	75.
		9999	BELOW MINIMUM	10,393.	4,559.
		*SUB-TOTAL CUSTOMS DIST. # 35		292,473.	80,880.
36	DULUTH, MINN.	8803	PARTS OF BALLOONS ETC, AIRCRAFT, SPACECRAFT ETC	400.	47.
		8436	AGRI ETC & POULTRY ETC EQUIP, INC INCUBATORS, PTS	283.	8.
		7318	SCREWS, BOLTS, NUTS, WASHERS ETC, IRON OR STEEL	252.	196.
		9999	BELOW MINIMUM	712.	307.
		*SUB-TOTAL CUSTOMS DIST. # 36		1,647.	557.
37	MILWAUKEE, WIS.	3501	CASEIN, CASEINATES AND OTHER CASEIN DERIVATIVES	34,046.	8,203.
		8708	PARTS & ACCESS FOR MOTOR VEHICLES (HEAD 8701-8705)	17,379.	3,095.
		4810	PAPER & PAPERBOARD, COATED WITH KAOLIN ETC, RL ET	17,169.	20,351.
		8431	PARTS FOR MACHINERY OF HEADINGS 8425 TO 8430	11,760.	3,315.
		7601	ALUMINUM, UNWROUGHT	10,911.	8,515.
		9503	TOYS NESOI, SCALE MODELS ETC, PUZZLES, PARTS ETC	9,040.	1,283.
		9502	DOLLS, REPRESENTING ONLY HUMAN BEINGS, & PARTS ETC	8,898.	593.
		8433	HARVEST ETC MACHINES, CLEANING EGGS ETC NESOI, PT	8,383.	1,459.
		8411	TURBOJETS, TURBOPROPELLERS & OTH GAS TURBINES, PTS	7,988.	563.
		4504	AGGLOMERATED CORK AND ARTICLES THEREOF	7,517.	2,221.
		8443	PRINTING MACHINERY, MACHINES ANCIL TO PRINTING, P	7,301.	372.
		504	ANIMAL (NOT FISH) GUTS, BLADDERS, STOMACHS & PARTS	6,085.	1,323.
		8412	ENGINES AND MOTORS NESOI, AND PARTS THEREOF	5,991.	286.
		6403	FOOTWEAR, OUTER SOLE RUB, PLAST OR LEA & UPPER LEA	5,801.	237.
		8407	SPARK-IGNITION RECIPI OR ROTARY INT COMB PISTON ENG	5,167.	1,059.
		8483	TRANSMISSION SHAFTS, BEARINGS, GEARS ETC, PARTS	5,055.	491.
		8481	TAPS, COCKS, VALVES ETC FOR PIPES, TANKS ETC, PTS	4,795.	401.
		3505	DEXTRINS ETC, GLUES BASED ON STARCHES, DEXTRIN ETC	4,563.	5,923.
		8409	PARTS FOR ENGINES OF HEADING 8407 OR 8408	3,789.	448.
		1302	VEG SAPS & EXTRACTS, PECTATES ETC, AGAR-AGAR ETC.	3,622.	571.
		3913	NATURAL (INC MODIFIED) POLYMERS NESOI, PRIMARY FM	3,510.	487.
		8408	COMPRESSION-IGNITION INTERNAL COMB PISTON ENGINES	3,398.	399.
		4811	PAPER, PAPERBOARD, WAD ETC, COAT ETC NESOI, RL ET	3,318.	1,900.
		8429	SELF-PROPELLED BULLDOZERS, GRADERS, SCRAPERS ETC	3,318.	436.
		8516	ELEC WATER, SPACE & SOIL HEATERS, HAIR ETC DRY, P	3,305.	271.
		8440	BOOKBINDING MACHINERY, INCL BOOK-SEWING, PARTS	3,302.	254.

1993 U.S. IMPORTS TRANSSHIPPED VIA CANADA ABOVE \$200,000
 BY CUSTOMS DISTRICT BY DESCEND. VALUE IN \$1000'S ESTIM. WEIGHT IN METRIC TONS

CD#	CUSTOMS DISTRICT	CODE	HARMONIZED COMMODITY DESCRIPTION	\$1000S	EST. M.TONS
37	MILWAUKEE, WIS.	8518	MICROPHONES, LOUDSPEAKERS, SOUND AMPLIFIER ETC, P	3,143.	261.
		2204	WINE OF FRESH GRAPES, GRAPE MUST NESOI	3,107.	1,549.
		8419	MACHINERY ETC FOR TEMP CHANG TREAT MAT, W HEAT, P	3,004.	239.
		7013	GLASSWARE FOR TABLE, KITCHEN, TOILET ETC USE NESOI	2,997.	856.
		1805	COCOA POWDER, NOT SWEETENED	2,900.	2,129.
		3926	ARTICLES OF PLASTICS (INC POLYMERS & RESINS) NESO	2,843.	352.
		8414	AIR OR VAC PUMPS, COMPR & FANS, HOODS & FANS, PTS	2,702.	321.
		8426	DERRICKS, CRANES, MOBILE LIFTING FRAMES ETC	2,605.	1,331.
		8430	MACH NESOI, MOVING, GRAD ETC, PILE-DR, SNOPLow ET	2,575.	410.
		2005	VEGETABLES NESOI PREPARED ETC NESOI, NOT FROZEN	2,548.	2,396.
		3920	PLATES, SHEETS, FILM ETC NO AD, NON-CEL ETC, PLAS	2,404.	637.
		9401	SEATS (EXCEPT BARBER, DENTAL, ETC), AND PARTS	2,404.	485.
		8474	MACHINERY FOR SORTING SCREENING ETC MINERALS, PTS	2,351.	819.
		7202	FERROALLOYS	2,330.	4,338.
		8438	MACH NESOI, IND PREP OF FOOD OR DRINK ETC, PARTS	2,275.	119.
		8413	PUMPS FOR LIQUIDS, LIQUID ELEVATORS, PARTS THEREO	2,269.	148.
		8428	LIFTING, HANDLING, LOADING & UNLOAD MACHINES NESO	2,197.	295.
		3503	GELATIN & DERIV, ISINGLASS, GLUES, ANIMAL OR NESOI	2,164.	336.
		9403	FURNITURE NESOI AND PARTS THEREOF	2,068.	805.
		8213	SCSSRS,TLRS A SMLR SHRS, BLDS A OTH BS MTL PTS	2,041.	135.
		404	WHEY & MILK PRODUCTS NESOI, FLAVORED ETC. OR NOT	1,949.	1,145.
		6812	FABRICATED ASBESTOS FIBERS, ITEMS OF MIXTURES ETC	1,907.	3,225.
		8422	MACHINES, DISHWASH, CLEAN ETC CONT & FILL, PAK ET	1,774.	55.
		7326	ARTICLES OF IRON OR STEEL, NESOI	1,715.	522.
		2831	DITHIONITES AND SULFOXYLATES	1,675.	1,150.
		3801	ARTIFICIAL GRAPHITE, COLLODIAL GRAPHITE & PREP ETC	1,656.	1,870.
		8439	MACHINERY FOR MAKING PULP & MAKING ETC PAPER, PTS	1,637.	80.
		3906	ACRYLIC POLYMERS IN PRIMARY FORMS	1,596.	657.
		8441	MACH FOR MAKING UP PULP & PAPER, INC CUTTERS, PTS	1,596.	57.
		4009	TUBES, PIPES & HOSES OF UNHARD VULCANIZED RUBBER	1,529.	299.
		2208	ETHYL ALCOHOL, UNDENAT, UND80% ALC, SPIRIT BEV ETC	1,439.	623.
		8450	WASHING MACHINES, HOUSEHOLD- OR LAUNDRY-TYPE, PTS	1,424.	233.
		4101	RAW HIDES & SKINS OF BOVINE OR EQUINE ANIMALS	1,253.	481.
		2835	PHOSPHINATES, PHOSPHONATES, PHOSPHATES & POLYPHOSP	1,204.	938.
		7219	FL-RL STAINLESS STEEL PRODUCTS, NOT UND 600MM WID	1,204.	717.
		7310	TANKS ETC, NOV 300 LITER CAPACITY, IRON OR STEEL	1,203.	498.
		6913	STATUETTES AND OTHER ORNAMENTAL CERAMIC ARTICLES	1,193.	317.
		8504	ELECTRIC TRANSFORM, STATIC CONVERTERS & INDUCT, PT	1,185.	179.
		8503	PARTS OF ELECTRIC MOTORS, GENERATORS & SETS	1,179.	140.
		4016	ARTICLES NESOI OF UNHARDED VULCANIZED RUBBER	1,145.	86.
		8515	ELECTRIC, LASER OR OTH LIGHT OR PHOTON BEAM ETC	1,139.	68.
		7019	GLASS FIBERS & ARTICLES THEREOF (YARN ETC.)	1,076.	47.
		7323	HOUSEHOLD ART & PTS, IR & ST, IR OR STEEL WOOL ET	1,076.	284.
		8207	INTERCHANGE TOOLS FOR HAND- OR MACHINE-TOOLS, BMPT	1,064.	74.
		5503	SYNTHETIC STAPLE FIBERS, NOT CARDED, COMBED ETC.	1,053.	235.
		2309	PREPARATIONS USED IN ANIMAL FEEDING	1,047.	633.
		9405	LAMPS & LIGHTING FITTINGS & PARTS ETC NESOI	1,047.	68.
		8406	STEAM TURBINES & OTHER VAPOR TURBINES, PARTS	992.	33.

1993 U.S. IMPORTS TRANSSHIPPED VIA CANADA ABOVE \$200,000
 BY CUSTOMS DISTRICT BY DESCEND. VALUE IN \$1000'S ESTIM. WEIGHT IN METRIC TONS

CD#	CUSTOMS DISTRICT	CODE	HARMONIZED COMMODITY DESCRIPTION	\$1000S	EST. M.TONS
---	-----	---	-----	---	-----
37	MILWAUKEE, WIS.	3923	CONTAINERS (BOXES, BAGS ETC), CLOSURERS ETC, PLAS	956.	187.
		7217	WIRE OF IRON & NONALLOY STEEL	905.	939.
		7222	BARS & RODS, ST STEEL NESOI, ANGLES ETC, ST STEEL	904.	256.
		8508	ELECTROMECHANICAL TOOLS, WORKING IN HAND, PARTS	894.	28.
		7318	SCREWS, BOLTS, NUTS, WASHERS ETC, IRON OR STEEL	890.	205.
		7315	CHAIN & PARTS, OF IRON OR STEEL	889.	92.
		8714	PARTS & ACCESS FOR CYCLES & INVALID CARRIAGES	886.	85.
		2203	BEER MADE FROM MALT	862.	1,413.
		2712	PETROLEUM JELLY, MINERAL WAXES & SIMILAR PRODUCTS	839.	921.
		7606	ALUMINUM PLATES, SHEETS & STRIP OVER .2MM THICK	837.	368.
		9021	ORTHOPEDIC APPL, ARTIF BODY PTS, HEAR AID, PTS ET	828.	69.
		8302	HARDWARE, FIXTURES, CASTORS ETC & PARTS, BASE METL	796.	165.
		8201	HANDTOOLS & TOOLS USED IN AGRICULT ETC, B MET PTS	787.	201.
		5607	TWINE, CORDAGE, ROPE & CABLES, COATED ETC OR NOT	781.	1,025.
		8434	MILKING MACHINES & DAIRY MACHINERY & PARTS	776.	141.
		5309	WOVEN FABRICS OF FLAX	762.	89.
		8417	INDUSTRIAL OR LAB FURNACES & OVENS, NONELECT, PTS	756.	61.
		8208	KNIVES & BLADES FOR MACHINES & APPLIANCES, B MT PT	751.	122.
		6506	HEADGEAR NESOI, WHETHER OR NOT LINED OR TRIMMED	727.	39.
		8454	CONVERTERS, LADLES, INGOT MOLDS & CASTING MACH, P	726.	138.
		6908	GLAZED CERAMIC FLAGS & PAVING, HEARTH TILES, ETC	714.	1,329.
		8466	PARTS ETC FOR MACHINE TOOLS OF HEAD 8456 TO 8465	703.	44.
		7010	GLASS CONTAINERS FOR PACKING ETC & GLASS CLOSURES	682.	325.
		2836	CARBONATES, PEROXOCARBONATES, COMM AMM CARBONATE	668.	570.
		8467	TOOLS FOR WORKING IN THE HAND, PNEUMATIC ETC, PTS	641.	25.
		6802	WORKED MONUMENT ETC STONE & ART NESOI, GRANULE ETC	633.	606.
		3921	PLATES, SHEETS, FILM, FOIL & STRIP NESOI, PLASTIC	629.	177.
		8425	PULLEY TACKLE & HOISTS (EXC SKIP), WINCH ETC, JAK	619.	164.
		8453	MACHINERY FOR WORK LEATHER ETC & FOOTWEAR ETC, PT	606.	84.
		8479	MACHINES ETC HAVING INDIVIDUAL FUNCTIONS NESOI, P	602.	36.
		8436	AGRI ETC & POULTRY ETC EQUIP, INC INCUBATORS, PTS	591.	118.
		8459	MACHINE TOOLS FOR DRILLING, BORING, MILLING ETC	588.	73.
		3924	TABLEWARE & OTHER HOUSEHOLD ARTICLES ETC, PLASTIC	587.	65.
		2007	JAMS, FRUIT JELLIES, MARMALADES ETC, COOKED	584.	235.
		9022	X-RAY ETC APPARATUS, TUBES, PANELS, SCREEN ETC, P	577.	16.
		9507	FISHING RODS & TACKLE, NETS, DECOYS ETC, PARTS ETC	577.	470.
		8538	PARTS FOR ELEC APPAR ETC OF HEAD 8535, 8536 & 853	574.	41.
		8424	MECH APPL TO DISPERSE LIQ ETC, SAND ETC BLAST MAC	566.	80.
		8423	WEIGHING MACHINES & WEIGHING MACHINE WEIGHTS, PTS	545.	68.
		4104	BOVINE OR EQUINE LEATHER, NO HAIR NESOI	538.	131.
		8432	AGRICULT ETC MACH FOR SOIL ETC, LAWN ROLLERS, PTS	536.	129.
		1301	LAC/SHELLAC/STICK LAC/SEED LAC/BUTTON LAC/OTHR LAC	505.	181.
		9504	ARTICLES FOR ARCADE, TABLE OR PARLOR GAMES, PARTS	500.	114.
		4818	TOILET PAPER, PAPER TISSUES, TOWELS, NAPKINS ETC	499.	84.
		2009	FRUIT JUICES (& GRAPE MUST) & VEG JUICE, NO SPIRIT	498.	458.
		4805	PAPER & PAPERBOARD, UNCOAT, NESOI, ROLLS OR SHEETS	496.	236.
		8447	MACHINES, KNITTING, STITCH-BOND, LACE, NET ETC.	494.	31.
		2918	CARBOXYLIC ACID, ADDED OXYGEN & ANHY ETC, HAL ETC	482.	356.

1993 U.S. IMPORTS TRANSSHIPPED VIA CANADA ABOVE \$200,000
 BY CUSTOMS DISTRICT BY DESCEND. VALUE IN \$1000'S ESTIM. WEIGHT IN METRIC TONS

CD#	CUSTOMS DISTRICT	CODE	HARMONIZED COMMODITY DESCRIPTION	\$1000S	EST. M.TONS
37	MILWAUKEE, WIS.	3802	ACTIVATED CARBON ETC., ANIMAL BLACK, INC SPENT	471.	134.
		7216	ANGLES, SHAPES & SECTIONS OF IRON & NONALLOY STEE	466.	336.
		9018	MEDICAL, SURGICAL, DENTAL OR VET INST, NO ELEC, P	457.	43.
		8472	OFFICE MACHINES NESOI (HECTOGRAPH, ADDRESSING ETC	446.	43.
		8465	MACHINE TOOLS FOR WORKING WOOD, CORK, BONE ETC	445.	34.
		8421	CENTRIFUGES, FILTER ETC MACH FOR LIQ OR GASES, PT	443.	28.
		2924	CARBOXYAMIDE-FUNCTION COMP, AMIDE-FUNCTION COM ET	429.	144.
		7306	TUBES, PIPES & HOLLOW PROFILES NESOI, IRON & STEEL	412.	68.
		6406	PARTS OF FOOTWEAR, INSOLES ETC, GAITORS ETC, PARTS	394.	53.
		8305	LOOSELEAF BINDER ETC FITTINGS, PAPER CLIPS ETC BMP	387.	192.
		3907	POLYETHERS, EXPOXIDES & POLYESTERS, PRIMARY FORMS	378.	100.
		6903	REFRACTORY CERAMIC GOODS, RETORTS, TUBES ETC NESOI	371.	190.
		8477	MACHINERY FOR WORKING RUBBER & PLAST ETC NESOI, P	345.	24.
		8514	INDUSTRIAL OR LAB ELEC FURNACES ETC, PARTS	337.	26.
		3917	TUBES, PIPES & HOSES & THEIR FITTINGS, OF PLASTIC	331.	40.
		4803	TOILET ETC HSHLD/SANTRY STOCK PPR ROLL/SHT OV 36CM	317.	458.
		6401	WATERPROOF FOOTWEAR, RUBBER OR PLASTICS, BOND SOLE	306.	125.
		8544	INSULATED WIRE, CABLE ETC, OPT SHEATH FIB CABLES	302.	37.
		8480	MOLDING BOXES FOR METAL FOUNDRY, MOLD BASES ETC	295.	8.
		7403	REFINED COPPER & ALLOYS (NO MAST ALLOY), UNWROUGHT	292.	137.
		8501	ELECTRIC MOTORS AND GENERATORS (NO SETS)	264.	53.
		3507	ENZYMES, PREPARED ENZYMES NESOI	262.	25.
		8507	ELECTRIC STORAGE BATTERIES, INCL SEPARATORS, PARTS	262.	59.
		3918	FLOOR COVER (ROLLS & TILES) & WALL COVER, PLASTIC	261.	43.
		4804	KRAFT PAPER & PAPERBOARD, UNCOAT NESOI, ROLLS ETC	260.	300.
		2833	SULFATES, ALUMS, PEROXOSULFATES (PERSULFATES)	237.	284.
		2102	YEASTS, DEAD SING-CELL MICRO-ORG NESOI, BAK POWDER	233.	101.
		5904	LINOLEUM, FLOOR COVER WITH COAT ETC ON A TEXT BASE	232.	93.
		3105	M OR CH FERTILIZ, NUN2OF3EL, FERT NESOI, FERT PACK	223.	379.
		8458	LATHES FOR REMOVING METAL	218.	63.
		2803	CARBON, NESOI (INCLUDING CARBON BLACK)	214.	66.
		1107	MALT, WHETHER OR NOT ROASTED	205.	380.
		8509	ELECTROMECH DOMESTIC APPLIANCES, PARTS	204.	16.
		9999	BELOW MINIMUM	11,891.	6,356.
		*SUB-TOTAL CUSTOMS DIST. # 37		349,671.	120,351.
38	DETROIT, MICH.	8708	PARTS & ACCESS FOR MOTOR VEHICLES (HEAD 8701-8705)	342,935.	69,979.
		8483	TRANSMISSION SHAFTS, BEARINGS, GEARS ETC, PARTS	64,472.	6,873.
		8409	PARTS FOR ENGINES OF HEADING 8407 OR 8408	41,780.	5,271.
		3910	SILICONES, IN PRIMARY FORMS	40,797.	7,083.
		8501	ELECTRIC MOTORS AND GENERATORS (NO SETS)	40,629.	4,811.
		8515	ELECTRIC, LASER OR OTH LIGHT OR PHOTON BEAM ETC	28,295.	954.
		8408	COMPRESSION-IGNITION INTERNAL COMB PISTON ENGINES	28,167.	3,319.
		8414	AIR OR VAC PUMPS, COMPR & FANS, HOODS & FANS, PTS	27,724.	3,289.
		8511	ELECTRIC IGNITION ETC EQUIP, GENERATORS, PARTS	26,872.	6,669.
		3004	MEDICAMENTS NESOI, MIXED OR NOT, IN DOSAGE ETC FM	26,730.	2,000.
		3501	CASEIN, CASEINATES AND OTHER CASEIN DERIVATIVES	25,601.	6,399.

1993 U.S. IMPORTS TRANSSHIPPED VIA CANADA ABOVE \$200,000
 BY CUSTOMS DISTRICT BY DESCEND. VALUE IN \$1000'S ESTIM. WEIGHT IN METRIC TONS

CD#	CUSTOMS DISTRICT	CODE	HARMONIZED COMMODITY DESCRIPTION	\$1000S	EST. M.TONS
38	DETROIT, MICH.	2905	ACYCLIC ALCOHOLS & HALOGENAT, SULFONATD ETC DERIVS	25,082.	8,593.
		8471	AUTOMATIC DATA PROCESS MACHINES, MAGN READER ETC	25,056.	696.
		8421	CENTRIFUGES, FILTER ETC MACH FOR LIQ OR GASES, PT	24,259.	1,857.
		9403	FURNITURE NESOI AND PARTS THEREOF	20,900.	5,808.
		8431	PARTS FOR MACHINERY OF HEADINGS 8425 TO 8430	20,041.	3,817.
		3917	TUBES, PIPES & HOSES & THEIR FITTINGS, OF PLASTIC	18,188.	915.
		8481	TAPS, COCKS, VALVES ETC FOR PIPES, TANKS ETC, PTS	17,450.	2,060.
		8479	MACHINES ETC HAVING INDIVIDUAL FUNCTIONS NESOI, P	15,784.	817.
		7606	ALUMINUM PLATES, SHEETS & STRIP OVER .2MM THICK	15,589.	5,585.
		8477	MACHINERY FOR WORKING RUBBER & PLAST ETC NESOI, P	14,596.	1,122.
		4104	BOVINE OR EQUINE LEATHER, NO HAIR NESOI	14,551.	1,369.
		8456	MACHINE TOOLS FOR MATERIAL REMOVAL BY LASER ETC	13,715.	560.
		2936	PROVITAMINS AND VITAMINS & DERIVATIVES & INTERMIX	13,263.	405.
		8701	TRACTORS (OTHER THAN WORKS TRUCKS OF HEADING 8709)	13,149.	8,143.
		8512	ELECTRIC LIGHT ETC EQUIP, WINDSH WIPERS ETC, PART	12,578.	841.
		7403	REFINED COPPER & ALLOYS (NO MAST ALLOY), UNWROUGHT	12,278.	6,166.
		8443	PRINTING MACHINERY, MACHINES ANCIL TO PRINTING, P	12,119.	669.
		4002	SYNTH RUBBER & FACTICE, INC NAT-SYN MIX, PR FM ETC	12,066.	7,395.
		8473	PARTS ETC FOR TYPEWRITERS & OTHER OFFICE MACHINES	11,164.	497.
		3926	ARTICLES OF PLASTICS (INC POLYMERS & RESINS) NESO	10,283.	1,526.
		8413	PUMPS FOR LIQUIDS, LIQUID ELEVATORS, PARTS THEREO	10,204.	691.
		2907	PHENOLS, PHENOL-ALCOHOLS	9,889.	3,042.
		2204	WINE OF FRESH GRAPES, GRAPE MUST NESOI	9,572.	4,456.
		4810	PAPER & PAPERBOARD, COATED WITH KAOLIN ETC, RL ET	9,050.	11,169.
		8412	ENGINES AND MOTORS NESOI, AND PARTS THEREOF	8,901.	871.
		4011	NEW PNEUMATIC TIRES, OF RUBBER	8,893.	2,509.
		8428	LIFTING, HANDLING, LOADING & UNLOAD MACHINES NESO	8,884.	1,101.
		7215	BAR & RODS, IRON & NA STEEL NESOI	8,671.	13,361.
		2818	ALUMINUM OXIDE (INCL ART CORUNDUM), ALUM HYDROXIDE	8,021.	10,970.
		8422	MACHINES, DISHWASH, CLEAN ETC CONT & FILL, PAK ET	7,278.	532.
		8703	MOTOR CARS & VEHICLES FOR TRANSPORTING PERSONS	7,275.	405.
		7228	AL STEEL NESOI BARS, ANG ETC, HOL DR ST BARS ETC	7,166.	4,821.
		3208	PAINT & VARNISH FROM SYNTH ETC POLYMERS NONAQ, ETC	6,902.	1,362.
		7318	SCREWS, BOLTS, NUTS, WASHERS ETC, IRON OR STEEL	6,877.	2,784.
		8527	RECEPTION APPARATUS FOR RADIOTELEPHONY ETC	6,824.	251.
		3823	BINDERS FOR FOUND MOLDS, CHEMICAL PROD ETC NESOI	6,784.	2,786.
		8407	SPARK-IGNITION RECIP OR ROTARY INT COMB PISTON ENG	6,724.	2,845.
		4016	ARTICLES NESOI OF UNHARDED VULCANIZED RUBBER	6,695.	456.
		8459	MACHINE TOOLS FOR DRILLING, BORING, MILLING ETC	6,649.	1,278.
		8465	MACHINE TOOLS FOR WORKING WOOD, CORK, BONE ETC	6,621.	492.
		8411	TURBOJETS, TURBOPROPELLERS & OTH GAS TURBINES, PTS	6,422.	878.
		3908	POLYAMIDES IN PRIMARY FORMS	6,195.	1,543.
		3206	COLORING MATTER NESOI, COLORING PREP NESOI, ETC.	6,147.	3,928.
		9401	SEATS (EXCEPT BARBER, DENTAL, ETC), AND PARTS	6,118.	1,385.
		8458	LATHES FOR REMOVING METAL	5,865.	1,514.
		3507	ENZYMES, PREPARED ENZYMES NESOI	5,627.	478.
		306	CRUSTACEANS, LIVE, FRESH ETC, AND COOKED ETC.	5,567.	840.
		8507	ELECTRIC STORAGE BATTERIES, INCL SEPARATORS, PARTS	5,550.	260.

1993 U.S. IMPORTS TRANSSHIPPED VIA CANADA ABOVE \$200,000
 BY CUSTOMS DISTRICT BY DESCEND. VALUE IN \$1000'S ESTIM. WEIGHT IN METRIC TONS

CD#	CUSTOMS DISTRICT	CODE	HARMONIZED COMMODITY DESCRIPTION	\$1000S	EST. M.TONS
---	-----	---	-----	---	-----
38	DETROIT, MICH.	7202	FERROALLOYS	5,391.	4,803.
		8466	PARTS ETC FOR MACHINE TOOLS OF HEAD 8456 TO 8465	5,178.	638.
		8518	MICROPHONES, LOUDSPEAKERS, SOUND AMPLIFIER ETC, P	5,038.	260.
		8424	MECH APPL TO DISPERSE LIQ ETC, SAND ETC BLAST MAC	4,986.	666.
		7217	WIRE OF IRON & NONALLOY STEEL	4,923.	4,237.
		8301	PADLOCKS, LOCKS & KEYS & PARTS, OF BASE METAL	4,909.	715.
		2931	ORGANO-INORGANIC COMPOUNDS NESOI	4,890.	1,752.
		3808	INSECTICIDES, RODENTICIDES, FUNGICIDES ETC, RETAIL	4,866.	1,451.
		8105	COBALT MATTES ETC, COBALT & ART, INC WASTE & SCRAP	4,850.	145.
		8429	SELF-PROPELLED BULLDOZERS, GRADERS, SCRAPERS ETC	4,770.	961.
		2208	ETHYL ALCOHOL, UNDENAT, UNDBOX% ALC, SPIRIT BEV ETC	4,674.	1,409.
		8112	BERYLLIUM, CHROM, GERM, VANAD, GALLIUM, HAFNM, ETC	4,623.	1,512.
		7220	FL-RL STAINLESS STEEL PRODUCTS, UNDER 600MM WIDE	4,467.	1,662.
		2926	NITRILE-FUNCTION COMPOUNDS	4,310.	501.
		8504	ELECTRIC TRANSFORM, STATIC CONVERTERS & INDUCT, PT	4,266.	389.
		7601	ALUMINUM, UNWROUGHT	4,231.	3,770.
		8302	HARDWARE, FIXTURES, CASTORS ETC & PARTS, BASE METL	4,227.	767.
		8503	PARTS OF ELECTRIC MOTORS, GENERATORS & SETS	4,209.	388.
		8462	MACHINE TOOLS FOR FORGING, BENDING, STAMPING ETC	4,143.	374.
		9031	MACHINES, NESOI IN CHAPTER 90, PROFILE PROJECT, P	4,045.	164.
		3919	SELF-ADHESIVE PLATES, SHEETS, FILM ETC OF PLASTIC	4,004.	427.
		8454	CONVERTERS, LADLES, INGOT MOLDS & CASTING MACH, P	3,766.	1,132.
		8460	MACHINE TOOLS FOR HONING OR FINISHING METAL ETC	3,732.	297.
		8461	MACHINE TOOLS FOR SHAPING, SLOTTING, GEAR CUT ETC	3,711.	438.
		7325	CAST ARTICLES NESOI, OF IRON OR STEEL	3,706.	1,058.
		7404	COPPER WASTE AND SCRAP	3,675.	2,094.
		4901	BOOKS, BROCHURES & SIMILAR PRINTED MATTER	3,667.	583.
		2916	UNSAT ACYCLIC & CYCLIC MONOCARBOX ACID & ANHYD ET	3,611.	1,150.
		3810	PICKLING PREPS FOR METAL, SOLDERING ETC POWDER ET	3,567.	2,254.
		3702	PHOTO FILM IN ROLLS SENSITIZED, UNEXPOSED	3,555.	170.
		8108	TITANIUM & ARTICLES THEREOF, INCLUD WASTE & SCRAP	3,519.	869.
		6908	GLAZED CERAMIC FLAGS & PAVING, HEARTH TILES, ETC	3,455.	6,698.
		7326	ARTICLES OF IRON OR STEEL, NESOI	3,444.	1,087.
		7502	NICKLE, UNWROUGHT	3,366.	645.
		8516	ELEC WATER, SPACE & SOIL HEATERS, HAIR ETC DRY, P	3,231.	466.
		203	MEAT OF SWINE (PORK), FRESH, CHILLED OR FROZEN	3,216.	1,588.
		2921	AMINE-FUNCTION COMPOUNDS	3,198.	1,790.
		2203	BEER MADE FROM MALT	3,197.	4,714.
		8427	FORK-LIFT TRUCKS, OTH WORKS TRUCKS WITH LIFTS ETC	3,166.	814.
		8436	AGRI ETC & POULTRY ETC EQUIP, INC INCUBATORS, PTS	3,155.	965.
		4811	PAPER, PAPERBOARD, WAD ETC, COAT ETC NESOI, RL ET	3,111.	1,167.
		8426	DERRICKS, CRANES, MOBILE LIFTING FRAMES ETC	3,108.	620.
		7219	FL-RL STAINLESS STEEL PRODUCTS, NOT UND 600MM WID	3,082.	1,603.
		3921	PLATES, SHEETS, FILM, FOIL & STRIP NESOI, PLASTIC	3,063.	679.
		3505	DEXTRINS ETC, GLUES BASED ON STARCHES, DEXTRIN ETC	3,062.	3,815.
		3909	AMINO-RESINS, PHENOLICS & POLYURETHANES, PRIM FORM	3,031.	859.
		8482	BALL OR ROLLER BEARINGS AND PARTS	2,987.	333.
		8536	ELECTRICAL APPARATUS FOR SWITCHING ETC, NOV 1000	2,878.	130.

1993 U.S. IMPORTS TRANSSHIPPED VIA CANADA ABOVE \$200,000
 BY CUSTOMS DISTRICT BY DESCEND. VALUE IN \$1000'S ESTIM. WEIGHT IN METRIC TONS

CD#	CUSTOMS DISTRICT	CODE	HARMONIZED COMMODITY DESCRIPTION	\$1000S	EST. M.TONS
38	DETROIT, MICH.	8542	ELECTRONIC INTEGRATED CIRCUITS & MICROASSEMBL, PT	2,872.	63.
		3920	PLATES, SHEETS, FILM ETC NO AD, NON-CEL ETC, PLAS	2,855.	1,078.
		2933	HETEROCYCLIC COMP, NIT HETERO-ATOM, NUCLEIC ACIDS	2,846.	1,509.
		2009	FRUIT JUICES (& GRAPE MUST) & VEG JUICE, NO SPIRIT	2,786.	2,568.
		6802	WORKED MONUMENT ETC STONE & ART NESOI, GRANULE ETC	2,746.	3,567.
		7005	FLOAT GLASS & SURF GROUND OR POLISHED SHEETS ETC	2,722.	1,796.
		7210	FL-RL IRON & NA STEEL NUN600MM WD, CLAD ETC	2,696.	4,857.
		7216	ANGLES, SHAPES & SECTIONS OF IRON & NONALLOY STEE	2,692.	3,639.
		9603	BROOMS, BRUSHES, MOPS, FEATHER DUSTERS ETC	2,662.	450.
		1302	VEG SAPS & EXTRACTS, PECTATES ETC, AGAR-AGAR ETC.	2,651.	189.
		7006	GLS OF 7003-5 BNT,EDG WKD, ENGR,DRL,ENML OTHR ETC	2,649.	1,602.
		6902	REFRACTORY BRICKS & OTHER REFR CER CONST ART NESOI	2,639.	2,560.
		2918	CARBOXYLIC ACID, ADDED OXYGEN & ANHY ETC, HAL ETC	2,582.	1,322.
		7607	ALUMINUM FOIL (BACK OR NOT) NOV .2MM TH (EX BACK)	2,570.	542.
		8433	HARVEST ETC MACHINES, CLEANING EGGS ETC NESOI, PT	2,469.	985.
		7211	FL-RL IRON & NA STEEL UN 600MM WD, NOT CLAD ETC	2,443.	1,787.
		9109	CLOCK MOVEMENTS, COMPLETE & ASSEMBLED	2,437.	57.
		3903	POLYMERS OF STYRENE, IN PRIMARY FORMS	2,405.	2,085.
		5906	RUBBERIZED TEXTILE FABRICS, OTHER THAN TIRE CORD	2,379.	274.
		901	COFFEE, COFFEE HUSKS ETC, SUBSTITUTES WITH COFFEE	2,103.	1,086.
		8521	VIDEO RECORDING OR REPRODUCING APPARATUS	2,076.	74.
		3815	REACTION INITIATORS & ACCELER & CATALYT PREP NESO	2,070.	276.
		8432	AGRICULT ETC MACH FOR SOIL ETC, LAWN ROLLERS, PTS	2,063.	636.
		4909	PRINTED OR ILLUSTR POST CARDS, GREETING CARDS, ETC.	2,009.	175.
		8438	MACH NESOI, IND PREP OF FOOD OR DRINK ETC, PARTS	2,007.	159.
		9503	TOYS NESOI, SCALE MODELS ETC, PUZZLES, PARTS ETC	1,999.	245.
		5603	NONWOVENS, WHETHER OR NOT IMPREGNATED, COATED ETC	1,975.	456.
		2812	HALIDES & HALIDE OXIDES OF NONMETALS	1,966.	2,518.
		8309	STOPPERS, CAPS & LIDS, SEALS ETC & PTS, BASE METAL	1,958.	305.
		2934	HETEROCYCLIC COMPOUNDS NESOI	1,945.	287.
		3904	POLYMERS OF VINYL CHLORIDE ETC., IN PRIMARY FORMS	1,930.	1,419.
		4009	TUBES, PIPES & HOSES OF UNHARD VULCANIZED RUBBER	1,912.	224.
		4823	PAPER, PAPERBOARD, CELLUL WAD TO SIZE & ARTS NESO	1,909.	388.
		9506	ARTICLES & EQUIP FOR SPORTS ETC NESOI, POOLS, PTS	1,907.	334.
		8716	TRAILERS ETC, OTHER VEHICLES, NOT MECH PROPELD, P	1,868.	675.
		2811	INORGANIC ACIDS & INORGANIC OXY NONMET COMP NESOI	1,830.	853.
		9010	APPARATUS ETC FOR PHOTO LABS ETC NESOI, PARTS ETC	1,802.	71.
		8205	HANDTOOLS NESOI, BLOW TORCHES ETC, ANVILS ETC	1,795.	130.
		9504	ARTICLES FOR ARCADE, TABLE OR PARLOR GAMES, PARTS	1,795.	239.
		7205	PIG IRON, SPIEGEL, IRON OR STEEL GRANULES & POWDER	1,759.	3,108.
		905	VANILLA BEANS	1,756.	77.
		8441	MACH FOR MAKING UP PULP & PAPER, INC CUTTERS, PTS	1,716.	98.
		8430	MACH NESOI, MOVING, GRAD ETC, PILE-DR, SNOFLOW ET	1,707.	225.
		9032	AUTOMATIC REGULATING OR CONTROL INSTRUMENTS, PART	1,637.	98.
		2005	VEGETABLES NESOI PREPARED ETC NESOI, NOT FROZEN	1,632.	1,575.
		8480	MOLDING BOXES FOR METAL FOUNDRY, MOLD BASES ETC	1,619.	200.
		8537	BOARDS, PANELS ETC WITH ELEC SWITCH APPAR ETC.	1,609.	46.
		9114	CLOCK OR WATCH PARTS, NESOI	1,551.	30.

1993 U.S. IMPORTS TRANSSHIPPED VIA CANADA ABOVE \$200,000
 BY CUSTOMS DISTRICT BY DESCEND. VALUE IN \$1000'S ESTIM. WEIGHT IN METRIC TONS

CD#	CUSTOMS DISTRICT	CODE	HARMONIZED COMMODITY DESCRIPTION	\$1000S	EST. M.TONS
---	-----	---	-----	-----	-----
38	DETROIT, MICH.	2841	SALTS OF OXOMETALLIC OR PEROXOMETALLIC ACIDS	1,545.	2,158.
		8439	MACHINERY FOR MAKING PULP & MAKING ETC PAPER, PTS	1,535.	133.
		7007	SAFETY GLASS, OF TEMPERED OR LAMINATED GLASS	1,525.	201.
		4004	WASTE OF RUB, EXC HD RUB, & POWDER OBTAIN THEREOF	1,518.	3,424.
		2930	ORGANO-SULFUR COMPOUNDS	1,514.	497.
		7602	ALUMINUM WASTE AND SCRAP	1,495.	2,236.
		4814	WALLPAPER ETC., WINDOW TRANSPARENCIES OF PAPER	1,491.	368.
		5402	SYNTHETIC FILAMENT YARN (NO SEW THREAD), NO RETAIL	1,486.	360.
		3816	REFRACTORY CEMENTS, MORTARS, CONCRETES, ETC. NESO	1,475.	1,085.
		6403	FOOTWEAR, OUTER SOLE RUB, PLAST OR LEA & UPPER LEA	1,473.	97.
		2833	SULFATES, ALUMS, PEROXOSULFATES (PERSULFATES)	1,427.	1,893.
		2826	FLUORIDES, FLUOROSILICATES, FLUOROALUMINATES ETC	1,416.	870.
		9501	WHEEL TOYS RDDN BY CHILD,DOLL STRLL, PTS & ACCESS	1,409.	411.
		3303	PERFUMES AND TOILET WATERS	1,401.	55.
		8541	SEMICONDUCTOR DEVICES, LIGHT-EMIT DIODES ETC, PTS	1,377.	28.
		3906	ACRYLIC POLYMERS IN PRIMARY FORMS	1,368.	1,012.
		7407	COPPER BARS, RODS AND PROFILES	1,360.	562.
		7225	FL-RL ALLOY STEEL NESOI NUM 600MM WIDE	1,356.	876.
		4408	VENEER SHEETS ETC, NOT OVER 6 MM THICK	1,352.	216.
		8715	BABY CARRIAGES (INC STROLLERS) AND PARTS THEREOF	1,346.	127.
		3907	POLYETHERS, EXPOXIDES & POLYESTERS, PRIMARY FORMS	1,333.	490.
		3214	GLAZIERS PUTTY, RESIN CEMENTS, CAULKING COMPS ETC	1,314.	269.
		7010	GLASS CONTAINERS FOR PACKING ETC & GLASS CLOSURES	1,314.	302.
		8702	PUBLIC-TRANSPORT TYPE PASSENGER MOTOR VEHICLES	1,290.	83.
		7411	COPPER TUBES AND PIPES	1,287.	404.
		8457	MACHINING CENTERS, UNIT CONST MACH ETC WORK METAL	1,273.	71.
		3105	M OR CH FERTILIZ, NUN2OF3EL, FERT NESOI, FERT PACK	1,258.	2,136.
		9026	INST ETC MEASURE OR CHECK FLOW, LEVEL ETC, PTS ET	1,246.	84.
		3923	CONTAINERS (BOXES, BAGS ETC), CLOSURERS ETC, PLAS	1,243.	360.
		6912	CERAMIC TABLEWRE, KITCHNWRE ETC, EARTHENWARE ETC	1,241.	486.
		8417	INDUSTRIAL OR LAB FURNACES & OVENS, NONELECT, PTS	1,218.	63.
		8202	HANDSAWS & MET PTS, SAW BLADES, BASE MTL SAW PARTS	1,214.	105.
		6805	ABRASIVE POWDER ETC ON A BASE TEXT MATERIAL ETC	1,212.	308.
		8104	MAGNESIUM & ARTICLES THEREOF, INCL WASTE & SCRAP	1,208.	604.
		2825	HYDRAZINE ETC, OTH INORG BASES, METAL OXIDES ETC	1,202.	471.
		7616	ARTICLES OF ALUMINUM NESOI	1,185.	81.
		8517	ELECTRIC APPARATUS FOR LINE TELEPHONY ETC, PARTS	1,182.	57.
		3506	PREPARED GLUES & ADHESIVES NESOI, GLUE RETAIL PACK	1,175.	332.
		7019	GLASS FIBERS & ARTICLES THEREOF (YARN ETC.)	1,173.	286.
		8484	GASKETS & SIMILAR JOINTS OF METAL SHEETING	1,162.	61.
		7307	TUBE OR PIPE FITTINGS, OF IRON OR STEEL	1,156.	838.
		8420	CALENDERING MACHINES ETC NESOI & CYLINDERS, PARTS	1,142.	88.
		8207	INTERCHANGE TOOLS FOR HAND- OR MACHINE-TOOLS, BMPT	1,105.	104.
		6907	UNGLAZED CERAMIC FLAGS & PAVING, HEARTH TILES ETC	1,102.	1,761.
		8474	MACHINERY FOR SORTING SCREENING ETC MINERALS, PTS	1,097.	420.
		9027	INST ETC FOR PHYSICAL ETC ANAL ETC, MICROTOME, PT	1,096.	59.
		8524	RECORDS, TAPES & OTHER RECORDED SOUND MEDIA ETC	1,095.	32.
		7312	STRANDED WIRE, ROPES ETC, NO ELEC INS, IR OR STEEL	1,091.	532.

1993 U.S. IMPORTS TRANSSHIPPED VIA CANADA ABOVE \$200,000
 BY CUSTOMS DISTRICT BY DESCEND. VALUE IN \$1000'S ESTIM. WEIGHT IN METRIC TONS

CD#	CUSTOMS DISTRICT	CODE	HARMONIZED COMMODITY DESCRIPTION	\$1000S	EST. M.TONS
----	-----	----	-----	-----	-----
38	DETROIT, MICH.	8519	TURNTABLES, RECORD & CASSETTE PLAYERS ETC.	1,054.	52.
		8419	MACHINERY ETC FOR TEMP CHANG TREAT MAT, W HEAT, P	1,043.	113.
		9009	PHOTOCOPY APPARATUS & THERMOCOPY APPARATUS, PTS	1,036.	57.
		8544	INSULATED WIRE, CABLE ETC, OPT SHEATH FIB CABLES	1,023.	152.
		4012	RETREAD OR USED PNEU TIRES, SOLID TIRES ETC, RUBB	1,010.	792.
		3802	ACTIVATED CARBON ETC., ANIMAL BLACK, INC SPENT	999.	249.
		3918	FLOOR COVER (ROLLS & TILES) & WALL COVER, PLASTIC	990.	192.
		8543	ELECTRICAL MACH ETC, WITH IND FUNCTIONS NESOI, PT	978.	42.
		8523	PREPARED UNRECORDED MEDIA (NO FILM) FOR SOUND ETC	947.	84.
		7208	FL-RL IRON & NA STEEL NUN600MM WD HOT-RL, NOT CLAD	934.	3,183.
		7317	NAILS, TACKS, DRAWING PINS ETC OF IRON OR STEEL	931.	433.
		6302	BED LINEN, TABLE LINEN, TOILET LINEN & KITCH LINEN	920.	79.
		3707	PHOTOGRAPHIC CHEMICALS, UNMIXED PROD RETAIL PACKED	916.	63.
		1901	MALT EXT, FOOD PREP OF FLOUR ETC UN 50% COCOA ETC	914.	727.
		2803	CARBON, NESOI (INCLUDING CARBON BLACK)	914.	472.
		2836	CARBONATES, PEROXOCARBONATES, COMM AMM CARBONATE	901.	2,190.
		8514	INDUSTRIAL OR LAB ELEC FURNACES ETC, PARTS	890.	76.
		7304	TUBES, PIPES ETC, SEAMLESS, IRON NESOI & STEEL	872.	849.
		9505	FESTIVE, CARNIVAL OR OTHER ENTERTAINMENT ART, PTS	870.	88.
		2830	SULFIDES, POLYSULFIDES	868.	461.
		7212	FL-RL IRON & NA STEEL UN 600MM WD, CLAD ETC	846.	768.
		3924	TABLEWARE & OTHER HOUSEHOLD ARTICLES ETC, PLASTIC	837.	185.
		2201	WATERS, NATURAL ETC, NOT SWEETENED ETC, ICE & SNOW	835.	2,634.
		6903	REFRACTORY CERAMIC GOODS, RETORTS, TUBES ETC NESOI	820.	205.
		801	COCONUTS, BRAZIL NUTS & CASHEW NUTS, FRESH OR DRY	819.	315.
		2909	ETHERS, ETHER-ALCOHOLS, ALCOHOL PEROXIDES ETC.	819.	1,405.
		8469	TYPEWRITERS & WORD PROCESSING MACHINES	802.	45.
		8406	STEAM TURBINES & OTHER VAPOR TURBINES, PARTS	747.	120.
		8704	MOTOR VEHICLES FOR TRANSPORT OF GOODS	737.	87.
		8509	ELECTROMECH DOMESTIC APPLIANCES, PARTS	709.	76.
		6803	SLATE, WORKED AND ARTICLES, ARTICLS OF AGGLOM SLT	701.	1,013.
		9105	CLOCKS, WITH CLOCK MVTS OTH THAN INST PANEL ETC	684.	35.
		4819	CARTONS ETC PAPER, OFFICE BOX FILES ETC, PAPER ET	680.	221.
		7013	GLASSWARE FOR TABLE, KITCHEN, TOILET ETC USE NESOI	680.	203.
		8418	REFRIGERATORS, FREEZERS ETC, HEAT PUMPS NESOI, PT	677.	129.
		1108	STARCHES, INULIN	670.	1,833.
		8451	MACHINERY (NOT LAUNDRY) FOR CLEANING, DRYING ETC	668.	39.
		8530	ELECTRIC SIGNAL, SAFETY OR TRAFFIC CONTROL EQUIP	666.	118.
		3503	GELATIN & DERIV, ISINGLASS, GLUES, ANIMAL OR NESOI	664.	103.
		8714	PARTS & ACCESS FOR CYCLES & INVALID CARRIAGES	664.	42.
		304	FISH FILLETS & OTH FISH MEAT, FRESH, CHILL OR FROZ	658.	196.
		8525	TRANS APPAR FOR RADIOTELEPHONY ETC, TV CAMERAS	658.	11.
		3912	CELLULOSE AND CHEMICAL DERIV NESOI, PRIMARY FORMS	657.	404.
		4203	ARTICLES OF APPAREL & ACCESS, LEATH & COMP LEATHER	656.	28.
		1006	RICE	647.	567.
		2908	PHENOL OR PHENOL-ALCOHOL DERIV, HALOG, SULF ETC	642.	168.
		7004	DRAWN & BLOWN GLASS, IN SHEETS ETC	635.	120.
		902	TEA	618.	206.

1993 U.S. IMPORTS TRANSSHIPPED VIA CANADA ABOVE \$200,000
 BY CUSTOMS DISTRICT BY DESCEND. VALUE IN \$1000'S ESTIM. WEIGHT IN METRIC TONS

CD#	CUSTOMS DISTRICT	CODE	HARMONIZED COMMODITY DESCRIPTION	\$1000S	EST. M.TONS
38	DETROIT, MICH.	3801	ARTIFICIAL GRAPHITE, COLLOIDAL GRAPHITE & PREP ETC	613.	189.
		9018	MEDICAL, SURGICAL, DENTAL OR VET INST, NO ELEC, P	612.	54.
		2835	PHOSPHINATES, PHOSPHONATES, PHOSPHATES & POLYPHOSP	609.	897.
		8538	PARTS FOR ELEC APPAR ETC OF HEAD 8535, 8536 & 853	605.	42.
		603	CUT FLOWERS & BUDS FOR BOUQUETS ETC., PREPARED	601.	740.
		2309	PREPARATIONS USED IN ANIMAL FEEDING	596.	468.
		6911	CERAMIC TABLEWARE ETC. OF PORCELAIN OR CHINA	594.	152.
		8453	MACHINERY FOR WORK LEATHER ETC & FOOTWEAR ETC, PT	582.	73.
		1602	PREPARED OR PRESERV MEAT, MEAT OFFAL & BLOOD NESOI	577.	193.
		8464	MACHINE TOOLS FOR WORKING STONE, ETC & GLASS	564.	23.
		1905	BREAD, PASTRY, CAKES ETC, COMM WAFRS, EMP CAPS ETC	560.	225.
		4413	DENSIFIED WD BLOCKS/PLATES/STRIPS/PROFILE SHAPES	559.	203.
		4804	KRAFT PAPER & PAPERBOARD, UNCOAT NESOI, ROLLS ETC	559.	456.
		2816	HYDROX ETC OF MAGNESIUM, OXIDES ETC STRONTIUM ETC	558.	526.
		2805	ALKALI METALS ETC, RARE-EARTH METALS ETC, MERCURY	555.	219.
		3204	SYN ORG COLORING MATTER & PREP, SYN ORG BRIT AGENT	554.	63.
		6506	HEADGEAR NESOI, WHETHER OR NOT LINED OR TRIMMED	554.	19.
		8529	PARTS FOR TELEVISION, RADIO AND RADAR APPARATUS	542.	25.
		1605	CRUSTACEANS, MOLLUSCS ETC. PREPARED OR PRESERVED	539.	113.
		8455	METAL-ROLLING MILLS AND ROLLS THEREFOR, PARTS	535.	139.
		2922	OXYGEN-FUNCTION AMINO-COMPOUNDS	531.	129.
		9608	PENS (BALL POINT, S TIP ETC), MECH PENCILS ETC, PT	478.	56.
		8803	PARTS OF BALLOONS ETC, AIRCRAFT, SPACECRAFT ETC	468.	2.
		8307	FLEXIBLE TUBING OF BASE METAL	466.	46.
		2804	HYDROGEN, RARE GASES AND OTHER NONMETALS	465.	215.
		402	MILK AND CREAM, CONCENTRATED OR SWEETENED	459.	453.
		2914	KETONES & QUINONES & HALOGENATD, SULFONATD DER ET	457.	64.
		8425	PULLEY TACKLE & HOISTS (EXC SKIP), WINCH ETC, JAK	454.	56.
		7615	HOUSEHOLD ART ETC, POT SCOUR ETC, SAN WR, ALUMINUM	452.	104.
		5911	TEXTILE PRODUCTS ETC. FOR SPECIFIC TECH USES NESOI	449.	21.
		7308	STRUCTURES NESOI & PARTS THEREOF, OF IRON OR STEEL	446.	164.
		7222	BARS & RODS, ST STEEL NESOI, ANGLES ETC, ST STEEL	445.	149.
		9021	ORTHOPEDIC APPL, ARTIF BODY PTS, HEAR AID, PTS ET	445.	24.
		2902	CYCLIC HYDROCARBONS	443.	474.
		3212	PIGMENTS NONAQ LIQ ETC FOR PAINT, ST FOIL, DYE ET	435.	61.
		8442	MACH ETC NESOI FOR TYPESET, MAKING PR PLATES ETC	434.	17.
		4010	CONVEYOR OR TRANSMISS BELTS OF VULCANIZED RUBBER	429.	90.
		7323	HOUSEHOLD ART & PTS, IR & ST, IR OR STEEL WOOL ET	426.	91.
		3811	ANTIKNOCK PREPS & OTHER ADDITIVES FOR MINERAL OIL	421.	177.
		6813	FRICTION MATERIAL & ART BASED ON MINERAL SUBST ETC	415.	131.
		7604	ALUMINUM BARS, RODS AND PROFILES	411.	148.
		712	VEGETABLES, DRIED, WHOLE, CUT ETC., NO ADDED PREP	407.	123.
		4412	PLYWOOD, VENEERED PANELS & SIMILAR LAMINATED WOOD	407.	743.
		2837	CYANIDES, CYANIDE OXIDES AND COMPLEX CYANIDES	405.	234.
		2516	GRANITE, PORPHYRY, BASALT ETC., CRUDE OR CUT ETC.	403.	1,561.
		4911	PRINTED MATTER NESOI, INCL PRINT PICTURES & PHOTOS	402.	80.
		3215	INK, PRINTING, WRITING, DRAWING ETC, CONCEN OR NO	400.	28.
		2925	CARBOXYIMIDE-FUNCTION COMP, IMINE-FUNCTION COM ET	397.	65.

1993 U.S. IMPORTS TRANSSHIPPED VIA CANADA ABOVE \$200,000
 BY CUSTOMS DISTRICT BY DESCEND. VALUE IN \$1000'S ESTIM. WEIGHT IN METRIC TONS

CD#	CUSTOMS DISTRICT	CODE	HARMONIZED COMMODITY DESCRIPTION	\$1000S	EST. M.TONS
38	DETROIT, MICH.	8208	KNIVES & BLADES FOR MACHINES & APPLIANCES, B MT PT	389.	32.
		8470	CALCULATING & ACCOUNT MACHINES, CASH REGISTERS ET	387.	15.
		8607	PARTS OF RAILWAY OR TRAMWAY LOCOMOTIVES OR R STOCK	380.	188.
		8463	MACHINE TOOLS FOR WORKING METAL, NESOI	376.	77.
		802	NUTS NESOI, FRESH OR DRIED	372.	122.
		2903	HALOGENATED DERIVATIVES OF HYDROCARBONS	371.	272.
		2924	CARBOXYAMIDE-FUNCTION COMP, AMIDE-FUNCTION COM ET	370.	402.
		3812	PREPARED RUBBER ACCELERATORS, COM PLASTICIZERS ET	370.	165.
		8001	TIN, UNWROUGHT	370.	69.
		7009	GLASS MIRRORS, FRAMED OR NOT, INC REARVIEW MIRRORS	368.	57.
		9022	X-RAY ETC APPARATUS, TUBES, PANELS, SCREEN ETC, P	364.	11.
		3925	BUILDERS'' WARE OF PLASTICS, NESOI	363.	162.
		8452	SEWING MACHINES (NOT BOOK-SEW), COVER ETC, NEEDLE	355.	30.
		4015	ART OF APPAREL & ACCESS OF UNHARD VULCANIZED RUBB	354.	68.
		8434	MILKING MACHINES & DAIRY MACHINERY & PARTS	350.	60.
		3901	POLYMERS OF ETHYLENE, IN PRIMARY FORMS	349.	205.
		4202	TRAVEL GOODS, HANDBAGS, WALLETS, JEWELRY CASES ETC	345.	54.
		3402	ORGANIC SURF-ACT AGENTS, PREPS & CLEANING PREPS	340.	177.
		8475	MACHINES FOR ASSEMB ELEC TUBES ETC & GLASS MFR, P	340.	74.
		3403	LUBRICATING PREPS, ANTIRUST & TREATING TEXTILES ETC	339.	80.
		4806	VEG PARCHMENT, GREASEPROOF PAPERS ETC, ROLLS ETC	339.	145.
		1001	WHEAT AND MESLIN	338.	862.
		5903	TEXTILE FABRICS (NOT TIRE CORD) COAT ETC, PLASTICS	338.	43.
		6804	MILLSTONES ETC FOR GRINDING ETC, VARIOUS MATERIALS	330.	115.
		8520	MAGNETIC TAPE & OTHER SOUND RECORDERS	330.	11.
		7903	ZINC DUST, POWDERS AND FLAKES	327.	554.
		5702	CARPETS & OTH TEXT FLOOR COVER, WOVEN, NO TUFT ETC	326.	43.
		1109	WHEAT GLUTEN, WHETHER OR NOT DRIED	322.	296.
		8903	YACHTS & OTHER VESSELS FOR PLEAS ETC, ROW BOAT ETC	320.	42.
		3703	PHOTO PAPER, PAPERBOARD & TEXTILES, SENS, UNEXPOS	318.	40.
		5107	YARN OF COMBED WOOL, NOT PUT UP FOR RETAIL SALE	318.	28.
		8472	OFFICE MACHINES NESOI (HECTOGRAPH, ADDRESSING ETC	316.	21.
		8415	AIR CONDITIONING MACHINES (TEMP & HUM CHANGE), PT	312.	35.
		7214	BARS & RODS, IRON & NA STEEL NESOI, H-R ETC	311.	745.
		7320	SPRINGS & LEAVES FOR SPRINGS, IRON OR STEEL	310.	81.
		3202	SYN ORG & INORG TANNING SUBST, TAN PREP, ENZ PREP	308.	304.
		3706	MOTION-PICTURE FILM, EXPOSED AND DEVELOPED	308.	25.
		6307	MADE-UP ARTICLES OF TEXTILE MATERIALS NESOI	299.	122.
		7204	FERROUS WASTE & SCRAP, REMELT SCR IRON/STEEL INGOT	296.	1,965.
		8706	CHAS W ENG F TRAC, MTR VEH F PASS/GD & SPECIAL PUR	294.	30.
		9013	LIQUID CRYSTAL DEVICES NESOI, LASERS, OPT APPL, P	294.	4.
		9405	LAMPS & LIGHTING FITTINGS & PARTS ETC NESOI	292.	60.
		7321	STOVES, RANGES ETC, NONEL DOMEST & PTS, IR & STEE	288.	94.
		7310	TANKS ETC, NOV 300 LITER CAPACITY, IRON OR STEEL	285.	148.
		6806	MINERAL WOOLS, EXPANDED MINERAL MATERIAL & MIXTURE	283.	24.
		2941	ANTIBIOTICS	281.	22.
		904	PEPPER, GENUS PIPER, GENUS CAPSICUM OR PIMENTA	280.	206.
		2915	SAT ACYCLIC NONOCARBOX ACID & ANHYD, HALOGON ETC	278.	93.

1993 U.S. IMPORTS TRANSSHIPPED VIA CANADA ABOVE \$200,000
 BY CUSTOMS DISTRICT BY DESCEND. VALUE IN \$1000'S ESTIM. WEIGHT IN METRIC TONS

CD#	CUSTOMS DISTRICT	CODE	HARMONIZED COMMODITY DESCRIPTION	\$1000S	EST. M.TONS
38	DETROIT, MICH.	6913	STATUETTES AND OTHER ORNAMENTAL CERAMIC ARTICLES	276.	112.
		8437	MACH FOR CLEANING SEED ETC & WORK CEREAL ETC, PTS	272.	80.
		2846	RARE-EARTH METAL COMPOUNDS OF YTTRIUM OR SCANDIUM	270.	154.
		9502	DOLLS, REPRESENTING ONLY HUMAN BEINGS, & PARTS ETC	270.	42.
		6110	SWEATERS, PULLOVERS, VESTS ETC, KNIT OR CROCHETED	268.	8.
		2505	NATURAL SANDS OF ALL KINDS, EXCEPT METAL-BEARING	265.	198.
		8534	PRINTED CIRCUITS	263.	6.
		601	BULBS, TUBERS ETC, CHICORY PLANTS & ROOTS NESOI	260.	73.
		3806	ROSIN & RESIN ACIDS ETC, ROSIN SPIRIT ETC, RUN GUM	260.	213.
		9612	TYPEWRITER ETC RIBBONS, INKED OR PREP, INK PADS	259.	14.
		3304	BEAUTY, MAKE-UP & SKIN-CARE PREP, MANICURE ETC PRP	257.	21.
		2205	VERMOUTH & OTH WINE OF FRESH GRAPES SPEC FLAVORED	254.	169.
		2615	NIOBIUM, TANTALUM, VANADIUM & ZIRCONIUM ORE & CONC	254.	944.
		6402	FOOTWEAR, OUTER SOLE & UPPER RUBBER OR PLAST NESOI	254.	27.
		2829	CHLORATES ETC, BROMATES ETC, IODATES ETC.	246.	171.
		9508	MERRY-GO-ROUNDS, OTH FAIRGROUND AMUSEMENTS, PARTS	246.	11.
		9017	DRAWING, MATH, MEASURING INST ETC NESOI, PARTS	240.	27.
		307	MOLLUSCS & AQUATIC INVERTEBRATES NESOI, LIVE ETC.	237.	97.
		8528	TELEVISION RECEIVERS (INCL MONITORS & PROJ RECEIV	237.	22.
		8531	ELECTRIC SOUND OR VISUAL SIGNALING APPARATUS, PTS	237.	15.
		9024	MACHINES ETC FOR TESTING MECH PROP OF MATERIAL, P	232.	27.
		2939	VEG ALKALOIDS, NAT OR SYNTH & SALTS, ETHERS ETC.	231.	34.
		6910	CERAMIC SINKS, WASHBASINS, WATER CLOSET BOWLS ETC	228.	196.
		8510	ELECTRIC SHAVERS & HAIR CLIPPERS, PARTS	227.	39.
		7412	COPPER TUBE OR PIPE FITTINGS	226.	13.
		8508	ELECTROMECHANICAL TOOLS, WORKING IN HAND, PARTS	225.	13.
		6002	KNITTED OR CROCHETED FABRICS, NESOI	223.	16.
		8545	CARBON ELECTRODES & BRUSHES, LAMP CARBONS ETC	218.	76.
		8201	HANDTOOLS & TOOLS USED IN AGRICULT ETC, B MET PTS	217.	102.
		8445	MACHINES FOR PREPARING TEXTILE FIBERS & YARNS	215.	6.
		8540	THERMIONIC, COLD CATHODE OR PHOTOCATHODE TUBES, P	215.	16.
		7419	ARTICLES OF COPPER NESOI	212.	27.
		6810	ARTICLES OF CEMENT, CONCRETE OR ARTIFICIAL STONE	210.	281.
		2929	NITROGEN FUNCTION COMPOUNDS NESOI	203.	18.
		6812	FABRICATED ASBESTOS FIBERS, ITEMS OF MIXTURES ETC	203.	443.
		9611	DATE SEALING OR NUMBERING STAMPS,ETC FOR HAND OPE	201.	266.
		9999	BELOW MINIMUM	22,255.	16,633.
		*SUB-TOTAL CUSTOMS DIST. # 38		1,684,615.	452,971.
39	CHICAGO, ILL.	8708	PARTS & ACCESS FOR MOTOR VEHICLES (HEAD 8701-8705)	116,892.	24,179.
		8483	TRANSMISSION SHAFTS, BEARINGS, GEARS ETC, PARTS	99,397.	9,589.
		8431	PARTS FOR MACHINERY OF HEADINGS 8425 TO 8430	75,156.	19,609.
		3501	CASEIN, CASEINATES AND OTHER CASEIN DERIVATIVES	56,697.	13,228.
		8481	TAPS, COCKS, VALVES ETC FOR PIPES, TANKS ETC, PTS	51,324.	4,674.
		8413	PUMPS FOR LIQUIDS, LIQUID ELEVATORS, PARTS THEREO	50,305.	2,515.
		3815	REACTION INITIATORS & ACCELER & CATALYT PREP NESO	29,549.	4,051.
		7219	FL-RL STAINLESS STEEL PRODUCTS, NOT UND 600MM WID	26,908.	14,407.

1993 U.S. IMPORTS TRANSSHIPPED VIA CANADA ABOVE \$200,000
 BY CUSTOMS DISTRICT BY DESCEND. VALUE IN \$1000'S ESTIM. WEIGHT IN METRIC TONS

CD#	CUSTOMS DISTRICT	CODE	HARMONIZED COMMODITY DESCRIPTION	\$1000S	EST. M.TONS
39	CHICAGO, ILL.	8479	MACHINES ETC HAVING INDIVIDUAL FUNCTIONS NESOI, P	25,881.	2,094.
		8408	COMPRESSION-IGNITION INTERNAL COMB PISTON ENGINES	25,712.	3,967.
		2918	CARBOXYLIC ACID, ADDED OXYGEN & ANHY ETC, HAL ETC	23,401.	11,382.
		8409	PARTS FOR ENGINES OF HEADING 8407 OR 8408	22,508.	3,752.
		3920	PLATES, SHEETS, FILM ETC NO AD, NON-CEL ETC, PLAS	21,078.	5,781.
		3926	ARTICLES OF PLASTICS (INC POLYMERS & RESINS) NESO	20,799.	2,631.
		8412	ENGINES AND MOTORS NESOI, AND PARTS THEREOF	18,750.	1,377.
		8438	MACH NESOI, IND PREP OF FOOD OR DRINK ETC, PARTS	17,540.	819.
		8482	BALL OR ROLLER BEARINGS AND PARTS	17,190.	1,439.
		8519	TURNTABLES, RECORD & CASSETTE PLAYERS ETC.	16,737.	1,254.
		8703	MOTOR CARS & VEHICLES FOR TRANSPORTING PERSONS	15,760.	1,401.
		2933	HETEROCYCLIC COMP, NIT HETERO-ATOM, NUCLEIC ACIDS	15,723.	1,819.
		8515	ELECTRIC, LASER OR OTH LIGHT OR PHOTON BEAM ETC	15,550.	751.
		8433	HARVEST ETC MACHINES, CLEANING EGGS ETC NESOI, PT	15,546.	2,092.
		8421	CENTRIFUGES, FILTER ETC MACH FOR LIQ OR GASES, PT	14,871.	1,062.
		3917	TUBES, PIPES & HOSES & THEIR FITTINGS, OF PLASTIC	14,741.	1,227.
		8407	SPARK-IGNITION RECIP OR ROTARY INT COMB PISTON ENG	14,509.	698.
		3206	COLORING MATTER NESOI, COLORING PREP NESOI, ETC.	14,503.	9,027.
		4104	BOVINE OR EQUINE LEATHER, NO HAIR NESOI	13,522.	1,415.
		8424	MECH APPL TO DISPERSE LIQ ETC, SAND ETC BLAST MAC	13,436.	2,786.
		7606	ALUMINUM PLATES, SHEETS & STRIP OVER .2MM THICK	12,936.	5,187.
		8471	AUTOMATIC DATA PROCESS MACHINES, MAGN READER ETC	12,916.	402.
		9403	FURNITURE NESOI AND PARTS THEREOF	12,297.	3,959.
		6908	GLAZED CERAMIC FLAGS & PAVING, HEARTH TILES, ETC	12,196.	23,378.
		8414	AIR OR VAC PUMPS, COMPR & FANS, HOODS & FANS, PTS	12,032.	1,150.
		8477	MACHINERY FOR WORKING RUBBER & PLAST ETC NESOI, P	12,032.	698.
		8422	MACHINES, DISHWASH, CLEAN ETC CONT & FILL, PAK ET	11,814.	597.
		4810	PAPER & PAPERBOARD, COATED WITH KAOLIN ETC, RL ET	11,555.	13,665.
		7607	ALUMINUM FOIL (BACK OR NOT) NOV .2MM TH (EX BACK)	11,457.	3,792.
		4016	ARTICLES NESOI OF UNHARDED VULCANIZED RUBBER	11,051.	1,071.
		4802	PAPER, UNCOAT, FOR WRITING ETC, ROLLS, HNDMD PAPER	10,933.	16,621.
		8544	INSULATED WIRE, CABLE ETC, OPT SHEATH FIB CABLES	10,797.	1,723.
		8428	LIFTING, HANDLING, LOADING & UNLOAD MACHINES NESO	10,457.	1,253.
		7217	WIRE OF IRON & NONALLOY STEEL	10,407.	8,887.
		7318	SCREWS, BOLTS, NUTS, WASHERS ETC, IRON OR STEEL	10,258.	3,817.
		7202	FERROALLOYS	10,201.	6,716.
		8452	SEWING MACHINES (NOT BOOK-SEW), COVER ETC, NEEDLE	9,761.	403.
		8466	PARTS ETC FOR MACHINE TOOLS OF HEAD 8456 TO 8465	9,690.	1,477.
		8501	ELECTRIC MOTORS AND GENERATORS (NO SETS)	9,544.	1,221.
		4901	BOOKS, BROCHURES & SIMILAR PRINTED MATTER	9,499.	1,670.
		7215	BARS & RODS, IRON & NA STEEL NESOI	9,275.	13,207.
		8462	MACHINE TOOLS FOR FORGING, BENDING, STAMPING ETC	8,849.	9,913.
		8427	FORK-LIFT TRUCKS, OTH WORKS TRUCKS WITH LIFTS ETC	8,792.	2,112.
		7326	ARTICLES OF IRON OR STEEL, NESOI	8,748.	3,118.
		2204	WINE OF FRESH GRAPES, GRAPE MUST NESOI	8,726.	3,885.
		3003	MEDICAMENTS NESOI OF MIXTURES, NOT DOSAGE ETC FORM	8,695.	2,454.
		7013	GLASSWARE FOR TABLE, KITCHEN, TOILET ETC USE NESOI	8,580.	2,360.
		7315	CHAIN & PARTS, OF IRON OR STEEL	8,476.	2,270.

1993 U.S. IMPORTS TRANSSHIPPED VIA CANADA ABOVE \$200,000
 BY CUSTOMS DISTRICT BY DESCEND. VALUE IN \$1000'S ESTIM. WEIGHT IN METRIC TONS

CD#	CUSTOMS DISTRICT	CODE	HARMONIZED COMMODITY DESCRIPTION	\$1000S	EST. M.TONS
39	CHICAGO, ILL.	8511	ELECTRIC IGNITION ETC EQUIP, GENERATORS, PARTS	8,463.	923.
		404	WHEY & MILK PRODUCTS NESOI, FLAVORED ETC. OR NOT	8,447.	6,915.
		2931	ORGANO-INORGANIC COMPOUNDS NESOI	8,137.	1,872.
		9401	SEATS (EXCEPT BARBER, DENTAL, ETC), AND PARTS	8,135.	1,185.
		8419	MACHINERY ETC FOR TEMP CHANG TREAT MAT, W HEAT, P	7,998.	679.
		2916	UNSAT ACYCLIC & CYCLIC MONOCARBOX ACID & ANHYD ET	7,980.	2,169.
		2208	ETHYL ALCOHOL, UNDENAT, UNDBOX% ALC, SPIRIT BEV ETC	7,672.	3,465.
		3823	BINDERS FOR FOUND MOLDS, CHEMICAL PROD ETC NESOI	7,502.	3,273.
		8504	ELECTRIC TRANSFORM, STATIC CONVERTERS & INDUCT, PT	7,140.	1,386.
		3907	POLYETHERS, EXPOXIDES & POLYESTERS, PRIMARY FORMS	7,102.	2,191.
		8207	INTERCHANGE TOOLS FOR HAND- OR MACHINE-TOOLS, BMPT	7,033.	350.
		7211	FL-RL IRON & NA STEEL UN 600MM WD, NOT CLAD ETC	6,926.	3,905.
		1302	VEG SAPS & EXTRACTS, PECTATES ETC, AGAR-AGAR ETC.	6,852.	714.
		7307	TUBE OR PIPE FITTINGS, OF IRON OR STEEL	6,754.	2,689.
		8202	HANDSAWS & MET PTS, SAW BLADES, BASE MTL SAW PARTS	6,634.	334.
		9506	ARTICLES & EQUIP FOR SPORTS ETC NESOI, POOLS, PTS	6,529.	548.
		8459	MACHINE TOOLS FOR DRILLING, BORING, MILLING ETC	6,445.	1,325.
		7228	AL STEEL NESOI BARS, ANG ETC, HOL DR ST BARS ETC	6,126.	5,277.
		8472	OFFICE MACHINES NESOI (HECTOGRAPH, ADDRESSING ETC	6,091.	440.
		2915	SAT ACYCLIC MONOCARBOX ACID & ANHYD, HALOGON ETC	6,077.	4,707.
		6402	FOOTWEAR, OUTER SOLE & UPPER RUBBER OR PLAST NESOI	6,014.	507.
		9503	TOYS NESOI, SCALE MODELS ETC, PUZZLES, PARTS ETC	5,986.	652.
		1805	COCOA POWDER, NOT SWEETENED	5,821.	4,306.
		8460	MACHINE TOOLS FOR HONING OR FINISHING METAL ETC	5,819.	525.
		8543	ELECTRICAL MACH ETC, WITH IND FUNCTIONS NESOI, PT	5,814.	215.
		9022	X-RAY ETC APPARATUS, TUBES, PANELS, SCREEN ETC, P	5,775.	186.
		7304	TUBES, PIPES ETC, SEAMLESS, IRON NESOI & STEEL	5,766.	2,767.
		8536	ELECTRICAL APPARATUS FOR SWITCHING ETC, NOV 1000	5,728.	215.
		6802	WORKED MONUMENT ETC STONE & ART NESOI, GRANULE ETC	5,726.	6,230.
		3909	AMINO-RESINS, PHENOLICS & POLYURETHANES, PRIM FORM	5,710.	1,442.
		7223	WIRE OF STAINLESS STEEL	5,650.	1,235.
		9018	MEDICAL, SURGICAL, DENTAL OR VET INST, NO ELEC, P	5,640.	207.
		4002	SYNTH RUBBER & FACTICE, INC NAT-SYN MIX, PR FM ETC	5,552.	4,439.
		3204	SYN ORG COLORING MATTER & PREP, SYN ORG BRIT AGENT	5,538.	524.
		4011	NEW PNEUMATIC TIRES, OF RUBBER	5,442.	1,589.
		4805	PAPER & PAPERBOARD, UNCOAT, NESOI, ROLLS OR SHEETS	5,319.	8,979.
		2930	ORGANO-SULFUR COMPOUNDS	5,192.	853.
		6403	FOOTWEAR, OUTER SOLE RUB, PLAST OR LEA & UPPER LEA	5,125.	376.
		7325	CAST ARTICLES NESOI, OF IRON OR STEEL	5,103.	1,839.
		8518	MICROPHONES, LOUDSPEAKERS, SOUND AMPLIFIER ETC, P	5,081.	442.
		2811	INORGANIC ACIDS & INORGANIC OXY NONMET COMP NESOI	5,055.	4,478.
		3507	ENZYMES, PREPARED ENZYMES NESOI	5,005.	679.
		6902	REFRACTORY BRICKS & OTHER REFR CER CONST ART NESOI	4,997.	4,818.
		9026	INST ETC MEASURE OR CHECK FLOW, LEVEL ETC, PTS ET	4,996.	490.
		2203	BEER MADE FROM MALT	4,944.	7,570.
		2835	PHOSPHINATES, PHOSPHONATES, PHOSPHATES & POLYPHOSP	4,905.	5,668.
		8458	LATHES FOR REMOVING METAL	4,802.	1,465.
		8714	PARTS & ACCESS FOR CYCLES & INVALID CARRIAGES	4,765.	755.

1993 U.S. IMPORTS TRANSSHIPPED VIA CANADA ABOVE \$200,000
 BY CUSTOMS DISTRICT BY DESCEND. VALUE IN \$1000'S ESTIM. WEIGHT IN METRIC TONS

CD#	CUSTOMS DISTRICT	CODE	HARMONIZED COMMODITY DESCRIPTION	\$1000S	EST. M.TONS
39	CHICAGO, ILL.	8527	RECEPTION APPARATUS FOR RADIOTELEPHONY ETC	4,746.	233.
		9504	ARTICLES FOR ARCADE, TABLE OR PARLOR GAMES, PARTS	4,683.	491.
		7409	COPPER PLATES, SHEETS & STRIP, OVER 0.15MM THICK	4,653.	1,374.
		8302	HARDWARE, FIXTURES, CASTORS ETC & PARTS, BASE METL	4,620.	1,025.
		4813	CIGARETTE PAPER, CUT TO SIZE ETC OR NOT	4,592.	250.
		712	VEGETABLES, DRIED, WHOLE, CUT ETC., NO ADDED PREP	4,576.	1,131.
		2914	KETONES & QUINONES & HALOGENATD, SULFONATD DER ET	4,540.	1,201.
		6912	CERAMIC TABLEWRE, KITCHNWRE ETC, EARTHENWARE ETC	4,444.	1,401.
		9009	PHOTOCOPY APPARATUS & THERMOCOPY APPARATUS, PTS	4,396.	186.
		2936	PROVITAMINS AND VITAMINS & DERIVATIVES & INTERMIX	4,346.	287.
		2934	HETEROCYCLIC COMPOUNDS NESOI	4,327.	652.
		4009	TUBES, PIPES & HOSES OF UNHARD VULCANIZED RUBBER	4,276.	842.
		8467	TOOLS FOR WORKING IN THE HAND, PNEUMATIC ETC, PTS	4,271.	168.
		3908	POLYAMIDES IN PRIMARY FORMS	4,113.	1,321.
		5402	SYNTHETIC FILAMENT YARN (NO SEW THREAD), NO RETAIL	4,077.	294.
		7010	GLASS CONTAINERS FOR PACKING ETC & GLASS CLOSURES	4,068.	2,027.
		1905	BREAD, PASTRY, CAKES ETC, COMM WAFRS, EMP CAPS ETC	4,062.	1,372.
		6903	REFRACTORY CERAMIC GOODS, RETORTS, TUBES ETC NESOI	3,972.	1,172.
		8205	HANDTOOLS NESOI, BLOW TORCHES ETC, ANVILS ETC	3,880.	480.
		2905	ACYCLIC ALCOHOLS & HALOGENAT, SULFONATD ETC DERIVS	3,809.	1,737.
		8484	GASKETS & SIMILAR JOINTS OF METAL SHEETING	3,781.	175.
		8505	ELECTROMAGNETS, PERMANENT MAGNETS ETC & PARTS	3,773.	1,046.
		9402	MEDICAL, SURGICAL, DENTAL OR VETERINARY FURN ETC	3,749.	325.
		2917	POLYCARBOXYLIC ACIDS & ANHYD ETC, HALOG, SULF ETC	3,664.	3,354.
		7407	COPPER BARS, RODS AND PROFILES	3,616.	1,377.
		9016	BALANCES, SENSITIVITY >=5 CG, W OR W/O WGT, & PTS	3,603.	156.
		9031	MACHINES, NESOI IN CHAPTER 90, PROFILE PROJECT, P	3,581.	116.
		8503	PARTS OF ELECTRIC MOTORS, GENERATORS & SETS	3,534.	383.
		8512	ELECTRIC LIGHT ETC EQUIP, WINDSH WIPERS ETC, PART	3,459.	202.
		3913	NATURAL (INC MODIFIED) POLYMERS NESOI, PRIMARY FM	3,417.	469.
		3808	INSECTICIDES, RODENTICIDES, FUNGICIDES ETC, RETAIL	3,325.	949.
		8456	MACHINE TOOLS FOR MATERIAL REMOVAL BY LASER ETC	3,325.	120.
		7408	COPPER WIRE	3,314.	852.
		8441	MACH FOR MAKING UP PULP & PAPER, INC CUTTERS, PTS	3,294.	182.
		8443	PRINTING MACHINERY, MACHINES ANCIL TO PRINTING, P	3,289.	176.
		4823	PAPER, PAPERBOARD, CELLUL WAD TO SIZE & ARTS NESO	3,172.	1,023.
		2924	CARBOXYAMIDE-FUNCTION COMP, AMIDE-FUNCTION COM ET	3,171.	296.
		3905	POLYMERS OF VINYL ACETATE & OTH VINYL POLYM, PR FM	3,086.	753.
		8480	MOLDING BOXES FOR METAL FOUNDRY, MOLD BASES ETC	3,082.	566.
		3402	ORGANIC SURF-ACT AGENTS, PREPS & CLEANING PREPS	3,067.	1,755.
		9405	LAMPS & LIGHTING FITTINGS & PARTS ETC NESOI	3,003.	351.
		8485	MACHINERY PTS, NO ELECT CONNECTORS ETC NESOI	2,999.	196.
		7323	HOUSEHOLD ART & PTS, IR & ST, IR OR STEEL WOOL ET	2,994.	498.
		8423	WEIGHING MACHINES & WEIGHING MACHINE WEIGHTS, PTS	2,983.	164.
		3505	DEXTRINS ETC, GLUES BASED ON STARCHES, DEXTRIN ETC	2,950.	3,506.
		8434	MILKING MACHINES & DAIRY MACHINERY & PARTS	2,945.	527.
		9611	DATE SEALING OR NUMBERING STAMPS,ETC FOR HAND OPE	2,940.	1,601.
		3809	FINISHING AGENTS ETC FOR TEXTILES, PAPER ETC NESOI	2,895.	672.

1993 U.S. IMPORTS TRANSSHIPPED VIA CANADA ABOVE \$200,000
 BY CUSTOMS DISTRICT BY DESCEND. VALUE IN \$1000'S ESTIM. WEIGHT IN METRIC TONS

CD#	CUSTOMS DISTRICT	CODE	HARMONIZED COMMODITY DESCRIPTION	\$1000S	EST. M.TONS
---	-----	---	-----	-----	-----
39	CHICAGO, ILL.	2106	FOOD PREPARATIONS NESOI	2,887.	986.
		4010	CONVEYOR OR TRANSMISS BELTS OF VULCANIZED RUBBER	2,879.	738.
		3004	MEDICAMENTS NESOI, MIXED OR NOT, IN DOSAGE ETC FM	2,875.	150.
		4012	RETREAD OR USED PNEU TIRES, SOLID TIRES ETC, RUBB	2,870.	1,217.
		4202	TRAVEL GOODS, HANDBAGS, WALLETS, JEWELRY CASES ETC	2,865.	201.
		8607	PARTS OF RAILWAY OR TRAMWAY LOCOMOTIVES OR R STOCK	2,756.	614.
		8716	TRAILERS ETC, OTHER VEHICLES, NOT MECH PROPELD, P	2,743.	1,491.
		1704	SUGAR CONFECTION (INCL WHITE CHOCOLATE), NO COCOA	2,739.	1,124.
		3503	GELATIN & DERIV, ISINGLASS, GLUES, ANIMAL OR NESOI	2,736.	729.
		9508	MERRY-GO-ROUNDS, OTH FAIRGROUND AMUSEMENTS, PARTS	2,659.	232.
		8545	CARBON ELECTRODES & BRUSHES, LAMP CARBONS ETC	2,648.	1,615.
		9209	PARTS ETC OF MUSICAL INSTR, METRONONES, T FORK ETC	2,598.	254.
		3923	CONTAINERS (BOXES, BAGS ETC), CLOSURERS ETC, PLAS	2,589.	701.
		8464	MACHINE TOOLS FOR WORKING STONE, ETC & GLASS	2,567.	345.
		6907	UNGLAZED CERAMIC FLAGS & PAVING, HEARTH TILES ETC	2,526.	3,989.
		8509	ELECTROMECH DOMESTIC APPLIANCES, PARTS	2,516.	175.
		7411	COPPER TUBES AND PIPES	2,514.	746.
		1519	IND MONOCARB FAT ACIDS, ACID OIL, REF, IND FAT ALC	2,494.	2,397.
		8461	MACHINE TOOLS FOR SHAPING, SLOTTING, GEAR CUT ETC	2,483.	336.
		2929	NITROGEN FUNCTION COMPOUNDS NESOI	2,453.	408.
		8455	METAL-ROLLING MILLS AND ROLLS THEREFOR, PARTS	2,442.	445.
		9608	PENS (BALL POINT, S TIP ETC), MECH PENCILS ETC, PT	2,441.	186.
		8514	INDUSTRIAL OR LAB ELEC FURNACES ETC, PARTS	2,401.	425.
		6506	HEADGEAR NESOI, WHETHER OR NOT LINED OR TRIMMED	2,395.	77.
		1005	CORN (MAIZE)	2,394.	1,564.
		8432	AGRICULT ETC MACH FOR SOIL ETC, LAWN ROLLERS, PTS	2,388.	776.
		2519	MAGNESITE, FUSED MAGNESIA, D-B MAGN, M OXIDE NESOI	2,385.	5,428.
		7601	ALUMINUM, UNWROUGHT	2,340.	1,944.
		2922	OXYGEN-FUNCTION AMINO-COMPOUNDS	2,318.	680.
		5806	NARROW WOVEN FABRICS EXCEPT LABELS ETC IN PC ETC	2,293.	292.
		8465	MACHINE TOOLS FOR WORKING WOOD, CORK, BONE ETC	2,283.	229.
		7418	HOUSEHOLD ART & PTS, COP, POT SCOURERS ETC, COPPE	2,277.	279.
		2818	ALUMINUM OXIDE (INCL ART CORUNDUM), ALUM HYDROXIDE	2,237.	1,539.
		2921	AMINE-FUNCTION COMPOUNDS	2,219.	675.
		2309	PREPARATIONS USED IN ANIMAL FEEDING	2,212.	2,773.
		8463	MACHINE TOOLS FOR WORKING METAL, NESOI	2,207.	102.
		8542	ELECTRONIC INTEGRATED CIRCUITS & MICROASSEMBL, PT	2,203.	48.
		7210	FL-RL IRON & NA STEEL NUN600MM WD, CLAD ETC	2,172.	3,372.
		2849	CARBIDES	2,170.	1,521.
		7604	ALUMINUM BARS, RODS AND PROFILES	2,152.	884.
		8208	KNIVES & BLADES FOR MACHINES & APPLIANCES, B MT PT	2,146.	326.
		7406	COPPER POWDERS AND FLAKES	2,144.	293.
		2201	WATERS, NATURAL ETC, NOT SWEETENED ETC, ICE & SNOW	2,132.	6,710.
		8516	ELEC WATER, SPACE & SOIL HEATERS, HAIR ETC DRY, P	2,124.	242.
		3212	PIGMENTS NONAQ LIQ ETC FOR PAINT, ST FOIL, DYE ET	2,119.	400.
		3506	PREPARED GLUES & ADHESIVES NESOI, GLUE RETAIL PACK	2,095.	891.
		7605	ALUMINUM WIRE	2,067.	559.
		9703	ORIGINAL SCULPTURES AND STATUARY, IN ANY MATERIAL	2,045.	495.

1993 U.S. IMPORTS TRANSSHIPPED VIA CANADA ABOVE \$200,000
 BY CUSTOMS DISTRICT BY DESCEND. VALUE IN \$1000'S ESTIM. WEIGHT IN METRIC TONS

CD#	CUSTOMS DISTRICT	CODE	HARMONIZED COMMODITY DESCRIPTION	\$1000S	EST. M.TONS
39	CHICAGO, ILL.	8104	MAGNESIUM & ARTICLES THEREOF, INCL WASTE & SCRAP	2,026.	861.
		8437	MACH FOR CLEANING SEED ETC & WORK CEREAL ETC, PTS	2,015.	654.
		8457	MACHINING CENTERS, UNIT CONST MACH ETC WORK METAL	2,006.	174.
		4408	VENEER SHEETS ETC, NOT OVER 6 MM THICK	2,004.	387.
		6910	CERAMIC SINKS, WASHBASINS, WATER CLOSET BOWLS ETC	1,991.	435.
		8105	COBALT MATTES ETC, COBALT & ART, INC WASTE & SCRAP	1,988.	82.
		2005	VEGETABLES NESOI PREPARED ETC NESOI, NOT FROZEN	1,974.	1,762.
		8301	PADLOCKS, LOCKS & KEYS & PARTS, OF BASE METAL	1,933.	162.
		3403	LUBRICATING PREPS, ANTIRUST & TREATING TEXTILES ETC	1,922.	1,116.
		3901	POLYMERS OF ETHYLENE, IN PRIMARY FORMS	1,920.	1,155.
		4101	RAW HIDES & SKINS OF BOVINE OR EQUINE ANIMALS	1,909.	561.
		8507	ELECTRIC STORAGE BATTERIES, INCL SEPARATORS, PARTS	1,874.	495.
		7226	FL-RL ALLOY STEEL NESOI UN 600MM WIDE	1,872.	1,624.
		8418	REFRIGERATORS, FREEZERS ETC, HEAT PUMPS NESOI, PT	1,872.	215.
		8473	PARTS ETC FOR TYPEWRITERS & OTHER OFFICE MACHINES	1,857.	92.
		8439	MACHINERY FOR MAKING PULP & MAKING ETC PAPER, PTS	1,853.	425.
		3924	TABLEWARE & OTHER HOUSEHOLD ARTICLES ETC, PLASTIC	1,828.	238.
		4814	WALLPAPER ETC., WINDOW TRANSPARENCIES OF PAPER	1,827.	378.
		3912	CELLULOSE AND CHEMICAL DERIV NESOI, PRIMARY FORMS	1,822.	855.
		3921	PLATES, SHEETS, FILM, FOIL & STRIP NESOI, PLASTIC	1,787.	321.
		8506	PRIMARY CELLS & BATTERIES, PARTS	1,787.	266.
		9107	TIME SWITCHES W CLK/WTCH MOVEMNT/SYNCHRONOUS MOTOR	1,774.	82.
		4811	PAPER, PAPERBOARD, WAD ETC, COAT ETC NESOI, RL ET	1,769.	842.
		7016	GLASS PAVING BLOCKS ETC, GL CUBES, LEAD WINDOW ET	1,761.	2,669.
		8454	CONVERTERS, LADLES, INGOT MOLDS & CASTING MACH, P	1,744.	143.
		2803	CARBON, NESOI (INCLUDING CARBON BLACK)	1,741.	1,066.
		8430	MACH NESOI, MOVING, GRAD ETC, PILE-DR, SNOFLOW ET	1,741.	199.
		7225	FL-RL ALLOY STEEL NESOI NUN 600MM WIDE	1,732.	1,388.
		9019	MECH-THER, MASSAGE, PSYCH TEST, OZONE APP ETC, PT	1,707.	72.
		504	ANIMAL (NOT FISH) GUTS, BLADDERS, STOMACHS & PARTS	1,681.	397.
		4911	PRINTED MATTER NESOI, INCL PRINT PICTURES & PHOTOS	1,674.	295.
		8529	PARTS FOR TELEVISION, RADIO AND RADAR APPARATUS	1,670.	57.
		3406	CANDLES, TAPERS AND THE LIKE	1,669.	545.
		2904	HYDROCARBON DERIVATIVES, SULFONATED, NITRATED ETC	1,658.	580.
		9603	BROOMS, BRUSHES, MOPS, FEATHER DUSTERS ETC	1,658.	317.
		3910	SILICONES, IN PRIMARY FORMS	1,653.	307.
		8539	ELECTRIC FILAMENT OR DISCHARGE LAMPS, PARTS	1,650.	74.
		4806	VEG PARCHMENT, GREASEPROOF PAPERS ETC, ROLLS ETC	1,649.	706.
		7616	ARTICLES OF ALUMINUM NESOI	1,642.	171.
		6911	CERAMIC TABLEWARE ETC. OF PORCELAIN OR CHINA	1,575.	134.
		8474	MACHINERY FOR SORTING SCREENING ETC MINERALS, PTS	1,563.	204.
		2920	ESTERS OF INORG ACIDS & SALTS, THEIR HALOG ETC DE	1,549.	571.
		8508	ELECTROMECHANICAL TOOLS, WORKING IN HAND, PARTS	1,509.	97.
		8523	PREPARED UNRECORDED MEDIA (NO FILM) FOR SOUND ETC	1,506.	107.
		3911	PETRO RESINS, POLYSULFIDES ETC NESOI, PRIMARY FOR	1,497.	464.
		2819	CHROMIUM OXIDES AND HYDROXIDES	1,469.	404.
		7229	WIRE OF ALLOY STEEL NESOI	1,462.	299.
		8425	PULLEY TACKLE & HOISTS (EXC SKIP), WINCH ETC, JAK	1,431.	479.

1993 U.S. IMPORTS TRANSSHIPPED VIA CANADA ABOVE \$200,000
 BY CUSTOMS DISTRICT BY DESCEND. VALUE IN \$1000'S ESTIM. WEIGHT IN METRIC TONS

CD#	CUSTOMS DISTRICT	CODE	HARMONIZED COMMODITY DESCRIPTION	\$1000S	EST. M.TONS
----	-----	----	-----	-----	-----
39	CHICAGO, ILL.	9023	INST, APPTS&MODELS, FOR DEMONSTRATIONAL USE& PARTS	1,426.	69.
		3407	MODELING PASTES FOR CHILD ETC, DENTA IMPR CP ETC	1,413.	112.
		9109	CLOCK MOVEMENTS, COMPLETE & ASSEMBLED	1,401.	31.
		8440	BOOKBINDING MACHINERY, INCL BOOK-SEWING, PARTS	1,400.	113.
		2820	MANGANESE OXIDES	1,376.	968.
		6810	ARTICLES OF CEMENT, CONCRETE OR ARTIFICIAL STONE	1,375.	1,577.
		2925	CARBOXYIMIDE-FUNCTION COMP, IMINE-FUNCTION COM ET	1,340.	192.
		1806	CHOCOLATE & OTHER FOOD PRODUCTS CONTAINING COCOA	1,334.	431.
		1509	OLIVE OIL & ITS FRACTIONS, NOT CHEMICALLY MODIFIED	1,313.	714.
		9006	PHOTOGRAPHIC STILL CAMERAS, FLASH APPARATUS ETC	1,271.	40.
		2941	ANTIBIOTICS	1,241.	208.
		2821	IRON OXIDES & HYDROXIDES, EARTH COLORS NUN 70% IR	1,232.	1,680.
		7314	CLOTH, GRILL ETC IR OR ST, EXPAND METAL, IR OR ST	1,226.	826.
		7221	BARS AND RODS, STNLS STL, HT-RLD, IRREG COILS	1,222.	658.
		2919	PHOSPHORIC ESTERS & SALTS, LACTOPHOSPHATES ETC.	1,214.	705.
		8453	MACHINERY FOR WORK LEATHER ETC & FOOTWEAR ETC, PT	1,213.	106.
		5702	CARPETS & OTH TEXT FLOOR COVER, WOVEN, NO TUFT ETC	1,202.	202.
		8531	ELECTRIC SOUND OR VISUAL SIGNALING APPARATUS, PTS	1,187.	53.
		3822	COMPOSITE DIAGNOSTIC/LAB REAGENTS, EXC PHARMACEUT	1,182.	110.
		5407	WOVEN FAB OF SYN FIL YN, INCL MONOFIL 67 DEC ETC	1,175.	90.
		8436	AGRI ETC & POULTRY ETC EQUIP, INC INCUBATORS, PTS	1,168.	270.
		7410	COPPER FOIL (BACKED OR NOT) NOV .15MM TH (EX BACK)	1,154.	177.
		7222	BARS & RODS, ST STEEL NESOI, ANGLES ETC, ST STEEL	1,152.	481.
		2101	EXTRACTS ETC OF COFFEE, TEA OR MATE, ROAST CHICORY	1,137.	193.
		9027	INST ETC FOR PHYSICAL ETC ANAL ETC, MICROTOME, PT	1,135.	16.
		7317	NAILS, TACKS, DRAWING PINS ETC OF IRON OR STEEL	1,131.	730.
		8309	STOPPERS, CAPS & LIDS, SEALS ETC & PTS, BASE METAL	1,125.	128.
		9207	MUSICAL INSTRUMENTS WITH SOUND ELECTRIC PROD ETC	1,120.	76.
		2712	PETROLEUM JELLY, MINERAL WAXES & SIMILAR PRODUCTS	1,115.	1,306.
		4407	WOOD SAWN OR CHIPPED LENGTH, SLICED ETC, OV6MM TH	1,107.	2,572.
		3903	POLYMERS OF STYRENE, IN PRIMARY FORMS	1,103.	736.
		3002	HUMAN BLOOD, ANIMAL BLOOD, ANTISERA, VACCINES ETC	1,098.	327.
		3404	ARTIFICIAL AND PREPARED WAXES	1,092.	375.
		7320	SPRINGS & LEAVES FOR SPRINGS, IRON OR STEEL	1,084.	139.
		6804	MILLSTONES ETC FOR GRINDING ETC, VARIOUS MATERIALS	1,077.	313.
		3707	PHOTOGRAPHIC CHEMICALS, UNMIXED PROD RETAIL PACKED	1,071.	196.
		9010	APPARATUS ETC FOR PHOTO LABS ETC NESOI, PARTS ETC	1,071.	40.
		6805	ABRASIVE POWDER ETC ON A BASE TEXT MATERIAL ETC	1,066.	132.
		3918	FLOOR COVER (ROLLS & TILES) & WALL COVER, PLASTIC	1,048.	142.
		4001	NATURAL RUBBER, BALATA, CHICLE ETC, PRIM FORM ETC	1,031.	1,180.
		9507	FISHING RODS & TACKLE, NETS, DECOYS ETC, PARTS ETC	1,021.	21.
		2836	CARBONATES, PEROXOCARBONATES, COMM AMM CARBONATE	1,019.	3,214.
		9202	STRING MUSICAL INSTRUMENTS NESOI (VIOLINS ETC.)	1,019.	92.
		3811	ANTI-KNOCK PREPS & OTHER ADDITIVES FOR MINERAL OIL	1,013.	438.
		6110	SWEATERS, PULLOVERS, VESTS ETC, KNIT OR CROCHETED	1,003.	26.
		8715	BABY CARRIAGES (INC STROLLERS) AND PARTS THEREOF	1,003.	128.
		9032	AUTOMATIC REGULATING OR CONTROL INSTRUMENTS, PART	992.	37.
		3208	PAINT & VARNISH FROM SYNTH ETC POLYMERS NONAQ, ETC	985.	289.

1993 U.S. IMPORTS TRANSSHIPPED VIA CANADA ABOVE \$200,000
 BY CUSTOMS DISTRICT BY DESCEND. VALUE IN \$1000'S ESTIM. WEIGHT IN METRIC TONS

CD#	CUSTOMS DISTRICT	CODE	HARMONIZED COMMODITY DESCRIPTION	\$1000S	EST. M.TONS
39	CHICAGO, ILL.	9015	SURVEY, HYDROGR, METEORO ETC INST, RANGEF ETC, PT	984.	46.
		3919	SELF-ADHESIVE PLATES, SHEETS, FILM ETC OF PLASTIC	963.	163.
		9105	CLOCKS, WITH CLOCK MVTS OTH THAN INST PANEL ETC	963.	68.
		8710	TANK & OT ARMORED FIGHT VEH, MOTORIZED, AND PARTS	958.	23.
		3810	PICKLING PREPS FOR METAL, SOLDERING ETC POWDER ET	945.	669.
		6913	STATUETTES AND OTHER ORNAMENTAL CERAMIC ARTICLES	943.	666.
		2907	PHENOLS, PHENOL-ALCOHOLS	933.	195.
		4421	ARTICLES OF WOOD, NESOI	927.	118.
		3502	ALBUMINS AND ALBUMIN DERIVATIVES	921.	219.
		8417	INDUSTRIAL OR LAB FURNACES & OVENS, NONELECT, PTS	911.	125.
		2007	JAMS, FRUIT JELLIES, MARMALADES ETC, COOKED	888.	901.
		2833	SULFATES, ALUMS, PEROXOSULFATES (PERSULFATES)	884.	1,168.
		1108	STARCHES, INULIN	882.	2,644.
		7505	NICKEL BARS, RODS, PROFILES AND WIRE	871.	80.
		3906	ACRYLIC POLYMERS IN PRIMARY FORMS	865.	347.
		8538	PARTS FOR ELEC APPAR ETC OF HEAD 8535, 8536 & 853	861.	24.
		9205	WIND MUSICAL INSTRUMENTS NESOI	846.	26.
		3005	BANDAGES ETC COATED ETC OR IN RETAIL MEDIC ETC FM	840.	328.
		7312	STRANDED WIRE, ROPES ETC, NO ELEC INS, IR OR STEEL	840.	420.
		3922	BATHS, WASHBASINS, LAVATORY SEATS ETC OF PLASTICS	839.	499.
		8712	BICYCLES & OTH CYCLES (INC DEL TRICYCLE) NO MOTOR	835.	157.
		7220	FL-RL STAINLESS STEEL PRODUCTS, UNDER 600MM WIDE	834.	287.
		8537	BOARDS, PANELS ETC WITH ELEC SWITCH APPAR ETC.	832.	30.
		7306	TUBES, PIPES & HOLLOW PROFILES NESOI, IRON & STEEL	827.	453.
		2826	FLUORIDES, FLUOROSILICATES, FLUOROALUMINATES ETC	818.	962.
		9021	ORTHOPEDIC APPL, ARTIF BODY PTS, HEAR AID, PTS ET	817.	75.
		713	LEGUMINOUS VEGETABLES, DRIED SHELLD	807.	672.
		3801	ARTIFICIAL GRAPHITE, COLLODIAL GRAPHITE & PREP ETC	800.	217.
		8311	WIRE, RODS ETC FOR SOLDERING ETC & MET SPRAY, BMPT	797.	213.
		7007	SAFETY GLASS, OF TEMPERED OR LAMINATED GLASS	796.	242.
		8426	DERRICKS, CRANES, MOBILE LIFTING FRAMES ETC	786.	125.
		3816	REFRACTORY CEMENTS, MORTARS, CONCRETES, ETC. NESO	785.	1,263.
		2912	ALDEHYDES, ITS CYCLIC POLYMERS, PARAFORMALDEHYDE	777.	250.
		7308	STRUCTURES NESOI & PARTS THEREOF, OF IRON OR STEEL	769.	194.
		2926	NITRILE-FUNCTION COMPOUNDS	765.	455.
		8604	RAILWAY OR TRAMWAY MAINTENANCE OR SERVICE VEHICLES	765.	23.
		8416	FURNACE BURNERS, MECHANICAL STOKERS ETC, PARTS	761.	38.
		8420	CALENDERING MACHINES ETC NESOI & CYLINDERS, PARTS	760.	103.
		8532	ELECTRIC CAPACITORS, FIXED, VAR OR ADJ (PRESET) P	760.	134.
		2903	HALOGENATED DERIVATIVES OF HYDROCARBONS	752.	319.
		2830	SULFIDES, POLYSULFIDES	748.	370.
		8525	TRANS APPAR FOR RADIOTELEPHONY ETC, TV CAMERAS	746.	16.
		6807	ARTICLES OF ASPHALT OR OF SIMILAR MATERIAL	744.	1,269.
		1006	RICE	737.	818.
		8305	LOOSELEAF BINDER ETC FITTINGS, PAPER CLIPS ETC BMP	735.	314.
		7205	PIG IRON, SPIEGEL, IRON OR STEEL GRANULES & POWDER	730.	220.
		5602	FELT, IMPREGNATED, COATED, ETC. OR NOT	720.	50.
		3401	SOAP, ORGANIC SURF-ACT PREP FOR SOAP USE, BARS ETC	713.	202.

1993 U.S. IMPORTS TRANSSHIPPED VIA CANADA ABOVE \$200,000
 BY CUSTOMS DISTRICT BY DESCEND. VALUE IN \$1000'S ESTIM. WEIGHT IN METRIC TONS

CD#	CUSTOMS DISTRICT	CODE	HARMONIZED COMMODITY DESCRIPTION	\$1000S	EST. M.TONS
39	CHICAGO, ILL.	3405	POLISHES & CREAMS FOR LEATHER, WOOD ETC, SCOUR PRP	687.	126.
		8451	MACHINERY (NOT LAUNDRY) FOR CLEANING, DRYING ETC	683.	41.
		2839	SILICATES, COMMERCIAL ALKALI METAL SILICATES	681.	1,364.
		1301	LAC/SHELLAC/STICK LAC/SEED LAC/BUTTON LAC/OTHR LAC	678.	460.
		4109	PATENT & PATENT LAMINATED LEATHER, METALLZD LEATHR	678.	18.
		9505	FESTIVE, CARNIVAL OR OTHER ENTERTAINMENT ART, PTS	677.	60.
		7118	COIN	673.	62.
		3701	PHOTO PLATES & FILM, FLAT, SENSITIZED, UNEXPOSED	664.	45.
		909	SEEDS, ANISE, BADIAN, FENNEL, CORIANDER, CUMIN ETC	663.	490.
		3821	PREPARED CULTURE MEDIA FOR DEVEL OF MICROORGANISM	656.	116.
		3215	INK, PRINTING, WRITING, DRAWING ETC, CONCEN OR NO	651.	73.
		2832	SULFITES, THIOSULFATES	639.	1,604.
		7602	ALUMINUM WASTE AND SCRAP	634.	794.
		3902	POLYMERS OF PROPYLENE OR OTHER OLEFINS, PRIM FORMS	632.	371.
		8450	WASHING MACHINES, HOUSEHOLD- OR LAUNDRY-TYPE, PTS	629.	101.
		5112	WOVEN FABRICS OF COMBED WOOL OR FINE ANIMAL HAIR	628.	14.
		904	PEPPER, GENUS PIPER, GENUS CAPSICUM OR PIMENTA	620.	390.
		3703	PHOTO PAPER, PAPERBOARD & TEXTILES, SENS, UNEXPOS	613.	115.
		7404	COPPER WASTE AND SCRAP	608.	356.
		7419	ARTICLES OF COPPER NESOI	605.	58.
		7324	SANITARY WARE & PARTS, IRON OR STEEL	601.	78.
		8524	RECORDS, TAPES & OTHER RECORDED SOUND MEDIA ETC	601.	19.
		9029	REVOLUTION & PRODUCTION COUNT, TAXIMETERS ETC, PT	592.	39.
		6302	BED LINEN, TABLE LINEN, TOILET LINEN & KITCH LINEN	589.	69.
		9206	PERCUSSION MUSICAL INSTRUMENTS DRUMS ETC.)	569.	42.
		7005	FLOAT GLASS & SURF GROUND OR POLISHED SHEETS ETC	568.	424.
		9502	DOLLS, REPRESENTING ONLY HUMAN BEINGS, & PARTS ETC	564.	74.
		7321	STOVES, RANGES ETC, NONEL DOMEST & PTS, IR & STEE	554.	109.
		8546	ELECTRICAL INSULATORS OF ANY MATERIAL	554.	96.
		7310	TANKS ETC, NOV 300 LITER CAPACITY, IRON OR STEEL	553.	179.
		4821	LABELS OF PAPER OR PAPERBOARD, PRINTED OR NOT	549.	92.
		8429	SELF-PROPELLED BULLDOZERS, GRADERS, SCRAPERS ETC	548.	99.
		3302	ODORIFEROUS MIXTURES AS RAW MATERIALS FOR INDUSTRY	543.	109.
		5911	TEXTILE PRODUCTS ETC. FOR SPECIFIC TECH USES NESOI	542.	19.
		8522	PARTS & ACCESS OF RECORD PLAY, MAG TAPE RECORD ET	542.	41.
		4201	LEATHER ART, SADDLERY ETC, HANDBAGS ETC, GUT ART	536.	39.
		3307	PERSONAL TOILET ETC PREP NESOI, SHAVING, BATH ETC.	530.	102.
		8535	ELECTRICAL APPARATUS FOR SWITCHING ETC, OV 1000 V	528.	32.
		8517	ELECTRIC APPARATUS FOR LINE TELEPHONY ETC, PARTS	525.	34.
		9406	PREFABRICATED BUILDINGS	516.	188.
		9017	DRAWING, MATH, MEASURING INST ETC NESOI, PARTS	509.	30.
		3914	ION-EXCHANGERS BASD ON PLASTICS, IN PRIMARY FORMS	508.	203.
		8307	FLEXIBLE TUBING OF BASE METAL	499.	38.
		7506	NICKLE PLATES, SHEETS, STRIP AND FOIL	480.	41.
		2009	FRUIT JUICES (& GRAPE MUST) & VEG JUICE, NO SPIRIT	472.	434.
		4819	CARTONS ETC PAPER, OFFICE BOX FILES ETC, PAPER ET	472.	179.
		3105	M OR CH FERTILIZ, NUN2OF3EL, FERT NESOI, FERT PACK	466.	807.
		9028	GAS, LIQUID OR ELECTRIC SUPPLY ETC METERS, PARTS	464.	8.

1993 U.S. IMPORTS TRANSSHIPPED VIA CANADA ABOVE \$200,000
 BY CUSTOMS DISTRICT BY DESCEND. VALUE IN \$1000'S ESTIM. WEIGHT IN METRIC TONS

CD#	CUSTOMS DISTRICT	CODE	HARMONIZED COMMODITY DESCRIPTION	\$1000S	EST. M.TONS
39	CHICAGO, ILL.	7214	BARS & RODS, IRON & NA STEEL NESOI, H-R ETC	459.	897.
		9001	OPT FIBERS & BUND ETC, POL SHEETS, UNMOUN OPT ELEM	459.	5.
		9612	TYPEWRITER ETC RIBBONS, INKED OR PREP, INK PADS	458.	38.
		2102	YEASTS, DEAD SING-CELL MICRO-ORG NESOI, BAK POWDER	456.	262.
		2932	HETEROCYCLIC COMPOUNDS, OXYGEN HETERO-ATOM(S) ONL	456.	112.
		4415	PACKING CASES ETC OF WOOD, PALLETS ETC OF WOOD	444.	234.
		2707	OILS ETC FROM HIGH TEMP COAL TAR, SIM AROMATIC ETC	441.	905.
		4904	MUSIC, PRINTED OR IN MANUSCRIPT, BOUND ETC OR NOT	437.	31.
		8203	FILES, RASPS, PLIERS, METALCUT SHEARS ETC, B MT PT	433.	35.
		8476	AUTOMATIC GOODS-VENDING MACHINES, PARTS	433.	14.
		5607	TWINE, CORDAGE, ROPE & CABLES, COATED ETC OR NOT	432.	73.
		8403	CENTRAL HEAT BOILERS NESOI, AND PARTS	431.	133.
		6803	SLATE, WORKED AND ARTICLES, ARTICLS OF AGGLOM SLT	421.	583.
		1209	SEEDS, FRUIT AND SPORES, FOR SOWING	419.	202.
		8540	THERMIONIC, COLD CATHODE OR PHOTOCATHODE TUBES, P	419.	24.
		4909	PRINTED OR ILLUSTRATED POST CARDS, GREETING CARDS, ETC.	410.	51.
		4003	RECLAIM RUB IN PRIMARY FORM/PLATES, SHEETS/STRIP	399.	946.
		905	VANILLA BEANS	398.	6.
		4704	CHEMICAL WOODPULP, SULFITE, NOT DISSOLVING GRADES	398.	365.
		4804	KRAFT PAPER & PAPERBOARD, UNCOAT NESOI, ROLLS ETC	398.	321.
		8304	OFFICE AND DESK EQUIP A PRTS, OF BASE METAL	395.	231.
		2104	SOUPS, BROTHS & PREPS, HOMOGENIZED COMP FOOD PREPS	392.	112.
		1902	PASTA, PREPARED OR NOT, COUSCOUS, PREPARED OR NOT	388.	375.
		2842	SALTS OF INORGANIC ACIDS OR PEROXOACIDS NESOI	388.	216.
		2103	SAUCES & PREP, MIXED CONDIMENTS, MUSTARD FLOUR ETC	383.	242.
		8502	ELECTRIC GENERATING SETS AND ROTARY CONVERTERS	378.	28.
		5903	TEXTILE FABRICS (NOT TIRE CORD) COAT ETC, PLASTICS	376.	69.
		6307	MADE-UP ARTICLES OF TEXTILE MATERIALS NESOI	374.	108.
		4903	CHILDREN'S PICTURE, DRAWING OR COLORING BOOKS	372.	93.
		9306	BOMBS, GRENADES ETC, CARTRIDGES ETC AND PARTS	355.	120.
		8475	MACHINES FOR ASSEMB ELEC TUBES ETC & GLASS MFR, P	352.	24.
		8547	INSULATING FITTINGS FOR ASSEMBLY NESOI	352.	17.
		7117	IMITATION JEWELRY	350.	28.
		7019	GLASS FIBERS & ARTICLES THEREOF (YARN ETC.)	349.	98.
		5601	TEXT WADDING & ARTICLES, TEXT FIBERS NOV 5 MM, ETC	347.	43.
		8442	MACH ETC NESOI FOR TYPESET, MAKING PR PLATES ETC	347.	21.
		9615	COMBS, HAIR-SLIDES ETC, HAIRPINS, CURLING PINS ET	345.	51.
		3812	PREPARED RUBBER ACCELERATORS, COM PLASTICIZERS ET	342.	74.
		4820	REGISTERS, NOTEBOOKS, BINDERS, BUS FORMS ETC, PAP	341.	146.
		3209	PAINT & VARNISH FROM SYNTH ETC POLYMERS AQUEOUS MD	338.	128.
		2850	HYDRIDES, NITRIDES, AZIDES, SILICIDES & BORIDES	333.	90.
		3306	PREPARATIONS FOR ORAL OR DENTAL HYGIENE	330.	134.
		8713	INVALID CARRIAGES, MECHANICALLY PROPELLED OR NOT	327.	62.
		1109	WHEAT GLUTEN, WHETHER OR NOT DRIED	326.	298.
		8201	HANDTOOLS & TOOLS USED IN AGRICULT ETC, B MET PTS	325.	75.
		3303	PERFUMES AND TOILET WATERS	322.	24.
		7612	ALUMINUM CASKS, CANS ETC NOV 300 LITER CAPACITY	320.	33.
		2851	INORGANIC COMPOUNDS NESOI, LIQ AIR, AMALGAMS NESOI	314.	121.

1993 U.S. IMPORTS TRANSSHIPPED VIA CANADA ABOVE \$200,000
 BY CUSTOMS DISTRICT BY DESCEND. VALUE IN \$1000'S ESTIM. WEIGHT IN METRIC TONS

CD#	CUSTOMS DISTRICT	CODE	HARMONIZED COMMODITY DESCRIPTION	\$1000S	EST. M.TONS
39	CHICAGO, ILL.	7907	ARTICLES OF ZINC NESOI	314.	79.
		9618	TAILORS' DUMMIES & OTHR MANNEQUINS FOR DISPLAY	313.	21.
		8530	ELECTRIC SIGNAL, SAFETY OR TRAFFIC CONTROL EQUIP	312.	19.
		2935	SULFONAMIDES	308.	25.
		4005	COMPOUNDED RUBBER, UNVULCANISED, PRIMARY FORMS ETC	306.	457.
		7009	GLASS MIRRORS, FRAMED OR NOT, INC REARVIEW MIRRORS	303.	1,480.
		4809	PAPER, CARBON, SELF-COPY ETC, ROLLS ETC OV 36 CM W	302.	190.
		4008	PLATES, SHEETS, PROFILE SHAPES ETC, SOFT VULC RUBR	301.	50.
		7004	DRAWN & BLOWN GLASS, IN SHEETS ETC	298.	268.
		7014	SIGNAL GLASSWARE & GLASS OPTIC ELEM NESOI NOT WRK	298.	7.
		2008	FRUIT, NUTS ETC PREPARED OR PRESERVED NESOI	296.	226.
		3702	PHOTO FILM IN ROLLS SENSITIZED, UNEXPOSED	294.	13.
		6303	CURTAINS & INTERIOR BLINDS, CURTAIN & BED VALANCES	290.	28.
		7615	HOUSEHOLD ART ETC, POT SCOUR ETC, SAN WR, ALUMINUM	289.	39.
		1212	LOCUST BEANS, SEAWEED, S BEET & CANE, FR PITS ETC.	283.	251.
		2827	CHLORIDES ETC, BROMIDES ETC, IODIDES ETC.	283.	290.
		8706	CHAS W ENG F TRAC, MTR VEH F PASS/GD & SPECIAL PUR	283.	59.
		4818	TOILET PAPER, PAPER TISSUES, TOWELS, NAPKINS ETC	281.	41.
		2001	VEG, FRUIT, NUTS ETC, PREP OR PRES BY VINEGAR ETC	280.	260.
		8541	SEMICONDUCTOR DEVICES, LIGHT-EMIT DIODES ETC, PTS	280.	11.
		9114	CLOCK OR WATCH PARTS, NESOI	279.	12.
		8468	MACHINES, SOLDER ETC, GAS SURF TEMPER MACHINES, P	278.	19.
		8520	MAGNETIC TAPE & OTHER SOUND RECORDERS	278.	6.
		3817	MIXED ALKYL BENZENES & MIXED ALKYL NAPHTHALENE NESO	276.	416.
		3820	ANTIFREEZING PREP & PREPARED DEICING FLUIDS	275.	160.
		5904	LINOLEUM, FLOOR COVER WITH COAT ETC ON A TEXT BASE	274.	110.
		9201	PIANOS, HARPSICHORDS & OTHER KEYBOARD STRING INSTR	274.	12.
		406	CHEESE AND CURD	272.	75.
		8215	TABLEWARE ETC OF BASE METAL, & BASE METAL PARTS	269.	35.
		1702	SUGARS NESOI, INCL CHEM PURE LACTOSE ETC, CARAMEL	268.	630.
		5211	WOVEN COTTON FABRICS, UN85% COT, MMFMIX, OV200G/M2	267.	28.
		2823	TITANIUM OXIDES	266.	170.
		6406	PARTS OF FOOTWEAR, INSOLES ETC, GAITORS ETC, PARTS	266.	21.
		3203	COLORING MATTER OF VEGETABLE OR ANIMAL ORIGIN	261.	57.
		4902	NEWSPAPERS, JOURNALS & PERIODICALS	261.	100.
		9404	MATTRESS SUPPORTS, ARTICLES OF BEDDING ETC.	256.	177.
		7414	CLOTH, GRILL & NET OF COPPER WIRE, EXPAND COP MET	254.	21.
		2202	WATERS, SWEETENED ETC & OTH NONALC BEVERAGES NESOI	247.	452.
		2822	COBALT OXIDE & HYDROXIDE, COMMERCIAL COBALT OXIDES	243.	7.
		604	FOLIAGE, GRASSES ETC FOR BOUQUETS ETC, PREPARED	240.	77.
		910	GINGER, SAFFRON, TUMERIC, THYME, BAY LEAVES ETC.	237.	188.
		7020	ARTICLES OF GLASS, NESOI	235.	30.
		7804	LEAD PLATES, SHEETS, STRIP, FOIL, POWDER & FLAKES	234.	228.
		7216	ANGLES, SHAPES & SECTIONS OF IRON & NONALLOY STEE	233.	384.
		6404	FOOTWEAR, OUTER SOLE RUB, PLAST OR LEA & UPPER TEX	229.	23.
		902	TEA	227.	63.
		6806	MINERAL WOOLS, EXPANDED MINERAL MATERIAL & MIXTURE	227.	124.
		8411	TURBOJETS, TURBOPROPELLERS & OTH GAS TURBINES, PTS	221.	8.

1993 U.S. IMPORTS TRANSSHIPPED VIA CANADA ABOVE \$200,000
 BY CUSTOMS DISTRICT BY DESCEND. VALUE IN \$1000'S ESTIM. WEIGHT IN METRIC TONS

CD#	CUSTOMS DISTRICT	CODE	HARMONIZED COMMODITY DESCRIPTION	\$1000S	EST. M.TONS
39	CHICAGO, ILL.	3304	BEAUTY, MAKE-UP & SKIN-CARE PREP, MANICURE ETC PRP	219.	20.
		3925	BUILDERS'' WARE OF PLASTICS, NESOI	217.	80.
		5208	WOVEN COTTON FABRICS, NU 85% COT, WT NOV 200 G/M2	217.	16.
		3904	POLYMERS OF VINYL CHLORIDE ETC., IN PRIMARY FORMS	216.	74.
		1518	ANML/VEG FATS & OILS CHEM MODIFIED, INEDBL MXT ETC	213.	276.
		7309	TANKS ETC, OVER 300 LITER CAPACITY, IRON OR STEEL	211.	37.
		1903	TAPIOCA AND SUBSTITUTES FROM STARCH IN FLAKES, ETC	209.	238.
		4205	ARTICLES OF LEATHER, NESOI	209.	49.
		8211	KNIVES WITH BLADES & BLADES FOR KNIVES NESOI, BMP	209.	19.
		8534	PRINTED CIRCUITS	207.	6.
		1211	PLANTS ETC FOR PHARMACY, PERFUME, INSECTICIDES ETC	202.	105.
		6914	CERAMIC ARTICLES NESOI	201.	61.
		9999	BELOW MINIMUM	17,853.	18,568.
			*SUB-TOTAL CUSTOMS DIST. # 39	2,005,675.	596,213.
41	CLEVELAND, OHIO	8708	PARTS & ACCESS FOR MOTOR VEHICLES (HEAD 8701-8705)	59,534.	15,551.
		8483	TRANSMISSION SHAFTS, BEARINGS, GEARS ETC, PARTS	19,144.	1,974.
		8477	MACHINERY FOR WORKING RUBBER & PLAST ETC NESOI, P	14,410.	951.
		8482	BALL OR ROLLER BEARINGS AND PARTS	13,909.	1,280.
		3823	BINDERS FOR FOUND MOLDS, CHEMICAL PROD ETC NESOI	12,934.	5,269.
		7502	NICKLE, UNWROUGHT	9,383.	2,079.
		8539	ELECTRIC FILAMENT OR DISCHARGE LAMPS, PARTS	8,393.	606.
		8413	PUMPS FOR LIQUIDS, LIQUID ELEVATORS, PARTS THEREO	8,284.	395.
		3204	SYN ORG COLORING MATTER & PREP, SYN ORG BRIT AGENT	8,093.	744.
		3501	CASEIN, CASEINATES AND OTHER CASEIN DERIVATIVES	7,712.	1,812.
		4011	NEW PNEUMATIC TIRES, OF RUBBER	7,477.	2,790.
		2825	HYDRAZINE ETC, OTH INORG BASES, METAL OXIDES ETC	7,415.	637.
		8105	COBALT MATTES ETC, COBALT & ART, INC WASTE & SCRAP	6,134.	282.
		8412	ENGINES AND MOTORS NESOI, AND PARTS THEREOF	5,816.	354.
		8481	TAPS, COCKS, VALVES ETC FOR PIPES, TANKS ETC, PTS	5,526.	781.
		8302	HARDWARE, FIXTURES, CASTORS ETC & PARTS, BASE METL	5,497.	843.
		2934	HETEROCYCLIC COMPOUNDS NESOI	5,300.	31.
		3206	COLORING MATTER NESOI, COLORING PREP NESOI, ETC.	5,031.	3,038.
		8431	PARTS FOR MACHINERY OF HEADINGS 8425 TO 8430	4,960.	1,026.
		8503	PARTS OF ELECTRIC MOTORS, GENERATORS & SETS	4,214.	428.
		7409	COPPER PLATES, SHEETS & STRIP, OVER 0.15MM THICK	4,106.	1,347.
		8409	PARTS FOR ENGINES OF HEADING 8407 OR 8408	4,023.	572.
		2818	ALUMINUM OXIDE (INCL ART CORUNDUM), ALUM HYDROXIDE	4,002.	4,892.
		8439	MACHINERY FOR MAKING PULP & MAKING ETC PAPER, PTS	3,899.	398.
		4002	SYNTH RUBBER & FACTICE, INC NAT-SYN MIX, PR FM ETC	3,815.	2,390.
		2821	IRON OXIDES & HYDROXIDES, EARTH COLORS NUN 70% IR	3,780.	2,597.
		7606	ALUMINUM PLATES, SHEETS & STRIP OVER .2MM THICK	3,778.	1,441.
		7202	FERROALLOYS	3,760.	3,060.
		7315	CHAIN & PARTS, OF IRON OR STEEL	3,416.	582.
		6805	ABRASIVE POWDER ETC ON A BASE TEXT MATERIAL ETC	3,240.	399.
		8414	AIR OR VAC PUMPS, COMPR & FANS, HOODS & FANS, PTS	3,228.	332.
		3208	PAINT & VARNISH FROM SYNTH ETC POLYMERS NONAQ, ETC	3,048.	757.

1993 U.S. IMPORTS TRANSSHIPPED VIA CANADA ABOVE \$200,000
 BY CUSTOMS DISTRICT BY DESCEND. VALUE IN \$1000'S ESTIM. WEIGHT IN METRIC TONS

CD#	CUSTOMS DISTRICT	CODE	HARMONIZED COMMODITY DESCRIPTION	\$1000S	EST. M.TONS
41	CLEVELAND, OHIO	2839	SILICATES, COMMERCIAL ALKALI METAL SILICATES	3,010.	1,646.
		2849	CARBIDES	2,990.	2,015.
		8419	MACHINERY ETC FOR TEMP CHANG TREAT MAT, W HEAT, P	2,977.	302.
		3909	AMINO-RESINS, PHENOLICS & POLYURETHANES, PRIM FORM	2,947.	703.
		8711	MOTORCYCLES (INCL MOPEDS) & CYCLES WITH AUX MOTOR	2,849.	129.
		4814	WALLPAPER ETC., WINDOW TRANSPARENCIES OF PAPER	2,637.	569.
		8433	HARVEST ETC MACHINES, CLEANING EGGS ETC NESOI, PT	2,631.	693.
		8511	ELECTRIC IGNITION ETC EQUIP, GENERATORS, PARTS	2,526.	177.
		4901	BOOKS, BROCHURES & SIMILAR PRINTED MATTER	2,522.	409.
		8479	MACHINES ETC HAVING INDIVIDUAL FUNCTIONS NESOI, P	2,399.	199.
		3908	POLYAMIDES IN PRIMARY FORMS	2,372.	684.
		3903	POLYMERS OF STYRENE, IN PRIMARY FORMS	2,319.	962.
		2930	ORGANO-SULFUR COMPOUNDS	2,298.	631.
		7607	ALUMINUM FOIL (BACK OR NOT) NOV .2MM TH (EX BACK)	2,277.	805.
		2204	WINE OF FRESH GRAPES, GRAPE MUST NESOI	2,184.	948.
		7010	GLASS CONTAINERS FOR PACKING ETC & GLASS CLOSURES	2,090.	919.
		2613	MOLYBDENUM ORES AND CONCENTRATES	2,074.	3,579.
		7326	ARTICLES OF IRON OR STEEL, NESOI	2,069.	652.
		3923	CONTAINERS (BOXES, BAGS ETC), CLOSURERS ETC, PLAS	2,066.	243.
		7217	WIRE OF IRON & NONALLOY STEEL	2,061.	1,947.
		3506	PREPARED GLUES & ADHESIVES NESOI, GLUE RETAIL PACK	2,037.	1,020.
		8461	MACHINE TOOLS FOR SHAPING, SLOTTING, GEAR CUT ETC	2,031.	237.
		9014	DIRECTION FINDING COMPASSES & NAVIG INST ETC, PTS	2,026.	67.
		4015	ART OF APPAREL & ACCESS OF UNHARD VULCANIZED RUBB	1,981.	508.
		8608	RAILWAY FIXTURES, MECH SIGNALING, SAFETY, ETC, EQ	1,898.	102.
		7219	FL-RL STAINLESS STEEL PRODUCTS, NOT UND 600MM WID	1,892.	1,032.
		2819	CHROMIUM OXIDES AND HYDROXIDES	1,877.	433.
		9009	PHOTOCOPY APPARATUS & THERMOCOPY APPARATUS, PTS	1,863.	112.
		3811	ANTIKNOCK PREPS & OTHER ADDITIVES FOR MINERAL OIL	1,856.	1,103.
		2841	SALTS OF OXOMETALLIC OR PEROXOMETALLIC ACIDS	1,783.	1,312.
		2907	PHENOLS, PHENOL-ALCOHOLS	1,739.	342.
		8421	CENTRIFUGES, FILTER ETC MACH FOR LIQ OR GASES, PT	1,737.	115.
		8102	MOLYBDENUM & ARTICLES THEREOF, INCL WASTE & SCRAP	1,729.	87.
		8501	ELECTRIC MOTORS AND GENERATORS (NO SETS)	1,719.	72.
		7318	SCREWS, BOLTS, NUTS, WASHERS ETC, IRON OR STEEL	1,699.	499.
		9019	MECH-THER, MASSAGE, PSYCH TEST, OZONE APP ETC, PT	1,683.	120.
		6903	REFRACTORY CERAMIC GOODS, RETORTS, TUBES ETC NESOI	1,625.	352.
		8432	AGRICULT ETC MACH FOR SOIL ETC, LAWN ROLLERS, PTS	1,619.	388.
		8208	KNIVES & BLADES FOR MACHINES & APPLIANCES, B MT PT	1,593.	206.
		8519	TURNTABLES, RECORD & CASSETTE PLAYERS ETC.	1,583.	69.
		3926	ARTICLES OF PLASTICS (INC POLYMERS & RESINS) NESO	1,566.	173.
		7314	CLOTH, GRILL ETC IR OR ST, EXPAND METAL, IR OR ST	1,535.	740.
		7211	FL-RL IRON & NA STEEL UN 600MM WD, NOT CLAD ETC	1,457.	1,191.
		8527	RECEPTION APPARATUS FOR RADIOTELEPHONY ETC	1,443.	22.
		8001	TIN, UNWROUGHT	1,417.	573.
		2827	CHLORIDES ETC, BROMIDES ETC, IODIDES ETC.	1,404.	1,996.
		9404	MATTRESS SUPPORTS, ARTICLES OF BEDDING ETC.	1,391.	144.
		2803	CARBON, NESOI (INCLUDING CARBON BLACK)	1,374.	686.

1993 U.S. IMPORTS TRANSSHIPPED VIA CANADA ABOVE \$200,000
 BY CUSTOMS DISTRICT BY DESCEND. VALUE IN \$1000'S ESTIM. WEIGHT IN METRIC TONS

CD#	CUSTOMS DISTRICT	CODE	HARMONIZED COMMODITY DESCRIPTION	\$1000S	EST. M.TONS
41	CLEVELAND, OHIO	9402	MEDICAL, SURGICAL, DENTAL OR VETERINARY FURN ETC	1,349.	127.
		8417	INDUSTRIAL OR LAB FURNACES & OVENS, NONELECT, PTS	1,345.	150.
		7007	SAFETY GLASS, OF TEMPERED OR LAMINATED GLASS	1,327.	197.
		8443	PRINTING MACHINERY, MACHINES ANCIL TO PRINTING, P	1,310.	102.
		8485	MACHINERY PTS, NO ELECT CONNECTORS ETC NESOI	1,310.	92.
		7308	STRUCTURES NESOI & PARTS THEREOF, OF IRON OR STEEL	1,283.	595.
		7407	COPPER BARS, RODS AND PROFILES	1,262.	529.
		8104	MAGNESIUM & ARTICLES THEREOF, INCL WASTE & SCRAP	1,237.	615.
		3919	SELF-ADHESIVE PLATES, SHEETS, FILM ETC OF PLASTIC	1,219.	118.
		6902	REFRACTORY BRICKS & OTHER REFR CER CONST ART NESOI	1,219.	1,018.
		3907	POLYETHERS, EXPOXIDES & POLYESTERS, PRIMARY FORMS	1,214.	540.
		8515	ELECTRIC, LASER OR OTH LIGHT OR PHOTON BEAM ETC	1,193.	109.
		2917	POLYCARBOXYLIC ACIDS & ANHYD ETC, HALOG, SULF ETC	1,187.	305.
		3901	POLYMERS OF ETHYLENE, IN PRIMARY FORMS	1,158.	819.
		4810	PAPER & PAPERBOARD, COATED WITH KAOLIN ETC, RL ET	1,144.	1,306.
		8504	ELECTRIC TRANSFORM, STATIC CONVERTERS & INDUCT, PT	1,139.	53.
		4408	VENEER SHEETS ETC, NOT OVER 6 MM THICK	1,125.	261.
		3214	GLAZIERS PUTTY, RESIN CEMENTS, CAULKING COMPS ETC	1,087.	176.
		2519	MAGNESITE, FUSED MAGNESIA, D-B MAGN, M OXIDE NESOI	1,085.	2,441.
		2811	INORGANIC ACIDS & INORGANIC OXY NONMET COMP NESOI	1,049.	698.
		3505	DEXTRINS ETC, GLUES BASED ON STARCHES, DEXTRIN ETC	1,047.	1,220.
		7405	MASTER ALLOYS OF COPPER	998.	742.
		2850	HYDRIDES, NITRIDES, AZIDES, SILICIDES & BORIDES	971.	110.
		2208	ETHYL ALCOHOL, UNDENAT, UNDB0% ALC, SPIRIT BEV ETC	950.	476.
		2933	HETEROCYCLIC COMP, NIT HETERO-ATOM, NUCLEIC ACIDS	947.	60.
		8428	LIFTING, HANDLING, LOADING & UNLOAD MACHINES NESO	942.	200.
		8538	PARTS FOR ELEC APPAR ETC OF HEAD 8535, 8536 & 853	936.	26.
		6204	WOMEN'S OR GIRLS' SUITS, ENSEMB ETC, NOT KNIT ET	900.	27.
		6912	CERAMIC TABLEWRE, KITCHNWRE ETC, EARTHENWARE ETC	899.	302.
		8471	AUTOMATIC DATA PROCESS MACHINES, MAGN READER ETC	899.	20.
		9031	MACHINES, NESOI IN CHAPTER 90, PROFILE PROJECT, P	898.	22.
		8422	MACHINES, DISHWASH, CLEAN ETC CONT & FILL, PAK ET	862.	36.
		5806	NARROW WOVEN FABRICS EXCEPT LABELS ETC IN PC ETC	846.	53.
		3920	PLATES, SHEETS, FILM ETC NO AD, NON-CEL ETC, PLAS	840.	215.
		7404	COPPER WASTE AND SCRAP	838.	946.
		8607	PARTS OF RAILWAY OR TRAMWAY LOCOMOTIVES OR R STOCK	833.	122.
		504	ANIMAL (NOT FISH) GUTS, BLADDERS, STOMACHS & PARTS	826.	188.
		2915	SAT ACYCLIC NONOCARBOX ACID & ANHYD, HALOGON ETC	823.	446.
		2918	CARBOXYLIC ACID, ADDED OXYGEN & ANHY ETC, HAL ETC	816.	485.
		1901	MALT EXT, FOOD PREP OF FLOUR ETC UN 50% COCOA ETC	806.	702.
		6907	UNGLAZED CERAMIC FLAGS & PAVING, HEARTH TILES ETC	800.	1,095.
		3905	POLYMERS OF VINYL ACETATE & OTH VINYL POLYM, PR FM	785.	305.
		8505	ELECTROMAGNETS, PERMANENT MAGNETS ETC & PARTS	785.	67.
		8441	MACH FOR MAKING UP PULP & PAPER, INC CUTTERS, PTS	783.	74.
		2826	FLUORIDES, FLUOROSILICATES, FLUOROALUMINATES ETC	768.	718.
		9018	MEDICAL, SURGICAL, DENTAL OR VET INST, NO ELEC, P	752.	72.
		9405	LAMPS & LIGHTING FITTINGS & PARTS ETC NESOI	742.	66.
		7320	SPRINGS & LEAVES FOR SPRINGS, IRON OR STEEL	740.	100.

1993 U.S. IMPORTS TRANSSHIPPED VIA CANADA ABOVE \$200,000
 BY CUSTOMS DISTRICT BY DESCEND. VALUE IN \$1000'S ESTIM. WEIGHT IN METRIC TONS

CD#	CUSTOMS DISTRICT	CODE	HARMONIZED COMMODITY DESCRIPTION	\$1000S	EST. M. TONS
----	-----	----	-----	-----	-----
41	CLEVELAND, OHIO	7013	GLASSWARE FOR TABLE, KITCHEN, TOILET ETC USE NESOI	727.	235.
		7601	ALUMINUM, UNWROUGHT	718.	530.
		7212	FL-RL IRON & NA STEEL UN 600MM WD, CLAD ETC	717.	522.
		3912	CELLULOSE AND CHEMICAL DERIV NESOI, PRIMARY FORMS	708.	346.
		2823	TITANIUM OXIDES	706.	501.
		3810	PICKLING PREPS FOR METAL, SOLDERING ETC POWDER ET	698.	288.
		4004	WASTE OF RUB, EXC HD RUB, & POWDER OBTAIN THEREOF	697.	1,380.
		8466	PARTS ETC FOR MACHINE TOOLS OF HEAD 8456 TO 8465	692.	89.
		9504	ARTICLES FOR ARCADE, TABLE OR PARLOR GAMES, PARTS	685.	104.
		3407	MODELING PASTES FOR CHILD ETC, DENTA IMPR CP ETC	680.	66.
		2835	PHOSPHINATES, PHOSPHONATES, PHOSPHATES & POLYPHOSP	679.	1,129.
		8103	TANTALUM & ARTICLES THEREOF, INCLUD WASTE & SCRAP	677.	41.
		2921	AMINE-FUNCTION COMPOUNDS	655.	320.
		9403	FURNITURE NESOI AND PARTS THEREOF	650.	249.
		2833	SULFATES, ALUMS, PEROXOSULFATES (PERSULFATES)	648.	1,341.
		7225	FL-RL ALLOY STEEL NESOI NUN 600MM WIDE	644.	1,002.
		8716	TRAILERS ETC, OTHER VEHICLES, NOT MECH PROPELD, P	643.	343.
		7411	COPPER TUBES AND PIPES	639.	198.
		8516	ELEC WATER, SPACE & SOIL HEATERS, HAIR ETC DRY, P	633.	79.
		4101	RAW HIDES & SKINS OF BOVINE OR EQUINE ANIMALS	629.	310.
		8462	MACHINE TOOLS FOR FORGING, BENDING, STAMPING ETC	623.	129.
		8438	MACH NESOI, IND PREP OF FOOD OR DRINK ETC, PARTS	615.	19.
		1209	SEEDS, FRUIT AND SPORES, FOR SOWING	604.	454.
		9026	INST ETC MEASURE OR CHECK FLOW, LEVEL ETC, PTS ET	595.	22.
		2922	OXYGEN-FUNCTION AMINO-COMPOUNDS	584.	75.
		8101	TUNGSTEN (WOLFRAM) & ARTICLES, INCL WASTE & SCRAP	582.	114.
		8475	MACHINES FOR ASSEMB ELEC TUBES ETC & GLASS MFR, P	577.	32.
		8418	REFRIGERATORS, FREEZERS ETC, HEAT PUMPS NESOI, PT	568.	34.
		8544	INSULATED WIRE, CABLE ETC, OPT SHEATH FIB CABLES	564.	82.
		2919	PHOSPHORIC ESTERS & SALTS, LACTOPHOSPHATES ETC.	560.	238.
		2101	EXTRACTS ETC OF COFFEE, TEA OR MATE, ROAST CHICORY	549.	102.
		3917	TUBES, PIPES & HOSES & THEIR FITTINGS, OF PLASTIC	540.	100.
		6908	GLAZED CERAMIC FLAGS & PAVING, HEARTH TILES, ETC	536.	938.
		6802	WORKED MONUMENT ETC STONE & ART NESOI, GRANULE ETC	528.	383.
		7418	HOUSEHOLD ART & PTS, COP, POT SCOURERS ETC, COPPE	528.	60.
		7310	TANKS ETC, NOV 300 LITER CAPACITY, IRON OR STEEL	524.	330.
		9503	TOYS NESOI, SCALE MODELS ETC, PUZZLES, PARTS ETC	523.	82.
		8301	PADLOCKS, LOCKS & KEYS & PARTS, OF BASE METAL	516.	103.
		8474	MACHINERY FOR SORTING SCREENING ETC MINERALS, PTS	512.	118.
		3403	LUBRICATING PREPS, ANTIRUST & TREATING TEXILES ETC	498.	137.
		7210	FL-RL IRON & NA STEEL NUN600MM WD, CLAD ETC	496.	850.
		7019	GLASS FIBERS & ARTICLES THEREOF (YARN ETC.)	493.	81.
		4016	ARTICLES NESOI OF UNHARDED VULCANIZED RUBBER	482.	33.
		8507	ELECTRIC STORAGE BATTERIES, INCL SEPARATORS, PARTS	477.	43.
		4807	COMPOSITE PAPER & PAPERBOARD, NO SURF COAT, RL ETC	472.	346.
		4012	RETREAD OR USED PNEU TIRES, SOLID TIRES ETC, RUBB	457.	249.
		8307	FLEXIBLE TUBING OF BASE METAL	455.	46.
		8480	MOLDING BOXES FOR METAL FOUNDRY, MOLD BASES ETC	455.	79.

1993 U.S. IMPORTS TRANSSHIPPED VIA CANADA ABOVE \$200,000
 BY CUSTOMS DISTRICT BY DESCEND. VALUE IN \$1000'S ESTIM. WEIGHT IN METRIC TONS

CD#	CUSTOMS DISTRICT	CODE	HARMONIZED COMMODITY DESCRIPTION	\$1000S	EST. M. TONS
----	-----	----	-----	-----	-----
41	CLEVELAND, OHIO	6201	MEN'S OR BOYS' OVERCOATS, CLOAKS ETC, NOT KNIT E	447.	16.
		8459	MACHINE TOOLS FOR DRILLING, BORING, MILLING ETC	443.	76.
		8205	HANDTOOLS NESOI, BLOW TORCHES ETC, ANVILS ETC	439.	41.
		6403	FOOTWEAR, OUTER SOLE RUB, PLAST OR LEA & UPPER LEA	434.	37.
		8536	ELECTRICAL APPARATUS FOR SWITCHING ETC, NOV 1000	426.	12.
		8509	ELECTROMECH DOMESTIC APPLIANCES, PARTS	423.	27.
		8408	COMPRESSION-IGNITION INTERNAL COMB PISTON ENGINES	421.	46.
		8465	MACHINE TOOLS FOR WORKING WOOD, CORK, BONE ETC	415.	39.
		3212	PIGMENTS NONAQ LIQ ETC FOR PAINT, ST FOIL, DYE ET	412.	59.
		3401	SOAP, ORGANIC SURF-ACT PREP FOR SOAP USE, BARS ETC	406.	107.
		2804	HYDROGEN, RARE GASES AND OTHER NONMETALS	401.	73.
		8210	HND-OP MECH APPL 10KG OR LSS,FD/DRK PRP/CON/SRV P	397.	72.
		7117	IMITATION JEWELRY	393.	14.
		7228	AL STEEL NESOI BARS, ANG ETC, HOL DR ST BARS ETC	393.	400.
		7608	ALUMINUM TUBES AND PIPES	389.	45.
		7307	TUBE OR PIPE FITTINGS, OF IRON OR STEEL	373.	121.
		2830	SULFIDES, POLYSULFIDES	368.	187.
		2846	RARE-EARTH METAL COMPOUNDS OF YTTRIUM OR SCANDIUM	368.	171.
		7002	GLASS IN BALLS (NOT MICROS), RODS OR TUBES, UNWORK	360.	22.
		7901	ZINC, UNWROUGHT	359.	623.
		8803	PARTS OF BALLOONS ETC, AIRCRAFT, SPACECRAFT ETC	357.	24.
		4911	PRINTED MATTER NESOI, INCL PRINT PICTURES & PHOTOS	345.	57.
		8436	AGRI ETC & POULTRY ETC EQUIP, INC INCUBATORS, PTS	343.	73.
		2916	UNSAT ACYCLIC & CYCLIC MONOCARBOX ACID & ANHYD ET	339.	311.
		2931	ORGANO-INORGANIC COMPOUNDS NESOI	333.	162.
		8457	MACHINING CENTERS, UNIT CONST MACH ETC WORK METAL	332.	53.
		4009	TUBES, PIPES & HOSES OF UNHARD VULCANIZED RUBBER	322.	57.
		7612	ALUMINUM CASKS, CANS ETC NOV 300 LITER CAPACITY	320.	29.
		9209	PARTS ETC OF MUSICAL INSTR, METRONONES, T FORK ETC	314.	29.
		6913	STATUETTES AND OTHER ORNAMENTAL CERAMIC ARTICLES	289.	92.
		6803	SLATE, WORKED AND ARTICLES, ARTICLS OF AGGLOM SLT	277.	402.
		8424	MECH APPL TO DISPERSE LIQ ETC, SAND ETC BLAST MAC	269.	27.
		8512	ELECTRIC LIGHT ETC EQUIP, WINDSH WIPERS ETC, PART	269.	45.
		8411	TURBOJETS, TURBOPROPELLERS & OTH GAS TURBINES, PTS	266.	22.
		2908	PHENOL OR PHENOL-ALCOHOL DERIV, HALOG, SULF ETC	265.	36.
		3301	ESSENT OILS, RESINOIDS, TERPENIC BY-PRODUCTS ETC	259.	24.
		8523	PREPARED UNRECORDED MEDIA (NO FILM) FOR SOUND ETC	258.	18.
		3603	SAFETY FUSES, DETONATING FUSE, PERCUSSION CAPS ETC	253.	19.
		3502	ALBUMINS AND ALBUMIN DERIVATIVES	251.	59.
		8542	ELECTRONIC INTEGRATED CIRCUITS & MICROASSEMBL, PT	251.	8.
		2201	WATERS, NATURAL ETC, NOT SWEETENED ETC, ICE & SNOW	249.	801.
		7609	ALUMINUM TUBE OR PIPE FITTINGS	247.	52.
		3402	ORGANIC SURF-ACT AGENTS, PREPS & CLEANING PREPS	245.	216.
		8430	MACH NESOI, MOVING, GRAD ETC, PILE-DR, SNOFLOW ET	245.	8.
		6804	MILLSTONES ETC FOR GRINDING ETC, VARIOUS MATERIALS	244.	66.
		8455	METAL-ROLLING MILLS AND ROLLS THEREFOR, PARTS	241.	68.
		3809	FINISHING AGENTS ETC FOR TEXTILES, PAPER ETC NESOI	239.	107.
		7408	COPPER WIRE	237.	46.

1993 U.S. IMPORTS TRANSSHIPPED VIA CANADA ABOVE \$200,000
 BY CUSTOMS DISTRICT BY DESCEND. VALUE IN \$1000'S ESTIM. WEIGHT IN METRIC TONS

CD#	CUSTOMS DISTRICT	CODE	HARMONIZED COMMODITY DESCRIPTION	\$1000S	EST. M.TONS
41	CLEVELAND, OHIO	8207	INTERCHANGE TOOLS FOR HAND- OR MACHINE-TOOLS, BMPT	237.	13.
		8506	PRIMARY CELLS & BATTERIES, PARTS	237.	25.
		505	BIRD SKINS & OTHER FEATHERED PARTS AND DOWN	235.	203.
		8407	SPARK-IGNITION RECIP OR ROTARY INT COMB PISTON ENG	230.	20.
		9024	MACHINES ETC FOR TESTING MECH PROP OF MATERIAL, P	225.	5.
		3925	BUILDERS'' WARE OF PLASTICS, NESOI	221.	67.
		2906	CYCLIC ALCOHOLS & HALOGENATD, SULFONATD ETC DERIVS	220.	119.
		3601	PROPELLANT POWDERS	216.	28.
		5911	TEXTILE PRODUCTS ETC. FOR SPECIFIC TECH USES NESOI	213.	10.
		6506	HEADGEAR NESOI, WHETHER OR NOT LINED OR TRIMMED	209.	8.
		7004	DRAWN & BLOWN GLASS, IN SHEETS ETC	209.	41.
		4202	TRAVEL GOODS, HANDBAGS, WALLETS, JEWELRY CASES ETC	204.	4.
		9105	CLOCKS, WITH CLOCK MVTS OTH THAN INST PANEL ETC	204.	9.
		7505	NICKEL BARS, RODS, PROFILES AND WIRE	203.	14.
		2712	PETROLEUM JELLY, MINERAL WAXES & SIMILAR PRODUCTS	201.	211.
		8514	INDUSTRIAL OR LAB ELEC FURNACES ETC, PARTS	200.	20.
		9999	BELOW MINIMUM	18,000.	14,365.
		*SUB-TOTAL CUSTOMS DIST. # 41		474,218.	145,303.
45	ST. LOUIS, MO.	2918	CARBOXYLIC ACID, ADDED OXYGEN & ANHY ETC, HAL ETC	17,552.	7,791.
		8708	PARTS & ACCESS FOR MOTOR VEHICLES (HEAD 8701-8705)	12,274.	2,184.
		8803	PARTS OF BALLOONS ETC, AIRCRAFT, SPACECRAFT ETC	10,878.	51.
		2941	ANTIBIOTICS	6,066.	441.
		8413	PUMPS FOR LIQUIDS, LIQUID ELEVATORS, PARTS THEREO	5,015.	251.
		8424	MECH APPL TO DISPERSE LIQ ETC, SAND ETC BLAST MAC	4,893.	1,207.
		8457	MACHINING CENTERS, UNIT CONST MACH ETC WORK METAL	4,660.	194.
		6805	ABRASIVE POWDER ETC ON A BASE TEXT MATERIAL ETC	4,571.	572.
		2933	HETEROCYCLIC COMP, NIT HETERO-ATOM, NUCLEIC ACIDS	4,433.	382.
		2804	HYDROGEN, RARE GASES AND OTHER NONMETALS	4,152.	654.
		8481	TAPS, COCKS, VALVES ETC FOR PIPES, TANKS ETC, PTS	4,048.	313.
		6902	REFRACTORY BRICKS & OTHER REFR CER CONST ART NESOI	3,836.	4,809.
		8479	MACHINES ETC HAVING INDIVIDUAL FUNCTIONS NESOI, P	3,583.	165.
		3501	CASEIN, CASEINATES AND OTHER CASEIN DERIVATIVES	3,525.	803.
		7217	WIRE OF IRON & NONALLOY STEEL	3,324.	3,009.
		3003	MEDICAMENTS NESOI OF MIXTURES, NOT DOSAGE ETC FORM	2,828.	430.
		8466	PARTS ETC FOR MACHINE TOOLS OF HEAD 8456 TO 8465	2,616.	174.
		4901	BOOKS, BROCHURES & SIMILAR PRINTED MATTER	2,303.	332.
		9506	ARTICLES & EQUIP FOR SPORTS ETC NESOI, POOLS, PTS	2,258.	151.
		2934	HETEROCYCLIC COMPOUNDS NESOI	2,092.	135.
		3808	INSECTICIDES, RODENTICIDES, FUNGICIDES ETC, RETAIL	2,012.	298.
		2208	ETHYL ALCOHOL, UNDENAT, UND80% ALC, SPIRIT BEV ETC	1,893.	760.
		8465	MACHINE TOOLS FOR WORKING WOOD, CORK, BONE ETC	1,654.	105.
		8414	AIR OR VAC PUMPS, COMPR & FANS, HOODS & FANS, PTS	1,630.	411.
		5407	WOVEN FAB OF SYN FIL YN, INCL MONOFIL 67 DEC ETC	1,540.	104.
		8463	MACHINE TOOLS FOR WORKING METAL, NESOI	1,512.	36.
		8527	RECEPTION APPARATUS FOR RADIOTELEPHONY ETC	1,400.	29.
		8407	SPARK-IGNITION RECIP OR ROTARY INT COMB PISTON ENG	1,346.	87.

1993 U.S. IMPORTS TRANSSHIPPED VIA CANADA ABOVE \$200,000
 BY CUSTOMS DISTRICT BY DESCEND. VALUE IN \$1000'S ESTIM. WEIGHT IN METRIC TONS

CD#	CUSTOMS DISTRICT	CODE	HARMONIZED COMMODITY DESCRIPTION	\$1000S	EST. M.TONS
45	ST. LOUIS, MO.	4416	CASKS, BARRELS, VATS, ETC. AND PARTS, OF WOOD	1,313.	209.
		4016	ARTICLES NESOI OF UNHARDED VULCANIZED RUBBER	1,234.	53.
		8411	TURBOJETS, TURBOPROPELLERS & OTH GAS TURBINES, PTS	1,200.	60.
		3801	ARTIFICIAL GRAPHITE, COLLODIAL GRAPHITE & PREP ETC	1,185.	654.
		8436	AGRI ETC & POULTRY ETC EQUIP, INC INCUBATORS, PTS	1,074.	309.
		6912	CERAMIC TABLEWARE, KITCHNWARE ETC, EARTHENWARE ETC	1,015.	292.
		8607	PARTS OF RAILWAY OR TRAMWAY LOCOMOTIVES OR R STOCK	993.	621.
		4008	PLATES, SHEETS, PROFILE SHAPES ETC, SOFT VULC RUBR	974.	441.
		9403	FURNITURE NESOI AND PARTS THEREOF	971.	402.
		7403	REFINED COPPER & ALLOYS (NO MAST ALLOY), UNWROUGHT	928.	549.
		8408	COMPRESSION-IGNITION INTERNAL COMB PISTON ENGINES	883.	88.
		7410	COPPER FOIL (BACKED OR NOT) NOV .15MM TH (EX BACK)	877.	301.
		2835	PHOSPHINATES, PHOSPHONATES, PHOSPHATES & POLYPHOSP	859.	771.
		8208	KNIVES & BLADES FOR MACHINES & APPLIANCES, B MT PT	763.	62.
		8524	RECORDS, TAPES & OTHER RECORDED SOUND MEDIA ETC	754.	37.
		2204	WINE OF FRESH GRAPES, GRAPE MUST NESOI	729.	330.
		4821	LABELS OF PAPER OR PAPERBOARD, PRINTED OR NOT	705.	253.
		8428	LIFTING, HANDLING, LOADING & UNLOAD MACHINES NESO	688.	62.
		9202	STRING MUSICAL INSTRUMENTS NESOI (VIOLINS ETC.)	653.	61.
		3912	CELLULOSE AND CHEMICAL DERIV NESOI, PRIMARY FORMS	637.	291.
		7801	LEAD, UNWROUGHT	634.	1,409.
		9305	PARTS & ACCESSORIES OF ARMS OF HEAD 9301 TO 9304	634.	15.
		8438	MACH NESOI, IND PREP OF FOOD OR DRINK ETC, PARTS	631.	45.
		8513	PORTABLE ELEC LAMPS FUNCTION BY OWN ENERGY SOURCE	626.	95.
		3926	ARTICLES OF PLASTICS (INC POLYMERS & RESINS) NESO	613.	44.
		7409	COPPER PLATES, SHEETS & STRIP, OVER 0.15MM THICK	605.	166.
		8301	PADLOCKS, LOCKS & KEYS & PARTS, OF BASE METAL	589.	112.
		8205	HANDTOOLS NESOI, BLOW TORCHES ETC, ANVILS ETC	563.	39.
		7019	GLASS FIBERS & ARTICLES THEREOF (YARN ETC.)	558.	101.
		7404	COPPER WASTE AND SCRAP	548.	447.
		8480	MOLDING BOXES FOR METAL FOUNDRY, MOLD BASES ETC	544.	145.
		4811	PAPER, PAPERBOARD, WAD ETC, COAT ETC NESOI, RL ET	539.	255.
		8462	MACHINE TOOLS FOR FORGING, BENDING, STAMPING ETC	539.	62.
		5102	FINE OR COARSE ANIMAL HAIR, NOT CARDED OR COMBED	538.	52.
		7320	SPRINGS & LEAVES FOR SPRINGS, IRON OR STEEL	529.	274.
		4111	COMPOSITION LEA, LEA FIBER IN SLABS, SHEETS, STRIP	523.	95.
		2818	ALUMINUM OXIDE (INCL ART CORUNDUM), ALUM HYDROXIDE	498.	254.
		8502	ELECTRIC GENERATING SETS AND ROTARY CONVERTERS	496.	50.
		9206	PERCUSSION MUSICAL INSTRUMENTS DRUMS ETC.)	495.	29.
		8477	MACHINERY FOR WORKING RUBBER & PLAST ETC NESOI, P	481.	66.
		8501	ELECTRIC MOTORS AND GENERATORS (NO SETS)	480.	69.
		7312	STRANDED WIRE, ROPES ETC, NO ELEC INS, IR OR STEEL	461.	200.
		8483	TRANSMISSION SHAFTS, BEARINGS, GEARS ETC, PARTS	460.	111.
		9402	MEDICAL, SURGICAL, DENTAL OR VETERINARY FURN ETC	442.	66.
		8461	MACHINE TOOLS FOR SHAPING, SLOTTING, GEAR CUT ETC	420.	14.
		3921	PLATES, SHEETS, FILM, FOIL & STRIP NESOI, PLASTIC	417.	194.
		2811	INORGANIC ACIDS & INORGANIC OXY NONMET COMP NESOI	411.	169.
		2106	FOOD PREPARATIONS NESOI	410.	82.

1993 U.S. IMPORTS TRANSSHIPPED VIA CANADA ABOVE \$200,000
 BY CUSTOMS DISTRICT BY DESCEND. VALUE IN \$1000'S ESTIM. WEIGHT IN METRIC TONS

CD#	CUSTOMS DISTRICT	CODE	HARMONIZED COMMODITY DESCRIPTION	\$1000S	EST. M.TONS
45	ST. LOUIS, MO.	8536	ELECTRICAL APPARATUS FOR SWITCHING ETC, NOV 1000	408.	24.
		6913	STATUETTES AND OTHER ORNAMENTAL CERAMIC ARTICLES	403.	101.
		4104	BOVINE OR EQUINE LEATHER, NO HAIR NESOI	396.	18.
		8512	ELECTRIC LIGHT ETC EQUIP, WINDSH WIPERS ETC, PART	391.	30.
		9401	SEATS (EXCEPT BARBER, DENTAL, ETC), AND PARTS	385.	51.
		8460	MACHINE TOOLS FOR HONING OR FINISHING METAL ETC	383.	12.
		8427	FORK-LIFT TRUCKS, OTH WORKS TRUCKS WITH LIFTS ETC	381.	66.
		8703	MOTOR CARS & VEHICLES FOR TRANSPORTING PERSONS	375.	17.
		2833	SULFATES, ALUMS, PEROXOSULFATES (PERSULFATES)	364.	1,128.
		8544	INSULATED WIRE, CABLE ETC, OPT SHEATH FIB CABLES	361.	25.
		8431	PARTS FOR MACHINERY OF HEADINGS 8425 TO 8430	359.	89.
		7326	ARTICLES OF IRON OR STEEL, NESOI	353.	126.
		8422	MACHINES, DISHWASH, CLEAN ETC CONT & FILL, PAK ET	349.	10.
		8433	HARVEST ETC MACHINES, CLEANING EGGS ETC NESOI, PT	347.	62.
		3406	CANDLES, TAPERS AND THE LIKE	337.	80.
		8002	TIN WASTE AND SCRAP	332.	69.
		7407	COPPER BARS, RODS AND PROFILES	331.	160.
		2619	SLAG, DROSS, SCALINGS A OTH WASTE FRM MANU IRN/STL	328.	1,255.
		3913	NATURAL (INC MODIFIED) POLYMERS NESOI, PRIMARY FM	327.	51.
		9503	TOYS NESOI, SCALE MODELS ETC, PUZZLES, PARTS ETC	296.	45.
		6403	FOOTWEAR, OUTER SOLE RUB, PLAST OR LEA & UPPER LEA	288.	21.
		9504	ARTICLES FOR ARCADE, TABLE OR PARLOR GAMES, PARTS	288.	39.
		3910	SILICONES, IN PRIMARY FORMS	283.	50.
		7405	MASTER ALLOYS OF COPPER	276.	161.
		9006	PHOTOGRAPHIC STILL CAMERAS, FLASH APPARATUS ETC	273.	8.
		4817	ENVELOPES, POSTCARDS ETC & BOXES ETC OF STATIONAR	272.	20.
		8434	MILKING MACHINES & DAIRY MACHINERY & PARTS	270.	55.
		8421	CENTRIFUGES, FILTER ETC MACH FOR LIQ OR GASES, PT	256.	21.
		3924	TABLEWARE & OTHER HOUSEHOLD ARTICLES ETC, PLASTIC	252.	40.
		9608	PENS (BALL POINT, S TIP ETC), MECH PENCILS ETC, PT	252.	30.
		3909	AMINO-RESINS, PHENOLICS & POLYURETHANES, PRIM FORM	242.	80.
		8437	MACH FOR CLEANING SEED ETC & WORK CEREAL ETC, PTS	237.	23.
		5903	TEXTILE FABRICS (NOT TIRE CORD) COAT ETC, PLASTICS	231.	18.
		7013	GLASSWARE FOR TABLE, KITCHEN, TOILET ETC USE NESOI	230.	45.
		3811	ANTI-KNOCK PREPS & OTHER ADDITIVES FOR MINERAL OIL	229.	145.
		9405	LAMPS & LIGHTING FITTINGS & PARTS ETC NESOI	228.	34.
		2912	ALDEHYDES, ITS CYCLIC POLYMERS, PARA-FORMALDEHYDE	221.	12.
		9603	BROOMS, BRUSHES, MOPS, FEATHER DUSTERS ETC	219.	74.
		3906	ACRYLIC POLYMERS IN PRIMARY FORMS	216.	59.
		9014	DIRECTION FINDING COMPASSES & NAVIG INST ETC, PTS	215.	12.
		2916	UNSAT ACYCLIC & CYCLIC MONOCARBOX ACID & ANHYD ET	214.	203.
		3823	BINDERS FOR FOUND MOLDS, CHEMICAL PROD ETC NESOI	212.	81.
		4009	TUBES, PIPES & HOSES OF UNHARD VULCANIZED RUBBER	207.	50.
		5910	TRANSMN/CONVYR BELTS, TEX MATRL, WHTHR/NOT REINFRCD	206.	14.
		8453	MACHINERY FOR WORK LEATHER ETC & FOOTWEAR ETC, PT	202.	21.
		9015	SURVEY, HYDROGR, METEORO ETC INST, RANGEF ETC, PT	201.	14.
		9999	BELOW MINIMUM	10,921.	6,418.
			*SUB-TOTAL CUSTOMS DIST. # 45	175,360.	47,550.

1993 U.S. IMPORTS TRANSSHIPPED VIA CANADA ABOVE \$200,000
 BY CUSTOMS DISTRICT BY DESCEND. VALUE IN \$1000'S ESTIM. WEIGHT IN METRIC TONS

CD#	CUSTOMS DISTRICT	CODE	HARMONIZED COMMODITY DESCRIPTION	\$1000S	EST. M.TONS
---	-----	----	-----	-----	-----
54	WASHINGTON, D.C.	8803	PARTS OF BALLOONS ETC, AIRCRAFT, SPACECRAFT ETC	3,223.	13.
		9705	COLLECTORS ITEMS OF BOTANIC, HISTOR ETC INTEREST	563.	7.
		9101	WATCHES, WRIST, POCKET ETC, PREC METAL OR CLD CASE	465.	247.
		9302	REVOLVERS & PISTOLS, DESIGNED TO FIRE LIVE AMMO	398.	58.
		8481	TAPS, COCKS, VALVES ETC FOR PIPES, TANKS ETC, PTS	256.	42.
		9999	BELOW MINIMUM	1,831.	243.
		*SUB-TOTAL CUSTOMS DIST. # 54		6,736.	610.
TOTAL				8,153,114.	2,212,343.

1993 U.S. EXPORTS TRANSSHIPPED VIA CANADA ABOVE \$200,000
 BY CUSTOMS DISTRICT BY DESCEND. VALUE IN \$1000'S ESTIM. WEIGHT IN METRIC TONS

CD#	CUSTOMS DISTRICT	CODE	HARMONIZED COMMODITY DESCRIPTION	\$1000S	EST. M.TONS
1	PORTLAND, ME.	4810	PAPER & PAPERBOARD, COATED WITH KAOLIN ETC, RL ET	10,492.	8,792.
		811	FRUIT & NUTS (RAW OR COOKED BY STEAM ETC), FROZEN	8,269.	6,431.
		7312	STRANDED WIRE, ROPES ETC, NO ELEC INS, IR OR STEEL	6,564.	1,257.
		8803	PARTS OF BALLOONS ETC, AIRCRAFT, SPACECRAFT ETC	4,373.	84.
		4801	NEWSPRINT, IN ROLLS OR SHEETS	4,161.	5,470.
		4703	CHEMICAL WOODPULP, SODA OR SULFATE, NOT DISSOLY GR	2,984.	9,199.
		4802	PAPER, UNCOAT, FOR WRITING ETC, ROLLS, HNDMD PAPER	2,955.	2,156.
		4811	PAPER, PAPERBOARD, WAD ETC, COAT ETC NESOI, RL ET	2,727.	1,312.
		8413	PUMPS FOR LIQUIDS, LIQUID ELEVATORS, PARTS THEREO	1,168.	61.
		4410	PARTICLE BOARD & SIMILAR BOARD OF WOOD ETC.	1,108.	1,713.
		810	FRUIT NESOI, FRESH	832.	706.
		8431	PARTS FOR MACHINERY OF HEADINGS 8425 TO 8430	769.	97.
		8202	HANDSAWS & MET PTS, SAW BLADES, BASE MTL SAW PARTS	717.	55.
		407	BIRDS' EGGS, IN THE SHELL, FRESH, PRESERV OR COOK	612.	753.
		8701	TRACTORS (OTHER THAN WORKS TRUCKS OF HEADING 8709)	450.	65.
		8544	INSULATED WIRE, CABLE ETC, OPT SHEATH FIB CABLES	347.	71.
		7207	SEMIFINISHED PRODUCTS OF IRON OR NONALLOY STEEL	327.	229.
		3602	PREPARED EXPLOSIVES OTHER THAN PROPELLENT POWDERS	316.	74.
		8517	ELECTRIC APPARATUS FOR LINE TELEPHONY ETC, PARTS	309.	3.
		307	MOLLUSCS & AQUATIC INVERTEBRATES NESOI, LIVE ETC.	308.	36.
		8704	MOTOR VEHICLES FOR TRANSPORT OF GOODS	300.	24.
		1604	PREP OR PRES FISH, CAVIAR & CAVIAR SUBSTITUTES	269.	139.
		3603	SAFETY FUSES, DETONATING FUSE, PERCUSSION CAPS ETC	204.	24.
		7307	TUBE OR PIPE FITTINGS, OF IRON OR STEEL	201.	22.
		9999	BELOW MINIMUM	2,433.	2,250.
		*SUB-TOTAL CUSTOMS DIST. # 1		53,195.	41,023.
2	ST. ALBANS, VT.	7112	WASTE & SCRAP OF PREC METAL OR METAL CL W PREC MT	51,981.	904.
		1901	MALT EXT, FOOD PREP OF FLOUR ETC UN 50% COCOA ETC	50,431.	9,534.
		9305	PARTS & ACCESSORIES OF ARMS OF HEAD 9301 TO 9304	24,324.	706.
		6403	FOOTWEAR, OUTER SOLE RUB, PLAST OR LEA & UPPER LEA	11,870.	1,002.
		8442	MACH ETC NESOI FOR TYPESET, MAKING PR PLATES ETC	9,225.	513.
		9506	ARTICLES & EQUIP FOR SPORTS ETC NESOI, POOLS, PTS	8,394.	953.
		6001	PILE FABRICS, KNITTED OR CROCHETED	7,713.	2,772.
		4104	BOVINE OR EQUINE LEATHER, NO HAIR NESOI	6,481.	1,279.
		8471	AUTOMATIC DATA PROCESS MACHINES, MAGN READER ETC	6,131.	219.
		2850	HYDRIDES, NITRIDES, AZIDES, SILICIDES & BORIDES	6,024.	2,020.
		4811	PAPER, PAPERBOARD, WAD ETC, COAT ETC NESOI, RL ET	5,970.	2,352.
		8481	TAPS, COCKS, VALVES ETC FOR PIPES, TANKS ETC, PTS	5,803.	726.
		9403	FURNITURE NESOI AND PARTS THEREOF	5,520.	883.
		2106	FOOD PREPARATIONS NESOI	5,343.	1,637.
		9006	PHOTOGRAPHIC STILL CAMERAS, FLASH APPARATUS ETC	5,261.	117.
		2924	CARBOXYAMIDE-FUNCTION COMP, AMIDE-FUNCTION COM ET	5,060.	1,245.
		3003	MEDICAMENTS NESOI OF MIXTURES, NOT DOSAGE ETC FORM	5,009.	545.
		2922	OXYGEN-FUNCTION AMINO-COMPOUNDS	4,453.	1,910.
		8421	CENTRIFUGES, FILTER ETC MACH FOR LIQ OR GASES, PT	4,240.	422.
		4810	PAPER & PAPERBOARD, COATED WITH KAOLIN ETC, RL ET	3,855.	4,589.

1993 U.S. EXPORTS TRANSSHIPPED VIA CANADA ABOVE \$200,000
 BY CUSTOMS DISTRICT BY DESCEND. VALUE IN \$1000'S ESTIM. WEIGHT IN METRIC TONS

CD#	CUSTOMS DISTRICT	CODE	HARMONIZED COMMODITY DESCRIPTION	\$1000S	EST. M.TONS
2	ST. ALBANS, VT.	7409	COPPER PLATES, SHEETS & STRIP, OVER 0.15MM THICK	3,346.	424.
		3921	PLATES, SHEETS, FILM, FOIL & STRIP NESOI, PLASTIC	3,323.	409.
		8544	INSULATED WIRE, CABLE ETC, OPT SHEATH FIB CABLES	3,159.	519.
		3920	PLATES, SHEETS, FILM ETC NO AD, NON-CEL ETC, PLAS	3,152.	486.
		7019	GLASS FIBERS & ARTICLES THEREOF (YARN ETC.)	3,129.	535.
		8523	PREPARED UNRECORDED MEDIA (NO FILM) FOR SOUND ETC	2,964.	204.
		8454	CONVERTERS, LADLES, INGOT MOLDS & CASTING MACH, P	2,943.	163.
		8414	AIR OR VAC PUMPS, COMPR & FANS, HOODS & FANS, PTS	2,622.	1,477.
		3401	SOAP, ORGANIC SURF-ACT PREP FOR SOAP USE, BARS ETC	2,490.	1,979.
		3402	ORGANIC SURF-ACT AGENTS, PREPS & CLEANING PREPS	2,419.	1,412.
		2516	GRANITE, PORPHYRY, BASALT ETC., CRUDE OR CUT ETC.	2,327.	11,635.
		8473	PARTS ETC FOR TYPEWRITERS & OTHER OFFICE MACHINES	2,272.	75.
		8103	TANTALUM & ARTICLES THEREOF, INCLUD WASTE & SCRAP	2,263.	82.
		4823	PAPER, PAPERBOARD, CELLUL WAD TO SIZE & ARTS NESO	2,214.	693.
		7407	COPPER BARS, RODS AND PROFILES	2,110.	292.
		2818	ALUMINUM OXIDE (INCL ART CORUNDUM), ALUM HYDROXIDE	2,034.	625.
		4407	WOOD SAWN OR CHIPPED LENGTH, SLICED ETC, OV6MM TH	1,959.	2,667.
		5907	TEXTL FABRC,COATD,ETC,THEATRCL SCENERY,BACK-CLOTHS	1,897.	185.
		3926	ARTICLES OF PLASTICS (INC POLYMERS & RESINS) NESO	1,817.	204.
		3707	PHOTOGRAPHIC CHEMICALS, UNMIXED PROD RETAIL PACKED	1,706.	167.
		9301	MILITARY WEAPONS EX REVOLVERS PISTOLS LANCES ETC	1,681.	21.
		8501	ELECTRIC MOTORS AND GENERATORS (NO SETS)	1,660.	216.
		8446	WEAVING MACHINES (LOOMS)	1,622.	1,746.
		8443	PRINTING MACHINERY, MACHINES ANCIL TO PRINTING, P	1,531.	222.
		5601	TEXT WADDING & ARTICLES, TEXT FIBERS NOV 5 MM, ETC	1,521.	212.
		2905	ACYCLIC ALCOHOLS & HALOGENAT, SULFONATD ETC DERIVS	1,486.	1,591.
		8002	TIN WASTE AND SCRAP	1,484.	1,188.
		1702	SUGARS NESOI, INCL CHEM PURE LACTOSE ETC, CAMEL	1,468.	1,119.
		6805	ABRASIVE POWDER ETC ON A BASE TEXT MATERIAL ETC	1,435.	143.
		8413	PUMPS FOR LIQUIDS, LIQUID ELEVATORS, PARTS THEREO	1,422.	50.
		3924	TABLEWARE & OTHER HOUSEHOLD ARTICLES ETC, PLASTIC	1,381.	273.
		7321	STOVES, RANGES ETC, NONEL DOMEST & PTS, IR & STEE	1,380.	424.
		302	FISH, FRESH OR CHILLED (NO FILLETS OR OTHER MEAT)	1,321.	929.
		9009	PHOTOCOPY APPARATUS & THERMOCOPY APPARATUS, PTS	1,307.	44.
		5503	SYNTHETIC STAPLE FIBERS, NOT CARDED, COMBED ETC.	1,282.	732.
		9112	CLOCK CASES & CASES FOR OTHER GOODS ETC, PARTS	1,268.	49.
		303	FISH, FROZEN (NO FISH FILLETS OR OTHER FISH MEAT)	1,259.	679.
		6815	ARTICLES OF STONE OR OTHER MINERAL SUBSTANCE NESOI	1,251.	697.
		6307	MADE-UP ARTICLES OF TEXTILE MATERIALS NESOI	1,227.	119.
		8516	ELEC WATER, SPACE & SOIL HEATERS, HAIR ETC DRY, P	1,141.	97.
		4801	NEWSPRINT, IN ROLLS OR SHEETS	1,064.	1,385.
		3809	FINISHING AGENTS ETC FOR TEXTILES, PAPER ETC NESOI	1,031.	135.
		9033	PTS, NESOI FOR MACHINES,APPLN,INST/APPTS OF CHAP9	967.	49.
		8419	MACHINERY ETC FOR TEMP CHANG TREAT MAT, W HEAT, P	947.	60.
		2918	CARBOXYLIC ACID, ADDED OXYGEN & ANHY ETC, HAL ETC	943.	454.
		3909	AMINO-RESINS, PHENOLICS & POLYURETHANES, PRIM FORM	932.	361.
		8539	ELECTRIC FILAMENT OR DISCHARGE LAMPS, PARTS	917.	63.
		304	FISH FILLETS & OTH FISH MEAT, FRESH, CHILL OR FROZ	905.	381.

1993 U.S. EXPORTS TRANSSHIPPED VIA CANADA ABOVE \$200,000
 BY CUSTOMS DISTRICT BY DESCEND. VALUE IN \$1000'S ESTIM. WEIGHT IN METRIC TONS

CD#	CUSTOMS DISTRICT	CODE	HARMONIZED COMMODITY DESCRIPTION	\$1000S	EST. M.TONS
2	ST. ALBANS, VT.	2915	SAT ACYCLIC NONOCARBOX ACID & ANHYD, HALOGON ETC	887.	1,139.
		5602	FELT, IMPREGNATED, COATED, ETC. OR NOT	840.	124.
		8518	MICROPHONES, LOUDSPEAKERS, SOUND AMPLIFIER ETC, P	838.	295.
		9015	SURVEY, HYDROGR, METEORO ETC INST, RANGEF ETC, PT	823.	58.
		8001	TIN, UNWROUGHT	821.	338.
		404	WHEY & MILK PRODUCTS NESOI, FLAVORED ETC. OR NOT	812.	931.
		3811	ANTIKNOCK PREPS & OTHER ADDITIVES FOR MINERAL OIL	770.	444.
		8418	REFRIGERATORS, FREEZERS ETC, HEAT PUMPS NESOI, PT	754.	77.
		3906	ACRYLIC POLYMERS IN PRIMARY FORMS	744.	334.
		8108	TITANIUM & ARTICLES THEREOF, INCLUD WASTE & SCRAP	739.	281.
		9018	MEDICAL, SURGICAL, DENTAL OR VET INST, NO ELEC, P	737.	52.
		4901	BOOKS, BROCHURES & SIMILAR PRINTED MATTER	696.	186.
		8466	PARTS ETC FOR MACHINE TOOLS OF HEAD 8456 TO 8465	695.	23.
		5407	WOVEN FAB OF SYN FIL YN, INCL MONOFIL 67 DEC ETC	671.	95.
		7220	FL-RL STAINLESS STEEL PRODUCTS, UNDER 600MM WIDE	665.	245.
		8479	MACHINES ETC HAVING INDIVIDUAL FUNCTIONS NESOI, P	661.	72.
		2805	ALKALI METALS ETC, RARE-EARTH METALS ETC, MERCURY	653.	375.
		1302	VEG SAPS & EXTRACTS, PECTATES ETC, AGAR-AGAR ETC.	610.	48.
		811	FRUIT & NUTS (RAW OR COOKED BY STEAM ETC), FROZEN	607.	608.
		4001	NATURAL RUBBER, BALATA, CHICLE ETC, PRIM FORM ETC	589.	180.
		8441	MACH FOR MAKING UP PULP & PAPER, INC CUTTERS, PTS	584.	37.
		2513	PUMICE, EMERY, NATURAL CORUNDUM AND GARNET ETC	574.	1,740.
		8450	WASHING MACHINES, HOUSEHOLD- OR LAUNDRY-TYPE, PTS	558.	49.
		9402	MEDICAL, SURGICAL, DENTAL OR VETERINARY FURN ETC	548.	37.
		2917	POLYCARBOXYLIC ACIDS & ANHYD ETC, HALOG, SULF ETC	546.	374.
		5603	NONWOVENS, WHETHER OR NOT IMPREGNATED, COATED ETC	537.	167.
		8477	MACHINERY FOR WORKING RUBBER & PLAST ETC NESOI, P	529.	26.
		8451	MACHINERY (NOT LAUNDRY) FOR CLEANING, DRYING ETC	524.	95.
		2825	HYDRAZINE ETC, OTH INORG BASES, METAL OXIDES ETC	523.	240.
		9024	MACHINES ETC FOR TESTING MECH PROP OF MATERIAL, P	518.	23.
		9603	BROOMS, BRUSHES, MOPS, FEATHER DUSTERS ETC	515.	87.
		3923	CONTAINERS (BOXES, BAGS ETC), CLOSURERS ETC, PLAS	509.	135.
		3305	PREPARATIONS FOR USE ON THE HAIR	491.	131.
		1108	STARCHES, INULIN	490.	1,035.
		4803	TOILET ETC HSHLD/SANTRY STOCK PPR ROLL/SHT OV 36CM	488.	286.
		4802	PAPER, UNCOAT, FOR WRITING ETC, ROLLS, HNDMD PAPER	471.	389.
		8903	YACHTS & OTHER VESSELS FOR PLEAS ETC, ROW BOAT ETC	468.	43.
		6110	SWEATERS, PULLOVERS, VESTS ETC, KNIT OR CROCHETED	450.	117.
		5911	TEXTILE PRODUCTS ETC. FOR SPECIFIC TECH USES NESOI	443.	46.
		4807	COMPOSITE PAPER & PAPERBOARD, NO SURF COAT, RL ETC	433.	229.
		2524	ASBESTOS	431.	1,838.
		8474	MACHINERY FOR SORTING SCREENING ETC MINERALS, PTS	428.	480.
		8525	TRANS APPAR FOR RADIOTELEPHONY ETC, TV CAMERAS	410.	4.
		8505	ELECTROMAGNETS, PERMANENT MAGNETS ETC & PARTS	395.	116.
		8711	MOTORCYCLES (INCL MOPEDS) & CYCLES WITH AUX MOTOR	394.	25.
		8524	RECORDS, TAPES & OTHER RECORDED SOUND MEDIA ETC	393.	58.
		3503	GELATIN & DERIV, ISINGLASS, GLUES, ANIMAL OR NESOI	387.	99.
		9002	OPTICAL ELEMENTS, MOUNTED, PARTS & ACCESSORIES	386.	31.

1993 U.S. EXPORTS TRANSSHIPPED VIA CANADA ABOVE \$200,000
 BY CUSTOMS DISTRICT BY DESCEND. VALUE IN \$1000'S ESTIM. WEIGHT IN METRIC TONS

CD#	CUSTOMS DISTRICT	CODE	HARMONIZED COMMODITY DESCRIPTION	\$1000S	EST. M.TONS
2	ST. ALBANS, VT.	8409	PARTS FOR ENGINES OF HEADING 8407 OR 8408	384.	91.
		9017	DRAWING, MATH, MEASURING INST ETC NESOI, PARTS	377.	82.
		9022	X-RAY ETC APPARATUS, TUBES, PANELS, SCREEN ETC, P	369.	71.
		6309	WORN CLOTHING AND OTHER WORN TEXTILE ARTICLES	368.	196.
		9021	ORTHOPEDIC APPL, ARTIF BODY PTS, HEAR AID, PTS ET	362.	46.
		8425	PULLEY TACKLE & HOISTS (EXC SKIP), WINCH ETC, JAK	356.	25.
		2902	CYCLIC HYDROCARBONS	351.	364.
		2926	NITRILE-FUNCTION COMPOUNDS	350.	88.
		5105	WOOL & FINE OR COARSE ANIMAL HAIR, CARDED & COMBED	338.	67.
		7219	FL-RL STAINLESS STEEL PRODUCTS, NOT UND 600MM WID	338.	117.
		7310	TANKS ETC, NOV 300 LITER CAPACITY, IRON OR STEEL	335.	130.
		3405	POLISHES & CREAMS FOR LEATHER, WOOD ETC, SCOUR PRP	330.	72.
		8102	MOLYBDENUM & ARTICLES THEREOF, INCL WASTE & SCRAP	330.	16.
		3911	PETRO RESINS, POLYSULFIDES ETC NESOI, PRIMARY FOR	316.	182.
		5903	TEXTILE FABRICS (NOT TIRE CORD) COAT ETC, PLASTICS	315.	84.
		8301	PADLOCKS, LOCKS & KEYS & PARTS, OF BASE METAL	311.	10.
		3907	POLYETHERS, EXPOXIDES & POLYESTERS, PRIMARY FORMS	304.	91.
		3504	PEPTONES, OTHER PROTEINS & DERIV ETC, HIDE POWDER	298.	111.
		5208	WOVEN COTTON FABRICS, NU 85% COT, WT NOV 200 G/M2	288.	55.
		8460	MACHINE TOOLS FOR HONING OR FINISHING METAL ETC	287.	14.
		2208	ETHYL ALCOHOL, UNDENAT, UN80% ALC, SPIRIT BEV ETC	282.	110.
		5806	NARROW WOVEN FABRICS EXCEPT LABELS ETC IN PC ETC	281.	80.
		3506	PREPARED GLUES & ADHESIVES NESOI, GLUE RETAIL PACK	277.	65.
		8543	ELECTRICAL MACH ETC, WITH IND FUNCTIONS NESOI, PT	252.	13.
		9405	LAMPS & LIGHTING FITTINGS & PARTS ETC NESOI	251.	11.
		3403	LUBRICATING PREPS, ANTIRUST & TREATING TEXILES ETC	249.	91.
		8207	INTERCHANGE TOOLS FOR HAND- OR MACHINE-TOOLS, BMPT	235.	70.
		2914	KETONES & QUINONES & HALOGENATD, SULFONATD DER ET	232.	277.
		5402	SYNTHETIC FILAMENT YARN (NO SEW THREAD), NO RETAIL	230.	123.
		7404	COPPER WASTE AND SCRAP	227.	235.
		8467	TOOLS FOR WORKING IN THE HAND, PNEUMATIC ETC, PTS	226.	23.
		8514	INDUSTRIAL OR LAB ELEC FURNACES ETC, PARTS	223.	10.
		4819	CARTONS ETC PAPER, OFFICE BOX FILES ETC, PAPER ET	219.	118.
		8529	PARTS FOR TELEVISION, RADIO AND RADAR APPARATUS	215.	54.
		3208	PAINT & VARNISH FROM SYNTH ETC POLYMERS NONAQ, ETC	213.	46.
		8515	ELECTRIC, LASER OR OTH LIGHT OR PHOTON BEAM ETC	212.	8.
		8703	MOTOR CARS & VEHICLES FOR TRANSPORTING PERSONS	211.	36.
		8803	PARTS OF BALLOONS ETC, AIRCRAFT, SPACECRAFT ETC	208.	2.
		7408	COPPER WIRE	207.	44.
		3823	BINDERS FOR FOUND MOLDS, CHEMICAL PROD ETC NESOI	203.	173.
		8542	ELECTRONIC INTEGRATED CIRCUITS & MICROASSEMBL, PT	201.	27.
		3005	BANDAGES ETC COATED ETC OR IN RETAIL MEDIC ETC FM	200.	24.
		9999	BELOW MINIMUM	15,082.	7,814.
		*SUB-TOTAL CUSTOMS DIST. # 2		373,945.	97,201.
7	OGDENSBURG, N.Y.	3702	PHOTO FILM IN ROLLS SENSITIZED, UNEXPOSED	63,446.	2,916.
		3701	PHOTO PLATES & FILM, FLAT, SENSITIZED, UNEXPOSED	20,746.	1,651.

1993 U.S. EXPORTS TRANSSHIPPED VIA CANADA ABOVE \$200,000
 BY CUSTOMS DISTRICT BY DESCEND. VALUE IN \$1000'S ESTIM. WEIGHT IN METRIC TONS

CD#	CUSTOMS DISTRICT	CODE	HARMONIZED COMMODITY DESCRIPTION	\$1000S	EST. M.TONS
----	-----	----	-----	-----	-----
7	OGDENSBURG, N.Y.	3920	PLATES, SHEETS, FILM ETC NO AD, NON-CEL ETC, PLAS	20,463.	2,789.
		3707	PHOTOGRAPHIC CHEMICALS, UNMIXED PROD RETAIL PACKED	16,819.	1,026.
		3703	PHOTO PAPER, PAPERBOARD & TEXTILES, SENS, UNEXPOS	15,936.	1,394.
		9006	PHOTOGRAPHIC STILL CAMERAS, FLASH APPARATUS ETC	15,398.	359.
		9009	PHOTOCOPY APPARATUS & THERMOCOPY APPARATUS, PTS	8,185.	496.
		2521	LMSTN FLUX, LMSTN A OTH CAL STO USD MFR LIME, CMT	8,080.	37,028.
		901	COFFEE, COFFEE HUSKS ETC, SUBSTITUTES WITH COFFEE	7,540.	5,243.
		9022	X-RAY ETC APPARATUS, TUBES, PANELS, SCREEN ETC, P	7,530.	492.
		2608	ZINC ORES AND CONCENTRATES	7,397.	30,272.
		8544	INSULATED WIRE, CABLE ETC, OPT SHEATH FIB CABLES	6,776.	1,274.
		8805	AIRCRAFT LAUNCH GEAR, DECK-ARREST, GR FL TRAIN, PT	5,248.	71.
		3904	POLYMERS OF VINYL CHLORIDE ETC., IN PRIMARY FORMS	4,522.	633.
		3910	SILICONES, IN PRIMARY FORMS	4,363.	1,175.
		4805	PAPER & PAPERBOARD, UNCOAT, NESOI, ROLLS OR SHEETS	3,812.	1,856.
		2516	GRANITE, PORPHYRY, BASALT ETC., CRUDE OR CUT ETC.	3,606.	8,445.
		8471	AUTOMATIC DATA PROCESS MACHINES, MAGN READER ETC	3,511.	102.
		9010	APPARATUS ETC FOR PHOTO LABS ETC NESOI, PARTS ETC	3,480.	107.
		3602	PREPARED EXPLOSIVES OTHER THAN PROPELLENT POWDERS	2,926.	408.
		3303	PERFUMES AND TOILET WATERS	2,815.	252.
		3307	PERSONAL TOILET ETC PREP NESOI, SHAVING, BATH ETC.	2,670.	513.
		2303	RESIDUES OF STARCH MFR OR SUGAR MFR OR BREWING ETC	2,636.	22,589.
		3402	ORGANIC SURF-ACT AGENTS, PREPS & CLEANING PREPS	2,180.	894.
		8415	AIR CONDITIONING MACHINES (TEMP & HUM CHANGE), PT	2,127.	268.
		3204	SYN ORG COLORING MATTER & PREP, SYN ORG BRIT AGENT	1,989.	199.
		7412	COPPER TUBE OR PIPE FITTINGS	1,934.	188.
		4107	LEATHER OF ANIMALS NESOI, NO HAIR NESOI	1,931.	485.
		8708	PARTS & ACCESS FOR MOTOR VEHICLES (HEAD 8701-8705)	1,909.	270.
		2513	PUMICE, EMERY, NATURAL CORUNDUM AND GARNET ETC	1,899.	2,907.
		3901	POLYMERS OF ETHYLENE, IN PRIMARY FORMS	1,873.	1,513.
		2917	POLYCARBOXYLIC ACIDS & ANHYD ETC, HALOG, SULF ETC	1,765.	1,048.
		9027	INST ETC FOR PHYSICAL ETC ANAL ETC, MICROTOME, PT	1,760.	34.
		8474	MACHINERY FOR SORTING SCREENING ETC MINERALS, PTS	1,703.	477.
		2936	PROVITAMINS AND VITAMINS & DERIVATIVES & INTERMIX	1,698.	193.
		6204	WOMEN'S OR GIRLS' SUITS, ENSEMB ETC, NOT KNIT ET	1,622.	111.
		3603	SAFETY FUSES, DETONATING FUSE, PERCUSSION CAPS ETC	1,542.	177.
		7604	ALUMINUM BARS, RODS AND PROFILES	1,526.	310.
		9018	MEDICAL, SURGICAL, DENTAL OR VET INST, NO ELEC, P	1,430.	65.
		4823	PAPER, PAPERBOARD, CELLUL WAD TO SIZE & ARTS NESO	1,426.	414.
		2933	HETEROCYCLIC COMP, NIT HETERO-ATOM, NUCLEIC ACIDS	1,424.	418.
		7502	NICKLE, UNWROUGHT	1,424.	426.
		3923	CONTAINERS (BOXES, BAGS ETC), CLOSURERS ETC, PLAS	1,390.	379.
		3926	ARTICLES OF PLASTICS (INC POLYMERS & RESINS) NESO	1,352.	147.
		7112	WASTE & SCRAP OF PREC METAL OR METAL CL W PREC MT	1,330.	15.
		3004	MEDICAMENTS NESOI, MIXED OR NOT, IN DOSAGE ETC FM	1,317.	159.
		8711	MOTORCYCLES (INCL MOPEDS) & CYCLES WITH AUX MOTOR	1,310.	77.
		2922	OXYGEN-FUNCTION AMINO-COMPOUNDS	1,247.	486.
		3215	INK, PRINTING, WRITING, DRAWING ETC, CONCEN OR NO	1,225.	144.
		9403	FURNITURE NESOI AND PARTS THEREOF	1,136.	332.

1993 U.S. EXPORTS TRANSSHIPPED VIA CANADA ABOVE \$200,000
 BY CUSTOMS DISTRICT BY DESCEND. VALUE IN \$1000'S ESTIM. WEIGHT IN METRIC TONS

CD#	CUSTOMS DISTRICT	CODE	HARMONIZED COMMODITY DESCRIPTION	\$1000S	EST. M.TONS
7	OGDENSBURG, N.Y.	4811	PAPER, PAPERBOARD, WAD ETC, COAT ETC NESOI, RL ET	1,072.	427.
		3905	POLYMERS OF VINYL ACETATE & OTH VINYL POLYM, PR FM	1,070.	196.
		3705	PHOTO PLATES & STILL FILM, EXPOSED & DEVELOPED	1,023.	203.
		8480	MOLDING BOXES FOR METAL FOUNDRY, MOLD BASES ETC	1,010.	93.
		9008	IMAGE PROJECTORS, STILL, ENLARGERS ETC, STILL, PTS	982.	74.
		8479	MACHINES ETC HAVING INDIVIDUAL FUNCTIONS NESOI, P	969.	315.
		8421	CENTRIFUGES, FILTER ETC MACH FOR LIQ OR GASES, PT	954.	76.
		808	APPLES, PEARS AND QUINCES, FRESH	929.	1,631.
		5407	WOVEN FAB OF SYN FIL YN, INCL MONOFIL 67 DEC ETC	913.	128.
		9503	TOYS NESOI, SCALE MODELS ETC, PUZZLES, PARTS ETC	911.	110.
		7504	NICKEL POWDERS AND FLAKES	901.	589.
		3811	ANTIKNOCK PREPS & OTHER ADDITIVES FOR MINERAL OIL	886.	417.
		8205	HANDTOOLS NESOI, BLOW TORCHES ETC, ANVILS ETC	870.	95.
		9506	ARTICLES & EQUIP FOR SPORTS ETC NESOI, POOLS, PTS	868.	73.
		2821	IRON OXIDES & HYDROXIDES, EARTH COLORS NUN 70% IR	867.	300.
		8473	PARTS ETC FOR TYPEWRITERS & OTHER OFFICE MACHINES	865.	44.
		4909	PRINTED OR ILLUST POST CARDS, GREETING CARDS, ETC.	817.	68.
		2309	PREPARATIONS USED IN ANIMAL FEEDING	815.	467.
		8101	TUNGSTEN (WOLFRAM) & ARTICLES, INCL WASTE & SCRAP	811.	221.
		8536	ELECTRICAL APPARATUS FOR SWITCHING ETC, NOV 1000	811.	80.
		6406	PARTS OF FOOTWEAR, INSOLES ETC, GAITORS ETC, PARTS	780.	432.
		7318	SCREWS, BOLTS, NUTS, WASHERS ETC, IRON OR STEEL	780.	58.
		8703	MOTOR CARS & VEHICLES FOR TRANSPORTING PERSONS	778.	67.
		3305	PREPARATIONS FOR USE ON THE HAIR	776.	202.
		2106	FOOD PREPARATIONS NESOI	774.	260.
		8411	TURBOJETS, TURBOPROPELLERS & OTH GAS TURBINES, PTS	773.	1.
		4901	BOOKS, BROCHURES & SIMILAR PRINTED MATTER	757.	117.
		7607	ALUMINUM FOIL (BACK OR NOT) NOV .2MM TH (EX BACK)	756.	177.
		2918	CARBOXYLIC ACID, ADDED OXYGEN & ANHY ETC, HAL ETC	732.	541.
		8517	ELECTRIC APPARATUS FOR LINE TELEPHONY ETC, PARTS	732.	112.
		4418	BUILDERS' JOINERY AND CARPENTRY OF WOOD	729.	1,717.
		8539	ELECTRIC FILAMENT OR DISCHARGE LAMPS, PARTS	725.	99.
		4911	PRINTED MATTER NESOI, INCL PRINT PICTURES & PHOTOS	698.	124.
		6109	T-SHIRTS, SINGLET, TANK TOPS ETC, KNIT OR CROCHET	698.	148.
		2827	CHLORIDES ETC, BROMIDES ETC, IODIDES ETC.	692.	209.
		8469	TYPEWRITERS & WORD PROCESSING MACHINES	681.	12.
		2907	PHENOLS, PHENOL-ALCOHOLS	668.	435.
		8414	AIR OR VAC PUMPS, COMPR & FANS, HOODS & FANS, PTS	659.	70.
		6203	MEN'S OR BOYS' SUITS, ENSEMBLES ETC, NOT KNIT ET	656.	32.
		4818	TOILET PAPER, PAPER TISSUES, TOWELS, NAPKINS ETC	631.	173.
		8481	TAPS, COCKS, VALVES ETC FOR PIPES, TANKS ETC, PTS	627.	55.
		3909	AMINO-RESINS, PHENOLICS & POLYURETHANES, PRIM FORM	626.	185.
		9306	BOMBS, GRENADES ETC, CARTRIDGES ETC AND PARTS	617.	27.
		8454	CONVERTERS, LADLES, INGOT MOLDS & CASTING MACH, P	606.	40.
		8431	PARTS FOR MACHINERY OF HEADINGS 8425 TO 8430	594.	81.
		3401	SOAP, ORGANIC SURF-ACT PREP FOR SOAP USE, BARS ETC	590.	373.
		2915	SAT ACYCLIC MONOCARBOX ACID & ANHYD, HALOGON ETC	573.	422.
		9505	FESTIVE, CARNIVAL OR OTHER ENTERTAINMENT ART, PTS	564.	77.

1993 U.S. EXPORTS TRANSSHIPPED VIA CANADA ABOVE \$200,000
 BY CUSTOMS DISTRICT BY DESCEND. VALUE IN \$1000'S ESTIM. WEIGHT IN METRIC TONS

CD#	CUSTOMS DISTRICT	CODE	HARMONIZED COMMODITY DESCRIPTION	\$1000S	EST. M.TONS
7	OGDENSBURG, N.Y.	6403	FOOTWEAR, OUTER SOLE RUB, PLAST OR LEA & UPPER LEA	553.	44.
		307	MOLLUSCS & AQUATIC INVERTEBRATES NESOI, LIVE ETC.	550.	320.
		8482	BALL OR ROLLER BEARINGS AND PARTS	550.	32.
		8803	PARTS OF BALLOONS ETC, AIRCRAFT, SPACECRAFT ETC	549.	17.
		8543	ELECTRICAL MACH ETC, WITH IND FUNCTIONS NESOI, PT	543.	32.
		4421	ARTICLES OF WOOD, NESOI	532.	1,236.
		8525	TRANS APPAR FOR RADIOTELEPHONY ETC, TV CAMERAS	526.	23.
		3921	PLATES, SHEETS, FILM, FOIL & STRIP NESOI, PLASTIC	514.	109.
		3302	ODORIFEROUS MIXTURES AS RAW MATERIALS FOR INDUSTRY	510.	85.
		8477	MACHINERY FOR WORKING RUBBER & PLAST ETC NESOI, P	504.	24.
		3304	BEAUTY, MAKE-UP & SKIN-CARE PREP, MANICURE ETC PRP	499.	61.
		8516	ELEC WATER, SPACE & SOIL HEATERS, HAIR ETC DRY, P	497.	22.
		9024	MACHINES ETC FOR TESTING MECH PROP OF MATERIAL, P	474.	22.
		4819	CARTONS ETC PAPER, OFFICE BOX FILES ETC, PAPER ET	469.	372.
		7601	ALUMINUM, UNWROUGHT	467.	115.
		5903	TEXTILE FABRICS (NOT TIRE CORD) COAT ETC, PLASTICS	439.	24.
		3003	MEDICAMENTS NESOI OF MIXTURES, NOT DOSAGE ETC FORM	427.	77.
		8441	MACH FOR MAKING UP PULP & PAPER, INC CUTTERS, PTS	424.	34.
		8467	TOOLS FOR WORKING IN THE HAND, PNEUMATIC ETC, PTS	420.	49.
		9603	BROOMS, BRUSHES, MOPS, FEATHER DUSTERS ETC	419.	109.
		8302	HARDWARE, FIXTURES, CASTORS ETC & PARTS, BASE METL	414.	47.
		5905	TEXTILE WALL COVERINGS	396.	104.
		8524	RECORDS, TAPES & OTHER RECORDED SOUND MEDIA ETC	381.	36.
		4820	REGISTERS, NOTEBOOKS, BINDERS, BUS FORMS ETC, PAP	378.	93.
		7207	SEMIFINISHED PRODUCTS OF IRON OR NONALLOY STEEL	375.	689.
		3208	PAINT & VARNISH FROM SYNTH ETC POLYMERS NONAQ, ETC	369.	42.
		9031	MACHINES, NESOI IN CHAPTER 90, PROFILE PROJECT, P	369.	18.
		8438	MACH NESOI, IND PREP OF FOOD OR DRINK ETC, PARTS	363.	21.
		8409	PARTS FOR ENGINES OF HEADING 8407 OR 8408	359.	26.
		8701	TRACTORS (OTHER THAN WORKS TRUCKS OF HEADING 8709)	357.	91.
		2804	HYDROGEN, RARE GASES AND OTHER NONMETALS	354.	295.
		3903	POLYMERS OF STYRENE, IN PRIMARY FORMS	349.	188.
		4407	WOOD SAWN OR CHIPPED LENGTH, SLICED ETC, OV6MM TH	339.	510.
		2916	UNSAT ACYCLIC & CYCLIC MONOCARBOX ACID & ANHYD ET	332.	150.
		8432	AGRICULT ETC MACH FOR SOIL ETC, LAWN ROLLERS, PTS	329.	86.
		8535	ELECTRICAL APPARATUS FOR SWITCHING ETC, OV 1000 V	329.	4.
		8408	COMPRESSION-IGNITION INTERNAL COMB PISTON ENGINES	324.	31.
		3808	INSECTICIDES, RODENTICIDES, FUNGICIDES ETC, RETAIL	309.	22.
		3405	POLISHES & CREAMS FOR LEATHER, WOOD ETC, SCOUR PRP	307.	100.
		8424	MECH APPL TO DISPERSE LIQ ETC, SAND ETC BLAST MAC	307.	24.
		3912	CELLULOSE AND CHEMICAL DERIV NESOI, PRIMARY FORMS	301.	89.
		8461	MACHINE TOOLS FOR SHAPING, SLOTTING, GEAR CUT ETC	295.	3.
		2403	TOBACCO & TOBACCO SUBST MFRS NESOI, TOB PROCES ETC	292.	115.
		6815	ARTICLES OF STONE OR OTHER MINERAL SUBSTANCE NESOI	288.	243.
		2930	ORGANO-SULFUR COMPOUNDS	287.	123.
		6107	MEN'S OR BOYS' UNDERPANTS, PJS, ETC, KNIT OR CRO	286.	30.
		2712	PETROLEUM JELLY, MINERAL WAXES & SIMILAR PRODUCTS	284.	142.
		8466	PARTS ETC FOR MACHINE TOOLS OF HEAD 8456 TO 8465	283.	55.

1993 U.S. EXPORTS TRANSSHIPPED VIA CANADA ABOVE \$200,000
 BY CUSTOMS DISTRICT BY DESCEND. VALUE IN \$1000'S ESTIM. WEIGHT IN METRIC TONS

CD#	CUSTOMS DISTRICT	CODE	HARMONIZED COMMODITY DESCRIPTION	\$1000S	EST. M.TONS
---	-----	---	-----	-----	-----
7	OGDENSBURG, N.Y.	7308	STRUCTURES NESOI & PARTS THEREOF, OF IRON OR STEEL	282.	158.
		2208	ETHYL ALCOHOL, UNDENAT, UND80% ALC, SPIRIT BEV ETC	281.	102.
		7019	GLASS FIBERS & ARTICLES THEREOF (YARN ETC.)	281.	73.
		8406	STEAM TURBINES & OTHER VAPOR TURBINES, PARTS	280.	16.
		302	FISH, FRESH OR CHILLED (NO FILLETS OR OTHER MEAT)	279.	227.
		6803	SLATE, WORKED AND ARTICLES, ARTICLES OF AGGLOM SLT	277.	274.
		5603	NONWOVENS, WHETHER OR NOT IMPREGNATED, COATED ETC	275.	65.
		1702	SUGARS NESOI, INCL CHEM PURE LACTOSE ETC, CAMEL	268.	440.
		3503	GELATIN & DERIV, ISINGLASS, GLUES, ANIMAL OR NESOI	268.	53.
		4101	RAW HIDES & SKINS OF BOVINE OR EQUINE ANIMALS	267.	130.
		4016	ARTICLES NESOI OF UNHARDED VULCANIZED RUBBER	264.	28.
		7010	GLASS CONTAINERS FOR PACKING ETC & GLASS CLOSURES	263.	60.
		9612	TYPEWRITER ETC RIBBONS, INKED OR PREP, INK PADS	259.	58.
		5806	NARROW WOVEN FABRICS EXCEPT LABELS ETC IN PC ETC	257.	82.
		2818	ALUMINUM OXIDE (INCL ART CORUNDUM), ALUM HYDROXIDE	252.	95.
		3911	PETRO RESINS, POLYSULFIDES ETC NESOI, PRIMARY FOR	252.	139.
		8418	REFRIGERATORS, FREEZERS ETC, HEAT PUMPS NESOI, PT	248.	21.
		4008	PLATES, SHEETS, PROFILE SHAPES ETC, SOFT VULC RUBR	247.	35.
		3924	TABLEWARE & OTHER HOUSEHOLD ARTICLES ETC, PLASTIC	246.	54.
		7606	ALUMINUM PLATES, SHEETS & STRIP OVER .2MM THICK	239.	101.
		3504	PEPTONES, OTHER PROTEINS & DERIV ETC, HIDE POWDER	237.	85.
		4011	NEW PNEUMATIC TIRES, OF RUBBER	237.	81.
		8523	PREPARED UNRECORDED MEDIA (NO FILM) FOR SOUND ETC	237.	19.
		8447	MACHINES, KNITTING, STITCH-BOND, LACE, NET ETC.	236.	73.
		2926	NITRILE-FUNCTION COMPOUNDS	235.	286.
		7503	NICKEL WASTE AND SCRAP	220.	131.
		8541	SEMICONDUCTOR DEVICES, LIGHT-EMIT DIODES ETC, PTS	220.	22.
		3918	FLOOR COVER (ROLLS & TILES) & WALL COVER, PLASTIC	218.	23.
		5808	BRAIDS IN PC, ORN TRIM IN PC ETC, TASSELS ETC.	218.	120.
		8413	PUMPS FOR LIQUIDS, LIQUID ELEVATORS, PARTS THEREO	218.	13.
		7326	ARTICLES OF IRON OR STEEL, NESOI	216.	60.
		3823	BINDERS FOR FOUND MOLDS, CHEMICAL PROD ETC NESOI	214.	70.
		2909	ETHERS, ETHER-ALCOHOLS, ALCOHOL PEROXIDES ETC.	211.	69.
		3917	TUBES, PIPES & HOSES & THEIR FITTINGS, OF PLASTIC	209.	31.
		8443	PRINTING MACHINERY, MACHINES ANCIL TO PRINTING, P	208.	145.
		9999	BELOW MINIMUM	16,347.	8,368.
			*SUB-TOTAL CUSTOMS DIST. # 7	363,178.	163,065.
9	BUFFALO-NIAGRA FALLS	8471	AUTOMATIC DATA PROCESS MACHINES, MAGN READER ETC	24,501.	930.
		8545	CARBON ELECTRODES & BRUSHES, LAMP CARBONS ETC	21,649.	10,080.
		8462	MACHINE TOOLS FOR FORGING, BENDING, STAMPING ETC	7,973.	569.
		1901	MALT EXT, FOOD PREP OF FLOUR ETC UN 50% COCOA ETC	7,932.	1,209.
		3822	COMPOSITE DIAGNOSTIC/LAB REAGENTS, EXC PHARMACEUT	5,296.	1,109.
		9009	PHOTOCOPY APPARATUS & THERMOCOPI APPARATUS, PTS	4,997.	321.
		4407	WOOD SAWN OR CHIPPED LENGTH, SLICED ETC, OV6MM TH	4,319.	5,088.
		8451	MACHINERY (NOT LAUNDRY) FOR CLEANING, DRYING ETC	4,294.	211.
		8404	AUXILIARY PLANT USED WITH BOILERS, CONDENSERS, PTS	3,967.	363.

1993 U.S. EXPORTS TRANSSHIPPED VIA CANADA ABOVE \$200,000
 BY CUSTOMS DISTRICT BY DESCEND. VALUE IN \$1000'S ESTIM. WEIGHT IN METRIC TONS

CD#	CUSTOMS DISTRICT	CODE	HARMONIZED COMMODITY DESCRIPTION	\$1000S	EST. M.TONS
9	BUFFALO-NIAGRA FALLS	3811	ANTIKNOCK PREPS & OTHER ADDITIVES FOR MINERAL OIL	3,087.	1,602.
		2825	HYDRAZINE ETC, OTH INORG BASES, METAL OXIDES ETC	2,707.	844.
		3002	HUMAN BLOOD, ANIMAL BLOOD, ANTISERA, VACCINES ETC	2,573.	97.
		3507	ENZYMES, PREPARED ENZYMES NESOI	2,419.	750.
		3920	PLATES, SHEETS, FILM ETC NO AD, NON-CEL ETC, PLAS	2,074.	571.
		8409	PARTS FOR ENGINES OF HEADING 8407 OR 8408	2,074.	196.
		2915	SAT ACYCLIC MONOCARBOX ACID & ANHYD, HALOGON ETC	1,899.	1,416.
		2526	NATURAL STEATITE, ROUGHLY TRIMMED ETC, TALC	1,809.	7,062.
		8477	MACHINERY FOR WORKING RUBBER & PLAST ETC NESOI, P	1,747.	92.
		5806	NARROW WOVEN FABRICS EXCEPT LABELS ETC IN PC ETC	1,661.	132.
		8473	PARTS ETC FOR TYPEWRITERS & OTHER OFFICE MACHINES	1,351.	57.
		3821	PREPARED CULTURE MEDIA FOR DEVEL OF MICROORGANISM	1,305.	111.
		8607	PARTS OF RAILWAY OR TRAMWAY LOCOMOTIVES OR R STOCK	1,298.	182.
		3926	ARTICLES OF PLASTICS (INC POLYMERS & RESINS) NESO	1,214.	179.
		9027	INST ETC FOR PHYSICAL ETC ANAL ETC, MICROTOME, PT	1,194.	43.
		8481	TAPS, COCKS, VALVES ETC FOR PIPES, TANKS ETC, PTS	1,102.	67.
		7903	ZINC DUST, POWDERS AND FLAKES	1,064.	807.
		9018	MEDICAL, SURGICAL, DENTAL OR VET INST, NO ELEC, P	1,028.	82.
		8479	MACHINES ETC HAVING INDIVIDUAL FUNCTIONS NESOI, P	1,023.	69.
		8466	PARTS ETC FOR MACHINE TOOLS OF HEAD 8456 TO 8465	992.	171.
		8803	PARTS OF BALLOONS ETC, AIRCRAFT, SPACECRAFT ETC	963.	16.
		2835	PHOSPHINATES, PHOSPHONATES, PHOSPHATES & POLYPHOSP	931.	364.
		3004	MEDICAMENTS NESOI, MIXED OR NOT, IN DOSAGE ETC FM	929.	349.
		2904	HYDROCARBON DERIVATIVES, SULFONATED, NITRATED ETC	906.	557.
		8407	SPARK-IGNITION RECIP OR ROTARY INT COMB PISTON ENG	895.	155.
		8442	MACH ETC NESOI FOR TYPESET, MAKING PR PLATES ETC	862.	59.
		7210	FL-RL IRON & NA STEEL NUN600MM WD, CLAD ETC	852.	1,907.
		3904	POLYMERS OF VINYL CHLORIDE ETC., IN PRIMARY FORMS	850.	123.
		8703	MOTOR CARS & VEHICLES FOR TRANSPORTING PERSONS	812.	84.
		8517	ELECTRIC APPARATUS FOR LINE TELEPHONY ETC, PARTS	796.	165.
		8108	TITANIUM & ARTICLES THEREOF, INCLUD WASTE & SCRAP	794.	211.
		3205	COLOR LAKES, PREPARATIONS BASED ON COLOR LAKES	781.	62.
		5407	WOVEN FAB OF SYN FIL YN, INCL MONOFIL 67 DEC ETC	779.	214.
		8525	TRANS APPAR FOR RADIOTELEPHONY ETC, TV CAMERAS	745.	24.
		8411	TURBOJETS, TURBOPROPELLERS & OTH GAS TURBINES, PTS	732.	18.
		6403	FOOTWEAR, OUTER SOLE RUB, PLAST OR LEA & UPPER LEA	728.	330.
		8109	ZIRCONIUM & ARTICLES THEREOF, INCLUD WASTE & SCRAP	708.	7.
		8544	INSULATED WIRE, CABLE ETC, OPT SHEATH FIB CABLES	692.	81.
		205	MEAT OF HORSES, ASSES, MULES, HINNIES FR, CHLD, FZ	678.	396.
		2933	HETEROCYCLIC COMP, NIT HETERO-ATOM, NUCLEIC ACIDS	676.	81.
		9024	MACHINES ETC FOR TESTING MECH PROP OF MATERIAL, P	674.	33.
		6902	REFRACTORY BRICKS & OTHER REFR CER CONST ART NESOI	666.	303.
		3912	CELLULOSE AND CHEMICAL DERIV NESOI, PRIMARY FORMS	599.	125.
		8514	INDUSTRIAL OR LAB ELEC FURNACES ETC, PARTS	596.	34.
		3815	REACTION INITIATORS & ACCELER & CATALYT PREP NESO	575.	120.
		8406	STEAM TURBINES & OTHER VAPOR TURBINES, PARTS	567.	43.
		8503	PARTS OF ELECTRIC MOTORS, GENERATORS & SETS	530.	55.
		4802	PAPER, UNCOAT, FOR WRITING ETC, ROLLS, HNDMD PAPER	526.	210.

1993 U.S. EXPORTS TRANSSHIPPED VIA CANADA ABOVE \$200,000
 BY CUSTOMS DISTRICT BY DESCEND. VALUE IN \$1000'S ESTIM. WEIGHT IN METRIC TONS

CD#	CUSTOMS DISTRICT	CODE	HARMONIZED COMMODITY DESCRIPTION	\$1000S	EST. M.TONS
9	BUFFALO-NIAGRA FALLS	8413	PUMPS FOR LIQUIDS, LIQUID ELEVATORS, PARTS THEREO	506.	47.
		8536	ELECTRICAL APPARATUS FOR SWITCHING ETC, NOV 1000	497.	26.
		7019	GLASS FIBERS & ARTICLES THEREOF (YARN ETC.)	493.	47.
		4104	BOVINE OR EQUINE LEATHER, NO HAIR NESOI	487.	139.
		8543	ELECTRICAL MACH ETC, WITH IND FUNCTIONS NESOI, PT	480.	47.
		3919	SELF-ADHESIVE PLATES, SHEETS, FILM ETC OF PLASTIC	472.	50.
		7503	NICKEL WASTE AND SCRAP	462.	96.
		9015	SURVEY, HYDROGR, METEORO ETC INST, RANGEF ETC, PT	461.	18.
		3204	SYN ORG COLORING MATTER & PREP, SYN ORG BRIT AGENT	456.	55.
		4011	NEW PNEUMATIC TIRES, OF RUBBER	448.	84.
		8419	MACHINERY ETC FOR TEMP CHANG TREAT MAT, W HEAT, P	442.	75.
		9023	INST, APPTS&MODELS, FOR DEMONSTRATIONAL USE& PARTS	430.	10.
		8461	MACHINE TOOLS FOR SHAPING, SLOTTING, GEAR CUT ETC	418.	164.
		3909	AMINO-RESINS, PHENOLICS & POLYURETHANES, PRIM FORM	396.	167.
		2907	PHENOLS, PHENOL-ALCOHOLS	394.	318.
		7202	FERROALLOYS	386.	297.
		2930	ORGANO-SULFUR COMPOUNDS	375.	182.
		3902	POLYMERS OF PROPYLENE OR OTHER OLEFINS, PRIM FORMS	374.	335.
		2530	MINERAL SUBSTANCES NESOI	364.	462.
		2818	ALUMINUM OXIDE (INCL ART CORUNDUM), ALUM HYDROXIDE	363.	97.
		9402	MEDICAL, SURGICAL, DENTAL OR VETERINARY FURN ETC	349.	30.
		4811	PAPER, PAPERBOARD, WAD ETC, COAT ETC NESOI, RL ET	347.	312.
		5602	FELT, IMPREGNATED, COATED, ETC. OR NOT	342.	51.
		2712	PETROLEUM JELLY, MINERAL WAXES & SIMILAR PRODUCTS	338.	255.
		3402	ORGANIC SURF-ACT AGENTS, PREPS & CLEANING PREPS	329.	136.
		2836	CARBONATES, PEROXOCARBONATES, COMM AMM CARBONATE	326.	520.
		9006	PHOTOGRAPHIC STILL CAMERAS, FLASH APPARATUS ETC	321.	3.
		5515	WOVEN FABRICS OF SYNTHETIC STAPLE FIBERS NESOI	312.	21.
		8112	BERYLLIUM, CHROM, GERM, VANAD, GALLIUM, HAFNM, ETC	300.	9.
		8537	BOARDS, PANELS ETC WITH ELEC SWITCH APPAR ETC.	297.	7.
		9032	AUTOMATIC REGULATING OR CONTROL INSTRUMENTS, PART	287.	13.
		8421	CENTRIFUGES, FILTER ETC MACH FOR LIQ OR GASES, PT	286.	14.
		3405	POLISHES & CREAMS FOR LEATHER, WOOD ETC, SCOUR PRP	283.	576.
		3907	POLYETHERS, EXPOXIDES & POLYESTERS, PRIMARY FORMS	278.	128.
		9504	ARTICLES FOR ARCADE, TABLE OR PARLOR GAMES, PARTS	262.	16.
		8531	ELECTRIC SOUND OR VISUAL SIGNALING APPARATUS, PTS	258.	7.
		4810	PAPER & PAPERBOARD, COATED WITH KAOLIN ETC, RL ET	253.	235.
		3801	ARTIFICIAL GRAPHITE, COLLODIAL GRAPHITE & PREP ETC	252.	57.
		2508	CLAYS NESOI, ANDALUSITE, KYANITE ETC, MULLITE ETC	251.	1,398.
		8474	MACHINERY FOR SORTING SCREENING ETC MINERALS, PTS	248.	21.
		2827	CHLORIDES ETC, BROMIDES ETC, IODIDES ETC.	239.	38.
		8516	ELEC WATER, SPACE & SOIL HEATERS, HAIR ETC DRY, P	239.	12.
		8515	ELECTRIC, LASER OR OTH LIGHT OR PHOTON BEAM ETC	232.	20.
		2905	ACYCLIC ALCOHOLS & HALOGENAT, SULFONATD ETC DERIVS	231.	550.
		4013	INNER TUBES FOR TIRES, OF RUBBER	231.	10.
		8456	MACHINE TOOLS FOR MATERIAL REMOVAL BY LASER ETC	230.	8.
		8414	AIR OR VAC PUMPS, COMPR & FANS, HOODS & FANS, PTS	227.	22.
		6806	MINERAL WOOLS, EXPANDED MINERAL MATERIAL & MIXTURE	226.	393.

1993 U.S. EXPORTS TRANSSHIPPED VIA CANADA ABOVE \$200,000
 BY CUSTOMS DISTRICT BY DESCEND. VALUE IN \$1000'S ESTIM. WEIGHT IN METRIC TONS

CD#	CUSTOMS DISTRICT	CODE	HARMONIZED COMMODITY DESCRIPTION	\$1000S	EST. M.TONS
9	BUFFALO-NIAGRA FALLS	8483	TRANSMISSION SHAFTS, BEARINGS, GEARS ETC, PARTS	222.	31.
		2106	FOOD PREPARATIONS NESOI	217.	78.
		2918	CARBOXYLIC ACID, ADDED OXYGEN & ANHY ETC, HAL ETC	214.	94.
		4820	REGISTERS, NOTEBOOKS, BINDERS, BUS FORMS ETC, PAP	214.	78.
		8455	METAL-ROLLING MILLS AND ROLLS THEREFOR, PARTS	205.	44.
		8422	MACHINES, DISHWASH, CLEAN ETC CONT & FILL, PAK ET	200.	11.
		9999	BELOW MINIMUM	14,679.	7,836.
		*SUB-TOTAL CUSTOMS DIST. # 9		171,820.	56,286.
30	SEATTLE, WASH.	8803	PARTS OF BALLOONS ETC, AIRCRAFT, SPACECRAFT ETC	107,433.	3,105.
		1604	PREP OR PRES FISH, CAVIAR & CAVIAR SUBSTITUTES	82,685.	21,984.
		8471	AUTOMATIC DATA PROCESS MACHINES, MAGN READER ETC	69,027.	2,941.
		9030	OSCILLOSCOPES, SPECTRUM ANALYZERS ETC, PARTS ETC	57,034.	3,641.
		8473	PARTS ETC FOR TYPEWRITERS & OTHER OFFICE MACHINES	54,046.	2,620.
		8542	ELECTRONIC INTEGRATED CIRCUITS & MICROASSEMBL, PT	46,314.	2,273.
		9018	MEDICAL, SURGICAL, DENTAL OR VET INST, NO ELEC, P	37,599.	2,750.
		303	FISH, FROZEN (NO FISH FILLETS OR OTHER FISH MEAT)	33,815.	11,429.
		8524	RECORDS, TAPES & OTHER RECORDED SOUND MEDIA ETC	31,458.	2,462.
		8541	SEMICONDUCTOR DEVICES, LIGHT-EMIT DIODES ETC, PTS	30,275.	1,667.
		4407	WOOD SAWN OR CHIPPED LENGTH, SLICED ETC, OV6MM TH	19,083.	30,245.
		4301	RAW FURSKINS NESOI (INCL PCS FOR FUR USE)	18,148.	5,900.
		4901	BOOKS, BROCHURES & SIMILAR PRINTED MATTER	16,474.	2,746.
		9021	ORTHOPEDIC APPL, ARTIF BODY PTS, HEAR AID, PTS ET	12,066.	715.
		9506	ARTICLES & EQUIP FOR SPORTS ETC NESOI, POOLS, PTS	11,776.	1,201.
		8532	ELECTRIC CAPACITORS, FIXED, VAR OR ADJ (PRESET) P	9,872.	266.
		8411	TURBOJETS, TURBOPROPELLERS & OTH GAS TURBINES, PTS	6,835.	489.
		809	APRICOTS, CHERRIES, PEACHES, PLUMS & SLOES, FRESH	6,498.	3,710.
		8543	ELECTRICAL MACH ETC, WITH IND FUNCTIONS NESOI, PT	6,452.	493.
		1210	HOP CONES, FRESH OR DRIED, LUPULIN	6,170.	1,129.
		2402	CIGARS, CIGARETTES ETC., OF TOBACCO OR SUBSTITUTES	5,835.	497.
		8525	TRANS APPAR FOR RADIOTELEPHONY ETC, TV CAMERAS	5,743.	232.
		3818	CHEM ELEM DOPED, USED IN ELECTRON, DISCS WAFERS E	5,203.	4,110.
		8504	ELECTRIC TRANSFORM, STATIC CONVERTERS & INDUCT, PT	5,104.	1,548.
		8109	ZIRCONIUM & ARTICLES THEREOF, INCLUD WASTE & SCRAP	4,908.	236.
		1302	VEG SAPS & EXTRACTS, PECTATES ETC, AGAR-AGAR ETC.	4,900.	369.
		305	FISH, DRIED, SALTED ETC, SMOKED ETC, ED FISH MEAL	4,174.	909.
		2804	HYDROGEN, RARE GASES AND OTHER NONMETALS	3,614.	826.
		8413	PUMPS FOR LIQUIDS, LIQUID ELEVATORS, PARTS THEREO	3,174.	245.
		1901	MALT EXT, FOOD PREP OF FLOUR ETC UN 50% COCOA ETC	3,169.	726.
		8479	MACHINES ETC HAVING INDIVIDUAL FUNCTIONS NESOI, P	3,119.	282.
		9306	BOMBS, GRENADES ETC, CARTRIDGES ETC AND PARTS	3,027.	508.
		8431	PARTS FOR MACHINERY OF HEADINGS 8425 TO 8430	2,956.	337.
		4704	CHEMICAL WOODPULP, SULFITE, NOT DISSOLVING GRADES	2,875.	7,404.
		304	FISH FILLETS & OTH FISH MEAT, FRESH, CHILL OR FROZ	2,771.	1,306.
		8517	ELECTRIC APPARATUS FOR LINE TELEPHONY ETC, PARTS	2,718.	166.
		3926	ARTICLES OF PLASTICS (INC POLYMERS & RESINS) NESO	2,466.	331.
		8456	MACHINE TOOLS FOR MATERIAL REMOVAL BY LASER ETC	2,411.	130.

1993 U.S. EXPORTS TRANSSHIPPED VIA CANADA ABOVE \$200,000
 BY CUSTOMS DISTRICT BY DESCEND. VALUE IN \$1000'S ESTIM. WEIGHT IN METRIC TONS

CD#	CUSTOMS DISTRICT	CODE	HARMONIZED COMMODITY DESCRIPTION	\$1000S	EST. M.TONS
30	SEATTLE, WASH.	302	FISH, FRESH OR CHILLED (NO FILLETS OR OTHER MEAT)	2,346.	875.
		9612	TYPEWRITER ETC RIBBONS, INKED OR PREP, INK PADS	2,327.	835.
		306	CRUSTACEANS, LIVE, FRESH ETC, AND COOKED ETC.	2,317.	371.
		8202	HANDSAWS & MET PTS, SAW BLADES, BASE MTL SAW PARTS	2,309.	128.
		9027	INST ETC FOR PHYSICAL ETC ANAL ETC, MICROTOME, PT	2,154.	298.
		1209	SEEDS, FRUIT AND SPORES, FOR SOWING	2,151.	1,323.
		8534	PRINTED CIRCUITS	2,128.	49.
		4101	RAW HIDES & SKINS OF BOVINE OR EQUINE ANIMALS	2,043.	907.
		8518	MICROPHONES, LOUDSPEAKERS, SOUND AMPLIFIER ETC, P	1,998.	199.
		3301	ESSENT OILS, RESINOIDS, TERPENIC BY-PRODUCTS ETC	1,980.	87.
		9015	SURVEY, HYDROGR, METEOR ETC INST, RANGEF ETC, PT	1,957.	107.
		4412	PLYWOOD, VENEERED PANELS & SIMILAR LAMINATED WOOD	1,910.	3,640.
		4702	CHEMICAL WOODPULP, DISSOLVING GRADES	1,905.	2,733.
		8548	ELECTRICAL PARTS OF MACHINERY NESOI	1,813.	161.
		7003	CAST & ROLLED GLASS, IN SHEETS OR PROFILES ETC	1,812.	1,152.
		9402	MEDICAL, SURGICAL, DENTAL OR VETERINARY FURN ETC	1,794.	256.
		7202	FERROALLOYS	1,744.	1,859.
		8501	ELECTRIC MOTORS AND GENERATORS (NO SETS)	1,673.	160.
		9608	PENS (BALL POINT, S TIP ETC), MECH PENCILS ETC, PT	1,630.	138.
		8529	PARTS FOR TELEVISION, RADIO AND RADAR APPARATUS	1,605.	128.
		8544	INSULATED WIRE, CABLE ETC, OPT SHEATH FIB CABLES	1,594.	214.
		7112	WASTE & SCRAP OF PREC METAL OR METAL CL W PREC MT	1,566.	8.
		8467	TOOLS FOR WORKING IN THE HAND, PNEUMATIC ETC, PTS	1,545.	201.
		4911	PRINTED MATTER NESOI, INCL PRINT PICTURES & PHOTOS	1,479.	374.
		9014	DIRECTION FINDING COMPASSES & NAVIG INST ETC, PTS	1,471.	66.
		8805	AIRCRAFT LAUNCH GEAR, DECK-ARREST, GR FL TRAIN, PT	1,467.	167.
		8540	THERMIONIC, COLD CATHODE OR PHOTOCATHODE TUBES, P	1,453.	172.
		3920	PLATES, SHEETS, FILM ETC NO AD, NON-CEL ETC, PLAS	1,444.	460.
		709	VEGETABLES NESOI, FRESH OR CHILLED	1,423.	2,787.
		604	FOLIAGE, GRASSES ETC FOR BOUQUETS ETC, PREPARED	1,286.	529.
		9403	FURNITURE NESOI AND PARTS THEREOF	1,228.	295.
		8438	MACH NESOI, IND PREP OF FOOD OR DRINK ETC, PARTS	1,222.	69.
		8421	CENTRIFUGES, FILTER ETC MACH FOR LIQ OR GASES, PT	1,195.	140.
		9025	HYDROMETERS, THERMOMETERS, PYROMETERS ETC, PTS ET	1,161.	78.
		1904	FOODS PREP BY SWELL CEREAL, CEREAL NESOI, GRAIN FM	1,100.	476.
		8419	MACHINERY ETC FOR TEMP CHANG TREAT MAT, W HEAT, P	1,075.	166.
		8907	FLOATING STRUCTURES NESOI, RAFTS, TANKS, BUOYS ETC	1,039.	194.
		8466	PARTS ETC FOR MACHINE TOOLS OF HEAD 8456 TO 8465	1,011.	156.
		9013	LIQUID CRYSTAL DEVICES NESOI, LASERS, OPT APPL, P	990.	57.
		8708	PARTS & ACCESS FOR MOTOR VEHICLES (HEAD 8701-8705)	962.	158.
		4302	TANNED OR DRESSED FURSKINS (INCL PCS ETC)	930.	73.
		2008	FRUIT, NUTS ETC PREPARED OR PRESERVED NESOI	910.	579.
		8531	ELECTRIC SOUND OR VISUAL SIGNALING APPARATUS, PTS	891.	87.
		3006	PHARMACEUTICAL GOODS (SPECIFIED STERILE PROD ETC.)	857.	58.
		8414	AIR OR VAC PUMPS, COMPR & FANS, HOODS & FANS, PTS	855.	119.
		8443	PRINTING MACHINERY, MACHINES ANCIL TO PRINTING, P	855.	118.
		205	MEAT OF HORSES, ASSES, MULES, HINNIES FR, CHLD, FZ	834.	297.
		8442	MACH ETC NESOI FOR TYPESET, MAKING PR PLATES ETC	767.	38.

1993 U.S. EXPORTS TRANSSHIPPED VIA CANADA ABOVE \$200,000
 BY CUSTOMS DISTRICT BY DESCEND. VALUE IN \$1000'S ESTIM. WEIGHT IN METRIC TONS

CD#	CUSTOMS DISTRICT	CODE	HARMONIZED COMMODITY DESCRIPTION	\$1000S	EST. M.TONS
---	-----	----	-----	-----	-----
30	SEATTLE, WASH.	3002	HUMAN BLOOD, ANIMAL BLOOD, ANTISERA, VACCINES ETC	708.	105.
		7326	ARTICLES OF IRON OR STEEL, NESOI	705.	202.
		8424	MECH APPL TO DISPERSE LIQ ETC, SAND ETC BLAST MAC	703.	97.
		8401	NUCLEAR REACTORS, FUEL ELEM (N-I), MACH ISOTOP SEP	692.	27.
		8533	ELECTRICAL RESISTORS EXCEPT HEATING RESISTORS, PT	685.	30.
		5601	TEXT WADDING & ARTICLES, TEXT FIBERS NOV 5 MM, ETC	681.	87.
		8441	MACH FOR MAKING UP PULP & PAPER, INC CUTTERS, PTS	670.	53.
		8537	BOARDS, PANELS ETC WITH ELEC SWITCH APPAR ETC.	664.	29.
		8527	RECEPTION APPARATUS FOR RADIOTELEPHONY ETC	649.	49.
		1211	PLANTS ETC FOR PHARMACY, PERFUME, INSECTICIDES ETC	643.	164.
		7019	GLASS FIBERS & ARTICLES THEREOF (YARN ETC.)	632.	250.
		8712	BICYCLES & OTH CYCLES (INC DEL TRICYCLE) NO MOTOR	624.	57.
		7601	ALUMINUM, UNWROUGHT	582.	380.
		4408	VENEER SHEETS ETC, NOT OVER 6 MM THICK	581.	542.
		3822	COMPOSITE DIAGNOSTIC/LAB REAGENTS, EXC PHARMACEUT	558.	40.
		9024	MACHINES ETC FOR TESTING MECH PROP OF MATERIAL, P	553.	30.
		7616	ARTICLES OF ALUMINUM NESOI	549.	122.
		8474	MACHINERY FOR SORTING SCREENING ETC MINERALS, PTS	542.	116.
		8538	PARTS FOR ELEC APPAR ETC OF HEAD 8535, 8536 & 853	541.	61.
		2713	PETROLEUM COKE, PETROLEUM BITUMEN & OTHER RESIDUES	539.	25,271.
		808	APPLES, PEARS AND QUINCES, FRESH	526.	917.
		8430	MACH NESOI, MOVING, GRAD ETC, PILE-DR, SNOFLOW ET	523.	59.
		8480	MOLDING BOXES FOR METAL FOUNDRY, MOLD BASES ETC	518.	83.
		6403	FOOTWEAR, OUTER SOLE RUB, PLAST OR LEA & UPPER LEA	514.	42.
		8429	SELF-PROPELLED BULLDOZERS, GRADERS, SCRAPERS ETC	503.	75.
		3923	CONTAINERS (BOXES, BAGS ETC), CLOSURERS ETC, PLAS	496.	162.
		6309	WORN CLOTHING AND OTHER WORN TEXTILE ARTICLES	495.	178.
		8409	PARTS FOR ENGINES OF HEADING 8407 OR 8408	490.	62.
		4016	ARTICLES NESOI OF UNHARDED VULCANIZED RUBBER	484.	134.
		6406	PARTS OF FOOTWEAR, INSOLES ETC, GAITORS ETC, PARTS	483.	59.
		8439	MACHINERY FOR MAKING PULP & MAKING ETC PAPER, PTS	466.	51.
		9603	BROOMS, BRUSHES, MOPS, FEATHER DUSTERS ETC	452.	21.
		3811	ANTIKNOCK PREPS & OTHER ADDITIVES FOR MINERAL OIL	450.	270.
		8536	ELECTRICAL APPARATUS FOR SWITCHING ETC, NOV 1000	443.	51.
		201	MEAT OF BOVINE ANIMALS, FRESH OR CHILLED	441.	106.
		9031	MACHINES, NESOI IN CHAPTER 90, PROFILE PROJECT, P	441.	29.
		1905	BREAD, PASTRY, CAKES ETC, COMM WAFRS, EMP CAPS ETC	440.	314.
		7606	ALUMINUM PLATES, SHEETS & STRIP OVER .2MM THICK	435.	135.
		8483	TRANSMISSION SHAFTS, BEARINGS, GEARS ETC, PARTS	428.	118.
		3921	PLATES, SHEETS, FILM, FOIL & STRIP NESOI, PLASTIC	427.	50.
		8526	RADAR APPARATUS, RADIO NAVIG AID & REMOTE CONT AP	413.	8.
		9503	TOYS NESOI, SCALE MODELS ETC, PUZZLES, PARTS ETC	408.	39.
		8523	PREPARED UNRECORDED MEDIA (NO FILM) FOR SOUND ETC	401.	16.
		8108	TITANIUM & ARTICLES THEREOF, INCLUD WASTE & SCRAP	393.	25.
		307	MOLLUSCS & AQUATIC INVERTEBRATES NESOI, LIVE ETC.	381.	51.
		4403	WOOD IN THE ROUGH, STRIPPED OR NOT OF SAPWOOD ETC	379.	1,249.
		4411	FIBERBOARD OF WOOD OR OTHER LIGNEOUS MATERIALS	373.	1,135.
		9032	AUTOMATIC REGULATING OR CONTROL INSTRUMENTS, PART	372.	41.

1993 U.S. EXPORTS TRANSSHIPPED VIA CANADA ABOVE \$200,000
 BY CUSTOMS DISTRICT BY DESCEND. VALUE IN \$1000'S ESTIM. WEIGHT IN METRIC TONS

CD#	CUSTOMS DISTRICT	CODE	HARMONIZED COMMODITY DESCRIPTION	\$1000S	EST. M.TONS
----	-----	----	-----	-----	-----
30	SEATTLE, WASH.	9703	ORIGINAL SCULPTURES AND STATUARY, IN ANY MATERIAL	372.	27.
		7304	TUBES, PIPES ETC, SEAMLESS, IRON NESOI & STEEL	368.	38.
		8462	MACHINE TOOLS FOR FORGING, BENDING, STAMPING ETC	367.	32.
		3804	RESIDUAL LYES FROM WOOD PULP MFR (EXCEPT TALL OIL)	366.	2,290.
		8477	MACHINERY FOR WORKING RUBBER & PLAST ETC NESOI, P	364.	22.
		9026	INST ETC MEASURE OR CHECK FLOW, LEVEL ETC, PTS ET	363.	24.
		8454	CONVERTERS, LADLES, INGOT MOLDS & CASTING MACH, P	356.	33.
		8535	ELECTRICAL APPARATUS FOR SWITCHING ETC, OV 1000 V	354.	20.
		9005	OPTICAL TELESCOPES & MOUNT, ASTRO INST & MOUNT, PT	329.	6.
		4823	PAPER, PAPERBOARD, CELLUL WAD TO SIZE & ARTS NESO	326.	215.
		8422	MACHINES, DISHWASH, CLEAN ETC CONT & FILL, PAK ET	323.	46.
		2309	PREPARATIONS USED IN ANIMAL FEEDING	316.	519.
		8528	TELEVISION RECEIVERS (INCL MONITORS & PROJ RECEIV	308.	16.
		8465	MACHINE TOOLS FOR WORKING WOOD, CORK, BONE ETC	304.	19.
		8423	WEIGHING MACHINES & WEIGHING MACHINE WEIGHTS, PTS	301.	50.
		8714	PARTS & ACCESS FOR CYCLES & INVALID CARRIAGES	299.	65.
		9019	MECH-THER, MASSAGE, PSYCH TEST, OZONE APP ETC, PT	295.	38.
		8207	INTERCHANGE TOOLS FOR HAND- OR MACHINE-TOOLS, BMPT	294.	20.
		8716	TRAILERS ETC, OTHER VEHICLES, NOT MECH PROPELD, P	294.	108.
		9405	LAMPS & LIGHTING FITTINGS & PARTS ETC NESOI	284.	47.
		8428	LIFTING, HANDLING, LOADING & UNLOAD MACHINES NESO	283.	40.
		4410	PARTICLE BOARD & SIMILAR BOARD OF WOOD ETC.	279.	1,005.
		4418	BUILDERS'' JOINERY AND CARPENTRY OF WOOD	272.	104.
		603	CUT FLOWERS & BUDS FOR BOUQUETS ETC., PREPARED	268.	189.
		3924	TABLEWARE & OTHER HOUSEHOLD ARTICLES ETC, PLASTIC	267.	58.
		8502	ELECTRIC GENERATING SETS AND ROTARY CONVERTERS	267.	20.
		713	LEGUMINOUS VEGETABLES, DRIED SHELLD	263.	468.
		2308	VEG MATERIAL, WASTE ETC FOR FEEDING ANIMALS NESOI	255.	1,545.
		9023	INST, APPTS&MODELS, FOR DEMONSTRATIONAL USE& PARTS	253.	27.
		7318	SCREWS, BOLTS, NUTS, WASHERS ETC, IRON OR STEEL	245.	51.
		8415	AIR CONDITIONING MACHINES (TEMP & HUM CHANGE), PT	241.	33.
		8112	BERYLLIUM, CHROM, GERM, VANAD, GALLIUM, HAFNM, ETC	236.	98.
		8539	ELECTRIC FILAMENT OR DISCHARGE LAMPS, PARTS	234.	15.
		6201	MEN''S OR BOYS'' OVERCOATS, CLOAKS ETC, NOT KNIT E	225.	17.
		8509	ELECTROMECH DOMESTIC APPLIANCES, PARTS	224.	25.
		9209	PARTS ETC OF MUSICAL INSTR, METRONONES, T FORK ETC	220.	33.
		4104	BOVINE OR EQUINE LEATHER, NO HAIR NESOI	217.	27.
		8101	TUNGSTEN (WOLFRAM) & ARTICLES, INCL WASTE & SCRAP	217.	56.
		3215	INK, PRINTING, WRITING, DRAWING ETC, CONCEN OR NO	216.	29.
		3707	PHOTOGRAPHIC CHEMICALS, UNMIXED PROD RETAIL PACKED	214.	21.
		8482	BALL OR ROLLER BEARINGS AND PARTS	210.	25.
		9001	OPT FIBERS & BUND ETC, POL SHEETS, UNMOUN OPT ELEM	208.	24.
		7409	COPPER PLATES, SHEETS & STRIP, OVER 0.15MM THICK	207.	63.
		2916	UNSAT ACYCLIC & CYCLIC MONOCARBOX ACID & ANHYD ET	200.	219.
		9999	BELOW MINIMUM	15,079.	8,141.
			*SUB-TOTAL CUSTOMS DIST. # 30	855,892.	194,625.

1993 U.S. EXPORTS TRANSSHIPPED VIA CANADA ABOVE \$200,000
 BY CUSTOMS DISTRICT BY DESCEND. VALUE IN \$1000'S ESTIM. WEIGHT IN METRIC TONS

CD#	CUSTOMS DISTRICT	CODE	HARMONIZED COMMODITY DESCRIPTION	\$1000S	EST. M.TONS
33	GREAT FALLS, MONT.	2526	NATURAL STEATITE, ROUGHLY TRIMMED ETC, TALC	629.	2,659.
		9999	BELOW MINIMUM	209.	332.
		*SUB-TOTAL CUSTOMS DIST. # 33		838.	2,991.
34	PEMBINA, N. DAK.	2613	MOLYBDENUM ORES AND CONCENTRATES	1,142.	629.
		1206	SUNFLOWER SEEDS, WHETHER OR NOT BROKEN	1,013.	1,339.
		2402	CIGARS, CIGARETTES ETC., OF TOBACCO OR SUBSTITUTES	486.	58.
		8204	HAND-OPERATED SPANNERS & WRENCHES ETC, B MET PARTS	252.	23.
		9999	BELOW MINIMUM	1,305.	443.
		*SUB-TOTAL CUSTOMS DIST. # 34		4,198.	2,492.
35	MINNEAP/ST. PAUL	9999	BELOW MINIMUM	203.	513.
		*SUB-TOTAL CUSTOMS DIST. # 35		203.	513.
36	DULUTH, MINN.	1604	PREP OR PRES FISH, CAVIAR & CAVIAR SUBSTITUTES	1,587.	401.
		8803	PARTS OF BALLOONS ETC, AIRCRAFT, SPACECRAFT ETC	704.	4.
		8541	SEMICONDUCTOR DEVICES, LIGHT-EMIT DIODES ETC, PTS	590.	50.
		8471	AUTOMATIC DATA PROCESS MACHINES, MAGN READER ETC	450.	25.
		4301	RAW FURSKINS NESOI (INCL PCS FOR FUR USE)	389.	203.
		303	FISH, FROZEN (NO FISH FILLETS OR OTHER FISH MEAT)	297.	116.
		9018	MEDICAL, SURGICAL, DENTAL OR VET INST, NO ELEC, P	209.	16.
		9999	BELOW MINIMUM	1,854.	709.
		*SUB-TOTAL CUSTOMS DIST. # 36		6,080.	1,524.
38	DETROIT, MICH.	8708	PARTS & ACCESS FOR MOTOR VEHICLES (HEAD 8701-8705)	481,139.	60,870.
		8471	AUTOMATIC DATA PROCESS MACHINES, MAGN READER ETC	105,596.	4,206.
		8409	PARTS FOR ENGINES OF HEADING 8407 OR 8408	75,159.	6,928.
		9504	ARTICLES FOR ARCADE, TABLE OR PARLOR GAMES, PARTS	69,181.	4,947.
		8407	SPARK-IGNITION RECIPIER OR ROTARY INT COMB PISTON ENG	65,613.	11,919.
		8479	MACHINES ETC HAVING INDIVIDUAL FUNCTIONS NESOI, P	63,922.	5,273.
		8413	PUMPS FOR LIQUIDS, LIQUID ELEVATORS, PARTS THEREO	61,750.	5,062.
		713	LEGUMINOUS VEGETABLES, DRIED SHELLD	59,061.	86,111.
		8431	PARTS FOR MACHINERY OF HEADINGS 8425 TO 8430	56,720.	8,706.
		9018	MEDICAL, SURGICAL, DENTAL OR VET INST, NO ELEC, P	54,362.	2,792.
		8473	PARTS ETC FOR TYPEWRITERS & OTHER OFFICE MACHINES	53,946.	2,145.
		2933	HETEROCYCLIC COMP, NIT HETERO-ATOM, NUCLEIC ACIDS	53,210.	10,415.
		1005	CORN (MAIZE)	52,156.	144,516.
		8509	ELECTROMECH DOMESTIC APPLIANCES, PARTS	51,061.	5,152.
		2005	VEGETABLES NESOI PREPARED ETC NESOI, NOT FROZEN	44,431.	68,749.
		8436	AGRI ETC & POULTRY ETC EQUIP, INC INCUBATORS, PTS	43,128.	7,940.
		2309	PREPARATIONS USED IN ANIMAL FEEDING	42,331.	61,367.
		8421	CENTRIFUGES, FILTER ETC MACH FOR LIQ OR GASES, PT	42,304.	5,070.
		2922	OXYGEN-FUNCTION AMINO-COMPOUNDS	41,204.	27,488.
		8433	HARVEST ETC MACHINES, CLEANING EGGS ETC NESOI, PT	40,935.	6,872.

1993 U.S. EXPORTS TRANSSHIPPED VIA CANADA ABOVE \$200,000
 BY CUSTOMS DISTRICT BY DESCEND. VALUE IN \$1000'S ESTIM. WEIGHT IN METRIC TONS

CD#	CUSTOMS DISTRICT	CODE	HARMONIZED COMMODITY DESCRIPTION	\$1000S	EST. M.TONS
----	-----	----	-----	-----	-----
38	DETROIT, MICH.	1206	SUNFLOWER SEEDS, WHETHER OR NOT BROKEN	39,836.	46,217.
		3920	PLATES, SHEETS, FILM ETC NO AD, NON-CEL ETC, PLAS	39,456.	13,033.
		8408	COMPRESSION-IGNITION INTERNAL COMB PISTON ENGINES	37,663.	4,721.
		4408	veneer sheets etc, not over 6 mm thick	32,427.	17,194.
		9506	ARTICLES & EQUIP FOR SPORTS ETC NESOI, POOLS, PTS	32,416.	4,866.
		8424	MECH APPL TO DISPERSE LIQ ETC, SAND ETC BLAST MAC	31,890.	4,784.
		9403	FURNITURE NESOI AND PARTS THEREOF	30,850.	7,014.
		2917	POLYCARBOXYLIC ACIDS & ANHYD ETC, HALOG, SULF ETC	25,238.	9,154.
		8712	BICYCLES & OTH CYCLES (INC DEL TRICYCLE) NO MOTOR	25,066.	2,013.
		8418	REFRIGERATORS, FREEZERS ETC, HEAT PUMPS NESOI, PT	24,523.	3,275.
		8501	ELECTRIC MOTORS AND GENERATORS (NO SETS)	24,390.	3,470.
		3808	INSECTICIDES, RODENTICIDES, FUNGICIDES ETC, RETAIL	24,267.	4,278.
		4104	BOVINE OR EQUINE LEATHER, NO HAIR NESOI	24,254.	6,733.
		8518	MICROPHONES, LOUDSPEAKERS, SOUND AMPLIFIER ETC, P	24,051.	2,435.
		3926	ARTICLES OF PLASTICS (INC POLYMERS & RESINS) NESO	23,523.	3,368.
		8803	PARTS OF BALLOONS ETC, AIRCRAFT, SPACECRAFT ETC	23,337.	445.
		3815	REACTION INITIATORS & ACCELER & CATALYT PREP NESO	22,461.	4,429.
		8415	AIR CONDITIONING MACHINES (TEMP & HUM CHANGE), PT	22,373.	2,439.
		8711	MOTORCYCLES (INCL MOPEDS) & CYCLES WITH AUX MOTOR	21,434.	1,466.
		8422	MACHINES, DISHWASH, CLEAN ETC CONT & FILL, PAK ET	21,196.	1,269.
		2904	HYDROCARBON DERIVATIVES, SULFONATED, NITRATED ETC	20,905.	10,393.
		8419	MACHINERY ETC FOR TEMP CHANG TREAT MAT, W HEAT, P	20,475.	1,526.
		2921	AMINE-FUNCTION COMPOUNDS	19,874.	5,602.
		8483	TRANSMISSION SHAFTS, BEARINGS, GEARS ETC, PARTS	19,508.	2,534.
		3402	ORGANIC SURF-ACT AGENTS, PREPS & CLEANING PREPS	19,489.	9,840.
		3811	ANTI-KNOCK PREPS & OTHER ADDITIVES FOR MINERAL OIL	18,557.	10,313.
		8414	AIR OR VAC PUMPS, COMPR & FANS, HOODS & FANS, PTS	18,557.	2,672.
		1904	FOODS PREP BY SWELL CEREAL, CEREAL NESOI, GRAIN FM	18,508.	10,121.
		9009	PHOTOCOPY APPARATUS & THERMOCOPY APPARATUS, PTS	18,361.	899.
		7326	ARTICLES OF IRON OR STEEL, NESOI	17,892.	7,019.
		8481	TAPS, COCKS, VALVES ETC FOR PIPES, TANKS ETC, PTS	17,784.	1,682.
		9402	MEDICAL, SURGICAL, DENTAL OR VETERINARY FURN ETC	17,464.	1,283.
		4802	PAPER, UNCOAT, FOR WRITING ETC, ROLLS, HNDMD PAPER	17,220.	13,985.
		8430	MACH NESOI, MOVING, GRAD ETC, PILE-DR, SNOFLOW ET	16,895.	3,948.
		3822	COMPOSITE DIAGNOSTIC/LAB REAGENTS, EXC PHARMACEUT	16,757.	1,916.
		4901	BOOKS, BROCHURES & SIMILAR PRINTED MATTER	16,439.	3,041.
		8438	MACH NESOI, IND PREP OF FOOD OR DRINK ETC, PARTS	16,076.	882.
		1107	MALT, WHETHER OR NOT ROASTED	16,021.	47,892.
		8477	MACHINERY FOR WORKING RUBBER & PLAST ETC NESOI, P	15,724.	1,326.
		2941	ANTIBIOTICS	15,569.	2,216.
		8538	PARTS FOR ELEC APPAR ETC OF HEAD 8535, 8536 & 853	15,016.	900.
		8704	MOTOR VEHICLES FOR TRANSPORT OF GOODS	14,940.	3,357.
		3923	CONTAINERS (BOXES, BAGS ETC), CLOSURERS ETC, PLAS	14,176.	4,801.
		8525	TRANS APPAR FOR RADIOTELEPHONY ETC, TV CAMERAS	13,904.	911.
		8443	PRINTING MACHINERY, MACHINES ANCIL TO PRINTING, P	13,853.	2,173.
		8529	PARTS FOR TELEVISION, RADIO AND RADAR APPARATUS	13,709.	1,854.
		8428	LIFTING, HANDLING, LOADING & UNLOAD MACHINES NESO	13,530.	2,478.
		2918	CARBOXYLIC ACID, ADDED OXYGEN & ANHY ETC, HAL ETC	13,426.	6,623.

1993 U.S. EXPORTS TRANSSHIPPED VIA CANADA ABOVE \$200,000
 BY CUSTOMS DISTRICT BY DESCEND. VALUE IN \$1000'S ESTIM. WEIGHT IN METRIC TONS

CD#	CUSTOMS DISTRICT	CODE	HARMONIZED COMMODITY DESCRIPTION	\$1000S	EST. M.TONS
38	DETROIT, MICH.	8540	THERMIONIC, COLD CATHODE OR PHOTOCATHODE TUBES, P	13,091.	1,393.
		8511	ELECTRIC IGNITION ETC EQUIP, GENERATORS, PARTS	12,982.	2,661.
		8703	MOTOR CARS & VEHICLES FOR TRANSPORTING PERSONS	12,545.	1,721.
		4811	PAPER, PAPERBOARD, WAD ETC, COAT ETC NESOI, RL ET	12,318.	6,136.
		4011	NEW PNEUMATIC TIRES, OF RUBBER	12,090.	3,795.
		8429	SELF-PROPELLED BULLDOZERS, GRADERS, SCRAPERS ETC	12,076.	2,028.
		3301	ESSENT OILS, RESINOIDS, TERPENIC BY-PRODUCTS ETC	12,018.	772.
		7506	NICKLE PLATES, SHEETS, STRIP AND FOIL	11,957.	870.
		1702	SUGARS NESOI, INCL CHEM PURE LACTOSE ETC, CARAMEL	11,793.	27,299.
		9032	AUTOMATIC REGULATING OR CONTROL INSTRUMENTS, PART	11,700.	838.
		8536	ELECTRICAL APPARATUS FOR SWITCHING ETC, NOV 1000	11,278.	858.
		3707	PHOTOGRAPHIC CHEMICALS, UNMIXED PROD RETAIL PACKED	11,074.	1,243.
		8466	PARTS ETC FOR MACHINE TOOLS OF HEAD 8456 TO 8465	10,966.	1,915.
		8482	BALL OR ROLLER BEARINGS AND PARTS	10,831.	1,655.
		7606	ALUMINUM PLATES, SHEETS & STRIP OVER .2MM THICK	10,675.	4,918.
		4407	WOOD SAWN OR CHIPPED LENGTH, SLICED ETC, OV6MM TH	10,529.	14,186.
		8716	TRAILERS ETC, OTHER VEHICLES, NOT MECH PROPELD, P	10,487.	3,535.
		3919	SELF-ADHESIVE PLATES, SHEETS, FILM ETC OF PLASTIC	10,454.	1,731.
		2613	MOLYBDENUM ORES AND CONCENTRATES	10,139.	4,959.
		1201	SOYBEANS, WHETHER OR NOT BROKEN	10,091.	42,706.
		2208	ETHYL ALCOHOL, UNDENAT, UNDBO% ALC, SPIRIT BEV ETC	9,876.	7,511.
		7325	CAST ARTICLES NESOI, OF IRON OR STEEL	9,854.	5,367.
		3305	PREPARATIONS FOR USE ON THE HAIR	9,840.	2,544.
		3921	PLATES, SHEETS, FILM, FOIL & STRIP NESOI, PLASTIC	9,812.	1,899.
		4823	PAPER, PAPERBOARD, CELLUL WAD TO SIZE & ARTS NESO	9,650.	2,798.
		8439	MACHINERY FOR MAKING PULP & MAKING ETC PAPER, PTS	9,603.	830.
		8537	BOARDS, PANELS ETC WITH ELEC SWITCH APPAR ETC.	9,483.	332.
		9022	X-RAY ETC APPARATUS, TUBES, PANELS, SCREEN ETC, P	9,479.	697.
		6902	REFRACTORY BRICKS & OTHER REFR CER CONST ART NESOI	9,468.	20,977.
		2934	HETEROCYCLIC COMPOUNDS NESOI	9,376.	5,851.
		7310	TANKS ETC, NOV 300 LITER CAPACITY, IRON OR STEEL	9,307.	3,359.
		9027	INST ETC FOR PHYSICAL ETC ANAL ETC, MICROTOME, PT	9,231.	342.
		9401	SEATS (EXCEPT BARBER, DENTAL, ETC), AND PARTS	9,129.	2,108.
		205	MEAT OF HORSES, ASSES, MULES, HINNIES FR, CHLD, FZ	8,842.	3,226.
		3503	GELATIN & DERIV, ISINGLASS, GLUES, ANIMAL OR NESOI	8,822.	1,969.
		8302	HARDWARE, FIXTURES, CASTORS ETC & PARTS, BASE METL	8,684.	1,442.
		8204	HAND-OPERATED SPANNERS & WRENCHES ETC, B MET PARTS	8,580.	989.
		4016	ARTICLES NESOI OF UNHARDED VULCANIZED RUBBER	8,550.	2,632.
		8434	MILKING MACHINES & DAIRY MACHINERY & PARTS	8,505.	1,722.
		1704	SUGAR CONFECTION (INCL WHITE CHOCOLATE), NO COCOA	8,345.	3,384.
		8507	ELECTRIC STORAGE BATTERIES, INCL SEPARATORS, PARTS	8,314.	2,467.
		9503	TOYS NESOI, SCALE MODELS ETC, PUZZLES, PARTS ETC	8,304.	1,190.
		8544	INSULATED WIRE, CABLE ETC, OPT SHEATH FIB CABLES	8,267.	1,076.
		1901	MALT EXT, FOOD PREP OF FLOUR ETC UN 50% COCOA ETC	8,253.	6,677.
		3903	POLYMERS OF STYRENE, IN PRIMARY FORMS	8,186.	3,708.
		8205	HANDTOOLS NESOI, BLOW TORCHES ETC, ANVILS ETC	8,125.	1,190.
		3905	POLYMERS OF VINYL ACETATE & OTH VINYL POLYM, PR FM	8,119.	3,460.
		7321	STOVES, RANGES ETC, NONEL DOMEST & PTS, IR & STEE	8,045.	1,739.

1993 U.S. EXPORTS TRANSSHIPPED VIA CANADA ABOVE \$200,000
 BY CUSTOMS DISTRICT BY DESCEND. VALUE IN \$1000'S ESTIM. WEIGHT IN METRIC TONS

CD#	CUSTOMS DISTRICT	CODE	HARMONIZED COMMODITY DESCRIPTION	\$1000S	EST. M.TONS
38	DETROIT, MICH.	4818	TOILET PAPER, PAPER TISSUES, TOWELS, NAPKINS ETC	7,960.	2,305.
		8460	MACHINE TOOLS FOR HONING OR FINISHING METAL ETC	7,934.	416.
		2106	FOOD PREPARATIONS NESOI	7,706.	3,794.
		8523	PREPARED UNRECORDED MEDIA (NO FILM) FOR SOUND ETC	7,698.	666.
		8427	FORK-LIFT TRUCKS, OTH WORKS TRUCKS WITH LIFTS ETC	7,678.	1,708.
		8516	ELEC WATER, SPACE & SOIL HEATERS, HAIR ETC DRY, P	7,661.	853.
		2909	ETHERS, ETHER-ALCOHOLS, ALCOHOL PEROXIDES ETC.	7,639.	3,194.
		7308	STRUCTURES NESOI & PARTS THEREOF, OF IRON OR STEEL	7,630.	3,715.
		3904	POLYMERS OF VINYL CHLORIDE ETC., IN PRIMARY FORMS	7,556.	2,904.
		8701	TRACTORS (OTHER THAN WORKS TRUCKS OF HEADING 8709)	7,540.	1,566.
		8517	ELECTRIC APPARATUS FOR LINE TELEPHONY ETC, PARTS	7,471.	1,203.
		7607	ALUMINUM FOIL (BACK OR NOT) NOV .2MM TH (EX BACK)	7,445.	2,327.
		3924	TABLEWARE & OTHER HOUSEHOLD ARTICLES ETC, PLASTIC	7,399.	1,744.
		4103	RAW HIDES AND SKINS NESOI (FR OR PRES NOT TAN ETC)	7,354.	3,212.
		2008	FRUIT, NUTS ETC PREPARED OR PRESERVED NESOI	7,248.	5,805.
		7019	GLASS FIBERS & ARTICLES THEREOF (YARN ETC.)	7,064.	1,889.
		7505	NICKEL BARS, RODS, PROFILES AND WIRE	6,898.	597.
		3906	ACRYLIC POLYMERS IN PRIMARY FORMS	6,892.	2,904.
		3912	CELLULOSE AND CHEMICAL DERIV NESOI, PRIMARY FORMS	6,840.	1,012.
		3901	POLYMERS OF ETHYLENE, IN PRIMARY FORMS	6,740.	5,359.
		9406	PREFABRICATED BUILDINGS	6,674.	4,104.
		4101	RAW HIDES & SKINS OF BOVINE OR EQUINE ANIMALS	6,641.	3,186.
		1209	SEEDS, FRUIT AND SPORES, FOR SOWING	6,625.	4,325.
		3823	BINDERS FOR FOUND MOLDS, CHEMICAL PROD ETC NESOI	6,606.	3,702.
		9031	MACHINES, NESOI IN CHAPTER 90, PROFILE PROJECT, P	6,386.	508.
		8502	ELECTRIC GENERATING SETS AND ROTARY CONVERTERS	6,346.	674.
		8607	PARTS OF RAILWAY OR TRAMWAY LOCOMOTIVES OR R STOCK	6,346.	1,028.
		6506	HEADGEAR NESOI, WHETHER OR NOT LINED OR TRIMMED	6,164.	833.
		8515	ELECTRIC, LASER OR OTH LIGHT OR PHOTON BEAM ETC	6,086.	742.
		3504	PEPTONES, OTHER PROTEINS & DERIV ETC, HIDE POWDER	6,028.	2,347.
		2505	NATURAL SANDS OF ALL KINDS, EXCEPT METAL-BEARING	5,811.	8,249.
		9021	ORTHOPEDIC APPL, ARTIF BODY PTS, HEAR AID, PTS ET	5,725.	397.
		7304	TUBES, PIPES ETC, SEAMLESS, IRON NESOI & STEEL	5,666.	4,972.
		7318	SCREWS, BOLTS, NUTS, WASHERS ETC, IRON OR STEEL	5,644.	1,428.
		6403	FOOTWEAR, OUTER SOLE RUB, PLAST OR LEA & UPPER LEA	5,643.	499.
		7307	TUBE OR PIPE FITTINGS, OF IRON OR STEEL	5,641.	901.
		4911	PRINTED MATTER NESOI, INCL PRINT PICTURES & PHOTOS	5,593.	1,586.
		3908	POLYAMIDES IN PRIMARY FORMS	5,591.	2,379.
		8475	MACHINES FOR ASSEMB ELEC TUBES ETC & GLASS MFR, P	5,575.	201.
		8476	AUTOMATIC GOODS-VENDING MACHINES, PARTS	5,555.	719.
		3208	PAINT & VARNISH FROM SYNTH ETC POLYMERS NONAQ, ETC	5,515.	1,392.
		8543	ELECTRICAL MACH ETC, WITH IND FUNCTIONS NESOI, PT	5,447.	383.
		8432	AGRICULT ETC MACH FOR SOIL ETC, LAWN ROLLERS, PTS	5,406.	931.
		8510	ELECTRIC SHAVERS & HAIR CLIPPERS, PARTS	5,290.	318.
		7210	FL-RL IRON & NA STEEL NUN600MM WD, CLAD ETC	5,257.	12,172.
		8412	ENGINES AND MOTORS NESOI, AND PARTS THEREOF	5,226.	575.
		8472	OFFICE MACHINES NESOI (HECTOGRAPH, ADDRESSING ETC	5,160.	453.
		8710	TANK & OT ARMORED FIGHT VEH, MOTORIZED, AND PARTS	5,127.	236.

1993 U.S. EXPORTS TRANSSHIPPED VIA CANADA ABOVE \$200,000
 BY CUSTOMS DISTRICT BY DESCEND. VALUE IN \$1000'S ESTIM. WEIGHT IN METRIC TONS

CD#	CUSTOMS DISTRICT	CODE	HARMONIZED COMMODITY DESCRIPTION	\$1000S	EST. M.TONS
38	DETROIT, MICH.	8462	MACHINE TOOLS FOR FORGING, BENDING, STAMPING ETC	5,117.	436.
		2923	QUATERNARY AMMONIUM SALTS ETC, LECITHINS ETC.	5,075.	4,195.
		2906	CYCLIC ALCOHOLS & HALOGENATD, SULFONATD ETC DERIVS	5,047.	2,628.
		3204	SYN ORG COLORING MATTER & PREP, SYN ORG BRIT AGENT	5,019.	775.
		8531	ELECTRIC SOUND OR VISUAL SIGNALING APPARATUS, PTS	4,985.	308.
		1108	STARCHES, INULIN	4,883.	6,876.
		8714	PARTS & ACCESS FOR CYCLES & INVALID CARRIAGES	4,802.	792.
		712	VEGETABLES, DRIED, WHOLE, CUT ETC., NO ADDED PREP	4,769.	2,543.
		9015	SURVEY, HYDROGR, METEORO ETC INST, RANGEF ETC, PT	4,719.	93.
		8441	MACH FOR MAKING UP PULP & PAPER, INC CUTTERS, PTS	4,688.	996.
		3907	POLYETHERS, EXPOXIDES & POLYESTERS, PRIMARY FORMS	4,631.	1,468.
		4902	NEWSPAPERS, JOURNALS & PERIODICALS	4,517.	1,256.
		3505	DEXTRINS ETC, GLUES BASED ON STARCHES, DEXTRIN ETC	4,469.	3,940.
		8467	TOOLS FOR WORKING IN THE HAND, PNEUMATIC ETC, PTS	4,441.	388.
		3917	TUBES, PIPES & HOSES & THEIR FITTINGS, OF PLASTIC	4,403.	1,109.
		2811	INORGANIC ACIDS & INORGANIC OXY NONMET COMP NESOI	4,361.	2,471.
		8503	PARTS OF ELECTRIC MOTORS, GENERATORS & SETS	4,343.	464.
		8504	ELECTRIC TRANSFORM, STATIC CONVERTERS & INDUCT, PT	4,246.	552.
		8207	INTERCHANGE TOOLS FOR HAND- OR MACHINE-TOOLS, BMPT	4,240.	356.
		9405	LAMPS & LIGHTING FITTINGS & PARTS ETC NESOI	4,182.	792.
		8411	TURBOJETS, TURBOPROPELLERS & OTH GAS TURBINES, PTS	4,180.	143.
		3100	FERTILIZERS, EXPORTS ONLY INCL OTHER CRUDE MAT'LS	4,158.	104.
		4403	WOOD IN THE ROUGH, STRIPPED OR NOT OF SAPWOOD ETC	4,102.	11,245.
		3816	REFRACTORY CEMENTS, MORTARS, CONCRETES, ETC. NESO	4,030.	3,060.
		4009	TUBES, PIPES & HOSES OF UNHARD VULCANIZED RUBBER	3,937.	1,003.
		2818	ALUMINUM OXIDE (INCL ART CORUNDUM), ALUM HYDROXIDE	3,825.	2,167.
		8480	MOLDING BOXES FOR METAL FOUNDRY, MOLD BASES ETC	3,806.	1,073.
		9019	MECH-THER, MASSAGE, PSYCH TEST, OZONE APP ETC, PT	3,799.	339.
		8465	MACHINE TOOLS FOR WORKING WOOD, CORK, BONE ETC	3,778.	744.
		9024	MACHINES ETC FOR TESTING MECH PROP OF MATERIAL, P	3,776.	354.
		8508	ELECTROMECHANICAL TOOLS, WORKING IN HAND, PARTS	3,765.	381.
		7202	FERROALLOYS	3,754.	4,072.
		8311	WIRE, RODS ETC FOR SOLDERING ETC & MET SPRAY, BMPT	3,687.	1,815.
		9603	BROOMS, BRUSHES, MOPS, FEATHER DUSTERS ETC	3,680.	468.
		9010	APPARATUS ETC FOR PHOTO LABS ETC NESOI, PARTS ETC	3,666.	290.
		7616	ARTICLES OF ALUMINUM NESOI	3,619.	610.
		8539	ELECTRIC FILAMENT OR DISCHARGE LAMPS, PARTS	3,575.	410.
		8109	ZIRCONIUM & ARTICLES THEREOF, INCLUD WASTE & SCRAP	3,558.	227.
		9028	GAS, LIQUID OR ELECTRIC SUPPLY ETC METERS, PARTS	3,541.	297.
		1302	VEG SAPS & EXTRACTS, PECTATES ETC, AGAR-AGAR ETC.	3,538.	278.
		2924	CARBOXYAMIDE-FUNCTION COMP, AMIDE-FUNCTION COM ET	3,478.	635.
		4809	PAPER, CARBON, SELF-COPY ETC, ROLLS ETC OV 36 CM W	3,442.	1,869.
		3304	BEAUTY, MAKE-UP & SKIN-CARE PREP, MANICURE ETC PRP	3,439.	445.
		3005	BANDAGES ETC COATED ETC OR IN RETAIL MEDIC ETC FM	3,417.	398.
		8452	SEWING MACHINES (NOT BOOK-SEW), COVER ETC, NEEDLE	3,401.	178.
		7323	HOUSEHOLD ART & PTS, IR & ST, IR OR STEEL WOOL ET	3,388.	465.
		3307	PERSONAL TOILET ETC PREP NESOI, SHAVING, BATH ETC.	3,371.	564.
		4810	PAPER & PAPERBOARD, COATED WITH KAOLIN ETC, RL ET	3,368.	2,417.

1993 U.S. EXPORTS TRANSSHIPPED VIA CANADA ABOVE \$200,000
 BY CUSTOMS DISTRICT BY DESCEND. VALUE IN \$1000'S ESTIM. WEIGHT IN METRIC TONS

CD#	CUSTOMS DISTRICT	CODE	HARMONIZED COMMODITY DESCRIPTION	\$1000S	EST. M.TONS
38	DETROIT, MICH.	8437	MACH FOR CLEANING SEED ETC & WORK CEREAL ETC, PTS	3,344.	939.
		2520	GYPSPUM, ANHYDRITE, PLASTERS (CAL GYPSM OR SULFATE)	3,305.	13,478.
		8214	ARTICLES OF CUTLERY NESOI, MANICURE SETS ETC, BMP	3,295.	118.
		3801	ARTIFICIAL GRAPHITE, COLLODIAL GRAPHITE & PREP ETC	3,242.	1,616.
		810	FRUIT NESOI, FRESH	3,166.	1,863.
		7409	COPPER PLATES, SHEETS & STRIP, OVER 0.15MM THICK	3,158.	379.
		8485	MACHINERY PTS, NO ELECT CONNECTORS ETC NESOI	3,149.	214.
		4819	CARTONS ETC PAPER, OFFICE BOX FILES ETC, PAPER ET	3,145.	2,451.
		3909	AMINO-RESINS, PHENOLICS & POLYURETHANES, PRIM FORM	3,010.	994.
		8524	RECORDS, TAPES & OTHER RECORDED SOUND MEDIA ETC	2,995.	285.
		7005	FLOAT GLASS & SURF GROUND OR POLISHED SHEETS ETC	2,988.	3,978.
		8474	MACHINERY FOR SORTING SCREENING ETC MINERALS, PTS	2,972.	337.
		9608	PENS (BALL POINT, S TIP ETC), MECH PENCILS ETC, PT	2,940.	284.
		8542	ELECTRONIC INTEGRATED CIRCUITS & MICROASSEMBL, PT	2,937.	283.
		8484	GASKETS & SIMILAR JOINTS OF METAL SHEETING	2,931.	202.
		9030	OSCILLOSCOPES, SPECTRUM ANALYZERS ETC, PARTS ETC	2,879.	219.
		2508	CLAYS NESOI, ANDALUSITE, KYANITE ETC, MULLITE ETC	2,868.	14,770.
		8440	BOOKBINDING MACHINERY, INCL BOOK-SEWING, PARTS	2,864.	158.
		8425	PULLEY TACKLE & HOISTS (EXC SKIP), WINCH ETC, JAK	2,854.	970.
		4421	ARTICLES OF WOOD, NESOI	2,844.	863.
		2827	CHLORIDES ETC, BROMIDES ETC, IODIDES ETC.	2,816.	2,248.
		2907	PHENOLS, PHENOL-ALCOHOLS	2,815.	4,691.
		4415	PACKING CASES ETC OF WOOD, PALLETS ETC OF WOOD	2,808.	3,086.
		3302	ODORIFEROUS MIXTURES AS RAW MATERIALS FOR INDUSTRY	2,806.	449.
		3910	SILICONES, IN PRIMARY FORMS	2,774.	673.
		7204	FERROUS WASTE & SCRAP, REMELT SCR IRON/STEEL INGOT	2,741.	9,747.
		1008	BUCKWHEAT, MILLET & CANARY SEED, CEREALS NESOI	2,725.	11,386.
		2915	SAT ACYCLIC NONOCARBOX ACID & ANHYD, HALOGON ETC	2,725.	3,549.
		9205	WIND MUSICAL INSTRUMENTS NESOI	2,672.	124.
		8442	MACH ETC NESOI FOR TYPESET, MAKING PR PLATES ETC	2,647.	369.
		511	ANIMAL PRODUCTS NESOI, DEAD ANIMALS, INEDIBLE ETC.	2,636.	6,024.
		1905	BREAD, PASTRY, CAKES ETC, COMM WAFRS, EMP CAPS ETC	2,598.	1,826.
		8451	MACHINERY (NOT LAUNDRY) FOR CLEANING, DRYING ETC	2,595.	473.
		8514	INDUSTRIAL OR LAB ELEC FURNACES ETC, PARTS	2,590.	522.
		8512	ELECTRIC LIGHT ETC EQUIP, WINDSH WIPERS ETC, PART	2,588.	274.
		8202	HANDSAWS & MET PTS, SAW BLADES, BASE MTL SAW PARTS	2,554.	322.
		8004	TIN PLATES, SHEET AND STRIP OVER 0.2 MM THICK	2,550.	6,250.
		7403	REFINED COPPER & ALLOYS (NO MAST ALLOY), UNWROUGHT	2,537.	1,439.
		9612	TYPEWRITER ETC RIBBONS, INKED OR PREP, INK PADS	2,508.	758.
		2825	HYDRAZINE ETC, OTH INORG BASES, METAL OXIDES ETC	2,453.	753.
		8463	MACHINE TOOLS FOR WORKING METAL, NESOI	2,452.	325.
		7112	WASTE & SCRAP OF PREC METAL OR METAL CL W PREC MT	2,435.	26.
		7222	BARS & RODS, ST STEEL NESOI, ANGLES ETC, ST STEEL	2,380.	607.
		3911	PETRO RESINS, POLYSULFIDES ETC NESOI, PRIMARY FOR	2,367.	783.
		7228	AL STEEL NESOI BARS, ANG ETC, HOL DR ST BARS ETC	2,367.	3,201.
		3004	MEDICAMENTS NESOI, MIXED OR NOT, IN DOSAGE ETC FM	2,349.	321.
		8505	ELECTROMAGNETS, PERMANENT MAGNETS ETC & PARTS	2,302.	410.
		3506	PREPARED GLUES & ADHESIVES NESOI, GLUE RETAIL PACK	2,256.	519.

1993 U.S. EXPORTS TRANSSHIPPED VIA CANADA ABOVE \$200,000
 BY CUSTOMS DISTRICT BY DESCEND. VALUE IN \$1000'S ESTIM. WEIGHT IN METRIC TONS

CD#	CUSTOMS DISTRICT	CODE	HARMONIZED COMMODITY DESCRIPTION	\$1000S	EST. M.TONS
38	DETROIT, MICH.	7905	ZINC PLATES, SHEET, STRIP AND FOIL	2,254.	3,077.
		9008	IMAGE PROJECTORS, STILL, ENLARGERS ETC, STILL, PTS	2,209.	163.
		8108	TITANIUM & ARTICLES THEREOF, INCLUD WASTE & SCRAP	2,206.	597.
		8450	WASHING MACHINES, HOUSEHOLD- OR LAUNDRY-TYPE, PTS	2,190.	248.
		7008	MULTIPLE-WALLED INSULATING UNITS OF GLASS	2,142.	948.
		3401	SOAP, ORGANIC SURF-ACT PREP FOR SOAP USE, BARS ETC	2,133.	1,272.
		8461	MACHINE TOOLS FOR SHAPING, SLOTTING, GEAR CUT ETC	2,069.	255.
		7610	ALUMINUM STRUCTURES NESOI (NO PREFAB) & PARTS OF	2,055.	440.
		2303	RESIDUES OF STARCH MFR OR SUGAR MFR OR BREWING ETC	2,013.	18,271.
		4409	WOOD, CONTINUOUSLY SHAPED (TONGUED, GROOVED ETC.)	2,013.	1,734.
		4804	KRAFT PAPER & PAPERBOARD, UNCOAT NESOI, ROLLS ETC	2,009.	2,849.
		3403	LUBRICATING PREPS, ANTIRUST & TREATING TEXTILES ETC	2,006.	808.
		4012	RETREAD OR USED PNEU TIRES, SOLID TIRES ETC, RUBB	1,937.	642.
		2712	PETROLEUM JELLY, MINERAL WAXES & SIMILAR PRODUCTS	1,911.	1,442.
		2920	ESTERS OF INORG ACIDS & SALTS, THEIR HALOG ETC DE	1,911.	1,391.
		9026	INST ETC MEASURE OR CHECK FLOW, LEVEL ETC, PTS ET	1,908.	228.
		5911	TEXTILE PRODUCTS ETC. FOR SPECIFIC TECH USES NESOI	1,905.	286.
		3404	ARTIFICIAL AND PREPARED WAXES	1,880.	1,181.
		4010	CONVEYOR OR TRANSMISS BELTS OF VULCANIZED RUBBER	1,871.	187.
		6806	MINERAL WOOLS, EXPANDED MINERAL MATERIAL & MIXTURE	1,785.	2,207.
		8455	METAL-ROLLING MILLS AND ROLLS THEREFOR, PARTS	1,784.	1,134.
		8402	STEAM ETC GENERATING BOILERS NESOI, SUP W BOILERS	1,766.	274.
		7603	ALUMINUM POWDERS AND FLAKES	1,757.	983.
		7309	TANKS ETC, OVER 300 LITER CAPACITY, IRON OR STEEL	1,754.	508.
		3405	POLISHES & CREAMS FOR LEATHER, WOOD ETC, SCOUR PRP	1,744.	664.
		9023	INST, APPTS&MODELS, FOR DEMONSTRATIONAL USE& PARTS	1,731.	378.
		7013	GLASSWARE FOR TABLE, KITCHEN, TOILET ETC USE NESOI	1,723.	843.
		9002	OPTICAL ELEMENTS, MOUNTED, PARTS & ACCESSORIES	1,717.	54.
		3922	BATHS, WASHBASINS, LAVATORY SEATS ETC OF PLASTICS	1,704.	608.
		4202	TRAVEL GOODS, HANDBAGS, WALLETS, JEWELRY CASES ETC	1,692.	267.
		8548	ELECTRICAL PARTS OF MACHINERY NESOI	1,685.	222.
		8102	MOLYBDENUM & ARTICLES THEREOF, INCL WASTE & SCRAP	1,672.	72.
		7224	ALLOY STEEL NESOI IN INGOTS, OTH PR FRM & SEMIF P	1,656.	764.
		2101	EXTRACTS ETC OF COFFEE, TEA OR MATE, ROAST CHICORY	1,645.	410.
		2930	ORGANO-SULFUR COMPOUNDS	1,617.	442.
		1104	CEREAL GRAINS, WORKED ETC NESOI, CEREAL GERMS, WRK	1,608.	4,750.
		6903	REFRACTORY CERAMIC GOODS, RETORTS, TUBES ETC NESOI	1,601.	1,006.
		6909	CERAMIC LAB ETC WARES, AGR TUBS ETC & PACKING ART	1,590.	310.
		8709	WORKS TRUCKS, SELF-PROP, NO LIFT, STAT TRACTRS, PT	1,578.	472.
		3507	ENZYMES, PREPARED ENZYMES NESOI	1,556.	464.
		3902	POLYMERS OF PROPYLENE OR OTHER OLEFINS, PRIM FORMS	1,538.	1,384.
		8309	STOPPERS, CAPS & LIDS, SEALS ETC & PTS, BASE METAL	1,531.	163.
		8203	FILES, RASPS, PLIERS, METALCUT SHEARS ETC, B MT PT	1,530.	202.
		5603	NONWOVENS, WHETHER OR NOT IMPREGNATED, COATED ETC	1,529.	507.
		7205	PIG IRON, SPIEGEL, IRON OR STEEL GRANULES & POWDER	1,515.	2,026.
		4817	ENVELOPES, POSTCARDS ETC & BOXES ETC OF STATIONAR	1,511.	580.
		809	APRICOTS, CHERRIES, PEACHES, PLUMS & SLOES, FRESH	1,500.	1,382.
		6307	MADE-UP ARTICLES OF TEXTILE MATERIALS NESOI	1,482.	259.

1993 U.S. EXPORTS TRANSSHIPPED VIA CANADA ABOVE \$200,000
 BY CUSTOMS DISTRICT BY DESCEND. VALUE IN \$1000'S ESTIM. WEIGHT IN METRIC TONS

CD#	CUSTOMS DISTRICT	CODE	HARMONIZED COMMODITY DESCRIPTION	\$1000S	EST. M.TONS
---	-----	----	-----	-----	-----
38	DETROIT, MICH.	9208	MUSICAL BOXES, FAIRGROUND ORGANS ETC, WHISTLES ETC	1,477.	58.
		7404	COPPER WASTE AND SCRAP	1,465.	1,091.
		6108	WOMEN''S OR GIRLS'' SLIPS, PJS, ETC, KNIT OR CROCH	1,463.	206.
		7009	GLASS MIRRORS, FRAMED OR NOT, INC REARVIEW MIRRORS	1,458.	290.
		3306	PREPARATIONS FOR ORAL OR DENTAL HYGIENE	1,443.	372.
		1103	CEREAL GROATS, MEAL AND PELLETS	1,413.	5,345.
		3925	BUILDERS'' WARE OF PLASTICS, NESOI	1,412.	508.
		2932	HETEROCYCLIC COMPOUNDS, OXYGEN HETERO-ATOM(S) ONL	1,399.	457.
		3215	INK, PRINTING, WRITING, DRAWING ETC, CONCEN OR NO	1,390.	252.
		6815	ARTICLES OF STONE OR OTHER MINERAL SUBSTANCE NESOI	1,389.	555.
		6813	FRICITION MATERIAL & ART BASED ON MINERAL SUBST ETC	1,359.	228.
		8211	KNIVES WITH BLADES & BLADES FOR KNIVES NESOI, BMP	1,355.	73.
		8546	ELECTRICAL INSULATORS OF ANY MATERIAL	1,345.	335.
		8535	ELECTRICAL APPARATUS FOR SWITCHING ETC, OV 1000 V	1,344.	117.
		3205	COLOR LAKES, PREPARATIONS BASED ON COLOR LAKES	1,342.	118.
		8545	CARBON ELECTRODES & BRUSHES, LAMP CARBONS ETC	1,318.	692.
		9209	PARTS ETC OF MUSICAL INSTR, METRONONES, T FORK ETC	1,317.	181.
		7016	GLASS PAVING BLOCKS ETC, GL CUBES, LEAD WINDOW ET	1,310.	257.
		4418	BUILDERS'' JOINERY AND CARPENTRY OF WOOD	1,292.	980.
		8519	TURNTABLES, RECORD & CASSETTE PLAYERS ETC.	1,274.	162.
		2821	IRON OXIDES & HYDROXIDES, EARTH COLORS NUN 70% IR	1,273.	617.
		2841	SALTS OF OXOMETALLIC OR PEROXOMETALLIC ACIDS	1,253.	1,489.
		2004	VEGETABLES NESOI PREPARED OR PRESERV NESOI, FROZEN	1,244.	1,133.
		9404	MATTRESS SUPPORTS, ARTICLES OF BEDDING ETC.	1,243.	197.
		8506	PRIMARY CELLS & BATTERIES, PARTS	1,238.	468.
		7412	COPPER TUBE OR PIPE FITTINGS	1,226.	196.
		3810	PICKLING PREPS FOR METAL, SOLDERING ETC POWDER ET	1,217.	455.
		8454	CONVERTERS, LADLES, INGOT MOLDS & CASTING MACH, P	1,202.	782.
		7215	BARs & RODS, IRON & NA STEEL NESOI	1,189.	2,002.
		3812	PREPARED RUBBER ACCELERATORS, COM PLASTICIZERS ET	1,187.	382.
		2207	ETHYL ALCOHOL, UNDENAT, NUN80% ALC, ALCOHOL, DENAT	1,181.	1,460.
		1516	AN OR VEG FATS & OILS, HYDROGEN ETC, NOT FUR PREP	1,170.	818.
		7502	NICKLE, UNWROUGHT	1,162.	127.
		8713	INVALID CARRIAGES, MECHANICALLY PROPELLED OR NOT	1,161.	92.
		8459	MACHINE TOOLS FOR DRILLING, BORING, MILLING ETC	1,160.	119.
		8469	TYPEWRITERS & WORD PROCESSING MACHINES	1,154.	284.
		7322	RADIATORS, AIR HEATERS ETC, NONEL & PT, IR & STEE	1,146.	139.
		8453	MACHINERY FOR WORK LEATHER ETC & FOOTWEAR ETC, PT	1,145.	305.
		3214	GLAZIERS PUTTY, RESIN CEMENTS, CAULKING COMPS ETC	1,140.	396.
		8456	MACHINE TOOLS FOR MATERIAL REMOVAL BY LASER ETC	1,122.	38.
		9701	PAINTINGS, DRAWINGS ETC BY HAND AS ART, COLLAG ETC	1,114.	109.
		2103	SAUCES & PREP, MIXED CONDIMENTS, MUSTARD FLOUR ETC	1,112.	846.
		8417	INDUSTRIAL OR LAB FURNACES & OVENS, NONELECT, PTS	1,103.	160.
		8301	PADLOCKS, LOCKS & KEYS & PARTS, OF BASE METAL	1,101.	89.
		2302	BRAN, SHARPS ETC FROM WORKING CEREALS & LEG PLANTS	1,094.	4,150.
		4803	TOILET ETC HSHLD/SANTRY STOCK PPR ROLL/SHT OV 36CM	1,094.	667.
		7002	GLASS IN BALLS (NOT MICROS), RODS OR TUBES, UNWORK	1,094.	182.
		7615	HOUSEHOLD ART ETC, POT SCOUR ETC, SAN WR, ALUMINUM	1,083.	292.

1993 U.S. EXPORTS TRANSSHIPPED VIA CANADA ABOVE \$200,000
 BY CUSTOMS DISTRICT BY DESCEND. VALUE IN \$1000'S ESTIM. WEIGHT IN METRIC TONS

CD#	CUSTOMS DISTRICT	CODE	HARMONIZED COMMODITY DESCRIPTION	\$1000S	EST. M.TONS
---	-----	----	-----	-----	-----
38	DETROIT, MICH.	4805	PAPER & PAPERBOARD, UNCOAT, NESOI, ROLLS OR SHEETS	1,075.	974.
		2102	YEASTS, DEAD SING-CELL MICRO-ORG NESOI, BAK POWDER	1,069.	355.
		2902	CYCLIC HYDROCARBONS	1,067.	784.
		3916	MONOFIL, CR-SECT OVIMM, RODS, STICKS ETC, PLASTIC	1,067.	257.
		7407	COPPER BARS, RODS AND PROFILES	1,067.	264.
		6203	MEN''S OR BOYS'' SUITS, ENSEMBLES ETC, NOT KNIT ET	1,061.	122.
		4002	SYNTH RUBBER & FACTICE, INC NAT-SYN MIX, PR FM ETC	1,046.	351.
		5407	WOVEN FAB OF SYN FIL YN, INCL MONOFIL 67 DEC ETC	1,040.	99.
		7315	CHAIN & PARTS, OF IRON OR STEEL	1,037.	261.
		2519	MAGNESITE, FUSED MAGNESIA, D-B MAGN, M OXIDE NESOI	1,033.	1,434.
		8423	WEIGHING MACHINES & WEIGHING MACHINE WEIGHTS, PTS	1,022.	161.
		8303	SAFES, CASH OR DEED BOXES ETC A PRTS, BASE METAL	1,009.	299.
		6910	CERAMIC SINKS, WASHBASINS, WATER CLOSET BOWLS ETC	1,006.	213.
		3003	MEDICAMENTS NESOI OF MIXTURES, NOT DOSAGE ETC FORM	997.	246.
		7604	ALUMINUM BARS, RODS AND PROFILES	991.	297.
		7020	ARTICLES OF GLASS, NESOI	987.	214.
		6201	MEN''S OR BOYS'' OVERCOATS, CLOAKS ETC, NOT KNIT E	986.	31.
		7324	SANITARY WARE & PARTS, IRON OR STEEL	982.	129.
		6302	BED LINEN, TABLE LINEN, TOILET LINEN & KITCH LINEN	965.	141.
		2931	ORGANO-INORGANIC COMPOUNDS NESOI	953.	178.
		3206	COLORING MATTER NESOI, COLORING PREP NESOI, ETC.	935.	526.
		7413	STRANDED WIRE, CABLES ETC OF COPPER, NOT ELEC INS	935.	219.
		7306	TUBES, PIPES & HOLLOW PROFILES NESOI, IRON & STEEL	932.	562.
		1102	CEREAL FLOURS, EXCEPT OF WHEAT OR OF MESLIN	929.	2,235.
		8426	DERRICKS, CRANES, MOBILE LIFTING FRAMES ETC	925.	162.
		8464	MACHINE TOOLS FOR WORKING STONE, ETC & GLASS	907.	60.
		7211	FL-RL IRON & NA STEEL UN 600MM WD, NOT CLAD ETC	906.	920.
		8541	SEMICONDUCTOR DEVICES, LIGHT-EMIT DIODES ETC, PTS	905.	82.
		6301	BLANKETS AND TRAVELING RUGS	900.	228.
		9014	DIRECTION FINDING COMPASSES & NAVIG INST ETC, PTS	881.	31.
		8105	COBALT MATTES ETC, COBALT & ART, INC WASTE & SCRAP	879.	109.
		3406	CANDLES, TAPERS AND THE LIKE	872.	355.
		8534	PRINTED CIRCUITS	860.	39.
		4203	ARTICLES OF APPAREL & ACCESS, LEATH & COMP LEATHER	856.	467.
		4820	REGISTERS, NOTEBOOKS, BINDERS, BUS FORMS ETC, PAP	845.	347.
		7312	STRANDED WIRE, ROPES ETC, NO ELEC INS, IR OR STEEL	844.	276.
		8903	YACHTS & OTHER VESSELS FOR PLEAS ETC, ROW BOAT ETC	833.	83.
		6110	SWEATERS, PULLOVERS, VESTS ETC, KNIT OR CROCHETED	827.	70.
		7209	FL-RL IRON & NA STEEL NUN600MM WD COLD-RL, NO CLAD	824.	1,908.
		7608	ALUMINUM TUBES AND PIPES	822.	180.
		6802	WORKED MONUMENT ETC STONE & ART NESOI, GRANULE ETC	806.	1,090.
		9507	FISHING RODS & TACKLE, NETS, DECOYS ETC, PARTS ETC	803.	102.
		8468	MACHINES, SOLDER ETC, GAS SURF TEMPER MACHINES, P	795.	86.
		9306	BOMBS, GRENADES ETC, CARTRIDGES ETC AND PARTS	793.	77.
		210	MEAT & ED OFFAL SALTED, DRIED ETC. & FLOUR & MEAL	789.	268.
		2901	ACYCLIC HYDROCARBONS	781.	1,518.
		3209	PAINT & VARNISH FROM SYNTH ETC POLYMERS AQUEOUS MD	778.	237.
		7317	NAILS, TACKS, DRAWING PINS ETC OF IRON OR STEEL	764.	281.

1993 U.S. EXPORTS TRANSSHIPPED VIA CANADA ABOVE \$200,000
 BY CUSTOMS DISTRICT BY DESCEND. VALUE IN \$1000'S ESTIM. WEIGHT IN METRIC TONS

CD#	CUSTOMS DISTRICT	CODE	HARMONIZED COMMODITY DESCRIPTION	\$1000S	EST. M.TONS
38	DETROIT, MICH.	1515	FIXED VEG FATS & OILS NESOI ETC, NOT CHEM MODIFIED	760.	534.
		7503	NICKEL WASTE AND SCRAP	759.	381.
		8104	MAGNESIUM & ARTICLES THEREOF, INCL WASTE & SCRAP	758.	262.
		1602	PREPARED OR PRESERV MEAT, MEAT OFFAL & BLOOD NESOI	755.	410.
		3804	RESIDUAL LYES FROM WOOD PULP MFR (EXCEPT TALL OIL)	753.	740.
		7219	FL-RL STAINLESS STEEL PRODUCTS, NOT UND 600MM WID	743.	443.
		4107	LEATHER OF ANIMALS NESOI, NO HAIR NESOI	739.	202.
		404	WHEY & MILK PRODUCTS NESOI, FLAVORED ETC. OR NOT	737.	953.
		2804	HYDROGEN, RARE GASES AND OTHER NONMETALS	737.	109.
		6205	MEN''S OR BOYS'' SHIRTS, NOT KNITTED OR CROCHETED	732.	34.
		8208	KNIVES & BLADES FOR MACHINES & APPLIANCES, B MT PT	726.	60.
		9007	CINEMATOGRAPHIC CAMERAS & PROJECTORS, PARTS ETC	724.	23.
		3207	PREP PIGMENTS ETC FOR CERAMIC ETC INDUST, FRIT ETC	721.	188.
		8526	RADAR APPARATUS, RADIO NAVIG AID & REMOTE CONT AP	720.	49.
		7007	SAFETY GLASS, OF TEMPERED OR LAMINATED GLASS	716.	595.
		9033	PTS, NESOI FOR MACHINES,APPLN,INST/APPTS OF CHAP9	716.	71.
		7216	ANGLES, SHAPES & SECTIONS OF IRON & NONALLOY STEE	705.	329.
		3806	ROSIN & RESIN ACIDS ETC, ROSIN SPIRIT ETC, RUN GUM	704.	398.
		5903	TEXTILE FABRICS (NOT TIRE CORD) COAT ETC, PLASTICS	698.	96.
		8527	RECEPTION APPARATUS FOR RADIOTELEPHONY ETC	696.	87.
		3212	PIGMENTS NONAQ LIQ ETC FOR PAINT, ST FOIL, DYE ET	694.	233.
		8805	AIRCRAFT LAUNCH GEAR, DECK-ARREST, GR FL TRAIN, PT	691.	128.
		2839	SILICATES, COMMERCIAL ALKALI METAL SILICATES	689.	1,275.
		2304	SOYBEAN OILCAKE & OTH SOLID RESIDUE, WH/NOT GROUND	679.	4,051.
		2916	UNSAT ACYCLIC & CYCLIC MONOCARBOX ACID & ANHYD ET	669.	378.
		7014	SIGNAL GLASSWARE & GLASS OPTIC ELEM NESOI NOT WRK	667.	140.
		2530	MINERAL SUBSTANCES NESOI	657.	476.
		9618	TAILORS'' DUMMIES & OTHR MANNEQUINS FOR DISPLAY	653.	111.
		8457	MACHINING CENTERS, UNIT CONST MACH ETC WORK METAL	648.	26.
		4821	LABELS OF PAPER OR PAPERBOARD, PRINTED OR NOT	640.	139.
		3809	FINISHING AGENTS ETC FOR TEXTILES, PAPER ETC NESOI	638.	120.
		9105	CLOCKS, WITH CLOCK MVTS OTH THAN INST PANEL ETC	633.	69.
		6913	STATUETTES AND OTHER ORNAMENTAL CERAMIC ARTICLES	620.	92.
		2715	BIT MIX FR NAT ASPH, NAT BIT,PET BIT,MIN TAR OR PT	616.	678.
		6406	PARTS OF FOOTWEAR, INSOLES ETC, GAITORS ETC, PARTS	615.	64.
		7226	FL-RL ALLOY STEEL NESOI UN 600MM WIDE	614.	277.
		9502	DOLLS, REPRESENTING ONLY HUMAN BEINGS, & PARTS ETC	613.	115.
		9202	STRING MUSICAL INSTRUMENTS NESOI (VIOLINS ETC.)	601.	29.
		1806	CHOCOLATE & OTHER FOOD PRODUCTS CONTAINING COCOA	600.	462.
		7212	FL-RL IRON & NA STEEL UN 600MM WD, CLAD ETC	599.	281.
		9006	PHOTOGRAPHIC STILL CAMERAS, FLASH APPARATUS ETC	598.	25.
		7612	ALUMINUM CASKS, CANS ETC NOV 300 LITER CAPACITY	594.	191.
		6109	T-SHIRTS, SINGLET, TANK TOPS ETC, KNIT OR CROCHET	593.	297.
		6505	HATS & HEADGEAR, KNIT ETC, LACE, ETC IN PC, HR NET	593.	28.
		3006	PHARMACEUTICAL GOODS (SPECIFIED STERILE PROD ETC.)	592.	69.
		6914	CERAMIC ARTICLES NESOI	592.	100.
		709	VEGETABLES NESOI, FRESH OR CHILLED	591.	658.
		2912	ALDEHYDES, ITS CYCLIC POLYMERS, PARAFORMALDEHYDE	590.	147.

1993 U.S. EXPORTS TRANSSHIPPED VIA CANADA ABOVE \$200,000
 BY CUSTOMS DISTRICT BY DESCEND. VALUE IN \$1000'S ESTIM. WEIGHT IN METRIC TONS

CD#	CUSTOMS DISTRICT	CODE	HARMONIZED COMMODITY DESCRIPTION	\$1000S	EST. M.TONS
---	-----	----	-----	-----	-----
38	DETROIT, MICH.	2940	SUGARS, CHEM PURE (EXC SUCROSE, LACTOSE, ETC)	588.	219.
		7217	WIRE OF IRON & NONALLOY STEEL	587.	283.
		1001	WHEAT AND MESLIN	585.	4,656.
		8406	STEAM TURBINES & OTHER VAPOR TURBINES, PARTS	569.	36.
		7602	ALUMINUM WASTE AND SCRAP	564.	339.
		802	NUTS NESOI, FRESH OR DRIED	561.	290.
		4808	PAPER AND PAPERBOARD, CORRUGATED ETC, ROLLS ETC	557.	1,024.
		4001	NATURAL RUBBER, BALATA, CHICLE ETC, PRIM FORM ETC	552.	150.
		2903	HALOGENATED DERIVATIVES OF HYDROCARBONS	549.	876.
		6805	ABRASIVE POWDER ETC ON A BASE TEXT MATERIAL ETC	548.	75.
		9011	COMPOUND OPTICAL MICROSCOPES, PARTS & ACCESSORIES	547.	32.
		4413	DENSIFIED WD BLOCKS/PLATES/STRIPS/PROFILE SHAPES	544.	336.
		4806	VEG PARCHMENT, GREASEPROOF PAPERS ETC, ROLLS ETC	526.	415.
		2905	ACYCLIC ALCOHOLS & HALOGENAT, SULFONATD ETC DERIVS	525.	772.
		8308	CLASPS, BUCKLES, HOOKS ETC, BEADS & SPANG, B METAL	523.	50.
		6405	FOOTWEAR NESOI	518.	77.
		6107	MEN''S OR BOYS'' UNDERPANTS, PJS, ETC, KNIT OR CRO	517.	18.
		5810	EMBROIDERY IN THE PIECE, IN STRIPS OR IN MOTIFS	510.	104.
		8705	SPECIAL PURPOSE MOTOR VEHICLES NESOI	506.	98.
		4816	PAPER, CARBON, SELF-COPY ETC NESOI, BOXED OR NOT	501.	283.
		1208	FLOUR & MEAL OF OIL SEED & OLEA FRUIT (NO MUSTARD)	495.	968.
		3701	PHOTO PLATES & FILM, FLAT, SENSITIZED, UNEXPOSED	488.	41.
		8404	AUXILIARY PLANT USED WITH BOILERS, CONDENSERS, PTS	479.	115.
		7218	STAINLESS STEEL IN INGOTS ETC & SEMIFIN PRODUCTS	477.	92.
		7601	ALUMINUM, UNWROUGHT	472.	141.
		4201	LEATHER ART, SADDLERY ETC, HANDBAGS ETC, GUT ART	466.	86.
		3213	ARTIST COLORS ETC IN TABLETS, TUBES, JARS ETC.	464.	91.
		7010	GLASS CONTAINERS FOR PACKING ETC & GLASS CLOSURES	464.	150.
		3818	CHEM ELEM DOPED, USED IN ELECTRON, DISCS WAFERS E	460.	322.
		602	LIVE PLANTS NESOI, CUTTINGS ETC., MUSHROOM SPAWN	458.	413.
		5402	SYNTHETIC FILAMENT YARN (NO SEW THREAD), NO RETAIL	457.	135.
		9207	MUSICAL INSTRUMENTS WITH SOUND ELECTRIC PROD ETC	455.	18.
		7320	SPRINGS & LEAVES FOR SPRINGS, IRON OR STEEL	453.	105.
		7214	BARS & RODS, IRON & NA STEEL NESOI, H-R ETC	448.	87.
		9029	REVOLUTION & PRODUCTION COUNT, TAXIMETERS ETC, PT	448.	21.
		2009	FRUIT JUICES (& GRAPE MUST) & VEG JUICE, NO SPIRIT	444.	893.
		3502	ALBUMINS AND ALBUMIN DERIVATIVES	443.	119.
		7220	FL-RL STAINLESS STEEL PRODUCTS, UNDER 600MM WIDE	442.	238.
		6404	FOOTWEAR, OUTER SOLE RUB, PLAST OR LEA & UPPER TEX	440.	34.
		8206	TOOLS OF 2 OM OF HDG 8202-8205, STS FR RTAIL SALE	438.	53.
		8522	PARTS & ACCESS OF RECORD PLAY, MAG TAPE RECORD ET	438.	65.
		2939	VEG ALKALOIDS, NAT OR SYNTH & SALTS, ETHERS ETC.	436.	28.
		4008	PLATES, SHEETS, PROFILE SHAPES ETC, SOFT VULC RUBR	436.	146.
		1211	PLANTS ETC FOR PHARMACY, PERFUME, INSECTICIDES ETC	435.	250.
		2306	OILCAKE ETC NESOI, FROM VEG FATS & OILS NESOI	432.	2,637.
		9013	LIQUID CRYSTAL DEVICES NESOI, LASERS, OPT APPL, P	428.	43.
		9305	PARTS & ACCESSORIES OF ARMS OF HEAD 9301 TO 9304	428.	47.
		6204	WOMEN''S OR GIRLS'' SUITS, ENSEMB ETC, NOT KNIT ET	422.	112.

1993 U.S. EXPORTS TRANSSHIPPED VIA CANADA ABOVE \$200,000
 BY CUSTOMS DISTRICT BY DESCEND. VALUE IN \$1000'S ESTIM. WEIGHT IN METRIC TONS

CD#	CUSTOMS DISTRICT	CODE	HARMONIZED COMMODITY DESCRIPTION	\$1000S	EST. M.TONS
---	-----	----	-----	-----	-----
38	DETROIT, MICH.	408	BIRDS'' EGGS, NOT IN SHELL & YOLKS, FRESH, DRY, ET	421.	240.
		7301	SHEET PILING, WELDED ANGLES ETC OF IRON OR STEEL	418.	261.
		2835	PHOSPHINATES, PHOSPHONATES, PHOSPHATES & POLYPHOSP	417.	447.
		3918	FLOOR COVER (ROLLS & TILES) & WALL COVER, PLASTIC	417.	251.
		4205	ARTICLES OF LEATHER, NESOI	417.	32.
		3821	PREPARED CULTURE MEDIA FOR DEVEL OF MICROORGANISM	408.	27.
		6001	PILE FABRICS, KNITTED OR CROCHETED	408.	110.
		6103	MEN''S OR BOYS'' SUITS, ENSEMBLES ETC, KNIT OR CRO	401.	41.
		7605	ALUMINUM WIRE	401.	151.
		1006	RICE	400.	1,641.
		3703	PHOTO PAPER, PAPERBOARD & TEXTILES, SENS, UNEXPOS	399.	55.
		8304	OFFICE AND DESK EQUIP A PRTS, OF BASE METAL	399.	97.
		4005	COMPOUNDED RUBBER, UNVULCANISED, PRIMARY FORMS ETC	397.	105.
		2936	PROVITAMINS AND VITAMINS & DERIVATIVES & INTERMIX	392.	79.
		4013	INNER TUBES FOR TIRES, OF RUBBER	387.	145.
		9508	MERRY-GO-ROUNDS, OTH FAIRGROUND AMUSEMENTS, PARTS	384.	19.
		8513	PORTABLE ELEC LAMPS FUNCTION BY OWN ENERGY SOURCE	379.	15.
		2929	NITROGEN FUNCTION COMPOUNDS NESOI	377.	122.
		5601	TEXT WADDING & ARTICLES, TEXT FIBERS NOV 5 MM, ETC	377.	65.
		7311	CONTNRS FR CMPRSSD O LQFD GAS OF IRON O STEEL	377.	162.
		8533	ELECTRICAL RESISTORS EXCEPT HEATING RESISTORS, PT	377.	17.
		2615	NIOBIUM, TANTALUM, VANADIUM & ZIRCONIUM ORE & CONC	376.	966.
		7305	TUBES & PIPES NESOI, EXT DIA OV406-4MM, IR & STEEL	374.	73.
		9304	ARMS NESOI, OTHER THAN SIDE ARMS AND SIMILAR ARMS	374.	40.
		9114	CLOCK OR WATCH PARTS, NESOI	372.	5.
		1521	VEG WAXES NESOI, BEESWAX ETC AND SPERMACETI	369.	168.
		3002	HUMAN BLOOD, ANIMAL BLOOD, ANTISERA, VACCINES ETC	369.	151.
		2942	ORGANIC COMPOUNDS NESOI	363.	65.
		3914	ION-EXCHANGERS BASD ON PLASTICS, IN PRIMARY FORMS	361.	78.
		1204	FLAXSEED (LINSEED), WHETHER OR NOT BROKEN	357.	584.
		3802	ACTIVATED CARBON ETC., ANIMAL BLACK, INC SPENT	348.	454.
		7405	MASTER ALLOYS OF COPPER	348.	160.
		6911	CERAMIC TABLEWARE ETC. OF PORCELAIN OR CHINA	345.	91.
		8416	FURNACE BURNERS, MECHANICAL STOKERS ETC, PARTS	345.	23.
		8532	ELECTRIC CAPACITORS, FIXED, VAR OR ADJ (PRESET) P	344.	18.
		3303	PERFUMES AND TOILET WATERS	343.	107.
		2523	PORTLAND CEMENT, ALUMINOUS CEMENT, SLAG CEMENT ETC	341.	5,257.
		7904	ZINC BARS, RODS, PROFILES AND WIRE	341.	255.
		9505	FESTIVE, CARNIVAL OR OTHER ENTERTAINMENT ART, PTS	341.	67.
		6309	WORN CLOTHING AND OTHER WORN TEXTILE ARTICLES	340.	434.
		2203	BEER MADE FROM MALT	339.	716.
		5602	FELT, IMPREGNATED, COATED, ETC. OR NOT	337.	54.
		7229	WIRE OF ALLOY STEEL NESOI	337.	92.
		2516	GRANITE, PORPHYRY, BASALT ETC., CRUDE OR CUT ETC.	335.	1,153.
		6804	MILLSTONES ETC FOR GRINDING ETC, VARIOUS MATERIALS	334.	35.
		2301	FLOUR, MEAL ETC OF MEAT ETC, NOT FOR HUMAN, GREAVS	332.	624.
		8210	HND-OP MECH APPL 10KG OR LSS,FD/DRK PRP/CON/SRV P	329.	475.
		8101	TUNGSTEN (WOLFRAM) & ARTICLES, INCL WASTE & SCRAP	323.	48.

1993 U.S. EXPORTS TRANSSHIPPED VIA CANADA ABOVE \$200,000
 BY CUSTOMS DISTRICT BY DESCEND. VALUE IN \$1000'S ESTIM. WEIGHT IN METRIC TONS

CD#	CUSTOMS DISTRICT	CODE	HARMONIZED COMMODITY DESCRIPTION	\$1000S	EST. M.TONS
---	-----	----	-----	-----	-----
38	DETROIT, MICH.	2620	ASH & RESIDUES (NOT FR IRON ETC MFR) W METAL CONT	319.	344.
		3210	PAINTS & VARNISHES NESOI, WATR PIGMTS FOR LEATHER	317.	157.
		3602	PREPARED EXPLOSIVES OTHER THAN PROPELLENT POWDERS	317.	60.
		4006	UNVULC RUBBER FORMS NESOI & UNVULC RUBBER ARTICLES	315.	150.
		4301	RAW FURSKINS NESOI (INCL PCS FOR FUR USE)	315.	130.
		8528	TELEVISION RECEIVERS (INCL MONITORS & PROJ RECEIV	315.	22.
		2908	PHENOL OR PHENOL-ALCOHOL DERIV, HALOG, SULF ETC	314.	109.
		4909	PRINTED OR ILLUSTR POST CARDS, GREETING CARDS, ETC.	313.	51.
		409	HONEY, NATURAL	310.	198.
		3805	TURPENTINE ETC, CRUDE DIPENTENE, PINE OIL ETC	310.	342.
		7206	IRON & NONALLOY STEEL IN INGOTS ETC NESOI	307.	132.
		9017	DRAWING, MATH, MEASURING INST ETC NESOI, PARTS	303.	32.
		604	FOLIAGE, GRASSES ETC FOR BOUQUETS ETC, PREPARED	298.	122.
		3407	MODELING PASTES FOR CHILD ETC, DENTA IMPR CP ETC	297.	134.
		9206	PERCUSSION MUSICAL INSTRUMENTS DRUMS ETC.)	297.	11.
		4102	RAW SKINS OF SHEEP OR LAMBS NESOI	293.	211.
		5604	RUB THRED & CORD, TEXT COV, TEX YN ETC COV RUB ETC	291.	122.
		4904	MUSIC, PRINTED OR IN MANUSCRIPT, BOUND ETC OR NOT	277.	20.
		7801	LEAD, UNWROUGHT	275.	96.
		1007	GRAIN SORGHUM	272.	273.
		603	CUT FLOWERS & BUDS FOR BOUQUETS ETC., PREPARED	260.	75.
		8470	CALCULATING & ACCOUNT MACHINES, CASH REGISTERS ET	260.	7.
		6808	PNLS BRDS ETC O VEG FBR AG W CMNT PLSTR ETC BNDRS	259.	367.
		2925	CARBOXYIMIDE-FUNCTION COMP, IMINE-FUNCTION COM ET	250.	51.
		5210	WOVEN COTTON FABRICS, UN85% COT, MMFMIX, NOV200G/M	250.	29.
		2803	CARBON, NESOI (INCLUDING CARBON BLACK)	249.	964.
		7408	COPPER WIRE	244.	89.
		1003	BARLEY	243.	1,774.
		2801	FLUORINE, CHLORINE, BROMINE & IODINE	243.	229.
		2308	VEG MATERIAL, WASTE ETC FOR FEEDING ANIMALS NESOI	241.	1,361.
		2509	CHALK	237.	806.
		7001	CULLET A OTH WST A SCRIP GLASS, GLASS IN MASS	237.	314.
		8715	BABY CARRIAGES (INC STROLLERS) AND PARTS THEREOF	235.	48.
		9703	ORIGINAL SCULPTURES AND STATUARY, IN ANY MATERIAL	235.	49.
		3913	NATURAL (INC MODIFIED) POLYMERS NESOI, PRIMARY FM	233.	117.
		4910	CALENDARS, CALENDAR BLOCKS OF ANY KIND, PRINTED	232.	18.
		2812	HALIDES & HALIDE OXIDES OF NONMETALS	230.	92.
		2805	ALKALI METALS ETC, RARE-EARTH METALS ETC, MERCURY	229.	184.
		8530	ELECTRIC SIGNAL, SAFETY OR TRAFFIC CONTROL EQUIP	229.	6.
		9025	HYDROMETERS, THERMOMETERS, PYROMETERS ETC, PTS ET	225.	17.
		2828	HYPOCHLORITES ETC, CHLORITES, HYPOBROMITES	223.	187.
		3813	PREP & CHGS FOR FIRE-EXTINGUISHERS ETC	223.	108.
		8112	BERYLLIUM, CHROM, GERM, VANAD, GALLIUM, HAFNM, ETC	222.	96.
		4017	HARD RUBBER IN ALL FORMS, ARTICLES OF HARD RUBBER	221.	107.
		9004	SPECTACLES, GOGGLES ETC, CORRECT, PROTECT ETC	220.	5.
		7314	CLOTH, GRILL ETC IR OR ST, EXPAND METAL, IR OR ST	219.	121.
		2815	SODIUM HYDROX, POTASS HYDROX, SOD OR POTASS PEROX	216.	746.
		2914	KETONES & QUINONES & HALOGENATD, SULFONATD DER ET	214.	48.

1993 U.S. EXPORTS TRANSSHIPPED VIA CANADA ABOVE \$200,000
 BY CUSTOMS DISTRICT BY DESCEND. VALUE IN \$1000'S ESTIM. WEIGHT IN METRIC TONS

CD#	CUSTOMS DISTRICT	CODE	HARMONIZED COMMODITY DESCRIPTION	\$1000S	EST. M.TONS
----	-----	----	-----	-----	-----
38	DETROIT, MICH.	4015	ART OF APPAREL & ACCESS OF UNHARD VULCANIZED RUBB	214.	15.
		4111	COMPOSITION LEA, LEA FIBER IN SLABS, SHEETS, STRIP	212.	66.
		2402	CIGARS, CIGARETTES ETC., OF TOBACCO OR SUBSTITUTES	210.	23.
		6114	GARMENTS NESOI, KNITTED OR CROCHETED	209.	18.
		3203	COLORING MATTER OF VEGETABLE OR ANIMAL ORIGIN	208.	111.
		8307	FLEXIBLE TUBING OF BASE METAL	208.	36.
		2504	NATURAL GRAPHITE	203.	62.
		6504	HATS&OTHR HDGR,PLAITD/ASSEMBLD STRIPS ANY MATERIAL	203.	10.
		811	FRUIT & NUTS (RAW OR COOKED BY STEAM ETC), FROZEN	202.	77.
		9106	TIME OF DAY RECORDING APPAR ETC, WITH CLOCK ETC MT	201.	8.
		504	ANIMAL (NOT FISH) GUTS, BLADDERS, STOMACHS & PARTS	200.	181.
		4406	RAILWAY OR TRAMWAY SLEEPERS (CROSS-TIES) OF WOOD	200.	1,048.
		9999	BELOW MINIMUM	21,329.	21,174.
		*SUB-TOTAL CUSTOMS DIST. # 38		3,998,292.	1,531,448.
41	CLEVELAND, OHIO	9999	BELOW MINIMUM	682.	186.
		*SUB-TOTAL CUSTOMS DIST. # 41		682.	186.
		TOTAL		5,828,323.	2,091,355.