

HE
1780
.A33
no.
81-4

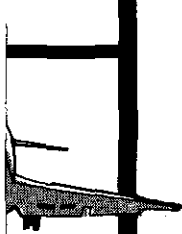

NATIONAL TRANSPORTATION SAFETY BOARD

DEPARTMENT OF
TRANSPORTATION

MAY 28 1982

LIBRARY

WASHINGTON, D.C. 20594

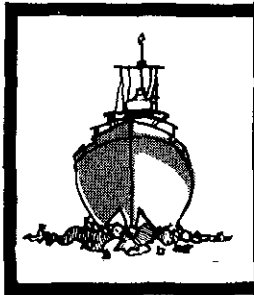
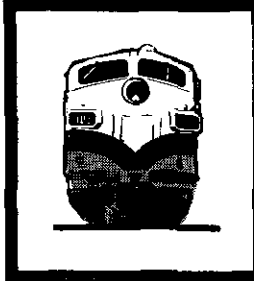

RAILROAD ACCIDENT REPORT

HEAD-END COLLISION OF
AMTRAK PASSENGER TRAIN NO. 74
AND CONRAIL TRAIN OPSE-7
DOBBS FERRY, NEW YORK
NOVEMBER 7, 1980

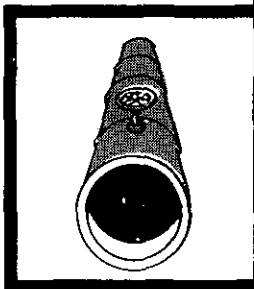

NTSB-RAR-81-4



UNITED STATES GOVERNMENT

1. Report No. NTSB-RAR-81-4		2. Government Accession No. PB81-204869		3. Recipient's Catalog No.	
4. Title and Subtitle Railroad Accident Report--Head-end Collision of Amtrak Passenger Train No. 74 and Conrail Train OPSE-7, Dobbs Ferry, New York, November 7, 1980				5. Report Date April 28, 1981	
				6. Performing Organization Code	
7. Author(s)				8. Performing Organization Report No.	
9. Performing Organization Name and Address National Transportation Safety Board Bureau of Accident Investigation Washington, D.C. 20594				10. Work Unit No. 3245	
				11. Contract or Grant No.	
12. Sponsoring Agency Name and Address NATIONAL TRANSPORTATION SAFETY BOARD Washington, D. C. 20594				13. Type of Report and Period Covered Railroad Accident Report November 7, 1980	
				14. Sponsoring Agency Code	
15. Supplementary Notes The subject report was distributed to NTSB mailing lists: 8A, 8D, 14A and 14B.					
16. Abstract About 4:12 p.m., on November 7, 1980, Conrail freight train OPSE-7 struck the head-end of Amtrak train No. 74 while it was standing on track No. 2 at Dobbs Ferry, New York. The lead locomotive unit of train OPSE-7 overrode and destroyed the operating cab of the power car of train No. 74. Of the estimated 234 persons aboard the trains, 75 passengers and 9 crewmembers were injured. Damage to the equipment was estimated at \$915,000. The National Transportation Safety Board determines that the probable cause of this accident was the failure of the OW operator to apply a blocking device to the signal lever which permitted him to clear the signal and allowed train No. 74 to proceed on an occupied track, and Conrail's condoning the transmission of train orders without requiring the operator to display the train order signal. Contributing to the accident were the improper training and inadequate supervision of the operator and the failure of Conrail to provide a reasonable means of displaying train order signals at OW. Contributing to the injuries were the design of the seats and lack of emergency evacuation instructions.					
17. Key Words Head-end collision, freight train, passenger train, turbotrain, automatic block signal system, interlocking, operator, dispatcher, train order signal, signal lever blocking device.				18. Distribution Statement This document is available to the public through the National Technical Information Service Springfield, Virginia 22161 (Always refer to number listed in item 2)	
19. Security Classification (of this report) UNCLASSIFIED		20. Security Classification (of this page) UNCLASSIFIED		21. No. of Pages 47	22. Price

CONTENTS

SYNOPSIS	1
INVESTIGATION	1
The Accident	1
Injuries to Persons	4
Damage	4
Crewmember Information	6
Train Information	9
Postaccident Inspection of Train Equipment	11
Track and Signal Information	12
Postaccident Inspection of Signal Equipment	12
Method of Operation	15
Meteorological Information	18
Survival Aspects	18
ANALYSIS	19
Protection For Trains	19
Radio Communications	20
Crashworthiness	21
Emergency Evacuation	23
Training and Supervision of Operator	23
CONCLUSIONS	24
Findings	24
Probable Cause	25
RECOMMENDATIONS	25
APPENDIXES	27
Appendix A—Investigation	27
Appendix B—Crewmember Information	28
Appendix C—Transcript of the Dispatcher's Open Wire Incident Involving OPSE-7 and No. 74 on November 7, 1980	30
Appendix D—Excerpts from Conrail Rules of the Transportation Department	37
Appendix E—Excerpts from Conrail Timetable Special Instructions	39
Appendix F—Excerpts from 49 CFR 217 Railroad Operating Rules And 49 CFR 220 Radio Procedures	40
Appendix G—Excerpt from Rail Safety/Equipment Crashworthiness Report No. FRA/ORD-77/73, IV	43
Appendix H—Structural Testing - Trailer Car	44
Appendix I—FRA Letter	46

**NATIONAL TRANSPORTATION SAFETY BOARD
WASHINGTON, D.C. 20594**

RAILROAD ACCIDENT REPORT

Adopted: April 28, 1981

**HEAD-END COLLISION OF AMTRAK PASSENGER TRAIN NO. 74 AND
CONRAIL TRAIN OPSE-7, DOBBS FERRY, NEW YORK
NOVEMBER 7, 1980**

SYNOPSIS

About 4:12 p.m., on November 7, 1980, Conrail freight train OPSE-7 struck the head end of Amtrak train No. 74 while it was standing on track No. 2 at Dobbs Ferry, New York. The lead locomotive unit of train OPSE-7 overrode and destroyed the operating cab of the power car of train No. 74. Of the estimated 234 persons aboard the trains, 75 passengers and 9 crewmembers were injured. Damage to the equipment was estimated at \$915,000.

The National Transportation Safety Board determines that the probable cause of this accident was the failure of the OW operator to apply a blocking device to the signal lever which permitted him to clear the signal and allowed train No. 74 to proceed on an occupied track, and Conrail's condoning the transmission of train orders without requiring the operator to display the train order signal. Contributing to the accident were the improper training and inadequate supervision of the tower operator, and the failure of Conrail to provide a reasonable means of displaying train order signals at OW. Contributing to the injuries were the design of the seats and lack of emergency evacuation instructions.

INVESTIGATION

The Accident

At 12:30 p.m. on November 7, 1980, westbound Conrail Freight Train Extra 2806 (OPSE-7), consisting of 3 locomotive units, 120 cars, and a caboose, departed the Oak Point Yard, Bronx, New York. At 1:24 p.m., the train entered the Conrail metropolitan region, Hudson Line, at the Melrose (MO) interlocking station. (See figure 1.) At this point, the train came under the direction of the lower Hudson Line train dispatcher. The train continued westward on track No. 1 and approached Spuyten Duyvil (DV) interlocking station at approximately 2:50 p.m. The train dispatchers at Grand Central Terminal, New York City, were changing shifts at the time, and the oncoming dispatcher was notified by the upper Hudson Line train dispatcher that he was not able to take OPSE-7 on the upper Hudson Line because he had two tracks out of service. Work was being performed on track No. 1, and track No. 4 was being used by the track department to unload material. Serious delays to the evening commuter rush hour trains would have developed had the long, slow moving freight train been allowed to continue westward. Confronted with this problem, the lower Hudson Line dispatcher decided to allow OPSE-7 to continue westward on track No. 1 as far as Glenwood, New York, where a remote interlocking controlled by DV was located; back it over from westward track No. 1 to eastward track No. 2; issue a

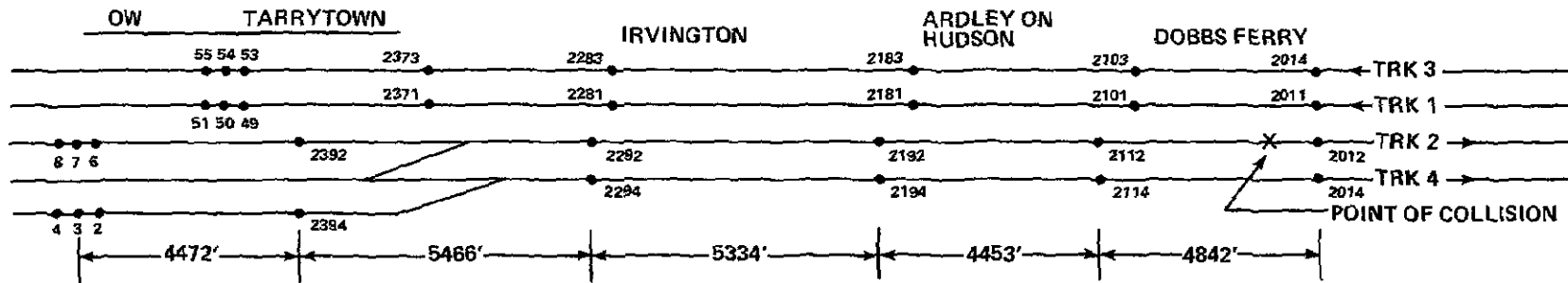

DISTANCE BETWEEN SIGNALS

STATION	MILEPOST
NEW YORK (GCT)	0
5.4	
MO TOWER	5.4
5.8	
SPUYTEN DUYVIL (DV)	11.2
5.1	
GLENWOOD	16.3
4.5	
DOBBS FERRY	20.8
3.9	
OW TOWER	24.7
0.6	
TARRYTOWN	25.3
8.1	
CROTON-HARMON	33.4

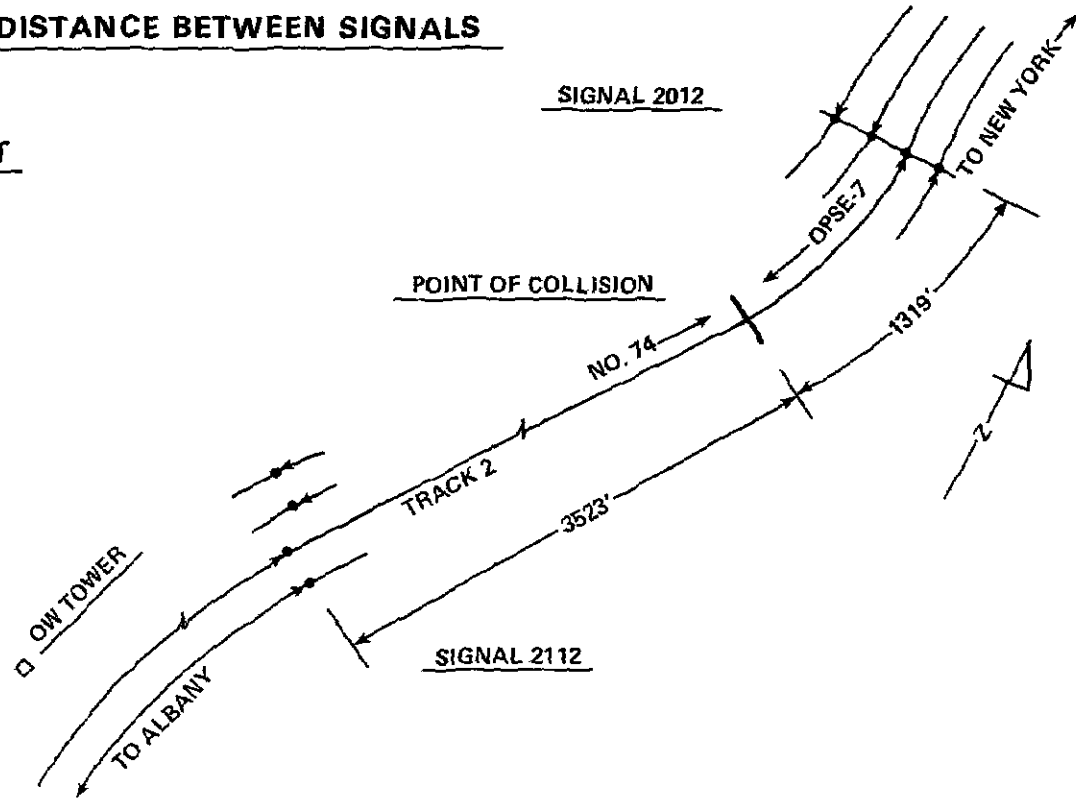

Figure 1.—Sketch of track alignment.

train order to run OPSE-7 westward against the current of traffic on track No. 2, by train order, to the OW interlocking station at Tarrytown, New York; and hold it at OW until the upper Hudson Line dispatcher could take the train when it would not delay the westbound commuter trains.

OPSE-7 arrived at Glenwood at 3:20 p.m. and had completed backing onto track No. 2 at 3:42 p.m. After talking with the operators at the DV and OW interlocking stations, the dispatcher determined that there were no trains between OW and Glenwood on track No. 2. (See appendix C.) The dispatcher instructed the OW operator to apply a blocking device for track No. 2 east. The OW operator did not apply the blocking device, but he replied "BDA (blocking device applied) signal 6 1/ at 3:49." Even though the operator did not indicate train order signal displayed, the train dispatcher issued train order No. 304, a "J" order 2/ to the OW operator:

Hold all eastward trains clear of No. 2 track between OW and Glenwood.

The OW operator copied the order and repeated it to the dispatcher. The order was "made complete" 3/ at 3:50 p.m.

The dispatcher then issued train order No. 305 to the OW operator, the DV operator, and the conductor and the engineer of Extra 2806 (OPSE-7) in care of the DV operator:

Extra 2806 West has right over opposing trains on No. 2 track Glenwood to OW.

Both operators copied and repeated the order, and the order was made complete at 3:54 p.m. The OW operator confirmed to the dispatcher that the block between Glenwood and OW was clear of any trains. The DV operator transmitted order No. 305 over Conrail radio channel No. 2 to the engineer of OPSE-7. The engineer repeated the order and it was made complete at 3:57 p.m. The DV operator reported that OPSE-7 departed Glenwood westbound on track No. 2 at 4:08 p.m.

As westbound OPSE-7 rounded a 0°54' curve approaching Dobbs Ferry, New York, about 4:12 p.m., the engineer and head brakeman saw a train approaching in the distance. At the first sighting of the train, the engineer and head brakeman said they were not able to determine which track the train was on because of the curve; but they thought that it was on another track. However, as OPSE-7 continued around the curve, the engineer and head brakeman saw that the train was on the same track. The engineer said he immediately applied the train brakes in emergency and the train started slowing from 38 mph. When it became evident that a collision would occur, the engineer and head brakeman laid on the locomotive cab floor.

At 3:56 p.m., eastbound Amtrak passenger train No. 74, the Empire State Express, consisting of a power club car, a food service car, three coach cars, and a power car, departed Croton-Harmon Station on track No. 2. At this time, the engineer switched, as required, from channel 2 to channel 3 because his train was now entering the commuter district.

1/ Controls the straight eastward movement on track No. 2.

2/ A J Order is issued to the operator for the purpose of holding a train.

3/ When an order has been repeated correctly by an operator, the response "complete" and the time, with the initials of the superintendent, will be given by the train dispatcher. The operator receiving this response will then write the word "complete," followed by the time and his last name in full.

As train No. 74 approached the OW interlocking, the engineer saw a red (stop) signal indication. The engineer, using the Metro Region Commuter Radio channel No. 3, called, "74 to OW," twice between 4:05 and 4:06 p.m. After the second call, the OW operator replied, "OK 74," and activated the signal lever, which cleared the signal for the train to continue east of OW on track No. 2. The OW operator recorded movement of train No. 74 east on track No. 2 at 4:08 p.m.

Train No. 74 continued eastward on track No. 2 in response to clear indications on the next three signals. However, the fourth signal, just west of Dobbs Ferry station, indicated "Advance Approach." However, before train No. 74 arrived at the signal, it changed to "Approach." The engineer reduced the train's speed to approximately 25 mph as it passed the signal and entered a 0°46' right-hand curve. On exiting the curve, the engineer and fireman saw a freight train about 0.5 mile to the east approaching on one of the four tracks. When the engineer determined that the approaching train was on the same track, he shouted a warning to the fireman and simultaneously applied the train brakes in emergency. The engineer and fireman jumped from the locomotive, without alerting the conductor or passengers, just before the train came to a stop.

Moments later, OPSE-7 collided with standing train No. 74 at about 10 mph. The impact derailed the lead unit of OPSE-7 and pushed train No. 74 rearward about 112 feet, derailling the lead power car (see figure 2) and the following three passenger cars. (See figure 3.) Electrical power to the four tracks was shut off after a crewmember boarded the cab of the rear power car and used the radio to request that the power be shut off because of the collision and because passengers were getting onto the tracks. An employee of a restaurant adjacent to the accident site immediately called the Dobbs Ferry Police Department. Within 3 minutes after the accident, emergency forces began to arrive at the accident site.

Injuries to Persons

<u>Injuries</u>	<u>OPSE-7 Crewmembers</u>	<u>Train No. 74 Crewmembers</u>	<u>Passengers</u>	<u>Total</u>
Fatal	0	0	0	0
Nonfatal	4	5	75	84
None	0	0	150*	150*
Total	4	5	225*	234*

* Estimated because a number of uninjured passengers left the scene of the accident before a total count could be obtained.

Damage

Damage to OPSE-7 was limited to the derailed lead locomotive unit. The front end coupler was broken and the front deck, handrails, and side steps were bent, torn, and twisted. The short hood was forward and it was crushed inward.

The operating cab of the power club car of train No. 74 was destroyed because of the 10-mph impact. All floor or deck mounted equipment was torn or sheared off. The other cars in the train sustained minor structural damage.

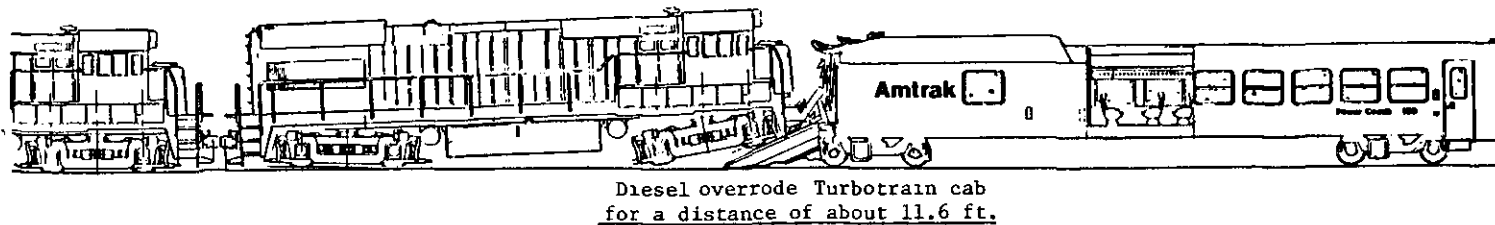
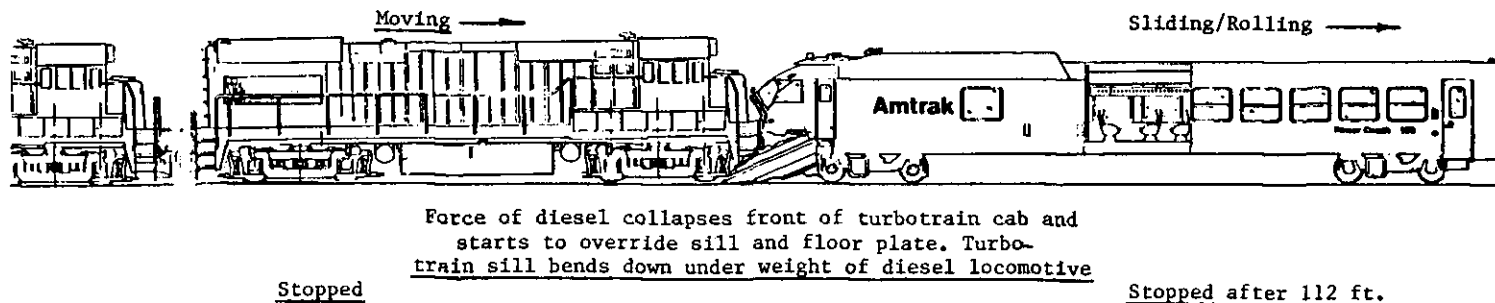
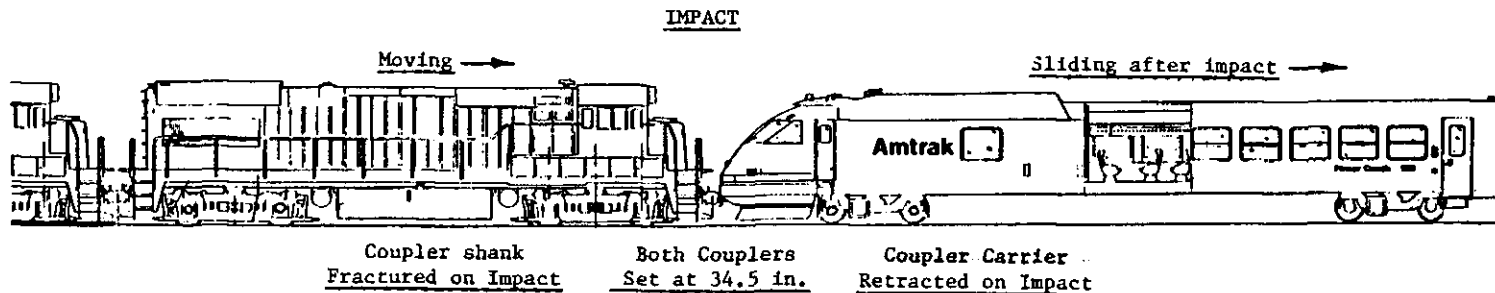
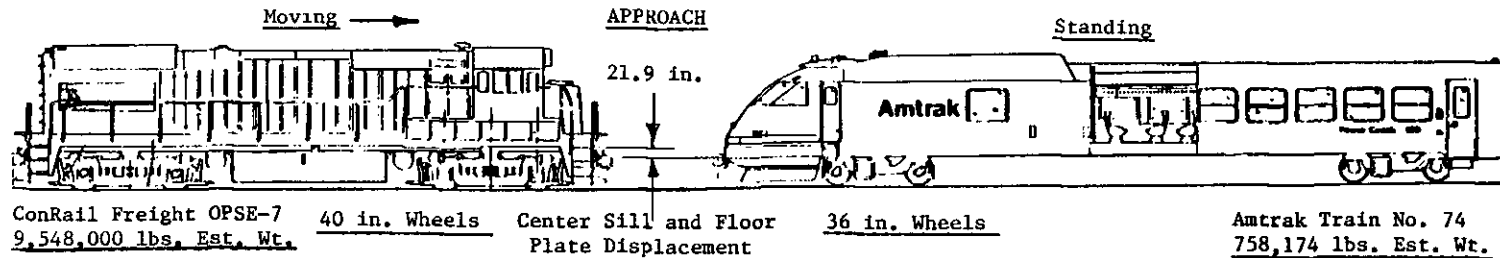

Figure 2.—Diagram of impact of OPSE-7 and No. 74.

Track damage was confined to the area of the collision and the 112 feet No. 74 was pushed rearward. The third rail equipment 4/ was also damaged when the second car of train No. 74 derailed and came to rest against it.

Damage was estimated as follows:

Equipment	\$900,000
Track	10,000
Wreckage and cleanup	<u>5,000</u>
Total	\$915,000

Crewmember Information

The crew of Conrail OPSE-7 consisted of an engineer, a conductor, and two trainmen. All were qualified under Conrail operating rules without restrictions. They had reported for work at Oak Point Yard, Bronx, New York, at 10:30 a.m., and had been on duty about 6 hours. (See appendix B.)

The crew of Amtrak train No. 74 consisted of an engineer, a fireman, a conductor, and two trainmen. All were Conrail employees and were qualified under Conrail operating rules without restrictions. The engineer and fireman had reported for work at Harmon at 2:55 p.m., and had been on duty approximately 1 hour 30 minutes. The conductor and two trainmen had reported for work at Albany, New York, about 1:05 p.m., and had been on duty about 3 hours 15 minutes. (See appendix B.)

The train dispatcher was qualified under Conrail operating rules without restrictions. He had been on duty about 1 hour 30 minutes. He had worked for Conrail for 4 years 6 months and had been a dispatcher for 1 year 6 months. Before becoming a dispatcher, he had worked as an operator. During his employment as an operator, he attended a 2-week school for operators in Wilmington, Delaware. He had 2 months on-the-job dispatcher training, which included operating rules classes, train order classes, and observing dispatchers responsible for three separate districts. After the accident, he stated that he had not required the operator to respond "stop signal and train order signal displayed" as required by Conrail rules for issuing a "J" order because, "it was never a practice in our office because the facilities for displaying a train order signal does not exist in most towers." He further stated that when he was an operator he had received train orders but did not display a train order signal because the facilities did not exist.

The OW operator was qualified under Conrail operating rules without restrictions. He had been on duty about 1 hour 15 minutes. After the accident, the OW operator stated he did not apply the blocking device. He further stated, "that is something you do automatically. You say 'BDA' and then go over and do it. This was the way I was trained." He had been working for Conrail for 1 year and 22 days. He had received on-the-job training with various operators on duty for 57 days and had worked on all three shifts. Before beginning the on-the-job training, he had attended 4 days of classroom instruction on the Conrail Rules of the Transportation Department. Before completing the on-the-job training, he successfully passed a written examination on the Rules of the

4/ A sliding contact shoe attached to the car truck of the electric equipment which collects current from the rail located alongside the running rail.

STA. 104.5
PT + 553.16 STONE MON.

MON. 105

STA. 105.5

20
STA 105 + 600

MON.

LOW DRY WALL

RET. WALL

BUTTRESS MASONRY

P.C. + 597.39
NEW STATION

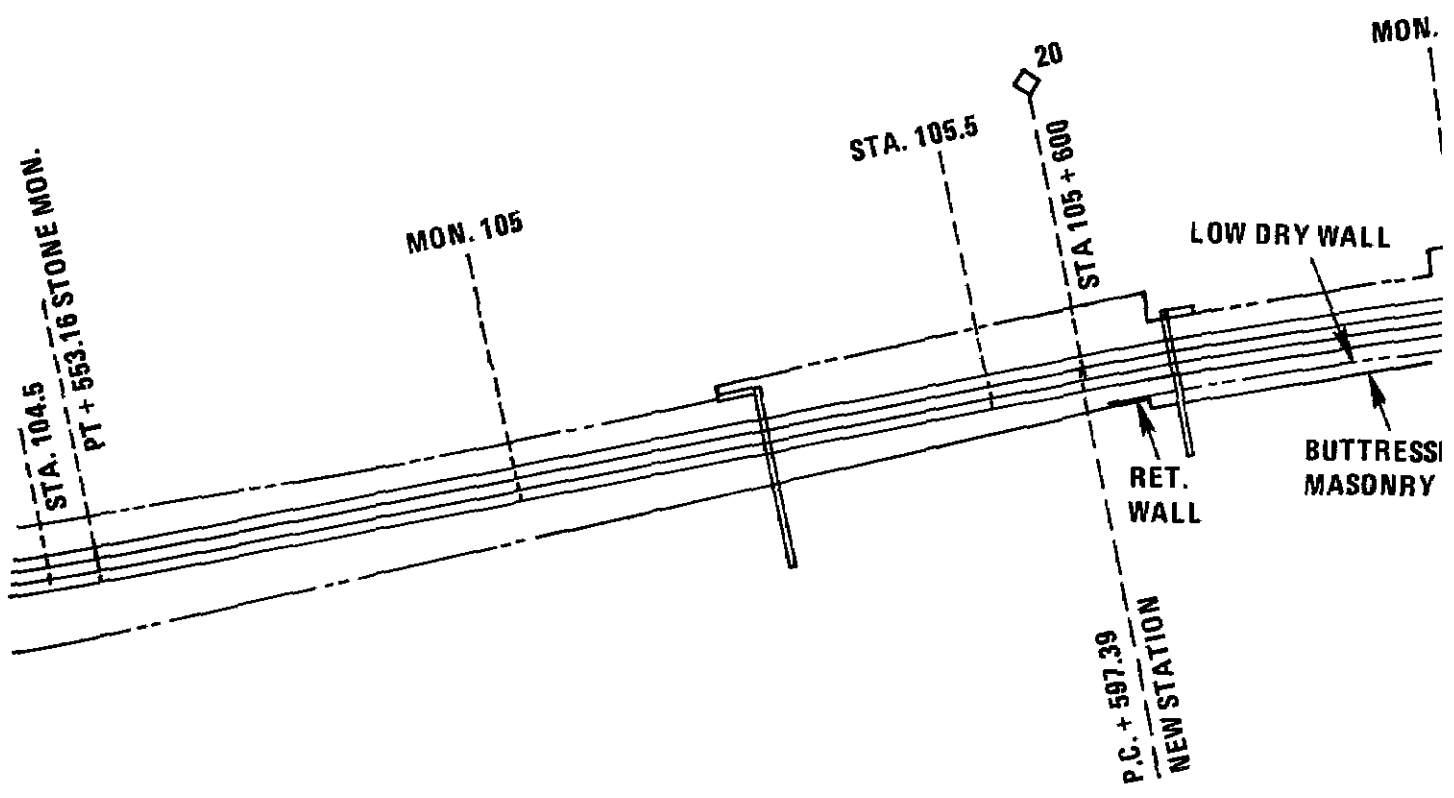

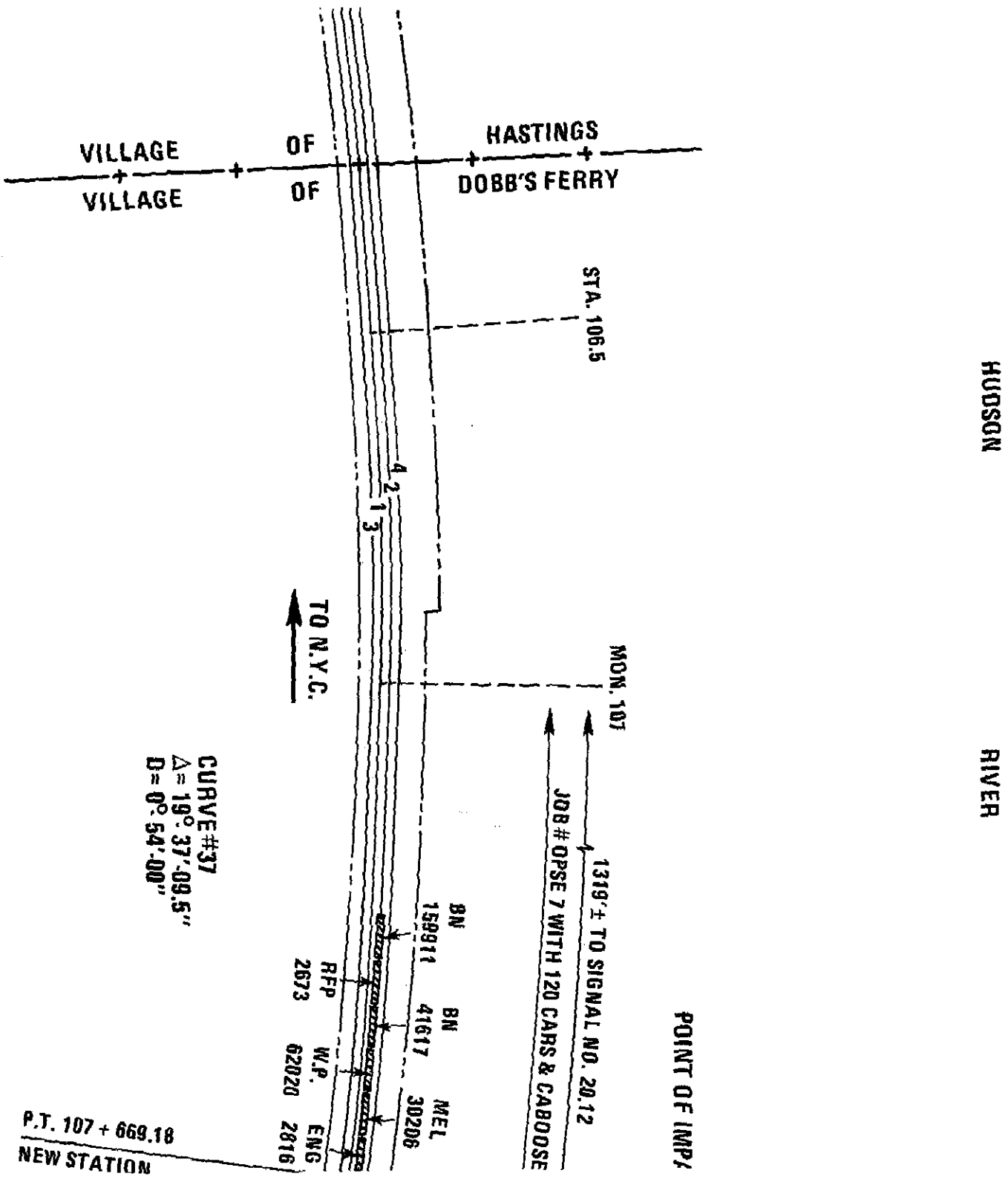

HUDSON

RIVER

POINT OF IMP1

Figure 3. -- DOBBS FERRY ACCI

RRRY ACCIDENT SITE.

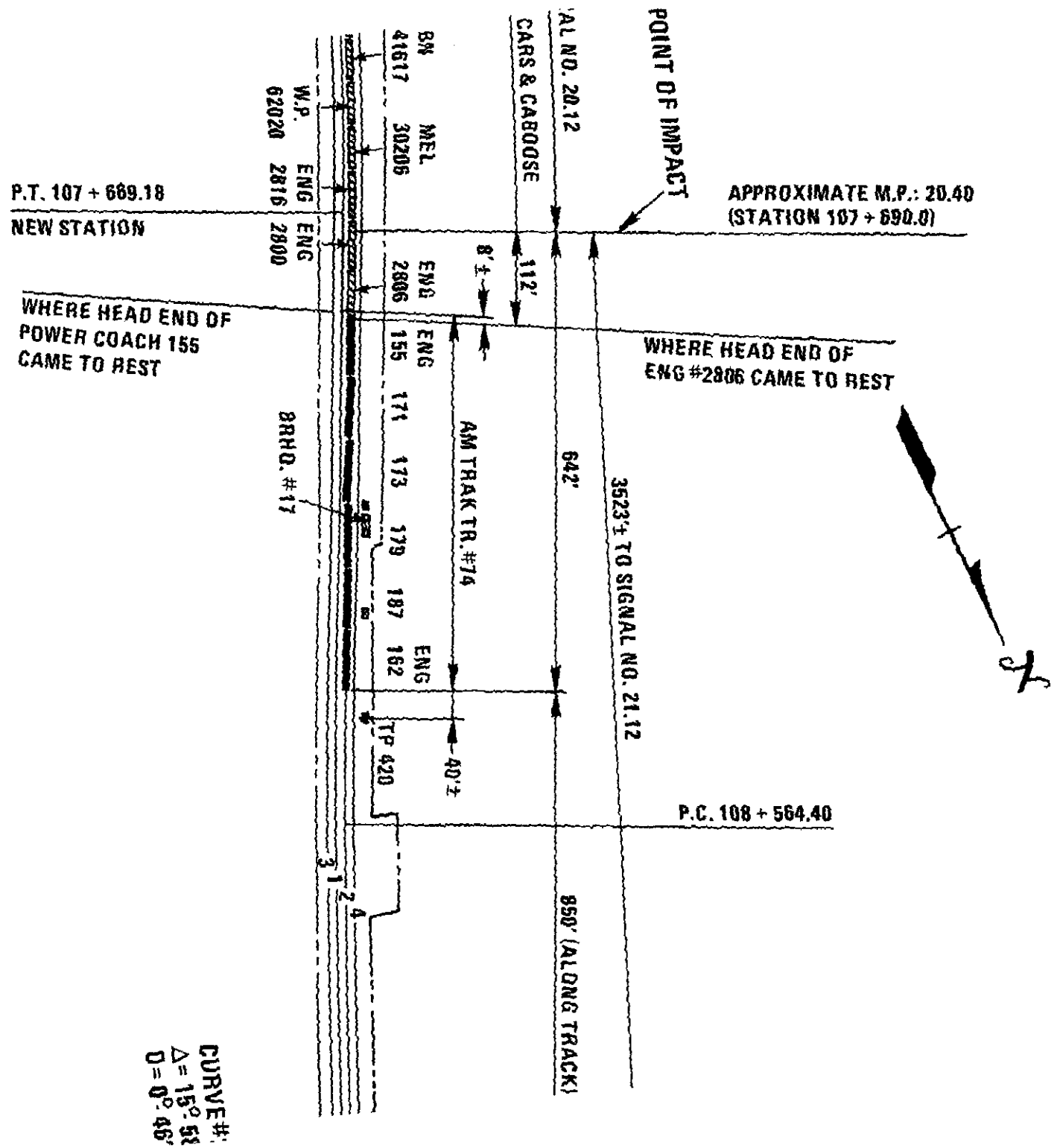

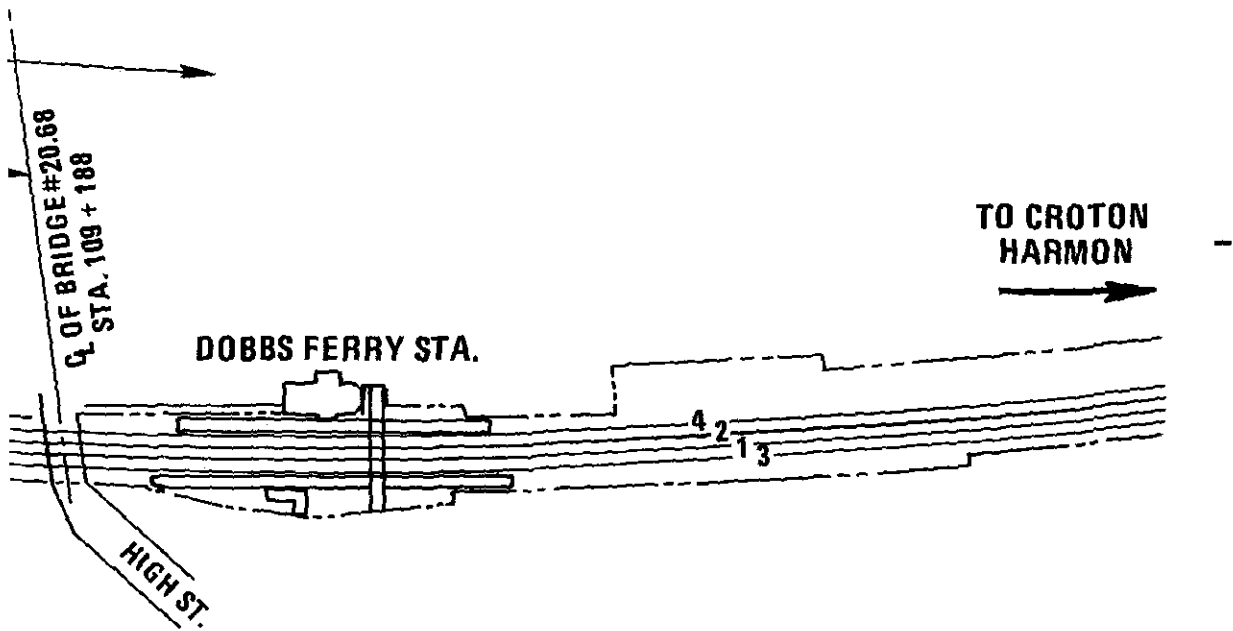

Transportation Department. He did not attend the 2-week school for operators at Wilmington because the school, which had been established by Conrail's predecessor company, Penn Central, and the 10-day program were eliminated during March 1977. During his employment, he had worked most of his time at OW; however, he had worked at White Plains for about 1 month and had been back at OW for 2 weeks before the accident. (See appendix B.)

Examination of the efficiency tests conducted on the dispatcher indicated that on June 12, 1980, the dispatcher had been observed and a record was prepared of the observation as he transmitted a train order. The report indicated that he complied with the Conrail rules for the transmission of train orders. There was no record of any observation of the performance of the OW operator.

Train Information

Train No. 74.--Train No. 74 had been inspected and its brakes tested before leaving Niagara Falls. No exceptions were taken during the inspection and tests. The train equipment was built by the Rohr Corporation and was model Rohr turboliner (RTL) Turbotrain equipment, an American version of the (ANF) built turbotrain which is operated by the French National Railway. The major difference between the two models, other than slight exterior appearance and interior equipment, is the ability of the RTL equipment to operate in the third-rail electric propulsion territory. This function is accomplished by the addition of four third-rail current collectors mounted on the truck side frames of each power car and various controls which provide electric power to a 150-hp electric traction motor in each power car. The motor is connected through an overrunning clutch to a hydraulic transmission which, in turn, is connected to axle-mounted gear boxes. When operating on third-rail electric propulsion, the main traction turbine engine is shut down and propulsion power is provided only by the electric traction motors.

All the cars of the turboliner including the power cars were of all steel construction and designed to comply with Association of American Railroads (AAR) specifications Nos. C-75 through -82 for the construction of new passenger cars to be used in trains having a total empty weight of 600,000 pounds or more.

The operating cab of the power car had two 10-inch I-beam forward posts, identified by Amtrak as collision posts, (see figure 4 item "A"), welded to the floor. One end of the angled supports (item "B") was welded to the I-beams and the other end was welded to the floor. The forward posts (item "A") were tested in a mock-up configuration to meet the AAR specifications Nos. C-75 through -84, revised 1967. (See appendix H.) The height of the sill and floor plate on the power club car was 45.67 inches above the top of the rail.

Each passenger car was equipped with electric-pneumatically operated sliding type-doors on each end and on each side of the car. The doors could be automatically opened by inserting a key in the control panel. In an emergency, the doors could be opened manually by first breaking the glass in the control panel, located adjacent to the door, pushing in a valve, and manually operating a door handle which allowed the door to slide open. Operational instructions were indicated on a tag attached to the control panel.

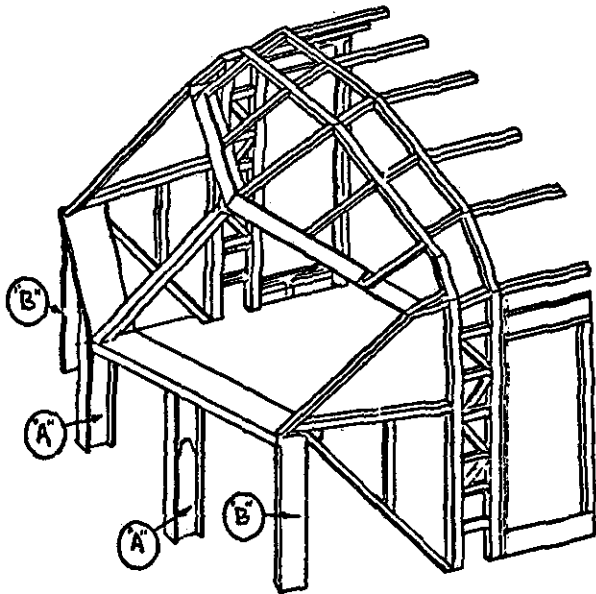
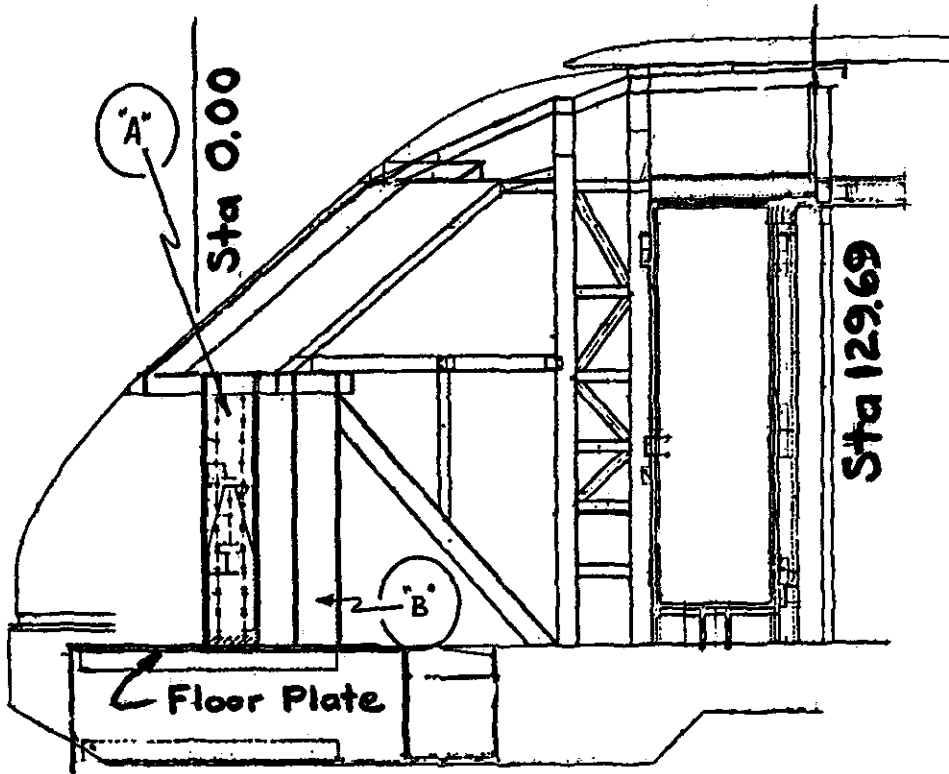

"A" = Collision Posts (Center)

"B" = Collision Posts (Side)

Figure 4. -- Structural design of the engineman's cab front (turbotrain).

Steps at each door were covered by a trapdoor which, when opened, would extend the steps. The car was also equipped with a pair of retractable sliding/folding steps. These retractable steps were operated by insertion of a key in the control panel. No instructions were provided on the car for the operation of the trapdoor or folding steps.

Two emergency-escape windows were located in the center on each side of the cars. Emergency exit through these windows could be initiated after the window stripping was peeled away and the pane of glass pulled inward. However, several of the emergency windows were not properly identified. At one emergency window, the pull handle for the window stripping had been detached from the window stripping, but the stripping was still in place.

Passenger seating capacity for each car was as follows:

<u>Type of Car</u>	<u>Seating Capacity</u>
Power Club Car	27
Food Service Car	52
Coach Car	72
Coach Car	72
Coach Car	72
Power Car	40
Total	335

The seats in the coach cars were two-abreast units, supported by a single base frame. These two-seat units were designed to rotate 180° on their bases. Amtrak had arranged the seats in the coaches so that half the seats in the car faced forward and the other half faced rearward with both halves facing toward the center of the car.

The operating stations of the power cars were equipped with radios which the engineer could use to communicate with other trains and with operators along the route. These radios had three channels designated as Conrail road channels 1, 2, and Metro Region Commuter radio channel 3. The train was also equipped with a public address system that permitted announcements throughout the train.

OPSE-7--OPSE-7 consisted of three U-28B General Electric Diesel locomotive units, 120 freight cars, and a caboose. Total gross tonnage of the train was 4,774 tons.

The height from the sill and floor plate of the diesel locomotive units to the top of the rail was 67.625 inches. Each locomotive unit weighed about 252,000 pounds and was equipped with a speedometer, a speed recorder device, and a 26-L type air brake system. Each unit was also equipped with radios with Conrail road radio channels 1 and 2. The radios were not equipped with the Metro Region Commuter radio channel 3.

Postaccident Inspection of Train Equipment

A speed tape was removed from the first and second locomotive units of OPSE-7. The tapes indicated that OPSE-7 had traveled approximately 4 miles after departing Glenwood on track No. 2, and the train had accelerated to about 37 mph before the train brakes were applied in emergency. The tapes showed a continuing decrease in speed until the trains collided between 8 and 10 mph.

Train No. 74 had traveled approximately 4 miles east of OW when it stopped. Two vertical I-beams were located at the forward end of the power car at Body STA. 0:00. (See figure 4.) These I-beams, identified as collision posts, had failed at the base welds and were pushed rearward about 7 feet. Outboard angled supports which were tied laterally to the vertical I-beams by welded steel structural members had failed at the floor attachment and had torn the floor material. The attaching welds had not failed. These posts were also pushed rearward about 75 inches. The car frame was bent downward until the forward section of the frame contacted the rail. The front AAR type E-coupler, mounted in a retractable coupler box, was found in the retracted position. The two pin-type locks which secured the coupler carrier in the extended position were found undamaged but pushed rearward to an angle of about 60° on both sides. The structural metal of the coupler carrier and the lock pin guides were bent and deformed. The lock pin retracting mechanism was severely bent and damaged. All exterior metal and fiberglass skin panels were destroyed to about 112 inches from the front. All four of the third-rail contact shoes were severely damaged.

In addition to being derailed, the food service coach of train No. 74 had contacted the third rail. Fire damage, confined to the exterior of the coach, existed in the area of the forward truck.

Track and Signal Information

At Dobbs Ferry, the railroad follows the shore of the Hudson River. There are four main tracks numbered from north to south as Nos. 3, 1, 2 and 4. Approaching Dobbs Ferry from the west, there is a 0°46' right-hand curve in the track about 1,980 feet long, then 895 feet of tangent track, followed by a 0°54' left-hand curve 2,310 feet long. The Conrail timetable designates the direction of the tracks as east and west.

The OW interlocking machine is electric, and the switches and signals are electrically activated. There are six tracks at the interlocking numbered from north to south as Nos. 5, 3, 1, 2, 6, and 4. Crossovers and switches are so arranged that eastward movements can be made from each of the six tracks to track No. 2. Three searchlight-type signals are mounted above and to the right of each track on a signal bridge for tracks Nos. 2 and 4. (See figure 5.) The numbers for the signals and switches correspond to the lever numbers on the lever frame in the tower.

The OW interlocking tower has a unit lever-type machine. (See figure 6.) The machine is equipped with 56 hand-operated levers: 33 levers control 34 signals; 19 levers control 20 switches, 3 levers control 4 electric locks, and there is 1 spare lever. The levers are a pistol grip-type which can only be moved by depressing the trigger in the handle. (See figure 6.) The blocking devices are metal boxes with opened ends.

Four automatic signals are located eastbound on track No. 2 between OW interlocking and the point of collision at Dobbs Ferry.

Postaccident Inspection of Signal Equipment

On the eastward signal mast for track No. 2 at OW interlocking, there was a fixture for a flashing letter "O", a train order signal; however, the signal had been electrically disconnected. A bracket for attaching a yellow flag or light, also a train order signal, to the tower building at OW was not accessible to the operator because the storm windows were nailed shut.

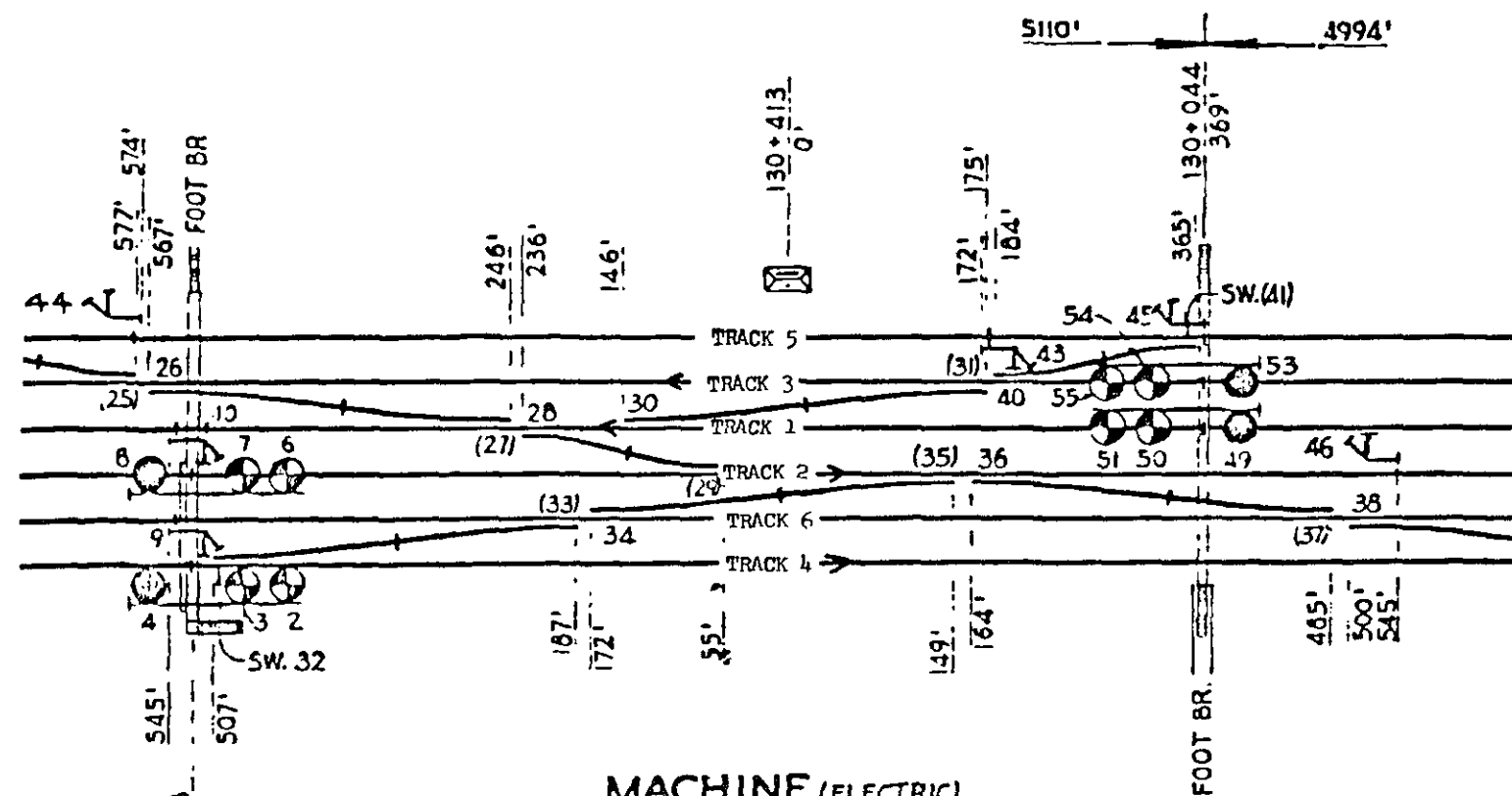

MACHINE (ELECTRIC)
 33 LEVERS FOR 34 SIGNALS
 19 " " 20 SWITCHES
 3 " " 4 ELEC. LOCKS
 55 WORKING LEVERS
 1 SPARE SPACE 42
 56 LEVER FRAME

Figure 5.-- OW interlocking.

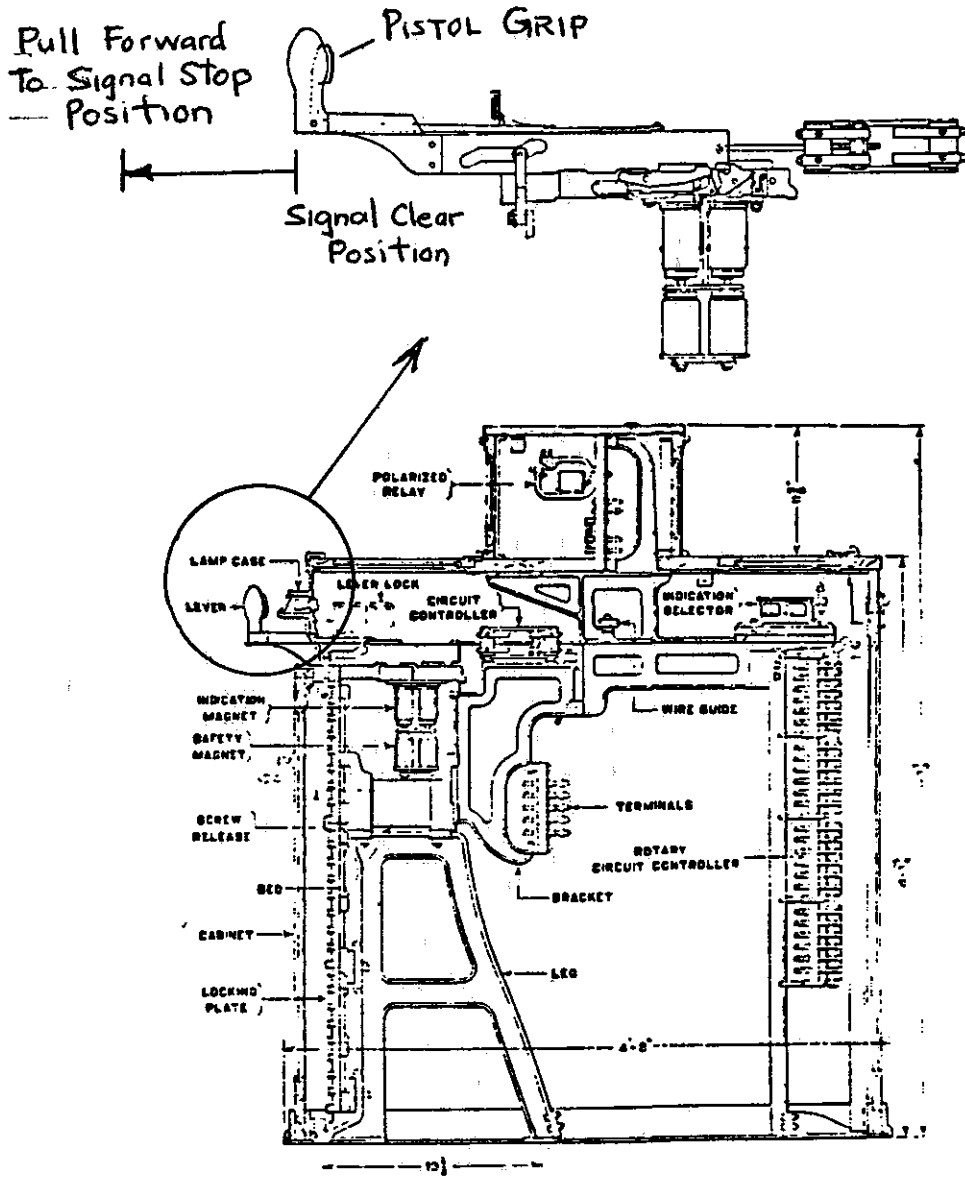

Figure 6.-- Unit lever-type machine.

Method of Operation

Trains are operated through Dobbs Ferry by signal indications of an approach color lighted automatic block signal system. Each track is signaled for the current of traffic, westward on track Nos. 1 and 3 and eastward on track Nos. 2 and 4.

Signal 21.12 controls the eastward movement into the block where the accident occurred and is 3,523 feet east of the collision point.

If the block beyond an intermediate signal is occupied by a train, the signal will display the following aspect:

<u>Aspect</u>	<u>Name</u>	<u>Indication</u>
Red over red	Stop and Proceed	Stop; then proceed at restricted speed.

If the block governed by the signal is clear and the block in advance of that block is occupied, the signal will display the following aspect:

<u>Aspect</u>	<u>Name</u>	<u>Indication</u>
Yellow over Red	Approach	Proceed not exceeding medium speed prepared to stop at next signal. Reduction to medium speed must commence before engine passes approach signal. Medium speed-not exceeding 30 miles per hour.

If the block beyond an intermediate signal is not occupied, but the third block ahead of the signal is occupied, the signal will display the following aspect:

<u>Aspect</u>	<u>Name</u>	<u>Indication</u>
Yellow over Yellow	Advance Approach	Proceed at limited speed prepared to stop at second signal. Reduction to limited speed must commence before engine passes signal. Limited speed not exceeding 45 miles per hour.

If three blocks in advance of the signal are unoccupied, the signal will display the following aspect:

<u>Aspect</u>	<u>Name</u>	<u>Indication</u>
Green over Green	Clear	Proceed

(See appendix D.)

When it is necessary to operate a train against the current of traffic in an automatic block signal system, Conrail Rule D-508 states:

When a train is operated against the current of traffic, manual block signal system rules must apply.

Operator may permit switching or similar movements against the current of traffic limited to a sufficient distance to clear the interlocking for a subsequent movement in the opposite direction.

Operators must be granted permission for such movement when a train has been authorized to move in the direction of the point where the movement is to be made.

When permission has been granted for a movement beyond the interlocking limits, the operator at that point and the operator in charge of the next block station or interlocking must know that the movement against the current of traffic has been completed before allowing a train to move in the direction of the point where such movement is being made.

Block stations designated in the timetable indicate the limits of the manual blocks except as otherwise provided in Rule D-308."

Block stations designated by timetable, bulletin order or train order indicate the limits of the manual block. When a train is directed by train order to run against the current of traffic to an interlocking remotely controlled, that portion of the main track between that interlocking and the first block station or interlocking in the rear will constitute a block for that train."

Train order No. 305, as issued by the train dispatcher, established the limits of the manual block as the remote interlocking at DV and the interlocking at OW.

Conrail Timetable Special Instruction 1157-C2 indicates that the maximum authorized speed of a freight train operating against the current of traffic between "MO" and "CD," which includes the accident site, is 40 mph. Conrail timetable special instruction 1157-C1 indicates that the speed of a passenger train in the area of the accident is 60 mph. (See appendix E.)

Conrail rules require that a form "J" holding order must be addressed to the operator at the point to be restricted before a train order is issued to a train to be operated against the current of traffic. The instructions state:

These orders will be addressed to the operator and must not be transmitted by the train dispatcher until the operator has placed the fixed signal at "stop" for the track and in the direction of the approaching train to be held, displayed train order signal, applied blocking devices to switch or signal controls governing all routes to the track affected, and stated to the train dispatcher "stop signal and train order signal displayed."

When a train has been so held, it must not proceed until the order to hold is annulled or an order given to the operator in the form:

No. _____ ENG. _____ MAY GO.

Conrail Rules 201 states "Train order signal is indicated by a yellow flag by day or a yellow light by night attached to the building where train orders are delivered, or a flashing letter "O" attached to the mast of the fixed signal governing movement."

Conrail interlocking Rule 611 states "Signals must display their most restrictive aspects, except when cleared for an immediate movement, unless otherwise specified in timetable special instructions. Signals must be cleared sufficiently in advance of approach trains to avoid delay."

Conrail Rule 219 regarding train orders states "When the train order signal is displayed, unless otherwise restricted, the speed of a train receiving orders must not exceed 25 miles per hour to enable the operator to deliver the orders. If delivery is not effected to crew on the engine, the train must be stopped."

The Conrail Special Rules for train dispatchers are as follows:

901. Train dispatchers report to the Chief Train Dispatcher.

902. Train dispatchers are in charge of the movement of trains and have supervision over employees connected with those trains.

903. They will issue and record train orders, over the signature of the Superintendent and in accordance with the rules, and must issue such other instructions as may be required for the safe and efficient movement of trains.

904. They must be familiar with the physical characteristics of the territory in their charge, and with all General Orders, Bulletin Orders, Division Notices, and other instructions relating to the movement of trains which are in effect on their territory.

906. They must report immediately to the Chief Train Dispatcher any violation of the rules and any irregularities relating to the movement of trains.

908. They must be conversant with the requirements of the Special Instructions Governing Operations of Signals and Interlockings that relate to their duties.

909. They must require those responsible to report promptly the departure, passing and arrival of trains. In the event of accidents or the existence of hazardous conditions, immediate action must be taken for the protection of trains.

For operators, the rules are as follows:

911. Operators, train directors, their assistants and levermen report to the Chief Train Dispatcher or Supervisor of Operating Rules.

912. They must be qualified at that particular block or interlocking station before accepting an assignment for duty.

913. They are responsible for delivery of train orders and messages, the use of blocks, tracks, interlocking switches and signal, and for prompt movement of trains in accordance with the rules. They must see that General Orders, Bulletin Orders and Division Notices are posted promptly in the proper location.

914. They must obey the instructions of the train dispatcher and advise him immediately of any condition which may affect normal operation or safety of train movements. They must report the weather as required; and in case of sudden change, high water, storm or fog, promptly advise the train dispatcher.

915. Operators must promptly record and report to the train dispatcher the direction, time of arrival, time of departure, and when directed, the engine number of all trains.

They must maintain an accurate and legible station record of train and track car movements, and record any pertinent information affecting the movement of trains.

916. . . They must repond promptly when called by radio or telephone, and communicate clearly and properly in compliance with the rules.

* * * * *

Conrail operational procedures 5/ require supervisors to observe the performance of employees and to take corrective action upon noting noncompliance with the rules. Supervisors are required to record the observations showing compliance or noncompliance with the rules during the observation. (See appendix F.) In an August 17, 1978, letter to the Safety Board, Conrail states that, "The value of trained employees is unquestionable. To evaluate the effectiveness of the present training program is to observe the performance of the individual trained. Observance of employee's performance by supervisory personnel using 1872 efficiency forms (POSTS Program) give management a periodic check as to rules compliance or violation. These checks are recorded." However, Conrail does not specify how often these checks are to be conducted on operators.

Conrail further stated in its letter that an operator is qualified and his proficiency is checked "By successfully completing his on-the-job training, and by being examined on his knowledge of operating and safety rules before performing service. Mandatory re-examinations yearly or bi-yearly revalidates his proficiency, as well as periodic rules compliance checks (POSTS Program)."

According to Conrail timetable special instruction 1702-A2, Metro Region Commuter Radio Channel 3 is in operation between GCT (Grand Central Terminal) and CD (Harmon). (See appendix E.) Conrail freight locomotive units are equipped with radios that have the capability to receive or transmit on channels 1 and 2 but not on channel 3. Amtrak locomotives are equipped to operate on all three radio channels. Both the OW and DV towers have radios that receive and transmit on channel 3 and on Conrail road channel 2, and which are monitored simultaneously in addition to the open telephone line with the dispatcher.

Title 49 CFR Part 220.23 requires that railroads "designate appropriate radio channels by publishing them in a timetable or special instruction." Part 220.39 further requires "Engine and caboose radios must be turned on to the appropriate channel as designated in ¶ 220.23 with the volume adjusted to receive communications while the engine or caboose is manned." (See appendix F.)

In the accident area, there are 103 scheduled passenger trains operating each day, including Conrail Commuter Trains and Amtrak through passenger trains.

Meteorological Information

The Westchester County Airport, located 4 miles north of the accident site reported the weather at 3:45 p.m., as temperature 62°, mostly cloudy, daylight with a 9 mph wind blowing from the west. Visibility was 7 miles.

Survival Aspects

When the trains collided, passenger train No. 74 was stopped and freight train No. OPSE-7 had slowed between 8 and 10 mph. The lead freight locomotive unit overrode the passenger train power car. The operating cab was crushed; the engineer's console, the fireman's seat, and all intervening structure were pushed about 112 inches from the front

5/ Required by 49 CFR Part 217.9.

end of the unit rearward into the electrical locker. In addition to crushing the operating cab, train No. 74 was pushed rearward 112 feet. The engineer and fireman were injured when they jumped from the operating cab to the ground before the collision.

Many of the passengers, who had no warning before the collision and were not aware of the impending collision, were thrown forward into seatbacks at impact. Many seats rotated when struck from behind when passengers were thrown against them. The largest number of injuries to passengers were to the legs when they became caught under the seats ahead. The next largest number was facial lacerations, bruises, and teeth broken and knocked out. One female passenger was seriously injured and required emergency surgery.

When a fire started outside of the second car, the conductor and a trainman removed a fire extinguisher from the power car to extinguish the fire. There was some panic when word of the fire spread through the cars and passengers began to smell the smoke. However, this was of a short duration and when the passengers realized the fire was not spreading, they calmed down.

Passengers experienced extreme difficulty when they attempted to evacuate the cars. Many passengers tried to push the emergency windows outward; however, because the windows were designed to be taken out by pulling inward, they would not open. Other passengers could not determine how to open the trapdoor over the steps, so many passengers jumped from the car to the ground.

The Westchester County disaster plan resulted in speedy response by police, fire, and rescue personnel, and in the swift evacuation of the passengers. The Dobbs Ferry Police Department was notified of the accident at 4:13 p.m. They immediately dispatched personnel to the accident site, requested ambulances, and notified local hospitals. The Fire Department and the Dobbs Ferry ambulance arrived simultaneously within 12 minutes after being notified. The Dobbs Ferry Hospital had its disaster plan in effect within 5 minutes after notification. Previous drills conducted by the hospital and ambulance corps were of substantial benefit in the prehospital response. The hospital's disaster plan was so detailed that doctors and nurses knew which streets to take to avoid blocked traffic.

ANALYSIS

Protection For Trains

When the dispatcher decided to run train OPSE-7 against the current of traffic, the primary safeguard-placing a blocking device on the signal lever and the primary redundant feature - displaying the train order signal - were ignored by the OW operator. Additionally, the dispatcher failed to comply with the instruction governing the "J" holding orders which required him to assure that the train order signal was displayed.

The action of the OW operator in displaying a clear signal for train No. 74 to proceed onto a segment of track in conflict with an opposing train which had been given absolute rights by a train order is a perfect example of why its necessary to block signal levers in such operations. Throughout the years, investigation of accidents and incidents have shown that human failure cannot be eliminated completely; therefore, the needed redundant requirement to display the train order signal which made the engineer of a restricted train also responsible for not passing the point where the train order was in effect was lacking. The dispatcher violated a Conrail rule by transmitting a holding order to the OW operator without requiring the operator to state that "stop signal and train order signal displayed". A further safeguard would have been to address the order to the engineer of train No. 74; however, this is not required by Conrail operating rules.

The dispatcher had been working regularly on his assignment for about 1 year 6 months and had been regularly issuing train orders to operators without requiring them to display the train order signal and confirm it with the statement required by the rules. This practice was also being followed by the dispatcher when he was an operator and he could not display a train order signal. The OW operator stated that in his year's experience, he had been led to believe through on-the-job training that it was acceptable to state to the dispatcher, "BDA," and then copy the train order before applying the blocking device. That is contrary to the intent of the required exchange between an operator and a dispatcher which is to insure that a blocking device is applied and confirmed before the order is transmitted.

The Conrail management had to have known if they have been performing periodic inspections, that improper procedures were being used, such as no train order signals being displayed at towers because the operators did not have the ability to do so. Thus, it seemed a fair inference that Conrail management had been condoning the procedures through acquiescence. Further, the disconnecting of the flashing "O" train order signal, the nailing shut of the window which prevented the display of the train order signal at the OW tower, and the existence of this situation for at least 4 years seems to confirm that Conrail management had been condoning improper train order procedures. The situation was worsened by the fact that an improperly trained operator, who had acquired the bad habit of replying BDA (blocking device applied) before actually doing so, had been working for more than a year without being checked in the performance of his duties by a supervisor.

Radio Communications

Since the engineer of OPSE-7 received his train order on channel 2 and train No. 74 was on channel 3, the engineer of train No. 74 was not alerted by radio traffic on channel 2 that OPSE-7 was operating on track No. 2 from the opposite direction. No. 74 was monitoring channel 3 in compliance with the timetable special instructions and OPSE-7 was not monitoring channel 3 because the Conrail freight locomotive units are not equipped with a radio with channel 3. However, the Conrail timetable had established limits of operation that required the use of channel 3 in the area of the accident. If both trains had been operating on the same radio channel, the engineer of train No. 74 may have heard the train order given to the engineer of OPSE-7 to use track No. 2 and thus have been alerted that an opposing move was being made, and have stopped his train on track No. 2 at OW. If train No. 74 had stopped at OW, this accident would have been prevented. However, Conrail management instead of having their freight train locomotives equipped with radios to receive and transmit on channel 3 so that the engineers could comply with the timetable instructions, equipped the towers with a radio with channel 2. The operators then monitored channel 2 and 3 simultaneously and when necessary could transmit train orders to freight trains on channel 2.

The conflict between the Conrail timetable instructions and the Conrail procedures for operation of train radio on different channels between MO Tower, Bronx, New York, and CD Tower, Harmon, New York, which includes the area of the accident, is a failure to comply with 49 CFR Part 220.39 requiring radios to operate on the designated channel. The engineer of OPSE-7 could not turn to channel No. 3, as specified by the timetable and required by 49 CFR Part 220.23, because his locomotive was not equipped with a radio to operate on channel 3. This is another example of the failure of management and supervision to ensure that operations were conducted in accordance with Conrail rules and Federal requirements for safe train operations.

Crashworthiness

Since the sill section and floor plate of train No. 74 were 21.9 inches lower than the sill and floor of the freight locomotive unit of OPSE-7, the operating cab of the power car was not survivable in this accident. Penetration of the power car at this height above the floor plate insured failure of the cab's forward structure.

Although the I-beam forward posts of the power car were intended to be collision posts, they failed to provide any protection since they were torn loose and pushed rearward even in a relatively low speed collision. In the test mockup that was performed on the collision posts before they were installed in the power car, the collision posts were welded to an I-beam before the test loading was applied. (See appendix H.) The actual installation of these collision posts differed from the testing because they were welded only to the much thinner floor plate. In this accident, the collision posts tore loose from the floor plate, or tore the floor plate metal. It is evident that modern passenger equipment, such as that used on train No. 74, will always sustain extensive damage in a collision with conventional locomotives because of the incompatibility of the rigid frames; its frame being approximately 21 inches lower than standard railroad equipment. Apparently, this matchup was not considered when the turboliner equipment was adopted for use on American railroads.

The Safety Board identified the lack of crash protection provided the occupants of locomotives in an accident at Riverdale, Illinois, on September 8, 1970, ^{6/} and made a recommendation to the FRA for timely improvement of the crashworthiness of railroad equipment particularly as it is related to the protection of the occupants of locomotive control compartments. In a letter to the Safety Board dated May 3, 1971, the FRA outlined its concern for this problem and set up a meeting with the locomotive and car builders, labor organizations, carriers, and the AAR. (See appendix I.) On January 16, 1973, the FRA advised the Safety Board that a locomotive control compartment committee had been organized, that the AAR had requested a contractor to design a program of testing to determine locomotive cab crashworthiness, and that the test program would set requirements for anticlimbing devices and design requirements for locomotive crash posts and pilots. However, this committee, still in existence, has not published any minimal criteria for the structural design of locomotives. Since the original meeting in 1971 with the FRA, numerous accidents ^{7/} have been investigated by the Safety Board in which crashworthiness and collision posts have been identified as inadequate to provide protection to the occupants of locomotive control compartments. Amtrak apparently gave little consideration to crashworthiness in the design and adaptation of the turboliner power cars as demonstrated by the extensive damage done to the locomotive cab in this relatively low speed collision. The damage to the cab would have made it unsurvivable for the occupants if they had remained in the cab. The acquisition of this lighter and lower turboliner equipment was possible because of the lack of design requirements established by the FRA for locomotive construction.

^{6/} Railroad Accident Report—"Illinois Central Railroad Company and Indiana Harbor Belt Railroad Company Collision Between Yard Trains at Riverdale, Illinois, on September 8, 1970" (NTSB-RAR-71-3).

^{7/} Railroad Accident Report—"Freight Train Derailment Passenger Train Collision with Hazardous Material Car, Sound view, Connecticut, October 8, 1970" (NTSB-RAR-72-1); Railroad Accident Report—"Derailment of Extra 5701 East at Sherman, Wyoming, March 28, 1971" (NTSB-RAR-72-4); Railroad Accident Report—"Collision of the State-of-the-Art Transit Cars with a Standing Car, High Speed Ground Test Center, Pueblo, Colorado, August 11, 1973" (NTSB-RAR-74-2); and Railroad Accident Report—"Head-End Collision of Louisville and Nashville Railroad Local Freight and Yard Train at Florence, Alabama, September 18, 1978" (NTSB-RAR-72-2).

In its investigation of an accident at Goldonna, Louisiana, on December 28, 1977, 8/ it was determined that the lack of crashworthiness features on the locomotive caused the death of two crewmembers. Because of this investigation, the Safety Board issued to the FRA recommendation R-78-27 which requested that it expedite its study of improvements to the design of locomotive operator compartments to minimize crash damage. The Safety Board reiterates this recommendation to the FRA and strongly urges that the crashworthiness study be accelerated so that the problem of inadequate crash protection for the occupants of locomotive cabs can be swiftly resolved.

Many passenger injuries were sustained when passengers were thrown forward into seatbacks and the seats rotated because of inadequate locking devices. Other passengers sustained injuries when they were thrown forward and their legs became trapped under seats. The Safety Board has investigated other accidents 9/ involving passenger injuries caused by inadequately locked seats.

The Safety Board identified fixtures within passenger cars as injury-producing in its investigation of an accident at Glendale, Maryland, on June 28, 1969, 10/ and recommended to the FRA that it initiate studies to determine the relationship between rail passenger car design and passenger injury and, where practical, take action to improve in the design of future high-speed and rapid transit passenger cars. Amtrak has placed many cars in service since that report was issued. The Safety Board has investigated other accidents 11/ in which passenger injuries have been caused by the fixtures within the car. No Federal regulations exist for even minimum standards for interior design of passenger cars. Amtrak's newest cars still have some of the same injury-producing equipment that was cited in past Safety Board investigations.

A 1978 crashworthiness study 12/ conducted by the FRA identified seat rotation as being a cause of passenger injuries and concluded that it is necessary to "prevent double seats from swiveling by providing a positive lock to improve occupant containment." (See appendix G.) The problem of leg entrapment was also identified as a significant cause of

8/ Railroad Accident Report--Collision of a Louisiana and Arkansas Railway Freight Train and a L. V. Rhymes tractor-semitrailer at Goldonna, Louisiana, December 28, 1977 (NTSB-RHR-78-1).

9/ Railroad Accident Report--"Rear End Collision of Conrail Commuter Train No. 400 and Amtrak Passenger Train No. 60, Sea Brook, Maryland, June 9, 1978" (NTSB-RAR-79-3), and Railroad Accident Report "National Railroad Passenger Corporation (Amtrak) Head-End Collision of Train No. 111 and Passenger Track Machine Equipment, Edison, New Jersey, April 20, 1979" (NTSB-RAR-79-10).

10/ Railroad Accident Report--"Penn Central Company Train Second 115 (Silver Star) Derailment at Glendale, Maryland, June 28, 1969" (RAR-70-1).

11/ Railroad Accident Report--"Richmond, Fredericksburg and Potomac Railroad Company Train No. 10/76 Derailment with Three Fatalities and Numerous Personal Injuries, Franconia, Virginia, January 27, 1970" (NTSB-RAR-71-1); Railroad Accident Report--"Derailment of Amtrak Train No. 1 while operating on the Illinois Central Railroad near Salem, Illinois, June 10, 1971" (NTSB RAR-72-5); Railroad Accident Report--"Collision of Illinois Central Gulf Railroad Commuter Trains, Chicago, Illinois, October 30, 1972" (NTSB RAR -73-5); Railroad Accident Report--"Derailment of an Amtrak train on the tracks of the Atchison, Topeka and Santa Fe Railroad Company, at Melvern, Kansas, July 5, 1974" (NTSB-RAR-75-1); and Railroad Accident Report--"Collision of two Penn Central commuter trains at Botanical Garden Station, New York City, January 2, 1975" (NTSB RAR-74-8).

12/ "Rail Safety/Equipment Crashworthiness." FRA/ORD 77/73.

passenger injuries in the FRA study. The report concluded that there was a need to "prevent leg entrapment under seats by adding a back skirt to reduce high frequency of leg injury in collisions."

Since the findings of the FRA study identified the injury-producing fixtures that are present in passenger train accidents, the Safety Board finds it difficult to understand why the FRA has not yet taken steps to require correction of these unsafe and obvious injury-producing conditions. The Safety Board reiterates to the FRA the urgent need for establishing passenger car safety standards.

Emergency Evacuation

Instructions for opening the trapdoors, which covered the steps at the side door locations, were not posted and the passengers were required to jump from the floor level of the car to the ground. The failure of Amtrak to provide adequate instructions for emergency evacuation resulted in additional passenger injuries.

Some emergency escape windows were not identified. One handle needed for removing the window stripping to effect an emergency escape was separated from the window stripping. Instructions were not posted to advise passengers that the window glass must be pulled inward to remove it. These conditions prevented the passengers from removing some of the windows and resulted in panic when the passengers smelled smoke and thought they were trapped. If adequate instructions had been displayed in the cars outlining the operation of trapdoors and emergency escape windows, the panic and the injuries sustained as a result of jumping to the ground may have been avoided.

The flagman and engineer jumped from the power car of train No. 74 when they realized that collision was imminent. This action saved their lives. However, they did not have sufficient time to warn the passengers of the impending collision. Because the conductor and a trainman were occupied in extinguishing the fire outside the second car, only one trainman was available to assist passengers in the rear of the train. No crewmen assisted the passengers in the second, third, and fourth cars.

Training and Supervision of Operator

The OW operator stated that he had been trained to apply the blocking device after copying a train order. Additionally, the operator said that he learned the improper procedure from other operators during his on-the-job training. The operator's statement indicates that other operators were following this unsafe practice, even though it was a violation of Conrail Rules for a "J" holding order. This situation at the OW tower highlights a problem with on-the-job training - if the employees used to train new employees are using improper and unsafe procedures, these methods are being taught to the new employees. Therefore, it is evident that Conrail needs to improve its overview and direct supervision of on-the-job training for operators.

Federal regulations require that Conrail make periodic tests and inspections to determine the extent of compliance with its operating rules, timetables and special instructions by its operating employees. Records must be retained and made available to the FRA so that performance can be checked by FRA.

Conrail's training of the OW operator was inadequate because it did not assure that he was copying and delivering train orders according to the rules. The absence of supervisory monitoring during his first year of work as an operator resulted in the

operator's failure to comply with that train order practice which requires the application of a blocking device to the pertinent signal lever and the display of the train order signal before copying a train order. Since the dispatcher also failed to require the display of the train order signal before transmitting the train order, it suggests that the questionable practices may be widespread on this division.

Conrail's program which was submitted to FRA failed to accomplish its intent - to assure the understanding of the rules and compliance with them. FRA's monitoring of Conrail to determine if it were following its program was also ineffective. The Safety Board questions the adequacy of Federal oversight in this case to insure the Conrail program of operating tests and inspections that allows an employee, such as the OW operator, to be hired, trained on the job, and work for over a year without any supervisory review of his performance.

The Safety Board is concerned for the safety of train operations on the Metropolitan Region of Conrail because of the large volume of passenger traffic. The apparent failure of Conrail management to recognize the danger of failing to take corrective action to bring train operations in compliance with their operating rules and timetable special instructions must be corrected. Therefore, the Safety Board urges the FRA to immediately launch a safety review of the operation of trains on the Metropolitan Region of Conrail to bring those operations in compliance with the operating rules and timetable instructions as issued by Conrail.

CONCLUSIONS

Findings

1. The operator at OW interlocking operated the signal lever which permitted train No. 74 to obtain a clear signal because he failed to remember that an opposing train order was issued to OPSE-7 and that he had not applied a blocking device to the signal lever.
2. The operator at OW interlocking did not display a train order signal. Therefore, train No. 74 proceeded on a clear signal. The operator could not display a train order signal because the wiring to the signal had been disconnected, and because the windows were nailed shut, the alternate method of hanging a yellow light or flag on the tower could not be used.
3. Conrail condoned the unauthorized train order practice of not displaying a train order signal which violated their own operating rules.
4. The engineer of train No. 74 was not aware that OPSE-7 was westbound on track No. 2 because he was monitoring radio channel 3, as directed, while OPSE-7 was receiving train orders on channel 2, as directed.
5. Conrail freight trains cannot monitor radio communications to passenger trains from Grand Central Terminal to Harmon because Conrail freight locomotive units are not equipped with radios that have Metro Region Commuter radio channel 3, the established channel for operations in the area of the accident. Failing to provide freight locomotives with a radio for channel 3 is a poor operating practice and a violation of Conrail rules and Federal regulations.

6. Because no supervisor had conducted a check of his job performance in the year and 22 days of his employment, the operator continued to use the improper practice of not applying the blocking device to the signal lever which he had learned due to improper instruction during his on-the-job training.
7. The Federal Railroad Administration Regulation 49 CFR 217.9 does not require Conrail or any other railroad to have a plan to regularly check specific employees, such as operators, in the proficiency of their job performance.
8. The operating cab of the power car of train No. 74 was destroyed in the low-speed collision because of the lack of adequate crashworthiness features.

Probable Cause

The National Transportation Safety Board determines that the probable cause of this accident was the failure of the OW operator to apply a blocking device to the signal lever which permitted him to clear the signal and allowed train No. 74 to proceed on an occupied track, and Conrail's condoning the transmission of train orders without requiring the operator to display the train order signal. Contributing to the accident were the improper training and inadequate supervision of the tower operator, and the failure of Conrail to provide a reasonable means of displaying train order signals at OW. Contributing to the injuries were the design of the seats and lack of emergency evacuation instructions.

RECOMMENDATIONS

As a result of its investigation of this accident, the National Transportation Safety Board made the following recommendations:

--to the Federal Railroad Administration:

Conduct a safety review of the Metropolitan Region to determine why the actual operation of trains was not in compliance with Conrail rules, and provide the Safety Board a report of the findings. (Class II, Priority Action) (R-81-52)

Amend 49 CFR 217.9 to require sufficient monitoring to insure that each operating employee is evaluated for compliance with operating rules on a regular basis. (Class II, Priority Action) (R-81-53)

--to the Consolidated Rail Corporation (Conrail):

Establish better procedures for the training and followup by supervisors of operators and dispatchers to insure compliance with the rules. Provide formal training. (Class II, Priority Action) (R-81-54)"

Require that all trains operating on the main line monitor the same channel as designated in the timetable. (Class II, Priority Action) (R-81-55)

Provide the operators on the Metropolitan Region with the ability to display a train order signal at train order stations as required by the operating rules. (Class II, Priority Action) (R-81-56)

--to the National Railroad Passenger Corporation (Amtrak):

Establish a retrofit schedule to provide skirts at the bottom of seats to prevent leg injuries because of leg entrapment. (Class II, Priority Action) (R-81-57)

Install an adequate locking device on rotating seats which will prevent undesired rotation in accidents. (Class II, Priority Action) (R-81-58)

Revise turbotrains to improve cab crashworthiness in a collision. (Class II, Priority Action) (R-81-59)

Promptly provide for passengers identification of emergency exits which includes instructions for proper use. (Class II, Priority Action) (R-81-60)

BY THE NATIONAL TRANSPORTATION SAFETY BOARD

/s/ JAMES B. KING
Chairman

/s/ ELWOOD T. DRIVER
Vice Chairman

/s/ FRANCIS H. McADAMS
Member

/s/ G. H. PATRICK BURSLEY
Member

PATRICIA A. GOLDMAN, Member, did not participate.

April 28, 1981

APPENDIXES

APPENDIX A

INVESTIGATION

The National Transportation Safety Board was notified of the accident about 4:50 p.m., on November 7, 1980. The Safety Board immediately dispatched two investigators from its New York Field office and two investigators from its Washington, D. C., Headquarters office to the scene. Investigation of operations, vehicle factors, and human factors were conducted.

APPENDIX B

CREWMEMBER INFORMATION

OW Interlocking Station

Operator J. G. Quirk, 32, entered service on October 16, 1979, passed a company physical on October 26, 1979, and was last examined on the company operating rules on February 8, 1980. The operator's first assignment was at OW interlocking where he posted (worked with the regular operator) on all three shifts, for 57 days. At the beginning of the posting period, he attended a 4-day class of instruction on the Rules of the Transportation Department. Before finishing the posting period, the operator passed an 85-question examination on the Rules of the Transportation Department with an 89-percent score.

The operator was first assigned to the second shift on February 25, 1980, without a qualified operator's supervisor. He had worked 34 days on second shift and a total of 40 days on first and third shifts at OW interlocking up to the date of the accident.

Dispatcher R. F. Thompson, 27, entered service in 1976 and was promoted to dispatcher in 1979. He had been off duty for 16 hours before reporting for duty at the C-desk, 357 Madison Avenue, New York, N.Y. regional headquarters on November 7, 1980. He was last physically approved by a company doctor on October 16, 1979.

Train No. 74

Engineman W. K. Balluff, 63, entered service in 1942, was promoted in 1962, and was last examined and approved by a company physician in 1979. He last attended a class on the carrier's operating rules and air brakes in 1979.

Fireman W. R. Edell, 35, entered service in 1969 and was promoted to engineman in 1973. He was last examined and approved by a company doctor in 1980, attended a class on the carrier's operating rules in 1980, and attended air brake class in 1979.

Conductor J. C. Redgrave, 36, entered service in 1974, was promoted in 1977, and was last examined and approved by a company doctor in 1978. He attended a class on the carrier's operating rules in 1980 and attended an air brake class in 1979.

Trainman A. J. Petronis, 63, entered service in 1945, was promoted in 1951, and was last examined and approved for service by a company doctor in 1980. He attended classes on the carriers operating rules and air brake rules in 1980.

Trainman J. P. McMahon, 62, entered service in 1941 and was last examined and approved by a company doctor in 1978. He attended a class on the carrier's operating rules and airbrake rules in 1980.

Train OPSE-7 Extra 2806 West

Engineman A. J. O'Brien, 57, entered service in 1942, was promoted in 1964, and was last examined and approved by a company doctor in 1980. He attended a class on the carrier's operating rules in 1980 and the air brake rules in 1979.

Conductor J. Saleski, 40, entered service in 1974, was promoted in 1977, and was last examined and approved by a company doctor in 1978. He attended a class on the carrier's operating rules and air brake rules in 1980.

Head-end Brakeman R. Anselmo, 43, entered service in 1955 and was last examined and approved by a company doctor in 1979. He attended class on the carrier's operating rules and air brake rules in 1979.

Flagman T. Dougherty, 48, entered service in 1951 and was last examined and approved by a company doctor in 1979. He was examined on the carrier's operating rules and airbrake rules in 1979.

APPENDIX C

TRANSCRIPT OF THE DISPATCHER'S OPEN
WIRE INCIDENT INVOLVING OPSE-7
AND NO. 74 ON NOVEMBER 7, 1980.

Beginning 15:45:45

15:45:49

DV: Spike.

DISPATCHER: Yeah Alex.

DV: You said on figuring on holding the freight on 2 until after the rush hour right?

DISPATCHER: Uh, we may be able to handle him as soon as I get the O.K. from the Upper Hudson, Alex.

DV: O.K., then it would be shortly.

DISPATCHER: Yeah, it should be shortly.

15:46:20

DISPATCHER: Out a minute. Out a minute.

15:47:46

DISPATCHER: Back. Back.
Alex, what time the deadhead over to 4 at Glenwood?

DV: 3:44 and 739 on 3 at 3:46.

DISPATCHER: OW (no answer)

15:48:55

DISPATCHER: OW

OW: OW

DISPATCHER: What was your last on 2 eastbound, George?

OW: Last 2 east was a deadhead, track 2 at 3:24.

DISPATCHER: All right. B.D.A. 2 east.

OW: B.D.A. signal 6 at 3:49.

DISPATCHER: All right, let me know when you're ready for an order.

OW: O.K.
O.K. ready.

15:49:42

DISPATCHER: OW, this will be 304, today's date to the Operator at OW. Hold all eastward e-a-s-t-w-a-r-d trains. Clear of Number 2 t-w-o track between OW, capital O capital W, and Glenwood capital G-l-e-n-w-o-o-d. L.W.M.

OW: OW Train Order 304, November 7, 1980 to Operator at OW. Hold all eastward trains clear of Number 2 t-w-o track between OW, capital O capital W and Glenwood, Capital G-l-e-n-w-o-o-d. L.W.M.

DISPATCHER: All right 304 complete 3:50 P.M. L.W.M.

OW: 304 complete 3:50 P.M. L.W.M. G.Q.

15:50:49

DISPATCHER: Hello Spike.

DV: Spike.

DISPATCHER: Alex, ask OPSE if his head engine is 2806.

DV: Right.

15:51:20

DV: 2806.

DISPATCHER: All right. Let me know when you're ready for an order Alex.

DV: Go ahead Bob.

DISPATCHER: OW, you're ready for another one George?

OW: Ready.

DISPATCHER: At OW 305 today's date Operator OW.
Spike 305. Today's date
C&E Extra 2806 at Glenwood.
Care of Operator and Operator at DV
Extra 2806, t-w-o e-i-g-h-t z-e-r-o s-i-x
West w-e-s-t has right over opposing trains on Number 2 t-w-o track Glenwood, capital G-l-e-n-w-o-o-d to OW, capital O capital W. L.W.M.

OW: OW. Train Order 305, November 7, 1980 to Operator at OW Extra 2806, t-w-o e-i-g-h-t z-e-r-o s-i-x west has right over opposing trains on Number 2 t-w-o track Glenwood, to OW, capital G-l-e-n-w-o-o-d, O capital O capital W.

DV: Spike 19 Order 305, November 7, 1980 to C&E Extra 2806 at Glenwood care of Operator and Operator at DV. Extra 2806 t-w-o e-i-g-h-t z-e-r-o s-i-x west w-e-s-t has right over opposing trains on Number 2 t-w-o track Glenwood, capital G-l-e-n-w-o-o-d to OW, capital O capital W. L.W.M.

DISPATCHER: All right 305 complete OW and Spike at 3:54 P.M. L.W.M.

OW: OW Train Order 305 made complete 3:54. L.W.M. G.Q.

DV: Spike 305 complete 3:54 P.M. L.W.M. F.D.E.
Want a repeat time on that OPSE and the name of the man who took it?

DISPATCHER: What's that Alex?
Oh yeah, repeat time.
An OW can we get the clear block for Extra 2806 West?

OW: O.K., you have the block at 3:54.

DISPATCHER: O.K. Alex. 3:54 P.M. clear block Glenwood to OW. He doesn't need an A card.

DV: Roger.

15:55:50
DISPATCHER: Alex, there's alot of static on the radio.
Make sure he gets it before you go any further.

DV: Right.

15:57:17
DISPATCHER: O.K. Hello, OW.
Hello OW.
OW - OW
74 Can you ask him if the bridge plates are being removed at Tarrytown when he shows?

OW: O.K.

15:57:37
DV: Spike.

DISPATCHER: Yeah Alex.

DV: West of Glenwood 739 on 3, 3:57 the deadhead eastbound on 4 at 3:52 and you can make the receiving time on that order 3:57 by A.J. O'Brien, engineer.

DISPATCHER: O.K. Alex. 770 is on 4. Behind him, 74.

DV: Roger and O.K. to let the freight west on 2.
DISPATCHER: Right.
(conversation with HM - Circuit trouble (east of CR))

16:00:27

DISPATCHER: OW.

OW: OW, what was that signal number?

HM: The approach at Harmon, Track 3.

OW: O.K. I'll tell them.

DISPATCHER: O.K., let me know when 739 shows and if 74 reports the bridge plates clear, George.

OW: O.K.

HM: Everything is going to keep coming 1 right?

DISPATCHER: Uh, No, 739 will be your first on 3.

HM: O.K., Roger.

16:02:57

OW: OW

DISPATCHER: Yeah George.

OW: I heard from Mule, he's at Tarrytown removed the bridge plate at Tarrytown Station. He would like an M Form to work on Track 1 OW to CR he wants to change some angle bars at the scene of that location.

DISPATCHER: Ask him if it is absolutely necessary, George. We have track 3 with a restriction and a red signal.

OW: All right.

DISPATCHER: And if it is, how long is it gonna take them?

OW: O.K.

16:04:19

OW: OW.

DISPATCHER: Yeah George.

OW: Yeah, Mule says he has orders from his office, Collins or somebody, that he has to, he just wants the track out on 1 and he wants to change the angle bars on 3.

DISPATCHER: Is that where that hole in the rail is? Will that, will that, take away the restriction when he's through? (pause)

OW: Yeah, he said once he is finished he will take the speed restriction off.

DISPATCHER: How long is he gonna need, George? (pause)

OW: He says 2 to 2 1/2 hours.

DISPATCHER: No way 2, 2 1/2 hours. After the rush, he's gonna have to wait, George.

OW: O.K. (16:05:37)

16:07:30
DISPATCHER: OW.

OW: OW.

DISPATCHER: You tell Mule after the rush?

OW: Yeah, I told him.

DISPATCHER: O.K., You're B.D.R. . . You didn't have a B.D.A. on 3, huh? We just had a verbal block, right?

OW: Yeah.

DISPATCHER: O.K., you could remove that verbal block and 739. Any train going 3 will have to get that restriction 29 point 1, 29 point 2, 15 miles an hour.

OW: O.K.

16:08:01
DISPATCHER: Hello Spike.

DV: Spike.

DISPATCHER: Alex, the freight go west at Glenwood?

DV: Make him 4:08 at Glenwood on 2.

DISPATCHER: Thank you.

16:14:01
DISPATCHER: OW.

OW: OW.

DISPATCHER: All right George, when this freight calls when this freight shows you can tell him the Upper Hudson has only one track till 5 o'clock. We are not gonna move until at least 5 o'clock.

OW: O.K., he's gonna stay here then.

DISPATCHER: Yeah, hold him east of you on 2.

OW: Right.

16:16:20
OW: OW west 739 track 3, 4:15. He had no radio. I had to stop him by the tower to give him the message.

DISPATCHER: O.K., thanks George.

16:18:59
OW: OW east 770 looped 3:45
74 track 2, 4:08
772 track 4, 4:18

DISPATCHER: 74 went 4, right? (pause)
George, 74 went 4. (pause)

OW: Uh Oh. I think on my sheet. I have two here written.

DISPATCHER: Well, you know we went 4 though, right? If he went 2 tell him to stop his train.

OW: Let me get a hold of him.

16:21:08
DV: Spike.

DISPATCHER: Yeah, Alex.

DV: 74 wants the rail dead on track 2. . on track 2 there -- OW --.

DISPATCHER: Yeah. We're killing it now. Where, where, can you, can you raise, can you raise either 74 or the SELI for the exact location?

DV: Right, he wants the rail dead on 2. All the rail, 1, 3 and 4.

DISPATCHER: Where exactly, Alex?

DV: Tarrytown. Tarrytown.

DISPATCHER: Tarrytown?

DV: Right.

16:21:50

DISPATCHER: Alex, ask if there's any injuries, if they're gonna need any ambulances.

DV: All right, I believe so. He says there's alot of people all over.

DISPATCHER: All right, the exact location is Tarrytown?

DV: That's right. He wants all emergency squads you can send, Bobby.

DISPATCHER: At Tarrytown?

DV: That's right.

DISPATCHER: Hello, OW.

OW: South of Tarrytown.

DISPATCHER: Tarrytown?

OW: South of Tarrytown.

DISPATCHER: Just east of Tarrytown. George, what's the exact location?

16:22:29

(no answer)

16:22:44

OW: He just east of Dobbs Ferry Station

DISPATCHER: Just east of Dobbs Ferry, right.

end 16:22:50

APPENDIX D

EXCERPTS FROM CONRAIL RULES OF THE
TRANSPORTATION DEPARTMENT

Rule 281

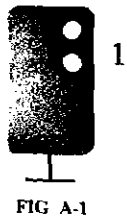
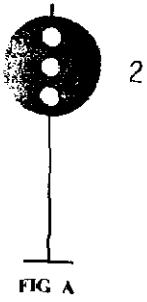

Rule 282(A)

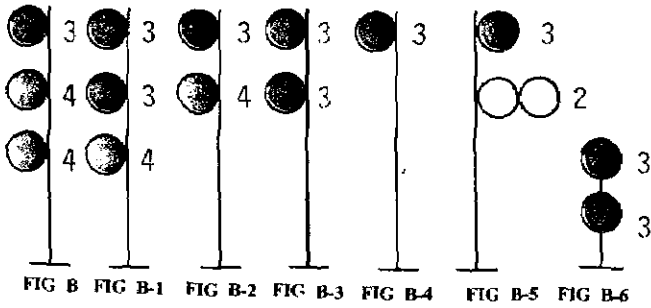
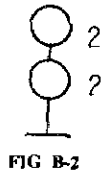
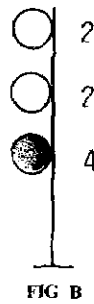

IN CAB SIGNAL TERRITORY
CAB SIGNAL WILL DISPLAY

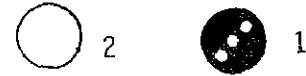

AND FIXED SIGNAL INDICATION WILL GOVERN

INDICATION: Proceed at Limited Speed prepared to stop at second signal Reduction to Limited Speed must commence before engine passes Advance Approach signal

NAME: Advance Approach

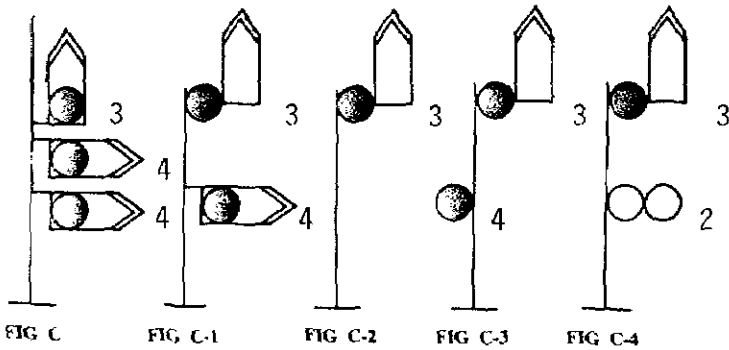

IN CAB SIGNAL TERRITORY
CAB SIGNAL WILL DISPLAY

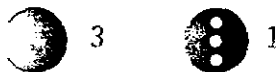

INDICATION: Proceed
NAME: Clear

NTSB note:

- 1 indicates white
- 2 indicates yellow
- 3 indicates green
- 4 indicates red

Rule 285

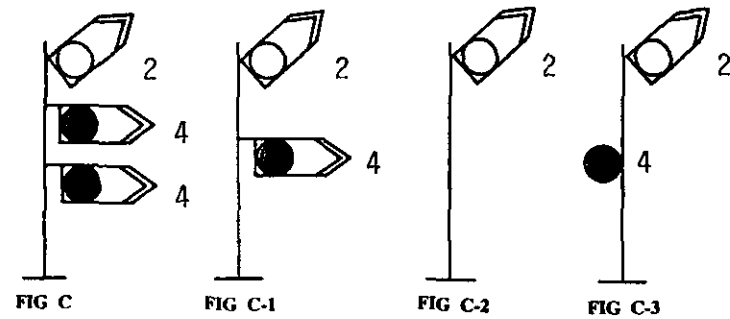
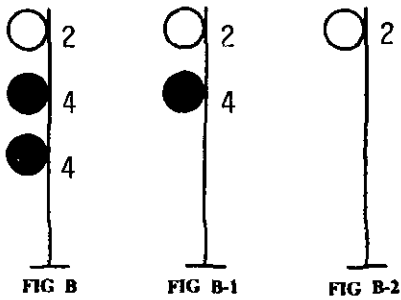
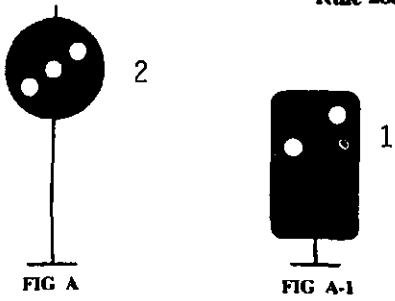

IN CAB SIGNAL TERRITORY
CAB SIGNAL WILL DISPLAY



INDICATION: Proceed not exceeding Medium Speed prepared to stop at next signal Reduction to Medium Speed must commence before engine passes Approach signal

NAME: Approach

NTSB note:

- 1 indicates white
- 2 indicates yellow
- 3 indicates green
- 4 indicates red

Rule 291

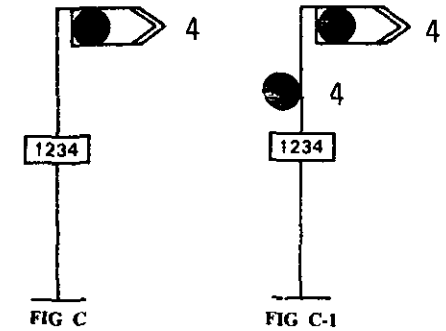
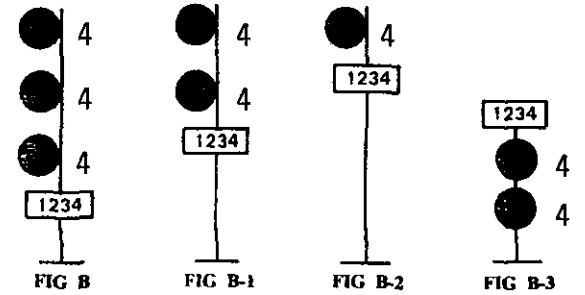
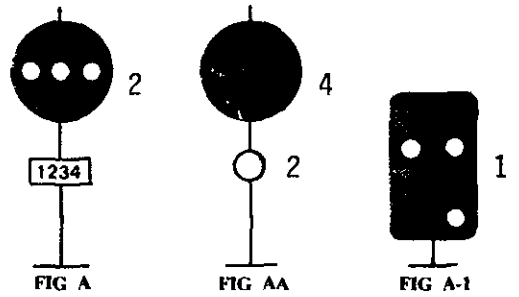

IN CAB SIGNAL TERRITORY
CAB SIGNAL WILL DISPLAY



AND FIXED SIGNAL INDICATION WILL GOVERN

INDICATION: Stop, then proceed at Restricted Speed

NAME: Stop and Proceed

NOTE: Where, in addition to the number plate, a letter G, grade marker, is displayed as part of these aspects, Rule 290 applies

APPENDIX E

EXCERPTS FROM CONRAIL TIMETABLE
SPECIAL INSTRUCTIONS

SPEEDS

PASSENGER TRAINS AND FREIGHT TRAINS

1157-C1 Maximum Speeds Unless Otherwise Specified

	Single Track		No 4 Track		No 2 Track		No 1 Track		No 3 Track		Other Track	
	Pgr.	Ft.	Pgr.	Ft.	Pgr.	Ft.	Pgr.	Ft.	Pgr.	Ft.	Pgr.	Ft.
Hudson Line												
Between												
Miles Per Hour												
G.C.T. and U											10	10
U and Signals 103W 101W 102W 104W Westward			15	15	15	15	15	15	15	15		
Signals 113E 111E 112E 114E and U Eastward			15	15	15	15	15	15	15	15		
Signals 103W 101W 102W 104W and MO Westward			35	35	35	35	35	35	35	35		
MO and Signals 113E 111E 112E, 114E, Eastward			35	35	35	35	35	35	35	35		
MO Int. and FH Int.			60	40	60	40	60	40				
FH Int. and DV Int.					30	25	30	25				
DV Int. and MP 14.3			75	40	79	40	79	40	60	40		
MP 14.3 and Glenwood Int.			75	40	60	40	75	40	60	40		
Glenwood Int. and MP 23.0			75	40	60	40	79	40	60	40		
MP 23.0 and OW			60	40	60	40	79	40	60	40		
OW and MP 28.5			60	40	60	40	79	40	60	40		
MP 28.5 and CD			60	40	60	40	60	40	60	40		
CD and CP40			60	40	60	40	60	40				
CP40 and MP51.0					60	40	60	40				
MP 51.0 and MP 75.5					70	40	70	40				
MP 75.5 and MP 114.1					79	40	79	40				
MP 114.1 and MP 121.5					90	50	90	50				
MP 121.5 and MP 124.3					85	50	85	50				
MP 124.3 and MP 140.5					100	50	110	50				
MP 140.5 and CP 1					79	30	79	30				
CP 1 and CP 2	15	15										
CP 2 and CP 3	20	20										
CP 3 and CP 4					25	25	15	15				
CP 4 and Rock Cut			15	15			40	25				
Rock Cut and CP 5	80	30										
All Controlled Sidings											30	30

NOTE—75 MPH and 79 MPH in Third Rail Territory applicable to M 1 ACMU and TURBO TRAINS only

SPECIAL MAXIMUM SPEEDS

1157-C1b Trains with cars not equipped for passenger service must not exceed maximum speed for freight trains, unless otherwise instructed

Trail-van trains, unless otherwise restricted, must not exceed maximum speed for freight trains

1157-C2 Operating against the current of traffic unless otherwise specified

	Miles Per Hour	
	Pgr.	Ft.
Hudson Line		
MO to CD	60	40
CP89 and Hud Int (No 1 Track)	70	40
R-94 and Hud Int (No 2 Track)	70	40
Rock Cut and CP4 (No 4 Track)	15	15
MO to Div Post (N.E. Reg)	*15	*15

*At night over facing point hand operated switches where switch lights are not in use

1701 A1 Radio Operation

Radio on MU equipment is turned on by toggle switch located in Electrical Control compartment of car. Switch has three positions. Center position is off. Up or down position establishes operation of Radio from either Number 1 or Number 2 end of car. Hand microphone is fastened into the bottom of microphone holder box. Microphone button must be depressed to transmit and released to receive

1702-A1 Road Train Radio Service

Hudson Train Dispatcher	Commuter Channel	Roads 1 & 2
Croton Yard Office		Road 2
Harmon Yard Office	Commuter Channel and	Road 2
Albany-Rensselaer-Station Master		Road 1
LAB Block Station		Road 1

1702-A2 Use of Radios

Conrail Road Radio channel 1 in operation between CP-75 and CP5

Conrail Road Radio channel 2 in operation between CD and CP75

Metro Region Commuter Radio Channel 3 in operation between GCT and CD, GCT and Dover Plains and GCT and New Haven including the New Canaan, Danbury and Waterbury Branches

1705 A1 In the application of Rule 705, Engineman or Conductor will make talking test of Radio to nearest Block Station when taking charge of equipment and before departure from Terminal other than GCT. When departing from GCT, talking test of Radio on Hudson Line trains will be made with DV, Harlem Line trains with Woodlawn and New Haven Line trains with Shelf

If radio does not operate properly, Engineman or Conductor will report defect to either Yardmaster or Car Foreman at terminal where train originates or terminates

Only the Radio in operating end of MU trains will be turned on. If Conductor must use Radio elsewhere in train, he will turn Radio on in car he is occupying. It will be the responsibility of the Engineman to turn off Radio in Head or Operating car upon termination of run and the responsibility of the Conductor to know that Radios in all other cars in train are turned off

APPENDIX F

EXCERPTS FROM 49 CFR 217 RAILROAD OPERATING RULES AND 49 CFR 220 RADIO PROCEDURES

§ 217.9

Federal Railroad Administrator within 30 days after it is issued.

§ 217.9 Program of operational tests and inspections; recordkeeping

(a) Each railroad to which this part applies shall periodically conduct operational tests and inspections to determine the extent of compliance with its code of operating rules, timetables, and timetables special instructions in accordance with a program filed with the Federal Railroad Administrator.

(b) Before March 1, 1975, or 30 days before commencing operations, whichever is later, each railroad to which this part applies shall file with the Federal Railroad Administrator, Washington, D C. 20590, three copies of a program for periodic conduct of the operational tests and inspections required by paragraph (a) of this section. The program shall—

(1) Provide for operational testing and inspection under the various operating conditions on the railroad,

(2) Describe each type of operational test and inspection adopted, including the means and procedures used to carry it out;

(3) State the purpose of each type of operational test and inspection,

(4) State, according to operating divisions where applicable, the frequency with which each type of operational test and inspection is conducted,

(5) Begin within 30 days after it is filed with the Federal Railroad Administrator; and

(6) Include a schedule for making the program fully operative within 210 days after it begins.

(c) Each amendment to a railroad's program for periodic conduct of operational tests and inspections required under paragraph (a) of this section shall be filed with the Federal Railroad Administrator within 30 days after it is issued

(d) *Records* Each railroad shall keep a record of the date and place of each operational test and inspection performed in accordance with its program. Each record must provide a brief description of the operational test or inspection, including the characteristics of the operation tested or inspected, and the results thereof.

Title 49—Transportation

Records must be retained for one year and made available to representatives of the Federal Railroad Administration for inspection and copying during regular business hours.

§ 217.11 Program of instruction on operating rules.

(a) To ensure that each railroad employee whose activities are governed by the railroad's operating rules understands those rules, each railroad to which this part applies shall periodically instruct that employee on the meaning and application of the railroad's operating rules in accordance with a program filed with the Federal Railroad Administrator.

(b) Before March 1, 1975 or 30 days before commencing operations, whichever is later, each railroad shall file with the Federal Railroad Administrator, Washington, D C. 20590, three copies of a program for the periodic instruction of its employees as required by paragraph (a) of this section. This program shall—

(1) Describe the means and procedures used for instruction of the various classes of affected employees;

(2) State the frequency of instruction and the basis for determining that frequency;

(3) Include a schedule for completing the initial instruction of employees who are already employed when the program begins,

(4) Begin within 30 days after it is filed with the Federal Railroad Administrator;

(5) Provide for initial instruction of each employee hired after the program begins.

(c) Each amendment to a railroad's program for the periodic instruction of its employees required under paragraph (a) of this section shall be filed with the Federal Railroad Administrator within 30 days after it is issued.

Subpart B—Radio Procedures

§ 220.21 Railroad operating rules; radio communications.

(a) After August 1, 1977, the operating rules of each railroad with respect to radio communications shall conform with the requirements of this part.

(b) Before November 1, 1977 or 30 days before it commences to use radio communications in connection with railroad operations, whichever is later, each railroad shall file with the Federal Railroad Administrator, Washington, D C 20590, one copy of its operating rules with respect to radio communications. Each amendment to these rules shall be filed with the Federal Railroad Administrator within 30 days after it is issued.

§ 220.23 Publication of radio information.

Each railroad shall designate its territory where radio base stations are installed, where wayside stations may be contacted, and designate appropriate radio channels by publishing them in a timetable or special instruction. The publication shall indicate the periods during which base and wayside radio stations are attended or in operation.

§ 220.25 Instruction of employees.

Each employee who is authorized to use a radio in connection with a railroad operation, shall be

(a) Provided with a copy of the railroad's operating rules governing the use of radio communication in a railroad operation.

(b) Instructed in the proper use of radio communication as part of the program of instruction prescribed in § 217.11 of this chapter.

§ 220.27 Identification

(a) Except as provided in paragraph (c) of this section, the identification of each wayside, base or yard station shall include at least the following minimum elements, stated in the order listed:

(1) Name of railroad. An abbreviated name or initial letters of the railroad may be used where the name or initials are in general usage and are understood in the railroad industry.

(2) Name of office or other unique designation of the station, and

(3) Location of the station.

(b) Except as provided in paragraph (c) of this section, the identification of each mobile station shall consist of the following elements, stated in the order listed:

(1) Name of the railroad. An abbreviated name or initial letters of the railroad may be used where the name or initial letters are in general usage and are understood in the railroad industry;

(2) Train name (number), if one has been assigned, or other appropriate unit designation; and

(3) The word "engine", "caboose", "motorcar", "pakset" or other word which indicates to the listener the precise mobile transmitting station, unless identical to the requirement of paragraph (b)(2) of this section.

(c) If positive identification is achieved in connection with switching, classification, and similar operations wholly within a yard, fixed and mobile units may use short identification after the initial transmission and acknowledgement consistent with applicable Federal Communications Commission regulations governing "Station Identification".

§ 220.29 Statement of letters and numbers

(a) If necessary for clarity, a phonetic alphabet shall be used to pronounce any letter used as an initial, except initial letters of railroads. See Appendix "A", of this part for the recommended phonetic alphabet.

(b) A word which needs to be spelled for precision or clarity shall first be pronounced, and the word shall then be spelled. If necessary, the word shall be spelled again, using a phonetic alphabet.

(c) Numbers shall be spoken by digit, except that exact multiples of hundreds and thousands may be stated as such. A decimal point shall be indicated by the word "decimal". (See Appendix B to this part, for a recommended guide to the pronunciation of numbers.)

§ 220.31 Initiating a transmission.

Before transmitting by radio, an employee shall:

(a) Listen to insure that the channel on which he intends to transmit is not already in use;

(b) Identify his station in accordance with the requirements of § 220.27, and

(c) Verify that he has made radio contact with the person or station with whom he intends to communicate by listening for an acknowledgement. If the station acknowledging his transmission fails to identify itself properly, the employee shall require a proper identification before proceeding with the transmission.

§ 220.33 Receiving a transmission

(a) Upon receiving a radio call from another station, an employee shall promptly acknowledge the call, identifying his station in accordance with the requirements of § 220.27 and stand by to receive. An employee need not attend the radio, however, if this would interfere with other immediate duties relating to the safety of railroad operations.

(b) An employee shall acknowledge receipt of all transmissions directed to him or his station

(c) An employee who receives a transmission shall repeat it to the transmitting party unless the communication:

(1) Relates to yard switching operations;

(2) Is a recorded message from an automatic alarm device, or

(3) Is general in nature and does not contain any information, instruction or advice which could affect the safety of a railroad operation.

§ 220.35 Ending a transmission.

(a) At the close of each transmission to which a response is expected, the transmitting employee shall say "over" to indicate to the receiving employee that the transmission is ended

(b) At the close of each transmission to which no response is expected, the transmitting employee shall state his identification followed by the word "out" to indicate to the receiving employee that the exchange of transmissions is complete.

§ 220.37 Voice test.

(a) Each radio which is used in connection with a railroad operation outside yard limits shall be tested at the point where the train is originally made up. At least once during each tour of duty, the engineer and conductor shall be responsible for the testing of the radio to verify that the radio is operating properly on the engine and caboose. The tests shall consist of an exchange of voice transmissions with another station. The other station shall advise the station conducting the test of the quality and readability of its transmission.

(b) Any radio found not to be functioning properly shall be removed from service until it has been repaired

(c) When a radio is removed from service, each crew member of the train and the train dispatcher or other employee designated by the railroad shall be so notified.

§ 220.39 Continuous monitoring

Engine and caboose radios must be turned on to the appropriate channel as designated in § 220.23 with the volume adjusted to receive communications while the engine or caboose is manned.

§ 220.41 Notification on failure of train radio.

The failure of an engine or caboose radio en route shall be reported as soon as practicable to the train dispatcher or other employee designated by the railroad by any alternate means of communication available

§ 220.43 Communication consistent with rules.

Radio communication may not be used in connection with a railroad operation in a manner which conflicts with the requirements of this Part 220, Federal Communication Commission regulations or the railroad's operating rules. The use of citizen band radios for railroad operating purposes is prohibited.

§ 220.45 Communication must be complete.

Any radio communication which is not fully understood or completed in accordance with the requirements of Part 220 and the operating rules of the railroad, shall not be acted upon and shall be treated as though not sent.

§ 220.47 Emergencies.

(a) An emergency transmission shall be preceded by the word "emergency", repeated three times. An emergency transmission shall have priority over all other transmissions and the frequency or channel shall be kept clear

APPENDIX G

EXCERPT FROM RAIL SAFETY/EQUIPMENT CRASHWORTHINESS REPORT NO. FRA/ORD-77/73, IV

5. CONCLUSIONS

The conclusions reached in this study are based on data obtained from accident investigation reports and T-Forms, visual surveys of rail vehicle interiors, analytical determination of occupant impact forces and logical assumptions. Accident data, in the majority of incidents, reported the initiating factors of the accident, the type of vehicle the occupant was injured in and the nature of the injuries. The area of minimal information was on the injury mechanism or object contacted by the occupant. Conclusions as to the items requiring improvement to reduce injuries were based to a great extent on the visual surveys to determine the likely object to cause injury in a collision. This was particularly true for passenger rail vehicle occupants where collision injury mechanism data was practically non-existent. The severity of injuries, based on the assumptions from the visual survey, was determined by the use of mathematical analysis to obtain force levels.

Severity of injuries was found to be less pronounced for passenger railcar occupants than locomotive and caboose occupants. This is assuming that the passenger car does not telescope or become penetrated by an object. Calculations show that acceleration pulses experienced in passenger cars, regardless of the velocity at collision, should not cause occupants to impact interior furnishings at a velocity sufficient to cause fatal injuries. Injuries experienced in passenger cars fell into the minor to moderate level range. Modifications to passenger cars for collision safety will be for the purpose of eliminating or reducing injuries rather than so much to prevent fatalities. The principal modifications to passenger railcars are as follows:

- Prevent double seats from swiveling by providing a positive lock to improve occupant containment
- Prevent leg entrapment under seats by adding a back skirt to reduce high frequency of leg injury in collisions
- Provide padded armrests, headrests and shoulder wings to improve containment
- Provide padding on rigid bulkheads, doors and nonyielding partitions
- Compartment lounge and lavatory areas to minimize distance occupant can be thrown

APPENDIX H

STRUCTURAL TESTING - TRAILER CAR

VOM (Empty, Ready to Run) - Conducted May 26, 1975

Car Shell Weight	12,680 KG
Added Weight for VOM	17,363 KG
VOM	<u>30,043</u> KG

Deflection - 2 MM on left side (looking aft)
1 MM on right side

VOM Plus Overload - Conducted May 27, 1975

VOM	30,043 KG
Overload	5,900
	<u>35,943</u> KG

Deflection - 3 MM left Deflection is total from basic car shell weight of
2.5 MM right 12,680 KG

Camber was checked at VOM plus overload by means of a taunt wire strung between bolsters under center sill - plus 9.75 MM.

800K Compression Test - Conducted May 29, 1975.

Test results were not satisfactory - two different locations of strain gages showed readings up to 62.6 KG/MM² on material capable of 36 KG/MM². Location was in the tapered section of center sill at the base of the "H" coupler structure.

800K Test was reconducted June 13 after beef up of discrepant section. Test was successful. "B" end of power cars and both ends of trailer cars and food service cars, will represent this redesign. -

500K Test was conducted June 18, 1975, and was successful.

Natural frequency test was conducted June 20, 1975.

Results are being clarified by AMF and will appear in official AMF test report.

Structural Testing - Collision Posts

Test was conducted April 11, 1975.

Test was made on a mockup representing the two collision posts with the two posts facing each other and held together at the top and bottom with cross pieces.

A 150K load was applied 18" above lower attachment with no failure.

A 300K load was applied at the base with no failure.

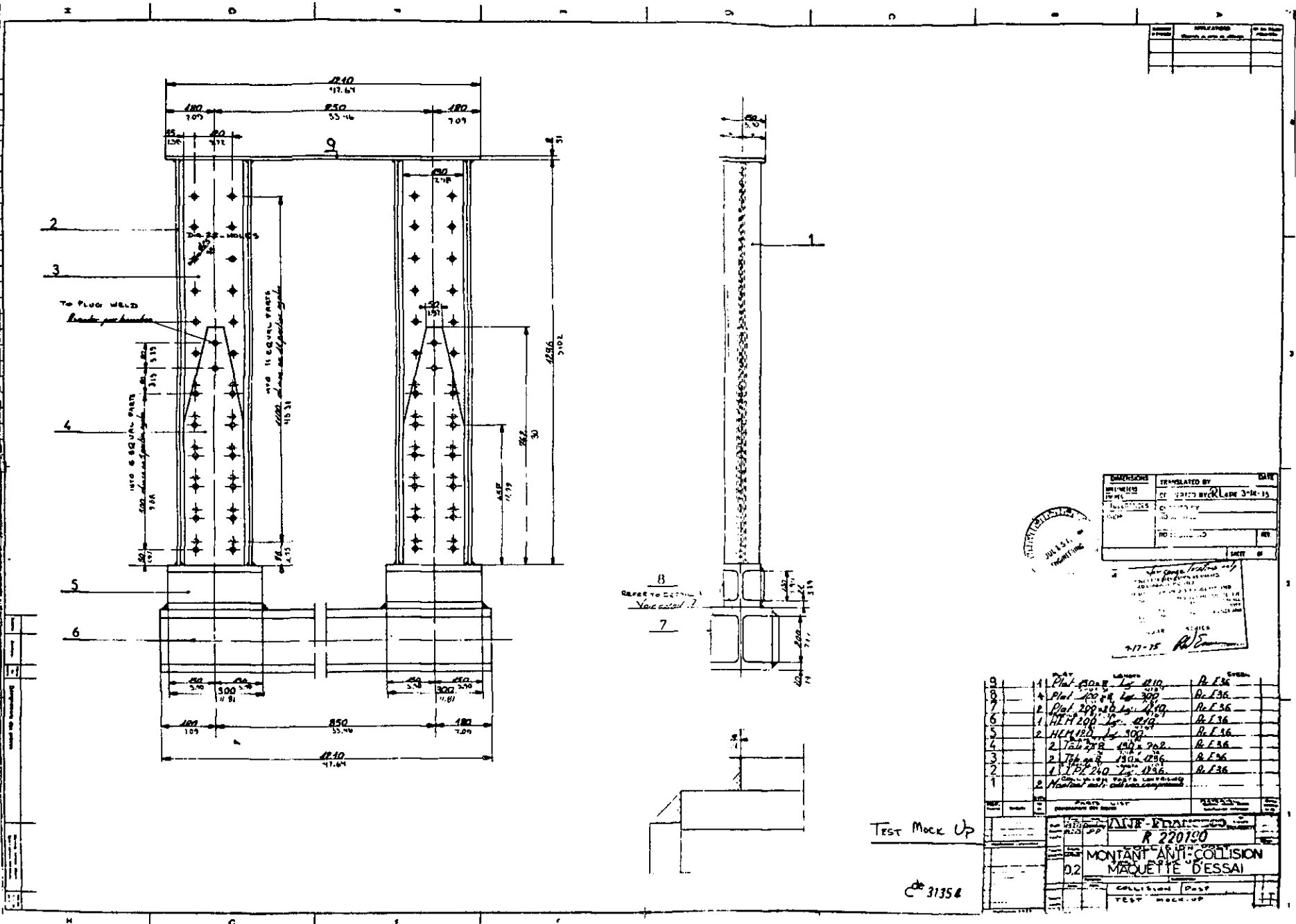

DIMENSIONS		TEMPERATURE	DATE
SYMBOLS	BY	TESTED BY	DATE
DESCRIPTION			
NO.			
		SHEET OF	

QTY	DESCRIPTION	REMARKS	DATE
1	Plat 400 x 400	Pl. E36	
1	Plat 200 x 80	Pl. E36	
2	Plat 200 x 80	Pl. E36	
1	HT 200	Pl. E36	
2	HT 100	Pl. E36	
4	HT 200	Pl. E36	
2	HT 200	Pl. E36	
2	HT 200	Pl. E36	
2	HT 200	Pl. E36	
1	HT 200	Pl. E36	

TEST Mock Up

C 3135

MONTANT ANTI-COLLISION
MAQUETTE D'ESSAI
 R 220100
 COLLISION POST
 TEST MOCK-UP

APPENDIX I

FRA LETTER



DEPARTMENT OF TRANSPORTATION
FEDERAL RAILROAD ADMINISTRATION
WASHINGTON, D. C. 20591

MAY 8 1971

Mr. John Reed
Chairman of the Board
National Transportation Safety Board
Federal Building
800 Independence Avenue, S. W.
Washington, D. C. 20591

Dear Chairman Reed:

During the years 1955-1968, inclusive, the Bureau of Railroad Safety has investigated approximately three hundred train accidents involving collisions where, in most instances, the control compartment (cab) of the locomotive, multiple unit commuter car as well as diesel-electric unit, was extensively damaged or destroyed, resulting in the death or serious injury of the cab occupants. In addition, during the same period, the Bureau has investigated more than two hundred accidents in which cab occupants have sustained injuries as the result of seat failures, insecure cab accessories, and defective cab floors, windows, and doors.

Of this type accident most recently investigated by the Bureau were those which occurred on the Southern Railway at Parrish, Alabama, on May 12, 1969, and at Leadville Junction, Tennessee, on October 26, 1969, and on the Penn Central at Wellington, Ohio, on August 18, 1969. In addition, a similar accident but involving commuter-type passenger carrying equipment which occurred on the Penn Central at Darien, Connecticut, on August 20, 1969, was investigated by the National Transportation Safety Board. A copy of the investigation report covering each of the foregoing accidents is enclosed for your ready reference. It should be noted that in each of these reports a reference is made to the design and location of the engineer's control compartment or to the application of a crash bar or other buffer device to the control compartment end of the locomotive.

We believe that this matter now warrants serious consideration with respect to recognizing the possibility and/or feasibility of effecting improvements in the design, location, and construction of control compartments not only to enhance the safety of cab occupants in the event of collisions or derailments, but to achieve an optimum environment under normal operating conditions.

Accordingly, we are hopeful of arranging an informal conference in this office at 2:00 p.m. on June 9, 1971, Conference Room No. 7234, which will be attended by representatives of locomotive and car builders, labor organizations, carriers, and the Association of American Railroads to discuss this matter with a view toward developing some meaningful and substantive proposals which will ultimately result in improving the safety of railroad operation.

It will, therefore, be appreciated very much if you will advise the undersigned at your earliest convenience if you desire to attend or to be represented at the subject conference. The Association of American Railroads is indeed welcome to invite the participation of appropriate carrier representatives, and we would welcome suggestions relative to extending invitations to others not included in this listing.

Sincerely,

Carl V. Lyon
Acting Administrator

Enclosures