



PB98-122864



U.S. Department
of Transportation

**Federal Highway
Administration**

Publication No. FHWA-SA-97-105

Guide to Nondestructive Testing of Concrete

September 1997

REPRODUCED BY:
U.S. Department of Commerce **NTIS**
National Technical Information Service
Springfield, Virginia 22161

NOTICE

This publication is disseminated under the sponsorship of the Department of Transportation in the interest of information exchange. The report does not constitute a standard, specification, or regulation. The United States Government does not endorse products or manufacturers. Trade or manufactures' names appear in the publication only because they are considered essential to the object of this document.

Technical Report Documentation Page

1. Report No. FHWA-SA-97-105	2. Government Accession No.	3. Recipient's Catalog Number	
4. Title and Subtitle Guide to Nondestructive Testing of Concrete		5. Report Date September 1997	
		6. Performing Organization Code HTA-20	
7. Author G. I. Crawford		8. Performing organization Report	
9. Performing Organization Name and Address Federal Highway Administration 400 Seventh Street, SW Washington, DC 20590		10. Work Unit No. (TRAIS)	
		11. Contract or Grant No.	
12. Sponsoring Agency name and Address		13. Type of Report and Period Code Technical Report	
		14. Sponsoring Agency Code	
15. Supplementary Notes			
16. Abstract <p>In recent years, significant developments have occurred in concrete testing and in establishing test procedures for nondestructive testing (NDT). There continues to be an ever-increasing demand by the traveling public to open pavements and structures earlier to traffic. Because of this shortened construction schedule, the inspection force needs to make quick decisions about construction quality. With NDT equipment, inspectors can now determine concrete strength, pavement thickness, degree of consolidation, and curing temperatures quickly and accurately.</p> <p>The purpose of this guide is to present general information on several pieces of commercially available NDT equipment. The majority of the equipment covered is used for measuring the early age, in-situ, strength of the concrete at ages less than 28 days.</p>			
17. Key Words Nondestructive testing, concrete		18. Distribution Statement No restrictions. This document is available to the public from the National Technical Information Service.	
19. Security Classif. (of this report) Unclassified	20. Security Classif. (of this page) Unclassified	21. No. of Pages 60	22. Price

TABLE OF CONTENTS

<u>Chapter</u>		<u>Page</u>
1	INTRODUCTION	1
2	SURFACE HARDNESS TEST	3
	Background	3
	Test Equipment and Procedure	3
	Laboratory Calibration Procedure	5
	Advantages and Disadvantages	5
	Interpretation of Test Results	7
	Limitations	7
3	PENETRATION RESISTANCE TEST	8
	Background	8
	Test Equipment and Procedure	8
	Mechanism of Concrete Failure	8
	Factors Affecting Probe Test Results	10
	Laboratory Calibration Procedure	10
	Typical Applications	11
	Advantages and Disadvantages	11
4	PULLOUT TEST	12
	Test Equipment and Procedure	14
	Laboratory Calibration Procedure	14
	Failure Mechanism	16
	Within-Test Variability	16
	Field Tests	17
	Typical Applications	18
	Capo (Cut and Pullout)	18
5	BREAK-OFF TEST	20
	Background	20
	Test Equipment and Procedure	22
	Development of Correlation Curves	27
	Typical Applications	27
	Advantages and Disadvantages	30
6	TENSILE BOND STRENGTH TEST	31
	Background	31
	Test Equipment and Procedure	31
	Tensile Strength of Concrete	35
	Compressive Strength of Concrete	35
	Typical Applications	36
7	MATURITY TEST	37
	Background	37
	Test Equipment and Procedure	40
	Laboratory Calibration Procedure	42

	Typical Applications	42
	Advantages and Disadvantages	43
8	PULSE VELOCITY TEST	44
	Background	44
	Theory of Wave Propagation	44
	Test Equipment and Procedure	45
	Laboratory Calibration Procedure	48
	Factors Affecting Pulse Velocity	49
	Typical Applications	51
	Advantages and Disadvantages	52
9	IMPACT ECHO METHOD	53
	Background	53
	Basic Principles	53
	Test Equipment and Procedures	56
	Typical Applications	58
	Advantages and Disadvantages	58

FIGURES

<u>Figure</u>		<u>Page</u>
1	Rebound hammer.	4
2	Schematic of rebound hammer operation	4
3	Windsor probe device	9
4	Typical failure of concrete from probe penetration	9
5	Configuration of early pullout device	12
6	Configuration of early pullout device	12
7	Test configuration for early tests by Kierkegaard-Hanson	13
8	Schematic of pullout insert	14
9	Failure mechanism of pullout test according to Krenchel and Bickley	17
10	A) Drilled-in test using split-sleeve and tapered bolt. B) CAPO test using routed shoulder and expandable washer	19
11	Tubular plastic sleeves for inserting into fresh concrete for the break-off test . . .	21
12	Core drill bit for drilling a core for break-off testing	21
13	Break-off test equipment: (1) load cell, (2) manometer, and (3) hydraulic hand pump	22
14	Schematic of cylindrical slit and application of load for break-off test	23
15	Break-off tester calibrator	24
16	Calibrator placed in the load cell	24
17	Plastic sleeve inserts placed in fresh concrete	25
18	Strength diagram for “L-level.”	28
19	Strength diagram for “H-level.”	29
20	Commercially available tensile bond strength tester	33
21	Methods of testing uncored and cored patched or overlaid surfaces	34
22	James maturity meter	41
23	System 4104 maturity meter	42
24	Schematic of pulse velocity device	45
25	Methods of pulse velocity measurement. (A) Direct method (B) Semi-direct method (C) Surface method	47
26	Use of surface method to determine depth of deterioration	48
27	The behavior of a P-wave incident upon an interface between two dissimilar media: (A) reflection and refraction; (B) mode conversion	55
28	Principle of the impact-echo method	56
29	Impact-echo equipment. Impact source and receiving transducer housed in unit to the right of the laptop computer (waveform analyzer)	57

TABLES

<u>Table</u>		<u>Page</u>
1	Corrections for pulse velocity due to temperature changes	50

CHAPTER 1

INTRODUCTION

Nondestructive testing (NDT) for the inspection of metals has been an accepted practice for a long time. However, the use of NDT for estimating the in-place strength of concrete, and/or for supplementary Quality Assurance or Quality Control testing programs is relatively new. The reason for the slow development of NDT techniques for concrete is because, unlike steel, concrete is a highly non-homogeneous material, making the results more variable.

Despite the limitations, there has been progress in the development of nondestructive methods of testing concrete. In recent years several methods have been standardized by the American Society for Testing and Materials (ASTM). The direct determination of mechanical properties such as compressive, flexural, or tensile strength requires that concrete specimens be tested destructively. Nondestructive methods cannot yield absolute values of these properties; therefore, NDT methods have been developed to measure other properties of concrete from which estimates of mechanical properties can then be calculated.

Broadly speaking, there are two types of NDT methods for concrete. The first type consists of the following methods, which are used to estimate the compressive strength: *surface hardness*, *penetration resistance*, *pullout*, *break-off*, and *maturity*. Most of these methods are not truly nondestructive because they cause some surface damage that often must be repaired. The damage, however, is minor compared with damage done by core drilling. Some people refer to these tests as “semi-destructive.” The second type includes those methods that measure other properties of concrete, such as moisture content, density, thickness, pulse velocity, and dynamic modulus of elasticity. Also included in the second category are the stress wave, radar, and infrared thermography techniques that are used to locate delaminations, voids, and cracks in concrete.⁽¹⁾

In a relatively short span of 40 years, nondestructive testing has achieved an important place in the quality control of hardened concrete and the evaluation of existing structures with regard to their strength and durability. In certain instances, for example when investigating the width and depth of cracks or voids in concrete, NDT methods can provide reasonable and accurate answers without conducting a substantial coring and testing program.

Although nondestructive tests are relatively simple to perform, the analysis and interpretation of test data can be difficult because of the non-homogeneity of concrete. The interpretation of any test data should be performed by experienced personnel. If used properly, nondestructive tests can form a very important link in the chain of testing and evaluation of concrete.⁽¹⁾

The purpose of this guide is to present information on several pieces of commercially available NDT equipment and to support a series of NDT workshops designed to give participants “hands-on” experience with some of the equipment. Most of the equipment demonstrated is available through a FHWA loan program to State highway agencies.

This guide is not intended as an all-inclusive document on NDT methods, but merely an introduction to some of the more practical pieces of NDT equipment. The majority of the equipment covered is used for measuring the early age, *in-situ* strength of the concrete at less than 28 days.

CHAPTER 2

SURFACE HARDNESS TEST

BACKGROUND

In 1948, Swiss engineer Ernst Schmidt developed a test hammer for measuring the hardness of concrete by the rebound principle. By 1990, approximately 100,000 Schmidt rebound hammers had been sold worldwide, making the rebound hardness test the most commonly used nondestructive test method to estimate the *in-situ* compressive strength of concrete.⁽²⁾ The rebound hammer has also been used to assess the overall uniformity of concrete prior to undertaking more extensive destructive tests, such as coring. The rebound hammer is easy to use and provides a large number of readings in a short time. However, extreme care should be taken in evaluating the results. Frequent calibration of the hammer is also required to ensure the greatest accuracy.

The rebound hammer is basically a surface hardness tester with little apparent theoretical relationship between the strength of concrete and the rebound number of the hammer. However, within certain limits, empirical correlations have been established between compressive strength and the rebound number. In general, most investigators have found that the accuracy of the rebound hammer is between 60 and 70 percent.⁽²⁾

TEST EQUIPMENT AND PROCEDURE

A typical rebound hammer is shown in figure 1. The rebound hammer test method is described in ASTM Standard C 805.⁽³⁾ The hammer weighs about 1.8 kg (4 lb) and can be used in the laboratory and field. Figure 2 contains a schematic view of a rebound hammer, showing its main components.

To perform a rebound test, release the plunger from its locked position by gently pushing the plunger against a hard surface and slowly allow the spring to push the body of the hammer away from the hard surface. This causes the plunger to extend from the hammer body, allowing the latch to engage the spring-loaded steel hammer and the plunger rod (figure 2(a)). Hold the plunger perpendicular to the concrete surface to be tested and slowly push the hammer towards the surface. As the hammer is pushed towards the concrete surface, the main spring connecting the hammer mass to the plunger is stretched (figure 2(b)). When the hammer is pushed to the limit, the latch is automatically released, and the energy stored in the spring propels the hammer mass toward the plunger tip (figure 2(c)). The mass impacts the shoulder of the plunger rod and rebounds (figure 2(d)). During rebound, the slide indicator travels with the hammer mass and records the rebound distance (rebound number). A button on the side of the hammer is pushed to lock the plunger in the retracted position, and the rebound number is read from the scale. The rebound distance is indicated by a pointer on a scale graduated from 0 to 100; the rebound readings are termed "R-values." These values give an indication of the concrete surface hardness with values increasing with the hardness of the concrete.



Figure 1. Rebound hammer.

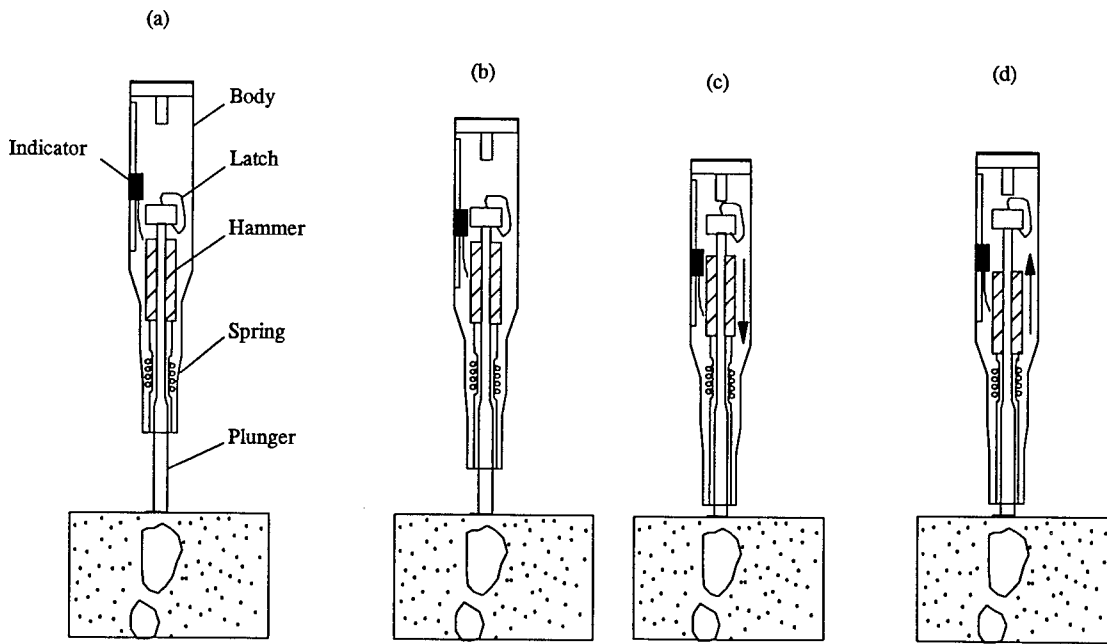

Figure 2. Schematic of rebound hammer operation.

Estimate the rebound number on the scale to the nearest whole number and record the rebound number. Take 10 readings from each test area. No two impact tests shall be closer than 25 mm (1 in). Examine the impression made on the surface after impact; if the impact crushes or breaks through a near-surface air void, disregard the reading and take another reading.

Discard readings differing from the average of 10 readings by more than 6 units and determine the average of the remaining readings. If more than 2 readings differ from the average by 6 units, discard the entire set of readings and determine rebound numbers at 10 new locations within the test area.⁽³⁾

The test can be conducted horizontally, vertically upward or downward, or at any intermediate angle. Due to different effects of gravity on the rebound of the hammer mass as the test angle is changed, the rebound number will be different for the same concrete, and requires a separate calibration or correction chart for each test angle.

Each hammer is furnished with correlation curves developed by the manufacturer based on standard cube specimens. However, the use of these curves is not recommended because materials and testing conditions may be different from those when the hammer was calibrated by the manufacturer. To achieve the most accurate results, a separate correlation should be developed for each test angle and mix design tested.

LABORATORY CALIBRATION PROCEDURE

1. Prepare fifteen 150x300 mm (6x12-in) cylinders whose strengths will cover the expected strength range to be encountered on the job site. Use the same cement, aggregates, admixtures and mix design that are to be used on the job. Cure cylinders under standard moist curing conditions. Test 3 cylinders at each of the following test ages: 1, 3, 7, 14, and 28 days.
2. After capping, place a cylinder in a compression-testing machine and apply an initial load of approximately 15 percent of anticipated ultimate load to restrain the specimen. Ensure that all cylinders are tested in a saturated surface-dry condition.
3. Make 15 rebound hammer readings, 5 on each of 3 vertical lines 120° apart, against the side surface in the middle two-thirds of each cylinder. Avoid testing the same spot twice.
4. Average all of the readings, then use the discard criteria given in ASTM C 805 to determine the rebound number for the cylinder being tested.
5. Repeat steps two through four for all of the cylinders.
6. Test each cylinder to failure in compression and plot the average rebound numbers at each age against the compressive strengths on a graph.
7. Fit a curve or line to the data using the least squares approximation method.

ADVANTAGES AND DISADVANTAGES

The rebound hammer provides a quick and inexpensive means of assessing the general quality of concrete and for locating areas of poor quality. A large number of readings can be taken rapidly so that large exposed areas can be scanned in a few hours. To ensure more reliable results, project-specific calibrations are necessary when estimating the in-place concrete compressive strength. Because the test only measures the rebound of a given mass on the concrete surface, the

results reflect only the quality of the surface, and not the entire depth of the section being tested. The results of the rebound hammer test are affected by the smoothness of the test surface, type of coarse aggregate, age of concrete being tested, moisture content, type of cement, and surface carbonation. A brief explanation of how these factors affect the results of the rebound hammer test is given below.

Surface Smoothness

Surface texture can have an important effect on the accuracy of test results. If a rebound test is performed on a rough-textured surface, the plunger tip causes excessive crushing of the cement paste, which will result in the reduction of the rebound number measured. To obtain more accurate results on rough surfaces, a Carborundum stone should be used to grind the surface to a uniform smoothness. Past research has also shown that troweled surfaces or surfaces formed by metal forms yield rebound numbers 5 to 25 percent higher than surfaces cast against wooden forms.⁽²⁾ Troweled surfaces also give a higher scatter of test results, which lower confidence in the estimated strength results.

Age of Material Being Tested

The rate of gain of surface hardness of concrete is rapid for the first 7 days, after which there is little or no gain in surface hardness. However, for properly cured concrete, there is a significant strength gain beyond 7 days, because cement continues to hydrate within the concrete and gain strength. When concrete over 28 days is to be tested, direct correlations need to be developed between the rebound numbers taken on the concrete and the compressive strength of cores taken from the concrete.

Caution should also be exercised when testing concrete less than 3 days old or concrete with expected compressive strengths less than 7 MPa (1000 psi). The reason for this is that the rebound numbers will be too low for an accurate reading, and the rebound hammer will leave blemishes on the concrete surface when impacted.

Moisture Content

The presence of surface moisture and the overall moisture content of the concrete have a profound effect on the results of the rebound hammer. Well-cured, air-dried specimens that have been soaked in water and tested in the saturated surface-dry (SSD) condition generally show rebound numbers 5 points lower than air-dried specimens. When SSD specimens were left in a room at 21 °C (70 °F) and air-dried, they gained 3 points in 3 days and 5 points in 7 days.⁽²⁾

To achieve the most accurate results for specimens where the actual moisture condition is unknown, the surface should be pre-saturated with water several hours prior to testing and use the correlation developed for SSD specimens.

Type of Cement

The type of cement can have a significant effect on the rebound number. Concrete containing Type III high-early strength cement can have higher rebound numbers at an early age than concrete made with Type I cement.

Carbonation of Concrete Surface

The rebound number is significantly affected by the surface carbonation of concrete. The rebound numbers for carbonated concrete can be up to 50 percent higher than those obtained on a non-carbonated concrete surface. The carbonation effects are more severe in older concretes where the carbonated layer can be several millimeters thick and in extreme cases up to 20 mm (3/4 in) thick. To achieve more accurate results, correction factors need to be established for specific concrete being tested.

Type of Coarse Aggregate

It is generally agreed that the rebound number is affected by the type of coarse aggregate. For equal compressive strengths, concrete made with crushed limestone shows rebound numbers approximately 7 points higher than those for concretes made with gravel, representing approximately 7 MPa (1000 psi) difference in compressive strength. The same type of coarse aggregate obtained from different sources can yield different concrete strength estimations. Correlation testing of materials is necessary.

INTERPRETATION OF TEST RESULTS

A general correlation exists between the compressive strength of concrete and the hammer rebound number. However, there is a big disagreement among researchers concerning the accuracy of the hammer for estimating the compressive strength of concrete. Coefficients of variation for compressive strength of concrete can vary from 15 percent to over 30 percent for a wide variety of specimens. **These large deviations can be reduced by developing a proper correlation curve for the hammer that takes into account the variables discussed earlier, instead of relying on the correlation curves provided by the manufacturer of the rebound hammer.**

For a properly calibrated hammer the accuracy is between 15 and 20 percent for test specimens cast, cured, and tested under lab conditions. However, the accuracy of the rebound hammer for estimating *in-situ* compressive strength is approximately 30 to 40 percent.

LIMITATIONS

The Schmidt hammer should not be regarded as a substitute for standard compression tests but as a method for determining the uniformity of concrete in structures, and comparing one concrete against another. Estimation of the strength of concrete by the rebound hammer within an accuracy of ± 15 to 20 percent may be possible **only for specimens cast, cured, and tested under similar conditions as those from which the correlation curves are established.**

CHAPTER 3

PENETRATION RESISTANCE TEST

BACKGROUND

The penetration resistance test is based on the depth of penetration of steel-alloy probes that are shot into the concrete. This test method determines the hardness or penetration resistance of the concrete, which is related to its strength. Between 1964 and 1966, the Windsor probe test system was introduced in the U.S. for penetration testing of concrete in the laboratory as well as in the field. The development of this equipment was the joint undertaking of the New York Port Authority and the Windsor Machinery Company of Connecticut.⁽⁴⁾

TEST EQUIPMENT AND PROCEDURE

The Windsor probe, like the rebound hammer, is a hardness tester. The probe penetration relates to the compressive strength of the concrete below the surface, which makes it possible to develop empirical correlations between compressive strength properties and the penetration depth of the probe.⁽⁴⁾

The Windsor probe consists of a powder-actuated gun or driver (see figure 3) into which a 6 mm (1/4-in) diameter hardened steel-alloy probe is inserted, then driven into the concrete by firing a precision powder 32-caliber cartridge. For testing relatively low-strength concrete, the power level can be reduced by placing the probe further into the barrel, which decreases its distance to the concrete surface. After the probe is driven into the concrete, the exposed probe length is used as a measure of the penetration resistance. The depth of penetration is inversely proportional to the mortar strength and coarse aggregate hardness.

Test procedures are provided in ASTM C 803.⁽⁵⁾ The area to be tested must have a relatively smooth surface. For coarse finishes, the surface must first be ground smooth in the area to be tested. A series of three measurements should be made using a triangular template, or for irregular shapes three probes are driven individually using a single probe template. Once the measured values of exposed probe lengths are averaged and the Moh's hardness of the coarse aggregate is determined, the *in-situ* compressive strength can be determined from the appropriate correlation data provided by the manufacturer.

MECHANISM OF CONCRETE FAILURE

A given initial amount of probe energy is absorbed during penetration due to the crushing and fracturing of the concrete and to a smaller extent through friction between the probe and the concrete. The probe causes the concrete to fracture in a cone-shaped zone below the surface with cracks propagating up to the surface (see figure 4). Further penetration below this zone is resisted by the compression of the adjacent material and the hardness of the aggregate.



Figure 3. Windsor probe device.

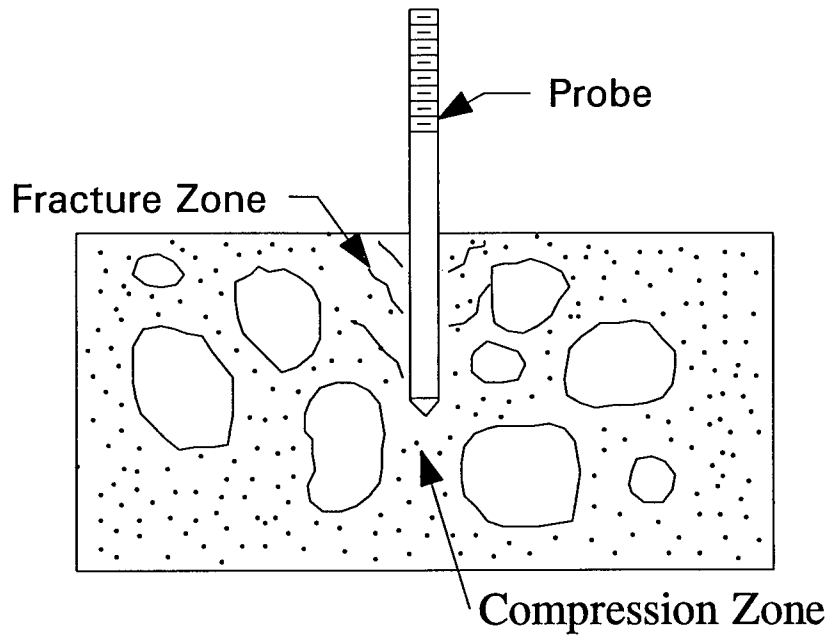

Figure 4. Typical failure of concrete from probe penetration.

FACTORS AFFECTING PROBE TEST RESULTS

The coarse aggregate hardness has a profound effect on the accuracy of the probe test for estimating the compressive strength. The equipment manufacturer has made an effort to account for this in the correlation tables by developing values based on the hardness of the aggregate. Several researchers have found varying concrete strengths for aggregates with similar Moh's hardness numbers. This implies that other factors in addition to aggregate hardness affect the probe penetration. Mortar strength also has a large effect on the compressive strength at early ages. Apart from its hardness, the type and size of coarse aggregate will also have a significant effect on probe penetration. Other parameters that affect the correlation are mix proportions, moisture content of hardened concrete, curing conditions, surface conditions, degree of carbonation, and age of the concrete.⁽⁴⁾

The penetration resistance test is generally considered nondestructive; however, the probe leaves a minor hole in the concrete for the depth of the probe penetration 25 to 63.5 mm (~ 1 to 2.5 in). For more mature concrete a cone-shaped area of concrete may be heavily fractured around the probe. For exposed surfaces the probe would have to be removed and the surface patched. The test is considered nondestructive to the extent that concrete can be tested *in-situ*, and the strength integrity of the concrete is not affected significantly by the test.

LABORATORY CALIBRATION PROCEDURE

The manufacturer of the Windsor probe has published tables relating exposed probe length with the compressive strength of concrete. Depending on the hardness of the aggregate used in the concrete, a different value for the compressive strength is given for each exposed probe-length reading. The tables provided by the manufacturer are based on empirical relationships established in the laboratory. In some cases these tables may not provide satisfactory results; therefore, **it is recommended that the user correlate probe test results with the type of concrete being used.** A recommended procedure for developing a correlation is outlined below:

1. Prepare a minimum of fifteen 150x300 mm (6x12-in) cylinders and a companion 600x600x200 mm (24x24x8-in) concrete slab that is representative of the strength range expected on the job site. The specimens should be moist cured under standard conditions, keeping the curing period the same as the specified control age in the field.
2. Test three cylinders in compression at the specified ages (suggested ages 1, 3, 7, 14, and 28 days). At the time of cylinder tests, fire three probes into the top surface of the slab at least 180 mm (7 in) apart and at least 100 mm (4 in) from any edge, per ASTM C 803. If any of the probes fail to properly penetrate the slab, it should be removed and another fired. Measure the exposed probe lengths and average the three results.
3. Repeat step 2 for the remaining ages.
4. Plot the average exposed probe length against the average compressive strength at each test age, and fit a curve to the data using the least squares approximation method. The 95 percent confidence limits may also be drawn on the graph. This graph should also be compared with the correlation graph provided by the manufacturer for accuracy.

TYPICAL APPLICATIONS

An increasingly important area of application for nondestructive techniques is in the estimation of early-age strength of concrete for safe early form removal. The Windsor probe test is probably the most widely used NDT method in determining safe stripping times due to simplicity of equipment and test procedure. Based on previous research it was concluded that unlike the rebound method, the penetration resistance test can estimate the early-age strength development of concrete within a reasonable degree of accuracy, and therefore, can determine safe formwork removal times for early form removal.

The determination of the *in-situ* concrete strength of a structure may be necessary if standard cylinder strengths are less than specified values, or the in-place quality of the concrete is in question because of inadequate placing or curing procedures. It is also necessary sometimes to check the changes in concrete quality of older structures. The most common method to determine the concrete strength in these cases is to obtain concrete cores; however, some NDT techniques such as penetration resistance, or break-off testing, are gaining acceptance as a means of estimating the *in-situ* compressive strength of concrete.

In cases where cylinder strengths are being disputed based on the specifications, cores provide a direct measure of the compressive strength and the most reliable means of estimating *in-situ* strength. For many situations, however, it is possible to establish correlations between probe penetration and compressive strength of cores that are accurate enough so that the probe test can be used to reduce the number of cores required.

In general, the penetration resistance test is more accurate at estimating the *in-situ* compressive strength than the rebound hammer because it actually penetrates into the concrete about 50 mm (2 in). The penetration resistance test is also less affected by surface moisture, surface texture, and carbonation due to this greater penetration into concrete compared to the rebound hammer test. However, the size and distribution of coarse aggregate in the concrete has a greater effect on the probe test.

ADVANTAGES AND DISADVANTAGES

The Windsor probe is simple to operate, durable, and requires minimal maintenance except for occasional cleaning of the gun barrel. The concrete strength correlations are affected by a relatively smaller number of variables than the rebound hammer.

The minimum member thickness should not be less than 100 mm (4 in), and steel reinforcement has an effect on the depth of penetration. The test is limited to concrete with compressive strengths less than 41 MPa (6000 psi), and for concrete strengths less than 28 MPa (4000 psi) a lower power level must be used. For lightweight concrete, a probe with a larger cross-sectional area must be used.

CHAPTER 4

PULLOUT TEST

BACKGROUND

The pullout test measures the force required to pull an embedded metal insert from hardened concrete. The earliest known description of the pullout test method was reported in 1938 by Skramtajeu of the Central Institute for Omdistroa in the Soviet Union.⁽⁶⁾ Figures 5 and 6 show the schematics for some of the first pullout equipment.

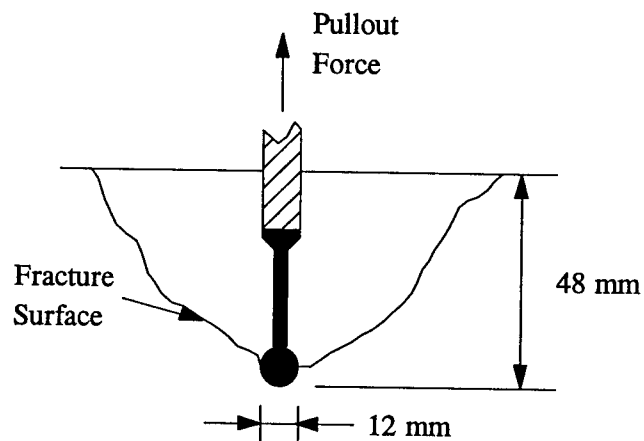

Figure 5. Configuration of early pullout device.

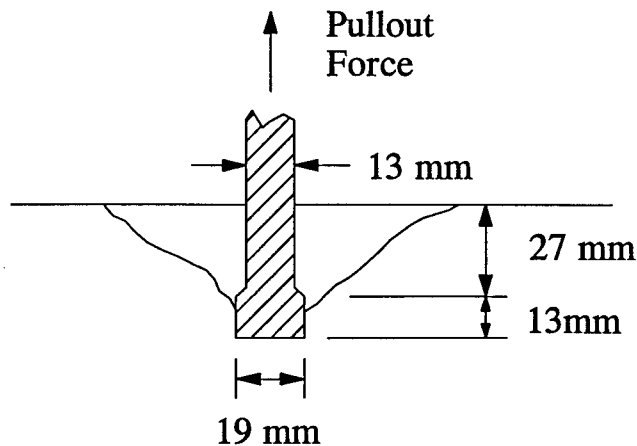

Figure 6. Configuration of early pullout device.

In 1962, Kierkegaard-Hansen initiated a research program to determine the optimum geometry for the pullout test. The objectives of this research program were to develop simple equipment that could be used in the field and also have a high correlation between the ultimate pullout force and the compressive strength. According to Kierkegaard-Hansen, the embedment depth should be sufficient to assure that more than the outer-most surface of the concrete is tested and some coarse aggregate is included within the failure cone. This suggests that a deeper embedment is better. However, with increasing depth, the force required to pull out the insert also increases, which would require bulkier equipment and a larger failure area. Based on these factors, an embedment depth of 50 mm (1 in) was chosen arbitrarily.⁽⁶⁾

Kierkegaard-Hansen also performed a number of tests in an effort to establish the optimum diameter to be used for the insert head and the bearing ring. Because a suitable tension loading system did not exist, a lab compression machine was used to apply the load. The insert was tested by applying a compressive load to the bottom of the embedded disk. Figure 7 graphically shows that the test can also be considered as a punching-type test. The Danish word for punching is “lokning.” Therefore, the quantity measured by the test was called “lok-strength” rather than the pullout strength. This is why the pullout test is sometimes referred to as the “LOK” test.⁽⁶⁾

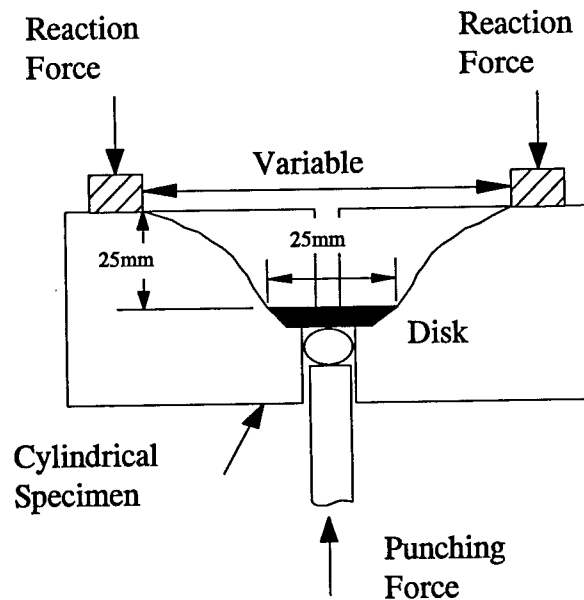

Figure 7. Test configuration for early tests by Kierkegaard-Hansen.

As a result of this research, the correlation between pullout strength and compressive strength was found to be nonlinear. In 1962, Kierkegaard-Hansen improved on the initial research by introducing a bearing ring. This modification resulted in a failure cone with a well-defined geometry that resulted in linear correlation between pullout strength and compressive strength.

TEST EQUIPMENT AND PROCEDURE

Figure 8 shows a schematic of the pullout insert. A force is applied to the insert by a loading ram that is seated on a bearing ring and is concentric with the insert shaft. The bearing ring transmits the reaction force to the concrete. As the insert is pulled out, a conical-shaped fragment of concrete is extracted from the concrete.

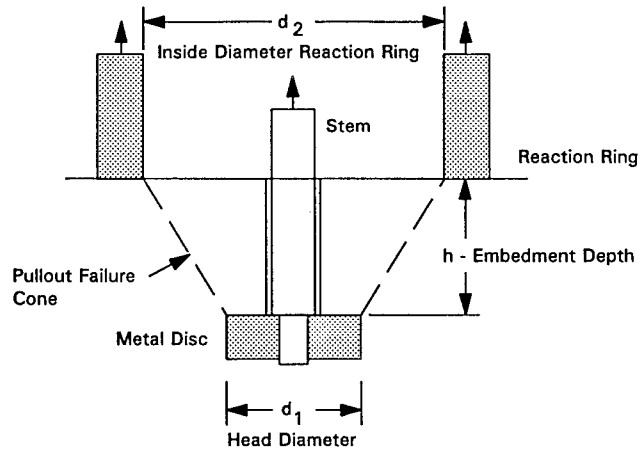

Figure 8. Schematic of pullout insert.

In the pullout test, a 25 mm (1 inch) diameter steel disc on a conical shaped stem is embedded at least 25 mm (1 inch) below the surface of the concrete during casting. A pull bolt is screwed into the stem of the disk and pulled by hydraulic force against a surface mounted reaction ring. The disk is loaded to failure by means of a hand operated portable hydraulic jack and the total force is measured on a gauge attached to the jack.

The pullout test can be used during construction to estimate the in-place strength of concrete to help determine whether construction activities such as form removal, application of post-tensioning, early opening to traffic, or termination of cold weather protection can proceed. Because compressive strength is usually required to evaluate structural safety, the ultimate pullout force measured during the in-place test is converted to an equivalent compressive strength by means of a previously established correlation relationship.

LABORATORY CALIBRATION PROCEDURE

Development of the correlation relationship between pullout force and compressive strength should be performed for each specific concrete mix to be used. To date, there are no standard procedures to establish the correlation data. However, suggested correlation procedures are provided below.

Various techniques have been used to acquire companion pullout strength and compressive strength data. Kierkegaard-Hansen placed pullout inserts in the bottoms of standard cylinder specimens. A pullout test was performed on the cylinder, and then the same cylinder was capped and tested for compressive strength. As long as the pullout test was stopped at the point of maximum load, a cone was not extracted, and the cylinder could be tested in compression without a significant effect on the results. However, for compressive strength above 40 MPa

(5800 psi), lower pullout strengths resulted for 150x300 mm (6x12-in) cylinders compared to companion slabs.

A recommended alternative method is to place inserts in slabs and cast companion standard cylinders. At designated ages, replicate pullout tests are performed on the slab and replicate cylinders are compression tested. **A drawback to this approach is to assure that the pullout tests and compression tests are performed at the same maturity.** Because of their different masses and shapes, the slab and cylinders are not likely to experience the same temperature history during the critical early stages when strength changes rapidly with age and is strongly dependent on temperature history. Failure to account for possible maturity differences can lead to inaccurate correlation relationships. Either maturity meters should be used to ensure companion testing at equal maturities, or compression tests should be performed on cores drilled from the slab. While the latter approach helps ensure equal maturities, it is time consuming. Refer to Chapter 7 in this guide for information on the maturity concept.

For commercially available pullout systems, having embedment depths of 30 mm (1.2 in) or less and apex angles of 70° or less, the preferred approach is to place inserts on the side faces of 200-mm (8 in) cubes and cast companion standard cylinders. Because of similar surface-to-volume ratios, the early-age temperature histories of the two types of specimens will be similar. The cubes and cylinders should be compacted similarly, and the use of an internal vibrator or a vibrating table is recommended.

American Concrete Institute (ACI) Committee 228 recommends in its “In-Place Methods for Determination of Strength of Concrete,” ACI 228.1R-89, performing eight replicate pullout tests and two cylinder compression tests at each test age. These numbers of tests ensure that the average pullout strength and average compressive strength are determined with about the same degree of certainty. By placing four inserts in each cube, this recommendation requires two cubes and two cylinders at each age. The specimens should be moist-cured until the time of testing.

The number of pullout and compression tests chosen to establish the correlation relationship should satisfy two needs: (1) the tests should span as wide a range of strength as possible, and (2) there should be enough points to define the relationship with a reasonable degree of accuracy. Based on field experience, Bickley suggested that the range of compressive strength should be at least 20 MPa (3000 psi) but preferably greater than this.⁽⁷⁾ ACI Committee 228 recommends performing companion tests at a minimum of six evenly spaced strength levels. Generally, if test ages are increased by a factor of two there will be about the same strength increase between successive tests.⁽⁶⁾ For example, tests at ages of 1, 2, 4, 8, 16, and 32 days should result in approximately evenly spaced test points. This assumes a constant temperature during the curing period. If pullout tests will be used to estimate in-place strengths at very low levels, the first test age should be reduced to 12 hours. This will require special care in handling low-strength specimens. Thus the recommended correlation testing program involves casting at least 12 cubes, with 4 inserts per cube and 12 cylinder specimens. The inserts in two cubes and two cylinders are tested at each test age so as to produce evenly spaced points when correlation data are plotted. The average of the pullout strengths and compressive strengths are used in a least squares fit analysis to develop the correlation relationship.

FAILURE MECHANISM

The pullout test subjects the concrete to a static load. Therefore, it should be possible to calculate the internal stresses in the concrete and predict the onset of cracking and the ultimate pullout force. This is desirable so that the ultimate pullout force can be related to the strength properties of concrete. Unfortunately, the stress distribution is not easy to calculate because the stresses are altered by the presence of coarse aggregate particles. There is not a consensus on the failure mechanism at the ultimate load. One theory is that the ultimate load occurs as a result of compressive failure of concrete along a line from the bottom of the bearing ring to the top face of the insert. The other theory is that the ultimate failure is governed by aggregate interlock across the secondary crack system, and the ultimate load is reached when a sufficient number of aggregate particles have been pulled out of the matrix.

Based on review of various analytical and experimental investigations that had been conducted, Krenchel and Bickley concluded that the failure mechanism of the pullout test involves the following stages⁽⁷⁾ (see figure 9):

Stage 1 - At a load of about 30 to 40 percent of the ultimate, “tensile cracks” originate at the corner of the insert head and propagate into the concrete for a distance of 15 to 20 mm (0.6 to 0.8 in) forming an apex angle between 100 and 135° (see figure 9(a)). This cracking concentrates subsequent straining of the concrete so that “all load is taken up in the truncated zone” between the insert head and the bottom of the bearing ring.

Stage 2 - A large number of stable micro-cracks develop in the truncated zone, These cracks run from the top of the insert head to the bottom of the bearing ring, forming an apex angle of about 84° (see figure 9(b)). This second-stage cracking occurs as the load increases up to and just past the ultimate load. These stable microcracks are analogous to the vertical microcracks observed during an ordinary uniaxial compression test of a cylinder or prism.

Stage 3 - Beyond the ultimate load, a circumferential “tensile/shear” crack develops that forms the final shape of the extracted cone (see figure 9(c)).

Despite the lack of agreement on the exact failure mechanism, it has been shown that the pullout strength has good correlation with the compressive strength of concrete and the test also has good repeatability.

WITHIN-TEST VARIABILITY

Within-test variability, also called “repeatability,” refers to the scatter of results when the test is repeated on identical concrete using the same test equipment, procedures, and personnel.⁽⁶⁾ For a given concrete, the repeatability of a test affects the number of tests required to establish, with a desired degree of certainty, the average value of the property being measured by the test.

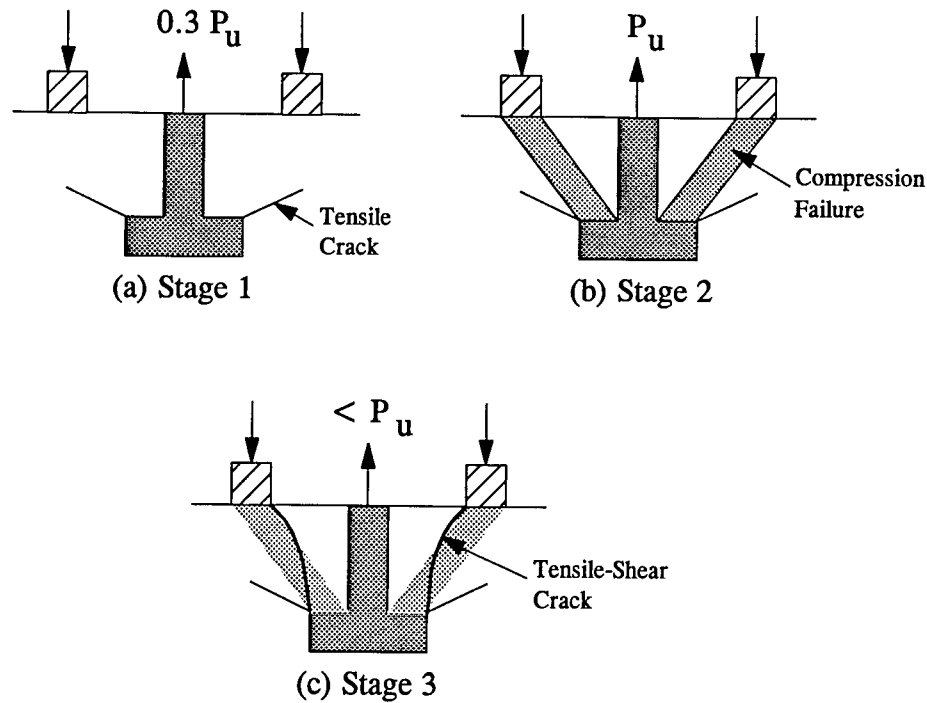

Figure 9. Failure mechanism of pullout test according to Krenchel and Bickley.

If pullout tests are repeated on the same concrete at the same maturity, the ultimate pullout loads would be expected to be normally distributed about the average value and the standard deviation would be the measure of repeatability. However, if replicate tests were performed on the same concrete but at different maturities, so that there would be different average pullout strengths, it has been generally agreed among several investigators that the coefficient of variation is the better statistic for quantifying the repeatability of the pullout test. Reported values of the coefficient of variation, for different aggregates and test configurations, have ranged from about 4 to 15 percent with an average value of about 8 percent. The maximum size of the aggregate in relation to the embedment depth appears to be a significant factor. Tests on concrete made with coarse aggregate having a maximum size less than the embedment depth tend to have lower variability.⁽⁷⁾

FIELD TESTS

To estimate in-place strength, pullout tests are performed on a particular part of the structure and the correlation relationship is used to convert the test results to a compressive strength values. To determine if sufficient strength has been attained, the estimated compressive strength is compared with the required strength in the specifications. However, to provide for a margin of safety, the pullout test results need to be looked at statistically rather than simply comparing the average estimated in-place strength with the required strength.

Number of Tests

ASTM C 900 requires a minimum of five pullout tests for every 115 m³ (150 yd³) of concrete, or in case of slabs or walls for every 465 m² (5000 ft²) of the surface area of one face. However, a greater number of inserts is recommended for added reliability and as a safety measure in the event testing is begun too soon or some of the tests were considered invalid.

Some investigators have suggested that a minimum of ten pullout tests should be performed for a given concrete placement. As a practical matter, Bickley advocated the placement of 15 inserts per 100 m³ (130 yd³).⁽⁹⁾ When the anticipated desired strength level is reached, five inserts are randomly selected for testing. If the results indicate less than the required strength, testing is discontinued and additional curing is provided. At a later age, the remaining 10 inserts are tested. This technique provides for a reserve in the event that testing is done too soon. It is recommended that the maturity method be used to determine the appropriate time to perform the pullout tests, therefore reducing the possibility of doing the pullout tests too soon.

TYPICAL APPLICATIONS

The pullout test has been adopted as a standard test method in many parts of the world, including North America, and has been used successfully on numerous large construction projects. Primary use of the system has been in either controlling formwork removal and the time of post-tensioning, or determining the minimum amount of curing needed in cold-weather concreting. The system has been used on cooling towers, chimneys, multi-story building frames, pipelines, bridges, and other forms of construction.

CAPO (CUT AND PULLOUT)

A disadvantage of the standard pullout test is that the locations of the inserts must be planned in advance of concrete placement so that the inserts can be fastened to the formwork or floated in from the surface. In an effort to extend the application of pullout testing to existing structures, the CAPO technique has been developed. It should be noted however that the CAPO test method has not been approved as an ASTM standard test method.

This technique involves drilling a 18 mm (0.7in) diameter hole into the concrete. A special concrete router bit is then used to route a 25 mm (1in) diameter slot at a depth of 25 mm (1 in). An expandable metal washer is placed in the hole and the ring is expanded. Figure 10 shows a schematic of the equipment. The expanded washer is then pulled out of the concrete using the same loading system as that used for an ordinary pullout test. Attempts at using the CAPO test in the field have indicated that the test is cumbersome and has high variability. This high variability is probably due to the need for a flat concrete surface that is perpendicular to the drilled hole. If these conditions are not achieved, the bearing ring will not seat properly and test results will be erratic.

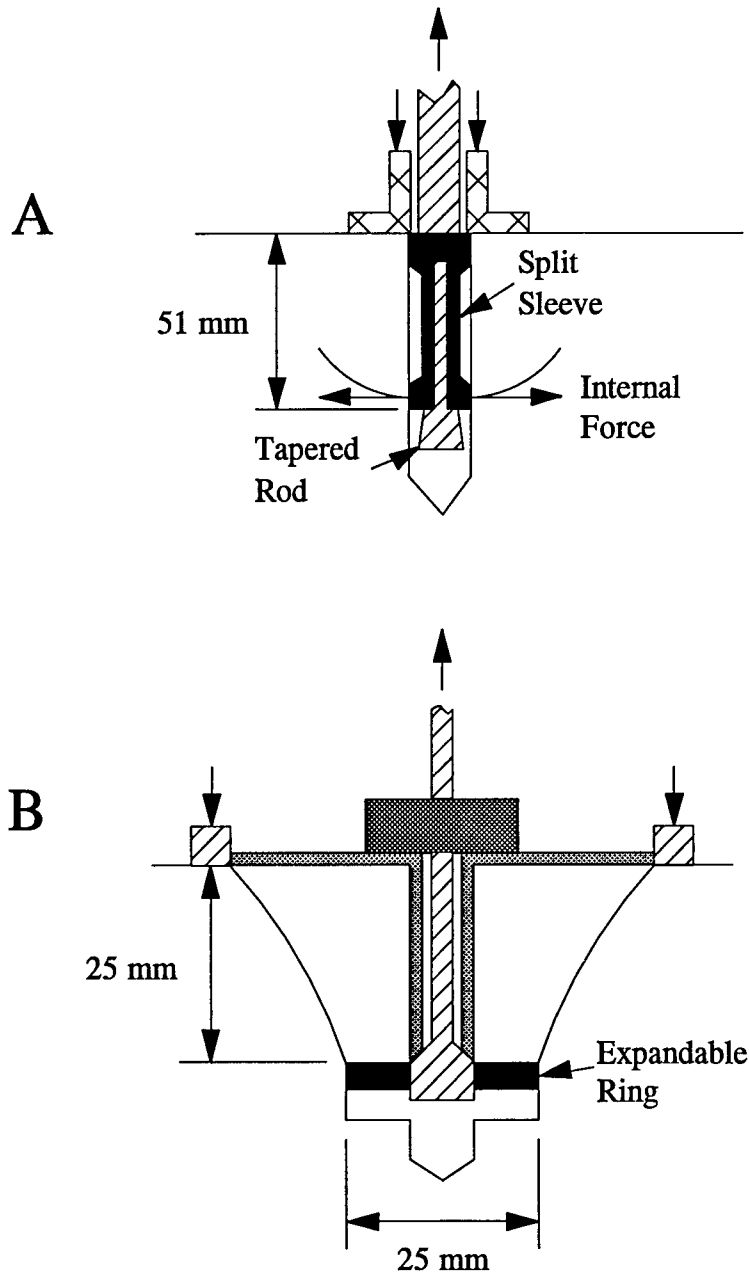

Figure 10.
 A) Drilled-in test using split-sleeve and tapered bolt.
 B) CAPO test using rounded shoulder and expandable washer.

CHAPTER 5

BREAK-OFF TEST

BACKGROUND

Out of the many currently available NDT methods, only the break-off and the pullout tests measure a direct strength parameter.⁽¹⁰⁾ The break-off test consists of breaking off an in-place cylindrical concrete specimen at a failure plane parallel to the finished surface of the concrete. The cylindrical specimen is formed either by inserting a plastic sleeve into fresh concrete or by drilling a core after the concrete has hardened (see figures 11 and 12). The break-off stress at failure can then be related to the compressive strength or flexural strength of concrete using a predetermined relationship which relates the concrete strength to the break-off strength for a particular concrete mix. The break-off test is not very widely used in North America. The primary factor in limiting the widespread use of this method being the lack of necessary technical data and experience in North America. Initial work at the Canada Centre for Minerals and Energy Technology (CANMET) in the early 1980s indicated a lack of reproducibility in results of this test method.⁽¹⁰⁾

The break-off test was developed at the Norwegian Technical Institute by Johansen in 1976, and in his first paper he indicated that this method was a very efficient way of determining the in-place concrete strength for form removal. In 1977, researchers at the Norwegian Technical University and the Research Institute for Cement and Concrete in Norway developed and patented the break-off tester as a method for determining the in-place compressive strength of concrete.

In 1979, Dahl-Jargensen and Johansen published a paper on the use of the break-off method to detect the variation in concrete strength and curing conditions.⁽¹¹⁾ The paper discussed the research results of a comparison between the break-off method and the pullout method. The break-off results and compressive strength results from cores were able to detect variations in curing conditions; however, the pullout test was not as effective at detecting curing differences.

In 1980, Byfors published research results that used the break-off method to test concrete at early ages. Byfors tested concrete with different water/cement ratios and different size aggregates. He was able to conclude that the break-off method is well suited to detecting low-strength concrete made with different size aggregate and varying water/cement ratios.

In 1987, Naik et al. conducted a comprehensive laboratory investigation of the break-off test method at the University of Wisconsin-Milwaukee.^(12, 13, 14) This was the first known research that studied the effects of the method used to obtain a break-off test specimen. Plastic sleeves were inserted into fresh concrete and cores were drilled in hardened concrete. The effect of aggregate shape and slab thickness on the break-off test results were also studied. Furthermore, they investigated the use of the break-off test for determining the in-place strength of 27 MPa (4000 psi) concrete as well as concrete ranging in compressive strength between 41 MPa (6000 psi) and 55 MPa (8000 psi). A total of 524 tests were run under this research. They concluded that the break-off results for crushed aggregate generally averaged 10 percent higher than those for rounded aggregates. Also, the results for the crushed aggregate were less variable. The drilled



Figure 11. Tubular plastic sleeves for inserting into fresh concrete for the break-off test.

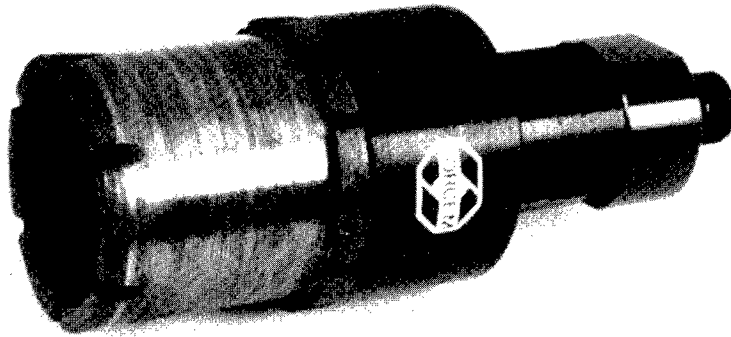

Figure 12. Core drill bit for drilling a core for break-off testing.

core break-off test results averaged 9 percent higher than the inserted sleeve method. Both methods, however, showed good correlation with the compressive strength of in-place concrete and yielded consistent break-off test results.

TEST EQUIPMENT AND PROCEDURE

The break-off tester, figure 13, consists of a load cell, a manometer, and a manual hydraulic pump capable of breaking a cylindrical concrete specimen 55 mm (2.17 in) diameter and 70 mm (2.76 in) long, as shown in figure 14. The load cell has two measuring ranges: low range setting for low-strength concrete up to approximately 20 Mpa (3000 psi) and high range setting for higher strength concrete up to about 62 Mpa (9000 psi). The manufacturer also provides a calibrator for calibration and adjustment of the break-off tester (figures 15 and 16).

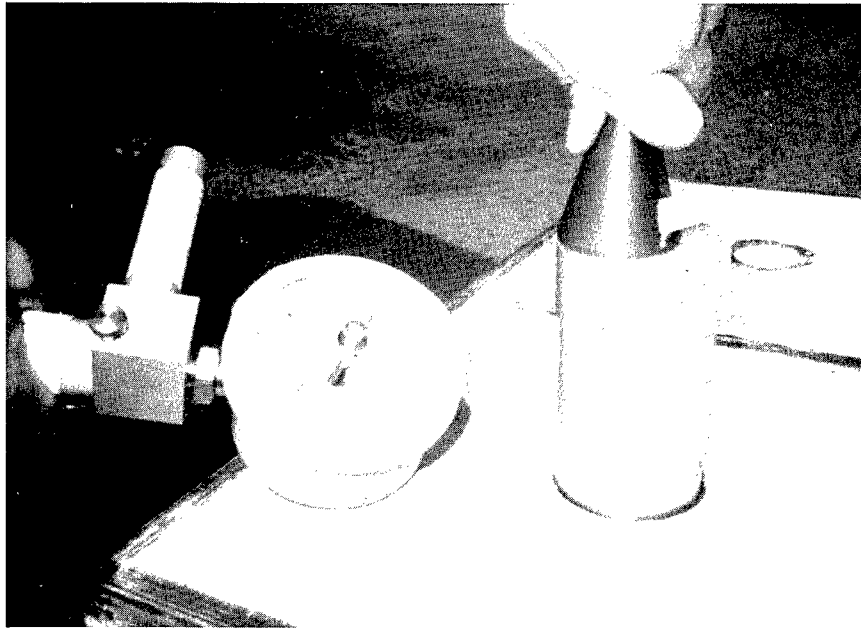

Figure 13. Break-off test equipment: (1) load cell, (2) manometer, and (3) hydraulic hand pump.

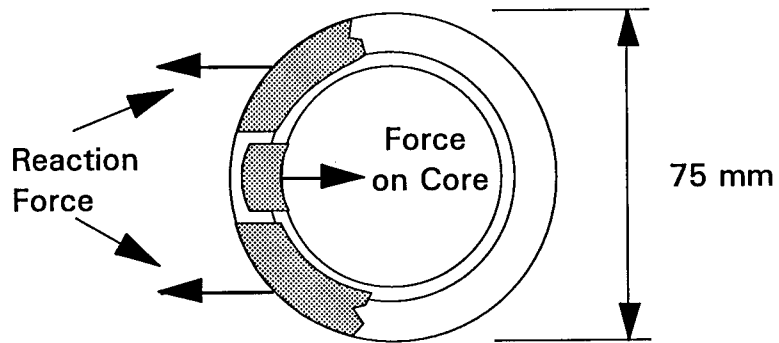
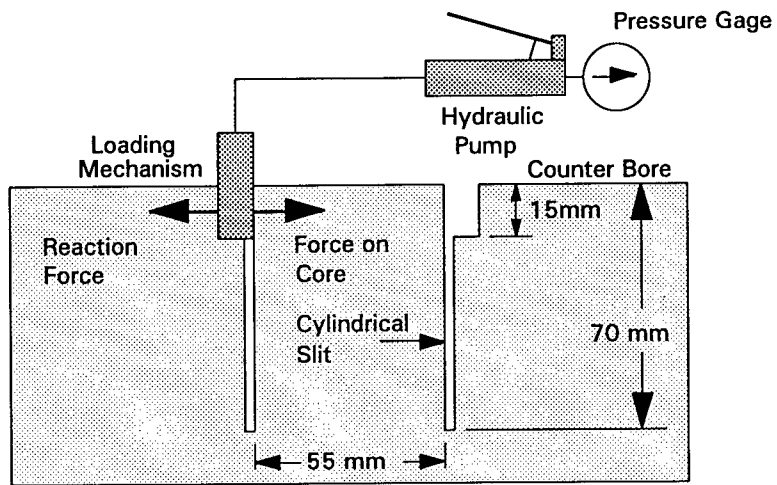

Figure 14. Schematic of cylindrical slit and application of load for break-off test.

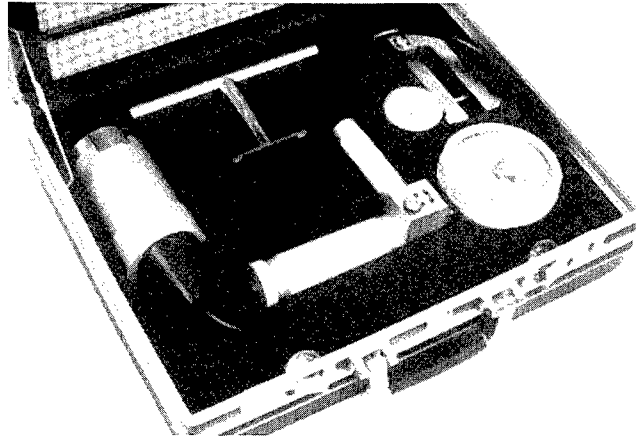

Figure 15. Break-off tester calibrator.

Inserting Sleeves Into Fresh Concrete

The break-off test locations should be separated so that the center-to-center distance between the sleeves and the distance between the sleeves and the edge of the concrete member is at least 150

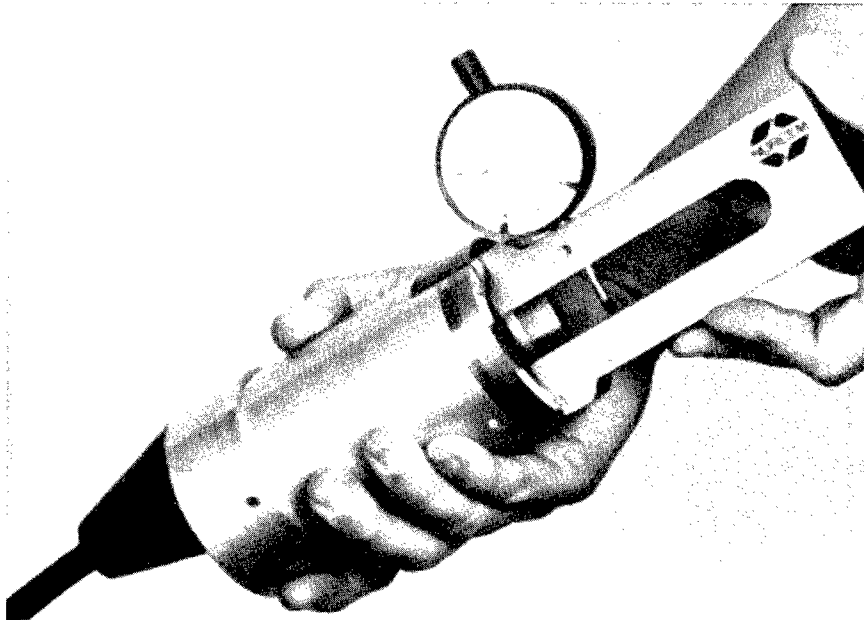

Figure 16. Calibrator placed in the load cell.

mm (6 in). See figure 17 for an example of the plastic sleeves in place. At each test location the sleeve should be coated with heavy grease or other form of release agent for easier removal after the concrete hardens. The plastic sleeves are best inserted by simultaneously rocking and twisting the sleeves into the concrete until the top is flush with the concrete surface. Concrete inside the sleeve, as well as the plastic sleeve, should then be tapped by fingers to insure good compaction of the test specimen. The sleeves then should be moved gently up and down in-place

and brought to the same level as the concrete surface. For concrete with a slump less than 75 mm (3 in), a slight depression may occur in the center of the sleeve during the insertion process. If this occurs, the depression should be filled with additional concrete, tapped in by fingers, slightly jiggled from side to side, and the surface struck off flush. On the other hand, for high slump mixes the sleeve may move upward due to bleeding. In such cases, the sleeves should be gently pushed back into place, as necessary, flush with the finished concrete surface. If the sleeve continues to move upward, a small weight may be placed on top of the sleeve to prevent additional movement.

Preparation of Cylindrical Specimens by Coring

The drilling equipment should be set up, using a vacuum plate or bolt to ensure rigidity, so that the core drill is perpendicular to the concrete surface. The drilling should continue until a cantilever cylindrical core 70 mm (2.76 in) long, with a groove at the top of the core to hold the

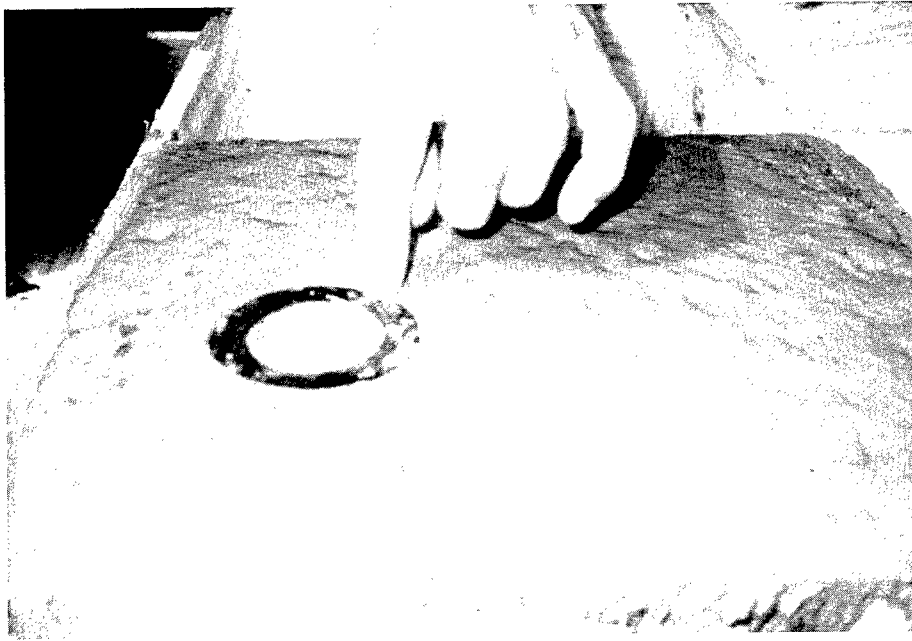

Figure 17. Plastic sleeve inserts placed in fresh concrete.

load cell. A special core barrel is available to achieve this configuration. A slightly longer drilled core will affect the break-off reading.

Calibration Procedure for Break-Off Tester

The equipment should be checked for calibration preferably before each use or at the start of each day. To check the calibration of the equipment, perform the following steps:

1. Set the calibrator gauge to zero.
2. Place the calibrator in the load cell unit (see figures 15 and 16).
3. Set load cell on *high setting*.
4. Pump handle until manometer pressure of 100 bars is obtained.
5. Record the dial gauge reading on the calibrator gauge and compare it to the manufacturer's calibration chart. Deviation within ± 4 percent is satisfactory and requires no adjustment.
6. Repeat the above procedure for 150 bars.

Performing the Break-Off Test

If the plastic sleeves were inserted into the concrete, remove the plastic sleeve using the sleeve removal tool, just prior to running the test. Leave the plastic ring in place. Remove all loose concrete or other debris from around the cylindrical slit and top groove of the concrete cylinder formed by either coring or plastic sleeve before testing. Select the desired range setting and place the load cell in the groove on top at the concrete surface ensuring that the unit is uniformly seated. The load should be applied to the test specimen at a rate approximately one stroke of the hand pump per second. This loading rate is approximately 0.5 MPa (70 psi) of hydraulic pressure per second. After breaking off the core, record the maximum reading on the pressure gage dial. This reading can then be translated to concrete compressive strength using pre-established correlation curves.

Evaluation of Test Specimens

Before accepting a particular reading, the core should be examined to insure a valid test. The failure plane should be approximately parallel to the concrete surface. The depth of the break must be 70 mm (2.76 in) from the finished surface. The presence of large aggregate particles, reinforcing steel, and other abnormalities such as soft aggregate particles or excessive air pockets (honeycombing) at the failure plane, could shift the rupture plane from its intended place. Such test specimen results should be discarded.

Drilled core specimens generally give higher readings than inserted sleeve specimens. This lower reading for sleeve specimens is due to the accumulation of bleed water under the bottom edge of the sleeve that would tend to create a weaker zone of concrete exactly where the failure plane for the break-off test occurs.

DEVELOPMENT OF CORRELATION CURVES

The manufacturer of the break-off equipment provides correlation curves relating the break-off results and the compressive strength of standard 150x300 mm (6x12 in) cylinders and 150 mm (6 in) cubes. See figures 18 and 19, which show the manufacturer's correlation curves. The numbers next to the cubes and cylinders in the figures are the dimensions in centimeters. This correlation is nonlinear and was empirically derived taking into account many variables. However, to increase the accuracy and dependability of the equipment, correlation curves should be developed for the concrete to be tested.

The following are precautions and steps to consider when developing correlations:

1. All center-to-center and edge distances for inserting plastic sleeves or drilling cores should be at least 150 mm (6 in)
2. A minimum of five break-off readings and three corresponding standard strength measurements, i.e., 150x300 mm (6x12 in) cylinders for compressive strength or beams for flexural strength, should be performed at each test age.
3. Test three cylinders in compression at specified ages (suggested ages 1, 3, 7, 14, and 28 days) according to ASTM C 39, and obtain the average cylinder strength for each test age.⁽¹⁵⁾
4. The average of the five break-off readings and the average of the three cylinder tests constitute one point on the correlation curve. Plot break-off readings vs. compressive strength for each test age.

TYPICAL APPLICATIONS

The break-off method can be used both as quality control and quality assurance tools. The most practical use of the break-off test equipment is for determining the time for safe form removal and the release time for transferring the force in prestressed or post-tensioned members.

BREAK-OFF TESTER

STRENGTH DIAGRAM

L-level

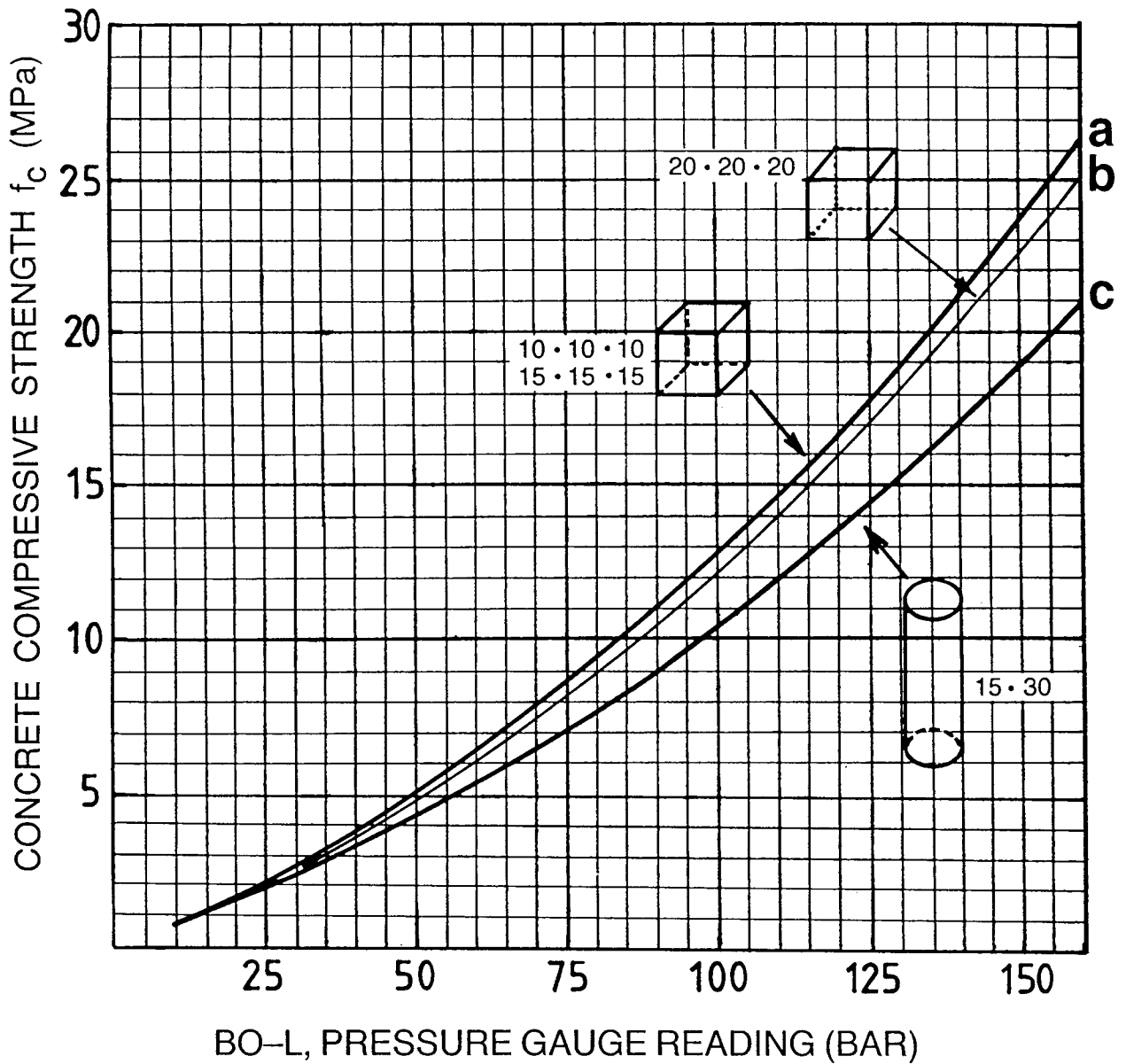

Figure 18. Strength diagram for "L-level."

BREAK-OFF TESTER

STRENGTH DIAGRAM

H-level

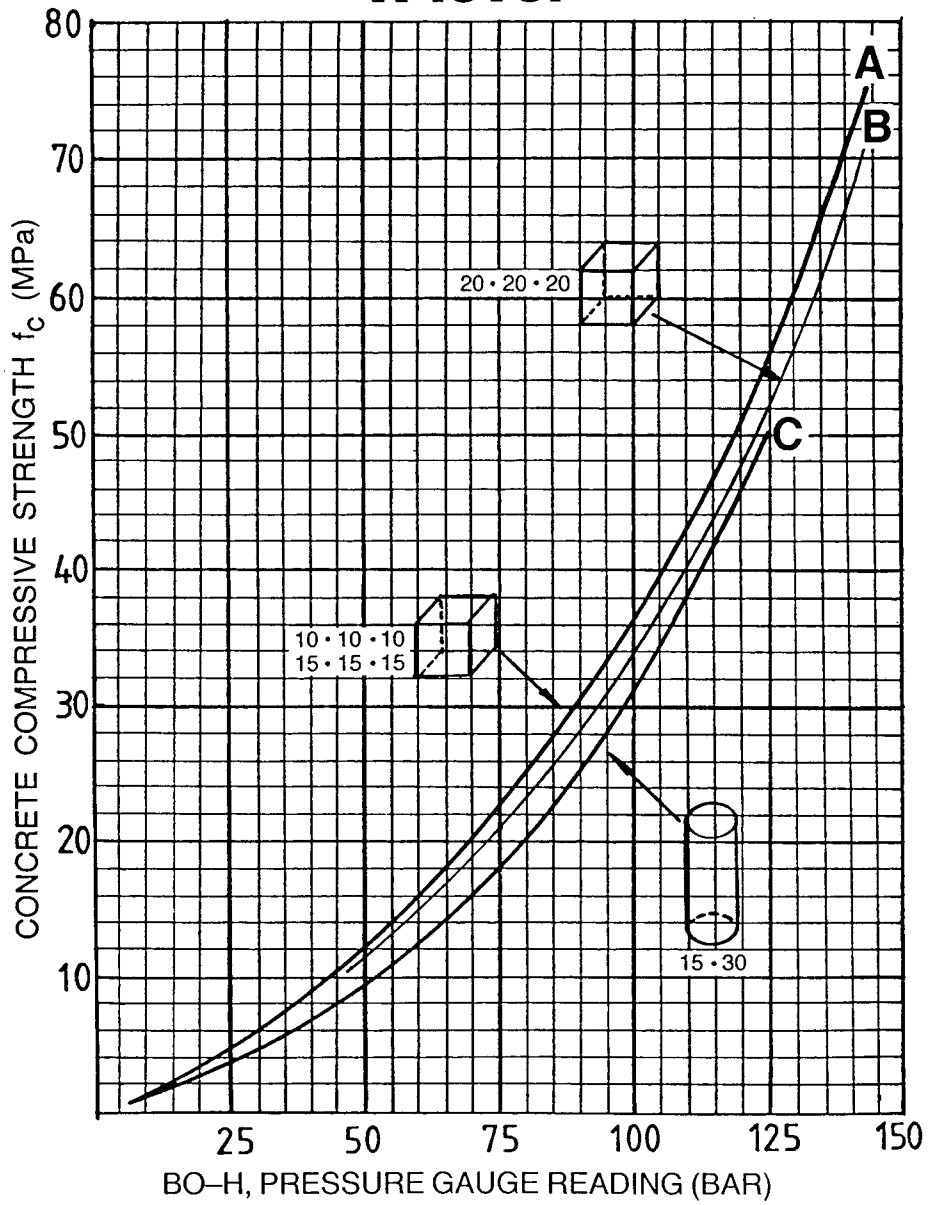

Figure 19. Strength diagram for "H-level."

ADVANTAGES AND DISADVANTAGES

The main advantage of the break-off test is its ability to measure in-place compressive strength. The equipment is safe and simple to use, and the test is quickly performed and requires only one exposed surface. Test specimens can be obtained by drilling cores, thereby eliminating the need to pre-plan test locations prior to concrete placement. The test is reproducible to an acceptable degree of accuracy and correlates well with the compressive strength of concrete. Two limitations of the break-off equipment are: (1) the maximum aggregate size is 19 mm ($\frac{3}{4}$ in) for the current equipment being used, and (2) the minimum thickness of a member to be tested is 100 mm (4 in). The major disadvantage of the break-off test is the damage to the concrete member that requires patching. However, this test is considered nondestructive because the test member does not have to be removed and replaced.

CHAPTER 6

TENSILE BOND STRENGTH TEST

The rehabilitation of concrete commonly requires the removal of deteriorated concrete and repair with a patch material and/or an overlay. To ensure long service of the rehabilitated concrete, it is imperative that the repair materials are well bonded to the underlying concrete. Proper surface preparation of the substrate is an important factor for the success of any repair. The tensile bond strength (pull-off) test is a quick, simple, and accurate method for determining how well the repair material is bonded to the underlying concrete.

BACKGROUND

There is not a lot of published material on the use of devices to measure the tensile bond strength of concrete. In 1984, A.E. Long and A.M. Murray reported about a pulloff test in which a metal disc was bonded to the concrete surface. A tensile load was then applied causing a tensile failure in the concrete.

The slant shear test method [ASTM C 882] uses concrete samples containing an overlay which have been prepared, cured, and tested under ideal conditions in the laboratory.⁽¹⁶⁾ The slant shear test was developed to determine the quality of a bonding agent, not the bond strength of an overlay in the field. This test is not suited to measure the in-place bond strength of cores containing an overlay.

The guillotine shear test requires that a core containing a bonded overlay be placed in a shear jig where a load is applied perpendicular to the core along the bond face. This test however must be run in the lab and is more variable than the tensile bond strength test method.

The results of these two tests can be used to evaluate the quality and strength of the bond; however, they do not represent actual field conditions. The tensile bond test can directly measure the strength and quality of the bonded repair material and can be used as a quality control tool for overlay, patch work, and shotcrete applications during concrete rehabilitation programs.

A test method suitable for field evaluation of the tensile bond strength of patched or overlaid concrete is discussed in the American Concrete Institute (ACI) report ACI 503R-93, "Use of Epoxy Compounds with Concrete."⁽¹⁷⁾

TEST EQUIPMENT AND PROCEDURE

Test equipment required to evaluate the tensile bond (pull-off) strength of a patch or an overlay to underlying concrete in a repair area consists of: (1) a dynamometer to measure the tensile load applied to a metal pipe cap or disc bonded with epoxy to the repaired surface, (2) 50 mm (2 in) diameter metal pipe caps with the bottoms machined smooth or 50 mm (2 in) diameter metal discs with threaded pull bolts, and (3) an electric core drill fitted with a carbide-tipped or diamond core drill capable of producing a cored disc 50 mm (2 in) in diameter. Figure 18 shows a commercially available tensile bond tester.

Two field tests are available for determining the need for surface preparation and the adequacy of surface preparation, as shown in figure 19. The first (simplified) test involves the application of a tensile load to a metal disc bonded to an uncured patch, and the second involves the application of a tensile load to a metal disc bonded to a patched or overlaid surface that has been subsequently cored.

Simplified Field Test for Surface Soundness

This test can be used to determine the need for surface preparation, detecting relative differences in potential surface strength over an area to be repaired, and to determine the adequacy of surface preparation. The procedures are as follows:

1. ***Determine Need for Surface Preparation.*** Thoroughly clean the bottom surface of a 50 mm (2 in) diameter aluminum disc by abrading with crocus or emery cloth being careful to water wash and dry before using. Bond the aluminum disc to the concrete surface using a fast setting epoxy compound mixed just prior to its use in accordance with the supplier's recommendations. The following day, or as soon as the epoxy has set, attach a testing device similar to the one shown in figure 19 to the pull bolt threaded to the disc. Apply tension at an uninterrupted, uniform rate [approximately 0.4 kN (100 lb) every 5 seconds], reading the tensile load on the dynamometer gauge. Record the load at which the disc is separated from the concrete surface and express it as unit stress. Note the type of failure as described below:
 - a. Failure in the concrete (cohesive concrete failure)
 - b. Separation of the epoxy compound from the concrete surface (adhesive failure)
 - c. Failure in the epoxy compound (cohesive resin failure)
2. ***Determine Adequacy of Surface Preparation.*** Clean the area, or portions thereof if a large area, according to the prescribed cleaning methods. Portions of large areas to be test cleaned should be sufficient in number to be representative of the total area and each portion should be large enough so that the cleaning equipment intended for the full-scale application can be used in a standard cleaning operation. Provision should be made for conducting the test at the rate of at least one test per 9.3 m² (100 ft²) of area to be repaired. The surface to be tested must be dry before proceeding.

Thoroughly clean the bottom surface of a 50 mm (2 in) diameter aluminum disc by abrading with crocus or emery cloth being careful to water wash and dry before using. Bond the aluminum disc to the concrete surface using a fast setting epoxy compound mixed just prior to its use in accordance with the supplier's recommendations. The following day, or as soon as the epoxy has set, attach a testing device similar to the one shown in figure 19 to the pull bolt threaded to the disc. Apply tension at an uninterrupted, uniform rate [approximately 0.4 kN (100 lb) every 5 seconds], reading the tensile load on the dynamometer gage. Record the load at which the disc is separated from the concrete surface and express it as unit stress. Note the type of failure as described below:



Figure 20. Commercially available tensile bond strength tester.

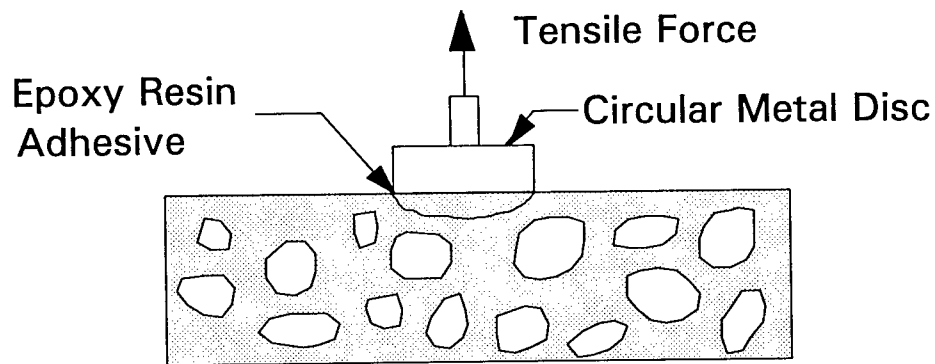

a) Method for testing uncored concrete

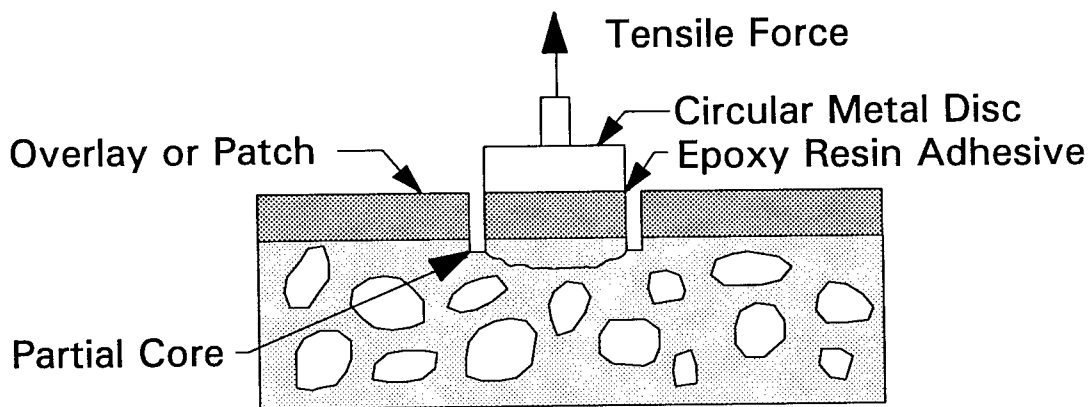

b) Method for testing partially cored concrete

Figure 21. Methods of testing uncured and cured patched or overlaid surfaces.

- a. Failure in the concrete (cohesive concrete failure)
- b. Separation of the epoxy compound from the concrete surface (adhesive failure)
- c. Failure in the epoxy compound (cohesive resin failure)

Field Test for Surface Soundness and Adhesion

Clean an area large enough so that the proposed cleaning equipment and cleaning techniques are consistent with what will be used during full-scale operations. By using a larger section this helps to eliminate the possibility of achieving a degree of cleanliness that is not economically feasible for full-scale production. The area selected for testing should represent the worst surface area to be repaired.

Apply a test patch following the same procedures as those to be used for full-scale production. The test patches should be placed in areas representative of the typical surface condition for the job. After the test patch has hardened, drill a partial-depth core through the material and barely into the substrate. The core bit should produce a cored disc 50 mm (2 in) in diameter. The depth of the core should extend beyond the bond line and into the original concrete material. See the

lower sketch in figure 18 for details. A metal disc with a threaded pull bolt is then bonded with a rapid-set epoxy to the top of the unbroken core. After the epoxy has cured, approximately one hour at 22 °C (72 °F), place an appropriate loading device similar to the ACI 503R device, or a commercially available device (figure 19).⁽¹⁷⁾ Use the loading device to apply a tensile force sufficient to pull the core out in tension. The total load applied divided by the cross-sectional area of the core is a direct measurement of the tensile bond strength. The load should be applied at the approximate rate of 0.4 kN (100 lb) every 5 seconds. Failure types include the following:

1. Failure in the concrete (cohesive concrete failure)
2. Separation of the epoxy compound from the concrete surface (adhesive failure)
3. Failure in the epoxy compound (cohesive resin failure)

Record the percent of each type of failure along with the load required to cause the failure. Tests should be performed in several areas representing the worst conditions to give a statistical estimate of results to be expected.

According to ACI, a tensile bond strength ≥ 0.7 MPa (100 psi) is required for satisfactory performance. Virginia DOT, for example, requires a minimum tensile bond strength of 1.7 MPa (250 psi) or a failure area—at a depth of 6 mm (0.25 in) or more into the base concrete—greater than 50 percent of the test area.

Since failure occurs at the weakest plane, this test not only provides an indication of the tensile bond strength, but also the location and type of failure. This information often provides valuable information, such as poor surface preparation, low bond strength, or microcracking due to surface preparation techniques.

TENSILE STRENGTH OF CONCRETE

One of the biggest disadvantages in concrete is its brittle nature and its inability to resist cracking due to direct tensile forces. Direct tensile strength of concrete ranges from 7 to 11 percent of its compressive strength. However, laboratory tests for direct tension are seldom carried out because of difficulties in mounting the specimens and secondary stresses induced by the holding device. The direct tensile/compressive strength ratio is 10 to 11 percent for low strength, 8 to 9 percent for medium strength, and 7 percent for high strength concrete.

COMPRESSIVE STRENGTH OF CONCRETE

The pull-off test, when used to predict the in-place compressive strength of concrete, involves bonding a metal disc to the surface of the concrete with a rapid-set epoxy adhesive. Before performing the test, the surface of the concrete to be tested should be abraded to remove any laitance and ensure a good bond between the metal disc and the concrete surface. Drill a partial depth core into the concrete. The core bit should produce a cored disc two inches in diameter. Sometimes adequate results have been obtained by bonding the metal directly to the cleaned surface without coring first. See figure 19 for details. A metal disc with a threaded pull bolt is then bonded with a rapid-set epoxy to the top of the unbroken core. See figure 20. After the

epoxy has cured, approximately one hour at 22 °C (72 °F), place an appropriate loading device similar to the ACI 503R device, or a commercially available device. See figures 21 and 22. Use the loading device to apply a tensile force sufficient to pull the core out in tension. The total load applied divided by the cross-sectional area of the core or the metal disc for uncured sections is a direct measurement of the tensile strength of the concrete. The load should be applied at the approximate rate of 0.2 kN (100 lb) every 5 seconds. Calibration graphs, based on pull-off tests and cube/cylinder compressive tests, provide a reliable estimate of equivalent cube/cylinder strengths.

TYPICAL APPLICATIONS

This test is important because it is performed *in-situ* and can be reliably used as a quality control tool. It is very useful for assessing the best procedure to be used for surface preparation for patches or concrete overlays, as well as determining whether a bonding agent is required and the effect of the bonding agent on the bond strength. The test also has been used to estimate the expected service life of overlays by measuring the degradation of bond strength with time.

CHAPTER 7

MATURITY TEST

The maturity concept is a useful technique for estimating the strength gain of concrete at early ages, generally less than 14 days old. The method accounts for the combined effects of temperature and time on concrete strength development. An increase in the curing temperature can speed up the hydration process which will increase the strength development. Maturity is a function of the product of curing time and internal concrete temperature. It is then assumed that a given mix at equal maturities will have the same strength, independent of the curing time and temperature histories.⁽¹⁸⁾

BACKGROUND

The strength of a given concrete mixture that has been properly placed, consolidated, and cured is a function of its age and temperature history. Temperature has a dramatic effect on the concrete strength development at early ages. This dependence on temperature presents a problem when an estimate of the in-place strength is based on strength development that has been collected under standard laboratory conditions.

In 1949, McIntosh introduced a term called “basic age,” which he defined as the product of time and temperature above a datum temperature of 1 °C (30°F). This is the first known introduction of the maturity concept. The temperature of 1 °C (30°F) was selected as the datum because it was thought to be the temperature at which cement hydration ceases.⁽¹⁸⁾ The results of McIntosh’s study show that:

1. “The strength of heated specimens at a given basic age is not independent of the maximum temperature; therefore, the assumption that rate of hardening is directly proportional to the difference of specimen temperature and the no-hardening temperature cannot be true; it appears that the reaction occurs more rapidly at higher temperatures than the simple relationship would suggest; and
2. heated concrete attains a larger portion of its strength at an early age, the period during which its temperature is near the maximum.”

In 1951, Saul introduced and defined the term “maturity” during his investigation on steam-curing of concrete at atmospheric pressure. His definition is as follows: “The maturity of concrete may be defined as its age multiplied by the average temperature above freezing that it has maintained.” From this definition he went on to develop the law of strength gain with maturity. The law states: “Concrete of the same mix at the same maturity (reckoned in temperature-time) has approximately the same strength whatever combination of temperature and time goes to make up that maturity.” Thus maturity is computed based on temperature history using the following equation:

$$M = \sum_0^t (T - T_0) \Delta t$$

where,

M = maturity at age t,

T = average temperature of the concrete during time interval Δt

T_0 = datum temperature

This equation is known as the *Nurse-Saul* function. In using this equation, only those time intervals in which the concrete temperature is greater than T_0 would be considered. Generally, a value of a -10°C (14°F) has been used as the datum temperature when using the Nurse-Saul equation.⁽¹⁸⁾

In 1953 Bergstrom analyzed previously published data to check the validity of the Nurse-Saul maturity law. He found that an excellent correlation exists between the strength and maturity functions. He warned about the indiscriminate application of the maturity concept to massive concrete structures because the rates of heat loss during the curing process would be different from those of standard specimens. Several other research efforts were carried out in the 1950s, resulting in several other mathematical representations of the maturity concept; however, the Nurse-Saul relationship remains the most widely accepted.

In 1956, Plowman presented a landmark paper on the maturity method.⁽¹⁹⁾ He made standard concrete cubes that were cured at temperatures varying between -11.5 and 18°C (61 to 64°F). Cubes were tested at regular intervals, and he demonstrated that for each mixture there was a unique relationship between strength and maturity. An important detail in Plowman's procedure was that all specimens were initially cured at a normal curing temperature (16 to 19°C [61 to 66°F]) for 24 hours before being exposed to the different curing temperatures. Thus, the early-age temperature histories of all specimens were identical and their long-term strengths were approximately equal. It was for this reason that Plowman was able to obtain unique strength-maturity relationships for each mixture. Two years later, Klieger also noted that initial curing temperature influenced the shape of the strength-maturity relationship.^(18,20)

After the publication of the maturity concept, several reports followed that supported the validity of the concept. However, there were also reports of cases where the concept was found to be invalid. Several time-temperature functions have been proposed that purportedly better account for the combined effects of time and temperature on concrete strength gain. One function, which has gained widespread acceptance in Europe, is based on the Arrhenius equation. The Arrhenius equation states: "The rate of a chemical reaction is proportional to a rate constant K, whose relationship to absolute temperature T, the gas constant R, and the activation energy E is given in the equation:

$$K = A^{(-E/RT)}$$

where,

K = rate constant

A = constant

E = activation energy

R = gas constant

T = absolute temperature

The constant “A” depends on whether the reaction is uni- or bi-molecular. The activation energy E depends on the properties of the cement, water/cement ratio, and aggregates in the concrete mixture. The maturity equation becomes:

$$t_e = \sum_0^t e^{-\frac{E}{R} \left[\frac{1}{273+T} - \frac{1}{273+T_r} \right] \Delta t}$$

where,

T	=	average temperature of concrete during the time interval Δt , C
T_r	=	reference temperature, C
E	=	activation energy, J/mol
		for $T \geq 20^\circ\text{C}$: E = 33500 J/mol
		for $T < 20^\circ\text{C}$: E = 33500 + 1470 (20 - T) J/mol
R	=	universal gas constant, 8.3144 J/ (mol K)

According to Carino from the National Institute of Standards and Technology (NIST), the Arrhenius equation is a better representation of the time-temperature function of the traditional equation when a wide variation is expected in the concrete temperature.⁽²¹⁾

In a report based on research that covered the properties of early-age concrete, Okamoto et.al. reported:⁽²²⁾

- Strength is a linear function of the logarithm of maturity. Thus, it is possible to express strength at any maturity as a percent of strength at any other maturity. The reference maturity is often taken to be 19,000 °C-hr (35,000°F-hr), the maturity of concrete cured at 18 °C (64°F) for 28 days. Research shows that there is an optimum temperature during the early life of the concrete that will lead to the highest strength at a desired age. In the laboratory, the optimum temperature of normal concrete has been determined to be about 13 °C (55°F), and for rapid-hardening concrete, around 4 °C (40°F). This is relevant only to the early life of the concrete; once initial setting has occurred and hardening has begun, temperature influences strength according to the maturity concept; higher temperatures accelerate early strength development.
- Initial setting occurs at the end of a dormant period, typically 2 to 4 hours after placement. As the C (calcium) and S (silicate) concentrations reach critical levels, the reaction rate accelerates, reaching a maximum about 8 to 12 hours after placement, bringing about final setting and initial hardening. Within 12 to 24 hours after placement, the reaction reaches a steady state in which hydration products continue to form slowly. This process, which contributes to long-term strength gain in the concrete, may continue for years.
- A disadvantage of the maturity method is that it does not account for relative humidity, which has a major influence on paste porosity and strength, as well as shrinkage in fresh concrete. Hydration of cement can take place only in the initially water-filled capillaries of the cement paste. The object of curing is to keep the concrete as nearly saturated as possible until the water is replaced by reaction products to the extent necessary to provide

the desired concrete strength. Excessive evaporation of water must be prevented at least until this level of strength is attained. Evaporation of water from the concrete depends on the ambient temperature, relative humidity, solar radiation, and wind velocity. Curing compounds effectively retain moisture in the concrete, but do not permit entry of additional water into the concrete; therefore, slower cement hydration will generally occur in membrane-cured concrete than in continuously moist-cured concrete.

A summary of the work done between 1900 and the early 1970s is as follows:⁽²²⁾

- Most of the early research dealing with the effects of different curing temperatures on the strength of concrete originated in the United States during the period 1904-1940. The majority of this work was done to study winter concreting; however, no attempt was made to establish relationships between strength and the combined effects of time and temperature. The time-temperature function known as maturity was the result of research efforts conducted in England and Europe during the period 1940-1960. The need for information on electric and steam curing in England appears to have been the driving force behind this research.
- Although modifications and limitations have been suggested by some, the Nurse-Saul equation appears to best describe the strength development in concrete.
- The exact datum temperature at which concrete ceases to gain strength is a matter of conflicting opinion. However, the temperature range which has found most acceptance is -12 to -10 °C (10 to 14°F).
- Although there is a lack of data concerning strength at low maturities (usually associated with accelerated strength testing) there appears to be some degree of correlation between various ASTM accelerated strength tests.
- Conventional age-strength relationships cannot be plotted when accelerated strength testing is being conducted. The problem is easily overcome by use of maturity-strength relationships.
- Generally, maturity functions have found little acceptance among concrete technologists. This is especially true in the area of bridges and pavements.

TEST EQUIPMENT AND PROCEDURE

It is essential that proper curing procedures be used to apply the maturity method for estimating strength development. If this is not the case, then strength estimates based upon the maturity method are meaningless. Application of the maturity method involves two steps: (1) laboratory calibration, and (2) actual measurement of time-temperature history of concrete placed in a structure. Because laboratory testing establishes the strength-maturity relationship for a particular mix, it must be performed prior to any field work.

In the field, the time-temperature history of concrete placed in a structure must be collected in order to determine in-place maturity. This in-place maturity is then used in conjunction with the

strength-maturity relationship to estimate the in-place strength. Careful consideration should be given in selecting appropriate locations for the temperature sensors.

Maturity Test Equipment

In order to determine concrete maturity, a temperature-time record of the in-place concrete must be kept. The most basic method of measuring concrete maturity would be to measure and record the in-place concrete temperature with a thermometer and measure the elapsed time with a watch. This method is very labor intensive, and is not economical or practical.

Several maturity devices are now available which continuously measure concrete temperature and calculate maturity at least once every hour. The meters can also display the maturity value digitally at any point in time. Some maturity meters can be set up to use either the Nurse-Saul or the Arrhenius equation. The choice of equation depends on the range of ambient temperature to which concrete will be exposed during curing. Depending on the meter being used, four to sixteen different locations can be monitored simultaneously.

Figure 22 shows the M-Meter, one of the most commonly used maturity meters. The M-Meter is a microprocessor-based, battery operated data collection system. It has six channels for temperature measurement, and calculates the maturity value for each channel for up to 240 hours of elapsed time. Depending on the model, the M-Meter uses either the Nurse-Saul or Arrhenius equation to calculate maturity. It also records the temperature for each channel every hour and can print out data on a battery operated printer. This device uses disposable thermistor probes to measure temperature changes in the concrete.

Figure 23 shows another concrete maturity meter, the System 4101 meter. This meter is also a microprocessor-based, battery operated data collection system. It has four channels for temperature measurement and saves the maturity value, based on either the Nurse-Saul or Arrhenius equation, for up to 327 days. It also has the ability to download the data to a computer, modem printer, or another meter. This device uses re-usable, low cost, type T thermocouple wire to measure temperature changes in concrete.

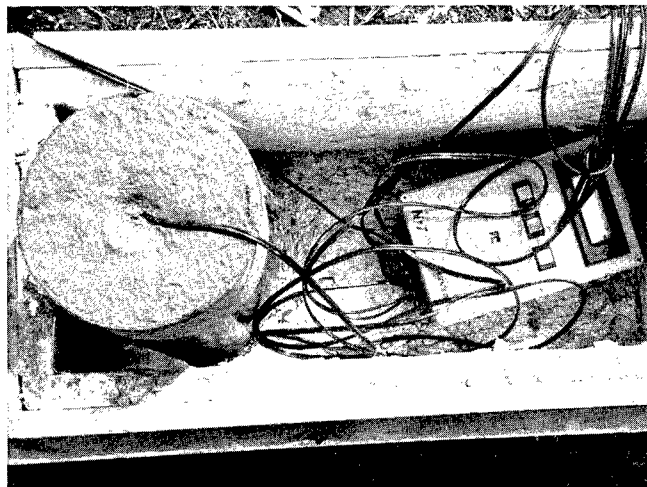

Figure 22. James maturity meter.

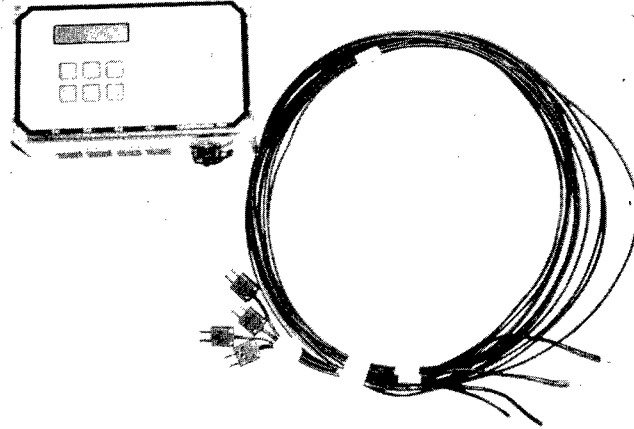

Figure 23. System 4101 maturity meter.

LABORATORY CALIBRATION PROCEDURE

Prepare a concrete mix, which will be representative of the concrete to be used for the project, according to procedures described in ASTM C 192⁽²³⁾. For each concrete mix tested, the following procedures should be followed:

1. Measure and record slump, air content, air and concrete temperatures, unit weight, and water/cement ratio.
2. Prepare a minimum of sixteen 150x300 mm (6x12 in) cylinders.
3. Insert a maturity probe into one of the cylinders at mid-depth; note the time of insertion and turn on the maturity meter.
4. Moist cure all of the cylinders as per ASTM C 192, including the cylinder containing the maturity probe. Keep the maturity meter outside of the moist room.
5. Compression test three cylinders at specified ages (suggested ages: 1, 3, 7, 14, and 28 days) and average the cylinder strength for each age.
6. Record the maturity value at the time cylinders were compression tested at each age.
7. Plot the average strength values vs. maturity for each age on semi-log graph paper, showing maturity on the x-axis and compressive strength on the y-axis, as described in ASTM C 918, "Standard Test Method for Developing Early-Age Compressive Strength and Projecting Later-Age Strength."

TYPICAL APPLICATIONS

The maturity method has numerous applications in concrete construction. It has been used successfully to estimate in-place strength of concrete to assure critical construction operations, such as form removal or the application of prestressing or post-tensioning force. It can also be

used to determine when traffic can be turned on to new pavement construction or the opportune time to saw joints in concrete pavement.

The method has also been used for laboratory work involving different size test specimens. Due to heat of hydration, specimens which have lower surface-to-volume ratios experience higher early-age temperature rises than specimens with higher surface-to-volume ratios. The maturity method is used to ensure that different-sized specimens are tested at the same maturity. Often in-place tests are performed on large specimens which experience higher early-age temperatures than companion cylinders. Failure to test the companion cylinders at the same maturity as concrete in the structure will result in an inaccurate correlation relationship.

Some of the more advanced maturity techniques, such as the Computer Interactive Maturity System (CIMS) can be used for quality control and concrete mix verification. Match-curing techniques utilize the concept of measuring *in-situ* heat development in a concrete structure and matching the temperature of the cylinders to that of the structure. This technique provides a more realistic strength evaluation of concrete in a structure.

ADVANTAGES AND DISADVANTAGES

The maturity method is a useful, easily implemented, accurate means of estimating *in-situ* concrete strength. Due to its simple application with the currently available maturity meters, the maturity concept should continue to grow in every area where knowledge of maturing concrete strength can be advantageously used to reduce construction costs and time schedules. In a time when public agencies and contractors are concerned with escalating costs and shrinking budgets, this method provides a viable means of reducing costs through testing and scheduling. Also, quality assurance costs can be reduced because the number the number of test cylinders is reduced by using the maturity concept.

CHAPTER 8

PULSE VELOCITY TEST

The ultrasonic pulse velocity method has been used successfully to evaluate the quality of concrete for over 50 years. This method can be used for detecting internal structure changes in concrete such as deterioration due to aggressive chemical environment, cracking, and changes due to freezing and thawing. By using the pulse velocity method it is also possible to obtain the dynamic modulus of elasticity, Poisson's ratio, thickness of concrete slabs, and estimate the strength of concrete test specimens as well as in-place concrete.⁽²⁴⁾

The pulse velocity method is a truly nondestructive method, as the technique involves the use of sonic waves resulting in no damage to the concrete element being tested. The same sample can be tested again and again, which is very useful for testing concrete undergoing internal structure changes over a long period of time or in cases where the early-age strength development is needed.

BACKGROUND

Over the last 60 years extensive research has been performed trying to develop nondestructive tests to determine properties of concrete. Beginning in the 1930s several test methods were proposed for use on laboratory test specimens using vibrational methods.

World War II accelerated the ongoing research dealing with sonic methods of NDT. Development of pulse velocity began in Canada and England at about the same time. In Canada, Leslie and Cheeseman developed an instrument called the ultrasonic tester. In principle, both of these instruments were quite similar, with only minor differences. Since the 1960s, pulse velocity equipment has moved out of the laboratories into the field.⁽²⁴⁾

THEORY OF WAVE PROPAGATION

Three basic types of stress waves are created when a solid medium is disturbed by a vibratory load. These waves are called longitudinal or *compression* waves, transverse or *shear* waves, and Rayleigh or *surface* waves. These stress waves travel through an elastic medium in a similar fashion as sound waves travel through air. Compression waves travel the fastest, followed by shear waves and surface waves. The velocity of these waves depends on the elastic properties of the material they are traveling through. Therefore, if the mass of the material and the velocity of the waves are known, the elastic properties of the material can be estimated.⁽²⁴⁾

In the ultrasonic pulse velocity test method an ultrasonic pulse is created at a point on the test object, and the time of its travel from that point to another is measured. Knowing the distance between these two points, the velocity of the pulse can be determined. Portable pulse velocity equipment available today for testing concrete measures the time of arrival of the first wave. This is the compression wave. The compression wave velocity for an infinite, homogeneous, isotropic, elastic medium can be shown to be:

$$V = (KE/D)^{1/2}$$

where:

- V = Compression wave velocity
- K = $(1-u)g/(1+u)(1-2u)$
- E = Modulus of elasticity
- D = Unit weight
- g = Acceleration due to gravity
- u = Poisson's ratio

The K value varies within a very narrow band. For example, for $u = 0.15, 0.20,$ and $0.25,$ $K = 10.9, 11.8 \text{ m/s}^2$ ($34.00, 35.78,$ and 38.74 ft/s^2), respectively. Therefore, an error in determining Poisson's ratio within 0.05 leads to an error in the calculated pulse velocity of about 6 percent.⁽²⁴⁾

TEST EQUIPMENT AND PROCEDURE

The test instrument introduces a pulse into the concrete using a pulse generator and a transmitter. A receiver detects the transmitted pulse, and a timer accurately measures the travel time of the pulse through the concrete. Most of the commercially available equipment can also be connected to a cathode ray oscilloscope (CRO). The oscilloscope is sometimes useful for looking at the stress waves which travel through the concrete. A schematic of the circuit diagram is shown in figure 24. A more complete description is provided in ASTM C 597, "Standard Test Method for Pulse Velocity Through Concrete." Most of the equipment is portable, commercially available worldwide, and simple to operate.

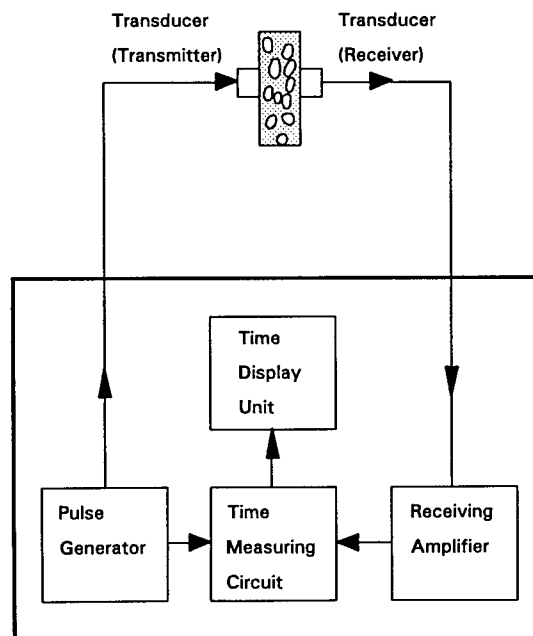

Figure 24. Schematic of pulse velocity device.

The transmitting transducer of the pulse velocity equipment generates a pulse on one face of the concrete and the receiving transducer detects the pulse after it travels through the concrete a distance L . The pulse velocity equipment displays the travel time, T , in microseconds (μs). The longitudinal vibration pulse velocity, therefore, is: $V = L/T$. The longitudinal vibration pulse transmitted to the concrete undergoes many reflections at various aggregate-mortar boundaries. By the time the pulse reaches the receiving transducer it has been transformed into a complex wave form, which contains compression waves and shear waves. Compression waves travel the fastest, reaching the receiver first.

In order to transmit or receive the pulse, the transducers must be in full contact with the test medium, otherwise the air pocket between the transducer and the test medium will introduce an error in the indicated transit time, because only a small amount of the pulse can be transmitted through air. Many couplants are available, such as grease, liquid soap, and Kaolin-glycerol paste. However, petroleum jelly has proven to be the most effective. The couplant should be spread as thin as possible so it will not affect the overall reading. Repeated readings at a particular location should be taken until a minimum value of transit time is obtained. If the concrete surface is very rough, then it should be ground smooth, or the surface should be made smooth through the application of a thin layer of plaster of Paris or a suitable quick setting mortar or paste.

The pulse velocity for ordinary concrete is typically of the order of 3660 m/s (12,000 ft/s). Therefore, for a path length of about 292 mm (11.5 in), the travel time would be approximately 80 microseconds (0.000080 seconds). It becomes obvious that the time must be measured very accurately for such a small transit time. The path length should also be carefully measured. Because pulse velocity measurements use a vibration technique, any sources creating even the slightest vibration in the element being tested, such as a jackhammer, should be eliminated during the time of test.

There are three possible ways that the transducers can be configured, as shown in figure 25. These are: (1) direct transmission; (2) semi-direct transmission; and (3) indirect or surface transmission and are described below.

- The *direct transmission* method (figure 25A) is the most reliable because the maximum energy of the pulse is transmitted and received using this arrangement.
- The *semi-direct transmission* method (figure 25B) can also be used successfully; however, care should be taken to keep the transducers not too far apart so that the transmitted pulse is not attenuated and, thus, not received. This method has been used in avoiding concentrations of reinforcing steel.
- The *indirect or surface transmission* method (figure 25C) is the least accurate because the amplitude of the received signal may only be about 3 percent or less than that received by the direct transmission method. This method is also more prone to errors. A disadvantage of this method is that a special procedure may be necessary for determining the pulse velocity (see figure 26). To determine the pulse velocity using this method, the location of the receiver is changed in fixed increments along a line while the location of the transmitter remains fixed. The direct distance between the two transducers is plotted on the X-axis, and the corresponding pulse transit time is plotted on the Y-axis. The slope of this plot is the surface pulse velocity along the line.

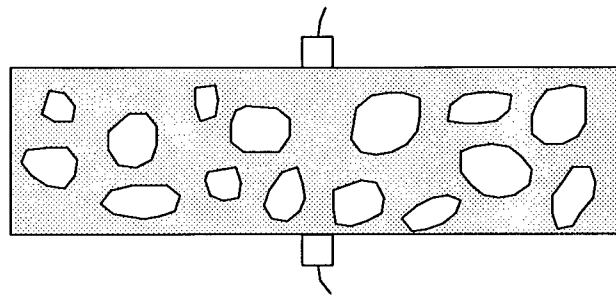

Direct
Method

A

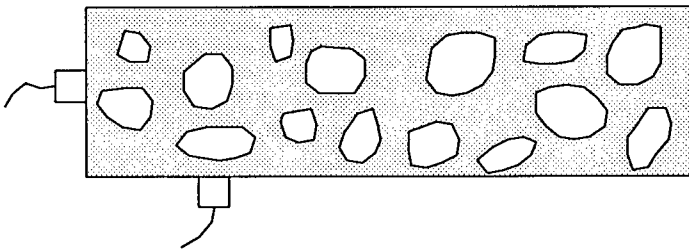

Semi-direct
Method

B

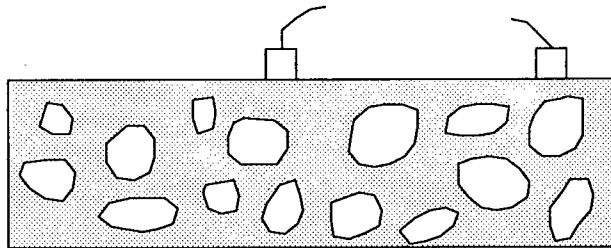

Indirect
Method

C

Figure 25. Methods of pulse velocity measurement.
(A) Direct method. (B) Semi-direct method.
(C) Surface method.

Another disadvantage of the indirect method is that the pulse propagates in the concrete layer near the surface. This concrete may consist of a slightly different composition than concrete in the lower layer. This disadvantage can sometimes be useful in detecting and estimating the thickness of a layer of different concrete quality. A layer of different concrete quality may occur due to poor construction practices (e.g., poor vibration and finishing, cold joints due to delay, incorrect placement, etc.), damage due to freeze-thaw, sulfate attack, alkali-aggregate reaction, corrosion of reinforcing steel, and fire. The thickness of this layer can be estimated using a procedure similar to the one described for determining surface pulse velocity. When two transducers are placed close together, the pulse travels through the upper layer of concrete, and as transducers are moved farther apart, the pulse travels through a deeper layer of concrete. The pulse velocity through the upper layer of concrete (V_1) and the lower layer (V_2) are indicated on a plot by the different slopes of the two straight lines fitted to the data (see figure 26). The distance X in figure 26 where the slope changes is measured and the thickness of the upper layer, t , is calculated using the following equation: $t = (X/2) [(V_2 - V_1)/V_2 + V_1]^{1/2}$. This method is particularly suitable where the upper layer is distinct and of reasonably uniform thickness.

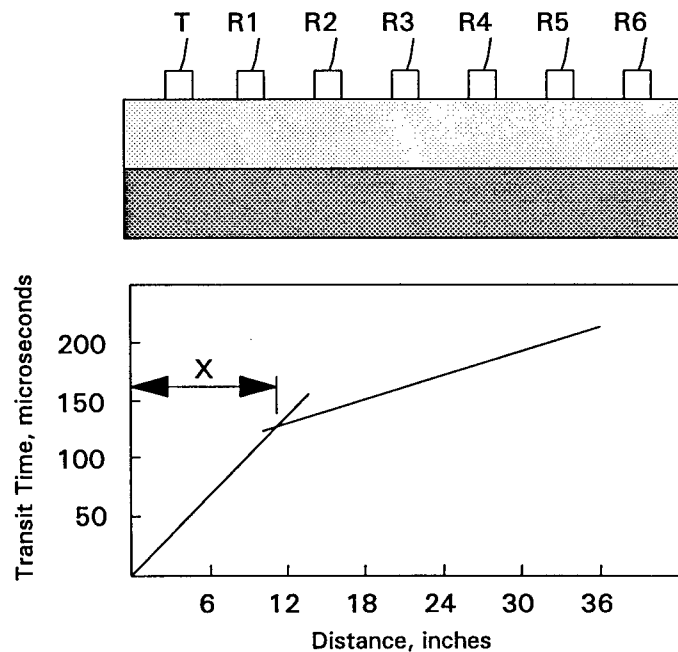

Figure 26. Use of surface method to determine depth of deterioration.

LABORATORY CALIBRATION PROCEDURE

Prepare a representative concrete mix, which will be used on the project, according to procedures described in ASTM C 192.⁽²³⁾ For each concrete mix, the following procedures should be followed:

1. Record slump, air content, air and concrete temperatures, unit weight, and water/cement ratio.
2. Prepare a minimum of fifteen 150x300 mm (6x12 in) cylinders.

3. Take pulse velocity readings end-to-end and record the value for each test cylinder to be compression tested.
4. Compression test three cylinders at specified ages (suggested ages: 1, 3, 7, 14, and 28 days) according to ASTM C 39⁽¹⁵⁾ and obtain the average cylinder strength for each test age.
5. Plot the average compressive strength and pulse velocity values, showing pulse velocity on the x-axis and compressive strength on the y-axis.

FACTORS AFFECTING PULSE VELOCITY

It is important that pulse velocity tests are conducted such that the pulse velocity readings are reproducible and that they are affected only by the properties of the concrete under investigation rather than other factors. The factors affecting pulse velocity can be divided into two categories: (1) factors affecting concrete properties that affect pulse velocity, and (2) factors affecting pulse velocity regardless of concrete properties.

Factors Affecting Concrete Properties

Aggregate size, grading, type, and content may affect the relationship between pulse velocity and compressive strength. For the same concrete mix at the same compressive strength level, pulse velocity may vary from lowest to highest in concrete with rounded gravel, crushed granite, and crushed limestone, respectively. At the same strength level, concrete with the highest aggregate content will probably have the highest pulse velocity.

Cement type does not appear to have a significant effect on pulse velocity; however, as the degree of cement hydration increases, strength increases and the pulse velocity will also increase.

Water/Cement ratio increase decreases pulse velocity because of decrease in density and in compressive and flexural strengths.

Admixtures will most likely influence pulse velocity in about the same manner as they influence the degree of hydration. Air entrainment does not appear to influence the relationship between pulse velocity and compressive strength.

Degree of compaction has a direct influence on pulse velocity. As the density of concrete decreases due to inadequate compaction, pulse velocity decreases.

Curing and age of concrete affect pulse velocity in a manner similar to their effect on concrete strength development. Moist-cured concrete has a higher pulse velocity than air-dried concrete. Pulse velocity and strength are similarly affected by age; therefore, the relationship between pulse velocity and strength is independent of age.

Factors Affecting Pulse Velocity (Regardless of Concrete Properties)

Acoustical contact must be good, or erroneous pulse velocity readings will be obtained.

Concrete temperature variations between 5 and 30°C (40 and 90°F) have an insignificant effect on pulse velocity. For temperatures outside this range, the corrections in table 1 are recommended.

Table 1⁽²⁴⁾
Corrections for Pulse Velocity Due to Temperature Changes

Concrete Temperature °C (°F)	Correction (percent)	
	Air Dried Concrete	Water Saturated Concrete
60 (140)	+5.0	+4.0
40 (104)	+2.0	+1.7
20 (68)	0.0	0.0
0 (32)	-0.5	-1.0
-4 (<25)	-1.5	-7.5

Concrete moisture conditions can also be corrected for using table 1. The effect of moisture condition has little effect on pulse velocity.

Path length has a slight effect on pulse velocity. In practice, smaller path lengths tend to give a slightly higher pulse velocity. RILEM has recommended the following minimum path lengths: (1) 100 mm (4 in) for concrete with maximum aggregate size of 30 mm (1.3 in), and (2) 150 mm (6 in) for concrete with maximum aggregate size of 45 mm (1.75 in).

Specimen size and shape in most cases do not affect pulse velocity; however, the equation $V = (KE/D)^{1/2}$ is valid only for a medium having an infinite extent. This requirement can be easily satisfied for a finite dimension test specimen by requiring the least lateral dimension of the specimen to be greater than the wave length of the pulse.

The wave length W is given by $W = V/f$, where V = pulse velocity, and f = frequency of vibration.

Assuming concrete has a pulse velocity of 3660 m/s (12,000 ft/s) and a transducer frequency of 54,000 cps, the wave length would be about 68 mm (2.7 in). Therefore, when taking pulse velocity readings with the standard 54 kHz transducers, the minimum lateral distance should be 68 mm (2.7 in). If this minimum lateral distance cannot be met, a higher frequency transducer should be used, thus reducing the wavelength and the corresponding minimum lateral dimension requirement. The maximum aggregate size should also be smaller than the wavelength, otherwise the wave energy will attenuate to the point that no clear signal may be received at the receiving transducer.

Level of stress in an element under test generally does not affect pulse velocity; however, when the level of stress is very high in a concrete test specimen (65 percent of the ultimate stress or greater), microcracks develop within the concrete and reduce the pulse velocity considerably.

Reinforcing steel in concrete subjected to pulse velocity measurements will cause the pulse velocity to be 1.5 to 2 times what it would be in normal concrete. Whenever possible, all test readings should be located so that the reinforcement is avoided within the path length. If the reinforcement is perpendicular to the path length, correction factors can be used. In heavily reinforced sections, it is next to impossible to obtain satisfactory pulse velocity readings.

TYPICAL APPLICATIONS

The pulse velocity method has been used successfully in the laboratory as well as in the field for quality control and quality assurance, as well as for the evaluation of deterioration.

Dynamic Modulus of Elasticity and Poisson's Ratio

One of the most direct uses, and theoretically the most correct use of the pulse velocity method, is in determining the dynamic modulus of elasticity and Poisson's ratio for concrete. The dynamic Poisson's ratio of concrete can be assumed to fall between 0.2 and 0.3 for most concrete. This assumed value will lead to an error of about 10 percent, or less, for the calculated dynamic modulus of elasticity.

Estimation of Concrete Strength

The pulse velocity method provides a convenient means of estimating the strength of concrete using a pre-established correlation between pulse velocity and compressive strength based on testing of 150x300 mm (6x12 in) cylinders. The relationship between pulse velocity and compressive strength is not unique, and is affected by many factors, such as aggregate size, type and percentage, W/C ratio, moisture content, etc. Therefore, it is important that a correlation be developed between pulse velocity and compressive strength for the concrete in question prior to any pulse velocity measurements on *in-situ* concrete.

Establishing Uniformity of Concrete

The pulse velocity method is an excellent application for assessing the uniformity of concrete and, therefore, the quality of concrete. The *in-situ* strength of concrete will vary in a structure due to variations in materials, mixing and supply of concrete, and placement, consolidation and curing of the concrete. When assessing the uniformity of concrete in a structure, a grid pattern is normally used. Depending on the amount of concrete to be evaluated and the accuracy required, a grid spacing of 300 mm (6 in) or greater is used. For most applications a spacing of 1 m (3.3 ft) works well.

Pulse velocity has also been used successfully to measure strength gain of concrete at early ages, monitor the progressive deterioration of concrete due to aggressive environments, and detect air-filled cracks and estimate the depth of perpendicular surface cracks.

ADVANTAGES AND DISADVANTAGES

The pulse velocity method is an excellent means for investigating the uniformity of concrete. The test procedure is simple and the equipment is readily available, portable, and it is as easy to use on the construction site and as it is in the laboratory.

Testing procedures have been standardized by ASTM and other organizations. Because the pulse velocity is truly nondestructive and several tests can be run in a short amount of time, this equipment is becoming more popular as a means for estimating early age concrete strength development.

A large number of variables can affect the relation between the strength properties of concrete and its pulse velocity; therefore, it is important that a correlation between pulse velocity and compressive strength be developed for project mixes prior to any measurements *in-situ*.

CHAPTER 9

IMPACT ECHO METHOD

BACKGROUND

The use of acoustic methods is one of the oldest methods used to nondestructively determine flaws in materials. Striking an object with a hammer and listening to the quality of the “ringing” sound has long been a useful technique for detecting cracks, voids, and delaminations in concrete structures.⁽²⁵⁾

In 1929, Solokov in the USSR first suggested the use of ultrasonic waves to find defects in metal objects. However, it was not until World War II spurred the development of sophisticated electronic instrumentation that significant progress was made. Ultrasonic pulse-echo flaw detectors were first introduced in 1942 by Firestone of the University of Michigan and, independently, by Sproule of England. Since then, ultrasonic pulse-echo testing of metals, plastics, and other homogeneous materials has developed into an efficient and reliable nondestructive test method.⁽²⁵⁾

The development of test techniques and equipment for ultrasonic evaluation of less homogeneous materials, such as concrete, was hindered by the difficulties inherent in obtaining and interpreting a signal record from a heterogeneous material. Because high frequency (1 MHz or greater) stress pulses cannot penetrate into concrete, none of the commercially available transducers were satisfactory for pulse-echo testing of concrete. An alternative approach is to generate low frequency stress pulses using mechanical impact. At present, there is no standard or routine method based on the use of stress wave propagation for finding flaws in concrete structures. Since 1980, there has been extensive research conducted in the use of stress wave propagation for detection of flaws in concrete at the National Institute of Standards and Technology (NIST) and Cornell University. Impact-echo equipment developed as a result of this research is currently available and is being evaluated in the field.

BASIC PRINCIPLES

Wave Types

When a stress such as an impact is applied suddenly to a solid, the disturbance that is generated travels through the solid as stress waves. There are three primary modes of stress wave propagation through isotropic, elastic media: dilational, distortional, and Rayleigh waves. Dilational and distortional waves, commonly referred to as compression and shear waves, or P- and S- waves, are characterized by the direction of particle motion with respect to the direction the wavefront is propagating. In a P-wave, motion is parallel to the direction of propagation; in the S-wave, motion is perpendicular to the direction of propagation. P-waves can propagate in all types of media; S-waves can propagate only in media with shear stiffness, i.e., in solids. Rayleigh waves, or R-waves, are waves that propagate along the surface of a solid. The particular motion in an R-wave near the surface is retrograde elliptical.

The wavefront defines the leading edge of a stress wave as it propagates through a medium. The shapes of the P-, S-, and R-wavefronts depend on the characteristics of the source used to generate the waves. There are three idealized types of wavefronts: planar, spherical, and cylindrical. For example, when the stress waves are generated by impact at a point on the surface of a solid, the resulting P- and S-waves are spherical and the R-wavefront is cylindrical.⁽²⁵⁾

Wave Speed

In most applications of stress wave propagation, the input is an impulse of finite duration and the resulting disturbance propagates through the solid as transient waves. The propagation of transient stress waves through a heterogeneous bounded solid, such as a structural concrete member, is a complex phenomenon. However, a basic understanding of the relationship between the physical properties of a material and the wave speed can be acquired from the theory of wave propagation in isotropic elastic media.

In infinite elastic solids, the P-wave speed C_p is a function of Young's modulus of elasticity E , the mass density ρ , and Poisson's ratio ν :⁽²⁵⁾

$$C_p = \sqrt{\frac{E(1 - \nu)}{\rho(1 + \nu)(1 - 2\nu)}}$$

The S-wave speed C_s in an infinite solid is given by the equation:

$$C_s = \sqrt{\frac{G}{\rho}}$$

where G = shear modulus of elasticity = $E/2(1-\nu)$.

R-waves propagate at a speed C_R , which can be determined from the following approximate formula:

$$C_R = \frac{0.87 + 1.12\nu}{1 + \nu} C_s$$

For Poisson's ratio of 0.2, the R-wave speed is 92 percent of the S-wave speed, or 56 percent of the P-wave speed.

Reflection and Refraction

When a P- or S-wavefront is incident upon an interface between dissimilar media, "specular" reflection occurs. (The term specular reflection is used because the reflection of stress waves is similar to the reflection of light by a mirror.) As shown in figure 27A, stress waves can be visualized as propagating along ray paths. The geometry of ray reflection is analogous to that of

light rays, that is, the angle of reflection of any ray is equal to the angle of incidence θ for that ray.

At a boundary between two different media only a portion of the stress wave is reflected. The remainder penetrates into the underlying medium (wave refraction). The angle of refraction β is a function of the angle of incidence θ and the ratio of wave speeds C_2/C_1 in the different media and is given by Snell's law:

$$\sin \beta = \frac{C_2}{C_1} \sin \theta$$

unlike light waves, stress waves can change their mode of propagation when striking the surface of a solid at an oblique angle. Depending on the angle of incidence, P-waves can be partially reflected as both P- and S-waves and can be refracted as both P- and S-waves. Since S-waves propagate at lower velocity than P-waves, they will reflect and refract at angles (determined using Snell's law) θ_s and β_s , that are less than the angles of reflection and refraction for P-waves, as shown in figure 27B.⁽²⁵⁾

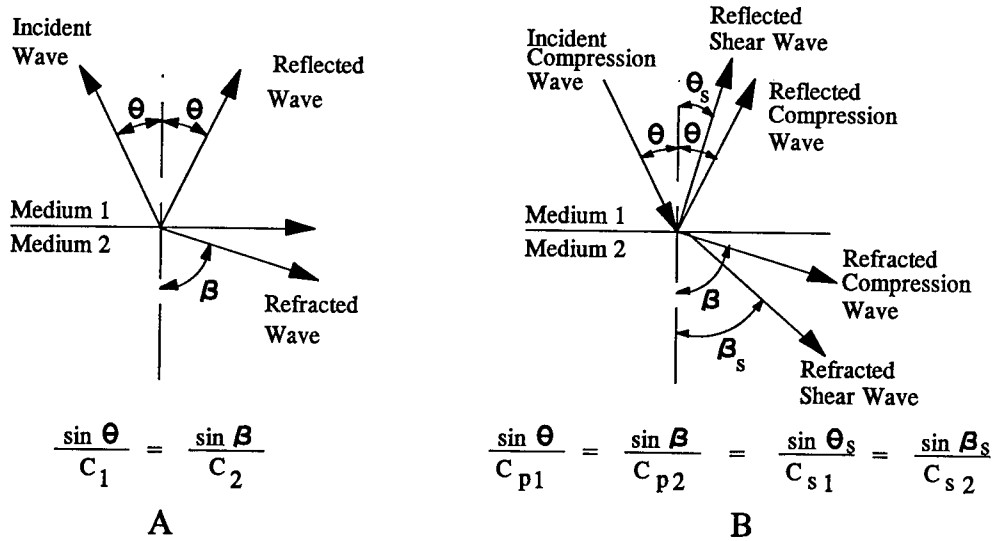

Figure 27. The behavior of a P-wave incident upon an interface between two dissimilar media: (A) reflection and refraction; (B) mode conversion.

TEST EQUIPMENT AND PROCEDURES

The impact-echo method was developed by Carino and Sansalone⁽²⁵⁾ for the testing of thin concrete structures.

Impact-Echo Method

The principle of the impact-echo technique is illustrated in figure 28. A transient stress pulse is introduced into a test object by mechanical impact on the surface. The stress pulse propagates into the object along spherical wavefronts as P- and S-waves. In addition, a surface wave (R-wave) travels along the surface away from the impact point. The P- and S-waves are reflected by internal interfaces or external boundaries. The arrival of these reflected waves, or echoes, at the surface where the impact was generated produces displacements that are measured by a receiving transducer and recorded on a digital oscilloscope. Because of the wave patterns associated with P- and S-waves, if the receiver is placed close (approximately 50 mm (2-in)) to the impact point, the waveform is dominated by the displacements caused by the P-wave arrivals. The success of the method depends on using the correct impact. The disadvantage of using an impact to generate the stress pulse is that the pulse does not have the directionality of a pulse from a large diameter transducer.⁽²⁵⁾

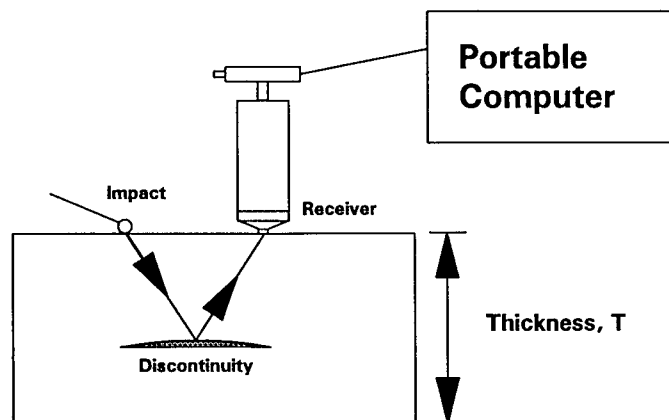

Figure 28. Principle of the impact-echo method.

Signal Analysis

For relatively thin structures, such as concrete slabs and walls, *time-domain analysis* can be used, but it is time consuming and gets complicated depending on the geometry of the structure being tested. Another approach, which is quicker and easier, is the *frequency analysis* of the displacement waveforms. In figure 28 the stress pulse, which is generated by the impact, travels back and forth between the flaw and the top surface. Each time the pulse reaches the top surface it produces a characteristic displacement. Therefore, the waveform is periodic, and the period is equal to the travel path, $2T$, divided by the P-wave speed. The frequency is the inverse of the period; therefore, the frequency, f , is:

$$f = \frac{C_P}{2T}$$

where C_p is the P-wave speed which has been determined from an impact-echo test performed in an area of the structure where the thickness is known. If the frequency content of a waveform can be determined, the thickness of plate (or distance to a reflecting interface) can be calculated:

$$T = \frac{C_P}{2f}$$

The frequency content of the digitally recorded waveforms is obtained by using the fast Fourier transform (FFT) technique, which states that any waveform can be represented as a sum of sine curves, each with a particular amplitude, frequency, and phase shift. See figure 29 for a typical frequency analysis for solid concrete and a section of concrete which contains a flaw.

Instrumentation

An impact-echo system consists of three main components: an impact source, a receiving transducer, and a waveform analyzer or a digital processing oscilloscope, which is used to capture the output of the transducer, store the digitized waveform, and perform the signal analysis. Figure 29 shows impact-echo equipment commercially available.

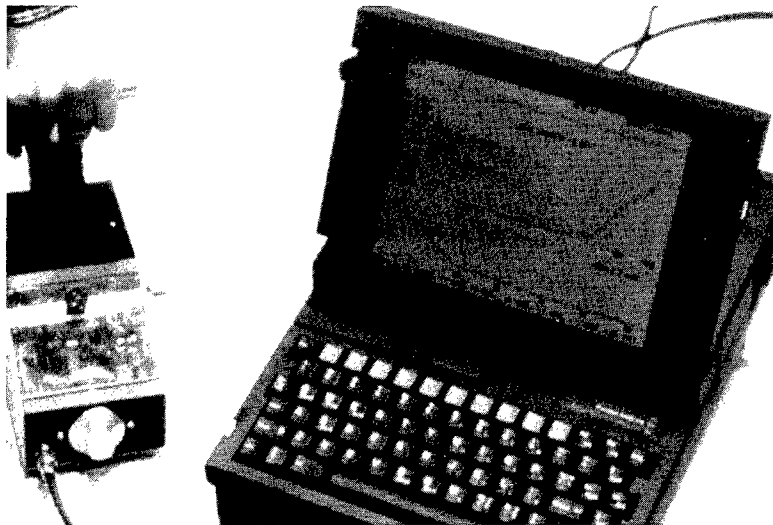

Figure 29. Impact-echo equipment. Impact source and receiving transducer housed in unit to the right of the laptop computer (waveform analyzer).

The selection of an impact source is critical in achieving a valid test result. The force-time history of an impact can be approximated as a half-sine curve, and the duration of the impact is the “contact time.” The contact time determines the frequency content of the stress pulse generated by the impact. The shorter the contact time, the higher the range of frequencies contained in the pulse. Therefore, **the contact time determines the size of the defect which can be detected by impact-echo testing.** As the contact time decreases and the pulse contains higher frequency (shorter wavelength) components, smaller defects can be detected. In addition, short duration impacts are needed to accurately locate shallow defects.

Many impact sources have been tried. In evaluation of piles, hammers are used. Hammers produce energetic impacts with long contact times (greater than 1 ms) that are acceptable for testing long, slender structures but are not suitable for detecting flaws within thin structures such as slabs or walls. Impact sources with shorter duration impacts (20 to 60 μ s), such as small steel spheres and spring-loaded spherically-tipped impactors, have been used for detecting flaws within slab and wall structures ranging from 0.15 to 1 m (0.49 to 3.3 ft). Steel spheres are convenient impact sources because contact time is proportional to the diameter of the sphere.

TYPICAL APPLICATIONS

Since the early 1970s, the impact-echo method has been used successfully for the evaluation of concrete piles. A stress pulse is produced by impacting the top surface and the returning echoes can be monitored by an accelerometer mounted on the same surface. The time-domain signal record is used to detect partial or complete discontinuities, such as voids, abrupt changes in cross section, very weak concrete, and soil intrusions, as well as approximate location where such irregularities exist. In the absence of major imperfections, the location of the bottom of a sound pile can be determined. The success of the method depends upon the pile length and the characteristics of the surrounding soil; echoes from the bottom of the long pile in a stiff, dense soil with an acoustic impedance similar to that of concrete may be too weak to be detected. The impact-echo method can also be used to detect various types of interfaces and defects in concrete slabs, walls, beams, and columns. Some of these defects include cracks and voids in plain and reinforced concrete, depth of surface opening cracks, voids in prestressing tendon ducts, honeycombed concrete, thickness of slabs and overlays, and the detection of delaminations in slabs with and without asphalt overlays.

ADVANTAGES AND DISADVANTAGES

The impact-echo equipment is very lightweight, portable, easy to operate, and requires access to only one side of the structure. It is one of the few pieces of NDT equipment that can locate flaws as well as accurately determine at what depth the flaws are occurring. Results are achieved very quickly (<10 s) through the use of a portable computer. The biggest disadvantage is the experience required to interpret the frequency results because the various materials that make up concrete generally cause numerous frequency peaks.

REFERENCES

1. Malhotra, V.M. and N.J. Carino, Editors, Preface, "Handbook on Nondestructive Testing of Concrete," CRC Press, Inc., Boca Raton, FL, 1991.
2. Malhotra, V.M., Chapter 1 "Surface Hardness Methods, Handbook on Nondestructive Testing of Concrete," CRC Press, Inc., Boca Raton, FL, 1991, pp. 1-17.
3. ASTM Designation C 805-94, "Standard Test Method for Rebound Number of Hardened Concrete," "1995 Annual Book of ASTM Standards," Volume 04.02 "Concrete and Concrete Aggregates," American Society for Testing and Materials, Philadelphia, PA.
4. Malhotra, V.M. and G.G. Carette, Chapter 2 "Penetration Resistance Methods, Handbook on Nondestructive Testing of Concrete," CRC Press, Inc., Boca Raton, FL, 1991, pp. 19-38.
5. ASTM Designation C 803-90, "Standard Test Method for Penetration Resistance of Hardened Concrete," "1995 Annual Book of ASTM Standards," Volume 04.02 "Concrete and Concrete Aggregates," American Society for Testing and Materials, Philadelphia, PA.
6. Carino, N.J., Chapter 3 "Pullout Test," "Handbook on Nondestructive Testing of Concrete," CRC Press, Inc., Boca Raton, FL, 1991, pp. 39-82.
7. Bickley, J.A., "The Variability of Pullout Tests and In-Place Concrete Strength, Concrete International," Volume 4, No. 4, 1982, p. 44.
8. Krenchel, H. and J.A. Bickley, "Pullout Testing of Concrete: Historical Background and Scientific Level Today," "Nordisk Betong," Publication No. 16, Nordic Concrete Federation, 1987, 155.
9. Bickley, J.A., "Evaluation and Acceptance of Concrete Quality by In-Place Testing," "In-situ/Nondestructive Testing of Concrete," Malhotra, V.M., Ed., ACI SP-82, American Concrete Institute, Detroit, MI, 1984, p. 95.
10. Naik, T.R., Chapter 4 "The Break-Off Test Method," "Handbook on Nondestructive Testing of Concrete," CRC Press, Inc., Boca Raton, FL, 1991, pp. 83-100.
11. Dahl-Jorgensen, E. and R. Johansen, "General and Specialized use of the Break-Off Concrete Strength Test Method," ACI SP 82-15, 1984, 294.
12. Hassaballah, A., "Evaluation of In-Place Crushed Aggregates Concrete by the Break-Off Method," Civil Engineering Department, University of Wisconsin-Milwaukee, December 1987.
13. Salameh, Z., "Evaluation of In-Place Rounded Aggregates Concrete by the Break-Off Method," Civil Engineering Department, University of Wisconsin-Milwaukee, December 1987.

14. Naik, T.R., Z. Salameh, and A. Hassaballah, "Evaluation of In-Place Strength of Concrete by the Break-Off Method," Department of Civil Engineering and Mechanics, University of Wisconsin-Milwaukee, March 1988.
15. ASTM Designation C 39-94, "Standard Test Method for Compressive Strength of Cylindrical Concrete Specimens," "1995 Annual Book of ASTM Standards," Volume 04.02 "Concrete and Concrete Aggregates," American Society for Testing and Materials, Philadelphia, PA.
16. ASTM Designation C 882-91, "Standard Test Method for Bond Strength of Epoxy-Resin Systems Used With Concrete by Slant Shear," "1995 Annual Book of ASTM Standards," Volume 04.02 "Concrete and Concrete Aggregates," American Society for Testing and Materials, Philadelphia, PA.
17. ACI Committee 503 report ACI 503R-93, "Use of Epoxy Compounds with Concrete," Appendix A - Test Methods, Part 5, "ACI Manual of Concrete Practice," 1995, pp. 503R-25 through 503R-27.
18. Carino, N.J., Chapter 5 "The Maturity Method, Handbook on Nondestructive Testing of Concrete," CRC Press, Inc., Boca Raton, FL, 1991, pp. 101-146.
19. Plowman, J.M., "Maturity and The Strength of Concrete," "Magazine of Concrete Research," 8(22), 1956, p. 13.
20. Klieger, P., "Effects of Mixing and Curing Temperatures on Concrete Strength," "Journal of the American Institute," 54(12), 1958, p.1063.
21. Carino, N.J., "The Maturity Method: Theory and Application," "ASTM Journal of Cement, Concrete, and Aggregates," 6(2), Winter 1961, p. 1984.
22. Okamoto, P.A., P.J. Nussbaum, S.D. Tayabji, M.I. Darter, R.J. Roman, and K.T. Hall, "Interim Report of the State-of-the-Art Review on Early Age Concrete Properties," "Timing for Control of Joint Sawing in New Age Concrete Pavements," and "Establishing Guidelines for Early Pavement Loadings," Task A Report for FHWA Contract - DTFH 61-88-C-00062, April 1989.
23. ASTM C 192-90A, "Standard Practice for Making and Curing Concrete Test Specimens in the Laboratory," "1995 Annual Book of ASTM Standards," Volume 04.02 "Concrete and Concrete Aggregates," American Society for Testing and Materials, Philadelphia, PA.
24. Naik, T.R. and V.M. Malhotra, Chapter 7 "The Ultra-Sonic Pulse Velocity Method," "Handbook on Nondestructive Testing of Concrete," CRC Press, Inc., Boca Raton, FL, 1991, pp. 169-202.
25. Sansalone, M. and N.J. Carino, Chapter 12 "Stress Wave Propagation Methods," "Handbook on Nondestructive Testing of Concrete," CRC Press, Inc., Boca Raton, FL, 1991, pp. 275-304.