



U.S. Department
of Transportation

**Federal Highway
Administration**

PB2001-101722



Publication No. FHWA-HI-00-007
September 1999

NHI Course No. 13154

Pavement Preventive Maintenance

Participant Workbook



National Highway Institute

REPRODUCED BY:
U.S. Department of Commerce
National Technical Information Service
Springfield, Virginia 22161





U.S. Department
of Transportation

**Federal Highway
Administration**

Publication No. FHWA-HI-00-007
September 1999

NHI Course No. 13154

Pavement Preventive Maintenance

Participant Workbook

Prepared by:

**Applied Pavement Technology, Inc
17 W 703 Butterfield Road, Suite A
Oak Brook Terrace, IL 60181**



National Highway Institute



ACKNOWLEDGMENTS

This training course is the product of the efforts of many people. Five states willingly agreed to share their pavement preventive maintenance experience with the project team and serve as case studies for this manual. Those states, and the representatives listed below, gave generously of their time and knowledge so that their agencies' experience could be more broadly disseminated.

<u>Case Study State</u>	<u>Contact Person(s)</u>
California	Randell H. Iwasaki, Deputy Director–Maintenance and Operations Larry H. Orcutt, Program Manager–Maintenance
Georgia	Wouter Gulden, State Materials and Research Engineer
Michigan	Larry Galehouse, Pavement Maintenance Engineer
New York	Ed Denehy, Transportation Maintenance Division
Texas	Joe S. Graff, Director–Maintenance Section

This entire project came about as a result of a joint initiative among several AASHTO states, the Federal Highway Administration (FHWA), and the Foundation for Pavement Preservation (FPP). FPP is a non-profit industry organization whose purpose is to promote research and training in preventive maintenance. Their assistance was supplemented by financial support from the Asphalt Emulsion Manufacturers Association (AEMA), the Asphalt Recycling & Reclaiming Association (ARRA), and the International Slurry Surfacing Association (ISSA). In addition to financial contributions to the project, FPP staff helped organize and coordinate meetings and facilitate the distribution and evaluation of preliminary draft reports. In that regard, the efforts of John Fiegel, FPP Executive Director, are especially appreciated.

Throughout the course of assembling the technical material for this project, input, feedback, and evaluations have been provided by a Preventive Maintenance Expert Task Group (ETG) and members of FPP. Specifically, input was provided by the following individuals:

<u>Member</u>	<u>Affiliation</u>
Mr. Bill Ballou	FPP and Koch Materials Company
Mr. Jim Chehovits	CRAFCO
Mr. Barry Dunn	International Slurry Surfacing Association
Mr. John Fiegel	FPP
Mr. Larry Galehouse	Michigan DOT
Mr. Jose Garcia	FHWA
Mr. Kent Hansen	National Asphalt Pavement Association
Mr. Jack Hardin	Mariani Asphalt Company
Dr. Gary Hicks	FPP and Oregon State University
Mr. Denny Jackson	FPP and Washington State DOT
Ms. Pat Lees	National Highway Institute
Mr. Bob McQuiston	FHWA
Mr. Jim Moulthrop	Koch Materials Company
Mr. Richard Nelson	Consultant
Mr. John Roberts	ACPA
Mr. Jim Sorenson	FHWA
Mr. Jim Stevenson	Montana DOT

PROTECTED UNDER INTERNATIONAL COPYRIGHT
 ALL RIGHTS RESERVED
 NATIONAL TECHNICAL INFORMATION SERVICE
 U.S. DEPARTMENT OF COMMERCE

From Applied Pavement Technology, Inc.'s staff, Monty Wade, Chuck Wienrank, Rachel DeSombre, and Adheer Bahulkar worked tirelessly to help produce the training materials. Their contributions are always appreciated.

Finally, the FHWA's leadership, and in particular the contributions of Mr. Jim Sorenson, are recognized for bringing together industry and agency to address system preservation needs. This leadership has offered technical support and funding flexibility to allow the owner agencies to reevaluate their business practices and better manage their infrastructure investments to meet the demands of the next century.

David G. Peshkin
Kurt D. Smith
Kathryn A. Zimmerman

Donald N. Geoffroy

Applied Pavement Technology, Inc.

Consultant

September 1999

Reproduced from
best available copy. 

TABLE OF CONTENTS

INTRODUCTION	1
About the Course.....	1
Overall Course Objectives	1
About This Workbook.....	2
Course Schedule.....	2
Key Technical References	4
For More Information	6
MODULE 1—OVERVIEW	9
Cross Reference.....	11
Overview	11
Brief Outline.....	11
Review Questions.....	11
Key References	11
Presentation Graphics	13
MODULE 2—BENEFITS AND CHALLENGES	19
Cross Reference.....	21
Overview	21
Brief Outline.....	21
Review Questions.....	21
Key References	21
Presentation Graphics	23
MODULE 3—TECHNIQUES	37
Cross Reference.....	39
Overview	39
Brief Outline.....	39
Review Questions.....	40
Key References	40
Presentation Graphics	43
MODULE 4—COST ANALYSES	77
Cross Reference.....	79
Overview	79
Brief Outline.....	79
Review Questions.....	79

Key References	80
Presentation Graphics	81
MODULE 5—CASE STUDIES	101
Cross Reference.....	103
Overview	103
Brief Outline.....	103
Review Questions.....	103
Key References	104
Presentation Graphics	105
MODULE 6—IMPLEMENTING PREVENTIVE MAINTENANCE AS PART OF A PAVEMENT PRESERVATION PROGRAM.....	123
Cross Reference.....	125
Overview	125
Brief Outline.....	125
Review Questions.....	125
Key References	126
Presentation Graphics	127
Appendix A—Glossary.....	A-1

INTRODUCTION

About The Course

This training course on *Pavement Preservation: The Preventive Maintenance Concept* provides an introduction to the concept of pavement preventive maintenance, including a description of currently available tools and technology that make the implementation of a pavement preventive maintenance program feasible. Targeting an audience of upper management and policy makers in highway agencies, the course focuses on the information needed to develop or improve a preventive maintenance program and illustrates the steps that five states have gone through in the development of their own preventive maintenance programs. Considerably less emphasis is given to the actual pavement preventive maintenance techniques themselves, although an extensive listing of pertinent references is provided for each technique.

An accompanying *Reference Manual* has been prepared to serve as the technical basis for the course. This training course presents the information contained in that document in a series of six modules, each focusing on a specific topic:

- Module 1—Overview
- Module 2—Benefits and Challenges
- Module 3—Techniques
- Module 4—Cost Analyses
- Module 5—Case Studies
- Module 6—Implementing Preventive Maintenance as Part of a Pavement Preservation Program

As part of the training course, a series of four workshops are conducted. These workshops underscore some of the key points of the presentation material and allow course participants the opportunity to work together to establish objectives and program components for their own preventive maintenance programs.

Overall Course Objectives

The overall objectives of this training course are:

1. Become familiar with the concepts of a Pavement Preventive Maintenance program.
2. Define potential pavement preventive maintenance techniques and materials.
3. Describe the interrelationships between pavement management and PPM.
4. Explain cost/benefit concepts to decision makers.

About This Workbook

This *Participant's Workbook* has been assembled to augment the formal presentations of the *Pavement Preservation: The Preventive Maintenance Concept* training course. It has been developed to assist participants in following the presentation of the course materials and to facilitate the comprehension of the information. However, it is not intended as a replacement for the technical reference manual, which provides more detailed information on the various course topics.

This *Participant's Workbook* contains a section corresponding to each training session. These sections consist of the following items:

- Cross reference information to the applicable pages of the *Reference Manual*.
- A brief overview of the information to be presented in the session.
- An outline of the information to be presented.
- A list of review questions applicable to the session.
- A list of key references for additional information on the topic.
- A reproduction of the presentation graphics used in the session, presented in two-column format to allow note-taking by the participants during the presentation.

The above information is provided for each of the six training sessions. With these features, participants should have no trouble following along during the technical presentations and will more easily recognize the key discussion points of each session. To further aid the participant, a glossary of key technical terms used in the training course and in the *Reference Manual* is found at the end of the *Participant's Workbook*.

Course Schedule

This training course is intended to be completed over 2 days of instruction. A generic course schedule for this training course is found on the next page, based on starting the first day after lunch. This schedule provides the approximate starting and ending times for each session or workshop, as well as anticipated break and lunch times. The actual times for each of these will undoubtedly vary depending upon the flow of the course.

Pavement Preventive Maintenance Typical Course Schedule

Suggested Duration	Topic
1:00 to 1:15	Welcome and Course Introduction
1:15 to 1:45	Module 1: Overview
1:45 to 2:45	Module 2: Benefits and Challenges
2:45 to 3:00	<i>Break</i>
3:00 to 4:30	<i>Workshop 1: Defining Your Pavement Maintenance Strategies</i>
8:00 to 8:15	Review of Day 1
8:15 to 10:00	Module 3: Techniques, Part 1
10:00 to 10:15	<i>Break</i>
10:15 to 11:30	Module 3: Techniques, Part 2
11:30 to 12:30	<i>Lunch</i>
12:30 to 1:30	<i>Workshop 2: Identifying Your Preventive Maintenance Program Treatment Strategies</i>
1:30 to 2:45	Module 4: Cost Analyses
2:45 to 3:00	<i>Break</i>
3:00 to 4:30	Module 5: Case Studies
8:00 to 8:15	Review of Day 2
8:15 to 9:15	<i>Workshop 3: Demonstrating the Importance of Your Preventive Maintenance Program to Management</i>
9:15 to 10:15	Module 6: Implementing Preventive Maintenance as Part of a Pavement Preservation Program
10:15 to 10:30	<i>Break</i>
10:30 to 11:45	<i>Workshop 4: Integrating the Preventive Maintenance Program Into the Agency</i>
11:45 to 12:00	Course Summary

Key Technical References

The *Reference Manual* serves as the primary source of information for this training course. It provides an excellent overview of pavement preventive maintenance concepts and pavement preventive maintenance techniques. In the development of that manual, the following key references were noted as being particularly useful, and interested participants may wish to refer to these references for more detailed information:

Asset Management/Pavement Management

1. Federal Highway Administration (FHWA). 1997. *Asset Management: Advancing the State of the Art Into the 21st Century Through Public-Private Dialogue*. FHWA-RD-97-046. Federal Highway Administration, Washington, DC.
2. Federal Highway Administration (FHWA). 1996. *Pavement Management Analysis Multi-Year Prioritization*. Demonstration Project No. 108. FHWA-SA-97-071. Federal Highway Administration, Washington, DC.
3. Zimmerman, K. A. and ERES Consultants, Inc. 1995. *Pavement Management Methodologies to Select Projects and Recommend Preservation Treatments*. NCHRP Synthesis of Highway Practice 222. Transportation Research Board, Washington, DC.

Cost Analysis

4. Peterson, D. E. 1985. *Life-Cycle Cost Analysis of Pavements*. NCHRP Synthesis of Highway Practice No. 122. Transportation Research Board, Washington, DC.
5. Walls, J. and M. R. Smith. 1998. *Life Cycle Cost Analysis in Pavement Design—Interim Technical Bulletin*. FHWA-SA-98-079. Federal Highway Administration, Washington, DC.

Pavement Preventive Maintenance—Concepts and Implementation

6. Denehy, E. J. 1997. “Implementing New York State Department of Transportation’s Pavement Preventive Maintenance Program.” *Transportation Research Record 1597*. Transportation Research Board, Washington, DC.
7. Galehouse, L. 1998. “Innovative Concepts for Preventive Maintenance.” *Transportation Research Record 1627*. Transportation Research Board, Washington, DC.
8. Geoffroy, D. N. 1996. *Cost-Effective Preventive Pavement Maintenance*. NCHRP Synthesis of Highway Practice 223. Transportation Research Board, Washington, DC.
9. O’Brien, L. G. 1989. *Evolution and Benefits of Preventive Maintenance Strategies*. NCHRP Synthesis of Highway Practice 153. Transportation Research Board, Washington, DC.

10. Shober, S. F. and D. A. Friedrichs. 1998. "Pavement Preservation Strategy." *Transportation Research Record 1643*. Transportation Research Board, Washington, DC.

Pavement Preventive Maintenance—Flexible Pavement Treatments

11. Asphalt Institute. 1996. *Asphalt in Pavement Maintenance*. Manual Series No. 16, Third Edition. Asphalt Institute, Lexington, KY.
12. Asphalt Institute. 1997. *A Basic Emulsion Manual*. Manual Series No. 19, Third Edition. Asphalt Institute, Lexington, KY, and the Asphalt Emulsion Manufacturers Association, Annapolis, MD.
13. Button, J. W., D. N. Little, and C. K. Estakhri. 1994. *Hot In-Place Recycling of Asphalt Concrete*. NCHRP Synthesis of Highway Practice 193. Transportation Research Board, Washington, DC.
14. Epps, J. A. 1990. *Cold-Recycled Bituminous Concrete Using Bituminous Materials*. NCHRP Synthesis of Highway Practice 160. Transportation Research Board, Washington, DC.
15. Federal Highway Administration. 1995. *Pavement Maintenance Effectiveness/ Innovative Materials Workshop—Participant's Manual*. FHWA-SA-96-007. Federal Highway Administration, Washington, DC.
16. Federal Highway Administration. 1998. *Techniques for Pavement Rehabilitation*. Participants Manual. Federal Highway Administration, Washington, DC.
17. Joseph, P. E. and G. J. Kennepohl. 1996. "Crack Sealing in Flexible Pavements: A Life-Cycle Cost Analysis." *Transportation Research Record 1529*. Transportation Research Board, Washington, DC.
18. Kandhal, P. S. and R. J. Mallick. 1997. *Pavement Recycling Guidelines for State and Local Governments—Participants Reference Book*. FHWA-SA-98-042. Federal Highway Administration, Washington, DC.
19. Raza, H. 1992. *An Overview of Surface Rehabilitation Techniques for Asphalt Pavements*. FHWA-PD-92-008. Federal Highway Administration, Washington, DC.
20. Raza, H. 1994a. *State-of-the-Practice Design, Construction, and Performance of Micro-Surfacing*. FHWA-SA-94-051. Federal Highway Administration, Washington, DC.
21. Raza, H. 1994b. *An Overview of Surface Rehabilitation Techniques for Asphalt Pavements—Instructor's Guide*. FHWA-SA-94-074. Federal Highway Administration, Washington, DC.
22. Smith, H. A. 1992. *Performance Characteristics of Open-Graded Friction Courses*. NCHRP Synthesis of Highway Practice 180. Transportation Research Board, Washington, DC.

23. Zaniwski, J. P. and M. S. Mamlouk. 1996. *Preventive Maintenance Effectiveness—Preventive Maintenance Treatments, Participant's Handbook*. FHWA-SA-96-027. Federal Highway Administration, Washington, DC.

Pavement Preventive Maintenance—Rigid Pavement Treatments

24. American Concrete Pavement Association. 1990. *Diamond Grinding and Concrete Pavement Restoration 2000*. Technical Bulletin TB-008.0 CPR. American Concrete Pavement Association, Arlington Heights, IL.
25. American Concrete Pavement Association. 1993. *Joint and Crack Sealing and Repair for Concrete Pavements*. Technical Bulletin TB-012.0. American Concrete Pavement Association, Skokie, IL
26. American Concrete Pavement Association. 1994. *Slab Stabilization Guidelines for Concrete Pavements*. Technical Bulletin TB-018P. American Concrete Pavement Association, Skokie, IL.
27. Federal Highway Administration. 1995. *Pavement Maintenance Effectiveness/ Innovative Materials Workshop—Participant's Manual*. FHWA-SA-96-007. Federal Highway Administration, Washington, DC.
28. Federal Highway Administration. 1998. *Techniques for Pavement Rehabilitation. Participants Manual*. Federal Highway Administration, Washington, DC.
29. Federal Highway Administration and American Concrete Pavement Association. 1998. *Concrete Pavement Rehabilitation, Guide for Load Transfer Restoration*. FHWA Report No. FHWA-SA-97-103, ACPA Report No. JP001P. Federal Highway Administration, Washington, DC, and American Concrete Pavement Association, Skokie, IL.
30. McGhee, K. H. 1995. *Design, Construction, and Maintenance of PCC Pavement Joints*. NCHRP Synthesis of Highway Practice 211. Transportation Research Board, Washington, DC.
31. Zaniwski, J. P. and M. S. Mamlouk. 1996. *Preventive Maintenance Effectiveness—Preventive Maintenance Treatments, Participant's Handbook*. FHWA-SA-96-027. Federal Highway Administration, Washington, DC.

For More Information

To obtain more information on this course, to request specific technical documents, publications, or computer software, or to secure additional information on a specific maintenance technique, interested participants may contact the following governmental, professional, and industry associations.

Course Scheduling and Information

National Highway Institute
4600 North Fairfax Drive, Suite 800
Arlington, VA 22203
(703) 235-0500
<http://www.nhi.fhwa.dot.gov>

Technical Information

Federal Highway Administration
Office of Asset Management
400 Seventh Street, S.W.
Washington, DC 20590
(202) 366-1333
<http://www.fhwa.dot.gov>

Foundation for Pavement Preservation

Foundation for Pavement Preservation (FPP)
1200 19th Street, NW, Suite 300
Washington, DC 20036
(202) 429-5146

Publications

AASHTO
P.O. Box 96716
Washington, DC 20090-6716
(800) 231-3475
<http://www.aashto.org>

National Technical Information Service (NTIS)
5285 Port Royal Road
Springfield, VA 22161
(703) 605-6000
<http://www.ntis.gov/index.html>

Transportation Research Board
P.O. Box 289
Washington, DC 20055
(202) 334-3213
<http://www.nas.edu/trb/> *(general)*
<http://www2.nas.edu/trbbooks> *(bookstore)*

Asphalt Pavement Industry Associations

Asphalt Emulsion Manufacturers Association (AEMA)
3 Church Circle, Suite 250
Annapolis, MD 21401
(410) 267-0023
<http://www.aema.org>

Asphalt Institute
Research Park Drive
P.O. Box 14052
Lexington, KY 40512
(606) 288-4960
<http://www.asphaltinstitute.org>

Asphalt Recycling and Reclaiming Association (ARRA)
3 Church Circle, Suite 250
Annapolis, MD 21401
(410) 267-0023
<http://www.arra.org>

International Slurry Surfacing Association (ISSA)
1200 19th Street NW, Suite 300
Washington, DC 20036
(202) 857-1160
<http://slurry.org> [Note: does not include "www"]

National Asphalt Pavement Association (NAPA)
NAPA Building
5100 Forbes Boulevard
Lanham, MD 20706
(301) 731-4748
<http://www.hotmix.org>

Concrete Pavement Industry Associations

American Concrete Institute (ACI)
P.O. Box 9094
Farmington Hills, MI 48333-9094
(248) 848-3800
<http://www.aci-int.org>

American Concrete Pavement Association (ACPA)
5420 Old Orchard Road, Suite A100
Skokie, IL 60077-1083
(847) 966-2272
<http://www.pavement.com>

Portland Cement Association (PCA)
5420 Old Orchard Road
Skokie, IL 60077-1083
(800) 868-6733
<http://www.portcement.org>

Professional Organizations

American Society for Testing and Materials (ASTM)
100 Barr Harbor Drive
West Conshohocken, PA 19428-2959
(610) 832-9585
<http://www.astm.org>

American Society of Civil Engineers (ASCE)
P.O. Box 79404
Baltimore, MD 21279-0404
(800) 548-2723
<http://www.pubs.asce.org>

Other Web Sites

AASHTO Innovative Highway Technologies
<http://leadstates.tamu.edu>

Course Developers

Applied Pavement Technology, Inc.
<http://www.pavementsolutions.com>

MODULE 1

OVERVIEW

NOTES

MODULE 1 OVERVIEW

Cross Reference

Reference Manual, Module 1, "Overview," pages 1–6.

Overview

This module provides an overview of pavement preventive maintenance. It is noted that the manual and the associated presentation are intended to provide to interested state highway agencies (SHAs) the currently available tools and technology that make the implementation of a pavement preventive maintenance program feasible. The objectives in developing these materials are to enable readers and participants in the training courses to accomplish the following:

- Become familiar with the concepts of a Pavement Preventive Maintenance (PPM) program.
- Define potential pavement preventive maintenance techniques and materials.
- Describe the interrelationships between pavement management and PPM.
- Explain cost/benefit concepts to decision makers.

Brief Outline

Introduction
Course Overview
FHWA Initiatives
Summary

Review Questions

1. What benefits are expected to be derived from timely pavement maintenance?
2. What is meant by the saying "there are no ribbon cuttings for pavement maintenance"?
3. What is the current FHWA initiative in preventive maintenance?
4. What is asset management? What are the FHWA objectives in asset management?

Key References

American Association of State Highway and Transportation Officials (AASHTO). 1987. *AASHTO Maintenance Manual*. American Association of State Highway and Transportation Officials. Washington, DC

Federal Highway Administration (FHWA). 1995. *Pavement Maintenance Effectiveness/ Innovative Materials Workshop*. FHWA-SA-96-007. Federal Highway Administration, Washington, DC.

FHWA. 1997. *Asset Management. Advancing the State of the Art Into the 21st Century Through Public-Private Dialogue*. FHWA-RD-97-046. Federal Highway Administration, Washington, DC.

Geoffroy, D. N. 1996. *Cost-Effective Preventive Pavement Maintenance*. NCHRP Synthesis of Highway Practice 223. Transportation Research Board, Washington, DC.

O'Brien, L. G. 1989. *Evolution and Benefits of Preventive Maintenance Strategies*. NCHRP Synthesis of Highway Practice 153. Transportation Research Board, Washington, DC.

Presentation Graphics

Slide
1

**Pavement Preservation:
The Preventive
Maintenance Concept**



National Highway Institute Federal Highway Administration Foundation for Pavement Preservation

Slide
2

Introductions

Slide
3

Course Format

- Lecture/Discussion
- Workshops
- Protocol
 - Informal
 - Questions are encouraged
 - Class participation is essential

Slide
4

Module 1

Overview

Slide
5

Course Objectives

- Explain components of a Pavement Preventive Maintenance program
- Define techniques and materials
- Describe relationships between pavement management and PPM
- Explain cost/benefit concepts

Slide
6

Course Objectives (cont'd)

- **Not** meant to serve as a guide to preventive maintenance techniques
- Rather, focus is on how to implement or improve a preventive maintenance program

Slide
7

Future Direction

As we move towards the 21st century, it is clear that the Federal-Aid highway program is undergoing a significant transition from its original focus on new construction to that of preservation of the highway system.

- FHWA Program Development Office

Slide
8

Importance of Preventive Maintenance

- Maintenance has always had a role
- Focus is no longer on new construction but on preserving the existing system
- Preventive maintenance plays an essential role in this preservation
- We can't afford to keep doing things the same way

Slide
9

The Concept of Preventive Maintenance

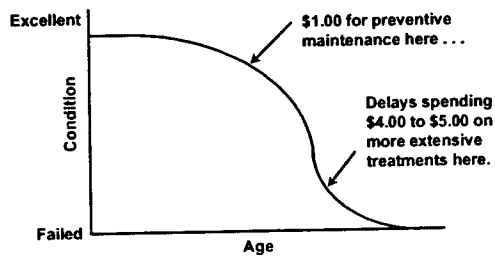

Slide
10

Common Perceptions of Preventive Maintenance

- Valued activity
- Benefits are often poorly defined
- Not exciting or glamorous
 - *“There are no ribbon cuttings for pavement maintenance”*
- Funding levels fluctuate

Slide
11

Course Modules

- Module 1. Overview
- Module 2. Benefits and Challenges
- Module 3. Techniques
- Module 4. Cost Analyses

Slide
12

Course Modules (cont'd)

- Module 5. Case Studies
- Module 6. Implementing Preventive Maintenance as Part of a Pavement Preservation Program
- Module 7. Workshops
- Executive Overview

Slide
13

Related FHWA Initiatives

- Preventive Maintenance
- Maintenance Effectiveness
- Maintenance Materials
- QC/QA in Maintenance
- Asset Management

Slide
14

Summary

- The benefits of preventive maintenance are being recognized
- FHWA and industry are now promoting benefits
- This course focuses on implementation of a PPM program

NOTES

MODULE 2

BENEFITS AND CHALLENGES

NOTES

MODULE 2

BENEFITS AND CHALLENGES

Cross Reference

Reference Manual, Module 2, “Benefits and Challenges,” pages 7–28.

Overview

This module reviews basic information about pavement maintenance and provides background information on preventive maintenance. The terminology associated with preventive maintenance is introduced and several definitions are presented. An overview of the advantages of a preventive maintenance program, both conceptually and as actually realized, is presented. Finally, the barriers to implementation of a pavement preventive maintenance program are also reviewed.

Brief Outline

Introduction
Defining Pavement Preventive Maintenance
Goals of a Pavement Preventive Maintenance Program
Current Funding Status
Challenges
Summary

Review Questions

1. Define “pavement preventive maintenance.” How is it different from routine or reactive maintenance?
2. What is pavement preservation? What activities are included in pavement preservation?
3. List some of the benefits associated with preventive maintenance.
4. How is maintenance viewed in the latest Federal highway legislation (TEA-21)?
5. What are some challenges facing pavement preventive maintenance programs?

Key References

American Association of State Highway and Transportation Officials (AASHTO). 1998. *AASHTO Strategic Highway Safety Plan – A Comprehensive Plan to Substantially Reduce Vehicle-Related Fatalities and Injuries on the Nation’s Highways*. AASHTO, Washington, DC.

- AASHTO. 1993. *Guide for Design of Pavement Structures*. AASHTO, Washington, DC.
- AASHTO. 1987. *Maintenance Manual*. AASHTO, Washington, DC.
- Clark, R. *Integrating Maintenance and Pavement Management*. Presentation at the Forum for the Future, Kansas City, MO, October 26-28, 1998.
- Denehy, E. J. 1997. "Implementing New York State Department of Transportation's Pavement Preventive Maintenance Program." *Transportation Research Record 1597*, Transportation Research Board, Washington, DC.
- Federal Highway Administration (FHWA). 1995a. *A Report on the Evaluation of Maintenance and the Use of Preventive Maintenance on the Interstate System*. OPR96-01. Federal Highway Administration, Washington, DC.
- FHWA. 1995b. *Pavement Maintenance Effectiveness/ Innovative Materials Workshop—Participant's Manual*. FHWA-SA-96-007. Federal Highway Administration, Washington, DC.
- FHWA. 1996. *Pavement Management Analysis Multi-Year Prioritization*. Demonstration Project No. 108. FHWA-SA-97-071. Federal Highway Administration. Washington, DC.
- FHWA. 1999. *Pavement Preservation: A Road Map for the Future*. FHWA-SA-99-015. Forum held October 26-28, 1998, Kansas City, MO.
- Galehouse, L. 1998. "Innovative Concepts for Preventive Maintenance." *Transportation Research Record 1627*. Transportation Research Board, Washington, DC.
- Geoffroy, D. N. 1996. *NCHRP Synthesis of Highway Practice 223: Cost Effective Preventive Pavement Maintenance*. Transportation Research Board, Washington, DC.
- O'Brien, L. G. 1989. *NCHRP Synthesis of Highway Practice 153: Evolution and Benefits of Preventive Maintenance Strategies*. Transportation Research Board, Washington, DC.
- Zaniewski, J. P. and M. S. Mamlouk. 1996. *Preventive Maintenance Effectiveness—Preventive Maintenance Treatments, Participant's Handbook*. FHWA-SA-96-027. Federal Highway Administration, Washington, DC.

Presentation Graphics

Slide
1

Module 2
Benefits and
Challenges

Slide
2

Learning Objectives

- Become familiar with terminology
- Describe advantages of PPM
- Understand TEA-21 legislation
- Identify barriers to implementation

Slide
3

Issues

- What is pavement preventive maintenance?
- How does it differ from other pavement preservation activities?
- When should it be applied?
- Is it effective?
- If so, then why isn't everyone doing it?

Slide
4

Definitions

- Pavement preservation
- Pavement rehabilitation
- Pavement reconstruction

Slide
5

Routine Maintenance

- Reactive in nature (not planned)
- Performed on pavements that are failing
- Does not contribute to long-term performance
- Often performed under harsh conditions
- Repairs perform poorly

Slide
6

Preventive Maintenance

A program strategy intended to arrest light deterioration, retard progressive failures, and reduce the need for routine maintenance and service activities.

- Louis O'Brien (NCHRP 153)

Slide
7

Preventive Maintenance

An organized, systematic process for applying a series of preventive maintenance treatments over the life of the pavement to minimize life-cycle costs.

- Don Geoffroy (NCHRP 223)

Slide
8

Preventive Maintenance

The planned strategy of cost effective treatments to an existing roadway system and its appurtenances that preserves the system, retards future deterioration, and maintains or improves the functional condition of the system (without increasing structural capacity).

- AASHTO's Standing Committee on Highways

Slide
9

Philosophy of Preventive Maintenance

Applying the right treatment 

 ... *To the right pavement*

... *At the right time* 

Slide
10

Challenges

- Safety issues
- Americans with Disabilities Act (ADA)
- Training to wrong people
- Restructuring within agencies to implement preventive maintenance

Slide
11

Benefits of a Preventive Maintenance Program

- Higher customer satisfaction
- Better informed decisions
- Improved strategies and techniques
- Improved pavement condition
- Costs savings
- Increased safety

Slide
12

Customer Satisfaction

- Roads exist to serve the traveling public
- Decisions should be made to improve customer satisfaction
- Roads are merely a product

A PPM program should focus on customer satisfaction

Slide
13

NQI Survey of Users

- Moderate level of satisfaction with highway system
- Considerable opportunity to improve customer satisfaction
- Prefer permanent over temporary repairs
- Complete construction in a timely fashion

Slide
14

Washington State Survey

- Roadway surface maintenance is the highest priority maintenance activity
- Public is willing to pay more:
 - to achieve desired levels of maintenance
 - to reduce future costs

Slide
15

Arizona Survey

- #1 priority: safety (85 %)
- #2 priority: preservation (74 %)
- Over 60 % would be willing to pay more taxes to improve maintenance service levels
- 90 % would be willing to spend more now to save money in the long term

Slide
16

California Survey

- Ranking of public priorities
 - Maintenance response to accidents/disasters
 - Safety
 - Pavement conditions
 - Traffic flow

Slide
17

Better Informed Decisions

- Program relies on proper treatment selection and treatment timing
- Need information to make decisions
- Successful programs have been integrated with PMS

Slide
18

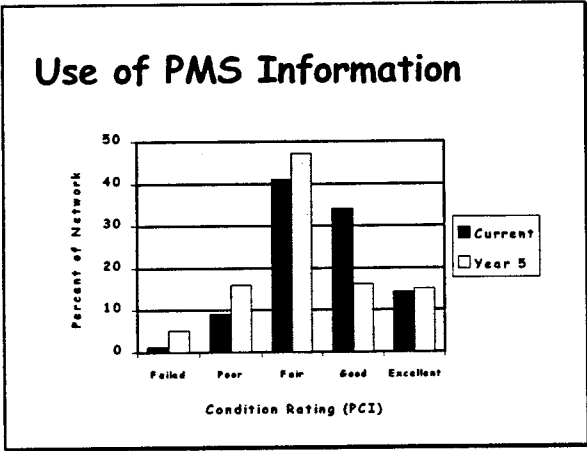

Slide
19

Montana's Experience

- Began integration with PMS in 1992
- Use PMS data to identify maintenance needs (increased funding from \$2 to \$13 million)
- Provide feedback into PMS database
 - Track location, type, and cost of treatment
 - Helps to identify cost effectiveness

PMS ↔ PPM

Slide
20

Continuous Improvement of Strategies and Techniques

- Develop new and improved treatments
- Correct observed deficiencies in existing protocols
- Apply treatments while pavement is still in good condition
- Minimize traffic disruptions

Slide
21

Improved Pavement Condition

- Preventive maintenance helps to preserve a pavement and extend its performance
- Overall condition of network improves

Slide
22

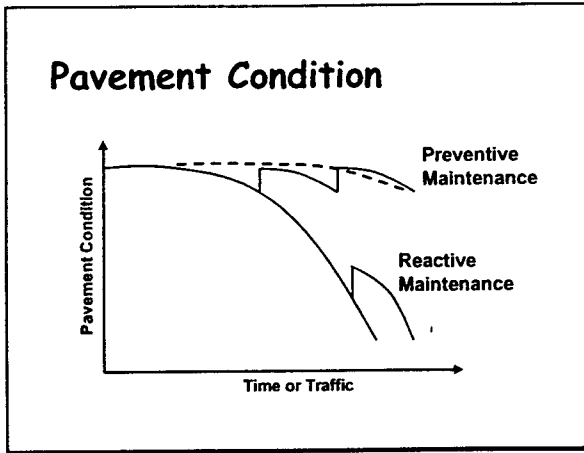

Slide
23

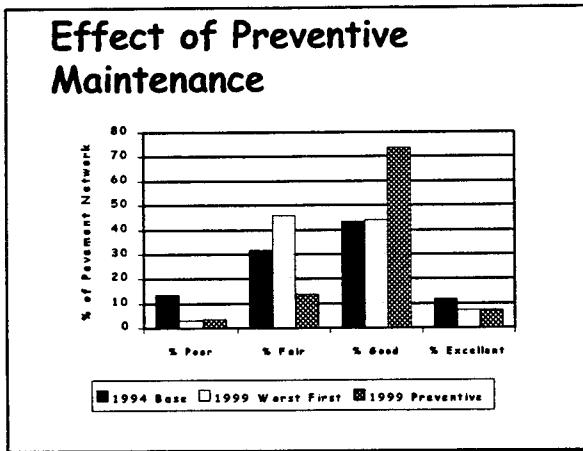

Slide
24

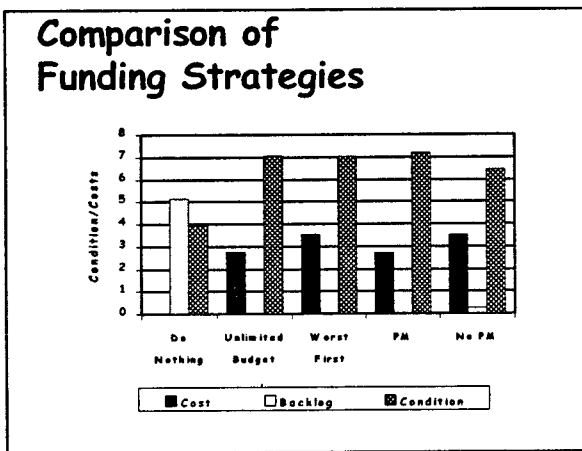

Slide
25

Cost Savings

- Most persuasive argument for shifting to preventive maintenance strategies
- Forms of cost savings
 - ▮ Less expensive treatments
 - ▮ Longer pavement life
 - ▮ Reduction of user delay costs

Slide
26

Cost Comparison of Options

■ Preventive maintenance:	\$ 10,270
■ Rehabilitation:	\$ 45,570
■ Reconstruction:	\$ 574,000

Costs obtained from City of Bedford (Texas) on a per-lane mile basis

Slide
27

Reported Cost Savings

- Michigan
 - ▮ Initial preventive maintenance costs 14 times less than rehabilitation or reconstruction
 - ▮ \$700 million savings from 1992 to 1996
 - ▮ Overall LCCA appears to be 6:1
- California
 - ▮ 4:1 to 6:1 overall cost benefit with preventive maintenance treatments

Slide
28

Increased Safety

- Safety is the #1 priority of users
- Explicit benefits
 - Improved surface friction
 - Fewer defects
- Implicit benefits
 - Better pavement condition
 - Fewer and less disruptive repairs

Slide
29

Additional Benefits of Preventive Maintenance

- Agencies have a stable budget
- Agencies have stable workforce
- Contractors have stable workforce
- Not affected by upswings and downswings

Slide
30

Current Funding Status

- In the past, eligibility for Federal funding required that the pavement be improved structurally
- Recent highway bills have changed the way preventive maintenance is funded

Slide
31

ISTEA

- First highway bill to allow Federal funds for preventive maintenance activities
- Restrictions
 - ▮ Demonstrate that treatments are a cost-effective means of extending pavement life
 - ▮ Projects must address safety deficiencies

Has not become a widespread practice

Slide
32

TEA-21



- Barriers have been removed
 - ▮ Greater flexibility to address safety concerns
 - ▮ More funding with fewer strings attached
- Federal funding increased to 80 percent

The Federal Government is encouraging preventive maintenance programs

Slide
33

Challenges to Implementation

- Agencies that have implemented a preventive maintenance program report extremely positive results.
- Why isn't everyone doing it?
- Barriers, both real and perceived...

Slide
34

Public Perceptions

- Public averse to steering maintenance dollars toward pavements in good condition
- Agencies more likely to receive complaints about specific defects than overall network
- Need to educate the public about new philosophy

Slide
35

Management Perceptions

- Need commitment from management to succeed
- Maintenance not traditionally given a high priority
- Need to create awareness of benefits
- Personnel changes disrupt continuity

Slide
36

Research Needs

- More data are needed to support the advantages of preventive maintenance
 - Treatment timing
 - What treatments are appropriate
 - Life extension gained

Slide
37

Training

- Confusion exists about what preventive maintenance is and how best to apply it
- Previous training efforts have focused on different aspects
 - Specific materials
 - Specific methods
- This course is a starting point

Slide
38

Data Management

- Historically, performance monitoring only done as part of research projects
- Must become a standard practice of highway agencies
- Could be incorporated in pavement management system

Slide
39

Dedicated Funding Challenges

- Preventive maintenance programs are particularly susceptible to funding variability
- Makes it difficult to project long-term benefits of the program

Slide
40

Safety Issues

- TEA-21 requires the development of a plan to address safety issues
- Should not affect decisions for preventive maintenance (need to address safety anyway)

Slide
41

Summary

- Anticipated benefits
 - Higher customer satisfaction
 - Better informed decisions
 - Improved strategies and techniques
 - Improved pavement condition
 - Cost savings
 - Increased safety
 - Stability

Slide
42

Summary (cont'd)

- Challenges are widespread
 - Public perception
 - Management perception
 - Shortage of applicable research
 - Absence of relevant training
 - Poor data tracking
 - Dedicated funding
 - Safety

MODULE 3
TECHNIQUES

NOTES

MODULE 3 TECHNIQUES

Cross Reference

Reference Manual, Module 3, "Techniques," pages 29–86.

Overview

This module describes the most commonly used pavement maintenance techniques and provides information regarding their use and application, performance, and costs. The pavement maintenance techniques are presented for both AC pavement surfaces (including composite [AC/PCC] pavements) and PCC pavement surfaces. The purpose is to familiarize the reader with the techniques without getting into details regarding design and construction.

Brief Outline

Introduction

AC-Surfaced Distresses

- Crack Filling/Crack Sealing
- Fog Seals
- Slurry Seals
- Microsurfacing
- Chip Seals
- Cold In-Place Recycling (CIR)
- Hot In-Place Recycling (HIR)
- Milling
- Thin Hot-Mix Asphalt (HMA) Overlays
- Maintenance of Drainage Features

PCC-Surfaced Distresses

- Joint Resealing
- Crack Sealing
- Diamond Grinding/Diamond Grooving
- Undersealing
- Joint Spall Repair
- Full-Depth Repair
- Load Transfer Restoration
- Maintenance of Drainage Features

Selection of Preventive Maintenance Treatments

Timing of Preventive Maintenance Treatment

Summary

Review Questions

1. What is the distinction between slurry seals and microsurfacing? When is each appropriate to use?
2. What benefits are provided by chip seals? What are the differences between chip seals, sand seals, cape seals, and sandwich seal?
3. Differentiate between cold in-place recycling and hot in-place recycling.
4. What advantages are offered by an open-graded friction course?
5. How are diamond grinding and diamond grooving different?
6. When might load transfer restoration be considered in preventive maintenance?
7. List some of the benefits associated with preventive maintenance.
8. What steps are recommended for the selection of maintenance treatments?

Key References

American Concrete Pavement Association (ACPA). 1990. *Diamond Grinding and Concrete Pavement Restoration 2000*. Technical Bulletin TB-008.0 CPR. American Concrete Pavement Association, Arlington Heights, IL.

American Concrete Pavement Association (ACPA). 1994. *Slab Stabilization Guidelines for Concrete Pavements*. Technical Bulletin TB-018P. American Concrete Pavement Association, Skokie, IL.

Asphalt Institute (AI). 1996. *Asphalt in Pavement Maintenance*. Manual Series No. 16, Third Edition. Asphalt Institute, Lexington, KY.

Asphalt Institute (AI). 1997. *A Basic Emulsion Manual*. Manual Series No. 19, Third Edition. Asphalt Institute, Lexington, KY, and the Asphalt Emulsion Manufacturers Association, Annapolis, MD.

Button, J. W., D. N. Little, and C. K. Estakhri. 1994. *Hot In-Place Recycling of Asphalt Concrete*. NCHRP Synthesis of Highway Practice 193. Transportation Research Board, Washington, DC.

Epps, J. A. 1990. *Cold-Recycled Bituminous Concrete Using Bituminous Materials*. NCHRP Synthesis of Highway Practice 160. Transportation Research Board, Washington, DC.

Evans, L. D. and A. R. Romine. 1993. *Innovative Materials Development and Testing, Volume 4: Joint Seal Repair*. SHRP-H-355. Strategic Highway Research Program, Washington, DC.

Federal Highway Administration (FHWA). 1990. *Open Graded Friction Courses*. Technical Advisory T 5040.31. Federal Highway Administration, Washington, DC.

Federal Highway Administration (FHWA). 1995. *Pavement Maintenance Effectiveness/ Innovative Materials Workshop—Participant's Manual*. FHWA-SA-96-007. Federal Highway Administration, Washington, DC.

Federal Highway Administration (FHWA). 1998. *Techniques for Pavement Rehabilitation. Participants Manual*. Federal Highway Administration, Washington, DC.

Federal Highway Administration (FHWA) and American Concrete Pavement Association (ACPA). 1998. *Concrete Pavement Rehabilitation, Guide for Load Transfer Restoration*. FHWA Report No. FHHA-SA-97-103, ACPA Report No. JP001P. Federal Highway Administration, Washington, DC, and American Concrete Pavement Association, Skokie, IL.

Geoffroy, D. N. 1996. *Cost-Effective Preventive Pavement Maintenance*. NCHRP Synthesis of Highway Practice 223. Transportation Research Board, Washington, DC.

Kandhal, P. S. and R. J. Mallick. 1997. *Pavement Recycling Guidelines for State and Local Governments—Participants Reference Book*. FHWA-SA-98-042. Federal Highway Administration, Washington, DC.

Pierce, L. M. "Design, Construction, Performance, and Future Direction of Dowel Bar Retrofit in Washington State." *Proceedings, Sixth International Purdue Conference on Concrete Pavement Design and Materials for High Performance*. Purdue University, West Lafayette, IN.

Raza, H. 1992. *An Overview of Surface Rehabilitation Techniques for Asphalt Pavements*. FHWA-PD-92-008. Federal Highway Administration, Washington, DC.

Raza, H. 1994a. *State-of-the-Practice Design, Construction, and Performance of Micro-Surfacing*. FHWA-SA-94-051. Federal Highway Administration, Washington, DC.

Shober, S. F. 1997. "The Great Unsealing: A Perspective on Portland Cement Concrete Joint Sealing." *Transportation Research Record 1597*. Transportation Research Board, Washington, DC.

Shuler, S. 1991. "High-Traffic Chip Seal Construction: The Tulsa Test Road." *Transportation Research Record 1300*. Transportation Research Board, Washington, DC.

Smith, H. A. 1992. *Performance Characteristics of Open-Graded Friction Courses*. NCHRP Synthesis of Highway Practice 180. Transportation Research Board, Washington, DC.

Smith, K. L. and A. R. Romine. 1993. *Innovative Materials Development and Testing, Volume 3: Treatment of Cracks in Asphalt Concrete Surfaced Pavements*. SHRP-H-354. Strategic Highway Research Program, Washington, DC.

Stuart, K. D. 1992. *Stone Mastic Asphalt (SMA) Mixture Design*. FHWA-RD-92-006. Federal Highway Administration, Washington, DC.

Zaniewski, J. P. and M. S. Mamlouk. 1996. *Preventive Maintenance Effectiveness—Preventive Maintenance Treatments, Participant's Handbook*. FHWA-SA-96-027. Federal Highway Administration, Washington, DC.

NOTES

Presentation Graphics and Instructor Notes

Slide
1

*Module 3
Techniques*

Slide
2

Learning Objectives

- ◆ Become familiar with preventive maintenance techniques
 - ◆ AC-surfaced pavements
 - ◆ PCC-surfaced pavements
- ◆ Understand selection process

Will not get into design and construction details

Slide
3

Benefits of Preventive Maintenance Treatments

- ◆ Retard future deterioration
- ◆ Maintain or improve the functional condition of the pavement system
- ◆ Preserve the pavement system and extend the life

But no structural improvement

Slide
4

*Techniques for
AC-Surfaced Pavements*

- ◆ Maintenance of drainage features
- ◆ Crack filling/sealing
- ◆ Fog seals
- ◆ Slurry seals
- ◆ Microsurfacing
- ◆ Chip seals
- ◆ Cold in-place recycling
- ◆ Hot in-place recycling
- ◆ Milling
- ◆ Thin HMA overlays

Slide
5

*Techniques for
PCC-Surfaced Pavements*

- ◆ Joint resealing
- ◆ Crack sealing
- ◆ Diamond grinding/grooving
- ◆ Undersealing
- ◆ Joint spall (partial-depth) repair
- ◆ Full-depth repair
- ◆ Load transfer restoration
- ◆ Maintenance of drainage features

Slide
6

Other Treatments

Do you use treatments other than those listed?



Slide
7

*Techniques for
AC-Surfaced Pavements*





Slide
8

Crack Treatments

- ◆ Crack Filling
 - ◆ Lower level operation with lower quality sealant and little preparation
 - ◆ Applicable only to non-working cracks
- ◆ Crack Sealing
 - ◆ Higher level operation with higher quality sealant and more preparation
 - ◆ Working cracks

Slide
9

Placement Configurations

	
Flush-Fill	Overband
	
Reservoir	Combination

Slide
10

Performance of Crack Filling

- ◆ Performance life
 - ◆ Not well established
 - ◆ New York reports an average of 2 years
- ◆ Timing
 - ◆ Temperature not as critical
 - ◆ Often conducted prior to surface remediation

Slide
11

Performance of Crack Sealing

- ◆ Performance life
 - ◆ Average life of 3 to 5 years
 - ◆ Ontario and New York report 5 to 6 years (pavement life extension of about 2 years)
 - ◆ SPS-3 results suggest 6 to 8 years
- ◆ Timing
 - ◆ Moderate temperatures (spring or fall)
 - ◆ Most effective if performed right after cracks develop

Slide
12

Cost of Crack Treatments



- ◆ Material costs, \$/kg (\$/lb)
 - ◆ Rubberized asphalt: 0.60 - 1.25 (0.27 - 0.57)
 - ◆ Low modulus rubberized asphalt: 1.30 - 1.60 (0.59 - 0.73)
 - ◆ Silicone: 8.50 - 11.80 (3.86 - 5.36)
- ◆ Installation costs are about \$1.00 to \$1.50 per meter (\$0.90 to \$1.40 per yard) for most rubberized asphalt materials

Slide
13

Surface Treatments

- ◆ Fog Seals
- ◆ Slurry Seals
- ◆ Microsurfacing
- ◆ Chip Seals

Slide
14

Fog Seals

- ◆ Light application of diluted, slow-setting asphalt emulsion without aggregate cover
- ◆ Purpose
 - ◆ Seal the pavement
 - ◆ Inhibit raveling
 - ◆ Enrich hardened/oxidized asphalt
 - ◆ Provide delineation with shoulder
- ◆ For pavements in good condition
- ◆ Not recommended on high-speed roadways

Slide
15

Performance of Fog Seals

- ◆ Most effective on pavements in good condition
 - ◆ Minor cracks
 - ◆ Some raveling or oxidation
- ◆ Performance life is typically 1 to 2 years
- ◆ Effectiveness improves with repeated applications

Slide
16

Slurry Seals

- ◆ Mixture of materials
 - ◆ Well-graded fine aggregate
 - ◆ Mineral filler (if needed)
 - ◆ Slow-setting asphalt emulsion
 - ◆ Thicknesses of 3 to 12 mm (0.12 to 0.5 in)
- ◆ Purpose
 - ◆ Stop raveling and loss of matrix
 - ◆ Reduce potential for stripping
 - ◆ Improve surface friction

Slide
17

Types of Slurry Seals

Type	Max. Agg. Size, mm (in)	Purpose
I	3.2 (0.12)	Seal cracks on low volume roads
II	6.4 (0.25)	Correct raveling/oxidation on low to medium roads
III	9.5 (0.38)	Fill minor surface irregularities and restore friction

Slide
18

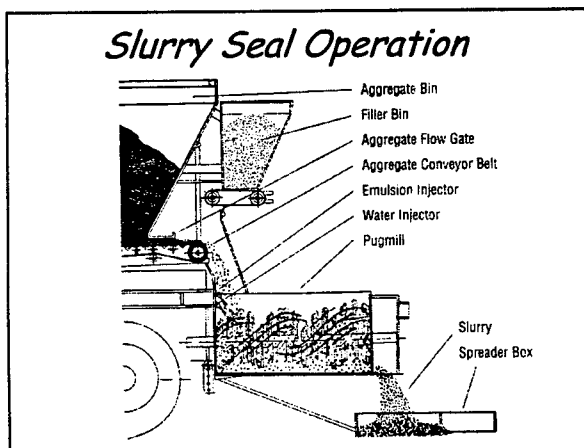

Slide
19

Schematic of Slurry Equipment

- ◆ The slide is a schematic of the slurry seal equipment showing key materials mixing and placement components.
- ◆ The materials are combined into a homogenous mix within the truck and placed in a thin layer on the pavement.

Slide
20

Photo of Slurry Equipment

- ◆ This photograph shows the equipment in operation.
- ◆ Note the thin material placement.
- ◆ The slurry is brown until it breaks and turns black.

Slide
21

Performance of Slurry Seals

- ◆ Typical life of 3 to 5 years
- ◆ Findings of SPS-3 study
 - ◆ Reduce development of cracking and raveling
 - ◆ Perform better in warmer climates
 - ◆ Perform best on pavements in good condition
 - ◆ Reflective cracks appear after 1 year

Slide
22

Microsurfacing

- ◆ Mixture of materials
 - ◆ Polymer-modified emulsion binder
 - ◆ High-quality aggregates
- ◆ Thicknesses of 10 to 20 mm (0.4 to 0.8 in)
- ◆ Purpose
 - ◆ Improve surface friction
 - ◆ Fill ruts/minor surface irregularities
 - ◆ Seal pavement surface
 - ◆ Open to traffic in 1 hour

Slide
23

***Schematic of
Microsurfacing Equipment***

- ◆ The slide is a schematic of the microsurfacing equipment showing key materials mixing and placement components.
- ◆ This specialized equipment is similar to the slurry seal equipment.

Slide
24

***Photo of Microsurfacing
Equipment***

- ◆ This photo shows the microsurfacing equipment in action.

Slide
25

***Performance of
Microsurfacing***

- ◆ Typically provides service lives of 4 to 7 years
 - ◆ Effective in rut filling applications
 - ◆ Provides high initial friction values that are maintained
 - ◆ Delays development of reflection cracking when underlying cracks are inactive
- ◆ Effective on both low and high volume roadways

Slide
26

Chip Seals

- ◆ Application of asphalt and aggregate chips rolled into pavement
- ◆ Purpose
 - ◆ Seal the pavement
 - ◆ Improve surface friction
 - ◆ Wearing course
- ◆ Some recent application on high-volume roads

Slide
27

Types of Chip Seals

- ◆ Conventional chip seals
- ◆ Rubberized asphalt chip seals
- ◆ Sand seals
- ◆ Sandwich seals
- ◆ Cape seals

Can be placed in two or more consecutive layers

Slide
28

Application of Chip Seals



Single Chip Seal
Double Chip Seal

Pneumatic-Tired
Rolling

Application of
Aggregate

Application of
Asphalt or Emulsion

Existing AC
Pavement

Slide
29

Chip Seal Operation

- ◆ Photo of chip seal operation.
- ◆ In this photo, the chips are being rolled to embed the aggregate
- ◆ Some agencies also broom after rolling and before traffic.

Slide
30

Performance of Chip Seals

- ◆ Typical performance life of 4 to 7 years
- ◆ Multiple chip seals can increase life (may provide up to 10 years of service)
- ◆ SPS-3 study shows chip seals performing well after 5 years

Slide
31

Cost Comparison of Surface Treatments



Treatment	Life, years	Cost, \$/m ² (\$/yd ²)
Fog seal	1 - 2	0.24 - 0.30 (0.20 - 0.25)
Slurry seal	3 - 5	0.84 - 1.14 (0.70 - 0.95)
Chip seal	4 - 7	0.96 - 1.32 (0.80 - 1.10)
Microsurfacing	4 - 7	1.50 - 2.40 (1.25 - 2.00)

Slide
32

Recycling Treatments

- ◆ Cold In-Place Recycling
- ◆ Hot In-Place Recycling

Slide
33

Cold In-Place Recycling (CIR)

- ◆ Process in which
 - ◆ Portion of existing AC pavement is milled
 - ◆ Reclaimed material is sized and mixed with new binder, additives, and sometimes virgin aggregate
 - ◆ Remixed material is placed back on the pavement
 - ◆ New wearing course placed later
- ◆ Construction options:
 - ◆ Single machine process
 - ◆ Single-pass equipment train

Slide
34

Purpose of CIR

- ◆ Improves profile, crown, and slope
- ◆ Corrects surface distresses
- ◆ Reworks AC to depth of 50 to 100 mm (2 to 4 in)
- ◆ Mostly used on lower volume roadways (<10,000 ADT)

Slide
35

Schematic of Single Recycling Machine

- ◆ This schematic shows the material handling in a single pass machine
- ◆ This equipment is highly maneuverable.

Slide
36

Schematic of Single Pass Equipment Train

- ◆ The pavement is milled, sized, remixed, and placed in a single long equipment train.

Slide
37

*Photo of Cold In-Place
Recycling Equipment Train*

The train includes, from left to right:

- Milling machine
- Crusher
- Mixer
- Emulsion Tanker

Slide
38

Performance of CIR

- ◆ Performance of CIR generally between 5 and 10 years
 - ◆ New Mexico reports excellent performance after 10 years
 - ◆ Maine reports no reflective cracking after 3 years
 - ◆ Indiana reports less distress and greater support than control section after 5 years
- ◆ No information on effect of treatment on pavement service life

Slide
39

*Hot In-Place
Recycling (HIR)*

- ◆ Process in which the upper 25 to 50 mm (1 to 2 in) of the existing pavement is heated, mixed with a recycling agent (and perhaps virgin materials), and relaid on the pavement
- ◆ Addresses surface distresses such as:
 - ◆ Corrugations
 - ◆ Bleeding
 - ◆ Minor cracking
 - ◆ Low surface friction
 - ◆ Rutting

Slide
40

Available HIR Techniques

- ◆ Heater-scarification
- ◆ Repaving
- ◆ Remixing

Slide
41

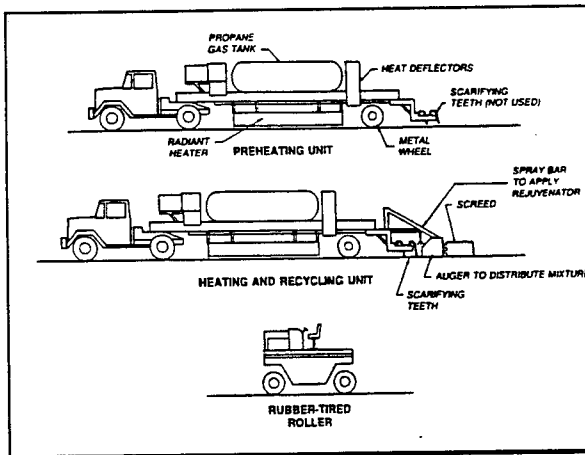

Slide
42

Photo of Heater Scarifier

- ◆ In foreground is scarifier with spring-loaded teeth.
- ◆ Behind the scarifier can be seen the heater.

Slide
43

Schematic of Repaving Process

- ◆ Steps include
 - ◆ Heating
 - ◆ Milling or scarification
 - ◆ Remixing
 - ◆ Construction of an overlay

Slide
44

Photo of Repaving Process

- ◆ Single-pass equipment train
- ◆ Placement is occurring in the lower left and the operation is moving to the right.

Slide
45

Schematic of Remixing Process

- ◆ Mill/scarify existing surface.
- ◆ Add virgin mix or rejuvenator.
- ◆ Replace material as a surface course.

Slide
46

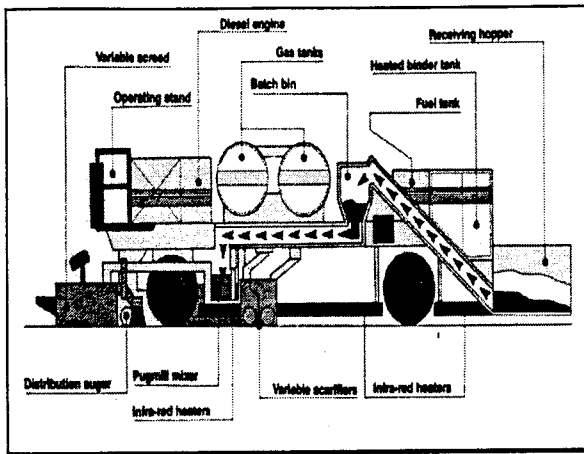

Slide
47

Surface Remixing Equipment

The photo shows surface remixing
equipment in operation.

Slide
48

Drum Mix Recycling

This photo shows a drum mix
operation in which all of the existing
materials are combined with about 4%
new materials. Up to 2 inches of
material may be removed.

Slide 49

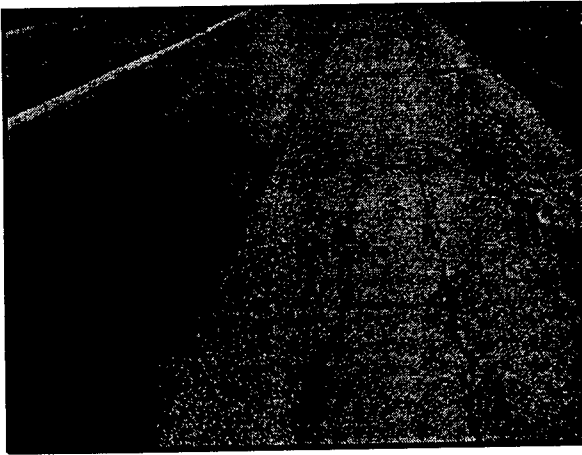

Slide 50

Performance of HIR

- ◆ Some variability in service life depending on operation
 - ◆ Heater-scarification: 3 to 5 years
 - ◆ Repaving: 8 to 12 years
 - ◆ Remixing: not yet established
- ◆ Pavement must be at least 75 mm (3 in) thick and must have stable base and subgrade

Slide 51

Cost of Recycling Techniques



- ◆ Cold in-place recycling
 - ◆ 25 mm (1 in) deep: \$0.96/m² (\$0.80/yd²)
 - ◆ 75 mm (3 in) deep: \$2.00/m² (\$1.67/yd²)
- ◆ Hot in-place recycling (upper 25 mm [1 in])
 - ◆ Heater-scarify: \$0.90-\$1.61/m² (\$0.75-\$1.35/yd²)
 - ◆ Repaving: \$1.50-\$2.40/m² (\$1.25-\$2.00/yd²)
 - ◆ Remixing: \$2.39-\$3.90/m² (\$2.00-\$3.25/yd²)

Slide
52

Cold Milling

- ◆ Removal of pavement surface using carbide-tipped cutting bits
- ◆ Purpose
 - ◆ Restore profiles and slopes
 - ◆ Re-establish surface friction
 - ◆ Remove layer for recycling
 - ◆ Prepare for an overlay

Slide
53

*Triple
Wrap
Milling
Head*

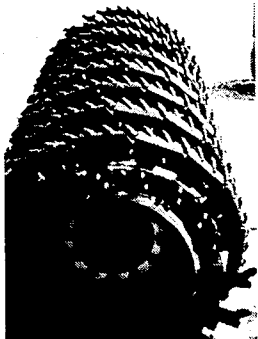

Slide
54



Slide 55

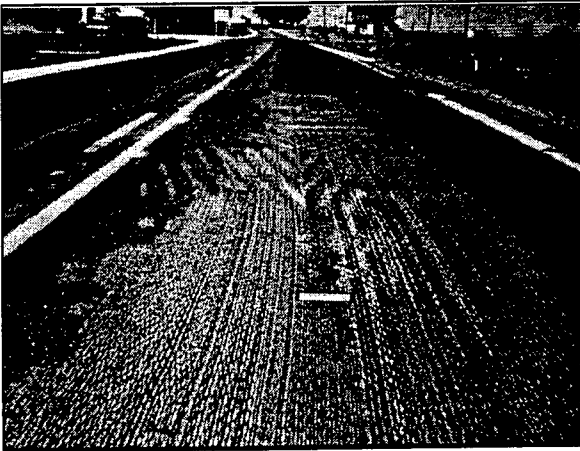

Slide 56

Performance and Costs of Cold Milling

- ◆ Integral part of many overlay projects and most recycling projects
- ◆ Cold-milled surface can last 3 to 7 years
- ◆ Typical costs range from \$0.60 to \$3.60 per m² (\$0.50 to \$3.00 per yd²)



Slide 57

Thin HMA Overlays

- ◆ Thin (19 to 38 mm) plant mixtures of asphalt cement and aggregate
 - ◆ Dense Graded
 - ◆ Open Graded (OGFC)
 - ◆ Stone Matrix Asphalt
- ◆ Purpose
 - ◆ Restore rideability
 - ◆ Improve surface friction
 - ◆ Reduce hydroplaning and tire splash (OGFC)

Slide 58

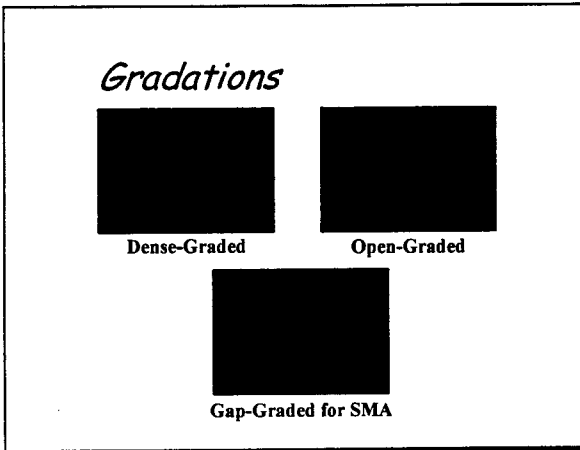

Slide 59

Performance of Thin HMA Overlays

- ◆ Dense-graded HMA
 - ◆ Widely varying service lives (5 to 10 years)
 - ◆ Pavement must be in relatively good condition
- ◆ Open-graded friction course
 - ◆ 8 to 12 years
 - ◆ May be more susceptible to stripping
- ◆ Stone matrix asphalt
 - ◆ No long-term performance data
 - ◆ Short-term results show increased resistance to cracking, rutting

Slide 60

Costs of Thin HMA Overlays



- ◆ Dense-graded HMA
 - ◆ \$28 - \$34 per Mg (\$31 to \$38 per ton)
 - ◆ \$2.03 - \$2.63 per m² (\$1.70 - \$2.20 per yd²)
- ◆ Open-graded friction course
 - ◆ \$39 - \$40 per Mg (\$43 - \$44 per ton)
 - ◆ \$1.50 - \$1.70 per m² (\$1.25 - \$1.42 per yd²)
- ◆ Stone matrix asphalt
 - ◆ 20 to 40 % greater than dense-graded HMA

Slide
61

Maintenance of Drainage Features

- ◆ Applicable to both AC and PCC
- ◆ Any activity that will improve drainability of pavement section
 - ◆ Install and maintain reference markers
 - ◆ Clear debris from outlets and culverts
 - ◆ Inspect edge drain pipes
 - ◆ Flush and rod edge drain system
 - ◆ Clean ditches and re-establish grades
 - ◆ Restore cross slopes

Slide
62

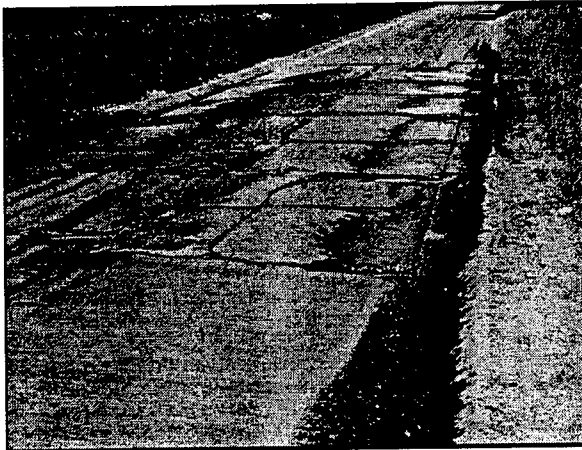

Slide
63

Drainage Recommendations

- ◆ Pavement cross slope $\geq 2\%$
- ◆ Shoulder cross slope $\geq 3\%$
- ◆ Slope of ditches 4:1 max
- ◆ Width of ditches 0.9 - 1.2 m
- ◆ Depth of ditches ≥ 1.2 m
- ◆ Grade of ditchline $\geq 1\%$

Slide
64

Performance of Drainage Maintenance

- ◆ Depending on activity and exposure conditions, drainage enhancement may last from several months to several years.
- ◆ Periodic inspections are required throughout the life of the pavement
- ◆ Costs also dependent on activity being performed
- ◆ Impact of positive drainage on pavement performance currently being studied

Slide
65

Other Emerging Maintenance Treatments

- ◆ Scrub seals
- ◆ Ultrathin friction courses

Slide
66

Scrub Seals

- ◆ Surface restoration that rejuvenates asphalt and fills voids and cracks
- ◆ Application process
 - ◆ Apply polymer-modified asphalt agent
 - ◆ Broom asphalt into voids and cracks
 - ◆ Apply sand or small aggregate
 - ◆ Broom aggregate and asphalt mixture
 - ◆ Roll with pneumatic tire roller

Slide
67

***Performance of
Scrub Seals***

- ◆ Good performance on low volume roads
- ◆ Advantages:
 - ◆ Seals small cracks
 - ◆ Address raveling
 - ◆ Easy to apply
 - ◆ Inexpensive
- ◆ Disadvantages
 - ◆ Possible low friction numbers
 - ◆ Requires special equipment

Slide
68

Ultrathin Friction Course

- ◆ Gap-graded, polymer-modified HMA placed on a heavy, polymer-modified emulsified asphalt tack coat
- ◆ Thicknesses of 10 to 20 mm (0.4 to 0.8 in)
- ◆ Benefits:
 - ◆ Addresses surface distress
 - ◆ Reduces noise
 - ◆ Increases surface friction

Slide
69

***Performance of Ultrathin
Friction Courses***

- ◆ No long-term performance data
- ◆ Short-term performance promising
 - ◆ Texas and Pennsylvania report pavements in excellent condition after 3 years
 - ◆ Noticeable increase in surface friction
 - ◆ No raveling or stripping
- ◆ Installation costs: \$3.00/m² (\$2.50/yd²)

Slide
70

*Techniques for
PCC-Surfaced Pavements*





Slide
71

Joint/Crack Resealing

- ◆ Application of a sealant material in concrete pavement joints and cracks
- ◆ Purpose
 - ◆ Minimize moisture infiltration
 - ◆ Prevent intrusion of incompressibles
- ◆ Sealant Materials
 - ◆ Rubberized asphalt
 - ◆ Silicone

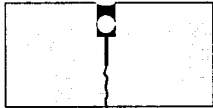
Slide
72

Joint Sealant Configurations

 <p>Sawed and Recessed</p>	 <p>Sawed and Overbanded</p>
 <p>Plowed and Overbanded</p>	 <p>Sawed and Flush-Filled</p>

Slide
73

Performance of Joint Resealing

- ◆ Original sealant typically requires resealing after 5 to 10 years
- ◆ Resealing required every 5 to 8 years thereafter
- ◆ Regular resealing may extend pavement life 5 to 6 years
- ◆ Most beneficial on pavements that are not badly deteriorated

Slide
74

Crack Sealing

- ◆ Similar techniques and materials used for joint resealing
- ◆ Purpose
 - ◆ Minimize moisture infiltration
 - ◆ Prevent intrusion of incompressibles

Slide
75

Performance of Crack Sealing

- ◆ Resealing of cracks required about every 5 years
- ◆ No data regarding extension to pavement life
- ◆ Most effective on cracks between 3 and 19 mm (1/8 and 3/4 in) wide with limited spalling

Slide 76

Joint Sealing Costs 

- ◆ Material costs, \$/kg (\$/lb)
 - ◆ Rubberized asphalt: 0.60 - 1.25 (0.27 - 0.57)
 - ◆ Low modulus rubberized asphalt: 1.30 - 1.60 (0.59 - 0.73)
 - ◆ Silicone: 8.50 - 11.80 (3.86 - 5.36)
- ◆ Installation costs range from about \$2.50 to \$6.50 per meter (\$2.30 to \$5.95 per yard)

Slide 77

Surface Texturing

- ◆ Diamond Grinding
 - ◆ Removes thin layer of PCC surface
 - ◆ Removes faulting
 - ◆ Restores smoothness
 - ◆ Increases friction
- ◆ Diamond Grooving
 - ◆ Creates discrete grooves in PCC surface
 - ◆ Reduce hydroplaning and wet weather accidents

Slide 78

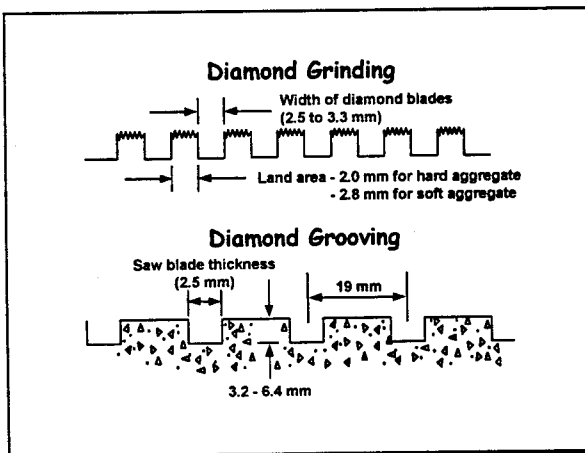

Slide
79

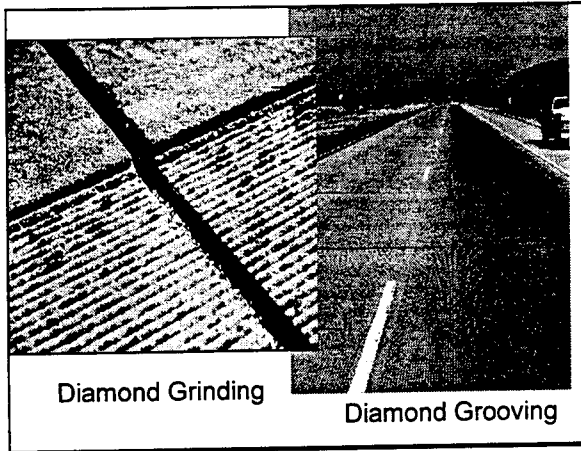

Slide
80

Performance

- ◆ Diamond grinding
 - ◆ Provides about 10 years of service
 - ◆ May be reground 3 to 4 times
 - ◆ Faulting can return to significant levels in a few years if cause(s) not concurrently addressed
- ◆ Diamond grooving
 - ◆ 60 to 75 % reductions in wet-weather accidents
 - ◆ Benefits achieved throughout service life

Slide
81

Surface Texturing Costs



- ◆ Diamond grinding
 - ◆ Soft Aggregate:
 - ◆ \$2.40 - \$3.60/m² (\$2.00 - \$3.00/yd²)
 - ◆ Med. Aggregate:
 - ◆ \$3.60 - \$6.00/m² (\$3.00 - \$5.00/yd²)
 - ◆ Hard Aggregate:
 - ◆ \$6.00 - \$9.60/m² (\$5.00 - \$8.00/yd²)
- ◆ Diamond grooving
 - ◆ \$1.80 - \$3.00/m² (\$1.50 - \$2.50/yd²)

Slide
82

Undersealing

- ◆ Pressure insertion of flowable material (grout) beneath the PCC slab
- ◆ Purpose
 - ◆ Fill underlying voids (not to raise slab)
 - ◆ Reduce pavement deflections
 - ◆ Minimize pumping and faulting

Slide
83

Undersealing Operation

Usual material is cement-flyash grout

Design issues include number and location of holes, amount of material

Slide
84

Performance of Undersealing

- ◆ Short- and long-term reductions in pavement deflections
- ◆ Most effective on pavements with little structural damage
- ◆ Should be conducted only where voids are known to exist

Slide
85

Undersealing Costs 

- ◆ Cement-grout undersealing
 - ◆ \$1.08 - \$1.20/m² (\$0.90 - \$1.00/yd²)
- ◆ Asphalt undersealing
 - ◆ \$0.54 - \$0.60/m² (\$0.45 - \$0.50/yd²)

Slide
86

Joint Spall Repair

- ◆ Partial-depth repair of surface defects and joint spalls that are limited to the upper one-third of the PCC slab
- ◆ Typically along transverse and longitudinal joints
- ◆ Restores ride quality

Slide
87

Application

- ◆ Candidates for joint spall repair
 - ◆ Spalling caused by incompressibles in joint
 - ◆ Localized areas of scaling
- ◆ Not candidates for joint spall repair
 - ◆ Spalling caused by dowel lockup
 - ◆ Spalling at working cracks
 - ◆ Spalling caused by durability distress

Slide
88

Performance of Joint Spall Repairs

- ◆ Proper installation is critical
 - ◆ Service life of 8 to 10 years with appropriate use and installation
 - ◆ Can fail within 2 years when used inappropriately
- ◆ Cementitious and polymer-based materials are best suited for long-term repairs

Slide
89

Joint Spall Repair Material Costs



- ◆ Type III PCC
 - ◆ \$375/m³ (\$10.62/ft³)
- ◆ Proprietary magnesium phosphate cement
 - ◆ \$1,300/m³ (\$36.82/ft³)
- ◆ Epoxy patching mixture
 - ◆ \$8,500/m³ (\$240.69/ft³)
- ◆ Bituminous patching mixture
 - ◆ \$185/m³ (\$5.25/ft³)

Slide
90

Full-Depth Repair

- ◆ Removal and replacement of concrete through entire depth
- ◆ Typically performed at joints and cracks
- ◆ Purpose
 - ◆ Restore rideability
 - ◆ Prevent further deterioration

Slide 91

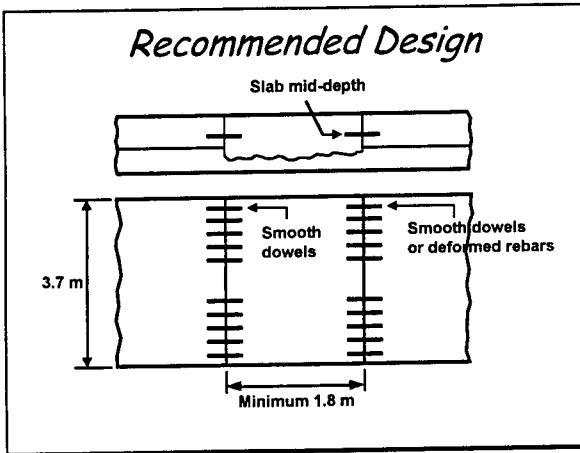

Slide 92

Performance of Full-Depth Repairs

- ◆ Performance has been variable, but can provide 10 or more years of service when properly designed and constructed
- ◆ High-early strength materials allow early opening to traffic and limited lane closures

Slide 93

Full-Depth Repair Costs



- ◆ Will vary depending on location, repair materials, size of the project, thickness of the existing pavement, etc.
- ◆ Typical costs \$78 to \$84 per m² (\$65 to \$70 per yd²)

Slide
94

Load Transfer Restoration

- ◆ Placement of load transfer devices across joints or cracks of existing pavements
- ◆ Candidate projects
 - ◆ Poor load transfer (< 70 %)
 - ◆ Pumping
 - ◆ Faulting
 - ◆ Corner breaks

Slide
95

Retrofitted Dowel Bar Assembly

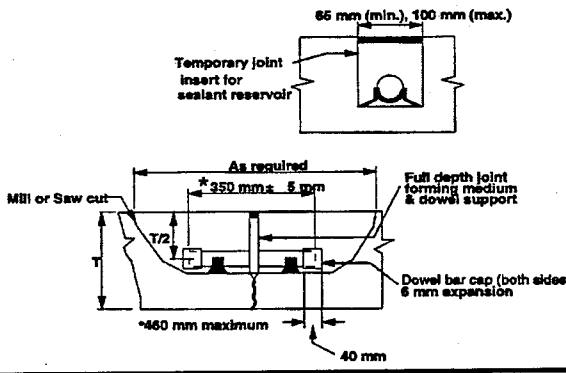

Slide
96

Retrofitted Dowel Bar Layout

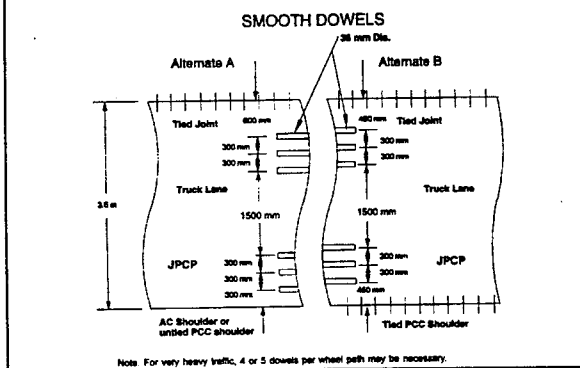

Slide
97

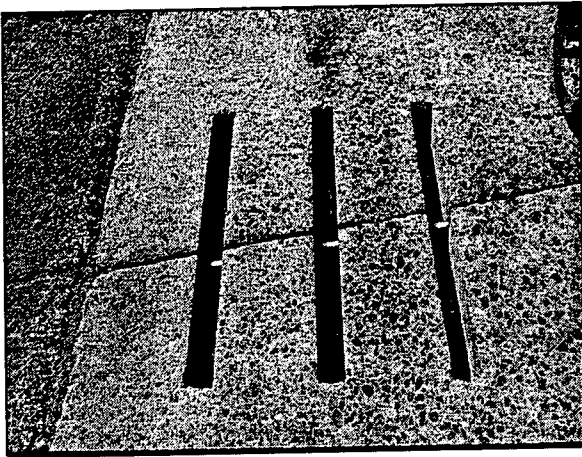

Slide
98

*Performance of Load
Transfer Restoration*

- ◆ FHWA - 9 years of service
- ◆ Puerto Rico - 0.5 % failures after 8 years (7,000 dowels installed)
- ◆ Washington - excellent performance with service lives of 10 to 15 years

Slide
99

*Load Transfer
Restoration Costs*



- ◆ Installed costs: \$25 to \$35 per dowel on production jobs

Slide
100

Treatment Selection Process

1. Establish existing pavement condition
2. Obtain project information
3. Determine causes of distress
4. Develop feasible alternatives
5. Perform life cycle cost analyses
6. Select preferred alternative
7. Construct and monitor performance

Slide
101

Project Timing

- ◆ Applying the right treatment to the right pavement *at the right time*
- ◆ No universal method available
- ◆ Most agencies rely on policy or experience of field personnel

Slide
102

Summary

- ◆ Many available treatments for AC and PCC pavements
- ◆ Each has advantages and limitations
- ◆ Performance and cost vary with given conditions

MODULE 4 COST ANALYSES

Cross Reference

Reference Manual, Module 4, "Cost Analyses," pages 87–122.

Overview

This module introduces some of the techniques available for demonstrating the cost-effectiveness of preventive maintenance programs and the importance of early maintenance in reducing the life cycle costs of pavement preservation. The analyses support a shift in emphasizing the importance of preventive maintenance from a program that receives the funds remaining after all other needs have been addressed to a recognized program that receives cyclic funding for scheduled activities. The results of the cost analyses discussed in this module provide the information needed for preventive maintenance programs to more effectively compete for funding with other road needs such as rehabilitation, reconstruction, or reactive maintenance activities.

Brief Outline

Introduction

Introduction to Engineering Economic Analysis (EEA) Approach

Basic Principles of Engineering Economics

Methods to Compare Alternatives

Use of Results for Decision Making

Addressing User Costs in a Cost Analysis

Summary

Review Questions

1. What role does cost analysis play in the development and implementation of pavement preventive maintenance programs?
2. How does a pavement management system provide information for engineering economic analyses?
3. List some benefits that could be considered in a cost analysis.
4. What are some approaches to cost analyses? Which are most commonly used?
5. Differentiate between an interest rate, an inflation rate, and a discount rate.
6. Why are user costs controversial in the computation of life-cycle costs?
7. What advantages does the Benefit/Cost approach have? What disadvantages does it have?
8. Why are sensitivity analyses often conducted on cost analysis results? How does this lend credence to a probabilistic (i.e., risk analysis) approach?

Key References

- Al-Mansour, A. I., and K. C. Sinha, 1994. "Economic Analysis of Effectiveness of Pavement Preventive Maintenance." *Transportation Research Record 1442*. Transportation Research Board, Washington, D.C.
- Butler, B. C., Jr., R. F. Carmichael, III, P. Flanagan, and F. N. Finn. 1986. *Evaluating Alternative Maintenance Strategies*. National Cooperative Highway Research Program, Report 285. Transportation Research Board, Washington, D.C.
- Geoffroy, D. N. 1996. *Cost-Effective Preventive Pavement Maintenance*. Synthesis of Highway Practice 223. Transportation Research Board, Washington, D.C.
- Kirk, S. J. and A. J. Dell'Isola. 1995. *Life Cycle Costing for Design Professionals*. McGraw-Hill, New York, NY.
- Markow, M. J., F. D. Harrison, P. D. Thompson, E. A. Harper, W. A. Hyman, R. M. Alfelor, W. G. Mortenson, and T. M. Alexander. 1994. *Role of Highway Maintenance in Integrated Management Systems*. National Cooperative Highway Research Program Report 363. Transportation Research Board, Washington, D.C.
- O'Brien, L. G. 1989. *Evolution and Benefits of Preventive Maintenance Strategies*, Synthesis of Highway Practice 153. Transportation Research Board, Washington, D.C.
- Reno, A.T., M.E. Shaw, and W.A. Hyman. 1994. *Guidelines for Effective Maintenance-Budget Strategies*. National Cooperative Highway Research Program Report 366. Transportation Research Board, Washington, D.C.
- Walls, J., III, and M. R. Smith. 1998. *Life-Cycle Cost Analysis in Pavement Design*, FHWA-98-079. Federal Highway Administration, Washington, DC.

Presentation Graphics

Slide
1

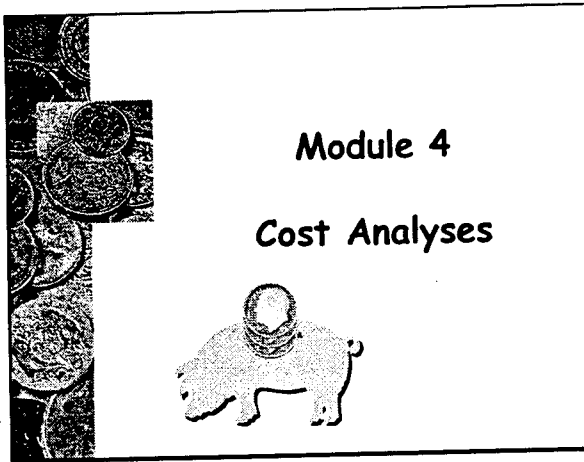

Slide
2

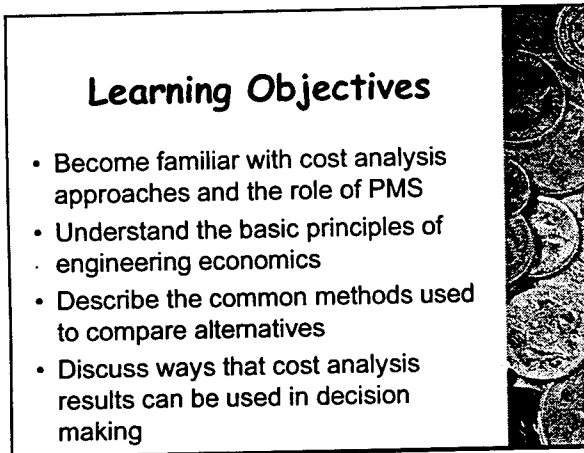

Slide
3

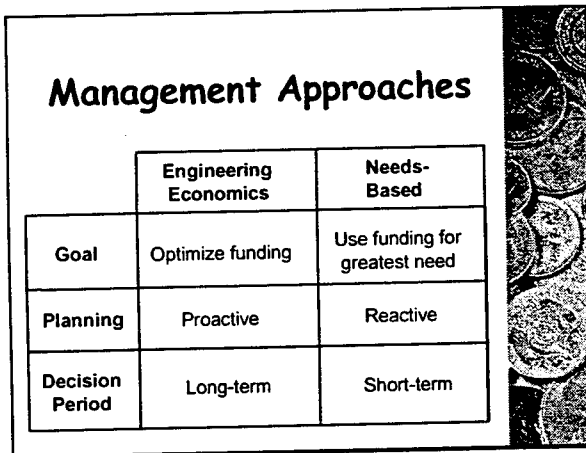

Slide
4

A Shift in Approaches

Needs-Based Approach → Engineering-Economic Approach

Movement toward engineering economics approach requires cost analyses

Slide
5

What Information is Needed?

- Treatment costs
- Treatment lives
- Treatment effects

Slide
6

Where Can I Get This Information?

- Bid documents
- Construction records
- Design office
- Research
- Maintenance

Pavement Management System

Slide
7

Use of Pavement Management Systems

- Provide inputs
- Quantify benefits
- Determine treatment type and timing
- Evaluate impacts



Slide
8

Treatment Issues in Engineering Economics

- Timely application of treatment
- Quality of treatment application
- Quantification of benefit (effectiveness)

Slide
9

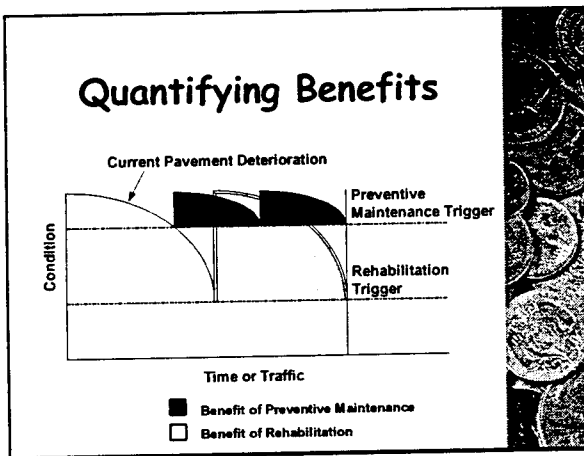

Slide
10

Public vs. Private Agencies

- Similar decision steps
- Private industries focus on profits
 - Inter-office political considerations
 - Rate of return
- Public agencies have different objectives
 - Protect public interests
 - Outside political considerations



Slide
11

Basic Principles of Engineering Economics



- Time value of money
- Expenditure stream diagrams
- Economic values
- Types of costs
- Calculation approaches



Slide
12

Time Value of Money

1999 2009

 7% Interest 

\$100 \$197



Slide 13

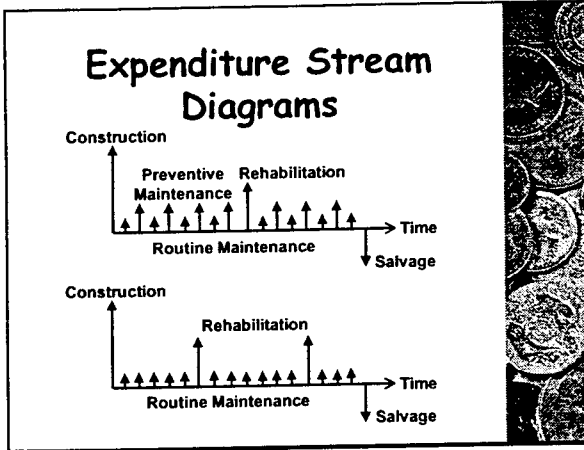

Slide 14

Economic Values

- Nominal versus real dollars
- Cost of money factor
- Analysis period

Slide 15

Nominal vs. Real Dollars

- Real (constant) dollars
 - Purchasing power stays the same over time
- Nominal (inflated) dollars
 - Purchasing power fluctuates over time

Do not mix nominal and real dollars.
Use the same approach for discount rate.

Slide
16

Cost of Money Factor

- Interest rate
- Inflation rate
- Discount rate

Using real dollars:
Discount Rate = $(Int - Infl) / (1 + Infl)$
 ~ Int - Infl

Using nominal dollars:
Discount Rate = Interest Rate



Slide
17

Analysis Period

- Time period over which future costs are evaluated
- Length of analysis period
 - Long enough to reflect cost differences
 - Longer than performance period
- Set the base year



Slide
18

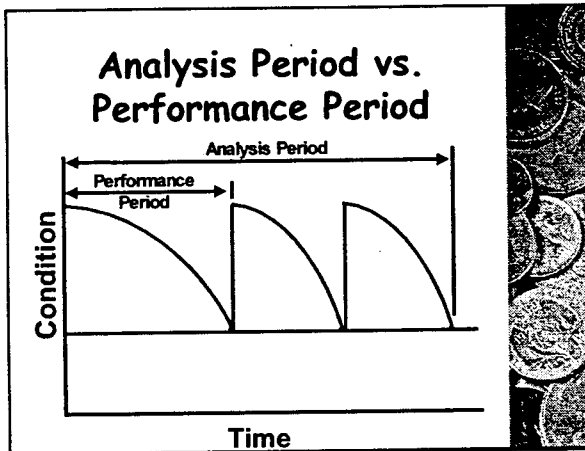

Slide
19

Types of Costs

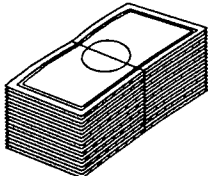

- Initial costs
- Periodic costs
- Annual costs
- Salvage value
 - Residual value
 - Serviceable life
- User costs

Slide
20

Calculation Approaches

- Deterministic
 - All inputs (costs, design lives, interest rates) are fixed over the analysis period (no regard for variability)
 - Result is a single cost value
- Probabilistic
 - Accounts for variability associated with all factors
 - Result is a probability distribution of expected values

Slide
21

Variability of Inputs

<u>Input</u>	<u>Source</u>
Construction Costs	Estimation
Maintenance Costs	Estimation
Pavement Performance	Projection
Traffic Levels	Projection
Discount Rate	Assumption

Slide
22

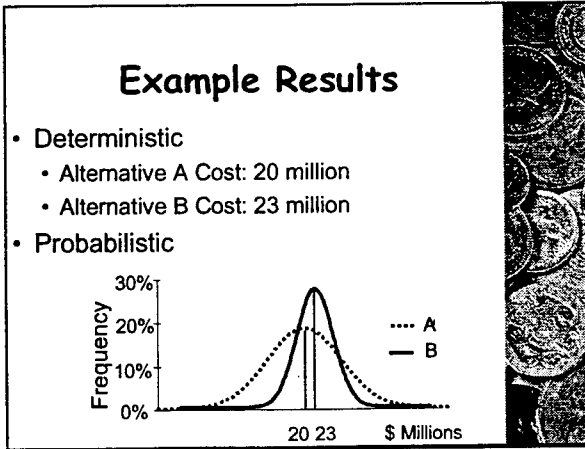

Slide
23

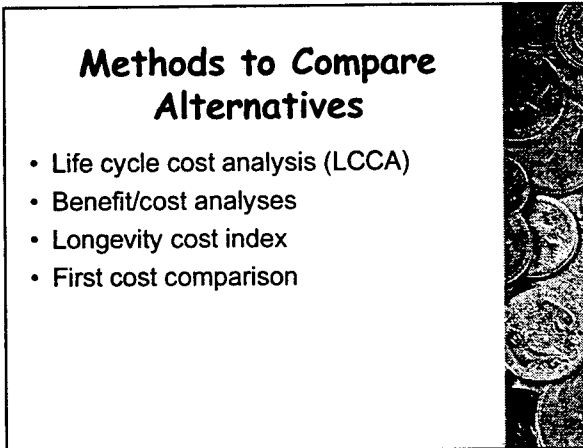

Slide
24

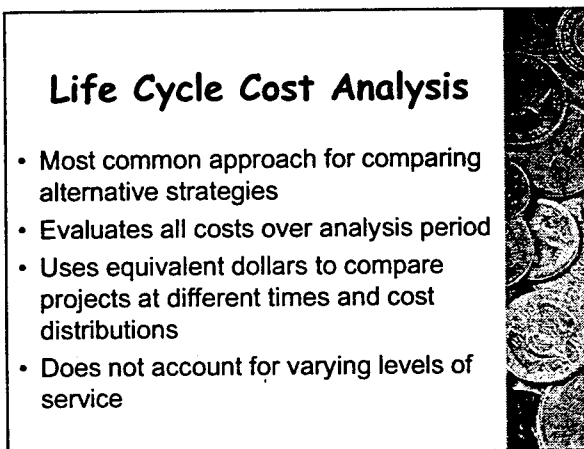

Slide
25

Approaches to Life Cycle Cost Analysis

- Present worth (PW)
- Equivalent uniform annual cost (EUAC)



Slide
26

Present Worth Method

Takes a series of costs:



And converts costs to one point in time:



Slide
27

Equivalent Uniform Annual Cost Method

Takes a series of costs:



And converts costs to an equivalent series of payments:

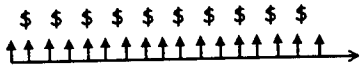

Slide 28

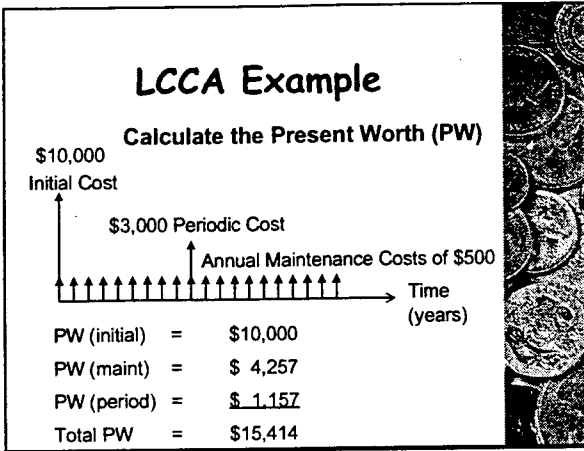

Slide 29

Life Cycle Cost Analysis

- Advantages
- Disadvantages

Slide 30

Benefit/Cost Analysis

- Considers both the cost and effectiveness of a treatment
- Costs determined using LCCA
- Benefit accounts for performance and users impacted
- Approach is used in many PMS

Slide
31

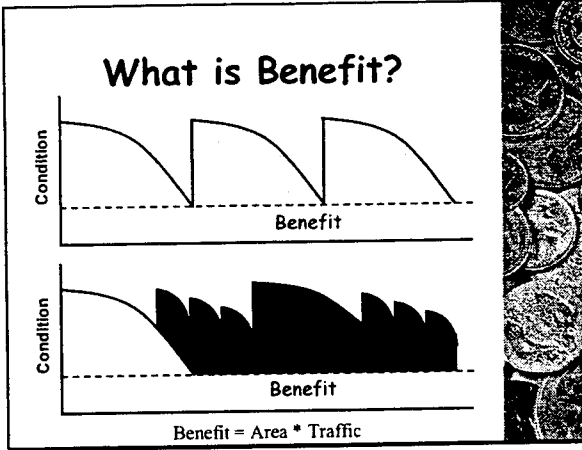

Slide
32

Benefit/Cost Comparison

Strategy	Benefit	ADI	Cost
Preventive Maint.	250	7000	\$500,000
Rehabilitation	1000	7000	\$3,500,000

PM Strategy: $B/C = \frac{250 * 7000}{500,000} = 3.5$

Rehab Strategy: $B/C = \frac{1000 * 7000}{3,500,000} = 2.0$

Slide
33

Benefit/Cost Strategy On A Network Level

Σ Highest Benefit/Cost Ratios

The most cost-effective strategies
are selected

Slide
34

Benefit/Cost Analysis

- Advantages
- Disadvantages



Slide
35

Longevity Cost Index

- Developed by Oregon DOT to evaluate thin surface pavement treatments
- Considers three factors
 - Treatment unit cost
 - Traffic loading
 - Treatment life

$$LCI = \frac{\text{Price/sy} + \text{MCOST/sy}}{\text{Life} \cdot \text{Annual MEGASALs}}$$

Slide
36

Longevity Cost Index

- Advantages
- Disadvantages



Slide
37

First Cost Comparison

- Most basic means of comparison
- Considers first costs only



Slide
38

First Cost Calculation

- Sealant costs = \$6,000
- Labor costs = \$4,000
- Equipment costs = \$2,000
- 4000 feet of cracks to seal

What is the unit cost?

$$\frac{\$12,000}{4000 \text{ ft}} = \$3.00/\text{ft} (\$9.84/\text{m})$$



Slide
39

First Cost Comparison Analysis

- Strategy 1: Crack Sealing
 - Unit cost = \$0.91/m (3.00/ft)
- Strategy 2: Chip seal
 - Unit cost = \$1.67/m² (1.40/yd²)

How do you compare these strategies?



Slide
40

First Cost Comparison Analysis

- Advantages
- Disadvantages



Slide
41

Use of Results for Decision Making

- Determine cost-effective strategies
- Lower overall life cycle cost of pavement preservation
- Improve overall network conditions



Slide
42

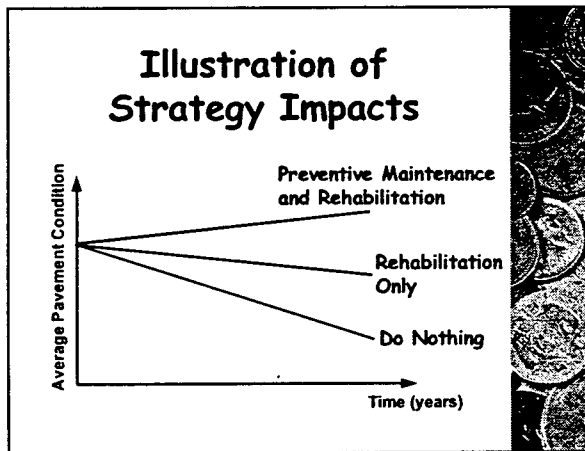

Slide
43

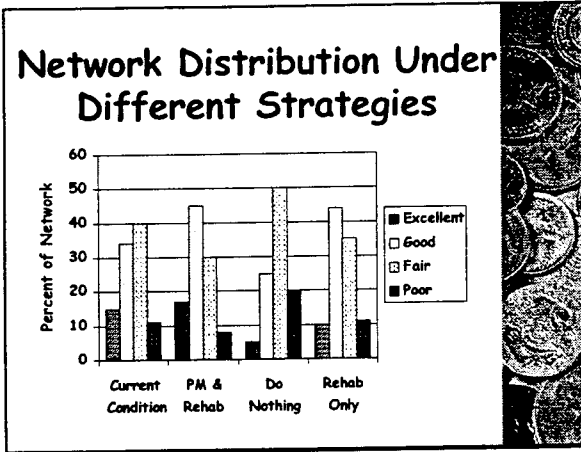

Slide
44

Cost Comparison (New York)

Description	Preventive Maintenance	
	Yes	No
Life Cycle Cost	\$144,036	\$382,590
Life Cycle Cost Ratio	0.376	1.0
Effectiveness (Cond. Years)	176	128
Cost-Effectiveness Factor	1.22	0.335
Cost-Effectiveness Ratio	3.65	1.0

Slide
45

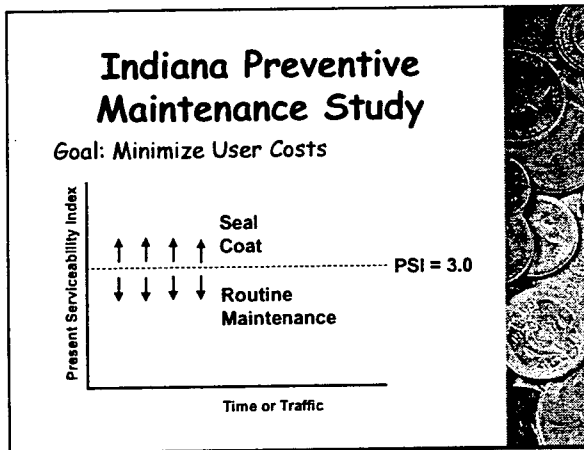

Slide
46

Indiana Preventive Maintenance Study

Goal: Minimize Agency and User Costs

PSI = 3.0

If seal coat when
PSI > 3.0, then
apply 3 chip seals

PSI = 3.0

If seal coat when
PSI < 3.0, then
apply 1 chip seal

Slide
47

Michigan DOT Example

\$315 million
Rehabilitation and
Reconstruction

=

+

\$190 million
Rehabilitation and
Reconstruction
\$10 million
Preventive
Maintenance

Achieved same results for \$115 million less

Slide
48

Wisconsin Transportation Center Example

Strategy	Expenditure	Backlog	Condition Rating
Do Nothing	\$0	\$5.1	4.0
PM Only	\$0.5	\$3.6	5.6
PM First	\$2.7	\$0	7.2
Unconstrained	\$2.7	\$0	7.1
Worst-First	\$3.5	\$0	7.0
No PM	\$3.5	\$0.3	6.5

Slide
49

Sample Problem

- 1,000 lane-kilometers of AC pavements
- No preventive maintenance strategy
- Currently fix when pavements reach poor condition
- Annual budget of \$5 million
- Growing backlog



Slide
50

Challenge

- Requested an additional \$2.5 million annually to rehabilitate 20 more lane-kilometers per year
- Legislature says to consider some alternative policies



Slide
51

Step 1

- Project network condition if continue using present practice with extra funding

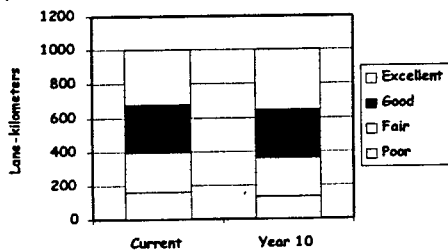

Slide 52

Step 2

- Develop preventive maintenance policy
- Determine impacts
 - 6 more years to reach poor condition
 - 4 more years of excellent condition
 - 2 more years of good condition
- Estimate costs

Slide 53

Step 3

- Project network condition using preventive maintenance strategy

The chart shows the distribution of lane-kilometers across four condition categories: Excellent (white), Good (black), Fair (light gray), and Poor (dark gray). The y-axis represents Lane-kilometers from 0 to 1200. The x-axis compares 'Current' and 'Year 10'.

Condition	Current (Lane-km)	Year 10 (Lane-km)
Excellent	~500	~600
Good	~150	~100
Fair	~150	~150
Poor	~50	~50

Slide 54

Step 4

- Compare strategies

The chart compares the 'Existing Strategy' and 'Preventive Maintenance' strategies. The y-axis represents Lane-kilometers from 0 to 1200. The x-axis compares 'Existing Strategy' and 'Preventive Maintenance'.

Condition	Existing Strategy (Lane-km)	Preventive Maintenance (Lane-km)
Excellent	~500	~600
Good	~150	~100
Fair	~150	~150
Poor	~50	~50

Slide
55

User Costs

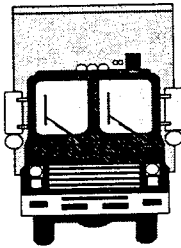

- Vehicle operating costs
- Crashes
- User delays
- Passenger discomfort

Slide
56

How to Address User Costs in a Cost Analysis

- Cost components
 - Normal operating costs
 - Work zone operating costs
- Comparison of user delay times
- Comparison of cost effectiveness (try to quantify benefits)
- User costs can dominate LCCA so some agencies ignore

Slide
57

Summary

- Basics of engineering economics presented
- Various cost analysis methods available for comparing alternatives
- Cost analyses is an integral part of implementing a preventive maintenance program by demonstrating the benefits and cost effectiveness of the approach

NOTES

MODULE 5

CASE STUDIES

NOTES

MODULE 5 CASE STUDIES

Cross Reference

Reference Manual, Module 5, "Case Studies," pages 123–154.

Overview

This module summarizes the findings obtained from a series of visits and interviews with highway agencies regarding their pavement preventive maintenance programs. The case studies presented here include information about the events that led to the development and implementation of the preventive maintenance program as well as key information about some important elements of implementation. These elements include the following: funding sources, levels, and allocations; treatments used; project and treatment selection procedures and guidelines; performance; barriers to implementation; maturing of the plans; and lessons learned during the implementation and maturation process. The five DOTs visited were California, Georgia, Michigan, New York, and Texas.

Brief Outline

Introduction
California
Georgia
Michigan
New York
Texas
Conclusions

Review Questions

1. How does studying other agencies' pavement preventive maintenance help in getting a program established?
2. What are some ways that agencies select suitable projects?
3. What types of barriers to implementation were encountered by the various agencies? How were these overcome?
4. Why is selling a pavement preventive maintenance program a continuing effort?

Key References

Denehy, E.J. 1997. "Experiences in Implementing the Pavement Preventive Maintenance Program in the New York State Department of Transportation." *Transportation Research Record 1597*. Transportation Research Board, Washington, DC.

Hauer, E., D. Terry, and M.S. Griffith. 1994. "The Effects of Resurfacing on the Safety of Two-Lane Rural Roads in New York State." *Transportation Research Record 1467*. Transportation Research Board, Washington, DC.

Presentation Graphics

Slide
1

Module 5

Case Studies



Slide
2

Learning Objectives

- Become familiar with preventive maintenance programs in other states
- Recognize similarities in the implementation and execution
- Understand potential barriers and how to overcome them



Slide
3

Reasons for Case Studies

- Provide success stories
- Illustrate the benefits of implementation
- Learn means of overcoming challenges
- Avoid repeating same problems as other States



Slide
4

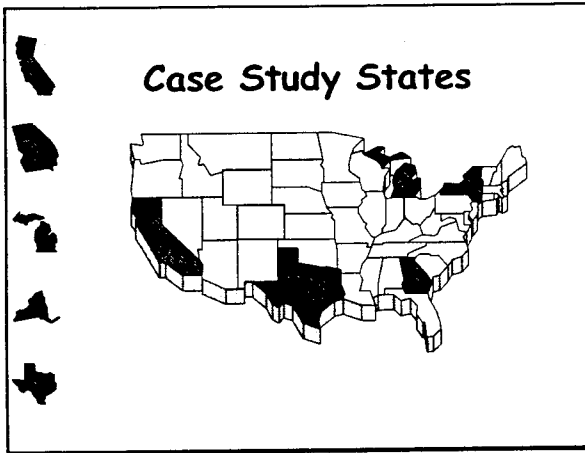

Slide
5



California

- Decision to reduce the number of lane miles that need rehabilitation
- A preventive maintenance strategy was analyzed
- Presented to CTC in July 1996
- 10-year program (SHOPP) submitted in 1998

Slide
6

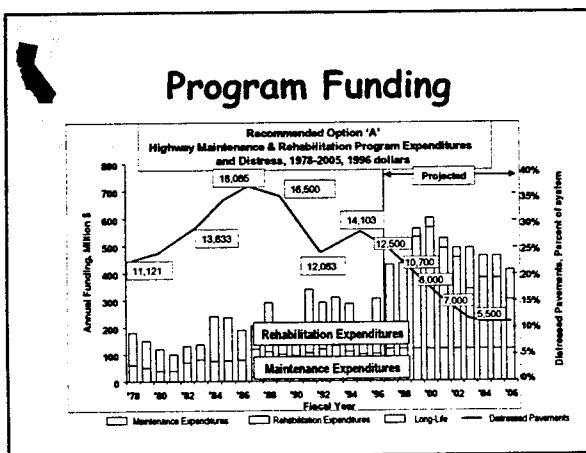

Slide
7



Goals of the Program

- Reduce deteriorated pavement needs from 14,100 to 5,500 miles (29 to 11 %)
- Switch from a “worst-first” to “preventive treatment” management strategy
- Use longer-life rehabilitation on roadways
 - ◆ ADT > 150,000
 - ◆ ADTT > 15,000

Slide
8



Funding

Category	Current Funding	Projected Increase	Steady State
Routine Maint.	\$70		\$50
Preventive Maint.	\$50	\$53	\$75
CAPM	\$75		\$50
Rehabilitation	\$300		\$100

Slide
9



AC Pavement Strategies and Expected Life

- Crack seal 1-3 years
- Patching 1-3 years
- Slurry seal 2-4 years
- Chip seal 2-5 years
- Thin overlay 2-5 years
- Thick overlay 4-7 years
- AC overlay (rehab) 7-15 years

Slide
10

PCC Pavement Strategies and Expected Life

- Crack seal 2 years
- Shoulder grind/fill 2-5 years
- Undersealing 3-10 years
- Diamond grinding 5-10 years
- Slab replacement 3-7 years
- Crack/seal/overlay 10-15 years
- Lane replacement 15-20 years

Slide
11

Treatment Categorization Matrix

Ride Quality	Structural Problem	Highway Class		
		1	2	3
Poor	Major	1	2	11
	Minor	3	4	12
	None	5	6	13
Acceptable	Major	7	8	14
	Minor	9	10	15

Slide
12

Program Assignments

- Rehabilitation
 - ◆ All priority 1-6
 - ◆ 1/3 AC priority 7-8
 - ◆ All PCC priority 7-8
- Preventive Maintenance
 - ◆ All priority 9-10 with little alligator cracking
- Class 3 Road Maintenance
 - ◆ All class 3 roads (11-14)
- Routine Maintenance
 - ◆ All other roads

Slide
13



Lessons Learned

- Develop plan that demonstrates benefits
- Promote plan externally to obtain funds and internally to achieve acceptance
- Address concerns of doubters
- Provide training that emphasizes timing
- Do the right thing at the right time

Slide
14



Potential Vulnerabilities

- Support may be lost if benefits do not materialize
- Change in administration with different objectives
- Emergence of high visibility issues can divert funding (e.g., 1989 earthquake)

Slide
15



Michigan

- Implemented a Preventive Maintenance Program in 1992 with passage of ISTEA
 - ◆ Pavements
 - ◆ Bridges
- Preventive maintenance extends the remaining service life of pavements and bridges

Slide
16

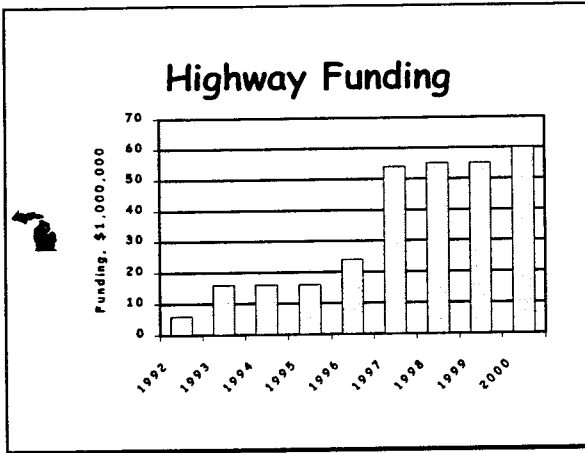

Slide
17

Funding Allocation

- Funds distributed to 7 Regions based on need
- Regions can distribute funds as needed
- 1998 distribution
 - ◆ Joint/crack sealing \$10 million
 - ◆ Surface seals \$19 million
 - ◆ Enhancements \$25 million

Slide
18

Treatments

● AC Pavements	● PCC Pavements
◆ Thin overlay	◆ Joint resealing
◆ Mill and overlay	◆ Spall repair
◆ Chip seal	◆ Crack sealing
◆ Microsurfacing	◆ Diamond grinding
◆ Crack treatment	◆ Shoulder ribbons
◆ Shoulder ribbons	◆ Drain cleanout
◆ Ultrathin Overlay	◆ Dowel retrofit
	◆ CPR

Slide
19

Project Selection

- Regions select projects based on goals assigned by central office
- Goal is 95 percent of expressways and 85 percent of trunk highways in good to fair condition in 10 years
- Procedure to plan, design, and let projects within 22 weeks

Slide
20

Challenges to Implementation

- Some elected officials believe preventive maintenance is a waste of money
- Special interest groups
- Training is needed
- Need support from management
- Selection and timing are essential to success
- Safety enhancements

Slide
21

Maturing of the Plan

- All projects are delivered in first 6 months of fiscal year
- PMS used as network planning tool and to assist in treatment selection
- Structural design does not consider preventive maintenance even though extended life is expected

Slide
22

Lessons Learned

- Keep the projects simple
- Seal cracks (overband) before applying single surface treatment
- Need management support and backing
- Allow the program to build up
- Work with industry to develop specs
- Keep workload balanced

Slide
23

More Lessons Learned

- Requires long-term commitment
- Don't oversell the treatments
- Update costs
- PMS and preventive maintenance support each other

Slide
24

Georgia

- Began current strategy approximately 25 years ago
- Commitment to perform rehabilitation
 - ◆ 10 percent of road network each year
 - ◆ Network resurfaced every 10 years
- Do not build any roads they can not maintain

Slide
25

Funding

- Annual budget of \$200 million for pavement preservation
- More funding is needed to continue to meet target of 10 percent per year
- TEA-21 provides more funding, but may come from maintenance budget
- Preventive maintenance program comprised of 40 % State and 60 % Federal funding

Slide
26

Treatment Methods

● AC Pavements	● PCC Pavements
◆ Crack seal	◆ Slab replacement
◆ Surface seal	◆ Undersealing
◆ Spot overlay	◆ Joint Sealing
◆ Deep patching	◆ Grinding
◆ Milling	◆ Spall repair
◆ Thin overlay	
◆ Mill and inlay	

Slide
27

Project Selection

- Project selection made at central office
- Condition survey conducted each year by Area Asst. Maintenance Engineers
- Identify and re-inspect all sections with rating less than 70
- Submit final list to Maintenance Division in Central Office
- Add sections to reach target of 10 %

Slide
28

Maintenance and Rehabilitation Treatment Selection

Treatment	Rating	Forces
Crack/Joint Sealing	75-80	In-house
Surface Seal	70-77	Both
Spot Overlay	70-80	In-house
Deep patching	Localized	In-house
Mill/Thin Overlay	< 70	Contract
PCC Restoration	< 70 (also ride and faulting)	Both

Slide
29

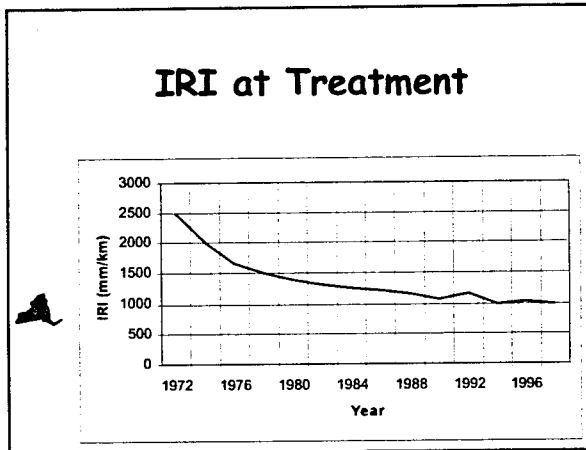

Slide
30

- ### Lessons Learned
- Policy has improved conditions
 - Now at steady-state condition
 - State must expand its preventive maintenance program
 - Support from top management is critical
 - PATIENCE; benefits are not immediate

Slide
31

More Lessons Learned

- Reinforce program goals and objectives
- Minimize contract time
- Centralized approach has been successful
- Need to involve Area and District personnel
- Higher customer expectations

Slide
32

New York

- 1991 - Established the Dedicated Highway and Bridge Trust Fund
 - ◆ Received money from gas tax
- 1992 - Established system for preservation of state capital assets
 - ◆ Department annually prepares 5-year plan for preventive maintenance of highways and bridges

Slide
33

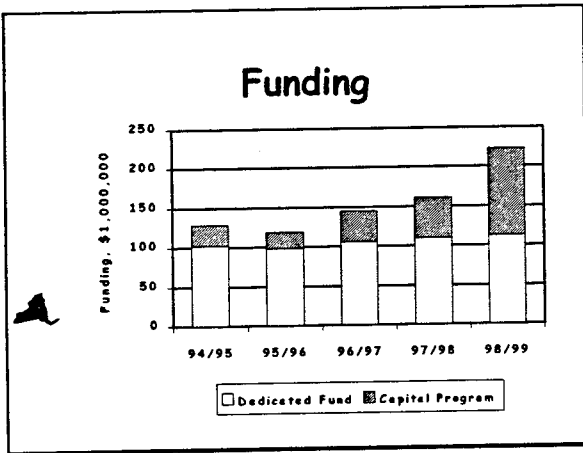

Slide
34

**Initial Treatments
and Cycles**

- PCC joint and crack seal 8 years
- AC crack seal 4 years
- Thin AC overlays 12 years
- Surface treatments 4 years
- Clean drains 10 years

Slide
35

**Changes to Treatment
Methods**

- Eliminated overbanding on crack seal
- Crack seal on 2-year cycle
- Eliminated use of chip seals
- Added microsurfacing and Novachip®
to list of treatments
- Contracts for cold in-place recycling

Slide
36

Project Selection

- Regions select, based on guidelines
- Resident Engineer develops
candidate list of projects
- By 1997, 70% of paving mileage was
PM projects

Slide 37

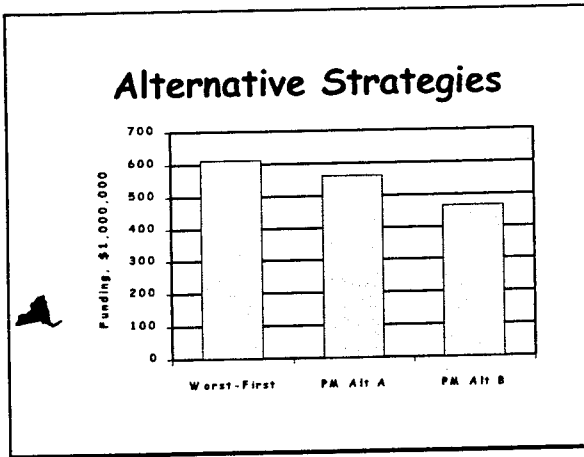

Slide 38

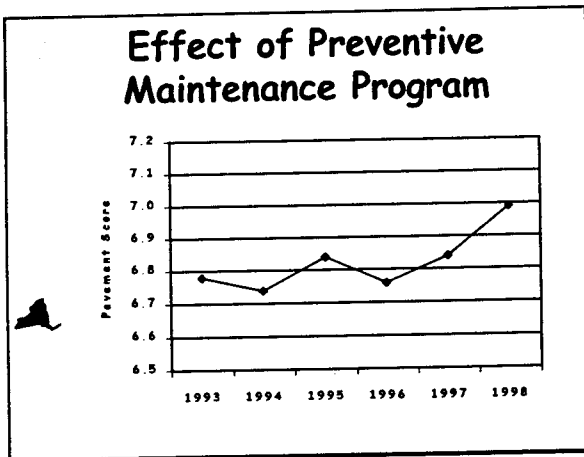

Slide 39

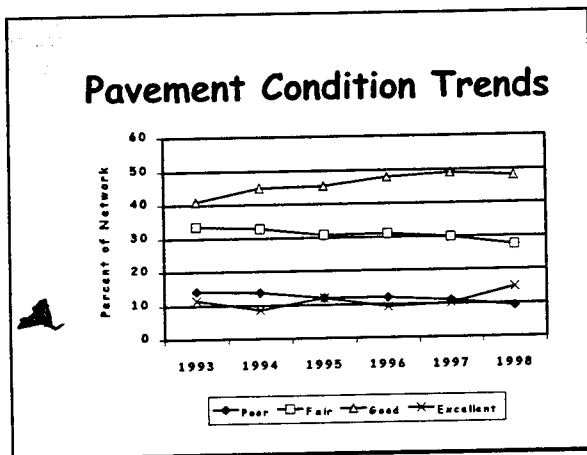

Slide
40

Maturing of the Program

- Vendor In Place Paving
 - ◆ Asphalt delivered to site by vendors
 - ◆ Placed and compacted by state forces
- Simplified Contracts
 - ◆ Simplification of normal process
 - ◆ Limited to 15 pay items, work to be done in one month, and only one final payment
- Changes to Treatments
- Safety Appurtenance Program

Slide
41

Challenges to Implementation

- Fiscal and budgetary problems can occur at state level
- Change in administration can jeopardize the program
- Public complaints about specific treatments can cause setbacks

Slide
42

Lessons Learned

- Need dedicated funding
- Need support of management
- Program needs champions
- Selling the program is a continuing effort
- Monitor the program and solve problems quickly

Slide
43

Texas

- Has applied preventive maintenance treatments for over 20 years
- Developed a formal "Preventive Maintenance Program" in 1987



Slide
44

Funding

- Current funding is \$175 million per year
- Increase of \$75 million in 2000
- Generally supported by state funds
- Funds are allocated to Districts



Slide
45

Treatment Methods

● AC Pavements	● PCC Pavements
◆ Crack sealing	◆ Joint sealing
◆ Chip seals	◆ Crack sealing
◆ Fog seals	
◆ Microsurfacing	
◆ Thin AC overlays	



Slide
46

Priority Considerations

1. Safety
2. Protect investment
3. User comfort
4. Aesthetics



Slide
47

Challenges to Implementation

- Needs support of the administration
- Loss of experienced personnel
- PMS models have a credibility problem
- Decentralization
- No guidance on treatments



Slide
48

Maturing of the Plan

- Obtain dedicated funding for preventive maintenance at time of construction
- Ability to transfer funds
- Develop consistent ride specification
- Statewide specifications for treatments



Slide
49

 **Case Study Summary**

- Preventive maintenance programs have improved pavement condition
- Preventive maintenance is most cost-effective approach to achieve goals
- Need training to obtain support and approval of executive management
- Need to be patient; benefits are not immediate
- Selling the program is a continuous effort

NOTES

MODULE 6

**IMPLEMENTING PREVENTIVE
MAINTENANCE AS PART OF A PAVEMENT
PRESERVATION PROGRAM**

NOTES

MODULE 6

IMPLEMENTING PREVENTIVE MAINTENANCE AS PART OF A PAVEMENT PRESERVATION PROGRAM

Cross Reference

Reference Manual, Module 6, "Implementing Preventive Maintenance As Part of a Pavement Preservation Program," pages 155–180.

Overview

In this module, an approach to developing a preventive maintenance program is outlined. The suggested approach draws on the experiences of the agencies that have made preventive maintenance a cornerstone of their pavement preservation practices, as described in module 5. It also draws upon the economic analysis tools presented in module 4. This module is intended to help agencies assemble these and other components of preventive maintenance into a working preventive maintenance program. In the process, it also addresses how the obstacles to these programs can be addressed.

Brief Outline

Introduction

Keys to Successful Programs

- Establish Goals

- Document the Benefits

- Obtain Dedicated Funding

- Develop and Improve the Available Treatments and Timings

Innovative Practices to Promote Program Success

- Contracting

- Warranties

- Training

Summary

Review Questions

1. What are the major benefits that can be obtained through the implementation of a pavement preventive maintenance program?
2. List some of the keys to successful pavement preventive maintenance programs. Why are each of these important?
3. What are some of the primary data items to be collected as part of a pavement preventive maintenance monitoring program? Why is ongoing monitoring important?

4. Why is securing dedicated funding for pavement preventive maintenance programs important?
5. Describe some of the innovative practices of promoting pavement preventive maintenance programs.

Key References

American Association of State Highway and Transportation Officials (AASHTO). 1987. *AASHTO Maintenance Manual*. American Association of State Highway and Transportation Officials. Washington, DC.

Denehy, E. J. 1997. "Implementing New York State Department of Transportation's Pavement Preventive Maintenance Program," *Transportation Research Record 1597*. Transportation Research Board, Washington, DC.

Federal Highway Administration (FHWA). 1995. *Pavement Maintenance Effectiveness/ Innovative Materials Workshop*. FHWA-SA-96-007. Federal Highway Administration, Washington, DC.

Federal Highway Administration (FHWA). 1997. *Asset Management. Advancing the State of the Art Into the 21st Century Through Public-Private Dialogue*. FHWA-RD-97-046. Federal Highway Administration, Washington, DC.

Galehouse, L. 1998. "Innovative Concepts for Preventive Maintenance," *Transportation Research Record 1627*, Transportation Research Board. Washington, DC

Geoffroy, D. N. 1996. *Cost-Effective Preventive Pavement Maintenance*. NCHRP Synthesis of Highway Practice 223. Transportation Research Board, Washington, DC.

NYSDOT. 1997. "Preventive Maintenance Plan for State Fiscal Years 1998-99—2002/03." New York State Department of Transportation. Albany, NY.

O'Brien, L. G. 1989. *Evolution and Benefits of Preventive Maintenance Strategies*. NCHRP Synthesis of Highway Practice 153. Transportation Research Board, Washington, DC.

Rohde, G. T., M. I. Pinard, and E. Sadzik. 1997. "Long-Term Network Performance: Function of Pavement Management System Maintenance Selection Policy." *Transportation Research Record 1592*. Transportation Research Board, Washington, DC.

Shober, S. F., and D. A. Friedrichs. 1998. "Pavement Preservation Strategy." *Transportation Research Record 1643*. Transportation Research Board, Washington, DC.

Presentation Graphics

Slide
1

Module 6





Implementing Preventive Maintenance As Part of A Pavement Preservation Program



Slide
2

 **Major Benefits**





- Improved pavement condition
- Safer roads
- Lower life cycle costs
- Reduced congestion
- Customer satisfaction
- More cost effective use of funds

Slide
3







 **Challenges**

- Dedicated funding challenges
- Management resistance
- Management's perception of public reaction
- Poor data tracking
- Lack of applicable research
- Absence of relevant training







Slide
4

 **Keys to Successful Programs**

-  ● Establish goals
-  ● Document the benefits
-  ● Promote the benefits
-  ● Obtain dedicated funding
-  ● Develop guidelines
-  ● Identify champion
-  ● Obtain top management support

Slide
5

 **Establish Goals**

It is essential that a road agency select a long-term objective and structure its maintenance selection policy to achieve its objective.



- Rohde et al. 1997

 *Advocating a philosophy of preventive maintenance is the most important factor in developing a successful program.*

- Galehouse 1998





Slide
6

 **Simple, Effective Goals**

-  ● California - reduce pavements in need of rehabilitation from 29% to 11%
-  ● Wisconsin - provide the highest quality service possible per unit of service
-  ● Michigan - keep good roads good
 - By 2007 (after 10 years)
 - 95% of expressways in fair/good
 - 85% of non-expressways in fair/good

Slide
7

 **Measurable Goals**

-  ● Pavement condition
-  ● Average rating
-  ● Percent of pavements in condition category
-  ● Cost savings







Slide
8

 **Document the Benefits**

There is a need to conduct and publish the results of formal research on the cost-effectiveness of pavement preventive maintenance techniques.



- Geoffroy 1996





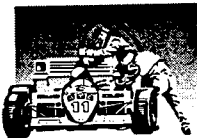

Slide
9

 **Benefits of Maintenance**

  People understand the importance of preventive maintenance on their cars.

  Why is it so hard to understand the same benefits on roads?

Slide 10

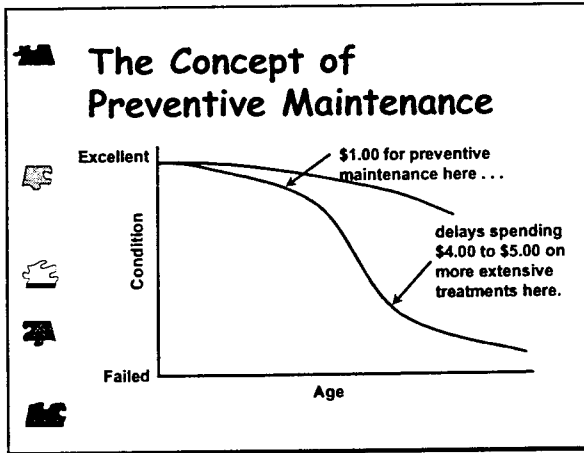

Slide 11

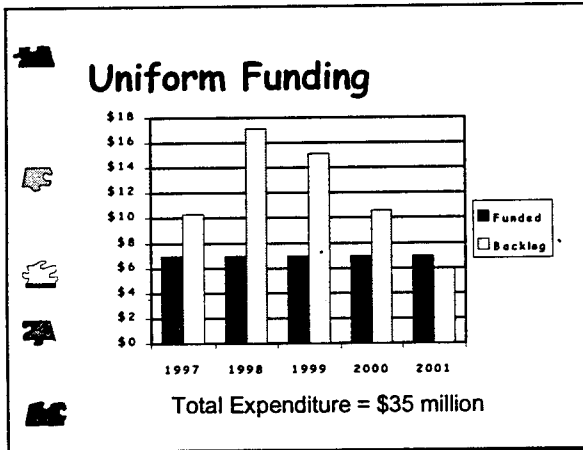

Slide 12

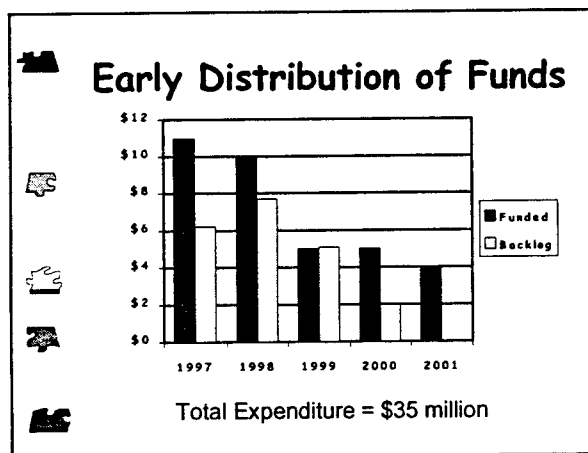

Slide 13

GIS Link

The screenshot shows a GIS interface for 'District 2 Lassen County'. It includes a map area, a legend, and a data table. The table has columns for 'City of Lassen Precincts' and 'Number of Pavement Miles'. The legend lists 'City of Lassen Precincts' and 'Number of Pavement Miles'.

City of Lassen Precincts	Number of Pavement Miles
...	...

Slide 14

Contribution of Research

- SHRP SPS-3 and SPS-4
- Ontario's crack sealing study
- 3-year evaluation of Novachip®
- In-house research studies (AZ, IA, MN)

Regional or local studies may be more meaningful than national studies

Slide 15

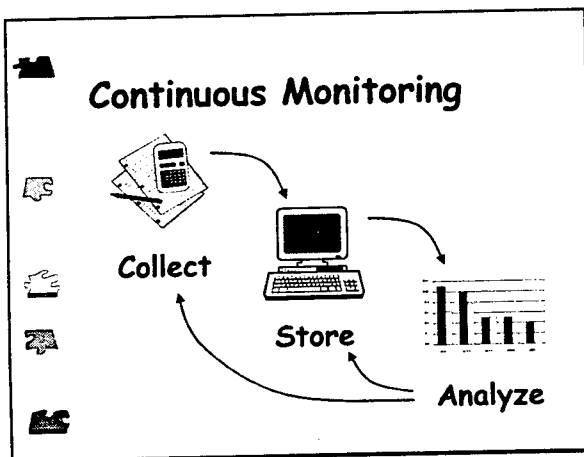

Slide
16

 **Data Collection**

- Pavement condition before treatment
- Ambient conditions at treatment
- Design and construction of treatment
- Location and limits
- Duration of construction (user costs)
- Construction costs
- Performance monitoring

Slide
17

 **Means of Assessing Benefits**

- First cost comparison
- Life cycle cost analysis
 - Present worth (PW)
 - Equivalent uniform annual cost (EUAC)
- Benefit/cost
- Longevity cost index

Slide
18

 **Obtain Dedicated Funding**

Long-term support and financial commitment are the keys.

- Wayne Shackleford

Dedicated funding requires a strong commitment to the philosophy of preventive maintenance.

Slide
19

 **Importance of Dedicated Funding**

- Benefits take time to realize
- Allows for improved asset management

 **Funding levels should match preventive maintenance needs**



Slide
20

 **Use of a Pavement Management System**

- Determine funding level to achieve an agency goal
- Determine the most cost-effective strategy for a given funding level
- Integrate with preventive maintenance (feedback)



Slide
21

 **Example Problem**

- Goal: reduce backlog by 50 percent within 5 years
- Objective: determine funding levels to attain the goal and maintain that condition level for 10 years



Slide 22

Given Conditions

- Total network 6,000 miles
 - Poor condition 500 miles
 - Fair condition 4,000 miles
 - Good condition 1,000 miles
- 5 percent deteriorate to lower level each year
- Repair costs
 - Poor condition \$400,000
 - Fair condition \$100,000
 - Good condition \$ 40,000

Slide 23

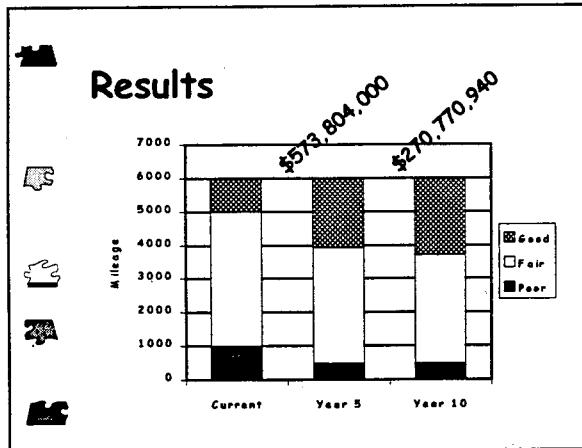







Slide 24

Sources of Funding

- New money (revenue enhancement)
- Available funds from other programs
- Increased flexibility with Federal funds

Slide
25





 **Develop and Improve Treatments and Timing**

-  ● Don't become complacent because it works; it could be better
-  ● Monitor feedback
-  ● Modify guidelines
-  ● Develop Manuals of Practice
-  ● Industry is constantly developing new treatments and better materials



Slide
26







 **Innovative Practices to Promote Success**

-  ● Contracting
-  ● Incentive-based financing (warranties)
-  ● Innovative materials and techniques
-  ● Training approaches
-  ● Partnering



Slide
27

 **Contracting**

-  ● Michigan
 -  ■ Simplified designs
 -  ■ Contractor responsible for quality control
-  ● New York
 -  ■ Vendor-placed paving
 -  ■ Simplified contracts





 Resulting benefit: reduced costs for design and engineering



Slide
28

 **Warranties**





- Michigan developed due to limited staff
- Warranty periods of 2 to 3 years
- Contractors select projects suitable for preventive maintenance
- Benefits
 - Cost savings
 - Shift in liability

Slide
29



 **Training**



- Concepts of preventive maintenance are different than typical projects
- Training needs
 - Overall purpose
 - Treatments and timing
 - Integration with other strategies









Slide
30

 **Philosophy of Preventive Maintenance**

 *Applying the right treatment* 

  *... To the right pavement*

 *... At the right time* 

Slide
31

 **Summary**

- Must get away from a worst-first policy
- Preventive maintenance can extend pavement life and reduce costs
- Keys to success
 - Measurable goal
 - Assessing and promoting benefits
 - Dedicated and continuous funding
 - Feedback from PMS

NOTES

Appendix A—Glossary

AADT – The average 24-hour traffic volume counts collected over a number of days greater than 1 but less than a year, at a given location. AADT can also be approximated by adjusting the ADT count for daily (weekday versus weekend) and seasonal (summer versus winter) variations.

ADT – The average 24-hour traffic volume counts collected over a number of days greater than 1 but less than a year, at a given location.

ADTT – The average 24-hour truck traffic volume counts collected over a number of days greater than 1 but less than a year, at a given location. ADTT may be expressed as a percentage of ADT.

Annual Costs – Any costs associated with the annual maintenance and repair of the facility.

Asphalt Emulsion Mix – A mixture of emulsified asphalt materials and mineral aggregate usually prepared in a conventional hot-mix plant or drum mixer at a temperature of not more than 127 °C (260 °F). It is spread and compacted at the job site at a temperature above 93 °C (200 °F).

Cape Seal – A surface treatment that involves the application of a slurry seal to a newly-constructed surface treatment or chip seal. Cape seals are used to provide a dense, waterproof surface with improved skid resistance.

Chip Seal – A surface treatment in which a pavement surface is sprayed with asphalt (generally emulsified) and then immediately covered with aggregate and rolled. Chip seals are used primarily to seal the surface of a pavement with non load-associated cracks and to improve surface friction, although they also are commonly used as a wearing course on low-volume roads.

Cold In-Place Recycling (CIR) – A process in which a portion of an existing bituminous pavement is pulverized or milled, the reclaimed material is mixed with new binder and virgin materials, and the resultant blend is placed as a base for a subsequent overlay. Emulsified asphalt is especially suited for cold in-place recycling. Although not necessarily required, a softening agent may be used along with the emulsified asphalt.

Cold Milling – A process of removing pavement material from the surface of the pavement either to prepare the surface (by removing rutting and surface irregularities) to receive overlays, to restore pavement cross slopes and profile, or even to re-establish the pavement's surface friction characteristics.

Crack Filling – A maintenance procedure that involves placement of materials into non-working cracks to substantially reduce infiltration of water and to reinforce the adjacent pavement. Working cracks are defined as those that experience significant horizontal movements, generally greater than about 2 mm (0.1 in). Crack filling should be distinguished from crack sealing.

Crack Sealing – A maintenance procedure that involves placement of specialized materials, either above or into working cracks, using unique configurations to reduce the intrusion of incompressibles into the crack and to prevent intrusion of water into the underlying pavement layers. Working cracks are defined as those that experience significant horizontal movements, generally greater than about 2 mm (0.1 in).

Dense-Graded Asphalt Overlay – An overlay course consisting of a mix of asphalt cement and a well-graded (also called dense-graded) aggregate. A well-graded aggregate is uniformly distributed throughout the full range of sieve sizes.

Diamond Grinding – A maintenance procedure for concrete pavements that involves the removal of a thin layer of concrete (generally no more than 6.4 mm [0.25 in]) from the surface of the pavement to remove surface irregularities (most commonly joint faulting), to restore a smooth riding surface, and to increase pavement surface friction.

Diamond Grooving – The establishment of discrete grooves in the concrete pavement surface using diamond saw blades to provide a drainage channel for water and thereby reduce the potential for hydroplaning and wet weather accidents.

Discount Rate – The rate of interest reflecting the investor's time value of money, used to determine discount factors for converting benefits and costs occurring at different times to a baseline date. Discount rates can incorporate an inflation rate, depending on whether real discount rates or nominal discount rates are used.

Emulsified Asphalt – An emulsion of asphalt cement and water, which contains a small amount of an emulsifying agent. Emulsified asphalt droplets, which are suspended in water, may be either the anionic (negative charge) or cationic (positive charge) type, depending upon the emulsifying agent.

Equivalent Uniform Annual Cost (EUAC) – The net present value of all discounted cost and benefits of an alternative as if they were to occur uniformly throughout the analysis period. Net Present Value (NPV) is the discounted monetary value of expected benefits (i.e., benefits minus costs).

Fog Seal – A light application of slow setting asphalt emulsion diluted with water. It is used to renew old asphalt surfaces and to seal small cracks and surface voids.

Heater Scarification – A form of Hot In-Place Recycling in which the surface of the old pavement is heated, scarified with a set of scarifying teeth, mixed with a recycling agent, and then leveled and compacted.

Hot In-Place Recycling (HIR) – A process which consists of softening the existing asphalt surface with heat, mechanically removing the surface material, mixing the material with a recycling agent, adding (if required) virgin asphalt or aggregate to the material, and then replacing the material back on the pavement.

Hot Mix Asphalt (HMA) – High quality, thoroughly controlled hot mixture of asphalt cement and well-graded, high-quality aggregate thoroughly compacted into a uniform dense mass.

Hot Surface Recycling – See hot in-place recycling.

Inflation rate – The rate of increase in the general price levels, caused usually by an increase in the volume of money and credit relative to available goods. The inflation rate is also reflective of the rate of decline in the general purchasing power of a currency.

Initial Costs – All costs associated with the initial design and construction of a facility, placement of a treatment, or any other activity with a cost component.

International Roughness Index (IRI) – A ratio of the accumulated suspension motion to the distance traveled obtained from a mathematical model of a standard quarter car transversing a measured profile at a speed of 80 km/h (50 mph). Expressed in units of meters per kilometer (inches per mile), the IRI summarizes the longitudinal surface profile in the wheelpath.

Joint Resealing – The resealing of transverse joints in concrete pavements to minimize the infiltration of surface water into the underlying pavement structure and to prevent the intrusion of incompressibles into the joint.

Joint Sealant Reservoir – The channel sawed or formed at a joint that accommodates the joint sealant.

Load Transfer Restoration (LTR) – The placement of load transfer devices across joints or cracks in an existing jointed PCC pavement. LTR is used on existing jointed PCC pavements that were constructed without dowel bars at transverse joints.

Life Cycle Costing – An economic assessment of an item, system, or facility and competing design alternatives considering all significant costs of ownership over the economic life, expressed in terms of equivalent dollars.

Microsurfacing – Microsurfacing is a mixture of polymer modified asphalt emulsion, mineral aggregate, mineral filler, water, and other additives, properly proportioned, mixed and spread on a paved surface.

Mineral Filler – A finely divided mineral product, at least 70 percent of which will pass a 0.075 mm (No. 200) sieve. Pulverized limestone is the most commonly manufactured filler, although other stone dust, hydrated lime, portland cement, and certain natural deposits of finely divided mineral matter are also used.

Nominal Dollars – Dollars of purchasing power in which actual prices are stated, including inflation or deflation. Hence, nominal dollars are dollars whose purchasing power fluctuates over time.

NOVACHIP™ – A maintenance treatment for AC pavements, sometimes called an ultrathin friction course: it consists of a layer of hot-mix material placed over a heavy, polymer modified emulsified asphalt tack coat; the total thickness of the application being typically between 10 and 20 mm (0.40 and 0.80 in). It can be used to reduce deterioration caused by weathering, raveling, and oxidation, and can be used to fill ruts and to smooth corrugations and other surface irregularities.

Open-Graded Friction Course (OGFC) – An overlay course consisting of a mix of asphalt cement and open-graded (also called uniformly-graded) aggregate. An open-graded aggregate consists of particles of predominantly a single size.

Partial-Depth Recycling – See cold in-place recycling.

Pavement Preservation – The sum of all activities undertaken to provide and maintain serviceable roadways; this includes corrective maintenance and preventive maintenance, as well as minor rehabilitation projects.

Pavement Preventive Maintenance – Planned strategy of cost-effective treatments to an existing roadway system and its appurtenances that preserves the system, retard future deterioration, and maintains or improves the functional condition of the system (without increasing the structural capacity).

Pavement Reconstruction – Construction of the equivalent of a new pavement structure which usually involves complete removal and replacement of the existing pavement structure including new and/or recycled materials.

Pavement Rehabilitation – Work undertaken to extend the service life of an existing pavement. This includes the restoration, placing an overlay, and/or other work required to return an existing roadway to a condition of structural and functional adequacy.

Pavement Serviceability Index (PSI) – A subjective rating of the pavement condition made by a group of individuals riding over the pavement.

Periodic Costs – Costs associated with rehabilitation activities that must be applied periodically over the life of the facility.

Present Worth Method – Economic method that requires conversion of costs and benefits by discounting all present and future costs to a single point in time, usually at or around the time of the first expenditure.

Real Dollars – Dollars of uniform purchasing power exclusive of general inflation or deflation. Real dollars have a constant purchasing power over time.

Recycling Agents – Organic materials with chemical and physical characteristics selected to address any binder deficiencies and to restore aged asphalt material to desired specifications.

Rejuvenating Agent – Similar to recycling agents in material composition, these products are added to existing aged or oxidized AC pavements in order to restore flexibility and retard cracking.

Retrofitted Load Transfer – See Load Transfer Restoration.

Rubberized Asphalt Chip Seal – A variation on conventional chip seals in which the asphalt binder is replaced with a blend of ground tire rubber (or latex rubber) and asphalt cement to enhance the elasticity and adhesion characteristics of the binder. Commonly used in conjunction with an overlay to retard reflection cracking.

Salvage Value – The remaining worth of the pavement at the end of the analysis period. There are generally two components of salvage value: residual value – the net value from recycling the pavement and serviceable life – the remaining life of the pavement at the end of the analysis period.

Sand Seal – An application of asphalt material covered with fine aggregate. It may be used to improve the skid resistance of slippery pavements and to seal against air and water intrusion.

Sandwich Seal – A surface treatment that consists of application of a large aggregate, followed by a spray of asphalt emulsion that is in turn covered with an application of smaller aggregate. Sandwich seals are used to seal the surface and improve skid resistance.

Scrub Seal – Application of a polymer modified asphalt to the pavement surface followed by the broom-scrubbing of the asphalt into cracks and voids, then the application of an even coat of sand or small aggregate, and finally a second brooming of the aggregate and asphalt mixture. This seal is then rolled with a pneumatic tire roller.

Shape Factor – The width to depth ratio of a joint sealant reservoir. A proper shape factor is required to allow the sealant to effectively withstand repeated extension and compression as the temperature and moisture in the slab changes. Most commonly available sealants require a shape factor between 1 and 2.

Slurry Seal – A mixture of slow-setting emulsified asphalt, well-graded fine aggregate, mineral filler, and water. It is used to fill cracks and seal areas of old pavements, to restore a uniform surface texture, to seal the surface to prevent moisture and air intrusion into the pavement, and to provide skid resistance.

Stockpiled Cold Mix – An asphalt maintenance mix consisting of aggregate and emulsified asphalt, which once prepared can be stored and readily used for a period up to six months depending on the formulation of the emulsion used and the aggregate characteristics.

Stone Mastic Asphalt Overlay – An overlay course consisting of a mix of asphalt cement, stabilizer material, mineral filler, and gap-graded aggregate. A gap-graded aggregate is similar to an open-graded material but is not quite as open.

Surface Texture – The characteristics of the concrete pavement surface that contribute to both surface friction and noise.

Undersealing – Also called subsealing, pressure grouting, or slab stabilization: this process consists of the pressure insertion of a flowable material beneath a PCC slab used to fill cavities beneath PCC slabs and occasionally to correct the vertical alignment by raising individual slabs.

User Costs – Costs incurred by highway users traveling on the facility and the excess costs incurred by those who cannot use the facility because of either agency or self-imposed detour requirements. User costs typically are comprised of vehicle operating costs (VOC), accident costs, and user delay costs.