

Web-Based Training for FHWA Roadway Lighting Workshop

Module 2: Lighting Hardware and Light Source Considerations for Roadway Lighting



FHWA Safety Program



U.S. Department of Transportation
Federal Highway Administration



<http://safety.fhwa.dot.gov>

Web-Based Training for FHWA Roadway Lighting Workshop

Participant Workbook

Module 2: Lighting Hardware and Light Source Considerations for Roadway Lighting

(Other modules include:

Module 1: Roadway Lighting Design Overview

Module 3: Street and Roadway Lighting Design

Module 4: Other Roadway Lighting Topics)

May 2018

NOTICE

This document is disseminated under the sponsorship of the U.S. Department of Transportation in the interest of information exchange. The United States Government assumes no liability for its contents or the use thereof. This Report does not constitute a standard, specification, or regulation.

The contents of this Report reflect the views of the contractor, who is responsible for the accuracy of the data presented herein. The contents do not necessarily reflect the official policy of the U.S. Department of Transportation.

The United States Government does not endorse products or manufacturers named herein. Trade or manufacturers' names appear herein solely because they are considered essential to the object of this report.

QUALITY ASSURANCE STATEMENT

The Federal Highway Administration (FHWA) provides high-quality information to serve Government, industry, and the public in a manner that promotes public understanding. Standards and policies are used to ensure and maximize the quality, objectivity, utility, and integrity of its information. FHWA periodically reviews quality issues and adjusts its programs and processes to ensure continuous quality improvement.

TECHNICAL REPORT DOCUMENTATION PAGE

1. Report No. FHWA-SA-18-034		2. Government Accession No.		3. Recipient's Catalog No.	
4. Title and Subtitle Web-Based Training for FHWA Roadway Lighting Workshop Module 2: Lighting Hardware and Light Source Considerations for Roadway Lighting			5. Report Date May 2018		
			6. Performing Organization Code		
7. Author(s) Daniel C. Frering, John D. Bullough, Kevin Chiang, Levenson Boodlal			8. Performing Organization Report No.		
9. Performing Organization Name and Address KLS Engineering, LLC (Prime), 45155 Research PI, Suite 200, Ashburn, VA 20147			10. Work Unit No. (TRAI5)		
			11. Contract or Grant No. DTFH6116D00017, TOPR No. 16-16		
12. Sponsoring Agency Name and Address Federal Highway Administration Office of Safety 1200 New Jersey Ave. SE Washington, DC 20590			13. Type of Report and Period Covered Report (2016-2018)		
			14. Sponsoring Agency Code FHWA		
15. Supplementary Notes Joseph Cheung from FHWA served as the Project Manager. Cathy Satterfield, George Merritt, Michelle Arnold and Wilmari Valentin Medina from FHWA provided helpful technical comments.					
16. Abstract This document serves as a participant workbook for Web-Based Training for FHWA Roadway Lighting Workshop, Module 2: Lighting Hardware and Light Source Considerations for Roadway Lighting. Module 2 covers light sources, roadway luminaire classifications, luminaire poles, and lighting controls. Other modules include Module 1: Roadway Lighting Design Overview, Module 3: Street and Roadway Lighting Design, and Module 4: Other Roadway Lighting Topics.					
17. Key Words Roadway lighting, safety, visibility, crash avoidance			18. Distribution Statement No restrictions		
19. Security Classif. (of this report) Unclassified		20. Security Classif. (of this page) Unclassified		21. No. of Pages 89	22. Price
Form DOT F 1700.7 (8-72)			Reproduction of completed page authorized		

List of Acronyms and Abbreviations

AASHTO	American Association of State Highway and Transportation Officials
AllnGaP	Aluminum indium gallium phosphide
ANSI	American National Standards Institute
APL	Advanced plasma lighting
BUG	Backlight-uplight-glare
CCT	Correlated color temperature
cd/m ²	Candela per square meter
CRI	Color rendering index
DC	Direct current
DOE	Department of Energy
EMI	Electromagnetic interference
EPA	Environmental Protection Agency
HEP	High efficiency plasma
HID	High intensity discharge
HPS	High pressure sodium
IES	Illuminating Engineering Society
InGaN	Indium gallium nitride
K	Kelvin
L70	70% lumen maintenance
lm	lumen
LED	Light emitting diode
LEP	Light emitting plasma
LPS	Low pressure sodium
LRC	Lighting Research Center
MH	Metal halide
MPH	Miles per hour
MV	Mercury vapor
PC	Phosphor converted
PIR	Passive infrared
RF	Radio frequency
RP	Recommended practice
W	Watt

Module 2: Lighting Hardware and Light Source Considerations for Roadway Lighting

Roadway Lighting Design Overview Module 2, Slide 1

This section of the Participant Workbook will help you review the content for Module 2, entitled "Lighting Hardware and Light Source Considerations for Roadway Lighting." The top of each workbook slide will indicate the module slide title and slide number in order to help you locate content within the workbook that matches content in the online modules.

Navigating This Course
Module 2, Slide 2

This slide in the online module describes how to navigate through the course module. It is similar to the instructions in this workbook.

Course Objectives
Module 2, Slide 3

Following completion of this module, the user will be able to accomplish the following objectives:

- Select characteristics of roadway light sources
- Evaluate luminaires based on luminaire classifications
- Identify appropriate mounting hardware and equipment
- Determine when adaptive lighting control is appropriate and quantify its benefits

Table of Contents
Module 2, Slide 4

Section 1: Light Sources - high pressure sodium (HPS), mercury vapor (MV), low pressure sodium (LPS), metal halide (MH), plasma, induction, light emitting diodes (LEDs)

Section 2: Roadway Luminaire Classifications - luminaire classification system “BUG” rating, luminaire light distribution classifications, luminaire shapes and sizes, luminaire design considerations

Section 3: Luminaire Poles - pole types, pole design, breakaway devices

Section 4: Lighting Controls - photosensors, time clocks, occupancy sensors, networked control systems, adaptive roadway lighting

Lamps and Light Sources
Module 2, Slide 5



A high intensity discharge (HID) lamp.

Commonly known as "light bulbs," electric light sources are called "lamps" in the lighting profession. The word lamp is a generic term for a manufactured light source device that converts electric energy into light. To simplify the discussion of lamps, it is common practice to group types that share operating characteristics. This has been done here.

This course section will discuss several characteristics that should be considered when selecting the best lamp for a particular application. These characteristics include color, distribution, light output, efficacy, and life. For older technologies, such as high intensity discharge (HID) lamps, information will also be provided on the types of light sources that can be used to replace these technologies, and issues to consider when making a replacement.

In this section we will discuss only those light source types commonly used in roadway lighting.

High Intensity Discharge (HID) and Low Pressure Sodium Lamps Module 2, Slide 6



High wattage HID lamps are often used to light parking lots and roadways due to their high lumen output and efficacy.

Introduction

The family of lamps known as high intensity discharge (HID) generally has higher light output (lumens) than incandescent, fluorescent, and other light sources typically used in building interiors. HID lamps are most often used in street lighting, parking lots, and other outdoor lighting applications.

There are four basic types of lamps covered in this section: metal halide, high pressure sodium, mercury vapor, and low pressure sodium. Low pressure sodium lamps technically do not qualify as HID sources due to their low vapor pressure. However, because of their similarity to HID lamps in operation and application, they are included in this discussion.

Metal halide and high pressure sodium lamps are covered with greater emphasis here than mercury vapor or low pressure sodium lamps because they are used in many more roadway applications.

General Operation of HID Lamps
Module 2, Slide 7

Lamp	Chemical Composition
Metal Halide	Mercury + Halides
High Pressure Sodium	Mercury + Sodium
Low Pressure Sodium	Sodium + Neon + Argon
Mercury Vapor	Mercury + Argon

HID and low pressure sodium lamps produce light by an electric discharge between two electrodes through a small vapor-filled chamber called an 'arc tube.' The chemical composition of these vapors determines the characteristics of the lamp, such as its color, life, and efficacy. The table above lists different HID lamps and the chemical composition they utilize to generate light.

HID and low pressure sodium sources require a ballast to operate. The ballast supplies the high initial voltage necessary to start the electric discharge between the electrodes and the subsequent chemical reactions inside the arc tube. Because of these chemical reactions, HID lamps often need time to warm up in order to reach full light output. This starting period varies between the different lamp technologies; typically, it takes several minutes. Once the lamp has started, the ballast regulates the supply voltage for its proper operation.

***High Pressure Sodium (HPS) Lamps
Module 2, Slide 8***

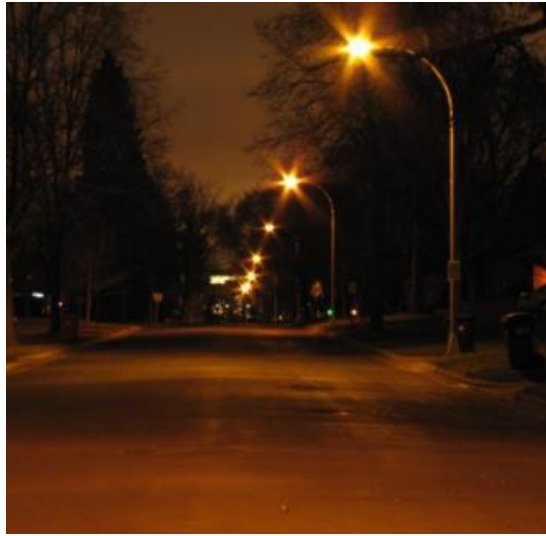

A roadway lighted with HPS streetlights. Notice the “golden-yellow” color of the light.

Because of their long life and high efficacy, high pressure sodium lamps are the most commonly used HID light sources for exterior applications such as streets, roadways, and security lighting. These lamps are easily distinguished from other HID sources due to the golden-yellow appearance of the light they produce. The color rendering capabilities of most high pressure sodium lamps are generally low compared to other available light sources.

HPS Lamp Operation

Module 2, Slide 9

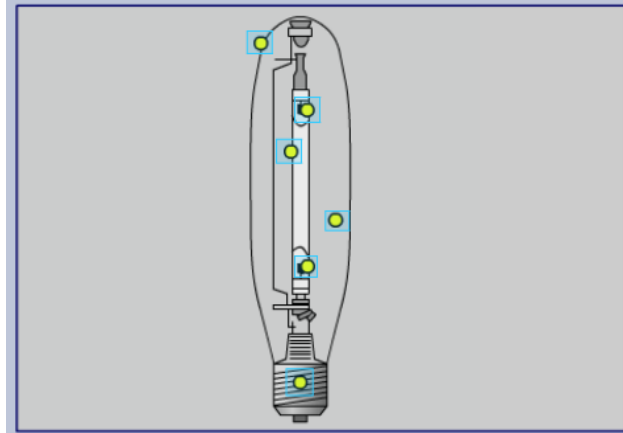

The yellow "mouse-over" circles in the diagram above (from top to bottom) refer to the following lamp components:

- **Outer Bulb** – Hard glass that protects the arc tube.
- **Electrode (1)** – Double coiled tungsten coated with emissive materials are located at each end of the arc tube.
- **Arc Tube** – Translucent ceramic structure suitable to withstand thermal shocks caused by enclosed xenon gas, mercury, and sodium vapor.
- **Vacuum** – The outer bulb is evacuated to prevent chemical degradation of the metal parts of the arc tube and to maintain the appropriate arc tube temperature.
- **Electrode (2)** – Double coiled tungsten coated with emissive materials are located at each end of the arc tube.
- **Base** – Several different types used to connect the lamp to the electric circuit and to support the lamp in the lamp holder. The most common types are mogul and medium screw base.

HPS lamps produce light by an electric discharge through combined vapors of mercury and sodium, with the sodium radiation dominating the color appearance. These gases are contained within the arc tube of the lamp under high pressure. The arc tube in turn, is surrounded by an outer hard-glass bulb. The arc tube material most widely used is a translucent ceramic material.

On either end of the cylindrical arc tube, tungsten electrodes are held in place with a sealing ceramic. When the ballast sends a high voltage pulse to the lamp, an electric discharge is initiated between the two electrodes. The pulse continues until an electrical arc is established. The arc tube also contains a small amount of xenon that serves as a starting gas. The arc vaporizes the xenon and produces heat, which causes the sodium and mercury to vaporize as well. The lamp achieves full light output after approximately 10 minutes.

***HPS Lamp Shapes and Sizes
Module 2, Slide 10***



Some common HPS lamps.

HPS lamps come in a variety of shapes and sizes.

Nomenclature (the naming convention) of HPS lamps is standardized by ANSI (American National Standards Institute), but this system is generally not used by the manufacturers for ordering purposes. Each company has its own HPS trade name, and some reference to the trade name typically appears in the lamp designation.

The names adopted by the three major manufacturers are:

Company	Trade Name
GE Lighting	Lumalux LU
SYLVANIA	Lucalox LU
Philips Lighting	Ceramalux C

HPS Lamp Color Characteristics

Module 2, Slide 11

Standard HPS lamps have poor color rendering properties. Typically, high pressure sodium lamps have a CRI (color rendering index) of 20-30 and correlated color temperatures (CCT) of 1900-2100 degrees Kelvin. The light from high pressure sodium lamps generally appears golden-yellow in color.

Although color shift is not often discussed for high pressure sodium lamps, they can undergo a change in CCT throughout life. Some lamps may look green, deep yellow, or even pink near end of life due to individual differences in sodium loss and current rise. As the improved or "white" color high pressure sodium lamps age, they tend to shift to a warmer CCT, closer to that of standard high pressure sodium lamps



Light sources differ in their ability to render the color of objects "naturally" or as we expect them to look. CRI expresses the color rendering capability of a lamp on a scale of 0 (no ability to render color) to 100 (the best ability to render colors natural). CRI is generally not a concern in roadway lighting except in populated areas, such as city streets and plazas, where there will be people and activities at night and the naturalness of colors will matter.

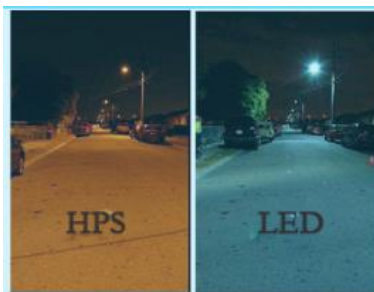

CCT is a measure of the color appearance of the light emitted by a lamp, relating its color to the color of light from a reference source when heated to a particular temperature, measured in degrees kelvin (K). The CCT rating for a lamp is a general "warmth" or "coolness" measure of the appearance of its light output. However, contrary to the temperature scale, lamps with lower CCT rating, below 3000 K, are usually considered "warm" sources with a more yellowish appearance, while those with a CCT above 4000 K are usually considered "cool" with a more white appearance.

HPS Lamp Life Module 2, Slide 12

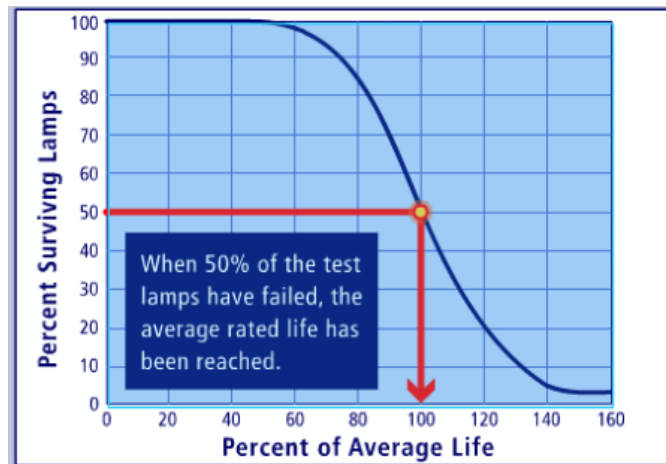

Average rated life for traditional light sources is the number of hours when 50% of a large group of lamps have failed. The actual life of any electric lamp is a median value of life expectancy. The actual life of any individual lamp, or group of lamps, may vary from the published average rated life.

In general, high pressure sodium lamps have a long average rated life, which makes them suitable for applications that require low maintenance and possibly involve hard-to-reach places, such as the tall poles used in outdoor lighting and high-ceiling applications in interior lighting. High pressure sodium lamp life ranges from 10,000 to 40,000 hours. Lamp life for these lamps is rated based on an 11 hour-per-start burn cycle. It must be noted that operation for cycles shorter than 11 hours at a time reduces lamp life.

The temperature of the coldest spot on the arc tube of a high pressure sodium lamp rises throughout its life, causing the vapor pressure to change and lamp voltage to rise. Once lamp voltage has risen to approximately 140% of its rated value, the lamp extinguishes, cools down, and then tries to restart. This cycling phenomenon signals the end of life and indicates that the lamp should be replaced. If not replaced promptly, damage to the ballast will occur. Manufacturers offer non-cycling high pressure sodium lamps to eliminate this problem.

HPS Light Output and Distribution Module 2, Slide 13



An HPS lamp in a fixture. See how the reflector behind the lamp directs the light down and out of the fixture.

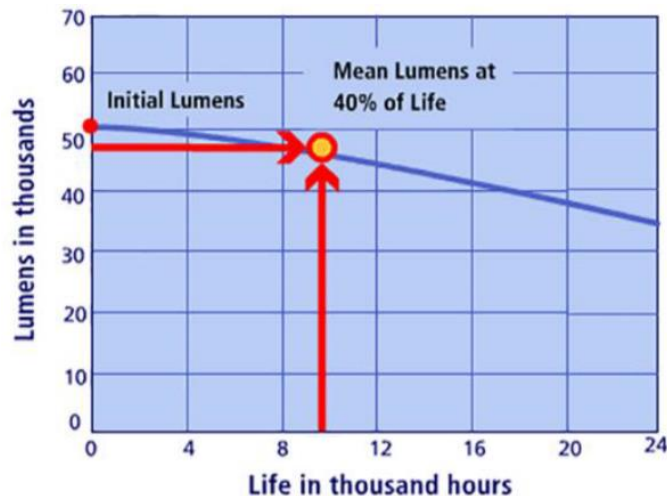

Lumen depreciation (light output reduction) of an HPS lamp throughout its life.

Neither temperature nor burning position appreciably affects the light output (lumens) of high pressure sodium lamps. However, the light output of these lamps decreases over time. The graph at right shows a lumen depreciation curve for high pressure sodium lamps. Lumen depreciation in these lamps is mainly due to the darkening of both the arc tube and the outer glass bulb, which reduce the amount of light that gets out of the lamp. Generally speaking, high pressure sodium lamps have very good lumen maintenance through their life (greater than 80%).

Most high pressure sodium lamps emit light in all directions. In most applications, high pressure sodium lamps are used in luminaires that have a reflector behind or above the lamp. This allows the light from the lamp to be directed to where it is needed. The hard glass outer bulb wall of the lamps used in roadway lighting is typically clear.

HPS Lamp Efficacy Module 2, Slide 14

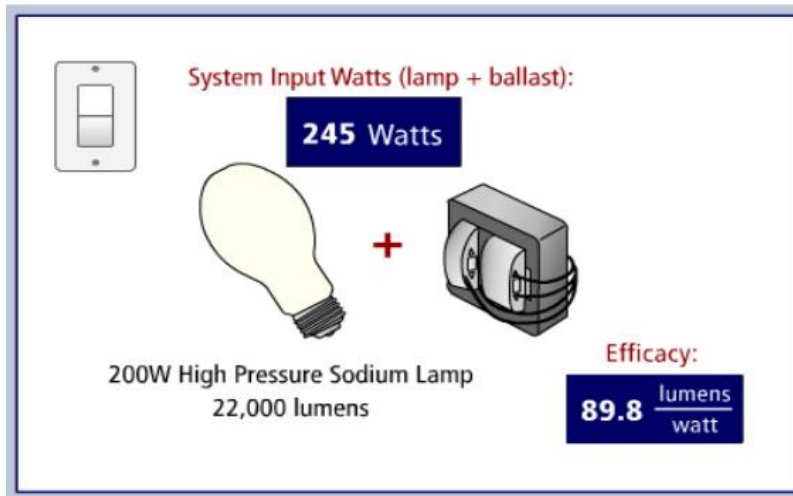

The efficacy of HPS lamps (lumens/Watt) is quite high in comparison to other sources, but efficacy decreases as the CRI of the lamp improves and/or the CCT of the lamp increases.

HPS lamp efficacies range from 64 to 140 lumens/Watt. The higher wattage high pressure sodium lamps also tend to have higher efficacies than their low wattage counterparts.

As with other HID lighting systems, lighting professionals must consider the system input wattage (lamp + ballast), rather than the lamp's rated wattage when performing energy-use calculations. This is because the ballast will require a certain amount of power during operation.

As shown in the example above, the ballast “adds” 45 additional Watts to the wattage of the 200 W HPS lamp when these are combined as an operating system.

***HPS Lamp Electrical Operation
Module 2, Slide 15***



An HPS lamp and ballast. Also shown are a capacitor and an igniter.

All HPS lamps require a ballast to start and operate the lamp. The ballast must be compatible with the particular lamp and the line voltage to which it is connected. Ballasts for high pressure sodium lamps can be either magnetic or electronic, but magnetic ballasts are by far the most common type used.

HPS lamps need time to warm up when started to achieve full light output. Warm up time is generally up to 10 minutes. High pressure sodium lamps also need time for the arc tube to cool once extinguished before the lamp will restart. This "restrike" time generally ranges between 1 and 2 minutes.

A few types of high pressure sodium lamps can be dimmed using an appropriately designed ballast and control system, but it is difficult and expensive to do so. It is not recommended to dim HPS lamps below 50% of their full light output. HPS lamps will become much more yellow when dimmed.

Most HPS lamps contain a small amount of mercury. Therefore, gloves should be worn when handling broken lamp fragments. Most high pressure sodium lamps must be disposed of according to guidelines established by the U.S. EPA or other state or local authority. However, there are low/no mercury types that do not fall under these guidelines. Consult lamp manufacturers' catalogs for information on these lamps.

Knowledge Check
Module 2, Slide 16

Select the correct answer:

HPS lamps generally have a lumen depreciation of less than ____ over their lifetime.

- a) 250 lumens
- b) 20 percent
- c) 80 percent
- d) 100 footcandles

The correct answer is on the next page.

Knowledge Check Answer
Module 2, Slide 17

The correct answer is "b" – 20 percent.

HPS lighting systems maintain over 80 percent of their lumen output over the life of each lamp. (See *Module 2, Slide 13*)

Mercury Vapor Lamps
Module 2, Slide 18

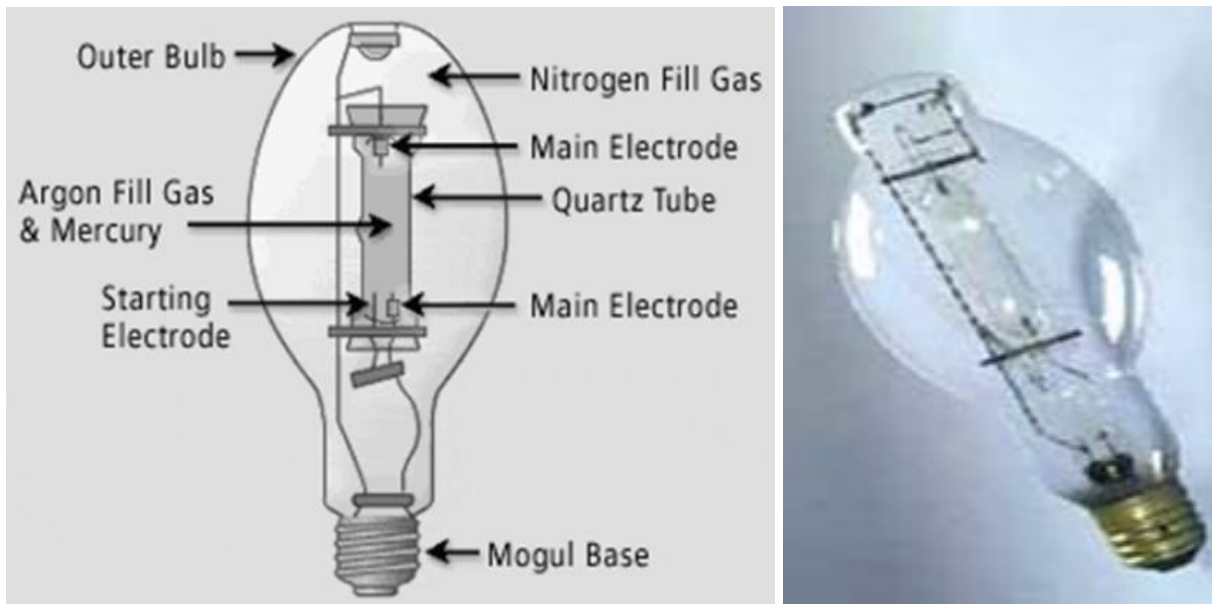

Left: Components of a mercury vapor lamp. Right: Photograph of a mercury vapor lamp.

Developed in the early 20th century, mercury vapor (MV) lamps were the first HID lamps and are now the least efficacious. These lamps, which provide bluish-white light, were used in street lighting for years, because they were more efficient and had longer lives than incandescent lamps, which had been the primary light source used for roadway lighting prior to their introduction. Because of their low efficacies (37 to 56 lumens per watt) and low CRIs (15 for clear versions and 50 for coated), mercury vapor lamps are used less often over the past few years.

Federal legislation banned the sale of mercury vapor ballasts and luminaires after 2008, due to the low efficacy of MV lamps. New federal rules in the US ban the sale of screw-based mercury vapor lamps for general illumination by the end of 2017. These lamps are already banned in Europe, because they are not energy-efficient and a number of suitable replacements exist for these lamps, including metal halide, high pressure sodium, and LEDs.

Low Pressure Sodium Lamps
Module 2, Slide 19

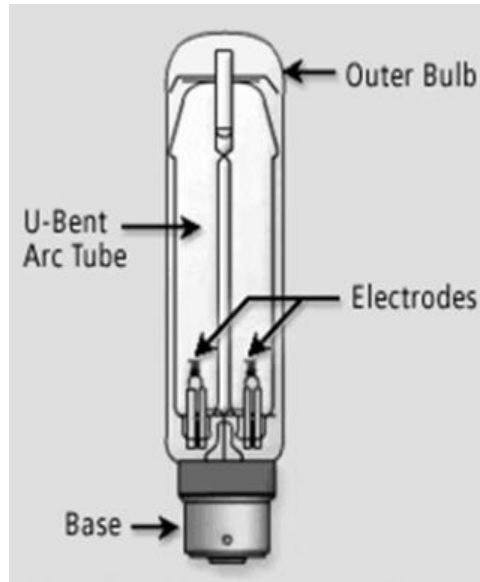

Components of an LPS lamp.



Appearance of a roadway under LPS streetlighting.

Although low pressure sodium (LPS) lamps are often categorized as HID sources, technically they do not fit into this category. With their characteristic deep-yellow color, low pressure sodium lamps have high efficacies. However, the CRI of low pressure sodium lamps is very low. Colors appear either as yellow or as shades of gray, making color identification extremely difficult.

These lamps are rarely used for roadway lighting in the US, (mainly due to their poor color rendering capabilities) except around observatories, where their narrow emission wavelengths can be easily filtered out by astronomers.

Metal Halide (MH) Lamps

Module 2, Slide 20

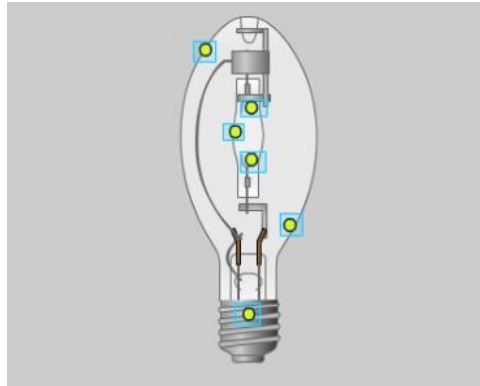

The yellow "mouse-over" circles in the diagram above (from top to bottom) refer to the following lamp components:

- **Outer Bulb:** Hard glass that protects the arc tube.
- **Electrode (1):** Double coiled tungsten coated with emissive materials are located at each end of the arc tube.
- **Arc Tube:** Quartz or ceramic structure suitable to withstand thermal stress and internal pressure during operation.
- **Electrode (2):** Double coiled tungsten coated with emissive materials are located at each end of the arc tube.
- **Phosphor Coating:** Provides slightly warmer CCTs and improves the CRIs of clear standard lamps. Lamps used for roadway lighting are typically not phosphor coated.
- **Base:** Several different types used to connect the lamp to the electric circuit and to support the lamp in the lamp holder. The most common types are mogul and medium screw base.

Metal halide (MH) lamps have superior color rendering abilities, compared to other HID lamps, and their light has a "white" color appearance. These lamps are used in exterior applications where color rendering is important and/or where a whiter light is preferred.

Metal halide lamps produce light by an electric discharge through combined vapors of mercury and other compounds called halides. These gases are contained within the arc tube of the lamp under high pressure. The arc tube is surrounded by an outer hard-glass bulb filled with a mixture of gases to help provide a stable thermal environment. The arc tube is generally made of either quartz or ceramic material. Ceramic arc tubes keep the lamp's operation more stable over time.

Electrodes are usually embedded in each end of the arc tube of an MH lamp. When proper starting voltage is applied by the ballast through an igniter, which can be either located within or external to the lamp, an arc is established between the two electrodes. Heat from this arc causes the mercury and halides to vaporize, and a gradual color change occurs as the lamp warms up. Most metal halide lamps achieve full light output after 4-6 minutes; however, it can take even longer for lamps of higher wattage.

***MH Lamp Shapes and Sizes
Module 2, Slide 21***



Various shapes and sizes of metal halide lamps.

Metal halide lamps come in a variety of shapes and sizes.

Nomenclature of metal halide lamps is standardized by ANSI, but this system is generally not used by the manufacturers for ordering purposes. Most standard screwbase metal halide lamp designations begin with the letter "M."

Since the designations for metal halide lamps are too diverse for generalization, it is best to refer to the lamp manufacturers' catalogs for written descriptions that accompany ordering codes.

MH Lamp Color Characteristics
Module 2, Slide 22



Example of “color shift” (change in CCT) of MH lamps. As they age, these lamps can begin to change from emitting white light, to light that may appear green or pink.

The CCT ranges of MH lamps are 2900 K to 5200 K. The CCT of standard metal halide lamps may shift over time due to variations in manufacturing, a change in the lamp's position or temperature, a variation of the supply voltage, or when the lamp begins to age. This should not be an issue with roadway lighting, where color appearance of light is not an important factor.

"Improved color" MH lamps with ceramic arc tubes (typically referred to as ceramic metal halide lamps) have improved color rendering capabilities and are designed to reduce color variation over time.

Metal halide lamps exhibit color rendering properties that can range from fair to very good, depending on the lamp selected. Improved color rendering ceramic MH lamps have CRIs of 80 or above.

Standard MH Lamps - CRI 60-75

Ceramic MH Lamps - CRI 80-95

MH Lamp Life and Light Output Module 2, Slide 23

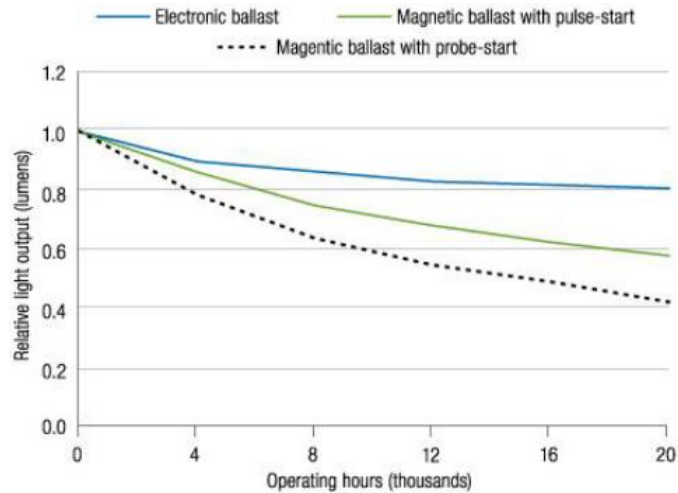

Lumen depreciation curves for various types of MH lamp/ballast systems.

Life

In general, MH lamps have a long average rated life, which makes them suitable for applications that require low maintenance and possibly involve hard-to-reach places, such as in roadway lighting. MH lamp life ranges from 5,000 to 20,000 hours. Lamp life for these lamps is rated based on an 11 hour-per-start burn cycle. It must be noted that operation for cycles shorter than 11 hours at a time will result in reduced lamp life.

Light Output

Metal halide lamps can be affected in their light output (lumens) by a number of different factors. First and foremost is the fact that light output decreases over time due to material deposits and transformation of the chemical elements inside the arc tube. Lamp manufacturers not only publish "initial" lumens (100% of light output) but also "mean" lumens (light output at 40% of the lamp's rated life) for metal halide lamps.

A lighting professional must take lumen depreciation into account when performing illuminance calculations to ensure that the lamps will deliver the desired light levels well after the lighting system has been installed. Newer electronic ballasts with pulse start technology have improved lumen maintenance so that some metal halide lamps lose less than 20% of their light output over their rated life.

MH Lamp Light Distribution Module 2, Slide 24

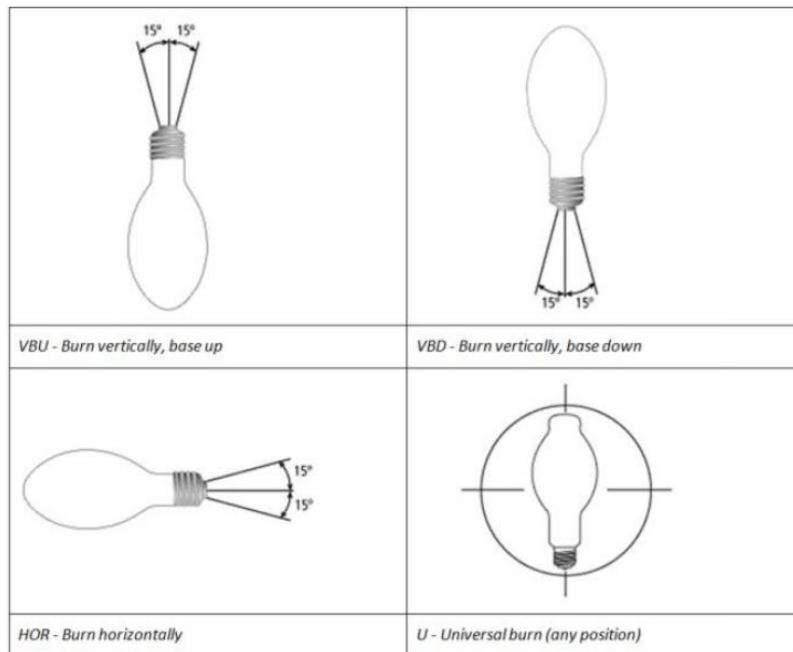

Adapted from *The Outdoor Lighting Pattern Book*

Various orientations of MH lamps.

Light Output

Generally speaking, ambient temperature does not affect the light output of metal halide lamps. In some cases, though, light output of metal halide sources is affected by lamp orientation or burning position. Manufacturers label lamps so users can select the ones that will function best in their application. For example, a lamp may be labeled as shown at left.

Light Distribution

Metal halide lamps with clear glass envelopes are generally considered to be "point sources" because their light is emitted from a relatively small area, the arc tube. This allows the light from the lamp to be efficiently directed using a reflector as part of an appropriately designed luminaire. Metal halide lamps can also provide a more diffuse light by means of a phosphor coating that is applied to the inside of the glass bulb wall. These lamps are marked "C" for coated and are generally not used in roadway lighting luminaires.

Lighting professionals might want to consider LED (light emitting diode) lamps or luminaires instead of MH. LEDs are more efficient, have a longer rated life, turn on instantly with no warm up time required, and are available in a similar range of CCTs.

MH Lamp Efficacy
Module 2, Slide 25

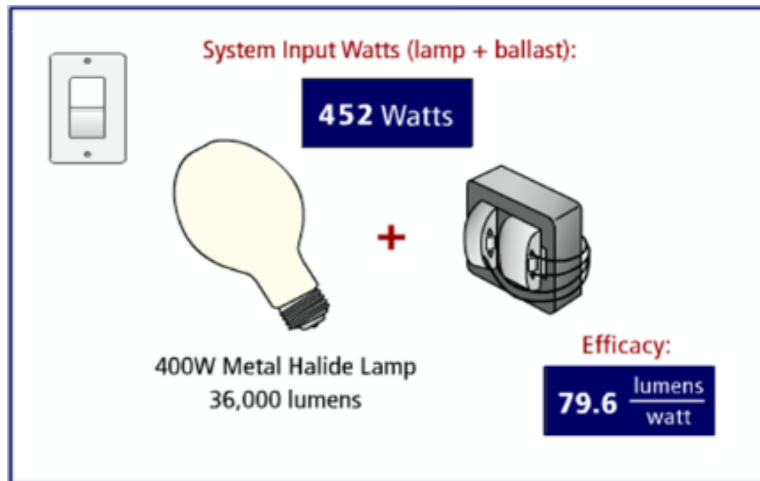

In general, MH lamps are very efficacious sources. Efficacies of standard metal halide lamps range from approximately 56 to 110 lm/W, with lamps of higher wattages achieving higher efficacy. Efficacies of improved-color metal halide lamps are not as high as the standard lamps. Improved-color metal halide lamps usually range between 70 to 90 lm/W. Lighting professionals must consider the system input wattage (lamp + ballast) rather than the lamp's rated wattage alone when performing energy-use calculations. Similar to a fluorescent lighting system, the ballast in a metal halide system will require a certain amount of power during operation.

MH Lamp Electrical Operation Module 2, Slide 26

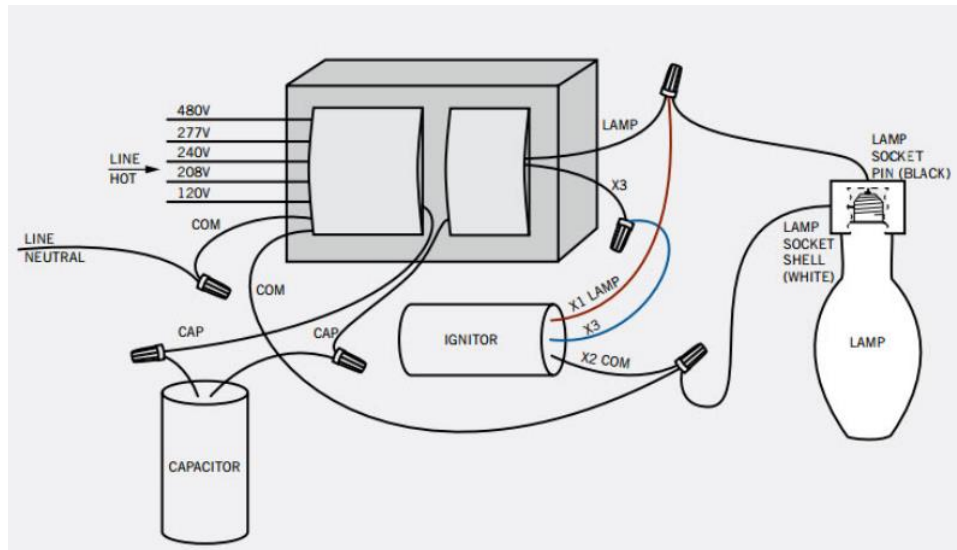

Wiring diagram of a MH/ballast system.

All higher wattage MH lamps require a ballast to start and operate the lamp. The ballast must be compatible with the particular lamp chosen and the line voltage to which it is connected. Ballasts for metal halide lamps can be either magnetic or electronic. Newer electronic ballast technology is typically more efficient than magnetic technology.

MH lamps need time to warm up when started to achieve full high output. They also need time when extinguished for the arc tube to cool before the lamp will restart. This is known as the lamp's "restrike" time, and it varies among lamp types and wattages.

Some metal halide lamps can be dimmed using an appropriately designed ballast and control system, but it is difficult and expensive to do so. In general, metal halide lamps respond to changes in dimmer settings much more slowly than incandescent or fluorescent sources. Lamps should be started at full power, with dimming delayed until the lamp is fully warmed up. Properly designed dimming systems ensure that this occurs. Metal halide lamps are also susceptible to color shifts (changes in CCT) when dimmed. It is recommended that metal halide lamps not be dimmed below 50% of full light output.

Pulse-Start MH Systems
Module 2, Slide 27

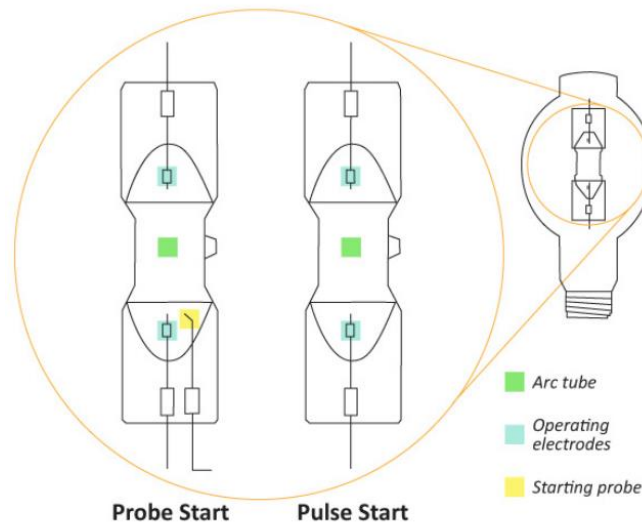

Detail of a pulse-start metal halide lamp arc tube.

An MH lighting system, commonly known as a "pulse start," has become the standard metal halide technology. Pulse start lamps operate on a ballast with a pulse igniter located external to the lamp. Pulse start metal halide lamps have improved efficacies as compared with standard metal halide lamps. Pulse start lamps have higher initial and mean lumens, longer life (up to 40,000 hours), improved color stability, and faster restrike times (as short as 4 minutes).

When planning to replace an existing metal halide system with pulse start technology, lighting professionals should keep in mind that the ballast and lamp socket will need to be replaced in addition to the lamp itself. These replacement components will usually fit into the existing luminaire housing. New metal halide systems available on the market will be designed to use pulse start technology. Older, "probe start" technology has been phased out through government regulations.

***MH Lamp Safety
Module 2, Slide 28***



MH lamp in an enclosed luminaire.

Because of their "warm up" and "restrike" times, do not use metal halide lamps in situations where instantaneous start is required. Most metal halide lamps should be operated within enclosed luminaires or have other protective measures to guard against possible end-of-life rupture and to filter ultraviolet light. Be sure to check the lamp manufacturer's catalog to determine if a particular lamp is rated for use in open luminaires. MH lamps contain a small amount of mercury. Therefore, gloves should be worn when handling broken lamp fragments. Always dispose of metal halide lamps according to guidelines established by the U.S. EPA or other appropriate state or local authority.

In any application where lamps are operated continuously (24 hours per day, seven days per week), the lamps should be turned off once per week for a period of at least 15 minutes to reduce stress on the glass caused by extreme pressure within the lamp. This may reduce the possibility of non-passive failure (end-of-life rupture).

Knowledge Check
Module 2, Slide 29

Select the correct answer:

An important feature of a pulse start metal halide lighting system is _____.

- a) Higher maintained lumens
- b) Longer lamp life
- c) Faster restrike times
- d) All of the above

The correct answer is on the next page.

Knowledge Check Answer
Module 2, Slide 30

The correct answer is "d" – All of the above.

All of the attributes listed:

- Higher maintained lumens
- Longer lamp life
- Faster restrike times

Are features of pulse start metal halide lighting systems. (*See Module 2, Slide 27*)

Plasma Lighting Systems
Module 2, Slide 31



High mast lighting, like that shown in the picture above, is possibly a good fit for plasma lighting systems.

Plasma lighting systems, also known as light-emitting plasma (LEP), high-efficiency plasma (HEP), or advanced plasma lighting (APL) are emerging in the marketplace primarily for high ceiling interior applications and outdoor lighting applications. These lamps are essentially electrodeless metal halide lamps.

Manufacturers claim that plasma lighting systems are better suited for roadway, area and high mast lighting applications than conventional HID and LED systems because of their long life, high luminaire efficiency, and low overall system price. They also claim to have accurate color rendering (95 CRI) and controllability for dimming and motion sensing.

For roadway lighting applications, an evaluation conducted by the Lighting Research Center (LRC) in 2013 found that plasma lighting systems were no more effective or energy efficient than other HID lighting systems. This evaluation also found that LED systems were approximately 30% more efficient than available plasma lighting systems. (See the resource slide at the end of this course module for a link to this report.)

Plasma Lighting System Operation
Module 2, Slide 32

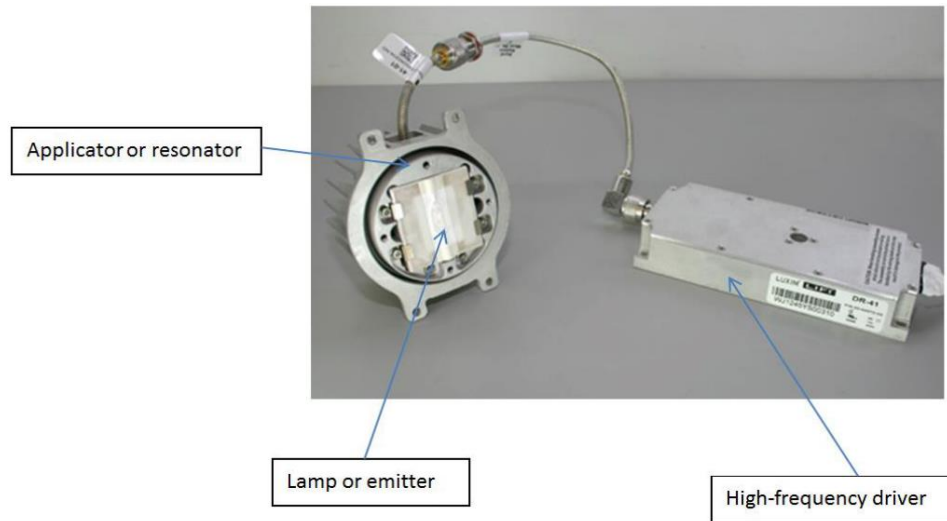

A plasma lighting system.

Plasma lighting systems are electrodeless metal halide lamps that produce light directly from an arc discharge operated under high pressure. The arc discharge is powered by a high-frequency electromagnetic field generated externally to the lamp. This is different from conventional HID lamps which have electrodes within the arc tube that convey current to sustain the arc discharge.

Plasma lighting systems are also known as electrodeless HID systems, however, they are typically referred to by the generic term “plasma lighting system” in the lighting industry.

Plasma lighting systems typically have multiple components including:

- a lamp or emitter which contains the light-emitting gas that operates under high pressure
- an applicator or resonator for “coupling” the power to the lamp
- a high-frequency ballast/driver, such as a radio frequency (RF) generator or magnetron (microwave) generator.

***Plasma Lamps Shapes and Color
Module 2, Slide 33***

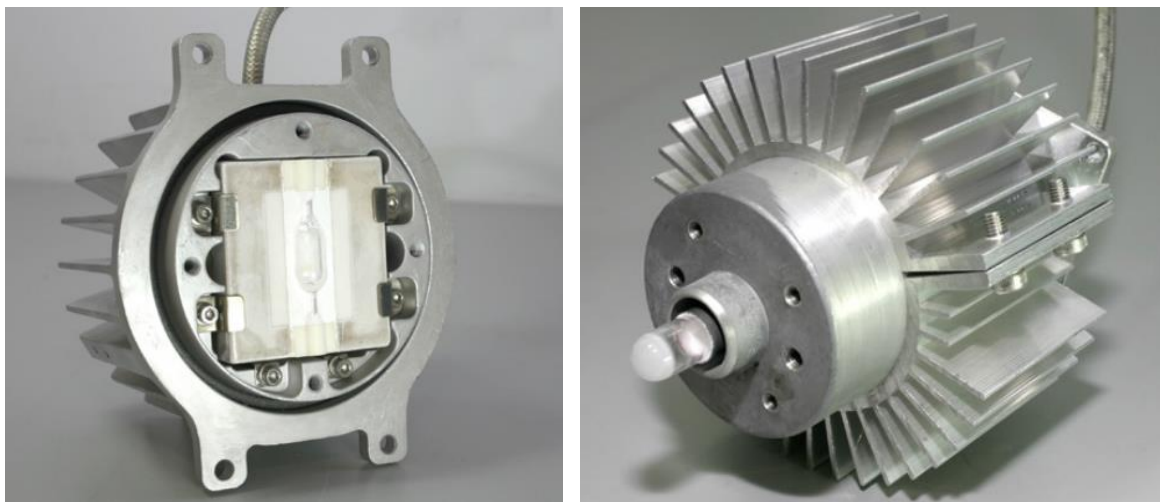

Examples of plasma lamps.

Shapes

There is no standard naming system for plasma lamps, and the lamps and other system components such as the resonator and power supply or ballast must be purchased from the same manufacturer as the lamp. At the left are examples of plasma lamps with their resonators or applicators. Some manufacturers have limits on the orientation of their plasma lamps, so it will be important to check with the manufacturer before determining the system to purchase for your application.

Color Characteristics

The CRI of plasma lighting systems range from 70 to 95, making them acceptable for all exterior applications. Each manufacturer offers different CCTs for their product, ranging from 3200 to 7650 K. Similar to conventional metal halide lamps, shifts or changes in the CCT of the light from plasma lamps may occur as lamps age. The CCT is also affected by lamp orientation. The light from plasma lighting systems may also appear to have a greenish-white tint.

Plasma Lamp Life and Efficacy Module 2, Slide 34

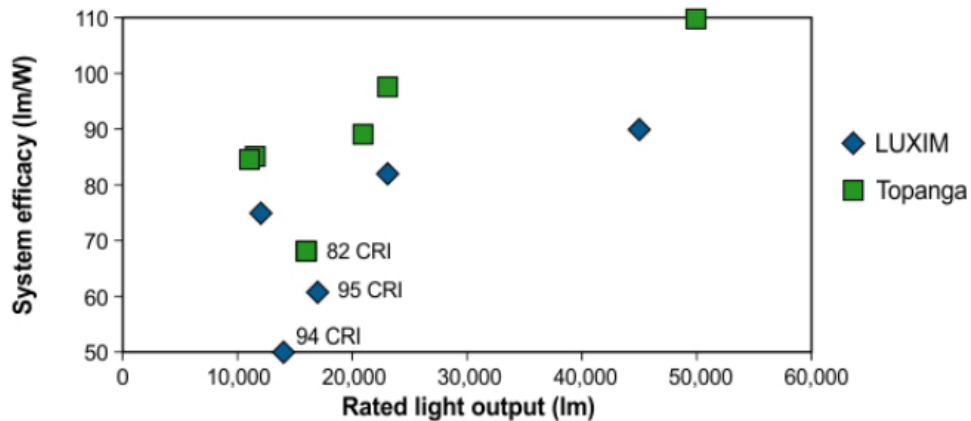

Efficacy and light output of plasma lighting systems.

Life

Manufacturers claim that plasma lighting systems have longer rated life than HID lamps because they are electrodeless. The rated life of plasma lighting systems typically ranges from 30,000 to 50,000 hours depending on manufacturer and product. Topanga, whose plasma lighting system allows for the replacement of the arc tube separately from the RF driver, specifies that the life of the emitter is 50,000 hours while the life of the RF driver is 100,000 hours.

Light Output and Efficacy

The rated light output for plasma lighting systems ranges from 11,000 lumens (lm) (with an input power of 130 W) to 50,000 lm (with an input power of 455 W), with system efficacies ranging from 50 lm/W to 110 lm/W, as shown in the graph above. The system efficacies include the power demand of the commercial dc power supply. The manufacturers' specified efficacies are shown in the graph as a function of rated light output. Typically, products with a higher light output have a higher efficacy.

Plasma Lamp Electrical Operation Module 2, Slide 35

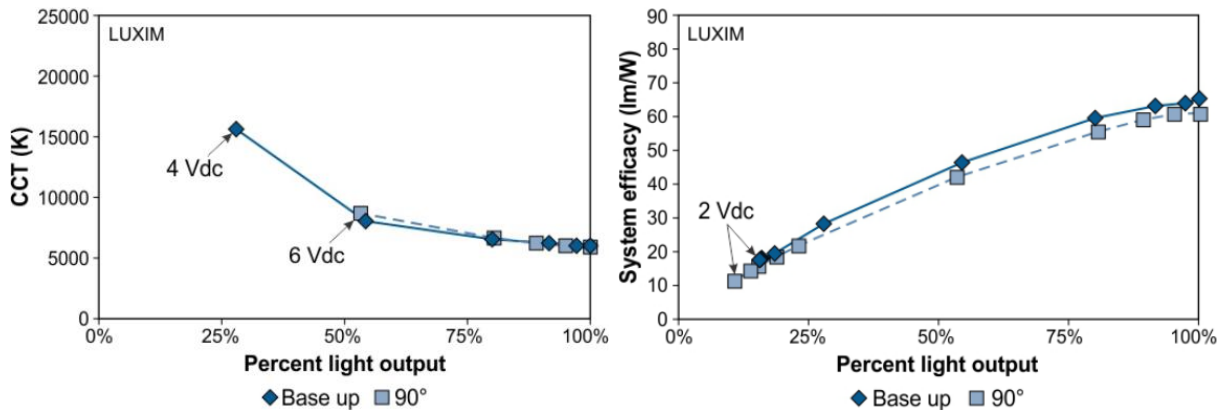

Left: CCT increases as plasma lamp is dimmed. Right: Efficacy decreases as plasma lamp is dimmed.

Electrical Operation

Plasma lighting systems do not achieve their full light output immediately after starting. Rather, they require a few minutes to warm up. After the plasma lighting system has been on for a period of time and then extinguished, the lamp cannot immediately turn back on. The lamp must have a chance to cool down before the system will restart (restrike). Warm up and restrike times for plasma lighting systems can range from 2 to 6 minutes. Plasma lighting systems operate at high frequencies and can be a source of both radiated and conducted electromagnetic interference (EMI). If the luminaire containing the plasma lighting system is not shielded, the luminaire can cause interference with other electronic equipment.

Dimming

Plasma lighting systems can be dimmed, but dimming these systems results in color shifts (changes in CCT) and decreases in luminous efficacy. Most plasma lighting system manufacturers specify that their products are dimmable down to 20% of maximum light output. The graphs above show the changes in efficacy and CCT as two plasma lamps tested were dimmed.

Safety

Plasma lamps contain small amounts of mercury. Gloves should be worn when handling any broken lamp fragments. These lamps should be disposed of or recycled in accordance with applicable U.S. E.P.A. guidelines.

Knowledge Check
Module 2, Slide 36

Select the correct answer:

When dimming a plasma lighting system, the efficacy (lumens per watt) generally _____.

- a) Increases
- b) Remains the same
- c) Decreases
- d) Cannot be determined

The correct answer is on the next page.

Knowledge Check Answer
Module 2, Slide 37

The correct answer is "c" – Decreases.

When a plasma lighting system is dimmed the system efficacy (lumens per watt) decreases. (See *Module 2, Slide 35*)

***Electrodeless Induction Lamps
Module 2, Slide 38***



Electrodeless lamps used for street lighting.

Inductive discharge lamps, commonly known as induction lamps, are available from a number of global lighting manufacturers. These lamps are essentially electrodeless fluorescent lamps. The main differences between these and the more common fluorescent lamp technologies is their use of an electromagnetic field, rather than an electric arc passing between the electrodes, to excite the mercury in the gas within the bulb, which in turn excites the phosphors on the bulb wall producing light. Because it is usually the damage caused to the electrodes that is responsible for most fluorescent lamp failures, eliminating the need for electrodes in a fluorescent lamp should extend its life significantly.

Induction lamps are relatively large devices and come in high lumen packages, with significant light output per lamp, and are therefore typically used in parking lot, tunnel, and roadway applications.

Induction Lamp Operation
Module 2, Slide 39

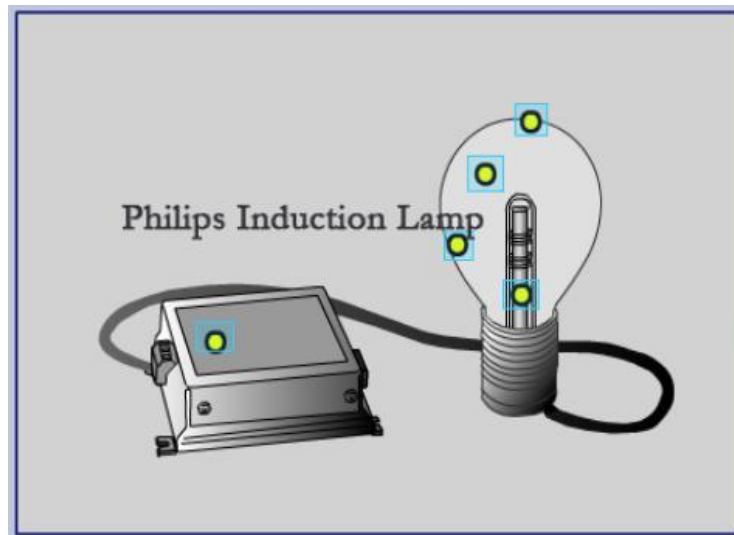

The yellow "mouse-over" circles in the diagram above (from top to bottom) refer to the following lamp components:

- **Outer bulb**
- **Gas and mercury fill**
- **Phosphor coating**
- **Induction coil**
- **Radio frequency power supply**

In an induction (electrodeless) lamp, light is generated by means of induction (the transmission of energy via an electromagnetic field) combined with a gas discharge within a bulb. The induction lamp system is powered by a radio frequency power supply which sends an electric current to an induction coil (a wire wrapped around a plastic or in some cases a metal core interior to the lamp). This current generates an electromagnetic field when it passes through the induction coil. This electromagnetic field excites the mercury in the gas within the lamp causing it to emit ultraviolet energy. This ultraviolet energy in turn strikes and excites the phosphor coating on the inside of the glass bulb, producing light.

When turned on, induction lamps start instantly, and unlike HID lamps, there is no delay in restrike time. The lamps can be mounted in any orientation. The figure above shows the construction of one common type of induction lamp system.

Induction Lamp Shapes and Color Module 2, Slide 40



Left: Philips Induction Lamp. Right: SYLVANIA Icetron Lamp.

Lamp Shapes and Sizes

There are two common configurations for the induction lamps sold by major lighting manufacturers. The nomenclature, or lamp-naming system for these lamps, has been established separately by each manufacturer and follows no standards.

Two common electrodeless fluorescent lamps are, the "Induction Lamp" (also known as QL lamp) manufactured by Philips Lighting and the "Icetron" manufactured under the trade name SYLVANIA. These generally come in higher wattages, best suited for outdoor use where a lamp with a high lumen output is desired.

Color

Because induction lamps utilize the same kind of improved phosphor technology as the new generation of fluorescent lamps, their color rendering properties are very good. They generally achieve color rendering indexes of 80 or higher. Each manufacturer offers different correlated color temperatures for their product, ranging from 2700 to 4100 K.

***Induction Lamp Life
Module 2, Slide 41***



Induction lighting installed in Union Square Park in New York City.

Life

The main benefit of using induction technology to generate light is long system life. The system's life in this case is governed mainly by the life of the electronic components in the high-frequency generator that powers the lamp, which may have a shorter life than the lamps themselves. Philips Lighting and SYLVANIA currently rate the life of their induction lamps at or near 100,000 hours. This life expectancy is greater than that of many other traditional light sources, making it a good choice for applications that require low maintenance or involve hard-to-reach places.

However, with long life linear fluorescent lamps now on the market with rated lives of 85,000 hours, and some LED systems that can have rated lives nearly as long, the life of induction lamp technology is no longer as exceptional as it once was. There is also no industry standard for testing induction systems, so it is not clear how system life is derived.

Induction Lamp Output and Efficacy Module 2, Slide 42

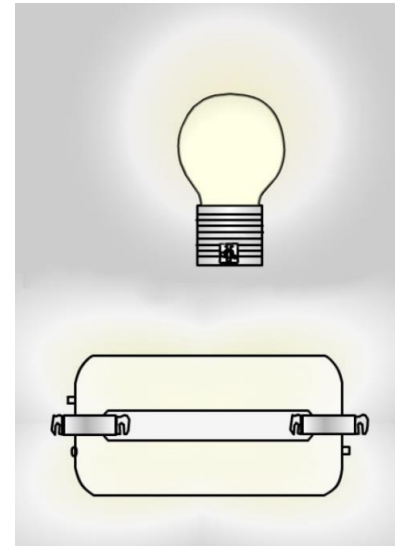
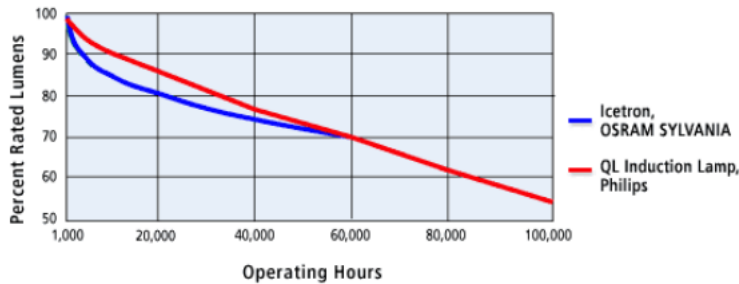

Left: Lumen depreciation curves of two induction lamps. Right: Illustration of induction lamp light distribution.

Light Output and Distribution

As with all fluorescent lamps, the light output of induction lamps decreases over time due to the degradation of the light-emitting phosphors that coat the glass bulb. This process is known as lumen depreciation. The graph at right depicts the lumen depreciation of two different induction lamps. It is also important to note that while the lamps turn on instantly, it takes several minutes for them to reach full light output. Because these lamps produce light by exciting a phosphor coating on the bulb's wall, their distribution is generally diffuse, making it somewhat difficult to direct with optics such as reflectors.

Efficacy

Induction lamps exhibit good efficacy, ranging from 70 to 89 lumens per Watt. This efficacy range is comparable to many fluorescent and HID lamps. For induction lamps a lighting professional should use total system watts (lamp plus power supply) when performing energy calculations because a certain amount of power will be used by the power supply itself.

***Induction Lamp Electrical Operation
Module 2, Slide 43***



Compared to the HPS lighting in the background, induction lighting is a much whiter light source.

Electrical Operation

Induction lamp systems are available in 120 and 240 volts. All of these lamps require a radio frequency power supply to start and operate the lamp. In induction lamp systems this power supply is external to the lamp itself. Induction lamps are electronic devices, and like all electronic devices they generate electromagnetic waves. To avoid electromagnetic interference (EMI), which may be caused by these lamps, be sure to use them in accordance with manufacturer specifications.

Safety

Induction lamps generate electric and magnetic fields during operation. Special care should be taken when using them in close contact with devices that are sensitive to these fields. These lamps also contain small amounts of mercury. Gloves should be worn when handling any broken lamp fragments. These lamps should be disposed of or recycled in accordance with applicable U.S. EPA guidelines and/or state and local ordinances.

Knowledge Check
Module 2, Slide 44

Select the correct answer:

In an induction lamp, light is generated by means of _____ combined with a gas discharge.

- a) Heating a tungsten filament
- b) The transmission of energy via an electromagnetic field
- c) An electric arc passing between two electrodes
- d) Heating a carbon electrode

The correct answer is on the next page.

Knowledge Check Answer
Module 2, Slide 45

The correct answer is "b" – The transmission of energy via an electromagnetic field.

The main differences between electrodeless induction lamps and the more common fluorescent lamp technologies is their use of an electromagnetic field, rather than an electric arc passing between the electrodes, to excite the mercury in the gas within the bulb, which in turn excites the phosphors on the bulb wall producing light. (See *Module 2, Slide 39*)

LEDs (Light Emitting Diodes) Module 2, Slide 46

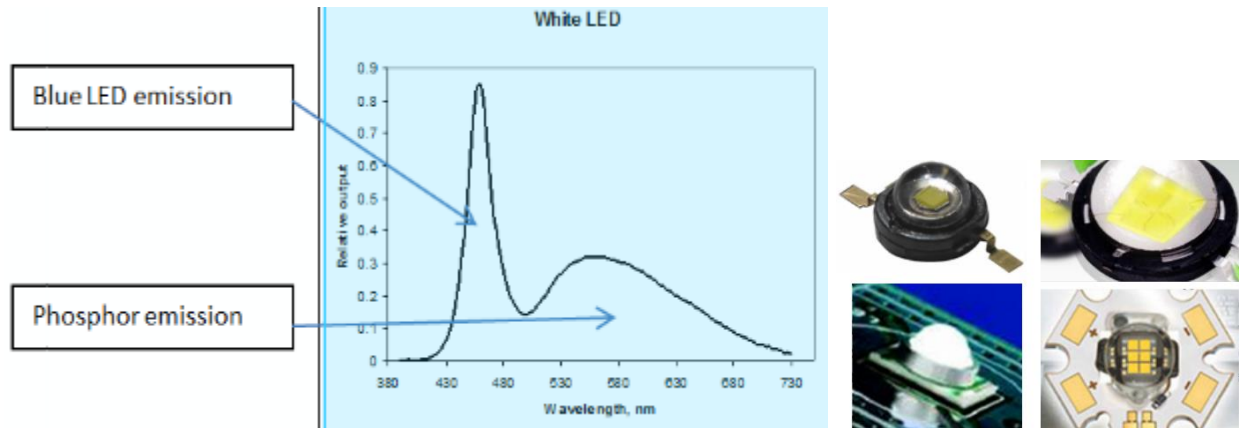

Left: The spectral power distribution (SPD) of a phosphor-coated LED. Right: Examples of phosphor-coated LEDs.

Light emitting diodes, commonly referred to as LEDs, are small electronic light sources. They are available in a variety of colors including red, amber, green, and blue. Unlike many other light sources that produce colored light by using a filter placed over the lamp, LEDs produce "true" colored light in narrow wavelengths within the visible spectrum. Prior to the 1990s, when the blue LED was developed, LEDs were commonly seen as colored indicator lights on electronic equipment such as stereos. Colored LEDs are currently used in a wide range of lighting applications including signage, traffic signals, and vehicle signal lighting.

The most common means of creating white light using LEDs is to cover a blue or short wavelength LED with a phosphor. The short wavelength radiation from the LED excites the phosphor, creating white light with the combination of the blue light emitted directly by the LED and the light emitted by the phosphor. This type of LED is typically referred to as a phosphor converted or "PC" LED.

LED Operation
Module 2, Slide 47

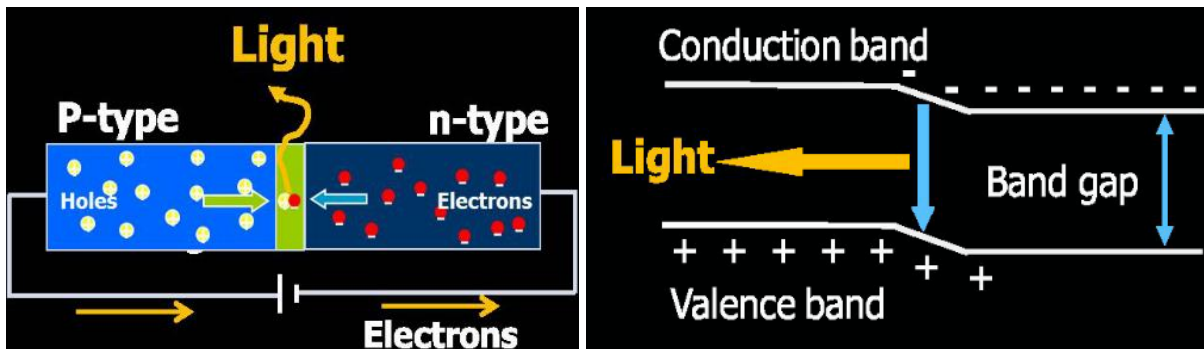

In the illustration above, the following terms are shown:

*The **band gap** refers to the energy difference (in electron volts) between the top of the valence band and the bottom of the conduction band in semiconductors. The **conduction band** is normally empty and may be defined as the lowest unfilled energy band. In the conduction band, electrons can move freely and are generally called conduction electrons. The **valence band** is the highest range of electron energies in which electrons are normally present. **P-type** semiconductors have a larger hole concentration than electron concentration. The term p-type refers to the positive charge of the hole. In p-type semiconductors, holes are the majority carriers and electrons are the minority carriers. An **n-type** semiconductor is created by adding impurities, called dopants. The purpose of doing this is to make more charge carriers, or electrons available in the material for conduction. In n-type semiconductors the number of electrons is more than the holes, so electrons are measured as majority charge carriers and holes are referred to as minority charge carriers. **Electrons** are the lightest stable subatomic particle known. An electron carries a negative charge, which is considered the basic unit of electric charge.*

LEDs are semiconductors, which convert electrical energy directly into light. The light is generated inside a small semiconductor chip, which is a solid crystal material. The different layers of crystal in the semiconductor chip determine the wavelength, or color, of light emitted. Aluminum indium gallium phosphide (AlInGaP) and indium gallium nitride (InGaN) are two of the most common compounds.

As seen in the illustration, LEDs are made up of “P-type” material with slight electron “deficiency” or holes for molecular bonding; and “N-type” material with excess electrons leftover from the crystal bonding process. Photons (light) are generated when the positive and negative charges recombine and release energy.

Not all recombinations of electrons within the LED result in light. Charges that are trapped in defects within the LED result in heat. It is also important to note that about 70% of the light generated by an LED is trapped within the device. This trapped light also results in heat.

**LED Lamp Shapes and Sizes
Module 2, Slide 48**



An LED mogul screwbase lamp that could be used to replace an MH or HPS lamp in an existing roadway lighting luminaire.

LEDs are not typically purchased as single devices or packages. They are purchased as lighting systems (lamps or luminaires) that include the LEDs and the electronic and optical components needed for them to operate and distribute their light properly.

LED Screwbase Lamps

LED mogul screwbase lamps are available to replace HPS, MH, and mercury vapor lamps. However, these lamp may not operate well in existing luminaires designed to house these other light sources. For example, because roadway luminaires are typically tightly enclosed, heat will build up around the LED lamps. This heat will negatively affect the light output, color appearance, and life of LED lamps. Some of these replacement lamps will operate on the existing ballast within the luminaire, while others will require that the ballast be bypassed or removed and the lamp sockets wired directly to line voltage.

Selecting LED Replacement Lamps Module 2, Slide 49



Another LED mogul screwbase LED replacement lamp.

When selecting LED replacement lamps it is important to consider how the LED lamp will function within the existing luminaire. For most roadway lighting luminaires, the optical distribution of the luminaire will be altered by the LED replacement lamp. As such, the luminaire might not still provide the distribution or light levels needed on the roadway.

LED lamps marketed as “replacements” for typical wattages of existing lamps will sometimes provide significantly less light than the lamps they are marketed to replace. Therefore, it is important to match the lumen output of LED replacement lamps as closely as possible to existing lamps.

If the ballast of the existing luminaire is bypassed and line voltage provided directly to the lamp sockets the sockets may not be designed to handle line voltage safely. Also, any attempt to replace the LED lamp with the original technology, such as an MH lamp, may result in rupture or explosion of the lamp when operated directly on line voltage.

Due to their heat sinks, LED lamps may also be too heavy to be properly supported by the socket within the existing luminaire.

LED Life
Module 2, Slide 50

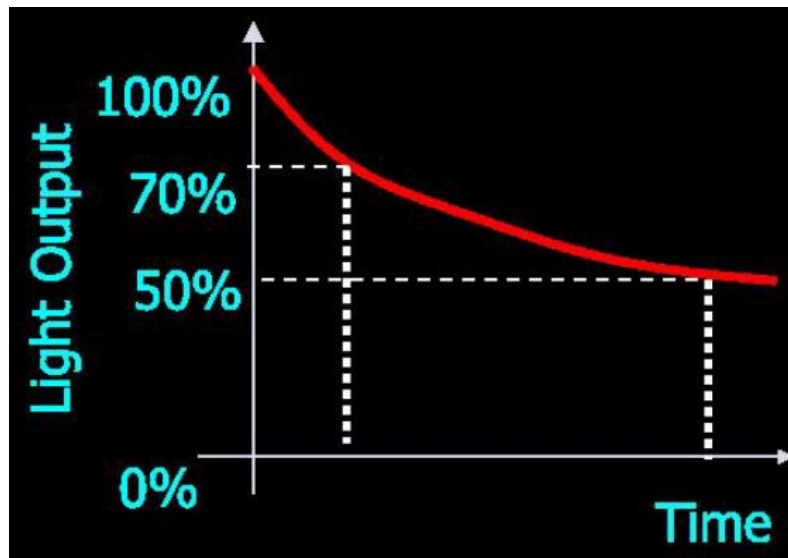

The life of an LED lamp or luminaire is when the LED's lumen depreciation is expected to reach 70% of its initial light output.

One of the advantages of LEDs is their long life. Life ratings for LED lamps and luminaires for roadway lighting range from a low of 30,000 hours to as much as 85,000 hours or more. Unlike other light sources, LEDs do not generally cease to produce light. Instead, their light output degrades gradually over time. Therefore, manufacturers rate the end of life of LEDs at a certain percentage of their initial light output value, typically 70%. This "lumen depreciation" metric is typically referred to as "L70."

Life for LEDs is determined by operating individual LEDs under a standard set of conditions (continual operation; at least 3 different temperatures) for between 6,000 and 10,000 hours. The data obtained from this test period is then put into an "exponential decay" model which is used to predict the point at which the LED will reach 70% of its light output. This information is then used by luminaire and replacement lamp manufacturers to determine the rated life of their products.

The problem with using this lumen depreciation metric as a life predictor for an LED product is that it only pertains to the LEDs themselves, and does not take into account the many other components within an LED lamp or luminaire.

LED Life and Color
Module 2, Slide 51



The LED roadway luminaires shown above have a CCT rating of 6000 K, providing a bright white light along this roadway.

Life

The lighting industry is currently working on a life test method that will better quantify the life of an entire LED system including electrical and other components. However, until this new method is agreed upon, lighting practitioners should look carefully at long life claims. It might be reasonable to expect an LED product to last up to 50,000 hours. However, a life of 100,000 hours or more may be an unreasonable prediction.

The main factor that will shorten the life of an LED product is heat. Manufacturers will typically set limits for the temperatures under which their products will operate effectively and provide the expected life and light output. Every 10 degrees Celsius (C) an LED product is operated above its rated temperature will shorten its life by approximately 10%. Therefore, it is very important to be aware of these temperature limits and carefully adhere to them.

Color

LED lamps and luminaires can be found with a range of CRI's that will easily meet the requirements for roadway lighting. LEDs can also be found in a range of CCTs from 2700 K to 6500 K.

LED Light Output and Distribution Module 2, Slide 52



A close up image of an LED roadway luminaire.

The light output and distribution of LEDs is dictated by the lamp or luminaire in which they are operated. Light output is increased by adding more LEDs to a lamp or luminaire or using LEDs of higher light output. Distribution can be altered through the use of reflectors, lenses, or other optical components.

When considering replacing existing roadway lighting with LEDs, it is often best to select an LED luminaire rather than a replacement lamp. This will provide the best light distribution, efficacy, and life for the LEDs.

Currently available LED roadway luminaires will meet North American roadway lighting design criteria (light levels, uniformity ratios, glare) at similar or better pole spacing than common HPS solutions. A few LED products can be spaced up to 280 ft apart compared with an average of 220 ft for HPS systems.

LED Electrical Operation and Dimming

Most LEDs are low voltage DC (direct current) devices and require a driver to start and operate the LEDs. A driver is similar to a ballast in an HID system. Many LED roadway luminaires are available with drivers that allow them to be dimmed using a compatible control such as an occupancy sensor, time clock, or other controller.

LED Efficacy Module 2, Slide 53

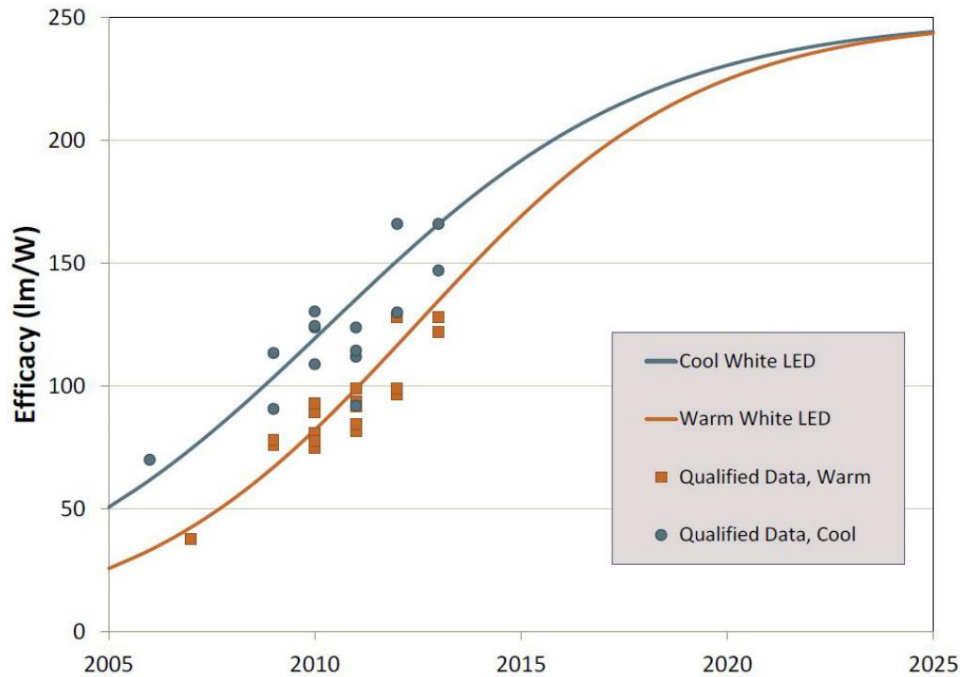

LED efficacy predictions through 2025.

For a long time the efficacies of white light LEDs have been a constantly moving target, with efficacies increasing year over year. The U.S. Department of Energy (US DOE) publishes a “roadmap” which tracks the efficacies of LEDs and makes predictions for efficacy improvements in the future. The graph at left shows the efficacy predictions for phosphor converted LEDs.

Although individual LEDs may be available approaching 200 lumens per watt, LED lamps and luminaires cannot achieve these efficacies. This is because of electrical, thermal, and optical losses of the LED lamp or luminaire. This means that an LED product will typically achieve only about 60% of the efficacy of the LEDs it contains. So expect to see roadway luminaires with efficacies between 85 and 120 lumens/Watt.

Typically an LED roadway lighting installation will use 15% to 40% less energy than a comparable HPS system, making LEDs the most efficient system you can buy.

Knowledge Check
Module 2, Slide 54

Select the correct answer:

The life of an LED product is based on the point at which _____.

- a) The electrical components within the product are expected to fail
- b) 50% of the LEDs operated for a test period have failed
- c) The LEDs within the product are expected to lose 30% of their light output
- d) The LEDs within the product will lose 70% of their light output

The correct answer is on the next page.

Knowledge Check Answer
Module 2, Slide 55

The correct answer is "c" – .The LEDs within the product are expected to lose 30% of their light output.

The life of an LED product is based on the point at which the LED within the product are predicted to lose 30% of their light output.

Unlike traditional light sources whose life is based on testing until the product is no longer operational, LED life is based on light output (lumen) depreciation (*See Module 2, Slide 50*)

Summary of Key Light Source Operating Factors
Module 2, Slide 56

Lamp Type	Life (hours)	Efficacy (lm/W)	CCT	CRI
High Pressure Sodium (HPS)	24,000 – 40,000	64 - 160	1,900 – 2,100	21 – 30
Mercury Vapor (MV)	16,000 – 24,000	25 - 58	3,900 – 5,900	15 – 50
Metal Halide (MH)	5,000 – 40,000	44 - 164	2,900 – 5,000	55 – 95
Low Pressure Sodium (LPS)	18,000	100 - 178	1,700	0
Plasma	3,000 – 50,000	50 - 110	3,200 – 7,650	70 – 95
Induction	60,000 – 100,000	47 - 88	2,700 – 5,000	80
LEDs	25,000 – 100,000	60 - 140	2,900 – 6,500	60 - 90

The table above summarizes some key factors for each type of light source covered in the previous section of this course module including: average rated life, efficacy in lumens per watt, correlated color temperature (CCT), and color rendering index (CRI).

Summary of Key Light Source Considerations
Module 2, Slide 57

The table below reviews some of the important considerations when using each light source type for roadway lighting.

Light Source Type	Considerations
High pressure sodium (HPS)	Use non-cycling lamps if regular maintenance is not performed <i>(Slide 12)</i>
Mercury vapor (MV)	Banned for use in 2017 <i>(Slide 18)</i>
Metal halide (MH)	Probe-start technology being phased out; use pulse-start lamps <i>(Slide 27)</i>
Low pressure sodium (LPS)	Color rendering non-existent; still used near astronomical observatories <i>(Slide 19)</i>
Plasma	Color and efficacy change when dimmed <i>(Slide 35)</i>
Induction	No standardized lamp shape/wattage <i>(Slide 40)</i>
Light emitting diode (LED)	Failure mechanisms differ from other sources <i>(Slide 51)</i>

Roadway Luminaire Classifications
Module 2, Slide 58

The next portion of this module will go over roadway luminaire classifications.

Luminaire (Light Fixture) Module 2, Slide 59

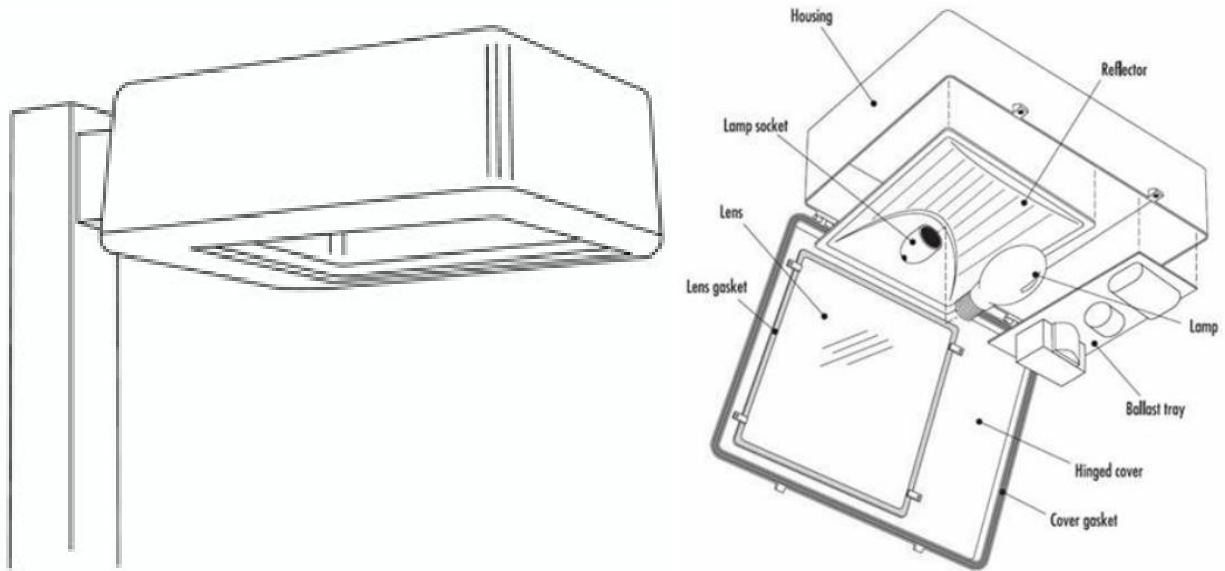

IES (Illuminating Engineering Society) Definition: a complete lighting unit consisting of a light source or light sources and a ballast or driver (when applicable) together with the parts designed to distribute the light, to position and protect the light source(s), and to connect the light source(s) to the power supply.

Primary Luminaire Components

Roadway luminaires come in many shapes, sizes, and designs. The type of luminaire you select typically depends upon its aesthetic appropriateness for the site as well as its function and ability to deliver light where needed. In all cases, the luminaire will have a housing, usually made of steel. For HID luminaires, the housing will typically include a lamp socket, a reflector, and a ballast or driver compartment. For LED luminaires, the LEDs will either be built directly into the luminaire, be configured as a replaceable component.

The luminaire would typically be enclosed by some type of lens that has a gasket to keep out dirt, insects, and prevent water infiltration into the luminaire housing.

Luminaire Classification System "BUG"
Module 2, Slide 60

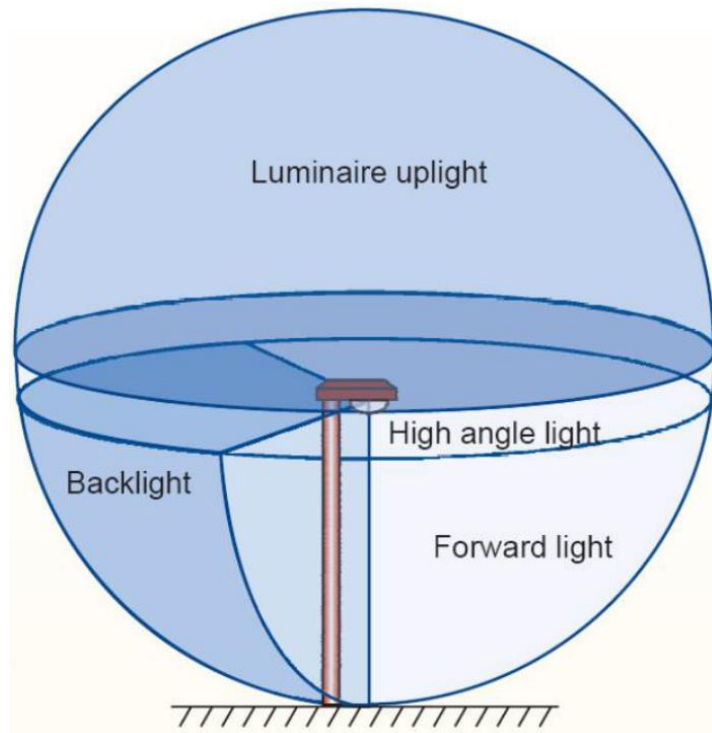

An illustration of the IES luminaire classification system or BUG rating.

The "BUG" rating of a roadway luminaire does not describe its ability to attract insects. It describes the vertical distribution of the luminaire in terms of:

Backlight (B) – the amount of light the luminaire emits behind the pole on which it is mounted

Uplight (U) – the amount of light the luminaire emits directly into the sky

Glare (G) – the amount of light the luminaire emits at high angles, which may cause glare when viewing the luminaire.

The remaining light classified by this system is the forward light emitted by the luminaire, which is considered to be the useful portion. However, in some cases, the other portions of the light, such as backlight, may also be useful, if there were an area, such as a walkway, behind the pole that you wished to light.

This luminaire classification system is illustrated above.

Luminaire BUG Rating Module 2, Slide 61

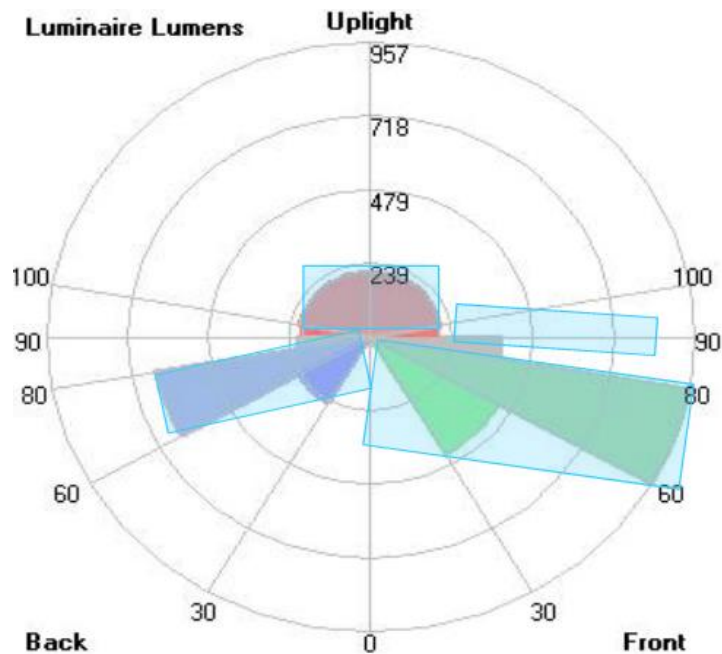

Illustration of BUG rating light distribution zones:

- **Uplight (above 90 degrees)** into the sky will contribute to sky glow. This is wasted light.
- **High angle light (between 80 and 90 degrees)** is likely to cause glare for oncoming drivers.
- **Useful forward light (between 0 and 80 degrees at the front)** onto the roadway.
- **Back light (between 0 and 80 degrees at the back)**. Only useful if there is something to light off the side of the roadway, such as a sidewalk or path.

The BUG rating was developed primarily to assist lighting practitioners to assess luminaires as contributors to light pollution. Light pollution is considered unwanted light up into the sky that contributes to skyglow, and hinders our view of the night sky. The luminaire uplight portion would be considered to contribute to skyglow. Some municipalities place limits on the amount of uplight a luminaire can produce. Another factor that could be considered light pollution is light leaving a site, such as from roadway or street; this is typically referred to as light trespass. The backlight portion of a luminaire placed at the edge of a roadway, for example, could contribute to light trespass. High angle light from the luminaire contributes to glare, and therefore should be limited, especially in roadway luminaires.

There are typically 10 “zones” of light that are shown in this luminaire classification system, four forward light zones, four backlight zones, and two uplight zones. The illustration at the right shows a typical BUG report for a roadway luminaire.

Luminaire Light Distribution
Module 2, Slide 62

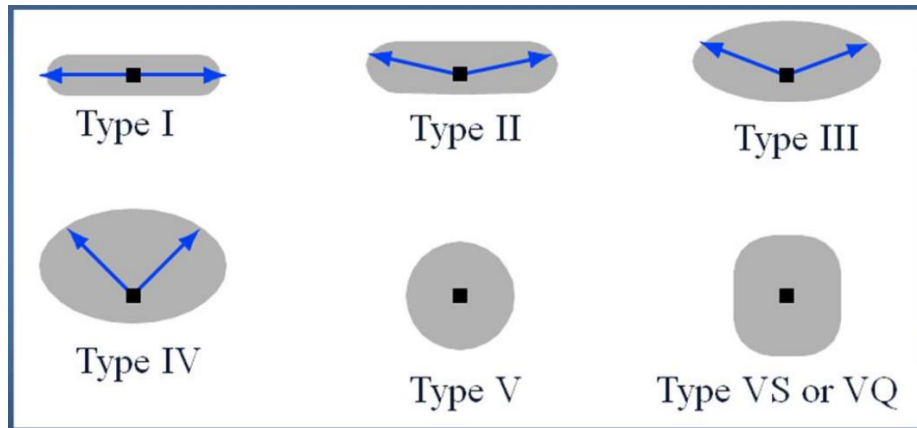

Luminaire distribution types.

Luminaire type

There are several methods used by lighting practitioners and manufacturers to describe the distribution of pole mounted luminaires. These categories were developed and standardized in North America by the Illuminating Engineering Society (IES). The first method describes the lateral light distribution that the luminaire provides across the roadway. These distribution categories are used for most roadway luminaires. The chart at left shows the five types of lateral light distributions produced by pole mounted exterior luminaires. These are in plan view, as if you were looking down from above the luminaire at the distribution of light on the ground.

Type I and II are typically used for roadway lighting. For large parking lots, type III and IV are common.

The other commonly used light distribution term describes the luminaire's vertical light distribution along the roadway. The possible choices for vertical distribution are short, medium, and long. The "long" distribution provides light over the longest distance along the roadway.

Luminaire Shapes and Sizes
Module 2, Slide 63



Left: Cobra head luminaire. Center: Post top luminaire. Right: High mast luminaire.

A very common roadway luminaire is typically referred to as a “cobra head”(1) because of its shape. These are usually lamped with HPS or MH lamps, but could also include electrodeless fluorescent or plasma lamps. These luminaires can be distribution types I through IV.

A luminaire that is mounted on top of a pole is typically referred to as a “post top” (2). This type of luminaire is usually mounted at a lower height to provide a more “pedestrian scale” to the lighting. These can be lamped with a wide variety of source types, including HPS, MH, electrodeless fluorescent, or LEDs. A post top luminaire can be designed to distribute light all around the post (type V) or in a particular direction with distribution types I through III.

Another type of roadway luminaire is typically referred to as “high mast” (3) lighting. As its name implies, this type of lighting system usually includes a number of luminaires mounted on a very tall (often 100 ft. or more) pole. These are used to light large areas such as highway interchanges. These typically use HPS, MH, or plasma lamps, but LED versions are also available. High mast luminaires will typically have a motorized system to raise and lower the luminaires for cleaning and relamping. Although this type of lighting can be very effective at lighting large areas uniformly at night, it should generally not be used near residential or other areas where light pollution or light trespass might be an issue.

***Luminaire Design Considerations
Module 2, Slide 64***



Luminaires in the median of this roadway provide uniform lighting on each side of the street.

There are several things that need to be considered when selecting roadway luminaires.

Light Distribution - The most important design consideration is if the luminaire provides light where needed. It is very important to select a luminaire with the light distribution that best suits the needs of the site.

Pole Height and Spacing - It is also important to optimize the pole height and spacing of an installation to provide the most uniform lighting possible. When selecting new luminaires for existing poles, this can be a challenge since pole location and height can often not be changed. Pole height and spacing will affect both light levels (illuminance) as well as illuminance uniformity, which is a key factor in good roadway lighting design.

Glare Control – Glare is an important issue to control at night when peoples' eyes are adapted to low light levels. This can be done by selecting luminaires with low light output in the “glare zone” between 80 and 90 degrees (see BUG rating). Luminaires should also be well shielded with high quality optical materials or by recessing the light source up into the housing of the luminaire.

Luminaire Design Considerations (continued)
Module 2, Slide 65



An example of a high mast lighting installation. This is probably not the correct solution for a residential area, but may work well at a freeway interchange.

Aesthetics and Appearance – Roadway luminaires will be visible both at night and during the day. Therefore it is important to select luminaires that fit the style and character of a site. Roadway luminaires come in many designs from historic to contemporary.

Light Pollution – It is important to select luminaires that will control the light well so as not to send light directly up into the sky, or onto adjacent properties.

Controls – At a minimum, roadway luminaires should always be controlled by either a photosensor or an astronomical timeclock. These will ensure that the luminaires are only operated during nighttime hours. In areas that are not used heavily late at night, you might also consider using a timeclock or other method to dim the lighting during late night hours. LED luminaires are easily dimmed and will instantly come up to full light output when needed.

Nighttime Vision – At night, the sensitivity of the human eye shifts towards shorter wavelengths of light. This means that lighting that is generally more “blueish white” such as the light produced by MH, plasma lamps, or LEDs, will better meet the visual needs of people. This type of light will also generally be perceived as brighter, making people feel safer.

Knowledge Check
Module 2, Slide 66

Select the correct answer:

A roadway luminaire with a "Type I" distribution would be effective at lighting a narrow (two lane) roadway.

- a) True
- b) False

The correct answer is on the next page.

Knowledge Check Answer
Module 2, Slide 67

The correct answer is "a" – True.

As you can see from the illustration on Slide 61, a Type I luminaire will spread light along a narrow roadway. (See *Module 2, Slide 61*)

Luminaire Poles
Module 2, Slide 68

The next portion of this module will review considerations for poles used in lighting systems.

***Pole Types
Module 2, Slide 69***



There are many pole types onto which roadway luminaires can be mounted. Luminaires are often mounted to wooden or other types of utility poles. The picture above shows several types and configurations of poles specifically designed for mounting luminaires.

**Pole Design
Module 2, Slide 70**

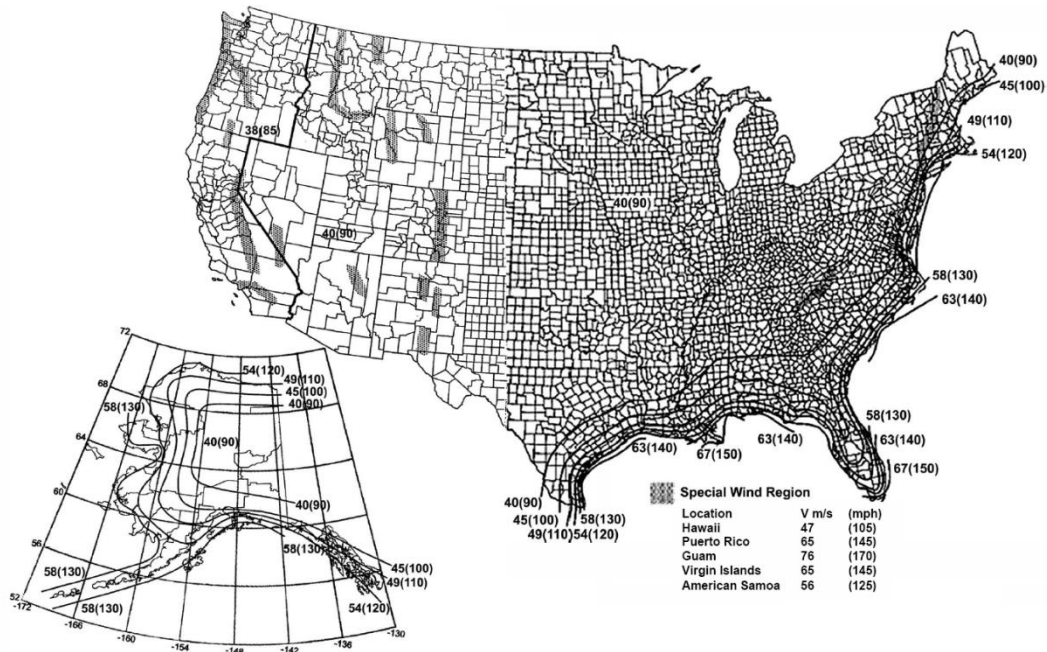

AASHTO wind map.

AASHTO (the American Association of State Highway and Transportation Officials) produces a publication called **Standard Specifications for Structural Supports for Highway Signs, Luminaires and Traffic Signals**. These specifications are applicable to the structural design of supports for highway signs, luminaires, and traffic signals. The specifications are intended to serve as a standard and guide for the design, fabrication, and erection of these types of supports.

This publication applies wind speed based on the AASHTO wind map (seen at left). Poles, foundations and anchor bolts designed by a structural engineer, must meet the requirements for the various regions based on wind speed.

Factors to consider in pole design and selection include, wind loading (MPH), shape (round or square, straight or tapered), effective projected area (surface area) and weight.

Breakaway Devices
Module 2, Slide 71



Top: Breakaway devices. Bottom: Example of what happens when a vehicle strikes a breakaway pole.

Use a breakaway design to reduce the impact severity of sign supports and poles whenever feasible.

Locate poles where they are less likely to be struck (e.g., further from the roadway, along the inside of curves, or behind existing barrier).

However, if a breakaway device is located on a downward slope, that slope should be 6:1 or flatter. Placing a breakaway device on a steeper slope may result in a vehicle striking the pole too high to activate the release mechanism at its base.

When none of the above options are practical, a traffic barrier or impact attenuator may be required.

Check the **AASHTO Roadside Design Guide** for more information on breakaway devices (link on slide 85).

Lighting Controls
Module 2, Slide 72

The next section of this module will discuss controls for roadway lighting systems.

Photosensors
Module 2, Slide 73



The most basic type of lighting control for street and roadway lighting is a photosensor. The photosensor provides an on-off switching response. It turns roadway lights on at dusk, and turns them off the next morning at dawn. The typical arrangement for these devices is to have one photosensor on the top of each luminaire controlling only that individual luminaire, although photosensors can be configured to control a group or zone of luminaires with one device.

The failure mode for photosensors is always in the “on” position. In other words, if the photosensor fails, the luminaire will remain on 24 hours per day, until someone comes and replaces the photosensor. Photosensors are typically faced toward the north so that direct sunlight does not fall on the photocell within the device. There is also typically a time delay between the period when light levels are sensed as low enough to turn the roadway luminaire on, or high enough to turn it off. This prevents the sensor from turning the lights on and off continuously at dusk and/or dawn.

Photosensors typically will last at least 10 to 15 years under normal operation, but you should check the manufacturer’s specification for the particular device you are purchasing.

Astronomical Time Clocks Module 2, Slide 74



An astronomical time clock is used to turn on a group of luminaires on at a preset time each night, and off at a preset time each morning.

It is called “astronomical” because it tracks the seasons of the year and will turn luminaires on earlier in the winter, when it gets dark earlier; and later in the summer.

The time clock can also be adjusted to vary light levels at preset times during the night, for example, dimming the lights down after midnight when traffic volume in an area decreases, and raising it back up an hour before dawn when it increases again.

These devices are commonly used for parking lot lighting, but are less likely to be used to control street and roadway lighting, except as part of a larger, networked control system.

Occupancy Sensors Module 2, Slide 75

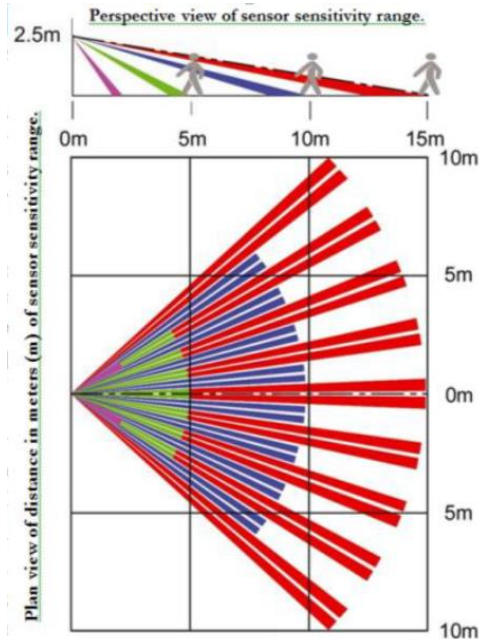

Left: An outdoor occupancy sensor. Right: An example of the field of view of an outdoor occupancy sensor.

Most occupancy sensors used for outdoor lighting are PIR (passive infrared) devices which sense the movement of heat (such as a person or a car) through a “field of view” for the sensor. These devices can either be integrated directly into a luminaire or mounted elsewhere, such as on a luminaire pole. Occupancy sensors work in conjunction with dimming ballasts or drivers to dim down luminaires during time periods when no motion is detected.

While occupancy sensors can work well for parking lots, their use for roadway lighting is more challenging. If an occupancy sensor were used for roadway lighting it would need to be part of a networked system. An occupancy sensor, for example, could be placed at each access point on a roadway. Once it sensed motion there, it would send a signal through the network to other luminaires on the roadway to turn them up to full light output. Then, if no motion were sensed by any of the sensors along that roadway for a period of time (e.g., 15 minutes) the occupancy sensors would send a signal to dim the lights down again.

You should not put non-networked occupancy sensors on each individual luminaire along a roadway because each luminaire will not turn on until a car approaches the field of view of its sensor. This will likely be annoying and distracting for drivers, and will not provide the amount of light needed for the driver to see very far ahead on the roadway.

Networked Control Systems Module 2, Slide 76

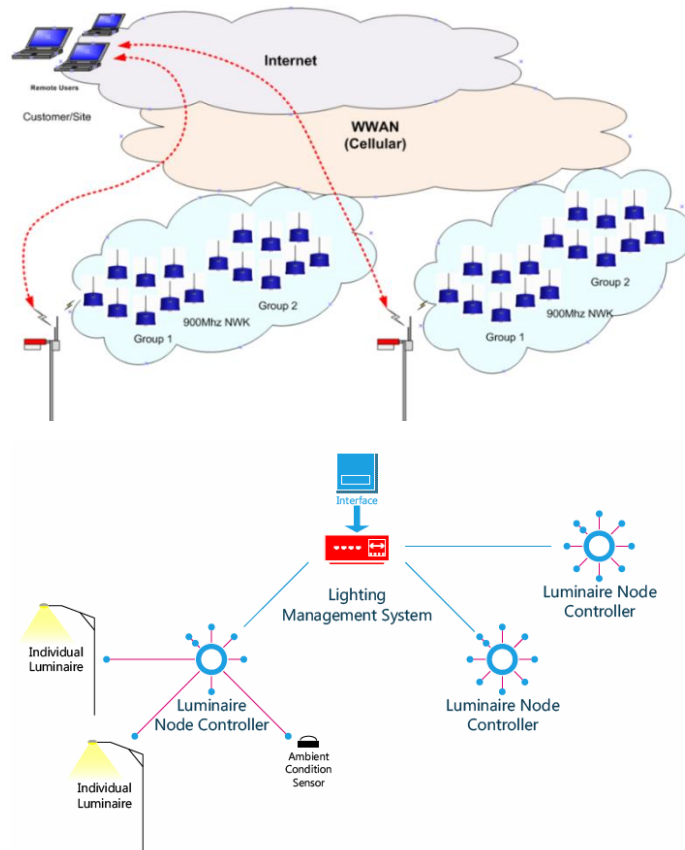

Two illustrations of networked control systems.

A centralized or networked control system allows you to operate and receive feedback from all devices on the system (sensors, light fixtures) from one central location. These systems either are wired, sometimes using the power lines to communicate to sensors and light fixtures, or, more frequently, they are wireless, allowing multiple devices to communicate using a radio frequency, Wi-Fi, or cellular signals. At their simplest, these centralized or networked systems are comprised of three main components:

A Centralized Control through which you communicate with all devices on the network, set-up and commission these devices, make any changes, and collect information back from the devices so that you can monitor the system. Some systems have “cloud-based” services that host data and assist in the operation of the system.

A Gateway(s) is the device through which the central controller communicates with all of the other parts of the system. You will need at least one gateway, or multiple gateways for larger distributed systems. On some systems the central controller communicates directly with the end point luminaires via a cellular network, so a gateway is not needed. The Control Nodes are those devices (typically luminaires and sensors) that are being controlled. These are the end use devices that perform the commands as set up on the system.

Adaptive Roadway Lighting Module 2, Slide 77

Road and Area Classification		Avg. Luminance (L_{avg} , cd/m ²)	Max. Uniformity Ratio (L_{avg}/L_{min})	Max. Uniformity Ratio (L_{max}/L_{min})	Max. Veiling Luminance Ratio (L_{vmax}/L_{avg})
Road	Pedestrian Area Classification				
Freeway Class A	N/A	0.6	3.5	6	0.3
Freeway Class B	N/A	0.4	3.5	6	0.3
Expressway	High	1.0	3.0	5	0.3
	Medium	0.8	3.0	5	0.3
	Low	0.6	3.5	6	0.3
Major	High	1.2	3.0	5	0.3
	Medium	0.9	3.0	5	0.3
	Low	0.6	3.5	6	0.3
Collector	High	0.8	3.0	5	0.4
	Medium	0.6	3.5	6	0.4
	Low	0.4	4.0	8	0.4
Local	High	0.6	6.0	10	0.4
	Medium	0.5	6.0	10	0.4
	Low	0.3	6.0	10	0.4

IES Recommended Practice (RP-8) for Roadway Lighting allows for the use of adaptive lighting throughout the night as pedestrian class and/or traffic volume is reduced. For example, using the chart above, if a study showed that on an expressway after midnight, the pedestrian class of the roadway reduced from “high” to “low”, the light levels could be reduced from 1 cd/m² to 0.6 cd/m².

Street classification	Pedestrian area class.	Avg. luminance (cd/m ²)
Major	High	x
	Medium	0.9
	Low	x
Collector	High	x
	Medium	x
	Low	0.4
Local	High	x
	Medium	x
	Low	x

Similarly, if the traffic volume of a roadway reduced after 1:00 AM allowing it to drop from the designation of a “major” road with medium pedestrian conflict to a “collector” road with low pedestrian conflict, the light levels could be reduced from 0.9 cd/m² to 0.4 cd/m², as shown in the chart above.

Adaptive roadway lighting varies light level automatically and precisely in response to changes such as the level of pedestrian use or traffic volume on a roadway at night. This is typically done by first conducting a study on a roadway to determine the traffic volume and level of pedestrian conflict by hour, and then using a control system to dim the lighting on the roadway as either or both factors change over the night. This can also be done by use of an occupancy sensor, although that is less common.

Adaptive Roadway Lighting (continued)
Module 2, Slide 78

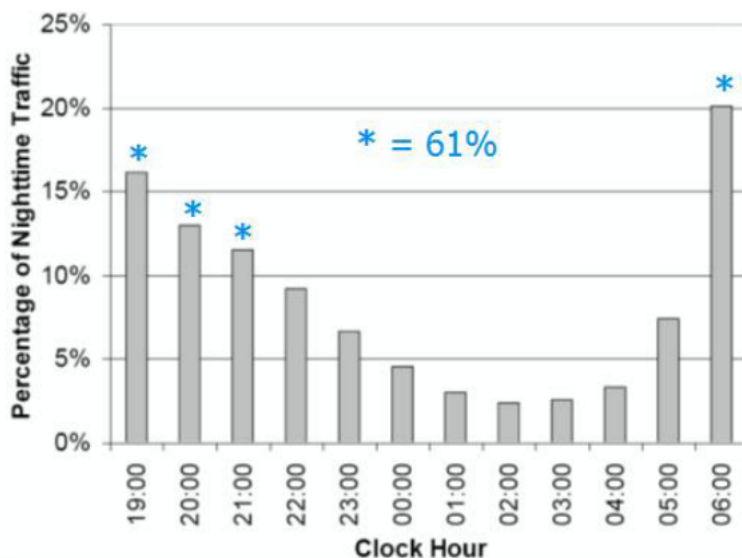

Traffic volume on a roadway by hour, over a 12-hour nighttime period.

As a further example of the use of adaptive lighting, look at the chart to the left. This chart shows that 61% of traffic volume occurs during the busiest four hours of the 12-hour night. This heaviest traffic volume occurs from 19:00 to 21:00 hours (7:00 to 9:00 PM) and after 6:00 AM in the morning. Based on research showing the relationship between traffic volume and crash frequency (Donnell et al., 2009, "Analysis of Safety Effects for the Presence of Roadway Lighting," Report to the National Cooperative Highway Research Program), we can estimate that 50% of crashes would be expected to happen during this 4-hour period.

If a municipality wanted to use lighting during the times it would provide the most "value" in terms of crash reduction, it could provide more light during these hours, and reduce light levels over the remainder of the night.

Self-Assessment Quiz
Module 2, Slides 79 to 86

Please answer each question.

1. The average rated life of an HPS lamp can be up to _____.
 - a. 40,000 hours of operation
 - b. 20,000 hours of operation
 - c. 60,000 hours of operation
 - d. 100,000 hours of operation
2. True or False? Plasma lighting systems are generally no more efficient than other types of HID lighting systems.
 - a. True
 - b. False
3. When replacing an HID lamp with a screw-based LED replacement lamp you should consider _____.
 - a. how the LED lamp will alter the light distribution of the luminaire
 - b. the amount of heat that will build up within the luminaire
 - c. the light output of the LED replacement lamp
 - d. all of the above
4. True or False? In order to control glare from a roadway luminaire, limit the amount of backlight emitted by the luminaire.
 - a. True
 - b. False
5. Light trespass and sky glow are both considered to be components of _____.
 - a. a quality roadway lighting design
 - b. useful light for lighting the roadway
 - c. light pollution
 - d. an ecologically sensitive lighting design
6. True or False? The IES Recommended Practice for Roadway Lighting (RP-8) allows for roadway lighting to be dimmed as the traffic volume or pedestrian class of a roadway changes over the night.
 - a. True
 - b. False

See the following page for the answer key to this self-assessment.

Self-Assessment Quiz Answer Key
Module 2, Slides 79 to 86

The correct answers for the self-assessment are provided below.

1. The average rated life of an HPS lamp can be up to _____.
 - a. 40,000 hours of operation (see *Module 2, Slide 12*)
 - b. 20,000 hours of operation
 - c. 60,000 hours of operation
 - d. 100,000 hours of operation
2. True or False? Plasma lighting systems are generally no more efficient than other types of HID lighting systems.
 - a. True (see *Module 2, Slide 31*)
 - b. False
3. When replacing an HID lamp with a screw-based LED replacement lamp you should consider _____.
 - a. how the LED lamp will alter the light distribution of the luminaire
 - b. the amount of heat that will build up within the luminaire
 - c. the light output of the LED replacement lamp
 - d. all of the above (see *Module 2, Slides 48-49*)
4. True or False? In order to control glare from a roadway luminaire, limit the amount of backlight emitted by the luminaire.
 - a. True
 - b. False (see *Module 2, Slide 60*)
5. Light trespass and sky glow are both considered to be components of _____.
 - a. a quality roadway lighting design
 - b. useful light for lighting the roadway
 - c. light pollution (see *Module 2, Slide 60*)
 - d. an ecologically sensitive lighting design
6. True or False? The IES Recommended Practice for Roadway Lighting (RP-8) allows for roadway lighting to be dimmed as the traffic volume or pedestrian class of a roadway changes over the night.
 - a. True (see *Module 2, Slide 76*)
 - b. False

Extended Example Problem

Complete the empty cells in the following table:

Light Source	Efficacy (lm/W)	Life (hours)	Correlated color temperature (K)	Color rendering index (CRI)	Lumen maintenance (%)	Warm-up time (min.)	Restrike time (min.)
<i>High pressure sodium (HPS)</i>		24,000-40,000	1900-2100	21-30	80%	10	1-2
<i>Mercury vapor (MV)</i>	25-58	16,000-24,000	3900-5900		60%	5	3-10
<i>Metal halide (MH)</i>	44-164	5000-40,000	2900-5000	55-95	60%-80%		5-20
<i>Low pressure sodium (LPS)</i>	100-178	18,000	1700	0	90%	7-15	instant
<i>Plasma</i>	50-110	3,000-50,000		70-95	70%-80%	2-6	2-6
<i>Induction</i>	47-88	60,000-100,000	2700-5000	80	70%		instant
<i>Light emitting diode (LED)</i>	60-140	30,000-85,000*		60-90	*	instant	instant

*LED life is for roadway lighting systems. Life is defined at the point where lumen maintenance reaches 70%.

See the following page for the answer to this extended example problem.

Extended Example Problem (Answer Key)

Light Source	Efficacy (lm/W)	Life (hours)	Correlated color temperature (K)	Color rendering index (CRI)	Lumen maintenance (%)	Warm-up time (min.)	Restrike time (min.)
<i>High pressure sodium (HPS)</i>	64-160	24,000-40,000	1900-2100	21-30	80%	10	1-2
<i>Mercury vapor (MV)</i>	25-58	16,000-24,000	3900-5900	15-50	60%	5	3-10
<i>Metal halide (MH)</i>	44-164	5000-40,000	2900-5000	55-95	60%-80%	4-6	5-20
<i>Low pressure sodium (LPS)</i>	100-178	18,000	1700	0	90%	7-15	instant
<i>Plasma</i>	50-110	30,000-50,000	3200-7650	70-95	70%-80%	2-6	2-6
<i>Induction</i>	47-88	60,000-100,000	2700-5000	80	70%	instant	instant
<i>Light emitting diode (LED)</i>	60-140	3,000-85,000*	2900-6500	60-90	*	instant	instant

*LED life is for roadway lighting systems. Life is defined at the point where lumen maintenance reaches 70%.

Links to Other Resources
Module 2, Slide 87

FHWA Lighting Handbook

https://safety.fhwa.dot.gov/roadway_dept/night_visib/lighting_handbook

IES RP-8 Roadway Lighting

<https://www.ies.org/store/recommended-practices-and-ansi-standards/roadway-lighting>

LRFD Specifications for Structural Supports for Highway Signs, Luminaires, and Traffic Signals, 1st Edition

https://bookstore.transportation.org/Item_details.aspx?id=2369

AASHTO Roadside Design Guide

https://bookstore.transportation.org/collection_detail.aspx?ID=105

Mogul Base LED Replacement Lamps

https://www.bpa.gov/EE/Technology/EE-emerging-technologies/Projects-Reports-Archives/Documents/Mogul_LED_Lamps_LRC_BPA_Phase1_finalNov24.pdf

Lighting Answers: Plasma Lighting Systems

<http://www.lrc.rpi.edu/programs/nlpip/lightingAnswers/plasma>

Design Criteria for Adaptive Roadway Lighting

<https://www.fhwa.dot.gov/publications/research/safety/14051/14051.pdf>

Credits
Module 2, Slide 89

Slide 69: Image courtesy of Virginia Tech Transportation Institute, WSP Global Inc., and DMD & Associates Ltd.

Slide 70: From Standard Specifications for Structural Supports for Highway Signs, Luminaires, and Traffic Signals, 2009, by the American Association of State Highway and Transportation Officials, Washington, DC. Used by permission.

Slide 71: Photograph courtesy of Virginia Tech Transportation Institute, WSP Global Inc., and DMD & Associates Ltd.

Slide 76: Upper image courtesy of Virginia Tech Transportation Institute, WSP Global Inc., and DMD & Associates Ltd.

All other images taken from U.S. Government publications or are released to the public domain by the module authors.