

Composite Bridge Decking

Final Project Report

Publication No. FHWA-HIF-13-029
March 2013

HIGHWAYS FOR LIFE

Accelerating Innovation for the American Driving Experience.



U.S. Department of Transportation
Federal Highway Administration

Notice

This document is disseminated under the sponsorship of the U.S. Department of Transportation in the interest of information exchange. The U.S. Government assumes no liability for the use of the information contained in this document.

The U.S. Government does not endorse products or manufacturers. Trademarks or manufacturers' names appear in this report only because they are considered essential to the objective of the document.

Quality Assurance Statement

The Federal Highway Administration (FHWA) provides high-quality information to serve Government, industry, and the public in a manner that promotes public understanding. Standards and policies are used to ensure and maximize the quality, objectivity, utility, and integrity of its information. FHWA periodically reviews quality issues and adjusts its programs and processes to ensure continuous quality improvement.

Technical Report Documentation Page

1. Report No. FHWA-HIF-13-029	2. Government Accession No.	3. Recipient's Catalog No.	
4. Title and Subtitle Composite Bridge Decking: Final Project Report		5. Report Date March 2013	
7. Author(s) J. S. O'Connor, P.E., F.ASCE		6. Performing Organization Code	
9. Performing Organization Name and Address BridgeComposites, LLC 121 Upper Bennett St. Hornell, NY 14843-1451		8. Performing Organization Report No.	
12. Sponsoring Agency Name and Address Federal Highway Administration Highways for LIFE Program – HIHL-1 1200 New Jersey Avenue, SE Washington, D.C. 20590		10. Work Unit No. (TRAI5)	
		11. Contract or Grant No. DTFH61-09-RA-00006	
		13. Type of Report and Period Covered	
		14. Sponsoring Agency Code	
15. Supplementary Notes			
16. Abstract <p>The overall objective of this Highways for LIFE Technology Partnerships project was to find the optimal materials and methods to fabricate a composite bridge deck based on a prototype devised by the University at Buffalo, under the sponsorship of New York State Department of Transportation. Benefits of this type of deck are their resistance to corrosion and fatigue, their light weight, and the ability to prefabricate into panels that can be installed on a bridge quickly to minimize disruption to traffic and improve safety.</p> <p>The process used to fabricate deck panels was improved by combining consistent-quality pultruded subcomponents with a vacuum-infused outer wrap. The strength and stiffness were first determined analytically using finite element methods, then validated independently with extensive full-scale laboratory testing. Details of the installation were demonstrated on a 40-foot-long bridge during August 2012. After a two-course wearing surface was applied, the bridge was instrumented and load tested to further refine the finite element model.</p> <p>The numerical model was found to be a reliable and accurate representation of actual conditions, with predicted strains and deflections within 5 percent of what was measured in the field. With working stresses less than 25 percent of the material's ultimate strength, a sudden failure of the deck is virtually impossible. Furthermore, panels purposely overloaded in the lab exhibited a pseudo-ductile behavior and had residual strength after failure. The 5-inch-thick composite deck carried two 35-ton test trucks during a field test, with a self-weight of about 20 psf. The lightweight deck helped improve the load rating of the bridge, which was a priority for the owner.</p> <p>The end result of the project is a robust, high-quality deck suitable for many applications, including moveable bridges, historic trusses, and posted bridges. Because the initial material cost is higher than conventional alternatives, future use may be restricted to situations where the rapid installation offsets the cost of maintenance and protection of traffic, or where the light weight is especially important, such as on moveable, deteriorated or historic structures. In any case, the total life cycle cost is competitive because of the material's innate resistance to deterioration (such as corrosion and fatigue).</p>			
17. Key Words Fiber-reinforced polymer composite, FRP, bridge decking		18. Distribution Statement No restrictions. This document is available to the public through the National Technical Information Service, Springfield, VA 22161.	
19. Security Classification (of this report) Unclassified	20. Security Classification (of this page) Unclassified	21. No. of Pages 91	22. Price

SI* (MODERN METRIC) CONVERSION FACTORS

APPROXIMATE CONVERSIONS TO SI UNITS

Symbol	When You Know	Multiply By	To Find	Symbol
LENGTH				
in	inches	25.4	millimeters	mm
ft	feet	0.305	meters	m
yd	yards	0.914	meters	m
mi	miles	1.61	kilometers	km
AREA				
in ²	square inches	645.2	square millimeters	mm ²
ft ²	square feet	0.093	square meters	m ²
yd ²	square yard	0.836	square meters	m ²
ac	acres	0.405	hectares	ha
mi ²	square miles	2.59	square kilometers	km ²
VOLUME				
fl oz	fluid ounces	29.57	milliliters	mL
gal	gallons	3.785	liters	L
ft ³	cubic feet	0.028	cubic meters	m ³
yd ³	cubic yards	0.765	cubic meters	m ³
NOTE: volumes greater than 1000 L shall be shown in m ³				
MASS				
oz	ounces	28.35	grams	g
lb	pounds	0.454	kilograms	kg
T	short tons (2000 lb)	0.907	megagrams (or "metric ton")	Mg (or "t")
TEMPERATURE (exact degrees)				
°F	Fahrenheit	5 (F-32)/9 or (F-32)/1.8	Celsius	°C
ILLUMINATION				
fc	foot-candles	10.76	lux	lx
fl	foot-Lamberts	3.426	candela/m ²	cd/m ²
FORCE and PRESSURE or STRESS				
lbf	poundforce	4.45	newtons	N
lbf/in ²	poundforce per square inch	6.89	kilopascals	kPa

APPROXIMATE CONVERSIONS FROM SI UNITS

Symbol	When You Know	Multiply By	To Find	Symbol
LENGTH				
mm	millimeters	0.039	inches	in
m	meters	3.28	feet	ft
m	meters	1.09	yards	yd
km	kilometers	0.621	miles	mi
AREA				
mm ²	square millimeters	0.0016	square inches	in ²
m ²	square meters	10.764	square feet	ft ²
m ²	square meters	1.195	square yards	yd ²
ha	hectares	2.47	acres	ac
km ²	square kilometers	0.386	square miles	mi ²
VOLUME				
mL	milliliters	0.034	fluid ounces	fl oz
L	liters	0.264	gallons	gal
m ³	cubic meters	35.314	cubic feet	ft ³
m ³	cubic meters	1.307	cubic yards	yd ³
MASS				
g	grams	0.035	ounces	oz
kg	kilograms	2.202	pounds	lb
Mg (or "t")	megagrams (or "metric ton")	1.103	short tons (2000 lb)	T
TEMPERATURE (exact degrees)				
°C	Celsius	1.8C+32	Fahrenheit	°F
ILLUMINATION				
lx	lux	0.0929	foot-candles	fc
cd/m ²	candela/m ²	0.2919	foot-Lamberts	fl
FORCE and PRESSURE or STRESS				
N	newtons	0.225	poundforce	lbf
kPa	kilopascals	0.145	poundforce per square inch	lbf/in ²

*SI is the symbol for the International System of Units. Appropriate rounding should be made to comply with Section 4 of ASTM E380.
(Revised March 2003)

TABLE OF CONTENTS

1. INTRODUCTION.....	1
Project Description and Objectives.....	1
Project Scope and Tasks	2
2. NUMERICAL MODELING AND VALIDATION.....	5
Materials	5
Finite Element Analysis	5
Experimental Validation	5
3. DECK FABRICATION	7
Materials	7
4. DECK INSTALLATION	17
5. CONCLUSIONS AND LESSONS LEARNED.....	29
Lessons Learned – Design	29
Lessons Learned – Fabrication	30
Lessons Learned – Installation.....	31
APPENDIX A: LESSONS LEARNED—ALLEGANY COUNTY PERSPECTIVE	33
APPENDIX B: REPORT ON FINITE ELEMENT ANALYSIS.....	38
APPENDIX C: REPORT ON FIELD LOAD TEST	46
APPENDIX D: SPECIFICATION FOR COMPOSITE BRIDGE DECKING.....	70
APPENDIX E: DRAWINGS FOR PROOF-OF-CONCEPT BRIDGE	78
ACKNOWLEDGMENTS	88

LIST OF FIGURES

Figure 1. Photo. Pultruded tube.	10
Figure 2. Diagram. Dimensions of tube cross-section.	10
Figure 3. Diagram. Fiber architecture of the tube.	11
Figure 4. Photo. Pultruded tube subcomponent consisting of E-glass and vinyl ester resin.	11
Figure 5. Photo. Tube subcomponents are bonded together with adhesive to form a panel.	12
Figure 6. Photo. Panel ends are capped and radii between tubes filled with thixotropic resin.	12
Figure 7. Photo. The panel is wrapped in glass fiber in preparation for infusion with vinyl ester resin.	13
Figure 8. Photo. Infusion of resin for outer wrap using vacuum-assisted resin transfer molding (VARTM) method.	13
Figure 9. Photo. Infused deck panel is stripped and inspected for thorough wet-out.	14
Figure 10. Photo. Adhesive and stone applied for course 1 of the wearing surface. Note the black prefabricated railing post pad and stone bonded to the sloped surface.	14
Figure 11. Photo. Panels labeled for shipping to the job site.	15
Figure 12. Photo. Stringline girders to determine if haunch corrections are needed. Note that the A588 stringer has replaced one that was corroded due to the previous open grating.	17
Figure 13. Photo. Place prefabricated haunches (black epoxy-coated red oak).	17
Figure 14. Photo. Situate crane and pick panels with two slings. Approximate panel weight is 20 psf, including wearing surface course 1. On this project, a panel weighed approximately 1,800 lb.	18
Figure 15. Photo. Place panels on top of prefabricated haunches. Note studs that make a fixed connection between the deck and stringers at midspan.	18
Figure 16. Photo. Place prefabricated deck panels so transverse field joints are as tight as possible, making fine adjustments with a steel road bar.	19
Figure 17. Photo. Secure panels with stainless steel clips and expansion bolts. Expansion bolt is shown.	19
Figure 18. Photo. Secure panels with stainless steel clips and expansion bolts. Clip is shown. ..	20
Figure 19. Photo. Installed clip. Methacrylate adhesive can be used to fill voids above or below prefabricated haunches to ensure uniform bearing. This was done on 9/4/2012.	20
Figure 20. Photo. Install fixed connection between deck and steel stringers per plan.	21
Figure 21. Photo. Install 5/8-inch foam backer rod at bottom of field joints.	21
Figure 22. Photo. Install transverse rebar and epoxy grout in field joints. Thirty-six-inch #3 stainless rebar provides a positive tie across the centerline joint.	22

Figure 23. Photo. Embed clean, dry, angular aggregate on the surface of the epoxy-grout field joints.....	22
Figure 24. Photo. Mix epoxy grout for deck nosing at bridge joints.	23
Figure 25. Photo. Install 1-inch foam backer board at bridge joint at each end of the deck to square up the end of the deck. Install epoxy grout in deck nosing at joints.	23
Figure 26. Photo. Apply resin for second course of wearing surface.	24
Figure 27. Photo. Broadcast crushed stone for second course of wearing surface.	24
Figure 28. Photo. Spread crushed stone aggregate for second course of wearing surface. Then install 1-inch foam backer rod at the bottom of the begin and end bridge joints (not pictured)...	25
Figure 29. Photo. Install two-part pourable joint material per manufacturer’s instructions.....	25
Figure 30. Photo. Align prefabricated high-density polyethylene pad for bridge railing posts....	26
Figure 31. Photo. Install bridge railing posts, rails, and approach railing.	26
Figure 32. Photo. Load test to determine the load capacity of the bridge; not normally needed to assess the deck.	27
Figure 33. Diagram. 3D view.	41
Figure 34. Diagram. Half of FRP deck (7 panels with 11 cells and 1 panel with 8 cells).....	41
Figure 35. Diagram. Cross-section of a part of the FRP deck.	42
Figure 36. Diagram. Girders.	42
Figure 37. Diagram. Cross-section of the girders.	42
Figure 38. Diagram. Loading and boundary conditions.	43
Figure 39. Diagram. Deflection (service load), small footprint.....	43
Figure 40. Diagram. Mesh.	44
Figure 41. Diagram. Tsai-Hill Index (LRFD), small footprint.	44
Figure 42. Photos and diagrams. 7600 tri-axle dump trucks used for live-load test.....	46
Figure 43. Diagrams and photos. Illustration of load path A.....	48
Figure 44. Diagrams and photos. Illustration of load path B.....	49
Figure 45. Diagrams and photos. Illustration of load path C.....	51
Figure 46. Diagrams and photos. Illustration of load path D.....	52
Figure 47. Photos. Field equipment setup.....	53
Figure 48. Diagrams. Repetition 1 strain gage locations.	54
Figure 49. Diagrams. Repetition 2 strain gage locations.	56
Figure 50. Diagrams. String pot locations.	57
Figure 51. Graph. SG 5 data from test 1_63_CN.	59
Figure 52. Graph. Test 1_63_CN, SG 7 and SG 8 results vs. time.....	60

Figure 53. Graph. Dynamic test results, string pots 2 and 5.....	62
Figure 54. Diagram. Proof-of-concept installation drawings—cover sheet.	78
Figure 55. Diagram. Plan view.	79
Figure 56. Diagram. Panel layout.	80
Figure 57. Diagram. Existing cross-section.....	81
Figure 58. Diagram. Proposed cross-section.	82
Figure 59. Diagram. Fascia and details.....	83
Figure 60. Diagram. Longitudinal section and details.....	84
Figure 61. Diagram. Panel cross-section and details.	85
Figure 62. Diagram. Haunch plan and sections.	86

LIST OF TABLES

Table 1. Project tasks.....	3
Table 2. Ply details for horizontal walls of pultruded tube.....	7
Table 3. Ply details for inclined walls of pultruded tube.....	8
Table 4. Material properties of composite material.....	9
Table 5. Material properties of polymer grout.....	9
Table 6. Material properties (composite).....	38
Table 7. Material properties (concrete).....	38
Table 8. Material properties (steel).....	39
Table 9. Service load deflection and failure index with concrete, small footprint (6 by 7 in ²), with lane load.....	39
Table 10. Service load deflection and failure index with graphite, small footprint (6 by 7 in ²), no lane load.....	39
Table 11. Service load deflection and failure index with graphite, large footprint (10 by 20 in ²), no lane load.....	39
Table 12. State of stress in the critical composite element (SL loading), small footprint, no lane load.....	40
Table 13. State of stress in the critical composite element (LRFD loading), small footprint, no lane load.....	40
Table 14. State of stress in the critical composite element (SL loading), large footprint, no lane load.....	40
Table 15. State of stress in the critical composite element (LRFD loading), large footprint, no lane load.....	40
Table 16. 7600 tri-axle dump truck axle spacings.....	47
Table 17. Strain gage locations and orientations.....	55
Table 18. String pot locations and descriptions.....	57
Table 19. Test names and conditions.....	58
Table 20. Maximum deformations at bearing locations.....	59
Table 21. Maximum midspan FRP deck deformations (repetition 1).....	60
Table 22. SG 7 and SG 8 response for load case 1_63_A.....	61
Table 23. Strains in all girders for critical load cases.....	61
Table 24. Maximum vertical displacements at midspan.....	62
Table 25. Test 2_64_A.....	64
Table 26. Test 2_64_B.....	65

Table 27. Test 2_64_BN.....	66
Table 28. Test 2_64_C.....	67
Table 29. Test 2_64_CN.....	68
Table 30. Test 2_643_D.....	69

LIST OF ABBREVIATIONS AND ACRONYMS

AASHTO	American Association of State Highway and Transportation Officials
CSM	Chopped strand mat
FRP	Fiber-reinforced polymer
LRFD	Load and resistance factor design
MSDS	Material safety data sheet
SG	Strain gage
VARTM	Vacuum-assisted resin transfer molding

1. INTRODUCTION

PROJECT DESCRIPTION AND OBJECTIVES

FHWA's Highways for LIFE Technology Partnerships program was established "to work with the highway construction industry to accelerate the adoption of promising innovations... to refine or improve existing equipment, materials, practices, or processes that have been demonstrated but have not become adopted as routine or common practice in the highway industry.... and to fund innovations that have been developed to a prototype and require further refinement, testing, evaluation and first application in a real-world setting before they would be available for purchase, or conventional practice."¹ The Composite Bridge Decking project (originally called Composite Bridge Decking for Moveable Bridges) was selected for funding under the Technology Partnerships Program to build on 7 years of applied research that had been conducted at the University at Buffalo for the New York State Department of Transportation.² Although a hybrid material design had been proven technically in a laboratory environment, the prototype used for testing was made using a hand lay-up method, which is not particularly cost-effective. The purpose of the Composite Bridge Decking project is to show that a high-quality deck section meeting all American Association of State Highway and Transportation Officials (AASHTO) service requirements can be produced economically.

There is a need for lightweight decks on moveable bridges, historic bridges, and other structures that were not designed for heavy concrete decks. Many existing bridges were built with open steel grating, but long-term durability of the deck has been a maintenance problem because of corrosion and fatigue cracking. Lack of a solid surface can also contribute to the deterioration of the superstructure itself because steel is exposed to the elements, road salt, and sandy debris that can trap moisture.

Although many of the more than 100 fiber-reinforced polymer (FRP) composite decks/structures that are in service were used because of their light weight, widespread use of these systems has not been attained for a variety of reasons. Most have been proprietary in nature, which is generally not attractive to bridge owners. Public sector purchasing regulations were written to foster competition with the goal of cost reduction. Proprietary systems do not conform to this model, so adoption of the technology may be hindered. There also have been some troubles with bonded wearing surfaces cracking, spalling, and delaminating.

The product intent is a solid-surface, lightweight system that is corrosion resistant, fatigue resistant, modular and easy to install, one that provides good skid resistance, low noise levels, is cyclist friendly, is repairable, and requires little maintenance while in service.

This document summarizes the final deck design that was derived from the cost sharing provided by the project team and FHWA. Through finite element analysis, validated by material, component, and system testing, this design has been shown to be capable of functioning in a wide range of applications, with a support spacing of up to 5 feet. The system is adaptable to

¹ <http://www.fhwa.dot.gov/hfl/tech.cfm>.

² http://www.fhwa.dot.gov/hfl/partnerships/composite_bridge/

different support conditions, so strength and stiffness requirements can be met with just minor adjustments to the material architecture. The design yields a generous factor of safety for strength, as well as a controlled failure mode. At the same time, the deck is sufficiently stiff to avoid any serviceability issues related to local deflections, including the wearing surface cracking that has occurred in the past. The project began July 15, 2010, and the deck was installed on a bridge in Allegany County, New York, during August 2012. Appendix A provides lessons learned from Allegany County's perspective.

PROJECT SCOPE AND TASKS

A wide range of bridges could benefit from the deck discussed in this report. Although variations of the deck can be used on almost any bridge, the project scope originally targeted moveable bridges, since the demand for a lightweight system is most pressing in that situation. Other bridges that would benefit from a lightweight composite deck are historic bridges that were not designed for a heavy deck. Bridges that are weight restricted because of excessive dead load and those whose load-carrying capacity is diminished due to rust and section loss also would benefit from this type of deck. Sites with poor soil conditions may also benefit.

Project tasks that contributed to this outcome included:

- Material evaluation and selection.
- Development of appropriate fabrication methods and installation details.
- Testing of subcomponents and full-scale structural panels to validate finite models.
- Installation and evaluation of the installation procedures.
- Documentation.

Specific tasks are listed in table 1.

Table 1. Project tasks.

Phase I

1	Preliminary Design	Project Management
2		Define Performance Objectives
3		Set Deck Geometrics
4		Create Finite Element Model
5		Analyze details
6		Design Review I (Preliminary Design Review)
7	Testing	Qualify Materials
8		Qualify Tube Subcomponents
9		Consider Alternative Assembly Methods
10		Fabricate & Test 3-ft by 10-ft Test Panels
11		Evaluate Details
12		Report
13		Design Review II (After-Test Review)

Phase II

14	Final Design	Set Final Design, Materials & Assembly Method
15		Design Review III (Final Design Review)
16		Update Finite Element Model
17	Field Installation	Fabricate “Proof of Concept” Panels
18		Field Installation
19		Field Validation
20		Technology Transfer

2. NUMERICAL MODELING AND VALIDATION

MATERIALS

The Phase I Design Report contains a report on the selection of materials for the deck. Section 3 of this report summarizes the final design.

FINITE ELEMENT ANALYSIS

A summary report for the finite element analysis of the bridge stringers and deck system, including railing, is presented in appendix B.

EXPERIMENTAL VALIDATION

Numerous laboratory tests were performed to gain information about the behavior and consistency of tube subcomponents and full depth deck panels. Connections, the railing anchorage, the wearing surface, and fire resistance were also proof tested. Each test is summarized in the appendixes in the Phase I Design Report.

Appendix C is a report on the field testing, done to validate the finite element analysis. The live-load test shows that the maximum tensile strains experienced by the FRP deck under the truck loading are below 3 percent of the ultimate failure tensile strain of the FRP panel ($315 \mu\epsilon$) and that maximum midspan deflections registered by the steel girders and FRP deck satisfy AASHTO deflection limits. The 3D finite element model is used to further evaluate the response of the FRP deck and steel girders to the truck loading. Numerical results match very closely the experimental data. For example, for the load case of both trucks placed at midspan, differences between the measured strain values on the FRP deck and the numerical model are on the order of 5 percent, whereas differences in steel girder deflections are on the order of 4 percent.

3. DECK FABRICATION

This section describes the materials and methods used to fabricate deck panels. The fabrication method is flexible enough that various support spans can be accommodated with a slight modification of the panel structure; however, all variations are based on a standard pultrusion that serves as a building block for the deck.

MATERIALS

Resin

The resin used is a fire-resistant vinyl ester resin from Ashland Chemical called Derakane 510C.

Fiber

See tables 2 and 3 for detailed descriptions of the fiber layers. The reinforcement is E-glass rovings, woven mat, and chopped strand mat (CSM) from PPG and Owens-Corning. Glass from other manufacturers could be used as well. The individual ply details of the laminate constructions for the horizontal and vertical walls also are given in the tables.

Table 2. Ply details for horizontal walls of pultruded tube.

Material	Angle (°)	Areal Weight (oz/yd ²)	Thickness (in.)
1 ½ oz CSM	n/a	1.5	0.016
E-TTXM 2308	45	6.27	0.032
	90	11.52	
	-45	6.27	
	CSM	8.10	
Roving - 3.7 ends/in.	0	38.3	0.038
E-TTXM 2308	45	6.27	0.032
	90	11.52	
	-45	6.27	
	CSM	8.10	
Roving - 3.7 ends/in.	0	38.3	0.038
E-TTXM 2308	45	6.27	0.032
	90	11.52	
	-45	6.27	
	CSM	8.10	
1 ½ oz CSM	n/a	1.5	0.016
TOTALS	0	76.6	0.204
	90	34.6	
	+45/-45	37.6	
	CSM	27.3	

Table 3. Ply details for inclined walls of pultruded tube.

Material	Angle (°)	Areal Weight (oz/yd²)	Thickness (in.)
1 ½ oz CSM	n/a	1.5	0.017
E-TTXM 2308	45	6.27	0.032
	90	11.52	
	-45	6.27	
	CSM	8.10	
E-TTXM 2308	45	6.27	0.032
	90	11.52	
	-45	6.27	
	CSM	8.10	
Roving – 7.6 ends/in.	0	78.6	0.078
E-TTXM 2308	45	6.27	0.032
	90	11.52	
	-45	6.27	
	CSM	8.10	
E-TTXM 2308	45	6.27	0.032
	90	11.52	
	-45	6.27	
	CSM	8.10	
1 ½ oz CSM	n/a	1.5	0.017
TOTALS	0	78.6	0.240
	90	46.1	
	+45/-45	50.2	
	CSM	27.3	

Composite Materials

Table 4 provides details of the material properties of the composite material.

Table 4. Material properties of composite material.

Laminate Unit Value	Unit	Values for Horizontal Walls Thickness = 0.20 in.	Values for Inclined Walls Thickness = 0.24 in.
Elastic modulus of 0 degree, E_x	psi	3.39 E+6	3.18 E+6
Elastic modulus of 90 degree, E_y	psi	2.33 E+6	2.39 E+6
Shear modulus, G_{xy}	psi	0.74 E+6	0.75 E+6
Ultimate tensile strength of 0 degree	psi	63,600	55,600
Ultimate tensile strength of 90 degree	psi	20,600	22,300
Ultimate compressive strength of 0 degree	psi	54,800	51,600
Ultimate compressive strength of 90 degree	psi	22,300	23,600
Ultimate shear strength	psi	8,000	8,600
Poisson's ratio	-	0.27	0.27

Grout

The grout selected was epoxy based. This is used to add compressive strength to tube sections and is used for field joints. Properties are shown in table 5.

Table 5. Material properties of polymer grout.

Properties	Unit	Value
Compressive strength	psi	1.32E+4
Tensile strength	psi	2.35E+3
Elastic modulus	psi	2.16E+6

Tubes

A basic building block of the deck is the trapezoid-shaped pultrusion. It is a three-cavity trapezoid, as shown in figure 1. Figure 2 shows the standard dimensions, and figure 3 provides details regarding the fiber architecture.



Figure 1. Photo. Pultruded tube.

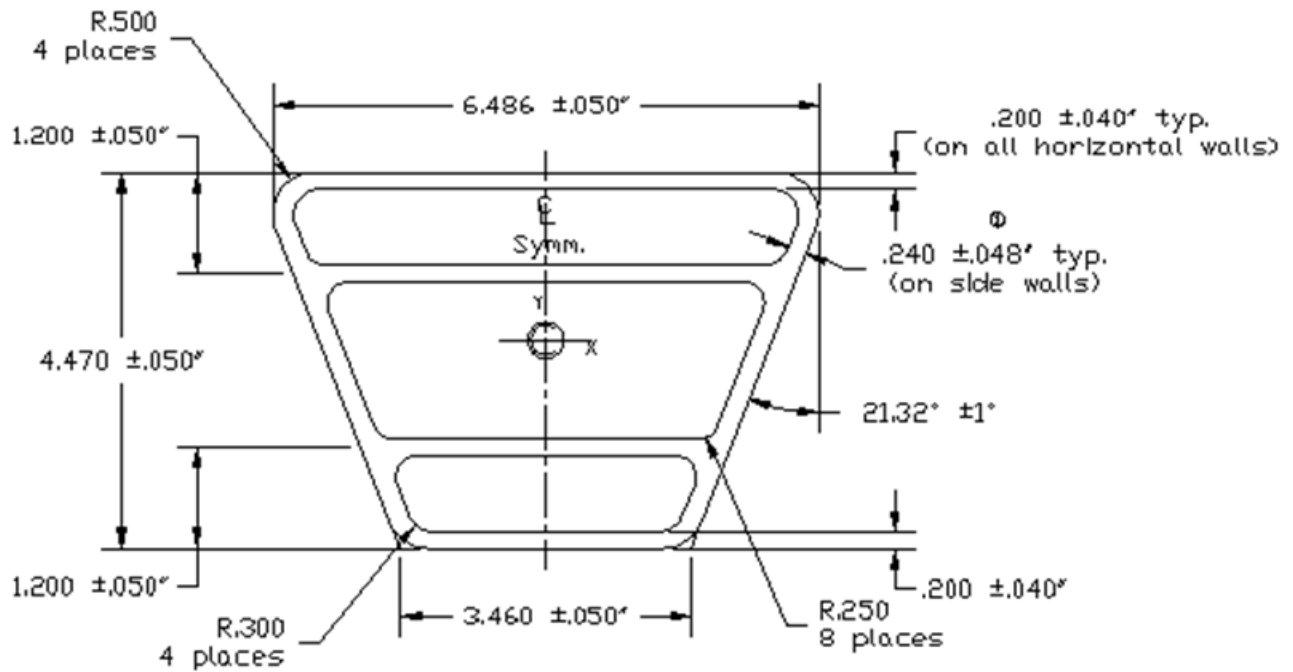

Figure 2. Diagram. Dimensions of tube cross-section.

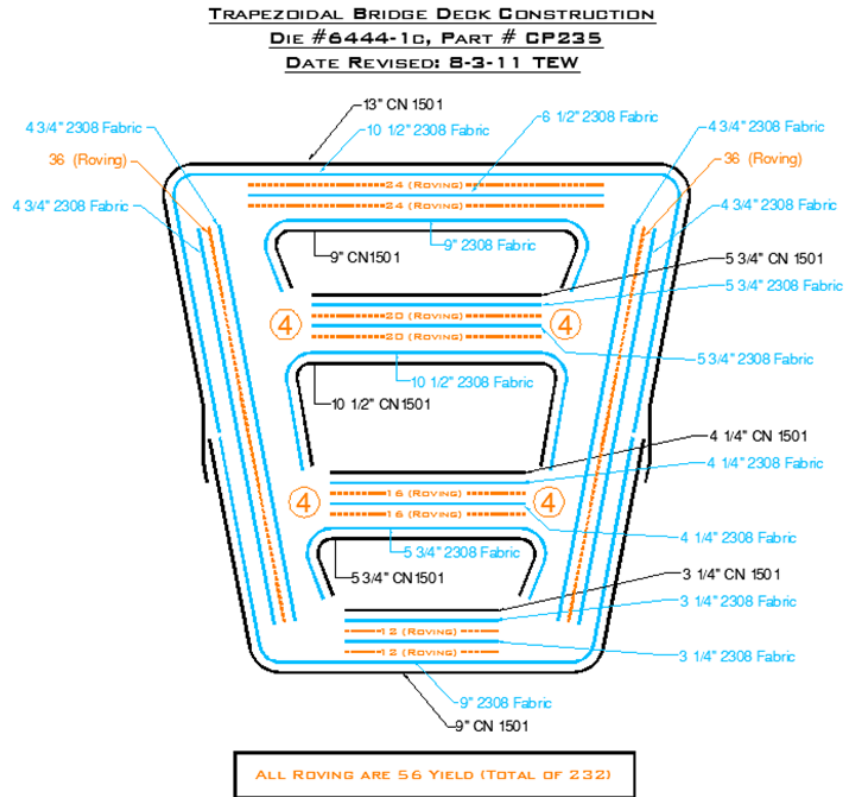

Figure 3. Diagram. Fiber architecture of the tube.

Panel Fabrication Methods

Figures 4 through 11 illustrate the steps for assembling the deck panels.

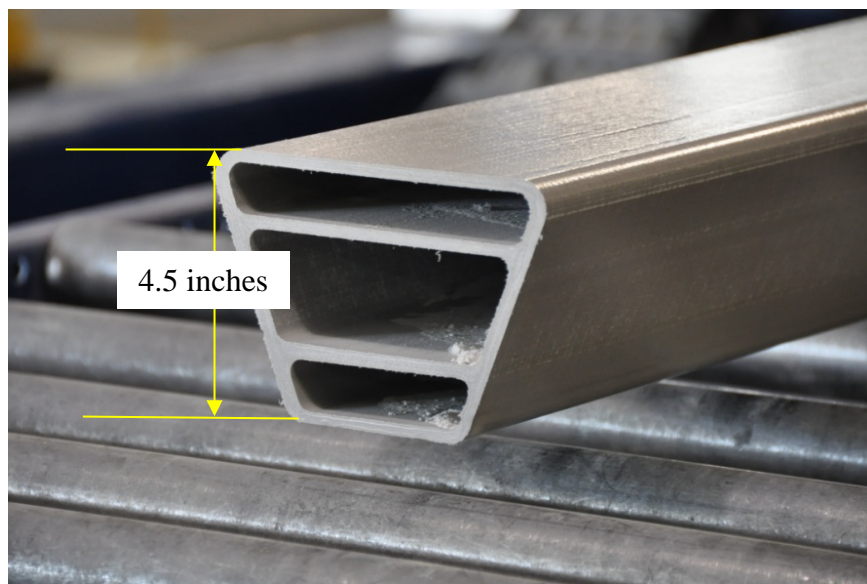

Figure 4. Photo. Pultruded tube subcomponent consisting of E-glass and vinyl ester resin.



Figure 5. Photo. Tube subcomponents are bonded together with adhesive to form a panel.



Figure 6. Photo. Panel ends are capped and radii between tubes filled with thixotropic resin.



Figure 7. Photo. The panel is wrapped in glass fiber in preparation for infusion with vinyl ester resin.

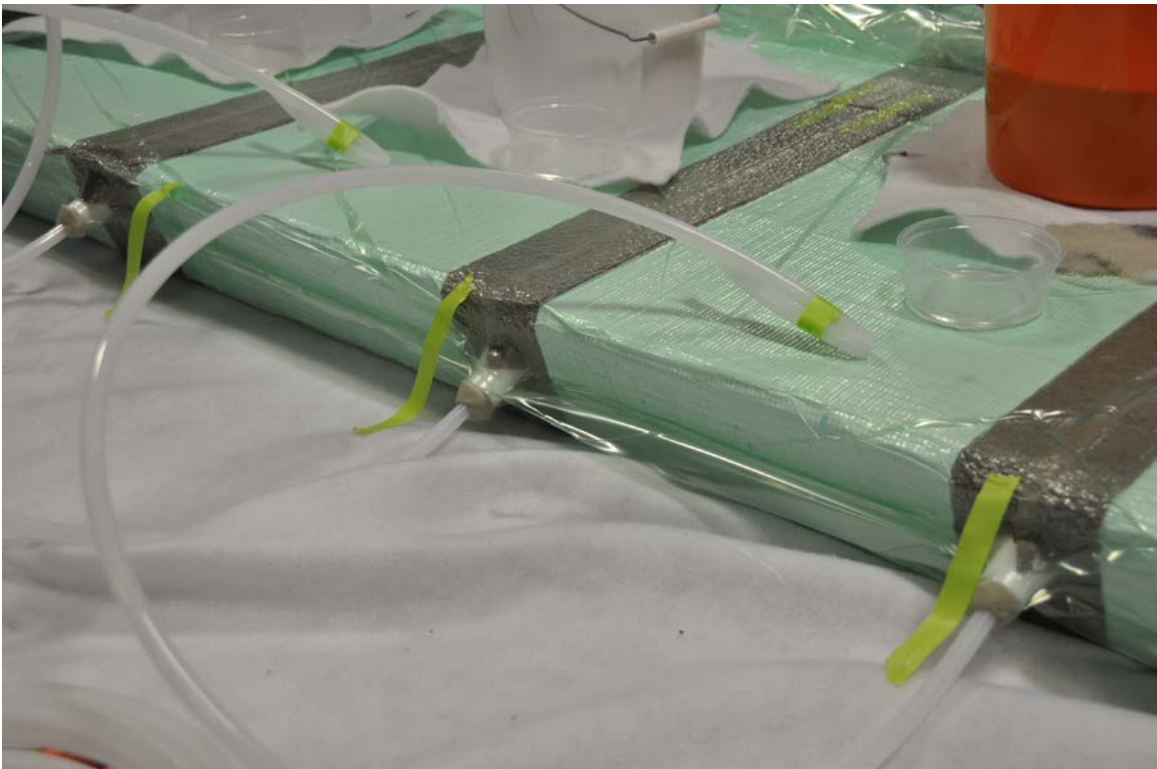

Figure 8. Photo. Infusion of resin for outer wrap using vacuum-assisted resin transfer molding (VARTM) method.



Figure 9. Photo. Infused deck panel is stripped and inspected for thorough wet-out.



Figure 10. Photo. Adhesive and stone applied for course 1 of the wearing surface. Note the black prefabricated railing post pad and stone bonded to the sloped surface.



Figure 11. Photo. Panels labeled for shipping to the job site.

4. DECK INSTALLATION

The figures in this section illustrate the steps in a typical deck installation. Where available, actual dates are noted for each step to provide a timeline for the operation.



Figure 12. Photo. Stringline girders to determine if haunch corrections are needed. Note that the A588 stringer has replaced one that was corroded due to the previous open grating.



Figure 13. Photo. Place prefabricated haunches (black epoxy-coated red oak).



Figure 14. Photo. Situate crane and pick panels with two slings. Approximate panel weight is 20 psf, including wearing surface course 1. On this project, a panel weighed approximately 1,800 lb.



Figure 15. Photo. Place panels on top of prefabricated haunches. Note studs that make a fixed connection between the deck and stringers at midspan.



Figure 16. Photo. Place prefabricated deck panels so transverse field joints are as tight as possible, making fine adjustments with a steel road bar.



Figure 17. Photo. Secure panels with stainless steel clips and expansion bolts. Expansion bolt is shown.



Figure 18. Photo. Secure panels with stainless steel clips and expansion bolts. Clip is shown.



Figure 19. Photo. Installed clip. Methacrylate adhesive can be used to fill voids above or below prefabricated haunches to ensure uniform bearing. This was done on 9/4/2012.



Figure 20. Photo. Install fixed connection between deck and steel stringers per plan.

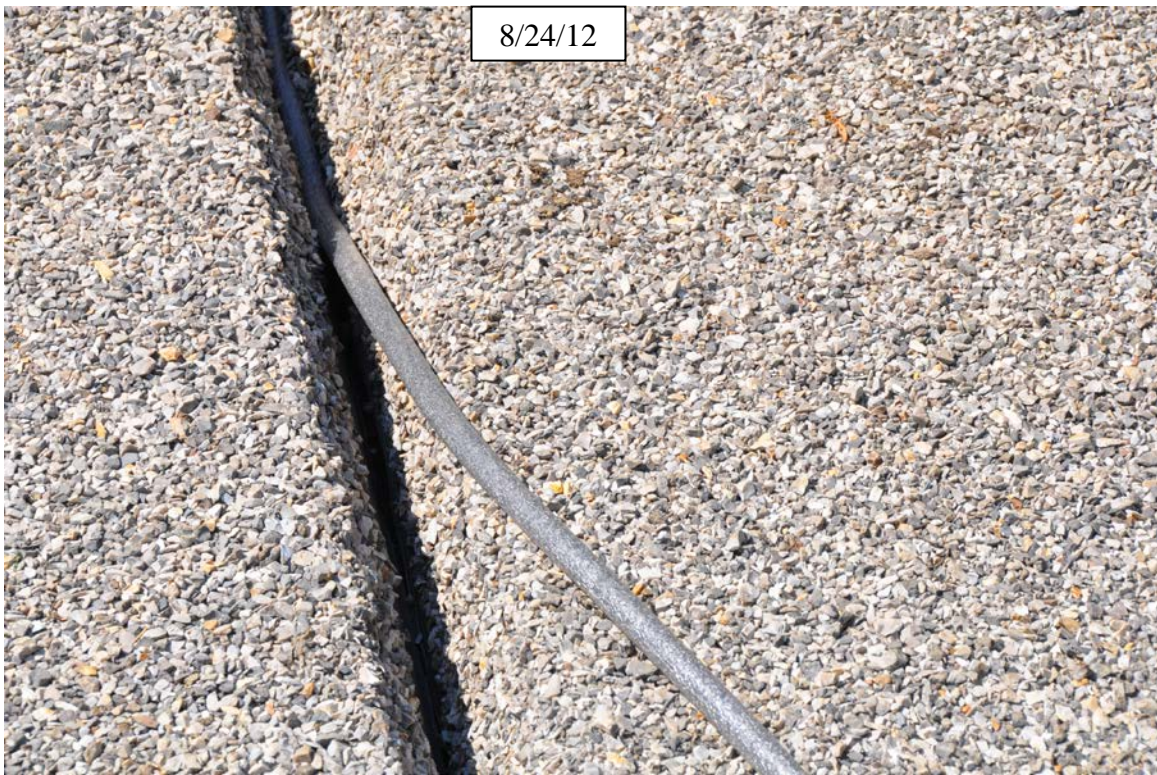

Figure 21. Photo. Install 5/8-inch foam backer rod at bottom of field joints.



Figure 22. Photo. Install transverse rebar and epoxy grout in field joints. Thirty-six-inch #3 stainless rebar provides a positive tie across the centerline joint.



Figure 23. Photo. Embed clean, dry, angular aggregate on the surface of the epoxy-grout field joints.



Figure 24. Photo. Mix epoxy grout for deck nosing at bridge joints.



Figure 25. Photo. Install 1-inch foam backer board at bridge joint at each end of the deck to square up the end of the deck. Install epoxy grout in deck nosing at joints.



Figure 26. Photo. Apply resin for second course of wearing surface.

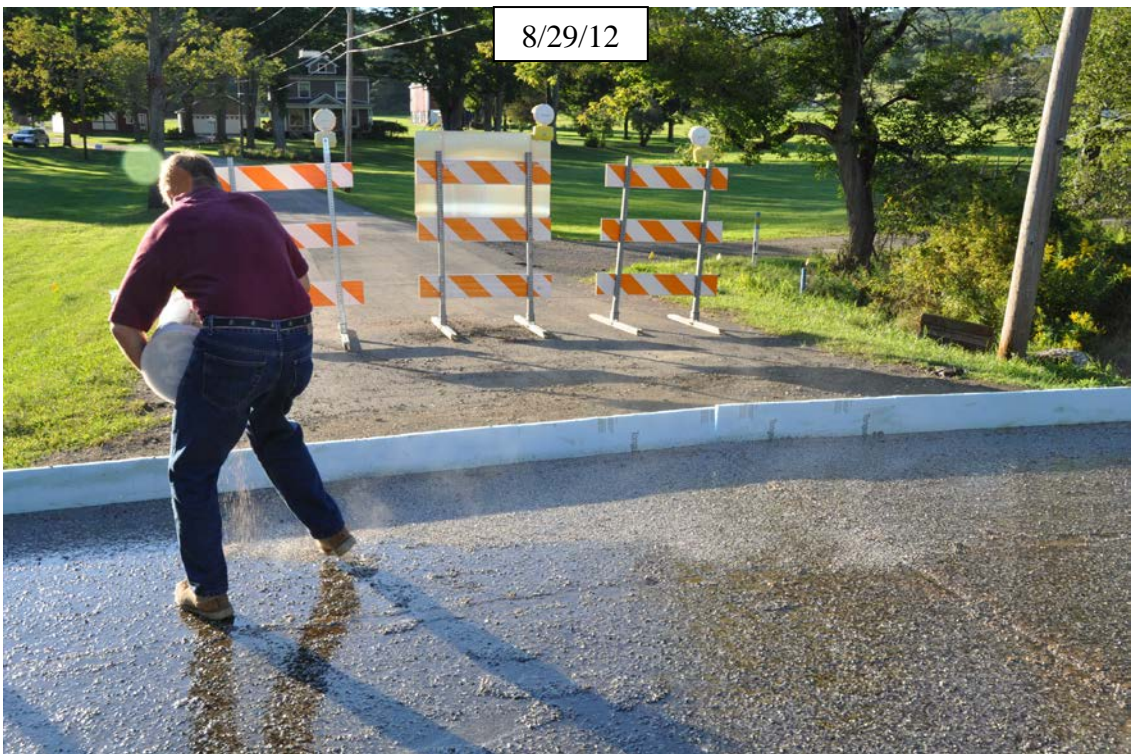

Figure 27. Photo. Broadcast crushed stone for second course of wearing surface.

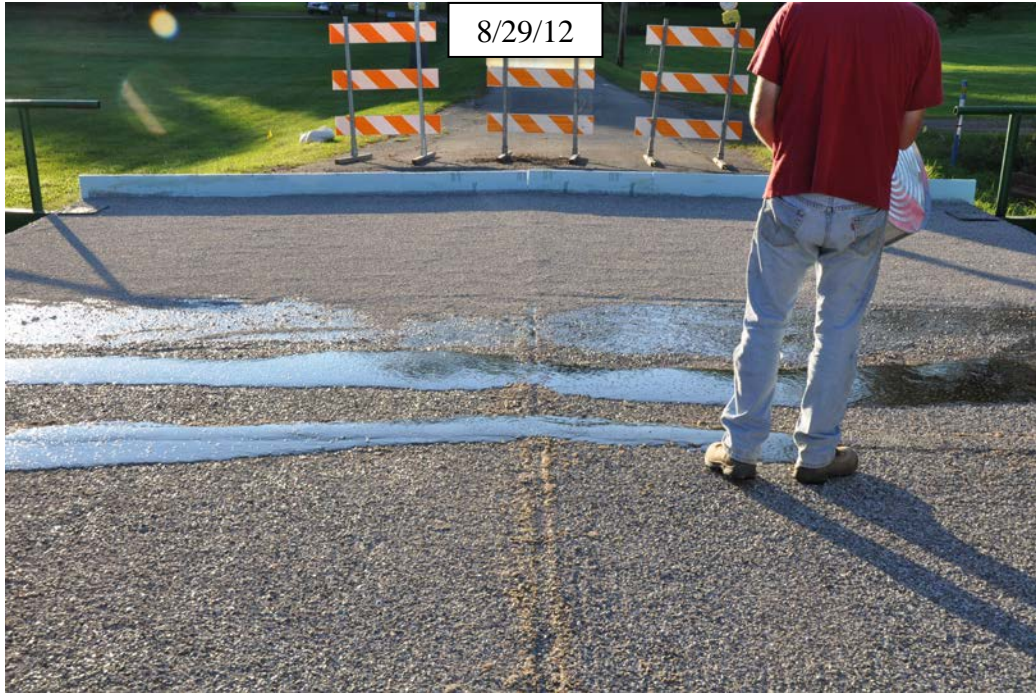

Figure 28. Photo. Spread crushed stone aggregate for second course of wearing surface. Then install 1-inch foam backer rod at the bottom of the begin and end bridge joints (not pictured).



Figure 29. Photo. Install two-part pourable joint material per manufacturer's instructions.



Figure 30. Photo. Align prefabricated high-density polyethylene pad for bridge railing posts.



Figure 31. Photo. Install bridge railing posts, rails, and approach railing. Opened to traffic on 9/27/2012.

11/19/12



Figure 32. Photo. Load test to determine the load capacity of the bridge; not normally needed to assess the deck.

A sample specification for this deck system is provided in appendix D. Appendix E is a set of engineering drawings used to illustrate the deck and installation details.

5. CONCLUSIONS AND LESSONS LEARNED

Deck panels were made by combining consistent-quality pultruded subcomponents with a vacuum-infused outer wrap. The strength and stiffness were first determined analytically using finite element methods, then validated independently with extensive full-scale laboratory testing. Details of the installation were demonstrated on a 40-foot-long bridge during August 2012. Load testing further added to the calibration of the finite element model, so there is a high level of confidence that the numerical model is reliable.

The 5-inch-thick composite deck is versatile and can be tailored to be light or especially robust, depending on the need. With working stresses less than 25 percent of the material's ultimate strength, a catastrophic failure of the deck is virtually impossible. Furthermore, panels purposely overloaded in the laboratory exhibited a pseudo-ductile behavior and had residual strength after failure.

The end result of the project is a robust, high-quality deck suitable for many applications, including moveable bridges, historic trusses, and posted bridges. Although the deck has many desirable attributes, the initial material cost is higher than conventional alternatives. This may mean that future use will be restricted to situations where the rapid installation offsets the cost of maintenance and protection of traffic, or situations where the light weight is especially important, such as on deteriorated or historic structures. Further data and analyses will be necessary to accurately compare the cost of this deck system to alternative lightweight decks on a materials basis, an in-place basis, and a life cycle basis.

The performance of the bridge deck will be monitored for the next 5 years. Inspections will be primarily visual, but opportunities will be sought to gather in-service deflection data with a structural health monitoring system that is accessible via the internet. Condition reports will be made available by the authors upon request.

The following sections highlight some of the most important findings of the project. Appendix A provides lessons learned from Allegany County's perspective.

LESSONS LEARNED – DESIGN

- From the beginning, the project team and its advisors agreed that the most important design criterion was deck performance (driven by stiffness needed for good durability), even if it came at a higher cost. Evidence abounds that a superior deck has been produced and that it can be expected to serve worry-free for the life of the bridge, but the cost was not driven down as much as the project director had anticipated.
- There is a large factor of safety for strength. The design is driven by the stiffness of the deck under local deformation because of the need to assure the integrity of the wearing surface. Deflection, per se, (rider comfort) is not the issue.
- The pultruded combination tube was developed during this project. In the words of one advisor, "I also like the concept of alternate top and bottom grouted sections. It performs well and looks like it responds well to the local deformation issue. It has the benefit of

efficiencies in the manufacturing process by having only one tube section to manufacture.”

- The two-course wearing surface appears to have the potential to eliminate wearing surface problems. Laboratory testing seems to support this argument, but long-term performance in the field will be the key.
- A key benefit of the design is the deck’s versatility. The stiffness can be increased 40 percent over an empty panel when needed for wider stringer spacing by strategically adding grout or modifying the fiber architecture of the outer wrap. Since the proof-of-concept bridge had tightly spaced stringers (24 inches), no grout was needed. Using the deck without grout fill made it extremely light (17 pounds per square foot).
- The county specified test level TL-2 for the railing on the bridge because of the low operating speed and light traffic. The rail post connection provided and tested is sufficient for TL-2 loading without any special treatment. Grout fill will be needed to withstand greater loads when the railing must be mounted on the deck and a higher level of performance is warranted.
- A low-modulus epoxy grout achieved high compressive strengths yet remains compatible with the rest of the deck system.
- Further testing may be necessary to assess the potential for debonding between the grout and FRP tube as a result of thermal cycling.
- Internal shear blocks would diminish concerns about slippage between the FRP tubes and the grout (from either overload or thermal cycles).
- The bond between the cementitious grout and FRP is not satisfactory without some additional measure being taken to ensure load transfer (other than simply sanding).
- Testing showed that direct fire can damage the deck panels by burning off the resin, even when a fire-resistant resin is used. However, the damage was limited to the exposed area, and deterioration of strength (and stiffness) is slow. After 20 minutes of a 1500 °F fire under the deck, the top surface was not much above room temperature and did not appear to suffer any damage. The damaged panel would still be considered serviceable after the fire test.

LESSONS LEARNED – FABRICATION

- The use of prefabricated haunches worked well, but machining them with the proper cross slope was more difficult than planned. Perhaps a combination of a rectangular section and a small wedge would simplify this detail.
- When installing the first course of the wearing surface, it is important to be aware of the pot life of the adhesive. There are some deck panels that did not get the proper embedment of stone because the adhesive had set up before the stone was applied. An attempt was made to remove the hardened adhesive and reapply it in the field to make sure course 1 was bonded well, but it was very difficult to do, even with a grinder.
- It may be because of the uniquely difficult economic times that we have lived through (dubbed The Great Recession), but the project team found that there were few FRP fabricators willing to take any financial risk. It was difficult to get quotations when trying to find a variety of sources for the tubes. In the end, the pultruded tube proved to be a good solution, but it would have been better to have more competitive quotes. The size of

deck panels and, thus, the number of field joints was constrained by the lifting capacity of the fabrication shop.

- The size of the panels is customizable, so applying the system each bridge is not a problem.

LESSONS LEARNED – INSTALLATION

- Installation was fairly straightforward, even for a work crew that was inexperienced at installing FRP decks.
- Drilling holes in the deck for expansion bolts from underneath proved to be more tedious and time-consuming than anticipated. On-site drilling was selected because it would have been hard to align predrilled holes precisely. Perhaps a different type of drill, like one with a magnetic mount, would have facilitated this part of the field installation operation.
- A prefabricated “grout pad” made of recycled high-density polyethylene material simplified and accelerated the post installations.
- Applying course 2 of the wearing surface in the field worked well because it sealed the deck surface with one layer for water tightness. It also served to level out small irregularities in course 1. The resin and stone were spread manually on this project, but this process could be mechanized for a bridge deck that had a large surface area.
- The sloped faces at the edges of panels allowed for a better panel-to-panel joint. It was easy to construct in the field. Based on laboratory testing, the epoxy grout selected for the joint is expected to perform well.
- The stainless steel hardware is excellent quality, but it was relatively expensive. Some parts needed to be custom made because of the variation in dimensions caused by making the cross slope with a haunch. If the weight of the deck system were not as much of a concern, the deck could be applied flat on the stringers and a cross slope created with asphalt paving or a polymer concrete. This would have made the connection hardware more uniform and less expensive.

APPENDIX A: LESSONS LEARNED—ALLEGANY COUNTY PERSPECTIVE

OWNER'S PERSPECTIVE BEFORE STARTING THE PROJECT

Allegheny County DPW approached participation in the Highways for Life Composite Bridge Decking project as an opportunity to perform a complete rehabilitation of a deteriorating local bridge owned by the Town of Bolivar, NY. The selected location was BIN 2215390, Local Bridge # 10-06, Pleasant Street over Little Genesee Creek in the Village of Bolivar, NY. Since 2006, the County had twice performed section loss repairs to multiple girders of the superstructure to address Red and Yellow Structural Flags issued under New York State's bridge inspection program.

DPW is the responsible party or designated point of contact for all County and Town owned bridges in Allegheny County, NY. As such, all correspondence pertaining to the NYS Bridge Management and Inspection Program for the 298 locally owned bridges in our County is handled through the Department. DPW provides assistance to the Towns in the form of engineering, repair, and maintenance services of the town owned bridges as they request, with the understanding that they pay for all materials needed. County equipment and labor costs of the work provided are typically absorbed by the County under this arrangement.

This relationship was the basis for the agreement between the Town of Bolivar (bridge owner) and Allegheny County for the rehab of LB #10-06. The County agreed to provide the equipment and labor, the HfL project would provide the deck and means to anchor the deck, and the Town would provide the rest of the required materials and hardware. The proof of concept installation afforded the opportunity to put local money into other structural elements of the bridge and extend the scope of the rehab. Instead of just replacing the deck, three of eleven girders were replaced, new steel backwalls were installed, and new crash-worthy, deck mounted bridge railing was installed that was far superior to that which existed prior to the project. Also, approach guide railing was installed where there had been none prior.

LB #10-06 seemed to be a good candidate for the proof-of-concept installation because it was relatively small, it had an open grate steel deck, and it had started to become a bridge that required regular repairs to the girders due to section loss. The high section loss measurements were a direct result of the use of chlorides from winter maintenance getting to the primary structural members through the open grate deck. It was understood from the beginning that the use of a composite deck would provide protection of the main superstructure elements (by being more weather proof) at a near zero increase in deadload supported by said elements. Other improvements were the incorporation of fascia overhangs on the deck for additional protection to the fascia girders that did not exist prior.

Alternatives that Allegheny County would normally have considered for a rehab of this type were a transverse glulam deck with asphalt pavement wearing course or corrugated steel bridge decking filled with asphalt pavement. Both of these options would likely have reduced the load rating of the bridge due to the associated increases in deadload. Our experience with these deck

types is that they don't completely prevent moisture from making its way from the deck surface to the structural elements of the superstructure either.

EXPERIENCES ON PROJECT SPECIFIC DETAILS

As the owner's engineering representative and installer, Allegany County DPW's preferences and recommendations were considered and incorporated if possible by the project design team when determining the final geometry and anchorage utilized for the proof-of-concept deck. DPW has extensive experience in installing Steel multi-girder simple-span bridges with transverse glulam timber decks as well as simple-span glulam timber stringer with transverse glulam timber deck bridges. Therefore, Allegany County's recommendations for the anchorage used on the composite deck were provided in an attempt to make installation procedures as close as possible to the procedures used for transverse timber decks. The project design team designed and supplied a system that utilized a fabricated clip and threaded expansion anchor for the proof-of-concept installation. This avoided having anchorage penetrations through the top surface of the panels as would normally occur on a timber deck. (This was a steadfast issue for the deck design team, and rightly so. The composite panels are hollow, and water migrating into the cavities from top surface penetrations was deemed detrimental to the long term performance of the system. Also, the top surface of the composite panel was the base of support for the thin, 2 part wearing course. The solid nature (no voids) of a glulam timber deck does not allow for the migration and retention of surface water entering the top surface penetrations. Most water just passes right through and out the bottom of the anchorage hole.)

To provide drainage from the closed surface created by the composite panels, the deck was installed with a 2% cross slope from the centerline to the fascia overhangs. This required the use of a shim system as the existing beams were installed flat to accommodate the open grate steel decking. The shim system was composed of composite coated, planed hardwood planks, each milled to specified thicknesses based on a beam elevation survey. This survey was taken during the first portion of the rehab just after 3 of the girders were replaced. The shims came predrilled to provide a template to follow for drilling the holes in the bottom of the panels to install the deck anchors.

The normal crown 2% cross slope dictated the use of a longitudinal centerline joint along the full length of the bridge. This was because of the nature of the straight, pultruded, trapezoidal shaped tubes bonded together to form each panel. It also provided a means to get better bearing to all the shims and beams from such a stiff deck. A full width panel may have caused some bridging action to occur over one or more beams if the crown wasn't perfect. Also, the number of panels was dictated by the size and weight handling capabilities of the composites manufacturer who was contracted to assemble the panels. It took 12 panels to complete the 40' long deck, so attention needed to be given to the panel-to-panel field joint detailing to ensure a watertight deck.

Selection of the panel anchorage method was influenced by the various project budgets. Allegany County DPW forces were participating under the constraint of no cash outlay from the County. The County was restricted to contributing manpower, equipment, and materials that were already in County inventory only. (Inventory materials were billed to the Town of Bolivar.) The Town of Bolivar was also participating under a similar constraint after they had finished

purchasing the steel and hardware for the rehab items not associated with installing the composite deck. Also, it was understood that the HfL project budget was nearly exhausted by the time the project reached the proof-of-concept stage. A different method of shimming (pressure grouting?) the panels may have required the use of rented equipment or work by contract, which none of the three parties involved could afford. Use of prefabricated HDPE haunches were investigated, but were not selected due to cost.

The use of the clip and expansion anchor bolt detail to secure the deck down to the beams posed the greatest challenge to the County staff installing the deck. The deck panels could not be pre-drilled prior to shipment due to the inability to ensure that the pre-drilled anchorage holes in the shims would line up with pre-drilled holes in the underside of the deck during placement in the field. This required the installation crew to drill all of the required anchorage holes (approx. 264) in the field, over their heads, in a very narrow work space. Each hole was drilled with a 15/16 dia. conventional drill bit driven by a ½ inch drill motor. Each hole was required to progress through two layers of glass reinforced composite to accommodate the correct expansion anchor bolt embedment. Two men were required to progress the drill. The first held alignment and the trigger. The other advanced the drill with the use of two scrap 2x4 pieces of lumber positioned as a fulcrum and lever propped under the drill motor. Most of the time the drill crew was a three person team, each member rotating between the two positions on the drill and resting. Employees of Allegany County DPW, The Town of Bolivar, and Bridge Composites, LLC, all had their turns working this operation. Everyone involved shared in the misery each night due to the drill cuttings (glass fiber dust) getting on exposed arms and necks. It took nearly a month to complete this operation. In fact, this operation continued on below the deck at the same time work progressed above on the panel joints and the second course of the 2 part wearing surface.

Panel-to-panel joints in the deck were filled with a two-part resin concrete. This operation went as expected and very similar to methods of joint repair and replacement that Allegany County staff were already familiar with. The installation of the joint material went quickly and was accomplished from the top, while monitoring the bottom side to stop any potential leakage.

The second course for the wearing surface was a two-part resin layer with dry aggregate broadcast by hand before the resin cured. This operation was also accomplished easily. Significant guidance was provided by Bridge Composites, LLC during this activity. A few days after this operation was completed, excess aggregate was removed by push brooms and a leaf blower. Any blemishes that appeared where the aggregate did not bond were quickly addressed and repaired by Bridge Composites, LLC.

A deck overhang was included in the panel width at the request of Allegany County. This offered protection to the fascia girders from further deterioration due to winter maintenance operations. The existing bridge railing posts had been mounted directly to the fascia girders of the bridge prior to the start of the rehab. The new deck configuration required the use of a deck mounted bridge railing system installed on the fascia overhang.

The bridge railing type was chosen because Allegany County had in storage a quantity of bridge railing posts and box beam railing that it acquired free of charge from the NYS Department of Transportation. These posts and rail came from an existing bridge on I-86 that NYSDOT

removed over an abandoned railroad grade. The County provided the posts and railing for the two-rail system to the project at no cost. The Town of Bolivar bought and provided new anchorage and assembly hardware for the railing as part of the rehab materials. Because of the very low traffic volumes on the bridge and its location near the end of a dead end street, a Test Level of TL-2 was deemed adequate by Allegany County DPW for the completed railing installation. The loads associated with TL-2 were tested on a sample panel and post at Penn State during design development. The anchorage configuration used on the proof of concept installation was found adequate.

LESSONS LEARNED AND OPPORTUNITIES FOR IMPROVEMENT

Future installations of this particular deck system should eliminate the field drilling requirement associated with the deck anchorage because of the time and effort that was required to do it in the field. Therefore, a different method for shimming the panels to achieve cross-slope should be used (being that it was the pre-drilled shims that necessitated the field drilling of the panels.) Perhaps a method that uses leveling bolts already installed in the bottom of the panels and pre-installed threaded anchorage studs already protruding from the underside of the panels at the correct offsets to straddle the existing girders. When the panels are set in place to the correct elevation, shimming could then be done by some sort of grouting procedure, be it cementitious or synthetic material. This change may be easier if done outside the realm of a research project. A capital budget could be planned to accommodate the use of specialty contractors or special tool/equipment rental that didn't exist within the constraints of this project.

Deck panel sizes should be based on a maximum handling weight provided in the prospective owner's bid specification, especially if the owner knows which piece of equipment will be used to set the panels. In Allegany County's case, a maximum allowable panel weight of 28,000 pounds could have been specified. This is an achievable pick for the County Bridge Crew's crane to make at midspan of a 40' long bridge if the crane is set up in the approach. In reality the proof-of-concept deck could have been set with only 2 panels instead of 12, and just a single longitudinal joint instead of the 5 transverse joints that were also necessary. Having fewer field joints would not only require less time and materials needed to make the joints, it would also reduce the potential for problems in the future.

The design team's requirement of no top surface penetrations in the deck panels precluded the use of embedded anchors in the top to lift and set the individual panels. This required the crew assigned to the proof-of-concept installation to use polyester rigging straps slung around the underside of the panels during installation. This posed no problem at the fascia end of the panel. However, at the centerline end of the panel, where the longitudinal joint occurred over the center girder, the panels had to be propped with pry-bars to remove the strap. A lifting solution might be developed where high tensile synthetic strand lifting loops cast into the top of the panels could be cut off flush with the top of the deck prior to the installation of the second course of the wearing surface. A solution similar to one used by prestressed beam manufacturers who install lifting loops in the beams made of looped prestressing strand protruding from the top surface of the beam.

IN SERVICE OBSERVANCES

At the time of this writing, the deck has been in service for approximately 7 months, including one winter maintenance season. The wearing course has no observable deterioration due to snow plowing operations and has appeared to stand up well in service. The polymeric-concrete joints at the begin and end of the deck have shown to have sufficient durability to withstand plowing operations, especially considering their exposure due to the adjusted roadway profile over the bridge.

There seems to be one location on the deck where the top side outer wrap of one of the panels has separated from the transverse trapezoidal tubes within. This was brought up by the Bolivar Town Highway Superintendent and observed in the field on May 6, 2013. This occurrence is isolated to panel No. 9. The condition is observable under foot or tire as an audible crunch is emitted by the deck. The condition is also felt as a soft spot under foot, as if you are displacing an air pocket when you press down forcing the outer wrap back down onto the tubes. Even with this condition, the wearing surface shows no visible signs of distress or cracking. The rest of the deck appears to be in excellent condition, nearly silent under traffic. Bridge Composites, LLC is aware of the issue, but there hasn't been sufficient time to diagnose exactly what is happening yet. Bridge Composite's initial recommendation is to have the Town and County monitor the condition as a repair attempt may be more detrimental than beneficial. Plans are in place to rerun the FE model for the panel design with the outer wrap modeled in a debonded condition.

PROCUREMENT OUTSIDE THE REALM OF A DEMONSTRATION PROJECT

Without knowing what the actual costs were for the deck that was installed, it is hard to suggest items to consider if a prospective owner is interested in using this technology. Assuming costs are still very high, Allegany County would have limited use for such a product in the immediate future. The concept of the HfL project originally focused on moveable bridges. This would probably be a strong market to continue trying to break into, but Allegany County has none in its inventory. A possible use for rural municipalities might be federally funded bridge rehabilitations where State regulatory agencies deem the superstructure of the existing bridge to be historic. Otherwise a rehabilitation that allows the owner to replace the superstructure in its entirety is probably more cost effective. This would especially be true for many single-span, locally owned structures where span ranges are less than 65 feet or so.

The specification provided in Appendix D of this report should form the basis of a prospective owner or owner's representative construction specification.

Jeremy D. Ferris, P.E.
Allegany County Department of Public Works
May 13, 2013

APPENDIX B: REPORT ON FINITE ELEMENT ANALYSIS

FINITE ELEMENT MODEL FOR THE WHOLE BRIDGE

Tables 6 through 8 detail the properties of the various materials used to model the composite bridge deck.

Table 6. Material properties (composite).

Laminate Unit Value	Unit	Values for Horizontal Walls Thickness = 0.20"	Values for Inclined Walls Thickness = 0.24"	Values for graphite (thickness for each layer = 0.172in)
Elastic modulus of 0 degree, Ex	psi	3.89 E+6	3.43 E+6	3.13 E+6
Elastic modulus of 90 degree, Ey	psi	1.77 E+6	2.73 E+6	2.03 E+6
Shear modulus, Gxy	psi	0.86 E+6	0.75 E+6	1.32 E+6
Ultimate tensile strength of 0 degree	psi	39,960	33,000	50,960
Ultimate tensile strength of 90 degree	psi	19,890	10,340	44,340
Ultimate compressive strength of 0 degree	psi	70,000	54,120	35,710
Ultimate compressive strength of 90 degree	psi	33,430	37,060	35,710
Ultimate shear strength	psi	14,580	14,770	9,090
Poisson's ratio		0.223	0.231 modeling	0.184

Table 7. Material properties (concrete).

Properties	Unit	Value
Compressive strength	psi	1.32E+4
Tensile strength	psi	2.35E+3
Elastic modulus	psi	2.16E+6

Table 8. Material properties (steel).

Properties	Unit	Value
Elastic modulus	psi	2.90E+7
Poisson's ratio		0.3

RESULTS

Using AASHTO Load and Resistance Factor Design (LRFD) Bridge Design specifications:

- Load Factor for Lane Load = 1.75.
- Load Factor for Truck Load = $1.75 \cdot (1 + 0.33) = 2.3275$.

Tables 9 through 11 show the response of the deck under service load, as obtained from finite element analysis. The finite element model used property values that were primarily derived from the physical testing of as-fabricated composite specimens.

Table 9. Service load deflection and failure index with concrete, small footprint (6 by 7 in²), with lane load.

Loading	Maximum Deflection (in.) (Service Load)	Square root of Tsai-Hill Index (R) $(\sqrt{I_{TH}})$ (LRFD)
HL-93	0.284	0.413

Maximum local deflection between two girders = **0.02 inches**.

Table 10. Service load deflection and failure index with graphite, small footprint (6 by 7 in²), no lane load.

Loading	Maximum Deflection (in.) (Service Load)	Square root of Tsai-Hill Index (R) $(\sqrt{I_{TH}})$ (LRFD)
HL-93	0.357	1.38

Maximum local deflection between two girders = **0.17 inches**.

Table 11. Service load deflection and failure index with graphite, large footprint (10 by 20 in²), no lane load.

Loading	Maximum Deflection (in.) (Service Load)	Square root of Tsai-Hill Index (R) $(\sqrt{I_{TH}})$ (LRFD)
HL-93	0.279	0.853

Maximum local deflection between two girders = **0.088 inches**.

The most critical element (the element with the highest Tsai Hill index under LRFD loading) is located under the area of applying the truck load (on the top flange). The stress states for these elements are presented in tables 12 through 15.

Table 12. State of stress in the critical composite element (SL loading), small footprint, no lane load.

Element No.	S₁₁ (psi)	% of Ultimate	S₂₂ (psi)	% of Ultimate	S₁₂ (psi)	% of Ultimate
Under truck load (vertical wall)	-19342	27	-28021	84	13	0.09

Table 13. State of stress in the critical composite element (LRFD loading), small footprint, no lane load.

Element No.	S₁₁ (psi)	% of Ultimate	S₂₂ (psi)	% of Ultimate	S₁₂ (psi)	% of Ultimate
Under truck load (vertical wall)	-45019	64	-65219	195	30	0.2

Table 14. State of stress in the critical composite element (SL loading), large footprint, no lane load.

Element No.	S₁₁ (psi)	% of Ultimate	S₂₂ (psi)	% of Ultimate	S₁₂ (psi)	% of Ultimate
Under truck load (vertical wall)	-2391	7	-8197	23	168	2

Table 15. State of stress in the critical composite element (LRFD loading), large footprint, no lane load.

Element No.	S₁₁ (psi)	% of Ultimate	S₂₂ (psi)	% of Ultimate	S₁₂ (psi)	% of Ultimate
Under truck load (vertical wall)	-5565	16	-19079	53	390	4

Figures 33 through 41 graphically illustrate the finite element model made for the proof-of-concept bridge.

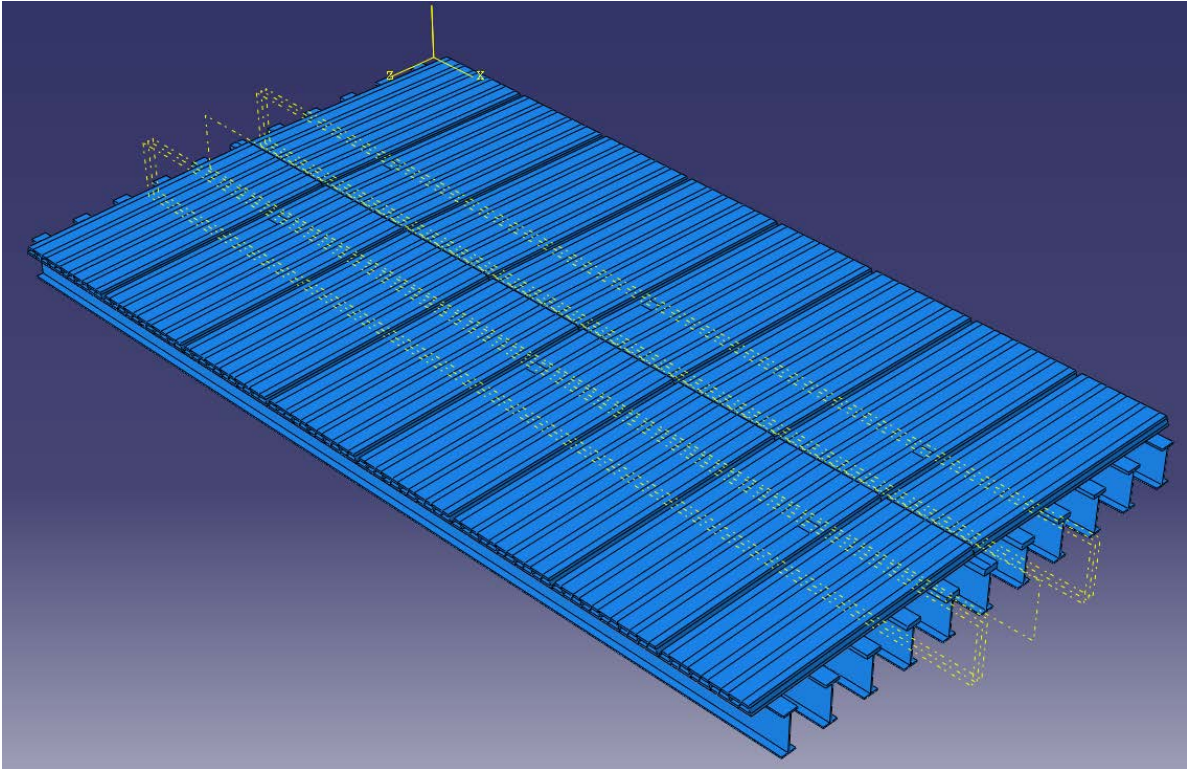

Figure 33. Diagram. 3D view.

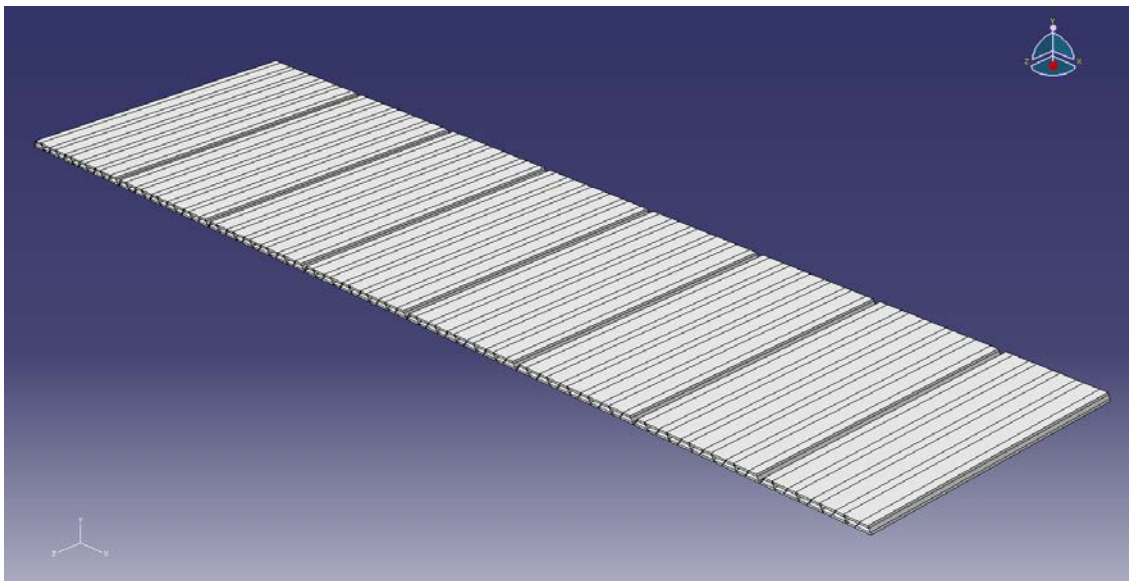

Figure 34. Diagram. Half of FRP deck (7 panels with 11 cells and 1 panel with 8 cells).

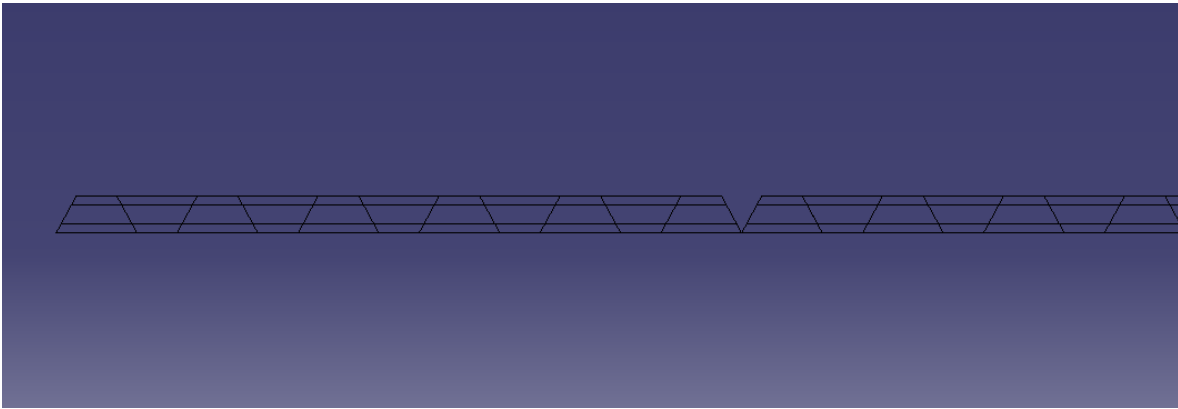

Figure 35. Diagram. Cross-section of a part of the FRP deck.

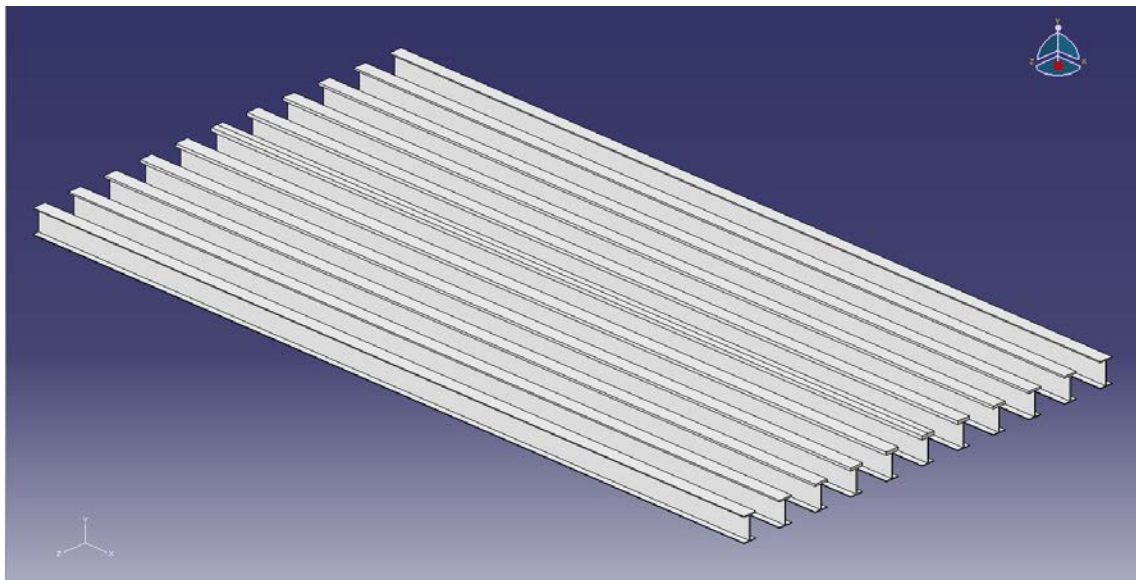

Figure 36. Diagram. Girders.

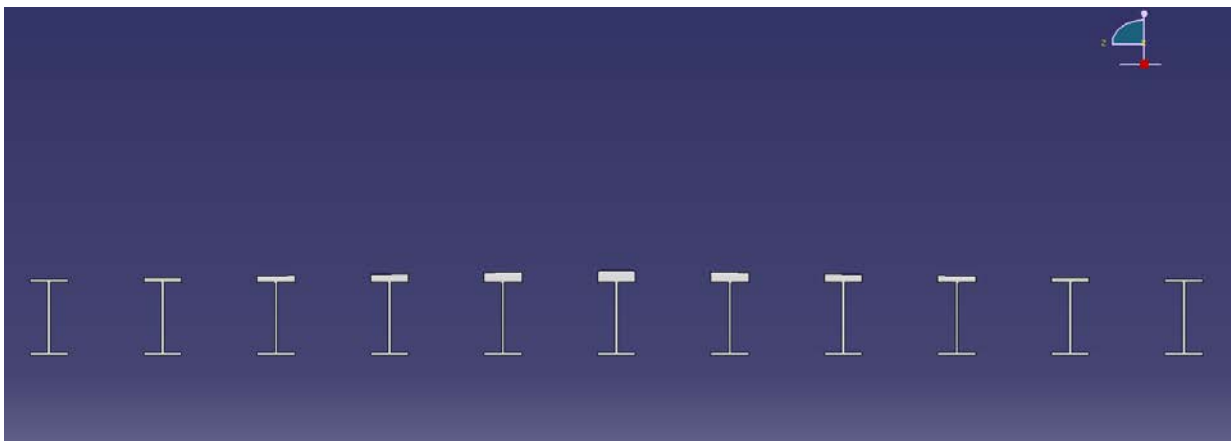

Figure 37. Diagram. Cross-section of the girders.

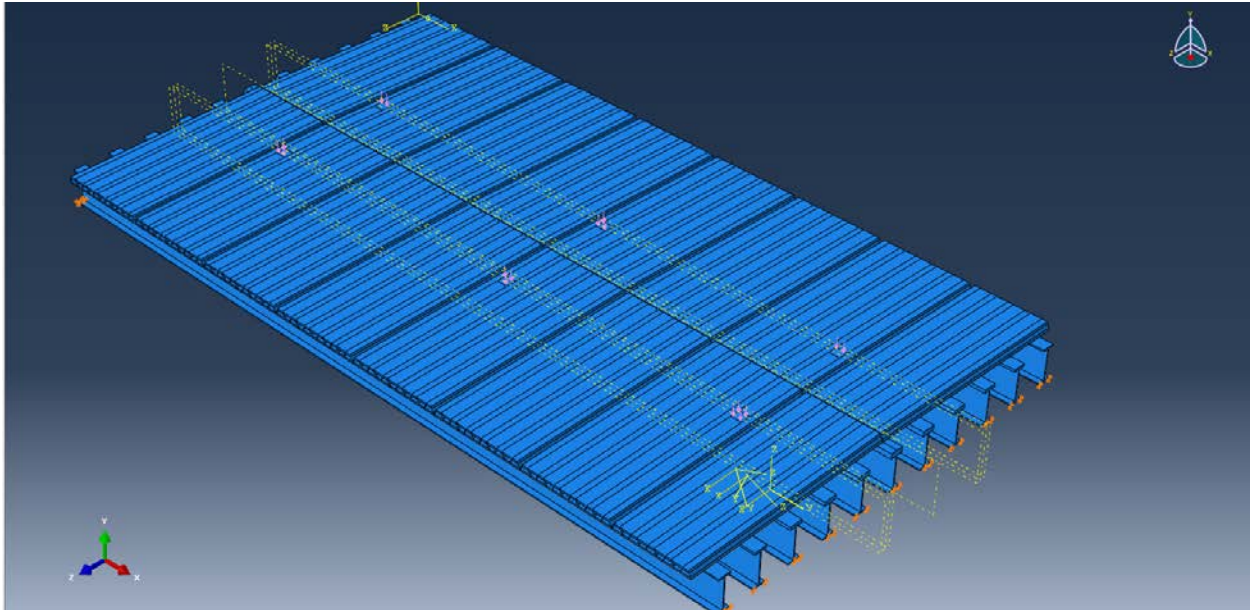

Figure 38. Diagram. Loading and boundary conditions.

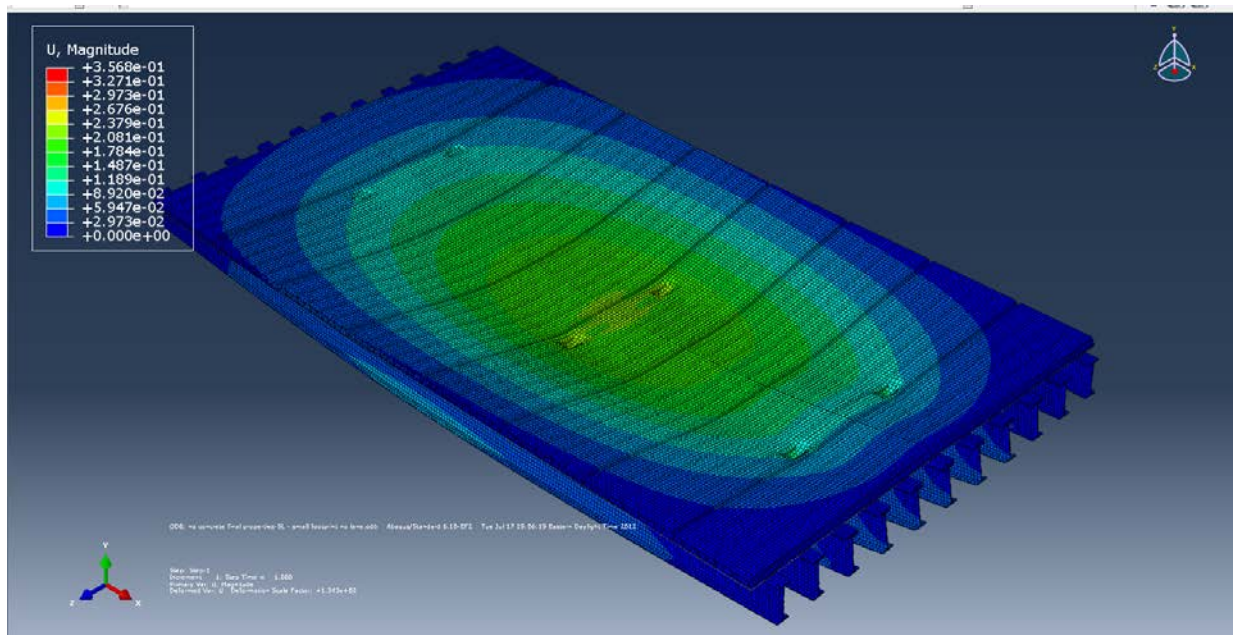

Figure 39. Diagram. Deflection (service load), small footprint.

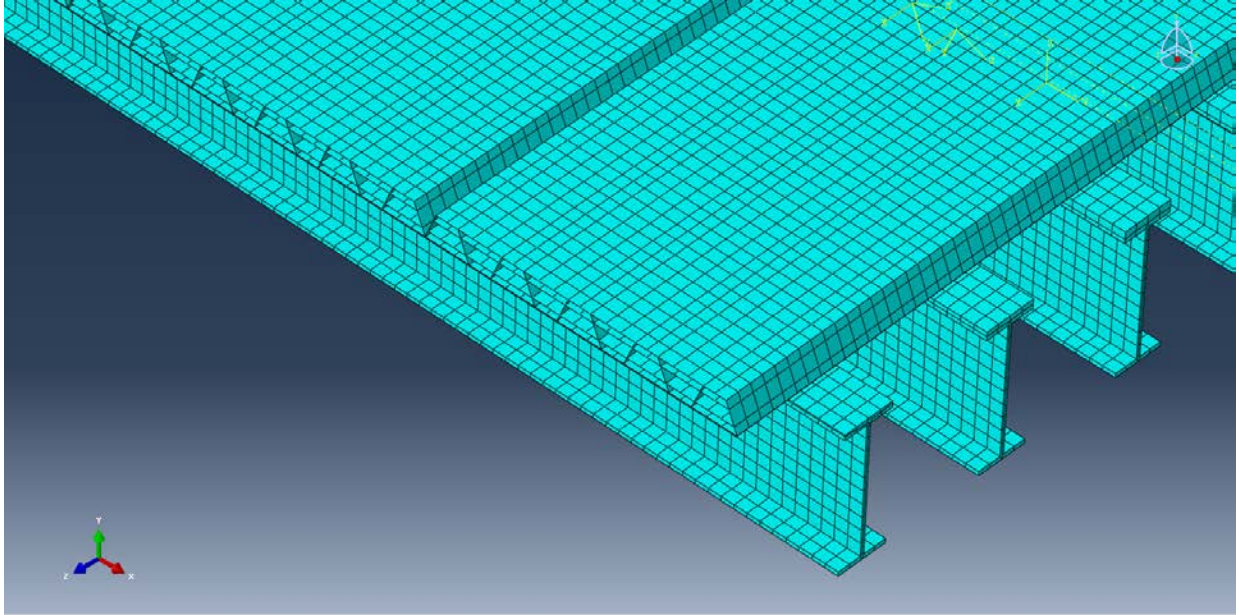

Figure 40. Diagram. Mesh.

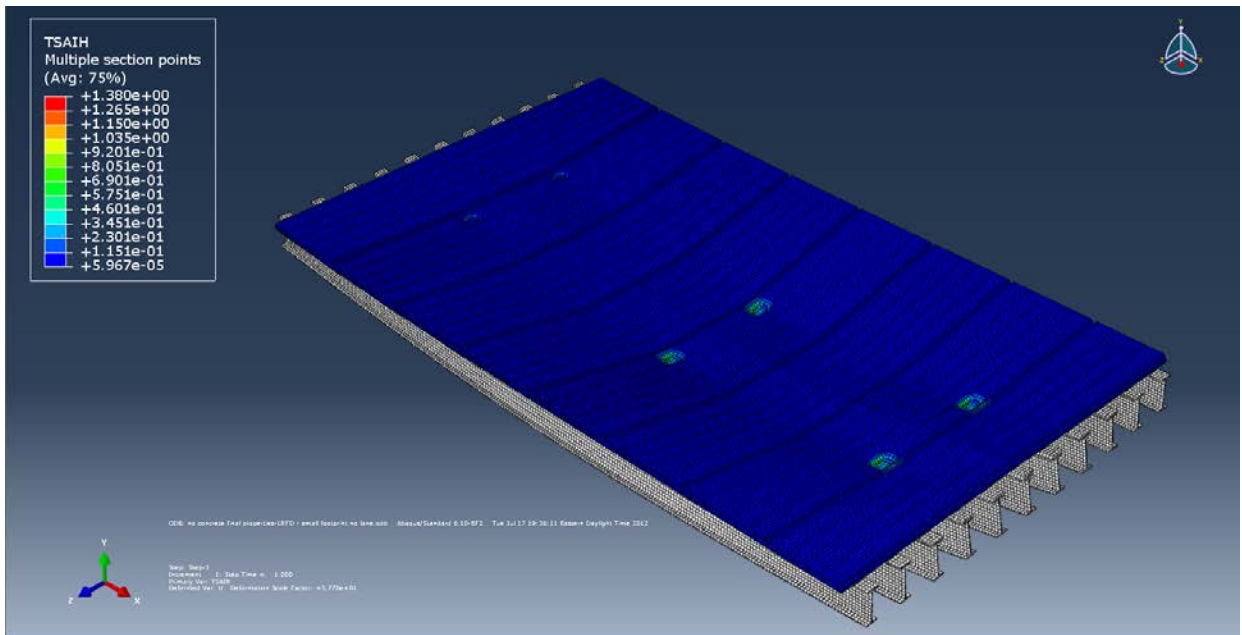

Figure 41. Diagram. Tsai-Hill Index (LRF), small footprint.

APPENDIX C: REPORT ON FIELD LOAD TEST

OBJECTIVE

The purpose of this live-load test was to collect data (i.e. strains and deflections) on the performance of the FRP bridge deck that was installed in Bolivar, NY. This information complements the information derived from the finite element model (appendix B).

TRUCK INFORMATION

The county of Allegany, NY, selected two International 7600 tri-axle dump trucks to be used for this live-load test. Figure 42 and table 16 provide information on the axle spacings. Each of the two trucks used was loaded to 71,260 lb prior to the test. The axle loads, provided by the county, are also shown in figure 42.



a) Truck 63

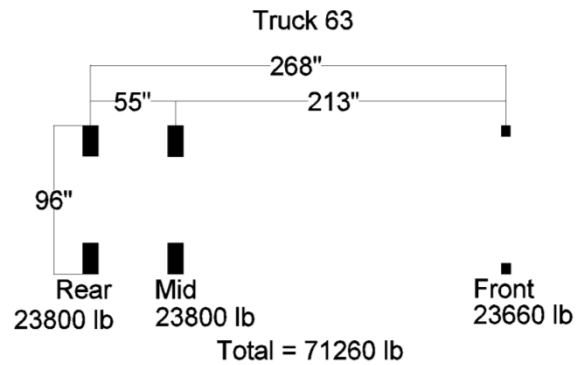

b) Truck 63 dimensions and axle loads



c) Truck 64

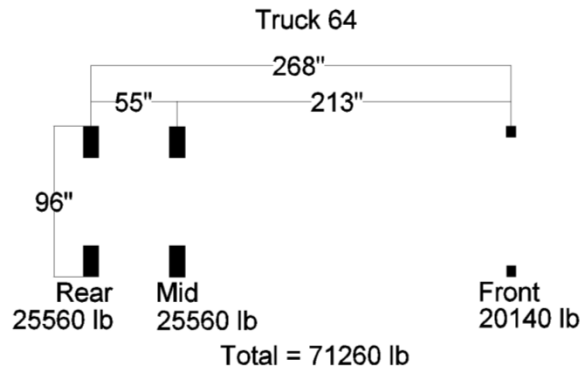

d) Truck 64 dimensions and axle loads

Figure 42. Photos and diagrams. 7600 tri-axle dump trucks used for live-load test.

Table 16. 7600 tri-axle dump truck axle spacings.

Description	Dimension (in.)
Front axle to last rear axle	268
Tag axle to last rear axle (raised during test)	105
Second drive axle to last rear axle	55
Tires, out-out	96

LOAD PATHS

Three basic load paths (A, B, C) were used to conduct a series of static tests. The trucks were placed at specific locations along the length of the bridge and data sampled for a minimum of 10 seconds before moving to the next position. For each load path, the trucks started on the Bolivar, east side of the bridge, drove through the bridge, drove off, turned around, and drove over the bridge again (starting from the west side this time). Each load path had five basic specific locations (referred as load cases), where the truck mid-axle was placed on the bridge deck at:

- Approximately 18 inches from the front edge of the FRP deck.
- Quarter span.
- Midspan.
- Three-quarter span.
- 18 inches from the far end of the bridge deck.

Five additional load cases were added when the trucks drove over the bridge from the opposite direction. Truck 64 ran load paths A, B, BN, C, CN, and D, and truck 63 was used on A, BN, CN, and D.

Load Path A

Truck 64 drove on a path over the bridge mid-width (see figure 43a). The wheels of the truck were placed symmetrical with respect to the bridge centerline (outer side of the wheels positioned approximately at 84 in. from the north or south edge of the deck. Figure 43b shows load case 8 (truck at mid-span, reentering from the west side of the bridge). The same load path was repeated with truck 63.

Load Path B

Truck 64 drove over the south lane when starting from the Bolivar side of the bridge. After turning around, the truck reentered from the west side using the opposite lane. The truck was positioned centering its outside tires between girders 1 and 2 (in the south lane) and girders 10 and 11 (return, north lane). The outside wheel (on the driver's side) was positioned approximately 14 inches from the edge of the bridge, as shown in figure 44. Load case 8 is shown in figure 44b.

Load Path BN

Load path BN is similar to load path B, but starting from the Bolivar side, north lane, and returning on the south lane.

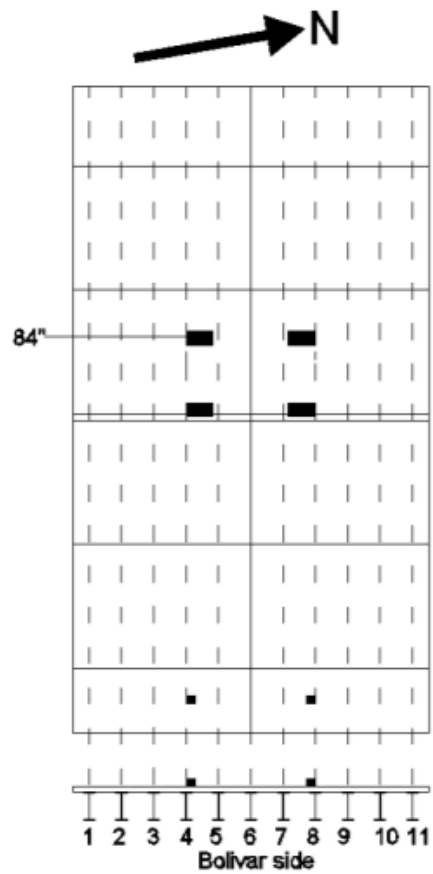
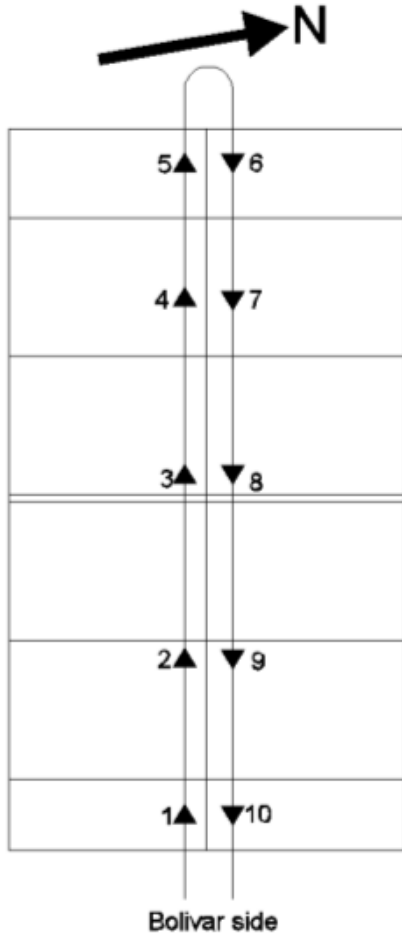

a) Load path A

b) Load case 8 - truck placed at midspan



c) Photograph of truck on load path A, load case 8



d) Photograph of truck on load path A, load case 4

Figure 43. Diagrams and photos. Illustration of load path A.

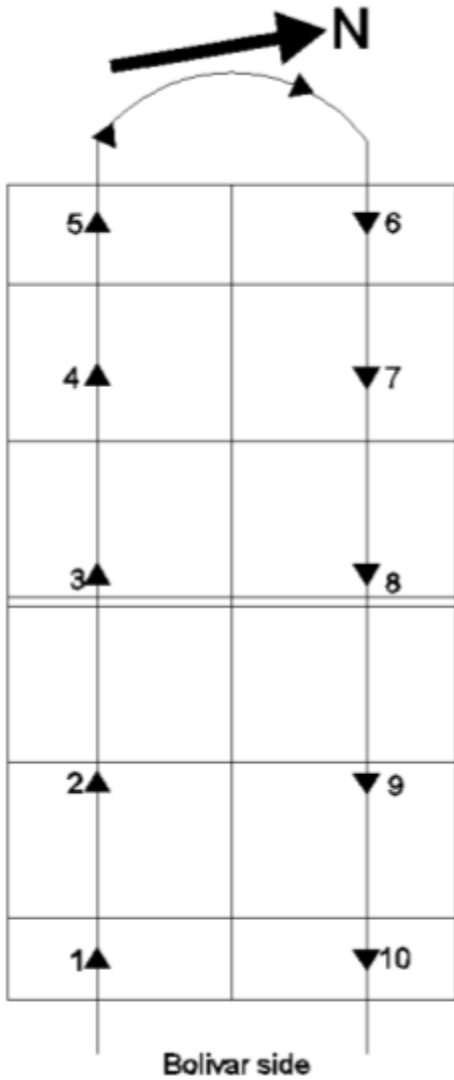

a) Load path B

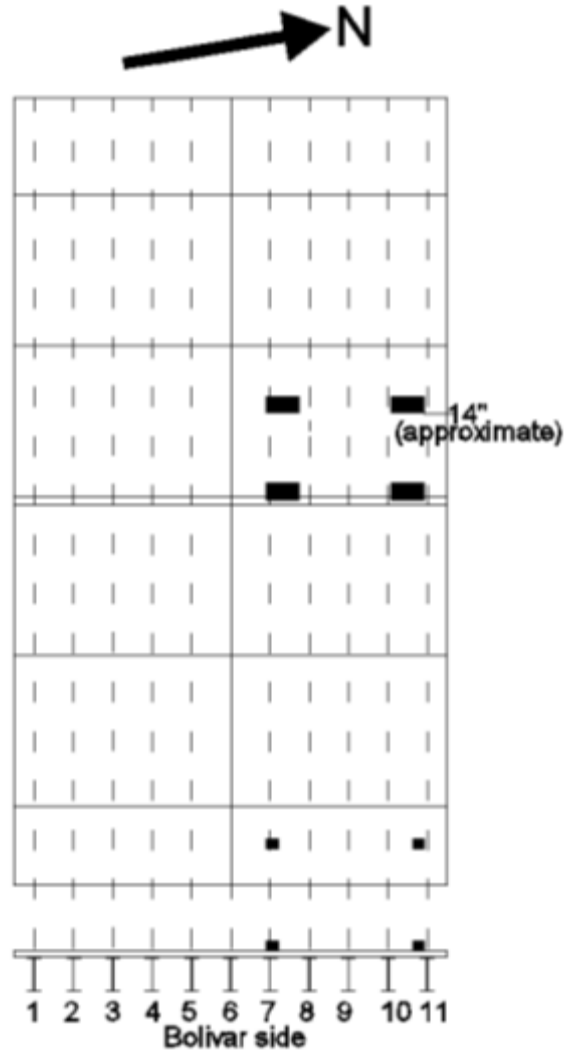

b) Load case 8 - truck at midspan, right lane



c) Photograph of truck on load path B, load case 1



d) Photograph of truck on load path BN, load case 2

Figure 44. Diagrams and photos. Illustration of load path B.

Load Path C

Truck 64 drove over the south lane, starting from the Bolivar side of the bridge. After turning around, the truck reentered from the west side using the opposite lane. The truck was positioned centering its outside tires over girder 2 (south lane) and over girder 10 (return north lane). The outside wheel (on the driver's side) was positioned approximately 28 inches from the edge of the bridge, as shown in figure 45.

Load Path CN

Load path CN is similar to load path C, starting from the Bolivar side, north lane, and returning in the south lane.

Load Path D

Trucks 64 and 63 followed load paths C and CN, respectively, starting from the Bolivar end of the bridge, turning, and reentering the bridge in the opposite lanes. See figure 46.



a) Load path C

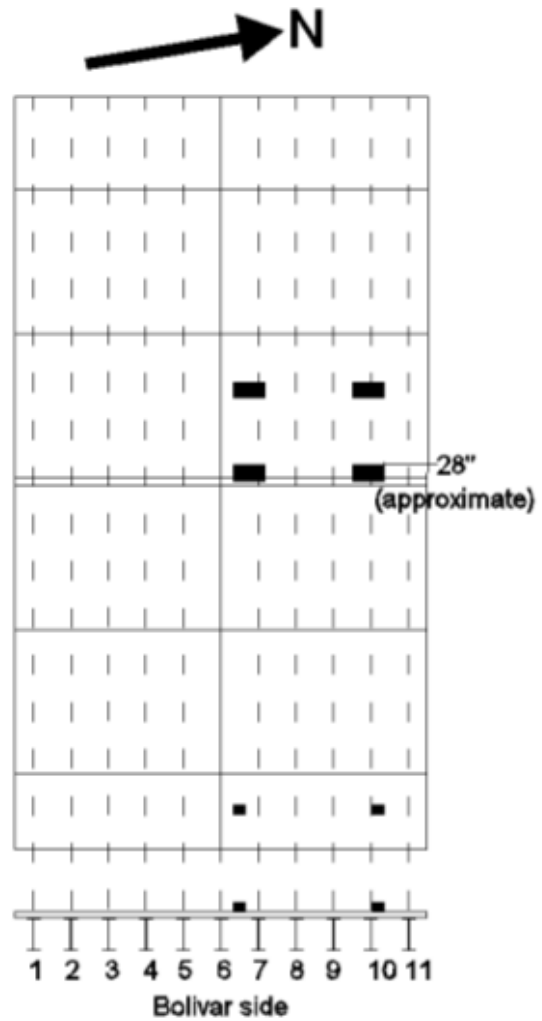

b) Load case 8 - truck at midspan, right lane



c) Truck on load path CN, load case 2



d) Truck on load path C, load case 3

Figure 45. Diagrams and photos. Illustration of load path C.

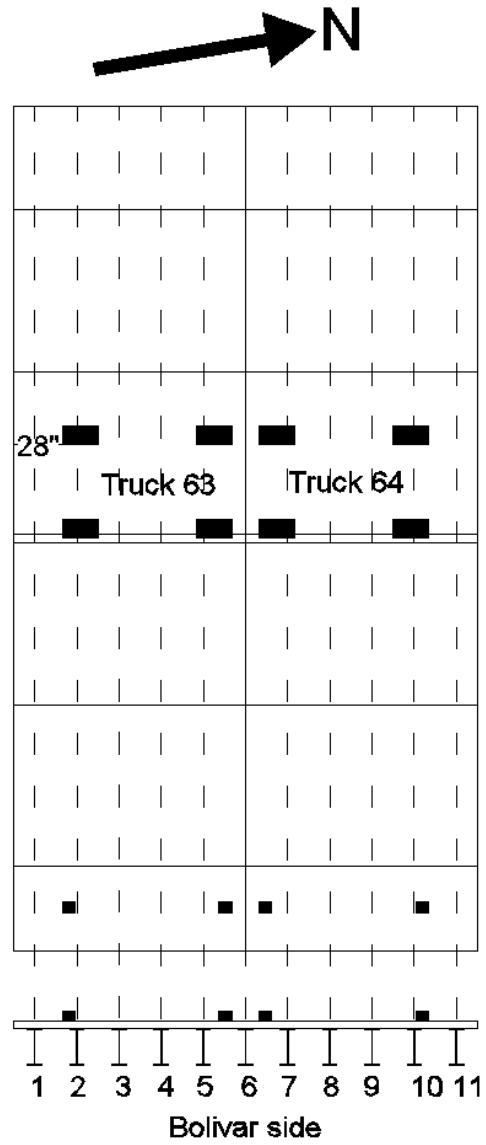
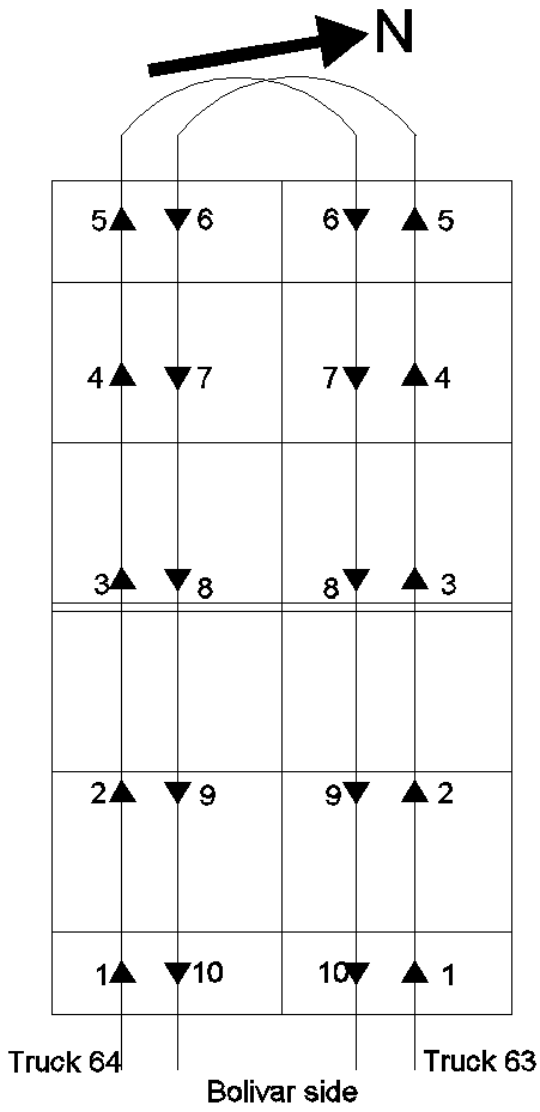

c) Trucks on Path D, Case 1

d) Trucks on Path D, Case 8

Figure 46. Diagrams and photos. Illustration of load path D.

INSTRUMENTATION

Data Acquisition System

Iotech's Waveview software was used to collect data from a Wavebook WBK 20A data acquisition system with supporting WBK 10A and two WBK 16 modules. The portable system can support up to nine 120 ohm, quarter-bridge strain gages and six string pots through the wire platform. A portable AC generator powered the system. Figure 47 shows the equipment setup, approximately 20 feet from the bridge.

The strain gages were calibrated to measure in units of microstrain ($\mu\epsilon$), and the string pots were calibrated to measure in inches. Data were stored as ASCII text files (.txt) for analysis. During testing, measurements were continuously taken at 20 Hz. The trucks were stopped at each load case for approximately 10 seconds. A dynamic test with truck 64 was performed following path BN, and data were collected at 50 Hz for this load case.



a) String pot bases



b) Portable data acquisition system

Figure 47. Photos. Field equipment setup.

Strain Gages

Seventeen strain gages (SG) were installed on the bridge on September 3 and November 18, 2012. They were quarter-bridge gages with a resistance of 120 ohms. Measurements were taken on each repetition of each load case. The strain gage setup for repetition 1 is shown in figure 48, with gage locations and orientations noted in table 17. These strain gages were selected to obtain information on the behavior of the FRP deck. SG 1 and 2 measured the bottom deck panel deformations at the bearings to compare with similar mid span deformations measured by SG 3 and 4. SG 5 and 6 were used to compare the deck deformation to the steel girder deformation at midspan. SG 7 and 8 compared deformations across the transverse panel joint at midspan. The profile detail shows the typical locations of these strain gages: those placed at the bottom of the FRP deck were centered between adjacent girders, approximately 7.5 inches from the end of the nearest girder flange. Those placed on the steel girder were centered on the bottom steel flange (approximately 4 inches from the edge of the flange).

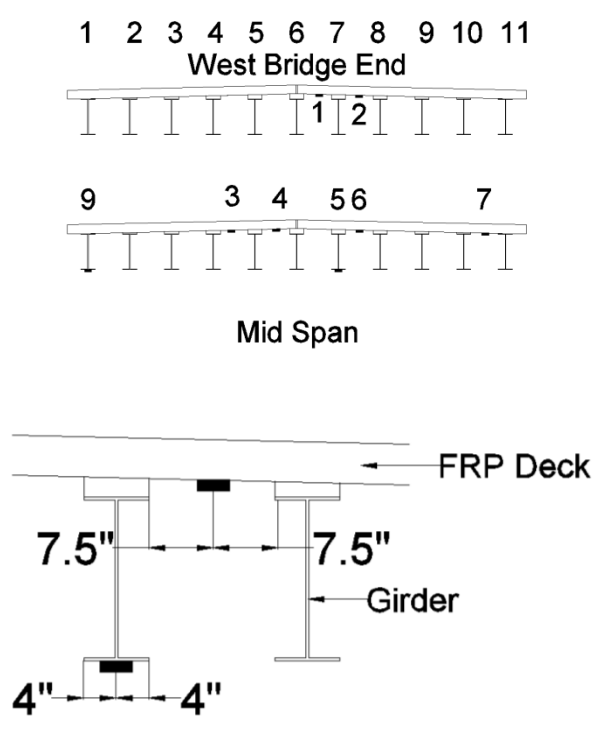
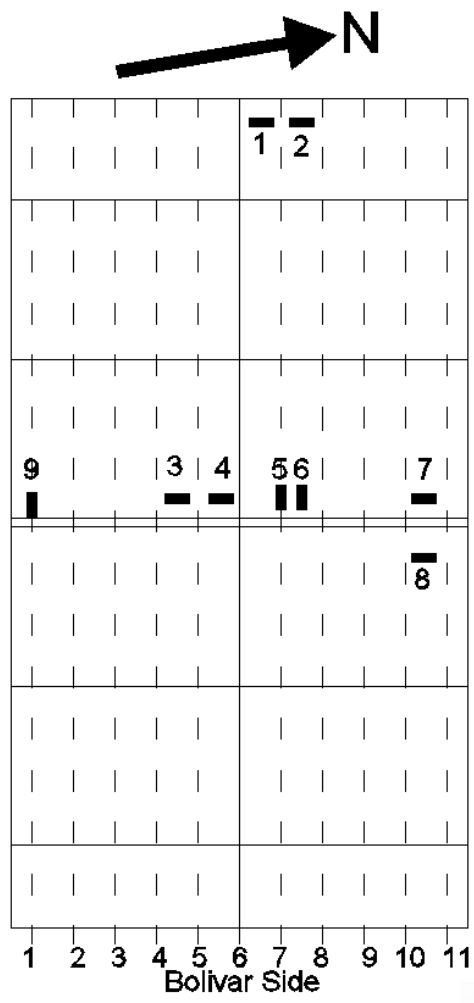

a) Strain gage locations, plan

b) Strain gage locations, profile and typical detail

Figure 48. Diagrams. Repetition 1 strain gage locations.

Table 17. Strain gage locations and orientations.

Strain Gage	Direction	Location	Longitudinal Placement	Centered (between girders or on girder)
1	Transverse	Bottom FRP deck	West end	6 and 7
2	Transverse	Bottom FRP deck	West end	7 and 8
3	Transverse	Bottom FRP deck	Midspan	4 and 5
4	Transverse	Bottom FRP deck	Midspan	5 and 6
5	Longitudinal	Bottom steel girder	Midspan	7
6	Longitudinal	Bottom FRP deck	Midspan	7 and 8
7	Transverse	Bottom FRP deck	Midspan	10 and 11
8	Transverse	Bottom FRP deck	Midspan across panel joint	10 and 11
9	Longitudinal	Bottom steel girder	Midspan	1
10	Longitudinal	Bottom steel girder	Midspan	2
11	Longitudinal	Bottom steel girder	Midspan	3
12	Longitudinal	Bottom steel girder	Midspan	4
13	Longitudinal	Bottom steel girder	Midspan	5
14	Longitudinal	Bottom steel girder	Midspan	6
15	Longitudinal	Flange steel girder	Midspan	1, 7 in. from bottom
16	Longitudinal	Flange steel girder	Midspan	3, 7 in. from bottom
17	Longitudinal	Flange steel girder	Midspan	5, 7 in. from bottom

The strain gage setup used in the second repetition is shown in figure 49, and the locations and orientations were the same as for the first repetition. These measurements were selected to obtain strain information on adjacent steel support girders. SG 9 to 14 all measured the bottom flange strains; SG 15 to 17 indicated longitudinal strain at one third (1/3) of the girders' height (approximately 7 inches from the bottom flange). Figure 49 shows SG 9 to 14 centered on the underside of the bottom flange with SG 15, 16, and 17 located on the north side of the web girders.

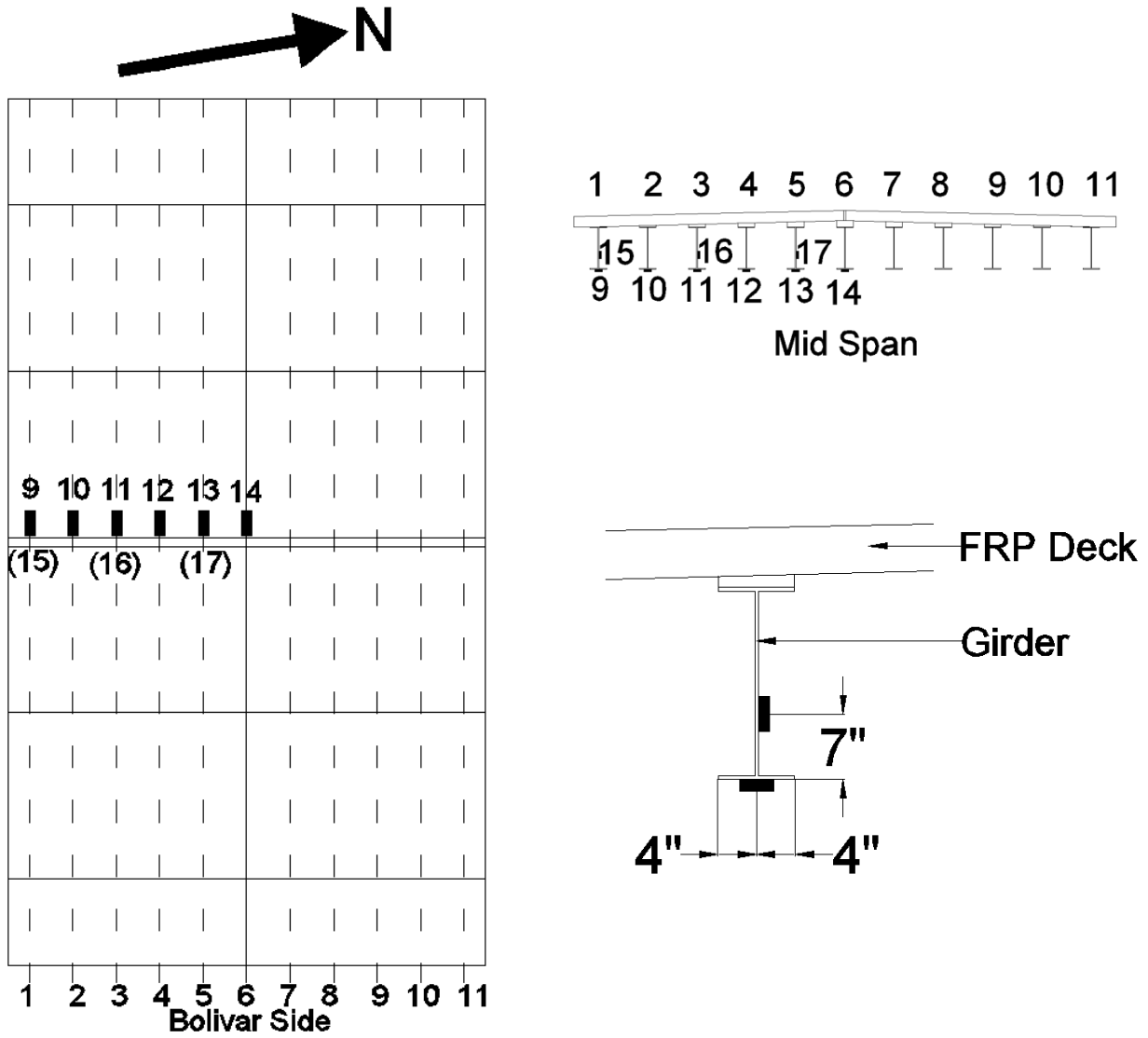

a) Strain gage locations, plan

b) Strain gage locations, profile and typical detail

Figure 49. Diagrams. Repetition 2 strain gage locations.

String Pots

Vertical displacements were measured by six string potentiometers, or string pots. These transducers measured displacement of a flexible wire attached to an anchor on either the bottom of the FRP bridge girders or the bottom of the FRP deck panels. Unimeasure HX series string pots were used in this field test. String pot locations and descriptions are presented in figure 50 and table 18. The string pot detail shows the typical locations of all string pot attachment points: string pots 4 and 6 were placed at 7.5 inches from the girder flange on the bottom of the FRP deck panels; string pots 1, 2, 3, and 5 were centered at 4 inches on the underside of the bottom flange. String pot 4 measured FRP deck deflections relative to girders 4 and 5, while the others

were firmly attached to a concrete base to measure absolute deflections. The same six string pots were used for both repetitions.

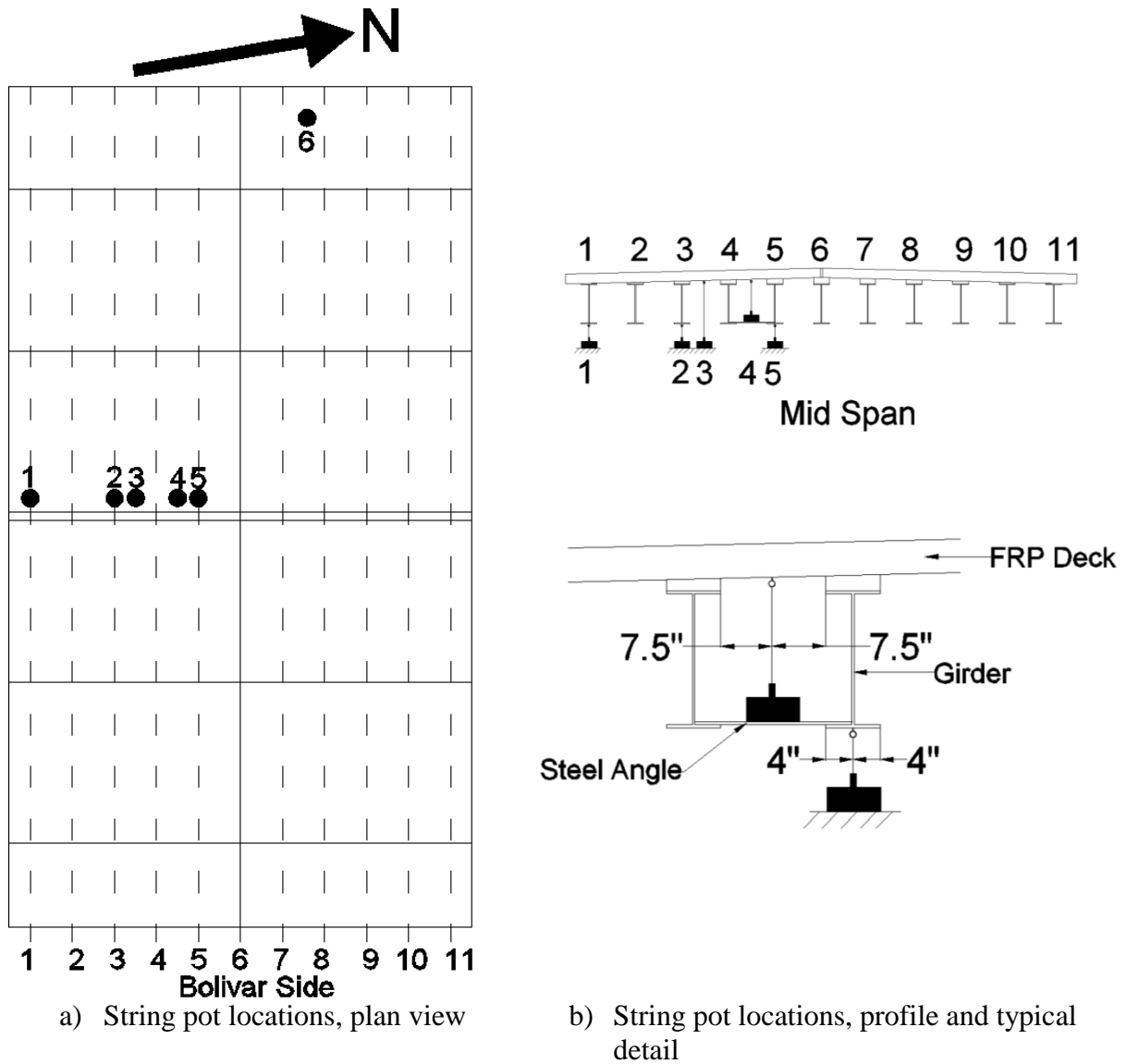

Figure 50. Diagrams. String pot locations.

Table 18. String pot locations and descriptions.

String Pot	Longitudinal Placement	Attachment	Movement Relative To
1	Midspan	On girder 1	Ground
2	Midspan	On girder 2	Ground
3	Midspan	On FRP between 3 and 4	Ground
4	Midspan	On FRP between 4 and 5	Girders 4 and 5
5	Midspan	On girder 5	Ground
6	At bearing	On FRP between 7 and 8	Abutment

RESULTS

A summary of file names, gage setup, truck number, and the tested condition is shown in table 19. Truck 64 was used for the second repetition of the load paths with single loadings, so only one driver was needed for the second half of the live-load test. The file name follows the notation X_Y_Z, where X is repetition 1 or 2, Y is the truck number, and Z is the load path (described before). These file names will be referred to throughout this discussion of the test results.

Table 19. Test names and conditions.

Test/File Name	Repetition	Truck	Load Path	Test Condition	Note
1_64_A	1	64	A	Centered loading	
1_63_A	1	63	A	Centered loading	
1_64_B	1	64	B	Maximum positive moment	No load case 10
1_63_BN	1	63	BN	Maximum positive moment	
1_64_C	1	64	C	Single loading, maximum positive moment	
1_63_CN	1	63	CN	Single loading, maximum positive moment	
1_643_D	1	63 and 64	D	Dual loading, maximum negative moment	Load cases 1, 3, 5, 6, 8, and 10 only
2_64_A	2	64	A	Centered loading	
2_64_B	2	64	B	Maximum positive moment	
2_64_BN	2	64	BN	Maximum positive moment	Used truck 64
2_64_C	2	64	C	Single loading, maximum positive moment	
2_64_CN	2	64	CN	Single loading, maximum positive moment	Used truck 64
2_643_D	2	63 and 64	D	Dual loading, maximum negative moment	
2_64_DYN	2	64	A	Road conditions	Dynamic test, 50 Hz

The data obtained from each path loading were analyzed as follows:

- The mean values of the pre-trigger measurements, before the trucks entered, were subtracted from all values to eliminate initial displacements. Figure 51 shows the raw and adjusted data for test 1_63_CN.
- The adjusted data were used to determine the time intervals for each load case. The average displacements of each gage during each load case were calculated as well as the standard deviation of that population. The average values used for 1_63_CN are shown in figure 51.

Since there was no clear indication of when load cases 6 to 10 and 1 to 5 occurred in tests 1_64_B and 1_63_BN, these data were omitted from the results. The other data points were used in the analyses described below.

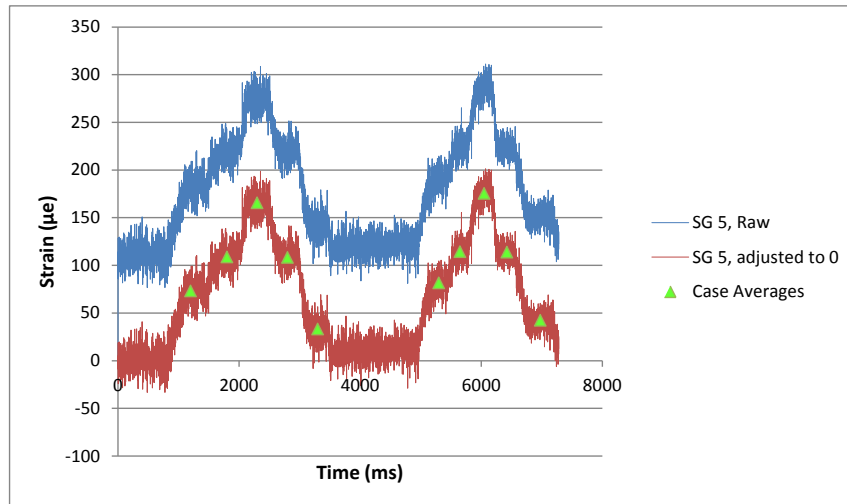

Figure 51. Graph. SG 5 data from test 1_63_CN.

Maximum FRP Deck Deformations at a Bearing Location

Table 20 shows the calculated maximum deformations of the gages located at one of the bearings. Maximum response occurred with the truck directly over the bearings. String pot 6 registered the largest deflection with the front end of truck 64 off the bridge (load case 5), and SG 1 and 2 registered maximum values with the rear wheels off (load case 6). The maximum uplift for string pot 6 was 0.006 inches and was approximately 10 percent of the downward deflection of 0.07 inches. These data show that the maximum FRP deck deflections at this location are less than 0.1 inch and the maximum FRP deck strain, perpendicular to the steel girder axis, is in the order of 300 µε (in tension). Therefore, it can be inferred the maximum bottom panel stress is also in tension.

Table 20. Maximum deformations at bearing locations.

	StrPot 6 (min) (in.)	StrPot 6 (max) (in.)	SG 1 (abs max) (µε)	SG 2 (abs max) (µε)
Max	-6.87E-02	5.98E-03	1.66E+02	3.15E+02
Load Path/File	2_64_A	1_63_BN	1_64_C	1_63_CN
Load Case	5	10	6	6

Maximum Midspan FRP Deck Deformation

Table 21 shows the maximum strains from each of the midspan strain gages measured during repetition 1. Similar to the strain gages located over the bearing, all seven midspan gages experienced tensile strains. Maximum values occurred when the truck's center axle was at midspan (except for SG 8, which was aligned across the center joint, not at midspan). Maximum strain values recorded on the FRP deck were on the order of 100 to 300 $\mu\epsilon$. SG 5 on the steel girder registered a maximum tensile strain in the same order of magnitude.

Table 21. Maximum midspan FRP deck deformations (repetition 1).

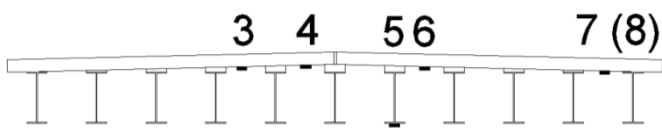
						
	SG 3 ($\mu\epsilon$)	SG 4 ($\mu\epsilon$)	SG 5 ($\mu\epsilon$)	SG 6 ($\mu\epsilon$)	SG 7 ($\mu\epsilon$)	SG 8 ($\mu\epsilon$)
Absolute Max	2.78E+02	2.17E+02	2.21E+02	1.88E+02	1.10E+02	1.94E+02
Load Path/File	1_63_A	1_64_C	1_643_D	1_63_CN	1_643_D	1_643_D
Load Case	8	3	3	3	8	1

SG 7 and SG 8 were located across the midspan FRP panel joint, and a typical plot of their displacement is shown in figure 52. The plot shows that when the truck is traveling over the gages (cases 1 to 5), the panels move together relatively closely. When the truck is traveling over the opposite side of the panels, the difference in strain readings increased. In fact, the west side panel (SG 7) moves much more than the east side panel (SG 8). Strain readings are listed in table 22.

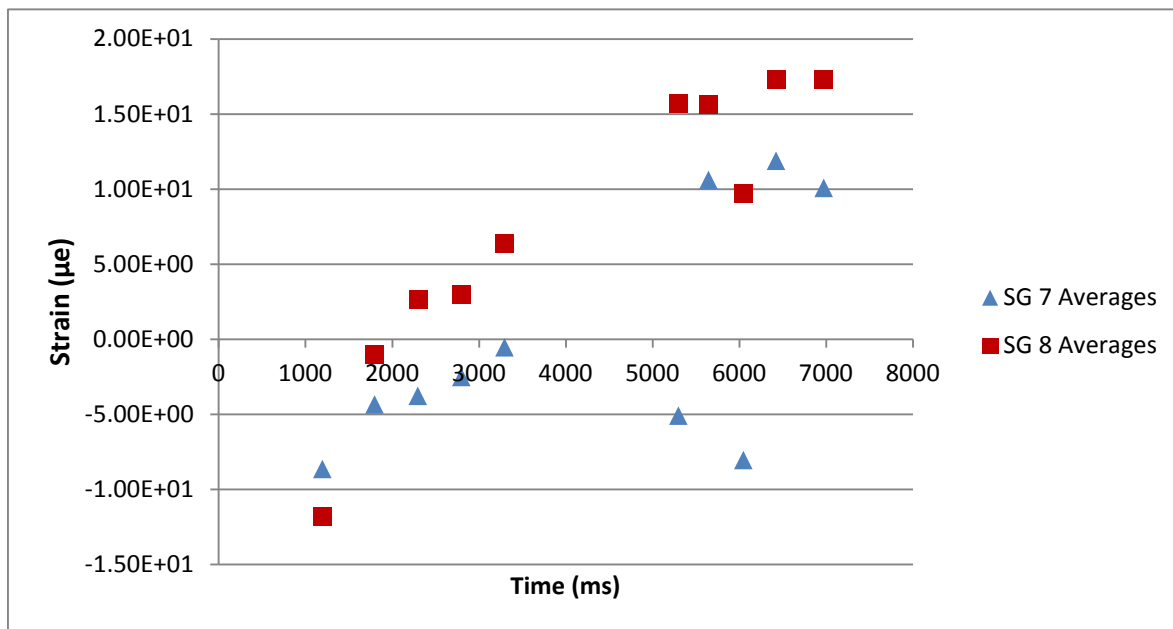

Figure 52. Graph. Test 1_63_CN, SG 7 and SG 8 results vs. time.

Table 22. SG 7 and SG 8 response for load case 1_63_A.

Load Case 1_63_A	Strain at SG 7 ($\mu\epsilon$)	Strain at SG 8 ($\mu\epsilon$)
1	-9.65E+00	-1.88E+01
2	-1.85E+00	-1.18E+00
3	-9.99E+00	3.19E+00
4	2.37E+00	4.19E+00
5	5.13E+00	8.55E+00
6	-7.03E+00	8.31E+00
7	1.28E+01	1.46E+01
8	-4.17E+00	5.35E+00
9	1.18E+01	1.02E+01
10	5.47E+00	8.69E+00

Strain Response of Steel Girders

Table 23 shows the strain registered at the underside of the bottom flanges and 1/3 height for what were found to be the two critical cases: 2_64_BN, load case 8, and 2_643_D, load case 3. Each has the trucks positioned at midspan. The data show the strains in the girder webs were lower than those of the flanges, as expected. The flange strains were in the order of 200 $\mu\epsilon$. Loading 2_64_BN, load case 8, shows the strain decreasing from the outside girder to the inside girder. For 2_643_D, load case 3, the largest strain was found in girder 5. For more information on girder strains for each load case during the second repetition, please refer to tables 25 through 30 at the end of this appendix.

Table 23. Strains in all girders for critical load cases.

	Girder Number/Strain Gage - Strains ($\mu\epsilon$)									
	1/SG 9	2/SG 10	3/SG 11	4/SG 12	5/SG 13	6/SG 14	1/SG 15	3/SG 16	5/SG 17	
2_64_BN, Load Case 8	238.72	214.84	191.67	167.74	141.83	99.30	84.69	77.47	41.38	
2_643_D, Load Case 3	197.70	193.86	167.99	209.99	220.13	198.26	50.70	56.07	65.50	

Vertical Displacements at Midspan

The maximum midspan string pot displacements occurred during repetition 2 and are shown in table 24. All maximum displacements occurred with the trucks positioned at midspan. String pots 1, 2, and 5 all measured the displacements of the steel girders, and string pots 3 and 4

measured vertical deflecting of the FRP deck (string pot 3 with respect to a concrete base, and string pot 4 with respect to steel angle attached to the adjacent girders).

Table 24. Maximum vertical displacements at midspan.

	StrPot 1 (in.)	StrPot 2 (in.)	StrPot 3 (in.)	StrPot 4 (in.)	StrPot 5 (in.)
Abs. Max	-4.47E-02	-3.62E-01	1.24E-02	-3.25E-02	-3.43E-01
File	2_64_BN	2_643_D	2_64_A	2_64_A	2_643_D
Load Case	8	3	8	8	8

Dynamic Test

Figure 53 shows data from string pots 2 and 5, of the dynamic test of the truck at regular driving speed, approximately 20 mph, load path BN. The curves show spikes for each of the two passes of the truck. Since the spikes have relatively short durations compared to recorded time, the two spikes for string Pots 2 and 5 were analyzed. The time shown is simply the duration of the spike. The data show that once the truck was off the bridge, it returned to its original position without much vibration very quickly. It also shows the movement of the bridge panels was very similar, with only a change in magnitude, no matter which direction the truck entered from. The maximum deformations were in the order of -0.2 to -0.3 inches, similar order to those found during the static tests described earlier, indicating that the deformations seen in the static tests can simulate the behavior under real driving conditions, at this age of the deck.

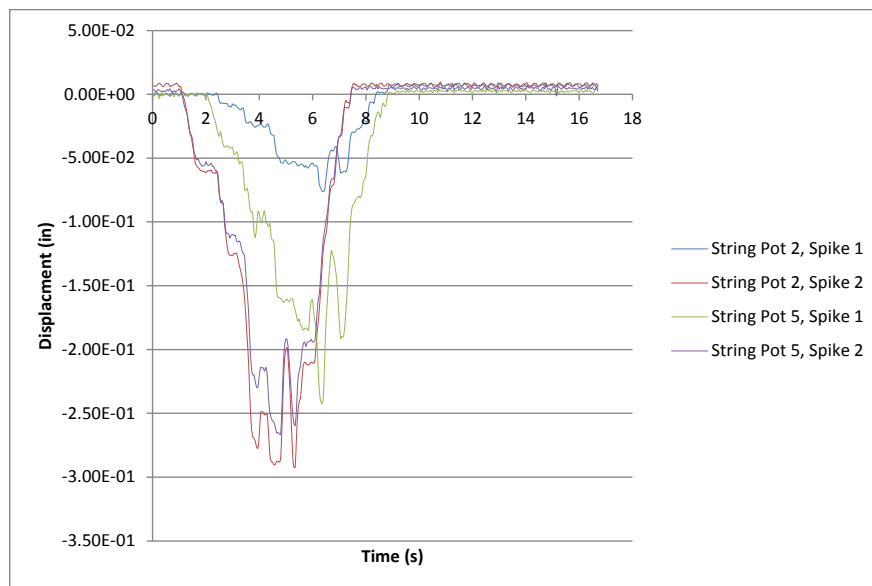

Figure 53. Graph. Dynamic test results, string pots 2 and 5.

CONCLUSIONS

- The bridge deck showed only small deformations when carrying two 72-kip dump trucks. No damage was reported.
- The maximum strain registered by the installed gages at the bottom of the FRP deck under all load paths and load cases was $315 \mu\epsilon$ in SG 2 with loading 1_63_CN, load case 6 (3 percent of the tensile strain of the deck material).
- The maximum vertical deflection (downward) of the FRP deck was found to be 0.07 inches, measured by string pot 6 between girders 7 and 8 during loading 2_64_A and load case 5.
- The maximum strain at midspan on the steel girder was measured by SG 9 at $239 \mu\epsilon$ on the bottom, outside flange, with loading 2_64_BN and load case 8.
- The maximum vertical deflection of the steel girders was 0.362 inches downward, measured by string pot 2 on girder 3 during loading 2_643_D and load case 3.
- The deformations of the bridge during the dynamic test were on the same order of magnitude as the static testing.

Table 25. Test 2_64_A.

2_64_A		Girder Number/Strain Gage - Strains ($\mu\epsilon$)					
Load Case		1/SG 9	2/SG 10	3/SG 11	4/SG 12	5/SG 13	6/SG 14
1	Average	58.30	25.96	49.97	66.90	77.23	74.88
	Standard Deviation	5.18	6.76	3.73	5.44	5.50	2.65
2	Average	83.38	50.63	59.33	90.42	109.96	83.79
	Standard Deviation	5.32	6.28	3.37	5.25	5.86	2.10
3	Average	85.91	61.37	92.81	138.38	168.37	168.33
	Standard Deviation	5.41	6.77	3.52	5.90	6.09	3.52
4	Average	63.14	47.11	69.23	83.41	117.85	85.10
	Standard Deviation	6.82	7.91	3.97	6.31	6.35	1.78
5	Average	34.41	18.96	21.27	27.71	36.95	3.96
	Standard Deviation	5.16	6.44	3.36	5.01	5.37	1.13
6	Average	61.49	45.31	65.35	78.55	91.79	89.68
	Standard Deviation	5.97	8.20	4.25	6.27	6.76	2.57
7	Average	77.51	60.53	61.81	98.44	120.34	87.34
	Standard Deviation	4.71	5.83	3.39	4.56	5.17	2.60
8	Average	77.13	66.79	96.78	139.84	176.97	155.87
	Standard Deviation	5.49	6.62	3.44	5.78	5.79	2.07
9	Average	81.84	63.64	57.20	102.15	116.93	99.96
	Standard Deviation	5.16	6.88	3.56	5.33	5.89	1.92
10	Average	75.24	34.82	23.06	37.32	44.73	14.01
	Standard Deviation	5.18	6.83	3.48	5.07	5.71	1.03

Table 26. Test 2_64_B.

2_64_B		Girder Number/Strain Gage - Strains ($\mu\epsilon$)					
Load Case		1/SG 9	2/SG 10	3/SG 11	4/SG 12	5/SG 13	6/SG 14
1	Average	136.17	104.69	88.75	88.85	80.12	67.34
	Standard Deviation	6.64	7.80	4.22	6.02	6.63	1.98
2	Average	156.52	148.78	120.82	135.65	97.11	60.74
	Standard Deviation	5.91	7.21	4.21	6.22	6.32	1.53
3	Average	239.01	211.82	181.63	185.23	151.09	114.11
	Standard Deviation	5.51	7.05	4.01	5.78	5.73	1.67
4	Average	158.25	127.11	128.89	121.02	105.94	65.34
	Standard Deviation	5.85	6.68	3.90	4.99	5.56	1.47
5	Average	52.44	27.55	40.89	45.52	38.00	11.12
	Standard Deviation	5.20	6.30	3.43	4.75	4.90	0.74
6	Average	2.30	17.51	21.25	35.68	48.61	68.56
	Standard Deviation	5.60	7.43	3.47	5.61	6.02	1.55
7	Average	-7.28	15.60	23.91	50.20	69.55	63.56
	Standard Deviation	6.04	8.17	4.18	6.17	6.27	1.44
8	Average	-14.26	12.79	19.18	52.16	79.15	96.93
	Standard Deviation	5.45	7.23	3.49	5.48	6.00	3.29
9	Average	-7.88	19.23	20.41	48.73	66.96	67.75
	Standard Deviation	5.17	6.58	3.63	5.46	5.38	1.37
10	Average	4.26	20.49	18.30	28.02	32.80	14.23
	Standard Deviation	5.53	7.30	3.47	5.69	6.19	1.18

Table 277. Test 2_64_BN.

2_64_BN		Girder Number/Strain Gage - Strains ($\mu\epsilon$)					
Load Case		1/SG 9	2/SG 10	3/SG 11	4/SG 12	5/SG 13	6/SG 14
1	Average	4.20	7.38	17.02	23.56	32.59	63.08
	Standard Deviation	6.10	7.66	3.84	5.52	5.77	2.59
2	Average	4.05	8.81	27.05	44.01	61.50	57.75
	Standard Deviation	4.71	6.95	3.50	5.75	5.75	1.10
3	Average	3.49	9.88	27.31	47.74	70.54	109.83
	Standard Deviation	5.41	6.96	3.80	5.37	5.85	2.06
4	Average	3.31	8.24	18.79	38.63	54.85	54.55
	Standard Deviation	5.62	7.31	4.71	5.94	7.26	20.33
5	Average	5.56	7.62	5.74	16.57	17.63	5.33
	Standard Deviation	6.62	8.18	3.91	6.13	6.59	0.89
6	Average	142.63	111.18	93.68	73.54	61.15	55.92
	Standard Deviation	6.59	7.38	3.99	5.30	5.84	1.43
7	Average	173.73	140.49	121.80	118.43	85.90	49.80
	Standard Deviation	5.00	5.98	3.30	4.82	5.39	1.22
8	Average	238.72	214.84	191.67	167.74	141.83	99.30
	Standard Deviation	6.16	6.98	3.68	5.31	6.22	1.47
9	Average	175.81	157.92	115.87	129.32	87.24	64.70
	Standard Deviation	6.48	8.66	4.14	6.12	6.28	1.30
10	Average	55.12	57.08	39.68	46.09	28.37	15.52
	Standard Deviation	5.57	6.88	3.52	4.89	5.24	1.01

Table 288. Test 2_64_C.

2_64_C		Girder Number/Strain Gage - Strains ($\mu\epsilon$)					
Load Case		1/SG 9	2/SG 10	3/SG 11	4/SG 12	5/SG 13	6/SG 14
1	Average	81.44	81.82	66.87	64.85	71.71	69.19
	Standard Deviation	6.11	7.89	4.37	6.03	6.37	2.92
2	Average	114.69	100.62	82.45	115.77	97.44	43.67
	Standard Deviation	5.60	7.17	3.56	6.07	6.01	1.41
3	Average	159.41	159.23	146.57	163.03	147.74	109.01
	Standard Deviation	6.27	12.56	8.14	7.55	8.81	9.10
4	Average	114.52	101.43	108.21	115.72	108.97	61.98
	Standard Deviation	11.01	13.54	10.92	11.12	9.46	12.27
5	Average	22.89	11.32	22.56	32.42	30.32	-4.77
	Standard Deviation	5.30	7.51	4.23	5.79	6.04	1.00
6	Average	-8.79	8.12	17.92	33.55	48.64	72.39
	Standard Deviation	5.59	6.80	3.23	5.65	6.17	7.37
7	Average	-8.22	4.20	16.38	43.24	67.98	55.61
	Standard Deviation	5.93	7.38	4.12	5.81	6.26	1.70
8	Average	-23.11	-2.21	9.40	44.30	76.28	93.72
	Standard Deviation	6.05	7.17	3.89	5.62	5.89	8.57
9	Average	-31.82	-3.06	4.18	34.65	57.29	53.37
	Standard Deviation	6.63	7.81	3.74	5.94	6.15	1.21
10	Average	-16.48	-5.07	-7.06	6.91	14.78	-8.04
	Standard Deviation	6.35	6.85	3.71	5.66	6.18	0.82

Table 29. Test 2_64_CN.

2_64_CN		Girder Number/Strain Gage - Strains ($\mu\epsilon$)					
Load Case		1/SG 9	2/SG 10	3/SG 11	4/SG 12	5/SG 13	6/SG 14
1	Average	-26.76	-9.90	-2.28	8.31	26.48	53.90
	Standard Deviation	5.61	6.88	3.52	5.66	5.86	1.28
2	Average	-31.85	-8.89	8.22	27.68	56.05	47.40
	Standard Deviation	5.99	7.42	3.83	5.85	6.35	1.24
3	Average	-23.06	-3.13	14.35	39.47	70.90	104.00
	Standard Deviation	6.49	8.22	4.12	6.12	6.19	8.04
4	Average	-16.59	0.13	14.25	34.00	57.37	55.98
	Standard Deviation	6.62	8.25	3.82	5.91	6.16	2.02
5	Average	-12.01	0.50	3.08	9.73	14.47	2.43
	Standard Deviation	5.84	7.01	3.58	5.59	6.33	1.32
6	Average	113.52	88.22	76.32	61.40	57.85	55.74
	Standard Deviation	7.78	8.04	4.88	6.01	6.72	2.64
7	Average	125.26	112.47	101.68	112.09	86.19	44.79
	Standard Deviation	6.27	7.57	4.14	6.28	6.41	1.65
8	Average	172.24	177.11	165.27	149.80	140.39	99.14
	Standard Deviation	6.05	7.53	3.76	5.55	5.67	1.06
9	Average	116.70	120.34	84.06	109.60	83.44	55.09
	Standard Deviation	5.41	7.00	3.85	5.21	5.04	1.59
10	Average	20.62	28.96	13.63	30.37	20.75	3.86
	Standard Deviation	6.93	8.61	3.92	6.31	6.59	1.47

Table 300. Test 2_643_D.

2_643_D		Girder Number/Strain Gage - Strains ($\mu\epsilon$)					
Load Case		1/SG 9	2/SG 10	3/SG 11	4/SG 12	5/SG 13	6/SG 14
1	Average	98.42	100.17	82.27	103.01	124.35	132.00
	Standard Deviation	5.68	7.83	4.09	6.11	6.43	2.05
2	Average	124.27	128.80	109.13	157.79	156.94	97.60
	Standard Deviation	5.48	7.92	3.97	6.26	6.36	0.75
3	Average	197.70	193.86	167.99	209.99	220.13	198.26
	Standard Deviation	5.81	6.91	3.36	5.28	5.57	1.32
4	Average	121.02	110.56	107.98	133.17	147.72	89.67
	Standard Deviation	6.84	7.88	3.57	5.99	6.81	1.34
5	Average	23.05	12.48	11.76	32.24	37.51	-11.88
	Standard Deviation	5.56	7.16	3.41	5.11	5.41	0.82
6	Average	97.76	92.46	79.56	87.72	102.10	114.25
	Standard Deviation	5.43	6.57	3.46	5.36	5.28	1.04
7	Average	126.67	119.07	108.94	151.25	149.64	93.39
	Standard Deviation	6.55	7.95	4.38	5.92	6.28	1.22
8	Average	176.75	186.02	174.51	192.81	212.13	184.35
	Standard Deviation	5.92	7.51	3.86	5.76	6.01	1.06
9	Average	124.85	134.90	100.15	151.04	145.49	117.27
	Standard Deviation	5.76	7.36	3.95	5.88	6.32	1.48
10	Average	35.37	43.71	22.65	52.02	50.02	17.72
	Standard Deviation	5.59	7.41	3.61	5.77	5.95	1.26

APPENDIX D: SPECIFICATION FOR COMPOSITE BRIDGE DECKING

DESCRIPTION

This work shall consist of *furnishing and installing* a prefabricated, lightweight, solid-surface bridge deck system that includes a shop applied wearing surface (course 1), a field applied wearing surface (course 2), connections to the steel stringers, and any necessary haunch/bedding material, as shown on the plans and in accordance with these specifications.

MATERIALS

All materials used to furnish and install the deck system are subject to the approval of the Engineer and shall be selected from a Department Approved Material List. To be listed as an approved decking system, prior to fabrication, specifications for materials proposed to be used in the deck system, design calculations (or finite element analysis), and a detailed description of the installation procedure shall be submitted with shop drawings to Engineer as per the “Submittals” section of this specification for preapproval. The bidder should be aware that some deck systems are proprietary in nature and may require additional time to design/detail/manufacture. In addition, certain tasks necessary for the satisfaction of this specification may need to be performed by, or in the presence of, the Supplier’s representative.

All materials, whether steel, grout, fiber-reinforced polymer composite, or structural adhesive, shall meet the design requirements provided by the deck Supplier. All steel hardware shall be stainless steel, hot-dip galvanized steel, or entirely encapsulated in epoxy. The interior of the deck cross-section shall be predominantly hollow and not consist of core material, or made using sandwich construction.

Properties

The Supplier shall submit the test methods and minimum values for all material properties, presented in a tabular format as shown below. The proposed design/analysis and shop drawings shall include the minimum guaranteed properties that are assumed in the design.

PROPERTY	MIMIMUM VALUE	TEST METHOD
<i>Steel</i>		
Tensile Yield Strength		ASTM A36
<i>Concrete/Grout</i>		
Compressive Strength		ASTM C39
Tensile Strength		ASTM C190
Flexural strength		ASTM C78
<i>Composite Materials</i>		
Ultimate Tensile Strength		ASTM D3039
Ultimate Compressive Strength		ASTM D5379
Ultimate Shear Strength		ASTM D5379
Tensile Modulus of Elasticity		ASTM D3039
Shear Modulus		ASTM C273
Coefficient of Thermal Expansion		ASTM D696
Thermal Conductivity		ASTM C177
Fiber Content		ASTM D3171
Density		ASTM D792
Bearing Strength		ASTM D953
Glass Transition Temperature		ASTM D4065
Water Absorption		ASTM D570
<i>Structural Adhesives</i>		
Ultimate Tensile Strength		ASTM D2095
Pull off test		ACI 503R
<i>Wearing Surface Aggregate</i>		
Gradation		ASTM C136
Hardness		ASTMC131, E660
<i>Wearing Surface Resin</i>		
Ultimate Tensile Strength		ASTM D638
Compressive Strength		ASTM D695
% Elongation at Failure		ASTM D638
Tensile Modulus of Elasticity		ASTM D790

Deck Design

- General documentation of the deck design shall be submitted to the Engineer for preapproval and listing on an Approved List.
- The design of the deck shall be accordance with the AASHTO LRFD Bridge Design Specifications. If sufficient reliability data are not available, with the Owner's approval, the Standard Specifications for Highway Bridges may be used.
- Dimensions and skew are shown on the plans, but field verification shall be required and is the sole responsibility of the contractor.
- The structural support members for the deck system shall be as designated on the plans.
- The design load shall include dead load plus HL-93 live load with an additional 30 percent of the live load to account for impact loading. Course 1 and course 2 of the

wearing surface shall be included in the dead load. No additional loading will be required for a future wearing surface, unless specified on the drawings.

- Deck weight, including the wearing surface, haunch material, and connection hardware, shall not exceed 30 psf.
- The deck shall be designed for a service life of 100 years.
- The design shall ensure that actual stresses in the fiber-reinforced polymer composite materials under full dead and live load (i.e., allowable stresses) do not exceed 25 percent of the minimum guaranteed failure stresses (i.e., ultimate strength). The minimum guaranteed failure stresses shall be verifiable by experimental tests, and test results shall be made available to Engineer upon request.
- For durability, design calculations shall include a check of the wearing surface's tensile strength and its adhesive bond to ensure that cracking or debonding will not result from temperature changes or local deformations under wheel loading. In lieu of such documentation, the deflection between stringers shall not exceed $S/500$, where S is the 0.9 multiplied by the center-to-center spacing of the steel supports.
- All exposed surfaces shall be protected from abrasion and ultraviolet light using a protective coat according to the Supplier's recommendation. The color shall be selected to resemble concrete (Color System 4000 Balsam SW-4022 or approved equal).
- Deck panels shall be designed to minimize the overall number of joints on the structure and reduce the overall weight increase to the structure's dead load.
- The deck shall be of constant depth. The cross slope shall be created using course 2 of the wearing surface or haunch material between the support steel and the deck.
- For durability reasons, no penetrations in the top surface of the deck will be allowed for fastening or lifting.
- The minimum thickness of material directly under a wheel load shall be at least 3/8 inches.

Connection Design

- Connections between the deck and the steel supporting members shall *not* be designed to provide full composite bending action, unless specifically approved by the Engineer.
- Connections between the deck and the supports shall be designed for a minimum of 2,000,000 load cycles.
- Steel clips and expansion bolts used to connect the deck to the superstructure shall be included in the design submittal package and subject to the approval of the Engineer.

Panel Joints

- Field joints between prefabricated panels shall be designed to transfer loads between panels without inducing cracks in the wearing surface.
- Details of the panel field joints are subject to the approval of the Engineer.
- Field joints will be subject to a watertight integrity test (i.e., New York State Department of Transportation Standard Specifications subsection 567-3.01H Watertight Integrity Test). Joints that leak shall be repaired by the Contractor using repair methods and materials that are approved by Engineer.

Wearing Surface

- The wearing surface shall consist of two courses: course 1 applied in the shop and course 2 applied on-site after the deck panels are installed on the bridge. Materials proposed for use in the wearing surface shall be subject to the approval of Engineer, and samples of the materials shall be made available upon request.
- Course 1 shall consist of a clean, coarse, hard aggregate shop-applied with a structural adhesive to the deck surface.
Course 2 shall consist of a thin, polymer concrete layer meeting the requirements of New York State DOT Material Specification 734-01 Thin Polymer (Epoxy) Overlays for Structural Slabs, with the exception of the surface preparation that is intended for concrete decks. If necessary to form the cross slope as shown on the plans, the material may be used as a slurry rather than broadcasting the aggregate.

Adhesives and Resins

- Adhesives and resins shall be as approved by the deck Supplier's design Engineer.
- Material Safety Data Sheets (MSDS) shall be provided for any adhesive or resin brought to the job site.

SUBMITTALS

- The deck system shall be approved by the Engineer, prior to use on the project. Evidence of this approval shall be provided as part of the project submittal package (e.g., an approval letter or inclusion on a Department List of Approved Materials). The preapproval package shall contain, as a minimum: shop drawings, manufacturing quality assurance plan, an installation procedure, and design calculations (or finite element analysis) for the bridge deck system. The design shall be certified and signed by a Professional Engineer and provided to the Engineer prior to acceptance. A finite element analysis may be done using any commercial industry software, subject to the approval of the Engineer.
- The project-specific submittal package shall contain the following:
 - Shop drawings with dimensioned plan and cross-section views.
 - Design assumptions upon which the deck and connection design is based.
 - Materials to be used, with assumed design values.
 - Details of panel joints, bearing, and connections to supporting steel.
 - Dimensional tolerances.
 - Lifting instructions, including panel weights.
 - Installation procedures.
 - Wearing surface type and installation procedure.
- The Engineer reserves the right to inspect the Supplier's facilities during the fabrication of panels, to install any sensors necessary for long-term monitoring, and to measure residual stresses during the fabrication process.
- The Supplier shall engage an independent testing laboratory satisfactory to the Engineer to conduct material testing necessary to validate the assumptions made about material properties used in the design. The Supplier is to arrange for random samples to be taken

from the product being produced or alternatively to make witness panels representative of the materials and methods used in the deck. Results of material testing shall be provided directly to the Engineer upon request. If any test results do not confirm the minimum guaranteed values shown on the shop drawings and the design calculations, the relevant deck component or entire system shall be rejected.

- Lot numbers for all fiber, resin, or adhesive used in the deck system shall be recorded and provided to the Engineer.
- Data sheets and the Supplier's quality control sheets for all materials and methods used in the fabrication and installation of the deck shall be provided to the Engineer upon request.
- MSDS shall accompany any materials delivered to the site, with a copy provided to the Engineer upon request.
- Deliverables shall include detailed instructions for properly mixing any on-site materials, preventing spills, cleaning up, and disposing of excess material.
- The Supplier shall provide adequate documentation that the approved manufacturing quality assurance plan was followed for all aspects of the manufacturing process.

BASIS OF ACCEPTANCE

- **Deck System Warranty** – The supplier shall provide a 5-year Supplier's warranty on the structural deck. The warranty shall protect the owner from direct financial loss due to manufacturing defects. Defects include a) deflections in excess of those specified in the design parameters under design load, b) delamination or any material failure under normal service, or c) any other flaw that could reasonably be considered the result of faulty workmanship or failure to meet the design specifications. In case of a defect, the Supplier's warranty shall contain provisions for repair, strengthening, or replacement of the faulty component within 30 days of notification by the Engineer that there is a defect. The decision to repair or replace the wearing surface shall rest solely with the Engineer. The warranty shall be transferable to the new Owner should there be a transfer of ownership during the warranty period.
- **Wearing Surface Warranty** – A 5-year warranty shall be provided for the wearing surface bond. The wearing surface warranty shall protect the Owner against delamination or loss of skid resistance during the entire warranty period. The wearing surface shall provide a wet skid resistance of 60 BPN according to the British Portable Pendulum Test (ASTM E303). The warranty shall also cover any other flaw that could reasonably be considered the result of faulty workmanship or failure to meet the design specifications. The State reserves the right to perform a standard test method for pull-off strength per ASTM D4541-95 at any time during the warranty period. A wearing surface failing to meet the minimum design requirements will be considered as a defect. In case of a defect, the Supplier's warranty shall contain provisions of repair, strengthening, or replacement of the faulty component within 30 days of notification by the Engineer of the defect. The decision to repair or replace the wearing surface shall rest solely with the Engineer. The warranty shall be transferable to the new Owner should there be a transfer of ownership during the warranty period.
- **Performance Tests** – The Owner reserves the right to physically load test the deck system up to HL-93 loading at the Owner's expense any time during the warranty period

to verify that the design parameters have been satisfactorily met. A deck failing to meet the performance requirements at any time during the warranty period shall be cause for exercise of the rights provided under warranty.

- **As-Built Drawings** – Within 30 days of installation, as-built drawings shall be provided to the Engineer.
- **Inspection and Maintenance Guidelines** – Guidance for inspection and maintenance of the deck shall be provided to the Engineer prior to acceptance.

CONSTRUCTION DETAILS

- **Dimensions and Tolerances** – Deck panel dimensions shall not vary more than ¼ inch from those shown on the approved working drawings. The flatness of the panels shall not vary more than ¼ inch in 10 feet. The top surface of the construction joints between the deck panels shall be flush within a ¼-inch tolerance. Regardless of tolerances, the panels shall fit together and function per design.
- **Transportation and Site Handling** – This shall be performed with acceptable equipment methods, and by qualified personnel and in accordance with the Supplier's recommendations. The contractor is responsible until acceptance. The panels shall be lifted and supported during transportation, and erection operations only at lifting or supporting points as shown on the shop drawings, and with approved lifting devices. The panels shall be stored flat, right side up, and protected from the weather until installation. All panels shall be stored off the ground and kept dry prior to installation. Panels damaged by improper handling, storing, transporting, or lifting shall be repaired or replaced at the discretion of the Engineer at no expense to the State.
- **Joints** – All joints in the deck shall be demonstrated to the Engineer to be watertight in accordance with New York State Department of Transportation Standard Specifications subsection 567-3.01H Watertight Integrity Test.
- **Installation** – An experienced technical representative of the Supplier shall be present during the complete installation procedure to assure that the deck panels are installed correctly. Upon completion and prior to payment for the item, the technical representative shall certify that the installation has been done correctly. Field measurements necessary to fabricate the deck and install it to the limits shown on the plans shall be the Contractor's responsibility.
- **Damages Prior to Acceptance** – The Contractor shall be responsible for any damage incurred prior to acceptance. If there is damage and in the opinion of the Engineer, the damage is repairable with no long term effect on the structure, the deck shall be repaired without compensation. If, in the opinion of the Engineer, the material is damaged beyond repair, it shall be removed and replaced by the Contractor at no cost to the State.
- **Damages after Acceptance** – If the product is damaged by the installer after acceptance, the Supplier shall be available for consultation and guidance on field repairs at no expense to the State.

METHOD OF MEASUREMENT

The quantity of work to be paid for under this item will be measured as the actual number of deck systems provided (one each per bridge site).

BASIS OF PAYMENT

The lump sum price bid for this item shall include all costs necessary to provide and install the products associated with the specified deck system and provide the necessary quality assurance.

Shipping – The cost of the item shall include all transportation expenses necessary to deliver the deck system to the job site and unload it. This includes the cost of any special hauling permits, escort vehicles, and police escorts that are required.

Installation – The cost of the item shall include the expense of a qualified representative of the Supplier who will be present to facilitate the installation procedure. Field measurements necessary to fabricate the deck and install it to the limits shown on the plans shall be the Supplier's responsibility.

Partial payment – Progress payments will be made as follows:

- 50 percent of the lump sum price bid will be paid upon delivery to the project site.
- 50 percent of the lump sum price bid will be paid upon completion and approval of the installation.

APPENDIX E: DRAWINGS FOR PROOF-OF-CONCEPT BRIDGE

COMPOSITE BRIDGE DECKING

"PROOF OF CONCEPT" INSTALLATION

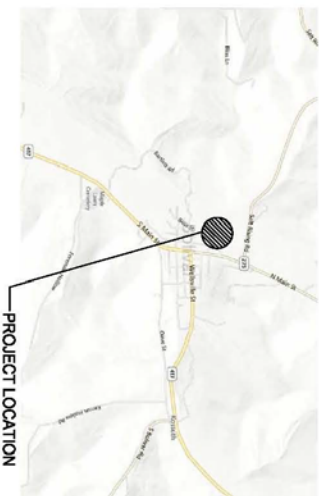

PROJECT LOCATION



PROJECT WORK SITE

INDEX OF DRAWINGS

DWG. NO.	DRAWING TITLE
1	COVER SHEET
2	PLAN VIEW
3	PANEL LAYOUT
4	EXISTING CROSS SECTION
5	PROPOSED CROSS SECTION
6	FASCIA AND DETAILS
7	LONGITUDINAL SECTION AND DETAILS
8	PANEL CROSS SECTION AND DETAILS
9	HAUNCH PLAN AND SECTIONS

State	County	Contract	Sheet	Total Sheets
NY	Albany	Highways for LIFE DTHS:09-04-0006		
Town of Bolivar				
Project Name: Bridge Rehabilitation (by County Force)				
Project Location: Pleasant Street over Little Genesee Creek				
Bridge Identification Number: 6/1 213590				
Agreement 09/13/2009				

Revision	Location	Description of Change	SA	DA	Approved	DA
0		Original drawing				
1		Revised drawing				

Bridge Composites

Fabrication and Installation Drawings

U.S. Customary Units

Scale: As noted. Do not scale from this drawing.

Sheet 1 of 9

Legal Notice: This is a violation of law for any person, unless they are under the direction of a licensed professional engineer, architect, landscape architect or land surveyor to draw or sign in any way, if an individual or firm, any drawing, plan, specification, report, or other document prepared or intended to be prepared by or for the individual or firm, and any other document or drawing, plan, specification, report, or other document, the preparation of which requires the exercise of professional judgment, and the specific description of the violation.

Figure 54. Diagram. Proof-of-concept installation drawings—cover sheet.

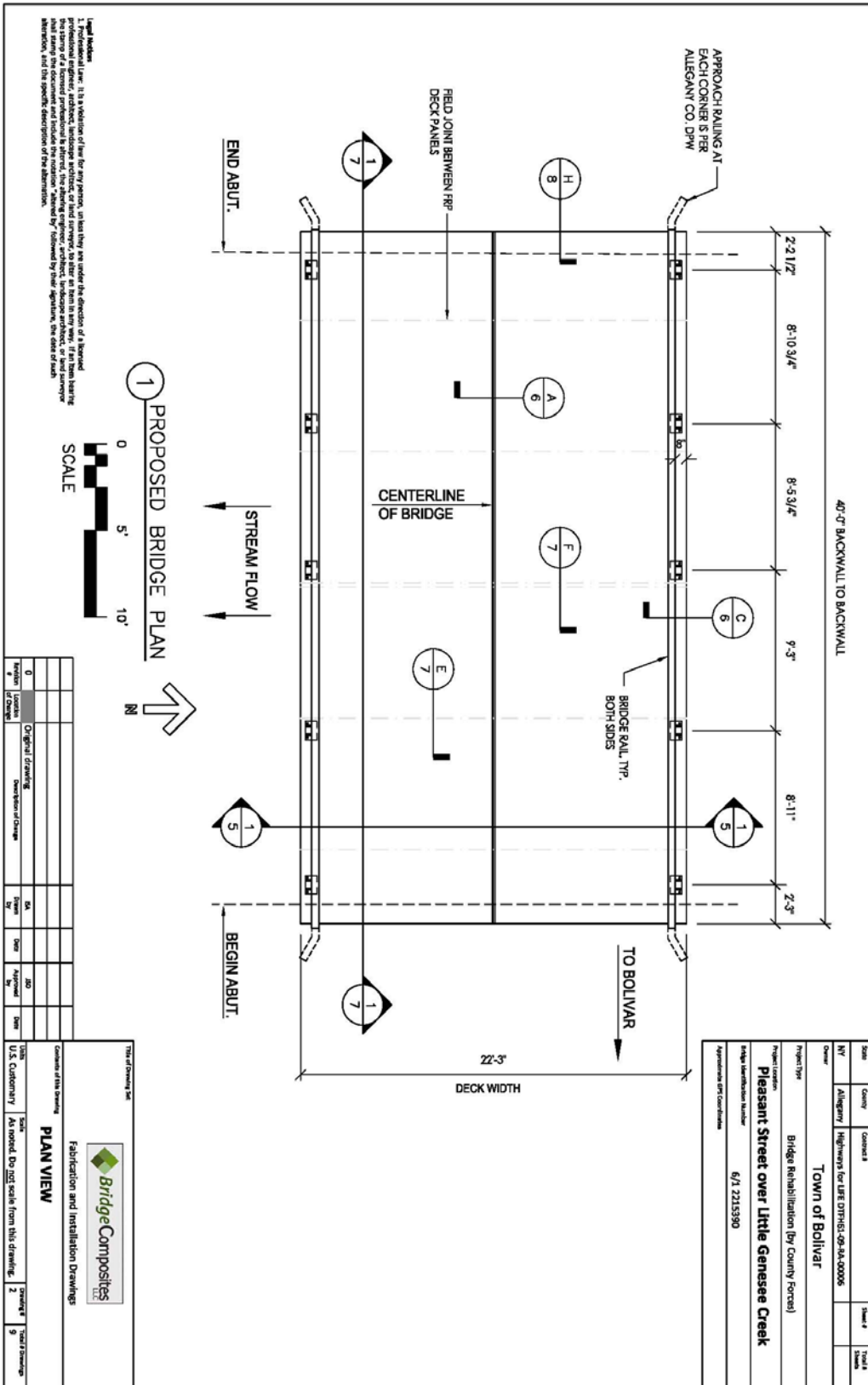

Figure 55. Diagram. Plan view.

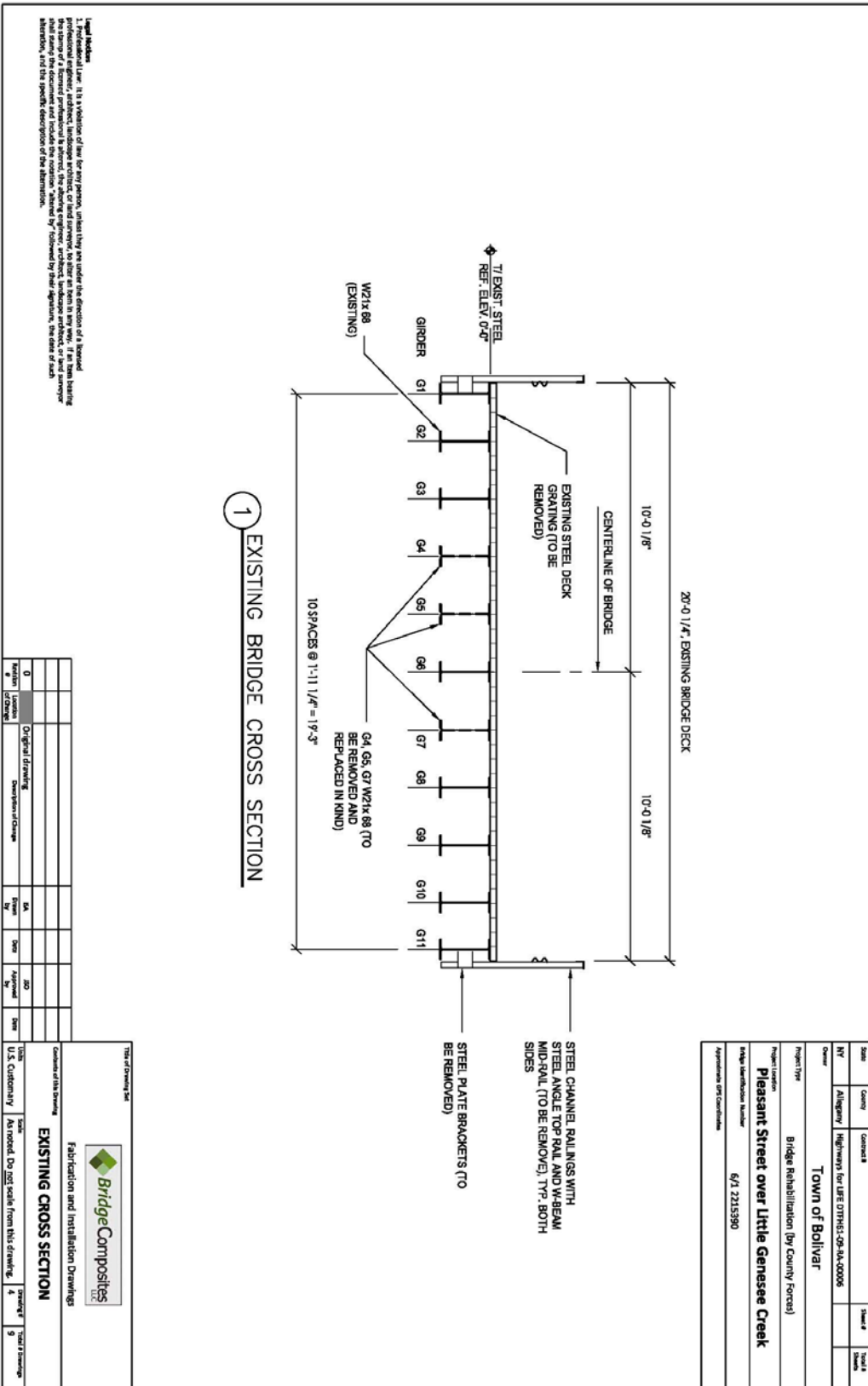

Figure 57. Diagram. Existing cross-section.

Legal Notice: It is the policy of the State of New York that no person, without being duly qualified by the education of a licensed professional engineer, architect, landscape architect, or land surveyor, shall be permitted to practice his or her profession in any of these fields in this State. The State of New York does not discriminate on the basis of race, sex, or religion in its laws, regulations, or policies. Any person who is a member of a minority group or a person with a physical or mental disability shall not be discriminated against on the basis of race, sex, or religion in the exercise of his or her profession. This notice is provided for your information and is not intended to constitute an offer of insurance or any other financial product. The specific description of the insurance policy is provided on the reverse side of this document.

Title of Drawing EXISTING BRIDGE CROSS SECTION		Author BridgeComposites LLC	
Content of this Drawing EXISTING BRIDGE CROSS SECTION		Scale As noted. Do not scale from this drawing.	
Original Drawing Designed by Checked by Approved by		Date 10/1/2020	
Revision 1		Date 10/1/2020	
U.S. Customary		Scale 4" = 1'-0"	
Total of Drawing Set 1 of 1		Total Number of Sheets 1 of 1	

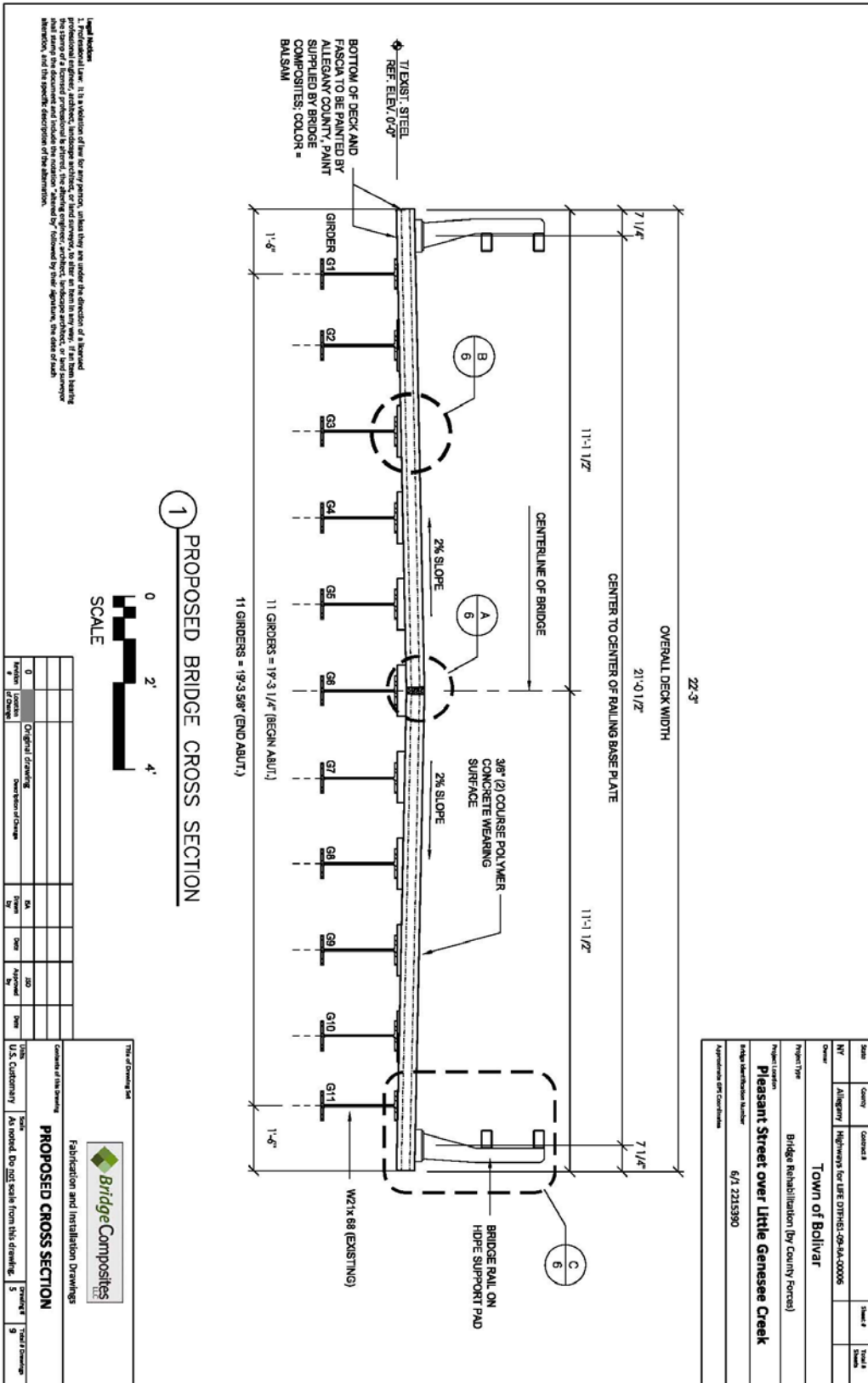

Figure 58. Diagram. Proposed cross-section.

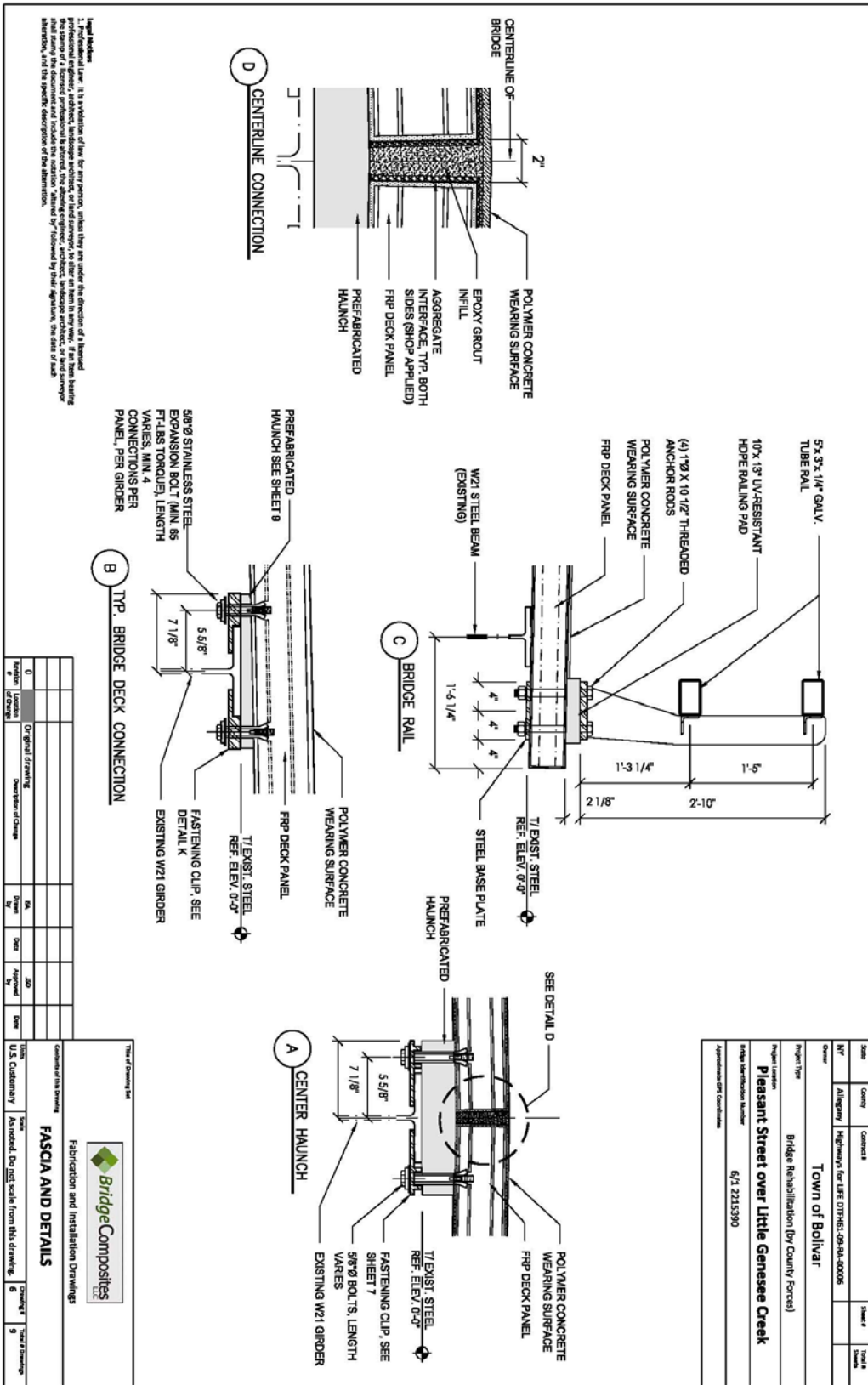
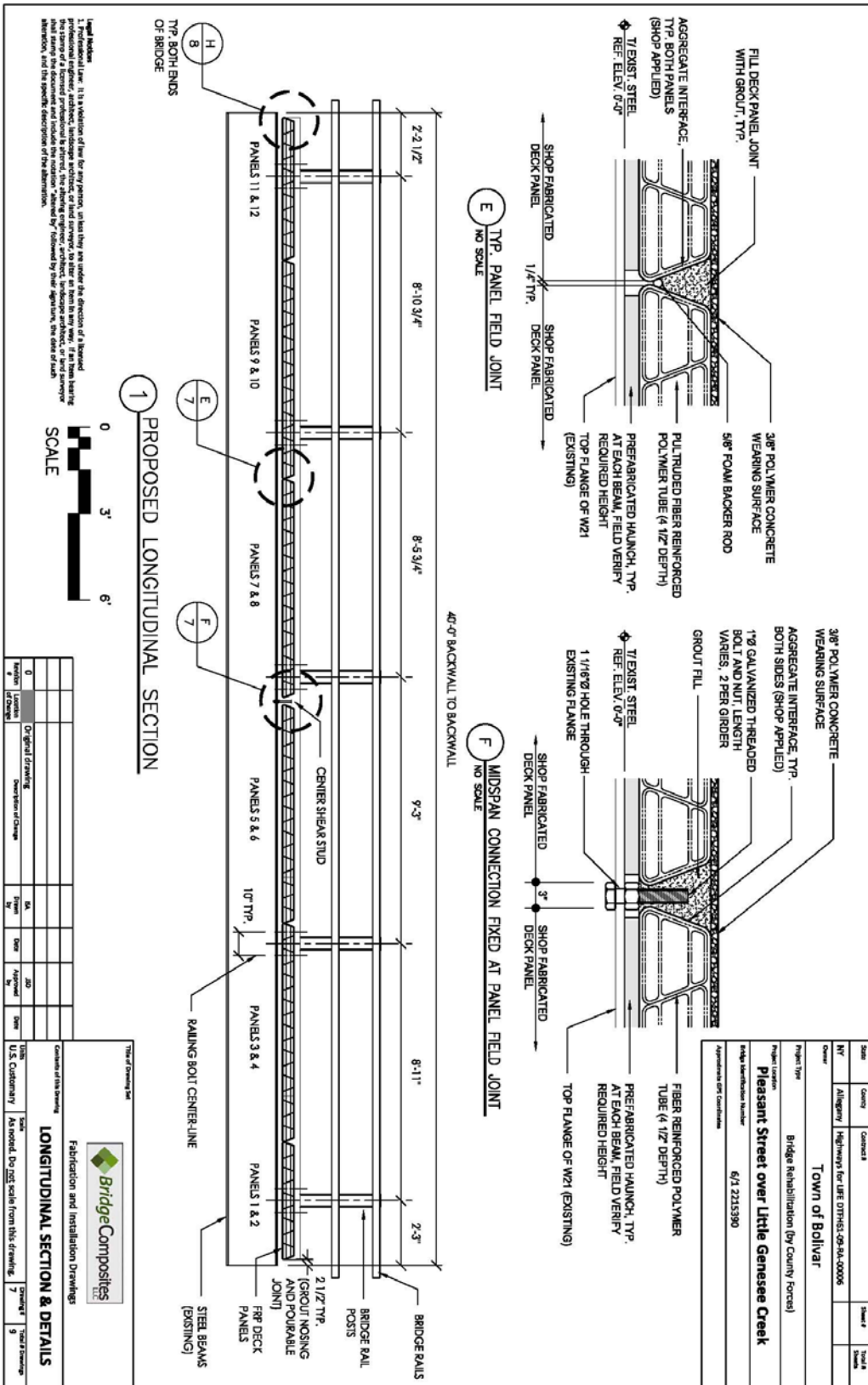

Figure 59. Diagram. Fascia and details.



1. The fabricator shall be responsible for the design of the proposed FRP deck panels. The fabricator shall be responsible for the design of the proposed FRP deck panels. The fabricator shall be responsible for the design of the proposed FRP deck panels.

Revision	Description	By	Appr'd	Date
0	Original Drawing	EA	JED	
1	Revised Drawing			

Author	Checker	Designer	Engineer	Scale	Notes

Consent of this owner
LONGITUDINAL SECTION & DETAILS
Fabrication and Installation Drawings



Figure 60. Diagram. Longitudinal section and details.

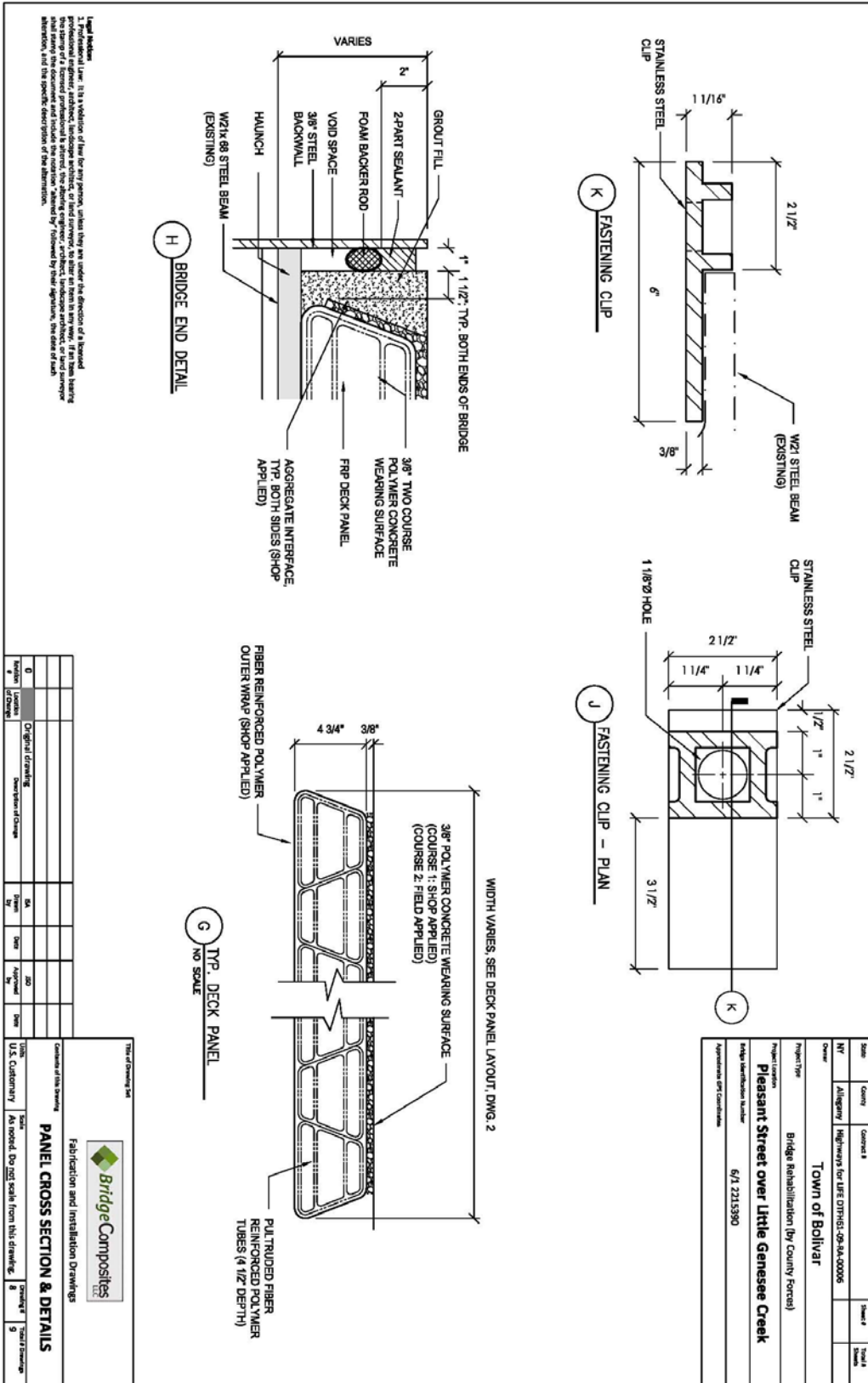
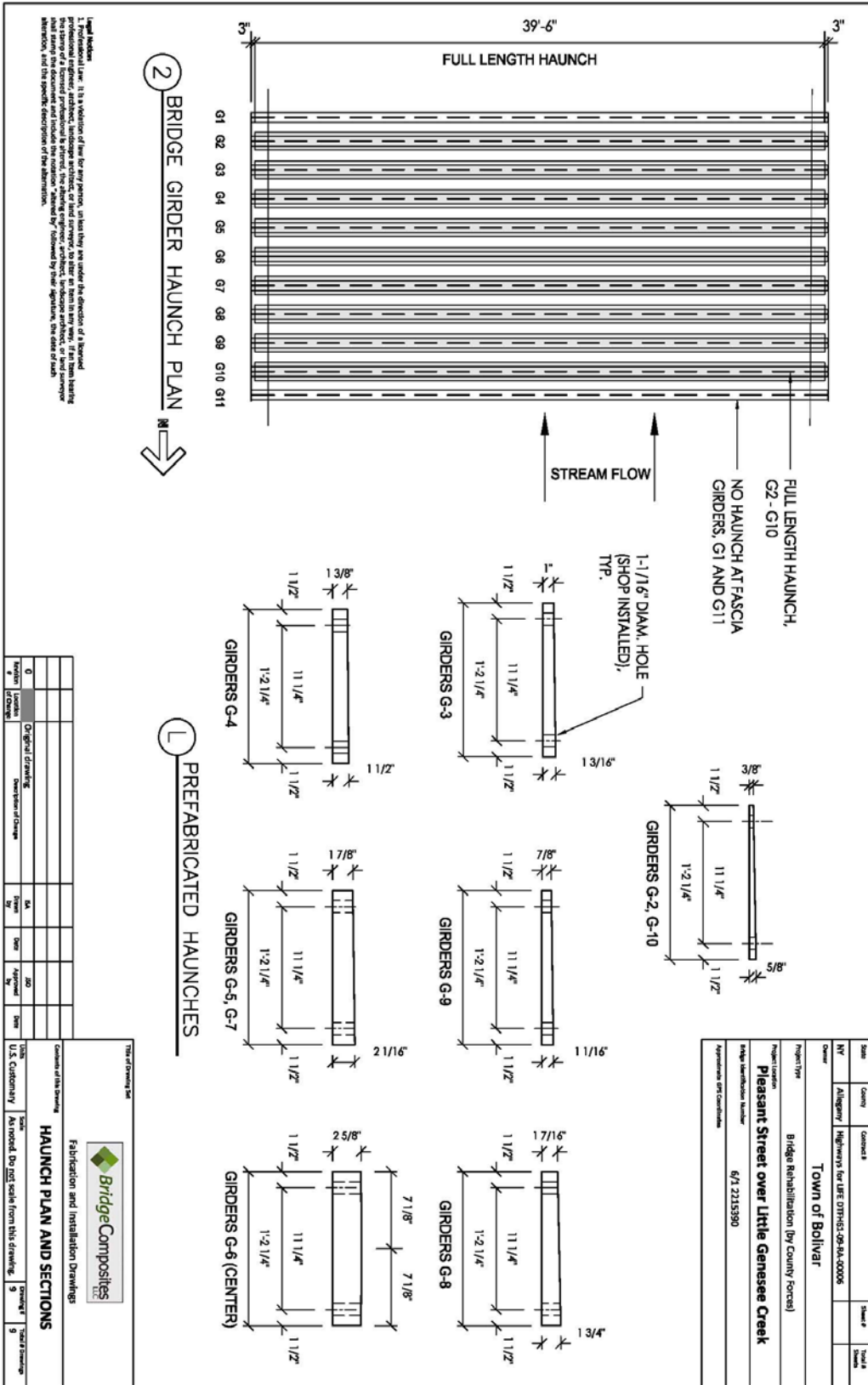

Figure 61. Diagram. Panel cross-section and details.



1. Read these notes in conjunction with the drawings to fully understand the intent of the design. The design is based on the information provided in the drawings. The design engineer, architect, landscape architect, or civil engineer shall be responsible for the design and construction of the project. The design engineer, architect, landscape architect, or civil engineer shall be responsible for the design and construction of the project. The design engineer, architect, landscape architect, or civil engineer shall be responsible for the design and construction of the project.

Revision #	Description	By	Appr'd	Date
0	Original drawing			
1	Revised drawing			

Scale	Sheet #	Sheet #	Sheet #
1" = 10'-0"	1	1	1

BridgeComposites
 Fabrication and Installation Drawings
HAUNCH PLAN AND SECTIONS
 Date: Approved: Do not scale from this drawing.

Project Name: Pleasant Street over Little Genesee Creek
 Project Number: 6/1 223590
 Bridge Identification Number: 6/1 223590
 Approximate project completion:

State: NY
 County: Albany
 Highway for I.D.E.C. DTSPIC: 06-84-00005
 Town of Bolivar
 Bridge Rehabilitation (by County Force)

Title of Drawing Set:

Figure 62. Diagram. Haunch plan and sections.

ACKNOWLEDGMENTS

The following individuals provided review comments during various stages of this Highways for LIFE Technology Partnerships project. The authors acknowledge their contribution to the successful outcome of the project.

TECHNICAL ADVISORY PANEL

Raymond Bottenberg, P.E. Corrosion Engineer, Oregon DOT Salem, OR	Duane R. Daniels, P.E. Director, Construction Inspection Larson Design Group Williamsport, PA
Jeremy Ferris, P.E. County Engineer Allegany County Department of Public Works Belmont, NY	Paul B. Fossier, Jr., P.E., M.ASCE Assistant Bridge Design Administrator Louisiana Department of Transportation & Development Baton Rouge, LA
Paul Liles, P.E. Director of Engineering, Georgia DOT Atlanta, GA	George C. Patton, P.E., MSCE Senior Bridge Engineer URS Inc. (E.C. Driver & Associates, Inc.) Tampa, FL
Will Potter, E.I. Structures Research Center Florida Department of Transportation	Herbert Protin, P.E., Professional Associate Senior Movable Bridge Engineer HDR, Inc. Newark, NJ
Tom Sheehan, P.E. NYSTA Canals Division Cheektowaga, NY	Kevin Thompson, P.E. URS Inc. (former CA State Bridge Engineer) San Francisco, CA
Arthur Yannotti, P.E. Consultant (former NY State Bridge Engineer) Queensbury, NY	

PROJECT MANAGEMENT ADVISORY PANEL

Sreenivas Alampalli, Ph.D., P.E., MBA New York State DOT Albany, NY	Paul McAnany, P.E. Consulting Civil Engineer Hornell, NY
---	--