

# Utilizing 3D Digital Design Data in Highway Construction - Case Studies

---

---

PUBLICATION NO. FHWA-HIF-17-027

APRIL 2017



U.S. Department of Transportation  
**Federal Highway Administration**

Research, Development, and Technology  
Turner-Fairbank Highway Research Center  
6300 Georgetown Pike  
McLean, VA 22101-2296

Office of Infrastructure  
Asset Management, Pavements, and Construction  
1200 New Jersey Ave. S.E.  
Washington, DC 20590-9898

## FOREWORD

The Federal Highway Administration (FHWA) conducted a comprehensive case study of how 3D digital design data was used successfully by both the owner agency and the construction contractor during six specific highway construction projects. A State Transportation Agency should read this report because of the emphasis placed on the data integration and data transfer standards. Researchers explored the factors that did or did not enable data integration and migration. The case studies were analyzed to identify the characteristics of projects that were conducive to the use of 3 D digital design data in construction. The research synthesized processes for data integration and characterized the data necessary for specific uses in construction, including layout, AMG paving, construction acceptance, and measuring pay quantities. It also identified gaps in data exchange schemas that need to be addressed to better support the use of 3 D digital design data in highway construction. The actionable products of the research are guidelines for determining if a project has the characteristics likely to support use of 3D digital design data in construction, defining the data specifications to support those uses, and opportunities to streamline processes to enable data integration and maximize the utility of the data.



Cheryl Allen Richter, P.E., Ph.D.,  
Director, Office of Infrastructure  
Research and Development

### Notice

This document is disseminated under the sponsorship of the U.S. Department of Transportation in the interest of information exchange. The U.S. Government assumes no liability for the use of the information contained in this document. This report does not constitute a standard, specification, or regulation.

The U.S. Government does not endorse products or manufacturers. Trademarks or manufacturers' names appear in this report only because they are considered essential to the objective of the document.

### Quality Assurance Statement

The Federal Highway Administration (FHWA) provides high-quality information to serve Government, industry, and the public in a manner that promotes public understanding. Standards and policies are used to ensure and maximize the quality, objectivity, utility, and integrity of its information. FHWA periodically reviews quality issues and adjusts its programs and processes to ensure continuous quality improvement.

**THIS PAGE INTENTIONALLY LEFT BLANK**

## TECHNICAL REPORT DOCUMENTATION PAGE

1. Report No. FHWA-HIF-17-027	2. Government Accession No. N/A	3 Recipient Catalog No. N/A	
4. Title and Subtitle Utilizing 3D Digital Design Data in Highway Construction - Case Studies		5. Report Date April 2017	
		6. Performing Organization Code N/A	
7. Author(s) Francesca Maier, PE, Laura E. Chummers, Shashank Pulikanti, Jonathan Q. Struthers, Dr. Jagannath Mallela, and Ralph H. Morgan, PLS		8. Performing Organization Report No. N/A	
9. Performing Organization Name and Address WSP   Parsons Brinckerhoff 1015 Half St. SE, Suite 650 Washington, DC 20003		10. Work Unit No. (TRAIS) N/A	
		11. Contract or Grant No. DTFH6114C00039	
12. Sponsoring Agency Name and Address Federal Highway Administration Office of Infrastructure Research and Technology 6300 Georgetown Pike McLean, VA 22101-2296		13. Type of Report and Period Covered Draft Final Report	
		14. Sponsoring Agency Code N/A	
15. Supplementary Notes The Contracting Officer's Representative is Richard Duval, HRDI-20.			
16. Abstract <p>There are numerous benefits afforded to using 3D digital design data in highway construction. These include: the ability to identify and resolve constructability challenges prior to mobilization, more accurate estimation and better control of pavement material quantities through Automated Machine Guidance (AMG), faster execution of construction with AMG, which has associated efficiency and safety benefits, faster inspection activities using real-time verification with associated safety benefits, and more efficient workflows to measure payment quantities that provide ancillary transparency and repeatability improvements through the collection of 3D data to support the measurements.</p> <p>The key to these myriad benefits is 3D digital design data, but State Transportation Agencies are challenged to determine the right time to invest in generating that data. While it is possible to generate sufficiently detailed 3D data, and new software tools make it relatively simple to do so, the data are limited by the uncertainty inherent in the original ground survey and subsurface information upon which they are founded. Incomplete and inconsistently implemented data schemas, and a prevalence of different proprietary software and data schemas used by State Transportation Agencies and their contractor partners, are complications that add to the challenge of having 3D digital design data used directly in construction. Avoiding manual data exchange and careful scrutiny to validate exchanged data often leads in practice to deferring investment in 3D data used in construction, and puts the owner's engineer at a disadvantage—reliant on contractor-generated data that must be carefully reviewed for consistency with the contract plans.</p> <p>This research explores opportunities to refine processes for generating the 3D digital design data used in construction, identifies priorities for addressing data schema gaps, offers strategies for determining and controlling 3D data quality, and identifies project characteristics that lend themselves toward creating 3D digital design data for use in construction.</p>			
17. Key words Automation in highway construction, 3D digital design data, Data schema, Automated machine guidance, Automation, Guidelines		18. Distribution Statement No restrictions. This document is available to the public through the National Technical Information Service, Springfield, VA 22161. <a href="http://www.ntis.gov">http://www.ntis.gov</a>	
19. Security Classif. (of this report) Unclassified	20. Security Classif. (of this page) Unclassified	21. No. of Pages 196	22. Price



# SI\* (MODERN METRIC) CONVERSION FACTORS

## APPROXIMATE CONVERSIONS TO SI UNITS

Symbol	When You Know	Multiply By	To Find	Symbol
<b>LENGTH</b>				
in	inches	25.4	millimeters	mm
ft	feet	0.305	meters	m
yd	yards	0.914	meters	m
mi	miles	1.61	kilometers	km
<b>AREA</b>				
in <sup>2</sup>	square inches	645.2	square millimeters	mm <sup>2</sup>
ft <sup>2</sup>	square feet	0.093	square meters	m <sup>2</sup>
yd <sup>2</sup>	square yard	0.836	square meters	m <sup>2</sup>
ac	acres	0.405	hectares	ha
mi <sup>2</sup>	square miles	2.59	square kilometers	km <sup>2</sup>
<b>VOLUME</b>				
fl oz	fluid ounces	29.57	milliliters	mL
gal	gallons	3.785	liters	L
ft <sup>3</sup>	cubic feet	0.028	cubic meters	m <sup>3</sup>
yd <sup>3</sup>	cubic yards	0.765	cubic meters	m <sup>3</sup>
NOTE: volumes greater than 1000 L shall be shown in m <sup>3</sup>				
<b>MASS</b>				
oz	ounces	28.35	grams	g
lb	pounds	0.454	kilograms	kg
T	short tons (2000 lb)	0.907	megagrams (or "metric ton")	Mg (or "t")
<b>TEMPERATURE (exact degrees)</b>				
°F	Fahrenheit	5 (F-32)/9 or (F-32)/1.8	Celsius	°C
<b>ILLUMINATION</b>				
fc	foot-candles	10.76	lux	lx
fl	foot-Lamberts	3.426	candela/m <sup>2</sup>	cd/m <sup>2</sup>
<b>FORCE and PRESSURE or STRESS</b>				
lbf	poundforce	4.45	newtons	N
lbf/in <sup>2</sup>	poundforce per square inch	6.89	kilopascals	kPa
<b>APPROXIMATE CONVERSIONS FROM SI UNITS</b>				
Symbol	When You Know	Multiply By	To Find	Symbol
<b>LENGTH</b>				
mm	millimeters	0.039	inches	in
m	meters	3.28	feet	ft
m	meters	1.09	yards	yd
km	kilometers	0.621	miles	mi
<b>AREA</b>				
mm <sup>2</sup>	square millimeters	0.0016	square inches	in <sup>2</sup>
m <sup>2</sup>	square meters	10.764	square feet	ft <sup>2</sup>
m <sup>2</sup>	square meters	1.195	square yards	yd <sup>2</sup>
ha	hectares	2.47	acres	ac
km <sup>2</sup>	square kilometers	0.386	square miles	mi <sup>2</sup>
<b>VOLUME</b>				
mL	milliliters	0.034	fluid ounces	fl oz
L	liters	0.264	gallons	gal
m <sup>3</sup>	cubic meters	35.314	cubic feet	ft <sup>3</sup>
m <sup>3</sup>	cubic meters	1.307	cubic yards	yd <sup>3</sup>
<b>MASS</b>				
g	grams	0.035	ounces	oz
kg	kilograms	2.202	pounds	lb
Mg (or "t")	megagrams (or "metric ton")	1.103	short tons (2000 lb)	T
<b>TEMPERATURE (exact degrees)</b>				
°C	Celsius	1.8C+32	Fahrenheit	°F
<b>ILLUMINATION</b>				
lx	lux	0.0929	foot-candles	fc
cd/m <sup>2</sup>	candela/m <sup>2</sup>	0.2919	foot-Lamberts	fl
<b>FORCE and PRESSURE or STRESS</b>				
N	newtons	0.225	poundforce	lbf
kPa	kilopascals	0.145	poundforce per square inch	lbf/in <sup>2</sup>

\*SI is the symbol for the International System of Units. Appropriate rounding should be made to comply with Section 4 of ASTM E380.  
(Revised March 2003)

## TABLE OF CONTENTS

1. INTRODUCTION .....	1
Objective .....	2
Acronyms .....	2
2. BACKGROUND .....	4
3. METHODOLOGY .....	7
Case Studies .....	7
Selected Case Study Projects .....	11
Interviews.....	18
4. CASE STUDIES .....	22
Southern Expressway.....	23
Route 60 Reconstruction.....	38
I-80 Silver Creek to Wanship Reconstruction .....	48
I-35 Unbonded Concrete Overlay .....	63
US 17 Bridge and Safety Improvements .....	71
US 219 Mill and Resurface.....	76
5. GENERAL OBSERVATIONS .....	81
New York.....	81
Virginia .....	89
Missouri .....	92
Utah.....	94
6. PROCESS ANALYSIS .....	98
Preconstruction Quality Control .....	100
Construction Layout And Orientation .....	108
Automated Machine Guidance .....	111
Real-Time Verification .....	114
As-Built Record Documentation.....	118
7. DATA USES AND SCHEMAS .....	119
Preconstruction quality control.....	120
Construction Layout and Orientation.....	124
Automated Machine Guidance .....	126
Real-Time Verification .....	128
Measure Pay Quantities: .....	132
As-built Record Documentation: .....	133
LOD Designation .....	134
8. DATA SCHEMA DEVELOPMENT .....	141
Data Schema Comparison.....	141
Data Schema Development Needs.....	144
Outlook .....	153

9. QUALITY CONTROL FOR DIGITAL DELIVERY .....	154
PreConstruction Quality Control .....	155
10. Construction Data Delivery .....	162
Project Characteristics .....	166
Data Types and Schemas .....	170
Priorities for Plan Sheet Reduction.....	171
11. Conclusion .....	172
OPPORTUNITIES FOR, AND CHALLENGES TO, DIGITAL DELIVERY .....	172
SUMMARY .....	178
Acknowledgements.....	180
References.....	182

## LIST OF FIGURES

Figure 1: Illustration. Contrast of crew size and time taken to measure earthwork. (12).....	5
Figure 2: Illustration. Estimated inspection time savings on the Parksville Bypass. (12).....	5
Figure 3: Chart. Continuing challenges to implementing 3D modeling. (13) .....	6
Figure 4: Worksheet. Project characteristics for case study screening.....	8
Figure 5: Worksheet. Case study screening matrix. ....	10
Figure 6: Map. Selected case study project locations. ....	11
Figure 7: Map. Location of US 219 Southern Expressway. ....	12
Figure 8: Map. Location of Route 60 Reconstruction. ....	13
Figure 9: Map. Location of I-80 Silver Creek to Wanship. ....	14
Figure 10: Map. Location of I-35 Unbonded Concrete Overlay. ....	15
Figure 11: Map. Location of US 17 Bridge and Safety Improvements. ....	16
Figure 12: Map. Location of US 219 Mill and Overlay. ....	17
Figure 13: Photo. Looking north through the landslide area. ....	23
Figure 14: Illustration. Hinman Wetlands design plans.....	24
Figure 15: Screenshot. Review of contractor's surface for Hinman Wetlands. ....	25
Figure 16: Screenshot. Hinman Wetlands Berm #8 for inspector's data collector. ....	26
Figure 17: Photo. The project had challenging terrain and heavy woods.....	27
Figure 18: Photo. The original ground was covered by heavy woods.....	28
Figure 19: Photo. GPS rover and data collector used by inspectors. ....	29
Figure 20: Map. NYSDOT CORS network in September 2008.....	30
Figure 21: Screenshot. Cross-section view of surfaces used to compute quantities.....	32
Figure 22: Screenshot. Work orders in the Trimble® SCS Data Manager software.....	33
Figure 23: Photo. An inspector waits safely during excavation. ....	33
Figure 24: Flowchart. Workflow used to measure earthwork volumes.....	34
Figure 25: Screenshot. A field data report for the Office Engineer's review.....	34
Figure 26: Screenshot. A quantity calculation report generated by the data collector. ....	35
Figure 27: Illustration. Flow line offsets to check pipe installation. ....	36
Figure 28: Photo. Maintenance of traffic was a significant concern. ....	38
Figure 29: Illustration. Graphical surface review of the redesigned Route 60. ....	40
Figure 30: Illustration. The solution involved wedging and 3D profile milling.....	41
Figure 31: Photo. Truck with GNSS receivers for rolling survey. ....	42
Figure 32: Illustration. Rolling survey surface compared to designed final ground. ....	42
Figure 33: Photo. TopoLIFT® system collecting static lidar survey. ....	43
Figure 34: Screenshot. Registered point cloud from static lidar.....	43
Figure 35: Screenshot. Reduced lidar data overlaid on PDF plans.....	44
Figure 36: Illustration. Expected (blue) and actual (red) ground when work stopped. ....	44
Figure 37: Photo. Route 60 after final paving.....	47
Figure 38: Photo. Route 60 in May 2015.....	47
Figure 39: Photo. All CTAB operations used RTS control. ....	49
Figure 40: Photo. Tight clearances under the Tollgate Bridge. ....	49
Figure 41: Photo. String line paving for the eastbound in 2014. ....	51
Figure 42: Illustration. Line diagram of the project with typical sections.....	52
Figure 43: Photo. Hubs were set every 30 feet for string lines.....	53
Figure 44: Illustration. Various methods were used to test the data. (17) .....	54
Figure 45: Illustration. Survey limits by collection method. (17).....	54

Figure 46: Chart. Difference between published elevation and leveled elevation. ....	55
Figure 47: Photo. AMG operations need staggered, accurate control. ....	56
Figure 48: Illustration. Contrast of preferred and actual survey data density. ....	57
Figure 49: Photo. The contractor’s surveyor checks grade behind the paver. ....	57
Figure 50: Photo. Three RTSSs are necessary at each AMG paving setup. ....	58
Figure 51: Photo. Stringless paving provides better access to the work area. ....	59
Figure 52: Photo. String line and stringless paving had good smoothness. ....	60
Figure 53: Chart. Plot of daily and cumulative yield with stringless paver. ....	61
Figure 54: Chart. Daily yield by daily paving length for stringless paver. ....	61
Figure 55: Photo. Construction used full closure and head-to-head traffic. (19) ....	63
Figure 56: Illustration. Cross-slopes varied to optimize yield. (19) ....	64
Figure 57: Photo. All asphalt was milled before survey could be collected. (19) ....	65
Figure 58: Photo. Concrete pavers use resection for positioning. ....	66
Figure 59: Illustration. Control requirements for static lidar and AMG paving. ....	66
Figure 60: Photo. Dowel bar cages were placed ahead of the paver. ....	68
Figure 61: Illustration. Cross-slopes on the original concrete varied. ....	69
Figure 62: Photo. The work zone was close to live traffic. ....	70
Figure 63: Illustration. Two approaches to cross-slope improvements. ....	71
Figure 64: Illustration. The design was documented through sketches and notes. ....	72
Figure 65: Illustration. The work was concentrated in interchanges. ....	74
Figure 66: Illustration. Survey for mainline sections. ....	75
Figure 67: Photo. Cracks above the concrete joints in 2015. ....	77
Figure 68: Photo. A bridge on US 219 looking south. ....	77
Figure 69: Illustration. Sonic tracers on an averaging ski. ....	78
Figure 70: Photo. Asphalt overlay with sonic skis. ....	79
Figure 71: Photo. Good smoothness outcomes were achieved. ....	80
Figure 72: Illustration. Earthwork model for a bridge foundation. ....	82
Figure 73: Illustration. Examples of an abutment and a pier. ....	82
Figure 74: Screenshot. Multiple models in MicroStation. ....	83
Figure 75: Illustration. Kosciuszko Bridge Project on 6/5/15. ....	86
Figure 76: Screenshot. How-to documents for file transfer. ....	88
Figure 77: Screenshot. Elevation inconsistencies flagged. ....	90
Figure 78: Illustration. Constructability issues for AMG. ....	91
Figure 79: Flowchart. Quality control on the 3D data was a required first step. ....	98
Figure 80: Flowchart. Validation process for 3D data. ....	99
Figure 81: Flowchart. Inspector training that resulted in accurate original ground. ....	103
Figure 82: Flowchart. Profile refinements to achieve CTAB mass balance. ....	104
Figure 83: Flowchart. Data collection and modeling for geometric optimization. ....	105
Figure 84: Flowchart. 3D data was not developed throughout design. ....	106
Figure 85: Flowchart. Data preparation for Southern Expressway. ....	106
Figure 86: Flowchart. Modified Designer's role to deliver construction data. (31). ....	107
Figure 87: Photo. Painted reference marks for orientation. ....	109
Figure 88: Flowchart. Construction layout for Route 60 Reconstruction curbs. ....	110
Figure 89: Flowchart. Determination of inspection methods. ....	112
Figure 90: Flowchart. Response to the Stop Work Order for Route 60 Reconstruction. ....	113
Figure 91: Flowchart. Workflow for Real-time Verification. ....	116
Figure 92: Flowchart. Action precipitated by detecting a tolerance issue. ....	116
Figure 93: Flowchart. Measurement workflow. ....	117

Figure 94: Chart. Relationship between MD, CL, and 3D data use. ....	119
Figure 95: Screenshot. Reviewing 2D and 3D lines strings over scanned plans. ....	121
Figure 96: Illustration. Margin of error affects the value of surface comparison volumes. ....	122
Figure 97: Flowchart. Data exchanges and schemas for AMG surfaces. ....	122
Figure 98: Illustration. Mid-ordinate distance. (8).....	125
Figure 99: Illustration. Derivation of 3D data densities. ....	129
Figure 100: Illustration. Staking compared to Real-time Verification. ....	130
Figure 101: Illustration. Uncertainty varies by feature and location. ....	134
Figure 102: Illustration. Data fusion approach to increase CL. ....	135
Figure 103: Flowchart. Comparison of traditional and digital delivery processes. ....	154
Figure 104: Flowchart. Metadata risk identification.....	156
Figure 105: Flowchart. Risk identification for topographic survey.....	157
Figure 106: Flowchart. Impact assessment for topographic survey. ....	158
Figure 107: Illustration. Cumulative effect of GNSS solution precision.....	160
Figure 108: Illustration. Using Real-time Verification for pipe installation. ....	160
Figure 109: Flowchart. Inclusion criteria for Real-time Verification. ....	167
Figure 110: Photo. Asphalt paving operation for an urban mill and overlay. ....	167
Figure 111: Flowchart. Inclusion criteria for asphalt paving.....	168
Figure 112: Flowchart. Inclusion criteria for profile milling.....	169
Figure 113: Photo. Urban milling and asphalt paving. ....	169
Figure 114: Illustration. Proposed redistribution of effort for survey and design. ....	179

## LIST OF TABLES

Table 1: Final Case Study Project List .....	11
Table 2: Project Information for Southern Expressway .....	12
Table 3: Project information for Route 60 Reconstruction.....	13
Table 4: Project information for I-80 Silver Creek to Wanship .....	14
Table 5: Project Information for I-35 Unbonded Concrete Overlay.....	15
Table 6: Project information for US 17 Bridge and Safety Improvements .....	16
Table 7: Project information for US 219 Mill and Overlay.....	17
Table 8: Interview Topics for Processes, Policies, and Data Integration .....	19
Table 9: Interview Topics for Data Specifications and Data Uses .....	20
Table 10: Southern Expressway Project Characteristics .....	23
Table 11: Route 60 Reconstruction Project Characteristics .....	38
Table 12: I-80 Reconstruction Project Elements .....	48
Table 13: Contrast of string line and stringless paving outcomes .....	60
Table 14: Summary of Costs.....	62
Table 15: I-35 Unbonded Concrete Overlay Project Elements .....	63
Table 16: US 17 Bridge and Safety Project Elements .....	71
Table 17: Quantities modified in Addendum 3.....	73
Table 18: US 219 Mill and Resurface Project Characteristics .....	76
Table 19: Top eight bid items by contract value.....	78
Table 20: Models and LOD for Kosciuszko Bridge .....	85
Table 21: Original ground survey issue detection timing and impact. ....	100
Table 22: Examples of traditional processes modified for Real-time Verification. (30).....	102
Table 23: Comparison of data management practices .....	108
Table 24: Pay factors for deficient concrete pavement depth. (18) (25) .....	113
Table 25: Data uses and data types for preconstruction quality control .....	123
Table 26: Data uses and data types for construction layout and orientation .....	126
Table 27: Data uses and data types for AMG. (8) .....	127
Table 28: Illustrative staking tolerances (23).....	130
Table 29: Data uses and data types for Real-time Verification .....	131
Table 30: Data uses and data types for measuring pay quantities. (8).....	132
Table 31: Data uses and data types for as-built record documentation. ....	134
Table 32: Definition of Confidence Levels. ....	136
Table 33: Definition of Model Density bands. ....	137
Table 34: Sample digital data manifest.....	140
Table 35: Comparison of data schemas with supported file formats for highways.....	142
Table 36: Necessary survey metadata within 3D digital data file. ....	158
Table 37: Variables to control for successful Real-time Verification. ....	159
Table 38: Risk profile for MD and CL combinations.....	163
Table 39: Deficiencies in 3D data and mode of resolution for MD and CL combinations. ....	164
Table 40: Design data types and data schemas.....	170

## 1. INTRODUCTION

Section 1304 of The Moving Ahead for Progress in the 21st Century Act (MAP-21) emphasizes (1) the identification and deployment of innovative technologies and practices to achieve three goals in relation to highways and bridges: increase the efficiency of their construction, improve their safety, and extend their service life. The use of three-dimensional (3D) engineered models in construction, promoted under the Federal Highway Administration's (FHWA's) Every Day Counts (EDC) initiative, is one tool in the innovative technologies toolbox that helps meet this MAP-21 provision. (2)

The objective of this research is to conduct a comprehensive case study of how 3D digital design data was used successfully by both the owner agency and the construction contractor during highway construction. Emphasis is placed on the data integration and data transfer standards that enable such integration. Also included with this case study is the identification of the elements, guidance, and applications that are needed to develop means and methods for optimizing construction, earthwork balancing, equipment Automatic Machine Guidance (AMG) control systems, and modeling software.

Electronic project data may include drawings, reports, or project files and may be vector or raster in nature. (3) For the purposes of this study, 3D Digital Design Data ("3D data") is defined as any 3D vector data that represents the design intent of the contract documents. This includes data developed during the course of creating the contract documents, or 3D data created from the contract documents, generally in a Computer-Aided Design and Drafting (CADD) or extensible markup language (XML) format.

This report summarizes the literature search that set the context for the study, introduces the methodology, and presents the comprehensive case studies of six specific construction projects in four States: New York, Virginia, Utah, and Missouri. The information collected during the case studies was then analyzed to present synthesized data uses (and characterization), process maps for the data integration, and to identify project characteristics that led to favorable uses of 3D digital data in construction.

One of the most significant lessons learned in the case studies was the need for careful digital data quality control, especially prior to construction. The reliability and resolution of the original ground survey information had the most significant impact on the successful use of 3D digital data in construction. The final chapters present guidance on quality control for digital data that will be used in construction.

The most significant factor that supported or constrained the use of 3D digital data by both the contractor and the owner was data exchange. Generally, owners and contractors used different software and hardware. While careful data exchange via open data schemas was generally possible, more successful data integration resulted where both parties used common data, either through collaborative interaction with the data or through using the same hardware and software to obviate the need for converting the data into different proprietary formats. This informed the chapter on data schema types and areas for further development.



## OBJECTIVE

Studying individual projects yielded quantitative and qualitative data on the use, enabling policies, and results of applying 3D digital design data and AMG to highway construction. The objective was therefore to gather data from sample projects that are representative of typical State transportation agencies' construction work in an era of constrained budgets and a vast need for renewal.

While high-profile, large projects may provide opportunities for advanced uses of 3D digital data and AMG, the objective of this project was to ascertain where 3D digital design data and AMG may benefit in the usual workflow of standard projects. The research provides actionable tools for State transportation agencies to use in scoping and executing projects to result in the optimal, most favorable application of 3D digital data in highway construction.

## ACRONYMS

This section introduces some of the acronyms used in this report.

**3R: Resurfacing, Restoration, or Rehabilitation.** A category of common construction project types that typically falls on the lower end of construction contract value.

**AMG: Automated Machine Guidance.** The use of real-time positioning equipment with 3D digital data to guide or control the blade on construction equipment, resulting in real-time construction layout without the need for physical markers such as stakes or hubs.

**CADD: Computer-Aided Design and Drafting.** A category of computer software that is used to develop roadway designs. CADD software typically uses an object-oriented approach to apply mathematical rules that automate the process of drafting roadway designs. 3D digital design data is a common output of the application of CADD software.

**CIM: Civil Integrated Management.** The collection, organization, and managed accessibility to accurate data and information related to a highway facility. The concept may be used by all affected parties for a wide range of purposes, including planning, environmental assessment, surveying, design, construction, maintenance, asset management, and risk assessment. (4)

**DTM: Digital Terrain Model.** A topographic model of the bare earth – terrain relief - that can be manipulated by computer programs. The data files contain the spatial elevation data of the terrain in a digital format which usually presented as triangulated irregular network (TIN).

**GNSS: Global Navigation Satellite System.** A satellite navigation system with global coverage. In this report, GNSS usually refers to survey equipment that is able to receive and triangulate position using signals from one or many GNSSs, including the U.S. Global Positioning System (GPS).

**GPR: Ground Penetrating Radar.** Device that uses radar pulses to image the makeup of what lies under the physical surface of a road or unfinished surface.

**GPS: Global Positioning System.** A satellite navigation system maintained by the United States Air Force Space Command.

**ISO: International Organization for Standardization.** A non-governmental international organization that researches and develops standards.

**IRI: International Roughness Index.** A mathematical property of any road profile obtained by a valid method. Units are in in/mi or m/km, and is an indication of the smoothness of a road; the lower the value, the smoother the road.

**Lidar: (Portmanteau of “light” and “radar”).** Remote sensing technology that measures distance and other information by recording information about laser reflections. Typically, lidar machines consist of rapidly pulsing lasers that are capable of taking millions of measurements in a short time. Information that can be gathered by such devices includes x,y,z coordinates of objects that the laser strikes and intensity of the returned beam. Commonly, a camera captures simultaneous images to extract RGB color of the remote object as well and assign it to the point.

**RTS: Robotic Total Station.** A Total Station survey tool that automatically tracks the prism and can be operated by a single person, controlling the instrument remotely.

**STIP: Statewide Transportation Improvement Program.** A list of all projects, or project phases, proposed for federal funding.

**XML: Extensible Markup Language.** A text-based, human-readable and machine-readable structured data schema.

## 2. BACKGROUND

Prior to selecting case studies, a focused literature search gained insight into the most current and best practices employed for utilizing 3D design data in construction, both domestically and internationally. The literature search concluded that the highway industry continues to evolve toward a new paradigm in which 3D digital design data is an essential source of highway-project information for the construction phase and beyond. While barriers remain on the road to maturity and widespread adoption, many uses of 3D digital design data in highway construction were identified. (5), (6), (7), (8)

Tellingly, 3D data was found to be most widely implemented among contractors in the highways construction industry. (6) This high rate of adoption and increasing sophistication of 3D-related workflows (most notably AMG) in a notably competitive business such as contracting is instructive. Contractors who use 3D data commonly cite more accurate estimates, better communication, higher rates of productivity, and significant safety improvements. (6) (9) Isolated return on investment studies for implementing specific AMG systems are presented from the perspective of the vendor or contractor. (10) The cost of 3D data preparation is currently being borne by contractors. (6) The extent to which it makes sense to shift all or part of that burden to the designer is being tested by this research.

Despite significant efficiencies for grade checking first reported as early as 2007 (5), adoption of 3D data by owner agencies for construction engineering and inspection has been slower, but it is an area of rapidly evolving practice. Location awareness is a fundamental need for an inspector on site; inspectors traditionally rely on stakes for orientation to the alignment and proposed grade. (11) As such, location-aware tools such as GNSS rovers and mobile devices have begun to see use among inspection staff, usually, but not always, when the contractor is using AMG systems. (11) In order for inspectors to use these tools to check tolerances, the inspector needs a reliable source of 3D data that the resident engineer is confident reflects the design intent of the contract plans. This is the same data needed by the contractor for AMG. This synergy creates the opportunity to shift the responsibility for robust 3D data creation to the designer.

Figure 1 contrasts the manpower (crew size) and time (days) taken to measure earthwork on the Parksville Bypass project in New York by the traditional cross-section level-and-tape method (estimated), with a total station (observed), and with a GNSS rover (observed). (12) The GNSS rover enabled a one-person crew to traverse the site unencumbered, collecting data and processing it on the data collector to compute volumes. Other observed benefits included the inspector adopting a more upright body position and a wider field of view when exposed to construction equipment movements. (12)

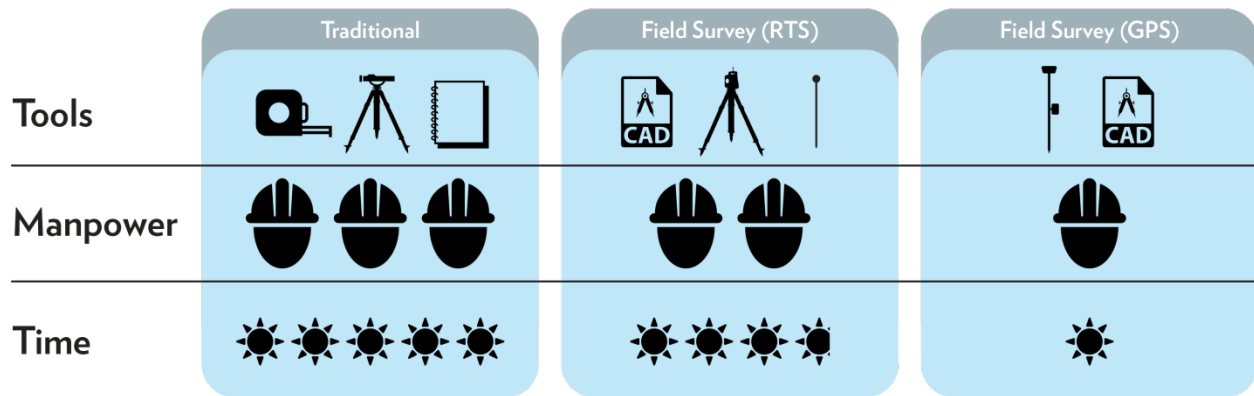

= 1 person    = 1 working day per crew

**Figure 1: Illustration. Contrast of crew size and time taken to measure earthwork. (12)**

The majority of the data used to measure pay quantities on the Parkville Bypass project was not design data, but rather as-built data collected in construction. Nevertheless, some of the largest time savings (shown relatively in Figure 2) measured on the Parkville Bypass project were for measuring pay quantities. (12)

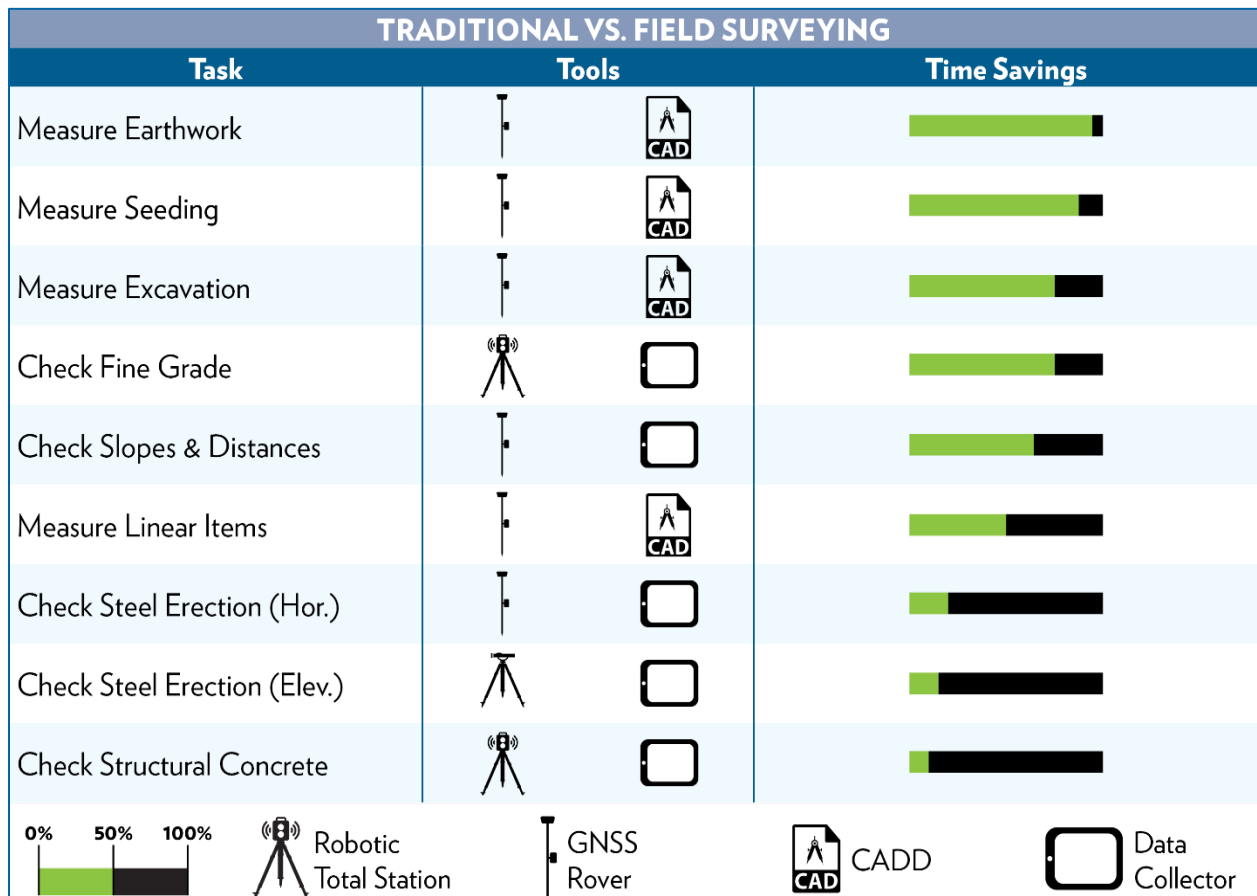

**Figure 2: Illustration. Estimated inspection time savings on the Parkville Bypass. (12)**

The adoption of 3D data as a vehicle for project information is hindered in several ways. CADD standards differ widely from state to state, many of which have implemented formal or informal policies for providing 3D design data to contractors with a statement disclaiming liability for the use of that data. The ability to produce and utilize 3D data in design and construction workflows requires a new skill set atypical of the personnel charged with its implementation. Legal uncertainty and the shortcomings associated with data interchange formats are other hindrances. Other perceived challenges noted by participants in an EDC-3 webinar in September 2015 (13) are shown in Figure 3.



**Figure 3: Chart. Continuing challenges to implementing 3D modeling. (13)**

It is becoming accepted that the barriers to the mobility of 3D design data into construction are not technological. Roads are routinely constructed using 3D data. It is a matter of risk allocation, education, standards development, and evaluation of the optimum level of investment. (6)

Legal disclaimers are not the only option for managing any liability associated with errors, omissions, and incomplete data. These three risks also apply to contract plans, and many agencies have developed specification language to manage them. (14) While 3D CADD data is incomplete and imperfect, the completeness and accuracy of the CADD design data are within the designer’s control. (8) The risks with using 3D digital design data directly in construction are a function of the uncertainty associated with the underlying survey and subsurface information. With contractors shouldering the risk for data placed on AMG systems, it is typical that contractors invest much more heavily in higher accuracy construction control, topographic survey, and utility potholing. This, too, is instructive in the mode of risk mitigation.

### **3. METHODOLOGY**

The purpose of studying real-world projects is to gather measurable information on the application of 3D data during representative construction projects. The research effort attempted to cast a wide net for potential projects from various states and to have those projects cover a wide range of project characteristics. While the focus was primarily on the case study projects and the data they provide, additional information such as general observations, lessons learned, and the perspectives of various stakeholders will also be presented. This information will aid in the creation of implementation guidelines and a repository of resources that State transportation agencies may draw upon.

#### **CASE STUDIES**

Developing case studies that provide a comprehensive view of the use of 3D digital data in highway construction was a primary objective of the research. Recognizing that a comprehensive view of 3D digital data use in construction and an emphasis on smaller, more typical construction projects were competing objectives, the research team chose to study multiple projects across several states. The research included two projects in which no 3D data was used in construction to identify project characteristics for which using 3D digital data in construction may not add value.

#### **Purpose**

The intent was to look at the use of 3D data in construction. This considered 3D data received or created between advertising and acceptance. The application of 3D data on each project provides data and examples that may be used to make value judgments about the effectiveness of the data, the workflows in which it plays a role, and the policies of the State transportation agency that govern or affect its use. Taken together, value judgments based on these case studies will help guide and promote the application of 3D digital design data for highway construction projects.

#### **Project Identification**

State transportation agencies were contacted for their interest in participating in the research and asked to provide lists of potential projects on which 3D data was used, with any accompanying datasets that the contact felt appropriate. Emphasis was placed on projects of a typical size and with AMG components, along with several other criteria related to or involved with the use of 3D digital design data. The projects identified did not have the complexity or maturity of AMG use that was known to be available. A revised strategy was to approach contractors to identify specific projects and then approach the owner agency to seek approval to study the project. All agencies contacted were agreeable and very supportive of the research objectives.

#### **Selection Criteria**

Selection criteria were developed to select the best combination of projects that comprehensively met the research objectives in terms of data applications while staying within the definition of a “typical” highway construction project. A “typical” highway project was defined as Design-Bid-

Build procurement, under \$100 million construction value (with preference on the lower category of up to \$25 million).

A Project Element Data Capture Sheet was developed for use by those solicited for potential projects. The priority elements are highlighted in bold typeface in Figure 4. Responding State transportation agencies sent this filled-out form back to the research team for entry into a larger project selection matrix.

Delivery Mode	<b>Design-Bid-Build</b> Design-Build CM/GC Other (describe below)	<input type="checkbox"/> <input type="checkbox"/> <input type="checkbox"/> <input type="checkbox"/>	3D data used in construction by	<b>Owner</b> Contractor <b>Both owner and contractor</b>	<input type="checkbox"/> <input type="checkbox"/> <input type="checkbox"/>
Contract Value	<b>&lt;\$25 million</b> <b>\$25m to \$50</b> <b>\$50m to \$100</b> \$100m to \$250m \$250m to \$500m >\$500 million	<input type="checkbox"/> <input type="checkbox"/> <input type="checkbox"/> <input type="checkbox"/> <input type="checkbox"/> <input type="checkbox"/>	Origin of 3D data used in construction	<b>Original Design Data</b> Recreated by Contractor Recreated by Owner	<input type="checkbox"/> <input type="checkbox"/> <input type="checkbox"/>
Project Type	New Construction <b>Rehabilitation/Reconstruction (3R)</b> Other	<input type="checkbox"/> <input type="checkbox"/> <input type="checkbox"/>	Other project elements	<b>3D means &amp; methods planning</b> 3D Models available for Bidding 3D Models for Fabrication 4D/5D Modeling <b>Bridge</b> Full-depth Recycling Intelligent Compaction <b>Model-based Earthworks Calcs</b> Subsurface Utility Engineering	<input type="checkbox"/> <input type="checkbox"/> <input type="checkbox"/> <input type="checkbox"/> <input type="checkbox"/> <input type="checkbox"/> <input type="checkbox"/> <input type="checkbox"/> <input type="checkbox"/>
AMG Elements	Excavation Grading <b>Asphalt Paving</b> <b>Concrete Paving</b> <b>Variable Depth Milling</b>	<input type="checkbox"/> <input type="checkbox"/> <input type="checkbox"/> <input type="checkbox"/> <input type="checkbox"/>	Can 3D modeling cost information be captured?	<b>Direct costs available</b> Direct and inferred costs Inferred costs only	<input type="checkbox"/> <input type="checkbox"/> <input type="checkbox"/>
Real-time Verification	by contractor <b>by owner</b>	<input type="checkbox"/> <input type="checkbox"/>	Additional Comments		
Survey Instruments for Real-time Verification	<b>GNSS Rovers</b> <b>Robotic Total Stations</b> <b>Static (tripod) LIDAR</b> Mobile LiDAR Aerial Photogrammetry	<input type="checkbox"/> <input type="checkbox"/> <input type="checkbox"/> <input type="checkbox"/> <input type="checkbox"/>	<hr/> <hr/> <hr/> <hr/> <hr/> <hr/>		

**Figure 4: Worksheet. Project characteristics for case study screening.**

The research priorities were as follows:

**Delivery Mode: Design-Bid-Build.** Most projects put out for bid by State transportation agencies are Design-Bid-Build. Design-Build is less common and in some cases not permissible by state law.

**Contract Value: <\$100 million.** Some information is already available regarding the effective use of 3D digital design data for large construction projects. The effects of scale are of interest to determine if there is a lower limit at which it becomes worth investing in 3D digital design data.

**Project Type: 3R.** Especially in these fiscally constrained times, 3R projects comprise a large proportion of State Transportation Improvement Programs (STIPs). It was therefore a priority to explore the extent to which 3D design data is applicable to this type of construction project.

**AMG Operations: Asphalt Paving, Concrete Paving, and 3D Milling.** Use of AMG for grading and excavation is a mature practice that has a relatively low investment in equipment. More sophisticated systems, such as those used for paving and milling, were of interest to explore the data requirements, costs, and value realized.

**Real Time Verification.** How inspectors execute their work when the contractor does not use stakes is of interest, specifically the equipment needs, sources of data, and opportunities to save time and improve safety when also using survey equipment to measure completed work.

**Users of 3D Data: Owners and both Owner and Contractor.** It is accepted that contractors will use 3D data to their own advantage, but opportunities for the owner to use 3D digital design data to the owner's advantage were explored.

**Origin of 3D Data: Original Design Data.** Common practice is for contractors to create 3D models from plans. Use of the data created in design was a priority to identify and establish the exchanges and operations on that data to make it useful for executing or inspecting construction.

**Other.** Other factors included the presence of a bridge to determine the extent to which there is data integration between roadway and bridge. Soft factors also were included in the case study selection, including existing relationships with contractors and owner agencies to secure buy-in to the research and cooperation with interviews and sharing data.

## **Prioritization**

Projects were listed in a screening matrix and evaluated. Figure 5 shows the projects that were considered, with priority criteria highlighted in blue. Twenty-four projects from ten states were considered. The final selection was five projects from four agencies, and a sixth project emerged during the course of New York interviews.





## SELECTED CASE STUDY PROJECTS

This section introduces the six case study projects, which are listed in descending order of size and complexity in Table 1 and in the chapter. The projects are shown geographically in Figure 6.

**Table 1: Final Case Study Project List**

State	PIN	Project	Contract Value
New York	D260140	Southern Expressway Section 5 (US 219)	\$85,685,250.50
Virginia	0060-127-106	Route 60 Reconstruction	\$35,412,772.30
Utah	10878	I-80 Reconstruction	\$35,795,397
Missouri	4I1382-P	I-35 Unbonded Concrete Overlay	\$18,934,454.88
New York	D262079	US 17 Bridge and Safety Improvements	\$11,861,397.74
New York	D262554	US 219 Mill & Resurface	\$6,960,329.50

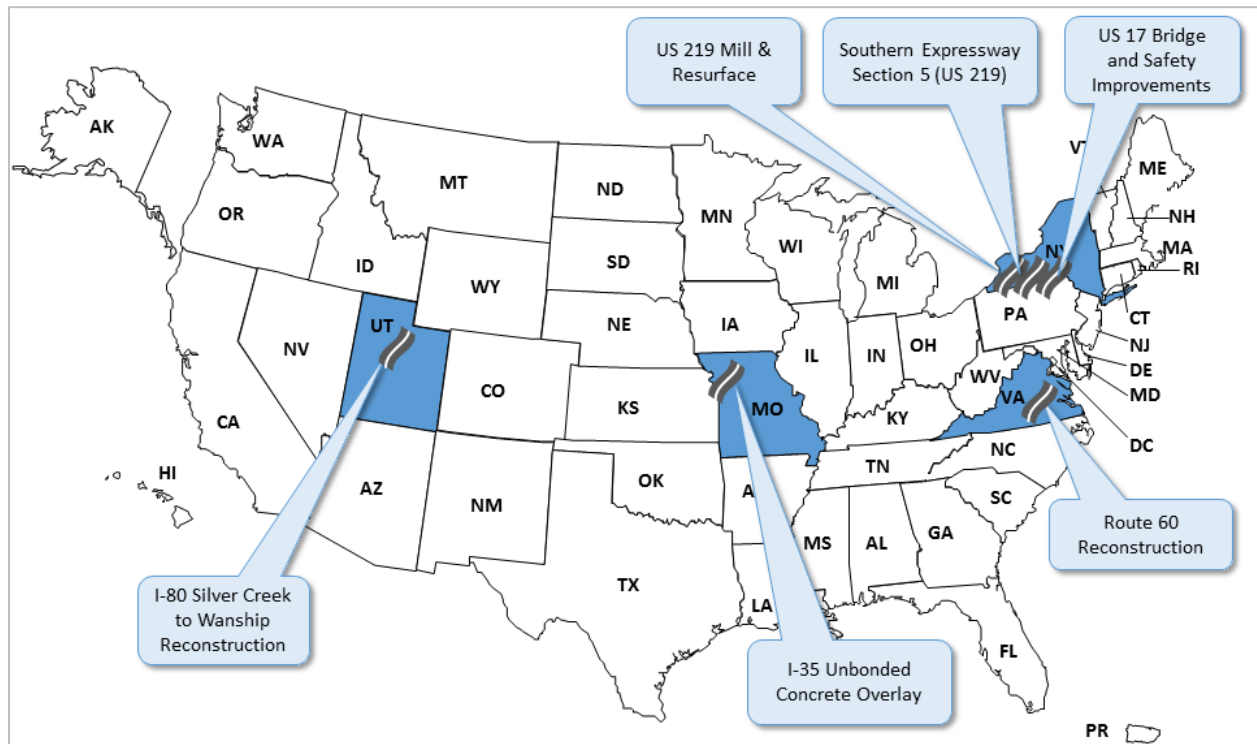

**Figure 6: Map. Selected case study project locations.**

The selected projects comprise new construction (Southern Expressway), urban reconstruction (Route 60), rural reconstruction (I-80 Silver Creek to Wanship), unbonded concrete overlay (I-35), asphalt mill-and-pave with superelevation corrections (US 17), and asphalt mill-and-pave (US 219).

## New Construction: Southern Expressway, NY

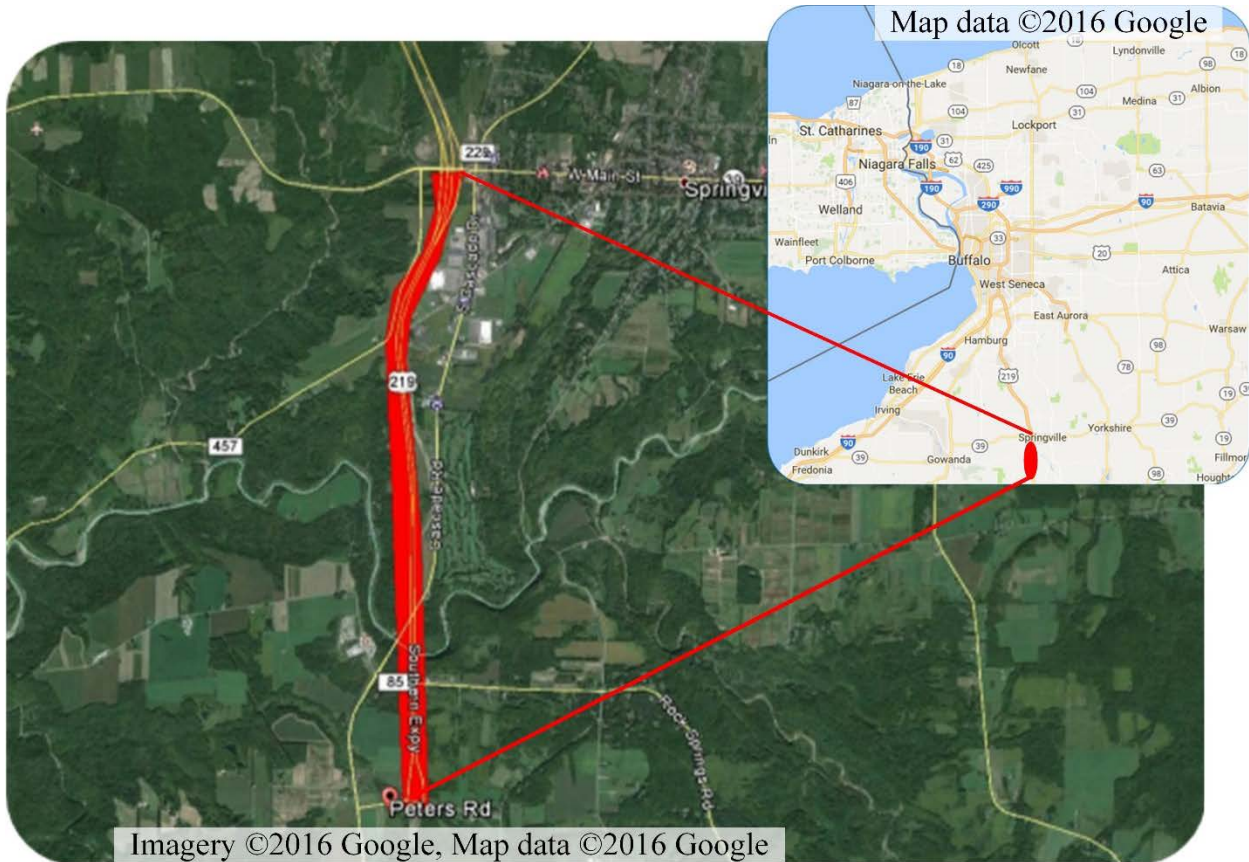

**Figure 7: Map. Location of US 219 Southern Expressway.**

Southern Expressway is located in Springville, NY, per Figure 7. It was intended to be New York State Department of Transportation’s (NYSDOT’s) first paperless project and, as a consequence, was a pilot project for real-time verification and measurement using survey instruments. It was also the first use of what became NYSDOT’s Section 625 of its current standard specifications. (15)

**Table 2: Project Information for Southern Expressway**

Category	Project Information
Owner	New York State Department of Transportation (NYSDOT)
Consultant CE&I	WSP   Parsons Brinckerhoff
Contractor	Cold Spring Construction
PIN	D260140
Contract Value	\$85,685,250.50 (final: \$129 million)
Major Activities	New construction of a divided two-lane highway with nine bridges
Length of Paving	4.9 miles
3D Data Uses	Real-time verification, grading, concrete paving



## Urban Reconstruction: Route 60, Midlothian, VA

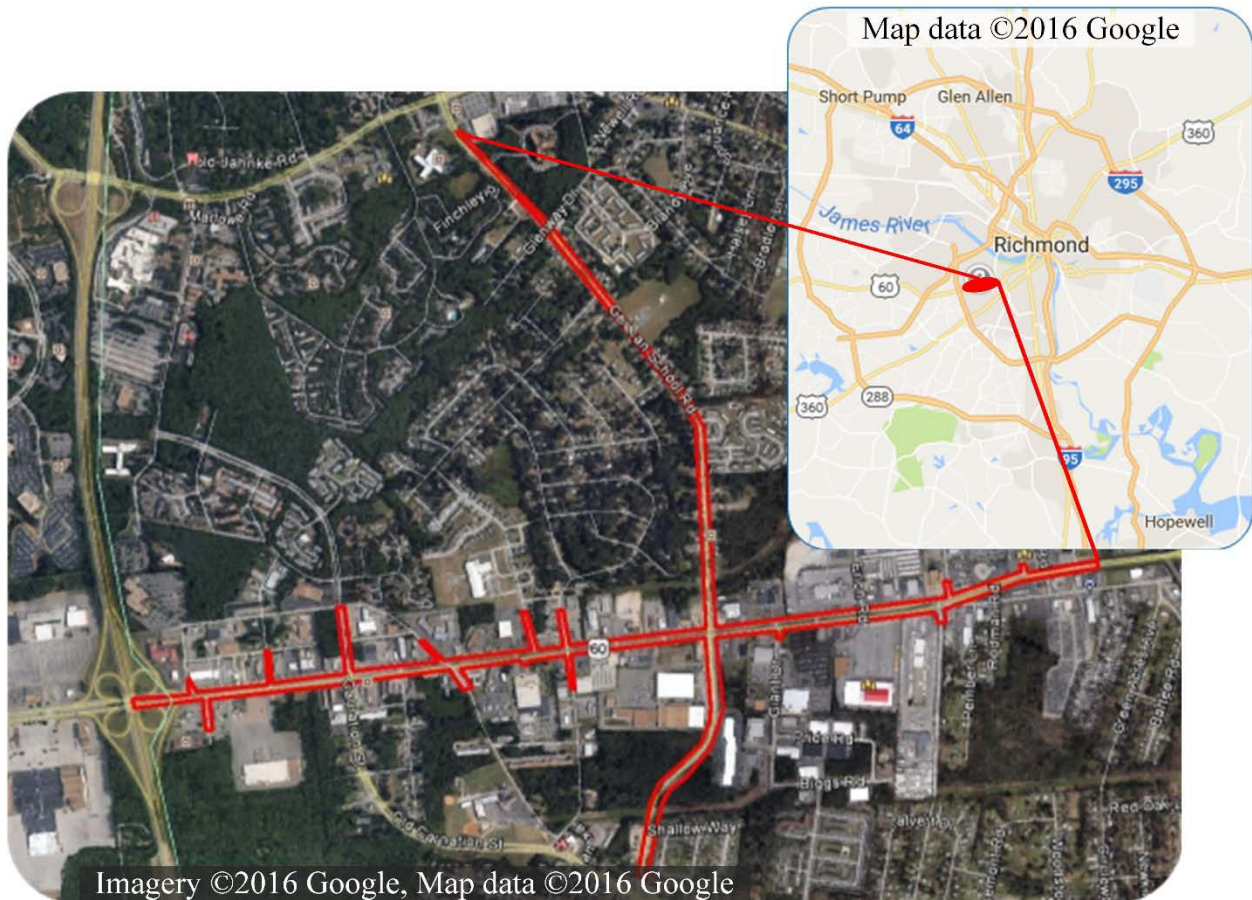

**Figure 8: Map. Location of Route 60 Reconstruction.**

This project is known colloquially as the Route 60 Reconstruction project, but it was two projects designed separately that meet at the intersection of Route 60 and German School Road, shown in Figure 8. The latter was reconstructed, while the former was largely a resurfacing project with drainage improvements, including setting curbs and gutters. Issues with curb elevations not meeting roadway elevations led to a stop work order. The resolution involved high-accuracy lidar survey, 3D modeling, and 3D milling. The job restarted within three weeks.

**Table 3: Project information for Route 60 Reconstruction**

Category	Project Information
Owner	Virginia Department of Transportation (VDOT)
Consultant E&I	RK&K
Contractors	American Infrastructure (Prime), Flora & Associates (survey and 3D data preparation subcontractor), Certainty 3D (survey subcontractor)
Project ID #	0060-127-106
Contract Value	\$35,412,772.30 (bid), \$45,363,769.03 (final)
Major Activities	Reconstruction, mill & pave, utility relocation, drainage improvements
Length of Paving	2.5 miles
3D Data Uses	Layout, grading, 3D profile milling, constructability review

## Rural Reconstruction: I-80, Silver Creek to Wanship, UT

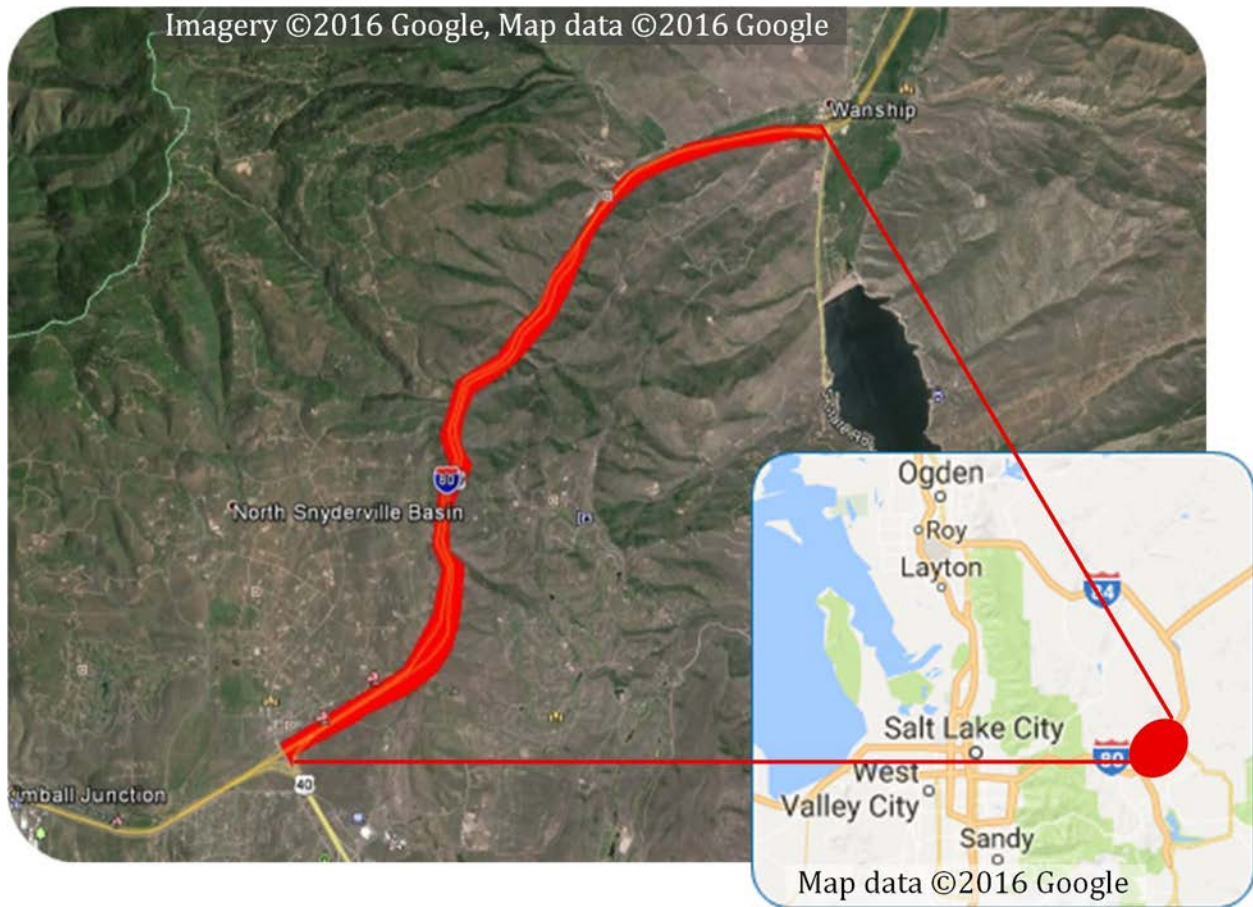

**Figure 9: Map. Location of I-80 Silver Creek to Wanship.**

The section of I-80 shown in red in Figure 9 was constructed during two construction seasons, with the eastbound reconstructed in 2014 and the westbound reconstructed in 2015. A bridge was replaced in the westbound section. 3D milling and grading were used on the Cement-Treated Asphalt Base (CTAB) on both sections; however, 3D paving was also used on the westbound section. This project provides an opportunity for direct comparison of wired and wireless paving with similar technical challenges.

**Table 4: Project information for I-80 Silver Creek to Wanship**

Category	Project Information
Owner	Utah Department of Transportation (UDOT)
Contractor	Geneva Rock Products
PIN	10878
Contract Value	\$35,795,397 (final payment \$33,591,502)
Major Activities	3D asphalt milling, CTAB, concrete paving, bridge replacement
Length of Paving	14 miles
3D Data Uses	3D profile milling, RTS on motor graders and concrete paver



## Unbonded Concrete Overlay: I-35, MO

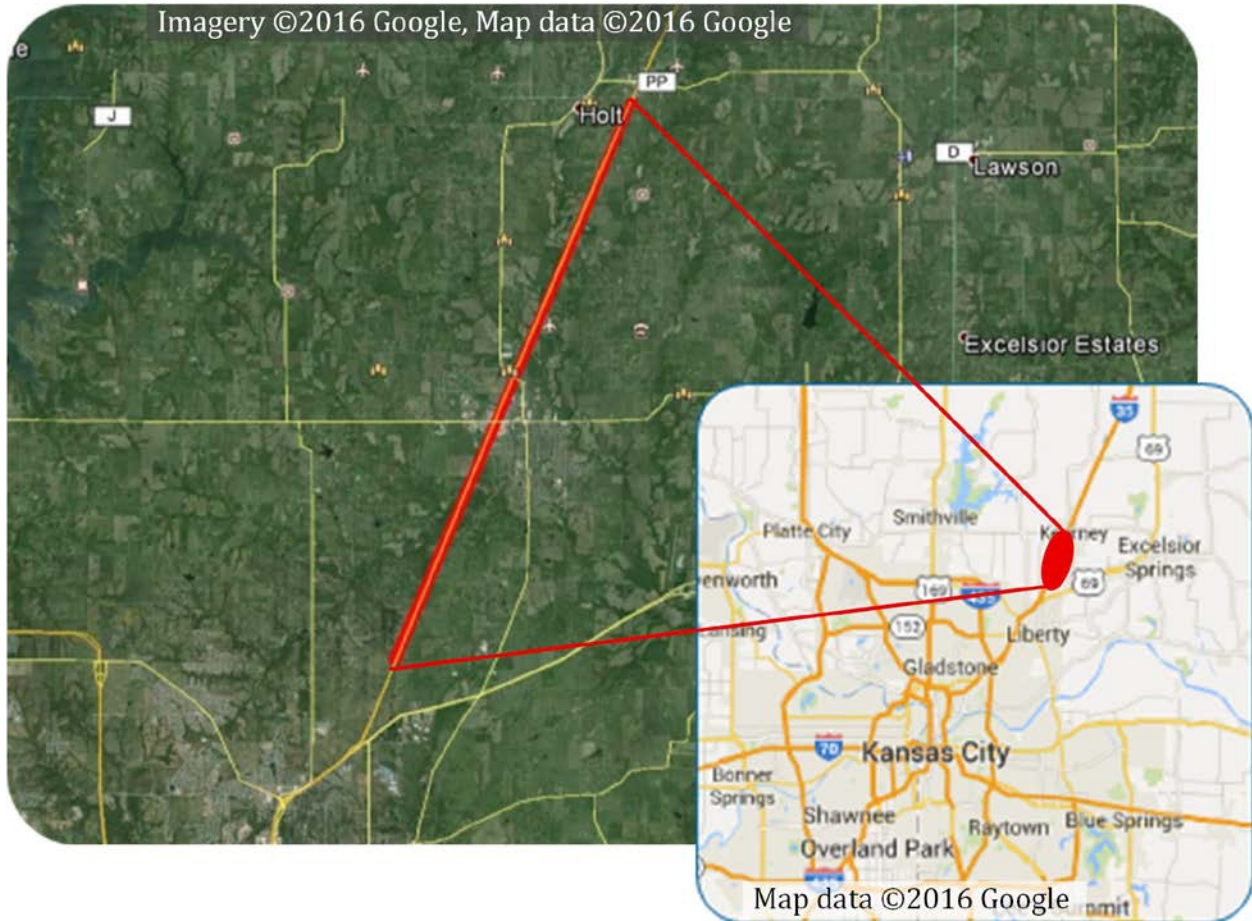

**Figure 10: Map. Location of I-35 Unbonded Concrete Overlay.**

The original portion of I-35 shown in red in Figure 10 was a concrete road that had been overlaid with asphalt. This project was to remove the asphalt and optimize the profile for yield, geometrics, and smoothness while adding an 8-inch unbonded concrete overlay. It was a pilot project for Missouri Department of Transportation (MoDOT) looking at the potential of a risk-balanced bid item structure that incentivized the outcomes MoDOT desired.

**Table 5: Project Information for I-35 Unbonded Concrete Overlay**

Category	Project Information
Owner	Missouri Department of Transportation (MoDOT)
Contractors	Ideker, Inc. (prime), Applied Construction Technology (data preparation), Laser Specialists (survey and AMG support)
PIN	4I1382
Contract Value	\$18,934,454.88
Major Activities	Milling and unbonded concrete overlay
Length of Paving	16 lane-miles (8.3 centerline miles)
3D Data Uses	3D milling, 3D concrete paving

## Bridge and Safety Improvements: US 17, NY

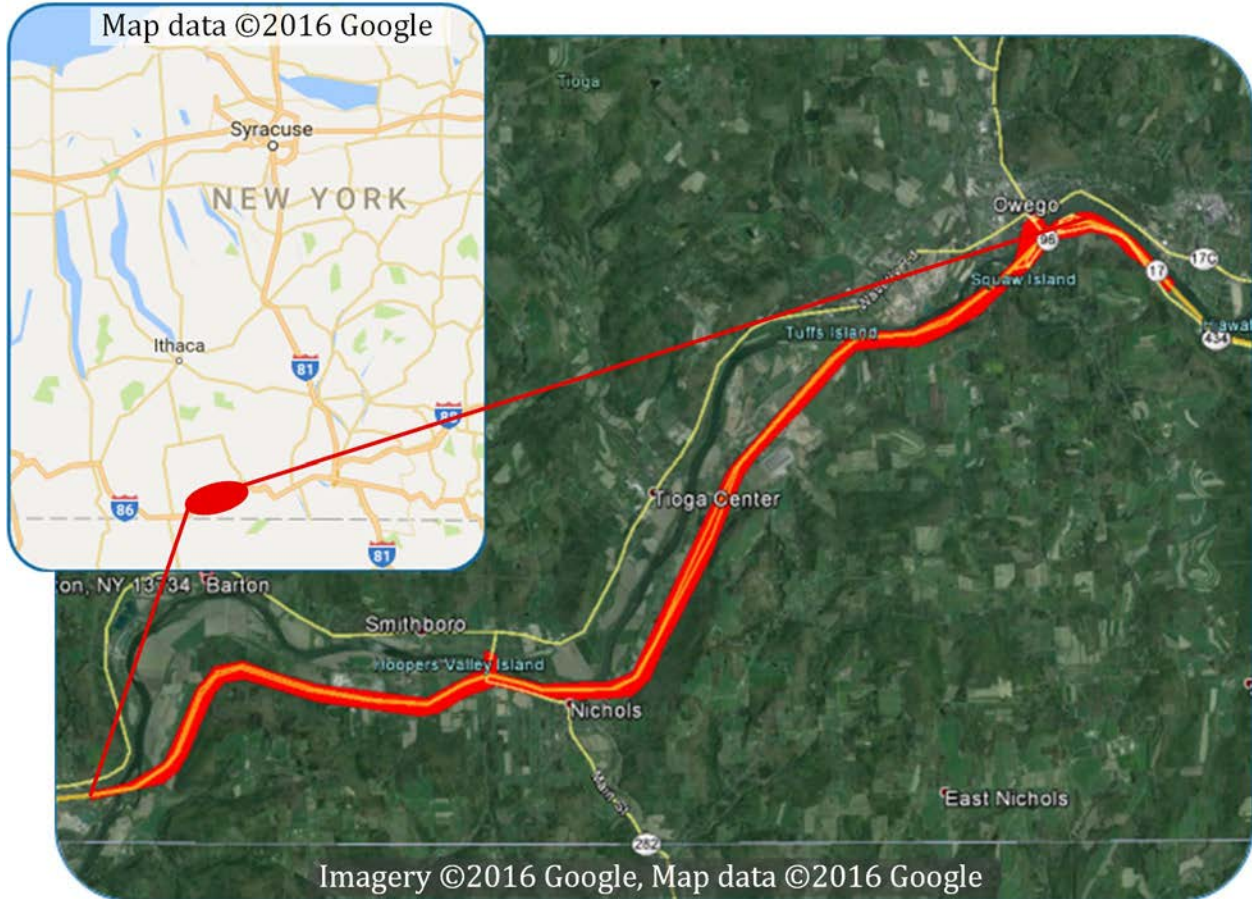

**Figure 11: Map. Location of US 17 Bridge and Safety Improvements.**

This project, shown in red in Figure 11, made use of 3D design, but the design files were not delivered to the contractor. The contractor attempted to use 3D data. However, issues arose after equipment was mobilized that precluded further 3D efforts. This project explores the costs that would have accrued to the contractor if 3D milling was used to execute the superelevation corrections and why the problems were larger than those just related to 3D digital design data.

**Table 6: Project information for US 17 Bridge and Safety Improvements**

Category	Project Information
Owner	New York State Department of Transportation (NYSDOT)
Contractor	Cold Spring Construction
PIN	D262079
Contract Value	\$11,861,397.74
Major Activities	Milling and paving to effect superelevation corrections
Length of Paving	Sporadic, limited to ramps and curves
3D Data Uses	3D design



## Mill and Overlay: US 219, Concord, NY

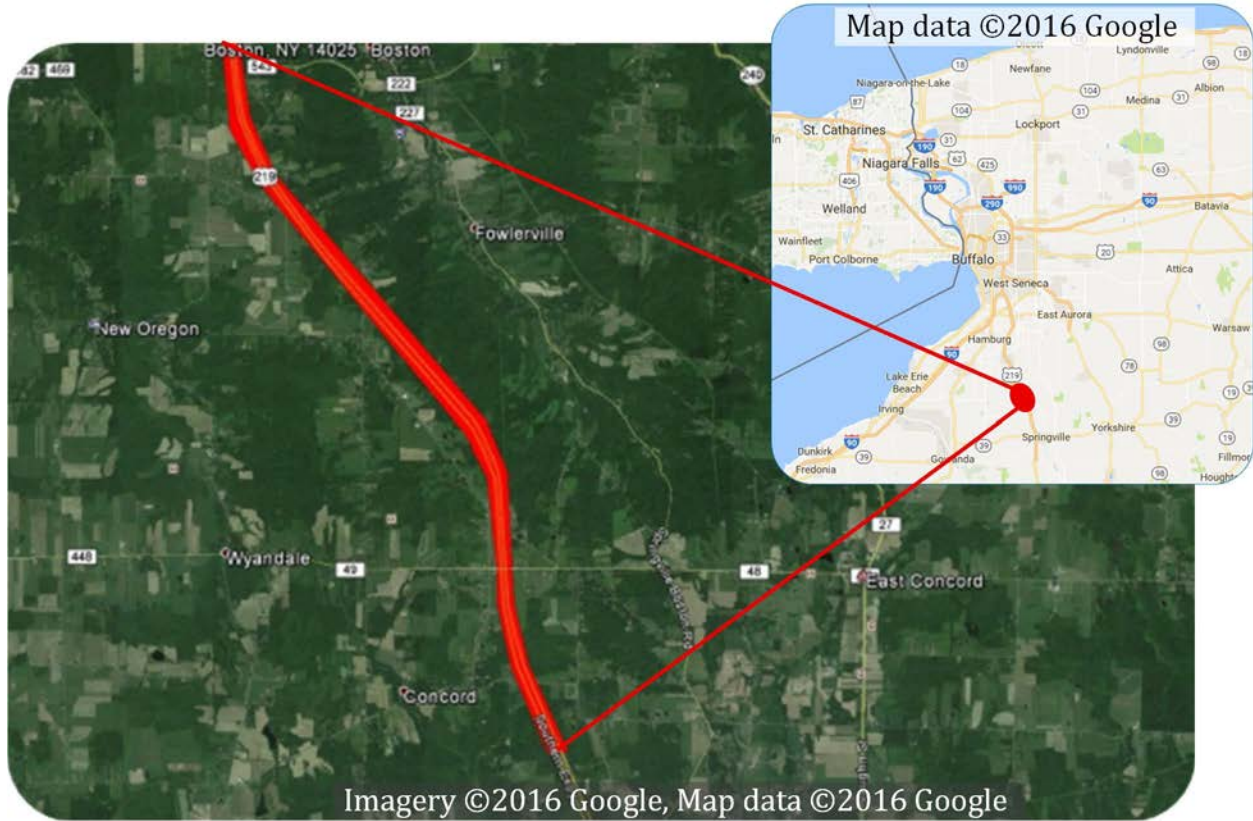

**Figure 12: Map. Location of US 219 Mill and Overlay.**

This project, shown in red in Figure 12, did not make use of 3D digital design data, neither in design nor in construction. It is selected to illustrate a situation in which 3D digital design data is not warranted. This project made use of sonic averaging skis on the mill and paver, which collects depth information to adjust the mill or paver in real-time. Good outcomes were achieved without any investment in survey, design, 3D data prep, or positioning equipment, and the crew to run the positioning equipment.

**Table 7: Project information for US 219 Mill and Overlay**

Category	Project Information
Owner	New York State Department of Transportation (NYSDOT)
Contractor	Cold Spring Construction
PIN	D262554
Contract Value	\$6,960,329.5
Major Activities	Mill and pave
Length of Paving	13.4 miles
3D Data Uses	None



## **INTERVIEWS**

Interviews were held with stakeholders using 3D digital design data for each state. The goal was to document the elements and project characteristics that led to the success (or failure) of the use of 3D data. This includes documenting any missed opportunities where 3D data could have been beneficial but was unavailable. The interviews occurred between April and July of 2015.

Interviewees included surveyors, designers, construction data preparers, contractors, inspectors, resident engineers, and other design and construction professionals. Each interview was intended to obtain information regarding how and what 3D digital design data was used, processes and policies that support or constrain its use, practices for data exchange, project characteristics, and circumstances that led to the use of 3D digital design data. General observations and lessons learned from other experiences were also solicited.

Follow-up activities sourced documentation and sample datasets to substantiate the information provided in the interviews. Other sources of project-related data included desktop searches for information from the STIP, project awards, and conference proceedings about the projects. Information about some projects was more accessible than others, leading to a more comprehensive dataset.

### **Structure**

The interviews were organized into smaller groups of interviewees to constrain the discussion to topics concerning the information being sought, but they were *not* supposed to be a rigid question and answer format. Instead, they were intended to be open-ended discussions that would facilitate the discovery of information regarding the 3D digital design data used in construction.

The format of each interview was an in-person, sit-down meeting, which would take place at a location convenient for the interviewees. For each state in which a case study project occurred, at least one interview would be held with a key member of the owning State Transportation Department. At least one interview would be held with the contractor or contractor's data preparation consultant for each project.

The interviews began with a description of the research objectives, a summary of information gathered to date, and a definition of terms. Interviewees were then asked to provide the information that they felt best aided the research objectives.

A sample of the interview discussion topics is presented in Table 8 and Table 9. The topics were selected to gather across all interviews a broad range of policies, processes, data uses, and data characteristics, as well as mechanisms for and challenges to data integration. Table 8 identifies policies and processes that governed 3D digital design data across project phases from pre-construction through post-construction. In this case, post-construction includes the quality assurance reviews and payment quantity measurements of the owner's representative.

**Table 8: Interview Topics for Processes, Policies, and Data Integration**

<b>Phase</b>	<b>Policies and Processes</b>	<b>Data Integration</b>
Pre-construction	Policy instruments (e.g., manuals, guidelines, standards) Original survey mapping standards Design and CADD standards Design deliverables and bid documents Policies for providing 3D data at bid Contractor practices for estimating	Data types for integration Proprietary and open data schemas Data exchange practices Data reviews and quality control Limitations and opportunities Risks and impacts of data quality
Construction	Policy instruments (e.g., manuals, guidelines, specifications) Policies for providing 3D data post-award Role of designer and surveyor during construction Contractor practices for layout and AMG Contractor practices for data review Policies for providing equipment and training Responsibilities for checking layout and tolerances	Data types for integration Proprietary and open data schemas Data exchange practices Data reviews and quality control Limitations and opportunities Risks and threats to data quality
Post-Construction	Policy instruments (e.g., manuals, guidelines, specifications) Acceptance criteria Policies for computing pay quantities Policies for as-built documentation Manuals and standards for 3D data Systems to receive and manage as-built information	Data types for integration Proprietary and open data schemas Data exchange practices Data reviews and quality control Limitations and opportunities Risks and impacts of data quality

Table 9 identifies data specifications and data uses for various types of 3D digital data. The data types are survey data, design data, construction data, and post-construction data. Here, construction data refers to the data used by the contractor to execute construction, while post-construction data refers to the data used by the owner’s representative for quality assurance reviews and payment quantity measurements.

**Table 9: Interview Topics for Data Specifications and Data Uses**

<b>Phase</b>	<b>Data Specifications</b>	<b>Data Uses</b>
Survey Data	Control accuracies Topographic mapping accuracies Topographic mapping densities Topographic mapping products Software tools and data schemas Documentation of metadata and methods	Design development and documentation Estimating and bid preparation Construction means and methods planning Construction layout and AMG Real-time verification and measurement
Design Data	Standard naming conventions Data types created by project type Data densities for 3D line strings and surfaces Software tools and data schemas Documentation of metadata and methods	Design development and documentation Estimating and bid preparation Construction means and methods planning Construction layout and AMG Real-time verification and measurement
Construction Data	Standard naming conventions Data types created by construction activity Data densities for 3D line strings and surfaces Software tools and data schemas Documentation of metadata and methods	Construction means and methods planning Construction layout and AMG Real-time verification and measurement
Post-Construction Data	Standard naming conventions Data types created by activity Data densities for 3D line strings and surfaces Software tools and data schemas Documentation of metadata and methods	As-built documentation Real-time verification and measurement

**Interviews conducted**

Interviews were conducted in New York, Virginia, Missouri, and Utah. The New York interviews were conducted in the Albany, Buffalo, and New York City areas. The latter afforded the opportunity to meet at the Kosciuszko Bridge project and collect information on the use of 4D and 5D models for monitoring construction progress and payments. In addition to the interviews, the research team visited the site of the US 219 Mill & Pave and US 219 Southern Expressway projects on May 21, 2015, and the Kosciuszko Bridge project on June 5, 2015.

Virginia interviews were conducted in Richmond and Glens. After the third interview, a brief visit was made to the project location. The Missouri interview was held in Lenexa, KS, in the greater Kansas City area. Only one interview was held for this project and it involved all affected stakeholders. It was not possible to visit this project location, but photographs were provided.

Four interviews were held in Utah over two days. The second day included a visit to the I-80 Silver Creek to Wanship site and a site visit by two software vendors that provided an opportunity to discuss data integration and accessibility.

### **Data collection**

Following a thorough review of the notes and correspondence between the research team and interviewees, follow-up data collection was initiated to gain additional qualitative and quantitative data for the case study projects. Desktop research was also conducted to assimilate information about the projects, including records from the STIP and past presentations or awards from the projects.

It was a significant challenge to collect follow-up data to verify and expand on the information provided in interviews. One of the factors was that interviews were conducted during the construction season and there was limited time available to the interviewees to track down information and share it. Another issue was that all the projects studied except for one were complete and their records had been archived.

A lack of digital construction records was a major constraint. Where digital records were available, these were much easier to access. The digital records included the following:

- Site Manager bid and final quantities from Virginia
- 3D digital data from Virginia and Utah
- Publically available bid records and cost summaries from New York and Utah

Timely collection of information from the I-80 Silver Creek to Wanship project was also challenging, in part because construction needed to conclude before complete datasets were available to compare yields, depths, and smoothness from the concrete paving on the westbound (wireless) and eastbound (wired) paving.

## 4. CASE STUDIES

This chapter provides a narrative of the characteristics of each project studied and the way that 3D digital design data was used in construction. Subsections provide specifics of the 3D digital design data as it was created or used for Information Modeling, Surveying, Data Management, Real-time Verification, and Post-Construction Survey, as applicable to each project. An additional subsection for Technology Impacts examines the challenges, benefits, opportunities, and costs to the extent that this information was available. The type, quantity, and availability of data were not uniform for all projects; therefore, each case study may not include all of the following elements:

**“Information Modeling”** sections address the processes and policies related to the use of data, as well as the characteristics and sources of 3D digital design data used in construction.

**“Surveying”** sections address processes and policies related to the collection and use of survey data, including the roles, responsibilities, and timing of data collection, as well as the characteristics and sources of survey data used in construction.

**“Data Management”** sections describe the specifics of data exchange, as well as the policies and procedures that supported or constrained how and when data was passed between stakeholders.

**“Real-time Verification and Post-Construction Survey”** sections address roles and responsibilities for post-construction survey data collection, as well as the policies and procedures that supported or constrained the direct use of post-construction survey data for acceptance and measurement. It also describes the practices developed for using survey instruments to check tolerances and measure quantities, as well as to manage and store that data in compliance with the specification and other policies.

**“Technology Impacts”** sections address the benefits, costs, and other outcomes from using 3D digital design data during construction.

## SOUTHERN EXPRESSWAY

Route 219, when complete, will extend from West Seneca, NY to Rich Creek, VA. The section of the highway under contract D260140 was titled “Section 5.” It spanned 4.2 miles between Route 39 in Springville, NY and Peters Road in Ashford, NY. The original scope of D260140 was for new earthwork and pavement and 11 new structures—two of which were 705-foot steel arch spans over Cattaraugus Creek—and offsite environmental mitigation.

**Table 10: Southern Expressway Project Characteristics**

Characteristic	Project Information
AMG Elements	Excavation, rough grading, fine grading, and concrete paving
Real-time Verification	Used by contractor and owner Used GNSS rovers and robotic total stations
3D Data Users	Contractor and owner
3D Data Origin	Original design data Re-created by contractor Collected by inspectors
Other Project Elements	Inclusion of bridges Model-based earthwork calculations Real-time verification for checking tolerances Post-construction survey data for measurement

A landslide occurred during embankment construction in June 2007. The slope was unloaded and the profile lowered, which eliminated two bridges. Figure 13 is a photograph looking north through the landslide area. The change order was approximately \$40 million.



**Figure 13: Photo. Looking north through the landslide area.**

Cold Spring Construction, the prime contractor, used a number of 3D data technologies for various portions of this project, especially AMG for earthwork, base preparation, and concrete paving. However, the most significant feature of this project for this research is that it was NYSDOT's first project to use GPS rovers and 3D data for construction engineering and inspection. The project was intended to be a paperless construction management pilot utilizing a variety of software and mobile hardware. The project was the pilot for what became Section 625 of the NYSDOT standard specifications. (15)

### Information Modeling

NYSDOT does not have statewide policies and standards in 3D modeling, but is working toward a vision for Civil Integrated Management (CIM). At the time of the project, NYSDOT used Bentley InRoads SS2 for in-house design and had requirements for delivering MicroStation-format and paper plans. The use of InRoads was not standardized for design development and it was left to the project manager's discretion in regard to how the tool was used to develop plans and estimates. The project manager, at their discretion, provides 3D design data in InRoads format (ALG, DGN, DTM, XIN) for reference information at advertising.

With aspirations for paperless construction management, NYSDOT wished to use the 3D digital design data directly in construction. The designer and contractor both supported this intent. The 3D design data was provided for reference information only to both the contractor and the construction management team. It was the Resident Engineer-in-Charge's responsibility to review and accept the 3D data used by the inspectors as representative of the design intent of the contract plans. The contractor also had a responsibility to ensure that the data used for AMG construction was representative of the design intent of the contract plans. Figure 14 and Figure 15 respectively show the contract plans and contractor's 3D model for the Hinman Wetlands.

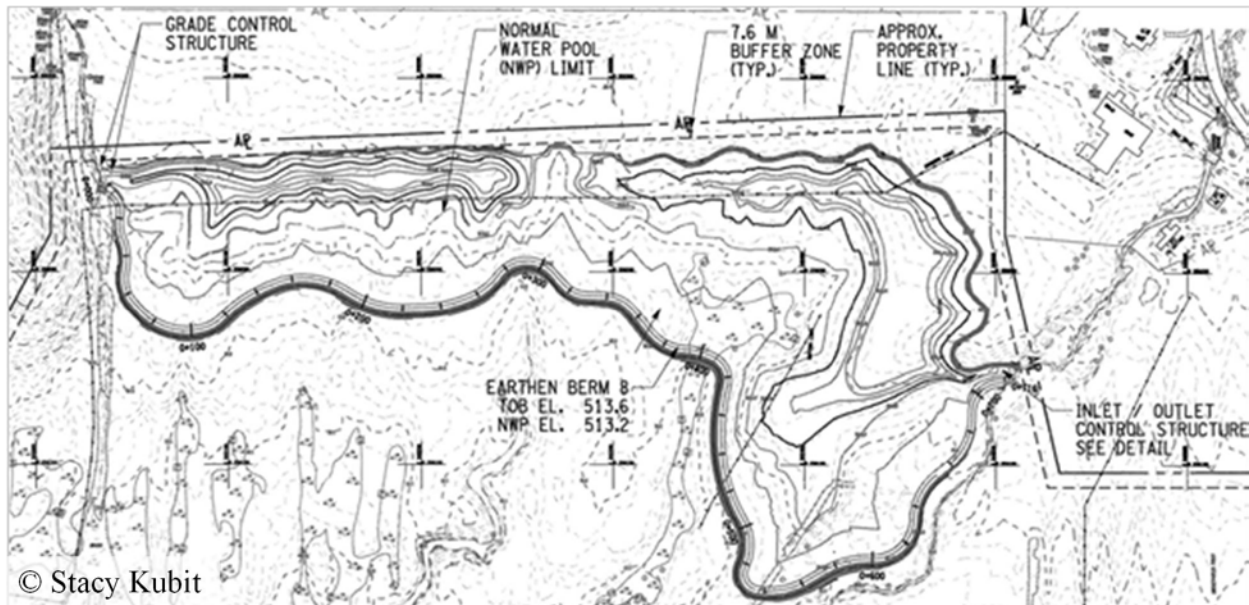

**Figure 14: Illustration. Hinman Wetlands design plans.**

Post-award, the contractor's 3D modeler spent one week with NYSDOT's designer in an attempt to develop the design models to the level necessary for AMG construction. Ultimately, this was

not successful, and the contractor's 3D modeler spent six weeks creating 3D models from the contract plans using Terramodel<sup>®</sup> software. Figure 15 shows the contractor's Hinman Wetlands model. A challenge to using the original design data was that the design model was only a tool to create cross-sections. Subsequent design revisions were not migrated to the 3D model. The contractor also modeled construction activities that were not typically reflected in the plans or design model, such as interim surfaces and excavation surfaces for bridge foundations. The contractor's models were then delivered to the Engineer-in-Charge to review and use.

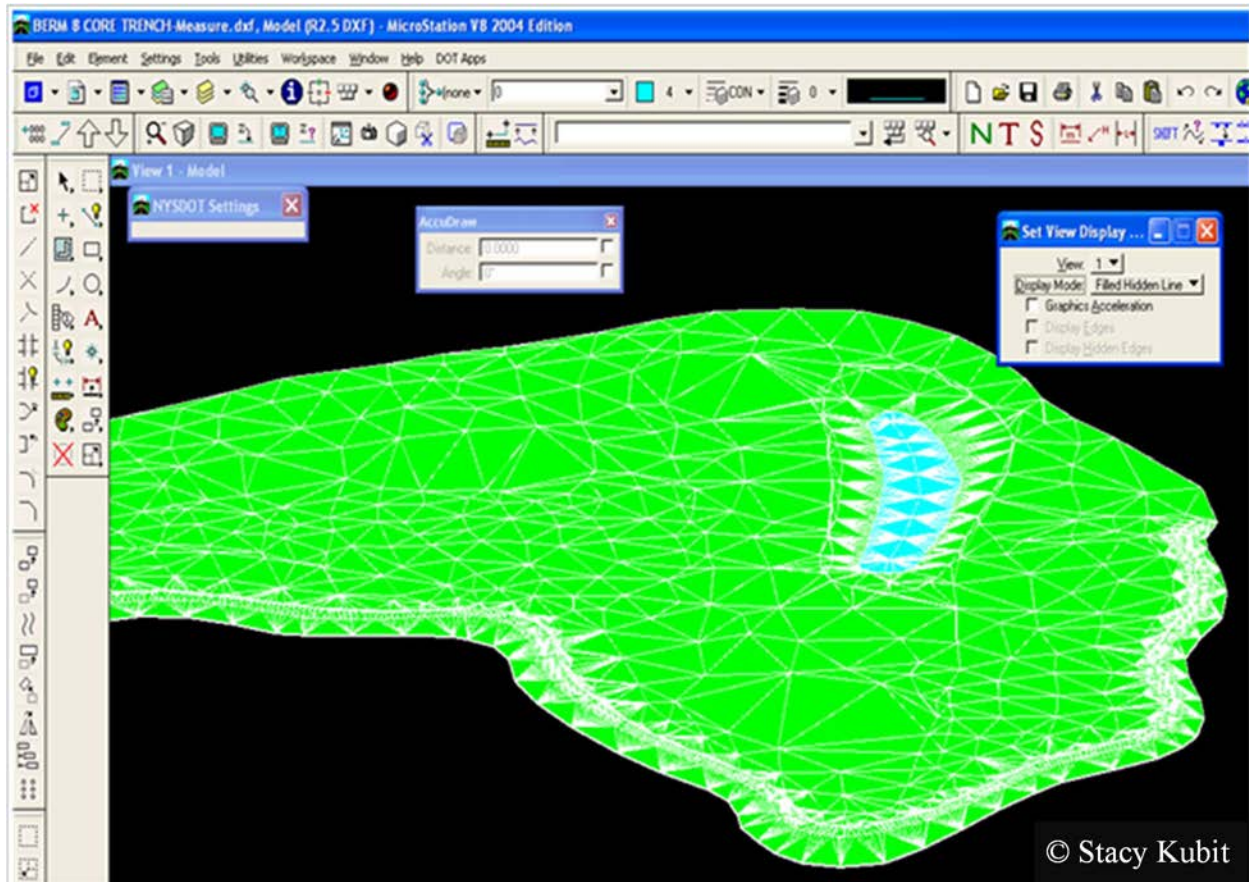

**Figure 15: Screenshot. Review of contractor's surface for Hinman Wetlands.**

The inspection team included a Resident Engineer-in-Charge, an Office Engineer, and five inspectors. The Office Engineer had prior InRoads experience and was comfortable manipulating and interpreting 3D CADD data. The office engineer and some of the inspectors were consultant inspectors who had hardware and software resources available from their employer in addition to those provided by NYSDOT and the contractor via the specification. InRoads software was available on the NYSDOT-provided computer. However, the contractor was not using InRoads software, so to avoid having to translate the data, the contractor provided a workstation and software for the Office Engineer's use to review the contractor's native files. This saved time and mitigated the risk of data corruption during data exchange. Figure 16 shows the Hinman Wetlands data used by the inspectors.



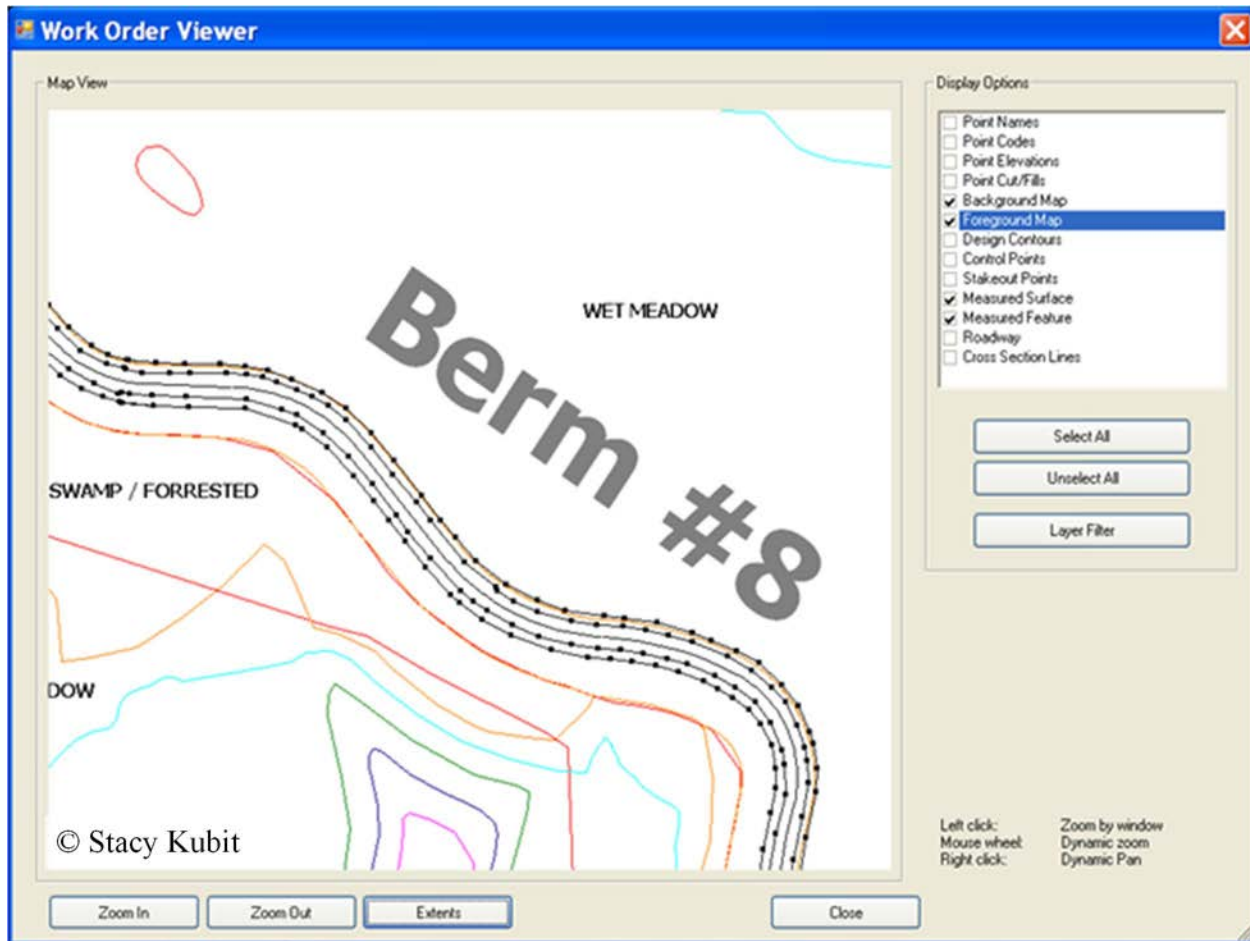

**Figure 16: Screenshot. Hinman Wetlands Berm #8 for inspector's data collector.**

The Office Engineer was responsible for checking and processing construction payments. Thus the Office Engineer was responsible for reviewing and managing the 3D digital data used to compute these quantities. This included checking the base surfaces used for earthwork computations. As the individual with the most skill and experience manipulating and creating 3D CADD data, the Office Engineer became the person responsible for reviewing all 3D digital data, including the original design data and the contractor's models. The Office Engineer developed processes for the inspectors to collect post-construction survey data, compute quantities, and manage and store that data. NYSDOT's Design, Survey, and CADD Manuals were used as much as possible for data management.

After the landslide, topographic information was collected that verified and documented the extent of the landslide, and this data was used to estimate quantities and plan the approach to unloading the slope. Post-construction survey data was collected and used to develop designs for other construction issues, including documenting crack locations in the concrete paving after the subgrade heaved over the winter. The data collected for inspection was useful because the inspectors and Office Engineer had followed NYSDOT existing standards.

The landslide was not the only source of field changes and design changes that involved a Request for Information (RFI) or Change Order. The Office Engineer followed existing policies for Field Changes, RFIs, and Change Orders to determine which could be modeled either by the Office Engineer or the contractor's 3D modeler, and which had to involve NYSDOT's designer. Field changes were required to be documented in Field Change Sheets, so modeling the changes in the field office did not add work. The models, which had been developed using NYSDOT CADD standards, were used to create the Field Change Sheets. Using existing NYSDOT Design, CADD, and Survey Manuals for 3D Data meant that data collected for construction management could be used to develop design changes.

## Surveying

This project involved new construction through a heavily wooded area. There was also an access road to the foundation construction for the two parallel arch bridges over Cattaraugus Creek at the base of a gorge, shown in Figure 17. Offsite mitigation work at the Hinman Wetlands also involved significant earthwork construction.



**Figure 17: Photo. The project had challenging terrain and heavy woods.**

The survey data was collected using photogrammetry and processed using InRoads. NYSDOT requires the design project manager to visually review survey triangulation in the DTM, but the data points are assumed to be accurate and the designer does not have the equipment or time to check the accuracy of the data points. The dense woods, shown in Figure 18, were a limiting factor on the accuracy of the photogrammetry.



**Figure 18: Photo. The original ground was covered by heavy woods.**

Inspectors verified the original ground survey data prior to construction because the original ground surface would be used to compute earthwork quantities. The inspectors collected new survey data to use instead in construction so that the pay quantities would be accurate.

Verifying the original ground was a good training exercise for the inspectors, who were new to the GPS equipment and would need topographic survey skills for collecting routine topographic survey data to compute interim and final earthwork quantities.

### **Data Management**

The Field Automated Communication System (FACS) was the document management system used for electronic construction administration submissions. Inspectors used Toughbooks to enter electronic daily Inspection Reports (IRs). NYSDOT now uses ProjectWise as a document management system for both design and construction. The Toughbooks with FACS included all contract documents, such as plans and specifications, proposal, critical path method schedule, quantity estimates, project safety plan, and standard drawings, as well as reference documents such as standard details and NYSDOT construction manuals. Without the FACS Toughbooks, the average inspector would have carried the eight proposal books, project plans, reference documents, and a clipboard to hold the paper Daily Work Reports to record the information.

Initially, the electronic system made review, edits, and approvals a painful process, creating resistance to using FACS. Inspectors embraced the system after about a year when they realized they could copy a previous day's IR and edit it instead of starting over every day.



Inspectors were also supplied with a Toughbook containing Bentley's OnSite software. This was for use with the 3D digital design data in a familiar software environment. Inspectors had Leica 1200 GPS rovers that were carried either with a backpack setup with multiple cables or with everything mounted on the pole. Inspectors were provided a bracket to mount the OnSite Toughbooks to free up their hands. Later, a Bluetooth connection was used between the rover and Toughbook to make the data collection process with Bentley OnSite easier.

The GPS rovers also came with a data collector, as shown in Figure 19. Inspectors became comfortable with the technology and began using the data collectors. This removed the need for Bentley OnSite software and its dedicated Toughbook. The contractor provided a computer with the same software products they were using for data management (i.e., Terramodel® and Trimble® SCS software). Terramodel® was the primary 3D model development and review tool, while Trimble®'s SCS software was used for migrating 3D data to and from the data collectors and AMG equipment. The Trimble® software managed field data in Work Orders.



**Figure 19: Photo. GPS rover and data collector used by inspectors.**

While existing NYSDOT standards were used as much as possible, there were no standards that could be used for back-up and archival storage. The Office Engineer bought an external hard drive to use as a back-up for all 3D digital data used in construction inspection. This was not an International Organization for Standardization (ISO)-compliant process, but there was a need to do something. Digital data was delivered on USB thumb drives alongside six filing cabinets of paper. The thumb drives likely now reside in archive storage.

### Real-time Verification and Post-Construction Survey

This project was the pilot for what became Section 625 of the standard specifications. This section modifies the construction surveying requirements when the contractor is using AMG to reduce the staking interval and requires the contractor to provide equipment for inspectors. At the time, the specification required the contractor to furnish GPS equipment for the inspectors. However, the contractor elected to provide total stations for the inspectors' use during bridge construction, concrete paving, and other operations when the GPS equipment did not have the necessary accuracy to inspect the work.

A Statewide Continuously Operating Reference Station (CORS) network, shown in Figure 20, is available to contractors, surveyors, and inspectors for Real-time Kinematic (RTK) correction. At the time, NYSDOT used Leica products in the field but processed data in InRoads. The contractor elected to use a base station rather than the CORS network.



Figure 20: Map. NYSDOT CORS network in September 2008.

Section 625 of the standard specifications also requires the contractor to provide its 3D models for review. This enables the Resident Engineer-in-Charge to accept the contractor's models as representative of the design intent of the contract plans and use them on the data collectors to check tolerances. Inspectors collect independent post-construction survey data to measure pay quantities; however, earthwork quantities require a base surface for comparison. Spot checks on the original survey information found it to be insufficiently accurate for computing pay quantities. Inspectors collected new topographic survey using their GPS equipment.

Two dedicated headquarters construction surveyors and two headquarters CADD coordinators support the regions. Each region has a regional CADD coordinator and a regional survey coordinator for construction to provide support to the Resident Engineers-in-Charge, inspectors, and consultants. The headquarters survey and CADD coordinator helped the inspection team become accustomed to the equipment and to develop workflows for transferring the 3D data between the data collectors and the workstations.

CADD skills are needed in the site office to fully utilize 3D data for real-time verification and to use post-construction survey to measure pay quantities. When using real-time verification, inspectors need to be comfortable that the model on their data collector reflects the design intent of the plans. However, most inspectors do not have the skill set to make this determination. This was the Office Engineer's responsibility because she was the person most experienced and comfortable with creating and manipulating CADD data.

Initially, the contractor's data was converted into InRoads format via LandXML to be reviewed. The contractor provided a workstation and software for the inspection team. This avoided exchanging data into InRoads for review and use on the inspectors' data collectors. It was much easier to access the contractor's data directly using the contractor-provided computer and software. Direct access to the data avoided the need to exchange data into Bentley-format to review before loading on the inspectors' data collectors. The contractor's 3D modeler and surveyor provided support for using the contractor-provided software and equipment.

The Office Engineer reviewed alignments, surfaces, coordinate geometry (northings and eastings), and cut cross-sections to compare to the contract plans. The designer had made manual edits to the line work on the plans without writing those edits into the surfaces. All 3D data needed to be verified, not just surfaces. The contractor used surfaces, not the lines, in AMG equipment, but inspectors used line work for orientation and checking linear features.

The 3D data reviews occurred during project start-up. Design changes were effected early to address issues caught in the data reviews. The Office Engineer also reviewed models for interim surfaces and other activities not developed by Design. These fall under the contractor's means and methods and were not required for review by the specification; however, their review enabled the inspection team to use them as well. One example of these means-and-methods surfaces that was useful to the inspectors is bridge excavations.

The inspectors and the Office Engineer needed to understand how the data related to their job functions before they could use it confidently. Inspectors needed more than just confidence in the data on the data collectors. They needed to develop familiarity with how the data on the data collector reflected the conditions they saw on the ground and how the data they collected related



to how it would be used, stored, manipulated, and reused in the future. Figure 21 is an annotated cross-section illustrating how the 3D data related to the quantities being computed. Inspectors also needed training in when they could or should use the GPS rover, how to use it, and how to know that the information on the data collector was correct. The Office Engineer also needed to build confidence in the information downloaded off the inspectors' data collectors.

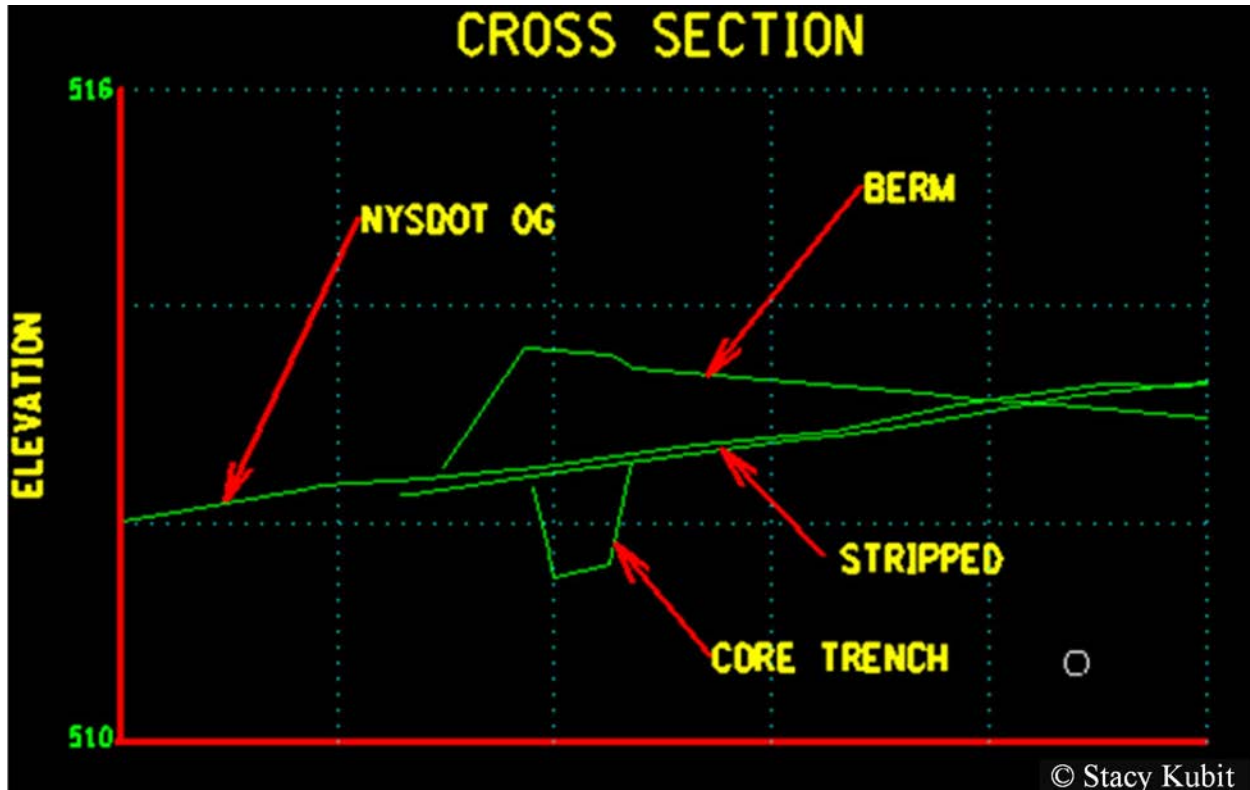
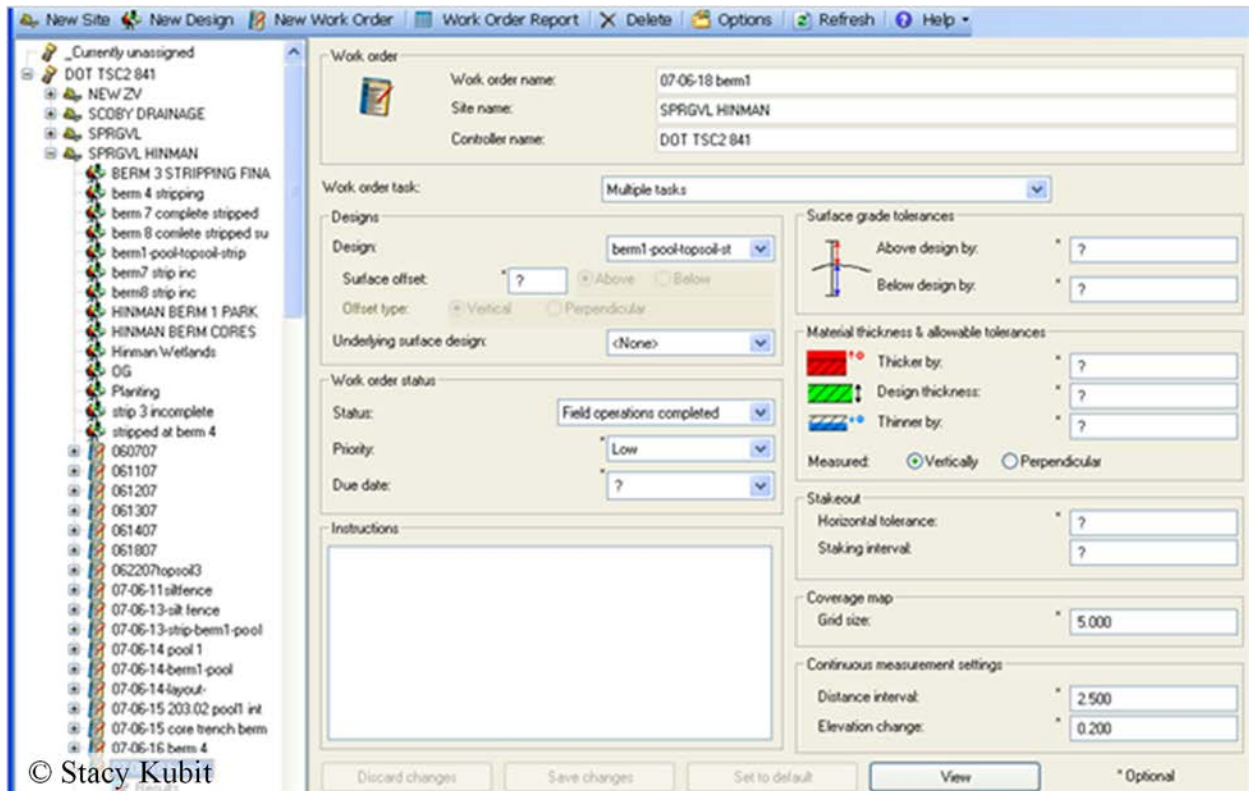

**Figure 21: Screenshot. Cross-section view of surfaces used to compute quantities.**

Data management was especially important. While existing CADD, Survey, and Design Manuals were followed, inspectors used the GPS rovers daily and collected vast amounts of data. A data collector file-naming convention was developed using GPS rover number, date, specification item, and location. The CADD and Survey Manuals were followed for point naming conventions, levels, and line styles in MicroStation.

The Office Engineer maintained a record of all work orders created, as well as all surfaces and alignments. Figure 22 shows a list of work orders and how they were organized within the work order management software. This helped inspectors load the correct data on their data collectors before proceeding into the field each day. Inspectors referenced the work orders on the IRs, using the work order names, surfaces created, and quantities computed. The work orders provided backup documentation for the IRs. The office engineer had to determine what data to provide at project closeout.

The GPS equipment was most extensively used for earthwork measurement. It would have been impossible to keep up with all the interim phases and design changes without the GPS rovers.



**Figure 22: Screenshot. Work orders in the Trimble® SCS Data Manager software.**

After the landslide, the contractor conducted 24-hour operations to unload the slope, with load counts on the order of 600 off-road trucks per night shift. The ground conditions were dangerous in places. One flagger became stuck in mud and had to be dug out with an excavator. The GPS rovers allowed the inspectors to stay out of the contractor’s way during construction, as Figure 23 shows, and collect topographic survey biweekly to calculate the quantities.



**Figure 23: Photo. An inspector waits safely during excavation.**



The contractor had a continuous grade checker behind the paver with a total station. Taking a copy of the contractor’s grade checker’s as-built data would be beneficial but was not necessary for acceptance. There is no provision in the specification to require the contractor to provide this data. Without the contractor’s total station, inspectors would have used a digital level, which is part of the standard inspection toolkit, to check elevations, while checking horizontal locations with the GPS rovers. The total station made this a one-step operation.

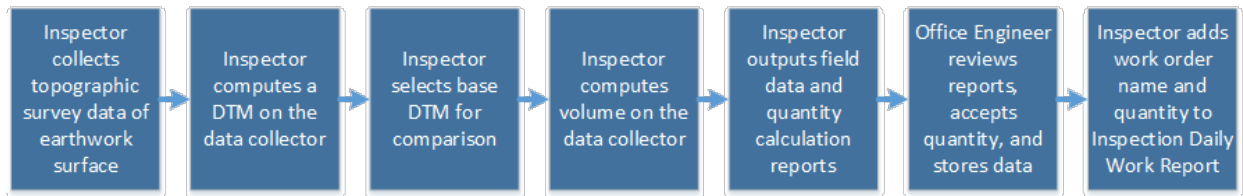





**Figure 24: Flowchart. Workflow used to measure earthwork volumes.**

The workflow used to compute quantities is shown in Figure 24. This workflow maintains normal responsibilities for collecting, computing, reviewing, and documenting pay quantities. Initially, Bentley® OnSite, MicroStation, and InRoads were used for data collection, review, and processing. However, as inspectors became more comfortable with the data collector software and the Office Engineer became more comfortable with the reports from the data collector, the workflow became more streamlined and efficient. Figure 25 is an example of a field data report viewed in Microsoft Excel®, and Figure 26 is an example of a quantity calculation report, also viewed in Microsoft Excel®.

Record Type Data		Base Measurement Data (m)									
Record type	Sub type	Point Name	Line Name	Point Code	Measured N	Measured E	Measured Elev	HA / Lat	VA / Long	SD / VGSR	Precision
Topo	Breakline	LineP1	CORE1	CORE1	258128.272	342494.522	512.326				0.008
Topo	Breakline	LineP2	CORE1	CORE1	258136.859	342488.971	512.125				0.004
Topo	Breakline	LineP3	CORE1	CORE1	258131.971	342484.111	512.116				0.006
Topo	Breakline	LineP4	CORE1	CORE1	258127.229	342481.636	512.088				0.005
Topo	Breakline	LineP5	CORE1	CORE1	258121.072	342480.390	512.928				0.007
Topo	Breakline	LineP6	CORE1	CORE1	258115.880	342480.236	512.795				0.005
Topo	Breakline	LineP7	CORE1	CORE1	258111.634	342478.772	512.789				0.004
Topo	Breakline	LineP8	CORE2	CORE1	258107.554	342494.226	512.696				0.004
Topo	Breakline	LineP9	CORE2	CORE1	258106.276	342490.829	512.566				0.006
Topo	Breakline	LineP10	CORE2	CORE1	258103.057	342486.695	512.488				0.006
Topo	Breakline	LineP11	CORE2	CORE1	258102.223	342483.632	512.373				0.005
Topo	Breakline	LineP12	CORE2	CORE1	258104.612	342481.840	512.312				0.004

**Figure 25: Screenshot. A field data report for the Office Engineer's review.**

When using GPS rovers for real-time verification rather than measuring pay quantities, inspectors only stored data points when there was a need to collect an as-built record or a need to collect objective evidence to support a decision made in the field. No as-built shots were stored when real-time verification confirmed construction was executed per plan.

	A	B	C	D	E
49					
50			<b>Open VO</b>	<b>Work Order Name</b>	BERM 8 CORE TRENCH
51				<b>Date</b>	7/12/2007
52				<b>Time</b>	6:27:49 PM
53				<b>Operator Name</b>	GARY DOT
54				<b>Site</b>	SPRGVL HINMAN
55				<b>Design Folder</b>	HINMAN BERM CORES
56				<b>Underlying Surface Design</b>	
57			<b>Change Design</b>	<b>Date</b>	7/12/2007
58				<b>Time</b>	6:28:01 PM
59				<b>Design Folder</b>	berm8 strip inc
60			<b>Tapped Outer Boundary</b>	<b>Date</b>	7/12/2007
61				<b>Time</b>	6:29:39 PM
62			<b>Compute Volume</b>	<b>Date</b>	7/12/2007
63				<b>Time</b>	6:30:14 PM
64				<b>Base Surface</b>	berm8 strip inc
65				<b>Expansion Factor</b>	(None)
66				<b>Total Cut</b>	0.064 cu m
67				<b>Total Fill</b>	224.181 cu m
68				<b>Volume Balance (Cut)</b>	224.117 cu m
69				<b>Base Area</b>	365.727 m <sup>2</sup>
70				<b>Base Perimeter</b>	153.644 m
71				<b>Surface Area</b>	401.079 m <sup>2</sup>
72				<b>Boundary Name</b>	berm8 strip inc
73					
74			<b>Open VO</b>	<b>Work Order Name</b>	BERM 8 CORE TRENCH
75				<b>Date</b>	7/17/2007
76				<b>Time</b>	1:32:03 PM
77				<b>Operator Name</b>	dan b
78				<b>Site</b>	SPRGVL HINMAN
79				<b>Design Folder</b>	berm8 strip inc
80				<b>Underlying Surface Design</b>	
81					
82					
83					
84			© Stacy Kubit		

**Figure 26: Screenshot. A quantity calculation report generated by the data collector.**

## Technology Impacts

Inspectors were less exposed to public and construction traffic when using the GPS rovers as compared to traditional methods. Inspectors considered this a significant benefit. The largest time savings were for earthwork, which was a significant part of this project, especially after the slope failure. All inspection tasks saw efficiencies, however.

Inspectors also felt that they were able to check more work items and check work more thoroughly. Without the GPS rovers, the inspectors would have had to use a level and done manual computations, leaving time to do far fewer checks. With the GPS rovers, they could inspect every pipe segment. With the flowline of a pipe loaded on the data collector, an inspector could check that the pipe is on grade and on alignment. Offsetting the flowline in the data collector, as shown in Figure 27, the inspector can then check the trench excavation, top of stone grade, and the cover. Using the GPS rovers in this way enabled the inspector and contractor to identify a construction issue where the specified high-density polyethylene (HDPE) pipe was being placed too high into the roadbed. Where this occurred, the HDPE was replaced with concrete pipe. With the GPS rovers, the inspector and contractor could identify these areas quickly and adapt on the fly.

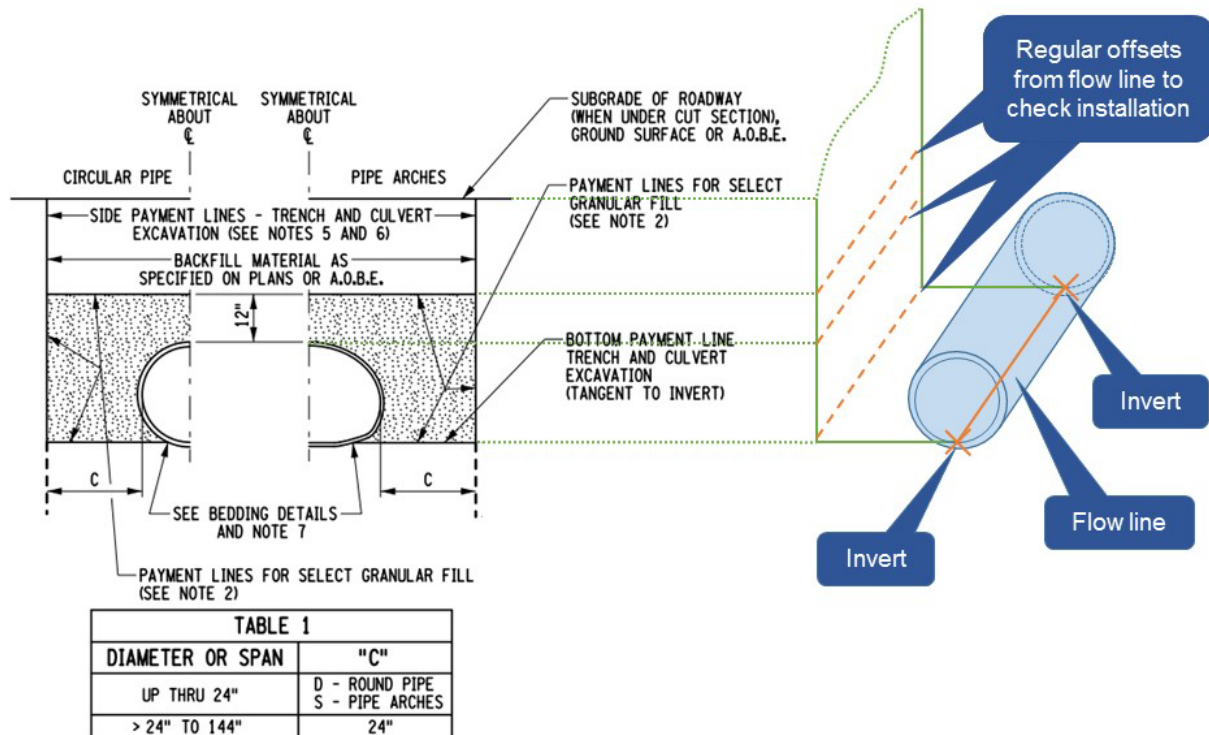

**Figure 27: Illustration. Flow line offsets to check pipe installation.**

The autonomy in the field with CADD and Rover software enabled rapid turn-around of accurate payments. Biweekly payments processed on Saturday reflected completed work through the previous Wednesday, a faster turn-around than without the GPS rovers and data collectors that could compute volume quantities quickly. Without GPS rovers, the inspectors would have had to use truck load counts for interim earthwork payments. This would have required more inspectors producing quantities with less accuracy and would have required inspectors to collect more accurate earthwork volumes to adjust at the end of each construction season.

Real-time verification of the earthwork meant that the contractor and inspectors felt that payments were fully representative of the work performed. However, inspectors were only comfortable computing quantities with the data collectors. The ability to implement effective processes for real-time verification and post-construction survey for measurement depends on the skill set of the Office Engineer. To retain a capable individual in that position, they need to be compensated accordingly. It is unreasonable to expect a person with National Institute for Certification in Engineering Technologies (NICET) Level III to have the skill to effectively use field survey technologies and manipulate CADD data to process data for verification and measurement.

The first evidence of the landslide was inconsistency between the earthwork volumes computed by the inspectors, who field collected topography every two weeks for payment, and the contractor, who used the surfaces used in AMG construction to estimate volumes. The source of the discrepancy became apparent when a culvert set with a laser at the end of one week had moved significantly over the weekend.

The use of AMG technology enabled a rapid response to the landslide, which included 24-hour operations to unload the slope while the roadway was being redesigned. Designers used the interim earthwork surfaces, which the inspectors had collected to measure earthwork quantities, to develop the landslide remediation design. Designers also used surfaces to design sediment basins for erosion control.

During the time-critical work to unload the slope, the contractor worked in two, 12-hour shifts per day, achieving production rates of up to 600 off-road trucks per shift. Instead of keeping load counts, inspectors spent alternate Saturdays collecting the topographic data for the interim earthwork quantity. This enabled the inspectors to stay out of the contractor's way and unload the slope as quickly as possible. Four inspectors worked simultaneously to collect the field data. The Office Engineer consolidated the field data into a single surface and calculated the quantity.

Without these 3D data-related processes, the contractor would have had to set stakes for the inspectors to check cross-sections every 10 to 20 feet and compute average end area volumes. On the Southern Expressway Section 4 project, two or three 3-person crews spent each winter collecting this information to process interim earthwork payments based on 50-foot cross-sections to correct load count volumes paid during the construction season.

In the process of checking subsurface utility and drainage construction, the invert shots were stored as as-built records. Shots were taken at changes in orientation on water lines as well. These shots may not have been needed during construction, but they take very little effort to collect. If they are needed, the value far exceeds the cost of the inspectors collecting them while they are exposed.

The utility as-built shots were used to prepare the as-built plans, but the field data was retained as well. The field codes and descriptions used were consistent with the survey manual. In total, 18 miles of horizontal drains were as-built with elevation attached to the horizontal line work. Any exposed existing utilities were also collected. The CADD line work was used to update the National Highway System Inventory Database. The process of creating as-built plans was quicker with CADD and the field data. The data was already in CADD from the design changes, so the larger effort was plans production.

One winter, the asphalt shoulders heaved and the concrete paving cracked. All the cracks were mapped using the GPS rovers and that information was sent to designers. The designers then developed the remediation plan to drill in tie-bars.

The processes that were designed for this project have continued to be developed, especially on the Parkville Bypass and now on the Prospect Mountain Interchange. There were similar experiences on the Prospect Mountain Interchange regarding how extensively inspectors used the technology as they became comfortable with it. Contractors also recognize the benefits of inspectors using 3D methods for measurement and may request these methods of quantity computation.

## ROUTE 60 RECONSTRUCTION

The shorthand name for this Virginia project is a misnomer; the project was a combination of several separate design projects that were let together. That is, it consisted of full-depth reconstruction on German School Road, milling and resurfacing on Route 60, relocating water, sewer, and gas utilities, as well as upgrading storm drains and installing curbs and gutters along Route 60. This was not a Federal-aid project; there were some American Recovery and Reinvestment Act funds to supplement state funds.

**Table 11: Route 60 Reconstruction Project Characteristics**

Characteristic	Project Information
AMG Elements	Grading Asphalt milling
Real-time Verification	Used by contractor Used GNSS rovers Used total stations
3D Data Users	Contractor
3D Data Origin	Contractor
Other Project Elements	Means and methods planning, curb layout

Route 60 is heavily trafficked, as can be seen in Figure 28. This led to challenging maintenance of traffic and careful sequencing and phasing of all work. There were numerous driveways along Route 60, often as close as 25 feet apart.



**Figure 28: Photo. Maintenance of traffic was a significant concern.**



One of the primary objectives of the project was to install a 70-inch trunk storm water main under Route 60 with an outlet into Reedy Creek to address a flooding issue at the intersection of German Church Road and Route 60. Standing water was common in the intersection in inclement weather, sometimes several feet deep. Maintenance of the existing storm sewers and the very flat conditions contributed to the flooding.

Six different designers and several VDOT project managers were involved. Both Route 60 and German School Road had separate roadway and drainage designers (four contracts in total). There were also separate designers for utility relocation and lighting design.

During curb construction it became apparent that there was an issue with curb grades. Route 60 had been milled by 90 mm and curbs were being set to meet the proposed grade after resurfacing. A 6-inch curb reveal was required, but in some places the curbs were being set below the road grade. Initially, the curbing subcontractor was instructed to work on a different section of the project while the issue was resolved. A stop work order was issued when it became apparent that the issue was systemic. After the original design and the contractor's 3D model were confirmed to correctly reflect the plans, scrutiny turned to the accuracy of the original survey. The claim arising out of the stop work order was significant. Utility conflicts—including a gas main strike—and the presence of contaminated soils also caused cost overruns.

### **Information Modeling**

German School Road was designed using GEOPAK<sup>®</sup> V8 2004 edition, which computes cross-sections based on criteria files that mathematically define the cross-section. While it is possible to convert GEOPAK<sup>®</sup> cross-sections into a DTM, this was not done for this project. The GEOPAK<sup>®</sup> V8 2004 edition was used with 2D MicroStation files to visualize the plan graphics, including plan view, profiles, cross-sections, and coordinate geometry. This was done in accordance with VDOT standards.

The contractor originally intended to use 3D digital design data to lay out the curbs and use GNSS for earthwork. For Route 60, the intent was to mill and replace a consistent depth of 90 mm without making geometry changes. The curb grades were thus established to match existing conditions as depicted by the original ground survey. The contractor planned to use AMG for rough grading on German School Road, which was full reconstruction, and on the drainage improvements. The contractor planned to use hubs for fine grading and paving.

The contractor's data preparation consultant developed surface files for the rough grading and 3D line strings to layout the curbs. These were created with Terramodel<sup>®</sup> software and exported to the AMG systems and data collectors. The surfaces were created in an iterative process using the original design files provided by VDOT and using the PDF contract plans to verify the digital design data.

Information modeling became a significant tool for responding to the issue with the curbs. New survey was collected to develop a plan to retain as much of the curb and sidewalk that had already been constructed, while resuming construction as quickly as possible. The contractor's data preparation consultant took the lead on the 3D modeling, but decisions were made collaboratively after viewing the 3D data, shown in Figure 29, in project meetings. The original

designer was actively involved in the redesign, but for the sake of expedience, the contractor's data preparation consultant did the 3D modeling. This avoided exchanging the new survey data into GEOPAK® format and then exchanging the GEOPAK® data into a format compatible with the contractor's AMG systems and data collectors.

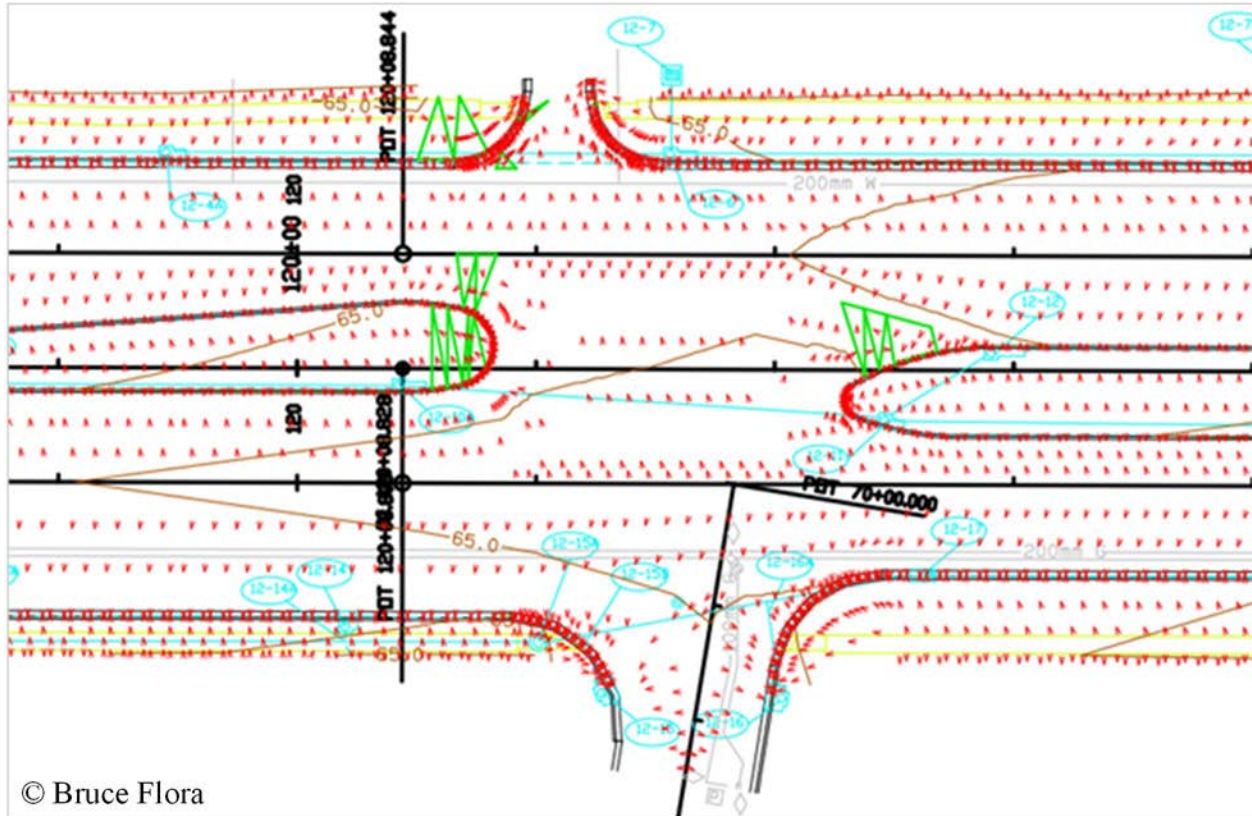
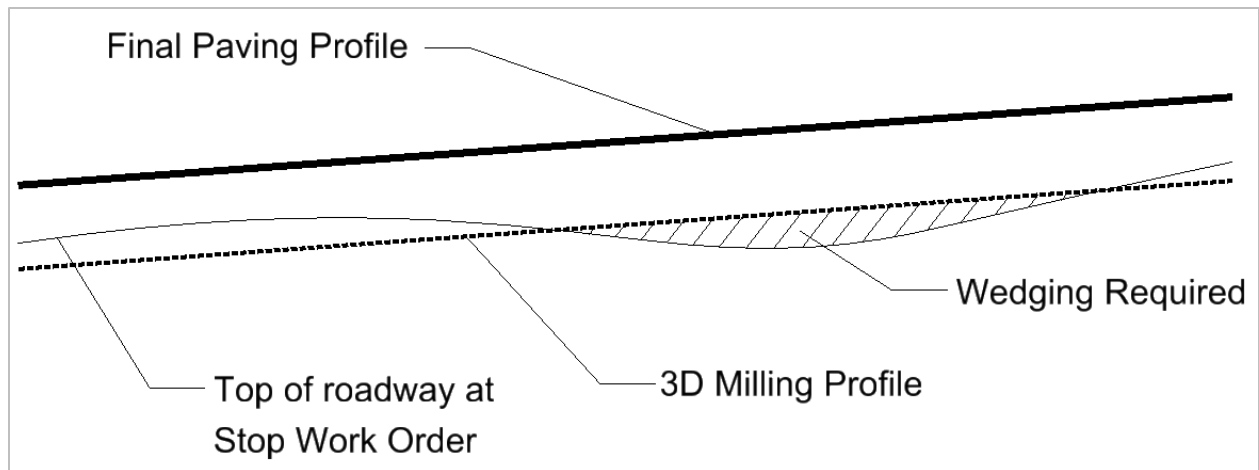

**Figure 29: Illustration. Graphical surface review of the redesigned Route 60.**

The designer set the constraints for the redesign, which included the following:

- Preserve structural depth of existing asphalt
- Retain as much of the drainage system, curb, and sidewalk as possible
- Meet or exceed minimum grades on Route 60
- Maintain positive drainage on Route 60
- Tie into driveways on Route 60

The proposed solution was a combination of wedging and 3D milling to a designed surface, followed by constant depth lifts with averaging skis. Figure 30 illustrates (with exaggeration) the concept of the proposed solution. Some locations required up to 14 inches of wedging. In areas where the mill depth was greater than 2 inches, cores were taken to ensure that the structural depth would be preserved. The easiest way to simultaneously review whether the design met the constraints was to view drainage maps with the flow arrows on the proposed surface, as well as surface triangles that did not meet or exceed the minimum grades displayed in color. In Figure 29, the flow arrows are shown in red and the triangles that did not meet minimum grade are shown in green. Drainage inlets are displayed in cyan.



**Figure 30: Illustration. The solution involved wedging and 3D profile milling.**

To help reduce rework, the Resident Engineer-in-Charge was able to secure approval from the City of Richmond to have a 4-inch curb reveal instead of the required 6 inches. In addition to reviewing the flow arrows and colored triangles, the contractor and designer reviewed the entire roadway and drainage redesign cross-section by cross-section. The areas where the roadway was flatter than minimum grade were a concern, but the contractor brought in a very seasoned paving foreman who felt confident he could pull a string line in those areas and maintain positive drainage. The areas where the string lines would be needed were indicated on plans for the paving crew. Construction resumed using the 3D data, but the designer ultimately provided plans to VDOT as the record of design.

### Surveying

This section relates specifically to Route 60, where the issue with the curb grades occurred. After verifying that the issue was caused neither by the design nor in preparing the contractor’s 3D data, scrutiny turned to the survey data. The original survey was provided to the consultant designer. The consultant designer did not have the resources to verify the survey they were provided. It was standard procedure to accept the signed and sealed survey without independent verification. The survey was not delivered with detailed metadata and a surveyor’s report, and given the age of the survey, it was difficult to locate its origins. Based on the information available, the survey appeared to be from 1997 and with high altitude photogrammetry for data acquisition. The age of the survey data (over a decade old) contributed to the accuracy issues.

The contractor’s surveyor attached GNSS receivers to a truck, as shown in Figure 31. The rod height for the GNSS receivers was calibrated with a total station. The surveyor drove the roadway with the data collectors automatically collecting observations at regular intervals, every few feet. This “rolling survey” allowed for a relatively accurate survey (one tenth of a foot) without the need for further maintenance of traffic or interruptions to motorists. The survey data was converted into a surface and compared to the original design final surface. In Figure 32, the contours from the rolling survey are plot at 1-inch intervals and colored red if they were higher than expected and green if they were lower than expected. The rolling survey confirmed both that redesign was required and the approach to a resolution.





**Figure 31: Photo. Truck with GNSS receivers for rolling survey.**

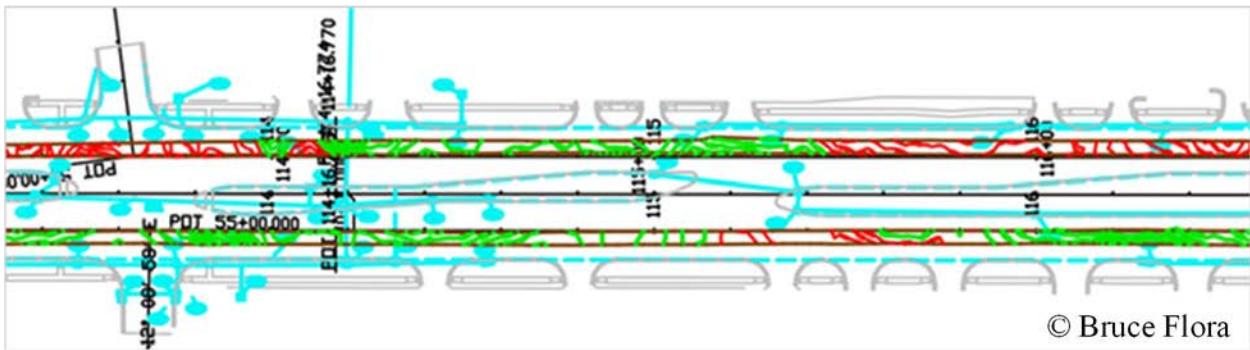

**Figure 32: Illustration. Rolling survey surface compared to designed final ground.**

Grade-related construction issues had occurred throughout the project. They were difficult to attribute because of their variability. In some places the grades were higher than expected, while in other places they were lower. Normally, an issue with control would create a systemic error. Systemic errors manifest as elevations that are consistently too high or too low, or as horizontal offsets in one consistent direction or angle. Systemic errors are easy to detect and correct. The source of the error with the survey became academic once the stop work order was issued and there was pressure to resume work. Recollecting survey data became the fastest solution. In light of the minimum grades and the frequent hard tie-ins at the existing curbs and driveways, the rolling survey approach was not sufficiently accurate to design the resolution.

It was decided to conduct a static lidar survey to collect survey with approximately one-quarter-inch vertical accuracy. The TopoLIFT<sup>®</sup> system shown in Figure 33 was selected for its accuracy and quick set-up. With the self-leveling mount, the TopoLIFT<sup>®</sup> system takes a short time to set up and does not require the operator to get out of the cab. The higher set-up increases the angle of incidence on the ground and improves the accuracy of the data.



**Figure 33: Photo. TopoLIFT® system collecting static lidar survey.**

The lidar surveying was contracted out to a specialist who reduced the data to a digital terrain model (DTM) at the contractor's surveyor's specifications. The first step was to carefully plan the set-up locations and set the control. The setups were planned with software that takes into consideration specifications of the scanner such as scan time and coverage, the number of control points, control distance, and operating cost. It then provides a visual environment to plan the locations of control and scanner set-ups, as well as scanning times. A longer scanning time was used in the intersections because of the noise from passing vehicles. The software also provided a scan time and cost estimate based on the control and set-up configuration selected.

The raw scan data included noise from passing vehicles and all the traffic control devices shown in Figure 28. The scans were registered to the control, and noise from the vehicles was removed. The resulting point cloud is shown in Figure 34.

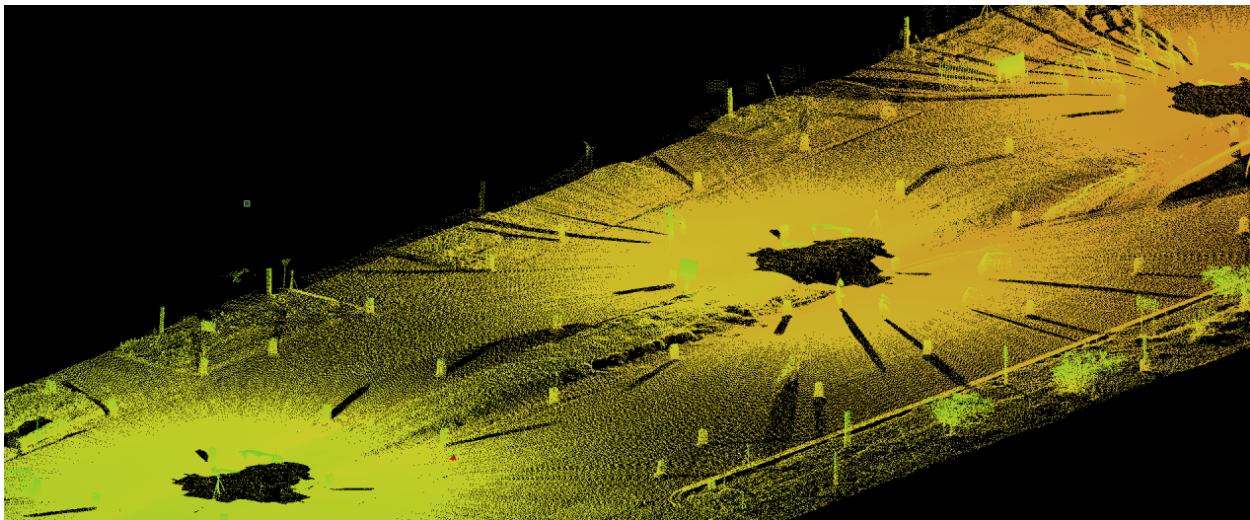

**Figure 34: Screenshot. Registered point cloud from static lidar.**



The lidar data was reduced to cross-sections and a DTM to develop the design for resuming work. The reduced data provided cross-sections every 2 meters with dense points along each cross-section. The scan was also clipped to the right-of-way and all non-terrain points were filtered out. Figure 35 shows the cross-section points overlaid on the PDF plans in the surveyor's software.

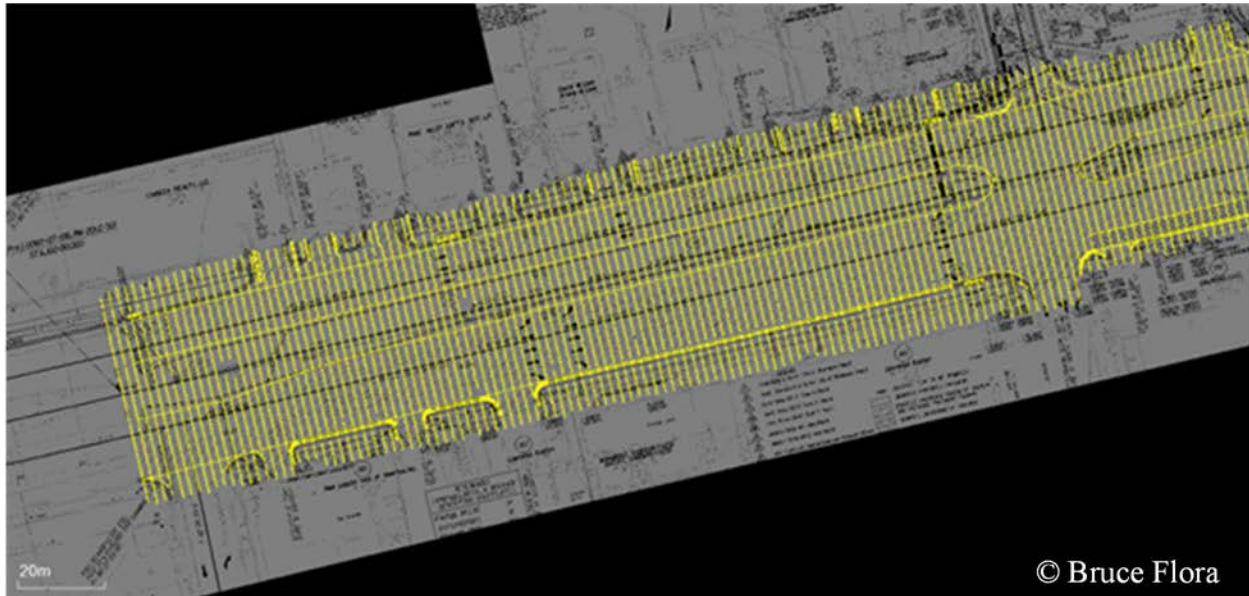

**Figure 35: Screenshot. Reduced lidar data overlaid on PDF plans.**

At the time that work stopped, Route 60 had been milled and should have needed only a 90 mm asphalt lift to bring it up to final conditions. In Figure 36, the final conditions are shown by the black line. The blue line is what was expected to be the existing ground, but the red line shows the surface collected by the static lidar. This explains the variability in the contours collected in the rolling survey, as shown in Figure 32. One of the most significant issues appeared to be that the original survey had missed a crown in the eastbound lane.

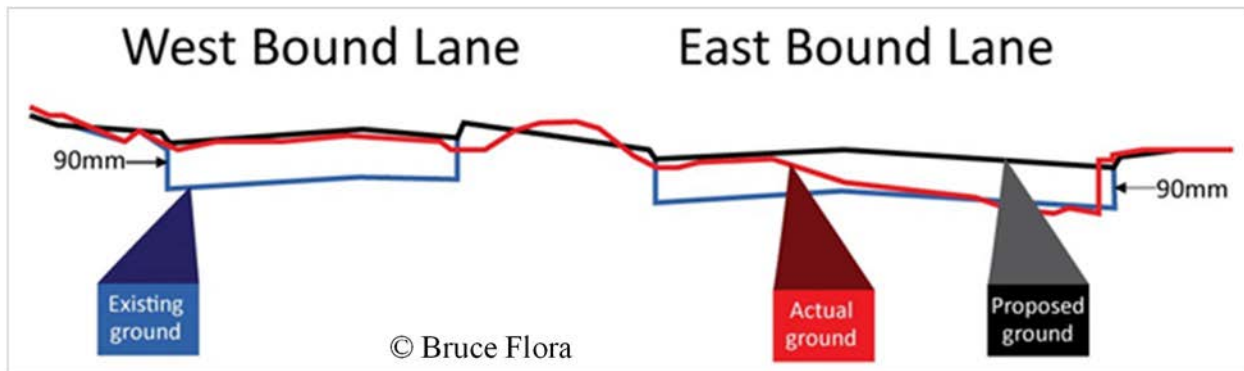

**Figure 36: Illustration. Expected (blue) and actual (red) ground when work stopped.**

## **Data Management**

Data exchange was not a significant challenge because the 3D data was only used by the contractor. Initially, the GEOPAK<sup>®</sup> chains (alignments and profiles) and TIN (surface) were converted via LandXML. The contractor's software could read the MicroStation line work files and import and orient the PDF plans. The contractor's software was compatible with the software used by the lidar surveyor and with the AMG equipment and data collectors used by the contractor in the field.

## **Real-time Verification and Post-Construction Survey**

VDOT's quality assurance surveyor regularly visited the site to check control, layout, and completed work. The quality assurance surveyor found the layout to be in accordance with design. The original ground data, which was the root cause of the problem, was not part of the quality assurance review. The construction issue related to how the design for the curbs and sidewalk tied into the original grade, which the milling and overlay were intended to restore.

The inspection team did not use real-time verification or post-construction survey for measurement. The specification allowed the contractor to reduce the staking interval when using AMG for grading. Inspectors used tripods and levels to check grades every 50 feet on the fine grading. On German School Road, the contractor used hubs for fine grading, so there was no additional effort for setting the hubs for the inspection team.

On Route 60, cross-slope was a primary acceptance criterion. This was a mill-and-pave, primarily, so positive drainage and density were acceptance priorities. Plan elevations were provided for Route 60 after work resumed using the 3D data prepared by the contractor's surveyor. Inspectors used Site Manager for Daily Work Reports and entering quantities for payment. Materials quantities were calculated with tickets.

## **Technology Impacts**

A stop work order was issued with no known root cause, but the project resumed construction with a viable solution within three weeks. The combination of lidar and 3D modeling isolated the issue and provided the data needed to perform the needed redesign. The laser scanning cost \$50,298. Additional costs were incurred for the contractor's surveyor who did the 3D modeling, for the wedging, and for the additional 3D profile milling. The unit cost for profile milling changed with the addition of 3D grade control.

A significant success factor for resuming construction within three weeks was the willingness of the parties to collaborate with 3D data. By agreeing to use a single model of record, the time to prepare plans for review and approval was eliminated. Moreover, the 3D model provided confidence that the redesigned roadway and curbs would work before work resumed. There were five days of formal partnering on the project.

The project had an early completion bonus that was tied to claims waiver language. The original incentive payments were \$1,000,000 (milestone A) and \$600,000 (milestone B). The contract was adjusted to modify the incentive payments in Work Order 46. These were \$500,000 and \$250,000 for milestones A and B, respectively. The early completion bonus was at stake when

the stop work order was issued. The project concluded more than six months ahead of schedule despite the stop work order. A sample of the claims waiver incentive is below:

*The Department will pay the Contractor a “no excuses” incentive in the amount of \$1,000,000 for meeting Project Milestone A, or \$600,000 for meeting Project Milestone B, whichever is applicable, if either, but not both, of the appropriate Project Milestone work is satisfactorily completed and accepted by the Department on or before the dates prescribed below. For the purposes of this provision, the Project Milestones and Incentives are defined as follows:*

*Project Milestone A [\$1,000,000 Incentive]: Project Milestone A is defined as substantial completion of all contract items on projects 0060-127-106, C501 & U000-127-754, C501, that are physically located within the project limits as displayed on the project plans with the exception of landscaping items, roadway lighting poles, luminaire arms, and luminaire light fixtures on or before July 31, 2012. All contract items include, but are not limited to, all items shown or identified, or added by contractual means, to the plans and contract, underdrains, roadway patching, joint repair/crack sealing, asphalt placement and overlay, curbing, pavement markings/markers, utilities items, drainage items, grading (with the exception of the associated grading required for the installation and finishing of landscaping items), incidental items (excluding those associated with excepted items mentioned above), seeding and erosion control items, demolition of structures, storm water management facilities and related items, traffic signalization items, permanent roadway signing, and roadway lighting components with the exception of those components referenced previously in this paragraph (roadway lighting poles, luminaire arms, and luminaire light fixtures).*

*The Engineer will be the sole approving authority in determining completion. Should the Contractor successfully qualify for and petition payment for the incentive for Project Milestone A, he will not be eligible for any incentive whatsoever for Project Milestone B. The “no excuses” incentive substantial completion date for Milestone A will not be adjusted for any reason, cause, or circumstances whatsoever, even if the alleged cause or reason or circumstance was in whole or in part the fault of the Department or an act of God or parties or circumstances beyond the control of the Contractor.*

The finished Route 60 has outstanding smoothness and drainage. Smoothness is affected in the outside lanes where there are many driveways, often only 25 feet apart. Figure 37 shows Route 60 at the conclusion of paving and during inclement weather. Figure 38 shows Route 60 in May 2015; the pavement is still in good condition.



**Figure 37: Photo. Route 60 after final paving.**



**Figure 38: Photo. Route 60 in May 2015**

## I-80 SILVER CREEK TO WANSHIP RECONSTRUCTION

Interstate 80 is a transcontinental highway extending between San Francisco, CA and New York City, NY. Interstate 80 closely follows the route of Lincoln Highway, the first road to span the US from coast to coast. A little more than 196 miles of the highway lie inside Utah, which includes the desolate Bonneville Salt Flats.

The I-80 Reconstruction project under study concerns seven miles of the interstate between the intersection of US 40 (at mile post 148) and the town of Wanship (at mile post 155). The road's existing asphalt surface was removed completely and replaced with a reinforced concrete pavement, which helps the highway carry heavy trucks and freight traffic. The westbound bridge over Silver Creek was also replaced.

**Table 12: I-80 Reconstruction Project Elements**

Characteristic	Project Information
AMG Elements	Excavation 3D profile milling Cement-treated asphalt base Fine grading Concrete paving
Real-time Verification	Used by contractor With robotic total stations
3D Data Users	Contractor
3D Data Origin	Original design data Re-created by contractor
Other Project Elements	3D means and methods planning 3D models for bidding Inclusion of a bridge Full-depth reconstruction

Reconstruction of the road occurred in two phases in the construction seasons of 2014 and 2015. In Phase 1, traffic was shifted to the westbound lanes of the divided highway as the eastbound side was reconstructed. After a winter where normal service was restored, traffic was then shifted to the eastbound side while the westbound lanes were reconstructed.

This was UDOT's first use of Cement-Treated Asphalt Base (CTAB), which is created by milling and pulverizing the existing asphalt and mixing it with cement and water to form a base for the road slab, thus recycling the deteriorating road. CTAB is constructed by a series of passes with a milling machine. First, the existing asphalt is brought to grade and the cement is applied, as shown in Figure 39. Then the asphalt is pulverized and cement is mixed in while injecting water. There is a three-hour window in which to grade and compact the CTAB before it becomes unworkable. Geneva Rock performed all of these activities using 3D grade control on the milling machine. UDOT required that a tack coat be applied to retain moisture during cure. There is a seven-day cure time before the CTAB can be accessed with construction equipment.





**Figure 39: Photo. All CTAB operations used RTS control.**

The project was located in a canyon, which provided extreme technical challenges for concrete paving. There were few horizontal and vertical tangents, horizontal spirals, and constant superelevation transitions. As Figure 40 shows, there was very limited horizontal clearance. The shoulders required zero clearance paving set-ups. On the westbound lanes in particular, there was no room to lay a string line.



**Figure 40: Photo. Tight clearances under the Tollgate Bridge.**



## Information Modeling

The design took less than six months and was conducted using Bentley's InRoads V8i Select Series 2 (SS2) per UDOT's design and CADD standards. The project was not originally intended to be a 3D project, but the design had been developed using corridor modeling regardless. The 3D design data was provided to contractors in bid addendum number 2. It took approximately half a day to produce the outputs for the contractor, which included 2D line work in MicroStation format and alignments, profiles, and surfaces in InRoads V8i SS2 format.

UDOT has been designing with 3D models using Bentley InRoads for many years, perhaps 15 years or more. UDOT designers are very comfortable with 3D modeling for roadways and pavements. The project manager usually makes the decision to use 3D corridor modeling for all design projects that involve survey data. UDOT's designers have used the corridor modeling tool specifically as a means to develop PDF plans (i.e., plan symbology and visual aesthetics have taken precedence over standardizing model data and methods).

Design is recognized as a service, which enables UDOT to specify proprietary data formats for design. Construction is not a service, so it cannot rely on proprietary tools and formats and must provide data that works for all vendors' products. Transferring 3D digital design data to construction is a new frontier for UDOT. There is an informal policy to provide any 3D design data that is available accompanied by a legal disclaimer. The legal disclaimer states that the data is for informational purposes only.

Design data may be provided at advertising in a proprietary format. UDOT is exploring providing data exchange formats such as LandXML and the Bentley i-Model. Post-award, UDOT provided all 3D information to the contractor, including complete survey data with metadata and process documentation, and InRoads format design data.

UDOT pays some items using plan quantities. There is a requirement that these quantities are disputed before construction if the contractor disagrees with them. Geneva Rock makes extensive use of 3D data for estimating, means and methods planning, materials quantity control, layout, AMG construction, and quantity tracking. Geneva Rock uses 3D modeling methods to verify quantities and mitigate the risk of overruns. For earthwork and materials quantities, this involves checking the accuracy of the existing survey. However, it was not possible to check the accuracy of the original ground survey data because the road was under live traffic.

Geneva Rock has access to both Autodesk and Bentley software, but primarily uses Autodesk's AutoCAD® Civil 3D® for design data manipulation and Trimble® Business Center for estimating and construction data preparation. Geneva Rock has had better success with the Trimble® Link tool that exchanges data between AutoCAD® Civil 3D® and Trimble® Business Center than with the Bentley i-Model exchange format.

Estimators are not primarily modelers; they usually do not have the skillset to increase detail in models where needed. Thus, Geneva Rock prefers to receive a model from the designer for estimating purposes. The design model received by Geneva Rock had sufficient detail for construction. Geneva Rock exported the 3D design data from InRoads to Trimble® Business Center via LandXML. The i-Model data exchange format was not yet available at the time and is

specifically for Bentley’s OpenRoads version of its InRoads and GEOPAK® products (SS3 and SS4). Estimators did not run a mass haul during the bid, but it was reasonable to assume that the designers had balanced the site based on the survey data.

Once it was determined that the original survey mapping was insufficiently accurate, Geneva Rock realized that there would be issues with the quantities and earthwork balance if they proceeded with the design. The profiles needed to be adjusted to bring the earthwork into balance. CTAB construction had begun, so there was limited time to adjust the design without causing delays. The further the CTAB construction progressed, the less opportunity there was to balance the earthwork with minor adjustments to the profile. Given the constraints of the canyon, there was very little room to do earthwork at all. As visible in Figure 41, there was nowhere to borrow or spoil material.



**Figure 41: Photo. String line paving for the eastbound in 2014.**

Figure 42 is a line diagram of the project with two street views illustrating typical sections. The replacement of the bridge over Silver Creek around Mile Post 152.5 made the east and west sides of the site effectively inaccessible. There needed to be two local mass balances on the westbound to avoid hauling material between 10 and 15 miles through work zone traffic. There were effectively three separate mass balances for the site: one for the entire eastbound, which was constructed in the 2014 season, and two for the westbound. The westbound profiles were

adjusted more than the eastbound, partly because the eastbound was already under construction when the profiles were adjusted and partly because of the two mass balances for the westbound.

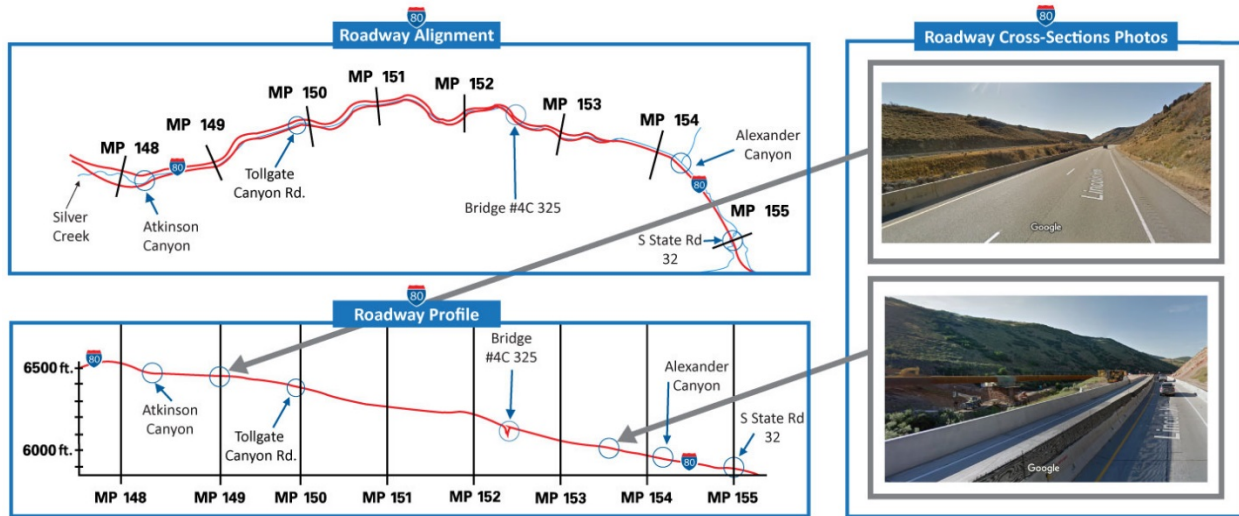

**Figure 42: Illustration. Line diagram of the project with typical sections.**

After increasing the accuracy of the control and recollecting topographic survey in the roadbed, Geneva Rock used AutoCAD® Civil 3D® to adjust the profiles and achieve mass balance. The new topographic data collected by Geneva Rock was exported in LandXML format from Trimble® Business Center and imported into AutoCAD Civil 3D. The design geometrics were exported from InRoads to LandXML and imported into AutoCAD Civil 3D. The MicroStation 3D line strings were converted to AutoCAD DWG format and referenced into AutoCAD® Civil 3D® to provide horizontal targets. The line strings were difficult to work with because they were discontinuous and had vertices every 1 foot. Converting the 3D line strings to 2D line strings did not improve performance by much. Once the corridor models had been rebuilt, they were exported into Trimble® Business Center via the Trimble® Link, which creates a corridor model within Trimble® Business Center.

Geneva Rock usually uses Trimble® Business Center for data preparation, but the horizontal spirals and complex geometrics meant that a robust design software tool was necessary. Geneva Rock’s expert 3D modelers are more comfortable in AutoCAD® Civil 3D® than they are in InRoads. The 1,000 feet of relief in the canyon made it relatively easy to adjust the vertical profiles to achieve mass balance.

The grade control for stringless paving had more than twice as many data points. For setting string lines, the corridor surface was projected with a 6-foot offset to set the string line elevation. Hubs, visible in Figure 43, were set every 30 feet. For the stringless paving on the westbound, the corridor template drop interval was changed to 12.5 feet.





**Figure 43: Photo. Hubs were set every 30 feet for string lines.**

The 3D data was exported from Trimble® Business Center into the AMG systems for CTAB construction. It was also exported into the surveyors' data collectors for setting hubs and string lines for the concrete paving on the eastbound. On the westbound, the AMG paving system used the same surface data that the CTAB construction used. AMG systems can offset a surface vertically for interim stages. If operators are experienced with AMG, they are able to use the final grade surface for all operations.

### **Surveying**

In 2012, a contractor had collected asset-grade mobile lidar data for over 5,000 lane-miles of UDOT's highway inventory. UDOT had successfully used this data to create a complete and current asset inventory for a range of asset classes and began to explore other opportunities to use the data. This project was selected as a pilot to determine whether the mobile lidar data could be used for design projects.

The original purpose for data collection was not design, so design-grade survey equipment had not been used. After a successful proof-of-concept using data on I-15, this project was identified as a pilot to test the ability to calibrate the point cloud to design parameters. As a pilot project, this offered the ability to test the method under rigorous conditions, including interstate speeds, two traffic lanes, bifurcated roadways, steep side slopes, multi-pathing errors in the GNSS positioning, two interchanges, two bridges, and challenging roadway geometrics.

Targets were set at 1,000-foot intervals prior to the mobile lidar data collection. Reflective materials made the targets highly visible in the point cloud. The targets were surveyed in using a GNSS rover and the UDOT Virtual Reference Station (VRS) network. While the GNSS rovers used with the VRS are usually able to achieve 0.1-foot vertical accuracy and higher horizontal accuracy, multipath errors in the canyon make 0.25-foot accuracy typical. (16)

Various calibration methods were used to first increase the local accuracy and then the network accuracy of the mobile lidar data. The method was validated in six test sections, one of which is shown in Figure 44. The registered point cloud consistently achieved accuracies sufficient for design. In all test areas, 83 percent of the points exceeded 0.1-foot vertical accuracy and 73 percent exceeded 0.05-foot vertical accuracy. However, all of the verification methods use the same control that had been set with the GNSS rover and VRS. (16)

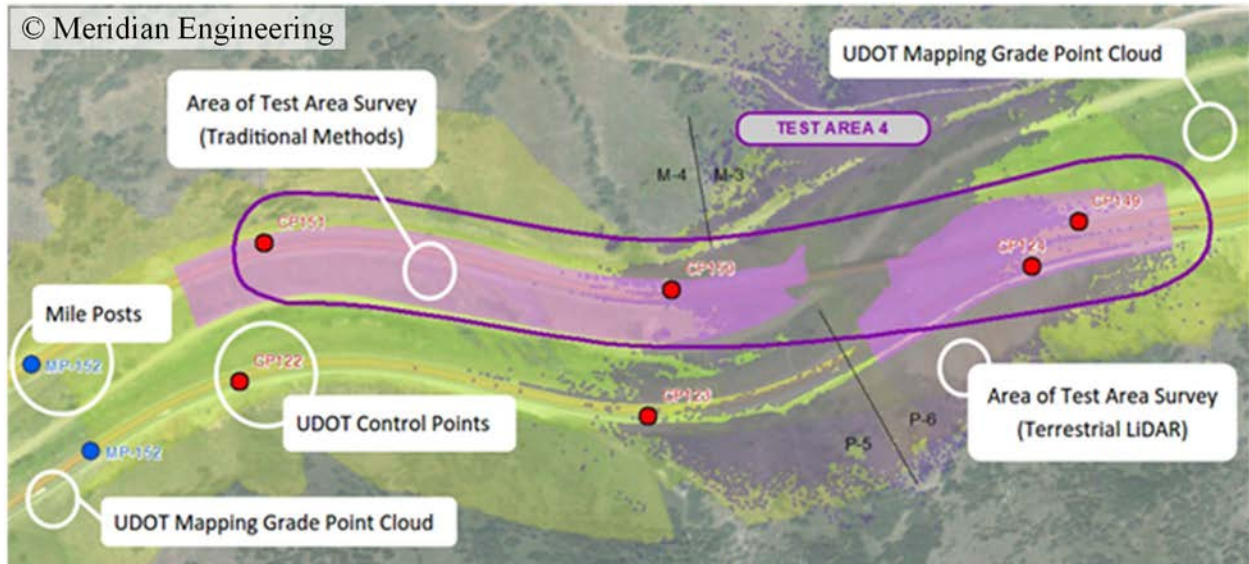

**Figure 44: Illustration. Various methods were used to test the data. (16)**

The points with lowest accuracy were consistently outside of the roadbed and on the side slopes. Traditional methods (i.e., GNSS rovers and Total Stations) were used to survey slopes, ramps, and drainage features. In Figure 45, areas in tan are from the mobile lidar survey data and areas in blue are from the supplemental survey. More observations were extracted from the mobile lidar survey; 52 percent of survey observations representing 34 percent of the project area came from the mobile lidar survey. The hybrid approach to survey data collection was estimated to provide a cost savings of \$2,215.60 per mile. (16)

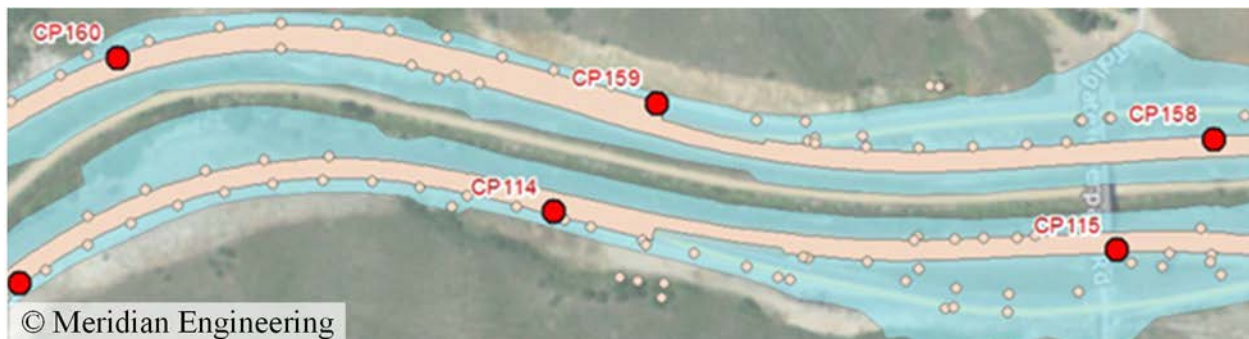

**Figure 45: Illustration. Survey limits by collection method. (16)**

Designers have no responsibility to verify that the survey data is sufficient for design. The surveyor signs and seals the survey to certify that it meets the requested specifications. However, the specifications may not be sufficient for 3D construction methods. (It should be noted that

UDOT updated the survey specification in 2015. (17)) Given how thoroughly the methods had been documented and reviewed, it was reasonable to trust the results of the validation.

Prior to mobilization, Geneva Rock spot-checked the original ground survey. UDOT provided the full survey information to Geneva Rock post-award. This included the complete information to review the various steps in processing the mobile lidar data. The plans included more than 60 sheets of control monuments, but most were right-of-way markers high up on the canyon walls and, as such, were not usable for construction. Only the lidar targets were visible from the work zone. Initially, the plan was for Geneva Rock to set supplemental control between the mobile lidar targets to run the AMG systems.

The relief from the bottom to the top of the canyon exceeded 1,000 feet. The UDOT survey elevations were based off one National Oceanic and Atmospheric Administration (NOAA) benchmark. There was a second NOAA benchmark at the top of the canyon; however, the elevations did not tie in, so this benchmark was ignored. The plans stated that this second benchmark was inaccurate. AMG systems require consistency from one control point to the next because the RTS-controlled systems use resection for positioning.

Inconsistency in the control elevation can cause a shift where the equipment transitions between set-ups. Geneva Rock's surveyor spent a day running a level loop from the NOAA benchmark at the bottom of the canyon through as much of the control on the eastbound lanes as possible, about 2.5 miles of the project, and closing back on the NOAA benchmark. The closure on the level loop was about 1/100th of a foot. Figure 46 shows the difference in published and leveled elevations was both significant and inconsistent. A systemic could have been corrected.

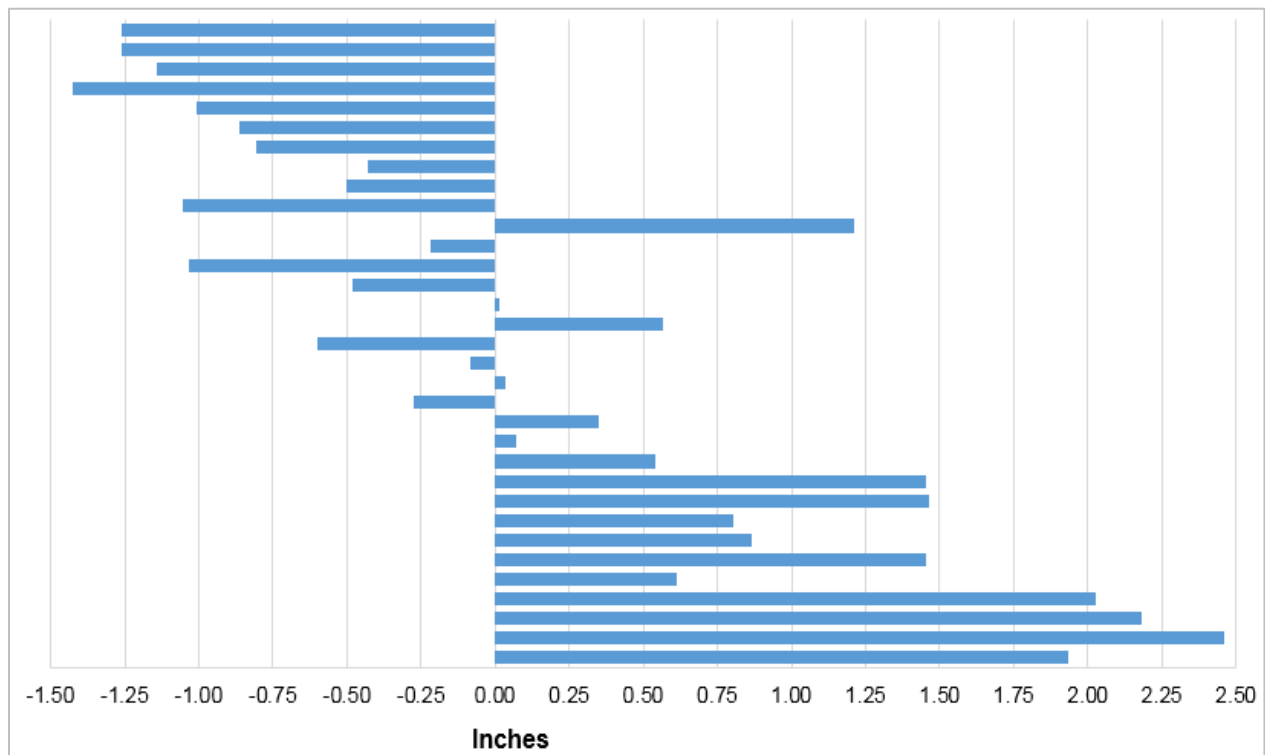

**Figure 46: Chart. Difference between published elevation and leveled elevation.**



Section 01721 Part 1.5 C of the survey specification requires the contractor to verify the project control and certify that it is sufficient for construction. The specific language is as follows: (18)

*Submit a statement before beginning work indicating all Department provided horizontal and vertical control has been field checked and the control has been determined to be accurate within the tolerances specified in this section. Attach field survey information used to verify control. Notify the Engineer verbally and in writing if discrepancies are found.*

Given the results of the leveling, Geneva Rock's surveyor could not certify the control. Construction was set to begin late in the 2014 season, and the control issue posed a threat to completing the eastbound before the winter weather began. Geneva Rock proposed resetting control as the fastest solution to beginning construction. Geneva Rock's surveyor set control on 500-foot maximum intervals, staggered left (shown in Figure 47) and right of the roadway, using 9-foot-deep stakes to prevent frost heave. The horizontal control was set using GNSS rovers and the UDOT VRS, but vertical control was set with a digital level loop. Geneva Rock was compensated for the survey work to reset control.



**Figure 47: Photo. AMG operations need staggered, accurate control.**

Once the control was reset, construction commenced beginning with CTAB preparation. The CTAB used 3D grade control for all operations, beginning with profile milling on the existing asphalt to reduce the effort to finish the grade after the cement had been injected. Issues with the 3D design data became apparent during milling. The mill was supposed to be milling to 12 inches below final grade. In some places, this meant milling off just a few inches, whereas in other locations more than 1 foot was milled off. In other places the mill was above grade. Millings were moved ahead to fill in the grade. Geneva Rock became concerned about material balance as there was little room within the canyon to borrow or spoil material.

Geneva Rock spot-checked the DTM based on the new control. In one location, less than 100 feet from a control point, the difference was an inch and a half. Geneva Rock had low confidence in the original ground data. New topographic data was collected to check the material balance.

Geneva would have preferred to use static lidar to collect the data, extracting a 5-foot by 5-foot grid for the DTM, as shown on the left of Figure 48. This would have provided a tight DTM with



which to control materials volumes. However, as CTAB construction was already underway, a faster solution was needed. The canyon created multipath errors with GNSS, so Geneva Rock used Robotic Total Stations (RTSs) to collect new topographic survey. Over a holiday weekend, three one-man crews collected topographic survey for the eastbound lanes. Given the time constraints, they collected shots every 50 feet along the centerline, taking shots at the edges of pavement, centerline, and any crowns, as shown to the right of Figure 48.

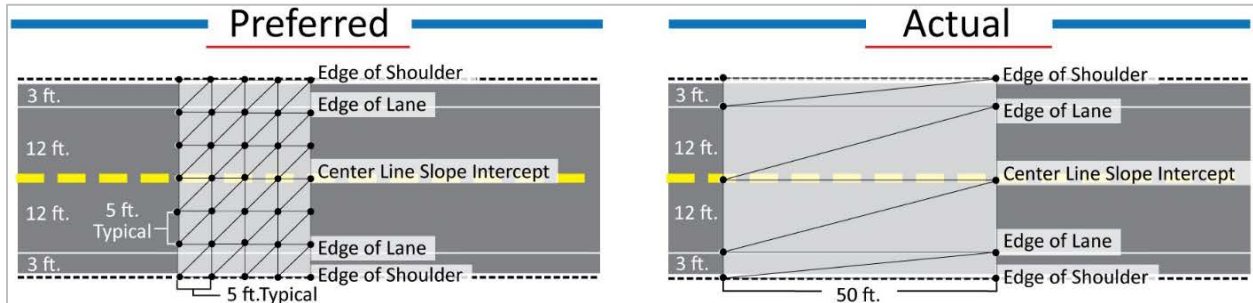

**Figure 48: Illustration. Contrast of preferred and actual survey data density.**

## Data Management

UDOT has an internal project and program management tool called EPM. Bentley's ProjectWise is used for engineering CADD document management during design and construction.

## Real-time Verification and Post-Construction Survey

While most inspection tasks can be accomplished with GNSS rovers, and UDOT has a robust VRN, multipath errors make GNSS unviable in a canyon. The contractor's grade checker used RTS, as shown in Figure 49. Inspectors would also have needed RTSs for inspection, but the cost and skill level needed to use RTSs make it more challenging to provide these for inspectors to use as efficiently and effectively as they use GNSS rovers.



**Figure 49: Photo. The contractor's surveyor checks grade behind the paver.**

UDOT has not had a construction survey crew for many years. There was a discussion between UDOT and the FHWA Division Office prior to construction on how inspectors would check positional tolerances. Positional tolerances for paving were not an acceptance priority. Larger priorities were as follows:

- K-factors on vertical curves
- Superelevation transitions
- Ride quality (smoothness)
- Slab thickness
- Drainage

The contractor was responsible for Quality Control and had a grade checker on the paving crew. A third RTS was set up explicitly for independent grade checks. The AMG system for the paver used nine RTSs. There were three sets of three RTSs, visible in Figure 50: two to control the paver and one for grade checking. Three sets of RTSs were needed to have uninterrupted paving operations. UDOT's inspectors did not use 3D data directly. They had neither the hardware nor the software to be autonomous with 3D data. Instead, inspectors walked with the contractor's grade checker and requested specific spot checks.



**Figure 50: Photo. Three RTSs are necessary at each AMG paving setup.**

### **Technology Impacts**

There were 40 miles of string lines and hubs for the eastbound and none for the westbound. The time and labor cost for setting the string line that was eliminated by using the AMG system on the westbound was a reduction of 600 hours. The labor cost is not entirely eliminated as those



who formerly set string lines would now operate the RTSs. Manual labor used to set hubs is replaced by smart labor running sophisticated equipment. Quotes for setting hubs on the wire line were \$100,000 each for eastbound and westbound. The savings in survey cost not setting stringlines help offset the purchase price of the AMG system. The cost of data preparation was unaffected; the same data is used either to set the hubs for the string line or on the AMG system.

String line affects the accessibility of the work area. Crews appreciate being able to park their trucks closer to the work zone. Finishers used to have to stop, step over the wire line, and continue finishing the concrete. Dump trucks with concrete have a much wider berth without the string lines, as seen in Figure 51. Geneva Rock was able to reduce the fleet of trucks hauling the concrete by 10 to 15 percent with the stringless paver. Crews had to tear down the string line every night to make room for the water truck. String line needs to be set 30 feet in front of the paver. When paving into an intersection, traffic control is required to set the string line, complete the paving, and remove the string line. AMG saves time because traffic control is only needed to move the paver after completion of paving.



**Figure 51: Photo. Stringless paving provides better access to the work area.**

Both the eastbound (string line) seen in Figure 52 and the westbound (stringless) paving achieved good smoothness. The full closure makes it easier to achieve good smoothness outcomes. The stringless paving achieved better smoothness results but with higher grind costs. The increase in grind cost was more than offset by an increase in smoothness bonus, however. The smoothness outcomes for the eastbound and westbound are contrasted in Table 13.

**Table 13: Contrast of string line and stringless paving outcomes**

<b>Outcome Measure</b>	<b>Eastbound</b>	<b>Westbound</b>
Grade Control Method	String line	Stringless
Final Smoothness (PI)	3.29 inches/mile	3.29 inches/mile
Grinding Cost	\$27,680	\$41,145
Smoothness Bonus	\$51,000	\$75,000



**Figure 52: Photo. String line and stringless paving had good smoothness.**

AMG paving is less risky for the contractor. There is an ability to control yields, depth, and grade. Three grade checks were recorded from the back of the paver for every 25 feet. The grade checks stored station, offset, and the depth in feet relative to the theoretical bottom of paving surface. The depth was recorded as a negative increment. From Rail Trail (Sta 495+00) to Wanship (Sta 629+35), a distance of over 13,250 feet, nearly 1,600 depth checks were recorded. The average paving depth was 1.039 feet (12.47 inches), with a variance of 0.001.

In 2014 using string line the paving crew achieved a yield of 8 percent. In 2015 with the stringless paver the yield was improved to 7 percent. Figure 53 charts the daily and cumulative yield for the 2015 (stringless) paving season. While the daily yield was variable, over the season the cumulative yield showed consistent improvement.

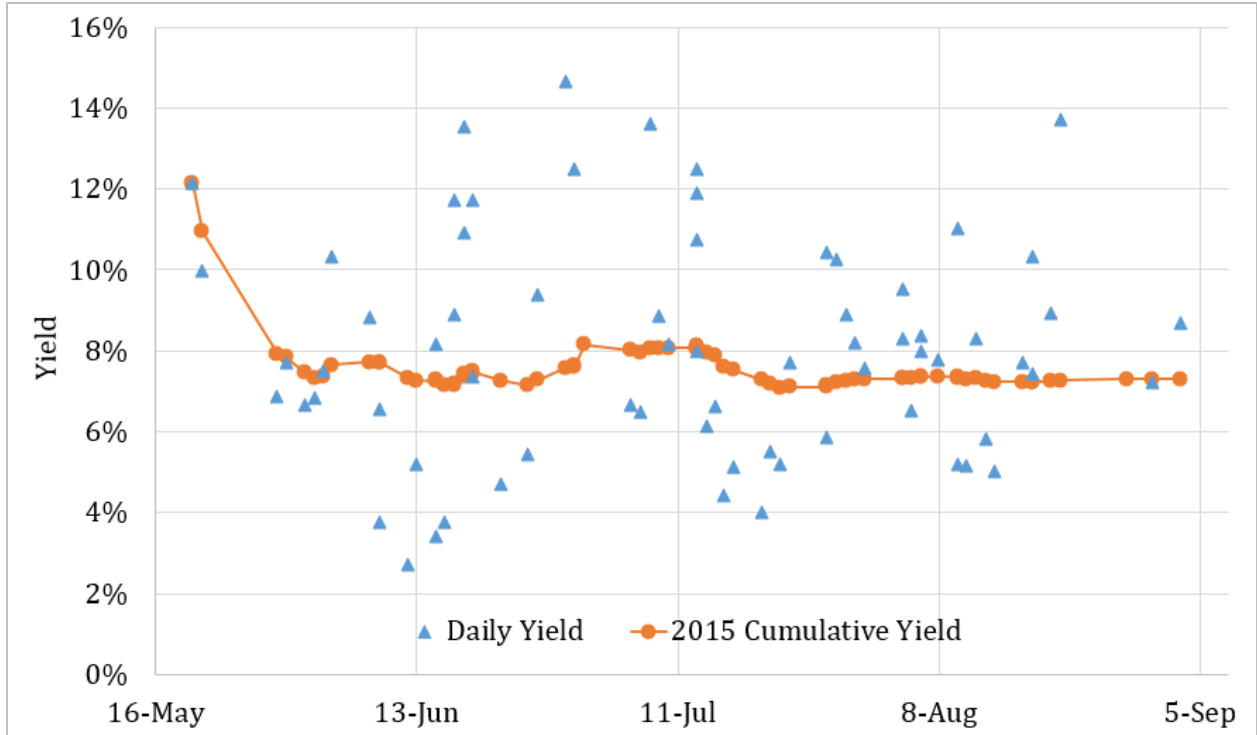

**Figure 53: Chart. Plot of daily and cumulative yield with stringless paver.**

Paving width did not correlate at all to the daily yield results. The correlation between daily paving length and yield, shown in Figure 54, also did not correlate well. What is notable is that there were more outliers for days with short paving distances.

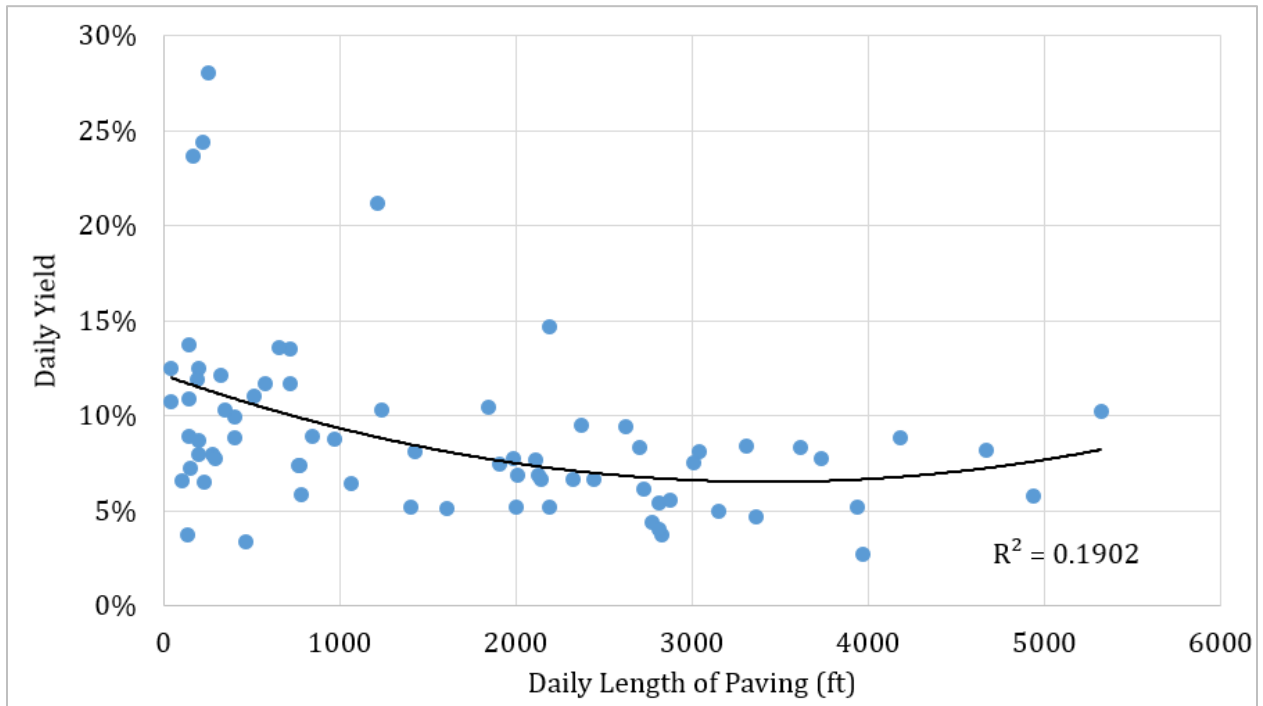

**Figure 54: Chart. Daily yield by daily paving length for stringless paver.**

Wire paving requires three workers to check thickness: two to pull a string and one to check and record slab depths. With AMG, grade checking is a one-person job to check grade and depth, and store data in the data collector. There is a lead time on materials from the batch plant, and the labor cost of the paving crew is approximately \$90 per minute. With grade and depth checks off the back of the paver, there is higher confidence in the paving outcomes and an opportunity to identify issues and react quickly to correct them.

UDOT’s specification assigns penalties to thin slabs. If one core is thin, a second core is taken to confirm. On the eastbound (string line) there were two thin cores. One passed on the second core and the other resulted in a paving lot being paid at 90 percent.

The AMG system enables the contractor to check elevations on the pan of the paver to ensure that the paver is level. It is a big task to re-level a paver. The ability to determine whether the paver is level before starting operations helps with quality control.

A significant benefit to the project was the ability to identify and expeditiously address the problem with the original survey accuracy using 3D data. There would have been materials quantity overruns and potentially a need to import material or remove it from the job site. When decision-makers trust in 3D data and are willing to partner using digital reviews, there is an opportunity to accelerate the schedule or react quickly to issues to avoid delays.

The contractor’s willingness to partner and offer a viable solution to address the survey issues and consequent material balance minimized delays at the start of construction. Normally, a project would go on standby until UDOT had addressed the control issues. UDOT did not have the internal capacity to address the issue as quickly as the contractor could. Still, it was only due to unseasonably warm weather that enabled paving operations to continue into November that the eastbound was able to open to traffic over the winter.

Table 14 lists the costs through November 30, 2015. The bid award was \$35,795,397, so the project concluded \$2.2 million (6 percent) under budget in spite of the issues with the original ground survey.

**Table 14: Summary of Costs**

<b>Expense Category</b>	<b>Cost</b>
Construction Management	\$2,102,401
Construction	\$33,591,502
Preliminary Engineering	\$1,063,512
Right-of-Way	\$1,252
<b>Total Project Expenditures</b>	<b>\$36,758,667</b>



## I-35 UNBONDED CONCRETE OVERLAY

The I-35 Unbonded Concrete Overlay project in Clay County, MO was constructed in 2010. It consisted of approximately 8.3 miles of asphalt milling and unbonded concrete overlay. The project was constructed with 10-mile full closures in one direction at a time, as shown in Figure 55. The project was an alternate pavement bid; concrete was the cheaper alternative.

For each direction there were two driving lanes and inside and outside shoulders. The original I-35, constructed in 1966, was 9-inch jointed reinforced concrete paving (JRPC). It had been overlaid with between 4 and 8 inches of asphalt, which was now deteriorating. MoDOT made a decision to remove all of the asphalt, install a geotextile interlayer, and apply an 8-inch unbonded concrete overlay. There was about 1 mile of cumulative 10-inch JRPC at the bridge approaches where there were clearance and depth transition concerns.

**Table 15: I-35 Unbonded Concrete Overlay Project Elements**

Characteristic	Project Information
AMG Elements	3D profile milling Concrete paving
Real-time Verification	Used by contractor With robotic total stations
3D Data Users	Contractor
3D Data Origin	Re-created by contractor
Other Project Elements	3D means and methods planning 3D models for estimating Inclusion of a bridge



**Figure 55: Photo. Construction used full closure and head-to-head traffic. (19)**

The shoulders were 5.75-inch hot mix asphalt (HMA). The shoulders were 3D profile milled at the same time that the driving lanes were milled to remove all of the asphalt. This created a drainage issue in the driving lanes, which were lower than the shoulders after milling. Edge drains were inserted to prevent water collecting in the work area and to facilitate long term drainage. The base had been retaining water and the edge drains began to drain immediately.

## Information Modeling

The project needed to address geometric deficiencies in the original concrete road. The overlay design was based on 8 inches of overlay; however, the plan quantities assumed 8.5 inches because of the need to correct surface irregularities and geometric deficiencies.

The original plan was to mill off the asphalt, collect survey information, optimize the profile, and place the overlay. MoDOT considered the distribution of risk based on how the bid items were structured. If the paving were paid per cubic yard for furnishing and placing, much like asphalt is paid, then MoDOT would have carried all the risk of overruns. Alternatively, if furnishing and placing were paid by square yard, then the contractor would carry all of the risk. MoDOT opted to balance the risk, paying by cubic yard to furnish the concrete and by square yard to place it.

With paving paid by square foot, the contractor was motivated to pave as quickly as possible. The shared risk model incentivized a highly technical approach using AMG to mill the original concrete and pave the overlay. The contractor used 3D modeling to estimate the yields and optimize the profile. Optimizing the profile introduced opportunities to expand the use of AMG.

The contractor provided MoDOT with a proposal to 3D profile mill the existing concrete to remove irregularities and increase yields. The optimized profile for both alternatives and a cost estimate were provided, backed up with quantities. MoDOT decided to accept the proposal and pay for 3D profile milling of the existing concrete.

Carlson Civil software was used to develop the paving profiles and to take off quantities. The software could predict smoothness by performing an IRI calculation on the 3D data. It could also receive profiler data and perform a grinding optimization plan. The concrete paving system used 3D line strings of the finished grade to control the paver. The profile was developed using the 1990s asphalt overlay plans, the original 1966 concrete paving plans, the in-situ conditions, and the need to correct cross-slopes and improve geometrics to meet modern standards. Carlson Software developed a tool to create the optimized profile, now a standard feature in the software.

There was an opportunity to improve yields by varying the cross-slope within acceptable tolerance, between 1.56 percent and 2.25 percent, as illustrated in Figure 56. Cross-slope variations were made gradually because of concern over smoothness impacts. There was a 1-inch to 1.5-inch leeway in the mill depth, which provided an opportunity to correct a number of irregularities if there was confidence in the pavement structure. The mill depth parameters were set based on where the steel was in the existing concrete. Spot milling was up to 2.5 inches.

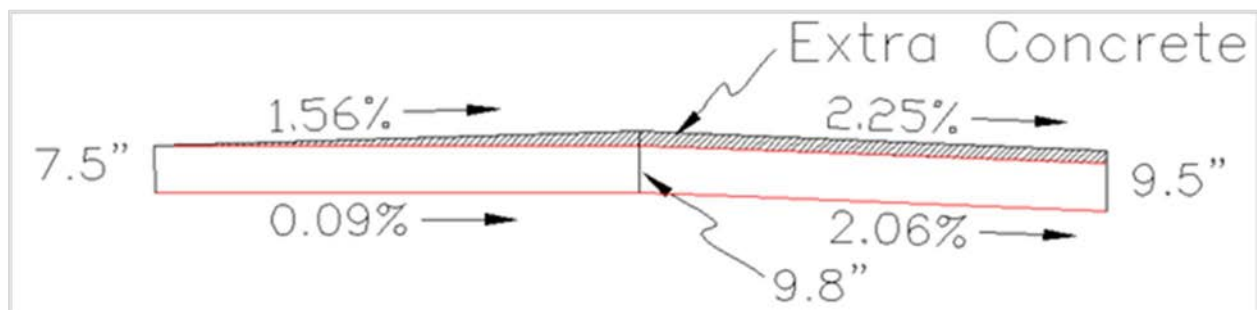

**Figure 56: Illustration. Cross-slopes varied to optimize yield. (19)**

During profile optimization, MoDOT and the contractor met weekly to review profiles and cross-sections. MoDOT uses Carlson software for surveying, so a designer could potentially have been able to read the contractor's 3D models, but the reviewers were most comfortable with plans. The contractor prepared profiles for left edge, center, and right edge, as well as overlay thickness maps and cut/fill maps showing where the overlay was thicker/thinner than specification.

## Surveying

All the asphalt was removed, as shown in Figure 57, based on lessons learned on a project to the north that was similar in scope. There were rock saw cuts every 50 feet to locate the edge of the base concrete prior to milling. MoDOT could not collect meaningful topographic survey until after the asphalt had been milled. The decision to collect topographic survey and use 3D data for estimating and AMG construction was left to the contractor.



**Figure 57: Photo. All asphalt was milled before survey could be collected. (19)**

The RTS-controlled AMG systems require horizontal and vertical control every 500 feet with vertical accuracy being crucial for the successful use of the stringless paver. Relative accuracies between vertical control must not exceed 1/100th of a foot because resection with control is used for positioning. In order to achieve these vertical accuracies, the surveyor must employ high accuracy level techniques.

The contractor's surveyor collected cross sections on the milled surface at 10-foot intervals along the centerline with a Leica robotic total station, which is shown in Figure 58. Points were collected at the edge of lane, shoulder, and centerline. In the unlikely event that there had been wheel ruts within the concrete lanes, those points would have been important to collect as well for the yield calculations. It may not have been necessary to collect points every 10 feet at all locations, but collecting additional points while walking down the road was easier than collecting more data later. The denser the DTM, the more opportunity there is to optimize yield.



**Figure 58: Photo. Concrete pavers use resection for positioning.**

The tie-in locations on the finished bridge decks were surveyed to ensure a smooth transition between the overlay, the full depth reconstruction, and the finished bridge decks with the epoxy coating. From this data, the contractor was able to optimize the profile grade to meet current standards and to minimize yield. The surveyors did not collect locations where there had been full-depth repairs, nor did they collect other areas with pavement irregularities. The patches were higher than the surrounding concrete and affected the accuracy of the yield prediction.

Today, the contractor's surveyor would use static lidar to collect the topographic data. The dense and accurate, staggered control needed for the AMG operations would be sufficient to support the needs for static lidar survey, as shown in Figure 59. Both the RTS-controlled AMG equipment and the lidar equipment use resection to determine their position. Lidar can be set up in the median or in the clear zone, maintaining access to the work zone.

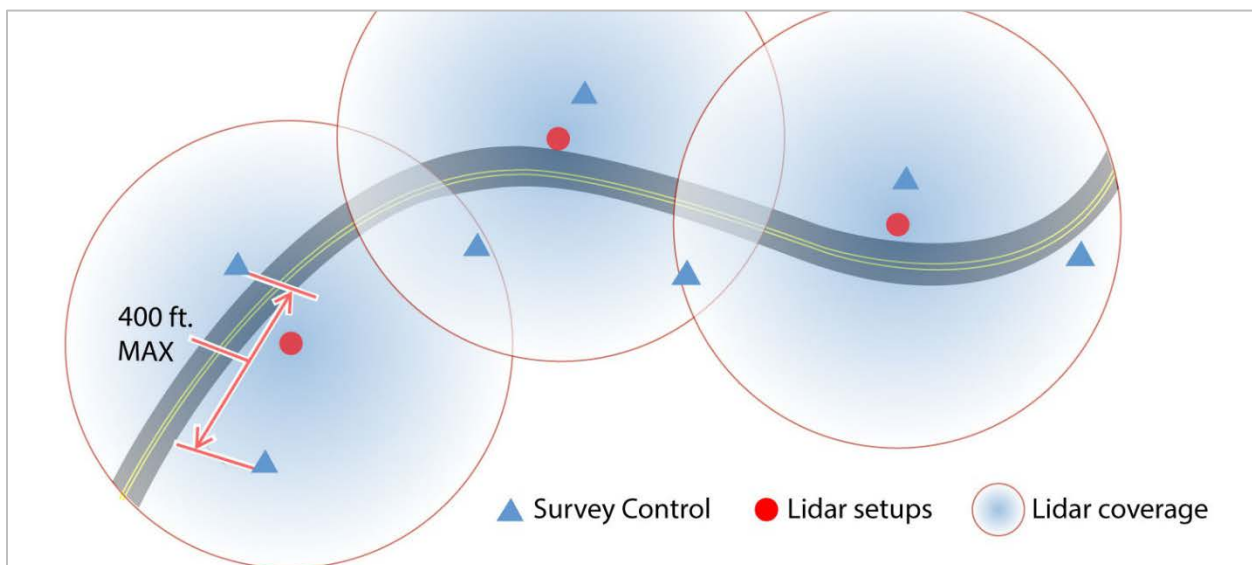

**Figure 59: Illustration. Control requirements for static lidar and AMG paving.**

Static lidar would have taken three weeks to survey both sides. Lidar has more processing time than total station survey, but it prevents the need to collect additional observations to address future concerns such as clearance under bridges. Lidar would have collected the full-depth patches. The ability to collect more irregularities in the existing surface provides greater control on the yield optimization.

The topographic survey was performed with a one-man RTS crew. It took two weeks per direction, four weeks altogether, to collect all the topographic data. With static lidar it is possible to use a one-man crew, but a two-man crew is more common for faster set-ups. The survey rate with static lidar is 1 mile per day per side, using an interval of 500 feet between set-ups. The accuracy of static lidar survey degrades quickly if the range increases beyond 250 feet, less for fresh asphalt, which is less reflective.

### **Real-time Verification and Post-Construction Survey**

The contractor had a grade checker behind both the mill and the paver using an independent RTS. Most grade checkers use a prism, data collector, and topo shoe on the pole. Some contractors attach a bracket to the pole on the grade checker to also check slump on the edge of the slip formed pavement.

The grade checker detected issues in real-time during milling in areas where there were thin milling sections. None of the grade checker's observations were stored, although they could easily have been. While the paver used 3D line strings, the grade checker used a DTM. This meant that the grade checker could check grade anywhere within the road bed. The grade checking software is also able to interpolate in real-time between 3D line strings.

The acceptance priorities were pavement depth and strength, both of which were determined by taking cores. MoDOT's inspectors walked with the contractor's grade checker to review the results on the data collector. MoDOT's inspectors also checked stab depths on the paving. MoDOT's inspectors had a GNSS rover, but it did not have the accuracy to check paving. The GNSS rover was used to as-built and measure pavement repair areas, document temporary signs, and document erosion control.

Volume quantities were computed using manual calculations of length multiplied by width multiplied by depth. Load tickets were also checked.

MoDOT designers do not normally have a role in construction. Designers typically move onto the next project once a design has been submitted for a letting. Similarly, MoDOT Construction usually resolves issues in the field where possible. In some cases, MoDOT Design has placed designers in construction offices on projects they have designed. This has built good relationships between the Design and Construction departments, leading to a quicker turn-around on RFIs. The designer was in the project office, which enabled drainage issues to be resolved within a day or two.



## Technology Impacts

The contractor had past experience with AMG for grading and was relatively technology savvy. With a number of upcoming overlay and concrete paving projects, the contractor decided to purchase an AMG concrete paving system. The AMG system was an investment of \$600,000 and this was the contractor's pilot project. There was a will to see it succeed, and the contractor had invested in support from a data preparation consultant and from the AMG vendor.

Allowing the contractor to collect the mapping and create the overlay profiles made the contractor responsible for the schedule and MoDOT could not be the source of any delay related to mapping or design data.

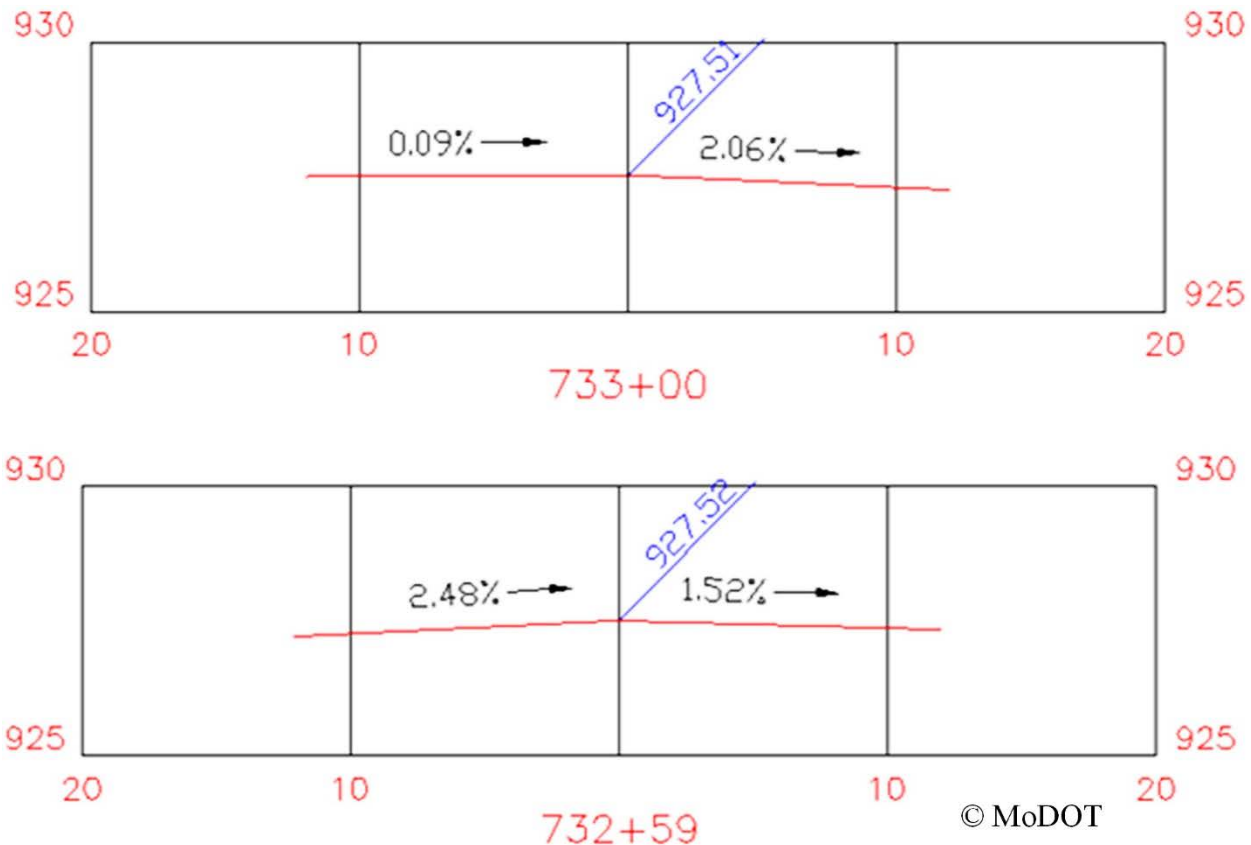

**Figure 60: Photo. Dowel bar cages were placed ahead of the paver.**

The contractor maintained an average of 7,000 feet of mainline paving per day. The paver did not have dowel bar inserters, which meant that the dowel bar cages, visible in Figure 60, needed to be in place ahead of the paving. This limited access to the work area; the shoulders had to be used to haul concrete, which was placed with a belt. The contractor did not have confidence that the AMG system would markedly improve smoothness and always planned to diamond grind after curing. The final IRI ranged from 20 inches/mile to 37 inches/mile. Diamond grinding might have been avoided by paving more slowly. However, other factors provided an incentive to pave quickly, such as removing the full closure and labor costs on an area-based pay item.

The cross-slopes on the original concrete were highly variable, as shown in Figure 61. The original plan sheets called for 1.56 percent (3/16-inch per foot). Applying the new geometric criteria of a 2.00 percent cross-slope, minimum 300-foot curve length, and design thickness would have yielded about a 25 percent Portland cement concrete overrun.





**Figure 61: Illustration. Cross-slopes on the original concrete varied.**

The 3D modeling provided both the contractor and MoDOT with a high degree of confidence in the ability to predict and control yields. The bid was based on a one-half-inch waste factor, which allowed for about a 6 percent overrun. By allowing the cross-slope to vary, MoDOT saved 8,500 cubic yards of concrete overruns, which equates to a savings of over \$600,000.

Allowing a reasonable tolerance on overruns created an opportunity to optimize the profile and make geometric corrections. Using 3D milling before the overlay added much more flexibility to make geometric improvements and control yields. The ability to mill would be a more significant factor for thinner overlays. The ability to control yields depends not only on the AMG system, but also the data used to estimate the quantities and load onto the paver. There needs to be a high accuracy, a high detail surface of the base, and a high detail surface for the paving.

The project won a gold award for Highway Overlays at the 22nd Annual American Concrete Paving Association Excellence in Concrete Paving Awards. The contractor used only 219 of the allowable 259 days of head-to-head traffic (i.e., full closure in one direction), a savings of more than 15 percent. This was a notable achievement considering that bad weather and unanticipated earthwork were encountered.

MoDOT does not normally collect mapping information for mill and overlay projects. The outcomes of this project could make a case for providing mapping for concrete overlay projects. However, in this case, mapping had to occur after the asphalt was milled.

Other benefits of the stringless paving approach are harder to quantify, but no less significant. Not having strings on the job site improved safety and mobility in the work area. As Figure 62 shows, the work zone was relatively close to live traffic. With string line paving, the strings would have extended 6 feet into the median, which may have required placement of a physical barrier in the median to protect workers.



**Figure 62: Photo. The work zone was close to live traffic.**

## US 17 BRIDGE AND SAFETY IMPROVEMENTS

The US 17 Bridge, and Safety Improvements project (PIN D262079) in New York was primarily a mill-and-fill project with some geometric improvements, reconstruction, and bridge rehabilitation. There were also retaining walls, shoulder work, and superelevation corrections in interchanges. The project was spread over 12 miles, but work was concentrated at curves and in the interchanges.

**Table 16: US 17 Bridge and Safety Project Elements**

Characteristic	Project Information
AMG Elements	Candidate for 3D profile milling (not used)
Real-time Verification	Smart level
3D Data Users	Designer
3D Data Origin	Original design data
Other Project Elements	Inclusion of a bridge

This project was a potential candidate for 3D profile milling because of the need to make geometric corrections to alter the superelevation in curves and on ramps. Superelevation and cross-slope adjustments can either be made by build-up on the high side or by lowering one side and building up the other.

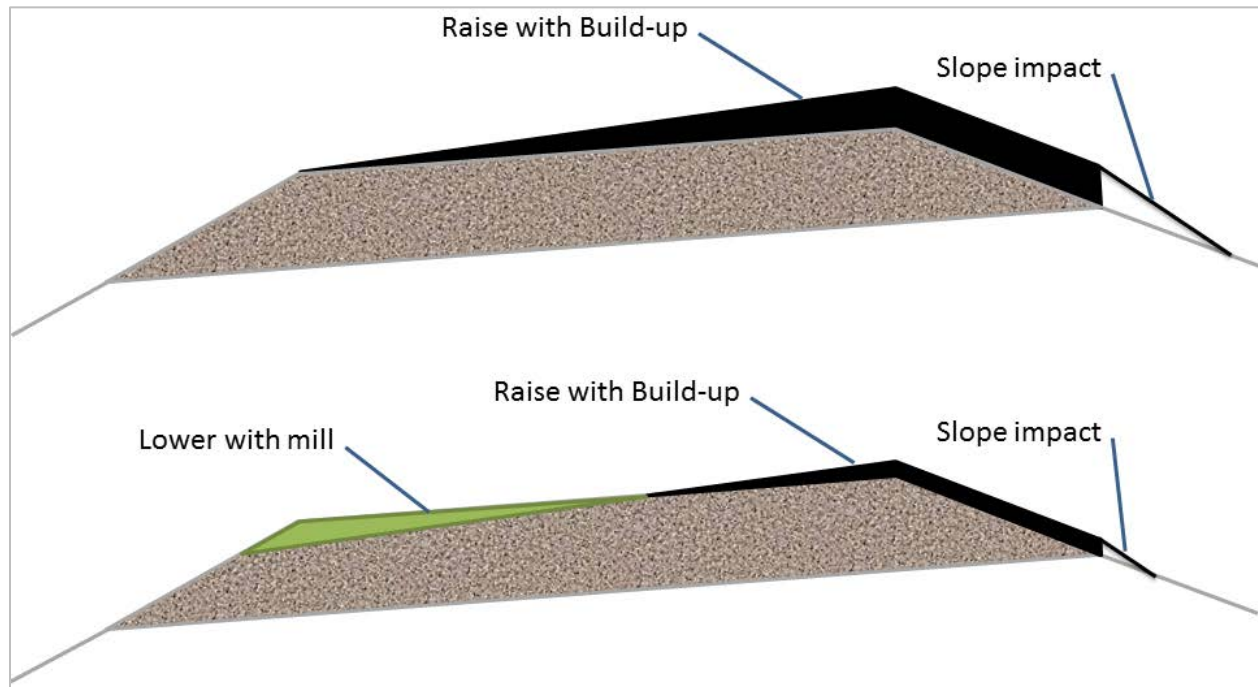

**Figure 63: Illustration. Two approaches to cross-slope improvements.**

As Figure 63 shows, the approach using both milling and build-up uses less asphalt and has less of an impact in fill slopes where build up has cascading impacts on the shoulders and down the

fill slope. However, there needs to be sufficient structural depth in the existing pavement to support milling, which is often uncertain or known with low confidence.

Pavement cores were taken before design to provide information on the pavement structure. The design called for eight different milling depths in different areas. The contractor did additional coring to get more complete pavement information. However, unexpected in-situ pavement conditions were still encountered. Shoulders were supposed to be full-depth asphalt, but in some areas milling exposed the base.

It became apparent after mobilization that some of the work items had already been performed, mostly at the bridges. These work items were eliminated, making significant differences between bid and final quantities.

### Information Modeling

The designer opted to use 3D modeling (Bentley InRoads v8i SS2) to develop the design. It is normal practice to use 3D models where survey data is accessible, especially when working with complex superelevation, retaining walls, and estimating pavement quantities. The 3D modeling was particularly useful for computing quantities and for designing the retaining walls. The 3D modeling also helped to determine the milling depths and develop the overlay design.

The plans used 2D graphics to delineate work areas and call-out notes to describe activities. A typical example of how the design was documented is shown in Figure 64. There were also profiles and mill depths. While 3D data was used to design the retaining walls and estimate quantities, the plans did not include any additional information beyond what is typical for this type of project.

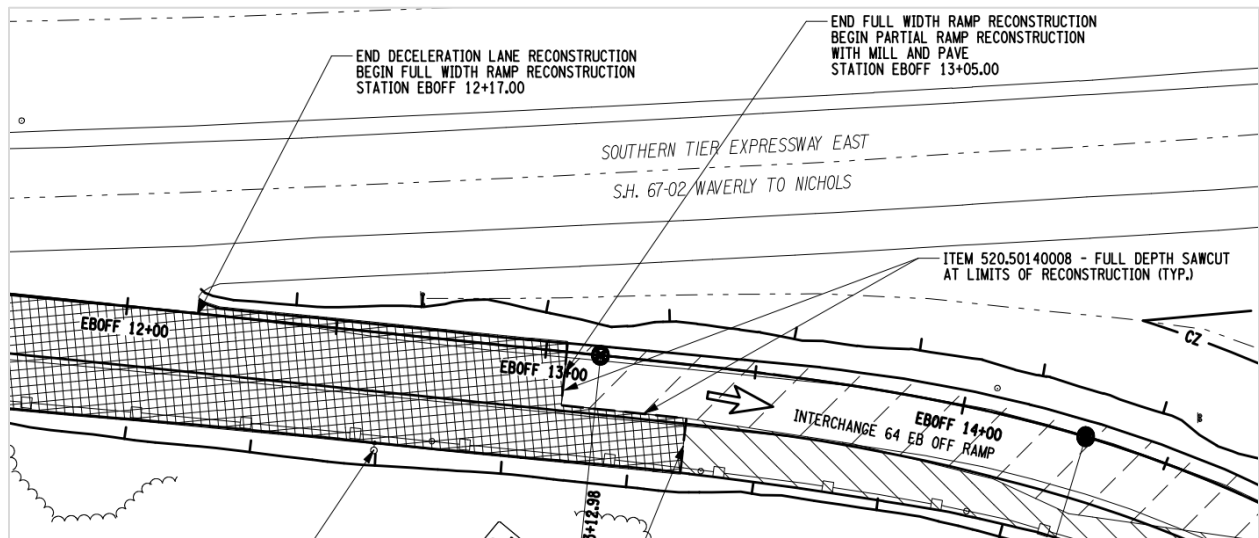

**Figure 64: Illustration. The design was documented through sketches and notes.**

Despite 3D data being available, and it being a common practice at NYSDOT to provide 3D data with bid documents, the 3D data was not provided to contractors during advertising. Bid addendum 3 notified contractors that 3D data was available but would not be provided until post-award. The specific language read:

The XML versions of the Inroads ALG and DTM files were not intended to be part of the Supplemental Information Available to Bidders. XML versions of the Inroads ALG and DTM files will be provided to the winning contractor.

Bid addendum three also modified the quantities for a range of items that accounted for almost one-third of the contract value. The total contract value was \$11,861,297.74. The total value of the addendum was \$3,859,085.50, or 32.5% of the contract value. Table 17 shows the modified quantities in Addendum 3 and the respective proportion of each item to the total contract value.

**Table 17: Quantities modified in Addendum 3**

<b>Bid Item No.</b>	<b>Item</b>	<b>Unit</b>	<b>Quantity</b>	<b>Unit Price</b>	<b>Estimate</b>	<b>% of Bid</b>
203.02	Unclass Exc	CY	22,515	\$15.00	\$337,725.00	2.8%
304.15	Subbase	CY	10,469	\$33.50	\$350,711.50	3.0%
402.011902	Base	TON	5,685	\$66.00	\$375,210.00	3.2%
402.011912	Quality Adj	QU	284	\$65.00	\$18,460.00	0.2%
402.098202	HMA	TON	15,012	\$92.00	\$1,381,104.00	11.6%
402.098212	Quality Adj	QU	751	\$65.00	\$48,815.00	0.4%
402.198902	Binder	TON	3,899	\$83.50	\$325,566.50	2.7%
402.198912	Quality Adj	QU	195	\$65.00	\$12,675.00	0.1%
402.378902	HMA	TON	10,138	\$76.00	\$770,488.00	6.5%
402.378912	Quality Adj	QU	507	\$65.00	\$32,955.00	0.3%
407.0101	Tack Coat	GAL	15,754	\$3.15	\$49,625.10	0.4%
490.1	Milling	SY	129,792	\$1.20	\$155,750.40	1.3%

Three of the six bidders likely considered this job to be a good candidate for AMG. The top three bids were within 0.5 percent, although one of the three contractors with a high penetration of AMG was the highest bidder nearly 25 percent over the winning bid.

The contractor did not consider that there was a need to field-verify anything in the plans during the bid. The plans were clear and did not indicate any sign of the issues that eventually arose during construction. Asphalt, which made up more than one-quarter of the bid value, was paid by ton, so NYSDOT bore the risk of overruns.

The contractor had not yet invested in 3D profile milling; this was considered a potential pilot. The contractor modeled some sections in 3D, but the plan data did not match field conditions and it was decided to continue with traditional methods to avoid delays. An early, firm commitment to 3D profile milling and 3D paving could have identified issues before mobilization.

It was not yet known that the issues were systemic, but confidence was low. With equipment already mobilized it was not considered that there would be value in taking the time to pursue 3D methods. Continuing with 3D methods would have required sending updated survey information back to design to adjust the profiles. There was uncertainty in how long this would take, and the survey crew was on another job.



## Surveying

The survey information available for this project was photogrammetry data, and the data was old. Aerial photogrammetry cannot sufficiently measure superelevation accurately or determine bridge tie-in elevations. The NYSDOT survey specification required 2-inch network accuracy on hard surfaces and 1-foot accuracy beyond the clear zone. In practice, the survey was significantly less accurate than specified. Moreover, it predated maintenance work, especially at the bridges.

To collect the necessary data to use 3D milling and paving would have required setting control and collecting more accurate topographic survey. While the project limits extended about 12 miles, the work, as shown in Figure 65, was concentrated in curves and at interchanges. This would have required either setting an extensive control network or setting independent control at each work area, both of which are time-consuming options.

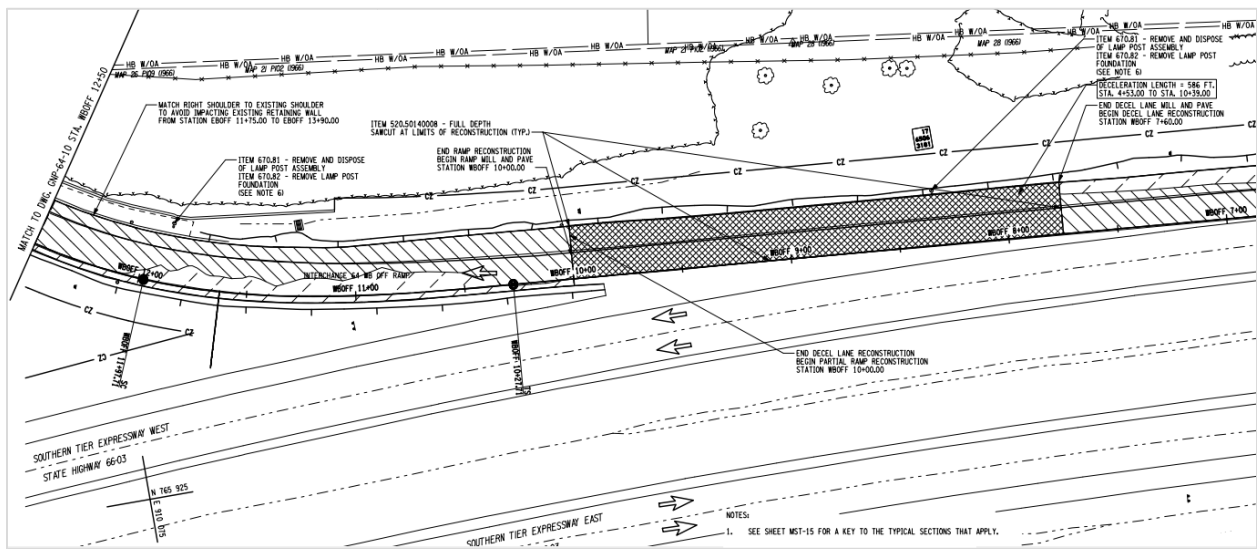

**Figure 65: Illustration. The work was concentrated in interchanges.**

Given the high speeds and interchange locations, a maintenance of traffic crew would have been needed to maintain rolling lane closures to protect the surveyor. The contractor estimated that it would take a one-man survey crew four weeks to set the control and collect new topographic survey with a RTS capable of taking reflectorless observations on the hard surfaces. This would have cost approximately \$5,000 per day, or \$100,000 in total.

The survey data needed to successfully prepare surfaces for 3D profile milling and paving would have required an accuracy of one-quarter inch and a density of 3-foot intervals in the ramps and 10-foot intervals on the main line and at bridge approaches, as illustrated in Figure 66. In both cases, points would be collected on all superelevation critical points, including edges of shoulder, edges of lane, and centerline or other crown or roll-over points.

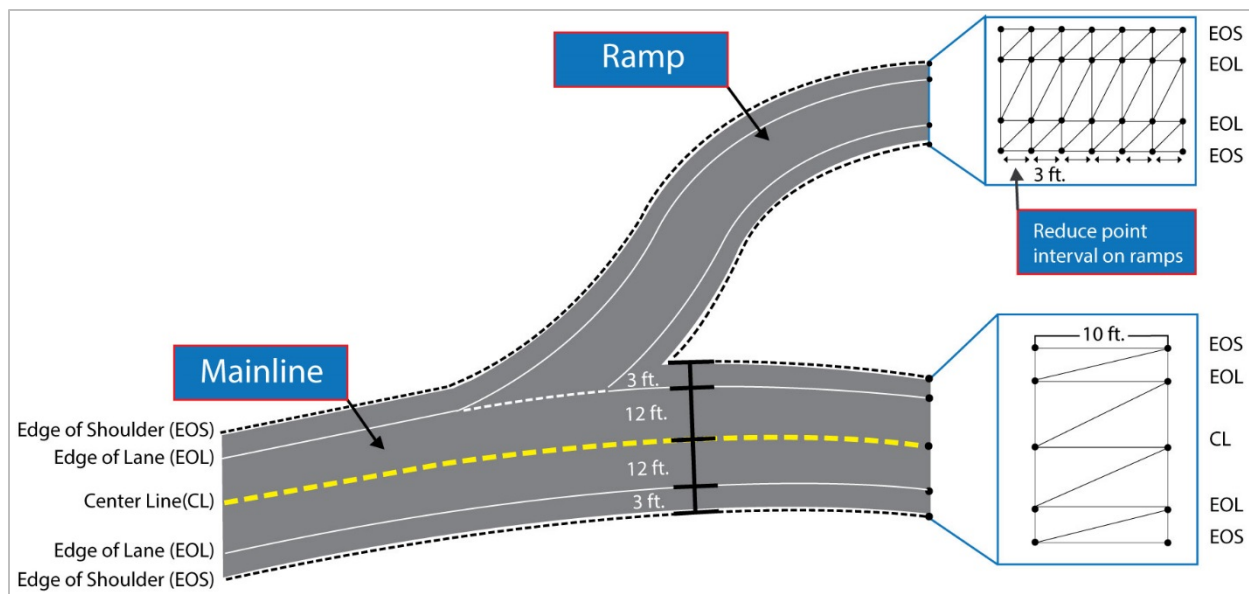

**Figure 66: Illustration. Survey for mainline sections.**

Static lidar would have been another option for collecting the topographic data. The scanner could be set up in the clear zone and avoid the need for lane closures. Data collection would also be faster, but it takes more time to process the data into the DTM, as indicated in Figure 66.

### Technology Impacts

Both the age and method of survey contributed to issues in the field. The photogrammetry survey was collected with an older generation of camera that is less accurate than current methods. This affected the accuracy of the profiles. The age of the survey meant that more recent maintenance work was not reflected. This was most significant for the bridge work, some of which had already been completed.

It is not clear that using 3D milling and paving would have had a positive return on investment. In addition to the approximately \$100,000 in survey costs, there would have been data preparation costs. These costs could have been recouped with the combined milling and build-up approach to effecting the superelevation corrections. However, this method may not have been possible due to the in-situ pavement conditions.

Issues regarding the variable depth of asphalt pavement were common. The wide variability was unusual; cores were taken by both NYSDOT and the contractor, but in-situ conditions were not predictable. Ground penetrating radar (GPR) may have provided sufficiently complete information to predict the pavement conditions. Combined with sufficiently accurate survey information, the 3D design would then have resulted in data that was usable for 3D profile milling and 3D paving. Whether this approach would have provided a positive return for NYSDOT is still not certain due to the cost of GPR, the variability of the in-situ conditions, and the likelihood of a contractor being skilled and motivated to use the approach of milling to partially correct the superelevations.

Using 3D data to plan and execute AMG could have helped identify the issues prior to mobilization, provided that part of the data preparation included verifying the accuracy of the original ground DTM. If the contractor had spot-checked the original ground DTM, it would have been readily apparent that there were systemic issues with the accuracy and that the milling profiles were not correct. Instead, the contractor and Resident Engineer-in-Charge decided to adapt in the field to the conditions as they found them. The other alternative would have been to collect new survey data and send the project back to design.

In one area, about 12 inches of asphalt build-up was necessary to achieve the required cross-slope. This necessitated an unexpected sliver fill down the fill slope on the outside of the curve. The slope of the fill needed to be adjusted to stay within the right-of-way.

### **US 219 MILL AND RESURFACE**

The US 219 Mill and Resurface project (D262554) in New York occurred on a 13.4-mile section of US 219 north of the section studied above. This section of roadway has a jointed concrete base with asphalt surface. In parts, the design called for cracking and reseating the jointed concrete base. The project was let in February 2014 and completed that summer. Project elements are listed in Table 18.

**Table 18: US 219 Mill and Resurface Project Characteristics**

<b>Characteristic</b>	<b>Project Information</b>
AMG Elements	2D sonic averaging on the mill and paver
Real-time Verification	None
3D Data Users	None
3D Data Origin	None
Other Project Elements	Inclusion of a bridge

The rural road is access controlled. The shoulders tie into grassy side slopes with side ditches. There were a few bridges, but few other constraints of significance that affect milling and paving operations. This project is an example of where 3D technology would not have provided advantages in terms of quality, speed of operations, or safety. In fact, attempting to use 3D technologies would have meant investment in survey and design, additional staff exposed to equipment and traffic to run the grade-control equipment, and slower operations.

Instead, the approach was to use sonic averaging skis on both the mill and the paver. In sections where the base concrete was cracked and seated, the mill was operated by feel to fully expose the concrete. Sections of the roadway not cracked and seated already show longitudinal and transverse cracks above the base concrete joints one year on, as seen in Figure 67, which was taken in 2015.



**Figure 67: Photo. Cracks above the concrete joints in 2015.**

The sonic averaging skis were able to adapt to the few hard tie-ins located at the bridge abutments. Figure 68 shows one of the bridge approaches.



**Figure 68: Photo. A bridge on US 219 looking south.**

The total contract value was \$6,960,329.50. The total value of the top eight bid items, shown in Table 19, was \$5,661,175.00, or 81% of the contract value. A single item, the asphalt top course, accounted for more than half. Three of the top eight bid costs were line items for quality payment adjustments and for field change payments.

**Table 19: Top eight bid items by contract value**

Item No.	Description	Quantity	Unit	Unit Price	Value	%
402.095202	9.5 F2 Top Course HMA, 50 Series Compaction	47,800	TON	\$77.00	\$3,680,600.00	53%
402.017902	True and Leveling F9, Superpave HMA, 70 Series Compaction	8,200	TON	\$65.00	\$ 533,000.00	8%
697.03	Field Change Payment	370,000	DC	\$1.00	\$ 370,000.00	5%
699.040001	Mobilization	1	LS	\$250000	\$ 250,000.00	4%
490.1	Production Cold Milling Of Bituminous Concrete	450,500	SY	\$0.55	\$ 247,775.00	4%
407.0102	Diluted Tack Coat	52,500	GAL	\$3.76	\$ 197,400.00	3%
402.095212	Plant Production Quality Adjustment To 402.095202	2,390	QU	\$80.00	\$ 191,200.00	3%
402.095222	Pavement Density Quality Adjustment To 402.095202	2,390	QU	\$80.00	\$ 191,200.00	3%

With asphalt paid per ton, NYSDOT bore most of the risk of overruns. This may have incentivized the contractor to use additional asphalt build-up to improve ride quality. However, the project was concluded successfully about \$1 million below contract value.

**Information Modeling**

The sonic averaging system did not require any 3D digital data. Instead, the system uses a ski with sonic sensors to collect depth information and average it in real time. The sonic averaging ski, as shown in Figure 69, may be mounted on one or both sides of a mill or a paver.

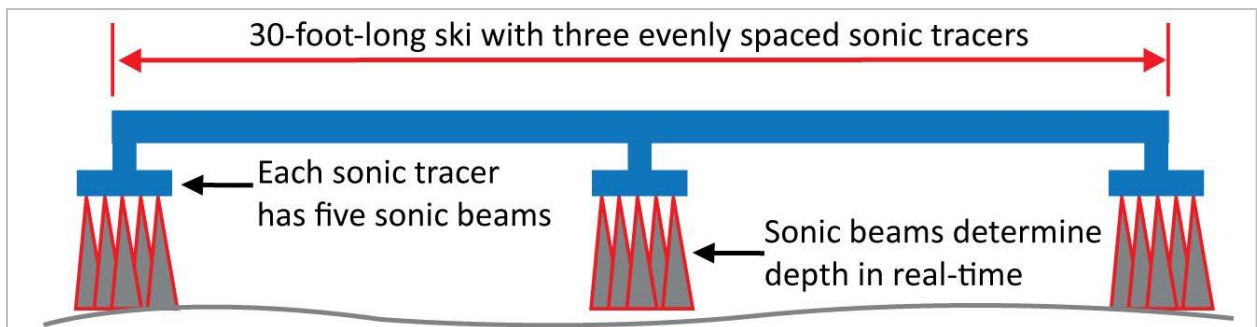

**Figure 69: Illustration. Sonic tracers on an averaging ski.**

The real-time depth information is sent to the control box where it is averaged and used to control the grade of the mill or the paver. Each sonic tracer has five sonic beams, which enables the system to ignore stones and irregularities that could affect the accuracy.



The ski—or skis—may be used in a number of configurations, making the system applicable for a variety of different milling and overlay requirements. In Figure 70, an asphalt overlay is being applied using sonic skis while tying into a curb on the right. While not needed on this project, the system could be used to effect cross-slope corrections. Sonic averaging and ground contact averaging skis are common for asphalt paving, but less common for milling.



**Figure 70: Photo. Asphalt overlay with sonic skis.**

### **Real-time Verification**

Acceptance was based on depth and density. Stab depths were checked in the uncompacted asphalt behind the paver. Other acceptance measures were performed after paving operations were complete. Cores were taken for depth and density testing. There were smoothness requirements for which the contractor collected data using a lightweight profiler.

### **Technology Impacts**

The original ride quality was poor, although the smoothness requirement did not adjust for the existing conditions. Most of the work to improve ride quality was done by the sonic averaging on the mill. Sonic averaging on the paver can provide additional smoothness benefits by making small increases in the asphalt depth to even out depressions. However, compaction is more challenging where there are inconsistent asphalt depths.



**Figure 71: Photo. Good smoothness outcomes were achieved.**

The asphalt quantity underran, indicating that depths were not significantly increased by the sonic averaging on the paver. The final smoothness results were good, achieving IRIs between 50 and 60 inches/mile, sufficient to secure the full smoothness incentive. Figure 71 shows the finished roadway.

A 3D profile milling operation would have cost about 10 percent more. The operation requires one RTS to control grade on the mill and another RTS for independently checking grade. One or two more pair of RTSs would be needed to maintain continuous operations as the mill moved beyond the range of the first RTS. The job would have required a surveyor during milling to operate the RTSs. The mill speed is slower when milling to a profile, so the operation would have been less productive.

There would also have been a large survey cost to set control and collect high accuracy survey. Extrapolating the survey cost on Route 60, the survey cost for 3D profile milling would have been several hundred thousand dollars. There would have been additional data preparation costs to create the milling profiles.

## 5. GENERAL OBSERVATIONS

One objective of the interviews was to take advantage of the knowledge and experiences of the interviewees from other projects by soliciting more general observations and lessons learned from other projects. This section documents these discussions, some of which were more detailed than others.

### NEW YORK

NYSDOT has a committee that meets quarterly to explore the potential benefits of Civil Integrated Management (CIM) to the agency. Members of this CIM committee shared general observations during the interviews to collect project-specific data.

#### Information Modeling

At the time of writing, NYSDOT's CADD standard software environment for geometric design is MicroStation, with the InRoads V8i SS2, although this platform will change in 2017 when there is an open procurement of new CADD software. This will require retraining in a state where software proficiency extends beyond design and into the field, with the software used on many construction sites. There are legacy data durability considerations, especially if the new software is provided by a different vendor. NYSDOT's large library of how-to documents and workflows for using MicroStation and InRoads V8i SS2 with the Leica survey equipment will need to be updated for new software and survey hardware in 2017.

This is not the first software update that NYSDOT has propagated. NYSDOT first provided training in 3D modeling in 1995. There is a distinction between proficiency in 3D design—a skill that transfers between different software platforms—and specific software proficiency. NYSDOT has noticed in recent years that skill with 3D modeling has concentrated, with staff developing separate skill sets in 3D modeling or drafting.

Where and in what capacity 3D models are applied on design projects are decisions left to the design project manager. Personal preference is a small factor, but in-house designers have a preference for using 3D modeling to develop designs if survey data is available. Other project characteristics influence the decision to model. For example, a small, 300-foot-long project to replace a culvert would not normally invoke a 3D model. Complex projects, projects containing subsurface utilities, and projects where survey data is available will very likely use 3D models. The need for public outreach/design visualization is also a factor. As the demand for these later services grows, so does the incentive to use 3D modeling.

The NYSDOT design teams stated that 3D design models reduce the time required for plans production. However, construction-ready 3D models are more time intensive, requiring detail at intersections and transition areas not necessary for producing standard plans sets. Creating plans takes significant time, and designers frequently need to stop advancing the model to complete the plans according to the schedule.

Internally, the NYSDOT structures group has been expanding its use of 3D modeling on a project-by-project basis, depending on the availability of skilled individuals and survey data. The

structures group uses the same 3D modeling tools as the roadway designers. Bridge design production first used 3D CADD models in 2003. Methods were standardized and incorporated into the bridge design manual in 2008. In 2010 3D models for substructures became a requirement for all new and replacement projects. Using 3D modeling for other bridge elements is at the designer's discretion. It is recommended that all items paid by volume and detailed by section are modeled in 3D, especially earthwork, an example of which is shown in Figure 72.

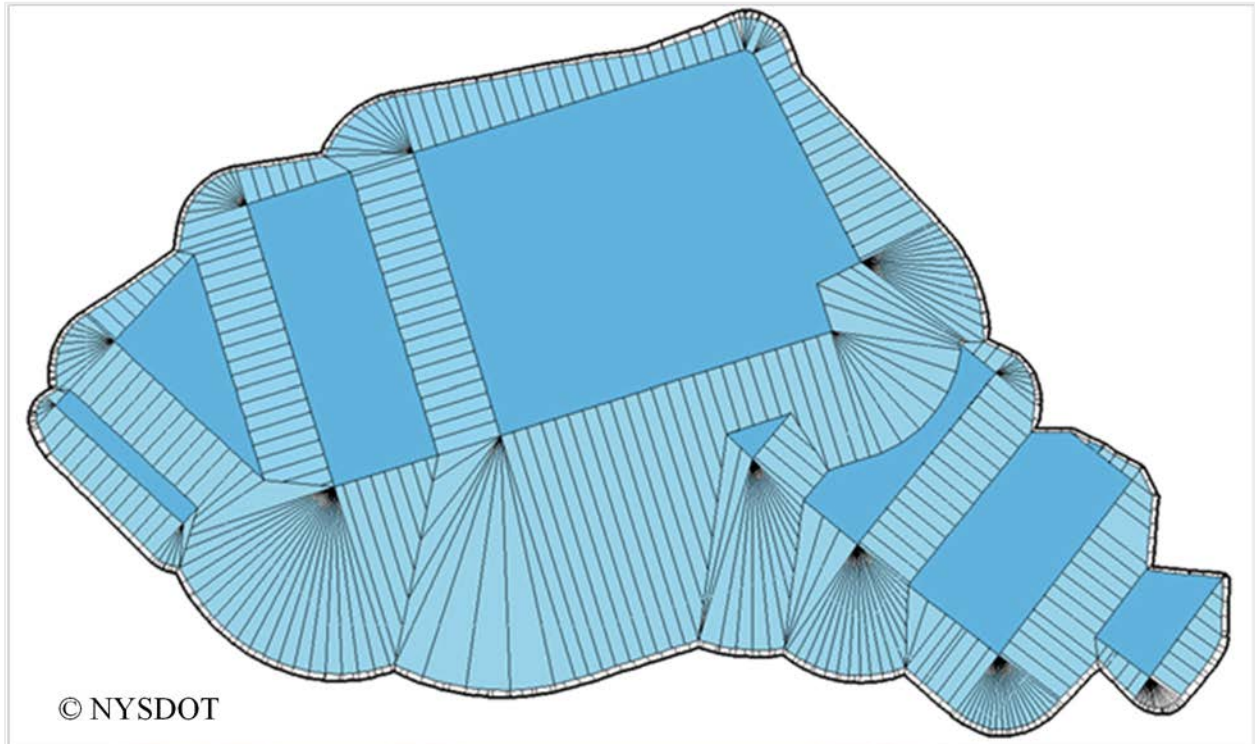

**Figure 72: Illustration. Earthwork model for a bridge foundation.**

Bridge models are feature-based, which means that they contain MicroStation CAD elements. Examples are shown in Figure 73.

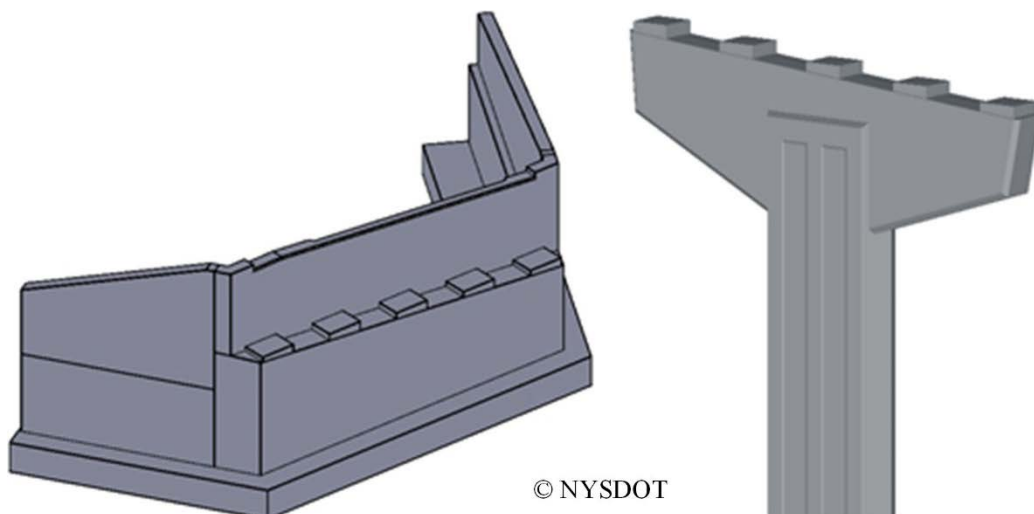

**Figure 73: Illustration. Examples of an abutment and a pier.**



Unlike roadway corridor models, the components are not parametric objects that have geometry governed by mathematical relationships. This restricts change propagation through design evolutions. However, they are developed in project geospatial coordinates consistent with the roadway models. The models are used for geometric analysis and detailing, and are not integrated with structural analysis. The models aid in plans production, quantity take-off, and inter-disciplinary coordination.

The modeling standard makes extensive use of the MicroStation model feature. Models within MicroStation are analogous to sheets in an Excel spreadsheet file. It is a means to segment and name individual 3D model content, as shown in Figure 74. However, this is a unique function of MicroStation and requires MicroStation software to access all but the current model. Bridge files may have over two dozen models within them. While these files are made available to contractors with other 3D data as part of the bid reference documents, the ability to use them requires advanced knowledge of MicroStation and access to the software to export each model individually.

Type	2D/3D	Name	Description	© NYSDOT
<input checked="" type="checkbox"/>	<input checked="" type="checkbox"/>	190 HIGHWAY LINES	FROM HIGHWAY DESIGNER	
<input checked="" type="checkbox"/>	<input type="checkbox"/>	ALL ROADWAY SECTIONS	FROM HIGHWAY DESIGNER	
<input checked="" type="checkbox"/>	<input checked="" type="checkbox"/>	BORINGS	PLOTTED BY COORDINATES	
<input checked="" type="checkbox"/>	<input checked="" type="checkbox"/>	CONTOURS	GENERATED FROM 558039a.dtm	
<input checked="" type="checkbox"/>	<input checked="" type="checkbox"/>	Default	( NOT USED )	
<input checked="" type="checkbox"/>	<input type="checkbox"/>	EXISTING SUBSTRUCT. 2D LA...	2D LAYOUT	
<input checked="" type="checkbox"/>	<input checked="" type="checkbox"/>	EXISTING SUBSTRUCTURES R...	3D SOLIDS	
<input checked="" type="checkbox"/>	<input type="checkbox"/>	HORIZONTAL DATA	FROM HIGHWAY DESIGNER	
<input checked="" type="checkbox"/>	<input type="checkbox"/>	MASTER BORDER	ALL ST1 DWGS	
<input checked="" type="checkbox"/>	<input type="checkbox"/>	NYSTA HORIZONTAL DATA	FROM HIGHWAY DESIGNER	
<input checked="" type="checkbox"/>	<input checked="" type="checkbox"/>	RAMP B PAVEMENT MARKINGS	FROM HIGHWAY DESIGNER	

**Figure 74: Screenshot. Multiple models in MicroStation.**

There is an informal practice that 3D models are provided as bid reference documents at the discretion of the designer. Sometimes, as in the case of the US 17 Bridge and Safety Improvements project described earlier, there is a note to alert contractors to bid in anticipation of 3D data being provided post-award. There is a perception that contractors can spend between \$25,000 and \$50,000 to create AMG data from the contract plans.

It could be cost-effective to extend the modeling efforts in design to bring the design models up to the level of detail needed for construction. NYSDOT may see cost savings passed on from contractors in the bids. More importantly, it would provide robust 3D data to the inspection team. If the designer were able to sign and seal a 3D model, then the Resident Engineer-in-Charge could be confident that the 3D data reflects the design intent in the contract documents.



In the past three or four years, the number of construction projects has expanded in instances where the inspection team is using 3D data for real-time verification and collecting post-construction survey data for measuring payment quantities. While initially Region 9 led the development of these methods and workflows, now all regions have proficiency. The technology is sometimes initiated in reaction to a contractor's use of AMG, where the 3D methods allow the inspectors to keep pace with the faster AMG operations. However, that is not always the case. Sometimes it is a preferred approach by the inspection team. Time savings from using these 3D methods were evaluated on the Parksville Bypass project, as illustrated in Figure 1 and Figure 2 in Chapter 2 of this report.

Visualization is another opportunity for using 3D digital data. Visualization is a mature practice, but opportunities exist to use design models to reduce the time and cost of creating the 3D geometry for visualization. NYSDOT has invested in 4D and 5D modeling, especially in the New York City area (Region 11). Here, projects have a wide impact on operations on roads with high average daily traffic.

On the Kosciuszko Bridge project, 4D simulations and 3D renderings were requirements of the design-build-bids. Both 4D and 5D models were also routine deliverable requirements during construction. The successful bidder included simulations of the maintenance of traffic staging on the Long Island Expressway, although there were still RFIs post-award and design exception requests for the ramp speeds once detailed design started and it was determined that it was not physically possible to meet the 45 mile per hour design speed.

The Request for Proposal (RFP) for Kosciuszko Bridge required a MicroStation format for 3D deliverables and allowed the contractor to select from a limited number of software applications for the 5D model. Synchro 4D was selected and the model is hosted within LoadSpring, a cloud-based environment. LoadSpring hosts not only the data but the software as well. It is tailored to the construction industry and also hosts Primavera P6, the specified scheduling software, as well as a growing range of other engineering software applications.

The project requirements for Kosciuszko Bridge provided some specific guidance as to the 3D data and 4D and 5D model requirements. Section 26 of the project requirements extended to 10 pages, including sections to define the scope, standards and references, requirements, and 4D/5D modeling deliverables. (20) The requirements included a set of definitions, one of which defined Level of Development (LOD) in accordance with the American Institute of Architects (AIA) standard. (20) The content requirements for the 3D models were broken down by discipline, with an LOD assigned to each model, as shown in Table 20.

**Table 20: Models and LOD for Kosciuszko Bridge**

<b>Discipline</b>	<b>Model</b>	<b>LOD</b>
Existing Conditions	Surface Terrain DTM, Bathymetry DTM	300
Existing Conditions	Elevated Structure, incl. foundations, abutments, piers, main truss, approach framing, and decking.	200
Existing Conditions	Buildings to be demolished	200
Existing Conditions	Buildings – Context	100
Existing Conditions	Local Streets, other topographic context features	100
Civil	Local Streets – Paving	200
Civil	Local Streets – Relocated, Grading	300
Civil	Utilities, ITS, Lighting/Power, Drainage, Geotechnical, Fire Standpipe System, Fences, Signage/Striping, Landscaping	200/300
Traffic	Work Zones, Staging/MPT/Traffic Signals	100
Structure	Approaches Substructure (Piers, Abutments, Foundations), Main Span Substructure (Towers, Piers, Foundations)	300
Structure	Approaches Superstructure, Main Span Superstructure	300
Temporary Structures	Temporary Bridges at Connectors	-
Temporary Staging	Falsework, SOE, Cofferdams, Equipment, Marine Equipment	200

The guidance for the schedule structure was more detailed and has been very successfully utilized from the onset of construction. The RFP defined 34 units of work, which provided maximum percentages of the overall contract value that each unit of work could contain. The contractor's percent complete is extracted from the schedule and entered into SiteManager to generate interim payments.

Using the schedule in this way has made it a very meaningful project controls tool. The contractor has a full-time scheduler on site who maintains the schedule for weekly reviews and six-week look aheads. The 5D model provides a visual check on the schedule. The units of work are broken down into activities with durations up to two weeks. The schedule has several thousand activities in total. This requires a highly disaggregate 3D model. Figure 75 is a comparison of a 4D simulation showing the schedule on June 5, 2015, and photographs taken on the site that afternoon.

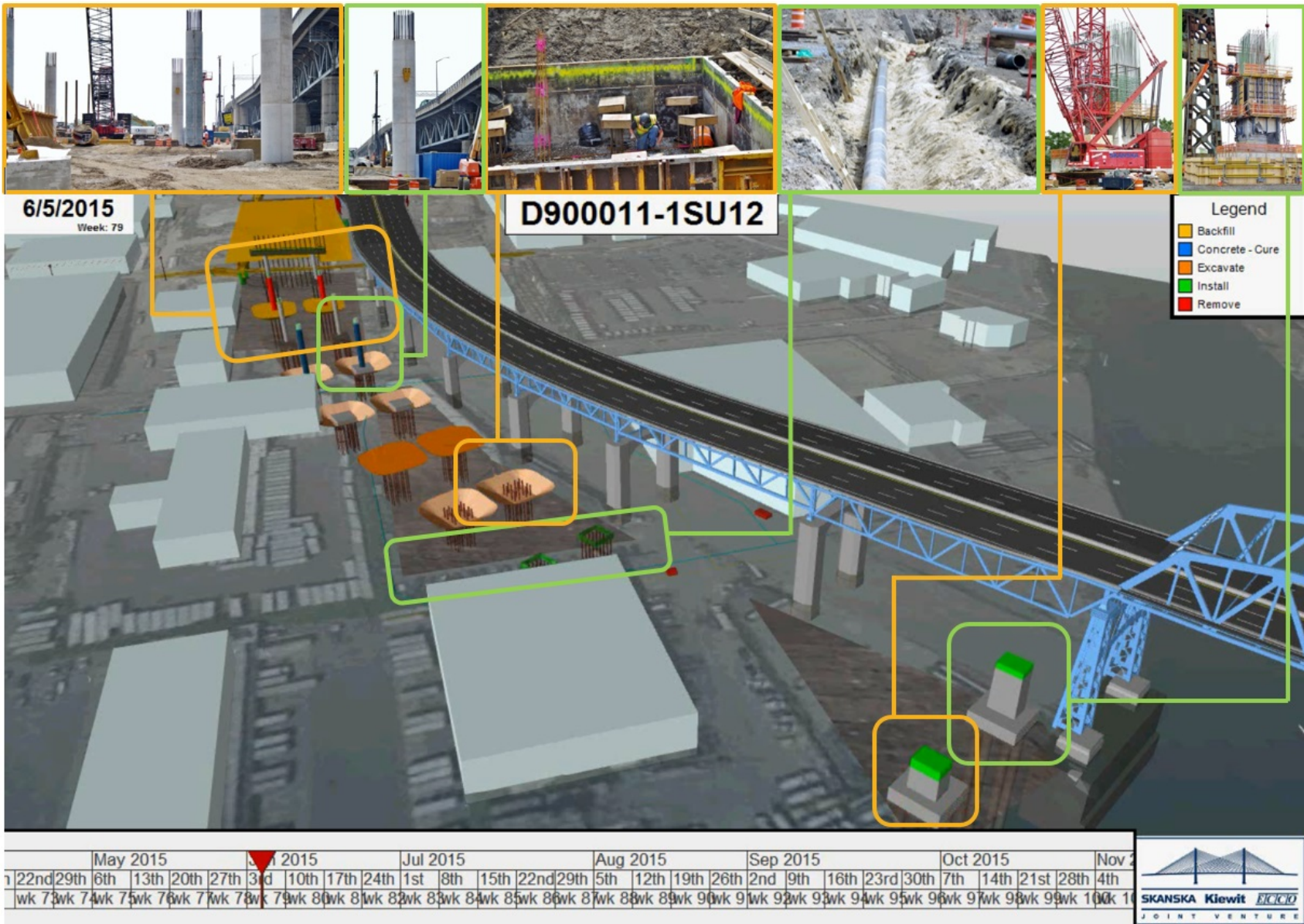

Figure 75: Illustration. Kosciuszko Bridge Project on 6/5/15.

## **Surveying**

Projects with old surveys, especially photogrammetric surveys where data collection occurred prior to 1995, have been the source of issues and construction claims on projects. Photogrammetric survey collected between 1995 and 2005 has reliable network accuracy within 1 foot. Past experience has led to an impetus to verify the original ground surface before finalizing plans, specifications, and estimates. Every region now has the equipment and a skilled survey coordinator who could perform this function.

Some consultant surveyors are using lidar for survey data collection without being expressly required to do so. While this provides the opportunity for more comprehensive datasets, NYSDOT is only requesting the standard survey products defined in the survey manual. This is a noted missed opportunity to receive the lidar data.

In addition to being wary of the accuracy of survey data based on the timing and method for data collection, designers are less trusting of the survey information for asphalt pavements due to the possibility that they have been overlaid since the survey data was collected. This is less likely for concrete pavements. The confidence designers have in the accuracy of the survey data affects their confidence in providing the 3D data for construction.

Agreeing on control is vital for successful construction, especially where the inspectors are using 3D technologies. There have been prior experiences where survey data was not useful because it was collected on control that did not match the project control. In construction, NYSDOT now uses a Contract Control Plan to establish the control that all parties will use, and it is signed and sealed by the contractor's licensed surveyor.

A common misperception is that GNSS has a 0.1-foot variability in each observation that is evenly distributed. While GNSS is only accurate to 0.1 foot, it is very precise (in the absence of multipath errors) within each half-day. There can be variability from one day to the next, however, within a total range of variability of up to 0.1 foot. GNSS-controlled AMG may have wider applications than rough grading and excavating if conducted under the close watch of an experienced operator and grade checker.

### **Real-time Verification and Post-Construction Survey**

The section of the standard specifications that enables the use of real-time verification and post-construction survey for measurement is Section 625. This now includes the Contract Control Plan described above. This is the foundation upon which all real-time verification and post-construction survey rests. This section of the standard specifications also allows for the contractor to provide survey tools for the inspectors' dedicated use.

The Contract Control Plan documents all survey control that was unrecovered or disturbed, and allows the contractor to determine which survey network diagrams will be used for construction. The form documents additional control set for stake-out, horizontal and vertical datums, combined scale factor, and source of Real-time Kinematic correction for GNSS operations. The contractor submits the form for the state surveyor's review before the contractor's licensed surveyor seals it. The Resident Engineer-in-Charge then signs it to accept the contract control.

NYSDOT currently uses Leica products in the field and processes field data in InRoads V8i SS2. The regional CADD and survey coordinators have built up a large library of how-to guidance for a wide range of inspection activities, both to measure pay quantities and verify completed work. A small selection of these guidance documents is listed in Figure 76. In addition to the file transfer guidance and how-to documents shown below, there are guidance and how-to documents for general MicroStation operations, drainage procedures, printing procedures, mapping, InRoads applications, ProjectWise, and construction CADD resources.

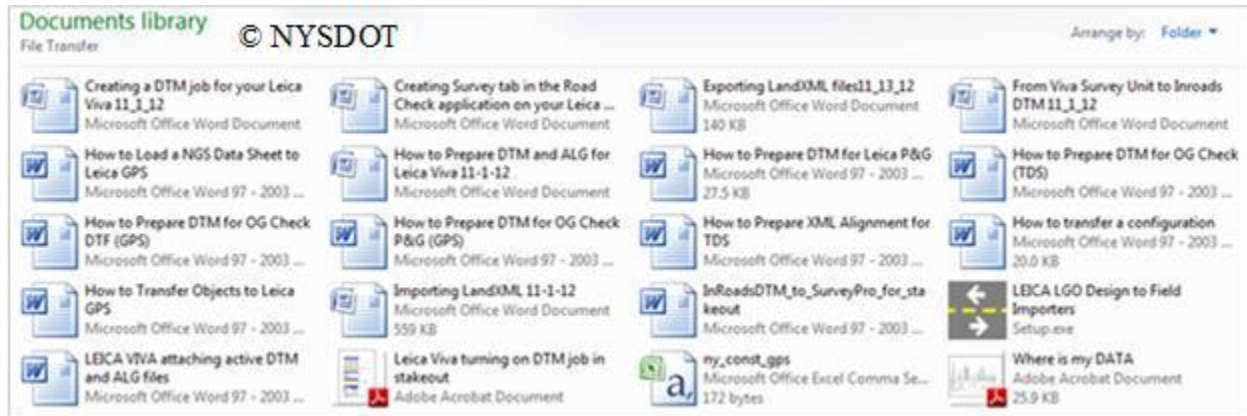

**Figure 76: Screenshot. How-to documents for file transfer.**

The headquarters construction survey and CADD support review the upcoming lettings and assess the suitability of the projects for use of AMG, post-construction survey, and real-time verification. Based on this assessment, Section 625 of the construction specification will be applied and a Special Provision will specify the equipment that the contractor will provide. Typically, a contractor will provide equipment from the same vendor, which often is not Leica equipment. In this case, the library of how-to and guidance documents is of limited use, and the inspectors need to be trained on that vendor’s equipment and software.

The headquarters coordinators will meet with the in-house inspection staff to determine their training needs for the project. Hardware and software specific training is provided in accordance with Section 625 of the standard specifications if the contractor has provided the equipment. The headquarters coordinators will make site visits once the job is underway in partnership with the regional coordinators. They will provide training and over-the-shoulder support to the inspection team to support them as they build familiarity and confidence with the equipment and general workflows.

Annual construction CADD and survey training is offered to inspection staff, usually over the winter. The annual survey training is provided as part of the equipment lease contract. Additional training on the leased equipment is provided by the regional coordinators, with tailored, project-specific training also offered as noted above.



## **VIRGINIA**

VDOT has a robust project risk assessment approach that is used on alternate delivery projects such as Public-Private Partnerships and Design-Build. This process is being expanded to Tier II Design-Bid-Build projects, which comprise approximately 15 percent of VDOT's annual projects. This arose out of a formal resolution by the Virginia Commonwealth Transportation Board.

The project management procedure for project risk management provides a framework for systematically identifying, analyzing, documenting, and mitigating risks prior to advertisement. A Risk Analysis Matrix was developed to facilitate the process, which amounts to a formalization of current practices. The intent is to be risk aware and proactive rather than to attempt to eliminate uncertainty.

This risk management process could be used to identify and manage risks associated with 3D digital design data. The stop work order described in the case study of the Route 60 Reconstruction project in Richmond, Virginia, could have been avoided if the issue had been detected earlier. Not all costs would have been avoided, but the timing to resolve the issue would have been more favorable. Early identification of issues with the accuracy of the survey data on the I-80 Reconstruction and the Southern Expressway projects led to the resolution without an impact on the project schedule, while the US 17 Bridge and Safety Improvements project proceeded but without using AMG methods.

### **Information Modeling**

VDOT is in the process of moving to Bentley OpenRoads software and is currently conducting training in corridor modeling and the use of civil cells to create 3D design models. Previously, VDOT used GEOPAK<sup>®</sup> V8i SS with criteria files, which use programmed rules to generate cross-sections at defined stations. These cross-sections can be converted to TIN surfaces, but it is not a simple process.

Contractors or their data preparation consultants typically create models using plan geometrics rather than trying to use the TINs from GEOPAK<sup>®</sup> criteria. There are two reasons for this. First, details between the cross-sections are not included in design data from GEOPAK<sup>®</sup> criteria. Transitions are shown in plan view only and the vertical transitions must be resolved. Second, there are often issues with how DTMs are created from design data that are not readily detected at the level of detail that designers usually scrutinize models.

Corridor modeling enables the designer to create plan graphics of the horizontal limits, for instance lane width transitions and curb returns, and use parametric templates that stretch the edges of lane to meet these. This is called using a horizontal target or a point control, depending on the software. These horizontal targets are not always detailed in plans, meaning that the contractor needs to scale them or submit an RFI to determine the design intent.

Issues that can occur in AMG construction, such as blade shudder, are only visible when contours are displayed with a very small interval. The order in which points and break lines are added to surfaces can affect triangulation. Contractor software such as Trimble<sup>®</sup> Business Center

analyzes surface definitions and flags inconsistencies such as two elevations being provided for the same horizontal location. Design software usually allows the user to control which elevation will take precedence, but that option is not preserved with LandXML and the designer's intent may not be preserved by the receiving software.

In Figure 77, a surface included a curb break line that has elevation inconsistencies with other surface definition data. This break line has been ignored by the software in the surface interpretation and has been flagged. By visual inspection, the software seems to have made the correct interpretation, but that may not always be the case.

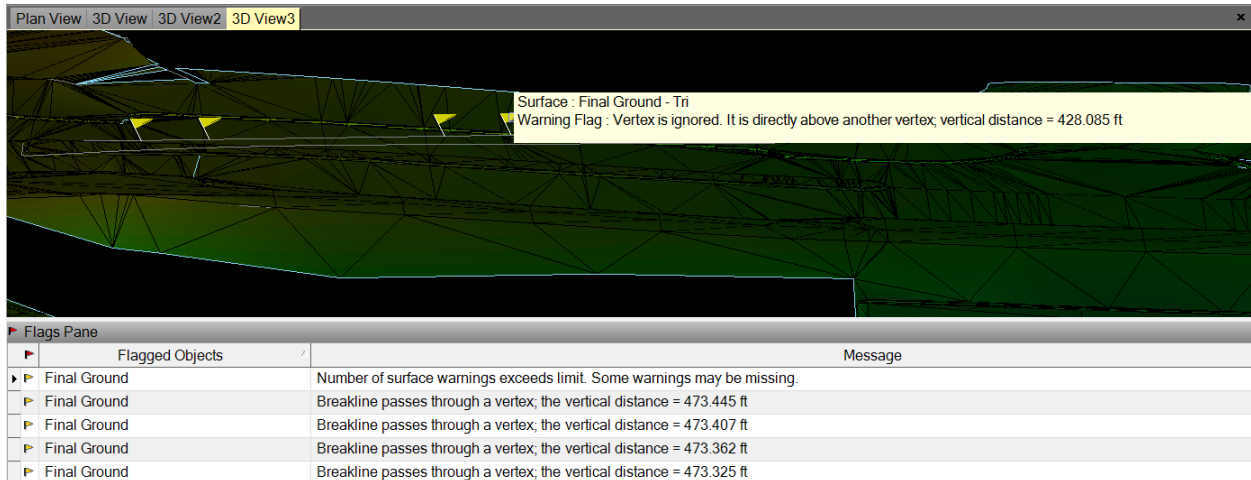

**Figure 77: Screenshot. Elevation inconsistencies flagged.**

Digital design data can save contractors considerable time in creating models for AMG. However, when the digital design data is inconsistent with the plans, then it is a trade-off in time savings to create the AMG models and time spent determining how the digital data differs from the contract plans and verifying that all differences have been caught.

It is a common practice among designers to use 3D models or GEOPAK<sup>®</sup> criteria to automate the first draft of cross-sections only, completing the design through manual drafting. Contractor software will digitize cross-sections and use these with alignment, profile, and superelevation information to create 3D models. It becomes challenging, however, if inconsistent information is provided, such as the unedited cross-sections, which are easier to import into the contractor software than digitizing the plans. When this occurs, the contractor has to spend considerable time identifying which cross-sections have been edited and verifying each one individually.

While AMG offers significant safety and efficiency benefits, additional benefits can be realized when the design is developed with AMG construction in mind. Practices such as hand grading, especially for intersections, are well entrenched in design development. The hand-graded contours can be written into surfaces; however, they are not normally easy to construct. Construction equipment is most efficient with uniform cross-slopes and transition lengths (both horizontal and vertical) sufficiently long for the equipment. Non-uniform cross-slopes are particularly problematic for equipment, which will interpret the triangles one way on the first pass and another way on the return pass when encountering the triangles from a different direction. Short superelevation transition lengths can be problematic for asphalt pavers.

In Figure 78, contours are displayed in black at a 0.1-foot interval. Colored lines are break lines representing features such as the centerline, islands, edges of pavement, edges of shoulder, and toe of slope. Two areas with non-uniform cross-slopes are enclosed in yellow, and one area where blade shudder will occur is enclosed in red. The non-uniform cross-slopes are not easily graded with the blade of a motor grader.

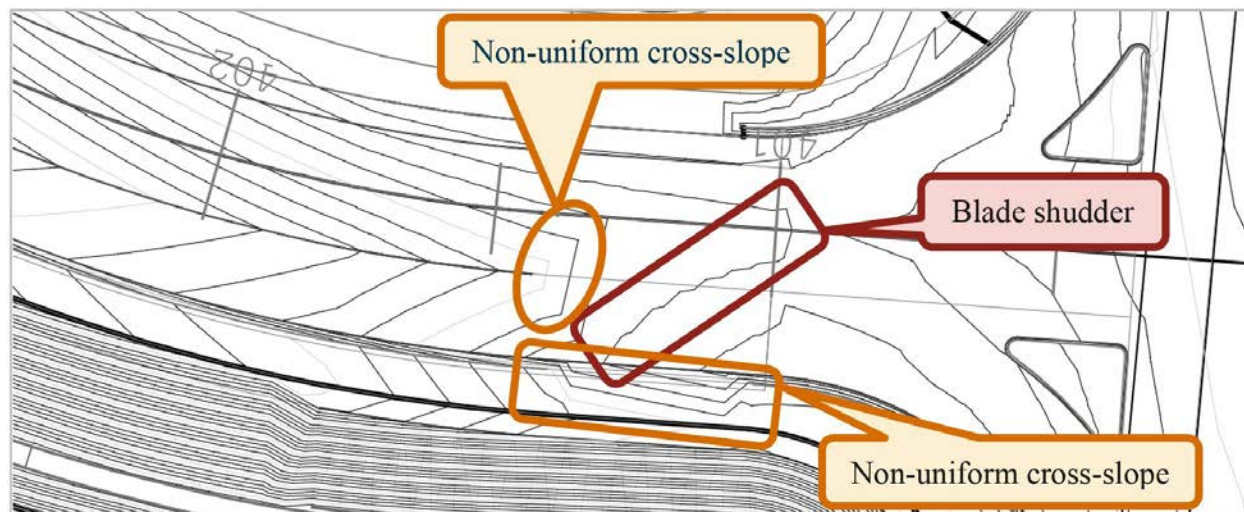

**Figure 78: Illustration. Constructability issues for AMG.**

Corridor models are well-suited to creating surfaces for AMG, but turning a corridor model into a surface requires nuance in how break lines are added and how points are densified. Modern design methods usually cater well for roadways, but intersections, bridge abutments, detention ponds, and non-linear areas are not commonly modeled with corridors and can pose challenges.

Other design practices that need careful consideration for AMG construction are station equations and superelevation. Station equations that decrease, that repeat stationing in two areas, or that start along a horizontal or vertical curve are especially tricky to manage correctly. Some designers will change the superelevation runoff rate at the point of adverse crown, but with the tight grade control from RTS AMG operations this rate change is challenging for the equipment, creating a blade shudder effect.

### **Real-time Verification and Post-Construction Survey**

VDOT has a specification that allows a reduced staking interval for AMG construction. The contractor is responsible for creating the data for AMG operations. There is no requirement for the contractor to share the 3D data with the Responsible Charge Engineer. Another challenge for using real-time verification and post-construction survey is that the specification does not provide a mechanism for the contractor to provide equipment.

On Federal-aid projects, the Responsible Charge Engineer is tasked with providing sufficient objective evidence that the job has been accepted in accordance with the plans and specifications. Post-construction survey data and 3D digital design data can bring rich, transparent data to the process of gathering the objective evidence. However, Responsible

Charge Engineers have no vehicle to receive 3D data for real-time verification under the current specification.

VDOT uses the surface-to-surface comparison to calculate payment quantities for earthwork and borrow pits. Two passages from the specifications that relate are as follows: (21)

*105.13—State Force Construction Surveying (d) 1. a. (1): Digital Terrain Model (DTM) and Construction Cross-sections: Original location Digital Terrain Model (DTM) will be provided by the Department and will serve as a basis of payment for earthwork. The Contractor shall be responsible for taking construction DTMs or cross-sections of areas that, in their determination, do not agree with the Department furnished original location DTMs. The Contractor shall submit the disputed DTM information to the Engineer for verification prior to any excavation by the Contractor in these alleged areas of change. The DTM information furnished by the Department and submitted by the Contractor shall be compatible to the Department’s current DTM format.*

*106.03—Local Material Sources (Pits and Quarries): (e) If payment is to be made for material measured in its original position, material shall not be removed until Digital Terrain Model (DTM) or cross-sections have been taken. The material shall be reserved exclusively for use on the project until completion of the project or until final DTM or cross-sections have been taken.*

On an I-64 project there is a work plan that defines how inspectors will work with 3D data, and the inspectors are equipped with GNSS rovers to perform real-time verification and collect post-construction survey data. Using the GNSS rovers significantly increases inspector productivity. Nevertheless, having stakes and hubs does increase confidence by providing an independent verification that the rovers are functioning correctly.

Inspection is becoming a more technology-based practice that requires increasing levels of formal education. An opportunity exists for inspectors to use 3D data workflows to enhance their own safety and efficiency, as well as to collect both 3D and non-graphical data. Inspectors could be collecting nuclear density test results with GPS coordinates associated with them, and locating cores and other materials tests, as well as installed utilities and cross-drains.

## **MISSOURI**

Electronic seals are permitted under Board Rule 20 CSR 2030-3.06. (22) One seal, date, and signature are required for each bound set of plans. The Board considers the term “signature” to mean a handwritten identification containing the name of the person who applied it; or, for electronic or digital documents, an electronic authentication process attached to or logically associated with the document. Scanned documents may have a copy of an original signature, but editable documents require a digital signature. The rules for digital signatures are detailed in 20 CSR 2030- 3.060(3). (22)

While it is implicitly possible to have contractual 3D data, it is not currently a priority for MoDOT. MoDOT recognizes that it is possible to have some 3D data be a contract document without all data being a contract document. However, the legal counsel has some concerns for

having contractual 3D data at this time. Current file types such as DWG, DGN, DXF, and LandXML are a working solution for data mobility from design to construction, but there are concerns for long-term accessibility. There would need to be more development to establish a portable, durable data schema for 3D digital data.

### **Information Modeling**

MoDOT has a long history of providing 3D data as bid reference documents, having started doing so in 2004. In the beginning, data preparation consultants would have to remodel using the information on plans, but recently the design models have been very good. The cost of AMG data preparation is now sometimes one-tenth of what it used to be and amounts mostly to reformatting the data for the contractor's specific needs. Normally, the DOT provides a 2D base map and electronic cross-sections, which together are sufficient to create and review a 3D model quickly. If there are issues, they are often with shoulder transitions coming out of superelevation.

Prior to stringless (AMG) paving, design did not develop profiles for the overlays. Now, the contractor will take the lead in establishing AMG models, and design will review the profiles and accept as-builts. There is a missed opportunity for designers to provide best-fit profiles for milling and overlay projects. This would let the DOT take the driver's seat in determining the final geometrics and have more accurate quantities in the bid, which might result in better prices.

Rarely is there enough time for the contractor to develop a good best-fit overlay profile. A faster approach is to use the original design geometrics with some adjustments for settlement, cross-slope corrections, and yield. In one case, plans from the 1940s were used to create a concrete paving surface with adjustments for tie-ins to hard surfaces that had been surveyed. There is a missed opportunity to collect the as-built surfaces from the AMG equipment and store that data for future maintenance or overlay work.

The structure of the bid quantities and the consequent distribution of risk allocation affect the level of effort a contractor will invest in checking quantities during the bid. Where actual quantities will be paid, such as materials paid by volume, contractors will not check quantities during the bid. Estimating is a very involved process, and the time savings of not checking quantities provides more time for preparing the bid.

### **Surveying**

The market penetration of AMG has not yet reached a threshold at which MoDOT feels that it would see value from increasing the accuracy of its topographic mapping. Taking into consideration the cost of survey data acquisition and cost overruns, MoDOT does not consider that the case is strong enough to exceed the current 4 centimeter accuracy in mapping data. The cost to procure survey with a greater accuracy increases non-linearly for greater than 4 centimeter accuracy. MoDOT uses aerial lidar for most engineering design surveys.

MoDOT does not currently provide mapping for resurfacing projects. Based on the outcomes of the I-35 Unbonded Concrete Overlay project in Clay County that was studied above, as well as lessons learned on other overlay projects, it could be possible to justify collecting mapping for



concrete overlays. It is a common practice in many states for contractors to collect mapping if they intend to use AMG for overlay projects.

It is important that the mapping be collected with a total station or static lidar if the intent is to control yields. Likewise, the AMG system for grade control needs to use RTSs or mmGPS. GNSS does not have the accuracy to control thickness to the extent needed for depth and yield control. The accuracy needs for AMG concrete paving are often underestimated.

Vertical accuracy is paramount for AMG paving systems. The AMG system uses a three-point resection to determine the position of the equipment. The controlling RTSs are set up and use resection with backsight and foresight to a control point to determine their position. If the vertical accuracy from one point to the next is variable, the machine will adjust as it moves from one RTS set-up to the next. With the mix design for paving, this will be noticeable in the pavement. For AMG concrete paving in particular, it is essential to run a level loop through the control such that the elevation error from one point to the next is less than 1/100th of a foot.

Normally, the bare minimum for AMG paving is four RTSs: two controlling grade on the paver, one checking grade, and one ahead of the paver to transition to the new set-up and maintain continuous paving operations. When paving 16-foot or narrower, it is possible to run the paver off a single total station and use a constant cross-slope. Six RTSs are more comfortable, and nine are becoming typical. As the number of RTSs increases, the number of people running the instruments remains constant; one person does the set-ups and one does grade checking.

### **Real-time Verification and Post-Construction Survey**

MoDOT has invested in a CORS network with 73 base stations and 13 base stations from neighboring states. It also invested in GNSS rovers for construction, although these instruments are now five years old. Generally, they are not well utilized. The Construction Manual does not provide guidance to Resident Engineers or inspectors on how to use the GNSS rovers or how to review or manage 3D data. Inspectors do not have access to RTSs to inspect paving or other high accuracy construction operations. They tend to rely on design survey if they feel that a grade needs to be checked, or they will use a digital level, although not many are available.

MoDOT has not yet evaluated the cost impact of inspection staff using real-time verification and post-construction survey. Currently, its design survey group is working with its construction staff to provide training in using survey equipment. MoDOT has secured State Transportation Innovation Council funding to purchase equipment for inspection and document workflows. The funding deliverables are guidelines and training for inspection staff. This guidance will ultimately be published in MoDOT's engineering policy guide.

### **UTAH**

Leveraging the potential of 3D digital design data for efficiency, safety, and quality in design, construction, maintenance, and asset management is a priority for UDOT. While the vision is holistic, pilot efforts are underway to learn more, especially in the area of 3D digital data as a contract document. UDOT already uses digitally signed PDF plans and digitally signed MicroStation standard details. The next step is to identify methods for delivering all the

information in contract plans through digital means that make the 3D digital design data more portable while preserving the accessibility and durability of the information afforded by PDF plans. PDF plans document design data in a digital, vector format that is durable, secure, and accessible. However, the data is not portable, which leads to duplicative efforts to create data for construction automation and inspection.

UDOT hosted a workshop in April 2014 that was delivered by the FHWA under the EDC-2 activity for deploying 3D Engineered Models for Construction. Prior to the workshop, some individuals from UDOT visited the Iowa Department of Transportation for a peer exchange, and several projects were identified for the 2014 construction season to pilot providing 3D digital data as reference documents during bidding. After hosting the workshop, UDOT developed short-term and and medium-term implementation plans for expanding the use of 3D digital design data in construction. The 2014 pilot projects found that some contractors did not use the 3D digital data at all, and only a few used the 3D data during bidding. When the data was used, the primary finding was that the vertical accuracy of the survey information, especially survey control, was insufficient.

### **Information Modeling**

UDOT recognizes that it takes additional time to prepare both a construction-ready 3D model and a set of contract plans. This additional time is an investment UDOT sees as valuable in the interim while pursuing an approach to eliminate the need for the contract plans. UDOT considers that it is a small effort to add detail to the model that is used to create the plans to bring it up to construction readiness. A series of pilots using the Construction Manager/General Contractor (CM/GC) procurement model seek more information, especially the extent to which the effort to create PDF plans can be avoided.

Three projects, with increasing complexity, have been identified for the 2016 construction season. These projects will attempt to use 3D digital data as the contract document. Contract plans will be used if needed to keep the lettings on schedule. UDOT has contracted with a consultant to attend and document workflows and strategies to present the design in 3D digital data through a series of meetings with the CM/GC teams.

One strategy is to use saved views in MicroStation to replicate the plan sheet workflow for delivering discipline information. MicroStation is capable of performing 3D clash detection, but a lack of design review software is a concern for general design reviews. Reliance on visual reviews is consistent with current methods for plan reviews. Another issue to resolve is how to break up a model into different disciplines. Bentley's i-Model format is being considered as the format for the contract document. The i-Model format is read-only and supported by Trimble® Business Center.

It is still uncertain how much detail to incorporate into the design models. The initial strategy is to provide enough detail that plans can be created without any manual edits to the cross-sections. It is expected that contractors in the CM/GC pilots will provide additional inputs into where effort is necessary and where it adds no value. Historically, alternate procurement projects have had reduced plan submittal requirements. Consultants and contractors report that data exchange

via a 3D model is typical in alternate delivery, and plans only serve to document the design. UDOT may pursue processes that result in fewer plan sheets when a 3D model is delivered.

UDOT is in the process of standardizing the content of the 3D digital design data. One effort is to standardize point naming conventions in the InRoads templates. Until recently, UDOT has not required the use of a standard template library. Consultants have augmented the standard point library with the ability to establish point names. These point names dictate feature names, which propagate to the data collector when the data is used in the field. The length of point and feature names has been an issue in some AMG systems. Point names are also important to be able to migrate data to UPLAN. Standard point names are also important to ensure that features remain connected through template transitions. The planned convention is that the name of the point reflects the top of the pavement material.

Involving in-house designers in complex design projects is now a priority for UDOT. Approximately 80 percent of UDOT's design work (by construction contract value) is performed by consultants. The majority of in-house design has been preservation work. Despite a significant cost impact, consultants now design some preservation work. UDOT believes it is important to develop and maintain an in-house skill with 3D modeling.

The I-215 project is the first complex design led by in-house designers. A contracting vehicle enables the two in-house design teams to draw on consultant support where necessary. UDOT has had a staff retention problem within the design department in particular. Two strategies are being employed to address this issue: providing the opportunity to do complex design in-house and creating a Senior Design position to provide continuing career opportunities within design.

UDOT is actively pursuing quality control protocols for 3D models. There are both software licensing cost and training implications if every person who needs to review a design must do so in design software. Current methods for design review are paper-based. Digital quality control processes are desired that do not require the design software. OpenRoads software can provide internal validation against design standards. Quality control can be performed within the design software, but quality assurance needs a free and accessible viewer that supports mark-ups.

## **Surveying**

UDOT recognizes that Contractors need to build confidence in the 3D data provided before there will be efficiencies. UDOT assembled a committee to update the Survey and Geomatics Standards incorporating feedback from the 2014 pilot projects. The standards were updated in May 2015. (17) In particular, the requirements for vertical control were enhanced. Design survey now takes responsibility for setting construction control and must run a level loop to set the vertical control. This restores a historical practice of construction being a customer of survey.

The State of Utah has invested in a CORS network and a Virtual Reference Network, called The Utah Reference Network (TURN), which is administered by the Utah Automated Geographic Reference Center. Annual access to TURN costs \$600 per user login. (23) There are 95 stations in TURN, including those within the State of Utah and those available from bordering states. TURN provide RTK correction to GNSS rovers and AMG systems. The annual access fee is substantially cheaper than the cost of purchasing a base station.

UDOT had largely abandoned photogrammetry in favor of field surveying before the Survey and Geomatics Standards replaced the Aerial and Photogrammetry Manual. Lidar is becoming favored in a move toward higher accuracy survey; safety and operations benefits of lidar have also been noted. There was consideration to increase the accuracy of the asset inventory mobile lidar survey to use it for pre-design mapping, but the current contract does not specify lidar as the data collection method, which is selected by the consultant.

While UDOT pays for most construction bid items with measured quantities, some are paid using plan quantities. There is a desire to expand the practice of paying plan quantities, which places the risk of overruns with the contractor, whereas paying measured quantities leaves the risk with the department. A level of effort to document measured quantities could be avoided by paying plan quantities. However, for this approach to be successful, contractors need to build confidence in the accuracy of pre-design survey and the quantities taken off from the plans.

Some contractors have surveyors who service multiple projects, supporting foremen who collect 3D as-built records of subsurface utilities and foundations. However, most contractors do not have the skill set to deliver signed and sealed as-built surveys in the UDOT CADD standards. If UDOT were to introduce this requirement, it is likely that contractors would sub-contract the work to firms that currently perform design surveying for UDOT. Signed and sealed surveys are not necessary if UPLAN is the ultimate destination for as-built information. However, survey-grade 3D as-builts are valuable for subsurface utilities. One project had a \$76,000 change order to relocate 900 linear feet of telecommunication line so that guardrail could be installed.

It is unclear whether comprehensive 3D as-built surveys of surface assets would reduce the frequency with which asset inventory surveys are needed. There is value in a comprehensive dataset as opposed to a fragmented dataset.

### **Real-time Verification and Post-Construction Survey**

The Resident Engineer should be supported by technical experts who can review 3D data. It is not in the inspectors' purview to check data or determine whether it reflects the design intent. With contractual 3D data, designers would have to be involved in processing change orders. One of the benefits to having contractual 3D data would be that designers would become more involved in construction and would incorporate feedback into designs. Currently, UDOT has some "one-hat project managers" who follow a project from planning through construction.

With contractual 3D digital data, inspectors would need equivalent access to the information that is available in plans. To reduce the training burden, the plans workflow needs to be reproduced with digital data. Intuitive user experiences are important to reduce training needs. Current technology requires a skilled designer or CADD technician in the field, which is not feasible for UDOT. Field tools need to be able to enable non-CADD users to access information with confidence.

UDOT considers real-time verification and post-construction survey part of e-Construction. With this vision, it is clear that inspectors need a seamless, single point of access to all 3D geometric data as well as non-graphical data, such as materials testing results and specifications. There is a desire for information to be searchable by location from mobile devices, for instance through a dashboard showing all assets within a specified radius of the mobile device's GPS location.

## 6. PROCESS ANALYSIS

The projects studied used a mix of formal processes that were governed by policy and informal processes developed to fill gaps not covered existing policy. In this chapter we will consider both types of processes and map them to determine where process improvements could improve data integration; data mobility; or broader efficiency, safety, or quality improvements. The largest gap in formal policy is for Real-time Verification. The informal processes used on the Southern Expressway project have been documented, along with their basis in formal policies and guidance, such as the NYSDOT CADD, Survey, and Design Manuals, as well as regulations surrounding acceptable field changes and design revisions.

### DATA MANAGEMENT

In all the projects studied, the 3D data was provided for reference information only. This meant that before either the Contractor or the Resident Engineer could use the 3D data, they first had to verify that the 3D data accurately reflected the design intent in the contract plans. As Figure 79 shows, verifying that the 3D data matches the contract plans was a process in itself. If that process led to the decision that the 3D data reflected the plans, the data could then be used for its intended purpose. If, however, the 3D data did not reflect the design intent in the contract plans, that precipitated another process to reconcile the data with the design intent of the contract plans before the data could be used.

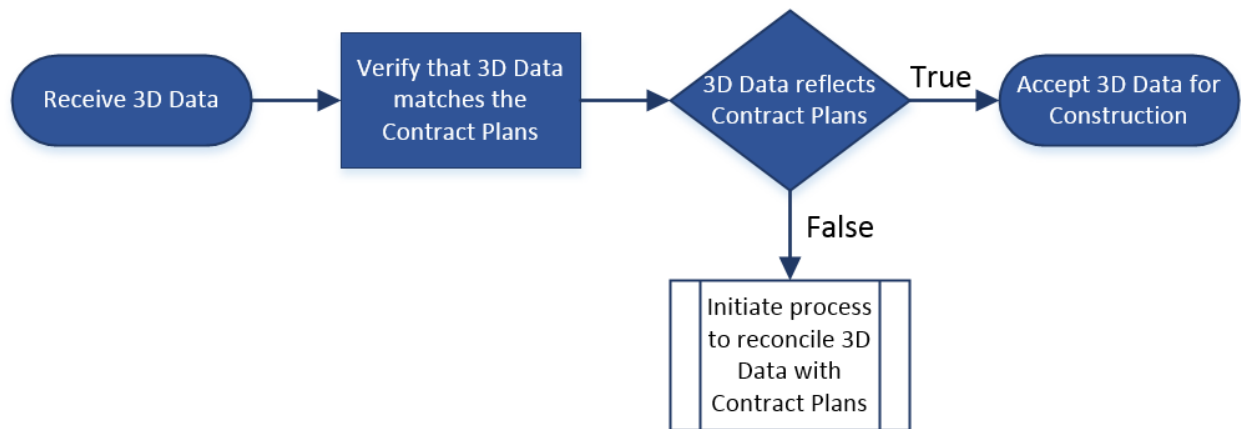
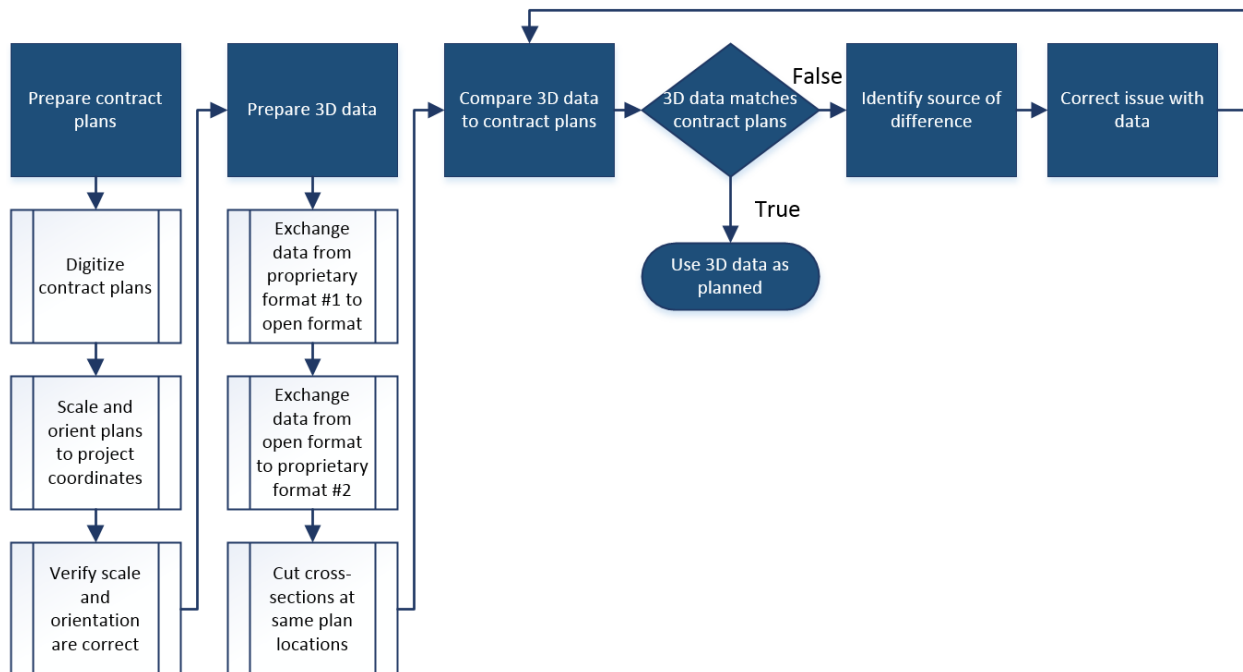

**Figure 79: Flowchart. Quality control on the 3D data was a required first step.**

The various projects studied used different approaches to check the 3D data against the contract plans. Figure 79 introduces the general 3D data validation process. The essential steps are as follows:

1. Digitize, scale, and orient the contract plans in project coordinates.
2. Perform needed data exchanges and sectioning to present the 3D data as it is documented on the contract plans.
3. Compare each piece of 3D data to each relevant sheet of contract plans.
4. Systematically resolve each difference between the plans and the 3D data.





**Figure 80: Flowchart. Validation process for 3D data.**

A number of troubleshooting processes initiate if the 3D data does not match the contract plans. First, verify that the contract plans and 3D data preparation processes were error-free and that the difference between the contract plans and 3D data is present in the data delivered by design. Then, the root cause of the difference must be isolated before determining how to proceed to resolve it. Some common causes of differences include the following:

- The designer used the 3D data to develop the design to a point prior to final design. Subsequent design refinements were made manually on the plans.
- The 3D data does not fully detail the design intent (e.g., the 2D horizontal data match the plans, but the surface data only matches the plans at the cross-section locations).
- The design was never fully explored in 3D dimensions, and the contract plans provide conflicting information regarding the design intent.

The process to remedy these issues depends upon several factors, such as whether it is the Contractor or Resident Engineer who has identified the issue, the type of issue, and the impact of the issue in terms of time or cost. The Controlling Work section of the specification guides the remedy. (24) A number of different processes could be used in combination or in isolation to reconcile the 3D data to the contract plans. Until such time as a more complete, open data schema emerges and is consistently implemented in software, the duplicative workflows to validate exchanged data cannot be eliminated.

Often, the Contractor and the Resident Engineer have a different level of capability to manipulate 3D data. The Construction Partnering process, which promotes teamwork, trust, and open communication, (25) is thus ideal for equitably and efficiently managing how and when the 3D data is brought into line with the design intent of the contract plans. In the Construction Partnering process, the Contractor, Resident Engineer, and a professional facilitator hold regular

meetings to advance mutually beneficial goals and objectives. The facilitator acts as a neutral party and helps facilitate communication between the Contractor and the Resident Engineer. (26)

**PRECONSTRUCTION QUALITY CONTROL**

The first opportunity to utilize 3D digital design data is for pre-construction quality control. This includes using the 3D data to identify and rectify issues prior to construction. If issues are identified and rectified before construction is one-third complete, then the schedule is unlikely to be adversely affected. (25) In the projects studied, the degree to which the original pre-construction survey data matched the ground conditions was identified as a major factor in determining whether the 3D data could be used directly for construction.

All the projects that had original ground data collected prior to construction had issues with how the original ground data matched the actual field conditions. These issues had a negative impact on the utility of the 3D design data. The timeliness of detecting and adapting to the issues influenced how extensively project operations were affected, as shown in Table 21.

**Table 21: Original ground survey issue detection timing and impact.**

<b>Project</b>	<b>Issue</b>	<b>Timing</b>	<b>Impact</b>
Southern Expressway	Original ground data was not sufficiently accurate to form the basis of earthwork payments.	After clearing and grubbing, before earthwork commenced.	Inspectors collected new original ground survey after clearing and grubbing. No delays.
Route 60 Reconstruction	Original ground data had systemic, inconsistent issues that caused the curb and gutter design not to match field conditions.	During curb and gutter installation.	Three-week work stoppage, some curb rework. Design modified to adapt to field conditions. \$1 million change order to cover survey, re-design and modified means and methods.
I-80 Reconstruction	Control was insufficiently precise for AMG operations and accurate CTAB quantities, creating a need to haul material large distances, possibly import or spoil off site.	At the start of CTAB construction.	No work stoppage. Profiles were redesigned to balance CTAB quantities. Costs to set new control.
US 17 Bridge and Safety Improvements	Original ground was not sufficiently accurate to support AMG operations. Ramp profiles did not match field conditions.	At the start of construction.	Contractor reverted to traditional methods.

## Processes used

The projects used a combination of formal and informal processes to detect and resolve issues with the original ground data that led to constructability and quantity issues. With a growing desire to accelerate construction, formalizing more robust pre-construction quality control and quality assurance checks of the survey data is important to avoid delays.

### *Formal processes governed by policy*

UDOT's specification (Section 01721 Part 1.5 C) includes a formal process for the Contractor to verify and certify the project control. Many other states have similar processes for control verification. However, UDOT's pre-construction quality control processes, while rigorous on this particular project, where repurposing mapping-grade mobile lidar data for preconstruction was piloted, did not include the same parameters for control location and precision as the Contractor required for construction. In fact, the formal quality control checklist used at the time of this project included a check for suitable control accuracy but not location. Hence, most of the control points were right-of-way markers that were not visible from the roadway as they were located high up the canyon walls. (27) UDOT has subsequently worked with industry to update its pre-construction survey requirements for establishing control. (17) The revised standards provide guidance for Resident Engineers on the control requirements for AMG construction:

*“Control should be staggered on either side of the highway to provide a good strength of figure. Typically the distance between control points set for MCG should be no farther than 650 ft, the actual distance may vary by the type of equipment used by the contractor. The instrument setup must obtain vertical accuracies within  $\pm 0.02$  ft of the existing control.”* (17)

Construction Manuals of agencies serve as a guide to Contractors and Engineers during construction, but they are not a contract document. As such, the processes outlined within these manuals, while having been formalized, are not governed by policy. It is likely that these formal processes were informed by lessons learned and experiences on previous projects as well as by processes developed in pilot projects, such as the Southern Expressway project, which piloted the revisions to the NYSDOT specification to accommodate AMG.

Section 625 of NYSDOT's standard specifications references the NYSDOT's Land Surveying Standards and Procedures Manual for establishing—or reestablishing—primary and secondary control. Both VDOT and NYSDOT allow for updating the original ground survey data during construction, expressly for determining accurate quantities. (28) (15) From Section 625:

*“When an existing digital terrain model was developed during design and provided for construction purposes, and possibly updated during construction by supplemental survey, the Department and Contractor shall use that information as a basis from which to develop contract pay item quantities.”* (15)

Section 625 requires the Contractor to provide a Contract Control Plan that has been signed and sealed by a registered land surveyor. The Contract Control Plan is where the Contractor communicates with the Resident Engineer that the means and methods will include AMG. (15)

Section 625-3.01 B 2 governs the data that shall be used by both the Contractor and the Resident Engineer. It imposes a requirement upon the Contractor to ensure that the 3D data reflects the design intent, check for constructability issues, notify the Resident Engineer in writing, and remedy the 3D data subject to the Resident Engineer’s approval:

*“Contractor shall first review its consistency with all other contract information, and review for any perceived physical conflicts or inconsistencies of information prior to using the data in the field for any construction purpose. All exceptions or discrepancies with the supplied data shall be brought to the attention of the Engineer, in writing, and terrain data, alignment or graphics modifications shall be approved by the Engineer prior to beginning construction operations within those areas being modified. All approved changes shall be shared electronically with both the Department and the Contractor, and both parties shall acknowledge acceptance of such changes before beginning the work.” (15)*

The Maryland State Highway Administration has developed a Construction Stakeout Checklist that provides Contractors with a guide to fulfilling their contract responsibilities, such as to set and mark stakes to define right-of-way and easement lines or to furnish and reference control points for both alignment and grade. (29) Many of these processes and guidelines can be coopted for Real-time Verification methods, as shown in Table 22.

**Table 22: Examples of traditional processes modified for Real-time Verification. (29)**

Traditional Guidance	Real-time Verification Process
Prior to construction, the Contractor should check the centerline or baseline stake out through the length of the project and to check that control points are not missing.	Load control points and centerline or baseline alignment onto data collector. Walk the centerline and check into each control point with a GNSS rover.
Average slope stake spacing of 50 feet should suffice, but closer intervals may be required in rough terrain.	Load a line string that represents the limits of construction onto the data collector and walk the limits to verify any flags for limits of disturbance are correctly located.
Slope stakes may be set before the clearing and grubbing operation and may be used as a guide for the limits of this work.	Limits of disturbance flags may be set before the clearing and grubbing operation and may be used as a guide for the limits of this work.
The Contractor should set grade stakes on the center line, edge of pavement, or shoulder of the roadway after the rough grading is substantially complete. This step enables the Inspector and the Contractor to check the grade before the fine grading or capping operations begin.	Stakes may be set on significantly higher intervals (usually 10x greater interval) or omitted entirely when the Inspector has 3D line strings representing centerline, edge of pavement, or shoulder loaded on the data collector. Line strings can be offset vertically to reflect elevations below finished grade.
The Inspector should check stakes for location, alignment, length, and grade of culverts before installation to ensure the drainage condition matches the design.	Load a line string that represents the flow line for culverts onto the data collector. The Inspector can check location, alignment, length, and grade of culverts during construction at any location along the pipe.

### *Informal processes developed by the project team*

For the Southern Expressway project, there were no formal processes for Real-time Verification or measurement workflows. The Office Engineer was responsible for managing the 3D data and for the quality of the measurements that Inspectors conducted. As part of the inspector training process and to build trust in the new tools, the Office Engineer developed the workflow shown in Figure 81. The byproducts of this workflow were not only an inspection team trained in using the new survey equipment, but also confidence in the tools and a new original ground surface that both the Office Engineer and Contractor felt represented an accurate comparison surface for earthwork measurements.

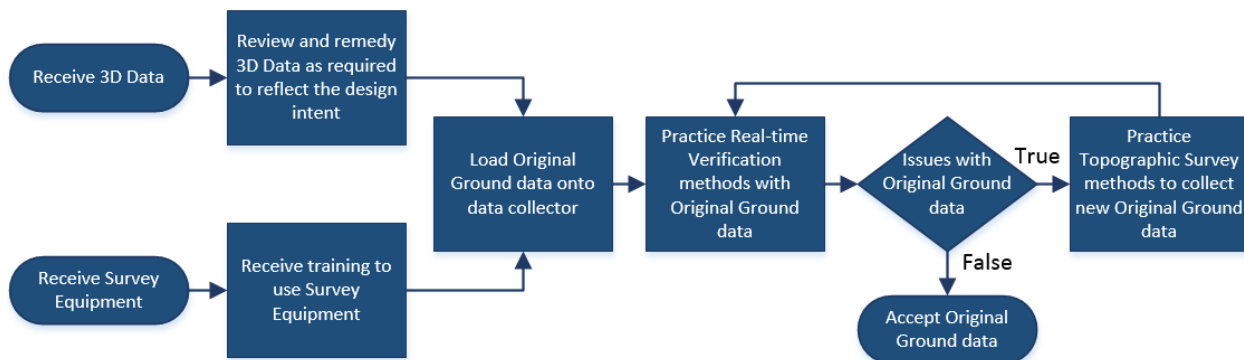

**Figure 81: Flowchart. Inspector training that resulted in accurate original ground.**

Original surveys may meet pre-design specifications but may not necessarily be sufficient for 3D construction. In the past, any issues during stake-out with how the design tied into the original ground were resolved in advance by the construction surveyor, and quantity differences were managed with change orders. The fallibility of this approach was demonstrated on the Route 60 Reconstruction project where issues with how the curb tied into the existing roadway were not caught until curb construction was underway. With AMG construction, the layout occurs in real-time as the machines do not require physical markers nor suitably equipped Inspectors. While this creates an opportunity to explore in advance any potential issues with tie-ins and quantities, it also creates an obligation to verify the original ground data.

As reflected by the example specifications above, Contractors are often burdened with the responsibility for effecting any required remedies to the 3D data provided by the designer, and it is the Resident Engineer who is burdened with the responsibility for accepting the 3D data used for construction and inspection activities, including checking tolerances and measuring pay quantities. Agencies need to ensure that the Resident Engineer is adequately supported with the expertise to manipulate the 3D data. Either the inspection team or readily accessible regional or headquarters staff can provide this support.

Until Contractors develop confidence in the pre-construction survey and design data provided to them, they will need to budget at the time of bidding for an uncertain amount of effort to remedy the 3D data. A facility to update the original ground data after clearing and grubbing, and the use of surface-to-surface earthwork computations reduce the risk of inaccurate earthwork quantities, at least where there is the capacity to borrow or spoil on the site.



On reconstruction and rehabilitation projects, earthwork costs are less significant, but as was illustrated by the I-80 Reconstruction project, quantities for more expensive paving materials, such as the asphalt millings for CTAB construction, can be affected. Given that these paving materials are more expensive, the opportunity to control the quantities is presented by tighter original ground survey tolerances. The Contractor acquired more accurate original ground data and used 3D data to control the CTAB quantities, as shown in Figure 82.

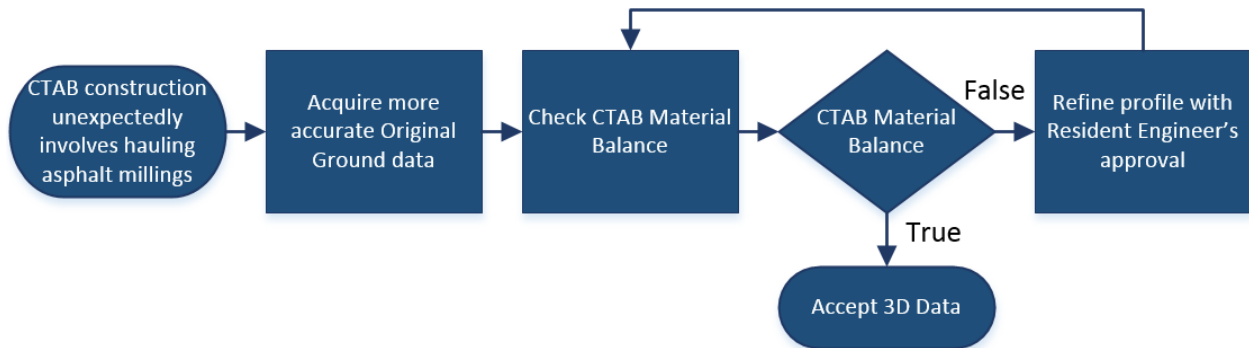

**Figure 82: Flowchart. Profile refinements to achieve CTAB mass balance.**

The I-35 Unbonded Concrete Overlay project is another example of the use of 3D data to effect preconstruction quality control. In this case, the 3D data was used to optimize the volume quantities and geometric corrections that could be affected. The project was a pilot for the Contractor who received a lot of vendor support. Carlson Civil software created a new module for overlay road optimization specifically for this project.

This tool enabled the team to optimize both along the profile and across the cross-section. As an overlay project constructed on the old, original concrete roadway after several inches of asphalt had been milled off, the base for the overlay was geometrically deficient by modern interstate standards. The contract stipulated a limit to the allowable concrete overruns, which limited the potential to achieve geometric improvements through increasing the overlay depth.

The Contractor identified an opportunity to achieve more geometric improvements while controlling the concrete yields by first milling the in-situ concrete to a profile to correct some of the more egregious deficiencies and irregularities. MoDOT and the Contractor worked together to define parameters for milling depths, as well as final cross-slopes and profile geometrics.

Given that data collection and modeling occurred after construction was underway, there was a very constrained window of time to develop, review, and agree on the 3D data. The Contractor output plans and profiles in PDF format as well as quantity estimates for both alternatives. The Contractor reviewed these plans on paper with MoDOT designers, who found PDF plan sheets to be a more consumable format. The process followed for collecting the original ground data and preparing the milling and overlay profiles is illustrated in Figure 83.

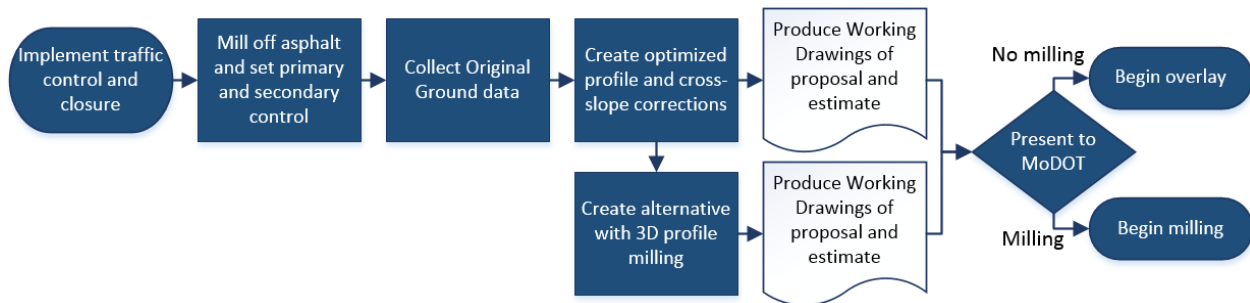

**Figure 83: Flowchart. Data collection and modeling for geometric optimization.**

The risk allocation in the bid items—paying the Contractor by volume to furnish, but by area to place, the concrete—meant that both MoDOT and the Contractor were incentivized to optimize the geometrics within a practical limit. Thus, MoDOT agreed to pay for 3D profile milling on the existing concrete because of the superior outcomes that could be achieved by improving the geometrics on the base. A key success factor was the confidence that both the Resident Engineer and the Contractor had in the ability to predict construction outcomes using 3D data.

Another key success factor was the speed at which the 3D data could be prepared. There were early completion incentives because the interstate was operating under head-to-head traffic with a full closure of lanes under construction for the season. The original ground survey of the top of concrete could not start until after construction was substantially underway: the mill had to remove all of the asphalt before the survey work could begin. However, in the well-controlled conditions of a full closure, the surveyors were able to work quickly to collect data with high accuracy. This accurate original ground gave the team the confidence to predict the construction outcomes, both for concrete yields and for geometric improvements.

The approach saved MoDOT \$600,000 in material costs, and the Contractor was compensated for the 3D profile milling on the concrete prior to beginning the overlay. Further, allowing the Contractor to collect the mapping and create the overlay profiles meant that the Contractor was responsible for the schedule and MoDOT could not be the source of any delay related to mapping or design data.

### **Missed opportunities**

All of the case studies present a missed opportunity to use the design data directly. In the Southern Expressway project, for instance, the Contractor’s 3D modeler spent one week with NYSDOT’s designer in an attempt to develop the original Bentley InRoads design data to the level necessary for AMG construction. However, the designer had not continued to develop the InRoads model throughout design. Instead, the designer used the InRoads model to automate creation of the plan sheets in MicroStation and then, as shown in Figure 84, completed documentation of the design in MicroStation only. This meant that the InRoads 3D data first needed to be updated to reflect the final design and then be converted into the Contractor’s proprietary software format.

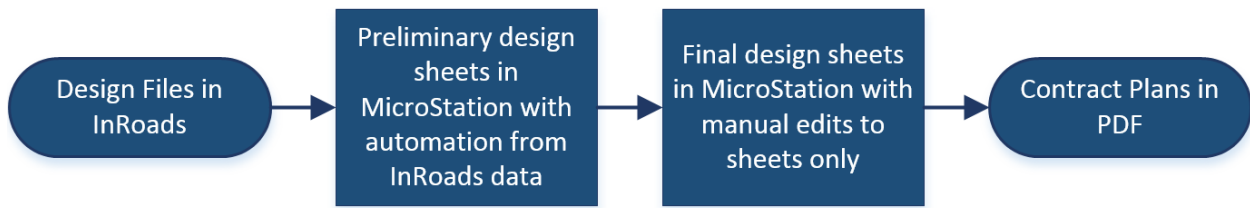

**Figure 84: Flowchart. 3D data was not developed throughout design.**

Ultimately, this was not successful, in part because the way in which the model had been developed for design did not readily produce the data that the Contractor needed for construction. The Contractor’s 3D modeler used the contract plans to re-create the design intent with Terramodel® software. While this provided the Contractor with the data necessary for construction, the other issue was that the inspection team had collected updated original ground data. This provided an opportunity to revise the design profiles to improve quantities and resolve any issues with tie-ins. However, it also created the need to exchange data back into the Office Engineer’s proprietary data format so that the Resident Engineer could review and accept the revisions. This cumbersome data preparation process, which took six weeks, is reflected in Figure 85.

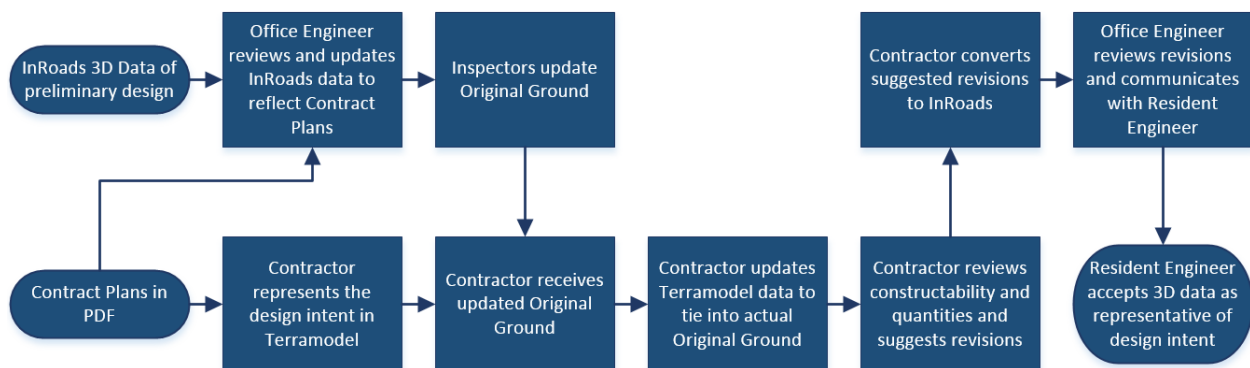

**Figure 85: Flowchart. Data preparation for Southern Expressway.**

Given that the Contractor will also create 3D data for construction activities that are not typically reflected in the plans or design model, such as interim surfaces and excavation surfaces for bridge foundations, it is reasonable to assume that the Contractor will always have some facility for developing and manipulating 3D data. This offers flexibility to agencies in developing and formalizing their processes for managing data in construction.

### Guidance

Several opportunities exist for process improvement to facilitate better pre-construction quality control. Ideally, designers will create construction-ready data in a format that Contractors and Inspectors can easily use with AMG systems and field survey equipment. However, there are harsh realities regarding (1) the challenge of data exchange, (2) the reliability of original ground survey data collected prior to the start of design, and (3) the fact that Contractors will always need to develop 3D data of some kind, be it for interim conditions reflective of their means and methods or because of opportunities to control quantities or other risks that they bear.

### ***Control the control***

The accuracy of the control directly affects the accuracy of the original ground. Past practices to increase the vertical accuracy of control after design and before construction limit the agency's ability to control quantities in design. Setting construction-ready primary control at the time of mapping affords the designer greater control over quantities and tie-ins, maximizing the value of the time spent in design.

### ***Allow for updating Original Ground after clearing and grubbing***

Project characteristics, such as dense woods or long time lapses between mapping and letting, mean that newer, more precise survey technologies are likely to be accessible and more effective immediately prior to starting construction. With reconstruction and rehabilitation, the higher value quantities are more likely to be more expensive pavement materials with tighter tolerances. If original ground topographic survey at the needed precision is not available prior to design, it may well be available prior to construction. Agencies should write specifications and policies that enable both the original ground survey and the design to be updated to reflect more accurate original ground information collected during construction.

While the NYSDOT specification provides an example and several years of successful implementation, some agencies may not be able to provide as much support to the Resident Engineers as that provided by NYSDOT's regional survey and CADD coordinators. Agencies can circumvent this by modifying design processes to extend the designer's final deliverable beyond delivering bid documents to delivering a construction survey hand-off package, such as implemented by Oregon DOT. (30) Figure 86 illustrates this modified designer's role. While Oregon DOT's process provides the final design deliverable at the pre-construction conference, an agency could extend the role past the point of clearing and grubbing to allow the designer to make changes to tie-ins or to control quantities.

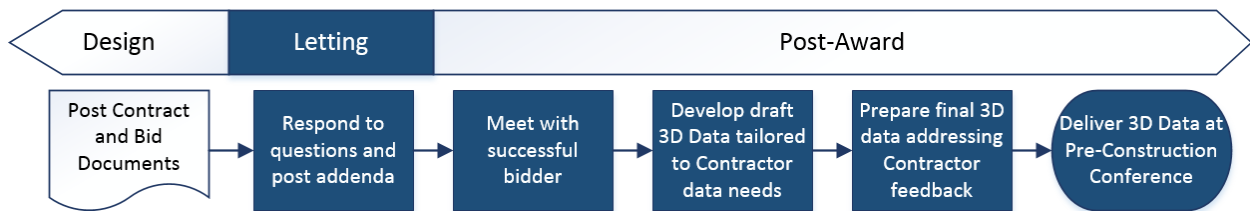

**Figure 86: Flowchart. Modified Designer's role to deliver construction data. (30)**

### ***Require consistent models and plans for final deliverables***

One measure holding back better integration of design and construction data is that the ratio of design cost to construction cost figures highly in how designers are evaluated. If more is spent in design to create savings in construction, design is perceived to be expensive and therefore designers might feel hesitant to expend resources to create construction-ready models.

In the past, there may have been a point at which the investment in 3D data updates for each minor cross-section change had diminishing or negative returns. However, both Figure 84 and Figure 85 illustrate that with modern construction, the effort to reflect final contract plans in 3D data is merely deferred. Moreover, newer CADD software makes it easier to invest design time

in the 3D model and utilize dynamic plan annotation and graphics updates for sheet production. This automation is essential to be able to react quickly to new original ground data or to make design changes.

***Expand the use of Construction Partnering specifically for 3D data management***

All three projects that ultimately used modified design data in construction, that is, both reconstruction projects and the Southern Expressway project, eventually evolved to a point where the Contractor and Resident Engineer partnered to use a single set of proprietary data maintained by the Contractor. For the Virginia project, this was in response to the stop work order, particularly to review the proposed resolution and resume work.

The case study did not collect information on how the UDOT project profile modifications were reviewed and accepted by the Resident Engineer. The other two projects provided different approaches, the differentiator being that on the Virginia project, the Resident Engineer did not use 3D data for Real-time Verification, whereas in New York, the Resident Engineer did. Table 23 contrasts the approaches taken with these two projects.

**Table 23: Comparison of data management practices**

<b>Practice</b>	<b>Real-time Verification</b>	<b>No Real-time Verification</b>
Contractor-provided hardware	Yes	No
Contractor-provided software	Yes	No
Contractor-provided training	Yes	No
Owner has a copy of the 3D data	Yes	No
Independent 3D data reviews	Yes	No
Collaborative 3D data reviews	Yes	Yes
Collaborative decision-making	Yes	Yes
Time savings	Yes	Yes
Confidence in 3D data	Yes	Yes
Resident Engineer has authority	Yes	Yes

**CONSTRUCTION LAYOUT AND ORIENTATION**

While some agencies still provide their own layout of construction stakes, lines, and grades, it is relatively common for the Contractor to be responsible for layout, especially when AMG is the Contractor’s chosen means and methods. (24) (15) In all of the projects studied the Contractor was responsible for layout.



## Processes used

The case studies only collected information on layout of physical references for the Route 60 Reconstruction project and the concrete paving on the eastbound I-80 Reconstruction project. In Virginia, the Contractor was not originally intending to use AMG for more than rough earthwork. Hence, traditional references were set for new construction features such as the curbs and gutters along Route 60. In Utah, the Contractor had not yet invested in an AMG system for concrete paving during 2014 when the eastbound was paved.

For the remaining case studies, layout was performed using AMG. As part of the layout process, reference stakes are usually placed to provide general orientation marks for recording daily diary and permit compliance reports. While the case studies did not go into detail regarding processes for general orientation, painted orientation marks were clearly visible during the Kosciuszko Bridge site visit, as shown in Figure 87.



**Figure 87: Photo. Painted reference marks for orientation.**

### *Formal processes governed by policy*

The Southern Expressway project team piloted Section 625 of the NYSDOT Standard Specifications. The specifications allowed survey operations to utilize conventional survey stakeouts, AMG, or both for the establishment, positioning, and guidance or verification of features. (15)

For conventional survey stakeouts, the language required Contractors to place two offset stakes or references points along the centerline at maximum intervals of 50 feet and at such intermediate locations as required to determine location and direction. The Contractor was also

required to locate and place all cut, fill, slope, fine grade, or other stakes and points for the proper progress of the work at a maximum station spacing of 66 feet.

For AMG-guided construction, layout is accomplished through digital data. Thus, all horizontal and vertical control, alignment control, existing terrain data, and proposed design data were required to be shared and exchanged electronically and kept current between the Contractor and the Resident Engineer. All original active files of electronic contract data were to be maintained and stored by the NYSDOT. A strong contract control network in the field needed to be integrated with the project control used during the design phase.

The specifications allowed the Resident Engineer to perform quality assurance verifications of feature positions and elevations at any time during the contract. Dimensional tolerances were assigned a higher order of importance than positional tolerances, but both required verification. The quality assurance activities undertaken by the Engineer did not remove any responsibilities of the Contractor for quality control of the accuracy or completeness of the work.

### ***Informal processes developed by the project team***

When layout is the responsibility of the Contractor, the processes that give rise to the stakes and hubs being set are part of the Contractor's means and methods. In both the Route 60 Reconstruction and In the I-80 Reconstruction projects, the Contractor set the physical construction layout and orientation markers using 3D data.

For Route 60 Reconstruction, the Contractor's surveyor computed 3D line strings of the curb controlling geometry and set reference points in the field using that 3D line string, as illustrated in Figure 88.

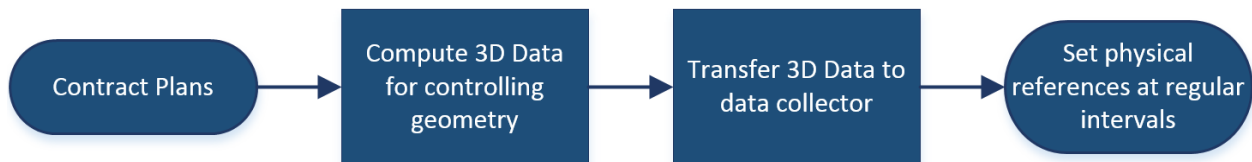

**Figure 88: Flowchart. Construction layout for Route 60 Reconstruction curbs.**

The process for setting the string line for the eastbound concrete paving on I-80 Reconstruction was more sophisticated for two reasons: first because the Contractor was using 3D data for the AMG systems for CTAB construction, and second because the profiles had been modified from the original plans to control the CTAB quantities. Thus, the 3D data used to set the string line hubs had begun as a 3D model rather than as a set of plans. For setting string lines, the corridor surface was projected with a 6-foot offset to set the string line elevation.

The 3D line string reflecting the string line elevation was also exported into the surveyors' data collectors for setting hubs and string lines for the concrete paving on the eastbound. Hubs were set every 30 feet; however, by using a 3D line string, the surveyor had the option to increase the frequency of hubs in areas with more challenging geometrics, such as superelevation transitions, horizontal curves, and vertical curves. For the stringless paving on the westbound, the corridor template drop interval was changed to 12.5 feet with template drops at key geometry points such

as superelevation and curve critical stations. The cost of data preparation was unaffected; the same data is used either to set the hubs for the string line or on the AMG system.

## **Guidance**

With expanded adoption of AMG, it is likely that construction layout will increasingly be the responsibility of the Contractor. There are synergies given that Contractors find it more efficient to perform traditional layout using 3D data. Owners should therefore focus efforts on ensuring that the Resident Engineer has the tools and capacity to operate in a stakeless environment.

### ***General Orientation***

It can take considerable time and cost to prepare stakeout data, set and maintain reference stakes. The specifications should accommodate alternative means of general, non-precise orientation. The use of mobile devices in construction is growing rapidly, which creates an opportunity to use these tools for general orientation. Numerous applications can read or create a geo-referenced PDF of the plans and use the mobile device's GPS to provide a location relative to the plans. (8) Other, lower technology options include painted references, such as at Kosciuszko Bridge above.

## **AUTOMATED MACHINE GUIDANCE**

AMG is essentially a Contractor's means and methods, so there is a limit to the Resident Engineer's involvement in the process beyond accepting the work in accordance with the specifications and more general quality control requirements.

### **Processes used**

We will explore the formal processes that governed the Contractor's quality control and owner's acceptance. Processes for acquiring and reviewing the 3D data used in AMG were discussed above under "Preconstruction Quality Control." As stated above, AMG creates both the opportunity and the need to identify and resolve potential issues prior to mobilization. For informal processes, we will note how the Contractor did or did not select AMG as part of the means and methods.

### ***Formal processes governed by policy***

Most agencies do not have specific policies that prescribe what the Contractor's Quality Control Plan must include for AMG. However, they do have general policies detailing requirements, for both the Contractor and department, regarding testing for verification. For example, in Wisconsin, general Quality Management Program (QMP) requirements include policies for both Contractor Quality Control testing and Department Quality Assurance testing. (31)

For NYSDOT, the Contractor is required to meet as soon as possible post-award to discuss scope, work plan, schedule, and administrative tasks, but the requirements for this work plan are not specific. (15) What is most germane to the discussion is the point at which the Contractor indicates that it will be using AMG, as that precipitates the Resident Engineer's decision-making on methods for verifying tolerances.

Section 105-10 of the NYSDOT specification is prescriptive of the methods that the Inspectors must use based on the methods used by the Contractor:

*“All survey work performed for quality control by the Contractor and for quality assurance by the Department should both utilize: (1) similar levels of measurement precision and methods to perform positional measurements, (2) the same control network from which measurements are made, and (3) the same survey measurement procedures to ensure consistency of results.” (15)*

This process is mapped in Figure 89, which illustrates how the Resident Engineer could be caught off-guard if the Contractor unexpectedly proposes quality control means and methods that the inspection team is unprepared for.

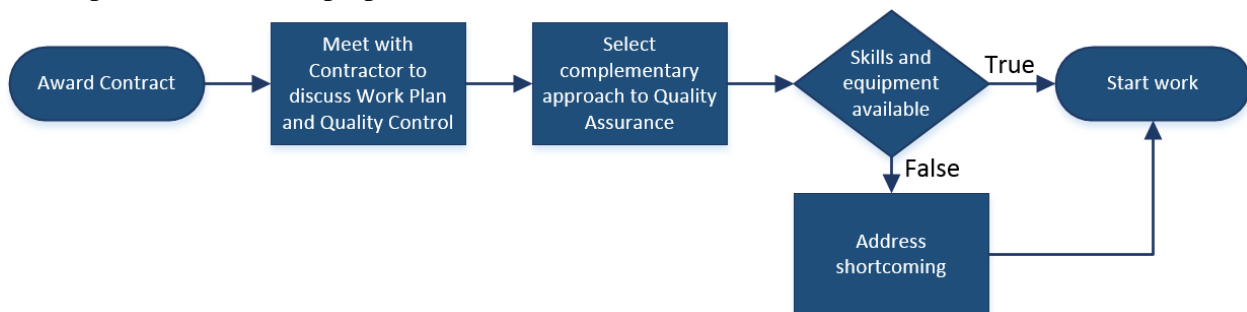

**Figure 89: Flowchart. Determination of inspection methods.**

### *Informal processes developed by the project team*

The discussion of preconstruction quality control processes for the I-35 Unbonded Concrete Overlay project is illustrative of how the risk profile in the pay items leads to the Contractor’s choice of means and methods. In that case, the decision to use AMG for the paving had already been taken as a result of the opportunity to control the yield quantities and limit the Contractor’s risk of overruns beyond the contract limits.

However, once the control set and 3D data had been prepared, the investment in 3D milling on the base concrete was small. The control location and precision requirements were the same for the total station-based topographic mapping, the 3D profile milling, and the stringless paving. The same data was used for the milling and the paving. The only cost increase was the milling cost, which MoDOT paid for. There was also an investment in milling time, but the construction was on target to meet the incentives for limiting the head-to-head traffic regardless.

The discussion of the CTAB preconstruction quality control for the I-80 Reconstruction project is also an example of the Contractor’s means and methods being informed by the risk allocation in the pay items. The Contractor was compensated for CTAB construction by area and was at risk of cost overruns if materials had to be hauled into or out of the canyon. Thus, the Contractor was highly invested in ensuring that there was a material balance for the asphalt millings. However, in this case, the project had a short construction window and any delays due to having to haul millings across the site or into or out of the canyon would have threatened the Contractor’s ability to complete the concrete paving before winter. This provided an incentive to the Resident Engineer to support the Contractor’s desire to control the milling quantities.

In Missouri and Utah, the Contractor had significant incentives to control yield and paving depth. Concrete paving is typically compensated by area, (24) with the Contractor at risk of overruns beyond a contract maximum, as was the case in the I-35 Unbonded Concrete Overlay project. The pay factors for thin pavement in Utah (18) and recommended by AASHTO (24) are shown in Table 24.

**Table 24: Pay factors for deficient concrete pavement depth. (18) (24)**

Utah Deficient Thickness	Utah Pay Factor	AASHTO Deficient Thickness	AASHTO Pay Factor
0 to 1/8 inch	1.00	0 to 0.2 inches	1.00
1/8 to 1/4 inch	0.90	0.21 to 0.30	0.80
1/4 to 1/2 inch	0.75	0.31 to 0.40 0.41 to 0.50	0.72 0.68
1/2 to 3/4 inch	0.60	0.51 to 0.75	0.57
> 3/4 inch	Reject	0.76 to 1.00	0.50
n/a	n/a	>1.00	Reject

The decision to use AMG for the Route 60 Reconstruction project was a combination of the following:

- The opportunity presented by having the data and control available having used 3D data in identifying, confirming, and developing the resolution to the stop work condition.
- The opportunity to proceed immediately once the 3D data for the resolution was agreed, as there was no need to set hubs or paint variable depths on the pavement prior to milling.
- The opportunity to control grades carefully and minimize the risks of drainage issues with the minimum grades, and the need to rework curb and gutter that had already been constructed.

While AMG presented the most expeditious approach to resume work, a significant factor in curtailing the stop work situation was the willingness of the Resident Engineer, Designer, and Contractor to work collaboratively to review the 3D data and identify solutions to problem areas. The process of identifying and resolving the issue is illustrated in Figure 90. If the Contractor had been required to exchange its 3D data into the Designer’s proprietary data format for review and to develop plans, and then back to the Contractor’s proprietary data format for construction, the stop work situation would have been significantly longer and the Contractor may have lost the early completion bonus, which was tied to a claims waiver.

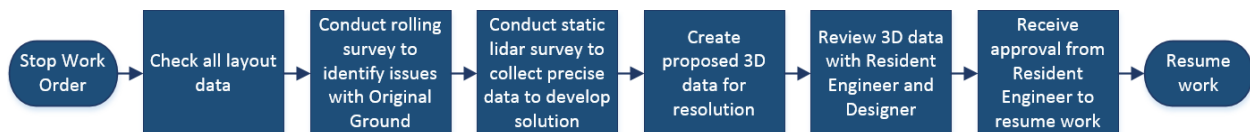

**Figure 90: Flowchart. Response to the Stop Work Order for Route 60 Reconstruction.**



### *Missed opportunities*

Asphalt pavements are typically paid by ton, without the depth pay factor disincentive (24). This limits the Contractor's share of the risk of overruns and likely contributes to the slow rate of adoption of AMG for asphalt paving. Further, the rate of response to grade changes on asphalt pavers is slow, about 1.5 times the length of the paver, which limits the extent to which AMG can control depths and yields. It is yet to be determined whether AMG contributes to pavement initial smoothness or whether AMG means and methods contribute to any significant measures of pavement quality.

The US 219 Mill & Resurface project did not use AMG, partly due to the cost of establishing suitably precise control and collecting suitably precise survey to develop the AMG surfaces. However, the payment structure (asphalt paid by ton) and incentive payments were not strong enough factors to support the use of AMG. The smoothness requirements were achievable with sonic averaging, so there was no need for variable depth milling.

### **Guidance**

Agencies should consider AMG as desirable for its ability to contribute to the Contractor's risk management, for its contribution to accelerating construction activities through reduced rework, and for its contribution to improved safety.

Agencies should take a broader view to the project characteristics that influence Contractors' decisions to use 3D data and/or AMG systems for project delivery. While certain activities such as earthwork construction are predisposed to AMG, risk allocation in the payment structure of the contract may strongly influence the Contractor's choice of AMG means and methods.

With performance-based specifications, the Contractor has internal motivation to control the quality of its work executed with AMG. Prescriptive work plans and quality control measures are unnecessary when the outcomes—such as thin pavement sections for concrete paving—provide strong incentive for robust quality control.

### **REAL-TIME VERIFICATION**

With AMG, layout is performed in real-time without the use of any physical reference. Contractors thus are reluctant to set stakes and hubs when executing construction with AMG; however, this places the Resident Engineer at a disadvantage if the inspection team lacks either or both the capacity to review the 3D data and the necessary equipment for Real-time Verification.

As noted above and as illustrated in Figure 89, if the Resident Engineer is reactive to Contractor notification that it intends to use AMG, there is a risk that the Resident Engineer will not have the necessary resources available if the Contractor's use of AMG was not anticipated. Thus, the Contractor's use of AMG is one reason that the inspection team should use Real-time Verification, but it should not be the only reason.

## Processes used

This section will explore factors that motivate Real-time Verification. It will then explore the processes themselves.

### *Formal processes governed by policy*

Most state transportation agency manuals or specifications do not provide specific guidelines for how to handle Real-time Verification processes. Many of the lessons learned and processes developed in piloting the specification revisions on the Southern Expressway project, among others, have now been adopted into the NYSDOT specifications.

The NYSDOT specification has also incorporated formal policies to ensure that the Contractor and Resident Engineer use consistent survey methods. Section 625-3.02 outlines the requirement for a Contract Control Plan. This deliverable is also how the Contractor notifies the Resident Engineer of the intent to use AMG:

*“All Survey Operations shall follow either Traditional Survey Stakeout or Automated Stakeout and Automated Machine Guidance Operations, or a combination of both, for the establishment, positioning, equipment guidance or verification of construction items. The proposed method shall be approved by the Engineer as part of the Contract Control Plan prior to beginning any field construction operations. Both methods include the same basic requirements that: (1) both parties (Contractor and Department) utilize the same contract control, the same existing terrain data, and the same proposed feature data; (2) both parties utilize the same accuracy and tolerance limits; and (3) both parties utilize equivalent survey verification techniques to ensure that field features are constructed as proposed.” (15)*

The NYSDOT specifications reference other policies and manuals of the NYSDOT for collecting and managing 3D data. These include the Land Surveying Standards and Procedures Manual, the Specifications for Photogrammetric Stereocompilation, the Highway Design Manual, and the Project Development Manual. (15)

Section 625-2.06 of the NYSDOT specification includes a provision for the Contractor to furnish GPS equipment and training for the Resident Engineer and Inspectors’ use. The types and numbers of equipment to be furnished are included in the bid items. (15) However, Section 105-10 quoted above requires the Inspectors to use equivalent tolerance equipment to that used by the Contractor. Where the Contractor uses more precise equipment than the GPS units furnished, the Resident Engineer has an obligation to provide equivalent equipment. Thus, the NYSDOT has several other options for Resident Engineers, including access to leased equipment and support from Regional Survey Coordinators.

Section 109-01 explicitly allows use of field surveying and CADD to measure payment quantities:

*“The Engineer will choose the method by which the work will be measured, such as: measured from documents/data (contract plans, cross sections, CADD files, etc.); measured with an appropriate device such as measuring tape or wheel; or measure from field survey of completed work.” (15)*

### *Informal processes developed by the project team*

The informal processes used on the Southern Expressway project for Real-time Verification evolved as the Inspectors became more comfortable with the equipment and the data. The processes for checking and updating the original ground data and performing preconstruction quality control are discussed above. This section will discuss specific processes for Real-time Verification, as well as for using the tools for measuring pay quantities.

Inspectors documented their Real-time Verification observations in their daily reports, referencing the work orders in which the actual survey observations were stored. More commonly, work orders stored observations for measuring pay quantities than for verifying tolerances. When accepting work per plan, as in Figure 91, no further documentation is needed. Observations of completed work were typically only stored for one of two reasons:

- To perform and then document a payment quantity measurement.
- To record as-built locations to be used to create the as-built record drawings.

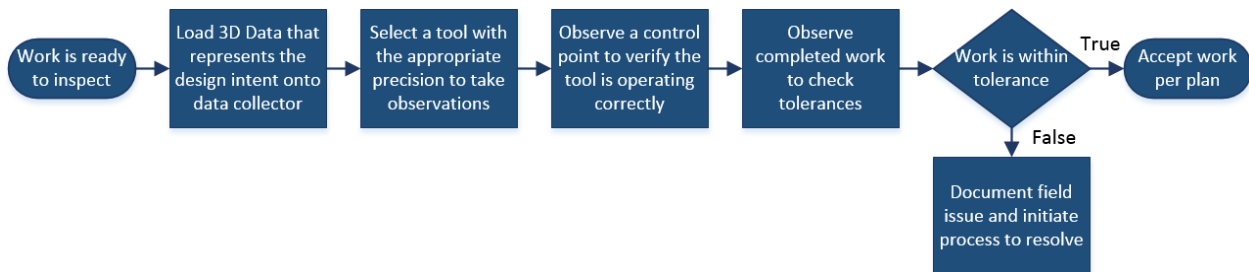

**Figure 91: Flowchart. Workflow for Real-time Verification.**

Inspectors documented work order name, rover number, and the area, length, and volume quantities computed on the data collectors. Less commonly, observations were stored when there was a need to gather objective evidence to substantiate decision-making, as in Figure 92.

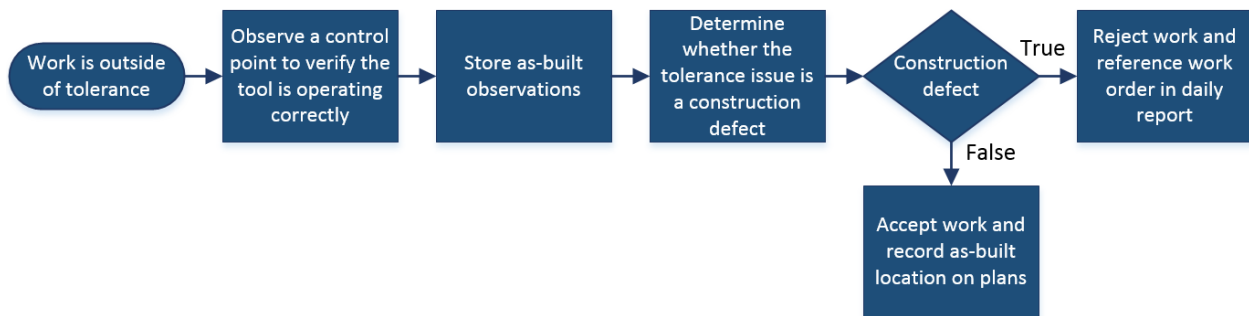

**Figure 92: Flowchart. Action precipitated by detecting a tolerance issue.**

When measuring pay quantities, the daily work orders for collecting the data and performing the length, area, or surface comparison volume calculations were printed and annotated so that the computations were repeatable. These quantities were entered into daily reports and were submitted to the Office Engineer for review. The Office Engineer then reviewed the work order reports and accepted the quantities, entering them into the system for payment. Figure 93 illustrates this workflow.

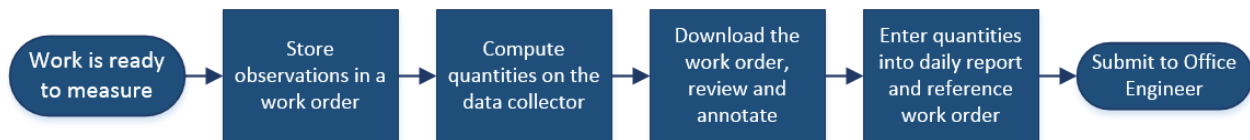

**Figure 93: Flowchart. Measurement workflow.**

One of the largest challenges was developing processes for digital data management. File naming and organization, as well as archiving and backup, were significant issues. On jobs with small inspection teams, clear file naming and organization standards may not be essential. However, on the Southern Expressway project, there were five Inspectors and an Office Engineer who shared data. The NYSDOT CADD and Survey Manuals served as an important references, especially for field data collection practices, such as assigning field codes to the survey points to identify what was observed. The Office Engineer provided an external hard drive to back up the work orders and 3D data. NYSDOT now uses the department’s ProjectWise server for digital data management.

### **Missed opportunities**

There is a missed opportunity to collect as-built information while accepting work per plan. Survey field data is highly durable and highly consumable, and could be more readily accessible and consumable to future users than the as-built plans. There is also a missed opportunity to leverage the as-built data collected during the course of measuring pay quantities.

### **Guidance**

AMG is one reason for the inspection team to use Real-time Verification, but it is too reactive, especially if the Resident Engineer is reliant upon the Contractor to furnish equipment and training. If the Contractor intends to use AMG but this intention was not predicted to include the bid items for furnishing the equipment, a contract change order may be needed to acquire the equipment and training for the inspection team. This may lead to delays in building comfort and skill for the inspection team.

There are additional reasons to use Real-time Verification processes and tools other than because the Contractor is not setting stakes—although that is a compelling reason. There is synergy between AMG and Real-time Verification because the two processes have the same survey and 3D data requirements. However, the survey needs to use post-construction 3D data for measurement only are not as rigid and may be available at low cost with a CORS network.

Safety and efficiency for the inspection teams may be larger factors, and the opportunity to collect transparent and more accurate measurements is important. The Resident Engineers for both the Southern Expressway and the Route 60 Reconstruction project reported from other experiences that they felt more confident in their ability to pay the Contractor accurately when using field survey technology to collect 3D data.

## **AS-BUILT RECORD DOCUMENTATION**

### **3D Digital As-Built Records**

#### *Formal processes governed by policy*

The most current version of NYSDOT's Contract Administration Manual requires as-built record plans to be developed via CADD whenever possible. Electronic files are archived upon completion of the Plans, Specifications, & Estimates (PS&E) within ProjectWise, and a Construction folder is created to store copies of needed files. (32)

#### *Informal processes developed by the project team*

For the Southern Expressway project, the invert shots were stored as as-built records during the process of checking subsurface utility and drainage construction. Shots were taken at changes in orientation on water lines as well. These shots may not have been needed during construction, but they take very little effort to collect. If they are needed, the value far exceeds the cost of the Inspectors collecting them while they are exposed.

The utility as-built shots were used to prepare the as-built plans, but the field data was retained as well. Points were stored as Northing, Easting, Elevation, and Description. The field codes and descriptions used were consistent with the survey manual. In total, 18 miles of horizontal drains were as-built with elevation attached to the horizontal line work. Any exposed existing utilities were also collected. The CADD line work was used to update the National Highway System Inventory Database.

As-built field mark-ups of PDF plans is another method of storing as-built records. While this process allows for records to be created in real-time, they would still need to undergo an additional conversion into 3D format in order to be integrated into future design or maintenance plans. A direct upload of CADD line work eliminates this step entirely.

#### **Missed opportunities**

While the as-built data was collected on the Southern Expressway project and rich 3D datasets were created for all of the projects that used AMG, the opportunity to capture and store these 3D datasets with an accessible location and organization was missed. The cost of re-creating these records, particularly for buried features, is prohibitive.

#### **Guidance**

There is a growing desire for agencies to collect consumable as-built records, particularly 3D subsurface utility locations. (33) When the inspection team has access to the tools and is familiar with the agency's standards for data collection, there is a meaningful opportunity to document as-built and as-located subsurface utilities and foundations, as well as to document the location and extent of full and partial depth repairs to pavements and bridge decks. Maintenance departments could also use 2D and 3D as-built locations of safety-related features such as striping, guardrail, and signs, as well as drainage features such as ditches and culverts, which need to be maintained. (34)



## 7. DATA USES AND SCHEMAS

Project teams usually apply 3D data for more than one use, and as such have the opportunity to optimize the Level of Development (LOD) of the data against target uses and investment. The LOD concept communicates two specific characteristics of the data. The first relates to how much detail is in the model, which we will characterize as Model Density (MD). The second relates to how much uncertainty the model is founded upon, which must be expressed qualitatively. This we will characterize as a qualitative Confidence Level (CL) and use a graded scale similar to that adopted for subsurface utility information. (35)

It is important not to confuse high detail in isolation as a high LOD. The convention with lidar data is to use a combination of point density and accuracy, the latter being a combination of both local and network accuracy for the point cloud as a whole. (36) When creating 3D digital design data, it is a relatively simple software action to add more detail into the model. To be used directly in construction, 3D digital design data needs to have both a high investment in engineering judgment and a high amount of detail to fully reflect the design intent without the need for interpolation or interpretation. Figure 94 illustrates the relationship between MD, CL, and appropriate uses for 3D digital data. This chapter delves into the nuances and considerations peculiar to each use that can inform project decisions around 3D data management.

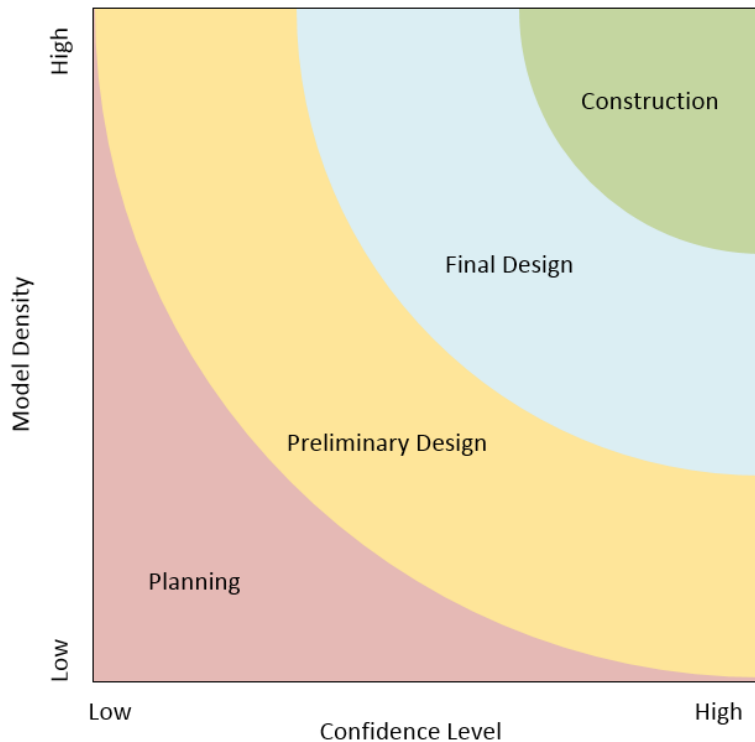

**Figure 94: Chart. Relationship between MD, CL, and 3D data use.**

This chapter starts by exploring the specific data uses, densities, and confidence levels revealed by the case studies and then synthesizes categories of MD, CL, and LOD and creates functional categories of project data that support the uses.

The overarching uses that were identified are as follows:

- Preconstruction quality control.
- Construction layout and orientation.
- Automated Machine Guidance.
- Real-time Verification and pay quantity measurements.
- As-built record documentation.

Specific uses under each category follow. The chapter then culminates with the LOD designations and definitions for MD and CL, and a sample digital data manifest.

## **PRECONSTRUCTION QUALITY CONTROL**

Three primary functions of pre-construction quality control involve 3D digital design data. First is a review of the data itself to verify that it accurately reflects the design intent conveyed by the contract documents. Second is a check of the accuracy of the estimated pay quantities. Finally, the design itself is reviewed, such as evaluating the maximum achievable pavement smoothness using ProVAL, checking transitions and tie-ins to fixed features, and reviewing staging and constructability.

The process of reviewing the data against the contract plans is essential in the current environment of incompatible data formats, limited data exchange schemas, and a low level of confidence in the 3D design data provided by designers. This low confidence lies with both the designers themselves, who argue 3D data has inherent liability associated with it, (37) and from contractors receiving that data. One source of the low confidence, as was the case in all of the projects studied that had survey data, was that the underlying original ground information did not match field conditions. This is the primary reason that pay quantities need to be reviewed prior to construction, especially when there is an opportunity to collect more accurate original ground survey information after mobilization. Of the projects studied, not one made direct use of the data created in design. However, it is a growing practice for digital design data to be used directly and also for that data to supersede the contract plans within narrowly defined uses specified in Special Provisions. (38) (39)

### **Verifying Data Matches the Contract Plans**

The main mechanism for performing this review is to underlay georeferenced PDFs of the plans, as shown in Figure 95. Surfaces are typically reviewed by overlaying horizontal line work in plan view and by cutting cross-sections and comparing individually to the plan cross-sections. The data that needs to be verified is as follows:

- 2D lines used for horizontal layout/verification.
- 3D lines used for horizontal layout/verification.
- Alignments used for horizontal layout/verification.
- Surfaces used for AMG.

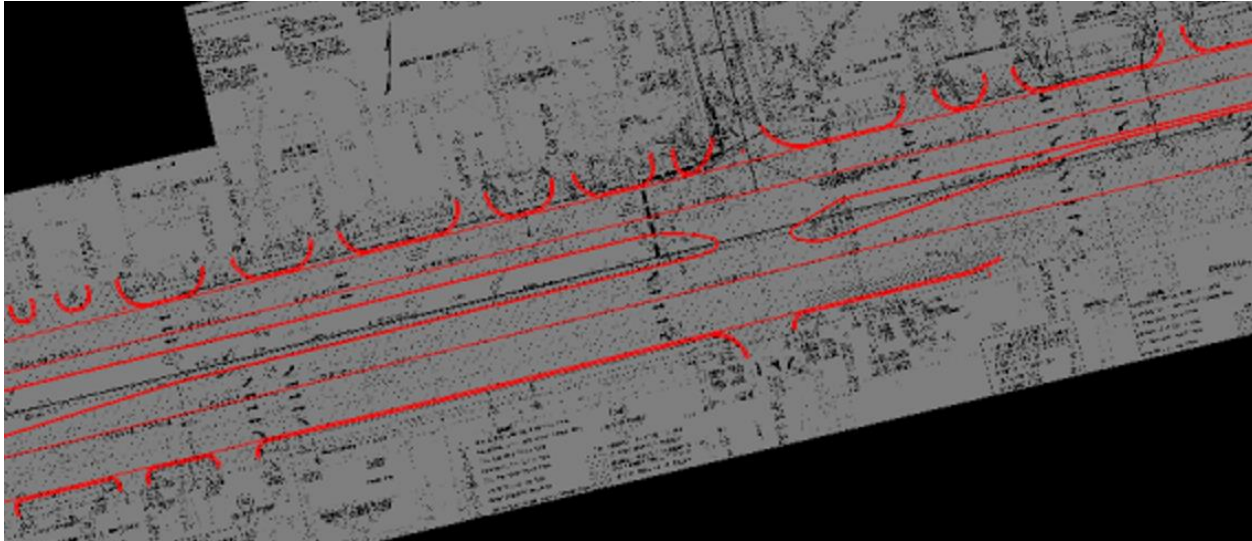

**Figure 95: Screenshot. Reviewing 2D and 3D lines strings over scanned plans.**

### **Verifying Pay Quantities**

The main pay quantities that are reviewed are earthwork, base, and concrete paving volume quantities. Comparing existing and final ground surfaces to measure volume quantities is more precise and accurate than the average end area method that many agencies still use as the basis for earthwork quantity estimates. (40) With the surface comparison method, the computer calculates the volume quantity using prismatic volumes defined by the full extent of the data points in both bounding surfaces. However, with the average end area method, representative cross-sections are applied uniformly for large distances, sometimes as great as 50 feet, and often at defined locations (e.g., regular station numbers) rather than at locations that are representative of a homogenous length of roadway.

Any reduction in interval below 50 feet provides enhanced precision. For preliminary earthwork quantities, 10 feet is sufficient. Except for particularly complex geometrics with tight horizontal and vertical curves, or in steep terrain with large variations in side slopes, smaller point density does not offer significant enhancements in precision.

In some cases the differences between surface-to-surface comparison quantities and 50-foot interval average end area computations may be significant. However, it is more common that the source of a significant difference is the accuracy of the original ground survey. Typical original ground survey accuracy is 0.5 feet vertically over the project limits. For a 1-mile project with a 50-foot-wide disturbed area, the potential source of error is almost 4,900 cubic yards per mile.

Depending on the volume of material, the margin of error from the original ground survey accuracy can be significant. For earthworks, it is often still worth using the more precise surface-to-surface comparison method. However, for smaller volumes such as milling, base, and paving quantities, the surface-to-surface method will only add value if the original ground survey accuracy is tight enough to restrict the margin of error. Figure 94 illustrates the different relative contributions made by margin of error to earthwork and pavement quantities.

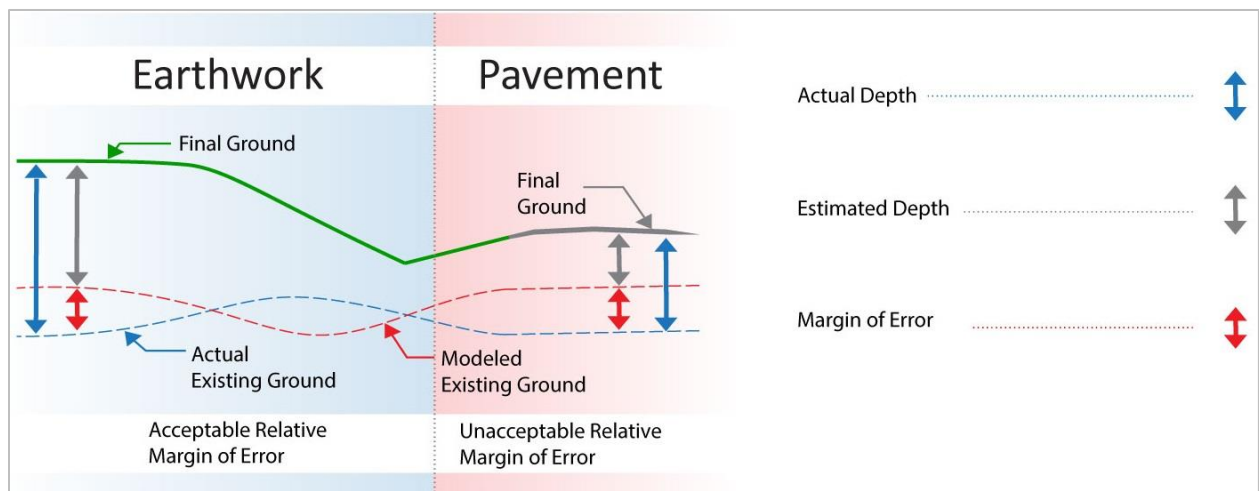

**Figure 96: Illustration. Margin of error affects the value of surface comparison volumes.**

The CTAB mass balance from the I-80 Reconstruction project illustrates the contribution of model density and confidence level to verifying pay quantities. The original ground data density was one point every 50 feet, while the final ground data density was one point every 2 feet. Both surfaces, being tops of interstate roadways, were relatively homogenous in spite of complex geometrics in the canyon. To get meaningful milling volume quantities, the precision of the original ground survey data points was more significant than the density of the data points.

There was more variability on the top of base concrete for the I-35 Unbonded Concrete Overlay project than there was on the I-80 original asphalt. Thus, for I-35, the density of the original ground data was five times larger, with a 10-foot interval between points. In both cases, the Contractor performed the mass balance using CADD software. The original ground survey was imported into the CADD software used to develop the AMG data. The design was recreated as a corridor model to create the proposed ground surface. The design profiles were revised within acceptable limits until suitable mass balance was achieved. The final surface was then exported into the AMG vendor’s tool. Figure 97 shows the workflow for taking original ground survey data into CADD systems to develop a design surface and export it, and open data schemas such as Comma Separated Values (CSV) for survey points and LandXML for surfaces.

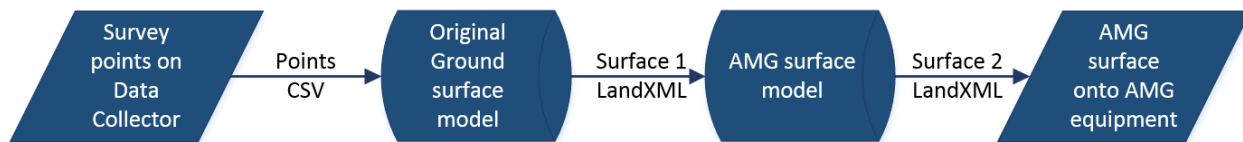

**Figure 97: Flowchart. Data exchanges and schemas for AMG surfaces.**

### Reviewing Constructability

Both the Utah and Missouri contractors indicated that they would prefer to use static lidar to capture denser original ground data. For both, static lidar would be the tool of choice for its potential to collect other data that could be mined later, such as checking the horizontal and vertical clearance for the paver and AMG reflectors under the Tollgate Bridge on the I-80 Reconstruction project. In Missouri, lidar data would have captured the pre-existing partial repairs on the original concrete that was problematic for the milling.

In Virginia on the Route 60 Reconstruction project, static lidar was ultimately the tool chosen specifically for constructability concerns. The stop work condition likely contributed to a low appetite for risk, and static lidar provided the most complete and most precise data in the shortest amount of time. There were many constructability issues:

- Tie to the curb that had already been set.
- Minimize rework on the curb that had already been set.
- Maintain positive drainage under minimum grade conditions.
- Tie into frequent driveways and intersections.
- Minimize asphalt quantity.
- Maintain structural depth of existing pavement.

Once original ground data had been collected with both high precision and high density (approximately 6-foot point interval), the process and data schemas were as shown in Figure 97. The data was equivalent, and the distinction between the three datasets was essentially a matter of what was most expedient that provided a minimum degree of confidence based on the risk being mitigated.

Paving typically has pavement smoothness requirements with incentives and disincentives for exceeding or underachieving on the smoothness outcomes. (15) (18) (24) This was the case in Utah, Virginia, and Missouri, but other factors were a larger concern. In Utah it was the material balance; in Missouri it was maximizing geometric corrections while optimizing yields; and in Virginia it was avoiding rework, maintaining positive drainage, and minimizing asphalt volumes. Nevertheless, the software used to address these priorities could also compute theoretical maximum pavement smoothness based on the geometrics. The software used the same surface data as used for other purposes.

Table 25 summarizes data uses and characteristics for pre-construction quality control.

**Table 25: Data uses and data types for preconstruction quality control**

Data Use	Data Types
Verify 3D data matches contract plans	Contract plans Alignments and profiles 3D line strings 2D line strings Original ground surface Proposed surfaces
Control volume quantities	Original ground surface Proposed surfaces
Review constructability, including tie-ins, positive drainage, and physical constraints	Original ground surface Proposed surfaces 3D line strings 2D line strings
Predict pavement smoothness outcomes	Alignments Proposed surfaces



## CONSTRUCTION LAYOUT AND ORIENTATION

Contract plans define the design intent in a variety of ways. For roadways, the plan, profile, and cross-section views must be reconciled to obtain the full intent of the design. Often, transitions in cross-section—such as gores and widenings—are defined only in the plan view. Curbs may be defined by horizontal location, a standard detail, and grades for the flow line or inferred from the roadway edge of pavement. The literal conversion of the plan graphics only to a 3D model does not fully reflect the design intent. Thus, the design models that were detailed only to the extent needed to develop the plans do not fully communicate the design intent.

When reviewing that the 3D data matches the design intent in the contract plans, the data density will vary by feature and location. Certainly, the 3D data will need to be more detailed than the graphics shown on the plans if it is to be used successfully for layout or AMG. Often notes such as “grade to drain” or variable dimensions need to be pieced together. Construction models are also incomplete. A curb and gutter may be represented by one single 3D line string that defines the controlling layout line, perhaps the flowline or top back of curb.

In addition to earthworks, grading, and paving, which are performed with real-time layout using AMG, the 3D data can be used to lay out other features, including point features (such as light poles, signs, and foundation piles), linear features (such as ditches, silt fences, slip form barriers, and curbs and gutters), or to delimit boundaries (such as limits of disturbance, rights-of-way, or slope limits). These features could be laid out in real-time using rovers to identify the location at which to install the features or to set physical markers such as stakes and hubs in advance of them being installed. Digital data representing baseline alignments can also be used with mobile devices for general orientation or with rovers to determine precise locations.

It is a fallacy that 3D models need to be complete or accurate at all locations in order to provide the interpretation of the design intent for construction. Rather, 3D data is just another, arguably more consumable (though perhaps less accessible) means with which to communicate the design intent. The amount of detail—model density—required for layout and orientation is determined by the tolerances prescribed by the specifications.

It is important to recognize that staking tolerances represent measurement precision relative to the control; essentially, it is a matter of local accuracy only. For optical survey methods such as total stations and lidar, the instrument precision is relative to the control. With GNSS methods of surveying, however, the instrument measures with precision relative to the localization established for using three or more control points. This localization produces a scale factor and rotation for horizontal distances and coordinates, and an inclined plane for a vertical datum. (8)

It is important not to confuse staking tolerances with network accuracies. For instance, to achieve smooth pavements, grade control needs to be very precise. The precision of the elevation from one control point to another for concrete paving will translate to the screed when the guidance system switches from one set of total stations to the next, causing the screed to adjust up or down. Given that the pay factors for concrete paving are in bands as small as one-eighth inch, concrete paving requires precise grade control to maintain pavement smoothness and slab depth.

By contrast, the network accuracy—where the roadway is located—does not need to be so precise. If the whole roadway were offset 6 inches in any direction the product would still meet the design intent as long as it was within the right-of-way, there were no significant quantity overruns, and no safety issues were introduced. Network accuracy is only germane when the precise location is important. This is typically at tie-ins to existing features that are fixed, such as subsurface utilities, foundations, bridge abutments, curbs and gutters, driveways, saw cut lines for widening, and existing roadways for rehabilitation or reconstruction.

The idealized design, baseline alignments and profiles, and the primary control can be considered absolute. All tolerances are relative to these two foundations. When using 3D data for layout, there are two sources of error that need to be managed. The first is the amount of approximation introduced by the Model Density. The idealized design, or design intent, is accurately depicted in the 3D model where there are superimposed horizontal and vertical tangents. Once curvature is introduced—either horizontally or vertically, or both—the 3D data becomes chorded and the maximum error is the mid-ordinate distance along the curve, illustrated in Figure 98. (8)

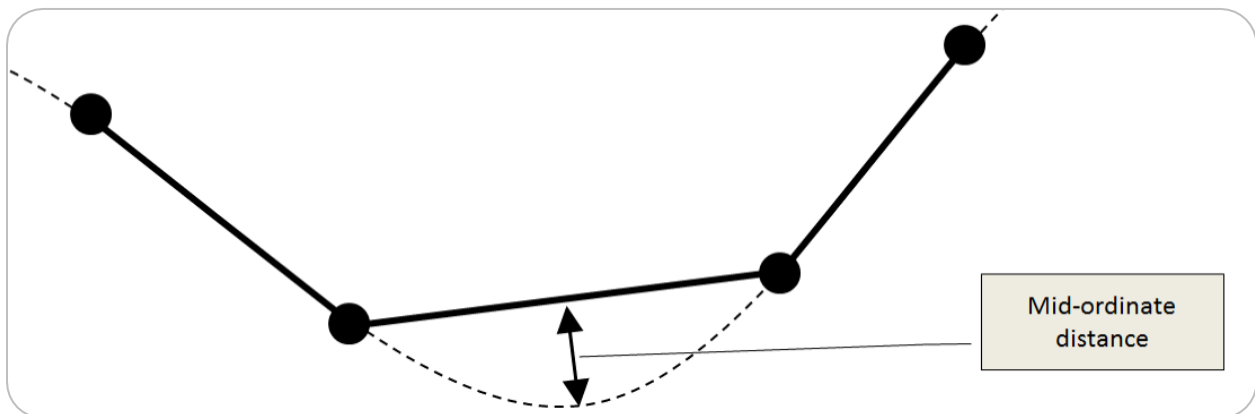

**Figure 98: Illustration. Mid-ordinate distance. (8)**

The second source of error is the tolerance of the equipment used for layout. The two are cumulative. Thus, the person responsible for layout needs to prepare the 3D data and select the tool for layout bearing both of these sources of error in mind. For some features, such as structures and curbs, the tolerances are so tight that the 3D data must be absolute as only the survey equipment tolerance can be sustained. For other features, such as limits of disturbance, the tolerance is relatively lax and there is flexibility to use more convenient, less precise survey equipment such as GNSS and larger mid-ordinate distances from less dense 3D data.

Most features lie somewhere in between. For paving, the need for tight vertical precision as discussed above dictates the survey tool selection, thus, there is flexibility in the model density. Concrete paving, for instance, has been successfully constructed using wire lines set with 30-foot spacing between the hubs. Where the tight vertical precision is not needed, usually GNSS is the preferred layout tool because it has a larger range. It is usually easier to increase the density of the 3D data than to use an optical survey tool that has a fixed line-of-sight constraint.

Table 26 summarizes data uses and characteristics for construction layout and orientation.

**Table 26: Data uses and data types for construction layout and orientation**

Data Use	Data Types
General orientation	Alignments
Layout point features	Points
Layout linear features	Alignments and profiles 3D line strings 2D line strings
Set stakes and hubs	Alignments and profiles 3D line strings 2D line strings Proposed surfaces
Delimit boundaries	2D line strings

**AUTOMATED MACHINE GUIDANCE**

AMG is perhaps the most common use of 3D design data in construction. The data inputs from a surface and associated data preparation and formatting are important parts of a successful AMG application. The design data must be passed on to the contractor, who often transforms it into a proprietary format compatible with the AMG equipment. Contractors might hire a data preparation consultant to provide the final machine files for use in the field or might develop their own model if not originally provided by the state transportation agency. (41)

Using a combination of 3D data along with onboard positioning equipment, AMG provides horizontal and vertical grade control in real time. As with layout, however, the errors in the 3D data and the positioning equipment compound. As noted above, pavement smoothness and depth requirement often dictate that precise positioning equipment be used. Thus, there is flexibility in the Model Density to still achieve outcomes within staking tolerances. Often, the constraint on the Model Density is the need to control material yields rather than to achieve tolerances.

For example, on the Utah project, the Contractor used a combination of Trimble® Business Center and AutoCAD® Civil 3D® to prepare the 3D data. For setting string lines, the corridor surface was projected with a 6-foot offset to set the string line elevation. Hubs were set every 30 feet, matched by the corridor template drop. For the stringless paving on the westbound, the corridor template drop interval was changed to 12.5 feet, resulting in a model detail twice as high as that for hubs and string lines. The AMG paving had twice as many data points for grade control as did the string line paving, and the yield improved by 1 percent. The data densities indicated for AMG paving are often set with the intent to control quantities.

There are locations where high network accuracies are necessary for the data points themselves. These are typically tie-ins to existing, immovable features such as curbs, bridge abutments, and existing hard pavements. In order to meet these tight network accuracies, the design must be based upon survey data that has this level of accuracy. When the design ties into points that are not fixed, the network accuracy needs are determined by the acceptable margin of error of the first pavement layer. Subsequent pavement layers will be offset by a consistent depth above the first layer. For earthwork, a margin of error of 3 inches over the area of disturbance may be

acceptable. However, for more expensive materials in the pavement, the acceptable margin of error will be smaller. For the Utah, Missouri, and Virginia projects, tight network accuracy was a requirement at all locations to control the quantities. For the Southern Expressway project, the first layer was earthwork and a low density surface collected using GNSS rovers was sufficient.

For general excavation, earthwork, milling, and paving, the data for AMG is a surface. The data needs for other types of AMG construction are often simple. A 3D line string for the bottom of the trench can suffice for excavation. (8) Slip form curb and gutter or median barrier paving requires an alignment and a cross-section, or in some cases, an alignment, profile, and cross-section. The median barrier on the I-80 Reconstruction project was constructed with slip form paving. The data that was needed was only the horizontal alignment and the cross-section because the already completed concrete paving provided the grade control. AMG is also used for linear paint striping. Only the horizontal geometry is needed.

Equipment operators do not need additional data for grade control, but it can be helpful to the operator to have additional information. Only concrete pavers are self-steering, so other AMG systems still require active management by the operator. Additional data does not necessarily need to be 3D; in many cases 2D line strings will suffice. It can be helpful to the operator to know the locations of all grade breaks. Excavator operators would benefit from having 3D models of any known subsurface features such as utilities and foundations. Line strings indicating limits of disturbance, wetlands, and other areas to be avoided can also be helpful. A summary of data uses and characteristics for AMG is provided in Table 27.

**Table 27: Data uses and data types for AMG. (8)**

Data Use	Data Types
Profile milling	Surface: Finished grade surface Alignment: Primary horizontal and vertical baseline, superelevation 2D line strings: Crown, edges of pavement, grade breaks, top of curb, and flow lines
Paving	Surface: Finished grade surface Alignment: Primary horizontal and vertical baseline, superelevation 2D line strings: Crown, edges of pavement, grade breaks, top of curb, and flow lines
Rough grading, fine grading, and base	Surface: Finished grade surface Alignment: Primary horizontal and vertical baseline, superelevation 2D line strings: Crown, edges of pavement, edges of shoulder, grade breaks, and ditch flow lines
Excavation (non-linear)	Surface: Finished grade 2D line strings: Limits of disturbance, grade breaks, ditch flow lines, and tops and toes of embankments
Excavation (linear)	3D line strings: Bottom center of ditch Other: Ditch cross-section, any known subsurface features
Slip form paving	Alignment: Layout line horizontal and vertical geometrics Other: Form cross-section
Paint striping (linear)	2D line strings: Center of striping

## **REAL-TIME VERIFICATION**

The purpose of Real-time Verification is to provide quality assurance during construction operations with minimal interruption and minimally exposing the Inspectors to the safety hazard of active construction equipment. (40) As AMG does not require stakes for the operators, there is an opportunity to substantially reduce stakes, often by 90 percent, or entirely eliminate stakes if the Inspectors have an alternate tool to execute quality assurance.

The types of quality assurance activities performed by Inspectors that relate to geometric properties include verification of the following:

- Primary acceptance factors such as slopes and material depths.
- Dimensions such as widths, lengths, and clearances.
- That structural work is at the correct elevation, such as inverts and beam seats.
- That work is in the correct horizontal location and grade.
- That safety devices are installed correctly, for instance excavation shoring and fall prevention equipment are used when necessary.
- That erosion prevention and sedimentation control devices are within compliance, such as sedimentation basins having sufficient capacity.

Another core inspection task is measuring pay quantities, which will be discussed in the next section. Many of the inspector's verification functions are concerned with local measurements rather than absolute positions. Thus, 3D design data is not needed for all of these functions, and when the work is in accordance with plans, specifications, permits, and regulations, there is no need to store any data. However, the Inspector does need a good understanding of how the field surveying equipment works to be able to use the tool for these other measurements. Real-time Verification offers the opportunity not just to replace the method by which locations are checked, but to replace or enhance the methods employed for other verification tasks as well.

One of the most meaningful ways that the practice can add value is as a documentation tool, not just for capturing as-built conditions, but for gathering documentation for claims, change orders, design revisions, or disputes. The documentation is effectively topographic survey, capturing a digital record of the as-found conditions. Field survey data collection is a primary skill set for Inspectors who will use these tools, but existing training for surveyors and policy or guidance documents such as a survey manual should be available.

Imbuing Inspectors with field survey skills also gives the agency an opportunity to utilize Inspectors in the off-season to augment the Survey department or to collect asset inventory information for the Maintenance and Asset Management departments. These opportunities for cross-utilization can help to develop the skills for inspection. In addition to developing field survey data collection skills, Inspectors can develop an understanding of the data needs of these downstream departments so that they can collect more useful records during construction.

The activities that do require 3D data representing the design involve verifying locations. Staking tolerances are an important guide to the 3D data density needs, and the discussion above regarding mid-ordinate distances and tool precision is germane. However, it is important not to confuse the staking tolerances, which inform tool selection and data preparation, and the



tolerances relative to the 3D data that the inspector will read on the data collector. Staking tolerances relate to layout, which is the baseline against which construction outcomes are compared. The verification tolerances that the inspector needs to check on the data collector are defined in the section of the specification that relates to each activity.

An agency can use staking tolerances to develop guidance on 3D data density for GNSS and RTS rovers. A RTS is a more precise tool, so it can be used with a less dense model—which has a larger mid-ordinate distance—and achieve the same outcomes regarding layout precision. Figure 99 illustrates the relationship between survey instrument precision and the 3D data density. GNSS is more precise for horizontal positioning than it is for vertical positioning. (8) The impact of tool selection on 3D data prepared for checking elevation or grade tolerances is therefore greater than for horizontal tolerances.

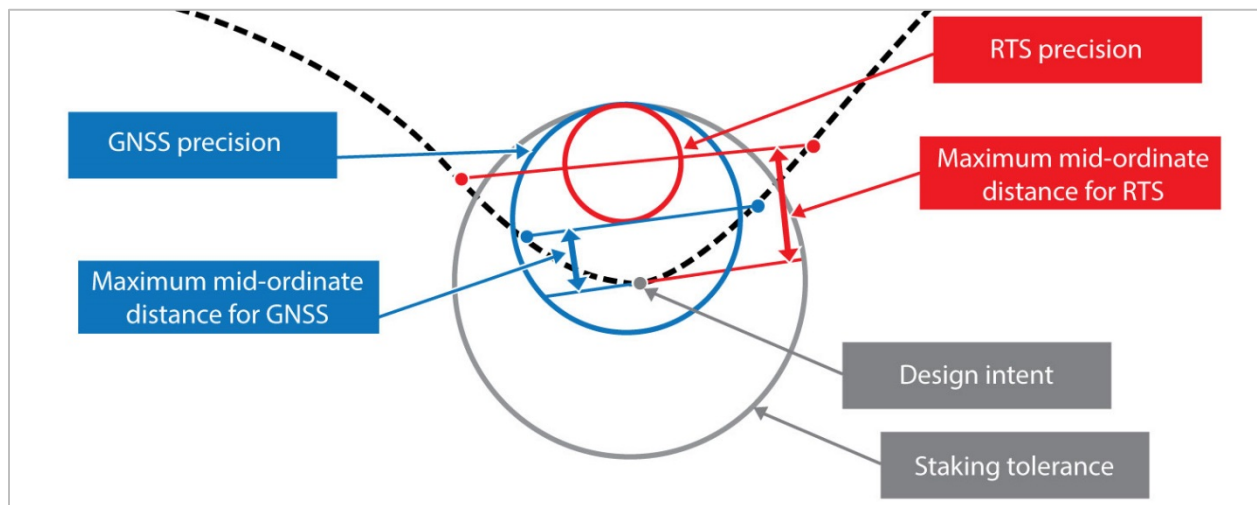

**Figure 99: Illustration. Derivation of 3D data densities.**

Table 28 presents illustrative staking tolerances. For centerline control points, the staking tolerance is equivalent to normal GNSS horizontal precision. Thus, to use a GNSS rover for centerline control point staking, the true alignment geometrics must be used with no chording on curves. Centerline station points, however, can tolerate some chording in the 3D data such that the mid-ordinate distance is 0.05 feet or less. The same is true for horizontal layout for culverts. However, the vertical tolerance is tighter than GNSS can achieve. The nominal precision for a RTS is 0.02 foot, (8) which suggests that there is no room for any chording in the 3D data. However, culverts are normally straight, so this is not a concern.

**Table 28: Illustrative staking tolerances (17)**

Feature	Horizontal	Vertical
Centerline control points	± 0.05 foot	n/a
Centerline station points	± 0.10 foot	n/a
Curbs, sidewalks, and bike paths	± 0.03 foot	± 0.02 foot
Roadway finished grade and PCC paving	± 0.10 foot	± 0.02 foot
Manholes, inlets, and culverts	± 0.10 foot	± 0.03 foot
Roadway subgrade grade stakes	± 0.20 foot	± 0.05 foot
Slope stakes and references	± 0.30 foot	± 0.10 foot
Wetland mitigation stakes, luminaire and signal poles	± 0.20 foot	± 0.20 foot
Clearing and grubbing stakes	± 1.00 foot	n/a

For roadway finished grade and PCC paving, however, the vertical staking tolerance is equivalent to the normal precision for a RTS. This means that there is no room for chording. That is problematic because the data used for this activity is a surface that chords both horizontal and vertical curves. The staking tolerance thus is not helpful for guiding the data density needs without exploring the intent behind the staking.

For roadway grading and paving, the intervals between stakes is typically 50 feet, often smaller around horizontal curves. (42) The VDOT survey manual directs staking roadway grades at each station, using a DTM, (28) but it does not provide guidance on how to establish that DTM. Normal design practices result in data points at regular stations, however. (43) (8) The outcome of staking is that inspectors have a reference on the ground at regular stations that is a precise indication of the design intent, but between stations design intent is interpolated. Real-time Verification is thus a trade-off between a more accurate interpretation of the design between regular stations, illustrated in Figure 100, and slightly less precision at the station locations.

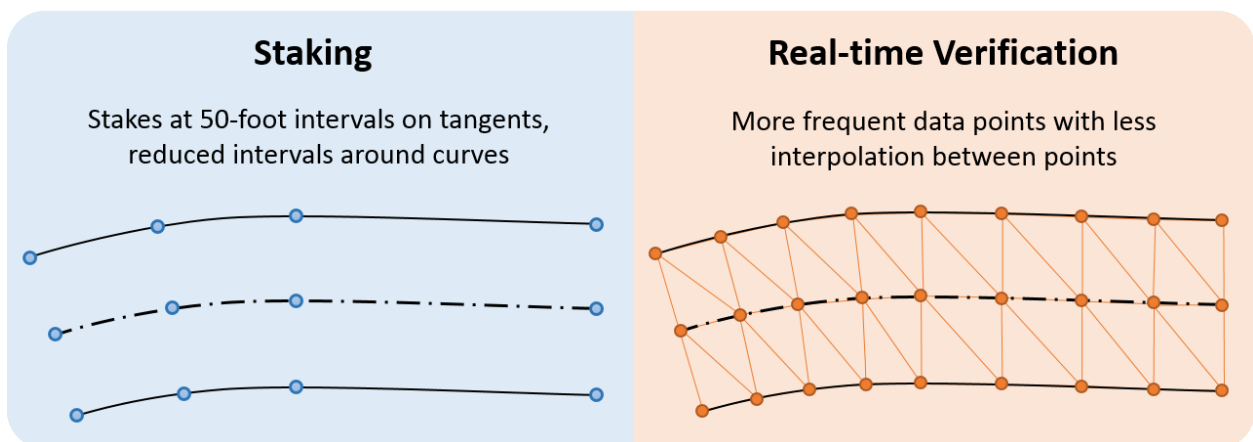

**Figure 100: Illustration. Staking compared to Real-time Verification.**

There are clear synergies between AMG and Real-time Verification, in part because a Contractor setting fewer stakes (40) creates a need for inspectors to have an alternate reference to the design. Other synergies are the availability of 3D data that is sufficiently developed for AMG construction and a robust survey network to support AMG, which the Real-time Verification survey tools will need to access. Partnering with the Contractor to take advantage of the opportunity of taking as-built data from the AMG systems or emerging Unmanned Aerial Systems (UAS) technologies can extend the range of the tools into depth checks for pavements. This would provide faster checks, better record keeping, fewer individuals on grade doing the verification, and verification being done in a safer, upright position.

Real-time Verification cannot currently measure pavement depth for payment. Pay factors are so tight that survey instruments cannot achieve repeatable measurements at the needed precision. However, Real-time Verification can replace the practice of taking stab depths. To take depth measurements, the Inspector needs to have a base surface for comparison. This could be the design data, but the depths would be more meaningful if they were relative to an as-built surface.

The Contractor could provide an as-built surface from an AMG system or UAS and the inspector could verify the surface through independent observations either ahead of the paving train during construction or in advance of the paving activity. There is also an opportunity to revisit the acceptance practices to use a comparison of very precise and dense as-built surfaces of the base and final grade (for instance from static lidar). At this time, it may be cost prohibitive, but as technology progresses, lower costs and increased precision will offer more opportunity to collect this data. Inspectors could use 3D data to avoid destructive testing to measure paving depths. The as-built 3D data could also be used to compute pavement smoothness outcomes on the base as well as the final grade. Any problem areas on the base could be corrected before paving.

The data density requirements for Real-time Verification are less stringent than those for controlling material quantities. Thus, when the Contractor uses AMG, the AMG data needs will more than accommodate Real-time Verification. A summary of data uses and characteristics for Real-time Verification is provided in Table 29.

**Table 29: Data uses and data types for Real-time Verification**

<b>Data Use</b>	<b>Data Types</b>
Verify slopes	Observe two points and compute slope on data collector
Verify material depths	As-built surface for bottom of material (preferable) Design surface for bottom of material (alternately)
Verify structure elevations	Points or 3D line strings
Verify horizontal layout	Alignment: Primary horizontal geometrics and stationing, curbs 2D line strings: Crown, edges of pavement, edges of shoulder, grade breaks, and ditch flow lines
Verify grade	Surface: Finished grade, top of base, subgrade. 2D line strings: grade breaks and ditch flow lines
Verify safety compliance	Observe two points and compute slope, height, or distance on data collector
Verify pond capacities	Topographic survey of pond bottom and compute volume below top of pond elevation to verify capacity

## MEASURE PAY QUANTITIES:

As noted above, the Real-time Verification equipment is a versatile measuring tool. Data collectors can capture observations to perform real-time slope, distance, area, and volume computations. (8) The data collector software can show a sketch on the screen that illustrates the computation. The data collectors store digital data that is repeatable and transparent, and the data collector software has robust reporting tools. Using the Real-time Verification equipment to capture measurements for pay quantities is faster, more accurate, and more transparent. The only 3D data that is needed is base surfaces for earthwork and excavation volumes. All other 3D data is captured by the Inspector during observations.

As noted above, topographic surveying is a core skill that an Inspector needs to use the Real-time Verification tools for measurement. However, most agencies already have established standards and guidelines, including standard field codes with which to annotate the points that can be used with “field to finish” automation to draw line work and create as-built plans. The data types that are collected are survey points. After processing, 3D line strings and polygons, 2D line strings and polygons, and surface data are also available.

Both the data density that the Inspector needs to collect and the tool the Inspector should use are a function of the measurement precision. The Inspector needs to be mindful of chords on length and area measurements. Capturing extra observations takes a matter of seconds. Observations do not need to be stored sequentially. Using survey field codes enables an Inspector to traverse an area collecting observations for a number of different features simultaneously. Thus, the tools increase the Inspector’s efficiency; the ability to perform tasks in a safer, more upright body position and with fewer Inspectors on grade; and to collect better documentation of the measurements that can be repeated or analyzed from the office in the event that there is a dispute or a claim.

A summary of data uses and characteristics for measuring pay quantities is provided in Table 30.

**Table 30: Data uses and data types for measuring pay quantities. (8)**

<b>Data Use</b>	<b>Data Type</b>
Volume quantities	Irregular shapes: Original ground and final ground surfaces Regular shapes: Points at deflections or along chords to measure length, multiply by payment cross-section defined by specification
Structural volume quantities	Irregular shapes (e.g., foundations): Define faces Regular shapes (e.g., curbs): Cross-section and length
Area	Irregular shapes: Points on the perimeter, use field-to-finish to generate 2D or 3D polygon Regular shapes: Points to measure width and length
Length	Points at deflections or along chords, use field to finish to create 2D or 3D line string
Unit	Collect as-built points with field codes

## **AS-BUILT RECORD DOCUMENTATION**

While none of the projects covered in the case studies formally had 3D as-built record documentation as an objective, it was clearly attainable. This marks a missed opportunity to retain valuable 3D information generated by and for the AMG, inspection, and Real-time Verification processes. There are three sources of 3D as-built data: design data representing features constructed per plan, as-built records collected via AMG systems, or post-construction survey data collected by Inspectors during the course of Real-time Verification or measuring payment quantities.

### **Design Data**

Data developed in design software are valuable as a resource to Maintenance and Asset Management departments to create or update their asset inventories. In particular, as agencies adopt facilities and asset management as core functions, the graphical and non-graphical design data can be processed for use in asset management databases, especially Geographical Information Systems (GIS). Many GIS software applications include tools that can consume 2D and 3D point, polygon, and line data.

The 3D data that is of interest includes alignments, mowing areas, wetland and other sensitive environmental features, noise and retaining walls, culvert inlets and outlets (point features), the culverts themselves (line features), paint striping, guardrails and other barriers, signs, billboards, ITS equipment, subsurface utilities, pavement areas, and many more.

### **As-built Records from AMG Systems**

AMG systems have the facility to store as-built records, although it is not always straightforward. AMG systems can be set to capture an observation at regular time or distance intervals, which will provide one point for each on-board position sensor. For finished grading, the operator can set the AMG system to record the last pass, but if that is not a regular traverse there may be extraneous data points. Excavators are especially useful to document underwater excavations or excavation of contaminated soil. However, the excavator operator must be careful in how the observations are stored or the data can be fraught with meaningless observations. As-built records collected by AMG systems need to undergo rigorous quality control.

### **Post-Construction Survey Data**

As described above, Inspectors have ample opportunity to record observations when performing Real-time Verification or measuring payment quantities. When standard field codes are used, field-to-finish automation can provide robust as-built plans consistent with the agency's CADD and survey manuals. In this way, the Office Engineer was able to efficiently prepare as-built drawings on the Southern Expressway project. As the owner's representative, the Inspector has a more vested interest in collecting robust survey data, but it still requires the proper oversight of a qualified individual to accept it as as-built survey data.

Policies should be put in place for file naming, organization, record retention, and backup. It is natural that any policies/guidelines developed for Inspection using 3D data should lead into policies for as-built records. For example, inverts should be tagged with survey field codes that



reveal the pipe material and size. Field-to-finish automation interprets the field codes associated with the points and sorts the data onto levels or layers in the CADD system, connects sequentially tagged points with line strings, encloses suitably tagged line strings into polygons, and applies line styles and line weights. GIS software can mine this sorted data to extract point, line, and polygon features to create asset inventories. The origin, oversight, and enterprise storage of this information goes beyond the scope of the research. A summary of data types and characteristics for as-built record documentation is provided in Table 31.

**Table 31: Data uses and data types for as-built record documentation.**

Data Use	Data Type
Top of pavement material layer	Surfaces
Area features	3D line strings, 2D line strings
Linear features	3D line strings, 2D line strings
Point features	Points with attributes

### LOD DESIGNATION

Generally, MD and CL are aligned, for instance, as the Engineer designs an intersection or gore area, more detail is added to the model in these locations. However, the CL also will consider the confidence that the designer has in the design based on the original ground survey data or other sources of uncertainty, such as subsurface characterization, pavement records, or utility locations. The intent is that the CL will inform for the designer where effort is best applied or deferred until the uncertainty can be reduced. Figure 101 illustrates the different impacts of the uncertainty in the original ground survey for a hypothetical inside shoulder widening. The LOD will often vary for different locations and different elements of the design. The contribution that the various sources of uncertainty have relative to the successful construction of that feature in that location dictates the CL.

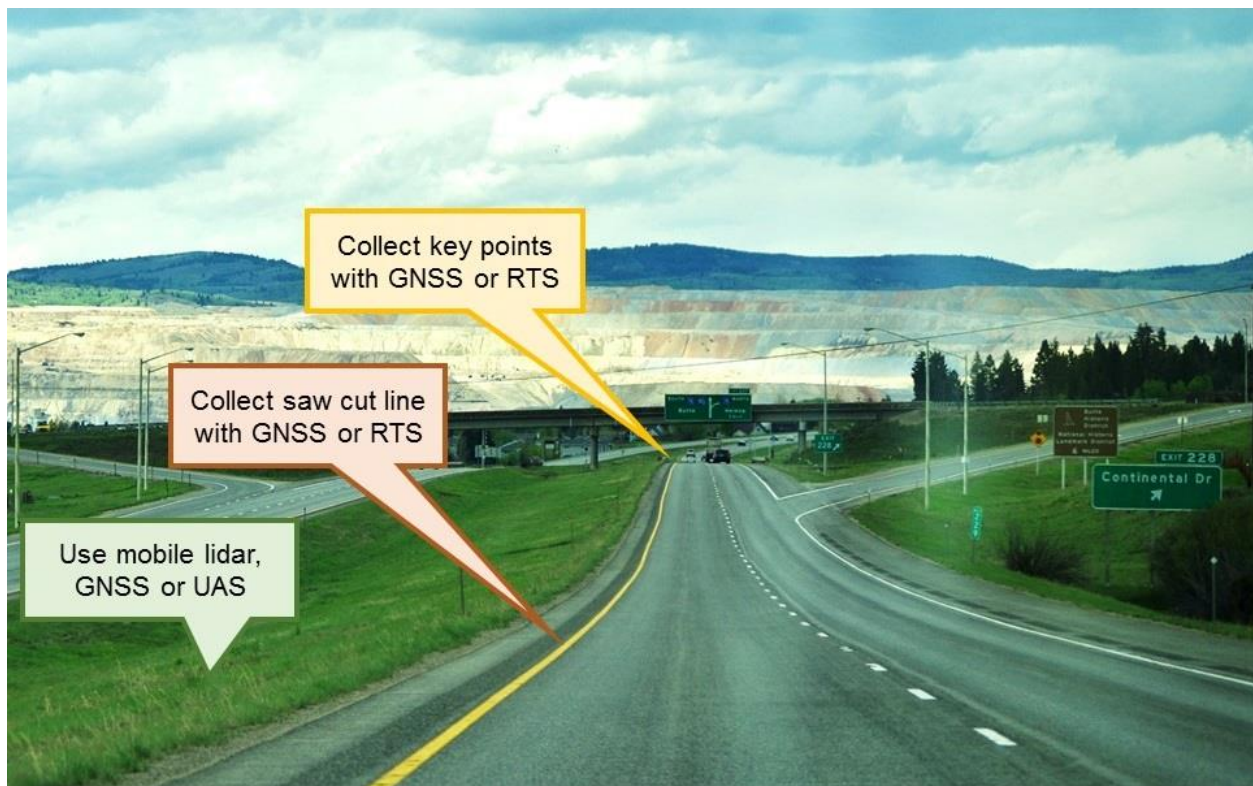

**Figure 101: Illustration. Uncertainty varies by feature and location.**

## Confidence Level (CL)

If, in the hypothetical example above, the original ground survey were accurate to 3 inches, the designer may have concerns over clearance under the bridge. Using the design for AMG construction would be risky because the new lane must tie exactly to the saw cut line. The inside shoulder slope is low risk, however, because there is ample right-of-way and gentle slopes so the impact of a 3-inch grade difference is minimal. With this original ground survey as a basis, the design for each of these features would have a different CL.

The designer can choose to differentiate survey data collection by feature (8), as shown in Figure 102, and use data fusion to produce the original ground survey. Alternately, the designer can elect to defer investing time in refining the design and articulate the different CLs in the design by feature. For better or for worse, it has been a standard practice of design-bid-build delivery to defer resolving tie-ins and transitions until construction. (37) Using the LOD approach, the designer can make a deliberate decision and provide the Contractor and Resident Engineer with clarity as to where the uncertainty is located.



**Figure 102: Illustration. Data fusion approach to increase CL.**

The CL concept is based on the Quality Levels used to designate subsurface utilities. (35) Subsurface utility engineers have used Quality Levels for many years to be risk-aware when making decisions with subsurface utility information. Depending on the location of the subsurface utilities in the context of the design, subsurface utility engineers make risk-aware decisions about where and when to collect more accurate subsurface utility location information. Often, investing sooner in more accurate subsurface utility locations (Quality Level B and

Quality Level A) has a significant cost savings in construction, (35) particularly where the subsurface utilities are complex.

Subsurface utility locating and topographic surveying have different orders of magnitude costs and precisions. Precise topographic surveying—using instruments such as RTS or static lidar—is still significantly less expensive than the cost of subsurface utility locating. The intent of introducing CL and LOD designations is that designers will be more risk-aware and align their effort in refined geometric designs to their confidence in the original ground survey matching construction field conditions, as well as the implications in construction if field conditions are different. Table 32 defines the CL bands, where CL-A is highest and CL-D is lowest.

**Table 32: Definition of Confidence Levels.**

Confidence Level	Definition
Confidence Level A	<ul style="list-style-type: none"> <li>• Founded on a primary control network of at least 4 monuments with vertical control established by optical leveling AND</li> <li>• All control has been recovered or replaced AND</li> <li>• Topographic accuracy has been field verified:               <ul style="list-style-type: none"> <li>○ For paved surfaces or engineering works is +/- 0.06 foot horizontal and +/- 0.05 foot vertical</li> <li>○ For natural ground points is +/- 0.15 foot horizontal and +/- 0.15 foot vertical</li> </ul> </li> <li>• OR topographic accuracy does not have a material impact on construction outcomes</li> </ul>
Confidence Level B	<ul style="list-style-type: none"> <li>• Founded on a primary control network of at least 4 monuments with vertical control established by optical leveling AND</li> <li>• Topographic accuracy has a high probability:               <ul style="list-style-type: none"> <li>○ For paved surfaces or engineering works being +/- 0.06 foot horizontal and +/- 0.05 foot vertical</li> <li>○ For natural ground points being +/- 0.15 foot horizontal and +/- 0.15 foot vertical</li> </ul> </li> <li>• OR topographic accuracy does not have a material impact on construction outcomes</li> </ul>
Confidence Level C	<ul style="list-style-type: none"> <li>• Complete metadata is available for primary control and topographic survey AND</li> <li>• Low probability that field conditions have changed since survey was performed OR</li> <li>• Topographic accuracy does not have a material impact on construction outcomes</li> </ul>
Confidence Level D	<ul style="list-style-type: none"> <li>• Basis of original ground survey is unknown OR</li> <li>• Low confidence that original ground survey reflects the field conditions at the time of construction</li> </ul>

## Model Density (MD)

Model Density is a measure of how completely the 3D data depicts the design intent, which guides appropriate uses. The definitions of MD bands and their authorized uses are indicated in Table 33. MD-1 through MD-4 define how the 3D data relates to the idealized design, whereas MD-5 defines how the 3D data relates to the as-built asset. Each use case has its own minimum data needs, but higher density data can support the uses at lower bands, except for MD-5.

**Table 33: Definition of Model Density bands.**

<b>Model Density</b>	<b>Definition</b>	<b>Authorized Uses</b>
MD-1	Data points are located at regular stations and key geometry points Transitions such as lane widenings, gore areas, and intersections are incorporated into the 2D data only	Preliminary design Right-of-way engineering Permit applications
MD-2	Data points are located at regular stations and key geometry points Transitions such as lane widenings, gore areas, and intersections are incorporated into the 3D data Typical data densities are: <ul style="list-style-type: none"> <li>• 25-foot point interval in tangents</li> <li>• 10-foot point interval in curves</li> <li>• 5-foot point interval in transitions</li> </ul>	Final design Bid documents Quantity take-off
MD-3	Mid-ordinate distances are small enough to support staking with GNSS or RTS Typical data densities are: <ul style="list-style-type: none"> <li>• 10-foot point interval in tangents</li> <li>• 2-foot point interval in curves</li> <li>• 2-foot point interval in transitions</li> </ul>	Quantity take-off Pre-construction quality control Construction orientation
MD-4	Mid-ordinate distances small enough to minimize risk of material overruns Typical data densities are: <ul style="list-style-type: none"> <li>• 5-foot point interval in tangents</li> <li>• 1-foot point interval in curves</li> <li>• 1-foot point interval in transitions</li> </ul>	Construction layout AMG construction Real-time Verification
MD-5	Mid-ordinate distances are small enough to measure quantities within the measurement precision Typical data densities are: <ul style="list-style-type: none"> <li>• 25-foot point interval for straight or regular features</li> <li>• 10-foot point interval in irregular terrain (such as borrow pits)</li> <li>• 5-foot point interval in curves</li> <li>• Points at horizontal deflections and/or grade breaks</li> </ul>	As-built record documentation Measure pay quantities Asset inventory

## Digital Data Manifest

The optimal LOD for various features will vary by project characteristics, particularly those that govern the uncertainty that underlies the design decision-making. The content of 3D data needs to be clearly described so that they can be requested, developed, and used with confidence. In the early days of BIM, there was concern that model data would be misinterpreted when viewing representative graphics that did not match the true design intent. The American Institute of Architects (AIA) created Level of Development (LOD) designations (44) to guide appropriate use of BIM content.

It is standard practice to create a list of objects in BIM models that includes the LOD designation by different project phases for each object category. This schedule of modeled objects progressed over phases is a planning tool to allow model users (Designers, Contractors, etc.) to anticipate the information or detail required in different models to satisfy targeted applications or uses. Such a digital data manifest for 3D highway data would clearly define the LOD for each feature, by location. Project-specific model element inventories, which subdivide design content into functional groups and assign standard measures of LOD, are used extensively with Building Information Modeling (BIM) as part of the Project Execution Planning process. (45)

Normally, BIM objects are categorized by their Uniclass format. (44) Uniclass does not comprehensively describe highway objects. There are other options, including expanding the Uniclass format or perhaps the Model Inventory of Roadway Elements (MIRE). (46) Although MIRE is not comprehensive, it is organized with alignments, including horizontal and vertical curvature, cross-sections, and intersections. Ideally, the 3D data will be organized around logic that supports using that data in construction and beyond. Even in the absence of object classes for civil data, assigning LOD to 3D data types commonly found in roadway designs, such as feature lines, surfaces, and points, will be part of successful data governance.

The digital data manifest could be a planning, documentation, and risk management tool. The manifest, listing both the MD and CL for each element of the design, would provide clarity to the data author's confidence in the 3D data that is delivered. It would serve as a shorthand for planning and documenting the content of a design model, as well as its intended uses. This is a tool for the Designer to plan the required information in models and to communicate the intent behind data creation, thus limiting their liability for the data being used for purposes that are inappropriate given its completeness and/or accuracy.

The digital data manifest would be used to establish clear requirements for digital data deliverables based on the likely uses in construction and availability of quality information to inform the engineering judgments, while providing flexibility to optimize the investment in creating that data based on the project characteristics. It could be used to identify the designer of record, define authorized uses for specific data, and provide a searchable reference to locate the digital data needed for specific construction or inspection tasks.

In essence, the digital data manifest would provide essential information to construction users as to the likelihood for the data being successfully used as it was delivered. Construction users can then modulate their efforts at reducing uncertainty and amend the data as necessary prior to mobilization or construction.



Table 34 provides sample digital data manifest information for various features in each of the case studies that used 3D data in construction. The samples contrast the original design data and the ultimate data used in construction. The table includes columns explaining the risks for the activities and the impacts of the risk events that occurred, as well as the positive outcomes of the risks avoided.

**Table 34: Sample digital data manifest.**

<b>Dataset</b>	<b>Features</b>	<b>Station Range</b>	<b>MD</b>	<b>CL</b>	<b>Risks</b>	<b>Impacts</b>
Utah original design data	Final grade CTAB grade	All	MD-2	CL-C	Inaccurate asphalt milling quantities require import/export of material into/out of the canyon	New topographic survey collected and profiles revised to effect material balance
Utah final AMG data	Final grade CTAB grade	All	MD-4	CL-A	Inaccurate asphalt milling quantities require import/export of material into/out of the canyon	Successful localized material balances. Good smoothness and yields for concrete paving
Virginia original design data	Curb and Gutter	All	MD-4	CL-D	Curbs do not tie to existing roadway after final resurfacing. Cannot maintain 6” reveal. Ponding and drainage issues.	3 week stop work condition, \$1m change order, new topographic survey and extensive design revisions.
Virginia final layout data	Curb and Gutter	All	MD-4	CL-A	Curbs do not tie to existing roadway after final resurfacing. Cannot maintain 6” reveal. Ponding and drainage issues.	Minimal rework, positive smoothness and drainage outcomes in minimum grade conditions
Virginia final roadway data	Final grade Milling profile	All	MD-4	CL-A	Cannot maintain 4” curb reveal, issues at numerous driveways and curb cuts, positive drainage in minimum grade, smoothness	Successful construction
Missouri	Final grade Milling profile	All	MD-4	CL-A	Overrun concrete quantities	High predictability of concrete yields. No overruns.
New York original design data	Final grade Subgrade	All	MD-2	CL-D	Earthwork, base, and concrete paving quantity discrepancies	New topographic survey after clearing and grubbing and design re-modeled for AMG
New York final AMG data	Final grade Subgrade	All	MD-4	CL-B	Earthwork, base, and concrete paving quantity discrepancies	Predictable payment quantities. Discrepancy in earthwork interim payment helped identify start of landslide.

## 8. DATA SCHEMA DEVELOPMENT

An effective open data schema is necessary for 3D survey and design data to improve data mobility and integration between the producers and consumers of that 3D data. This data sharing and integration is an everyday occurrence between many participants in a given project, and therefore must be trusted without any additional onus of back-checks and undo vigilance. Having a reliable and standard data schema alone would resolve many of the data fidelity and efficiency issues which end up hampering projects in their application of 3D survey and design data in highway projects. It is imperative to realize ambitions of having 3D data stand as the only contract document conveying the geometric design intent.

Earlier chapters have touched at length on the problems and uncertainty that arises out of flawed data exchange. Certainly, it should not be presumed that problems don't also spring from user error in the operation of the tool or poorly designed workflows. They certainly do, and always will. Nonetheless, a more robust and standardized open data schema would eliminate the great majority of errors and inconsistencies that arise from data exchange between proprietary software applications. In turn, more robust and standardized open data schemas, assuming this would lead to more normalized workflows and universally shared guidelines for data interoperability industry-wide, would minimize the chances for human error. In short, there would be a virtuous cycle between reliable automated data exchange enabled by open data schema and better error-free user practices to employ them.

In this chapter, we will compare current and emerging open data schemas that are standardly employed, such as LandXML, (47) TransXML, (48) IFC, (49) NIEM, (50) and InfraGML, (51) as well as the proprietary Bentley i-model schema, and how they may be further developed to accomplish reliable data exchange for highway projects. The Bentley i-model schema is proprietary and requires a software development kit to exchange i-model data into third part non-Bentley platforms such as those used to manage data and deploy it for AMG or inspection. (52)

LandXML, TransXML IFC, NIEM, and InfraGML are schemas; they are an organized arrangement of data. For example, NIEM is a data model that enables agencies to establish databases that can store equivalent data so that it can be shared. (50) For the XML-based schemas, the "format" is XML (i.e. marked-up text) and the schema is how the software knows to read the mark-up tags. IFC data may be written into either an XML format that is ISO certified (ifcXML extension) or another ISO certified file format that is more compressed than the plain text XML format (IFC extension). (53)

### DATA SCHEMA COMPARISON

When using 3D data for construction, sharing that data amongst parties is a daily transaction. The industry needs both a schema and a file format that is consistently implemented amongst proprietary software such that the same file can be read and interpreted equivalently by all. Table 35 summarizes the functionality and industry relevance of the different data schema that have been adopted in highway design and construction software and are available currently for sharing highway data.

**Table 35: Comparison of data schemas with supported file formats for highways**

<b>Schema</b>	<b>LandXML</b>	<b>i-model</b>
<b>Data types supported</b>	Surface, point, alignment, linear features (wall break lines, retaining wall break lines, surface boundaries), cross-sections, pipes and structures, metadata, etc. (47)	3D solids, linear features, alignments, pipes and utility structures, non-graphical data, etc.
<b>Relevance</b>	Survey Design Construction	Survey Design Construction Operations
<b>Standards governing body</b>	Yes, LandXML.org Industry Consortium with Carlson Software as the current active development supporter. (54)	Yes, Bentley. This is an unpublished, proprietary schema used by other vendors by private agreement. (52)
<b>Under active development</b>	Limited (47). Enhanced LandXML 2.0 released in 2016	Yes

Table 2 does the same for schemas that are not yet available in highway design and construction software. IFC is the subject of current research into its suitability as a schema for bridges. (55) This would create a need for IFC to support some highway data as it relates to bridges and other structures. Currently, this format is not available within the software used for highway design and construction.

The Open Geospatial Consortium (OGC), a consortium of over 400 universities, public agencies, private vendors, and non-profit organizations, chartered a land and infrastructure domain working group in 2013 with a remit to bring LandXML into the OGC framework. (51) The main motivating issues for InfraGML are that LandXML is not associated with a recognized international standards organization, was not supported for a number of years, lacked a unified model language model, and in its present form is not compliant with the OGC's Geography Markup Language (GML) standard. (51)

In this fractured schema environment, and lack of strong, strategic engagement by the highway community, it is understandable that vendors are investing in proprietary schemas. There is a critical and immediate need to make digital data more trustworthy and consumable. Current practices needlessly introduce wasted efforts and risks that for some are unacceptable whereas for others, are unavoidable.

Table 2: Comparison of Data Schemas without supported file formats for highway construction

<b>Schema</b>	<b>Data types supported</b>	<b>Relevance</b>	<b>Standards governing body</b>	<b>Under active development</b>
IFC/ifcXML	3D solids, linear features, alignments, utility structures, foundations, beams, bridge components (proposed), non-graphical data, etc. (49)	Building design tools Fabrication	Yes, BuildingSMART International (56)	Yes. Being targeted as schema for bridge information modeling (BrIM) by AASHTO T-19 (57)
TransXML (48)	Geotechnical, bridge structures, pay items, payroll	Survey Design Construction Materials Bridge Safety	Not active, AASHTO (58).	No. TransXML research team has identified need for refinements to the geometric design information in LandXML in order to reduce ambiguities and fill gaps. (48)
NIEM (50)	Roadway and bridge structures, alignment, grade, curve lengths, intersections/crossings, Lane/shoulder/median widths, lighting, metadata, etc.	Operations Asset Management	Yes, committees made up of governmental agencies. The primary sponsors are Chief Information Officers of the Department of Homeland Security, Department of Justice, and Health and Human Services (50).	Yes
InfraGML (51)	Considered linking pin between geospatial and BIM data via IFC classes and GML standard. Covers everything in LandXML plus support modern survey equipment	Survey Design Construction Operations Assets Management	Yes, OGC	No



## DATA SCHEMA DEVELOPMENT NEEDS

Table 3 summarizes the top ten areas for development based on the case studies. The table includes an assessment of the magnitude of need, return on investment, and likelihood of success for each. The areas are ordered by magnitude of need. Some of the needs identified are gaps in the currently used data schemas, whereas others are more strategic.

**Table 3: Areas for schema development.**

Description	Magnitude of Need	Return on Investment	Likelihood of Success
Governance body for schema development	Critical	High	Low
Corridor model parametric relationships	Critical	High	Medium
Subsurface utility attributes	High	High	High
Digital signatures and seals	High	High	Medium
Internal validation	High	High	High
Consistent surface implementation	High	High	Medium
Enhanced metadata	Medium	High	Medium
Surface data attributes	Medium	Medium	Medium
Pay item number and specification reference	Medium	Medium	High
Automated code checking	Medium	High	Medium

### Governance Body for Schema Development

For schema development to result in acceptance by the highway industry, there needs to be a governance body in place to vet development that the industry identifies as authoritative and legitimate. It is debatable whether it is better to have a highway-specific schema (such as TransXML), a discipline-specific schema (such as LandXML), or an industry-specific schema (such as IFC). With increasing reach comes a larger body of interested and affected parties (thus a smaller voice in assigning priorities for development), but economies of scale and opportunities for consistency where data types and asset types overlap.

What may be the watershed moment for determining which schema AASHTO or other legitimate and authoritative highways community spokesperson supports may be a decision on whether to focus on the data (such as alignments, profiles, surfaces, and line strings) or focus on the assets (such as pavements, bridges, and roadside appurtenances). There is a much broader spectrum of asset information—both graphical and non-graphical—created in design that has relevance in construction and beyond.

### ***Magnitude of need***

Critical. The need for a governance body that keeps pace with the ever changing software environment is high. Data loses its value if it cannot be trusted, so an organization needs to at a minimum verify and certify software implementation. The industry cannot let go of static presentations of the design intent such as paper and PDF plans until the design intent can be accessed by a variety of media and software tools and interpreted in a clear and consistent manner.

### ***Return on investment***

High. LandXML is currently being developed with support from one vendor, and some of the charter members of LandXML.org, the governance body, are members of the OGC, which has more legitimacy. Vendors need clarity on which schemas to implement, and a standards body to review and certify their implementations. As a first step, this would resolve the data exchange problems for current data models used in highway construction. Specifically, surfaces and parametric corridor models need to be more reliably exchanged between individuals and between proprietary software.

There are additional benefits from the standards body overseeing further development. Assuming that the industry trust and implement any schema development. Not only does research suggest that each schema would benefit from an ongoing governance body, it is arguably necessary that a single schema governing body take and consolidate where possible these schemas which have overlapping objectives and are duplicating work.

TransXML was initiated by AASHTO through NCHRP, but presently has no active governance body and is not being actively developed. There is significant value to be captured by closing the gaps identified by TransXML. It is a critical time now that construction is undergoing a digital revolution. There is a short window to establish clear, consistent, and legitimate industry standards for asset data to avoid each agency having to create unique data models.

### ***Likelihood of success***

Low. It is unlikely that a standards body will emerge on its own. The most legitimate body for highways is AASHTO (domestically). If AASHTO does not rise to the challenge, highway owners will lose agency over the data standards. This is the *de facto* situation, and the emergent proprietary schemas such as Bentley's i-model fill a critical need, but place highway owners at risk of being locked into single vendor solutions for increasingly more of their business line if they do not want to suffer data loss.

The data types used in highways are not exclusively used in highways. For bridges, AASHTO's T-19 committee is engaged in exploring IFC for bridges. (57) IFC has a standards governing body in place, so it's more a case of agreeing to use that standard and support it instead of alternatives. For highways, there are overlaps with other Civil Engineering applications – land development, utilities, environmental – so there are other alternatives, such as ASCE, AGC, and USACE. However, the Highways community has an immediate need, and can follow Bridge's

lead and have AAHSTO take ownership, champion, and provide governance to LandXML, or representation on a larger committee.

There is still a vast set of open schemas and standards that address many aspects of the design and construction industry. There is not, however, a unifying approach which brings together these disparate efforts or which leverages the work put forth by these developers. Future schemas should allow efforts to build upon each other. It is clear that a unifying approach to schemas has not yet emerged and that the need for such an approach is critical.

### **Corridor Model parametric Relationships**

Corridor models relate alignments, profiles, surfaces, and dynamic cross-sections through parametric rules that are computed at a pre-determined frequency. Currently, corridor models cannot be exchanged without losing the parametric rules. For instance, LandXML exports cross-sections, but not the mathematical relationships that created those cross-sections. There is not even a way to share the recipe for the corridor model to aid in recreating it from its ingredients.

#### ***Magnitude of need***

Critical. In order to successfully implement preconstruction quality control there needs to be a way to verify (or update) the original ground survey and propagate any changes through the design. The speed with which this can be performed is constrained by the accessibility of the corridor model.

If the preconstruction quality control process occurs immediately before advertising the project, the designer can propagate changes and produce static outputs for construction that have a high probability of success. If the practice is deferred until post-award, the agency either needs to involve the designer (who may have other priorities), the person doing it must have access to the proprietary software used for the design, or the corridor model and all of the parametric relationships must be reestablished.

#### ***Return on investment***

High. This facility would provide more flexibility to the Resident Engineer and a lower opportunity cost for preconstruction quality control. The corridor model defines much of the designer's intent, and is frequently not apparent when trying to reverse engineer from static outputs.

#### ***Likelihood of success***

Medium. The facility is at least partially implemented in the i-model schema, however, the number of proprietary software application program interfaces that need to be aligned is very low, and entirely with the control of the vendor who owns the schema. In order to standardize this, the rules of corridor modeling would need to be standardized. At a high level, this is practical; the combination of alignment, profile, template, and frequency are universal. However, how the software connects adjacent corridors is more nuanced and potentially intellectual property that vendors will not want to yield.

## **Subsurface utility attributes**

The objectives of this expanded information could be dual; first, to expand the subsurface utility information contained in open data schema to provide the support needed to effectively manage utility installations at agencies, and second, to develop a robust, reference data architecture for storing and managing utility data (including related attribute data) to support all project phases.

Perhaps the most important attribute associated with subsurface utility information is the Quality Level. The Quality Level communicates the trust that should be placed in the accuracy of the utility locations and is critical to making meaningful, risk-aware decisions. (35) The acute danger of sharing 3D models of subsurface utilities is that the recipient will have misplaced confidence in the accuracy of the locations, and with certain types of utilities, the consequences can be fatal.

### ***Magnitude of need***

High. LandXML does not provide adequate support for subsurface utilities. It neither preserves the geometric complexity of the utility structures such as manholes, nor directly supports Quality Levels. The Quality Level is not consistent at all locations, so for some utilities, some form of disaggregation is also necessary. IFC preserves more geometric integrity and disaggregation, but it is not supported by horizontal construction applications. (59)

### ***Return on investment***

High. Expanding on the data exchange standard for utility information would facilitate effective design decisions to reduce or eliminate unnecessary utility relocations and would enable identifying unknown or non-recorded utilities that cause risks and delays. Furthermore, in construction, better communication of the risks implicit in the utility data would result in more focused allocation of resources to lower the risk of utility strikes. Lastly, in operations, improved utility as-built data collection and data management practices would be realized.

### ***Likelihood of success***

High. There are already initiatives underway to conduct such studies and develop schema versions with this capability.

## **Digital Signatures and Seals**

Signatures and professional seals identify the responsible licensed professional.

### ***Magnitude of need***

Medium. It is currently possible to apply a digital signature to 3D data, but not to simultaneously view the data and validate the digital signature. There is no facility to store a seal digitally. The function of the seal is to identify the responsible licensed professional. This function can be performed by the digital signature, as long as the signatory can be identified while the data is being viewed. Thus, if schema reveals the validity of the signature, the identity of the signatory, and their professional license that is being applied, then digital data can fulfill the needs of contract documents as defined by the codes of many state boards of engineering.

Regardless of the industry's appetite for 3D data replacing parts of the contract plans, there is fundamental value to using an exchange schema which differentiates between data that is or is not signed and sealed. Digital signatures also secure the contents of the file. Any modification, no matter how slight, will invalidate the digital signature.

### ***Return on investment***

High. The security afforded by digital signatures will address one of the concerns designers have with sharing digital data, which is that the data will be modified. The ability to support digital signatures and seals would give the contractor and inspector confidence that the data is reliable, regardless of the software used to view the data. This would help eliminate the endless iterations currently required between the designer and downstream parties to ensure that the plans match the digital deliverable.

### ***Likelihood of success***

High. Developments in the area of digital/electronic signatures are already underway for XML schemas. (60) FDOT has developed a software application that will apply a digital signature to an XML file. (61) Both Autodesk and Bentley design software support applying and validating digital signatures for files in their proprietary data formats.

### **Internal Validation**

Internal validation checks for complete and valid data in the file. The identity of the responsible licensed professional, whether the data is certified, and the geospatial metadata (amongst other metadata identified below) is essential to provide context and meaning to the 3D data such that it is identifiable beyond the file name and storage location. At a minimum, internal validation should check for complete metadata fields, with valid data in each.

### ***Magnitude of need***

High. Current methods of validating essential metadata and other attributes of data quality are manual. Putting the data in the context of its agency project identifier, federal aid identifier, responsible professional, and status of the data (preliminary, final, issued for construction or not, etc.) depend on document management, transmittal letters, file naming conventions, and other highly fallible workflows.

### ***Return on investment***

Medium. While 3D data is supplemental to contract plans, even disclaimed, the returns are marginal. At best, it would increase confidence for Contractors and Resident Engineers who receive data. If 3D data were to supersede or replace parts of the contract plans, the value captured is greater, because the risks of errors, or fatal omissions, is less. It would expedite the process of quality assurance before finalizing and transmitting or archiving digital data.

### ***Likelihood of success***

High. The rules that determine what constitutes valid data for each component of the schema would need to be documented. Arguably, they are part of developing a robust data schema and data dictionary. Not all data necessarily needs to be validated; priority components would be geospatial metadata, digital signature information, project identifiers, and status of the data (such as final design, etc.).

### **Consistent Surface Implementation**

Surfaces are the primary data type used for AMG construction, and second only perhaps to line strings for general construction 3D data uses. Surface data needs more consistent implementation of boundary features.

The currently implemented release of LandXML (version 1.2) still requires multiple steps to verify surface data exchange has happened without data corruption or loss. While surface boundaries are recognized by LandXML version 1.2, there are still some inconsistencies in the implementation of that surface boundary in the software import and export implementations. Even exporting and importing LandXML data back into the same software causes data loss. Other software supports the boundary feature only if certain options are selected that cannot be established as default choices.

The software user community has identified known issues around how LandXML exports surface boundaries in one particular software. (62) Given such level of nuance it is easy to imagine the risk of data loss, especially in the hands of less experienced users. The skill and knowledge needed to manage such work-arounds to identify and resolve data corruption constrains the scalability of digital delivery.

### ***Magnitude of need***

High. Given the ubiquity of surface data through-out construction execution, there is a great need for reliable data exchange. When there are gaps in the reliability users have to employ time-consuming ad-hoc workarounds which are often poorly-documented and subject to change as software versions change. Such workarounds, assuming they work in the first place, make work difficult to budget and plan for, as well as introduce opportunity for human error (for example, forgetting to reapply or misaligning the surface boundary that didn't translate automatically).

### ***Return on investment***

High. The data corruption introduced by losing the boundary features is worse for certain shapes of surfaces. It will be obvious if the surface has acute angles, because the software will triangulate across those areas and the different shape of the surface is obvious. Triangulation across voids in the surface, or more oblique angles, may be difficult to identify visually, but will affect the area and volume quantities.



### ***Likelihood of success***

Medium. LandXML version 1.2 already supports the distinction of boundary features. Software already distinguishes between boundary features and other types of features. However, without an active governance body that has legitimacy, software vendors will be disinclined to certify their software or prioritize better implementation.

### **Enhanced Metadata**

Metadata is commonly defined as “data about the data.” The data can be seen as the “what,” whereas the metadata is the “who,” “when,” “where,” and “why.” As discussed above, priority attributes include, digital signature information, project identifiers, and status of the data (such as final design, etc.). Other attributes include the CL and MD (as defined in Chapter 7). A single latitude and longitude would also be beneficial.

### ***Magnitude of need***

Medium. Some of the suggested additions address construction uses, while others are forward looking. As the industry tends towards more integration between the different phases in a facility’s lifecycle, one can understand how more metadata and standardized metadata allows broader and extended use of a given dataset. For instance, including a single latitude and longitude reference for the data would enable location-based searches that would identify relevant information about a facility with no prior knowledge of its construction history. (63)

The challenge resides in developing interoperable metadata. Having interoperable metadata allows multiple systems to consume the same set of data and metadata. It ensures metadata records associated with one resource can be accessed, accurately interpreted and subsequently used by a system or integrated with metadata records associated with other resources.

### ***Return on investment***

High. The return on investment of metadata can be measured in the savings from having to recollect data in cases where previously collected data with better metadata could suffice. The limited exchange and re-use of information increases the project costs and more importantly, may lead to less optimization in project management. Similarly extended metadata can ensure data doesn’t get targeted for improper uses and cause errors.

What most justifies adding metadata is that it improves the data’s reliability longer into the future and for more parties. Metadata is the digital label which tells the downstream users and systems of its intended uses and validity long after the original source of the data has left the scene. Many heated discussions between GIS and surveying professionals might be avoided if the metadata included a bit more usable detail about the circumstances that established the location component.

### ***Likelihood of success***

Medium. Metadata is a relatively minor addition to a schema, but without an active governance body that has legitimacy, any schema development is unlikely to take hold.

## **Surface Data Attributes**

Surface data needs development to expand the range of attributes that can be associated with surfaces. Inclusion of the mid-ordinate distance is the highest priority, but other features like surface depth, material type, and status (design versus as-built, interim versus final grade, etc.) would be valuable. Some surface attributes such as textures were added in LandXML version 2.0, (54) but that version is not yet implemented in major software.

### ***Magnitude of need***

Medium. The mid-ordinate distance was previously discussed in Chapter 7 as it relates to the achievable tolerance for construction layout. It is a measure of the accuracy and approximation in the surface in design surfaces. Some software can report the mid-ordinate distance (maximum approximation compared to theoretical design in a corridor), but most design software does not, and LandXML does not exchange this information.

### ***Return on investment***

Medium. Mid-ordinate distances are most useful to individuals involved in layout and scrutinizing material volume quantities. With digital delivery and robust preconstruction quality control processes, the Designer can make these decisions and deliver surfaces ready for construction. These would already have the precision needed for layout and to manage material volumes and, for the purposes of construction, would be the baseline against which tolerances are measured.

### ***Likelihood of success***

Medium. The mid-ordinate distance is a simple geometry calculation and is supported by many construction software applications. It is less commonly presented in design software—some vendors use different methods to achieve densification around curves—but not challenging to implement. From a schema perspective, it is a non-graphical attribute to add; however, without an active governance body that has legitimacy, it may not be implemented by the vendor community.

## **Pay Item Number and Specification Reference**

The 3D data used for Real-time Verification and measurement would have more meaning for Inspectors and Resident Engineers if the associated specification sections and pay item numbers were part of that data.

### ***Magnitude of need***

Medium. Electronic construction inspection workflows are proliferating, in part because of a convergence of mobile technologies. The crux of construction management is to determine whether work has been constructed in accordance with the specifications and is compensated under the terms of the contract. All of the 3D data used in construction supports these higher objectives. From electronic bidding processes; transfer of bidding information into contractor payment systems for estimating; and tracking work performed for interim and final payments;

reconciling materials testing information to other information that affects payments; the common alignment is the specification reference and pay item number. Thus, successful construction data integration requires that the 3D data that is foundational to acceptance and measurement should also be tied to these to pieces of information, which currently can only be the case through file naming conventions and file organization such as directory structures.

### ***Return on investment***

Medium. Realizing a strong positive return relies upon strategic data alignment such that 3D measurements can be directly consumed by payment systems. Without that alignment, the best returns are convenience for the Inspector and Resident Engineer, who have a better means of identifying and locating data that supports payments.

### ***Likelihood of success***

High. TransXML most aims to be a vehicle for data critical to the construction bid, both during the design and the construction phase. TransXML is credited for bridging the semantic gap between design and construction by standardizing contract pay items as they evolve from design through bidding and into construction. Since TransXML was well on its way to accomplishing such inclusion of construction and construction management information.

### **Automated Code Checking**

In the BIM domain, there is wide adoption of tools (for example, Solibri) that can run automated checks on building models against a variety of rule-sets (naming, building codes, etc.). In highway construction, codes such as AASHTO geometric standards (or their localized equivalents) are supported with rule sets within design software, but they are more typically used to create geometry—such as alignments, profiles, and superelevation transitions—than for validating it. Thus, reviewing code compliance for 3D data is largely a manual, check list-driven process that is ripe for automation.

### ***Magnitude of need***

Medium. Automated code checking is need to make 3D data more accessible to the non-CADD users who need to interact with it as a reviewer. Often even the Designer of record is not an active CADD user, but rather directs the design by interacting with static PDF or paper views. To implement digital delivery at a scalable, industry-wide level, non-CADD users need a tool they can interact with for their purposes in a manner that is familiar such as code compliance reports.

### ***Return on investment***

High. The value of software tools capable of automating code checking are immeasurable. They would allow more agile design iteration so that the optimal design alternative is found quickly without overlooking any possible options. There has been much recent study into the return on investment for paperless construction processes, (64) but design can also be a paper intensive process with much time spent producing sheets for reviewers who are less comfortable with 3D data and transferring mark-ups into the design.

### ***Likelihood of success***

Medium. Data schema such as LandXML are already well suited for enabling automated code checking as they contain the attributes necessary to review alignment-based codes such as curve lengths and design speeds. Other design parameters are supported by other schemas; NIEM supports functional class, lane widths, barriers and intersections. Some schema consolidation is necessary and additional attributes would be necessary, like side slopes and lengths to determine clear zones. The rules of code compliance are already codified, and are digitized in a variety of software applications.

### **OUTLOOK**

The non-digital engineering complexities of a highway construction project alone are already daunting, before even considering the possibility of faulty data exchange inherent to such a fragmented set of data schema options. For this reason, the sooner the field of standard open data schemas narrows and the options become suitably reliable, the sooner agencies will feel comfortable moving from plan sheets to 3D data as construction contract documents. In many respects this schema consolidation and standardization is the low hanging fruit of addressable obstacles; it is easily accomplished, assuming the will is there, and will have *immediate* measurable impact.

The civil highway community can expect that safe, reliable data exchange enables more trust and adoption of the 3D data as the source of truth instead of a poor reflection of it. As the industry continues to use the imperfect LandXML schema and its implementation, there is a growing body of data that is being incorporated into construction contract documents that has uncertain durability. In twenty years, will today's LandXML file be consistently and reliably interpreted? With a lack of governance and engagement, the future of 3D highway data is uncertain. The growing momentum behind the IFC schema being adopted for the bridge industry, with AASHTO actively involved in schema governance, is promising, and sets a precedent that the roadway, maintenance, and asset management colleagues can follow. Which of the available schemas they should coalesce behind for roadway data, though, is debatable.

## 9. QUALITY CONTROL FOR DIGITAL DELIVERY

Digital delivery introduces a new need for robust 3D data quality control practices. One of the most burdensome processes encountered on the projects studied was 3D data quality management. Many issues encountered in the case studies arose from the following:

- 3D data entering construction that was not consistent with the plans and did not have a suitable LOD.
- Original ground survey data that no longer accurately reflected the ground conditions being used as the basis of design.
- A lack of processes and infrastructure to provide for good stewardship of the data.

The consequences were duplicative efforts to scrutinize digital data, recollect original ground data after construction was underway, recreate digital design data, and carefully manage data exchange between incompatible proprietary systems.

The exchange of data between proprietary systems will be an enduring challenge until data schema gaps have been closed and updated data schemas have been implemented by software vendors in a uniform manner. There are two options to address this challenge. The first is to create detailed procedures to support construction staff to manage the process. The second is to avoid data exchange entirely using Construction Partnering to share a common set of 3D data, called a Model of Record. (8) Common concerns with a Model of Record approach include the following:

- The 3D data may change, either legitimately or illegitimately.
- The 3D data is not reflective of the design intent conveyed in the contract documents.
- The owner's representative is not providing independent review when using 3D data created or managed by the Contractor.

One approach to overcoming these concerns is to have the designer certify the data to be used in construction and incorporate the 3D data into the contract documents defined in the Control of Work section of the specifications. (38) This gives the designer more control over how the work is constructed but removes the step where the construction surveyor verifies that the design fits the *in situ* ground conditions. Figure 103 shows how this preconstruction quality control fits into the traditional and digital delivery workflows.

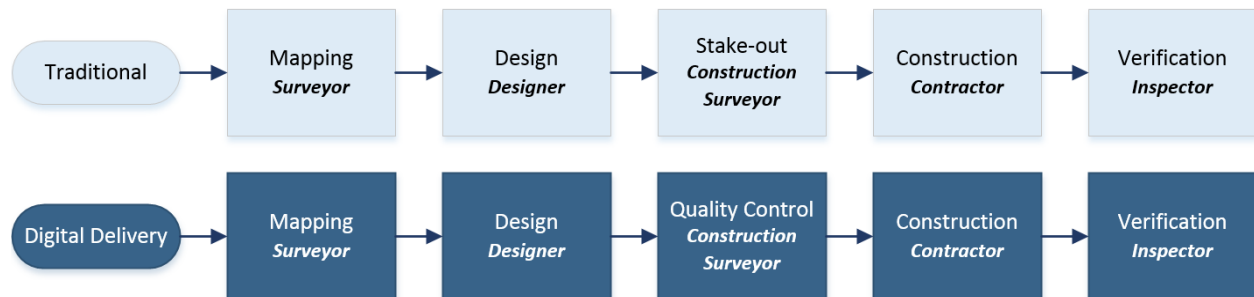

**Figure 103: Flowchart. Comparison of traditional and digital delivery processes.**

All the phases of delivery have internal quality management processes that rely upon receiving quality information from the previous phase. Preparation for construction layout is the last opportunity to identify and resolve potential issues before equipment is mobilized and the cost and schedule impacts from the issues escalate. Regardless of whether layout will be performed using the traditional staking processes or with 3D data that is accessed real-time via AMG, the process is essentially the same: first, verify control; second, verify original ground; and third, ensure that the design intent is constructible under the terms of the contract. This includes physical features—such as slopes, curve lengths, and locations—as well as material and other quantities.

Digital delivery has a relatively minor impact upon Surveyors, Designers, Construction Surveyors, and Contractors, who all use tools and data that they are familiar with in new ways. However, Real-time Verification is a significant change for Inspectors. The 3D data and field survey equipment are not traditional tools for inspection. Moreover, the field surveying methods are new to Inspectors. Given that inspection does not normally involve professional surveyors, there is a need to provide oversight to ensure the tools are being used correctly to capture meaningful data. The safety and efficiency benefits, and the opportunity to collect more consumable, transparent, accurate, and repeatable measurements, make Real-time Verification worth supporting.

## **PRECONSTRUCTION QUALITY CONTROL**

Preconstruction quality control first involves reviewing the survey data to establish the probability and severity of risks related to the accuracy of the control and original ground data. The next step is to review the 3D data for its completeness and LOD.

### **Survey Data**

The case studies illustrated that the survey data was a significant factor in both the usability of the original design data and the root cause of construction issues. The I-35 Unbonded Concrete Overlay and the Southern Expressway projects collected original ground survey data after mobilization. This meant that the data for AMG was created during construction. The Utah and Virginia projects both had issues with the original survey data. In Utah, the root causes were insufficiently accurate control and insufficiently precise topographic data collection. In Virginia, the problems could not be explained due to a lack of metadata. The Virginia project suffered a three-week stop work condition, whereas the Utah project was not delayed because of the Contractor's commitment to finding a solution to start work.

These experiences are instructive of opportunities to implement quality control processes to identify, manage, or avoid potential issues that affect construction quality, material quantities, and schedules. They are also instructive of the ability to revise, review, and accept new digital design data very quickly during construction when both the Contractor and owner's representative partner to use the same data.

It is debatable whether control and original ground verification should occur prior to the final plans or after letting. On the one hand, it is easier for the Designer to react to any necessary changes and produce outputs if it occurs before final design. On the other hand, the process is a



significant part of the Contractor's preconstruction risk identification and management, especially when the design is not in ground coordinates. If the Contractor shoulders all responsibility for the original ground verification, it may be too late to take corrective actions without incurring delays, or the opportunity to control quantities in the Owner's favor may be lost. Thus, it may be best to have the process take place in preconstruction, with the Contractor, Designer, and Resident Engineer involved.

A screening and ranking process can be used to determine if a project has a high risk for construction issues or if risk events would have a high impact on the project. Once the risks and impacts are understood, the Designer can take the appropriate mitigating actions. The Designer should review the original ground survey data as soon as it is received and revisit the data prior to concluding final design if additional data was collected and fused during design.

**Metadata**

The metadata that accompanies the original ground survey data describes the processes, methods and spatial reference information that gives meaning to the project coordinates. In the absence of the metadata, a construction surveyor may be able to use a project control sheet and the located control to successfully construct the project. However, if there are any issues with moved or unrecoverable control, the metadata is required to be able to reestablish the control. Figure 104 illustrates a process to identify whether there is a high risk of issues with the project control.

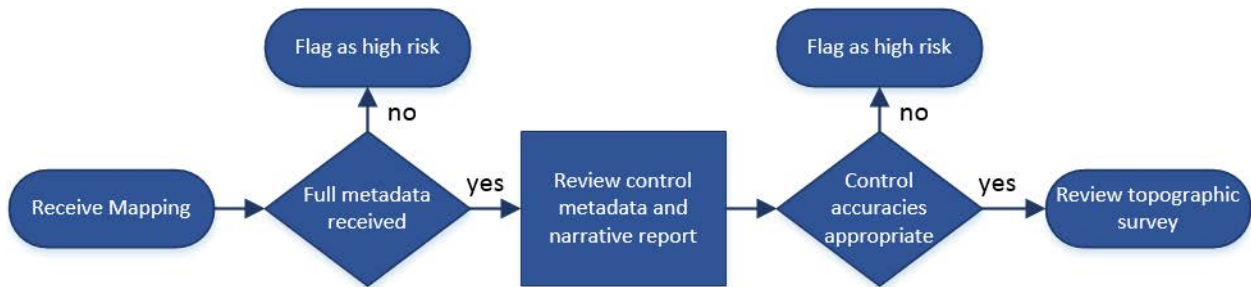

**Figure 104: Flowchart. Metadata risk identification.**

Design can only be as good as the existing data provided. The primary control forms the foundation of the topographic mapping. Thus, the control accuracies must be appropriate for the construction activities to achieve the necessary network accuracy in the original ground survey. Random error accumulates from primary control to secondary control to topographic data collection. Horizontal and vertical datums are established separately. For vertical control, consistent local accuracy is important more so than network accuracy. The vertical control can be set using a digital level loop closing on a single benchmark that establishes the datum. The closure error is more important than the network accuracy at that benchmark.

The metadata is also essential to be able to project the construction data onto other spatial projections, such as incorporating the information in a statewide database (e.g., a 3D utilities database or other geospatial asset management system).

## Topographic Network Accuracy

The topographic accuracy will affect tie-ins to hard surfaces or otherwise fixed features and material quantities. For partial depth construction such as concrete overlays or CTAB, or for construction that must tie to immovable features such as existing roadways (either to set a curb or add a lane), very high network accuracy is needed for the design to be meaningful. The need for high topographic accuracy is not necessarily uniform, however. Concrete overlays and CTAB construction need high network accuracy throughout to give meaning to the material quantities. Lane widenings and curb retrofits only need that high network accuracy at the location where the design ties to the existing feature.

Topographic survey often fuses data collected with a variety of tools and methods. The origins of the topographic survey should be provided in a narrative report that enables the Designer to verify that the appropriate network accuracy was achieved. For new build, topographic accuracy will only affect earthwork and slope limits, so a lower accuracy is tolerable. For widenings and partial depth construction, the designer needs to be aware of the limitations of the topographic survey so that they can manage the uncertainty or request supplemental survey at hard tie-ins if necessary.

It is important to weigh the age of the topographic survey data collection against how dynamic the site environment is. The topographic survey may have been very precise, but if conditions have changed, it will be obsolete. Figure 105 shows a workflow for identifying the risk that the topographic survey is insufficiently accurate.

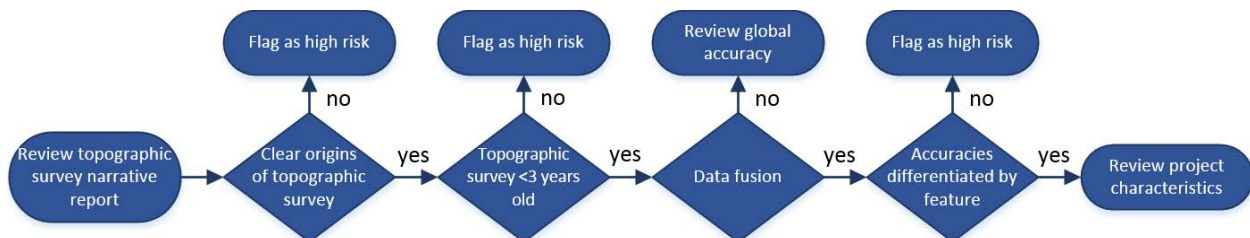
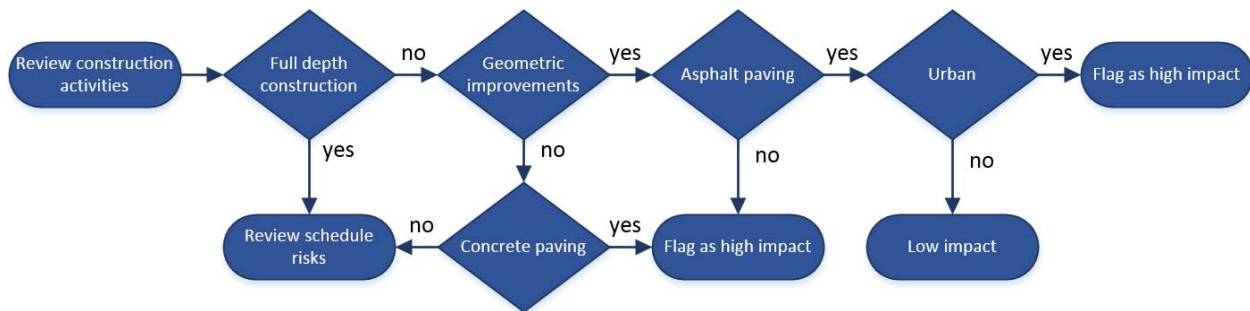

**Figure 105: Flowchart. Risk identification for topographic survey.**

Problems with topographic survey accuracy often have a high impact, such as the following:

- Delays when the design cannot be tied to the ground.
- Cost overruns when material needs to be imported or exported from the site.
- Suboptimal approach to geometric improvements that results in higher material volumes or fewer geometric corrections.

Figure 106 illustrates a workflow for evaluating the impact of topographic survey accuracy insufficiencies should they be present. It is important to note that more precise methods of data collection cost significantly more either to collect the data (such as RTS) or to process it (such as static lidar). It is a risk management issue to determine when to collect the data and how far to take design until the data is collected. Fortunately, modern parametric modeling tools mean that the design can quickly be updated in response to new topographic data.



**Figure 106: Flowchart. Impact assessment for topographic survey.**

## Digital Design Data

Once the basis for design is determined to be sound, attention turns to the completeness and accuracy of the design data itself. Geospatial data, including 3D data, is meaningless without the information that describes the coordinate system and connects the data to the ground. Thus, to be considered complete, the 3D data needs to include metadata.

Completeness and accuracy also refer to the extent to which the design intent is conveyed in the 3D data and how accurately the 3D data reflects the idealized design. These concepts were introduced in Chapter 7 as the Model Density. The final component of accuracy relates to error checking. Currently, processes for checking errors in 3D data are manual, visual reviews. The areas that are more prone to errors, such as voids and spikes in surfaces, are locations where different modeling approaches interface. (8) Newer design software makes it easier to connect different corridors and to integrate linear models such as corridors with non-linear models such as detention ponds and median grading.

### *Metadata*

The surveyor metadata is usually included on the survey base map and as text within the CAD version of the survey base map. It is typically printed on the control sheet in the plans and understood to apply to all sheets in the plan set. With digital delivery, the design intent is conveyed through several distinct files. The metadata should be included in each 3D data file. As shown in Table 36, this is simplified when standard coordinate systems are used.

**Table 36: Necessary survey metadata within 3D digital data file.**

Metadata Element	Include with Control Data	Include with Digital Design Data
Horizontal datum	Yes	Only if non-standard projection
Vertical datum	Yes	Only if non-standard projection
Coordinate system	Yes	Always
Projection definition	Yes	Only if non-standard projection
Grid scale factor	Yes	Always
Unit of measure	Yes	Always

Including the metadata within the individual files allows the 3D data to be aligned with other sources of data, such as GIS layers for wetlands, but does not affect the local accuracy in the data. In other words, this data allows one to place the data at the correct location on earth. It ensures the durability of the geospatial data if it is separated from the rest of the project dataset.

## CONSTRUCTION DATA QUALITY CONTROL

Construction data refers to the 3D data collected in the process of Real-time Verification and measuring payment quantities. The agency’s survey manual and CADD manual are valuable resources to the inspection team. The survey manual usually documents methods for quality control and standard procedures for data collection, including a set of standard field codes with which to tag points. The field codes give meaning to the points collected by indicating which feature they represent, and are used to automate the creation of lines, polygons, and surfaces.

Inspectors need information that helps them select the right tool for the task, (8) and understand the information they see on the data collector. Inspectors also need to be aware of how the quantity they are measuring is compensated; not all items pay the exact quantity performed.

### Real-time Feedback

An Inspector loads 3D data onto the data collector and proceeds into the field to check tolerances. Positional tolerances for grade checking should take this into consideration that the mid-ordinate distance in the 3D data, instrument tolerance, and AMG instrument tolerance are all additive. Location is often a minor acceptance factor; for instance, smoothness and slope—local accuracy concerns—are paramount for pavements. To minimize the potential for measurement differences, it is highly recommended that the variables that can be controlled are controlled. These are listed in Table 37 with the justification for this recommendation.

**Table 37: Variables to control for successful Real-time Verification.**

Variable	Impact	Mitigation
3D data	Mid-ordinate distances are cumulative.	Use the same 3D data, called a model of record, which has been reviewed and agreed to by Contractor and Resident Engineer. (8)
Survey instrument	Different types of instrument will provide different measurements for the same point due to precision differences\.	Use the same type of instrument to check construction that was used to execute it. (15)
Survey control	Measurements are relative to the truth established by the control. Measurements using different control are not comparable.	Use the same primary and secondary control to check the work that was used to execute it. (15)

Other variables that can result in different measurements are the source of RTK correction for GNSS surveying and the GNSS epoch. The GNSS solution precision is affected by both random and systemic errors. Different sources of RTK correction will provide different position solutions

because the base stations that provide the RTK correction will experience different random and systemic errors. Although both solutions should be within the advertised precision of the tool, the differences may be cumulative, leading to a larger perceived deviation from the 3D data.

Using the same source of RTK correction is not infallible if the work is not checked during the same GNSS epoch, because the systemic errors from atmospheric perturbations may be different in different epochs. The same point occupied with the same tool and the same source of RTK correction in different GNSS occupations may yield a different position solution. Again, both solutions should be within the advertised precision of the tool, but the differences relative to the 3D data may be cumulative, as shown in Figure 107.

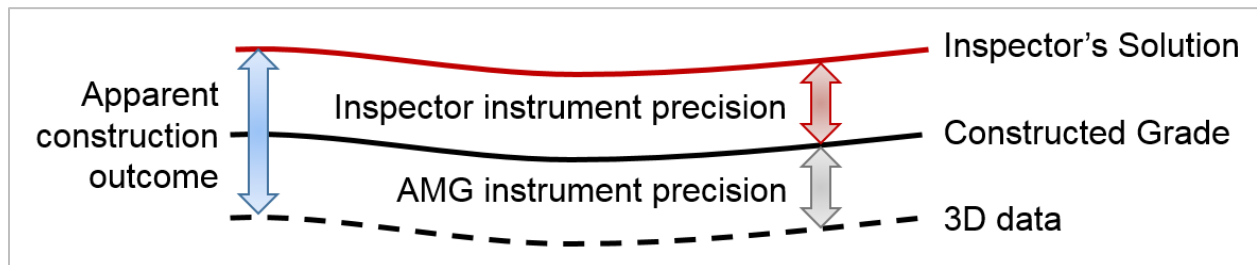

**Figure 107: Illustration. Cumulative effect of GNSS solution precision.**

### Interpreting the Specification

Some payments are made using regular sections rather than the exact work performed. In the case of the pipe shown in Figure 108, the Inspector would use the rover to take a number of observations to check, measure, and document the work performed.

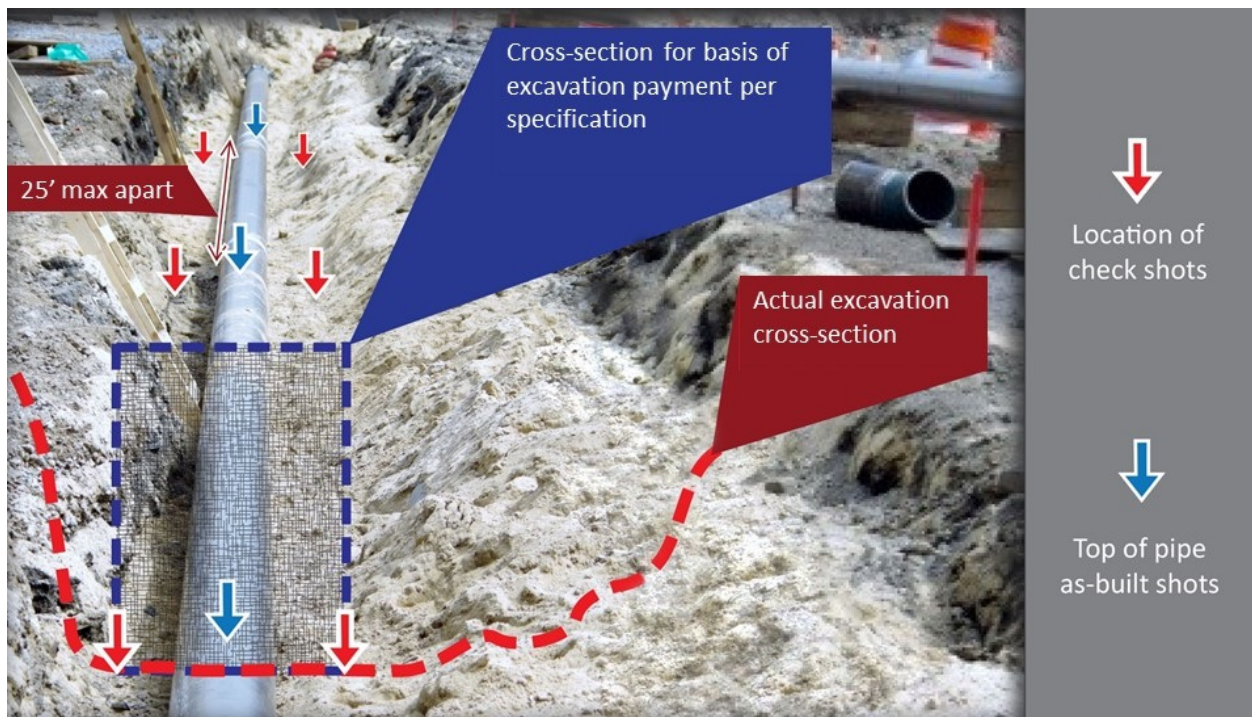

**Figure 108: Illustration. Using Real-time Verification for pipe installation.**

At intervals of 25 feet, the Inspector could verify the trench width, pipe location, bedding depth, and cover based on the final ground. The top of pipe observations could be stored to document the as-built location of the pipe. None of the other observations would need to be stored. The top of pipe observations would provide the length of the pipe. In this case, the specification pays for excavation based on a regular section. The Inspector does not need to collect the actual excavation surface to compute the payment quantity.



## 10. CONSTRUCTION DATA DELIVERY

This chapter assesses project characteristics in regard to how they contribute to when and how 3D digital design data is used in highway construction and the specifications of the data used. Of the six projects studied, all were found to be candidates for 3D data to some extent. There is growing industry motivation to have the 3D digital design data used directly in construction, superseding or replacing paper or PDF contract documents. (38) (39) (65) None of the projects studied used the 3D design data directly. However, the four projects that used 3D data in construction illustrated that 3D data is directly consumable for construction and inspection.

The Contractor and Resident Engineer were able to review the impacts of more accurate survey data on the design, make collaborative decisions, and propagate the 3D data to the field. Using 3D data as a tool to communicate design intent more completely and successfully can be beneficial to both the owner agency and the Contractor. It presents the opportunity to reduce the number of plan sheets needed to convey the design intent, as well as to react quickly to unexpected field conditions when the need for 3D data exchange could be avoided.

Some Designers have concerns of implicit risks when sharing 3D data for construction. (37) It is well understood that more detailed 3D data, represented by higher MD, are needed to support construction uses, (66) (30) (8) but Designers need guidance on knowing when investing in additional detail is worthwhile. If the original ground information upon which the design is based proves unreliable in construction, the effort expended in design to optimize material quantities, improve geometrics, or tie into fixed features can, in some circumstances, be wasted. CL is thus an important component informing the risks associated with the use of 3D data for construction.

MD and CL contribute differently to the risk profile, as Table 38 shows. Low MD presents risks of quantity discrepancies and the need for revisions at tie-ins when the slope and curvature impacts of horizontal transitions have not fully been explored in three dimensions. Moving from MD-1 to MD-2, transitions are incorporated into the 3D data. This is a threshold of engineering intent. Moving from MD-2 to MD-4, however, is a matter of adding precision, which generally only affects engineering intent as far as material balance.

Low CL can result in very different field conditions to those anticipated, with significant quantity differences and need for redesign at all tie-ins. On the US-17 Bridge and Safety Improvements project, even though 3D data was not used in construction, the low CL led to large asphalt build-up on fill slopes, with unanticipated sliver fills and challenges staying inside the right-of-way. No amount of MD can overcome the risks presented by low CL.

A Designer presented with low CL original ground data should identify the specific risks, quantify their impact, and evaluate their probability. With this risk awareness, a Designer can make a deliberate decision on whether the risks are acceptable to be passed to construction or whether steps should be taken to improve the CL before concluding the design. When the risks are passed to construction, there are two options to manage them, as Table 39 suggests. When the design intent is not affected, the Resident Engineer and Contractor can use Construction Partnering to finalize a common model of record. Otherwise, the Designer needs to remain involved to finalize the design as soon as possible.

**Table 38: Risk profile for MD and CL combinations.**

LOD	CL-D	CL-C	CL-B	CL-A
MD-4	<p><b>High probability</b> <b>High impact</b> Update control and topo and effect extensive design revisions to resolve transitions and balance material quantities</p>	<p><b>Moderate probability</b> <b>Moderate impact</b> Update control and topo. Revisions to resolve hard tie-ins and transitions, and/or balance material quantities</p>	<p><b>Low probability</b> <b>Low impact</b> Minor revisions to hard tie-ins and/or to balance material quantities</p>	<p><b>Very low probability</b> <b>Very low impact</b> Preconstruction quality control can detect and manage risks</p>
MD-3	<p><b>High probability</b> <b>High impact</b> Update control and topo and effect extensive design revisions to resolve transitions and balance material quantities</p>	<p><b>Moderate probability</b> <b>Moderate impact</b> Update control and topo. Revisions to resolve hard tie-ins and transitions, and/or balance material quantities</p>	<p><b>Low probability</b> <b>Low impact</b> Minor revisions to resolve transitions and/or balance material quantities</p>	<p><b>Very low probability</b> <b>Low impact</b> Minor material quantity discrepancies</p>
MD-2	<p><b>High probability</b> <b>High impact</b> Update control and topo and effect extensive design revisions to resolve transitions and balance material quantities</p>	<p><b>Moderate probability</b> <b>Moderate impact</b> Update control and topo. Revisions to resolve hard tie-ins and transitions, and/or balance material quantities</p>	<p><b>Low probability</b> <b>Moderate impact</b> Design revisions to hard tie-ins to resolve transitions and/or balance material quantities</p>	<p><b>Low probability</b> <b>Low impact</b> Minor revisions to balance material quantities or accept minor material volume adjustments</p>
MD-1	<p><b>High probability</b> <b>High impact</b> Update control and topo and effect extensive design revisions to resolve transitions and balance material quantities</p>	<p><b>Moderate probability</b> <b>Moderate impact</b> Update control and topo. Revisions to resolve hard tie-ins and transitions, and/or balance material quantities</p>	<p><b>Low probability</b> <b>Moderate impact</b> Design revisions to hard tie-ins to resolve transitions and/or balance material quantities</p>	<p><b>Low probability</b> <b>Low impact</b> Minor revisions to resolve transitions and/or balance material quantities</p>

**Table 39: Deficiencies in 3D data and mode of resolution for MD and CL combinations.**

LOD	CL-D	CL-C	CL-B	CL-A
MD-4	<p>Low value 3D data  <b>Design role in Construction</b>                      Design and material quantity changes are expected and may be significant. Change orders are likely. Greater risk of delays</p>	<p>Moderate value 3D data  <b>Construction Partnering to establish model of record or Design role in Construction</b>                      Changes may affect design intent and/or may result in change orders</p>	<p>High value 3D data  <b>Construction Partnering to establish model of record</b>                      Resident Engineer may need to sign off on field fits and/or material quantity changes</p>	<p>Very high value 3D data  <b>3D data can stand as contract document</b>                      No changes anticipated</p>
MD-3	<p>Low value 3D data  <b>Design role in Construction</b>                      Design and material quantity changes are expected and may be significant. Change orders are likely. Greater risk of delays</p>	<p>Moderate value 3D data  <b>Construction Partnering to establish model of record or Design role in Construction</b>                      Changes may affect design intent and/or may result in change orders</p>	<p>High value 3D data  <b>Construction Partnering to establish model of record</b>                      Resident Engineer may need to sign off on field fits and/or material quantity changes</p>	<p>High value 3D data  <b>3D data can stand as contract document</b>                      Contractor may densify 3D data for AMG, very minor material quantity differences</p>
MD-2	<p>Low value 3D data  <b>Design role in Construction</b>                      Design and material quantity changes are expected and may be significant. Change orders are likely. Greater risk of delays</p>	<p>Moderate value 3D data  <b>Construction Partnering to establish model of record or Design role in Construction</b>                      Changes may affect design intent and/or may result in change orders</p>	<p>High value 3D data  <b>Construction Partnering to establish model of record</b>                      Resident Engineer will need to sign off on transition areas and/or material quantity changes</p>	<p>High value 3D data  <b>Construction Partnering to establish model of record</b>                      Resident Engineer may need to sign off on field fits and/or minor material quantity changes</p>
MD-1	<p>Low value 3D data  <b>Design role in Construction</b>                      Design and material quantity changes are expected and may be significant. Change orders are likely. Greater risk of delays</p>	<p>Moderate value 3D data  <b>Construction Partnering to establish model of record or Design role in Construction</b>                      Changes may affect design intent and/or may result in change orders</p>	<p>High value 3D data  <b>Construction Partnering to establish model of record</b>                      Resident Engineer will need to sign off on transition areas and/or material quantity changes</p>	<p>High value 3D data  <b>Construction Partnering to establish model of record</b>                      Resident Engineer may need to sign off on field fits and/or material quantity changes</p>

Projects have been completed successfully for many years with what amounts to CL-D and MD-1 information presented on paper or PDF plans. Using 3D data in construction presents an opportunity to redefine measures of success. For the Missouri project, using 3D data to optimize the geometric improvements within the contract overrun limit led to more geometric improvements for the same volume of concrete. The addition of profile milling that enabled even more geometric improvements would not have been possible without the 3D data. However, the key to success for this project was deferring data collection to construction.

The US-17 Bridge and Safety Improvements project attempted to design geometric improvements in 3D prior to construction. The CL-D data that the design was based on meant that the design could not be used in construction. Instead, profiles and cross-slopes had to be developed in the field to fit the design intent without the aid of 3D data. The project was completed successfully, but the opportunity to be more intentional—especially with the asphalt quantity that comprised more than 10 percent of the bid value—was missed. The Designer’s low confidence in the design is evident by the fact that a bid addendum modified one-third of the quantities by contract value.

Designers need guidance on how to modulate their efforts by the confidence they have in the underlying survey information. Risks that the industry had to accept in the past can be managed with parametric 3D modeling and new survey technologies that are more accessible at lower cost than in the past. By understanding the different risk profiles associated with various combinations of MD and CL, designers can make risk aware decisions about adding detail, improving confidence, or deferring both until construction.

Perhaps the biggest opportunity that 3D data presents is to make accommodations to proactively and equitably allocate and manage risks that have been deferred to construction. Deliberate procedures to verify original ground and review the impact of discrepancies on the design intent and contract quantities would vastly improve outcomes for owners. VDOT and NYSDOT have policies that accommodate updating original ground survey in construction for the purpose of computing more accurate quantities. (15) (28)

The missing step is propagating the impacts of the more accurate original ground through the design before providing the final 3D data deliverable. When the designer has used modern 3D modeling practices and CADD automation to develop the contract documents, updates can be processed quickly. There are two primary approaches to accomplishing this.

The first approach is to use Construction Partnering for the Contractor and Resident Engineer to agree to a final model of record. A model of record is a single set of 3D data that is used by both the Contractor and the Resident Engineer. (8) This approach is appropriate where the anticipated impacts from updating the original ground do not affect the design intent. Specifications often include a section on plans and working drawings that enables the Contractor to provide enhanced details for activities such as fabrication, erection, and demolition. (24) (21) (18) Creating the model of record could be managed by this section of the specifications.

The second approach is to extend the Designer’s involvement beyond the letting and into construction. This approach is appropriate when the anticipated impacts from updating the original ground affect the design intent. Oregon DOT already extends the Designer’s final

deliverable to the preconstruction conference. (30) Design support is also common throughout construction to respond to requests for information and to process design changes. This was the approach followed for the Missouri project. Value Engineering is one avenue to facilitate this, (67) but there should be an owner-led and intentional vehicle when it is predictable that design revisions can reduce quantities or obtain more geometric improvements for the same cost.

Designers should consider the need and appropriate timing for improving the CL, and modulate efforts in developing MD accordingly. Fully parametric design models make it possible to react quickly to new original ground data, propagating the changes and producing new outputs. Low MD can be remedied easily if the fully parametric 3D design model is available. AMG data preparation software has data densification tools that can reduce chording and even target a specific mid-ordinate distance.

Designers need guidance to determine when they can deliver 3D data that can successfully be used directly in construction (for instance, as a contract document that either supersedes or replaces parts of the contract plans), and when the risk profile supports deferring effort to increase the CL and/or MD until construction. Further, designers need guidance in determining what the appropriate mechanism is for finalizing the 3D data in construction if the effort is deferred. Project characteristics will be explored that make it difficult for the Designer to fully mitigate the risks associated with the use of 3D design data directly in construction.

## **PROJECT CHARACTERISTICS**

This research focused on smaller projects to identify ways in which the use of 3D data might enhance smaller, more typical reconstruction, restoration, resurfacing, and remediation projects. Size and contract value were not found to be a significant factor for 3D data use, particularly opportunities for Real-time Verification and post-construction survey to measure pay quantities.

At a minimum, if there is a baseline alignment, that data in digital form has value for construction since it can be used with a mobile device for orientation. Likewise, any project that has control and requires measuring area, length, or volume quantities can benefit from the use of GNSS rovers to measure pay quantities faster and more safely, and that is better documented, transparent, and repeatable, as long as there is access to a source of RTK correction. Control and alignments are two types of data that are very well supported with open data schemas and thus are highly consumable in digital form.

Design-build and other alternate procurement contracts often pay by lump sum instead of requiring measured pay quantities. In this case, Real-time Verification will still be beneficial if there are activities such as earthwork, excavation, grading, or paving. These activities are well-suited to AMG, and Inspectors will need an alternative to stakes to properly execute their quality assurance role. Figure 109 illustrates an approach to determining whether a project is a candidate for Real-time Verification.



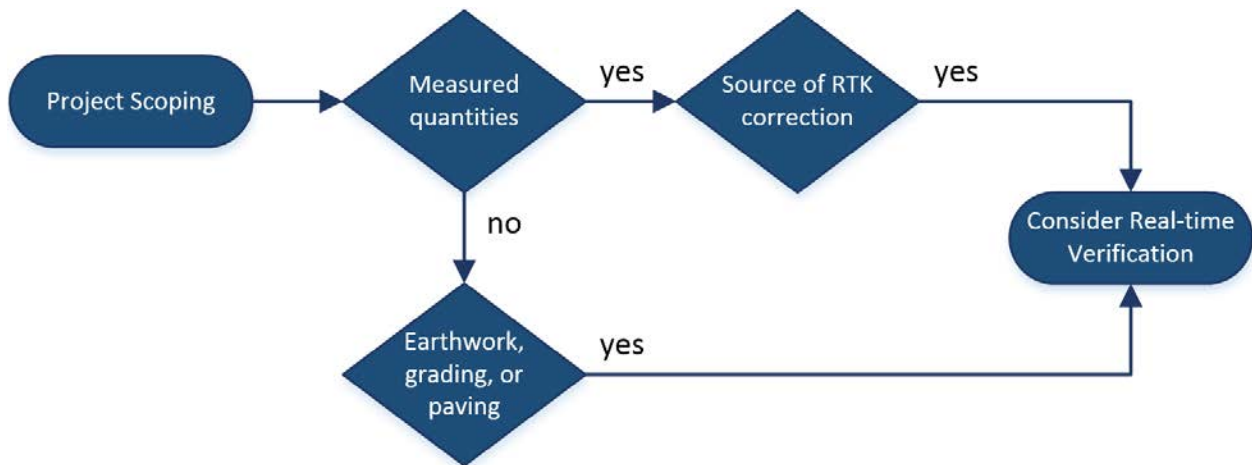

**Figure 109: Flowchart. Inclusion criteria for Real-time Verification.**

The projects studied illustrated how AMG methods can lead to positive outcomes in terms of meeting schedules. The Route 60 Reconstruction project ended early despite a three-week stop work situation, and the Missouri project realized incentives for reducing the number of days of head-to-head traffic. Using 3D data may help projects stay on schedule and react to issues—or to identify them and resolve them early—but the planned duration was not found to be a factor in the suitability or type of 3D data used in construction. Rather, early completion incentives were a significant motivator for embracing technology.

Asphalt paving, seen in Figure 110, generally does not seem to benefit from AMG, perhaps because grade control is less precise than concrete paving due to the viscosity of the material while it is being placed and the change in depth with compaction.



**Figure 110: Photo. Asphalt paving operation for an urban mill and overlay.**



Asphalt is usually measured by weight, which provides little incentive to Contractors to closely control yields. However, AMG affords less opportunity to control yields compared to concrete paving because of the relatively thin depths with which asphalt is placed and the reduced ability to control grade for asphalt.

Strong disincentives for pavement thickness and risk allocation to the Contractor for quantity overruns were other strong inclusion factors for AMG. There is an opportunity cost for establishing the strength of the primary and secondary control network needed to support AMG construction on pavements that is a factor for resurfacing and overlay projects. This is especially important if there are discontinuous construction activities over a wide area, such as was the case on the US-17 Bridge and Safety Improvements project.

For asphalt paving, the base preparation often uses AMG for full depth paving, but less commonly uses AMG for milling. Figure 111 introduces the nuanced selection criteria for AMG associated with asphalt paving. For mill-and-overlay projects, smoothness incentives were insufficient to indicate AMG for asphalt. The need to effect geometric improvements is the most significant determinant regarding whether AMG is indicated. In the absence of geometric improvements, urban areas may have other risks such as safety, schedule, or related construction activities that can offset the survey costs, which make AMG an option. Milling and paving without grade control is fastest and most appealing in urban areas where there is no need for geometric or smoothness improvements. On the Virginia project, the curb construction led to geometric changes to the roadway, which improved smoothness and drainage as a side benefit.

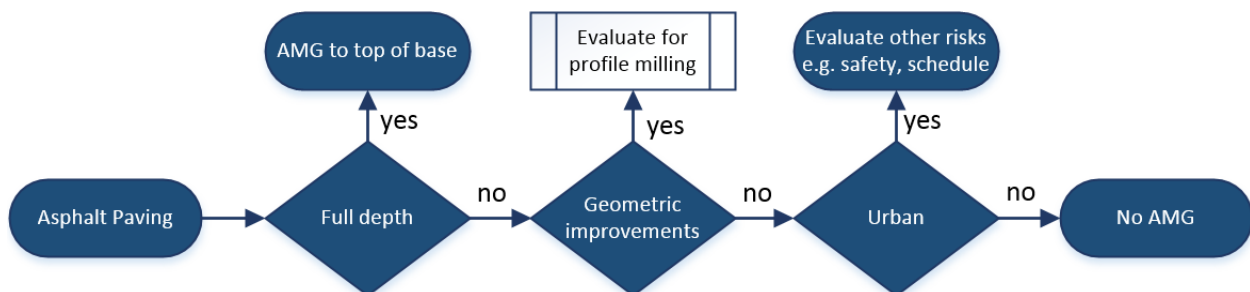

**Figure 111: Flowchart. Inclusion criteria for asphalt paving.**

Currently, the limiting cost for AMG profile milling is for collecting sufficiently accurate original ground data. New survey technologies, such as a downward-facing mobile lidar and UASs, may substantially reduce data collection costs and expand the range in which 3D data is viable for profile milling. Where the geometric corrections are localized, an important consideration is the chance of success of profile milling. On the US 17 Bridge and Safety Improvements project, unexpected in-situ pavement conditions prevented this approach.

Early completion incentives may support the use of 3D data for preconstruction quality control where there are continuous geometric improvements, especially if there are challenging geometrics such as the constant cross-slope variations in the canyon for the Utah project. Generally, sonic averaging can be used on a mill in combination with maintaining specific cross-slopes. Non-AMG approaches are faster, less expensive, and safer because they do not need the manpower for the total stations. Figure 112 introduces the selection process for profile milling.

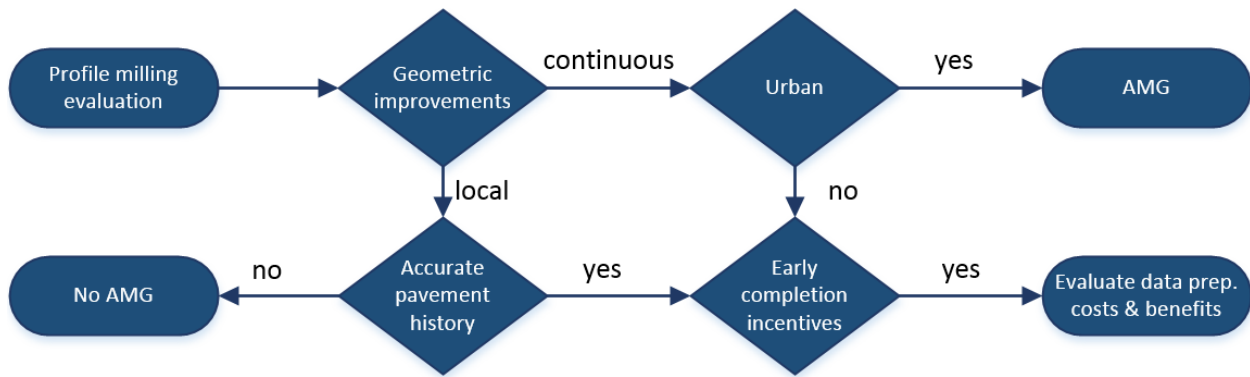

**Figure 112: Flowchart. Inclusion criteria for profile milling.**

In urban areas, such as shown in Figure 113, the combination of needing to effect geometric corrections and tie into intersections, driveways, and curbs, elevates the technical challenges and may merit the use of 3D data for preconstruction quality control and AMG for construction quality control. The impact of delays is also greater in urban areas, which further motivates the use of 3D data and AMG.



**Figure 113: Photo. Urban milling and asphalt paving.**

Concrete paving for full depth and overlays enjoys a very high penetration of AMG. The ability to control yields, avoiding the cost and safety hazards associated with string lines, and the increased ability to control depth all support the use of AMG. When designing overlays, however, the accuracy needs of the original ground are often underestimated. (68) The original ground survey must be established from a control network that has vertical precision established through digital leveling and must be captured using RTS, static lidar, or instruments with equivalent precision.

## DATA TYPES AND SCHEMAS

The primary 3D data types to execute construction are alignments, profiles, surfaces, 3D line strings, and 2D line strings. However, all of the case studies found there was an opportunity to create better construction outcomes by making some revisions to the design after establishing more precise vertical control and enhancing the topographic accuracy. The primary data type for making design updates is a corridor model. Thus, the fully parametric corridor models are perhaps the most valuable 3D data that can be delivered to construction. The other 3D data types are all part of the corridor model or can be readily extracted from it.

While the case studies primarily explored roadway data, subsurface utility data are helpful for any project with excavation. These are not well described by LandXML and may be better described with IFC or as 3D solids in DXF or other well supported CAD data schema. Another 3D data use not identified in the case studies is visualization. Visualization uses 3D solid or mesh objects that can be developed as part of roadway corridor components or from surfaces, exchanged via CAD or DXF schemas. Visualization is an effective way to convey the design intent to both technical and non-technical audiences. Visualization is applicable to a wide range of projects, from small bridge replacements to large megaprojects that affect hundreds of thousands of motorists daily with complicated traffic control.

Beyond substructure stakeout and abutment design coordination, uses of 3D data for bridges are not yet well understood, although they are being explored. (69) For visualization uses, 3D solid or mesh objects suffice, but for fabrication and detailing, tables of deck and beam elevations or IFC are more useful. There are sustained efforts toward standardization for comprehensive bridge data exchange, (70) and IFC is the emerging schema to be adopted and further developed.

The most complete and well supported open data formats for design data at this time are presented in Table 40. Currently, no open data schema supports corridor models, but proprietary data schemas are being developed and implemented by vendors by private agreement. When providing 3D data for use by the Contractor and Resident Engineer, agencies should provide both the open data formats and the proprietary format in which the design was developed.

**Table 40: Design data types and data schemas.**

<b>3D Design Data</b>	<b>Recommended Data Schema</b>
Primary and secondary control	LandXML, CSV
Alignments and profiles	LandXML
Corridor models	None
Surfaces	LandXML
2D or 3D line strings	DXF
3D solids or meshes	DXF
Subsurface utilities	LandXML, IFC, DXF
Bridges and structures	IFC, DXF
Non-graphical information	XML schemas for spreadsheets and text documents

## **PRIORITIES FOR PLAN SHEET REDUCTION**

One of the greatest opportunities that 3D data presents is to reduce the burden of design documentation in less consumable paper and PDF formats. The goal of reducing plan sheets is to provide the design intent in the most consumable, reliable, and durable format. The design intent conveyed by several types of plan sheets can be replaced with more consumable 3D data.

Paper or PDF copies of tables of numbers and paragraphs of text are the most obvious opportunity. This non-graphical data can remain in its native, read/write format, secured with a digital signature. Some geospatially derived tables, such as control coordinates, plan quantities, and bridge elevations, are also more consumable as spreadsheets.

The next opportunities are the data types most completely supported by open data schemas:

- Pages of plan-and-profile sheets can much more readily be consumed as LandXML files.
- Striping is an emerging use of AMG that can be supported with DXF or other CAD formats.
- Cross-section sheets are laborious to prepare and are a frequent source of confusion when the cross-sections have been manually manipulated and are no longer consistent with the surface models. While LandXML does not currently enjoy sufficiently consistent implementation for seamless data exchange between proprietary software, the value to be gained by replacing cross-section sheets with surfaces is worth pursuing as well.

It is possible to communicate an entire design in a CADD format, but there are diminishing returns when contemplating how to consume that data in construction. Standard drawings, signal, sign and lighting details, ITS, staging and traffic control plans, erosion prevention and sediment control plans and other permits are the lowest priority. Georeferenced PDFs and visualizations (such as rendered images and 4D models) can add value for bidding and executing construction.

## 11. CONCLUSION

This report describes the basis and development of the research methodology, the approach to case study identification, and data collection for the use of 3D digital design data in highway construction. It documents the case studies and other observations from interviewees and then summarizes challenges, opportunities, and project categories that influence how 3D data is used in highway construction. Many outcomes from the use of 3D data in highway construction are quantified to substantiate the information provided in the interviews.

It was surprising to find that the issues with design data—such as inconsistency with the design intent in the plans—took time to resolve, but had a minor impact on construction outcomes. The construction issues were a result of the unreliable original ground survey that the design was based on. For those projects that included pre-construction survey data, the accuracy needs of survey control and topographic mapping had been underestimated, but this was remedied quickly because of the robust survey networks established to support AMG. However, the original 3D design data was not used directly for construction. This is clearly a concern given that the trajectory of the industry is toward incorporating 3D design data into contract documents. The Contractors on the projects studied were able to create the AMG data quickly after acquiring more accurate original ground data.

Despite great effort spent on geometric design, location appears to be a lower priority for construction acceptance. As long as tie-ins are made to immovable features, horizontal and vertical alignments do not introduce safety issues, and the quantities do not significantly overrun, the network accuracy of the constructed product is a lower priority than the local accuracy of curve lengths, cross-slopes, superelevations, pavement depths, and pavement smoothness. This is instructive of what should be considered the true “design intent” and perhaps is why Resident Engineers have been willing to accept 3D data created by the Contractor, either indirectly by accepting the work or directly to use in Real-time Verification. This raises an ethical consideration regarding the responsibility for the design data used to execute construction.

The question is, given current practices for AMG construction, is responsibility being shifted from the Designer of Record to the Resident Engineer? The answer lies in whether the design intent is materially changed and, if so, whether the Designer is involved. Regardless, 3D digital design data can be used directly in construction if a formal preconstruction quality control process is adopted. That process would verify control, check the accuracy of topographic survey in key areas, and propagate any updates to the original ground through the design before finalizing the design data. The process is best performed by a Construction Surveyor who understands the accuracy needs, implications for tie-ins and material volume quantities, and opportunities presented by rapidly evolving survey technologies.

### **OPPORTUNITIES FOR, AND CHALLENGES TO, DIGITAL DELIVERY**

The case studies in Chapter 4 reveal many opportunities for better utilizing 3D data in highway construction, as well as the challenges associated with data exchange and the processes that no longer optimally manage risks associated with how the design fits into the original ground. Some of these challenges are surmountable through formalized preconstruction quality control and

support for Resident Engineers and Inspectors. Other challenges addressed in earlier chapters of this report are the identification of which projects are candidates for 3D data and the LOD designation for that 3D data.

The primary remaining opportunities and challenges are discussed below and can be organized into four categories: risk allocation, enterprise data management, workforce development, and industry issues.

### **Risk Allocation**

The case studies have revealed a number of specific ways that expanded use of 3D digital design data in highway construction can result in more predictable, efficient, safer, and better construction outcomes. The majority of the 3D data uses in the projects studied were for AMG construction, with the goal of controlling quantities, accelerating construction, and detecting and rectifying construction issues prior to mobilizing equipment. The latter was perhaps the most compelling reason to move forward into an era of digital delivery via 3D digital design data, either complementing or replacing sections of the contract plans.

In all cases, the 3D data was usable by all parties involved in construction: the Construction Surveyor, Contractor, Resident Engineer, Inspector, and occasionally, the Designer, with the Resident Engineers and Inspectors being the most affected by a move to digital delivery. With the right support, the outcomes of Real-time Verification—and perhaps even more so, the collection of post-construction 3D data to measure payment quantities—include safer, more efficient, and better documented inspection with more accurate and more transparent measurements. Without this support, however, Resident Engineers are at a disadvantage with neither the tools nor the skills to review 3D data. One approach to mitigate that disadvantage is through formal Construction Partnering to establish and maintain a single source of 3D data (a model of record).

Case studies show that opportunities exist to extend AMG into smaller reconstruction and restoration projects where risk allocation motivates the Contractor to pursue methods to control quantities, control grade where the geometrics are challenging, or predict outcomes such as for accelerated construction. High precision survey technologies continue to become more accessible, lowering the opportunity cost of the control and mapping needed for AMG, such as for profile milling to improve pavement smoothness with asphalt resurfacing.

Paying for materials by weight or by volume does not incentivize the Contractor to control yields, but paying by area can allocate too much risk to the Contractor which can lead to higher bid prices. Where there is uncertainty in the value of investing in 3D data, agencies can use a combination of both risk allocation in the bid item structure and incentive payments to let the market decide the optimal approach.

### **Enterprise Data Management**

In regard to industry practice, it is still novel to consider 3D data as having value beyond the development of contract plans. While agencies recognize the value, they have not yet developed an approach to strategically manage the data. Project-level data management is probably already



occurring to some degree within pockets of excellence in the agencies. But project-level data management cannot replace agency-wide enterprise data management. The theory of a centralized data repository that underlies the CIM philosophy is only possible with proactive management.

### ***Data Governance and Stewardship***

Non-standard, poorly documented data takes too long to scrutinize. It is quicker and users have more confidence in the data if they start from scratch, either re-collecting survey and as-built survey data or re-creating design data from contract plans. It takes a considerable amount of effort to re-create data and then scrutinize different data sets to verify that they match the contract plans.

The current, interim pervasive practice of providing 3D data with a disclaimer illustrates the perceived risks. The data is disclaimed, which then discourages others to invest in it. Under this approach, Designers have conflicting priorities, additional duties, and increasingly contracted design schedules. It is difficult for the Designers to justify spending the time to continue to develop the 3D model or to implement robust quality control protocols on data that is eventually output in a data exchange format, further diluting its reliability, for construction.

Data governance encompasses a range of proactive quality management strategies associated with data availability, integrity, usability, mobility, durability, and security. A data governance plan would need to define a set of standards and a data governance process (such as quality control), as well as identify data stakeholders and data stewards who have a defined (although not necessarily full-time) responsibility for data quality. (71)

For example, data governance for construction would create a clear standard for the data, including file organization, file naming, object naming, and point naming conventions. On the one hand, this would provide a clear reference to the Designer on how to *create* the data. On the other hand, it would provide similar reference to the Construction Surveyor, Resident Engineer, Inspectors, and the Contractor on how to *interpret* the data. A clear data quality process would enable all parties to verify that the data meets the standard. By eliminating disclaimers, all parties can rely on a single source of truth, eliminating a large workflow to verify data.

Strategic data planning is a data governance principle that applies especially where there are cross-functional uses of common data. (71) One example of cross-functional uses is that common asset data is created and used in design, construction, maintenance, and asset management. Processes must be implemented to optimize the creation and collection of asset inventory data wherever there is commonality across project lifecycle phases so that it is done only once. Mechanisms would be put in place to provide stewardship of this data in all of its uses, such that it is always accessible, available, and of good quality per the needs of the target systems that will consume that data.

Once the agencies formalize their data governance objectives, such as the high-level functional requirements for the data and the processes through which project staff engage with that data, the responsibility to maintain and enforce the data governance would naturally fall upon a qualified IT department.

Some agencies are tackling various components of data governance. UDOT had a pilot project in which 3D data replaced plans. Other agencies, such as the Oregon DOT (30) and Michigan DOT (72), have implemented quality control processes. Organic processes for data governance, while created in good faith, are unlikely to be comprehensive or to meet all document retention requirements, and certainly not for 3D digital data which requires careful consideration and planning to ensure durability and repeatability. Florida DOT has begun a data governance initiative called the Reliable, Organized, and Accurate Data Sharing (ROADS) Project. (73)

### ***Digitally Signed and Sealed 3D Data***

Data security is another important component of data governance. State boards of engineering and surveying regulate how licensed professionals sign and seal construction contract documents. Most state boards use positive or negative language that limits the definition of contract documents to being either paper or PDF plans, either explicitly or because of limitations in software functionality. Nonetheless, how other reference materials get included without being contract documents is chiefly a policy issue; for example, subsurface investigations are signed and sealed without being contract documents.

An opportunity exists to move beyond disclaimed 3D digital design data as a step toward a more complete data governance initiative. So while Designers may not be ready to replace contract plans with 3D data, they may be ready to sign and seal the 3D data and include it as bid reference material. As such, they could take responsibility for that—and only that—version of the 3D data. As was introduced in Chapter 8, developing the functionality of being able to simultaneously view the data and verify the digital signature and seal within open data schemas, such as LandXML, is one of the technical advancements necessary to instill confidence in all parties, whether signing or consuming the data.

### **Workforce Development**

Utilizing 3D data in construction requires working in new ways, with new technologies, and with new data types. Technology changes rapidly, and disruptive technologies, such as 3D printing, mobile internet, cloud technologies, low-cost sensors, and autonomous vehicles, are changing the way we work.

#### ***Training***

Without training, investments in tools and 3D data will not be fully exploited. Appropriate training is critical for users to have confidence in creating and/or interacting with the 3D data for their particular job junction, be it designing, reviewing, or constructing. A highly skilled and highly trained workforce will be able to fully utilize the data and technologies available to them and may identify further efficiencies.

Designers do not often get feedback from construction and quickly fall behind in their understanding of construction means and methods. Guidance on how 3D data supports construction and inspection and what those requirements are in terms of LOD and format will contribute to successful construction outcomes and more efficient design practices. Some designs are more economically constructed than others, and there is a practical limit on the rates of

superelevation change an asphalt paver can construct without negatively affecting smoothness. Understanding what causes blade shudder or additional passes to construct can lower the cost of construction or reduce the need for rework of design data. This is an issue mostly in transitions, intersections, drainage basins, bridge abutments, medians, and other non-roadway features. .

### ***Resources for Inspection***

Real-time Verification and post-construction survey can lead to safer and more efficient inspection practices; more complete and transparent documentation of construction, especially measurements for payments; and an ability to detect and react to construction issues more quickly. In turn, this can lead to avoiding delays and claims, making construction outcomes more predictable, and more proactively managing construction risks. Another significant reason to make this investment is the opportunity to reuse post-construction data, such as 3D as-built records, particularly for subsurface utilities.

Expanding the use of 3D data to Resident Engineers and Inspectors is more than justified, but it will require capital investment. The investment in hardware, software, and training to scale out 3D data consuming tools for inspection is significant. At the project level, the need exists for survey equipment, computers, backup and archiving media, access to Wi-Fi or cellular data to validate digital signatures, licenses, data, manuals, policy documents, and training resources. At the programmatic level, infrastructure is needed to receive and store the data generated in construction. Some of the current resources for outdated processes could be shifted to support the newer 3D data processes, and some of the resources being implemented for e-Construction deployment could be used to support a common purpose.

### **Industry Issues**

Some of the challenges need to be tackled at the industry level, either nationally or internationally. Through engaging as an industry with the vendor community, the challenges of incomplete and insufficiently governed open data schemas can be overcome. This would enable software vendors to focus efforts on developing innovative and intuitive ways to interact with data, rather than on the schemas with which to store and exchange the data. Another industry-level issue is to explore the uses and LOD designations of 3D data for bridges and structures.

### ***Comprehensive Open Data Schema***

There were notable gaps in schemas and in the governance of the open schemas that are available and used. The most complete open data schema for highway construction, LandXML, does not have an active governance body that represents the interests of the highway industry. This results in insufficient development and inconsistent implementation. The industry can collectively reject proprietary data schemas and motivate vendors to be more transparent with their proprietary schemas. In the age of digital delivery, vendors should be able to focus on software development to utilize a quickly growing volume and variety of data.

Reliance on an incomplete and inconsistently implemented data schema (LandXML) requires a large effort for data exchange that, in isolation, inhibits rather than adds value to the functions of highway design and construction. The lack of industry participation in governance for LandXML

limits its adoption and development. The industry is fragmented in efforts to develop other alternatives, such as TransXML, IFC, and NIEM. This lack of consensus around a common data exchange standard jeopardizes the durability of data stored in LandXML format.

With the development of a single comprehensive data schema, the current landscape, which is fraught by data exchange format alternatives that are too numerous and insufficient, could be greatly simplified. Currently, data exchange is time intensive and introduces risk to data quality that must be managed through skill, experience, and quality assurance processes. Removing the burden of managing an uncertain data exchange process, as is the case now, would permit Engineers and Contractors to focus on the high-value tasks of design and construction.

Effective data schemas normally are designed to support internal validation. For civil data, internal validation could be used to automate checks on LandXML data to ensure it includes the units, survey metadata, surface boundaries, and surface triangle definitions. This would automate part of a quality control or quality assurance review of the data.

Solibri Model Checker is a software that reads IFC files and performs code checks on the model. This is a next-level of automated data review. A similar tool for highways could check AASHTO Green Book curve lengths, Americans with Disabilities Act slope and clearance requirements on sidewalks, or curb heights.

### *Software User Experience*

The need for an improved user experience is critical. There are more than enough software features to quickly develop and construct efficient designs, but the interfaces to software to manipulate and review the 3D data are intimidating. The user experience is perhaps the biggest threat to scaling digital delivery, which relies on 3D data being usable by all parties involved in design and construction. Developing and maintaining skillsets to use 3D data with confidence is too onerous, especially in places where construction is a seasonal vocation and winter duties have their own set of growing technology demands.

The software user experience for today's tools is a barrier to greater adoption of 3D data. This is true in general, which has implications on design platforms, but is especially true for construction inspection.

While it may be unreasonable to expect the design platform interfaces to become more user-friendly, much less be standardized across vendors, it is reasonable to expect more user-friendly file readers or downstream analysis tools that managers or other functional staff use. Managers cannot be expected to use advanced CADD platforms, but they still must review and mark up designs. Currently, those who do not use 3D data daily and who never use CADD software perform quality control and quality assurance procedures in both design and construction using plans, such as PDF.

If the goal is to move away from creating plans, the format for that review and markup, instead of 2D PDF, must be a fuller readable view of the 3D data or model. Ultimately, an interface is needed that is preferably mobile, easily accessible, and intuitive for a variety of functions, including but not limited to design review.

An improvement in the data collector devices used for inspection could hasten the adoption of 3D data use. Most data collector software is designed for surveyors and survey workflows rather than construction verification. More intuitive software interfaces would reduce this training burden, increase accessibility to 3D data, and generally hasten the adoption of these new workflows.

### ***3d Digital Design Data for Bridges and Structures***

While most of the case study projects included bridges, very little was captured regarding how 3D data was used for bridges or structures. Either there is a clear division among Contractors between those who prepare data for AMG and those who work with bridges, or 3D data for bridges is an underutilized area. The latter may be likely because few agencies currently use 3D models for bridge design, although many are interested in doing so. (69)

With a national inventory of over 600,000 bridges, nearly one-quarter of which are structurally deficient or functionally obsolete, (74) even a small savings on each bridge rehabilitation or replacement project can have a large net impact. First, automation and change propagation in design documentation could be a significant area for the use of 3D models for bridges and structures. Second, interdisciplinary coordination during design and constructability reviews can help to avoid, catch, and resolve clashes at abutments. Clash detection can help with the interface between reinforcement and post-tensioning systems, especially deflectors and anchors.

A significant number of bridge construction projects are replacements or rehabilitation of existing bridges that significantly impact the communities they serve. Low detail and low accuracy 3D visualization models can facilitate coordination with stakeholders and communicate maintenance of traffic, detour, and closures to motorists.

### **SUMMARY**

For decades, standards and policies were in place that, when followed, led to optimal risk allocation and management. Since the emergence of newer survey technologies co-opted for AMG and Real-time Verification, risks associated with tying the new facility into the ground and accurately predicting material volume quantities can be managed earlier in the process through the acquisition of more accurate original ground survey data. This is a fundamental change in the established risk management protocols that have been implicit in the traditional delineation of survey, design, construction stakeout, and construction functions.

Figure 114 contrasts the traditional timing of survey and design effort with the optimal timing for these efforts in a digital delivery environment. The green line in Figure 114 identifies the relative ability to control costs through the project design and construction phases. The red line in Figure 114 illustrates the impact of design changes on overall project cost through the design and construction phases. The numbers one through six in the image have corresponding notes below.

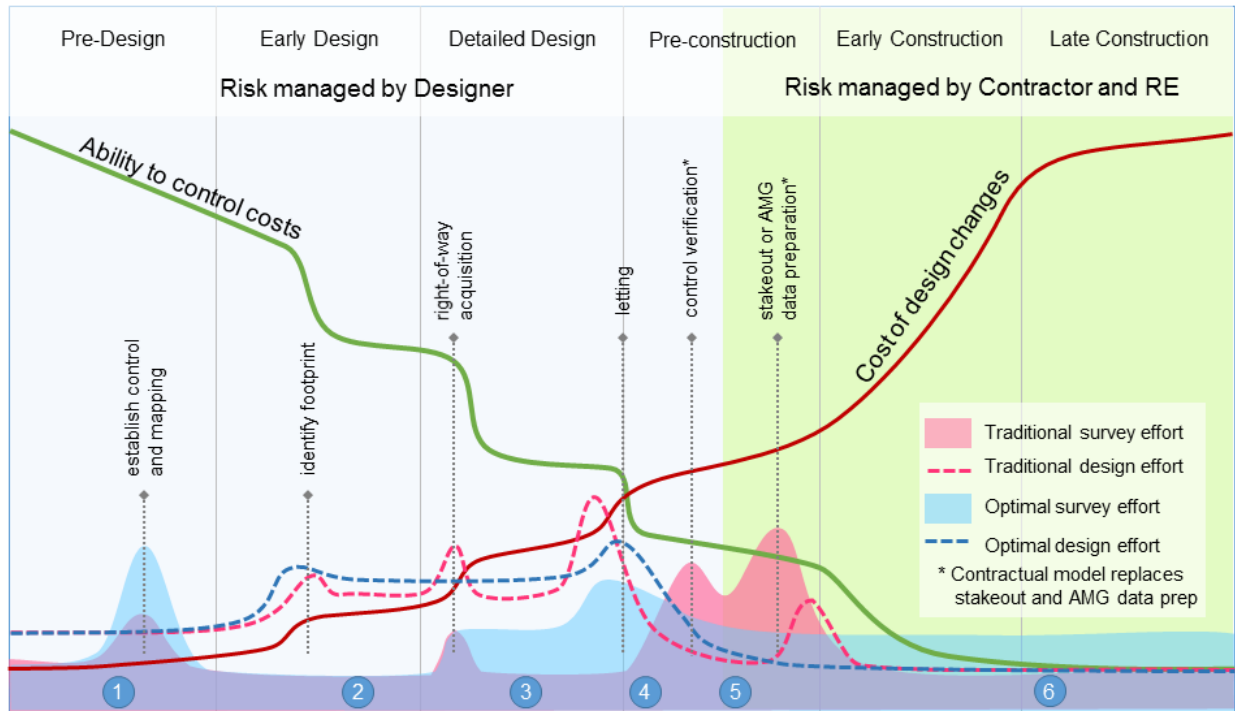

**Figure 114: Illustration. Proposed redistribution of effort for survey and design.**

1. More time spent establishing a stronger control network and collecting higher accuracy survey in some areas, base mapping with data fusion.
2. More time spent in early design optioneering and establishing parametric design model and automation for contract document production.
3. Right-of-way acquisition precipitates focused survey verification and/or collection of more accurate topo in areas significant to design intent.
4. Less time propagating the impacts of new survey through design intent, with documentation via CADD automation or contractual model that replaces stakeout.
5. Control verification reinforces confidence in the design data and avoids the need for resetting control, recapturing topo, and developing AMG data.
6. Sustained survey effort for Real-time Verification, measurement, and as-built records.

Digital delivery offers the industry the opportunity to better allocate and manage the risks associated with physical construction clashes and pavement material quantities. A cost is associated with the highly accurate and highly precise survey required to accurately predict both construction outcomes and payment quantities. However, for surface features, this is only possible provided that the survey data is verified or acquired sufficiently close to construction that the field conditions do not change in the intervening time.

Whether the risks are managed prior to the letting and the 3D design data stands as a contract document or the risks are managed in preconstruction through formal Construction Partnering is a matter to reconcile with the agency's risk appetite, regulatory environment, and specific project characteristics. Real-time Verification and 3D data-based payment quantity measurements improve safety and efficiency for inspectors; result in more accurate, transparent, and repeatable measurements; and yield a more complete record of construction.



## ACKNOWLEDGEMENTS

This report represents the results of research conducted by the authors and does not necessarily represent the views or policies of the State transportation departments or construction contractors whose policies and practices have been referenced, or who shared their insights via interview.

This project is possible due to the funding from FHWA and the assistance from State transportation departments and construction contractors leading efforts to implement the use of 3D engineered data in highway construction. The contribution of the following individuals is also acknowledged:

Caltrans:

- Mark Turner

Michigan Department of Transportation:

- John Lobbestael

Missouri Department of Transportation:

- John Donahue
- Alexa Mitchell
- Greg Stervinou
- Marc Hohe
- Ashley Reinkemeyer

New York State Department of Transportation:

- Dan D'Angelo
- Phil Bell
- John Izzo
- Jonathan King
- Robert Howland
- Peter VanKampem
- Craig Ruyle
- Brett Dean
- Varughese T. Joseph

Oregon Department of Transportation:

- Della Mosier
- Ray Thwaits
- Chris Bores

Utah Department of Transportation:

- Brad Palmer
- Becky Stromness
- Andrew P. Jordan
- Charles Mason Hill
- Sam Grimshaw
- Cameron Gay
- Michelle Page
- George Lukes
- David Schwartz
- Michelle Page
- Fred Doehring
- Bob Wight
- Matt Zundel
- Brent Hanfield

Virginia Department of Transportation:

- Ray Johnston

Wisconsin Department of Transportation:

- Brad Hollister

Federal Highway Administration:

- Richard Duval
- David Cox

Contractors and Consultants:

- Ryan M. Forrestel
- Stacy Kubit
- Bob Warner
- Bruce Flora
- Lee Yowell
- Brad Phipps
- Bob Parker
- Lance Greer
- Jack Robinson
- Scott Preston
- Marshall Childs
- Ed Reynolds

## REFERENCES

1. Moving Ahead for Progress in the 21st Century Act, Public Law 112-141. H.R. 4348 (112th). July 6, 2012.
2. Federal Highway Administration (FHWA). EDC-2 Final Report. Federal Highway Administration (FHWA). [Online] March 2015. [Cited: June 20, 2016.] <http://www.fhwa.dot.gov/innovation/everydaycounts/reports/edc-2-finalreport/>.
3. AASHTO-AGC-ARTBA. Joint Position Statement JPS-1-13 "Best Practices for Electronic Data-Sharing Between State DOTs and Contractors. s.l. : AASHTO Board of Directors, 2012.
4. Federal Highway Administration (FHWA). Civil Integrated Management (CIM). Washington, DC : s.n., 2012.
5. Hannon, John. Emerging Technologies for Construction Delivery (NCHRP 372). Transportation Research Board. Washington, DC : National Academy Press, 2007.
6. Vonderohe, Alan. 3D Design Terrain Models for Construction Plans and GPS Control of Highway Construction Equipment. [Online] March 2010. [http://minds.wisconsin.edu/bitstream/handle/1793/55940/CFIRE\\_02-05\\_Final\\_Report.pdf](http://minds.wisconsin.edu/bitstream/handle/1793/55940/CFIRE_02-05_Final_Report.pdf).
7. Torres, Helga N., et al. Automation in Highway Construction: Final Report - Part 1 Implementation Challenges at State Transportation Departments and Success Stories. Washington, DC : Federal Highway Administration, 2016.
8. Maier, Francesca, et al. Automation in Highway Construction Part II: Design Guidance and Guide Specification Manual. Washington, DC : Federal Highway Administration, 2016.
9. Schneider, Christopher. 3D, 4D, and 5D Engineered Models for Construction Executive Summary. [Online] 2014. <http://www.fhwa.dot.gov/construction/pubs/hif13048.pdf>.
10. CTC & Associates LLC. Quantitative Cost-Benefit Analyses of the Use of Automated Machine Guidance in Construction: An Examination of Current Practice. Sacramento, CA : Caltrans Division of Research, Innovation and System Information, 2015.
11. Lobbestael, John. Supporting AMG on site for QA. [Webinar] Washington, DC : FHWA, April 2, 2014.
12. Dean, Brett. Parksville Bypass CADD/Survey Tasks Performed. New York State Department of Transportation. Albany, NY : s.n., 2014. p. 3.
13. Federal Highway Administration. Introduction to 3D, 4D, 5D Schedule, Cost and Post-Construction. Washington, DC : s.n., 2015.

14. FHWA. 3D Engineered Models for Construction Workshop. [Online] 2014.  
[http://www.3dmodelsworkshop.com/Delaware/documents/EDC\\_3D%20Modeling%20Workshop%20DELAWARE%20PW.pdf](http://www.3dmodelsworkshop.com/Delaware/documents/EDC_3D%20Modeling%20Workshop%20DELAWARE%20PW.pdf).
15. LandXML.org Industry Consortium. LandXML Home. [Online] [Cited: July 18, 2016.]  
<http://www.landxml.org>.
16. New York State Department of Transportation. Standards Specifications (US Customary Units). Albany, NY : State of New York Department of Transportation, 2014.
17. Peterson, Troy. Project Report - Evaluate Use of the Supplied Mapping Grade LiDAR Point Cloud for Design. Utah Department of Transportation. [Online] Aug 8, 2013. [Cited: Jun 22, 2016.] <https://www.udot.utah.gov/public/ucon/uconowner.gf?n=11480200157073225>.
18. Utah Department of Transportation. Supplemental Specification - 2012 Standard Specification Book. Utah Department of Transportation. [Online] Feb 25, 2016. [Cited: Jun 22, 2016.] <https://www.udot.utah.gov/main/uconowner.gf?n=5897504876107850>.
19. Donahue, John P. I-35 Unbonded Concrete Overlay: The Ideal Project. National Concrete Pavement Technology Center. [Online] August 13, 2013. [Cited: June 22, 2016.]  
<http://www.cptechcenter.org/events/archive/Donahue%20-%20I35%20unbonded%20concrete%20example.pdf>.
20. New York State Department of Transportation. Kosciuszko Bridge Project - Phase 1 Contract Documents Part 3 Project Requirements. New York State Department of Transportation. [Online] Aug 27, 2013. [Cited: Jun 22, 2016.]  
<https://www.dot.ny.gov/portal/page/portal/content/delivery/region11/projects/X72977-Home/X72977-Repository/K-Bridge%20-%20Part%203%20-%20Project%20Requirements.pdf>.
21. Virginia Department of Transportation. 2016 Road and Bridge Specifications. Virginia Department of Transportation. [Online] 2016. [Cited: Jun 22, 2016.]  
[http://www.virginiadot.org/business/resources/const/VDOT\\_2016\\_RB\\_Specs.pdf](http://www.virginiadot.org/business/resources/const/VDOT_2016_RB_Specs.pdf).
22. Missouri Secretary of State. Rules of Department of Insurance, Financial Institutions and Professional Registration: Division 2030 - Missouri Board for Architects, Professional Engineers, Professional Land Surveyors, and Professional Landscape Architects: Chapter 3 - Seals. Missouri Secretary of State. [Online] Feb 29, 2016. [Cited: Jun 22, 2016.]  
<http://s1.sos.mo.gov/cmsimages/adrules/csr/current/20csr/20c2030-3.pdf>.
23. Utah Department of Transportation. Survey and Geomatics Standards. Utah Department of Transportation. [Online] May 14, 2015. [Cited: Jun 22, 2016.]  
<http://www.udot.utah.gov/main/uconowner.gf?n=21971224353070596>.
24. Utah AGRC (Automated Geographic Reference Center). TURN GPS VRS Network. Utah AGRC (Automated Geographic Reference Center). [Online] Utah AGRC (Automated Geographic Reference Center). [Cited: Jun 22, 2016.] <http://turngps.utah.gov/>.

25. Tynan, Jim, et al. Guide Specifications for Highway Construction. Washington, DC : American Association of State Highway and Transportation Officials, 2008. GSH-08.
26. California Department of Transportation. Field Guide to Partnering on Caltrans Construction Projects. Division of Construction. Sacramento, CA : California Department of Transportation, 2013.
27. —. Partnering Facilitator Standards and Expectations. Division of Construction. Sacramento, CA : California Department of Transportation, 2013.
28. Utah Department of Transportation. Survey/Mapping QC Checklist. Salt Lake City, UT : Utah Department of Transportation, 2014.
29. Virginia Department of Transportation. Commonwealth of Virginia Survey Manual. Richmond, VA : Commonwealth of Virginia, 2014.
30. Maryland State Highway Administration. Construction Manual. Maryland State Highway Administration. [Online] Apr 26, 2016. [Cited: Jul 5, 2016.] [http://www.roads.maryland.gov/OOC/OOC\\_Construction\\_Manual.pdf](http://www.roads.maryland.gov/OOC/OOC_Construction_Manual.pdf).
31. Oregon Department of Transportation. 2012 ODOT Highway Design Manual. Salem, OR : Oregon Department of Transportation, 2015. p. Appendix N.
32. Wisconsin Department of Transportation. Construction and Materials Manual Chapter 8 Section 30. Wisconsin Department of Transportation. [Online] Dec 2015. [Cited: Jul 5, 2016.] <http://wisconsindot.gov/rdwy/cmm/cm-08-30.pdf#cm8-30>.
33. New York State Department of Transportation. Contract Administration Manual. Albany, NY : New York State Department of Transportation, 2008.
34. Quiroga, Cesar. 3D Mapping and Marking of Underground Utilities during Project Development and Delivery. [Online] 2014. [http://iheep2014.com/files/presentations/3d\\_mapping\\_and\\_marking\\_underground\\_utilities.pdf](http://iheep2014.com/files/presentations/3d_mapping_and_marking_underground_utilities.pdf).
35. Blaesing-Thompson, Shawn. Collection and Use of 3D Digital As-built Records. [Online] Federal Highway Administration, March 22, 2016. [Cited: July 13, 2016.] <https://connectdot.connectsolutions.com/plrhnosvmp8/>.
36. American Society of Civil Engineers. Standard Guideline for the Collection and Depiction of Existing Subsurface Utility Data (38-02). Reston, VA : American Society of Civil Engineers, 2002.
37. Olsen, Michael J., et al. NCHRP Report 748: Guidelines for the Use of Mobile LIDAR in Transportation Applications. Washington, DC : Transportation Research Board, 2013.

38. Darter, S., Maier, F., & Struthers, J. Q. Final Report: Webinars and Workshops for 3D Engineered Models for Construction. Atlanta, GA, Washington, DC : Federal Highway Administration, 2015.
39. Iowa Department of Transportation. Special Provisions for Conformity with and Coordination of the Contract Documents. Ames, IA : Iowa Department of Transportation, 2015. SP- 120279.
40. Utah Department of Transportation. 3D Engineered Models for Construction Implementation Plan. Salt Lake City, UT : Utah Department of Transportation, 2014.
41. Reeder, Garret D. and Nelson, Gabriel A. Implementation Manual—3D Engineered Models for Highway Construction: The Iowa Experience. Ames, IA : Iowa Department of Transportation, 2015. Project RB33-014.
42. Townes, Douglas. Automated Machine Guidance. [Online] 2013. <http://www.fhwa.dot.gov/construction/pubs/hif13054.pdf>.
43. Florida Department of Transportation. Standard Specifications for Road and Bridge Construction. Tallahassee, FL : Florida Department of Transportation, 2015.
44. Oregon Department of Transportation. ODOT Highway Design Manual. Salem, OR : s.n., 2012.
45. The American Institute of Architects. Guide, Instructions and Commentary to the 2013 AIA Digital Practice Documents. Washington, DC : The American Institute of Architects, 2013.
46. Computer Integrated Construction Research Program. Building Information Modeling Project Execution Planning Guide -- Version 2.1. University Park, PA : The Pennsylvania State University, 2011.
47. Lefler, Nancy, et al. Model Inventory of Roadway Elements. Washington, DC : Federal Highway Administration, 2010. FHWA-SA-10-018.
48. LandXML. LandXML Schema. LandXML. [Online] [Cited: June 30, 2016.] <http://www.landxml.org/Spec.aspx>.
49. TransXML. TransXML. [www.transxml.org](http://www.transxml.org). [Online] Cambridge Systematics, Inc. [Cited: June 30, 2016.] <http://www.transxml.org/>.
50. International Organization for Standardization. ISO 16739:2013. Geneva, Switzerland : s.n.
51. National Information Exchange Model. NIEM Surface Transportation Schemas. [www.niem.gov](http://www.niem.gov). [Online] 2016. [Cited: June 30, 2016.] <https://release.niem.gov/niem/domains/surfaceTransportation/3.2/st.xsd>.
52. Scarponcini, Paul. OGC and buildingSMART International developing InfraGML, a new standard for land and infrastructure information.



53. Bentley Systems. i-model Software Development Kit. Bentley Developer Network. [Online] Bentley Systems. [Cited: July 19, 2016.] <https://www.bentley.com/en/software-developers/sharing-deliverables/i-model-sdk>.
54. buildingSMART International Ltd. IFC Overview Summary. [Online] buildingSMART International. [Cited: July 19, 2016.] <http://www.buildingsmart-tech.org/specifications/ifc-overview>.
55. Transportation Research Board. Standardized Format for Bridge and Structure Information Models. NCHRP 20-07/Task 377 [Active]. [Online] National Academy of Sciences. [Cited: July 19, 2016.] <http://apps.trb.org/cmsfeed/TRBNetProjectDisplay.asp?ProjectID=3923>.
56. buildingSMART. IFC Alignment. BuildingSmart Internaional Home of openBIM. [Online] 2015. [Cited: February 6th, 2015.]
57. Federal Highway Administration. Standardization of Bridge Information Modeling (BrIM). [Online] April 27, 2015. [Cited: July 19, 2016.] <http://www.fhwa.dot.gov/bridge/events/150427birm.pdf>.
58. AASHTO. Proposed Resolution, Joint Technical Committee on Electronic Engineering Data, Title: Endorsement of TransXML. AASHTO Subcommittee on Design. [Online] [Cited: July 19, 2016.] <http://design.transportation.org/Documents/ResolutionTransXML.pdf>.
59. Transportation Research Board. Data Exchange Standard for Utility Information. [www.trb.org](http://www.trb.org). [Online] [Cited: July 1, 2016.] <https://rns.trb.org/dproject.asp?n=40589>.
60. W3C. Security. [www.w3.org](http://www.w3.org). [Online] MIT , ERCIM , Keio, Beihang. [Cited: July 5, 2016.] <https://www.w3.org/standards/xml/security>.
61. LandXML – Signing & Sealing. Warren G. Clary, PE. New Orleans : Highway Engineering Exchange Program, 2014.
62. Bentley Systems. OpenRoadsForum. Bentley Communities. [Online] Bentley Systems. [Cited: June 30, 2016.] [http://communities.bentley.com/products/road\\_\\_\\_site\\_design/f/5922/t/98596](http://communities.bentley.com/products/road___site_design/f/5922/t/98596).
63. Singh, Ron. Engineering Automation: Key Concepts for a 25 Year Time Horizon. [Online] May 2008. <http://www.oregon.gov/ODOT/HWY/GEOMETRONICS/docs/engautokeyconcepts.pdf>.
64. Shah, Keyur, et al. Addressing Challenges and Return on Investment (ROI) for Paperless Project Delivery (e-Construction). Washington, DC : Federal Highway Administration, 2016. DTFH61-14-C-00045.
65. Schneider, Christopher and Littleton, Jason. Case Study for Policies and Organizational Changes for Implementation: Kentucky Case Study. Washington, DC : FHWA, 2013. p. 5. FHWA-HIF-13-049.

66. Iowa Department of Transportation. Design Manual. Ames, IA, USA : s.n.
67. Missouri Department of Transportation. Post-award Value Engineering Change Proposal Workshop JSP-16-01. Jefferson City, MO : Missouri Department of Transportation, 2016.
68. Girouard, Brian. 3D Technology in the Construction Continuum. Machine Control Technology in Milling and Paving. [Online] May 3, 2016. [Cited: July 16, 2016.] <http://conferences.dot.state.al.us/Preconstruction/files/2016presentations/Trimble%20AL%20ODOT%20Presentation%20May%2002%202016%20Final%20-%20Brian%20E%20Girouard.pdf>.
69. Federal Highway Administration. 3D Engineered Models for Bridges and Structures. [Online] 2016. [Cited: July 16, 2016.] <https://connectdot.connectsolutions.com/p285fedtrlu/>.
70. Chen, S. S. and Shirole, A. M. Bridge Data File Protocols for Interoperability and Life Cycle Management. Washington, DC : Federal Highway Administration, 2013. FHWA-HIF-16-003.
71. Thomas, Gwen. The DGI Data Governance Framework. Riverview, FL : The Data Governance Institute, 2014.
72. Michigan Department of Transportation. Developmen Guide. Lansing, MI : Michigan Department of Transportation, 2014.
73. Update on Information Technology Strategic Plan. Blackburn, April. Tallahassee, FL : Florida Department of Transportation, 2015.
74. Federal Highway Administration. 2015 - Deficient Bridges by Highway System - National Bridge Inventory - Bridge Inspection - Safety - Bridges & Structures -. Deficient Bridges by Highway System 2015. [Online] December 31, 2015. [Cited: July 18, 2016.] <http://www.fhwa.dot.gov/bridge/nbi/no10/defbr15.cfm>.