

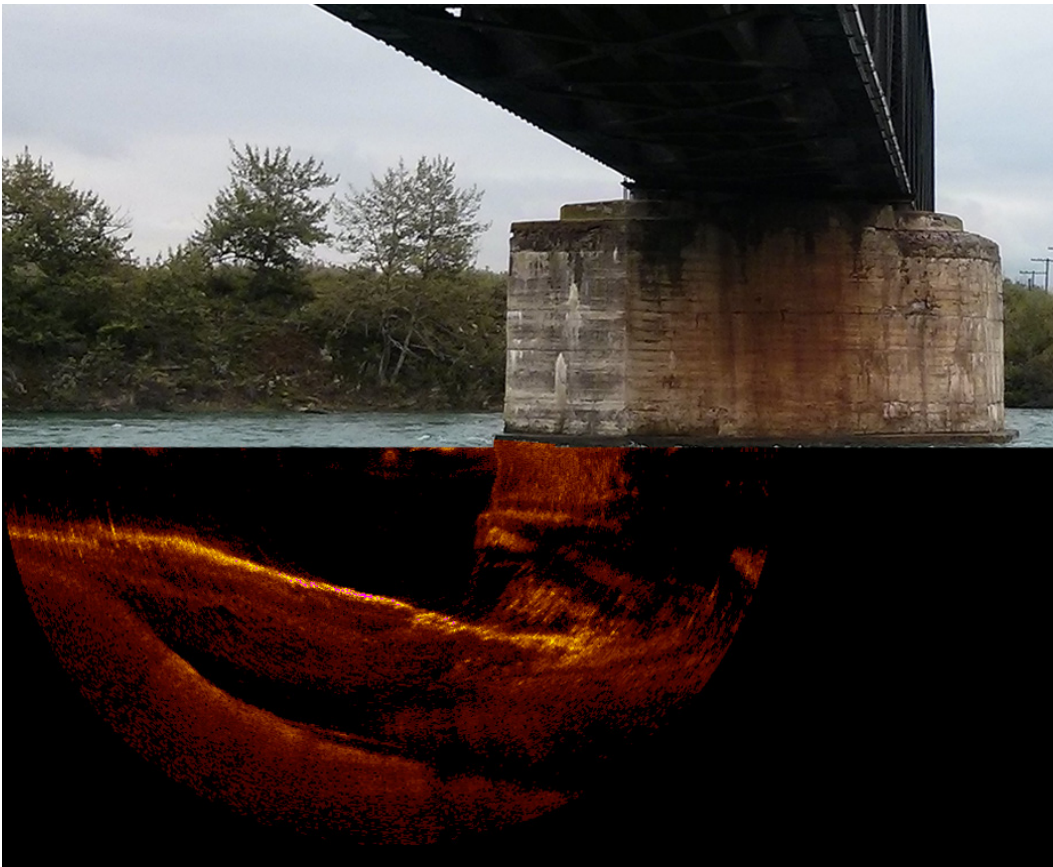


U.S. Department of  
Transportation

**Federal Railroad  
Administration**

## **A New Method for Detecting the Onset of Scour and Managing Scour Critical Bridges**

Office of Research,  
Development  
and Technology  
Washington, DC 20590



#### NOTICE

This document is disseminated under the sponsorship of the Department of Transportation in the interest of information exchange. The United States Government assumes no liability for its contents or use thereof. Any opinions, findings and conclusions, or recommendations expressed in this material do not necessarily reflect the views or policies of the United States Government, nor does mention of trade names, commercial products, or organizations imply endorsement by the United States Government. The United States Government assumes no liability for the content or use of the material contained in this document.

#### NOTICE

The United States Government does not endorse products or manufacturers. Trade or manufacturers' names appear herein solely because they are considered essential to the objective of this report.

<b>REPORT DOCUMENTATION PAGE</b>			<i>Form Approved</i> <i>OMB No. 0704-0188</i>	
Public reporting burden for this collection of information is estimated to average 1 hour per response, including the time for reviewing instructions, searching existing data sources, gathering and maintaining the data needed, and completing and reviewing the collection of information. Send comments regarding this burden estimate or any other aspect of this collection of information, including suggestions for reducing this burden, to Washington Headquarters Services, Directorate for Information Operations and Reports, 1215 Jefferson Davis Highway, Suite 1204, Arlington, VA 22202-4302, and to the Office of Management and Budget, Paperwork Reduction Project (0704-0188), Washington, DC 20503.				
1. AGENCY USE ONLY (Leave blank)		2. REPORT DATE September 2019		3. REPORT TYPE AND DATES COVERED Technical Report - December 2017
4. TITLE AND SUBTITLE A New Method for Detecting the Onset of Scour and Managing Scour Critical Bridges			5. FUNDING NUMBERS DTFR5317C00019	
6. AUTHOR(S) John Orsak				
7. PERFORMING ORGANIZATION NAME(S) AND ADDRESS(ES) SENSR Monitoring Technologies, LLC 111 W. Cooperative Way, Ste. 100 Georgetown, TX 78626-8201			8. PERFORMING ORGANIZATION REPORT NUMBER	
9. SPONSORING/MONITORING AGENCY NAME(S) AND ADDRESS(ES) U.S. Department of Transportation Federal Railroad Administration Office of Railroad Policy and Development Office of Research, Development and Technology Washington, DC 20590			10. SPONSORING/MONITORING AGENCY REPORT NUMBER  DOT/FRA/ORD-19/32	
11. SUPPLEMENTARY NOTES COR: Hugh Thompson				
12a. DISTRIBUTION/AVAILABILITY STATEMENT This document is available to the public through the FRA <a href="#">website</a> .			12b. DISTRIBUTION CODE	
13. ABSTRACT (Maximum 200 words)  This project explores monitoring railroad bridges using a hybrid sensor that measures acceleration, tilt, and temperature. The objective of the research is to detect scour and changing soil conditions at an early stage before railroad operations are affected. The sensors were installed on six railroad bridges and have been in operation since 2013. An overview of the data is presented including recommendations for continued monitoring. A methodology has been created for how to analyze the data and send alerts if changing conditions are detected. Scour conditions are not known to have occurred on any of the bridges, but the data collected can provide insight into the structural response of bridge piers.				
14. SUBJECT TERMS  Scour, bridges, monitoring, accelerometer, tilt meter, tilt sensor, motion sensor, real-time			15. NUMBER OF PAGES 104	
			16. PRICE CODE	
17. SECURITY CLASSIFICATION OF REPORT Unclassified	18. SECURITY CLASSIFICATION OF THIS PAGE Unclassified	19. SECURITY CLASSIFICATION OF ABSTRACT Unclassified	20. LIMITATION OF ABSTRACT	

NSN 7540-01-280-5500

Standard Form 298 (Rev. 2-89)  
Prescribed by ANSI Std. Z39-18  
298-102

# METRIC/ENGLISH CONVERSION FACTORS

## ENGLISH TO METRIC

### LENGTH (APPROXIMATE)

- 1 inch (in) = 2.5 centimeters (cm)
- 1 foot (ft) = 30 centimeters (cm)
- 1 yard (yd) = 0.9 meter (m)
- 1 mile (mi) = 1.6 kilometers (km)

### AREA (APPROXIMATE)

- 1 square inch (sq in, in<sup>2</sup>) = 6.5 square centimeters (cm<sup>2</sup>)
- 1 square foot (sq ft, ft<sup>2</sup>) = 0.09 square meter (m<sup>2</sup>)
- 1 square yard (sq yd, yd<sup>2</sup>) = 0.8 square meter (m<sup>2</sup>)
- 1 square mile (sq mi, mi<sup>2</sup>) = 2.6 square kilometers (km<sup>2</sup>)
- 1 acre = 0.4 hectare (he) = 4,000 square meters (m<sup>2</sup>)

### MASS - WEIGHT (APPROXIMATE)

- 1 ounce (oz) = 28 grams (gm)
- 1 pound (lb) = 0.45 kilogram (kg)
- 1 short ton = 2,000 pounds (lb) = 0.9 tonne (t)

### VOLUME (APPROXIMATE)

- 1 teaspoon (tsp) = 5 milliliters (ml)
- 1 tablespoon (tbsp) = 15 milliliters (ml)
- 1 fluid ounce (fl oz) = 30 milliliters (ml)
- 1 cup (c) = 0.24 liter (l)
- 1 pint (pt) = 0.47 liter (l)
- 1 quart (qt) = 0.96 liter (l)
- 1 gallon (gal) = 3.8 liters (l)
- 1 cubic foot (cu ft, ft<sup>3</sup>) = 0.03 cubic meter (m<sup>3</sup>)
- 1 cubic yard (cu yd, yd<sup>3</sup>) = 0.76 cubic meter (m<sup>3</sup>)

### TEMPERATURE (EXACT)

$$[(x-32)(5/9)]\text{ }^{\circ}\text{F} = y\text{ }^{\circ}\text{C}$$

## METRIC TO ENGLISH

### LENGTH (APPROXIMATE)

- 1 millimeter (mm) = 0.04 inch (in)
- 1 centimeter (cm) = 0.4 inch (in)
- 1 meter (m) = 3.3 feet (ft)
- 1 meter (m) = 1.1 yards (yd)
- 1 kilometer (km) = 0.6 mile (mi)

### AREA (APPROXIMATE)

- 1 square centimeter (cm<sup>2</sup>) = 0.16 square inch (sq in, in<sup>2</sup>)
- 1 square meter (m<sup>2</sup>) = 1.2 square yards (sq yd, yd<sup>2</sup>)
- 1 square kilometer (km<sup>2</sup>) = 0.4 square mile (sq mi, mi<sup>2</sup>)
- 10,000 square meters (m<sup>2</sup>) = 1 hectare (ha) = 2.5 acres

### MASS - WEIGHT (APPROXIMATE)

- 1 gram (gm) = 0.036 ounce (oz)
- 1 kilogram (kg) = 2.2 pounds (lb)
- 1 tonne (t) = 1,000 kilograms (kg) = 1.1 short tons

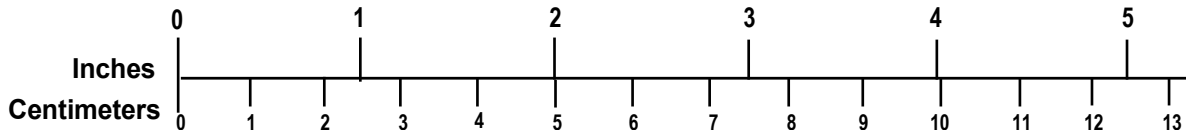
### VOLUME (APPROXIMATE)

- 1 milliliter (ml) = 0.03 fluid ounce (fl oz)
- 1 liter (l) = 2.1 pints (pt)
- 1 liter (l) = 1.06 quarts (qt)
- 1 liter (l) = 0.26 gallon (gal)
- 1 cubic meter (m<sup>3</sup>) = 36 cubic feet (cu ft, ft<sup>3</sup>)
- 1 cubic meter (m<sup>3</sup>) = 1.3 cubic yards (cu yd, yd<sup>3</sup>)

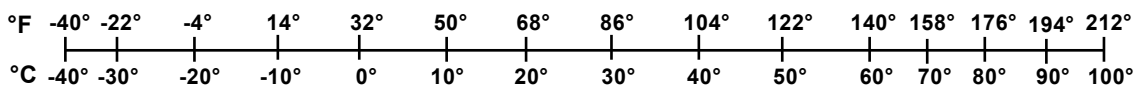
### TEMPERATURE (EXACT)

$$[(9/5)y + 32]\text{ }^{\circ}\text{C} = x\text{ }^{\circ}\text{F}$$

## QUICK INCH - CENTIMETER LENGTH CONVERSION



## QUICK FAHRENHEIT - CELSIUS TEMPERATURE CONVERSION



For more exact and or other conversion factors, see NIST Miscellaneous Publication 286, Units of Weights and Measures. Price \$2.50 SD Catalog No. C13 10286

Updated 6/17/98



# Contents

---

- Executive Summary ..... 1
- 1. Introduction ..... 2
  - 1.1 Background ..... 2
  - 1.2 Objective and Overall Approach..... 3
  - 1.3 Scope ..... 3
  - 1.4 Organization of the Report ..... 3
- 2. Monitoring System Overview ..... 4
  - 2.1 CX1 Monitoring Device ..... 4
  - 2.2 Installation Photos ..... 5
- 3. Data Analysis Methods..... 7
  - 3.1 The “Epoch” Method..... 7
  - 3.2 Key Performance Indicators for Scour Detection ..... 8
- 4. Monitoring Data Collected ..... 14
  - 4.1 BNSF Bridge 77.54, Nodway, MO ..... 14
  - 4.2 BNSF Bridge 279.7, Gorin, MO (Fabius) ..... 28
  - 4.3 CPR Bridge 195.20 Tomah ..... 37
  - 4.4 CPR BR00 0.30 Medicine Hat ..... 51
  - 4.5 CPR BR00 172.46 Calgary ..... 62
  - 4.6 CPR 121.95 Watertown..... 73
  - 4.7 Data Overview and Recommendations ..... 87
- 5. Scour Alert Methodology ..... 88
  - 5.1 Overview ..... 88
  - 5.2 Alert System Operation ..... 88
  - 5.3 Data Classification and Alert Tiers ..... 89
- 6. Conclusion and Lessons Learned ..... 91
  - 6.1 Hardware ..... 91
  - 6.2 Data Analysis and Software ..... 91
  - 6.3 Current State of the Technology and Future Developments ..... 91
- 7. References ..... 92
- Abbreviations and Acronyms ..... 93

## Illustrations

---

Figure 1 – Bridge Failure due to Scour.....	2
Figure 2 – CX1 Sensor Mounted on Bridge Pier.....	5
Figure 3 – SENSRnet Installed Inside Electrical Enclosure.....	6
Figure 4 – Graphical Depictions of Key Performance Indicators.....	8
Figure 5 – Example of Tilt-Temperature Relationship, Canadian Pacific BR00 172.46 West Pier9	
Figure 6 – Visual Analysis of Tilt-Temperature Relationship, Canadian Pacific BR00 172.46 West Pier.....	10
Figure 7 – Tilt Shift of Canadian Pacific BR00 172.46 West Pier Over Time.....	10
Figure 8 – Example of Above Average Dynamic Oscillations.....	11
Figure 9 – Example Response Signature from Train Loading .....	12
Figure 10 – Example Response Signature from Vibration Hammer .....	13
Figure 11 – Example Response Signature from Impact Hammer .....	13
Figure 12 – BNSF Bridge 77.54, Nodaway, MO .....	14
Figure 13 – Pier 2, X-Axis Average Tilt (Parallel to Track) .....	15
Figure 14 – Pier 2, Y-Axis Average Tilt (Perpendicular to Track) .....	16
Figure 15 – Pier 3, X-Axis Average Tilt (Parallel to Track) .....	16
Figure 16 – Pier 3, Y-Axis Average Tilt (Perpendicular to Track) .....	17
Figure 17 – Pier 4, X-Axis Average Tilt (Parallel to Track) .....	17
Figure 18 – Pier 4, Y-Axis Average Tilt (Perpendicular to Track) .....	18
Figure 19 – Pier 5, X-Axis Average Tilt (Parallel to Track) .....	18
Figure 20 – Pier 5, Y-Axis Average Tilt (Perpendicular to Track) .....	19
Figure 21 – Pier 2, X-Axis Dynamic Tilt (Parallel to Track).....	20
Figure 22 – Pier 2, Y-Axis Dynamic Tilt (Perpendicular to Track).....	20
Figure 23 – Pier 3, X-Axis Dynamic Tilt (Parallel to Track).....	21
Figure 24 – Pier 3, Y-Axis Dynamic Tilt (Perpendicular to Track).....	21
Figure 25 – Pier 4, X-Axis Dynamic Tilt (Parallel to Track).....	22
Figure 26 – Pier 4, Y-Axis Dynamic Tilt (Perpendicular to Track).....	22
Figure 27 – Pier 5, X-Axis Dynamic Tilt (Parallel to Track).....	23
Figure 28 – Pier 5, Y-Axis Dynamic Tilt (Perpendicular to Track).....	23
Figure 29 – Pier 2, X-Axis RMS Acceleration (Parallel to Track).....	24
Figure 30 – Pier 2, Y-Axis RMS Acceleration (Perpendicular to Track).....	25

Figure 31 – Pier 3, X-Axis RMS Acceleration (Parallel to Track).....	25
Figure 32 – Pier 3, Y-Axis RMS Acceleration (Perpendicular to Track).....	26
Figure 33 – Pier 4, X-Axis RMS Acceleration (Parallel to Track).....	26
Figure 34 – Pier 4, Y-Axis RMS Acceleration (Perpendicular to Track).....	27
Figure 35 – Pier 5, X-Axis RMS Acceleration (Parallel to Track).....	27
Figure 36 – Pier 5, Y-Axis RMS Acceleration (Perpendicular to Track).....	28
Figure 37 – BNSF Bridge 279.7 Sensor Locations.....	29
Figure 38 – East Pier, X-Axis Average Tilt (Perpendicular to Track) .....	30
Figure 39 – East Pier, Y-Axis Average Tilt (Parallel to Track) .....	30
Figure 40 – West Pier, X-Axis Average Tilt (Perpendicular to Track) .....	31
Figure 41 – West Pier, Y-Axis Average Tilt (Parallel to Track) .....	31
Figure 42 – East Pier, X-Axis Dynamic Tilt (Perpendicular to Track) .....	32
Figure 43 – East Pier, Y-Axis Dynamic Tilt (Parallel to Track) .....	33
Figure 44 – West Pier, X-Axis Dynamic Tilt (Perpendicular to Track).....	33
Figure 45 – West Pier, Y-Axis Dynamic Tilt (Parallel to Track).....	34
Figure 46 – East Pier, X-Axis RMS Acceleration (Perpendicular to Track).....	35
Figure 47 – East Pier, Y-Axis RMS Acceleration (Parallel to Track).....	35
Figure 48 – West Pier, X-Axis RMS Acceleration (Perpendicular to Track) .....	36
Figure 49 – West Pier, Y-Axis RMS Acceleration (Parallel to Track) .....	36
Figure 50 – CPR 195.20 Tomah Sensor Locations.....	37
Figure 51 – Deck Support, X-Axis Average Tilt (Parallel to Track).....	38
Figure 52 – Deck Support, Y-Axis Average Tilt (Perpendicular to Track).....	38
Figure 53 – Pier Cap, X-Axis Average Tilt (Parallel to Track).....	39
Figure 54 – Pier Cap, Y-Axis Average Tilt (Perpendicular to Track).....	39
Figure 55 – Deck Truss, X-Axis Average Tilt (Parallel to Track) .....	40
Figure 56 – Deck Truss, Y-Axis Average Tilt (Perpendicular to Track) .....	40
Figure 57 – Deck Plate Girder, X-Axis Average Tilt (Parallel to Track).....	41
Figure 58 – Deck Plate Girder, Y-Axis Average Tilt (Perpendicular to Track).....	41
Figure 59 – Deck Support, X-Axis Dynamic Tilt (Parallel to Track) .....	42
Figure 60 – Deck Support, Y-Axis Dynamic Tilt (Perpendicular to Track) .....	43
Figure 61 – Pier Cap, X-Axis Dynamic Tilt (Parallel to Track).....	43
Figure 62 – Pier Cap, Y-Axis Dynamic Tilt (Perpendicular to Track).....	44
Figure 63 – Deck Truss, X-Axis Dynamic Tilt (Parallel to Track) .....	44

Figure 64 – Deck Truss, Y-Axis Dynamic Tilt (Perpendicular to Track) .....	45
Figure 65 – Deck Plate Girder, X-Axis Dynamic Tilt (Parallel to Track).....	45
Figure 66 – Deck Plate Girder, Y-Axis Dynamic Tilt (Perpendicular to Track).....	46
Figure 67 – Deck Support, X-Axis RMS Acceleration (Parallel to Track).....	47
Figure 68 – Deck Support, Y-Axis RMS Acceleration (Perpendicular to Track).....	47
Figure 69 – Pier Cap, X-Axis RMS Acceleration (Parallel to Track) .....	48
Figure 70 – Pier Cap, Y-Axis RMS Acceleration (Perpendicular to Track) .....	48
Figure 71 – Deck Truss, X-Axis RMS Acceleration (Parallel to Track).....	49
Figure 72 – Deck Truss, Y-Axis RMS Acceleration (Perpendicular to Track).....	49
Figure 73 – Deck Plate Girder, X-Axis RMS Acceleration (Parallel to Track).....	50
Figure 74 – Deck Plate Girder, Y-Axis RMS Acceleration (Perpendicular to Track) .....	50
Figure 75 – CPR Medicine Hat Monitoring System Layout .....	51
Figure 76 – Pier 3, X-Axis Average Tilt (Parallel to Track) .....	52
Figure 77 – Pier 3, Y-Axis Average Tilt (Perpendicular to Track) .....	52
Figure 78 – Pier 5, X-Axis Average Tilt (Parallel to Track) .....	53
Figure 79 – Pier 5, Y-Axis Average Tilt (Perpendicular to Track) .....	53
Figure 80 – Pier 6, X-Axis Average Tilt (Parallel to Track) .....	54
Figure 81 – Pier 6, Y-Axis Average Tilt (Perpendicular to Track) .....	54
Figure 82 – Pier 3, X-Axis Dynamic Tilt (Parallel to Track).....	55
Figure 83 – Pier 3, Y-Axis Dynamic Tilt (Perpendicular to Track).....	56
Figure 84 – Pier 5, X-Axis Dynamic Tilt (Parallel to Track).....	56
Figure 85 – Pier 5, Y-Axis Dynamic Tilt (Perpendicular to Track).....	57
Figure 86 – Pier 6, X-Axis Dynamic Tilt (Parallel to Track).....	57
Figure 87 – Pier 6, Y-Axis Dynamic Tilt (Perpendicular to Track).....	58
Figure 88 – Pier 3, X-Axis RMS Acceleration (Parallel to Track).....	59
Figure 89 – Pier 3, Y-Axis RMS Acceleration (Perpendicular to Track).....	59
Figure 90 – Pier 5, X-Axis RMS Acceleration (Parallel to Track).....	60
Figure 91 – Pier 5, Y-Axis RMS Acceleration (Perpendicular to Track).....	60
Figure 92 – Pier 6, X-Axis RMS Acceleration (Parallel to Track).....	61
Figure 93 – Pier 6, Y-Axis RMS Acceleration (Perpendicular to Track).....	61
Figure 94 – Sensor Locations on CPR Calgary Bridge 172.46 .....	62
Figure 95 – Pier 1, X-Axis Average Tilt (Perpendicular to Track) .....	63
Figure 96 – Pier 1, Y-Axis Average Tilt (Parallel to Track) .....	63

Figure 97 – Pier 2, X-Axis Average Tilt (Perpendicular to Track) .....	64
Figure 98 – Pier 2, Y-Axis Average Tilt (Parallel to Track) .....	64
Figure 99 – Pier 3, X-Axis Average Tilt (Perpendicular to Track) .....	65
Figure 100 – Pier 3, Y-Axis Average Tilt (Parallel to Track) .....	65
Figure 101 – Pier 1, X-Axis Dynamic Tilt (Perpendicular to Track).....	66
Figure 102 – Pier 1, Y-Axis Dynamic Tilt (Parallel to Track).....	67
Figure 103 – Pier 2, X-Axis Dynamic Tilt (Perpendicular to Track).....	67
Figure 104 – Pier 2, Y-Axis Dynamic Tilt (Parallel to Track).....	68
Figure 105 – Pier 3, X-Axis Dynamic Tilt (Perpendicular to Track).....	68
Figure 106 – Pier 3, Y-Axis Dynamic Tilt (Parallel to Track).....	69
Figure 107 – Pier 1, X-Axis RMS Acceleration (Perpendicular to Track).....	70
Figure 108 – Pier 1, Y-Axis RMS Acceleration (Parallel to Track).....	70
Figure 109 – Pier 2, X-Axis RMS Acceleration (Perpendicular to Track).....	71
Figure 110 – Pier 2, Y-Axis RMS Acceleration (Parallel to Track).....	71
Figure 111 – Pier 3, X-Axis RMS Acceleration (Perpendicular to Track).....	72
Figure 112 – Pier 3, Y-Axis RMS Acceleration (Parallel to Track).....	72
Figure 113 – CPR 121.95 Watertown Sensor Locations .....	73
Figure 114 – Pier 1, X-Axis Average Tilt.....	74
Figure 115 – Pier 1, Y-Axis Average Tilt.....	74
Figure 116 – Pier 2, X-Axis Average Tilt.....	75
Figure 117 – Pier 2, Y-Axis Average Tilt.....	75
Figure 118 – West Abutment, X-Axis Average Tilt (Perpendicular to Track) .....	76
Figure 119 – West Abutment, Y-Axis Average Tilt (Parallel to Track) .....	76
Figure 120 – East Abutment, X-Axis Average Tilt (Perpendicular to Track).....	77
Figure 121 – East Abutment, Y-Axis Average Tilt (Parallel to Track).....	77
Figure 122 – Pier 1, X-Axis Dynamic Tilt .....	78
Figure 123 – Pier 1, Y-Axis Dynamic Tilt .....	79
Figure 124 – Pier 2, X-Axis Dynamic Tilt .....	79
Figure 125 – Pier 2, Y-Axis Dynamic Tilt .....	80
Figure 126 – West Abutment, X-Axis Dynamic Tilt (Perpendicular to Track) .....	80
Figure 127 – West Abutment, Y-Axis Dynamic Tilt (Parallel to Track) .....	81
Figure 128 – East Abutment, X-Axis Dynamic Tilt (Perpendicular to Track).....	81
Figure 129 – East Abutment, Y-Axis Dynamic Tilt (Parallel to Track).....	82

Figure 130 – Pier 1, X-Axis RMS Acceleration .....	83
Figure 131 – Pier 1, Y-Axis RMS Acceleration .....	83
Figure 132 – Pier 2, X-Axis RMS Acceleration .....	84
Figure 133 – Pier 2, Y-Axis RMS Acceleration .....	84
Figure 134 – West Abutment, X-Axis RMS Acceleration (Perpendicular to Track).....	85
Figure 135 – West Abutment, Y-Axis RMS Acceleration (Parallel to Track).....	85
Figure 136 – East Abutment, X-Axis RMS Acceleration (Perpendicular to Track) .....	86
Figure 137 – East Abutment, Y-Axis RMS Acceleration (Parallel to Track) .....	86
Figure 138 – Alert System Data Flow .....	88
Figure 139 – Example Email Alert .....	89

## Tables

---

Table 1 – Epoch Record Statistics .....	7
---	---

## **Executive Summary**

---

This report discusses the testing that SENSR Monitoring Technologies, LLC conducted of a new method of monitoring railroad bridges for scour and other changing soil conditions, through sponsorship from the Federal Railroad Administration. From 2013 to 2017, six monitoring systems were installed on six different bridges that continuously measured tilt, acceleration, and temperature. Methods for data analysis and alerting are presented that can be used as a framework for monitoring any rail bridge substructure.

The three-key metrics are defined over the course of the project: average tilt, dynamic tilt, and lateral acceleration. Average tilt is a moving 60 second average that is adjusted for temperature and best used when the bridge is unloaded. Any permanent differential settlement due to scour is reflected by a change in average tilt of the bridge pier. Dynamic tilt and lateral acceleration are response characteristics that are measured during train loading.

An overview of the structural response data collected since 2013 is presented as charts for each sensor. Interpretation and recommendations are provided for each specific substructure element. Scour is not known to have developed on any of the bridge piers, but some trends in the data are flagged for further investigation by the bridge owner.

The monitoring system technology used is a viable option for long-term monitoring. Similar monitoring systems are now deployed on over 40 rail bridges across the country. The two biggest challenges encountered over the course of the project have been power availability and lightning. Future hardware development efforts will focus on creating a solar friendly system that is hardened against lightning.



# 1. Introduction

---

This report provides an overview of the tasks and accomplishments of a new method for detecting the onset of scour and managing scour on critical bridges.

Many railroad bridge piers are susceptible to damage caused by scour and other changing soil conditions. Scour is the engineering term for the erosion of soil surrounding a bridge foundation (piers and abutments). Bridge scour occurs when fast-moving water around a bridge removes sediment from around the bridge foundation, leaving behind scour holes. These holes, in turn, can greatly compromise the bridge's integrity. Settlement and misalignment can lead to track outages and even bridge failure if not detected early enough. [Figure 1](#) shows bridge failure due to scour. Through sponsorship from the Federal Railroad Administration's (FRA) Office of Research, Development and Technology, a new detection system was developed using a combination tiltmeter and accelerometer sensor. The system continuously measures the structural response of each railroad bridge pier in the U.S. If a dangerous condition is detected, an automatic alert is sent to bridge inspectors over text message or email.



**Figure 1 – Bridge Failure due to Scour**

## 1.1 Background

Detecting the onset of scour has proven to be a difficult undertaking, in part because the condition can develop very quickly, and the period when scour is developing is the most difficult time to conduct an inspection. This project evaluates and field tests a new method for scour monitoring and scour warning based on sensing bridge pier responses. This method uses a new hybrid sensor that measures pier responses to determine the soil support conditions of a pier. The method can be used as a portable inspection tool or it can be configured to be a real-time

assessment and notification system. This new method could significantly enhance the industry's scour-damage detection capability and provide an operational foundation for assuring that trains do not traverse bridges that have scoured piers.

## **1.2 Objective and Overall Approach**

The overall objective is to detect the early signs of scour or other conditions that may result in undesirable outcomes. This is accomplished by measuring structural response data while the bridge is known to be in good condition. The initial data becomes the baseline response, and changes in tilt and vibration characteristics are used to alert bridge owners to any deteriorating conditions.

## **1.3 Scope**

The scope of this report covers the data collected, data analysis methods, scour alert methods, and an overall assessment of the technology. The previous phase of the project focused more on the instrumentation details and provides additional background knowledge. The 2014 annual report provides an overview of the previous work [1].

## **1.4 Organization of the Report**

The report is divided into four main sections as follows:

- [Section 2](#): Provides an overview of the instrumentation and how the monitoring system operates.
- [Section 3](#): Describes the methodology used to analyze the data collected.
- [Section 4](#): Presents and analyzes the data collected over the course of the project.
- [Section 5](#): Assesses the readiness level of the monitoring system.
- [Section 6](#): Summarizes and assesses any lessons learned from the project.

## 2. Monitoring System Overview

---

The primary sensor type used for this project is the CX1 monitoring device described below. Each sensor measures acceleration in three dimensions and tilt in two directions relative to vertical. The sensor continuously stores data and transmits it to the onsite data acquisition (DAQ) unit with the brand name “SENSRnet.”

### 2.1 CX1 Monitoring Device

The specifications for the CX1 sensor are as follows:

Size	4.718” x 4.323” x 2.295”
Weight:	20 oz.
Connectivity:	M12 Ethernet and M12 USB Communication
Power source:	M12 Ethernet and M12 USB Communication
Ethernet Power consumption:	20 mA at 48 V
USB Power consumptions:	200 mA at 5 V
Housing material:	Billet Aluminum
Accelerometer type:	3-axis MEMS
Accelerometer resolution:	0.00001 g
Accelerometer range:	±1.5 g
Frequency response:	DC – 200 Hz (0.1dB)
Accelerometer sample rate:	Variable up to 2,000 samples/second
Inclinometer type:	2-axis MEMS
Inclinometer range:	± 15 degrees

The CX1 continuously records the following six data streams:

1. Acceleration in X-Axis
2. Acceleration in Y-Axis
3. Acceleration in Z-Axis
4. Tilt in X-Axis
5. Tilt in Y-Axis
6. Temperature

The X-Axis and Y-Axis are the lateral axes and will be designated as either perpendicular to or parallel to the track when presented in charts.

## 2.2 Installation Photos

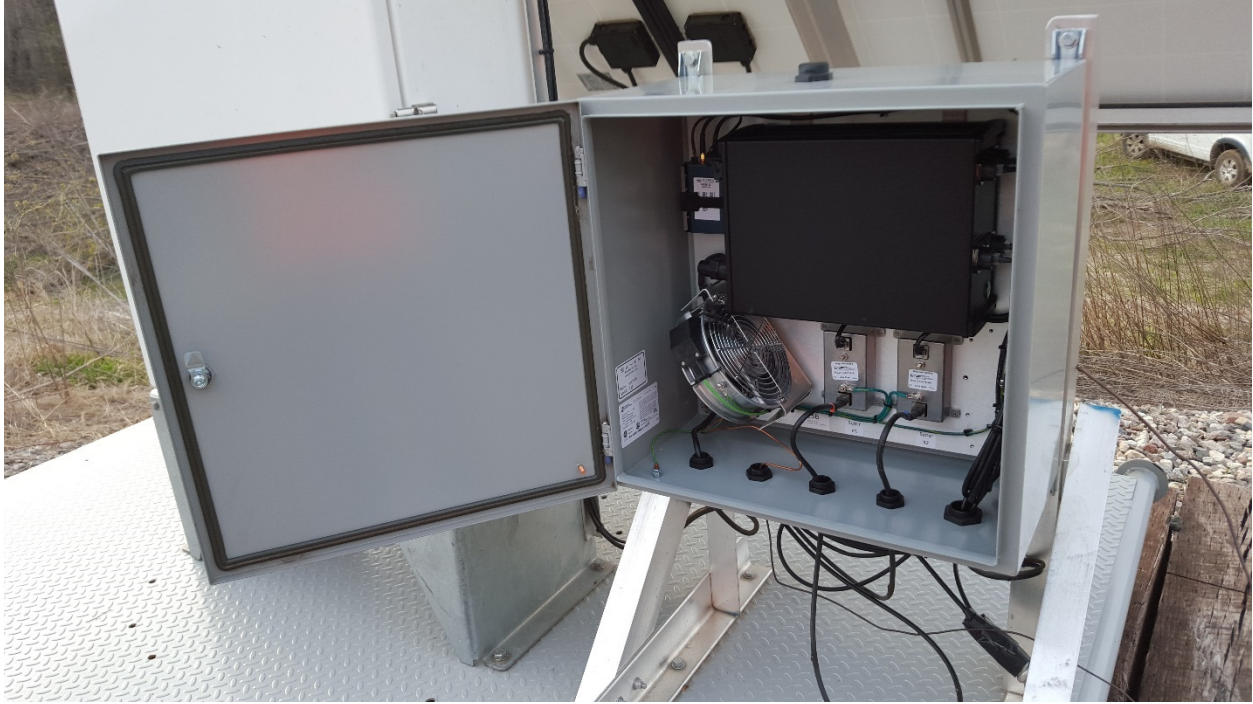
An example of a CX1 sensor mounted on a bridge pier is shown in [Figure 2](#). The sensor is installed onto an aluminum bracket with machine screws. The aluminum bracket is fastened to the concrete pier with anchor bolts.



**Figure 2 – CX1 Sensor Mounted on Bridge Pier**

An example of a SENSRnet is shown in [Figure 2](#). The device is installed inside of a sealed electrical enclosure for protection from the elements.





**Figure 3 – SENSnet Installed Inside Electrical Enclosure**

Additional installation details and photos are available in the first annual report submitted in December 2014 [1].

### 3. Data Analysis Methods

---

This section describes the data analysis methodology used to monitor railroad bridges for scour and other adverse conditions. A multi-step process is required to take raw data and transform it into actionable information that is useful to bridge owners. The primary consideration for developing this methodology is to create a practical approach that can be widely applied without requiring extensive computational power or advanced software packages.

#### 3.1 The “Epoch” Method

The Epoch Method has been developed to organize the data into a manageable format that reduces file size and allows for a better understanding of a bridge’s structural response. For every 60 seconds of data collected, a set of statistical parameters are calculated. Each set of statistics is referred to as an “Epoch” and provides an overview of how the structure responds during a given minute. The parameters contained in an epoch record are listed in [Table 1](#).

**Table 1 – Epoch Record Statistics**

<b>Data Stream</b>	<b>Epoch Statistics</b>
Acceleration, X-Axis	Maximum, Minimum, Average
Acceleration, Y-Axis	
Acceleration, Z-Axis	
Acceleration, Vector Magnitude	
Tilt, X-Axis	Maximum, Minimum, Average
Tilt, Y-Axis	
Temperature	Maximum, Minimum, Average

The Epoch Method is a necessity for continuously monitoring railroad bridges in remote locations. Transferring large quantities of data over a cellular connection can be difficult and expensive. Additionally, larger data sets require more extensive data analysis and higher overall cost. By creating epochs before the point of transmission, the total cost of monitoring rail bridges is reduced.

##### 3.1.1 Loaded and Quiet Epochs

Each Epoch record can be further classified as either “Loaded” or “Quiet.” Loaded Epochs are useful for assessing the dynamic response characteristics of the bridge. Quiet Epochs show the static, resting position of bridge elements and can be used to measure permanent deformation. The distinction between Loaded and Quiet can be made using the Root Mean Square (RMS) of the Acceleration Vector Magnitude. Each bridge may have a different threshold to distinguish between Loaded and Quiet conditions. Ambient vibrations and background noise affect the resting point of the accelerometers. The typical Acceleration RMS range that distinguishes Loaded from Quiet is approximately 0.0002 g to 0.001 g.

### 3.2 Key Performance Indicators for Scour Detection

The three Key Performance Indicators (KPIs) used for detecting the onset of bridge scour and changing soil conditions are Average Tilt, Dynamic Tilt, and Lateral Acceleration. Graphical depictions of the indicators are shown in Figure 4.

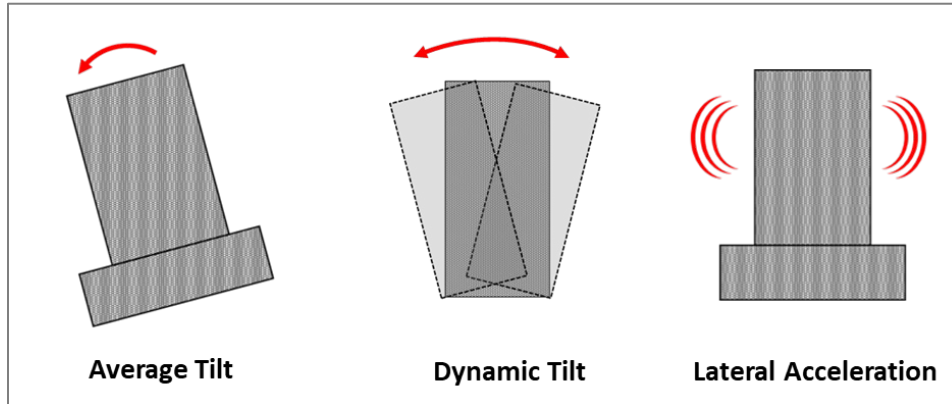


Figure 4 – Graphical Depictions of Key Performance Indicators

Average tilt is a quasi-static response characteristic that is best used when the bridge is unloaded and at rest. Any permanent differential settlement due to scour will be reflected by a change in average tilt of the bridge pier. Dynamic tilt and lateral acceleration are response characteristics that are measured during train loading. The dynamic response characteristics will increase in magnitude if a scour pocket develops and allows increased motion under load.

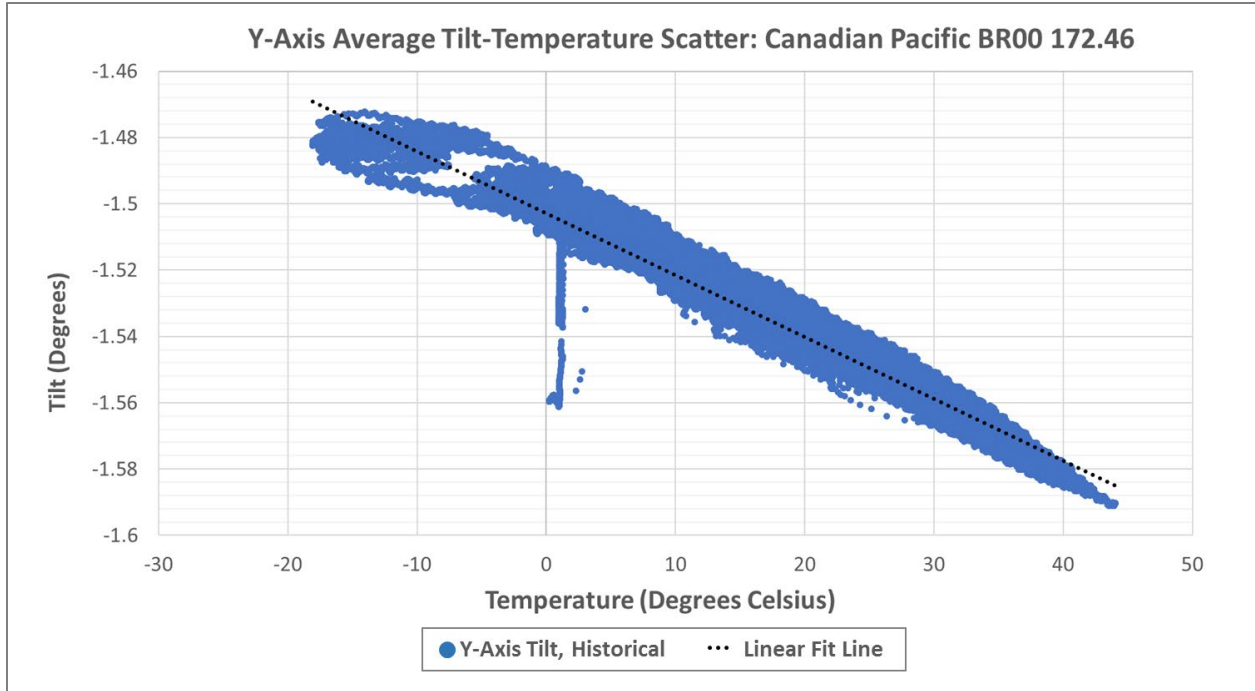
#### 3.2.1 Average Tilt

Railroad bridges naturally expand and contract due to thermal effects. To properly use Average Tilt measurements, the temperature and thermal expansion at the time of recording must be considered. A linear regression can be calculated to model the relationship between tilt and temperature. Typically, tilt data measured across a temperature range of at least 10 °C to 20 °C is required before an accurate trend line can be determined. Therefore, the linear regression may need to be recalculated throughout the first 6 months of monitoring.

An example scatter plot showing the relationship between tilt and temperature is shown in Figure 5. The data presented in the plot was collected from July 1, 2016, to January 1, 2017, from Canadian Pacific Railway (CPR) BR00 172.46 in Calgary, AB. This period covers a wide range of temperatures as well as the transition to near-permanent freezing temperatures. A well-defined linear relationship can be established between tilt and temperature. The total change in tilt due to thermal effects is relatively small: 0.12 degrees. However, very small changes in tilt can have a significant impact on the overall alignment of the structure. The corresponding displacement can be approximated by assuming a lever arm based on pier height and calculating the arc length using the following equation:

$$\text{Displacement} = \text{Lever Arm} * \text{Tilt}$$

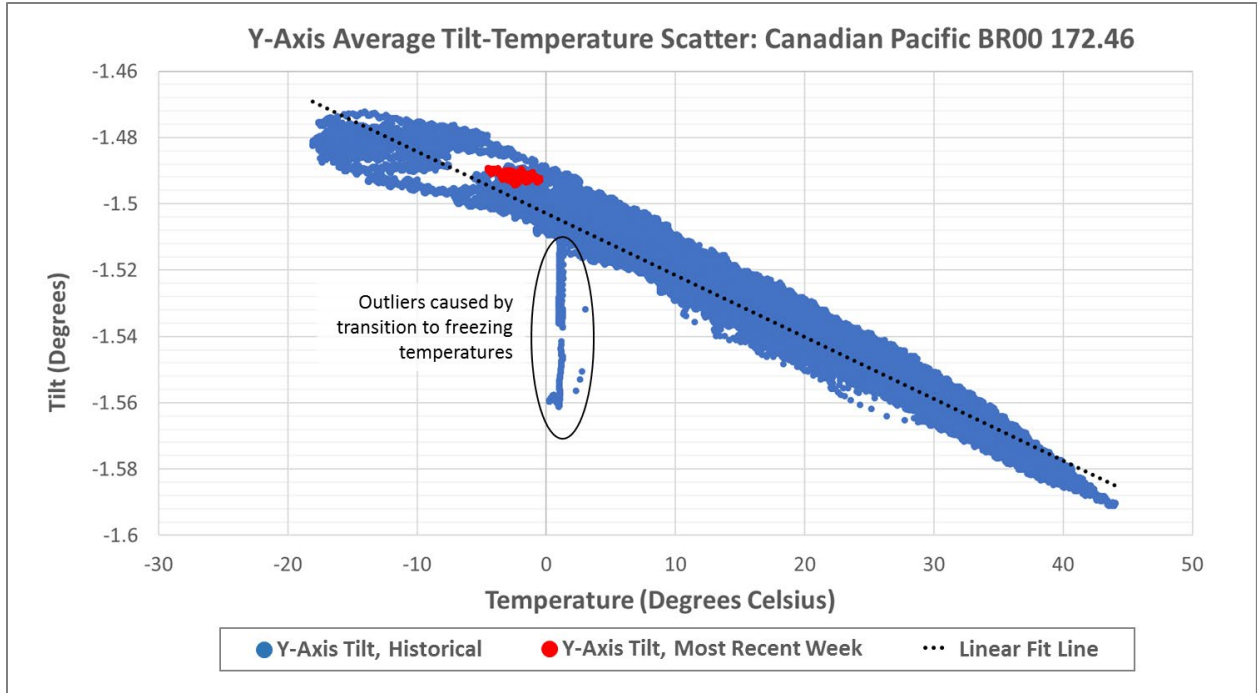
This equation requires tilt in units of radians. If a 30-ft. lever arm is assumed, the corresponding displacement for 0.12 degrees of tilt is 0.75 inches.



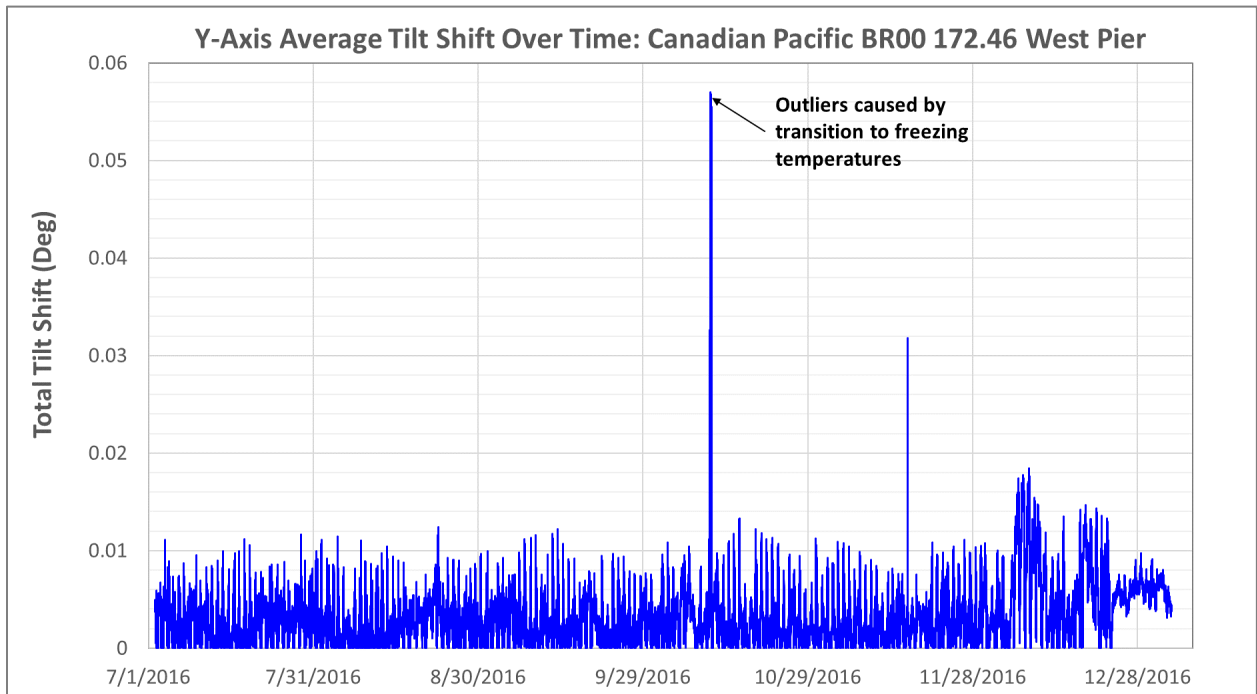
**Figure 5 – Example of Tilt-Temperature Relationship, Canadian Pacific BR00 172.46 West Pier**

Further visual analysis can be conducted by shading the most recent week of data a separate color from the historical data. If the recent data has drifted outside of the historical data band, permanent deformation has possibly occurred. The data in Figure 5 shows that the current position of the West Pier is within the historical band. Additionally, the outliers that occurred near 0 °C temperatures did not represent a permanent shift. These outliers were likely the result of the freeze/thaw cycle.





**Figure 6 – Visual Analysis of Tilt-Temperature Relationship, Canadian Pacific BR00 172.46 West Pier**

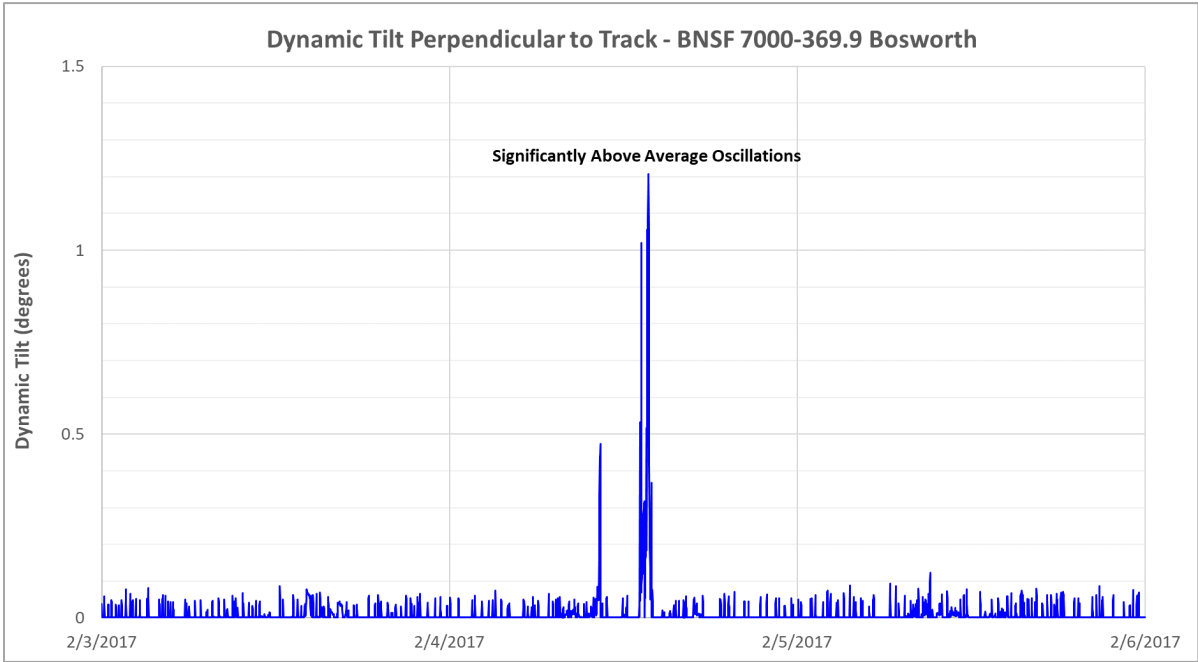


**Figure 7 – Tilt Shift of Canadian Pacific BR00 172.46 West Pier Over Time**

**3.2.2 Dynamic Tilt**

The dynamic tilt is determined by calculating the difference between the maximum and minimum tilt recorded for a given minute of data. This characteristic shows the magnitude of oscillation for a bridge pier under loading. Above normal dynamic tilt is an indicator of changing soil conditions that can affect the pier stability.

An example of dynamic tilt indicating changing soil conditions is shown in Figure 7. On the afternoon of February 4, 2017, the contractor was performing pile driving with a vibration hammer near the West abutment of Burlington Northern Santa Fe Railway (BNSF) Bridge 7000-369.9. Significantly above average dynamic tilt was recorded, and the contractor was immediately alerted. A survey was ordered after the alert, and it was discovered that the abutment had settled 0.5 inches over the course of 30 minutes. The vibration hammer had disturbed the soil enough to cause differential settlement.



**Figure 8 – Example of Above Average Dynamic Oscillations**

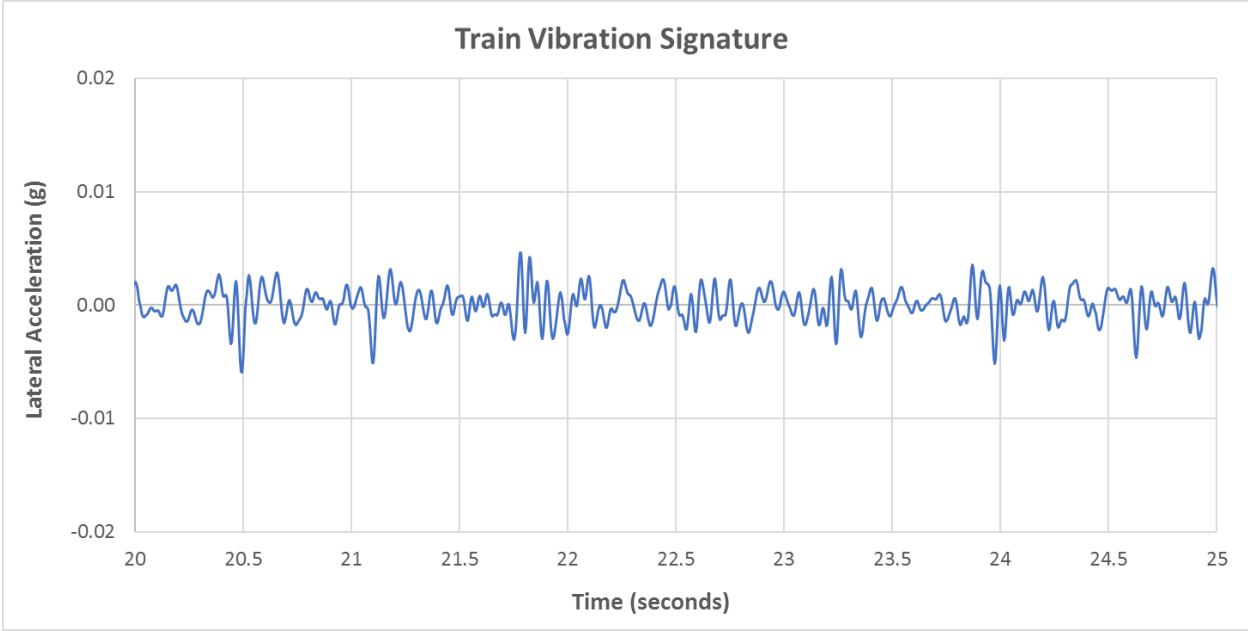
**3.2.3 Lateral Acceleration**

Lateral acceleration is directly measured by the CX1 sensor and characterizes the lateral vibration during live loads. As a scour pocket develops, an increase in lateral acceleration is expected. It is recommended to calculate the RMS values to eliminate any outliers due to random noise. The RMS is calculated using the following equation:

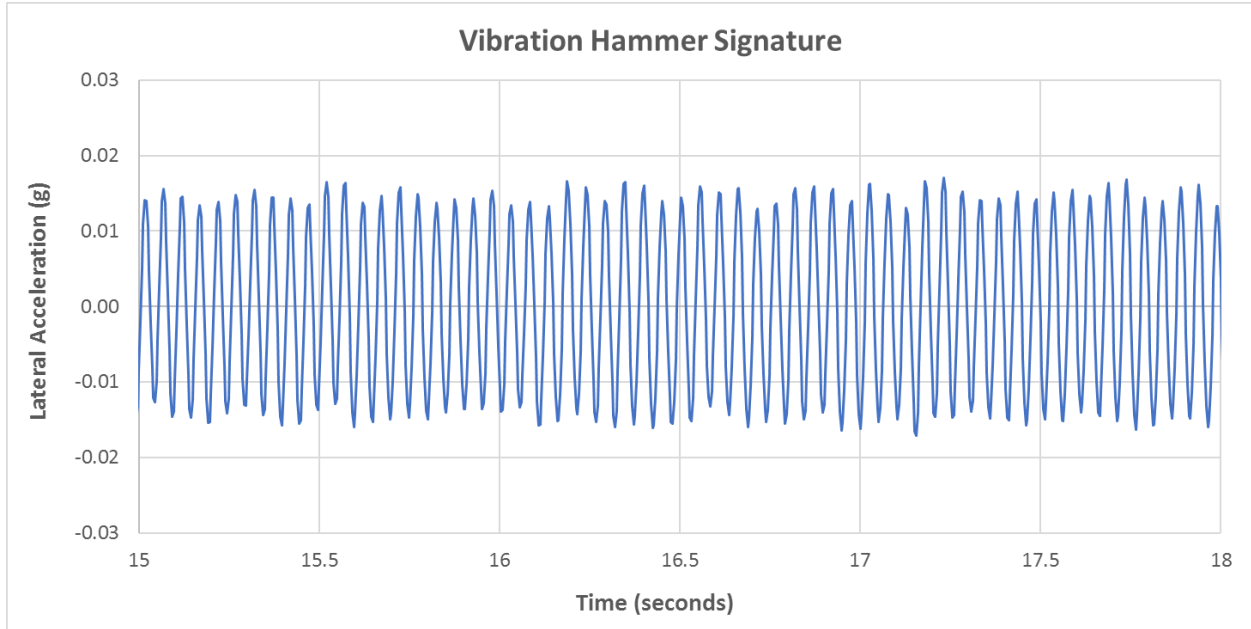
$$x_{RMS} = \sqrt{\frac{1}{n} + (x_1^2 + x_2^2 + \dots + x_n^2)}$$

Acceleration data is sampled at a much higher rate and is more prone to outliers causing false alarms. To make the best use of acceleration, a signal level analysis is recommended. Patterns in the data signature and frequency characteristics can be used to distinguish normal train loading from other types of loading. For example, train loading will produce vibrations with high variability and randomness as shown in Figure 8. Vibrations measured from construction equipment such as a vibration hammer will have a consistent high frequency as shown in Figure 9. Other types of equipment such as an impact hammer will have its own unique signature as shown in Figure 10.

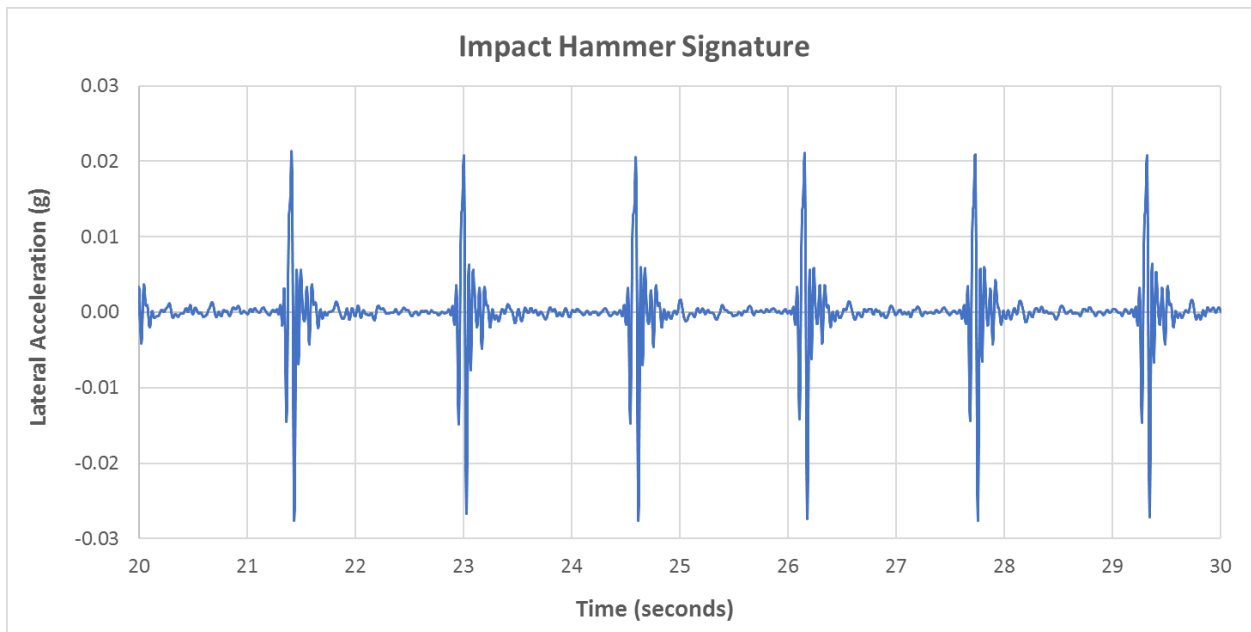
The acceleration data presented in this report is analyzed only using the epoch method. Time history and frequency domain analyses are tasks for future efforts outside the scope of this contact.



**Figure 9 – Example Response Signature from Train Loading**



**Figure 10 – Example Response Signature from Vibration Hammer**



**Figure 11 – Example Response Signature from Impact Hammer**

## 4. Monitoring Data Collected

---

### 4.1 BNSF Bridge 77.54, Nodway, MO

This bridge is a five span, 327-foot-long single-track bridge over the Nodaway river. The bridge was originally constructed in 1906. Between 1906 and 1922, the bridge underwent pier stabilization by means of pinning the piers; washouts and scour were chronic problems. One of the peculiar features of the Nodaway river is the large draining acreage and the subsequent amount of drift which enters the bridge at an angle. In 2007 a high-water event caused a 10 ft. scour hole to develop around Pier 2. The pier was stabilized and grouted to prevent settlement.

Piers 2, 3, 4, and 5 are each instrumented with a CX1 monitoring device. The system has been in place since September 2013.

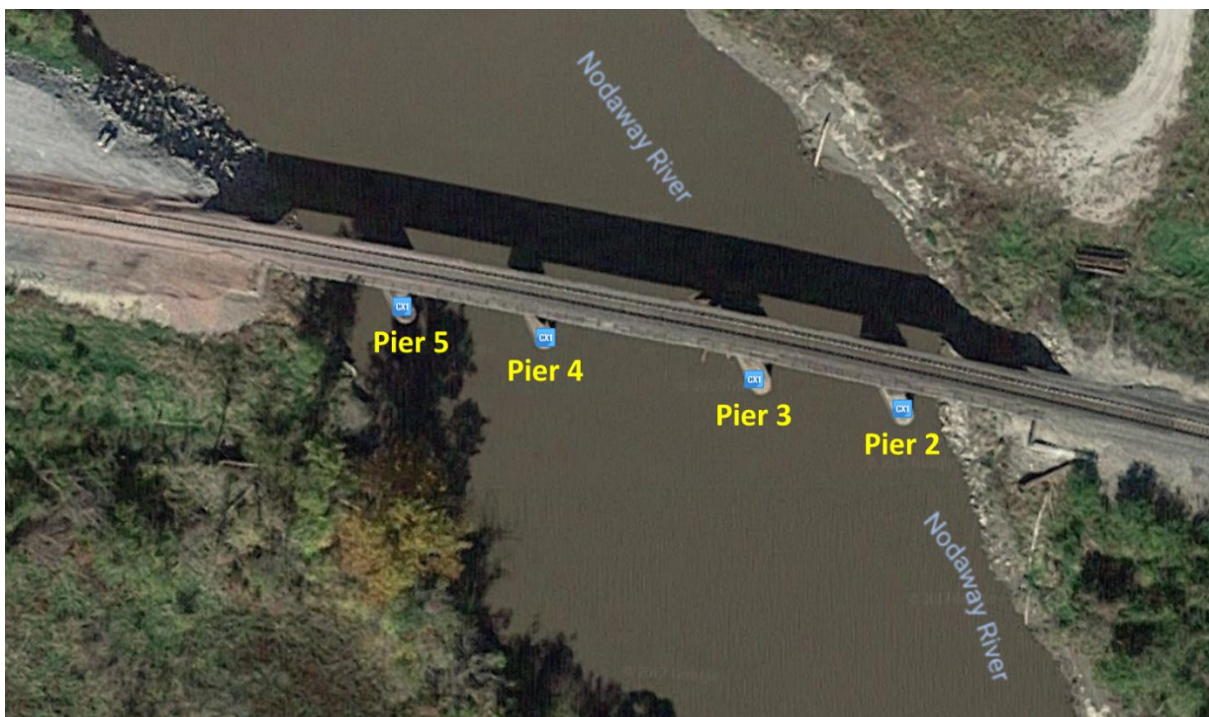


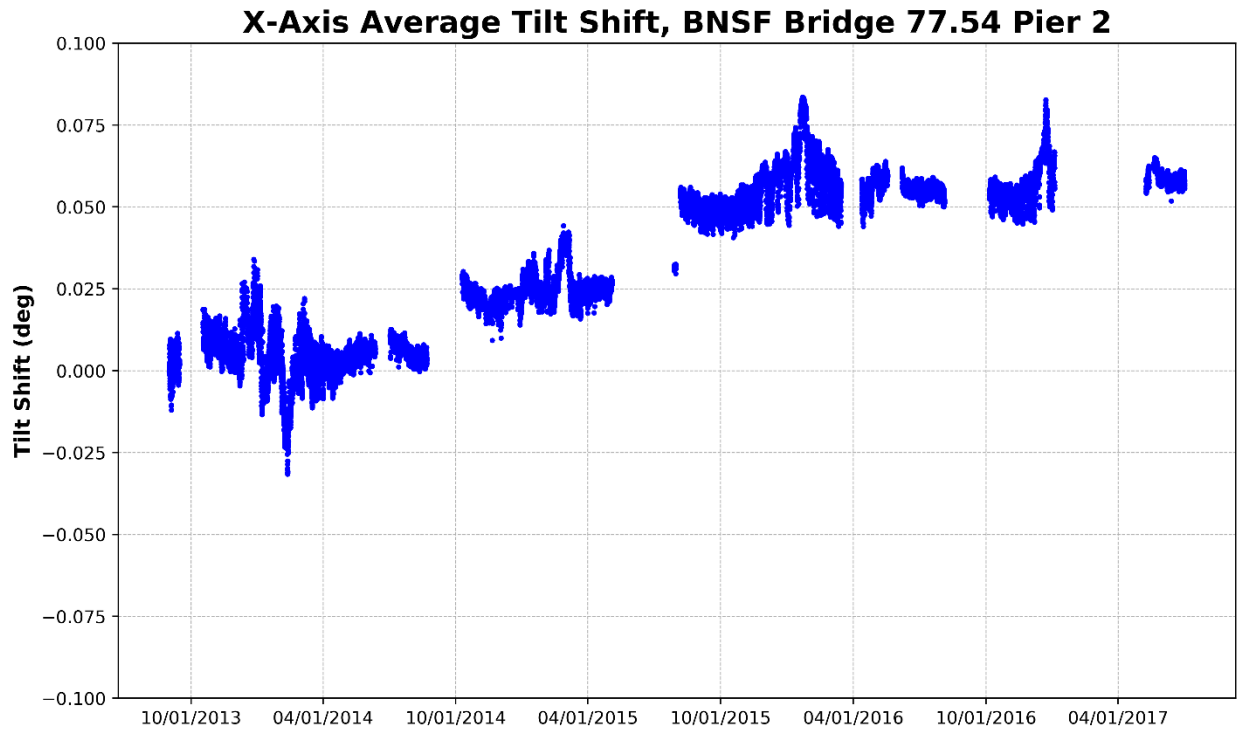
Figure 12 – BNSF Bridge 77.54, Nodaway, MO

#### 4.1.1 Average Tilt

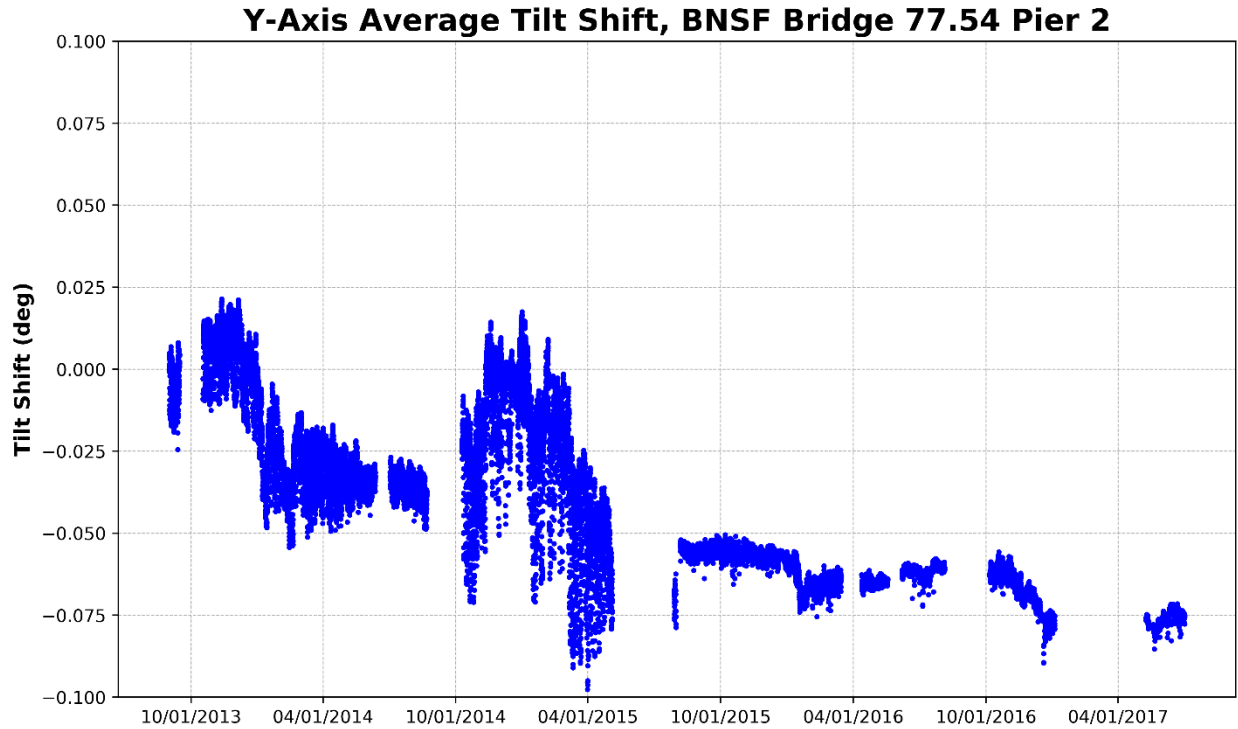
The average tilt measurements collected for Piers 2, 3, 4, and 5 are shown in [Figure 12](#) through [Figure 19](#). The measurements recorded in the sensor X-Axis are parallel to the track, and measurements in the sensor Y-Axis are perpendicular to the track.

Since September 2013, Pier 2 has shifted over 0.05 degrees parallel to the track and 0.075 degrees perpendicular to the track. This magnitude of tilt is likely associated with 0.25 to 0.50 inches of settlement. Pier 2 has shown indications of changing soil conditions. Given the scour history of Pier 2, an underwater inspection is recommended.

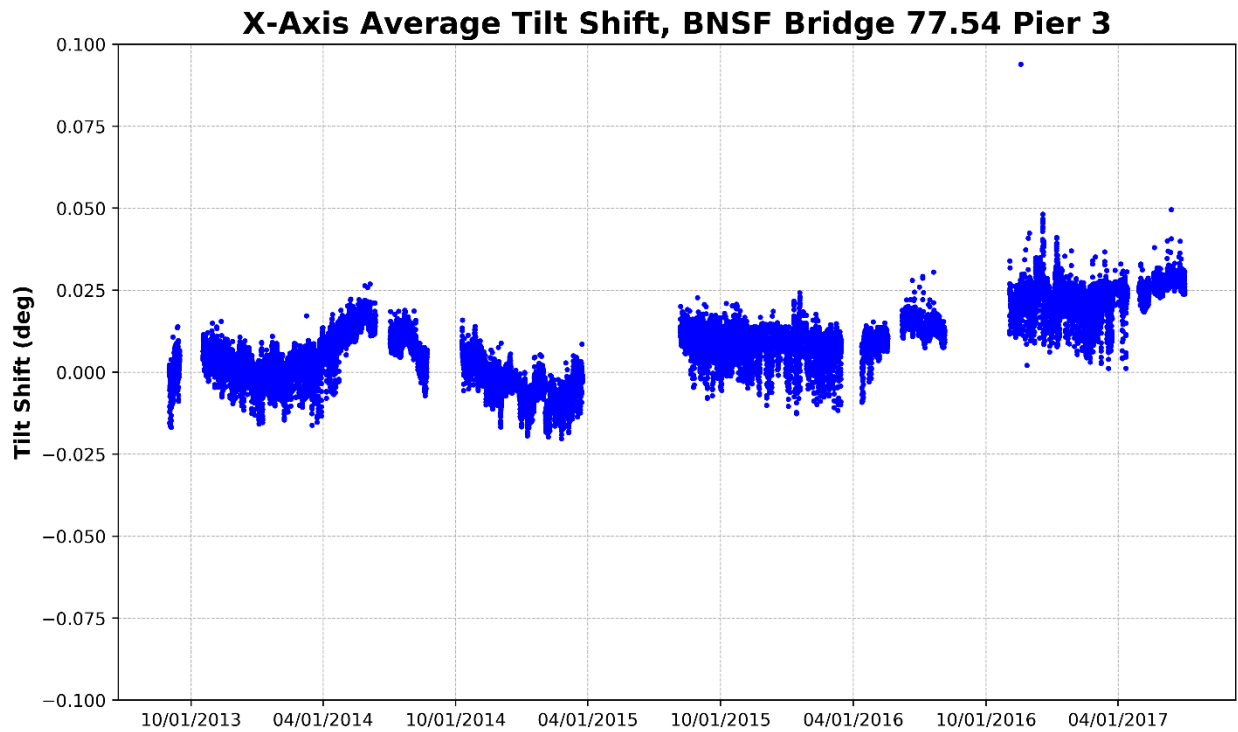
Pier 5 has shown much more variability compared to the other piers. The large changes throughout the course of the year are more indicative of changing temperatures and thermal expansion/contraction.



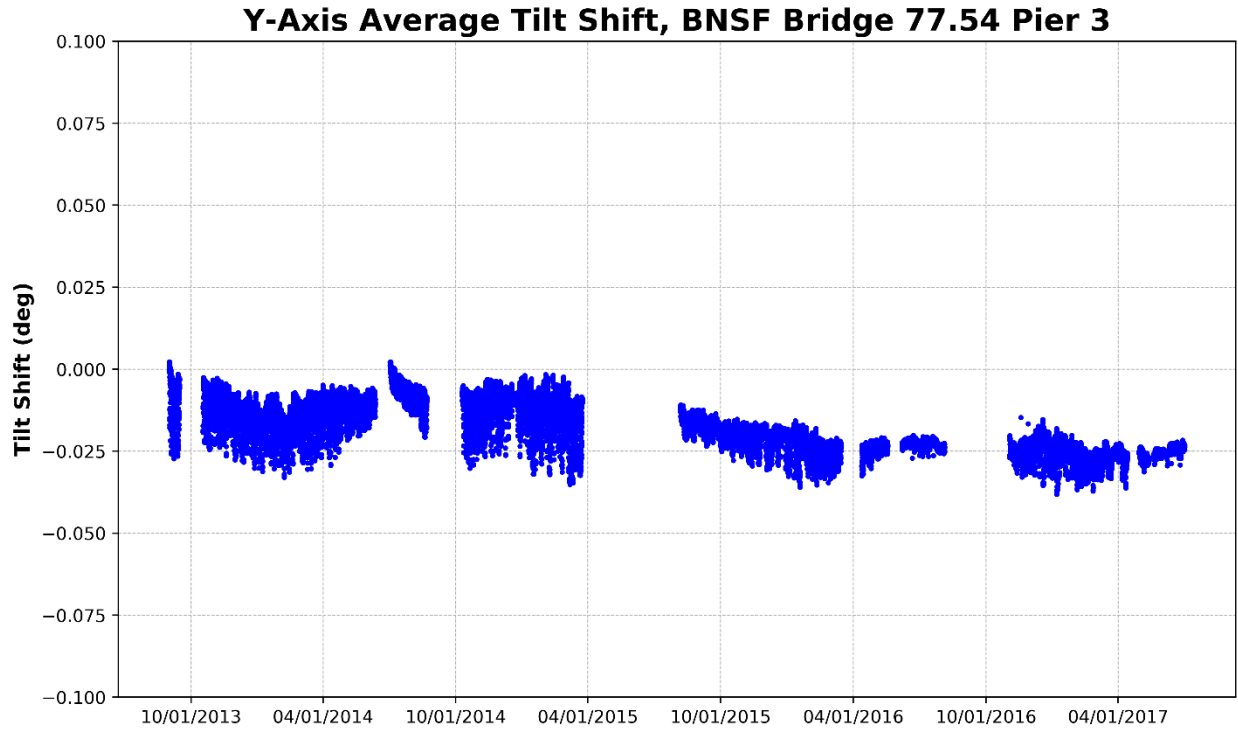
**Figure 13 – Pier 2, X-Axis Average Tilt (Parallel to Track)**



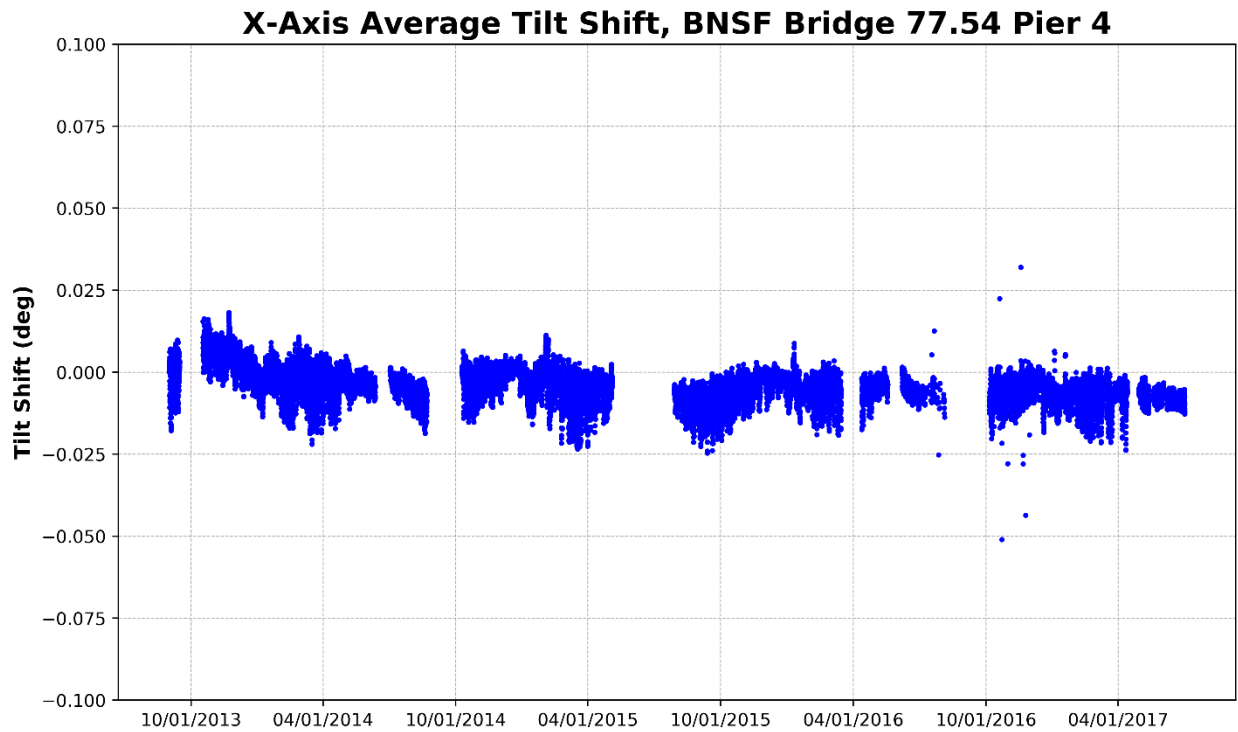
**Figure 14 – Pier 2, Y-Axis Average Tilt (Perpendicular to Track)**



**Figure 15 – Pier 3, X-Axis Average Tilt (Parallel to Track)**

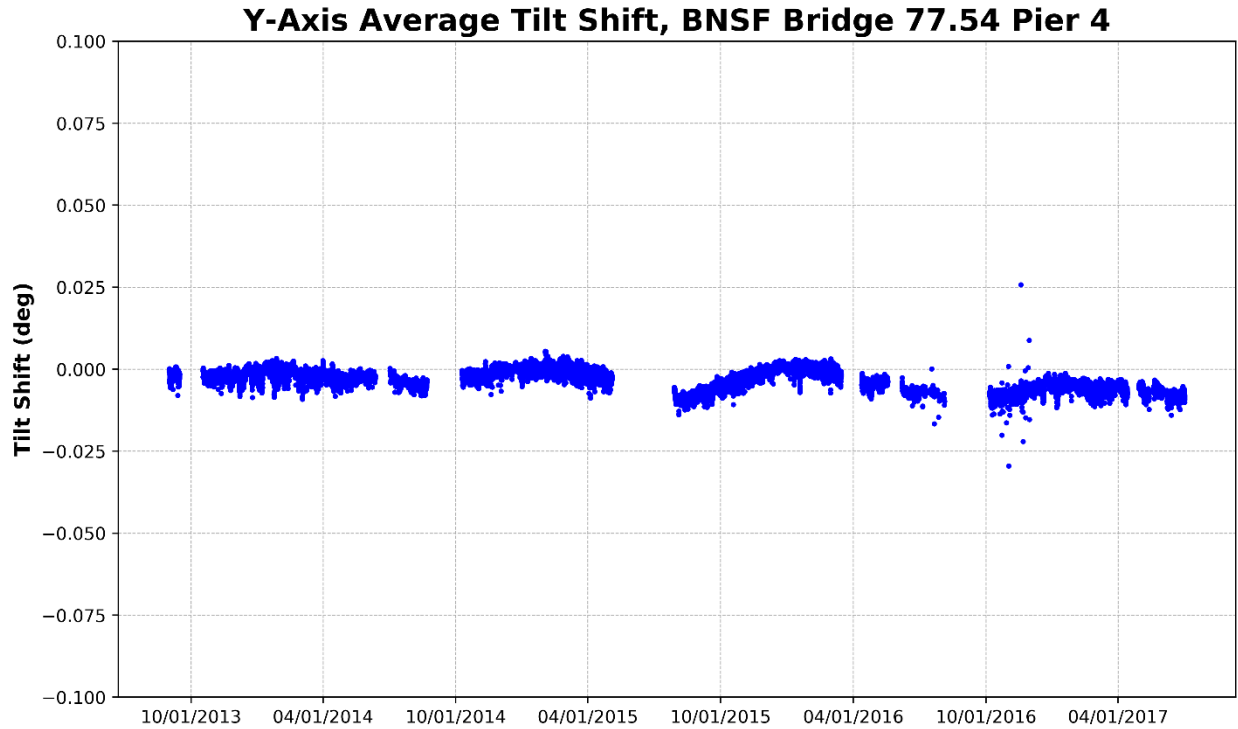


**Figure 16 – Pier 3, Y-Axis Average Tilt (Perpendicular to Track)**

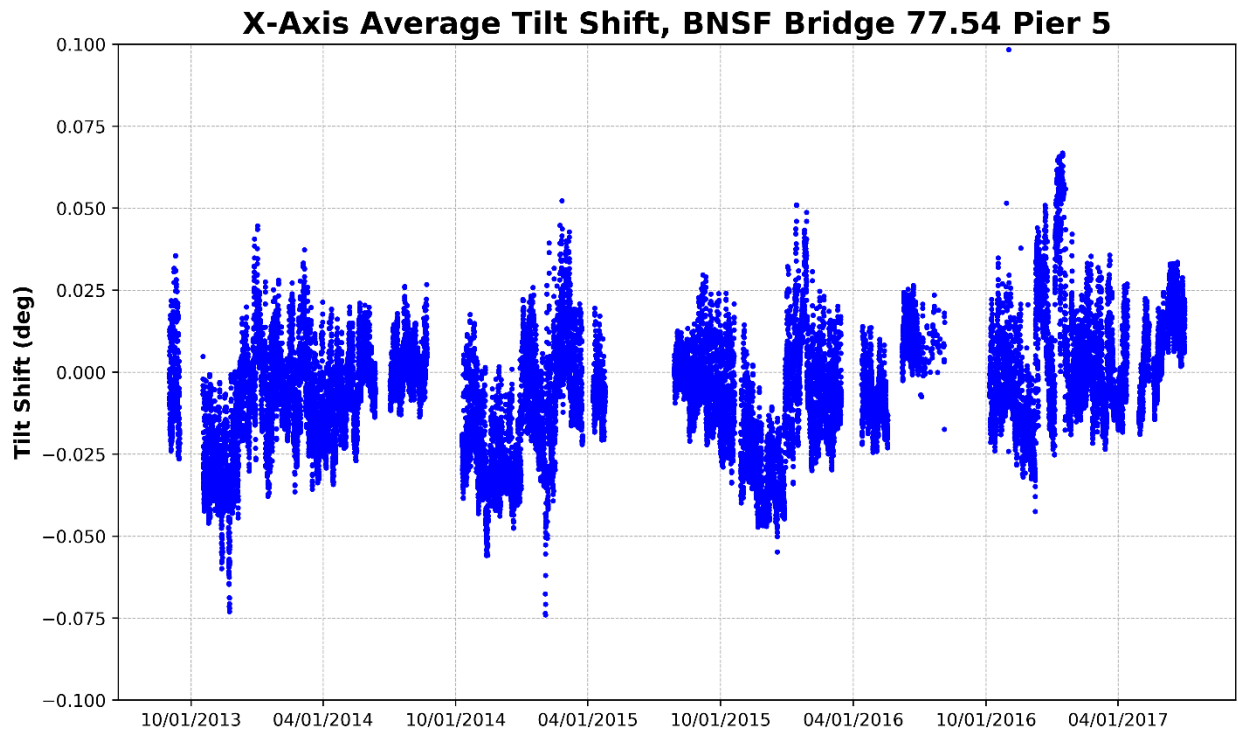


**Figure 17 – Pier 4, X-Axis Average Tilt (Parallel to Track)**

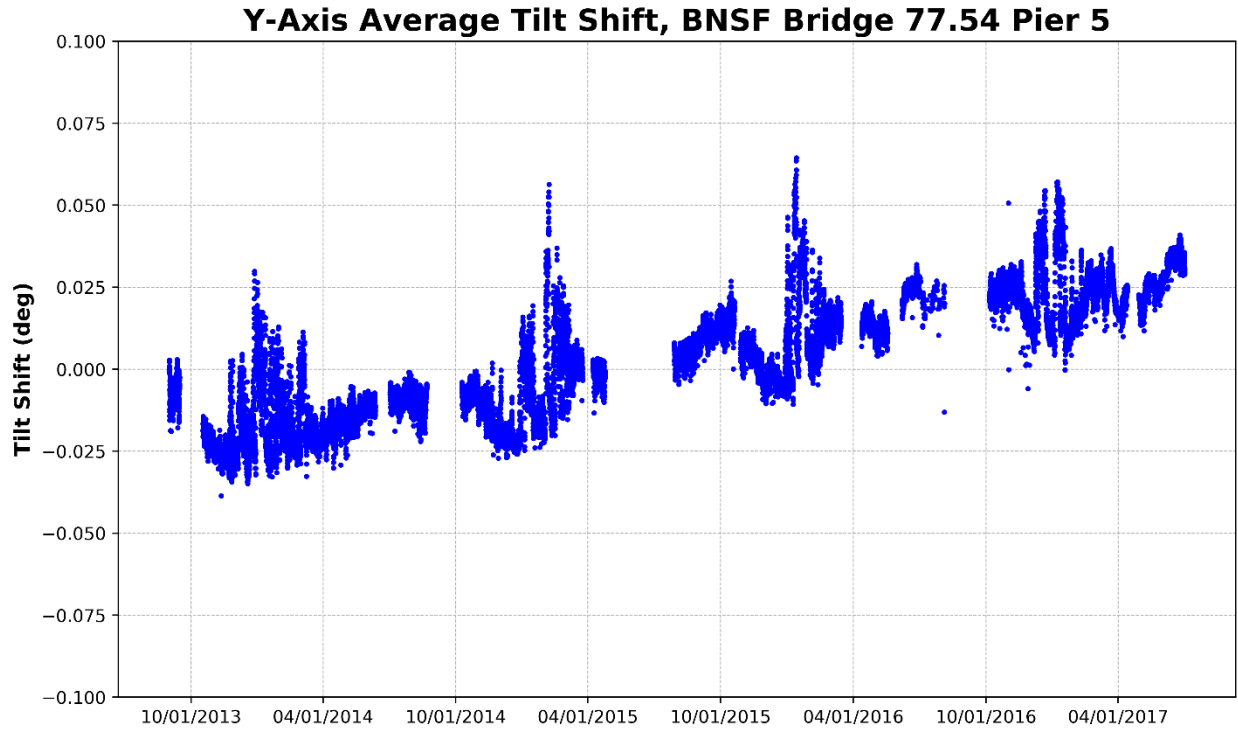




**Figure 18 – Pier 4, Y-Axis Average Tilt (Perpendicular to Track)**



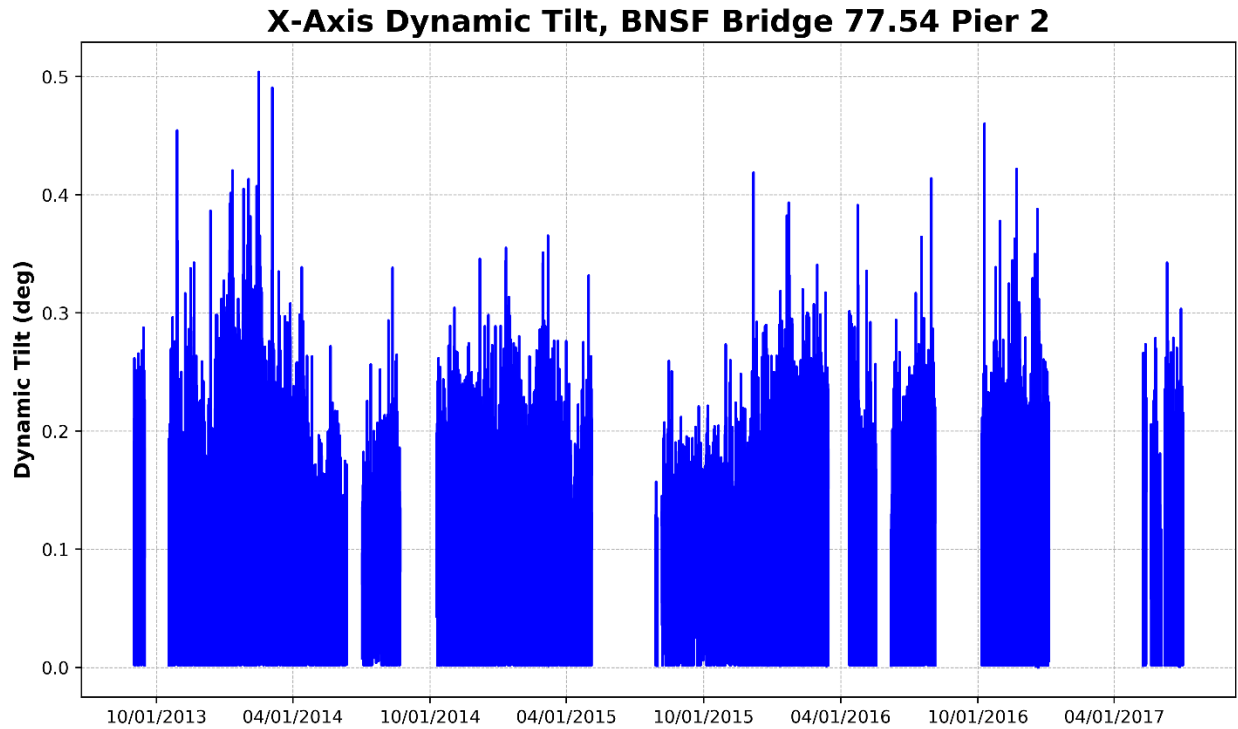
**Figure 19 – Pier 5, X-Axis Average Tilt (Parallel to Track)**



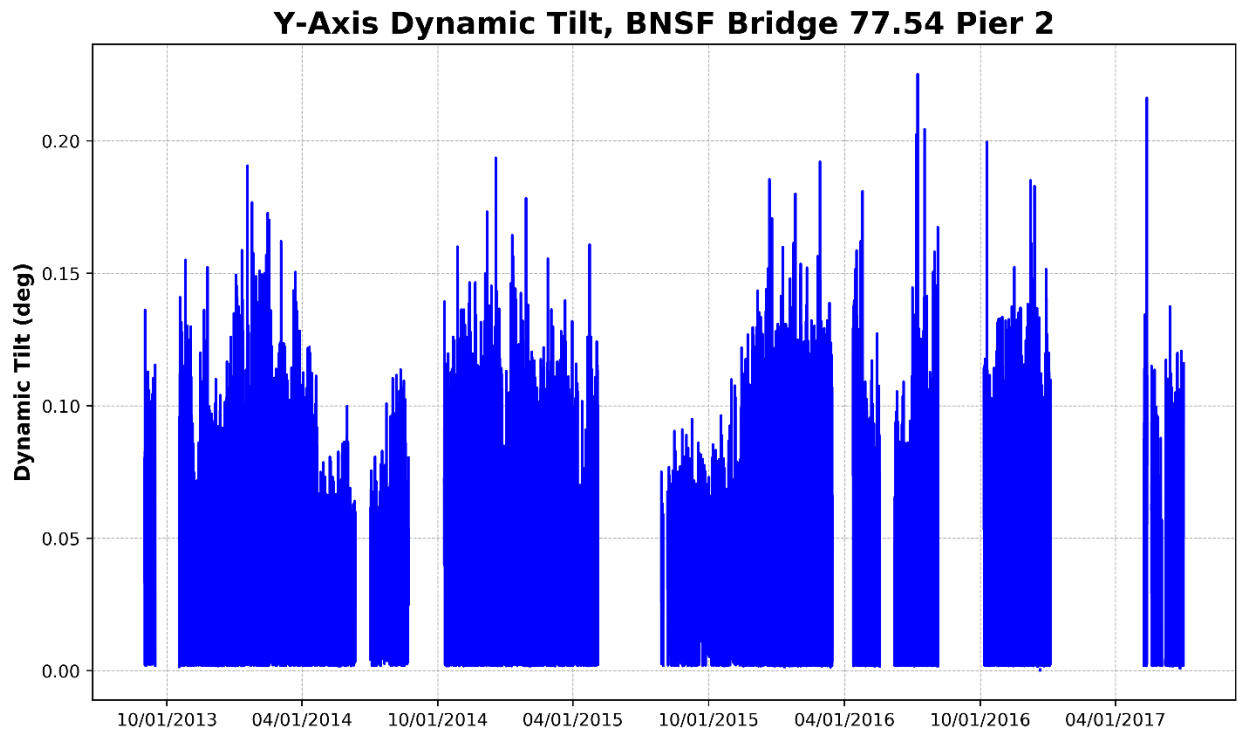
**Figure 20 – Pier 5, Y-Axis Average Tilt (Perpendicular to Track)**

#### **4.1.2 Dynamic Tilt**

The dynamic tilt measurements are shown in [Figure 20](#) through [Figure 27](#). The measurements for Pier 2 and Pier 3 have remained steady for both piers in both directions (perpendicular and parallel to track). The dynamic tilt of Pier 4 and Pier 5 have shown a tendency for larger motion starting in 2016 compared to previous years. This is a possible indicator of changing soil conditions, but the change in response is relatively small and inconsistent. Further monitoring of Piers 4 and 5 is recommended to observe the trend.

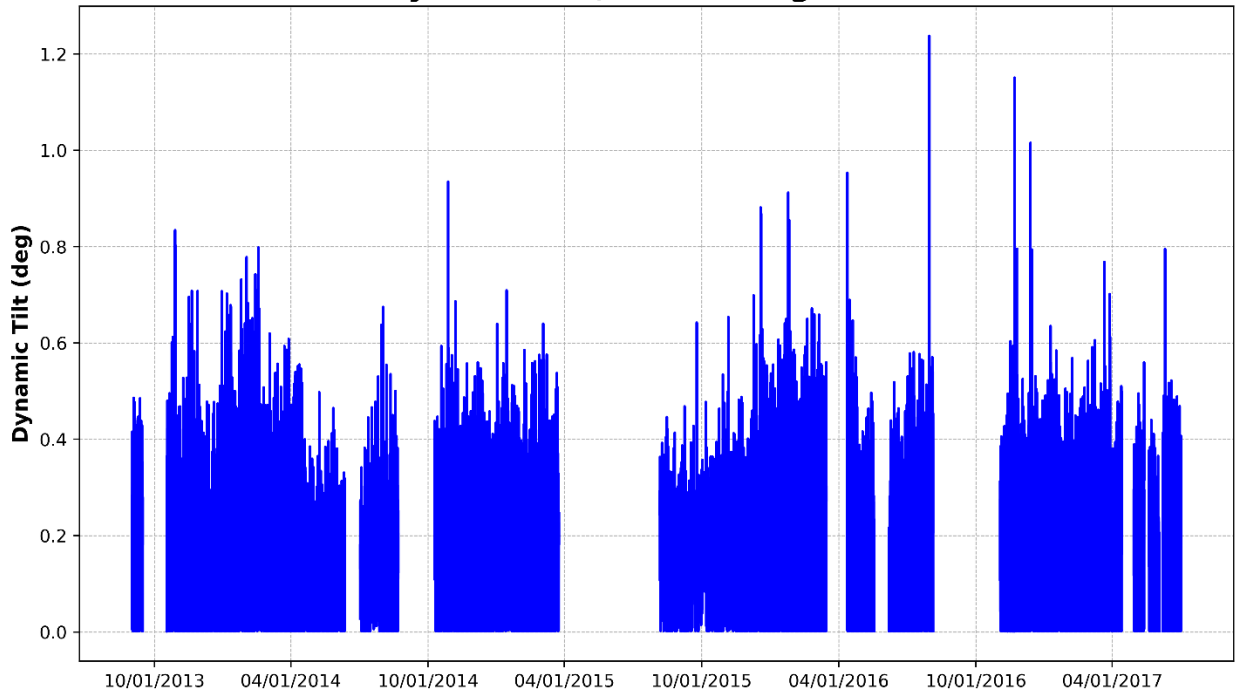


**Figure 21 – Pier 2, X-Axis Dynamic Tilt (Parallel to Track)**



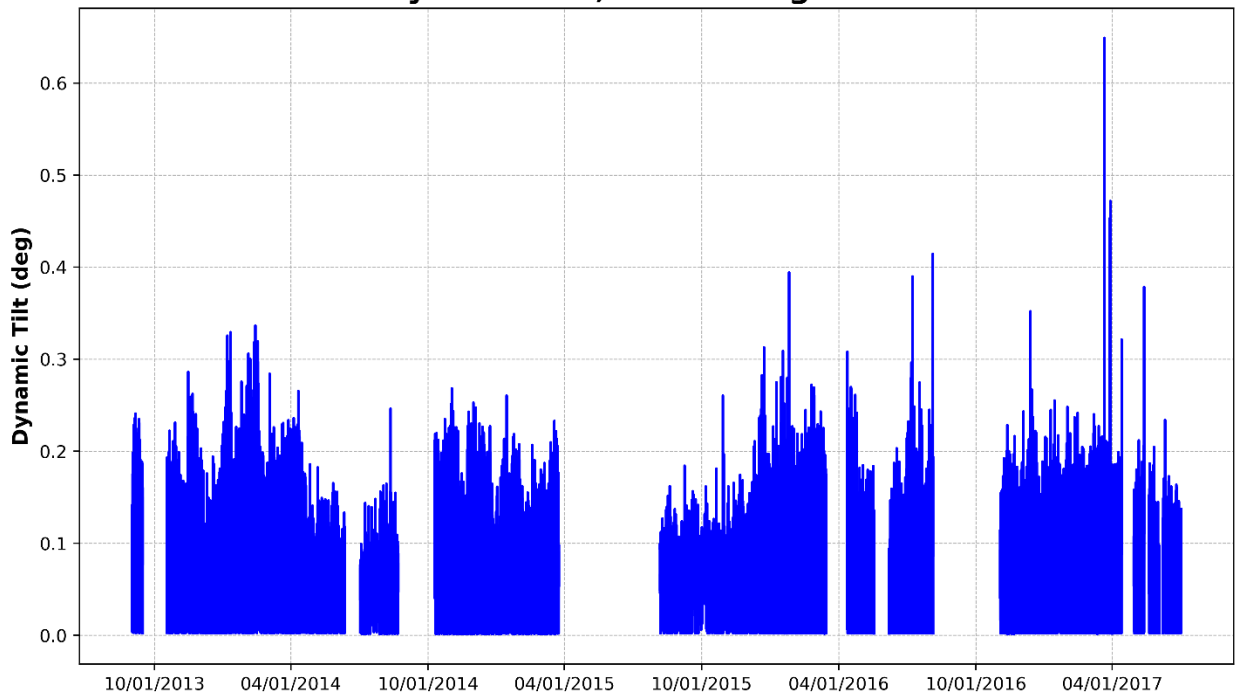
**Figure 22 – Pier 2, Y-Axis Dynamic Tilt (Perpendicular to Track)**

**X-Axis Dynamic Tilt, BNSF Bridge 77.54 Pier 3**

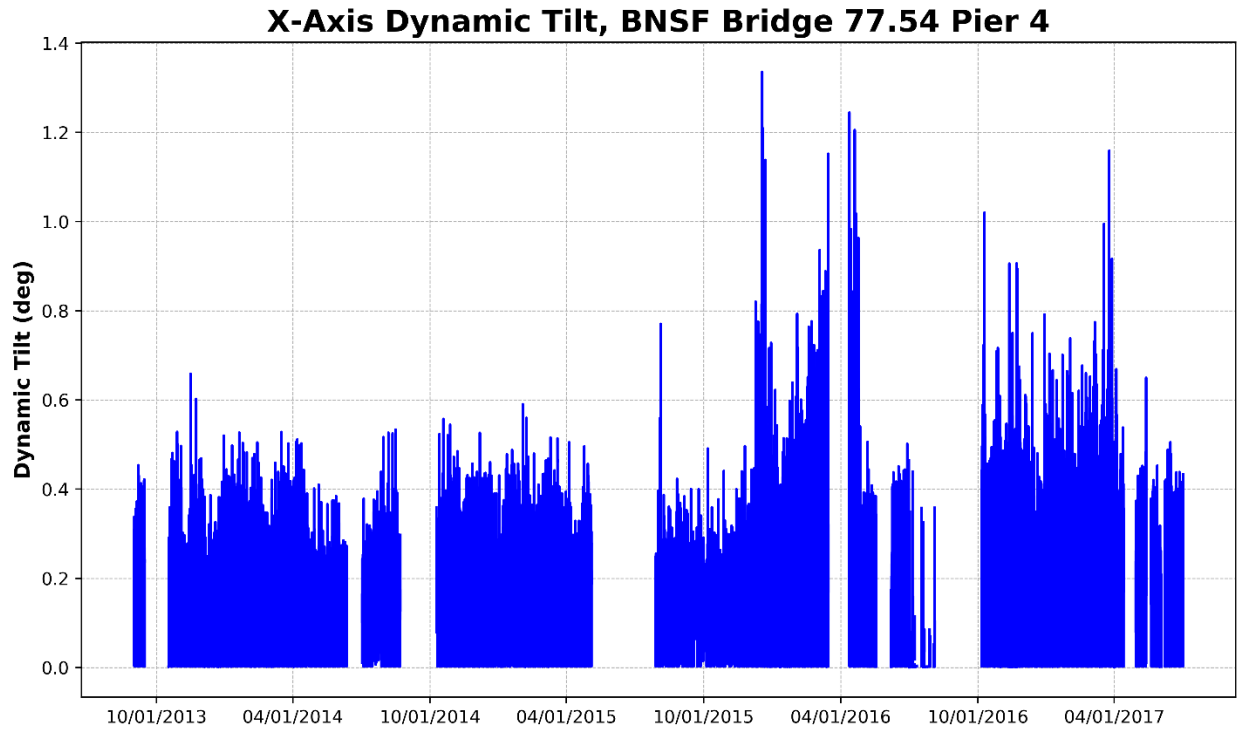


**Figure 23 – Pier 3, X-Axis Dynamic Tilt (Parallel to Track)**

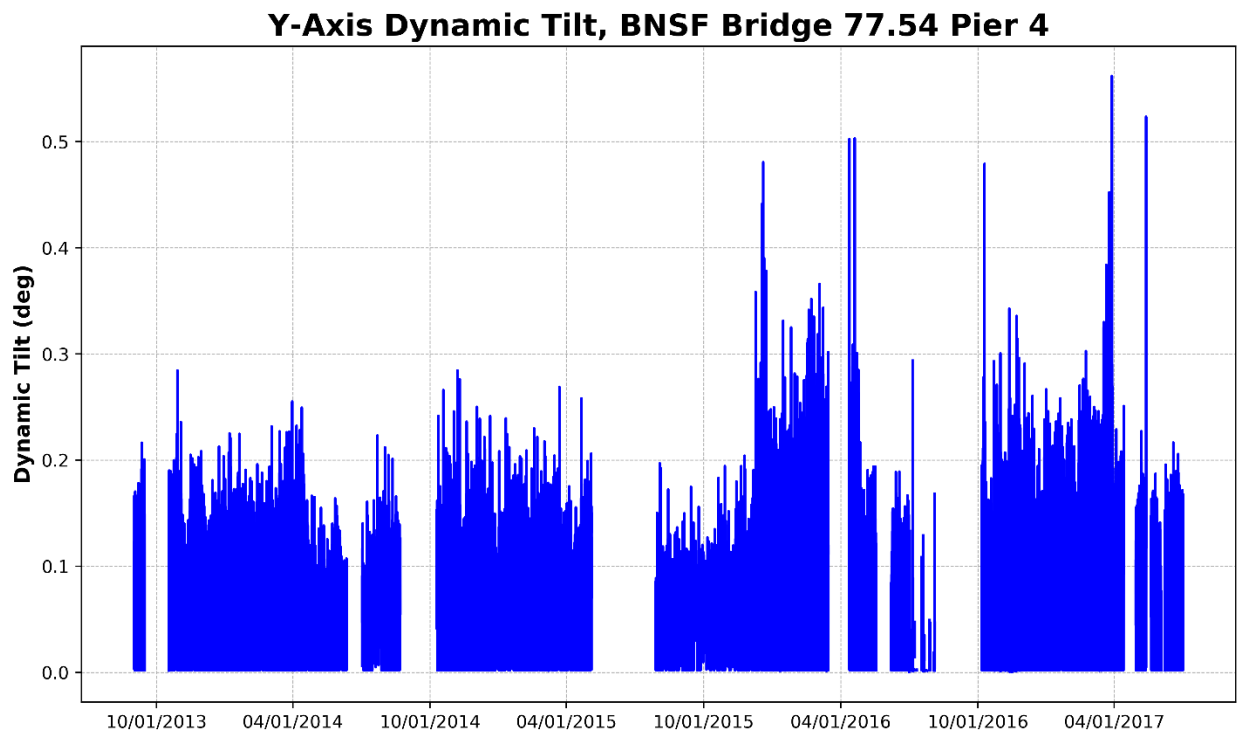
**Y-Axis Dynamic Tilt, BNSF Bridge 77.54 Pier 3**



**Figure 24 – Pier 3, Y-Axis Dynamic Tilt (Perpendicular to Track)**

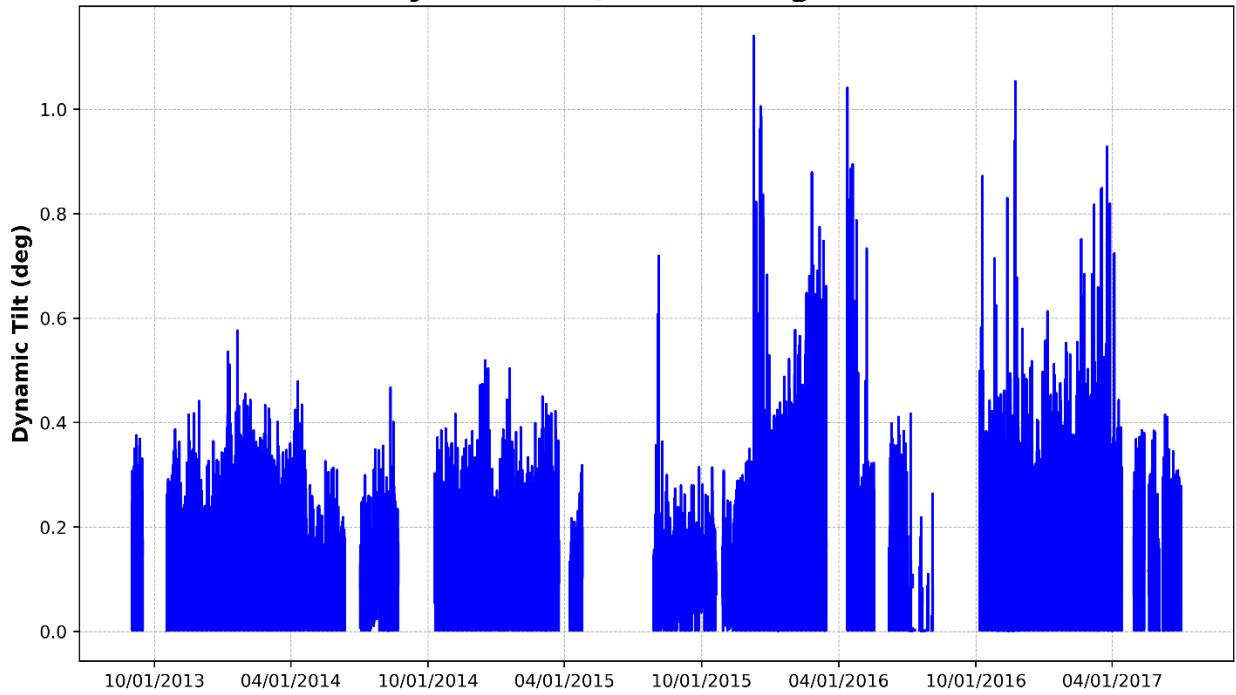


**Figure 25 – Pier 4, X-Axis Dynamic Tilt (Parallel to Track)**



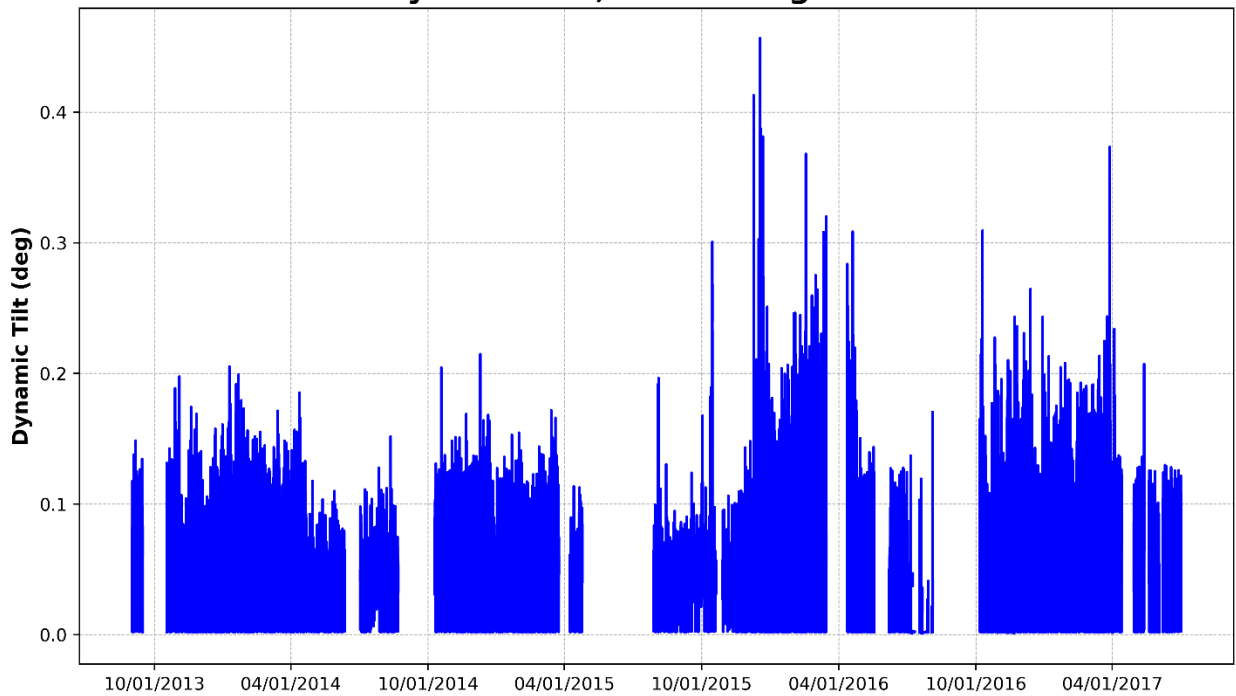
**Figure 26 – Pier 4, Y-Axis Dynamic Tilt (Perpendicular to Track)**

**X-Axis Dynamic Tilt, BNSF Bridge 77.54 Pier 5**



**Figure 27 – Pier 5, X-Axis Dynamic Tilt (Parallel to Track)**

**Y-Axis Dynamic Tilt, BNSF Bridge 77.54 Pier 5**



**Figure 28 – Pier 5, Y-Axis Dynamic Tilt (Perpendicular to Track)**

### 4.1.3 Lateral Acceleration

The acceleration measurements are shown in Figure 28 through Figure 35. Pier 2 and Pier 3 do not show any indications of increasing vibrations. The vibrations of Pier 4 and Pier 5 have shown a tendency for larger motion starting in 2016 compared to previous years. This is similar to the trend observed for dynamic tilt.

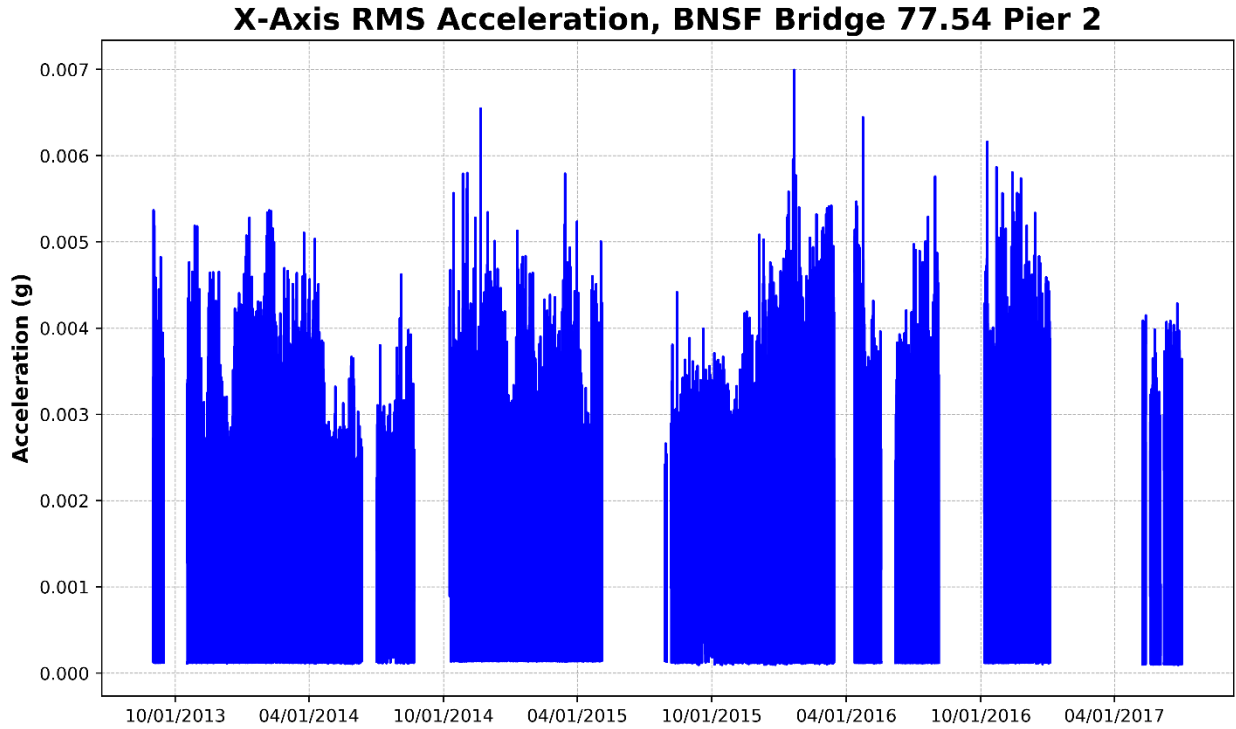
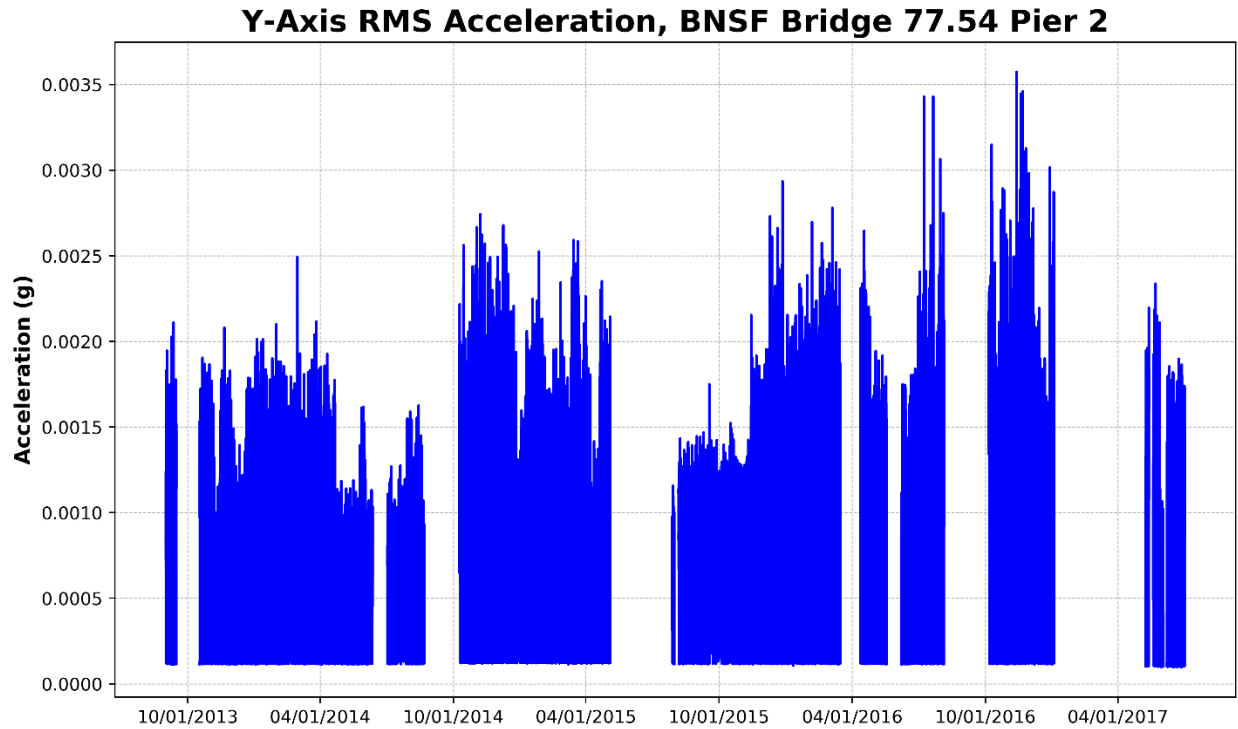
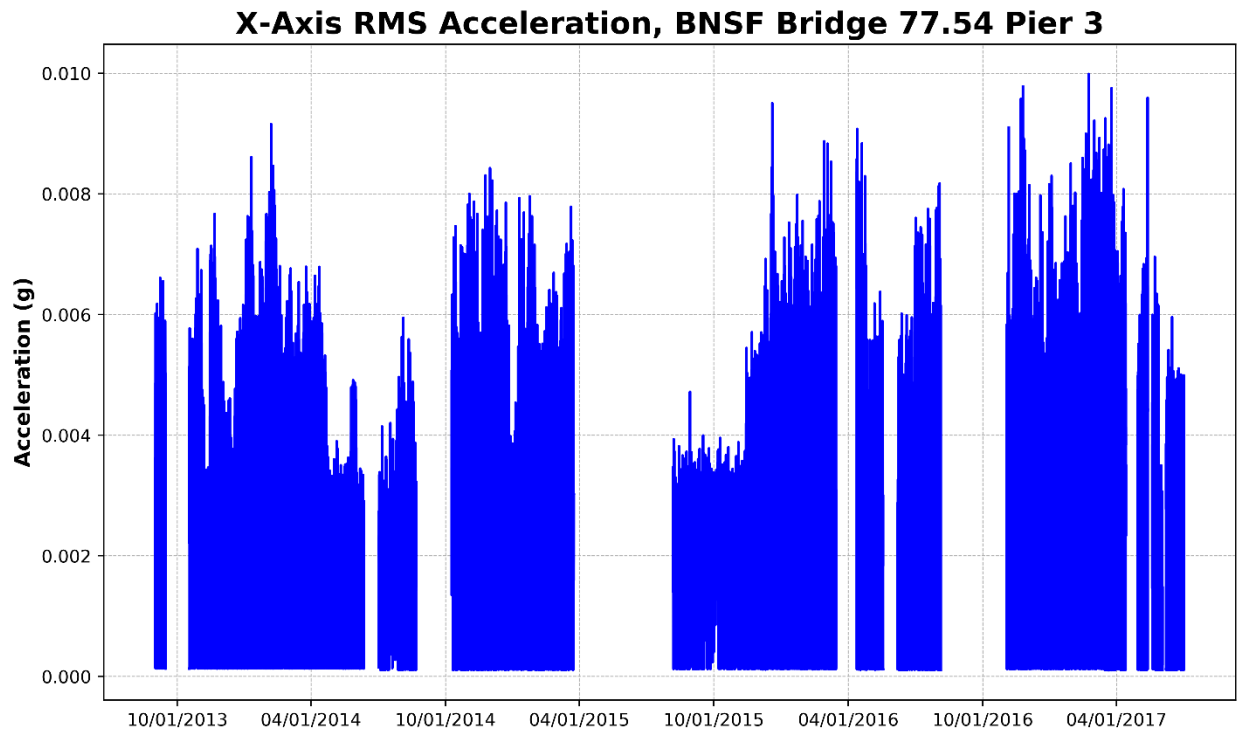


Figure 29 – Pier 2, X-Axis RMS Acceleration (Parallel to Track)

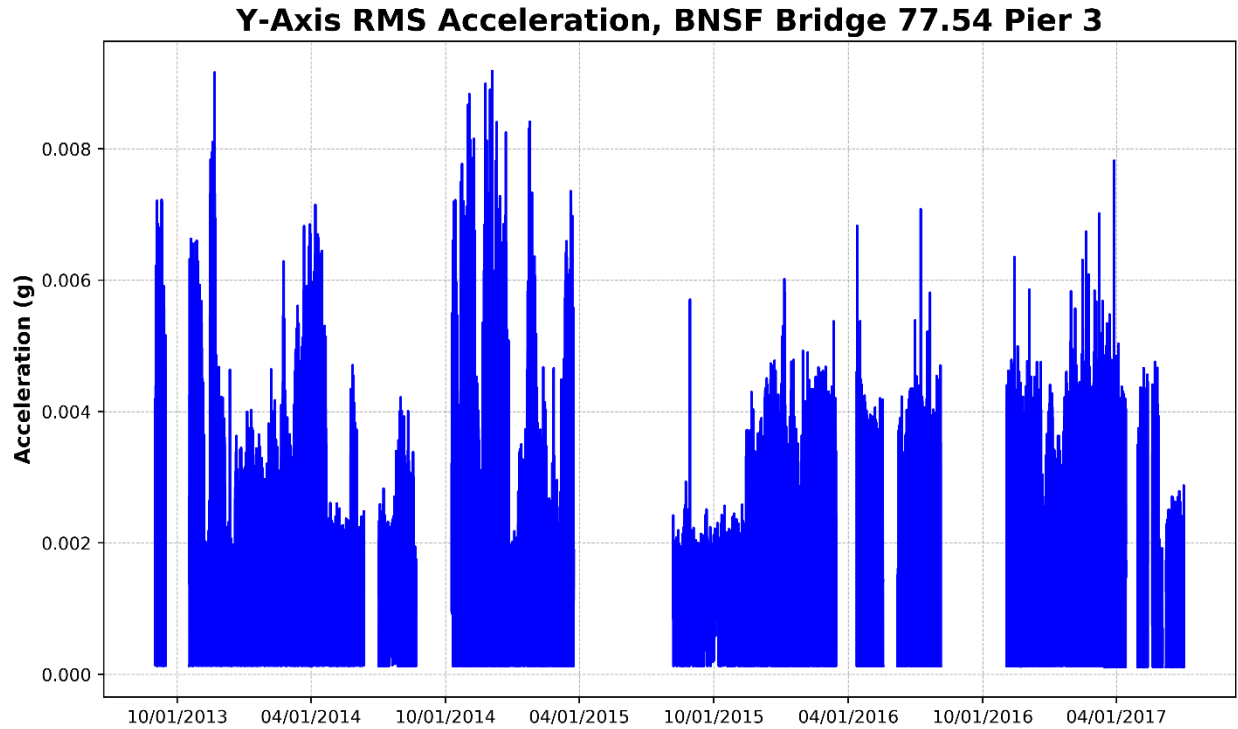


**Figure 30 – Pier 2, Y-Axis RMS Acceleration (Perpendicular to Track)**

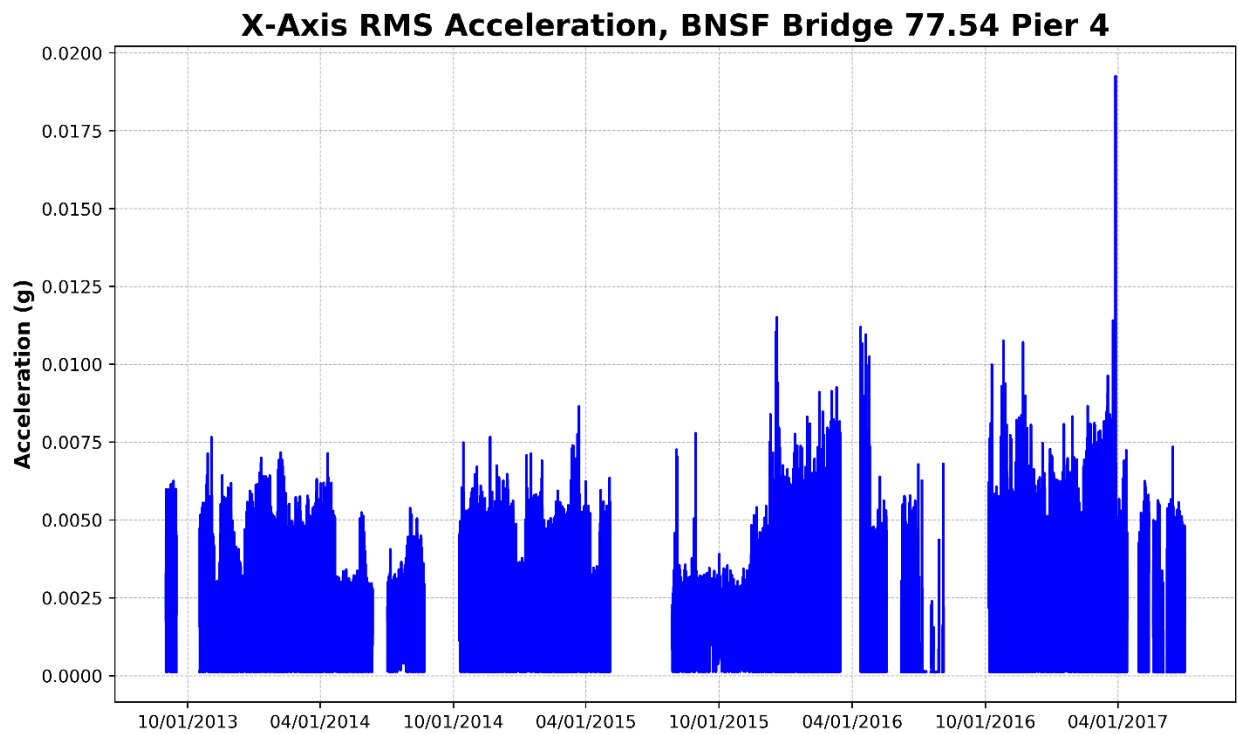


**Figure 31 – Pier 3, X-Axis RMS Acceleration (Parallel to Track)**

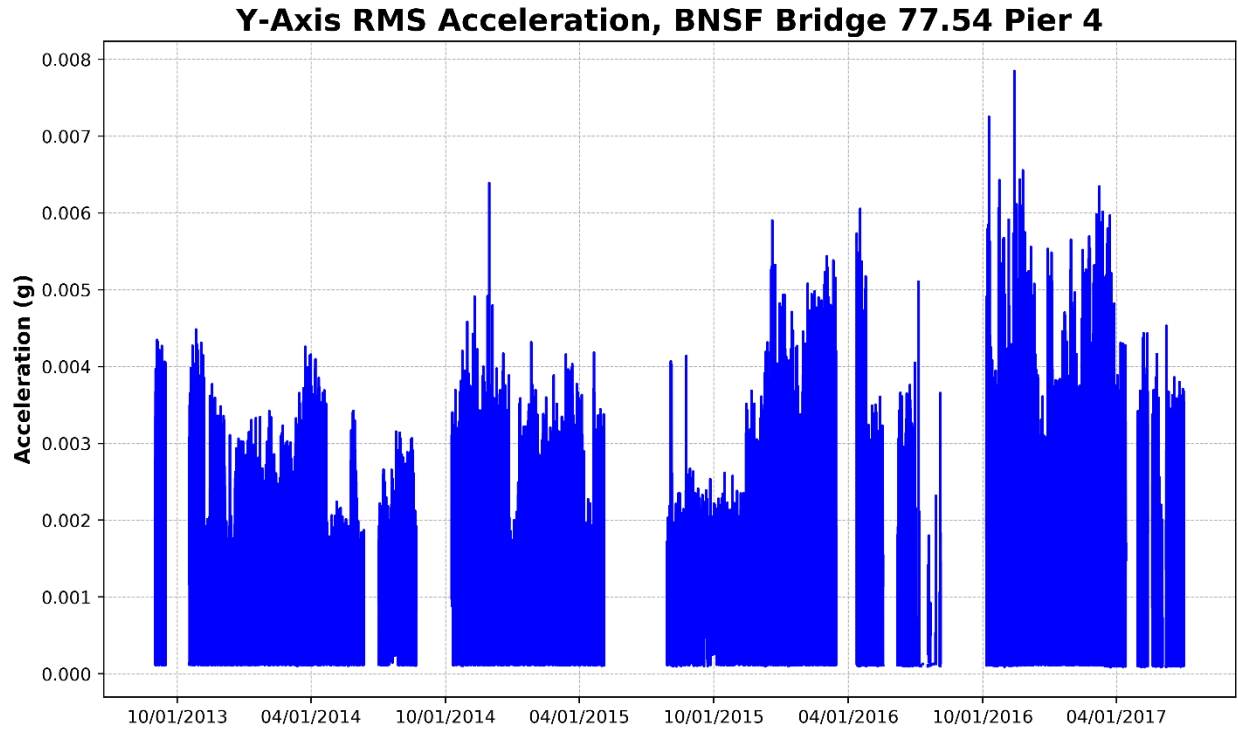




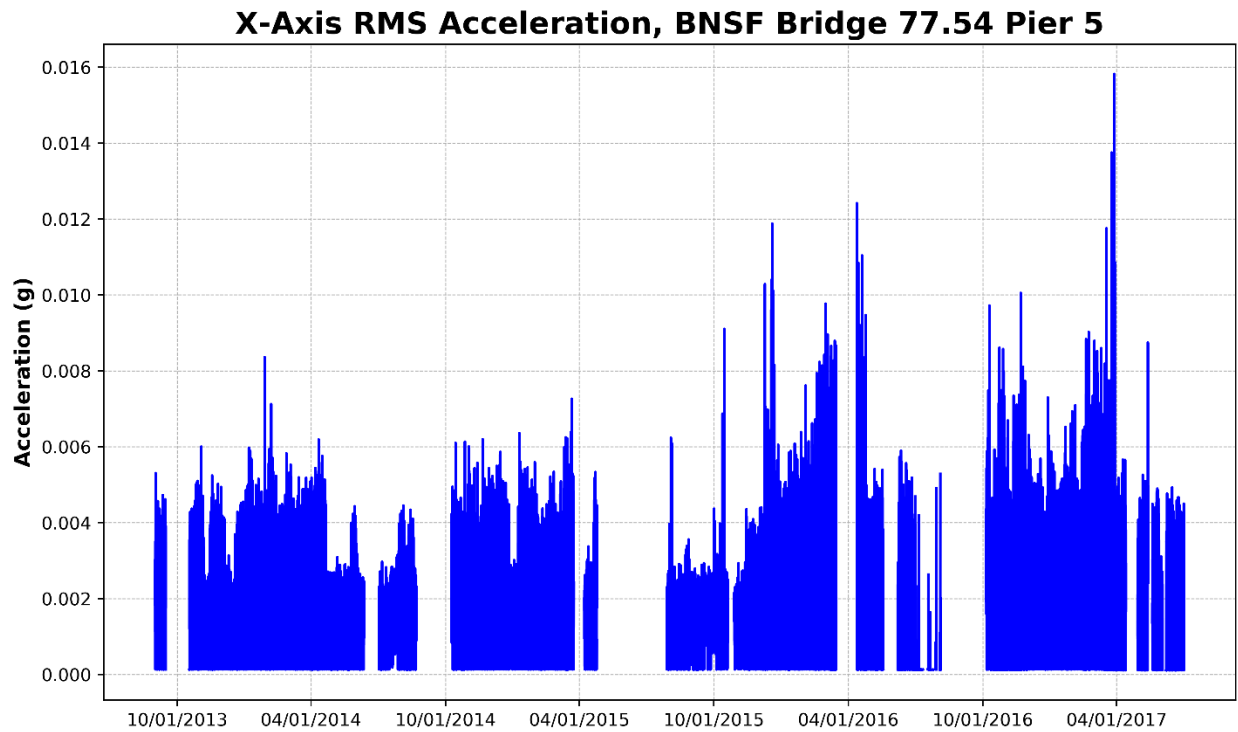
**Figure 32 – Pier 3, Y-Axis RMS Acceleration (Perpendicular to Track)**



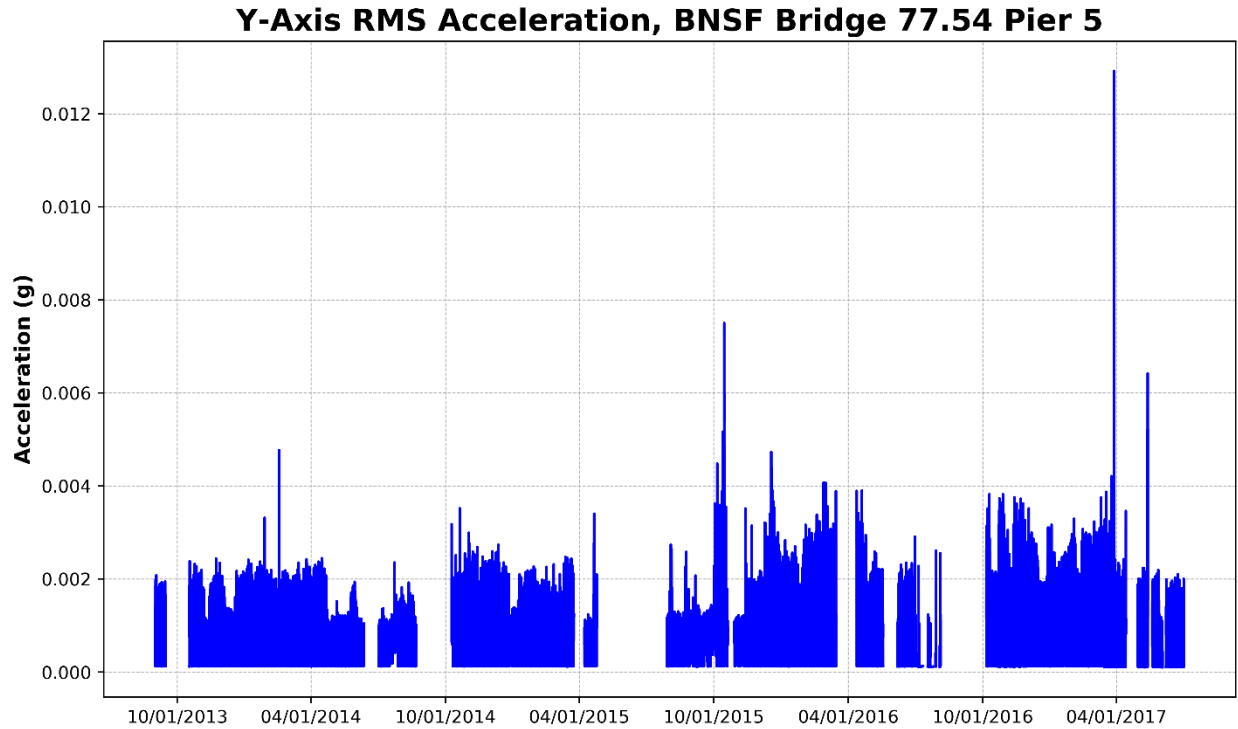
**Figure 33 – Pier 4, X-Axis RMS Acceleration (Parallel to Track)**



**Figure 34 – Pier 4, Y-Axis RMS Acceleration (Perpendicular to Track)**



**Figure 35 – Pier 5, X-Axis RMS Acceleration (Parallel to Track)**



**Figure 36 – Pier 5, Y-Axis RMS Acceleration (Perpendicular to Track)**

#### **4.2 BNSF Bridge 279.7, Gorin, MO (Fabius)**

This three-span, 264 ft.-long, double track bridge is located near Gorin, MO. This bridge has a history of scour challenges along with sheet pile, grouting and riprap repairs. The piers also collect a significant amount of drift during high-water events. The pier foundations are masonry elements on relatively short timber piles. The East and West Piers are both instrumented with one CX1 sensor each as shown in [Figure 36](#). The monitoring system on this bridge has been collecting data since February 2016.

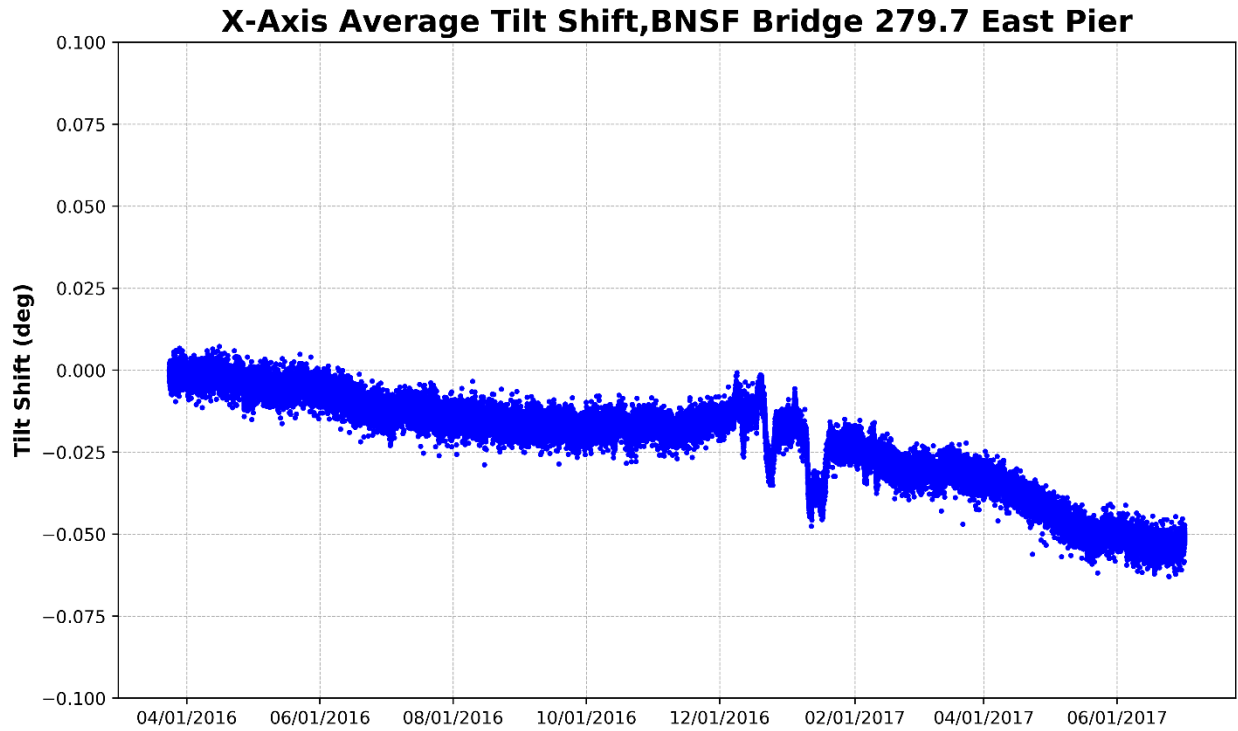


**Figure 37 – BNSF Bridge 279.7 Sensor Locations**

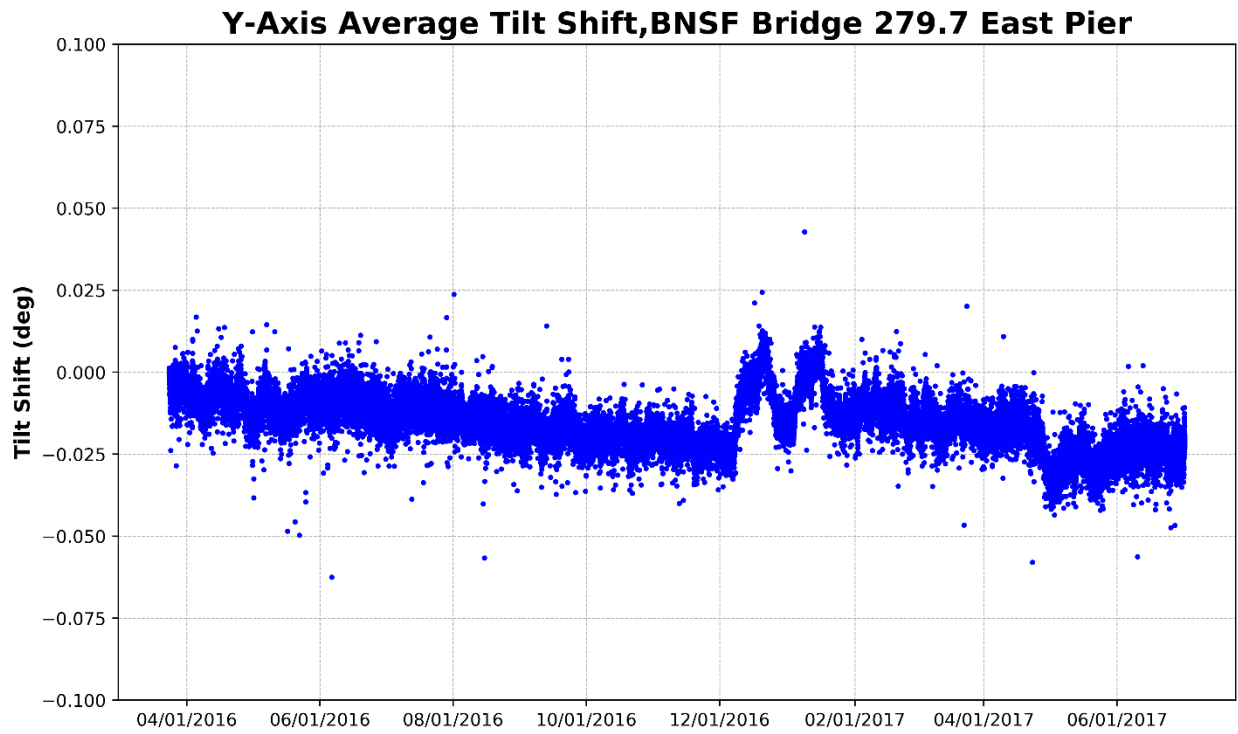
#### **4.2.1 Average Tilt**

The average tilt measurements collected for the east and west pier are shown in [Figure 37](#) through [Figure 40](#). The East Pier has shifted over 0.05 degrees perpendicular to the track, indicating possible differential settlement of 0.25 inches. It is recommended to continue monitoring the East Pier for further movement that could result in disruptions to railroad operations.

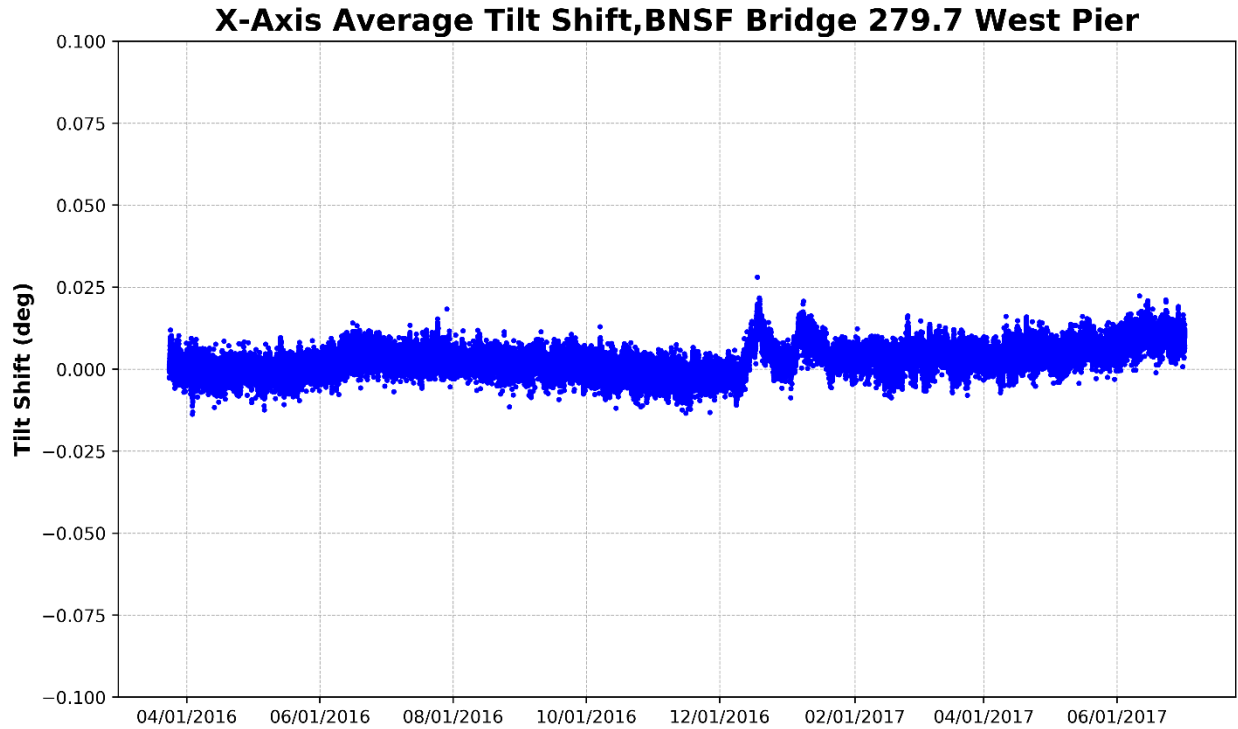
Overall, the West Pier has been much more stable than the East Pier. All average tilt measurements for the West Pier have stayed within 0.025 degrees of the starting point, indicating no perceptible movement.



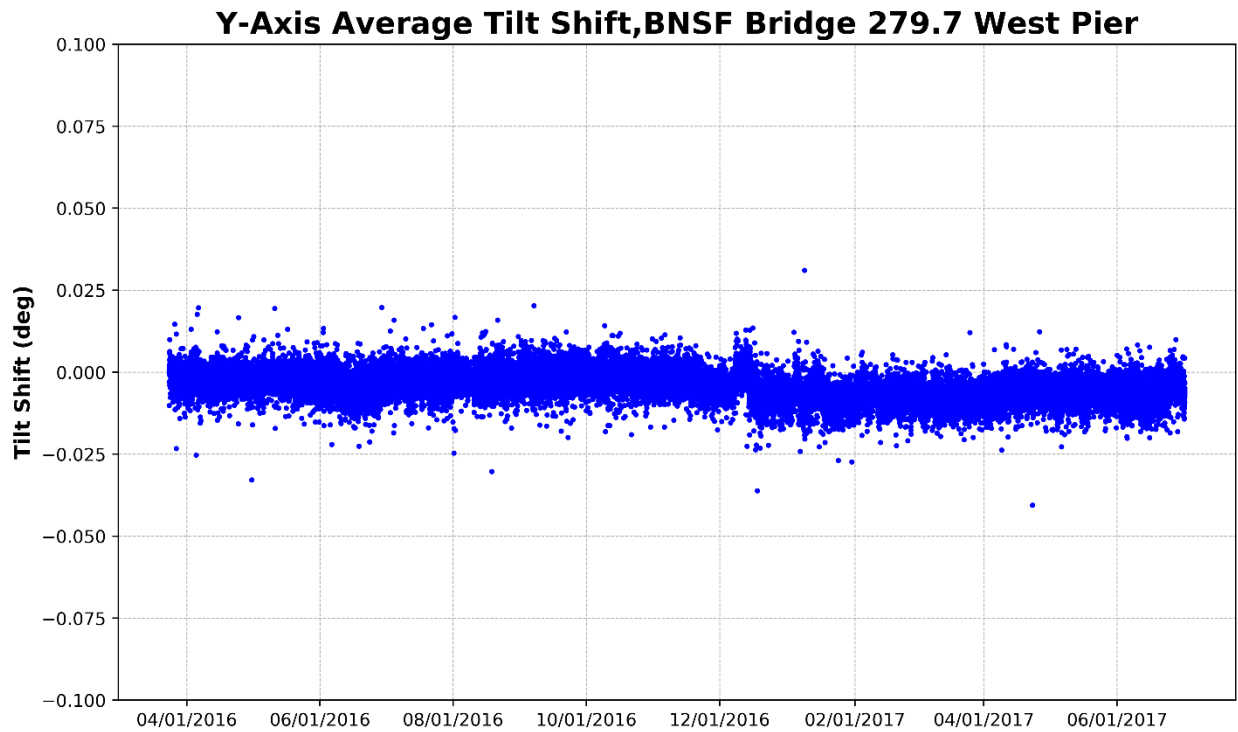
**Figure 38 – East Pier, X-Axis Average Tilt (Perpendicular to Track)**



**Figure 39 – East Pier, Y-Axis Average Tilt (Parallel to Track)**



**Figure 40 – West Pier, X-Axis Average Tilt (Perpendicular to Track)**



**Figure 41 – West Pier, Y-Axis Average Tilt (Parallel to Track)**

#### 4.2.2 Dynamic Tilt

The dynamic tilt measurements collected from the east and west piers are shown in Figure 41 through Figure 44. The measurements have remained steady for both piers in both directions (perpendicular and parallel to track). This indicates that the piers dynamic response under live load has not changed since April 1, 2016.

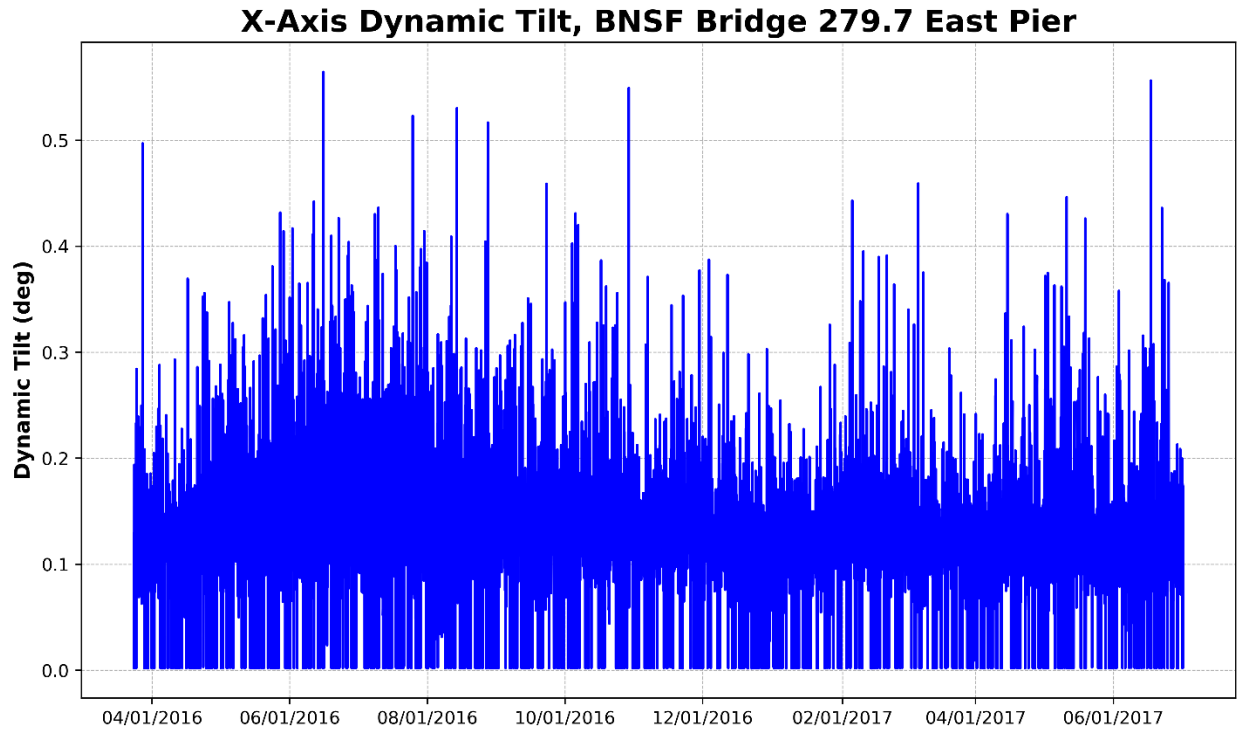
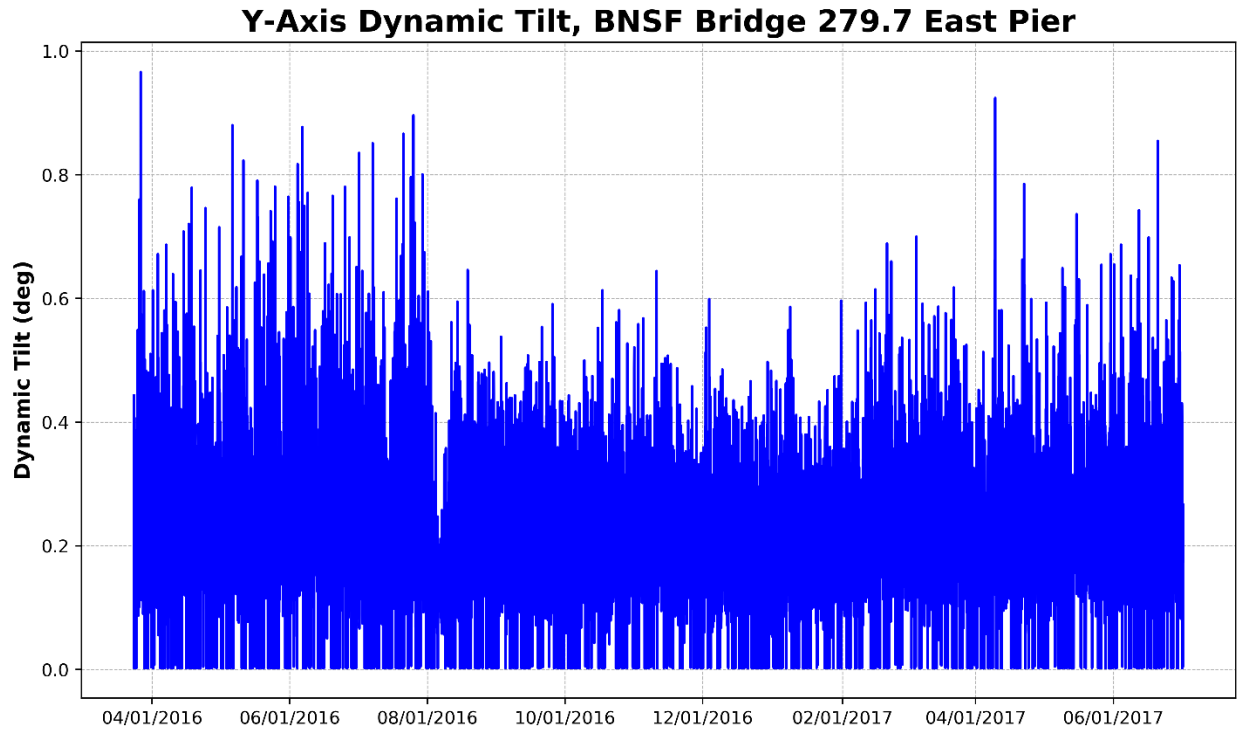
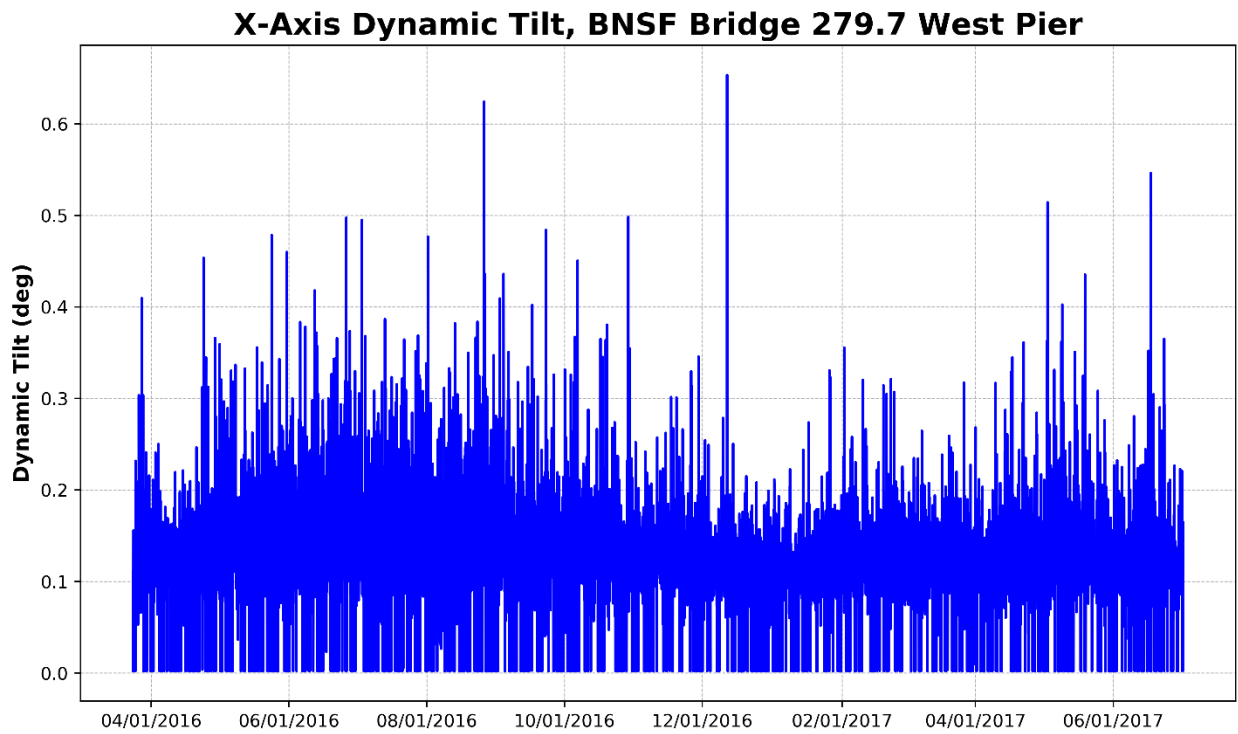


Figure 42 – East Pier, X-Axis Dynamic Tilt (Perpendicular to Track)

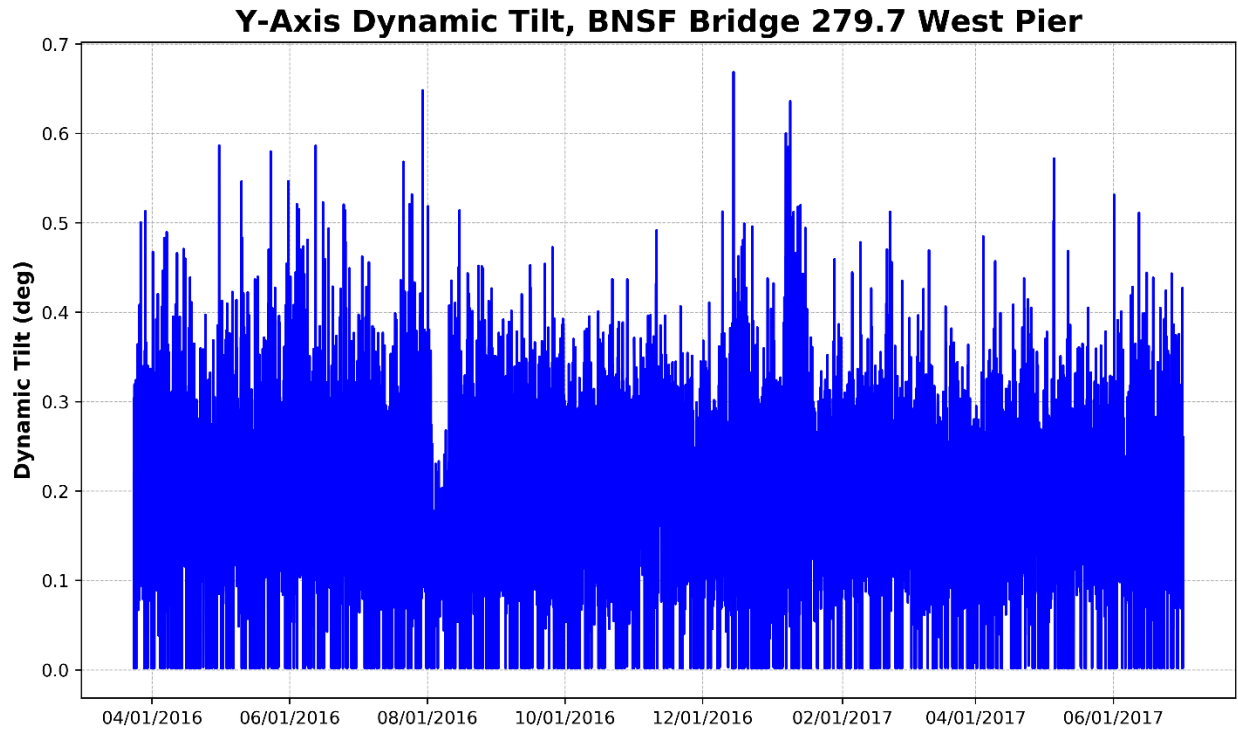


**Figure 43 – East Pier, Y-Axis Dynamic Tilt (Parallel to Track)**



**Figure 44 – West Pier, X-Axis Dynamic Tilt (Perpendicular to Track)**

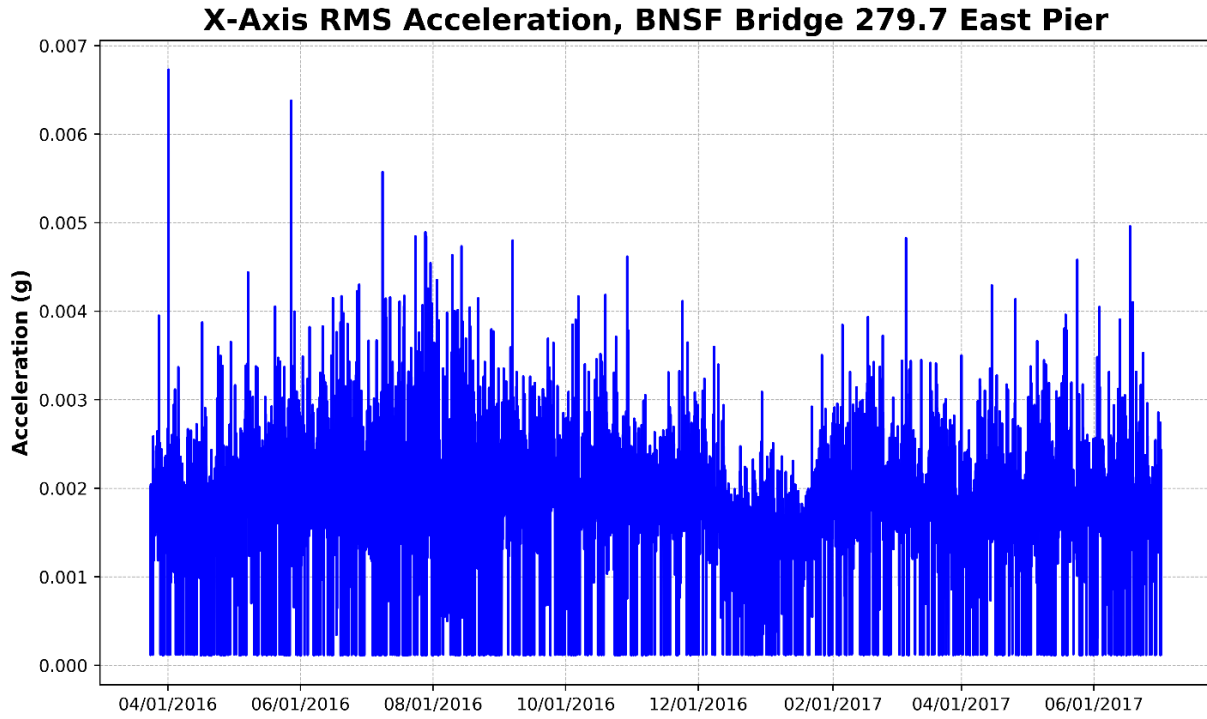




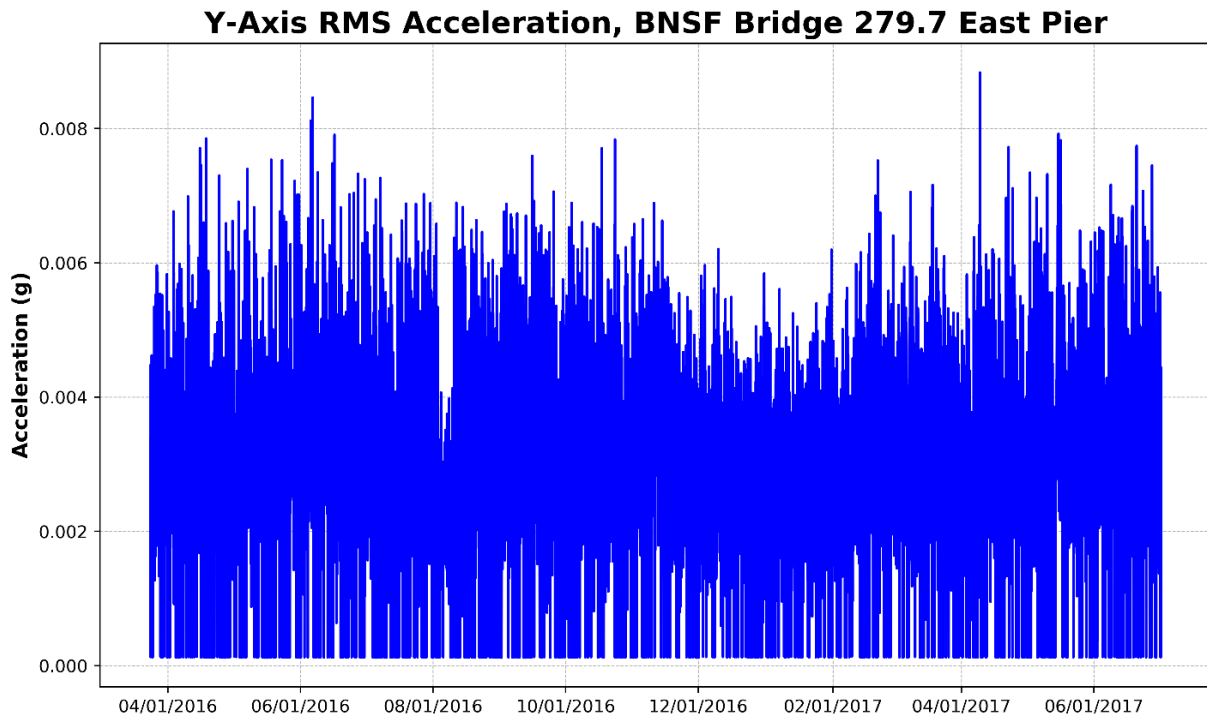
**Figure 45 – West Pier, Y-Axis Dynamic Tilt (Parallel to Track)**

#### **4.2.3 Lateral Acceleration**

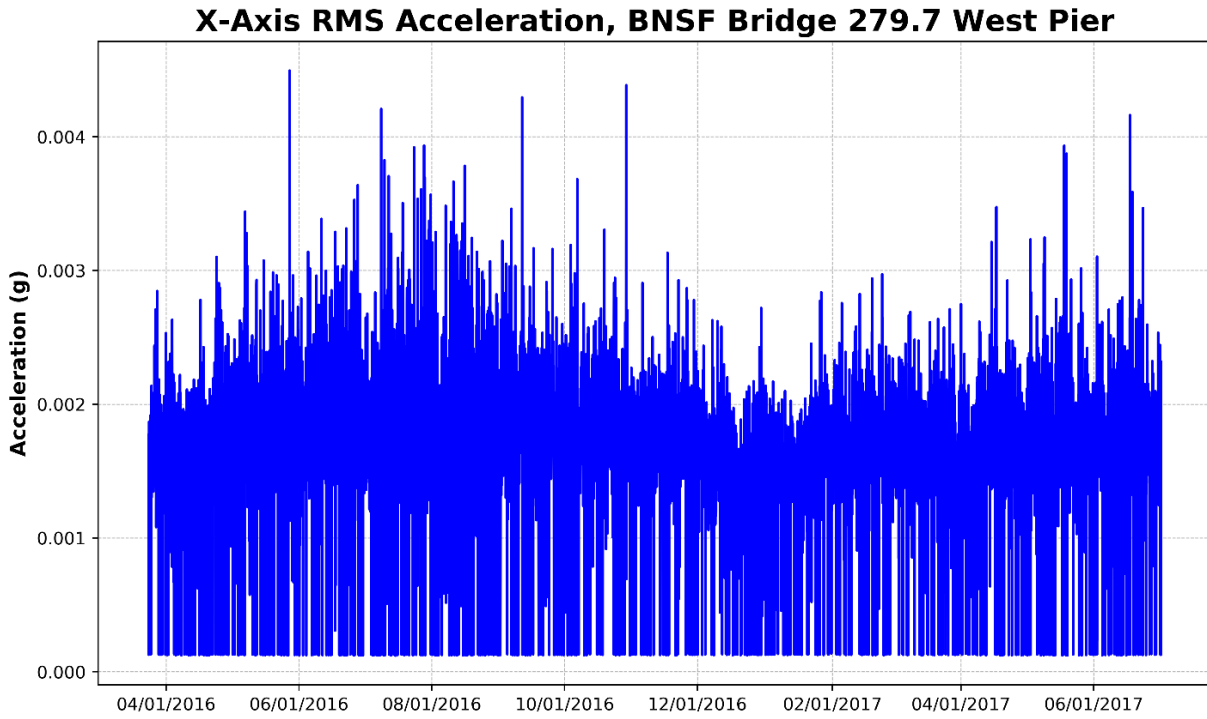
The acceleration measurements collected for the east and west piers are shown in [Figure 45](#) through [Figure 48](#). Similar to the dynamic tilt, the acceleration measurements have remained steady for both piers in both directions (perpendicular and parallel to track). There are no indications of increasing vibrations.



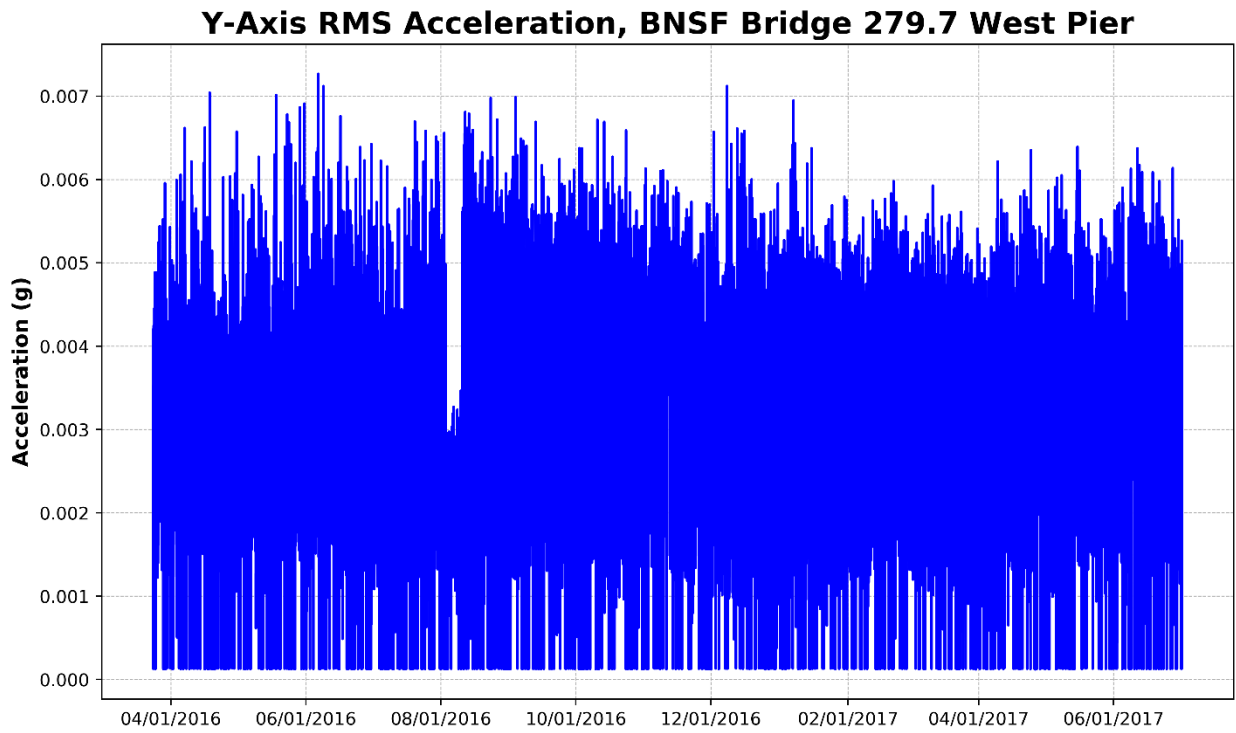
**Figure 46 – East Pier, X-Axis RMS Acceleration (Perpendicular to Track)**



**Figure 47 – East Pier, Y-Axis RMS Acceleration (Parallel to Track)**



**Figure 48 – West Pier, X-Axis RMS Acceleration (Perpendicular to Track)**



**Figure 49 – West Pier, Y-Axis RMS Acceleration (Parallel to Track)**

### 4.3 CPR Bridge 195.20 Tomah

This bridge is a four-span, 465-foot long, single track bridge in Wisconsin Dells, WI. Due to the configuration of this bridge, a mixture of substructure (1) and superstructure (3) elements are being monitored. The monitoring system was installed in April 2013. The location of each CX1 sensor is shown in [Figure 49](#).

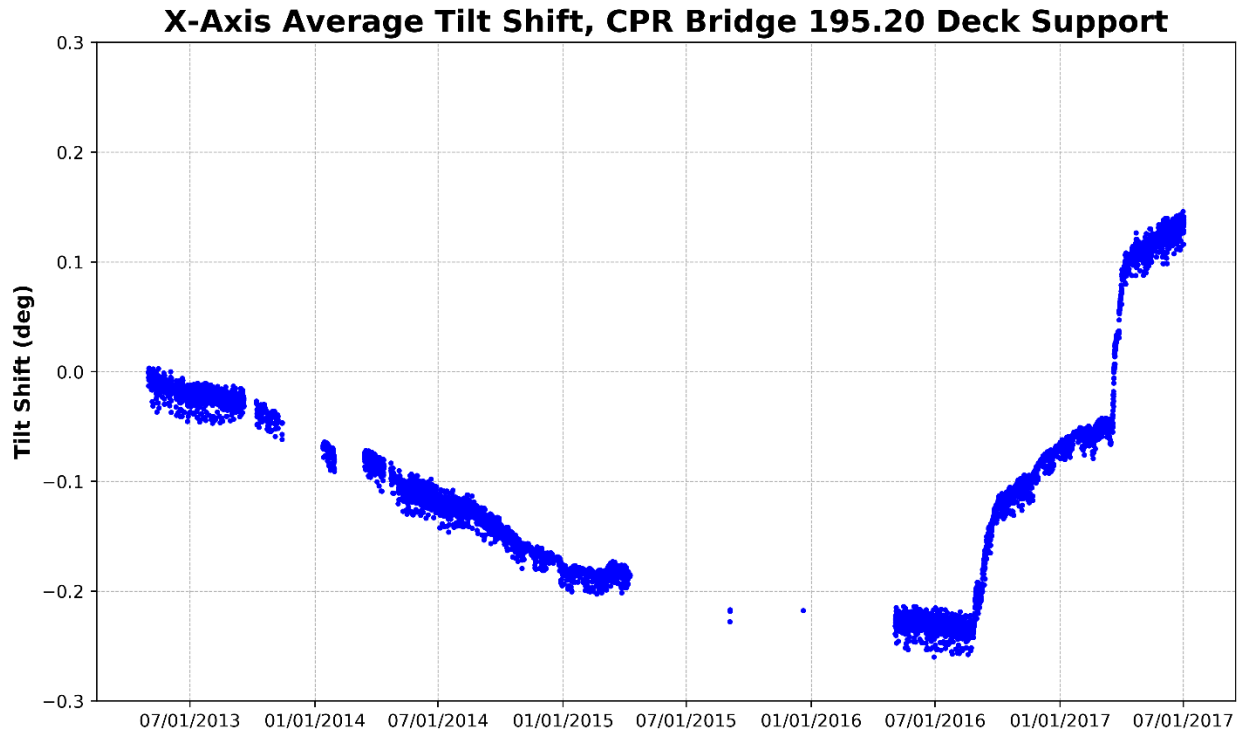


Figure 50 – CPR 195.20 Tomah Sensor Locations

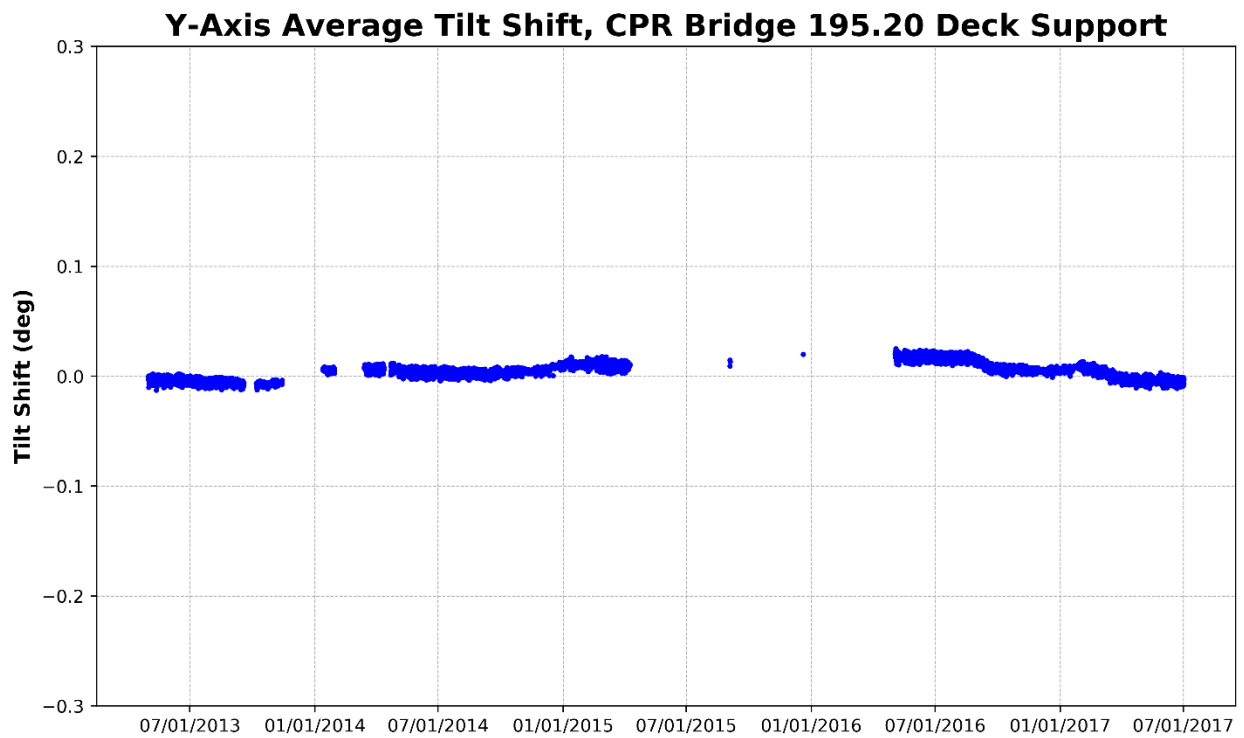
#### 4.3.1 Average Tilt

The average tilt measurements collected from the Tomah bridge are shown in [Figure 50](#) through [Figure 57](#). Throughout the duration of monitoring, the tilt of the Pier Cap sensor stayed within 0.025 degrees of the starting position indicating stable behavior.

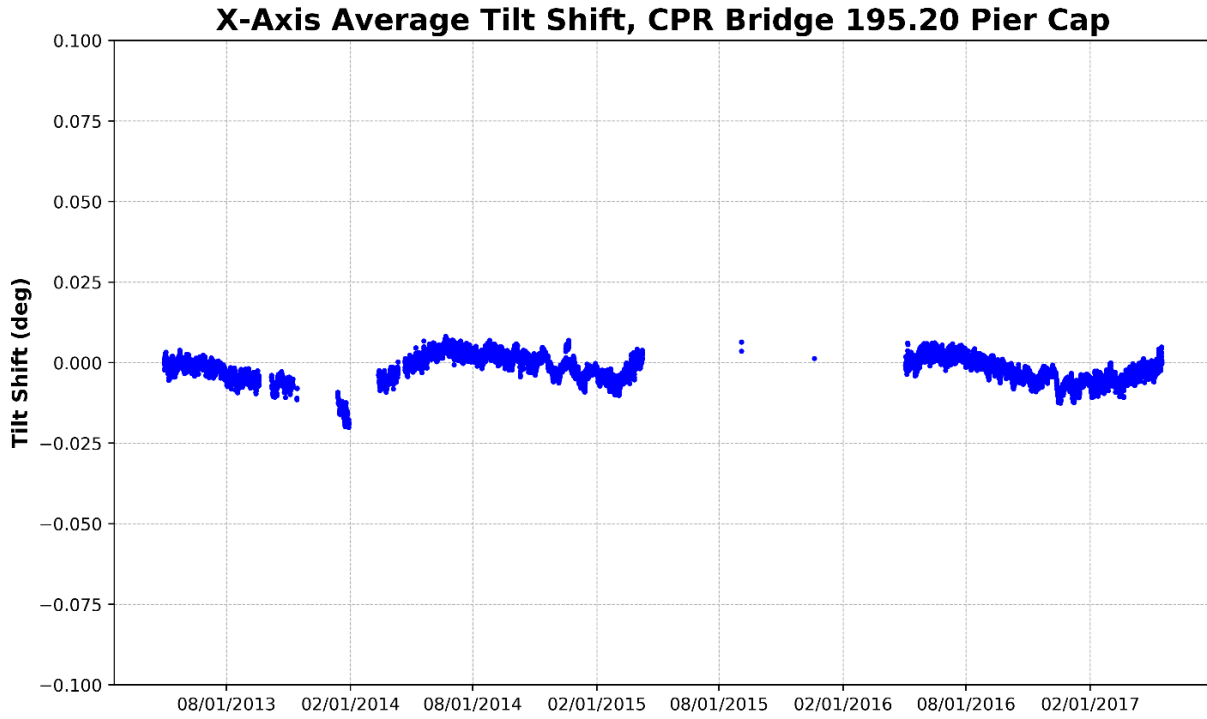
The data from the Deck Support sensor and Deck Plate Girder sensor show wide swings of variability. The parallel tilt in the Deck Support shifted 0.25 degrees from 2013 to mid-2016 before moving back the other direction. Both the parallel and perpendicular tilt shifted for the Deck Plate Girder sensor. Overall, the measurements from sensors mounted on steel are harder to interpret and less useful than data from sensors mounted directly on the piers.



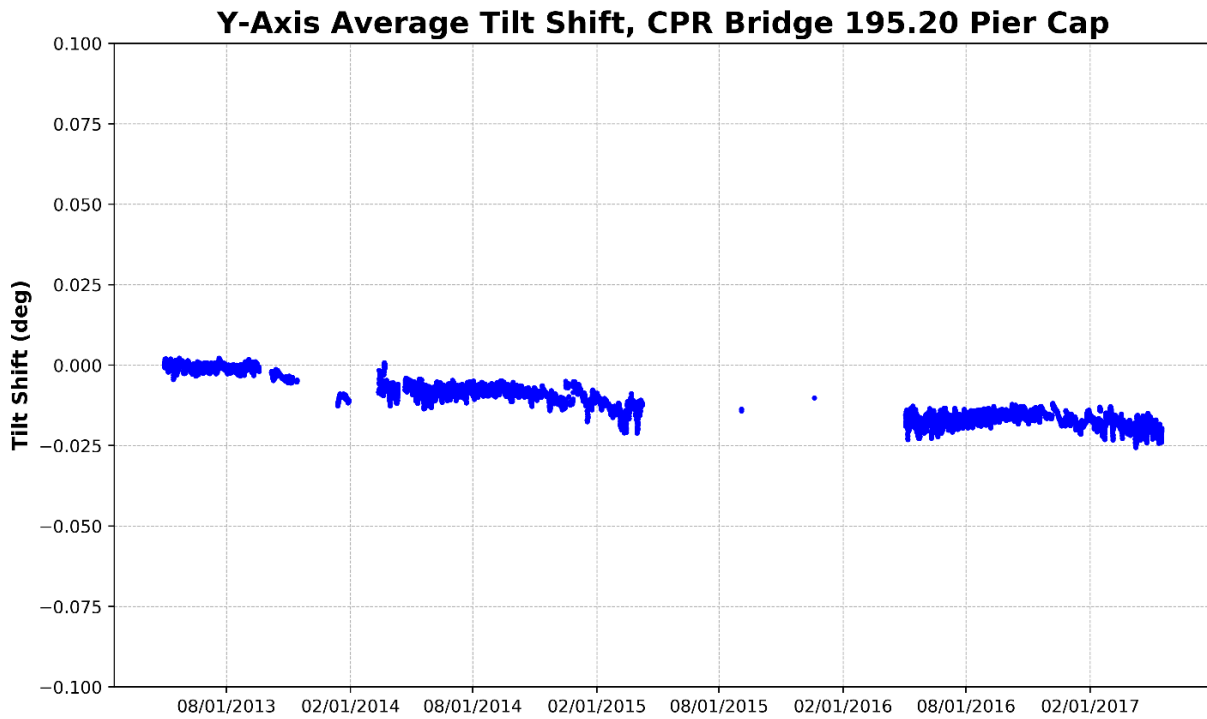
**Figure 51 – Deck Support, X-Axis Average Tilt (Parallel to Track)**



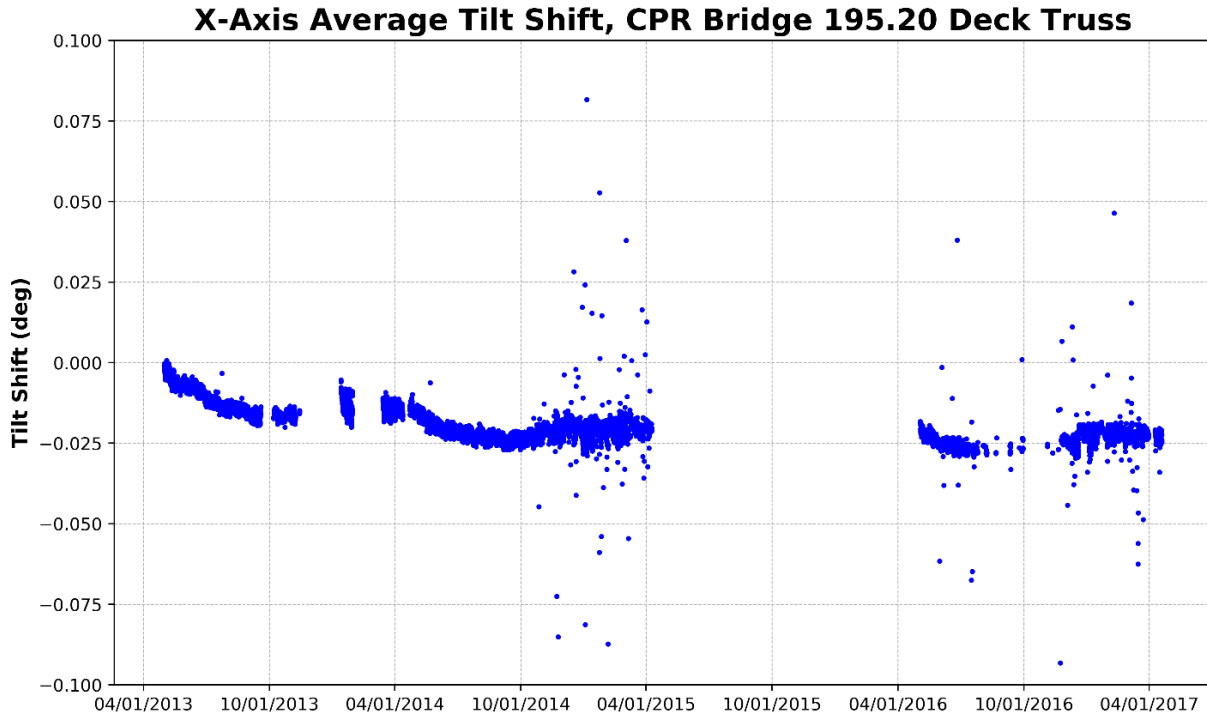
**Figure 52 – Deck Support, Y-Axis Average Tilt (Perpendicular to Track)**



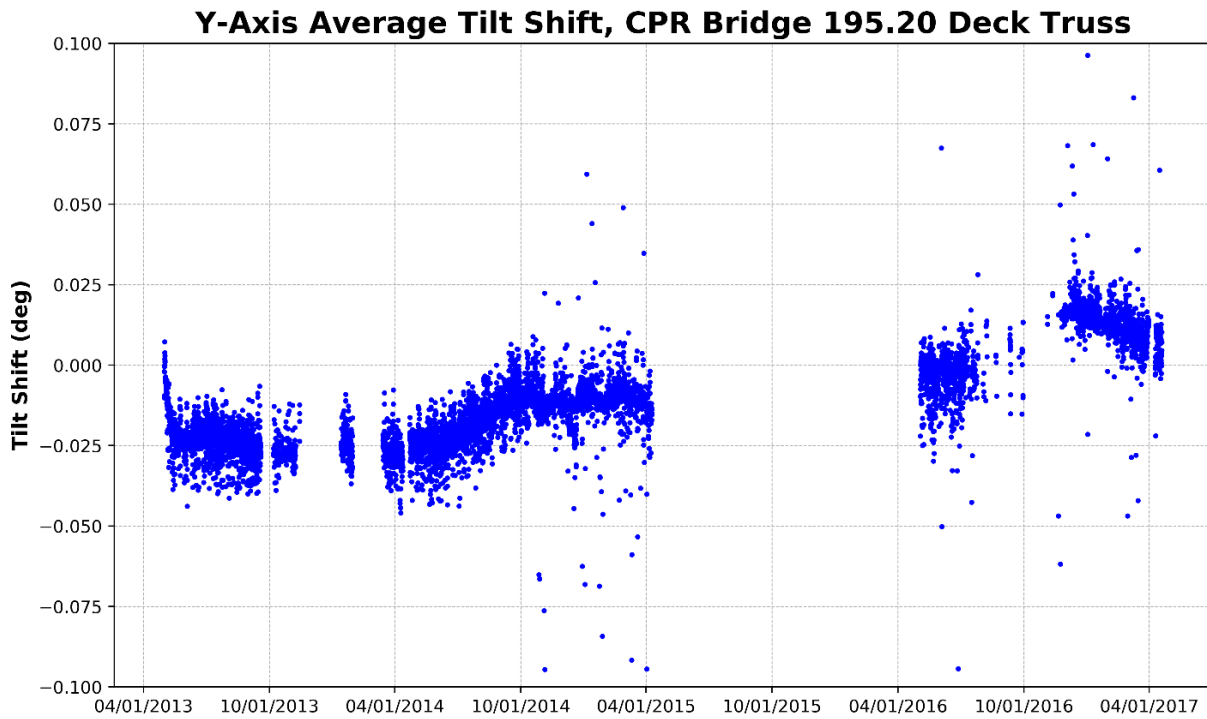
**Figure 53 – Pier Cap, X-Axis Average Tilt (Parallel to Track)**



**Figure 54 – Pier Cap, Y-Axis Average Tilt (Perpendicular to Track)**

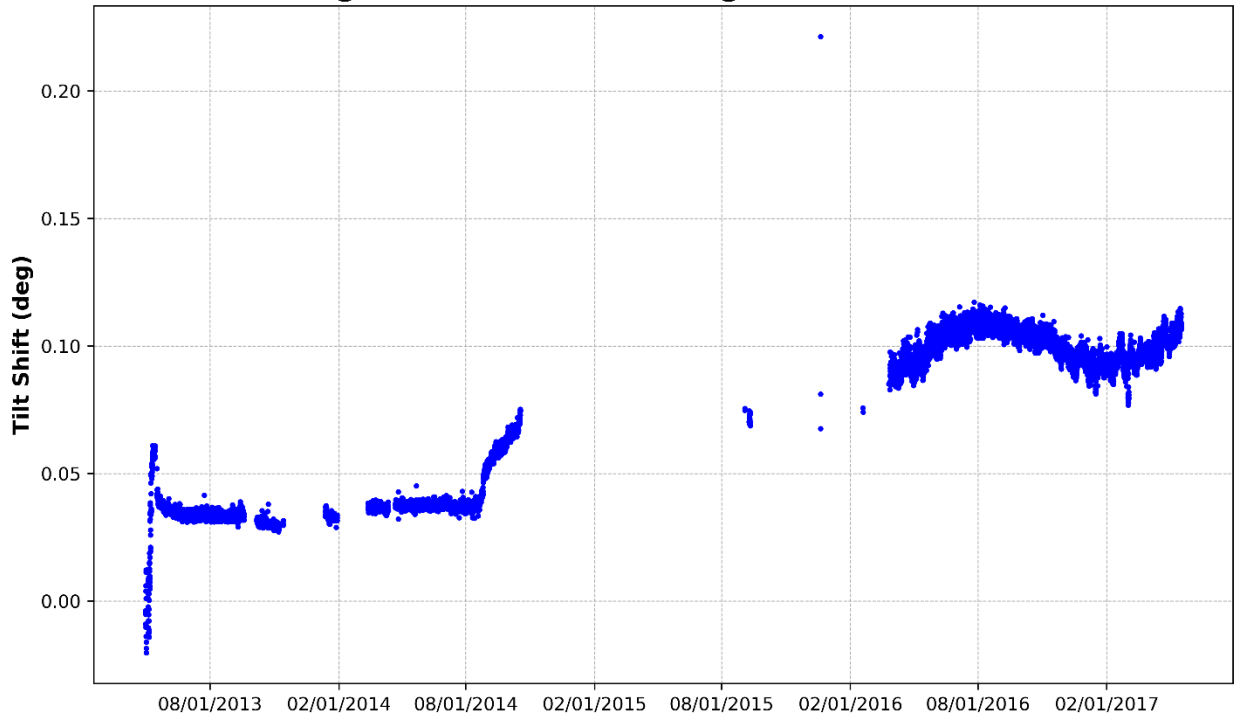


**Figure 55 – Deck Truss, X-Axis Average Tilt (Parallel to Track)**



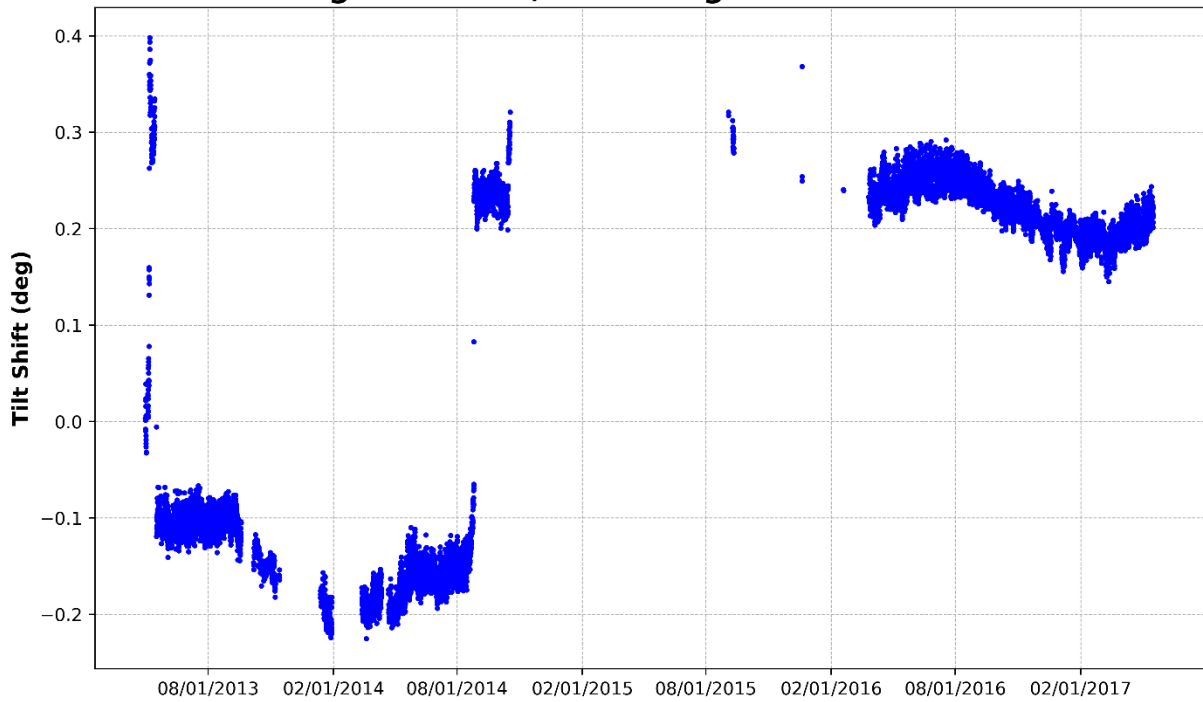
**Figure 56 – Deck Truss, Y-Axis Average Tilt (Perpendicular to Track)**

**X-Axis Average Tilt Shift, CPR Bridge 195.20 Deck Plate Girder**



**Figure 57 – Deck Plate Girder, X-Axis Average Tilt (Parallel to Track)**

**Y-Axis Average Tilt Shift, CPR Bridge 195.20 Deck Plate Girder**

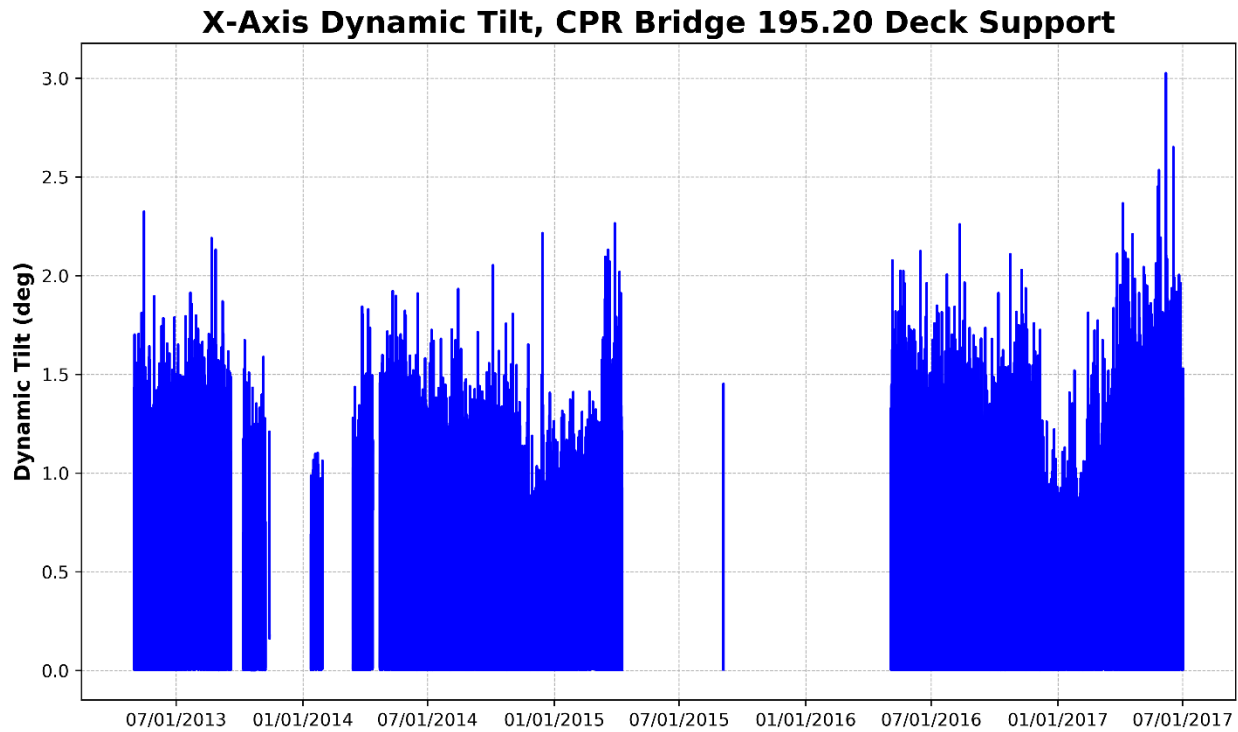


**Figure 58 – Deck Plate Girder, Y-Axis Average Tilt (Perpendicular to Track)**



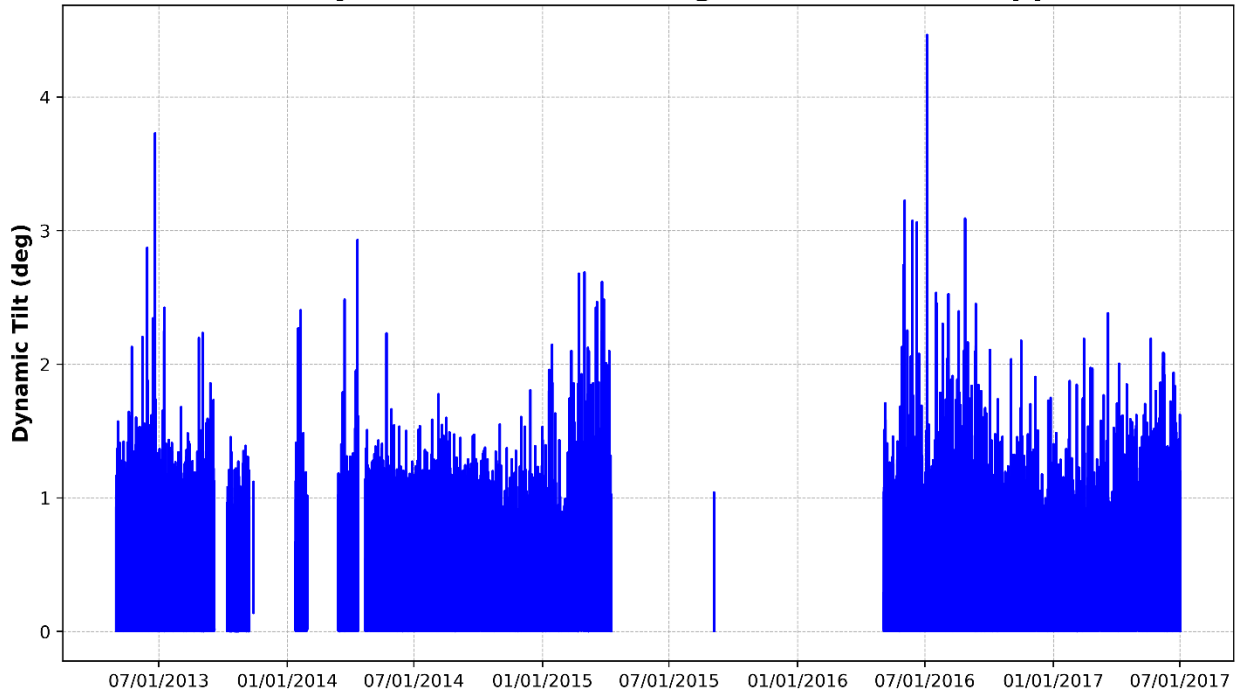
### 4.3.2 Dynamic Tilt

The dynamic tilt measurements collected from the Tomah bridge are shown in [Figure 58](#) through [Figure 65](#). The sensors mounted on steel record significantly higher dynamic tilt compared to the sensor on the pier cap. Overall, there are no increasing trends or outliers in the dynamic tilt data that indicate unstable conditions.



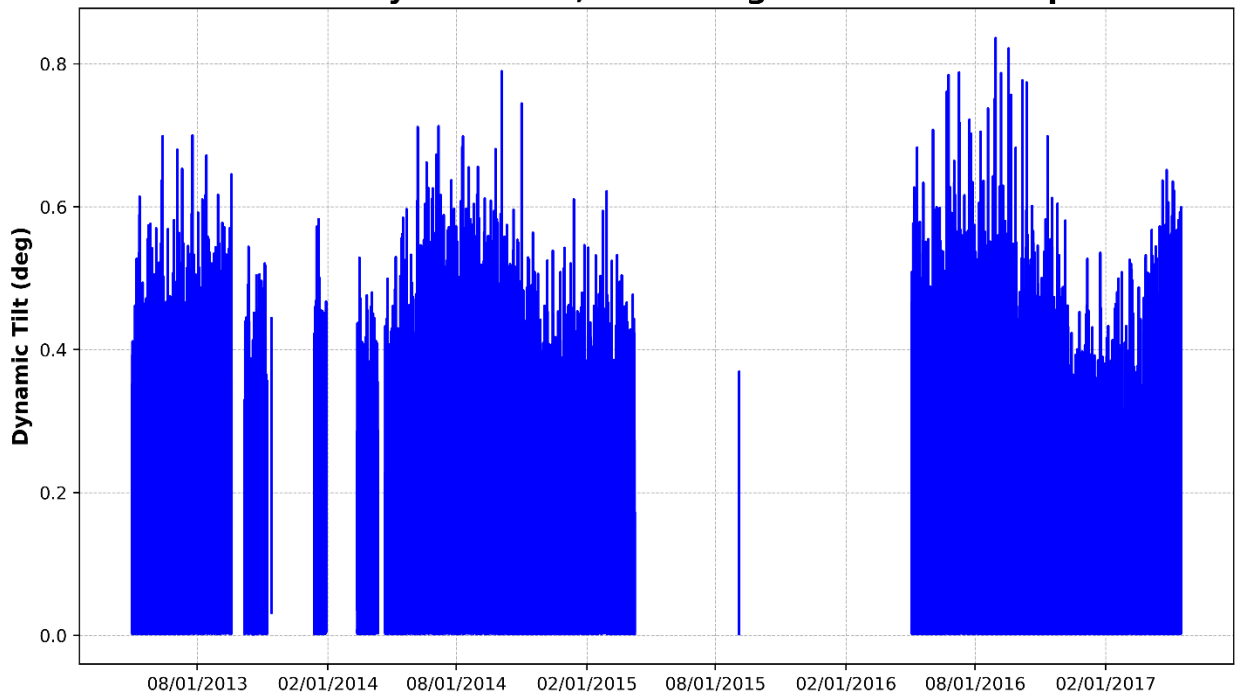
**Figure 59 – Deck Support, X-Axis Dynamic Tilt (Parallel to Track)**

**Y-Axis Dynamic Tilt, CPR Bridge 195.20 Deck Support**

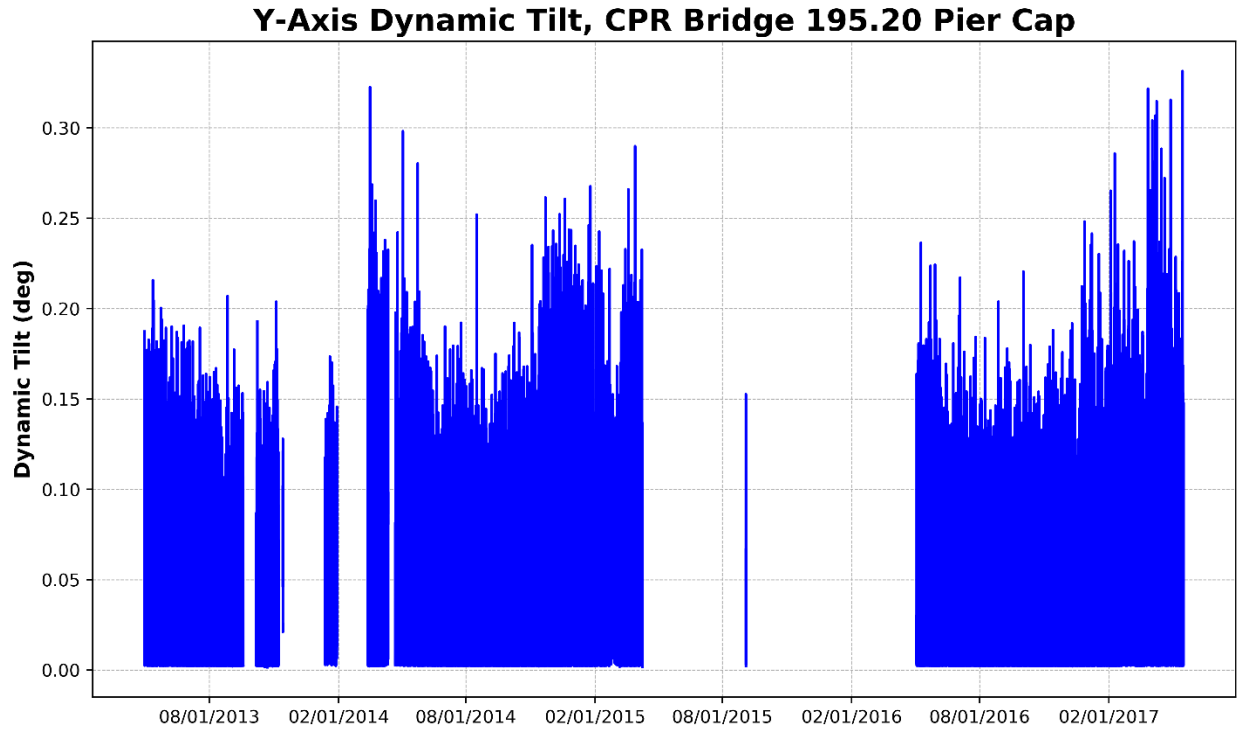


**Figure 60 – Deck Support, Y-Axis Dynamic Tilt (Perpendicular to Track)**

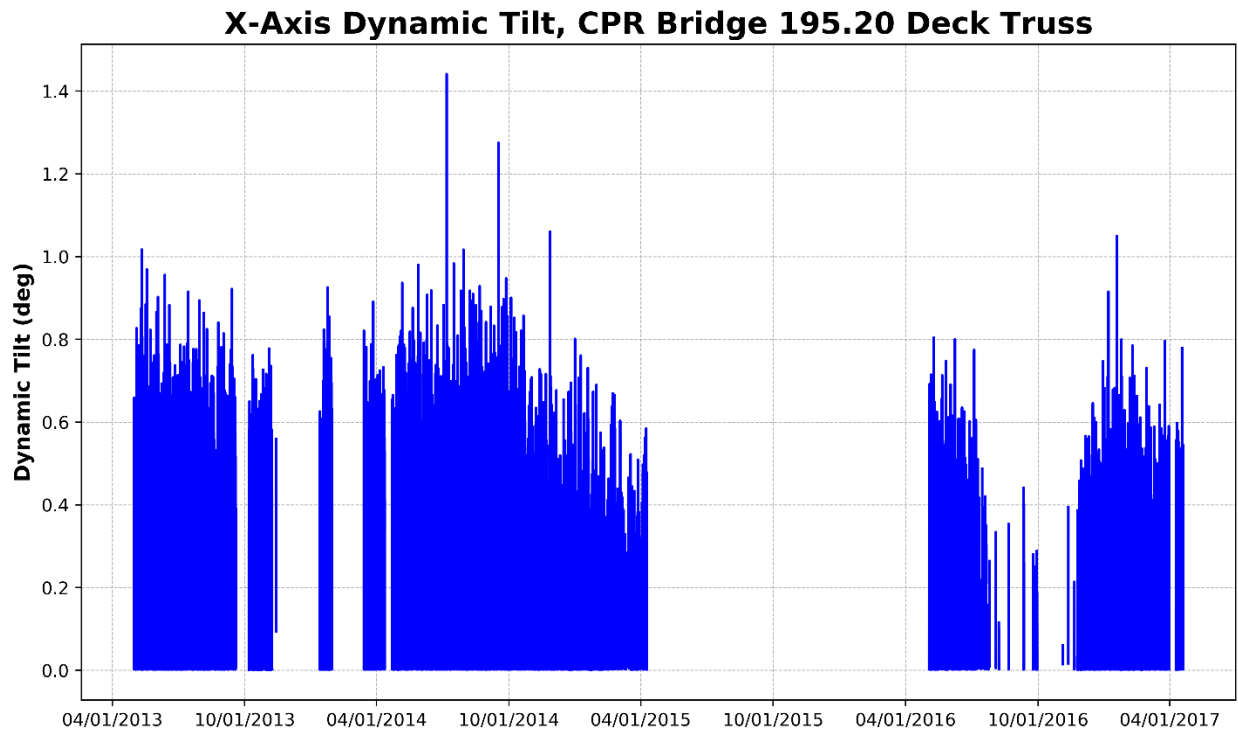
**X-Axis Dynamic Tilt, CPR Bridge 195.20 Pier Cap**



**Figure 61 – Pier Cap, X-Axis Dynamic Tilt (Parallel to Track)**



**Figure 62 – Pier Cap, Y-Axis Dynamic Tilt (Perpendicular to Track)**



**Figure 63 – Deck Truss, X-Axis Dynamic Tilt (Parallel to Track)**

### Y-Axis Dynamic Tilt, CPR Bridge 195.20 Deck Truss

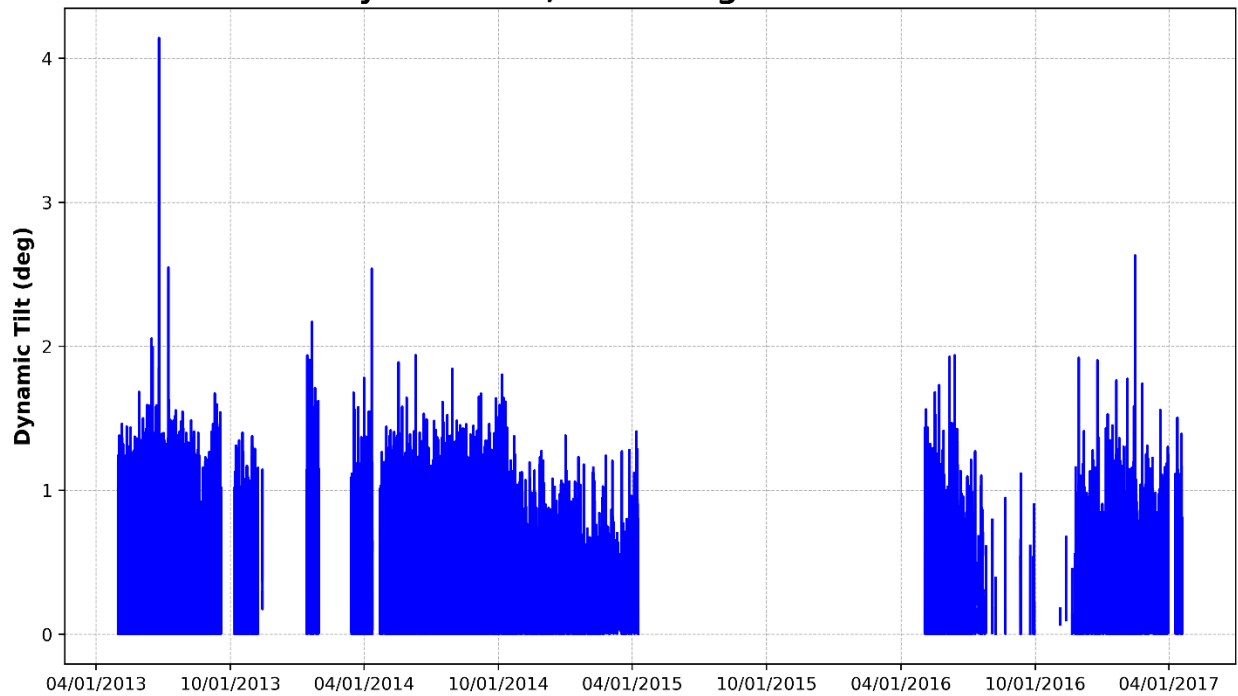


Figure 64 – Deck Truss, Y-Axis Dynamic Tilt (Perpendicular to Track)

### X-Axis Dynamic Tilt, CPR Bridge 195.20 Deck Plate Girder

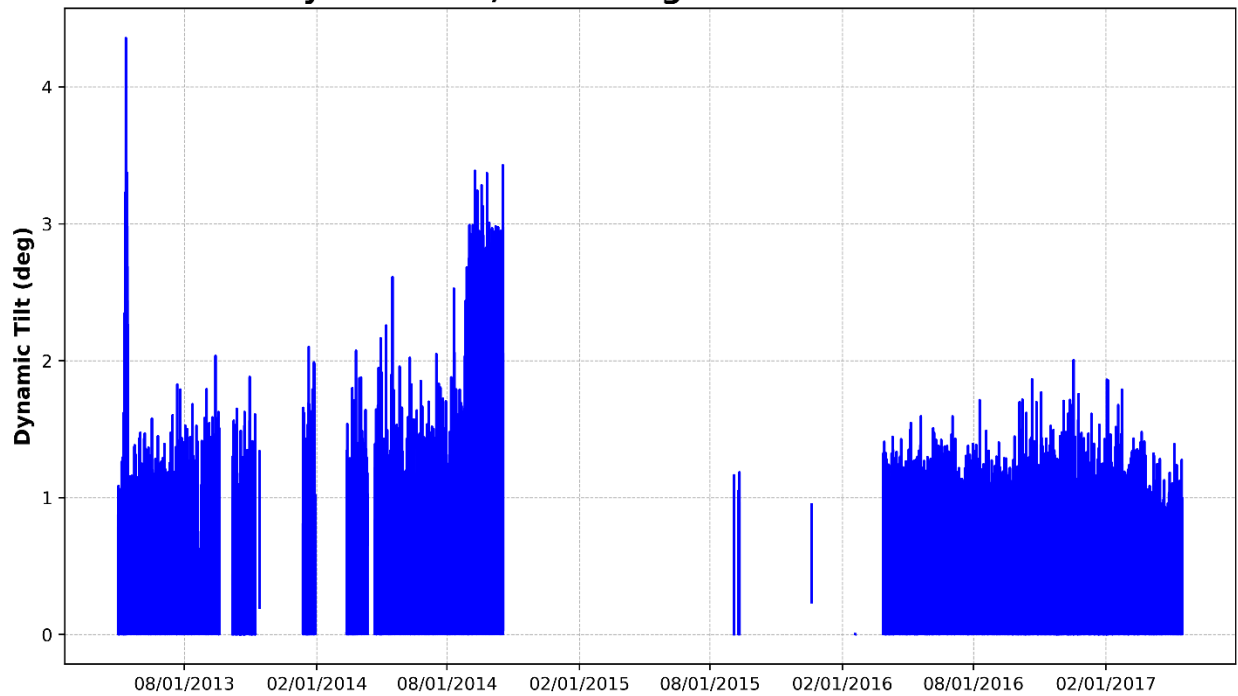
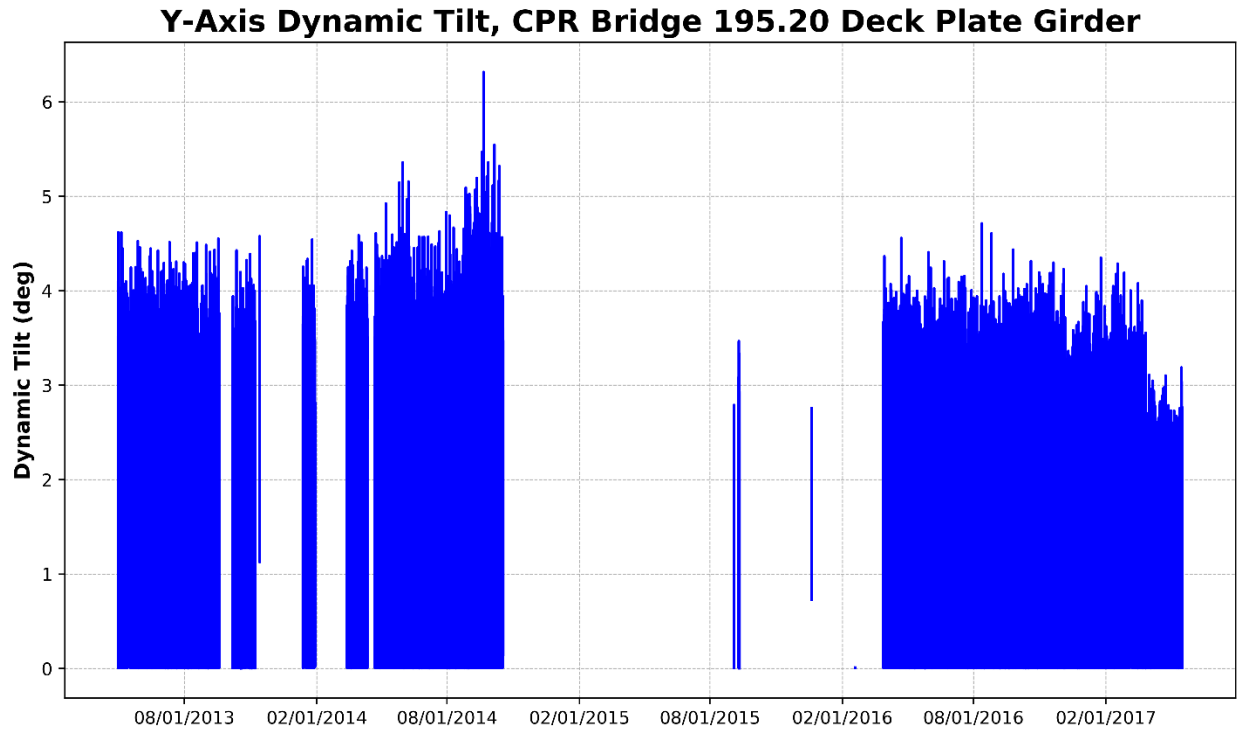


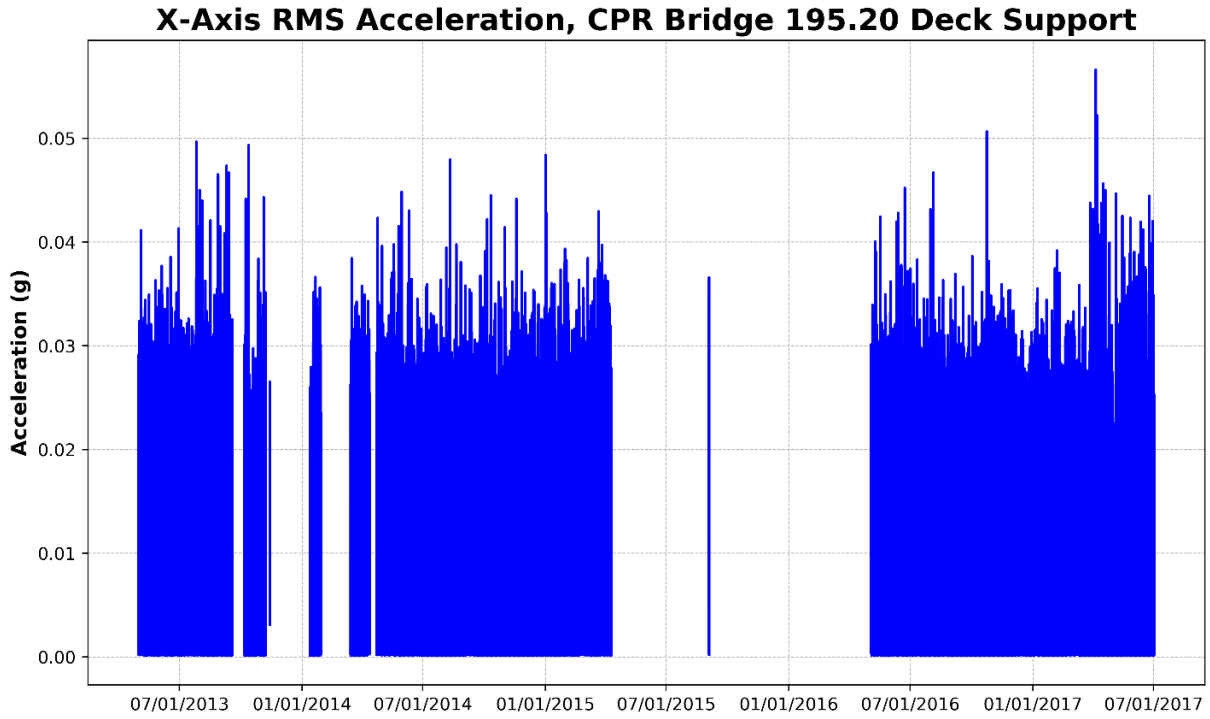
Figure 65 – Deck Plate Girder, X-Axis Dynamic Tilt (Parallel to Track)



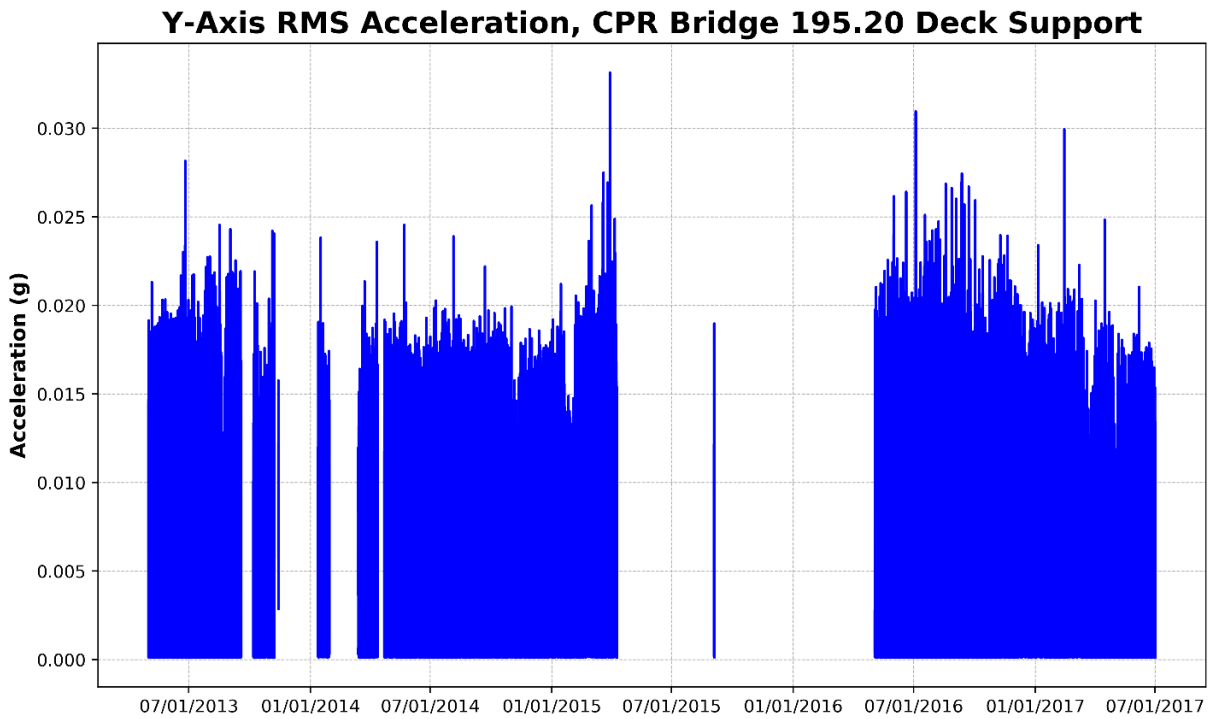
**Figure 66 – Deck Plate Girder, Y-Axis Dynamic Tilt (Perpendicular to Track)**

### **4.3.3 Lateral Acceleration**

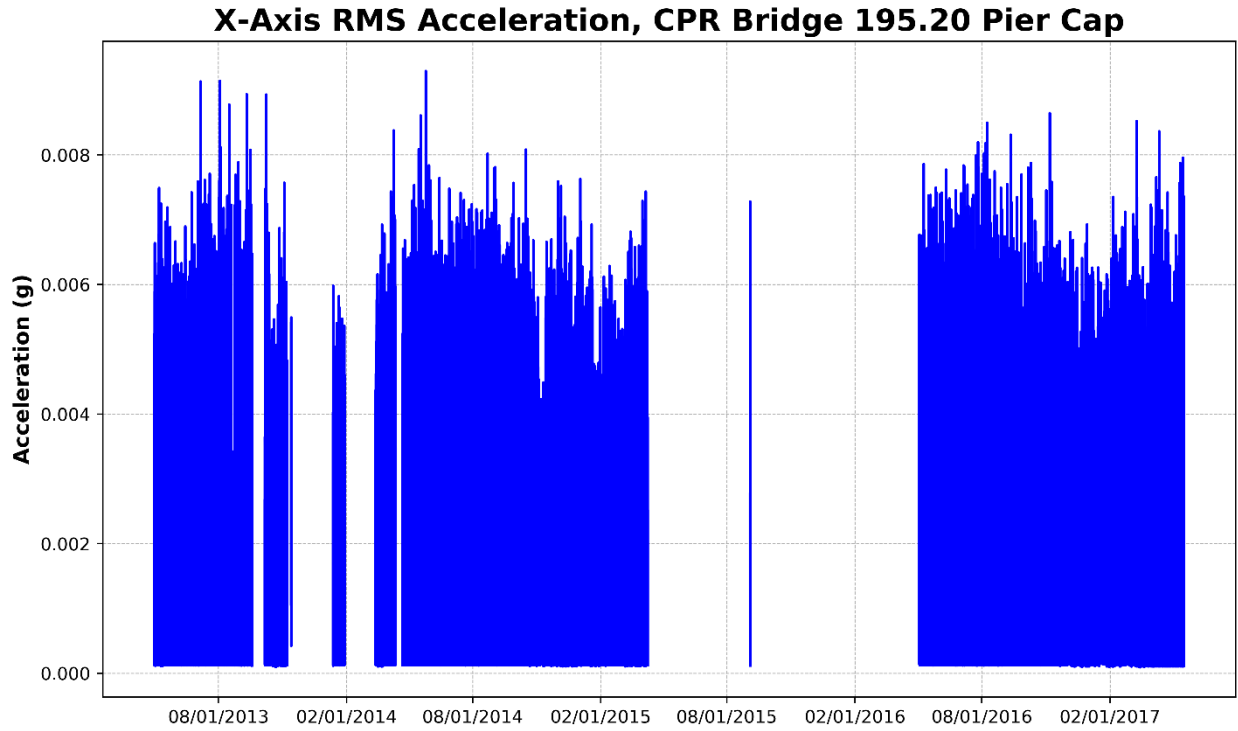
The acceleration measurements are shown in [Figure 67](#) through [Figure 73](#). The deck plate girder sensor shows a noticeable step change in December 2016 indicating an increased level of vibrations. It is recommended to investigate the girder and data to determine the cause. The acceleration data recorded from the other sensors has been relatively stable throughout the duration of monitoring.



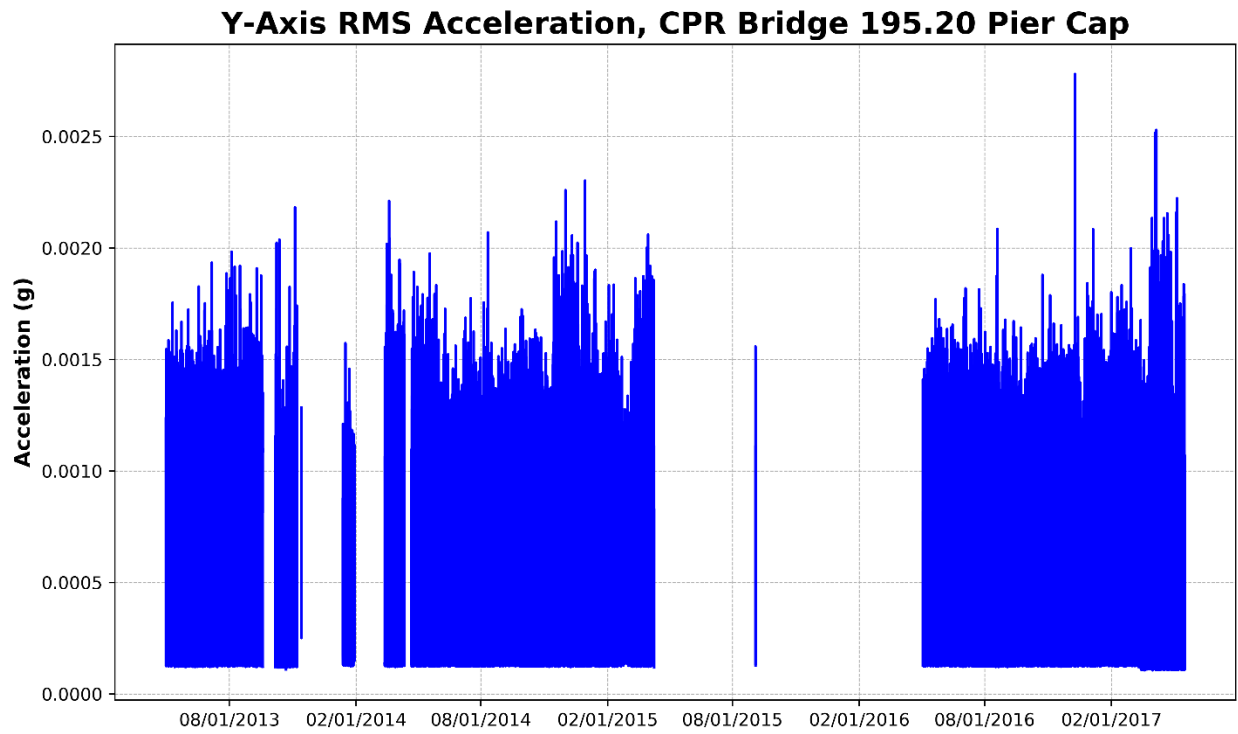
**Figure 67 – Deck Support, X-Axis RMS Acceleration (Parallel to Track)**



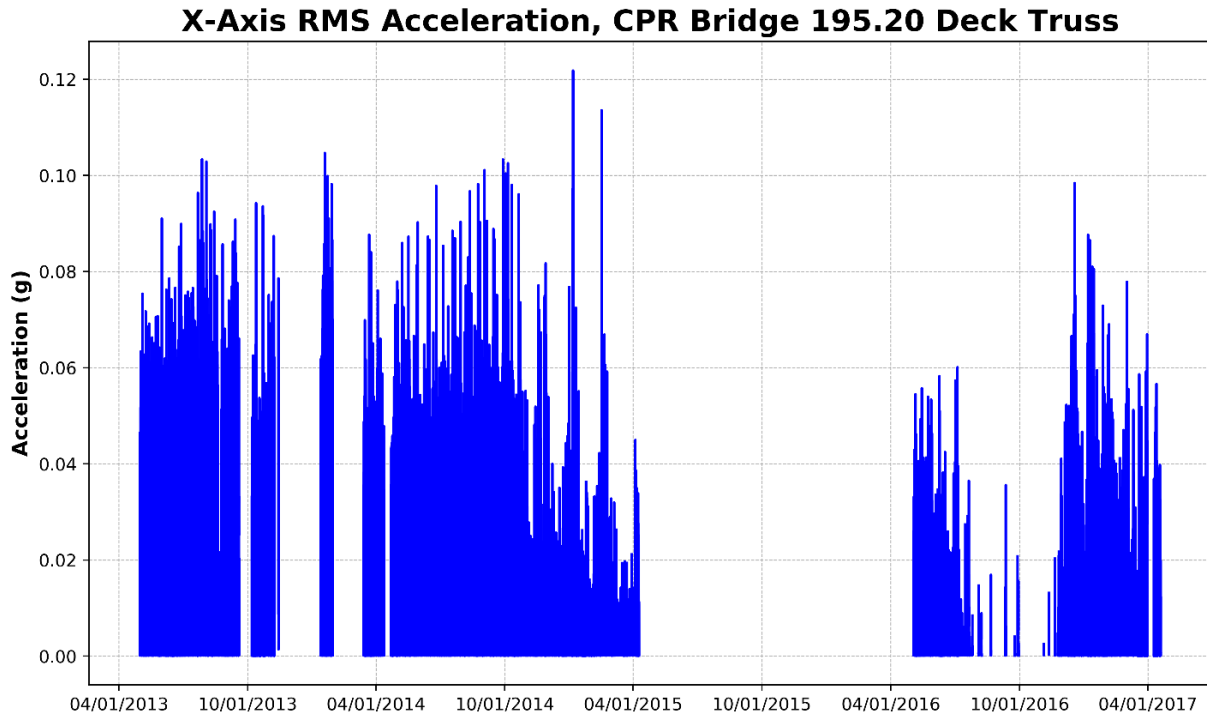
**Figure 68 – Deck Support, Y-Axis RMS Acceleration (Perpendicular to Track)**



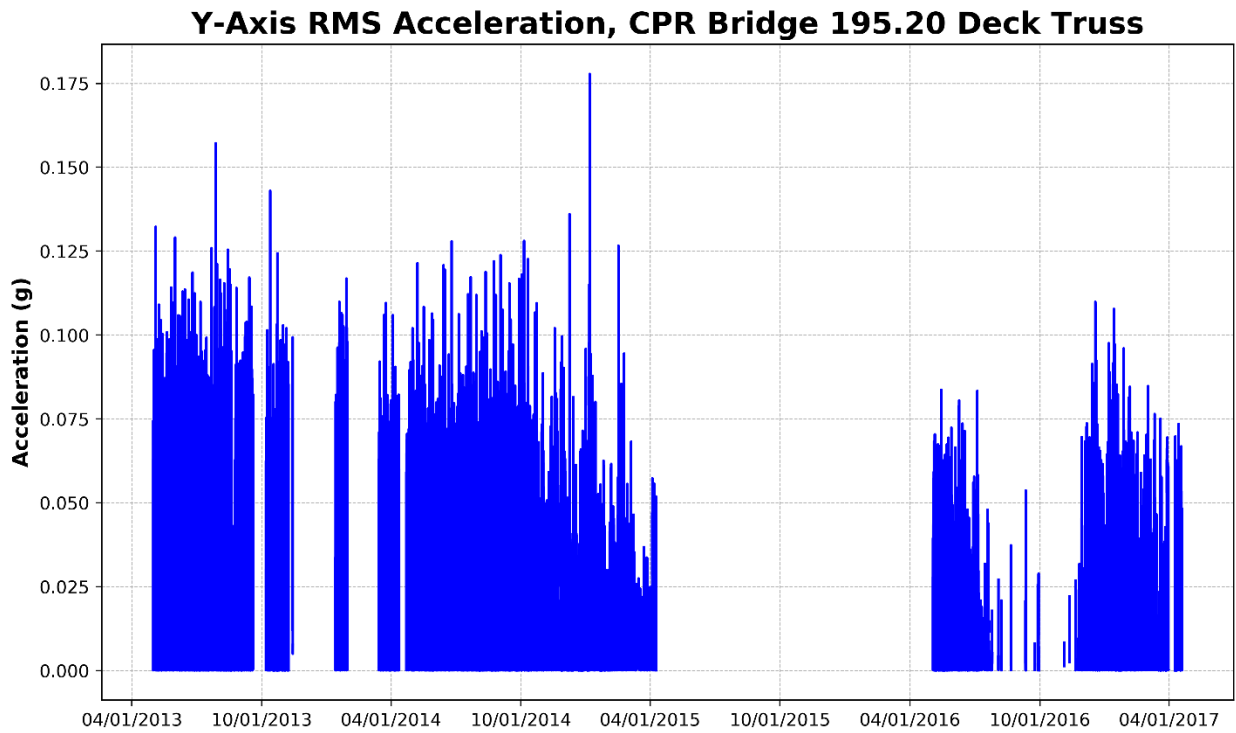
**Figure 69 – Pier Cap, X-Axis RMS Acceleration (Parallel to Track)**



**Figure 70 – Pier Cap, Y-Axis RMS Acceleration (Perpendicular to Track)**

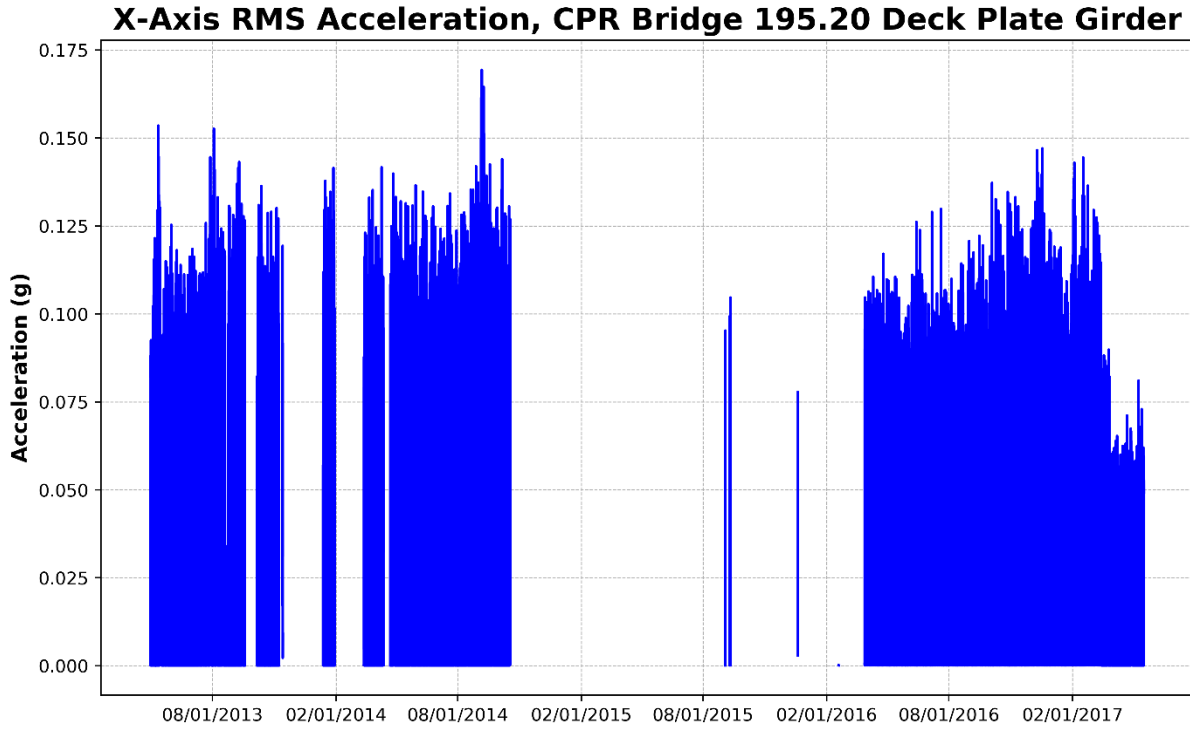


**Figure 71 – Deck Truss, X-Axis RMS Acceleration (Parallel to Track)**

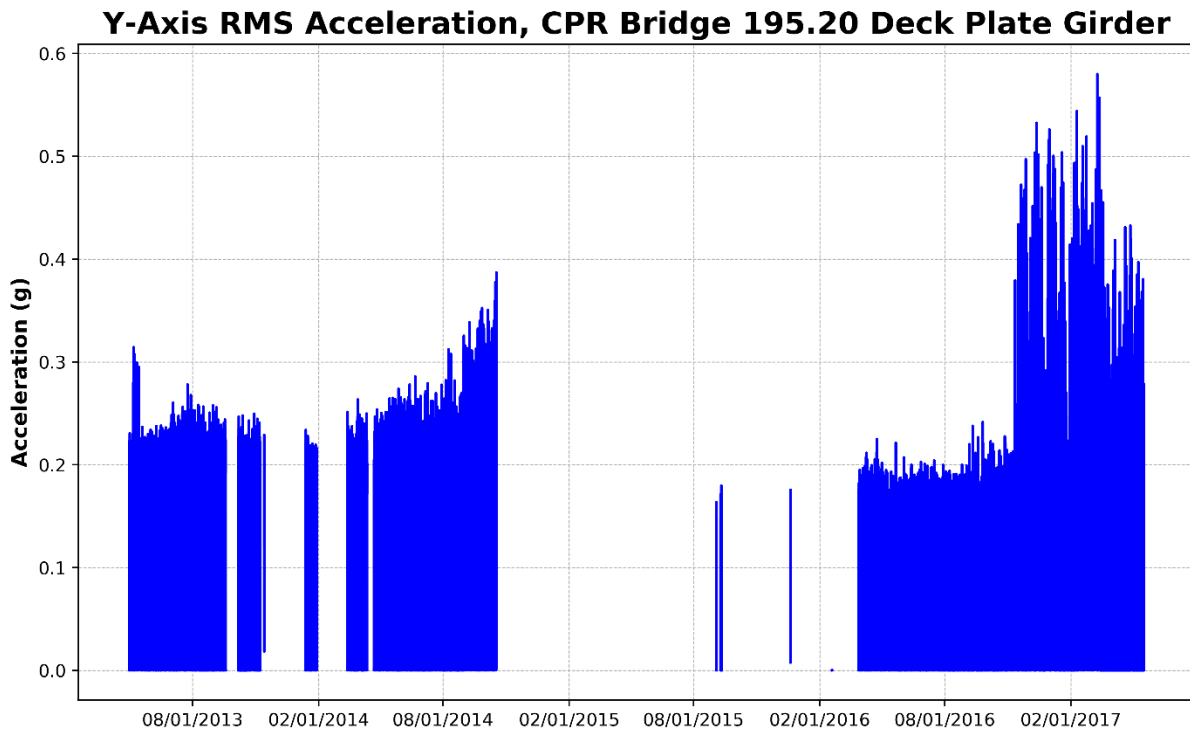


**Figure 72 – Deck Truss, Y-Axis RMS Acceleration (Perpendicular to Track)**





**Figure 73 – Deck Plate Girder, X-Axis RMS Acceleration (Parallel to Track)**



**Figure 74 – Deck Plate Girder, Y-Axis RMS Acceleration (Perpendicular to Track)**

#### 4.4 CPR BR00 0.30 Medicine Hat

This bridge is a seven-span, 1,012-foot long double track bridge located in Medicine Hat, AB. The bridge spans the South Saskatchewan River. Piers 3, 5, and 6 are being monitored as shown in Figure 74. The monitoring system was installed in November 2013.

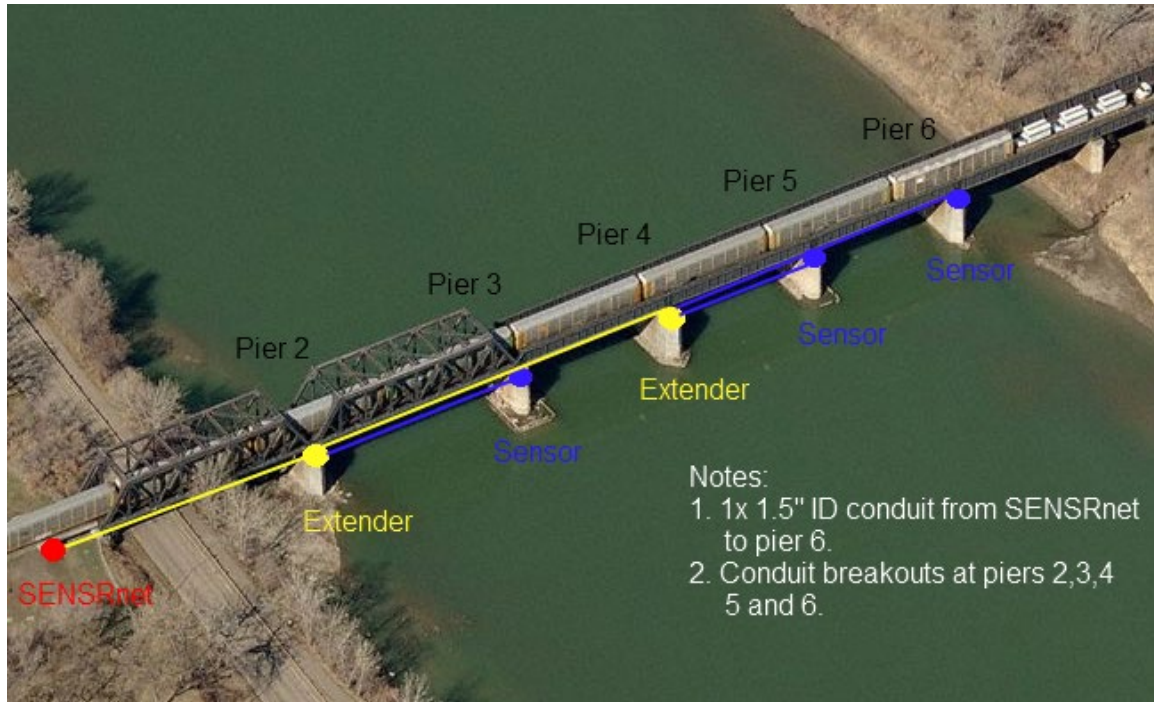
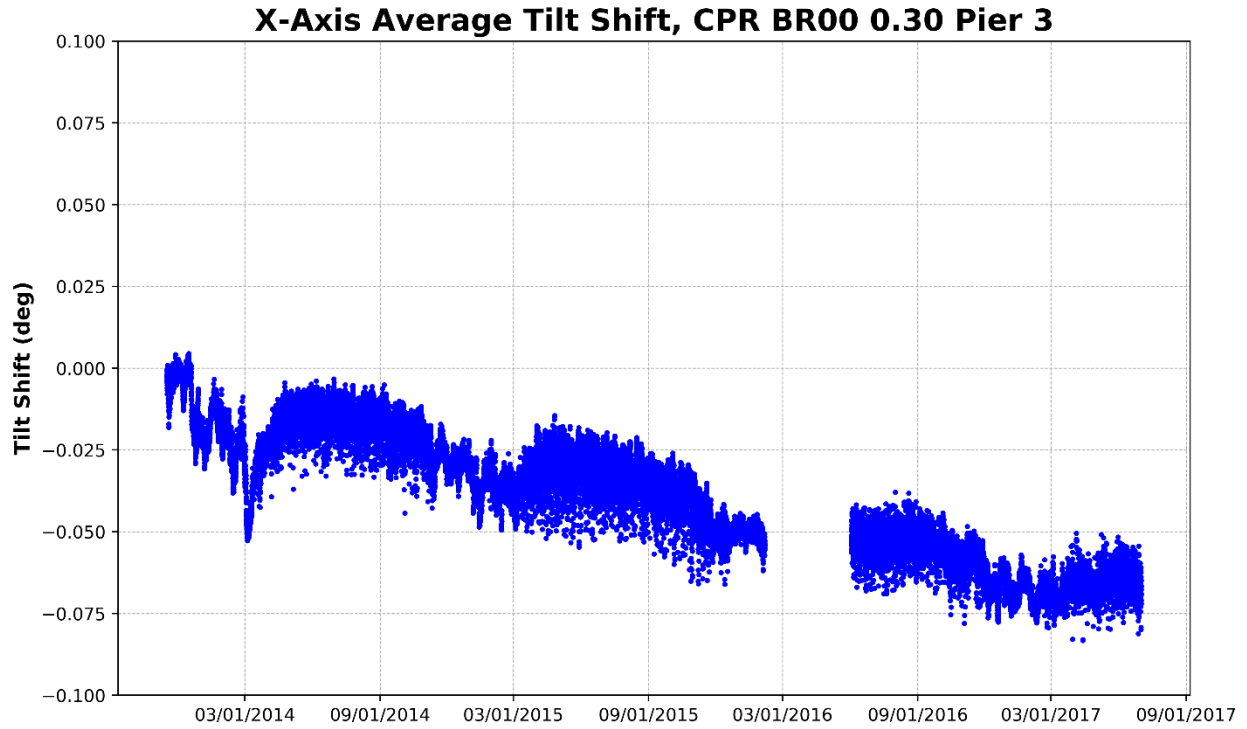


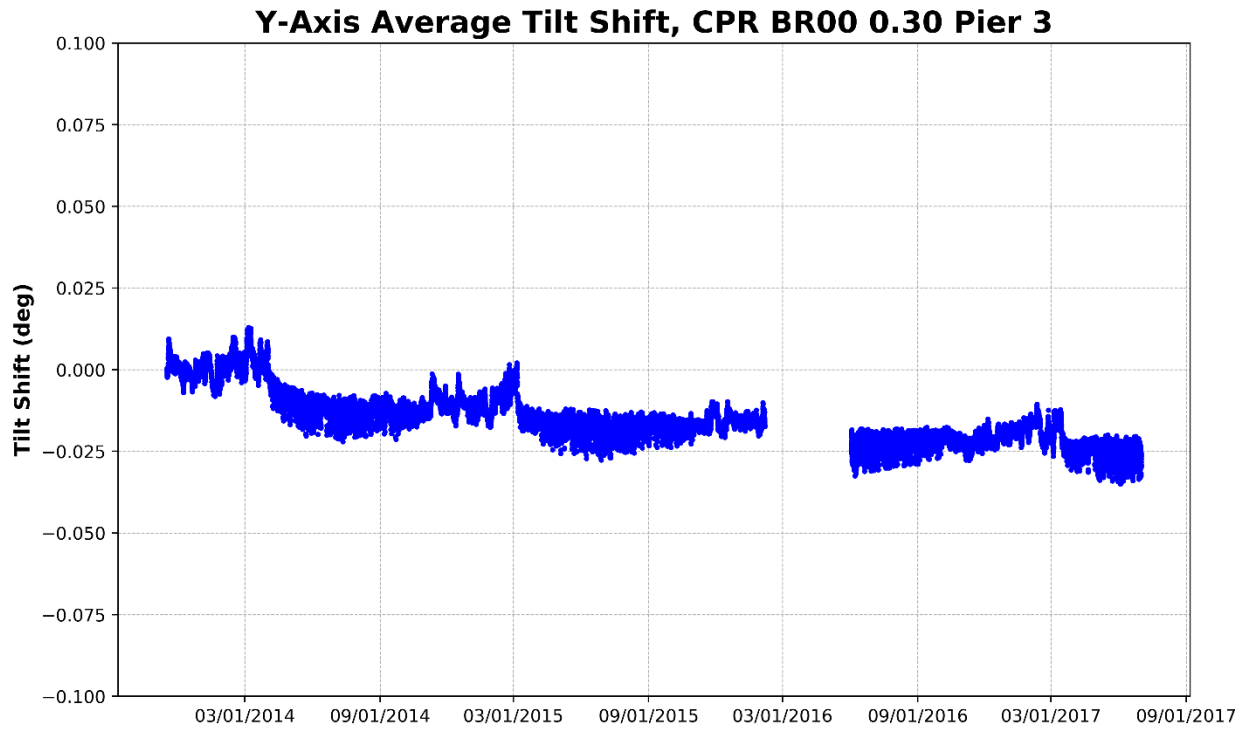
Figure 75 – CPR Medicine Hat Monitoring System Layout

##### 4.4.1 Average Tilt

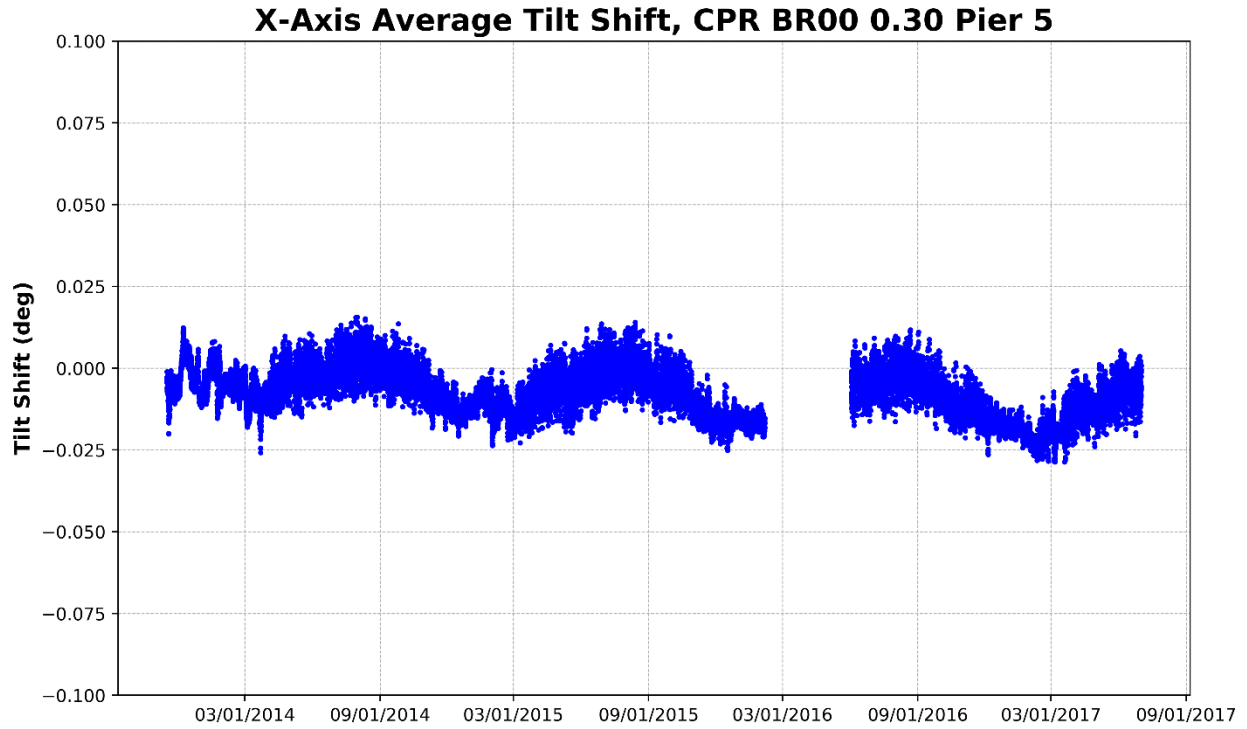
The average tilt charts are shown in Figure 75 through Figure 80. For all piers monitored, the tilt perpendicular to the track has remained within 0.03 degrees of the starting point since November 2013. The tilt parallel to the track has been more variable. The parallel tilt of Pier 3 has shifted approximately 0.075 degrees, indicating a possible change in conditions.



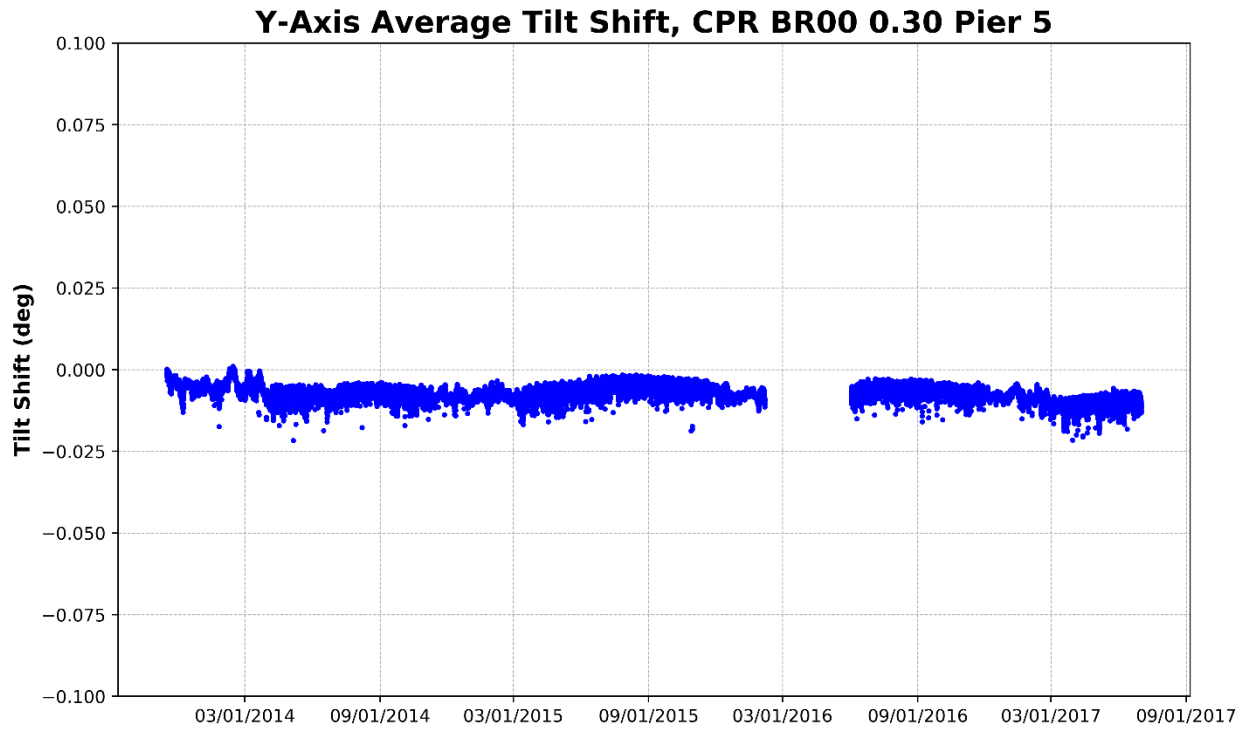
**Figure 76 – Pier 3, X-Axis Average Tilt (Parallel to Track)**



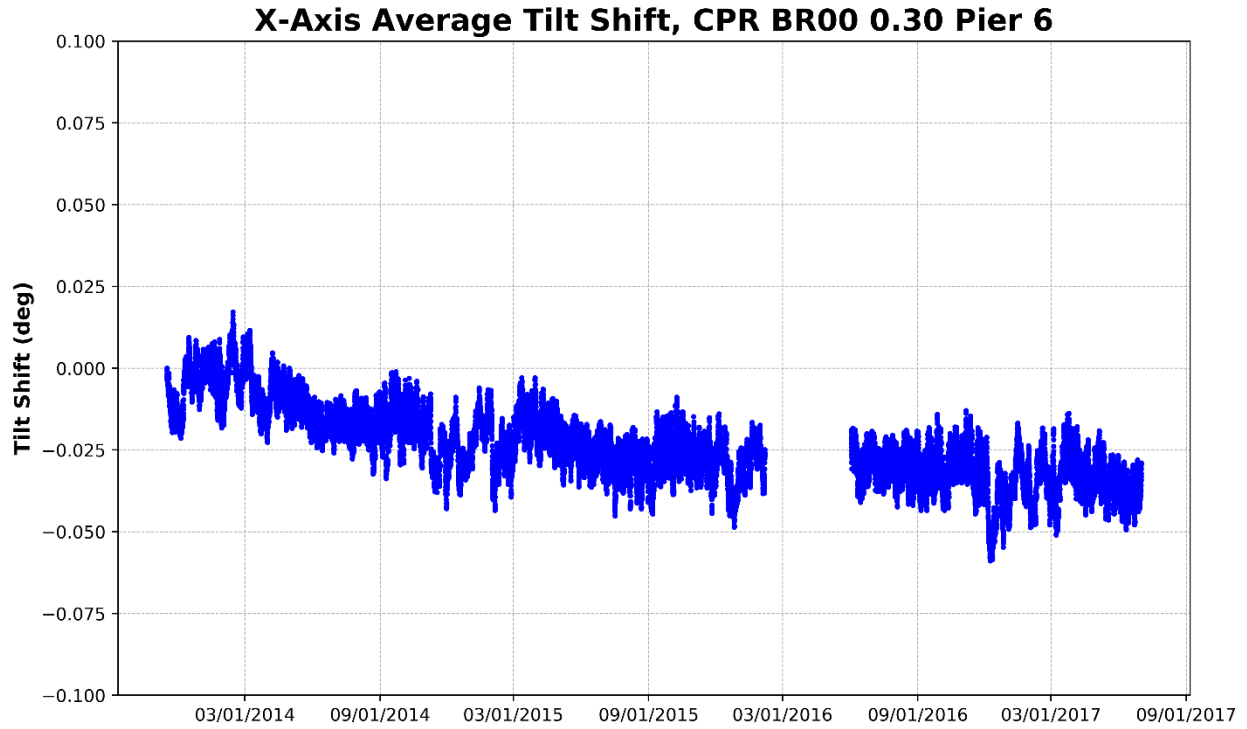
**Figure 77 – Pier 3, Y-Axis Average Tilt (Perpendicular to Track)**



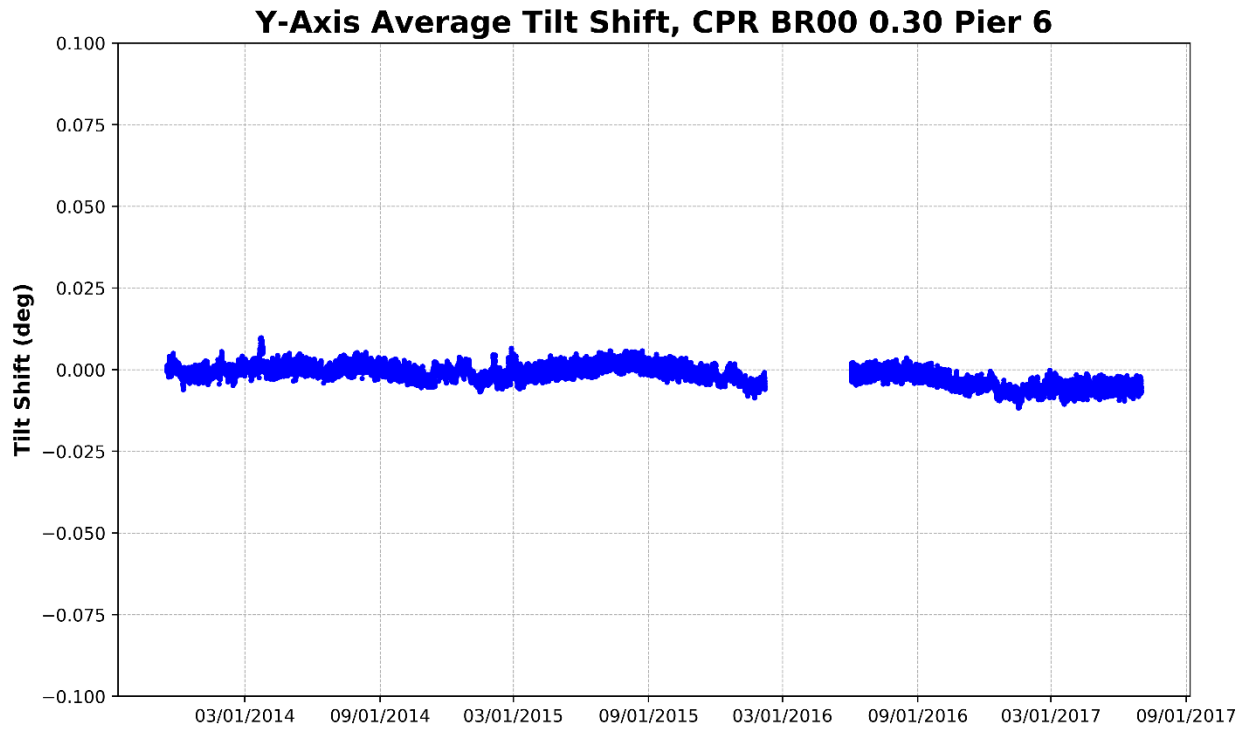
**Figure 78 – Pier 5, X-Axis Average Tilt (Parallel to Track)**



**Figure 79 – Pier 5, Y-Axis Average Tilt (Perpendicular to Track)**



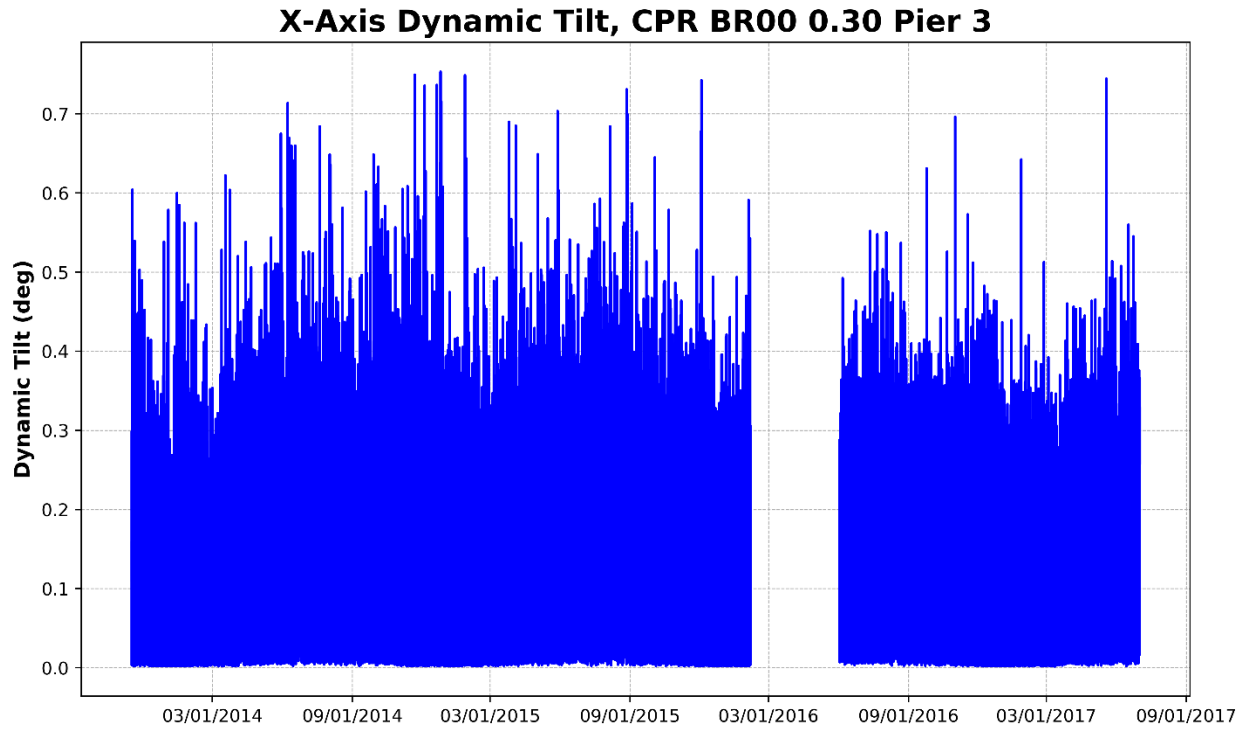
**Figure 80 – Pier 6, X-Axis Average Tilt (Parallel to Track)**



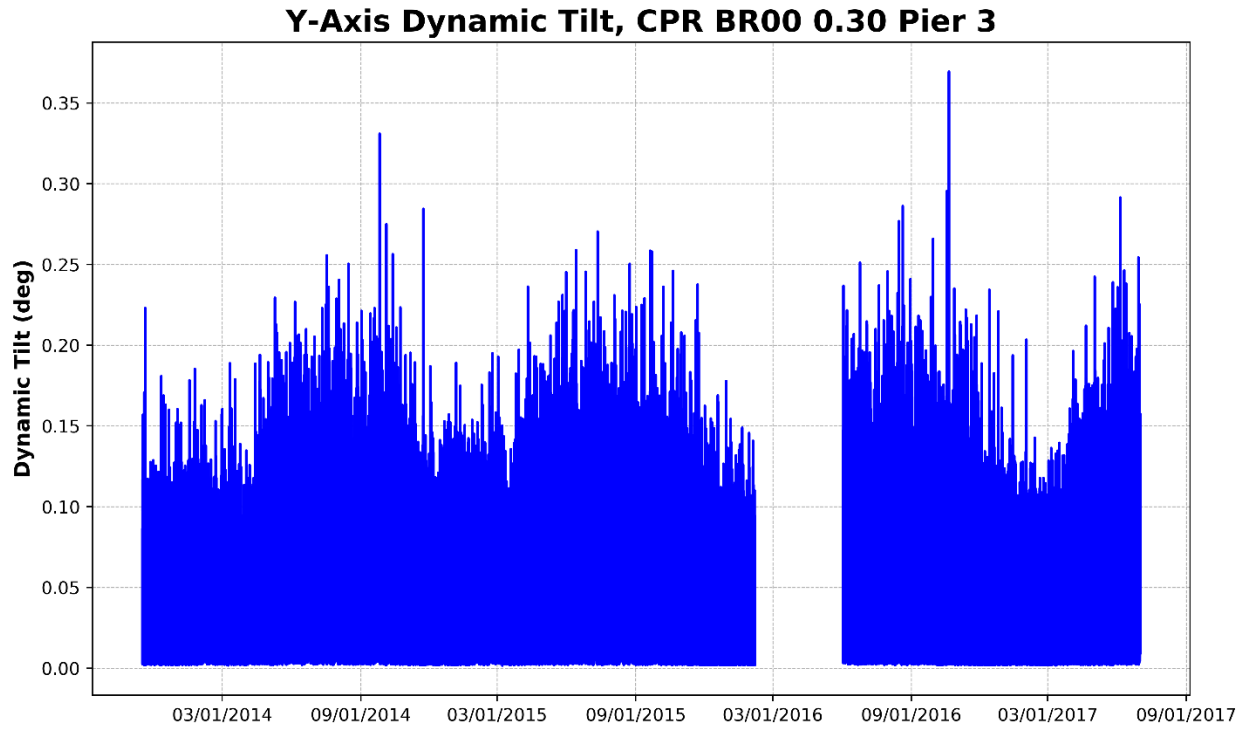
**Figure 81 – Pier 6, Y-Axis Average Tilt (Perpendicular to Track)**

#### 4.4.2 Dynamic Tilt

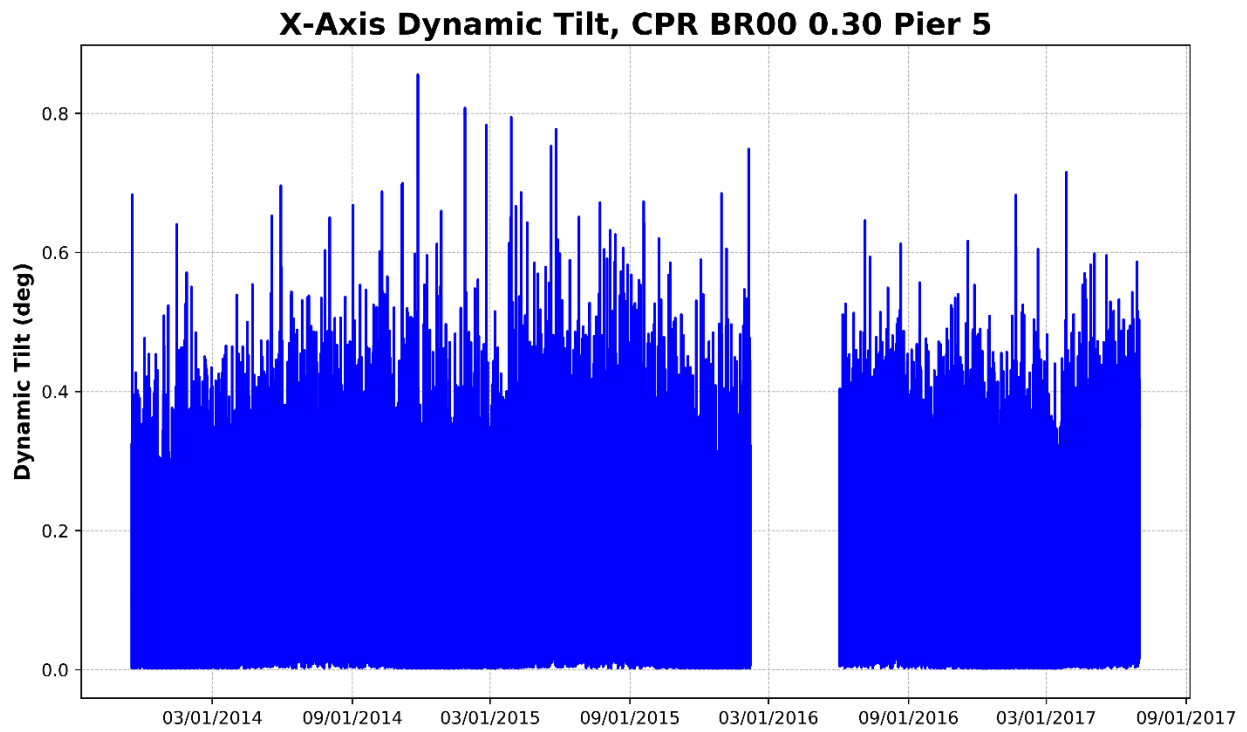
The dynamic tilt charts are shown in [Figure 81](#) through [Figure 86](#). Overall, there are no increasing trends or outliers that indicate unstable conditions.



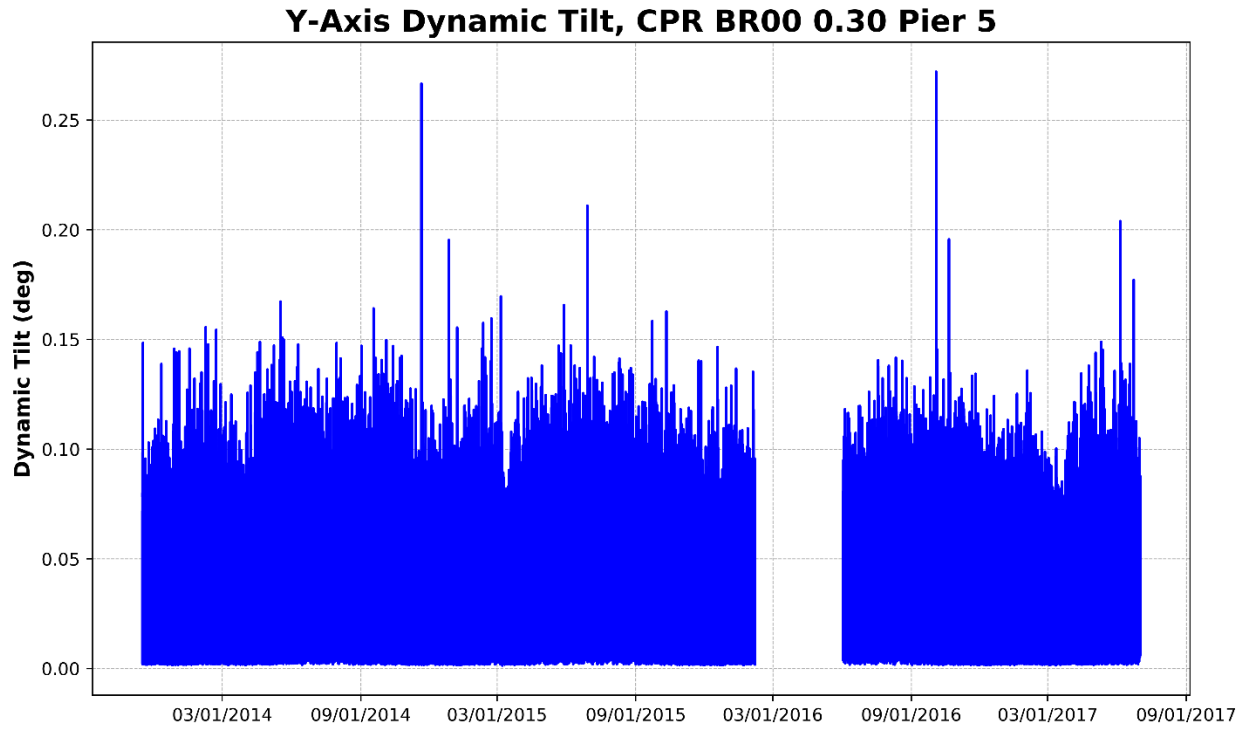
**Figure 82 – Pier 3, X-Axis Dynamic Tilt (Parallel to Track)**



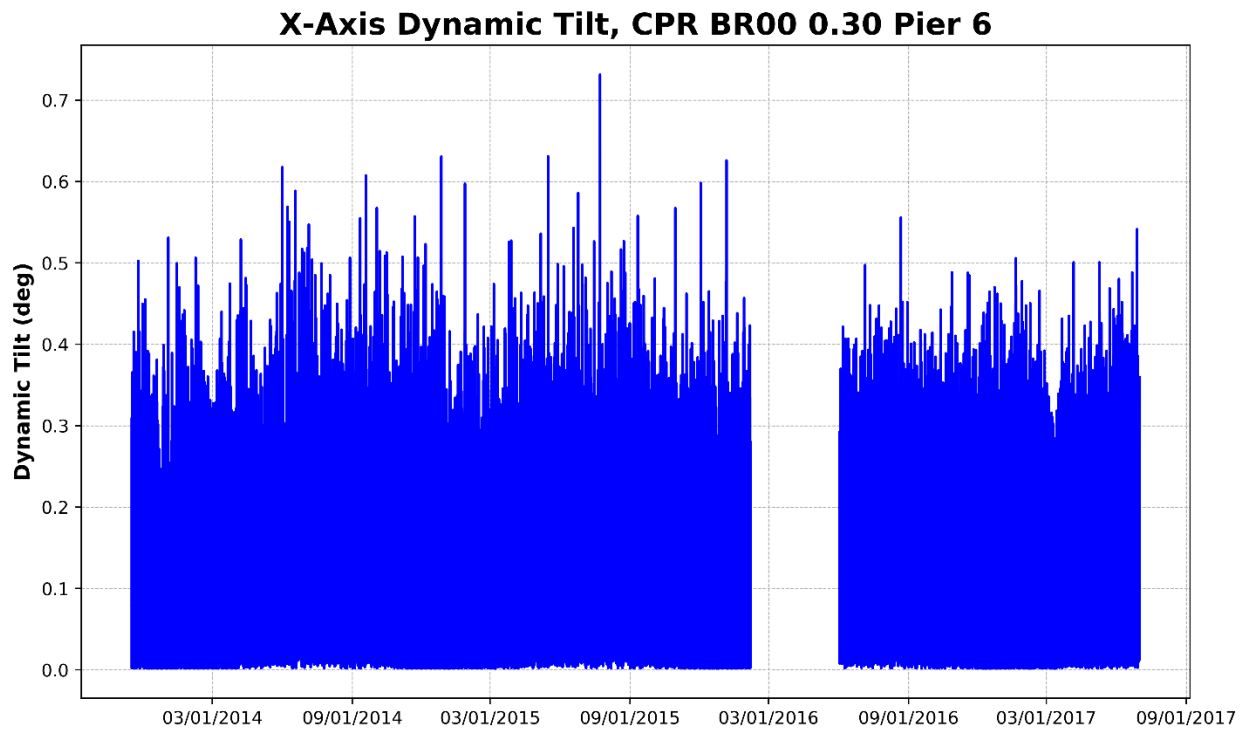
**Figure 83 – Pier 3, Y-Axis Dynamic Tilt (Perpendicular to Track)**



**Figure 84 – Pier 5, X-Axis Dynamic Tilt (Parallel to Track)**

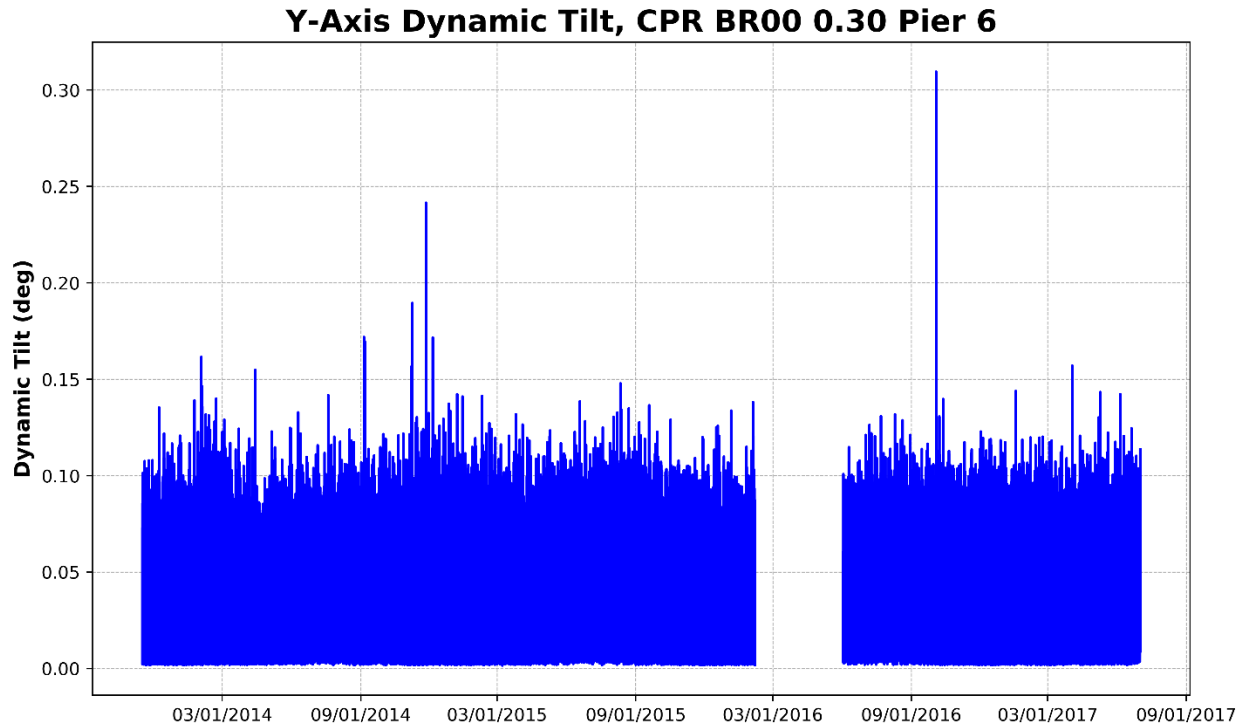


**Figure 85 – Pier 5, Y-Axis Dynamic Tilt (Perpendicular to Track)**



**Figure 86 – Pier 6, X-Axis Dynamic Tilt (Parallel to Track)**

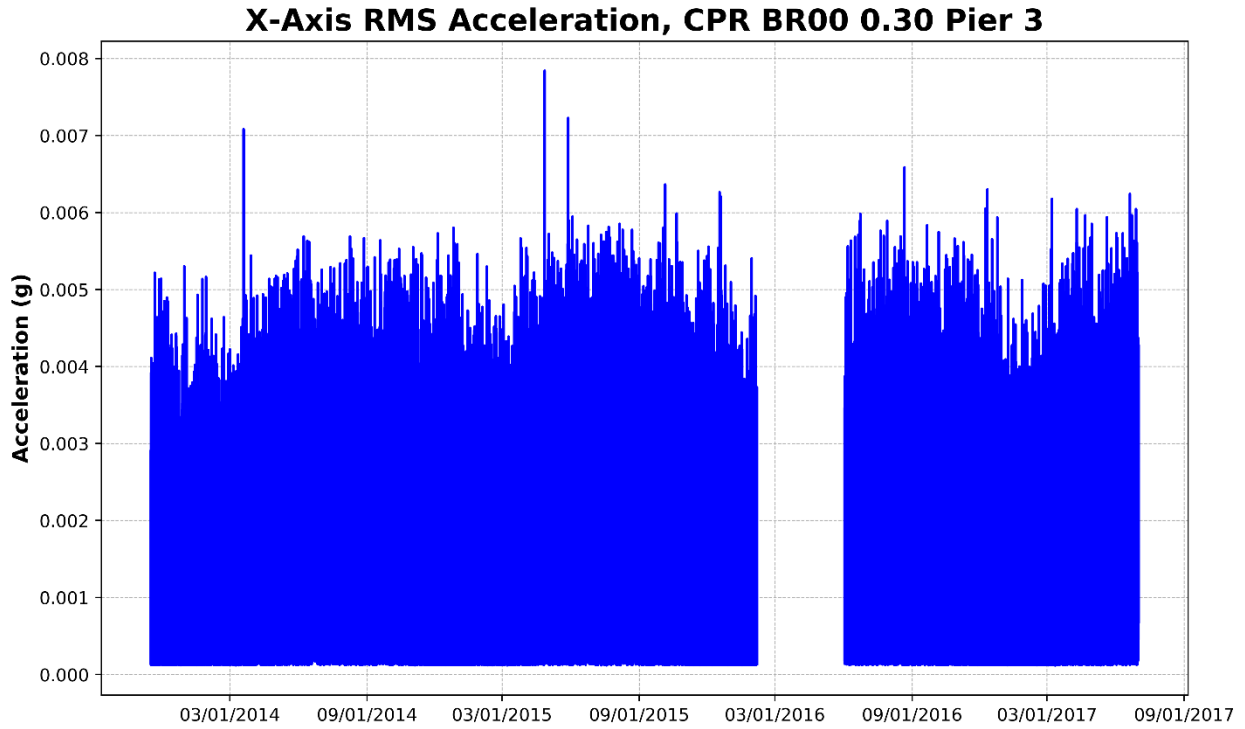




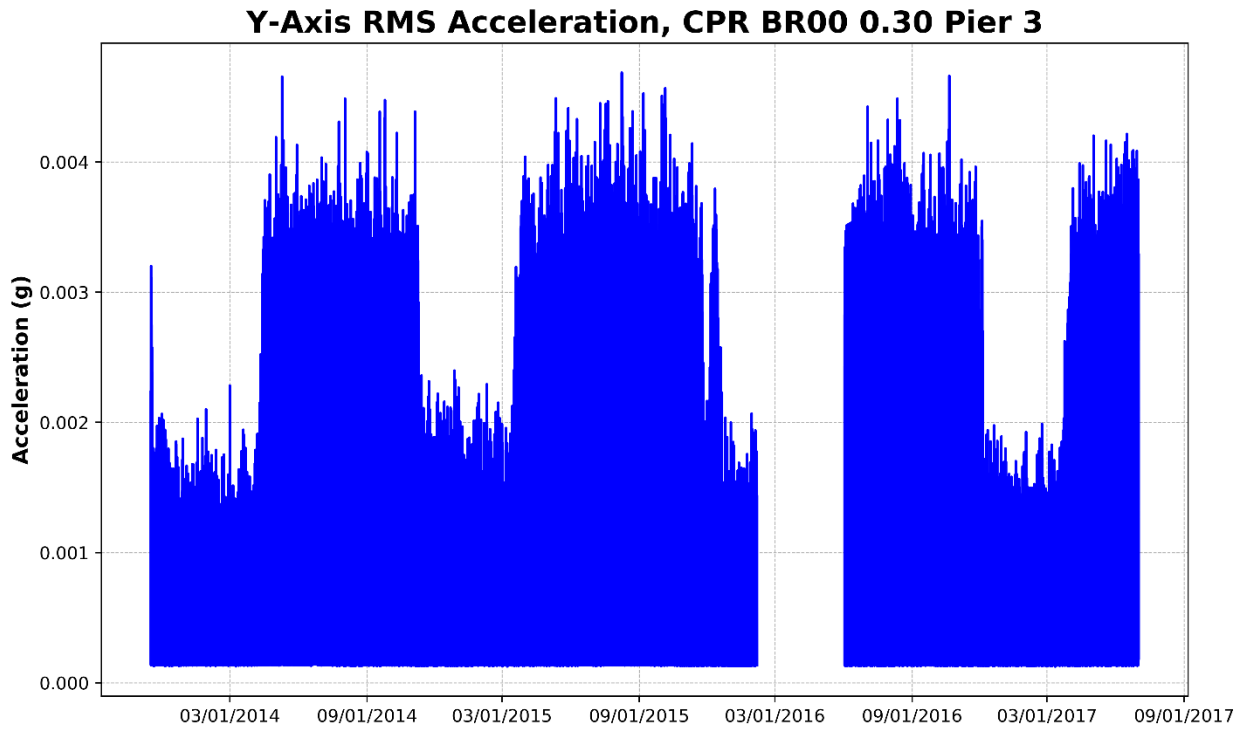
**Figure 87 – Pier 6, Y-Axis Dynamic Tilt (Perpendicular to Track)**

#### **4.4.3 Lateral Acceleration**

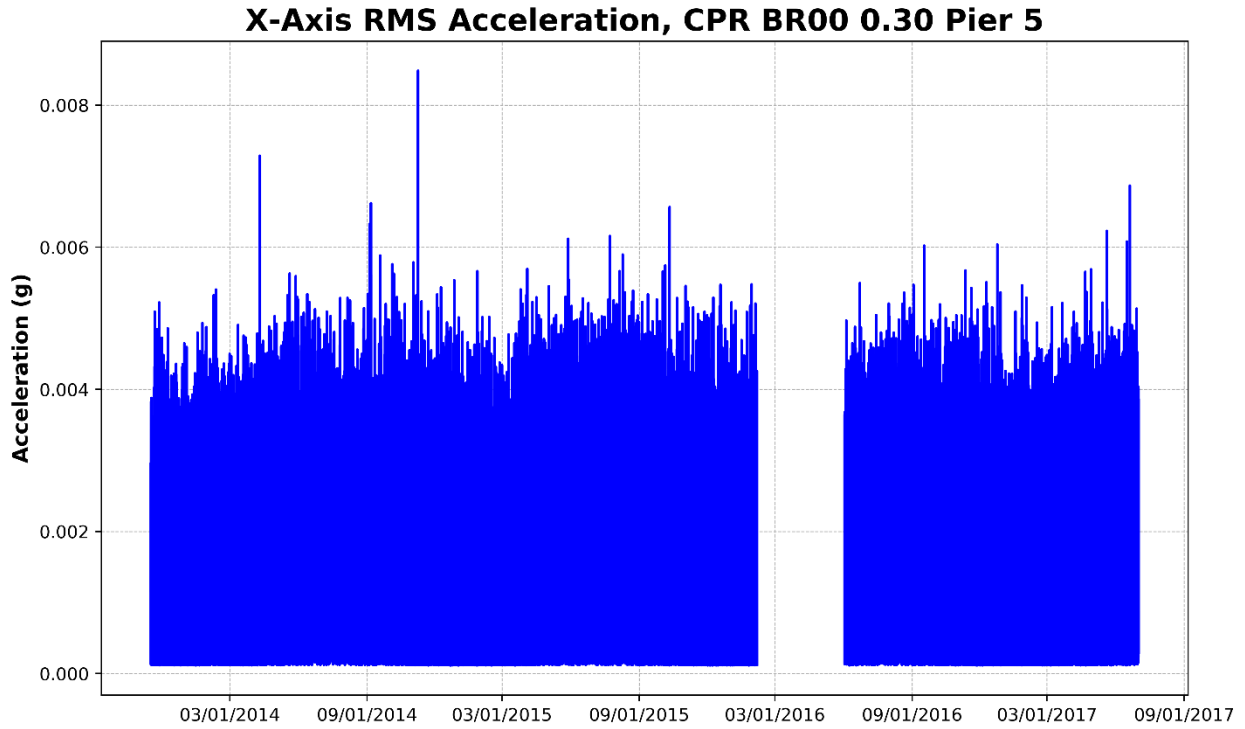
The acceleration plots are provided in [Figure 87](#) through [Figure 92](#). The data collected from Piers 3 and 5 show an interesting trend of lower vibration during the winter compared to the warmer months. This is likely related to the water level of the river and formation of ice.



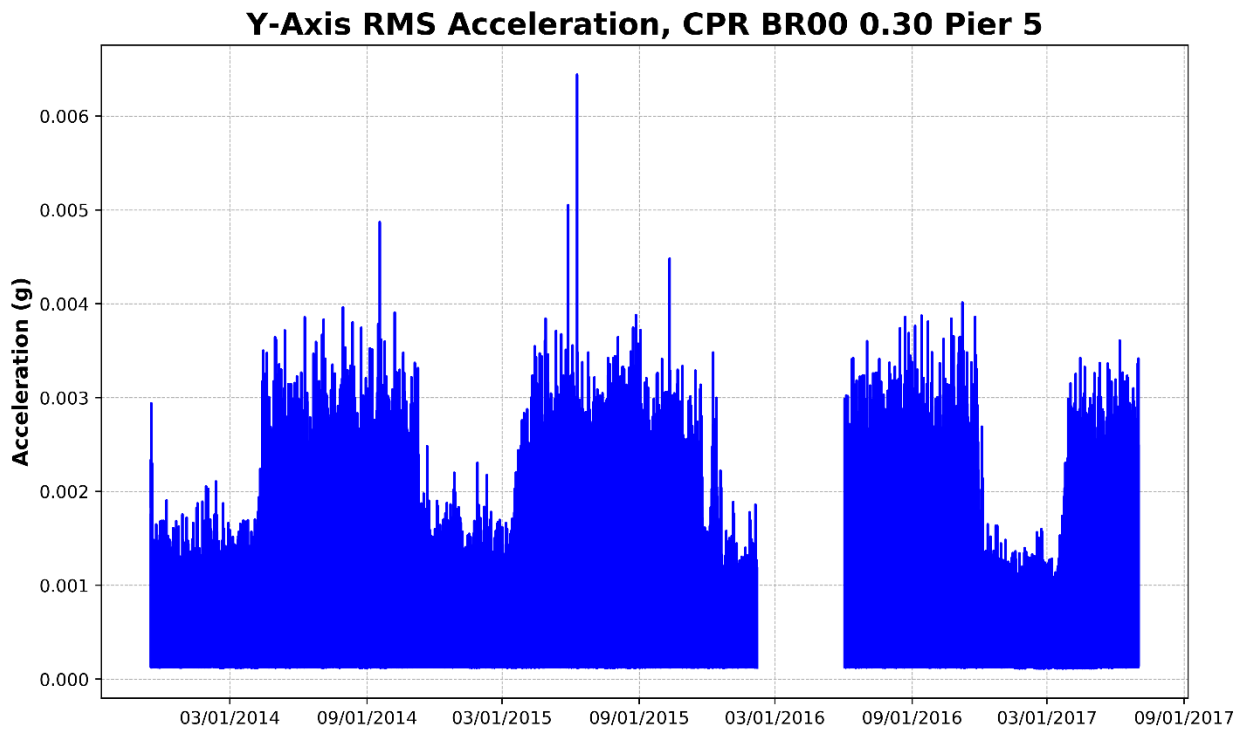
**Figure 88 – Pier 3, X-Axis RMS Acceleration (Parallel to Track)**



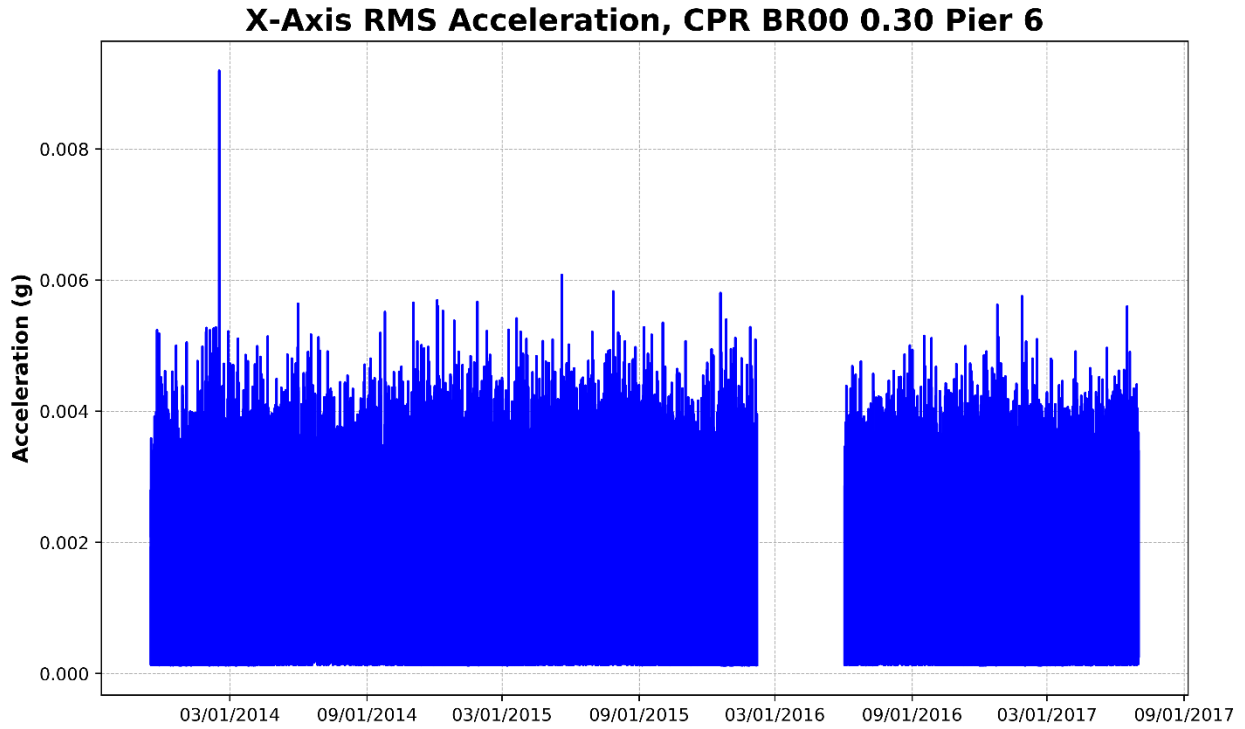
**Figure 89 – Pier 3, Y-Axis RMS Acceleration (Perpendicular to Track)**



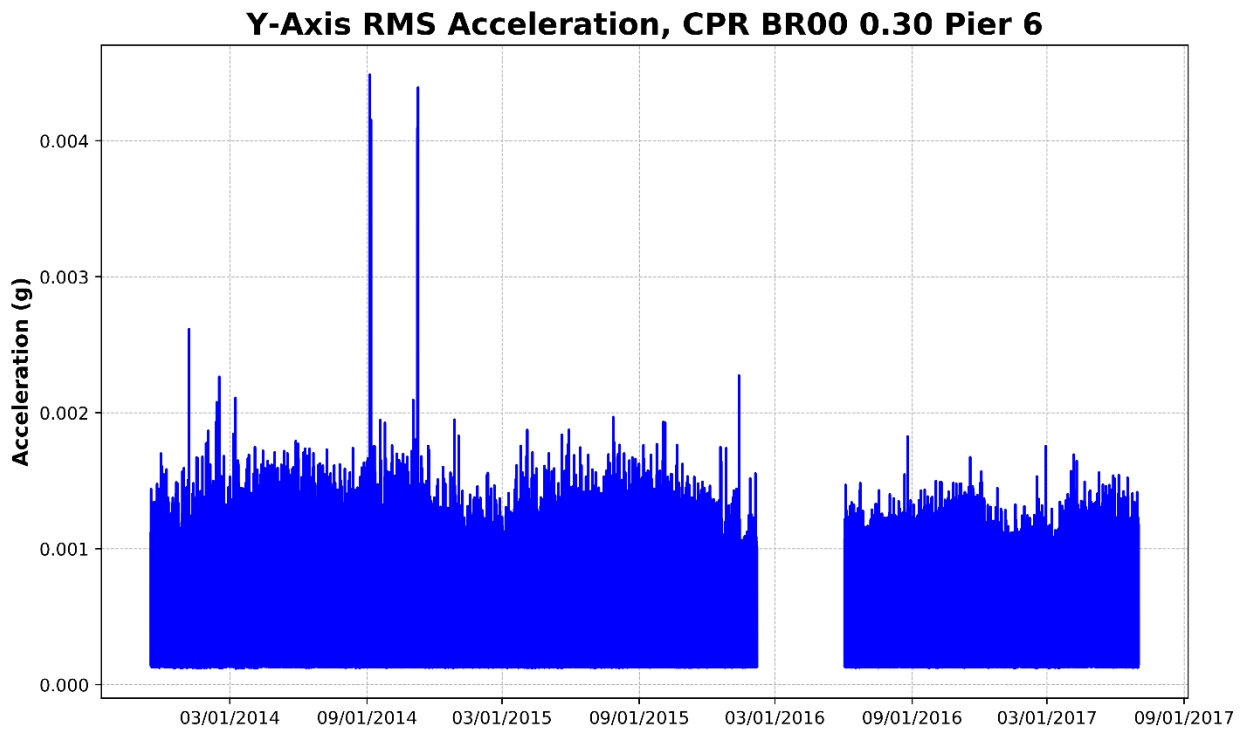
**Figure 90 – Pier 5, X-Axis RMS Acceleration (Parallel to Track)**



**Figure 91 – Pier 5, Y-Axis RMS Acceleration (Perpendicular to Track)**



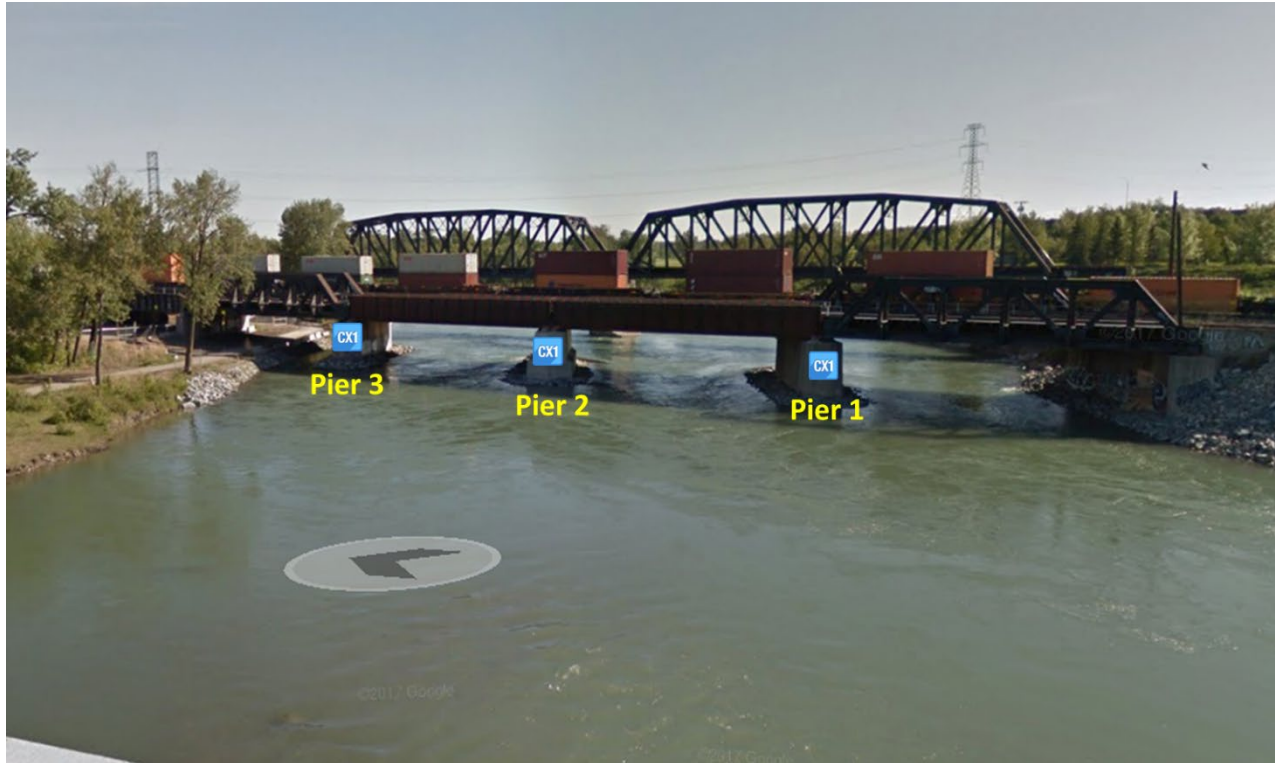
**Figure 92 – Pier 6, X-Axis RMS Acceleration (Parallel to Track)**



**Figure 93 – Pier 6, Y-Axis RMS Acceleration (Perpendicular to Track)**

#### 4.5 CPR BR00 172.46 Calgary

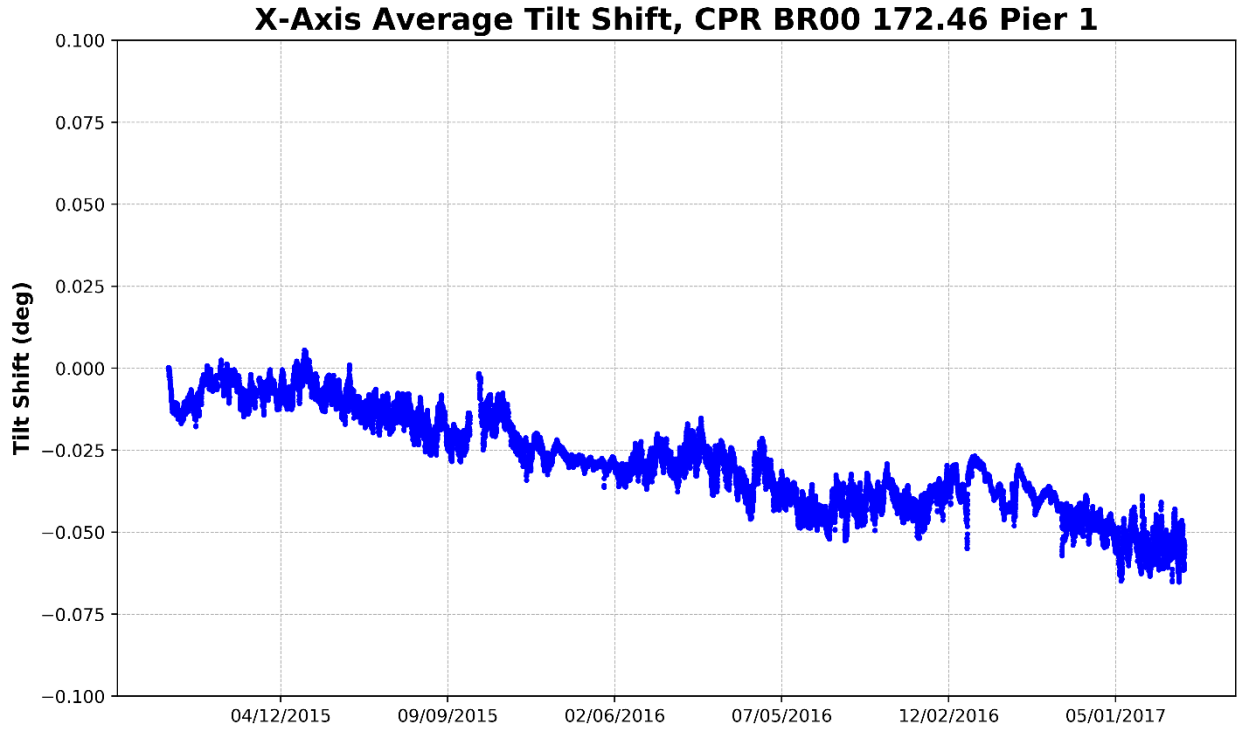
CPR BR00 172.46 is a five-span, 465-foot long bridge located in Calgary, AB. This bridge underwent reconstruction throughout the course of monitoring. Piers 1, 2, and 3 have a single CX1 installed as shown in [Figure 93](#).



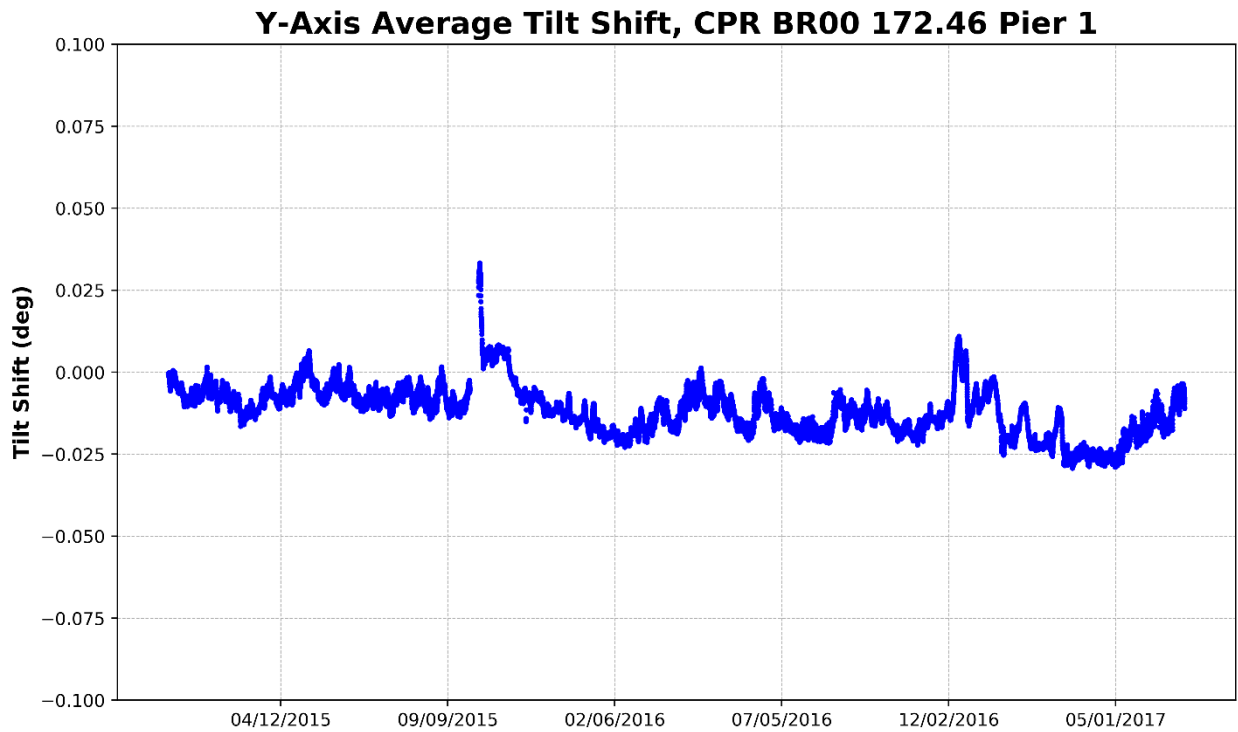
**Figure 94 – Sensor Locations on CPR Calgary Bridge 172.46**

##### 4.5.1 Average Tilt

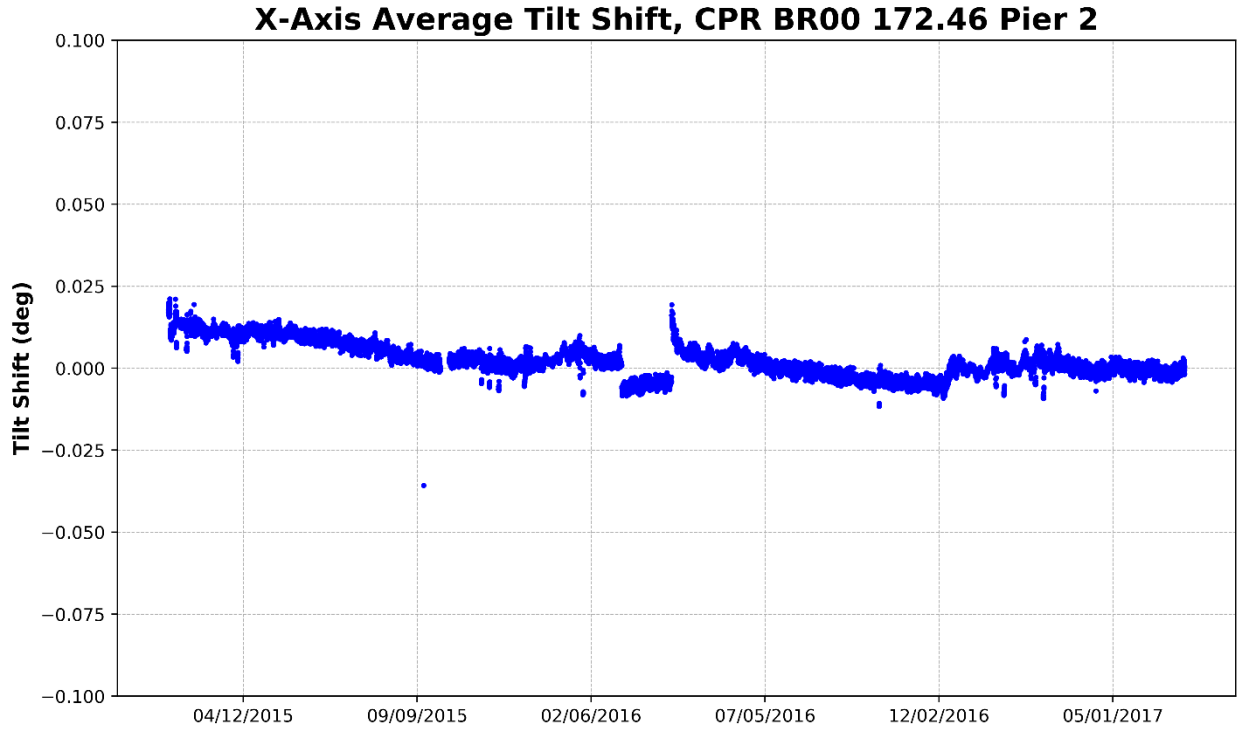
The average tilt charts are shown in [Figure 94](#) through [Figure 99](#). Piers 2 and 3 are within 0.03 degrees of their starting points both perpendicular and parallel to the track. Pier 1 has shifted over 0.05 degrees perpendicular to the track at a steady rate since monitoring began. It is recommended to continue watching this trend to see if it continues.



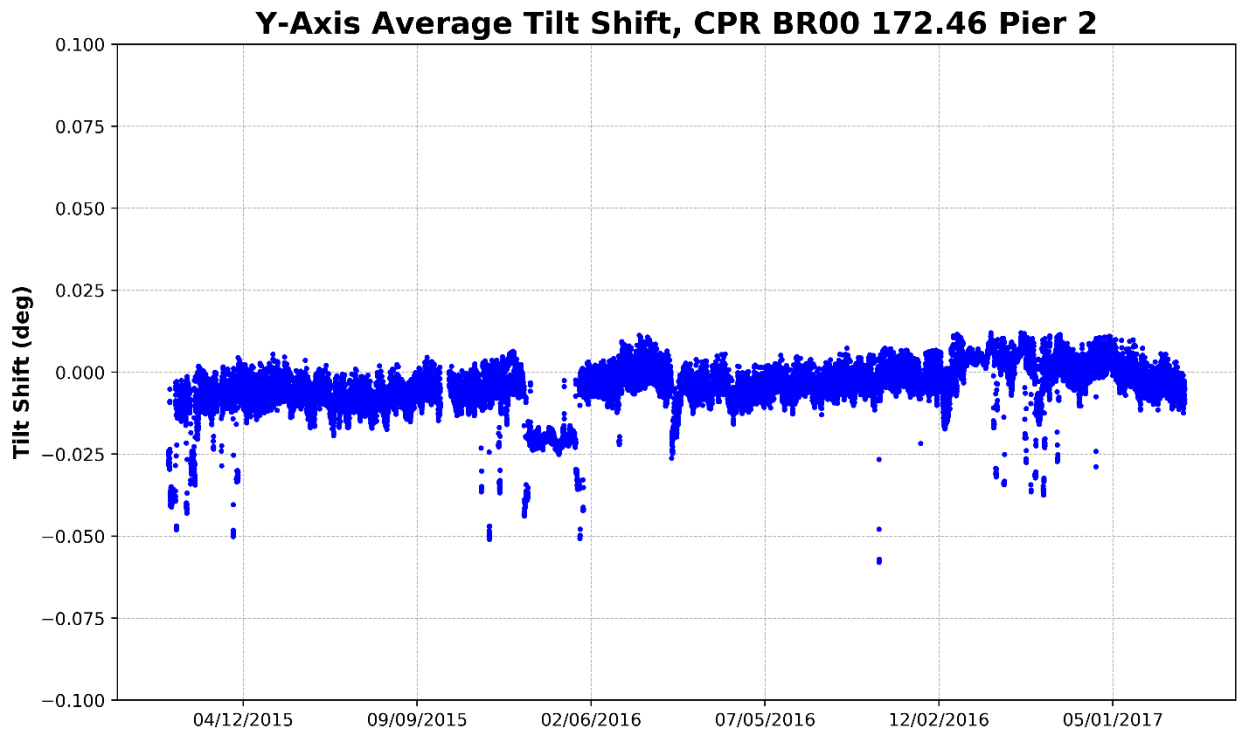
**Figure 95 – Pier 1, X-Axis Average Tilt (Perpendicular to Track)**



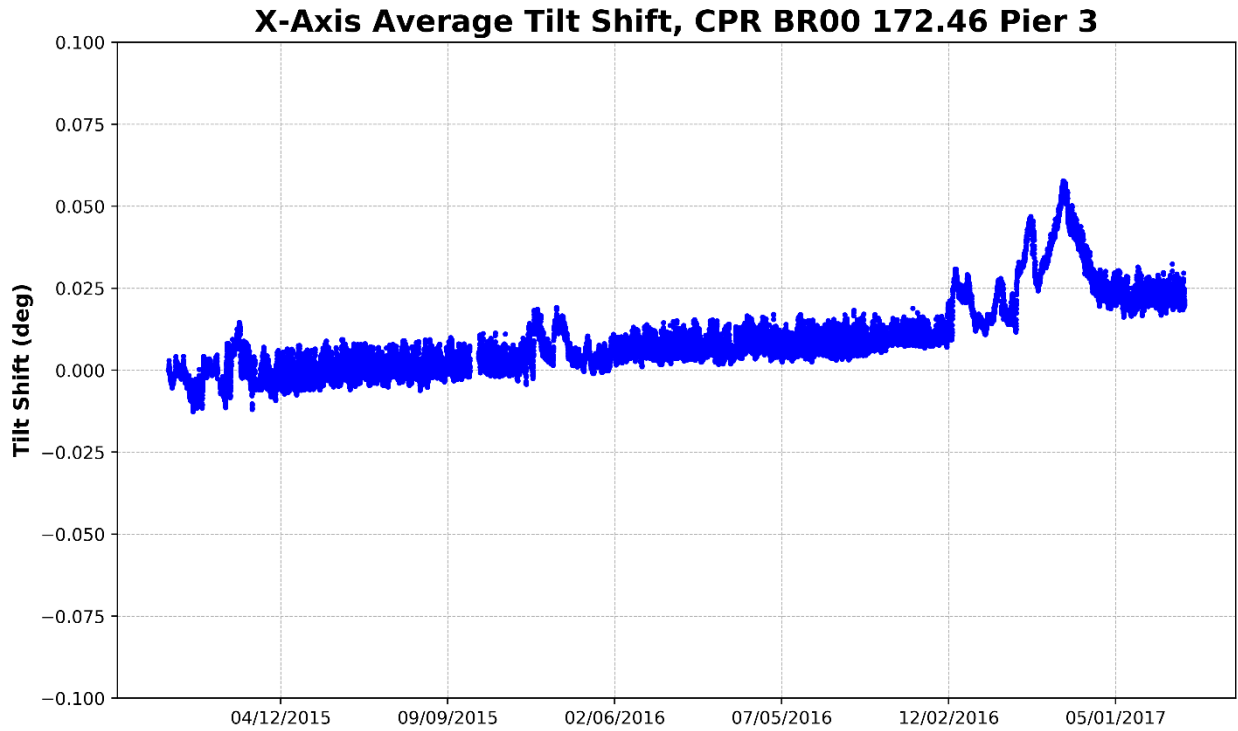
**Figure 96 – Pier 1, Y-Axis Average Tilt (Parallel to Track)**



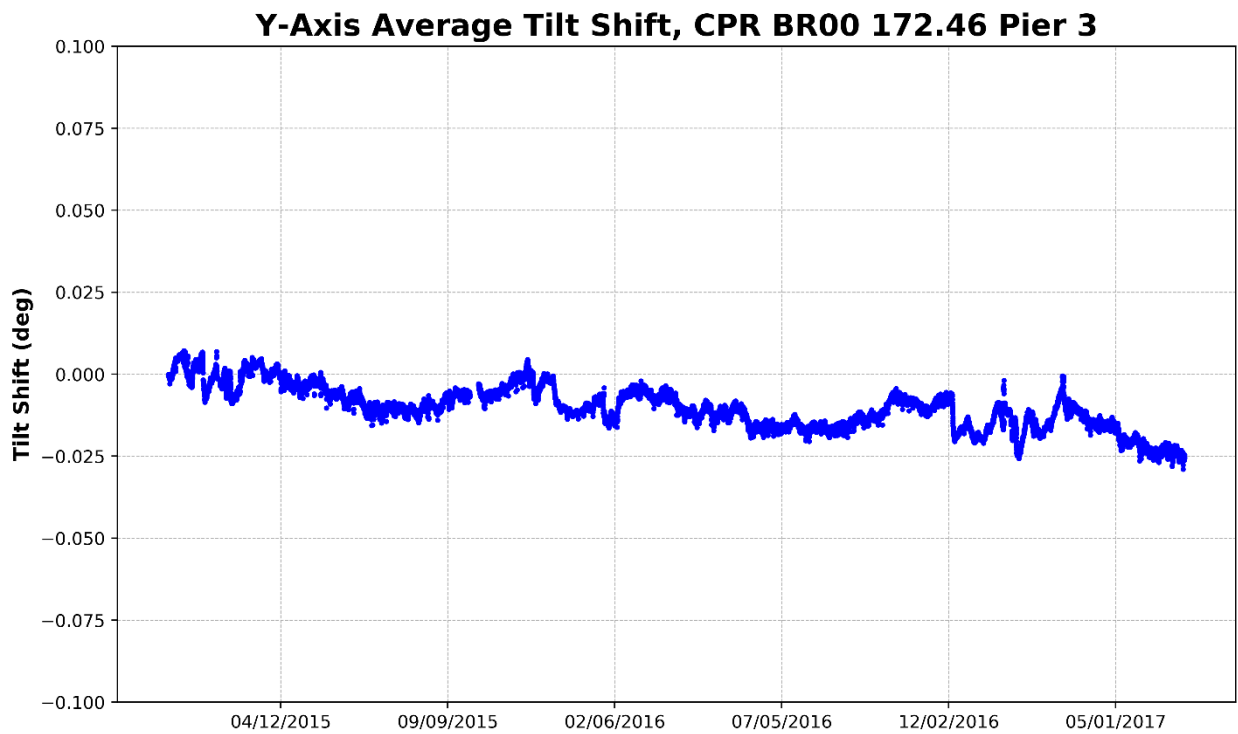
**Figure 97 – Pier 2, X-Axis Average Tilt (Perpendicular to Track)**



**Figure 98 – Pier 2, Y-Axis Average Tilt (Parallel to Track)**



**Figure 99 – Pier 3, X-Axis Average Tilt (Perpendicular to Track)**

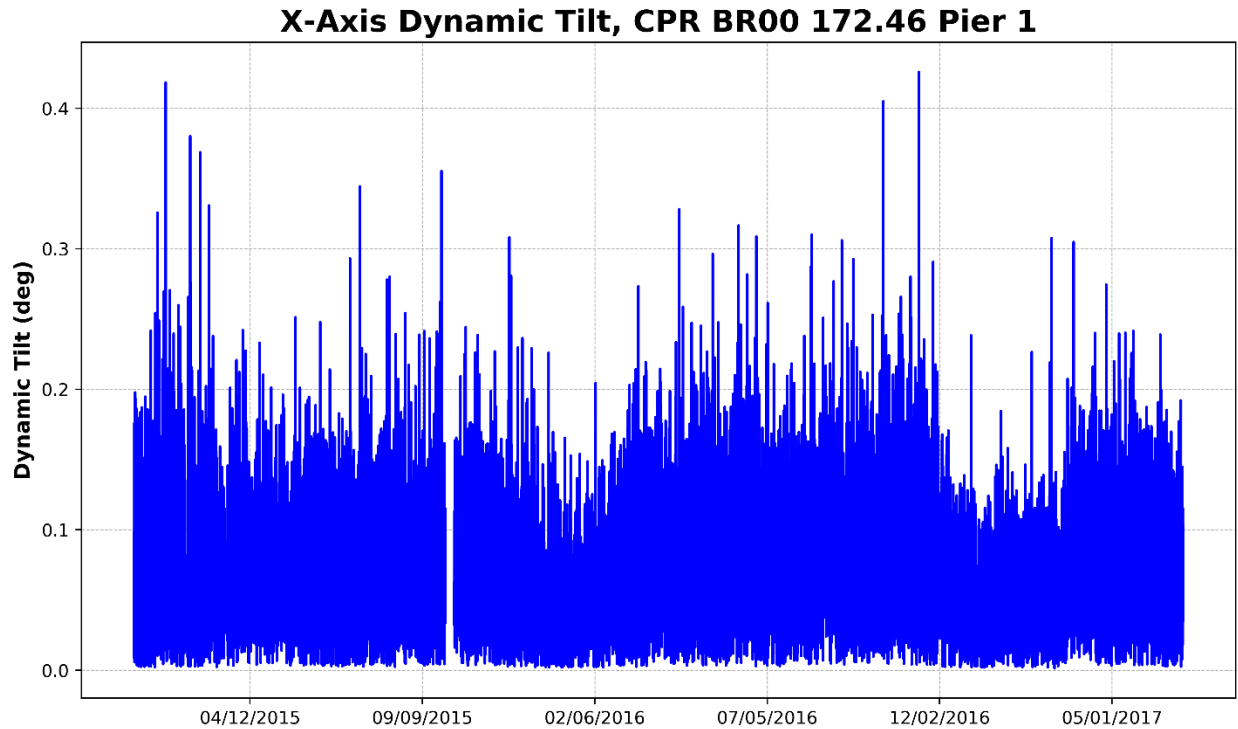


**Figure 100 – Pier 3, Y-Axis Average Tilt (Parallel to Track)**

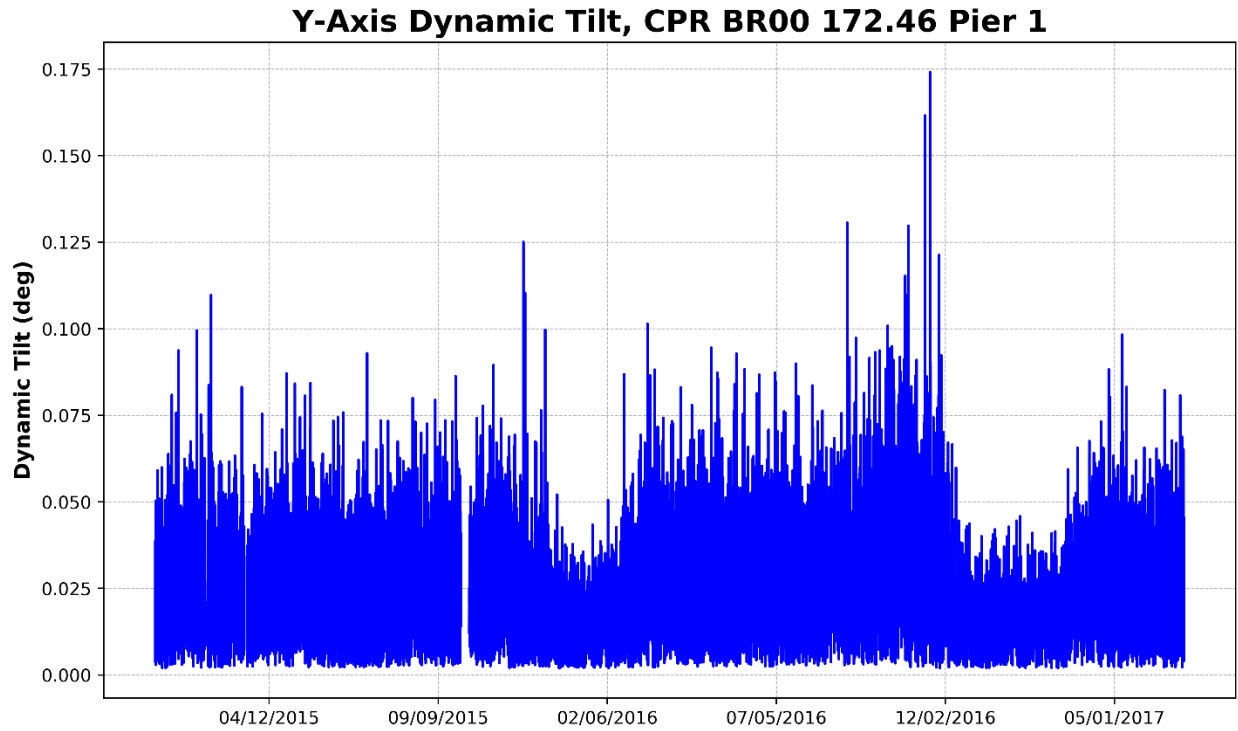


#### 4.5.2 Dynamic Tilt

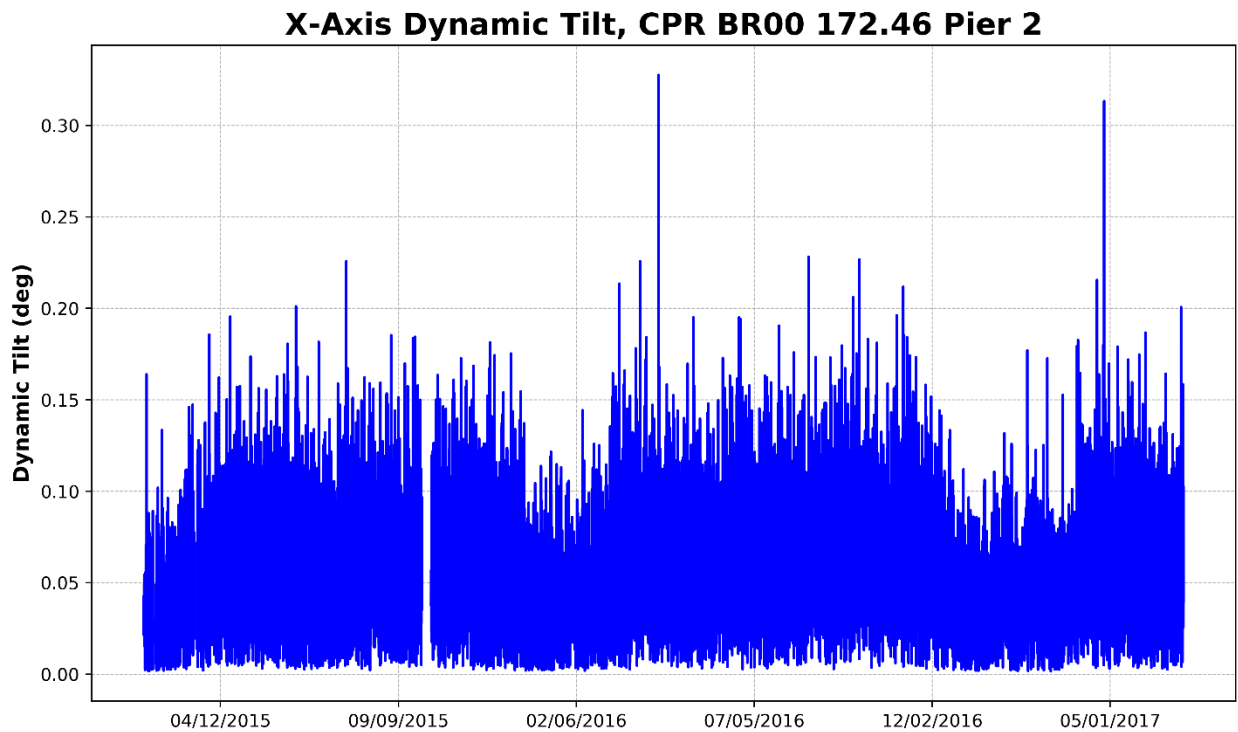
The dynamic tilt charts are shown in [Figure 100](#) through [Figure 105](#). The Pier 2 sensor recorded two outlier responses with magnitudes well above the normal range. The first was recorded in September 2015 and the second in April 2016. It is possible these correspond to construction related activities.



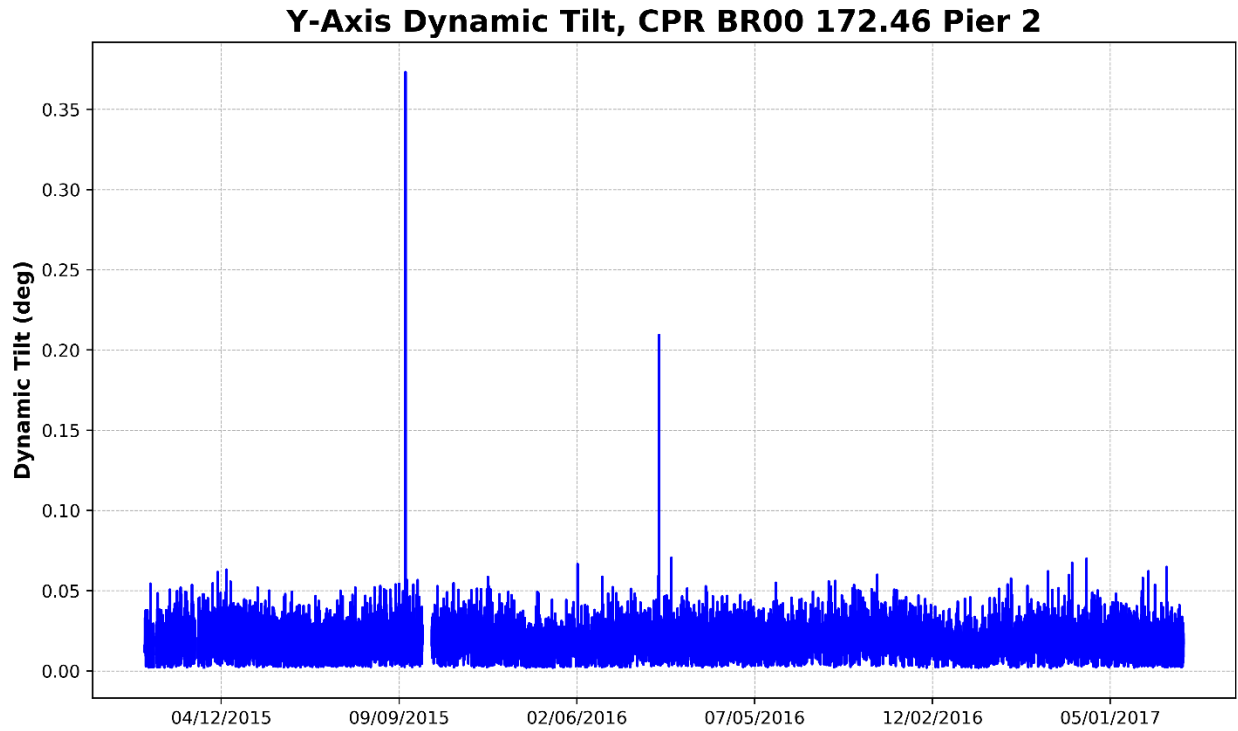
**Figure 101 – Pier 1, X-Axis Dynamic Tilt (Perpendicular to Track)**



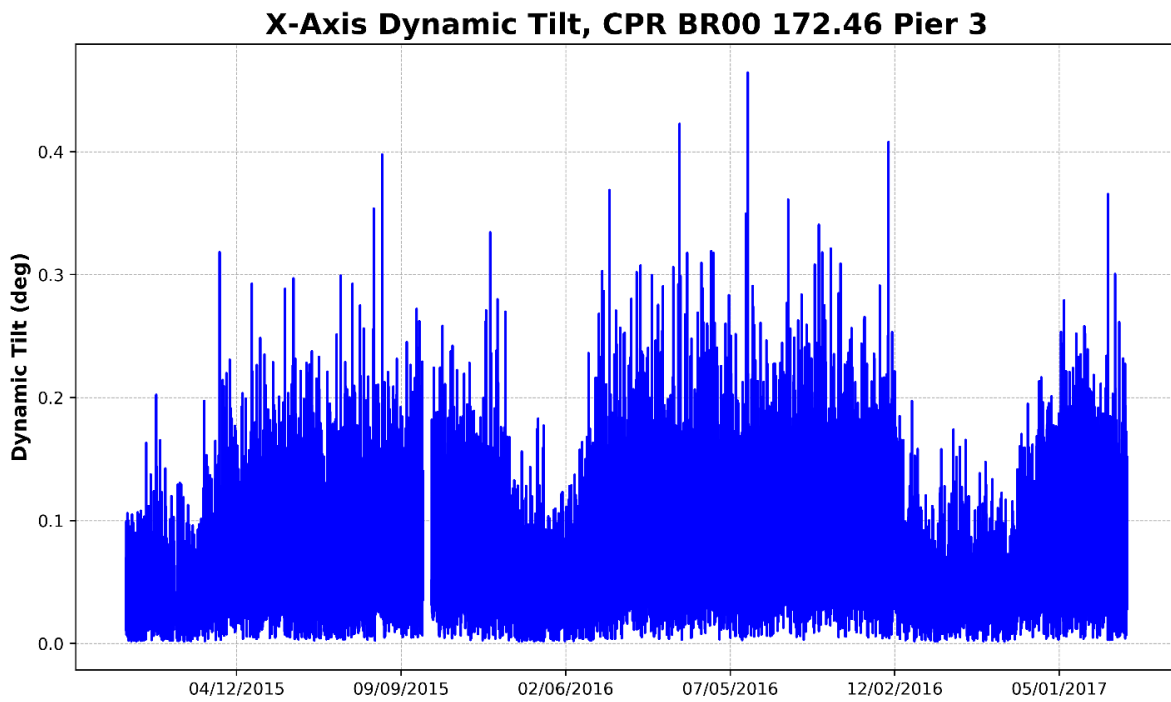
**Figure 102 – Pier 1, Y-Axis Dynamic Tilt (Parallel to Track)**



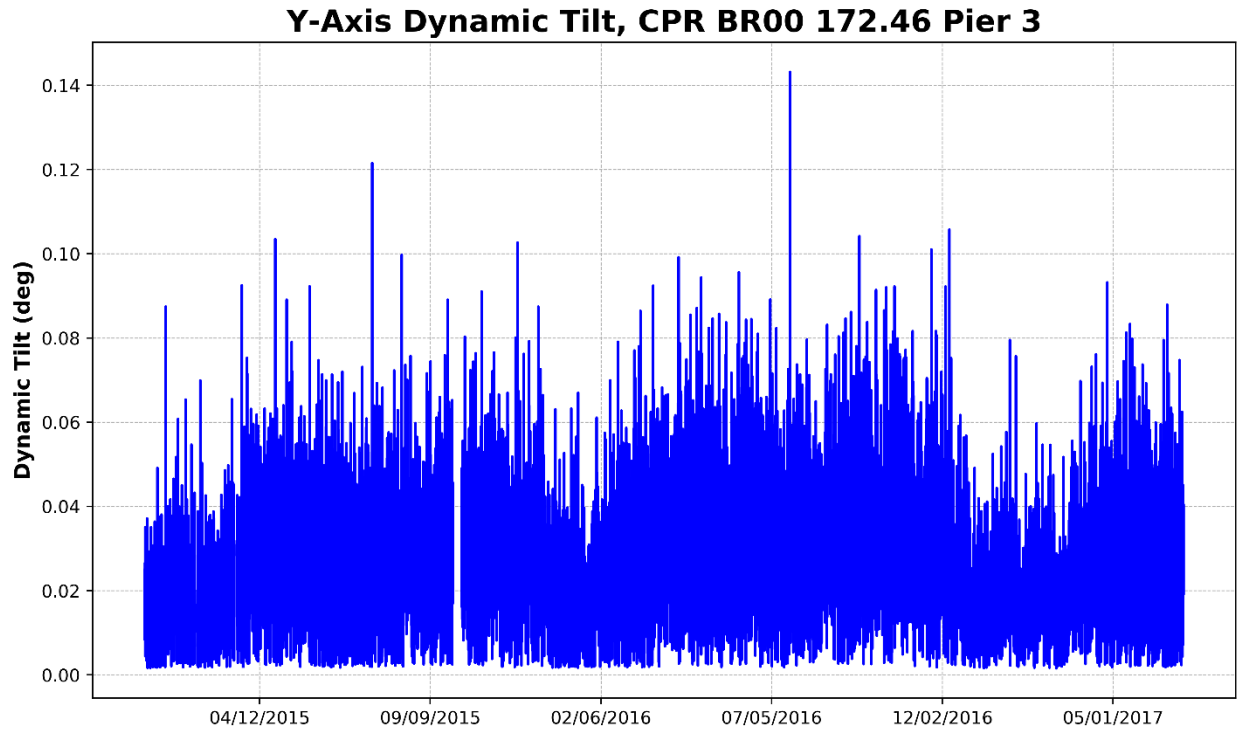
**Figure 103 – Pier 2, X-Axis Dynamic Tilt (Perpendicular to Track)**



**Figure 104 – Pier 2, Y-Axis Dynamic Tilt (Parallel to Track)**



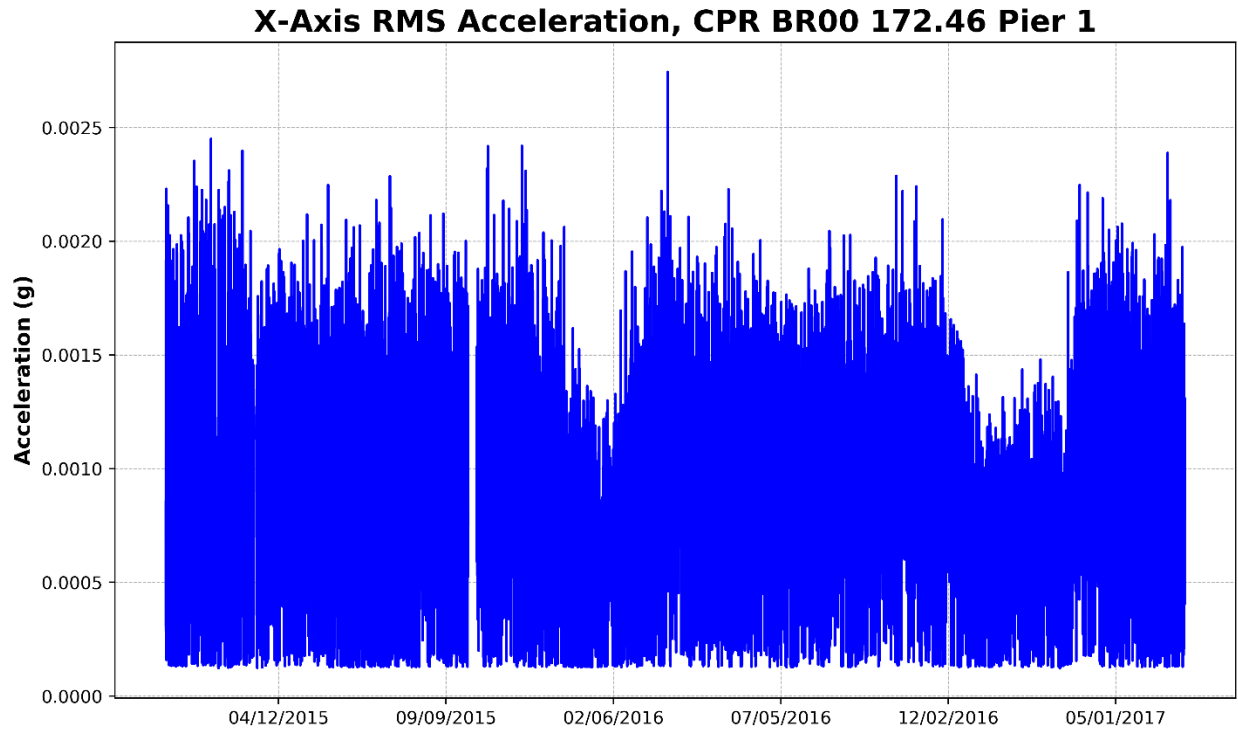
**Figure 105 – Pier 3, X-Axis Dynamic Tilt (Perpendicular to Track)**



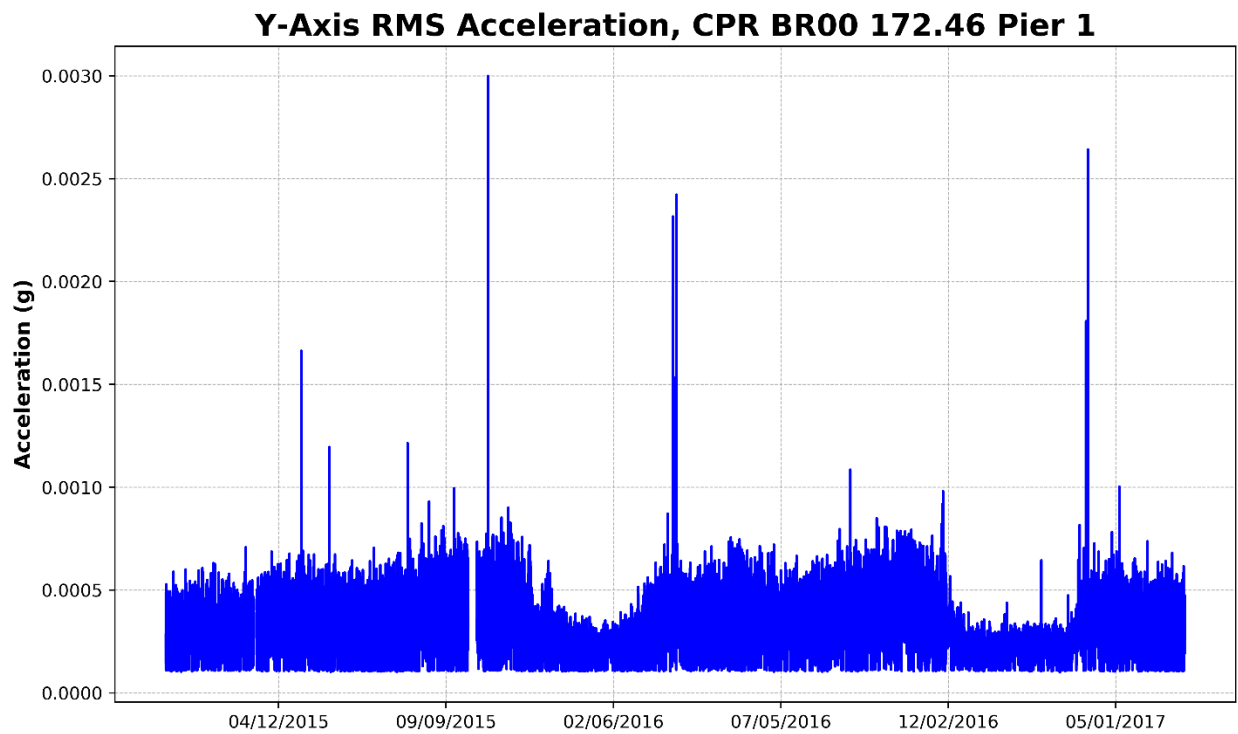
**Figure 106 – Pier 3, Y-Axis Dynamic Tilt (Parallel to Track)**

### **4.5.3 Lateral Acceleration**

The acceleration charts are shown in [Figure 106](#) through [Figure 111](#). Numerous outliers have been recorded by all three sensors. None of the outliers are indicative of a permanent change in structural response, but can be noted for future reference.



**Figure 107 – Pier 1, X-Axis RMS Acceleration (Perpendicular to Track)**



**Figure 108 – Pier 1, Y-Axis RMS Acceleration (Parallel to Track)**

### X-Axis RMS Acceleration, CPR BR00 172.46 Pier 2

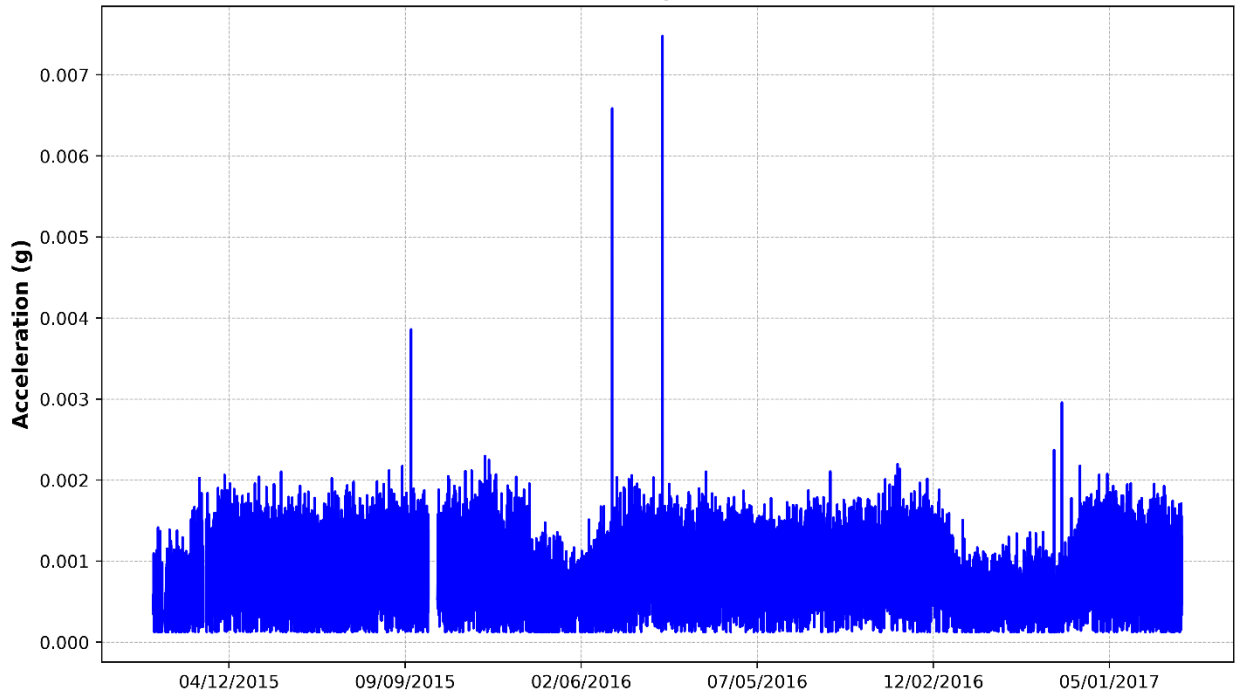


Figure 109 – Pier 2, X-Axis RMS Acceleration (Perpendicular to Track)

### Y-Axis RMS Acceleration, CPR BR00 172.46 Pier 2

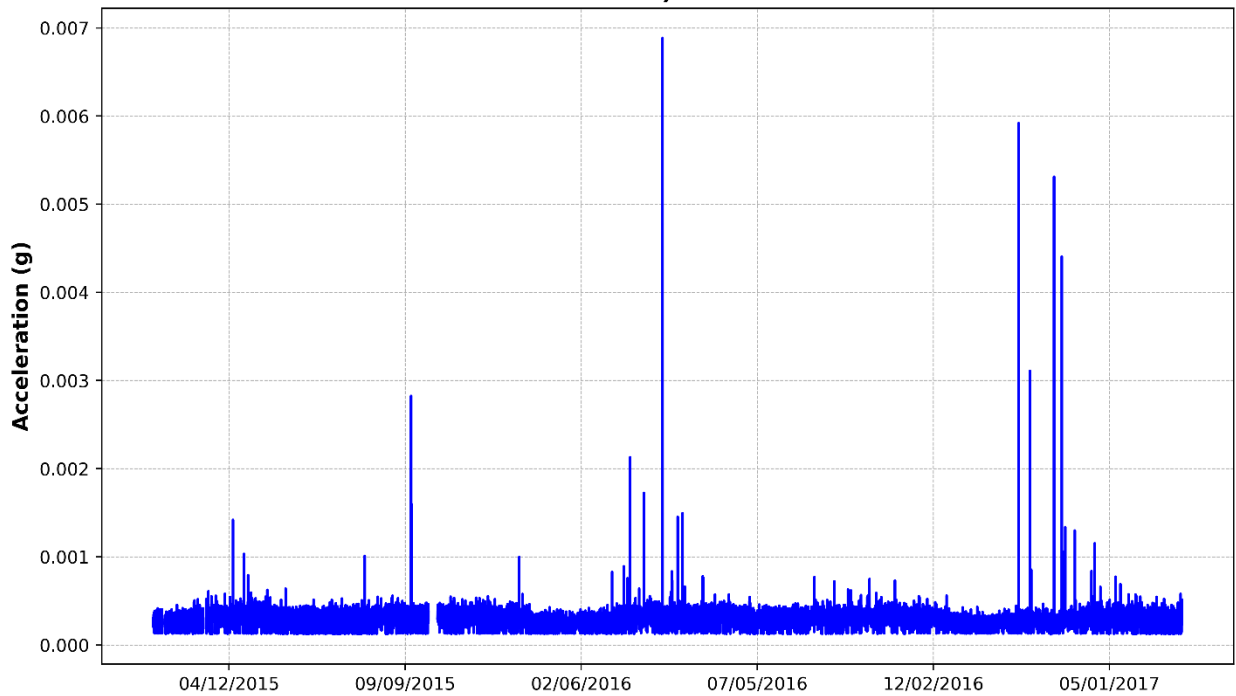
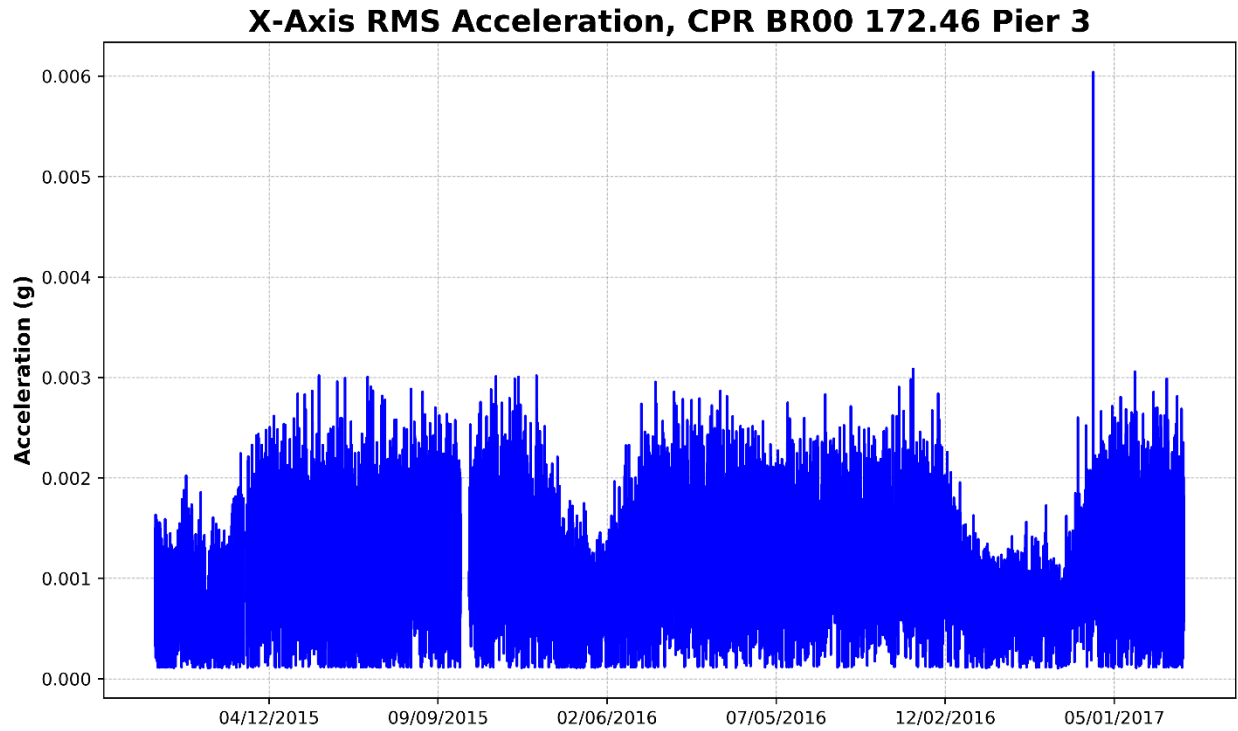
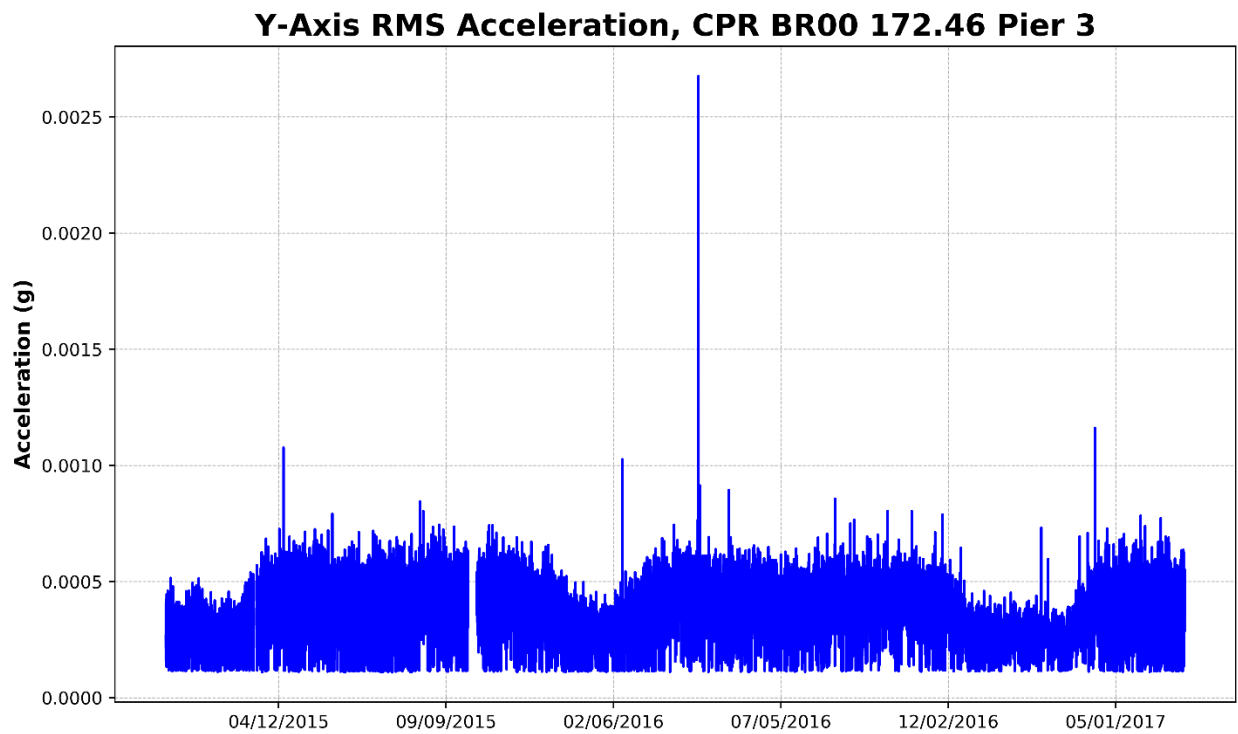


Figure 110 – Pier 2, Y-Axis RMS Acceleration (Parallel to Track)



**Figure 111 – Pier 3, X-Axis RMS Acceleration (Perpendicular to Track)**



**Figure 112 – Pier 3, Y-Axis RMS Acceleration (Parallel to Track)**

## 4.6 CPR 121.95 Watertown

This bridge is a three-span, 190-foot long single-track bridge located near Ixonia, WI. For this bridge, all substructure elements (4) are being monitored as shown in Figure 112. The piers of this bridge are skewed 30 degrees and the abutments are square. The monitoring system was installed in April 2013.

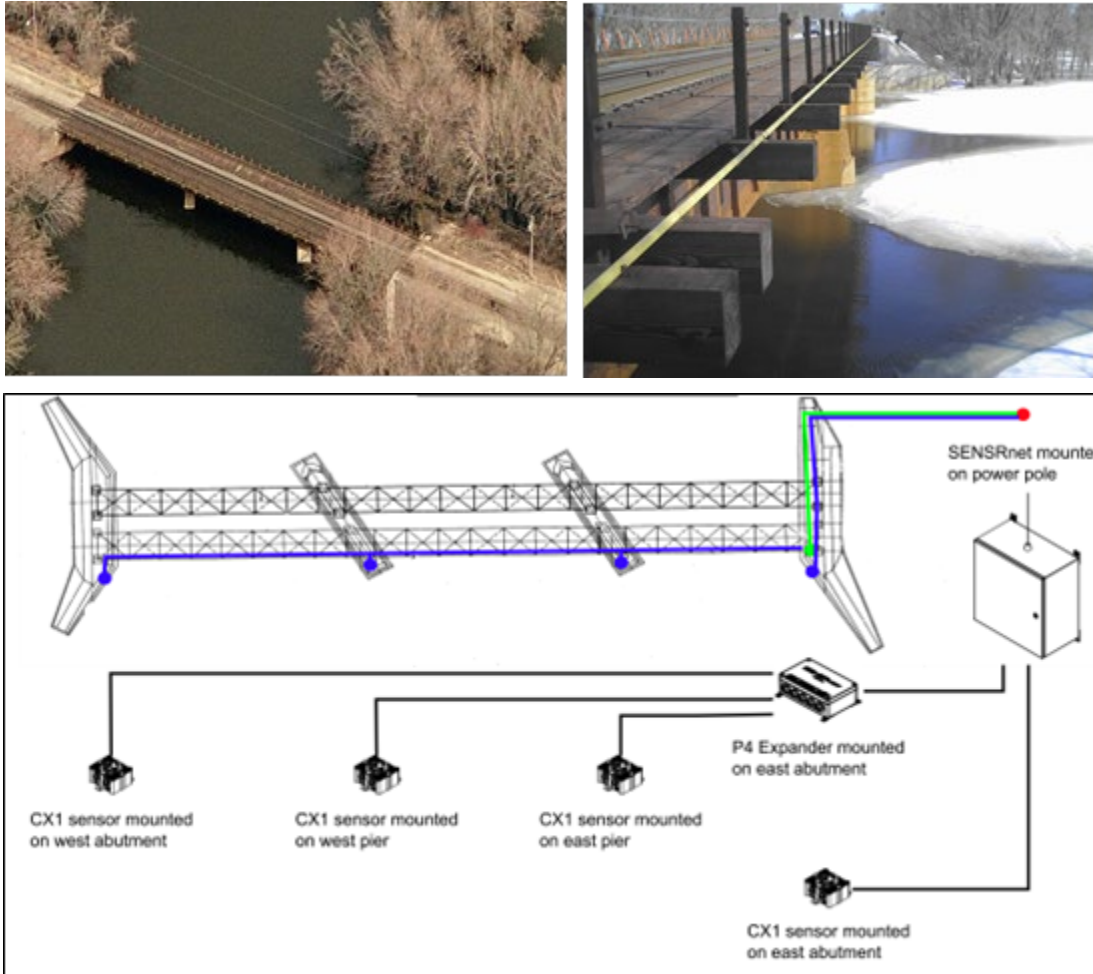
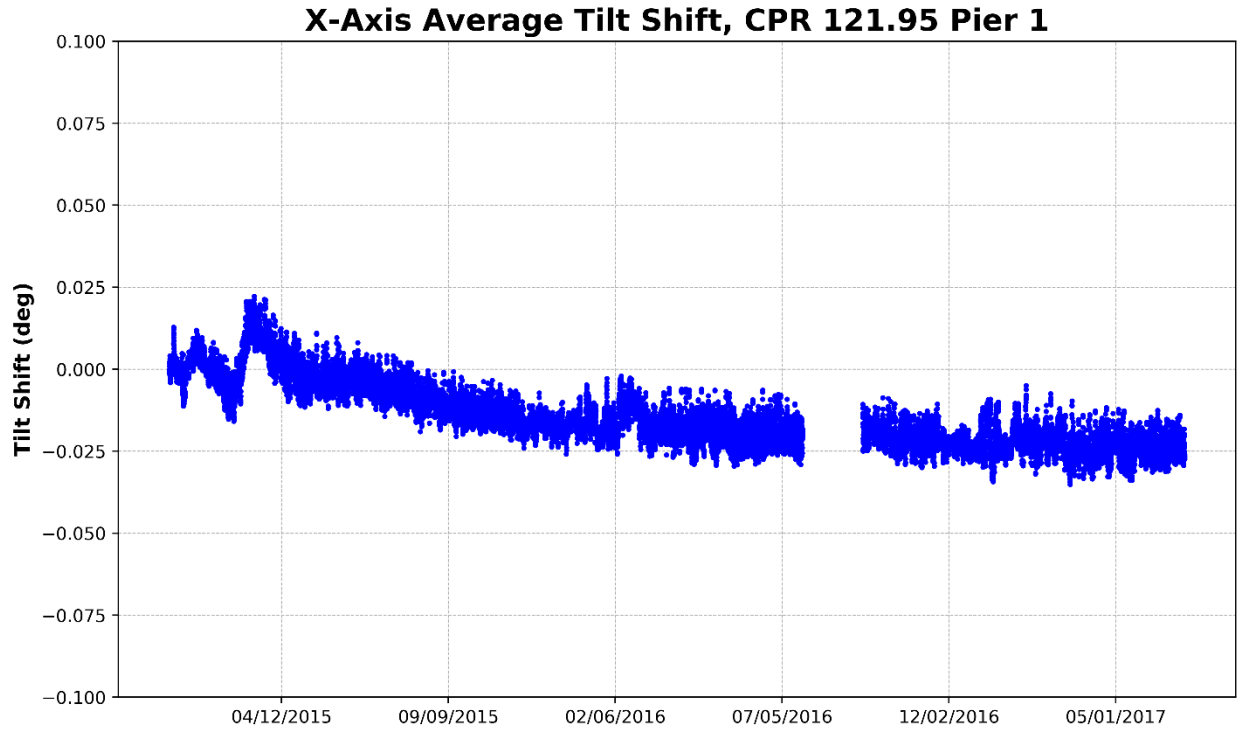


Figure 113 – CPR 121.95 Watertown Sensor Locations

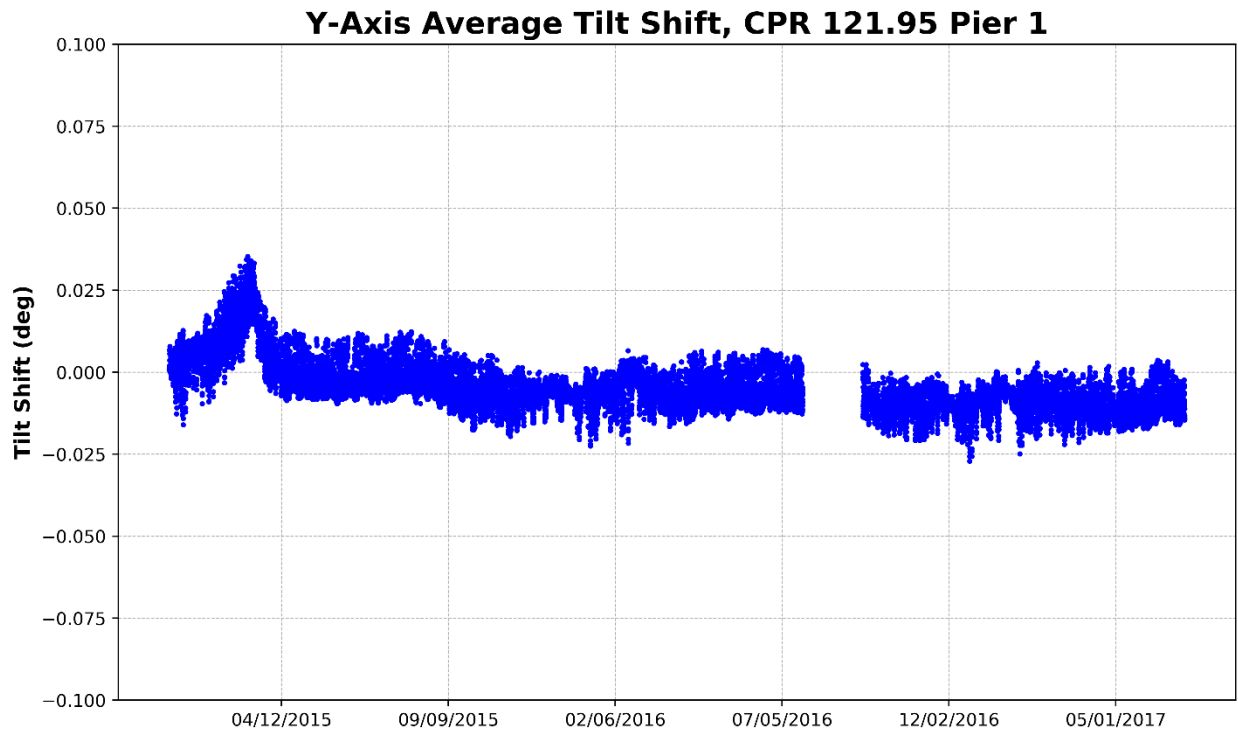
### 4.6.1 Average Tilt

The average tilt charts are shown in Figure 113 through Figure 120. The West abutment has shifted more than any substructure element from any bridge monitored as part of this project. The magnitude of the shift is over 0.15 degrees and the direction is parallel to the track. Continuous monitoring of the abutment is recommended. The other substructure elements on this bridge have shown stable tilt behavior.

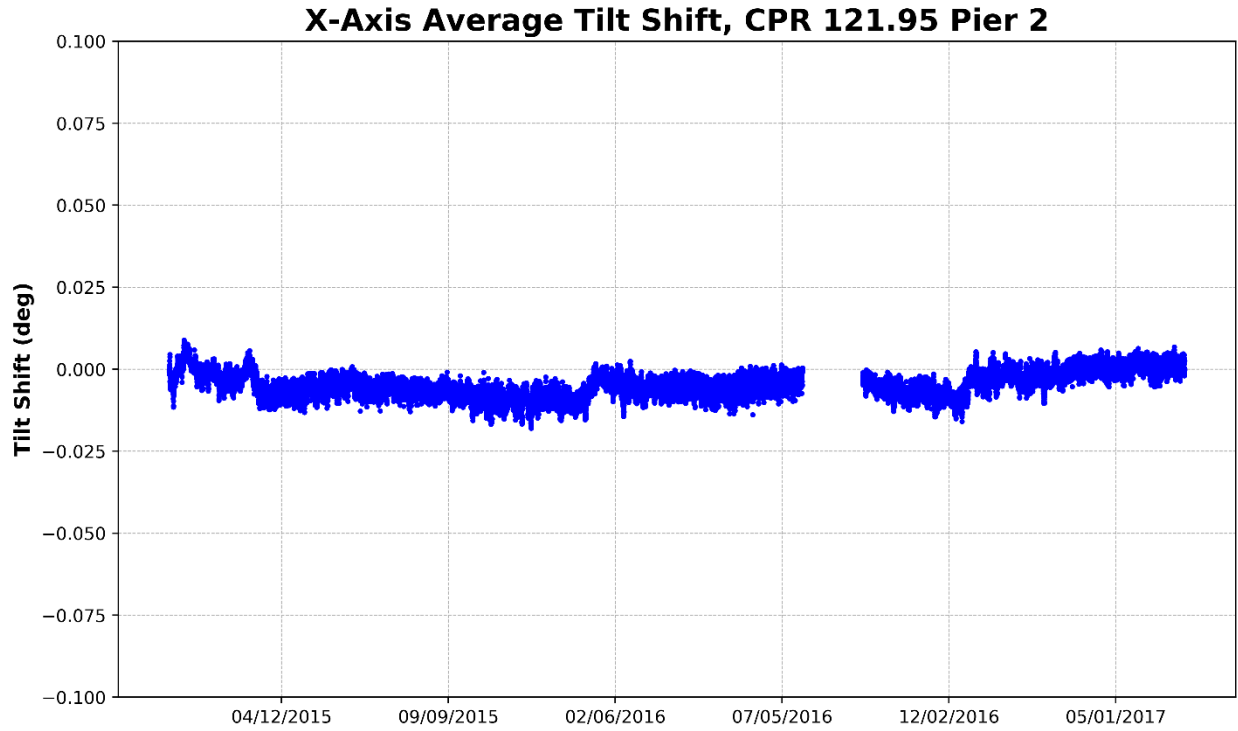




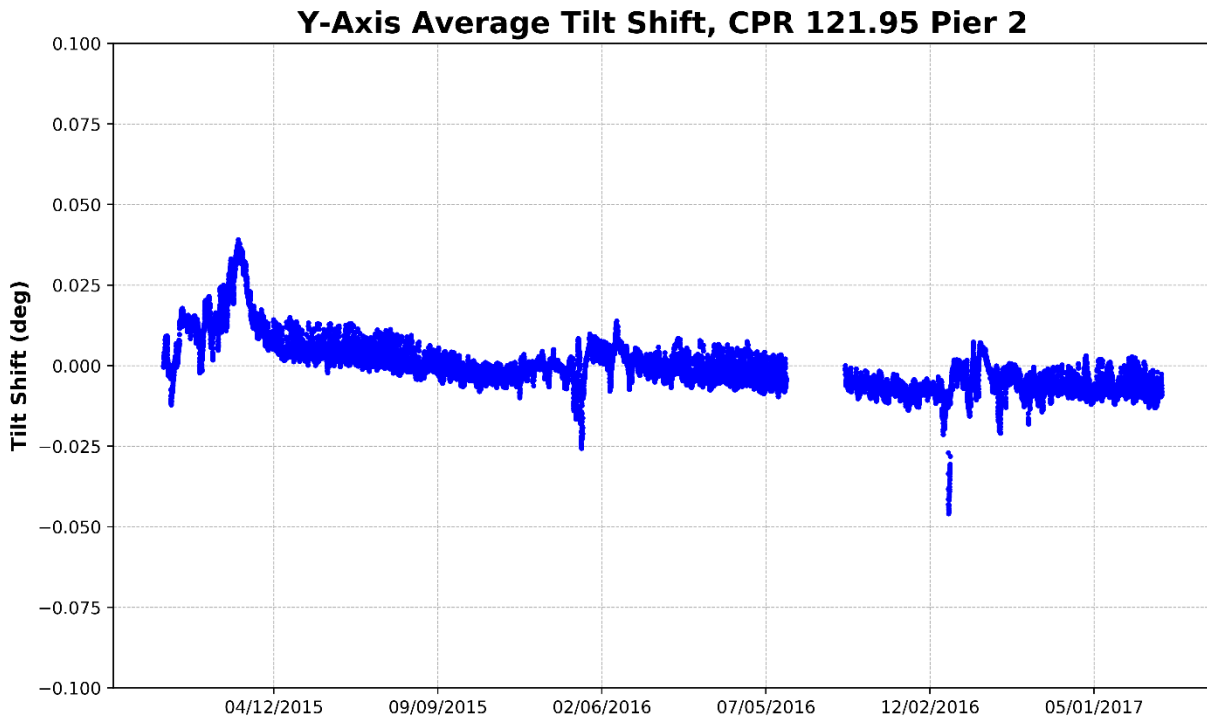
**Figure 114 – Pier 1, X-Axis Average Tilt**



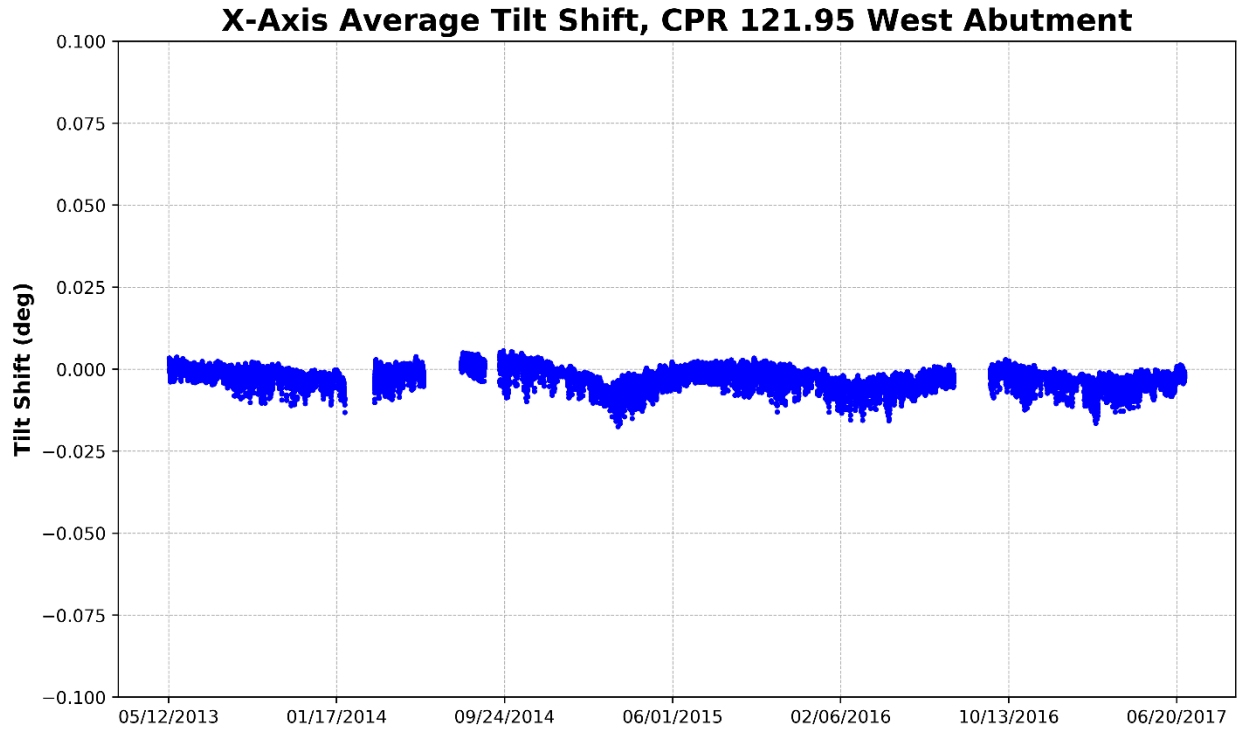
**Figure 115 – Pier 1, Y-Axis Average Tilt**



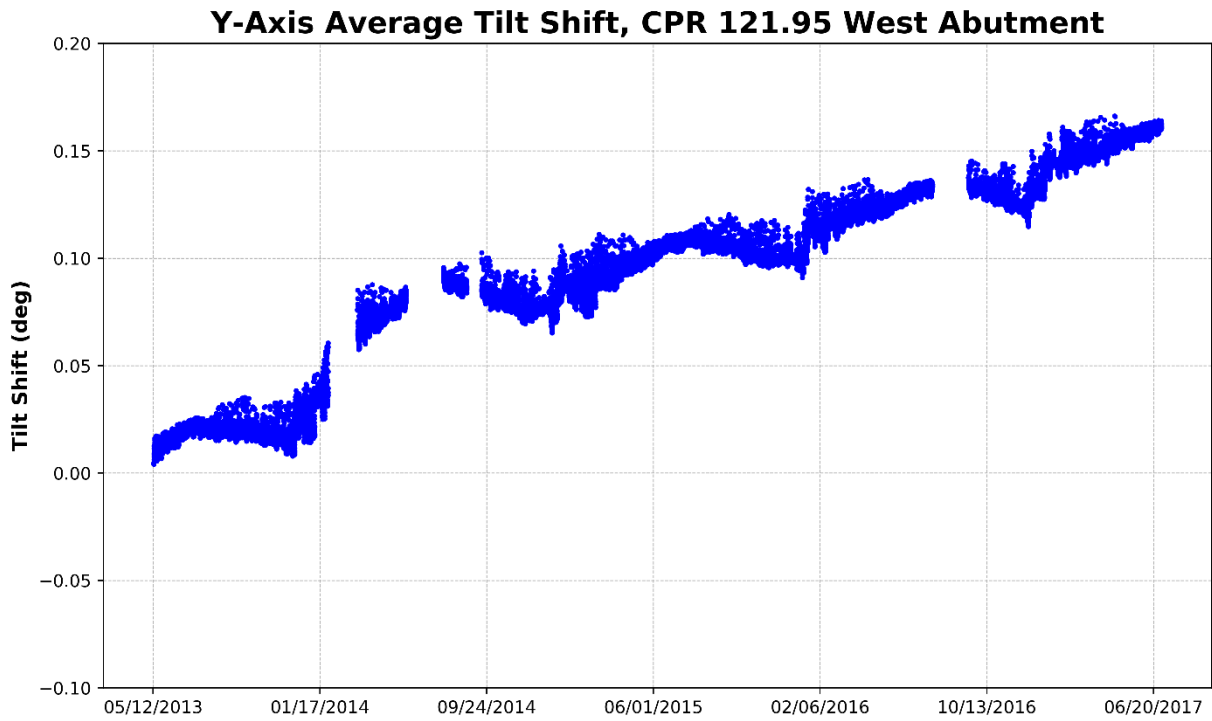
**Figure 116 – Pier 2, X-Axis Average Tilt**



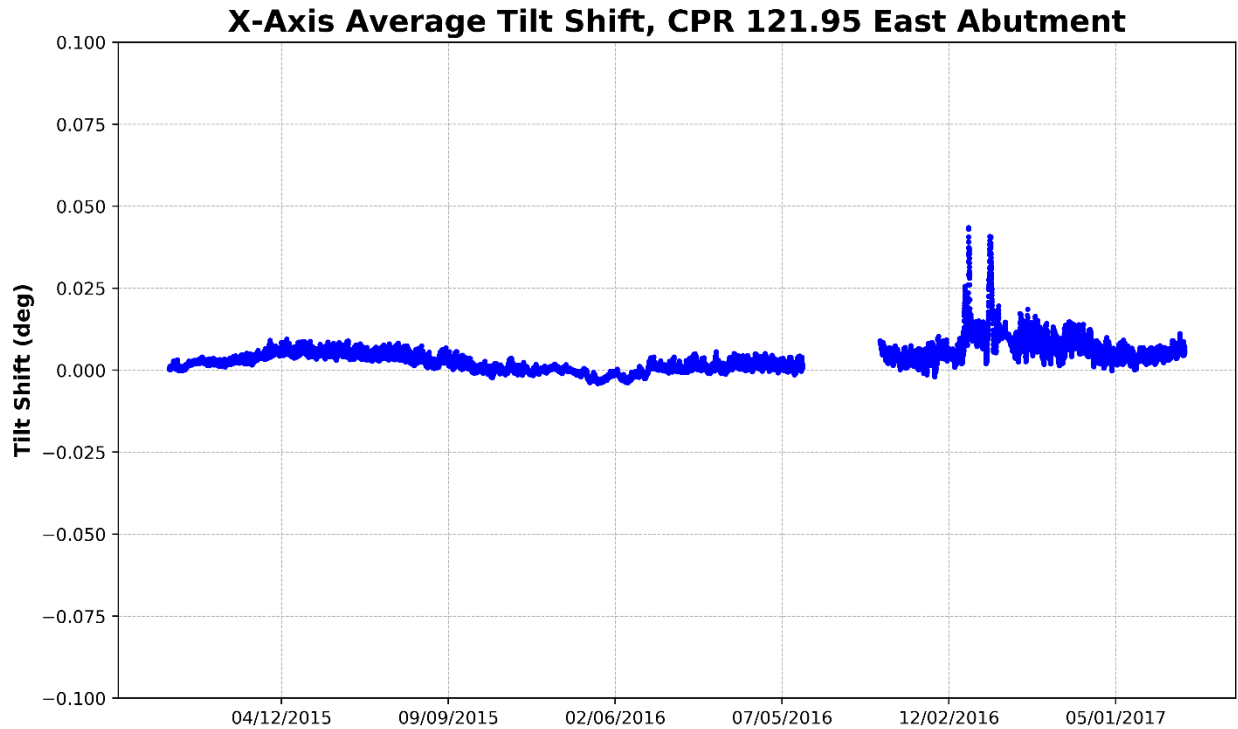
**Figure 117 – Pier 2, Y-Axis Average Tilt**



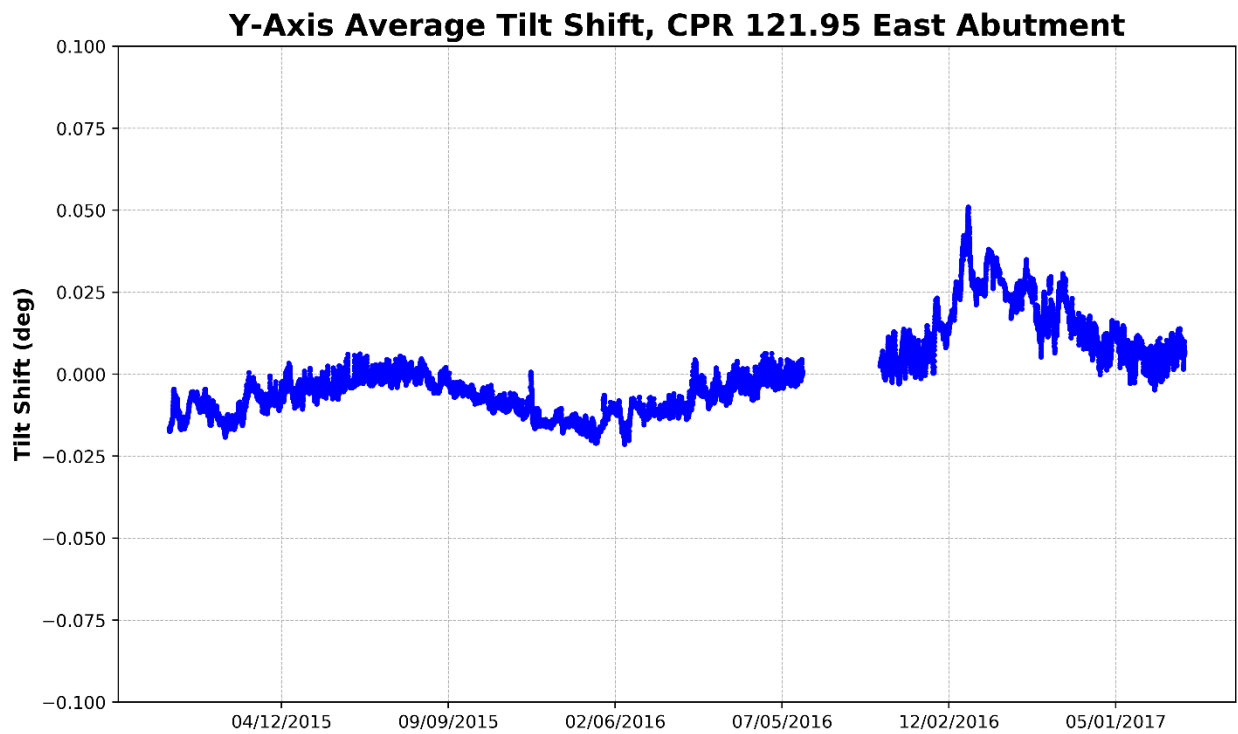
**Figure 118 – West Abutment, X-Axis Average Tilt (Perpendicular to Track)**



**Figure 119 – West Abutment, Y-Axis Average Tilt (Parallel to Track)**



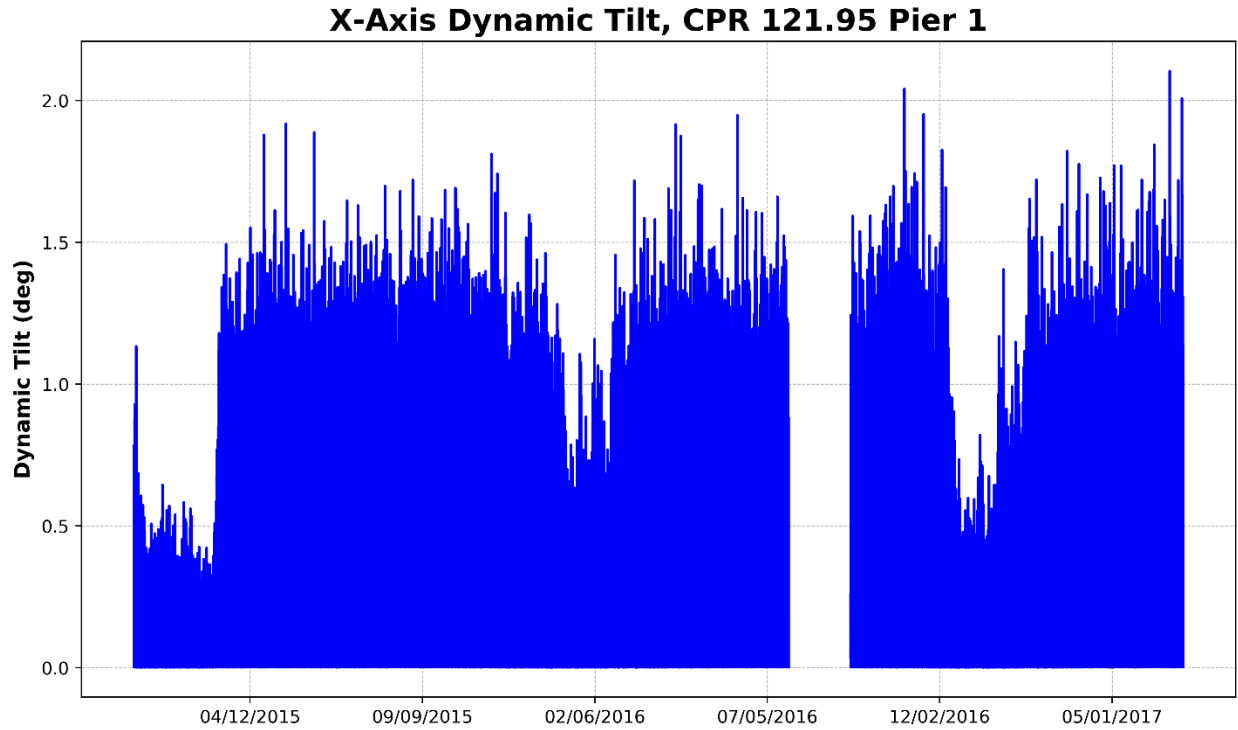
**Figure 120 – East Abutment, X-Axis Average Tilt (Perpendicular to Track)**



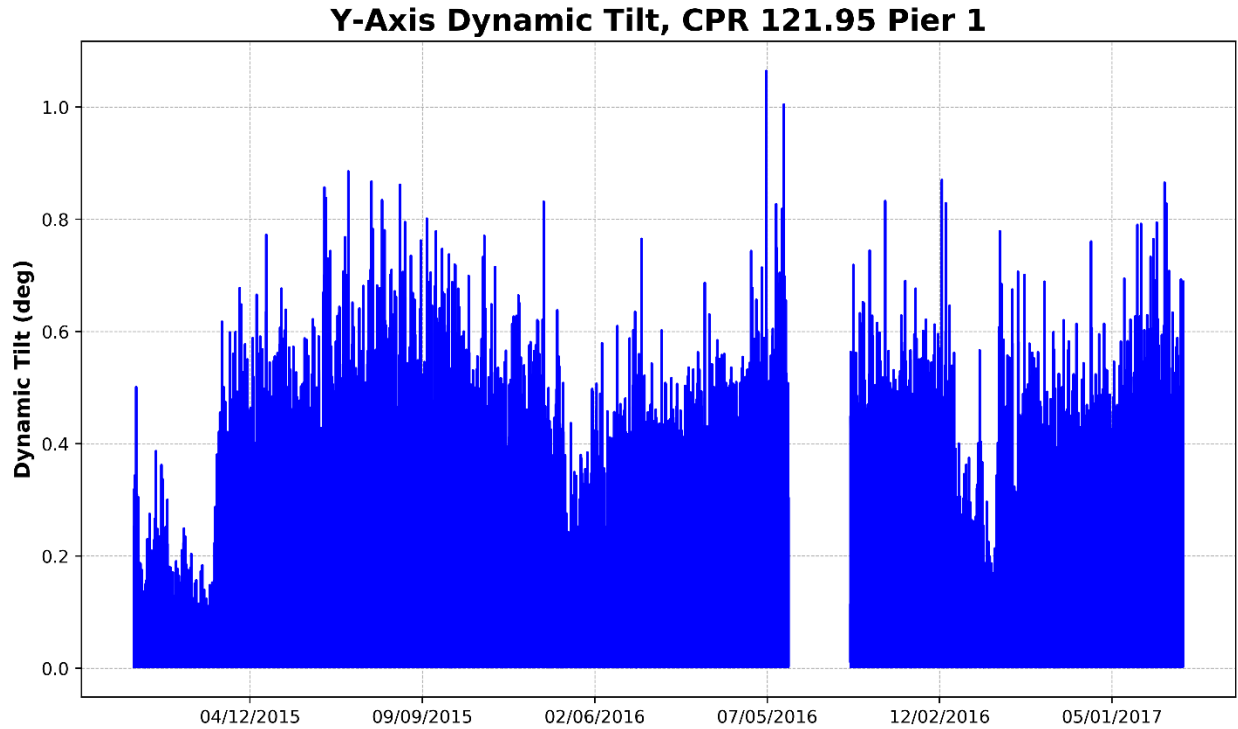
**Figure 121 – East Abutment, Y-Axis Average Tilt (Parallel to Track)**

#### 4.6.2 Dynamic Tilt

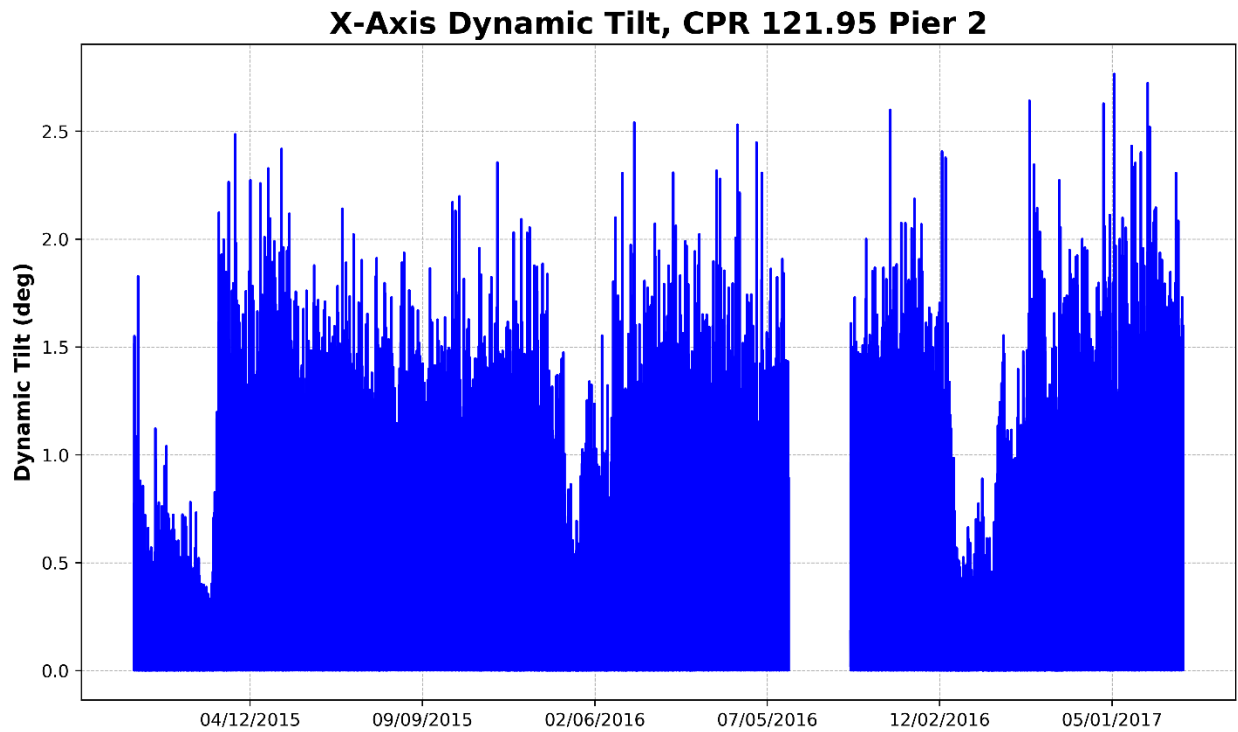
The dynamic tilt charts are shown in [Figure 121](#) through [Figure 128](#). Similar to the other bridges, the dynamic response magnitude is smaller in the winter compared to the rest of the year. No alarming trends in the dynamic tilt are identified in the data.



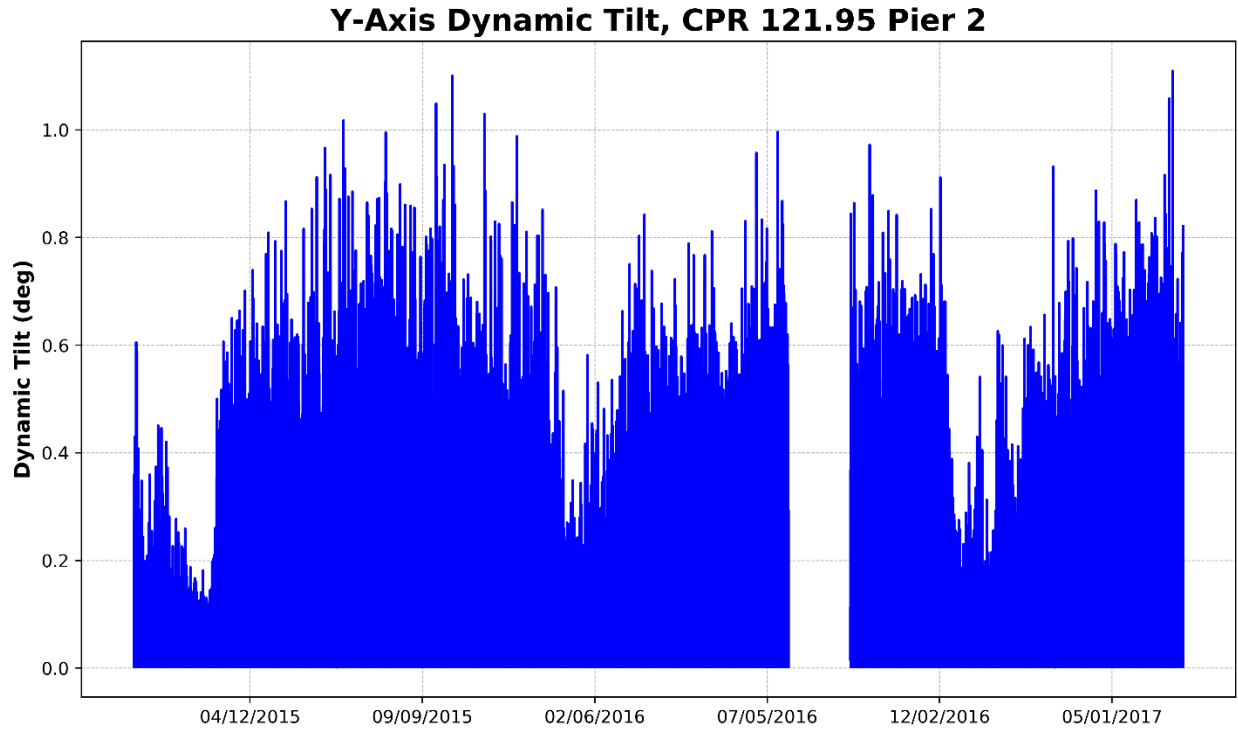
**Figure 122 – Pier 1, X-Axis Dynamic Tilt**



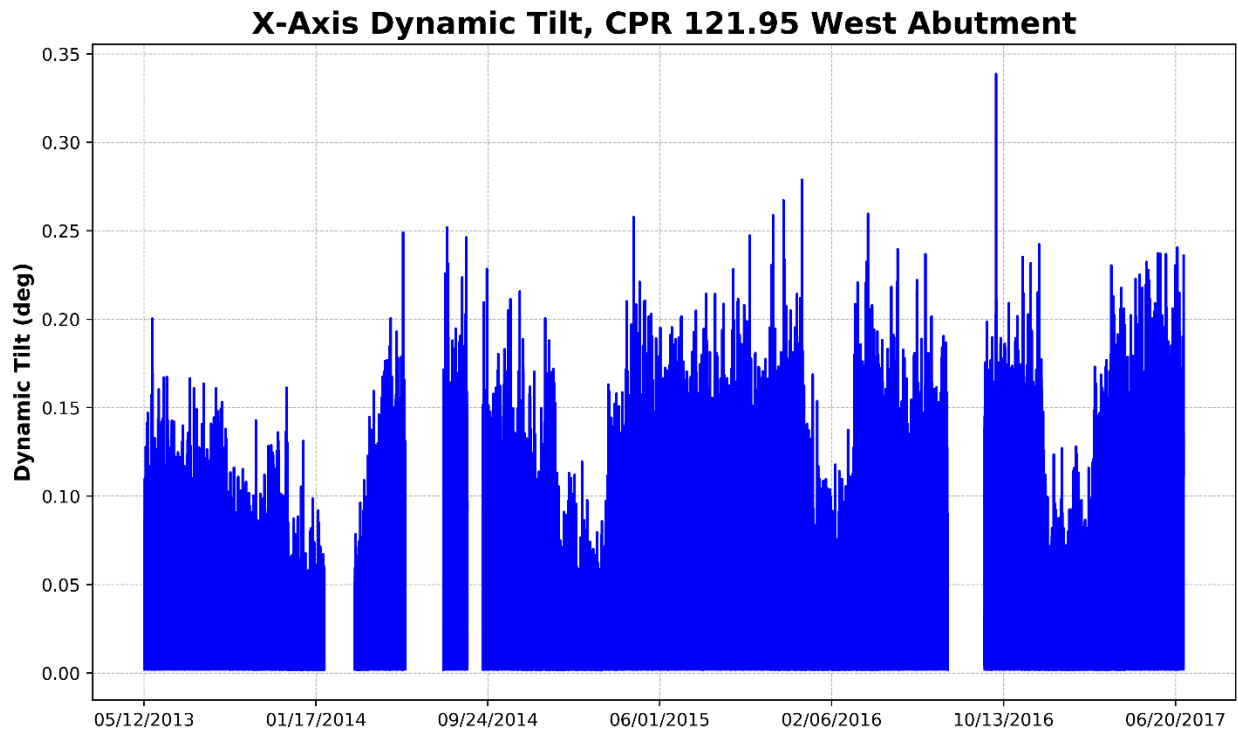
**Figure 123 – Pier 1, Y-Axis Dynamic Tilt**



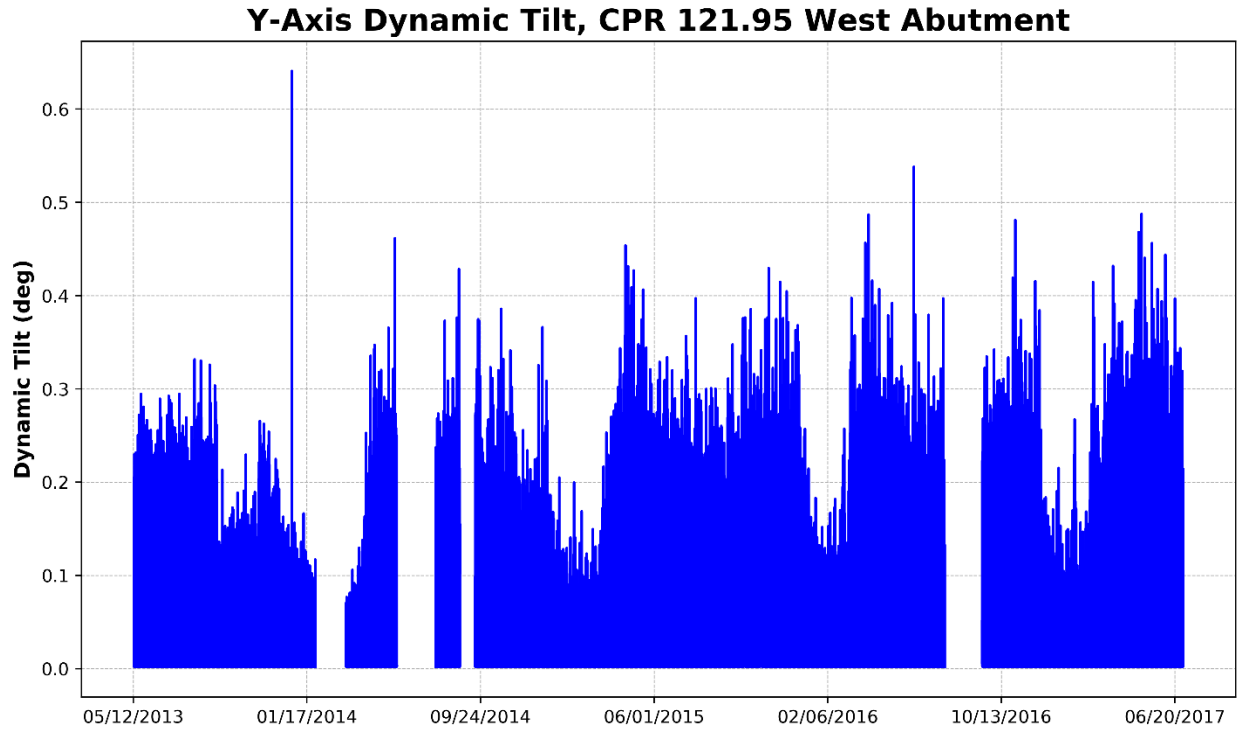
**Figure 124 – Pier 2, X-Axis Dynamic Tilt**



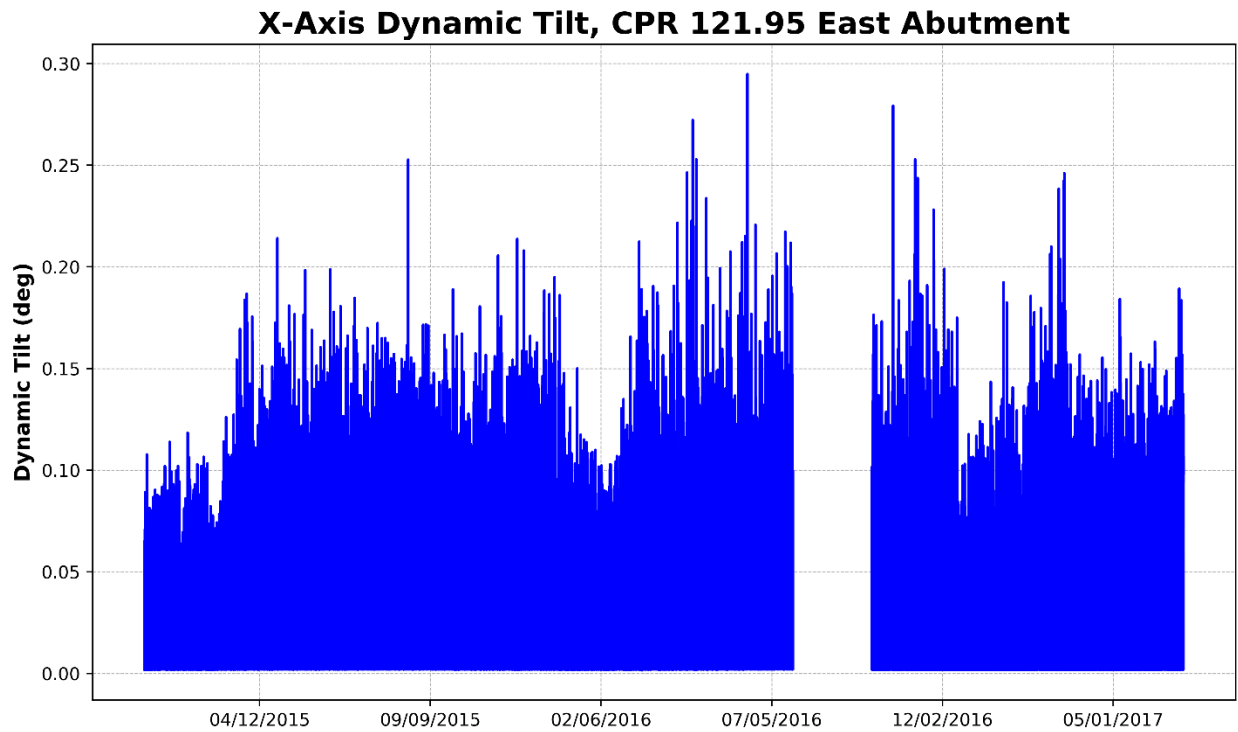
**Figure 125 – Pier 2, Y-Axis Dynamic Tilt**



**Figure 126 – West Abutment, X-Axis Dynamic Tilt (Perpendicular to Track)**

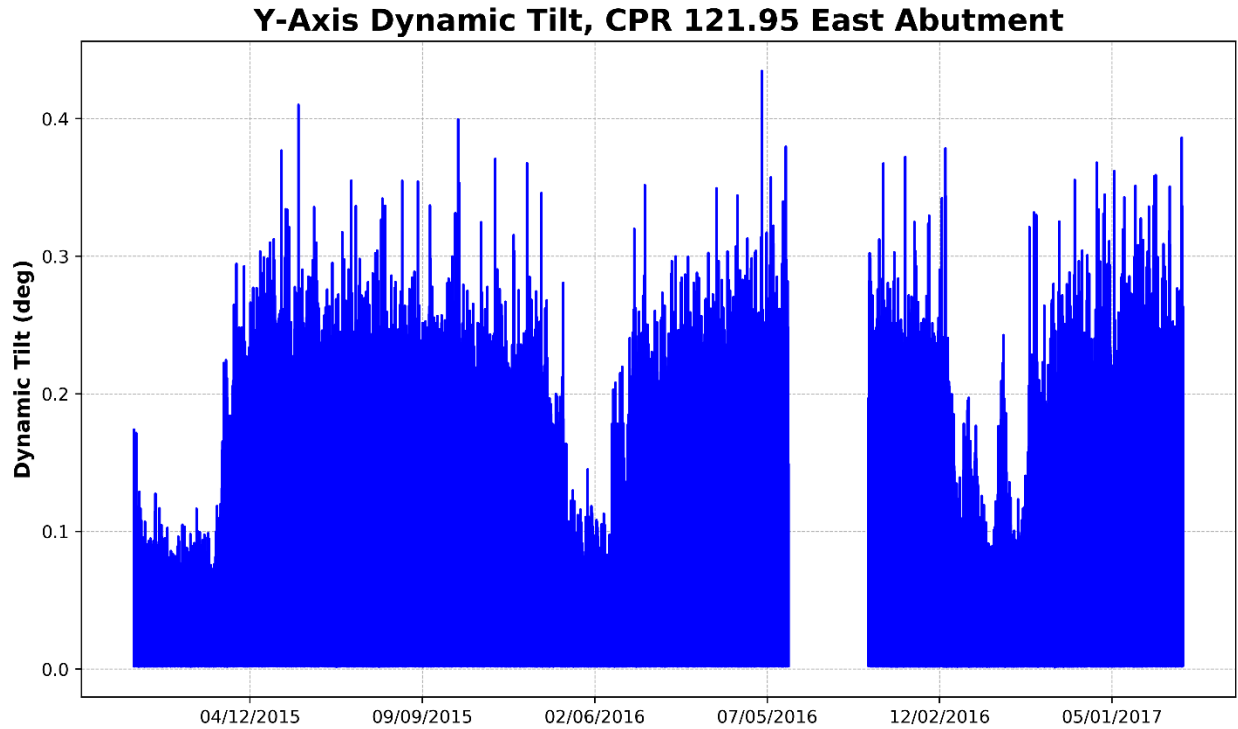


**Figure 127 – West Abutment, Y-Axis Dynamic Tilt (Parallel to Track)**



**Figure 128 – East Abutment, X-Axis Dynamic Tilt (Perpendicular to Track)**

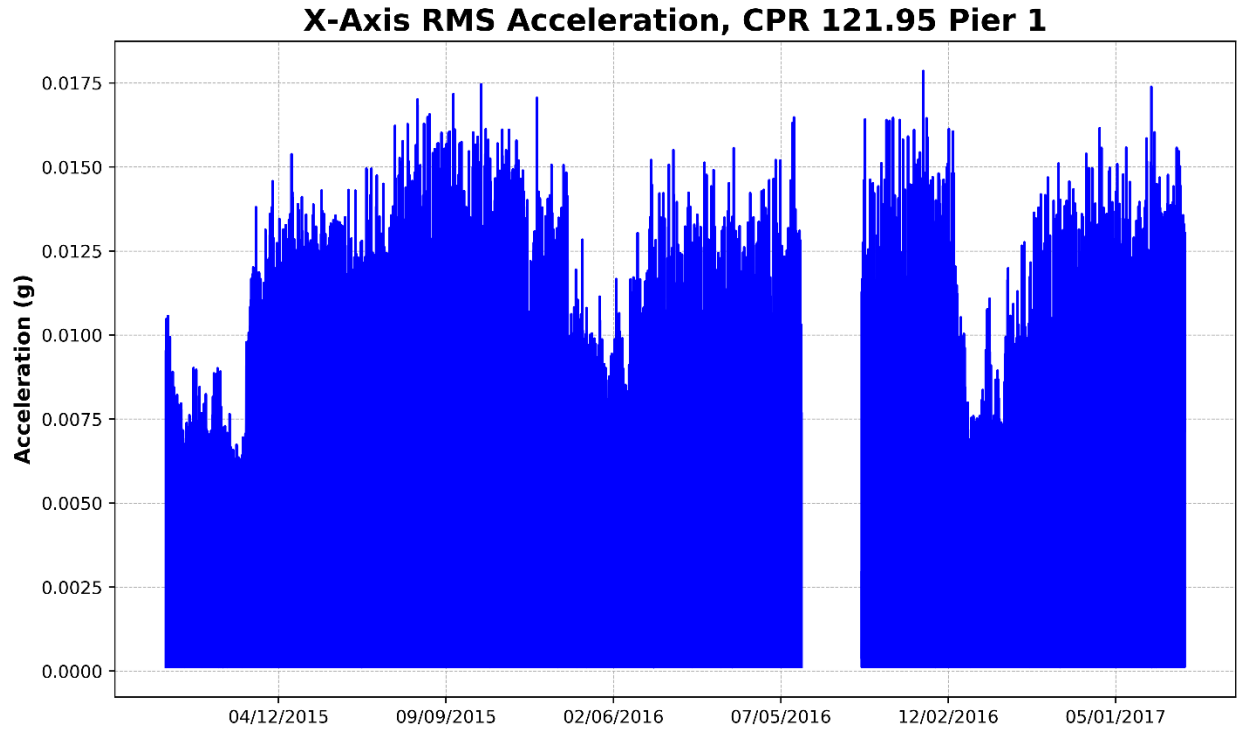




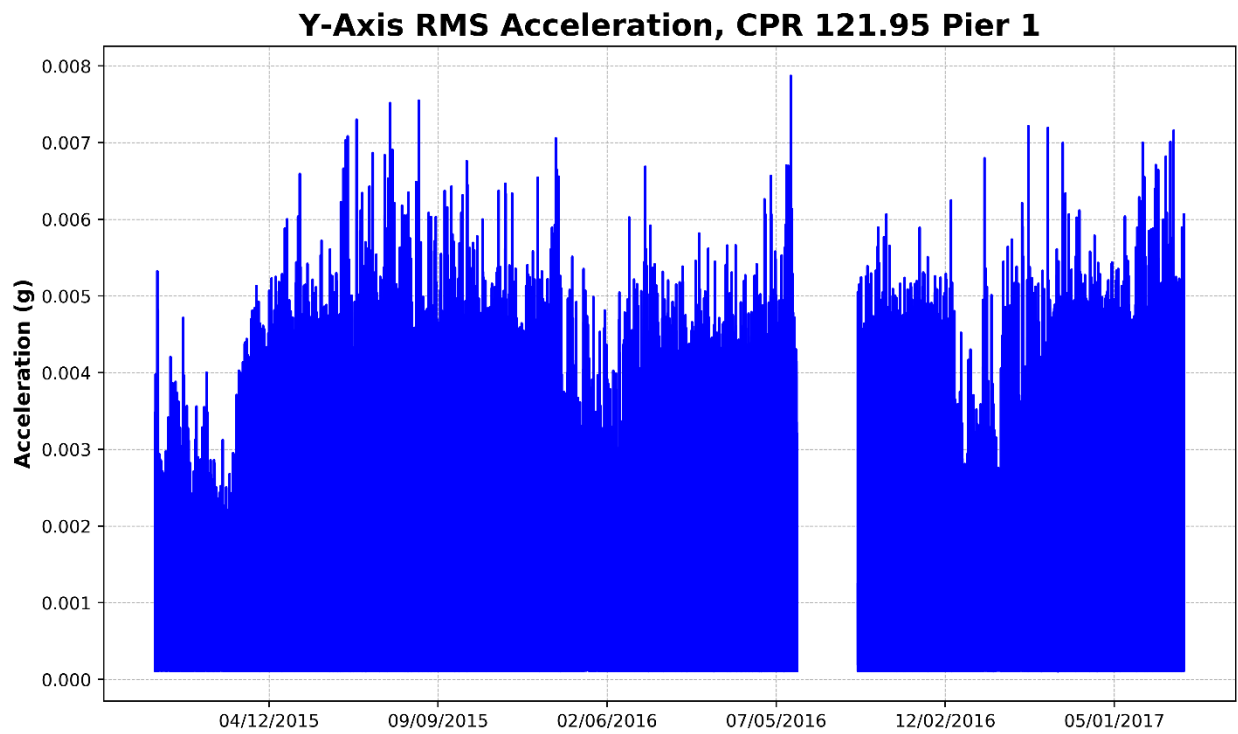
**Figure 129 – East Abutment, Y-Axis Dynamic Tilt (Parallel to Track)**

**4.6.3 Lateral Acceleration**

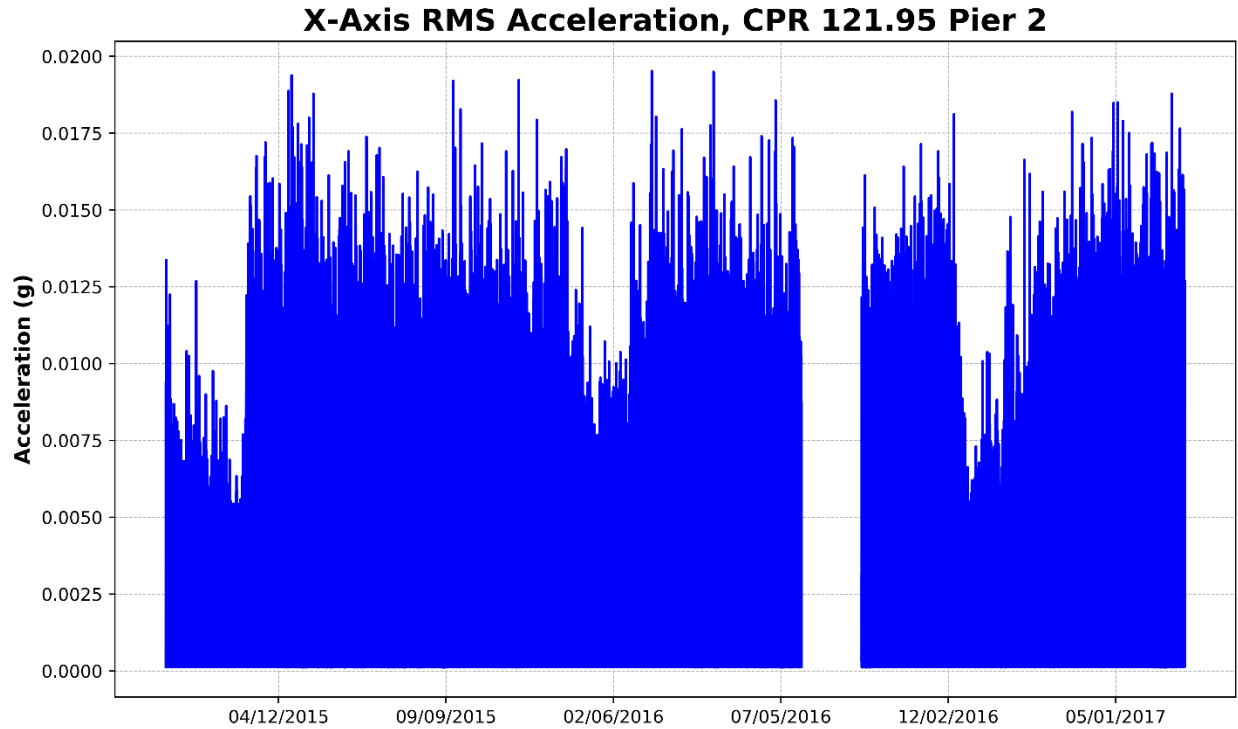
The acceleration charts are shown in [Figure 129](#) through [Figure 136](#). Various outliers in acceleration were recorded by the East and West abutments. Despite the outliers, no alarming trends in the acceleration data are identified.



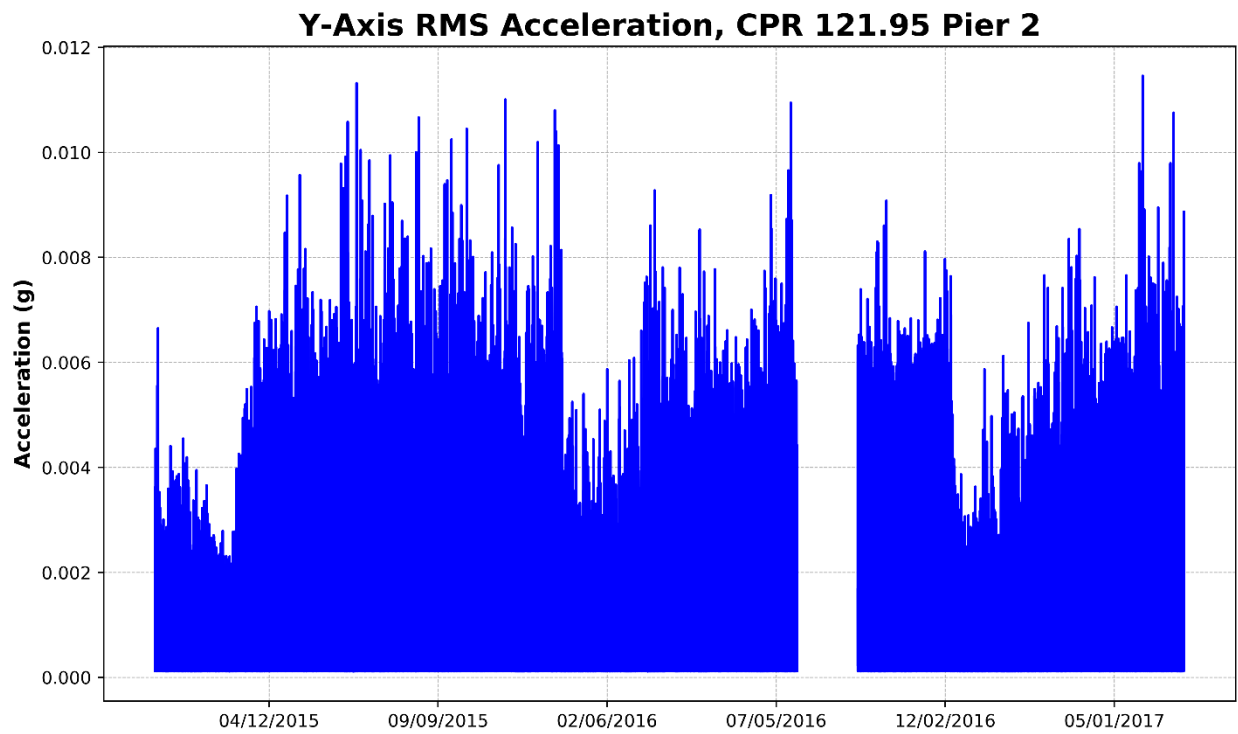
**Figure 130 – Pier 1, X-Axis RMS Acceleration**



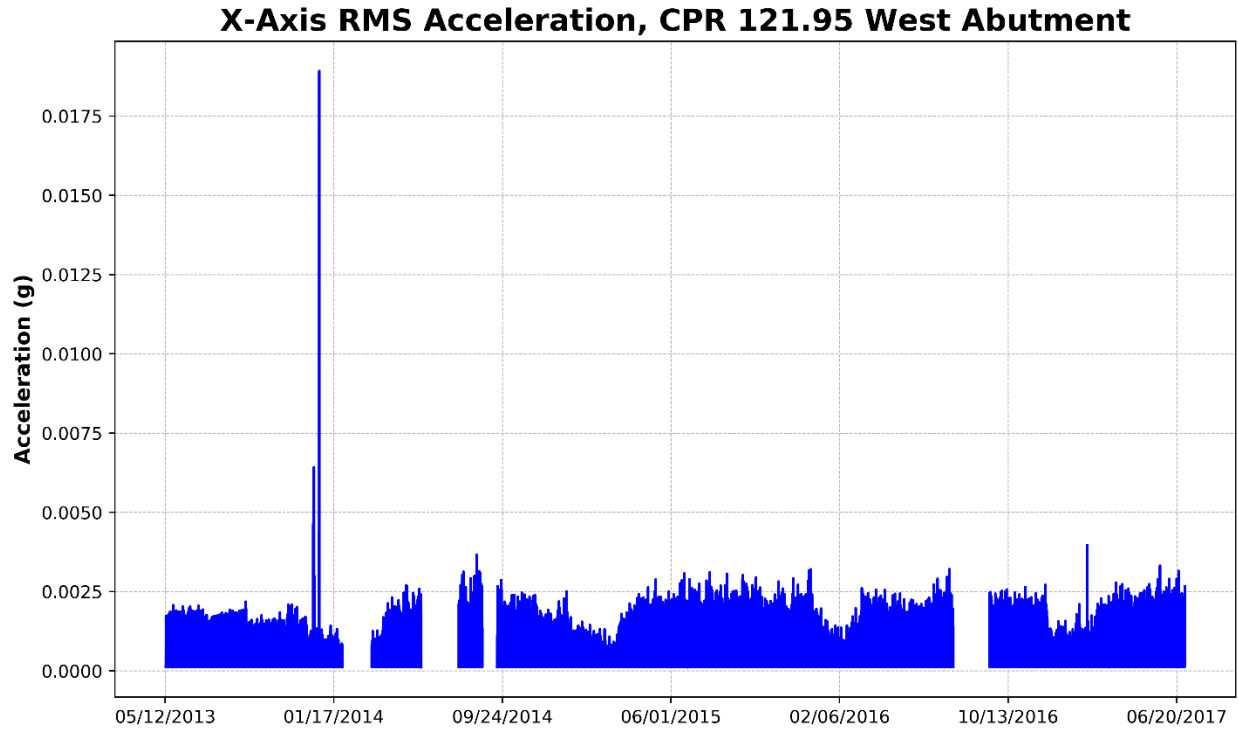
**Figure 131 – Pier 1, Y-Axis RMS Acceleration**



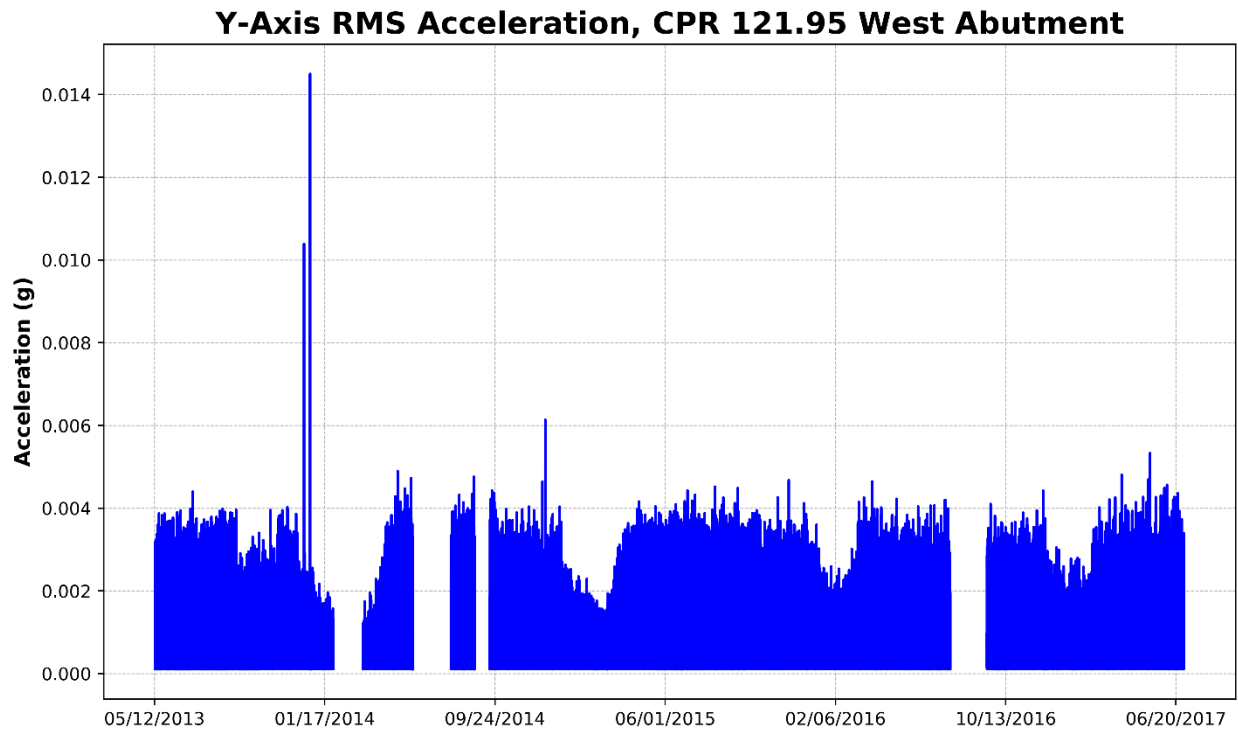
**Figure 132 – Pier 2, X-Axis RMS Acceleration**



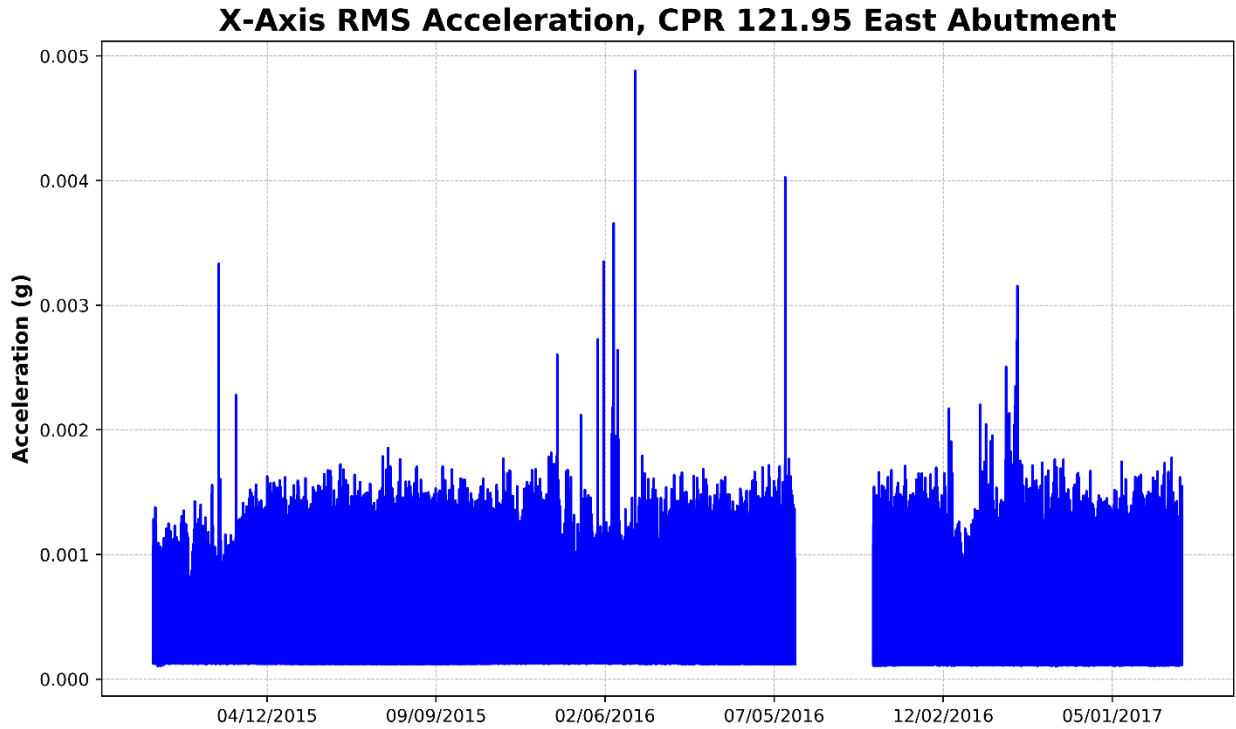
**Figure 133 – Pier 2, Y-Axis RMS Acceleration**



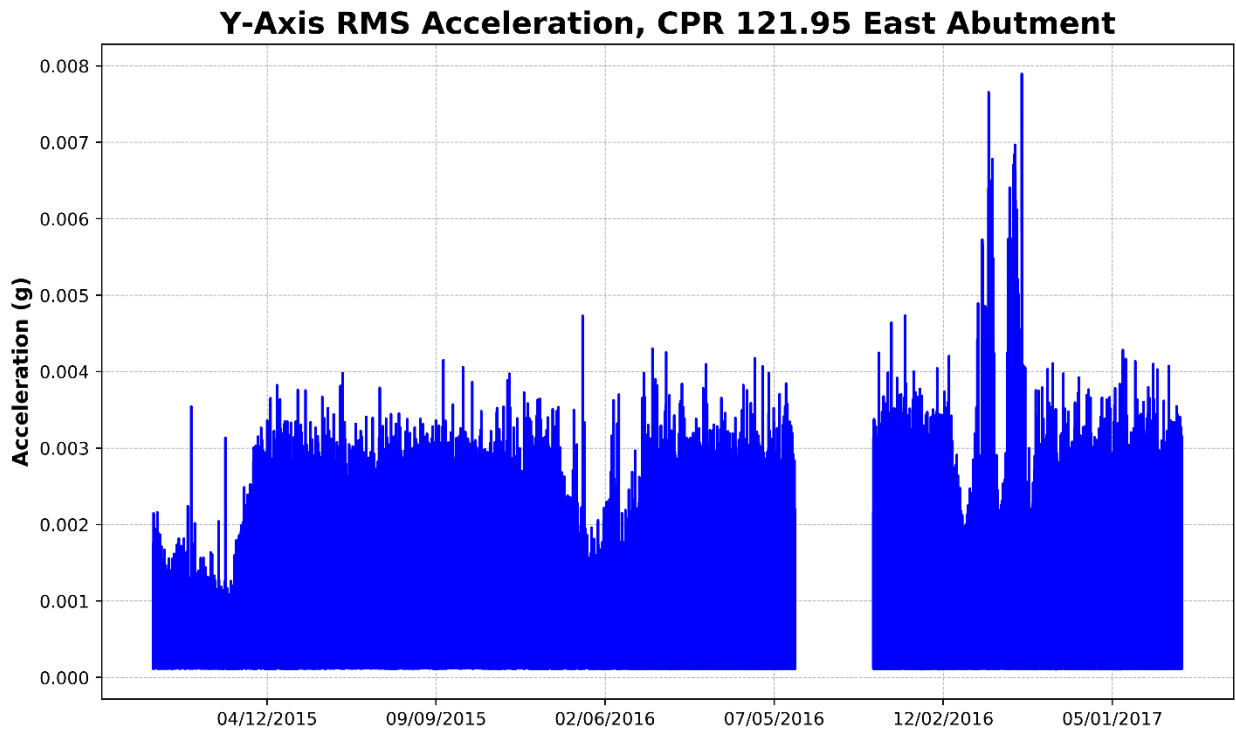
**Figure 134 – West Abutment, X-Axis RMS Acceleration (Perpendicular to Track)**



**Figure 135 – West Abutment, Y-Axis RMS Acceleration (Parallel to Track)**



**Figure 136 – East Abutment, X-Axis RMS Acceleration (Perpendicular to Track)**



**Figure 137 – East Abutment, Y-Axis RMS Acceleration (Parallel to Track)**

## **4.7 Data Overview and Recommendations**

An overview of the data and recommendations for continued monitoring are provided below.

### **4.7.1 BNSF Bridge 77.54, Nodaway, MO**

Piers 2, 4, and 5 should continue to be monitored for signs of scour. The data collected from these piers has shown changes in response that warrant continued monitoring efforts. Given the scour history of Pier 2, an underwater inspection may be necessary. Pier 3 has shown no alarming data.

### **4.7.2 BNSF Bridge 279.7, Gorin, MO**

The tilt of the East Pier has shifted over 0.05 degrees and should continue to be monitored. The West Pier has been stable overall with no alarming data.

### **4.7.3 CPR Bridge 195.20 Tomah, WI**

The sensors mounted on the steel structural members report highly variable and difficult-to-use data. It is recommended to focus future monitoring efforts on sensors mounted directly on concrete or masonry elements. The sensor mounted on the bridge pier has reported consistent tilt and vibration data indicative of stable conditions.

### **4.7.4 CPR BR00 0.30 Medicine Hat**

The tilt of Pier 3 has shifted up to 0.075 degrees since monitoring began. This magnitude of change warrants continued monitoring to watch for further changes. The data collected from Piers 5 and 6 does not indicate any changing conditions or alarming behavior.

### **4.7.5 CPR BR00 172.46 Calgary**

Pier 1 has shifted over 0.05 degrees perpendicular to the track at a steady rate since monitoring began. Continued monitoring is recommended to determine if the movement will continue. Piers 2 and 3 have not shown any alarming data.

### **4.7.6 CPR 121.95 Watertown**

The West abutment of the Watertown bridge has shifted over 0.15 degrees since monitoring began in 2013. This is the largest shift of a substructure element measured as part of this project. Continued monitoring of the West abutment is recommended to determine if the movement will continue. The other piers monitored have not shown any alarming data.

## 5. Scour Alert Methodology

### 5.1 Overview

A methodology has been created for alerting bridge owners to scour and other conditions that may affect railroad operations. This methodology requires cloud-based software to perform the following functions:

- 1) Pull data from the monitoring system over a cell connection
- 2) Analyze average tilt, dynamic tilt, and lateral acceleration data
- 3) Determine if measurements exceed pre-defined thresholds
- 4) Send out alerts via text message or email if a measurement exceeds the threshold

The alert thresholds for a given structural element should be defined using the initial baseline data, geometry, known history, material, and general design. Multiple alert tiers should be defined depending on the severity of the event. It is recommended to reserve the highest alert tier for events that have a high probability of affecting the track and safety. Potential responses to alerts include additional surveying, bridge inspection, more frequent reporting, and installation of additional instrumentation.

### 5.2 Alert System Operation

For the alerts to be reliable, the monitoring system should be capable of automatically generating incident reports without direct human intervention. The incident report can be sent to key personnel via email, text message, or phone call. The report should provide a time stamp of the event and any key data required to understand the event.

The overall data flow for the alert system is shown in [Figure 137](#), and an example email alert is shown in [Figure 138](#).

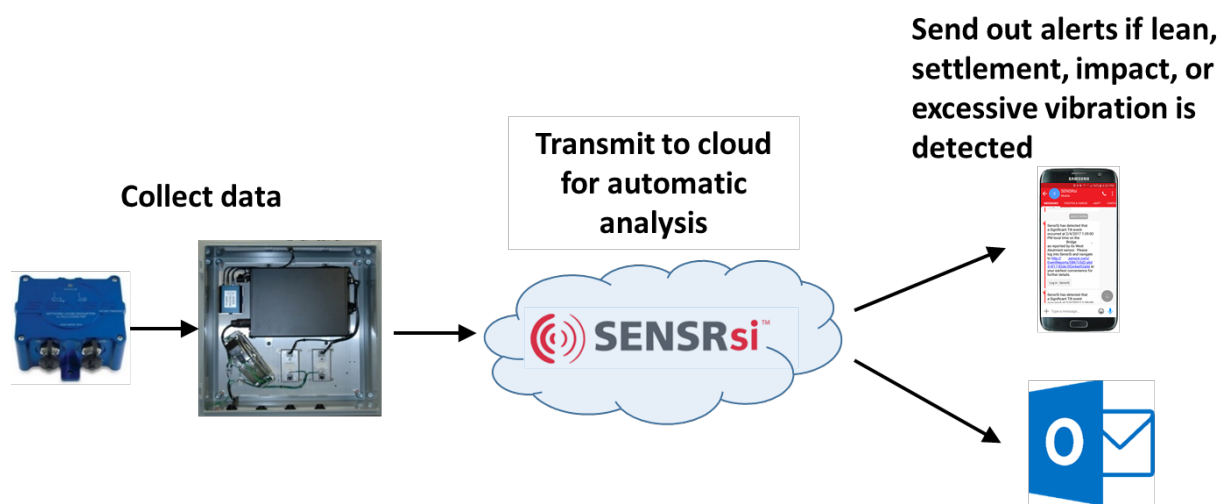
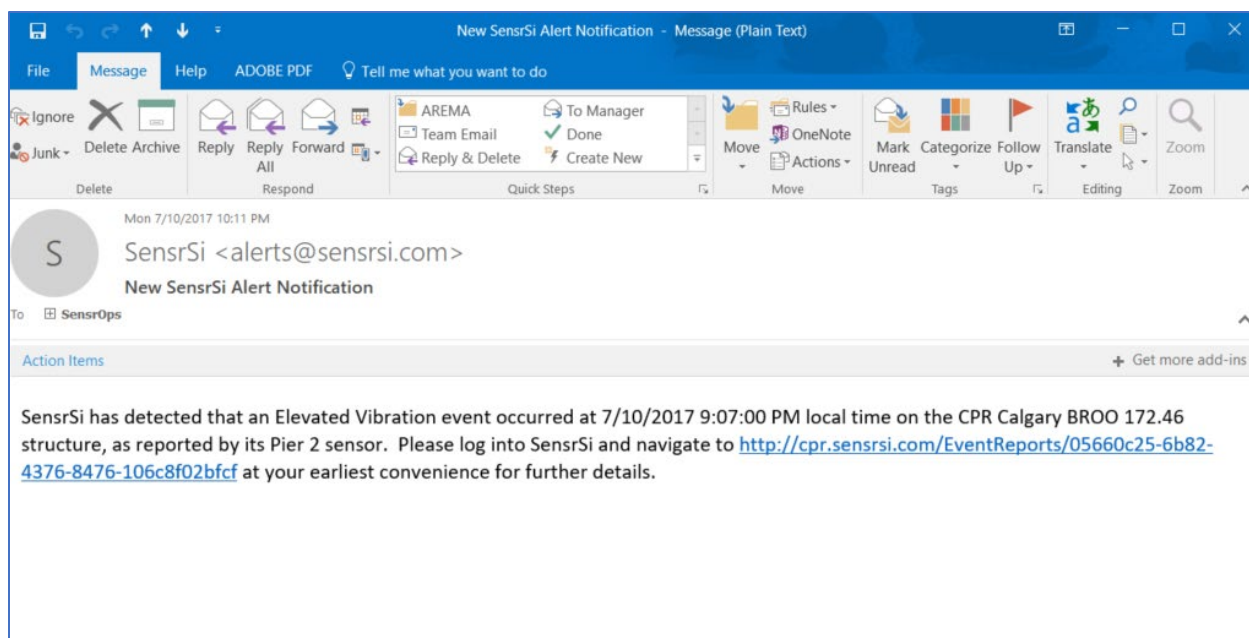


Figure 138 – Alert System Data Flow



**Figure 139 – Example Email Alert**

### 5.3 Data Classification and Alert Tiers

It is recommended to use the following classifications to characterize the data:

- Normal: Structural response and movement within historical range
- Elevated: Structural response or movement outside of historical range, but bridge is likely safe to continue operations
- Significant: Movement has occurred that has possible affected the track profile of the bridge. Inspection should occur as soon as possible.
- Critical: Movement has occurred that has likely affected the track profile of the bridge. Traffic should be halted.

For example, typical average tilt alert levels for a 30-ft. tall pier can be related to total displacement. At 30 ft., every 0.04 degrees is approximately 0.25 inches of displacement. The alert tiers would then be defined as:

- Normal - 0 to 0.04 degrees (0 to 0.25 inches)
- Elevated - 0.04 to 0.08 degrees (0.25 to 0.5 inches)
- Significant - 0.08 to 0.16 degrees (0.5 to 1.0 inches)
- Critical - 0.16 degrees and greater (1.0 inch and greater)

For dynamic tilt, the total range (max–min) of oscillation under normal train loading should first be determined. The absolute magnitude of this response is less important than the overall pattern of the response. If the initial data is collected while the bridge is known to be in good condition, that data can be described as the normal response.



Alert thresholds can be defined as multiples of the normal range. For example:

- Normal – Range of oscillation measured while bridge is known to be in good condition
- Elevated – Up to 2x Normal
- Significant – Up to 3x Normal
- Critical – Greater than 3x Normal

Defining alert tiers for acceleration is more difficult than tilt. The data is more prone to outliers and false alarms. It is recommended to limit the acceleration alerts to only two tiers:

- Normal – Range of acceleration measured while bridge is known to be in good condition
- Elevated – Anything outside of normal

More robust pattern recognition algorithms can be used to filter out acceleration and distinguish between different load sources. One method is to use artificial neural networks to analyze the data and look for relationships that are difficult to define using traditional formulas. This has been done successfully for detecting bridge strikes using the same instrumentation presented in this report [3].

## **6. Conclusion and Lessons Learned**

---

This section covers the lessons learned over the course of the project as well as the current state of the technology.

### **6.1 Hardware**

Many rail bridges do not have power available onsite. Even if power is available, it is often unreliable and prone to outages. A major lesson learned is that a solar efficient monitoring system is required to make remote monitoring a practical option for many bridges. The system should be capable of being powered by pole-mounted solar panels that are portable enough to be installed on railroad bridge piers.

In addition to power, lightning survivability is a critical aspect of monitoring hardware. The number one cause of hardware failure over the course of the project was lightning damage. External lightning suppressors were later used to provide a modest improvement in durability. The ideal structural monitoring system needs to be hardened against lightning at every level of the design.

### **6.2 Data Analysis and Software**

Continuous monitoring results in a large quantity of data that can overwhelm bridge owners. A key lesson learned was that the data needs to be summarized into easy-to-understand metrics that the average bridge owner can understand. It is important to provide actionable information that can be used to better manage the bridge.

At the beginning of the project, a desktop application was used to control alerts and notifications. This was an unreliable method that was not scalable to more than a handful of bridges. It was discovered early on that a cloud-based software solution is necessary to remotely monitor railroad bridges. This software was developed by SENSR independently of this research grant using the methodology presented in [Section 5](#) of this report.

### **6.3 Current State of the Technology and Future Developments**

None of the bridges monitored for this study are known to have developed scour conditions. However, the system has detected settlement, bridge strikes, and construction-related changes on other rail bridges being monitored. The technology was also used on a bridge pier with a known scour pocket, and the results were presented at American Railway Engineering and Maintenance-of-Way Association (AREMA) 2016 [2]. Similar monitoring systems are currently in service on over 40 rail bridges nationwide.

Future development efforts will focus on creating a solar efficient system that is hardened against lightning. Additionally, neural network pattern recognition will be investigated to improve detection algorithms [3]. The neural networks will help determine if any trends exist in the data that are not readily apparent through traditional analysis.

## 7. References

---

- [1] Kavars, C. “FRA Annual Report DTFR53-13-C-0038 2014 Final.” Unpublished report. Federal Rail Administration, December 2014.
- [2] Bleser, II, W. F., Cote, M. E., & Kavars, C. L. “A New Way to Detect, Monitor, and Manage Scour Critical Railway Bridges.” AREMA Conference Proceedings, August 30, 2016.
- [3] Orsak, J., Bonilla, A., & Story, B. “A New Way to Detect Bridge Strikes with Neural Network Pattern Recognition.” Railway Interchange Conference Proceedings, September 19, 2017.

## **Abbreviations and Acronyms**

---

<b>ACRONYMS</b>	<b>EXPLANATION</b>
AREMA	American Railway Engineering and Maintenance-of-Way Association
BNSF	Burlington Northern Santa Fe Railway
CPR	Canadian Pacific Railway
DAQ	Data Acquisition
FRA	Federal Railroad Administration
KIPs	Key Performance Indictors
NEMA	National Electrical Manufacturers Association
RMS	Root Mean Squared