



U.S. Department  
of Transportation

**National Highway  
Traffic Safety  
Administration**



---

DOT HS 812 659

July 2019

# **Technical Evaluation Of the TRL Pedestrian Upper Legform**

## DISCLAIMER

This publication is distributed by the U.S. Department of Transportation, National Highway Traffic Safety Administration, in the interest of information exchange. The opinions, findings and conclusions expressed in this publication are those of the authors and not necessarily those of the Department of Transportation or the National Highway Traffic Safety Administration. The United States Government assumes no liability for its contents or use thereof. If trade or manufacturers' names are mentioned, it is only because they are considered essential to the object of the publication and should not be construed as an endorsement. The United States Government does not endorse products or manufacturers.

Suggested APA Format Citation:

Suntay, B., & Stammen, J. (2019, July). *Technical evaluation of the TRL pedestrian upper legform* (Report No. DOT HS 812 659). Washington, DC: National Highway Traffic Safety Administration.

<b>1. Report No.</b> DOT HS 812 659		<b>2. Government Accession No.</b>		<b>3. Recipient's Catalog No.</b>	
<b>4. Title and Subtitle</b> Technical Evaluation of the TRL Pedestrian Upper Legform				<b>5. Report Date</b> July 2019	
				<b>6. Performing Organization Code</b>	
<b>7. Author</b> Brian Suntay, Transportation Research Center Inc. Jason Stammen, NHTSA Vehicle Research & Test Center				<b>8. Performing Organization Report No.</b>	
<b>9. Performing Organization Name and Address</b> Transportation Research Center Inc., 10820 OH-347 East Liberty, OH 43319; NHTSA Vehicle Research & Test Center				<b>10. Work Unit No. (TRAIS)</b>	
				<b>11. Contract or Grant No.</b>	
<b>12. Sponsoring Agency Name and Address</b> National Highway Traffic Safety Administration 1200 New Jersey Avenue SE. Washington, DC 20590				<b>13. Type of Report and Period Covered</b> Final Report	
				<b>14. Sponsoring Agency Code</b>	
<b>15. Supplementary Notes</b>					
<b>16. Abstract</b> <p>The upper legform impactor was introduced by Transport Research Laboratory (TRL) to address injuries to the upper leg, pelvis, and hip of a pedestrian when struck by a vehicle. The upper legform is instrumented to measure bending moment and force, the two principal modes of injury to a pedestrian in contact with a vehicle's bonnet leading edge. The upper legform is currently used by the European New Car Assessment Programme (Euro NCAP), Global Technical Regulation No. 9 (GTR 9), and the United Nations Economic Commission for Europe Regulation 127 (ECE R127). The upper legform impactor is new to NHTSA and was evaluated at its Vehicle Research and Test Center.</p> <p>There are two objectives of this study. Since the foam used in the TRL upper legform impactor has a history of being sensitive to humidity, the first objective is to evaluate the TRL upper legform impactor under different humidity conditions. Qualification tests were performed at the upper end and lower end of the allowed humidity range to see if a humidity change would affect the upper leg performance. Vehicle tests were also carried out under the same conditions to see if the upper legform sensitivity to humidity carries over to vehicle tests. The second objective of this study is to evaluate the TRL upper legform sensitivity to vehicle bumper design, repeatability, reproducibility, durability, and biofidelity.</p>					
<b>17. Key Words</b> pedestrian, legform, vehicle, injury, testing				<b>18. Distribution Statement</b> Document is available to the public from the National Technical Information Service, <a href="http://www.ntis.gov">www.ntis.gov</a> .	
<b>19. Security Classif. (of this report)</b> Unclassified		<b>20. Security Classif. (of this page)</b> Unclassified		<b>21. No. of Pages</b> 56	<b>22. Price</b>

**Table of Contents**

List of Figures ..... iv

List of Tables ..... vii

**1. Introduction..... 1**

    1.1. Background ..... 1

    1.2. Objective ..... 1

**2. Overview ..... 1**

    2.1. Description of the TRL Upper Legform ..... 1

**3. Qualification Test Procedure ..... 3**

**4. Vehicle Test Procedure..... 4**

    4.1. Vehicle Markup ..... 4

    4.2. Test Procedure ..... 7

**5. Part 1: TRL Upper Legform Sensitivity to Humidity ..... 8**

    5.1. Qualification Testing at High Humidity, 45 Percent RH ..... 9

    5.2. Qualification Testing at Low Humidity, 25 Percent RH ..... 14

    5.3. Vehicle Testing ..... 20

    5.4. Discussion..... 22

        5.4.1. Qualification Testing ..... 22

        5.4.2. Vehicle Testing ..... 22

        5.4.3. Assessing the Qualification Limits for Humidity ..... 22

    5.5. Conclusion ..... 23

**6. Part 2: TRL Upper Legform Evaluation ..... 24**

    6.1. Sensitivity to Vehicle Design ..... 28

        6.1.1. Analysis and Discussion: Sensitivity to Vehicle Design ..... 28

    6.2. Repeatability and Reproducibility ..... 29

        6.2.1. Analysis and Discussion: Repeatability ..... 30

            i. 2016 Honda Fit Repeatability..... 30

            ii. 2016 Chevrolet Malibu Repeatability..... 31

        6.2.2. Analysis and Discussion: Reproducibility ..... 33

            i. 2016 Honda Fit Reproducibility..... 33

            ii. 2016 Chevrolet Malibu Reproducibility ..... 36



6.3. Durability..... 39  
    6.3.1. Analysis and Discussion: Durability..... 40  
6.4. Comparison Between THUMS and Upper Legform ..... 41  
6.5. Conclusion ..... 42  
**Appendix .....A-1**

## List of Figures

Figure 1. The TRL upper legform and its attachment to the propulsion/guidance system.....	2
Figure 2. Top view of the assembled upper legform .....	2
Figure 3. TRL upper legform impactor without flesh and skin .....	3
Figure 4. Qualification test set-up.....	4
Figure 5. Determination of the bonnet leading edge reference line (Euro NCAP v8.3) .....	5
Figure 6. Determination of the bonnet side reference line (Euro NCAP v8.3) .....	5
Figure 7. Marking wrap around distances (Euro NCAP v8.3).....	6
Figure 8. Division of the upper legform grid points at the WAD 775 (Euro NCAP v8.3).....	6
Figure 9. Measurement of the internal bumper reference line height (Euro NCAP v8.3).....	7
Figure 10. Setup of upper leg impact test (Euro NCAP v8.3) .....	8
Figure 11. Femur bending moment time histories of tests at 45 percent RH using upper legform SN150 .....	10
Figure 12. Femur force time histories of tests at 45 percent RH using upper legform SN150.....	10
Figure 13. Upper legform SN 150 qualification results provided by TRL.....	11
Figure 14. Femur bending moment time histories of tests at 45 percent RH using upper legform SN153 .....	12
Figure 15. Femur force time histories of tests at 45 percent RH using upper legform SN153.....	13
Figure 16. Upper legform SN 153 qualification results provided by TRL.....	14
Figure 17. Femur bending moment time histories of 25 percent RH tests with upper legform SN153 using the same foam. ....	15
Figure 18. Femur force time histories of the 25 percent RH tests with upper legform SN153 using the same foam. ....	16
Figure 19. Femur bending moment time histories of the 25 percent RH tests with upper legform SN153 using multiple foams. ....	17
Figure 20. Femur force time histories of the 25 percent RH tests with upper legform SN153 using multiple foams. ....	17
Figure 21. Femur bending moment time histories of the 25 percent RH tests with upper legform SN150 using multiple foams. ....	19
Figure 22. Femur force time histories of the 25 percent RH tests with upper legform SN150 using multiple foams. ....	19
Figure 23. Damaged (red) and undamaged (green) bumper beam bracket in the Ford Edge .....	21

Figure 24. 2016 Honda Fit front end.....	25
Figure 25. 2016 Chevrolet Malibu front end .....	25
Figure 26. 2016 Nissan Rogue front end.....	26
Figure 27. 2015 Toyota Sienna front end .....	26
Figure 28. 2015 Ford F-150 front end .....	27
Figure 29. 2016 Chevrolet Tahoe front end.....	27
Figure 30. Repeatability: 2016 Honda Fit femur bending moment time histories of impacts at $\pm 500$ mm from centerline using upper legform SN150.....	30
Figure 31. Repeatability: 2016 Honda Fit femur force time histories of impacts at $\pm 500$ mm from centerline using upper legform SN150 .....	31
Figure 32. Repeatability: 2016 Chevrolet Malibu femur bending moment time histories of impacts at $\pm 500$ mm from centerline using upper legform SN150.....	32
Figure 33. Repeatability: 2016 Chevrolet Malibu femur force time histories of impacts at $\pm 500$ mm from centerline using upper legform SN150 .....	32
Figure 34. Reproducibility: 2016 Honda Fit femur bending moment time histories of impacts at $\pm 500$ mm from centerline.....	34
Figure 35. Reproducibility: 2016 Honda Fit femur force time histories of impacts at $\pm 500$ mm from centerline .....	34
Figure 36. Reproducibility: 2016 Honda Fit femur bending moment time histories of impacts at $\pm 500$ mm from centerline comparing impacts performed a couple months apart .....	35
Figure 37. Reproducibility: 2016 Honda Fit femur force time histories of impacts at $\pm 500$ mm from centerline comparing impacts performed a couple months apart .....	36
Figure 38. Reproducibility: 2016 Chevrolet Malibu femur bending moment time histories of impacts at + 100 mm from centerline.....	37
Figure 39. Reproducibility: 2016 Chevrolet Malibu femur force time histories of impacts at + 100 mm from centerline.....	37
Figure 40. Reproducibility: 2016 Chevrolet Malibu femur bending moment time histories of impacts at - 300 mm from centerline .....	38
Figure 41. Reproducibility: 2016 Chevrolet Malibu femur force time histories of impacts at - 300 mm from centerline .....	39
Figure 42. Minor damage to upper legform impactor.....	40
Figure 43. Comparison of human model-based (THUMS) and upper-legform-based injury risk functions.....	41

- Figure 44. Femur bending moment time histories of vehicle repeat tests at location U-1. Red (1701): legform that PASSES qualification requirements with CONFOR foam at 25 percent RH. Gray (1668) legform that FAILS (high) qualification requirements CONFOR foam at 45 percent RH. .... A-1
- Figure 45. Femur force histories of vehicle repeat tests at location U-1. Red (1701): legform that PASSES qualification requirements with CONFOR foam at 25 percent RH. Gray (1668) legform that FAILS (high) qualification requirements CONFOR foam at 45 percent RH. .... A-1
- Figure 46. Femur bending moment time histories of vehicle repeat tests at location U+3. Green (1707): legform that PASSES qualification requirements with CONFOR foam at 25 percent RH. Gray (1666) legform that FAILS (high) qualification requirements CONFOR foam at 45 percent RH. .... A-2
- Figure 47. Femur force time histories of vehicle repeat tests at location U+3. Green (1707): legform that PASSES qualification requirements with CONFOR foam at 25 percent RH. Gray (1666) legform that FAILS (high) qualification requirements with CONFOR foam at 45 percent RH. .... A-2
- Figure 48. Femur bending moment time histories of vehicle repeat tests at location U-5. Blue (1706): legform that PASSES qualification requirements with CONFOR foam at 25 percent RH. Gray (1670) legform that FAILS (high) qualification requirements CONFOR foam at 45 percent RH. .... A-3
- Figure 49. Femur force time histories of vehicle repeat tests at location U-5. Blue (1706): legform that PASSES qualification requirements with CONFOR foam at 25 percent RH. Gray (1670) legform that FAILS (high) qualification requirements CONFOR foam at 45 percent RH. .... A-3
- Figure 50. Femur bending moment time histories of vehicle repeat tests at location U+7. Pink (1704): legform that PASSES qualification requirements with CONFOR foam at 25 percent RH. Gray (1669) legform that FAILS (high) qualification requirements CONFOR foam at 45 percent RH. .... A-4
- Figure 51. Femur force time histories of vehicle repeat tests at location U+7. Pink (1704): legform that PASSES qualification requirements with CONFOR foam at 25 percent RH. Gray (1669) legform that FAILS (high) qualification requirements CONFOR foam at 45 percent RH. .... A-4

**List of Tables**

Table 1. Qualification test requirements ..... 4

Table 2. Upper legform SN 150 qualification test results at 45 percent RH ..... 11

Table 3. Upper legform SN 150 qualification results provided by TRL ..... 11

Table 4. Upper legform SN 153 qualification test results at 45 percent RH ..... 13

Table 5. Upper legform SN 153 qualification results provided by TRL ..... 14

Table 6. Upper legform SN 153 qualification test results using the same foam at 25 percent RH ..... 16

Table 7. Upper legform SN 153 qualification test results using same (1708, 1709, 1712) and new foams (1710, 1711) at 25 percent RH ..... 18

Table 8. Upper legform SN 150 qualification test results using new (1714, 1715, 1719) and previously tested (1705, 1718) foams at 25 percent RH ..... 20

Table 9. 2016 Ford Edge test results with 25 percent RH and 45 percent RH conditioned foams..... 20

Table 10. List and description of tested vehicles ..... 24

Table 11. Total number of grid points and tested points for each vehicle ..... 28

Table 12. Max femur bending moment (Nm) and sum of femur loads (N) for each upper leg test ..... 29

Table 13. %CV Scores ..... 29

Table 14. Repeatability results for the impacts on the 2016 Honda Fit using upper legform SN150 ..... 31

Table 15. Repeatability results for 2016 Chevrolet Malibu tests using upper legform SN150..... 33

Table 16. Repeatability results for UL 1659 and UL 1660 on the 2016 Chevrolet Malibu using upper legform SN150 ..... 33

Table 17. Reproducibility results for the impacts on the 2016 Honda Fit ..... 35

Table 18. Reproducibility results for the impacts on the 2016 Honda Fit that were performed a couple months apart..... 36

Table 19. Reproducibility results for the impacts on the 2016 Chevrolet Malibu at + 100 mm ..... 38

Table 20. Reproducibility results for the impacts on the 2016 Chevrolet Malibu at - 300 mm ..... 39

Table 21. Summary of vehicle impacts performed with upper legform SN150 ..... 40

## **1. Introduction**

### **1.1. Background**

The upper legform impactor was introduced by Transport Research Laboratory (TRL) to address injuries to the upper leg, pelvis, and hip of a pedestrian when struck by a vehicle. The upper legform is instrumented to measure bending moment and force, the two principal modes of injury to pedestrians in contact with a vehicle's bonnet leading edge. The upper legform is currently used by the European New Car Assessment Programme (Euro NCAP), Global Technical Regulation No. 9 (GTR 9), and the United Nations Economic Commission for Europe Regulation 127 (ECE R127). The upper legform impactor is new to the National Highway Traffic Safety Administration and was evaluated at NHTSA's Vehicle Research and Test Center (VRTC).

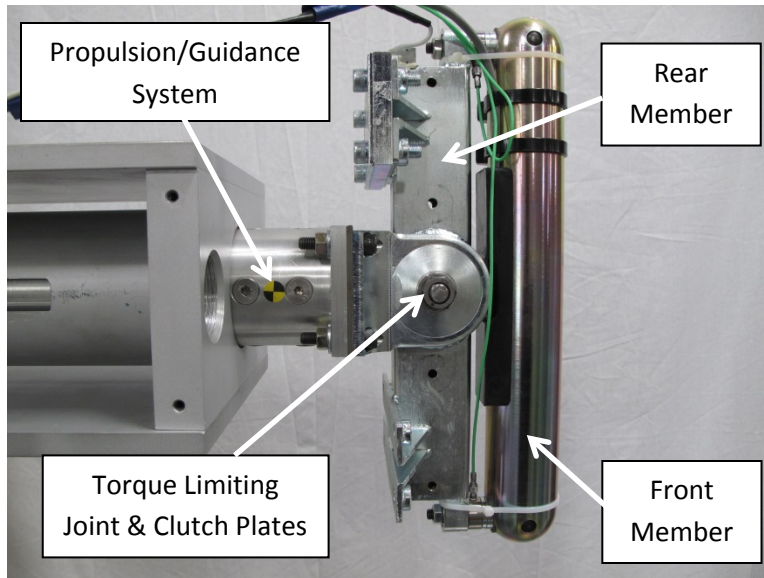
### **1.2. Objective**

There are two objectives of this study. Since the foam used in the TRL upper legform impactor has a history of being sensitive to humidity, the first objective is to evaluate the TRL upper legform impactor under different humidity conditions. Qualification tests were performed at the upper end and lower end of the allowed humidity range to see if a humidity change would affect the upper leg performance. Vehicle tests were also carried out under the same conditions to see if the upper legform sensitivity to humidity carries over to vehicle tests. The second objective of this study is to evaluate the TRL upper legform sensitivity to vehicle bumper design, repeatability, reproducibility, durability, and biofidelity.

## **2. Overview**

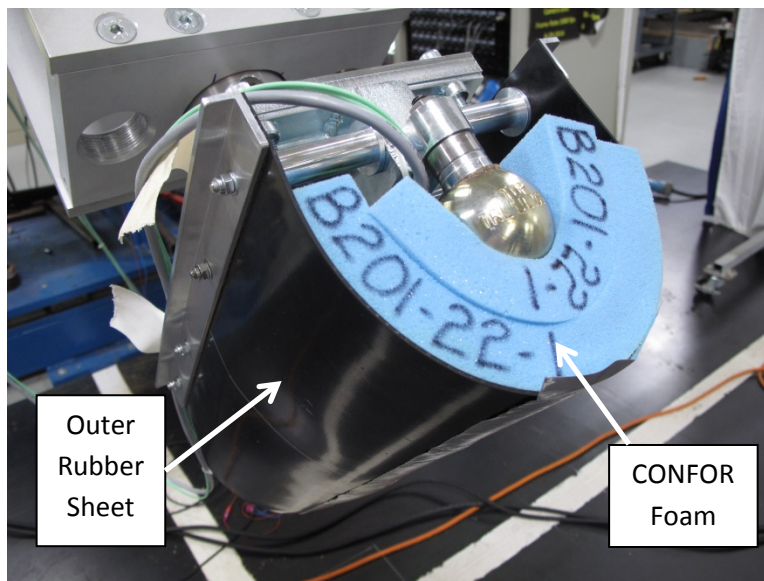
### **2.1. Description of the TRL Upper Legform**

The TRL upper legform impactor consists of a front member and a rear member with a torque limiting joint (Figure 1). The entire upper legform assembly is attached to the propulsion system by the two clutch plates of the torque limiting joint on the rear member. The torque limiting joint is designed so that it only rotates when forces high in magnitude and offset vertically are applied to the impactor, limiting the torque transferred to the propulsion system and thereby protecting it from damage.



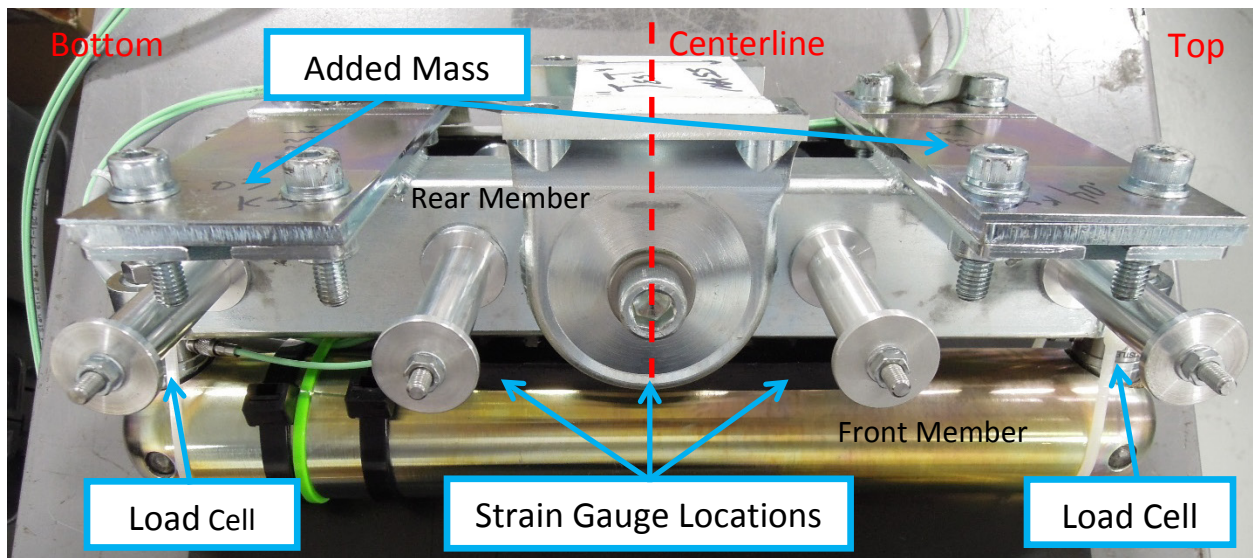
**Figure 1. The TRL upper legform and its attachment to the propulsion/guidance system**

Two 25.4 mm (1 inch) thick sheets of blue CONFOR foam (Type CF-45, CF-45AC, or CF-45M, Aearo Technologies LLC) and an outer rubber sheet to mimic flesh are attached to the rear member and wrapped around the front member (Figure 2).



**Figure 2. Top view of the assembled upper legform**

Bending moment is calculated by three full-bridge strain gages mounted at the centerline as well as 50 mm above and below the centerline (Figure 3). Force is measured between the front and rear members with two piezoelectric load transducers, one at the top and one at the bottom, which are powered by a charge amplifier through software (Kistler ManuWare v1.0.2).



**Figure 3. TRL upper legform impactor without flesh and skin**

Nominal lengths for the front member, rear member, and overall width of the impactor (between the outer edges of the skin reinforcement) are 351 mm, 345 mm, and 187 mm, respectively. The upper legform has a mass of  $5.725 \pm 0.125$  kg. Depending on the application (qualification versus vehicle testing), ballast may be added to the legform as shown by the added mass in Figure 3. The total effective impactor mass (upper legform plus attached propulsion/guidance system components) is specified to be  $12.0 \pm 0.1$  kg for qualification testing. The total effective impactor mass (upper legform plus attached propulsion/guidance system components) is specified to be  $10.5 \pm 0.105$  kg for vehicle testing following the 775 mm wrap around distance (WAD 775) procedure in the European New Car Assessment Programme (Euro NCAP) Pedestrian Testing Protocol (V8.3, December 2016). Depending on the mass of the attached propulsion/guidance system components, the addition of extra masses might be necessary to meet the specified mass requirement. At VRTC, the guidance system components have a mass of 3.759 kg. Therefore, ballasts of approximately 2.516 kg and 1.016 kg were added for qualification testing and vehicle testing, respectively.

Two upper legform impactors (SN150 and SN153) were used in this study. Both impactors were certified following the Euro NCAP qualification procedure (V8.3, December 2016) by TRL prior to their shipment to the NHTSA Vehicle Research and Test Center (VRTC).

### **3. Qualification Test Procedure**

The qualification test setup (Euro NCAP and all European regulations) is shown in Figure 4. A certification tube is suspended from two wire ropes so that it is free to move away when struck by the upper legform impactor. Any turnbuckles or similar hardware fitted to the suspension wires that allows for the adjustment of the certification tube should be located at least 2 meters above the certification tube to prevent adding to the effective mass of the tube. The impactor is fitted with a previously unused flesh set. Mass is added to the impactor such that its weight measures  $12.0 \pm 0.1$  kg. The impactor is propelled into the certification tube at  $7.1 \pm 0.1$  m/s. The foam and concrete block represent an option



to stop the impactor (if the propulsion system is unable to do so) and prevent the certification tube from swinging away post-impact.

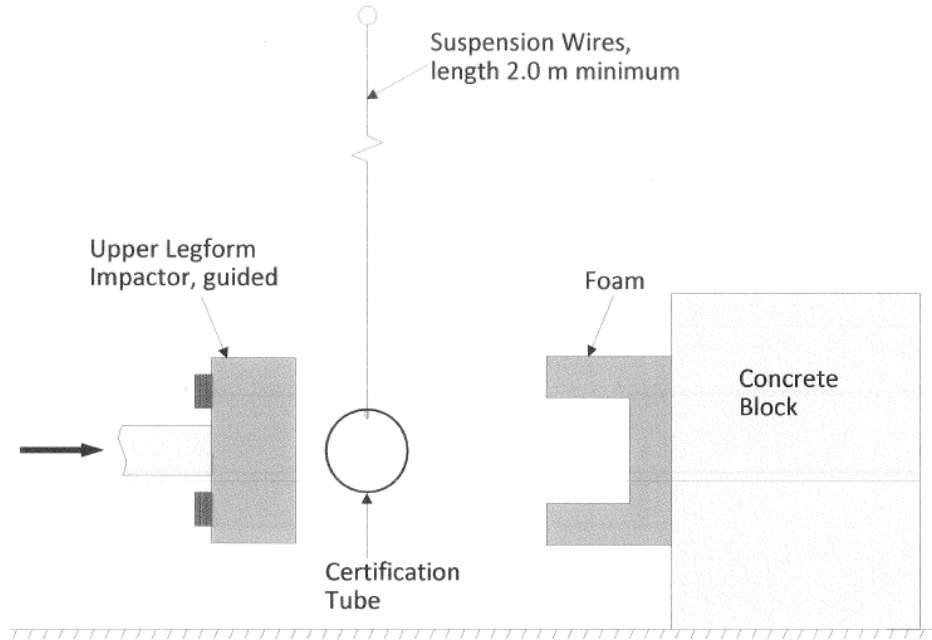


Figure 4. Qualification test set-up<sup>1</sup>

The bending moment and force requirements for the qualification test as well as the temperature and humidity soaking/testing conditions are shown in Table 1.

Table 1. Qualification test requirements

Requirements		
<b>Bending Moment (Nm)</b>	Peak Center	190 Nm to 250 Nm
	Peak Outer	160 Nm to 220 Nm
	Difference Between Outer (Top and Bottom) Strain Gauges	< 20 Nm
<b>Force (N)</b>	Peak Force	1200 N to 1550 N
	Difference Between Top and Bottom Load Cells	< 100 N
<b>Soak Conditions for Foam</b>		
Humidity of 35% ± 10%		
Temperature of 20°C ± 2°C		

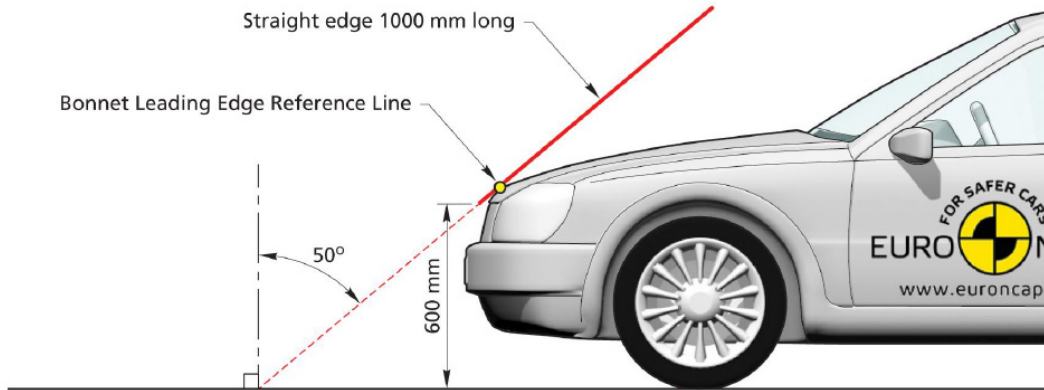
#### 4. Vehicle Test Procedure

##### 4.1. Vehicle Markup

Prior to testing, the vehicles were prepared and marked according to the Euro NCAP Pedestrian Testing Protocol (Figure 5 and Figure 6).

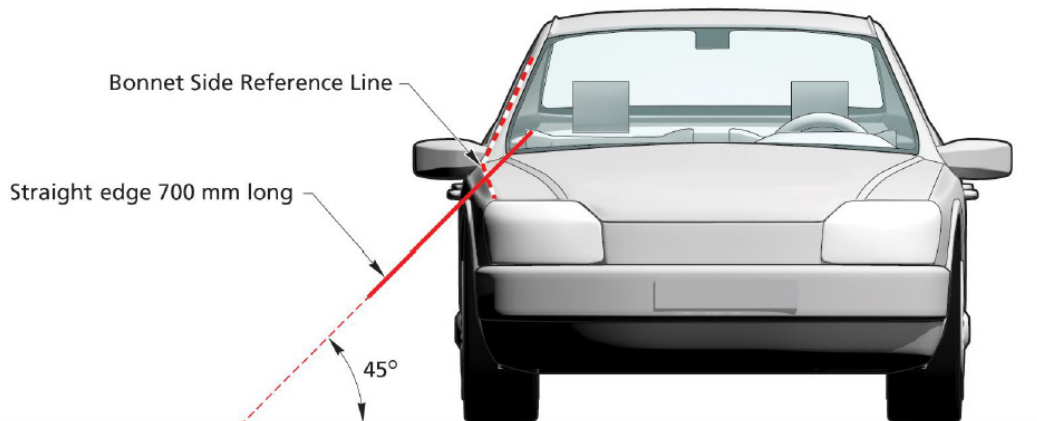
<sup>1</sup> TRL Upper Legform User Manual (Version 2.8, November 2016)

The bonnet leading edge reference line (Figure 5) is the geometric trace of points of contact of the front surface of a vehicle with a 1000 mm long straight edge that begins 600 mm above the ground and held parallel to the vertical-longitudinal plane of the vehicle and inclined 50 degrees towards the vehicle.



**Figure 5. Determination of the bonnet leading edge reference line (Euro NCAP v8.3)**

The bonnet side reference line (Figure 6) is the geometric trace of the highest points of contact between the sides of a vehicle’s front structure and a 700 mm long straight edge that is held parallel to the transverse-vertical plane of the vehicle and inclined 45 degrees inward, towards the vehicle.

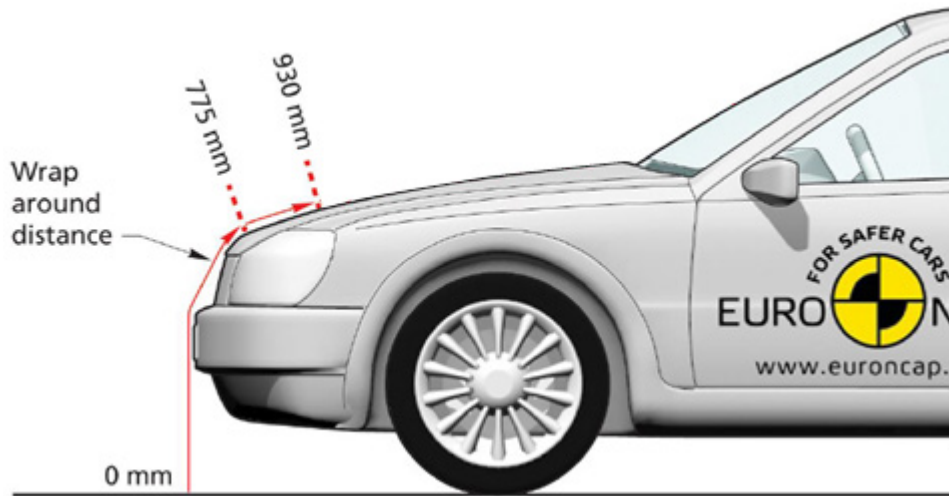


**Figure 6. Determination of the bonnet side reference line (Euro NCAP v8.3)**

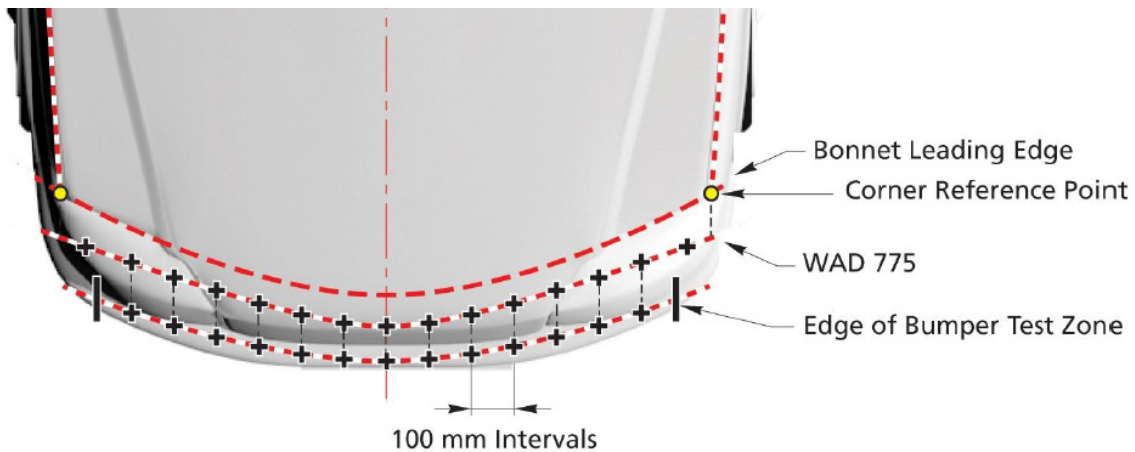
The corner reference point is defined as the intersection of the bonnet leading edge and the bonnet side reference lines.

For upper legform impacts, the WADs at 775 mm and 930 mm were marked across the front end of the vehicle. This was accomplished by placing the end of a flexible measuring tape on the ground and wrapping it over the vehicle while being held taut and maintained in the vehicle’s vertical longitudinal (X,Z) plane (Figure 7). Starting at the intersection of the vehicle’s centerline and WAD 775 mm, grid points were marked every 100 mm in both lateral directions up to the corner reference points (Figure 8). The resulting grid points along WAD 775 mm are the upper legform test points and are denoted “U±#”

where “U” denotes an upper legform impact, “-” indicates a driver side impact, “+” indicates a passenger side impact, and “#” indicates the 100 mm increment from the centerline. For example, impact location U-5 denotes an upper leg impact point 500 mm from the centerline on the driver side. The same procedure was followed for points along WAD 930 mm. The points along WAD 930 mm are used for defining the angle and speed of the impact. Grid points less than 50 mm from the corner reference points were deleted. The 100 mm distances were measured horizontally in a lateral vertical plane and projected onto the WAD.



**Figure 7. Marking wrap around distances (Euro NCAP v8.3)**



**Figure 8. Division of the upper legform grid points at the WAD 775 (Euro NCAP v8.3)**

Lastly, the internal bumper reference line (IBRL) is the height of the internal bumper beam measured from the ground in a vertical plane contacting the beam up to 10 mm into the profile at 100 mm intervals outboard of the vehicle centerline (Figure 9). For every upper legform grid point outboard of the bumper beam, the average bumper beam height is allocated to the outermost grid point on the bumper beam, per the Euro NCAP Pedestrian Testing Protocol. The IBRL heights were transferred at each 100 mm interval onto the external bumper fascia. These points in combination with the WAD 930 mm grid points are used for defining the angle and speed of the impact.

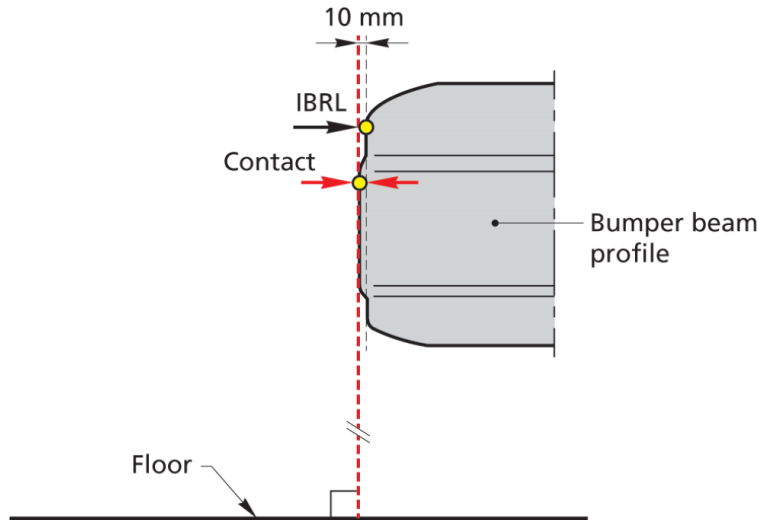


Figure 9. Measurement of the internal bumper reference line (IBRL) height (Euro NCAP v8.3)

#### 4.2. Test Procedure

Testing conducted in the following studies used the Euro NCAP Pedestrian Testing Protocol. The upper legform impactor was aligned such that at the time of first contact, the impactor centerline was coincident with the WAD 775 mm, and laterally with the selected impact point, both with a  $\pm 10$  mm tolerance. The propulsion system was aligned such that the longitudinal axis of the upper legform impactor is in the fore and aft (X-Z) vertical plane of the vehicle. The tolerances to these directions are  $\pm 2^\circ$ .

The propulsion system was adjusted to give the correct velocity and impact angle at the point of impact with tolerances of  $\pm 2\%$  and  $\pm 2^\circ$ , respectively. The impact angle,  $\alpha$ , in relation to the ground at each grid point, was perpendicular to a straight line passing through the IBRL and WAD 930 mm at the same lateral position from the vehicle centerline as the targeted grid point. After finding the impact angle,  $\alpha$ , the impact velocity,  $v_i$ , was calculated as follows:

$$m_n = 7.4 \text{ kg} \quad (\text{see footnote}^2)$$

$$v_o = 11.11 \text{ m/s}$$

$$v_c = v_o \cos(1.2\alpha)$$

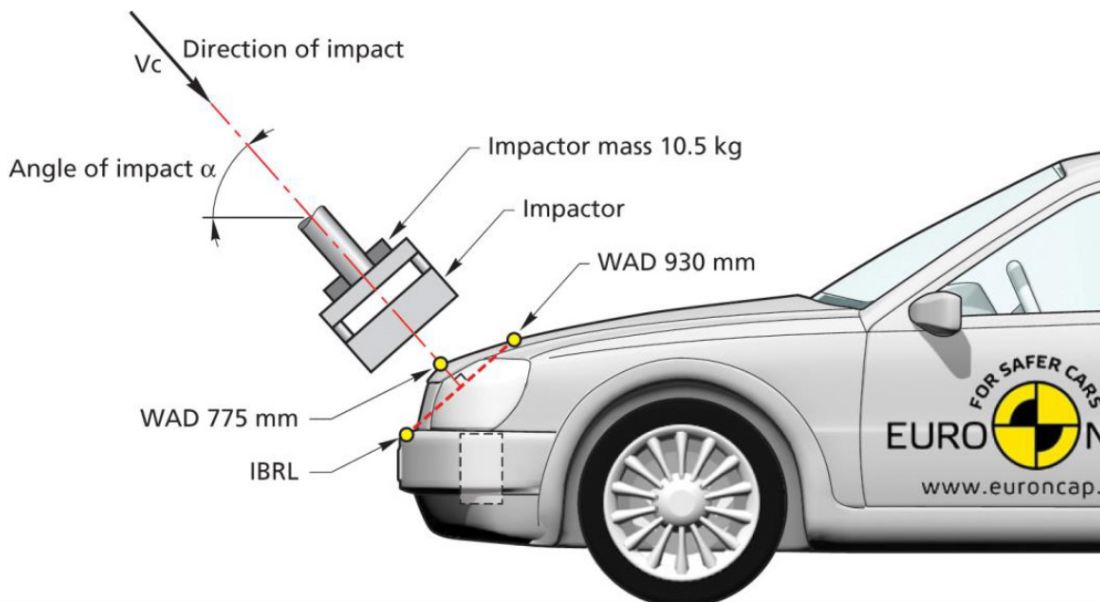
$$\text{Energy} = 0.5 * m_n * v_c^2$$

<sup>2</sup> The mass of the 50th percentile male human upper leg – inclusion of this mass accounts for the difference in impact energy between a 50 percent pedestrian male human upper leg and the TRL upper legform impactor.

Snedeker, J., Walz, F. H., Muser, M. H., Lanz, C. & Schroeder, G. (2005, May). *Assessing femur and pelvis injury risk in car-pedestrian collisions: Comparison of full body PMTO impacts and a human body finite element model* (Paper No. 05-103). Available at [www.researchgate.net/publication/237720276](http://www.researchgate.net/publication/237720276) ASSESSING FEMUR - AND PELVIS INJURY RISK IN CAR PEDESTRIAN COLLISIONS COMPARISON OF FULL BODY PMTO IMPACTS AND A HUMAN BODY FINITE ELEMENT MODEL. 19th International Technical Conference on the Enhanced Safety of Vehicles (ESV), Washington, DC, June 6-9, 2005.

$$v_t = \sqrt{\frac{2 * Energy}{10.5 \text{ kg}}}$$

The vehicle was positioned at the desired distance such that the impactor strikes the vehicle after it has been accelerated to the test speed so that the propulsion system does not interfere with the impactor's interaction with the vehicle. A diagram of the upper leg impact setup is shown in Figure 10.



**Figure 10. Setup of upper leg impact test (Euro NCAP v8.3)**

### 5. Part 1: TRL Upper Legform Sensitivity to Humidity

As shown in Figure 2, two sheets of blue CONFOR foam are wrapped around the front member of the upper legform. It is the properties of this foam, and its sensitivity to humidity, that has prompted the investigation described herein. CONFOR foam is characterized as a highly damped “memory foam” of medium density with open-celled polyurethane construction. The foam provides excellent energy absorption and exhibits temperature-softening behavior such that it will soften on contact with a warm surface. Because of its open-celled structure, CONFOR foam is “breathable” and highly sensitive to humidity (Aearo Technologies LLC).

The goal for this series of testing was to soak the foam at the lower and upper ends of the humidity range and identify any differences in response characteristics. Tests were carried out using CONFOR foams that were preconditioned at the two extremes: either 25 percent relative humidity (RH) or 45 percent RH. These levels represent the upper and lower limits specified by the qualification procedures as shown in Table 1.

For this study, only the relative humidity was varied. The temperature was not able to be controlled since the humidity control cabinet cannot regulate temperature. Therefore, the soaking temperature was the same as the ambient temperature and remained at the upper end of the range. For this series

of testing the foam was soaked between 21°C and 25°C and 45 percent RH in high humidity tests and 25 percent RH in low humidity tests. Note that the temperature levels were sometimes above the requirement (18°C to 22°C, Table 1). However, since studying the effect of humidity was the objective, testing continued as long as temperature remained consistent between the low and high humidity tests.

### **5.1. Qualification Testing at High Humidity, 45 Percent RH**

For this series, foams were soaked and conditioned at the ambient temperature and humidity levels within our laboratory room, which was 21°C to 25°C and approximately 45 percent RH. All tests were conducted within 15 minutes after installing the foam on the impactor. At the conclusion of each qualification test, the foam was removed from the impactor and inspected for damage. If no damage was found, the foam was re-soaked for at least 4 hours before testing again. Two upper legforms were used in this series (SN150 and SN153). Four trials at 45 percent RH were carried out on SN150 and five trials at 45 percent RH on SN153. Two sets of foams, one for each legform, were used in all trials at 45 percent RH.

Time histories of the femur bending moment and femur forces for legform SN150 are shown in Figure 11 and Figure 12 below. Peak values, means, standard deviations, and percentage coefficient of variations (%CV) are shown in Table 2. Peak bending moments and peak forces all exceeded the qualification requirements. For reference, the qualification results provided to NHTSA by TRL with the purchase of the upper legforms are plotted and tabulated in Figure 13 and Table 3. According to TRL, the foams “met” the conditioning requirements and the results indicate that the legform performed within the qualification limits.

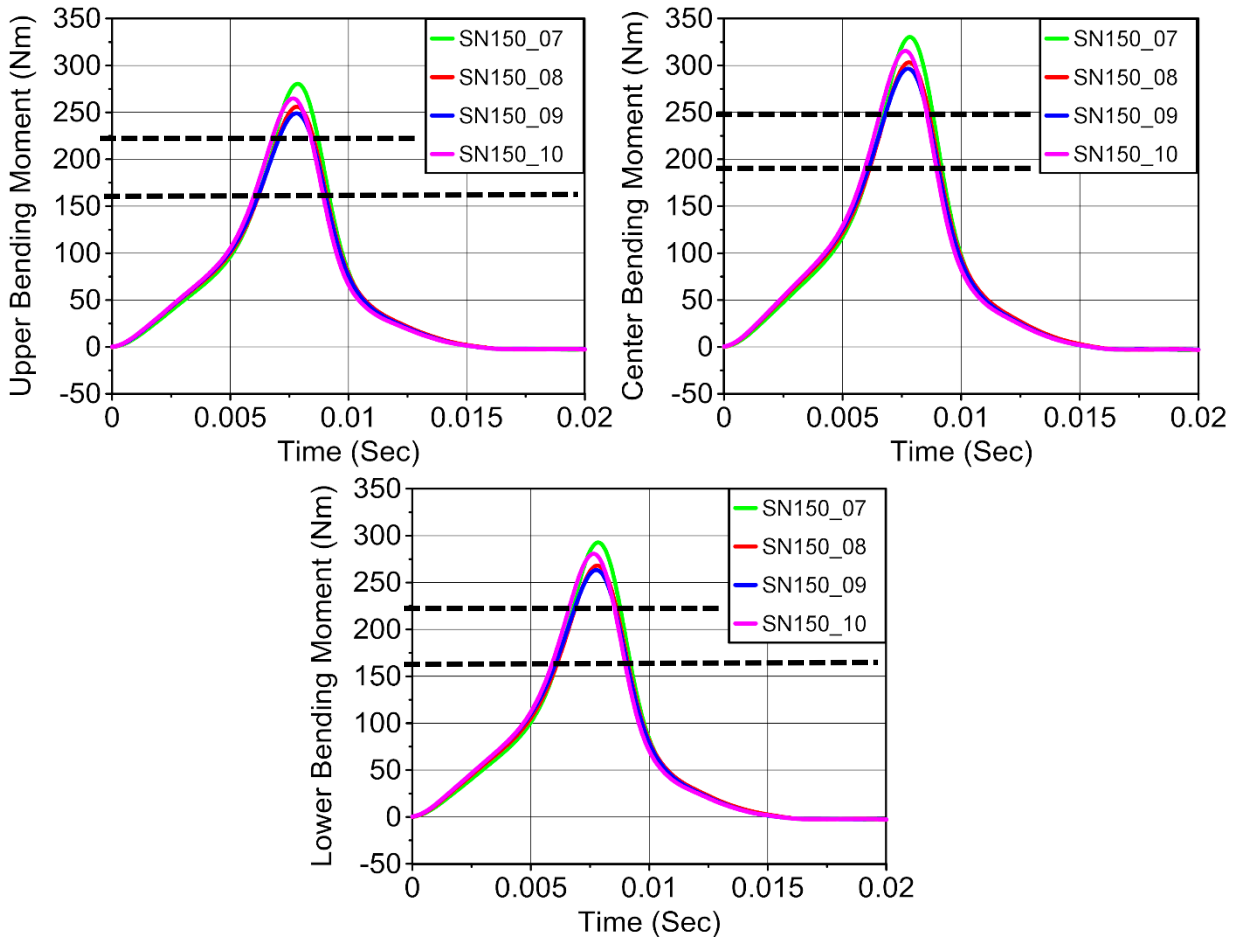


Figure 11. Femur bending moment time histories of tests at 45 percent RH using upper legform SN150

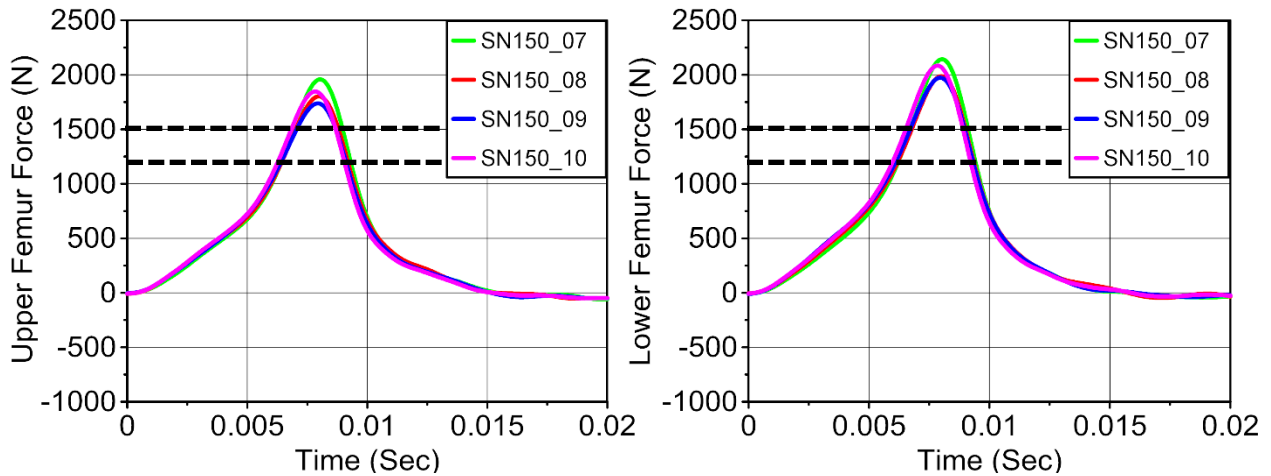
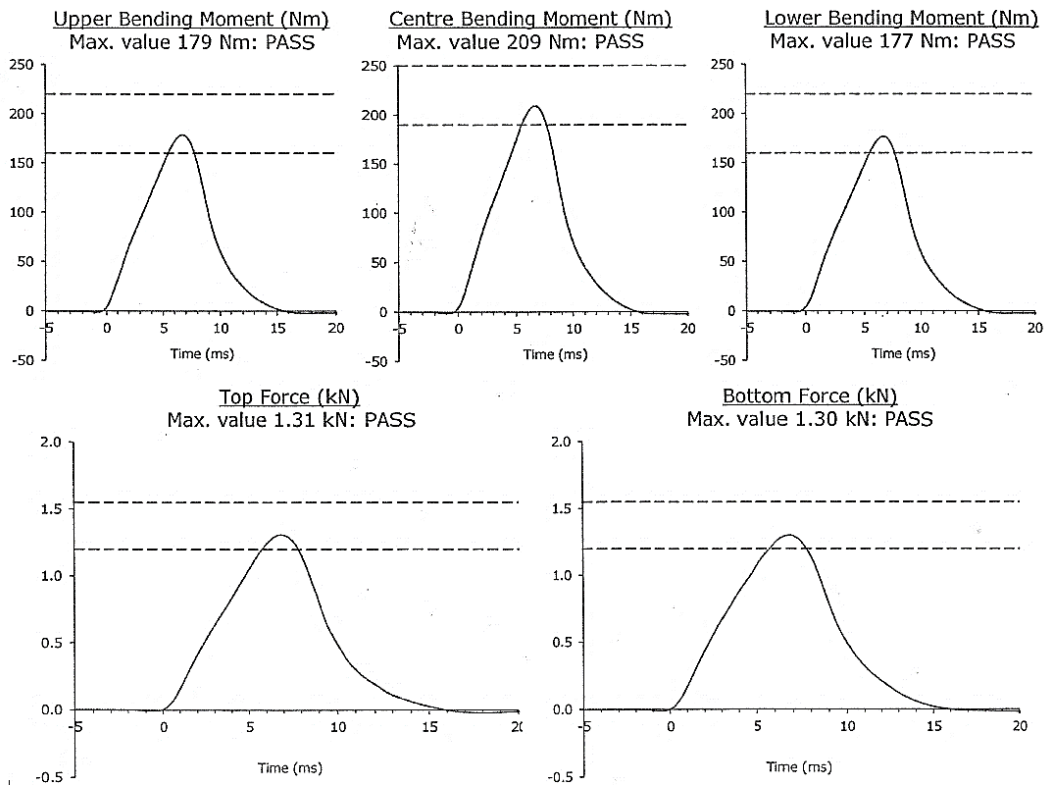


Figure 12. Femur force time histories of tests at 45 percent RH using upper legform SN150

**Table 2. Upper legform SN 150 qualification test results at 45 percent RH**

UL 150		Requirements	150_07	150_08	150_09	150_10	Mean	Standard Deviation	%CV
Femur Bending Moment (Nm)	Upper	160 Nm to 220 Nm	280	256	249	265	263	13.4	5.1%
	Center	190 Nm to 250 Nm	330	303	297	316	312	14.7	4.7%
	Lower	160 Nm to 220 Nm	293	268	263	281	276	13.5	4.9%
Femur Force (N)	Upper	1,200 N to 1,500 N	1,958	1,803	1,738	1,847	1,837	92.6	5.0%
	Lower		2,143	1,987	1,973	2,084	2,047	81.0	4.0%



**Figure 13. Upper legform SN 150 qualification results provided by TRL**

**Table 3. Upper legform SN 150 qualification results provided by TRL**

UL 150		Requirements	Results
Femur Bending Moment (Nm)	Upper	160 Nm to 220 Nm	179
	Center	190 Nm to 250 Nm	209
	Lower	160 Nm to 220 Nm	177
Femur Force (N)	Upper	1,200 N to 1,500 N	1,310
	Lower		1,300



Time histories of the femur bending moments and femur forces for legform SN153 are shown in Figure 14 and Figure 15 below. Peak values, means, standard deviations, and %CV are shown in Table 4. The results are similar to those for SN150 as peak bending moments and peak forces all exceeded the qualification requirements. According to TRL, the foams met the conditioning requirements and the qualification results provided to NHTSA by TRL (plotted and tabulated in Figure 16 and Table 5) indicate that the legform performed within the qualification limits.

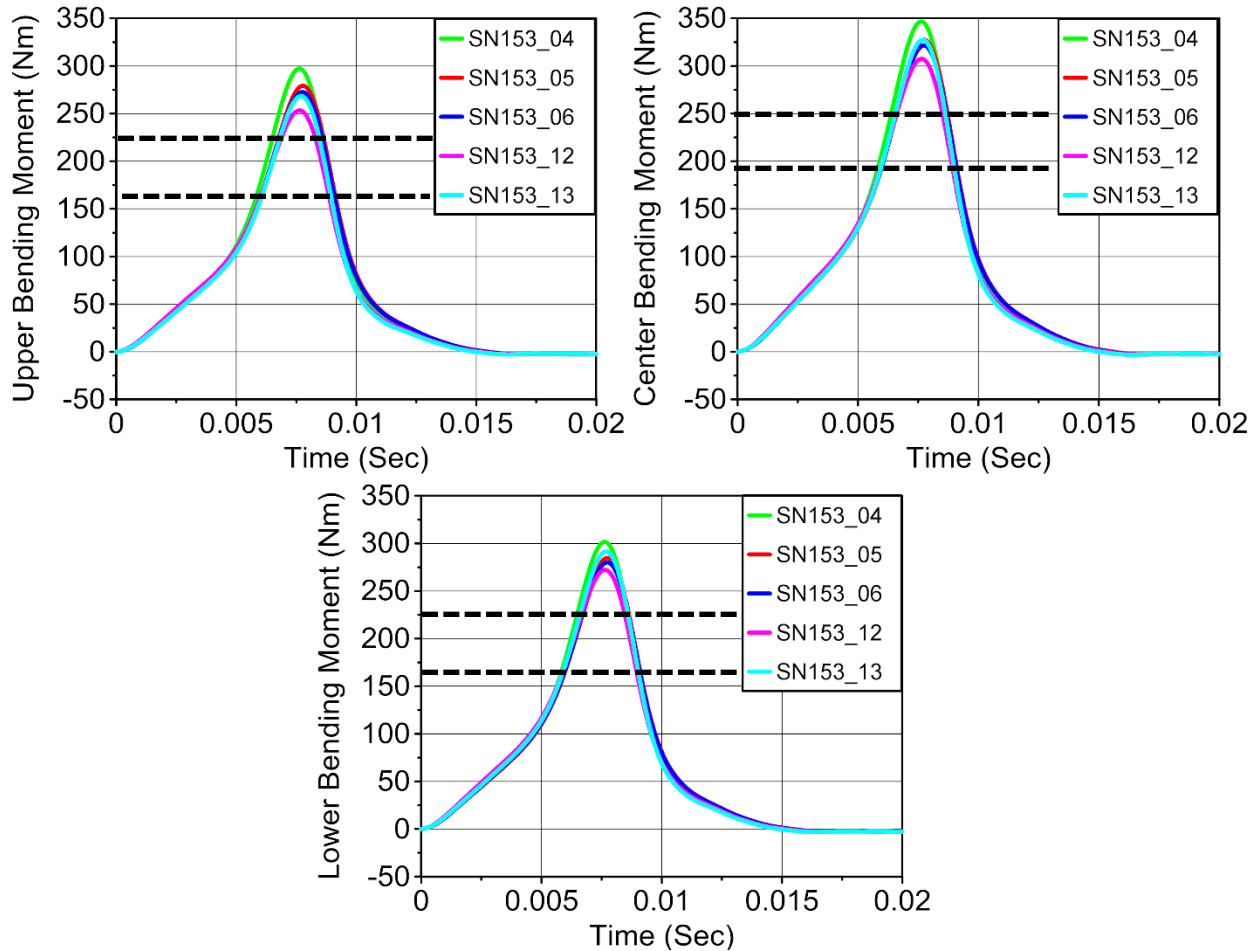


Figure 14. Femur bending moment time histories of tests at 45 percent RH using upper legform SN153

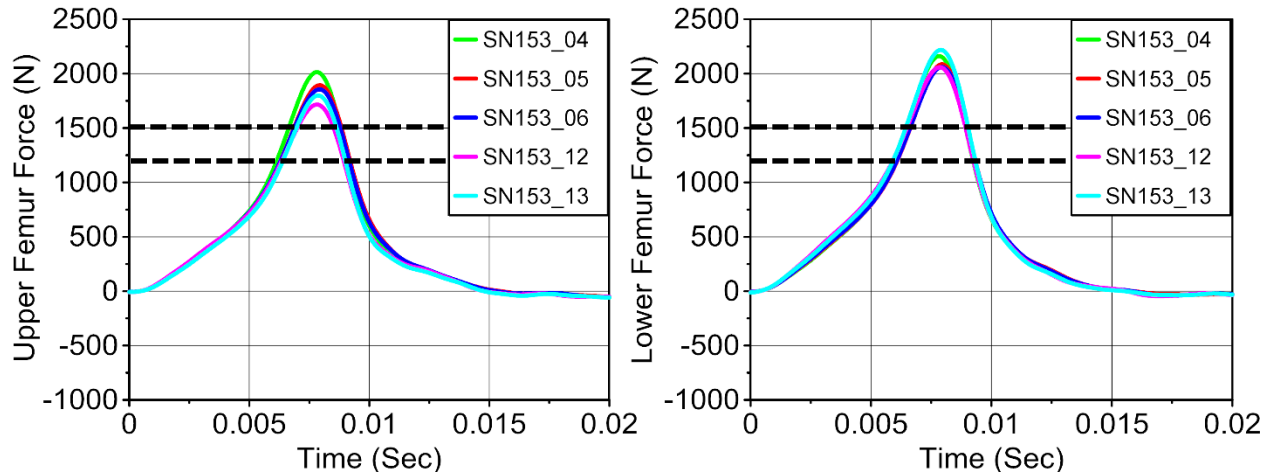


Figure 15. Femur force time histories of tests at 45 percent RH using upper legform SN153

Table 4. Upper legform SN 153 qualification test results at 45 percent RH

UL 153		Requirements	153_04	153_05	153_06	153_12	153_13	Mean	Standard Deviation	%CV
Femur Bending Moment (Nm)	Upper	160 Nm to 220 Nm	297	279	273	253	268	274	16.1	5.9%
	Center	190 Nm to 250 Nm	347	327	321	307	327	326	14.4	4.4%
	Lower	160 Nm to 220 Nm	302	285	280	272	291	286	11.3	4.0%
Femur Force (N)	Upper	1,200 N to 1,500 N	2,014	1,894	1,856	1,716	1,798	1,856	111	6.0%
	Lower	N	2,161	2,086	2,060	2,059	2,218	2,117	70.2	3.3%

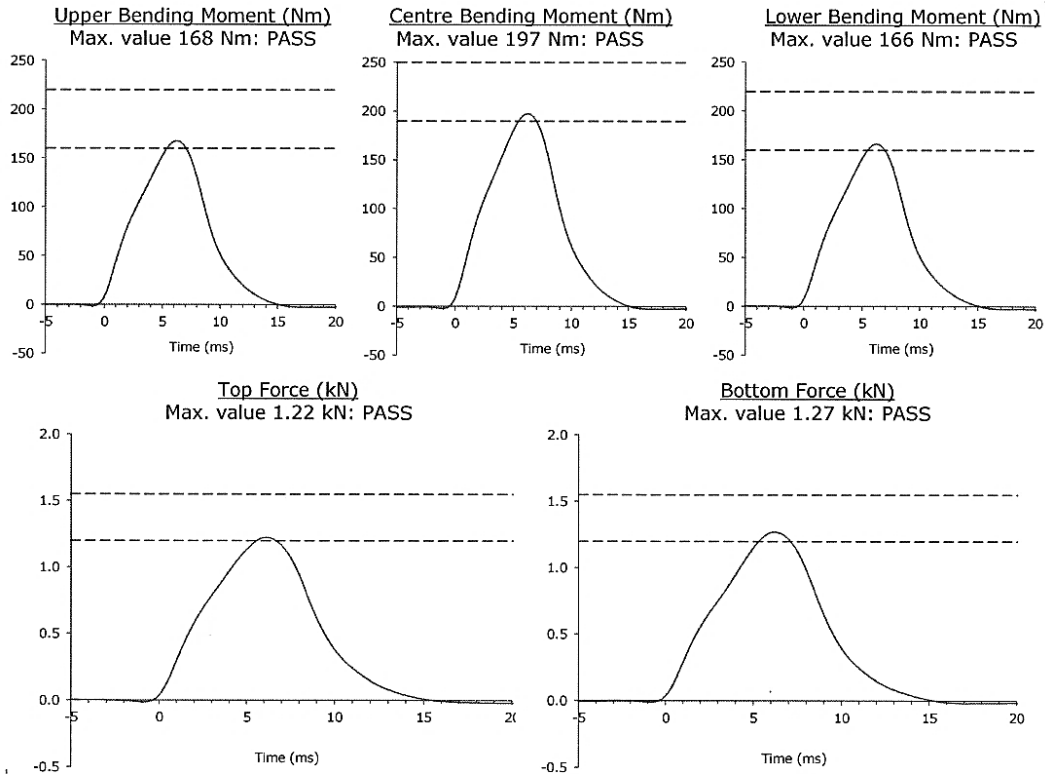


Figure 16. Upper legform SN 153 qualification results provided by TRL

Table 5. Upper legform SN 153 qualification results provided by TRL

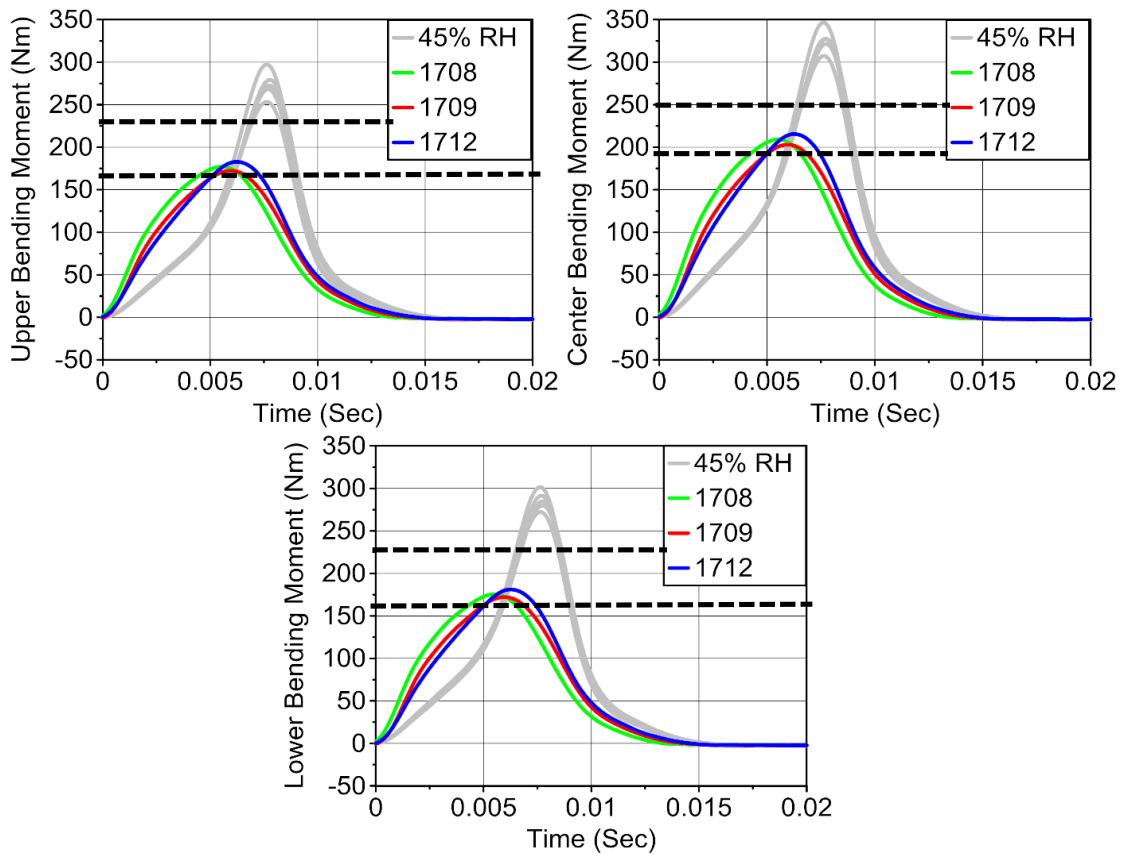
UL 153		Requirements	Results
Femur Bending Moment (Nm)	Upper	160 Nm to 220 Nm	168
	Center	190 Nm to 250 Nm	197
	Lower	160 Nm to 220 Nm	166
Femur Force (N)	Upper	1,200 N to 1,500 N	1,220
	Lower		1,270

## 5.2. Qualification Testing at Low Humidity, 25 Percent RH

Prior to this series, the blue CONFOR foams were soaked in an electronic humidity control cabinet (Model HC-30, Sirui USA, LLC, Verona, NJ). Soaking temperatures were between 21°C to 25°C and relative humidity was at around 25 percent. Foams were soaked for at least 4 hours prior to installation on to the impactor. In comparison to previous qualification testing, relative humidity was decreased from 45 percent to 25 percent but soaking and testing temperatures remained the same (more or less) because the humidity control cabinet can only regulate humidity (not temperature). Thus, in this test series, the soaking temperature was the same as the ambient lab temperature and remained at the upper end of the range.

All tests were conducted within 15 minutes after installing the foam on the impactor. At the conclusion of each qualification test, the foam was removed from the impactor and inspected for damage. If no damage was found, the foam was re-soaked for at least 4 hours before testing again. No damage was observed in this series of qualification tests.

Qualification tests were performed on upper legform SN153 using the same foam samples for each test (test numbers 1708, 1709, and 1712). Time histories of the femur bending moment and femur forces are shown in Figure 17 and Figure 18 below. Results from the 45 percent RH tests are also included in the plots for comparison. Peak values, means, standard deviations, and %CV for each test are shown in Table 6 below. All three tests passed the qualification requirements.



**Figure 17. Femur bending moment time histories of 25 percent RH tests with upper legform SN153 using the same foam.**

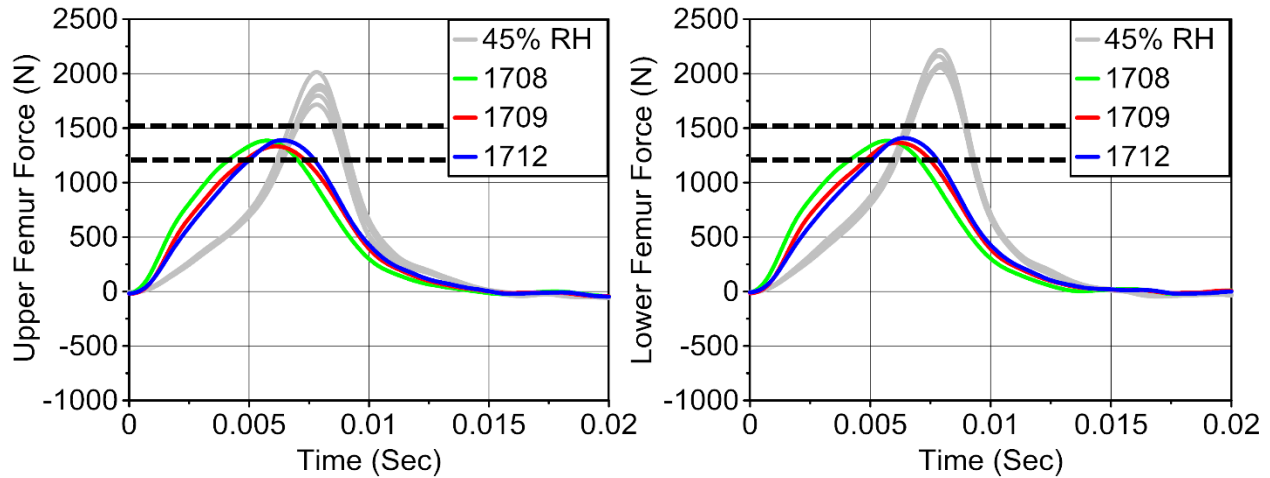
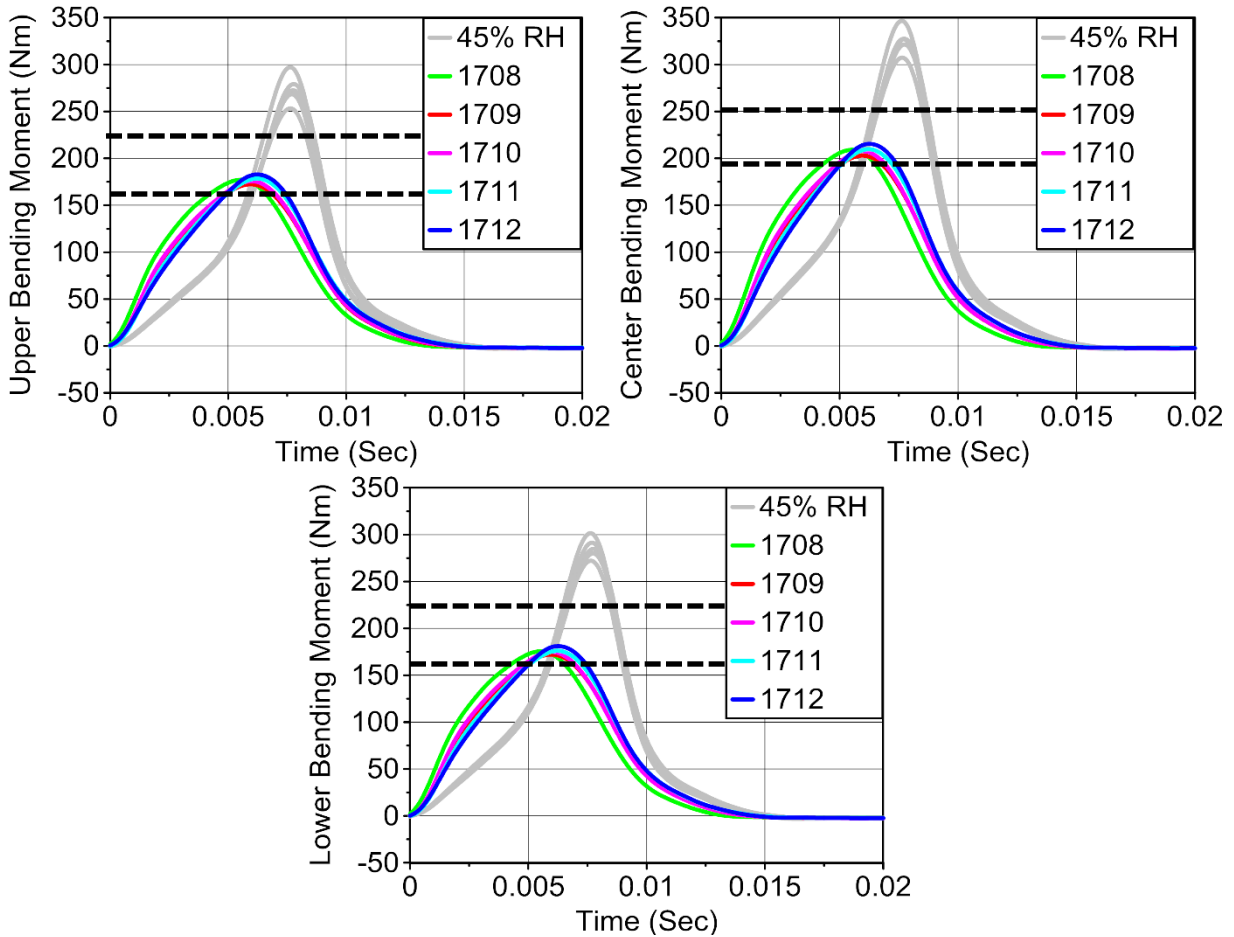


Figure 18. Femur force time histories of the 25 percent RH tests with upper legform SN153 using the same foam.

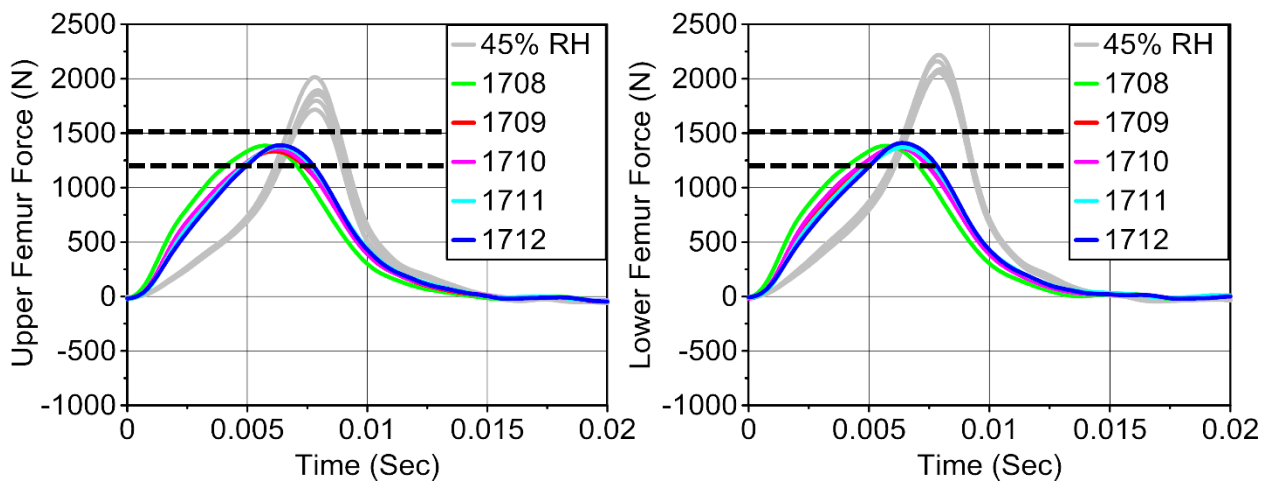
Table 6. Upper legform SN 153 qualification test results using the same foam at 25 percent RH

UL 153		Requirements	1708	1709	1712	Mean	Standard Deviation	%CV
			Foam B	Foam B	Foam B			
Femur Bending Moment (Nm)	Upper	160 Nm to 220 Nm	177	172	183	177	5.3	3.0%
	Center	190 Nm to 250 Nm	209	203	216	209	6.3	3.0%
	Lower	160 Nm to 220 Nm	175	172	181	176	4.6	2.6%
Femur Force (N)	Upper	1,200 N to 1,500 N	1,385	1,333	1,389	1,369	31.5	2.3%
	Lower		1,385	1,366	1,409	1,387	21.6	1.6%

Qualification tests were also performed with upper legform SN153 using new foams (test numbers 1710 and 1711) to verify that other foams can pass the qualification requirements in the same conditions. Time histories of the femur bending moment and femur forces are shown in Figure 19 and Figure 20 below. Peak values, means, standard deviations, and %CV for all qualification tests performed with upper legform SN153 are shown in Table 7 below. All tests passed the qualification requirements.



**Figure 19. Femur bending moment time histories of the 25 percentage RH tests with upper legform SN153 using multiple foams.**

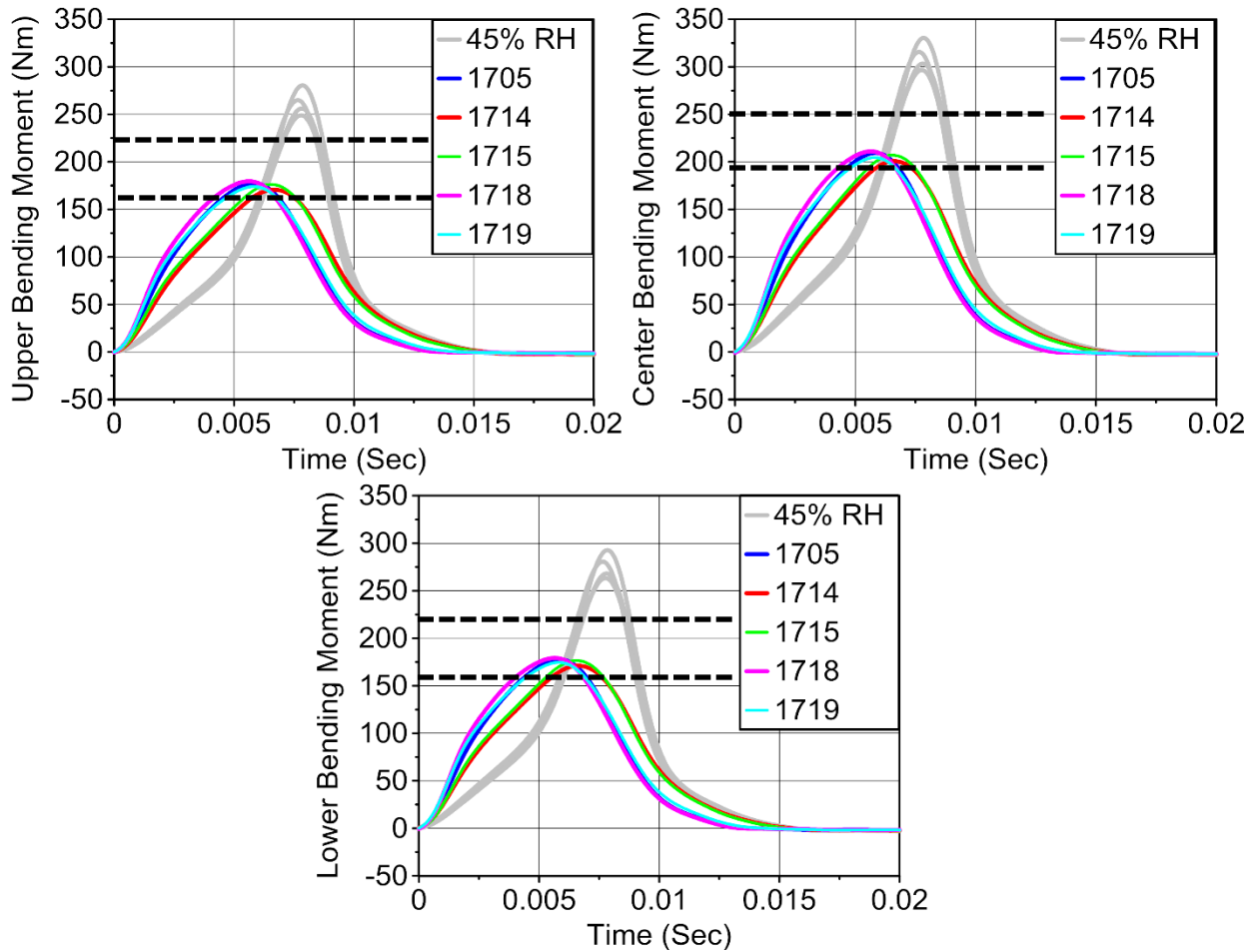


**Figure 20. Femur force time histories of the 25 percentage RH tests with upper legform SN153 using multiple foams.**

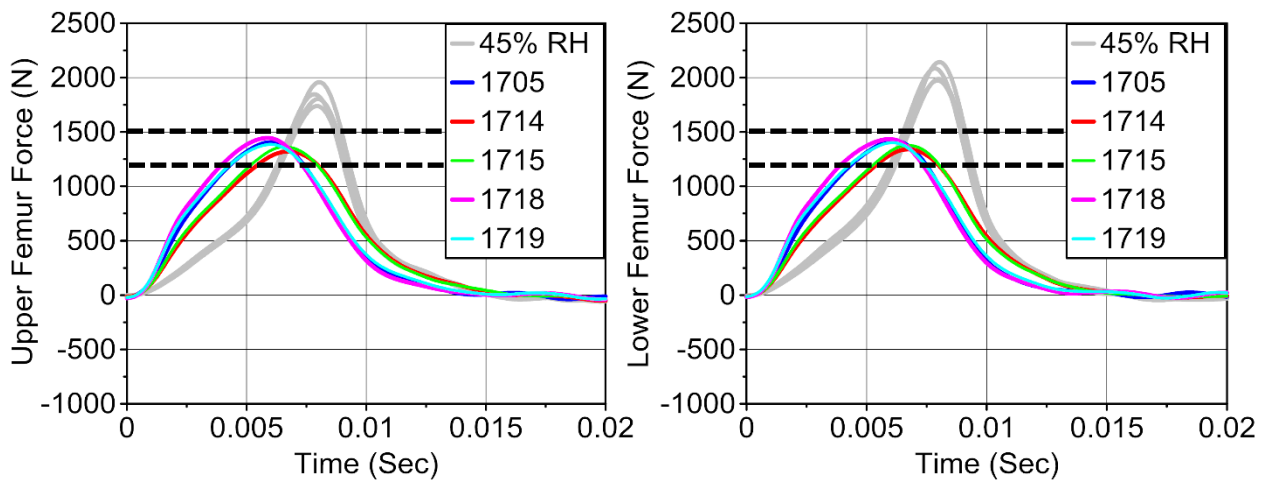
**Table 7. Upper legform SN 153 qualification test results using same (1708, 1709, 1712) and new foams (1710, 1711) at 25 percentage RH**

UL 153		Requirements	1708	1709	1710	1711	1712	Mean	Standard Deviation	%CV
			Foam B	Foam B	Foam C	Foam D	Foam B			
Femur Bending Moment (Nm)	Upper	160 Nm to 220 Nm	177	172	176	179	183	177	3.8	2.2%
	Center	190 Nm to 250 Nm	209	203	208	210	216	209	4.5	2.1%
	Lower	160 Nm to 220 Nm	175	172	175	176	181	176	3.3	1.9%
Femur Loads (N)	Upper	1,200 N to 1,500 N	1,385	1,333	1,359	1,379	1,389	1,369	23.4	1.7%
	Lower		1,385	1,366	1,372	1,372	1,409	1,381	17.3	1.3%

Qualification tests were also performed with upper legform SN150 using new foams (test numbers 1714, 1715, and 1719) as well as previously tested foams (test numbers 1705 and 1718). Time histories of the femur bending moments and femur forces are shown in Figure 21 and Figure 22 below. Peak values, means, standard deviations, and percentage%CV for all qualification tests performed with upper legform SN 150 are shown in Table 8 below. Again, all tests passed the qualification requirements. The shape and response of the upper legform in the low humidity qualification tests also matched the response of TRL's qualification tests.



**Figure 21. Femur bending moment time histories of the 25 percentage RH tests with upper legform SN150 using multiple foams.**



**Figure 22. Femur force time histories of the 25 percentage RH tests with upper legform SN150 using multiple foams.**



**Table 8. Upper legform SN 150 qualification test results using new (1714, 1715, 1719) and previously tested (1705, 1718) foams at 25 percentage RH**

UL 150		Requirements	1705	1714	1715	1718	1719	Mean	Standard Deviation	%CV
			Foam A	Foam E	Foam F	Foam C	Foam G			
Femur Bending Moment (Nm)	Upper	160 Nm to 220 Nm	178	171	176	180	174	176	3.5	2.0%
	Center	190 Nm to 250 Nm	209	201	207	211	205	207	4.1	2.0%
	Lower	160 Nm to 220 Nm	178	171	177	179	175	176	3.2	1.8%
Femur Force (N)	Upper	1,200 N to 1,500 N	1,406	1,320	1,363	1,445	1,385	1,384	46.5	3.4%
	Lower	1,500 N	1,419	1,340	1,377	1,435	1,401	1,395	37.2	2.7%

### 5.3. Vehicle Testing

To determine whether or not the blue CONFOR foam’s sensitivity to humidity affects the response of the upper legform in vehicle tests, repeatability tests were performed on the 2016 Ford Edge. A similar procedure, which was used for soaking and testing during qualification testing, was used for vehicle testing.

The same impact locations were tested with foams at 25 percentage RH and 45 percentage RH conditions. Setup photos were used to verify that the upper legform impacted the same location as close to identical as possible at both humidity conditions. Figure 44 to Figure 51 in the Appendix show time histories of the femur bending moments and femur forces. Table 9 below summarizes the resulting peak values. Upper legform SN 153 was used in all vehicle tests.

**Table 9. 2016 Ford Edge test results with 25 percentage RH and 45 percentage RH conditioned foams**

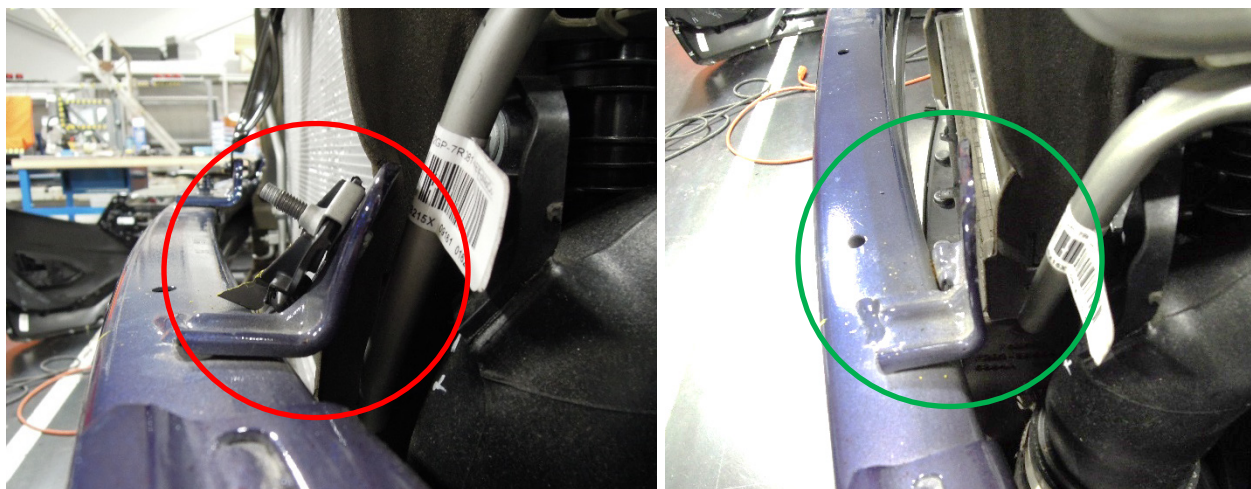
Test #	Foam RH (%)	Location	Femur Bending Moment, Nm			Femur Forces, N		
			Upper	Middle	Lower	Upper	Lower	Sum
UL 1668	45	U-1	235	269	231	2,963	3,906	6,869
UL 1701	25	U-1	210	244	213	3,626	3,171	6,797
UL 1666	45	U+3	212	229	187	2,232	4,077	6,309
UL 1707	25	U+3	220	239	201	2,352	3,555	5,907
UL 1670	45	U-5	128	125	100	4,573	1,972	6,545
UL 1706	25	U-5	160	161	132	4,837	1,957	6,794
UL 1669	45	U+7	127	137	124	1,539	3,381	4,920
UL 1704	25	U+7	162	177	162	2,039	3,027	5,066
AVG	45	All	176	190	161	2,827	3,334	6,161
AVG	25	All	188	205	177	3,214	2,928	6,141
p-value*			0.434	0.383	0.281	<b>0.049</b>	0.075	0.900

\*Student’s t-test (paired w/two tails,  $p < 0.05$  indicates significant difference between 25% and 45% datasets)

Table 9 shows the Ford Edge test results with foams soaked at various relative humidity conditions. According to Student's t-tests (paired two-tailed, significance level = 0.05) comparing the four samples at each humidity level, only the upper femur force was found to be significantly different between the two humidity levels and it was marginally different ( $p=0.049$ ). The individual upper femur forces were lower at 45 percentage RH than at 25 percentage RH at all four locations, while the lower femur forces were higher at 45 percentage at all four locations. However, the sums of the femur forces were very similar between humidity levels at each location; they were lower in the 25 percentage RH tests at impact locations U-1 and U+3 and slightly higher at U-5 and U+7. The femur bending moments are higher at 25 percentage RH than at 45 percentage RH, with the exception of test location U-1.

Additionally, although the magnitudes in bending moment and force are slightly different between the two humidity conditions, the shapes of their time histories as shown in the Appendix (Figure 44 to Figure 51) appear to be very similar. There is no drastic change in the shape of the responses like what was seen in the qualification tests. This suggests that the foam's changing stiffness due to humidity has less of an effect on the upper legform's response in vehicle impacts as compared to qualification tests.

The discrepancies in results from the repeat tests performed at different humidity levels are likely due to a combination of both damage below the bumper fascia that occurred during testing and the foam's sensitivity to humidity. Figure 23 shows an example of damage to a bracket on the bumper beam (circled in red) at a location 100 mm inboard from impact location U-5 that is hidden unless the fascia and headlights are removed. An undamaged bracket (circled in green) should be vertical and there should be a gap between the bracket and the radiator. The damaged bracket was not discovered until after the first set of tests (i.e., the test series run at 45 percentage RH) was complete and parts were being changed out for the 25 percentage RH series of testing. It is unknown after which of the previous tests this had occurred and running a test with a previously damaged bracket could slightly affect the results. The damaged bracket was repaired before the 25 percentage RH series of testing.



**Figure 23. Damaged (red) and undamaged (green) bumper beam bracket in the Ford Edge**

## 5.4. Discussion

### 5.4.1. Qualification Testing

In qualification tests where humidity was higher (45% RH), all upper legform measurements exceeded the requirements. The peak outer bending moments were at or above 250 Nm (requirement of 160 Nm to 220 Nm) and the peak center bending moments were all above 300 Nm (requirement of 190 Nm to 250 Nm). In addition, peak femur forces were all above 1700 N (requirement of 1200 N to 1550 N). In qualification tests where humidity was lower (25% RH), all passed and were within the requirements, demonstrating that the blue CONFOR foam's sensitivity to humidity is important in qualification testing.

In Figure 19 to Figure 22 the shape of the curves of the low humidity tests (colored curves in the figures) are different than in the high humidity tests (grey curves in the figures). The behavior of the CONFOR foam dominates the qualification test results as it is the only effective energy absorber during qualification testing since the certification tube is rigid. As explained through personal communication with TRL, in the colored curves (low humidity tests), the CONFOR foam is working efficiently and the impactor and certification tube reach a common velocity without a large peak in forces and moments. In the grey curves (high humidity tests), the slower initial rise time indicates that the impact is initially less severe due to the foam being less stiff. Later in the event, the foam is severely compressed and the impact forces and moments rise rapidly, indicating that the foam has been severely compressed and has bottomed out.

The effects of humidity on the dynamic performance of CONFOR foam have also been studied by Matsui, Takagi, Takabayashi, and Jimbo.<sup>3</sup> Like what was observed in this study, Matsui's group showed that CONFOR foam exhibits softer characteristics (less force at a given displacement) during displacements less than 50 mm when soaked at a higher humidity level versus a lower humidity level (60% versus 30%).

### 5.4.2. Vehicle Testing

In vehicle testing, the foam's behavior does not solely dictate the results because the soft vehicle structures also compress and absorb energy in addition to the foam. Therefore, the foam's sensitivity to humidity had less of an effect in vehicle tests than it did in qualification tests because in vehicle tests the CONFOR foam and vehicle are both compressed. As a result, the tests on the 2016 Ford Edge yielded about the same forces and bending moments for the high and low humidity conditions.

### 5.4.3. Assessing the Qualification Limits for Humidity

It is evident that the stiffness of the foam is strongly dependent on its humidity. Meeting the qualification limits for femur force and bending moment will depend on the humidity of the foams. However, meeting the pre-test 25 percentage-45 percentage humidity requirement may not be sufficient to yield an acceptable dynamic response. In our tests, foams that were soaked at the high end, 45 percentage humidity, did not meet the dynamic requirements. However, when the same foams were re-soaked at the low end, 25 percentage humidity, all dynamic requirements were met.

---

<sup>3</sup> Matsui, Y., Takagi, S., Takabayashi, M., & Jimbo, H. (2014). Effect of humidity on dynamic characteristics of foam CF45 for the TRL pedestrian legform impactor. *International Journal of Crashworthiness*, 19(4), 352-360.

Nonetheless, the 35% +/- 10% humidity limits (which are more restrictive than most Part 572 dummy component qualification test humidity limits of 10 to 70%) are still justified because it helps account for any variability in the manufacture of CONFOR foam itself, lot vs. lot. According to the User Manual provided by TRL, it is possible to obtain 13 sets of flesh from one 80 x 36-inch sheet of foam. It is unknown whether the foams that we tested came from the same sheet or from different sheets, or even if they were from the same manufacturing lot.

Whenever a new lot of foam is purchased, some amount of tests by trial and error may be needed to determine a specific humidity that will yield an acceptable response. Thus, the limits are set the way they are to be stringent when compared to other test devices, yet accommodating to different CONFOR lots.

## **5.5. Conclusion**

This study examined the degree to which humidity affects the performance of the TRL upper legform in qualification tests and tests on a vehicle front-end in accordance with Euro NCAP Pedestrian Testing Protocol.

Qualification tests that were performed at VRTC in the upper end of the humidity range (45% RH) did not meet the qualification requirements with approximately 50 percentage higher internal forces and approximately 40 percentage higher moments compared to the lower humidity (25% RH) tests. However, qualification tests that were performed at VRTC in the lower end of the humidity window (25% RH) did meet the requirements. In vehicle tests, Student's t-tests comparing the 25 percentage and 45 percentage RH datasets indicated that, out of the six measurements, only upper femur force was significantly different between the two humidity levels and that difference was marginal ( $p = 0.049$ ). While effort was taken to control the test setup/positioning and pre-existing vehicle damage, some of the variation between the 25 percentage and 45 percentage RH datasets was likely due to those factors in addition to foam sensitivity to humidity.

Since only humidity was controlled in this study, it would be beneficial to look at the effects of temperature on the upper legform response in both qualification and vehicle testing in a future study. Additionally, it may be beneficial to replace parts more frequently between vehicle tests as underlying damage may be present.

In conclusion, the blue CONFOR foam sensitivity to humidity has a significant effect on the upper legform response in qualification testing. Thus, the upper legform did not pass the dynamic requirements for femur force and bending moment at different humidity levels within the specified soaking range. However, in vehicle testing, it appears that foam sensitivity to relative humidity is less of an issue due to the vehicle sharing the energy absorption during the impact.

## 6. Part 2: TRL Upper Legform Evaluation

Historically, NHTSA has evaluated test tools intended for evaluations of vehicle safety systems by characterizing their technical performance in the following areas:

- Sensitivity to Vehicle Design: Is the tool sensitive enough to discern incremental differences in vehicle system performance with respect to other vehicles, test tools, or other regulatory requirements for that part of the vehicle?
- Repeatability: If the tool is tested multiple times in the same conditions, does it exhibit a consistent response?
- Reproducibility: Do multiple tools exhibit consistent response in the same condition?
- Durability: Does the tool maintain its structural integrity in the most aggressive test conditions that it would experience when evaluating vehicle systems in the field?
- Biofidelity: How closely does the tool mimic human behavior and can it be used to compare vehicles with regard to injury risk?

Table 10 presents a description of the vehicles tested in this study.

**Table 10. List and description of tested vehicles**

Vehicle				GVWR (kg)	Lateral Hood Width (mm)	Front End Width (mm)
Model Year (MY)	Make	Model	Description			
2016	Honda	Fit	Passenger Car	1,539	1,660	1,990
2016	Chevrolet	Malibu	Passenger Car	2,006	1,586	1,830
2016	Nissan	Rogue	Small SUV	2,122	1,546	1,820
2015	Toyota	Sienna	Minivan	2,715	1,660	1,990
2015	Ford	F-150	Standard Pickup Truck	2,726	1,646	1,970
2016	Chevrolet	Tahoe	Standard SUV	3,221	1,760	2,020

Figure 24 to Figure 29 show the front ends for each of the tested vehicles and the impact locations (dots correspond to WAD 775 line).



Figure 24. 2016 Honda Fit front end

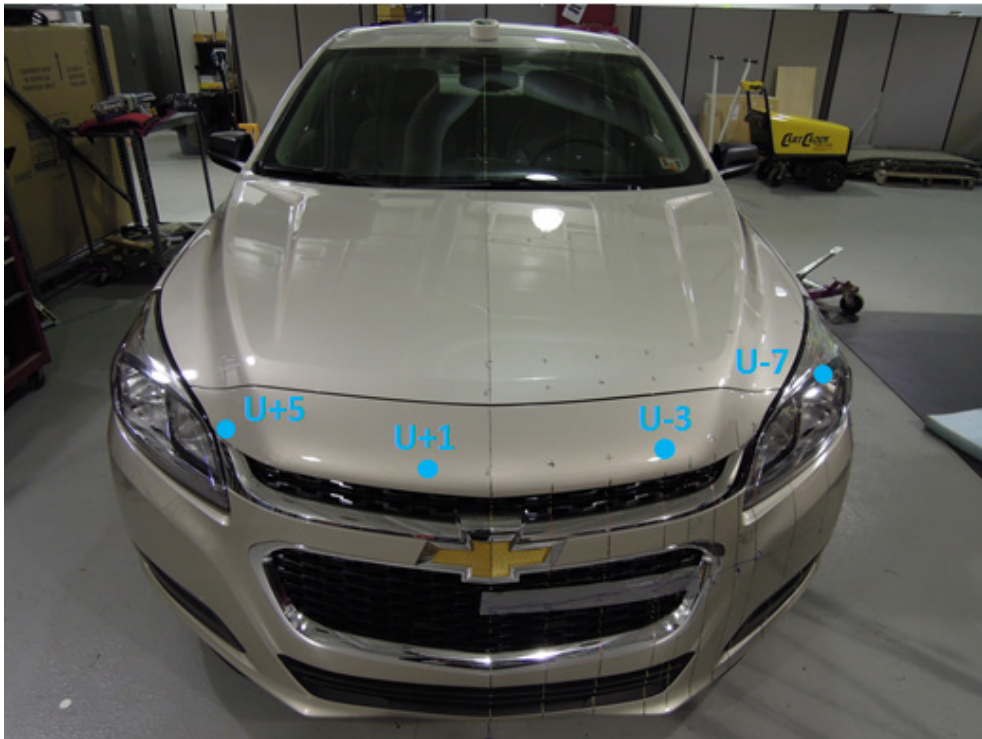


Figure 25. 2016 Chevrolet Malibu front end





Figure 26. 2016 Nissan Rogue front end



Figure 27. 2015 Toyota Sienna front end

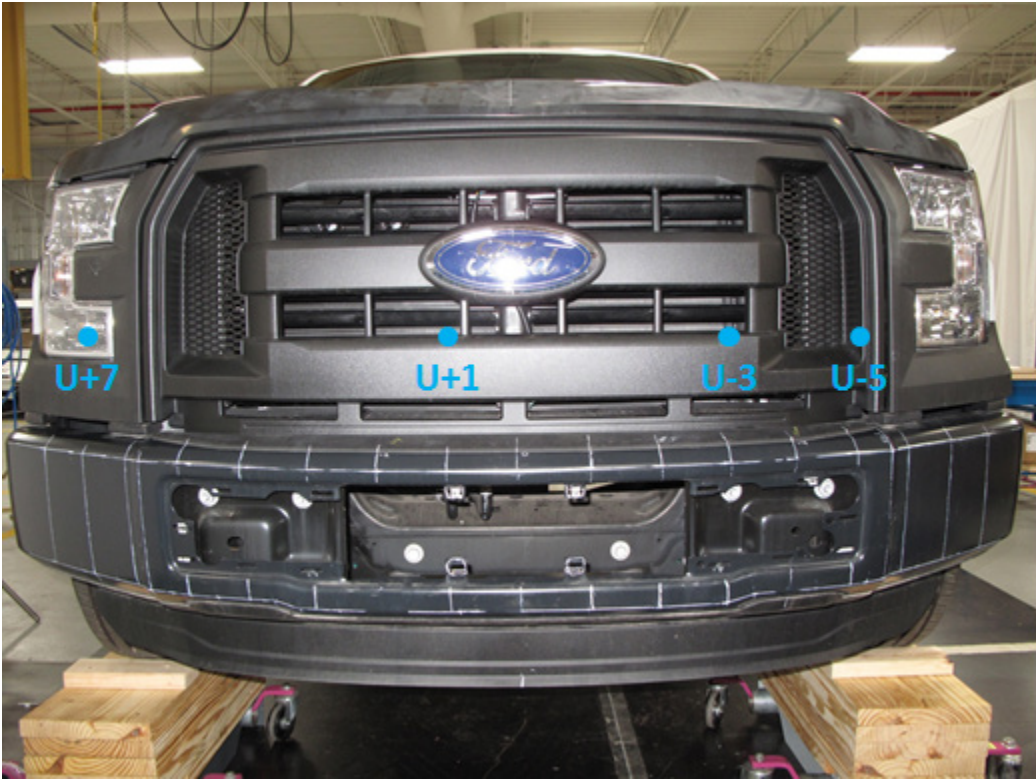


Figure 28. 2015 Ford F-150 front end

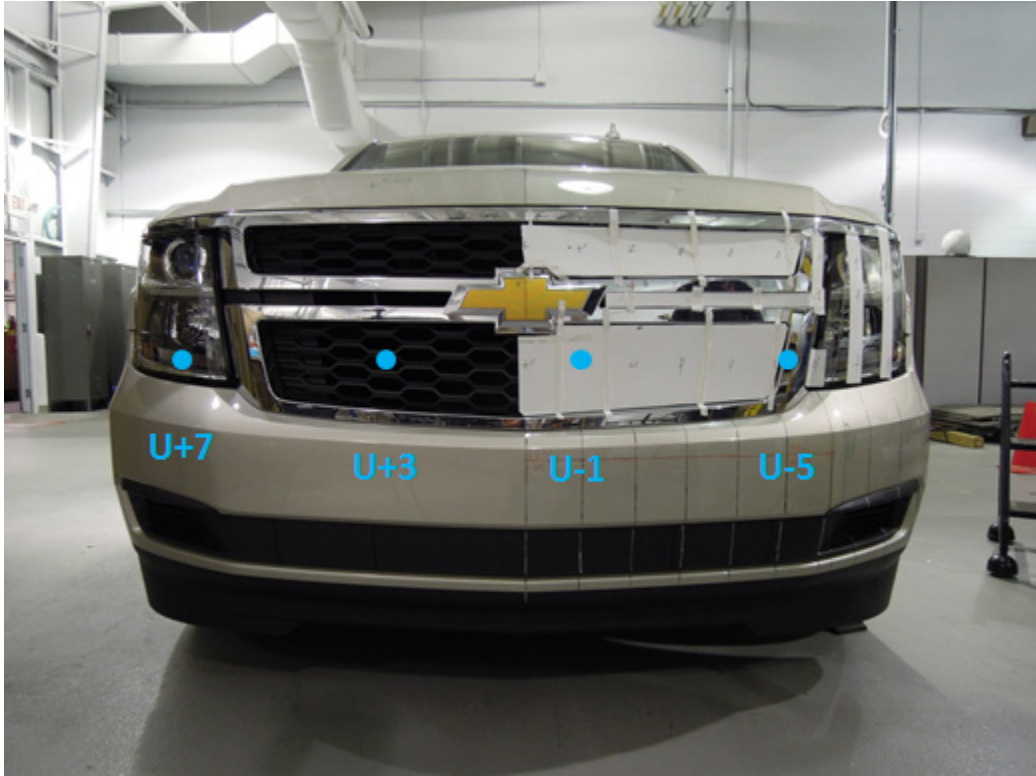


Figure 29. 2016 Chevrolet Tahoe front end



The number of grid points tested and the total number of grid points available according to the Euro NCAP Pedestrian Testing Protocol for each vehicle are presented in Table 11.

**Table 11. Total number of grid points and tested points for each vehicle**

Vehicle	Total # Grid Points	# Tested Points
2016 Honda Fit	13	3
2016 Chevrolet Malibu	15	4
2016 Nissan Rogue	15	4
2015 Toyota Sienna	15	4
2015 Ford F-150	15	4
2016 Chevrolet Tahoe	15	4
<b>Total # Points Tested</b>		<b>23</b>

### 6.1. Sensitivity to Vehicle Design

It is important for a test tool to (1) make measurements that are sensitive to small differences in performance of the type of systems that it is being used to evaluate, (2) improve upon the mitigation of injury provided by existing test tools, (3) provide valid feedback on how vehicle designs would have to change to comply with safety requirements, (4) have the instrumentation and response characteristics to provide adequate coverage of the injuries that are present in the field, and (5) possess injury assessment values that are feasible to meet in light of other regulatory constraints.

It is important for the upper legform to be able to differentiate between vehicle designs (be sensitive enough) so that critical vehicle front end design parameters can be identified for improving performance with respect to the upper legform injury limits. To evaluate this aspect, the upper legform was tested against a set of vehicles chosen to represent the U.S. vehicle fleet.

#### 6.1.1. Analysis and Discussion: Sensitivity to Vehicle Design

Table 12 presents the maximum femur bending moment of the three strain gages and the sum of the upper and lower loads for each of the upper leg impacts. The results are color coded relative to the Euro NCAP scoring bands. Results that fall below Euro NCAP's "higher performance limit" (bending moment < 285 Nm, sum force < 5.0 kN) are highlighted in green and those results that are above Euro NCAP's "lower performance limit" (bending moment > 350 Nm, sum forces > 6.0 kN) are highlighted in red. Results that fall between the higher and lower performance limit are highlighted in orange.

The lowest observed femur bending moment is 64 Nm and the highest observed bending moment is 313 Nm. Likewise, the lowest observed femur load is 2,757 N and the highest observed load is 10,479 N. The results covered a wide range of values that were both well below and well above the higher and lower performance limits. Some vehicles performed well while others performed poorly and some performed marginally, which indicated that the upper legform can discern the small differences in vehicle designs.

**Table 12. Max femur bending moment (Nm) and sum of femur forces (N) for each upper leg test**

Vehicle	U±1		U±3		U±5		U±7	
	Moment (Nm)	Force (N)	Moment (Nm)	Force (N)	Moment (Nm)	Force (N)	Moment (Nm)	Force (N)
2016 Honda Fit	150	2,757	231	3,531	245	4,585	--	--
2016 Chevrolet Malibu	249	5,663	220	5,304	313	5,066	225	3,777
2016 Nissan Rogue	171	4,421	104	4,373	200	4,239	153	3,518
2015 Toyota Sienna	267	5,969	229	5,861	197	5,154	137	3,877
2015 Ford F-150	119	4,785	95	7,786	64	7,549	164	7,927
2016 Chevrolet Tahoe	96	7,341	145	8,739	202	10,479	216	7,653

**6.2. Repeatability and Reproducibility**

A test tool must exhibit consistent response so that any variation in the measurements is dictated by the vehicle system itself. *Repeatability* refers to how consistent a single upper legform is when tested multiple times in the same conditions. *Reproducibility* quantifies how well multiple upper legforms exhibit consistent responses in the same condition.

Repeatability and reproducibility were assessed based on the performance of two TRL upper legforms (SN150 and SN153).

As described in Rhule, Rhule, and Donnelly,<sup>4</sup> NHTSA has categorized the percentage %CV scores for repeatability as shown in Table 13. A slightly greater range is used for reproducibility since multiple test tools are expected to produce a wider dispersion of response measurements than in testing a single test tool for repeatability.

**Table 13. %CV Scores**

Repeatability %CV Score	Reproducibility %CV Score	Assessment
%CV ≤ 5	%CV ≤ 6	Excellent
5 < %CV ≤ 8	6 < %CV ≤ 11	Good
8 < %CV ≤ 10	11 < %CV ≤ 15	Marginal
%CV > 10	%CV > 15	Poor

For repeatability, the “marginal” limit is set at a %CV value of 10 percentage. For reproducibility, the “marginal” limit is set at a slightly greater %CV value of 15 percentage. As shown in Table 13, to make the interpretation of the results easier, the %CV summary tables in this section use the following color code:

green – excellent, yellow – good, orange – marginal, red – poor.

<sup>4</sup> Rhule, D., Rhule, H., & Donnelly, B. (2005). *The process of evaluation and documentation of crash test dummies for Part 572 of the Code of Federal Regulations*. 19th International Technical Conference on the Enhanced Safety of Vehicles, Washington, DC, June 6-9, 2005. . Available at <http://citeseerx.ist.psu.edu/viewdoc/download?doi=10.1.1.621.5617&rep=rep1&type=pdf>

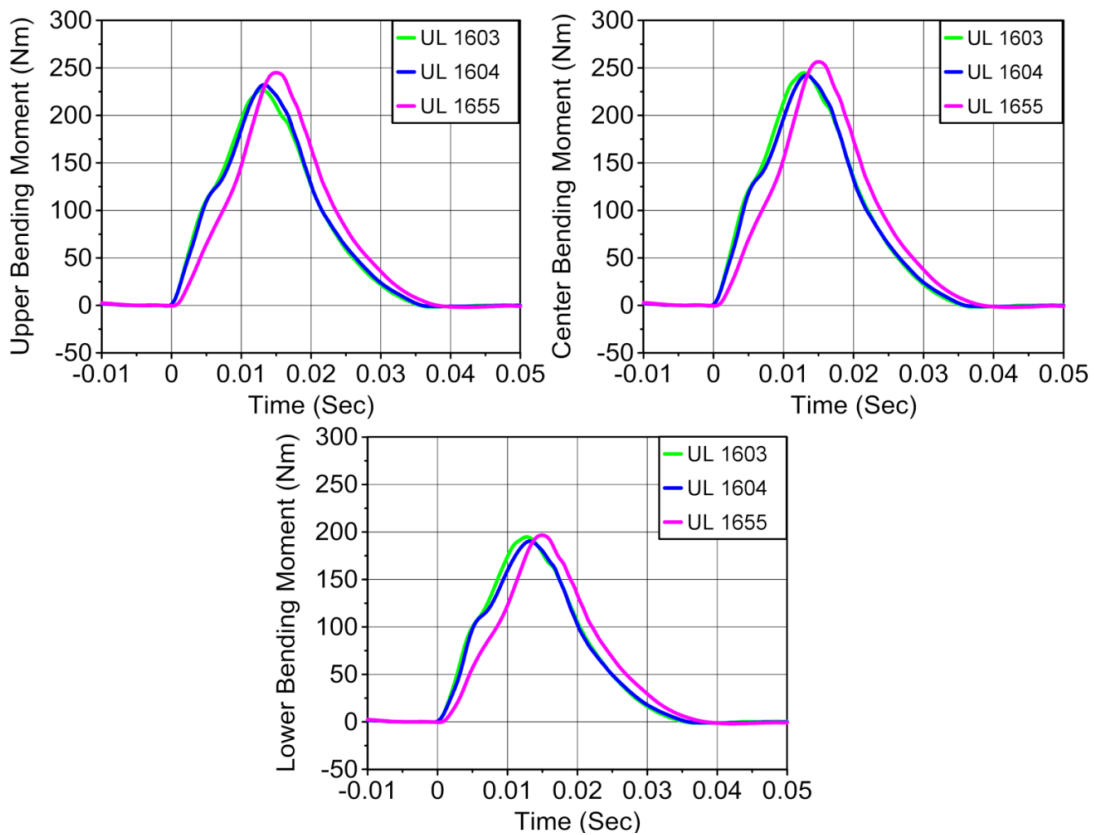
We note that %CV is an imperfect metric for assessing repeatability and reproducibility when the target range of a measurement contains zero or when a test measurement is low and affected by signal noise. Considering the formula for the percentage coefficient of variation (standard deviation divided by the mean response), the %CV value is generally higher when the magnitude of the mean response is low even if the standard deviation is relatively small. In comparison, where only two tests were conducted, percentage difference was used to assess repeatability and reproducibility, with less than 10 percent difference considered to be acceptable.

### 6.2.1. Analysis and Discussion: Repeatability

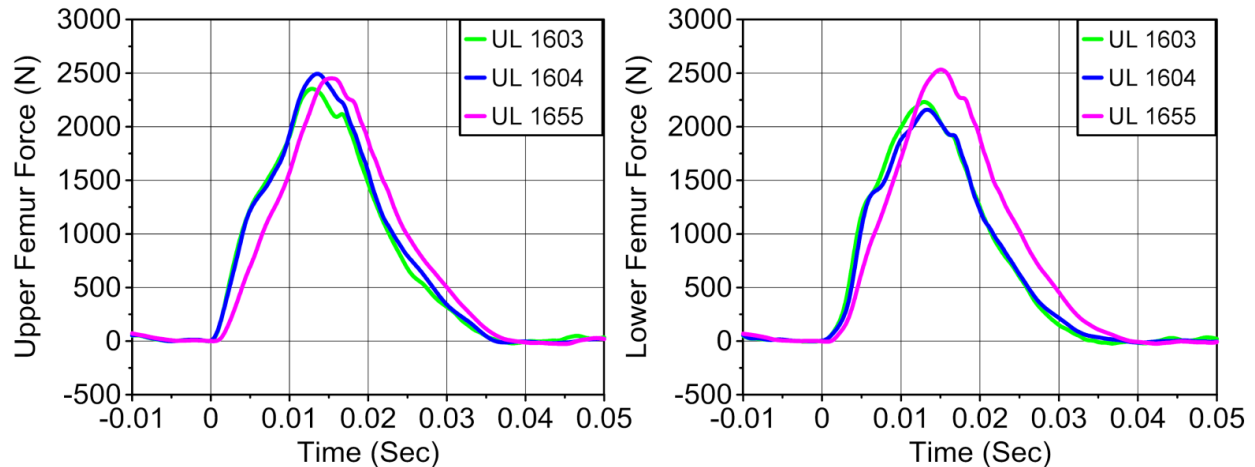
The series of tests in this section of the report was intended to evaluate the repeatability of the TRL upper legform. In order to evaluate repeatability, multiple impacts were performed on a 2016 Honda Fit and 2016 Chevrolet Malibu. TRL upper legform SN150 was used for repeatability testing.

#### i. 2016 Honda Fit Repeatability

Three tests (UL 1603, UL 1604, UL 1655) were performed on the 2016 Honda Fit at  $\pm 500$  mm from the centerline. Assuming symmetry, these three tests were analyzed for repeatability. Time histories of the femur bending moments and femur forces for the three tests are shown in Figure 30 and Figure 31 below. It should be noted that test UL 1655 was performed four months after UL 1603 and UL 1604.



**Figure 30. Repeatability: 2016 Honda Fit femur bending moment time histories of impacts at  $\pm 500$  mm from centerline using upper legform SN150**



**Figure 31. Repeatability: 2016 Honda Fit femur force time histories of impacts at  $\pm 500$  mm from centerline using upper legform SN150**

Figure 30 and Figure 31 show that the response of test UL 1655 is slightly delayed in comparison to tests UL 1603 and 1604. This is due to premature closing of the contact switch upon impact. However, the focus of the time histories should be on the magnitude and duration of the response, which seem to closely match between the three impacts. Mean, standard deviation, and percentage coefficient of variation were calculated at the peak value for each channel for the repeated tests and are shown in Table 14.

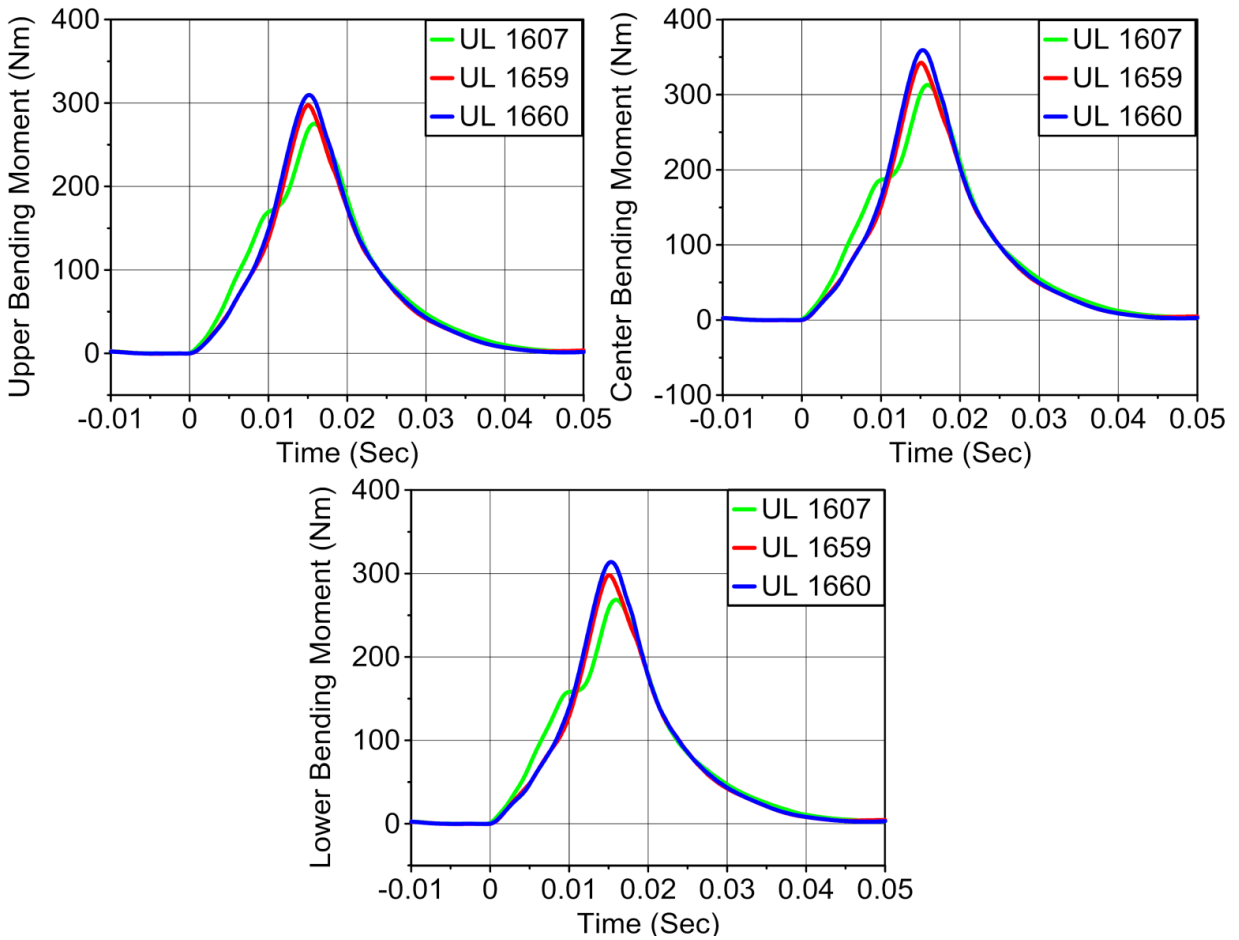
**Table 14. Repeatability results for the impacts on the 2016 Honda Fit using upper legform SN150**

Test #	Location	Speed (m/s)	Energy (J)	Femur Bending Moment			Femur Force		
				Upper	Middle	Lower	Upper	Lower	Sum
UL 1603	U-5	6.13	197	227	245	195	2,354	2,231	4,585
UL 1604	U+5	6.08	194	232	242	190	2,493	2,159	4,652
UL 1655	U+5	6.20	202	245	256	197	2,450	2,532	4,982
<b>Mean</b>				235	248	194	2,432	2,307	4,740
<b>StDev</b>				9.3	7.4	3.6	71.2	197.9	212.5
<b>%CV</b>				4.0%	3.0%	1.9%	2.9%	8.6%	4.5%

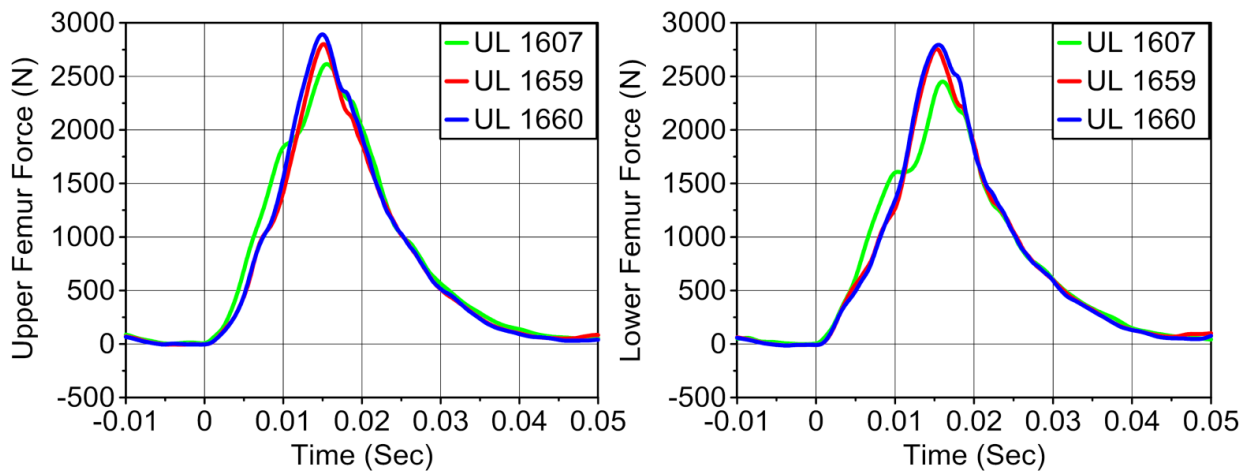
All results are within the marginal range with a majority of the results within the excellent range.

## ii. 2016 Chevrolet Malibu Repeatability

Three tests (UL 1607, UL 1659, UL 1660) were performed on the 2016 Chevrolet Malibu at  $\pm 500$  mm from the centerline. Assuming symmetry, these three tests were analyzed for repeatability. Time histories of the femur bending moments and femur forces for the three tests are shown in Figure 32 and Figure 33 below. It should be noted that tests UL 1659 and UL 1660 were performed several months after UL 1607.



**Figure 32. Repeatability: 2016 Chevrolet Malibu femur bending moment time histories of impacts at  $\pm$  500 mm from centerline using upper legform SN150**



**Figure 33. Repeatability: 2016 Chevrolet Malibu femur force time histories of impacts at  $\pm$  500 mm from centerline using upper legform SN150**

Mean, standard deviation, and percentage coefficient of variation were calculated for each channel for the repeated tests and are shown in Table 15.

**Table 15. Repeatability results for 2016 Chevrolet Malibu tests using upper legform SN150**

Test #	Location	Speed (m/s)	Energy (J)	Femur Bending Moment			Femur Force		
				Upper	Middle	Lower	Upper	Lower	Sum
UL 1607	U+5	6.53	224	275	313	269	2,615	2,451	5,066
UL 1659	U-5	6.48	220	297	342	298	2,802	2,756	5,558
UL 1660	U-5	6.48	220	309	359	314	2,892	2,795	5,687
<b>Mean</b>				294	338	294	2,770	2,667	5,437
<b>StDev</b>				17.2	23.3	22.8	1,41.3	188.4	327.7
<b>CV</b>				5.9%	6.9%	7.8%	5.1%	7.1%	6.0%

All results are found to be within the good range for repeatability. However, if test UL 1607 (performed four months prior) is removed from the analysis, the repeatability of tests UL 1659 and 1660 was improved, as the percentage differences for all six measurements were 5.4 percent or less, as shown in Table 16.

**Table 16. Repeatability results for UL 1659 and UL 1660 on the 2016 Chevrolet Malibu using upper legform SN150**

Test #	Location	Femur Bending Moment			Femur Force		
		Upper	Middle	Lower	Upper	Lower	Sum
UL 1659	U-5	297	342	298	5,603	5,512	11,115
UL 1660	U-5	309	359	314	5,784	5,589	11,373
<b>Mean</b>		303	351	306	5,694	5,551	11,244
<b>Pct Diff</b>		4.0%	5.0%	5.4%	3.2%	1.4%	2.3%

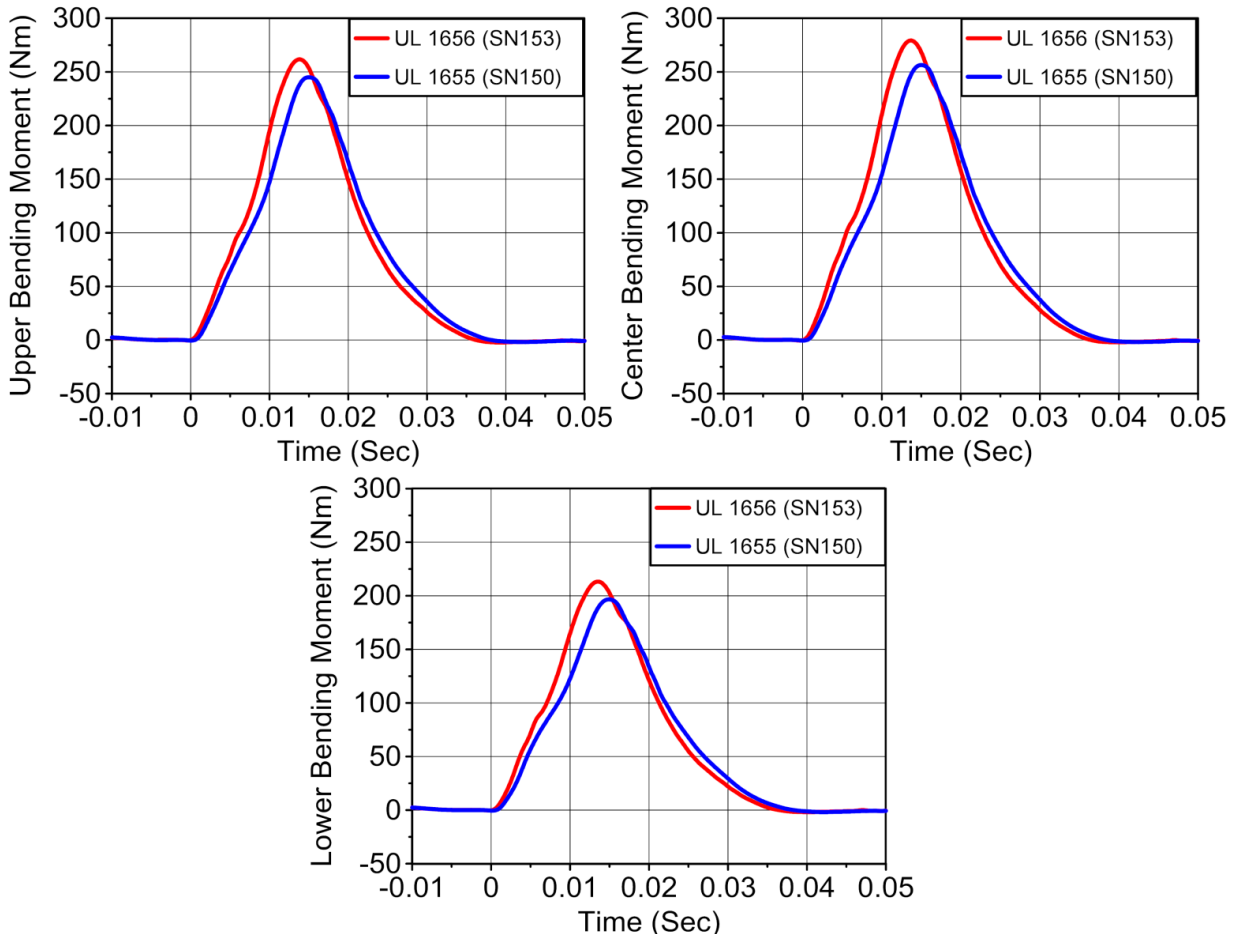
The differences in the results of the tests performed four months apart are likely due to differences in test setup (i.e., different vehicle parts, slight differences in impact locations, impact speeds). However, even with these differences, the TRL upper legform was found to exhibit good repeatability.

### 6.2.2. Analysis and Discussion: Reproducibility

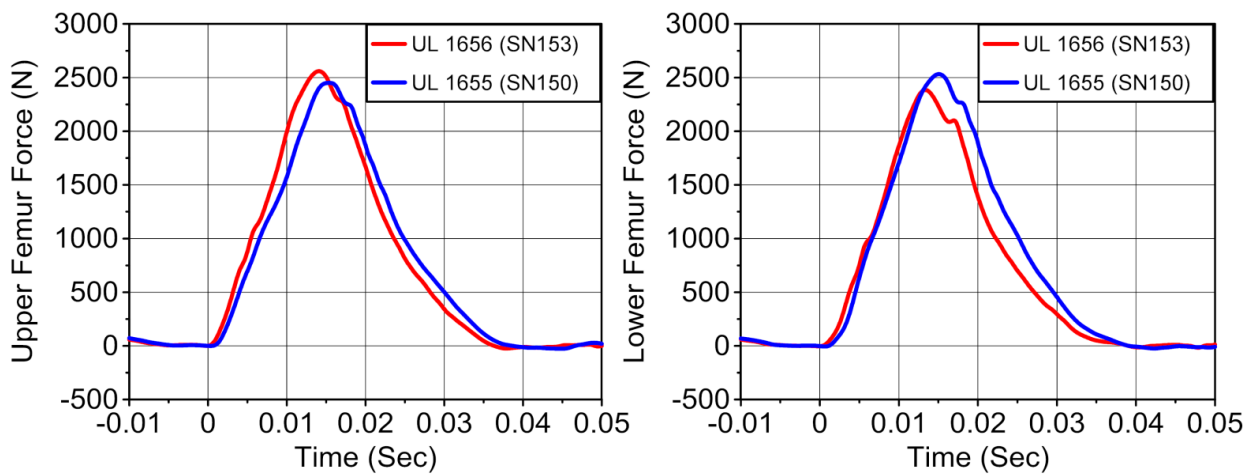
The series of tests in this section of the report was intended to evaluate the reproducibility of the TRL upper legform. In order to evaluate reproducibility, multiple impacts were performed on a 2016 Honda Fit and 2016 Chevrolet Malibu. TRL upper legforms SN150 and SN153 were used for reproducibility testing.

#### i. 2016 Honda Fit Reproducibility

Two tests (UL 1655, UL 1656) were performed on the 2016 Honda Fit at  $\pm 500$  mm from the centerline. Test UL 1655 was performed using upper legform SN150. Test UL 1656 was performed using upper legform SN153. Assuming symmetry, these two tests were analyzed for reproducibility. Time histories of the femur bending moment and femur forces for the two tests are shown in Figure 34 and Figure 35 below.



**Figure 34. Reproducibility: 2016 Honda Fit femur bending moment time histories of impacts at  $\pm 500$  mm from centerline**



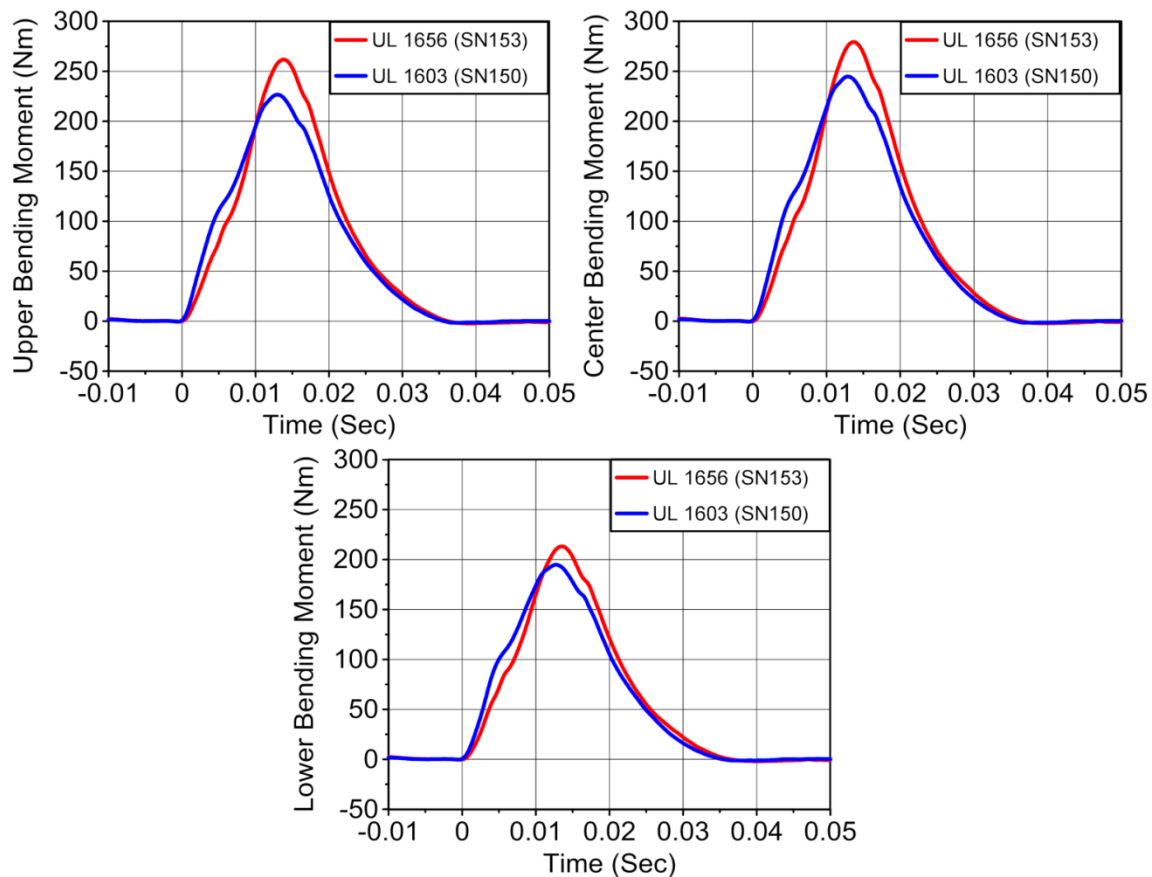
**Figure 35. Reproducibility: 2016 Honda Fit femur force time histories of impacts at  $\pm 500$  mm from centerline**

Percent differences were calculated and found to be less than 10 percent for each channel for the repeated tests, as shown in Table 17 below.

**Table 17. Reproducibility results for the impacts on the 2016 Honda Fit**

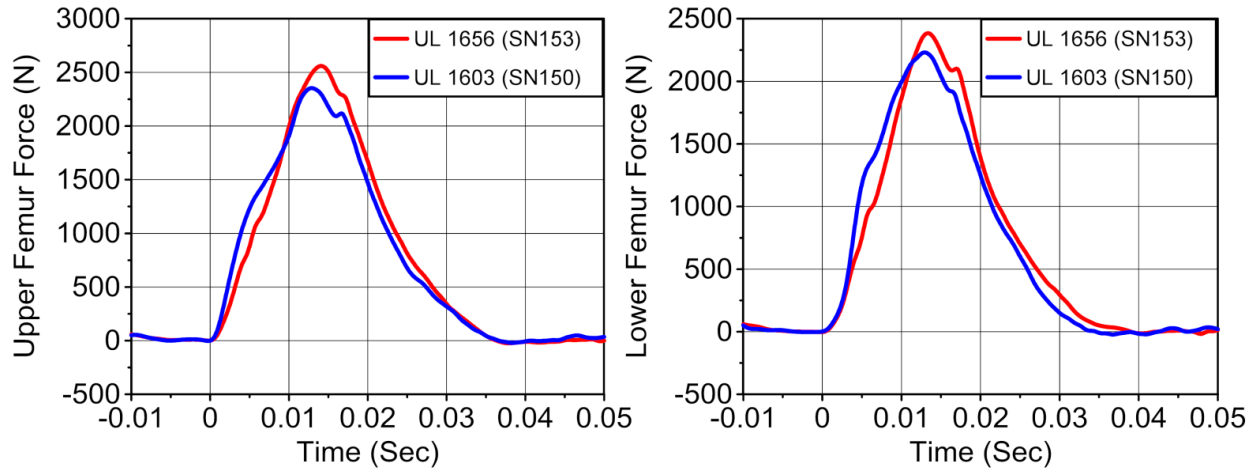
Test #	Location	Speed (m/s)	Energy (J)	Femur Bending Moment			Femur Force		
				Upper	Middle	Lower	Upper	Lower	Sum
UL 1655	U+5	6.2	202	245	256	197	2,450	2,532	4,982
UL 1656	U-5	6.21	203	262	279	213	2,560	2,384	4,944
<b>Mean</b>				254	268	205	2,505	2,458	4,963
<b>Pct Diff</b>				6.9%	9.0%	8.1%	4.5%	-5.8%	-0.8%

Reproducibility can also be analyzed by comparing two tests that were performed a couple months apart (UL 1603, UL 1656) at the same location. Test UL 1603 was performed with upper legform SN150. Test UL 1656 was performed with upper legform SN153 as mentioned above. Both tests were performed on the 2016 Honda Fit on the driver side, 500 mm from centerline (U-5). Time histories of the femur bending moment and femur forces for the two tests are shown in Figure 36 and Figure 37 below.



**Figure 36. Reproducibility: 2016 Honda Fit femur bending moment time histories of impacts at ± 500 mm from centerline comparing impacts performed a couple months apart**





**Figure 37. Reproducibility: 2016 Honda Fit femur force time histories of impacts at ± 500 mm from centerline comparing impacts performed a couple months apart**

Percent differences were calculated for each channel for the repeated tests and are shown in Table 18 below.

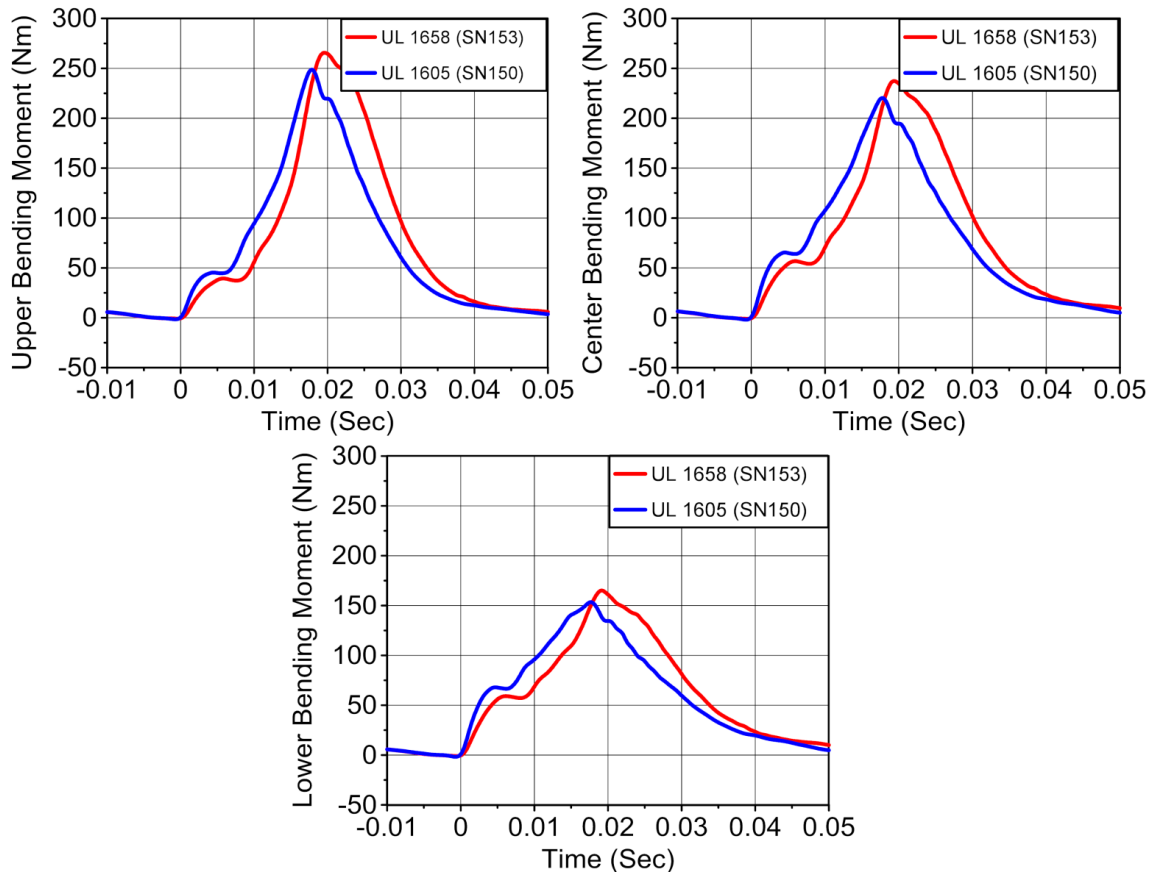
**Table 18. Reproducibility results for the impacts on the 2016 Honda Fit that were performed a couple months apart**

Test #	Location	Speed (m/s)	Energy (J)	Femur Bending Moment			Femur Force		
				Upper	Middle	Lower	Upper	Lower	Sum
UL 1603	U-5	6.13	197	227	245	195	2,354	2,231	4,585
UL 1656	U-5	6.21	203	262	279	213	2,560	2,384	4,944
<b>Mean</b>				245	262	204	2,457	2,308	4,765
<b>Pct Diff</b>				15.4%	13.9%	9.2%	8.8%	6.9%	7.8%

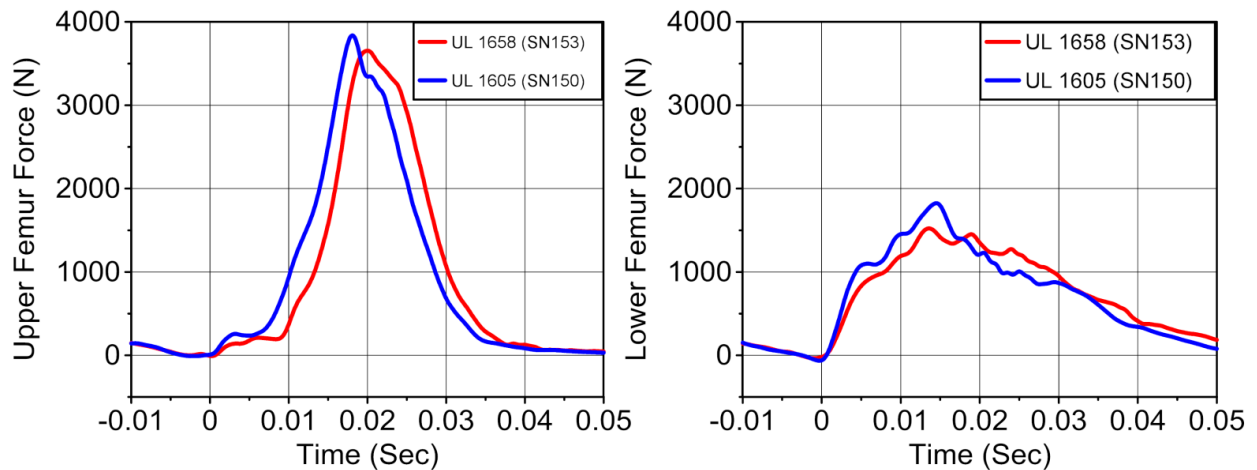
The greater percentage difference of the tests performed four months apart (Table 18) is likely due to differences in test setup (i.e. different vehicle parts, slight differences in impact locations, different impact speed/energy) rather than differences in the response of the upper legform itself.

## ii. 2016 Chevrolet Malibu Reproducibility

Two tests (UL 1605, UL 1658) were performed on the 2016 Chevrolet Malibu at + 100 mm from the centerline. Test UL 1605 was performed using upper legform SN150. Test UL 1658 was performed using upper legform SN153. Time histories of the femur bending moment and femur forces for the two tests are shown in Figure 38 and Figure 39 below.



**Figure 38. Reproducibility: 2016 Chevrolet Malibu femur bending moment time histories of impacts at + 100 mm from centerline**



**Figure 39. Reproducibility: 2016 Chevrolet Malibu femur force time histories of impacts at + 100 mm from centerline**

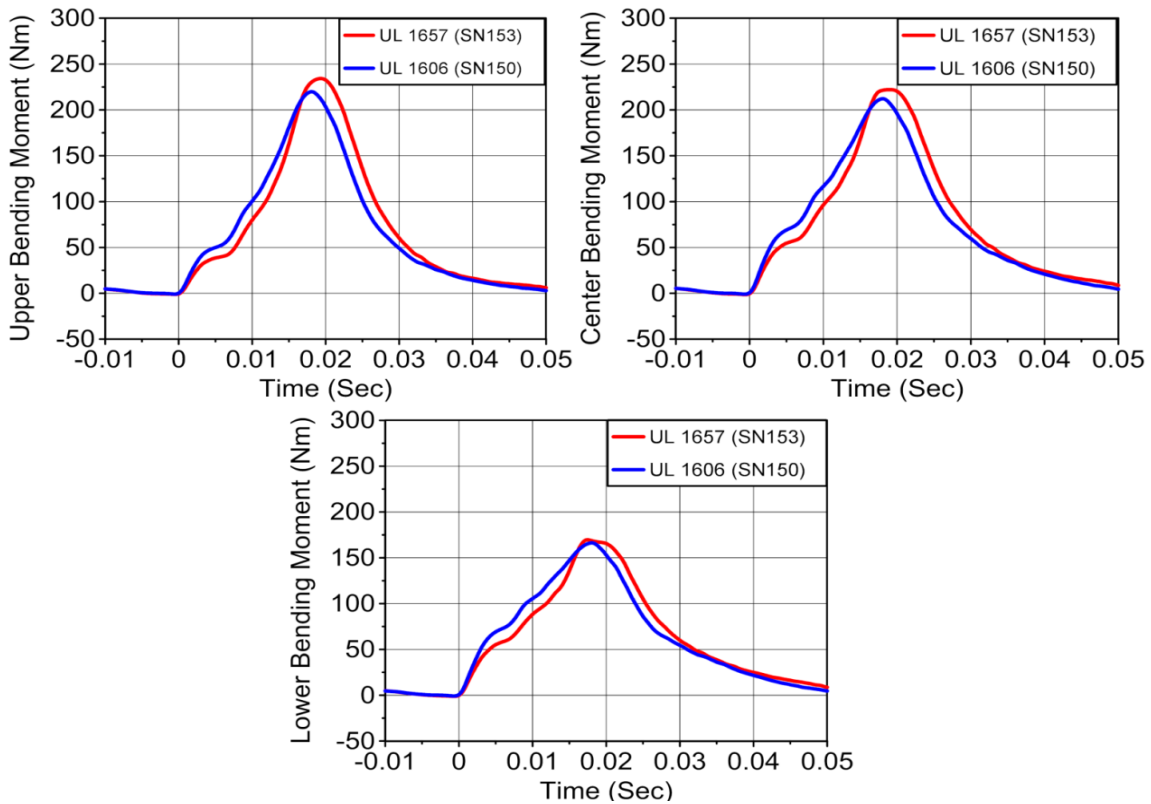
Percent differences were calculated for each channel for the repeated tests and are shown in Table 19 below.

**Table 19. Reproducibility results for the impacts on the 2016 Chevrolet Malibu at + 100 mm**

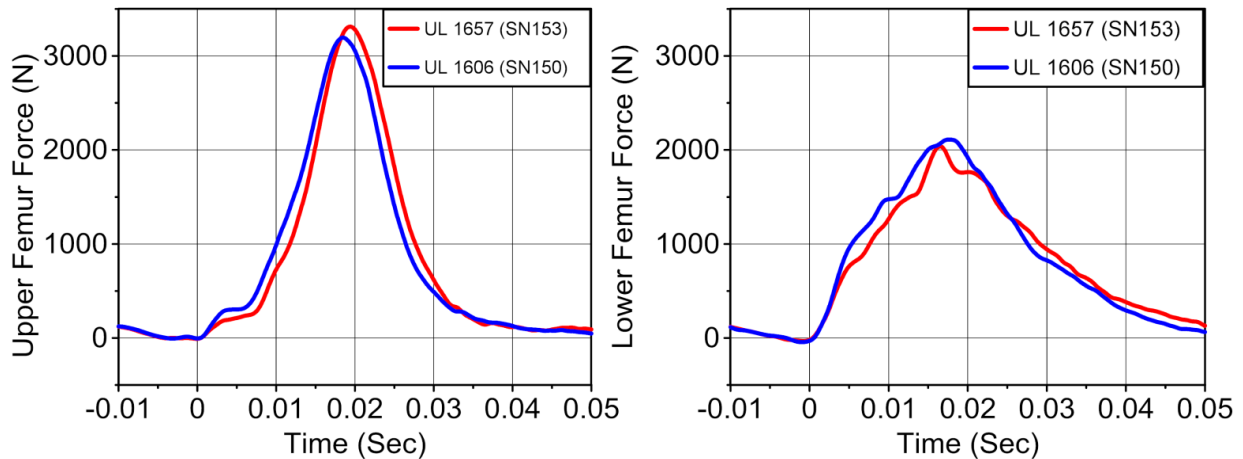
Test #	Location	Speed (m/s)	Energy (J)	Femur Bending Moment			Femur Force		
				Upper	Middle	Lower	Upper	Lower	Sum
UL 1605	U+1	7.78	318	249	220	153	3,838	1,825	5,663
UL 1658	U+1	7.79	318	266	237	165	3,654	1,523	5,177
<b>Mean</b>				258	229	159	3,746	1,674	5,420
<b>Pct Diff</b>				6.8%	7.7%	7.8%	-4.8%	-16.5%	-8.6%

All percentage differences were below 10 percent except for the lower femur load. The high percentage difference in the lower femur load might be due to differences in impact location. Review of high speed video footage shows test UL 1658 to be slightly higher than test UL 1605, subjecting the lower femur load cell to a slightly softer impact.

Another two tests (UL 1606, UL 1657) were performed on the 2016 Chevrolet Malibu at - 300 mm from the centerline. Test UL 1606 was performed using upper legform SN150. Test UL 1657 was performed using upper legform SN153. Time histories of the femur bending moment and femur forces for the two tests are shown in Figure 40 and Figure 41.



**Figure 40. Reproducibility: 2016 Chevrolet Malibu femur bending moment time histories of impacts at - 300 mm from centerline**



**Figure 41. Reproducibility: 2016 Chevrolet Malibu femur force time histories of impacts at - 300 mm from centerline**

Percent differences were calculated for each channel for the repeated tests and are shown in Table 20 below.

**Table 20. Reproducibility results for the impacts on the 2016 Chevrolet Malibu at - 300 mm**

Test #	Location	Speed (m/s)	Energy (J)	Femur Bending Moment			Femur Force		
				Upper	Middle	Lower	Upper	Lower	Sum
UL 1606	U-3	7.46	292	220	212	166	3,194	2,110	5,304
UL 1657	U-3	7.43	289	234	222	170	3,310	2,038	5,348
<b>Mean</b>				227	217	168	3,252	2,074	5,326
<b>Pct Diff</b>				6.4%	4.7%	2.4%	3.6%	-3.4%	0.8%

All percentage differences were 6.4 percent or less.

### 6.3. Durability

Table 21 shows a summary of tests performed with upper legform SN150. These vehicles were chosen to represent the U.S. vehicle fleet and include a small and midsize passenger car, a small and standard SUV, a minivan, and a standard pickup truck. All the vehicles tested were North American versions with front ends that may or may not have been designed to meet the pedestrian protection requirements outlined in European standards such as Euro NCAP and ECE R127. As observed earlier, several of these tests produced measurements above the proposed injury thresholds. As such, the testing regimen exposed the upper legform to a fairly harsh test environment in which its durability can be assessed.

**Table 21. Summary of vehicle impacts performed with upper legform SN150**

<b>Vehicle</b>	<b># Tests</b>
<b>2016 Honda Fit</b>	5
<b>2016 Chevrolet Malibu</b>	6
<b>2016 Nissan Rogue</b>	4
<b>2015 Toyota Sienna</b>	4
<b>2015 Ford F-150</b>	4
<b>2016 Chevrolet Tahoe</b>	4
<b>Total</b>	<b>27</b>

### **6.3.1. Analysis and Discussion: Durability**

Over 30 tests (including trial tests) were performed with the TRL upper legform SN150 and the only signs of damage are a few cuts and wearing of the black outer skin, corresponding cuts to the replaceable CONFOR foam, and some scuff marks on the bottom of the front member as shown in Figure 42. This damage was due to the direct and repeated contact with the hard bumper of the Ford F-150.



**Figure 42. Minor damage to upper legform impactor**

Results show impact loads up to 10 kN, which is well beyond the lower performance limit. During impacts with high loads, the torque limiting joint and clutch plates performed as designed, limiting the torque transferred to the propulsion system and thereby protecting it and the upper legform from damage.

Additionally, although Table 14 above shows a series of tests that were analyzed for repeatability, the durability of the upper legform can be indirectly evaluated. It should be noted that although the tests were performed on the same vehicle and at the same location, test UL 1655 was performed a couple months after tests UL 1603 and 1604. During the time between those tests, the upper legform was subjected to the harsher impacts of the Chevrolet Tahoe and the Ford F-150. While there was an increase in magnitude in several of the channels from the second to third test, the %CV values stayed within the acceptable range. Therefore, even after the harsher impacts, the response of the upper legform is shown to stay relatively consistent.

Due to its simple design and the inclusion of the protective torque limiting joint, the TRL upper legform survived the large number of impacts as well as the aggressive vehicle impacts. Additionally, the

responses of the upper legform remained consistent, even following aggressive impacts and with increasing wear of the rubber skin cover. The TRL upper legform impactor was therefore concluded to be a durable test device.

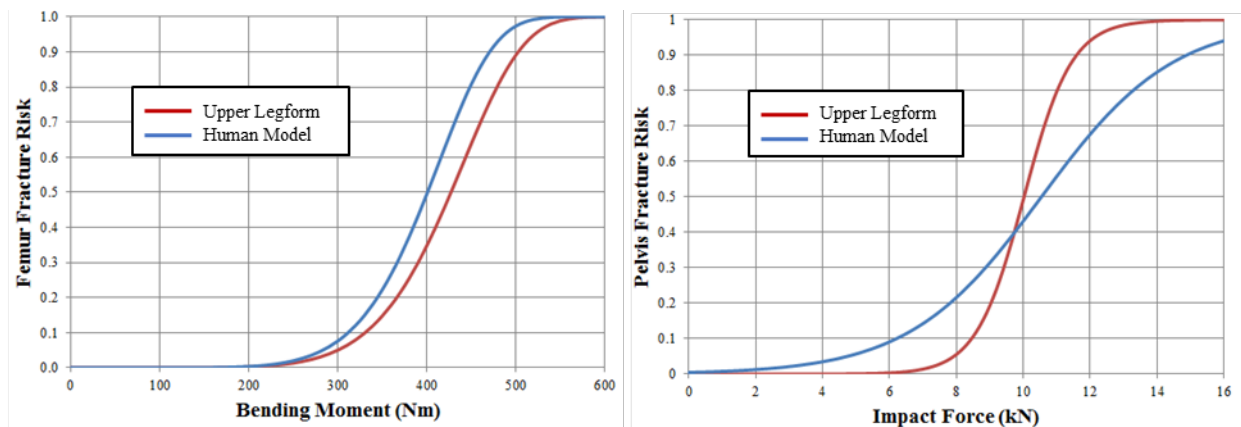
#### 6.4. Comparison Between THUMS and Upper Legform

The biofidelity of the upper legform has been a subject of contention for many years. It has been argued that even though upper legform scores in Euro NCAP tests were poor, there is a low relative injury frequency to the pelvis and hip due to the bonnet leading edge in European and Japanese motor vehicle crashes (Matsui, Ishikawa, & Sasaki, 1998),<sup>5</sup> indicating a mismatch between real-world data and the upper legform test condition. To address this mismatch between vehicle test scores and field injury data, Lubbe, Hikichi, Takahashi, and Davidsson (2011)<sup>6</sup> developed a transfer function between human model and upper legform measurements so that the injury risk obtained in a vehicle test is more representative of human pelvis/hip injury risk. They employed a combination of human experimental tests, simulations with the Total Human Model for Safety (THUMS) human body model, and matched pair upper legform tests to develop transfer functions for bending moment and sum of forces. The transfer functions to account for the difference between the THUMS human model and the upper legform are:

$$M_{\text{impactor}} = 1.0823 (M_{\text{THUMS}}) - 6.5579$$

$$F_{\text{impactor}} = 0.3619 (F_{\text{THUMS}}) + 6.2079$$

Figure 43 compares the human model-based and upper-legform-based injury risk functions for the femur and pelvis.



**Figure 43. Comparison of human model-based (THUMS) and upperlegform-based injury risk functions**

As indicated by the discrepancy in risk functions, the upper legform is more consistent with the THUMS model in its assessment of femur fracture risk than of pelvis fracture risk. The bending moment

<sup>5</sup> Matsui, Y., Ishikawa, H., & Sasaki, A. (1998). Validation of upper legform impact test – Reconstruction of pedestrian accidents (Paper No. 98-S10-O-05). 16th International Technical Conference for the Enhanced Safety of Vehicles, Windsor, Ontario, Canada, May 31-June 4, 1998. Available at [www-nrd.nhtsa.dot.gov/pdf/esv/esv16/98s10o05.pdf](http://www-nrd.nhtsa.dot.gov/pdf/esv/esv16/98s10o05.pdf)

<sup>6</sup> Lubbe, N., Hikichi, H., Takahashi, H., & Davidsson, J. (2011). *Review of the Euro NCAP upper leg test* (Paper No. 11-0137). 22th International Technical Conference on the Enhanced Safety of Vehicles, Washington, DC, June 13-16, 2011. Available at [www-esv.nhtsa.dot.gov/Proceedings/22/isv7/main.htm](http://www-esv.nhtsa.dot.gov/Proceedings/22/isv7/main.htm)

measurements from the legform are more closely aligned with the bending moment values from the human-based THUMS model for the same impact configuration. A given injury risk is associated with a slightly lower bending moment in the THUMS model than in the upper legform, which indicates that the upper legform is slightly more rigid in bending than the human-based model. In contrast, for the force measurement, it appears the upper legform is quite stiff in comparison with the THUMS model pelvis structure at injury risks below 40 percent, but then the risk of injury is actually lower for the THUMS model for a given impact force when the risk is above 40 percent. The steeper risk function for the upper legform indicates that it is less likely than the THUMS model to generate false positives (high impact force but no injury) or false negatives (low impact force but injury) in terms of predicting whether a vehicle impact is likely to produce a pelvis fracture.

While there is no data to indicate that upper leg injuries have decreased in Europe due to inclusion of the upper leg test in Euro NCAP, recent Euro NCAP vehicles have been able to do quite well in the upper legform test. At the very least, this trend indicates that the upper legform test has been effective at changing vehicle front end designs since the time when the mismatch between Euro NCAP scores and pelvis/hip injury prevalence was questioned.

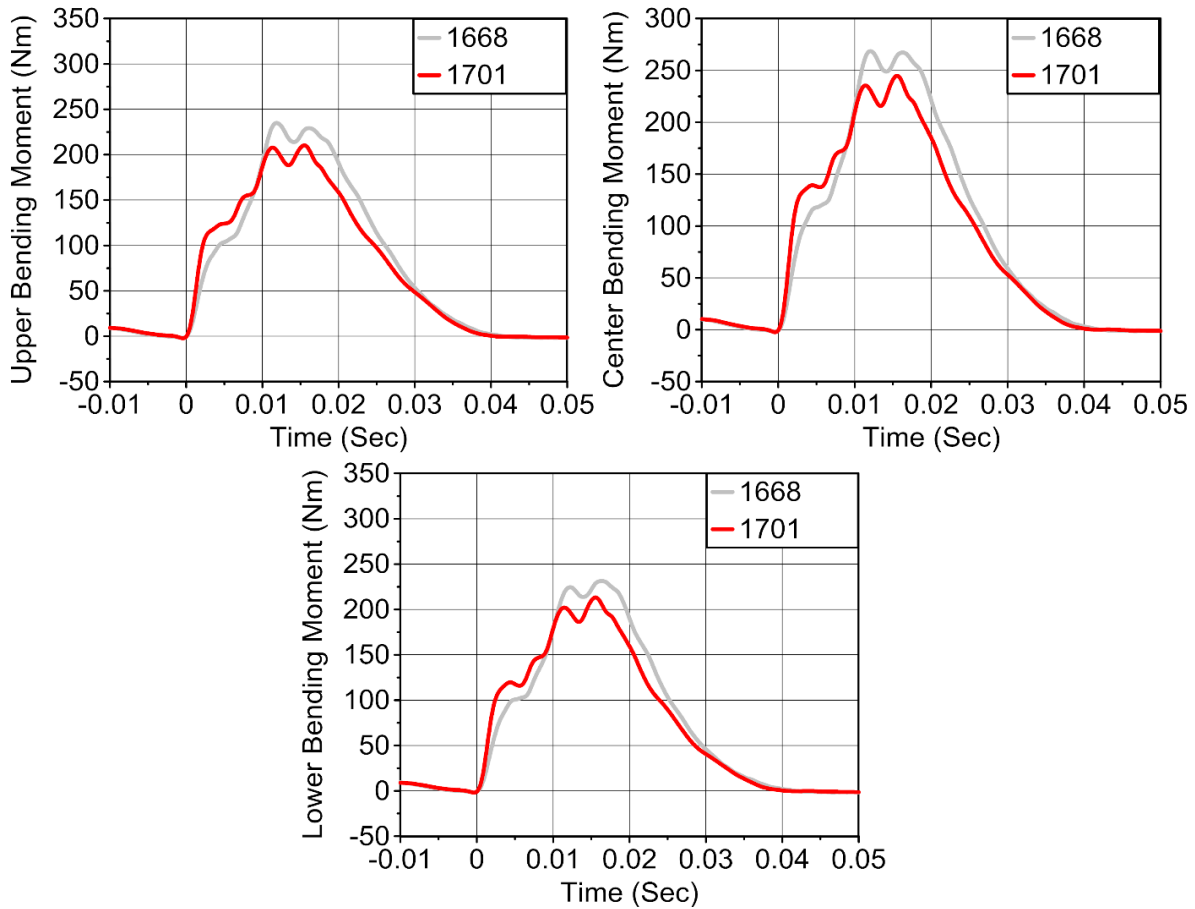
In summary, transfer functions have permitted the measurements made by the upper legform to be correlated to human injury risk despite concerns about the biofidelity of the upper legform. Given the improvement in NCAP scores for this test over time in both Europe and Japan, it appears manufacturers have been able to develop countermeasures required to reduce the risk of pelvis/hip injuries in pedestrians through the reduction of bending moments and forces due to vehicle impact.

## 6.5. Conclusion

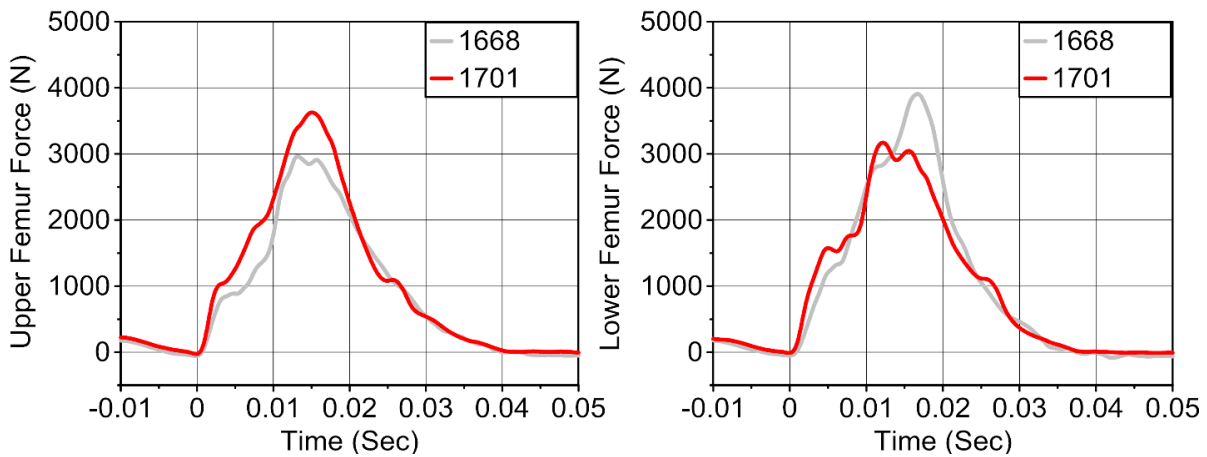
The primary findings from this evaluation were the TRL upper legform is:

- **Sensitive to vehicle design** – As demonstrated through testing a range of vehicles in the U.S. vehicle fleet. The TRL upper legform can differentiate between various vehicle designs and ranked them all differently. Some vehicles performed very well while others performed poorly when evaluated with the Euro NCAP scoring bands.
- **Repeatable** – With %CV below 10 percent for all channels in vehicle tests (see Tables 14-15).
- **Reproducible** – With percentage differences below 10 percent for 21 out of 24 (see Tables 17 to 20) measurement comparisons between two different upper legforms in vehicle tests.
- **Durable** – As the upper legform did not sustain any significant damage in 30 vehicle impacts of which some of the impacts observed forces far greater than the lower injury limits.

**Appendix**

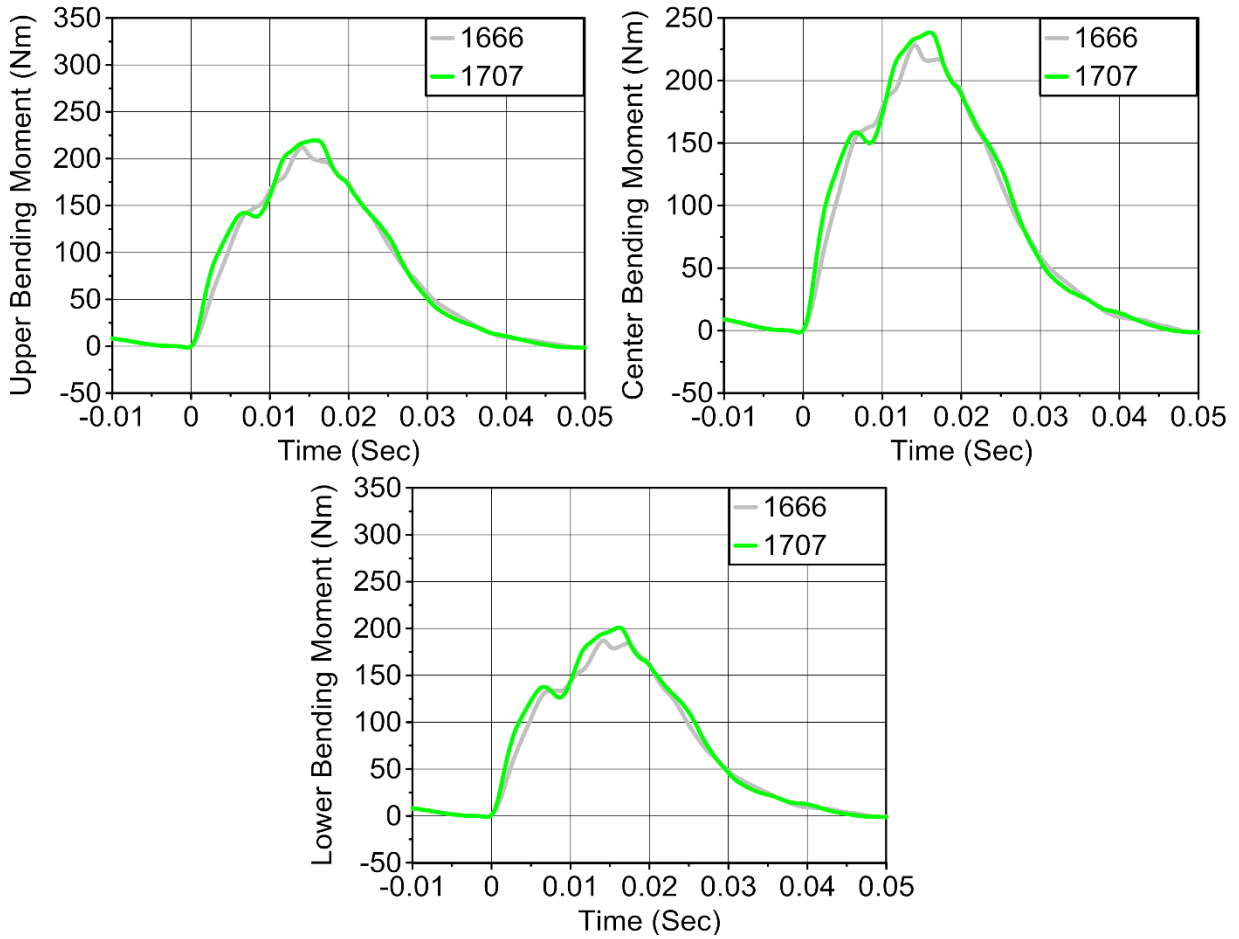


**Figure 44. Femur bending moment time histories of vehicle repeat tests at location U-1. Red (1701): legform that PASSES qualification requirements with CONFOR foam at 25 percent RH. Gray (1668) legform that FAILS (high) qualification requirements CONFOR foam at 45 percent RH.**

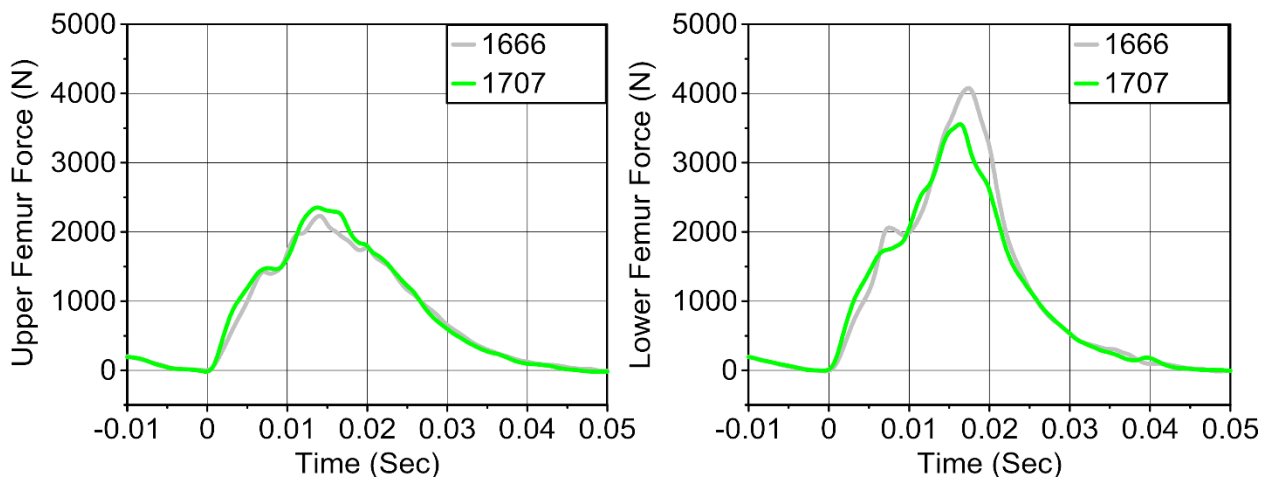


**Figure 45. Femur force histories of vehicle repeat tests at location U-1. Red (1701): legform that PASSES qualification requirements with CONFOR foam at 25 percent RH. Gray (1668) legform that FAILS (high) qualification requirements CONFOR foam at 45 percent RH.**

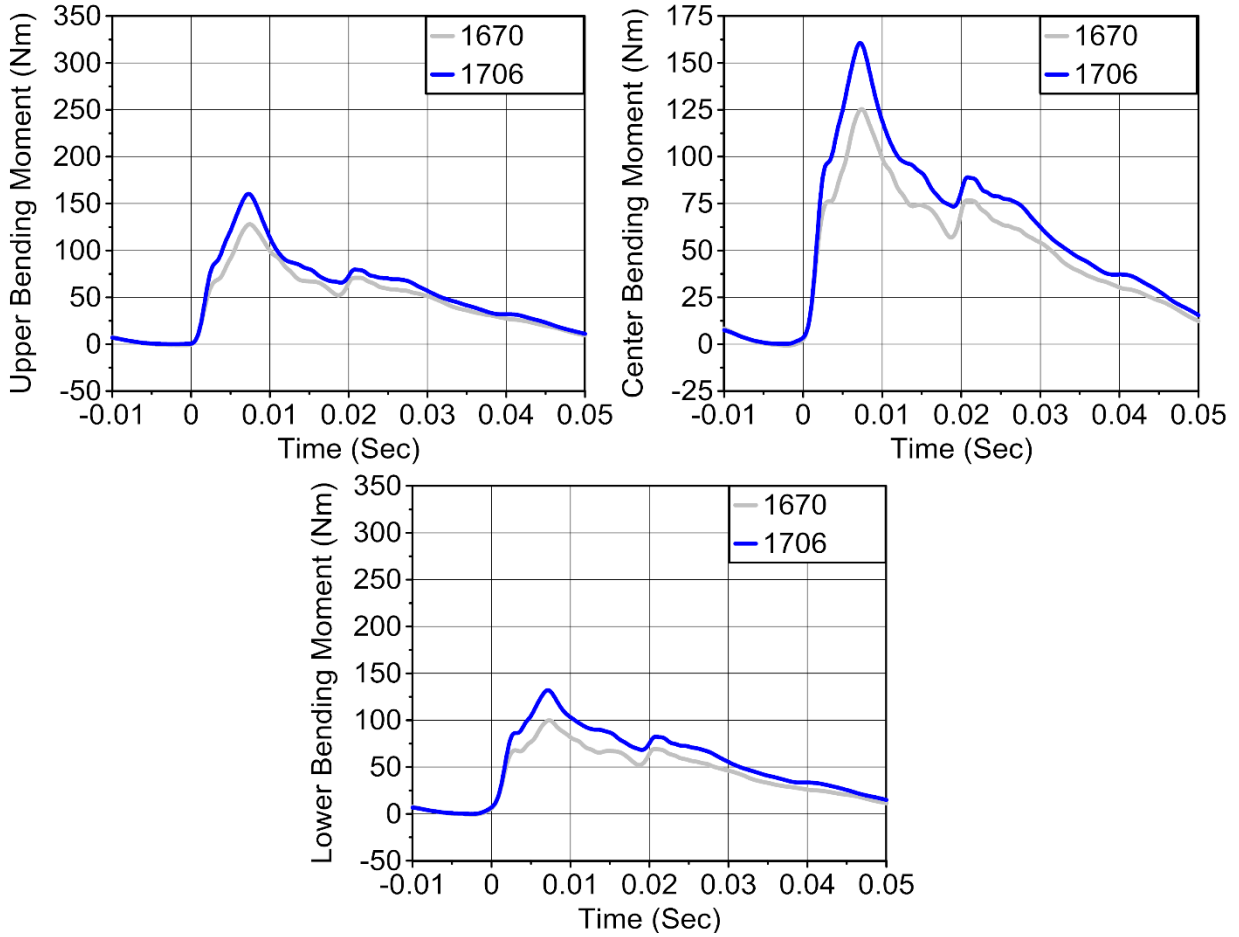




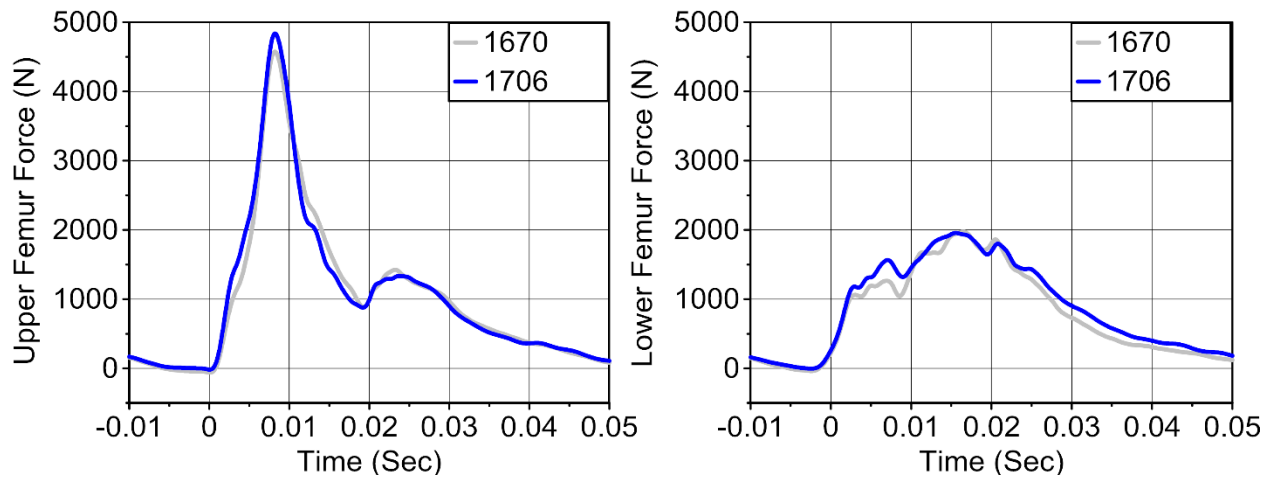
**Figure 46. Femur bending moment time histories of vehicle repeat tests at location U+3. Green (1707): legform that PASSES qualification requirements with CONFOR foam at 25 percent RH. Gray (1666) legform that FAILS (high) qualification requirements CONFOR foam at 45 percent RH.**



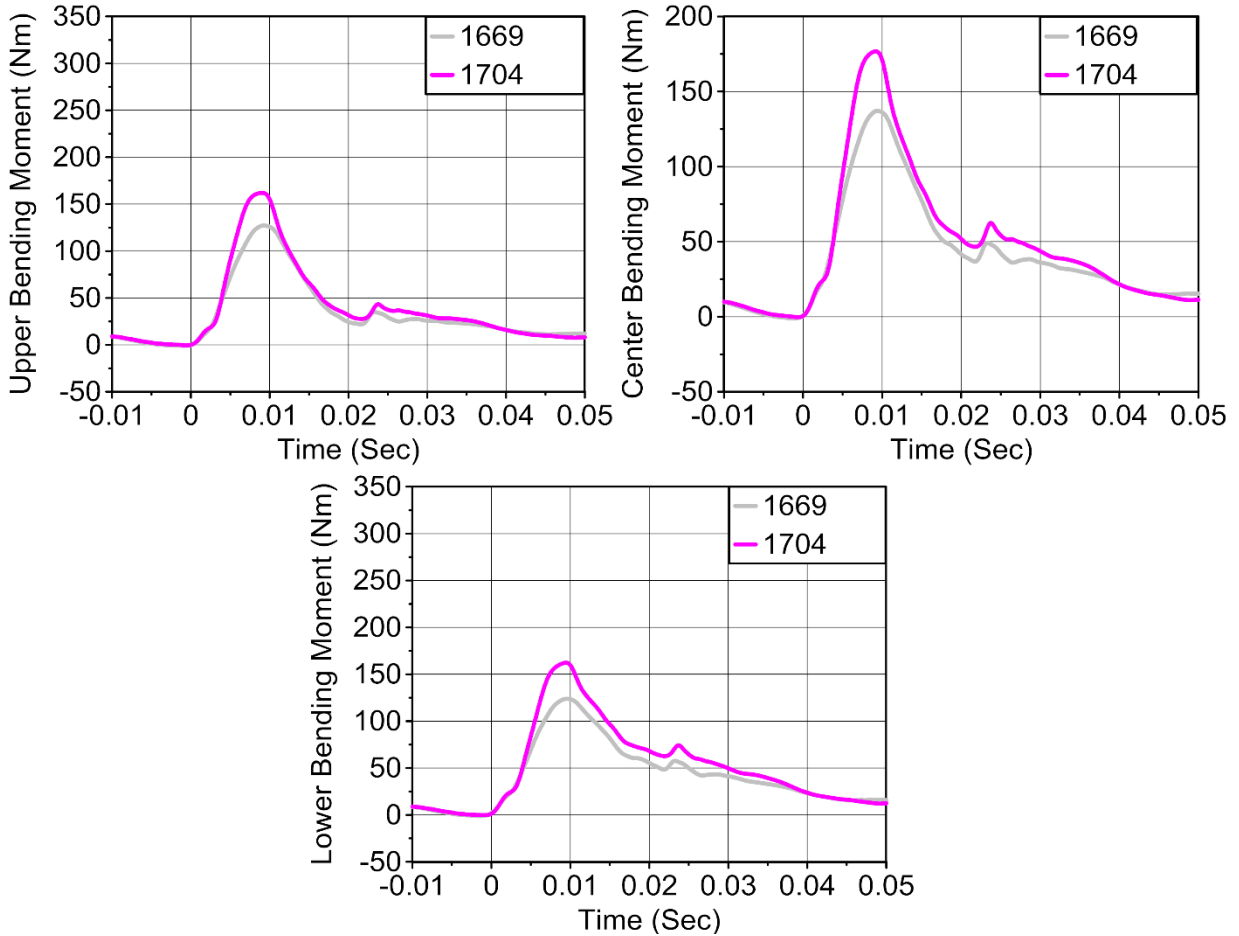
**Figure 47. Femur force time histories of vehicle repeat tests at location U+3. Green (1707): legform that PASSES qualification requirements with CONFOR foam at 25 percent RH. Gray (1666) legform that FAILS (high) qualification requirements with CONFOR foam at 45 percent RH.**



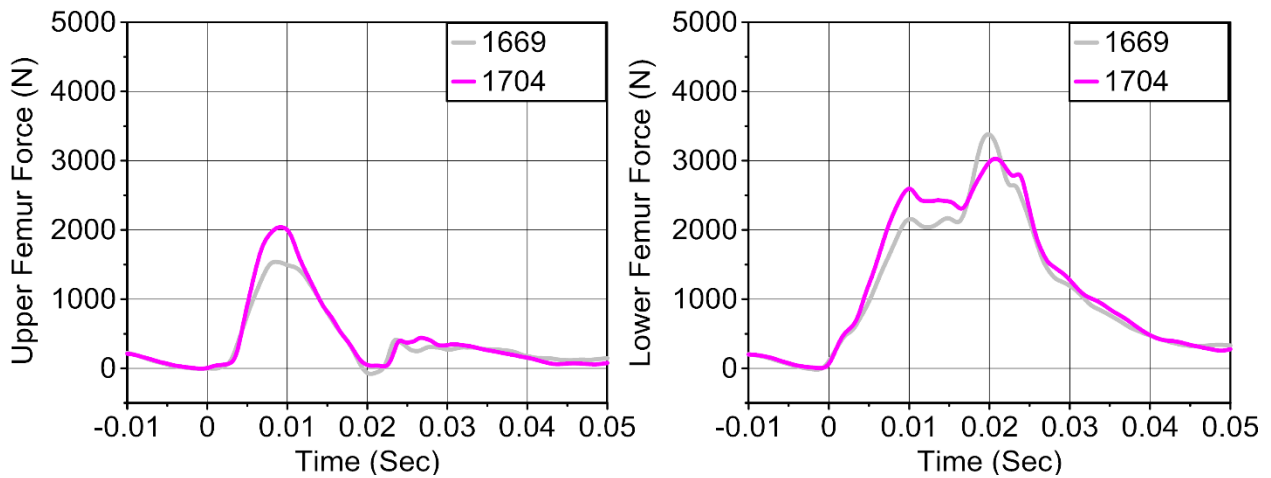
**Figure 48. Femur bending moment time histories of vehicle repeat tests at location U-5. Blue (1706): legform that PASSES qualification requirements with CONFOR foam at 25 percent RH. Gray (1670) legform that FAILS (high) qualification requirements CONFOR foam at 45 percent RH.**



**Figure 49. Femur force time histories of vehicle repeat tests at location U-5. Blue (1706): legform that PASSES qualification requirements with CONFOR foam at 25 percent RH. Gray (1670) legform that FAILS (high) qualification requirements CONFOR foam at 45 percent RH.**



**Figure 50. Femur bending moment time histories of vehicle repeat tests at location U+7. Pink (1704): legform that PASSES qualification requirements with CONFOR foam at 25 percent RH. Gray (1669) legform that FAILS (high) qualification requirements CONFOR foam at 45 percent RH.**



**Figure 51. Femur force time histories of vehicle repeat tests at location U+7. Pink (1704): legform that PASSES qualification requirements with CONFOR foam at 25 percent RH. Gray (1669) legform that FAILS (high) qualification requirements CONFOR foam at 45 percent RH.**

DOT HS 812 659  
July 2019



U.S. Department  
of Transportation  
**National Highway  
Traffic Safety  
Administration**

