



U.S. Department  
of Transportation

**National Highway  
Traffic Safety  
Administration**



---

DOT HS 812 755

July 2019

# **Evaluation of the Large Omni-Directional Child Anthropomorphic Test Device**

## DISCLAIMER

This publication is distributed by the U.S. Department of Transportation, National Highway Traffic Safety Administration, in the interest of information exchange. The opinions, findings and conclusions expressed in this publication are those of the authors and not necessarily those of the Department of Transportation or the National Highway Traffic Safety Administration. The United States Government assumes no liability for its contents or use thereof. If trade or manufacturers' names are mentioned, it is only because they are considered essential to the object of the publication and should not be construed as an endorsement. The United States Government does not endorse products or manufacturers.

Suggested APA Format Citation:

Suntay, B., Carlson, M., & Stammen, J. (2019, July). *Evaluation of the large omni-directional child anthropomorphic test device* (Report No. DOT HS 812 755). Washington, DC: National Highway Traffic Safety Administration.

<b>1. Report No.</b> DOT HS 812 755		<b>2. Government Accession No.</b>		<b>3. Recipient's Catalog No.</b>	
<b>4. Title and Subtitle</b> Evaluation of the Large Omni-Directional Child Anthropomorphic Test Device				<b>5. Report Date</b> July 2019	
				<b>6. Performing Organization Code</b>	
<b>7. Authors</b> Brian Suntay, Mike Carlson, Transportation Research Center; Jason Stammen, NHTSA Vehicle Research & Test Center				<b>8. Performing Organization Report No.</b>	
<b>9. Performing Organization Name and Address</b> Transportation Research Center, East Liberty, Ohio; NHTSA Vehicle Research & Test Center, East Liberty, Ohio				<b>10. Work Unit No. (TRAIS)</b>	
				<b>11. Contract or Grant No.</b>	
<b>12. Sponsoring Agency Name and Address</b> National Highway Traffic Safety Administration 1200 New Jersey Avenue SE Washington, DC 20590				<b>13. Type of Report and Period Covered</b> Final Report	
				<b>14. Sponsoring Agency Code</b>	
<b>15. Supplementary Notes</b>					
<b>16. Abstract</b> In 2016 a new pediatric anthropomorphic test device (ATD) – the large omni-directional child (LODC) – was introduced. The LODC has anthropometry representative of a seated 9- to 11-year-old child, a flexible thoracic spine, an instrumented abdomen, and realistic pelvis geometry to address the biofidelity and injury risk measurement limitations with the Hybrid III 10-year-old ATD (HIII-10C). The Rev3 version of the LODC was shown to have improved biofidelity with respect to the HIII-10C when compared to available biomechanical data. The LODC exhibited kinematics, head accelerations, and shoulder belt forces similar to PMHS data. In paired child restraint system (CRS) tests with the HIII-10C, the improved head kinematics and softer thoracic structure of the LODC mitigated the severe chin-to-chest contact often observed with the HIII-10C. Abdominal loading and the presence of kinematic submarining were also effectively identified with the instrumented abdomen. In addition, some wear was evident in the softer parts of the LODC Rev3 including the abdomen, thoracic spine rubber elements, and neck nodding blocks, but no catastrophic damage or failures were observed while repeatability was maintained. This study presents an evaluation of the latest versions of the LODC (Rev4 and Rev5) that have increased biofidelity and durability and are more user-friendly. In addition to assessing biofidelity, durability, and repeatability of the LODC, reproducibility was also evaluated for the first time using multiple LODC ATDs.					
<b>17. Key Words</b>			<b>18. Distribution Statement</b> No restrictions. This document is available to the public through the National Technical Information Service, <a href="http://www.ntis.gov">www.ntis.gov</a>		
<b>19. Security Classif. (of this report)</b> Unclassified		<b>20. Security Classif. (of this page)</b> Unclassified		<b>21. No. of Pages</b> 57	<b>22. Price</b>

Form DOT F 1700.7 (8-72)

Reproduction of completed page authorized

# TABLE OF CONTENTS

<b>LIST OF FIGURES.....</b>	<b>iv</b>
<b>LIST OF TABLES .....</b>	<b>vii</b>
<b>1. Background and Objective.....</b>	<b>1</b>
<b>2. Component Testing .....</b>	<b>2</b>
2.1. Head.....	2
2.2. Neck .....	4
2.3. Thoracic Spine.....	5
2.4. Thorax .....	6
2.5. Abdomen.....	8
2.6. Component Summary and BioRank.....	11
<b>3. FMVSS No. 213 Frontal Sled Testing.....</b>	<b>13</b>
3.1. Influence of LODC Modifications on Full Body Response .....	13
3.2. Feasibility of Testing the LODC Rev4 in Out-of-Position Scenarios .....	19
3.3. Summary of FMVSS No. 213 Sled Testing.....	20
<b>4. LODC Rev4 Repeatability and Reproducibility .....</b>	<b>22</b>
4.1. Component Repeatability and Reproducibility.....	22
4.2. FMVSS No. 213 Frontal Sled Testing to Assess LODC Rev4 Repeatability and Reproducibility.....	22
4.3. Summary of LODC Rev4 Repeatability and Reproducibility.....	24
<b>5. 2016 Chevrolet Malibu Vehicle Buck Sled Testing.....</b>	<b>25</b>
5.1. Vehicle Buck Sled Test Results .....	26
5.2. Additional LODC Modifications Component Testing .....	30
5.2.1. Abdomen.....	30
5.2.2. Shoulder Modification .....	31
<b>6. Additional Chevrolet Malibu Vehicle Buck Sled Tests.....</b>	<b>33</b>
6.1. Additional Vehicle Buck Sled Test Results .....	33
6.2. Additional Thorax Component Testing.....	36
<b>7. Side Curtain Air Bag and Side Impact Sled Tests.....</b>	<b>40</b>
7.1. Side Curtain Air Bag Results .....	40
7.2. FMVSS No. 213 Side Impact Results .....	42
<b>8. Summary and Future Work.....</b>	<b>45</b>

<b>References.....</b>	<b>46</b>
<b>Appendix: NHTSA Database Reference Table .....</b>	<b>47</b>

## LIST OF FIGURES

Figure 1. LODC Rev4 revised skull, skull cap, ballast, and complete headskin .....	2
Figure 2. CFR Part 572 Subpart T head drop specifications and test setup where the drop heights evaluated in this study were at 150 mm and 300 mm .....	3
Figure 3. LODC head drop results at 150 mm and 300 mm drop heights .....	3
Figure 4. CFR Part 572 Subpart T frontal neck flexion specifications and test setup .....	4
Figure 5. CFR 49 Part 572 Subpart T frontal neck flexion test results (corridor from Dibb et al., 2014).....	5
Figure 6. Updated flexible spine element.....	5
Figure 7. New spine design with fused middle vertebral elements and new neck and lumbar angle adjustment brackets .....	6
Figure 8. Updated shoulder joint .....	7
Figure 9. Comparison of IR-TRACC mounting configurations between the previous and current LODC.....	7
Figure 10. CFR Part 572 Subpart T frontal thorax impact specifications and test setup .....	8
Figure 11. CFR 49 Part 572 Subpart T frontal thorax test results. The force-deflection corridor was constructed using the same methodology as Parent, Crandall, Bolton, Bass, Ouyang, and Lau(2010), where the pediatric data corridor was scaled to a 10YO “ATD target” corridor using the Part 572 probe mass and velocity.....	8
Figure 12. LODC Rev3 and Rev4 abdomen designs.....	9
Figure 13. Fixed back abdomen belt pull test setup .....	10
Figure 14. Fixed back abdomen belt pull test results .....	10
Figure 15. Abdomen probe impact test setup .....	11
Figure 16. Abdomen probe impact results. The black box indicates pediatric data from Ouyang, Zhao, Xu, Chen, and Zhong(2006).....	11
Figure 17. FMVSS No. 213 setup with LODC Rev4 (BioDB #11756) and HIII-10C (BioDB #11755) seated in the five-point harness (Britax Frontier Clicktight) .....	13
Figure 18. FMVSS No. 213 setup with LODC Rev4 (BioDB #11760) and HIII-10C (BioDB #11757) seated in the highback belt positioning booster (Evenflo Big Kid).....	14
Figure 19. FMVSS No. 213 setup with LODC Rev4 (BioDB #11762) and HIII-10C (BioDB #11759) seated in the backless belt positioning booster (Graco TurboBooster).....	14
Figure 20. FMVSS No. 213 setup with LODC Rev4 (BioDB #11764/11766) and HIII-10C (BioDB #11761/11763) seated in the no-CRS upright (top) and slouched (bottom) posture configurations, respectively .....	15
Figure 21. FMVSS No. 213 head trajectory results for the HIII-10C (blue), LODC Rev3 (red), and LODC Rev4 (green). Note that for the 5-Pt harness, the LODC arm blocks the view of the head CG target. The dotted line is an estimate of the head CG target’s motion until it comes back in view at (340 mm, -271 mm).....	16
Figure 22. FMVSS No. 213 HIC 36 results for the HIII-10C (blue), LODC Rev3 (red), and LODC Rev4 (green) .....	17
Figure 23. FMVSS No. 213 head excursion results for the HIII-10C (blue), LODC Rev3 (red), and LODC Rev4 (green).....	17

Figure 24. FMVSS No. 213 knee excursion results for the HIII-10C (blue), LODC Rev3 (red), and LODC Rev4 (green).....	17
Figure 25. FMVSS No. 213 3 ms chest acceleration results for the HIII-10C (blue), LODC Rev3 (red), and LODC Rev4 (green).....	18
Figure 26. FMVSS No. 213 chest deflection results for the HIII-10C (blue), LODC Rev3 (red), and LODC Rev4 (green).....	18
Figure 27. Extreme head out-of-position setup in a sled test using the FMVSS No. 213 pulse .....	19
Figure 28. HIII-10C and LODC Rev4 HIC 36 results comparing a standard upright head position with two out-of-position scenarios.....	20
Figure 29. LODC Rev4 abdomen pressure results from various seating configurations .....	20
Figure 30. FMVSS No. 213 setup with two LODC Rev4 builds to evaluate reproducibility.....	23
Figure 31. Initial position of LODC 001 (left) that exhibited an unusually high chest acceleration versus an LODC that exhibited a more normal chest acceleration (right).....	24
Figure 32. 2016 Chevrolet Malibu sled buck in a frontal configuration .....	25
Figure 33. 2016 Chevrolet Malibu sled buck in an oblique configuration.....	25
Figure 34. HIII-10C and LODC Rev4 setup in a backless belt positioning booster (left) and with no-CRS (right) in the rear seat of the Chevrolet Malibu vehicle buck.....	26
Figure 35. HIC 36 (left) and chest acceleration (right) results from the frontal Malibu buck sled tests for the HIII-10C (blue) and LODC Rev4 (green).....	27
Figure 36. Near side occupant (left) and far side occupant (right) HIC 36 results from the oblique Malibu buck sled tests for the HIII-10C (blue) and LODC Rev4 (green) .....	27
Figure 37. Far side oblique tests with the backless BPB showing shoulder belt engagement with the LODC Rev4 (left) and lack of belt engagement and torso roll out of the HIII-10C (right).....	28
Figure 38. Near side occupant (left) and far side occupant (right) chest acceleration results from the oblique Malibu buck sled tests for the HIII-10C (blue) and LODC Rev4 (green).....	28
Figure 39. Near side occupant (left) and far side occupant (right) abdomen pressure results from the oblique Malibu buck sled tests for the LODC Rev4.....	29
Figure 40. Forward translation of the abdomen (left) and shoulder belt entrapment (right) of the LODC Rev4 in the Malibu vehicle buck sled tests .....	29
Figure 41. Abdomen retaining brackets to prevent forward translation during sled testing.....	30
Figure 42. Fixed back abdomen belt pull results for the LODC Rev5 abdomen with retaining brackets ...	31
Figure 43. LODC Rev5 shoulder modifications to provide distal clavicle support .....	31
Figure 44. LODC Rev5 upper arm modification to prevent shoulder belt entrapment.....	32
Figure 45. HIC 36 (left) and chest acceleration (right) results from the additional oblique Malibu buck sled tests for the updated LODC Rev5 .....	34
Figure 46. Chest deflection results from the additional oblique Malibu buck sled tests for the updated LODC Rev5.....	34
Figure 47. Abdomen pressure results from the additional oblique Malibu buck sled tests for the near side (left) and far side (right) updated LODC Rev5.....	35
Figure 48. Vehicle buck sled tests showing the previous LODC with shoulder belt entrapment (left) and the modified LODC without shoulder belt entrapment (right).....	35

Figure 49. Far side occupant HIC 36 results from the oblique Malibu buck sled tests comparing the original abdomen (LODC 001) with the modified abdomen with retaining brackets (LODC 003) ..... 36

Figure 50. Far side occupant abdomen pressure results from the oblique Malibu buck sled tests comparing the original Rev4 abdomen (left) with the Rev5 abdomen with retaining brackets (right) ..... 36

Figure 51. Frontal thorax impact results using a smaller probe (3.55 kg) similar to Ouyang, Zhao, Xu, Chen, and Zhong(2006). Force-deflection corridor is the old cohort (reanalyzed 6-year-old) corridor from Parent, Crandall, Bolton, Bass, Ouyang, and Lau (2010). ..... 37

Figure 52. Diagonal belt pull test setup of the LODC Rev5 thorax adapted from Kent et al. (2011)..... 38

Figure 53. Results of the diagonal belt pull tests for LODC Rev5 (color) and the pediatric subjects of the Kent study (black) ..... 38

Figure 54. Screen captures of the side curtain air bag sled test at 50 ms time intervals. Air Bag is deployed in all screen captures except for T = 0 ms..... 41

Figure 55. HIC 36 and chest acceleration results comparing the oblique Chevrolet Malibu vehicle buck sled test results with no side curtain air bag (green) and with a side curtain air bag (orange) ..... 42

Figure 56. Abdomen pressure results comparing the oblique Chevrolet Malibu vehicle buck sled test results with no side curtain air bag (green) and with a side curtain air bag (orange)..... 42

Figure 57. FMVSS No. 213 side impact test setup with no-CRS (left) and backless booster (right) ..... 43

Figure 58. HIC 36 and chest acceleration results for the FMVSS No. 213 side impact sled tests..... 43

Figure 59. Lateral chest deflection and abdomen pressure results for the FMVSS No. 213 side impact sled tests..... 44

Figure 60. LODC Rev5 side impact wall contact with no-CRS (left) and backless belt positioning booster (right) ..... 44



## LIST OF TABLES

Table 1. Summary of LODC Rev4 and Rev5 modifications.....	1
Table 2. Summary of component BioRank scores for the HIII-10C and LODCs. BioRank scores were not calculated for the Ouyang abdomen impacts since the comparison was with a single PMHS. ....	12
Table 3. Summary of component peak results for the three LODC Rev4 builds. Three repeats were performed for each component test and for each LODC Rev4 build (n = 9). ....	22
Table 4. Summary of mean, standard deviation, and percent coefficients of variation (CV) for the three LODC Rev4 builds .....	23
Table 5. Test matrix for 2016 Chevrolet Malibu vehicle buck sled tests .....	26
Table 6. Test matrix for additional oblique 2016 Chevrolet Malibu vehicle buck sled tests with LODC Rev5 .....	33
Table 7. Test matrix for side curtain air bag and 213 side impact sled tests.....	40

# 1. Background and Objective

In 2016 Stammen, Moorhouse, Suntay, Carlson, and Kang introduced a new pediatric anthropomorphic test device (ATD) – the large omni-directional child (LODC). The LODC was designed to have anthropometry representative of a seated 9- to 11-year-old child and features a flexible thoracic spine, instrumented abdomen, and realistic pelvis geometry to address the biofidelity and injury risk measurement limitations with the Hybrid III 10-year-old ATD (HIII-10C). The Rev3 version of the LODC was shown to have improved biofidelity (BioRank = 1.21) over the HIII-10C (BioRank = 2.70).

Additionally, in a test configuration similar to a previously conducted pediatric post-mortem human subject (PMHS) frontal test from the literature, the LODC exhibited kinematics, head accelerations, and shoulder belt forces similar to PMHS data. In paired child restraint system (CRS) tests with the HIII-10C, the improved head kinematics and softer thoracic structure of the LODC mitigated the severe chin-to-chest contact often observed with the HIII-10C. Abdominal loading and the presence of kinematic submarining were also effectively identified with the instrumented abdomen.

Having improved biofidelity requires more complex parts and softer materials, which tends to degrade both durability and repeatability. In the 2016 evaluation of the LODC, some wear was evident in the softer parts such as the abdomen, thoracic spine rubber elements, and neck nodding blocks, but no catastrophic damage or failures were observed while repeatability was maintained.

This study presents an evaluation of the latest versions of the LODC (Rev4 and Rev5) that have increased biofidelity and durability and are more user-friendly. A summary of LODC Rev4 and Rev5 modifications are shown in Table 1. In addition to assessing biofidelity, durability, and repeatability of the LODC, reproducibility was also evaluated for the first time using multiple LODC ATDs.

Table 1. Summary of LODC Rev4 and Rev5 modifications

Body Region	Modification Descriptions	
	Rev4	Rev5
<b>Head</b>	Full headskin instead of forehead insert; Adjusted skull mass and ballast	No changes
<b>Neck</b>	Better optimized nodding block combination and neck cable configuration	No changes
<b>Thoracic Spine</b>	Fused T6-T9 vertebrae; one-piece flexible elements; updated neck and thoraco-lumbar angle adjustment	No changes
<b>Thorax &amp; Shoulder</b>	Utilizes HIII-10C shoulder clevis joint instead of original ball-socket joint; redesigned flesh wrap for better fit; frontal 1D IR-TRACC	Modified shoulder bushing to support clavicle; modified upper arm to prevent shoulder belt entrapment
<b>Abdomen</b>	Geometry changes and holes added to optimize response	Addition of abdomen retaining brackets

The LODC is intended to be omni-directional in that it can be used in more loading modes than just frontal. While this report focuses primarily on frontal loading, oblique rear seat tests and side impact sled tests were also done to evaluate how the LODC design responds in non-frontal scenarios.

## 2. Component Testing

### 2.1. Head

The LODC head is a modified HIII-10C head in which material was removed from the mandible area of the skull, the skull cap was redesigned with reduced mass, and a tungsten ballast was added in order to reduce the total mass and move its center of mass upward and forward to match the inertial properties of a similar age (9-year-old) pediatric specimen (Loyd, 2009). LODC Rev3 also had a headskin insert at the forehead to tune its impact response. In LODC Rev4, a full headskin made of the same material as the Rev3 insert was fabricated and used (Figure 1). The skull mass and ballast were also adjusted in order to compensate for the different headskin moment of inertia.

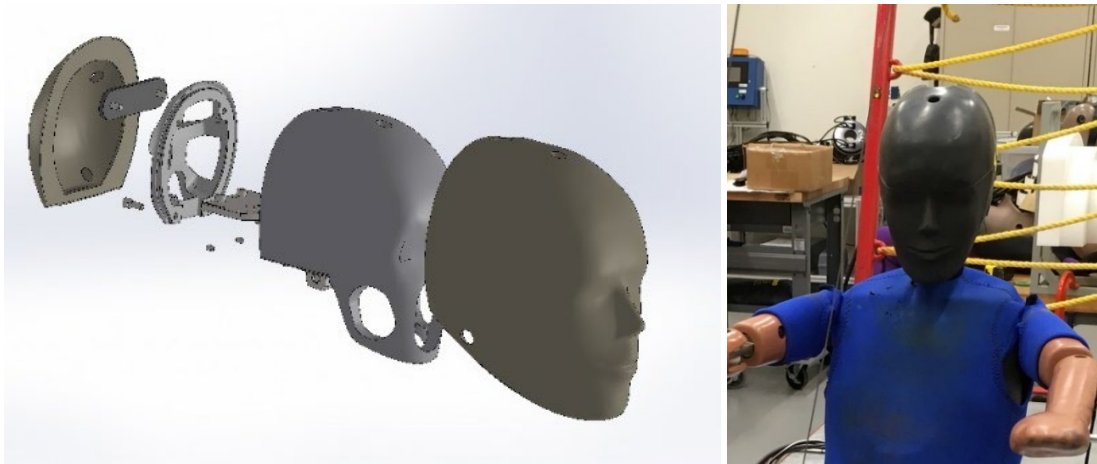

Figure 1. LODC Rev4 revised skull, skull cap, ballast, and complete headskin

Head drops were performed at 150 mm and 300 mm drop heights to match the pediatric specimen drop heights used by Loyd (2009). The Code of Federal Regulations (CFR) Part 572 Subpart T test procedure was used for positioning, releasing, and aligning the head such that the impacts to a drop plate were located at the forehead portion of the head. Head drop specifications and test setup are shown in Figure 2. Three tests were performed at each drop height so that repeatability could also be evaluated. Results from the head drop tests are shown in Figure 3 below. The average peak head resultant for the 300 mm and 150 mm tests are 139 g and 86 g, respectively. Tests at the two head drop heights fall within the biofidelity targets, which are represented by the black dashed boxes in Figure 3.

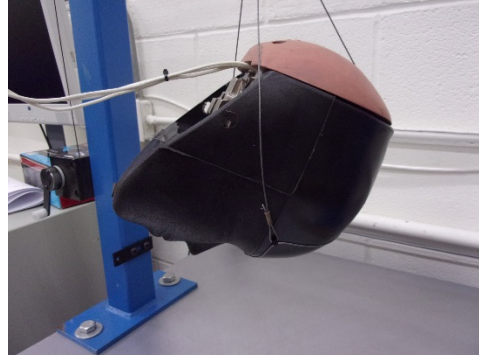
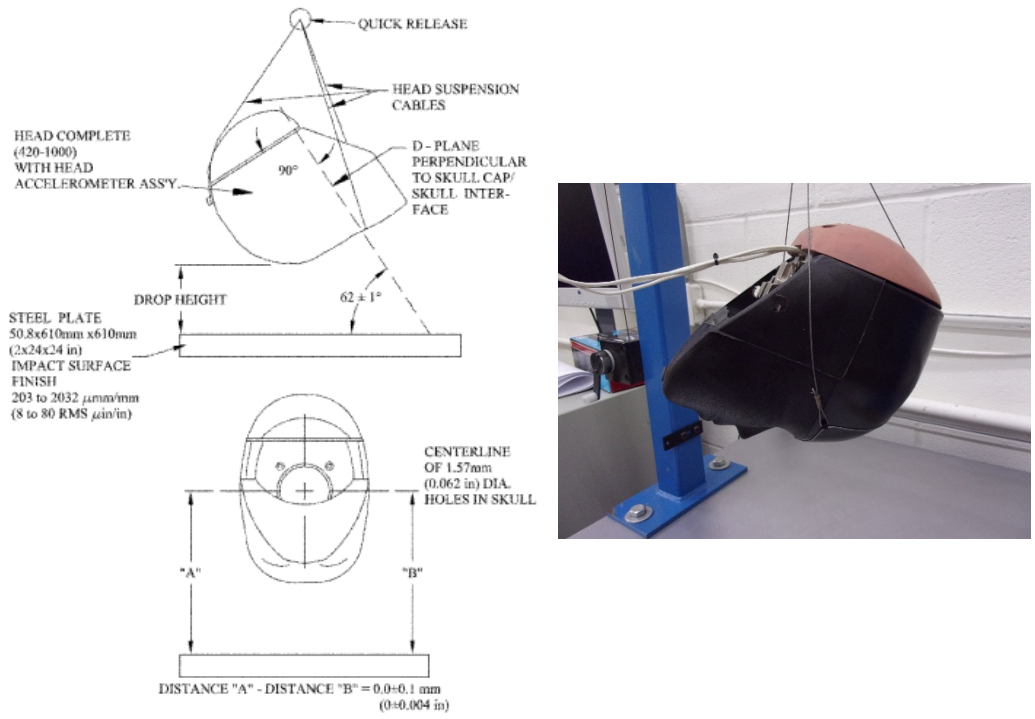

Figure 2. CFR Part 572 Subpart T head drop specifications and test setup where the drop heights evaluated in this study were at 150 mm and 300 mm

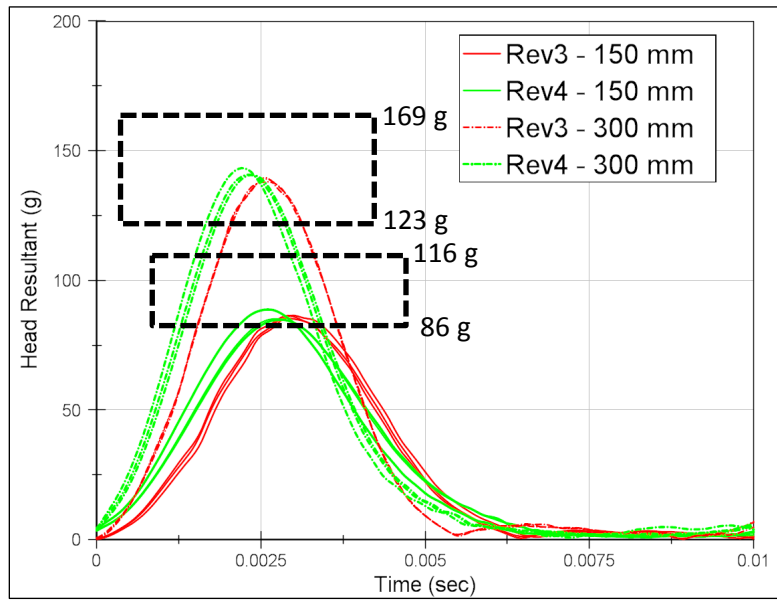

Figure 3. LODC head drop results at 150 mm and 300 mm drop heights

## 2.2. Neck

As presented in Stammen, Moorhouse, Suntay, Carlson, and Kang (2016), the LODC neck was designed and tuned to produce similar amounts of translational head lag that is observed in a human frontal flexion response. Additionally, soft nodding blocks were incorporated to tune angular head lag with respect to the neck. Although the neck biofidelity score for the LODC Rev3 was found to be better than the HIII-10C, the neck was observed to be too soft, with little to no moment about the occipital condyle at head rotations from 25 to 60 degrees. LODC Rev4 has a better optimized nodding block combination and neck cable configuration to increase occipital condyle moments between 25 to 60 degrees and maximize biofidelity.

Frontal neck flexion tests were conducted according to the CFR Part 572 test procedure. Frontal neck flexion test specifications and test setup are shown in Figure 4. To assess repeatability, three tests were conducted. Figure 5 below shows the moment about the occipital condyle versus head rotation for the Rev3 (red) and Rev4 (green) versions of the LODC neck. The Rev4 neck with tuned nodding blocks is observed to better match the response target as there is initial negative head rotation and a stiffer neck response between 25° to 60° of head rotation. The neck BioRank (Rhule, Moorhouse, Donnelly, & Stricklin, 2009) score has also improved for the current version (BioRank = 1.37) versus the previous version (BioRank = 1.57).

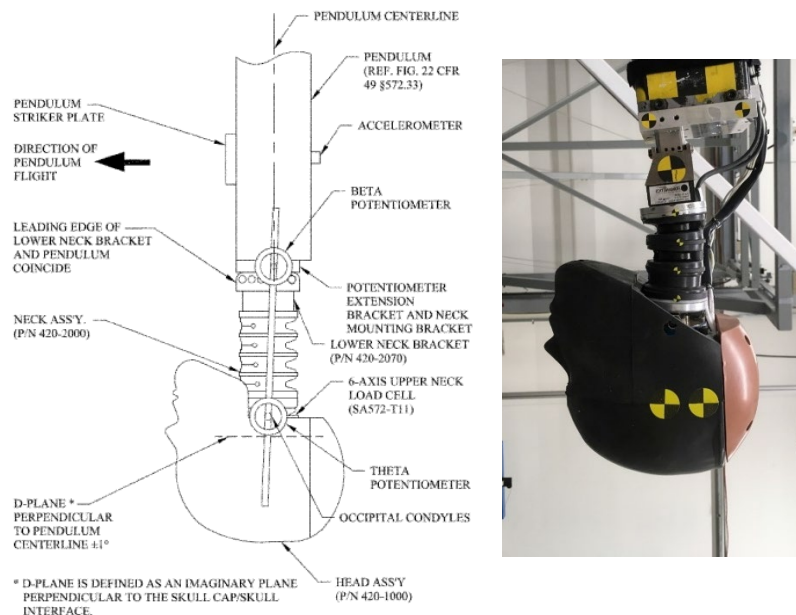

Figure 4. CFR Part 572 frontal neck flexion specifications and test setup

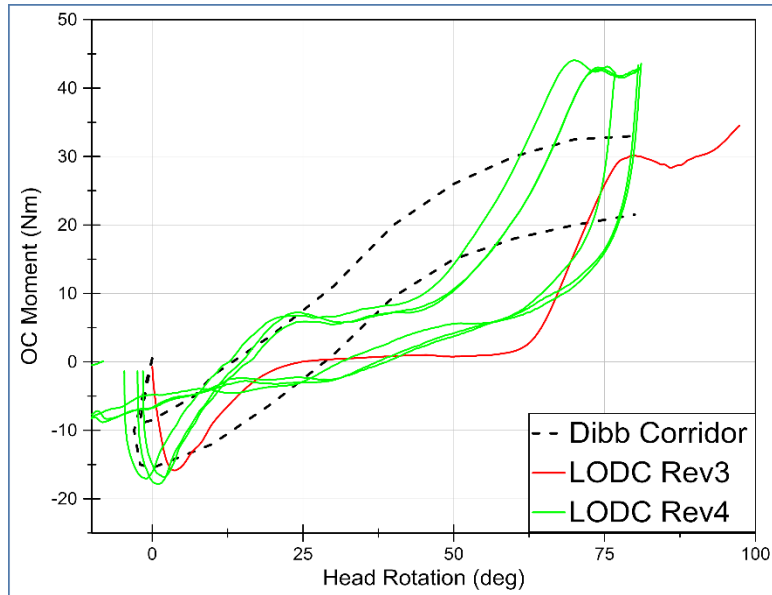

Figure 5. CFR Part 572 frontal neck flexion test results (corridor from Dibb et al., 2014)

### 2.3. Thoracic Spine

The LODC thoracic spine contains vertebral elements that represent T1, T3, T6, T9, and T12. Between each of the vertebrae are elements that give the thoracic spine its flexibility. Testing of the previous LODC Rev3 showed gradual wear of the soft, flexible elements during testing and during storage as they would remain in a compressed state while the dummy slouched forward for long periods of time. Additionally, since the flexible elements consisted of several pieces, they were relatively difficult to replace without having to remove the thorax and disassemble the spine.

In the LODC Rev4 thoracic spine, the design of the flexible elements was improved so that they are more easily replaced and more robust (Figure 6). The flexible elements are now of a one-piece modular design, making it easier to swap out an entire joint without having to disassemble the dummy. They are also equipped with low capacity compression springs to prevent long-term static compression of the rubber during storage.

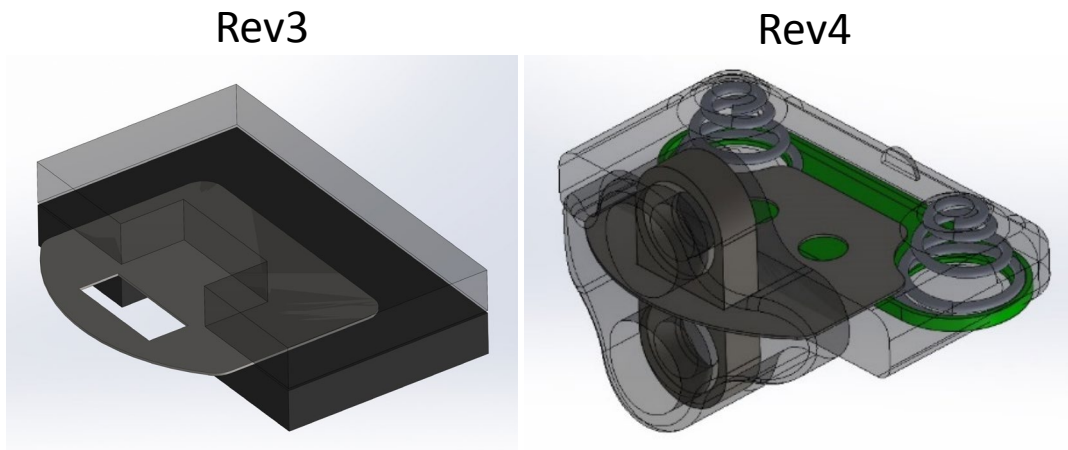

Figure 6. Updated flexible spine element

From testing LODC Rev3, it was observed that the middle vertebral elements (T6 and T9) did not bend during testing and thus had little effect on the ATD's response. Therefore, for LODC Rev4, the middle vertebral elements were fused (Figure 7). Having one less flexible element in the spine would mean fewer complications and better durability. Additionally, the fused vertebral elements provide more space so that a deflection measurement device can be centered in the ribcage, which will be described more in the next section. New neck and thoraco-lumbar angle adjustment brackets were also designed to be more accessible and user-friendly (Figure 7).

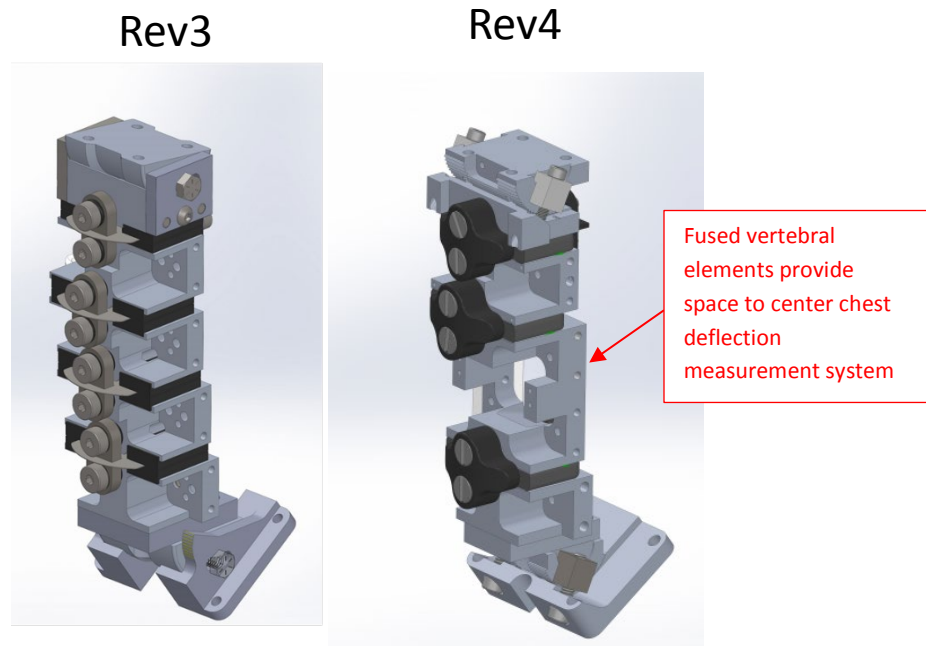

Figure 7. New spine design with fused middle vertebral elements and new neck and lumbar angle adjustment brackets

## 2.4. Thorax

LODC Rev4 uses the same two-piece ribcage from Rev3 that consists of an over-molded cable construction and continuous internal surface for preventing relative rib motion and for protecting internal instrumentation from sharp edges. The same scapulae are used that connect to the thoracic spine through a pivot that permits rotation about the z-axis while maintaining resistance in the x-axis. The upper ribcage stiffener along the mid-sagittal plane is also maintained in Rev4 to prevent the clavicles from collapsing into the spine.

One minor modification for Rev4 was to the shoulder joint where the ball and socket configuration of the previous version was changed to the clevis joint of the HIII-10C so that the arms of the HIII-10C can be utilized with the LODC (Figure 8). Another modification was to the flesh wrap around the ribcage, which was redesigned for better fit.

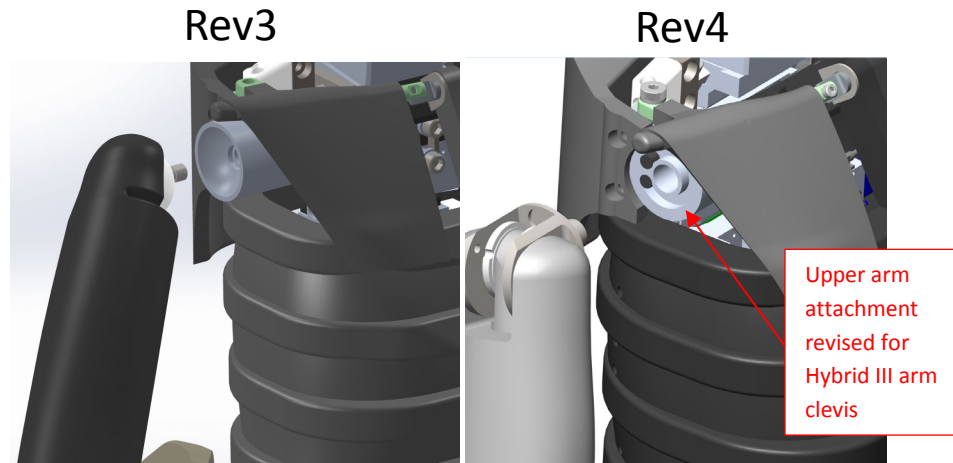

Figure 8. Updated shoulder joint

As mentioned earlier, the fused vertebral elements of LODC Rev4 create more space so that a deflection measurement device can be centered in the ribcage. LODC Rev3 used a 3D IR-TRACC (infrared telescoping rod for assessment of chest compression) that originated at the side of the spine and terminated at the sternum. Since there is limited space within the thorax, there were concerns that the 3D IR-TRACC would have a limited range of motion, can contact the spine or other internal instrumentation, or have rotary potentiometers that can be easily contacted and damaged. With the new design, a 1D IR-TRACC can be mounted in a frontal configuration within the fused spinal element where it will be better protected and have a greater range of displacement (Figure 9).

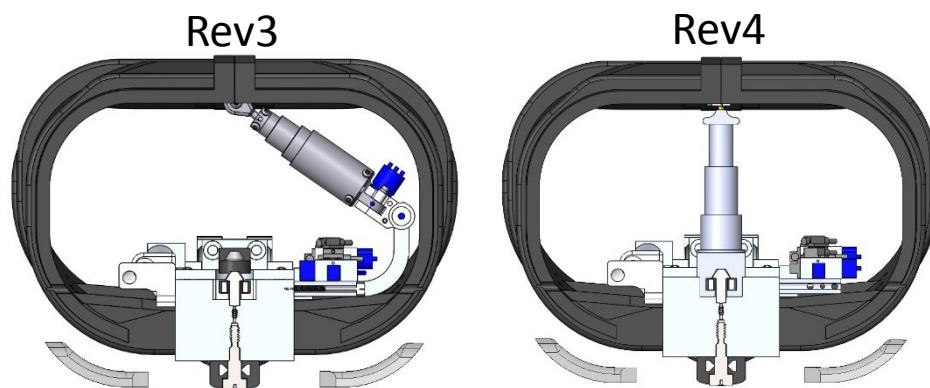

Figure 9. Comparison of IR-TRACC mounting configurations between the previous and current LODC

Frontal thorax tests were conducted according to the CFR Part 572 test procedure. Frontal thorax impact test specifications and test setup are shown in Figure 10. To assess repeatability, three tests were conducted. Figure 11 below shows the probe force versus external chest deflection for the Rev3 (red) and Rev4 (green) versions of the LODC thorax. The response of the LODC Rev4 thorax is observed to closely match the target. Although the response of Rev4 (green) is not much different than the response of Rev3 (red), BioRank scores do show an improvement with the current thorax having a BioRank score of 0.79 versus the previous thorax, which has a BioRank score of 1.84. The improvement is due to



reduction of the initial peak prior to 25 mm and the response staying closer to or within the lower boundary of the biofidelity target between 25 – 50 mm.

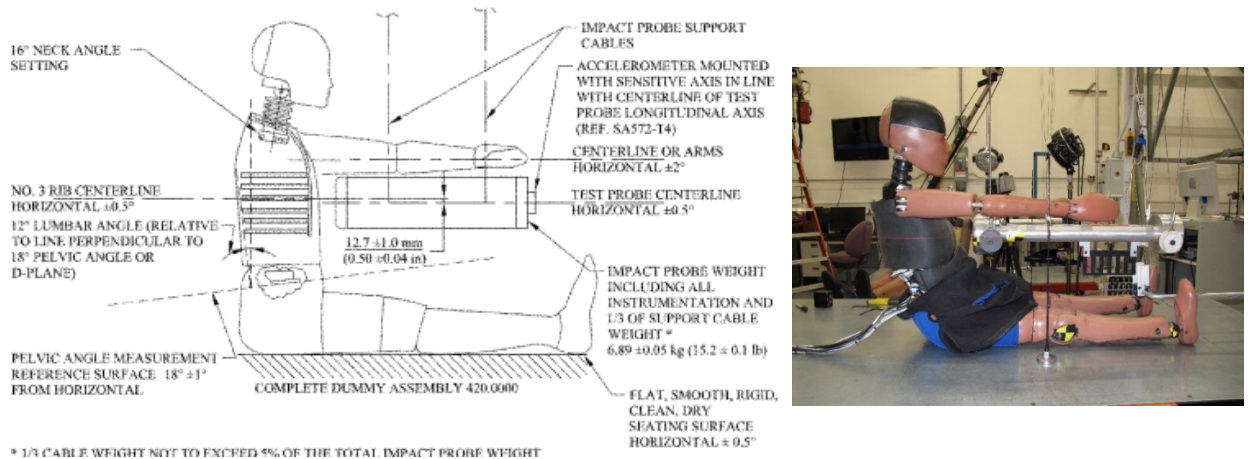

Figure 10. CFR Part 572 frontal thorax impact specifications and test setup

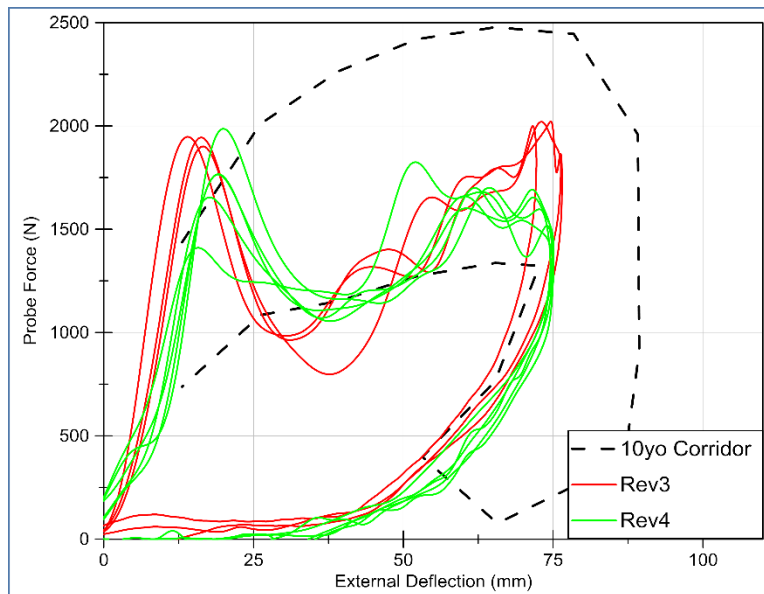

Figure 11. CFR Part 572 frontal thorax test results. The force-deflection corridor was constructed using the same methodology as Parent, Crandall, Bolton, Bass, Ouyang, and Lau (2010), where the pediatric data corridor was scaled to a 10YO “ATD target” corridor using the Part 572 probe mass and velocity.

## 2.5. Abdomen

The material and overall geometry of the LODC Rev3 abdomen was maintained for LODC Rev4. However, based on abdomen belt pull tests and frontal sled tests, slight modifications were made to prevent belt intrusion into the gap between the ribcage and abdomen and to prevent abdomen rotation. Due to these changes, abdomen material was removed to soften the response and better

match the biofidelity target. Figure 12 below shows the Rev3 abdomen (left) with the two holes for the abdomen pressure sensors (abdominal pressure twin sensors [APTS], Transpolis SAS, France) and the Rev4 abdomen with geometry changes and additional holes. In the previous version, an aluminum cup housing a 3 $\omega$  sensor was placed in the front recess of the abdomen. However, in component and sled tests, it was determined that the aluminum cup caused the lap belt to slip over the abdomen. Also, since pressure was already being measured, it was decided that measurement of penetration was not critical for monitoring abdominal loading severity. For these reasons, it was determined that the aluminum cup was not necessary for Rev 4. However, the front recess aided in softening the response to better match the target and was therefore maintained in the Rev 4 abdomen.

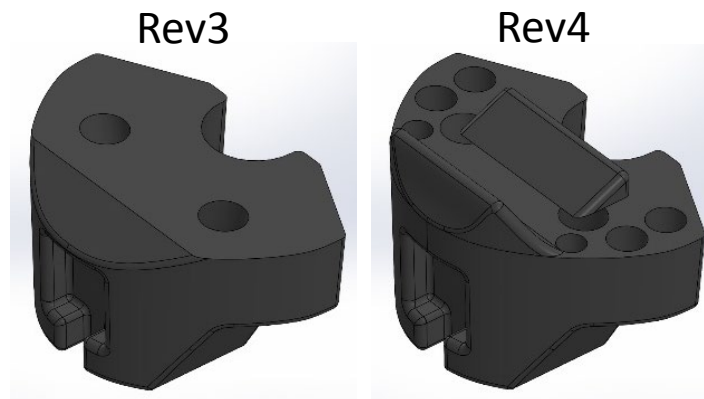

Figure 12. LODC Rev3 and Rev4 abdomen designs

As with LODC Rev3, fixed back abdomen belt pull tests were performed on LODC Rev4. The fixed back abdomen belt pull test setup is shown in Figure 13. Figure 14 shows the force versus belt penetration results of the Rev3 abdomen (red) and the Rev4 abdomen (green) with respect to a biofidelity corridor from Kent et al. (2011). Even with the geometry changes, the Rev4 abdomen matches the response of the Rev3 abdomen with the only difference being a slight increase in deflection, which might be due to the removal of the aluminum cup in the front recess. BioRank scores are also similar. The Rev3 abdomen had a BioRank score of 0.66. The Rev4 abdomen has a slightly worse but still excellent BioRank score of 0.78. This slight decrease in biofidelity was deemed acceptable as a compromise for a more stable design that prevents any risk of the belt entering the space between the ribcage and abdomen.

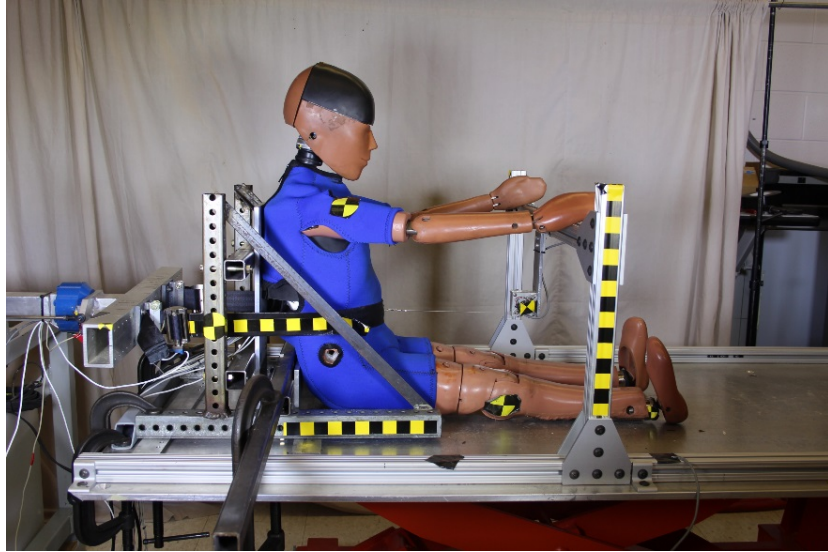

Figure 13. Fixed back abdomen belt pull test setup

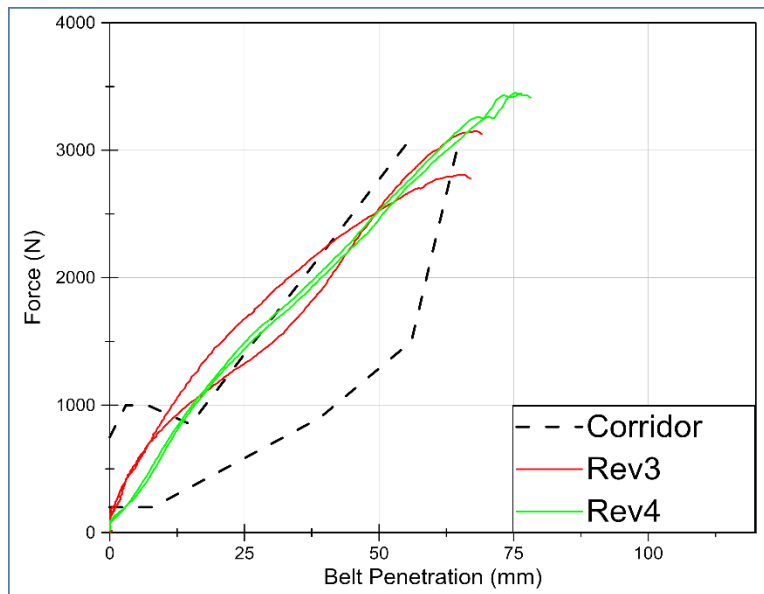

Figure 14. Fixed back abdomen belt pull test results

Impacts were also performed on the LODC Rev4 abdomen following a similar setup to a pediatric study performed by Ouyang, Zhao, Xu, Chen, and Zhong (2006). In the Ouyang study, frontal, mid-sagittal abdominal impacts were performed using a pneumatic ram system with a 3.5 kg, 7.5 cm diameter impactor at an impact speed of  $6.3 \pm 0.3$  m/s. To replicate that condition for this study, a frontal, mid-sagittal pendulum impact was performed using an existing 3.55 kg, 7 cm diameter probe at an impact speed of 6.3 m/s. The abdomen probe impact test setup is shown in Figure 15. Figure 16 below shows the force versus external displacement (calculated from accelerometers located on the probe and T12 location on the spine) results for the Rev4 abdomen. The black box represents the target peak displacement ( $\sim 100$  mm) and corresponding peak force ( $\sim 1000$  N) for a similar aged subject from the Ouyang study. The Rev4 response is observed to be slightly stiffer than the pediatric data. However, it should be noted that the Ouyang study only tested one subject that was similar in size to the LODC.

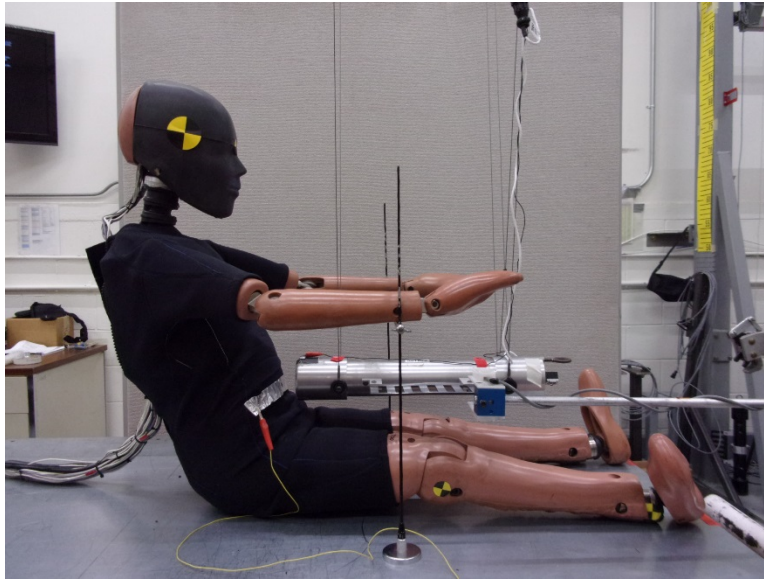

Figure 15. Abdomen probe impact test setup

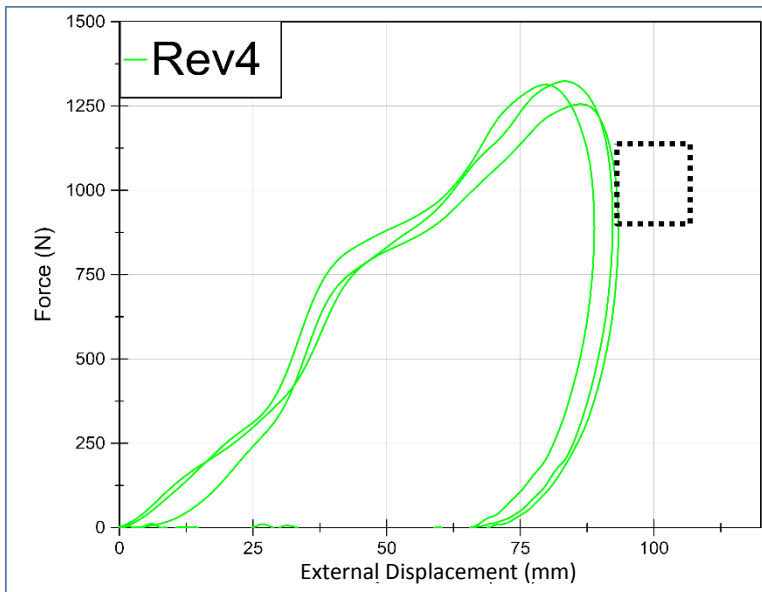

Figure 16. Abdomen probe impact results. The black box indicates pediatric data from Ouyang, Zhao, Xu, Chen, and Zhong (2006)

## 2.6. Component Summary and BioRank

A summary of the component BioRank scores for the HIII-10C, LODC Rev3, and LODC Rev4 is shown in Table 2 below. A lower BioRank score indicates better biofidelity. A score below 2.0 is considered to be acceptable biofidelity and a difference greater than 0.2 is considered to be a significant difference.

Table 2. Summary of component BioRank scores for the HIII-10C and LODCs. BioRank scores were not calculated for the Ouyang abdomen impacts since the comparison was with a single PMHS.

Body Region	HIII-10C	LODC	
		Rev3	Rev4
Head	1.81	0.61	0.79
Neck	2.73	1.57	1.37
Cervicothoracic	1.83	1.35	1.35
Thorax (Part 572)	5.50	1.84	0.79
Abdomen Belt Pull	1.61	0.66	0.78
Abdomen (Ouyang)	--	--	--
OVERALL ATD	2.70	1.21	1.02

The overall result of the update from LODC Rev3 to LODC Rev4 was a net improvement in biofidelity. More importantly, as Rev3 was already quite biofidelic, Rev4 is more practical and easier to work with. For the head and abdomen, necessary changes were made to improve usability while maintaining their biofidelity. The neck nodding block stiffnesses were optimized to achieve better biofidelity by increasing the occipital condyle moments between 25 to 60 degrees of head rotation. Centering the IR-TRACC and the new flesh wrap significantly improved the thorax BioRank score by maintaining the inertial response within the upper boundary of the corridor and by maintaining the force between 25 to 50 mm of deflection within the lower boundary of the corridor. No changes were made to the cervicothoracic region of the dummy.

### 3. FMVSS No. 213 Frontal Sled Testing

Federal Motor Vehicle Safety Standard (FMVSS) No. 213 sled testing was performed on LODC Rev4 in order to compare it to LODC Rev3 and the HIII-10C. The main objectives of this comparison were to: (1) understand how improvements in body region biofidelity influence full body kinematics and response; (2) determine the feasibility of testing the LODC in out of position scenarios; and (3) evaluate whether the LODC is robust enough to withstand crash simulation scenarios.

#### 3.1. Influence of LODC Modifications on Full Body Response

The LODC Rev4 and HIII-10C ATDs were positioned side-by-side on a FMVSS No. 213 bench (Wietholter, Echemendia, & Louden, 2017) that was modified to reflect seat stiffness and belt anchorage locations of modern vehicles. Four restraint configurations appropriate for a 10-year-old child occupant were applied: five-point harness (Britax Frontier Clicktight), highback belt positioning booster (Evenflo Big Kid), backless belt positioning booster (Graco TurboBooster), and no-CRS (Figures 17-20). The standard FMVSS No. 213 pulse was used and ATDs were positioned as consistently as possible with one another using body landmark locations and belt geometries. NHTSA Biomechanics Database (BioDB) numbers are included in the captions of Figures 17-20. The database numbers for all sled tests in this report are found in the appendix.



Figure 17. FMVSS No. 213 setup with LODC Rev4 (BioDB #11756) and HIII-10C (BioDB #11755) seated in the five-point harness (Britax Frontier Clicktight)



Figure 18. FMVSS No. 213 setup with LODC Rev4 (BioDB #11760) and HIII-10C (BioDB #11757) seated in the highback belt positioning booster (Evenflo Big Kid)



Figure 19. FMVSS No. 213 setup with LODC Rev4 (BioDB #11762) and HIII-10C (BioDB #11759) seated in the backless belt positioning booster (Graco TurboBooster)



Figure 20. FMVSS No. 213 setup with LODC Rev4 (BioDB #11764/11766) and HIII-10C (BioDB #11761/11763) seated in the no-CRS upright (top) and slouched (bottom) posture configurations, respectively

Figure 21 shows the head trajectories for LODC Rev4, LODC Rev3 (green and red curves, respectively), and the HIII-10C (blue curve). In the five-point harness, LODC Rev4 shows slightly less forward excursion than Rev3, which are both less than the HIII-10C. Both versions of the LODC show similar downward excursions, which are both greater than the HIII-10C. In the highback belt positioning booster (BPB), there is very little difference between both versions of the LODC and both show greater forward and downward excursions than the HIII-10C. In the backless BPB, LODC Rev4 shows less forward and downward excursion than Rev3, but more forward excursion than the HIII-10C. In the slouched scenario without a CRS, there is also very little difference between both LODCs, which have slightly more forward excursion than the HIII-10C. Overall, it appears that the modifications to improve component biofidelity and usability did not adversely influence head kinematics as LODC Rev4 had similar kinematics to Rev3, which had earlier been shown to exhibit similar kinematic characteristics to a human specimen.



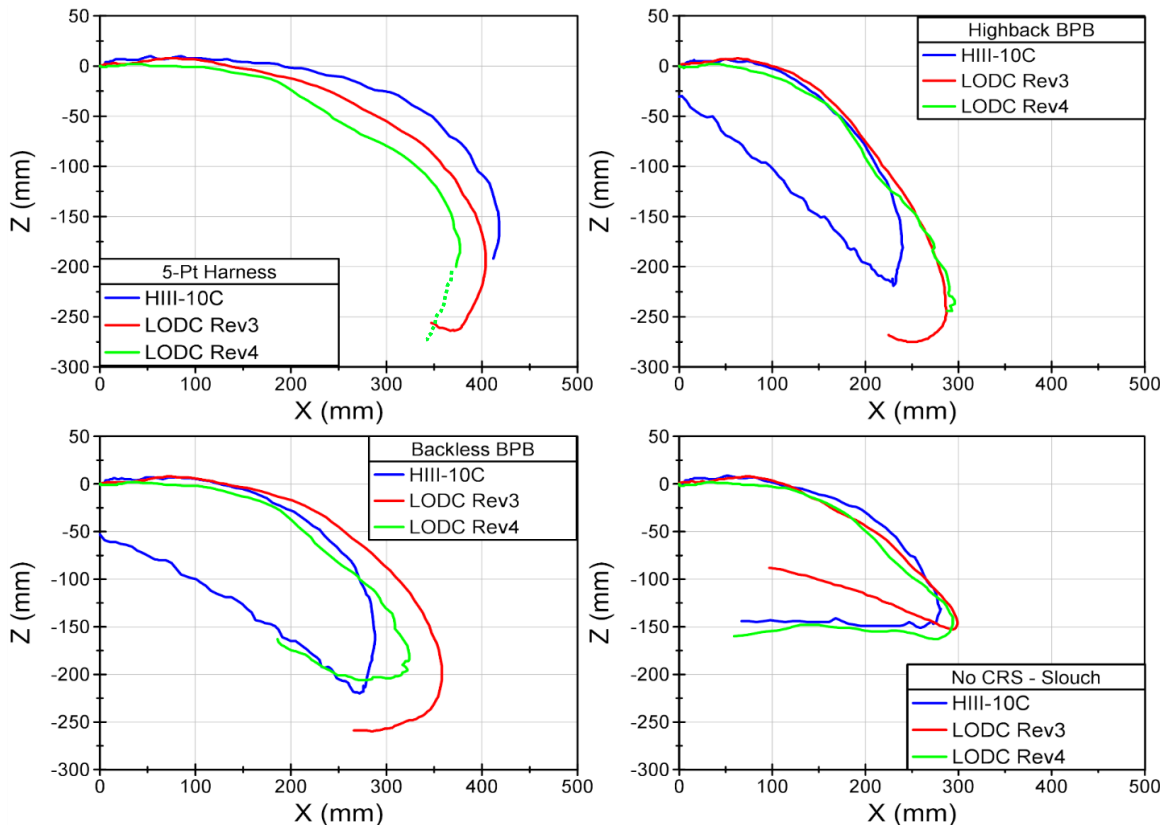

Figure 21. FMVSS No. 213 head trajectory results for the HIII-10C (blue), LODC Rev3 (red), and LODC Rev4 (green). Note that for the 5-Pt harness, the LODC arm blocks the view of the head CG target. The dotted line is an estimate of the head CG target's motion until it comes back in view at (340 mm, -271 mm).

Figure 22 to Figure 24 show the FMVSS No. 213 injury assessment reference values (IARVs) for the HIII-10C, LODC Rev3, and LODC Rev4 in the four restraint conditions. Looking at Head Injury Criterion (HIC) (Figure 22), values for both LODC Rev3 and Rev4 are similar to one another, and both are lower than the HIII-10C, indicating that LODC Rev4 is continuing to mitigate hard chin-chest contacts. Regarding forward head excursion (Figure 23), there is little difference between LODC Rev3 and Rev4 and the HIII-10C in the 5-pt harness and no-CRS cases. However, both LODCs show a greater amount of excursion in both BPB cases. Regarding knee excursion (Figure 24), there is little difference between any of the dummies.

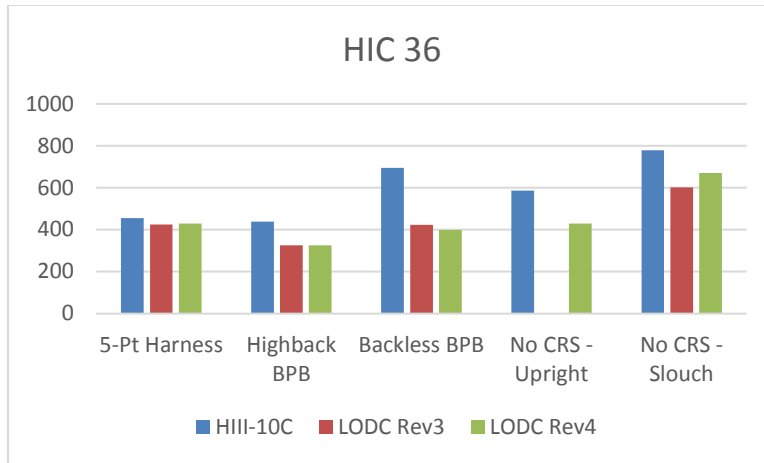

Figure 22. FMVSS No. 213 HIC 36 results for the HIII-10C (blue), LODC Rev3 (red), and LODC Rev4 (green)

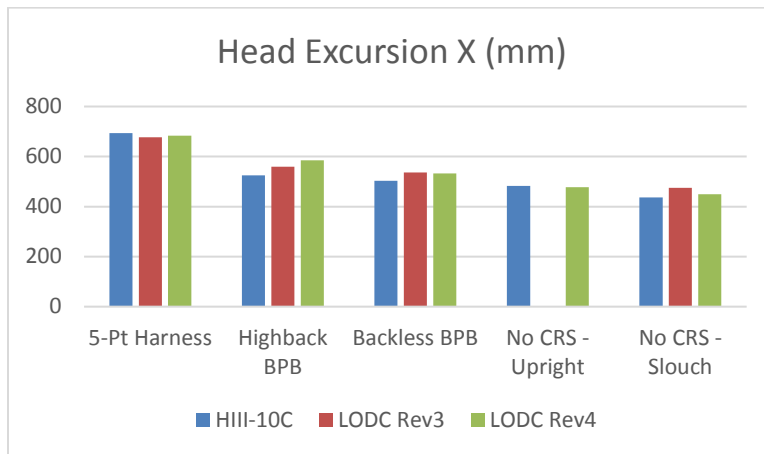

Figure 23. FMVSS No. 213 head excursion results for the HIII-10C (blue), LODC Rev3 (red), and LODC Rev4 (green)

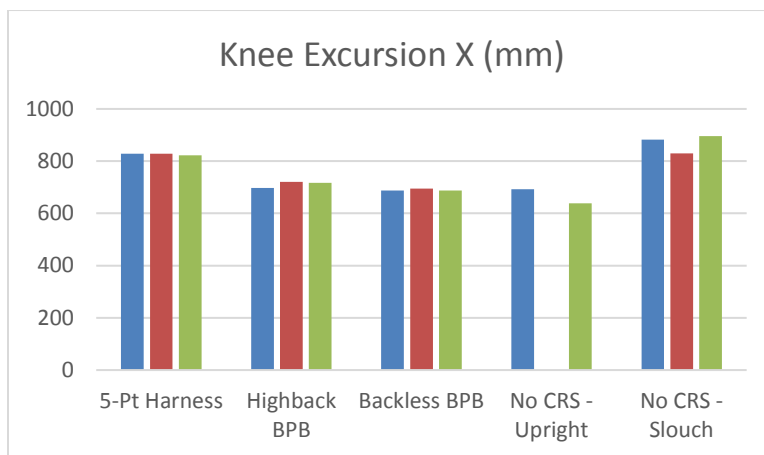

Figure 24. FMVSS No. 213 knee excursion results for the HIII-10C (blue), LODC Rev3 (red), and LODC Rev4 (green)

Comparing LODC Rev3 and Rev4, there was very little difference in HIC and forward head and knee excursion values, indicating that component improvements did not affect those IARVs. However, chest

accelerations were observed to increase from LODC Rev3 to Rev4 in the three child restraint cases as shown in Figure 25 below.

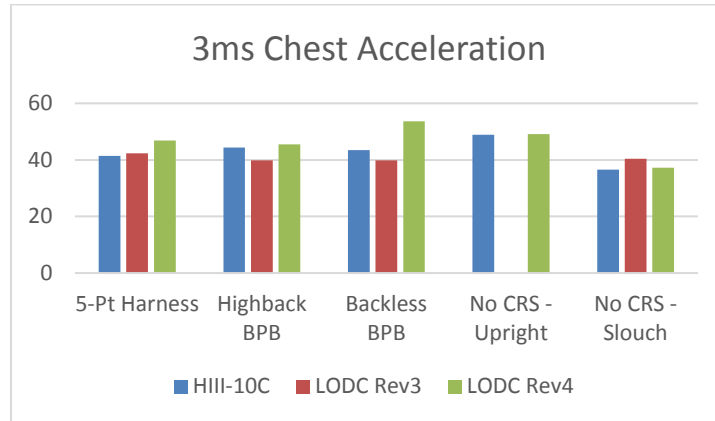

Figure 25. FMVSS No. 213 3 ms chest acceleration results for the HIII-10C (blue), LODC Rev3 (red), and LODC Rev4 (green)

The main difference between the LODC Rev3 and Rev4 thorax is the location of the IR-TRACC. As mentioned earlier and looking back at Figure 9, LODC Rev4 has an IR-TRACC that is centered along the spine rather than mounted to the side as in Rev3, allowing for greater range. Figure 26 below shows an increase in chest deflection for LODC Rev4 in both booster cases, indicating that the Rev4 thorax might be able to differentiate between the BPB cases and the no-CRS cases better than Rev3. This increase is due to the centered IR-TRACC being able to measure frontal deflection without any obstruction. In LODC Rev3, the side-mounted IR-TRACC was observed to rotate into and contact the spine and internal instrumentation, limiting its full range of deflection and bottoming out sooner. While the un-obstructed measurement of actual chest deflection is a positive outcome, the increased deflection in Rev4 might be an issue as the magnitude is at or near the maximum allowable deflection in the thorax even in situations where injury would not be expected, indicating that the LODC Rev4 thorax might be too soft. The LODC Rev4 thorax stiffness will therefore need to be further explored.

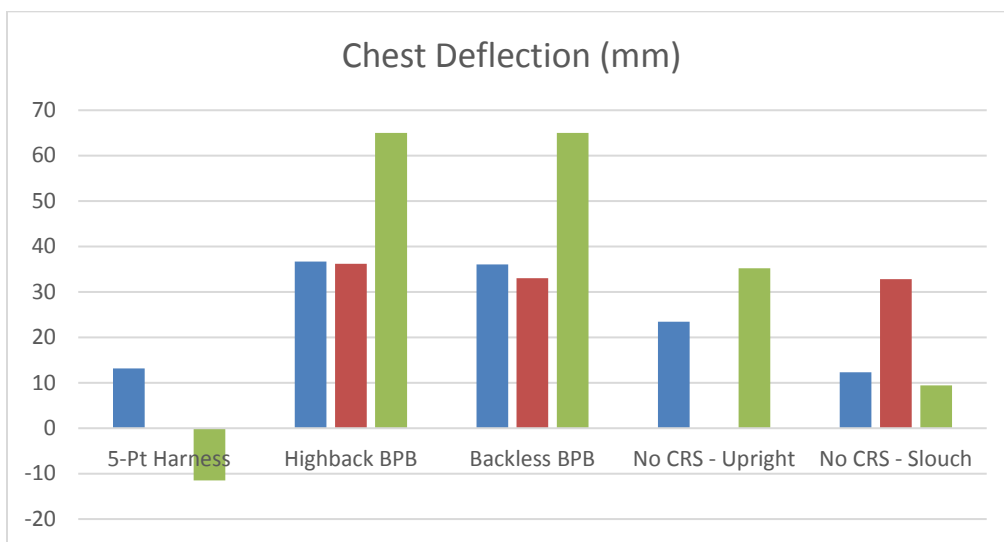

Figure 26. FMVSS No. 213 chest deflection results for the HIII-10C (blue), LODC Rev3 (red), and LODC Rev4 (green)

### 3.2. Feasibility of Testing the LODC Rev4 in Out-of-Position Scenarios

A recent study by Arbogast et al. (2016) monitored the head positions of children in naturalistic driving scenarios, and they found that children did not typically ride with their heads fully upright. To investigate the more realistic head positions, two head out-of-position (OOP) scenarios from that Arbogast study were replicated with both the LODC and Hybrid III 10 year old: (1) Head OOP where the top of the head was positioned 100 mm forward and 100 mm inboard from the standard position (LODC Rev4 = BioDB #11770, HIII-10C = BioDB #11769); and (2) Extreme Head OOP where the top of the head was positioned 300 mm forward and 100 mm inboard from the standard position (LODC Rev4 = BioDB #11772, HIII-10C = BioDB #11771). Figure 27 below shows an out-of-position sled setup.

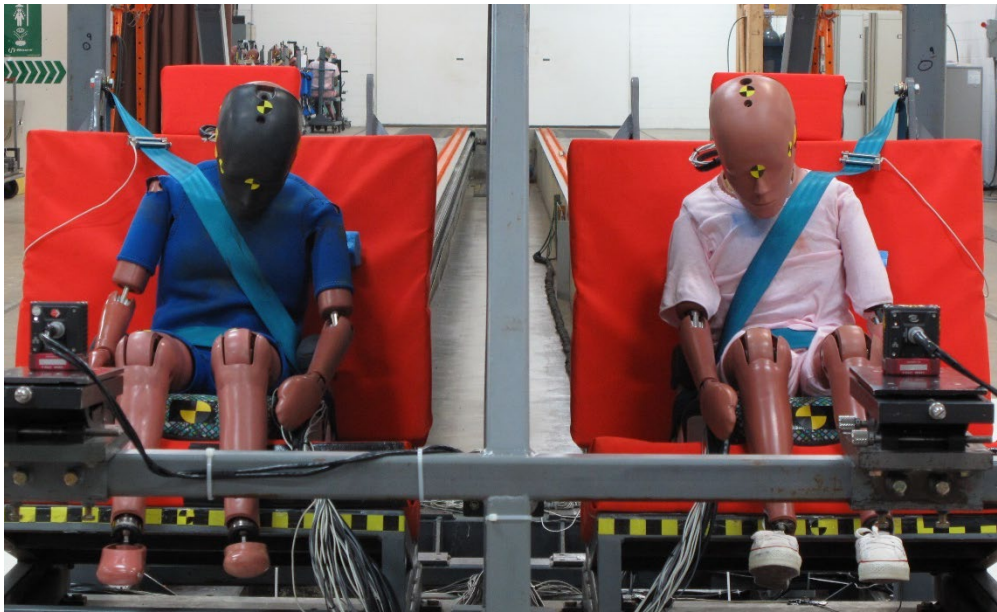

Figure 27. Extreme head out-of-position setup in a sled test using the FMVSS No. 213 pulse

When positioning the ATDs in the head out-of-position sled tests, foam was placed between the seatback and back of both ATDs to maintain the desired initial head position. Due to its stiff spine and stiff abdomen, it was a challenge to position the HIII-10C in the naturalistic position. On the other hand, because of its adjustable lumbar angle, adjustable neck angle, more flexible spine, and softer abdomen, the LODC head positioning was easier to accomplish. The LODC would slouch forward in a naturalistic position while the HIII-10C was rotated at its lumbar spine. Although the initial top of the head position was achieved in the forward (x) and inboard (y) directions, the height (z) of the LODC Rev4 head was observed to be lower than the HIII-10C, primarily due to its flexibility and adjustability.

Figure 28 shows HIC results comparing a standard FMVSS No. 213 upright head position with the two head out-of-position scenarios. In a previous study (Stammen & Sullivan, 2008), the HIII-10C was found to have HIC values that were very sensitive to initial posture. In the current comparison between LODC Rev4 and HIII-10C where head position was varied, the HIII-10C again exhibited more HIC variation than LODC Rev4 with respect to initial head position.

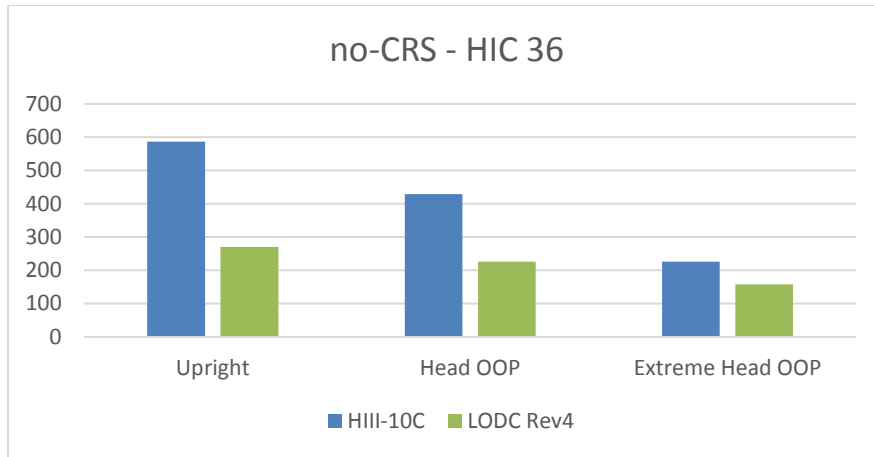

Figure 28. HIII-10C and LODC Rev4 HIC 36 results comparing a standard upright head position with two out-of-position scenarios

A worst-case scenario in which only a lap belt was used and in which the ATDs were in a slouched position was also tested to evaluate if the LODC Rev4 can detect submarining (LODC Rev4 = BioDB #11774, HIII-10C = BioDB #11773). Figure 29 below shows the abdomen pressures (average of left and right sensor) from all the tests in this series for LODC Rev4. The two expected submarining scenarios (no-CRS – Slouch and no-CRS – Lap Belt Only), which was also confirmed by high speed video, experienced significantly higher abdomen pressures, indicating that the LODC Rev4’s instrumented abdomen is effective for detecting submarining.

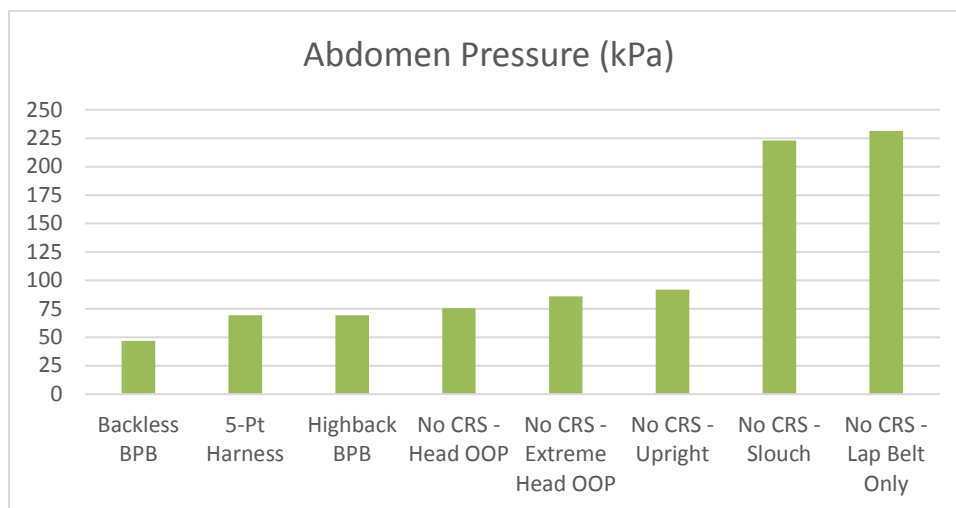

Figure 29. LODC Rev4 abdomen pressure results from various seating configurations

### 3.3. Summary of FMVSS No. 213 Sled Testing

The modifications to improve component biofidelity and usability did not greatly affect head kinematics of LODC Rev4 in sled testing and HIC values for the LODC Rev4 are still lower than the HIII-10C. However, the thorax response needs to be further explored. The threshold between non-injurious and injurious chest deflections still needs to be determined in the FMVSS No. 213 environment for the LODC. Unlike

the abdomen, there is no kinematic indicator like submarining to correlate with an injurious chest deflection magnitude using the dummy. To facilitate this, further research is needed to look into scenarios that result in thorax injury in child occupants seated in a three-point belt. Additionally, there are plans to look at different chest deflection measurement methods in the future. The LODC Rev4 was easier to position than the HIII-10C in more naturalistic scenarios due to its flexibility and adjustability. Lastly, the LODC Rev4 abdomen was observed to be a good discriminator between submarining and no submarining, but more testing and analysis will be needed to determine an appropriate IARV for the LODC Rev4 abdomen.

## 4. LODC Rev4 Repeatability and Reproducibility

As a result of component tests and FMVSS No. 213 sled tests with LODC Rev4, it was determined that the response of the LODC Rev4 was acceptable enough to build two additional dummies for evaluating reproducibility. Component tests and FMVSS No. 213 frontal sled tests were performed on the additional LODC Rev4 ATDs.

### 4.1. Component Repeatability and Reproducibility

The same component tests that are described in Section 2 of this report were performed on the two additional LODC Rev4 ATDs. For repeatability on a given LODC Rev4, the percent coefficients of variation (CV) for the measurements in all the component tests were below 4 percent, indicating excellent repeatability. Table 3 summarizes the component peak results for the three LODC Rev4 builds, including the mean, standard deviation, and CV. CVs were all below 10 percent for the three LODC Rev4 builds, which indicates good reproducibility (Rhule, Rhule & Donnelly,2005). All but two of the measurements were below 6 percent, which is the threshold for excellent reproducibility.

Table 3. Summary of component peak results for the three LODC Rev4 builds. Three repeats were performed for each component test and for each LODC Rev4 build (n = 9).

Component Test	Measurement	Mean	Std Dev	CV
Head Drop (150 mm)	Peak Resultant (g)	82.6	6.2	7.5%
Head Drop (300 mm)	Peak Resultant (g)	137.8	6.2	4.5%
Neck Flexion	Peak Rotation (deg)	79.2	1.8	2.3%
Neck Flexion	OC Moment @ Peak Rot (Nm)	41.0	2.9	7.1%
Frontal Thorax (Part 572)	Peak Deflection (mm)	74.9	0.2	0.3%
Frontal Thorax (Part 572)	Force @ Peak Deflection (N)	1356.6	50.5	3.7%
Abdomen Belt Pull	Peak Belt Penetration (mm)	107.0	2.0	1.9%
Abdomen Belt Pull	Belt Force @ Peak Penetration (N)	3596.6	120.1	3.3%

### 4.2. FMVSS No. 213 Frontal Sled Testing to Assess LODC Rev4 Repeatability and Reproducibility

Similar to the first series of sled testing described in Section 3, the two additional LODC Rev4 builds were positioned side-by-side on the same modified FMVSS No. 213 bench that reflects seat stiffness and belt anchorage locations of modern vehicles (Figure 30). Reproducibility was assessed using the backless belt

positioning booster (Graco TurboBooster), as this restraint condition was deemed the most likely for a child occupant of this size. The standard FMVSS No. 213 pulse was used and the ATDs were positioned as consistently as possible with earlier build levels of the LODC in the previous sled tests using body landmark locations and belt geometries. Three sled tests (two ATDs per test for a total of six ATD exposures) were performed (see BioDB #11775 – 11780).



Figure 30. FMVSS No. 213 setup with two LODC Rev4 builds to evaluate reproducibility

Table 4 summarizes percent coefficients of variation (CV) for HIC, chest acceleration, head and knee excursion, and chest deflection for the three LODC Rev4 builds. For repeatability, nine of the fifteen measures were below 5 percent (excellent), two measures were between 5 percent and 8 percent (good), one measure was between 8 percent and 10 percent (marginal), and three measures were above 10 percent (poor). LODC 003 was the most repeatable of the three dummies, with the highest CV being 3.0 percent across all measures. For reproducibility across the three dummies, CVs ranged from 1.5 percent (knee excursion) to 13.0 percent (HIC).

Table 4. Summary of mean, standard deviation, and percent coefficients of variation (CV) for the three LODC Rev4 builds

	NHTSA BioDB #	HIC 36	3 ms Chest Acceleration (g)	Chest Deflection (mm)	Head Excursion (mm)	Knee Excursion (mm)
<b>LODC 001</b>	11762, 11768	282 ± 52 (18.6%)	49 ± 6.7 (13.8%)	62 ± 4.5 (7.3%)	511 ± 30 (5.8%)	682 ± 9 (1.4%)
<b>LODC 002</b>	11776, 11778, 11780	284 ± 40 (13.9%)	40 ± 3.7 (9.2%)	56 ± 0.2 (0.3%)	544 ± 10 (1.8%)	698 ± 10 (1.4%)
<b>LODC 003</b>	11775, 11777, 11779	343 ± 4 (1.2%)	40 ± 1.2 (2.8%)	55 ± 1.5 (2.8%)	524 ± 16 (3.0%)	692 ± 11 (1.6%)
<b>Combined</b>	N = 8 tests listed above	305 ± 40 (13.0%)	42 ± 4.8 (11.3%)	57 ± 3.3 (5.9%)	528 ± 19 (3.6%)	692 ± 10 (1.5%)

A slight rear neck rubber delamination occurred with LODC 001 and 002, which is the likely reason for the higher CVs for HIC than observed in LODC 003. Additionally, note that the mean value for HIC across the three dummies was only 305, which is quite low to begin with, so small variation will lead to greater CVs than if the mean value was higher.



Regarding the high CV for chest acceleration in LODC 001, the average peak chest acceleration across the three dummies was 42 g. LODC 001 had one test in which the peak chest acceleration was 54 g and peak chest deflection was 65 mm (average across the three dummies was 57 mm). This outlier might be explained by the dummy's initial position in the sled test. Figure 31 shows the initial position of the LODC in two different sled tests. The photo on the left shows LODC 001 in the test that exhibited the abnormally high chest acceleration. The photo on the right is of a test with LODC 001 that exhibited a more normal chest acceleration. Notice that the left photo shows the thorax protruding forward of the abdomen, which might be due to the flesh wrap being installed incorrectly. This was the only test where this inconsistency in positioning was observed and could be a likely reason for the high chest acceleration and resulting high CV for LODC 001. This discrepancy in belt engagement with the ribcage highlights the need for a more detailed seating procedure for the dummy to be configured consistently from test to test.



Figure 31. Initial position of LODC 001 (left) that exhibited an unusually high chest acceleration versus an LODC that exhibited a more normal chest acceleration (right)

### 4.3. Summary of LODC Rev4 Repeatability and Reproducibility

Based on component testing of the two additional LODC builds, the Rev4 version of the LODC was found to be reproducible. In FMVSS No. 213 frontal sled testing, LODC 003 was found to be very repeatable. The neck delamination in LODC 001 and LODC 002 is the likely reason for the higher CVs for HIC, and the neck manufacturing process has been improved to prevent this from occurring in the future. In addition, a discrepancy in how the flesh wrap was configured over the ribcage led to some variation in chest acceleration and deflection. These issues will be addressed in the LODC Rev5, and LODC Rev5 reproducibility will be re-evaluated in future sled testing.

## 5. 2016 Chevrolet Malibu Vehicle Buck Sled Testing

To determine feasibility and durability in a vehicle rear seat test scenario, both the LODC Rev4 and HIII-10C were evaluated in the rear seat of a 2016 Chevrolet Malibu vehicle buck, which is shown in Figure 32 and Figure 33 below. Both frontal (Figure 32) and 20° oblique (Figure 33) impact scenarios were evaluated. Although the HIII-10C is a frontal dummy, it was included in this oblique testing to assess in what areas the omni-directional characteristics of the LODC improve upon the frontal-only design of the HIII-10C.



Figure 32. 2016 Chevrolet Malibu sled buck in a frontal configuration



Figure 33. 2016 Chevrolet Malibu sled buck in an oblique configuration

The LODC Rev4 and HIII-10C were evaluated in either a backless belt positioning booster (Graco TurboBooster) or in no child restraint (No CRS). For oblique tests, dummies were evaluated in both far-side and near-side seating positions. A test matrix for the vehicle buck sled tests is shown in Table 5 below. Figure 34 shows the LODC Rev4 and HIII-10C set up in backless belt positioning boosters (left) and in no-CRS (right). The FMVSS No. 213 standard pulse was applied in all tests.

Table 5. Test matrix for 2016 Chevrolet Malibu vehicle buck sled tests

Test #	Buck Orientation	Passenger (Far Side)	NHTSA BioDB #	Driver (Near Side)	NHTSA BioDB #	Child Restraint System
1	Frontal	LODC Rev4	11782	HIII-10C	11781	Backless BPB
2	Frontal	LODC Rev4	11784	HIII-10C	11783	No CRS
3	Oblique	LODC Rev4	11786	HIII-10C	11785	Backless BPB
4	Oblique	LODC Rev4	11788	HIII-10C	11787	No CRS
5	Oblique	HIII-10C	11790	LODC Rev4	11789	Backless BPB
6	Oblique	HIII-10C	11792	LODC Rev4	11791	No CRS



Figure 34. HIII-10C and LODC Rev4 setup in a backless belt positioning booster (left) and with no-CRS (right) in the rear seat of the Chevrolet Malibu vehicle buck

## 5.1. Vehicle Buck Sled Test Results

Figure 35 presents the HIC 36 and 3 ms chest accelerations for the LODC Rev4 and HIII-10C in the frontal Malibu buck sled tests using both the backless BPB and no CRS. A reduction in HIC is observed with the LODC Rev4, which was similarly observed in the FMVSS No. 213 sled series, indicating that the LODC Rev4 is mitigating hard chin-to-chest contact (see Figure 22). Although the LODC Rev4 and HIII-10C measured similar chest accelerations with the backless BPB in the vehicle buck, the LODC Rev4 exhibited much higher chest accelerations in the no-CRS scenario. This trend of higher chest accelerations contrasts with the FMVSS No. 213 sled tests, where the chest accelerations were similar for the CRS and no-CRS cases with the LODC Rev4 (see Figure 25). Differences between the FMVSS No. 213 and vehicle rear seat are also evident when comparing the HIII-10C with the LODC Rev4; the LODC Rev4 had higher chest accelerations than the HIII-10C in the CRS cases, but similar chest accelerations as the HIII-10C in the no-CRS cases in the FMVSS No. 213 tests. These differences between the FMVSS No. 213 and vehicle rear seat environment may be due to the legs interacting with the seatback, belt geometry, or seat cushion stiffness. More research is needed to investigate how these differences influence chest acceleration.

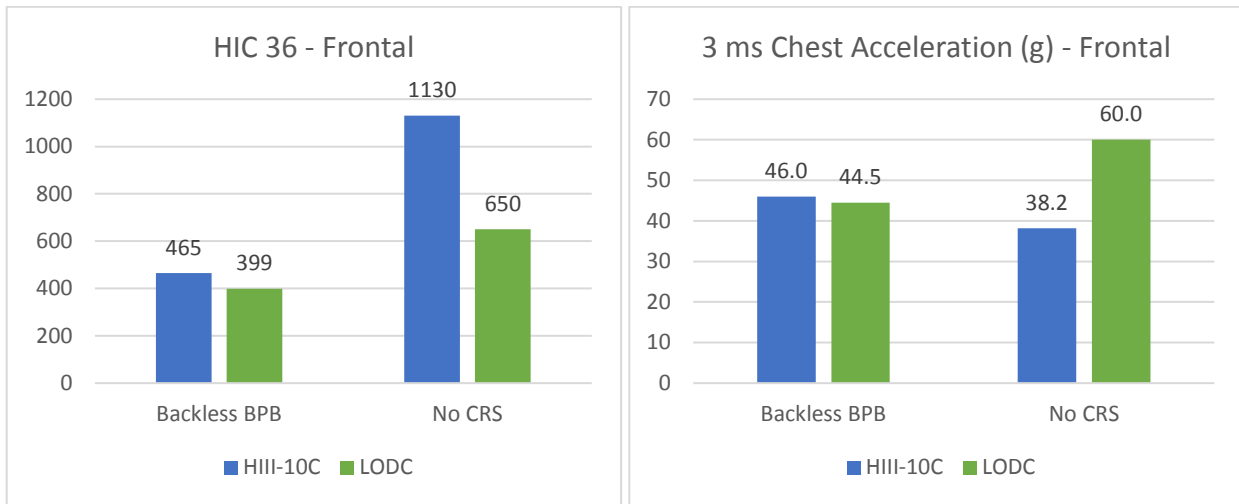

Figure 35. HIC 36 (left) and chest acceleration (right) results from the frontal Malibu buck sled tests for the HIII-10C (blue) and LODC Rev4 (green)

Figure 36 presents the HIC 36 results for the oblique Malibu sled tests. Near side oblique results are shown on the left and far side oblique results are shown on the right. As with the frontal tests, HIC is reduced in the LODC Rev4 relative to the HIII-10C, except the backless BPB in the far side oblique scenario. This exception is more due to the reduction in the HIII-10C HIC rather than a discrepancy for the LODC Rev4 in the two oblique modes. Note that HIC is consistent for the LODC Rev4 in the near (459) and far (465) side modes. The reduction in HIC for the HIII-10C is due to the shoulder belt sliding off the shoulder and the ATD subsequently rolling out of the belt and into the center area of the rear seat (Figure 37).

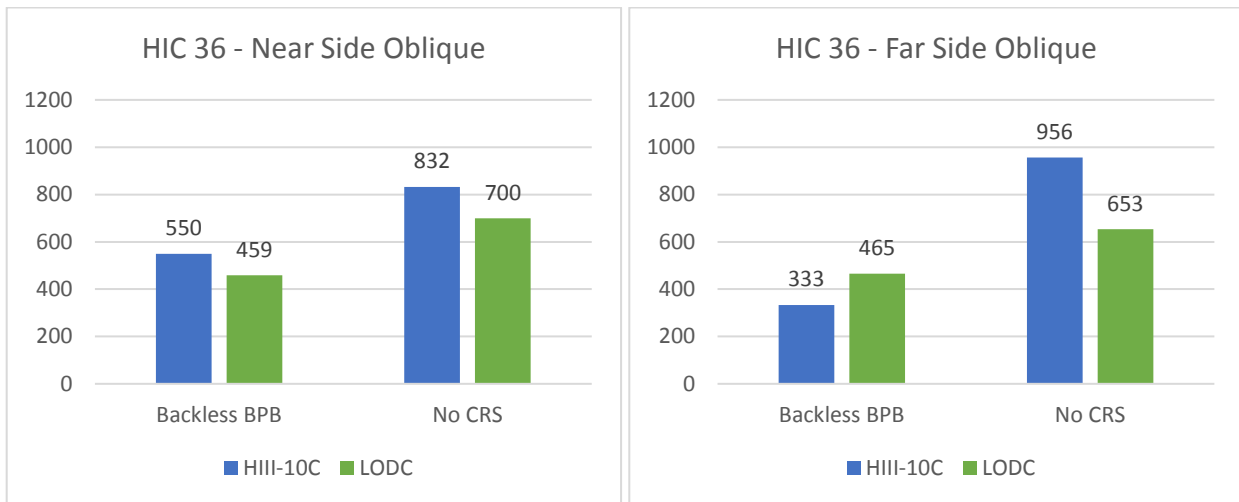

Figure 36. Near side occupant (left) and far side occupant (right) HIC 36 results from the oblique Malibu buck sled tests for the HIII-10C (blue) and LODC Rev4 (green)

Figure 38 presents the chest acceleration results for the oblique Malibu sled tests. In near side oblique tests (left), the LODC Rev4 performed similarly to the HIII-10C with the backless BPB, which is probably due to the shoulder belt being positioned appropriately over the sternum in both ATDs. The LODC Rev4

showed increased chest accelerations when using no CRS, which is consistent with the frontal tests. In far side oblique tests, the LODC Rev4 exhibited lower chest accelerations than the HIII-10C when using a BPB due to increased spine flexibility. When using no CRS, the LODC Rev4 exhibited higher chest accelerations than the HIII-10C due to the shoulder belt engagement of the LODC Rev4 and the lack of engagement and rolling out of the shoulder belt with the HIII-10C (Figure 37).

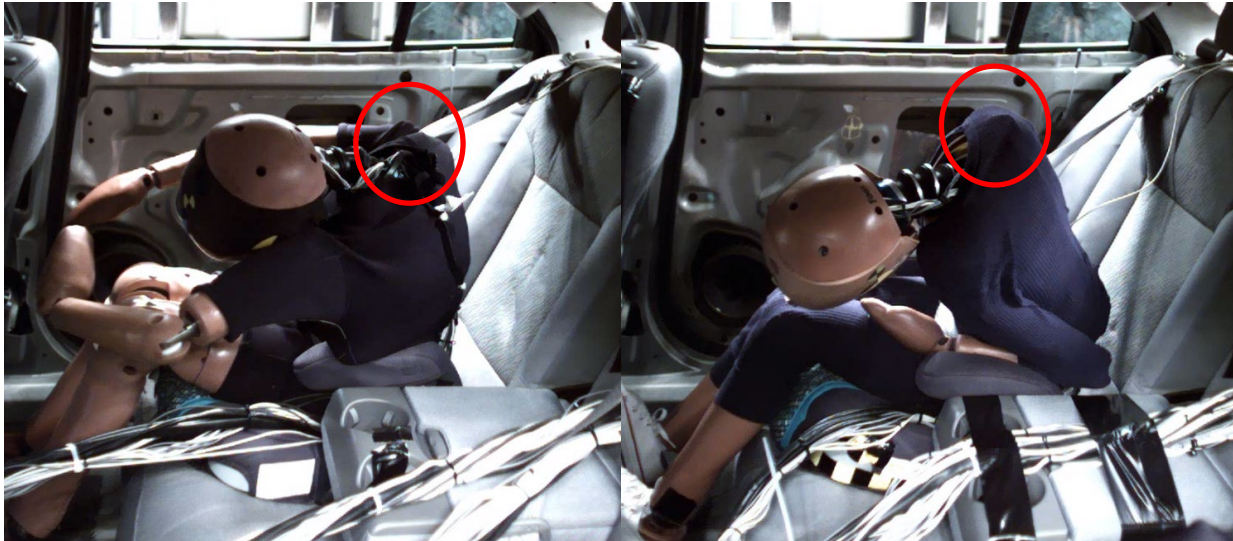

Figure 37. Far side oblique tests with the backless BPB showing shoulder belt engagement with the LODC Rev4 (left) and lack of belt engagement and torso roll out of the HIII-10C (right)

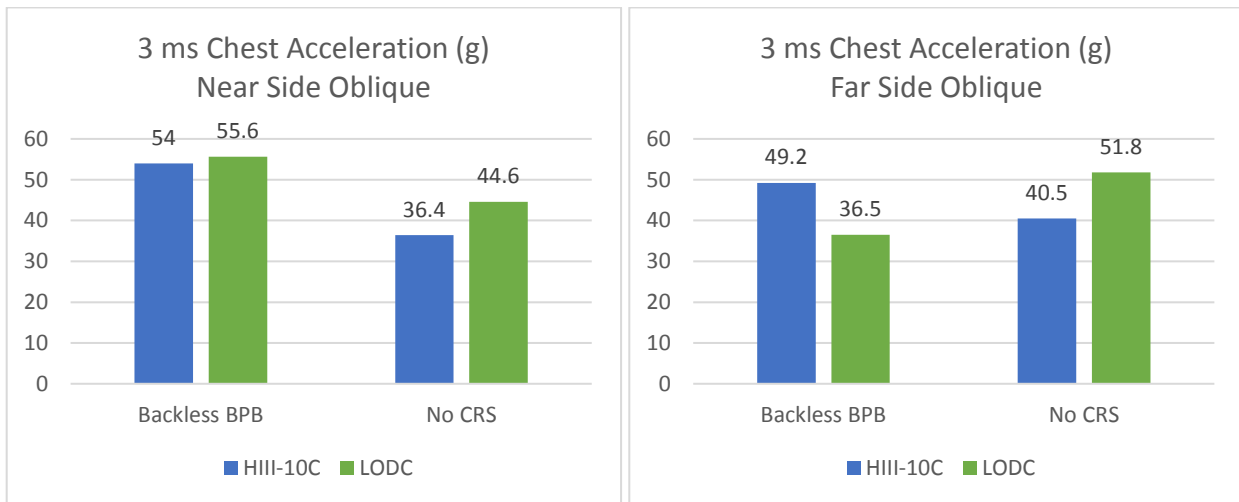

Figure 38. Near side occupant (left) and far side occupant (right) chest acceleration results from the oblique Malibu buck sled tests for the HIII-10C (blue) and LODC Rev4 (green)

Although no comparisons can be made with the HIII-10C, the LODC Rev4 abdomen pressures (left, right, and summation) are presented in Figure 39. As with the FMVSS No. 213 sled tests, the LODC Rev4 abdomen was observed to be a good indicator for submarining as the no-CRS scenarios experienced much higher abdomen pressures than the backless BPB scenario. Additionally, in the far side oblique scenario, the left pressure sensor of the abdomen experienced higher pressures than the right sensor, which is consistent with the LODC Rev4 engaging the bottom of the shoulder belt as it moves towards the left during the impact.

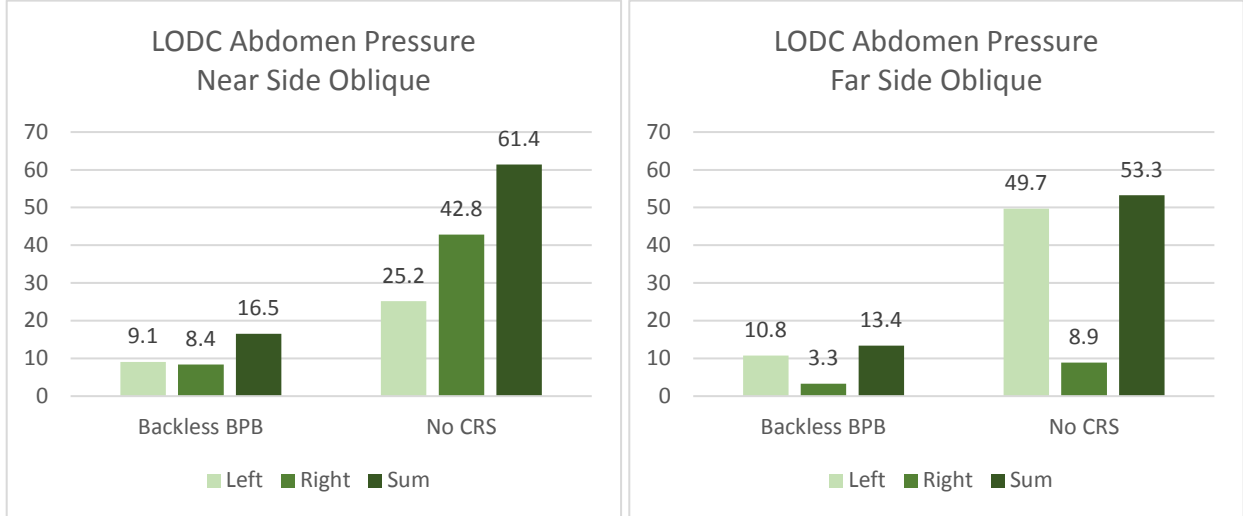

Figure 39. Near side occupant (left) and far side occupant (right) abdomen pressure results from the oblique Malibu buck sled tests for the LODC Rev4

No issues with durability arose during the vehicle buck sled tests with LODC Rev4. However, two design issues were observed that will need to be resolved. The first issue is with the abdomen. During the tests, the abdomen was observed to translate forward and out of its cavity as shown in Figure 40 (left). Additionally, in the far side oblique scenarios, the shoulder belt was observed to become trapped between the upper arm and distal clavicle as shown in Figure 40 (right).



Figure 40. Forward translation of the abdomen (left) and shoulder belt entrapment (right) of the LODC Rev4 in the Malibu vehicle buck sled tests

## 5.2. Additional LODC Modifications Component Testing

In the course of testing LODC Rev4, four main issues were observed: (1) neck delamination, (2) inconsistent chest wrap fit, (3) forward translation of the abdomen, and (4) shoulder belt entrapment between the clavicle and upper arm. The neck delamination issue was solved by addressing the manufacturing process. The chest wrap internal contours were refined to achieve consistent fit. The abdomen and shoulder issues warranted further investigation due to their influence on the response of the ATD. Additional modifications were made to the LODC Rev4 to address the abdomen and shoulder belt entrapment issues and the updated version will be referred to as LODC Rev5. Evaluation of those modifications is described in the following sections.

### 5.2.1. Abdomen

In the vehicle buck sled tests, the abdomen was observed to translate forward and out of LODC Rev4 as was shown in Figure 40. Abdomen retaining brackets were added to the Rev5 design to fasten the abdomen around the lumbar spine and prevent any forward translation. Additional holes were added to the abdomen to the areas that extend on either side of the lumbar spine. The retaining brackets are then inserted into these holes and a zip-tie is secured between the two retainers and around the rear side of the lumbar. The abdomen retaining brackets are shown in Figure 41.

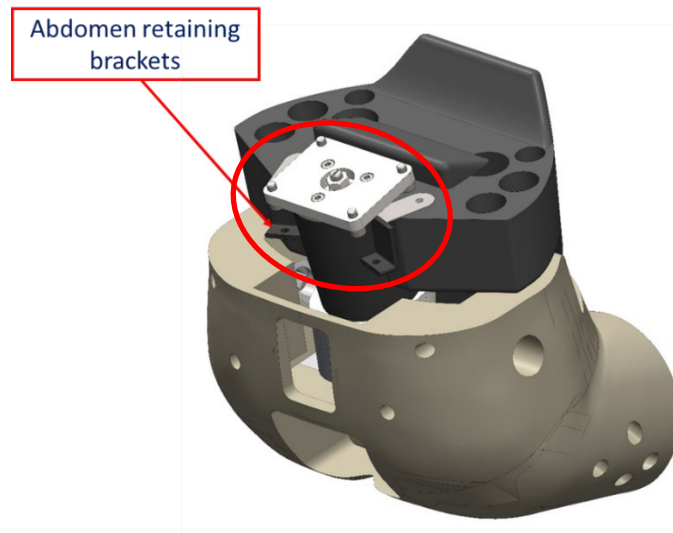

Figure 41. Abdomen retaining brackets to prevent forward translation during sled testing

The fixed back abdomen belt pull tests (see Figure 13 for setup) were performed on the modified LODC Rev5 abdomen to see if the response would change. Figure 42 below shows the force versus belt penetration results of the abdomen without (light green) and with (dark green) the new retaining brackets. Even with the additional retaining brackets, the Rev5 abdomen matches the response of the Rev4 abdomen.

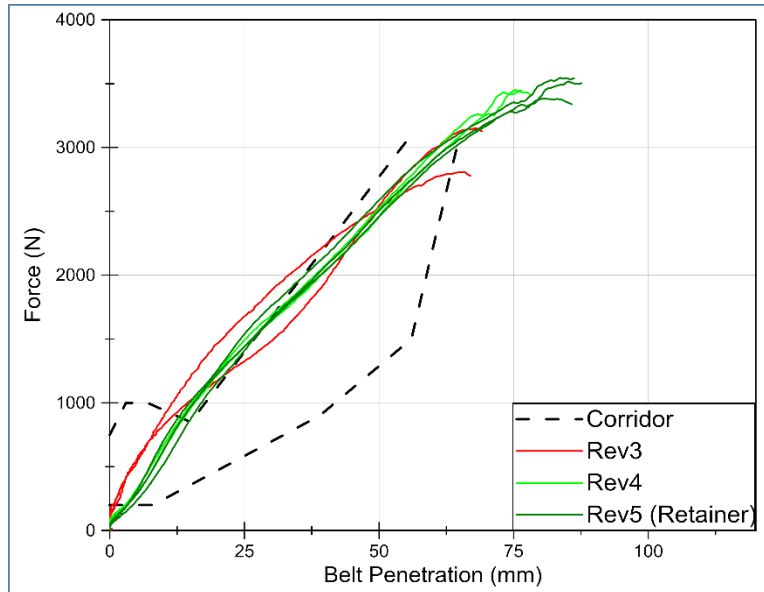

Figure 42. Fixed back abdomen belt pull results for the LODC Rev5 abdomen with retaining brackets

### 5.2.2. Shoulder Modification

In far side oblique sled tests, the shoulder belt was observed to get artificially trapped between the distal end of the clavicle and the upper arm as shown in Figure 40. To prevent this artificial shoulder belt entrapment, the LODC's shoulder bushing was modified and extended forward to provide lateral support to the clavicle (Figure 43).

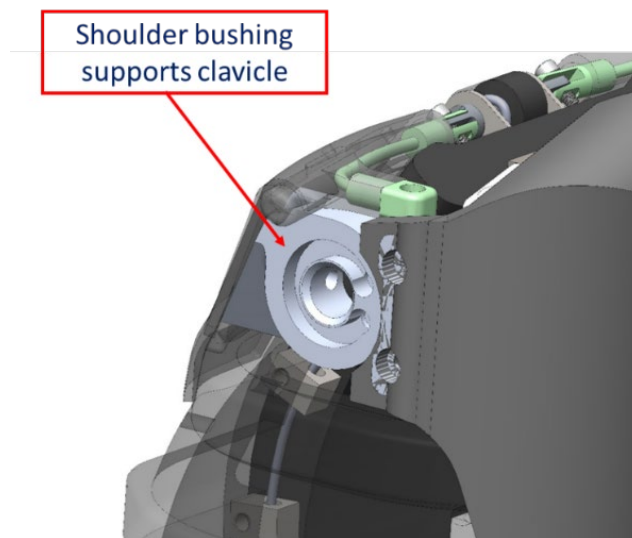

Figure 43. LODC Rev5 shoulder modifications to provide distal clavicle support

Additionally, a modification to the upper arm was made (Figure 44) to create a smoother transition between the distal clavicle and upper arm and to cover up any discontinuities between the upper arm attachment and upper arm flesh that the shoulder belt can catch regardless of the arm's position.



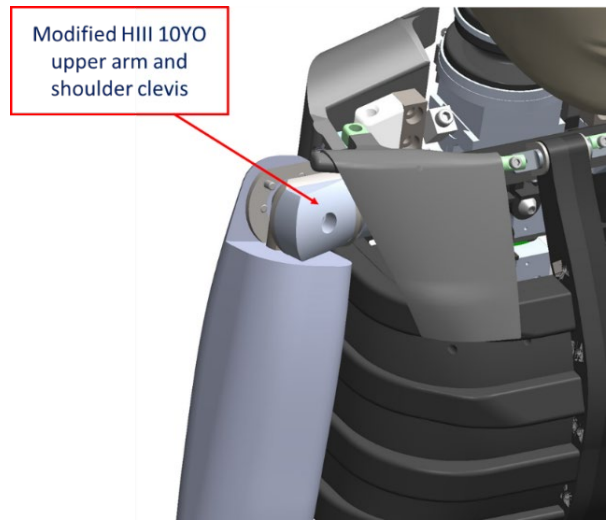

Figure 44. LODC Rev5 upper arm modification to prevent shoulder belt entrapment

## 6. Additional Chevrolet Malibu Vehicle Buck Sled Tests

Additional oblique Chevrolet Malibu vehicle buck sled tests were performed to evaluate the updated LODC Rev5 (abdomen retaining brackets and shoulder modifications). Two oblique sled tests were performed using the same FMVSS No. 213 pulse as the previous series. One test was performed with two LODC Rev5 ATDs seated in a backless belt positioning booster (Graco TurboBooster) and another test was performed using a standard three-point belt without the use of a child restraint system (no CRS). A test matrix is shown in Table 6 below.

Table 6. Test matrix for additional oblique 2016 Chevrolet Malibu vehicle buck sled tests with LODC Rev5

Test #	Buck Orientation	Passenger	NHTSA BioDB #	Driver	NHTSA BioDB #	Child Restraint System
1	Oblique	LODC Rev5 003	11796	LODC Rev5 001	11795	Backless BPB
2	Oblique	LODC Rev5 003	11798	LODC Rev5 001	11797	No CRS

### 6.1. Additional Vehicle Buck Sled Test Results

Results for HIC 36, chest accelerations, chest compressions, and abdomen pressures are shown in Figure 45 to Figure 47 below for the near side and far side positions and for the two child restraint configurations. Similar trends were observed in the additional tests as in the first vehicle buck sled series. The no-CRS configuration showed higher HIC 36 values than the backless booster configuration in both the near and far side occupant. The no-CRS configuration also showed higher chest accelerations than the backless booster configuration for the far side occupant. However, for the near side occupant, chest accelerations were lower (47.5 vs. 51.8 g) in the no-CRS configuration. Regarding the abdomen, higher pressures were observed in the no-CRS configuration than the backless booster for both near and far side occupants. In the no-CRS scenario, the lap belt rides over the abdomen whereas in the booster scenario, the lap belt sits over the pelvis. Additionally, the backless booster scenario produces greater chest deflections than no-CRS due to the shoulder belt being better centered over the thorax.

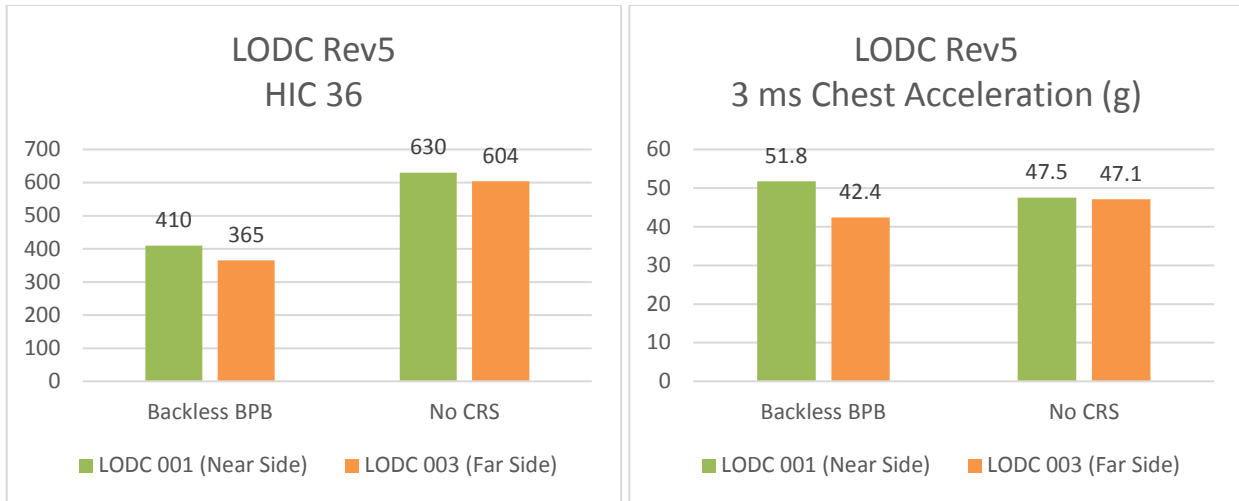

Figure 45. HIC 36 (left) and chest acceleration (right) results from the additional oblique Malibu buck sled tests for the updated LODC Rev5

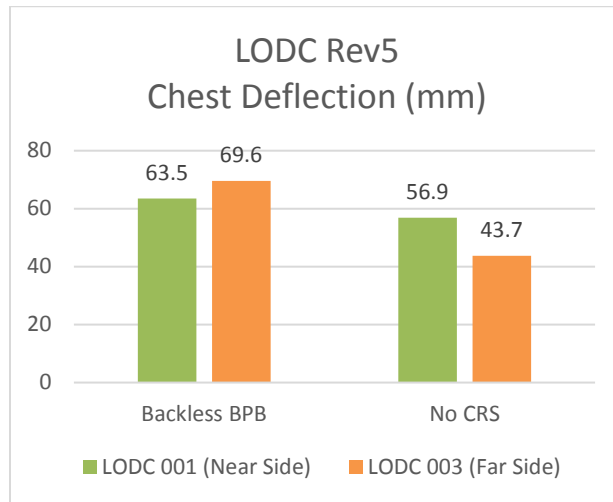

Figure 46. Chest deflection results from the additional oblique Malibu buck sled tests for the updated LODC Rev5

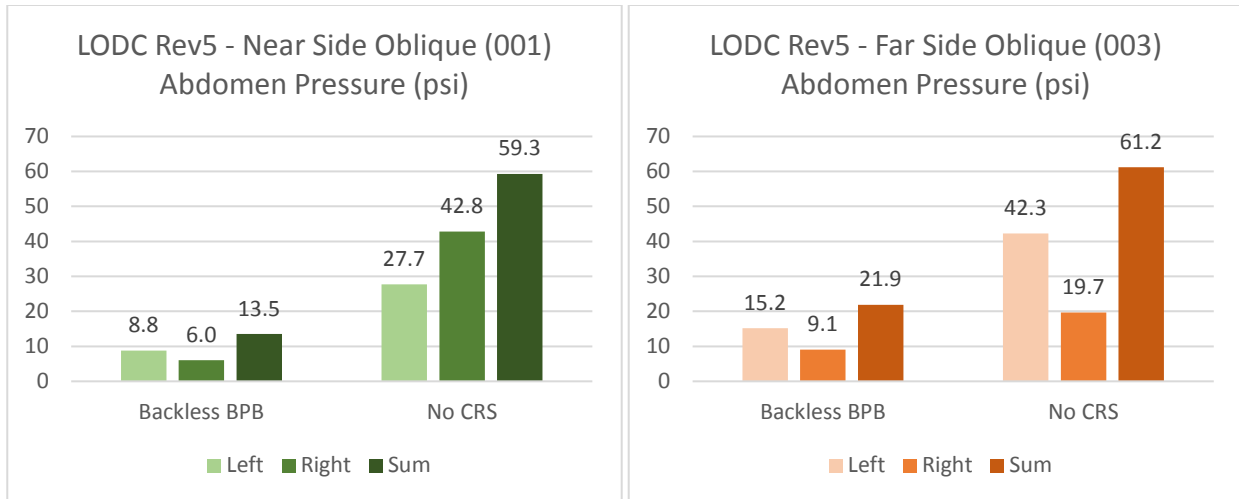

Figure 47. Abdomen pressure results from the additional oblique Malibu buck sled tests for the near side (left) and far side (right) updated LODC Rev5.

The LODC Rev5 shoulder modifications mitigated belt entrapment as the shoulder belt was observed to slide off the shoulder as shown in the right image in Figure 48 below. Additionally, the abdomen was observed not to translate forward as much as it did in Rev4.



Figure 48. Vehicle buck sled tests showing the previous LODC with shoulder belt entrapment (left) and the modified LODC without shoulder belt entrapment (right)

In addition to the modifications resolving some of the issues with LODC Rev4, dummy measurements were found to change only slightly. Figure 49 and Figure 50 below compare the LODC Rev4 results from the first series of vehicle buck sled tests with the results of the updated LODC Rev5 (i.e., shoulder and abdomen retaining brackets) from the additional tests. The updated LODC Rev5 shows slightly lower HIC

values, but still follows the same trend of higher HIC values with no-CRS than with the backless booster. Chest accelerations are slightly different with the backless booster values increasing slightly and the no-CRS values decreasing slightly. The updated LODC Rev5 also shows slightly higher abdomen pressures, which may be due to the stiffer rear boundary condition due to the retainers around the lumbar.

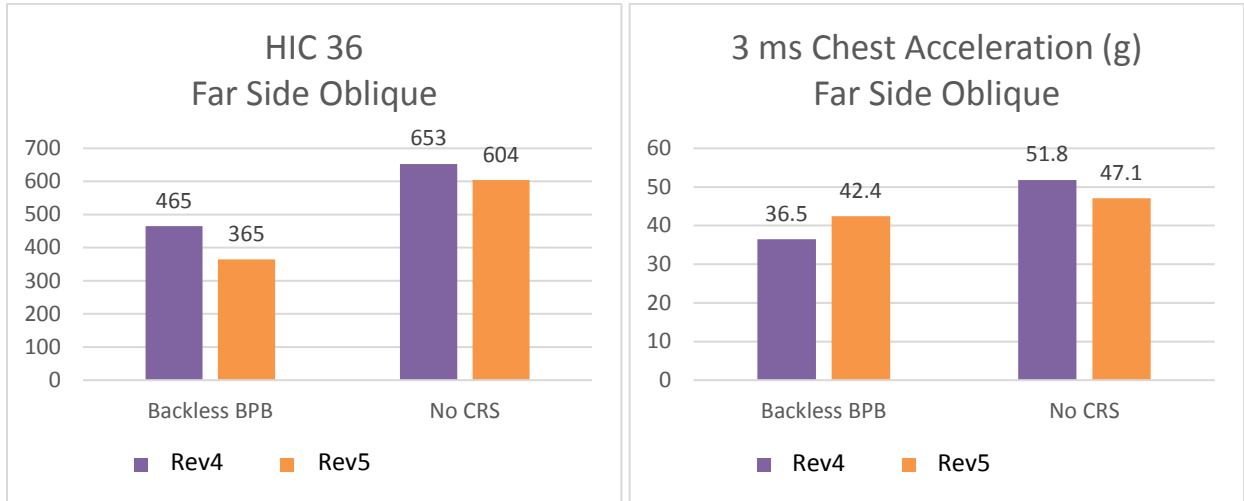

Figure 49. Far side occupant HIC 36 results from the oblique Malibu buck sled tests comparing the original abdomen (LODC 001) with the modified abdomen with retaining brackets (LODC 003)

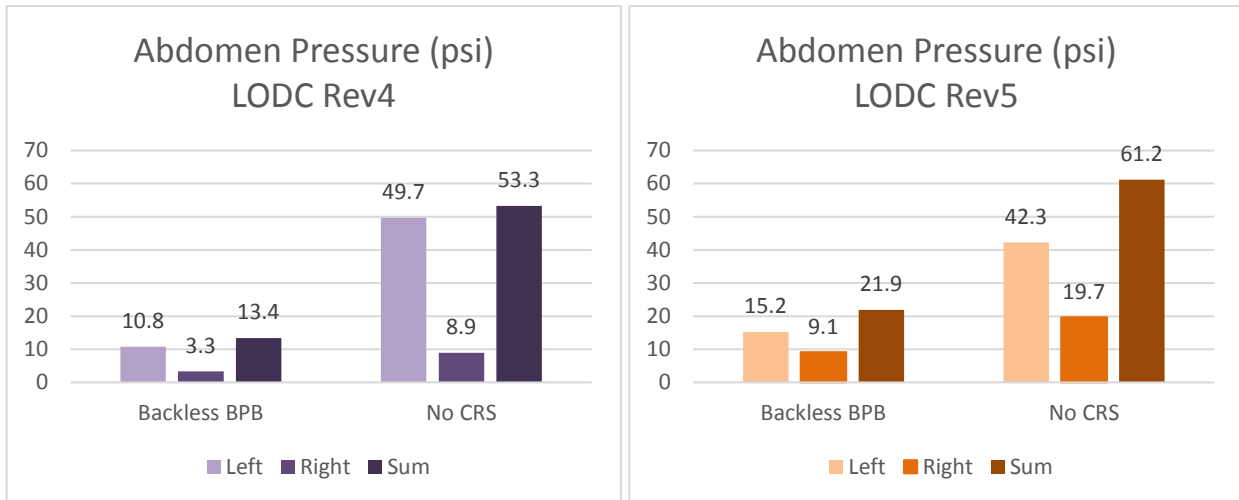

Figure 50. Far side occupant abdomen pressure results from the oblique Malibu buck sled tests comparing the original Rev4 abdomen (left) with the Rev5 abdomen with retaining brackets (right)

## 6.2. Additional Thorax Component Testing

High chest deflections (65-70 mm) were observed in sled testing even in CRS scenarios not expected to be injurious, indicating that the thorax might be too soft and bottoming out. It is therefore possible that the good biofidelity as shown by the thorax pendulum tests (Figure 11) might be an artifact of the thorax

bottoming out. The maximum chest deflection of the LODC is around 65-70 mm, which coincides with the biofidelity target. There is a good possibility that if the chest did not bottom out, more chest deflection would occur, pushing the LODC response outside and on the soft end of the biofidelity target.

In the Part 572 frontal thorax tests that have directed the LODC thorax design, both the probe size and mass and the target response corridors are scaled from adult data. Therefore, it is questionable whether the LODC is being designed to the correct thorax response target. In a study by Ouyang, Zhao, Xu, Chen, and Zhong (2006), impacts were performed to the thoraces of pediatric subjects, which would be a more ideal response to aim for with the LODC design since the data would not be scaled according to the Part 572 probe mass and velocity. In the Ouyang study, frontal, mid-sagittal thoracic impacts were performed using a pneumatic ram system with a 3.5 kg, 7.5 cm diameter impactor at an impact speed of 6.0 m/s. To replicate this loading condition as a check on the Part 572 probe mass/velocity biofidelity requirement, additional frontal, mid-sagittal pendulum impacts were performed on the LODC using a 3.55 kg, 7 cm diameter probe at an impact speed of 6.0 m/s. Figure 51 below shows the force versus displacement results for the LODC Rev5 thorax. Although the LODC response is observed to be similar to the pediatric data, the maximum chest deflections are again around 65 mm, which is near the LODC's design limit but not bottomed out.

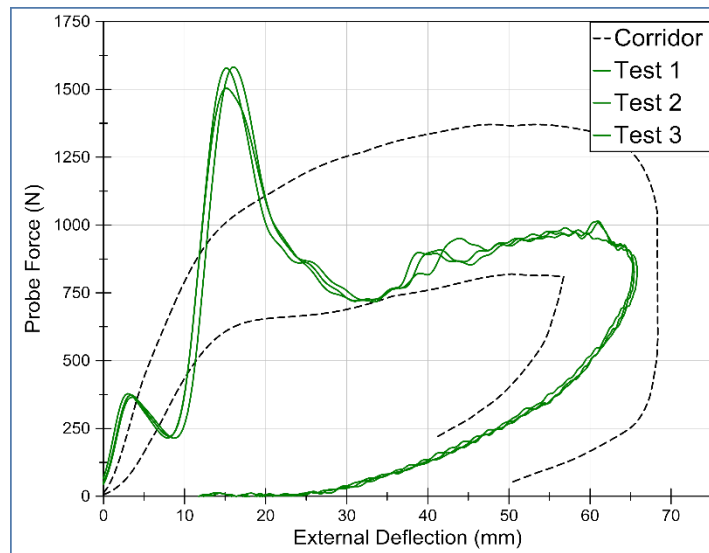

Figure 51. Frontal thorax impact results using a smaller probe (3.55 kg) similar to Ouyang, Zhao, Xu, Chen, and Zhong (2006). Force-deflection corridor is the old cohort (reanalyzed 6-year-old) corridor from Parent, Crandall, Bolton, Bass, Ouyang, and Lau (2010).

To further investigate overall thorax response, another biofidelity condition was employed. Kent et al. (2011) performed diagonal belt pull tests on the thoraces of pediatric subjects and posterior force versus belt penetration responses were obtained. The LODC Rev5 was tested in a similar fashion, but in a seated position instead of supine as was done in the Kent study. The diagonal belt test setup for LODC Rev5 is shown in Figure 52.



Figure 52. Diagonal belt pull test setup of the LODC Rev5 thorax adapted from Kent et al. (2011)

The force versus displacement response of LODC Rev5 in the diagonal belt pull test is shown in Figure 53. The LODC Rev5 response was found to be softer than the pediatric responses of the Kent study. The LODC Rev5 thorax observed approximately 1750 N of force at 50 mm of deflection whereas the pediatric subjects observed approximately 4000 N of force at 40 mm of deflection.

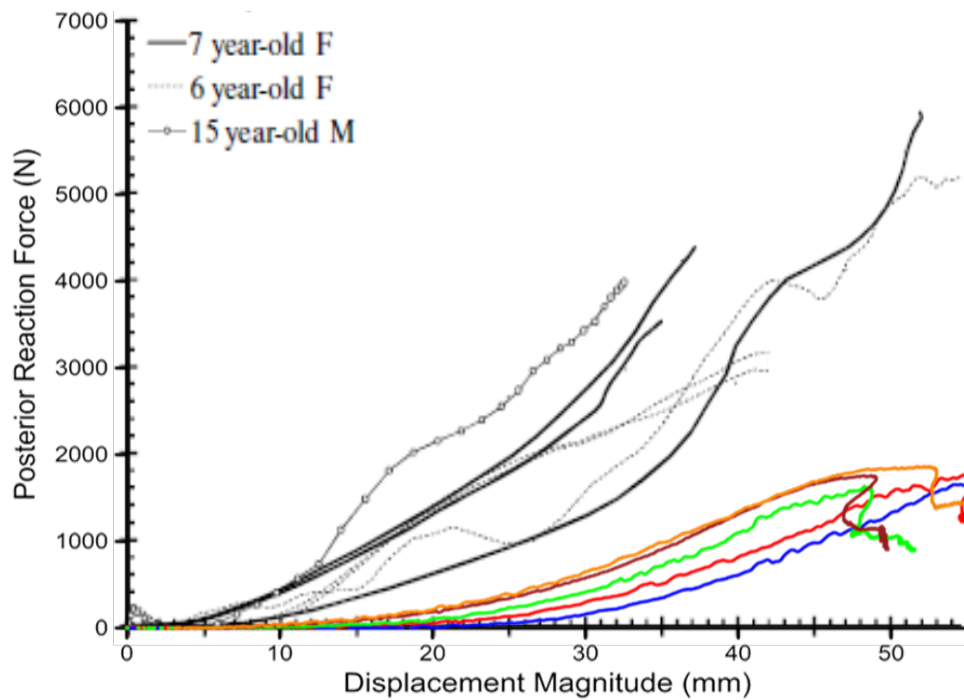

Figure 53. Results of the diagonal belt pull tests for LODC Rev5 (color) and the pediatric subjects of the Kent study (black)

As suspected, when belt loading is applied to exercise both the shoulder and thorax, the LODC Rev5 response is too soft and needs to be stiffened up. From the belt pull tests, the bottom of the ribcage was observed to collapse or fold under belt loading. Stiffening this area could produce a response similar to the Kent study and reduce chest deflection due to the shoulder belt in sled tests. Future modifications to the thorax include making the bottom rib thicker to prevent folding and extending the abdomen upward into the thorax cavity in order to stiffen the bottom ribcage. Once these modifications are made, both component and sled tests will be repeated to determine whether (a) the thorax response is biofidelic in both impact and belt loading scenarios and (b) chest deflections in sled tests are reduced to magnitudes more in line with reasonable levels relative to thorax injury risk assessment.



## 7. Side Curtain Air Bag and Side Impact Sled Tests

As mentioned earlier, the LODC is not intended for frontal test modes only. In addition to evaluating the LODC in oblique rear seat tests, sled tests were conducted to evaluate the feasibility and durability of testing the LODC Rev5 with a side curtain air bag and in side impact sled tests. One additional test was performed with the 2016 Chevrolet Malibu buck in an oblique configuration where a driver side (near side) curtain air bag was deployed during the event. Two tests were performed using the FMVSS No. 213 side impact buck with no-CRS (three-point belt only) and with a backless booster (Graco TurboBooster). LODC Rev5 was used for these tests. The test matrix is presented in Table 7 below.

Table 7. Test matrix for side curtain air bag and 213 side impact sled tests

Test #	Buck/Orientation	ATD	NHTSA BioDB #	Child Restraint System
1	Malibu/Oblique	LODC Rev5 001	11799	Backless BPB w/ Side Curtain Air Bag
2	213 Side Impact	LODC Rev5 003	11801	No CRS
3	213 Side Impact	LODC Rev5 003	11802	Backless BPB

### 7.1. Side Curtain Air Bag Results

The oblique vehicle buck sled tests with the side curtain air bag was set up the same as previous sled tests with the addition of the driver side curtain air bag, which was deployed upon the launch of the sled. LODC Rev5 was seated in a backless belt positioning booster (Graco TurboBooster) for this test. Unfortunately, during this test, only the outboard arm contacted the side curtain air bag (Figure 54).

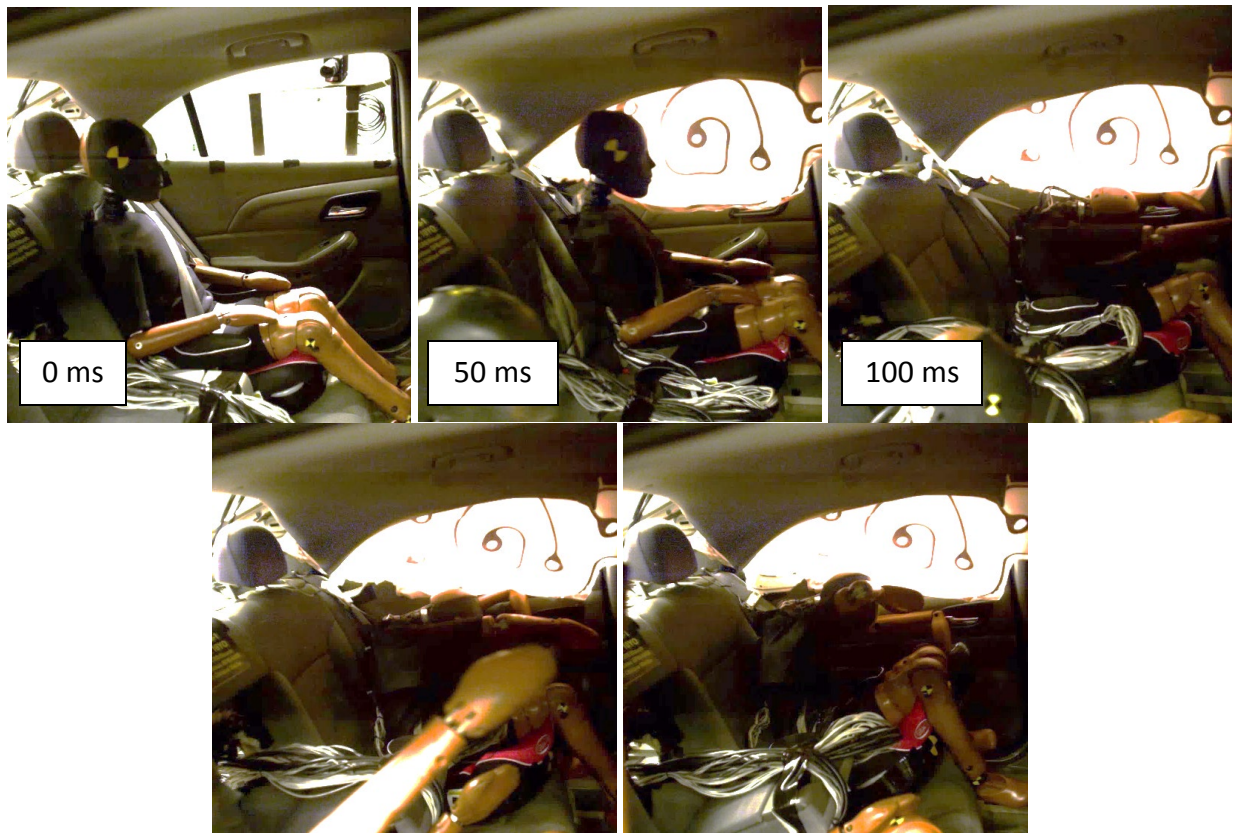

Figure 54. Screen captures of the side curtain air bag sled test at 50 ms time intervals. Air Bag is deployed in all screen captures except for T = 0 ms.

HIC 36, chest acceleration, and abdomen pressure results comparing the oblique Chevrolet Malibu vehicle buck sled tests without and with a side curtain air bag are shown in Figure 55 and Figure 56 below. The inclusion of a side curtain air bag did not greatly affect the LODC Rev5 response as results are shown to be very similar with and without an air bag. As with previous sled tests, the LODC Rev5 did not exhibit any damage.

Based on these tests, it appears that air bag interaction tests will require the LODC to be in out of position situations. Further investigation will examine the LODC response in static air bag deployment scenarios consistent with the FMVSS No. 208 procedure used for other child ATDs.

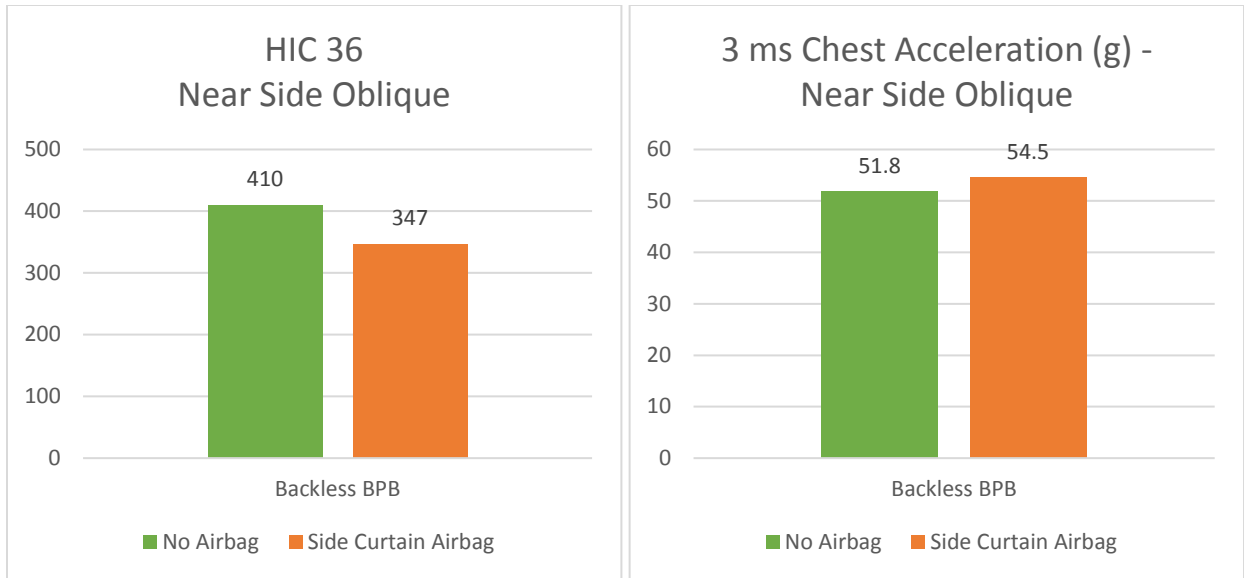

Figure 55. HIC 36 and chest acceleration results comparing the oblique Chevrolet Malibu vehicle buck sled test results with no side curtain air bag (green) and with a side curtain air bag (orange)

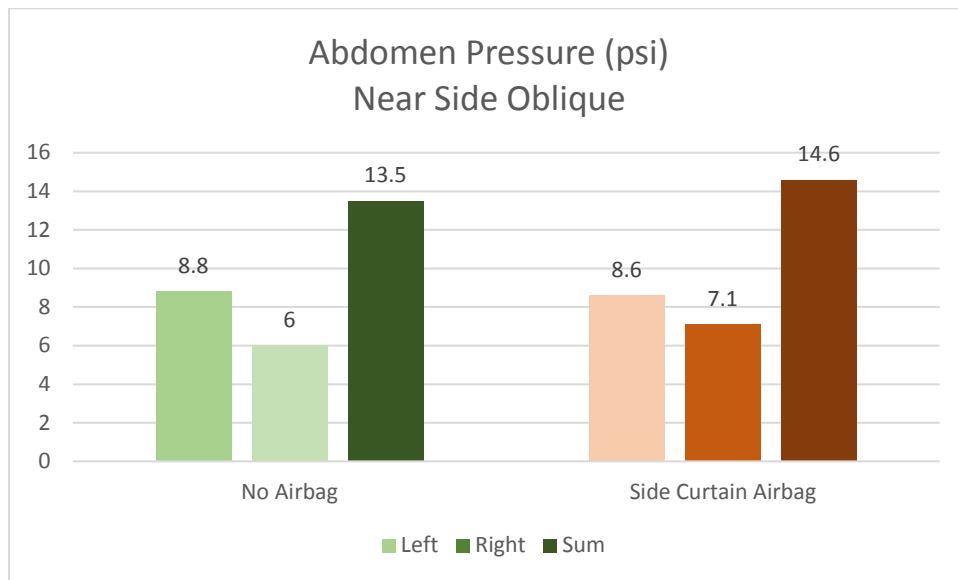

Figure 56. Abdomen pressure results comparing the oblique Chevrolet Malibu vehicle buck sled test results with no side curtain air bag (green) and with a side curtain air bag (orange)

## 7.2. FMVSS No. 213 Side Impact Results

A setup of a FMVSS No. 213 side impact sled test (NHTSA, 2014) with no CRS and backless belt positioning booster (Graco TurboBooster) are shown in Figure 57 below. LODC Rev5 was centered between the lap belt anchors and the proposed FMVSS No. 213 side impact procedures and pulse were employed.



Figure 57. FMVSS No. 213 side impact test setup with no CRS (left) and backless booster (right)

HIC 36, chest acceleration, lateral chest compression (measured using a 3D IR-TRACC mounted laterally inside the dummy), and abdomen pressure results for the FMVSS No. 213 side impact sled tests are shown in Figure 58 and Figure 59 below. Results show a lower chest acceleration but a higher lateral chest deflection when using no CRS. The opposite (higher chest acceleration and lower chest deflection) is observed for the backless booster. This is likely due to the contour of the impact wall, which is supposed to represent a vehicle door with an armrest. In the no-CRS scenario, the soft LODC Rev5 ribcage contacts the armrest (Figure 60), absorbing the impact and resulting in a large lateral chest deflection. In the booster scenario, the stiff LODC Rev5 pelvis contacts the armrest and the shoulder contacts the upper part of the door (Figure 60). In this scenario, the ribcage does not contact the door and does not compress, resulting in a harsh impact and higher chest accelerations.

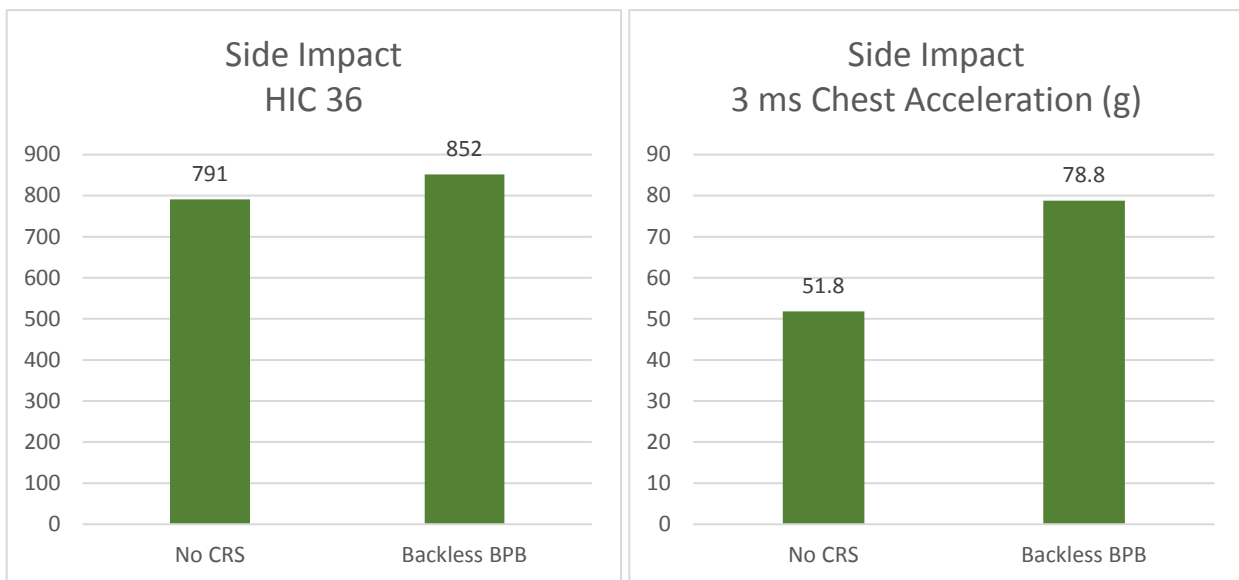

Figure 58. HIC 36 and chest acceleration results for the FMVSS No. 213 side impact sled tests

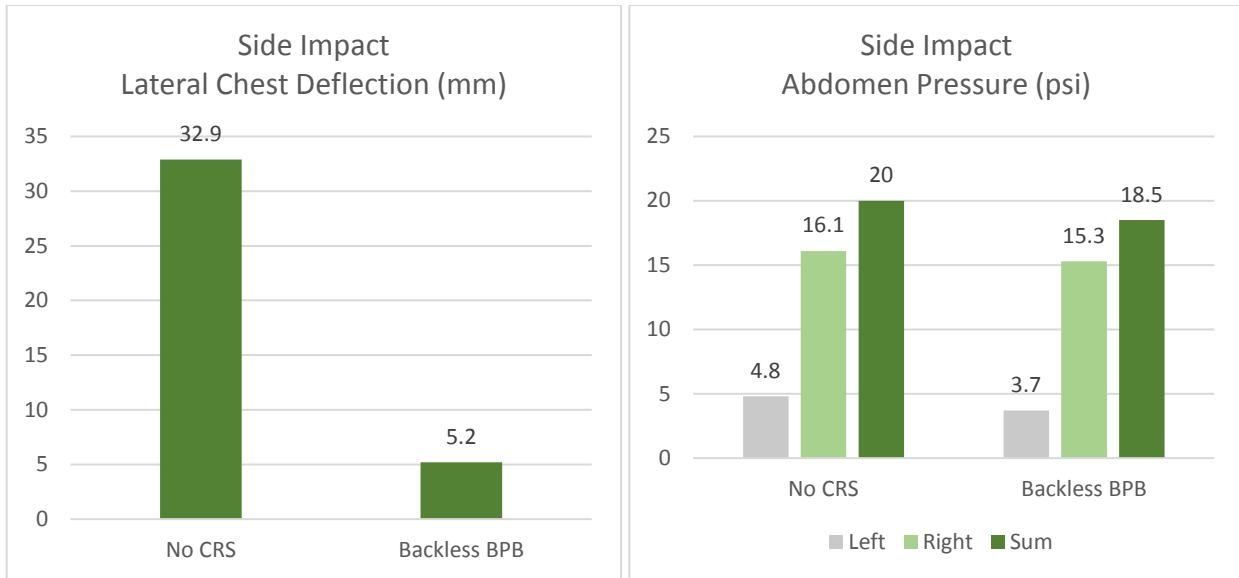

Figure 59. Lateral chest deflection and abdomen pressure results for the FMVSS No. 213 side impact sled tests

Figure 60 shows LODC Rev5 contact with the side impact wall for the no-CRS configuration (left) and backless belt positioning booster configuration (right). In the no-CRS configuration, the LODC Rev5 head CG remains below the top edge of the side wall. In the booster configuration, the head CG is above the top edge of the side wall and the head rotates over the wall during the event, contacting the metal back plate during the test. Even with this harsh impact, no damage was observed in either of the cases.

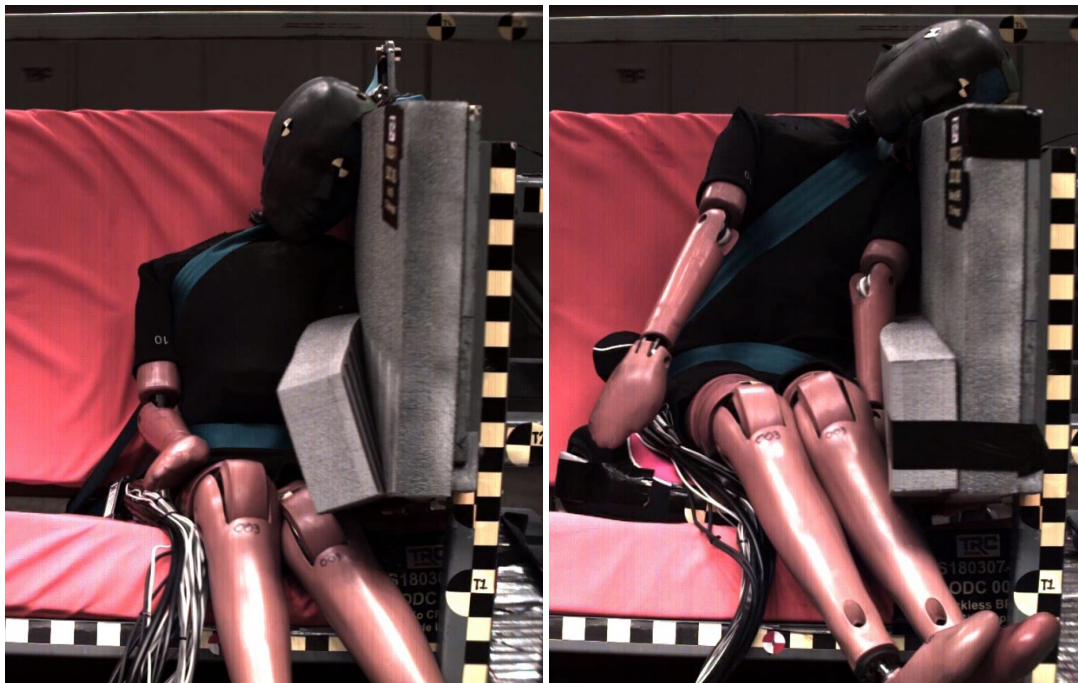

Figure 60. LODC Rev5 side impact wall contact with no-CRS (left) and backless belt positioning booster (right)

## 8. Summary and Future Work

The overall result of the change from LODC Rev3 to LODC Rev4 was a net improvement in component biofidelity. More importantly, as LODC Rev3 was already quite biofidelic, LODC Rev4 is more practical and easier to work with. Regarding sled testing, the modifications to improve component biofidelity and usability did not negatively affect the kinematics of the LODC as HIC values for LODC Rev4 are still lower than the HIII-10C and similar to LODC Rev3, indicating that chin-to-chest contact is still being mitigated. Additionally, head excursions of LODC Rev4 are similar to Rev3 as excursion values are maintained or are slightly greater than the HIII-10C. The LODC Rev4 abdomen was also observed to be a good discriminator between submarining and no submarining. Additionally, LODC Rev4 was easier to position than the HIII-10C in more naturalistic scenarios due to its flexibility and adjustability.

From the component and sled tests, it was determined that the response of LODC Rev4 was acceptable enough to build two additional dummies for evaluating reproducibility. LODC Rev4 was found to be repeatable and reproducible in component testing. However, in sled testing, results showed LODC Rev4 to be repeatable, but a neck manufacturing defect and inconsistencies in initial positioning led to slightly larger variations in reproducibility. More sled testing will be needed to evaluate LODC reproducibility after these issues are resolved.

Rear seat vehicle buck sled tests with LODC Rev4 also exposed a few issues with the LODC's design: (1) forward translation of the abdomen; (2) shoulder belt entrapment between the clavicle and upper arm; and (3) concerns about high chest deflections in belted tests. Additional modifications were made to the LODC design to address these issues resulting in LODC Rev5. However, the chest response still needs to be refined as realistic chest deflections for a typically non-injurious restraint condition at the FMVSS No. 213 pulse severity still need to be determined. Additionally, there are plans to look at different chest deflection measurement methods in the future.

Additional rear seat vehicle buck sled tests were performed with LODC Rev5, which included one test with a side curtain air bag. LODC Rev5 was also tested in a side impact scenario to determine feasibility and durability. No damage was observed in any of these tests.

Future work will include the following.

- Determination of a realistic range for chest deflections for typically non-injurious restraint conditions at the FMVSS No. 213 pulse severity
- Modifications to increase lower thorax stiffness, and evaluation of those changes in both thorax and abdomen test conditions
- Evaluation of chest deflection measurement systems other than IR-TRACC
- Modifications to the upper arm area to better produce a more realistic shoulder belt engagement
- Additional component tests and sled tests in frontal, oblique, and lateral directions
- Refinements to the dummy design and usability based on Center for Child Injury Prevention Studies round-robin project findings

## References

- Arbogast, K. B., Kim, J., Loeb, H., Kuo, J., Koppel, S., Bohman, K., & Charlton, J. L. (2016). Naturalistic driving study of rear seat child occupants: Quantification of head position using a Kinect sensor. *Traffic Injury Prevention, 17*(sup1), 168-174.
- Dibb, A. T., Cutcliffe, H. C., Luck, J. F., Cox, C. A., Myers, B. S., Bass, C. R., ... & Nightingale, R. W. (2014). Pediatric head and neck dynamics in frontal impact: Analysis of important mechanical factors and proposed neck performance corridors for 6-and 10-year-old ATDs. *Traffic Injury Prevention, 15*(4), 386-394.
- Kent, R., Lopez-Valdes, F. J., Lamp, J., Lau, S., Parent, D., Kerrigan, J., Lessley, D., & Salzar, R. (2011). *Characterization of the pediatric chest and abdomen using three post-mortem human subjects*. Presented at the 21st International Technical Conference on the Enhanced Safety of Vehicles, Stuttgart, Germany, June 15–18, 2009.
- Loyd, A. (2009). *Studies of the Human Head from Neonate to Adult: An Inertial, Geometrical and Structural Analysis*. (Doctoral dissertation). Duke University, Durham, NC.
- National Highway Traffic Safety Administration. (2014). Federal Motor Vehicle Safety Standards; Child Restraint Systems – Side Impact Protection. *79 FR 4570, Docket NHTSA-2014-0012*.
- Ouyang, J., Zhao, W., Xu, Y., Chen, W., & Zhong, S. (2006). Thoracic impact testing of pediatric cadaveric subjects. *Journal of Trauma and Acute Care Surgery, 61*(6), 1492-1500.
- Parent, D. P., Crandall, J. R., Bolton, J. R., Bass, C. R., Ouyang, J., & Lau, S. H. (2010). Comparison of hybrid III child test dummies to pediatric PMHS in blunt thoracic impact response. *Traffic Injury Prevention, 11*(4), 399-410.
- Rhule, D., Rhule, H., & Donnelly, B. (2005, June). *The process of evaluation and documentation of crash test dummies for Part 572 of the Code of Federal Regulations*. Presented at the 19th International Technical Conference on the Enhanced Safety of Vehicles, Washington DC, June 6-9, 2005..
- Rhule, H., Moorhouse, K., Donnelly, B., & Stricklin, J. (2009). *Comparison of WorldSID and ES-2re biofidelity using an updated biofidelity ranking system*. Presented at the 20th International Technical Conference on the Enhanced Safety of Vehicles, Lyon, France, June 18-21, 2007.
- Rhule, H., Donnelly, B., Moorhouse, K., & Kang, Y. S. (2013). *A methodology for generating objective targets for quantitatively assessing the biofidelity of crash test dummies*. Presented at the 22nd International Technical Conference on the Enhanced Safety of Vehicles, Washington, D.C., June 13-16, 2011.
- Stammen, J., & Sullivan, L. (2008). *Development of a Hybrid III 6YO and 10YO Seating Procedure for Booster Seat Testing*. NHTSA Docket #NHTSA-2007-0048.
- Stammen, J., Moorhouse, K., Suntay, B., Carlson, M., & Kang, Y. S. (2016). *The large omnidirectional child (LODC) ATD: biofidelity comparison with the hybrid III 10 year old*. (SAE Technical Paper No. 2016-22-0017). Warrendale, PA: SAE International.
- Wietholter, K., Echemendia, C., & Loudon, A. E. (2017). *Development of a representative seat assembly for FMVSS No. 213*. Presented at 25th International Technical Conference on the Enhanced Safety of Vehicles, Detroit, Michigan USA, June 2017.

## Appendix: NHTSA Database Reference Table

Test Number	NHTSA Biomechanics Database #	Driver Side ATD	Restraint Condition	NHTSA Biomechanics Database #	Passenger Side ATD	Restraint Condition	Pulse	Bench
S170627-1	11755	HIII-10C	Britax Frontier 85 Harness	11756	LODC rev4	Britax Frontier 85 Harness	FMVSS No. 213	Proposed FMVSS No. 213
S170628-1	11757	HIII-10C	Evenflo Big Kid BPB HB	11758	LODC rev4	Britax Frontier 85 Harness	FMVSS No. 213	Proposed FMVSS No. 213
S170628-2	11759	HIII-10C	Graco Turbo booster backless	11760	LODC rev4	Evenflo Big Kid BPB HB	FMVSS No. 213	Proposed FMVSS No. 213
S170629-1	11761	HIII-10C	No CRS upright posture	11762	LODC rev4	Graco Turbo booster backless	FMVSS No. 213	Proposed FMVSS No. 213
S170629-2	11763	HIII-10C	No CRS slouch posture	11764	LODC rev4	No CRS upright posture	FMVSS No. 213	Proposed FMVSS No. 213
S170630-1	11765	HIII-10C	Graco Turbo booster backless	11766	LODC rev4	No CRS slouch posture	FMVSS No. 213	Proposed FMVSS No. 213
S170630-2	11767	HIII-10C	Graco Turbo booster backless	11768	LODC rev4	Graco Turbo booster backless	FMVSS No. 213	Proposed FMVSS No. 213
S170705-1	11769	HIII-10C	Graco Turbo booster backless (head OOP)	11770	LODC rev4	Graco Turbo booster backless (head OOP)	FMVSS No. 213	Proposed FMVSS No. 213
S170705-2	11771	HIII-10C	Graco Turbo booster backless (head OOP)	11772	LODC rev4	Graco Turbo booster backless (head OOP)	FMVSS No. 213	Proposed FMVSS No. 213
S170707-1	11773	HIII-10C	No CRS slouch, lap belt only	11774	LODC rev4	No CRS slouch, lap belt only	FMVSS No. 213	Proposed FMVSS No. 213
S170920-1	11775	LODC rev4 (003)	Graco Turbo booster backless	11776	LODC rev4 (002)	Graco Turbo booster backless	FMVSS No. 213	Proposed FMVSS No. 213
S170921-1	11777	LODC rev4 (003)	Graco Turbo booster backless	11778	LODC rev4 (002)	Graco Turbo booster backless	FMVSS No. 213	Proposed FMVSS No. 213
S170921-2	11779	LODC rev4 (003)	Graco Turbo booster backless	11780	LODC rev4 (002)	Graco Turbo booster backless	FMVSS No. 213	Proposed FMVSS No. 213
S170926-1	11781	HIII-10C	Graco Turbo booster backless	11782	LODC rev4 (001)	Graco Turbo booster backless	FMVSS No. 213	Chevrolet Malibu Rear Seat (Frontal)
S170927-1	11783	HIII-10C	No CRS upright posture	11784	LODC rev4 (001)	No CRS upright posture	FMVSS No. 213	Chevrolet Malibu Rear Seat (Frontal)
S170928-1	11785	HIII-10C	Graco Turbo booster backless	11786	LODC rev4 (001)	Graco Turbo booster backless	FMVSS No. 213	Chevrolet Malibu Rear Seat (20 Deg Oblique)
S170928-2	11787	HIII-10C	No CRS upright posture	11788	LODC rev4 (001)	No CRS upright posture	FMVSS No. 213	Chevrolet Malibu Rear Seat (20 Deg Oblique)
S170929-1	11789	LODC rev4 (001)	Graco Turbo booster backless	11790	HIII-10C	Graco Turbo booster backless	FMVSS No. 213	Chevrolet Malibu Rear Seat (20 Deg Oblique)
S170929-2	11791	LODC rev4 (001)	No CRS upright posture	11792	HIII-10C	No CRS upright posture	FMVSS No. 213	Chevrolet Malibu Rear Seat (20 Deg Oblique)
S180207-1	11793	LODC rev5 (001)	Graco Turbo booster backless	11794	LODC rev5 (003)	Graco Turbo booster backless	FMVSS No. 213	Chevrolet Malibu Rear Seat (20 Deg Oblique)
S180213-1	11795	LODC rev5 (001)	Graco Turbo booster backless	11796	LODC rev5 (003)	Graco Turbo booster backless	FMVSS No. 213	Chevrolet Malibu Rear Seat (20 Deg Oblique)
S180214-1	11797	LODC rev5 (001)	No CRS upright posture	11798	LODC rev5 (003)	No CRS upright posture	FMVSS No. 213	Chevrolet Malibu Rear Seat (20 Deg Oblique)
S180215-1	11799	LODC rev5 (001)	Graco Turbo booster backless (side airbag)	11800	LODC rev5 (003)	Graco Turbo booster backless	FMVSS No. 213	Chevrolet Malibu Rear Seat (20 Deg Oblique)
S180307-1	11801	LODC rev5 (003)	No CRS		---	---	FMVSS No. 213 Side	FMVSS No. 213 Side
S180307-2	11802	LODC rev5 (003)	Graco Turbo booster backless		---	---	FMVSS No. 213 Side	FMVSS No. 213 Side



DOT HS 812 755  
July 2019



U.S. Department  
of Transportation  
**National Highway  
Traffic Safety  
Administration**

