



U.S. Department
of Transportation

Federal Highway
Administration

Pavement Instrumentation

Demonstration Project
Division

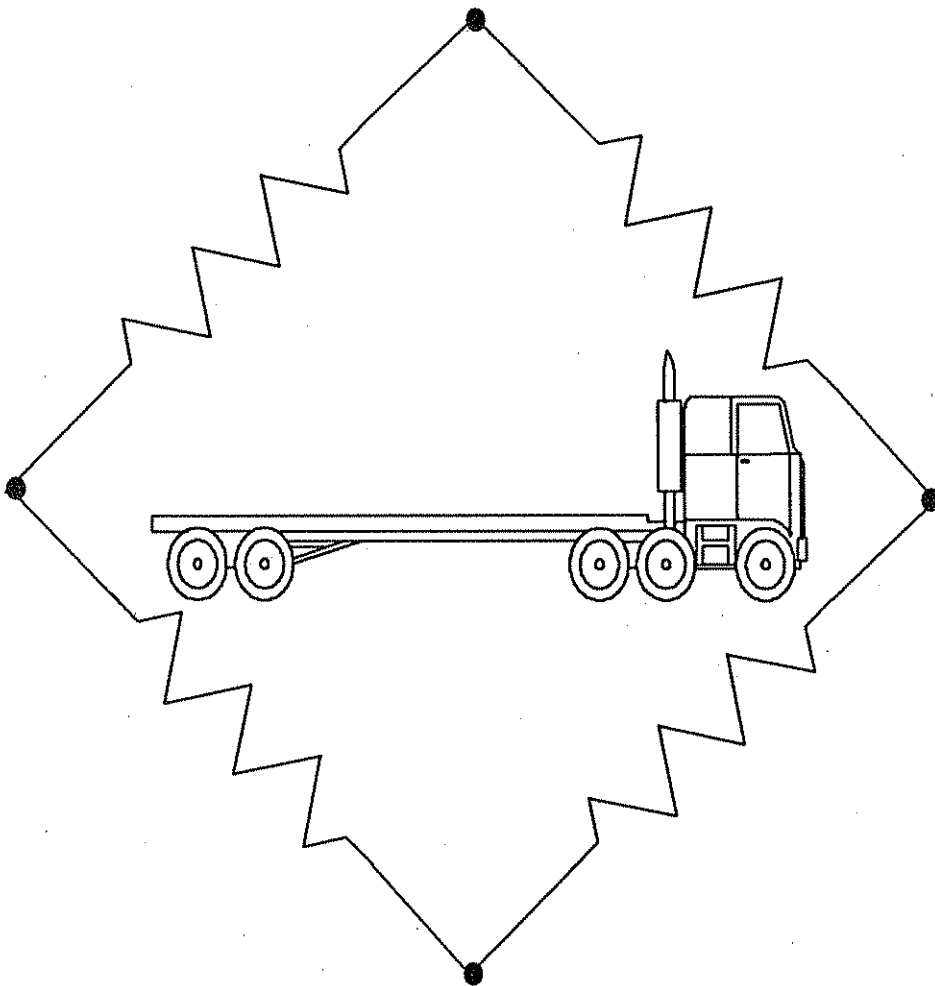

DTFH71-86-621-Ia-19

Sept. 1992



Iowa Department of Transportation
Iowa Highway Research Board
Project HR 293

1. Report No.		2. Government Accession No.		3. Recipient's Catalog No.	
4. Title and Subtitle Experimental Project No. 621, Pavement Instrumentation				5. Report Date September 1992	
				6. Performing Organization Code	
				8. Performing Organization Report No.	
7. Author(s) Marlee Walton and Steve Kadolph				10. Work Unit No. (TRAI5)	
9. Performing Organization Name and Address Office of Transportation Research Iowa Department of Transportation 800 Lincoln Way Ames, IA 50010				11. Contract or Grant No. DTFH71-86-621-Ia-19	
				13. Type of Report and Period Covered	
12. Sponsoring Agency Name and Address U.S. Department of Transportation Federal Highway Administration Washington, DC 20590				14. Sponsoring Agency Code	
15. Supplementary Notes Experimental Project No. 621, Pavement Instrumentation					
16. Abstract This document contains a discussion of the reasons why the project did not succeed. A detailed discussion of the steps taken by the Iowa Department of Transportation to make the experiment work are contained in this document, along with recommendations for future projects.					
17. Key Words			18. Distribution Statement		
19. Security Classif. (of this report)		20. Security Classif. (of this page)		21. No. of Pages	22. Price

SI* (MODERN METRIC) CONVERSION FACTORS

APPROXIMATE CONVERSIONS TO SI UNITS

Symbol	When You Know	Multiply By	To Find	Symbol
--------	---------------	-------------	---------	--------

LENGTH

in	inches	25.4	millimetres	mm
ft	feet	0.305	metres	m
yd	yards	0.914	metres	m
mi	miles	1.61	kilometres	km

AREA

in ²	square inches	645.2	millimetres squared	mm ²
ft ²	square feet	0.093	metres squared	m ²
yd ²	square yards	0.836	metres squared	m ²
ac	acres	0.405	hectares	ha
mi ²	square miles	2.59	kilometres squared	km ²

VOLUME

fl oz	fluid ounces	29.57	millilitres	mL
gal	gallons	3.785	litres	L
ft ³	cubic feet	0.028	metres cubed	m ³
yd ³	cubic yards	0.765	metres cubed	m ³

NOTE: Volumes greater than 1000 L shall be shown in m³.

MASS

oz	ounces	28.35	grams	g
lb	pounds	0.454	kilograms	kg
T	short tons (2000 lb)	0.907	megagrams	Mg

TEMPERATURE (exact)

°F	Fahrenheit temperature	5(F-32)/9	Celsius temperature	°C
----	------------------------	-----------	---------------------	----

APPROXIMATE CONVERSIONS FROM SI UNITS

Symbol	When You Know	Multiply By	To Find	Symbol
--------	---------------	-------------	---------	--------

LENGTH

mm	millimetres	0.039	inches	in
m	metres	3.28	feet	ft
m	metres	1.09	yards	yd
km	kilometres	0.621	miles	mi

AREA

mm ²	millimetres squared	0.0016	square inches	in ²
m ²	metres squared	10.764	square feet	ft ²
ha	hectares	2.47	acres	ac
km ²	kilometres squared	0.386	square miles	mi ²

VOLUME

mL	millilitres	0.034	fluid ounces	fl oz
L	litres	0.264	gallons	gal
m ³	metres cubed	35.315	cubic feet	ft ³
m ³	metres cubed	1.308	cubic yards	yd ³

MASS

g	grams	0.035	ounces	oz
kg	kilograms	2.205	pounds	lb
Mg	megagrams	1.102	short tons (2000 lb)	T

TEMPERATURE (exact)

°C	Celsius temperature	1.8C + 32	Fahrenheit temperature	°F
----	---------------------	-----------	------------------------	----

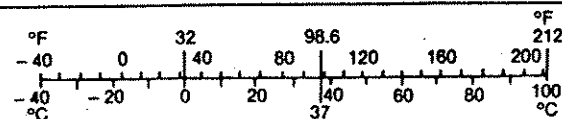

* SI is the symbol for the International System of Measurement

PAVEMENT INSTRUMENTATION

Office of Transportation Research
Iowa Department of Transportation
800 Lincoln Way
Ames, Iowa 50010

Principal Investigators: Marlee Walton
Steve Kadolph

Federal Highway Administration
Demonstration Project 621
Work Order: DTFH71-86-621-1a-19

NOTICE

This document is disseminated under the sponsorship of the U.S. Department of Transportation in the interest of information exchange. The United States Government assumes no liability for the contents or use thereof.

The contents of this paper reflect the views of the authors, who are responsible for the facts and the accuracy of the data presented herein. The contents do not necessarily reflect the official views or policies of the Iowa Department of Transportation. This does not constitute a standard, specification or regulation.

TABLE OF CONTENTS

	<u>Page</u>
Introduction	1
Project Background	3
Figure 1 - Overview of Site.	4
Equipment.	5
Figure 2 - Field Unit Configuration.	7
Figure 3 - 3852A and Extenders	8
Figure 4 - Dowel Sensors	10
Figure 5 - Concrete Sensors.	11
Figure 6 - LVDT Sensors.	12
Figure 7 - Temperature Sensors	13
Data Collection Sequence	14
Software Development	15
Troubleshooting.	16
Recommendations.	20
Conclusions.	21
APPENDIX A	A-1
HP Basic Computer Program.	A-2
APPENDIX B	B-1
Strain Gauge Graphs	B-2
APPENDIX C	C-1
Moisture and Nuclear Density Results.	C-2

INTRODUCTION

The reaction of pavement structures to traffic loads and the environment has been studied in the laboratory. Only recently has pavement testing through instrumentation received considerable attention. Various factors have driven this area of research. Among these are the effects of load-induced deflection and deformation, strain and stress; environmental factors of temperature, frost and moisture; and density and subdrainage on the life of the pavement.

There are many benefits to be derived by conducting pavement instrumentation studies. Some of these include a better understanding of the performance and response of pavement systems; the applicability and utility of mechanistic-based design procedures; and hard data on the effect of heavy loads, multiple axles and various tire pressures. A better understanding of these items should result in benefits to design, construction, maintenance, and pavement management processes. Iowa's efforts were directed at providing a better understanding of the performance of portland cement concrete pavements by installing instrumentation equipment in a 40-foot-long section of pavement on I-80 in Pottawattamie County, Iowa.

On June 27, 1986, the Iowa Department of Transportation (DOT) entered into an agreement with the Federal Highway Administration (FHWA) to conduct a pavement instrumentation project. On the same date, Iowa State University (ISU) signed an agreement to do laboratory testing, installation and analyses of the pavement responses measured for the DOT.

Several amendments to the above agreements asking for additional time and money were executed subsequent to the initial agreements. On July 1, 1989,

the DOT took responsibility for the entire project.

Pavement instrumentation items such as site selection and preparation, instrument selection and preparation, the processing equipment selection and installation, and the costs involved in this project are discussed in a study sponsored by the U.S. Department of Transportation, the Federal Highway Administration, the Iowa Department of Transportation and Iowa State University, Experimental Project No. 621, "Pavement Instrumentation." This study provided information on the costs, problems, planning steps and features of the analysis software that should be considered in establishment of instrumentation sites to answer pavement performance questions.

The following specific objectives were established:

- assess the feasibility, reliability and accuracy of the instrumentation system used in this study;
- evaluate the magnitude and frequency of dynamic loads versus static loads on rigid pavements; and
- determine relationship of pavement strains to pavement loads under various base moisture and density conditions.

To meet these objectives, pavement instrumentation equipment was installed and specific response data, such as deflection, strain, temperature and density, were to be collected for two years. From this data, a detailed analysis was to be performed to determine the reaction of pavement to traffic loads and the environment.

Unfortunately, numerous problems caused by equipment selection, installation and operational failures resulted in very little data being collected. The data from the nuclear density equipment and intermittent data

from the deflection gauges were the only data collected. Because of these factors, this report deals with experimental design, software development and trouble-shooting procedures. Recommendations to aid researchers in successful implementation of future projects of this type are also addressed.

PROJECT BACKGROUND

The site selected for the instrumentation is located in southwestern Iowa, near the town of Minden in Pottawattamie County, in the westbound lanes of I-80. This site was part of a 1986 seven-mile reconstruction project extending from near the I-80 and I-680 interchange (milepost 28.0/station 908+50) easterly to a point on the east end of the Shelby interchange (milepost 35.1/station 1380.85). The instrumented site is located near milepost 30+/station 1118+ at the west end of the Keg Creek Bridge as shown in Figure 1.

The reconstruction project involved 7.1 miles of pavement in the westbound lanes of I-80. The existing pavement consisted of 8 inches of continuously reinforced portland cement concrete pavement placed over a 4-inch granular base. Full depth 8-inch asphaltic concrete shoulders were built at the time of construction. A 4-inch diameter flexible plastic longitudinal subdrain was placed in the trench 4 feet below the surface of the pavement along the outside edge of the driving lane prior to the reconstruction.

The reconstruction included the removal of the concrete pavement, base, and 3 to 4 inches of the subgrade. The trench was also widened to allow for placement of a 24-foot, 10-inch wide portland cement concrete pavement. The existing pavement was crushed and used as a drainable base. The base varies

Figure 1: Overview of Site

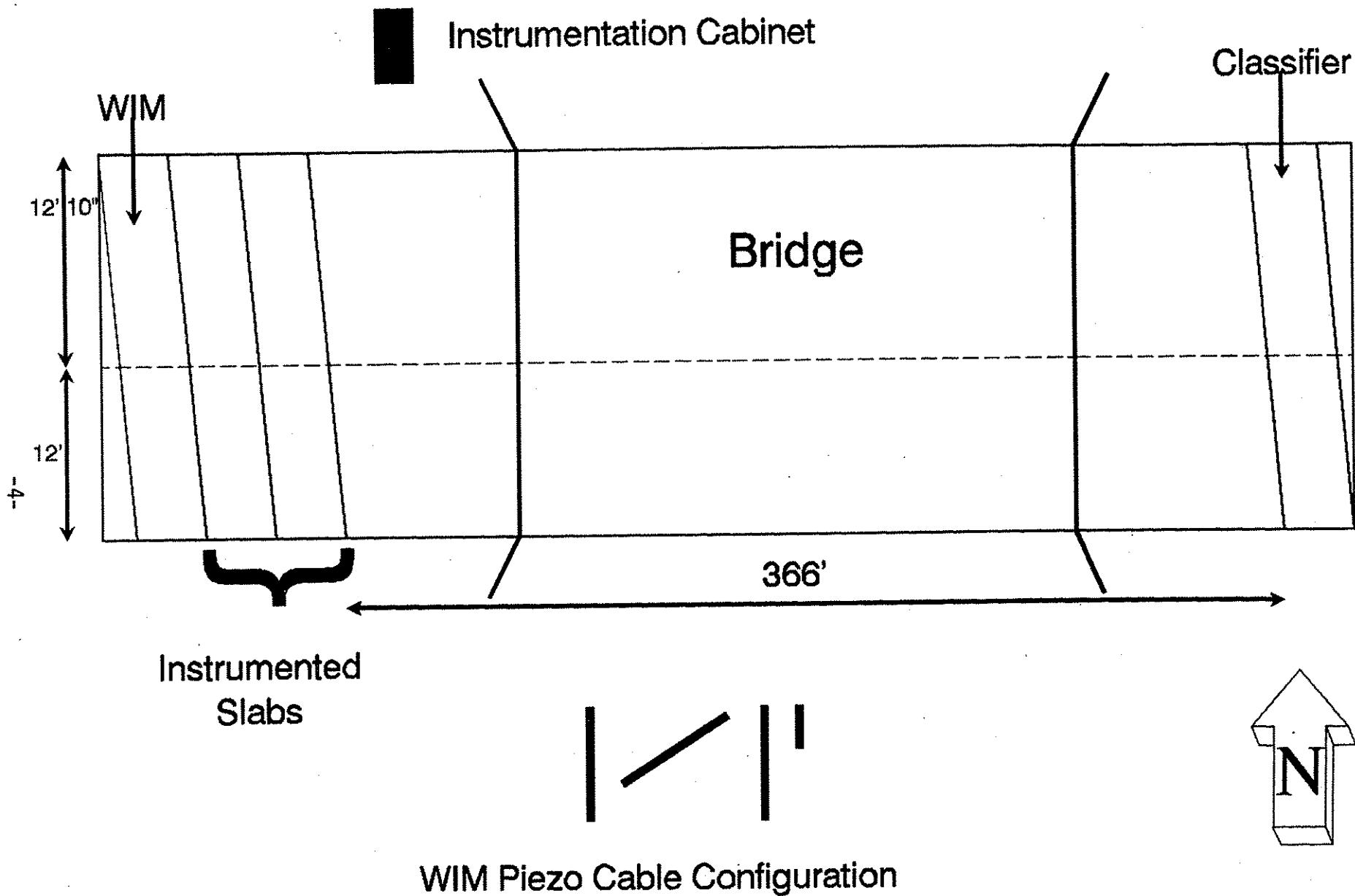

in thickness from 6.5 inches at the median side of the driving surface to 9.5 inches at the outside shoulder edge. An 11-inch-thick jointed reinforced concrete pavement was placed on top of the base. The shoulders were resurfaced with 2.5 inches of Type B asphaltic concrete base material.

The 40-foot-long section shown in Figures 4, 5, 6 and 7 was instrumented with nearly 120 sensors. Included were weldable strain gages on selected dowel bars at three consecutive joints, and concrete strain gages at selected locations across the slab, at two locations, and two exterior corner locations. The site also includes some 16 deflection gages at locations near the joints and near midslab in the wheel path. Metal pipes were placed under each of the three consecutive joints and in the two midslab locations in the base material. Temperature sensors were placed near the surface of the pavement, on top of the variable thickness base material, and 6 inches into the subgrade. An additional single temperature unit was placed outside the slab to measure ambient air temperature.

EQUIPMENT

Hewlett Packard equipment was selected for the project. The computer hardware consisted of a model 310 series workstation for the central Ames office and a model 320 series engineering workstation for the field location. The central location micro computer had a color graphic monitor and associated card, one megabyte of RAM, a 20-megabyte hard disk and a floppy disk. In addition to this, an 8-pen plotter, a printer, and a 2,400-baud modem were connected to the central location unit.

The field unit was equipped with a monochrome monitor, 3 megabytes of

RAM, and a 40-megabyte hard disk. A 2,400-baud modem for communication with the central location unit was attached to the field unit. Each of the units came with the basic operating software and the subroutines to perform the scanning, analysis, and data storage functions. Figure 2 shows the configuration of the computer equipment in the field.

The heart of the data collection system was a HP 3852A data acquisition and control unit with two extender units (3853A). Accessories included eight, 24-channel, high-speed fed multiplexers, two 14-bit high-speed voltmeters, a five-channel counter totalizer, data acquisition software routines, a DC power supply, four 120-ohm static strain bridge and 50 350-ohm static strain bridge strain cards. Figure 3 shows the configuration of the accessories installed in the 3852A and 3853As.

Operation software was acquired with the purchase of the three computers described above. Additional software that was purchased included Basic 4.0 and Data Acquisition Manager software. The Data Acquisition Manager software consists of a series of subroutines which enhanced the ability to communicate between the field unit and the HP 3852A.

Figure 1 shows an overview of the site. Each of the items found on Figure 1 will be discussed in the following paragraphs. It should be noted this site was selected because a bridge WIM was expected to be used to measure truck weights.

The concrete strain gauges were manufactured by Toykyo Sokki Kenkyujo Co., LTD. and were type PML-60 (120 ohm). These gauges were to measure the bending of the concrete slab. The dowel strain gauges were manufactured by Measurements Group, Inc. a Micro-Measurements Division and were type KWK-06-

Figure 2: Field Unit Configuration

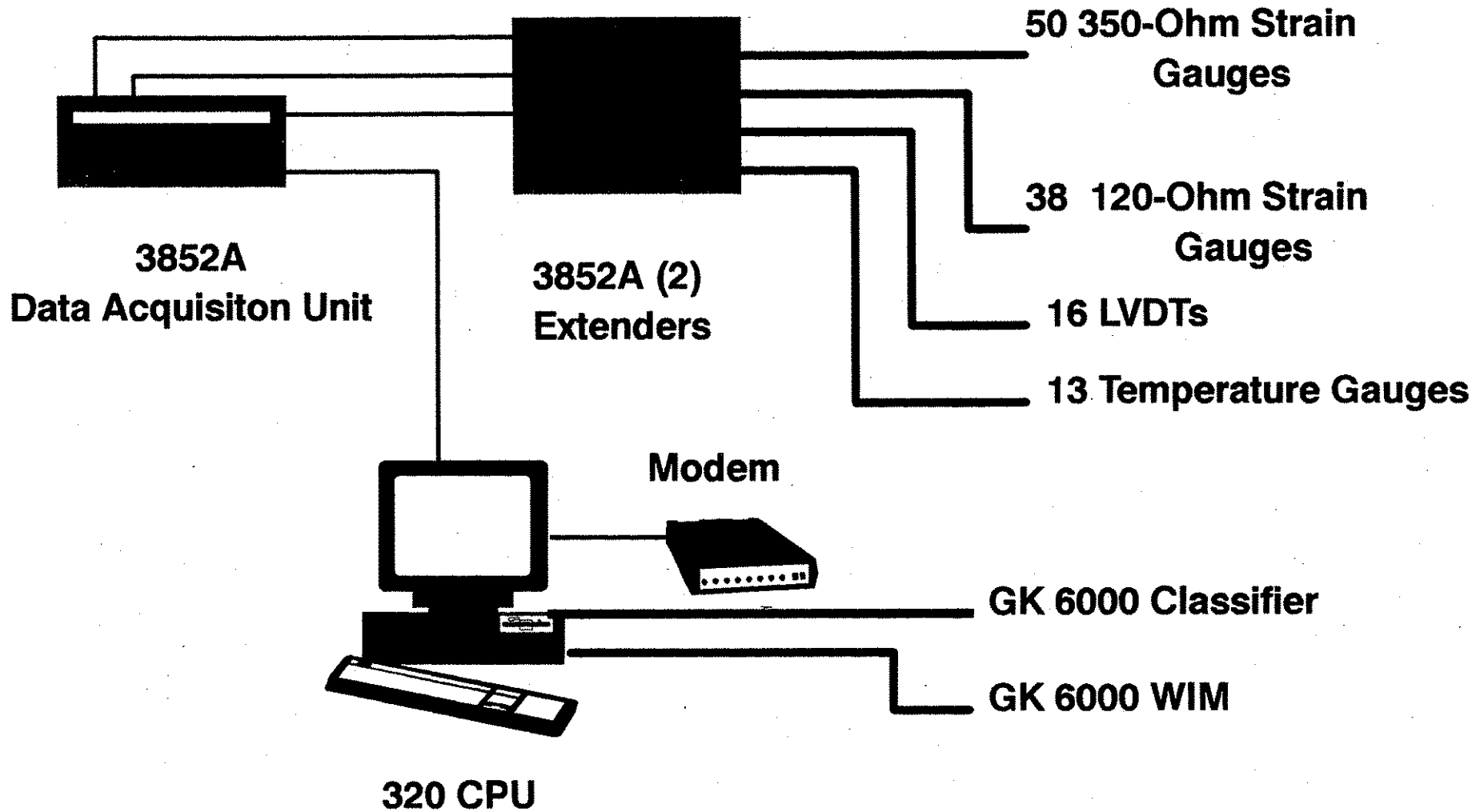

Figure 3: 3852A and Extenders

3852A Mainframe	
	High Speed Voltmeter
	24-Channel High-speed fet
	24-Channel High-speed fet
	24-Channel High-speed fet
	24-Channel High-speed fet
	24-Channel High-speed fet

3853A Extender #1	High Speed Voltmeter
	24-Channel High-speed fet
	24-Channel High-speed fet
	24-Channel High-speed fet
	24-Channel High-speed fet
	24-Channel High-speed fet
	5-Channel Counter/Totalizer

3853A Extender #2	10-Channel 120-Ohm Static Strain Bridge
	10-Channel 120-Ohm Static Strain Bridge
	10-Channel 120-Ohm Static Strain Bridge
	10-Channel 120-Ohm Static Strain Bridge
	10-Channel 350-Ohm Static Strain Bridge
	10-Channel 350-Ohm Static Strain Bridge
	10-Channel 350-Ohm Static Strain Bridge
	10-Channel 350-Ohm Static Strain Bridge
	10-Channel 350-Ohm Static Strain Bridge

W250B-350 (350 ohm). These gauges were to measure the bending of the dowel bars. The linear velocity deflection transducer (LVDT) used in the project was manufactured by Trans-Tek and was model number 0243-0000 J-9. These gauges were to measure the deflection of the entire slab. The temperature gauges were also manufactured by Measurements Group, Inc. and were type WTG-50C along with a LST-10F-350B. Figure 1 shows the relative location of the instrumented slabs just to the west of the bridge. Figures 4, 5, 6 and 7 show the location of the dowel, concrete, LVDT, and temperature sensors.

A GK 6000 weigh-in-motion system (WIM) was installed in October 1989. This system was placed in the first pavement slab downstream from the last instrumented pavement slab (see Figure 1). Diagonal piezo sensors were included in this system to allow for the measurement of lateral displacement from the edge of the slab and to allow for measurement of the footprint of the tires.

A GK 6000 vehicle classification unit was installed at the same time as the WIM system. This unit was placed 366 feet upstream from the first instrumented pavement slab (see Figure 1). This unit was used to determine vehicle presence and trigger the HP 3852A.

A Troxler 3321 depth moisture gauge and a Troxler 2601 Scaler-Ratemeter was used in conjunction with a Troxler 1352 Depth Density Gauge. These three devices were used to collect moisture and density information. This information was collected during the years 1987-1989 (see Appendix C).

Figure 4: Dowel Sensors

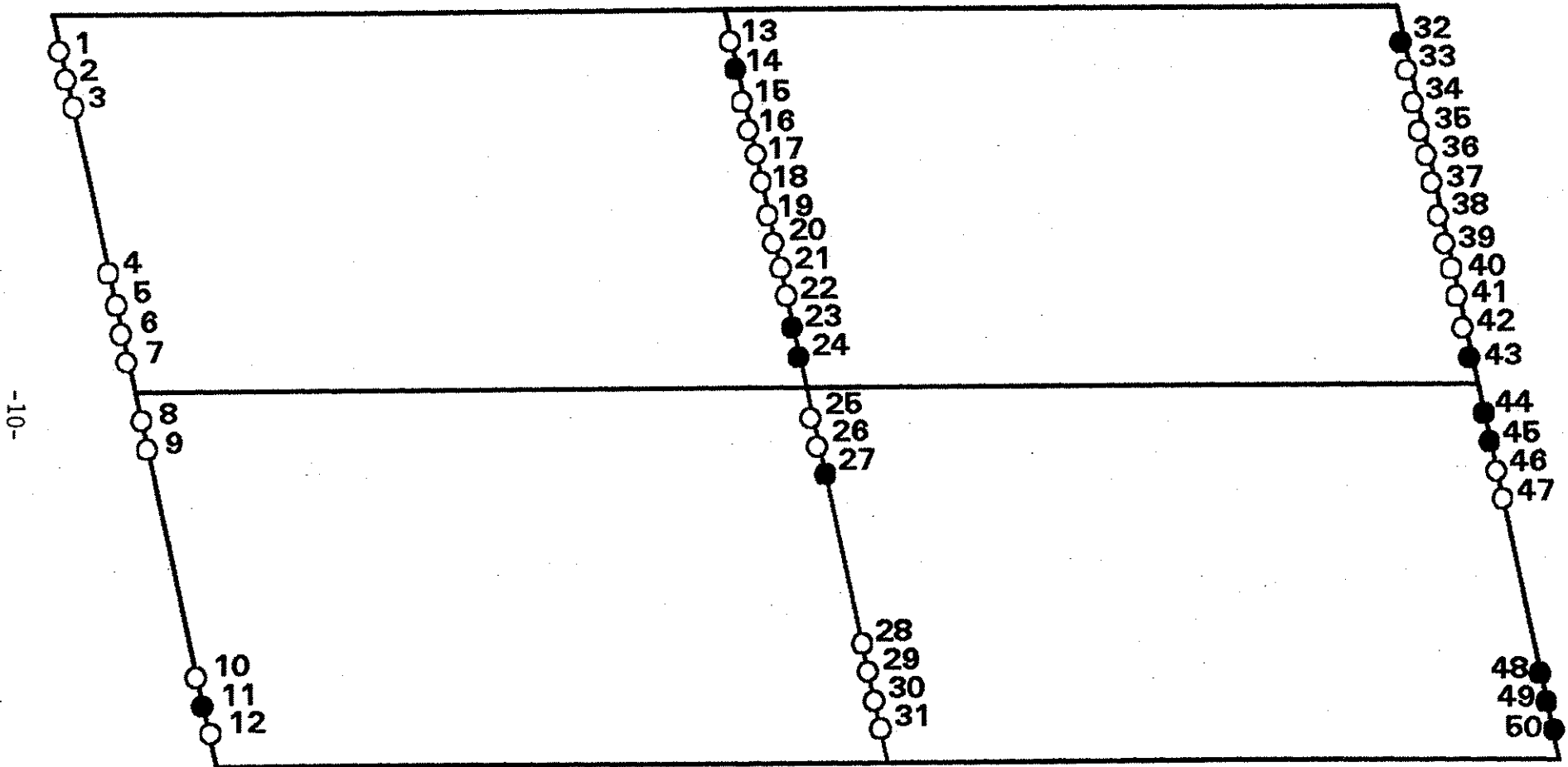

○ Sensors not working at end of project.

● Sensors still working at end of project.

Figure 5: Concrete Sensors

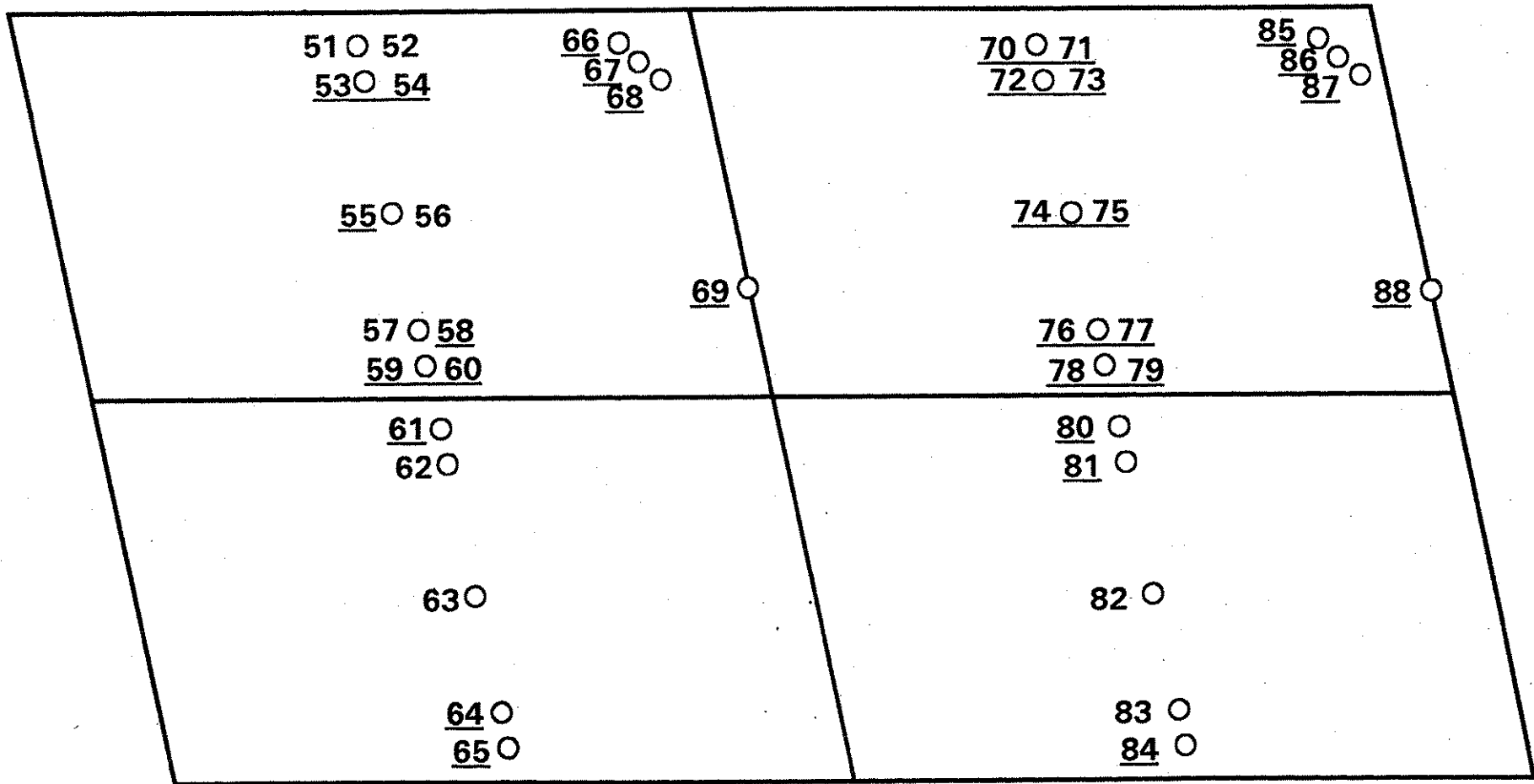

Sensors not working at end of project.

Sensors still working at end of project.

Figure 6: LVDT Sensors

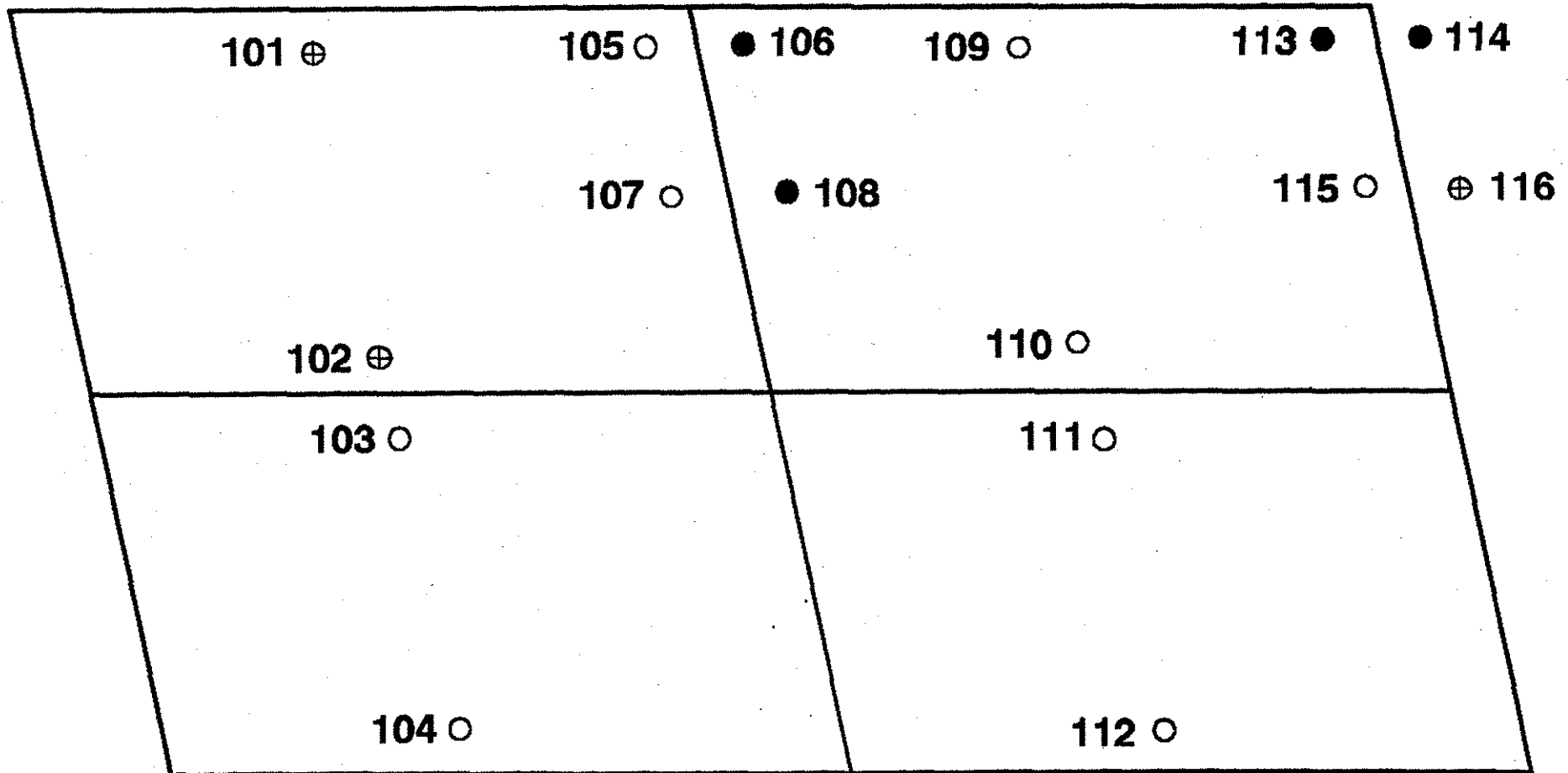

- Sensors not working at end of project.
- Sensors still working at end of project.
- ⊕ Sensor never installed due to construction damage.

Figure 7: Temperature Sensors

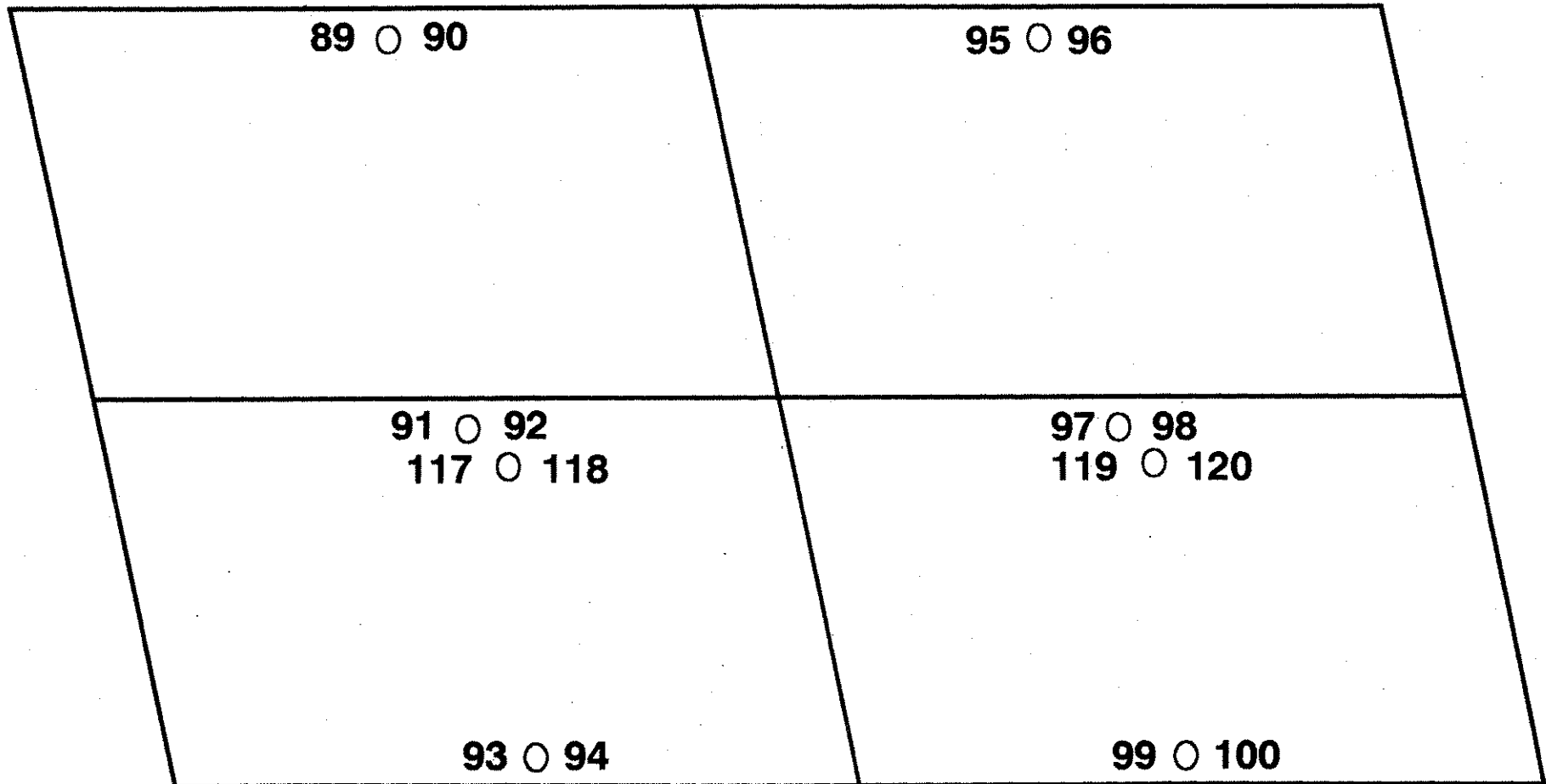

-13-

Note: Sensor 116 measured ambient temperature and was installed near the cabinet in the ditch.

DATA COLLECTION SEQUENCE

The data software gathering was designed to do the following:

1. As a single unit or larger truck enters the pavement slab containing the classifier system, a signal is sent to the HP field unit computer.
2. The field unit computer reads a data file downloaded from the central unit computer which determines which sensors will be used during data collection.
3. After a fixed interval (the time required for a vehicle to traverse the distance from the classification system to the first instrumented slab), the HP 3852A is activated.
4. The data collection continues for 3 seconds, the amount of time required for a long truck to traverse the instrumented pavement slabs.
5. If less than the number of vehicles set in the initial program have been gathered, the field computer goes into a waiting state until another truck is detected by the classification system.
6. If the number of trucks specified has been gathered, the computer goes into a waiting state until called by the central computer.
7. Data from field unit is downloaded by central computer.
8. During downloading, a different set of sensors can be specified by uploading a file containing the required data to the field unit.
9. Data from both the WIM and classification sites are downloaded.

Original plans called for a much more sophisticated analysis of the data from the classification system. However the time used by the classification

system prior to transmission of the data to the HP field unit precluded any action other than triggering the HP 3852A. The remainder of the analysis was to be done via post processing. The clocks on all three devices (classifier, HP computer and WIM) were to be set to the same time. With this time data and data from the deflection gauges, it would be possible to identify those readings taken when multiple vehicles were present on the slab. Because of the large number of trucks present on I-80, the removal of those data sets with multiple vehicles would not have caused a problem in data analysis.

SOFTWARE DEVELOPMENT

Software development began during October 1987. This software was required by the contract to automatically begin acquiring data as specified by files transmitted from a remote site. Once the data had been acquired, it was stored on the local hard disk and another data acquisition cycle began. At the completion of the data acquisition cycle, the local computer would wait to upload the data to the remote site when a call was received. The initial development of software by ISU from October 1987 to April 28, 1988, did not result in any usable software and uncovered a potential problem in using the strain gauges and the HP monitoring equipment. The problem uncovered was that the electrical noise was masking the strain signals being received.

An ISU student was hired in the fall of 1988 to develop the software needed for the project. The specifications for this software were developed by the Iowa DOT. A partially functional program capable of reading data from the instrumented pavement slabs was operational on February 25, 1989. However, the subroutines for remote processing were not completed. Because of

this, the partially completed program was started and stopped manually, and data retrieval was also accomplished manually at the site.

On May 31, 1989, the DOT began its active involvement in the project by attempting to use the software developed by ISU to gather data. At this point it appeared that the software was not functioning correctly, based on the data collected.

After consultation with HP and a trip to its regional office by DOT staff, a simple program was developed to monitor readings from any given sensor. A thousand readings from each of the strain and deflection sensors was taken on June 18-19, 1989. At this point, it was apparent that the sensor data being gathered was of no value.

After consulting with ISU, it was mutually agreed that the DOT would take over control of the project July 1, 1989.

TROUBLESHOOTING

Numerous trips were made to the site, and the data gathered was analyzed. It became apparent that the data being gathered from the sensors in the pavement did not show any voltage changes that should have been associated with a truck. All of the gauges measure a change in voltage which is then converted into microstrain, deflection or temperature. At first the lack of change in voltage was thought to be caused by taking the readings at the wrong time (i.e., no vehicle present). In order to conduct further investigation on the gages, the linear velocity deflection transducers voltage readings were tested in September 1989. These gauges were selected because they were accessible from the surface of the road through capped pipes.

The vendor that supplied the LVDTs sent a representative to the site to assist the DOT in determining the problem. As soon as the representative saw the experimental setup, he identified a problem. The excitation voltage being supplied to the LVDTs was 5 volts. This excitation voltage would never generate a recognizable change in the output voltage. The DOT borrowed a 20-volt power supply from the vendor and attempted to measure deflection from the 13 LVDTs. With the new power supply, valid readings were taken from some of the LVDTs (see Appendix B) which clearly showed vehicle presence. However, when the gauges were tested in October 1989, only 5 of the 13 gauges that were installed were still working. The non-working gauges were sent to the LVDT vendor for analysis. A 20-volt Lambda LDS-Y power supply was purchased in late 1989 to replace the 5-volt power supply.

As of October 1989, no valid data had yet been taken from any of the strain gauges (dowel or concrete). All of the data gathered from these sensors showed no change that could be identified with a vehicle's presence. The presence of a vehicle was confirmed by the readings taken from the working LVDTs.

In October 1989 the data collection equipment was removed from the site and brought to the office for bench tests. A considerable amount of time was spent during the winter months familiarizing DOT staff with different pieces of the HP data collection equipment, and in writing software.

In the spring of 1990 new LVDTs were installed, and readings were taken. In addition, the faulty strain gages (concrete and dowel) and an expansion unit (3853A) were removed from the site (see Figures 4, 5, and 6 for location of the remaining gauges). Of the 50 original dowel strain gauges, only 12

were still operational. Of the original 38 concrete strain gauges, only 8 were still functional. After removal of the bad gauges, one of the HP 3853A expansion chassis was no longer required due to the large number of gages/wires that had failed.

During the summer of 1990 the DOT continued to work with HP in an attempt to get valid readings from the strain gauges.

In August, a condensation/moisture problem with the readings taken from the LVDTs was detected. Examination of several LVDTs revealed that rust and moisture were getting into the hollow core of the LVDTs. The faulty gauges were removed and cleaned, and silicon was placed on top the LVDTs. The silicon was used in an attempt to keep condensation and dirt from entering the middle of the LVDTs. In September 1990 the equipment was removed from the field location and brought into the main office for additional bench testing.

Working in cooperation with personnel from Hewlett-Packard, it was determined the hardware was incapable of separating the strain gage signal from the noise. Since the equipment had been purchased in 1987, new strain gauges had been developed. HP loaned the DOT a 3852A data acquisition unit, 44732A and 44733A strain gauge bridges. During October 1990 it was determined there was a bad bank on the loaned strain gauge bridge that the DOT was attempting to test. The equipment was returned to HP at their company's request in November 1990.

Over the winter months, a considerable amount of bench testing and software development took place. The software programs required for activation of the site from a remote location and the ability to download data were completed, subject to field testing (see main program in Appendix A).

In February 1991, arrangements were made to borrow a new 3852A and new strain gauge bridges from HP. Attempts to gather strain data at the site in April 1991 were again unsuccessful. The data acquisition software was tested at that time and proved capable of operating without human intervention. After a considerable amount of correspondence, both in writing and over the phone with HP, it was determined the small size of the signal vs. the noisy environment made it unlikely that the current equipment would be able to acquire any usable readings from the strain gauges.

Some of LVDTs were also showing problems (moisture/condensation?) similar to those experienced in August 1990. In June 1991 LVDTs were again removed and cleaned. As soon as the tube on the slab was opened, a considerable amount of condensation was seen. This condensation then evaporated. After a relatively short amount of time, the LVDTs appeared to be working properly. It appeared that condensation was affecting the gauges.

At this time it was also verified that all temperature gauges were incorrectly wired in the concrete. As was expected from the wiring diagram, the readings from these gauges measured the difference in potential from the power supply minus a small amount of resistance from several hundred feet of wire.

Considering the amount of time and effort expended to this point and the continuing problems in gathering useful data, it was decided to terminate the project.

RECOMMENDATIONS

A key ingredient in the success of an instrumentation project such as this one is detailed planning. In order for the project to succeed, a number of different professional disciplines need to be coordinated. Pavement engineering, computer science and electrical engineering should have been involved from the inception of the project. In addition to these professional disciplines, technical expertise in the areas of sensor selection and installation is required. Each of these disciplines and technical experts had a role to play in this project. In the case of this project, a pavement engineer and two people experienced in structural concrete instrumentation of railroad beds were involved in the first stages of the experiment. After equipment had been purchased and sensors had been installed in the pavement, a statistician and an electrical engineer became involved in the project.

A crucial step in such an instrumentation project is in the selection of equipment to measure the desired items. The fact that the HP equipment proved incapable of separating the signal from electrical noise at the expected level of strain, and at the rate at which the sensors had to be scanned, was the main reason for the failure of the experiment. Precise specifications of the nature of each device might have eliminated most of the problems encountered in this project. Rigid specifications for each of the items to be measured is a requirement if individual components are to be used to build a device to measure pavement behavior.

Installation of the sensors is another important step that requires additional effort. Since most of the sensors will not be accessible after installation, any mistakes made during installation (such as the temperature

gauges) will not be correctable. In addition to this, sensors which fail cannot be replaced. It would be wise to double-check each step in installation, buy more durable sensors if possible; and be aware of the expected failure rate from all causes so that sufficient redundant sensors can be included in the initial design.

CONCLUSIONS

The project successfully demonstrated that data could be gathered at a remote site and then transferred to a central location for analysis. It was also demonstrated that different configurations of sensors could be specified from the central location.

The primary failures in the project occurred in two separate areas. The first area was in the acquisition of hardware to monitor the sensors in the pavement. The most damaging failure in this area was the inability of the hardware to separate the small change in voltage expected from the strain gauges from the background noise inherent in the system (the system is defined here as the measuring device plus the wires and sensors in the pavement). The second area was multifaceted and involved a number of mistakes in installation and equipment purchased. Some of the areas were correctable such as purchase of a 20-volt power supply for the LVDTs. Others, such as the incorrect wiring of the temperature gauges, were not correctable.

Considering the amount of time spent on this project and the large number of sensors that had either failed during installation or during the project, it would be prudent in future undertakings to spend more time in the planning stages in the selection of sensors, design of the installation, and acquisition of proven hardware.

Appendix A

This appendix contains a computer listing of the program written in HP Basic 4.0 that automatically gathered data at the remote site. This program after gathering a user specified number of readings would then wait for the remote site to call. Only that portion of the code written by either ISU or the DOT is shown.

The code between lines 10 and 23590 contain the Meadow Soft Works telecommunication program. The lines of code following 24268 contain subroutines from the Data Acquisition software purchased from HP.

```

1      CALL Road_prog(Numit)
10     END
23590 SUB Road_prog(Numit)
23591 !
23603 ! {{{{{{
23604 ! *****>                                ROAD PROG
23605 ! {{{{{{
23606 Sys_init      ! INITIALIZE A 128 kbyte RAM VOLUME AT ""MEMORY.0,15"
23610 OPTION BASE 1      ! ALL ARRAYS BEGIN WITH "1".
23620 PRINTER is 1      ! PRINTER IS THE CRT.
23630 MASS STORAGE IS ":",1400,0"      ! HARD DISK ADDRESS.
23640 DIM Ztime$(20) [10]      ! DIMENSION OF STORAGE VECTORS
23650 DIM Stime$(100)[10]
23651 DIM Opt$(3) [20]
23660 DIM Clear$[2],Home$[2]
23661 DIM Class$[1]
23670 Clear$=CHR$(255)&CHR$(75)      ! CLEAR SCR KEY.
23680 Home$=CHR$(255)&CHR$(84)      ! HOME KEY.
23700 K=1      ! STORAGE COUNTER.
23710 Kount=0      ! VEHICLE COUNTER.
23720 Kount1=0      ! ZERO READINGS COUNTER
23730 Disk=1      ! DATA TRANSFER COUNTER
23731 !
23732 !*****>      READ INPUT DATA FILE 'INPUTX'.
23733 !
23739 Numit=1
23740 Timel=1
23741 Sen_option=8
23742 ASSIGN @File TO *
23743 !
23745 Opt$(1)="SENSOR OPTION"
23746 Opt$(2)="===== "      ! OPTION NUMBER RECORDING.
23748 Opt$(3)=VAL$(Sen_option)
23749 Save-svect(Opt$(*),"OPT")
23750 !
23752 THADD_patton=Numit      ! PARAMETER LIST HARD-WIRED VARIABLE
23758 !
23780 !*****>      SET-UP THE HP3852 WITH INTERNAL SUBROUTINES
23790 !      FOR EACH POSSIBLE SENSOR OPTION ALONG WITH HISPEED-INIT
23791 !      SUBPROGRAM DATA TRANSFER COUNTS.
23800 !
23810 ASSIGN @Hp3852 TO 709      ! HPIB ADDRESS OF 3852.
23820 !
23822 ON Sen_option GOTO Opt1, Opt2,Opt3,Opt4,Opt5,Opt6,Opt7,Opt8_9,Opt8_9
23831 !
23910 Opt1: !TEMPERATURE SENSORS READ
23937 OUTPUT @Hp3852; "SUB TEMP"
23938 OUTPUT @Hp3852; "INBUF ON;USE 600;SCANMODE ON;SCTRG HOLD"
23939 OUTPUT @Hp3852; "RDGSMODE DAVE;ASCAN ON;PRESCAN 1500;NRDGS 1"

```

```

23940 OUTPUT @Hp3852; "FUNC DCV; TERM RIBBON"
23941 OUTPUT @Hp3852; "CLWRITE SENSE 000-012"
23942 OUTPUT @Hp3852; "SUBEND"
23943 Xfer=19500
23944 Call$="CALL TEMP"
23952 GOTO Optzero
23988 !
23989 Opt2: ! DOWEL SENSORS READ
23991 OUTPUT @Hp3852; "SUBDOWEL"
23992 OUTPUT @Hp3852; "INBUF ON; USE 600; SCANMODE ON; SCTRIG HOLD"
23993 OUTPUT @Hp3852; "RDGSMODE DAV; ASCAN ON; PRESCAN 400; NRDGS 1"
23994 OUTPUT @Hp3852; "FUNC DCV; TERM RIBBON"
23995 OUTPUT @Hp3852; "CLWRITE SENSE 500-523, 400-423, 300-301"
23996 OUTPUT @Hp3852; "SUBEND"
23997 Xfer=20000
23998 Call$="CALL DOWEL"
23999 GOTO Optzero
24000 !
24001 Opt3: | CONCRETE SENSORS READ
24002 OUTPUT @Hp3852; "SUB CONCRETE"
24003 OUTPUT @Hp3852; "INBUF ON; USE 600; SCANMODE ON; SCRIG HOLD"
24004 OUTPUT @Hp3852; "RDGSMODE DAV; ASCAN ON; PRESCAN 500; NROGS 1"
24005 OUTPUT @Hp3852; "FUNC DCV; TERM RIBBON"
24006 OUTPUT @Hp3852; "CLWRITE SENSE 302-323, 200-215"
24007 OUTPUT @Hp3852; "SUBEND"
24008 Xfer=19000
24009 Call$= "CALL CONCRETE"
24010 GOTO Optzero
24011 !
24012 Opt4: ! DEFLECTION SENSORS READ
24013 OUTPUT @Hp3852; "SUB DEFLECT"
24014 OUTPUT @Hp3852; INBUF ON; USE 600; SCANMODE ON; SCTRIG HOLD"
24015 OUTPUT @Hp3852; RDGSMODE DAV; ASCAN ON; PRESCAN 1250; NRDGS 1"
24016 OUTPUT @Hp3852; "FUNC DCV; TERM RIBBON"
24017 OUTPUT @Hp3852; "CLWRITE SENSE 100-115"
24018 OUTPUT @Hp3852; "SUBEND"
24019 Xfer=2000
24020 Call$= CALL DEFLECT"
24021 GOTO Optzero
24022 !
24023 Opt5: | ALL SENSORS READ
24024 OUTPUT @Hp3852; "SUB ALL1"
24025 OUTPUT @Hp3852; "INBUF ON; USE 600; SCANMODE ON; SCTRIG HOLD"
24026 OUTPUT @Hp3852; "RDGSMODE DAV; ASCAN ON; PRESCAN 190; NRDGS 1"
24027 OUTPUT @Hp3852; "FUNC DCV; TERM RIBBON"
24028 OUTPUT @Hp3852; "CLWRITE SENSE 100-115, 200-215, 300-523"
24029 OUTPUT @Hp3852; "SUBEND"
24030 Xfer=19760
24031 Call$= "Call ALL1"

```

24032 GOTO Optzero
24033 !
24034 Opt6: ! EAST SENSORS READ
24035 OUTPUT @Hp3852: "SUB EAST"
24036 OUTPUT @Hp3852; "INBUF ON; USE 600; SCANMODE ON; SCTRIG HOLD"
24037 OUTPUT @Hp3852; "RDGSMODE DAV; ASCAN ON; PRESCAN 225; NRDGS 1"
24038 OUTPUT @Hp3852; "FUNC DCV; TERM RIBBON"
24039 OUTPUT @Hp3852; CLWRITE SENSE 512-523,400-423,300-323,200-215,104-115"
24040 OUTPUT @Hp3852; "SUBEND"
24041 Xfer=19800
24042 Call\$= "CALL EAST"
24043 GOTO Optzero
24044 !
24045 Opt7: ! WEST SENSORS READ
24046 OUTPUT @Hp3852; "SUB WEST"
24047 OUTPUT @Hp3852; "INBUF ON; USE 600; SCANMODE ON; SCTRIG HOLD"
24048 OUTPUT @Hp3852; RDGSMODE DAV; ASCAN ON; PRESCAN 340; NRDGS 1"
24049 OUTPUT @Hp3852; "FUNC DCV; TERM RIBBON"
24050 OUTPUT @Hp3852; "CLWRITE SENSE 500-523, 400-406, 302-320, 100-107"
24051 OUTPUT @Hp3852; "SUBEND"
24052 Xfer=19720
24053 Call\$= "CALL WEST"
24054 GOTO Optzero
24055 !
24056 Opt8_9: ! SOUTH/NORTH SENSORS READ
24057 OUTPUT @Hp3852; "SUB NORTH"
24058 OUTPUT @Hp3852; "INBUF ON; USE 600;SCANMODE ON; SCRTIG HOLD"
24059 OUTPUT @Hp3852; "RDGSMODE DAV; ASCAN ON; PRESCAN 9984; NRDGS 1"
24060 OUTPUT @Hp3852; "FUNC DCV; TERM RIBBON"
24061 OUTPUT @Hp3852; "CLWRITE SENSE 401,403"
24062 OUTPUT @Hp3852; "SUBEND"
24064 Xfer=19968
24065 Call\$= "CALL NORTH"
24066 GOTO Optzero
24067 !
24069 Optzero: ! ALL SENSOR ZERO
24070 OUTPUT @Hp3852; "SUB ZER"
24071 OUTPUT @Hp3852; "USE 600"
24072 OUTPUT @Hp3852; "INBUF ON; RDGSMODE DAV; SCANMODE ON; SCTRIG HOLD"
24073 OUTPUT @Hp3852; "FUNC DCV; TERM RIBBON; ASCAN ON; AZERO ONCE"
24074 OUTPUT @ Hp3852; "PRESCAN 1; NRDGS 1"
24075 OUTPUT @Hp3852; "CLWRITE SENSE 400-423"
24076 OUTPUT @Hp3852; "SUBEND"
24077 !
24078 ! SETS UP THE HP3852 INTO INTERNAL SUBROUTINES, USE
24079 ! THE VOLTMETER IN SLOT 600, INTERNAL BUFFER ON,
24080 ! READINGS MODE AS SOON AS DATA IS AVAILABLE, SCANMODE
24081 ! ON, SCAN TRIGGER ON HOLD, READ DC VOLTS, TRANSFER VIA
24082 ! RIBBON CABLE, AUTOSCAN THE LIST WHEN TRIGGERED, ZERO

```

24083 ! THE VOLTMETER INTERNALLY ONCE.
24084 ! {{{{{{
24085 ! *****>          MAIN PROGRAM LOOP SEQUENCE.
24086 ! {{{{{{
24088 Start: WHILE K<=Numit      ! # OF 3.5 FLOPPY DISKS TO FILL.
24089 Rezero:  GOSUB Zero_30      ! 30-MIN ZERO SUBROUTINE.
24090          Clock1=TIMEDATE    ! CLOCK TIMER
24091          WHILE Disk<=3      ! 3.5 FLOPPY DATA SIZE LIMIT.
24096          GOSUB Strain      ! STRAIN SENSORS SUBROUTINE.
24097          Disk=Disk+1
24098          Clock2=TIMEDATE    ! CLOCK TIMER
24099          Clock3=DROUND(Clock2-Clock1,4)
24100          IF Clock3>=1800 THEN GO TO Rezero
24101          END WHILE
24102 !
24103 Save_Svect(Ztime$(*),VAL$(K)&"ZT" ! SAVE ZERO AND STRAIN TIMES.
24104 Save_Svect(Stime$(*),VAL$(K)&"ST"
24105 !
24106 K=K+1                      ! RESET COUNTERS
24107 Disk=1
24108 Kount=0
24109 Kount1=0
24110 END WHILE
24111 !
24113 K=1                      ! RESET COUNTERS
24114 Disk=1
24115 Kount=0
24116 Kount1=0
24117 !
24118 Download=1                !DATA READY TO BE DOWNLOADED
24119 GOTO Leave
24120 ! {{{{{{
24121 ! SUBPROGRAM PROGRAM SEGMENTS
24122 ! {{{{{{
24123 ! _____
24124 !
24125 ! *****>          30 MIN ZERO
24126 ! _____
24127 ! THIS SUBROUTINE IS SCHEDULED TO TAKE THE ZERO READINGS ON THE
24128 ! SENSOR EQUIPMENT USED. THE MAIN PROGRAM WILL CALL ON THIS
24129 ! SUBROUTINE EVERY 30 MINTUES, AS PREVIOUSLY SCHEDULED.
24130 ! _____
24131 Zero_30:Kount1=Kount 1+1    ! ZERO COUNTER INCREMENTER
24133 Zer$=VAL$(K)&"ZR"&VAL$(Kount1)
24134 DISP "ZERO",ZER$
24138 !
24139 OUTPUT @Hp3852; "CALL ZER" ! CALL THE HP3852 INTERNAL SUBROUTINE.
24140 !
24141 Hispeed_init(12, "READ",24,709,600)

```



```

24142 !   SETS UP THE PATHS FOR THE HIGH-SPEED TRANSFER OF '116'
24143 !   VOLTAGE READINGS OVER THE GPI0 INTERFACE FROM THE HP 44702
24144 !   IN SLOT 6 OF THE HP 3852 AT ADDRESS '709' TO THE INTEGER
24145 !   VECTOR FILE 'READ' IN THE CURRENT MASS STORAGE IS
24146 !   DEVICE.
24147 !
24148 Ztime$(Kount1)=TIME$(TIMEDATE) ! CHARACTER VECTOR OF ZERO TIMES
24149 !
24150 OUTPUT @ Hp3852; "SCRTIG"
24151 !
24152 Hispeed_trans ! TRANSFERS 116 VOLTAGE READINGS FROM THE HP 44702
24153 ! TO THE VECTOR 'READ'.
24154 Hispeed_unpack ("READ",ZER$) ! CONVERTS THE PACKED INTEGER
24155 ! ELEMENTS OF THE VECTOR 'READ' TO TYPE REAL ELEMENTS
24156 ! IN THE VECTOR 'ZER$'.
24157 PURGE "READ" ! PURGE UNNEEDED FILES
24158 !
24159 RETURN
24160 !
24161 !
24162 ! *****> CLASSIFYING
24163 !
24164 ! THIS SUBROUTINE WILL RECEIVE DATA FROM CLASSIFYING CABLE THAT ARE
24165 ! WIRED DIRECTLY TO THE HP 98628A DATACOMM INTERFACE CARDS.
24166 ! ASYNCHRONOUS PROTOCOL IS USED WITH A RS232C CABLE TRANSMITTING THE
24167 ! DATA FROM THE CLASSIFIER TO THE COMPUTER. THE DATA IS NOT STORED
24168 ! IN THIS PROGRAM BUT IS CONTAINED WITHIN THE CLASSIFIER ITSELF.
24169 ! WHEN IDENTIFICATION IS POSITIVE FROM THE CLASSIFIER CONTROL IS
24170 ! DISCONNECTED AND TRANSFERRED BACK TO THE MAIN PROGRAM LOOP.
24171 !
24172 Class:DISP "WAITING FOR A TRUCK"
24176 Halt=0 ! SUBROUTINE RETURN INDICATOR.
24180 ! RESET DATACOMM CARD AND ENABLE ASYNCH PROTOCOL.
24182 Dc=20
24183 CLEAR Dc
24184 CONTROL Dc,0;1 ! CARD IDENTIFICATION.
24185 CONTROL Dc,3;1 ! ASSIGN ASYNC PROTOCOL.
24186 CONTROL Dc,0;1 ! RESET CARD.
24187 !
24188 ! SET NON DEFAULT SWITCHES ON THE DATACOMM CARD.
24189 !
24190 CONTROL Dc,14;0 ! CONTROL BLOCK DISABLED.
24191 CONTROL Dc,16;0 ! CONNECTION TIMEOUT DISABLED.
24192 CONTROL Dc,17;0 ! NO ACTIVITY TIMEOUT DISABLED.
24193 CONTROL Dc,22;0 ! PROTOCOL HANDSHAKE DISABLED.
24194 CONTROL Dc,23;0 ! HANDSHAKE OFF, NON-MODEM CONNECTION.
24195 ! DEFAULT SWITCHES SET ON THE DATACOM CARD = (NO PARITY, 1200 BAUD,
24196 ! 8 BITS/CHARACTER, HANDSHAKE OFF.
24197 !

```

```

24201 ! START THE CONNECTION AND SEND A BREAK ACROSS THE LINE TO WAKE
24202 ! THE G.K. (GEE KAY) UNIT UP.
24204 CONTROL Dc,12;1
24205 !
24208 Conn:STATUS Dc,12;Lines
24209 IF Lines< >3 THEN Conn
24210 OUTPUT Dc;6,1 ! SEND BREAK
24211 OUTPUT Dc; CHR$(32)
24213 ON INTR Dc GOSUB Datacomm ! UPON INTERRUPT READ BUFFER.
24214 IF Halt>0 THEN GOTO Disconnect ! END CLASS ROUTINE SERVICE.
24216 ENABLE INTR Dc;1
24217 !
24218 Background:GOTO Background ! IDLE OPERATIONS LOOP.
24219 !
24220 Datacomm:STATUS Dc;Inter_bits ! ACKNOWLEDGE INTERRUPT.
24221 ENABLE INTR Dc ! ENABLE INTERRUPT.
24222 !
24224 Again: STATUS Dc,5;Rx_bits ! DATA AVAILABLE QUEUE STATUS.
24225 IF Rx-bits=0 THEN ! IF EMPTY EXIT ROUTINE.
24226 Halt=1
24227 RETURN
24228 END IF
24229 ENTER DC using "#,-K";Class$ ! ENTER CHARACTER FROM BUFFER.
24230 GOTO Again ! CHECK FOR MORE DATA.
24231 !
24232 Disconnect:DISABLE INTR Dc ! EXIT SUBROUTINE.
24233 CONTROL Dc,12;0
24234 RETURN
24235 !
24236 !
24237 ! *****> STRAIN SENSORS
24238 !
24239 ! THIS SUBROUTINE WILL SCAN A SPECIFIED SET OF CHANNELS ON EACH FET
24240 ! MULTIPLEXER REFERENCED. THE SENSORS ARE READ AS IN THE 30 MIN ZERO
24241 ! SUBROUTINE.
24242 !
24243 Strain:Kount=Kount+1
24244 Veh$=VAL$(K)&"VH"&Val$(Kount)
24245 DISP "STRAIN READINGS ", VEH$
24246 !
24247 OUTPUT @Hp3852;Call$ ! CALL HP3852 LOADED INTERNAL SUBROUTINE.
24248 !
24249 Hispeed_init(12,"READ",Xfer,709,600)
24250 ! SETS UP THE PATHS FOR THE HIGH-SPEED TRANSFER OF THE
24251 ! VOLTAGE READINGS OVER THE GPIO INTERFACE AT SELECT CODE
24252 ! '12' FROM THE HP 44702 IN SLOT 600 OF THE HP 3852 AT
24253 ! ADDRESS 709 TO THE INTEGER VECTOR FILE 'READ' IN THE
24254 ! CURRENT MASS STOARGE IS DEVICE.
24255 !

```

24256 Stime\$(Kount)=TIME\$(TIMEDATE) ! CHARACTER VECTOR OF SCAN TIMES. 7
24257 !
24258 OUTPUT @Hp3852;"SCTRIG" ! TRIGGERS THE VOLTAGE SCANS.
24259 !
24260 Hispeed_trans ! TRANSFERS THE READINGS FROM THE HP 44702 TO
24261 ! THE INTEGER VECTOR 'READ'.
24262 !
24263 Hispeed_unpack("READ",VEH\$) ! CONVERTS THE PACKED INTERGER
24264 ! ELEMENTS OF THE VECTOR 'READ' TO TYPE REAL ELEMENTS
24265 ! IN THE VECTOR VEH\$.
24266 !
24267 PURGE "READ" ! PURGE UNNEEDED FILES.
24268 RETURN

Appendix B

This appendix contains graphs showing data gathered from the site. The first two graphs show readings taken from the sensors indicated. As can be seen, there is a substantial amount of noise present. The darker area graphed in the center is based on an algorithm which threw out high and low values and used a moving average of the remaining readings. In the case of the LVDTs, the change in voltage was sufficient that individual axle effects could be seen on the graphs. The first small peak on each of the graphs is the steering axle on a 5-axle tractor and semitrailer. The second and third peaks are the respective tandem axles on the tractor.

The next five graphs show readings taken during benchmark testing under laboratory conditions. These readings were taken in an effort to isolate the problems with noise that were occurring. The readings are as follows:

1ZERO	-	NO STRAIN ON STRAIN GAUGE
1000K	-	1 KILOGRAM 10.5" FROM STRAIN GAUGE
ZEROK	-	SAME AS 1ZERO WITH 10K RESISTANCE FROM LO TO CHASSIS
1000Kr	-	SAME AS 1000K WITH 10K RESISTANCE
PSR	-	EXTERNAL POWER SUPPLY OFF NO STRAIN
LIGHT	-	FLOURESCENT LIGHTS OFF UNSTRAINED READING

All of the above graphs were produced using a CEA-06-250UW-120 strain gauge. As can be seen by the graphs the only real change occurred when no power was supplied to the strain gauge and even then there was noise present.

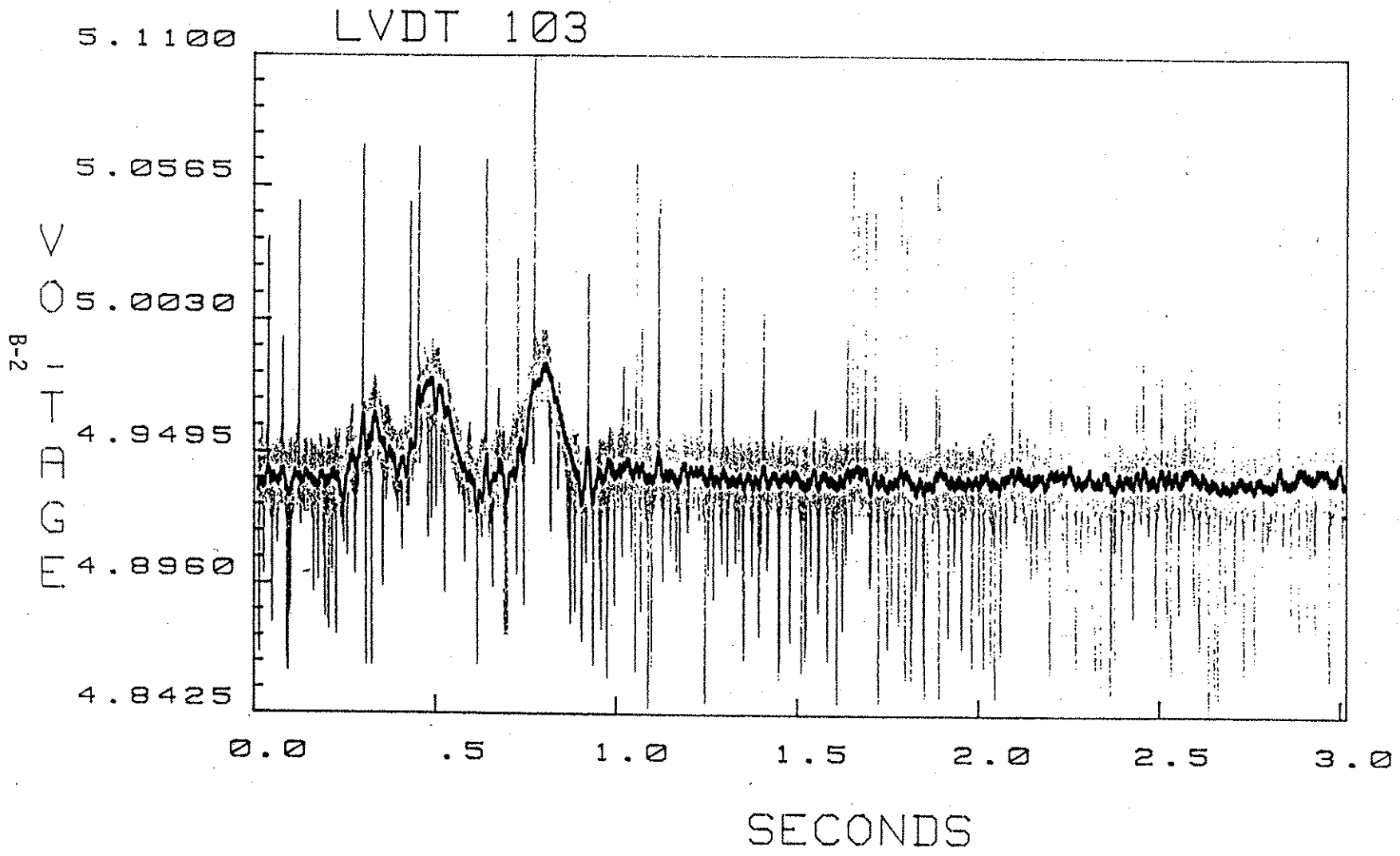

LVDT 107

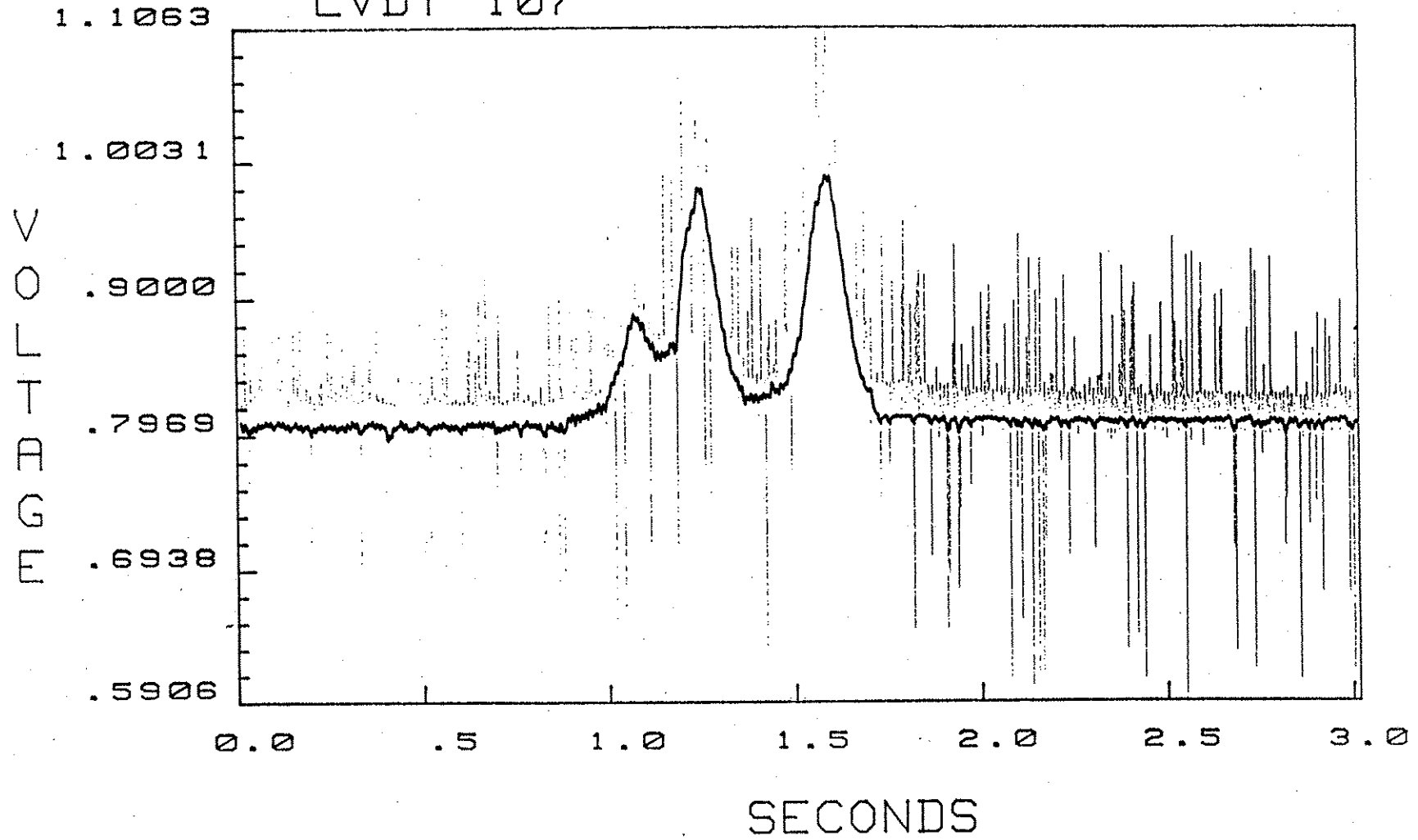

B-3

1 ZERO AVERAGE = -.00500

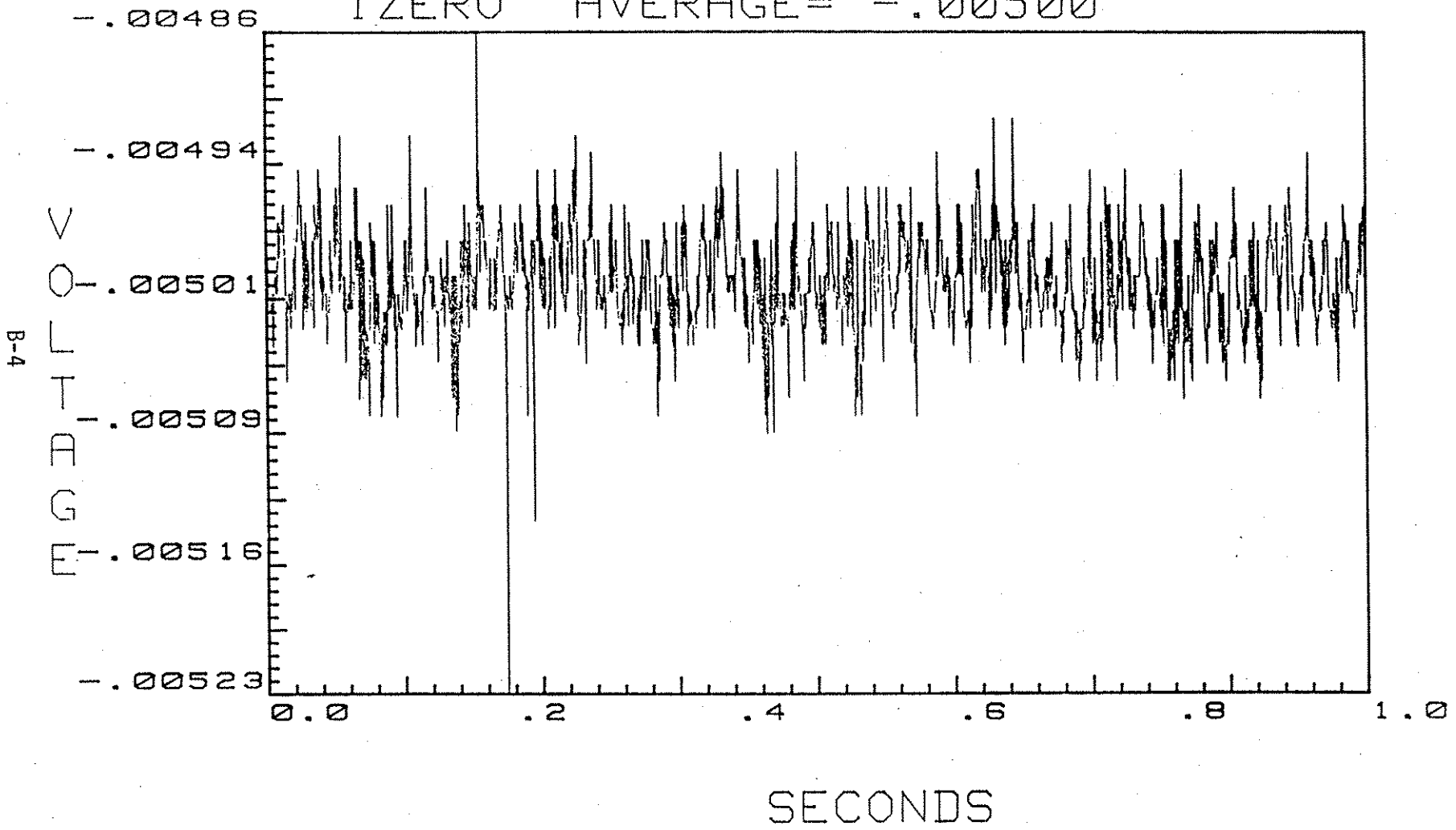

0 1 2 3 4 5 6 7 8 9 10 11 12 13 14 15 16 17 18 19 20 21 22 23 24 25 26 27 28 29 30 31 32 33 34 35 36 37 38 39 40 41 42 43 44 45 46 47 48 49 50 51 52 53 54 55 56 57 58 59 60 61 62 63 64 65 66 67 68 69 70 71 72 73 74 75 76 77 78 79 80 81 82 83 84 85 86 87 88 89 90 91 92 93 94 95 96 97 98 99 100

ZEROR AVERAGE = -.00499

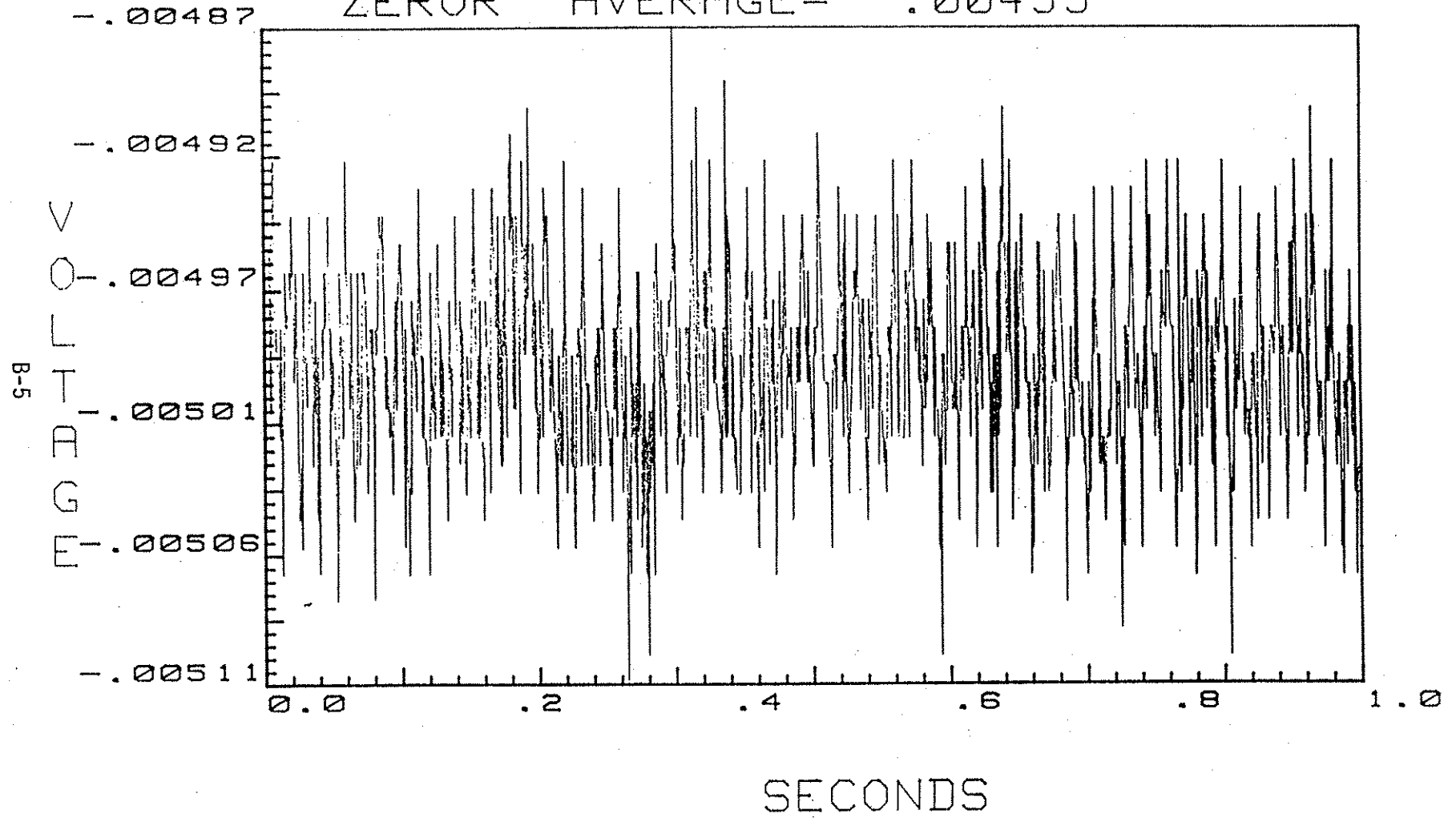

B-6

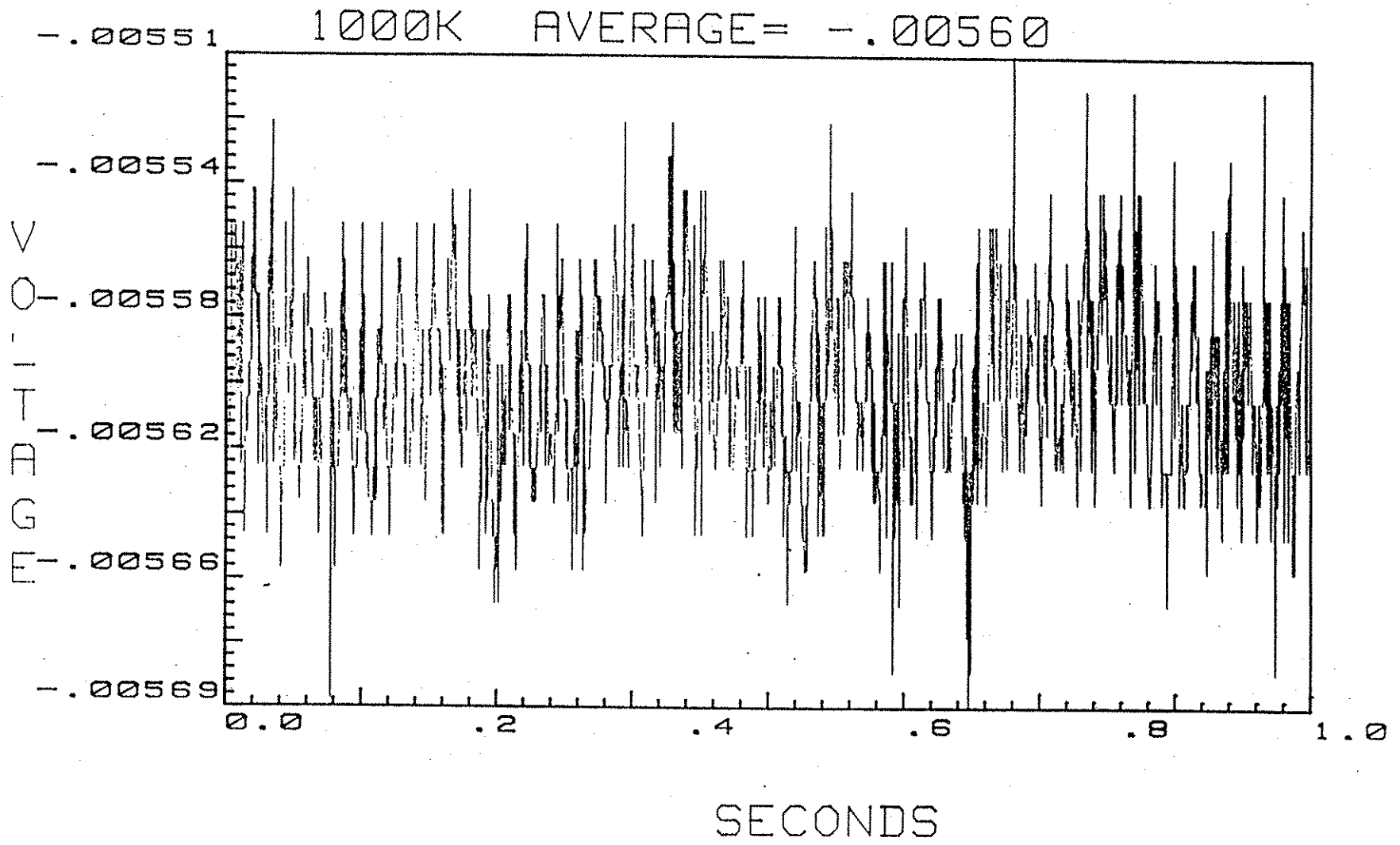

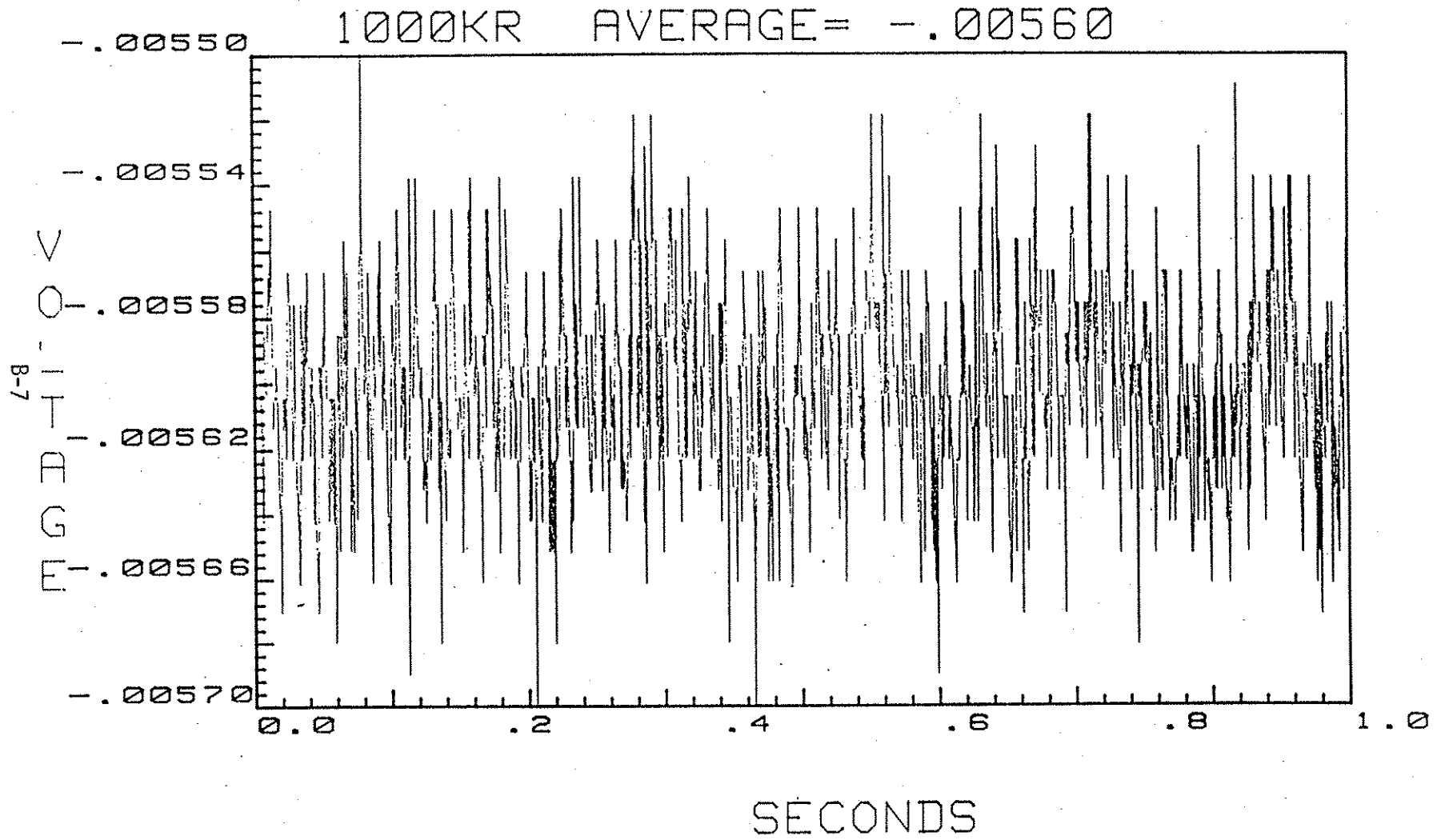

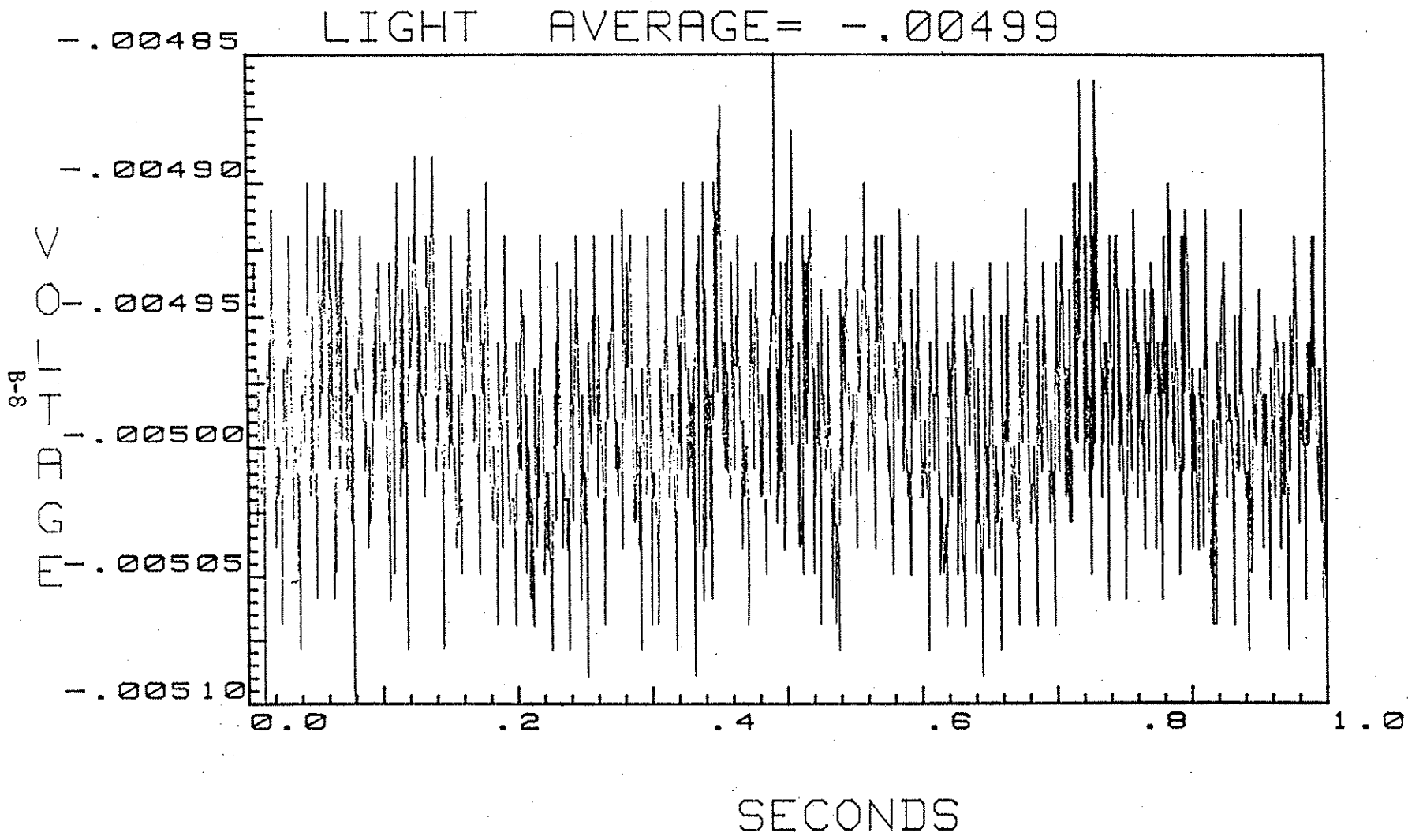

B-9

PSR AVERAGE = .000000

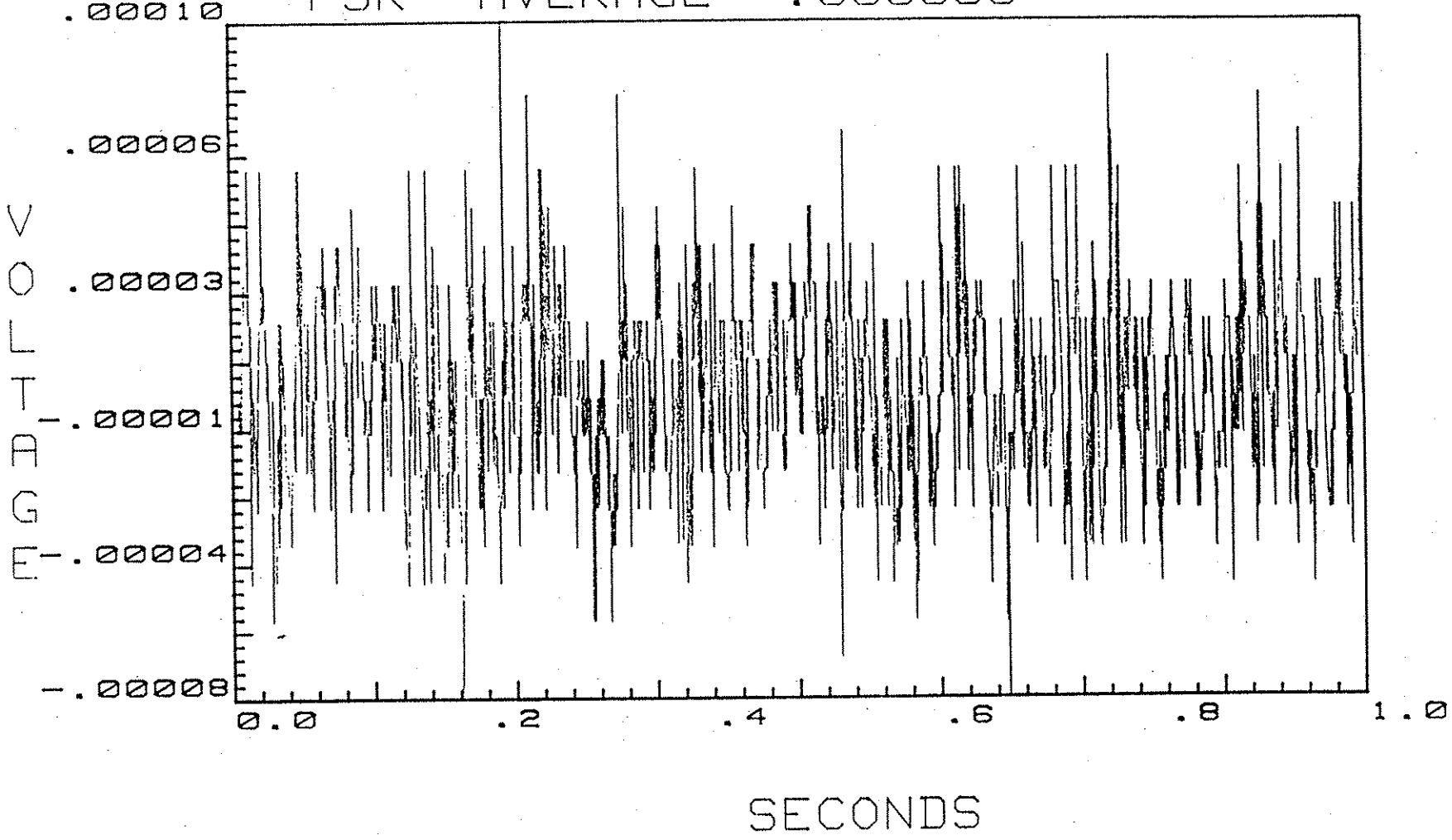

APPENDIX C

NUCLEAR DENSITY RESULTS
Pounds Per Cubic Foot

Date: May 7-8, 1987

	Tube #1	Tube #2	Tube #3	Tube #4	Tube #5
Right Edge of Shoulder	101.0	103.0	100.0	98.5	99.0
10' Right	104.0	101.0	97.0	98.0	96.5
8' Right	99.5	97.0	98.5	89.0	97.0
6' Right	99.5	87.5	104.0	94.0	101.0
4' Right	92.5	101.0	101.5	98.0	99.0
2' Right	93.0	98.0	100.5	95.0	99.0
Centerline	100.5	97.5	102.0	100.0	97.5
2' Left	100.0	99.5	103.0	97.0	100.5
4' Left	99.0	101.5	103.0	96.0	98.5
6' Left	99.5	99.5	103.5	100.0	98.5
8' Left	101.5	102.0	102.0	96.0	97.5
10' Left	101.0	101.0	101.0	95.5	93.5
12' Left	101.0	96.0	99.5	99.5	100.0
Left Edge of Shoulder	101.0	97.5	99.5	91.0	98.5

NUCLEAR DENSITY RESULTS
Pounds Per Cubic Foot

Date: June 17, 1987

	Tube #1	Tube #2	Tube #3	Tube #4	Tube #5
Right Edge of Shoulder	101.5	107.0	102.5	100.5	101.5
10' Right	105.0	101.0	95.0	97.5	96.0
8' Right	96.5	100.0	97.5	96.5	99.5
6' Right	101.0	91.0	105.0	93.5	101.0
4' Right	92.5	99.5	98.5	99.0	102.0
2' Right	95.0	99.5	101.0	98.5	100.5
Centerline	98.5	99.5	99.5	101.0	103.0
2' Left	102.0	98.5	100.0	99.0	103.0
4' Left	99.0	102.0	102.5	94.5	100.0
6' Left	101.0	98.0	100.5	103.0	100.5
8' Left	101.5	101.0	102.5	92.5	102.5
10' Left	102.5	103.0	99.0	96.5	95.5
12' Left	103.0	98.0	99.0	99.5	99.0
Left Edge of Shoulder	98.5	101.0	95.5	97.5	106.0

MOISTURE READINGS
Pounds Per Cubic Foot

Date: June 17, 1987

	Tube #1	Tube #2	Tube #3	Tube #4	Tube #5
Right Edge of Shoulder	17.5	22.0	22.0	19.0	20.5
10' Right	18.0	15.5	15.0	15.0	15.5
8' Right	17.0	14.0	14.5	15.0	15.0
6' Right	17.0	13.5	16.0	14.5	15.5
4' Right	16.0	12.5	15.0	14.0	15.5
2' Right	16.5	14.0	15.5	15.0	15.0
Centerline	17.0	14.0	15.5	13.5	15.5
2' Left	17.0	12.0	15.0	12.5	15.0
4' Left	17.0	13.0	15.0	12.5	15.0
6' Left	16.0	12.5	15.0	12.5	15.0
8' Left	17.0	13.0	15.0	12.0	16.0
10' Left	17.0	13.5	14.5	11.5	14.5
12' Left	15.0	12.0	15.0	12.5	14.5
Left Edge of Shoulder	17.0	14.0	15.0	12.5	17.0

NUCLEAR DENSITY RESULTS
Pounds Per Cubic Foot

Date: July 15, 1987

	Tube #1	Tube #2	Tube #3	Tube #4	Tube #5
Right Edge of Shoulder	100.0	99.5	96.0	99.5	101.0
10' Right	105.0	100.0	96.5	97.5	96.5
8' Right	98.0	98.5	99.5	91.0	97.5
6' Right	101.0	88.0	100.5	94.0	103.5
4' Right	93.5	100.5	100.0	97.5	100.0
2' Right	94.0	102.0	99.5	97.5	100.5
Centerline	94.0	95.0	103.5	98.5	98.0
2' Left	99.5	100.0	103.0	95.0	101.0
4' Left	101.0	98.0	102.5	97.0	101.0
6' Left	99.0	100.5	104.0	100.0	102.0
8' Left	99.5	101.5	101.0	97.0	99.0
10' Left	101.5	98.0	100.5	98.0	95.5
12' Left	101.5	98.0	98.0	98.5	102.5
Left Edge of Shoulder	98.5	98.0	96.5	97.5	96.5

MOISTURE READINGS
Pounds Per Cubic Foot

Date: July 17, 1987

	Tube #1	Tube #2	Tube #3	Tube #4	Tube #5
Right Edge of Shoulder	19.0	16.9	16.7	16.4	17.3
10' Right	18.8	14.4	16.1	15.7	16.4
8' Right	18.2	14.1	16.2	14.2	16.0
6' Right	17.1	13.5	16.9	14.9	16.9
4' Right	16.4	14.8	16.6	14.5	17.4
2' Right	16.6	14.0	16.9	14.2	17.1
Centerline	17.6	13.4	17.6	14.4	16.9
2' Left	17.3	12.4	17.2	11.9	17.1
4' Left	17.4	12.7	17.0	12.3	16.9
6' Left	16.4	12.6	16.7	13.4	16.8
8' Left	17.2	13.0	16.7	11.3	17.3
10' Left	17.3	11.7	16.3	11.6	16.3
12' Left	16.1	11.7	15.4	12.7	13.6
Left Edge of Shoulder	16.5	13.2	14.2	13.7	17.0

NUCLEAR DENSITY RESULTS
Pounds Per Cubic Foot

Date: August 10, 1987

	Tube #1	Tube #2	Tube #3	Tube #4	Tube #5
Right Edge of Shoulder	100.0	101.5	95.5	103.0	103.0
10' Right	102.5	100.5	95.5	98.0	98.5
8' Right	95.0	99.5	101.0	95.5	99.0
6' Right	102.5	89.0	101.5	95.5	103.5
4' Right	95.0	102.5	101.0	98.5	106.0
2' Right	95.5	103.5	99.5	102.0	102.0
Centerline	99.0	97.0	102.0	98.0	100.0
2' Left	102.5	100.5	103.5	95.0	103.0
4' Left	99.0	99.0	102.0	99.5	103.0
6' Left	102.5	101.0	103.5	100.5	104.0
8' Left	101.5	104.0	100.0	97.0	100.5
10' Left	102.5	99.5	102.5	101.0	98.0
12' Left	102.0	99.5	97.5	98.0	103.5
Left Edge of Shoulder	96.5	100.0	95.5	94.5	97.5

MOISTURE READINGS
Pounds Per Cubic Foot

Date: August 10, 1987

	Tube #1	Tube #2	Tube #3	Tube #4	Tube #5
Right Edge of Shoulder	19.6	17.5	17.7	17.1	19.8
10' Right	19.2	15.5	16.9	17.0	17.4
8' Right	19.1	14.9	16.8	16.2	16.7
6' Right	18.9	14.2	17.4	15.2	17.8
4' Right	17.2	15.6	17.9	15.8	19.0
2' Right	17.8	14.3	18.2	13.5	18.6
Centerline	18.2	13.9	18.9	13.5	17.8
2' Left	18.2	12.8	18.9	12.3	19.6
4' Left	18.1	12.5	18.3	12.8	19.2
6' Left	17.7	13.2	17.7	13.1	18.8
8' Left	18.4	13.2	17.9	11.4	19.0
10' Left	18.1	11.5	17.1	12.2	17.8
12' Left	15.9	11.8	15.7	13.0	14.0
Left Edge of Shoulder	17.0	13.6	15.4	12.9	17.9

MOISTURE READINGS
Pounds Per Cubic Foot

Date: September 11, 1987

	Tube #1	Tube #2	Tube #3	Tube #4	Tube #5
Right Edge of Shoulder	20.1	16.3	17.1	16.3	19.5
10' Right	19.0	14.3	16.2	15.4	17.0
8' Right	18.4	14.0	16.2	13.8	17.7
6' Right	17.7	13.6	17.5	14.2	16.4
4' Right	17.8	14.5	16.8	14.4	17.9
2' Right	17.8	13.8	17.4	14.7	18.3
Centerline	17.7	14.0	17.6	14.5	18.0
2' Left	19.3	12.7	17.2	11.9	17.4
4' Left	17.3	12.7	17.2	11.9	18.0
6' Left	18.3	12.9	16.4	13.4	17.4
8' Left	18.4	13.4	16.9	11.8	17.4
10' Left	16.5	12.4	15.9	12.2	17.8
12' Left	16.4	13.8	15.3	13.2	17.2
Left Edge of Shoulder	16.2	12.5	14.7	12.3	16.1

NUCLEAR DENSITY RESULTS
Pounds Per Cubic Foot

Date: September 9, 1987

	Tube #1	Tube #2	Tube #3	Tube #4	Tube #5
Right Edge of Shoulder	99.0				
10' Right	104.5				
8' Right	94.5				
6' Right	101.5				
4' Right	93.5				
2' Right	94.0				
Centerline	96.5				
2' Left	100.5				
4' Left	98.5				
6' Left	101.0				
8' Left	101.0				
10' Left	103.0				
12' Left	102.5				
Left Edge of Shoulder	96.5				

NUCLEAR DENSITY RESULTS
Pounds Per Cubic Foot

Date: November 6, 1987

	Tube #1	Tube #2	Tube #3	Tube #4	Tube #5
Right Edge of Shoulder	101.0		95.5	99.0	101.0
10' Right	105.5		95.0	96.0	97.0
8' Right	92.5		98.5	92.5	97.5
6' Right	101.5		100.0	93.0	97.5
4' Right	95.5		100.0	98.0	99.5
2' Right	95.0		97.5	98.5	100.5
Centerline	96.5		100.5	96.5	98.5
2' Left	104.0		101.0	93.0	101.0
4' Left	99.5		99.5	98.0	100.5
6' Left	101.0		100.5	98.5	102.5
8' Left	101.0		99.0	95.5	98.5
10' Left	102.5		101.0	99.0	95.5
12' Left	103.0		96.5	97.0	103.5
Left Edge of Shoulder	95.5		99.5	95.5	96.0

MOISTURE READINGS
Pounds Per Cubic Foot

Date: September 6, 1987

	Tube #1	Tube #2	Tube #3	Tube #4	Tube #5
Right Edge of Shoulder	19.7	16.6	16.6	16.3	18.3
10' Right	19.6	14.5	15.8	15.1	16.6
8' Right	18.7	13.8	15.7	13.5	16.2
6' Right	18.3	13.0	16.7	13.8	17.1
4' Right	17.5	14.6	16.4	14.2	17.7
2' Right	17.8	13.5	16.9	14.3	17.7
Centerline	17.4	14.0	17.6	14.2	17.1
2' Left	18.3	12.5	17.1	12.2	17.3
4' Left	18.4	12.9	16.9	12.4	17.0
6' Left	17.3	12.8	15.8	13.6	17.5
8' Left	18.3	13.5	16.1	11.6	17.3
10' Left	17.9	12.0	15.8	11.9	16.4
12' Left	16.4	12.1	14.8	12.8	13.9
Left Edge of Shoulder	16.3	13.3	14.9	12.8	17.7

NUCLEAR DENSITY RESULTS
Pounds Per Cubic Foot

Date: December 6, 1988

	Tube #1	Tube #2	Tube #3	Tube #4	Tube #5
Right Edge of Shoulder		100.0	96.0	100.5	101.0
10' Right		100.5	95.5	97.5	97.0
8' Right		98.0	100.0	93.5	97.5
6' Right		89.5	100.5	94.0	103.5
4' Right		100.5	99.0	98.5	100.5
2' Right		101.0	98.0	99.0	100.0
Centerline		96.5	100.0	99.5	98.5
2' Left		99.5	101.0	95.0	100.5
4' Left		98.0	99.5	98.5	100.0
6' Left		101.5	102.5	100.5	100.0
8' Left		105.0	99.0	98.0	100.5
10' Left		97.0	101.0	100.0	95.0
12' Left		100.0	99.5	99.0	100.0
Left Edge of Shoulder		94.5	96.0	91.0	101.5

MOISTURE READINGS
Pounds Per Cubic Foot

Date: December 6, 1988

	Tube #1	Tube #2	Tube #3	Tube #4	Tube #5
Right Edge of Shoulder		16.4	16.5	15.5	16.9
10' Right		14.7	15.7	14.9	16.1
8' Right		13.9	15.6	13.5	15.6
6' Right		13.3	16.6	14.1	16.3
4' Right		14.4	15.3	14.0	16.6
2' Right		13.3	15.7	14.3	16.0
Centerline		13.3	15.7	14.3	16.6
2' Left		13.1	15.4	11.8	15.9
4' Left		12.5	15.6	12.2	15.3
6' Left		13.0	15.0	12.6	15.4
8' Left		13.6	15.6	12.0	16.4
10' Left		12.1	15.0	12.2	15.1
12' Left		12.3	15.7	13.1	15.3
Left Edge of Shoulder		14.1	15.3	13.6	17.0

NUCLEAR DENSITY RESULTS
Pounds Per Cubic Foot

Date: January 15, 1988

	Tube #1	Tube #2	Tube #3	Tube #4	Tube #5
Right Edge of Shoulder		94.5	90.0	98.0	96.0
10' Right		95.5	88.5	92.5	92.5
8' Right		93.0	95.0	84.5	91.5
6' Right		88.0	93.5	88.5	99.0
4' Right		96.0	92.0	92.5	94.0
2' Right		91.5	93.0	92.5	94.5
Centerline		89.5	94.5	93.5	91.5
2' Left		93.5	95.0	89.0	95.0
4' Left		95.0	93.5	91.5	94.5
6' Left		94.0	95.5	94.0	96.0
8' Left		96.5	93.5	92.0	95.0
10' Left		94.0	93.5	95.0	91.0
12' Left		90.5	92.5	91.5	98.5
Left Edge of Shoulder		92.0	89.5	83.5	90.0

MOISTURE READINGS
Pounds Per Cubic Foot

Date: January 15, 1988

	Tube #1	Tube #2	Tube #3	Tube #4	Tube #5
Right Edge of Shoulder		16.6	16.4	16.6	11.1
10' Right		15.5	15.8	15.9	15.2
8' Right		14.4	15.9	14.2	14.1
6' Right		13.3	17.1	14.0	15.8
4' Right		14.9	14.9	13.9	15.2
2' Right		13.3	16.0	14.2	14.4
Centerline		13.3	14.2	14.1	14.9
2' Left		12.9	15.6	12.3	15.3
4' Left		12.0	15.1	12.3	16.0
6' Left		13.0	15.6	12.5	15.4
8' Left		13.6	16.6	12.0	16.4
10' Left		13.0	15.2	11.8	16.1
12' Left		12.5	15.7	12.5	15.4
Left Edge of Shoulder		12.6	14.9	12.8	15.5

NUCLEAR DENSITY RESULTS
Pounds Per Cubic Foot

Date: March 25, 1988

	Tube #1	Tube #2	Tube #3	Tube #4	Tube #5
Right Edge of Shoulder	98.0	99.5	94.5	100.0	98.0
10' Right	104.0	99.5	96.5	97.5	94.5
8' Right	92.5	99.0	97.5	89.5	95.0
6' Right	99.5	91.5	103.0	94.5	99.5
4' Right	95.5	101.5	98.5	98.0	98.0
2' Right	93.5	102.5	99.0	96.5	97.0
Centerline	97.0	97.0	98.5	102.5	100.0
2' Left	101.5	101.0	98.0	99.0	99.0
4' Left	97.0	99.0	101.0	95.0	97.0
6' Left	98.0	101.5	99.0	103.0	95.5
8' Left	101.0	103.0	101.0	93.0	100.0
10' Left	102.0	99.0	99.0	97.5	95.5
12' Left	100.0	99.5	101.5	100.0	94.0
Left Edge of Shoulder	96.0	97.5	98.5	99.0	97.0

MOISTURE READINGS
Pounds Per Cubic Foot

Date: September 1, 1988

	Tube #1	Tube #2	Tube #3	Tube #4	Tube #5
Right Edge of Shoulder		15.5	15.5	15.0	15.0
10' Right		13.5	14.5	13.5	15.0
8' Right		13.0	15.5	13.5	15.0
6' Right		12.5	15.0	13.5	15.0
4' Right		13.5	15.0	14.0	14.5
2' Right		13.0	14.0	13.5	14.5
Centerline		13.5	14.0	13.0	15.0
2' Left		12.5	14.5	12.0	15.0
4' Left		12.5	14.0	12.0	14.0
6' Left		13.0	14.5	12.5	14.5
8' Left		13.0	14.5	11.5	15.0
10' Left		11.5	15.0	12.5	14.5
12' Left		12.0	15.0	12.0	14.0
Left Edge of Shoulder		12.5	13.0	14.5	16.5

NUCLEAR DENSITY RESULTS
Pounds Per Cubic Foot

Date: September 7, 1988

	Tube #1	Tube #2	Tube #3	Tube #4	Tube #5
Right Edge of Shoulder	100.0	110.0	107.5	110.5	114.0
10' Right	104.5	118.5	96.0	108.0	95.0
8' Right	94.0	109.0	107.5	104.0	105.5
6' Right	100.0	101.5	106.0	96.5	100.5
4' Right	92.5	99.5	106.0	100.0	100.0
2' Right	94.5	101.5	100.0	100.5	99.5
Centerline	99.0	101.0	96.0	97.5	97.0
2' Left	101.5	99.0	97.5	94.5	98.5
4' Left	98.0	90.0	103.5	95.5	100.0
6' Left	100.0	101.5	98.5	99.5	101.0
8' Left	101.0	99.0	98.5	103.0	100.0
10' Left	102.5	96.0	99.0	97.0	102.5
12' Left	102.0	99.5	100.0	96.0	101.0
Left Edge of Shoulder	101.0	101.5	101.0	96.5	99.5

NUCLEAR DENSITY RESULTS
Pounds Per Cubic Foot

Date: October 19, 1988

	Tube #1	Tube #2	Tube #3	Tube #4	Tube #5
Right Edge of Shoulder	97.5	96.5	94.0	100.0	98.5
10' Right	94.5	102.5	94.0	97.0	96.0
8' Right	95.0	100.0	98.5	95.5	98.5
6' Right	100.5	95.0	99.5	93.5	99.5
4' Right	97.0	99.5	98.5	99.0	99.0
2' Right	97.0	97.5	95.5	100.0	99.0
Centerline	95.0	97.5	100.0	98.0	98.5
2' Left	97.5	100.0	99.0	95.0	101.0
4' Left	97.0	96.5	99.0	100.5	96.0
6' Left	98.0	99.0	101.5	96.5	99.0
8' Left	95.5	99.0	99.0	100.5	99.5
10' Left	94.0	96.5	99.5	92.0	99.5
12' Left	101.0	95.0	95.5	98.5	101.5
Left Edge of Shoulder	93.5	88.0	96.5	89.5	98.5

MOISTURE READINGS
Pounds Per Cubic Foot

Date: October 18, 1988

	Tube #1	Tube #2	Tube #3	Tube #4	Tube #5
Right Edge of Shoulder	18.3	15.9	16.4	15.4	15.0
10' Right	18.0	13.9	15.0	14.4	15.1
8' Right	17.8	13.6	15.0	13.2	15.1
6' Right	17.6	13.3	15.3	14.4	15.9
4' Right	16.8	14.7	14.5	14.1	14.7
2' Right	17.2	13.6	14.6	13.7	14.9
Centerline	17.4	13.6	14.7	12.6	15.0
2' Left	17.4	12.4	14.7	12.4	14.2
4' Left	17.3	12.6	14.0	12.9	13.7
6' Left	16.8	12.9	15.3	12.0	15.2
8' Left	17.0	13.3	14.4	12.0	15.0
10' Left	17.1	12.1	14.3	13.2	14.6
12' Left	15.4	12.0	14.1	13.0	17.3
Left Edge of Shoulder	17.5	13.4	13.6	15.5	17.0

MOISTURE READINGS
Pounds Per Cubic Foot

Date: January 17 1989

	Tube #1	Tube #2	Tube #3	Tube #4	Tube #5
Right Edge of Shoulder		17.1	15.9		
10' Right		17.3	14.8		
8' Right		16.7	14.1		
6' Right		17.9	13.5		
4' Right		16.0	13.5		
2' Right		16.1	14.6		
Centerline		17.0	14.6		
2' Left		15.4	12.6		
4' Left		15.9	12.6		
6' Left		15.0	12.8		
8' Left		15.2	12.7		
10' Left		15.2	12.5		
12' Left		16.2	13.3		
Left Edge of Shoulder		15.2	15.1		

NUCLEAR DENSITY RESULTS
Pounds Per Cubic Foot

Date: January 17 1989

	Tube #1	Tube #2	Tube #3	Tube #4	Tube #5
Right Edge of Shoulder			96.0	102.5	
10' Right			96.0	96.5	
8' Right			100.5	95.0	
6' Right			100.5	93.5	
4' Right			98.5	98.5	
2' Right			98.5	103.0	
Centerline			100.5	96.5	
2' Left			100.5	95.0	
4' Left			99.5	100.0	
6' Left			100.5	99.5	
8' Left			100.5	96.0	
10' Left			100.5	100.0	
12' Left			99.5	91.0	
Left Edge of Shoulder			94.5	96.5	