

Notice

This document is disseminated under the sponsorship of the U.S. Department of Transportation in the interest of information exchange. The U.S. Government assumes no liability for the use of the information contained in this document. This report does not constitute a standard, specification, or regulation.

The U.S. Government does not endorse products or manufacturers. Trademarks or manufacturers' names appear in this report only because they are considered essential to the objective of the document.

Quality Assurance Statement

The Federal Highway Administration (FHWA) provides high-quality information to serve Government, industry, and the public in a manner that promotes public understanding. Standards and policies are used to ensure and maximize the quality, objectivity, utility, and integrity of its information. FHWA periodically reviews quality issues and adjusts its programs and processes to ensure continuous quality improvement.

Archived

Technical Report Documentation Page

1. Report No. FHWA-HIF-08-009		2. Government Accession No.		3. Recipient's Catalog No.	
4. Title and Subtitle Construction of a Precast Prestressed Concrete Pavement Demonstration Project on Interstate 57 near Sikeston, Missouri				5. Report Date March 2008	
				6. Performing Organization Code	
7. Author(s) David K. Merritt, Richard B. Rogers, Robert Otto Rasmussen				8. Performing Organization Report No.	
9. Performing Organization Name and Address The Transtec Group, Inc. 6111 Balcones Dr. Austin, Texas 78731				10. Work Unit No. (TRAIS)	
				11. Contract or Grant No. DTEH61-03-C-00122	
12. Sponsoring Agency Name and Address U.S. Department of Transportation Federal Highway Administration 1200 New Jersey Avenue SE, HIPT-20 Washington, DC 20590				13. Type of Report and Period Covered Final Report September 2003 – September 2007	
				14. Sponsoring Agency Code HIPT-20	
15. Supplementary Notes Contracting Officer's Technical Representative: Sam Tyson, FHWA Office of Pavement Technology, 1200 New Jersey Avenue SE, HIPT-20 / E73-440, Washington, DC 20590, E-mail: sam.tyson@dot.gov, Phone: 202-366-1326					
16. Abstract State Highway Agencies are continually seeking new techniques for expedited pavement construction that will permit reconstruction and rehabilitation of existing pavements with minimal impact on the traveling public. Precast prestressed concrete pavement (PPCP) is one such technique which has been demonstrated in recent years to meet this need. Precast panels can be produced well in advance of construction, stockpiled, and hauled to the site for installation as needed. PPCP can be constructed during non-peak travel times, such as overnight or during weekend closures, in order to minimize lane closures and associated user delays. This report documents the construction of a PPCP demonstration project on Interstate 57 near Sikeston, Missouri. This work was conducted under an effort by FHWA to help familiarize State Highway Agencies with PPCP technology through the construction of demonstration projects in various states. All aspects of the Missouri demonstration project are presented, including the design, panel fabrication, pavement construction, and performance and condition during the first year in service. An evaluation of each of these aspects is also discussed with recommendations for future projects.					
17. Key Word precast pavement, precast prestressed concrete pavement, prestressed pavement, rapid construction			18. Distribution Statement No restrictions.		
19. Security Classif. (of this report) Unclassified		20. Security Classif. (of this page) Unclassified		21. No. of Pages 133	22. Price

SI* (MODERN METRIC) CONVERSION FACTORS

APPROXIMATE CONVERSIONS TO SI UNITS

Symbol	When You Know	Multiply By	To Find	Symbol
LENGTH				
in	inches	25.4	millimeters	mm
ft	feet	0.305	meters	m
yd	yards	0.914	meters	m
mi	miles	1.61	kilometers	km
AREA				
in ²	square inches	645.2	square millimeters	mm ²
ft ²	square feet	0.093	square meters	m ²
yd ²	square yard	0.836	square meters	m ²
ac	acres	0.405	hectares	ha
mi ²	square miles	2.59	square kilometers	km ²
VOLUME				
fl oz	fluid ounces	29.57	milliliters	mL
gal	gallons	3.785	liters	L
ft ³	cubic feet	0.028	cubic meters	m ³
yd ³	cubic yards	0.765	cubic meters	m ³
NOTE: volumes greater than 1000 L shall be shown in m ³				
MASS				
oz	ounces	28.35	grams	g
lb	pounds	0.454	kilograms	kg
T	short tons (2000 lb)	0.907	megagrams (or "metric ton")	Mg (or "t")
TEMPERATURE (exact degrees)				
°F	Fahrenheit	5 (F-32)/9 or (F-32)/1.8	Celsius	°C
ILLUMINATION				
fc	foot-candles	10.76	lux	lx
fl	foot-Lamberts	3.426	candela/m ²	cd/m ²
FORCE and PRESSURE or STRESS				
lbf	poundforce	4.45	newtons	N
lbf/in ²	poundforce per square inch	6.89	kilopascals	kPa
APPROXIMATE CONVERSIONS FROM SI UNITS				
Symbol	When You Know	Multiply By	To Find	Symbol
LENGTH				
mm	millimeters	0.039	inches	in
m	meters	3.28	feet	ft
m	meters	1.09	yards	yd
km	kilometers	0.621	miles	mi
AREA				
mm ²	square millimeters	0.0016	square inches	in ²
m ²	square meters	10.764	square feet	ft ²
m ²	square meters	1.195	square yards	yd ²
ha	hectares	2.47	acres	ac
km ²	square kilometers	0.386	square miles	mi ²
VOLUME				
mL	milliliters	0.034	fluid ounces	fl oz
L	liters	0.264	gallons	gal
m ³	cubic meters	35.314	cubic feet	ft ³
m ³	cubic meters	1.307	cubic yards	yd ³
MASS				
g	grams	0.035	ounces	oz
kg	kilograms	2.202	pounds	lb
Mg (or "t")	megagrams (or "metric ton")	1.103	short tons (2000 lb)	T
TEMPERATURE (exact degrees)				
°C	Celsius	1.8C+32	Fahrenheit	°F
ILLUMINATION				
lx	lux	0.0929	foot-candles	fc
cd/m ²	candela/m ²	0.2919	foot-Lamberts	fl
FORCE and PRESSURE or STRESS				
N	newtons	0.225	poundforce	lbf
kPa	kilopascals	0.145	poundforce per square inch	lbf/in ²

*SI is the symbol for the International System of Units. Appropriate rounding should be made to comply with Section 4 of ASTM E380.
(Revised March 2003)

TABLE OF CONTENTS

CHAPTER 1. INTRODUCTION.....	1
Background.....	1
FHWA Demonstration Projects.....	1
Benefits of Precast Concrete Pavement.....	3
Report Objectives.....	4
CHAPTER 2. PRECAST PRESTRESSED CONCRETE PAVEMENT CONCEPT...7	7
Key Features of PPCP.....	7
Prestressed Pavement.....	7
Full-Depth Panels.....	7
Keyed Panel Joints.....	8
Panel Assembly.....	8
Base Panels.....	9
Joint Panels.....	10
Anchor Panels.....	10
Base Preparation.....	10
Post-Tensioning.....	11
Grouting.....	12
Construction Process.....	12
CHAPTER 3. MISSOURI DEMONSTRATION PROJECT.....15	15
Project Scope.....	15
Location.....	15
Demonstration Project Goals.....	16
Project Coordination.....	16
Project Layout.....	16
Geometry.....	17
Cross-Section.....	17
Slab Length.....	19
CHAPTER 4. DESIGN.....21	21
Design Considerations.....	21
Traffic Loading.....	21
Temperature and Moisture Effects.....	21
Slab-Support Interaction.....	21
Prestress Losses.....	22
Design Procedure.....	22
Design for Pavement Stresses.....	22
Design for Slab Movement.....	23
Interstate 57 PPCP Design.....	23
Traffic.....	23
Pavement Structure.....	24
Layered Elastic Analysis.....	26
Stress Analysis.....	27
Slab Movement Analysis.....	29
Transverse Prestress Requirements.....	29
Design Details.....	30
Keyways.....	30

Expansion Joint.....	32
Post-Tensioning Details.....	32
CHAPTER 5. PANEL FABRICATION.....	35
Procedure.....	35
Tolerances.....	37
Panel Details.....	38
Reinforcement.....	38
Pretensioning.....	38
Post-Tensioning.....	39
Lifting Devices.....	40
Mixture Design.....	40
Concrete Placement, Finishing, and Curing.....	40
De-tensioning, Handling, and Storage.....	44
Trial Assembly.....	45
Panel Repairs.....	45
Challenges/Issues Encountered.....	45
CHAPTER 6. PAVEMENT CONSTRUCTION.....	49
Pre-Bid and Pre-Construction Meetings.....	49
Base Preparation.....	49
Panel Installation.....	51
Transportation and Staging.....	51
Installation Procedure.....	52
Installation Rate.....	54
Post-Tensioning.....	54
Strand Installation.....	54
Tendon Stressing.....	55
Mid-Slab Anchor.....	56
Expansion Joints.....	56
Filling Pockets.....	60
Tendon Grouting.....	60
Diamond Grinding.....	60
Tying to Existing Pavement.....	61
Construction Issues and Challenges.....	62
Panel Installation.....	62
Post-Tensioning.....	65
Grouting.....	65
Showcasing Workshop.....	65
CHAPTER 7. INSTRUMENTATION AND EVALUATION.....	69
Introduction.....	69
Project-Level Condition Survey.....	69
Distress Map.....	69
Possible Causes of Transverse Cracking.....	72
Possible Causes of Longitudinal Cracking.....	73
Deflection Testing.....	75
Summary of Instrumentation Program.....	76
Key Findings from Instrumentation Program.....	79
Concrete Properties.....	80

Panel Fabrication	81
Pretensioning	81
Post-Tensioning	82
In-Service Performance	82
Distresses	83
Recommendations Based on Instrumentation Program	83
CHAPTER 8. PROJECT EVALUATION AND RECOMMENDATIONS FOR FUTURE PROJECTS.....	87
Project Layout	87
Design	87
Design Procedure	87
Design Details	88
Panel Fabrication	89
Pavement Construction	90
Base Preparation	90
Panel Placement	90
Post-Tensioning	91
Grouting	92
Project Cost	92
CHAPTER 9. SUMMARY AND RECOMMENDATIONS	95
Summary	95
Recommendations for Future Construction	96
REFERENCES.....	97
APPENDIX.....	99

LIST OF FIGURES

Figure 1. Illustration. Typical PPCP panel layout.	9
Figure 2. Illustration. Typical Base Panel.....	9
Figure 3. Illustration. Typical Joint Panel.....	10
Figure 4. Illustration. Stressing ram with a curved nose used for longitudinal post-tensioning... ..	12
Figure 5. Illustration. Flowchart for the overall construction process.....	13
Figure 6. Illustration. Location of the Missouri PPCP demonstration project.....	15
Figure 7. Illustration. Cross section of the precast panels, incorporating the change in cross-slope into the surface of the panel. (<i>Note: 1 inch = 25.4 mm</i>).....	18
Figure 8. Photo. Precast panels at the fabrication plant after removal from the forms showing the variable thickness cross-section.....	18
Figure 9. Illustration. Layered pavement structure used for elastic layered analysis of slab stresses under traffic loading.	26
Figure 10. Illustration. Keyway dimensions for I-57 precast panels. (<i>Note: 1 inch = 25.4 mm</i>). ..	31
Figure 11. Photo. Discontinuous keyways are shown for the precast panels in storage at the fabrication plant.	31
Figure 12. Illustration. Expansion joint detail for the I-57 demonstration project (<i>Note: 1 inch = 25.4 mm</i>).	32
Figure 13. Illustration. Typical post-tensioning pocket cast into the joint panels (<i>Note: 1 inch = 25.4 mm</i>).	33
Figure 14. Photo. Joint panel prior to concrete placement, showing post-tensioning pockets, anchors, stirrups and dowels.	34
Figure 15. Illustration. Mid-slab anchor detail (<i>Note: 1 inch = 25.4 mm</i>).	34
Figure 16. Photo. Precast panel forms during installation of the pretensioning strands.....	35
Figure 17. Photo. Concrete placement for a base panel.....	36
Figure 18. Photo. Fabrication of the first half of a joint panel.....	36
Figure 19. Photo. Reinforcement for the non-post-tensioned half of a joint panel prior to casting.	38
Figure 20. Photo. Post-tensioning duct, anchor, and blockout former in a joint panel.....	39
Figure 21. Photo. Concrete placement operation showing the two-lift procedure.	41
Figure 22. Photo. Vibratory screeding of the panel surface.	42
Figure 23. Photo. Application of the light broom texture to the panel surface.....	42
Figure 24. Photo. Casting bed during steam curing operation.....	43
Figure 25. Photo. Wet burlap mat curing of the precast panels after removal from the forms. ...	43
Figure 26. Photo. Removal of a panel from the forms after curing.....	44
Figure 27. Photo. Panels stacked in the storage area after final curing and inspection.	45
Figure 28. Photo. Typical hairline longitudinal crack observed at the fabrication plant (photo taken after precast panel was delivered to the project site).	46
Figure 29. Hairline transverse crack in the shoulder after epoxy sealing (photo taken after panel was installed on site).....	47
Figure 30. Photo. Construction of the permeable asphalt treated base (photo from MoDOT).....	50
Figure 31. Photo. Finished surface of the permeable asphalt treated base.	50
Figure 32. Photo. Polyethylene sheeting rolled out prior to installation of precast panels.....	51
Figure 33. Photo. Staging of delivery trucks and the installation crane.	52
Figure 34. Photo. Sand was used to fill the ruts in the permeable asphalt treated base.....	52

Figure 35. Photo. Epoxy applied to the keyways (left) and installation of the foam gaskets (right).....	53
Figure 36. Photo. Laser and alignment guide used to align the precast panels as they were installed.....	53
Figure 37. Photo. Temporary post-tensioning was used to close the joints between panels as much as possible during panel installation.	54
Figure 38. Photo. Mechanical pusher used to feed post-tensioning strands through the panels...	55
Figure 39. Photo. Final longitudinal post-tensioning completed using two post-tensioning rams (photo from MoDOT).	56
Figure 40. Photo. Expansion joint after being pulled open during the post-tensioning operation. (photo from MoDOT).	57
Figure 41. Photo. Expansion joint No. 4 after fracturing during the post-tensioning operation. (photo from MoDOT).	57
Figure 42. Photo. Good performing header expansion joints. ⁽¹⁸⁾	58
Figure 43. Photo. Deterioration of header material for expansion joint No. 4. ⁽¹⁸⁾	59
Figure 44. Photo. Joint sealant protruding from the surface of the pavement during under summer climatic conditions. ⁽¹⁸⁾	59
Figure 45. Photo. Final pavement surface after diamond grinding.....	61
Figure 46. Photo. Adjacent cast-in-place pavement constructed at the end of the PPCP section. (photo from MoDOT)	62
Figure 47. Photo. Shims at the outside edge of the pavement used to correct centerline alignment.....	63
Figure 48. Photo. Faulted joint observed in the shoulder region.....	64
Figure 49. Photo. Presentations were provided by all parties involved with the project.....	66
Figure 50. Photo. The workshop participants were able to see a live demonstration pf the panel installation process at a MoDOT maintenance yard in Sikeston.	67
Figure 51. Photo. The workshop participants were able to visit the actual PPCP section on I-57.	67
Figure 52. Photo. Longitudinal crack near the pavement centerline extending away from one of the instrumentation blockouts. ⁽¹⁸⁾	70
Figure 53. Photo. Typical minor spalling observed.....	71
Figure 54. Photo. Typical condition of expansion joints 1,2,3, and 5 in service.....	71
Figure 55. Illustration. Overall layout of the instrumented precast panels from Sections 3 and 4. ⁽¹⁶⁾	78
Figure 56. Illustration. Instrumentation layout for Panel A32. ⁽²⁰⁾	78
Figure 57. Photo. Instrumented rebar and vibrating wire strain gages for measuring concrete strain.....	79
Figure 58. Photo. Junction box within an instrumented precast panel (left) and instrumentation cabinet next to the project site for collecting and uploading data (right).	79
Figure 59. Illustration. Project Level condition survey after opening to traffic.	85
Figure 60. Photo. Finished precast pavement after opening to traffic.....	96

LIST OF TABLES

Table 1. Design ESALs for Northbound Interstate 57 west of Route 105.	24
Table 2. Figure 6-03.12 of the MoDOT Project Development Guide showing guidelines for selecting rigid pavement thickness. ⁽¹¹⁾	25
Table 3. Bottom fiber tensile stress at the bottom of the 380 mm (15 in.) conventional pavement and 280 (11 in.) and 200 mm (8 in.) equivalent precast pavement.....	27
Table 4. Inputs used for the PSCP2 Analysis.	28
Table 5. Slab temperatures and top-bottom slab temperature differentials used for PSCP2 analysis.....	28
Table 6. Required expansion joint width following post-tensioning.....	29
Table 7. Table of panel tolerances from the project plans.	37
Table 8. Concrete mixture used for the precast panels. ⁽¹⁶⁾ (Note: 1 lb = 0.45 kg, 1 gal = 3.8 L, 1 yd ³ = 0.76 m ³).	41
Table 9. Summary of Load Transfer Efficiency calculated from deflection testing conducted by MoDOT.....	75
Table 10. Summary of concrete properties for the concrete mixture used for the precast panels. ⁽¹⁶⁾	81

CHAPTER 1. INTRODUCTION

BACKGROUND

Transportation agencies are continually seeking new techniques for rapid pavement construction and rehabilitation that will help them minimize disruption to the motoring public. This need is particularly critical in urban areas where traffic delays caused by construction can result in substantial user costs. Precast concrete pavement has received renewed attention in recent years as a construction technique to meet this need. Precast concrete pavement not only provides a rapid construction solution that minimizes lane closure time for construction, but also provides a high-performance long-term solution and not just a “quick fix.”

Recent efforts by the Federal Highway Administration (FHWA) have led to numerous advances in precast pavement technology. In 2000 an FHWA-sponsored feasibility study was completed by the Center for Transportation Research (CTR) at The University of Texas at Austin which examined the use of prestressed precast concrete panels for expedited pavement construction.⁽¹⁾ In order to evaluate the viability of the concept developed through the feasibility study, a subsequent FHWA-sponsored implementation study conducted by CTR, resulted in the construction of a 0.7 km (2,300 ft) precast prestressed concrete pavement pilot demonstration project near Georgetown, Texas in 2002,⁽²⁾ followed by a second demonstration project in El Monte, California in 2004.^(3,4)

The success of the initial precast prestressed pavement demonstration projects in Texas and California led to the construction of additional demonstration projects. In 2003, FHWA initiated a series of precast prestressed pavement demonstration projects, including projects in Missouri, Texas, and Iowa. The intent of these demonstration projects was to evaluate the precast prestressed pavement concept for various applications while also familiarizing state highway agencies with precast pavement technology. The demonstration project constructed near Sikeston, Missouri, will be described herein.

FHWA DEMONSTRATION PROJECTS

One of the primary goals of the FHWA-sponsored precast prestressed concrete (PPCP) demonstration projects is to examine various applications of precast pavement for expedited pavement construction. The first two projects in Texas and California have demonstrated the viability of PPCP construction for two different applications.

Interstate 35 Frontage Road – Georgetown, Texas⁽²⁾

Completed in spring 2002, the Interstate 35 frontage road pilot project was the first FHWA project demonstrating the viability of the precast prestressed pavement concept. While not constructed under traffic and short time windows, the intent of this project was to evaluate the design details and construction procedures for use on future projects. Approximately 0.7 km (2,300 ft) of precast prestressed pavement was constructed the full width of the roadway. Both “full-width” and “partial-width” panels were utilized. The full-width panels spanned the entire

11 m (36 ft) width of the roadway, including two traffic lanes and inside and outside shoulders. The partial-width panels were constructed in two adjacent sections, one 6 m (20 ft) wide and the other 5 m (16 ft) wide, to achieve the full 11 m (36 ft) roadway width. The adjacent sections were tied together with additional transverse post-tensioning. The aspects of precast concrete pavement that were demonstrated by this project included:

- Overall feasibility of constructing a precast prestressed concrete pavement,
- Use of an armored expansion joint in the precast panels,
- Use of central stressing with precast, post-tensioned pavement panels,
- Use of non-match-cast precast panels with interlocking keyways,
- Installation of precast panels over a hot-mix asphalt leveling course,
- Construction of precast pavement on a vertical curve, and
- Lane-by-lane construction of precast pavement using “partial-width” precast panels

Interstate 10 – El Monte, California^(3,4)

The second PPCP demonstration project was constructed by the California Department of Transportation (Caltrans) in April 2004. Precast prestressed concrete pavement was incorporated into a project to widen eastbound Interstate 10 near El Monte, California. A 76 m (248 ft) section of PPCP was installed adjacent to the existing mainlanes, adding 8.2 m (27 ft) of traffic lanes and a 3 m (10 ft) shoulder to the existing pavement. A few of the unique aspects demonstrated by this project included:

- Incorporation of a change in pavement cross-slope into the surface of the precast panels,
- Nighttime installation of precast panels during a 5-hour construction window,
- Installation of precast panels over a lean concrete base,
- Use of epoxy-coated strands for longitudinal post-tensioning,
- Use of a non-armored dowelled expansion joint, and
- Diamond grinding of the finished surface to achieve pavement smoothness requirements.

Interstate 57 – Sikeston, Missouri

The most recently completed demonstration project constructed on Interstate 57 near Sikeston, Missouri will be described in more detail in this report. A summary of the unique aspects that this project demonstrated includes:

- Incorporation of a pavement crown into the precast panels,
- Post-tensioning from the joint panels as opposed to central stressing,
- Use of a “header-type” non-armored expansion joint,
- Use of a non-continuous keyway along the panel joints,
- Installation of precast panels over a permeable asphalt-treated base, and
- Diamond grinding of the finished surface to achieve smoothness requirements.

BENEFITS OF PRECAST CONCRETE PAVEMENT

While the benefits of precast prestressed concrete pavement have been documented more thoroughly elsewhere,^(2,3,5) the following is a summary of some of these benefits:

Reduced User Delays

Perhaps the most apparent benefit of precast concrete pavement is rapid construction – not in terms of the placement rate – but in terms of how quickly the pavement can be opened to traffic. Because precast panels are fabricated and cured off site, they are able to withstand traffic loading almost immediately after they are installed. This permits precast pavement panels to be installed during non-peak travel times such as at night or during weekend closures, minimizing the impact of construction on the motoring public. By limiting construction to non-peak travel times, user delays and associated user delay costs can be minimized. This is where the primary economic benefit of precast concrete pavement will be realized.

Improved Quality and Performance

Expedited pavement construction is of little benefit if the pavement constructed is not a long-term solution. Precast concrete panels provide a long-term solution and not just a temporary “quick fix.” Because precast concrete panels can be fabricated in a controlled environment, there is a high degree of quality control over the production of the pavement panels. Precast concrete fabrication facilities offer a tremendous degree of flexibility over the concrete mixtures and materials used as well as the curing processes. Concrete mixtures are batched very consistently and hauled only short distances from the batch plant to the forms, minimizing the probability of variations in the mixture used for the panels. This permits the use of a very low water-cement ratio mixture with optimal air void characteristics. This also permits the use of lightweight aggregates to reduce the weight of the precast panels for shipping.

Curing of concrete pavements is critical. Precast fabrication facilities allow precast pavement panels to be cured under many different conditions. Steam curing, wet-mat curing, or heavy applications of curing compound are all techniques that can be utilized at precast fabrication plants. The result of improved curing operations is a more durable pavement surface with reduced “built-in curl” from moisture gradients in the panels.

Pavement performance is further enhanced through the incorporation of prestressing, which helps to reduce or even eliminate cracking. Because a compressive stress is induced in the pavement slab through prestressing, cracking will only occur if tensile stresses exceed the combination of the concrete’s tensile strength and prestress force. This can result in a significant savings in maintenance costs over the life of the pavement and may even prevent the occurrence of major pavement failures. A 150 mm (6 inch) thick cast-in-place post-tensioned pavement constructed near Waco, Texas in 1985 has demonstrated the improved performance that can be achieved with prestressing.⁽⁶⁾

Prestressing also benefits performance by giving the precast panels a certain ability to “span” voids beneath the pavement. This is beneficial when the precast panels must be installed over a base that is not perfectly flat, contains “soft” areas, or one in which voids are expected to form over time.

Reduced Slab Thickness

Another benefit of incorporating prestress into precast concrete pavement is a reduction in required slab thickness. By inducing a compressive stress in the pavement slab, stresses in a thinner pavement slab caused by traffic loading can be limited to those of a much thicker slab, providing an equivalent design life to a thicker pavement slab. A reduction in slab thickness not only results in material savings, but also allows for “in-kind” slab replacement. For example, an existing 200 mm (8 inch) thick pavement slab could be replaced with a 200 mm (8 inch) thick precast prestressed concrete pavement that will have an equivalent design life to a much thicker (e.g., 300 mm [12 inch]) slab. This is particularly beneficial for replacing pavement beneath bridge overpasses where a certain level of clearance must be maintained.

Extended Construction Season

Perhaps a less-obvious benefit of precast concrete pavement is the potential it provides for extending the construction season. Precast panels can be installed in colder (and hotter) temperatures that would normally prohibit cast-in-place pavement construction.

REPORT OBJECTIVES

The primary objective of this report will be to summarize the PPCP demonstration project on Interstate 57 near Sikeston, Missouri. This includes the design, fabrication, panel installation, instrumentation, and evaluation of the project. The report will also present recommendations for future precast prestressed concrete pavement projects based on lessons learned from this project. The following is a summary of the remaining chapters of this report:

Chapter 2 presents the precast pavement concept developed through the feasibility study, described previously. This includes the panel types, base preparation, panel assembly, post-tensioning, and grouting.

Chapter 3 presents the details of the Missouri Demonstration Project, including the scope of application and the project layout.

Chapter 4 presents the design for the Missouri Demonstration Project. This includes the design considerations for precast prestressed concrete pavement, the design procedure, and the final design recommendations.

Chapter 5 discusses the fabrication of the precast panels for the Missouri demonstration project. This includes the panel details and fabrication and handling procedures.

Chapter 6 discusses the construction of the precast pavement on site. This includes base preparation, transportation, panel placement, post-tensioning, and grouting.

Chapter 7 presents the instrumentation and evaluation of the Missouri demonstration project by the FHWA project team and by a research team from the University of Missouri-Columbia. This includes some of the significant findings from the instrumentation program, including performance and condition of the pavement during the first year in service.

Chapter 8 presents the overall project evaluation, including and assessment of design, fabrication, construction, and cost. Recommendations are also given for future precast pavement projects based on lessons learned from this project.

Chapter 9 presents a summary of the project and recommendations for future projects based on observations from the Missouri demonstration project.

Archived

Archived

CHAPTER 2. PRECAST PRESTRESSED CONCRETE PAVEMENT CONCEPT

KEY FEATURES OF PPCP

The basic concept for the Missouri PPCP demonstration project was developed through the original FHWA feasibility study completed by the Center for Transportation Research.⁽¹⁾ Certain refinements were made to the original concept based on the projects constructed in Texas⁽²⁾ and California.^(3,4) While additional modifications to the original concept were necessary in order to meet the project requirements for the Missouri demonstration project, the basic elements remained the same and are described in more detail below.

Prestressed Pavement

The PPCP concept incorporates prestressing in both the transverse and longitudinal direction in the form of pretensioning and/or post-tensioning. As discussed in the previous chapter, prestressing provides numerous benefits for long-term pavement performance. Prestressing induces a compressive stress in the slab, helping to reduce or even eliminating the occurrence of cracking, while also reducing the required slab thickness.

In general, the precast panels are pretensioned along the long axis of the panel (transverse pavement direction) during fabrication, and post-tensioned together along the short axis (longitudinal pavement direction) after installation, as will be described below. Transverse pretensioning not only provides the necessary permanent prestress in the pavement slab, but also permits longer and thinner precast panels to be used as it helps counteract lifting and handling stresses. Likewise, the longitudinal post-tensioning not only provides the necessary permanent prestress, but also provides load transfer between the panels.

The post-tensioning system used for the longitudinal tendons is a bonded post-tensioning system. After the longitudinal post-tensioning tendons are tensioned, grout is pumped into the ducts to bond the strands to the precast panels. A bonded post-tensioning system provides continuity between the prestressing strand and concrete, reducing the amount of non-prestressed steel required in the panels. This continuity also permits individual panels to be sawcut and removed from the pavement, if necessary, without compromising the integrity of the entire longitudinal post-tensioning system. Grouting also provides an additional layer of corrosion protection for the post-tensioning tendons, which is critical in colder climates where deicing salts are used.

Full-Depth Panels

The precast prestressed concrete pavement concept utilizes full-depth precast panels. Full-depth panels are an efficient solution in that the pavement can be opened to traffic almost immediately after installation of the precast panels. Additional steps such as placement of a thin hot-mix asphalt or bonded concrete overlay wearing course are not required prior to opening to traffic. Full-depth panels were demonstrated to provide acceptable ride quality without the need to overlay or even diamond grind for the Texas demonstration project.⁽²⁾ While diamond grinding was required for the California demonstration project in order to meet stringent smoothness

requirements for an Interstate pavement, opening to traffic temporarily, prior to grinding, would have been acceptable.^(3,4)

Using full-depth panels requires careful attention to base preparation to minimize vertical misalignment of the panels and voids beneath the panels as they are installed. Strict tolerances on the smoothness of the underlying base material are critical for helping to ensure alignment of the panels and minimization of voids. Flexible base materials, such as hot-mix asphalt or bituminous treated bases have been shown to actually conform to the bottom surface of the precast panels under the weight of the panels.

Keyed Panel Joints

Vertical alignment of full-depth precast panels is achieved through the use of keyways along the adjoining edges of the panels. These keyways facilitate rapid installation of the precast panels by helping to ensure vertical alignment during installation even if the underlying base is not perfectly flat. The keyways also provide temporary load transfer between panels prior to post-tensioning.

PANEL ASSEMBLY

Figure 1 shows the typical precast panel assembly used for the Missouri demonstration project. The panels are installed transverse to the flow of traffic, incorporating two traffic lanes and inside and outside shoulders. Three types of precast panels make up each post-tensioned section of PPCP: base panels (Figure 2), joint panels (Figure 3), and anchor panels. Each of the panels are pretensioned in the transverse direction (long axis of the panel), and post-tensioned in the longitudinal direction (short axis of the panel) through ducts cast into the panels. Keyways are cast into the edges of each panel, as described previously, to provide vertical alignment as the panels are assembled.

After each section of panels is installed (from joint panel to joint panel), the post-tensioning strands are fed into the post-tensioning ducts from the pockets in the joint panels (described below). The strands are pushed or pulled through all of the panels to the post-tensioning anchors in the joint panels at the other end of the section. Post-tensioning is then completed from the pockets in the joint panels. Each post-tensioned slab acts independently of the adjacent slab in terms of expansion and contraction movements. Expansion joints are cast into the joint panels (described below) to permit adjacent slabs to move independently, with dowels across the expansion joints for load transfer. The length of each post-tensioned slab can be adjusted by increasing or decreasing the number of base panels between the joint panels.

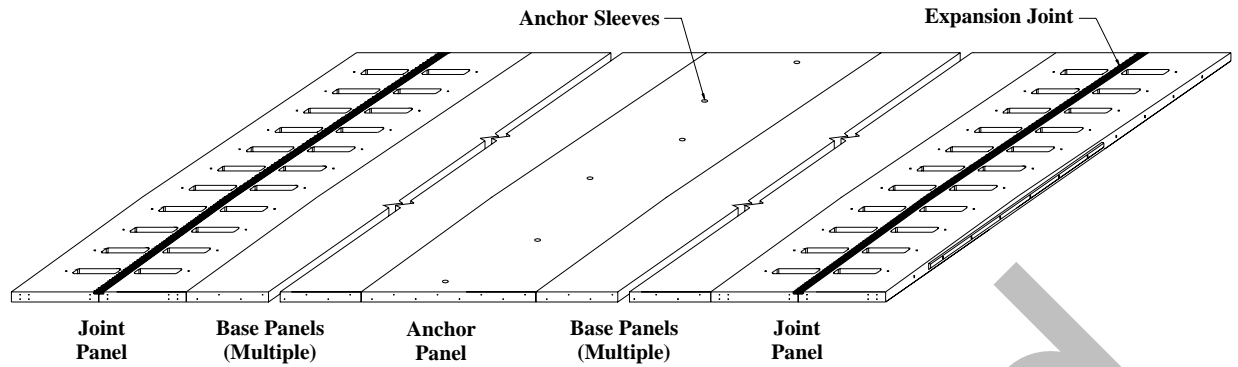

Figure 1. Illustration. Typical PPCP panel layout.

Base Panels

The base panels, shown in Figure 2, make up the majority of each post-tensioned slab. Figure 2 shows the typical components of the base panels, including the transverse pretensioning strands, longitudinal post-tensioning ducts, and keyways along the edges of the panels. Approximately every 5th base panel contains grout inlets/vents for the longitudinal post-tensioning tendons. For the Missouri demonstration project, a pavement crown was cast into the precast panels, resulting in panels with variable thickness, as will be described in Chapter 3. Because of the variable panel thickness, the keyway along the edge of the panel was only provided in the traffic lanes and discontinued in the shoulders.

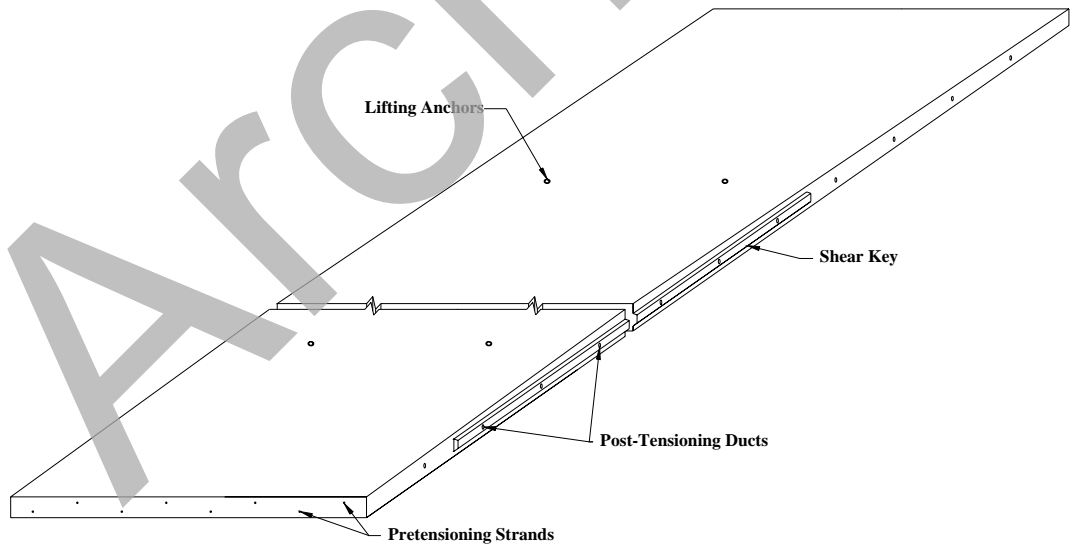

Figure 2. Illustration. Typical Base Panel.

Joint Panels

The joint panels, shown in Figure 3, contain both the expansion joint and the post-tensioning anchorage. The expansion joint is designed to accommodate the significant amount of horizontal slab movement during daily and seasonal temperature cycles, while providing load transfer across the joint. The pockets cast into the joint panels provide access to the post-tensioning anchors for stressing the tendons with a monostrand stressing ram. The stressing pockets are also used for temporary post-tensioning during installation of the panels (described in Chapter 6). Grout ports are located just in front of each of the post-tensioning anchors for grouting the longitudinal tendons.

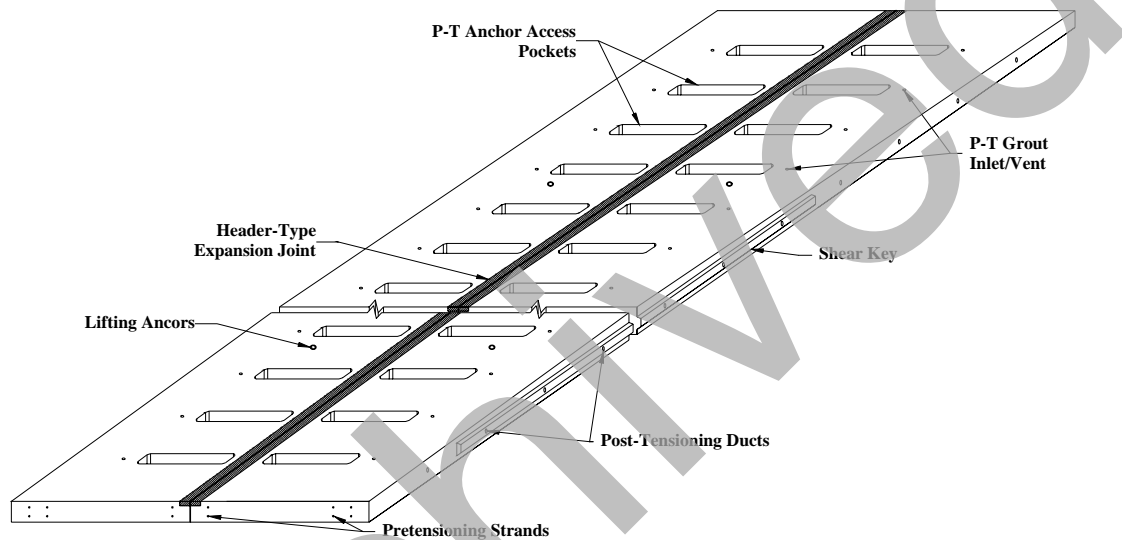

Figure 3. Illustration. Typical Joint Panel.

Anchor Panels

The anchor panels are located at the middle of each post-tensioned section. They contain sleeves cast into the panels for drilling and grouting anchor pins into the underlying base/subgrade (Figure 1). Anchoring the post-tensioned slab underlying base/subgrade is necessary so that the pavement expands and contracts outward from the center, helping to ensure uniform expansion joint widths, while also preventing the pavement slab from “creeping” or slowly moving in the direction of traffic over time.

BASE PREPARATION

Base preparation for PPCP consists of providing a smooth, flat surface to support the precast panels, as well as providing a bond-breaker friction-reducing material. Both hot-mix asphalt and lean concrete base materials have been used for the prepared base on previous projects. Strict tolerances on the evenness of the base surface helps to minimize high spots which could cause the panels to rest unevenly on the base and low spots which could create voids beneath the

panels. As mentioned previously, flexible base materials permit the precast panels to settle into the base somewhat, helping to reduce voids and high points.

Because PPCP consists of long sections of pavement tied together through post-tensioning, significant expansion and contraction movement can be expected with daily and seasonal temperature cycles. If this movement is restrained by friction between the bottom of the precast panels and the surface of the base, tensile stresses can develop, which are significant enough to cause cracking (similar to joint cracking in conventional jointed concrete pavement). Therefore, a bond-breaker or friction-reducing material is required to minimize frictional restraint. A single layer of polyethylene sheeting has proven to be an effective and economical material for this purpose. Polyethylene sheeting was used successfully for the demonstration projects in Texas⁽²⁾ and California,^(3,4) as well as for a cast-in-place prestressed concrete pavement constructed near West, Texas in 1985.⁽⁶⁾

POST-TENSIONING

As discussed previously, the purpose of longitudinal post-tensioning is to improve pavement performance, reduce slab thickness, and to provide load transfer between the precast panels. While the original PPCP concept utilized a technique known as “central stressing” for the longitudinal post-tensioning tendons, the Missouri demonstration project utilized end-stressing with larger stressing pockets in the joint panels, as described above. While central stressing has proved to be an efficient and effective post-tensioning technique, end-stressing eliminates the need for additional stressing pockets and “central stressing panels” in the post-tensioned slab.

Using the end-stressing technique, post-tensioning is completed from the stressing pockets in the joint panels. To help ensure that the full prestress force is attained along the length of the tendons, each is tensioned from both ends. The majority of the strand elongation will occur when stressing the first end of the tendon, with only a small amount of elongation occurring at the opposite end when it is tensioned.

In order to minimize the size of the stressing pockets in the joint panels, the monostrand stressing ram used for the Missouri project had a curved nose or “banana nose” that permits the ram to protrude from the surface of the precast panel rather than sitting inside the stressing pocket, as shown in Figure 4.

Post-tensioning ducts are located as close to mid-depth of the panel as possible to minimize any eccentric prestressing forces. It is essential that the ducts line up across panel joints and that the ducts are kept as straight as possible during panel fabrication to prevent post-tensioning losses due to “wobble.”

It should be noted that post-tensioning does not need to be completed before the pavement is opened to traffic. Post-tensioning can be completed during a subsequent construction operation if time constraints do not permit post-tensioning immediately after panel installation, as the keyways will provide some degree of load transfer prior to post-tensioning. Post-tensioning as soon as possible after panel installation will help to ensure the best pavement performance, particularly if epoxy is used to bond the panels together.

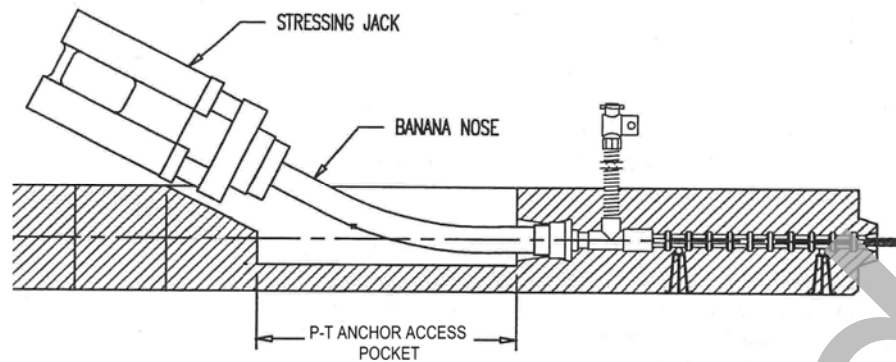

Figure 4. Illustration. Stressing ram with a curved nose used for longitudinal post-tensioning.

GROUTING

Grouting consists of both post-tensioning tendon grouting and, if necessary, underslab grouting. After the post-tensioning strands have been tensioned, the stressing pockets in the joint panels are patched to prevent grout leakage into the stressing pockets. At this point, grout can be pumped into the post-tensioning ducts to fully bond the post-tensioning strands to the pavement. Grout ports are located at each post-tensioning anchor and at approximately every 12-15 m (40-50 ft) along the length of the pavement.

Underslab grouting, when required, helps to ensure full support beneath the precast panels, filling any voids that may be present after panel installation. Underslab grouting is accomplished by pumping grout beneath the slab through grout ports cast into or drilled through the panel. It is necessary to seal or backfill the edges of the pavement slab and the bottom of the expansion joints to prevent grout from leaking from the edge of the slab or into the expansion joints.

Similarly to post-tensioning, grouting can be completed during a subsequent construction operation if time constraints do not permit grouting immediately following panel placement. Grouting should not be completed, however, until all post-tensioning tendons are stressed and the pockets in the joint panels are filled.

CONSTRUCTION PROCESS

Figure 5 shows a general flowchart for the construction process for PPCP. Although every project will have different design features and different constraints on construction, it should be noted that, when properly planned, many of the steps of the construction process can be completed independently, allowing the pavement to be opened to traffic in between steps. Each project must be carefully planned from the beginning to help ensure minimal impact on the motoring public during construction, as this is the primary benefit of precast concrete pavement construction.

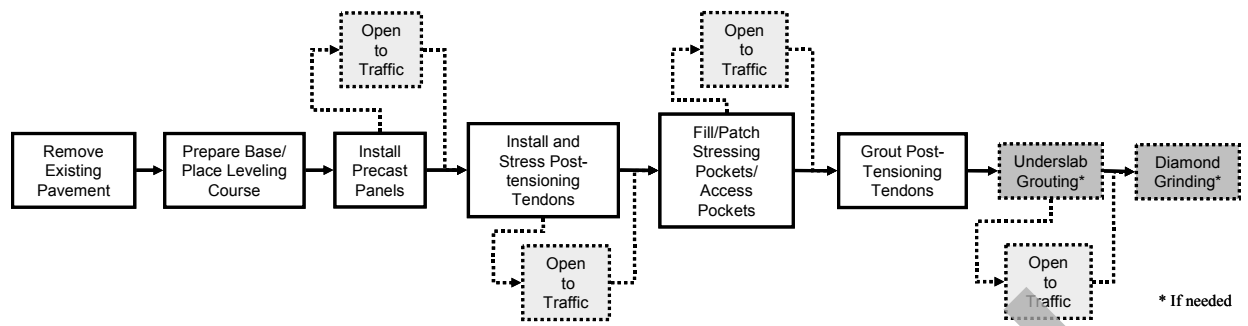

Figure 5. Illustration. Flowchart for the overall construction process.

Archived

Archived

CHAPTER 3. MISSOURI DEMONSTRATION PROJECT

PROJECT SCOPE

The intent of the Missouri PPCP demonstration project was familiarize the Missouri Department of Transportation (MoDOT) and local contractors with this new technology, while also further evaluating and refining the precast pavement concept developed through the original FHWA feasibility study⁽¹⁾ through another unique application.

Location

The location of the Missouri demonstration project was on northbound Interstate 57 approximately 16 km (10 mi) north of the Interstate 55 interchange in Sikeston, as shown in Figure 6. This project was incorporated into a larger rehabilitation project for Interstate 57 which included diamond grinding of the existing pavement, asphalt overlays, and full-depth pavement replacement.

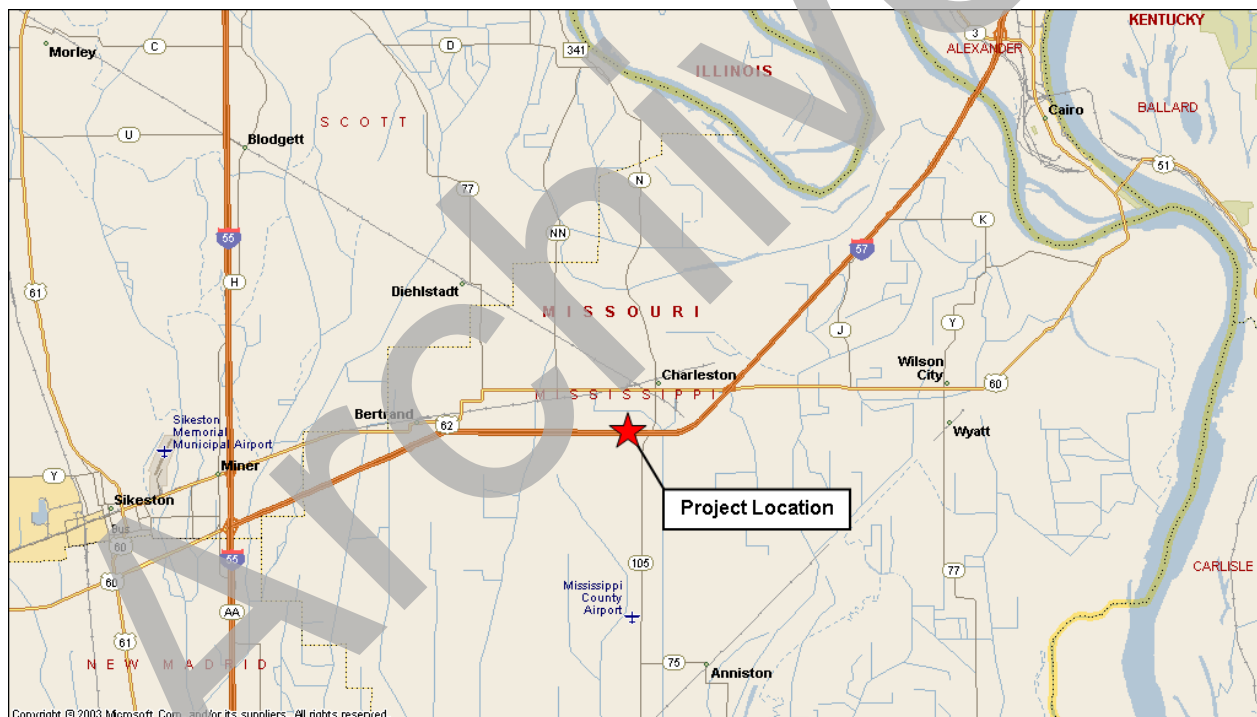

Figure 6. Illustration. Location of the Missouri PPCP demonstration project.

The existing pavement on Interstate 57 was constructed in 1959 and consisted of a 200 mm (8 inch) thick jointed reinforced concrete pavement with 18.7 m (61.5 ft) joint spacing over 100 mm (4 inch) of granular base. The existing pavement was 7.3 m (24 ft) wide with a 50 mm

(2 inch) crown and asphalt-treated shoulders. Longitudinal edge drains had been added to the pavement at a later date.

Demonstration Project Goals

The primary goal of this demonstration project was to provide MoDOT an opportunity to evaluate PPCP technology as a solution for rapid pavement construction and rehabilitation. As such, this initial project was constructed on a rural section of Interstate pavement that could be closed to traffic throughout the duration of construction, ensuring that any problems encountered would not significantly impact traffic on this critical section of Interstate 57. While PPCP is intended for use in urban areas where construction impacts on traffic must be minimized, this project permitted MoDOT an opportunity to evaluate and refine the construction process in a less critical environment first.

This project also permitted MoDOT to evaluate PPCP “side-by-side” with a conventional jointed concrete pavement constructed just south of the precast pavement section at the same time. Furthermore, this section of Interstate 57 carries a significant amount of truck traffic, which will provide a good test of long-term pavement performance.

A secondary goal of this demonstration project was to help familiarize local contractors with PPCP technology. Precast pavement is a very unique product for precast producers to produce and for highway contractors to install. If precast pavement technology is ever to be embraced by the precast and highway construction industries, they must have the opportunity to become familiar with the technology first, before it is required for time-critical urban applications.

PROJECT COORDINATION

As with any project utilizing new technology that is experimental in nature, coordination with all parties involved throughout the project is essential. In order to get precast producers involved early in the process, several meetings were held with MoDOT and regional precast producers during the project development stage. These meetings were used to not only give the producers a better understanding of precast pavement technology, but to also solicit their input in decision-making for design and construction details. As a result, many of the unknowns were addressed before the bidding process began, likely resulting in lower bids for the project.

In addition to the meetings during the project development stage, a pre-construction meeting was held with both the precast producer and installation contractor. This meeting was used to address any concerns the producer or installation contractor had as well as to emphasize the importance of the project to the contractors.

PROJECT LAYOUT

The layout for the demonstration project was dictated by the existing pavement on Interstate 57. The length of the precast pavement section was governed by the unit bid cost for the project and the available funding for construction.

Geometry

For this initial demonstration project, a tangent section of Interstate 57 with essentially no change in vertical curvature was selected. While complex geometries with superelevations are anticipated for future projects, a simple geometry permitted MoDOT to focus on overall construction details and procedures for this first project.

Cross-Section

The pavement cross-section was one of the more complex aspects of the project, with a “crowned” pavement cross-section required in order to match the existing pavement. The original pavement section consisted of a 7.3 m (24 ft) wide concrete pavement with asphalt shoulders. Based on current design standards, however, MoDOT elected to utilize integral shoulders for the precast pavement section. The resulting precast pavement section was 11.6 m (38 ft) wide, including two 3.7 (12 ft) wide traffic lanes, a 1.2 m (4 ft) inside shoulder, and 3 (10 ft) outside shoulder.

Three different alternatives were considered for achieving the 11.6 m (38 ft) pavement width with crowned cross-slope:

1. Partial-width panels with a uniform thickness: Two sections of panels (4.9 m [16 ft] wide section and 6.7 m [22 ft] wide section) tied together with transverse post-tensioning with the longitudinal joint located at the pavement crown. The underlying base would be trimmed to the crowned cross-section.
2. Full-width panels with uniform thickness: Single 11.6 m (38 ft) wide panels with the crown cast into the panel. The underlying base would be trimmed to the crowned cross-section.
3. Full-width panels with variable thickness: Single 11.6 m (38 ft) wide panels with a flat bottom and variable thickness to achieve the crowned cross section. The underlying base would be trimmed to a uniform horizontal grade.

The first alternative was ruled out due to the additional expense of fabricating and installing twice the number of panels and additional transverse post-tensioning. However, if lane-by-lane construction were required for this project, this option would have been the most viable alternative. Alternative #2 was ruled out due to the impracticality of fabricating a “bent” precast panel and grading the base material to such a tolerance that it would properly support the precast panels.

Alternative #3 was selected as the most practical solution for achieving both integral concrete shoulders and the necessary pavement crown. From a fabrication standpoint, casting panels with a flat bottom and sloping (crowned) surface is easily achievable. From a construction standpoint, grading the base to a uniform, horizontal profile is more viable than grading to a cross-slope, and installing a single precast panel to achieve the full pavement width is more efficient than using two or more panels.

In order to match the existing 200 mm (8 inch) thick pavement at either end of the precast pavement section, the thickness of the precast panels was specified as a minimum of 200 mm

(8 inches) for the traffic lanes. In order to achieve the two percent crown in the pavement surface, the thickness was varied from 276 mm (10 7/8 inches) at the peak of the crown down to 178 mm (7 inches) at the edge of the inside shoulder and 143 mm (5 5/8 inches) at the edge of the outside shoulder, as shown in Figure 7.

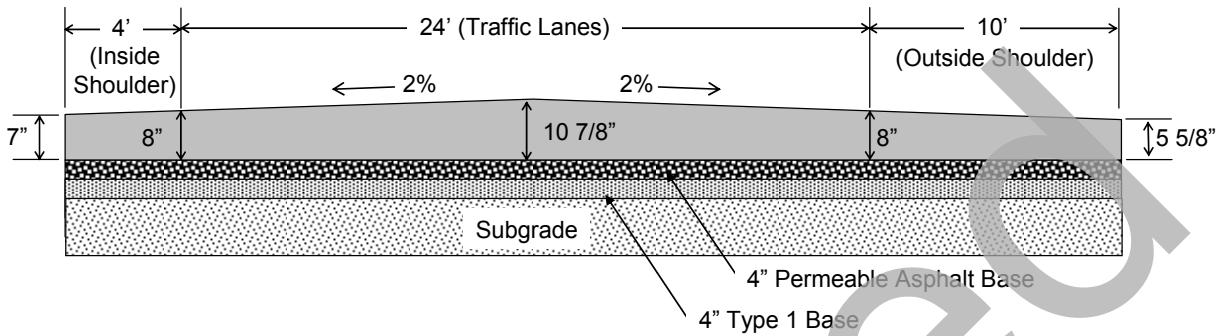

Figure 7. Illustration. Cross section of the precast panels, incorporating the change in cross-slope into the surface of the panel. (Note: 1 inch = 25.4 mm)

Figure 8 shows a profile view of the precast panels at the fabrication plant, showing the variable thickness panel. Because of the variable thickness of the panels and the need for the keyways to be parallel to the flat bottom of the panels, it was not possible to extend the keyways across the full width of the panels. As a minimum requirement, the keyways were maintained across both traffic lanes and extended one foot into each shoulder to ensure load transfer from the keyways within the traffic lanes.



Figure 8. Photo. Precast panels at the fabrication plant after removal from the forms showing the variable thickness cross-section.

Slab Length

During the design process (described in Chapter 4), the amount of horizontal slab movement and the resulting expansion joint widths during daily and seasonal temperature cycles were estimated. It was determined that a 76.2 m (250 ft) “standard” post-tensioned slab length (between expansion joints) would meet the necessary criteria for maximum expansion joint width for the prevailing site conditions. Considering the available funding for the demonstration project, it was determined that 305 m (1,010 ft) or four of these standard post-tensioned slabs could be constructed.

Archived

Archived

CHAPTER 4. DESIGN

DESIGN CONSIDERATIONS

There are several factors which must be considered for the design of a precast prestressed concrete pavement. While a detailed discussion of these design considerations can be found elsewhere,^(1,2) some of the primary design factors are summarized below.

Traffic Loading

Traffic loading is one of the governing factors for the thickness design of any pavement. Wheel loads on pavements are live loads that can fatigue pavement materials under repeated application, eventually leading to failure. For this reason, pavements are generally designed to withstand a predicted number of wheel load repetitions over the life of the pavement. In general, wheel load repetitions are quantified in terms of an 80 kN (18 kip) equivalent single axle load (ESAL). Accurate prediction of the number of ESALs over the life of the pavement is critical to ensuring that the pavement is properly designed, even though exact predictions are seldom realized due to continual changes in traffic volume and uncertainty in actual vehicle weights that the pavement will experience over its life.

Temperature and Moisture Effects

Temperature and moisture are also critical factors for concrete pavement design. Temperature differentials and moisture gradients over the depth of a concrete pavement slab cause it to curl. This curling movement is restrained by the weight of the concrete slab and by dowels at the joints, resulting in stresses in the top and bottom of the slab, depending on the curling condition. Temperature also causes expansion and contraction of pavement slabs. This horizontal movement is resisted by frictional restraint at the pavement-base interface, inducing compressive and tensile stresses in the pavement slab depending on the relative movement. The degree of horizontal movement is dependent upon the length of the slab and the frictional characteristics between the slab and base. For (precast) prestressed pavements with long slabs between expansion joints, this factor is very significant.

Slab-Support Interaction

As described above, horizontal slab movement (expansion and contraction) is resisted by friction between the bottom of the pavement slab and surface of the underlying base. The interaction at the slab-support interface essentially consists of four components: friction, interlock, adhesion, and cohesion.⁽⁷⁾ For long prestressed pavement slabs, it is essential to minimize restraint between the slab and base to reduce the magnitude of stresses that develop in the slab as a result of horizontal slab movements. Fortunately, precast panels normally have a smooth bottom surface which will help to reduce friction and interlock between the slab and base. However, a bond-breaking friction reducing material, such as polyethylene sheeting, is generally required to further reduce frictional restraint while also preventing adhesion.

Prestress Losses

Prestress losses are an important design consideration for PPCP. Fortunately, most of the factors are fairly well understood and can be estimated with reasonable accuracy. In general, losses of 15 to 20 percent of the applied prestress force can be expected for a carefully constructed post-tensioned concrete pavement.⁽⁸⁾ The factors that contribute to prestress losses include:

- Elastic shortening of the concrete,
- Creep of the concrete (shrinkage is a very minor factor for precast pavements),
- Relaxation of the stressing tendons,
- Slippage of the stressing tendons in the anchorage,
- Friction between the stressing tendons and ducts, and
- Horizontal restraint between the slab and support.

DESIGN PROCEDURE

The design procedure for the utilized for the Missouri demonstration project is an “equivalent thickness” procedure, wherein the precast pavement section was designed to be equivalent in terms of stresses experienced by the pavement under traffic loading to that of a typical MoDOT PCC pavement design for the specific site conditions. With this procedure, the precast pavement slab thickness can be selected based on site conditions and construction constraints, and the prestress level is then adjusted such that the stresses in the thinner precast pavement slab will be equivalent to those in a the thicker conventional (cast-in-place, non-prestressed) pavement slab. This benefit from prestressing helps to ensure that adequate pavement thickness (or “equivalent thickness”) is provided for traffic loading while also providing flexibility with selecting the pavement thickness.

Design for Pavement Stresses

The first step in the design procedure is to use a layered elastic analysis to determine tensile stresses at the extreme bottom fiber of both a conventional pavement slab that would normally be used for the given site conditions, and the precast pavement slab. The difference in stress between these two pavement sections is considered to be the compressive stress required in the precast pavement slab from prestress in order to achieve the equivalent thickness to the conventional pavement slab.

The next step is to analyze stresses in the precast prestressed pavement slab independently from traffic loading. These stresses are caused by environmental effects, which result in horizontal expansion and contraction, and slab curling. During this analysis, prestress levels in the slab are adjusted such that the worst case stress condition never exceeds the compressive stress required from the layered elastic analysis, described above. This analysis is performed using the computer program PSCP2, developed by The University of Texas at Austin specifically for analyzing prestressed concrete pavements. A more detailed description of this program can be found elsewhere.^(9,10)

It should be noted that this design procedure essentially only considers worst case stress conditions. The procedure assumes applications of design wheel loads from the layered elastic analysis under the most extreme stress condition in the prestressed pavement slab, which would occur only once or twice per day. For this reason, the design procedure is considered to be relatively conservative. However, the procedure is based on sound prestressed pavement design procedures using analysis software that has been calibrated with actual performance data. With continual monitoring and collection of long-term performance data, it will eventually be possible to evaluate how conservative this design procedure truly is.

Design for Slab Movement

In addition to designing for pavement stresses, slab movement must also be considered in order to ensure that the expansion joint is adequate to accommodate expected slab movements. After post-tensioning each section of precast panels together, the panels essentially act as a continuous slab, expanding and contracting with daily and seasonal temperature changes. If large movements (75-100 mm [3-4 inches]) are expected, an armored expansion joint, similar to those used for bridge decks, may need to be needed. If smaller movements (less than 25 mm [1 inch]) are expected, plain dowelled expansion joints may be adequate.

The amount of slab movement is dictated by a number of factors including prestress levels, prestress losses over time, concrete material properties (coefficient of thermal expansion, creep, and shrinkage), frictional restraint at the slab-base interface, and climatic conditions experienced by the pavement over time. Fortunately, the PSCP2 design program mentioned previously, takes all of these factors into account in computing the expected slab movement over the life of the pavement. At this stage in the design procedure the slab length (between expansion joints) that was selected during the preliminary project layout can be adjusted if necessary to meet expansion joint width limitation requirements.

INTERSTATE 57 PPCP DESIGN

Traffic

Traffic volumes were used to determine the thickness of a conventional jointed concrete pavement that might normally be constructed on Interstate 57. Table 1 shows the traffic information for the northbound lanes of Interstate 57 as provided by the MoDOT Transportation Planning Office.

Based on the recommendations of Section 6-03 (Pavement Structure Design) of the MoDOT Project Development Guide⁽¹¹⁾ for interstate pavements with over 50 million ESALs, this section of I-57 is considered a “Heavy Duty Pavement” and should be designed for 35-year ESALs. Using the American Association of State Highway and Transportation Officials (AASHTO) recommended design lane traffic distribution for highways with two or more lanes in each direction, the design lane ESALs should be 80-100% of the total ESALs for the northbound lanes, or between 130,687,000 and 163,359,000 ESALs.

Table 1. Design ESALs for Northbound Interstate 57 west of Route 105.

	ADT	Daily ESAL Units (Rigid Pavement)
Construction Year (2004)*	9,008	8,250
Design Year (2024)	14,233	13,040
*ADT Trucks – 39% (SU – 13%, Comb. – 87%)		
Accumulated 35-year ESAL units: 163,359,000		
Accumulated 40-year ESAL units: 199,285,000		
Accumulated 45-year ESAL units: 239,564,000		

Pavement Structure

The pavement support structure beneath the precast pavement section was assumed to be the same as that which would normally be constructed beneath a cast-in-place pavement. Figure 6-03.12 of the MoDOT Project Development Guide⁽¹¹⁾ (shown below in Table 2) requires the use of either an 455 mm (18 inch) rock base or a stabilized permeable base with drainage system on a 100 mm (4 inch) Type 1 base beneath all heavy-duty pavements. Figure 9, below, shows the resilient modulus and Poisson ratio values used for the layered elastic analysis based on recommendations from the 1993 AASHTO Design Guide.⁽¹²⁾

Table 2. Figure 6-03.12 of the MoDOT Project Development Guide showing guidelines for selecting rigid pavement thickness.⁽¹¹⁾

CHAPTER VI PAVEMENT STRUCTURE DESIGN				
RIGID ESAL's	WITH TIED SHOULDERS AND/OR 14 ft. [4.2 m] PAVEMENT NRPCCP		WITHOUT TIED SHOULDERS AND 12 ft. [3.6 m] PAVEMENT NRPCCP	
	(in.)	(mm)	(in.)	(mm)
200,000,000 (*)	15	375	16	400
100,000,000 (Heavy Duty)	14	350	15	375
50,000,000 (*)	13	325	14	350
40,000,000 (Medium Duty)	12	300	13	325
24,000,000	11	275	12	300
12,000,000	10	250	11	275
6,000,000	9	225	10	250
3,000,000	8	200	9	225
1,500,000	8	200	8	200

The values in this table were developed using the 1986 AASHTO design criteria.

All Heavy Duty pavements will be placed on an 18 in. [0.45 m] Rock Base, or a Stabilized Permeable Base with a drainage system on a 4 in. [100 mm] Type 1 Base. All Medium Duty pavements will be placed on an 18 in. [0.45 m] Rock base or a 4 in. [100 mm] Type 5 Base with a drainage system. All Light Duty pavements will be placed on a 4 in. [100 mm] Type 1 Base or an 18 in. [0.45 m] Rock Base. Rock Base is the preferred base and should be used when available on the job site or economically practical to haul in.

For the slab thickness of a conventional pavement, the table from Figure 6-03.12 of the MoDOT Project Development Guide (Table 2) was used. This table calls for a 380 mm (15 inch) pavement thickness for interstate pavements with more than 100 million ESALs for a 35-year design, when tied shoulders are provided. Although in practice MoDOT rarely constructs pavements of this thickness, a 380 mm (15 inch) slab thickness was used for design comparison purposes.

To determine the properties of the subgrade underlying this section of Interstate 57, MoDOT conducted falling weight deflectometer (FWD) and dynamic cone penetrometer (DCP) testing, and collected soil samples for laboratory testing. Soil sampling revealed silty and sandy-silty soils. The original 100 mm (4 inch) dense-graded granular base had become homogeneous with the underlying subgrade material. FWD testing revealed resilient modulus values ranging from 55 to 83 MPa (8,000 to 12,000 psi) when calculated from deflections 455 mm (18 inches) away from the load. Based on these tests, a subgrade resilient modulus of 69 MPa (10,000 psi) was used for the layered elastic analysis.

Layered Elastic Analysis

Figure 9 shows the pavement structures and loading condition used for the layered elastic analysis. A 380 mm (15 inch) slab thickness was analyzed representing the conventional pavement, and 200 mm (8 inch) and 280 mm (11 inch) slab thicknesses were analyzed for the precast pavement. The 200 mm (8 inch) and 280 mm (11 inch) slab thicknesses represent the precast panel thickness at the edges of the traffic lanes and at the pavement crown, respectively, as determined by the pavement cross section shown in Figure 7. Because the shoulders were integral with the mainlanes for the precast pavement panels and tied shoulders would be provided for conventional pavement, only interior slab loading was considered in the analysis. The wheel loads represent the loading from dual wheels on a 89 kN (20,000 lb) single axle.

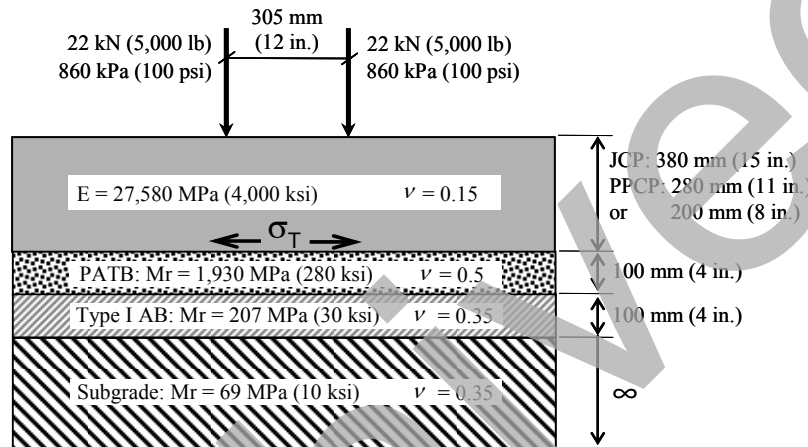

Figure 9. Illustration. Layered pavement structure used for elastic layered analysis of slab stresses under traffic loading.

The computer program BISAR (Bitumen Structures Analysis in Roads)⁽¹³⁾ was used for the layered elastic analysis. BISAR permits the degree of slip between the pavement and underlying base to be varied anywhere from no slip (full bond) to full (frictionless) slip. Because polyethylene sheeting will be provided as a bond breaker beneath the precast pavement, a full slip condition was analyzed for the precast (200 mm [8 inch]) pavement slab and a fully bonded condition was assumed for the conventional (380 mm [15 inch]) pavement.

Table 3 shows the results from the layered elastic analysis. The stresses shown are for the bottom fiber tensile stress directly beneath each of the loads. The “Difference” in stresses provided in Table 3 is the compressive stress required in the precast pavement from prestress. This is determined from the PSCP2 Stress Analysis, described below, for both 200 mm (8 inch) and 280 mm (11 inch) thicknesses.

Table 3. Bottom fiber tensile stress at the bottom of the 380 mm (15 in.) conventional pavement and 280 (11 in.) and 200 mm (8 in.) equivalent precast pavement.

	Pavement Thickness		
	380 mm (15 in.) Conventional	280 mm (11 in.) Precast	200 mm (8 in.) Precast
Bottom Tensile Stress, σ_T kPa (psi)	360 (52.1)	650 (94.4)	1,070 (155)
Difference, kPa (psi)		290 (42.3)	710 (102.9)

Stress Analysis

Using the stresses from the layered elastic analysis described above, the next step was to use the PSCP2 computer program to predict stresses in the I-57 precast pavement over the life of the pavement. This analysis was used to adjust the required prestress in the pavement such that the minimum compressive stress at the bottom of the pavement will be at least that shown as the “Difference” in Table 3.

The inputs used for the PSCP2 computer program for this analysis are summarized below in Table 4. The PSCP2 program was used to analyze pavement stresses during summer and winter climatic conditions. The pavement slab temperatures (at mid-depth) and top-bottom slab temperature differentials used for these climatic conditions in the PSCP2 analysis are shown in Table 5. Slab temperatures and top-bottom slab temperature differentials used for PSCP2 analysis. The mid-depth slab temperatures shown are those predicted for the climatic conditions near the project site (Sikeston, Missouri) for typical summer and winter conditions. The ambient temperatures used for prediction are based on the historical average highest high temperature of 33 °C (91°F) for summer months and lowest average low temperature of -4.4 °C (24 °F) for winter months. The following four scenarios were considered in the PSCP2 analysis:

- 1) Summer Construction/Winter Analysis
- 2) Summer Construction/Summer Analysis
- 3) Winter Construction/Summer Analysis
- 4) Winter Construction/Winter Analysis

The PSCP2 analysis examined stresses at very early age and at the intended design life of 45 years. The 30-day analysis, which is generally more critical for evaluation of slab movement, assumes the pavement was constructed under summer or winter conditions and was then subjected to the extreme opposite climatic conditions within 30 days. Again, this is a very conservative approach to the design analysis for lack of a better design methodology which considers reliability or a certain factor of safety. The analysis also considered both 200 mm (8 inch) and 280 mm (11 inch) slab thicknesses. These represented the two extreme thicknesses present in the traffic lanes.

Table 4. Inputs used for the PSCP2 Analysis.

Property	Input Value
Slab Length	76 m (250 ft)
Slab Thickness	200 and 280 mm (8 and 11 inches)
Slab Width	11.6 m (38 ft)
PCC CTE	9 $\mu\epsilon/^\circ\text{C}$ (5 $\mu\epsilon/^\circ\text{F}$)
PCC Unit Weight	2,320 kg/m ³ (145 pcf)
PCC Poisson's Ratio	0.15
PCC Ultimate Shrinkage Strain	0.00019
PCC Creep Coefficient	2.1
PCC Strength (28 day)	34.5 MPa (5,000 psi)
P-T Strand Diameter	15 mm (0.6 in)
P-T Strand Yield Strength	1,675 MPa (243 ksi)
P-T Strand CTE	12.6 $\mu\epsilon/^\circ\text{C}$ (7 $\mu\epsilon/^\circ\text{F}$)
P-T Strand MOE	196.5 GPa (28,500 ksi)
P-T Strand Area	140 mm ² (0.217 in ²)
Base Friction Coefficient	0.6
Displacement at Sliding	0.5 mm (0.02 in.)
Base k-value	136 kPa/mm 500 (pci)
Initial Post-Tensioning Stress (stress level at dead end of tendon after stressing live end to 75% fpu)	1,303 MPa (189 ksi) (70% fpu)
Final Strand Spacing	Variable

Table 5. Slab temperatures and top-bottom slab temperature differentials used for PSCP2 analysis.

Hour of Day	Summer		Winter	
	Mid-depth Slab Temperature, $^\circ\text{C}$ ($^\circ\text{F}$)	Top-Bottom Differential, $^\circ\text{C}$ ($^\circ\text{F}$)	Mid-depth Slab Temperature, $^\circ\text{C}$ ($^\circ\text{F}$)	Top-Bottom Differential, $^\circ\text{C}$ ($^\circ\text{F}$)
2:00	24.3 (75.7)	-3.6 (-6.5)	4.2 (39.6)	-3.9 (-7)
4:00	24.1 (75.3)	-3.9 (-7)	4.0 (39.2)	-3.6 (-6.5)
6:00	24.5 (76.1)	-3.7 (-6.6)	3.6 (38.4)	-3.4 (-6.2)
8:00	26.7 (80)	-2.7 (-4.8)	4.3 (39.7)	-2.1 (-3.8)
10:00	29.8 (85.6)	2.0 (3.6)	5.8 (42.4)	3.9 (7)
12:00	31.8 (89.2)	6.1 (11)	6.7 (44)	7.8 (14.1)
14:00	31.1 (88)	8.9 (16)	6.9 (44.5)	8.9 (16)
16:00	30.1 (86.2)	7.7 (13.9)	6.5 (43.7)	3.9 (7.1)
18:00	28.1 (82.6)	2.6 (4.6)	5.7 (42.3)	-2.2 (-4)
20:00	25.7 (78.2)	-1.1 (-1.9)	5.2 (41.3)	-3.1 (-5.6)
22:00	25.1 (77.1)	-2.7 (-4.9)	4.7 (40.5)	-3.3 (-6)
0:00	24.6 (76.3)	-3.3 (-5.9)	4.5 (40.1)	-3.8 (-6.8)

Prestress levels in the pavement slab were increased and decreased by adjusting the spacing of the longitudinal post-tensioning tendons. The critical location for analysis of bottom-fiber stresses was found to be at mid-slab at the 45-year analysis period. The PSCP2 analysis revealed

that 760 mm (30 inch) longitudinal strand spacing was adequate for both the 200 mm (8 inch) and 280 mm (11 inch) slab thicknesses. The bottom fiber compressive stresses at the early-age (30-day) and 45-year analysis periods at mid-slab exceeded the “Difference” values from Table 3 for the four climatic analysis scenarios presented above. Although 760 mm (30 inch) strand spacing was adequate, the final tendon spacing was set at 610 mm (24 inches) in order to “standardize” strand spacing for this and future projects.

Slab Movement Analysis

The PSCP2 program was also used for the slab movement analysis in order to predict expansion joint widths over the life of the pavement, such that the expansion joints could be designed to be adequate for those movements. The slab movement analysis also revealed what width the expansion joints needed to be set at initially in order to prevent them from closing completely or opening too wide.

The same inputs, temperatures, and climate scenarios presented above were used for the slab movement analysis. However, for this analysis, only the 610 mm (24 inch) tendon spacing was analyzed as this was used as the final design. Essentially, only the joints located between adjacent PPCP sections (joints 2, 3, and 4) were analyzed as twice the movement occurs at these joints as at the joints at the ends of the section. The PSCP2 slab movement analysis indicated a maximum joint closure (assuming construction in winter) of 15 mm (0.58 inches), and a maximum opening (assuming construction in the summer) of 45 mm (1.76 inches). Based on this analysis, the expansion joints (and seals) were required to accommodate a maximum “stretch” of 45 mm (1.76) inches and maximum “compression” of 15 mm (0.58 inches).

In order to set the initial joints widths at an optimal width, Table 6 below, was provided in the Job Special Provisions. The contractor was required to adjust the expansion joints following post-tensioning to these widths, based on the prevailing ambient temperatures during construction.

Table 6. Required expansion joint width following post-tensioning.

Ambient Temperature Condition	Required Expansion Joint Width
$T \leq 10^{\circ}\text{C}$ (50°F)	19 mm (0.75 in.)
10°C (50°F) < $T < 32^{\circ}\text{C}$ (90°F)	13 mm (0.5 in.)
$T \geq 32^{\circ}\text{C}$ (90°F)	6.4 mm (0.25 in.)

Transverse Prestress Requirements

Transverse prestress has been found from previous demonstration projects to be dictated by lifting and handling stresses for the precast panels. Because the “slab length” in the transverse direction is relatively short (11.6 m [38 ft]), stresses generated from the combination of wheel loading and slab expansion and contraction are much lower than those resulting from lifting the precast panels. The governing condition for calculation of lifting stresses is during stripping of

the precast panels from the forms when concrete strength is the lowest and “suction” forces create higher lifting stresses.

Transverse prestress requirements were calculated based on the flexural stresses in the precast panels during lifting of the precast panels as they were removed from the forms. Estimated locations of the lifting anchors (which were later confirmed by the fabrication plant) were first determined by locating the lifting points where bending stresses would be minimized. Because of the asymmetrical shape of the panel cross section, the lifting points were different distances from the ends of the panels. Bending stresses were then computed (using an additional 1.3 multiplier for the concrete unit weight to account for suction forces), and compared with allowable stresses. Allowable tensile stresses were limited to $3\sqrt{f'_{ci}}$, where f'_{ci} is the concrete compressive strength at the time of prestressing, or 1.2 MPa (177 psi) for $f'_{ci} = 24.1$ MPa (3,500 psi), as per ACI 318-95 requirements.⁽¹⁴⁾

Pretensioning tendons were assumed to be 13 mm (0.5 inch), grade 270 low-relaxation strands. The tendons were assumed to be tensioned to 80 percent of the ultimate strength of the strand, and a lump-sum loss of 310 MPa (45,000 psi) was assumed for calculating the total effective prestress in each strand.⁽¹⁵⁾ Based on these criteria and the difference between calculated lifting stresses and permissible lifting stresses, eight pretensioning strands were required for each precast panel. This level of transverse pretensioning provides an effective prestress of approximately 1.1 MPa (160 psi) at the pavement crown (thickness = 275 mm [10 7/8 inches]), 1.5 MPa (218 psi) at the lane edges (thickness = 200 mm [8 inches]), and 2.1 MPa (310 psi) at the outside shoulder edge (thickness = 143 mm [5 5/8 inches]). For the Joint Panels, 12 strands were provided, 6 on each side of the expansion joint, in order to give them additional rigidity due to the number of pockets contained in these panels.

DESIGN DETAILS

The overall concept and many of the design details for the I-57 demonstration project were based on the original FHWA feasibility study⁽¹⁾ and adaptations of the details used for previous demonstration projects in Texas⁽²⁾ and California.^(3,4) However, several unique design details were developed and implemented for this project based on job-specific constraints and in an attempt to simplify certain features of the PPCP system.

Keyways

Keyways along the joints between individual precast panels are a fundamental feature of the PPCP system, helping to ensure vertical alignment between panels as they are assembled. The keyway dimensions specified for the I-57 demonstration project, which were based on those used for previous demonstration project, are shown below in Figure 10.

For fabrication and installation purposes, horizontal keyways that are parallel to the bottom of the precast panels are preferred. Therefore, the keyways did not follow the “crowned” shape of the panels, but were kept parallel to the bottom of the panel. The crowned cross section was achieved by varying the depth of the vertical face above the keyways. As discussed previously, due to the thickness of the panels at the edges of the shoulders, it was necessary to discontinue

the keyways in the shoulders. The keyways extended a minimum of 0.3 m (1 ft) into each shoulder, however, to ensure that the top surface of adjacent precast panels matched in the traffic lanes. Figure 11 shows these discontinuous keyways for precast panels in storage at the fabrication plant.

A flared or trumpeted opening was provided at the end of each post-tensioning duct to accommodate slight misalignment of the ducts on site. For the recessed keyway, a recess around each post-tensioning duct was provided to receive compressible foam gaskets. The compressible foam gaskets were installed prior to setting each panel in place and helped to minimize grout leakage from the post-tensioning ducts during the tendon grouting operation.

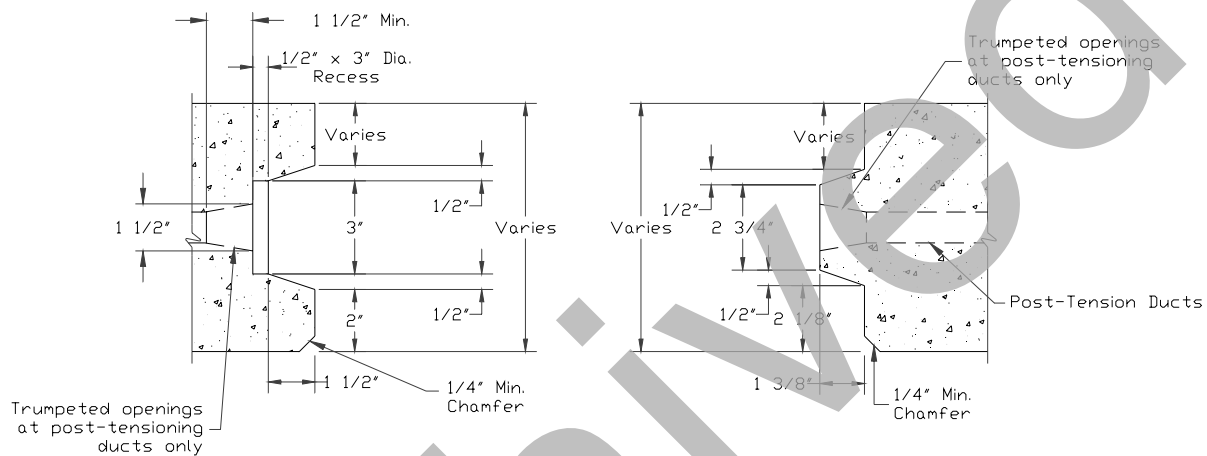

Figure 10. Illustration. Keyway dimensions for I-57 precast panels. (Note: 1 inch = 25.4 mm)



Figure 11. Photo. Discontinuous keyways are shown for the precast panels in storage at the fabrication plant.

Expansion Joint

The expansion joint is a critical design aspect of the PPCP concept as these joints essentially experience impact loading from traffic since they are typically open wider than conventional pavement joints. For the demonstration project in Texas, a steel armored joint was required to accommodate joint movement of 75-100 mm (3-4 inches). For the demonstration project in California, the expansion joint was not expected to open more than 13 mm (0.5 inches), and therefore a plain (non-armored) dowelled joint was adequate. As described above, up to two inches of movement are anticipated for the I-57 demonstration project. While this would normally necessitate the use of an armored joint, diamond grinding of the final pavement surface was anticipated, and there was a concern with diamond grinding over an armored joint.

The solution employed for the I-57 project was a dowelled header-type expansion joint, as shown in Figure 12, which is commonly used for bridge joints. The header material at the top of the joint, which can be diamond ground, gives the joint better ability (over a plain concrete joint) to withstand impact from heavy truck loading. This joint detail uses a poured silicon seal with the expansion and compression capacity discussed above. The recesses for the header material were cast into the precast panels and later filled in the field after the expansion joint width had been adjusted. The dowels, spaced at 305 mm (12 inches) on center, provide load transfer across the joint, and are epoxy coated for corrosion resistance. Expansion caps are provided at the ends of the dowels to permit movement of the dowels within the joint panels. The dowels were spaced such that they would not coincide with the post-tensioning anchor pockets.

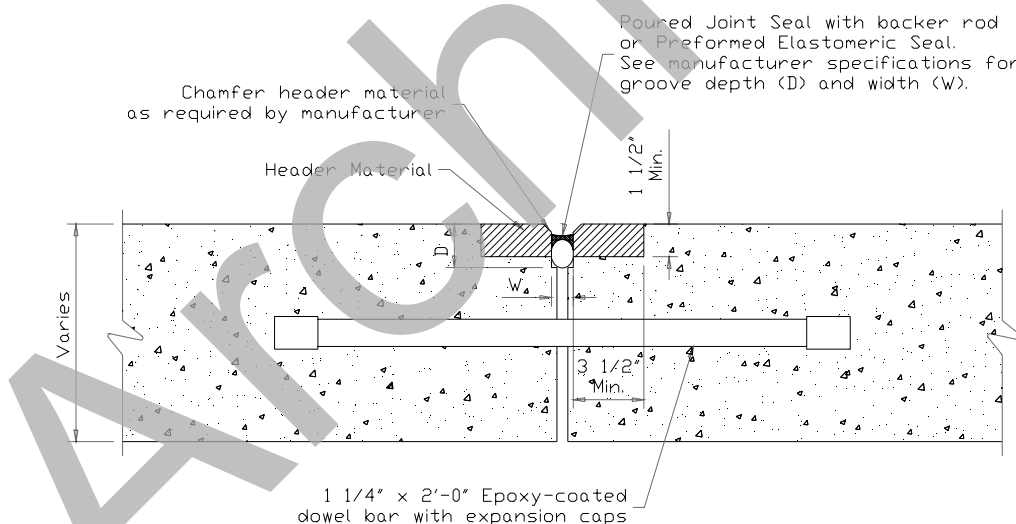

Figure 12. Illustration. Expansion joint detail for the I-57 demonstration project (Note: 1 inch = 25.4 mm).

Post-Tensioning Details

In an attempt to simplify the PPCP system by reducing the number of different types of precast panels, end stressing was used in lieu of central stressing. This eliminated the central stressing

pockets and the central stressing panels. It required, however, special attention to the process for post-tensioning the tendons.

To accommodate end stressing, anchor access pockets were specified such that they were large enough to accommodate the stressing ram and would permit the post-tensioning strands to be fed into the ducts from the pockets. Figure 13 shows the stressing pockets that were developed by the post-tensioning supplier (Dywidag Systems International) to meet these requirements. The intent was to minimize the size of the stressing pockets as much as possible. As such, a pocket which could accommodate a “banana-nose” post-tensioning ram was used. The pockets featured a sloped face in the back of the pocket to accommodate the ram. Because of the variable thickness of the precast panels, the dimensions for each pocket were different and required pocket formers to be fabricated for each individual pocket.

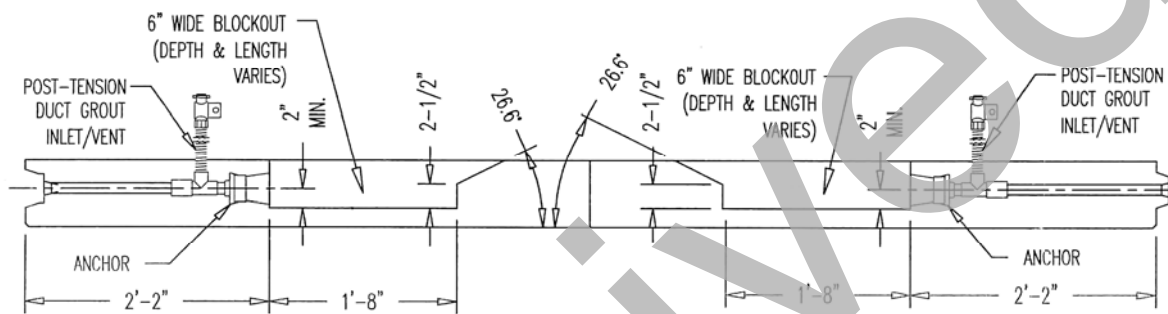

Figure 13. Illustration. Typical post-tensioning pocket cast into the joint panels (*Note: 1 inch = 25.4 mm*).

In order to transfer the post-tensioning force from the post-tensioning anchors back to the expansion joint opening, stirrups were provided, as shown in Figure 14. These stirrups confined the concrete between the post-tensioning anchors and the expansion joint, transferring prestress force through the joint panels. The stirrups wrapped around the longitudinal reinforcing bars located in front of the post-tensioning anchors as well as the pretensioning strands and reinforcing bars located near the expansion joint. The stirrups (No. 4, grade 60 reinforcement) were spaced at 100 mm (4 inches) on center across the width of the joint panels, except where post-tensioning blockouts were located. This stirrup detail was used successfully on the previous demonstration project in California.

As discussed in Chapter 2, it was necessary to anchor the center of each post-tensioned section of precast panels to the underlying base so that they will expand and contract outward from the center, ensuring uniform expansion joint widths and preventing the pavement sections from “creeping” in the direction of traffic under traffic loading. For this purpose, Anchor Panels were located at the center of each post-tensioned section of pavement. A series of 100 mm (4 inch) diameter sleeves were cast into these panels to receive dowel pins which were drilled and grouted into the underlying base/subgrade after installation of the panels, as shown in Figure 15. While this did create another type of precast panel, the anchor sleeves could have simply been drilled into standard base panels on-site if necessary.



Figure 14. Photo. Joint panel prior to concrete placement, showing post-tensioning pockets, anchors, stirrups and dowels.

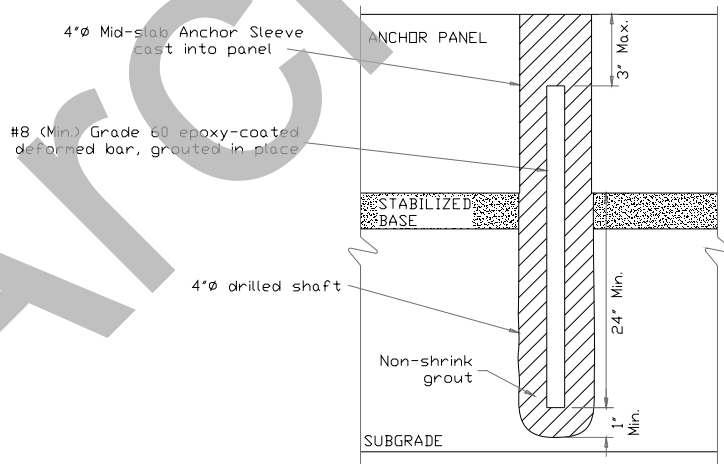

Figure 15. Illustration. Mid-slab anchor detail (Note: 1 inch = 25.4 mm).

CHAPTER 5. PANEL FABRICATION

PROCEDURE

The precast panels for the Missouri demonstration project were fabricated by CPI Concrete Products Inc. of Memphis, Tennessee, approximately 240 km (150 miles) from the I-57 project site. Prior to beginning fabrication, detailed shop drawings were developed by CPI and submitted to MoDOT for approval. The shop drawings provided the details for the formwork, including the post-tensioning anchor blockouts which had to be specially sized for each blockout. Panel fabrication began on October 1, 1005, and was completed by December 16, 2005.

The panels were fabricated on a 4.3 m (14 ft) wide flat steel casting table which was long enough to produce up to two panels end to end. Steel sideforms and bulkheads were custom made for the panels. The pretensioning strands extended through both panels, anchored at bulkheads at either end of the self-stressing casting bed. Bulkheads between the precast panels, bolted down to the casting bed, were used to hold the pretensioning strands at the proper elevation at the ends of the precast panels. Steel chairs were used to harp the strands within the precast panels to match the strand profile provided in the panel detail drawings. Figure 16 shows the forms as the pretensioning strands are threaded through the forms.



Figure 16. Photo. Precast panel forms during installation of the pretensioning strands.

In general, two base panels were cast each day. Panels were normally stripped from the forms in the morning and the bed was cleaned and set up for an afternoon pour. Joint panels required additional form set-up time due to the anchor blockouts and additional reinforcement and post-tensioning anchors. Joint panels were each cast in two halves on separate days. A separate sideform was used to hold the dowel bars in place and form the recess for the header material at

the expansion joint. The first half of the joint panel was cast and steam cured, but the pretensioning strands were not released until after the second half had been subsequently cast and cured. The second half of the panel was set up and cast either the afternoon of the same day (if the first half was cast in the morning) or the following day. Figure 17 shows the fabrication of a base panel and Figure 18 shows fabrication of a joint panel during concrete placement for the first half of the panel.



Figure 17. Photo. Concrete placement for a base panel.



Figure 18. Photo. Fabrication of the first half of a joint panel.

TOLERANCES

Tolerances specified in the Job Special Provisions were based on experience with previous demonstration projects in Texas and California.^(2,3,4) Tolerances for the keyways, post-tensioning ducts, and overall panel dimensions were particularly critical. Keyway tolerances helped to ensure that adjoining panels would fit together and provide a satisfactory riding surface. Tolerances for the position of the post-tensioning ducts helped to ensure that the ducts lined up between panels, and tolerances for overall dimensions helped to ensure that the panels were “square” so that a “curve” was not built into the finished pavement at the panels were assembled on site. Table 7 summarizes the tolerances for the precast panels, as shown in the Job Special Provisions.

Table 7. Table of panel tolerances from the project plans.

Measurement	Tolerance
Length (parallel to long axis of panel)	+/- 6 mm (1/4")
Width (normal to long axis of panel)	+/- 3 mm (1/8")
Nominal Thickness	+/- 1.5 mm (1/16")
Squareness (difference in measurement from corner to corner across top surface, measured diagonally)	+/- 3 mm (1/8")
Horizontal Alignment (upon release of stress)–Deviation from straightness of mating edge of panels	+/- 3 mm (1/8")
Vertical Alignment–Camber (upon release of stress)	+/- 3 mm (1/8")
Deviation of ends (horizontal skew)	+/- 3 mm (1/8")
Deviation of ends (vertical batter)	+/- 3 mm (1/8")
Keyway Dimensional Tolerance	+/- 1.5 mm (1/16")
Position of Strands	+/- 3 mm (1/8") Vertical +/- 6 mm (1/4") Horizontal
Position of post-tensioning ducts at mating edges	+/- 3 mm (1/8") Vertical +/- 3 mm (1/8") Horizontal
Straightness of post-tensioning ducts	+/- 6 mm (1/4") Vertical +/- 6 mm (1/4") Horizontal
Vertical Dowel Alignment (parallel to bottom of panel)	+/- 3 mm (1/8")*
Horizontal Dowel Alignment (normal to expansion joint)	+/- 3 mm (1/8")
Dowel Location (deviation from shop drawings)	+/- 6 mm (1/4") Vertical +/- 6 mm (1/4") Horizontal
Dowel Embedment (in either side of expansion joint)	+/- 25 mm (1")
Position of drainage and electrical conduit	+/- 13 mm (1/2")
Straightness of drainage and electrical conduit	+/- 13 mm (1/2") Vertical +/- 13 mm (1/2") Horizontal
Position of lifting anchors	+/- 75 mm (3")
Position of non-prestressed reinforcement	+/- 6 mm (1/4")
Straightness of expansion joints	+/- 3 mm (1/8")
Initial width of expansion joints	+/- 3 mm (1/8")
Dimensions of blockouts/pockets	+/- 3 mm (1/8")
	*Measured from bottom of panel

PANEL DETAILS

Reinforcement

Minimal mild-steel (non-prestressed) reinforcement was provided in the base panels. As the panel detail drawings in the Appendix show, only perimeter steel at the top and bottom of the panel was provided for the base panels. Joint panels also had perimeter steel, but were heavily reinforced with stirrups around the stressing pockets and post-tensioning anchors as discussed previously. Epoxy-coated grade 60 No. 4 deformed bars were specified for all non-prestressed reinforcement. For the joint panels abutting the existing cast-in-place pavement, the half of the panel not post-tensioned was reinforced with mild steel in the longitudinal direction. No. 6 epoxy-coated reinforcing bars spaced at 200 mm (8 inches) on center provided approximately 0.65 percent steel for this portion of the precast panel. Figure 19 shows the reinforcement for the non-post-tensioned half of a joint panel prior to concrete placement.



Figure 19. Photo. Reinforcement for the non-post-tensioned half of a joint panel prior to casting.

Pretensioning

All pretensioning steel was 13 mm (0.5 inch) diameter, Grade 270 low relaxation 7-wire strand. For the base panels, eight strands were required. The strands were spaced evenly across the width of the base panels and alternated above and below the post-tensioning ducts to minimize any prestress eccentricity. For the joint panels, the pretensioning strands were concentrated in the outer edges and along the expansion joint to avoid crossing through the post-tensioning

blockouts. Twelve strands were specified for the joint panels for to provide additional flexural strength for handling panels with post-tensioning blockouts. For both the base panels and joint panels, the strands were maintained at a constant depth over the portion of the panel which was 200 mm (8 inches) or thicker (traffic lanes). However, in the shoulder regions of the panels, it was necessary to harp the strands slightly to follow the top surface of the panels.

It should be noted that the pretensioning strands were only tensioned to 75 percent of their ultimate strength, rather than 80 percent assumed during the design process. While this will reduce the effective prestress in the panels, the lump-sum prestress loss assumed in the design calculations is likely very conservative anyway. Based on actual lifting and handling of the precast panels, the pretensioning level was clearly adequate to prevent cracking.

Post-Tensioning

Monostrand post-tensioning ducts with an inside diameter of 23 mm (0.9 inches) were used for the longitudinal post-tensioning tendons. The ducts were developed specifically for monostrand post-tensioning and are made of corrosion-proof polyethylene material. The ducts are ideal for monostrand bonded tendons, with ribs to facilitate bond with the concrete and two continuous channels along the length of the duct to facilitate the flow of grout. The ducts are flexible and required adequate chairing and the use of bar stiffeners inserted in the ducts during concrete placement to prevent sagging and bowing of the duct under the mass of fresh concrete.

Encapsulated monostrand anchors were used for the post-tensioning anchors. The anchors were cast into the joint panels and bolted to the post-tensioning blockout formers. Grout ports were located just in front of the anchors and in every 5th base panel along the length of each post-tensioned section of pavement. Trumpeted openings and recesses for the foam gaskets were formed at the ends of the post-tensioning ducts in each panel using machined steel recess formers. Figure 20 shows the post-tensioning duct, anchor, and blockout former used in the joint panels.



Figure 20. Photo. Post-tensioning duct, anchor, and blockout former in a joint panel.

Lifting Devices

Based on experience with previous demonstration projects, threaded coil inserts were specified for the lifting anchors. These anchors leave only a small hole in the surface of the precast panel to patch, and could potentially be left unpatched in a non-freezing environment. The lifting anchors were recessed below the surface of the panel slightly to minimize protrusions from the panel surface during screeding of the fresh concrete. The lifting inserts were made of galvanized steel to minimize the risk of corrosion of the anchors over time. The final location of the lifting inserts was determined by the precast fabricator such that the weight on each lifting line would be balanced.

MIXTURE DESIGN

In order to produce a set of panels every day, a concrete mixture was needed that would provide the necessary release strength within 12-15 hours after casting and steam curing. The concrete mixture also needed to be one that could be finished to the necessary tolerances required for the pavement driving surface. The compressive strength specified for the concrete mixture was 24.1 MPa (3,500 psi) at release of prestress and 34.5 MPa (5,000 psi) at 28 days. As presented in Chapter 7, actual 7-day strengths averaged 41.9 MPa (6,070 psi) and actual 28-day strengths averaged 49.6 MPa (7,190 psi). A 5 percent total air content and 160 mm (6 inch) slump were also required for the mixture.

The mixture used for the panels consisted of Type I portland cement with a 0.326 water-cement ratio, fine and coarse (limestone) aggregate, air entraining admixture, and two water reducing admixtures. The very low water-cement ratio helped to ensure that release strength could be achieved within 12-15 hours, while the water-reducing admixtures provided the necessary workability for placing the concrete in the forms. CPI utilizes a very advanced concrete batch plant for producing concrete mixtures. Proportioning is fully automated and the mixture components are combined using a twin-shaft mixer requiring only 30 seconds of mix time. Table 8 shows the concrete mixture used for the precast panels.

CONCRETE PLACEMENT, FINISHING, AND CURING

The concrete mixture was transported only a short distance (< 100 m) from the batch plant to the forms. Concrete was placed in the forms in two lifts; the first filling the forms to the level of the post-tensioning ducts, and the second, immediately following the first, filling the forms to the top surface, as shown in Figure 21. The flowable nature of the mixture required only minimal vibration to consolidate the concrete around the reinforcement, ducts, and blockouts.

A hand screed was used to initially strike off the concrete surface, flowed by a vibratory screed to achieve a uniform, smooth surface. An intermediate curing compound (Confilm[®]) was sprayed over the surface between the hand screed and vibratory screed to minimize moisture loss from the large surface area of the fresh concrete. Immediately following the vibratory screed, a light broom texture was applied along the length of the panels (transverse to the direction of traffic flow). A carpet drag texture was specified in the original Job Special Provisions, but was

changed to a broom finish after problems were experienced with the carpet drag. Figure 22 and Figure 23 show the screeding and texturing operations, respectively.

Table 8. Concrete mixture used for the precast panels.⁽¹⁶⁾ (Note: 1 lb = 0.45 kg, 1 gal = 3.8 L, 1 yd³ = 0.76 m³).

Constituent	Precast Pavement Mix /yd ³ *
Cement	722 lb
Fine Aggregate	1162 lb
Coarse Aggregate	1766 lb
Water	28.25 gal
Water - Cement Ratio	0.326
Air Entrainment Admixture	MB AE 90 1 -3 oz
Full-Range Water-Reducer	Glenium 3000NS 4 - 8 oz / 100 lb Cement
Water Reducing Admixture	Pozzolith 200N 2 -5 oz / 100 lb Cement

* Unless specified otherwise



Figure 21. Photo. Concrete placement operation showing the two-lift procedure.



Figure 22. Photo. Vibratory screeding of the panel surface.



Figure 23. Photo. Application of the light broom texture to the panel surface.

After application of the surface texture, the panels were covered with tarps and steam cured overnight, as shown in Figure 24. The steam was generally turned off by 5 am at which time strength was checked. If the strength was adequate for release, the tarps were removed and the pretensioning strands de-tensioned. If strength was not adequate, the steam was turned back on for 1-2 hours until adequate strength had been achieved. While steam curing was used to achieve

the necessary release strength overnight, some additional form of curing on the top surface and sides of the panels was required for a minimum of 72 hours after concrete placement or until the 28-day strength had been achieved. This requirement was satisfied by covering the panels with wet burlap and plastic sheeting for an additional 24 hours after they were moved from the forms to the storage area, as shown in Figure 25.



Figure 24. Photo. Casting bed during steam curing operation.



Figure 25. Photo. Wet burlap mat curing of the precast panels after removal from the forms.

DE-TENSIONING, HANDLING, AND STORAGE

Once the panels had reached the necessary release strength, the pretensioning strands were de-tensioned. De-tensioning was completed by flame-cutting the pretensioning strands at both ends of the casting bed. The same strand was cut simultaneously at the each end in a specific order to ensure proper transfer of prestress into the concrete. De-tensioning began with the strands at the outside edges of the panels, moving towards the center of the panel, alternating between strands on either side of the centerline.

The precast panels were removed from the forms and transported to the storage area using a straddle-lift crane, as shown in Figure 26. As per PCI Design Handbook recommendations, a lifting angle (angle between the top surface of the panel and the lifting line) of at least 60 degrees was required in order to minimize bending stresses in the panels when lifted.⁽¹⁷⁾ Because a spreader beam was used for lifting the panels at the fabrication plant, this was not a concern. For the joint panels, steel strongbacks (angle steel) were bolted across the expansion joints, using the lifting anchors as bolt-down points, to ensure that expansion joints remained closed during handling and that the dowels were not subjected to bending.



Figure 26. Photo. Removal of a panel from the forms after curing.

All of the precast panels were stored at the fabrication plant until installation. Each panel was initially stacked individually until it was fully cured and inspected. The bar stiffeners were removed from the post-tensioning ducts, and the ducts were capped with a foam plug to ensure that nothing would get into the ducts prior to installation on site. The stubs of the pretensioning strands were cut back flush with the edge of the panel and patched with an epoxy mixture to prevent corrosion of the ends of the strands. The panels were stacked 10 high in the storage area, as shown in Figure 27. Careful attention to the thickness and location of the dunnage between precast panels was required due to the sloped top surface of the panels.



Figure 27. Photo. Panels stacked in the storage area after final curing and inspection.

TRIAL ASSEMBLY

As part of the Job Special Provisions, the precast fabricator was required to demonstrate the fit of the panels prior to beginning large-scale production. Two panels were initially fabricated and assembled at the precast plant. After demonstrating proper fit of these panels, approval was given to continue with full-scale production of the remaining panels.

PANEL REPAIRS

Repairs to panels damaged at the fabrication plant were addressed by MoDOT on a case-by-case basis. Of primary concern was any damage to the mating edges and keyways and to the top (riding surface) of the panels. Any major spalls or corner breaks were required to be cleaned, sawcut square and patched with a MoDOT approved patch material. Any minor hairline cracking in the top surface of the panels was required to be sealed with epoxy. Minor shallow (< 6 mm [1/4 inch] deep) spalls in the shoulder regions of the panels were generally not required to be repaired.

CHALLENGES/ISSUES ENCOUNTERED

Overall, no major problems were encountered with the panel fabrication process, and no precast panels were rejected. The level of quality control and the quality of the finished precast panels was very good. Some of the issues that were encountered during the fabrication process are discussed below.

Longitudinal Cracking – The primary distress observed at the fabrication plant was hairline cracking along the long axis of the panel (Figure 28). Coring of these cracks from selected panels revealed that they generally extended the full-depth of the precast panel. While the exact cause of

this cracking has been difficult to determine, temperature and strain data collected in several of the panels during fabrication (described in Chapter 7) indicate very high and rapid changes in concrete temperature and strain during fabrication. This indicates that “thermal shock” could have potentially caused stresses in the precast panels high enough to result in cracking. Fortunately, longitudinal post-tensioning in the finished pavement will help keep these cracks closed and the epoxy injected in the cracks at the fabrication plant will prevent the ingress of water into these cracks.



Figure 28. Photo. Typical hairline longitudinal crack observed at the fabrication plant (photo taken after precast panel was delivered to the project site).

Transverse Cracking – A few instances of hairline cracking in the transverse (short) direction were also observed at the fabrication plant. The exact cause of these cracks is not known for sure, but is possibly be related to harping of the pretensioning strands in combination with the relatively thin panel depth in the shoulder region. Fortunately, these cracks generally occurred in the shoulder regions of the precast panels and will be held tightly closed by the transverse pretensioning in the panels. These cracks were sealed with epoxy at the fabrication plant, as shown in Figure 29.



Figure 29. Hairline transverse crack in the shoulder after epoxy sealing (photo taken after panel was installed on site).

Archived

Archived

CHAPTER 6. PAVEMENT CONSTRUCTION

PRE-BID AND PRE-CONSTRUCTION MEETINGS

Being the first project of its kind in Missouri, pre-bid and pre-construction meetings were an essential part of the I-57 PPCP demonstration project. Very early in the project development process, local precasters were invited to attend project meetings to discuss panel fabrication issues. Once preliminary details and specifications had been developed, a pre-bid meeting was conducted by MoDOT to reiterate the scope of the proposed project and answer questions from precast suppliers interested in bidding on the project.

After the contract which included the PPCP demonstration project had been awarded, a pre-construction meeting was held at the MoDOT offices in Sikeston, Missouri to discuss the specifics of the project. Representatives from MoDOT, Gaines Construction (installation contractor), CPI Concrete Products (precast fabricator), K. Bates Steel Services (post-tensioning contractor), University of Missouri-Columbia, and The Transtec Group, Inc. were present at the meeting. The purpose of the pre-construction meeting was to open the lines of communication between all parties involved and ensure coordination of all aspects of the demonstration project. Of particular importance was coordination of the instrumentation activities by the University of Missouri with both the precast fabricator and installation contractor. This meeting was very beneficial for establishing who was responsible for each aspect of the project, particularly for a project which was experimental in nature.

BASE PREPARATION

As discussed in Chapter 3, the PPCP demonstration project was incorporated into a much larger project to reconstruct a section of JRCP on Interstate 57 which had begun to rapidly deteriorate in previous years. For this reconstructed section, the existing JRCP was removed, the subgrade was re-graded, and a new base constructed. Outside of the limits of the PPCP section, new edge drains were installed to replace the clogged and deteriorated existing drains, and a new jointed concrete pavement was constructed.

The reconstructed base beneath the PPCP section consisted of 100 mm (4 inches) of permeable asphalt treated base over 100 mm (4 inches) of dense graded granular base. To better ensure that the precast panels would be properly supported, the straightedge requirement for the permeable asphalt treated base was specified such that a 150 mm (6 inch) diameter plate 3 mm (1/8 inch) thick could not be passed beneath a 6 m (20 ft) straightedge resting on the base at any location. Correction of any deviations from this requirement was completed at the contractor's expense. The contractor was also required to establish grade control for construction of the asphalt base. As such, a stringline was used for construction of the permeable asphalt-treated base. Figure 30 and Figure 31 show the construction of the permeable base and the final surface, respectively.



Figure 30. Photo. Construction of the permeable asphalt treated base (photo from MoDOT).



Figure 31. Photo. Finished surface of the permeable asphalt treated base.

The polyethylene sheeting used as friction-reducing material beneath the precast panels was rolled out just prior to placement of each panel, as shown in Figure 32. This minimized any damage to the sheeting cause by foot traffic or construction vehicles and equipment.



Figure 32. Photo. Polyethylene sheeting rolled out prior to installation of precast panels.

PANEL INSTALLATION

Precast panel installation took place from December 12-20, 2005. Because this was a first demonstration of PPCP construction in Missouri, time restrictions were not placed on the contractor for installing the panels. The intent was to evaluate the PPCP construction process to determine the viability for future rapid reconstruction and rehabilitation projects.

Transportation and Staging

The panels were transported to the job site on flat bed tractor trailers, approximately 240 km (150 miles) from the fabrication plant in Memphis, TN. Due to the weight of each panel (+/-18 Mg [20 tons]), only one panel could be transported on each truck.

The 54 Mg (60-ton) crawler crane used for panel installation was positioned on the base in front of the panel installation. Panel delivery trucks lined up on the existing pavement south of the project, then pulled onto the shoulder next to the PPCP section where the crane picked the panels off the truck and lowered them into place, as shown in Figure 33. Due to the “soft” nature of the permeable asphalt treated base, the tracks of the crane rutted the permeable asphalt base slightly. Sand was used to fill these ruts prior to installing the polyethylene sheeting and precast panels, as shown in Figure 34.



Figure 33. Photo. Staging of delivery trucks and the installation crane.



Figure 34. Photo. Sand was used to fill the ruts in the permeable asphalt treated base.

Installation Procedure

Prior to lifting each panel from the delivery truck, epoxy (segmental bridge adhesive) was applied to the mating faces of the panels, and the compressible foam gaskets were installed in the recess around each post-tensioning duct on the recessed keyway side of the panel, as shown in Figure 35. After the polyethylene sheeting was rolled out, each panel was installed. In general, two precast panels were installed before moving the crane.



Figure 35. Photo. Epoxy applied to the keyways (left) and installation of the foam gaskets (right).

A laser was used to align the precast panels to the centerline of the pavement. The laser was set on the panels already in place and aligned to nail heads marking the pavement centerline, pre-surveyed into the base. An alignment guide was installed in the post-tensioning duct at the centerline of each precast panel, and aligned the laser. Figure 36 shows the alignment laser and the alignment guide installed in a panel.

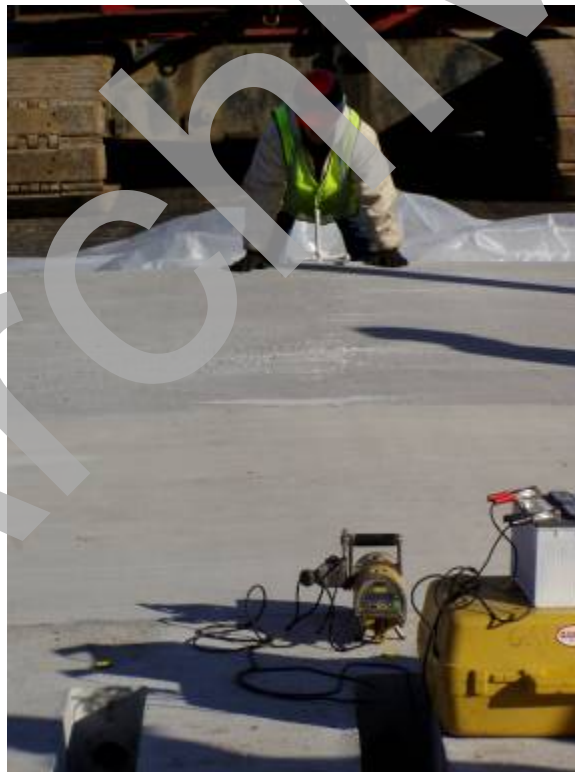

Figure 36. Photo. Laser and alignment guide used to align the precast panels as they were installed.

After two consecutive panels were installed, two temporary post-tensioning strands, located approximately at the quarter points, were fed through the panels. Post-tensioning rams were then used to temporarily post-tension the panels together from the face of the newly installed panels, as shown in Figure 37. Temporary post-tensioning helped to close the joints between individual panels as much as possible prior to final post-tensioning, and also seated the panels in the epoxy before it reached final set.



Figure 37. Photo. Temporary post-tensioning was used to close the joints between panels as much as possible during panel installation.

Installation Rate

Panel installation rate was primarily dictated by availability of delivery trucks. Because the roadway was closed to traffic during construction, panel installation was not constrained by traffic control restrictions. In general 20-30 minutes were required for the installation of each panel. This included applying the epoxy, installing the panel, and completion of temporary post-tensioning. Problems with alignment of the panels to the centerline of the roadway caused delays for installation of panels for Sections 2, 3, and 4, as will be discussed below.

POST-TENSIONING

Strand Installation

After all of the panels for each section were installed, the final longitudinal post-tensioning strands were inserted into the ducts from the stressing pockets in the joint panels and threaded through all of the panels to the stressing pockets at the opposite end of the section. A mechanical strand pusher was used to feed the strands through the panels, as shown in Figure 38. Difficulty

in feeding the strands through the ducts was experienced with several tendons. These difficulties were the result of offsetting panels to correct the pavement alignment, obstructions such as ice in the post-tensioning ducts, and possibly bowed ducts within the panels. For tendons where problems pushing the strands were experienced, it was necessary to use a smaller strand as a “fish line” to pull the strands through the ducts. In the end, all strands were successfully installed and tensioned. Issues associated with strand installation will be discussed in more depth below.



Figure 38. Photo. Mechanical pusher used to feed post-tensioning strands through the panels.

Tendon Stressing

Final longitudinal post-tensioning was completed from the stressing pockets in the joint panels using stressing rams with a “banana nose” attachment. The banana nose permitted the ram to protrude from the pockets in the precast panels, minimizing the required size of the pockets. Two tendons were stressed simultaneously, one on either side of the pavement centerline, in order to expedite the stressing process and to minimize stressing eccentricities (Figure 39). Stressing began with two tendons near the pavement centerline and progressed outward towards the outside edges of the pavement.

Tendons were stressed to 80 percent of the ultimate strength of the strand or approximately 209 kN (46.9 kips). Because of the loss of prestress over the length of the tendon due to friction and “wobble” in the post-tensioning ducts, tendons were stressed from both ends. This ensured that the full post-tensioning force was applied to the ends of each tendon. The majority of the elongation occurred when stressing the first end. The rams were then moved to the opposite end of the tendons and each strand was tensioned again. Elongations were measured by first tensioning the strand to 20 percent of the total required jacking force, marking the strand, then tensioning to the full required jacking force and measuring the movement of the mark on the strand.



Figure 39. Photo. Final longitudinal post-tensioning completed using two post-tensioning rams (photo from MoDOT).

MID-SLAB ANCHOR

Ideally, the mid-slab anchors should be installed prior to completion of final post-tensioning so that the ends of the section will be drawn in towards the middle of the section during post-tensioning. Due to the timing of the different construction operations, this was not possible for the I-57 project, and the mid-slab anchors were installed after the completion of post-tensioning. The mid-slab anchors, shown in Figure 15 in Chapter 4, consisted of a 25 mm (1 inch) diameter reinforcing bar drilled and grouted a minimum of 610 mm (24 inches) deep into the underlying base/subgrade using the anchor sleeves cast into the anchor panels.

EXPANSION JOINTS

The Job Special Provisions required the contractor to adjust the width of the expansion joints after completion of post-tensioning. However, because post-tensioning was not completed until all four sections of the pavement had been installed, it was necessary to adjust the joint width prior to post-tensioning, while also allowing the post-tensioning operation to pull the joints open. Unfortunately, attempts to open the joints using hydraulic rams attached to the top surface of the panels were not successful as the two halves of the joint panels bonding together. The solution was to leave a gap between the joint panel and adjacent base panel which would be pulled closed as the expansion joint opened during the post-tensioning operation. This worked successfully for joints 2 and 3, as shown in Figure 40, but the two halves of joint 4 were bonded together so well that the joint fractured along a plane parallel to the actual expansion joint, as shown in Figure 41. This required the concrete between the actual joint and the fracture to be removed and patched.



Figure 40. Photo. Expansion joint after being pulled open during the post-tensioning operation. (photo from MoDOT).



Figure 41. Photo. Expansion joint No. 4 after fracturing during the post-tensioning operation. (photo from MoDOT).

One of the reasons for using a header-type expansion joint was that it could be diamond ground with the rest of the pavement surface. Unfortunately, construction sequencing prevented the header material from being installed until after diamond grinding had been completed. The header material was finished flush with the existing pavement after diamond grinding, however, and did not significantly affect the overall smoothness of the pavement. All but one expansion joint have performed well, as shown in Figure 42, with the exception being joint 4, where the header material was installed over the patch, and has not performed well under traffic due to poor bond to the surrounding concrete. The header material deteriorated significantly (Figure 43) under traffic, but has since stabilized. Deflection testing by MoDOT (discussed in Chapter 7) however, shows load transfer across this joint comparable to the other expansion joints.

The expansion joint seals were installed after the header material. A poured silicon joint seal with back rod, compatible with the header material, was specified for the joint seal. The sealant had the expansion and compression capacity discussed previously in Chapter 4. The joint seals were installed under winter climatic conditions when the expansion joints would be expected to be at their maximum width. As such, during the hottest time of the day under summer climatic conditions, the joint sealant has been observed protruding from the pavement surface, as shown in Figure 44, which makes it susceptible to damage from traffic.⁽¹⁸⁾



Figure 42. Photo. Good performing header expansion joints.⁽¹⁸⁾



Figure 43. Photo. Deterioration of header material for expansion joint No. 4.⁽¹⁸⁾



Figure 44. Photo. Joint sealant protruding from the surface of the pavement during under summer climatic conditions.⁽¹⁸⁾

FILLING POCKETS

After completion of final longitudinal post-tensioning, the stressing pockets and mid-slab anchor sleeves were filled and finished flush with the pavement surface using a pea gravel concrete mixture. Subsequent diamond grinding of the pavement surface removed any roughness associated with the stressing pockets.

TENDON GROUTING

Grouting of the post-tensioning tendons was essentially the final step in the construction process, and was completed following post-tensioning and filling of the stressing pockets. As discussed previously, grout inlets/vents were located in front of the post-tensioning anchors and at every fifth base panel, limiting the maximum spacing between vents to 15 m (50 ft). The epoxy applied to the mating edges of the panels and the compressible foam gaskets around the post-tensioning ducts were provided to minimize grout leakage from the tendon ducts.

The grout mixture used was a pre-packaged non-bleed “cable grout” mixture specifically formulated for post-tensioning tendons. The efflux time for checking fluidity using ASTM C939 (“Standard Method for Flow of Grout for Preplaced-Aggregate Concrete – Flow Cone Method”),⁽¹⁹⁾ was required to be between 10 and 30 seconds, unless otherwise specified by the grout manufacturer. Grout was pumped from one end of each tendon to the other. Intermediate grout vents were closed off as the grout flowed through the tendons. If a significant amount of grout was pumped into a tendon and flow of grout was not observed from the end of the tendon or from intermediate vents, grout was then pumped into the nearest intermediate port.

Significant grout leakage from the tendons was apparent during the grouting operation as the quantity of grout used was several times what should have been required. In the end, all of the tendons were fully grouted, but the leakage of grout likely filled significant portions of the underlying permeable asphalt-treated base.

DIAMOND GRINDING

Based on the previous demonstration projects in Texas and California, diamond grinding to meet Interstate Highway smoothness requirements was expected. While the finished pavement surface was smooth enough to open to traffic if necessary, it did not meet MoDOT profilograph smoothness specifications for concrete pavement. Diamond grinding was used to bring the pavement surface back into specification. Only the traffic lanes were diamond ground to minimize the cost of diamond grinding. Figure 45 shows the final surface of the pavement after diamond grinding.

No major surface repairs were required for the finished pavement. While a number of minor spalls were observed at the joints between panels, diamond grinding removed many of these spalls. Deeper spalls will be monitored over time so that repairs can be made if needed.



Figure 45. Photo. Final pavement surface after diamond grinding.

TYING TO EXISTING PAVEMENT

As discussed previously, the pavement to the north and south of the PPCP section was also replaced with a conventional jointed concrete pavement. The adjacent pavement was not constructed until after the PPCP section was in place, so there was no need to develop a method for tying the PPCP panels to an existing pavement during panel installation. It was, however, still necessary to tie the PPCP section to the cast-in-place pavement to be constructed. To accomplish this, two-piece tie bars were cast into the joint panels abutting the cast-in-place pavement, as shown in the project plans in the Appendix. After the joint panels were installed, the second half of the tie bars were screwed into the half cast into the joint panels, and the cast-in-place pavement was constructed up to the PPCP section (Figure 46).



Figure 46. Photo. Adjacent cast-in-place pavement constructed at the end of the PPCP section. (photo from MoDOT)

CONSTRUCTION ISSUES AND CHALLENGES

This project was one of the first PPCP projects constructed in the U.S., and as such, construction challenges were anticipated. This section will discuss some of the more critical construction issues and the solutions developed or recommended for future projects.

Panel Installation

Rutting of Base – As discussed previously in this chapter, the weight of the crawler crane on the permeable asphalt treated base left ruts or track indentations. While these ruts were filled with sand to help level the surface, this situation should be avoided if possible for future projects. The sand may clog the permeable base (depending on the fineness of the sand), and it was also observed that when the sand “patches” were disturbed by foot traffic it created high points that the precast panels rested on, which could have potentially led to stress concentrations in the panels and problems with fitting the panels together. Whenever “soft” bases such as this are used, the crane should be located off of the base that will be supporting the panels. If traffic constraints do not allow this, the contact pressure of the crane on the base should be determined to see if additional measures are needed to distribute the weight of the crane (tracks or outriggers) over the base to prevent indentations.

Panel Alignment – Maintaining the alignment of the pavement, or keeping the centerline of the precast panel on the centerline of the roadway, was another issue that was encountered. Section 1 was installed without any problem, but Sections 2-4, were difficult to keep in alignment. One of the reasons for this was an uneven gap left between the final base panel of Section 1 and the joint panel between Sections 1 and 2. This gap was provided to allow the expansion joint at the end of

Section 1 to open during post-tensioning. Unfortunately, this uneven gap caused the alignment of subsequent panels for Section 2 to creep away from the centerline of the roadway by approximately 100 mm (4 inches) at the end of Section 2.

To correct the alignment, shims up to 13 mm (1/2 inch) thick were inserted in the joints between panels at the outside edge (Figure 47), and the panels were offset from one another. While offsetting helped to bring the panels back on line, it adversely affected feeding the post-tensioning strands through the ducts, requiring several of the strands to be pulled through the ducts using a “fish line” welded to the end of the post-tensioning strand. Shimming also helped bring the panels back on line, but prevented the joints between panels from closing completely, allowing incompressible material to fall into the joint, and also causing uneven distribution of the post-tensioning force across the width of the pavement (discussed in Chapter 7).



Figure 47. Photo. Shims at the outside edge of the pavement used to correct centerline alignment.

Because it is critical that the panel joints are closed and sealed as tight as possible, offsetting the panels may be the best solution for correcting alignment of the centerline. However, provision should be made for offsetting in the design process. A maximum permissible offset should be established based on the size of ducts and strands used for the project. Additionally, multi-strand flat ducts should be used to accommodate offsetting of up to 25-50 mm (1-2 inches).

Faulting – Several instances of faulted joints in the shoulder regions of the pavement were observed during the installation process, as shown in Figure 48. This faulting was the result of butt joints used in the shoulders rather than keyway joints, as discussed in Chapter 4.

Fortunately, this faulting was relatively minor and could be removed with diamond grinding if needed. Whenever possible, however, keyways should extend across the full width of the roadway to prevent this, particularly in the traffic lanes.



Figure 48. Photo. Faulted joint observed in the shoulder region.

Expansion Joints – One of the main problems with the expansion joints is that they did not open very easily during post-tensioning. This was likely caused by either strong bond between the two halves of the joint panels or by dowel bar misalignment. Because of the strict tolerances on the dowel bars during panel fabrication, and the rigid forms used to hold the dowel bars in place, dowel misalignment was likely not the problem. It is critical to ensure that the two halves of the joint panels do not bond together during fabrication. A heavy application of bond breaking material, such as grease or paint, should be applied, or alternatively a positive bond breaker such as plastic sheeting or Styrofoam should be included between the two halves.

The long term performance of the header-type expansion joint will determine whether it is truly viable for PPCP expansion joints. Based on its usage for bridge joints, there should not be any problems with long-term durability. Armored joints are likely a more durable alternative for expansion joints, but require consideration of diamond grinding the finished surface and corrosion protection for steel components.

Post-Tensioning

Strand Installation – The main issue with the post-tensioning operation was installing the strands in the panels. Offsetting of the panels to correct centerline alignment caused significant problems with feeding the tendons through the ducts, and also likely resulted in frictional losses in the tendons as they were stressed. If panel offsetting (which is preferable to shims) is used for future projects, larger diameter or flat multi-strand ducts should be used.

Ice in the post-tensioning ducts also inhibited strand installation. Water may have accumulated in the ducts during the steam curing operation at the fabrication plant and froze under the unusually cold conditions at the fabrication plant and project site. Based on this experience, it is recommended that compressed air be used to blow any water out of the ducts at the fabrication plant and, if possible, at the project site.

Timing of Post-Tensioning – The initial intent was for each section of precast panels to be installed and post-tensioned prior to installing subsequent sections. Unfortunately, workers were constrained to installing the precast panels as they arrived, and were not available for completing the post-tensioning. As a result, the epoxy between the precast panels set prior to applying final post-tensioning. Hardened epoxy in the joints between panels during final post-tensioning was likely the cause of some of the spalling observed at these joints. Additionally, if the epoxy bonded the panels together well enough so that they acted as a continuous concrete slab prior to final post-tensioning, the stresses in the pavement slab from daily expansion and contraction could have exacerbated the transverse cracking that was observed at the fabrication plant. Project planning is essential to ensuring that all of the different construction operations are completed in the correct sequence and that enough workers are available for all processes to be completed when needed.

Grouting

Grout Leakage – The primary issue with tendon grouting was leakage of grout from the tendons between panels. Even though foam gaskets and epoxy were used in the joints between panels, significant grout leakage occurred. While epoxy and gaskets are still recommended, a positive connection between tendons across the panel joints may need to be developed to prevent grout leakage altogether.

SHOWCASING WORKSHOP

In order to help familiarize other MoDOT offices, other regional state highway agencies, and the precast and concrete pavement industries with PPCP technology, MoDOT and FHWA sponsored a workshop to showcase the completed project. The workshop entitled, “National Rollout of Precast Prestressed Concrete Pavement Technology” attracted more than 60 participants from numerous state highway agencies, and industry representatives from throughout the U.S. The workshop was held on August 22-23, 2006, approximately 8 months after the project was constructed.

The workshop, in a two half-day format, featured presentations by the different parties involved with the project on the first day, including MoDOT, FHWA, CPI Concrete Products, University

of Missouri-Columbia, and Transtec. The first day also included a roundtable discussion which allowed participants to ask questions of those involved in the project. The second day featured a demonstration of the panel installation and a visit to the project site. For the installation demonstration, FHWA funded the fabrication of five additional precast panels, which were shipped to a MoDOT maintenance yard in Sikeston and installed by MoDOT personnel as the participants watched. For the site visit, MoDOT provided a lane closure on Interstate 57 so that the workshop participants could walk along the actual PPCP section. Figure 49, Figure 50, and Figure 51 show photos from the workshop.



Figure 49. Photo. Presentations were provided by all parties involved with the project.



Figure 50. Photo. The workshop participants were able to see a live demonstration of the panel installation process at a MoDOT maintenance yard in Sikeston.



Figure 51. Photo. The workshop participants were able to visit the actual PPCP section on I-57.

Archived

CHAPTER 7. INSTRUMENTATION AND EVALUATION

INTRODUCTION

As part of an evaluation of the FHWA PPCP demonstration projects, performance monitoring is conducted through condition surveys of the completed project and, whenever possible, instrumentation of the pavement section. For the I-57 demonstration project, an extensive instrumentation and monitoring program were conducted by the University of Missouri – Columbia through a separate research contract with MoDOT. This chapter will discuss the performance monitoring aspects as well as the instrumentation and monitoring program, including key findings from instrumentation and testing.

PROJECT-LEVEL CONDITION SURVEY

Distress Map

Soon after the pavement was opened to traffic, a project-level condition survey was performed in order to establish the initial as-constructed condition of the precast pavement. This initial project-level condition survey will be used for comparison with future condition surveys to identify any new distresses that occur over time. For this condition survey, a distress map was developed, noting any distresses visible after construction. The distresses that were mapped included:

- Longitudinal and transverse cracking,
- Random and shrinkage cracking,
- Spalling, and
- Corner breaks.

The distress map for the as-constructed condition is shown in Figure 59 at the end of this chapter. To summarize the as-constructed condition:

- Hairline cracks perpendicular to the direction of travel (Figure 28) were noted in approximately 25 percent of the panels, primarily in the first two sections (Sections 1 and 2). Many of these cracks occurred at the fabrication plant and were filled with epoxy prior to shipment to the project site. Most of these cracks were located at the middle of the panels, approximately 1.5 m (5 ft) from the panel edges, and were essentially parallel to the panel edges. With the exception of only a few of these cracks, none extend the full length of the precast panel, and were primarily contained within the traffic lanes.
- Hairline longitudinal cracks were noted primarily in Section 3 (Figure 52). These longitudinal cracks mainly extended from the instrumentation blockouts that were included in the panels for this section, as described below. These cracks were likely initiated by the “squared” corners on the blockouts, which resulted in stress concentrations. Slab curling may have also caused or exacerbated longitudinal cracking, although it would be expected in more than one section if this were the case. Minor

longitudinal cracking was also observed in several panels in the shoulder regions (Figure 29). Most of these cracks were observed at the fabrication plant and sealed with epoxy prior to shipment to the project site.

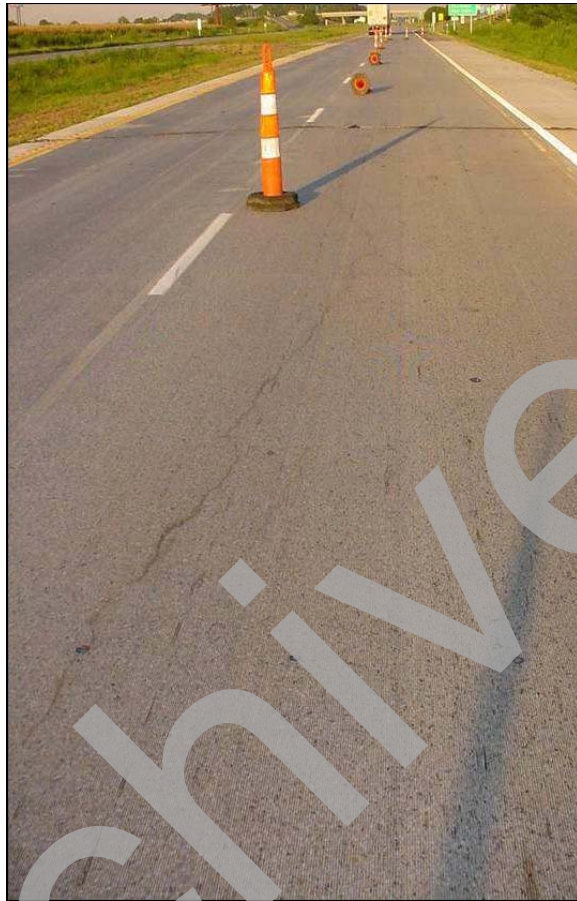

Figure 52. Photo. Longitudinal crack near the pavement centerline extending away from one of the instrumentation blockouts.⁽¹⁸⁾

- Several minor spalls were noted at joints between panels (Figure 53). These spalls were generally very shallow (< 6 mm [1/4 inch]).
- Several “stress concentration” cracks, which generally lead to spalling, were observed at joints between precast panels. Although these cracks had developed (likely during construction), the concrete was still intact.
- No corner breaks were observed.
- Faulting was observed between several of the precast panels (Figure 48). This faulting was observed only in the shoulders, which were not diamond ground, and was the result of vertical misalignment of the precast panels in the shoulders where the keyways were not provided.
- The fourth expansion joint, between Sections 3 and 4, has shown significant deterioration since construction (Figure 43), but the other four expansion joints are performing well (Figure 54). As discussed in a previous chapter, this expansion joint fractured and opened

approximately 100 mm (4 inches) away from the actual joint location, requiring the joint to be patched. The patch did not adequately support the header material and consequently, the header material has deteriorated under traffic.

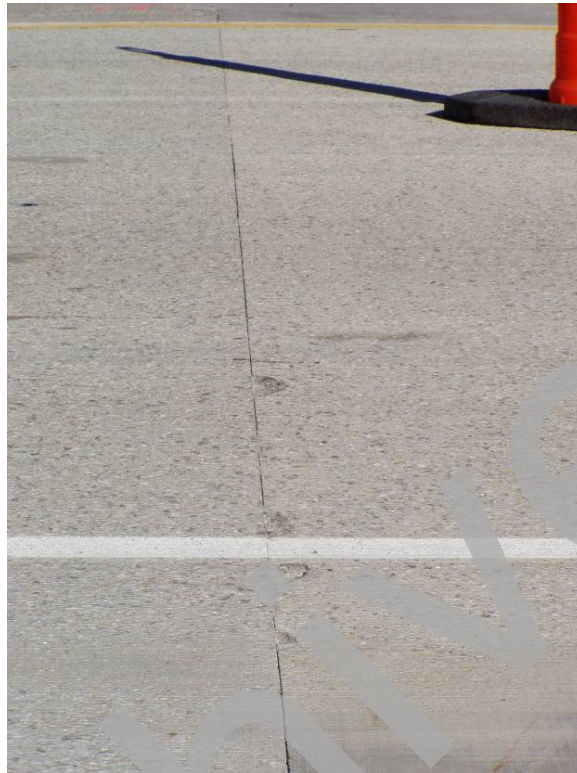

Figure 53. Photo. Typical minor spalling observed.



Figure 54. Photo. Typical condition of expansion joints 1,2,3, and 5 in service.

Despite the significant number of distresses observed, most should have little or no effect on pavement performance. The majority of the transverse cracks were sealed with epoxy at the precast plant to prevent infiltration of water and deicing salts (which are only used occasionally on this section of I-57). Both longitudinal and transverse cracks should also be adequately held closed by the prestressing in both directions. The deteriorated header material at the surface of either side of the expansion joint between Sections 3 and 4 will likely need replacement in time, but is performing adequately at present. The dowels for this joint are intact, and as described below, deflection testing across this expansion joint showed load transfer as good as or better than the other expansion joints.

Minimization or elimination of slab cracking is one of the primary benefits of incorporating prestress into a precast pavement system. Despite prestressing in the I-57 demonstration project, both transverse and longitudinal cracking occurred, and the possible causes deserve some consideration, as discussed below.

Possible Causes of Transverse Cracking

The majority of the transverse cracks, which were almost exactly at mid panel for most of the cracked precast panels, and almost perfectly parallel to the panel edges, were observed at the fabrication plant. This indicates that some aspect of the fabrication process led to some or all of the transverse cracking that occurred.

One possible cause is thermal shock. As will be described below, instrumentation in the precast panels showed that the highest levels of strains occurred during the curing process.⁽¹⁸⁾ Steam curing resulted in concrete temperatures in excess of 82 degrees C (180 degrees F) after casting the panels. The panels were generally removed from the forms in the early morning when ambient daily temperatures were at a minimum, resulting in significant thermal strains in the precast panels. High thermal strains are not necessarily the cause of cracking, however, but rather restraint of these thermal strain movements. If the precast panels are in an “expanded” state due to heat from the curing process and are subjected to rapid cooling due low ambient temperatures, they will try to “contract.” If this contraction is restrained, tensile stresses that are high enough to induce cracking can occur.

Restraint during the fabrication process (in the transverse or short axis dimension) could be caused by the casting bed itself, either from the sideforms which are fixed to the casting table, or from friction between the bottom of the precast panels and the casting table, or from the pretensioning strands prior to being released from the anchoring abutments. The restraint could also have occurred when the panels were stacked for storage at the fabrication plant. Dunnage between the precast panels, combined with the weight of the panels bearing down on one another, could have provided high levels of restraint as the panels were “cooling” in the storage location. Unfortunately, concrete temperatures were not monitored after removal from the forms and documentation of stacking order was not compiled to see if this could be a potential cause. What was measured, however, were the thermal strains which occurred during the curing process.

Another possible cause or contributor to the transverse cracking is “Poisson effect” strains in the transverse direction resulting from release of the pretensioning strands in the longitudinal direction. Poisson effect strains are essentially strains in the transverse direction opposite to the compressive strains induced in the longitudinal direction from the pretensioning force. For concrete, a Poisson ratio of 0.2 is generally used, which means that tensile strains in the transverse direction will be roughly 20 percent of the magnitude of the compressive strains in the longitudinal direction. Since pretensioning induces compressive strains in the longitudinal direction, tensile strains can be expected in the transverse direction. This effect was confirmed from strain gage instrumentation in the panels, monitored during pretensioning release, as described below.⁽²⁰⁾ As before, however, these strains do not necessarily lead to cracking, unless they are restrained by external forces, as described above.

It should be noted that the steam curing process is well established within the precast concrete industry and at the CPI fabrication plant. Curing and pretensioning release processes employed by CPI are established and accepted practices, as is pretensioning long, flat precast panels. Precast panels of similar size were used on previous demonstration projects in Texas and California, but no cracking occurred (steam curing was used in California but not Texas). In all likelihood, a simultaneous occurrence of multiple conditions (thermal shock, Poisson effect, and others) led to the observed cracking. This experience will help to ensure these issues are addressed do not occur on future projects.

It should also be noted that while much of the transverse cracking was observed at the fabrication plant, construction conditions may have exacerbated the cracking. As described in a previous chapter, the panels were installed over several days and epoxied together. Post-tensioning was not completed for several days following panel installation. As such, the epoxied panels may have acted as a long monolithic pavement slab with nothing to prevent transverse cracking from occurring in the panels themselves.

One possible measure which may have helped mitigate the extent of cracking is the inclusion of “temperature and shrinkage steel” reinforcement in the precast panels in the transverse direction. The ACI 318-95 Building Code recommends a minimum of 0.18 percent reinforcement (Grade 60) for structural slabs where the flexural reinforcement (pretensioning steel) extends in one direction only.⁽¹⁴⁾ For the I-57 precast panels, this would have required 23 No. 5 or 16 No. 6 reinforcing bars per panel, which would not have increased the cost of the panels significantly (< 113 kg [250 lbs] of additional reinforcing steel per panel). While the inclusion of reinforcing steel will not prevent cracking from occurring, it helps to hold cracks tightly closed, and may also prevent cracks from propagating through the full depth of the panel.

Possible Causes of Longitudinal Cracking

While not as extensive as the transverse cracking in the pavement section, longitudinal cracking was also unexpected and not observed on previous demonstration projects. There are several possible causes of the longitudinal cracking, and in all likelihood, a combination of these factors resulted in the observed cracking.

As described previously, the longitudinal cracking near the crown of the pavement propagated away from blockouts cast into the precast panels for instrumentation of the post-tensioning

strands. Squared corners used for these blockouts likely contributed to the observed cracking. A similar phenomenon was observed in a cast-in-place post-tensioned pavement constructed near Waco, Texas in 1985, as longitudinal cracking propagating away from squared corners of the post-tensioning blockouts was observed shortly after construction.⁽²¹⁾

Another potential cause or contributing factor to longitudinal cracking is curling of pavement slab in the transverse direction. Temperature gradients in concrete pavement slabs, particularly during the early morning and early afternoon periods, can result in significant slab curling, which when resisted by the self-weight of the pavement slab, can cause bending stresses and either top-down or bottom-up cracking. In the transverse direction, there is essentially nothing restraining curling movement at the ends of the precast panels, and therefore curling stresses are likely. A finite element analysis performed by researchers from the Indiana Department of Transportation estimated that tensile curling stresses at the top of the PPCP slab near the pavement crown could be as much as 2 MPa (290 psi) when the pavement is subjected to a negative (top of slab cooler than bottom) temperature gradient.⁽²²⁾ This analysis did not account for the counteracting compressive stress from pretensioning, but is still of significant magnitude. Additionally, if these curling stresses truly were large enough to cause longitudinal cracking, it would be expected to occur along the full length of all four sections of pavement, and to date this is not the case.

Potentially adding to the curling effect, is the eccentricity of the pretensioning strands through the center portion of the precast panels. Over this section (traffic lanes), the pretensioning strands were centered 100 mm (4 inches) from the bottom of the precast panel which is below the centroid of the pavement cross section for this region. This eccentricity could potentially cause downward bending of the precast panels, reducing the effective compressive stress from pretensioning in the top of the pavement.

Another potential contributing factor to transverse panel curling is the draped pretensioning strands in the precast panels. As described in a previous chapter, because of the non-uniform panel thickness, it was necessary to drape the top pretensioning strands within the end portion (shoulder region) of the precast panels. Draping causes a pretensioning force near the ends of the panels that is not parallel to the bottom of the precast panels, and may have caused a slight upward curvature, similar to that caused by temperature curling. This curvature, when resisted by the weight of the precast panels, can result in tensile stresses in the top of the precast panels and top-down cracking.

Finally, another potential contributor to the longitudinal cracking could have been the sand used to fill the ruts in the permeable base during construction. If the sand was not perfectly leveled with the surrounding base, it could have created a high point, which the precast panels rested on, resulting in a bending stress in the panels.

As with transverse cracking, longitudinal cracking of this nature had not been observed on previous projects. And as with the transverse cracking, a simultaneous combination of circumstances (curling, squared blockout corners, pretensioning eccentricity) could have resulted in the observed cracking. Simple measures, however, such as rounding the corners of instrumentation and stressing pocket blockouts and carefully examining potential curing stresses, may prevent the formation of such cracks on future projects.

DEFLECTION TESTING

As a result of the extensive cracking observed in the finished pavement section, MoDOT conducted deflection testing to check for anomalies in structural condition as a result of the cracking. The deflection testing was used to check load transfer across joints and cracks. Poor load transfer across a crack, in particular, could indicate a potential future structural failure.

Falling weight deflectometer (FWD) testing was conducted on September 12, 2006, approximately 8 months after the pavement had been open to traffic. FWD deflection testing was conducted at the following locations:

- Joints between individual panels – 19 locations/38 joints
- Transverse cracks within individual panels – 13 locations
- Expansion Joints – 2nd, 3rd, and 4th expansion joints

Deflections were measured at three load levels for each test, and tests were conducted on both the “approach” and “leave” sides of each crack and joint. The results of the deflection testing, as analyzed and provided by MoDOT, are summarized in Table 9, below. Deflection testing of transverse cracks was conducted on all four post-tensioned sections, with 5 measurements from the first section, 3 from the second, 1 from the third, and 4 from the final section. As these results show, with only one exception, load transfer across the transverse cracks in the individual panels was greater than 88 percent. This indicates that, despite some of the cracks extending through the depth of the precast panels, the aggregate interlock, which is enhanced by the longitudinal post-tensioning is adequate to prevent differential deflections on either side of the cracks.

Table 9. Summary of Load Transfer Efficiency calculated from deflection testing conducted by MoDOT.

Panel Joints			Transverse Cracks			Expansion Joints		
Location of Joint, m (ft)*	LTE (Percent)		Location of Crack, m (ft)*	LTE (Percent)		Joint No.	LTE (Percent)	
	Approach	Leave		Approach	Leave		Approach	Leave
3 (10)	87.8	97.6	4 (14)	92.2	91.9	2	57.3	82.8
18 (60)	46.8	46.4	20 (65)	89.9	98.8	3	71.9	82.1
34 (110)	97.8	88.6	35 (115)	92.3	100.4	4	81.2	
49 (160)	89.1	93.5	47 (155)	90.4	93.8			
64 (210)	90.7	94.2	62 (205)	91.4	92.3			
79 (260)	92.1	93.0	99 (326)	93.0	91.4			
98 (320)	46.8	56.7	109 (356)	93.3	93.3			
107 (350)	90.2	91.0	124 (406)	86.9	99.7			
125 (410)	90.7	95.9	185 (608)	88.1	94.5			
140 (460)	90.8	93.7	247 (809)	97.4	88.9			
171 (560)	88.4	96.2	259 (849)	92.0	96.1			
201 (660)	41.6	47.6	274 (899)	90.8	95.2			
216 (710)	91.0	93.4	290 (950)	91.1	94.7			
244 (800)	89.1	93.2						
256 (840)	92.4	93.0						
271 (890)	91.1	94.5						

*Distance from beginning of PPCP Section

287 (940)	80.3	96.5
302 (990)	86.7	91.9
308 (1,010)	82.2	

For deflection testing of joints between individual panels, at least three joints were selected from each post-tensioned section. With the exception of three of the 19 joints tested (shown in italics in Table 9), all showed very good load transfer, with most measuring in excess of 85 percent. The three joints exhibiting below-average load transfer (Long Term Pavement Performance Program recommends 60 percent as the threshold for load transfer restoration) had roughly the same load transfer for the approach and leave sides of the joint, indicating a possible void beneath the joint. Although it has not been verified with inspection data, it is believed that these three joints were likely shimmed during the panel installation process, as discussed in previous chapters. Shimming, which was used to correct deviation in centerline alignment of the pavement, likely kept the joints from closing completely during post-tensioning. This likely prevented the epoxy in the joint from bonding the panels together, resulting in a “loose” keyway joint. Also of note, with the exception of two of the joints showing good load transfer, those with below-average load transfer exhibited significantly higher raw deflections than those exhibiting good load transfer, further confirming voids were likely present.

The load transfer results for the expansion joints were also generally favorable. With the exception of measurements on the approach side of Joints 2 and 3, load transfer measured greater than 80 percent. The cause of low load transfer at these two approach joints is not known for certain, but could be due to voids beneath the Joint Panels at these locations as grout was not used to fill voids beneath the pavement to prevent clogging the underlying permeable base. Past experience that has shown, however, that precast panels tend to “settle” into flexible bituminous bases over time, which would help to eliminate any voids that may be present beneath the I-57 project. Fortunately, measurements on the “leave” side of these two joints showed good load transfer, indicating that if a void is present, it is likely only under the approach side of the joint.

MoDOT will continue to monitor the performance of the joints and cracks on this section of PPCP. If faulting, spalling, or other distresses are observed at these joint/cracks, additional investigation and possible mitigation will be required. At present, however, these joints and cracks do not present any performance problems for this section of pavement.

SUMMARY OF INSTRUMENTATION PROGRAM

The purpose of the instrumentation program conducted by MoDOT and the University of Missouri-Columbia was to monitor pavement performance, throughout construction and in service, in order to verify assumptions that were made during the design process, and to evaluate the overall PPCP process. The key aspects of the instrumentation program included monitoring of:

- Concrete properties (strength, durability, etc.),
- Hydration temperatures and curing strains at the fabrication plant,
- Strains during prestress transfer at the fabrication plant,
- Strains during post-tensioning on-site,

- In-service slab temperatures and strains, and
- Overall in-service pavement performance.

The results of instrumentation and monitoring of these aspects will help to provide a better understanding of stresses in the PPCP system during the different phases of construction and in-service. This includes a better understanding of prestress forces and the losses associated with pretensioning and post-tensioning. This information will help in the development of the design procedures for future PPCP projects in Missouri and elsewhere. Instrumentation also provided valuable information in assessing the possible causes of the distresses observed in the finished pavement, so that they can be avoided in the future.

Temperature sensors and strain gages were the primary devices used for instrumentation. Seven precast panels, six of them from one section of the pavement were instrumented, as shown in Figure 55, below. Section 3 was selected for instrumentation primarily because it was not one of the end sections, which could be affected by the adjacent pavement. Both Joint Panels (A31 and A32), three Base Panels (B1, B2, and B3), and the Anchor Panel (C1) were instrumented. Additionally, Base Panel B4 from Section 4 was also instrumented for comparison of behavior.

Strain gages embedded in the instrumented panels included 39 instrumented rebars, 14 vibrating wire strain gages, 4 strandmeters (for post-tensioning), and 38 thermocouples. Strain gages were oriented in both the longitudinal and transverse directions, both at mid-depth and at varying depths in the panels. Thermocouples were located primarily at mid-depth and close to the top and bottom of the precast panels in order to examine temperature gradients over the depth of the panels. Strandmeters were mounted to the longitudinal post-tensioning tendon at the pavement crown just prior to the post-tensioning operation for Section 3. Figure 56 shows the instrumentation layout for Panel A32, showing the locations of instrumented rebars (R), thermocouples (T), and vibrating wire strain gages (V). Figure 57 shows a typical instrumented rebar and vibrating wire strain gage in the forms prior to concrete placement.

Instrumentation was monitored during the panel fabrication process (until removal of the panels from the forms), and on-site for approximately 18 months. All wiring for the instrumentation was routed from a junction box in each instrumented panel (Figure 58) to a cabinet next to the project site which contained the data acquisition equipment (Figure 58) and a modem for remote data collection. For additional details on the instrumentation program and analysis of the results, please see the University of Missouri-Columbia Master of Science theses for Dailey,⁽²⁰⁾ Davis,⁽¹⁶⁾ and Luckenbill.⁽¹⁸⁾

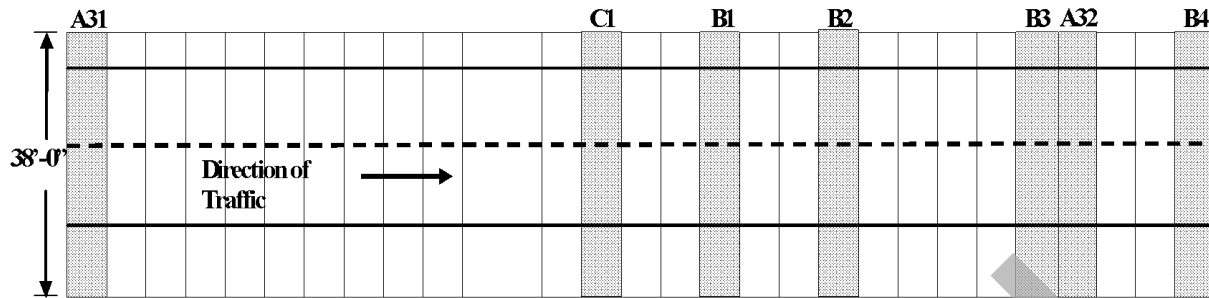

Figure 55. Illustration. Overall layout of the instrumented precast panels from Sections 3 and 4.⁽¹⁶⁾

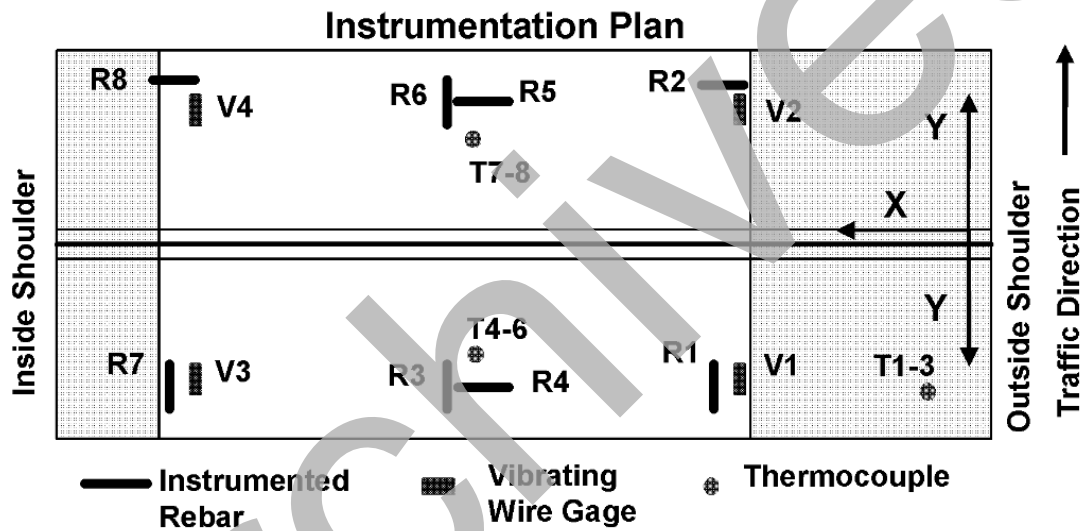

Figure 56. Illustration. Instrumentation layout for Panel A32.⁽²⁰⁾



Figure 57. Photo. Instrumented rebar and vibrating wire strain gages for measuring concrete strain.



Figure 58. Photo. Junction box within an instrumented precast panel (left) and instrumentation cabinet next to the project site for collecting and uploading data (right).

KEY FINDINGS FROM INSTRUMENTATION PROGRAM

The instrumentation program provided a number of key findings. These findings confirmed certain assumptions made during the design process and showed where improvements could be

made in the design process. Additionally, the instrumentation helped to ascertain the possible causes of some of the observed distresses.

Concrete Properties

As part of the instrumentation program, properties of the concrete mixture used for the precast panels were measured and monitored over time. These properties included:

- Strength – compressive and flexural at 7, 28, and 56 days,
- Modulus of Elasticity – at 28 and 56 days,
- Ultimate Shrinkage Strain,
- Creep,
- Chloride Permeability, and
- Freeze-thaw Durability.

Table 10 provides a summary of the concrete properties monitored. Some of the key findings from monitoring of concrete properties included:

- Concrete strength (compressive and flexural) and modulus of elasticity were significantly higher than those used for design and specified in the Job Special Provisions. While higher strength is not necessarily problematic, higher modulus of elasticity can result in significantly higher strains and stresses than designed for, particularly at early ages (7-day compressive strength averaged 41.9 MPa [6,070 psi]). Significant variation in compressive strength was also observed, and was likely caused by varying amounts of the different admixtures for the different pours.⁽²⁰⁾
- Chloride permeability was higher than expected for such a low water-cement ratio mixture. The 28-day permeability of 3,999 Coulombs is classified as “high” by ASTM.⁽²³⁾ While the permeability decreased significantly when measured at 112 days, it is still classified as “moderate.”⁽¹⁶⁾
- The concrete showed excellent freeze-thaw durability as measured by ASTM C 666 Procedure A,⁽²⁴⁾ after 300 freeze-thaw cycles.⁽¹⁶⁾

Table 10. Summary of concrete properties for the concrete mixture used for the precast panels.⁽¹⁶⁾

Tests Performed	Parameter	Experimental Result
Results from Compressive Strength Laboratory Studies (ASTM C 39)	28 Day Strength, f_c psi (MPa)	7,190 (49.6)
	28 Day Ultimate Strain, ϵ_{ult} in/in	0.00154
	28 Day Modulus of Elasticity, E_c psi (MPa)	5.69×10^6 (3.92×10^4)
	56 Day Strength, f_c psi (MPa)	8,830 (60.9)
	56 Day Ultimate Strain, ϵ_{ult} in/in	0.00159
	56 Day Modulus of Elasticity, E_c psi (GPa)	6.26×10^6 (4.31)
Results from Flexural Laboratory Studies (ASTM C 78)	Modulus of Rupture, f_r psi (MPa)	872 (6.01)
	Fracture Toughness, G_f lb-in/in ² (N-m/m ²)	0.237 (41.2)
Results from Freeze-Thaw Laboratory Studies (ASTM C 666 Procedure A)	Durability Factor, DF	97%
Results from Chloride Permeability Laboratory Studies (ASTM C 1202)	28 Day Charge Passed, Q_s Coulombs	3,999
	112 Day Charge Passed, Q_s Coulombs	3,151

Panel Fabrication

- Curing temperatures in the precast panels reached as high as 84 degrees C (183 degrees F). While this is not unusual for steam-cured precast products, it requires special attention to the “cooling down” process under cool ambient conditions in order to minimize “thermal shock” to the precast panels.
- Certain panels reached approximately 79 degrees C (175 degrees F), and were then exposed to approximately 0 degrees C (32 degrees F) ambient conditions when removed from the casting bed.⁽¹⁸⁾
- Strains measured during curing were the highest measured during any part of the construction process, ranging from 200-400 microstrain.⁽¹⁸⁾

Pretensioning

- Prestress transfer from pretensioning resulted in compressive strains of 40-60 microstrain, which were very close to theoretically-predicted values.⁽¹⁸⁾
- Tensile strains were measured in the transverse direction (perpendicular to the pretensioning strands) during prestensioning prestress transfer. These strains are caused by the Poisson effect discussed previously. Tensile strains (or change in strain from the start of the release operation) of approximately 17 microstrain and 32 microstrain were

measured at the crown (280 mm [11 inch] panel thickness) and lane edges (200 mm [8 inch] panel thickness), respectively.⁽²⁰⁾

- Based on measurement of creep and shrinkage properties, the estimated reduction in effective pretensioning force was approximately 16 percent.⁽¹⁶⁾ These estimates were not verified with actual strain data.

Post-Tensioning

- Strain in the post-tensioning tendon was 8.5 percent lower at mid-slab (~38 m [125 ft] from jacking end) than at the jacking end, and 21 percent lower at the dead end (~76 m [250 ft] from jacking end) than the jacking end.⁽¹⁶⁾
- Based on strain data from the post-tensioning operation, the post-tensioning loss due to duct friction was estimated to be 0.9 kN per meter (62 lb per foot) of pavement length.⁽²⁰⁾
- Losses in post-tensioning force were approximately 5.1 percent at mid-slab and 13.5 percent at the slab end based on strain measurements in the post-tensioning tendon.⁽¹⁶⁾
- Uneven distribution of compressive strains in the concrete from the post-tensioning operation was observed. This was likely due to uneven gaps between the individual panels across the pavement width (joints on the left side of the pavement were generally closed tighter than those on the right side), and also the use of shims between precast panels at the outside edge of the right side of the pavement.⁽²⁰⁾

In-Service Performance

- Positive (surface warmer than bottom) top-bottom temperature differentials of up to 8.3 degrees C (15 degrees F) and negative (bottom warmer than surface) top-bottom temperature differentials of up to ~3.9 degrees C (7 degrees F) were measured in the precast panels in service.⁽¹⁸⁾ These differentials, while not necessarily the most extreme temperature conditions that will be experienced by the pavement, are very close to the differentials assumed during the design process.
- Maximum “summer” temperatures measured in the precast panels at mid-depth were 34.7 degrees C (94.5 degrees F) under an ambient temperature of 32.8 degrees C (91 degrees F). Minimum “winter” temperatures measured at mid-depth were 0 degrees C (32 degrees F) under an ambient temperature of -7.5 degrees C (18.5 degrees F).⁽¹⁸⁾ These temperatures were slightly higher (for “summer”) and lower (for “winter”) than those used for the PSCP2 design analysis described in Chapter 4.
- Strain data collected continuously over a 6-month period showed changes in strain due to seasonal temperature changes (from fall to winter and winter to spring) were between 150 and 250 microstrain (measured at approximately 200 mm [8 inch] panel thickness), and were highest closer to mid-slab.⁽¹⁸⁾
- Traffic strains produced only 1-2 microstrain in the precast panels. This strain only a small percentage of the strain caused by environmental (thermal) changes in the slab.⁽¹⁸⁾
- Variations in post-tensioning tendon strain with changes in slab temperatures were approximately 6-7 microstrain/degree C (3-4 microstrain/degree F), which is less than 0.1 percent of the effective post-tensioning force.⁽¹⁸⁾

- Daily changes in longitudinal strain ranged from 50-100 microstrain for cool or mild days and 125-200 microstrain for hot days.⁽¹⁸⁾
- An attempt was made to monitor “global” slab movement (horizontal expansion and contraction and vertical curling at the expansion joints), but was abandoned due to poor resolution of the survey data used for this monitoring.⁽¹⁸⁾

Distresses

- Longitudinal cracks in the traffic lanes appeared to initiate from the instrumentation blockouts and propagated through several adjacent panels.⁽¹⁸⁾
- Longitudinal cracks were also observed in the shoulders of some of the panels.⁽¹⁸⁾ These cracks were generally isolated in individual panels.
- While expansion joint No. 4 initially deteriorated rapidly, it eventually stabilized under traffic and appears to be performing well. All other expansion joints have performed well since construction.⁽¹⁸⁾
- Expansion joint sealant squeezed up from the expansion joints during hot temperatures, protruding from the surface of the pavement.⁽¹⁸⁾ This is the result of the sealant being installed during winter months when the expansion joints were “open” the widest.

RECOMMENDATIONS BASED ON INSTRUMENTATION PROGRAM

The instrumentation program provided very valuable information for consideration of future projects. Some of the more salient recommendations for future projects include:

- Consideration of the post-tensioning losses from duct wobble and friction based on those measured on the I-57 project. The researchers calculated a 0.9 kN per meter (62 lb per foot) loss in post-tensioning force along the length of the tendon.
- Consider effects of transverse slab curling in the design process. Transverse prestress should be increased if curling stresses are found to be significant.
- Use more realistic values for concrete strength and modulus of elasticity in the design process. Check with the precaster to determine what concrete strengths are expected based on the mixture proportions they will be using.
- Consider Poisson effect stresses in the transverse direction during pretensioning stress transfer.
- Consider requiring a precast panel “cooling regimen” from the precaster prior to fabrication minimize thermal shock if steam or heat curing is used. This will help to ensure that additional precautions are taken during days with cooler ambient temperatures.
- Consider a requirement for the precast panels to be stacked individually until they “cool down” to near ambient temperatures. Restraint caused by stacking the panels after they are removed from the forms and still “cooling” may lead to transverse cracking.
- Ensure that all corners on stressing or instrumentation blockouts are rounded. A minimum 13-25 mm (0.5-1 inch) radius is recommended. Additionally, provide reinforcement around any blockouts to arrest any cracks that may form.

- Do not permit the use of shims between panels to correct alignment problems when installing the panels on site. Gaps between the panels can result in uneven distribution of the longitudinal prestress across the width of the pavement. Consider permitting alternative techniques such as offsetting the panels. If offsetting is permitted, ensure that larger (or flat) ducts are used and set a maximum limit for offset based on the ducts used.

Archived

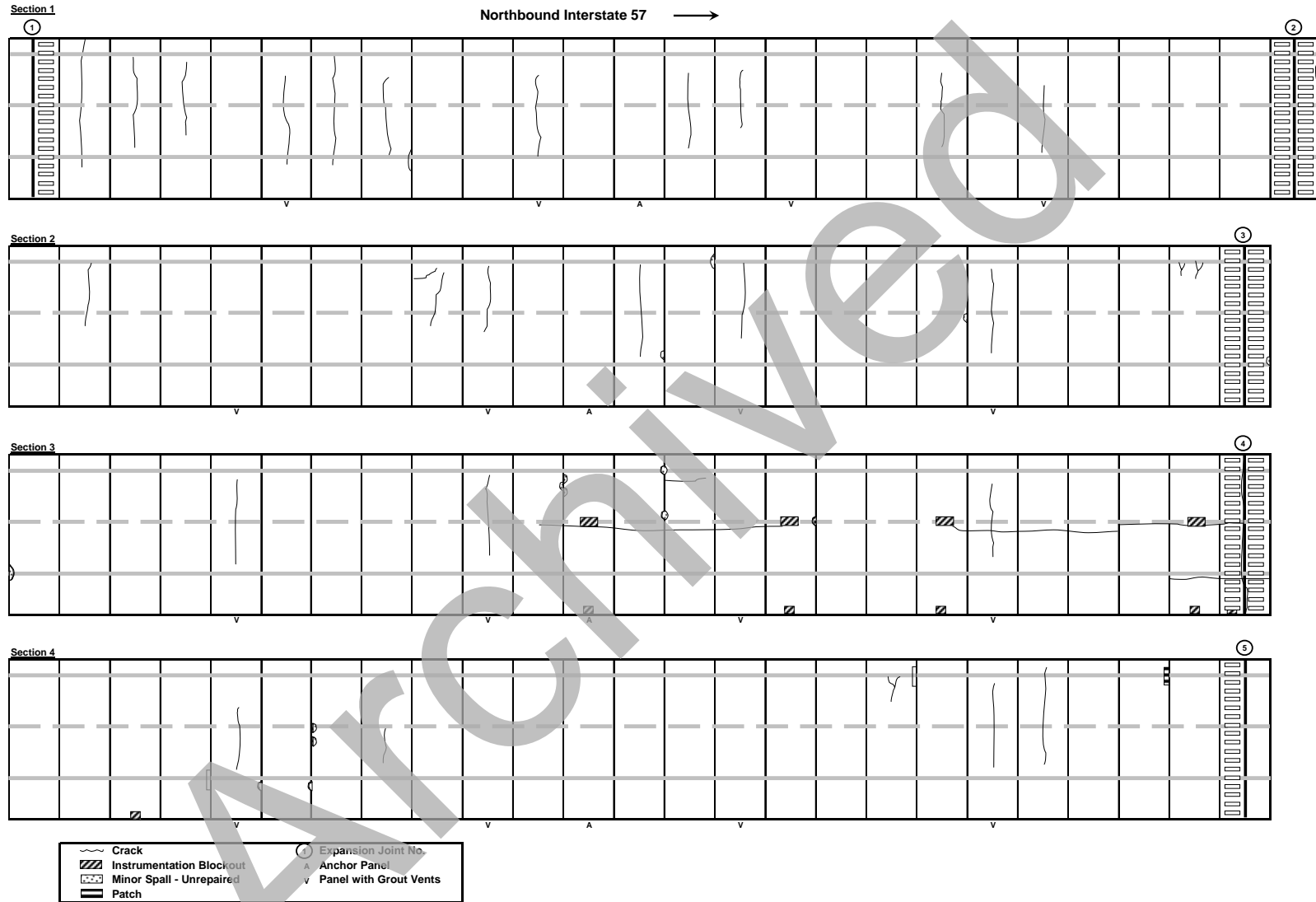

Figure 59. Illustration. Project Level condition survey after opening to traffic.

Archived

CHAPTER 8. PROJECT EVALUATION AND RECOMMENDATIONS FOR FUTURE PROJECTS

PROJECT LAYOUT

The Interstate 57 demonstration project allowed MoDOT and local contractors to evaluate PPCP technology as a new tool for rapid pavement construction. This initial project, constructed in a rural area on a tangent section of the highway with a relatively simple geometry, allowed for the details of the construction technique to be worked out on a smaller scale project prior to incorporation into larger, time-sensitive projects. Because this was not a time-critical project with restrictions on lane closures, no attempt was made to address issues such as traffic staging and lane-by-lane construction in the development of the project layout. The use of full-width precast panels for future projects will only be possible if a full closure of at least one side of the highway is possible. Had horizontal and vertical curves or superelevations been included, a detailed survey of the project site would have been required so that precast panels could be designed to fit the roadway geometry.

DESIGN

The design procedures and details for the I-57 demonstration project were based primarily on experience from the demonstration projects in Texas and California.^(2,3,4) A few different design details were implemented on this project, however, and should also be considered for future projects.

Design Procedure

The design procedure essentially provides a precast pavement section with an equivalent design life to a thicker conventional cast-in-place (non-prestressed) pavement. This procedure analyzes stress conditions over the life of the pavement to ensure that they do not exceed those of an equivalent conventional pavement. Prestress levels are adjusted to meet this condition by increasing or decreasing the spacing of the longitudinal prestressing tendons. This procedure is believed to be very conservative in that it analyzes “extreme” stress conditions, which may only occur a few times each year over the life of the pavement. The prestress requirements produced by this procedure, however, are not unreasonable in terms of fabrication (pretensioning) and on-site construction (post-tensioning) requirements. While performance data is limited, the performance of existing PPCP projects indicates that the design of the PPCP projects to date has been adequate. Due to limited availability of the PSCP2 computer program, simplified design procedures or catalogs will likely need to be developed for state highway agencies to use as PPCP technology becomes more widely used.

Transverse prestress requirements were determined based on stresses from lifting and handling of the precast panels to ensure that cracking did not occur during handling. For future projects where smaller precast panels are used, and lifting and handling stresses are not as critical, in-service stresses from traffic and environmental effects, particularly slab curing, should be considered in a similar fashion as longitudinal stresses.

Design Details

The design details for this demonstration project demonstrated different alternatives for the precast panels and assembly process, and overall, no major problems were encountered.

Pavement Cross Section – A single precast panel with a variable thickness was used to provide full-width pavement (including inside and outside shoulders) with a “rooftop” crown. The full-width panels provided an efficient solution in terms of the number of panels to be fabricated and installed, but may not be appropriate for projects where only one lane can be reconstructed at a time. Separate precast panels may be required for each lane on projects where only one lane is reconstructed at a time or for projects (such as unbonded overlays) where it is necessary to set the panels at the appropriate cross slope and not on a level base.

One of the disadvantages of the panels used for this project is that the cross-section is essentially unique to this project and therefore the precast panel formwork may not be useful for future projects which do not have the same cross-section. For future large projects, however, the capital investment in new panel formwork will likely only be a minor percentage of the overall project cost. It may also be possible to develop standard cross-sections or panel formwork that can be used for numerous projects.

Keyways – The variable-thickness precast panels precluded the use of continuous keyways across the full width of the precast panels. This resulted in some differential elevation or “faulted” joints between a few of the panels in the shoulder regions where there was only a butt joint between the panels. While this did not cause any problems with the driving surface of the pavement, future projects where similar keyways must be used, may consider the use of dowels or pins to help ensure vertical alignment in regions without keyways. These pins would only be needed during panel assembly as the longitudinal post-tensioning and epoxied joints between panels provide load transfer between panels.

Expansion Joints – This project demonstrated the viability of header-type expansion joints for PPCP. Header-type dowelled expansion joints were specified in order to permit diamond grinding over the expansion joints, while also providing durable joints which could accommodate approximately 50 mm (2 inches) of movement. Four of the five header joints are performing well, with the poor performance of the fifth joint attributed to problems with the two halves of the joint panel bonding together and fracturing away from the actual joint opening. The joint sealant protrudes from the surface of the pavement under summer climatic conditions, but this could be corrected by ensuring that the joint width is set correctly during panel installation.

Long term monitoring of the joint performance will provide an indication of the durability of this type of expansion joint for PPCP. Currently, header-type joints are used extensively for bridge decks, and provide good performance, as they should for PPCP as well. This type of joint does require special attention to installation of the header material and seal, however, and would even permit installation of the header material at the fabrication plant if necessary. This type of expansion joint should be considered for future projects, particularly where diamond grinding is anticipated, but should still be weighed against the durability advantages of armored joints for expansion joints which are expected to open more than 25-50 mm (1-2 inches).

End Stressing – End stressing (as opposed to central stressing) was used for this project in order to eliminate additional central stressing panels. This required careful detailing of the anchor region in the joint panels to ensure that the stressing pockets were large enough to accommodate the stressing rams, and to ensure that the prestress force would be transferred from the post-tensioning anchors back to the expansion joint. The primary disadvantage was that custom sized pocket formers were required for each stressing pocket due to the variable thickness of the precast panels, increasing the cost of the formwork. No problems were experienced with stressing the tendons from both ends on site.

End stressing was demonstrated to be a viable alternative to central stressing. From a design standpoint, central stressing is preferable to end stressing, as the effective tendon length and associated prestress losses are lower. It also requires special attention to detailing the anchorage region, including the anchor access blockouts and reinforcement around the anchors. From a construction standpoint, end stressing eliminates the need for the central stressing panels, potentially reducing the cost of panel fabrication, but adds an additional stressing operation if the tendons are stressed from both ends. Both end stressing and central stressing should be considered for future projects, with the alternative which best fits the project constraints selected.

PANEL FABRICATION

Overall, no major problems were encountered during the fabrication process. There were, however, some distresses observed in the precast panels at the fabrication plant. Minor changes to the precast panel details and fabrication requirements should eliminate these issues on future projects.

Tolerances – Tolerances were based on those developed from experience with previous PPCP demonstration projects. No problems were reported by MoDOT inspectors with achieving the tolerances during the panel fabrication process. The use of steel sideforms to form the keyways on this and previous projects helped to ensure that the panels would fit together properly.

Casting Bed – The “long line” casting process, where two panels were cast end-to-end, proved to be an efficient process for this and previous demonstration projects. While a longer casting bed would have permitted more panels to be cast each day, the cost of the custom sideforms for a longer casting bed may have been cost prohibitive, and the relatively small number of panels to be fabricated did not necessitate a longer bed. Panels with a flat bottom and variable thickness were a key design element which greatly simplified the formwork for these panels.

Finishing – The initial carpet drag finish was changed to a light broom finish due to problems applying the carpet drag which resulted in aggregate “overturning.” The light broom finish provided adequate texture as a “temporary” finish prior to diamond grinding. Scaling was observed on some of the precast panels, likely due to over-finishing of the surface. Any scaling in the traffic lanes was removed by diamond grinding.

Thermal Stresses – The cracks along the long axis of the precast panels observed at the fabrication plant and on site are believed to be caused at least in part by “thermal shock” as the

panels were exposed to cool ambient temperatures very shortly after they were steam cured. Significant strain levels measured by the University of Missouri in the precast panels during the fabrication process indicate that high thermal stresses were likely experienced by the panels. It is important to note again, however, that the fabrication procedures used were standard established practices and the cracking that occurred was not caused by poor fabrication practices.

Two primary recommendations for future projects to mitigate potential thermal cracking include:

- 1) Establishment of a “cooling” procedure for the panel fabrication process if they are steam cured under cold climatic conditions. No specific recommendation for the cooling procedure is made herein, but it should be developed with the precast supplier.
- 2) Inclusion of temperature reinforcement in the precast panels in the transverse direction (non-pretensioned direction). This additional reinforcement will not prevent thermal cracking, but will help hold any cracks that do form tightly closed. The ACI 318-95 Building Code recommends a minimum of 0.18 percent reinforcement for “temperature steel.”⁽¹⁴⁾

PAVEMENT CONSTRUCTION

No major problems prevented successful construction of the PPCP section. However, there were some issues encountered during construction where improvements could be made for future projects.

Base Preparation

The permeable asphalt-treated base proved to be a viable material for the prepared base beneath the precast panels. Stringline grade control was used for construction of the permeable asphalt treated base, and no problems in achieving the base surface tolerance were noted by MoDOT inspectors or the contractor. Similar tolerances should be considered for future projects.

Panel Placement

No major problems were experienced with installation of the precast panels. Some of the issues which should be addressed for future projects, however, are summarized below.

Staging/Crane Location – “Rutting” of the permeable asphalt-treated base under the weight of the crane was one of the primary issues observed during panel installation. Ideally, the crane should be located off of the base that will be supporting the precast panels, particularly if “softer” aggregate or asphalt bases are used. If it is not possible to keep the crane off of the prepared base, contact pressure under the crane should be determined prior to construction and additional measures should be taken to distribute the weight of the crane if necessary.

Panel Alignment – Deviation of the centerline of the precast panels from the true centerline of the roadway was the primary issue of concern for panel installation. An uneven gap left between two panels initiated this deviation, which was further accumulated as panel installation continued. To correct the alignment, panels were offset and shims were installed at some of the

joints between panels. Although the construction report from the Texas Demonstration Project⁽²⁾ recommended the use of shims (no greater than 3 mm [1/8-inch] thick) to correct deviation of alignment, strain measurements during post-tensioning of this project revealed that shims cause a non-uniform distribution of strains across the width of the pavement. Based on this experience, offsetting precast panels is recommended for correction of centerline alignment whenever possible (installing precast panels next to an existing pavement may preclude offsetting of the panels).

To prevent problems with post-tensioning duct alignment when the panels are offset, the use of larger diameter, or alternatively, flat multi-strand ducts which can accommodate offset ducts are recommended. A maximum offset, based on the dimensions of the ducts used, should be specified in the contract documents prior to construction. Also, as recommended from previous demonstration projects, a mark on the surface of the precast panels directly above a designated post-tensioning duct should be used to align the precast panels as they are installed.

Post-Tensioning

All of the post-tensioning tendons were successfully stressed. There were, however, some issues with installing the post-tensioning tendons and timing of the post-tensioning operation which should be addressed for future projects.

Post-tensioning Tendon Installation – The primary causes of difficulty in feeding the post-tensioning strands through the ducts were misalignment of the ducts due to offsetting of the precast panels and obstructions in the ducts. A mechanical strand pusher was used to feed the strands through the panels, and is recommended for use on future projects as well, particularly when long tendons are used. Offsetting of the panels to correct the alignment of the pavement caused difficulty in feeding the strands, but can be mitigated on future projects by using larger diameter or flat multi-strand ducts.

Additionally, although the precast producer carefully checked and (temporarily) plugged the post-tensioning ducts at the fabrication plant, ice formed in some of the ducts and caused problems with feeding the post-tensioning strands when temperatures were well below freezing. Ensuring that the ducts are clear of water, particularly in colder climatic conditions, will help mitigate problems with ice formation in the ducts. Using compressed air to blow any water or other debris out of the ducts prior to plugging them at the fabrication plant or prior to installing them on site may also prevent problems with tendon installation.

Timing of Post-Tensioning – The original construction sequencing called for a section of panels to be installed and post-tensioned each day of construction. Unfortunately, it was not possible to get enough delivery trucks to ship and entire (e.g., 76 m [250 ft]) section of panels. Because of this only partial sections were installed and the epoxy applied to the panel joints served to bond these partial sections together prior to post-tensioning. This essentially created long, non-post-tensioned sections of pavement. Additionally, final post-tensioning was not completed until all four sections of precast panels had been installed, leaving long, non-post-tensioned sections of pavement for several days until post-tensioning could be completed. While not observed directly, it is believed that this may have at least exacerbated transverse cracking in the pavement.

For future projects, it is essential that longitudinal post-tensioning is applied in a timely manner after panel installation. Ideally, final post-tensioning should be applied prior to final set of the epoxy used to bond the panels together. If this is not possible due to problems with panel delivery or installation, the temporary post-tensioning strands should be stressed and “locked off” at the end of a day’s placement in order to provide a clamping force as the epoxy sets and to reduce the possibility of any transverse cracking. The temporary strands can then be de-tensioned prior to installing the remaining precast panels. As an alternative, high-strength post-tensioning bars can be specified for the longitudinal post-tensioning tendons. These bars can be cut to the length of individual panels and coupled together for “segmental” post-tensioning as the panels are installed. Bars will likely increase the cost of the post-tensioning component, but may be necessary for projects where it is not possible to construct full sections of panels in a continuous operation.

Post-Tensioning Ducts – As discussed previously, offsetting of the precast panels made feeding the post-tensioning strands difficult for some of the tendons. An alternative to help mitigate the effects of offsetting panels for future projects would be the use of either larger diameter (e.g., 50 mm [2-inch] inside diameter) or flat, multi-strand (25 mm by 75 mm [1 inch by 3 inch]) ducts which could accommodate offsetting of up to 50 mm (2 inches).

Grouting

Joint Seal – Although MoDOT inspectors and the post-tensioning contractor were confident that every tendon was fully grouted, it often required pumping grout into more than one vent along each tendon. Grout leakage was the result of a poor seal between segments of the ducts across the joints between precast panels. The combination of the compressible foam gaskets and epoxy along the joints between panels was beneficial, but did not guarantee leak-free joints. The epoxy and gaskets are recommended for future projects, but it may be necessary to develop a positive connection or coupler to connect duct segments between panels. This connector/coupler may add cost and complexity to the panel installation process, but would help eliminate grout leakage and the time and expense associated with it. The only known duct couplers currently available require physically fitting the coupler around the duct segments after they are in place.

PROJECT COST

The approximate final cost for the Missouri Demonstration Project was \$1,057,500. This cost included panel fabrication, delivery, and installation costs. It did not include the cost of base preparation, which was required regardless of the type of pavement installed. This translates to a unit cost of approximately \$297/m² (\$248/yd²) of finished pavement. Of this cost, approximately 48 percent was for the precast panels delivered to the jobsite. The remainder of the cost was for panel installation (including labor, crane rental, epoxy, polyethylene sheeting, etc.), post-tensioning, grouting, and traffic control costs.

The unit cost of this project was slightly higher than the cost of the California Demonstration Project (\$268/m² [\$224/yd²]), and significantly higher than that of the Texas Demonstration Project (\$194/m² [\$162/yd²]). However, there are many factors which contribute to the project cost, including:

- Project size,
- Project location (for contractor mobilization),
- Project distance from the precast fabrication plant,
- Local labor costs (particularly if Union labor is required),
- Complexity of panel fabrication (including specialty formwork and fabrication procedures),
- Complexity of panel installation, post-tensioning, and grouting (equipment and labor requirements), and
- Date of construction (variability of material, equipment, and labor costs), among others.

As such, it is difficult to accurately compare projects constructed in different states at different times, particularly when the projects are different in size and scope. However, this project provides what could be considered typical costs for a rural project constructed in the Midwestern U.S. Because this project was competitively bid (even if as only a small portion of a much larger project), the costs (panel fabrication costs in particular), are likely representative of what could be expected for PPCP projects least during initial implementation of the technology. It should be recognized that this project was still relatively small in size, and the first of its kind for the State of Missouri. As such higher costs are not unexpected. There will likely be economies of scale with larger projects which will reduce the unit cost, and as contractors become more familiar with the technology, fabrication and installation costs will also likely decrease.

Archived

CHAPTER 9. SUMMARY AND RECOMMENDATIONS

SUMMARY

The PPCP demonstration project on Interstate 57 near Sikeston, Missouri demonstrated the viability of PPCP for pavement reconstruction. More importantly, it allowed MoDOT and regional contractors and precast suppliers to become familiar with PPCP technology, with the hope that it will be used again in the region where it is needed most – in busy urban corridors where lane closures for pavement reconstruction and rehabilitation are severely restricted. Although the project length was relatively small in scope (~310 m [1,010 ft]), it provided a good opportunity for evaluation of the technology, and will provide an adequate test section length for monitoring long-term performance.

While similar in concept to the projects completed in Texas and California, this project presented several challenges and demonstrated several unique solutions, including:

- Incorporation of a crowned pavement cross-section into the precast panels,
- Construction over permeable asphalt stabilized base,
- Use of end-stressing from the joint panels (vs. central stressing),
- Use of a header-type expansion joint,
- Use of a non-continuous keyway between panels,
- Extensive instrumentation during fabrication, construction/post-tensioning, and for the first 18 months after construction.

As with previous demonstration projects, the main objective of this demonstration project was to help familiarize the local state highway agency and local contractors with the technology, while also permitting further evaluation and refinement of PPCP technology. Although the project was constructed on a section of Interstate highway closed to traffic throughout the duration of construction, it demonstrated the PPCP construction process and permitted MoDOT to evaluate the viability of using it for future urban construction.

It is important to recognize that no specialty expertise was required for this project, nor should it be required for future projects. Although the precast panels were unique for this project, no special training was required by the precast fabricator to produce them. Installation of the panels on site was completed with standard equipment and did not require specially trained labor. Attention to detail was required on the part of the contractor, but this did not require any additional expertise. A specialty post-tensioning contractor completed the post-tensioning process, but in terms of post-tensioning complexity, this project was relatively simple.

It is also important to emphasize that despite the significant number of distresses observed after construction, most should have little or no effect on pavement performance. Deflection testing conducted by MoDOT confirmed that the pavement is structurally sound despite these distresses, and continued monitoring of the pavement performance over time will provide a true indication of long-term performance.

RECOMMENDATIONS FOR FUTURE CONSTRUCTION

This demonstration project showed once again the adaptability of PPCP technology to specific project needs. The intent of this project was to help MoDOT and local contractors evaluate PPCP technology as a technique for rapid pavement reconstruction and rehabilitation. Future projects should focus on applying PPCP technology under circumstances where lane closures for construction are severely limited, such as busy urban corridors. This type of project will require very careful planning and preparation to ensure that none of the issues encountered on this initial demonstration project will occur during short construction window projects. As agencies and contractors become more familiar with PPCP technology, it will become a new tool for agencies to achieve the common goal of minimizing the impact of pavement construction and rehabilitation on the motoring public.



Figure 60. Photo. Finished precast pavement after opening to traffic.

REFERENCES

- 1) Merritt, David K., B. Frank McCullough, Ned H. Burns, and Anton K. Schindler. *The Feasibility of Using Precast Concrete Panels to Expedite Highway Pavement Construction*, Research Report No. 1517-1, Center for Transportation Research, The University of Texas at Austin, February 2000.
- 2) Merritt, David K., B.F. McCullough, and Ned H. Burns, *Construction and Preliminary Monitoring of the Georgetown, Texas Precast Prestressed Concrete Pavement*, Research Report 1517-01-IMP, Center for Transportation Research, The University of Texas at Austin, December 2002.
- 3) Merritt, David K., B.F. McCullough, and Ned H. Burns. "Design-Construction of a Precast, Prestressed Concrete Pavement for Interstate 10, El Monte, California." *PCI Journal*. Vol. 50, No. 2. Precast/Prestressed Concrete Institute, Chicago, Illinois. March/April 2005.
- 4) Merritt, David K., Kirsten Stahl, Samuel S. Tyson, and B.F. McCullough. "Expedited Construction Using Precast Prestressed Concrete Pavement in California." *Proceedings, 8th International Conference on Concrete Pavements*. Colorado Springs, Colorado. August 2005, pp. 808-823.
- 5) Merritt, David K. and Samuel S. Tyson. "Precast Prestressed Concrete Pavement – A Long-life Approach for Rapid Repair and Rehabilitation." *Proceedings, International Conference on Long-Life Concrete Pavements*. Chicago, Illinois. October 2006, pp. 497-512.
- 6) Mendoza Diaz, Alberto, B. Frank McCullough, and Ned H. Burns. *Design of the Texas Prestressed Concrete Pavement Overlays in Cooke and McLennan Counties and Construction of the McLennan County Project*, Research Report No. 555/556-1, Center for Transportation Research, The University of Texas at Austin, February 1986.
- 7) Wesevich, James W., B. F. McCullough, and Ned H. Burns. *Stabilized Subbase Friction Study for Concrete Pavements*, Research Report 459-1, Center for Transportation Research, The University of Texas at Austin, April 1987.
- 8) Cable, Neil D., B. F. McCullough, and N. H. Burns. *New Concepts in Prestressed Concrete Pavement*. Research Report 401-2. Center for Transportation Research, The University of Texas at Austin. December 1985.
- 9) Mendoza Diaz, A., B. F. McCullough, and Ned H. Burns. *Behavior of Long Prestressed Pavement Slabs and Design Methodology*, Research Report 401-3, Center for Transportation Research, The University of Texas at Austin, September 1986.
- 10) Tena-Colunga, Jose A., B. Frank McCullough, and Ned H. Burns. *Analysis of Curling Movements and Calibration of PCP Program*, Research Report No. 556-3, Center for Transportation Research, The University of Texas at Austin, November 1989.
- 11) "Pavement Structure Design." *MoDOT Project Development Manual*. Chapter VI, Section 6-03. Missouri Department of Transportation. Jefferson City, Missouri. 2004.
- 12) *AASHTO Guide for Design of Pavement Structures*. American Association of State Highway and Transportation Officials. Washington, D.C. 1993.
- 13) Whiteoak, C.D. "Analytical Pavement Design Using Programs for Personal Computers," *Highways and Transportation*, v. 37, n. 8, August 1990, pp. 31-35.
- 14) *ACI 318-95 – Building Code Requirements for Structural Concrete and Commentary*. American Concrete Institute. Farmington Hills, MI. 1995.

- 15) *Standard Specifications for Highway Bridges, 17th Edition*. American Association of State Highway and Transportation Officials. Washington, D.C. 2002.
- 16) Davis, Brent M. *Evaluation of Prestress Losses in an Innovative Prestressed Precast Pavement System*. Master's Thesis. University of Missouri–Columbia. Columbia, Missouri. December 2006.
- 17) *PCI Design Handbook for Precast and Prestressed Concrete*. Precast/Prestressed Concrete Institute. Chicago, Illinois. 5th ed., 1999.
- 18) Luckenbill, Grant. Pending Masters Thesis (Anticipated 2008). University of Missouri–Columbia. Columbia, Missouri. December 2006.
- 19) *ASTM C939-02 – Standard Test Method for Flow of Grout for Preplaced-Aggregate Concrete (Flow Cone Method)*. ASTM International. West Conshohocken, PA. 2002.
- 20) Dailey, Cody L. *Instrumentation and Early Performance of an Innovative Prestressed Precast Pavement System*. Master's Thesis. University of Missouri–Columbia. Columbia, Missouri. December 2006.
- 21) Mandel, Elliott, Jose Tena-Colunga, Kenneth Hankins, Ned H. Burns, and B. Frank McCullough. *The Performance of a Prestressed Concrete Pavement*, Research Report No. 556-4F, Center for Transportation Research, The University of Texas at Austin, November 1989.
- 22) Personal correspondence with Dr. Tommy Nantung, P.E., Indiana Department of Transportation, September 6, 2006.
- 23) *ASTM C1202-05 – Standard Test Method for Electrical Indication of Concrete's Ability to Resist Chloride Ion Penetration*. ASTM International. West Conshohocken, PA. 2005.
- 24) *ASTM C666/C666M-03 – Standard Test Method for Resistance of Concrete to Rapid Freezing and Thawing*. ASTM International. West Conshohocken, PA. 2003.

APPENDIX A

PROJECT PLANS AND JOB SPECIAL PROVISION

Archived

Archived

Design

DESIGN DESIGNATION
 A.D.T. - 2005 = 18,390
 A.D.T. - 2025 = 29,060
 D.H.V. = 6.5%
 T = 39%
 V = 70 M.P.H.
 FUNCTIONAL CLASSIFICATION - INTERSTATE

**MISSOURI HIGHWAYS AND TRANSPORTATION COMMISSION
 PLANS FOR PROPOSED
 STATE HIGHWAY
 MISSISSIPPI COUNTY**

ROUTE I-57	STATE MO	SHEET NO 10
JOB NO JO10909		
CONTRACT ID		
PROJECT NO		
COUNTY MISSISSIPPI		

INDEX OF SHEETS

DESCRIPTION	SHEET NUMBER
TITLE SHEET	1
TYPICAL SECTIONS (2 SHEETS)	2
SUMMARY (1 SHEET)	2-A
SUMMARY (1 SHEET)	2-B
PLAN-PROFILE	3
REFERENCE POINTS	-
COORDINATE POINTS	-
SPECIAL SHEETS	4-14
TRAFFIC CONTROL SHEETS	-
EROSION CONTROL	15-16
LIGHTING	-
SIGNALS	-
SIGNING	-
PAVEMENT MARKING	-
CULVERT SECTIONS	-
BRIDGE DRAWINGS	-
CROSS SECTIONS	-
COMPUTER DATA	-

**CONVENTIONAL SYMBOLS
 (USED IN PLANS)**

EXISTING	NEW
BUILDINGS AND STRUCTURES	▭
GUARD RAIL	▬▬▬▬
CONCRETE RIGHT-OF-WAY MARKER	▬▬▬▬
STEEL RIGHT-OF-WAY MARKER	▬▬▬▬
LOCATION SURVEY MARKER	○
UTILITIES	
FIBER OPTICS	—FO—
OVERHEAD TELEPHONE	—OT—
UNDERGROUND TELEPHONE	—UT—
OVERHEAD POWER	—OP—
UNDERGROUND POWER	—UP—
GAS	—G—
WATER	—W—
MANHOLE	⊙
FIRE HYDRANT	⊙
WATER VALVE	⊙
WATER METER	⊙
DROP INLET	⊙
DITCH BLOCK	⊙
GROUND MOUNTED SIGN	⊙
LIGHT POLE	⊙
H-FRAME POWER POLE	⊙
TELEPHONE PEDESTAL	⊙
FENCE	—V—
CHAIN LINK	—V—
NOVEN WIRE	—V—
GATE POST	⊙
BENCHMARK	⊙

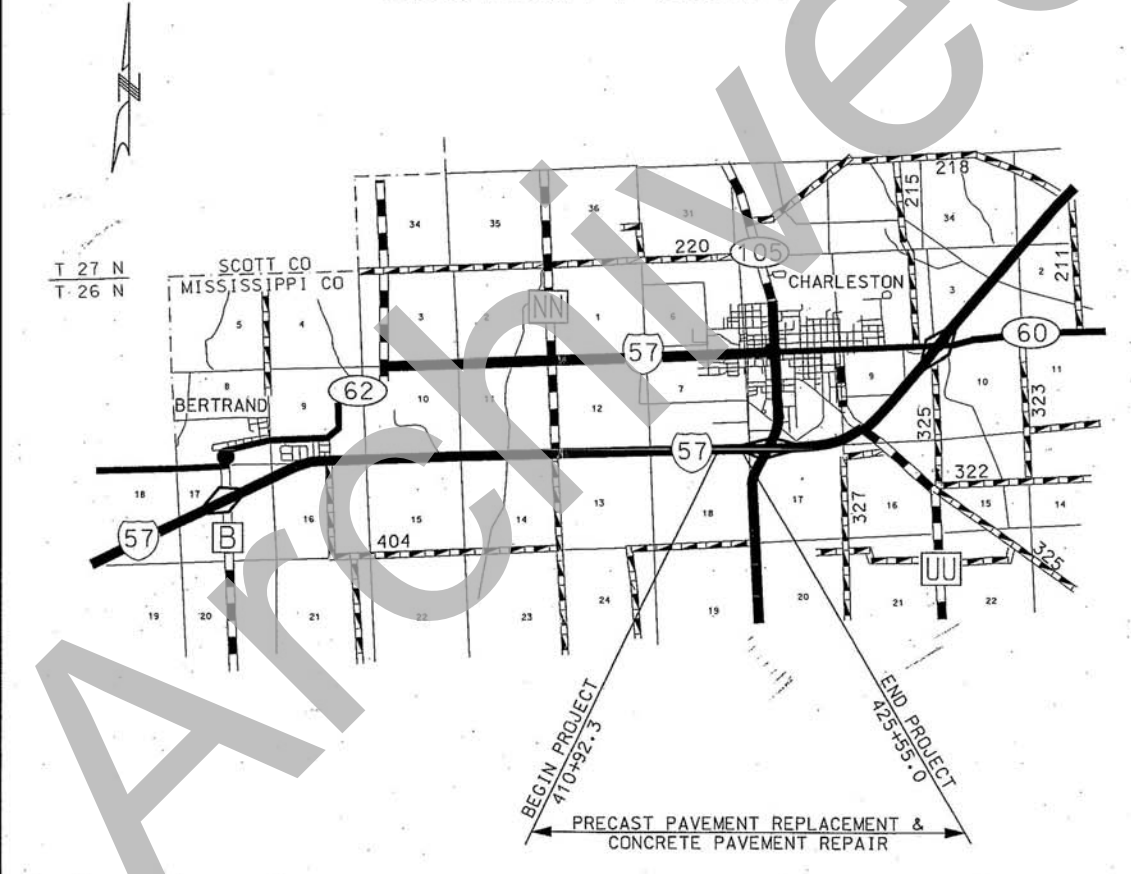

LENGTH OF PROJECT

BEGINNING OF PROJECT	STA. 410+92.3
END OF PROJECT	STA. 425+55.0
APPARENT LENGTH	1462.7 FEET
EQUATIONS AND EXCEPTIONS	STA 416+00 BK = 416+02.7
TOTAL CORRECTIONS	-2.70 FEET
NET LENGTH OF PROJECT	1460.00 FEET
STATE LENGTH	0.277 MILES

DATE 14 Feb 05

ROUTE I-57	STATE MD	DISTRICT 10	SHEET NO. 2
JOB NO. J010909			
CONTRACT ID			
PROJECT NO.			
COUNTY MISSISSIPPI			
			DATE 14 Feb 05

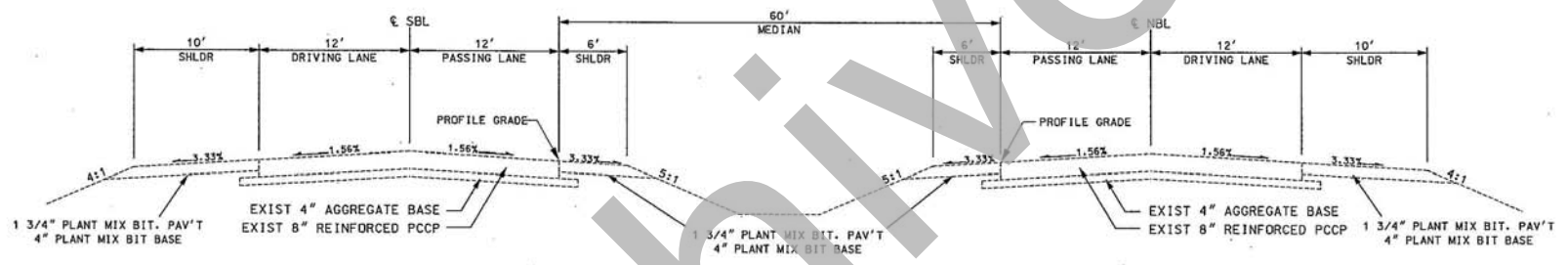

EXISTING TYPICAL SECTION
I-57 NBL
STA 410+92.3 TO STA 425+55

DRAWING NOT TO SCALE

TYPICAL SECTION
SHEET 1 OF 2

I:\de-proj\Mississippi\J010909\plan_sheets\002_typical_existing.dgn 09:03:33 PM 02/10/2005

ROUTE I-57	STATE MO	DISTRICT 10	SHEET NO. 2
JOB NO. J010909			
CONTRACT ID			
PROJECT NO.			
COUNTY MISSISSIPPI			
			DATE 14 Feb 05

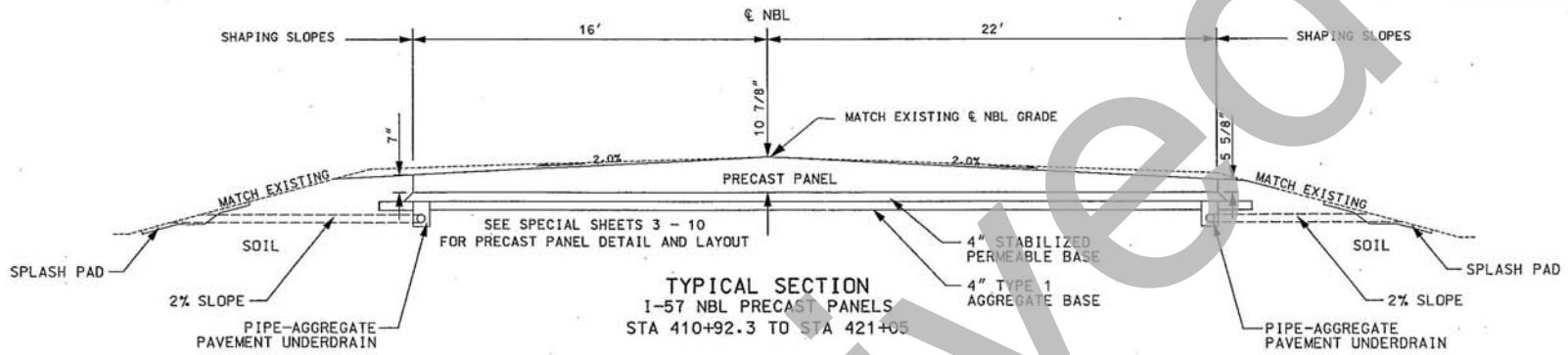

PAYMENT FOR SUBGRADE COMPACTION SHALL INCLUDE NECESSARY GRADING TO BRING EXIST ROADWAY TO FINISH GRADE OF THE BOTTOM OF TYPE 1 AGGREGATE BASE

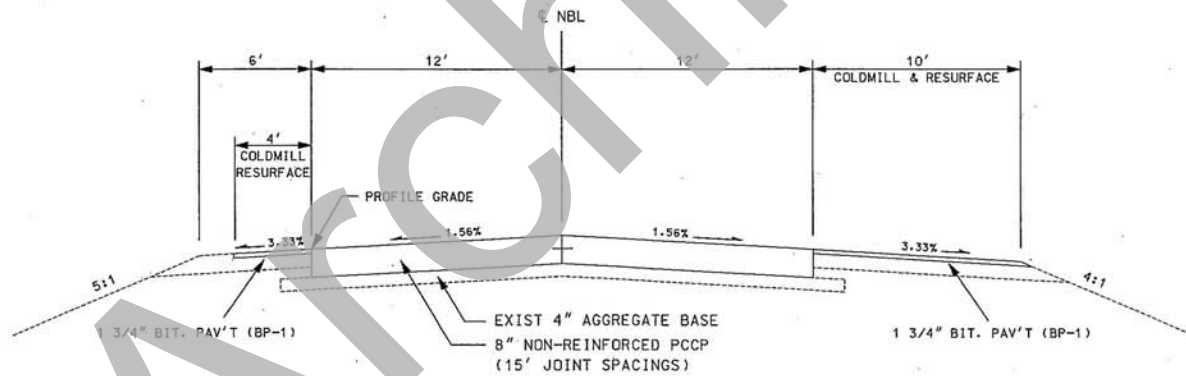

TYPICAL SECTION
SHEET 2 OF 2

DRAWING NOT TO SCALE

UNDERGROUND FACILITIES, STRUCTURES AND UTILITIES HAVE BEEN PLOTTED FROM AVAILABLE SURVEY AND RECORDS. THE COMMISSION DOES NOT WARRANT THE LOCATIONS OF THESE FACILITIES AS PRECISE. IT IS POSSIBLE THERE MAY BE OTHERS, THE EXISTENCE OF WHICH IS PRESENTLY NOT KNOWN OR SHOWN. IT IS THE CONTRACTOR'S RESPONSIBILITY TO DETERMINE THE EXISTENCE AND PRECISE LOCATION OF ALL FACILITIES AND TO AVOID DAMAGE.

UTILITIES

ELECTRIC - AMEREN UE
 45 S MINNESOTA
 CAPE GIRARDEAU, MO 63703
 CONTACT: JAY ESTES
 TELEPHONE: 573-651-5640

TELEPHONE - SBC
 800 BROADWAY
 CAPE GIRARDEAU, MO 63701
 CONTACT: PAT KELLY
 TELEPHONE: 573-339-1606

FIBER OPTIC - CABLE IN I-57 MEDIAN LIGHTCORE
 14567 N OUTER FORTY RD
 SUITE 500
 CHESTERFIELD, MO 63017
 CONTACT: JUSTIN FRENCH
 TELEPHONE: 314-880-1637

NOTES:

ANY WORK INDICATED ON THE PLANS THAT EXTENDS BEYOND THE PROJECT LIMITS IS CONSIDERED INCIDENTAL TO AND PART OF THIS PROJECT.

ALL BEARINGS ARE BASED ON MODIFIED STATE PLANE COORDINATES, EASTERN ZONE

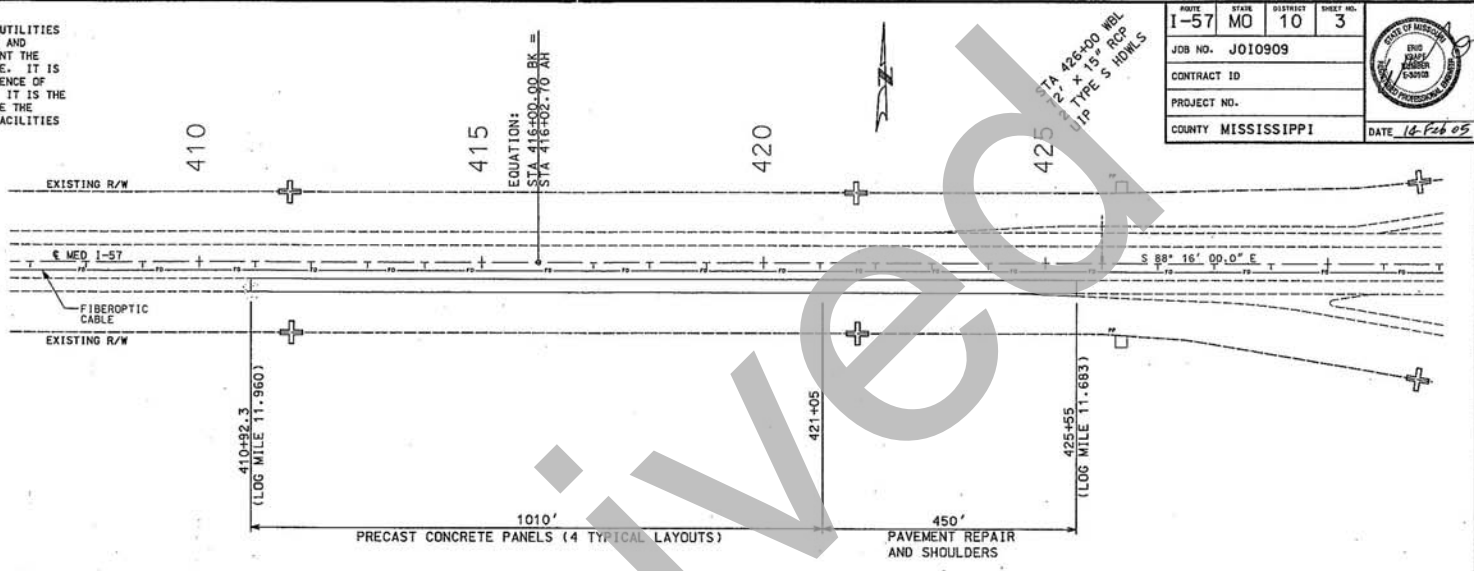

ROUTE	STATE	DISTRICT	SHEET NO.
I-57	MO	10	3
JOB NO. J010909			
CONTRACT ID			
PROJECT NO.			
COUNTY MISSISSIPPI			
			DATE 16-Feb-05

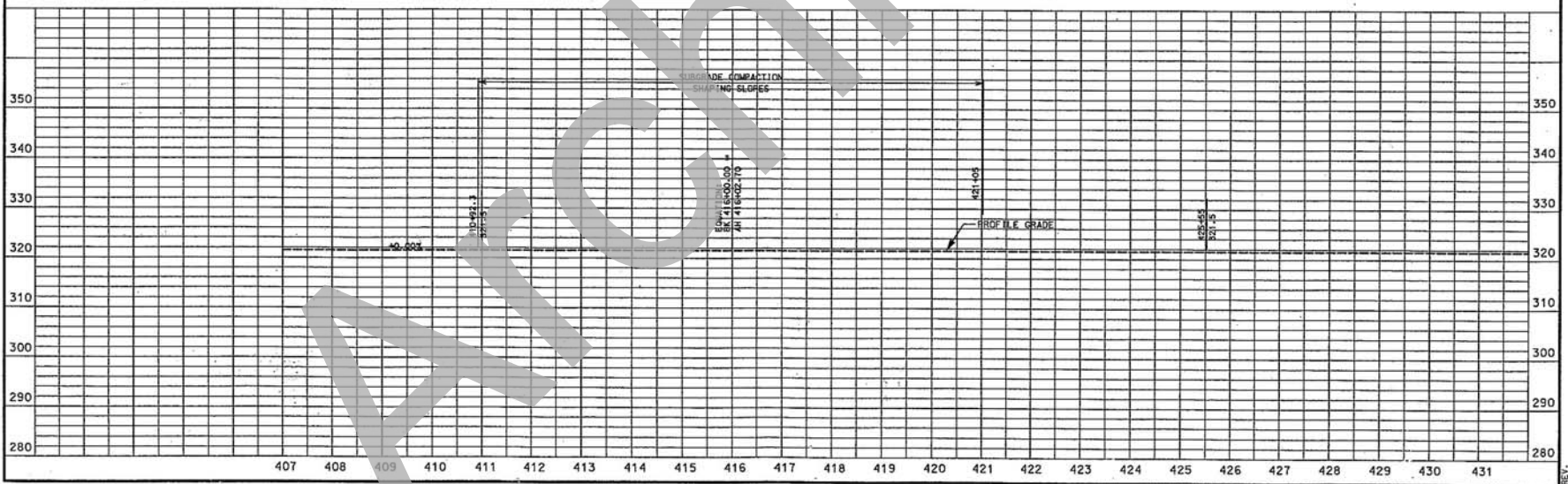

I:\de-pro\Mississippi\J010909\plan_sheets\003\plan_prof_j010909.dgn 05:03:48 PM 02/10/2005

PRECAST PAVEMENT PANEL LAYOUT AND TIE-IN DETAILS

ROUTE I-57	STATE MO	DISTRICT 10	SHEET NO. 6
JOB NO. J010909			
CONTRACT ID			
PROJECT NO.			
COUNTY MISSISSIPPI			DATE

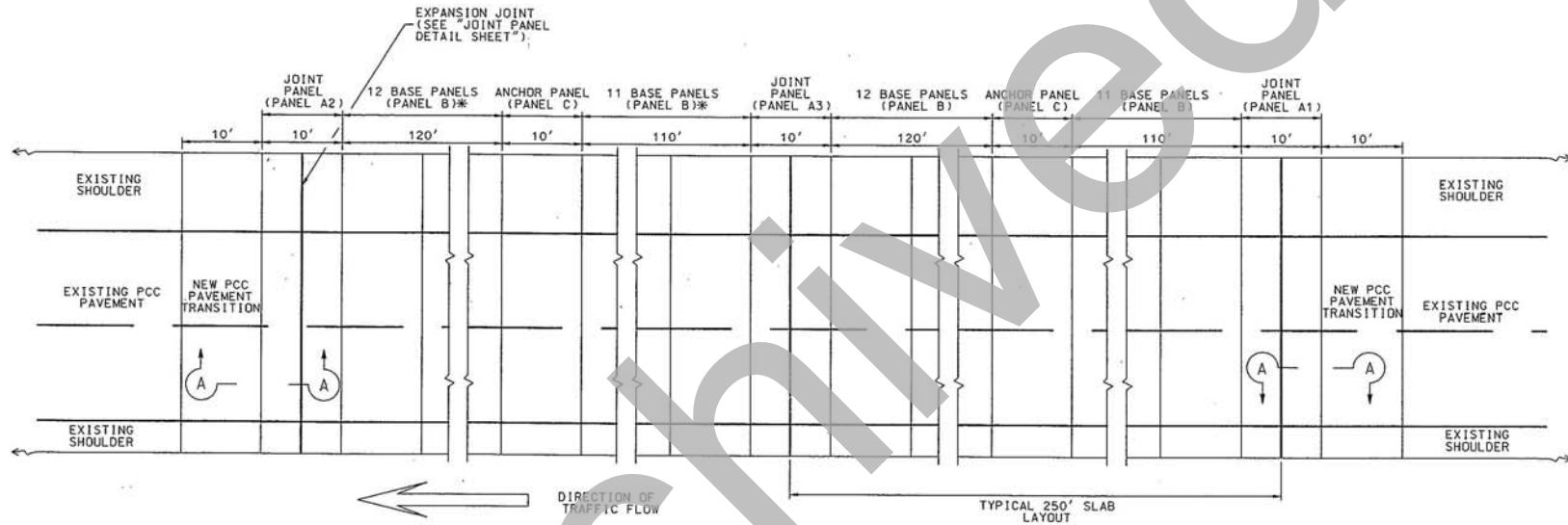

* NUMBER OF BASE PANELS MAY BE REDUCED TO STAY WITHIN PROJECT LIMITS. BASE PANELS SHOULD BE EVENLY DISTRIBUTED ON EITHER SIDE OF THE ANCHOR PANEL (TYPE C). TOTAL SLAB LENGTH (BETWEEN EXPANSION JOINTS) SHOULD NOT BE LESS THAN 100 FT.

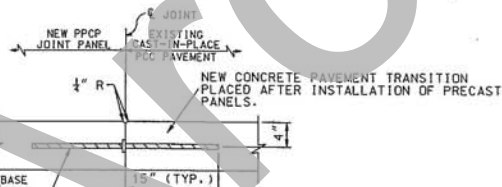

#6 X 30" MULTIPLE PIECE TIE BAR (EPOXY COATED, CAST INTO JOINT PANEL)

SECTION A-A: DETAIL FOR TIE-IN TO EXISTING PCC PAVEMENT

PRECAST PANEL
SPECIAL SHEET 3 OF 10

T:\de-proj\Mississippi\J010909\plan_sheets\006spec_sht_Layout.dgn 01:42:52 PM 01/13/2005

MISCELLANEOUS PANEL DETAILS

ROUTE I-57	STATE MO	DISTRICT 10	SHEET NO. 7
JOB NO. J010909			
CONTRACT 10			
PROJECT NO.			
COUNTY MISSISSIPPI			DATE

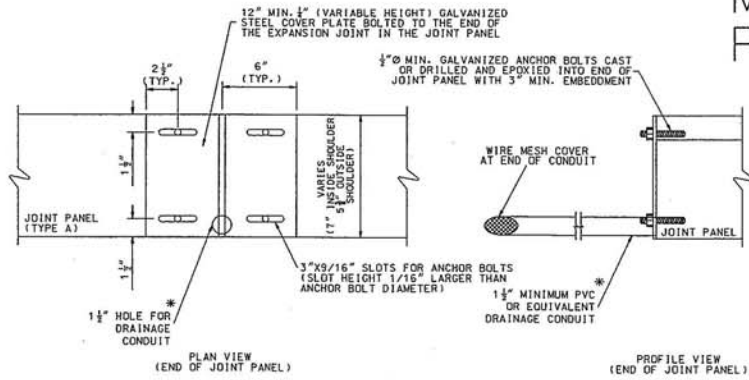

* DRAINAGE CONDUIT ONLY ON THE COVER PLATE AT THE "LOW" END OF THE EXPANSION JOINT. COVER PLATE AT "HIGH" END OF EXPANSION JOINT SHALL BE A SOLID PLATE (NO OPENING FOR DRAINAGE CONDUIT).

COVER PLATE AND EDGE DRAIN DETAIL
(FOR JOINT PANELS)

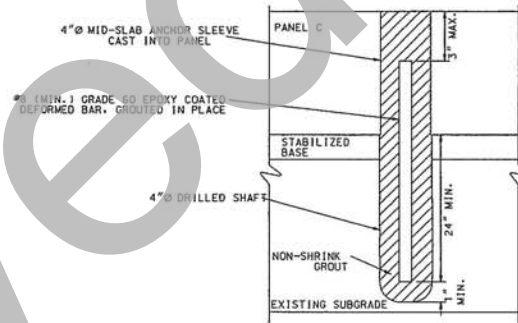

MID-SLAB ANCHOR DETAIL

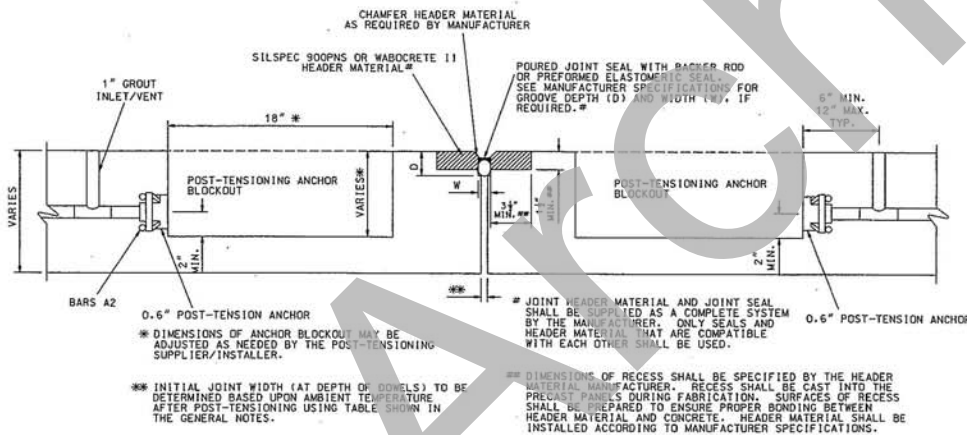

EXPANSION JOINT/POST-TENSIONING ANCHOR DETAIL



FEB 12 2005

TABLE OF ESTIMATED
QUANTITIES (PER PANEL)

1/2" DIA. ANCHOR BOLTS	8
1/4" GALVANIZED STEEL COVER PLATE	2
1 1/2" O PVC OR EQUIVALENT CONDUIT	8
ANCHOR BARS	10

PRECAST PANEL
SPECIAL SHEET 4 OF 10

\\de-pro\Mississippi\200909\plan_sheets\007_spec_sht_MiscDetail_1.dgn 01:36:40 PM 01/13/2005

MISCELLANEOUS PANEL DETAILS

ROUTE	STATE	DISTRICT	SHEET NO.
I-57	MO	10	8
JOB NO. J010909			
CONTRACT ID			
PROJECT NO.			
COUNTY	MISSISSIPPI		DATE

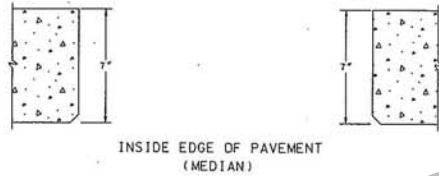
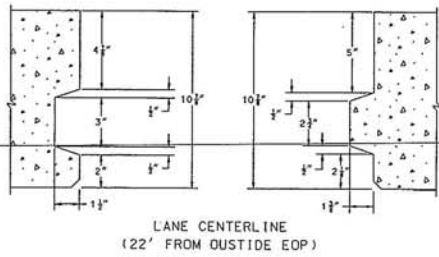
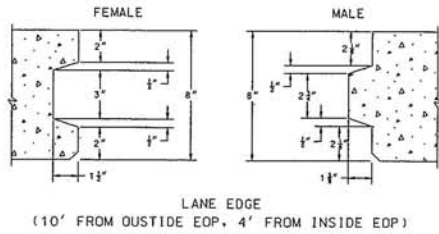

KEYWAY DIMENSIONS

NOT TO SCALE

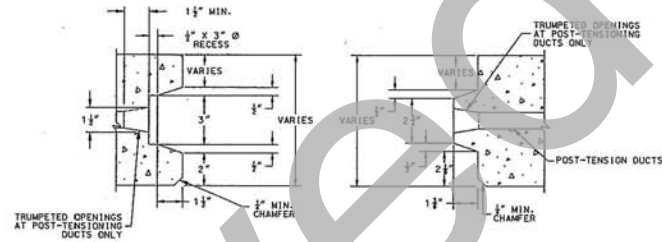

POST-TENSION DUCT OPENINGS AT KEYWAYS

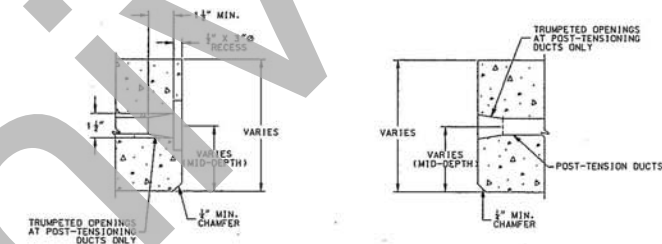

POST-TENSION DUCT OPENINGS AT NON-KEYWAYS

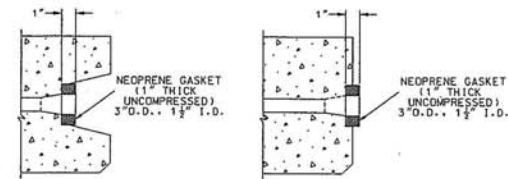

FEMALE KEYWAY

POST-TENSION DUCT SEAL DETAIL

PRECAST PANEL
SPECIAL SHEET 5 OF 10



FEB 12 2005

TABLE OF ESTIMATED QUANTITIES (PER PANEL)	
MATERIAL	NO.
FOAM/NEOPRENE GASKET	18

I:\vde-proj\Mississippi\J010909\plan_sheets\008_spec_sht_Misc-Detail_2.dgn 01/36/42 PM 01/13/2005

JOINT PANEL TYPE A1

DATE	DISTRICT	SHEET NO.
I-57	MD 10	9
JOB NO. J010909		
CONTRACT ID		
PROJECT NO.		
COUNTY MISSISSIPPI	DATE	

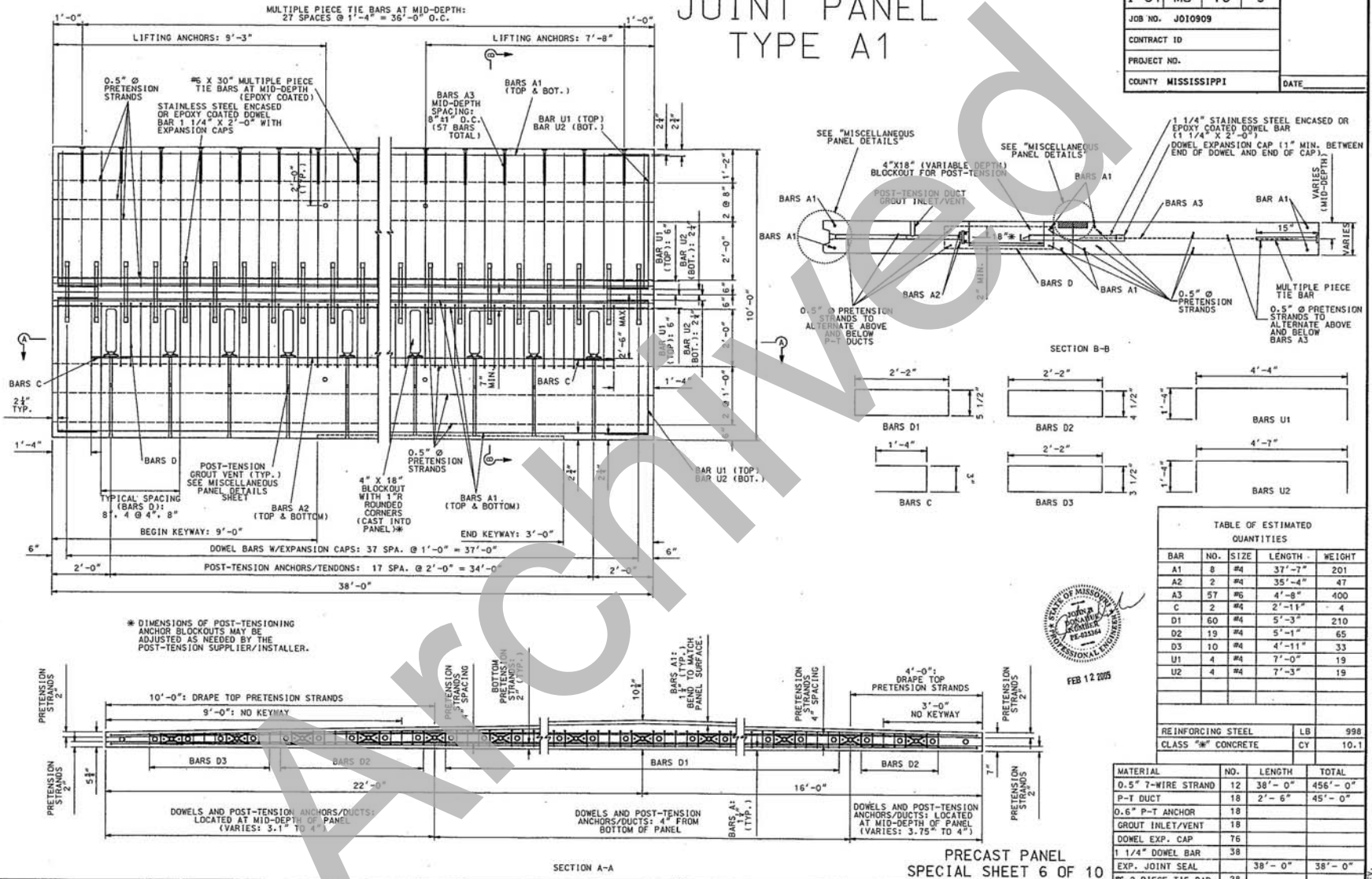

FEB 12 2005

PRECAST PANEL
SPECIAL SHEET 6 OF 10

JOINT PANEL TYPE A2

ROUTE	STATE	DISTRICT	SHEET NO.
I-57	MO	10	10
JOB NO. J010909			
CONTRACT ID			
PROJECT NO.			
COUNTY	MISSISSIPPI		DATE

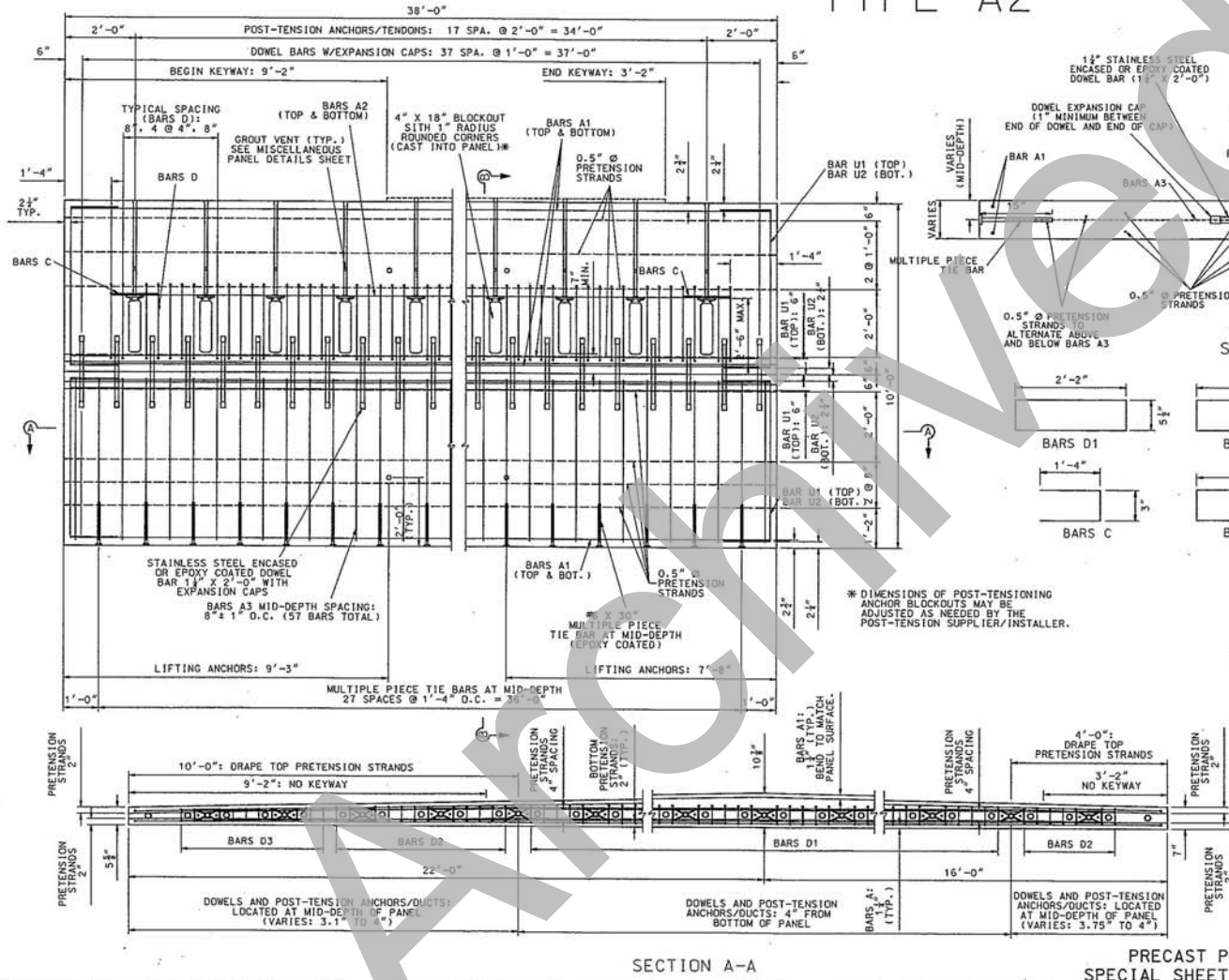

* DIMENSIONS OF POST-TENSIONING ANCHOR BLOCKOUTS MAY BE ADJUSTED AS NEEDED BY THE POST-TENSIONING SUPPLIER/INSTALLER.



SECTION B-B

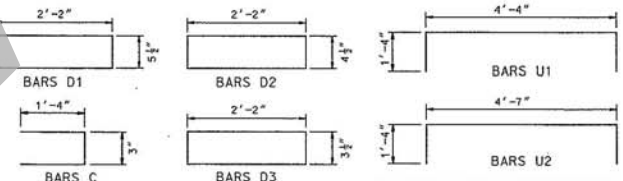

TABLE OF ESTIMATED QUANTITIES

BAR	NO.	SIZE	LENGTH	WEIGHT
A1	8	#4	37'-7"	201
A2	2	#4	35'-4"	47
A3	57	#6	4'-8"	400
C	2	#4	2'-11"	4
D1	60	#4	5'-3"	210
D2	19	#4	5'-1"	65
D3	10	#4	4'-11"	33
U1	4	#4	7'-0"	19
U2	4	#4	7'-3"	19

REINFORCING STEEL	LB	998
CLASS #6 CONCRETE	CY	10.1

MATERIAL	NO.	LENGTH	TOTAL
0.5" 7-WIRE STRAND	12	38'-0"	456'-0"
P-T DUCT	18	2'-6"	45'-0"
0.6" P-T ANCHOR	18		
GROUT INLET/VENT	18		
DOWEL EXP. CAP	76		
1 1/4" DOWEL BAR	38		
EXP. JOINT SEAL	38	38'-0"	38'-0"
#6 2-PIECE TIE-BAR	28		

PRECAST PANEL
SPECIAL SHEET 7 OF 10

F:\de-proj\Mississippi\J010909\plan_sheets\010spec_sht_Panel2.dgn 01:36:48 PM 01/13/2005

JOINT PANEL TYPE A3

ROUTE	STATE	DISTRICT	SHEET NO.
I-57	MO	10	11
JOB NO. J010909			
CONTRACT ID			
PROJECT NO.			
COUNTY MISSISSIPPI			DATE

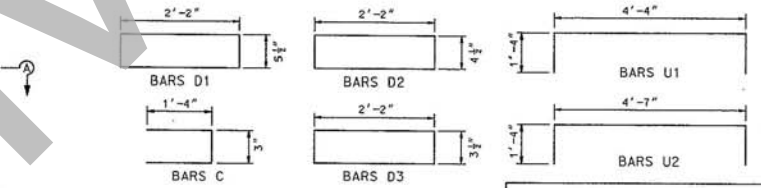
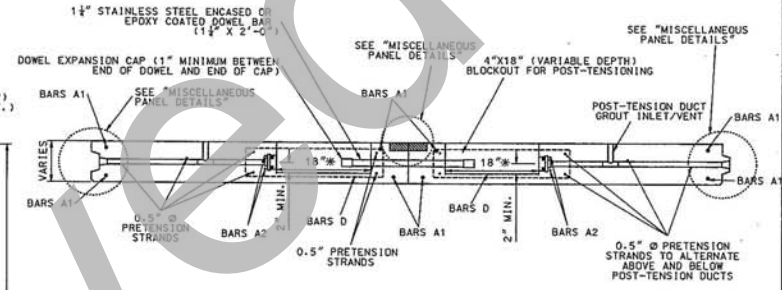
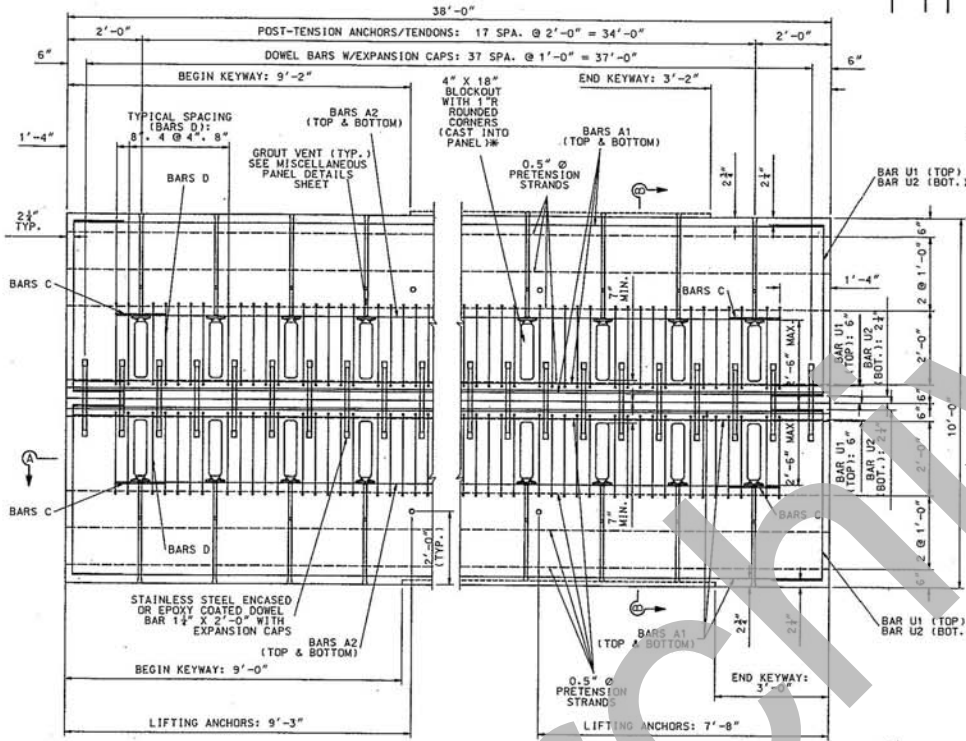

BAR	NO.	SIZE	LENGTH	WEIGHT
A1	8	#4	37'-7"	201
A2	4	#4	35'-4"	94
C	4	#4	2'-11"	8
D1	120	#4	5'-3"	421
D2	38	#4	5'-1"	129
D3	20	#4	4'-11"	66
U1	4	#4	7'-0"	19
U2	4	#4	7'-3"	19

REINFORCING STEEL	LB	957
CLASS #* CONCRETE	CY	10.1

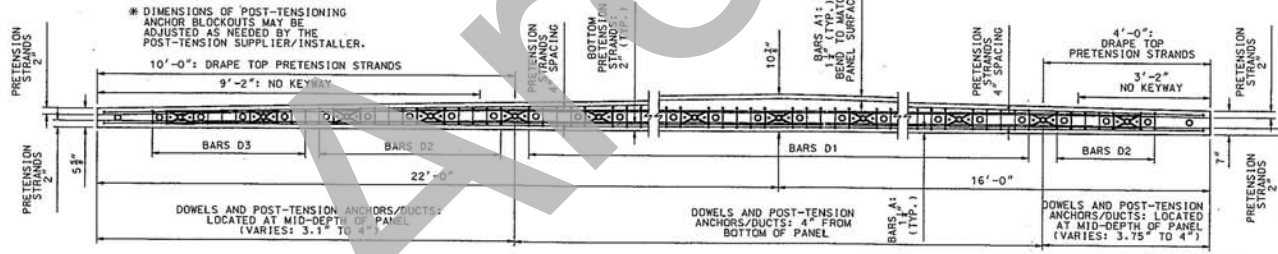

SECTION A-A

PRECAST PANEL
SPECIAL SHEET 8 OF 10

BASE PANEL TYPE B

ROUTE	STATE	DISTRICT	SHEET NO.
I-57	MO	10	12
JOB NO. J010909			
CONTRACT ID			
PROJECT NO.			
COUNTY MISSISSIPPI			DATE

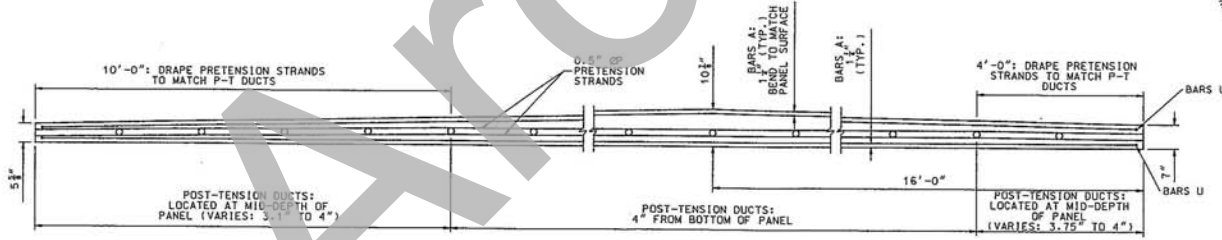
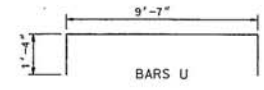
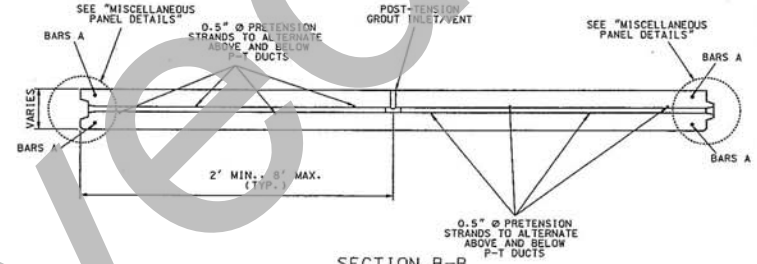
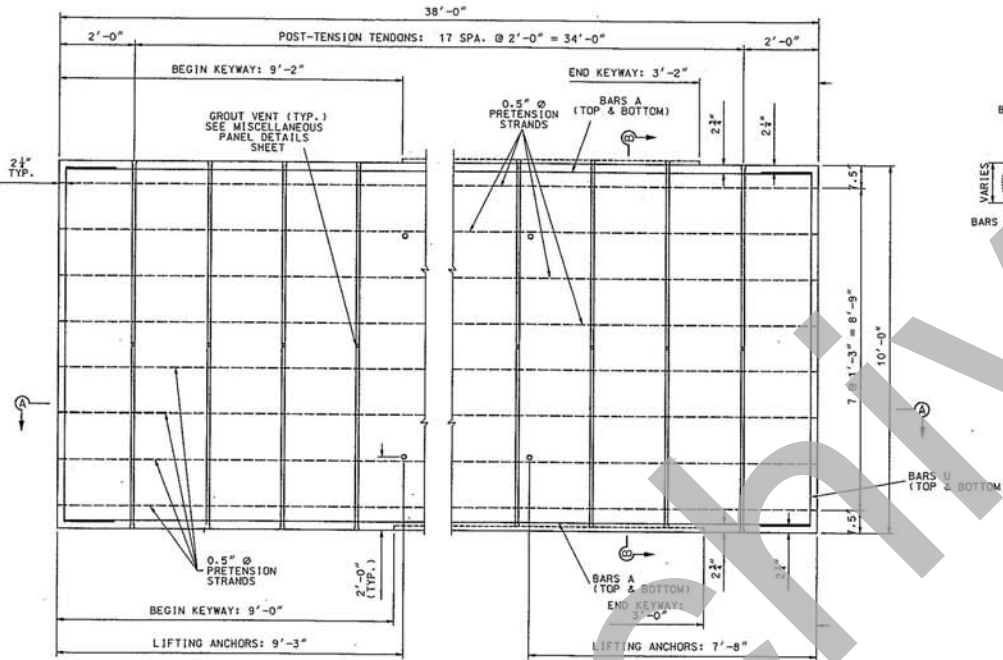

SECTION A-A

FEB 12 2005

BAR	NO.	SIZE	LENGTH	WEIGHT
A	4	#4	37'-7"	100
U	4	#4	12'-3"	33
REINFORCING STEEL			LB	133
CLASS "B" CONCRETE			CY	10.1

PRECAST PANEL
SPECIAL SHEET 9 OF 10

T:\de-proj\Mississippi\J010909\p\on_sheets\012spec_shL_Panels.dgn 01:36:53 PM 01/13/2005

BASE PANEL TYPE C

ROUTE	STATE	DISTRICT	SHEET NO.
1-57	MO	10	13
JOB NO. J010909			
CONTRACT ID			
PROJECT NO.			
COUNTY MISSISSIPPI			DATE

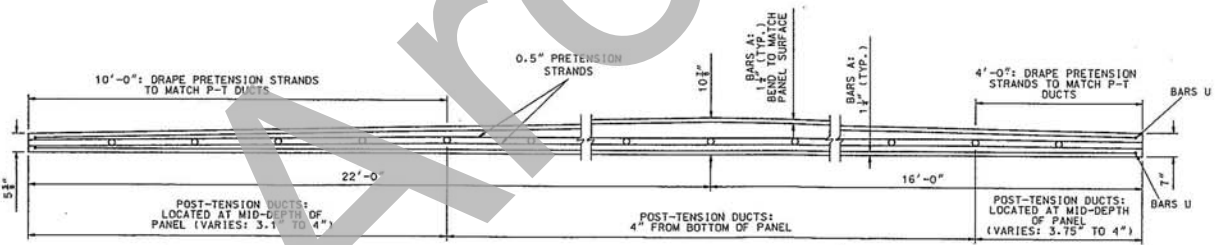
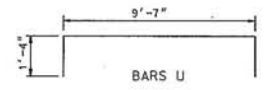
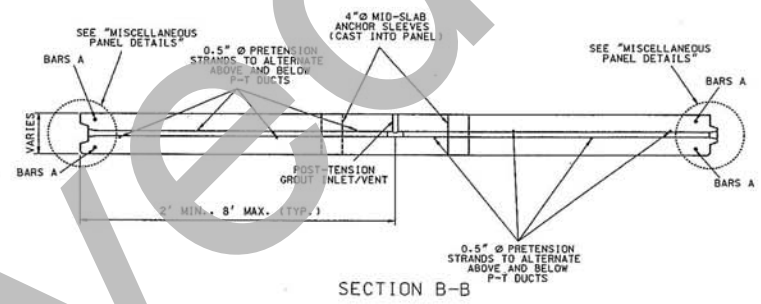
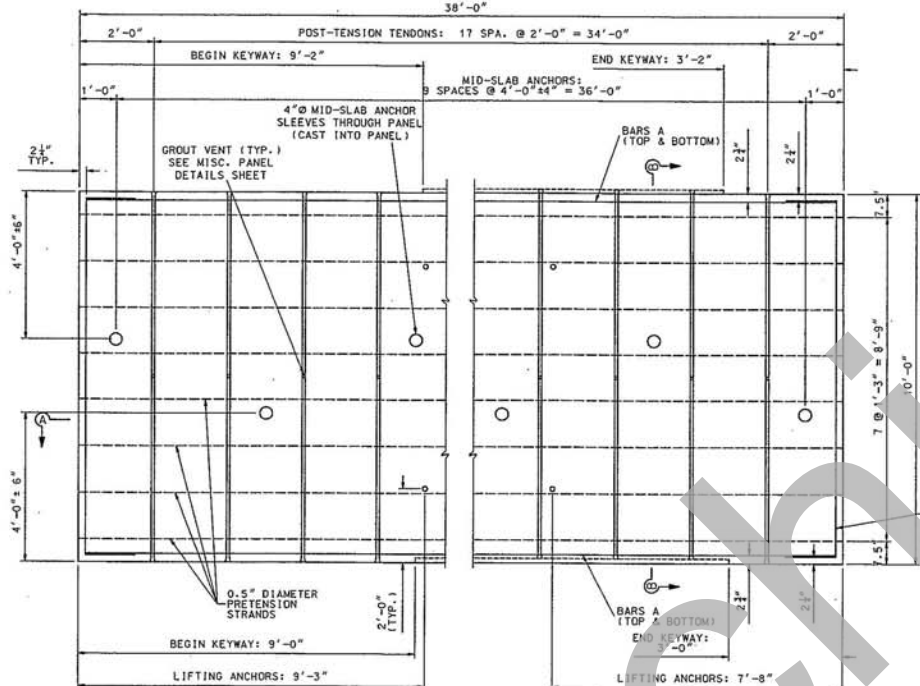

BAR	NO.	SIZE	LENGTH	WEIGHT	
A	4	#4	37'-7"	100	
U	4	#4	12'-3"	33	
REINFORCING STEEL				LB	133
CLASS #4 CONCRETE				CY	10.1

MATERIAL	NO.	LENGTH	TOTAL
0.5" 7-WIRE STRAND	8	38'-0"	304'-0"
P-T DUCT	18	10'-0"	180'-0"
GROUT INLET/VENT	18		

PRECAST PANEL
SPECIAL SHEET 10 OF 10

T:\de-proj\Mississippi\J010909\plan_sheets\013spec_sht_PanelC.dgn 01:36:58 PM 01/13/2005

instrumentation repaired or replaced as determined by the Engineer. All costs of repairs shall be reimbursed by the contractor. The contractor and the fabricator shall permit the University of Missouri Columbia research team access to the precast panels throughout fabrication and construction.

2.0 The contractor shall notify Dr. Vellore Gopalaratnam at the University of Missouri Columbia at the below address at least four weeks prior to the commencement of panel fabrication. The contractor shall also notify Dr. Gopalaratnam of the shipping and erection schedule of the panels.

Dr. Vellore Gopalaratnam

Department of Civil and Environmental Engineering

E2509 Engineering Building East

Columbia, MO 65211-2200

Phone: (573) 882-2683

Fax: (573) 882-4734

E-mail: gopalaratnamv@missouri.edu

3.0 No direct payment will be made for any expense incurred by the contractor for compliance with any of the specific requirements of this provision, including any delays, inconvenience or extra work, except for those items of work included for payment in the contract.

M. INSTRUMENTATION PLAN

1.0 Plan sheets detailing instrumentation layout and a letter documenting the research team's concerns are attached.

2.0 All cost incurred by the contractor for placement of the 3'x4' precast box shall be completely covered under item 902-99.02 placement of precast box.

3.0 The costs for all labor, equipment and materials for the installation of the 4" conduit and 6" conduit shall be completely covered under item numbers 902-54.00 conduit, 4", trench and 902-99.03 conduit, 6", trench, respectively.

N. POWER SUPPLY FOR INSTRUMENTATION

1.0 All work necessary for completion of the power supply to the instrumentation, as shown on the plans, shall be completed by June 15, 2005.

2.0 All cost for compliance with this provision shall be considered fully compensated for under the pay items in the contract.

O. PRECAST PRESTRESSED CONCRETE PAVEMENT

1.0 Description. This provision shall cover the fabrication, installation, post-tensioning, and grouting of precast prestressed concrete panels for pavement reconstruction. Herein, the term “panel” shall refer to individual precast concrete panels, including base panels, joint panels, and anchor panels. The term “slab” shall refer to a post-tensioned section of precast panels between expansion joints.

2.0 Materials. Materials shall conform to the requirements of the following Missouri Standard Specifications, except where noted in these Special Provisions.

Section 205, “Modified Subgrade”

Section 302, “Stabilized Permeable Base”

Section 501, “Concrete”

Section 502, “Portland Cement Concrete Base and Pavement”

Section 706, “Reinforcing Steel for Concrete Structures”

Section 717, “Neoprene and Silicone Joint Systems”

Section 1029, “Fabricating Prestressed Concrete Members for Bridges”

Section 1036, “Reinforcing Steel for Concrete”

Section 1039, “Epoxy Resin Material”

Section 1055, “Concrete Curing Material”

Section 1057, “Material for Joints”

Section 1058, “Polyethylene Sheeting”

Section 1073, “Joint Material for Structures”

3.0 Precast Panel Fabrication.

3.1 Tolerances for precast panels, regardless of type shall be as shown below in Table 1.

Table 1**Tolerances for Precast Panels**

Length (parallel to long axis of panel)	+/- 1/4"
Width (normal to long axis of panel)	+/- 1/8"
Nominal Thickness	+/- 1/8"
Squareness (difference in measurement from corner to corner across top surface, measured diagonally)	+/- 1/8"
Horizontal Alignment (upon release of stress)—Deviation from straightness of mating edge of panels	+/- 1/8"
Vertical Alignment—Camber (upon release of stress)	+/- 1/8"
Deviation of ends (horizontal skew)	+/- 1/8"
Deviation of ends (vertical batter)	+/- 1/8"
Keyway Dimensional Tolerance	+/- 1/16"
Position of Strands	+/- 1/8" Vertical ¹ +/- 1/4" Horizontal
Position of post-tensioning ducts at mating edges	+/- 1/8" Vertical ¹ +/- 1/8" Horizontal
Straightness of post-tensioning ducts	+/- 1/4" Vertical ¹ +/- 1/4" Horizontal
Vertical Dowel Alignment (parallel to bottom of panel)	+/- 1/8" ¹
Horizontal Dowel Alignment (normal to expansion joint)	+/- 1/8"
Dowel Location (deviation from shop drawings)	+/- 1/4" Vertical ¹ +/- 1/4" Horizontal
Dowel Embedment (in either side of expansion joint)	+/- 1"
Position of drainage and electrical conduit	+/- 1/2"
Straightness of drainage and electrical conduit	+/- 1/2" Vertical ¹ +/- 1/2" Horizontal
Position of lifting anchors	+/- 3"
Position of non-prestressed reinforcement	+/- 1/4"
Straightness of expansion joints	+/- 1/8"
Initial width of expansion joints	+/- 1/8"
Dimensions of blockouts/pockets	+/- 1/8"

1. Measured from bottom of panel

3.2 Concrete Mix. The concrete mix used will meet the strength requirements set forth in the plans. If minimum strength is not specified in the plans, the mix will be required to reach a compressive strength of 3,500 psi at release of prestress and 5,000 psi at 28 days. The mix will be workable enough to achieve the required surface finish as described below. The installation Contractor must approve the coarse aggregate to be used by the precast fabricator.

3.3 Non-Prestressed Reinforcement. Non-prestressed reinforcement shall be epoxy-coated and shall conform to the requirements of Section 1036.5.

3.4 Pretensioning. Pretensioning materials and procedures shall conform to Section 1029, “Fabricating Prestressed Concrete Members for Bridges.” Unless otherwise shown in the plans, all pretensioning material shall be Grade 270, 7-wire low-relaxation strand, as given in Section 1029.6.8.

3.5 Post-tensioning Materials. Post-tensioning ducts shall be rigid galvanized corrugated metal or rigid corrugated polypropylene. The ducts shall have an inside diameter a minimum of 3/8-inch larger than the nominal diameter of the post-tensioning strand.

Grout ports shall be located in the joint panels (Type A) and base panels (Type B), as shown on the panel detail sheets. The grout ports shall have a minimum 1/2-inch inside diameter and shall be compatible with the post-tensioning ducts, providing a watertight seal between the duct and port. Grout ports shall not protrude from the finished surface of the panels, and shall be located at the extreme ends of each tendon, and not more than 50 feet apart between the ends, unless otherwise approved.

3.6 Lifting Anchors. Lifting anchors shall be approved by the Engineer prior to use. Lifting anchors shall be located as shown on the panel detail sheets. The top of the lifting anchors shall be recessed 1/2-inch minimum from the surface of the panel.

3.7 Dowels and Expansion Joints. Shop drawings for the expansion joint detail shall be submitted for approval prior to fabrication of the Joint Panels. The expansion joint shall be able to withstand the expansion and compression and traffic loading requirements specified in the plans. Dowels for the expansion joints will conform to the requirements of Section 1057.3, with the exception that the dowel bars may either be stainless steel clad or epoxy coated. The entire length of the dowel shall be coated with graphite grease or other approved bond breaker, in accordance with Section 1057.3.

Dowels shall remain parallel to the bottom surface of the panel and normal to the expansion joint during casting. Dowel baskets shall not be used to support the dowels in the forms. Unless otherwise shown on the plans, the minimum length of dowel embedment on either side of the expansion joint (in the Joint Panel) shall be one-half the length of the dowel minus the specified initial width of the expansion joint.

Dowel expansion caps specified in the plans shall be approved prior to use. A minimum of 1.5 inches of free movement of the dowel end (within the expansion cap) shall be provided.

3.8 Finishing. Unless otherwise shown in the plans, the top surface of the panels (driving surface) shall receive a carpet drag texture finish, which meets the requirements of Section 502.48. The texture shall be applied in a timely manner after final screening such that the desired texture depth is achieved without disturbing the underlying concrete or turning over aggregate. The surface texture may be applied either parallel or normal to the long axis of the panel, at the discretion of the Engineer.

3.9 Placement in forms. Concrete formwork and placement procedures shall conform to the requirements of Section 1029.62. Concrete shall be placed in a single lift and distributed in such a manner that embedded items such as reinforcement, ducts, dowels, anchors, and lifting devices are not dislodged by the concrete mass. Proper consolidation must be achieved such that

honeycombing or segregation of the concrete does not occur and all spaces around embedded items and around the panel forms are filled.

3.10 Curing. Curing of the precast panels shall conform to the requirements of Section 1029.6.11. The Contractor shall submit the proposed curing methods and procedures for approval prior to placing concrete. Curing shall immediately after the surface finishing operation and as soon as marring of the concrete will not occur.

Membrane curing, in accordance with Section 502.6.1, shall be permitted at the discretion of the Engineer. A minimum two applications of the curing membrane, applied immediately after surface texture finishing, shall be required for membrane curing. Membrane curing residue shall be removed from all adjoining surfaces prior to shipment of the panels to the jobsite.

Curing shall be maintained for a minimum of 72 hours from the beginning of curing operations on the sides and top surface of the panels. While in the forms, the forms will be considered to provide adequate curing for the edges (vertical faces) of the panels. If any part of the form is removed, the exposed surface shall receive curing such as that described above. Removal of panels from the forms to a storage area shall be done in such a manner that curing is not interrupted for more than four hours for any member.

3.11 Form Removal and Storage. Panels shall be removed from the forms in such a manner that no damage occurs to the panel. Form removal shall conform to the requirements of Section 1029.6.12. Any materials forming blockouts in the panels shall be removed such that damage does not occur to the panel or the blockout.

Panels shall be stored in such a manner that adequate support is provided to prevent cracking or creep-induced deformation (sagging). Supports beneath the panels shall be located at approximately the same location as the lifting anchors. Panels shall be stacked no higher than five panels per stack, with adequate support between panels. Panels shall be stacked such that individual panels or stacks of panels are not touching one another. Panels stored for long periods of time (longer than one month) shall be checked at least once per month to ensure creep-induced deformation does not occur.

3.12 Unobstructed Ducts and Conduit. After removal from the forms and prior to shipment, the precast fabricator shall check for obstructions in all post-tensioning ducts. The post-tensioning ducts shall be checked by feeding a post-tensioning strand of the same size as that specified for actual post-tensioning completely through each duct. If the strand does not slide freely through the duct, the cause of the obstruction shall be remedied, at the expense of the Contractor, before the panel is shipped.

3.13 Lifting and Handling. Panels shall be handled in such a manner as not to damage the panel during lifting or moving. Lifting anchors cast into the panels shall be used for lifting and moving the panels at the fabrication plant. The angle between the top surface of the panel and the lifting line shall not be less than sixty degrees (60°), when measured from the top surface of the panel to the lifting line.

Provision shall be made to secure the two halves of each Joint Panel together such that the expansion joint remains closed or at a uniform specified width during handling and

transportation. A plan for securing the two halves of the Joint Panel together shall be submitted for approval prior to fabrication of the Joint Panels. The fastening technique shall prevent the expansion joint from opening or closing during lifting and handling and shall not rely upon the dowel bars to resist hinging at the expansion joint. Damage caused to any Joint Panel, including bending of dowel bars, as a result of inadequate bracing shall be repaired at the expense of the Contractor to the satisfaction of the Engineer.

3.14 Transportation. Panels shall be transported in such a manner that the panel will not be damaged during transportation. Panels shall be properly supported during transportation such that cracking or deformation (sagging) does not occur. If more than one panel is transported, proper support and separation must be provided between the individual panels. Panels shall be lying horizontally during transportation, unless otherwise approved.

3.15 Repairs. Repairs of damage caused to the panels during fabrication, lifting and handling, or transportation shall be addressed on a case-by-case basis. Damage within acceptable limits caused to the top surface (driving surface) or to keyed edges of the panels shall be repaired using an approved repair method at the fabrication plant at the expense of the Contractor. Repetitive damage to panels shall be cause for stoppage of fabrication operations until the cause of the damage can be remedied.

3.16 Demonstration of Panel Fit. The precast fabricator shall initially fabricate only three panels and assemble these panels at the fabrication plant to demonstrate the fit of the panels. The panels shall be assembled over a level surface that will not cause damage to the panels during or after assembly. Post-tensioning shall not be required for this trial assembly, and epoxy shall not be required in the joints between panels. Joints between panels should not be more than 1/4-inch wide when assembled. Any problems with fitting the panels caused by imperfections in the panels shall be corrected prior to proceeding with panel fabrication. Panel fabrication may commence following the trial assembly only upon approval.

3.17 Instrumentation. The precast fabricator shall permit the installation of instrumentation in the panel forms prior to placement of concrete. Instrumentation shall be permitted in no fewer than eight (8) precast panels. A schematic layout and instrumentation plan shall be provided to the fabricator and the Engineer for approval prior to beginning panel fabrication. The precast fabricator shall provide at least 7 days advanced notice to the instrumentation installer before casting the instrumented panels. Instrumentation shall include, but is not limited to, temperature sensors, strain gages, and load cells. Instrumentation shall not compromise the integrity of the reinforcing steel, prestressing system, or the precast panel itself. The precast fabricator shall protect the integrity of the instrumentation, including lead wires and connectors at the surface and edges of the precast panels, during fabrication and handling of the instrumented panels.

4.0 Base Preparation. The precast panels shall be placed over a prepared surface as shown on the plans. The surface shall be free from debris and other materials that prevent the panels from fully resting on the base.

4.1 Materials. The base material will be either the existing base material or a new stabilized or asphaltic or cementitious material as shown on the plans. The material will have the drainage characteristics required by the Department.

4.2 Grade Control for Placement. Grade control will be established for placement of the base material to ensure long-wavelength roughness is not built into the base. Grade control will be established using stringlines, laser guidance, or other comparable methods. Grade control methods must be approved prior to base preparation.

4.3 Surface Test. The finished surface of the base material shall be flat and smooth so as to provide full support beneath the panels. The smoothness of the surface of the base material shall be checked by the contractor in accordance with Section 502.8.1, "Straight edging." A 20-ft straightedge shall be used in lieu of a 10-ft straightedge, and the variation of the surface shall be such that a 6-inch diameter circular plate, 1/8 inch thick cannot be passed beneath the straightedge. Any areas of the base surface not conforming to this smoothness requirement shall be corrected at the Contractor's expense in accordance with Section 502.8.1.

5.0 Panel Installation on Site.

5.1 Equipment. The Contractor shall have all equipment required for panel installation, post-tensioning, and grouting on-site prior to beginning panel installation. Lifting and transporting equipment shall not damage the prepared base material prior to or during panel installation. Any damage to the prepared base material will be repaired at the Contractor's expense to the satisfaction of the Engineer.

5.2 Polyethylene Sheeting. A single layer of polyethylene sheeting will be placed over the prepared base material, beneath the precast panels, as shown on the plans. Polyethylene sheeting shall conform to the requirements of Section 1058.3, except that the minimum nominal thickness of the sheeting shall be 6.0 mills unless otherwise specified. Provision shall be made to prevent folds and creases in the sheeting beneath the panels. The surface of the prepared base shall be free from loose debris, which may puncture the polyethylene sheeting prior to placement of the polyethylene sheeting. Any tears or punctures in the polyethylene sheeting shall be repaired to the satisfaction of the Engineer prior to placement of the precast panels over the sheeting. Provision shall be made to prevent the polyethylene sheeting from becoming pinched in the joints between individual precast panels during panel installation.

5.3 Temporary Post-Tensioning. Panels shall be temporarily post-tensioned together during placement to ensure closure of transverse joints prior to final post-tensioning. Unless otherwise specified, temporary post-tensioning shall be completed after placement of no more than two adjacent panels. The anchor access pockets in the joint panels shall be used to feed the temporary post-tensioning strands into the longitudinal (parallel to roadway centerline) ducts. Temporary post-tensioning tendons shall be spaced no more than 20 feet apart and no more than 10 feet from the edge of the panels, as measured across the width of the pavement. Strand use for temporary post-tensioning shall be either 1/2-inch or 0.6-inch nominal diameter, with corresponding temporary anchorage. Any damage to the precast panels during temporary post-tensioning shall be repaired at the Contractor's expense to the satisfaction of the Engineer prior to installation of additional panels. No more than two panels may be placed in sequence between temporary post-tensioning operations.

5.4 Joint Treatment. Unless otherwise shown in the plans, epoxy shall be applied to the adjoining surfaces of the precast panels prior to assembly. The epoxy material shall be suitable

for bonding hardened concrete to hardened concrete and shall be approved prior to use. Epoxy shall be proportioned and applied according to the manufacturer's recommendations.

Epoxy shall be applied to both faces of adjoining panels, and shall be kept a minimum of 1/2 inch away from duct openings. The set time of the epoxy shall be such that final post-tensioning is completed before the epoxy hardens. Excess epoxy squeezed out of the joint onto the driving surface of the precast pavement during assembly and/or post-tensioning shall be removed before it hardens.

A compressible foam or neoprene gasket shall be placed around the opening of each post-tensioning duct as shown in the panel details. The seal shall be continuous around each duct opening and shall be compressible such that it will not protrude from the gasket recess shown in the panel details when compressed. The seal shall not cover any part of the opening to the duct and shall not inhibit the flow of grout. Provision shall be made to prevent damage to the gaskets during panel installation.

5.5 Placement Technique. Panels shall be installed one at a time, and shall be installed in such a manner that neither the base material nor the polyethylene sheeting is damaged during installation. The angle between the top surface of the panel and the lifting line attached to each lifting anchor shall not be less than 60 degrees (60°), when measured from the horizontal surface of the panel to the lifting line.

Panels shall be aligned in the longitudinal direction (parallel to the roadway centerline) using the centerline of the panels. The centerline of each panel shall be marked on the top surface of the panel—at the adjoining edges. The location of the centerline on each panel shall be determined from the location of the post-tensioning duct openings at the adjoining edges of the panels.

Panels may be pulled together during placement using approved temporary devices. Any damage to the panels caused by temporary devices shall be repaired at the Contractor's expense to the satisfaction of the Engineer.

The centerline of the panels shall be aligned to a line laid out by a surveyor (provided by the Contractor) on the surface of the base prior to placement of the panels. Shims may be placed in the joints between panels to correct horizontal misalignment of the centerline of the panels. The total thickness of shims used in any joint shall be no more than 1/8 inch. Any damage caused to the panels by shims shall be repaired at the Contractor's expense to the satisfaction of the Engineer.

5.6 Placement Tolerances. Unless otherwise indicated on the plans, the centerline of the panels shall be within 1/4 inch of the pre-surveyed centerline marked on the surface of the base, and the centerline of adjoining panels shall be within 1/8 inch of each other at the adjoining edge.

Vertical alignment of the panels shall be such that the top surface of an individual panel is no more than 3/16 inch higher or lower than the top surface of an adjoining panel at any point along the joint between the panels. The width of the gap between adjoining panels at the top surface of the joint shall be no more than 1/8 inch after completion of temporary post-tensioning.

5.7 Expansion Joints. The expansion joint seal shall conform to the requirements of Sections 1073.2 and 717.10 for a preformed compression seal or Sections 1057.10 and 717.30 for silicon expansion joint seals, as shown in the plans. The header material on either side of the expansion joint shall be approved prior to use and shall be installed at the fabrication plant prior to shipment of the panel, unless otherwise approved for installation at the job site. The header material and joint seal shall be compatible with each other.

The seal for the expansion joints shall be selected by the contractor and approved by the Engineer. The joint seal shall be able to accommodate expansion (stretch) of 1 3/4" and compression of 1/2". Groove dimensions ("W" and "D" on plans) and installation width for the joint seal shall be specified by the manufacturer. The width of the expansion joint at the level of the dowels shall be adjusted on-site immediately following completion of post-tensioning based upon the approximate ambient temperature according to:

- $T \leq 50^{\circ}\text{F}$: 3/4"
- $50^{\circ}\text{F} < T < 90^{\circ}\text{F}$: 1/2"
- $T \geq 90^{\circ}\text{F}$: 1/4"

Unless otherwise specified on the plans, expansion joint seals shall be installed following final post-tensioning and prior to opening the pavement to traffic. The width of expansion joints after final post-tensioning will be adjusted to the width specified on the plans. Any debris in the joint shall be removed using compressed air or other approved techniques prior to installing the joint seal.

5.8 Cover Plate/Edge Drain for Expansion Joints. Cover plates and/or edge drains shall be provided at both ends of each expansion joint as shown on the plans. A cover plate with an edge drain shall be installed at each end of the expansion joint where water is expected to drain to. Cover plates shall be installed such that they will not inhibit free movement of the expansion joint. Expansion joints shall be cleared of debris prior to installation of cover plates/edge drains.

5.9 Patching and Repairs. Anchor access pockets (joint panels) shall be "patched" only after completion of post-tensioning but prior to grouting the post-tensioning tendons. The pockets shall be patched with an approved patching material. A fast-setting patching material shall be permitted with the approval of the Engineer. The patching material shall be finished flush with the surface of the surrounding concrete, and shall be suitable for diamond grinding if necessary.

Damage caused to the precast panels during any part of the panel installation process shall be repaired by the contractor at the contractor's expense to the satisfaction of the Engineer. Repairs of damaged areas will be addressed on a case-by-case basis by the Engineer. Damage within acceptable limits caused to the top surface (driving surface) or to keyed edges of the panels shall be repaired using approved repair methods and materials. Repetitive damage to panels shall be cause for stoppage of installation operations until the cause of the damage can be remedied. Patching of post-tensioning anchor access pockets, lifting anchor recesses, and all other recesses shall be completed using approved patching materials and methods.

5.10 Voids Beneath Pavement. The pavement shall be inspected during panel installation for voids beneath the precast panels. At the discretion of the Engineer, the Contractor shall be required to stop panel installation and correct imperfections in the base material causing voids beneath the precast panels.

5.11 Matching Existing Pavement. The precast panels shall be tied into the existing pavement as shown on the plans. The top surface of the precast pavement shall no more than 1/4 inch above or below the surface of the precast pavement. Diamond grinding shall be used bring the top surface of the existing pavement and precast pavement into tolerance if necessary.

5.12 Mid-Slab and End-Slab Anchors. Mid-slab and end-slab anchors shall be provided as shown on the plans to tie the precast pavement slab to the existing subbase. Alternative mid-slab or end-slab anchors shall be approved by the Engineer.

5.13 Instrumentation. The Contractor shall permit access to instrumentation in the precast panels during the panel installation process and shall permit instrumentation of the precast panels and post-tensioning system during the construction process. A schematic layout and an instrumentation plan shall be provided to the Engineer and Contractor for approval at least one month prior to commencement of panel installation on site. Instrumentation shall include, but is not limited to, temperature sensors, strain gages, and load cells. Instrumentation shall not compromise the integrity of the base material, pavement, or the post-tensioning system. The Contractor shall protect the integrity of the instrumentation, including lead wires and connectors extending from the surface of the precast panels, during the panel installation and post-tensioning process.

6.0 Post-Tensioning. Post-tensioning materials, equipment, and procedures shall conform to the prestressing requirements given in Section 1029, "Fabricating Prestressed Concrete Members for Bridges."

The contractor shall use the post-tensioning system shown in the plans, unless a comparable system is approved for use. The dimensions of the anchor access pockets may be adjusted as needed prior to fabrication of the joint panels (Type A) in order to accommodate the stressing ram. The pocket dimensions shall be such that construction traffic can pass over the pockets without damage to the vehicle or disruption to the driver. Dimensions other than those shown in the plans shall be approved by the Engineer prior to fabrication of the joint panels (Type A).

6.1 Materials. Low-relaxation, Grade 270 strands with 0.65-inch nominal diameter, conforming to Section 1029.3.4, shall be used for post-tensioning.

6.2 Strand Insertion. Post-tensioning strands shall be inserted into the ducts at the Joint Panels (Type A), as shown on the plans. Strands shall be either pushed or pulled through the ducts by hand or using an approved mechanical strand pusher. Provision shall be made to prevent separation of the individual wires from the strand during strand insertion.

6.3 Tendon Stressing. Each end of each of the post-tensioning shall be stressed. Post-tensioning strands shall be stressed to 80% of the guaranteed ultimate tensile strength of the strand supplied. The tendon stressing sequence shall be approved prior to the start of post-tensioning. Stressing shall be completed in a single stage unless otherwise specified. Stressing of longitudinal tendons

(parallel to the roadway centerline) shall start with a tendon at or near the midpoint of the panels, subsequently alternating between the tendons on either side of the centerline until all tendons have been stressed. Tendons shall be stressed to the magnitude specified in the plans and elongations shall be measured and recorded, in accordance with Section 1029.6.9.

After completion of post-tensioning, the tails of the post-tensioning strands shall be trimmed, and an approved grease cap will be used to cover and seal the end of the strand and post-tensioning anchor.

6.4 Faulty Anchors and Wire Failures. In the event of a faulty post-tensioning anchor, the Contractor shall submit a repair or alternate stressing strategy for approval. No wire failures shall be accepted. The contractor shall provide and install a new strand in the event of a wire failure.

7.0 Tendon Grouting. Unless otherwise shown on the plans, the post-tensioning system shall consist of grouted tendons, in accordance with Section 1029.6.9.

7.1 Materials. The grout mixture shall be a pre-packaged grout specifically manufactured for prestressed tendon grouting, and shall be approved by the Department prior to use. Grout shall be proportioned with water according to the manufacturer's recommendations.

7.2 Equipment. Grouting equipment shall consist of at least the following:

- Equipment for accurately measuring and proportioning by volume or weight the various materials composing the grout,
- A colloidal mixer, capable of operating in a range from 800 rpm to 2,000 rpm and thoroughly mixing the various components of the grout in an approved manner,
- A positive action pump capable of forcing grout into the post-tensioning ducts. The injection pump shall be capable of continuous pumping at rates as low as 1-1/2 gal. per minute,
- The discharge line shall be equipped with a positive cut-off valve at the nozzle end, and a bypass return line for recirculating the grout back into a holding tank or mixer unless otherwise approved, and
- A stop watch and flow cone conforming to the dimensions and other requirements of ASTM C 939, "Standard Method for Flow of Grout for Preplaced-Aggregate Concrete (Flow Cone Method)."

7.3 Procedures. A grouting plan shall be submitted for approval at least 4 weeks before starting grouting operations. Grouting shall be completed within 7 days after stressing of the post-tensioning tendons, unless otherwise approved. Grouting shall not be performed until the anchor access pockets have been patched. Compressible foam shall be injected in each expansion joint to seal the bottom of the joint from grout intrusion. The sides of the pavement slab shall be backfilled to prevent grout leakage from beneath the slab.

The grout fluidity shall be checked according ASTM C 939. Efflux time for fluidity shall be between 10 and 30 seconds after mixing, but no more or less than recommended by the manufacturer. Fluidity shall be adjusted to achieve the necessary flow requirements to achieve fully grouted tendons. If excessive bleeding of the grout is observed, the Engineer may require the Contractor to adjust the grout mixture to reduce bleed. The fluidity of the grout shall be checked at the beginning of each grouting operation and after each time the grout pump and hose is flushed.

Samples for grout compressive strength determination will be collected at least once per day during grouting operations. A minimum of three strength cubes shall be made during each sampling. The average compressive strength of three cubes shall be a minimum of 5,000 psi at 28 days.

Grout shall be pumped into the lowest end of the tendon. Grouting pressure shall not exceed the bursting pressure of the duct/port connection or 145 psi, whichever is less. If grout does not flow from the nearest intermediate port after the maximum grouting pressure has been reached, grout may be pumped into an intermediate port. A diagram of grout flow shall be produced by the contractor to demonstrate full grouting of the tendons.

7.4 Grouting Problems. If grout is observed leaking into an expansion joint, from the end of a joint between panels, from beneath the slab, or out of an adjacent duct, pumping shall be stopped and grout shall be pumped into the nearest intermediate port. Any grout that flows into an expansion joint shall be flushed from the expansion joint immediately. Any grout that hardens in an expansion joint shall be removed at the contractor's expense.

7.5 Cleanup. Upon completion of grouting, recesses in the surface of the panels at the grout ports shall be filled with an approved mortar and finished flush with the surface of the pavement. Any grout that flows onto the finished surface of the pavement during the grouting operation shall be immediately flushed from the surface. Any residual grout which hardens on the pavement surface shall be removed using an approved technique to the satisfaction of the Engineer at the expense of the contractor.

8.0 Underslab Grouting. Underslab grouting shall be used to fill any voids beneath the precast panels that may be present after placing the panels over the prepared base. Underslab grouting shall utilize the underslab grout channels and ports shown in the plans.

8.1 Materials. Grout materials shall consist of a mixture of Type I, II or III Portland cement, a fluidifier, fly ash and water. All materials shall be furnished by the Contractor.

The fluidifier shall be a cement dispersing agent possessing such characteristics that will inhibit early stiffening of the pumpable mortar, tend to hold the solid constituents of the fluid mortar in suspension and prevent completely all setting shrinkage of the grout.

Class C fly ash, meeting the requirements of Section 1018 shall be used. The fly ash shall be selected from an approved source from FS-1018 Table 1.

8.2 Equipment. Equipment for underslab grouting shall consist of the same equipment listed in 7.2.

8.3. Proportioning Grout Mixture. The mixture used in pressure grouting, herein referred to as “Grout Slurry”, shall consist of proportions of Portland cement, fly ash, fluidifier and water. The contractor shall furnish the Engineer the proposed mix design meeting the following requirements:

- The grout slurry shall remain fluid and not exhibit a resistance to flow for a minimum of one hour,
- The time of efflux from the flow cone shall be between 10 and 20 seconds. The flow test shall be performed in accordance with ASTM C 939, “Standard Method for Flow of Grout for Preplaced-Aggregate Concrete (Flow Cone Method),”
- The grout slurry shall achieve initial set in less than 4 hours. The grout slurry shall not be allowed to carry traffic until which time it has set to the satisfaction of the Engineer; or until which set time, as determined by ASTM C 266, “Time of Setting of Hydraulic Cement Paste by Gillmore Needles,” has been reached, and
- The 7 day compressive strength of the grout slurry shall not be less than 200 psi.

8.4 Procedures. Underslab grouting shall be completed after stressing of the post-tensioning tendons, but not more than 7 days after placement of the precast panels. The Engineer may require grouting to be completed prior to opening the pavement to traffic if significant voids are observed during panel placement. Underslab grouting may be completed prior to tendon grouting only if underslab grouting will not interfere with tendon grouting.

Slab edges shall be backfilled or sealed to prevent grout leakage from beneath the slab during underslab grouting. Likewise, the bottom of all expansion joints shall be sealed prior to underslab grouting to prevent grout leakage into the joints. The sealant material shall be compressible such that it will not inhibit free movement of the expansion joints.

Underslab grouting shall require minimal pressure to force the grout beneath the pavement slab. Under no circumstances should underslab grouting cause the pavement slab to lift. Grout shall be pumped into each underslab grout port of each panel. Grout shall be pumped until it flows out of an adjacent grout port or until the line pressure on the grout pump reaches 5 psi. Grouting pressure of 5 psi may be exceeded if the Contractor can demonstrate the slab lift is not occurring at higher pressures.

The fluidity of the grout shall be checked at the beginning of each grouting operation and after each time the grout pump is flushed. Grout fluidity shall be checked in accordance with ASTM C 939, “Standard Method for Flow of Grout for Preplaced-Aggregate Concrete (Flow Cone Method).” Fluidity shall be adjusted to achieve the necessary flow requirements to achieve full undersealing. If excessive bleeding of the grout is observed, the Engineer may require the Contractor to adjust the grout mixture.

8.5 Grouting Problems. If grout is observed leaking into an expansion joint, from beneath the slab, or out of an adjacent port, grouting shall be stopped and grout will be pumped into the nearest intermediate port. Any grout that flows into an expansion joint shall be flushed from the

expansion joint immediately. Any grout that sets up in an expansion joint shall be removed at the Contractor's expense.

8.6 Cleanup. Upon completion of grouting, recesses in the surface of the panels at the grout ports shall be filled with an approved mortar and finished flush with the surface of the surrounding pavement. Any grout that flows onto the finished surface of the pavement during the grouting operation shall be immediately flushed from the surface. Any residual grout which hardens on the pavement surface shall be removed using an approved technique to the satisfaction of the Engineer at the expense of the Contractor.

9.0 Finished Surface. The finished pavement surface shall be tested for smoothness by profilographing in accordance with Section 502.8. Corrective action to improve the profile index shall be accomplished by diamond grinding. Grinding shall be performed with abrasive grinding equipment, designed specifically for grinding pavement surfaces to close tolerances, utilizing diamond cutting blades with a minimum cutting width of 36 inches. Such equipment shall accurately establish slope elevations and profile grade controls. The final ground surface shall not be smooth or polished.

10.0 Method of Measurement.

Measurement will be made by individual units of each panel, complete in place, in the finished pavement. The concrete, reinforcing bars, prestressing and post-tensioning tendons, anchorages and accessories, grout, and other incidentals will be considered a single unit.

11.0 Basis of Payment.

Accepted prestressed post-tensioned panels will be paid for at the contract unit price.

APPENDIX B

AGENDA FROM MODOT/FHWA SHOWCASING WORKSHOP

Archived



MoDOT/FHWA Precast Prestressed Concrete Pavement Showcasing Workshop

“National Rollout of Precast Prestressed Concrete Pavement (PPCP)
Technology”

August 15-16, 2006

AGENDA

OBJECTIVES

- To showcase the precast prestressed concrete pavement constructed on I-57.
- To discuss how MoDOT can utilize PPCP technology.
- To familiarize paving contractors, precasters, state DOTs, and others with PPCP technology.

AUDIENCE

- MoDOT
- Contractors and Industry
- FHWA and DOTs from other states

WORKSHOP LOCATION

Best Western Coach House Inn – Sikeston, Missouri

PRECAST PANEL INSTALLATION DEMONSTRATION

Transportation provided from hotel

SITE VISIT TO I-57 PRECAST PAVEMENT INSTALLATION

Transportation provided from hotel



WORKSHOP SCHEDULE

Moderator: John Donahue (MoDOT)

Day 1 (Tues., Aug. 15)

- 10:30 a.m. Session 1 – MoDOT Perspective (*David Nichols*)
- 10:50 a.m. Session 2 – FHWA Perspective (*Tommy Beatty*)
- 11:10 a.m. Session 3 – Background of FHWA Precast Pavement Demonstration Projects (*Sam Tyson*)
- 11:30 a.m. Session 4 – I-57 Project Background and Design (*Eric Krampf*)
- 12:00 p.m. Lunch and Presentation on the AASHTO TIG for the Precast Concrete Pavement systems (*Tim LaCoss*)
- 1:30 p.m. Session 5 – Design and Construction Considerations (*David Merritt*)
- 1:50 p.m. Session 6 – Project Instrumentation and Monitoring (*Dr. Gopalaratnam*)
- 2:20 p.m. Session 7 – Panel Fabrication (*Andrew Maybee*)
- 2:50 p.m. Session 8 – Pavement Construction (*John Donahue*)
- 3:20 p.m. Session 9 – Highways for Life Perspective
- 3:30 p.m. *Break*
- 3:45 p.m. Roundtable Discussion
- 5:00 p.m. *Adjourn*

Day 2 (Wed., Aug. 16)

- 8:30 a.m. Bus leaves hotel for installation demonstration at MoDOT
- 9:00 a.m. Panel installation demonstration
- 11:00 a.m. Bus leaves for I-57 project site
- 11:30 a.m. Walking tour of I-57 project site
- 12:00 p.m. Bus returns to hotel
- 12:30 p.m. *Adjourn*