

See discussions, stats, and author profiles for this publication at: <https://www.researchgate.net/publication/235173725>

# Development of Noise Dose/Visitor Response Relationships for the National Parks Overflight Rule: Bryce Canyon National Park Study

Article · July 1998

CITATIONS

9

READS

50

5 authors, including:



**Chris Roof**

U.S. Department of Transportation

21 PUBLICATIONS 82 CITATIONS

SEE PROFILE



**Amanda S. Rapoza**

U.S. Department of Transportation

18 PUBLICATIONS 80 CITATIONS

SEE PROFILE

Some of the authors of this publication are also working on these related projects:



Integrated Noise Model (INM) [View project](#)



Aviation Environmental Design Tool (AEDT) [View project](#)

FAA-AEE-98-  
DOT-VNTSC-FAA-98-6  
Office of Environment and Energy  
Washington, D.C. 20591

**Development of  
Noise Dose/Visitor Response  
Relationships for the  
National Parks Overflight Rule:  
Bryce Canyon National Park Study**

**July 1998  
Final Report**

**DISTRIBUTION STATEMENT A**

Approved for public release;  
Distribution Unlimited

**19981026 028**



**U.S. Department of Transportation  
Federal Aviation Administration**

**NOTICE**

This document is disseminated under the sponsorship of the Department of Transportation in the interest of information exchange. The United States Government assumes no liability for its contents or use thereof.

**NOTICE**

The United States Government does not endorse products or manufacturers. Trade or manufacturers' names appear herein solely because they are considered essential to the objective of this report.

# REPORT DOCUMENTATION PAGE

Form Approved  
OMB No. 0704-0188

Public reporting burden for this collection of information is estimated to average 1 hour per response, including the time for reviewing instructions, searching existing data sources, gathering and maintaining the data needed, and completing and reviewing the collection of information. Send comments regarding this burden estimate or any other aspect of this collection of information, including suggestions for reducing this burden, to Washington Headquarters Services, Directorate for Information Operations and Reports, 1215 Jefferson Davis Highway, Suite 1204, Arlington, VA 22202-4302, and to the Office of Management and Budget, Paperwork Reduction Project (0704-0188), Washington, DC 20503.

1. AGENCY USE ONLY (Leave blank)		2. REPORT DATE July 1998	3. REPORT TYPE AND DATES COVERED Final Report May 1997 - July 1998	
4. TITLE AND SUBTITLE Development of Noise Dose/Visitor Response Relationships for the National Parks Overflight Rule: Bryce Canyon National Park Study			5. FUNDING NUMBERS FA865/A8012	
6. AUTHOR(S) Gregg G. Fleming <sup>1</sup> , Christopher J. Roof <sup>1</sup> , Amanda S. Rapoza <sup>1</sup> , David R. Read <sup>1</sup> , Joel C. Webster <sup>2</sup> , Peggy C. Liebman <sup>2</sup> , Paul J. Valihura <sup>3</sup> , Kristin C. Lewis <sup>3</sup> , Paul D. Schomer <sup>4</sup> , Jake A. Plante <sup>5</sup> , Julie A. Draper <sup>5</sup>				
7. PERFORMING ORGANIZATION NAME(S) AND ADDRESS(ES) 1. U.S. Department of Transportation Research and Special Programs Administration John A. Volpe National Transportation Systems Center Acoustics Facility, DTS-34 Kendall Square Cambridge, MA 02142-1093			8. PERFORMING ORGANIZATION REPORT NUMBER DOT-VNTSC-FAA-98-6	
9. SPONSORING/MONITORING AGENCY NAME(S) AND ADDRESS(ES) 5. U.S. Department of Transportation Federal Aviation Administration Office of Environment and Energy, AEE-120 800 Independence Avenue Washington, D.C. 20591			10. SPONSORING/MONITORING AGENCY REPORT NUMBER FAA-AEE-98-01	
11. SUPPLEMENTARY NOTES 2. Chilton Research Services 201 King of Prussia Road Radnor, PA 19809 3. Environmental Transportation Consultants 38 Chauncy Street, Suite 302 Boston, MA 02111 4. US Army, CERL 2902 Farber Drive P.O. Box 9005 Champaign, IL 61821				
12a. DISTRIBUTION/AVAILABILITY STATEMENT This document is available to the public through the National Technical Information Service, Springfield, VA 22161			12b. DISTRIBUTION CODE	
13. ABSTRACT (Maximum 200 words) The Federal Aviation Administration's Office of Environment and Energy, with the assistance of the Acoustics Facility at the United States Department of Transportation's John A. Volpe National Transportation Systems Center is conducting research in support of the National Parks Overflight Rule (National Rule). The foundation of the research program for the National Rule is the performance of noise dose/visitor response (dose-response) studies in several National Parks. This document summarizes the results of a dose-response study conducted along two separate segments of a frontcountry, short-hike trail at Bryce Canyon National Park during the period August 19 through 27, 1997.				
14. SUBJECT TERMS Noise, Noise Dose, Dose-Response, Schultz Curve, Survey, Aircraft Noise, National Parks, Low-Level Noise, Noise Prediction, Noise Model, Integrated Noise Model			15. NUMBER OF PAGES 256	
			16. PRICE CODE	
17. SECURITY CLASSIFICATION OF REPORT Unclassified	18. SECURITY CLASSIFICATION OF THIS PAGE Unclassified	19. SECURITY CLASSIFICATION OF ABSTRACT Unclassified	20. LIMITATION OF ABSTRACT Unlimited	

NSN 7540-01-280-5500

Standard Form 298 (Rev. 2-89)  
Prescribed by ANSI Std. Z39-18  
298-102

**DTIC QUALITY INSPECTED-4**

## METRIC/ENGLISH CONVERSION FACTORS

ENGLISH TO METRIC	METRIC TO ENGLISH
<p style="text-align: center;"><b>LENGTH (APPROXIMATE)</b></p> <p>1 inch (in) = 2.5 centimeters (cm)                      1 foot (ft) = 30 centimeters (cm)                      1 yard (yd) = 0.9 meter (m)                      1 mile (mi) = 1.6 kilometers (km)</p>	<p style="text-align: center;"><b>LENGTH (APPROXIMATE)</b></p> <p>1 millimeter (mm) = 0.04 inch (in)                      1 centimeter (cm) = 0.4 inch (in)                      1 meter (m) = 3.3 feet (ft)                      1 meter (m) = 1.1 yards (yd)                      1 kilometer (km) = 0.6 mile (mi)</p>
<p style="text-align: center;"><b>AREA (APPROXIMATE)</b></p> <p>1 square inch (sq in, in<sup>2</sup>) = 6.5 square centimeters (cm<sup>2</sup>)                      1 square foot (sq ft, ft<sup>2</sup>) = 0.09 square meter (m<sup>2</sup>)                      1 square yard (sq yd, yd<sup>2</sup>) = 0.8 square meter (m<sup>2</sup>)                      1 square mile (sq mi, mi<sup>2</sup>) = 2.6 square kilometers (km<sup>2</sup>)                      1 acre = 0.4 hectare (ha) = 4,000 square meters (m<sup>2</sup>)</p>	<p style="text-align: center;"><b>AREA (APPROXIMATE)</b></p> <p>1 square centimeter (cm<sup>2</sup>) = 0.16 square inch (sq in, in<sup>2</sup>)                      1 square meter (m<sup>2</sup>) = 1.2 square yards (sq yd, yd<sup>2</sup>)                      1 square kilometer (km<sup>2</sup>) = 0.4 square mile (sq mi, mi<sup>2</sup>)                      10,000 square meters (m<sup>2</sup>) = 1 hectare (ha) = 2.5 acres</p>
<p style="text-align: center;"><b>MASS - WEIGHT (APPROXIMATE)</b></p> <p>1 ounce (oz) = 28 grams (gm)                      1 pound (lb) = .45 kilogram (kg)                      1 short ton = 2,000 pounds (lb) = 0.9 tonne (t)</p>	<p style="text-align: center;"><b>MASS - WEIGHT (APPROXIMATE)</b></p> <p>1 gram (gm) = 0.036 ounce (oz)                      1 kilogram (kg) = 2.2 pounds (lb)                      1 tonne (t) = 1,000 kilograms (kg) = 1.1 short tons</p>
<p style="text-align: center;"><b>VOLUME (APPROXIMATE)</b></p> <p>1 teaspoon (tsp) = 5 milliliters (ml)                      1 tablespoon (tbsp) = 15 milliliters (ml)                      1 fluid ounce (fl oz) = 30 milliliters (ml)                      1 cup (c) = 0.24 liter (l)                      1 pint (pt) = 0.47 liter (l)                      1 quart (qt) = 0.96 liter (l)                      1 gallon (gal) = 3.8 liters (l)                      1 cubic foot (cu ft, ft<sup>3</sup>) = 0.03 cubic meter (m<sup>3</sup>)                      1 cubic yard (cu yd, yd<sup>3</sup>) = 0.76 cubic meter (m<sup>3</sup>)</p>	<p style="text-align: center;"><b>VOLUME (APPROXIMATE)</b></p> <p>1 milliliter (ml) = 0.03 fluid ounce (fl oz)                      1 liter (l) = 2.1 pints (pt)                      1 liter (l) = 1.06 quarts (qt)                      1 liter (l) = 0.26 gallon (gal)                      1 cubic meter (m<sup>3</sup>) = 36 cubic feet (cu ft, ft<sup>3</sup>)                      1 cubic meter (m<sup>3</sup>) = 1.3 cubic yards (cu yd, yd<sup>3</sup>)</p>
<p style="text-align: center;"><b>TEMPERATURE (EXACT)</b></p> <p style="text-align: center;"><math>^{\circ}\text{C} = 5/9(^{\circ}\text{F} - 32)</math></p>	<p style="text-align: center;"><b>TEMPERATURE (EXACT)</b></p> <p style="text-align: center;"><math>^{\circ}\text{F} = 9/5(^{\circ}\text{C}) + 32</math></p>

### QUICK INCH-CENTIMETER LENGTH CONVERSION

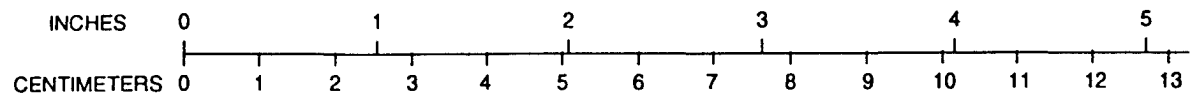

### QUICK FAHRENHEIT-CELSIUS TEMPERATURE CONVERSION

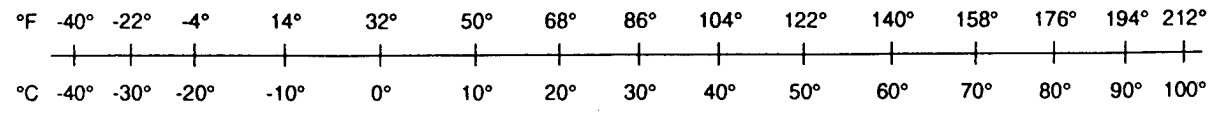

For more exact and or other conversion factors, see NIST Miscellaneous Publication 286, Units of Weights and Measures. Price \$2.50. SD Catalog No. C13 10286.

Updated 8/1/96

---

## ACKNOWLEDGMENTS

The authors of this report wish to express their sincere gratitude to all who helped make this a successful study. The coordination and support provided by the National Park Service proved invaluable. In particular, we would like to thank Wes Henry (Washington, D.C.), Rick Ernenwein (Denver, Colorado), Fred Fagergren (Bryce Superintendent), Richard Bryant (Bryce Chief of Resource Management), and Doug Neighbor, (Bryce Acting Chief of Resource Management), without whom the project would not have been possible. Additionally, the experience and insight provided in the field by Bob Baumgartner of Hagler Bailly Research Services, Inc. and Dick Horonjeff of Harris Miller Miller and Hanson Inc. (HMMH) further enabled a successful study. The historical data provided by Nick Miller and Grant Anderson of HMMH also allowed for comparative analysis with similar data collected previously in the parks.



---

## PREFACE

This document, entitled *Development of Noise Dose/Visitor Response Relationships for the National Parks Overflight Rule: Bryce Canyon National Park Study*, begins with an executive summary and glossary. Section 1 presents a general overview, including the objectives of the study and background of the **dose-response\*** concept. Section 2 describes the park/site selection process, and contains a detailed description of the study area. Section 3 discusses instrumentation, both the acoustic-related instrumentation and the survey-related instrumentation. Section 4 presents the measurement procedures employed in the field. Section 5 discusses reduction of both the acoustic and survey-related data, as well as the methodology used for computing the various noise-related descriptors and for developing the master database used in the analysis. Section 6 describes the data analysis and presents the results of the study. Section 7 presents related references.

Appendix A lists the members of the research team along with their responsibilities. Appendix B contains information specific to the low-level noise measurement system developed by the Volpe Center in support of this study. Appendix C presents the questionnaire used by the survey team. Appendix D presents an analysis of ambient sound levels in Bryce Canyon National Park. Appendix E presents a statistical summary of the responses to the questionnaire. Appendix F presents a statistical summary of the dose-related data, including a presentation of the variability in the observed acoustic doses.

---

\* Terms contained in the Glossary are highlighted when they first appear in the main body of this document.

---





---

**TABLE OF CONTENTS**

<u>Section</u>	<u>Page</u>
1. Introduction .....	1
1.1 Objectives .....	1
1.2 Background and Overview of Dose-Response Concept .....	2
1.3 Implementation of Dose-Response Concept .....	5
2. Selection and Description of Study Area .....	7
2.1 Selection Criteria .....	8
2.2 Scoping Visit .....	12
2.3 Description of Selected Study Area .....	14
2.4 Noise Measurement and Interview Sites .....	16
2.5 Research Team .....	17
3. Instrumentation .....	23
3.1 Acoustic-Related Instrumentation .....	23
3.1.1 Microphone, Preamplifier and Windscreen .....	23
3.1.2 Sound Level Meter (SLM) .....	24
3.1.3 Digital Audio Tape (DAT) Recorder .....	25
3.1.4 Acoustic Observer Log .....	26
3.1.5 Meteorological Instrumentation .....	29
3.1.6 Other Instrumentation .....	29
3.2 Survey-Related Instrumentation .....	29
3.2.1 Communication .....	30
3.2.2 Questionnaire .....	30

---

**TABLE OF CONTENTS (Continued)**

<u>Section</u>	<u>Page</u>
4. Field Measurement Procedures .....	33
4.1 Acoustic Team Procedures .....	33
4.1.1 Determination of Representative Microphone Location .....	33
4.1.2 Personnel Requirements .....	37
4.1.3 Measurement System Setup .....	37
4.1.4 Measurements .....	42
4.1.5 Measurement System Dismantling .....	46
4.2 Survey Team Procedures .....	47
4.2.1 Visitor Identification .....	47
4.2.2 Visitor Greeting and Screening .....	48
4.2.3 Respondent Interview .....	49
5. Data Reduction .....	51
5.1 Acoustic Data Reduction .....	51
5.1.1 Acoustic Data Cleaning and Editing .....	53
5.1.1.1 Acoustic Data .....	53
5.1.1.2 Acoustic Observer Log Data .....	53
5.1.1.3 Meteorological Data .....	54
5.1.2 Computing Respondent Doses .....	54
5.1.2.1 Event-Based Descriptors .....	56
5.1.2.2 Time-Based Descriptors .....	58
5.1.2.3 Level-Based Descriptors .....	61

---

---

**TABLE OF CONTENTS (Continued)**

<u>Section</u>	<u>Page</u>
5.2 Survey Data Reduction .....	67
5.2.1 Survey Editing and Data Entry .....	67
5.2.2 Survey Data Cleaning .....	68
5.3 Master Database .....	68
6. Data Analysis and Results .....	71
6.1 Framework .....	71
6.2 Exploratory Analysis for QGT and QGTX Combined .....	73
6.2.1 Correlation Among Acoustic Descriptors .....	73
6.2.2 Outlier Analysis .....	74
6.2.3 Non-Zero Intercept .....	75
6.3 Acoustic Model .....	76
6.3.1 Logistic Regression Analysis .....	76
6.3.2 Bootstrapped Confidence Intervals .....	95
6.3.3 Model Reliability .....	96
6.3.4 Overall Performance of Acoustic Descriptors .....	100
6.3.5 Noticeability Factor Sensitivity Test .....	101
6.4 Covariate Model .....	103
6.4.1 Logistic Regression Analysis .....	105
6.5 Comparison with Previous NPS Study .....	109
7. References .....	111

---

---

**TABLE OF CONTENTS (Continued)**

<u>Section</u>	<u>Page</u>
Appendix A: Research Team Members and Responsibilities .....	115
Appendix B: <u>Volpe Low-Amplitude Recording Equipment System Reference</u> .....	123
B.1 Instrumentation List .....	124
B.2 Configuration .....	125
B.3 Operation .....	127
B.4 System Performance Limits .....	133
B.5 Power Requirements and Considerations .....	134
B.6 LDL Model 820 SLM Special Calibration .....	136
B.7 NPS Two-Stage Windscreen and Mount Instructions .....	139
Appendix C: Questionnaire .....	147
Appendix D: Analysis of Ambient Sound Levels .....	159
D.1 Ambient Sound Level Definitions .....	160
D.2 Average Ambient Sound Level Data .....	161
D.3 Relationships Between Ambient Sound Level and Wind Speed .....	162
Appendix E: Summary of Responses .....	169
Appendix F: Summary of Acoustic Doses .....	213
Index .....	225

---

**LIST OF FIGURES**

<u>Figure</u>	<u>Page</u>
1 Illustration of the Dose-Response Concept .....	6
2 Bryce Canyon National Park (BCNP) .....	9
3 Nominal Helicopter Flight Tracks in BCNP .....	19
4 Queen's Garden Trail .....	21
5 Automated Acoustic Observer Log .....	27
6 Manual Acoustic Observer Log .....	28
7 Location of Proposed and Temporary Measurement Systems .....	34
8 Microphone/Preamplifier/Windscreen Arrangement at BCNP .....	39
9 Acoustic Observer Location at BCNP .....	40
10 TAMS System at BCNP .....	41
11 Flow for Processing of Dose-Response Data .....	52
12 Dose Calculation Methodology .....	55
13 Computing Percent Time Noticeable (%TN) .....	60
14 Computing Ambient-Corrected Aircraft Sound Levels .....	64
15 NUM <sub>ac</sub> vs. Percent Annoyed, QGT .....	81
16 NUM <sub>ac</sub> vs. Percent Annoyed, QGTX .....	81
17 NUM <sub>ac/hr</sub> vs. Percent Annoyed, QGT .....	82
18 NUM <sub>ac/hr</sub> vs. Percent Annoyed, QGTX .....	82
19 NUM <sub>loud</sub> vs. Percent Annoyed, QGT .....	83
20 NUM <sub>loud</sub> vs. Percent Annoyed, QGTX .....	83
21 %TA vs. Percent Annoyed, QGT .....	84

---

---

**LIST OF FIGURES (Continued)**

<u>Figure</u>	<u>Page</u>
22 %TA vs. Percent Annoyed, QGTX .....	84
23 %TA <sub>w/oJet</sub> vs. Percent Annoyed, QGT .....	85
24 %TA <sub>w/oJet</sub> vs. Percent Annoyed, QGTX .....	85
25 %TN vs. Percent Annoyed, QGT .....	86
26 %TN vs. Percent Annoyed, QGTX .....	86
27 TAA vs. Percent Annoyed, QGT .....	87
28 TAA vs. Percent Annoyed, QGTX .....	87
29 %TAA vs. Percent Annoyed, QGT .....	88
30 %TAA vs. Percent Annoyed, QGTX .....	88
31 L <sub>Aeq,Tac</sub> vs. Percent Annoyed, QGT .....	89
32 L <sub>Aeq,Tac</sub> vs. Percent Annoyed, QGTX .....	89
33 L <sub>Aeq,Tresp</sub> vs. Percent Annoyed, QGT .....	90
34 L <sub>Aeq,Tresp</sub> vs. Percent Annoyed, QGTX .....	90
35 L <sub>Aeq,1h</sub> vs. Percent Annoyed, QGT .....	91
36 L <sub>Aeq,1h</sub> vs. Percent Annoyed, QGTX .....	91
37 ΔL <sub>AE,Tac</sub> vs. Percent Annoyed, QGT .....	92
38 ΔL <sub>AE,Tac</sub> vs. Percent Annoyed, QGTX .....	92
39 ΔL <sub>AE,Tadj</sub> vs. Percent Annoyed, QGT .....	93
40 ΔL <sub>AE,Tadj</sub> vs. Percent Annoyed, QGTX .....	93
41 L <sub>ASmx</sub> vs. Percent Annoyed, QGT .....	94
42 L <sub>ASmx</sub> vs. Percent Annoyed, QGTX .....	94

---

---

**LIST OF FIGURES (Continued)**

<u>Figure</u>		<u>Page</u>
43	B&K Very Low Level Microphone System (VLLMS) .....	143
44	NPS Two-Stage Windscreen and Microphone Mount .....	144
45	VOLARE Instrumentation Block Diagram .....	145
46	Traditional Ambient $L_{Aeq}$ and Wind Speed By Time of Day .....	163
47	Existing Ambient $L_{Aeq}$ and Wind Speed By Time of Day .....	163
48	Natural Ambient $L_{Aeq}$ and Wind Speed By Time of Day .....	164
49	NPS Ambient $L_{Aeq}$ and Wind Speed By Time of Day .....	164
50	Traditional Ambient $L_{Aeq}$ vs. Wind Speed .....	166
51	Existing Ambient $L_{Aeq}$ vs. Wind Speed .....	166
52	Natural Ambient $L_{Aeq}$ vs. Wind Speed .....	167
53	NPS Ambient $L_{Aeq}$ vs. Wind Speed .....	167
54	Distribution- $NUM_{ac}$ .....	215
55	Distribution- $NUM_{ac/hr}$ .....	215
56	Distribution- $NUM_{loud}$ .....	216
57	Distribution- %TA .....	216
58	Distribution- %TA <sub>w/oJet</sub> .....	217
59	Distribution- %TN .....	217
60	Distribution- TAA .....	218
61	Distribution- %TAA .....	218
62	Distribution- $L_{Aeq,Tac}$ .....	219
63	Distribution- $L_{Aeq,Tresp}$ .....	219

---



---

**LIST OF FIGURES (Continued)**

<u>Figure</u>		<u>Page</u>
64	Distribution- $L_{Aeq,1h}$ .....	220
65	Distribution- $\Delta L_{AE,Tac}$ .....	220
66	Distribution- $\Delta L_{AE,Tadj}$ .....	221
67	Distribution- $L_{ASmx}$ .....	221

---

**LIST OF TABLES**

<u>Table</u>		<u>Page</u>
1	Preliminary Data on Aircraft and Visitor Volume at Queen’s Garden Trail .....	15
2	Determination of Representative Microphone Location, Queen’s Garden Trail (QGT) .....	35
3	Determination of Representative Microphone Location, Queen’s Garden Trail Extended (QGTX) .....	36
4	Analysis of Responses to Question 16 and Question 9 .....	73
5	Pearson Correlations of Acoustic Descriptors .....	74
6	Logistic Regression Results, QGT .....	78
7	Logistic Regression Results, QGTX .....	79
8	Stability Test Using Bootstrapping, QGT .....	97
9	Stability Test Using Bootstrapping, QGTX .....	98
10	Reliability Scores for Acoustic Descriptors .....	99
11	Overall Performance of Acoustic Descriptors .....	101
12	%TN Sensitivity Test .....	102
13	Covariate Analysis Summary .....	104
14	Logistic Regression Results, QGT With Covariates .....	106
15	Logistic Regression Results, QGTX With Covariates .....	107
16	Regression Coefficients for QGT and Haleakala .....	110
17	System Performance Limits .....	133
18	Summary of BCNP Ambient Sound Levels .....	162
19	Summary of BCNP Wind Effect on Ambient Sound Levels .....	165
20	Dose Statistics .....	222

---



---

## EXECUTIVE SUMMARY

This document summarizes the findings of a study investigating the effects of aircraft overflights on Bryce Canyon National Park (BCNP) visitors. Over 900 visitor interviews and simultaneous acoustical and meteorological measurements were collected during the period of August 19 through 27, 1997. These data and results constitute the largest single aircraft noise dose-response data set collected to date in the National Parks' environment and will be used to supplement other dose-response studies in the development of a National Rule for National Park Overflights (National Rule).

Located in southwestern Utah, Bryce Canyon National Park was initially recommended by the National Park Service (NPS) as a potential site for dose-response work in support of the National Rule. An initial scoping visit was made to the park in June 1997. As a result of this visit, and the subsequent collection of preliminary visitor and overflight information by BCNP personnel, it was decided that the Queen's Garden Trail was well suited for the study, with the rim trail between Sunrise and Sunset Points reserved as a backup. Concurrent with the selection of the study area, the John A. Volpe Center National Transportation Systems Center (Volpe Center) developed detailed field-data-collection procedures and finalized the instrumentation configuration for the study.

As part of the planning process, a team was assembled including members from the Federal Aviation Administration's (FAA) Office of Environment and Energy (AEE-120), the Volpe Center Acoustics Facility, the US Army Construction Engineering Research Laboratory, Environmental Transportation Consultants, and Chilton Research Services. Subsequently, both the *National Parks Overflights Rule Draft Research Plan*<sup>1</sup> (Master Plan) and the *Study Design for Bryce Canyon National Park*<sup>2</sup> (Study Design) were produced and disseminated. In developing these documents, efforts were made to: (1) ensure consistency with previous dose-response work performed in the National Parks; and (2)

---

improve upon methodologies and techniques wherever possible. Following acceptance of the Study Design by the NPS, the Bryce study was formally undertaken in August 1997.

The study site utilized was the Queen's Garden Trail, a "short hike, frontcountry" trail that begins on the rim of the canyon and descends more than 320 feet to the Queen's Garden. The data collected at this site greatly improve upon previous park dose-response data in that the uncertainty (i.e., statistical error) has been significantly reduced. This can be largely attributed to the large variation in doses to which respondents were subjected in BCNP. For example, respondents were subjected to doses from helicopters, propeller and jet aircraft, including a wide range of actual sound levels and durations (i.e., time during which aircraft were audible). Such a large variation in doses was not observed in previous park studies. The reason for such a wide variation in doses is twofold: (1) two study areas, of different length, were utilized along the Queen's Garden Trail (Queen's Garden and Queen's Garden Extended), thus increasing the possible range of observed dose values; and (2) there is a significant amount of varying air tour traffic over the park flying a wide range of flight tracks.

The findings of this study indicate that approximately one-quarter of the survey respondents expressed annoyance as a result of overflight noise, which included contributions from high-altitude jets, General Aviation, and air tour operations at BCNP. The level of visitor annoyance is mediated by the phenomenon of "base level of annoyance", indicating an apparent predisposition by a certain percentage of visitors who expressed annoyance yet in effect experienced no noise from overflights. It is also interesting to note that visitors as a whole reported a number of other factors besides overflight noise as their primary concern (e.g., the crowds/other people, trail conditions, weather, seeing footprints or people off the trail, lack of restroom facilities).

---

---

The relationship between visitor annoyance due to aircraft overflights and a total of fourteen time-, level- and event-based descriptors was investigated through statistical analyses for this study. In particular, three descriptors appear to model park visitor annoyance at BCNP better than others; in order of performance they are: change in sound exposure level ( $\Delta L_{AE,Tadj}$ ); aircraft percent time audible (%TA), and aircraft percent time audible without the inclusion of high-altitude jet aircraft (%TA<sub>w/ojet</sub>). The predicted models developed with the equivalent sound level family of descriptors also performed quite well. Additionally, the effect of several covariates, including U.S. citizenship, gender, group-size, and presence of children was investigated. The citizenship covariate was not found to significantly improve the predictive abilities of the models. The other covariates were found to have a positive effect. It is recommended, however, that further research be undertaken before the overall usefulness and practical application of these covariates can be determined with respect to the National Rule.

Logistic regressions were developed for all data collected. Multiple statistical models were developed and the effect of various mediators analyzed. The end result of this study is a set of dose-response relationships (curves) which may be used to provide guidance in important policy decisions with respect to park overflights. Further, there are now field-tested and proven methodologies for the collection and analysis of dose-response data in the National Parks.

As a result of the analyses performed in support of this study, improvements are planned for future dose-response work in the National Parks, including enhancements to the questionnaire and improving the portability of field instrumentation. Efforts are also being undertaken to shorten the duration needed for administering the questionnaire, as well as to enhance the quality of the specific data collected with the questionnaire.

Knowledge gained from this study has also aided in the development of *Draft Guidelines for the Measurement and Assessment of Low-Level Ambient Noise*.<sup>3</sup> This draft document presents detailed procedures for characterizing the ambient sound level environment in low-noise areas such as National Parks. Application of these guidelines will result in the collection of consistent, repeatable ambient sound level data in these environments. Specifically, it discusses in detail, issues related to determining acoustically unique categories for low-level ambient sound environments, appropriate instrumentation and procedures required for measurements, and various methodologies for data analysis. Accordingly, in addition to the analysis of dose-related acoustical data for BCNP, an analysis of ambient sound levels at the park is included in the current study.

With respect to advancing the knowledge-base in preparation for a National Rule, it is recommended that data of similar quality to those measured for this study be collected for both scenic overlook locations and **backcountry**, longer-hike locations within the National Parks. Given dose-response data for all these scenarios, policy-makers at both the FAA and NPS should have the tools necessary to make informed decisions related to park overflights.

---

## GLOSSARY

This section presents pertinent terminology used throughout the document. These terms are highlighted with boldface type when they first appear herein. Note: Definitions are generally consistent with those of the American National Standards Institute (ANSI)<sup>4</sup> and References 5 through 7.

<b>Term/Acronym</b>	<b>Definition/Full Name</b>
A-Weighted	A weighting methodology used to account for changes in human hearing sensitivity as a function of frequency. The A-weighting network de-emphasizes the high (6.3 kHz and above) and low (below 1 kHz) frequencies, and emphasizes the frequencies between 1 kHz and 6.3 kHz, in an effort to simulate the relative response of human hearing.
Acoustic Energy	Commonly referred to as the mean-square sound-pressure ratio, sound energy, or just plain energy, acoustic energy is the squared sound pressure (often frequency weighted), divided by the squared reference sound pressure of 20 $\mu$ Pa, the threshold of human hearing. It is arithmetically equivalent to $10^{\text{LEV}-10}$ , where LEV is the sound level, expressed in decibels.
Ambient Noise	The composite, all-inclusive sound that is associated with a given environment (usually from many sound sources), excluding the analysis system's electrical noise and the sound source of interest, which in most cases presented herein is aircraft. See Appendix D for a more detailed discussion of ambient noise.
Annoyance	The typical response of humans to aircraft noise is annoyance. The response is complex and, considered on an individual basis, widely varying for any given noise level. Frankel defines annoyance as "a psychological response to a given noise exposure". It may result from speech interference, but can arise in a variety of other circumstances.
Audibility	The ability of a human observer to detect an acoustic signal in the presence of noise (e.g., aircraft detection in the presence of ambient noise).

---



Backcountry	Any location in a study area subject to minimal human activity, such as designated wilderness areas or restricted, hiking and camping areas (destinations generally located 1 hour or more from frontcountry locations).
Commercial tour and sightseeing aircraft	Any aircraft operation with a primary purpose of providing scenic views of an area and whose primary objective is passenger revenue.
Day-Night Average Sound Level	(DNL, denoted by the symbol $L_{dn}$ ): A 24-hour time-averaged sound exposure level (see definition below), adjusted for average-day sound source operations. In the case of aircraft noise, a single operation is equivalent to a single aircraft operation. The adjustment includes a 10 dB penalty for operations occurring between 2200 and 0700 hours, local time.
Decibel	(abbreviated dB): The decibel is a unit of measure of sound level. The number of decibels is calculated as ten times the base-10 logarithm of the squared sound pressure (often frequency weighted), divided by the squared reference sound pressure of 20 $\mu$ Pa, the threshold of human hearing.
Detectability	The ability of a given signal to be detected in the presence of some type of noise (not necessarily related to audible signals, e.g., the detection of a radio signal in the presence of noise).
Dose-response	Quantitative dose data (in this case noise data measured in the field), correlated with qualitative response data (in this case visitors' responses to a questionnaire).

<p>Equivalent Sound Level</p>	<p>(TEQ, denoted by the symbol <math>L_{AeqT}</math>, also often referred to as LEQ): Ten times the base-10 logarithm of the time-mean-square, instantaneous A-weighted sound pressure, during a stated time interval, T (where <math>T=t_2-t_1</math>, in seconds), divided by the squared reference sound pressure of 20 <math>\mu</math>Pa, the threshold of human hearing.</p> <p><math>L_{AeqT}</math> is related to <math>L_{AE}</math> by the following equation:</p> $L_{AeqT} = L_{AE} - 10 \times \log_{10}(t_2-t_1) \quad (dB)$ <p>Where <math>L_{AE}</math> = Sound exposure level (see definition below).</p> <p>The <math>L_{Aeq}</math> for a specific time interval, T1 (expressed in seconds), can be normalized to a longer time interval, T2, via the following equation:</p> $L_{AeqT2} = L_{AeqT1} - 10 \times \log_{10}(T2 \div T1) \quad (dB)$
<p>Frontcountry</p>	<p>Any location in a study area subject to substantial human activity, such as scenic overlooks, visitor centers, recreation areas, or destinations reached by short hikes (1 hour or less).</p>
<p>INM</p>	<p>Integrated Noise Model, the noise modeling system designed and used by the FAA, as well as over 500 users worldwide, for noise assessment and prediction.</p>
<p>Low-Level Noise Environment</p>	<p>An outdoor sound environment typical of a remote suburban setting, or a rural or public lands setting. Characteristic average day-night sound levels (DNL, represented by the symbol <math>L_{dn}</math>) would generally be less than 45 dB, and the everyday sounds of nature, e.g., wind blowing in trees and birds chirping would be a prominent contributor to the DNL.</p>

Maximum Sound Level	(MXFA or MXSA, denoted by the symbol $L_{AFmx}$ or $L_{ASmx}$ , respectively): The maximum, A-weighted sound level associated with a given event (see figure with definition of sound exposure level). Fast exponential response ( $L_{AFmx}$ ) and Slow exponential response ( $L_{ASmx}$ ) characteristics effectively damp a signal as if it were to pass through a low-pass filter with a time constant ( $\tau$ ) of 125 and 1000 milliseconds, respectively.
Natural quiet	The natural sound conditions found in a study area. Natural quiet is a subset of ambient noise. Traditionally, it is characterized by the total absence of human or mechanical sounds, but includes all sounds of nature, such as wind, streams, and wildlife. In a park environment, the National Park Service (NPS) on Page 74 of its Report to Congress defines natural quiet as the absence of mechanical noise, but containing the sounds of nature, such as wind, streams, and wildlife, as well as human-generated "self-noise" (e.g., talking, the tread of hiking boots on the trail, a creaking packframe, the rattle of pots or pans).
NODSS	National Parks Service Overflight Decision Support System, the noise modeling system used by the NPS for noise assessment and prediction.
Noise	Broadly described as any unwanted sound. "Noise" and "sound" are used interchangeably in this document.
Noise dose	A measure of the noise exposure to which a person is subjected.
Noticeability	The difference in noise level (above detectability) at which a representative individual engaged in a particular activity other than listening for a particular sound source (e.g., aircraft) becomes aware of the source without other cues or prompts.
Offset Calibration Technique	A method used to adjust some conventional acoustic instrumentation for accurately measuring and storing extremely low sound level data.

---

## 1. Introduction

The Federal Aviation Administration's Office of Environment and Energy (FAA/AEE), with the assistance of the Acoustics Facility at the United States Department of Transportation's John A. Volpe National Transportation Systems Center (U.S. DOT/Volpe Center), as well as others (see Appendix A for a complete list of the study team along with their specific responsibilities), is conducting research in support of the National Parks' Overflight Rule (National Rule).<sup>1</sup> The foundation of the research program for the National Rule is the collection and analysis of **noise dose**/visitor response (dose-response) data in the parks. This document summarizes the results of a dose-response study conducted along a **frontcountry**, short-hike trail at Bryce Canyon National Park (BCNP) during the period August 19 through 27, 1997.

### 1.1 Objectives

The specific objectives of this study were:

- (1) To quantify park visitors' reactions to **commercial tour** overflights; and
- (2) To collect additional data for the development of **low-level** noise assessment in support of a National Rule on overflights in the National Parks.

Park visitors' reactions were quantified by relating noise (dose) and visitor (response) mathematically, i.e., through dose-response curves. Statistical analysis was used to determine which noise descriptor(s) correlate best with the visitor response data.

A more general all-encompassing objective was to determine, based on the results of this study, if the dose-response concept could be successfully used in a National Park environment and was a viable approach for establishing a National Rule for regulating park overflights.

---

---

## 1.2 Background and Overview of Dose-Response Concept

The need for predicting **annoyance** (response) in individuals and communities resulting from environmental noise (dose) was first realized when jet aircraft were introduced into the United States military fleet in the 1950s. This introduction was accompanied by adverse reactions from many communities surrounding air bases; and airbase planners needed a tool to predict the strength of the community reaction resulting from specific exposure levels. Researchers began surveying nearby communities about their attitudes towards the aircraft noise while developing measurement methods and descriptors which would describe the noise.<sup>8</sup>

The advent of civilian air travel brought about a more concerted effort in this field, resulting in dozens of social surveys, conducted around the world, during the 1960s and 1970s.<sup>9</sup> These surveys were based on the premise that a measure of how noise interferes with people's lives can be obtained by relating their qualitative response to a series of questions about the noise to the quantitative sound level. These data were generalized, and used to determine the proportion of a given population which was annoyed when exposed to similar sound levels, or noise doses. Unfortunately, there was little communication among researchers, resulting in numerous dose descriptors and response measures. For these reasons, direct comparison of the results between these studies was not possible.

In 1978, Schultz undertook the task of converting the dose measures to a common noise descriptor and harmonizing the responses.<sup>10</sup> The result was a compilation of 11 studies (ten of which were conducted in European countries) which included a single dose-response relationship. It relates the **day-night average sound level (DNL, denoted by the symbol  $L_{dn}$ )** to the percent of the population which is highly annoyed. Additional data from U.S. studies were later added to this compilation, and the relationship was refined. The relationship is still the basis for many current federal noise-related regulations.

---

---

As stated earlier, numerous scales on which the respondents were asked to base their judgements were used by the early researchers. There were differences in both the wording of the responses and the number of points on the associated scale. The wording of the response scales usually ran from variations of "not at all annoyed" to "very much annoyed." Sometimes, the wording of the categories at the top end of the scale was extreme, such as "altogether intolerable" or "quite unbearable." This caused problems, because most people would not rate their noise annoyance at the top end of these scales. Schultz based his dose-response relationship on the percent of the people who were "highly annoyed"; corresponding to approximately the top 27 percent of the scale. Percent highly annoyed has proven to be a very reliable measure of the average response of a population,<sup>11</sup> and has been used in the majority of recent dose-response research.

The number of points on the response scales ranged from as few as four to as many as eleven. In most of the studies that used between seven and eleven points, the responses tended to cluster around three points (the two extremes and the middle), showing that most people do not use the full range of the scale. Recently, there has been more consistency in the wording and number of points on the scales. Most of the major airport noise studies in the U.S. have used a 5-point scale, ranging from "not at all annoyed" to "extremely annoyed,"<sup>12</sup> with the top two categories traditionally representing those that are "highly annoyed."\*

As stated earlier, a wide range of noise exposure, or "dose" descriptors have been used in past efforts. The majority of these descriptors, including  $L_{dn}$ , are based on an average of the total sound energy

---

\* It is important to point out that the dose-response studies conducted to date in the parks departed from the traditional approach of representing "annoyance" with the top two categories of the traditional five-point scale. In these studies the top three categories were used. For consistency, the BCNP study also used the top three categories for representing "annoyance."

---

---

over time, according to the equal-energy principle. This principle is based on the hypothesis that people are equally annoyed by short duration, high level sounds as compared with long duration, low-level sounds. Other dose descriptors that have been used are percentile descriptors, such as  $L_{10}$  and  $L_{90}$ , counts, number/count-based descriptors, and **maximum** noise levels. However, these descriptors have provided little improvement in the correlation between dose and response.

In the early surveys, it was observed that the correlation between the noise exposure and the individual responses was poor; typical correlation coefficients ranged between 0.3 and 0.4 for the Schultz study. Little headway has been made in improving this correlation. Methods such as combining the answers to several questions and rewording the questions have made little difference. There are two reasons for this. First, there are many psychological factors in addition to the physical noise exposure which contribute to a person's perception of annoyance. Secondly, scales of human response yield ordinal data; there is no way to determine how much more annoyed "highly annoyed" is as compared with "moderately annoyed." Most popular statistical measures such as means, standard deviations, and regression analyses inherently assume that the data are in an interval scale. To try to eliminate this inherent error, responses are often dichotomized for analysis, i.e., respondents are either highly annoyed or not highly annoyed.<sup>13</sup>

The dose-response relationships developed by Schultz and others<sup>14</sup> have now been widely accepted as accurate predictors of the community response to environmental noise in residential settings. Unfortunately, these relationships do not extend to predicting the response of individuals in low-level environments,<sup>15</sup> and therefore are likely invalid when predicting the annoyance of park visitors to aircraft noise. Predicting the annoyance for this specific segment of the population is currently the focus of several research efforts in response to Public Law 100-91.

---

In 1992, a group of studies were performed by the NPS at Grand Canyon, Haleakala, and Hawaii Volcanoes National Parks.<sup>16</sup> The primary result of these studies is a series of curves which relate two dose descriptors, aircraft **equivalent A-weighted** sound level (TEQ, denoted by the symbol  $L_{Aeq}$ ) and percent time audible, to two response measures, percent of visitors annoyed and percent of visitors who judged that the sound from aircraft interfered with their appreciation of **natural quiet**. The use of dose descriptors which deviate from the de facto standard of  $L_{dn}$  was necessary because park visitors are usually in the park during the daytime for significantly less than 24 hours and have no prior knowledge of the park's noise environment. In 1997, a similar dose-response study was performed by the United States Air Force (USAF) at White Sands National Monument. The results of that study are currently being prepared.

### 1.3 Implementation of Dose-Response Concept

Figure 1 presents graphically a typical dose-response relationship. Measured dose values (i.e., noise descriptors in this study) are plotted on the x-axis, and the corresponding response values (i.e., percent of visitors annoyed by aircraft) are plotted on the y-axis. Shown in the figure is the predicted dose-response curve. The curve is represented by a solid line over the range of actual field-measured data, and a dashed line for portions of the curve extended beyond the range of measured data. The intersection of the predicted curve and the y-axis represents the base level of annoyance, or the percent of park visitors annoyed by aircraft noise, even when there is no aircraft noise present. Intuition might lead one to believe that the base level of annoyance should be zero percent, i.e., when there are no aircraft, zero percent of park visitors should be annoyed by aircraft noise. This would be the case in an ideal study. However, the current study, as well as most of the aforementioned studies, have documented a non-zero base annoyance level. Possible reasons for this counterintuitive behavior are discussed in more detail in Sections 6.2.3 and 6.3.1. Confidence interval limits, indicating the region of a particular certainty, are also often included.

---



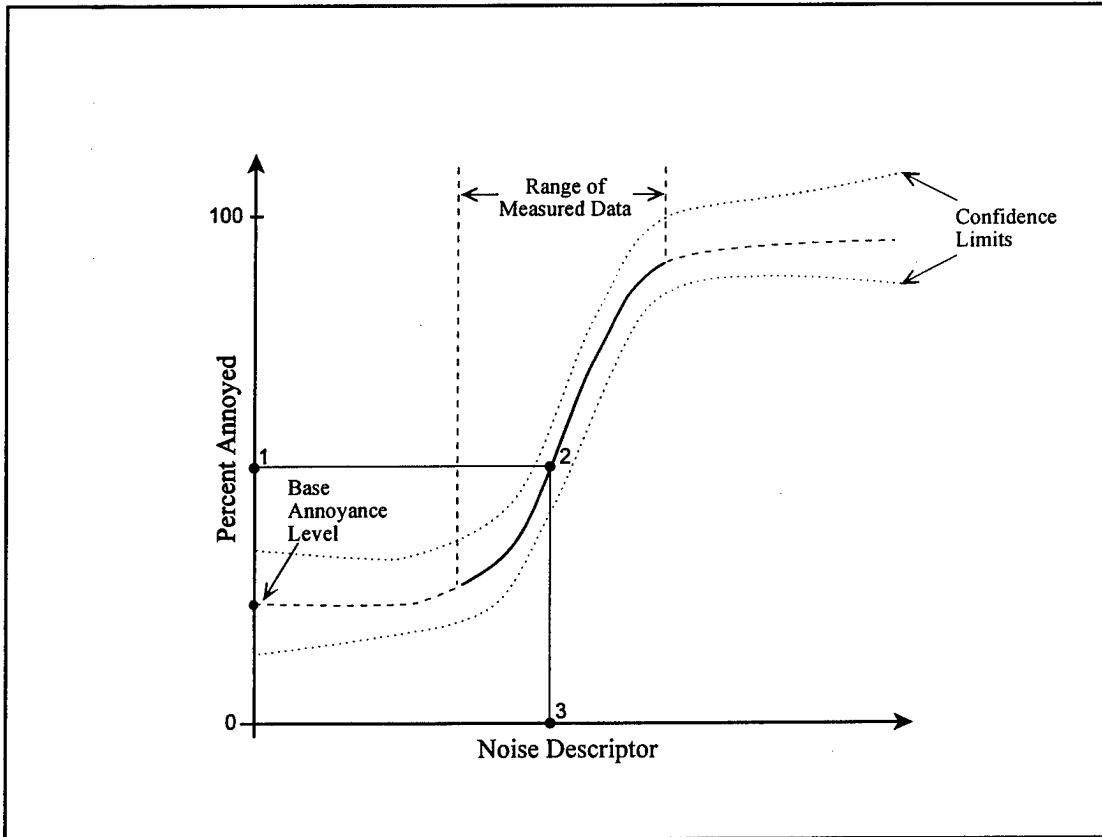

**Figure 1. Illustration of the Dose-Response Concept**

The simplest implementation of this curve is best illustrated by an example. The first step in utilizing this relationship is choosing an appropriate value on the y-axis for the percentage of annoyed park visitors. This value is designated by the point labeled 1 in the figure. (Determination of an appropriate value is beyond the scope of the current study and is a matter for decision-makers.) A horizontal line can then be drawn from Point 1 to Point 2, the intersection of the line and the predicted curve. A vertical line can then be drawn from Point 2 to Point 3, the intersection of the line and the x-axis, defined by the particular noise descriptor. The interpretation of such an exercise is that to ensure that the percentage of annoyed park visitors is less than or equal to the value at Point 1, the noise-related descriptor must be equal to or less than the value at Point 3. By using this information and process, an effective methodology can be developed to manage airspace in a National Park.

## **2. Selection and Description of Study Area**

In early 1997, the research team initiated the process of identifying the most suitable National Parks in terms of conducting dose-response measurements in support of the National Rule. Obviously, this process required joint support from the NPS. Consequently, based on informal discussions and a follow-up formal FAA request for a minimum of two candidate parks, the NPS recommended: the Great Smokey Mountain National Park (GSMNP) and Bryce Canyon National Park (BCNP). GSMNP was immediately discarded by the research team because there was only one operator offering commercial air tours of the park, introducing a significant risk that should the operator cease operations during the study, an insufficient amount of quality dose data would be obtained. As a result, BCNP and Grand Canyon National Park (GCNP) as proposed by the FAA, became the main focus of the research team. Subsequently, the FAA dose-response study proposal for GCNP was not accepted by the NPS, leaving BCNP as the sole research site.

BCNP is located in southwest Utah, approximately 80 miles east of Cedar City, Utah and 270 miles south of Salt Lake City, Utah. It was originally established as a National Monument in 1923, and later upgraded to a National Park in 1928. It is 18 miles (29 km) long and at its narrowest point just about a mile (1.6 km) wide. Elevations in the park range from 6600 to over 9100 ft. (2012 to 2774 m). The park encompasses an area of more than 35,000 acres (see Figure 2).

Each year the park is frequented by more than 1.7 million visitors from all over the world, with peak visitation occurring between the months of May and October. Historical data shows that visitation to BCNP is increasing at a rate of about 10 percent per year, and approximately 43 percent of the visitors are foreign. BCNP is truly a year-round park, offering over 50 miles (80 km) of hiking and horseback riding trails in the summer, and cross-country skiing, and snowshoeing trails in the winter.

---

---

Following the NPS recommendation, the research team examined the viability of conducting dose-response measurements at BCNP. This effort included preliminary investigation into aircraft and visitor activity at BCNP, and a scoping visit to meet with park personnel.

## 2.1 Selection Criteria

As a part of the site selection process at BCNP, the research team identified three criteria for judging the acceptability of a proposed dose-response study area. These criteria are as follows:

*Aircraft Activity:* Aircraft activity defines the dose portion of dose-response measurements. In that regard, aircraft activity is essential to a successful dose-response study. However, it's not simply a case of the more aircraft, the better. From the standpoint of aircraft activity, the most important aspect to ensuring a successful dose-response study is to have a wide range in the observed doses, which would in turn result in a wide range in responses, and a more statistically-reliable and complete dose-response model. That is to say, an ideal measurement site will have periods in which there are a lot of aircraft (e.g., several dozen per hour) and periods in which there are none, or preferably just a few. In addition, aircraft proximity to the study area, as well as the associated aircraft sound level should vary substantially. Without variability in the dose, the result is a set of data which will likely be clustered over a very small range, thereby greatly diminishing the value of the resultant dose-response relationship.

*Visitor Activity:* Park visitors provide the response portion of the dose-response measurements. In that regard, the best case scenario is to have a site in which the visitor volume was high enough so as to keep a survey team of five constantly conducting interviews. Assuming four completed interviews per surveyor hour, the ideal visitor volume

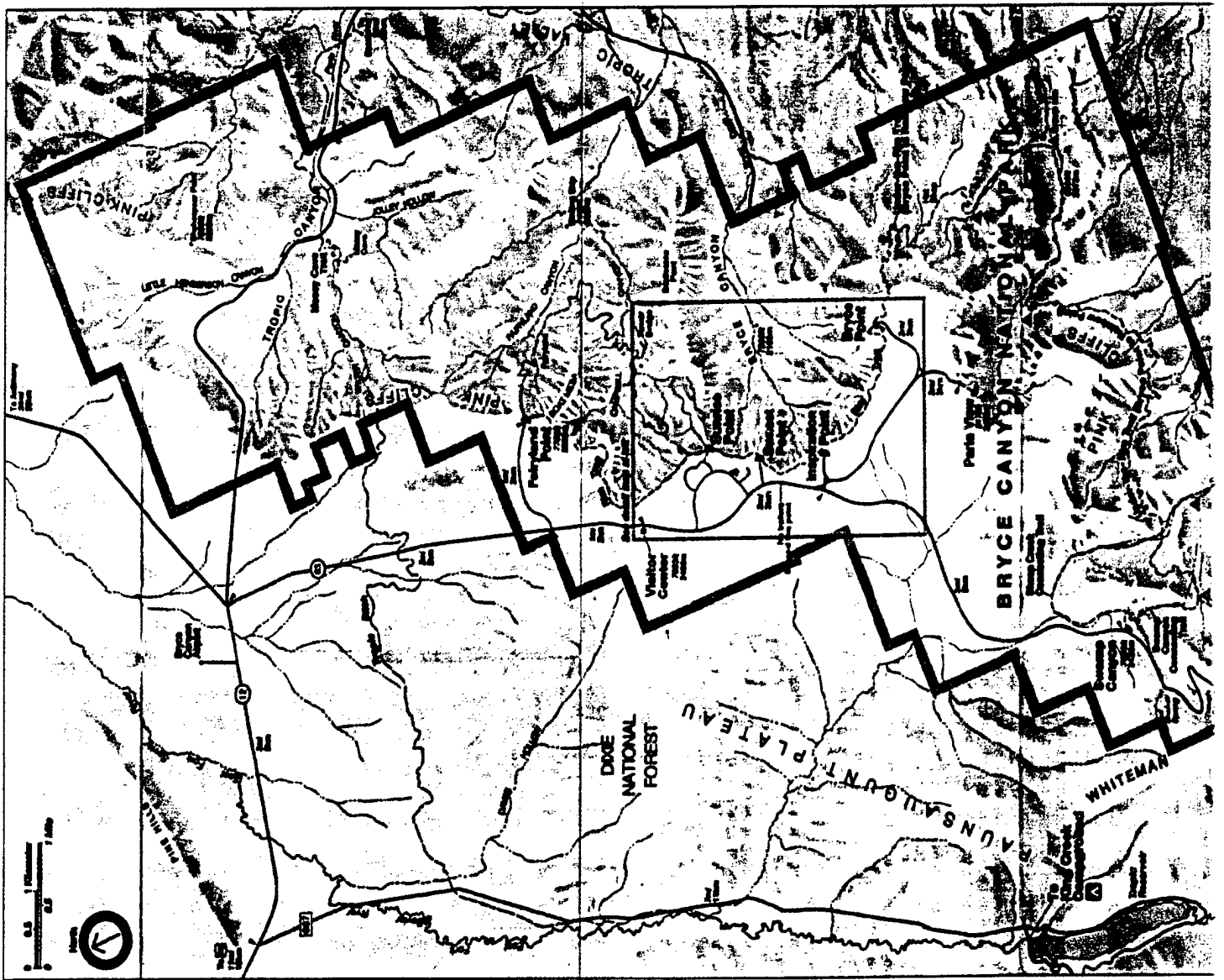

①

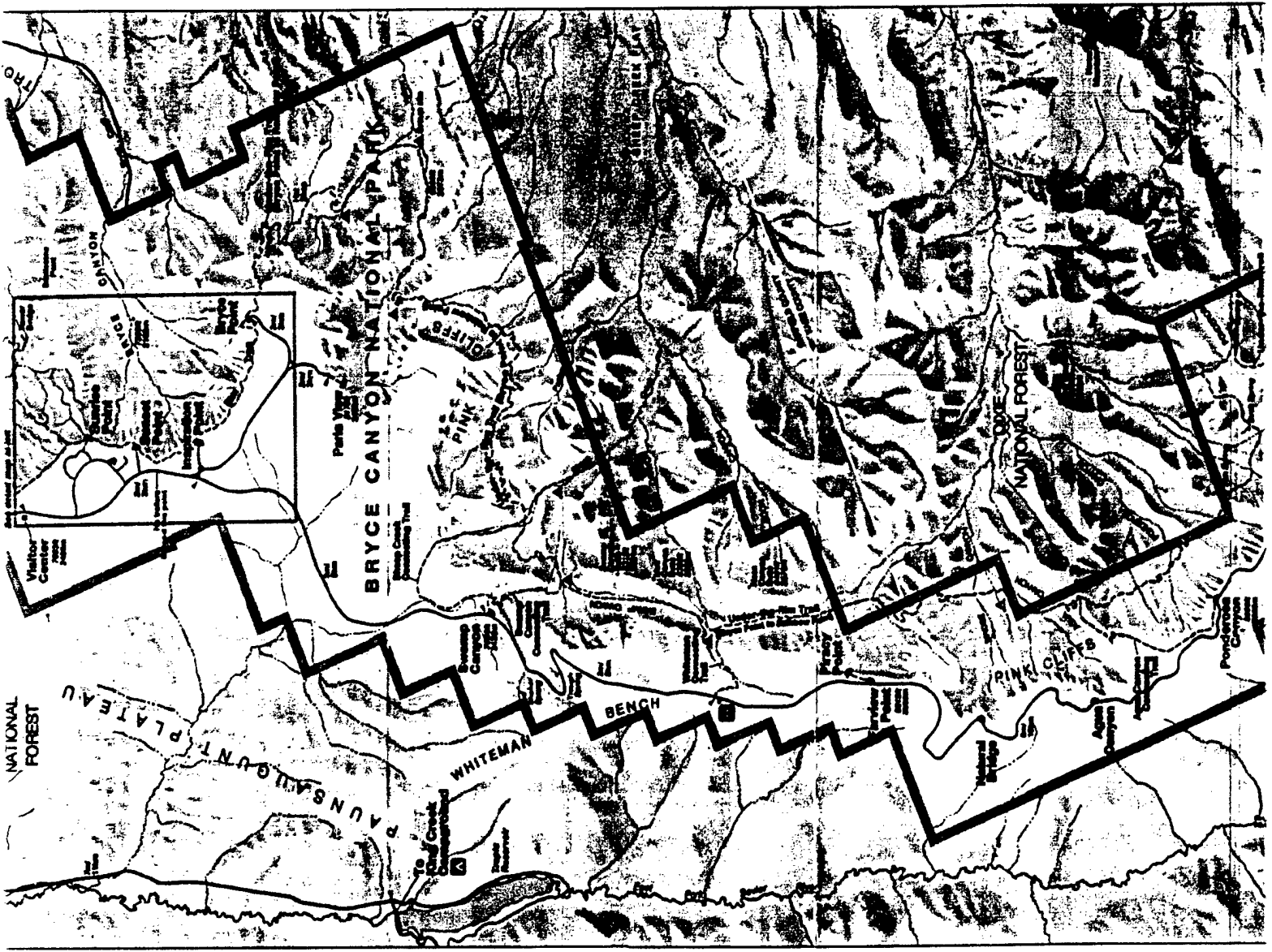

2

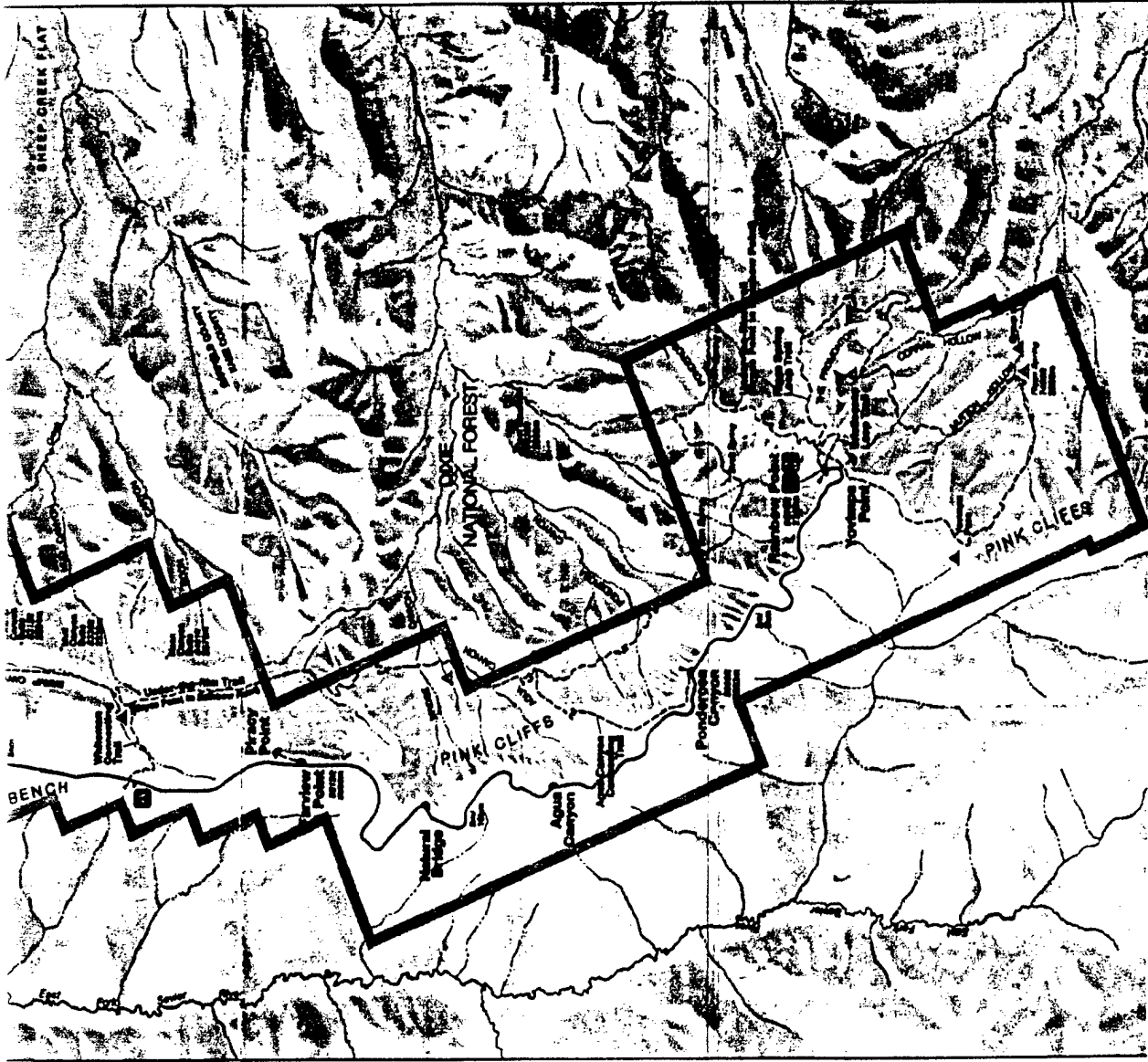

3

Figure 2. Bryce Canyon National Park (BCNP)

source: University of Texas at Austin web site -- Perry-Castañeda Library Map Collection

---

would be about 20 groups per hour (4 interviews per surveyor hour multiplied by 5 surveyors). On an ideal day the targeted volume would yield about 125 to 150 interviews.

*Weather:* Weather was somewhat of a secondary component, with precipitation being the primary concern. The goal was to try to avoid study areas and times of the year that were subject to a significant amount of precipitation, as acoustic measurements are not possible during these periods.

Prior to formal discussions with personnel at BCNP, the research team did some preliminary investigation into each of the above criteria within the context of BCNP, to determine the viability of conducting dose-response measurements in the park.

With regard to *aircraft activity* the research team contacted Utah Department of Transportation (UTDOT),<sup>17</sup> which had conducted a study of operational activity at the Garfield County-owned Bryce Canyon Airport in 1994. The study found that there were 4410 operations at the airport in 1994. Using a historically based growth rate of 4.5 percent per year, the total operations for 1997 were estimated to be just over 5000, with approximately 75 percent of the operations occurring between mid-May and mid-September. Assuming the operations were relatively consistent from day-to-day during the 4-month period, about 30 operations per day could be expected, not including helicopter tours operating out of one of the local hotels. According to the 1994 UTDOT study, the primary aircraft operating out of Bryce Canyon Airport included single-engine Cessna 182s, 172s and 206s (55 percent of total operations), twin-engine DeHaviland DHC-6s and single-engine Cessna 208s, which the study grouped into the twin-engine category because of the methodology used for aircraft identification (37 percent), Bell 206s and Enstrom 280s (8 percent), and a few small jet aircraft. The majority of the aircraft activity in BCNP supports the commercial air tour industry, i.e., **sightseeing** operations in the park.

---

---

While many of the operators are stationed at Bryce Canyon Airport which is about 4 miles to the north of the main entrance to the park, additional helicopter tour flights are offered from Ruby's Inn, the largest hotel in the immediate vicinity of the park. UTDOT estimated that the helicopter operations documented in their 1994 study would increase by a factor of three to four if the hotel-based operations were considered.<sup>17</sup>

After speaking with area hotels and vacation tour companies, as well as through further discussions with UTDOT regarding its study, which included surface transportation in addition to air traffic, the research team concluded that *visitor volume* to BCNP would not be a concern. However, it was recognized that further detailed information was needed if a specific study area was selected in the park.

Based on historical data, it was also concluded that *weather* should be of little concern since average temperatures in the July/August time frame were typically in the middle to high 70s; and with the exception of a late afternoon shower, precipitation in July/August tends to be quite low. NPS did express the possibility of a wetter season than usual due to El Niño weather patterns.

## 2.2 Scoping Visit

As discussed above in Section 2.1, preliminary investigation led to the conclusion that BCNP may very well be a viable location for a dose-response study and further investigation was warranted. Consequently, during the period of June 17 through 18, 1997 several members of the research team conducted a site-scoping visit to BCNP for the purpose of discussing with NPS personnel possible dose-response measurements in the park. An additional purpose of the visit was to identify potential study areas in the park. The two-day visit consisted of round-table discussions on the 17<sup>th</sup>, and visits to prospective sites on the 18<sup>th</sup>. Discussions were conducted with park personnel including BCNP

---



Superintendent, Mr. Fred Fagergren, his Chief of Resource Management, Mr. Richard Bryant, and Mr. Doug Neighbor, Acting Chief of Resource Management in Mr. Bryant's absence.

Topics of discussion during the two-day visit included: (1) aircraft activity at BCNP; (2) visitor activity at BCNP; (3) expected weather conditions in the July/August time frame; (4) the procedures for obtaining approval for performing measurements in the park, including the requirements for a research test plan and a survey approved by the Office of Management and Budget (OMB); and (5) proposed measurement sites.

In terms of the first three discussion topics, BCNP personnel essentially confirmed the information the research team had assembled in its preliminary investigation. Park personnel indicated that peak visitation occurs daily between 0800 and 1300, and that in the July/August time frame an afternoon thunderstorm is almost guaranteed.

The approval process for conducting survey work in BCNP included a formal study design and application, and an OMB-approved questionnaire. The research team indicated that the study plan was currently in preparation and would be submitted within the next two weeks, and that the questionnaire had been approved by OMB for use through November 30, 1997 (OMB approval has since been extended through September 30, 2000 -- Permit #2120-0610).

On June 18<sup>th</sup>, BCNP personnel led the research team on a tour of candidate sites in the park, including, from north to south, Fairyland Point, Sunrise Point, Sunset Point, Inspiration Point and Bryce Point (see Figure 2). In addition to these overlooks, short excursions were taken down many of the connecting trails. Locations south of Bryce Point were not visited, based on discussions with BCNP personnel. They indicated that the majority of air tours do not proceed south of Bryce Point, and the visitor volume is reduced somewhat beyond this overlook. The consensus of the research

---

team was that the rim trail connecting Sunrise Point to Sunset Point, and the Queen's Garden Trail, which descends into the canyon from Sunrise Point, offered the most promise in terms of a successful dose-response study.

During the scoping visit few aircraft were observed. The lack of observed aircraft lead to a concern on the part of the research team regarding the usefulness of the park for dose-response research. The concern was so great that the subject of alternative parks (e.g., Mount Rushmore National Park and Glacier National Park) was discussed with NPS personnel from the Denver office who also attended the meeting. However, BCNP personnel indicated that the hotel-based helicopter tour operator was not in operation during the scoping visit, and that this operator accounted for a significant percentage of the tours at BCNP. BCNP personnel offered to collect some preliminary data pertaining to both aircraft and visitor activity over the next several weeks to verify acceptable levels of aircraft traffic. The research team decided that definitive selection of BCNP hinged upon this preliminary data.

Additionally, at the two-day meeting, BCNP personnel provided the research team with ancillary material which would further facilitate planning of dose-response measurements in the park. It included area maps, aerial photographs, and historical data on visitor demographics.

### **2.3 Description of Selected Study Area**

Table 1 presents the results of the visitor volume and aircraft counts collected by the BCNP personnel subsequent to the research team's scoping visit and prior to the actual study. Specifically, between the hours of 0700 and 1400, aircraft were audible at least 31 and sometimes as much as 88 percent of the time -- potentially providing for a good range in observed doses. During that same time period, visitors descended the Queen's Garden Trail at a rate of between 10 and 18 groups per hour (based on the five-day average summary, just under the pre-established target rate of 20 groups per hour (see Section 2.1)).

---

Table 1. Preliminary Data on Aircraft and Visitor Volume at Queen's Garden Trail

DATE	START	END	% TIME AUDIBLE			TOTALS		GROUPS DESCENDING	
			HELI	JET	PROP	PROP/HELI	AIRCRAFT	# OF GRPS	AVG GRP SIZE
7/12/97	7:00	8:00	19	7	6	25	32	2	1.5
7/12/97	8:00	9:00	0	28	6	6	34	6	3.3
7/14/97	7:00	8:00	0	18	13	13	31	8	3.2
7/14/97	8:00	9:00	20	33	32	52	85	12	2.6
7/14/97	9:00	10:00	22	29	5	27	56	12	3.3
7/14/97	10:00	11:00	31	20	13	44	64	15	2.8
7/15/97	11:00	12:00	31	2	30	61	63	18	2.3
7/15/97	12:00	13:00	42	14	5	47	61	15	2.9
7/15/97	13:00	14:00	34	26	28	62	88	4	2.2
7/16/97	7:00	8:00	11	39	0	11	50	19	2.7
7/16/97	8:00	9:00	1	76	6	7	83	26	2.5
7/18/97	9:00	10:00	9	30	7	16	46	15	2.5
7/18/97	10:00	11:00	16	27	4	20	47	19	3.0
Five-Day Average Summary By Hour									
0700 to 0800			10	21	6	16	38	10	2.5
0800 to 0900			7	46	15	22	67	15	2.8
0900 to 1000			15.5	30	6	22	51	14	2.9
1000 to 1100			23.5	24	9	32	56	17	2.9
1100 to 1200			31	2	30	61	63	18	2.3
1200 to 1300			42	14	5	47	61	15	2.9

source: BCNP Personnel

Although radar tracking data was not available for the BCNP area, park personnel indicated that flight tracks were generally flown in a north-to-south loop, due primarily to the long thin "footprint" of the park. Additionally, the research team acquired, through discussions with the Ruby's Inn Air Tour Operator, typical routes for the helicopter tours operating out of Ruby's Inn. As can be seen from Figure 3, the nominal flight tracks for these tours were generally north-to-south loops in close proximity to the Queen's Garden Trail, further offering promise for a successful study.

---

Taking all of these factors into account, the research team concluded that Queen's Garden Trail would be the primary study area, with the rim trail between Sunrise and Sunset Point reserved as backup. Queen's Garden Trail is a short, 0.9-mile (1.4 km) route that drops about 320 ft. (97.5 m) below the canyon rim. It begins at Sunrise Point and terminates at the Queen's Garden. It is considered to be a short hike frontcountry trail of moderate hiking difficulty.

#### **2.4 Noise Measurement and Interview Sites**

Pending some limited field measurements to determine viability (See Section 4.1.1), the planned measurement microphone location, as shown in Figure 4, was to be approximately 200 ft. (61 m) to the north-northeast of the trail, about halfway down from Sunrise Point. The specific location was atop a small bluff with good visibility of the sky and no reflecting objects in the immediate vicinity. The bluff was primarily sandy soil with sparse vegetative cover. Positioned on the bluff, the microphone would be somewhat shielded visually from the trail by sparsely scattered coniferous trees.

The position on Figure 4 marked "QGT" (i.e., Queen's Garden Trail) was the location of the interview team for measurements made between August 19<sup>th</sup> and 23<sup>rd</sup>. It was about 0.7 miles (1.1 km) down the trail from Sunrise Point, essentially right at the junction of the horse trail. For measurements made between August 24<sup>th</sup> and 27<sup>th</sup> the interview team was positioned at the location marked "QGTX" (i.e., Queen's Garden Trail Extended). This site was just a few hundred feet before the end of the trail, at the junction of the Navajo Loop trail. The field estimated time for visitors to descend QGT and QGTX was 20 and 30 minutes, respectively (Actual average times based on all data collected turned out to be 19.1 and 31.2 minutes, respectively).

The locations earmarked for the interview team were somewhat of a natural stopping point for visitors because each was situated at the junction of another trail. These locations were also considered attractive because the trail was generally flat at these points and somewhat wider than other locations considered. In addition, the QGTX site in particular offered considerable shade in which interviews could be conducted.

Audible sounds observed along QGT and QGTX included the sounds of nature, visitor noise (i.e., footsteps, talking, and the rattle of equipment and supplies), aircraft, park trail-maintenance vehicles, and distant roadway traffic.

## **2.5 Research Team**

Appendix A lists the members of the research team along with their responsibilities.



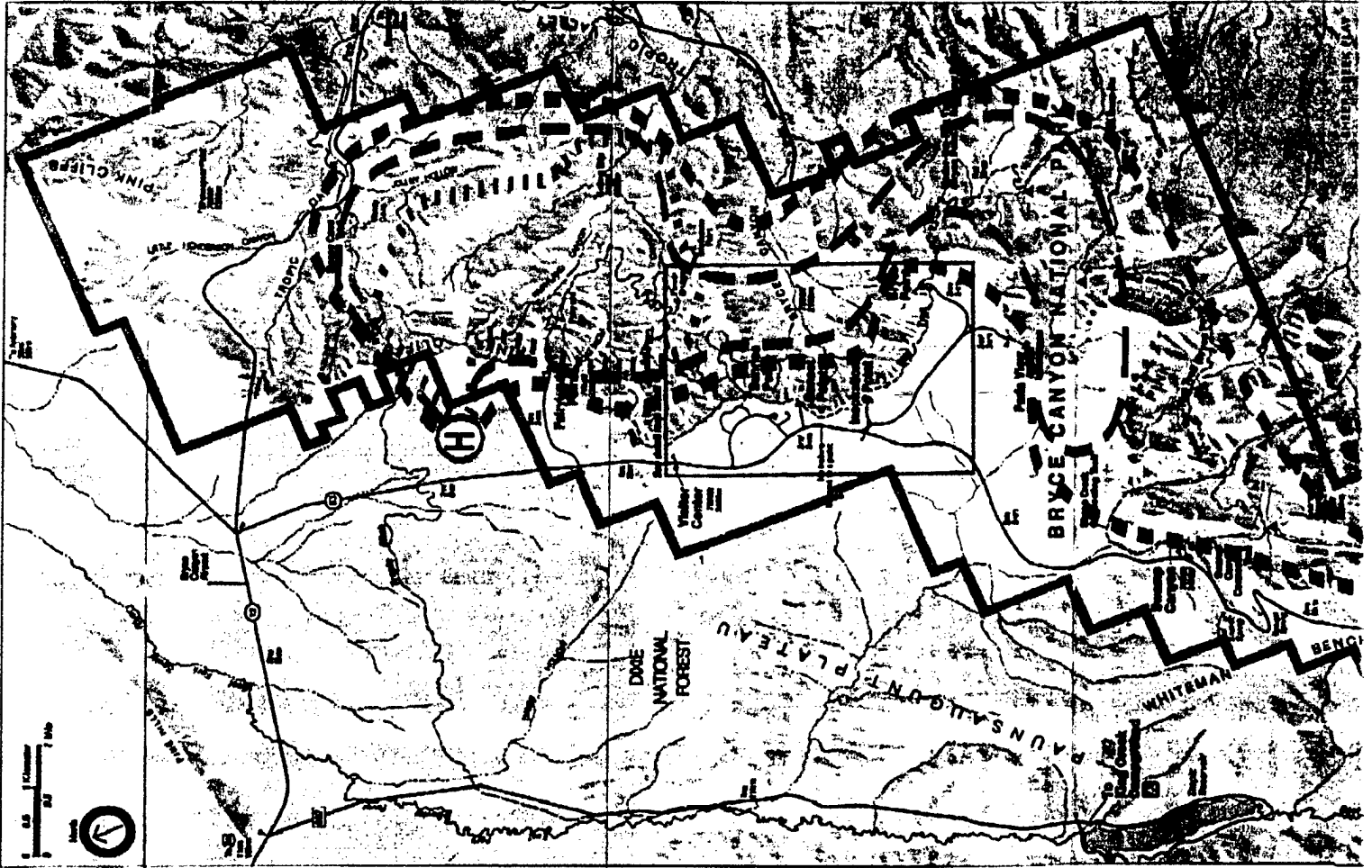

①

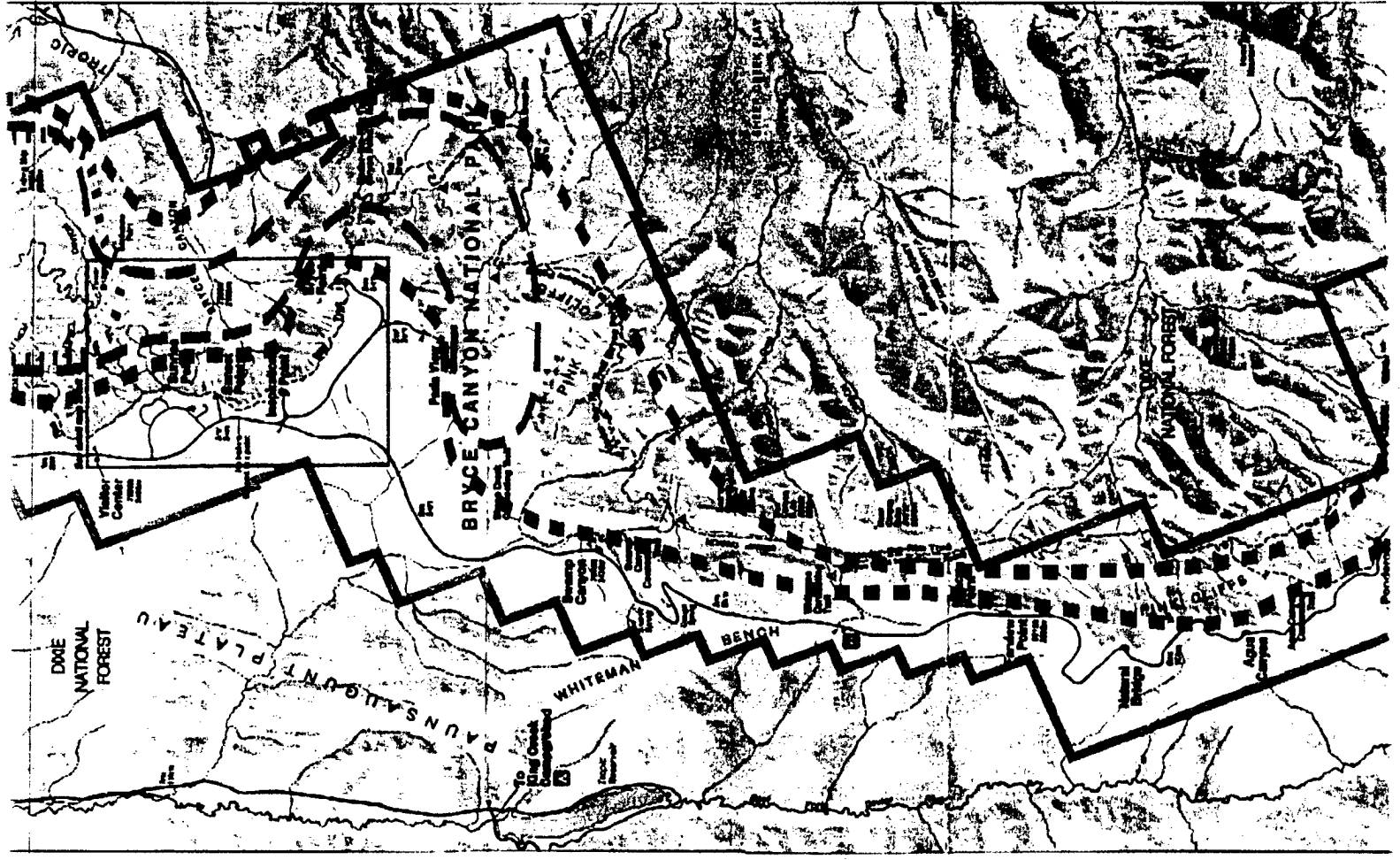

2



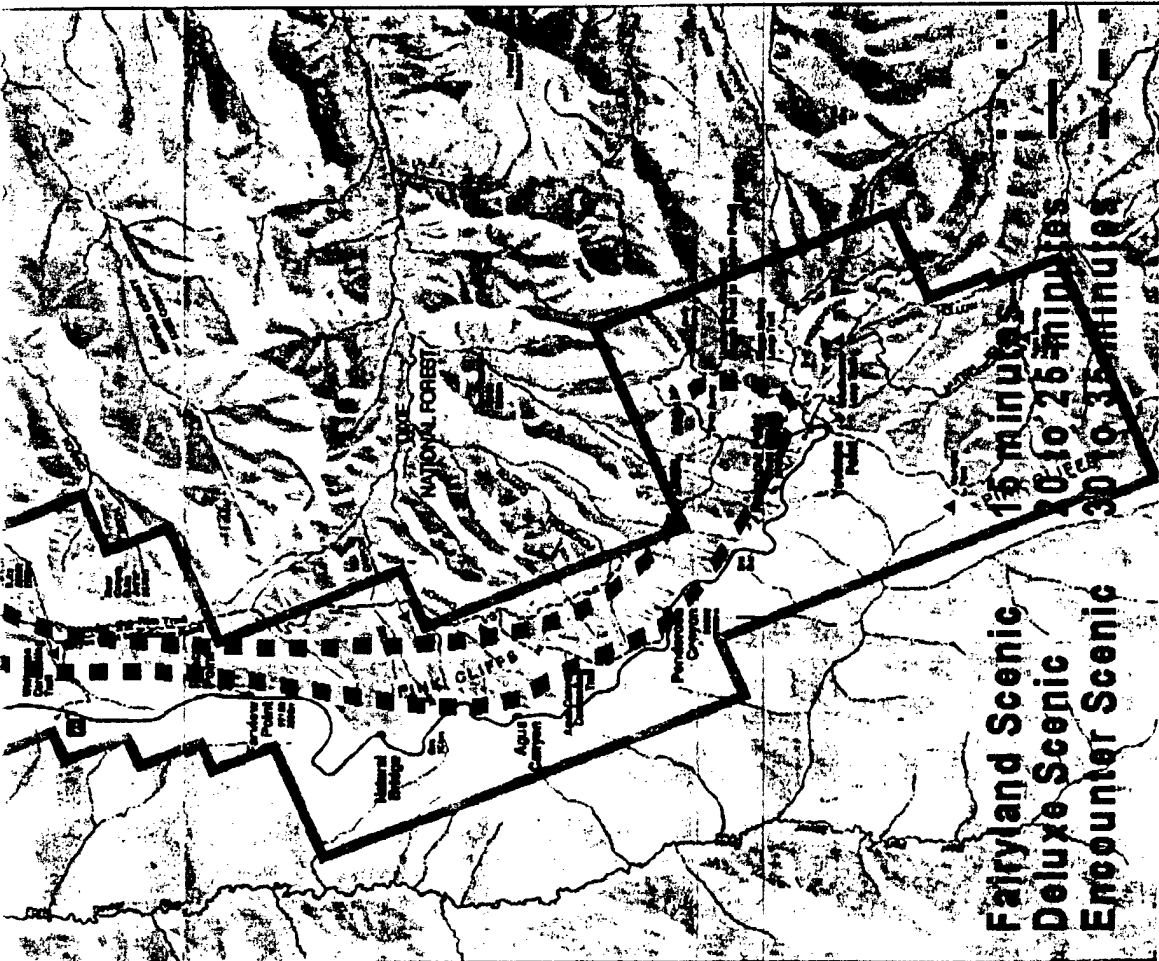

3

**Figure 3. Nominal Helicopter Flight Tracks in BCNP**

map source: University of Texas at Austin web site -- Perry-Castañeda Library Map Collection  
 flight track source: Private conversation with Ruby's Inn Air Tour Operator

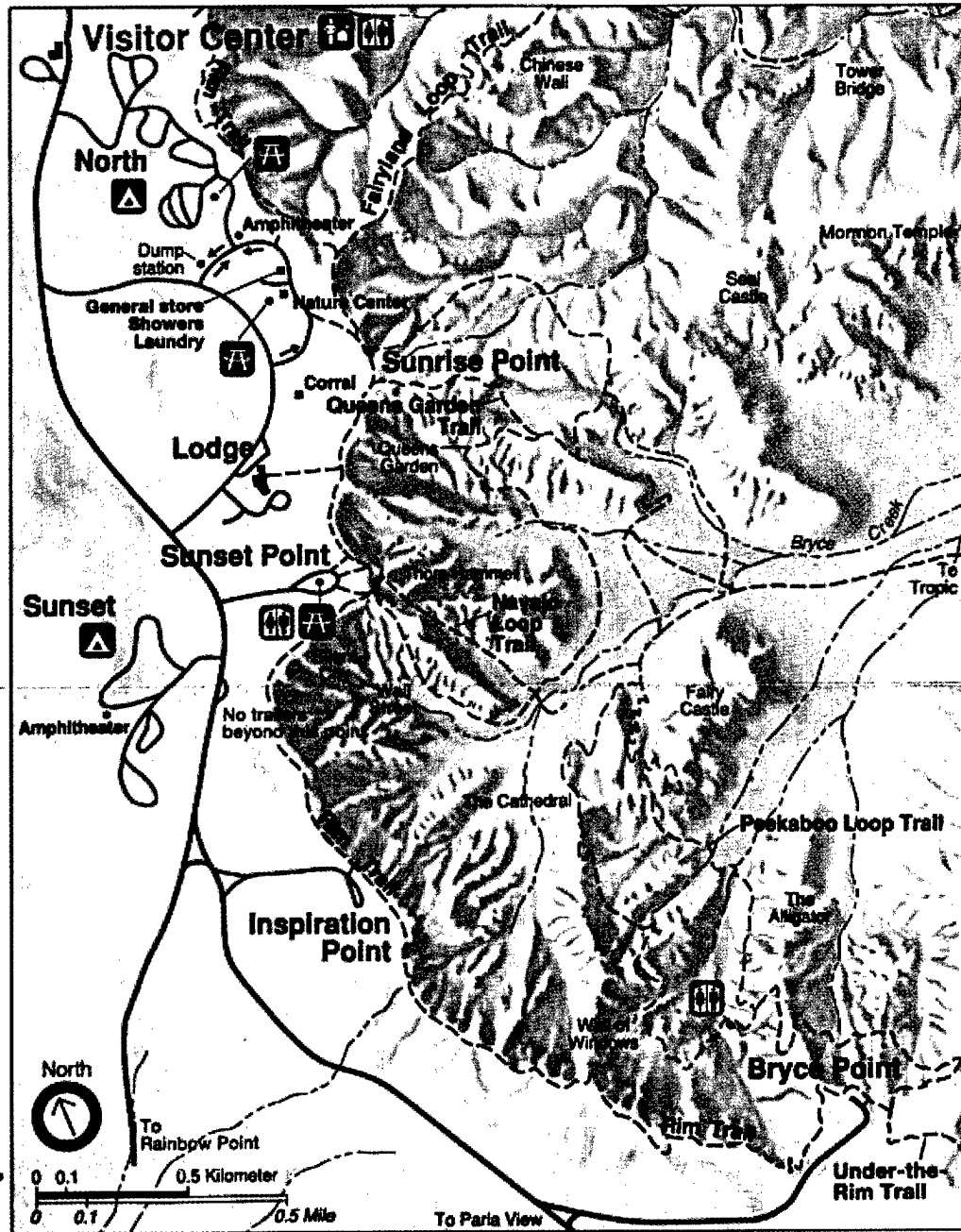

Figure 4. Queen's Garden Trail

source: University of Texas at Austin web site -- Perry-Castañeda Library Map Collection



---

### **3. Instrumentation**

This section describes both the acoustic and survey-related instrumentation.

#### **3.1 Acoustic-Related Instrumentation**

Documented sound levels measured in the National Parks under low wind conditions often approach the threshold of human hearing.<sup>18</sup> Consequently, special acoustic instrumentation is needed to accurately measure such low levels. This section discusses the acoustic instrumentation system used during the dose-response study at BCNP. Presented in Appendix B are detailed technical specifications for the system.

##### **3.1.1 Microphone, Preamplifier and Windscreen**

A microphone transforms sound-pressure variations into electrical signals, that are in turn measured by instruments such as a sound level meter (SLM) or a one-third octave-band analyzer (**spectrum analyzer**), and/or recorded on tape or some other media. The microphone in most conventional acoustic systems is capable of measuring sound levels down to about 15 or 20 dB(A), which was not adequate for measurements at BCNP. From the standpoint of measuring sound level data near the threshold of human hearing [approximately 0 dB(A)], which was deemed a requirement for the BCNP measurements, the microphone is the limiting component in a conventional measurement system.

The Brüel and Kjær (B&K) Model 4179 microphone which is specially designed for very low-level sound measurements, was used for dose-response measurements at BCNP. It is the only microphone known to the authors capable of measuring down to the threshold of human hearing. The Model 4179 is a highly sensitive, one-inch condenser microphone capable of measuring below 0 dB(A). Additionally the B&K Model 2660 preamplifier and Model 2804 power supply were employed at

---

---

BCNP. As per manufacturers specifications,<sup>19</sup> the Model 2804 power supply was modified for use with the Model 4179 and 2660.

A conventional windscreen is a porous sphere [usually made of foam and about 3.5 inches (9 cm) in diameter] which is placed atop a microphone to reduce the effects of wind-generated noise on the microphone diaphragm. By reducing the wind-generated noise on the microphone diaphragm, the signal-to-noise (S/N) ratio of a sound measurement is effectively improved. Due to the low sound levels associated with measurements in BCNP, conventional windscreens alone do not provide enough of an improvement in the S/N ratio, especially in moderate to high wind conditions. As part of the development of their "turn-key" Low Noise Monitoring System (LONOMS), the NPS funded the design and development of a tripod-mounted, two-stage windscreen to be used for measurements in the National Parks. The two-stage design, which is documented extensively in Reference 20, consists of a 20-inch-diameter (51 cm) fabric-covered outer stage, and a conventional B&K Model UA0207 foam windscreen making up the inner stage. This specially designed two-stage windscreen was used for dose-response measurements at BCNP.

### 3.1.2 Sound Level Meter (SLM)

The microphone/preamplifier was connected via 200 ft. (61 m) of cable to a Larson Davis Laboratories (LDL) Model 820 sound level meter (SLM). The Model 820 is a Type 1 SLM which performs true numeric integration and averaging in accordance with ANSI S1.4-1983.<sup>21</sup> It was setup to continuously measure and store at one-second time intervals, the  $L_{Aeq,1s}$  as well as the maximum A-weighted sound level with slow exponential time weighting (MXSA, denoted by the symbol  $L_{ASmx}$ ). In this mode the Model 820 is capable of storing over 18 hours of data. The use of 200 ft. of extension cable ensured that field personnel could move about and conduct whispered conversations without influencing the measured sound. Slow exponential time weighting, as compared with fast weighting, was utilized for three reasons: (1) consistency with previous NPS dose-response

---

---

measurements (although in previous NPS and USAF studies the  $L_{ASmx}$  was actually approximated by using the maximum  $L_{Aeq,1s}$ , any associated differences as compared with the true  $L_{ASmx}$  measured in the current study are expected to be small and most likely negligible); (2) consistency with most aircraft noise measurement studies; and (3) likelihood of slow response to systematically and predictably reduce the impulsive sounds of nature, e.g., bird chirps, insects, etc. It was considered beneficial to reduce these impulsive sounds in that: (1) they are generally considered to be unobtrusive, if not pleasant sounds; and (2) by minimizing their potentially contaminating effect, it is more likely that statistically representative doses could be computed.

To successfully utilize the Model 820 for measurements down to the threshold of human hearing, it was necessary to bypass the unit's built-in firmware parameters, which limit the minimum levels that can be quantified and stored. With the acoustic measurement system configured as described herein, the Model 820 was not capable of displaying or storing numbers below about 20 dB(A). To circumvent this limitation, an **offset calibration technique** was employed. Specifically, the Model 820 requires that the output level of the sound calibrator be specified. In this case, the B&K Model 4231's 94 dB output level was used. By means of setting the SLM so that the 94 dB level indicated a level of 119 dB, an effective 25 dB offset calibration was applied. The result was that all of the sound level data measured and stored by the Model 820 was artificially high by an offset of 25 dB. This 25 dB factor was accounted for, as if it were system gain, in the data reduction process (see Section 5). This technique allowed the Model 820 SLM to accurately measure sound levels down to below 0 dB(A).

### 3.1.3 Digital Audio Tape (DAT) Recorder

The AC output of the Model 820 SLM was connected directly to the input of a Sony Model PC208Ax digital audio tape (DAT) recorder. The DAT recorder was setup up to operate at single speed in a two-channel recording mode. At single speed, the 295-ft. (90-meter) tapes used were capable of

---

providing slightly more than 3 hours of recording time. Because a typical day of measurements at BCNP was approximately 9 hours in duration, the start-time of recording was varied from day-to-day so as to encompass the nine-hour duration over the course of the entire study.

The decision to use a DAT recorder as opposed to a portable one-third octave-band analyzer was due primarily to the fact that the actual purpose of the frequency-based data was not entirely known prior to measurements, and tape recording allows for repeated playback and analysis, including the option for narrow-band analysis if deemed necessary.

#### **3.1.4 Acoustic Observer Log**

An acoustic observer log was maintained to provide a continuous, timed record of audible sounds throughout the measurement period. An automated Microsoft Excel spreadsheet was used to perform the logging. The spreadsheet, displayed in Figure 5, offered a significant advantage over a manual logging system in that it produced an electronic file which was used in data reduction immediately following field measurements. A further advantage of the automated spreadsheet was that it offered the ability to quickly “click” on buttons using a traditional mouse, as well as “hot-key” entry of menu items and keyboard entry of text. The obvious disadvantages of the spreadsheet method were the bulk and battery power requirements for the supporting laptop computer. As a backup to the automated log, the manual log sheet shown in Figure 6 was available in the field should the automated system have failed for some reason.

(DATE) (SITE)

TIME	AIRCRAFT			HUMAN		NATURAL		RETURN
	[ ] [ ] [ ] [ ]	[ ] [ ]	[ ] [ ] [ ] [ ]	[ ] [ ]	[ ] [ ] [ ] [ ]	[ ] [ ] [ ] [ ]	[ ] [ ] [ ] [ ]	
	[ ] [ ] [ ] [ ] [ ] [ ]	[ ] [ ]	[ ] [ ] [ ] [ ]	[ ] [ ]	[ ] [ ] [ ] [ ]	[ ] [ ] [ ] [ ]	[ ] [ ] [ ] [ ]	
	[ ] [ ] [ ] [ ] [ ] [ ]	[ ] [ ]	[ ] [ ] [ ] [ ]	[ ] [ ]	[ ] [ ] [ ] [ ]	[ ] [ ] [ ] [ ]	[ ] [ ] [ ] [ ]	

TIME	ACOUSTIC STATE	A/C TYPE	OPERATOR	ALTITUDE	BCKGRND TYPE	COMMENTS

Figure 5. Automated Acoustic Observer Log



**Manual Aircraft Observer Log**

Date: \_\_\_\_\_ Site: \_\_\_\_\_ Page: \_\_\_\_\_ of \_\_\_\_\_

TIME	AIRCRAFT						HUMAN			NATURAL			COMMENTS					
	PROP	JET	UNK	COM	MIL	UNK	HIGH	MED	LOW	AUTO	HUMAN	PET		OTHER	ANIMAL	WIRE	WEATHER	WATER

Figure 6. Manual Acoustic Observer Log

---

### **3.1.5 Meteorological Instrumentation**

In addition to the acoustical instrumentation, a Qualimetrics Transportable Automated Meteorological Station (TAMS) was setup to measure temperature, relative humidity, wind speed and direction, and ambient atmospheric pressure at one-second intervals. The use of one-second time intervals allowed for direct correlation between the sampled acoustical and meteorological data.

### **3.1.6 Other Instrumentation**

A B&K Model 4231 sound calibrator was used in the field for establishing and checking the sensitivity of the entire acoustic instrumentation system (i.e., microphone, preamplifier, cables, SLM, and DAT). The Model 4231 produces a user-selectable 94 dB **sound pressure level** at a frequency of 1 kHz.

Time synchronization of all pertinent instrumentation in the measurement chain was performed with a single digital watch (master clock). In particular, the SLM, DAT, acoustic observer log and meteorological instrumentation were synchronized to the master clock each day to facilitate accurate data reduction and analysis. Digital watches used by the survey personnel were also synchronized to the master clock. Each day prior to field deployment, all digital watches were checked against the master clock and re-synchronized, if necessary. If greater than 2 seconds of time drift was observed in a single day, the watch was considered unreliable and discarded.

A Bushnell Laser Range Finder, Yardage Pro Model 800 was used to periodically obtain slant distances to observed aircraft.

## **3.2 Survey-Related Instrumentation**

As discussed in Section 3.1.6, survey team members were given digital watches to accurately identify the time-of-day for the commencement of each interview. They were also equipped with

---

---

pre-typed survey answer forms which they provided to respondents on clipboards. In addition, survey team members had pre-typed versions of the questionnaire attached to clipboards for their own use.

### **3.2.1 Communication**

One channel on hand-held Motorola Radius GP300 FM radios was utilized for communication between the personnel at the start of the trail and personnel at the interview location. A second channel on these radios was used for communication between the survey team and personnel at the acoustic measurement site.

### **3.2.2 Questionnaire**

The survey questionnaire utilized in this study (see Appendix C) was similar to those utilized previously by both the NPS and the USAF. Those questionnaires underwent several stages of development, during which goals were outlined for the proposed studies, questions were formulated to collect the data relevant to those goals, and the questionnaires were streamlined so as to minimize the time required and possibility for error due to misinterpretation. A stated goal was to keep the interview duration to less than 15 minutes, and even less than 10 minutes, whenever possible.

In formulating the 17-question survey for this study, steps were taken to: (1) ensure consistency with dose-response studies previously undertaken in the National Parks such that comparisons would be meaningful (in fact, minor editorial changes as requested by the NPS for the sake of consistency were included in the final version of the questionnaire); and (2) expand upon the data collected in those previous studies. In keeping with the first target step, the questionnaire used in the current study was generally consistent with that used in previous studies up to and including Question #9. The primary reason for maintaining consistency up to this point was that Question #9 is the question used to develop the dose-response relationships; and the research team felt that it was imperative that consistency be maintained in the questionnaire so as to facilitate unbiased comparison with previous studies.

---

---

One notable difference in the questionnaire as compared with those used in previous studies was the deletion of the text in the introduction referring to “problems in the park.” The research team unanimously agreed that referring to aircraft as a problem right up front introduced an unnecessary bias. Also, the language of Question #13 was simplified from previous studies in an attempt to clarify the distinction between the types of aircraft. Further, towards the end of the survey, three questions were added that asked about the respondent’s “overall” enjoyment of the park on that particular day. This was done in an effort to not limit the scope of questions solely to the Queen’s Garden Trail. In addition, Question #16 asks the respondent to differentiate between the number, sound level, and “time audible” of aircraft in terms of annoyance.

The 1997 USAF parks study cited in Section 1.2 investigated the use of signs as a mitigation factor for adverse respondent reactions to overflights. The BCNP study did not utilize this technique.



---

#### **4. Field Measurement Procedures**

The goal each day at BCNP was to commence with measurements as close as possible to sunrise. This of course required the research team to be onsite well before 0700. Typically the acoustic measurement team arrived at the site each day at approximately 0600 so as to have their instrumentation ready for measurements by 0645, which was about the time at which the survey team arrived at the site. Each measurement day began as close as possible to 0700 and concluded anywhere between 1400 and 1600, usually dependent upon weather -- specifically afternoon thunderstorms. Peak visitor and aircraft volume occurred between 0900 and 1300 each day. This four-hour time period accounted for about 75 percent of the total interviews conducted during the study. In the field, the research team consisted of the acoustic team and the survey team. The remainder of this section describes the specific field measurement procedures employed by both teams.

##### **4.1 Acoustic Team Procedures**

This section presents the field measurement procedures which were followed by the acoustic team during dose-response measurements at BCNP.

##### **4.1.1 Determination of Representative Microphone Location**

An essential prerequisite to the success of a dose-response study is that the measured dose must be representative of the entire study area: in this case, the Queen's Garden Trail (QGT) or the Queen's Garden Trail Extended (QGTX). As a result, prior to the commencement of dose-response measurements at QGT on August 19<sup>th</sup>, a measurement study of limited scope was conducted on August 18<sup>th</sup> to determine the appropriateness of the proposed microphone location. In addition to measurements at the proposed location (see Figure 7), two temporary measurement systems were setup, one at about a quarter of the distance down QGT (Site 1) and the other at about 3/4 the distance down QGT (Site 2). **Sound exposure level** (SEL, denoted by the symbol  $L_{AE}$ ) data were measured

---

for 7 uncontaminated aircraft events. As can be seen in Table 2 the difference in level measured at the three sites was extremely small. In fact, the arithmetic average of the  $L_{AE}$  values measured at the two temporary sites was within 1.2 dB of the average  $L_{AE}$  measured at the proposed location. Since a difference in sound level of 3.0 dB or less is generally not even considered perceptible to the human ear, the research team concluded that the proposed measurement location was suitably representative of the QGT.

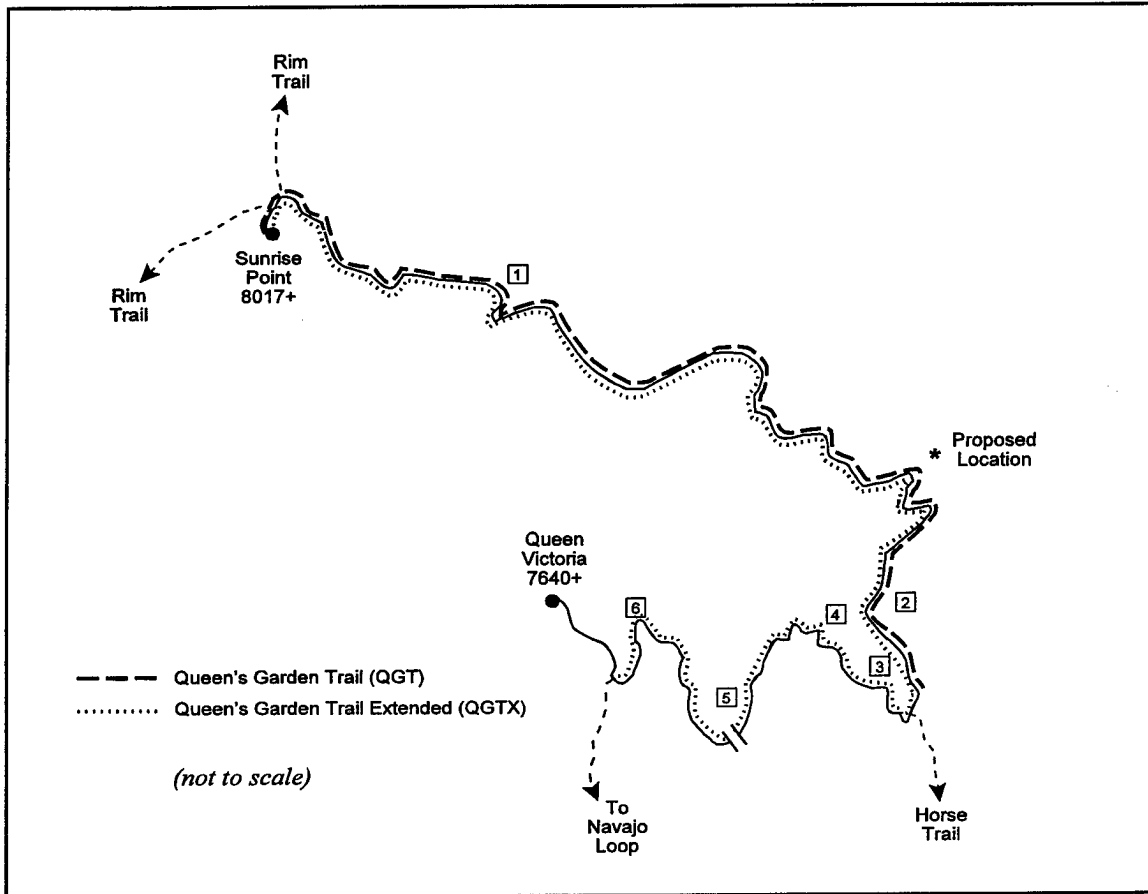

Figure 7. Location of Proposed and Temporary Measurement Systems

**Table 2. Determination of Representative Microphone Location,  
Queen's Garden Trail (QGT)**

Event #	Aircraft Type	Sound Exposure Level (dB)		
		Proposed Location	Temporary Site 1	Temporary Site 2
1	Helicopter	65.4	64.8	-
2	Helicopter	64.4	65.3	-
3	Helicopter	65.5	65.0	68.4
4	Helicopter	64.2	63.3	65.4
5	Jet	59.7	59.9	60.3
6	Jet	58.8	59.2	56.1
7	Jet	51.5	52.7	-
Average	-	61.4	61.5 (+0.1)	62.6 (+1.2)
Helicopter Average	-	64.9	64.6 (-0.3)	66.9 (+2.0)
Jet Average	-	56.7	57.2 (+0.5)	58.2 (+1.5)

Due to time and weather constraints, the research team was not able to assess the viability of the proposed measurement location for the QGTX prior to the commencement of dose-response measurements at QGT. Therefore, on August 22<sup>nd</sup> and 23<sup>rd</sup>, in parallel with the dose-response measurements on QGT, the research team set up temporary measurement systems at four, approximately equally-spaced locations on the extended portion of QGTX (see Figure 7). During these measurements,  $L_{AE}$  data were measured for a two-day total of 21 uncontaminated events. These  $L_{AE}$  data and their associated time-of-day information were correlated with the acoustic data measured during the dose-response measurements to obtain the comparable  $L_{AE}$  values. As can be seen from Table 3, with the exception of Site 3, the average  $L_{AE}$  measured at the four temporary sites was within 3 dB of the average  $L_{AE}$  measured at the proposed location. For Site 3 however, the  $L_{AE}$  was on average about 5.3 dB lower than that measured at the proposed location. The reason for the difference was that this location was shielded from a clear view of the sky looking northward by a large rock-face facade.



**Table 3. Determination of Representative Microphone Location,  
Queen's Garden Trail Extended (QGTX)**

Event #	Aircraft Type	Sound Exposure Level (dB)				
		Proposed Location	Temporary Site 3	Temporary Site 4	Temporary Site 5	Temporary Site 6
8/22/97						
1	Helicopter	62.6	-	65.9	65.8	61.7
2	Helicopter	64.0	-	66.1	66.9	63.0
3	Helicopter	63.5	-	62.4	64.5	59.5
4	Helicopter	66.3	-	68.5	69.1	66.1
5	Helicopter	61.7	-	62.4	63.6	58.0
6	Helicopter	61.1	-	63.0	63.6	57.5
7	Helicopter	61.9	-	60.2	63.2	60.9
8	Helicopter	69.9	-	69.6	69.1	63.4
9	Helicopter	65.4	-	67.8	67.9	66.3
10	Jet	57.2	-	60.4	60.3	60.3
11	Jet	52.1	-	52.2	53.0	52.7
12	Jet	55.3	-	57.7	55.4	56.5
13	Propeller	69.5	-	68.9 (0.6)	69.5 (0.0)	71.6 (2.1)
Average	-	62.3	-	63.5 (+1.2)	64.0 (+1.7)	61.3 (-1.0)
Helicopter Average	-	64.0	-	65.1 (+0.9)	66.0 (+2.0)	61.8 (-2.2)
Jet Average	-	54.9	-	56.8 (+1.9)	56.2 (+1.3)	56.5 (+1.6)
8/23/97						
1	Helicopter	62.2	56.0	-	64.6	60.5
2	Helicopter	68.7	66.9	-	71.8	68.1
3	Helicopter	62.9	56.3	-	66.8	61.2
4	Jet	45.9	46.8	-	47.4	46.8
5	Jet	59.0	60.1	-	57.7	58.4
6	Jet	60.3	50.9	-	56.2	53.0
7	Propeller	59.2	48.7	-	56.5	51.9
8	Propeller	63.5	53.8	-	63.3	57.8
Average	-	60.2	54.9 (-5.3)	-	60.5 (+0.3)	57.2 (-3.0)
Helicopter Average	-	64.6	59.7 (-4.9)	-	67.7 (+3.1)	63.3 (-1.3)
Jet Average	-	55.1	52.6 (-2.5)	-	53.8 (-1.3)	52.7 (-2.4)

---

However, the average  $L_{AE}$  measured at the adjacent temporary site on the extended segment of the trail (Site 4) was within 1.2 dB of that measured at the proposed location; and since the average walking duration between these two temporary sites was less than 50 seconds in a total average trip down QGTX of 31 minutes (approximately 3 percent of the total dose), this small segment of atypical trail was considered to be insignificant. The research team concluded that the proposed measurement site was also effectively representative of the QGTX.

#### **4.1.2 Personnel Requirements**

A three-person crew was deployed at the acoustic measurement site. One individual continuously logged the changes in the acoustic state at the site. The second individual monitored the SLM, the DAT recorder, and the meteorological system, while the third individual processed the previous day's acoustic data. Individuals rotated duties throughout a typical measurement day.

Prior to deployment, members of the acoustic team were tested to ensure consistent, accurate hearing. This was accomplished by conducting outdoor tests, during which personnel simultaneously logged acoustic states as they would during actual dose-response measurements. The results of this test were compared to ensure that the three team members were capable of consistently and accurately performing the logging activity. For further assurance, a similar activity was conducted in the field during which team members periodically performed manual logging of acoustic states while the automated observer log was being maintained by another team member. In the case of both tests, small variations between observers were documented. These variations were on the order of 1 to 3 seconds and were random in nature, and as such considered negligible.

#### **4.1.3 Measurement System Setup**

Following is a step-by-step description of the acoustic system setup which took place each day upon arrival at the BCNP measurement site:

- 
- (1) The microphone, preamplifier, and windscreen were attached to a tripod which was positioned atop a bluff, approximately 200 ft. (61 m) to the north of the Queen's Garden Trail (Microphone Location). The tripod was adjusted to locate the microphone diaphragm at a height of 5 ft. (1.5 m) directly above the local ground surface, oriented vertically (microphone grid facing the sky). Figure 8 shows the microphone/preamplifier/windscreen arrangement as it was deployed in the field at BCNP.
  - (2) The SLM, DAT, and acoustic data logging instrumentation was positioned in full view of the microphone location, but at a distance approximately 200 ft. (61 m) to the north (Observer Location). Figure 9 shows the acoustic observer location setup at BCNP.
  - (3) The meteorological instrumentation was positioned at a location approximately 200 ft. (61 m) to the north of the microphone location, but in a position still representative of the wind conditions at the Microphone Location. The 200 ft. (61 m) distance was maintained so that personnel could make periodic checks of meteorological station measurements and power supply status without influencing the acoustical measurements. The meteorological sensors were placed at a height of 5 ft. (1.5 m) directly above the local ground surface. Like the microphone, the meteorological instrumentation was positioned in an open area atop an adjacent bluff. Figure 10 shows the TAMS system as it was deployed in the field at BCNP.
  - (4) A total of 200 ft. (61 m) of cable was connected between the instrumentation at the microphone location and the observer location, and all instrumentation was then powered up.
  - (5) The next step was to establish that the internal clocks of all pertinent instrumentation (namely the SLM, DAT, meteorological system and laptop) were set to the time of the master clock.
  - (6) With all electrical components of the acoustic measurement system connected and given adequate time to warm up (typically 10 to 15 minutes), a preliminary sound level calibration of the system was performed. The purpose of the preliminary calibration was to ensure that all equipment was operating properly.
-

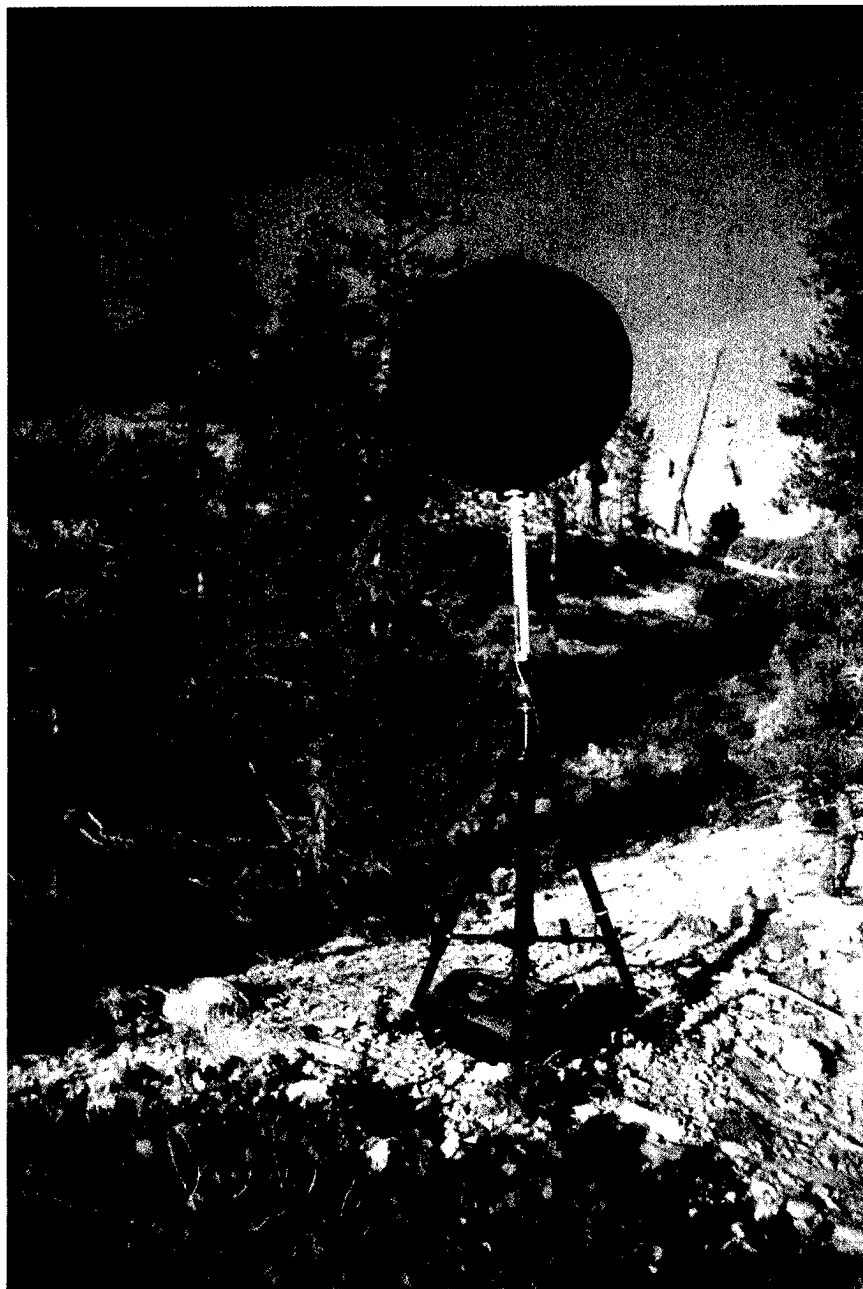
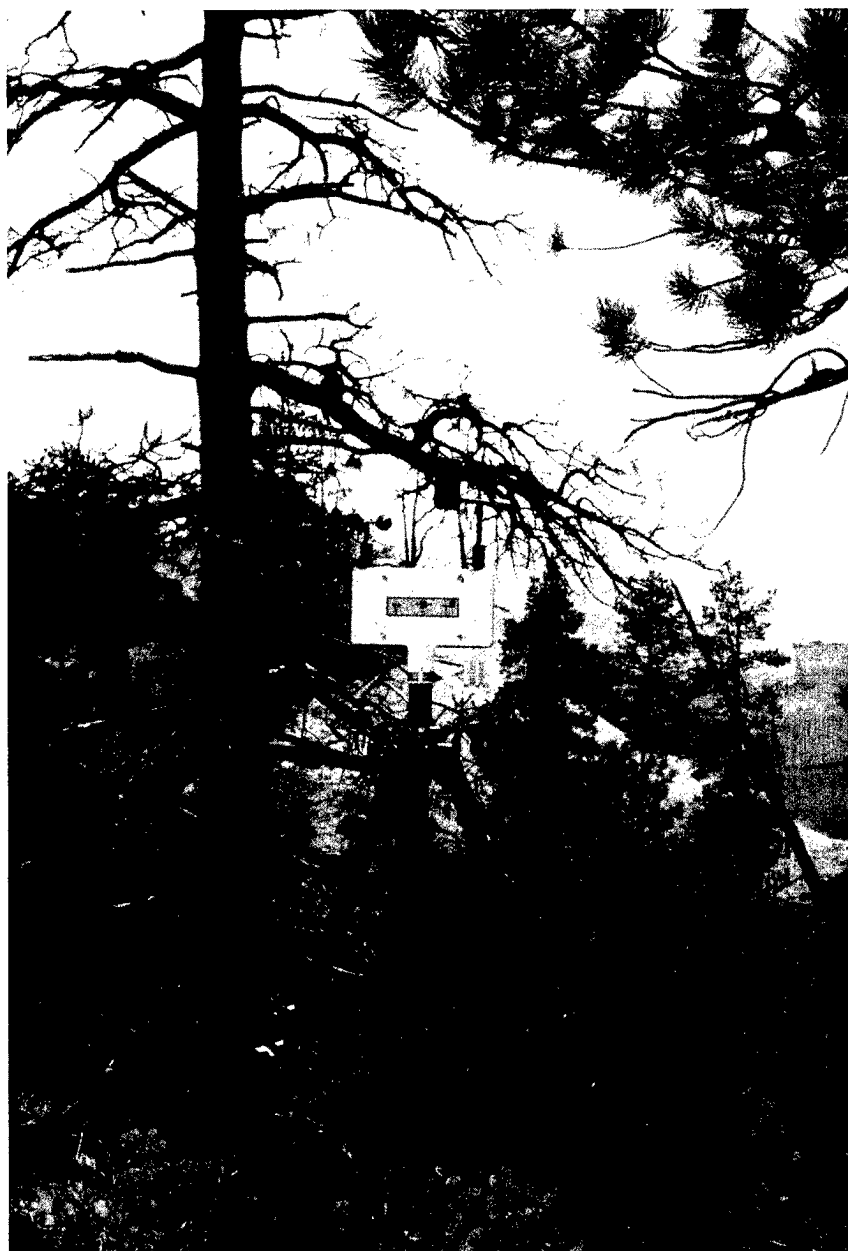

**Figure 8. Microphone/Preamplifier/Windscreen Arrangement at BCNP**

---



**Figure 9. Acoustic Observer Location at BCNP**



**Figure 10. TAMS System at BCNP**

---

- 
- (7) A frequency-response calibration of the entire electrical system, absent of the microphone was then performed with the pink noise generator.
  - (8) The electronic noise floor of the entire electrical system absent of the microphone was established, using a non-transductive (i.e., mechanically passive) capacitive load.
  - (9) After re-installation of the microphone and given adequate time to stabilize, a pre-measurement sound level calibration of the system was performed.
  - (10) The two-stage windscreen was then deployed and the preamplifier cable secured to a leg of the tripod, to prevent vibration. All other cables were "dressed" to allow for easy visual inspection, and to prevent disturbance by site activity.
  - (11) Ambient sound level measurements (SLM), sound recordings (DAT), meteorological measurements, and logging of the acoustic environment were then initiated.

#### 4.1.4 Measurements

During measurements, the acoustic observer continuously documented the acoustic environment at the site. In performing this activity, the acoustic environment was divided into three primary categories: (1) *Aircraft*; (2) *Non-Aircraft - Human*; and (3) *Natural*. These categories were arranged into a hierarchy, with *Aircraft* taking the highest priority; *Non-Aircraft - Human* taking second; and *Natural* taking third. This hierarchy allowed the observer in the field to select one category if several were applicable simultaneously. Thus, if an aircraft and a bus were audible simultaneously, the *Aircraft* category was documented. If a bus and a bird were simultaneously audible, the *Non-Aircraft - Human* category was documented. The *Natural* category was documented when no human-made sounds of any kind were audible. A particular category remained the documented category until a change in the acoustic state was heard by the observer.

---

The actual logging instrument was the automated spreadsheet depicted in Figure 5. In addition to the three primary acoustic categories, there are several subcategories. The spreadsheet inputs, including primary categories and associated subcategories are described in detail below:



: designates the exact time associated with a change of state in the current acoustic environment. Use of this input initiated a new entry in the spreadsheet, the details of which could be input as they became apparent to the observer. The availability of this input allowed for immediate identification of a change in the acoustic environment.



: designates *Aircraft* state. Note: The types of aircraft are presented in a hierarchal order. For example, if both a helicopter and a propeller-type aircraft were simultaneously audible, the helicopter was documented.



: designates Helicopter-type aircraft.



: designates Propeller-type aircraft.



: designates Jet-type aircraft.











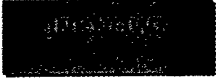

: designates Unknown-type aircraft (invoked primarily for aircraft which were heard but not seen).



: designates Tour operator.



- 
-  : designates Commercial operator.
  -  : designates General Aviation operator.
  -  : designates Military operator.
  -  : designates Unknown operator (invoked primarily for aircraft which were heard but not seen).
  -  : designates high altitude aircraft.
  -  : designates medium altitude aircraft.
  -  : designates low altitude aircraft.
  -  : designates *Non-Aircraft - Human* state.
  -  : designates noise produced by automobiles.
  -  : designates noise produced directly by humans, e.g., voices.
  -  : designates noise produced by pets, e.g., dog barking.
  -  : designates noise produced by other human-induced sources.
-

**NATURAL**

: designates *Natural* state.

**[REDACTED]**

: designates noise produced by wildlife, e.g., birds.

**[REDACTED]**

: designates noise as “wind-in-the-foliage.”

**[REDACTED]**

: designates noise as “wind-in-the-ear.”

**[REDACTED]**

: designates noise produced by water sources.

**[REDACTED]**

: designates noise produced by other natural sources.

**RETURN**

: returns active cell to beginning of next spreadsheet line in preparation for next acoustic environment.

Depending upon the time of day and associated dynamics of the sound environment at BCNP, the acoustic team found maintenance of the observer log to be an extremely tedious task in the field, and one that required frequent breaks. During measurements, the goal was to rotate logging personnel hourly to maintain the necessary level of alertness. As mentioned previously, at various points throughout the measurement period, individuals not performing the “official” logging activity occasionally conducted “unofficial” logging for the purpose of determining consistency among different loggers.

---

In addition, periodic checks were performed on both the acoustical and meteorological instrumentation for the following: available battery power, remaining internal memory for devices with internal data storage (SLM and meteorological system), and remaining tape in the case of the DAT recorder.

At various points throughout a measurement day, personnel at the acoustic site would document slant distances to tour aircraft. In general, the laser range finder was found to provide reliable readings only when the aircraft passed within a few degrees of overhead. In those instances, slant distances ranged from about 300 to 600 ft. (91.5 to 183 m).

#### **4.1.5 Measurement System Dismantling**

Following is a step-by-step description of the system dismantling which took place upon completion of measurements each day at BCNP:

- (1) A post-measurement sound level calibration of the entire acoustical system was performed and any drift from the initial calibration was documented.
- (2) The internal clocks of the SLM, DAT, meteorological system and laptop were compared with the master clock and any time drift was documented.
- (3) All instrumentation was powered down and the entire system was disconnected and stored.

Prior to data reduction (see Section 5), the stored sound level data in the Model 820 SLM were downloaded to a laptop computer and the binary files converted to comma-delimited ASCII text files. The acoustic observer log was initially saved in Microsoft Excel spreadsheet format and later converted to ASCII format. The meteorological data were saved in a comma-delimited ASCII text file.

## **4.2 Survey Team Procedures**

Three main functions were performed by survey team members: (1) identifying visitors as they entered the study area; (2) greeting and screening visitors as they exited the study area; and (3) interviewing eligible respondents. Throughout the entire study at BCNP, visitor volume was such that the survey team was able to greet and screen each prospective group that arrived at the interview site. In other words, volume never exceeded the capacity of the survey team, and consequently a random group sampling methodology was never employed. In the previous studies conducted by the NPS and USAF, a group sampling methodology had to be employed.

### **4.2.1 Visitor Identification**

A survey team member located at the entrance to the study area identified prospective survey respondents. This procedure included determining the exact time-of-day a group entered the study area, the number and make-up of a group's individuals (total number, ratio of males to females, and ratio of adults to children), as well as unique qualities of the group (i.e., clothing and accessories). This information was logged at the top of the trail and discreetly radioed to survey team members at the visitor greeting and screening area. Information received was recorded on charts for use in identification and determination of the exact time each visitor spent within the study area. Radio communication was initiated only when prospective respondents had descended the trail several hundred feet from the top, so as not to introduce bias from visitor curiosity.

Since interviews were only conducted at the end of the trail, in addition to identifying groups of respondents entering the study area, it was equally important to note groups leaving the study area at the top of Queen's Garden Trail. Positively identifying these people greatly simplified the task of correlating groups being administered the survey with their associated start times. In general, groups identified leaving the top of the trail consisted of people who did not traverse the entire Queen's Garden Trail top-to-bottom, or those who had been on longer hikes originating elsewhere in the park. Positive identification of these groups resulted in near 100 percent identification of prospective

---

respondents. If, however, an exact correlation of the group was not possible, the group was not interviewed.

The use of a radio-based identification methodology differed slightly from that employed in previous NPS and USAF studies in the parks. In those studies, the survey team used a blind identification process in which visitor-identifying information was logged at both the start and end of the trail and the logged data were reconciled subsequent to the field test. In general, this was an effective scheme for these previous studies because most of the test sites were loop trails, i.e., starting and ending at the same location, thus resulting in a fairly simple reconciliation process. The research team in the BCNP study agreed that a blind identification process on Queen's Garden Trail would be extremely difficult, if not impossible. Other methods such as distributing numbered or time-stamped cards at the top of the trail and collecting them at the interview site were considered, but unlike the radio-based method used or a blind identification process, the research team felt these other methods could introduce undue bias.

#### **4.2.2 Visitor Greeting and Screening**

As prospective respondents exited the study area at the bottom of the trail, they were intercepted by a survey team member. After a brief greeting and explanation that a study was being undertaken in cooperation with the NPS, a set of questions were posed to determine: (1) if the entire group was present; (2) if English was spoken fluently by all adults; and (3) if the group was willing to spend a few minutes responding to a survey. Given positive responses to these questions, the group was then introduced to a member of the survey team who would escort them a few steps off the main trail to conduct the interview. If, however, the group refused or it was determined that there might be a problem with English comprehension, they were released and no interviews were conducted.

Additionally, efforts were made to interview groups as a whole, rather than separately, to maximize efficiency and to simplify data reduction.

---

The study area entrance times and group identifying qualities logged and radioed from the top of the trail were also logged at the visitor greeting and screening area. As groups were greeted, they were positively identified on the log and the time-of-day was again noted. The time the interview began (representing the time-of-day they exited the study area), combined with the start time identified at the top of the trail, uniquely defined the interval over which the dose was to be computed.

#### **4.2.3 Respondent Interview**

Interviews were only conducted with visitors that traversed the entire QGT or QGTX. This approach differed slightly from the methodology used in the previous NPS and USAF studies. In these previous studies, interviews were conducted with visitors that were in the study area, i.e., on the trail, for at least 10 minutes. Because of the layout of the Queen's Garden Trail, this approach was not viable in the current study. Specifically, because the trail was a short but steep descent into the canyon, virtually every visitor who was on the trail for ten minutes had made the commitment to continue to the Queen's Garden at the end. In addition to the fact that only a handful of daily visitors returned to the top of the trail before actually reaching the Queen's Garden, it was impractical to conduct interviews at the top because visitors could continue on the trail system and return to the rim at other points.

Whenever possible, interviews were conducted slightly off the trail itself in an area that provided a little shade for the respondents. Groups were interviewed by a member of the survey team. During times of peak visitor volume, it was sometimes necessary to combine small groups for the purpose of the interview. In this case, however, each group was still treated as unique from the standpoint of its logged time on the trail.

The interviewer first distributed clipboards containing the answer sheets for the questionnaire to eligible respondents in a given group. Interviewees were instructed to formulate their own responses to questions, and accordingly, not discuss the survey until the end of the interview. Before and during

---

---

the interview, the interviewer would note group characteristics on a cover sheet that would be included with the completed answer sheets.\* At the conclusion of the interview, the clipboards were collected, the answer sheets briefly scanned for completeness and stapled together with their cover sheet organized by group number. Interviewees were then thanked for their participation and released.

At the end of each day, backup photocopies were made of all survey-related documentation, and answer sheets were thoroughly checked for completeness. A log was then created containing a running list of respondents and their respective start and end times. This log was provided to the acoustic team and used for the purpose of dose computations. The log was particularly useful in that it provided daily feedback relevant to project goals, including total numbers of respondents interviewed, variability in dose data, as well as information regarding the best periods during the day from the standpoint of maximum visitor volume.

---

\* If the interviewer noted any significant problems with English comprehension on the part of the interviewees at any time during the interview, they would be thanked for their participation and excused. Those questionnaires would then be excluded from any further analysis.

---

---

## 5. Data Reduction

Figure 11 presents a flow diagram of the data reduction process. Essentially there were two primary data sets, the acoustic data and the survey data. The acoustic data consisted of the contiguous one-second sound levels (both  $L_{Aeq,1s}$  and  $L_{ASmx}$ ) in addition to the acoustic observer data. The survey data consisted of hard copies of the questionnaires as well as a special data file which simply included respondent number and respondent start and end times for computing associated doses. The sound level data, the acoustic observer data, and the special respondent data file were used by the Volpe Center as input to their acoustic data processing program entitled DOSE. The output of the DOSE program defined the acoustic (i.e., dose) portion of the master database. In parallel to the acoustic data processing, Chilton Research Services prepared the survey (i.e., response) portion of the master database. The remainder of this section presents the detailed data reduction process employed in the development of the master database, which is specifically discussed in Section 5.3.

### 5.1 Acoustic Data Reduction

Acoustic data reduction was a two-step process, the first preparatory in nature and the second consisting of actual data processing. Section 5.1.1 describes the preparatory step of cleaning and editing the raw data collected in the field at BCNP. Section 5.1.2 describes the data processing employed in computing the various noise-related descriptors.



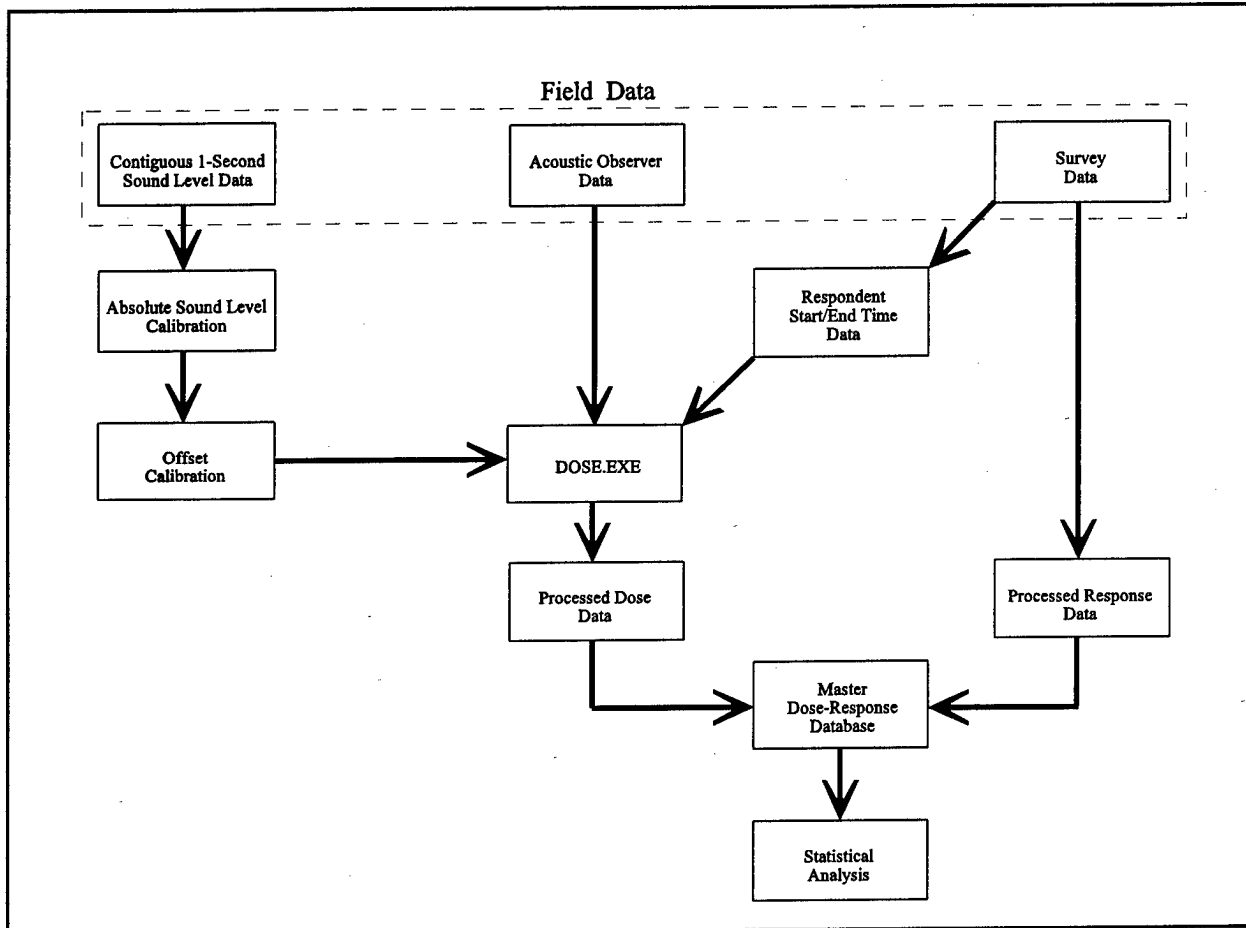

Figure 11. Flow for Processing of Dose-Response Data

---

### **5.1.1 Acoustic Data Cleaning and Editing**

Backup copies of all data files were made daily. The naming scheme for the data files was as follows: "MMDDYYai," where 'MM' is a two-digit representation of the month, 'DD' is a two-digit representation of the day, 'YY' is a two-digit representation of the year, 'a' is a unique character representing the site name and 'i' is an increment used when multiple files were required on a given day. Unique file extensions were given to the different types of data.

#### **5.1.1.1 Acoustic Data**

No editing was required for the acoustic data, which existed as ASCII text files, prior to running DOSE. A separate file containing calibration and time data was created. This file contained the 25 dB factor used in the offset calibration technique (see Section 3.1.2), any adjustments required for calibration drift, as well as the start and end time-of-day for all files.

#### **5.1.1.2 Acoustic Observer Log Data**

The acoustic observer log data files were checked daily for accuracy and edited as necessary. Editing generally consisted of clarifying comments. Occasionally, inconsistent data entries had to be deleted. In addition, the internal clock on the laptop computer used for running the observer log was found to be susceptible to lagging with respect to the master clock by as much as ten seconds (typically only one to three seconds) in any given day. When such a lag was encountered, it was assumed to have happened linearly over the course of the measurement day and edited accordingly prior to running DOSE. The spreadsheet files were then translated to comma-delimited ASCII format.

#### **5.1.1.3 Meteorological Data**

Prior to processing, the meteorological data were checked for dropouts (missing records for a given one-second time period). Less than ten dropouts, generally one record (one second) in length, were

---

---

encountered on any given day. Data for dropouts were simply copied from the record immediately preceding the dropout. It should be noted that it was not necessary to correct for dropouts of any meteorological data at or near wind speeds of 15 mph -- the predetermined wind-speed acceptability threshold (see Section 5.1.2).

### 5.1.2 Computing Respondent Doses

DOSE is a computer program developed by the Volpe Center for processing of the acoustic data measured at BCNP. Figure 12 presents the data types required for input to DOSE. They include: (1) the respondent start/end time data; (2) the contiguous one-second, time-stamped sound level data (both  $L_{Aeq,1s}$  and  $L_{ASmx}$ ); (3) the time-stamped acoustic observer data; and (4) a set of data (not shown) related to sound level calibration of the raw acoustic data. Given this information, DOSE currently computes 14 noise-related descriptors, as well as a complete set of diagnostic information. These descriptors can be easily grouped into three categories presented in order of increasing complexity (from the standpoint of both field measurement complexity, and complexity of understanding), as follows: (1) event-based descriptors, i.e., descriptors related strictly to numbers/counts of aircraft operations; (2) time-based descriptors, i.e., amounts or percentages of time during which the acoustical environment conditions satisfied a particular criterion; and (3) level-based descriptors, i.e., **decibel** values computed from acoustical data measured at the site. This section presents the specific processes, including equations used by DOSE for computing each of these 14 noise-related descriptors.

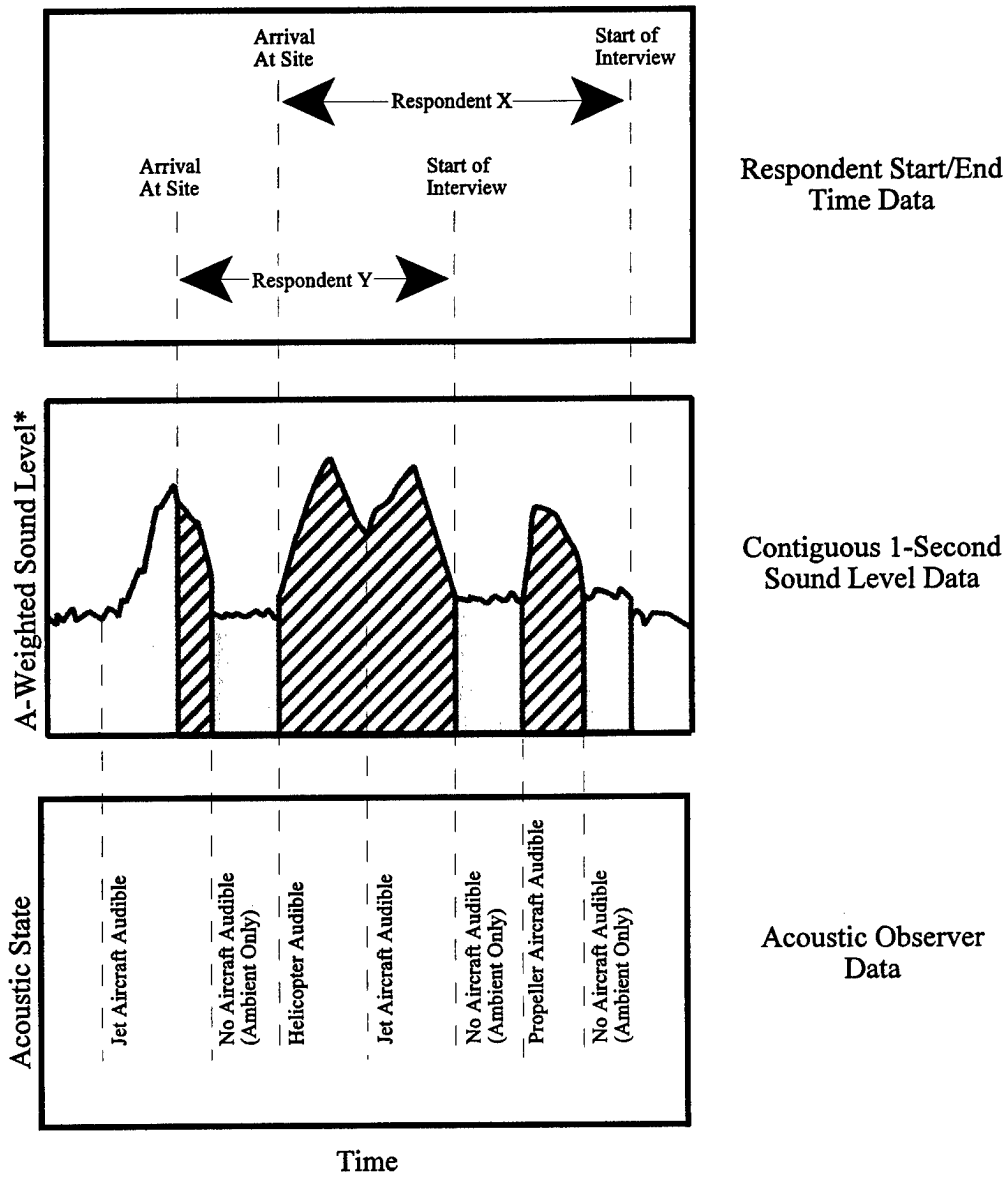

\* Calibrated (Absolute + Offset Adjusted)

Figure 12. Dose Calculation Methodology

---

Because of the highly sensitive nature of low-level noise measurements to wind, any sound level data measured during wind conditions greater than 15 mph would have been eliminated from further analysis during file preparation -- it happened that no data were taken for winds greater than 15 mph (an upper boundary to acceptable wind conditions was not considered in the previously-referenced NPS and USAF National Park studies). A complete statistical summary of the wind data is presented in Appendix D, along with a discussion of ambient sound levels measured at BCNP. No further discussion of the wind or associated ambient sound level data is presented in the main body of text.

Unlike previous National Park dose-response studies which employed a special algorithm for eliminating impulsive sounds such as bird chirps or park visitors yelling, no such algorithm was utilized in the current study. Acoustical data were initially processed both with and without such an algorithm implemented, and it was found that: (1) there was no statistically significant difference between the two data sets; and (2) there was the possibility that the algorithm could erroneously eliminate aircraft events from the computed dose. Accordingly, data analysis was undertaken without the use of such an algorithm.

#### **5.1.2.1 Event-Based Descriptors**

The event-based descriptors computed by DOSE include: (1) the number of aircraft observed during a respondent's visit ( $NUM_{ac}$ ); (2) the number of aircraft observed during a respondent's visit normalized to a one-hour time period ( $NUM_{ac/hr}$ ); and (3) the number of "loud" events observed during a respondent's visit ( $NUM_{loud}$ ).

The  $NUM_{ac}$  descriptor is very simply the total number of aircraft events of all types (helicopters, jet aircraft, propeller-driven aircraft and unknown types of aircraft) either partially or totally encompassed by a respondent's start and end time. DOSE was set up such that if only a single second of an aircraft event was bound by the respondent's start and end time, it would be counted as an

---

---

aircraft event rather than a fractional portion of an event. Like all descriptors computed in support of this study, the  $NUM_{ac}$  for a given respondent was based on the logging of an attentive listener, namely the person maintaining the acoustic observer log at the time of the event.

The  $NUM_{ac/hr}$  descriptor is the  $NUM_{ac}$  descriptor normalized to a one-hour time period. In other words, if Respondent X was on QGT for 30 minutes and the acoustic observer logged 6 aircraft events during that time period, the  $NUM_{ac/hr}$  for respondent X would be 12 (i.e., 60 minutes  $\div$  30 minutes  $\times$  6 aircraft). Similarly, if respondent Y was on QGTX for 70 minutes and the acoustic observer logged 19 aircraft events during that time period, the  $NUM_{ac/hr}$  for respondent Y would be 16.3 (i.e., 60 minutes  $\div$  70 minutes  $\times$  19 aircraft).

The  $NUM_{loud}$  descriptor was an attempt to quantify the number of aircraft events which contributed significantly to the total sound exposure experienced by a given respondent. It was computed using information from one of the diagnostic output files generated by DOSE. This diagnostic file includes for each respondent: (1) the total  $L_{AE}$  due to all aircraft; and (2) a rank-ordering of the  $L_{AE}$  for each individual aircraft event bound by the respondent's start and end time. The  $NUM_{loud}$  descriptor was arrived at by summing, on an **acoustic energy** basis, the rank-ordered  $L_{AE}$  values. The  $L_{AE}$  values were summed until the running  $L_{AE}$  was within 0.4 dB of the total  $L_{AE}$  for a given respondent. This criterion ensured that all aircraft events with  $L_{AE}$  values within 10 dB of the total  $L_{AE}$  for a given respondent were included. The number of aircraft needed to achieve the 0.4 dB criterion was the  $NUM_{loud}$  descriptor for that respondent. In general, this process tended to exclude most of the high-altitude jet aircraft. It is important to note that the  $L_{AE}$  values in this diagnostic file, like all level-based descriptors reported in this document, were corrected for **ambient noise** contamination using the procedure described in Section 5.1.2.3 below.

---

---

### 5.1.2.2 Time-Based Descriptors

The time-based descriptors computed by DOSE include: (1) the percentage of a respondent's time for which any aircraft were audible to an attentive listener (%TA); (2) the percentage of a respondent's time for which aircraft (other than high-altitude jet aircraft) were audible to an attentive listener (%TA<sub>w/ojet</sub>); (3) an estimate of the percentage of a respondent's time in which aircraft sound levels was audible (**noticeable**) to a typical park visitor (%TN); (4) the total duration in seconds during a respondent's time in which aircraft sound levels were greater than the ambient sound level (TAA); and (5) the percentage of a respondent's time in which the aircraft sound levels were greater than the ambient sound level (%TAA).

The equations used for computing the first two descriptors, %TA and %TA<sub>w/ojet</sub> are described below.

$$\%TA = TA/T_{resp} \times 100 \quad (\%)$$

where: TA is the time in seconds aircraft were audible to an attentive listener during a given respondent's visit; and

T<sub>resp</sub> is the duration in seconds of the respondent's visit.

$$\%TA_{w/ojet} = TA_{w/ojet}/T_{resp} \times 100 \quad (\%)$$

where: TA<sub>w/ojet</sub> is the time in seconds aircraft (excluding high-altitude jet aircraft) were audible to an attentive listener during a given respondent's visit; and

T<sub>resp</sub> is the duration in seconds of the respondent's visit.

---

The %TN descriptor, which is intended to be more closely related to the hearing of a typical park visitor rather than that of an attentive listener, is a refined version of the %TA descriptor. To help illustrate the %TN descriptor, Figure 13 presents a sound level time history of a single aircraft event. Point A1 represents the time the aircraft first became audible to the field observer. Point A2 represents the time the aircraft was no longer audible to the same listener. The time the aircraft was determined to be noticeable was the time the aircraft sound level was greater than the noticeability threshold. The noticeability threshold is the acoustic energy average of the sound levels associated with Point A1 and Point A2 plus a noticeability factor of 10 dB. The time noticeable was computed for each aircraft bound by the respondent's start and end time. These individual time values were then summed to obtain the total time noticeable for a respondent. The total time aircraft were noticeable was then converted to the percent time noticeable descriptor, %TN as follows:

$$\%TN = TN \div T_{\text{resp}} \times 100 \quad (\%)$$

where: TN is the time in seconds the aircraft sound level was greater than the noticeability threshold during a given respondent's visit; and

$T_{\text{resp}}$  is the duration in seconds of the respondent's visit.

The noticeability factor of 10 dB was derived from best available research conducted in support of the NPS.<sup>22</sup> Additionally, analyses were performed with noticeability factors of 1 dB, 2 dB, etc., up to 9 dB, in an attempt to discern the most appropriate value (see Section 6.3.5).



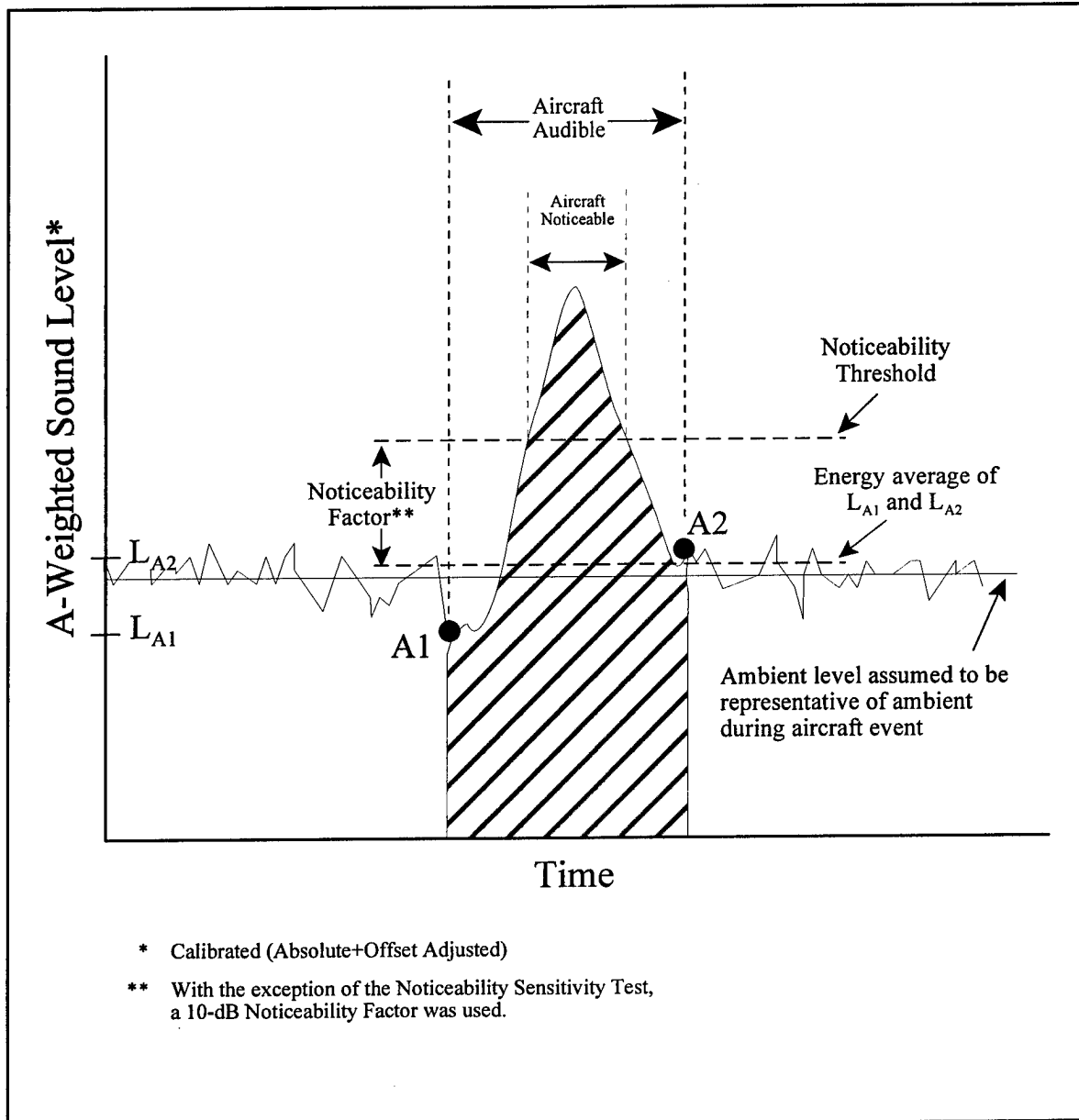

Figure 13. Computing Percent Time Noticeable (%TN)

---

In computing TAA for a respondent, the ambient sound level was defined as the energy average of all "non-aircraft"  $L_{Aeq,1s}$  values bound by the respondent's start and end time ( $L_{Aeq,Tamb}^*$ ). In other words, the ambient sound level for the respondent was the energy average of all  $L_{Aeq,1s}$  values measured when the associated acoustic state was either "non-aircraft - human" or "natural." It follows that the TAA for a respondent was very simply the amount of time in seconds for which the aircraft sound level was greater than the ambient sound level.

The percentage of time in which the aircraft sound level was greater than the ambient sound level was computed as follows:

$$\%TAA = TAA \div T_{resp} \times 100 \quad (\%)$$

where: TAA, as described above, is the time in seconds during which the aircraft sound level was greater than the ambient sound level during a given respondent's visit; and

$T_{resp}$  is the duration in seconds of the respondent's visit.

### 5.1.2.3 Level-Based Descriptors

The first step in the computation of the level-based descriptors is the process of correcting measured aircraft sound levels for the effects of ambient. Since ambient noise is present during the measurement of aircraft sound levels, the measurement values are artificially higher than they would have been in the absence of ambient noise (ambient levels add acoustic energy to measured aircraft sound levels). To present more accurate aircraft sound levels, this ambient "contamination" is removed in data processing. Figure 14 overviews the removal/correction process for a single aircraft event. Initially a single representative ambient value is computed for each event by energy-averaging the 30 seconds of non-aircraft sound levels leading up to Point A1 (the point in time the aircraft first

---

---

becomes audible) and the 30 seconds of non-aircraft sound levels subsequent to Point A2 (the point the aircraft was no longer audible).

Very often the 30 seconds of non-aircraft sound levels are not contiguous, i.e., the intervening sound levels may be associated with an aircraft event and therefore are not appropriate for determining the ambient value. As such, DOSE is structured so that it will skip aircraft-based sound levels to obtain the non-aircraft levels used for computing the ambient value. The program will go as far back, or forward in time as five minutes from the point of **audibility** to obtain the 30-second pre- and 30-second post-aircraft-event sound levels (the 5 minute/30 second criterion used in this study differs slightly from the 10 minute/2 minute criterion used by the NPS and the USAF in their park dose-response studies). The 5 minute/30 second criterion was selected herein because it is generally more consistent with that used in aircraft noise certification tests. In some cases a total of 60 seconds of non-aircraft sound levels were not available within the  $\pm 5$  minute constraint. In these instances the energy-average was computed from less than 60 seconds of one-second ambient data, and a data flag was set to identify this condition in subsequent processing and analysis.

An important assumption in this correction process is that the ambient value computed from the 60 seconds (or less) of ambient data surrounding the aircraft event ( $L_{Aeq,Tamb}$ ) is representative of the ambient during the aircraft event. Given this caveat, the ambient value is next normalized in time to the duration of the associated aircraft event as follows:

$$L_{AE,amb-ev} = L_{Aeq,Tamb} + 10 \times \log_{10}(T_{ac}) \quad (dB)$$

where:  $L_{Aeq,Tamb}$  is the energy-average of the 60 seconds (or less) of ambient data surrounding a given aircraft event; and  
 $T_{ac}$  is the duration in seconds of the aircraft event.

The uncorrected sound exposure level ( $L_{AE}$ ) for the aircraft event is then computed by summing the associated  $L_{Aeq,1s}$  values on an energy basis as follows:

$$L_{AE,ev} = 10 \times \log_{10}(\sum 10^{(L_{Aeq,1s}+10)}) \quad (dB)$$

where:  $L_{Aeq,1s}$  is the measured one-second sound level data associated with a given aircraft event.

The corrected sound exposure level ( $L_{AEc}$ ) for the aircraft event is then computed by subtracting on an energy basis the time-normalized ambient ( $L_{AE,amb-ev}$ ) from the uncorrected  $L_{AE,ev}$  as follows:

$$L_{AEc,ev} = 10 \times \log_{10}(10^{(L_{AE,ev}+10)} - 10^{(L_{AE,amb-ev}+10)}) \quad (dB)$$

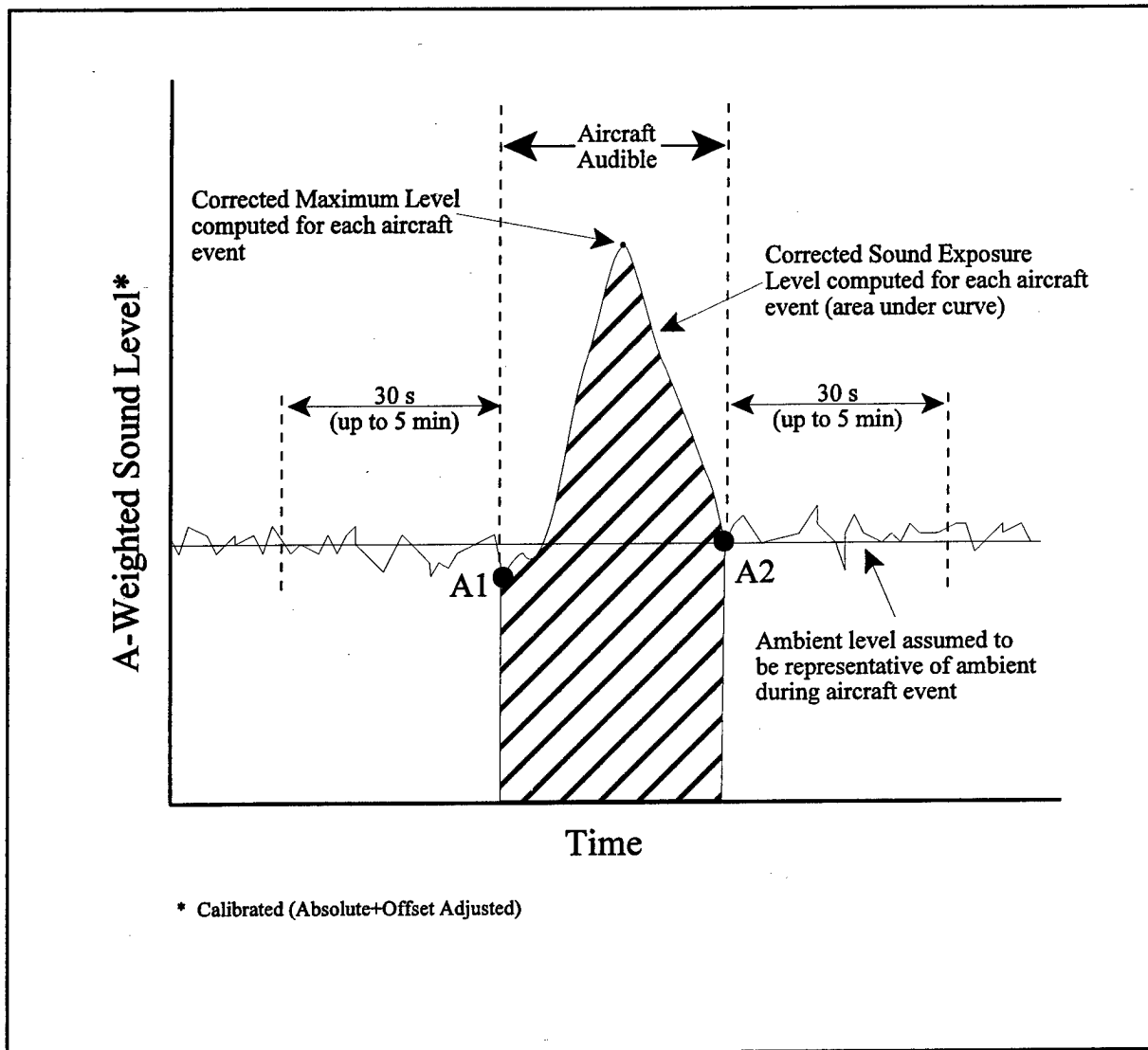

**Figure 14. Computing Ambient-Corrected Aircraft Sound Levels**

The  $L_{AEC, ev}$  values for a given respondent are then combined on an acoustic energy basis to obtain a total  $L_{AEC}$  taking into account all aircraft events for that respondent. The level-based descriptors computed by DOSE are generally arithmetic manipulations of the total  $L_{AEC}$  values computed for a given respondent.

The level-based descriptors computed by DOSE include: (1) the equivalent sound level due to aircraft ( $L_{Aeq, Tac}$ ); (2) the equivalent sound level due to aircraft normalized to the respondent's duration ( $L_{Aeq, Tresp}$ ); (3) the equivalent sound level due to aircraft normalized to a one-hour time period ( $L_{Aeq, 1h}$ ); (4) the change in sound exposure due to aircraft ( $\Delta L_{AE, Tac}$ ); (5) the change in sound exposure due to aircraft weighted by a special time adjustment factor ( $\Delta L_{AE, Tadj}$ ); and (6) the maximum A-weighted sound level (with slow exponential time weighting) due to aircraft ( $L_{ASmx}$ ).

The equivalent sound level due to aircraft ( $L_{Aeq, Tac}$ ) was computed as follows:

$$L_{Aeq, Tac} = L_{AEC} - 10 \times \log_{10}(T_{ac}) \quad (\text{dB})$$

where:  $L_{AEC}$  is the ambient-corrected sound exposure level taking into account all aircraft for a given respondent; and  
 $T_{ac}$  is the total duration in seconds associated with all aircraft events during the respondent's visit.

The equivalent sound level due to aircraft normalized to the respondent's duration ( $L_{Aeq, Tresp}$ ) was computed as follows:

$$L_{Aeq, Tresp} = L_{AEC} - 10 \times \log_{10}(T_{resp}) \quad (\text{dB})$$

---

where:  $L_{AEC}$  is the ambient-corrected sound exposure level taking into account all aircraft for a given respondent; and  
 $T_{resp}$  is the duration in seconds of the respondent's visit.

The equivalent sound level due to aircraft normalized to a one-hour time period ( $L_{Aeq,1h}$ ) was computed as follows:

$$L_{Aeq,1h} = L_{AEC} - 35.56 \quad (\text{dB})$$

where:  $L_{AEC}$  is the ambient-corrected sound exposure level taking into account all aircraft for a given respondent; and  
 35.56 is a normalization constant which spreads the acoustic energy associated with aircraft operations over a one-hour period, i.e.,  
 $10 \times \log_{10}(3600 \text{ seconds per hour}) = 35.56 \text{ dB}$ .

The change in sound exposure due to aircraft ( $\Delta L_{AE,Tac}$ ) was computed as follows:

$$\Delta L_{AE,Tac} = L_{AEC} - [L_{Aeq,Tamb*} + 10 \times \log_{10}(T_{ac})] \quad (\text{dB})$$

where:  $L_{Aeq,Tamb*}$  is the energy-average of all "non-aircraft"  $L_{Aeq,1s}$  values bound by the respondent's start and end time (it is the same ambient used for computing the TAA and %TAA descriptors); and  
 $T_{ac}$  is the total duration in seconds associated with all aircraft events during the respondent's visit.

---

---

The change in sound exposure due to aircraft weighted by a special time adjustment factor ( $\Delta L_{AE,Tadj}$ ) was computed as follows:

$$\Delta L_{AE,Tadj} = \Delta L_{AE,Tac} + 10 \times \log_{10}(T_{ac} \div T_{amb}) \quad (\text{dB})$$

where:  $\Delta L_{AE,Tac}$  is the change in sound exposure level due to aircraft as computed above;

$T_{ac}$  is the total duration in seconds associated with all aircraft events during the respondent's visit; and

$T_{amb}$  is the total duration in seconds associated with ambient during the respondent's visit.

The maximum A-weighted sound level due to aircraft ( $L_{ASmx}$ ) is very simply the ambient-corrected maximum of the one-second  $L_{ASmx}$  values measured for a given respondent when the corresponding acoustic state was "aircraft." The ambient correction process for the  $L_{ASmx}$  data is identical to that described at the beginning of this section for the  $L_{Aeq,1s}$  data, i.e., the same 5 minute/30 second criterion is utilized.

## 5.2 Survey Data Reduction

Survey data reduction was a two-step process. Section 5.2.1 describes the step of editing the raw surveys and entering them into a computer-readable format. Section 5.2.2 describes the data cleaning process which was essentially a quality control check.

### 5.2.1 Survey Editing and Data Entry

Initially, all answer sheets were checked for legibility, completeness, and accuracy. This process included ensuring that all responses were readable, making sure that only one response was given to

---



any particular question and cross-correlating times and other group-based information across respondents. Next, coding of open-ended questions was performed. This process involved reading all responses to open-ended questions, grouping them when possible, and assigning code numbers to each group. Finally, a master electronic database was created containing all responses to the survey.

### **5.2.2 Survey Data Cleaning**

Next, the database was "cleaned" using regimented data processing procedures. This process included checking to see that skip instructions were followed correctly and that answers to questions were coded consistently. For example, on Question #2, if the respondent had answered "yes" to the question "have you visited the park before?", then the response for the "number" of times would only be allowed to be greater than zero. Conversely, if the respondent had not visited the park before, anything besides no answer or a zero in response to the number of previous visits would be inconsistent. In addition, Question #9 on annoyance was coded as a "0" if Question #8 on whether aircraft were heard was "no." Finally, an "outlier" analysis was performed to further check for inconsistencies. The final, cleaned database was then double-checked by a second member of the data reduction staff.

### **5.3 Master Database**

The master database, which exists as a Microsoft Excel spreadsheet, is the foundation for the statistical data analysis presented in Section 6. It consists of a conglomeration of acoustic- and survey-related data collected at BCNP, including all acoustic descriptors, several diagnostic outputs, as well as the actual survey questions and responses. Appendix E presents a statistical summary of the responses to the questionnaire. Appendix F presents a statistical summary of the dose-related data, including a presentation of the variability in the observed acoustic doses.

---

---

All acoustic descriptors discussed in Section 6 are included in the database. Additionally, most descriptors are broken out by aircraft type (i.e., helicopter, propeller, jet and unknown), should further evaluation be required. Diagnostic outputs include the following on a per respondent basis: percent of aircraft sound levels that were uncorrectable ( $\%T_{unc}$ );  $L_{Aeq}$  for all uncorrectable aircraft sound levels ( $L_{Aeq,unc}$ ); difference between  $L_{Aeq}$  and  $L_{Aeq,unc}$  ( $\Delta G/B$ ); and a Quality Indicator (QI). The combination of  $\%T_{unc}$  and  $\Delta G/B$  enabled the determination of the relative decibel importance of any uncorrectable aircraft data. After this determination was made, the QI was assigned (0 to 7, 7 being the highest quality data). All respondents were included in the statistical analysis, however, should it be deemed necessary, future analysis could be performed using a partial data set based on the QI.



---

## 6. Data Analysis and Results

Section 6 presents the statistical analysis of the BCNP dose-response data. Section 6.1 begins with an outline of the analysis framework. In an effort to obtain a general understanding of the data collected in support of this study, Section 6.2 presents an exploratory analysis performed using the complete data set (i.e., the data from QGT and QGTX were combined). During subsequent development of the statistical models (Sections 6.3 and 6.4), analyses were performed separately for data collected from each of the two trails. Section 6.5 presents a general comparison of the BCNP dose-response results and the results of the previously-referenced NPS dose-response study.<sup>16</sup>

### 6.1 Framework

Two portions of the analysis framework were somewhat predefined before actively analyzing the data. First, it was determined that the analytical method to be used would be logistic regression. This is traditionally the method used in a dose-response study. An important advantage to this type of analysis is that the predicted probability of a "response" (in this case, "annoyance") will always fall between 0 and 1. This eliminates any possibility that the model could predict an impossible outcome (i.e., an outcome where greater than 100% or less than 0% of the population is annoyed). A logistic regression analysis was also selected to maintain consistency with the previously-referenced NPS dose-response work conducted in the National Parks.\*

---

\* Two alternative analysis methods could have been selected which would make more complete use of the total available data. Within the logistic regression framework, a cumulative logit approach could have been selected (Ref.: Agresti, A., 1990, *Categorical Data Analysis*, N.Y., Wiley, John). A cumulative logit regression does not dichotomize the visitor response data, instead, the separate categories of response data are retained, thereby using the data in the most complete fashion possible to determine annoyance. Also, upon visual inspection of the data, the relationship between annoyance and most acoustic descriptors appears to be linear, supporting the use of a general linear model. Unfortunately, in this model, it is possible to predict impossible outcomes (i.e., an outcome where greater than 100% or less than 0% of the population is annoyed). However, if the acoustic data covers the range of likely possible noise doses, this should not happen in most practical situations. Many of the acoustic descriptors themselves are self-limiting by definition (such as percentage), which further assures that unrealistic outcomes will not result.

---

---

The form of the logistic regression equation used is as follows:

$$\%Annoyance = \frac{e^{b_0 + b_1(\text{Acoustic Descriptor})}}{1 + e^{b_0 + b_1(\text{Acoustic Descriptor})}} \times 100$$

where  $b_0$  = the constant of the regression; and

$b_1$  = the coefficient of the acoustic descriptor.

Second, it was decided that the visitor responses to the "annoyance question" (Question #9) would be dichotomized as follows: (1) those that reported that they were "not at all" or "slightly annoyed" were coded as *not annoyed* (or "satisfied"); and (2) those that reported that they were "moderately," "very," or "extremely annoyed" were coded as *annoyed*. As stated earlier, this definition of "annoyance" was selected, in part to remain consistent with earlier NPS and USAF park dose-response studies.

Further data analysis also supports the decision to use the top three categories to define an annoyed park visitor. In Survey Question 16, visitors were asked, based on their overall park experience at BCNP today, "Which of these bothered or annoyed you the most?". They could respond in one of four ways: the "number of aircraft you heard," the "level of aircraft you heard," the "amount of time you heard aircraft," or "none." These responses were grouped into two categories; either some aspect of hearing the aircraft annoyed them, or nothing about hearing the aircraft annoyed them. Those that responded that something about hearing the aircraft annoyed them overwhelmingly rated themselves in the top three categories in response to the "annoyance question." Those that responded that nothing about the aircraft annoyed them usually rated themselves in the bottom two categories. This relationship is summarized in Table 4.

---

**Table 4. Analysis of Responses to Question 16 and Question 9**

		Question 16	
		Annoyed by number, level, or duration of aircraft	None
Question 9	Not at all annoyed	22%	78%
	Slightly annoyed	66%	33%
	Moderately annoyed	91%	9%
	Very annoyed	98%	2%
	Extremely annoyed	100%	0%

**6.2 Exploratory Analysis for QGT and QGTX Combined**

During the exploratory phase of the analysis, data from both QGT and QGTX were combined. In later sections, which discuss analytical approaches that proved most fruitful, data from the two trails were shown to behave quite differently. Therefore, Sections 6.3 and 6.4 discuss the trails separately and do not include the results for the two trails combined so as to avoid possible confusion.

**6.2.1 Correlation Among Acoustic Descriptors**

Although many of the acoustic descriptors have similar definitions, the Pearson Correlations between the acoustic descriptors show that they are only moderately related, as depicted in Table 5. In examining the Pearson Correlations, a 1.00 indicates a perfect relationship, while other values can be compared to determine the relative relationships. For example, a Pearson Correlation of 0.75 indicates better correlation than a value of 0.54. A negative value would indicate that raising one measure would lower the other measure, which in this analysis, indicates that one of the measures is behaving counter-intuitively.

**Table 5. Pearson Correlations of Acoustic Descriptors**

	NUM <sub>ac</sub>	NUM <sub>ac/hr</sub>	NUM <sub>loud</sub>	%TA	%TA <sub>w/objct</sub>	%TN	TAA	%TAA	L <sub>Aeq,Tac</sub>	L <sub>Aeq,Tresp</sub>	L <sub>Aeq,1h</sub>	ΔL <sub>AE,Tac</sub>	ΔL <sub>AE,Tadj</sub>	L <sub>ASmx</sub>
NUM <sub>ac</sub>	1.00	0.51	0.45	0.38	0.17	-0.02	0.60	0.15	0.06	0.23	0.38	0.04	0.04	0.26
NUM <sub>ac/hr</sub>		1.00	0.17	0.75	0.44	0.28	0.32	0.54	0.16	0.38	0.32	0.26	0.41	0.23
NUM <sub>loud</sub>			1.00	0.22	0.09	-0.01	0.34	0.14	-0.26	-0.02	0.05	-0.24	-0.15	-0.17
%TA				1.00	0.75	0.53	0.55	0.76	0.23	0.54	0.49	0.33	0.64	0.18
%TA <sub>w/objct</sub>					1.00	0.47	0.43	0.67	0.54	0.63	0.59	0.41	0.64	0.18
%TN						1.00	0.25	0.49	0.17	0.30	0.23	0.47	0.56	0.02
TAA							1.00	0.75	0.10	0.28	0.37	0.40	0.46	0.00
%TAA								1.00	0.20	0.40	0.33	0.56	0.79	-0.09
L <sub>Aeq,Tac</sub>									1.00	0.96	0.94	0.58	0.52	0.91
L <sub>Aeq,Tresp</sub>										1.00	0.97	0.59	0.60	0.60
L <sub>Aeq,1h</sub>											1.00	0.54	0.52	0.63
ΔL <sub>AE,Tac</sub>												1.00	0.85	0.48
ΔL <sub>AE,Tadj</sub>													1.00	0.28
L <sub>ASmx</sub>														1.00

The Pearson Correlation analysis indicated that additional information (and potentially, a better model) could be developed by using a multiple acoustic descriptor model rather than a single descriptor model. Unfortunately, none of the subsequent tests of this hypothesis proved to be significant: a model using multiple descriptors did not perform significantly better than the single descriptor models. In succeeding sections, only the single descriptor models are discussed.

**6.2.2 Outlier Analysis**

In this effort, "goodness-of-fit" tests were conducted against each of the respondent's actual and predicted values. Twelve respondents who were most deviant from their predicted values were then selected and removed from the data set and the models run again. There was a negligible change in

the coefficients of the models and the goodness-of-fit measures. Because of the need to justify the rationale for respondent removal, and because there was no improvement in the model due to their removal, no attempt was made to systematize an outlier selection process. All of the respondents were retained in the data set and reported in this study.

### **6.2.3 Non-Zero Intercept**

Preliminary analysis of the data used a model which forced an intercept of zero. The a priori rationale for that restriction was that the likelihood of annoyance due to aircraft noise should be zero when there is no aircraft noise present in the environment. When the preliminary work was peer reviewed, one of the recommendations was to allow the use of a non-zero intercept term in the models.<sup>23</sup> The reasons for this recommendation were as follows:

- (1) The results of the standard tests of significance or of power used to evaluate models are distorted in zero-intercept models. This makes it very difficult to actually decide whether the model is good or bad.
- (2) The models are much better at fitting the observed data when an intercept is allowed. This was seen both visually and via outlier analysis.
- (3) The intercept may actually reflect a psychological reality, wherein people may be annoyed by airplane noise regardless of whether any noise was actually present.

Although the questionnaire strongly emphasized that only noise occurring while on the trail should be considered, it is likely that respondents may be influenced by other variables that are inconsistent with the objectivity of the study. As a consequence of the recommendation from the peer reviewer and the compelling logic accompanying it, the final analysis was done with an intercept term included and all reported results used a model-with-intercept as a basis.

---



### 6.3 Acoustic Model

Section 6.3 presents the *pure acoustic model* developed in the current study. By definition this model was developed without considering any variables beyond the acoustic descriptor (i.e., no covariates were considered in the development of the pure acoustic model).

#### 6.3.1 Logistic Regression Analysis

Tables 6 and 7 present the results of the final logistic regression analyses performed for each acoustic descriptor for QGT and QGTX, respectively. Presented are the coefficient of the acoustic descriptor ( $b_1$ ), whether or not that coefficient is significant (if it was significant, and at what chi-square significance level), the constant of the regression ( $b_0$ ), the Akaike Information Criteria (AIC), and the %Concordance (%C). The chi-square significance level represents the level of confidence that the determination of significance is correct, e.g., if  $b_1$  is determined to be significant at a chi-square level of .05, then one can be 95 percent certain the coefficient is significant. The AIC is a criteria used to judge the "goodness-of-fit" of the model, taking into account the effect of different sample sizes and different numbers of variables. In general, the lower the AIC the better the model fit. Therefore, it provides a measure of relative "goodness" of models developed for individual noise descriptors. The %C is a statistic used to judge the ability of the model to agree, at least directionally, with the data points. It is calculated by matching all possible pairs of events and non-events (annoyed and not annoyed responses), and calculating the percent of time the model predicts a higher likelihood of occurrence for the event than for the non-event.

Several notable observations can be made regarding the data presented in Tables 6 and 7:

- (1) The average AIC for QGTX (364) is significantly lower than for QGT (524), indicating that the model for QGTX provides a better fit to the data. Likewise, the average %C for QGTX (56.6%) is higher than for QGT (53.6%), indicating that the model for QGTX is better able to agree with the directionality of the data.
-

- 
- (2) For QGT, the three descriptors with the lowest AIC's are  $\Delta L_{AE,Tadj}$ ,  $\Delta L_{AE,Tac}$ , and  $NUM_{ac/hr}$  and  $L_{ASmx}$  (tied). For QGTX, the three descriptors with the lowest AIC's are  $\Delta L_{AE,Tadj}$ ,  $\Delta L_{AE,Tac}$ , and  $L_{Aeq,1h}$  and  $L_{Aeq,Tresp}$  (tied).
  - (3) For, QGT the three descriptors with the highest %C are %TA, %TA<sub>w/oJet</sub>, and  $\Delta L_{AE,Tadj}$  and %TAA (tied). For QGTX, the three descriptors with the highest %C are %TA<sub>w/oJet</sub>, %TN, and  $L_{Aeq,Tresp}$ .
  - (4) The only descriptor with a coefficient that was significant at the .001 level (99.9% certainty) for QGTX was %TA<sub>w/oJet</sub>; none of the descriptors had coefficients that were significant at the .001 level for QGT.
  - (5) For QGT,  $NUM_{loud}$ , %TN,  $L_{Aeq,Tac}$ , and  $L_{ASmx}$ , and for QGTX,  $NUM_{ac/hr}$ , and  $NUM_{loud}$ , failed significance at even the lowest chi-square significance level (.05).
-

Table 6. Logistic Regression Results, QGT

Acoustic Descriptor	Coefficient (b <sub>i</sub> )	Coefficient Significant?	Constant (b <sub>0</sub> )	AIC	%C
NUM <sub>ac</sub>	0.090	Yes, *	-1.414	509	50.2
NUM <sub>ac/hr</sub>	0.046	Yes, **	-1.783	506	55.3
NUM <sub>loud</sub>	-0.013	No	-0.767	562	37.6
%TA	0.020	Yes, **	-2.001	548	60.9
%TA <sub>w/objct</sub>	0.012	Yes, **	-1.217	555	57.9
%TN	0.019	No	-0.988	559	56.5
TAA	0.001	Yes, **	-1.321	552	56.3
%TAA	0.012	Yes, **	-1.303	555	57.1
L <sub>Aeq,Tac</sub>	0.028	No	-2.000	513	49.0
L <sub>Aeq,Tresp</sub>	0.037	Yes, *	-2.242	510	53.7
L <sub>Aeq,lb</sub>	0.035	Yes, *	-1.982	510	53.4
ΔL <sub>AE,Tac</sub>	0.041	Yes, *	-1.255	500	55.3
ΔL <sub>AE,Tadj</sub>	0.042	Yes, **	-1.261	445	57.1
L <sub>ASmx</sub>	0.022	No	-2.003	506	50.5
Mean:				524	53.6

\* Significant at .05 (95% Certainty)

\*\* Significant at .01 (99% Certainty)

\*\*\* Significant at .001 (99.9% Certainty)

The pure acoustic model dose-response curves for the fourteen acoustic descriptors for both QGT and QGTx are shown in Figures 15 through 42. Also shown on these charts are the 95% confidence intervals around the predicted curves. As can be seen through inspection, the base level of annoyance (the intercept, or extrapolated intercept of the predicted regression curve with the y-axis) is generally higher for QGT than for QGTx. QGT shows an intercept of about 10% to 30% (depending on noise descriptor) while QGTx shows an intercept of about 5% to 25% (depending on noise descriptor). This observation should be carefully interpreted because it might be influenced by several factors. First, it could be due to people falsely reporting annoyance, based on some prior experience with

**Table 7. Logistic Regression Results, QGTX**

Acoustic Descriptor	Coefficient (b <sub>1</sub> )	Coefficient Significant?	Constant (b <sub>0</sub> )	AIC	%C
NUM <sub>ac</sub>	0.067	Yes, *	-1.674	373	53.2
NUM <sub>ac/hr</sub>	0.033	No	-1.633	375	53.0
NUM <sub>loud</sub>	-0.789	No	0.855	379	41.8
%TA	0.021	Yes, *	-2.127	374	58.5
%TA <sub>w/ojet</sub>	0.035	Yes, ***	-1.966	365	62.8
%TN	0.063	Yes, *	-1.464	374	60.7
TAA	0.001	Yes, *	-1.509	375	57.7
%TAA	0.018	Yes, **	-1.532	376	57.1
L <sub>Aeq,Tac</sub>	0.056	Yes, *	-3.172	370	56.0
L <sub>Aeq,Tresp</sub>	0.089	Yes, **	-4.069	364	60.4
L <sub>Aeq,1h</sub>	0.085	Yes, **	-3.709	364	60.1
ΔL <sub>AE,Tac</sub>	0.066	Yes, *	-1.505	345	57.0
ΔL <sub>AE,Tadj</sub>	0.069	Yes, *	-1.418	289	58.0
L <sub>ASmx</sub>	0.048	Yes, *	-3.594	370	55.8
Mean:				364	56.6

\* Significant at .05 (95% Certainty)      \*\* Significant at .01 (99% Certainty)      \*\*\* Significant at .001 (99.9% Certainty)

aircraft noise. There is also a large variance component inherent in the data which is due to the different ways individuals use rating scales and the different ways individuals evaluate their own emotional state, which will appear as a base annoyance level or intercept term. It can also be due to annoyance which has simply not been modeled by the predictor variable (i.e., by the acoustic descriptor). In general, it can be said that a model with a smaller intercept term is better at accounting for a larger portion of the ratings than a model with a larger intercept term. Note: These curves encompass the range of acoustic doses observed, i.e., no extrapolation of the curves, and therefore the measured data, was attempted in the current study.

---

It is also important to point out that for several of the noise descriptors, i.e., the change in exposure descriptors ( $\Delta L_{AE,Tac}$  and  $\Delta L_{AE,Tadj}$ ), the percent time noticeable (%TN), the time above ambient (TAA) and the percent time above ambient (%TAA), a base annoyance level of greater than zero was pre-determined to be possible, and can in fact be explained. For example, in the case of the change of exposure descriptors, several park visitors actually identified hearing aircraft when their associated sound level was less than that of the ambient (i.e., a negative change in exposure value). However, the displayed curve only shows values greater than or equal to zero because negative values could not be *accurately* determined in the data processing. Consequently, a base annoyance level of greater than zero for the change in exposure descriptors can be supported by the assumption that annoyance due to aircraft noise (at least for some visitors) occurs when the aircraft sound level is actually less than that of the ambient.

Ultimately in the development of a National Rule on park overflights it may be necessary, at least for some of the noise descriptors, e.g., %TA and %TA<sub>w/oJetz</sub>, to adjust the dose-response curves so as to *eliminate* the base annoyance level. This may be especially true for the time audible descriptors, i.e., when no aircraft noise could be heard by an attentive listener, zero percent of park visitors *should* be annoyed. One way of accomplishing this would be to force a zero intercept term, but this is not recommended for the reasons cited in Section 6.2.3. A second option would be to allow the data to define the intercept, as was done herein, but then to adjust or normalize the entire dose-response curve by the single value associated with the base annoyance level. For example, in Figure 23 the base annoyance level is about 22 percent. If the normalization approach were utilized every value on the dose-response curve would be adjusted downward by 22 percent. A third approach might be to use some type of a weighted normalization process where a function would be used to normalize the curve. Additional work would be required to determine an appropriate function.

---

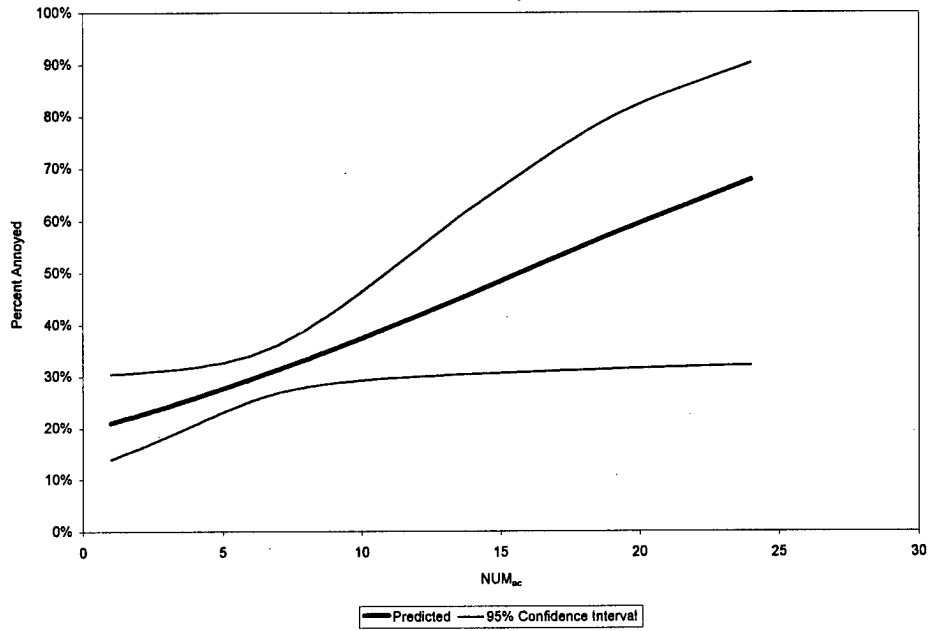

Figure 15. NUM<sub>ac</sub> vs. Percent Annoyed, QGT

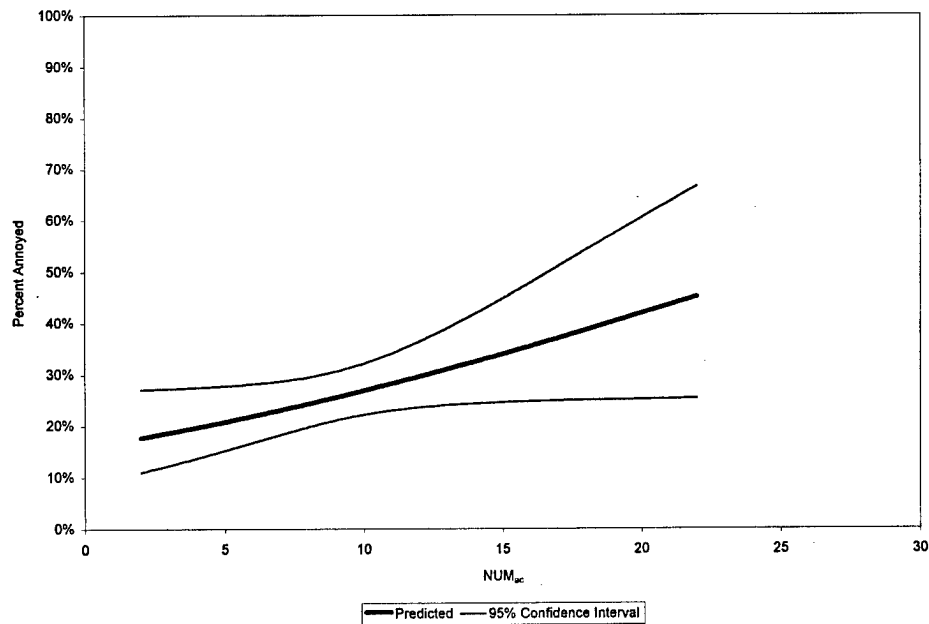

Figure 16. NUM<sub>ac</sub> vs. Percent Annoyed, QGTx

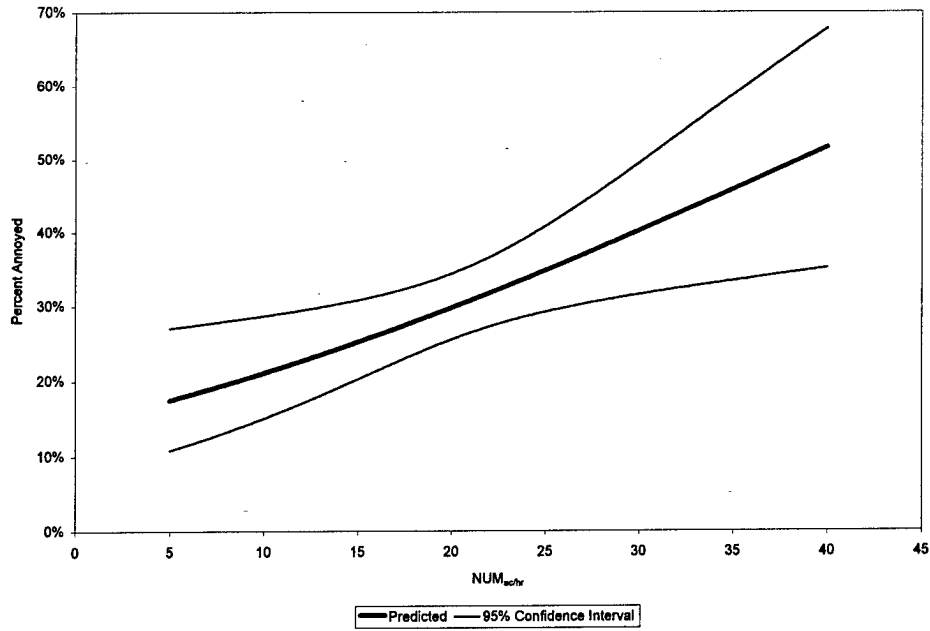

Figure 17. NUM<sub>ac/hr</sub> vs. Percent Annoyed, QGT

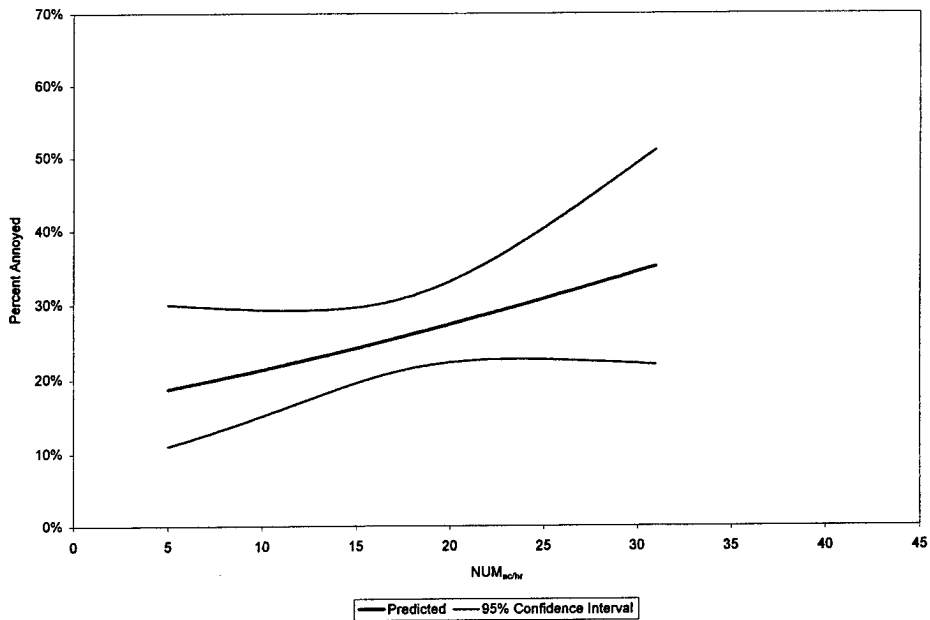

Figure 18. NUM<sub>ac/hr</sub> vs. Percent Annoyed, QGTx

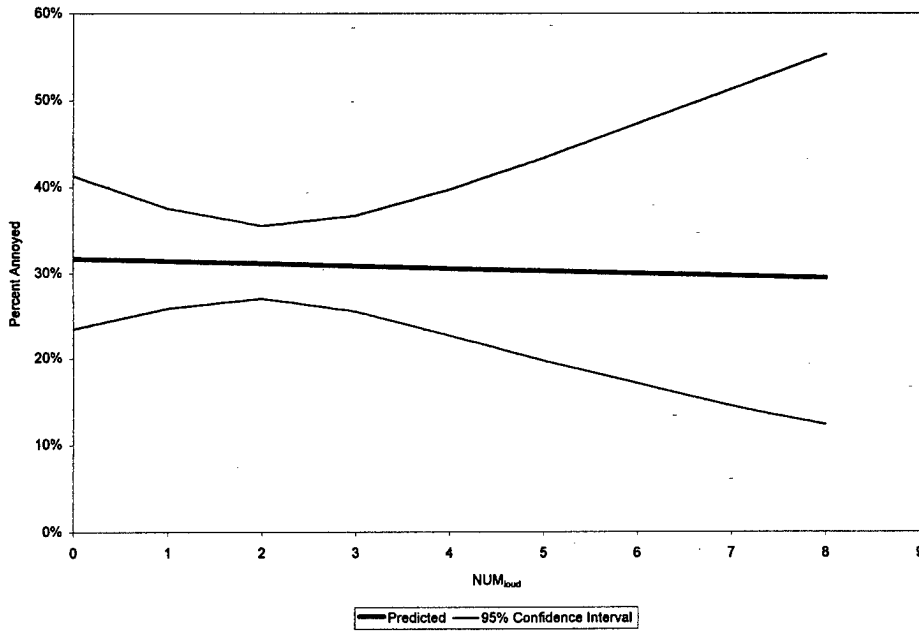

Figure 19. NUM<sub>loud</sub> vs. Percent Annoyed, QGT

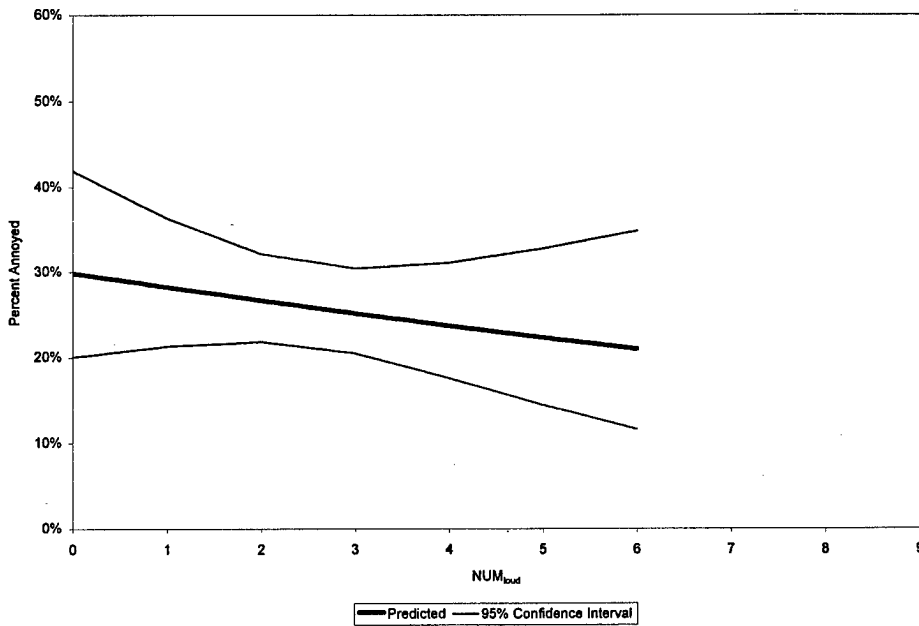

Figure 20. NUM<sub>loud</sub> vs. Percent Annoyed, QGTx



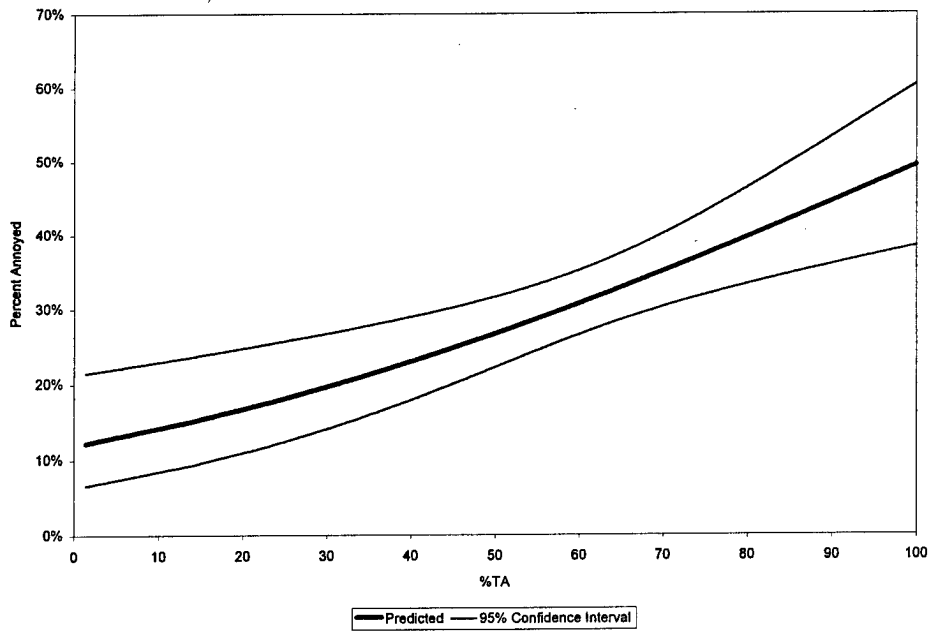

Figure 21. %TA vs. Percent Annoyed, QGT

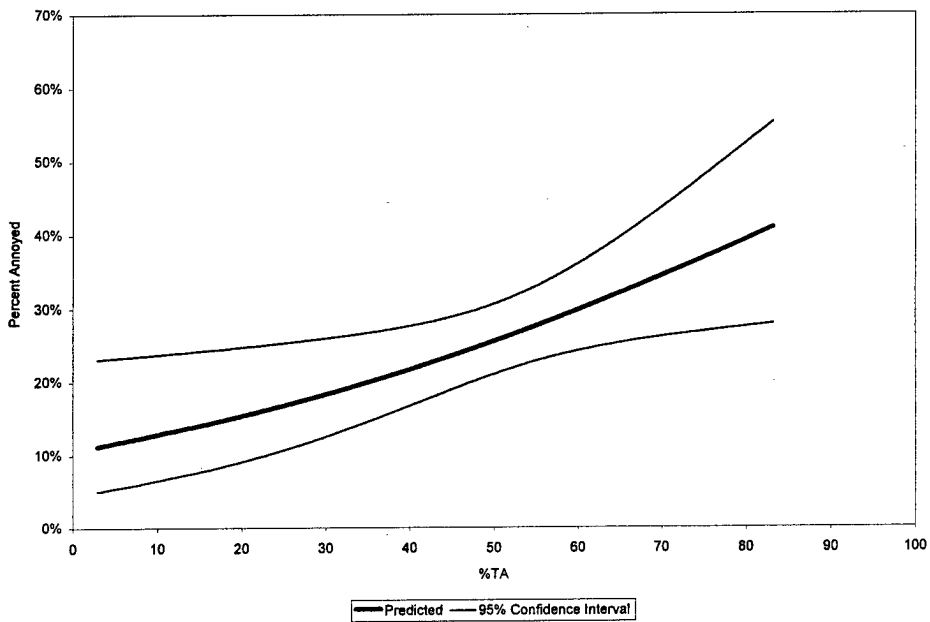

Figure 22. %TA vs. Percent Annoyed, QGTx

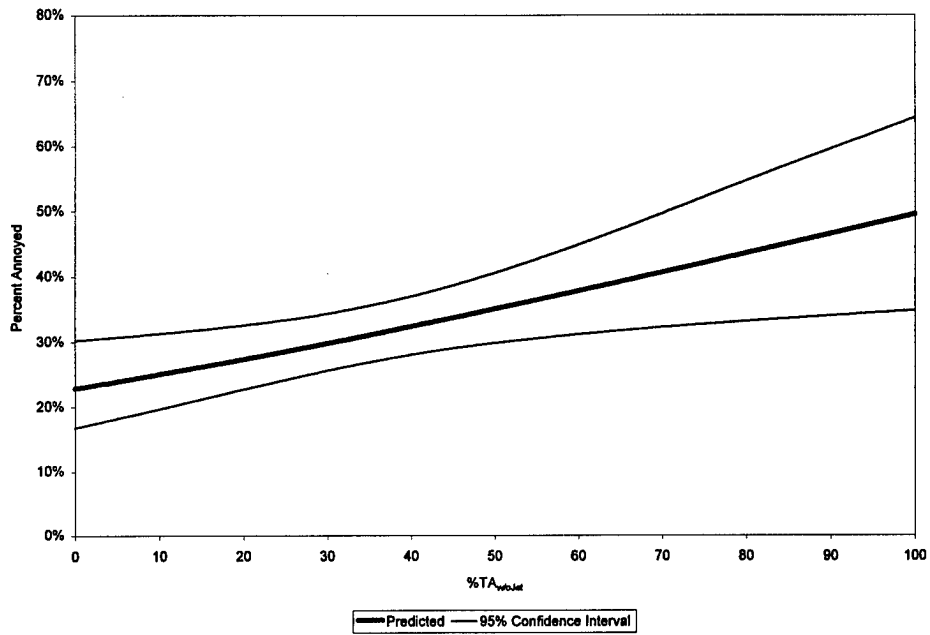

Figure 23. %TA<sub>w/ojet</sub> vs. Percent Annoyed, QGT

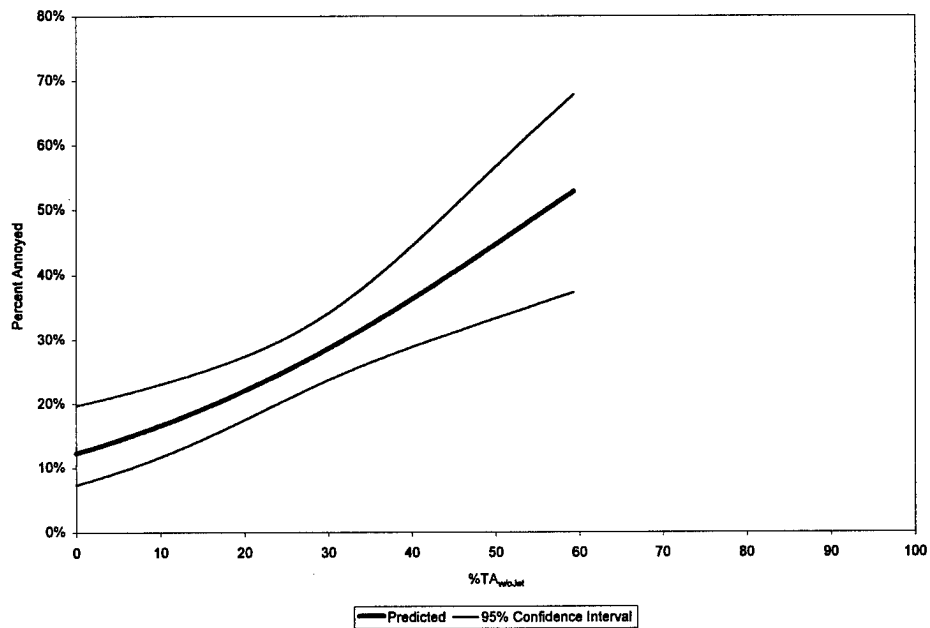

Figure 24. %TA<sub>w/ojet</sub> vs. Percent Annoyed, QGTx

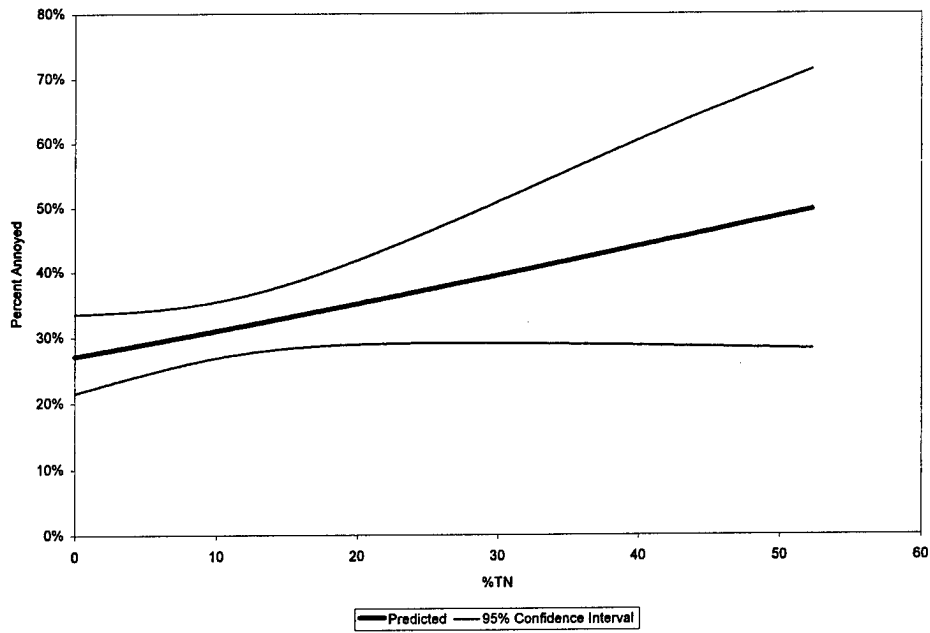

Figure 25. %TN vs. Percent Annoyed, QGT

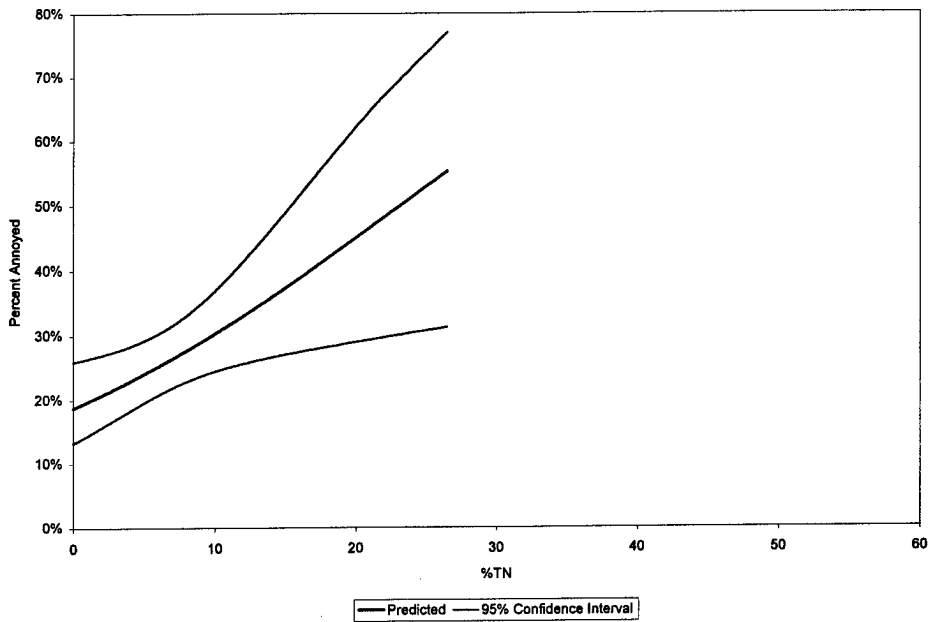

Figure 26. %TN vs. Percent Annoyed, QGTx

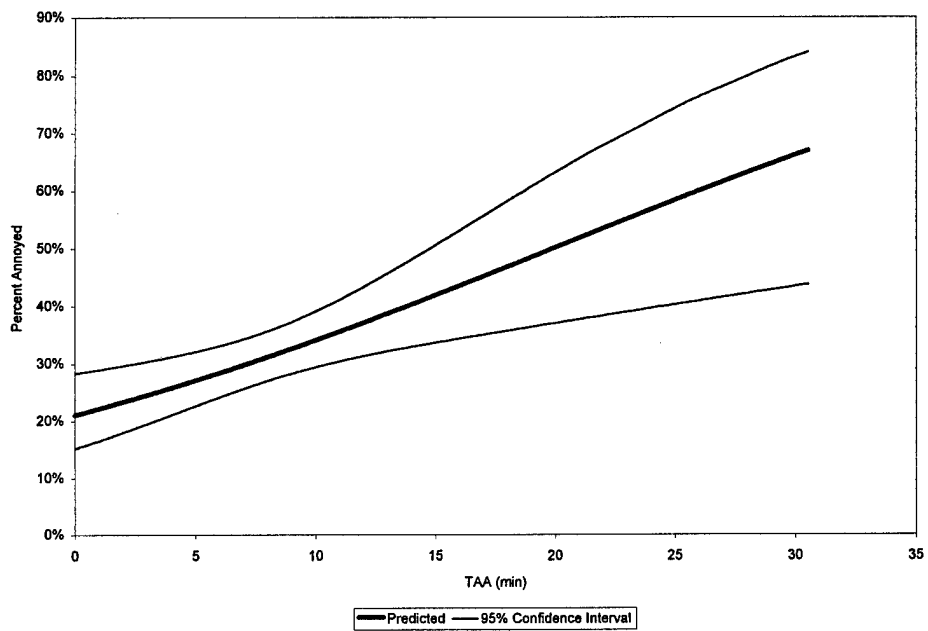

Figure 27. TAA vs. Percent Annoyed, QGT

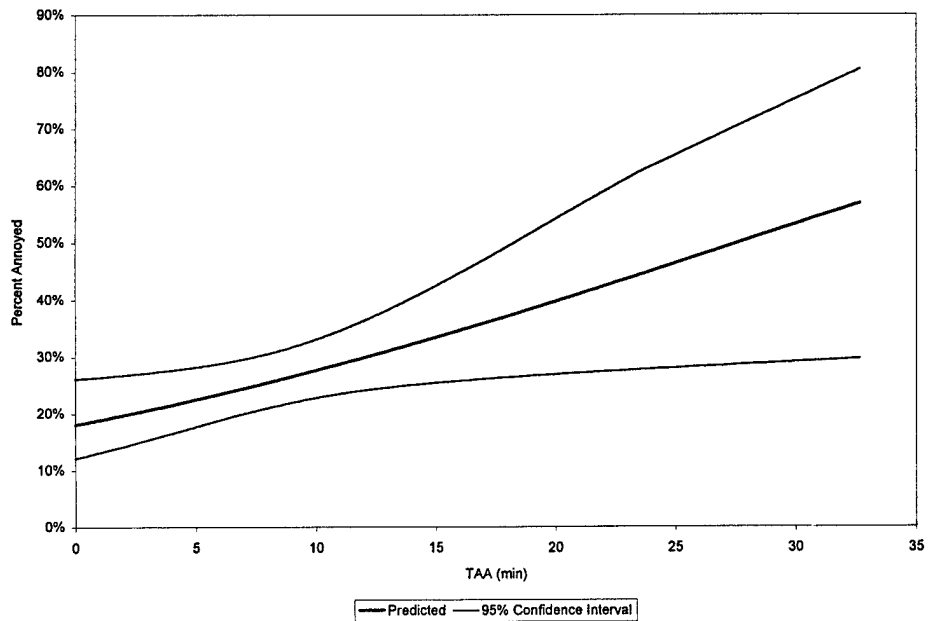

Figure 28. TAA vs. Percent Annoyed, QGTx

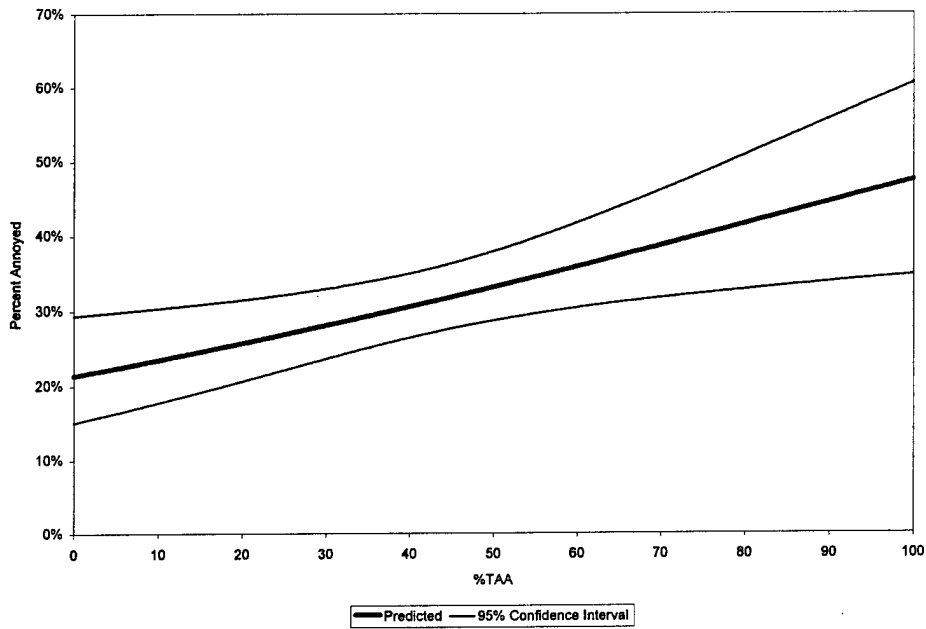

Figure 29. %TAA vs. Percent Annoyed, QGT

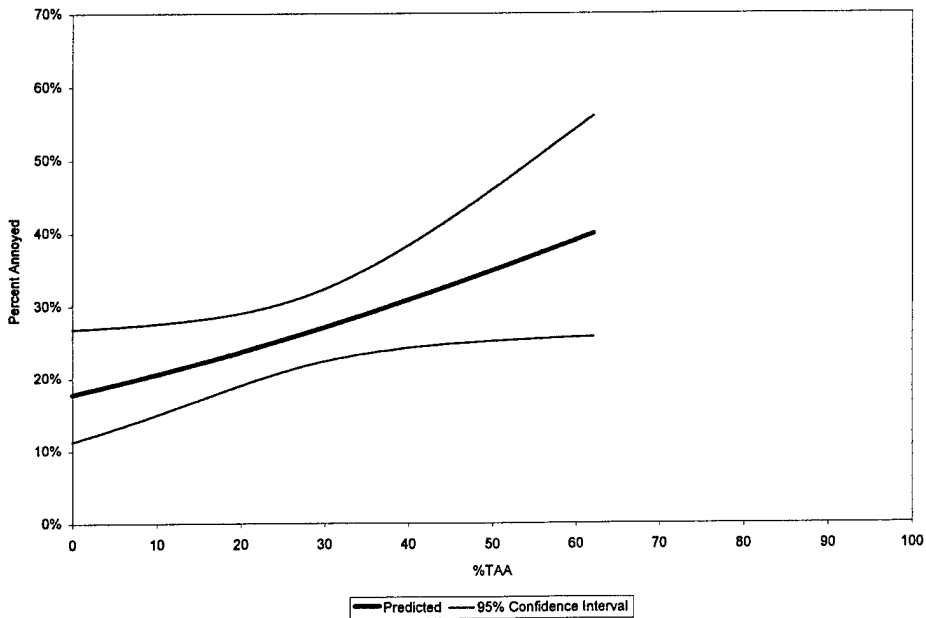

Figure 30. %TAA vs. Percent Annoyed, QGTx

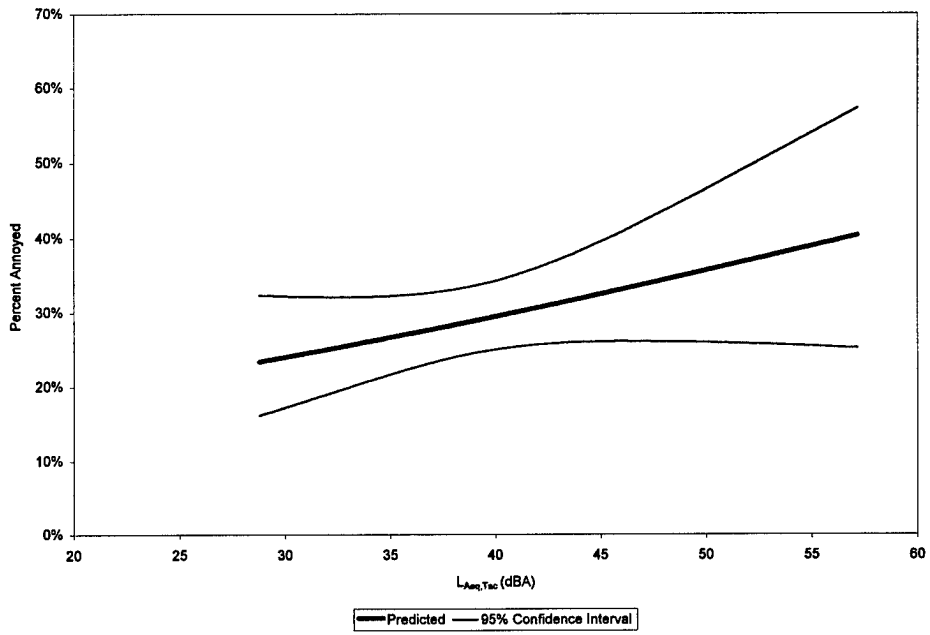

Figure 31.  $L_{Aeq,Tac}$  vs. Percent Annoyed, QGT

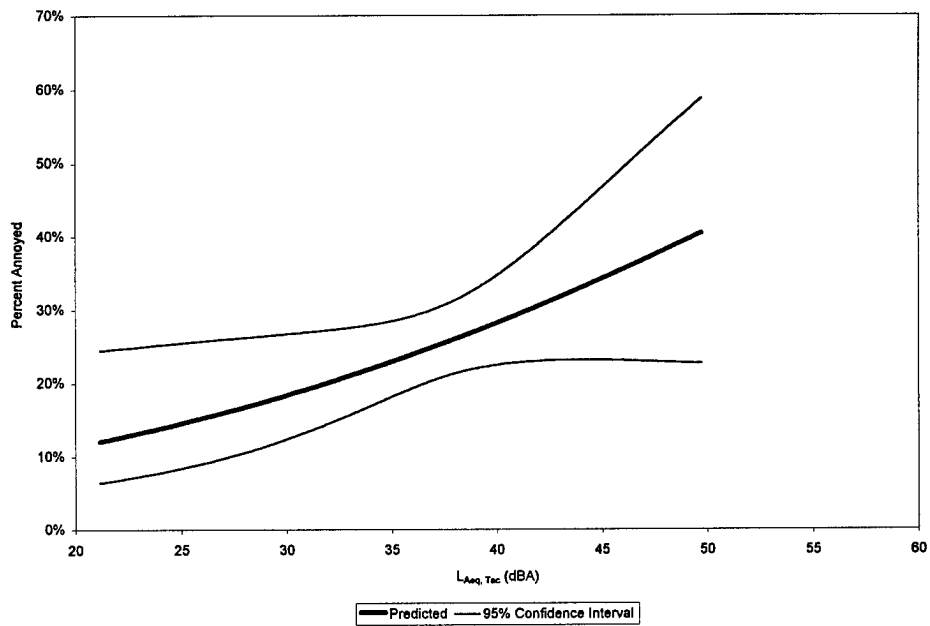

Figure 32.  $L_{Aeq,Tac}$  vs. Percent Annoyed, QGTx

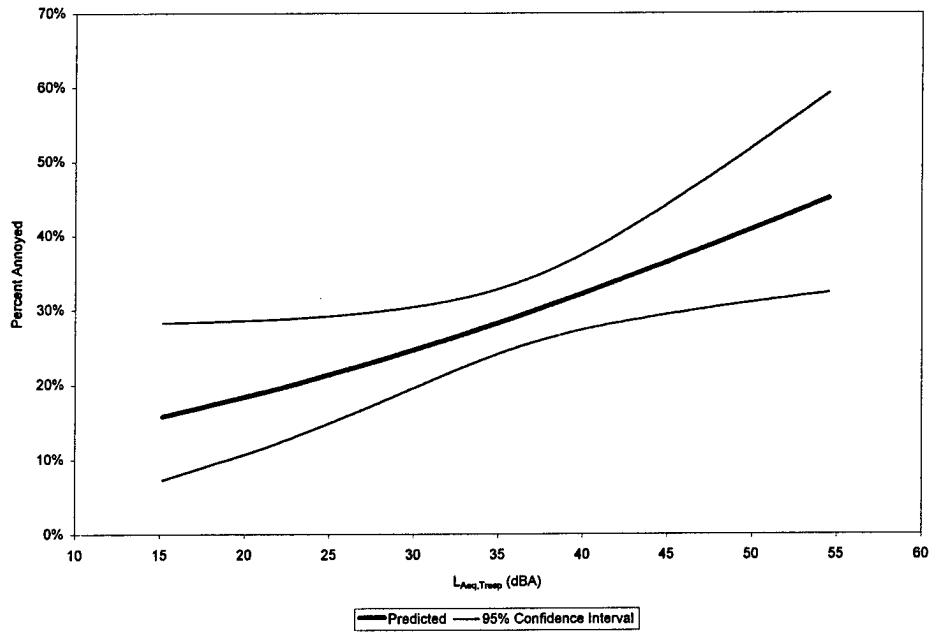

Figure 33.  $L_{Aeq,Tresp}$  vs. Percent Annoyed, QGT

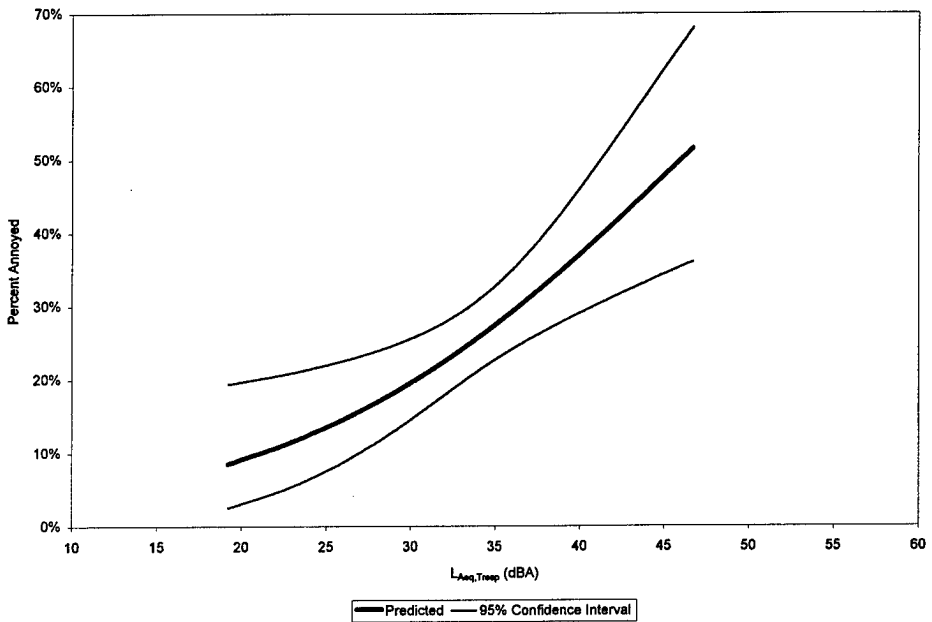

Figure 34.  $L_{Aeq,Tresp}$  vs. Percent Annoyed, QGTx

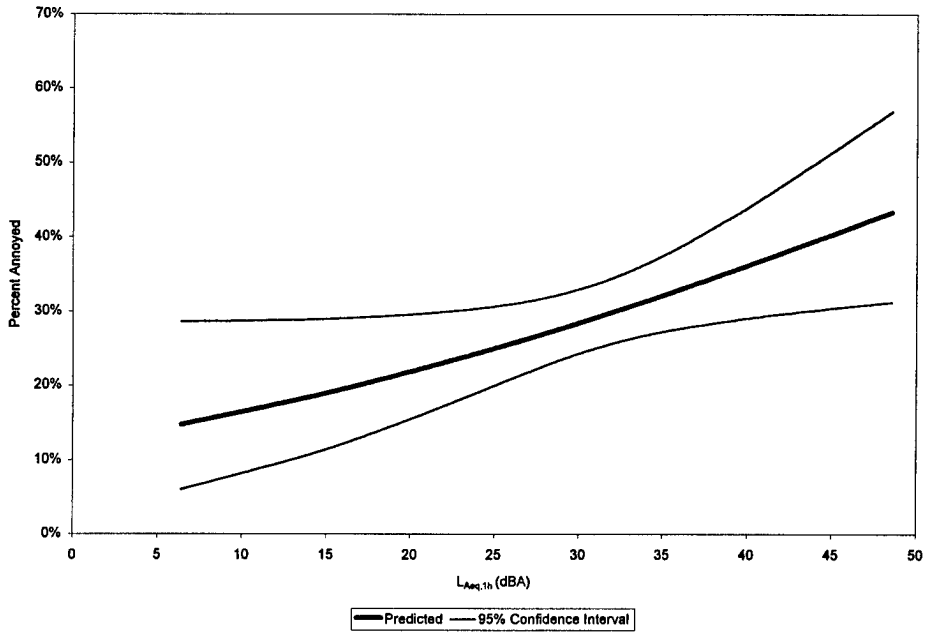

Figure 35.  $L_{Aeq,1h}$  vs. Percent Annoyed, QGT

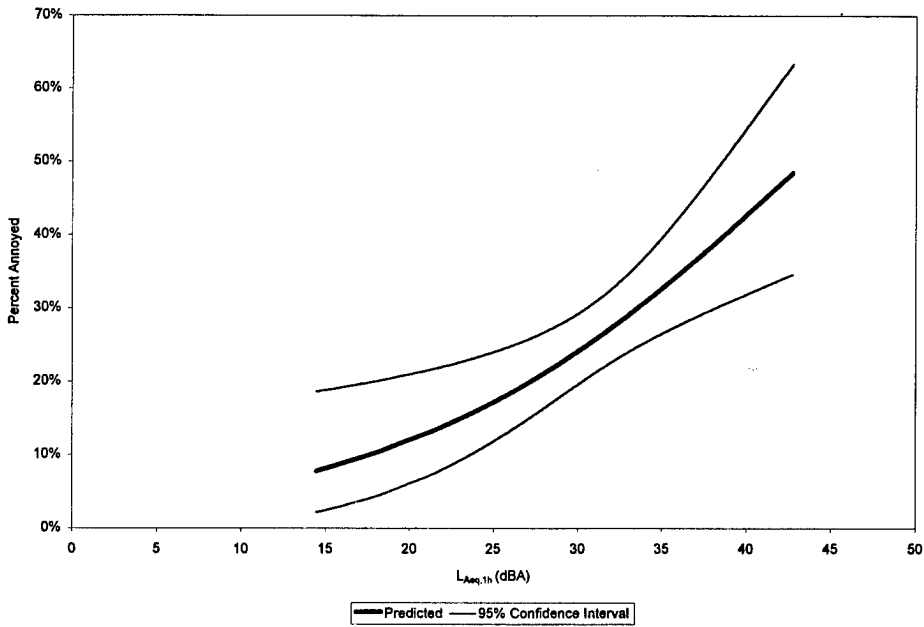

Figure 36.  $L_{Aeq,1h}$  vs. Percent Annoyed, QGTX



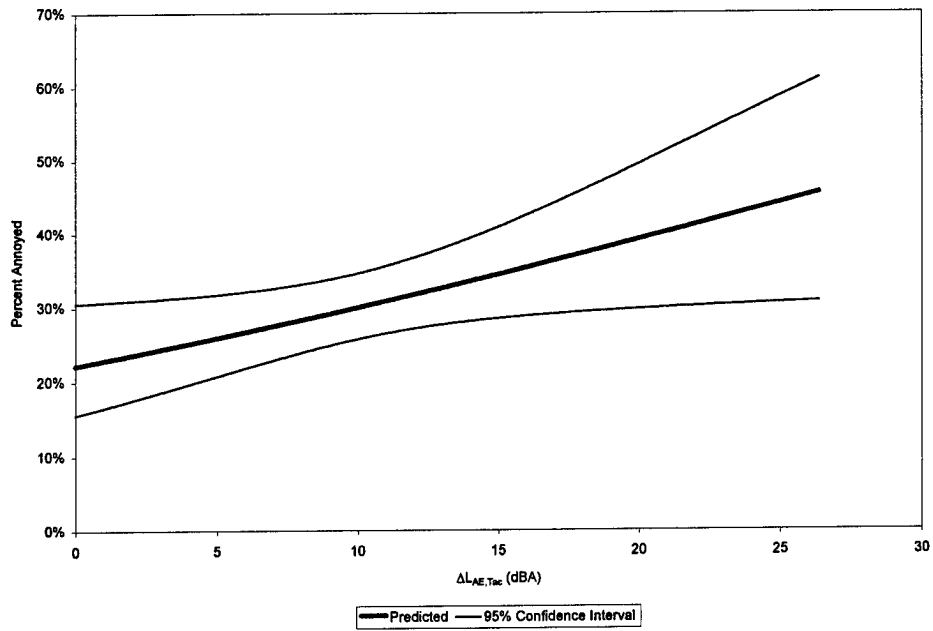

Figure 37.  $\Delta L_{AE,Tac}$  vs. Percent Annoyed, QGT

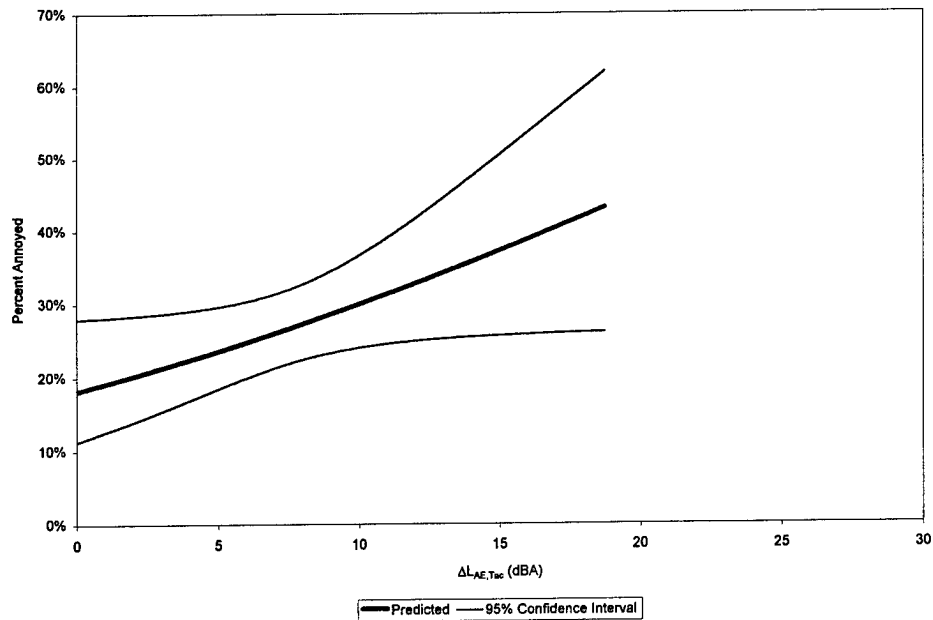

Figure 38.  $\Delta L_{AE,Tac}$  vs. Percent Annoyed, QGTx

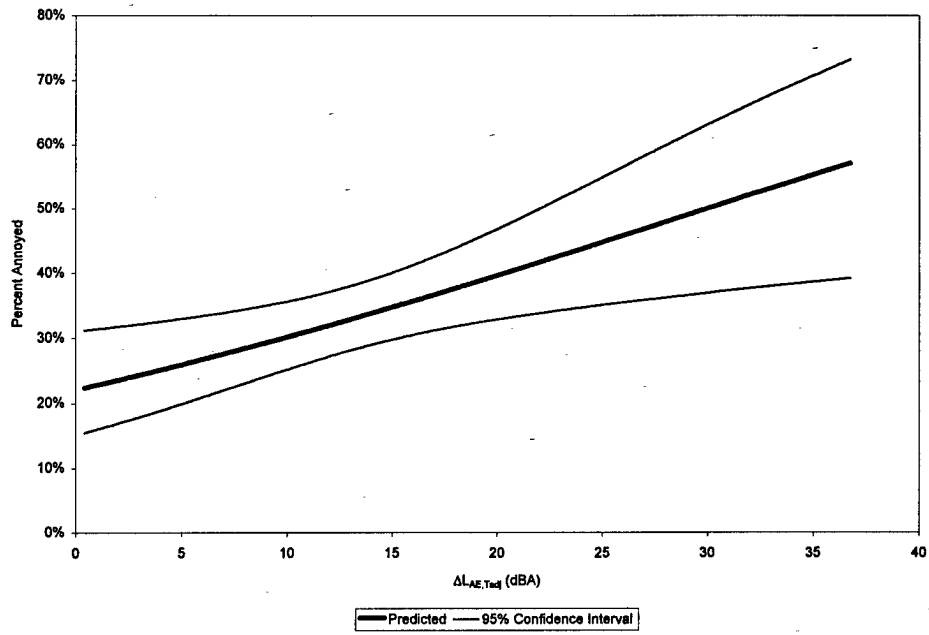

Figure 39.  $\Delta L_{AE,Tadj}$  vs. Percent Annoyed, QGT

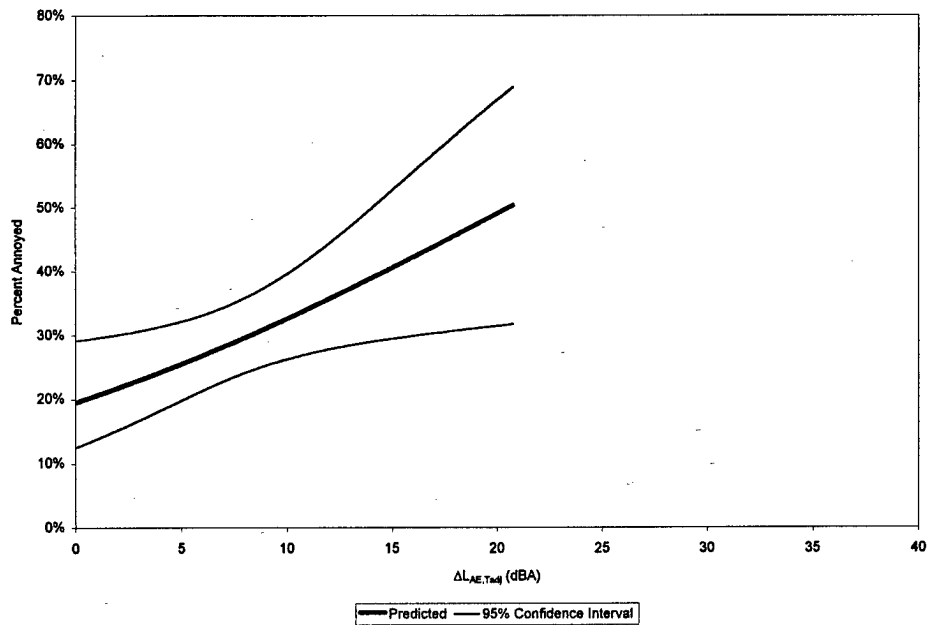

Figure 40.  $\Delta L_{AE,Tadj}$  vs. Percent Annoyed, QGTx

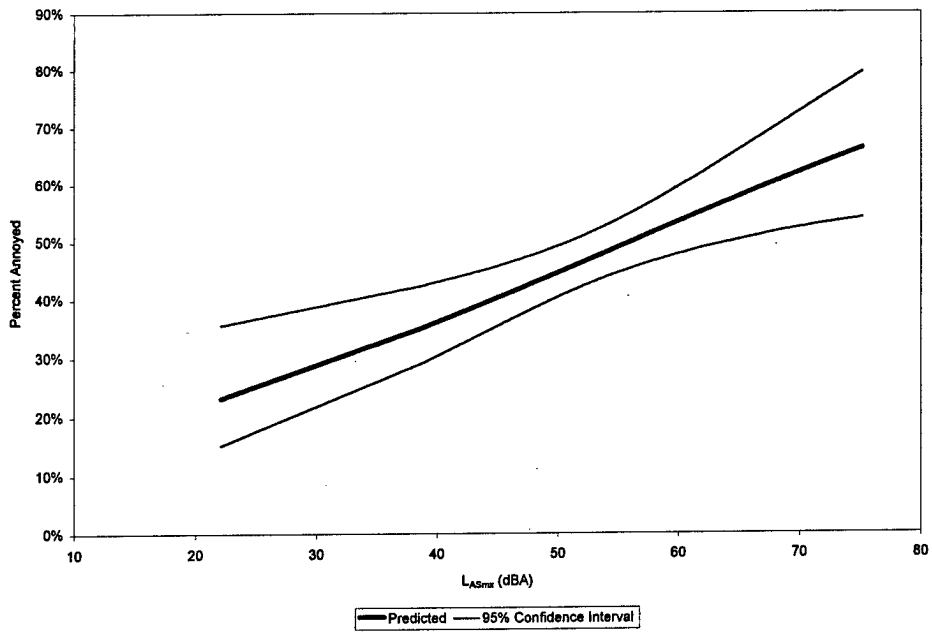

Figure 41. L<sub>ASmx</sub> vs. Percent Annoyed, QGT

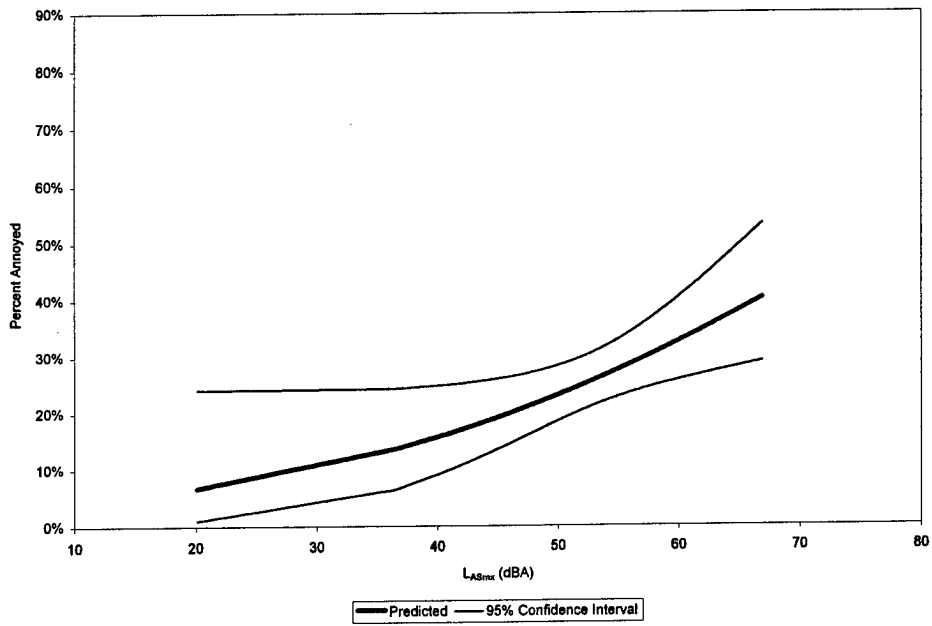

Figure 42. L<sub>ASmx</sub> vs. Percent Annoyed, QGTx

### **6.3.2 Bootstrapped Confidence Intervals**

Although the dose-response relationships presented in Figures 15 through 42 include a confidence interval for the predicted model at each point along the curve, they do not provide information regarding the precision across the entire curve, that is, they do not indicate how accurate the model is at predicting an overall level of annoyance for a particular trail.

This measure of overall predictive accuracy was estimated by bootstrapping fifty data sets and determining how much the mean visitor response varies from data set to data set. Each additional bootstrapped data set was developed by using the original data set as if it were a "fish bowl" containing all of the original responses. A sequence of random numbers was generated and used to pick from the responses in the fish bowl. These responses were included in a new data set. Selected responses were then replaced in the original data set so that an individual response had an equal probability of being chosen again, i.e., a sample and replace methodology was employed. This process was repeated until a data set of an equal size to that of the original was developed. The confidence measurement calculated by this technique showed that the estimate of the overall level of annoyance was very stable, with the confidence interval of each data set always less than one percent. For example, the proportion of the population annoyed for the entire data set (QGT and QGTX combined) was 28.9%. The average proportion annoyed, based on the 50 data sets combined, was also 28.9%, with a standard deviation of 2.9% and a 95% confidence interval of 0.56%. This means that the ability of the models to predict the overall level of annoyance on a trail was much better than would be indicated by the dose-response confidence intervals shown in Figures 15 through 42, which provide a point-by-point estimate of confidence.

---

### **6.3.3 Model Reliability**

In order to have reasonable confidence that an acoustic descriptor is suitable for the development of a general rule, it must predict the likelihood of annoyance and it must be reliable. In other words, a descriptor must be reliably significant when retested and different samples are produced. It often happens that simple sampling variation can cause one descriptor to perform better than another, but this superiority may disappear when a new sample is selected. To eliminate the possibility that the preferred models would be chosen solely because of some indeterminable quirk in the data, four additional data sets were generated using the bootstrapping technique discussed in Section 6.3.2. Although logistic regression is usually quite stable, generating bootstrapped data sets and performing similar analyses provided an extra insurance of reliability.

To judge a model's predictive reliability, three criteria were used: (1) the goodness-of-fit of the model for the four bootstrapped data sets was compared using the AIC; (2) the ability of the model to agree at least directionally with the data points was compared using the %C; and (3) it was also required that the acoustic descriptor be statistically significant within each model and have a positive coefficient (indicating that more noise will result in a higher predicted likelihood of annoyance).

Tables 8 and 9 show the significance of the acoustic measures for the original data set and for the four bootstrapped data sets for QGT and QGTX. When a measure was significant at the .05 chi-square significance level, it received a "Yes" in the appropriate column. Because it was also useful to know when a measure is "powerful" as well as just significant, an additional column indicates if the measure is significant at the .001 chi-square significance level.

**Table 8. Stability Test Using Bootstrapping, QGT**

Acoustic Descriptor	Original Data Set		Data Set #1		Data Set #2		Data Set #3		Data Set #4	
	Significant?		Significant?		Significant?		Significant?		Significant?	
	.05	.001	.05	.001	.05	.001	.05	.001	.05	.001
NUM <sub>ac</sub>	Yes	No	No	No	No	No	No	No	Yes	No
NUM <sub>ac/hr</sub>	No	No	Yes	No	Yes	No	No	No	Yes	Yes
NUM <sub>loud</sub>	No	No	Yes	No	Yes	No	Yes	No	No	No
%TA	Yes	No	Yes	No	Yes	Yes	No	No	Yes	Yes
%TA <sub>w/ojet</sub>	Yes	No	No	No	Yes	No	No	No	Yes	No
%TN	No	No	No	No	No	No	No	No	No	No
TAA	Yes	No	Yes	No	Yes	No	No	No	Yes	No
%TAA	Yes	No	No	No	No	No	No	No	Yes	No
L <sub>Aeq,Tac</sub>	No	No	Yes	No	Yes	No	No	No	Yes	No
L <sub>Aeq,Tresp</sub>	Yes	No	Yes	No	Yes	No	No	No	Yes	No
L <sub>Aeq,1h</sub>	Yes	No	Yes	No	Yes	No	No	No	Yes	No
ΔL <sub>AE,Tac</sub>	Yes	No	Yes	No	Yes	No	No	No	Yes	No
ΔL <sub>AE,Tadj</sub>	Yes	No	Yes	No	Yes	Yes	No	No	Yes	No
L <sub>ASmx</sub>	No	No	No	No	Yes	Yes	No	No	Yes	No

**Table 9. Stability Test Using Bootstrapping, QGTX**

Acoustic Descriptor	Original Data Set		Data Set #1		Data Set #2		Data Set #3		Data Set #4	
	Significant?		Significant?		Significant?		Significant?		Significant?	
	.05	.001	.05	.001	.05	.001	.05	.001	.05	.001
NUM <sub>ac</sub>	Yes	No	No	No	No	No	Yes	No	Yes	No
NUM <sub>ac/hr</sub>	No	No	Yes	No	No	No	No	No	Yes	No
NUM <sub>loud</sub>	No	No	No	No	No	No	No	No	No	No
%TA	Yes	No	Yes	Yes	Yes	No	No	No	Yes	Yes
%TA <sub>w/ojet</sub>	Yes	Yes	Yes	Yes	Yes	Yes	No	No	Yes	Yes
%TN	Yes	No	Yes	Yes	Yes	Yes	No	No	Yes	No
TAA	Yes	No	Yes	No	No	No	No	No	Yes	Yes
%TAA	Yes	No	Yes	No	No	No	No	No	Yes	no
L <sub>Aeq,Tac</sub>	Yes	No	Yes	No	Yes	Yes	Yes	No	No	No
L <sub>Aeq,Tresp</sub>	Yes	No	Yes	Yes	Yes	Yes	No	No	Yes	No
L <sub>Aeq,1h</sub>	Yes	No	Yes	Yes	Yes	Yes	No	No	Yes	No
ΔL <sub>AE,Tac</sub>	Yes	No	Yes	No	No	No	No	No	No	No
ΔL <sub>AE,Tadj</sub>	Yes	No	Yes	Yes	No	No	No	No	Yes	No
L <sub>ASmx</sub>	Yes	No	No	No	Yes	No	Yes	No	No	No

When combining the results presented in these tables with the results presented for the original data set, it is possible for any given descriptor to receive between 0 and 10 "Yes's" as a measure of overall reliability. If the descriptor scored a total of zero "yes's", it would indicate that the descriptor was never significant at the .05 level for any of the data sets. In the same way, a score of 10 "yes's" would indicate that the descriptor was always significant at the .001 level or better. The reliability scores are shown in Table 10 for QGT and QGTX.

Table 10. Reliability Scores for Acoustic Descriptors

Acoustic Descriptor	Reliability Score	
	QGT	QGTX
NUM <sub>ac</sub>	2	3
NUM <sub>ac/hr</sub>	4	2
NUM <sub>loud</sub>	3	0
%TA	6	6
%TA <sub>w/ojet</sub>	3	8
%TN	0	6
TAA	4	4
%TAA	2	3
L <sub>Aeq,Tac</sub>	3	5
L <sub>Aeq,Tresp</sub>	4	6
L <sub>Aeq,1h</sub>	4	6
$\Delta L_{AE,Tac}$	4	2
$\Delta L_{AE,Tadj}$	5	4
L <sub>ASmx</sub>	3	3

Out of the 14 acoustic descriptors, for QGT only two garnered scores equal to or better than a value of five. %TA, with a score of six, received the highest reliability score, closely followed by  $\Delta L_{AE,Tadj}$  with a score of five. For QGTX, six garnered scores equal to or better than five. %TA<sub>w/oJet</sub> with a score of eight, received the highest reliability score, followed by %TA, %TN, L<sub>Aeq,Tresp</sub>, and L<sub>Aeq,1h</sub> each with a score of six, and L<sub>Aeq,Tac</sub> with a score of five.



---

#### 6.3.4 Overall Performance of Acoustic Descriptors

A component of this study was to determine through statistical analyses which noise descriptor(s) correlate best with the visitor response data. Table 11 summarizes the overall descriptor evaluation summarizing the AIC, %C, and Reliability. XX indicates that the descriptor is the best choice for that statistical criterion, while X indicates that the descriptor is either the second or third best choice for that criterion. Across both trails, the descriptor that showed the best performance (in terms of the overall criteria presented in Table 11) was  $\Delta L_{AE, Tadj}$ . Looking at each trail individually, the %TA descriptor performed best on QGT and the %TA<sub>w/ojet</sub> descriptor performed best on QGTX. It can therefore be concluded that these three descriptors provide the highest-quality statistical model for the current data set. This is obviously a quantitatively based conclusion. It is interesting to note, however, that when visitors were asked which bothered or annoyed them most (Question 16): "the number of aircraft you heard"; "the level of aircraft sound you heard"; or "the amount of time you heard aircraft"; a far greater percentage of respondents identified the "level" as being most annoying (25.6%), followed by "time" (9.0%) and "number" (6.9%). This seems to indicate at least qualitatively that the respondents perceived themselves to be more sensitive to level as compared with time or number. This qualitative result may lend further credence to the  $\Delta L_{AE, Tadj}$  descriptor as being the single best performing noise descriptor across both trails, since by definition it is level-based.

**Table 11. Overall Performance of Acoustic Descriptors**

Acoustic Descriptor	QGT			QGTX		
	AIC	%C	Reliability	AIC	%C	Reliability
NUM <sub>ac</sub>						
NUM <sub>ac/hr</sub>	X		X			
NUM <sub>loud</sub>						
%TA		XX	XX			X
%TA <sub>w/objct</sub>		X			XX	XX
%TN					X	X
TAA						
%TAA		X				
L <sub>Aeq,Tac</sub>						
L <sub>Aeq,Tresp</sub>				X	X	X
L <sub>Aeq,1h</sub>				X	X	X
ΔL <sub>AE,Tac</sub>	X			X		
ΔL <sub>AE,Tadj</sub>	XX	X	X	XX		
L <sub>A5min</sub>	X					

**6.3.5 Noticeability Factor Sensitivity Test**

Percent time noticeable (%TN) is defined in Section 5.1.2.2 using a 10 dB Noticeability Factor. As stated earlier, this factor of 10 dB is based upon best-available research. However, it seemed possible that a different value may be analytically determined which would better agree with empirical data. Accordingly, a sensitivity analysis was performed which tested noticeability factors between one and ten dB at one dB intervals. The results are summarized in Table 12.

Table 12. %TN Sensitivity Test

Acoustic Descriptor	QGT			QGTX		
	Mean	AIC	%C	Mean	AIC	%C
%TN <sub>1</sub>	37.7	559	56.8	16.5	373	61.1
%TN <sub>2</sub>	32.3	559	57.0	15.7	374	60.4
%TN <sub>3</sub>	27.6	559	56.9	14.5	374	60.0
%TN <sub>4</sub>	23.7	558	57.4	13.4	374	59.9
%TN <sub>5</sub>	20.4	558	57.8	12.6	373	59.3
%TN <sub>6</sub>	17.7	557	57.9	11.8	372	59.8
%TN <sub>7</sub>	15.2	556	58.0	11.1	371	60.4
%TN <sub>8</sub>	13.1	556	57.1	10.4	370	60.7
%TN <sub>9</sub>	11.4	557	56.8	9.6	370	62.0
%TN	9.8	559	56.5	8.9	374	60.7

The results of the sensitivity test indicate that slightly better statistical performance was seen for a 7 dB factor on QGT (lowest relative AIC, 556, and highest relative %C, 58.0) and for a 9 dB factor on QGTX (lowest relative AIC, 370, and highest relative %C, 62.0). However, the fact remains that the AIC and %C for 8 dB are only slightly better than for 10 dB on QGT and QGTX. In fact, the second highest concordance value on QGTX was observed for a noticeability factor of 1 dB. It seems likely that any slight superiority from one factor to the next is specific to the particular data collected rather than to some "true" underlying superiority of one particular noticeability factor. As a result of the inconclusiveness of this analysis, a controlled field test of noticeability may be necessary.

#### **6.4 Covariate Model**

In addition to the pure acoustic descriptors, another source of information existed which might significantly improve the performance of the model. This information was the additional data obtained from questions asked in the visitor survey. Although there were many questions that might improve the model performance, the majority of the questions would require a visitor-intercept methodology at each of the parks for which the model was to be applied. To avoid this burdensome requirement, covariate candidates were selected which could be collected in an unobtrusive manner (e.g., by a park ranger simply recording the information at the entrance to a trail). The selected covariate candidates were gender, presence of children in the party, and number of persons in the party. These three covariates were analyzed to determine if there was a significant difference at the .05 level (i.e., 95 percent certainty) in the annoyance responses for each covariate category. Even though it was not considered easily obtainable information, U.S. citizenship was also initially considered as a possible covariate because the previously-referenced NPS and USAF dose-response study included only U.S. citizens, whereas the current study included all individuals fluent in the English language. A summary of the preliminary covariate analysis is presented in Table 13.

**Table 13. Covariate Analysis Summary**

		QGT			QGTX		
		Total Number	Percent Annoyed	Significant? (at .05)	Total Number	Percent Annoyed	Significant? (at .05)
U.S. Citizen	Yes	220	26.8%	No	224	24.1%	No
	No	293	27.7%		167	18.6%	
Gender	Male	259	30.1%	No	182	26.4%	Yes
	Female	250	24.8%		206	17.5%	
Children Present	Yes	156	19.2%	Yes	182	17.5%	No
	No	358	30.7%		206	22.8%	
Number of Persons in Party	1	32	34.4%	No	18	33.3%	Yes
	2	196	29.1%		220	25.9%	
	3	87	31.0%		41	19.5%	
	4	129	21.7%		46	21.7%	
	5	25	28.0%		31	9.7%	
	6+	45	22.2%		35	2.9%	

U.S. citizenship is not significantly related to annoyance for either QGT or QGTX, eliminating this as a possible reason for differences between this study and previous parks-related dose-response studies. As such, U.S. citizenship was not included in the development of the covariate model. Gender is significant for QGTX but not for QGT (although the directional results are identical) with females reporting significantly less annoyance than males. On the other hand, the presence of children is significant for QGT but not for QGTX (once again, the directional results are identical) with the presence of children reducing the level of reported annoyance. The number of persons in the party is significant for QGTX but not for QGT, with the reported level of annoyance dropping for parties of three or four and dropping again for parties of five or more.

---

Gender, the presence of children and the number of persons in the party were used together as covariates for analysis purposes. The resultant regression equation is as follows:

$$\%Annoyance = \frac{e^{b_0 + b_1(AcousticDescriptor) + b_2(Gender) + b_3(PresenceofChildren) + b_4(NumberOfPersons)}}{1 + e^{b_0 + b_1(AcousticDescriptor) + b_2(Gender) + b_3(PresenceofChildren) + b_4(NumberOfPersons)}} \times 100$$

where:  $b_0$  = the constant of the regression ;

$b_1$  = the coefficient of the acoustic descriptor;

$b_2$  = the coefficient of the gender variable;

$b_3$  = the coefficient of the presence of children variable; and

$b_4$  = the coefficient of the number of persons variable.

#### 6.4.1 Logistic Regression Analysis

Tables 14 and 15 present the results of the final logistic regression analyses performed for each acoustic descriptor for QGT and QGTX with covariates, respectively. Also presented, for informational purposes only, are the coefficients of the covariates.

**Table 14. Logistic Regression Results, QGT With Covariates**

Acoustic Descriptor	Coefficient (b <sub>1</sub> )	Significant?	Coefficient (b <sub>2</sub> )	Coefficient (b <sub>3</sub> )	Coefficient (b <sub>4</sub> )	Constant (b <sub>0</sub> )	AIC	%C
NUM <sub>ac</sub>	0.105	Yes, *	-0.228	-0.419	-0.109	-0.710	503	59.2
NUM <sub>ac/hr</sub>	0.047	Yes, **	-0.222	-0.241	-0.140	-0.960	501	60.6
NUM <sub>loud</sub>	-0.016	No	-0.256	-0.494	-0.048	-0.090	556	56.4
%TA	0.022	Yes, ***	-0.327	-0.284	-0.137	-1.125	541	64.0
%TA <sub>w/ojet</sub>	0.013	Yes, **	-0.284	-0.326	-0.121	-0.365	549	61.2
%TN	0.019	No	-0.259	-0.460	-0.063	-0.275	553	60.1
TAA	0.001	Yes, ***	-0.316	-0.440	-0.132	-0.440	543	61.7
%TAA	0.014	Yes, **	-0.304	-0.315	-0.135	-0.425	547	61.5
L <sub>Aeq,Tao</sub>	0.037	No	-0.232	-0.322	-0.161	-1.407	506	59.1
L <sub>Aeq,Treap</sub>	0.047	Yes, *	-0.250	-0.314	-0.174	-1.578	502	61.3
L <sub>Aeq,th</sub>	0.046	Yes, *	-0.253	-0.353	-0.169	-1.304	502	61.1
ΔL <sub>AE,Tao</sub>	0.052	Yes, **	-0.274	-0.402	-0.171	-0.312	490	61.4
ΔL <sub>AE,Tadj</sub>	0.050	Yes, **	-0.246	-0.282	-0.211	-0.258	436	63.1
L <sub>ASmx</sub>	0.028	Yes, *	-0.211	-0.451	-0.095	-1.588	505	58.3
Mean:							517	60.6

\* Significant at .05 (95% Certainty)

\*\* Significant at .01 (99% Certainty)

\*\*\* Significant at .001 (99.9% Certainty)

**Table 15. Logistic Regression Results, QGTX With Covariates**

Acoustic Descriptor	Coefficient (b <sub>1</sub> )	Significant?	Coefficient (b <sub>2</sub> )	Coefficient (b <sub>3</sub> )	Coefficient (b <sub>4</sub> )	Constant (b <sub>0</sub> )	AIC	%C
NUM <sub>iso</sub>	0.083	Yes, *	-0.415	0.330	-0.399	-0.220	361	64.7
NUM <sub>ac/hr</sub>	0.048	No	-0.429	0.333	-0.388	-0.296	362	64.3
NUM <sub>loud</sub>	-0.100	No	-0.422	0.317	-0.375	0.753	368	59.3
%TA	0.026	Yes, **	-0.389	0.269	-0.403	-0.787	361	66.1
%TA <sub>w/objct</sub>	0.037	Yes, ***	-0.342	0.211	-0.389	-0.529	354	67.8
%TN	0.054	Yes, *	-0.392	0.245	-0.327	-0.004	365	63.9
TAA	0.001	Yes, **	-0.411	0.281	-0.389	-0.006	363	65.3
%TAA	0.020	Yes, *	-0.422	0.274	-0.367	-0.033	365	65.2
L <sub>Aeq,Tac</sub>	0.057	Yes, *	-0.405	0.385	-0.408	-2.391	359	63.1
L <sub>Aeq,Trep</sub>	0.092	Yes, *	-0.371	0.374	-0.428	-1.877	352	65.6
L <sub>Aeq,Ih</sub>	0.091	Yes, *	-0.368	0.373	-0.439	-1.745	352	65.7
ΔL <sub>AE,Tac</sub>	0.047	No	-0.429	0.325	-0.372	0.192	336	63.6
ΔL <sub>AE,Tadj</sub>	0.064	Yes, *	-0.498	0.066	-0.260	0.040	283	64.4
L <sub>ASms</sub>	0.051	Yes, *	-0.389	0.314	-0.394	-2.191	359	63.7
Mean:							353	64.5

\* Significant at .05 (95% Certainty)      \*\* Significant at .01 (99% Certainty)      \*\*\* Significant at .001 (99.9% Certainty)

Several notable observations can be made regarding the data presented in Tables 14 and 15:

- (1) Adding the covariate set significantly improves the performance of the model. When covariates are added, the AIC for QGT drops from a mean value across all descriptors of 524 to 517 (a 1.3% improvement), and the AIC for QGTX drops from a mean value (across all descriptors) of 364 to 353 (a 3.0% improvement). Additionally, the %C for QGT rises from a mean value of 53.6% to 60.6% (a 13.1% improvement), and for QGTX it rises from a mean value of 56.6% to 64.5% (a 14.0% improvement).



- 
- (2) Adding the covariate set to the model does not have an important effect on the *relative* performance of the descriptors in terms of the AIC. For both QGT and QGTX, the three descriptors with the lowest AIC's remain the same when covariates are added.
  - (3) There is an effect of adding the covariates on the acoustic descriptor performance when percent concordance is evaluated. In the model without covariates (pure acoustic), for QGT the three best performing descriptors are (in order) %TA, %TA<sub>w/ojet</sub>, and  $\Delta L_{AE,Tadj}$  and %TAA (tied). In the model with covariates, the best performing descriptors are %TA,  $\Delta L_{AE,Tadj}$ , and TAA. For QGTX, the three best performing descriptors in the pure acoustic model are (in order) %TA<sub>w/ojet</sub>, %TN, and  $L_{Aeq,Tresp}$ ; and in the model with covariates, the best performing descriptors are %TA<sub>w/ojet</sub>, %TA, and  $L_{Aeq,1h}$ .
  - (4) For both trails, the effect of adding covariates on the majority of the descriptors is to raise the regression coefficient, indicating that covariates help to increase the predictive ability of the acoustic descriptor by controlling for the demographic and situational differences between respondents.
  - (5) The only regression coefficient that was significant at the .001 level or better in both models for QGTX was %TA<sub>w/ojet</sub>; none were significant at the .001 level or better in both models for QGT.
  - (6) For QGT, NUM<sub>loud</sub>, %TN,  $L_{Aeq,Tac}$ ,  $L_{Aeq,Tresp}$ , and  $L_{ASmx}$ , and for QGTX, NUM<sub>ac/hr</sub>, NUM<sub>loud</sub>, and  $\Delta L_{AE,Tac}$  failed significance for at least one of the models.

Although the presence of covariates greatly enhances the ability of the model to predict annoyance, further discussion will be needed before this information could be applied to a National Rule. Such discussion should address: (1) how to arrive at the average value of each covariate in order to modify the dose-response equation; (2) the feasibility of requiring parks to obtain this information; and

---

(3) the appropriateness of using each of the covariates in the context of a National Rule. As such, dose-response graphs and a detailed reliability analysis are not included for the covariate model.

### **6.5 Comparison with Previous NPS Study**

Several comparisons can be performed using the data collected in the BCNP study and the previously referenced dose-response study<sup>16</sup> performed in the National Parks.

- (1) The dose-response graphics in the previous study indicate that there were substantially wider confidence intervals for the resultant model than were observed with the BCNP model. While it is possible that some of the improvement was due to the slightly larger sample size, or to methods of on-site data collection, it seems most likely that the superior performance in the results of this study was due to the much wider range in acoustic doses observed at BCNP. This wider range of doses provided a much stronger basis to develop a statistical model. Future research design should make every effort to maximize the range of acoustic doses observed in the data set.
- (2) The previous dose-response graphics had models which were extended well beyond the range of the observed data. This makes the rather bold assumption that the models will support that extension into levels of acoustic doses not actually measured. This is only recommended given that the model has been repeatedly validated and confirmed in a wide variety of situations.
- (3) A comparison between the logistic regression coefficients for QGT and Haleakala National Park (in Hawaii) was performed. These sites are considered to be the most similar in nature (i.e., frontcountry, short-hike sites of similar duration and characteristics). Table 16 shows the regression coefficients:

**Table 16. Regression Coefficients for QGT and Haleakala**

	Coefficient of Acoustic Descriptor ( $L_{Aeq,Tac}$ )	Intercept Term
QGT without covariates	0.028	-2.00
QGT with covariates	0.037	-1.41
Haleakala with covariates*	0.032	-1.66

\*Covariates for the Haleakala study are different from those discussed in this study.

This table shows that the coefficient of the  $L_{Aeq,Tac}$  acoustic descriptor for Haleakala (with covariates) is in between that for QGT (with and without covariates), indicating that the change in visitor response for every change in noise dose is similar at these sites. The intercept term is also similar, indicating a similar "base annoyance level" at the two sites.

- (4) Because of the use of  $L_{Aeq,Tac}$  as the primary descriptor, the results from the previous study may not have been optimally sensitive, contributing to the wide variances and associated large confidence intervals observed in the modeling effort. Again assuming that QGT is most similar to the noise environment encountered, the BCNP study indicates that  $L_{Aeq,Tac}$  can provide a good fit to the data, but it is not as strongly related to annoyance as several other descriptors.

---

## 7. References

- <sup>1</sup> National Parks Overflights Rule, Draft Research Plan. Washington, D.C.: Federal Aviation Administration, December 1997.
  - <sup>2</sup> Dose Response Study for Commercial Air Tour Overflights in the National Parks: Study Design for Bryce Canyon National Park. Washington, D.C.: Federal Aviation Administration, August 1997.
  - <sup>3</sup> Fleming, et. al., "Draft Guidelines for the Measurement and Assessment of Low-Level Ambient Noise," Cambridge, MA: John A. Volpe National Transportation Systems Center Acoustics Facility, March 1998.
  - <sup>4</sup> "Acoustical Terminology." American National Standard, ANSI S1.1-1994. New York: American National Standards Institute, 1994.
  - <sup>5</sup> "Procedures for Outdoor Measurement of Sound Pressure Level." American National Standard, ANSI Standard S12.18-1994. New York: American National Standards Institute, 1994.
  - <sup>6</sup> Johnson, Dan L., Marsh, Alan H., and Harris, Cyril M. "Acoustical Measurement Instruments." Handbook of Acoustical Measurements and Noise Control. New York: Columbia University, 1991.
  - <sup>7</sup> Federal Interagency Committee on Aviation Noise (FICAN). "Report on Aviation Noise Research Conducted by U.S. Federal Agencies," Burlington, MA: Harris Miller Miller & Hanson Inc, June 1994.
-

- 
- <sup>8</sup> Von Gierke, H.E., and Harris, C. S., "Annoyance Response to Military Flight Operations and the Development of Standard Criteria For Community Annoyance," *Environmental Annoyance: Characterization, Measurement, and Control*, Elsevier Science Publishers B.V., 1987.
- <sup>9</sup> Fidell, Sanford, "An Historical Perspective on Predicting the Annoyance of Noise Exposure," *Proceedings; Noise-Con 90*, The University of Texas, October 1990, p. 13-22.
- <sup>10</sup> Schultz, Theodore J., "Synthesis of Social Surveys on Noise Annoyance," *Journal of the Acoustical Society of America*, 64(2), August 1978, p. 377-405.
- <sup>11</sup> Hall, Fred L., and Taylor, S. Martin, "Reliability of Social Survey Data on Noise Effects," *Journal of the Acoustical Society of America*, 72(4), October 1982, P. 1212-1221.
- <sup>12</sup> Horenjeff, Richard D., and Robert, William E., Attitudinal Responses to Changes in Noise Exposure in Residential Communities, NASA Report No. NASA/CR-97-205813, National Aeronautics and Space Administration, Langley Research Center, Hampton, Virginia 23681-2199, December 1997.
- <sup>13</sup> Fields, J.M., and Walker, J.G., "Comparing the Relationships Between Noise Level and Annoyance in Different Surveys: A Railway Noise vs. Aircraft and Road Traffic Comparison," *Journal of Sound and Vibration*, (1982) 81(1), p. 51-80.
- <sup>14</sup> Federal Agency Review of Selected Airport Noise Analysis Issues, Federal Interagency Committee on Noise, August, 1992.
-

- 
- 15     Fidell, Sanford, and Silvati, Laura, "Relating the Annoyance of Aircraft Overflights to their Audibility by Outdoor Recreationists," Proceedings; Noise-Con 90, The University of Texas, October 1990, p. 339-342.
- 16     Anderson, et. al., Dose-Response Relationships Derived From Data Collected at Grand Canyon, Haleakala and Hawaii Volcanoes National Parks, NPOA Report No. 93-6, National Park Service, Denver Colorado 80225, October 1993.
- 17     Yeager, Monty. Private Communication, June 1997.
- 18     Report on Effects of Aircraft Overflights on the National Park System. Washington, D.C.: National Park Service, July 1995.
- 19     Instruction Manual, Battery Driven Power Supply Type 2804. Nærum, Denmark: Brüel & Kjær, March 1988.
- 20     Miller, Nicholas P., Thompson, Richard H., Holey, George B., True, Joseph A. LOWNOMS User's Manual. Burlington, MA: Harris Miller Miller & Hanson Inc., February 1997.
- 21     "Specification for Sound Level Meters." American National Standard, ANSI Standard S1.4-1983 (1990). New York: American National Standards Institute, 1990.
- 22     Reddingius, Nick H., User's Manual for the National Park Service Overflight Decision Support System. Canoga Park, CA: BBN Systems and Technologies, May 1994.
- 23     Kruger, Abba. Private meeting, January 1998.
-



**Appendix A:**  
**Research Team Members and Responsibilities**



**Federal Aviation Administration, Office of Environment and Energy:**

**Jake A. Plante**

M.Ed., Ed.D., Education, University of Massachusetts, MA. Overall Project Manager for the dose-response study conducted at Bryce Canyon National Park, Dr. Plante was responsible for the senior management of all aspects of the study. On-site, Dr. Plante assisted with visitor identification and acoustic measurements.

**Julie A. Draper**

B.S., Applied Mathematics, James Madison University, VA. Ms. Draper is the FAA Program Manager and was the leader of the visitor identification process on-site.

**Volpe National Transportation Systems Center, Acoustics Facility:**

**Gregg G. Fleming**

B.S., Electrical Engineering, University of Lowell, MA. Manager of the Volpe Center Acoustics Facility, Mr. Fleming participated in the study design, questionnaire development, and site selection processes, and was in charge of all acoustics-related instrumentation, data collection, and analysis for the study.

**Christopher J. Roof**

B.S., Electrical Engineering and Music, Boston University, MA. Mr. Roof participated in the study design, questionnaire development, and site selection processes, and was a member of the team that performed all acoustics measurement and analysis.

**David R. Read**

Mr. Read was responsible for the development, configuration, and testing of the acoustical instrumentation, participated in the study design, questionnaire development, and site selection process, and was a member of the team that performed all acoustics measurement and analysis.

**Amanda Rapoza**

B.S., Acoustic Engineering, University of Hartford, CT. Ms. Rapoza assisted in all aspects of the statistical analysis, including model design, implementation, and analysis.

**Paul J. Gerbi**

B.S., Electrical Engineering, University of Lowell, MA. Mr. Gerbi developed the software programs used to calculate all dose-related noise descriptors for this study.

**US Army Construction Engineering Research Laboratory:**

**Paul D. Schomer**

Ph.D., Electrical Engineering-Acoustics, University of Illinois, IL; MS, Electrical Engineering-Acoustics, University of California, CA; B.S., Electrical Engineering, University of Illinois, IL. Dr. Schomer participated in the study design, questionnaire development, and data analysis phases of the study.

**Environmental Transportation Consultants:**

**Paul J. Valihura**

Ph.D., Urban and Environmental Studies, Rensselaer Polytechnic Institute, NY; M.S., Environmental Studies, University of Lowell, MA; B.S., Industrial Management, Lowell Technological Institute, MA. Dr. Valihura was involved in site selection, coordination with the National Park Service, and overall study design. In addition, Dr. Valihura coordinated the permit application and the logistics of the study. On site, Dr. Valihura managed logistics of the study and took on the duties of visitor greeter.

**Kristin C. Lewis**

B.S., Chemistry and Environmental Studies, Yale University, CT. Ms. Lewis assisted with the study design, permit applications, and logistics for the study. On site, Ms. Lewis assisted with logistics and visitor identification.

---

**Leslie Bordonaro**

B.A., Art, University of Lowell, MA. Ms. Bordonaro was responsible for graphics, questionnaire layout, formatting, and cover design for the permit application, study design, and other associated documents.

**Chilton Research Services:**

**Joel C. Webster**

Ph.D., Mathematical Psychology, minor in Computer Science, Indiana University, IN; B.A. Psychology, minor in Electrical Engineering, Brown University, RI. Dr. Webster was in charge of all aspects of the statistical analyses, including model design, implementation, and analysis.

**Peggy C. Liebman**

Ph.D., Business Administration, Drexel University, PA; M.B.A., Monmouth College, NJ; B.A., Business Administration, Stockton State College, NJ. Dr. Liebman assisted in all aspects of the statistical analyses, including model design, implementation, and analysis.

**Ruth Finkle**

B.A., Education, Long Island University, NY. As Sr. Research Manager, Ms. Finkle co-managed the team that performed the social survey.

---

**Joan Snader**

B.A., Sociology, Temple University, PA. As Sr. Research Manager, Ms. Snader co-managed the team that performed the social survey.

**Barbara Conway**

As Field Supervisor for the survey team, Ms. Conway was in charge of the daily, on-site details of the survey team.

**Sharon Dula**

B.A., English, Immaculata College, PA. Ms. Dula was team leader for the coding team as well as a member of the survey team.

**Dawn Tavani**

B.S., Economics, Wydener University. Ms. Tavani was a member of both the survey and coding teams.

**Barb Duncan**

B.A., Organizational Management, Cabrini College, PA. Ms. Duncan was a member of the coding team.

---

**Patty Dominguez**

Ms. Dominguez was a member of the survey team.

**Andrea Connant**

Ms. Connant was a member of the survey team.

**Muriel Smedlet**

Ms. Smedlet was a member of the survey team.

**Mary Gail Brassard**

Ms. Brassard was a member of the survey team.

**Brian Crowe**

Mr. Crowe was a member of the survey team.

**Halee Harmer**

Ms. Harmer was a member of the survey team.

---

**The Wharton School, University of Pennsylvania:**

**Abba M. Krieger**

Ph.D., Harvard University, MA; B.S., Harvard University, MA; B.S., M.S., Massachusetts Institute of Technology, MA. Dr. Krieger provided peer review of the statistical analyses performed in support of this study.

**Appendix B:**  
**Volpe Low-Amplitude Recording Equipment**  
**System Reference**



**B.1 Instrumentation List**

**A. B&K Very Low Level Microphone System, VLLMS (see Figure 43):**

Model 4179 One-inch Microphone.

Model 2660 Preamplifier.

Model 2804 Power Supply (modified).

**B. Sound Level Meter (SLM):**

LDL Model 820 SLM with LDL Model 827 Preamplifier.

**C. Spectrum Analyzer or Tape Recorder:**

LDL Model 2900 Spectrum Analyzer. *or*

Sony Model PC208Ax DAT.

**D. Ancillary:**

NPS Two-Stage Windscreen and Mount including B&K Model UA0207 Foam Windscreen (see Figure 44).

2 - B&K Model AO 0029 100 ft (30 m) Microphone Cables.

B&K Model 4231 Sound Calibrator.

Half-inch Microphone Simulator (Dummy Microphone).

Ivie Model IE-20B Pink Noise Generator.

40 Ah Gel-Cell Battery.

Tripod.

---

## **B.2 Configuration**

**A. B&K Model 2660 Preamplifier:** The user-selectable preamplifier switch should be set to "4179 + 20 dB"

**B. LDL Model 820 SLM:**

**1. 25 dB Offset Calibration** - Calibrate using 94 dB SPL signal, but set "Cal Level" on LDL Model 820 to "119.0" dB. For any SLM readings, subtract 25 dB from the indicated value, whether displayed or stored.

**2. Output Gain / Weighting** - During calibration, set the "AC Output Weighting" to "Flat."  
Note: Changing the output gain does not affect the SLM indications.

**3. Special Calibration** - Proper firmware calibration of the LDL Model 820 is dependent on a special calibration procedure using an approved ½-inch microphone and calibrator, or a 0.5 Vrms 1 kHz sine wave. Follow the procedure included in Section B6 of this Appendix entitled "LDL Model 820 SLM Special Calibration." This calibration need not be repeated unless the LDL Model 820 has a power failure during which setup information is lost. Normal calibration of the LDL Model 820 should include capturing a short duration of the calibration signal, in SLM mode, and notation of the indicated level.

**4. Modified A-Weight for SLM** - The A-weight filter in the Volpe Center's Model 820 SLM has been modified to meet Type 1 SLM response using a B&K Model 4155 microphone at grazing incidence. Though the B&K Model 4179 has differing response characteristics from the B&K Model 4155, the modified A-weight curve still improves the B&K Model 4179's grazing and random incidence response.

**5. LDL Model 827 Preamplifier for Impedance Matching** - Although the LDL Model 827 preamplifier does not add any gain to the signal, it *must* be connected between the B&K Model 2804 and the LDL Model 820 for impedance matching. Use of the LDL-to-BNC adapter alone will cause the LDL Model 820 input to overload and behave unpredictably.

**C. LDL Model 2900 Spectrum Analyzer:**

**1. LDL Model 827 Preamplifier not required** - Will accept output directly from the B&K Model 2804 without an LDL Model 827 preamplifier. Use the LDL-to-BNC adapter.

**2. Range settings** - Normal calibration will automatically set the input range to 90 dB. Change the input range to 70 dB for data collection. Any changes in range will also affect the gain applied to recorded data if the recorder is fed from the LDL Model 2900 AC output. All such changes must be logged.

**D. SONY Model PC208Ax DAT Recorder:**

**1. Mode** - Operate at 20 kHz bandwidth (10 kHz is sufficient if necessary). Configure as 2-channel@1X speed, or 4-channel@2X speed. Note: 295 ft (90 m) tape provides 3 hours recording time at 1X speed.

---

**2. Range** - Input voltage range: Calibrate at 2 V. Range changes made after calibration provide the following gain values:

<u>Range</u>	<u>Gain</u>	
0.5 V	+12 dB	(Suggested setting for measurement in most environments.)
1 V	+6 dB	
2 V	0 dB	
5 V	-8 dB	
10 V	-14 dB	

Note: If IRIG B Time Code is being recorded, set corresponding DAT input channel to 5 V range.

### **B.3 Operation**

#### **A. Setup:**

1. Install NPS Two-Stage windscreen and mount in accordance with Section B7 of this appendix entitled "NPS Two-Stage Windscreen and Mount Instructions."
2. Run microphone cable and connect between B&K Model 2660 preamplifier and B&K Model 2804 power supply. Note: When using older cables, connector extensions are required.
3. Interconnect equipment per Figure 45.

4. Connect power leads for LDL Model 2900 or Sony Model PC208Ax, Time Code Generator (If used), and LDL Model 820 to 40 Ah gel-cell battery. Connect power leads to equipment. Turn on all equipment.
5. Set time and date on LDL Model 2900 or Sony Model PC208Ax, and SLM per Master Clock.
6. Check instrument settings, especially recorder speed, channel configuration and input range.

**B. Calibration:**

[NOTE: The B&K Model 4179 Microphone obtains its low-level sensitivity by means of an under-damped diaphragm. Due to this lack of damping, the diaphragm can easily short against the backplate. This causes no permanent damage but requires recovery time. If this occurs, the microphone can take several minutes to stabilize. The B&K Model 2660 Preamplifier may also take time to stabilize its output current as a result of being powered by 28 V instead of the specified 120 V. Finally, the polarization voltage (200 V @ 40 kHz,) from the B&K Model 2804 power supply requires time to stabilize as well. For all these reasons, extreme caution must be exercised when handling the microphone capsule, and when applying the calibration signal.]

1. Remove fabric cover, rotate windscreen frame assembly out of the way (see Section B7) and remove foam windscreen from microphone.
2. Carefully apply calibrator to microphone.

3. Carefully apply power to calibrator (94 dB setting).
  
4. Wait at least three minutes for system to stabilize.
  
5. Perform normal calibration of LDL Model 820 or LDL Model 2900. Keep in mind that the LDL Model 820 calibration level must be set to 119.00 in order to properly set its dynamic range. If calibrator output level is unsteady after a three-minute wait, this is an indication that the calibration is unreliable, and the entire system must be allowed to rest for at least three minutes before retrying. Such instability is indicative of an error in sensitivity of approximately 3 to 4 dB.
  
6. Once the front-end has been calibrated and a steady calibration signal is observed, record the calibration signal on the Sony Model PC208Ax for one minute. The one-minute duration is required to ensure that the Sony Model PC208Ax event ID system does not get "scrambled." A 30 second duration is sufficient when in 2X speed model. Ensure that no gain or weighting is being applied at the front end by checking the setup parameters of the LDL Model 820 or LDL Model 2900. A normal calibration will illuminate 4 segments on the Sony Model PC208Ax LCD display.
  
7. After recording the calibration signal, very carefully turn off the calibrator and remove it from the microphone.

8. Very carefully remove the microphone capsule and the one-inch adapter sleeve from the B&K Model 2660 preamplifier. Feed a short length of preamplifier cable into the mast through the cable slot so that the preamplifier end does not slide down into the mast tube.
  9. Attach the Ivie Model IE-20B Pink Noise Generator to the B&K Model 2660.
  10. Set output level of the Ivie Model IE-20B to within 10 dB of the normal calibration level. Wait three minutes.
  11. Capture and record one minute of pink noise data (Recording of a 30-second duration should be sufficient when operating at 2X speed mode).
  12. Remove the Ivie Model IE-20B.
  13. Attach the half-inch microphone simulator to the B&K Model 2660.
  14. Apply gain at the level intended for use during the noise measurements (+20 dB available at the LDL Model 820 AC Output, 10 dB increments available at the LDL Model 2900 AC output by switching its input range, and +6, +12, -8 and -14 dB available at the Sony Model PC208Ax by changing its input range. For measurement in most environments use +12 dB gain by switching the Sony Model PC208Ax input range from 2 V to 0.5 V). Wait three minutes.
-

15. Capture and record one minute of microphone simulator floor (Recording of a 30-second duration should be sufficient when operating at 2X speed mode). The LDL Model 820 SLM should indicate approximately 25 dB(A) (which equals approximately 0 dB(A) in actuality) in the SLM mode. The Model 2900 should indicate approximately 6 dB(A) in the SUM display, and should indicate approximately -5 dB in the 1 kHz band.

16. Remove the microphone simulator.

17. Carefully reinstall the one-inch adapter sleeve and the B&K Model 4179 microphone. Use a lens brush to clean any dust or debris from the back of the microphone capsule and the end of the preamplifier. Due to the sensitivity of the VLLMS, small particles can adversely affect performance.

18. Carefully attach the calibrator to the microphone.

19. Set system gain back to 0 dB for final calibration.

20. Carefully apply power to calibrator (94 dB setting).

21. Wait three minutes for calibrator signal to stabilize.

22. Perform normal calibration of the LDL Model 820 and/or the LDL Model 2900.



23. After calibrating the front-end and observing a steady state calibration signal, record the calibration signal on the Sony Model PC208Ax for one minute (minimum 30 seconds at 2X speed).
  
24. After recording the calibration signal, very carefully turn off the calibrator and remove it from the microphone. Attach the foam windscreen and re-deploy the NPS Two-Stage windscreen (see Section B7).
  
25. Re-apply system gain to be used during measurements.
  
26. Let the system rest for three minutes before starting measurements.

**B.4 System Performance Limits**

**Table 17. System Performance Limits**

Component	Mode	Overload Point	Floor (Half-Inch Mic Simulator)		
			A-Weight	1kHz	10kHz
B&K VLLMS		104dB@1kHz	~-2.5dBA	~-16dBSPL	~-11dBSPL
LD820 & 827 SLM Indication	(Cal indicates 119.0dB)	103dBA (128 Indic.)	~0dBA (~25 Indic.)	n/a	n/a
AC Output	0dB Gain	102dB @1kHz	~-1dBA	~-11dBSPL	~-9dBSPL
	+20dB Gain	82dB @ 1kHz	~-1dBA	~-11dBSPL	~-9dBSPL
LD2900 Analyzer Display	90dB Range	97dB @1kHz	~17dB (linearity floor, FS-80dB) (~-26dBA; ~14dB@1kHz; ~14dB@10kHz)		
	70dB range	78dB @1kHz	~-2dB (linearity floor, FS-80dB) (~-6dB floor visible in display)		
AC Output	0dB Gain (90dB range)	103dB@1kHz	~0dBA	~-12dBSPL	~-11dBSPL (dip in filter)
	+20dB Gain (70dB range)	87dB@1kHz	~-1dBA	~-12dBSPL	~-18dBSPL (dip in filter)
SONY PC208Ax DAT Recorder	2V Input range (0db input gain)	100dB@1kHz	15dB (linearity floor, FS -85dB)		
	1V (after cal @ 2V) (+6dB DAT gain)	94dB@1kHz	9dB (linearity floor, FS -85dB)		
	0.5V (after cal @ 2V) (+12dB DAT gain)	88dB@1kHz	3dB (linearity floor, FS -85dB)		
	2V Input range (+20dB input gain at LD820 or 2900)	80dB@1kHz	-5dB (linearity floor, FS -85dB)		
	5V (after cal @ 2V) (-8dB DAT gain & +20dB input gain at LD820 or 2900 / System gain = +12dB)	88dB@1kHz	3dB (linearity floor, FS-85dB)		

## **B.5 Power Requirements and Considerations**

### **A. Effect of powering devices from same supply:**

There is an apparent grounding problem when the LDL Model 820 SLM is powered from the same battery as the B&K Model 2804, which degrades the noise floor by about 2 to 3 dB.

There is a lesser problem when powering the True Time GPS Time Code generator from the same battery as the B&K Model 2804, which results in a bump in the noise floor in the 630 Hz band.

There is also a grounding problem when powering the LDL Model 820 from the same battery as the LDL Model 2900, if the output from the B&K Model 2804 is split between them.

Due to these potential problems, it is recommended that the B&K Model 2804 be powered from a 12V lantern battery. Since the current draw is very low (~15 mA), a 1 Ah battery would last over 65 hours. It is also recommended that the LDL Model 820 be powered only from the internal battery, or from one or two external 9 V batteries.

### **B. Power requirements:**

**B&K Model 2804 Power Supply:** 3 x D cells plus external 12V lantern battery (15 mA)

---

Typical "life":	D cells - <b>40 hours</b> (per manual) 12V - unknown, assume > <b>60 hours</b> if battery = 1 Ah
<b>LDL Model 820:</b>	1 x 9V or external 6 to 12 V (23 mA @ 9V)
Typical "life":	9V - 250 mAh ~ <b>10 hours</b> Duracell 9V: 500 mAh ~ <b>20 hours</b> Radio Shack Ultralife lithium 9V: 1 Ah ~ <b>40 hours</b>
<b>LDL Model 2900:</b>	12V (~1 A)
Typical "life":	<b>40 hours</b> if powered by separate gel-cell battery <b>11 to 16 hours</b> if same gel-cell powers Sony Model PC208Ax
<b>SONY Model PC208Ax:</b>	11 to 30 V (~1.5 to 2.4 A @ 12V)
Typical "life":	<b>16 to 25 hours</b> if powered by separate gel-cell battery <b>11 to 16 hours</b> if same gel-cell battery powers LDL Model 2900
<b>B&amp;K Model 4231 Calibrator:</b>	4 x AA cells

---

**TAMS Met System:** 12 x AA cells or 12V

Typical "life": AA cells > **24 hours**

**Notebook PC (on inverter):** ~1.25 A (Internal battery fully charged)

Typical "life": **16 hours** (2 PCs on 1-40 Ah gel cell battery)

### **B.6 LDL Model 820 SLM Special Calibration**

It is fairly well documented that the LDL Model 820 can provide conflicting sound level readings for the same input signal when comparing readings taken with the unit in calibration mode versus SLM mode. Without proper adjustment, these differences can be as large as several tenths of a decibel. The following procedure was recommended by the manufacturer, LDL, to improve agreement between the calibrated level and the SLM indication on their Model 820 SLM. This is a procedure which should be performed in the laboratory prior to any field measurements. Experience has shown that this procedure generally reduces differences to one tenth of a decibel or less.

1. Apply a 1 kHz sine wave at calibration level through the LDL Model 827 preamplifier (NOTE: LDL's calibration level in their laboratory is equivalent to 0.5 Vrms, however they have indicated that the procedure will work fine with the B&K Model 4155 microphone and a 114 dB SPL calibrator, e.g., the B&K Model 4231; but it will not work properly with the B&K Model 4179 Low-Level Microphone System).





**B.7 NPS Two-Stage Windscreen and Mount Instructions****A. Introduction:**

The NPS Two-Stage Windscreen and Microphone Mount described herein is a modification of a design originally developed by the acoustic consulting firm of Harris Miller Miller and Hanson, Inc. (HMMH) for the NPS LONOMS system. It performs two primary functions:

1. It minimizes wind-induced noise enough to allow for the measurement of very low-level acoustic data, effectively improving the signal-to-noise ratio of the measured sound.
2. It acts as a mounting system for B&K's VLLMS.

The unit has standard camera-mount (1/4"-20) screw threads, that can be attached to any standard camera tripod.

**B. Components (see Figure 45):**

The windscreen frame is comprised of the *Top Disc* (which holds the top ends of the *Ribs* in place via an elastic loop, and is attached to the *Mast* by four *Suspension Cords*), 32 steel wire *Ribs* (which form the shape of the windscreen frame), and the *Sliding Ring* (which, like the *Top Disc*, has an elastic loop to hold the bottom ends of the *Ribs* in place, and which can be fixed into position via three slotted-head setscrews). The *Rib-Spacing Cord* is used to insure uniform spacing between the *Ribs* when the unit is fully deployed. The Retractable Suspension Fingers help the windscreen frame to form a spherical shape by limiting the vertical travel of the *Top Disc*.

---



The Microphone Mount is basically the *Mast* (which features a funnel-shaped Microphone Cradle opening at the top end, and a *Cable Slot* at the bottom for insertion and removal of the B&K Model 2660 Preamplifier while the unit is attached to a tripod.

Not shown is the Fabric Cover, which forms the outer stage of the windscreen. It features a drawstring closure at the bottom, which is used to tighten the fabric around the base of the windscreen frame.

**C. Installation Instructions:**

1. Set up the tripod for a 5 ft. (1.5 m) microphone height: set the top of the tripod to 33.5" (85 cm) above the local ground level.
  2. Carefully remove the Two-Stage Mount from its packing container.
  3. Attach the Mast to the Tripod. Tighten all Tripod fittings.
  4. Raise the *Sliding Ring* to a position just above the *Cable Slot* and tighten the slotted-head setscrews. Remove the foam from the *cable slot* and set aside. Make sure that the *Suspension Cords* are properly aligned by ensuring that the setscrew with the black ring around it is aligned with the vertical groove in the mast.
  5. Using the attached string, lower the B&K Model JJ2217 ½-inch adapter into the funnel-shaped microphone cradle opening at the top of the mast. Continue lowering the adapter until it appears at the bottom of the mast, visible through the *Cable Slot*.
  6. While holding the string at the top of the mast, attach the B&K Model JJ2217 adapter to the front end of the B&K Model 2660 Preamplifier. Do not misplace the black plastic cap which protects
-

the threaded end of the Model 2660.

7. Use the string to pull the B&K Model 2660 up through the *Mast* until it appears at the top. While pulling the string, feed the Model 2660 cable in through the *Cable Slot* at the bottom of the *Mast*.

8. Place the large end of the B&K Model 2660 Preamplifier in a protective container (e.g., fanny pack, plastic bag, etc.) and place at the base of the tripod. This container should also include a fabric windscreen cover, slotted screwdriver, microphone case, lens brush, and microphone simulator.

9. Loosen the setscrews on the *Sliding Ring*. Lower it, and rotate the windscreen frame assembly to one side. It may help to slide the *Rib Spacing Cord* downward a bit on the ribs. Gently spread the *Ribs* apart to clear the *Mast*, *Retractable Suspension Fingers*, etc. Be careful to avoid disengaging the ends of the *Ribs* from the retaining elastics at either end.

10. Remove the B&K Model JJ2217 adapter from the B&K Model 2660 Preamplifier and attach the 1-inch adapter in its place.

11. Gently pull back on the B&K Model 2660 cable to snugly fit the 1-inch adapter into the Microphone Cradle.

12. Attach the B&K Model 4179 Microphone to the 1-inch adapter / Model 2660 Preamplifier. Before attaching, use the lens brush to clean any dust/debris from the back of the microphone capsule and the threaded end of the preamplifier. Keep the clear plastic cap on the microphone until it can be covered by the foam windscreen or until a calibrator is applied. The presence of particles on the diaphragm or between the electrical contacts can degrade the system's performance.

13. Attach the B&K Model UA 0207 Foam Windscreen to the B&K Model 4179 Microphone.

---

***The remaining steps should be followed after the Calibration Procedure has been completed:***

14. Carefully rotate the windscreen frame assembly back into position.
15. Loosen the setscrews on the *Sliding Ring*. Make sure that the *Rib-Spacing Cord* is positioned approximately halfway up the length of each *Rib*.
16. Place the Fabric Cover over the top of the windscreen frame. The "X-seam" of the cover should be located directly over the *Top Disc*.
17. Slowly move the *Sliding Ring* upward until it is even with the lowest of the four *Vertical Alignment Grooves* on the *Mast*. Make sure that the setscrew with the black ring around it is aligned with the long vertical groove on the mast. Tighten the three setscrews.
18. Pull the fabric cover down evenly over the windscreen frame and pull the drawstring tight. Secure it with the string lock.
19. Dress the cable, securing it to the tripod. Tighten all tripod fittings. Replace the foam in the *Cable Slot*.

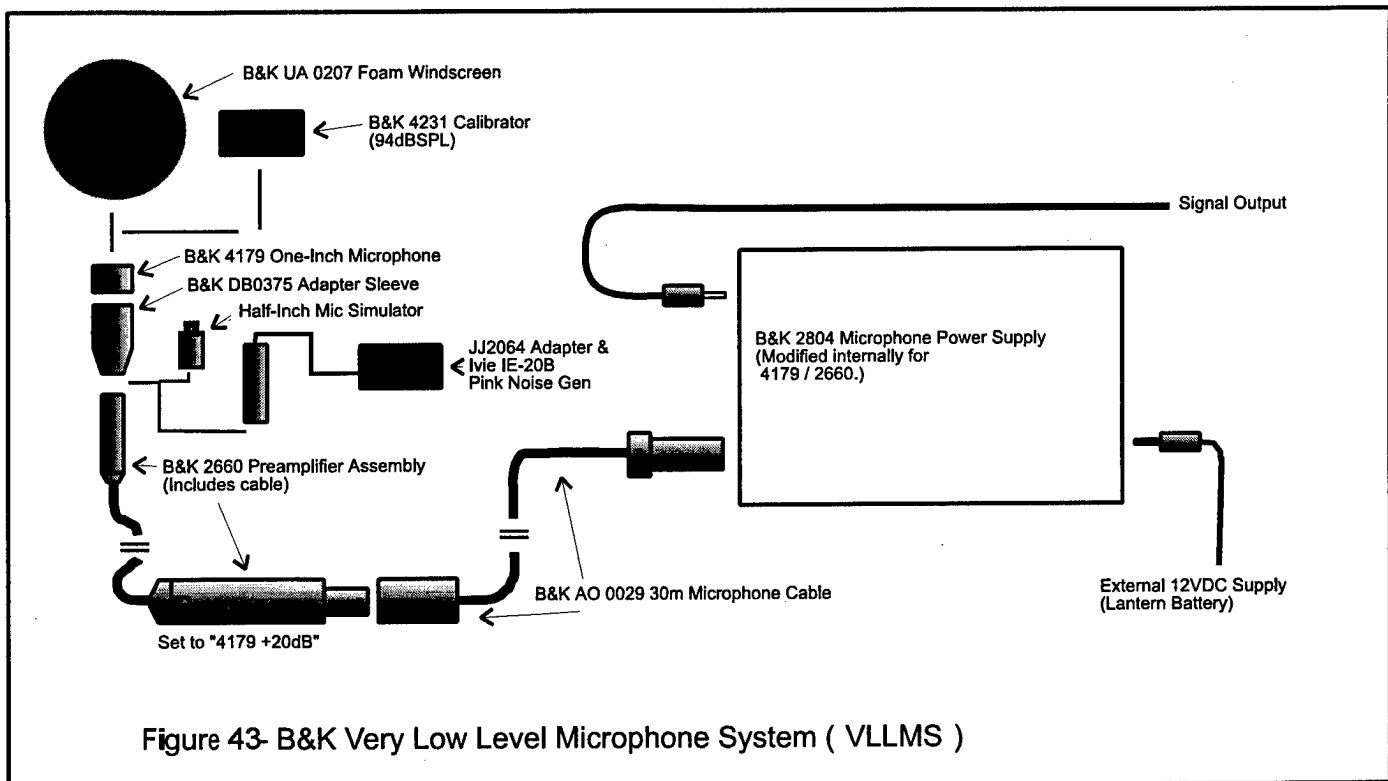

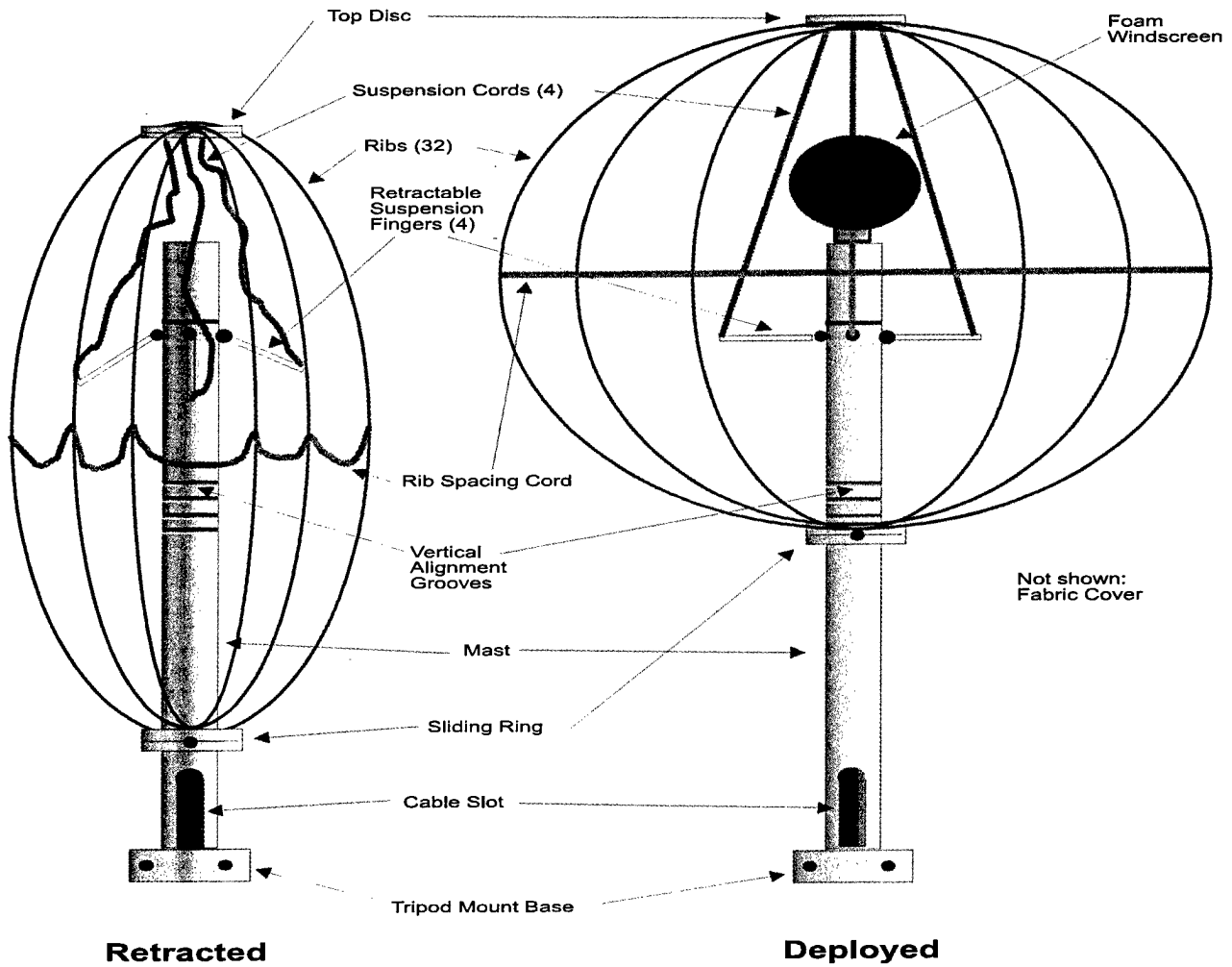
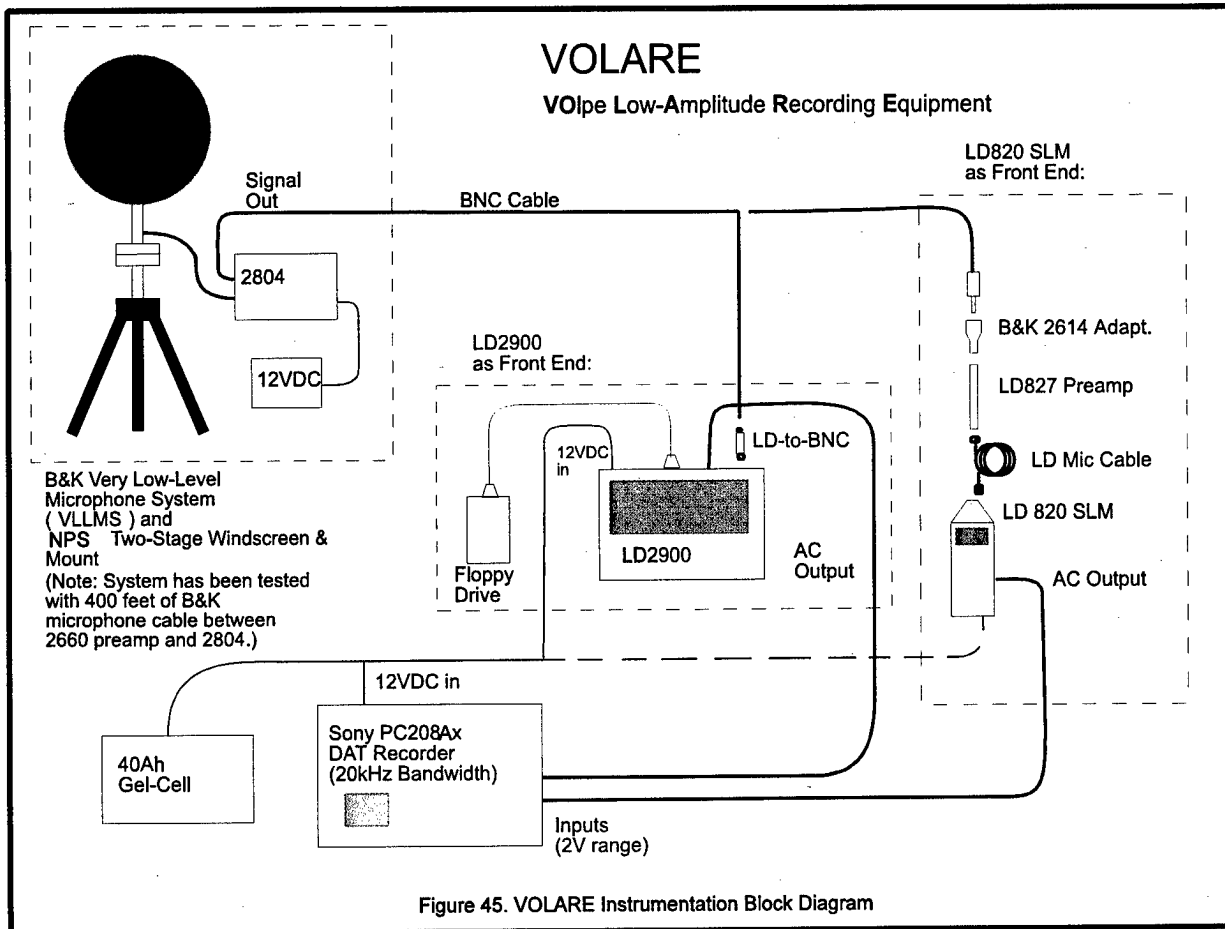

Figure 44. NPS Two-Stage Windscreen and Microphone Mount





**Appendix C:  
Questionnaire**





FAA COMMERCIAL TOUR OVERFLIGHTS STUDY  
DOSE-RESPONSE VISITOR QUESTIONNAIRE

OMB No. 2120-0610  
Page 1  
Expiration 11/30/97

PARK INFORMATION

Park Name: \_\_\_\_\_  
 Park Code: \_\_\_\_\_  
 Site Name: \_\_\_\_\_  
 Visitor Use Area: 1. Frontcountry (Overlook) 2. Frontcountry (Short Hike) 3. Backcountry  
 Month/Day: \_\_\_\_\_  
 Field Staff Code: \_\_\_\_\_

TIME INFORMATION

Observed Time: Arrived at Site: \_\_\_\_\_ : \_\_\_\_\_ a.m./p.m.  
 -----  
 Interview Begin: \_\_\_\_\_ : \_\_\_\_\_ a.m./p.m.  
 Time at Site: \_\_\_\_\_ Hours; \_\_\_\_\_ Minutes  
 Self-Reported Time:  
 A. Arrived at Site: \_\_\_\_\_ : \_\_\_\_\_ a.m./p.m.  
 B. Time at Site: \_\_\_\_\_ Hours; \_\_\_\_\_ Minutes

GROUP INFORMATION

Group #: \_\_\_\_\_  
 Type of Transportation:    1 Private car/van                    5 Bike  
    2 Tour bus/van                    6 Horse  
    3 RV                                    7 Motorcycle/ATV  
    4 Foot                                    8 Other: \_\_\_\_\_  
 Primary Language: \_\_\_\_\_  
 Number of People in Group:  
 \_\_\_\_\_ Adults  
 \_\_\_\_\_ Children (under 16 years of age)  
 \_\_\_\_\_ Total

NOTE: INTERVIEWER COMPLETES THIS COVER SHEET AND ATTACHES IT TO THE COMPLETED ANSWER SHEETS FOR EACH GROUP

#2

OMB No. 2120-0610  
Page 2  
Expiration 11/30/97

[INTERVIEWER READ THE INTRODUCTION]

(INTRODUCTION)

Hello, my name is (INTERVIEWER NAME). I am helping the National Park Service with a survey of visitors to Bryce Canyon National Park. The information visitors give us will help managers to better serve you. I would appreciate a few minutes of your time to answer some questions about your visit. Your participation in the survey is voluntary and your answers are confidential.

Now I would like to ask you a few questions about your visit.

If No objection →(CONTINUE)

If Objection → (THANK INDIVIDUALS FOR THEIR TIME AND SELECT NEXT ELIGIBLE GROUP)

Before we get started, is this your entire group?

I need to determine how long you have been at Queens Garden Trail. It is now (GIVE EXACT TIME). Do you remember what time you arrived at Queens Garden Trail?

No	1	About how long have you been at Queens Garden Trail? (RECORD GROUP CONSENSUS ON PARK INFORMATION SHEET (SELF-REPORTED TIME: B) AND THEN CONTINUE WITH Q.1)
Yes	2	(RECORD GROUP CONSENSUS ON PARK INFORMATION SHEET (SELF-REPORTED TIME: A) AND THEN CONTINUE WITH Q.1)

[INTERVIEWER: HAND OUT CLIPBOARDS AND ANSWER SHEETS AND GIVE INSTRUCTIONS ON HOW TO FILL OUT ANSWER SHEET.]

OMB No. 2120-0610  
Page 3  
Expiration 11/30/97

1. This first question asks about your visit to Bryce Canyon. What day and time did you start your visit to Bryce Canyon? (FILL IN BLANK)

Date: Month \_\_\_\_\_ Day \_\_\_\_\_

Time: \_\_\_\_\_ a.m./p.m.

From this point, please do not discuss the questions or answers until the interview has been completed.

2. Is this your first visit to Bryce Canyon or have you visited the park before?

First visit	1
Visited park before	2

If you visited before, approximately how many times have you visited Bryce Canyon before today?

\_\_\_\_\_

3. The remaining questions ask about your visit to Queens Garden Trail. Have you ever been to Queens Garden Trail before? (CIRCLE ONE NUMBER)

No	1
Yes	2

For those who have been to Queens Garden Trail before, about how many times have you visited this site in the past 5 years? (FILL IN BLANK)

\_\_\_\_\_ Number of visits in past 5 years

4. Overall, how enjoyable has your visit been at Queens Garden Trail? Has your visit been not at all, slightly, moderately, very, or extremely enjoyable? (CIRCLE ONE NUMBER)

Not at all enjoyable	1
Slightly enjoyable	2
Moderately enjoyable	3
Very enjoyable	4
Extremely enjoyable	5

OMB No. 2120-0610  
 Page 4  
 Expiration 11/30/97

5. What did you like most while you were at Queens Garden Trail? (FILL IN BLANK)

\_\_\_\_\_

\_\_\_\_\_

6. What did you like least while you were at Queens Garden Trail? (FILL IN BLANK)

\_\_\_\_\_

\_\_\_\_\_

7. How important was each of the following reasons for your visit to Queens Garden Trail? Would you say that (READ EACH REASON) was not at all important, slightly, moderately, very, or extremely important for your visit? (CIRCLE ONE NUMBER FOR EACH REASON)

	Not At All Important	Slightly Important	Moderately Important	Very Important	Extremely Important
Viewing the natural scenery was...	1	2	3	4	5
Enjoying the natural quiet and sounds of nature was...	1	2	3	4	5
Appreciating the history and cultural significance of the site was...	1	2	3	4	5

Next are two groups of questions about hearing and seeing aircraft at Queens Garden Trail. First, I would like to ask some questions about hearing aircraft, then about seeing aircraft.

OMB No. 2120-0610  
 Page 5  
 Expiration 11/30/97

**HEARING AIRCRAFT**

8. Did you hear any airplanes, jets, helicopters, or any other aircraft during your visit to Queens Garden Trail? (CIRCLE ONE NUMBER)

No	1
Yes	2

The next two questions are only for people who heard aircraft sounds here at Queens Garden Trail.

Only answer Q.9 if you said "Yes" in Q.8. If you did not hear any aircraft, please wait until I remind you to answer Q.11.

9. Were you bothered or annoyed by aircraft noise during your visit to Queens Garden Trail? Were you not at all annoyed, slightly annoyed, moderately annoyed, very annoyed, or extremely annoyed by aircraft noise? (CIRCLE ONE NUMBER)

Not at all annoyed	1
Slightly annoyed	2
Moderately annoyed	3
Very annoyed	4
Extremely annoyed	5

Only answer Q.10 if you said "Yes" to Q.8.

10. How much did the sound from aircraft interfere with each of the following aspects of your visit at Queens Garden Trail? Did the sound from aircraft interfere with your (READ EACH STATEMENT) not at all, slightly, moderately, very much, or extremely? (CIRCLE ONE NUMBER FOR EACH STATEMENT)

	Not at All	Slightly	Moderately	Very Much	Extremely
Enjoyment of the site	1	2	3	4	5
Appreciation of the natural quiet and sounds of nature at the site	1	2	3	4	5
Appreciation of the historical and/or cultural significance of the site	1	2	3	4	5

OMB No. 2120-0610  
 Page 6  
 Expiration 11/30/97

**SEEING AIRCRAFT**

Now, everyone should answer Q.11.

11. Did you see any airplanes, jets, helicopters or any other aircraft during your visit to Queens Garden Trail? (CIRCLE ONE NUMBER)

No	1
Yes	2

The next question is only for people who saw aircraft here at Queens Garden Trail. If you did not see any aircraft, please wait until I remind you to answer Question 13.

12. For those who did see aircraft, were you bothered or annoyed by seeing aircraft during your visit to Queens Garden Trail? Were you not at all annoyed, slightly annoyed, moderately annoyed, very annoyed, or extremely annoyed by seeing aircraft? (CIRCLE ONE NUMBER)

Not at all annoyed	1
Slightly annoyed	2
Moderately annoyed	3
Very annoyed	4
Extremely annoyed	5

Now, everyone who saw or heard aircraft on Queens Garden Trail today should answer Q.13.

13. To the best of your knowledge, were the aircraft that you saw or heard today at Queens Garden Trail primarily: (CIRCLE ONE NUMBER)

High altitude commercial jets	1
Fixed wing small aircraft	2
Helicopters	3
Other _____	4

OMB No. 2120-0610

Page 7

Expiration 11/30/97

**HEARING AIRCRAFT  
(OVERALL PARK)**

The next three questions refer to your overall park experience at Bryce Canyon National Park today.

14. About how many aircraft did you hear at Bryce Canyon today?

\_\_\_\_\_ number

15. If you heard aircraft at Bryce Canyon today, which of the following bothered or annoyed you?  
(CIRCLE ONE NUMBER FOR EACH STATEMENT)

	No	Yes
The number of aircraft you heard	1	2
The level of aircraft sound you heard	1	2
The amount of time you heard aircraft	1	2

16. Which of these bothered or annoyed you the most? (CIRCLE ONE ANSWER ONLY.)

The number of aircraft you heard	1
The level of aircraft sound you heard	2
The amount of time you heard aircraft	3
None	4

17. Is there anything else you would like to tell us about your visit to Bryce Canyon National Park?  
(FILL IN BLANK)

---



---

[INTERVIEWER: INSTRUCT RESPONDENT TO COMPLETE THE BACKGROUND INFORMATION REQUESTED ON THE LAST PAGE OF THE ANSWER SHEET]

THANK YOU VERY MUCH FOR YOUR TIME. HAVE A PLEASANT DAY!

COMMERCIAL TOUR OVERFLIGHTS STUDY  
VISITOR QUESTIONNAIRE ANSWER SHEET

OMB No. 2120-061  
Page 1  
Expiration 11/30/97

Your participation in the survey is voluntary. There are no penalties for not answering some or all of the questions, but since each interviewed person will represent many others who will not be surveyed, your cooperation is extremely important. The answers you provide are confidential. Our results will be summarized so that the answers you provide cannot be associated with you or anyone in your group or household.

Question 1 (FILL IN BLANK)

Date: Month \_\_\_\_\_ Day \_\_\_\_\_

Time: \_\_\_\_\_ : \_\_\_\_\_ a.m./p.m.

Question 2 (CIRCLE ONE NUMBER)

- 1 First visit
- 2 Visited park before → Approximately \_\_\_\_\_ times before today

Question 3 (CIRCLE ONE NUMBER)

- 1 No
- 2 Yes → \_\_\_\_\_ Number of visits in the past 5 years

Question 4 (CIRCLE ONE NUMBER)

- 1 Not at all enjoyable
- 2 Slightly enjoyable
- 3 Moderately enjoyable
- 4 Very enjoyable
- 5 Extremely enjoyable

Question 5 (FILL IN BLANK)

\_\_\_\_\_

\_\_\_\_\_

\_\_\_\_\_

\_\_\_\_\_



OMB No. 2120-0610  
 Page 2  
 Expiration 11/30/97

Question 6 (FILL IN BLANK)

\_\_\_\_\_

\_\_\_\_\_

\_\_\_\_\_

Question 7 (CIRCLE ONE NUMBER FOR EACH REASON)

Would you say that...	Not at all important	Slightly important	Moderately important	Very important	Extremely important
Reason 1	1	2	3	4	5
Reason 2	1	2	3	4	5
Reason 3	1	2	3	4	5

Question 8 (CIRCLE ONE NUMBER)

- 1 No
- 2 Yes

Answer Question 9 if you answered "Yes" in Question 8  
 Question 9 (CIRCLE ONE NUMBER)

- 1 Not at all annoyed
- 2 Slightly annoyed
- 3 Moderately annoyed
- 4 Very annoyed
- 5 Extremely annoyed

Answer Question 10 if you answered "Yes" to Question 8  
 Question 10 (CIRCLE ONE NUMBER FOR EACH STATEMENT)

Sounds from aircraft interfered with your...	Not at All	Slightly	Moderately	Very Much	Extremely
Statement 1	1	2	3	4	5
Statement 2	1	2	3	4	5
Statement 3	1	2	3	4	5

OMB No. 2120-0610  
Page 3  
Expiration 11/30/97

Question 11 (CIRCLE ONE NUMBER)

- 1 No
- 2 Yes

Answer Question 12 if you answered "Yes" to Question 11  
Question 12 (CIRCLE ONE NUMBER)

- 1 Not at all annoyed
- 2 Slightly annoyed
- 3 Moderately annoyed
- 4 Very annoyed
- 5 Extremely annoyed

Question 13 (CIRCLE ONE NUMBER)

- 1 High altitude commercial jets
- 2 Fixed wing small aircraft
- 3 Helicopters
- 4 Other \_\_\_\_\_

Question 14 (FILL IN BLANK)

\_\_\_\_\_ number (of aircraft)

Question 15

	NO	YES
The number of aircraft you heard	1	2
The level of aircraft sound you heard	1	2
The amount of time you heard aircraft	1	2

OMB No. 2120-0610  
Page 4  
Expiration 11/30/97

Question 16 (CIRCLE ONE NUMBER ONLY)

- 1 The number of aircraft you heard
- 2 The level of aircraft sound you heard
- 3 The amount of time you heard aircraft
- 4 None

Question 17 (FILL IN BLANK)

\_\_\_\_\_

\_\_\_\_\_

\_\_\_\_\_

PLEASE COMPLETE THE FOLLOWING BACKGROUND INFORMATION:

Sex: \_\_\_\_\_ Male \_\_\_\_\_ Female

What year were you born? 19 \_\_\_\_\_

State of Residence: \_\_\_\_\_

Zip Code: \_\_\_\_\_

United States Citizen? No Yes

Thank You for your time. Have a pleasant day.

The burden of the collection is estimated to average 10 minutes per request. Comments on the accuracy of the estimate or suggestions for reducing this burden should be directed to the U.S. Department of Transportation, Federal Aviation Administration, Technology Division, AEE-120, 809 Independence Avenue, SW, Washington, DC 20591. This information is considered voluntary. Persons are not required to respond to a collection of information unless it displays a currently valid OMB control number. The information collection requirements of this form have been approved under OMB control number 2120-0610.

**Appendix D:**  
**Analysis of Ambient Sound Levels**

---

Appendix D presents a summary of the BCNP ambient sound level data collected during the study period.

### **D.1 Ambient Sound Level Definitions**

The term "ambient noise" can be used in several ways, depending on the application. To avoid confusion, this document follows the precedent of *Draft Guidelines for the Measurement and Assessment of Low-Level Noise*<sup>3</sup> in using the following definitions for ambient noise:

*Traditional Ambient:* The composite, all-inclusive sound associated with a given environment, excluding the analysis system's electrical noise and the sound source of interest, which in this case is aircraft.

*Existing Ambient:* The composite, all-inclusive sound associated with a given environment, excluding only the analysis system's electrical noise (i.e., aircraft noise is included).

*Natural Ambient:* The natural sound conditions found in a study area, including all sounds of nature (i.e., wind, streams, wildlife, etc.), and excluding all human and mechanical sounds.

*Natural Quiet (NQ); NPS-defined:* The natural sound conditions found in a study area, including all sounds of nature (i.e., wind, streams, wildlife, etc.) and visitor-generated self-noise, and excluding all mechanical sounds.<sup>18</sup>

---

## D.2 Average Ambient Sound Level Data

Table 18 presents a summary of the overall average and average "peak-hour" ambient sound levels, along with their associated wind speeds, measured at BCNP. The average sound levels represent the energy-average of all  $L_{Aeq,1s}$  data measured over the entire study period for a given definition of ambient. The minimum and maximum sound levels represent the minimum and maximum  $L_{Aeq}$  values (ten-second energy average) for each ambient type, considering those measured over the entire study period. The "peak-hour" average sound levels represent the energy average of all  $L_{Aeq,1s}$  data from each day's peak hour, in terms of number of respondents. These values are presented because they may be more representative of the ambient from the standpoint of park visitors. All wind speeds are arithmetic averages for their respective time periods/ambient definitions.

As expected, the overall average value for the *Existing Ambient* is noticeably larger than that computed for the other three categories of ambient: 41.3 dB versus 35.2 dB for *Traditional Ambient*, 36.5 dB for *Natural Ambient* and 34.9 dB for *Natural Quiet (NPS-defined)*. The seemingly counter-intuitive relationship in the overall average value for the *Natural Ambient* is easily explained by its associated average wind speed. Specifically, *Natural Ambient* tended to be represented by the mid-to-late afternoon hours when visitor volume was low and wind speeds were high. In fact, the average wind speed associated with *Natural Ambient* was 3.9 mph, while it ranged from between 3.0 and 3.3 mph for the other ambient categories. As can be seen by the graphs presented in Section D.3, ambient sound level is strongly dependent on wind speed, i.e., ambient sound level increases with increasing wind speed. Similar results can be seen for the average ambient values presented for the peak hour.

Table 18. Summary of BCNP Ambient Sound Levels

		Traditional		Existing		Natural		NQ/NPS	
		L <sub>Aeq</sub> (dB)	Wind Speed (mph)	L <sub>Aeq</sub> (dB)	Wind Speed (mph)	L <sub>Aeq</sub> (dB)	Wind Speed (mph)	L <sub>Aeq</sub> (dB)	Wind Speed (mph)
Overall	Average	35.2	3.2	41.3	3.0	36.5	3.9	34.9	3.3
	Minimum	10.1	0	10.1	0	11.4	0	10.1	0
	Maximum	58.2	13.4	72.5	13.4	58.2	13.4	58.2	13.4
Peak-Hour	Average	33.6	3.4	39.5	3.4	34.0	3.5	32.3	3.4

### D.3 Relationships Between Ambient Sound Level and Wind Speed

Figures 46 through 49 present ambient sound level (for all four definitions of ambient presented in Section D.1) and wind speed as a function of time of day. The  $L_{Aeq}$  data represent the energy average of all ambient  $L_{Aeq,1s}$  data for a given hour of the day taking into account the entire study period. Wind speed data represent the arithmetic average of the wind data for the corresponding times. Data are shown according to the beginning of the one-hour period they represent (e.g., data plotted for 11:00 represent data measured between 11:00:00 and 11:59:59). As expected, excellent correlation is seen between the wind speed and ambient sound level data, and a general trend of increased wind speeds and increased sound levels is illustrated over the course of a day.

It should be noted that very little data were collected for the hours beginning at 07:00 and 16:00. This general lack of data is the reason for the often counter-intuitive behavior of the data presented for these time slots (e.g., Figure 48).

Traditional Ambient  $L_{Aeq}$  and Wind Speed By Time Of Day

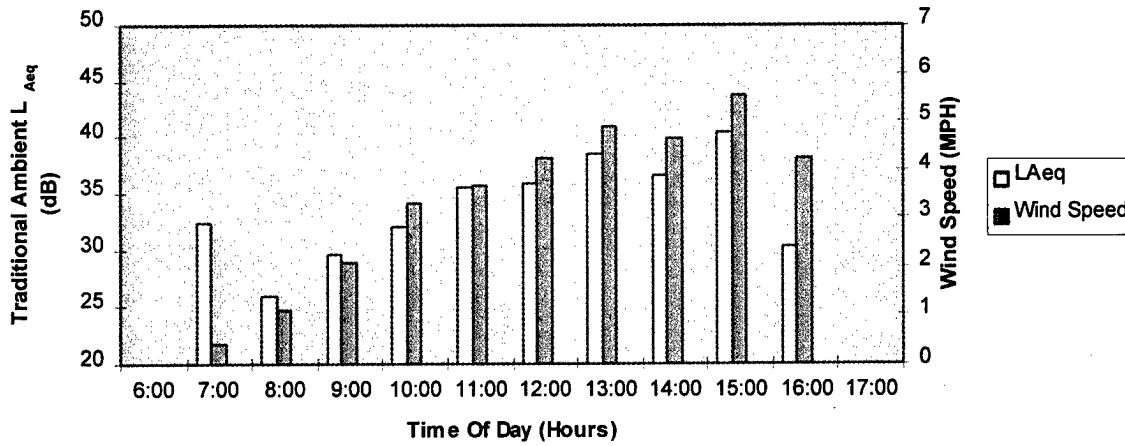

Figure 46.

Existing Ambient  $L_{Aeq}$  and Wind Speed By Time Of Day

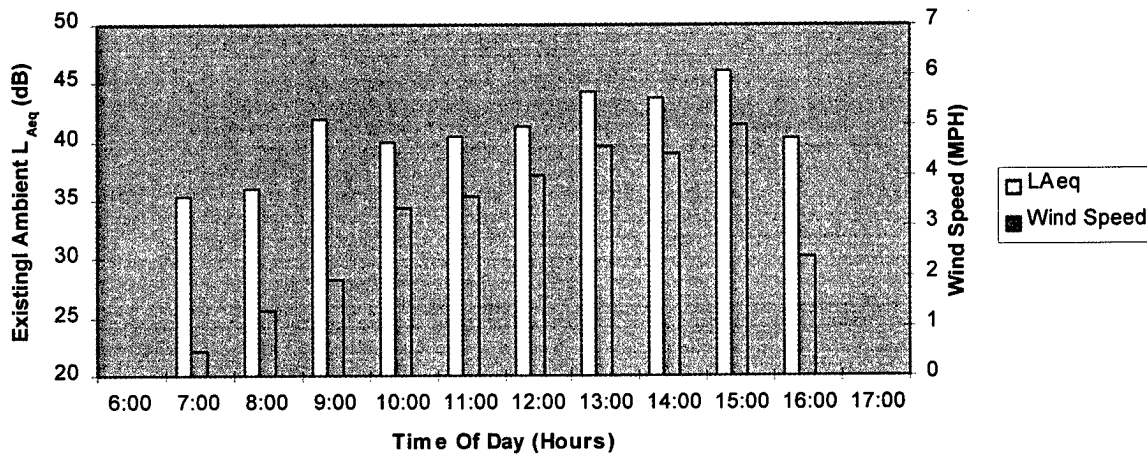

Figure 47.



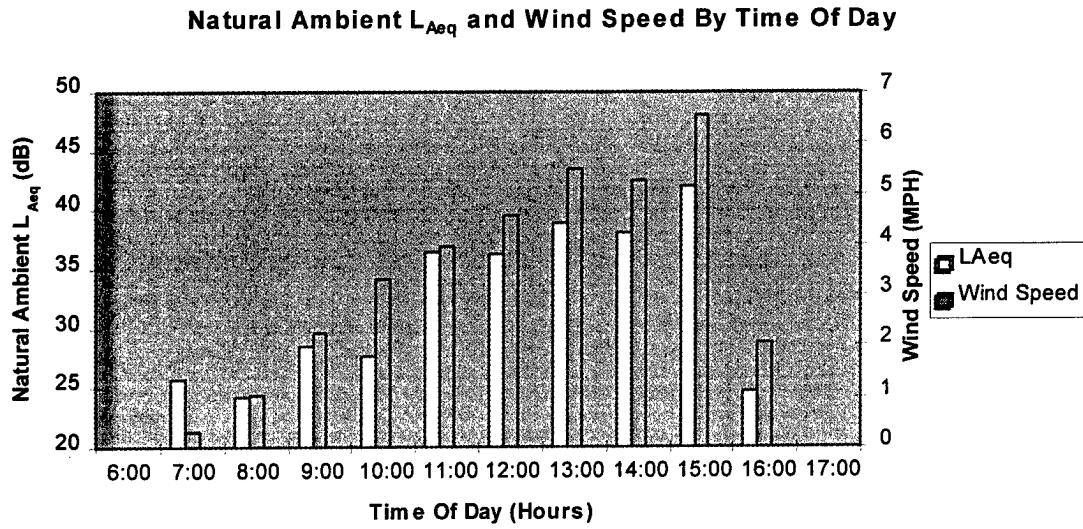

Figure 48.

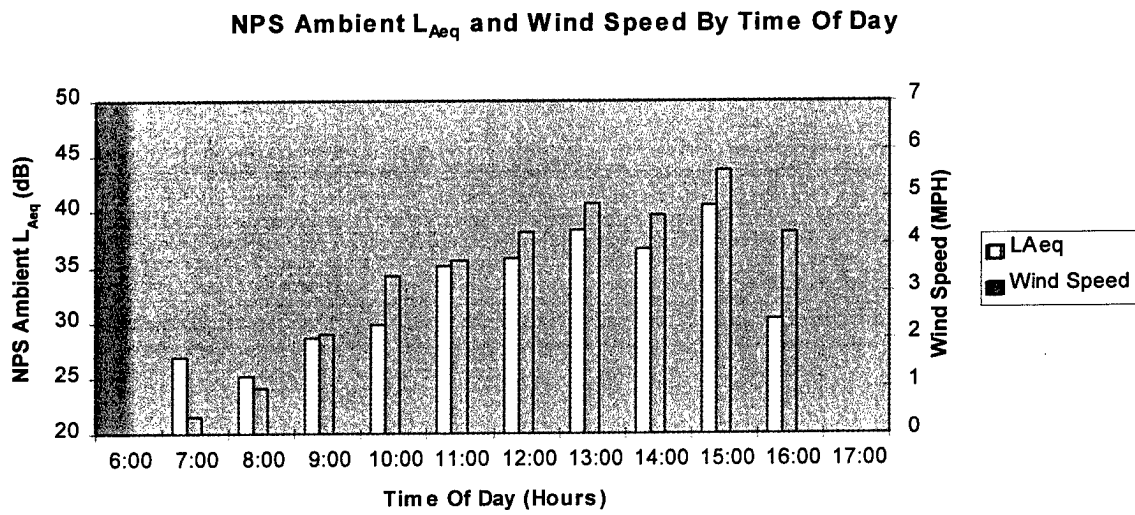

Figure 49.

Figures 50 through 53 present the relationships between ambient sound level and wind speed for each definition of ambient presented in Section D.1. Specifically, each data point in the figures represents the energy average of ten contiguous (in time)  $L_{Aeq,1s}$  values. The actual wind effect in terms of decibels per mile per hour change in wind speed is summarized in Table 19 for each definition of ambient.

**Table 19. Summary of BCNP Wind Effect on Ambient Sound Levels**

Wind Effect: Change in $L_{Aeq}$ (dB) per Mile Per Hour Change in Wind Speed (Rounded to nearest 0.1 dB)			
Traditional	Existing	Natural	NQ/NPS
1.9	1.4	2.2	1.9

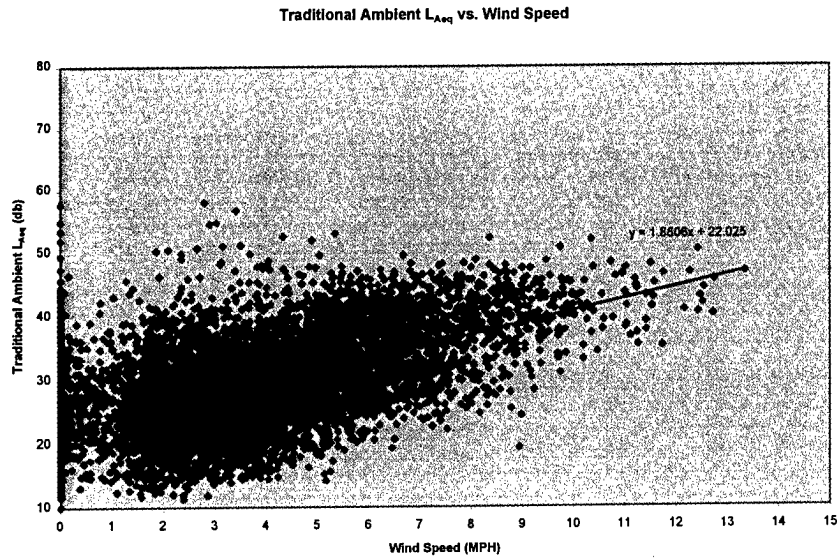

Figure 50.

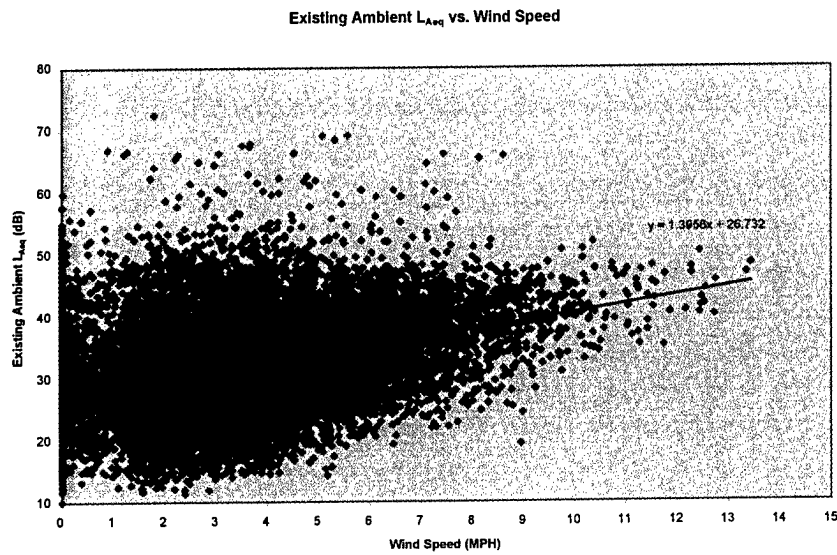

Figure 51.

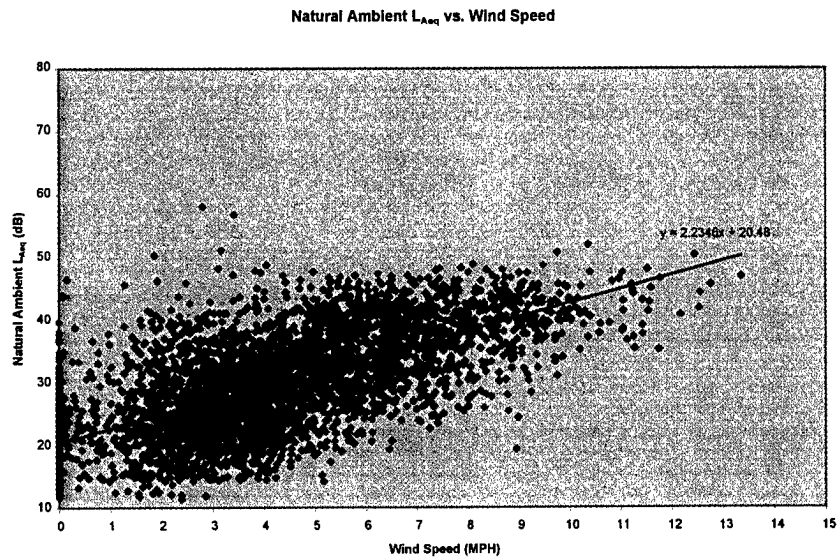

Figure 52.

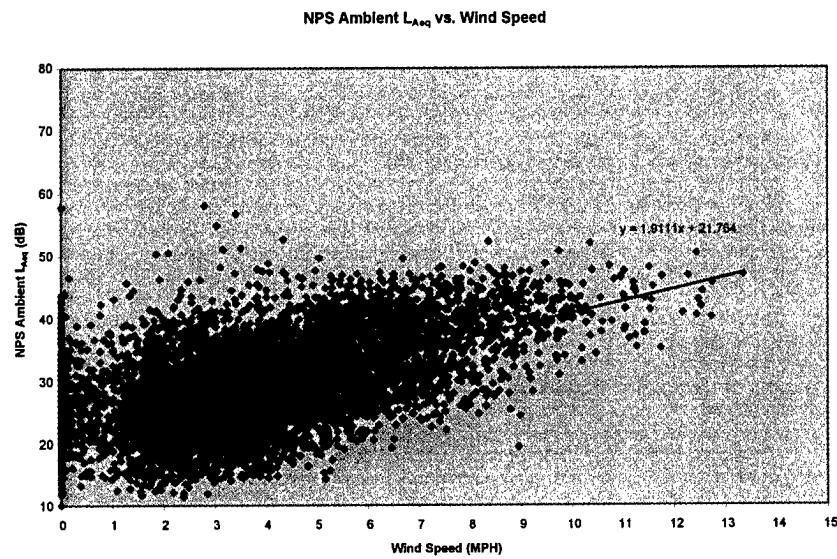

Figure 53.



**Appendix E:**  
**Summary of Responses**

**Q2A. Is this your first visit to Bryce Canyon or have you visited the park before?**

Q2A	All		Queens Garden		Queens Garden Extended	
	Count	Percent	Count	Percent	Count	Percent
First Visit	702	77.6	400	77.8	302	77.2
Visited Park Before	202	22.3	113	22.0	89	22.8
No Response	1	0.1	1	0.2	0	0.0
Total	905	100.0	514	100.0	391	100.0

**Q2B. If you visited before, approximately how many times have you visited Bryce Canyon before today?**

Q2B	All		Queens Garden		Queens Garden Extended	
	Count	Percent	Count	Percent	Count	Percent
1	114	56.4	60	53.1	54	60.7
2	46	22.8	28	24.8	18	20.2
3	19	9.4	11	9.7	8	9.0
4	6	3.0	4	3.5	2	2.2
5	2	1.0	2	1.8	0	0.0
6	2	1.0	1	0.9	1	1.1
7	3	1.5	2	1.8	1	1.1
8	2	1.0	2	1.8	0	0.0
10	3	1.5	2	1.8	1	1.1
15	1	0.5	0	0.0	1	1.1
19	1	0.5	0	0.0	1	1.1
20	1	0.5	0	0.0	1	1.1

Q2B	All		Queens Garden		Queens Garden Extended	
	Count	Percent	Count	Percent	Count	Percent
25	1	0.5	0	0.0	1	1.1
No Response	1	0.5	1	0.9	0	0.0
Total	202	100.0	113	100.0	89	100.0

**Q3A. Have you ever been to Queens Garden Trail before?**

Q3A	All		Queens Garden		Queens Garden Extended	
	Count	Percent	Count	Percent	Count	Percent
No	783	86.5	450	87.5	333	85.2
Yes	119	13.1	61	11.9	58	14.8
No Response	3	0.3	3	0.6	0	0.0
Total	905	100.0	514	100.0	391	100.0



**Q3B. For those who have been to Queens Garden Trail before, about how many times have you visited this site in the past 5 years?**

Q3B	All		Queens Garden		Queens Garden Extended	
	Count	Percent	Count	Percent	Count	Percent
0	29	24.4	14	23.0	15	25.9
1	54	45.4	30	49.2	24	41.4
2	24	20.2	13	21.3	11	19.0
3	5	4.2	2	3.3	3	5.2
5	1	0.8	1	1.6	0	0.0
7	1	0.8	1	1.6	0	0.0
10	1	0.8	0	0.0	1	1.7
15	1	0.8	0	0.0	1	1.7
No Response	3	2.5	0	0.0	3	5.2
Total	119	100.0	61	100.0	58	100.0

**Q4. Overall, how enjoyable has your visit been at Queens Garden Trail?**

Q4	All		Queens Garden		Queens Garden Extended	
	Count	Percent	Count	Percent	Count	Percent
Not at all enjoyable	0	0.0	0	0.0	0	0.0
Slightly enjoyable	4	0.4	4	0.8	0	0.0
Moderately Enjoyable	55	6.1	38	7.4	17	4.3
Very Enjoyable	452	49.9	271	52.7	181	46.3
Extremely Enjoyable	393	43.4	200	38.9	193	49.4

Q4	All		Queens Garden		Queens Garden Extended	
	Count	Percent	Count	Percent	Count	Percent
No Response	1	0.1	1	0.2	0	0.0
Total	905	100.0	514	100.0	391	100.0

**Q5.(1st response) What did you like most while you were at Queens Garden Trail?**

Q5 - 1st response	All		Queens Garden		Queens Garden Extended	
	Count	Percent	Count	Percent	Count	Percent
The view(s)/scenery/landscape/canyon	484	53.5	271	52.7	213	54.5
The hoodoos/rock formations	176	19.4	101	19.7	75	19.2
The colors	32	3.5	15	2.9	17	4.3
Other	27	3.0	16	3.1	11	2.8
Everything	23	2.5	9	1.8	14	3.6
The closeness of the hoodoos/rock formations	20	2.2	15	2.9	5	1.3
The color(s) of the rocks	19	2.1	10	1.9	9	2.3
No Answer	17	1.9	7	1.4	10	2.6
The beauty	13	1.4	8	1.6	5	1.3
Other specific view/scenery mentions	13	1.4	6	1.2	7	1.8
The ease of hiking/Easy to walk with children	10	1.1	6	1.2	4	1.0

Q5 - 1st response	All		Queens Garden		Queens Garden Extended	
The nature/natural wonder/ setting	10	1.1	2	0.4	8	2.0
The well kept trails/ maintenance of trails	6	0.7	6	1.2	0	0.0
The weather/ climate	6	0.7	4	0.8	2	0.5
Walking down into the canyon	6	0.7	4	0.8	2	0.5
The vistas	5	0.6	5	1.0	0	0.0
The trail/pathway	5	0.6	2	0.4	3	0.8
Don't know	4	0.4	3	0.6	1	0.3
The peace and quiet	4	0.4	3	0.6	1	0.3
The hiking	3	0.3	1	0.2	2	0.5
The accessibility of the trail	3	0.3	3	0.6	0	0.0
The panoramic/total view	3	0.3	3	0.6	0	0.0
View of the amphitheater	3	0.3	2	0.4	1	0.3
The fresh/ mountain air	2	0.2	2	0.4	0	0.0
Not too crowded	2	0.2	2	0.4	0	0.0
The geological formations/ geology	2	0.2	2	0.4	0	0.0
The uniqueness	2	0.2	2	0.4	0	0.0
The trees	1	0.1	0	0.0	1	0.3
The animals	1	0.1	1	0.2	0	0.0
The erosion of rock	1	0.1	1	0.2	0	0.0
The wide trails	1	0.1	1	0.2	0	0.0

Q5 - 1st response	All		Queens Garden		Queens Garden Extended	
	Count	Percent	Count	Percent	Count	Percent
Some shady areas	1	0.1	1	0.2	0	0.0
Total	905	100.0	514	100.0	391	100.0

**Q5. (2<sup>nd</sup> response) What did you like most while you were at Queens Garden Trail?**

Q5 - 2nd response	All		Queens Garden		Queens Garden Extended	
	Count	Percent	Count	Percent	Count	Percent
The hoodoos/rock formations	61	15.1	32	15.2	29	15.1
The colors	54	13.4	26	12.4	28	14.6
The color(s) of the rocks	41	10.2	18	8.6	23	12.0
The ease of hiking/Easy to walk with children	27	6.7	19	9.0	8	4.2
The beauty	27	6.7	13	6.2	14	7.3
Other	27	6.7	13	6.2	14	7.3
The trail/pathway	23	5.7	14	6.7	9	4.7
The closeness of the hoodoos/rock formations	13	3.2	7	3.3	6	3.1
The well kept trails/maintenance of trails	12	3.0	6	2.9	6	3.1
The nature/natural wonder/setting	12	3.0	5	2.4	7	3.6
The weather/climate	11	2.7	8	3.8	3	1.6
The trees	9	2.2	5	2.4	4	2.1

Q5 - 2nd response	All		Queens Garden		Queens Garden Extended	
The hiking	9	2.2	3	1.4	6	3.1
The peace and quiet	8	2.0	4	1.9	4	2.1
The vistas	7	1.7	5	2.4	2	1.0
The fresh/mountain air	7	1.7	4	1.9	3	1.6
The animals	7	1.7	4	1.9	3	1.6
Other specific view/scenery mentions	7	1.7	4	1.9	3	1.6
The accessibility of the trail	6	1.5	4	1.9	2	1.0
Walking down into the canyon	5	1.2	2	1.0	3	1.6
The panoramic/total view	5	1.2	1	0.5	3	1.6
The sunlight	5	1.2	2	1.0	3	1.6
Everything	3	0.7	0	0.0	3	1.6
The sky/color of the sky	3	0.7	2	1.0	1	0.5
The erosion of rock	3	0.7	2	1.0	1	0.5
The wide trails	3	0.7	3	1.4	0	0.0
Not too crowded	2	0.5	1	0.5	1	0.5
The geological formations/ geology	2	0.5	1	0.5	1	0.5
The cliffs/mountains	2	0.5	1	0.5	1	0.5
The uniqueness	1	0.2	1	0.5	0	0.0
The close-up/near view(s)	1	0.2	0	0.0	1	0.5
Total	403	100.0	210	100.0	192	100.0

Q5. (3<sup>rd</sup> response) What did you like most while you were at Queens Garden Trail?

Q5 - 3rd response	All		Queens Garden		Queens Garden Extended	
	Count	Percent	Count	Percent	Count	Percent
Other	13	10.8	8	13.3	5	8.3
The colors	11	9.2	6	10.0	5	8.3
The beauty	9	7.5	3	5.0	6	10.0
The sky/color of the sky	8	6.7	1	1.7	7	11.7
he well kept trails/maintenance of trails	7	5.8	5	8.3	2	3.3
The trees	7	5.8	3	5.0	4	6.7
The color(s) of the rocks	6	5.0	2	3.3	4	6.7
The vistas	5	4.2	2	3.3	3	5.0
The nature/natural wonder/ setting	5	4.2	4	6.7	1	1.7
The fresh/mountain air	4	3.3	2	3.3	2	3.3
The trail/pathway	4	3.3	1	1.7	3	5.0
The sunlight	4	3.3	3	5.0	1	1.7
The cliffs/mountains	4	3.3	2	3.3	2	3.3
The peace and quiet	3	2.5	2	3.3	1	1.7
The hiking	3	2.5	1	1.7	2	3.3
The animals	3	2.5	1	1.7	2	3.3
The geological formations/ geology	3	2.5	1	1.7	2	3.3
The uniqueness	3	2.5	2	3.3	1	1.7

Q5 - 3rd response	All		Queens Garden		Queens Garden Extended	
The ease of hiking/easy to walk with children	2	1.7	0	0.0	2	3.3
The closeness of the hoodoos/ rock formations	2	1.7	1	1.7	1	1.7
The accessibility of the trail	2	1.7	1	1.7	1	1.7
Walking down into the canyon	2	1.7	2	3.3	0	0.0
The panoramic/total view	2	1.7	2	3.3	0	0.0
Not too crowded	2	1.7	0	0.0	2	3.3
Everything	1	0.8	1	1.7	0	0.0
The erosion of rock	1	0.8	1	1.7	0	0.0
View of the amphitheater	1	0.8	1	1.7	0	0.0
The close-up/near views	1	0.8	1	1.7	0	0.0
Some shady areas	1	0.8	1	1.7	0	0.0
Other specific view/scenery mentions	1	0.8	0	0.0	1	1.7
<b>Total</b>	<b>120</b>	<b>100.0</b>	<b>60</b>	<b>100.0</b>	<b>60</b>	<b>100.0</b>

---

**Q5. (4<sup>th</sup> response) What did you like most while you were at Queens Garden Trail?**

Q5 - 4th response	All		Queens Garden		Queens Garden Extended	
	Count	Percent	Count	Percent	Count	Percent
The trail/pathway	6	28.6	3	27.3	3	30.0
The fresh/mountain air	2	9.5	2	18.2	0	0.0
The hiking	2	9.5	1	9.1	1	10.0
The animals	2	9.5	1	9.1	1	10.0
Everything	1	4.8	0	0.0	1	10.0
Other	1	4.8	1	9.1	0	0.0
The peace and quiet	1	4.8	1	9.1	0	0.0
The accessibility of the trail	1	4.8	0	0.0	1	10.0
The nature/natural wonder/setting	1	4.8	1	9.1	0	0.0
The sky/color of the sky	1	4.8	0	0.0	1	10.0
Not too crowded	1	4.8	0	0.0	1	10.0
The uniqueness	1	4.8	0	0.0	1	10.0
The close-up/near views	1	4.8	1	9.1	0	0.0
<b>Total</b>	<b>21</b>	<b>100.0</b>	<b>11</b>	<b>100.0</b>	<b>10</b>	<b>100.0</b>

---



**Q5. (5<sup>th</sup> response) What did you like most while you were at Queens Garden Trail?**

Q5 - 5th response	All		Queens Garden		Queens Garden Extended	
	Count	Percent	Count	Percent	Count	Percent
The uniqueness	1	50.0	1	50.0	0	0.0
The close-up/near views	1	50.0	1	50.0	0	0.0
Total	2	100.0	2	100.0	0	0.0

**Q6. (1<sup>st</sup> response) What did you like least while you were at Queens Garden Trail?**

Q6 - 1st response	All		Queens Garden		Queens Garden Extended	
	Count	Percent	Count	Percent	Count	Percent
Nothing	231	25.5	122	23.7	109	27.9
No Answer	164	18.1	98	19.1	66	16.9
The crowds/ too many people/ tourists	157	17.3	78	15.2	79	20.2
Other	82	9.1	47	9.1	35	9.0
Slippery/Loose rock/gravel on trail	45	5.0	26	5.1	19	4.9
The anticipation of climbing back up	35	3.9	22	4.3	13	3.3
The steepness	32	3.5	20	3.9	12	3.1
The heat/hot sun	23	2.5	18	3.5	5	1.3
The survey	21	2.3	14	2.7	7	1.8
Seeing footprints/people off trail	13	1.4	8	1.6	5	1.3

Q6 - 1st response	All		Queens Garden		Queens Garden Extended	
No bathrooms/restrooms	11	1.2	4	0.8	7	1.8
The weather	10	1.1	6	1.2	4	1.0
The helicopter noise	9	1.0	7	1.4	2	0.5
Don't know	9	1.0	9	1.8	0	0.0
Didn't know what numbered markers stood for	9	1.0	3	0.6	6	1.5
Signs could be better/ need more information along trails	9	1.0	4	0.8	5	1.3
The helicopters	5	0.6	5	1.0	0	0.0
No safety rails at dangerous/ steep places	5	0.6	5	1.0	0	0.0
Dangerous/risky trail	5	0.6	2	0.4	3	0.8
Dangerous to walk with children/fear of children falling	5	0.6	2	0.4	3	0.8
The elevation/altitude	5	0.6	2	0.4	3	0.8
Possibility/threat of rain	4	0.4	4	0.8	0	0.0
No water	4	0.4	2	0.4	2	0.5
Not having a trail guide/map	4	0.4	3	0.6	1	0.3
The aircraft noise	2	0.2	1	0.2	1	0.3
Trail erosion	2	0.2	0	0.0	2	0.5
The switchbacks/turns	2	0.2	1	0.2	1	0.3
The noise	1	0.1	1	0.2	0	0.0
The airplane noise	1	0.1	0	0.0	1	0.3

Q6 - 1st response	All		Queens Garden		Queens Garden Extended	
	Count	Percent	Count	Percent	Count	Percent
Total	905	100.0	514	100.0	391	100.0

**Q6. (2<sup>nd</sup> response) What did you like least while you were at Queens Garden Trail?**

Q6 - 2nd response	All		Queens Garden		Queens Garden Extended	
	Count	Percent	Count	Percent	Count	Percent
Other	11	22.0	4	13.3	7	35.0
Slippery/Loose rock/gravel on trail	3	6.0	2	6.7	1	5.0
The helicopters	3	6.0	2	6.7	1	5.0
Signs could be better/need more information along trails	3	6.0	2	6.7	1	5.0
The heat/hot sun	2	4.0	2	6.7	0	0.0
The survey	2	4.0	2	6.7	0	0.0
Seeing footprints/people off trail	2	4.0	1	3.3	1	5.0
Didn't know what numbered markers stood for	2	4.0	1	3.3	1	5.0
No bathrooms/restrooms	2	4.0	1	3.3	1	5.0
The noise	2	4.0	1	3.3	1	5.0
No water	2	4.0	1	3.3	1	5.0
Dangerous/risky trail	2	4.0	2	6.7	0	0.0
Not having a trail guide/map	2	4.0	1	3.3	1	5.0

Q6 - 2nd response	All		Queens Garden		Queens Garden Extended	
Dangerous to walk with children/fear of children falling	2	4.0	2	6.7	0	0.0
The airplane noise	2	4.0	1	3.3	1	5.0
The helicopter noise	1	2.0	0	0.0	1	5.0
The anticipation of climbing back up	1	2.0	1	3.3	0	0.0
The steepness	1	2.0	1	3.3	0	0.0
Possibility/threat of rain	1	2.0	1	3.3	0	0.0
The weather	1	2.0	0	0.0	1	5.0
The aircraft noise	1	2.0	1	3.3	0	0.0
Trail erosion	1	2.0	1	3.3	0	0.0
The switchbacks/turns	1	2.0	0	0.0	1	5.0
Total	50	100.0	30	100.0	20	100.0

**Q6. (3<sup>rd</sup> response) What did you like least while you were at Queens Garden Trail?**

Q6 - 3 <sup>rd</sup> response	All		Queens Garden		Queens Garden Extended	
	Count	Percent	Count	Percent	Count	Percent
The helicopters	3	42.9	1	25.0	2	66.7
Rangers driving a motorized vehicle on trail	2	28.6	2	50.0	0	0.0
Other	1	14.3	1	25.0	0	0.0
The airplane noise	1	14.3	0	0.0	1	33.3
Total	7	100.0	4	100.0	3	100.0

**Q7A. How important was viewing the natural scenery as a reason for your visit to Queens Garden Trail?**

Q7A	All		Queens Garden		Queens Garden Extended	
	Count	Percent	Count	Percent	Count	Percent
Not at all important	3	0.3	0	0.0	3	0.8
Slightly important	2	0.2	2	0.4	0	0.0
Moderately important	30	3.3	15	2.9	15	3.8
Very important	282	31.2	148	28.8	134	34.3
Extremely important	585	64.6	349	67.9	236	60.4
No answer	3	0.3		0.0	3	0.8
Total	905	100.0	514	100.0	391	100.0

**Q7B. How important was enjoying the natural quiet and sounds of nature as a reason for your visit to Queens Garden Trail?**

Q7B	All		Queens Garden		Queens Garden Extended	
	Count	Percent	Count	Percent	Count	Percent
Not at all important	22	2.4	10	1.9	12	3.1
Slightly important	81	9.0	48	9.3	33	8.4
Moderately important	204	22.5	108	21.0	96	24.6
Very important	341	37.7	181	35.2	160	40.9
Extremely important	250	27.6	163	31.7	87	22.3
No answer	7	0.8	4	0.8	3	0.8
Total	905	100.0	514	100.0	391	100.0

**Q7C. How important was appreciating the history and cultural significance of the site as a reason for your visit to Queens Garden Trail?**

Q7C	All		Queens Garden		Queens Garden Extended	
	Count	Percent	Count	Percent	Count	Percent
Not at all important	61	6.7	29	5.6	32	8.2
Slightly important	172	19.0	93	18.1	79	20.2
Moderately important	334	36.9	193	37.5	141	36.1
Very important	227	25.1	139	27.0	88	22.5
Extremely important	106	11.7	57	11.1	49	12.5
No answer	5	0.6	3	0.6	2	0.5
Total	905	100.0	514	100.0	391	100.0

**Q8. Did you hear any airplanes, jets, helicopters, or any other aircraft during your visit to Queens Garden Trail?**

Q8	All		Queens Garden		Queens Garden Extended	
	Count	Percent	Count	Percent	Count	Percent
No	259	28.6	128	24.9	131	33.5
Yes	646	71.4	386	75.1	260	66.5
No answer	0	0.0	0	0.0	0	0.0
Total	905	100.0	514	100.0	391	100.0

**Q9. Were you bothered or annoyed by aircraft noise during your visit to Queens Garden Trail?**

Q9	All		Queens Garden		Queens Garden Extended	
	Count	Percent	Count	Percent	Count	Percent
Not at all annoyed	148	22.9	95	24.6	53	20.4
Slightly annoyed	147	22.8	87	22.5	60	23.1
Moderately annoyed	122	18.9	69	17.9	53	20.4
Very annoyed	56	8.7	38	9.8	18	6.9
Extremely annoyed	47	7.3	33	8.5	14	5.4
No answer	126	19.5	64	16.6	62	23.8
Total	646	100.0	386	100.0	260	100.0

**Q10A. How much did the sound from aircraft interfere with each of the following aspects of your visit at Queens Garden Trail?                      Enjoyment of the site**

Q10A	All		Queens Garden		Queens Garden Extended	
	Count	Percent	Count	Percent	Count	Percent
Not at all	203	31.4	132	34.2	71	27.3
Slightly	128	19.8	74	19.2	54	20.8
Moderately	110	17.0	60	15.5	50	19.2
Very Much	48	7.4	35	9.1	13	5.0
Extremely	24	3.7	15	3.9	9	3.5
No answer	133	20.6	70	18.1	63	24.2
Total	646	100.0	386	100.0	260	100.0



**Q10B. How much did the sound from aircraft interfere with each of the following aspects of your visit at Queens Garden Trail?                      Appreciation of the natural quiet and sounds of nature at the site**

Q10B	All		Queens Garden		Queens Garden Extended	
	Count	Percent	Count	Percent	Count	Percent
Not at all	79	12.2	41	10.6	38	14.6
Slightly	136	21.1	92	23.8	44	16.9
Moderately	120	18.6	68	17.6	52	20.0
Very Much	100	15.5	64	16.6	36	13.8
Extremely	76	11.8	48	12.4	28	10.8
No answer	135	20.9	73	18.9	62	23.8
Total	646	100.0	386	100.0	260	100.0

**Q10C. How much did the sound from aircraft interfere with each of the following aspects of your visit at Queens Garden Trail?**

**Appreciation of the historical and/or cultural significance of the site**

Q10C	All		Queens Garden		Queens Garden Extended	
	Count	Percent	Count	Percent	Count	Percent
Not at all	263	40.7	169	43.8	94	36.2
Slightly	115	17.8	66	17.1	49	18.8
Moderately	76	11.8	42	10.9	34	13.1
Very Much	41	6.3	24	6.2	17	6.5
Extremely	16	2.5	12	3.1	4	1.5
No answer	135	20.9	73	18.9	62	23.8
Total	646	100.0	386	100.0	260	100.0

**Q11. Did you see any airplanes, jets, helicopters, or any other aircraft during your visit to Queens Garden Trail?**

Q11	All		Queens Garden		Queens Garden Extended	
	Count	Percent	Count	Percent	Count	Percent
No	456	50.4	234	45.5	222	56.8
Yes	449	49.6	280	54.5	169	43.2
No answer	0	0.0	0	0.0	0	0.0
Total	905	100.0	514	100.0	391	100.0

**Q12. Were you bothered or annoyed by seeing aircraft during your visit to Queens Garden Trail?**

Q12	All		Queens Garden		Queens Garden Extended	
	Count	Percent	Count	Percent	Count	Percent
Not at all annoyed	189	42.1	120	42.9	69	40.8
Slightly annoyed	125	27.8	73	26.1	52	30.8
Moderately annoyed	65	14.5	34	12.1	31	18.3
Very annoyed	37	8.2	29	10.4	8	4.7
Extremely annoyed	30	6.7	21	7.5	9	5.3
No answer	3	0.7	3	1.1	0	0.0
Total	449	100.0	280	100.0	169	100.0

**Q13. To the best of your knowledge, were the aircraft that you saw or heard today at Queens Garden Trail primarily:**

Q13	All		Queens Garden		Queens Garden Extended	
	Count	Percent	Count	Percent	Count	Percent
High altitude commercial jets	40	4.4	23	4.5	17	4.3
Fixed wing small aircraft	76	8.4	43	8.4	33	8.4
Helicopters	373	41.2	238	46.3	135	34.5
Other	2	0.2	2	0.4	0	0.0
No answer	414	45.7	208	40.5	206	52.7
Total	905	100.0	514	100.0	391	100.0

**Q14. About how many aircraft did you hear at Bryce Canyon today?**

Q14	All		Queens Garden		Queens Garden Extended	
	Count	Percent	Count	Percent	Count	Percent
0	269	29.7	132	25.7	137	35.0
1	282	31.2	159	30.9	123	31.5
2	196	21.7	121	23.5	75	19.2
3	80	8.8	47	9.1	33	8.4
4	32	3.5	24	4.7	8	2.0
5	24	2.7	15	2.9	9	2.3
6	8	0.9	6	1.2	2	0.5
7	2	0.2	2	0.4	0	0.0
8	5	0.6	4	0.8	1	0.3
10	3	0.3	2	0.4	1	0.3
12	2	0.2	0	0.0	2	0.5
15	1	0.1	1	0.2	0	0.0
No answer	1	0.1	1	0.2	0	0.0
Total	905	100.0	514	100.0	391	100.0

**Q15A. If you heard aircraft at Bryce Canyon today, which of the following bothered or annoyed you?**

The number of aircraft you heard

Q15A	All		Queens Garden		Queens Garden Extended	
	Count	Percent	Count	Percent	Count	Percent
No	415	45.9	254	49.4	161	41.2
Yes	196	21.7	111	21.6	85	21.7
No answer	294	32.5	149	29.0	145	37.1
Total	905	100.0	514	100.0	391	100.0

**Q15B. If you heard aircraft at Bryce Canyon today, which of the following bothered or annoyed you?**

The level of aircraft sound you heard

Q15B	All		Queens Garden		Queens Garden Extended	
	Count	Percent	Count	Percent	Count	Percent
No	303	33.5	179	34.8	124	31.7
Yes	308	34.0	187	36.4	121	30.9
No answer	294	32.5	148	28.8	146	37.3
Total	905	100.0	514	100.0	391	100.0

**Q15C. If you heard aircraft at Bryce Canyon today, which of the following bothered or annoyed you?**

**The amount of time you heard aircraft**

Q15C	All		Queens Garden		Queens Garden Extended	
	Count	Percent	Count	Percent	Count	Percent
No	395	43.6	236	45.9	159	40.7
Yes	209	23.1	126	24.5	83	21.2
No answer	301	33.3	152	29.6	149	38.1
Total	905	100.0	514	100.0	391	100.0

**Q16. Which of these bothered or annoyed you the most?**

Q16	All		Queens Garden		Queens Garden Extended	
	Count	Percent	Count	Percent	Count	Percent
The number of aircraft you heard	62	6.9	35	6.8	27	6.9
The level of aircraft sound you heard	232	25.6	142	27.6	90	23.0
The amount of time you heard aircraft	81	9.0	47	9.1	34	8.7
None	229	25.3	137	26.7	92	23.5
No answer	301	33.3	153	29.8	148	37.9
Total	905	100.0	514	100.0	391	100.0

**Q17. Is there anything else you would like to tell us about your visit to Bryce Canyon National Park?**

Q17 - 1st response	All		Queens Garden		Queens Garden Extended	
	Count	Percent	Count	Percent	Count	Percent
Loved/Enjoyed the park/visit/ it's a great park	108	11.9	52	10.1	56	14.3
Its very beautiful/lovely/nice	103	11.4	66	12.8	37	9.5
Great/Lovely views/scenery	25	2.8	14	2.7	11	2.8
It's a well organized park	3	0.3	1	0.2	2	0.5
Well designed/planned trails	4	0.4	3	0.6	1	0.3

Q17 - 1st response	All		Queens Garden		Queens Garden Extended	
Looking forward to returning/ coming back	2	0.2	1	0.2	1	0.3
Too many crowds/people/ tourists	13	1.4	5	1.0	8	2.0
Need transportation/shuttle bus	7	0.8	3	0.6	4	1.0
Nothing else	49	5.4	19	3.7	30	7.7
Other	113	12.5	63	12.3	50	12.8
No answer/Refused	342	37.8	204	39.7	138	35.3
Don't know	3	0.3	2	0.4	1	0.3
Annoyed by the survey	4	0.4	4	0.8	0	0.0
Annoyed by the air traffic/ aircraft in the park/Do not like aircraft in the park	8	0.9	5	1.0	3	0.8
Heard helicopter noise during sunrise	2	0.2	2	0.4	0	0.0
Put showers in at campground	9	1.0	2	0.4	7	1.8
It's a well maintained/clean park	1	0.1	1	0.2	0	0.0
Its exciting	2	0.2	1	0.2	1	0.3
Signs should be in several different languages	1	0.1	1	0.2	0	0.0
Too many foreign/non-U.S. tourists	4	0.4	2	0.4	2	0.5
Well maintained/clean trails	1	0.1	1	0.2	0	0.0



Q17 - 1st response	All		Queens Garden		Queens Garden Extended	
Saw trash/should be more trash collection points	2	0.2	2	0.4	0	0.0
Have more campsites/more camping	2	0.2	1	0.2	1	0.3
Liked the natural beauty/It's a place to observe nature	5	0.6	2	0.4	3	0.8
Its different/unique/haven't seen anything like this	2	0.2	1	0.2	1	0.3
Add more guide rails	4	0.4	2	0.4	2	0.5
Need better maps/trail guides/ have them available at start of trail	20	2.2	7	1.4	13	3.3
Need better signs/information plaques	9	1.0	4	0.8	5	1.3
Aircraft should be allowed only at certain times	4	0.4	2	0.4	2	0.5
Aircraft should be prohibited/ not allowed	9	1.0	7	1.4	2	0.5
Seeing or hearing aircraft would've annoyed me	4	0.4	3	0.6	1	0.3
The amount of aircraft should be limited	8	0.9	6	1.2	2	0.5
Helicopters should be prohibited/not allowed	3	0.3	2	0.4	1	0.3

Q17 - 1st response	All		Queens Garden		Queens Garden Extended	
	Count	Percent	Count	Percent	Count	Percent
Other aircraft/helicopter mentions (specified)	20	2.2	15	2.9	5	1.3
Enforce people to stay on trails	3	0.3	2	0.4	1	0.3
Liked the trails/walk/hiking	6	0.7	6	1.2	0	0.0
Total	905	100.0	514	100.0	391	100.0

**Q17 (2nd response). Is there anything else you would like to tell us about your visit to Bryce Canyon National Park?**

Q17 - 2nd response	All		Queens Garden		Queens Garden Extended	
	Count	Percent	Count	Percent	Count	Percent
Its very beautiful/lovely/nice	12	8.9	5	6.1	7	13.2
Great/Lovely views/scenery	15	11.1	8	9.8	7	13.2
It's a well organized park	4	3.0	2	2.4	2	3.8
Well designed/planned trails	1	0.7		0.0	1	1.9
Looking forward to returning/coming back	3	2.2	3	3.7	0	0.0
Too many crowds/people/tourists	9	6.7	5	6.1	4	7.5
Need transportation/shuttle bus	2	1.5	2	2.4	0	0.0
Other	33	24.4	19	23.2	14	26.4
Annoyed by the air traffic/aircraft in the park/Do not like aircraft in the park	4	3.0	4	4.9	0	0.0

Q17 - 2nd response	All		Queens Garden		Queens Garden Extended	
Put showers in at campground	2	1.5	2	2.4	0	0.0
It's a well maintained/clean park	4	3.0	1	1.2	3	5.7
Its exciting	2	1.5	1	1.2	1	1.9
Horse smell should be better controlled	2	1.5	2	2.4	0	0.0
Too many foreign/non-U.S. tourists	1	0.7	1	1.2	0	0.0
Well maintained/clean trails	1	0.7		0.0	1	1.9
Saw trash/should be more trash collection points	1	0.7	0	0.0	1	1.9
Have more campsites/more camping	1	0.7	1	1.2	0	0.0
Liked the natural beauty/It's a place to observe nature	7	5.2	4	4.9	3	5.7
Its different/unique/haven't seen anything like this	9	6.7	5	6.1	4	7.5
Add more guide rails	2	1.5	2	2.4	0	0.0
Need better maps/trail guides/ have them available at start of trail	3	2.2	2	2.4	1	1.9
Need better signs/information plaques	1	0.7	1	1.2	0	0.0
Aircraft should be prohibited/ not allowed	2	1.5	1	1.2	1	1.9

Q17 - 2nd response	All		Queens Garden		Queens Garden Extended	
Didn't see or hear any aircraft	1	0.7	1	1.2	0	0.0
The amount of aircraft should be limited	1	0.7	1	1.2	0	0.0
Helicopters should be prohibited/not allowed	1	0.7	1	1.2	0	0.0
Other aircraft/helicopter mentions (specified)	6	4.4	5	6.1	1	1.9
Enforce people to stay on trails	1	0.7	1	1.2	0	0.0
Liked the trails/walk/hiking	4	3.0	2	2.4	2	3.8
Total	135	100.0	82	100.0	53	100.0

**Q17 (3<sup>rd</sup> response). Is there anything else you would like to tell us about your visit to Bryce Canyon National Park?**

Q17 - 3rd response	All		Queens Garden		Queens Garden Extended	
	Count	Percent	Count	Percent	Count	Percent
It's a well organized park	1	3.1	1	5.6	0	0.0
Looking forward to returning/ coming back	1	3.1	0	0.0	1	7.1
Too many crowds/people/ tourists	2	6.3	0	0.0	2	14.3
Other	7	21.9	4	22.2	3	21.4
Put showers in at campground	1	3.1	0	0.0	1	7.1
Well maintained/clean trails	4	12.5	3	16.7	1	7.1
Saw trash/should be more trash collection points	1	3.1	1	5.6	0	0.0
Liked the natural beauty/It's a place to observe nature	1	3.1	0	0.0	1	7.1
Its different/unique/haven't seen anything like this	4	12.5	4	22.2	0	0.0
Need better signs/information plaques	3	9.4	2	11.1	1	7.1
Aircraft should be prohibited/ not allowed	1	3.1	1	5.6	0	0.0
The amount of aircraft should be limited	1	3.1	1	5.6	0	0.0

Q17 - 3rd response	All		Queens Garden		Queens Garden Extended	
	Count	Percent	Count	Percent	Count	Percent
Helicopters should be prohibited/not allowed	1	3.1	1	5.6	0	0.0
Other aircraft/helicopter mentions (specified)	2	6.3	0	0.0	2	14.3
Liked the trails/walk/hiking	2	6.3	0	0.0	2	14.3
Total	32	100.0	18	100.0	14	100.0

**Q17 (4<sup>th</sup> response).** Is there anything else you would like to tell us about your visit to Bryce Canyon National Park?

Q17B - 4th response	All		Queens Garden		Queens Garden Extended	
	Count	Percent	Count	Percent	Count	Percent
Signs should be in several different languages	1	100.0	1	100.0	0	0.0

**Q17 (5<sup>th</sup> response).** Is there anything else you would like to tell us about your visit to Bryce Canyon National Park?

Q17 - 5th response	All		Queens Garden		Queens Garden Extended	
	Count	Percent	Count	Percent	Count	Percent
Need better maps/trail guides/ have them available at start of trail	1	100.0	1	100.0	0	0.0

**Primary Language**

Primary Language	All		Queens Garden		Queens Garden Extended	
	Count	Percent	Count	Percent	Count	Percent
English	551	60.9	359	69.8	192	49.1
German	198	21.9	87	16.9	111	28.4
French	47	5.2	17	3.3	30	7.7
Dutch	48	5.3	23	4.5	25	6.4
Hebrew	27	3.0	7	1.4	20	5.1
Italian	13	1.4	8	1.6	5	1.3
Spanish	2	0.2	0	0.0	2	0.5
Japanese	5	0.6	2	0.4	3	0.8
Swedish	2	0.2	2	0.4	0	0.0
Danish	2	0.2	2	0.4	0	0.0
Thai	5	0.6	5	1.0	0	0.0
Hindu	2	0.2	2	0.4	0	0.0
Burmese	2	0.2	0	0.0	2	0.5
Polish	1	0.1	0	0.0	1	0.3
<b>Total</b>	<b>905</b>	<b>100.0</b>	<b>514</b>	<b>100.0</b>	<b>391</b>	<b>100.0</b>

**Number of Adults in Group**

Number of Adults	All		Queens Garden		Queens Garden Extended	
	Count	Percent	Count	Percent	Count	Percent
1	64	7.1	39	7.6	25	6.4
2	549	60.7	296	57.6	253	64.7
3	116	12.8	70	13.6	46	11.8
4	104	11.5	79	15.4	25	6.4
5	25	2.8	5	1.0	20	5.1
6	18	2.0	18	3.5	0	0.0
9	7	0.8	0	0.0	7	1.8
10	7	0.8	7	1.4	0	0.0
12	1	0.1	0	0.0	1	0.3
14	14	1.5	0	0.0	14	3.6
Total	905	100.0	514	100.0	391	100.0

**Number of Children (under 16 years of age) in Group**

Number of Children	All		Queens Garden		Queens Garden Extended	
	Count	Percent	Count	Percent	Count	Percent
0	669	73.9	358	69.7	311	79.5
1	106	11.7	65	12.6	41	10.5
2	92	10.2	66	12.8	26	6.7
3	26	2.9	14	2.7	12	3.1
4	1	0.1	0	0.0	1	0.3



Number of Children	All		Queens Garden		Queens Garden Extended	
	Count	Percent	Count	Percent	Count	Percent
5	3	0.3	3	0.6	0	0.0
6	4	0.4	4	0.8	0	0.0
7	4	0.4	4	0.8	0	0.0
Total	905	100.0	514	100.0	391	100.0

Total number of people in group

Total Number in Group	All		Queens Garden		Queens Garden Extended	
	Count	Percent	Count	Percent	Count	Percent
1	50	5.5	32	6.2	18	4.6
2	416	46.0	196	38.1	220	56.3
3	128	14.1	87	16.9	41	10.5
4	175	19.3	129	25.1	46	11.8
5	56	6.2	25	4.9	31	7.9
6	36	4.0	27	5.3	9	2.3
7	4	0.4	0	0.0	4	1.0
8	3	0.3	3	0.6	0	0.0
9	7	0.8	0	0.0	7	1.8
10	11	1.2	11	2.1	0	0.0
11	4	0.4	4	0.8	0	0.0
12	1	0.1	0	0.0	1	0.3
14	14	1.5	0	0.0	14	3.6
Total	905	100.0	514	100.0	391	100.0

**Gender**

Gender	All		Queens Garden		Queens Garden Extended	
	Count	Percent	Count	Percent	Count	Percent
Male	441	48.7	259	50.4	182	46.5
Female	456	50.4	250	48.6	206	52.7
No Answer	8	0.9	5	1.0	3	0.8
Total	905	100.0	514	100.0	391	100.0

**What year were you born?**

Year Born	Age	All		Queens Garden		Queens Garden Extended	
		Count	Percent	Count	Percent	Count	Percent
1909	88	1	0.1	1	0.2	0	0.0
1922	75	1	0.1	1	0.2	0	0.0
1923	74	3	0.3	3	0.6	0	0.0
1925	72	1	0.1	0	0.0	1	0.3
1929	68	3	0.3	1	0.2	2	0.5
1930	67	4	0.4	2	0.4	2	0.5
1931	66	4	0.4	4	0.8	0	0.0
1932	65	2	0.2	1	0.2	1	0.3
1933	64	5	0.6	1	0.2	4	1.0
1934	63	4	0.4	2	0.4	2	0.5
1935	62	6	0.7	3	0.6	3	0.8
1936	61	7	0.8	6	1.2	1	0.3

Year Born	Age	All		Queens Garden		Queens Garden Extended	
1937	60	5	0.6	3	0.6	2	0.5
1938	59	5	0.6	3	0.6	2	0.5
1939	58	6	0.7	4	0.8	2	0.5
1940	57	5	0.6	3	0.6	2	0.5
1941	56	18	2.0	8	1.6	10	2.6
1942	55	17	1.9	6	1.2	11	2.8
1943	54	10	1.1	6	1.2	4	1.0
1944	53	12	1.3	6	1.2	6	1.5
1945	52	14	1.5	5	1.0	9	2.3
1946	51	18	2.0	12	2.3	6	1.5
1947	50	16	1.8	13	2.5	3	0.8
1948	49	13	1.4	11	2.1	2	0.5
1949	48	18	2.0	9	1.8	9	2.3
1950	47	16	1.8	10	1.9	6	1.5
1951	46	29	3.2	25	4.9	4	1.0
1952	45	20	2.2	11	2.1	9	2.3
1953	44	30	3.3	22	4.3	8	2.0
1954	43	23	2.5	15	2.9	8	2.0
1955	42	30	3.3	19	3.7	11	2.8
1956	41	27	3.0	17	3.3	10	2.6
1957	40	19	2.1	12	2.3	7	1.8
1958	39	15	1.7	6	1.2	9	2.3
1959	38	24	2.7	15	2.9	9	2.3

Year Born	Age	All		Queens Garden		Queens Garden Extended	
1960	37	20	2.2	11	2.1	9	2.3
1961	36	15	1.7	10	1.9	5	1.3
1962	35	25	2.8	14	2.7	11	2.8
1963	34	17	1.9	7	1.4	10	2.6
1964	33	21	2.3	12	2.3	9	2.3
1965	32	25	2.8	10	1.9	15	3.8
1966	31	30	3.3	16	3.1	14	3.6
1967	30	34	3.8	14	2.7	20	5.1
1968	29	27	3.0	15	2.9	12	3.1
1969	28	32	3.5	20	3.9	12	3.1
1970	27	22	2.4	12	2.3	10	2.6
1971	26	25	2.8	13	2.5	12	3.1
1972	25	22	2.4	9	1.8	13	3.3
1973	24	23	2.5	8	1.6	15	3.8
1974	23	23	2.5	14	2.7	9	2.3
1975	22	25	2.8	10	1.9	15	3.8
1976	21	27	3.0	15	2.9	12	3.1
1977	20	14	1.5	9	1.8	5	1.3
1978	19	9	1.0	3	0.6	6	1.5
1979	18	7	0.8	5	1.0	2	0.5
1980	17	13	1.4	7	1.4	6	1.5
1981	16	12	1.3	10	1.9	2	0.5
No Answer	(NA)	6	0.7	4	0.8	2	0.5

Year Born	Age	All		Queens Garden		Queens Garden Extended	
		Count	Percent	Count	Percent	Count	Percent
Total		905	100.0	514	100.0	391	100.0

State of residence

State of Residence	All		Queens Garden		Queens Garden Extended	
	Count	Percent	Count	Percent	Count	Percent
Alaska	1	0.1	1	0.2	0	0.0
Arizona	18	2.0	15	2.9	3	0.8
California	138	15.2	88	17.1	50	12.8
Colorado	1	0.1	0	0.0	1	0.3
Connecticut	9	1.0	7	1.4	2	0.5
District of Columbia	4	0.4	3	0.6	1	0.3
Florida	8	0.9	6	1.2	2	0.5
Georgia	2	0.2	1	0.2	1	0.3
Illinois	8	0.9	6	1.2	2	0.5
Indiana	3	0.3	0	0.0	3	0.8
Kansas	3	0.3	0	0.0	3	0.8
Kentucky	3	0.3	1	0.2	2	0.5
Louisiana	3	0.3	3	0.6	0	0.0
Maine	2	0.2	0	0.0	2	0.5
Maryland	13	1.4	8	1.6	5	1.3
Massachusetts	32	3.5	26	5.1	6	1.5
Michigan	6	0.7	4	0.8	2	0.5

State of Residence	All		Queens Garden		Queens Garden Extended	
Minnesota	13	1.4	6	1.2	7	1.8
Montana	2	0.2	2	0.4	0	0.0
Nevada	8	0.9	8	1.6	0	0.0
New Hampshire	1	0.1	0	0.0	1	0.3
New Jersey	26	2.9	18	3.5	8	2.0
New Mexico	1	0.1	1	0.2	0	0.0
New York	54	6.0	32	6.2	22	5.6
North Carolina	6	0.7	0	0.0	6	1.5
Ohio	12	1.3	5	1.0	7	1.8
Oregon	8	0.9	8	1.6	0	0.0
Pennsylvania	18	2.0	11	2.1	7	1.8
Rhode Island	3	0.3	1	0.2	2	0.5
South Carolina	4	0.4	4	0.8	0	0.0
South Dakota	1	0.1	0	0.0	1	0.3
Texas	18	2.0	12	2.3	6	1.5
Utah	32	3.5	19	3.7	13	3.3
Vermont	5	0.6	5	1.0	0	0.0
Virginia	15	1.7	8	1.6	7	1.8
Washington	20	2.2	5	1.0	15	3.8
Wisconsin	2	0.2	0	0.0	2	0.5
Wyoming	1	0.1	0	0.0	1	0.3
France	40	4.4	18	3.5	22	5.6
Germany	145	16.0	74	14.4	71	18.2

State of Residence	All		Queens Garden		Queens Garden Extended	
Israel	24	2.7	7	1.4	17	4.3
Belgium	12	1.3	10	1.9	2	0.5
UK	36	4.0	19	3.7	17	4.3
Canada	13	1.4	11	2.1	2	0.5
Austria	13	1.4	9	1.8	4	1.0
Italy	13	1.4	8	1.6	5	1.3
Holland/Netherlands	41	4.5	20	3.9	21	5.4
Denmark	2	0.2	2	0.4	0	0.0
Sweden	3	0.3	3	0.6	0	0.0
Australia	12	1.3	2	0.4	10	2.6
Finland	1	0.1	1	0.2	0	0.0
Thailand	3	0.3	3	0.6	0	0.0
Switzerland	25	2.8	8	1.6	17	4.3
Ireland	1	0.1	1	0.2	0	0.0
New Zealand	4	0.4	2	0.4	2	0.5
Spain	2	0.2	0	0.0	2	0.5
Great Britain	1	0.1	0	0.0	1	0.3
Russia	1	0.1	0	0.0	1	0.3
Luxembourg	5	0.6	0	0.0	5	1.3
Poland	1	0.1	0	0.0	1	0.3
No Answer	3	0.3	2	0.4	1	0.3
Total	905	100.0	514	100.0	391	100.0

US Citizen

US Citizen	All		Queens Garden		Queens Garden Extended	
	Count	Percent	Count	Percent	Count	Percent
No	444	49.1	220	42.8	224	57.3
Yes	460	50.8	293	57.0	167	42.7
No Answer	1	0.1	1	0.2	0	0.0
Total	905	100.0	514	100.0	391	100.0





**Appendix F:**  
**Summary of Acoustic Doses**

---

Appendix F presents a summary of the acoustic data collected during the study, including distributions for the 14 acoustic descriptors computed (Figures 54 through 67) and related statistics for all doses (Table 20).

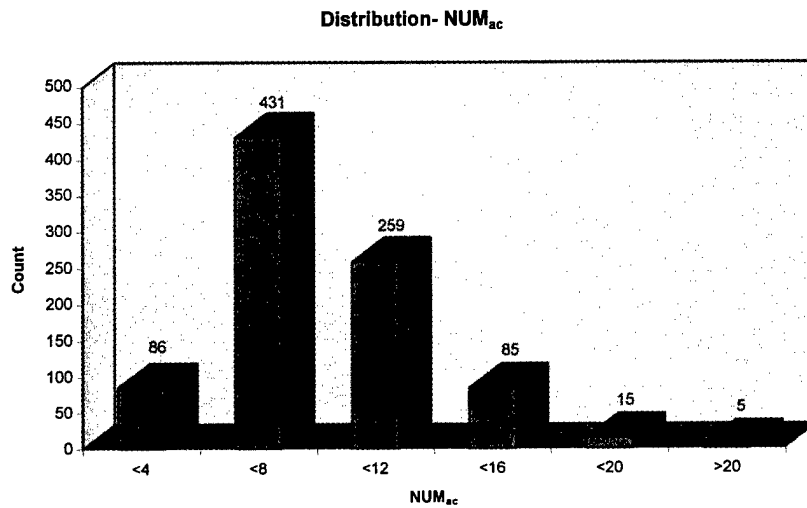

Figure 54.

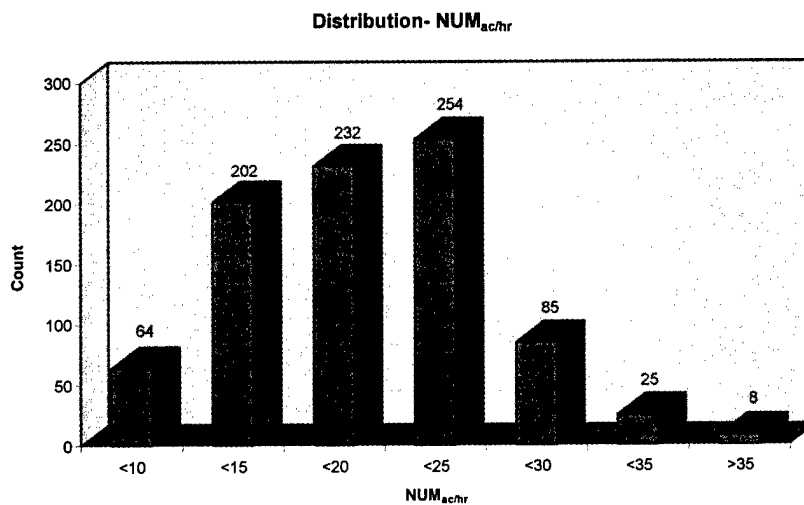

Figure 55.

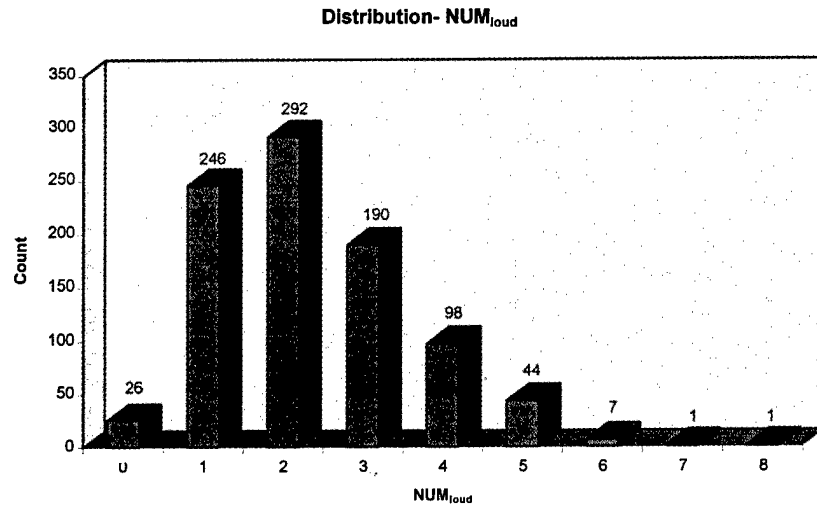

Figure 56.

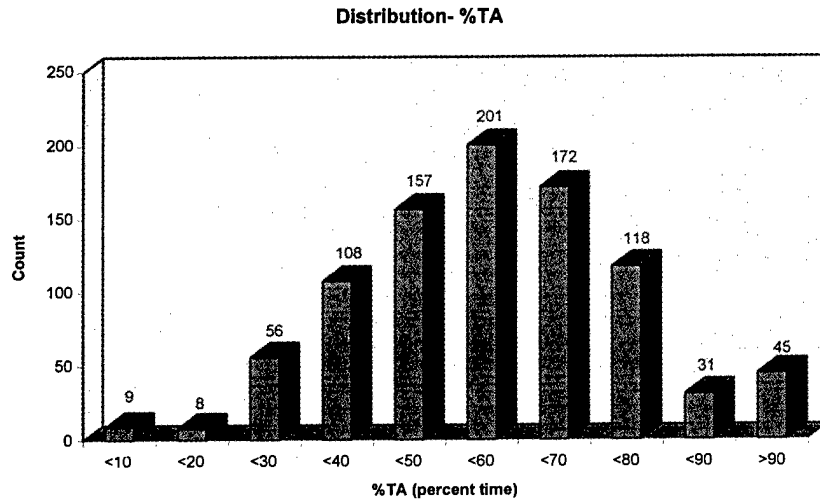

Figure 57.

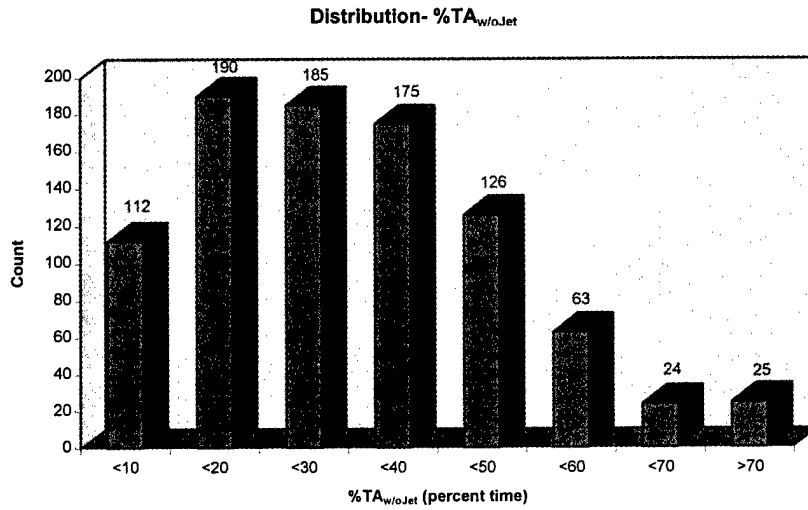

Figure 58.

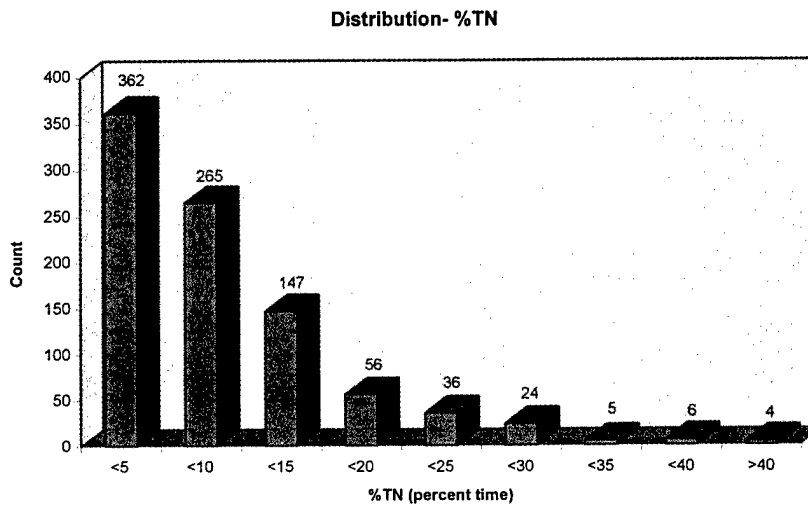

Figure 59.

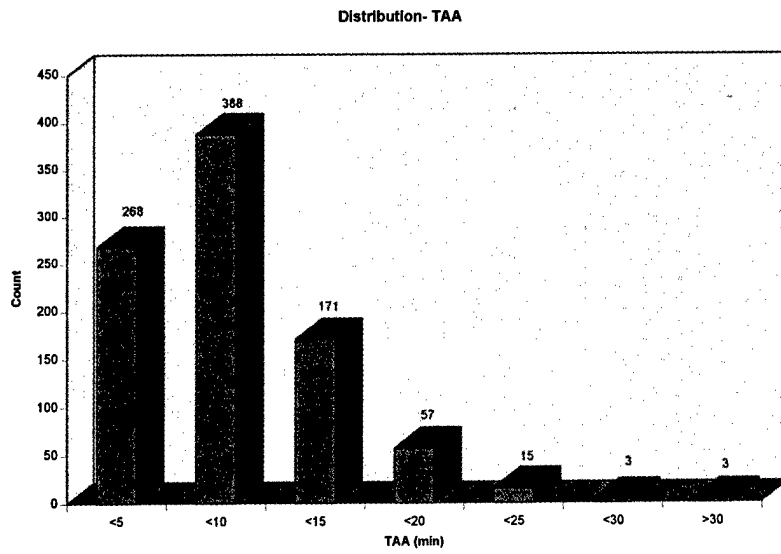

Figure 60.

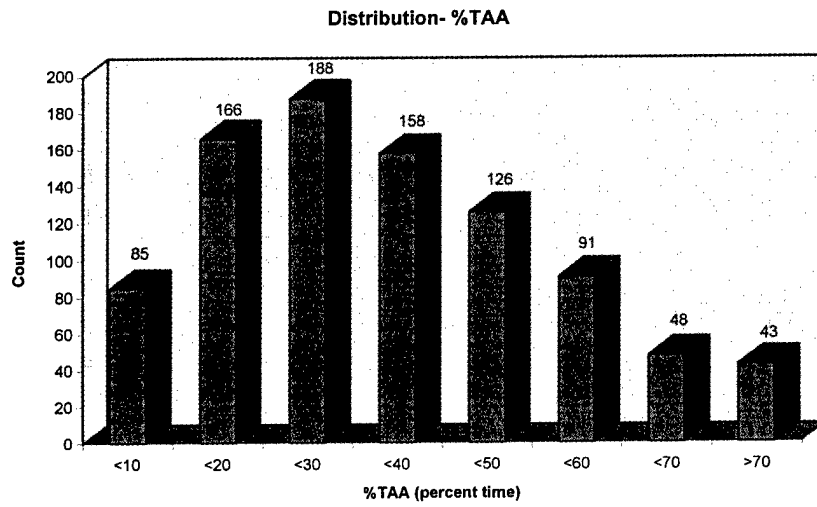

Figure 61.

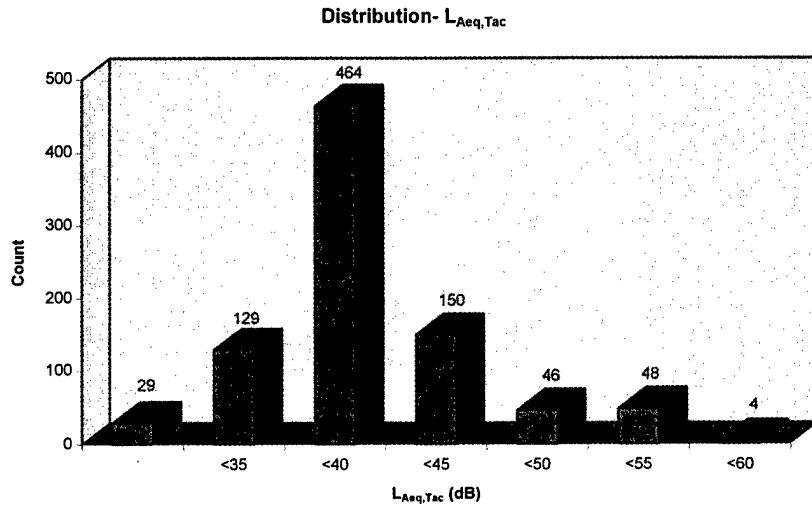

Figure 62.

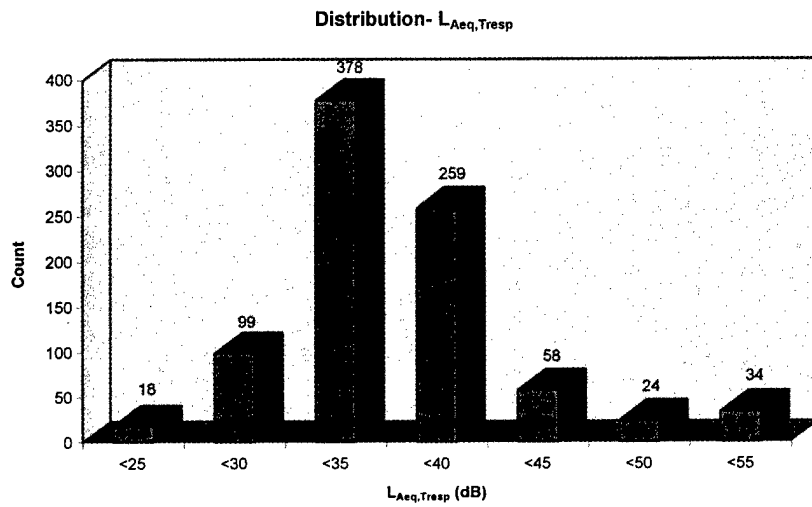

Figure 63.



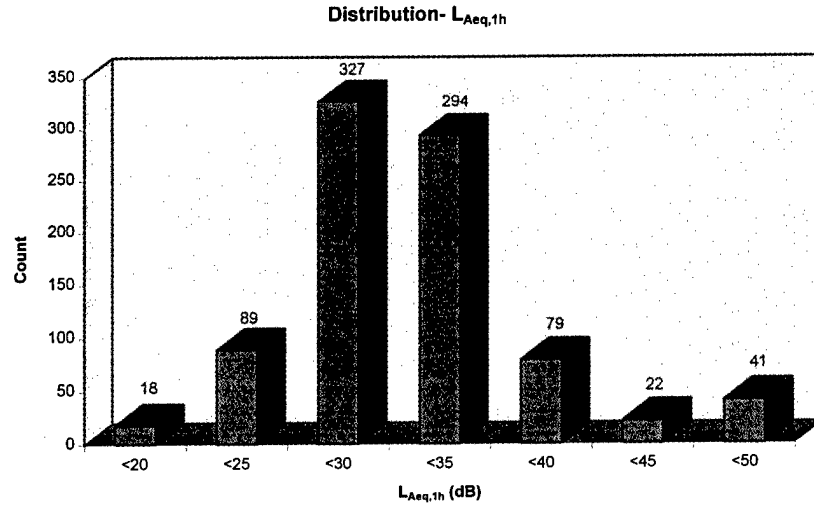

Figure 64.

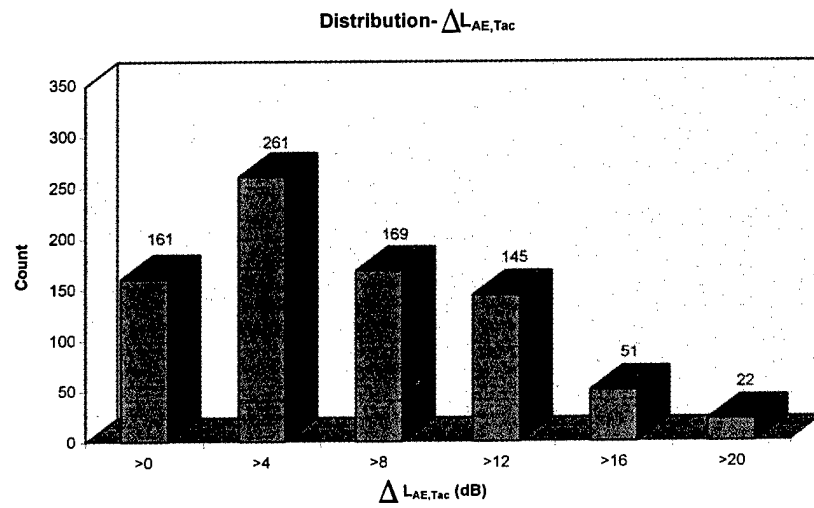

Figure 65.

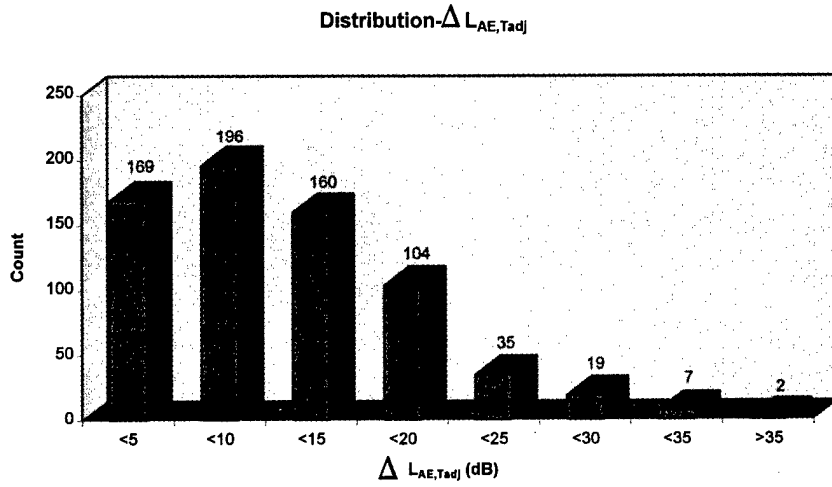

Figure 66.

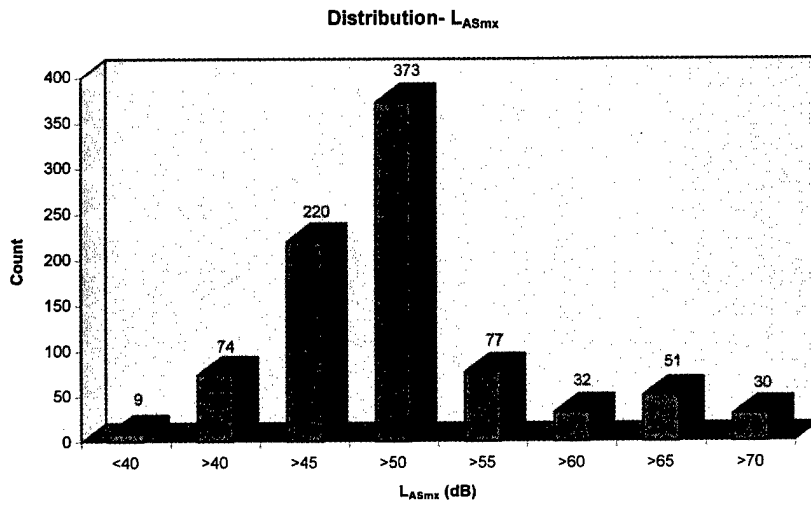

Figure 67.

Table 20. Dose Statistics

Descriptor	QGT			QGTx		
	Average	Minimum	Maximum	Average	Minimum	Maximum
NUM <sub>ac</sub>	5.8	0	24	9.0	0	22
NUM <sub>ac/hr</sub>	18.5	0	39.7	17.3	0	31.0
NUM <sub>loud</sub>	2.1	0	8	2.6	0	6
%TA (% time)	59.3	1.4	100	50.4	2.9	83.2
%TA <sub>w/oJet</sub> (% time)	33.7	0	100	24.6	0	59.3
%TN (% time)	9.8	0	52.3	6.2	0	26.5
TAA (min)	7.6	0	30.5	8.1	0	32.7
%TAA (% time)	40.3	0	100	26.0	0	62.1
L <sub>Aeq,Tac</sub> (dB)	38.6	28.1	57.2	36.6	21.2	49.7
L <sub>Aeq,Tresp</sub> (dB)	36.0	15.2	54.6	33.7	19.2	46.7
L <sub>Aeq,1h</sub> (dB)	30.9	6.4	48.6	30.7	14.5	42.7
ΔL <sub>AE,Tac</sub> (dB)	9.8	0.2	26.4	6.9	0.1	18.7
ΔL <sub>AE,Tadj</sub> (dB)	12.6	0.4	36.8	7.5	0.1	20.8
L <sub>ASmx</sub> (dB)	52.8	38.3	75.2	52.2	14.0	66.9
Time On Trail (min)	19	8	56	31	13	72

Index

-A-

%TA ..... xiii-xv, xx, 58, 59, 74, 77-80, 84, 97-101, 106-108, 222

%TAA ..... 58, 61, 66, 74, 77-80, 88, 97-99, 101, 106-108, 222

Acoustic data cleaning ..... x, 53

Acoustic data processing program ..... 51

Acoustic data reduction ..... x, 51

Acoustic descriptor ..... 72, 74, 76, 78-79, 96-99, 101, 102, 105-108, 110

Acoustic doses ..... vii, xii, 68, 79, 109, 213

Acoustic energy ..... xxiii, xxiv, xxvii, 57, 59, 61, 65, 66

Acoustic instrumentation ..... xxvi, 23, 29

Acoustic measurement site ..... 30, 37

Acoustic measurements ..... 11, 116

Acoustic measures ..... 96

Acoustic model ..... ix, 76, 79, 108

Acoustic observer location ..... xiii, 38, 40

Acoustic observer log ..... ix, x, xii, 26-29, 46, 53, 57

Acoustic state ..... 37, 42, 61, 67

Acoustic team ..... x, 33, 37, 45, 50

Acoustic team procedures ..... x, 33

Acoustical terminology ..... 111

Acoustics Facility ..... xix, 1, 111, 116

Air tour traffic ..... xx

Air tours ..... 7, 13

Aircraft ..... xiii, xv, xvii, xix, xx, xxiii, xxiv, xxvi, 2, 4, 5, 8, 11, 13-15, 17, 25, 29, 31, 33-36, 42-44, 46, 54, 56-59, 61-69, 72, 73, 75, 79, 80, 100, 112, 113, 160, 181, 183, 186, 201

Aircraft activity ..... 8, 11, 13

---

Aircraft counts .....	14
Aircraft noise .....	xix, xxiii, xxiv, 2, 4, 5, 25, 62, 75, 79, 80, 160
Aircraft noise certification tests .....	62
Aircraft operation .....	xxiv
Aircraft overflights .....	xix, xx, 113
Aircraft percent time audible .....	xx
Aircraft sound level .....	8, 59, 61, 80
Aircraft state .....	43
Aircraft volume .....	33
Airplanes .....	186, 189
Akaike Information Criteria (AIC) .....	78, 96, 100-102, 106-108
Ambient Noise .....	xxiii, xxvi, 57, 61, 111, 160
Ambient Sound Level .....	xii, xxi, 42, 56, 58, 61, 160-162, 165
Ambient-corrected sound exposure level .....	65, 66
American National Standard .....	111, 113
Analysis of responses .....	xvii, 73
ANSI Standard S1.4 -1983 (1990) .....	113
ANSI Standard S12.18-1994 .....	111
ASCII text files .....	46, 53
Audible .....	xx, xxv, 5, 14, 15, 17, 26, 42, 43, 58, 59, 62, 80
Automobiles .....	44
A-weight .....	126

**-B-**

B&K Model 2660 .....	23, 125, 127, 128, 130, 140, 141
B&K Model 2804 .....	126-128, 134
B&K Model 4155 .....	126, 136
B&K Model 4179 .....	126, 128, 131, 136, 141

---

---

B&K Model 4231 ..... 29, 124, 135, 136  
 B&K Model JJ2217 ..... 140, 141  
 B&K Model UA 0207 ..... 141  
 B&K Very Low Level Microphone System ..... xv, 124  
 Battery ..... 26, 46, 113, 124, 128, 134-136  
 Bootstrapped confidence intervals ..... xi, 95  
 Bryce Canyon Airport ..... 11, 12  
 Bryce Canyon National Park (BCNP) vii, xiii, xix, 1, 7, 9, 51, 54, 56, 58, 71, 72, 109-111, 116, 194, 197, 200, 201  
 Bryce Point ..... 13  
 Bushnell Laser Range Finder ..... 29

-C-

Calibration procedure ..... 125, 137, 138, 142  
 Chilton Research Services ..... xix, 51, 119  
 Chi-square significance level ..... 76, 77, 96  
 Covariate ..... xi, xvii, 103, 104, 107-109

-D-

dB ..... xxiv, xxv, xxvii, 23, 25, 29, 34-37, 53, 57, 59, 63, 65-67, 101, 102  
 125-127, 129-131, 134, 136, 137, 161, 162, 165, 224  
 Digital watch ..... 29  
 Dose-response ..... vii, ix, xix-xxii, xxv, 1-8, 11, 12, 14, 23, 24, 30, 33, 35, 37, 52, 56, 62, 71, 72, 78, 95  
 103, 104, 108, 109, 113, 116

---

**-E-**

Equal-energy principle ..... 4  
Energy average ..... 59, 61, 161, 162, 165  
Equivalent Sound Level ..... xx, xxv, xxvii, 65, 66  
Event-based descriptors ..... x, xx, 54, 56  
Exploratory analysis ..... xi, 71, 73

**-F-**

Federal Aviation Administration (FAA) ..... xix, xxi, xxii, xxv, 1, 3, 4, 6, 7, 111, 116  
Frequency-based data ..... 26  
Frequency-response ..... 42  
Frontcountry ..... xxiv, xxv, 1, 16, 109

**-G-**

Grand Canyon National Park ..... 7  
Grazing incidence ..... 126  
Great Smokey Mountain National Park (GSMNP) ..... 7

**-H-**

Hawaii Volcanoes National Parks ..... 113  
Helicopter ..... xiii, 11, 12, 14, 15, 20, 35, 36, 43, 69, 182, 183, 195, 197, 199, 201

**-I-**

---

Inspiration Point .....	13
Integrated Noise Model (INM) .....	xxv

**-L-**

$L_{AE}$ .....	xxiv, xxv, xxvii, 33-35, 37, 57, 63
$L_{Aeq}$ .....	xiv-xvi, xix, xxv, 5, 24, 25, 51, 54, 61, 63, 65-67, 69, 74, 77-79, 89-91, 97-99, 101 106-108, 110, 161, 162, 165, 224
$L_{ASmx}$ .....	xiv, xvi, xxvi, 24, 25, 51, 54, 65, 67, 74, 77-79, 94, 97-99, 101, 106-108, 222
LDL Model 2900 .....	124, 126, 128-131, 134, 135
LDL Model 820 .....	xii, 124-126, 128-131, 134-137
Level-based descriptors .....	x, 54, 57, 61, 65
Logistic regression .....	xi, xvii, 71, 72, 76, 78, 79, 96, 105-107, 109
Low-level .....	vii, xxi, xxv, 1, 4, 23, 56, 111, 128, 136, 139, 160

**-M-**

Master clock .....	29, 38, 46, 53, 128
Master database .....	vii, xi, 51, 68
Measurement system setup .....	x, 37
Measurement instruments .....	111
Meteorological data .....	x, 29, 46, 53
Meteorological instrumentation .....	ix, 29, 38, 46
Meteorological measurements .....	xix, 42
Microphone .....	ix, x, xiii, xv, xvii, 16, 21, 23, 24, 29, 33, 35, 36, 38, 39, 42, 124-132, 136, 139-141
Microphone cable .....	127
Microphone location .....	x, xvii, 16, 33, 35, 36, 38

---



---

-N-

National Park Service (NPS) . . . . . v, xi, xii, xix-xxii, xxvi, 4, 5, 7, 8, 12, 14, 24, 25, 30, 47-49, 56  
59, 62, 71, 72, 109, 113, 118, 124, 127, 132, 139, 160-162, 165

National Rule . . . . . xix, xx, xxii, 1, 7, 80, 108, 109

NODSS . . . . . xxvi

Nominal helicopter flight tracks . . . . . xii, 20

Noticeability . . . . . xi, xxvi, 59, 101, 102

NPS ambient . . . . . xv, 160

NPS LONOMS system . . . . . 139

NPS two-stage windscreen . . . . . xii, xv, 124, 127, 132, 139

-O-

Observer location . . . . . xiii, 38, 40

Offset calibration technique . . . . . 25, 53

OMB-approved questionnaire . . . . . 13

Outlier analysis . . . . . xi, 74, 75

-P-

Personnel requirements . . . . . x, 37

Pink noise generator . . . . . 42, 124, 130

Power supply . . . . . 23, 24, 38, 113, 124, 127, 128, 134

Preamplifier . . . . . ix, xiii, 23, 24, 29, 38, 39, 42, 124, 128, 130, 131, 136, 140, 141

Public Law 100-91 . . . . . 4

---

**-Q-**

QGT ..... xi, xii, xiv, xvii, 16, 21, 17, 33-35, 49, 57, 71, 73, 76-78, 81-102, 104-110  
Queens Garden ..... 170-173, 175, 177, 179, 180, 182, 183-194, 197, 200-205, 208, 211  
Qualimetrics Transportable Automated Meteorological Station (TAMS) ..... xiii, 29, 38, 41, 136

**-R-**

Radio ..... xxv, 47, 48, 135  
Respondent ..... x, 31, 49, 57, 71, 73, 76-78, 81-102, 104-110

**-S-**

Scoping visit ..... ix, xix, 8, 12, 14  
Short-hike trail ..... 1  
Sound Exposure Level ..... ix, xii, 33, 35, 36, 63, 65, 67  
Sound Level Meters (SLM) ..... ix, xii, 23-25, 29, 37, 38, 42, 46, 114, 124-126, 128, 131, 134, 136  
Statistical model ..... 100, 109  
Study design ..... xix, xx, 13, 111, 116-119  
Sunrise Point ..... 13, 14, 16  
Sunset Point ..... 13, 14, 16  
Survey data cleaning ..... xi, 68  
Survey-related data ..... vii, 68  
Survey-related instrumentation ..... vii, ix, 23, 29

**-T-**

TA ..... xiii-xv, xx, 58, 59, 74, 77-80, 84, 97-101, 106-108  
TAA ..... xiv, xv, 58, 61, 66, 74, 77-80, 87, 88, 97-99, 101, 106-108

---

---

Tape recorder .....	124
Time-based descriptors .....	x, 54, 58
Two-stage windscreen .....	xiii, xv, 24, 42, 124, 127, 132, 139

-U-

US Army Construction Engineering Research Laboratory (US CERL) .....	xix, 118
USAF .....	5, 25, 30, 31, 47-49, 56, 62, 72, 103
Utah Department of Transportation (UTDOT) .....	11, 12

-V-

Visitor activity .....	8, 13, 14
Visitor greeting .....	x, 47-49
Volpe Center .....	vii, xix, 1, 51, 54, 116

-W-

Weather constraints .....	35
White Sands National Monument .....	5
Windscreen .....	ix, xii, xiii, xv, 23, 24, 38, 39, 42, 124, 127, 128, 132, 139-142
Wind-generated noise .....	24, 139

-Y-

Yardage Pro Model 800 .....	29
-----------------------------	----