

**GEOTECHNICAL ENGINEERING**

**CIRCULAR (GEC) No. 8**

---

**DESIGN AND CONSTRUCTION**

**OF CONTINUOUS**

**FLIGHT AUGER PILES**

**FINAL**

**April 2007**

1. Report No. FHWA-HIF-07-03	2 . Government Accession No.	3. Recipients Catalog No.	
4. Title and Subtitle <b>GEOTECHNICAL ENGINEERING CIRCULAR NO. 8</b> <b>Design and Construction of Continuous Flight Auger (CFA) Piles</b>		5. Report Date	
		6. Performing Organization Code	
7. Author(s) Dan A. Brown, Ph.D., P.E., Steven D. Dapp, Ph.D., P.E., W. Robert Thompson, III, P.E., and Carlos A. Lazarte, Ph.D., P.E.		8. Performing Organization Report No.	
9. Performing Organization Name and Address GeoSyntec Consultants 10015 Old Columbia Road, Suite A-200 Columbia, Maryland 21046-1760		10. Work Unit No. (TRAIS)	
		11. Contract or Grant No.	
12. Sponsoring Agency Name and Address Office of Technology Application Office of Engineering/Bridge Division Federal Highway Administration U.S. Department of Transportation 400 Seventh Street, S.W. Washington D.C., 20590		13. Type of Report and Period Covered <b>Technical Report</b>	
		14. Sponsoring Agency Code	
15. Supplementary Notes FHWA Technical Consultant: J.A. DiMaggio, P.E., S.C. Nichols, P.E.			
16. Abstract <p>This manual presents the state-of-the-practice for design and construction of continuous flight auger (CFA) piles, including those piles commonly referred to as augered cast-in-place (ACIP) piles, drilled displacement piles, and screw piles. CFA pile types, materials, and construction equipment and procedures are discussed. A performance-based approach is presented to allow contractors greater freedom to compete in providing the most cost-effective and reliable foundation system, and a rigorous construction monitoring and testing program to verify the performance. Quality control (QC)/quality assurance (QA) procedures are discussed, and general requirements for a performance specification are given.</p> <p>Methods to estimate the static axial capacity of single piles are recommended based on a thorough evaluation and comparison of various methods used in the United States and Europe. Group effects for axial capacity and settlement, and lateral load capacities for single piles and pile groups are discussed. A generalized step-by-step method for selecting and designing CFA piles is presented, along with example calculations. An Allowable Stress Design (ASD) procedure is used.</p>			
17. Key Word Continuous flight auger piles, CFA, augered cast-in-place piles, ACIP, drilled displacement piles, screw piles, deep foundation, testing, automated monitoring, performance specification.		18. Distribution Statement No Restrictions.	
19. Security Classification (of this report) Unclassified	20. Security Classification (of this page) Unclassified	21. No. of Pages	22. Price

## ENGLISH TO METRIC (SI) CONVERSION FACTORS

The primary metric (SI) units used in civil and structural engineering are:

- meter (m)
- kilogram (kg)
- second (s)
- Newton (N)
- Pascal (Pa)

The following are the conversion factors for units presented in this manual:

Quantity	From English Units	To Metric (SI) Units	Multiply by	For Aid to Quick Calculations
Mass	lb	Kg	0.453592	1 lb(mass) = 0.5 kg
Force	lb	N	4.44822	1 lb(force) = 4.5 N
	kip	kN	4.44822	1 kip(force) = 4.5 kN
Force/Unit Length	plf	N/m	14.5939	1 plf = 14.5 N/m
	klf	kN/m	14.5939	1 klf = 14.5 kN/m
Pressure, Stress, Modulus of Elasticity	psf	Pa	47.8803	1 psf = 48 Pa
	ksf	kPa	47.8803	1 ksf = 48 kPa
	psi	kPa	6.89476	1 psi = 6.9 kPa
	ksi	MPa	6.89476	1 ksi = 6.9 MPa
Length	inch	mm	25.4	1 in = 25 mm
	foot	m	0.3048	1 ft = 0.3m
	foot	mm	304.8	1 ft = 300 mm
Area	square inch	mm <sup>2</sup>	645.16	1 sq in = 650 mm <sup>2</sup>
	square foot	m <sup>2</sup>	0.09290304	1 sq ft = 0.09 m <sup>2</sup>
	square yard	m <sup>2</sup>	0.83612736	1 sq yd = 0.84 m <sup>2</sup>
Volume	cubic inch	mm <sup>3</sup>	16386.064	1 cu in = 16,400 mm <sup>3</sup>
	cubic foot	m <sup>3</sup>	0.0283168	1 cu ft = 0.03 m <sup>3</sup>
	cubic yard	m <sup>3</sup>	0.764555	1 cu yd = 0.76 m <sup>3</sup>

A few points to remember:

1. In a “**soft**” conversion, an English measurement is mathematically converted to its **exact** metric (SI) equivalent.
2. In a “**hard**” conversion, a new **rounded** metric number is created that is convenient to work with and remember.
3. Use only the meter and millimeter for length (avoid centimeter).
4. The Pascal (Pa) is the unit for pressure and stress (Pa and N/m<sup>2</sup>).
5. Structural calculations should be shown in MPa or kPa.
6. A few basic comparisons worth remembering to help visualize metric dimensions are:
  - One mm is about 1/25 inch, or slightly less than the thickness of a dime.
  - One m is the length of a yardstick plus about 3 inches.
  - One inch is just a fraction (1/64 inch) longer than 25 mm (1 inch = 25.4 mm).
  - Four inches are about 1/16 inch longer than 100 mm (4 inches = 101.6 mm).
  - One foot is about 3/16 inch longer than 300 mm (12 inches = 204.8 mm).

## ACKNOWLEDGEMENTS

The authors express their appreciation to Mr. Jerry A. DiMaggio, P.E. of the Federal Highway Administration (FHWA), Office of Bridge Technology, Mr. Silas Nichols, P.E., of the FHWA Resource Center, and Mr. Chien-Tan Chang of the FHWA Office of Bridge Technology for providing valuable technical assistance, review, and project overview during this project. The authors thank the following individuals that served on the Technical Working Group for this project:

- Silas Nichols                      FHWA Resource Center
- Benjamin Rivers                FHWA Resource Center
- Khalid Mohamed                FHWA Eastern Federal Lands Highway Division
- Rich Barrows                    FHWA Western Federal Lands Highway Division
- James Brennan                 Kansas DOT
- Mark McClelland               Texas DOT

The authors thank the following organizations and individuals for providing valuable information and reviewing this manual:

- International Association of Foundation Drilling (ADSC-IAFD) - Emerging Technologies Task Force
- Deep Foundations Institute (DFI) - Augered Cast-In-Place Pile Committee

In addition, the authors thank the following organizations and individuals for providing valuable information for the preparation of this document:

- Applied Foundation Testing, Green Cove Springs, Florida
- Bauer Maschinen GmbH, Schrobenhause, Germany
- Berkel and Company Contractors, Inc., Bonner Springs, Kansas
- British Research Establishment, U.K.
- Cementation Foundations Skanska, U.K.
- DGI-Menard, Inc., Bridgeville, Pennsylvania
- Franki Geotechnics B, Belgium
- Jean Lutz, S.A., France
- Morris-Shea Bridge Company, Inc., Irondale, Alabama
- Pile Dynamics, Inc., Cleveland, Ohio
- Societa Italiana Fondazioni (SIF), S.p.A, Italy
- Soilmec, S.p.A., Italy
- Soletanche Bachy, France
- STS Consultants, Vernon Hills, Illinois
- Trevi, S.p.A., Italy
- Prof. A. Mandolini, Second University of Naples, Naples, Italy
- Prof. W. Van Impe, Ghent University, Ghent, Belgium
- Prof. C. Vipulanandan, University of Houston, Houston, Texas
- Prof. Michael O'Neill (deceased), University of Houston, Houston, Texas

Finally, the authors thank Ms. Lynn Johnson, of Geosyntec Consultants, for word processing, editing, and assisting in the layout of the document.

## PREFACE

The purpose of this document is to develop a state-of-the-practice manual for the design and construction of continuous flight auger (CFA) piles, including those piles commonly referred to as augered cast-in-place (ACIP) piles, drilled displacement (DD) piles, and screw piles. An Allowable Stress Design (ASD) procedure is presented in this document as resistance (strength reduction) factors have not yet been calibrated for CFA piles for a Load Resistance Factored Design (LRFD) approach. The intended audience for this document is engineers and construction specialists involved in the design, construction, and contracting of foundation elements for transportation structures.

CFA piles have been used in the U.S. commercial market but have not been used frequently for support of transportation structures in the United States. This underutilization of a viable technology is a result of perceived difficulties in quality control, and the difficulties associated with incorporating a rapidly developing (and often proprietary) technology into the traditional, prescriptive design-bid-build concept. Recent advances in automated monitoring and recording devices will alleviate concerns of quality control, as well as provide an essential tool for a performance-based contracting process.

This document provides descriptions of the basic mechanisms involving CFA piles, CFA pile types, applications for transportation projects, common materials, construction equipment, and procedures used in this technology. Recommendations are made for methods to estimate the static axial capacity of single piles. A thorough evaluation and comparison of various existing methods used in the United States and Europe is also presented. Group effects for axial capacity and settlement are discussed, as well as lateral load capacities for both single piles and pile groups. A generalized step-by-step method for the selection and design of CFA piles is presented. Quality control (QC)/quality assurance (QA) procedures are discussed, and a performance specification is provided. This generic specification may be adapted to specific project requirements.

A list of the references used in the development of this manual is presented. These references include the key publications on the design of augered pile foundations. Existing Federal Highway Administration (FHWA) and American Association of State Highway Officials (AASHTO) publications that include engineering principles related to the subject of CFA piles are also included in the references.

## TABLE OF CONTENTS

<b>CHAPTER 1 INTRODUCTION.....</b>	<b>1</b>
1.1 PURPOSE .....	1
1.2 BACKGROUND.....	1
1.3 RELEVANT PUBLICATIONS .....	2
1.4 DOCUMENT ORGANIZATION.....	2
<b>CHAPTER 2 DESCRIPTION OF CONTINUOUS FLIGHT AUGER PILE TYPES AND BASIC MECHANISMS.....</b>	<b>3</b>
2.1 INTRODUCTION.....	3
2.2 CONSTRUCTION SEQUENCE .....	6
2.2.1 Drilling.....	6
2.2.2 Grouting.....	8
2.2.2.1 General Sequence.....	8
2.2.2.2 Start of Grouting .....	9
2.2.2.3 Withdrawal of Auger .....	9
2.2.2.4 Grout vs. Concrete .....	11
2.2.2.5 Reinforcement (Rebar).....	13
2.3 SUMMARY .....	14
<b>CHAPTER 3 APPLICATIONS FOR TRANSPORTATION PROJECTS .....</b>	<b>15</b>
3.1 INTRODUCTION.....	15
3.2 ADVANTAGES AND LIMITATIONS OF CFA PILES.....	15
3.2.1 Background.....	15
3.2.2 Geotechnical Conditions Affecting the Selection and Use of CFA Piles.....	16
3.2.2.1 Favorable Geotechnical Conditions.....	16
3.2.2.2 Unfavorable Geotechnical Conditions.....	17
3.2.3 Project Conditions Affecting the Selection and Use of CFA Piles.....	20
3.3 ADVANTAGES AND LIMITATIONS OF DRILLED DISPLACEMENT PILES ....	23
3.4 APPLICATIONS .....	24
3.4.1 Soundwalls.....	24
3.4.2 Bridge Piers and Abutments .....	25
3.4.3 Retaining Structures.....	29
3.4.4 Pile-Supported Embankments.....	30
3.5 CONSTRUCTION COST EVALUATION.....	31

## TABLE OF CONTENTS (continued)

<b>CHAPTER 4</b>	<b>CONSTRUCTION TECHNIQUES AND MATERIALS .....</b>	<b>33</b>
4.1	INTRODUCTION.....	33
4.2	CONSTRUCTION EQUIPMENT .....	33
4.2.1	Drilling Rigs.....	33
4.2.2	Augers and Drilling Tools .....	38
4.2.3	Equipment for Concrete/Grout and Reinforcement Placement .....	48
4.2.3.1	Auger Plug .....	48
4.2.3.2	Pumping Equipment.....	49
4.2.3.3	Finishing the Top of the Pile.....	51
4.3	CONSTRUCTION MATERIALS .....	52
4.3.1	Grout and Concrete.....	52
4.3.1.1	Cement .....	55
4.3.1.2	Pozzolanic Additives .....	55
4.3.1.3	Water.....	56
4.3.1.4	Aggregate.....	56
4.3.1.5	Fluidifiers for Grout and Water Reducing Admixtures for Concrete .....	56
4.3.1.6	Retarders .....	57
4.3.1.7	Air Entraining Agents.....	57
4.3.1.8	Sampling and Testing .....	58
4.3.2	Reinforcing Steel .....	59
4.3.2.1	Reinforcing Steel Materials .....	59
4.3.2.2	Reinforcing Cage/Section.....	59
4.4	SUMMARY OF RECOMMENDED PRACTICES .....	61
<b>CHAPTER 5</b>	<b>EVALUATION OF STATIC CAPACITY OF CONTINUOUS FLIGHT AUGERED PILES .....</b>	<b>64</b>
5.1	INTRODUCTION.....	64
5.2	DEVELOPMENT OF SIDE-SHEAR AND END-BEARING RESISTANCE WITH PILE DISPLACEMENT.....	65
5.3	RECOMMENDED METHODS FOR ESTIMATING STATIC AXIAL CAPACITY OF CFA PILES .....	66
5.3.1	Cohesive Soils.....	68
5.3.1.1	Recommended Method for Side-Shear and End-Bearing Estimates using Undrained Shear Strength .....	68
5.3.1.2	Alternative Methods for Side-Shear Estimates using Undrained Shear Strength.....	69

## TABLE OF CONTENTS (continued)

5.3.1.3	Alternative Method for End-Bearing Estimates using Dynamic Cone Penetrometer .....	71
5.3.1.4	Alternative Method for Side-Shear and End-Bearing Estimates using SPT-N Values .....	71
5.3.1.5	Alternative Method for Side-Shear and End-Bearing Estimates using CPT Values .....	71
5.3.2	Cohesionless Soils .....	72
5.3.2.1	Recommended Method for Side-Shear Estimates using Pile Depth and End-Bearing Estimates using SPT-N Values .....	72
5.3.2.2	Alternative Methods for Side-Shear using Pile Depth.....	73
5.3.2.3	Alternative Method for Side-Shear and End-Bearing Estimates using CPT Values .....	74
5.3.3	Other Geo-Materials .....	75
5.3.3.1	Introduction.....	75
5.3.3.2	Vuggy Limestone.....	76
5.3.3.3	Clay-Shale.....	78
5.4	STATIC AXIAL CAPACITY OF DRILLED DISPLACEMENT PILES .....	82
5.4.1	Introduction.....	82
5.4.2	Recommended Method Using SPT-N Values or CPT Data .....	82
5.4.3	Amelioration .....	87
5.5	GROUP EFFECTS ON STATIC AXIAL COMPRESSION LOAD RESISTANCE OF CFA PILES .....	87
5.5.1	Introduction.....	87
5.5.2	Group Efficiencies .....	89
5.5.2.1	Conventional CFA Pile Groups .....	89
5.5.2.2	Drilled Displacement Pile Groups .....	94
5.5.3	Settlement of Pile Groups .....	95
5.5.3.1	Elastic Compression of the Pile .....	96
5.5.3.2	Compression Settlement in Cohesionless Soils .....	98
5.5.3.3	Consolidation Settlement in Cohesive Soils .....	99
5.5.4	Uplift of Single CFA Piles and CFA Pile Groups .....	103
5.6	LATERAL RESISTANCE AND STRUCTURAL CAPACITY OF CFA PILES .....	104
5.6.1	Behavior and Limitations of CFA Piles.....	104
5.6.2	Lateral Analyses Using the p-y Method .....	105
5.6.3	Lateral Analyses of CFA Pile Groups .....	111
5.6.4	Structural Capacity.....	113
5.6.4.1	Longitudinal Reinforcement .....	114
5.6.4.2	Shear Reinforcement.....	117
5.6.5	Concrete or Grout Cover and Cage Centering Devices .....	120



## TABLE OF CONTENTS (continued)

5.6.6	Seismic Considerations .....	120
5.7	DOWNDRAW IN CFA PILES .....	121
5.8	EXAMPLE PROBLEMS: AXIAL CAPACITY OF SINGLE PILES .....	125
5.8.1	Conventional CFA Pile in Cohesive Soils .....	125
5.8.2	Conventional CFA and Drilled Displacement Piles in Cohesionless Soils .....	127
<b>CHAPTER 6</b>	<b>RECOMMENDED DESIGN METHOD .....</b>	<b>133</b>
6.1	STEP 1: INITIAL DESIGN CONSIDERATIONS .....	133
6.1.1	General Structural Foundation Requirements .....	133
6.1.2	Site Geology and Subsurface Conditions .....	134
6.2	STEP 2: COMPARISON AND SELECTION OF DEEP FOUNDATION ALTERNATIVES .....	134
6.3	STEP 3: SELECT PILE LENGTH AND CALCULATE PERFORMANCE UNDER SPECIFIED LOADS .....	136
6.3.1	Limit States for Design .....	136
6.3.2	Design Procedures .....	139
6.4	STEP 4: CONSTRUCTABILITY REVIEW .....	144
6.5	STEP 5: PREPARE PLANS AND CONSTRUCTION SPECIFICATIONS, SET FIELD QC/QA AND LOAD TESTING REQUIREMENTS .....	145
6.6	EXAMPLE PROBLEM .....	145
6.6.1	Introduction .....	145
6.6.2	Step 1: Initial Design Considerations .....	145
6.6.2.1	General Structural Foundation Requirements .....	145
6.6.2.2	Site Geology and Subsurface Conditions .....	145
6.6.3	Step 2: Comparison and Selection of Deep Foundation Alternatives .....	146
6.6.4	Step 3: Select Pile Length and Calculate Performance Under Specified Loads .....	147
6.6.5	Step 4: Constructability Review .....	159
6.6.6	Step 5: Prepare Plans and Construction Specifications, Set Field QC/QA and Load Testing Requirements .....	159
<b>CHAPTER 7</b>	<b>QUALITY CONTROL (QC) / QUALITY ASSURANCE (QA) PROCEDURES .....</b>	<b>160</b>
7.1	INTRODUCTION .....	160
7.2	THE ROLE OF THE INSPECTOR .....	160
7.3	PRE-CONSTRUCTION PLANNING .....	162
7.3.1	Owner-Supplied Information .....	162
7.3.2	CFA Contractor Experience .....	163

## TABLE OF CONTENTS (continued)

7.3.3	Design Submittals .....	163
7.3.3.1	Design Calculations .....	164
7.3.3.2	Working Drawings.....	164
7.3.4	Pile Installation Plan .....	165
7.3.5	Testing Plan .....	167
7.3.5.1	Pre-Production Testing .....	167
7.3.5.2	Conformance Monitoring and Verification Tests .....	168
7.3.5.3	Materials Testing .....	170
7.4	PERFORMANCE MONITORING AND CONTROL DURING CONSTRUCTION .....	170
7.4.1	Monitoring and Control of the Drilling Phase .....	171
7.4.2	Monitoring and Control of the Grouting/Concreting Phase .....	172
7.4.3	Finishing the Pile Top and Installing Reinforcement .....	178
7.4.4	Sampling and Testing of the Grout or Concrete .....	180
7.5	POST-CONSTRUCTION INTEGRITY TESTING .....	183
7.5.1	Use of Integrity Testing .....	183
7.5.2	Integrity Testing by Surface Methods.....	184
7.5.3	Integrity Testing using Downhole Techniques .....	186
7.6	LOAD TESTING .....	188
7.6.1	Considerations in Planning a CFA Pre-Production Test Pile Program.....	188
7.6.2	Proof Tests on Production Piles.....	189
7.7	SUMMARY OF RECOMMENDED QC/QA PROCEDURES .....	191
7.7.1	Prior to Construction.....	191
7.7.2	On-site Review of Contractor’s Equipment.....	192
7.7.3	During Drilling.....	192
7.7.4	During Grout/Concrete Placement.....	192
7.7.5	During Reinforcement Placement and Pile Top Finishing .....	193
7.7.6	Post-Installation .....	193
<b>CHAPTER 8</b>	<b>GUIDE CONSTRUCTION SPECIFICATIONS FOR CONTINUOUS FLIGHT AUGER (CFA) PILES.....</b>	<b>194</b>
8.1	DESCRIPTION.....	195
8.1.1	Definitions.....	195
8.1.2	Related Specifications.....	196
8.1.3	Reference Codes and Standards.....	196
8.1.4	Available Information.....	196
8.1.5	Project Site Survey.....	197
8.1.6	CFA Pile Contractors Experience and Submittal of Experience .....	198

## TABLE OF CONTENTS (continued)

8.1.6.1	Experience Requirements .....	198
8.1.6.2	Experience Requirements and Submittal .....	198
8.1.7	CFA Pile Design Requirements .....	199
8.1.7.1	CFA Pile Design Submittals .....	199
8.1.7.2	Design Calculations .....	200
8.1.7.3	Working Drawings.....	201
8.1.8	Construction Submittals.....	202
8.1.8.1	Pile Installation Plan .....	202
8.1.8.2	Conformance Testing Plan.....	204
8.1.9	Pre-Construction Meeting.....	204
8.2	MATERIALS .....	205
8.3	CONSTRUCTION REQUIREMENTS .....	206
8.3.1	Site Preparation and Protection of Adjacent Structures.....	206
8.3.1.1	Site Preparation.....	206
8.3.1.2	Protection of Adjacent Structures .....	206
8.3.2	Grout or Concrete .....	207
8.3.2.1	Mix Design – Grout .....	208
8.3.2.2	Mix Design – Concrete .....	209
8.3.2.3	Field Operations.....	210
8.3.2.4	Grout or Concrete Sampling and Testing .....	211
8.3.3	Auger Equipment.....	212
8.3.4	Automatic Measurement and Recording Equipment.....	213
8.3.5	Drilling.....	213
8.3.6	Placement of Grout or Concrete .....	215
8.3.7	Pile Head Finishing and Protection.....	216
8.3.8	Reinforcing Steel Placement.....	217
8.3.9	Pile Cut-Off.....	218
8.3.10	Inspection and Records.....	218
8.3.11	Testing.....	219
8.3.11.1	Pre-Production Testing .....	219
8.3.11.2	Verification Load Testing.....	220
8.3.12	Integrity Testing.....	221
8.3.13	Unacceptable Piles.....	222
8.4	MEASUREMENT .....	223
8.5	PAYMENT.....	223
<b>CHAPTER 9</b>	<b>REFERENCES.....</b>	<b>224</b>

## TABLE OF CONTENTS (continued)

### LIST OF TABLES

Table 5.1	Relationship between Undrained Shear Strength, Rigidity Index, and Bearing Capacity Factor for Cohesive Soils for FHWA 1999 Method .....	69
Table 5.2	Soil Conditions Investigated for Drilled Displacement Piles.....	83
Table 5.3	Efficiency ( $\eta$ ) for Model Drilled Shafts Spaced 3 Diameters Center-to-Center in Various Group Configurations in Clayey Sand (Senna et al., 1993) .....	92
Table 5.4	$P$ -Multipliers ( $P_m$ ) for Design of Laterally Loaded Pile Groups.....	112
Table 6.1	Design Consideration for Foundation Selection of CFA and DD Piles .....	135
Table 6.2	Pile Group Settlement Computation .....	157
Table 7.1	General Guidelines for Auger Penetration Rate for CFA Piles .....	171
Table A.1	Soil-Pile Friction Angle, Limiting Unit Side-Shear Resistance, and Limiting End-Bearing Values (API, 1993) .....	A-15
Table A.2	Total Resistance - Results from Five Methods (McVay et al., 1994).....	A-17
Table A.3	Total Resistance - Results from Eight Different Methods (Zelada and Stephenson, 2000) .....	A-20
Table A.4	Total Resistance - Results from Eight Methods (Zelada and Stephenson, 2000) .....	A-21
Table A.5	Side-Shear Resistance - Results from Eight Methods (Zelada and Stephenson, 2000) .....	A-21
Table A.6	End-Bearing Resistance - Results from Eight Methods (Zelada and Stephenson, 2000) .....	A-22

### LIST OF FIGURES

Figure 2.1	CFA Pile Rig.....	3
Figure 2.2	Schematic of CFA Pile Construction.....	4
Figure 2.3	Schematic of Typical Drilled Shaft vs. CFA Foundation.....	5
Figure 2.4	Group of CFA Piles with Form for Pile Cap .....	5
Figure 2.5	Effect of Over-Excavation using CFA Piles.....	6
Figure 2.6	Displacement Pile .....	7
Figure 2.7	Hole at Base of Auger for Concrete.....	8
Figure 2.8	Grout Delivered to Pump .....	8
Figure 2.9	Grout at Surface after Auger Withdrawal.....	11
Figure 2.10	Finishing Pile and Reinforcement Placement.....	11
Figure 2.11	Placement of a Single Full-Length Bar.....	13
Figure 2.12	Vibratory Drive Head Used to Install Rebar Cage .....	13
Figure 3.1	Use of CFA Piles for Commercial Building Projects.....	16
Figure 3.2	Examples of Difficult Conditions for Augured Piles.....	18

## TABLE OF CONTENTS (continued)

Figure 3.3	CFA Piles at Bridge Interchange .....	20
Figure 3.4	Low Headroom CFA Pile Application .....	21
Figure 3.5	Secant Pile Wall with CFA Pile Construction .....	22
Figure 3.6	CFA Piles for Soundwall along Highway.....	22
Figure 3.7	Pilecaps on CFA Piles For A Pile-Supported Embankment.....	23
Figure 3.8	Drilled Displacement Piles Limit Spoil Removal.....	24
Figure 3.9	CFA Pile Foundation for Soundwall.....	25
Figure 3.10	Schematic Diagram of the Foundation on CFA Piles for the Krenek Road Bridge .....	26
Figure 3.11	CFA Piles at the Krenek Road Bridge Site.....	27
Figure 3.12	Comparison of Measured Settlements and Test Pile, Krenek Road Bridge Site .....	28
Figure 3.13	Secant CFA Pile Wall for a Light Rail System in Germany.....	29
Figure 3.14	Schematic Plan View of a Secant Pile Wall .....	30
Figure 3.15	Drilling CFA Piles through Guide for Secant Wall.....	30
Figure 3.16	Diagram of Pile-Supported Embankment for Italian Railway Project .....	32
Figure 4.1	Typical Crane-Mounted CFA Rig .....	34
Figure 4.2	Photo of Crane-Attached CFA System.....	35
Figure 4.3	Low Headroom CFA Pile Rig.....	36
Figure 4.4	Low Headroom Rig with Segmental Augers.....	36
Figure 4.5	Hydraulic Rig Drilling on M25 Motorway in England .....	37
Figure 4.6	Soilmec Hydraulic CFA Rig with Kelley Extension .....	38
Figure 4.7	Augers for Different Soil Conditions.....	38
Figure 4.8	Auger for Use in Clay with Auger Cleaner Attachment.....	39
Figure 4.9	Cutter Heads for Hard Material and Soil .....	39
Figure 4.10	Hardened Cutting Head.....	40
Figure 4.11	DeWaal Drilled Displacement Pile.....	41
Figure 4.12	Omega Screw Pile.....	42
Figure 4.13	Fundex Screw Pile .....	43
Figure 4.14	Drilled Displacement Piles .....	44
Figure 4.15	Additional Drilled Displacement Piles .....	45
Figure 4.16	Double Rotary Cased CFA Piles.....	46
Figure 4.17	Double Rotary Fixed Drive System.....	46
Figure 4.18	Double Rotary System with Kelly-Bar Extension .....	47
Figure 4.19	Typical Concrete/Grout Pumps.....	50
Figure 4.20	In-Line Flowmeter .....	51
Figure 4.21	Sensor for Concrete Pressure at Auger Tip.....	52
Figure 4.22	Completion of Pile Top Prior to Installation of Reinforcement .....	53
Figure 4.23	Sand-Cement Grout Mixes .....	54
Figure 4.24	Machine-Welded Reinforcement Cage on Project Site in Germany .....	60
Figure 4.25	Use of Steel Pipe to Reinforce a CFA Pile for a Wall.....	60
Figure 4.26	Installation of Reinforcement Cage into Battered CFA Pile .....	61

## TABLE OF CONTENTS (continued)

Figure 5.1	Load-Displacement Relationships .....	67
Figure 5.2	Relationship for the $\alpha$ Factor with $S_u$ for Calculating the Unit Side-Shear for Cohesive Soils for the Coleman and Arcement (2002) Method .....	70
Figure 5.3	Unit Side-Shear Resistance as a Function of Cone Tip Resistance for Cohesive Soils – LPC Method .....	72
Figure 5.4	Relationship for the $\beta$ Factor for Calculating the Unit Side-Shear for Cohesionless Soils for the FHWA 1999 and Coleman and Arcement Methods .....	74
Figure 5.5	Unit Side-Shear as a Function of Cone Tip Resistance for Cohesionless Soils - LPC Method .....	75
Figure 5.6	Unconfined Compressive Strength vs. Ultimate Unit Side-Shear for Drilled Shafts in Florida Limestone .....	77
Figure 5.7	Correlation of Ultimate Unit Side-Shear Resistance for South Florida Limestone with SPT- $N_{60}$ Value .....	77
Figure 5.8	Side-Shear Development with Displacement for South Florida Limestone .....	78
Figure 5.9	Relative Load Capacity vs. Relative Displacement for CFA Sockets in Clay-Shale .....	79
Figure 5.10	Hyperbolic Model Parameter $Q_{ULT}$ as a Function of the Unconfined Compressive Strength ( $Q_U$ ) for CFA Sockets in Clay-Shale .....	80
Figure 5.11	Parameter $P_{50}/D$ as a Function of Unconfined Compressive Strength for CFA Sockets in Clay-Shale .....	81
Figure 5.12	Ultimate Unit Side-Shear Resistance for Drilled Displacement Piles for Nesmith (2002) Method .....	85
Figure 5.13	Ultimate Unit End-Bearing Resistance for Drilled Displacement Piles for Nesmith (2002) Method .....	86
Figure 5.14	Overlapping Zones Of Influence in A Frictional Pile Group .....	88
Figure 5.15	Efficiency ( $H$ ) Vs. Center-To-Center Spacing ( $S$ ), Normalized By Shaft Diameter ( $B_{SHAFT}$ ), for Underreamed Model Drilled Shafts in Compression in Moist, Silty Sand .....	91
Figure 5.16	Relative Unit Side and Base Resistances for Model Single Shaft and Typical Shaft in a Nine-Shaft Group in Moist Alluvial Silty Sand .....	91
Figure 5.17	Block Type Failure Mode .....	93
Figure 5.18	Deeper Zone of Influence for End-Bearing Pile Group than for a Single Pile .....	96
Figure 5.19	Equivalent Footing Concept for Pile Groups .....	100
Figure 5.20	Pressure Distribution Below Equivalent Footing for Pile Group .....	101
Figure 5.21	Typical $e$ vs. $\log p$ Curve from Laboratory Consolidation Testing .....	102
Figure 5.22	p-y Soil Response of Laterally Loaded Pile Model .....	106
Figure 5.23	Example Deflection and Moment Response of Laterally Loaded Pile Model .....	108
Figure 5.24	Typical Stress-Strain Relationship Used for Steel Reinforcement .....	109
Figure 5.25	Typical Stress-Strain Relationship Used for Concrete .....	109
Figure 5.26	Variation of Pile Stiffness ( $EI$ ) with Bending Moment and Axial Load .....	111
Figure 5.27	The p-multiplier ( $P_m$ ) .....	112
Figure 5.28	Circular Column (Pile) with Compression Plus Bending .....	115
Figure 5.29	Example Interaction Diagram for Combined Axial Load and Flexure .....	116

## TABLE OF CONTENTS (continued)

Figure 5.30	Examples of Cases of Downdrag.....	122
Figure 5.31	Potential Geotechnical Limit States for Piles Experiencing Downdrag.....	123
Figure 5.32	Mechanics of Downdrag: Estimating the Depth to the Neutral Plane.....	124
Figure 5.33	Mechanics of Downdrag in a Pile Group.....	124
Figure 5.34	Soil Profile $S_u$ vs. Depth for Example Problem of CFA Pile in Cohesive Soil.....	128
Figure 5.35	Soil Profile SPT- $N$ vs. Depth for Example Problem of CFA Pile and DD Pile in Cohesionless Soil.....	129
Figure 6.1	GULS and Short Term SLS for Axial Load on a Single CFA Pile.....	137
Figure 6.2	Typical Conditions at the Project Site.....	146
Figure 6.3	Idealized Soil Profile for Design.....	148
Figure 6.4	Five-Pile Footing Layout.....	149
Figure 6.5	Computed Lateral Load vs. Deflection.....	151
Figure 6.6	Deflection and Bending Moments vs. Depth for Example Problem.....	152
Figure 6.7	Maximum Bending Moments as a Function of Pile Top Deflection.....	152
Figure 6.8	Bending Moment vs. Curvature for a 18-in. diameter Pile with 6 #7's.....	153
Figure 6.9	Computed Axial Resistance vs. Depth.....	156
Figure 7.1	Operator with Cab Mounted Display Used to Control Drilling.....	172
Figure 7.2	Depth Encoder Mounted on Crane Boom.....	175
Figure 7.3	In-line Flowmeter.....	175
Figure 7.4	Pressure Sensors on Hydraulics to Monitor Rig Forces.....	176
Figure 7.5	Display Panel for Observation by Inspector.....	176
Figure 7.6	Example Data Sheet from Project.....	177
Figure 7.7	Dipping Grout to Remove Contamination.....	178
Figure 7.8	Cleaning the Top of a CFA Concrete Pile.....	179
Figure 7.9	Placement of Reinforcing Cage with Plastic Spacers.....	180
Figure 7.10	Cubes for Grout Testing.....	182
Figure 7.11	Sonic Echo Testing Concept.....	184
Figure 7.12	Sonic Echo Testing of Long Piles.....	185
Figure 7.13	Downhole Sonic Logging Concept (SSL).....	187
Figure 7.14	Gamma-Gamma Testing Via Downhole Tube.....	187
Figure 7.15	Static Load Test Setup on CFA Piles.....	190
Figure 7.16	Proof Testing of Production Piles with Statnamic (RLT) Device.....	190
Figure 7.17	Effect of Multiple Load Cycles on a CFA Pile.....	191
Figure A.1	$\beta$ Factor vs. Pile Length (Neely, 1991).....	A-5
Figure A.2	$\alpha$ vs. Undrained Shear Strength - Clayey Soils (Clemente et al., 2000).....	A-6
Figure A.3	$\beta$ Factor vs. Depth - Zelada and Stephenson (2000) and FHWA 1999 Methods.....	A-8
Figure A.4	Ultimate Unit End-Bearing Resistance vs. SPT- $N$ Values - Zelada and Stephenson (2000) and Other Methods.....	A-9

## TABLE OF CONTENTS (continued)

Figure A.5	Normalized Load-Settlement Relationship for Design of CFA Piles - Clay Soils of Texas Gulf Coast (O'Neill et al., 2002).....	A-10
Figure A.6	$\alpha$ vs. Average Undrained Shear Strength along Pile Length (Coyle and Castello, 1981) .....	A-13
Figure A.7	Unit Side-Shear and End-Bearing Capacities - Cohesionless Soils (Coyle and Castello, 1981) .....	A-13
Figure A.8	Relationship between SPT- $N$ Values and $\phi$ (Coyle and Castello, 1981) .....	A-14
Figure A.9	Summary of Total Resistance - Results from Five Methods (McVay et al., 1994).....	A-19
Figure A.10	Summary of Total Resistance - Results from Eight Methods (Zelada and Stephenson, 2000).....	A-20
Figure A.11	Summary of Total Resistance - Results from Four Methods (Coleman and Arcement, 2002) .....	A-23
Figure A.12	Total Capacity - Results from FHWA 1999 Method (Coleman and Arcement, 2002).....	A-24
Figure A.13	Total Capacity Results - Coleman and Arcement (2002) Method.....	A-24
Figure A.14	Effective Lateral Earth Pressure near a CFA Pile during Construction (O'Neill et al., 2002).....	A-25
Figure A.15	Total Resistance - Results from Four Methods.....	A-26
Figure A.16	Comparison of Study Results - Axial Capacity in Cohesive Soils .....	A-27
Figure A.17	Comparison of Study Results - Axial Capacity in Cohesionless Soils.....	A-28

## LIST OF APPENDICES

### APPENDIX A: COMPARISONS OF METHODS FOR ESTIMATING THE STATIC AXIAL CAPACITY OF CFA PILES

A.1	INTRODUCTION.....	A-1
A.2	METHODS FOR AXIAL CAPACITY OF CFA PILES.....	A-2
A.2.1	Wright and Reese (1979) Method.....	A-2
A.2.2	Douglas (1983) Method .....	A-2
A.2.3	Rizkalla (1988) Method .....	A-3
A.2.4	Neely (1991) Method.....	A-4
A.2.5	Viggiani (1993) Method .....	A-4
A.2.6	Decourt (1993) Method.....	A-5
A.2.7	Clemente et al. (2000) Method .....	A-6
A.2.8	Frizzi and Meyer (2000) Method.....	A-7
A.2.9	Zelada and Stephenson (2000) Method .....	A-7
A.2.10	Coleman and Arcement (2002) Method .....	A-8
A.2.11	O'Neill et al. (2002) Method .....	A-9
A.3	METHODS FOR AXIAL CAPACITY OF DRILLED SHAFTS APPLICABLE CFA PILES .....	A-10



## TABLE OF CONTENTS (continued)

A.3.1	TxDOT Method (1972).....	A-10
A.3.2	FHWA 1999 Method .....	A-11
A.4	METHODS FOR DRIVEN PILES APPLICABLE TO CFA PILES .....	A-11
A.4.1	Coyle and Castello (1981) Method.....	A-11
A.4.2	American Petroleum Institute (API) (1993) Method .....	A-12
A.5	METHOD FOR DRILLED SHAFTS AND DRIVEN PILES APPLICABLE TO CFA PILES .....	A-15
A.6	COMPARISON OF DESIGN METHODS FOR AXIAL CAPACITY OF CFA PILES .....	A-16
A.6.1	Comparison of Five Methods in Predominantly Sandy Soils (McVay et al., 1994).....	A-16
A.6.2	Comparison of Eight Methods in Predominantly Sandy Soils (Zelada and Stephenson, 2000).....	A-16
A.6.3	Comparison of Four Methods in Mixed Soil Conditions (Coleman and Arcement, 2002).....	A-18
A.6.4	Comparison of Seven Methods - Sandy and Clay Soils (O'Neill et al., 1999).....	A-22
A.6.5	Summary of Comparison Study Results for Cohesive Soils .....	A-25
A.6.6	Summary of Comparison Study Results for Cohesionless Soils .....	A-25

## **APPENDIX B EXAMPLE PROBLEMS: SPREADSHEET SOLUTIONS FOR AXIAL CAPACITY OF SINGLE PILES WITH DEPTH..... B-1**

B.1	CONVENTIONAL CFA PILE IN COHESIVE SOIL .....	B-1
B.2	CONVENTIONAL CFA AND DRILLED DISPLACEMENT PILES IN COHESIONLESS SOILS .....	B-7

## TABLE OF CONTENTS (continued)

### LIST OF ABBREVIATIONS

AASHTO	American Association of State Highway and Transportation Officials
ACI	American Concrete Institute
ACIP	Augered cast-in-place
API	American Petroleum Institute
ASCE	American Society of Civil Engineers
ASD	Allowable stress design
ASTM	American Society of Testing Materials
bpf	Blows per foot
CFA	Continuous flight auger
CIP	Cast-in-place
CSL	Cross-hole sonic logging
DD	Drilled displacement
DFI	Deep Foundations Institute
DLT	Dynamic load test
DOT	Department of Transportation
FDOT	Florida Department of Transportation
FWHA	Federal Highway Administration
GULS	Geotechnical ultimate limit state
GWT	Ground water table
H <sub>2</sub> SO <sub>4</sub>	Sulphuric acid
IGM	Intermediate geotechnical material
kcf	Kips per cubic foot
kPa	KiloPascal
ksi	Kips per square inch
LPC	Laboratoire Des Ponts et Chaussées
LRFD	Load and Resistance Factor Design
MPa	Megapascal
Na <sub>2</sub> SO <sub>4</sub>	Sodium sulphate
NaCl	Sodium chloride
NGES	National Geotechnical Experimentation Site
NHI	National Highway Institute
pcy	Pounds per cubic yard
pH	Hydrogen potential
ppm	Parts per million
psi	pounds per square inch
PVC	Polyvinyl chloride

## TABLE OF CONTENTS (continued)

QA/QC	Quality Assurance/Quality Control
RLT	Rapid load test
SLD	Service load design
SLS	Service limit state
SPT	Standard penetration test
SSL	Single-hole sonic logging
SULS	Structural ultimate limit state
tsf	Tons per square foot
TSL	Total service load
TXDOT	Texas Department of Transportation
VMA	Viscosity-modifying admixtures
W/C	Water-to-cement ratio

## TABLE OF CONTENTS (continued)

### LIST OF SYMBOLS

$A_c$	Cross-sectional area of concrete inside spiral steel
$A_i$	Average cross-sectional area for pile segment “ $i$ ”
$A_g$	Gross area
$A_g'$	Effective area
$A_{pile}$	Cross-sectional area of single pile
$A_{piles}$	Cross-sectional area of all piles in a group
$A_{group}$	Cross-sectional area of pile group, not including overhanging cap area
$A_s$	Cross-sectional area of reinforced steel
$A_v$	Effective cross-sectional area in resisting shear
$A_{vs}$	Required area of transverse steel
$B_{shaft}$	Shaft diameter
$B$	Width of block
$B$	Pile diameter
$C$	Wave propagation velocity
$C_c$	Compression index
$C_r$	Recompression index
$d$	Pile diameter
$d_c$	Depth of concrete cover
$d_b$	Diameter of longitudinal bars
$d_{pile}$	Distance normal to neutral axis of outer piles
$D$	Pile diameter
$D$	Depth of block
$D_B$	Diameter of pile at the base
$D_i$	Diameter of pile segment “ $i$ ”
$e$	Void ratio
$e_o$	Initial void ratio
$E$	Elastic modulus
$E_c$	Initial tangent slope
$E_c$	Young’s Modulus of concrete or grout
$E_e$	Average Young’s Modulus of equivalent pier within compressible layer
$E_i$	Average composite modulus for pile segment “ $i$ ”
$EI$	Flexural rigidity of pile/beam
$E_{pile}$	Average Young’s modulus of pile
$E_s$	Undrained Young’s modulus or secant modulus
$E_{soil}$	Soil average Young’s modulus
$E_{st}$	Young’s Modulus of geomaterial between piles

## TABLE OF CONTENTS (continued)

$f$	Side-Shear resistance
$f'_c$	Concrete compressive strength
$f''_c$	Ultimate compressive strength
$f_{max}$	Ultimate Side-Shear resistance
$f_s$	Ultimate unit Side-Shear resistance
$f_{s-ave}$	Average unit Side-Shear resistance
$f_{s,i}$	Unit Side-Shear resistance of segment “ $i$ ”
$f_y$	Steel yield stress
$F_{pile}$	Axial force on pile
$H$	Original thickness of layer
$i$	Generic pile segment number
$I_f$	Influence factor for group embedment
$I_r$	Rigidity index
$k$	Subgrade modulus
$K, K_s, K'$	Lateral earth pressure coefficient
$K_o$	In-situ lateral earth pressure coefficient
$K_a$	Active lateral earth pressure coefficient
$K_p$	Passive lateral earth pressure coefficient
$L$	Pile embedment length below top of grade
$L$	Pile socket length
$L_i$	Length of pile segment “ $i$ ”
$L_{pile}$	Pile length
$M, M_t$	Moment
$M_{overturn}$	Overturning moment
$M_x$	Nominal ultimate flexural resistance
$N$	Number of pile segments
$N$	SPT blow-count
$N_{eq}$	Average equivalent $N$ value
$N_{60}$	SPT- $N$ value (bpf) corrected for 60% efficiency
$\overline{N_{60}'}$	Average corrected SPT- $N$ value
$N_c$	CPT cone factor
$N_C^*, N_q$	Bearing capacity factor
$N_{TxDOT}$	Value obtained from the Texas Cone Penetrometer
$p$	Vertical effective consolidation stress
$p$	Lateral soil reaction
$p_c$	Preconsolidation pressure
$p_f$	Foundation pressure

## TABLE OF CONTENTS (continued)

$p_o$	Effective overburden or vertical pressure
$P$	Compressive force
$P_a, P_{atm}$	Standard atmospheric pressure
$P_m$	P-multiplier
$P_n$	Nominal ultimate axial resistance
$P_t$	Lateral force
$P_x$	Axial load
$P_x$	Nominal ultimate axial resistance
$q_c$	CPT tip resistance
$\overline{q_c}$	Average CPT tip resistance
$q_p$	Ultimate unit end-bearing resistance
$q_u$	Unconfined compressive strength
$Q$	Pile total resistance
$Q_i$	Average axial load at pile segment “ $i$ ”
$Q_i$	Value of load of type “ $i$ ”
$Q_t$	Ultimate total load
$Q_b, Q_{ult}, Q_{max}$	Ultimate resistance
$r_{ls}$	Radius of rings formed along centroids of longitudinal bars
$R$	Computed resistance at GULS
$R_{allowable}$	Allowable static axial resistance
$R_B, R_{Bd}$	End-bearing resistance
$R_{Block}$	Resistance of the block
$R_S$	Side-shear resistance
$R_T$	Total axial compressive resistance
$R_{ug}$	Ultimate resistance of pile group
$R_{u,i}$	Ultimate resistance of “ $i$ ” in pile group
$S$	Pile spacing
$S$	Pile slope
$S$	Longitudinal spacing of reinforcement ties (spiral pitch)
$S_{group}$	Total settlement of pile group
$S_i$	Total settlement
$SF$	Safety factor
$S_R$	Stiffness ratio
$S_u$	Soil undrained shear strength
$S_{ua}$	Average undrained shear strength along pile length
$S_{u ave}$	Average soil undrained shear strength
$V$	Shear force

## TABLE OF CONTENTS (continued)

$V_c$	Concrete shear strength
$V_n$	Nominal shear resistance of concrete section
$V_{steel}$	Nominal shear resistance of transverse steel
$w$	Load along pile length
$W$	Pile displacement
$W_S$	Correlation constant
$W_T$	Correlation constant
$x$	Coordinate along pile length
$y$	Lateral deflection at a point with coordinate $x$
$z_{soil, i}$	Thickness of soil layer “ $i$ ”
$z_w$	Depth below watertable
$Z$	Length of block
$Z$	Depth from ground surface to middle of a soil layer or pile segment (in ft)
$Z_m$	Depth from ground surface to middle of a soil layer or pile segment (in m)
$\alpha$	Reduction factor
$\beta$	Pile segment factor
$\beta$	Reduction factor
$\gamma$	Soil unit weight
$\gamma_{soil, i}$	Unit weight of soil layer “ $i$ ”
$\gamma_w$	Water unit weight
$\delta$	Soil-to-pile interface friction angle
$\Delta$	Elastic compression of pile
$\Delta p$	Change in overburden pressure
$\varepsilon_{50}$	Strain at 50% of compressive strength in compression load tests
$\varepsilon_y$	Yield strain
$\eta$	Pile efficiency
$\eta_g$	Pile group efficiency
$\rho$	Pile displacement
$\sigma'_v$	Vertical effective stress
$\phi$	Soil drained angle of internal friction
$\phi$	Resistance factor
$\Psi$	Ratio of undrained shear strength and vertical effective stress in soil

# CHAPTER 1 INTRODUCTION

## 1.1 PURPOSE

The purpose of this document is to develop a state-of-the-practice manual for the design and construction of continuous flight auger (CFA) piles, including those piles commonly referred to as augered cast-in-place (ACIP) piles, drilled displacement (DD) piles, and screw piles. An Allowable Stress Design (ASD) procedure is presented in this document as resistance (strength reduction) factors have not yet been calibrated for CFA piles for a Load Resistance Factored Design (LRFD) approach. The intended audience for this document is engineers and construction specialists involved in the design, construction, and contracting of foundation elements for transportation structures.

## 1.2 BACKGROUND

CFA piles have been used worldwide and also in the U.S. commercial market, but have not been used frequently for support of transportation structures in the United States. This underutilization of a viable technology is a result of perceived difficulties in quality control and of the difficulties associated with incorporating a rapidly developing (and often proprietary) technology into the traditional, prescriptive design-bid-build concept. Recent advances in automated monitoring and recording devices will alleviate concerns of quality control, as well as provide an essential tool for a performance-based contracting process.

A performance-based approach is presented to allow the specialty contractors greater freedom to compete in providing the most cost-effective foundation system while satisfying the project requirements. The performance specification places a greater responsibility for the resulting foundation performance on the contractor or design-build team. Rather than rigorous prescriptive specifications, a comprehensive testing program is used to verify performance. Full-scale load testing is used to verify the load carrying capabilities of the foundations provided. Automatic monitoring and recording devices are used during construction of both test piles and production piles to establish construction parameters (down-force, torque, grout take, etc.), and to verify that these parameters are met for every production pile. Full-scale load testing may be performed on production piles throughout the project, as selected by the owner.

This document provides descriptions of CFA pile types, materials, construction equipment, and procedures. Quality control (QC)/quality assurance (QA) procedures are discussed. A performance specification is provided in a format that may be adapted to specific project requirements. Recommendations are made for methods to estimate the static axial capacity of single piles. A thorough evaluation and comparison of various existing methods used in the United States and Europe is presented. Group effects for axial capacity and settlement are discussed, as well as lateral load capacities for both single piles and pile groups. A generalized step-by-step method for the selection and design of CFA piles is presented.



### **1.3 RELEVANT PUBLICATIONS**

A list of the references used in the development of this manual is presented in Chapter 9. These references include key publications on the design of augered pile foundations. Existing Federal Highway Administration (FHWA) and American Association of State Highway Officials (AASHTO) publications that include engineering principles related to the subject of CFA piles are also included in the references.

### **1.4 DOCUMENT ORGANIZATION**

The remainder of this document is organized as follows.

- *Chapter 2 – Description of Continuous Flight Auger Pile Types and Basic Mechanisms.* This chapter provides a general overview of CFA piles, including a description of the main system components, typical equipment, and the sequence of construction.
- *Chapter 3 – Applications for Transportation Projects.* This chapter presents advantages and limitations of CFA piles in transportation projects, describes favorable and unfavorable project and geotechnical conditions, and illustrates applications of CFA piles in transportation projects.
- *Chapter 4 – Construction Techniques and Materials.* This chapter provides details on construction techniques, materials, and recommended practice for the construction of CFA piles in transportation projects.
- *Chapter 5 – Evaluation of Static Capacity of Continuous Flight Augered Piles.* This chapter presents an evaluation and comparison of various existing methods used in the United States and Europe to calculate the static capacity of CFA piles.
- *Chapter 6 – Recommended Design Method.* This chapter presents a step-by-step generalized method for the selection and design of CFA piles. An annotated example is included in this chapter.
- *Chapter 7 – Quality Control (QC)/Quality Assurance (QA) Procedures.* This chapter discusses the use of automated QC/QA equipment and presents guidelines.
- *Chapter 8 – Guide Construction Specifications for Continuous Flight Auger Piles.* This chapter presents a performance specification for CFA piles.
- *Chapter 9 – References.* A list of the references used in this document is presented.
- *Appendix A – Comparisons of Methods for Estimating the Static Axial Capacity of CFA Piles.*
- *Appendix B – Spreadsheet Solutions for Axial Capacity of Single CFA Piles.*

## CHAPTER 2 DESCRIPTION OF CONTINUOUS FLIGHT AUGER PILE TYPES AND BASIC MECHANISMS

This chapter provides a general overview of continuous flight auger (CFA) piles. CFA piles have also been referred to as auger-cast, augered-cast-in-place, auger-pressure grout, and screw piles. The term CFA is used to generally refer to these types of piles constructed according to the recommendations in this document. This overview includes: (1) a description of the main components of a CFA pile; (2) typical drilling and grouting equipment used; and (3) a description of the sequence of construction.

A comparison of CFA piles with common deep foundations is presented to provide context for readers who are more familiar with driven piles and drilled shafts. Considerations are presented for: (1) initial hole drilling; (2) potential soil caving or mining; and (3) subsequent grout or concrete placement, including reinforcement placement. Additionally, basic information regarding the effects of soil type (i.e., clay, sand, or mixed) on load transfer will also be presented.

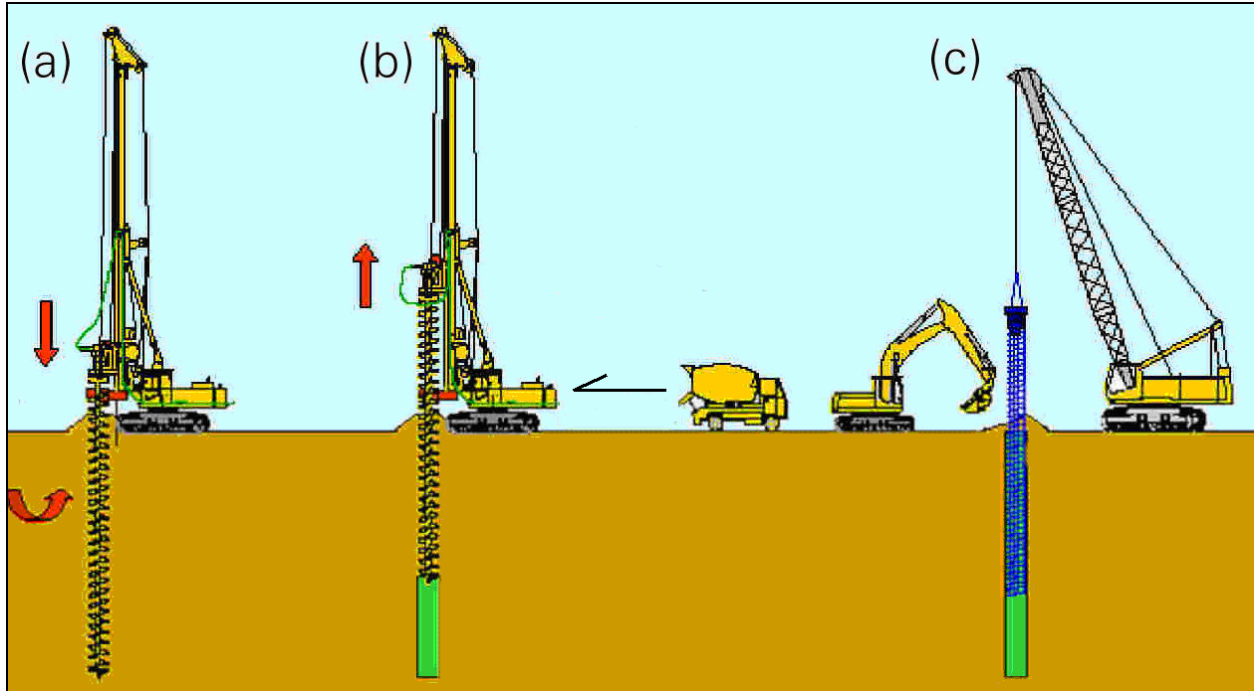
### 2.1 INTRODUCTION

CFA piles are a type of drilled foundation in which the pile is drilled to the final depth in one continuous process using a continuous flight auger (Figure 2.1). While the auger is drilled into the ground, the flights of the auger are filled with soil, providing lateral support and maintaining the stability of the hole (Figure 2.2a). At the same time the auger is withdrawn from the hole, concrete or a sand/cement grout is placed by pumping the concrete/grout mix through the hollow center of the auger pipe to the base of the auger (Figure 2.2b). Simultaneous pumping of the grout or concrete and withdrawing of the auger provides continuous support of the hole. Reinforcement for steel-reinforced CFA piles is placed into the hole filled with fluid concrete/grout immediately after withdrawal of the auger (Figure 2.2c).



Source: Cementation Foundation Skanska

**Figure 2.1: CFA Pile Rig**



Source: Bauer Maschinen

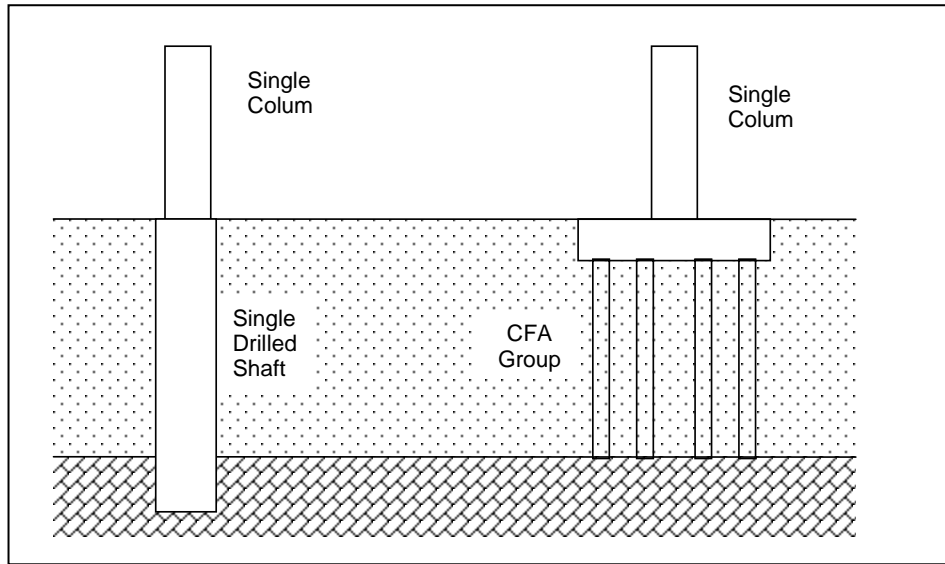
**Figure 2.2: Schematic of CFA Pile Construction**

CFA piles are typically installed with diameters ranging from 0.3 to 0.9 m (12 to 36 in.) and lengths of up to 30 m (100 ft), although longer piles have occasionally been used. In the United States, the practice has typically tended toward smaller piles having diameters of 0.3 to 0.6 m (12 to 24 in.) primarily because less powerful rigs have typically been used for commercial practice with these piles in the United States. European practice tends toward larger diameters [up to 1.5 m (60 in.)]. In recent years, the trend in the United States has been toward increased use of CFA piles in the 0.6 to 0.9 m (24 to 36 in.) diameter range.

The reinforcement is often confined to the upper 10 to 15 m (33 to 50 ft) of the pile for ease of installation and also due to the fact that in many cases, relatively low bending stresses are transferred below these depths. In some cases, full-length reinforcement is used, as is most common with drilled shaft foundations.

CFA piles can be constructed as single piles (similar to drilled shafts), for example, for soundwall or light pole foundations. For bridges or other large structural foundations, CFA piles are most commonly installed as part of a pile group in a manner similar to that of driven pile foundations as illustrated in Figures 2.3 and 2.4. Similarly to driven piles, the top of a group of CFA piles is terminated with a cap (Figure 2.4). Typical minimum center-to-center spacing is 3 to 5 pile diameters.

CFA piles differ from conventional drilled shafts or bored piles, and exhibit both advantages and disadvantages over conventional drilled shafts. The main difference is that the use of casing or



**Figure 2.3: Schematic of Typical Drilled Shaft vs. CFA Foundation**

slurry to temporarily support the hole is avoided. Drilling the hole in one continuous process is faster than drilling a shaft excavation, an operation that requires lowering the drilling bit multiple times to complete the excavation. In contrast, the torque requirement to install the continuous auger is high compared with a conventional drilled shaft of similar diameter; therefore, the diameter and length of CFA piles are generally less than drilled shafts. The use of a continuous auger for installation also limits CFA piles to soil or very weak rock profiles, while drilled shafts are often socketed into rock or other very hard bearing materials.



**Figure 2.4: Group of CFA Piles with Form for Pile Cap**

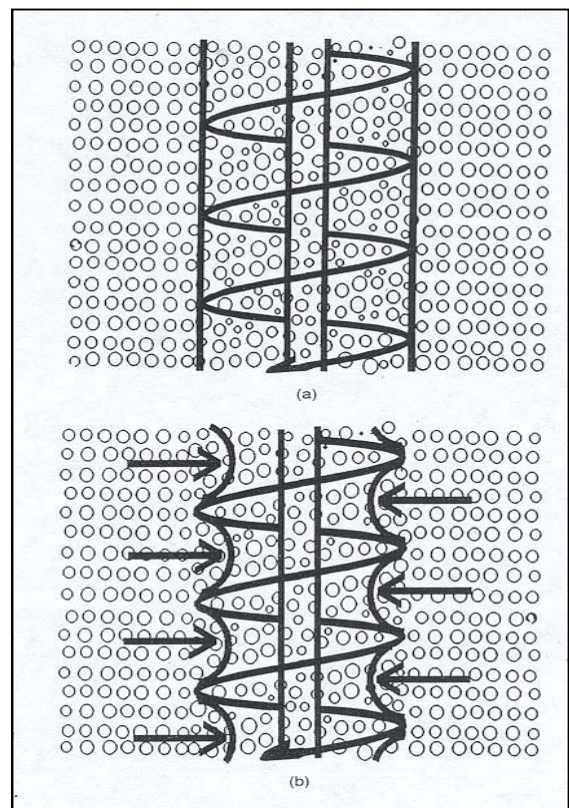
Because CFA piles are drilled and cast in place rather than being driven, as are driven piles, noise and vibration due to pile driving are minimized. CFA piles also eliminate splices and cutoffs. Soil heave due to driving can be eliminated when non-displacement CFA piles are used. A disadvantage of CFA piles compared to driven piles is that the available QA methods to verify the structural integrity and pile bearing capacity for CFA piles are less reliable than those for driven piles. Another disadvantage of CFA piles is that CFA piles generate soil spoils that require collection and disposal. Handling of spoils can be a significant issue when the soils are contaminated or if limited room is available on the site for the handling of material. Certain types of CFA piles that do not generate spoils will be discussed later in this document.

The remainder of this chapter provides an overview of the construction process of CFA piles.

## 2.2 CONSTRUCTION SEQUENCE

### 2.2.1 Drilling

The key component of the CFA pile system, contributing to the speed and economy of these piles, is that the pile is drilled in one continuous operation using a continuous flight auger, thus reducing the time required to drill the hole. While advancing the auger to the required depth, it is essential that the auger flights be filled with soil so that the stability of the hole is maintained. If the auger turns too rapidly, with respect to the rate of penetration into the ground, then the continuous auger acts as a sort of “Archimedes pump” and conveys soil to the surface. As illustrated in Figure 2.5, this action can result in a reduction of the horizontal stress necessary to maintain stability of the hole. Consequently, lateral movement of soil towards the hole and material loss due to over-excavation can result in ground subsidence at the surface and reduced confinement of nearby installed piles. The top of Figure 2.5 represents an auger having balanced auger rotation and penetration rates, so that the flights are filled from the digging edge at the base of the auger with no lateral “feed”. The bottom of Figure 2.5 illustrates an auger having an excessively slow penetration rate and an insufficient base feed to keep the auger flights full; as a result, the auger feeds from the side with attendant decompression of the ground.



After Fleming (1995)

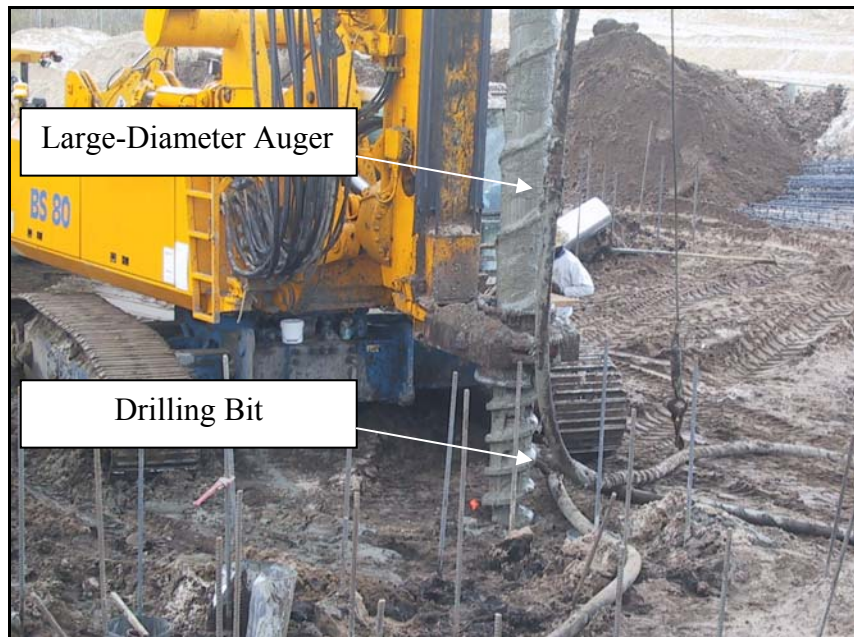
**Figure 2.5: Effect of Over-Excavation using CFA Piles**

As the auger cuts the soil at the base of the tool, material is loaded onto the flights of the auger. The volume of soil through which the auger has penetrated will tend to “bulk” and take up a larger volume after cutting than the in-situ volume. Some of the bulk volume is also due to the

volume of the auger itself, including the hollow center tube. Thus, it is necessary that some soil is conveyed up the auger during drilling. To maintain a stable hole at all times, it is necessary to move only enough soil to offset the auger volume and material bulking without exceeding this volume. Controlling the rate of penetration helps to avoid lateral decompression of the ground inside the hole, the loosening of the in-situ soil around the hole, and ground subsidence adjacent to the pile.

The proper rate of penetration may be difficult to maintain if the rig does not have adequate torque and down-force to rotate the auger. When a soil profile being drilled has mixed soil conditions (e.g., weak and strong layers), difficulties may arise. For example, if a rig having a low torque-capacity is used for drilling through a mostly-hard profile, difficulties can arise when drilling through a weak, embedded stratum to penetrate the strong soil. If the rig cannot penetrate the strong soil stratum at the proper rate, the augers can “mine” the overlying weak soil to the surface and cause subsidence.

One solution to properly balance soil removal and penetration rate is to use auger tools that actually displace soil laterally during drilling. In this construction technique, these types of piles are more commonly described as Drilled Displacement (DD) piles. DD piles include a variety of patented systems, which typically consist of a center pipe within the auger, an auger of larger diameter than that of conventional CFA equipment (Figure 2.6), and some type of bulge or plug within the auger string to force the soil laterally as it passes (not shown in Figure 2.6). The advantage of this system is that soil mining is avoided. In addition, the soil around the pile tends to be densified and the lateral stresses at the pile/soil wall are increased, thus leading to soil improvement and increased pile capacity for a given length. The main disadvantage is that the demand for torque and down-force from the rig is greater and this creates a limitation on the ability to install piles to great depths, as well as in very firm to dense soils.



**Figure 2.6: Displacement Pile**

For some soil conditions, the concern for soil mining and the need to establish a good penetration rate is not as critical. CFA piles have been successfully installed in many geologic formations without any consideration of the rate of penetration or soil mining. Where soils are stable due to cohesion, cementation, and/or apparent cohesion due to low groundwater levels, and pile lengths are relatively short, it may be feasible to neglect some of the considerations of drilling rate and soil mining. For example, residual soil, weak limestone formations, and cemented sands are soil types that favor easy construction. In such instances, the continuous auger is essentially used to construct a small open-hole, drilled shaft, or bored pile. However, such practice should be allowed only after the completion of successful test installations and after load tests have confirmed that satisfactory results are obtained and that with no adverse effects from ground subsidence will take place.

### 2.2.2 Grouting

When the drilling stage is complete and the auger has penetrated to the required depth, the grouting stage must begin immediately. Grout or concrete is pumped under pressure through a hose to the top of the rig and delivered to the base of the auger via the hollow center of the auger stem. The generic term grout will be mostly used in the remainder of this document; however, it is understood that grout or concrete can be used in this process. Figure 2.7 shows the hole at the base of the auger stem. Figure 2.8 shows grout being delivered to the project site by truck to a pump located near the drill rig.



**Figure 2.7: Hole at Base of Auger for Concrete**



**Figure 2.8: Grout Delivered to Pump**

#### 2.2.2.1 General Sequence

The general grouting sequence is as follows:

- Upon achieving the design pile tip elevation, the auger is lifted a short distance [typically 150 to 300 mm (6 to 12 in.)] and grout is pumped under pressure to expel the plug at the base of the internal pipe and commence the flow. The auger is then screwed

back down to the original pile tip elevation to establish a small head of grout or concrete on the auger and to achieve a good bearing contact at the pile tip.

- The grout is pumped continuously under pressure [typically up to 2 MPa (300 psi) measured at the top of the auger] while the auger is lifted smoothly in one continuous operation.
- Simultaneously, as the auger is lifted, the soil is removed from the flights at the ground surface so that soil cuttings are not lifted high into the air (potential safety hazard).
- After the auger has cleared the ground surface and the grouting/concrete procedure is completed, any remaining soil cuttings are removed from the area at the top of the pile and the top of the pile is cleared of debris and contamination.
- The reinforcement cage is lowered into the fluid grout/concrete to the required depth and tied off at the ground surface to maintain the proper reinforcement elevation.

#### 2.2.2.2 Start of Grouting

It is essential that the grouting process begin immediately upon reaching the pile tip elevation; if there is any delay the auger may potentially become stuck and impossible to retrieve. To avoid “hanging” the auger (i.e., getting the auger stuck), some contractors may wish to maintain a slow steady rotation of the auger while waiting for delivery of grout; this rotation without penetration may lead to soil mining as described in the previous section and should be avoided. Another concern with excess rotation is degradation and subsequent reduction or loss of side friction capacity. The practice of maintaining rotation without penetration is not recommended. The best way to avoid such problems is to not start the drilling of a pile until an adequate amount of concrete/grout is available at the jobsite to complete the pile.

After reaching the pile tip elevation, the operator typically must lift the auger about 150 mm (6 in.) and pump grout/concrete under pressure to expel the plug used as a stopper in the bottom of the hollow auger. This operation is typically called “clearing the bung” or “blowing the plug” among contractors. Occasionally, some contractors lift the auger up to about 300 mm (12 in.), although a distance limited to 150 mm (6 in.) is preferable. Lifting of the auger prior to blowing the plug must be limited to 150 mm (6 in.) because a greater lift-up distance does not favor the development of good end-bearing in the pile. If the lift-up distance is excessive, the stress relief in the hole walls below the auger may be large, the bearing surface may be disturbed, and this may result in mixing of grout with loose soil at the pile toe. Prior to starting withdrawal, the auger is re-penetrated to the original pile tip elevation while maintaining pressure on the grout.

#### 2.2.2.3 Withdrawal of Auger

Grout should be pumped to develop pressure at the start of the grouting operation. The pressure developed should be monitored to ensure that an adequate value is maintained. The grouting pressure typically depends on the equipment being used, but commonly, the applied grouting pressure is in the range of 1.0 to 1.7 MPa (150 to 250 psi) as measured at the top of the auger.



As a minimum, the pressure must be in excess of the overburden pressure at the discharge point at the tip of the auger after accounting for elevation head differences between the measurement point and the auger tip. The grouting pressure must be maintained as the auger is slowly and smoothly withdrawn. This pressure replaces the soil-filled auger as the lateral support mechanism in the hole. When the grout pressure is applied, the grout also pushes up the auger flights and presses the soil against the auger.

If over-rotation has been applied during drilling, it could be difficult to maintain the grout pressure during withdrawal. Over-rotation refers to the excess rotation of the auger relative to the depth penetrated for each turn. During over-rotation, the auger does not have a sufficient feed of soil from the cutting edge to maintain the flights full of soil and to prevent soil from loading the auger from the side. Over-rotation of the augers during drilling tends to clear the auger of soil and permits the concrete or grout to flow up the auger flights rather than remaining below the base of the auger under pressure. If grout flows up the auger flights for a large distance, it will be vented to the surface while the auger is still in the ground and at that point it will no longer be possible to maintain pressure in excess of surrounding overburden stress.

As the auger is slowly and steadily withdrawn, an adequate and controlled volume of grout/concrete must be delivered at the same time to replace the volume of soil and auger being removed. An overrun in the grout replacement volume of about 15 to 20% above the theoretical volume of the pile should be required. The necessary volume of grout must be delivered continuously as the auger is removed, and this volume should be measured and monitored to ensure that an adequate volume of concrete/grout is delivered. If the auger is pulled too fast in relation to the ability of the pump to deliver volume, the soil will tend to collapse inward and form a neck in the pile. Continuous monitoring of the volume is required to avoid the possibility that the rig operator could pull too fast for a short segment and then slow down for the volume to “catch up”. This discontinuous withdrawal could result in the pile being constructed as a series of necks and bulges rather than the uniform structural section that is desired.

During grouting, the auger should be pulled with either no rotation or slow continuous rotation in the direction of drilling. A static pull with no rotation can help maintain a static condition at the base of the auger against which the grout pressure acts. Some contractors prefer to slowly rotate the auger during withdrawal to minimize the risk of having the auger flight getting stuck. In addition, some augers have an off-center discharge plug at the base and slow rotation may help avoid concentrating the distribution of the grout pressure to an off-center location within the hole. If rotation is used, it must be very slow so that the auger does not tend to conduct the soil on the auger flights to the surface ahead of the auger. When the grout reaches the surface, the grout pressure is vented, and the high pressure under the auger can no longer be maintained. At this point, it is important that the proper volume of grout be continuously delivered per increment of length as the auger is removed, and the grout that is on the augers should not be allowed to flow back into the hole. If grout and soil become mixed on the auger during this process, the soil and contaminated grout could fall into the top of the pile and be difficult to remove.

After withdrawal of the auger and removal of spoil, it is necessary that the top of the pile be cleared of debris and any soil contamination be removed. The use of a small form is recommended to provide definition of the top of the pile prior to placement of the reinforcement.

As seen in Figure 2.9, the top of the pile can be difficult to find among the surface disturbance. Attention to detail in the final preparation of the surface is critical to ensure that structural integrity is maintained. Figure 2.10 shows a sequence of the final preparation of the pile surface and placement of the reinforcement. A dipping tool is typically used to remove any soil contamination near the top of the pile (top two photos of Figure 2.10) before placing reinforcement into the fluid grout (bottom two photos).



**Figure 2.9: Grout at Surface after Auger Withdrawal**



**Figure 2.10: Finishing Pile and Reinforcement Placement**

#### 2.2.2.4 Grout vs. Concrete

In the current U.S. practice, the majority of work is completed using a sand/cement grout mixture. In European practice, concrete is used almost exclusively. In the United States, contractors are starting to use concrete more frequently. Successful projects have been completed using both materials. Some of the advantages of each material are discussed below. Details of these materials are provided in Chapter 4.

Grout has been used since the early days of CFA pile construction in the United States because of the fluidity and ease of installation of reinforcement. The typical range of compressive strength of grout in transportation projects is 28 to 35 MPa (4,000 to 5,000 pounds per square inch [psi]). Grouts used with CFA piles are usually rich in cement, having 8 to 11 sacks per 0.76 cubic meter (1 cubic yard). Aggregate is generally limited to sand with the gradation of concrete sand. A Fluidifier is often used as a pumping aid, to act as a retardant, and to help control shrinkage because the mix is so rich in cement. Fly ash and slag are often substituted for a portion of the cement. Typical percentages for fly ash and slag are around 12% to 15%, for a combined replacement of cement of 24% to 30%. When only fly ash is used to partly replace the cement, its content can range commonly between 25 and 70 lbs per cubic yard (pcy) of concrete, with 40 lbs per cubic yard being a typical quantity.

The partial replacement of cement with fly ash and slag tends to produce mixes with higher workability and pumpability, reduced bleeding, and reduced shrinkage. Fly ash and/or slag tend to slightly retard the early strength gain of the grout mix relative to an equivalent mix using only Portland cement, although long-term strength (e.g., 56 days) may be comparable. If fly ash and/or slag are used in the mix, the submittal of the grout mix design should include information on strength development vs. time.

Grout is so fluid that the workability is typically measured using a flow cone (as described in Chapter 7) in lieu of the slump measurement that is typical for concrete mixes. With the use of grout aids (which provide some retarding effect) and the relatively rapid construction of these piles (casting is normally completed in a matter of minutes), the loss of workability during the placement operations is not normally a significant consideration and retarding admixtures are not commonly used. However, the mix must remain fluid during rebar placement.

Workability during time after placement of the grout is important in CFA pile construction because of the need to place reinforcement within the pile soon after completion. It is considered good practice to start drilling only after the concrete or grout has arrived on the project site and delivery of the full volume needed for completion of the pile without interruption is assured. The characteristics of the soil at the site play a significant role in the workability of the grout during rebar placement. Rebar may be easy to install for up to 30 minutes after grout casting for piles in saturated clays; on the other hand, dry sandy soils may tend to dewater the grout very quickly. If sandy soils are producing rapid dewatering of the grout, conventional measurements of concrete setting time alone may not provide a reliable indication of the ability to place the reinforcing cage. Retarding admixtures or anti-washout agents [such as viscosity-modifying admixtures (VMA)] may be needed for piles with long rebar cages constructed in sandy soils. The use of test pile installations, together with a willingness to adjust the mix characteristics based on observations, are important components of achieving constructability.

The concrete used by most European and some U.S. contractors generally uses a pea-gravel size aggregate with around 42% sand used in the mix. Concrete is cited as being less costly than grout, less prone to overrun volume, and is considered to be more stable in the hole when constructing piles through soft ground. Concrete slump for CFA construction is similar to that of wet-hole drilled shaft construction, with target slump values in the 200 mm  $\pm$  25 mm (8 in.  $\pm$  1 in.) range. Considerations for rebar placement are similar to those for sand/cement grout cited above.

### 2.2.2.5 Reinforcement (Rebar)

Reinforcement is placed into the fluid grout/concrete immediately after the auger is removed. In general, reinforcement lengths between 10 and 15 m (33 and 50 ft) are considered feasible, depending on soil conditions. However, longer reinforcement has been used. Contractors often install a single, full-length bar (i.e., it extends the entire depth of the pile) into the center of the pile (Figure 2.11) and a cage of partial-length bars around the perimeter of the pile. The full-length bar provides continuity and acts as a guide for the cage. A full-length bar is also used for tension resistance. In this case, a wire “football” is installed on the end of the bar to anchor the bar in the grout. A minimum cover of 75 mm (3 in.) is commonly adopted for most applications. Difficulties in placing the cage can arise if the concrete starts to set and loses workability. Soil conditions can also have an effect on the reinforcement placement, as a free draining sand or dry soil can tend to dewater the concrete rapidly and lead to increased difficulty in placing the cage.



**Figure 2.11: Placement of a Single Full-Length Bar**

A common practice in Europe is to utilize a small vibratory drive head to install the cage. The photo in Figure 2.12 is from a project in Munich, in which 1-m (3-ft) diameter piles were used to construct a wall through gravelly sand, and 18-m (60-ft) long cages were installed along the entire length of the pile to provide flexural strength. These cages were machine-welded using weldable reinforcement and the piles were constructed using concrete. The use of a vibratory drive head could lead to problems with cages that are not securely tied or welded, and could also produce segregation and bleeding if the concrete mix is not well proportioned. The system appeared to work very well on this project, as the concrete in the exposed piles appeared to be sound and free of segregation or voids.



**Figure 2.12: Vibratory Drive Head Used to Install Rebar Cage**

It is worth noting the differences in grout placement for a CFA pile in contrast with that of a drilled shaft foundation. Concrete used for a drilled shaft is placed through a tremie pipe into a fluid-filled hole or via a drop chute into a dry open hole. In each case, the inspector and

contractor have some means of observing the location of the concrete relative to the surface and/or tremie. Additionally, the reinforcement cage is pre-positioned and held in place, often with some access tubes for subsequent non-destructive testing to verify structural integrity. The concrete must maintain workability to pass through the cage and fill the hole. The placement of grout in CFA piles can only be monitored remotely and indirectly by measurement of the volume delivered through the auger at any given time and the pressure at which it was pumped. The grout must maintain workability so that the cage can pass through the grout. Quality control issues are present with both systems and difficulties can arise with either system. The CFA pile system is particularly dependent upon operator control during grout placement and auger withdrawal.

### **2.3 SUMMARY**

This chapter provides a general overview of CFA piles, including the general construction sequence used and potential limitations and/or difficulties using the technique. CFA piles have some significant advantages in terms of speed and cost effectiveness if used in favorable circumstances, and can clearly pose difficulties in terms of quality control if careful construction practices are not followed. The following chapter will describe potential applications of this technology in transportation related projects and will outline favorable and unfavorable project and geotechnical conditions for CFA piles.

## **CHAPTER 3    APPLICATIONS FOR TRANSPORTATION PROJECTS**

### **3.1 INTRODUCTION**

This chapter presents several advantages and limitations of using CFA piles, and provides information on project and geotechnical conditions that may be favorable or problematic for this type of pile. This chapter also illustrates applications of CFA piles on transportation projects, including bridge piers and abutments, soundwalls, earth retaining structures, and pile-supported embankments. At the end of this chapter, several examples of typical costs for CFA piles in U.S. construction are provided, which can be beneficial when considering CFA as an alternative foundation to more traditional methods.

### **3.2 ADVANTAGES        AND LIMITATIONS OF CFA PILES**

#### **3.2.1 Background**

CFA piles have been more widely used in private, commercial work in the United States and abroad than in transportation work. Several factors appear to contribute to this trend; some factors are inherently associated with CFA pile technology and some are institutional perceptions. The factors that might have contributed to a wider acceptance of CFA piles in commercial applications than in transportation projects are:

- Simple foundation requirements: a large number of piles are commonly used in a compact area (Figure 3.1) primarily to support large concentrated dead loads.
- Speed of installation of CFA piles over other pile types.
- Increased use of design-build contracting in private work, in which contractors are highly motivated toward speed, economy, and innovations to those means.
- Increased requirements to minimize noise and vibrations from pile installation in heavily populated areas.
- A reluctance by many owners to utilize CFA piles because of concerns about quality control and structural integrity.
- The typical demand on bridges for uplift and lateral load capacity, scour considerations, and/or seismic considerations, require pile diameters and possibly lengths up to a range not commonly used with CFA piles in private commercial work in U.S. markets.

The following sections describe advantages and limitations of CFA piles and present geotechnical and project conditions that affect the selection and use of these piles.



**Figure 3.1: Use of CFA Piles for Commercial Building Projects**

### **3.2.2 Geotechnical Conditions Affecting the Selection and Use of CFA Piles**

#### **3.2.2.1 Favorable Geotechnical Conditions**

CFA piles generally work well in the following types of soil conditions:

- *Medium to very stiff clay soils.* In these soils, the side-shear resistance can provide the needed capacity within a depth of approximately 25 m (80 ft) below the ground surface. The major advantage of cohesive soils for CFA pile construction is that clays are generally stable during drilling and less subject to concerns about soil mining during drilling.
- *Cemented sands or weak limestone.* These soils are favorable if the materials do not contain layers that are too strong to be drilled using continuous flight augers. In cemented materials, it is not so critical that the cuttings on the auger maintain stability of the hole. In addition, CFA piles can often produce excellent side-shear resistance in cemented materials because of the high side resistance created by the rough sidewall and good bond achieved using cast-in-place grout or concrete.
- *Residual soils.* Residual soils, particularly silty or clayey soils that have a small amount of cohesion, are favorable for CFA pile installation because installation can be particularly fast and economical.

- *Medium dense to dense silty sands and well-graded sands.* These sands, even when containing some gravel, are commonly favorable. This is especially true if the groundwater table is deeper than the pile length.
- *Rock overlain by stiff or cemented deposits.* CFA piles can achieve significant end-bearing capacity on rock, provided that the overlying soil deposits are sufficiently competent to allow installation to the rock without excessive flighting. Flighting is the lifting of soil on the auger as the auger turns, in the manner of an Archimedes pump. Rock that is directly overlain by strong material or a transitional zone is well suited.

### 3.2.2.2 Unfavorable Geotechnical Conditions

The installation of CFA piles can be problematic in the following types of soil conditions:

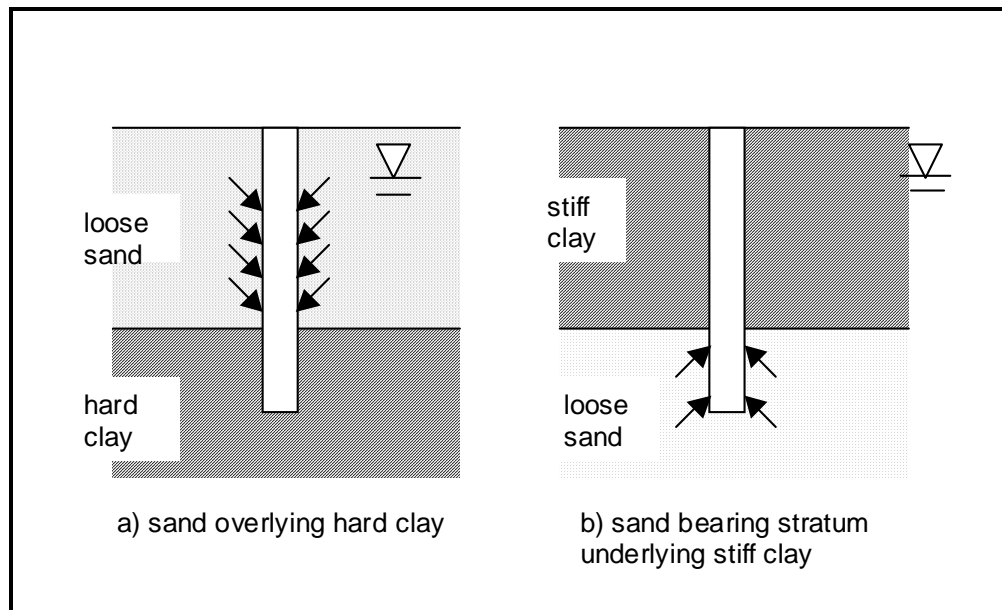
- *Very soft soils.* In these soils, the installation of CFA piles can present problems concerning ground stability due to soft-ground conditions, which can produce necks or structural defects in the pile. Even with oversupply of concrete or grout (which is a costly measure and the piles become less economical), the result is a bulge in the very soft zones that can cause an increase in downdrag loads. Under these conditions, it is difficult to reliably control the volume per unit length of the pile during withdrawal of the auger.
- *Loose sands or very clean uniformly graded sands under groundwater.* Clean, loose sands with shallow groundwater are unfavorable because the potential for soil mining is high. Therefore, under these conditions, the control of the penetration rate during drilling and grout placement is extremely critical. For these soil conditions, DD piles are likely to be more reliable because this type of pile tends to densify the surrounding loose soil.
- *Geologic formations containing voids, pockets of water, lenses of very soft soils, and/or flowing water.* These subsurface conditions may cause the hole to collapse, initiate problems during drilling and grouting, and make the penetration and grouting rates hard to control. For example, solution cavities in limestone are a common source of such difficulties.
- *Hard soil or rock overlain by soft soil or loose, granular soil.* The installation of CFA piles is typically difficult in a soil profile in which it is necessary to drill into a hard bearing stratum overlain by soft soil or loose granular soil (Figure 3.2a). The problem occurs when the hard stratum is encountered and the rate of penetration is slowed because of the difficult drilling; the overburden soils are then flighted by side loading of the auger above the hard stratum. Decompression of the ground above the hard stratum and ground subsidence can result in the case of a stiff clay layer underlying a water-bearing sand deposit, even if the stiff clay can be drilled without great difficulty. The rate of penetration required for the stiff clay is lower than that for the sand, and the sand will tend to flight during drilling of the clay.



In addition, a hard rock layer overlain by soft material presents a quality assurance concern in that there is difficulty ensuring that the pile has sound bearing on the rock formation. Piles are typically driven to a resistance that ensures sound bearing, and drilled shafts are typically socketed a short depth into the rock.

The potential for difficult drilling conditions also exists when a sand stratum is sandwiched between an upper and a deeper clay deposit; in this case, the sand also tends to be flighted and a cone of sand tends to collapse and displace toward the hole. This cone of depression in the sand deposit is caused by over-removal of the sand, which may not be visible at the surface, but could result in: (1) a void beneath the upper clay; (2) loosening of the sand; and (3) over consumption of concrete or grout.

In comparison, these soil conditions are more favorable for the use of driven piles or drilled shafts, for which cases drilling through sands can be controlled using casing or slurry.



**Figure 3.2: Examples of Difficult Conditions for Augered Piles**

- *Sand-bearing stratum underlying stiff clay.* When the bearing stratum is composed of clean, dense, water-bearing sand and is overlain by a stiff clay deposit, pile installation may be difficult (Figure 3.2b). In this case, the slower rate of penetration (relative to the rate of turning of the auger) used in the clay can cause loosening of the sand stratum below when this stratum is encountered, and this results in excessive flighting of the sand from the stratum intended as the primary bearing formation. Excessive flighting occurs when the auger is rotated too much in proportion to the penetration into the soil, such that too much soil is flighted towards the surface and the auger flights do not maintain adequate soil to provide lateral support for the hole. The water pressure in a confined

aquifer may contribute to this problem. The result is that the pile does not support the load at the tip in the deeper sand as intended, but almost solely relies on side-shear resistance in the clay. Under these conditions, it is better that the pile either terminate in the clay (assuming an appropriate design capacity is achieved) or the pile be drilled into the sand.

- *Highly variable ground conditions.* When highly variable ground conditions exist, in which one of the cases noted above may be encountered at some locations across the site, it is more difficult to provide a relatively uniform drilling criteria for the site. Having varying drilling criteria across the site can lead to problems with quality control and quality assurance, particularly if the wrong criteria are applied to individual piles. Highly variable ground conditions also create additional problems with respect to reliability of capacity predictions.
- *Conditions requiring penetration of very hard strata.* When a stratum is very hard to penetrate (e.g., rock), drilling of CFA piles would be very difficult. This condition requires a modification to the CFA pile design so that penetration in the rock is avoided or the use of drilled shafts socketed into the material or driven piles driven to refusal on the material are employed. CFA piles designed to bear on hard rock that cannot be penetrated with an auger must be designed for a smaller bearing value than the rock may be capable of sustaining in other conditions because of the difficulty in achieving sound contact at the pile/rock bearing surface.
- *Ground conditions requiring uncommonly long piles.* CFA piles longer than 30 m (100 ft) require unusual equipment for this technique; however, there have been isolated circumstances in which CFA piles longer than 30 m (100 ft) have been used. CFA piles of such length are uncommon, and may require equipment with unusually high torque, high lifting capacity, and tall leads
- *Ground conditions with deep scour or liquefiable sand layers.* In these circumstances, where a total or near-total loss of lateral support may occur at significant depths, the piles may be subject to high bending stresses at great depths. CFA piles are most efficient in relatively smaller diameters, and placement of a rebar cage to great depths can be difficult. CFA piles also are not typically designed with reinforcement to achieve high bending resistance. If ground conditions exist where deep loss of support may occur, this condition tends to favor the use of larger diameter drilled shafts or large driven piles. CFA piles may require structural steel inserts, such as steel pipe or H sections, to achieve adequate bending resistance through a zone where loss of support may occur.

Design applications requiring significant shear, bending, or uplift resistance may not be suitable for CFA piles, regardless the type of soil conditions at the site. The limitations associated with reinforcement installation typically restrict the use of CFA piles in these applications. In some cases, groups of CFA piles can provide adequate shear, bending, or uplift resistance; however, another deep foundation system may be more economical.

### 3.2.3 Project Conditions Affecting the Selection and Use of CFA Piles

CFA piles may be a viable alternative for projects with the following conditions:

- *Projects where speed of installation is important.* CFA piles can be installed very quickly, provided the rig has a good working platform on which to move around the site and the geotechnical conditions are otherwise favorable (Figure 3.3). For projects requiring a large number of piles and on projects where high production rates are important, CFA piles can have advantages over drilled shafts or some types of driven piles. Typical production rates on private projects for piles having diameters of 300 to 450 mm (12 to 18 in.) and lengths of less than 20 m (65 ft) are about 300 to 450 m (1,000 to 1,500 ft) per day. These rates are achievable on private projects, such as large buildings, where most of the piles on the project are relatively close together, reducing the amount of movement of the rig between piles. Lower production rates, such as 60 to 150 m (200 to 500 ft) per day, should be expected for transportation projects where pile groups supporting bridge bents are spread across a large project area, or a significant number of battered piles are installed.
- *Batter Piles Required.* Although not commonly a viable alternative, it is also possible to install CFA piles on a batter, but the speed of installation decreases and these piles are more difficult to construct in other ways. For example, the drill rig capability is diminished when working on a batter and the reinforcing cage is more difficult to install with proper cover. Pile batter should generally be limited to 1 (horizontal):4 (vertical) or steeper for bearing piles. Greater batter angles ranging to even horizontal can be used to install anchor piles in competent, non-caving soil, but these are typically not designed to support large axial compression loads.
- *Projects where large numbers of piles are required.* The costs for CFA piles reflect the high productivity for projects where large numbers of piles are required. Prices for CFA piles are often a few dollars per foot less than prestressed concrete or steel piles of similar size and axial capacity, assuming both pile types meet the project performance criteria.



**Figure 3.3: CFA Piles at Bridge Interchange**

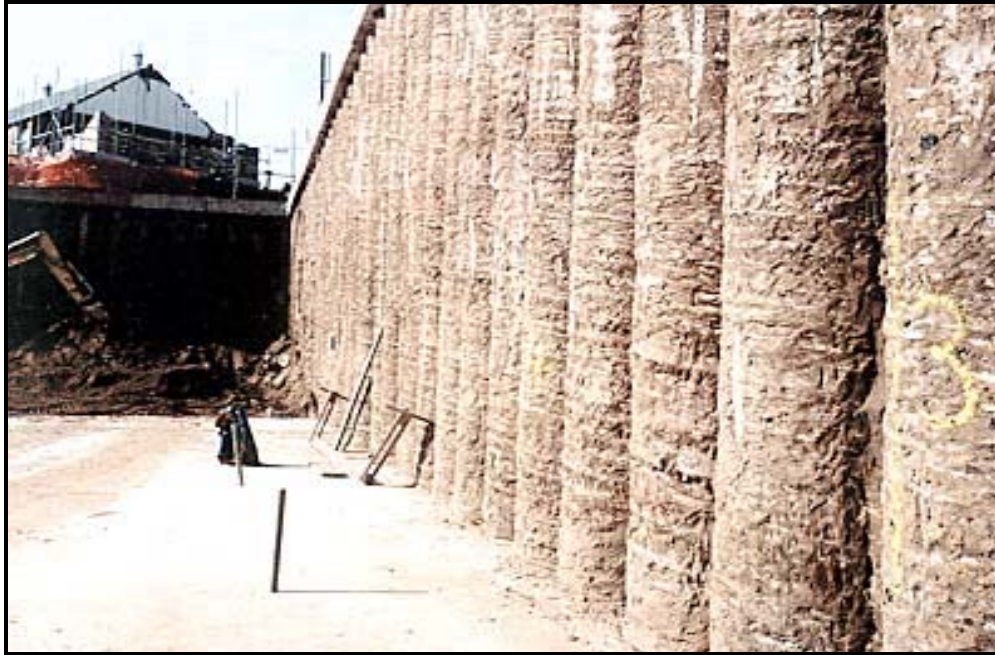
- *Low headroom conditions.* Low headroom equipment can be used effectively with CFA piles and is often more cost effective than high strength micropiles if the ground conditions are favorable for CFA pile installation (Figure 3.4). Note that continuous placement of grout is not possible when the auger string must be broken during withdrawal. Therefore, this technique should only be used in favorable ground conditions and with close control to maintain grout pressure and volume during extraction.



**Figure 3.4: Low Headroom CFA Pile Application**

- *Secant or tangent pile walls up to 10 m (33 ft) of exposed wall height.* When CFA piles of less than 1.2 m (4 ft) in diameter can be used for a retaining wall, and when geotechnical conditions are otherwise favorable, CFA piles can be a viable alternative to drilled shafts or slurry walls (Figure 3.5). For this application, it is important to utilize heavy drilling equipment, which can maintain good vertical alignment. A structural steel section may be used for pile reinforcement rather than a reinforcing cage. The CFA drilling technique has been used successfully on many such projects with both anchored earth retention and cantilever walls. Higher walls are possible with the use of tiebacks.
- *Soundwalls in favorable soil conditions.* Because soundwalls tend to have large numbers of relatively short piles, CFA piles can be quite fast and economical. Figure 3.6 illustrates an example of a long row of CFA piles for a soundwall along a highway.
- *Pile-supported embankments.* Although this type of construction commonly takes place in relatively soft soils, the loading demands on a per pile basis are not particularly very large. The speed and economy of CFA piles especially DD piles, make them a potentially effective alternative to ground modification (Figure 3.7). CFA piles have been utilized for embankment support to limit excessive settlement from soft or

compressible foundation soils. This is a special application of CFA piles that requires consideration of edge stability, design of the individual pile caps (if any) and reinforced embankment overlying the piles, as well as the magnitude and time rate of settlement. The reader is referred to Collin (2004) and Han and Akins (2004) for further details.



**Figure 3.5: Secant Pile Wall with CFA Pile Construction**



**Figure 3.6: CFA Piles for Soundwall (at right) along Highway (out of view to left)**

### 3.3 ADVANTAGES AND LIMITATIONS OF DRILLED DISPLACEMENT PILES

Drilled displacement (DD) piles have many of the same features, advantages, and limitations as CFA piles. Some of the factors that may differ for DD piles compared to CFA piles are outlined below.

- *Better performance in loose sandy soils.* DD piles increase the horizontal stress in the ground and densify sandy soils around the pile during installation (Figure 3.8).



**Figure 3.7: Pilecaps on CFA Piles for a Pile-Supported Embankment**

Therefore, this technique achieves some ground improvement around the pile. This improvement leads to higher values of side-shear resistance in granular soils, especially in loose to medium dense sands. DD piles are less subject to the problems of soil flighting, described previously for CFA piles. Hence, mixed soil profiles having loose granular soils interbedded with clays are less of a concern. In general, DD piles will achieve a given load carrying capacity at a shorter length than for a CFA pile of similar diameter.

- *Little or no spoil removed from site.* In areas where contaminated ground exists or it is desirable to limit the spoil removed from the site, DD piles are more advantageous than CFA piles or drilled shafts because little or no spoil is generated.
- *Difficult to penetrate dense or hard soils and more limited depth range.* Because of the much greater torque required for DD piles relative to CFA piles, it may be impossible or impractical to penetrate deeply into soils with strong resistance. In general, DD piles are not installed as deep as CFA piles and lengths greater than about 20 to 25 m (65 to 80 ft) are not very common. DD piles are not used in rock (a condition favoring drilled shafts), or even weak rock or hard cemented soils (where CFA piles may be used).

- *Effect of displacement.* In confined areas or areas in close proximity to utilities or sensitive structures, the use of DD piles can pose potential problems for affecting these structures. Closely spaced DD piles can also cause large pore pressures in loose fine grained soils. Partial displacement piles may work better in this application.



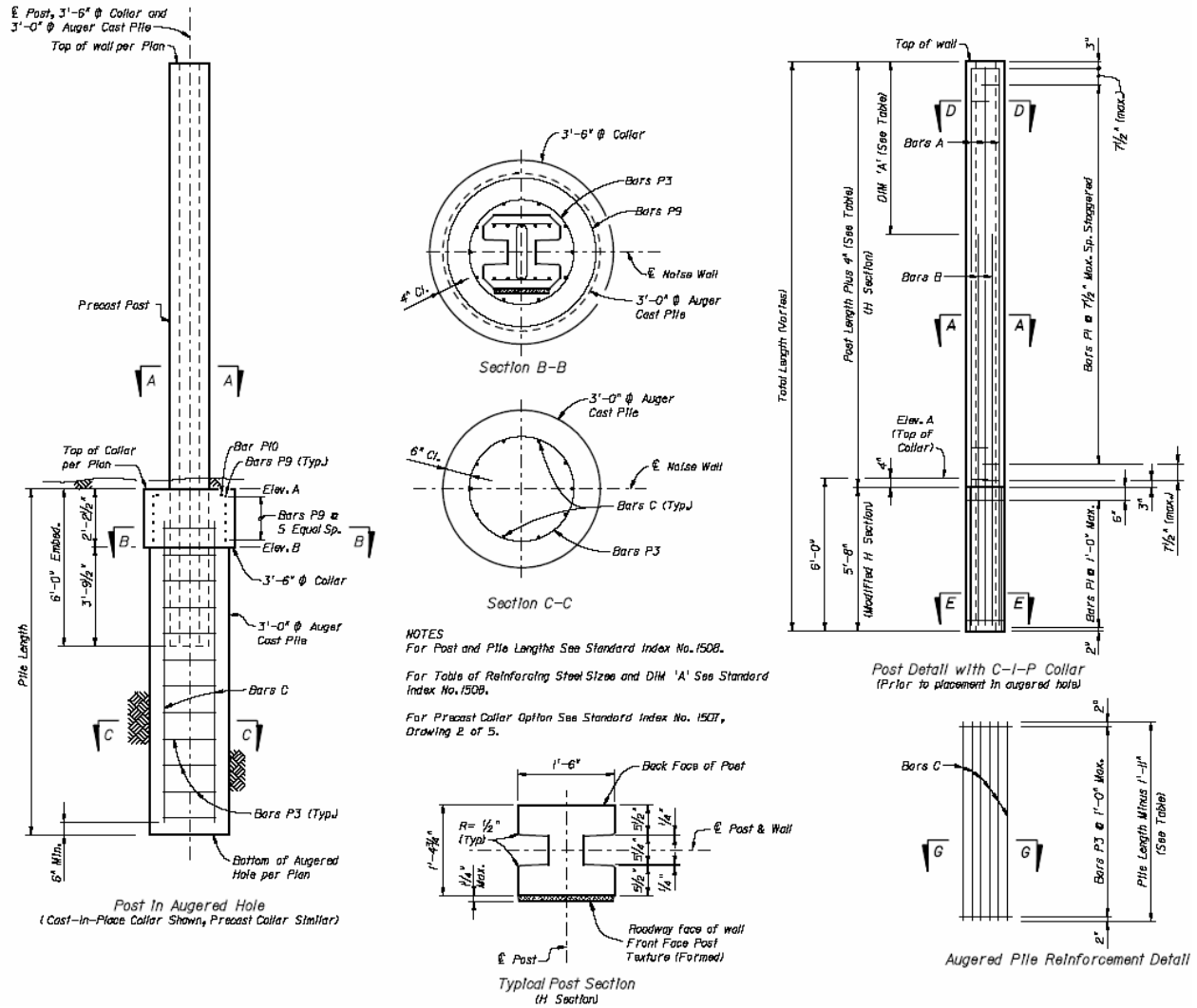
**Figure 3.8: Drilled Displacement Piles Limit Spoil Removal**

### **3.4 APPLICATIONS**

In this section, several typical applications of CFA piles for transportation projects are described.

#### **3.4.1 Soundwalls**

The use of CFA pile foundations for soundwalls represents an easy-to-implement application. Soundwall foundations are commonly characterized by single piles at each column location and by the use of reinforcement or anchor bolts designed to make a moment connection to the column. Figure 3.9 provides an illustration of the standard design detail used by the Florida Department of Transportation (FDOT). These piles are relatively lightly loaded, with the foundation design controlled by overturning from wind loads. A typical foundation has a diameter of 450 to 900 mm (18 to 36 in.) and a depth of 4 to 8 m (13 to 26 ft). CFA piles are an alternative to drilled shafts for these foundations.



**Figure 3.9: CFA Pile Foundation for Soundwall**

### 3.4.2 Bridge Piers and Abutments

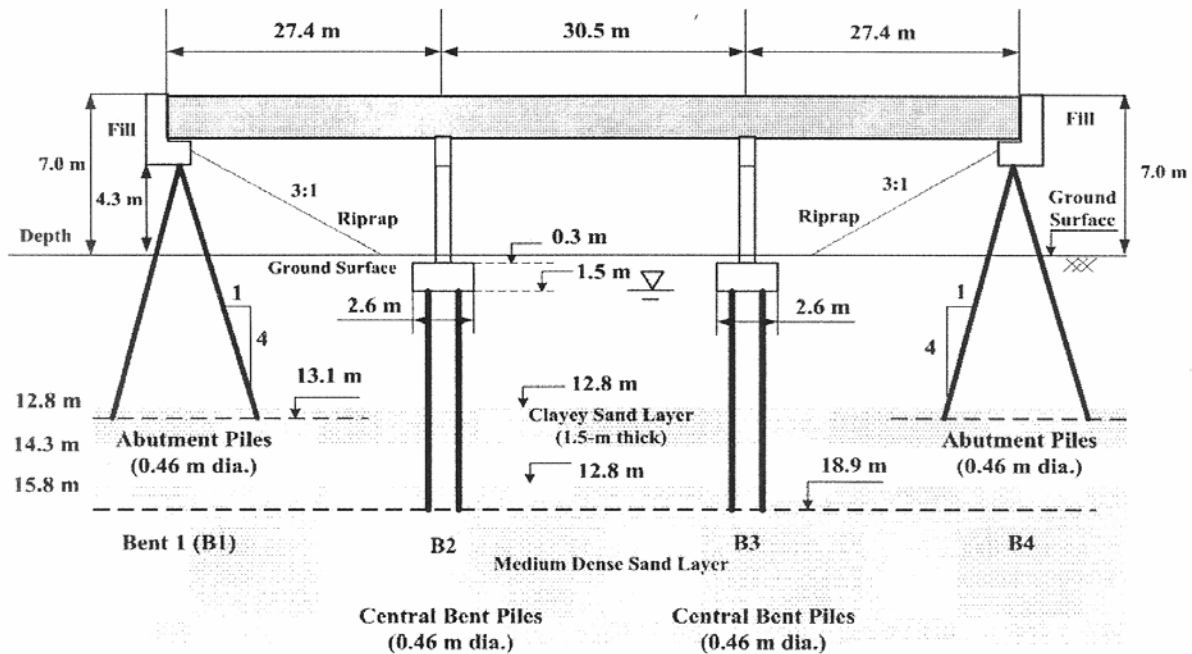
Where conditions are favorable, the use of CFA pile foundations is a feasible alternative to other types of deep foundations for bridges. Most often, the type of bridge most suited for the use of CFA foundations are interchange structures (where scour is not a major issue), approach structures, or those involving bridge widening. CFA piles may be favored in areas where pile driving vibrations or noise requirements cannot be met or simply for situations where cost or speed advantages can be achieved.

As of this writing, there have been relatively few cases of bridge structures supported on CFA pile foundations in the United States. An example is provided by Vipulanandan et al. (2004) for a bridge at the Krenek Road site in Crosby, Texas, constructed in the Pleistocene soils of the Gulf coast region. The Texas Department of Transportation (TXDOT) constructed this bridge



entirely using CFA piles as an implementation project to provide a comparison of the CFA alternative to driven piles. The project included load tests up to failure on instrumented piles as well as instrumentation on production piles to monitor pile performance in service. The CFA bridge project is located a short distance [about 1 km (0.6 mile)] from the Runneburg Road Bridge site, where a bridge was constructed using driven piles in very similar soil conditions. An examination of the two projects provides a comparison of CFA and driven pile alternates on two very similar projects.

The Krenek Road site for the CFA pile-supported bridge was underlain predominantly by stiff clays with two thin layers of sand and the groundwater table located about 1.5 m (5 ft) below the ground surface. The bridge was founded on 64 CFA piles, 17 to 19 m (56 to 62 ft) long and 450 mm (18 in.) in diameter. A schematic diagram is presented in Figure 3.10. The abutment piles were installed on a batter of 1:4. Intermediate bent columns were founded on 4-pile groups of vertical piles. The piles were designed to terminate in a dense sand stratum (Figure 3.11). Side-shear and end-bearing resistance provide a design axial capacity of 810 kN (90 tons). There was no significant design uplift or lateral load requirements for these piles.



Vipulanandan et al. (2004)

**Figure 3.10: Schematic Diagram of the Foundation on CFA Piles for the Krenek Road Bridge**

The foundation for the Runneburg Road Bridge was almost identical to the Krenek Road Bridge, except that the Runneburg Road Bridge was founded on 400 mm (16 in.) square prestressed concrete piles driven to a depth of 14 m (46 ft). The piles of the Runneburg Road Bridge were terminated entirely within the stiff clay formation and designed to support the design axial load of 810 kN (90 tons) primarily using side friction.



Source: University of Houston

**Figure 3.11: CFA Piles at the Krenek Road Bridge Site**

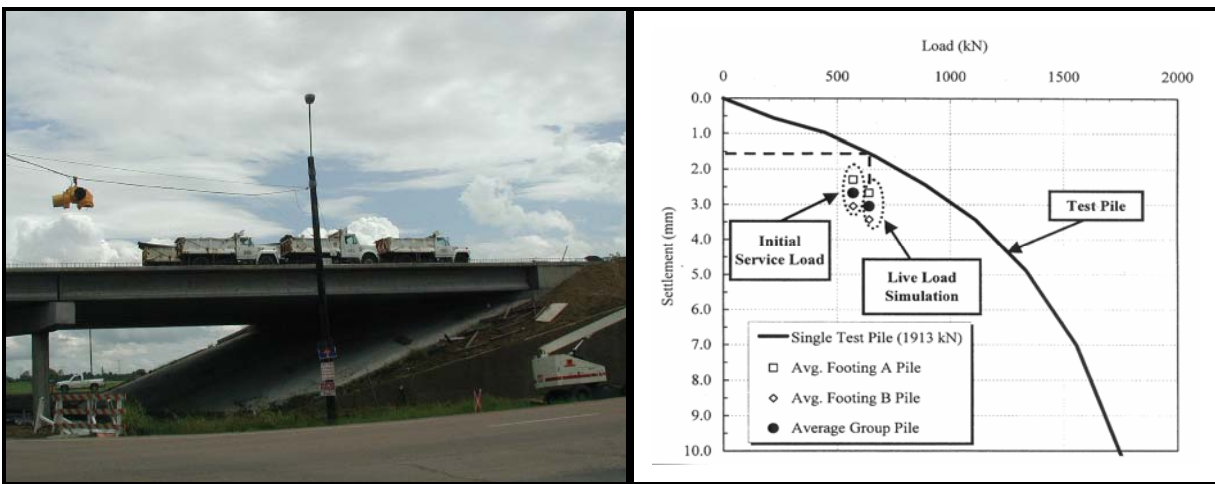
Each vertical CFA pile of the Krenek Road Bridge was installed relatively fast, within about 15 minutes. For this project, the time needed to move the rig was a significant factor to the schedule, especially for the driven piles, which experienced equipment delays during installation of the central bent piles. The cycle time for the battered abutment piles was about 45 minutes for each type. For the driven piles, about one third of this time was due to the required pre-boring.

Vipulanandan et al. (2004) noted some construction issues for the installation of CFA piles. In several cases, the contractor had difficulty installing the full-length cages due to excessive grout viscosity and/or lack of timely work to install the cages immediately after completion of the grouting. On numerous occasions, the contractor was observed slowly turning the auger with the auger in the borehole and without either excavating or pumping grout. This operation was performed because grout was not available in a timely fashion and the operator could not stop rotation and risked seizing the auger in the ground. This practice increased soil mining, particularly in the sand strata.

Load tests were conducted on test piles at both sites, and the CFA piles were instrumented to determine the distribution of side-shear and end-bearing resistance. Although the designers had anticipated higher side-shear strength values for the driven piles, the CFA piles actually mobilized higher side friction than the driven prestressed piles. Note that this conclusion is

based on an estimated distribution of side-shear and end-bearing in the driven piles, because the driven piles were not fully instrumented. The base resistance for CFA piles was virtually zero, probably reflecting the effect of decompression of the dense sand-bearing stratum during installation of the pile through the stiff clay. The CFA piles actually provided the needed axial capacity, but through higher than anticipated side-shear resistance and much lower than anticipated end-bearing resistance.

Twelve production piles were instrumented and monitored during construction and load testing using trucks. The results from the pile instrumentation suggest that the piles supported the fully loaded bridge entirely by mobilizing side friction alone and with very small [around 3 mm (0.1 in.)] movements (Figure 3.12). A lesson learned from this project is that CFA piles would have been better designed to terminate in the clay rather than attempting to mobilize end-bearing in a water-bearing sand stratum below the stiff clay.



Vipulanandan et al., (2004)

**Figure 3.12: Comparison of Measured Settlements and Test Pile, Krenek Road Bridge Site**

The unit cost of CFA piles was approximately \$65 per linear meter (\$20 per linear foot). The instrumentation and full-length cage, required for the instrumentation, affected the unit cost, which was estimated to be about \$7 higher per linear meter (\$2 per linear foot) than would normally be anticipated for production piles. Cost per pile for CFA piles at the central bent was \$1,140 per pile. The cost for the driven piles at the central bent of the Runneburg Road Bridge was less than the CFA pile cost at the Krenek Road Bridge; however, the load tests indicated that a higher factor of safety was achieved for the CFA piles than for the driven piles and, if the lengths were adjusted to provide a similar factor of safety for axial loading, the unit cost of the CFA piles would have been about 8% less.

The comparison study between these two bridges suggests that CFA piles can provide a viable alternative to conventional driven pile foundations. As a result of these experiences, TXDOT plans to utilize CFA piles on other future bridge projects where conditions appear favorable.

### 3.4.3 Retaining Structures

CFA piles can be used to construct secant or tangent pile walls in a manner very similar to that of drilled shaft walls, which can be designed as cantilever or anchored walls. The most significant distinction relating to CFA piles, as opposed to other types of vertical elements, is the construction method for the vertical element. The CFA piles are intended to provide a reinforced vertical wall member having a similar function as that of a drilled shaft, slurry wall section, or sheet pile. In almost all such cases, the contractor provides designs of CFA piles for retaining structures as a design-build option. Figure 3.13 illustrates a typical CFA secant pile wall.

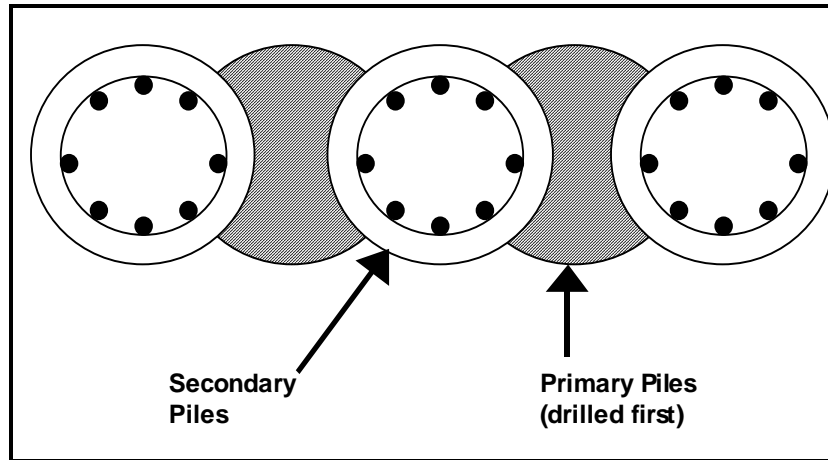


**Figure 3.13: Secant CFA Pile Wall for a Light Rail System in Germany**

The major differences for CFA pile wall systems as compared to other pile types are discussed below.

- Diameters of CFA piles are generally limited to about 1 m (40 in.).
- Maximum depths for CFA piles are generally no more than 10 to 18 m (33 to 60 ft) with wall heights generally around 12 m (40 ft) or less. This limitation is not only related to machine capability, but also due to the fact that the reinforcement must be placed into the fluid concrete and verticality of the piles can be difficult to maintain for long piles.
- Control of verticality is critical to keep the piles aligned, especially if a watertight structure is needed; some of the hydraulic rigs equipped with inclinometers are well-suited for this construction.
- For secant pile systems, the sequencing of pile installation and set time and initial strength characteristics of the concrete is critical so that the excavation equipment can cut into previously drilled piles. Some contractors install primary piles using a weaker concrete mix and utilize a stronger mix for the secondary piles, which provide the main structural strength of the wall (see Figures 3.14 and 3.15). Large, high torque-capacity rigs are necessary, especially when cutting into existing concrete piles.

- Placement of reinforcement can be more difficult in a CFA pile than in a conventional drilled shaft or slurry wall, in which the reinforcement is placed ahead of the concrete.



**Figure 3.14: Schematic Plan View of a Secant Pile Wall**



**Figure 3.15: Drilling CFA Piles through Guide for Secant Wall**

### 3.4.4 Pile-Supported Embankments

The use of CFA piles for a pile-supported embankment may represent a cost-effective alternative to ground modification or embankment support using driven piles. The use of pile support for embankments is likely to be considered only when the foundation strata consist of weak and compressible subsoils, which would take a long time to consolidate. Furthermore, there is an interest in minimizing post-construction settlements of the embankment or accelerating construction. Examples include, widening of existing embankments (where the additional fill may result in costly or disruptive damage to the existing structure); a fill supporting a

transportation facility that is particularly sensitive to settlements (such as a high-speed rail); or the fill approach to a pile-supported structure (where differential settlements may be a problem). Accelerated construction is required for projects where additional cost due to traffic shifts, geotechnical instrumentation, and related time delays present an unacceptable situation to project owners.

CFA piles offer the advantages of installation speed and economy (cycle times of 15 minutes or less per pile are not uncommon), and costs on the order of \$40 per linear meter (\$12 per linear foot) are feasible on a large volume project using many small diameter [i.e., 300 to 350 mm (12 to 14 in.)] CFA piles.

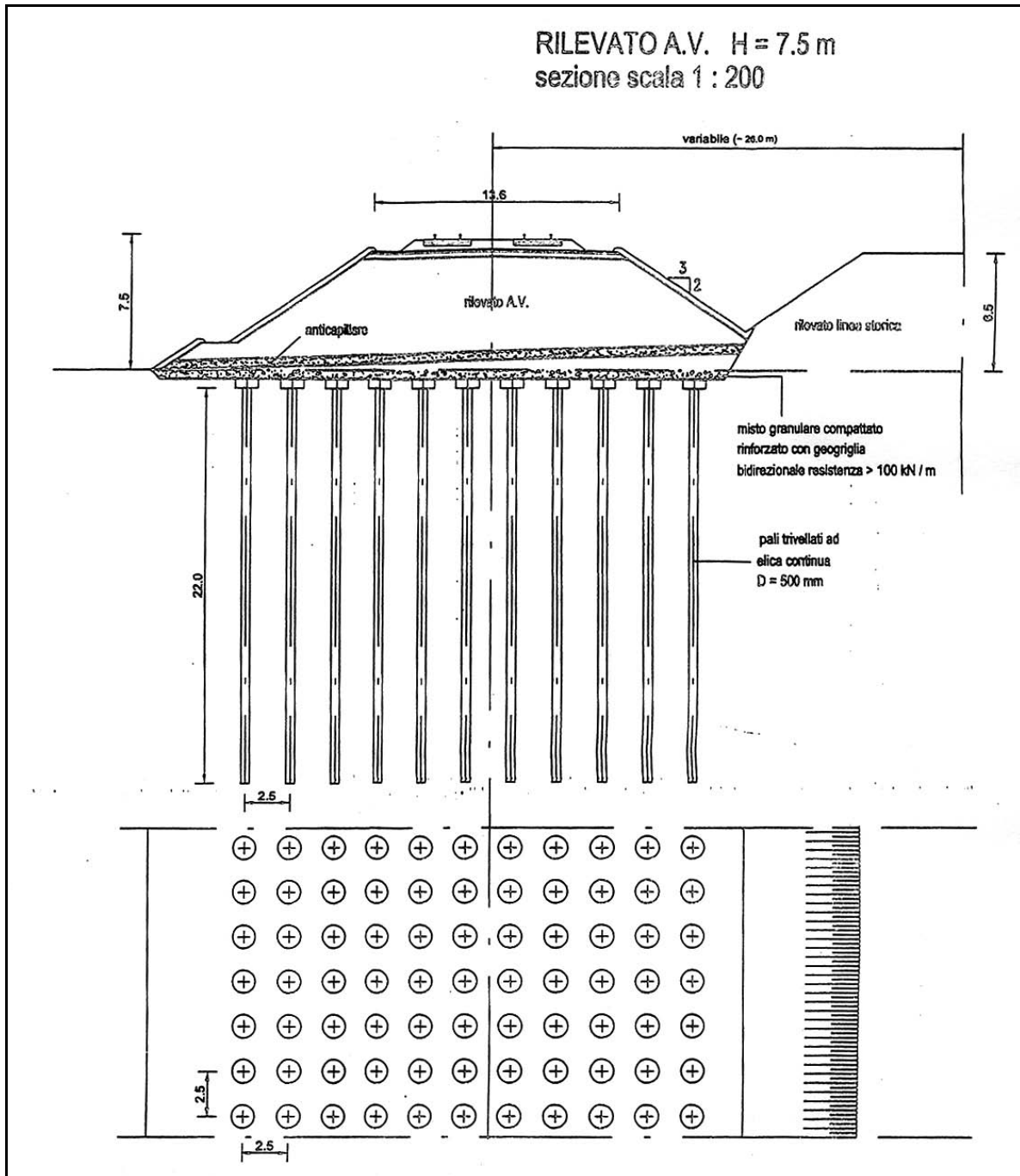
A diagram of a pile-supported embankment for a railway project in Italy is illustrated in Figure 3.16. This embankment was designed as part of a widening project to increase traffic capacity. The pile support was used to limit settlements produced by the new fill on the existing railway structure and the new rail line. The piles were capped using precast cylinder sections filled with concrete (shown previously in Figure 3.7), and the fill overlying the pile caps was reinforced using geotextiles.

### **3.5 CONSTRUCTION COST EVALUATION**

Because the use of CFA piles in U.S. transportation facilities has been very limited, there are few records of cost data for transportation projects. Costs of CFA piles on private projects often range from approximately \$40 to \$60 per linear meter (\$12 to \$20 per linear foot) for 300- to 450-mm (12- to 18- in.) diameter piles. However, these projects typically include much greater quantities of piling and fewer moves across the site than is typical for a bridge or soundwall; prices on transportation projects are likely to be higher. In addition, costs relating to performance and integrity testing are likely to be higher on transportation projects. A major factor on transportation projects is the impact of site constraints on productivity. Many variables affect pile costs, including length, diameter, reinforcement, and grout strength. Costs will also vary according to region of the country, as well as the size of the project.

The aforementioned project in Texas has been followed by another bridge project on State Highway 7 in Houston County, which was awarded in early 2005. This project includes 24 760-mm (30-in.) diameter piles. The bid price was \$200 per linear meter (\$60 per linear foot) for 237 linear meters (778 linear feet) of piling, along with a mobilization cost of \$25,000 and a cost of \$25,000 each for two static load tests.

The Kansas DOT has used CFA piles on only a few projects, including two bridges and a secant pile wall. These projects utilized 400- to 450-mm (16- to 18-in.) diameter piles, with typical costs in the range of \$72 to \$85 per linear meter (\$22 to \$26 per linear foot). Some low headroom work was bid at \$320 per linear meter (\$98 per linear foot). According to Jim Brennan, Kansas State Geotechnical Engineer, the prices are quite sensitive to mobilization costs and the numbers of piles on the project, with fewer piles resulting in higher unit costs.



**Figure 3.16: Diagram of Pile-Supported Embankment for Italian Railway Project**

The Florida DOT has used CFA piles for soundwalls, usually in the 760- to 900-mm (30- to 36-in.) diameter range and for depths typically less than 9 m (30 ft). Bid prices on these projects are typically in the range of \$200 to \$260 per linear meter (\$60 to \$80 per linear foot). Production ranges from 6 to 15 piles per day. Frizzi and Vedula (2004) identify relative costs of CFA piles vs. driven precast concrete piles for a project in south Florida. Details of their cost comparison can be found in their paper.

## **CHAPTER 4 CONSTRUCTION TECHNIQUES AND MATERIALS**

### **4.1 INTRODUCTION**

This chapter provides details of the construction techniques, materials, and recommended practice for the construction of CFA piles for transportation projects. The guide specification included in Chapter 8 of this manual is a performance-based specification that allows the contractor to select the equipment, materials, and techniques to install a pile to provide the foundation capacity required for the job. This chapter is thus written with the performance-based specification in mind. Many types of equipment for installing CFA piles are presented, including some that are proprietary, which have been difficult to fit into the traditional design-bid-build project delivery method. Using a performance-based specification will allow for these systems to be considered more often because the contractor is bidding to provide the pile that meets the performance specifications at the least cost, regardless of pile type.

### **4.2 CONSTRUCTION EQUIPMENT**

This chapter describes various types of drilling equipment used for the construction of CFA piles and DD piles, and provides details of tools, grouting/concrete equipment. Advantages and limitations of various types of drilling rigs are discussed, particularly with respect to torque capabilities.

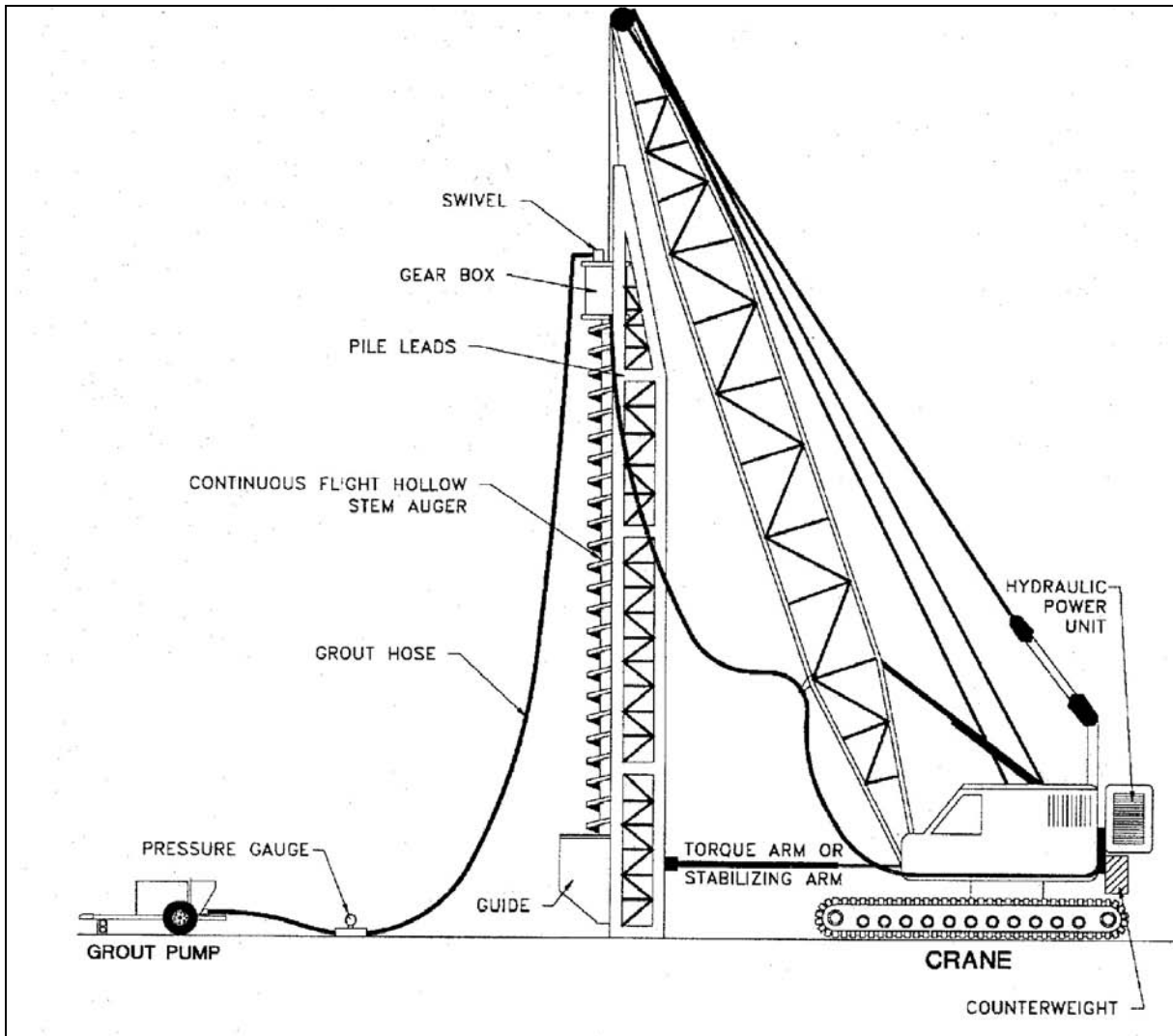
#### **4.2.1 Drilling Rigs**

A typical crane-mounted drill rig for CFA piles is illustrated in Figures 4.1 and 4.2. The continuous-flight hollow-stem auger is driven by a hydraulic gearbox located at the top of the auger. The only downward force (referred to as “crowd” or “downcrowd” among contractors) that can be applied by such a system is via the total weight of the gearbox, augers above ground, and any soil on the auger flights. Typical crowd values are in the range between 13 and 45 kN (3,000 and 10,000 lbs) and typically are around 22 kN (5,000 lbs).

The pile leads, which are similar to those used by driven pile rigs, serve to provide a guide for the auger. The leads may hang freely from the crane boom or be fixed to the crane. The torque arm, or stabilizing arm, holds the leads at a point near the ground surface and absorbs torque from the drilling operation. A hydraulic spotter may be used to install batter piles.

The top of the auger is held into the leads via the attached gearbox. The swivel at the top of the auger provides for freedom of rotation of the auger without disconnecting the grout/concrete line, so that grout placement can begin immediately after completion of the drilling. The auger is hollow to act as a conduit for grout/concrete placement. Grout, rather than concrete, is more common with this type of rig, and is delivered from a piston pump through the grout hose, as shown in Figure 4.1.





Source: Deep Foundations Institute

**Figure 4.1: Typical Crane-Mounted CFA Rig**

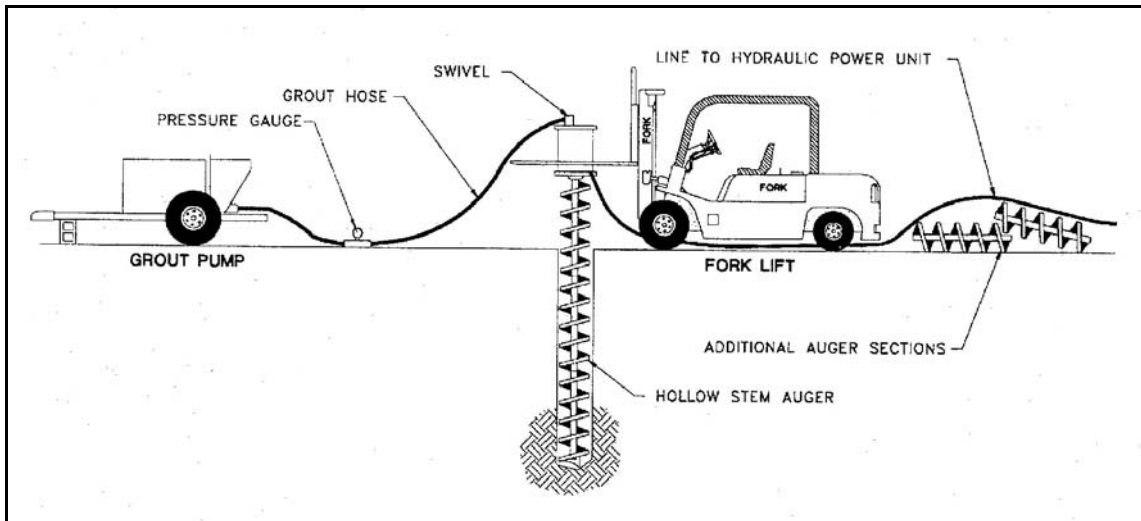
In the current U.S. practice, torque capacities for crane-attached rigs range from 20 to 120 kN-m (15,000 to 90,000 ft-lbs); rigs in the range of 27 to 50 kN-m (20,000 to 36,000 ft-lbs) are most common for private commercial work. Auger diameters of up to 450 mm (18 in.) are most common with these rigs, although diameters of 600 mm (24 in.) are possible with crane-mounted rigs at the higher end of the range of torque.

For CFA piles used on transportation projects, a suggested minimum torque capacity of 40 kN-m (30,000 ft-lbs) should be required. This value may not be sufficient to avoid soil mining for some pile lengths and diameters and soil conditions. Under a performance-based project delivery method, the contractor will have the responsibility of selecting the appropriate rig torque capacity for the project requirements to ensure that piles are installed properly and without soil mining. The minimum torque capacity recommended above may be relaxed for light duty projects, including small soundwall piles or low headroom conditions.



**Figure 4.2: Photo of Crane-Attached CFA System**

A diagram of a special CFA pile rig adapted to function in low headroom conditions is provided in Figure 4.3. These special rigs avoid using a crane mast and utilize segmental auger sections to achieve the low headroom capability (Figure 4.4). The torque capacity and crowd for such rigs are limited to about 28 kN-m (21,000 ft-lbs) and 13 kN (3,000 lb), respectively. Because of these limitations, the low headroom equipment should only be used in the most favorable soil conditions described in Chapter 2, for which minimal risk of soil mining exists.



Source: Deep Foundations Institute

**Figure 4.3: Low Headroom CFA Pile Rig**



**Figure 4.4: Low Headroom Rig with Segmental Augers**

Hydraulic rigs are common in European practice and are readily available in the United States. These rigs typically have torque capacities in the range of 90 to 400 kN-m (66,000 to 300,000 ft-lbs) and can apply a crowd of up to 270 kN (60,000 lb). The rigs shown in Figures 4.5 and 4.6 are typical examples. In European practice with this type of equipment, pile diameters ranging from 450 mm to 1,200 mm (18 to 48 in.) are possible, with a range of 600 to 900 mm (24 to 36 in.) being most common. Lengths are typically less than 28 m (90 ft), although somewhat longer piles can be installed with the Kelly-bar extensions, as shown on the rig in Figure 4.6.



Source: Cementation Foundation Skanska

**Figure 4.5: Hydraulic Rig Drilling on M25 Motorway in England**

The hydraulic pressure used to drive the auger can readily be measured and provides an indication of applied torque or downward force. Thus, these rigs lend themselves readily to computer monitoring and control. Besides the more sophisticated built-in controls, the high torque and downward crowd forces offer advantages over conventional crane attachments in the ability to drill larger piles and control the tendency for soil mining. The fully hydraulic rigs are often used in the United States for installation of DD piles, because of the need for downcrowd and greater torque for installation of DD piles. Compared to crane-mounted rigs, the most significant disadvantages of the hydraulic rigs are the high cost of the equipment and the greater weight of the rig. The heavy rig weight can be a problem on some sites because of the need for a more stable working platform than a crane rig may require. Additional significant disadvantages include slower drilling rates and a lack of “reach”, which requires that the entire rig be moved from pile to pile. These two issues can lead to lower production rates than with a crane rig.



**Figure 4.6: Soilmec Hydraulic CFA Rig with Kelly-Bar Extension**

#### **4.2.2 Augers and Drilling Tools**

A variety of auger types may be used to drill the piles depending on the soil conditions encountered. Figures 4.7 through 4.10 illustrate some of the auger types that may be used for CFA piles. The pitch for CFA piles is, in general, smaller than that for DD piles (Figure 4.7). The augers for drilling in clay soils may tend to have a larger pitch to facilitate removal of the cuttings (Figure 4.8). Selecting the correct auger pitch is important because, for a given soil type, an excessively large pitch could result in mining of the soil around the pile.



**Figure 4.7: Augers for Different Soil Conditions: Auger for CFA Piles in Sandy Soil (Top) and Augers for DD Piles (Bottom)**



**Figure 4.8: Auger for Use in Clay, with Auger Cleaner Attachment**

The base of the auger is usually a double start, with two cutting faces merging into a single flight auger a short distance above the tip. The double start cutting head helps keep vertical alignment better than a single cutting face, but can tend to pack with clay where the two flights merge. The cutting teeth on the base of the auger may utilize hardened points for drilling weak rock (Figures 4.9 and 4.10).



**Figure 4.9: Cutter Heads for Hard Material (left) and Soil (right)**



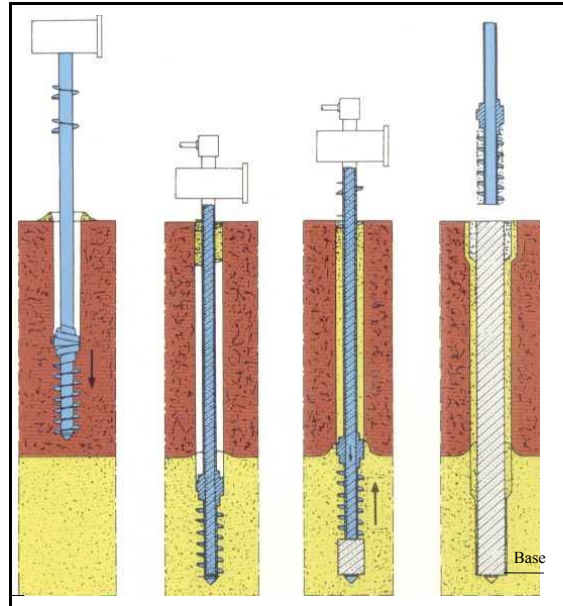
**Figure 4.10: Hardened Cutting Head**

The augers and tools in Figures 4.11 through 4.15 are for use with full or partial displacement piles in which all or a portion of the soil is displaced laterally rather than excavated. These systems have advantages in many circumstances over conventional CFA piles as described in previous chapters.

Virtually all of these displacement-drilling systems are proprietary in some form or another. Some types of DD piles are designed to allow placement of reinforcement inside the tool prior to concreting. Some have a sacrificial shoe that is left in place on the bearing surface and may help provide improved end-bearing capacity and result in less chances of a soft toe condition.

The common characteristics of DD piles include greater requirements for torque and downforce compared to conventional CFA tools that do not displace soil. The depth to which a pile can be installed is limited by the capability of the rig. The greater torque demand due to rig capabilities for DD piles can be more significant for limiting pile depth than for conventional CFA piles. At the same rig capacity, partial displacement systems can generally penetrate more deeply than full displacement systems because there is some opportunity to drill through dense soil layers. The level of soil removal for partial displacement systems can vary widely depending on the rig operator controlling the rate of penetration.

The DeWaal displacement pile, which is installed in the United States by the Morris-Shea Bridge Co. of Alabama, utilizes a short section of screw auger below the soil displacement bulge in the drill pipe (Figure 4.11). This pile type uses a sacrificial shoe, which is usually knocked out with a full-length center bar, and grout, which is placed by gravity through the center of the pipe.

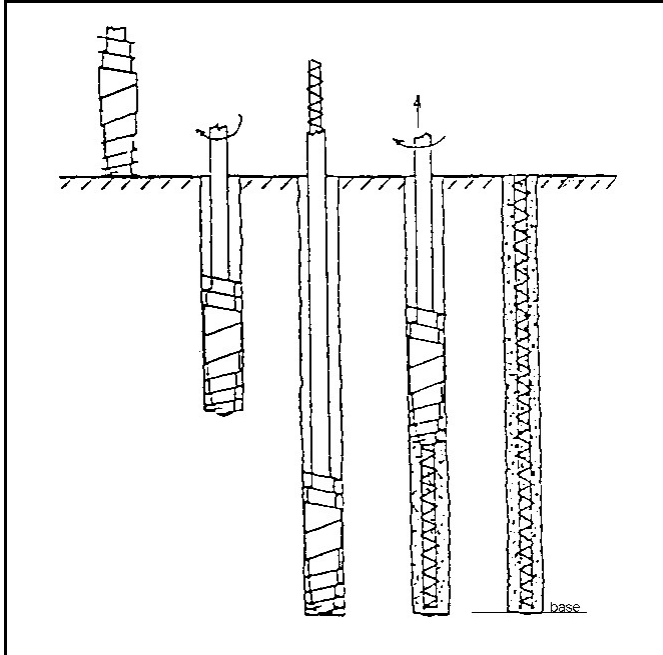


Source: Prof. W. Van Impe of Ghent University, Belgium

**Figure 4.11: DeWaal Drilled Displacement Pile**

Another term used for DD piles is screw piles. The Omega pile, which is an European pile type, is an example of a screw pile. This system uses a short, tapered screw section leading into the displacement bulge (Figure 4.12). A small reinforcement cage is placed through the hollow auger prior to concrete placement. Omega piles are installed in the U.S. market by L.G. Barcus & Sons.



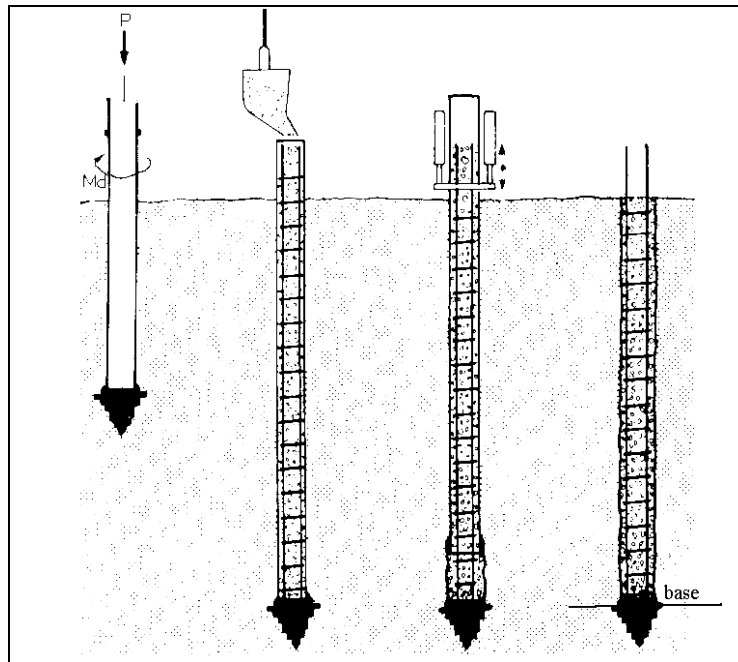


Source: Prof. W. Van Impe of Ghent University, Belgium

**Figure 4.12: Omega Screw Pile**

The Fundex screw pile is one of the oldest types of screw piles in use. American Pile Driving, Inc., of California, is the U.S. representative for this technology. Fundex piles are installed with an over-sized sacrificial shoe and a full-length cage that is placed in advance of grout/concrete placement. Concrete is placed by gravity through the hollow pipe. The pipe is oscillated as it is

removed, and the oversized shoe on the bottom of the pipe is intended to provide a rough texture to the hole and thus to the surface of the pile.



Source: Prof. W. Van Impe of Ghent University, Belgium

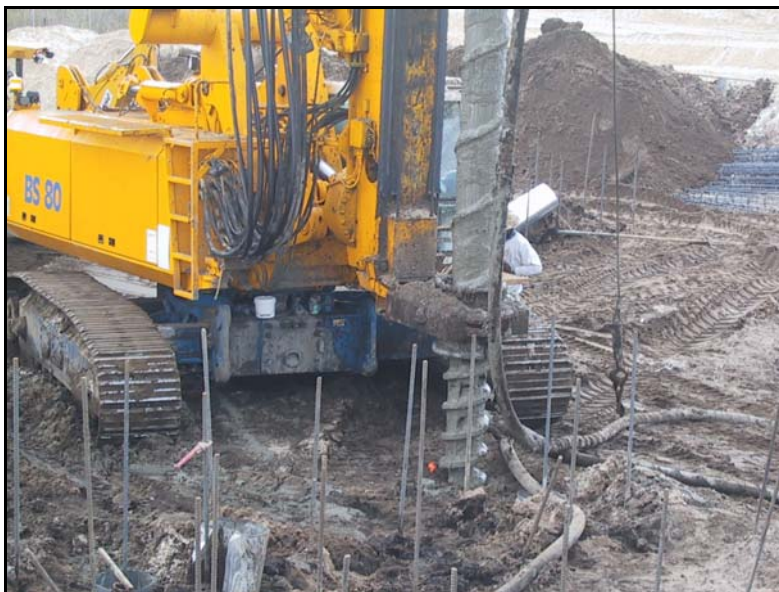
**Figure 4.13: Fundex Screw Pile**

Berkel and Company Contractors, Inc. of Kansas, has developed their own proprietary tools for installing full and partial displacement piles. The full displacement pile in Figure 4.14a is similar to others in outward appearance, but uses pressure grouting to construct the pile with reinforcement placed after completion of grouting. The partial displacement pile in Figure 4.14b

is intended to provide partial displacement of soil but still allowing some soil removal via the flights on the enlarged auger above the short screw section at the bottom. Partial displacement techniques are intended to allow pile penetration to depths beyond those possible with full displacement piles, because the removal of some soil can allow easier penetration. The full and partial displacement piles shown in Figure 4.15 are manufactured by Bauer Maschinen of Germany, and are sold to multiple contractors in the U.S. using Bauer equipment.

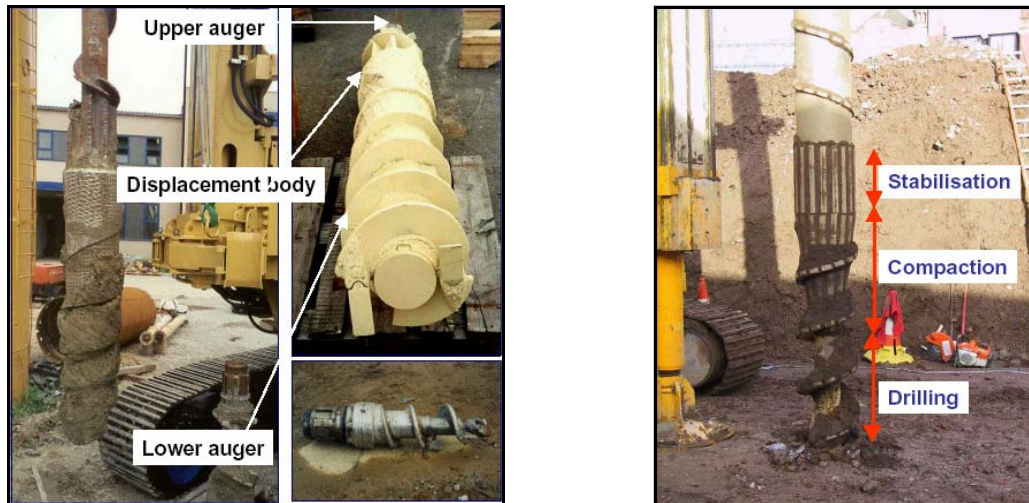


**(a) Full Displacement Pile**



**(b) Partial Displacement Pile**

**Figure 4.14: Drilled Displacement Piles**



(a) Full Displacement Augers



(b) Partial Displacement Auger

Source: Bauer Maschinen

**Figure 4.15: Additional Drilled Displacement Piles**

The double rotary system represents another class of augering equipment (Figures 4.16 through 4.18). These rigs include a full-length casing, which is advanced simultaneously with the auger, generally by rotating the casing in the opposite direction of the auger. This technique is especially useful for constructing secant pile walls using CFA piles, as the fully cased system provides stability for the hole, allows rapid drilling without the need for drilling fluid, and increases the verticality of the piles. The casing makes the system quite stiff, and the casing itself acts as a type of core barrel for cutting through hard materials, including the secondary concrete piles.



(a) Movable Rotary Drive      (b) Fixed Twin Drive

**Figure 4.16: Double Rotary Cased CFA Piles**

The double rotary can have independent movable rotary drives (Figure 4.16a) or fixed twin drives (Figure 4.16b and 4.17). The movable drive system works more like a conventional drilled shaft in that the two drive motors can move independent of each other, allowing the auger to be removed from the casing while leaving a cased hole. The reinforcement and concrete is then placed into the cased hole as with a cased drilled shaft, and the rig reattaches to the casing and withdraws the casing. This system has the advantage of pre-placement of the reinforcement prior to concrete placement, like a drilled shaft. If the pile is terminated in a water-bearing zone, it is necessary to add water or drilling fluid to stabilize the base of the cased excavation and then place concrete using a tremie. Double rotary cased CFA drilling systems are manufactured and sold in the U.S. by Bauer, Delmag, and Soilmec.

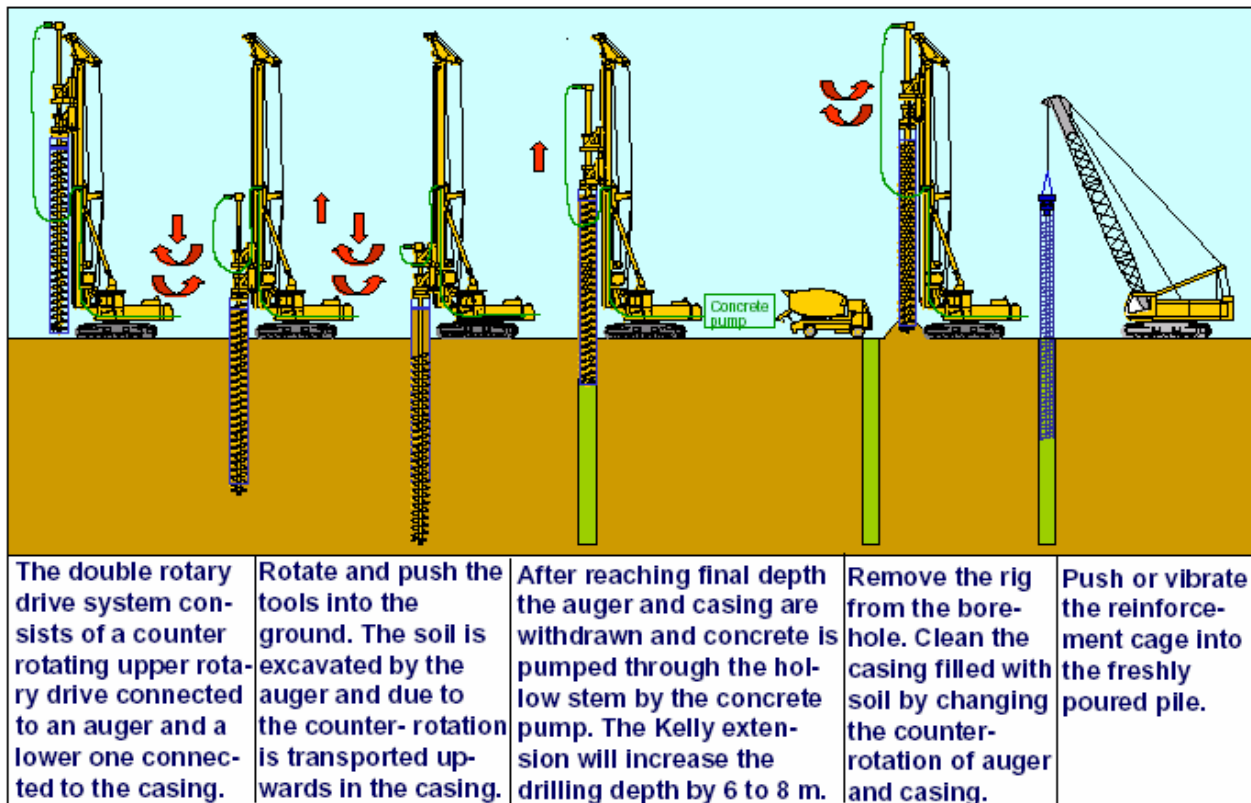


(a) Cutting Head      (b) Concrete Placement      (c) Cuttings Discharge

**Figure 4.17: Double Rotary Fixed Drive System**

With the fixed twin drives (Figures 4.16b and 4.17), the two motors are not capable of independent operation. The auger and casing are advanced together and removed together while concrete is pumped through the center of the auger, similar to a conventional CFA pile. The control of the rate of rotation of the auger relative to the casing is important; the auger must rotate faster so that the proper amount of soil is flighted to the top, which allows the auger to advance without hanging up inside the casing, and to maintain soil on the augers to stabilize the base of the excavation. The flighted soil is discharged through a discharge chute located at the drive head (see Figure 4.16b). In some systems, (Figure 4.17b), the auger/casing system is then moved to a location for depositing spoils after concrete placement; then the auger is reversed and the soil is discharged from the bottom of the casing (Figure 4.17c). Reinforcement is then placed into the fluid concrete.

Some rigs are equipped with a Kelly-bar extension, which allows the auger to penetrate deeper than the casing and extend the hole beyond as a CFA pile (Figure 4.18). This system may be advantageous when drilling to form a wall through a granular material by extending the piles to depths beyond the capability of the casing. The Kelly-bar extension also allows the contractor installing the casing slightly behind the leading edge of the auger and thereby permits the cutting of relief prior to forcing the casing forward.



Source: Bauer Maschinen

**Figure 4.18: Double Rotary System with Kelly-Bar Extension**

### 4.2.3 Equipment for Concrete/Grout and Reinforcement Placement

The concrete or grout is normally obtained from a ready-mix plant and delivered to the site by trucks. For most CFA pile construction, the concrete or grout is pumped under pressure through pump lines to the top of the auger string and through the auger to provide positive pressure at the point of discharge at the base of the auger. Some types of DD piles are designed for placement of concrete into the top of the large diameter auger tool without pressure (see Figures 4.11 through 4.13). General reference in this section will be to the more common construction of CFA piles or partial DD piles. Most CFA piles in the United States are currently constructed using sand-cement grout, while most CFA piles in Europe are constructed using concrete of small aggregate. In general, the practices and equipment used in the United States and Europe are similar. The terms “grout” and “concrete” will be used interchangeably in this section, unless specific differences are referenced.

#### 4.2.3.1 Auger Plug

The grout discharge point should be located at the bottom of the auger below the cutting teeth (e.g., Figures 2.7 and 4.10). In most cases, this grout discharge point is oriented away from the leading edge of the cutter head so that high ground pressures do not press against the plug during drilling. Some augers are equipped with a centered plug so that a single bar can be placed through the center of the auger string prior to concrete placement. Ordinarily, the pressure of the grout blows out the plug. A center plug is usually made of a steel shoe or plug of some other hard material. The normal off-centered plug is most often cork or plastic.

Problems with the plug (or “bung” as it sometimes is called by contractors) can occur if the plug does not come out or the plug comes out prematurely and the line fills with soil. In either case, pumping grout through the line is no longer possible and the pile must be abandoned and re-drilled. If the pile needs to be abandoned, the contractor must reverse the direction of rotation and remove the auger while leaving soil behind to keep the hole from collapsing. After correcting the problem (e.g., by clearing the discharge point), the pile is re-drilled. The pile can be re-drilled a short distance away from the first location, as long as the pile layout allows doing so. Alternatively, the pile can be re-drilled in the same location, although it is likely that some adverse effect on the subsequent pile performance will occur due to soil disturbance. Depending upon conditions, the re-drilled pile may be acceptable as is, may require to be deepened, or additional piles may be required to compensate.

Some contractors have successfully used an auger having no plug in the bit by pumping compressed air through the auger during the drilling process. The air pressure can be useful in some stiff clays or other difficult drilling conditions in helping prevent the soil from adhering to the auger and breaking up the soil as it is cut. This technique is used successfully in some parts of the country having stiff cohesive soils, such as Texas and northern Georgia. Soil conditions that are more susceptible to mining, such as relatively clean sands, may not be suitable for the use of compressed air during pile installation. One case of using compressed air to install 600-mm (24-in.) diameter piles in northeast Florida showed a significantly lower side-shear capacity for a test pile installed using compressed air when compared to a test pile installed

without using compressed air. The contractor used compressed air during installation of a 16.8-m (55-ft) long, 600-mm (24-in.) diameter piles. Instrumented Statnamic<sup>TM</sup> load tests were performed on two piles installed less than 3 m (10 ft) apart, one installed with compressed air and one without. The unit side-shear resistance measured in the pile installed using compressed air was about half of that measured in the pile installed without compressed air. The soils consisted of relatively clean, poorly-graded fine sands, with the piles tipped into a loose to firm clayey sand layer. As with many techniques, the use of compressed air should take into consideration the potential impact on pile capacity. With a performance-based specification, a contractor could choose to use air, provided that a test pile is successfully load-tested and the pile meets the required performance.

#### 4.2.3.2 Pumping Equipment

The grout pumping equipment should be a positive displacement pump capable of developing pressures at the pump of up to 2.4 MPa (350 psi). The typical grout pump operates with reciprocating pistons, each delivering around 10 to 30 liters per stroke (0.4 to 1 ft<sup>3</sup> per stroke). The size and capacity of the pump must be suitable for the size of the pile being constructed. Several examples of pumps are shown in Figure 4.19. Most commonly, the pump is located close to the piling rig with grout lines running to the rig and an operator manning the pump (Figures 4.19a and 4.19b). The grout line is typically around 63 to 100 mm (2.5 to 4 in.) in diameter and can extend 30 to 60 m (100 to 200 ft) from the pump. Some contractors have the pump mounted directly on the rig, which allows pumping to be controlled by the operator (Figure 4.19c). The pumping operation shown in Figure 4.19d includes a rotating drum for holding a full truck load of grout/concrete [approximately 8 m<sup>3</sup> (10 yd<sup>3</sup>)] on-site so that a ready-mix concrete truck can discharge into the holding drum and return to the concrete plant.

It is important that the pump does not deliver an excessive grout volume with each stroke, which would cause the operator to have difficulty controlling the pile grouting operation. In general, a pump should deliver a volume per stroke that corresponds to around 100 mm (4 in.) of pile length or less. If the volume per stroke is too large in relation to the pile size, the operator cannot maintain a steady progress of pumping and cannot construct a uniform pile. If the volume per stroke is too small in relation to the pile size, the operation is slow and inefficient. A related problem could also be when there is a tendency to withdraw the auger too rapidly in relation to the grout volume supplied.

In order to verify the volume and pressure of grout delivered to the pile, it is necessary that instrumentation be provided to monitor the grouting operations. Two methods are available for real-time monitoring of grout/concrete volume during installation: stroke count and in-line flowmeter. The simplest of these two methods is to count the strokes from the pump, which can be automated by using the pressure sensor or a proximity switch. In this method, the cumulative volume is determined by multiplying the number of strokes by an estimated volume of grout/concrete delivered per stroke. Volume estimation by counting strokes suffers from the inaccuracy of assuming a constant volume per stroke, and possibly due to variations in the efficiency of the ball-valves sealing off against the seats. Sometimes, the pump strokes are inconsistent and the volume delivered per stroke can vary. The automated stroke counter can



miss strokes or count erratic behavior as multiple strokes. The volume pumped per stroke can also vary with the pressure against which the pump is operating, and can vary with time for other reasons. With the introduction of modern sensors and monitoring equipment, stroke counting is now considered a poor quality control practice.



**(a) Trucks Discharging into Pump**

**(b) Close up View of Grout Pump**



**(c) Concrete Pump Mounted on Rig**

**(d) Pump with Rotating Drum On-Site**

**Figure 4.19: Typical Concrete/Grout Pumps**

The second and preferred method to monitor volume is to use an in-line magnetic flowmeter, shown in Figure 4.20. This device provides a more accurate and reliable indication of the actual volume delivered. Flowmeters work by placing a magnetic field around a tube such that the conductive medium moving through the tube induces a voltage in the medium. The voltage of the medium is proportional to the average flow velocity. The flowmeter thus makes a voltage measurement that is proportional to the average velocity of the grout flowing through it; this average velocity can be converted to volume using the known cross-sectional area of flow. The flowmeter is sensitive only to conductivity of the grout and is independent of density or viscosity. The interior of the tube is generally lined with a ceramic material for durability.



**Figure 4.20: In-Line Flowmeter**

A pressure sensor should be mounted in-line to provide a real-time monitor of the pressure being delivered to the auger and to ensure that positive grout pressure is maintained in the hole as it is being filled. The best place for this sensor would obviously be at the base of the auger, as shown in Figure 4.21. This instrument provides a measure of grout pressure inside the auger about 1 m (3 ft) above the tip. The system requires an interior mount and a cable extending up through the auger and through a slide ring body at the swivel atop the auger. At present, the “in-auger” pressure sensors have been difficult to maintain and therefore are not widely used.

A more common location for measuring pressure is in the line just above the swivel on top of the auger string. If the line is completely filled, the pressure at the auger tip should differ by the difference in head from the top to bottom, minus a small loss due to flow in the lines. Pressure measurements in the line farther away from the auger can be affected by losses between the measurement location and the auger, and thus it is preferred that the pressure measurements be made as near to the auger as possible.

The minimum pressure during all grouting operations should be displayed in real-time for operator control and inspector observation. This information can be used to immediately correct areas of the pile where the pressure has dropped due to grout contamination with soil or other problems. These readings should also be recorded for quality control documentation.

#### 4.2.3.3 Finishing the Top of the Pile

After the grout placement is complete and the auger is withdrawn, the workers must finish the top of the pile prior to reinforcement placement. A recommended procedure is to place a small form or casing around the top of the pile to prevent fall-in from surrounding soil. Sheet metal ductwork or prefabricated column forms are often used for this purpose, as shown in Figure 4.22. While not all contractors use this technique in private contracts, the use of the top form to prevent fall-in is required in public projects. Besides the use of the top form, it is also necessary to scoop the grout or shovel out the contaminated uppermost portion of grout. The workman in Figure 4.22c is using a folding circular screen to remove soil contamination from the fluid grout.



Source: Bauer Maschinen

**Figure 4.21: Sensor for Concrete Pressure at Auger Tip**

## **4.3 CONSTRUCTION MATERIALS**

The component materials of a CFA pile consist of grout/concrete and reinforcing steel.

### **4.3.1 Grout and Concrete**

Both grout and concrete have been successfully used for the construction of CFA piles. Concrete used for CFA piles is very similar to the concrete used for wet-hole placement in drilled shafts. Grout used for CFA piles is similar to concrete except that the grout mix contains only sand, not coarse aggregate. While the grout used for pressure-grouting applications in some types of micropiles and other grouting applications is often a mixture of only cement and water; such thin, fluid grouts are not used for CFA piles. Both grout and concrete mixes typically contain a mixture of Portland cement, fly ash, water, aggregate (fine aggregate only for grout) and admixtures. Water reducers are typically added to concrete mixes, and fluidifiers have been developed to overcome problems associated with grout placement. Retarders are often added to grout or concrete mixes to increase grout flowability or extend the slump loss time of concrete. Regardless of whether grout or concrete is used, the mix must be made such that all solids remain in suspension without excessive bleed-water. Additionally, the mix must be capable of:

(1) being pumped without difficulty; (2) penetrating and filling open voids in the adjacent soil; and (3) allowing for insertion of the steel reinforcement.



(a) Spoil Removal

(b) Clearing Top of Pile and Form Placement



(c) and (d) Contaminated Grout Removal

**Figure 4.22: Completion of Pile Top Prior to Installation of Reinforcement**

While some contractors and engineers have personal preferences for either grout or concrete, both have been used successfully in CFA pile applications. In general, the perceived advantages and disadvantages of grout relative to concrete may be summarized as follows.

Advantages:

- Grout mixes are sometimes preferred for easier insertion of steel reinforcement into the pile;
- Grout mixes tend to be more fluid and have greater workability; and
- Grout mixes tend to be easier to pump, and many contractors, who have historically used grout mixes, have grout pumps and equipment that may not be suitable for use with concrete.

Disadvantages:

- Grout will generally have a higher unit cost than concrete;
- Grout will tend to have a slightly lower elastic modulus than concrete; and
- Grout will tend to be less stable within the hole when drilling through extremely soft soils (such as organic clays or silt).

Grout mixes will tend to be more susceptible to small variations in water content which could lead to segregation or excessive bleed water. In general, any mix (concrete or grout) having extremely high workability requires greater attentiveness to quality control both at the batch plant and at the project site.

DD piles may induce excess pore water pressures in the surrounding soil that could result in water intrusion into a newly constructed pile as the excess pore pressure dissipates. Grout may be more susceptible to this effect than concrete. Special fluidifiers are often added to grout mixes to counteract these effects, as will be described in Section 4.3.6.

A grout mix will have a slightly lower elastic modulus than a comparable concrete mix at the same compressive strength. While a lower elastic modulus may be of concern in structural applications where deflections control the design, it would typically have a relatively small effect on the load/settlement characteristics of CFA piles. The elastic shortening of a pile is proportional to the modulus of the grout/concrete pile. As CFA piles are relatively short, the load/settlement characteristics are predominantly controlled by the interaction between the pile and surrounding soil, regardless of whether grout or concrete is used.



**Figure 4.23: Sand-Cement Grout Mixes**

A study at the University of Houston (O'Neill et al., 1999) compared the chemical resistance of auger grout (i.e., grout steel in CFA piles) and conventional Portland cement concrete to solutions of acid, sodium sulfate ( $\text{Na}_2\text{SO}_4$ ), and sodium chloride ( $\text{NaCl}$ ). The researchers tested samples in chemical solutions over a period of two years and determined the following:

- The grout gained over 3% weight in a solution with 2% of sodium over 2 years. By contrast, the concrete gained about 1% in 500 days.
- The sulfate solutions produced a 2% weight loss in a period of 180 to 270 days in the auger grout. The concrete had a weight loss of 0.2 to 0.3% in 500 days, indicating a faster degradation of auger grout in a sulfate environment.
- Leaching of calcium in sulfates was about five times higher in auger grout than in concrete.
- Sulfates produced a slightly increased degradation in pulse velocity in auger grout compared to cement concrete.
- There was a notable decrease in compressive strength in auger grouts immersed in hydrochloric acid ( $\text{pH} = 2$  to  $4$ ) or sulfate solutions. Sulfuric acid ( $\text{H}_2\text{SO}_4$ ) at  $\text{pH} = 4$  and 5 parts per million (ppm) of sulfate had minimal effect on the grout and concrete.

Based on this study, it can be expected that auger grouts will not perform as well as normal Portland cement concrete in aggressive soil environments that contain sulfates and acids.

The following sections describe the components of grout and concrete used for CFA piles.

#### 4.3.1.1 Cement

Ordinary Type I or Type I/II Portland cement can normally be used in grout/concrete for CFA piles. The cement should meet the requirements of ASTM C 150 or AASHTO M85. Special sulfate resistant cements should be considered in environments where the sulfate content of the geo-material or groundwater is extremely high.

#### 4.3.1.2 Pozzolanic Additives

Both grout and concrete mixes may contain pozzolanic additives. The most commonly used is fly ash (ASTM C 618-94 1995); however, finely ground silica fume and blast furnace slag (ASTM 989-94 1995) can also be used. The use of pozzolanic additives results in lower permeability of the hardened concrete and tends to retard the set time of the cement paste, thereby increasing the time that the grout/concrete remains workable. As a consequence of providing a more workable mix, the use of fly ash, silica fume, and/or slag will probably severely retard the early strength gain of the grout mix, typically until about 10 to 14 days of age. If these additives are to be used in the mix, the submitted mix design should include information on strength development vs. time so that the design engineer is informed of the delay in strength gain corresponding to the mix and make any adjustments, if necessary.

Fly ash is now widely available in most areas of the United States as a by-product of burning coals. ACI 232.2R-96 of the American Concrete Institute (ACI, 2006) provides an excellent overview of the use of fly ash in concrete. ASTM C 618 categorizes ash by chemical composition. Class C and Class F ashes are most commonly used in concrete and grout mixes. As a group, these ashes tend to show different performance characteristics. However, there are important differences in fly ash from different sources and the performance of a fly ash is not determined solely by its classification as either Class C or Class F. For instance, problems have been reported in some cases when power companies turn to scrubber systems to remove sulfur dioxide from stack gasses. This occurs when fly ashes are mixed with scrubber products and contain free lime and calcium sulfates or sulfites (see p. 95 in Mindess et al., 2003). The mix design for CFA piles should be developed specifically for a project site using locally available materials.

#### 4.3.1.3 Water

Water used for mixing the grout/concrete should be potable (free of organic contamination and deleterious material) and should have low chloride and sulfate contents.

#### 4.3.1.4 Aggregate

All aggregate should meet the appropriate specifications. Some of the relevant ASTM specifications for aggregate are: ASTM C 33-93, Specification for Concrete Aggregate; ASTM C 87-90, Test for Effect of Organic Impurities in Fine Aggregate on Strength of Mortar; and ASTM C 227-90, ASTM C 289-94, ASTM C 295-90, ASTM C 586-92, all of which address tests that measure the alkali susceptibility of aggregates.

In general, rounded gravel is strongly preferred over crushed stone due to the benefits in terms of workability of the mix for pumping and placement. Aggregate gradation will depend upon the specific mix design requirements. Concrete mixes having extremely high workability will tend to require a greater ratio of fine to coarse aggregate to minimize the tendency for segregation and bleeding.

#### 4.3.1.5 Fluidifiers for Grout and Water Reducing Admixtures for Concrete

Both low-range and high-range (i.e., superplasticizer) water reducing admixtures have routinely been used in concrete mix designs for drilled shafts. ASTM C 494 is a performance specification that classifies an admixture as water-reducing if it reduces the water requirements by 5%. Thus both low-range and high-range water reducers are specified by ASTM C 494. High-range water reducers may also be conveniently specified by requiring that the performance specification ASTM C 1017 also be met, as this specification requires that an increase in slump of 90 mm (3.5 in.) or greater be obtained. For low-range water reducers, admixture Type D (per ASTM C 494) is preferred for piles over admixture Type A to provide some retarding properties and reduce slump loss. Similarly, for high-range water reducers (superplasticizers), admixture Type G is often preferred over admixture Type F to reduce slump loss, but the newer polycarboxylate-based superplasticizers are designed to maintain a high slump for extended periods.

Low-range water reducers can be used to obtain water/cement ratios in the range of 0.40 to 0.45, and can consist of lignosulfonates, hydroxylated carboxylic acids, and similar compounds (see ASTM C 494). High-range water reducers can be used to obtain water/cement ratios of 0.3 or lower while maintaining a high slump (see ASTM C1017). Many of the older naphthalene-based superplasticizers had a tendency for rapid slump loss, could even result in a flash set, and thus were very risky to use for cast-in-place deep foundations. However, many of the modern superplasticizer products are polycarboxylate compounds that lose their effectiveness much slower and are very useful for drilled shafts and CFA piles. These products also act as a mild retarder. It is important to note that high-slump concrete mixes must be designed carefully to avoid problems of segregation and bleeding. Water reducers can be very effective at reducing the water/cement ratio for a given workability requirement and thus reducing the tendency for segregation and bleeding in the mix.

Grout fluidifiers have been developed for intrusion grout mixtures to offset the effects of bleeding, reduce the water/cement ratio while providing a desired consistency, and retard stiffening so that handling times may be extended. A grout fluidifier may be specified by meeting the requirements of ASTM C937. Grout fluidifiers typically contain a water reducing admixture, a suspending agent, aluminum powder, and a chemical buffer to assure timed reaction of the aluminum powder with the alkalies in the Portland cement.

#### 4.3.1.6 Retarders

Retarders [described in ASTM C494-92 (ASTM, 2006)] consist of lignosulfonic acids, hydroxycarboxylic acids, sugars, and phosphates. Many of these possess water-reducing capabilities and can be classified as water-reducing, set-retarding admixtures [Type D in ASTM C494 (ASTM, 2006)]. Retarding admixtures may be needed in the grout/concrete mix when it is placed during periods of high temperature [ $> 20^{\circ}\text{C}$  ( $68^{\circ}\text{F}$ )] to reduce the slump loss in the period during which the grout/concrete is placed. Some types of retarders slow down the rate of early hydration of cement, but hydration proceeds normally after the effect is overcome. Some inorganic retarders are more complex and can form coatings around the cement particles that severely reduce the rate of reaction. Thus, retarders can slow the rate of early strength development. The strength should approach that of unretarded concrete within eight days, unless an overdose has been used. Overdosing the mix with retarder can prevent set entirely.

#### 4.3.1.7 Air Entraining Agents

Air entraining agents (ASTM C 260-94, 1995) can be used when deterioration of the grout/concrete by freeze-thaw action is possible. Entrained air will also improve workability and pumpability and reduce bleeding. However, it can produce a slightly more permeable grout/concrete and thus be more susceptible to deterioration due to a chemical attack (e.g., chlorides). When air is added, about 5% is needed to improve pumpability. Because air tends to be lost during the mixing, pumping, and placement processes, much of the entrained air is likely to be lost by diffusion by the time the grout/concrete begins to set.



#### 4.3.1.8 Sampling and Testing

Representative samples of grout and concrete mixes must be obtained at the project site for QA/QC testing, as described in greater detail in Chapter 7. The three parameters most typically measured are temperature, workability, and strength. Workability is measured using slump testing for concrete and flow cone testing for grout. Strength testing is performed in a laboratory after curing samples from the field.

Typical strength requirements for CFA piles are 27.6 to 34.5 MPa (4,000 to 5,000 psi). Strength testing of concrete utilizes conventional 150-mm (6-in.) diameter cylinders. For the sand-cement grout often used with CFA piles, some engineers use small cylinders 50 or 75 mm (2 or 3 in.) in diameter, but most use 50-mm (2-in.) cubes. There is not a consensus at present on which method is preferred, but the cubes are easier to prepare and transport. The compressive strength of properly prepared and tested cubes are slightly higher than that of cylinders with a height to diameter ratio of 2, so the strength requirement from tests on cubes is typically 10% higher than that of cylinders.

The ideal location and time to obtain samples for testing would be at the point of discharge into the soil and after the mix has been pumped through the lines and the auger, as the properties (particularly workability) can be altered by pumping extended distances, especially in hot weather. However, this location is generally not possible, therefore, samples are typically obtained from the discharge location into the pump hopper. Workability and temperature should be checked on every truck as a means of verifying consistency of the mix. Because the grout/concrete must be placed immediately when the auger achieves the tip elevation, the sampling and inspection must be expeditious.

Slump ranges for concrete for CFA piles should typically be 200 mm +/- 25 mm (8 in. +/- 1 in.), similar to that used for drilled shafts constructed using the wet method. Workability of grout is tested using a flow cone instead of the conventional slump test used for concrete. Standards ASTM C939 and U. S. Army Corps of Engineers CRD-C 611-94 provide specifications for flow cone testing in which fluid consistency is described according to an efflux time per standard volume. Because the grout mixes used for CFA piles are typically too thick to flow effectively from the standard 12 mm (0.5 in.) outlet specified in these standards, it is common practice to modify the above specs to provide a 19 mm (0.75 in.) opening. This modification can be made by taking out the removable orifice that extends out the bottom of the Corps of Engineers device to leave a 19 mm (0.75 in.) opening or to cut the flow cone specified in the ASTM standard to modify the outlet diameter. Grouts suitable for CFA pile construction typically have a fluid consistency represented by an efflux time of 10 to 25 seconds, when tested in accordance with the modifications described above.

Most standard mix designs will maintain workability for a period of up to 2 hours without any additional retarding admixtures (other than the typical grout fluidifier), if agitated continuously in the ready-mix truck. Flow cone or slump tests should be performed on site at the time of placement to ensure grout/concrete workability over time. If a project has an unusual concern for a lengthy time for rebar cage placement or a great depth, additional retarding admixtures may

be used to extend the slump or flow life. Flow cone or slump tests at the time corresponding to rebar cage placement may be used to evaluate the workability associated with the mix at this critical time.

Grout or concrete should not be placed when its temperature falls below 4°C (40° F) or exceeds 38°C (100° F), unless approved procedures for cold or hot weather grouting are followed.

### **4.3.2 Reinforcing Steel**

#### **4.3.2.1 Reinforcing Steel Materials**

Reinforcing bars for CFA piles typically consist of ASTM A615 Grade 60 steel, the same as those used for drilled shaft construction. Occasionally, CFA piles may be reinforced with high-strength threaded bars meeting ASTM A722 (1,035 or 1,100 MPa [150 or 160 ksi]). The high-strength bars are normally used where large tensile loads are to be supported. Transverse steel may consist of either circular ties or spirals. Steel pipe may be used in cases where large bending stresses may occur, such as in a wall. Steel pipe used in CFA piles is steel ASTM A572, Grade 50 having a nominal minimal yield strength of 350 MPa (50 ksi) or ASTM A252, Grade 2, nominal minimal yield strength of 420 MPa (60 ksi or Grade 60). In the case of steel pipes, the CFA pile is really designed as a concrete- or grout-filled steel element rather than a reinforced concrete member; guidelines suitable for micropile design would be appropriate in this case.

#### **4.3.2.2 Reinforcing Cage/Section**

Reinforcing cages should be fabricated so that lifting and handling does not cause permanent distortion or racking. For this reason, it is important that wire ties be used on all longitudinal bars at every tie or spiral. Welding is only permitted if weldable reinforcement is specified (see Figure 4.24). The use of weldable reinforcement is rare in U.S. practice, but can assist in handling the cage with a minimum of distortion. Spliced steel cages and/or coupled threaded bars are often necessary to install reinforcement in low headroom applications.

Where bending stresses are potentially high as in the case for a pile wall or slope stabilization scheme, it is possible to construct CFA piles using structural steel sections for reinforcement. Figure 4.25 illustrates the use of a steel pipe section within a CFA pile to provide flexural strength in a tangent pile wall application.

Reinforcement cages are normally specified with 75 mm (3 in.) clear cover to the outside of the pile. Plastic or cementitious spacers should be placed at intervals of no more than about 3 m (10 ft) along the cage to provide cover. Spacers made of steel should not be permitted as they may greatly accelerate corrosion of the reinforcing steel, particularly above the groundwater table. Centering guides made of steel, such as a wire “basket” or “football” tied at the base of single-rod reinforcement may be used. A reinforcing cage may be tied together at the bottom to create a “point” to facilitate installation into the pile. If CFA piles are used on a batter, special provisions may be necessary to maintain cover. For the project illustrated in Figure 4.26, a

continuous PVC pipe was used on the bottom side of the cage to maintain cover and act as a “runner” to slide the reinforcement cage into position within the grouted pile.



**Figure 4.24: Machine-Welded Reinforcement Cage on Project Site in Germany**



**Figure 4.25: Use of Steel Pipe to Reinforce a CFA Pile for a Wall**



**Figure 4.26: Installation of Reinforcement Cage into Battered CFA Pile**

Where a single bar is used for tensile reinforcement, centralizers are used at spacing of no more than 3 m (10 ft). Some rigs are equipped to install a center bar through the hollow auger prior to placement of grout/concrete. These bars cannot be used with a centralizer because the centralizer cannot fit through the auger stem while attached to the bar. Splices may sometimes be used with CFA piles, but it is better to avoid the use of splices. Splices are common for piles supporting tensile forces or for piles reinforced with a single full-length center bar. Mechanical splices are preferred in such cases, and high-strength threaded bars are convenient for this purpose.

#### **4.4 SUMMARY OF RECOMMENDED PRACTICES**

This chapter describes equipment, techniques, and materials used to construct CFA piles. A wide variety of techniques and equipment have been used to construct these piles. Several parameters are summarized below that are key components of good quality construction. The specifications section of this document (Chapter 8) provides detailed guidelines.

- *Drilling Rigs.* The rig must have adequate torque capacity to install the pile without excessive flighting of the soil during drilling. While specs may include a minimum torque provision, it seems most prudent to set as a performance requirement that the contractor provide a rig capable of doing the project. The torque and power of the rig will directly affect the depth to which piles can be installed and the resulting axial capacity that can be achieved.

- *Drilling.* In order to avoid excessive flighting and to construct piles of consistent quality and axial capacity, target penetration rates must be established and maintained during drilling of CFA piles. It is essential that this parameter be controlled by the rig operator and monitored for verification. Automated monitoring systems must be used to provide direct feedback to the operator and verification of performance. Details of monitoring systems will be described in Chapter 7. It is essential that the installation method used for construction of production piles be consistent with that used for construction of load test (control) piles.
- *Cementitious Materials.* Either grout or concrete may be used for construction of CFA piles. Each has relative advantages under different circumstances. In general it is recommended that: (1) the specifications for grout/concrete materials be performance-based verified using strength tests on either cubes or cylinders; and (2) testing for workability and mix temperature be routinely performed on each truck as a means of monitoring consistency. Mix proportions and characteristics should be established based on test piles or control piles and maintained at a consistent quality throughout the project. Workability of concrete is monitored using slump tests. Workability of grout is monitored using flow cone tests with a modified opening enlarged to 19 mm (0.75 in.). Workability of the mix must be maintained for the entire duration of pile construction, including rebar installation into the pile. Slump or flow cone tests should be performed at times corresponding to rebar cage installation.
- *Placement of Grout or Concrete.* Placement of grout or concrete through the auger is a critical part of the operation and must be monitored using automated systems to ensure that adequate volumes are pumped at a positive pressure at all times as auger withdrawal is in progress. Slow, steady pulling of the auger at a rate appropriate for the delivery from the pump is essential. Some contractors prefer to use a static pull of the auger and some prefer a very slow rotation in the direction of drilling. It appears that both methods can be used successfully. The auger should never be allowed to turn in place without either drilling or pumping taking place. The systems utilizing automated monitoring of volume and pressure delivered to the pile as a function of auger tip elevation are the most effective to obtain consistent quality and verification. In-line flow meters are the preferred means of monitoring volume of grout/concrete over stroke counters.
- *Completion of the Pile Top.* It is essential that the contractor continue to deliver the appropriate volume of grout/concrete to the pile when the auger is close to the surface and significant positive pressure can no longer be maintained. The completion of the pile top requires manual work to remove any debris or contaminated grout/concrete near the top of the pile before reinforcement is placed into the fluid grout/concrete. The use of a small form at the pile top extending above grade is recommended to maintain a sound surface. If below-grade cutoff is required, it is necessary to complete the pile to grade and then chip or cut the top down later. It is necessary to flush the grout/concrete to the surface of the working platform to remove any questionable or contaminated material.

- *Reinforcement.* Installation of reinforcement requires that the grout/concrete mix retain adequate workability for the time necessary to install the cage after removal of the auger and clearing the top of the pile. The mix requirements with respect to this aspect of the work can vary with differing soil conditions, particularly with respect to the tendency of dry sandy soils to rapidly dewater the pile. The mix should be developed to demonstrate that workability is maintained within the slump or flow cone guidelines for the entire duration of time required for drilling and grouting the pile and placing the rebar cage. In addition, other measures such as anti-washout admixtures may be required if soil conditions cause excessive dewatering of the mix after casting that results in rebar installation difficulties. Designers should include reinforcement cages that use: (1) fewer heavy bars instead of many smaller bars; (2) are no longer than the minimum necessary to provide structural capacity and anchorage; and (3) allow the cage installation proceed with minimum difficulty. The contractor should tie the cage to permit handling without permanent distortion.
- *Installation Plan.* The contractor should submit an installation plan including details of the equipment and methods proposed for the project. Many aspects of the construction work are performance-oriented with respect to the contractor's equipment requirements and methodology. The installation details and monitoring of the installation are key components of verifying that the performance requirements are met. Contractors should be held accountable for developing an installation plan that will achieve the required objective.
- *Test Piles and Test Installations.* The recommended means of verifying that the installation plan will achieve the project requirements is using a carefully monitored test pile program. The program should consist of pre-production static load tests, production static and/or rapid and/or dynamic load tests, and post-installation integrity tests in sufficient quantities to provide the data necessary to demonstrate that the installed piles meet the load and deflection criteria established in the project plans with an appropriate factor of safety. It is imperative that the demonstrated installation procedure be followed for all production pile installations.

## CHAPTER 5 EVALUATION OF STATIC CAPACITY OF CONTINUOUS FLIGHT AUGERED PILES

### 5.1 INTRODUCTION

In many respects, the static capacity of a well-constructed continuous flight auger (CFA) pile can be considered to fall between that of a drilled shaft and a driven pile. This concept is primarily attributed to different changes in lateral stress during the installation of the various pile types. During construction of a drilled shaft, the soil stress tends to reduce or remain unchanged in the vicinity of the pile excavation. During installation of a driven pile, the pile driving process displaces the soil laterally and increases the stresses in the surrounding soil. In the case of conventional CFA pile construction, the stresses in the soil tend to remain near the pre-construction stress values (similar to a drilled shaft), while the construction of drilled displacement (DD) piles tend to increase the stresses in the surrounding soil (similar to driven piles).

It is reasonable to estimate static capacity of CFA piles using methods developed specifically for driven piles and drilled shafts, because the load-settlement behavior of CFA piles are similar. Some methods, however, have been developed specifically for CFA piles, and usually take the form of modifications made to methods previously developed for drilled shafts or driven piles. For these methods, measured pile capacity (via full-scale load-testing) of CFA piles has also been correlated to parameters including, SPT blowcount, CPT cone penetration tip resistance, and soil undrained shear strength.

This chapter provides specific methods of estimating static axial capacity for different soil types and type of strength data. Four comparison studies are available in which several prediction methods were compared to various CFA load-test databases. The methods presented in Section 5.2 were chosen as those that appeared to generally provide reliable and accurate results for conventional CFA piles according to the four studies. Appendix A contains a summary of other analysis methods of estimating static axial capacity of CFA piles that are currently or have traditionally been used in the United States and abroad, and a summary of the four comparison studies to assess the adequacy of various methods. Section 5.3 presents a method for DD piles.

This chapter also presents information on pile group behavior, settlement, and lateral load capacity; this information is also used in Chapter 6 to present a recommended design procedure for CFA piles.

It should be noted that computations of static axial resistance should be considered as estimates to be validated and/or modified on a project-specific basis using the results of load-tests. The guide specification provided in Chapter 8 is written as a performance-based specification, in which the contractor is responsible to compute static resistance, set pile length requirements for a given design axial loading, and verify that the performance requirements are achieved via the use of load-tests.

## 5.2 DEVELOPMENT OF SIDE-SHEAR AND END-BEARING RESISTANCE WITH PILE DISPLACEMENT

Similar to other types of deep foundations, the total axial compressive resistance ( $R_T$ ) of a CFA pile is calculated as the combination of the side-shear resistance ( $R_S$ ), and end-bearing resistance ( $R_B$ ):

$$R_T = R_S + R_B \quad (\text{Equation 5.1})$$

To calculate the total side-shear resistance, the pile length must first be divided into  $N$  pile segments. The side resistance of a particular pile segment “ $i$ ” (of length  $L_i$ , and diameter,  $D_i$ ) is obtained by multiplying the unit side-shear resistance ( $f_{s,i}$  sometimes referred to as load or transfer rate) of the segment by the surface area of the pile segment ( $\pi D_i L_i$ ). The total side-shear resistance is obtained by adding the contribution of all  $N$  pile segments as:

$$R_S = \sum_i^N f_{s,i} \pi D_i L_i \quad (\text{Equation 5.2})$$

Some of the methods presented in this chapter and Appendix A use an average unit side-shear ( $f_{s-ave}$ ) for the entire pile length, instead of summing individual pile segments. In these cases, the total side-shear resistance is calculated as:

$$R_S = f_{s-ave} \pi D L \quad (\text{Equation 5.3})$$

where  $D$  is the average diameter of the pile, and  $L$  is the pile total embedment length.

The total end-bearing resistance ( $R_B$ ) is calculated as:

$$R_B = q_p \left( \frac{\pi D_B^2}{4} \right) \quad (\text{Equation 5.4})$$

where  $q_p$  is the unit end-bearing resistance, and  $D_B$  is the diameter of the pile at the base.

The side-shear component is mobilized with relatively small pile vertical displacements relative to the surrounding soil, typically less than 10 mm (0.4 in.). The end-bearing component is fully mobilized with larger displacements, typically at a pile tip movement in the range of 5% to 10% of the pile diameter. Driven piles of comparable axial resistance are likely to mobilize the tip resistance at a smaller vertical displacement due to the inherent preloading at the tip that occurs during installation. Consequently, the load-settlement curve from a load-test of a CFA pile may appear somewhat softer than that of a typical driven pile and methods used to interpret ultimate load resistance from load-tests on driven piles could be conservative for CFA piles.



The mobilized side- and end-bearing resistances can be assessed using Figure 5.1, which is based on a study by Reese and O'Neill (1988) for drilled shafts. The CFA pile resistance at any desired displacement (expressed as a ratio to the diameter) may be obtained from the calculated ultimate resistance for that CFA pile multiplied by the normalized resistance at comparable displacement ratio given in the figure. Reese and O'Neill (1988), AASHTO (2006), and others consider the ultimate end-bearing capacity to be mobilized at a tip displacement equal to 5% of the pile diameter. Many studies of CFA pile resistance use a similar definition and the methods presented in this document are also based on the ultimate end-bearing capacity defined at a pile tip displacement equal to 5% of the pile diameter, unless otherwise noted.

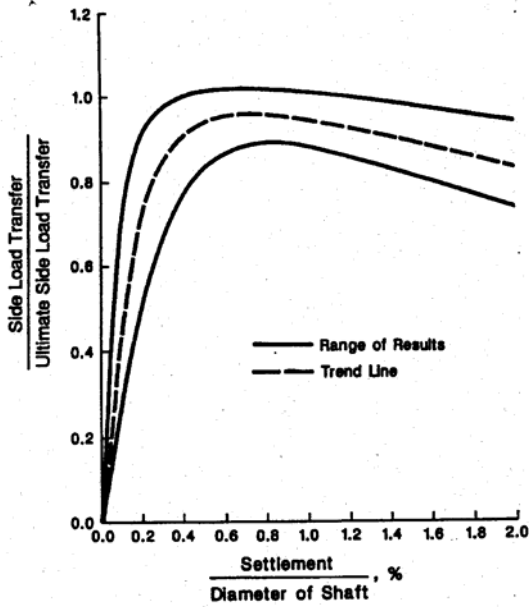
Elastic compression of the pile under load can have a small effect on the distribution of displacement of the pile relative to the surrounding soil. However, the elastic compression is relatively small for the pile lengths and load levels that are typical of CFA piles, and can often be disregarded. For instance, consider a load of 445 kN (100 kip) acting on a pile 450 mm (18 in.) in diameter and 25 m (82 ft) long, and a pile elastic modulus ( $E$ ) of 27,500 MPa (4,000 ksi). If half of the load goes to the tip and the side-shear is evenly distributed along the pile length, the average load in the pile would be 0.75 of the load, or 334 kN (75 kips) and the elastic shortening would be  $334 \text{ kN} \times 25 \text{ m} / (A_{pile}E) = 2 \text{ mm}$  (0.08 in.), where  $A_{pile}$  is the cross-sectional area of the pile. Details of the calculation of the elastic compression of a pile are presented in Section 5.5.3.1.

### **5.3 RECOMMENDED METHODS FOR ESTIMATING STATIC AXIAL CAPACITY OF CFA PILES**

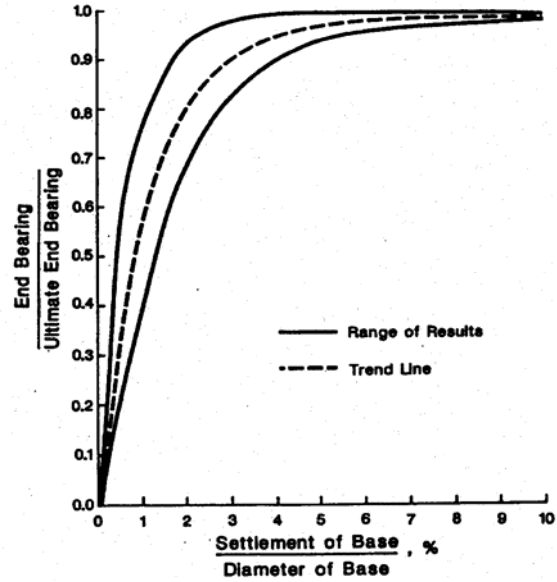
The recommended methods presented for estimation of static axial capacity of single CFA piles assume that a conventional continuous flight auger construction technique will be employed, and construction practices and quality assurance procedures consistent with those recommended herein are adhered to such extent that excessive flighting of soil and ground loosening is avoided. The use of high-displacement auger cast piles (DD piles) and/or the use of amelioration (introduction of coarse sand or gravel from the ground surface down into the annular area between the borehole wall and the drill stem) could significantly increase the pile capacity, and is discussed subsequently in Section 5.4.

Recommended design procedures are broadly organized by soil type as either cohesive or cohesionless in the subsections that follow. Note that silty soils require judgment on the part of the engineer to evaluate the most reasonable approach to use. In general, these fine-grained soils should be classified in response to the anticipated behavior under the load being considered, as to whether the soil is likely to behave more nearly in an undrained or fully drained manner. Depending on this clarification, methods for either cohesive or cohesionless soils must be used. Recommendations are further categorized by the available type of in-situ or laboratory test data.

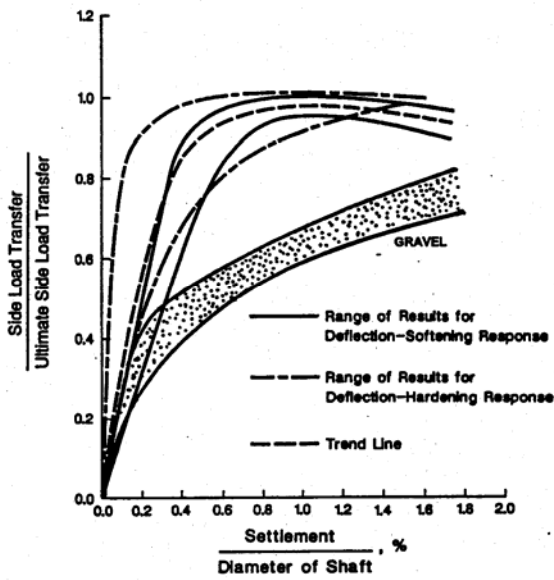
Appendix A summarizes results from comparison studies of different procedures, and provides the basis by which the recommended methods were chosen. Appendix A also summarizes other methods used to predict CFA pile capacities.



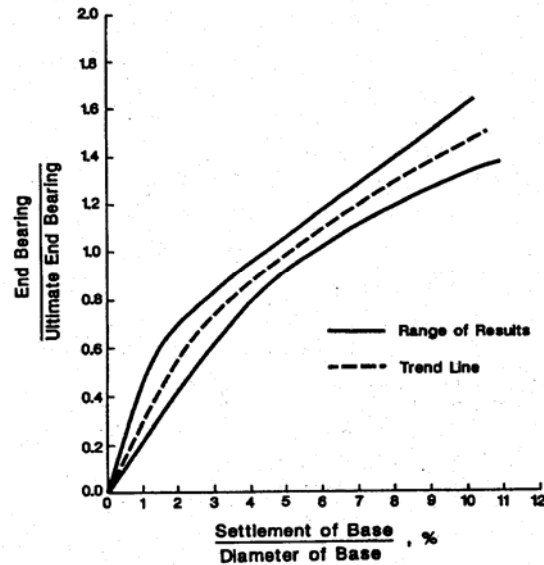
(a) Normalized Load Transfer in Side-Shear vs. Settlement in Cohesive Soils



(b) Normalized End-Bearing Capacity vs. Settlement in Cohesive Soils



(c) Normalized Load Transfer in Side-Shear vs. Settlement in Cohesive Soils



(d) Normalized End-Bearing vs. Settlement in Cohesive Soils

Source: Reese and O'Neill (1988)

Figure 5.1: Load-Displacement Relationships

The design procedures recommended in the following subsections appear to provide good correlations to CFA pile capacity for generalized soil types across the broad scope of North

American practice. The design engineer should consider the specific soil composition and construction techniques to be used at their particular site and experience within the local area or geology. The design engineer is encouraged to investigate the formulation of alternative design procedures in order to identify documented procedures that have a basis that may more closely match the specific conditions of their site. While the estimates of capacity derived from static analyses are useful for preliminary design, it must also be emphasized that a well designed load-testing program is a critical and necessary component for the effective use of CFA piles.

### 5.3.1 Cohesive Soils

#### 5.3.1.1 Recommended Method for Side-Shear and End-Bearing Estimates Using Undrained Shear Strength

The FHWA 1999 method for drilled shafts is recommended for prediction of both the side-shear and end-bearing resistances for CFA piles in cohesive materials. The FHWA 1999 method was originally proposed by Reese and O'Neill (1988) and later modified by O'Neill and Reese (1999).

For a given pile segment, the ultimate unit side-shear resistance ( $f_s$ ) is calculated as:

$$f_s = \alpha S_u \quad (\text{Equation 5.5})$$

where  $S_u$  is the undrained shear strength of the soil at the pile segment location, and  $\alpha$  is a reduction factor that varies as follows:

$$\alpha = 0.55 \text{ for } S_u/P_a \leq 1.5 \quad (\text{Equation 5.6})$$

where  $P_a$  is the standard atmospheric pressure (equal to 1 atm or approximately equal to 101 kPa [1.06 ton per square foot or tsf]), for  $1.5 < S_u/P_a \leq 2.5$ ,  $\alpha$  varies linearly from 0.55 to 0.45.

If the bottom of the pile is bearing on clay, the side-shear contribution to the capacity of the bottom one-diameter length of the pile is neglected. If the top layer is clayey, there exists the potential for this soil to shrink away from the top of the pile when exposed to the atmosphere. If such a condition is suspected, then the side-shear contribution from this layer should be neglected in the greater of either the top 1.5 m (5 ft) of soil or the depth of seasonal moisture change.

In the FHWA 1999 method, the ultimate unit end-bearing resistance ( $q_p$ ) is calculated as:

$$q_p = N_c^* S_u \quad (\text{Equation 5.7})$$

where  $S_u$  is the average undrained shear strength of the soil between the pile tip and two-pile diameters below the pile tip, and  $N_c^*$  is the bearing capacity factor. The value of  $N_c^*$  is adopted as follows:

$$N_c^* = 9 \quad (\text{Equation 5.8})$$

for  $200 \text{ kPa (2 tsf)} \leq S_u \leq 250 \text{ kPa (2.6 tsf)}$ , and  $L \geq 3D$ , or

$$N_c^* = \frac{4}{3} [\ln I_r + 1] \quad (\text{Equation 5.9})$$

for  $S_u < 200 \text{ kPa (2 tsf)}$ , and  $L \geq 3D$ .

where  $L$  is the pile embedment length below top of grade, and  $I_r$  is the rigidity index.

Note that values of  $S_u$  greater than  $250 \text{ kPa (2.6 tsf)}$  are treated as intermediate geo-materials in accordance with O'Neill and Reese (1999). The rigidity index ( $I_r$ ) is calculated as follows:

$$I_r = \frac{E_s}{3S_u} \quad (\text{Equation 5.10})$$

where  $S_u$  and the undrained Young's modulus ( $E_s$ ) are those of the soil just below the pile tip.  $E_s$  is best determined from triaxial testing or in-situ testing (such as the pressuremeter test). If  $E_s$  is not measured, it can be assumed with less accuracy to be a function of  $S_u$  for design purposes by interpolating between the values given in Table 5.1 below.

**Table 5.1: Relationship between Undrained Shear Strength, Rigidity Index, and Bearing Capacity Factor for Cohesive Soils for FHWA 1999 Method**

Source: O'Neill and Reese (1999)

$S_u$	$I_r = E_s/(3S_u)$	$N_c^*$
25 kPa (0.25 tsf)	50	6.5
50 kPa (0.50 tsf)	150	8.0
100 kPa (1.00 tsf)	250	8.7
200 kPa (2.00 tsf)	300	8.9

Although not expected to occur for CFA piles, if the pile embedment length below grade were to be less than three pile diameters, the ultimate unit end-bearing resistance ( $q_p$ ) should be reduced according to the FHWA 1999 method, as follows:

$$q_p = \frac{2}{3} \left[ 1 + \frac{1}{6} \frac{L}{D} \right] N_c^* S_u \quad \text{for } L < 3D \quad (\text{Equation 5.11})$$

### 5.3.1.2 Alternative Methods for Side-Shear Estimates Using Undrained Shear Strength

The Coleman and Arcement (2002) method was derived from CFA pile load-tests conducted in mixed soil conditions consisting of mostly alluvial and loessial deposits, and interbedded sands and clays in Mississippi and Louisiana. Section A.2.10 of Appendix A contains further details of the test program. The method may be considered as an alternative for soils of similar geology and properties as described in Appendix A and below. This method provides modifications to the  $\alpha$  factor for clays and silts (exhibiting an undrained condition) that may be utilized for

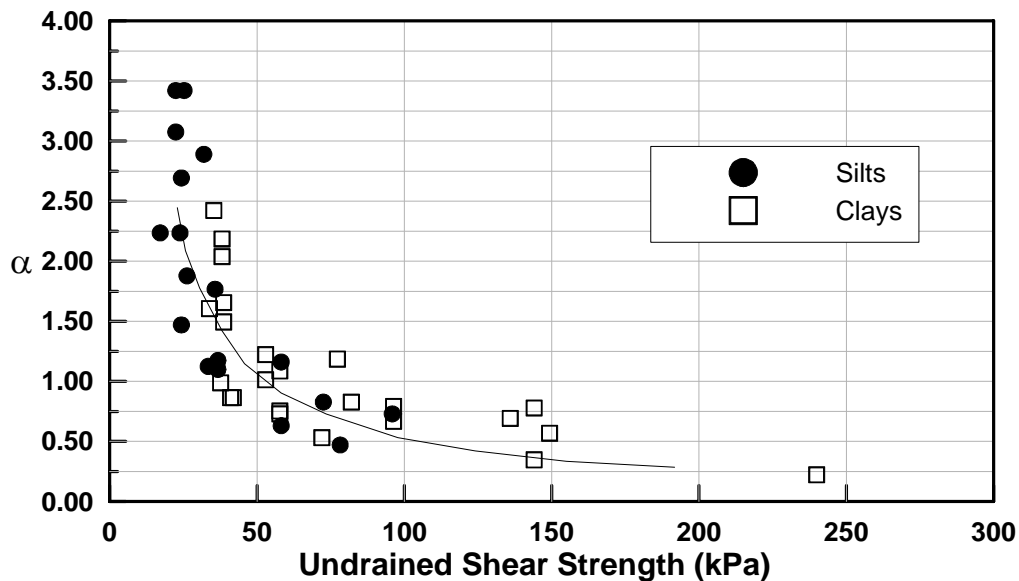
estimation of side-shear capacities. The ultimate unit side-shear resistance ( $f_s$ ) is again calculated from the average undrained shear strength ( $S_u$ ), and the  $\alpha$  factor as:

$$f_s = \alpha S_u \quad (\text{Equation 5.12})$$

$$\alpha = \frac{56.2}{S_u} \quad (S_u \text{ in kPa}) \quad (\text{Equation 5.13a})$$

$$\alpha = \frac{0.56}{S_u} \quad (S_u \text{ in tsf}) \quad (\text{Equation 5.13b})$$

Coefficients above are rounded from Coleman and Arcement (2002). The valid range of  $S_u$  for this equation is between about 25 and 150 kPa (0.25 to 1.5 tsf), as shown in Figure 5.2. Note that in the recommended FHWA 1999 method,  $\alpha$  would be constant and equal to 0.55 for soils with  $S_u$  less than approximately 150 kPa [1.5 tsf]), and would reduce to as low as 0.45 for greater values of  $S_u$ . The design engineer may consider the use of this correlation for similar deposits where it is anticipated that the FHWA 1999 method may be too conservative for similar deposits of clays and silts that are very soft to medium in consistency (i.e.,  $S_u$  up to approximately 50 kPa [0.5 tsf]).



Source: Coleman and Arcement (2002)

**Figure 5.2: Relationship for the  $\alpha$  Factor with  $S_u$  for Calculating the Unit Side-Shear for Cohesive Soils for the Coleman and Arcement (2002) Method**

The TXDOT 1971 Method (Texas Highway Department, 1972) for drilled shafts has shown favorable results in predicting the static axial capacity of CFA piles in stiff clays, which have been over-consolidated by desiccation. The ultimate unit side-shear resistance ( $f_s$ ) in cohesive soils is calculated for a given pile segment simply as a function of  $S_u$  (i.e., here the  $\alpha$  factor is constant at 0.7):

$$f_s = 0.7 S_u \quad \leq 120 \text{ kPa (1.25 tsf)} \quad (\text{Equation 5.14})$$

### 5.3.1.3 Alternative Method for End-Bearing Estimates Using Dynamic Cone Penetrometer

The TXDOT 1971 Method (Texas Highway Department, 1972) for drilled shafts has shown favorable results in predicting the static axial capacity of CFA piles in cohesive soils. However, the method relies on the use of a Dynamic Cone Penetrometer value ( $N_{TXDOT}$ ) for estimation of ultimate unit end-bearing resistance, which is uncommon in most areas outside of Texas. The ultimate unit end-bearing resistance ( $q_p$ ) can be determined using the  $N_{TXDOT}$  value as follows:

$$q_p (tsf) = \frac{N_{TXDOT}}{8.25} \quad (\text{Equation 5.15})$$

### 5.3.1.4 Alternative Method for Side-Shear and End-Bearing Estimates Using SPT-N Values

The design methods for prediction of side-shear and end-bearing resistance components in cohesive soils rely almost exclusively on undrained shear strength ( $S_u$ ). When no other types of geotechnical data other than SPT- $N$  values are available, the undrained shear strength can be estimated from SPT- $N$  values using local or published correlations appropriate for the soil deposit in question. However, this procedure is recommended only in feasibility studies, and not for design, because SPT- $N$  values obtained in soils are not highly-reliable in estimating the undrained shear strength.

### 5.3.1.5 Alternative Method for Side-Shear and End-Bearing Estimates Using CPT Values

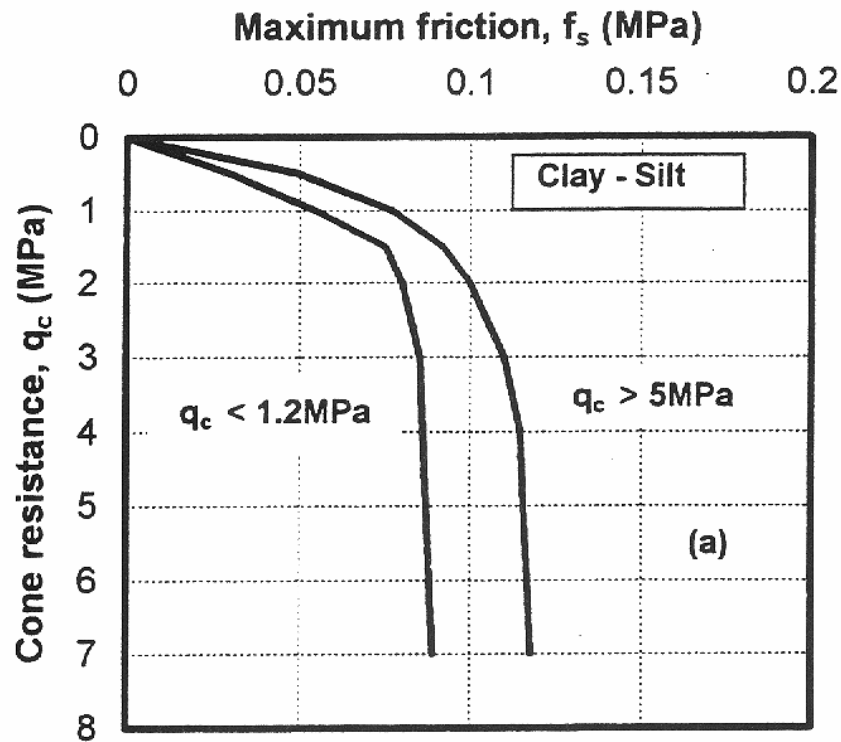
CPT testing has shown good results in prediction of both end-bearing and side-shear of CFA piles, as well as other types of deep foundations. This method of testing has become common in geotechnical soil exploration. For many engineers, the CPT is the preferred tool for use in predicting pile capacities in soils. Current research is focused on developing improved correlations for the use of CPT data in estimating CFA pile capacities, and improved correlations may become available as CPT becomes more widespread in the U.S. market.

The Laboratoire Des Ponts et Chaussées (LPC) method for drilled shafts and driven piles, developed by Bustamante and Gianeselli (1981, 1982), is recommended to be used over the previously presented methods for cohesive soils when cone bearing resistance ( $q_c$ ) data from CPT testing. Side-shear resistance estimates can be made using Figure 5.3 for clays and silts exhibiting an undrained condition.

The ultimate unit side-shear in cohesive soils ( $f_s$ ) at a given depth (shown in Figure 5.3 as Maximum friction) is determined from the cone bearing resistance ( $q_c$ ) at that depth (as shown on the Y-axis), and then by interpolation between the limiting curves shown ( $q_c < 1.2$  MPa [12.5 tsf] and  $q_c > 5$  MPa [52 tsf]) based upon the average  $q_c$  along the pile length or pile segment length within a cohesive stratum.

The ultimate unit end-bearing resistance ( $q_p$ ) in cohesive soils may also be estimated directly from the cone tip resistance ( $q_c$ ) from CPT testing:

$$q_p = 0.15 q_c \quad (\text{Equation 5.16})$$



Source: Bustamante and Gianeselli (1982)

**Figure 5.3: Unit Side-Shear Resistance as a Function of Cone Tip Resistance for Cohesive Soils – LPC Method**

The cone tip resistance used in this equation is averaged for a range of two to three pile diameters below the pile tip, whichever gives a lesser average value.

### 5.3.2 Cohesionless Soils

#### 5.3.2.1 Recommended Method for Side-Shear Estimates Using Pile Depth and End-Bearing Estimates Using SPT-N Values

The FHWA 1999 method for drilled shafts is recommended for the prediction of CFA pile capacity in cohesionless soils. The FHWA 1999 method was originally proposed by Reese and O’Neill (1988), and later modified by O’Neill and Reese (1999). This method uses SPT  $N_{60}$  values (in blows per 0.3 m or per foot [bpf]) for calculations; these values should be based on 60% hammer efficiency but should not be depth corrected.

The ultimate unit side-shear resistance ( $f_s$ ) of a pile segment is estimated as:

$$f_s = K \sigma_v' \tan \phi \leq 200 \text{ kPa (2.0 tsf)} \quad (\text{Equation 5.17})$$

Where  $K$  is the lateral earth pressure coefficient,  $\sigma'_v$  is the vertical effective stress, and  $\phi$  is the soil drained angle of internal friction. The  $\beta$  factor is defined as:

$$\beta = K \tan \phi \quad (\text{Equation 5.18})$$

and is limited to  $0.25 \leq \beta \leq 1.2$ . The  $\beta$  factor for a pile segment is estimated as:

$$\beta = 1.5 - 0.135 \cdot Z^{0.5} \quad \text{for } N \geq 15 \text{ bpf} \quad (\text{Equation 5.19a})$$

$$\beta = \frac{N}{15} (1.5 - 0.135 Z^{0.5}) \quad \text{for } N < 15 \text{ bpf} \quad (\text{Equation 5.19b})$$

where  $Z$  is the depth (in feet) from the ground surface to the middle of a given soil layer or pile segment.

In the FHWA 1999 method, the ultimate unit end-bearing resistance ( $q_p$ ) is estimated as:

$$q_p \text{ (tsf)} = 0.6N_{60} \quad \text{for } 0 \leq N_{60} \leq 75 \quad (\text{Equation 5.20a})$$

$$q_p = 4.3 \text{ MPa [45 tsf]} \quad \text{for } N_{60} > 75 \quad (\text{Equation 5.20b})$$

where  $N_{60}$  is the SPT- $N$  value (bpf) at 60% of hammer efficiency near the tip of the pile, which is typically taken as the average within the depth interval of approximately 1 pile diameter above, to 2 or 3 pile diameters below, the pile tip.

### 5.3.2.2 Alternative Methods for Side-Shear Using Pile Depth

The Coleman and Arcement (2002) method was derived from CFA pile load-tests conducted in Mississippi and Louisiana in mixed soil conditions consisting of mostly alluvial, loessial deposits, and interbedded sands and clays. Section A.6.3 of Appendix A contains further details of the test program. This method provides modifications to the  $\beta$  factor of the recommended FHWA 1999 method for sandy soils and silty soils (exhibiting a drained condition) as follows:

$$f_s = \beta \sigma_v \leq 200 \text{ kPa (2.0 tsf)} \quad (\text{Equation 5.21})$$

The values of  $\beta$  are computed as follows:

$$\beta = 2.27 Z_m^{-0.67} \quad (\text{for silty soils}) \quad (\text{Equation 5.22})$$

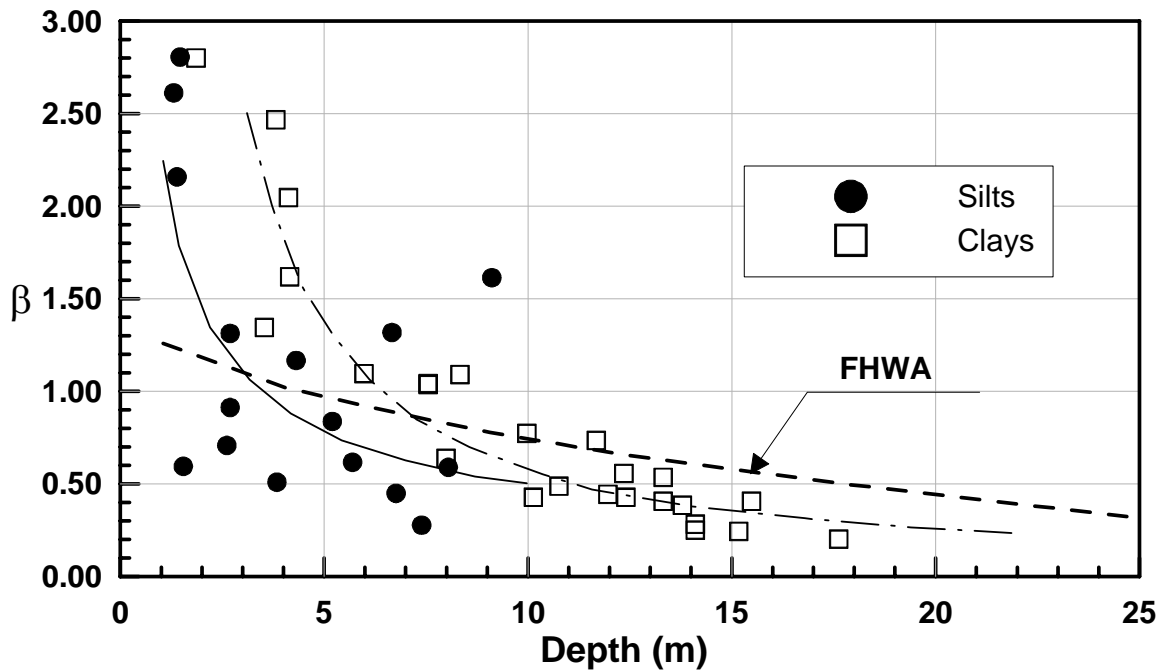
$$\beta = 10.72 Z_m^{-1.3} \quad (\text{for sandy soils}) \quad (\text{Equation 5.23})$$

Where  $Z_m$  is the depth (in meters) from the ground surface to the middle of a given soil layer or pile segment. The values of  $\beta$  are limited to  $0.2 \leq \beta \leq 2.5$ .

The resulting  $\beta$  values in this method are shown in Figure 5.4, which also shows  $\beta$  values obtained using the FHWA 1999 method for comparison. The higher  $\beta$  factors at shallow depths



are most likely a result of the weakly cemented deposits (i.e., with a cohesion of approximately 24 kPa [500 psf]) used in this study; these cemented soils have appreciable strength even when the effective overburden stress is low.



Source: Coleman and Arcement (2002)

**Figure 5.4: Relationship for the  $\beta$  Factor for Calculating the Unit Side-Shear for Cohesionless Soils for the FHWA 1999 and Coleman and Arcement Methods**

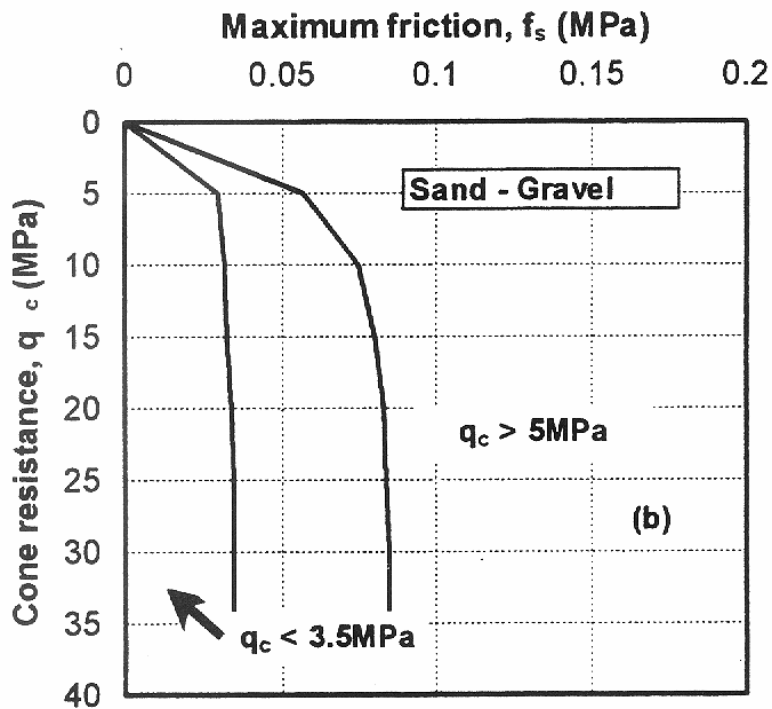
### 5.3.2.3 Alternative Method for Side-Shear and End-Bearing Estimates Using CPT Values

The LPC method for drilled shafts and driven piles, developed by Bustamante and Gianselli (1981, 1982), is recommended when the capacities are to be estimated directly from the CPT cone bearing resistance ( $q_c$ ). These estimates can be made using Figure 5.5 for sands and gravel.

The ultimate unit side-shear in cohesionless soils ( $f_s$ ) at a given depth (shown on the X-axis as Maximum friction) is determined from the cone bearing resistance ( $q_c$ ) at that depth (as shown on the Y-axis), and by the interpolating between the limiting curves shown ( $q_c < 3.5$  MPa [36 tsf] and  $q_c > 5$  MPa [52 tsf]) based upon the average  $q_c$  along the pile length or pile segment length within a cohesionless stratum.

The ultimate unit end-bearing resistance ( $q_p$ ) in cohesionless soils may also be estimated directly from the cone bearing resistance ( $q_c$ ) from CPT testing, which is typically averaged over two to three pile diameters below the pile tip. According to the LPC method:

$$q_p \text{ (MPa)} = 0.375 \cdot q_c \quad \text{(Equation 5.24)}$$



Source: Bustamante and Gianselli, (1982)

**Figure 5.5: Unit Side-Shear as a Function of Cone Tip Resistance for Cohesionless Soils - LPC Method**

### 5.3.3 Other Geo-Materials

#### 5.3.3.1 Introduction

CFA piles have been used with success in strong, non-caving materials including vuggy limestones, shales, and other types of weathered or weak rocks. However, it is generally not possible to install CFA piles in such hard material while maintaining a rate of penetration that would normally be required to penetrate caving soil without mining. The use of continuous flight augers to construct CFA piles in weak or weathered rock is thus comparable to drilling an open hole drilled shaft without removing the auger. The potential problem of such practice is for conditions where non-cohesive overburden soils are present and will be subject to soil mining of the overburden as the rock socket is drilled. Where cohesive or stable overburden soils permit the installation of CFA piles into weak or weathered rock without problems, it is recommended that computational procedures should follow that of drilled shafts as outlined in O'Neill and Reese (1999). The following subsections present experience with CFA piles installed in vuggy limestone and shale.

For hard rock overlain by soil materials, it may be difficult to construct a CFA pile with sufficient base resistance on the rock without soil mining. Piles should penetrate at least one pile diameter into the rock bearing stratum to utilize end-bearing capacity associated with the rock.

Even when the overlying soil is cohesive and the risk of soil mining is low, the reliability of the pile/rock interface is uncertain unless penetration of the rock can be assured. Conditions with soil overlying an extremely hard rock formation would be better suited to alternate foundation types, such as a drilled shaft, micropile, or driven steel pile.

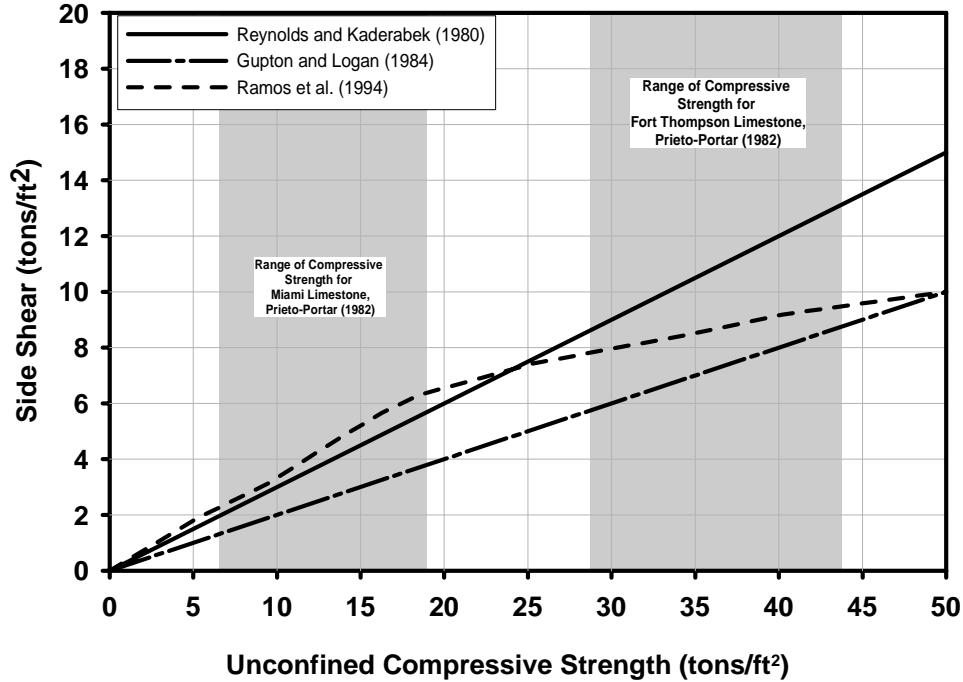
### 5.3.3.2 Vuggy Limestone

For vuggy limestone formations of South Florida, or for similar formations elsewhere, CFA piles may be designed according to the relationships suggested by Frizzi and Meyer (2000). These relationships were derived from over 60 load-tests in the Miami limestone and Fort Thompson limestone formations found in South Florida (Broward and Miami-Dade Counties).

Frizzi and Meyer (2000) presented relationships of unconfined compressive strength vs. ultimate unit side-shear resistance, shown on Figure 5.6. The relationship shown on that figure by Gupton and Logan (1984) was based upon drilled shaft experience in Florida limestone, the relationship by Kaderabek and Reynolds (1981) was based on anchor pullout tests performed on rock core specimens, and the relationship developed by Ramos et al. (1994) was developed primarily from full-scale field grout plug tests and limited CFA load-tests in various Florida limestone. The trend lines suggest that the smaller scale anchor tests and grouted plugs tend to mobilize higher side-shear resistance than larger foundations when tested in rock at the lower end of the unconfined compressive strength range; as the intact rock strength increases, they will tend to perform more similarly to drilled shafts. These data suggest that the effect of scale is important in interpreting field test data for drilled foundations in Florida limestone, and design correlations for CFA piles should be based on tests of full-scale piles.

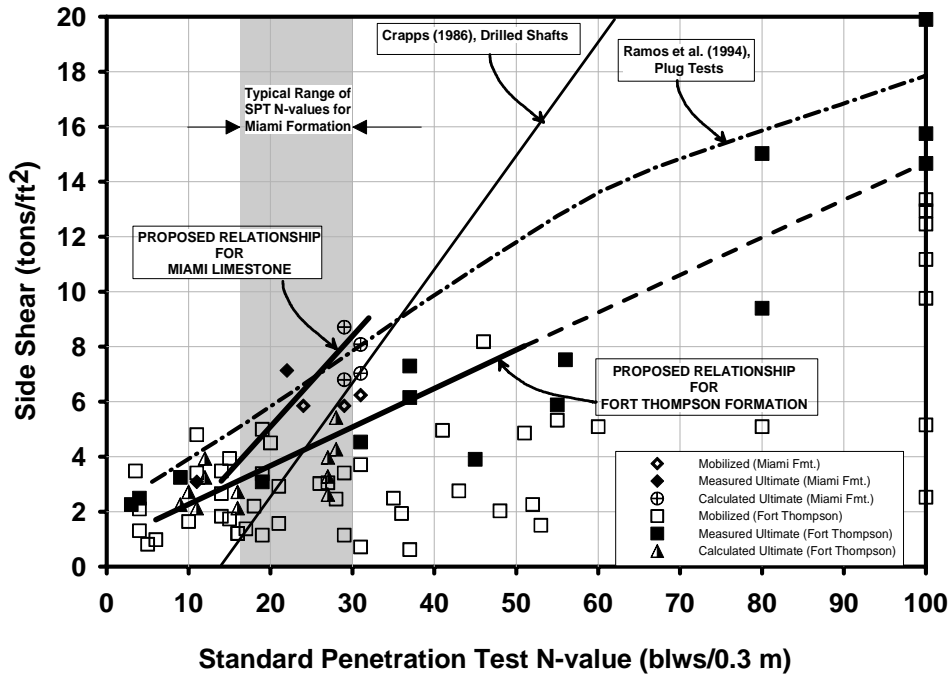
In the Frizzi and Meyer (2000) method, the ultimate unit side-shear resistance for a given pile segment in either the Miami limestone or Fort Thompson limestone formations are correlated to the  $SPT-N_{60}$ , as shown in Figure 5.7.  $SPT-N_{60}$  values for calculations should be based on 60% hammer efficiency but should not be depth corrected. The data utilized to develop these relationships were limited to ultimate unit side-shear resistance values not exceeding approximately 9 and 8 MPa (94 to 84 tsf) for the Miami limestone and Fort Thompson limestone formations, respectively. Note that the smaller scale plug tests data from Ramos et al. (1986) again appears to be unconservative when compared to full-scale field load-test data.

Figure 5.8 presents a relationship of side-shear stress development with displacement from load-tested CFA piles constructed in the Miami limestone and Fort Thompson limestone formations. Note that this data is presented as the ratio of the developed side-shear to the ultimate side-shear resistance ( $f/f_{max}$ ) vs. the pile displacement ( $W$ ) expressed as a percentage of the diameter ( $D$ ). This relationship is compared with curves for drilled shafts proposed by Reese and O'Neill (1988) and with load-test data published by Semeraro (1982). No modifications or methods for predicting the end-bearing capacity were proposed by Frizzi and Meyer (2000). Note that in most cases, the CFA piles mobilized a very high load-carrying capacity initially (at a very low displacement), after which the load mobilization characteristics become similar to the deflection hardening response shown for granular soil.



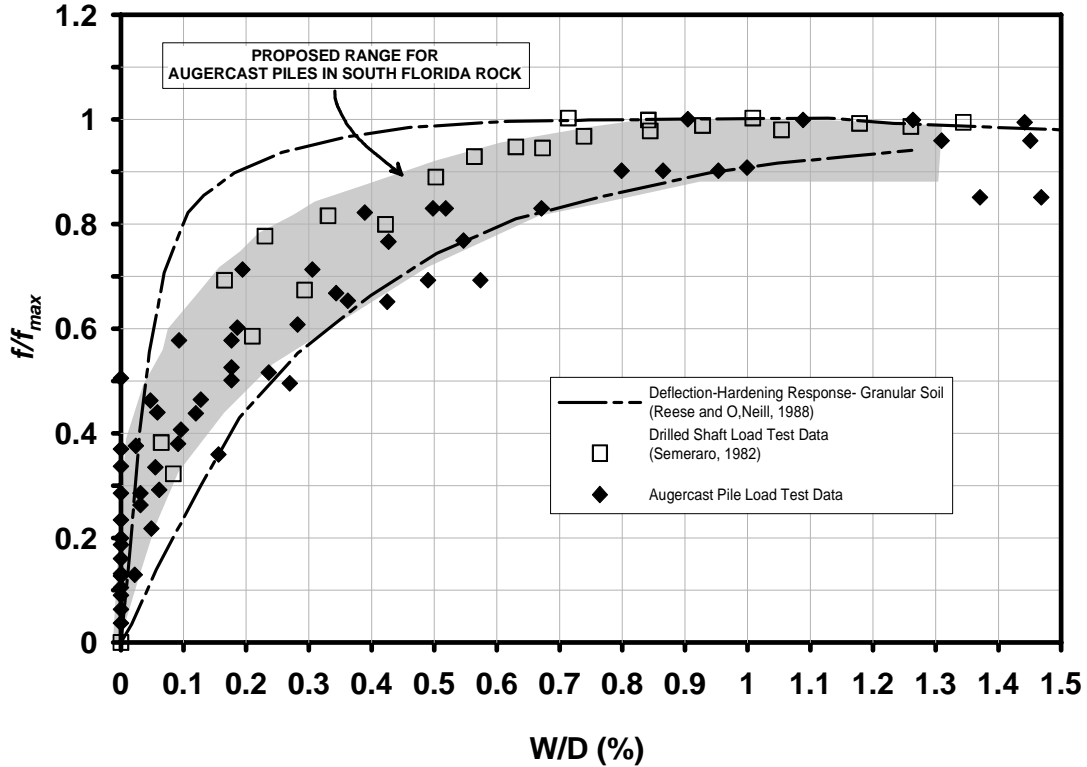
Source: Frizzi and Meyer (2000)

Figure 5.6: Unconfined Compressive Strength vs. Ultimate Unit Side-Shear for Drilled Shafts in Florida Limestone



Source: Frizzi and Meyer (2000)

Figure 5.7: Correlation of Ultimate Unit Side-Shear Resistance for South Florida Limestone with SPT- $N_{60}$  Value



Source: Frizzi and Meyer (2000)

**Figure 5.8: Side-Shear Development with Displacement for South Florida Limestone**

### 5.3.3.3 Clay-Shale

For CFA piles socketed into clay-shale formations of North-Central Texas, or for similar formations elsewhere, the total capacity developed in the socket may be estimated according to the relationships suggested by Vipulanandan et al. (2005). These relationships were derived from eight load-tests of CFA piles socketed into clay-shale with unconfined compression strengths ( $q_u$ ) ranging from 100 to 3,000 kPa (1 to 30 tsf) (measured in situ from a Texas Cone Penetrometer value,  $N_{TxDOT}$ ). Overburden soils were predominantly clay and sandy clay, and thus allowed for construction of the socket without appreciable soil mining effects. The diameter and length of the CFA piles varied from 450 to 600 mm (18 to 24 in.) and 12 to 25 m (40 to 83 ft), respectively.

The load-test results are presented in dimensionless form for all eight test piles as a relative load capacity ( $Q/Q_{ult}$ ), which is a function of the relative displacement ( $\rho/D$ ). This is shown in Figure 5.9 and is represented by the following hyperbolic function:

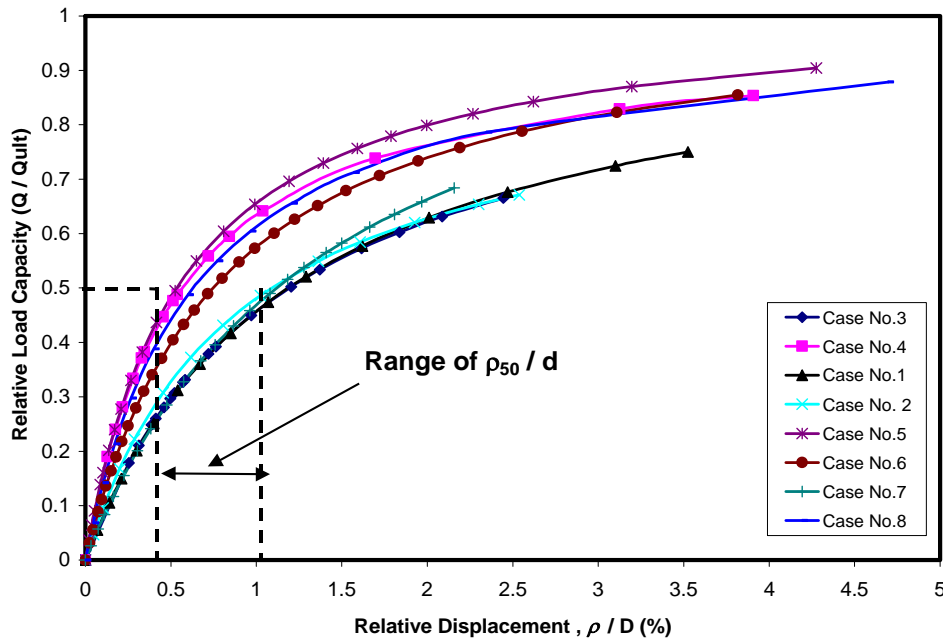
$$\frac{Q}{Q_{ult}} = \frac{\frac{\rho}{D}}{\frac{\rho_{50}}{D} + \frac{\rho}{D}} \quad \text{(Equation 5.25)}$$

where:

- $Q$  = resistance at the given displacement (in any consistent units);
- $Q_{ult}$  = the ultimate resistance that occurs for very large displacements (in the same, consistent units of  $Q$ );
- $\rho$  = pile displacement (in any consistent units);
- $D$  = diameter of the pile (in the same, consistent units of  $\rho$ ); and
- $\rho_{50}/D$  = the displacement-to-diameter ratio at  $Q/Q_{ult} = 0.5$ .

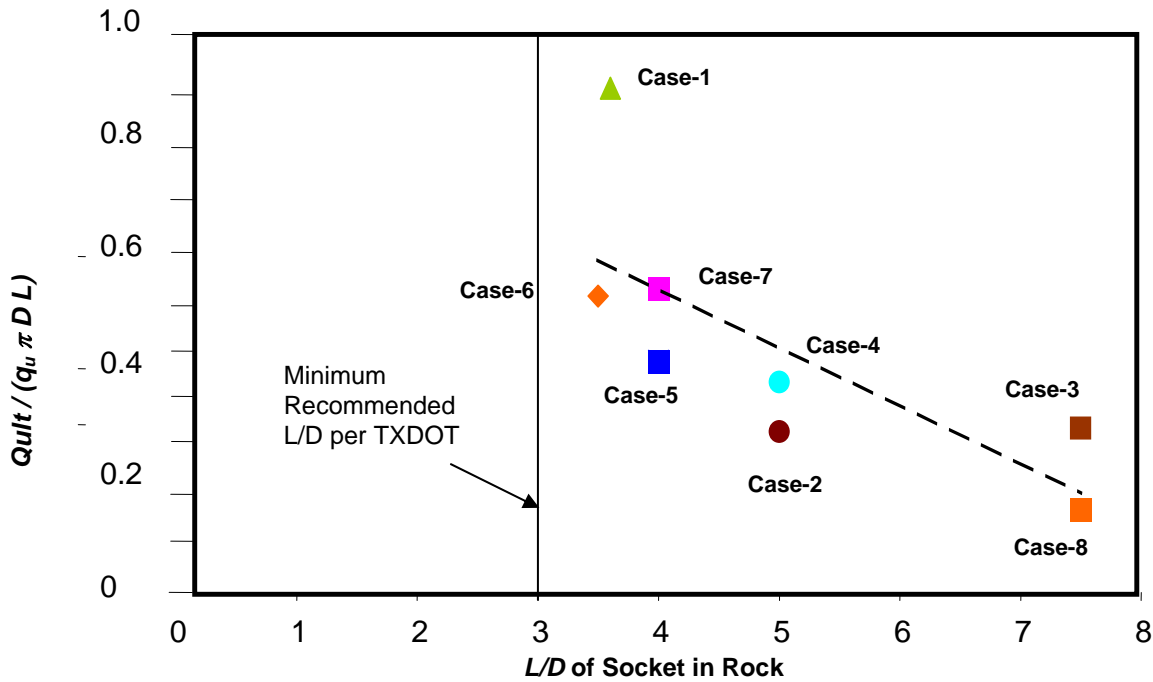
The parameter  $Q_{ult}$  was correlated to the unconfined compressive strength ( $q_u$ ) of the clay-shale, pile circumference ( $\pi D$ ), and socket length ( $L$ ) and is shown in Figure 5.10 and is represented as:

$$\frac{Q_{ult}}{q_u \pi D L} = -0.11 \frac{L}{D} + 0.96 \quad (\text{Equation 5.26})$$



Source: Vipulanandan et al. (2004)

**Figure 5.9: Relative Load Capacity vs. Relative Displacement for CFA Sockets in Clay-Shale**



Source: Vipulanandan et al. (2004)

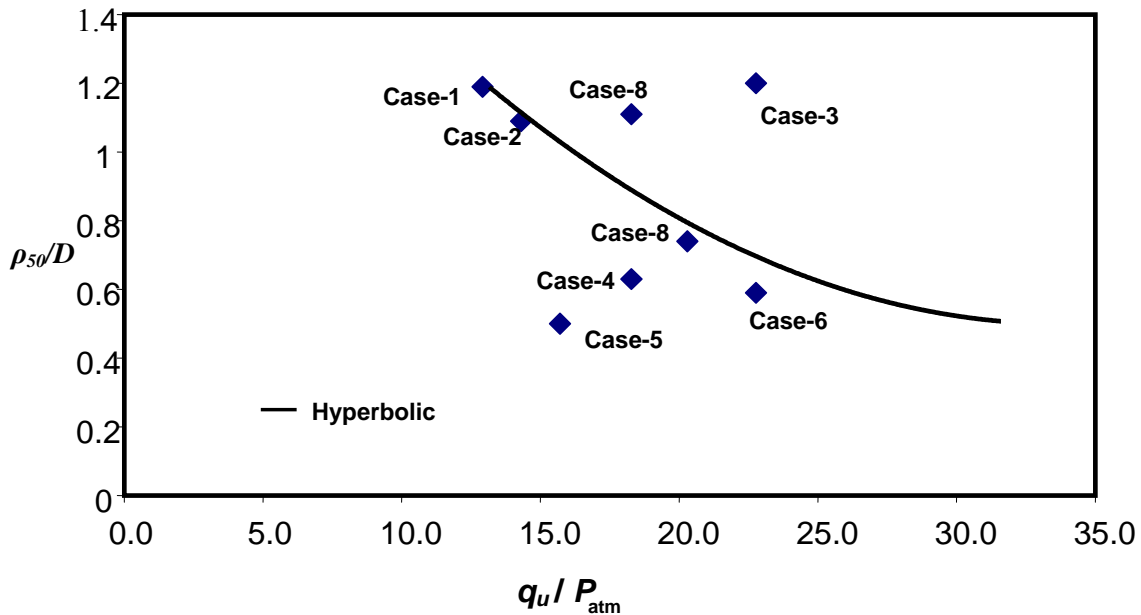
**Figure 5.10: Hyperbolic Model Parameter  $Q_{ult}$  as a Function of the Unconfined Compressive Strength ( $q_u$ ) for CFA Sockets in Clay-Shale**

The parameter  $\rho_{50}/D$  was also correlated to the unconfined compressive strength of the clay-shale normalized by the standard atmospheric pressure (in any consistent units) in the equation below.

$$\frac{\rho_{50}}{D} [\text{in } \%] = \frac{15.8}{\frac{q_u}{P_{atm}}} \quad (\text{Equation 5.27})$$

This relationship is shown in Figure 5.11.

To use the Vipulanandan et al. (2004) method, the unconfined compressive strength obtained from the field or laboratory is considered first. After normalizing  $q_u$  with the atmospheric pressure the ratio  $\rho_{50}/D$  is obtained from Figure 5.11 or Equation 5.27. The ultimate capacity is computed using Figure 5.10 or Equation 5.26. With the pile diameter  $D$  and socket length  $L$  known, and the variables previously presented already determined, the relative load capacity can be computed for a range of pile displacements. An example in English units is provided to illustrate the method.



Source: Vipulanandan et al. (2004)

**Figure 5.11: Parameter  $\rho_{50}/d$  as a Function of Unconfined Compressive Strength for CFA Sockets in Clay-Shale**

For:

- a pile with diameter  $D = 1.5$  ft;
- drilled into clay shale of  $q_u = 20$  tsf; and
- a socket  $L = 3 D = 4.5$  ft.

The following results are obtained using the method described above:

- for ratio  $q_u/P_{atm} = 20$ ;
- Equation 5.27 results  $\rho_{50}/D = 0.79\%$ .

With Equation 5.26, the ultimate capacity is estimated as:

$$Q_u = q_u \pi D L (-0.11 \times L/D + 0.96) = 20 \times 3.14 \times 1.5 \times 4.5 (-0.11 \times 3 + 0.96) = 267 \text{ tons.}$$

For a pile displacement of 0.25 in. and using Equation 5.25, the mobilized load capacity is estimated to be:

$$\begin{aligned} Q &= Q_{ult} [\rho/D \div (\rho_{50}/D + \rho/D)] = \\ &= 267 \times [0.25/18 \div (0.0079 + 0.25/18)] = 0.64 \times 267 = 170 \text{ tons.} \end{aligned}$$



## 5.4 STATIC AXIAL CAPACITY OF DRILLED DISPLACEMENT PILES

### 5.4.1 Introduction

Numerous construction techniques and tools have been developed to increase the load capacity over that which is attained from conventional CFA piles for a given soil condition. Most of these systems have been developed by specialty contractors and/or equipment manufacturers, and thus may perform differently depending upon the relative volume of soil displaced in proportion to the pile volume, the magnitude of the permanent increase in lateral stress or soil improvement at the pile/soil interface, the relative roughness of the resulting pile/soil interface, and the effective diameter of the resulting pile. Different techniques may achieve superior results in different types of soil conditions. For example, increased lateral stress and soil densification may be a very desirable effect of installation in sandy soil profiles, while increased roughness or effective diameter may be effective in cohesive soils where densification of saturated cohesive soil is unlikely to occur.

Most of these specific techniques and tools share some common features regarding the mechanisms by which higher capacities may be realized. In general, in DD piles, the drilling spoils and the surrounding soil are displaced laterally or compacted into the borehole wall to varying degrees during auger penetration. The relative volume of soil displaced in proportion to the pile volume determines whether the technique is termed a “high displacement” or a “partial displacement” pile. In cases where an amelioration technique is employed, sand or gravel introduced into the top of the borehole may also be compacted into the borehole wall by specialty tooling. As a result, localized densification of the soil will occur to some limited extent away from the pile, and the effective lateral stresses in the soil surrounding the pile will increase.

A number of studies have attempted to quantify the effects of displacement on surrounding soils during pile construction. Kulhawy (1984) showed that the lateral earth pressure coefficient ( $K_o$ ) may decrease as much as one third (resembling an active lateral earth pressure,  $K_a$ ) for drilled shafts, and may nearly double (resembling a passive lateral earth pressure,  $K_p$ ) for high-displacement driven piles. Displacement effects have also been quantified by other means. Webb et al. (1994) indicated an increase of 20 to 50% in CPT resistance over the length of pile after the installation of displacement piles in sandy soils. Nataraja and Cook (1983) used SPT to quantify the effects of displacement and concluded that the increased stresses were also a function of the soil uniformity coefficient, over-consolidation ratio, and effective stress conditions before displacement.

### 5.4.2 Recommended Method Using SPT-N Values or CPT Data

The recommended method for estimating axial resistance of DD piles is based on the published work of NeSmith (2002). Caution is warranted in using the correlations presented for DD piles, as the static axial capacity is very sensitive to the construction technique and tooling, and relies heavily on the abilities and experience of the specialty contractors. Improved side-shear resistance and end-bearing capacities obtainable with this technique over conventional CFA piles must be verified for the specific site, technique, and equipment using full-scale load-testing, automated monitoring, and recording equipment for all test and production piles.

NeSmith (2002) studied the results of 22 full-scale compression load-tests and six full-scale pullout tests of DD piles located at 19 different sites throughout the United States. The pile diameters ranged from 0.36 to 0.46 m (14 to 18 in.), with the majority at 0.41 m (16 in.). The pile lengths ranged from 6 to 21 m (20 to 69 ft), with an average length of approximately 13 m (43 ft). A variety of soil conditions were investigated (listed in Table 5.2), which generally ranged from clean sands, fine gravels, to silty and clayey sands. Five of the compression test piles (included as one site in the Piedmont geologic setting in Table 5.2) were from the research conducted by Brown and Drew (2000); the soils at this site consisted of clayey silts to silty clays with around 50% passing the #200 sieve, and represent the soil profile with the highest fines content in the NeSmith (2002) study.

**Table 5.2: Soil Conditions Investigated for Drilled Displacement Piles**

Source: NeSmith (2002)

Geologic Setting	Sites	Major Features
Alluvium in a major river (AR, CA, FL, IA, WA)	5	Loose to dense sand, some gravel, well-graded (primarily), clean to some silt and clay
Post Miocene (FL)	4	Loose (primarily) to medium silty, clayey sand
Barrier Island (FL, AL, MD)	4	Medium to very dense sand, uniform, clean
Piedmont (GA)	3	Loose (primarily), silty sand/sandy silt, micaceous (toe in partially weathered rock)
Glacial Outwash (MN)	1	Loose to medium sand with fine gravel, clean, well-graded
Gulf Coastal Plain (FL)	1	Loose to medium silty clayey sand
Colma Formation (CA)	1	Medium to very dense silty and clayey sand

NeSmith (2002) defined ultimate pile capacity to occur at displacements of 25.4 mm (1 in.) of tip movement, or when the displacement rate of the loading curve reached 0.057 mm/kN (0.02 in./ton), whichever occurred first. While the two stated failure criteria occasionally occurred near the same load, the displacement rate criterion did not govern in any case. In the event that the load was not increased to a level sufficient to reach either of the criteria, the load displacement relationship was extrapolated to ultimate by the method proposed by Chin (1970), and this method was also used to estimate the shaft end-bearing component for test piles where no instrumentation was available.

Figure 5.12 (a) and (b) shows correlations of the ultimate unit side-shear ( $f_s$ ) with CPT tip resistance ( $q_c$ ) and SPT- $N$  values, respectively. SPT- $N_{60}$  values should be based on 60% hammer efficiency but should not be depth corrected. These relationships should only be applied to cohesionless materials in which displacement of the spoils into the borehole wall during construction will result in densification of the surrounding soil. Based on these trends, the ultimate unit side-shear resistance ( $f_s$ ) for a given pile section can be correlated with  $q_c$  or to SPT- $N_{60}$  values as follows:

$$f_s = 0.01 q_c + W_S \quad \text{for } q_c \leq 200 \text{ tsf (20 MPa)} \quad (\text{Equation 5.28})$$

$$f_s \text{ (tsf)} = 0.05 N + W_S \quad \text{for } N \leq 50 \quad (\text{Equation 5.29})$$

$$f_s \text{ (MPa)} = 0.005 \cdot N + W_s \quad \text{for } N \leq 50$$

where the correlation constant ( $W_s$ ) and limiting ultimate unit side-shear ( $f_s$ ) are as follows:

- $W_s = 0$ , and  $f_s \leq 0.16$  MPa (1.7 tsf) for uniform, rounded materials having up to 40% fines.
- $W_s = 0.05$  MPa (0.5 tsf) and  $f_s \leq 0.21$  MPa (2.2 tsf) for well-graded angular materials having up to 10% fines.
- For soil conditions with material properties falling between the provided ranges, a linear interpolation between the limiting values should be made.

Note that the recommended method for estimating the ultimate  $f_s$  from CPT- $q_c$  values for DD piles (Figure 5.12), are more than twice that predicted by the alternative method (LPC) for computing  $f_s$  from CPT- $q_c$  values for conventional CFA piles (Figure 5.5).

The ultimate unit end-bearing ( $q_p$ ) was correlated to either CPT- $q_c$  or SPT- $N$  values obtained near the pile tip. SPT- $N_{60}$  values should be based on 60% hammer efficiency. These values should be obtained between approximately  $4D$  above and  $4D$  below the pile tip. Figure 5.13 (a) and (b) show the ultimate unit end-bearing capacity ( $q_p$ ) data, and the correlations with CPT- $q_c$  and SPT- $N$  values, respectively. Capacities may be estimated according to the following relationships:

$$q_p = 0.4 q_c + W_T < 19 \text{ MPa (200 tsf)} \quad \text{(Equation 5.30)}$$

$$q_p \text{ (MPa or tsf)} = 0.19 N_{60} + W_T \quad \text{for } N_{60} \leq 50 \quad \text{(Equation 5.31)}$$

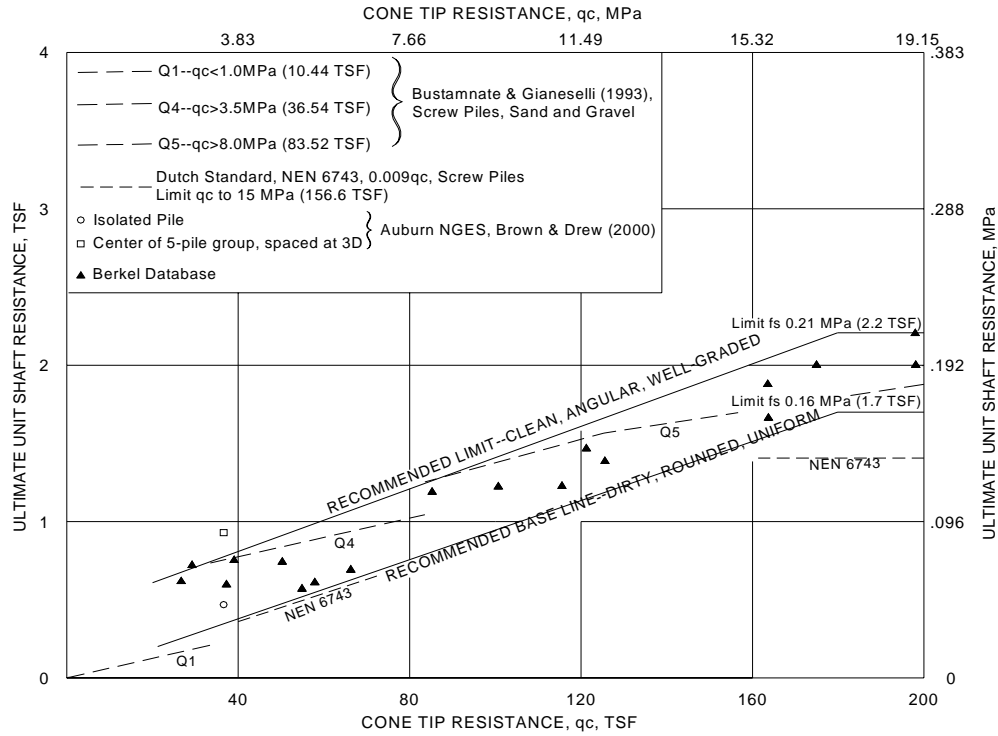
where the constant ( $W_T$ ) is as follows:

$W_T = 0$ , for  $q_p \leq 7.2$  MPa (75 tsf) and uniform, rounded materials having up to 40% fines.

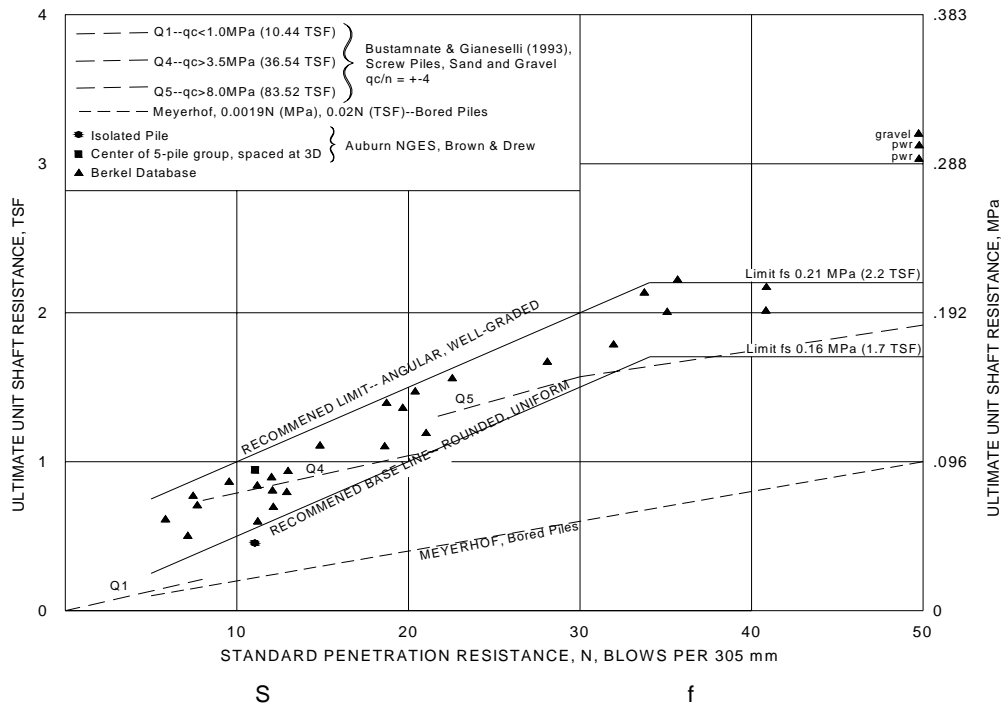
$W_T = 1.34$  MPa (14 tsf), for  $q_p \leq 8.62$  MPa (89 tsf) and well-graded angular materials having up to 10% fines.

For soil conditions with material properties falling between the ranges provided above, a linear interpolation between the limiting values should be made.

It is worthwhile comparing the above recommendations for DD piles with that for conventional CFA piles as described in the preceding section. For CFA piles, the recommended method and the alternative method for computing ultimate unit end-bearing ( $q_p$  in units of tsf) from SPT- $N_{60}$  values ranged from  $0.6 N_{60}$  to  $1.7 N_{60}$ , respectively. The recommended method for ultimate unit end-bearing ( $q_p$  in units of tsf) from SPT- $N_{60}$  values for DD piles ranges from  $1.9 N_{60}$  to  $1.9 N_{60} + 14$  tsf, depending on soil material properties. Similarly, the alternative method (LPC) for computing the ultimate unit end-bearing ( $q_p$ ) from CPT- $q_c$  values for conventional CFA piles was  $0.375 q_c$ . The recommended method for ultimate unit end-bearing ( $q_p$ ) from CPT- $q_c$  values for DD piles ranged from  $0.4 q_c$  to  $0.4 q_c + 14$  tsf, depending on soil material properties.



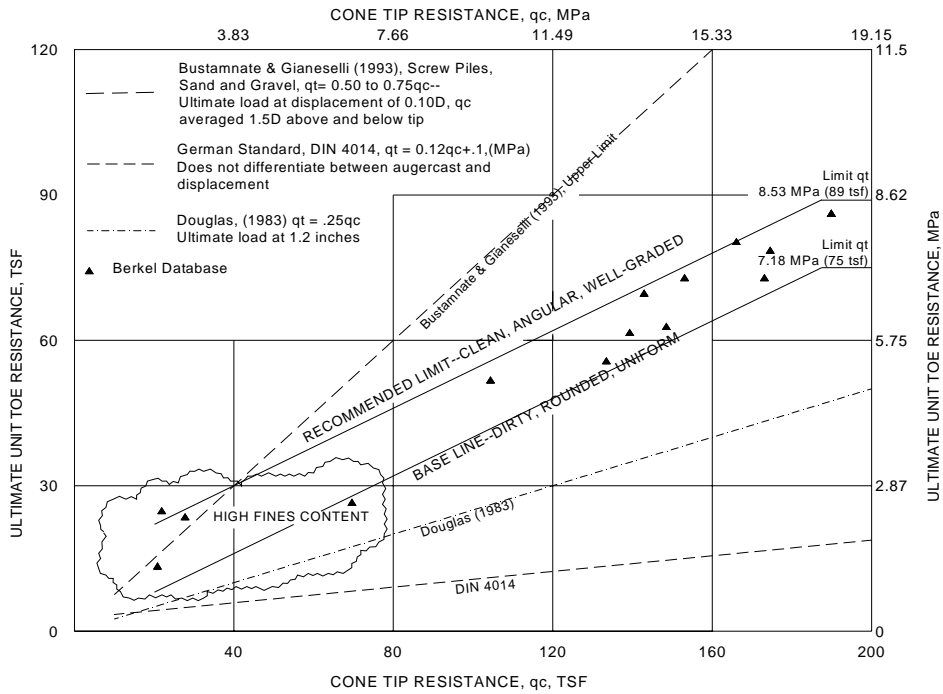
(a) Correlated to CPT Testing



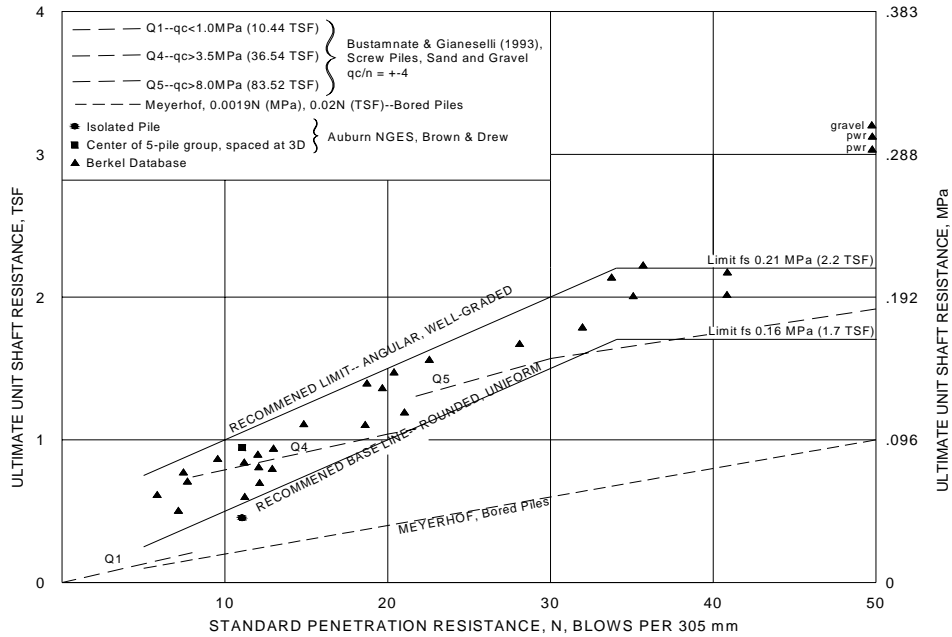
(b) Correlated to SPT Testing

Note: N in Figure above refers to  $N_{60}$ . Source: NeSmith (2002)

Figure 5.12: Ultimate Unit Side-Shear Resistance for Drilled Displacement Piles for NeSmith (2002) Method



**(a) Correlated to CPT Testing**



**(b) Correlated to SPT Testing**

Note: N in Figure above refers to  $N_{60}$ . Source: NeSmith (2002)

**Figure 5.13: Ultimate Unit End-Bearing Resistance for Drilled Displacement Piles for NeSmith (2002) Method**

### **5.4.3 Amelioration**

The amelioration technique involves introducing coarse sand or gravel into the top of the borehole as the specialty tooling is advanced. A section of reversed auger flights (pitched opposite to the direction of rotation) is situated above the normal auger flights, and a packer (enlarged drill stem) lies in the drill string between these two sets of auger flights. The sand or gravel introduced falls down into the annular between the borehole wall and the drill stem. The reversed flights catch the introduced granular material and force it into the borehole wall.

In addition to densifying the surrounding soil and increasing the effective stress, this technique was shown by Brown and Drew (2000) to be advantageous in silty clays to clayey silts where the soil-to-pile interface friction angle ( $\delta$ ) would have otherwise been smaller. They found amelioration with sand to increase an individual pile's side-shear resistance by approximately 25% over that of an individual pile constructed without amelioration. However, they found amelioration with sand to increase side-shear by only 16% of a single pile tested individually within a pile group (spaced at 3 pile diameters center-to-center) over that of a similar single pile within a group constructed without amelioration and tested individually within the group. Also, they found amelioration with crushed stone (maximum aggregate size typically 10 mm [0.4 in.]) to increase side-shear resistance of individual piles by approximately 50% over that of an individual pile constructed without amelioration. The introduced free-draining granular material may allow for any excess pore pressures around the pile to be dissipated more rapidly than they would otherwise, as well as potentially increasing the effective diameter of the pile. While both grouping of piles and amelioration both provided marked increases in capacity, their combined effects were not as substantial as the simple sum of the two.

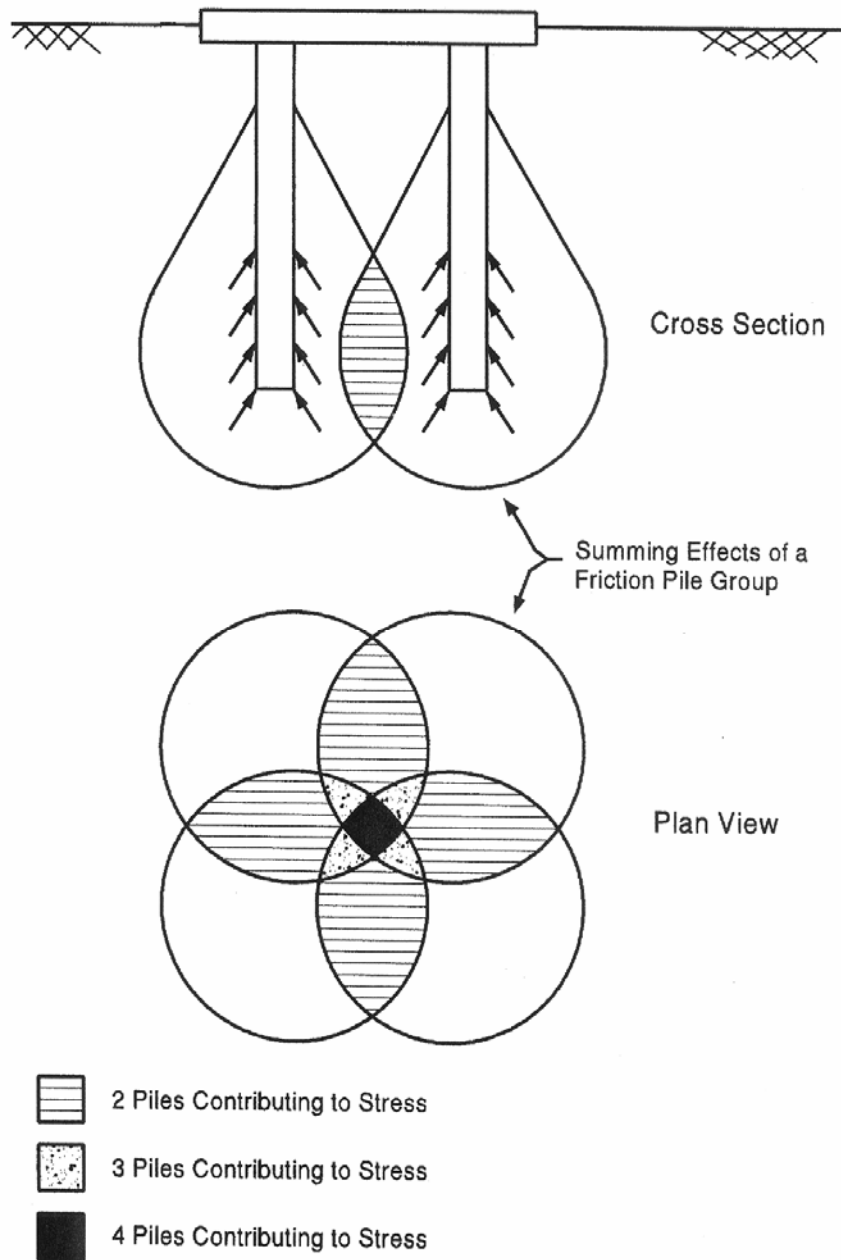
This technique, which may result in substantial improvements to the capacity, relies heavily on the abilities and experience of the specialty contractors, and is typically utilized as only a contractor-proposed method. However, with the use of performance-based specifications for contracting as described in Chapter 8, the use of these innovative pile types may be encouraged. Improved capacities obtainable with DD techniques must be verified for the specific site and tooling/technique with full-scale load-testing and the use of automated monitoring and recording equipment for all test and production piles. Note also that the required resistance may tend to be achieved with shorter piles than anticipated with conventional CFA, and thus group effects and settlement considerations may be controlling issues in some cases. Effects of installation of DD piles with amelioration on adjacent structures may also be a limiting factor in selection of this technique.

## **5.5 GROUP EFFECTS ON STATIC AXIAL COMPRESSION LOAD RESISTANCE OF CFA PILES**

### **5.5.1 Introduction**

The axial compressive capacity of a pile group is not necessarily the sum of the single pile capacity within the group. In pile groups, the zone of influence from an individual pile may intersect with other piles, depending on the pile spacing, as illustrated in Figure 5.14. Evaluations of pile group capacities should also consider potential block failure of the pile group,

and the potential contribution of the pile cap to bearing capacity contribution regarding the total capacity of the pile group system (termed occasionally as a pile raft). Finally, the designer should be aware that settlement of a pile group may often exceed that which would be predicted based upon a single pile analysis



Source: Hannigan et al. (2006)

**Figure 5.14: Overlapping Zones of Influence in a Frictional Pile Group**

### 5.5.2 Group Efficiencies

The efficiency of a pile group ( $\eta_g$ ) is defined as:

$$\eta_g = \frac{R_{ug}}{\sum_{i=1}^n R_{u,i}} \quad (\text{Equation 5.32})$$

where  $R_{ug}$  is the ultimate resistance of the pile group, and  $R_{u,i}$  is the ultimate resistance of a single pile “ $i$ ” in the pile group with a total of  $n$  piles in the group.

Displacement piles (such as driven piles and to a lesser extent DD piles) generally tend to increase the effective stress of the surrounding soil, and thus can create a pile group capacity greater than the sum of the individual pile capacities when these densified zones of influence surrounding the pile overlap. This soil improvement effect creates an efficiency greater than 1.0. Conversely, excavated piles (such as drilled shafts and conventional CFA piles), generally tend to decrease the effective stress of the surrounding soil, or at best maintain it at the at-rest ( $K_o$ ) condition, creating an efficiency less than or equal to 1.0, respectively. Changes in effective stress are more pronounced in cohesionless soils. Note also that installation effects from poorly controlled pile construction resulting in soil mining during drilling can adversely affect the lateral stress of previously installed piles.

#### 5.5.2.1 Conventional CFA Pile Groups

Groups of conventional CFA piles may be designed with drilled shaft group efficiencies that may tend to be conservative if proper techniques are used for CFA pile construction, as verified with appropriate construction monitoring. However, the reader is strongly cautioned that if soil mining were to occur, the resulting efficiency for the CFA group would be substantially less than that for a group of drilled shafts in the same soil conditions. Note that cohesionless soils are particularly sensitive to this effect.

The overlapping zones of influence from individual piles in a group, and the tendency for the pile cap to bear on the underlying soils (if in contact) tend to cause the piles, pile cap system, and the soil surrounding the piles to act as a single unit and exhibit a block-type failure mode (i.e., bearing failure). The group capacity should be checked to see if a block-type failure mode controls the group capacity, as will be discussed in the next paragraph.

Block failure mode for pile groups generally will only control the design for pile groups in soft cohesive soils or cohesionless soils underlain by a weak cohesive layer. Note that closer spacing of the piles in the group will also tend to increase the potential of the block failure mode.



### *Cohesionless Soils*

In the absence of site-specific data to indicate otherwise, it is recommended that the AASHTO provisions (AASHTO, 2002) for group efficiencies for drilled shafts in cohesionless soils (AASHTO 10.8.3.9.3) be followed for conventional CFA piles in the same soils. This provision states that regardless of cap contact with the ground:

$\eta = 0.65$  for a center-to-center spacing of 2.5 diameters,

$\eta = 1.0$  for a center-to-center spacing of 6.0 diameters or more, and

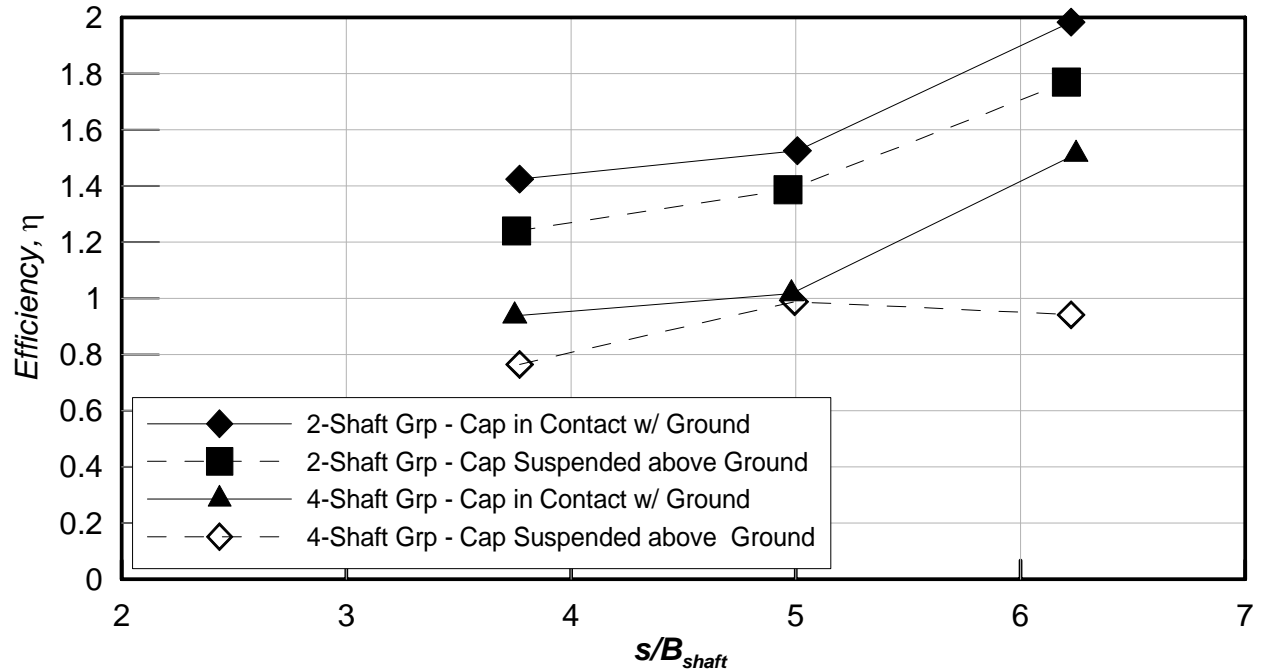
The value of  $\eta$  must be determined by linear interpolation for intermediate spacing.

There is evidence that the recommended values are most likely conservative for CFA piles in cohesionless soils, in circumstances where the pile cap is in firm contact with the ground and contributes significantly to the bearing capacity, and/or when the cohesionless soil is not loosened by the installation process. Results from small-scale field tests in cohesionless soils from diverse locations around the world suggest that an efficiency of 1.0 or greater may be obtained with pile center-to-center spacing of approximately 3 to 4 diameters, and that 0.67 may be a lower bound for group efficiencies. Note that a typical center-to-center spacing of 3 pile diameters would result in a recommended efficiency of 0.7 using the AASHTO (2002) provisions cited above.

Studies of drilled shaft groups in cohesionless soils include Garg (1979), Liu et al. (1985), and Senna et al. (1993). The shafts in these studies did not exceed the range of 125 to 330 mm (5 to 13 in.) in diameter, and from 8 to 24 times their respective diameter in length. While these piles may be considered model-scale for drilled shafts, their sizes approached that typical of CFA piles. Note that all three of the studies sites were performed in either dry sand or sand with fines above the water table. Efficiencies for groups in clean sands below the water table may be lower than reported in the cited studies due to a greater potential for relaxation of lateral stress.

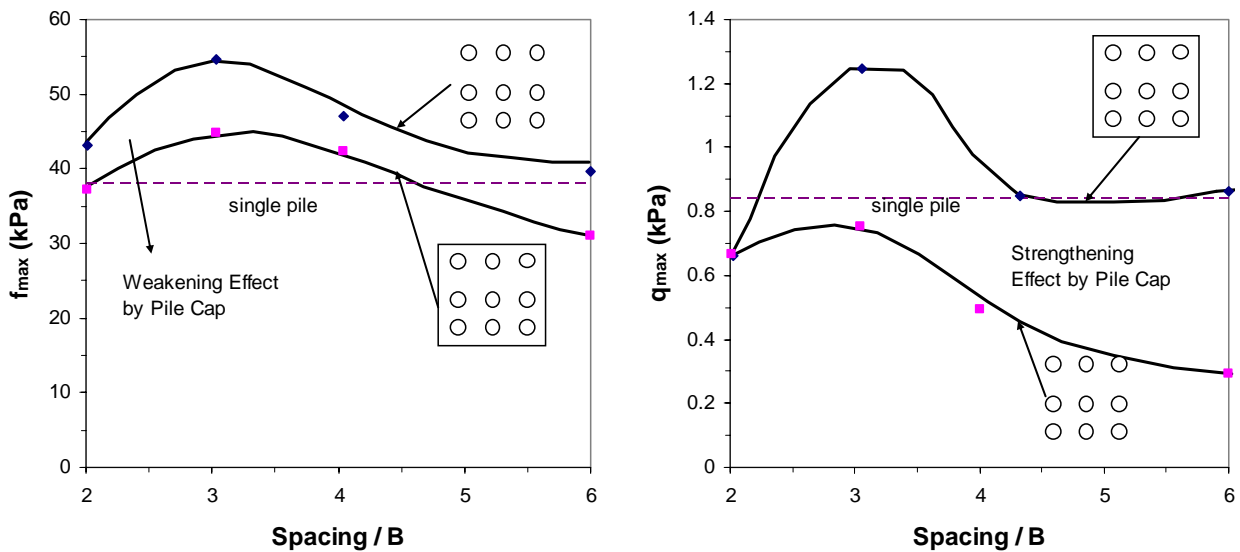
Garg (1979) conducted compression model tests of underreamed shafts in moist, poorly-graded silty sand with SPT- $N$  values ranging from 5 to 15. The efficiency vs. the ratio of spacing to diameter ( $S/B_{shaft}$ ) for 2 and 4 pile groups, both with and without the cap in contact with the ground, are shown in Figure 5.15. Note that the efficiency of a group with its pile cap in contact with the ground is consistently higher than the efficiency of the group with the cap not in contact with the ground.

Liu et al. (1985) conducted model axial compression tests in moist alluvial silty sand, soil density for side-shear resistance was not reported. The group effects on side-shear and end-bearing contributions of a 3 by 3 pile group as a function of the ratio of spacing to diameter ( $spacing/B$ ) are shown in Figure 5.16. The relationship is shown for the cases of the pile cap in contact or not in contact with the ground. Note that the case of the cap in contact with the ground results in lower efficiencies but higher efficiencies for end-bearing than with the cap not in contact with the ground for comparable spacing-to-diameter ratios.



Source: O'Neill and Reese (1999) (Modified after Garg, 1979)

**Figure 5.15: Efficiency ( $\eta$ ) vs. Center-to-Center Spacing ( $s$ ), Normalized by Shaft Diameter ( $B_{shaft}$ ), for Underreamed Model Drilled Shafts in Compression in Moist, Silty Sand**



Source: O'Neill and Reese (1999)

**Figure 5.16: Relative Unit Side and Base Resistances for Model Single Shaft and Typical Shaft in a Nine-Shaft Group in Moist Alluvial Silty Sand**

Senna et al. (1993) conducted model axial compression tests in clayey sand with SPT- $N$  values ranging from approximately 4 at the surface to as high as 18 at the tip depths (6 m [19.7 ft]). Four different group configurations were tested and compared to a single pile response with the resulting efficiencies as shown in Table 5.3. Note that all groups had center-to-center spacing of 3 diameters, and all caps were in contact with the ground.

**Table 5.3: Efficiency ( $\eta$ ) for Model Drilled Shafts Spaced 3 Diameters Center-to-Center in Various Group Configurations in Clayey Sand (Senna et al, 1993)**

Configuration	2 × 1 Pile Bent	3 × 1 Pile Bent	3 Triangular Pile Group	4 Square Pile Group
Efficiency	$\eta = 1.1$	$\eta = 1.1$	$\eta = 1.04$	$\eta = 1.0$

While these studies have limitations with respect to application to CFA pile design in cohesionless soils, they suggest that there may be circumstances in which the AASHTO (2002) specifications would result in a significantly conservative estimate of group capacity. The group effects of CFA pile installation in cohesionless soil are generally attributed to reductions in lateral stress and/or reductions in soil relative density. For granular soils with considerable fines or light cementation and pile construction that is conducted with care to avoid potential reductions in lateral stress, it may be worthwhile to include an evaluation of group effects into the test pile program. Effects of pile installation on soil density or stress should be reflected in post-construction in-situ tests (SPT or CPT) within the pile group. Likewise, verification tests of an interior pile should provide a representative indication of a typical pile within a group after installation of the entire group. If reliable interpretations from a well-conceived test pile program can demonstrate that negative group effects are less severe than indicated by the AASHTO recommendations for drilled shafts, then an alternate approach may be justified on a project-specific basis.

#### *Cohesive Soils*

It is recommended that the AASHTO (2002) provisions for group efficiencies for drilled shafts in cohesive soils (AASHTO 10.8.3.9.2) be followed for conventional CFA piles in similar soils. This provision states that, regardless of cap contact with the ground, the efficiency should be determined from a block failure mode, and that the efficiency be limited to  $\eta = 1.0$ , or:

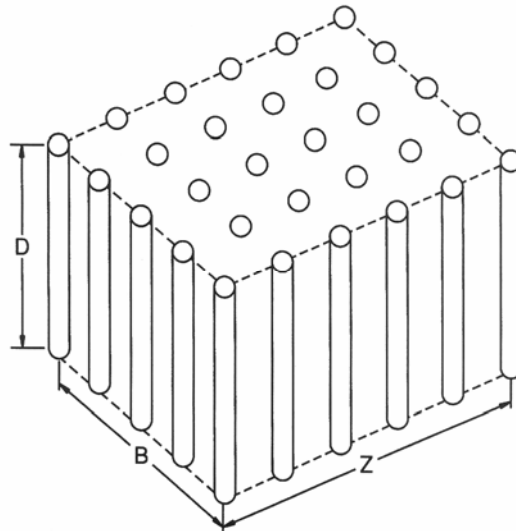
$$\eta_g = \frac{R_{Block}}{\sum_{i=1}^n R_{u,i}} \leq 1 \quad (\text{Equation 5.33})$$

The resistance of the block failure ( $R_{Block}$ ) mode can be simply estimated as the sum of the side-shear resistance contribution from the peripheral area of the block, as shown in Figure 5.17, and the end-bearing capacity contribution from the block footprint area:

$$R_{Block} = 2 f_s [DZ + B] + q_p (Z B) \quad (\text{Equation 5.34})$$

where:  $D$ ,  $Z$ , and  $B$  are the depth, length, and width of the block, respectively,  $f_s$  is the ultimate unit side-shear resistance of the block,  $R_{u,i}$  is the individual pile ultimate resistance and  $q_p$  is the ultimate unit end-bearing capacity for the block,  $R_{u,i}$  is estimated as described in Section 5.3 for conventional CFA piles.

Most often, the limiting pile-to-soil friction angle ( $\delta$ ) is used to conservatively calculate shear resistance for the entire peripheral surface of the block at corresponding depths, rather than a combination of pile-to-soil ( $\delta$ ) and soil-to-soil ( $\phi$ ) friction angles. The ultimate unit end-bearing capacity for the block is similar to that determined for a single pile; however, the ultimate unit end-bearing capacity of the block must take into account that the influence zone of the block is deeper than that of a single pile. This may be accounted for by assuming a zone of approximately 2 to 3 times  $Z$ , and determining  $q_p$  by the methods presented in Section 5.3 for this deeper zone of influence.



Source: Hannigan et al. (2006)

**Figure 5.17: Block Type Failure Mode**

*Pile in a Strong Layer with a Weak Underlying Layer*

If a weak formation is present, the group efficiency should be checked to ascertain whether a group efficiency of less than 1.0 is warranted. The group efficiency may be checked as described in Section 5.5.2.1.2, where the individual pile ultimate resistance ( $R_{u,i}$ ) is estimated as described in Section 5.3 (for conventional CFA piles) and the block extends to the weak layer. It should be noted that a weak layer below the pile group will, in most cases, present a significant consideration from the standpoint of group settlement as outlined in section 5.5.3.3. Settlement considerations may require that minimum pile penetration be achieved to an elevation below the compressible layer.

### 5.5.2.2 Drilled Displacement Pile Groups

The efficiency of DD pile groups are comparable to that of driven displacement pile group. The recommendations included in this section are consistent with recommendations for the design of driven pile groups. In general, even a modest amount of displacement with intermediate DD piles can result in the conditions required to avoid the negative installation effects associated with conventional drilled foundations. For conditions where positive displacement of at least 15% of the pile volume is achieved, the methods in the sections below are recommended.

#### *Cohesionless Soils*

It is recommended that the AASHTO provisions for group efficiencies for driven piles in cohesionless soils (see, AASHTO 10.7.3.10.3 in AASHTO, 1996) be followed for DD piles in the same soils. This provision states that  $\eta = 1.0$  regardless of cap contact with the ground.

Groups of driven displacement piles typically exhibit a group efficiency greater than 1.0 (especially for cohesionless soils). However, a group efficiency of 1.0 is typically used in the interest of a conservative design. Likewise, groups of DD piles have typically exhibited a group efficiency greater than 1.0; however the group efficiency should also be limited to 1.0. Adequate spacing for DD piles may be considered to be approximately 3 pile diameters on centers or more.

For cohesionless soils, the DD pile group efficiency is recommended to be taken as 1.0 if a weak deposit is not encountered in the underlying formation. If a weak formation is present, the group efficiency should be checked to ascertain whether a group efficiency of less than 1.0 is warranted. The group efficiency may be checked with the equation in Section 5.5.2.1 where the ultimate resistance of the block ( $R_{Block}$ ) is estimated as described in Section 5.5.3, while the individual pile ultimate resistance ( $R_{u,i}$ ) is estimated as described in Section 5.4 (for auger displacement piles).

#### *Cohesive Soils*

A study by Brown and Drew (2000) of full-scale DD piles in the Piedmont geologic setting of the National Geotechnical Experimentation Site (NGES) (clayey silts to silty clays), suggested that DD piles behave like neither driven displacement piles nor conventional CFA piles, but in-between these extremes. Although not tested as a group, comparisons showed an increase in unit side-shear resistance of approximately 100% of the single interior pile within a 5-pile group (spaced at 3 pile diameters center-to-center) over an isolated pile. Also tested and compared was an isolated pile and a 5-pile group (spaced at 3 pile diameters center-to-center), all of which were constructed using an amelioration technique with coarse sand. The same comparison yielded an increase in unit side-shear resistance of 90% for the single interior central pile of the five-pile group over the isolated pile.

For cohesive soils with undrained shear strengths greater than 100 kPa (1 tsf) or for groups with the pile cap in firm contact with the ground, the DD pile group efficiency may be taken as 1.0. For the condition of cohesive soils with undrained shear strengths less than 100 kPa (1 tsf) and the pile cap not in firm contact with the ground, a group efficiency should be linearly interpolated in accordance with the pile spacing as follows: adopt an efficiency of 0.7 for a pile spacing of 3 diameters on-centers and increase to an efficiency of 1.0 for a pile spacing of 6 diameters or greater on-centers.

In all cases, a block failure mode should be checked to see if it governs the efficiency. The group efficiency for this mode should be checked with the equation shown in the previous section, where again, the ultimate resistance of the block ( $R_{Block}$ ) is estimated as described in Section 5.5.3, while the individual pile ultimate resistance ( $R_{u,i}$ ) is estimated as described in Section 5.4 (for auger displacement piles).

#### *Piles in a Strong Layer with a Weak Underlying Layer*

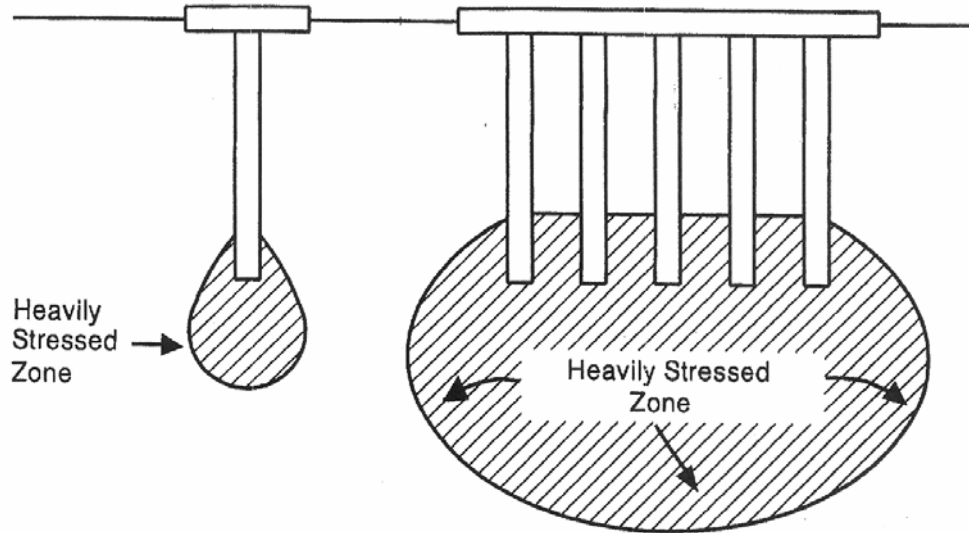
If a weak formation is present the group efficiency should be checked to ascertain whether a group efficiency of less than 1.0 is warranted. The group efficiency may be checked as described in Section 5.5.2.1, where the individual pile ultimate resistance ( $R_{u,i}$ ) is estimated as described in Section 5.4 (for auger displacement piles). Note that a potentially problematic condition may exist if the overlying strong layer is capable of stopping the penetration of DD piles. If the piles are terminated at this shallow “refusal” depth, the group effect must be checked for punching shear through into the underlying weak layer using the block failure concept described in the previous section. However, it is likely that settlement concerns could be significant, and these issues must be addressed as outlined in the following sections.

### **5.5.3 Settlement of Pile Groups**

The development of resistances with pile displacements of individual piles was discussed in Chapter 5.2. Displacements of individual piles at ultimate resistances (or in limited cases the load development with pile displacement) derived from many studies and prediction methods were presented in Section 5.3 and Appendix A. However, the settlement of a pile group is likely to be many times greater than the settlements predicted with the assumption that the piles act individually, especially for cases where the soils near the pile tips are more compressible.

The greater settlement of the pile group is attributed to a deeper zone of influence for the pile group than that for a single pile. The group effect of the piles mobilize a much deeper zone than that of a single pile, as illustrated in Figure 5.18.

Settlement of pile groups can be attributed to a combination of elastic compression of the piles and settlement of the surrounding soils. Settlement of the surrounding soils primarily consists of nearly instantaneous compression for purely cohesionless soils, and primarily time-dependant consolidation for purely cohesive soils. Note that layered systems of soils may contain appreciable amounts of both compression and consolidation settlements.



Source: Hannigan et al. (2006), after Tomlinson (1994)

**Figure 5.18: Deeper Zone of Influence for End-Bearing Pile Group than for a Single Pile**

Design engineers, who must consider pile foundation settlements, should carefully consider the magnitude and timing of the application of loads and their effect on the structure. For instance, the dead load of the column, pier cap, and perhaps other portions of the bridge structure may be in place, therefore, settlement due to these loads may be complete before the final connections of any settlement-sensitive portions of the structure are made. It may be possible that only settlements resulting from loads are imposed after the girder bearing plates are set are of significance to the structure.

Simplified methods for estimating pile group settlement are presented in the following sections. The methods presented were formulated for driven pile groups and are considered to be generally representative of CFA and DD pile group settlements. The deeper zone of influence for a pile group is unlikely to be significantly affected by differences in installation between piles of different types, although differences in individual pile stiffness and mobilization of capacity can affect settlements to some degree.

#### 5.5.3.1 Elastic Compression of the Pile

The elastic compression of the pile is a function of the imposed load, pile stiffness, and the load transfer characteristics from the pile to the surrounding soil.

Defining the stiffness ratio as:

$$S_R = \left( \frac{L}{B} \right) \cdot \left( \frac{E_{soil}}{E_{pile}} \right) \quad \text{(Equation 5.35)}$$

where:  $L$  = pile embedment depth,  $B$  = pile diameter,  $E_{soil}$  = average Young's modulus of the soil, and  $E_{pile}$  = Young's modulus of the pile.

For many practical problems, a pile may be considered “rigid” if its stiffness ratio ( $S_R$ ) is approximately  $S_R \leq 0.010$ . In these cases, the elastic shortening of the pile is likely to be very small compared to the settlements of the soil in which the pile is embedded. Otherwise, elastic compression ( $\Delta$ ) should be estimated and included in settlement calculations. This compression should be subtracted from the pile total displacement when determining the development of side-shear or end-bearing developed stresses at values less than ultimate.

The elastic compression of a pile ( $\Delta$ ) may be calculated as the sum of elastic compression of “ $n$ ” pile segments as follows:

$$\Delta = \sum_{i=1}^n \frac{Q_i \cdot L_i}{A_i \cdot E_i} \quad (\text{Equation 5.36})$$

Where:  $L_i$ ,  $A_i$ , and  $E_i$  are the length, average cross-sectional area, and average composite modulus, respectively, for each of the pile segments.  $Q_i$  is the average axial load at the pile segment. The load at the top pile segment would be the total imposed load to that individual pile, and would reduce in magnitude down to the mobilized end-bearing load at the pile tip in accordance with the load transfer response of the pile to soil system. If downdrag or uplift were to occur, the load distribution would be as described in Section 5.7.

The load imposed to an individual pile could become a complex solution if the pile cap were to provide a contribution to the total capacity of the pile group system (i.e., a pile raft as described in Section 5.5.4), and the group was subject to eccentric effects. However, to estimate the load imposed to the individual pile for purposes of elastic compression calculations, it may be sufficient to simply divide the total load of the pile group by the number of piles.

For many practical problems, an estimate of elastic shortening may be made using simplified assumptions regarding the load distribution in the pile. For example, a constant load transfer rate (i.e., a uniform unit side-shear stress along the entire length of the pile) and axial load supported entirely in side friction would result in a triangular distribution of load in the pile vs. depth ranging from the maximum load at the pile top to 0 load at the pile toe. For this condition, the elastic compression may be computed as:

$$\Delta = \left(\frac{1}{2}\right) \cdot \frac{Q_{\max} \cdot L_{\text{pile}}}{A_{\text{pile}} \cdot E_{\text{pile}}} \quad (\text{Equation 5.37})$$

Where:  $Q_{\max}$  is the total maximum imposed load and  $L_{\text{pile}}$  and  $A_{\text{pile}}$  are the pile total length and cross-sectional area, respectively.

An upper bound (other than the possibility of downdrag) is represented by a pile acting as a free-standing column with no load transfer along the entire length of the pile and the total maximum imposed load to the pile-supported in end-bearing. For this condition, Equation 5.38 provides an upper bound estimate of elastic shortening in the pile.



$$\Delta_{\max} = \frac{Q_{\max} \cdot L_{\text{pile}}}{A_{\text{pile}} \cdot E_{\text{pile}}} \quad (\text{Equation 5.38})$$

Note that downdrag or soil swell conditions could present a more significant pile load, and for such a case  $Q_{\max}$  would be determined as described in Section 5.7.

Equations 5.37 and 5.38 can be used to quickly estimate the potential magnitude of elastic shortening and determine if a more complete evaluation of load distribution is justified for the purpose of computing settlement.

### 5.5.3.2 Compression Settlement in Cohesionless Soils

Meyerhof (1976) recommended that the compression settlement of a pile group ( $S_{\text{group}}$ ) in a homogeneous sand deposit (not underlain by a more compressible soil at greater depth) be conservatively estimated by the correlations to either SPT- $N$  values or to CPT- $q_c$  values. If the group was underlain by cohesive deposits, time-dependant consolidation settlements would be needed, as described in the following section. The method proposed by Meyerhof (1976) does not distinguish 60% hammer efficiency for  $N$ -values. However, the 60% correction is recommended.

For SPT- $N$  values in cohesionless soils:

$$S_{\text{group}} = \frac{0.96 p_f I_f \sqrt{B}}{\overline{N}_{60'}} \quad \text{for sands} \quad (\text{Equation 5.39})$$

$$S_{\text{group}} = \frac{1.92 p_f I_f \sqrt{B}}{\overline{N}_{60'}} \quad \text{for silty sands} \quad (\text{Equation 5.40})$$

For CPT  $q_c$  values in cohesionless saturated soils:

$$S_{\text{group}} = \frac{42 p_f I_f B}{q_c} \quad (\text{Equation 5.41})$$

where:

- $S_{\text{group}}$  = estimated total settlement (in.);
- $p_f$  = foundation pressure (tsf), which is obtained as the group load divided by group area on plan view;
- $B$  = width of pile group (ft);
- $D$  = pile embedment depth below grade (ft)
- $I_f$  = influence factor for group embedment =  $1 - D/(8B) \geq 0.5$ ;
- $\overline{N}_{60'}$  = average corrected SPT- $N$  value (bpf per 0.3 m) within a depth  $B$  below the pile tip level; and
- $\overline{q_c}$  = average static cone tip resistance (tsf) within a depth  $B$  below the pile tip.

### 5.5.3.3 Consolidation Settlement in Cohesive Soils

Consolidation settlement of cohesive soils is generally associated with sustained loads and occurs as excess pore pressure dissipates (primary consolidation). For purpose of discussion in this section, the time rate of settlement will not be addressed directly. Design for a total magnitude of settlement for the full sustained dead load on the structure would represent a conservative approach to settlement in cohesive soils. For most structures, a portion of the dead load will be in place (pile cap, column, pier cap, etc.), and consolidation for that portion of the load may be nearly complete, before settlement-sensitive portions of the structure (above the girder bearing plates) are in place. Should computed settlements for total sustained dead load be found to significantly affect the design, it may be prudent to evaluate the time rate of the settlement for construction loads to more accurately assess the post-construction settlements. Time rate of primary consolidation is a topic covered in most geotechnical texts and in the FHWA Soils and Foundations Workshop Manual (FHWA NH1-06-088).

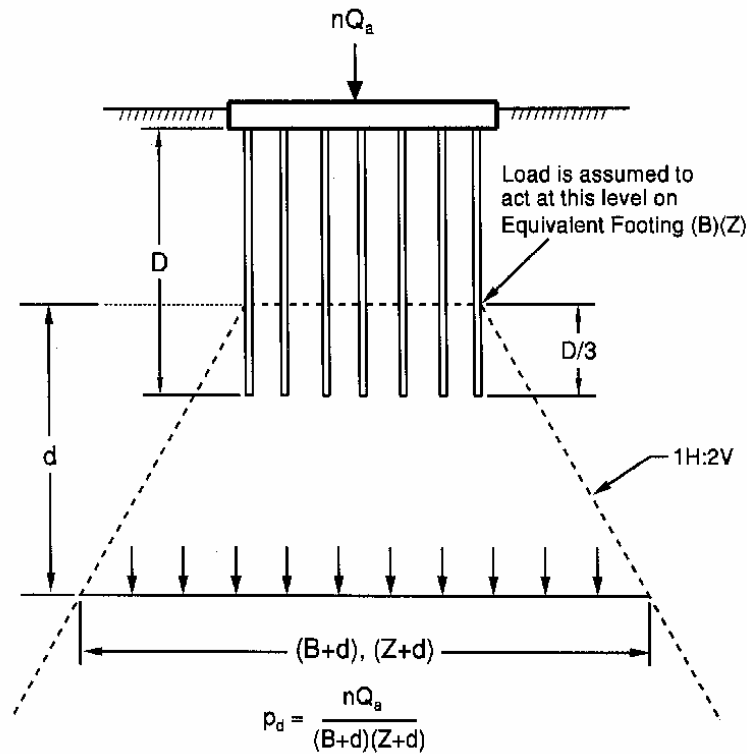
The consolidation settlement is driven by the load exerted on the pile group and resulting stress distribution into the soil below and around the pile group. The actual stress distribution in the subsurface can be affected by many factors including the soil stratigraphy, relative pile/soil stiffness, pile to soil load transfer distribution, pile cap rigidity, and the amount of load sharing between the cap and the piles. For most practical problems, a simplified model of stress distribution is sufficient to estimate pile group settlements. The equivalent footing method is presented below as a simplified method to estimate vertical stress with depth in the soil below the pile group.

Terzaghi and Peck (1967) proposed that pile group settlements could be evaluated using an equivalent footing situated  $1/3$  of the pile embedment depth ( $D$ ) above the pile toe elevation, and this equivalent footing would have a plan area of the pile group equal to the width ( $B$ ) times the pile group length ( $Z$ ). The pile group load over this plan area is then the bearing pressure transferred to the soil through the equivalent footing. The same load is then assumed to spread within the frustum of the pyramid of side slopes of 1 (horizontal): 2 (vertical), thus reducing the bearing pressure ( $p_d$  with depth) with depth as the area increases. This concept is illustrated in Figure 5.19.

In some cases, the depth of the equivalent footing should be adjusted based on soil stratigraphy and load transfer mechanism to the soil, rather than fixing the equivalent footing at a depth of  $1/3 D$  above the pile toe for all soil conditions. Figure 5.20 presents the recommended location of the equivalent footing for a variety of load transfer and soil resistance conditions.

The cohesive soils below the equivalent footing elevation are broken into layers, and the total consolidation settlement is the sum of the settlements of each layer. A plot of the relationship between void ratio ( $e$ ) and logarithm of the vertical effective consolidation stress ( $p$ ) determined in the laboratory is used to estimate the consolidation settlement. Multiple laboratory curves may need to be generated to accommodate the different layers depending on the soil consistency and maximum past pressures. The settlement of each layer may be calculated as presented in the

three following equations. A generic example of this consolidation curve is shown in Figure 5.21 to illustrate the terms in these equations.



Note: Pile Group has Plan Dimension of B and Z

Source: Hannigan et al. (2006)

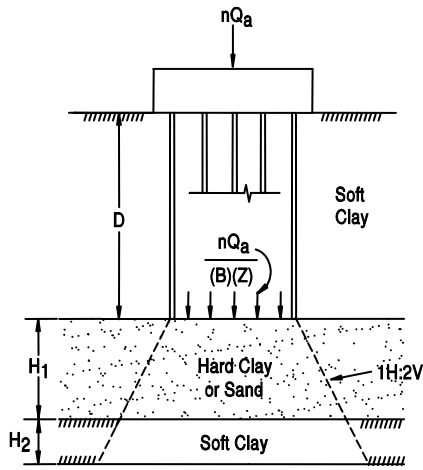
**Figure 5.19: Equivalent Footing Concept for Pile Groups**

The settlement ( $S_i$ ) for an overconsolidated cohesive soil layer, where the pressure after the foundation pressure increase is greater than the soil preconsolidation pressure ( $p_o + \Delta p > p_c$ ), is obtained as:

$$S_i = H \left[ \frac{C_r}{1+e_0} \log \left( \frac{p_c}{p_0} \right) \right] + H \left[ \frac{C_c}{1+e_0} \log \left( \frac{p_\sigma + \Delta p}{p_c} \right) \right] \quad (\text{Equation 5.42})$$

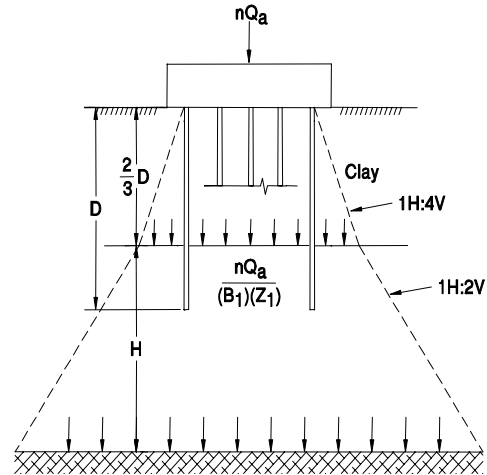
The settlement ( $S_i$ ) for an overconsolidated cohesive soil layer, where the pressure after the foundation pressure increase is less than the soil preconsolidation pressure ( $p_o + \Delta p < p_c$ ), is obtained as:

$$S_i = H \left[ \frac{C_r}{1+e_\sigma} \log \left( \frac{p_o + \Delta p}{p_\sigma} \right) \right] \quad (\text{Equation 5.43})$$



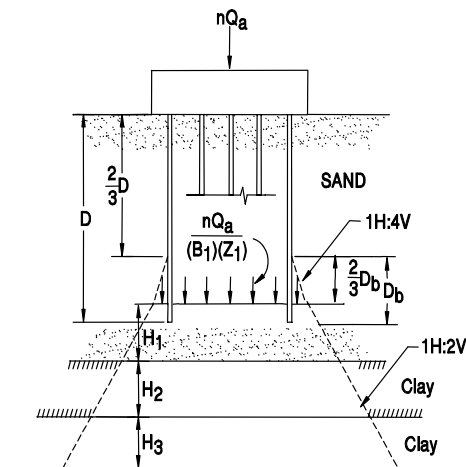
Equivalent Footing at Depth D  
Settlement of Pile Group = Compression of Layers  $H_1$  and  $H_2$  Under Pressure Distribution Shown.

a) Toe Bearing Piles in Hard Clay or in Sand Underlain by Soft Clay



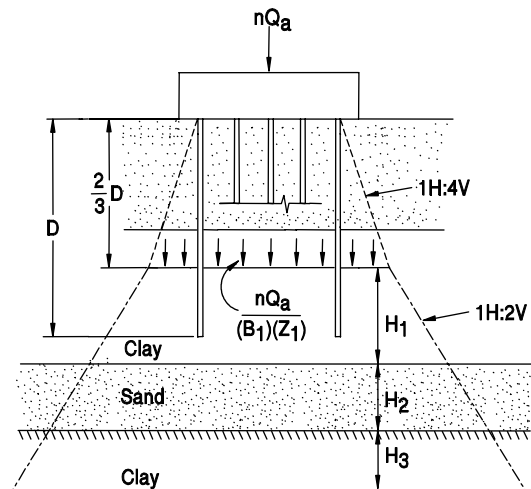
Equivalent Footing at Depth  $2/3 D$   
Settlement of Pile Group = Compression of Layer H Under Pressure Distribution Shown.

b) Piles Supported by Shaft Resistance in Clay



Equivalent Footing at Depth  $8/9 D$   
Settlement of Pile Group = Compression of Layers  $H_1$ ,  $H_2$ , and  $H_3$  Under Pressure Distribution Shown.  
 $nQ_a$  is Limited by Bearing Capacity of Clay Layers

c) Piles Supported by Shaft Resistance in Sand Underlain by Clay



Equivalent Footing at Depth  $2/3 D$   
Settlement of Pile Group = Compression of Layers  $H_1$ ,  $H_2$ , and  $H_3$  Under Pressure Distribution Show

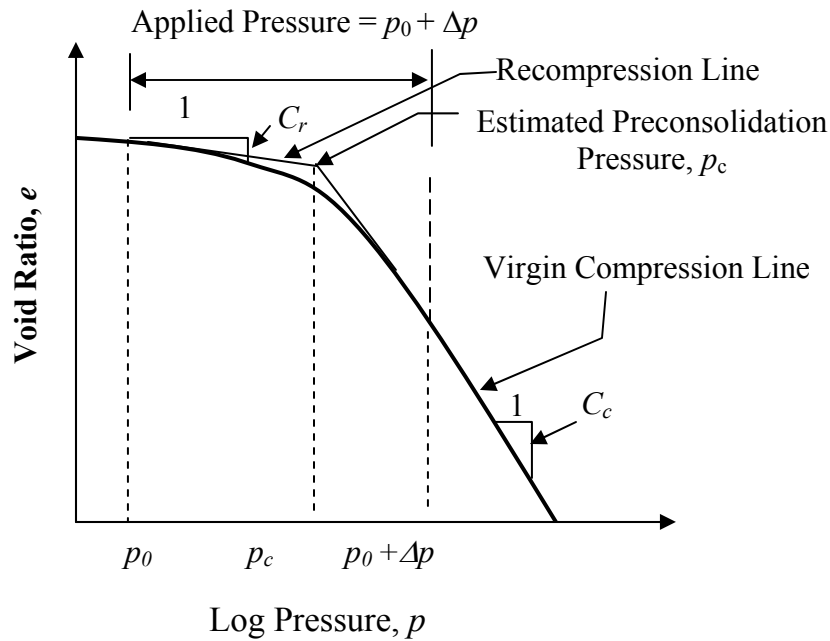
d) Piles Supported by Shaft and Toe Resistance in Layered Soil Profile

Notes:

- (1) Plan area of perimeter of pile group =  $(B)(Z)$ .
- (2) Plan area  $(B_1)(Z_1)$  = projection of area  $(B)(Z)$  at depth based on shown pressure distribution.
- (3) For relatively rigid pile cap, pressure distribution is assumed to vary with depth as above.
- (4) For flexible slab or group of small separate caps, compute pressures by elastic solutions.

Source: Cheney and Chassie (1993) and Hannigan et al. (2006)

**Figure 5.20: Pressure Distribution Below Equivalent Footing for Pile Group**



Source: Hannigan et al. (2006)

**Figure 5.21: Typical  $e$  vs.  $\text{Log } p$  Curve from Laboratory Consolidation Testing**

The settlement for a normally consolidated cohesive soil layer ( $p_o = p_c$ ) is:

$$S_i = H \left[ \frac{C_c}{1 + e_o} \log \left( \frac{p_o + \Delta p}{p_o} \right) \right] \quad (\text{Equation 5.44})$$

where:  $S_i$  = total settlement;  
 $H$  = original thickness of layer;  
 $C_c$  = compression index;  
 $C_r$  = recompression index;  
 $e_o$  = initial void ratio;  
 $p_o$  = effective overburden pressure at midpoint of stratum, prior to pressure increase;  
 $p_c$  = estimated preconsolidation pressure; and  
 $\Delta$  = average change in pressure.

If the soil were underconsolidated (i.e.,  $p_o > p_c$ ), the consolidation process due to loads imposed prior to placement of the foundation would continue, and this would result in an additional downdrag load to the pile group, as discussed in Section 5.7.

#### 5.5.4 Uplift of Single CFA Piles and CFA Pile Groups

CFA piles behave essentially as drilled shafts in response to uplift. CFA piles can be particularly efficient in uplift because their long, slender shape maximizes side-shear for a given volume of grout or concrete. A limiting factor for uplift may be the ability to place sufficient reinforcing steel; however, a single high-strength bar can be placed full length in most circumstances.

Uplift forces may be exerted on CFA piles by either an applied external uplift force or due to swelling of surrounding soils. Note that an uplift resistance is provided in response to the case of externally applied loads, while an uplift load is applied to the pile in the case of swelling soils.

The ultimate upward side-shear resistance may be determined as a portion of the ultimate downward side-shear resistance using the methods for axial compression loading on CFA piles recommended in this chapter, but with opposite sign (direction). For piles in cohesive soils subjected to uplift, the upward resistance may be estimated as the same magnitude as the downward resistance. For piles in cohesionless soils subjected to uplift, the upward directed side-shear from the pile can produce a potential reduction in effective stress in the vicinity of the pile. The ultimate uplift side-shear resistance in cohesionless soils can be maintained up to 100%. However, it has been determined in numerous studies that the remaining side-shear resistance range from about 70 to 100% of the downward ultimate resistance. It is recommended that to obtain the ultimate side-shear resistance in cohesionless soils for uplift the side-shear resistance used for compressive loading be multiplied by a factor of 0.8. Note that appropriate safety factors still need to be applied to obtain the allowable uplift resistance.

The uplift resistance of a pile group should be determined in accordance with AASHTO (1996) for service load design that states that the group uplift should be determined as the lesser of:

- (1) The design allowable uplift capacity of a single pile times the number of piles in the group. The design uplift capacity of a single pile has been specified above. The design allowable uplift should be taken as one third of the ultimate, if determined by a static analysis method, or one half, if determined by a load test.
- (2) Two thirds of the effective weight of the group and soil contained within a block defined by the perimeter of the pile group and the embedded length of the piles (see Figure 5.17).
- (3) One half of the effective weight of the pile group and soil contained within a block defined by the perimeter of the pile group and the embedded pile length plus one half of the total soil shear resistance on the peripheral surface of the pile group (see Figure 5.17).

Soil uplift on a pile is most often caused by the swelling of expansive soils, or may also occur through ice jacking (frost heave, or upward load imposed from an ice sheet frozen to the pile or column/pier). When the uplift force is caused by the swelling of surrounding soils, it should be considered as a load to the pile and may be determined equal to the ultimate downward side-

shear values on the CFA piles, using the methods recommended herein [but opposite sign (direction)]. Note that a reduction factor should not be applied to cohesionless soils when the uplift is a soil load because the reduction in effective stress around the pile would not be anticipated in such a condition.

## **5.6 LATERAL RESISTANCE AND STRUCTURAL CAPACITY OF CFA PILES**

### **5.6.1 Behavior and Limitations of CFA Piles**

Although published results are limited, lateral load-tests have shown that CFA piles behave essentially like drilled shafts when the differences between the pile material properties are accounted for (i.e., differences in grout or concrete used for CFA piles and amount of reinforcing steel). References for lateral load-tests on CFA piles include O'Neill et al. (2000) in over-consolidated clays in Coastal Texas, and Frizzi and Meyer (2000) in the dense Pamlico sand and Miami limestone (vuggy) formations are typical of South Florida.

Because of structural capacity limitations related to reinforcement, CFA piles generally do not provide large resistances to lateral loading compared to that which can typically be developed with drilled shafts and driven pile groups. Typically, a reinforcing cage is set to only a sufficient depth to accommodate the section of pile where the bending stresses are at or near the maximum, with a single bar often set through the centerline of the pile to the full pile depth. For applications requiring greater reinforcement than is practical from reinforcing cages, it is possible to reinforce CFA piles with structural steel sections such as H or pipe, similar to micropile construction techniques.

In the construction of CFA piles, the reinforcing cages are typically set into the freshly placed grout or concrete except for the special case of some types of screw piles where the cage is placed through the hollow auger. Placing the reinforcing cages in freshly placed grout can limit the amount of steel that can be penetrated into the grout to the pile full depth. This limitation is affected by soil conditions and the concrete or grout mix properties.

CFA piles constructed in cohesive soils generally provide for greater penetration ability for a full reinforcing steel cage (often to 45 m [150 ft] or more), as the water in the concrete or grout mix is better retained and thus workability is better maintained. Conversely, free-draining cohesionless soil will allow bleed water from the concrete or grout mix to escape into the surrounding soil; this rapid fluid loss limits the in-situ workability of the remaining grout. Penetration ability for a full reinforcing steel cage in free-draining soils (e.g., sand) may thus be limited, especially if the sand is dry.

CFA piles typically have a diameter in the range of 0.35 to 0.60 m (14 to 24 in.) and are rarely constructed in excess of 0.9 m (36 in.) in diameter. When accounting for concrete cover of the reinforcing steel (particularly in aggressive environments), this leaves little room for a rebar cage diameter to provide a cross-sectional moment to resist the bending stresses.

It is possible to design groups of CFA piles to include batter piles to enhance lateral stiffness and capacity of the group, as may be done with driven piles. Analyses of a CFA pile group may be

performed in a similar manner to other deep foundation types, using computer codes such as GROUP (Ensoft, 2006) or FB-Pier (BSI, 2003). However, the use of batter piles can be limited by concerns relating to ground movement from settlement and by the increased construction difficulty associated with placing a rebar cage within a batter CFA pile. The use of batter piles over water is not a typical CFA pile application.

In the special case of a secant or tangent pile wall constructed using CFA piles, the procedures for analysis are similar to other types of deep foundation elements. The differences for CFA piles are in the sizes and depth limitations, along with the need to install reinforcement after the grout or concrete is in place.

### **5.6.2 Lateral Analyses Using the p-y Method**

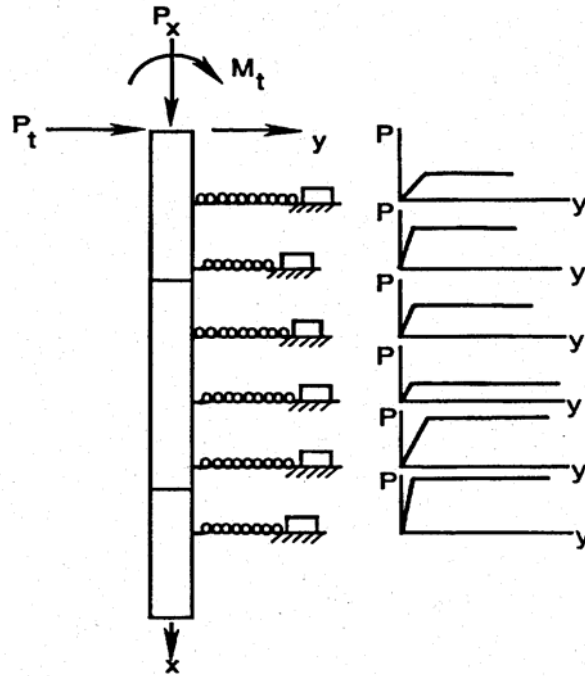
The p-y method is recommended for lateral load analyses of vertical CFA piles and pile groups. The p-y method is a general method for analyzing laterally loaded piles with combined axial and lateral loads, including distributed loads along the pile, non-linear bending characteristics (including cracked sections), layered soils and/or rock, and non-linear soil response. The method utilizes a numerical solution to the governing equations, and a variety of software is available to perform the analyses.

A physical model for a vertical laterally loaded pile is shown in Figure 5.22. The pile is modeled as a simple beam with boundary condition specified as pile head loads, as shown. The soil has been idealized by a series of non-linear springs with depth that provide reaction to the external loading imposed at the head. At each pile depth ( $x$ ) the soil reaction ( $p$ ) resisting force per unit length along the pile) is a nonlinear function of ( $y$ ) lateral deflection, which is dependent on the soil shear strength and stiffness, piezometric surface, pile diameter, depth, and whether the loading is static (monotonic) or cyclic.

Although the curves have been shown as bi-linear in the preceding figure, actual p-y curves used for design are usually more complex-curvilinear functions. The nonlinear soil resistance ( $p$ ) as a function of displacement ( $y$ ) has been derived from instrumented full-scale load-tests in a variety of soils. From these instrumented tests and simple theory of passive earth pressure response around a pile, empirical correlations of p-y response with soil properties have been developed for different soil types. Computer programs for lateral load analyses of piles contain many of these models, and allow the user to input a user-developed curve of any shape (presumably based on local experience, correlations with in-situ tests, latest research in a specific geology, etc.).

Lateral models for soils are correlated with basic strength and stiffness information obtained during the geotechnical investigation. For example, cohesive soils will require input profiles to the depth along the pile of shear strength ( $S_u$ ), a stiffness parameter associated with strain at a compressive stress equal to 50% of the compressive strength from uniaxial strength testing ( $\epsilon_{50}$ ), and unit weight ( $\gamma$ ). Cohesionless soils will require input profiles of soil friction angle ( $\phi$ ), subgrade modulus ( $k$ ), and unit weight ( $\gamma$ ). Ground water elevation must also be defined.





Source: O'Neill and Reese (1999)

**Figure 5.22: p-y Soil Response of Laterally Loaded Pile Model**

A more detailed description of many lateral soil models may be found in Reese (1986) and O'Neill and Reese (1999).

Note that loss of soil resistance due to scour or liquefaction must be considered as a part of the lateral load analysis. In some cases, it may be necessary to consider the loss of soil resistance when calculating the axial capacity of piles. Conditions in which liquefaction results in loss of soil resistance along a significant portion of the pile length could be problematic for CFA piles of small diameter due to the inherent limitations of bending capacity and reinforcement in small diameter piles.

For these analyses, the pile is modeled as a beam-column with a distributed load along the length of the beam produced by the elastic (spring) foundation. The governing differential equations for the solution of a beam on an elastic foundation were derived by Hetenyi (1946). For the general case of combined lateral and axial loading, the following governing differential equation applies:

$$EI \frac{d^4 y}{dx^4} + P_x \frac{d^2 y}{dx^2} - p - w = 0 \quad (\text{Equation 5.45})$$

where:  $x$  = distance along pile length;  
 $P_x$  = axial load;  
 $y$  = lateral deflection at a point with coordinate  $x$ ;  
 $p$  = lateral soil reaction, (measured as a force per unit length of pile);  
 $EI$  = flexural rigidity of pile;  
 $E$  = pile elastic modulus;  
 $I$  = movement of inertia of pile cross-section; and  
 $w$  = distributed load along the length of the pile (due to either soil or water, if any).

Available computer codes typically discretize the pile and soil into a number of segments and nodes (i.e., finite difference, finite elements) via numerical methods to obtain solutions to complex problems. The numerical methods can handle great complexity and offer the advantage of their relative simplicity to the user. In these models, the solution produces computed soil resistance ( $p$ ), shear ( $V$ ), moment ( $M$ ), pile slope ( $S$ ), and pile deflection ( $y$ ) at each node along the pile. The beam equations for shear, moment, and slope are derived as follows (FHWA-RD-85-106):

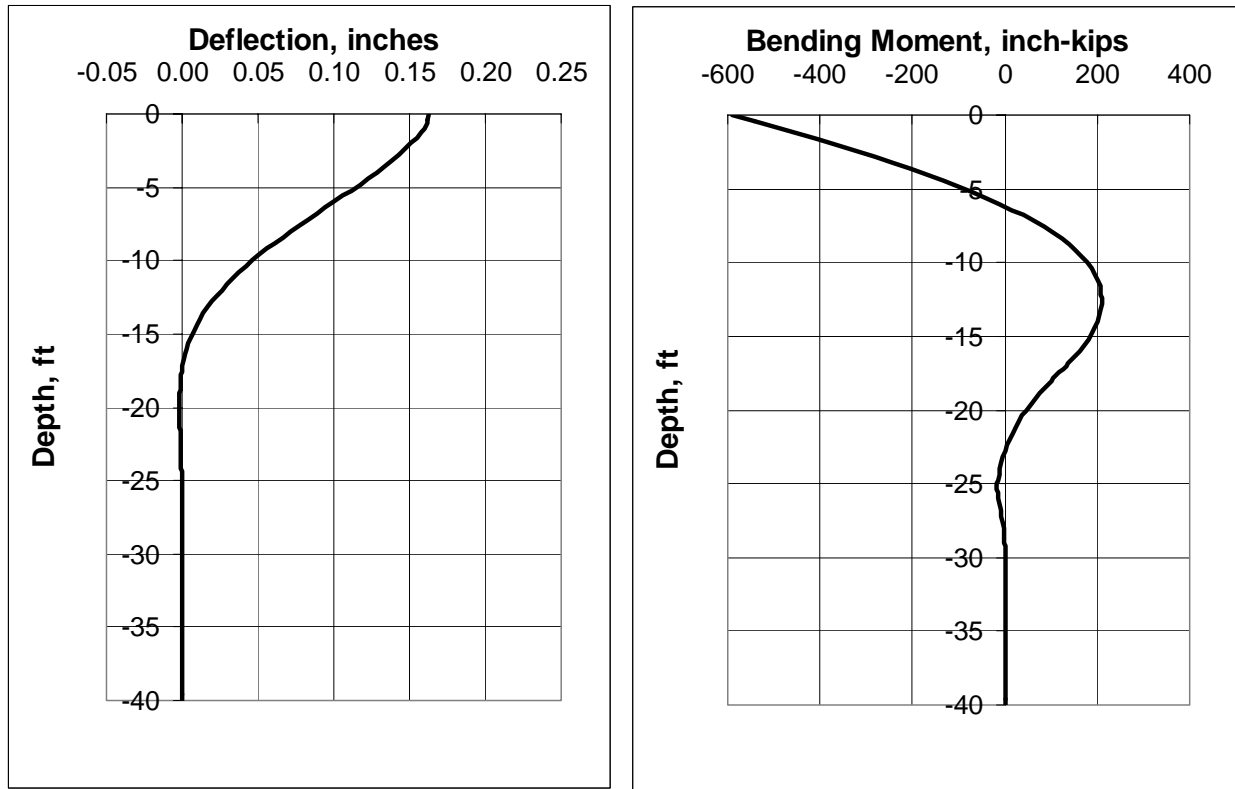
$$V = EI \frac{d^3 y}{dx^3} \quad (\text{Equation 5.46})$$

$$M = EI \frac{d^2 y}{dx^2} \quad (\text{Equation 5.47})$$

$$S = \frac{dy}{dx} \quad (\text{Equation 5.48})$$

In addition to the axial load, the boundary conditions at the pile head must be specified by a lateral force ( $P_t$ ) and a moment ( $M_t$ ), as shown in Figure 5.22. Alternatively, these conditions may be specified in terms of lateral displacement, slope, or a rotational restraint, relating the slope at the top of the pile to the pile head moment. A free-head condition is represented by a specified lateral force and moment, as shown in Figure 5.22. This condition might be representative of a CFA pile used to support a soundwall, sign, light pole, or any similar free-standing structure that is cantilevered above a single CFA pile. For groups of CFA piles incorporated into a rigid cap, the rotational stiffness of the group and a full moment connection into the cap would result in a pile top condition approaching that of a fixed head pile (i.e., pile head is completely restrained). A fixed-head condition might be specified by using a lateral force and a slope at the pile head of zero. Computer software for modeling pile groups can be used to specify the group loads and incorporate the appropriate boundary condition for each pile into the group solution.

Figure 5.23 illustrates a computed solution for a pile that is restrained against rotation at the pile head and is subjected to a lateral shear force. The moment is observed to be a maximum at the pile head due to the rotational restraint; the pile slope approaches zero at the pile head.



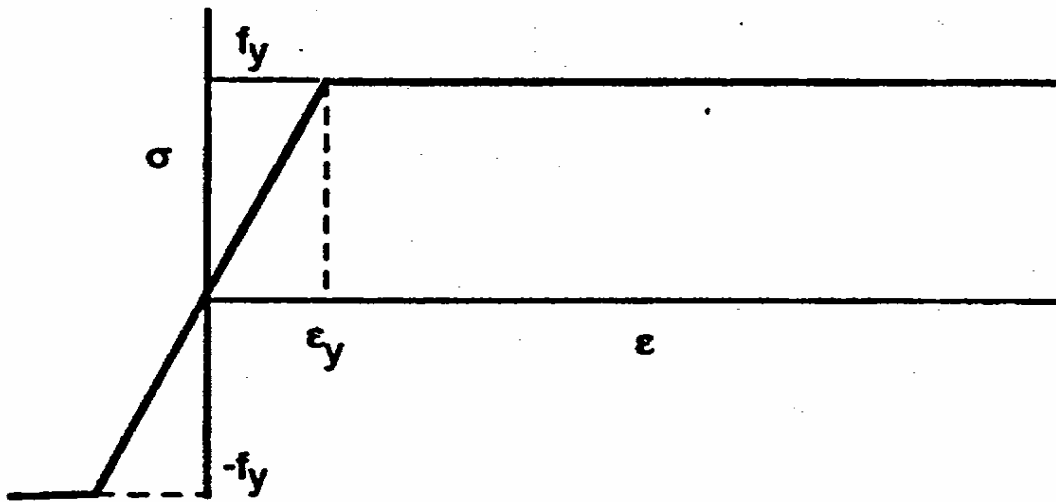
**Figure 5.23: Example Deflection and Moment Response of Laterally Loaded Pile Model**

The nonlinear p-y relationship described earlier is implemented at each node by using a secant modulus ( $E_s$ ), as indicated below:

$$E_s = \frac{P}{y} \quad (\text{Equation 5.49})$$

Therefore, at each node ( $i$ ) along the length of the pile, the value of soil reaction ( $p_i$ ) is expressed as the secant modulus multiplied by the deflection (or  $E_{si} y_i$ ). Because the p-y response is nonlinear, an iterative solution is used to repetitively update the secant modulus so as to track the nonlinear relation of  $p$  at a range of differing values of  $y$ . This method of successive approximation using a secant modulus is computationally intense but very stable, and allows p-y curves to incorporate features such as strain-softening, loss of resistance due to cyclic loading, and other deflection-dependent effects on soil resistance that may be observed in experiments.

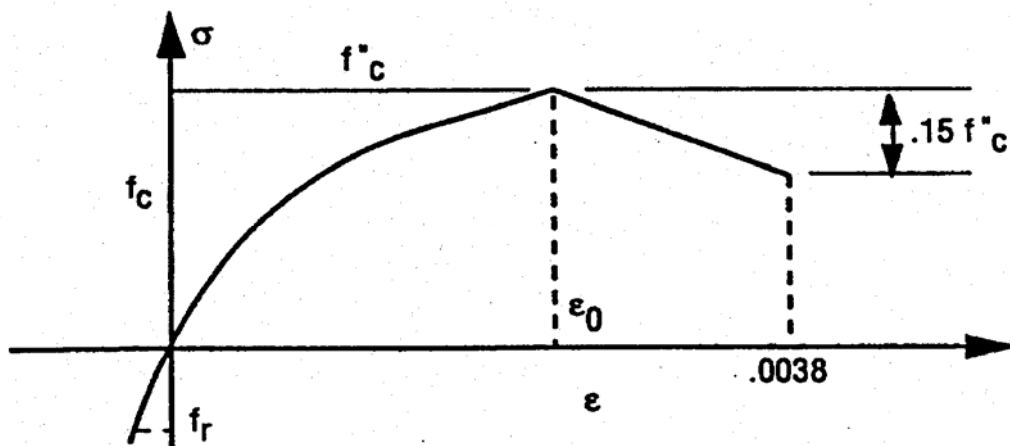
Non-linear stress-strain relationships are also available for both the steel and the concrete materials in a computer solution. The assumed stress strain relationship built into most programs for the steel is shown in Figure 5.24, while that for concrete is shown in Figure 5.25.



Source: O'Neill and Reese (1999)

**Figure 5.24: Typical Stress-Strain Relationship Used for Steel Reinforcement**

For steel, the value of yield stress ( $f_y$ ) is the same in compression (positive or +, in the sign convention adopted herein) and in tension. Reinforcing steel used is usually Grade 60 with a yield stress of 413 MPa (60 ksi) and a modulus ( $E$ ) of 200,000 MPa (2,900 ksi). By definition, the yield strain is the yield stress divided by the modulus ( $\epsilon_y = f_y / E$ ).



Source: O'Neill and Reese (1999)

**Figure 5.25: Typical Stress-Strain Relationship Used for Concrete**

For concrete, the compressive strength depends on the mobilized compressive strain. First, the compressive strength increases up to the reduced ultimate compressive strength ( $f'_c$ ), which is taken as a percentage of the 28-day cylinder compressive strength. The strength is expressed as

$$f_c = f''_c \left[ 2 \left( \frac{\varepsilon}{\varepsilon_o} \right) - \left( \frac{\varepsilon}{\varepsilon_o} \right)^2 \right] \quad \text{for: } \varepsilon < \varepsilon_o \quad (\text{Equation 5.50a})$$

$$f_c = 0.85 f''_c \quad \text{for: } \varepsilon = 0.038 \quad (\text{Equation 5.50b})$$

$f_c$  = linearly interpolated for  $\varepsilon_o \leq \varepsilon \leq 0.038$

With:

$$f''_c = 0.85 f'_c \quad (\text{Equation 5.51})$$

$$\varepsilon_o = \frac{1.7 f'_c}{E_c} \quad (\text{Equation 5.52})$$

Where  $f'_c$  is the concrete compressive strength at 28 days, and  $E_c$  is the initial tangent slope of the stress-strain area. The value  $E_c$  can be estimated as:

$$E_c = 57,000 \sqrt{f'_c} \text{ (psi)} \quad (\text{Equation 5.53a})$$

$$\text{or } E_c = 151,000 \sqrt{f'_c} \text{ (kPa)} \quad (\text{Equation 5.53b})$$

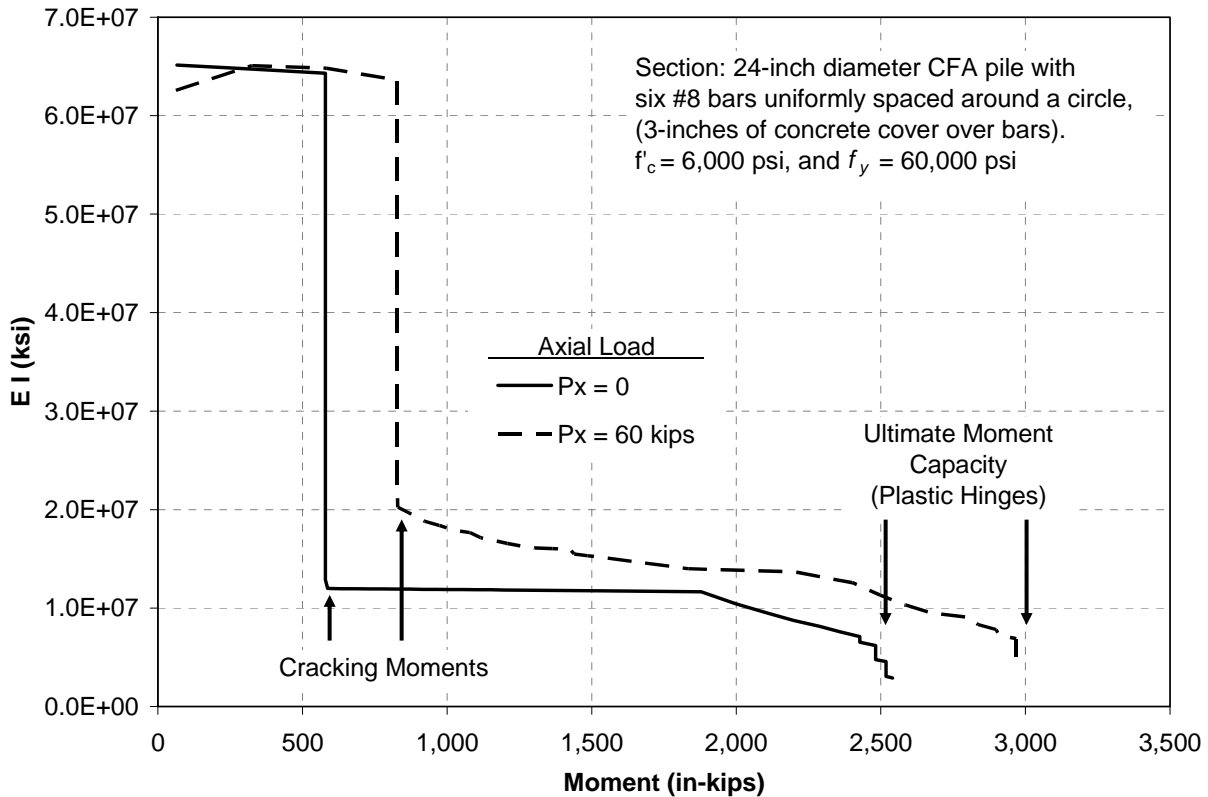
The ultimate tensile strength of concrete ( $f_r$ ) is estimated as

$$f_r = 7.5 \sqrt{f'_c} \text{ (psi)} \quad (\text{Equation 5.54a})$$

$$\text{or } f_r = 19.7 \sqrt{f'_c} \text{ (kPa)} \quad (\text{Equation 5.54b})$$

The authors' experience from observed behavior of instrumented load-tests on drilled shafts suggests that the computed modulus using the equations above tends to be somewhat conservative for concrete. Sand cement grout without coarse aggregate may have a slightly lower modulus than that of concrete of similar strength.

The bending stiffness ( $EI$ ) of the beam column system is not actually constant once cracking occurs in the concrete or grout. As the bending moment at any of the steel reinforced sections increases to the point at which tensile stresses at one side of the pile exceeds the tensile strength of the concrete or grout, the section cracks, and the value of  $EI$  is reduced significantly at that cracked section. Note that a uniform, concentric axial compressive load ( $P_x$ ) will produce a uniform compressive stress ( $P_x \times Area$ ). The superposition of this uniform compressive stress to the stress distribution produced by the bending moment on the uncracked section will allow for a larger bending moment at the point of crack initiation and beyond. Computer programs for lateral load analyses can include the reduction in stiffness. Figure 5.26 illustrates an example of computed  $EI$  as a function of moment for the case of an axial load of varying magnitude.

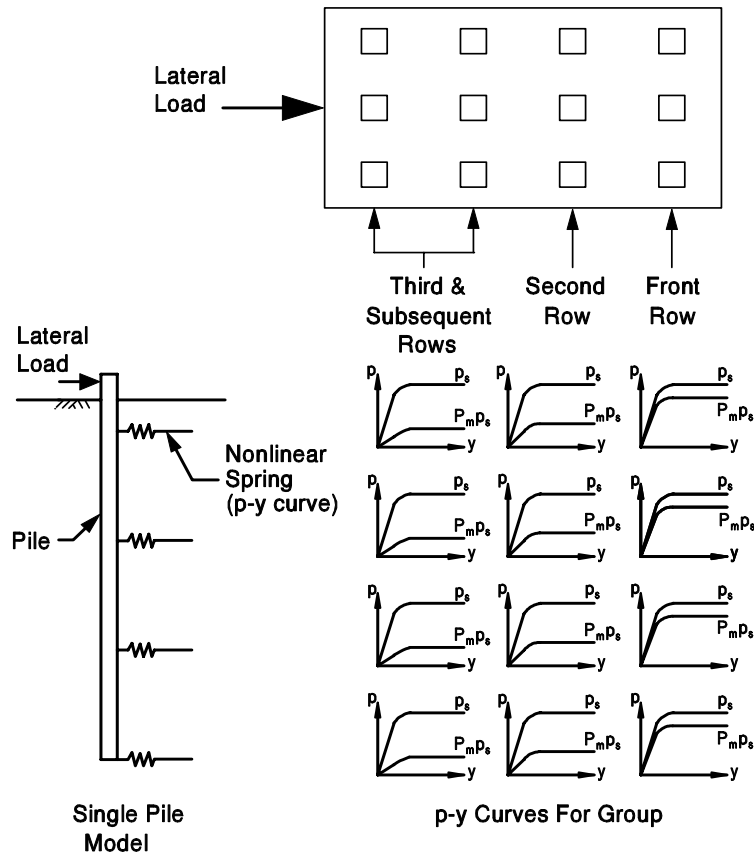


**Figure 5.26: Variation of Pile Stiffness ( $EI$ ) with Bending Moment and Axial Load**

### 5.6.3 Lateral Analyses of CFA Pile Groups

The  $p$ -multiplier ( $P_m$ ) method is recommended to account for group effects on lateral load response. For closely spaced piles in a group, values of soil resistance for a given  $p$ - $y$  relationship are multiplied by a  $p$ -multiplier less than 1 (i.e.,  $P_m < 1$ ), as shown in Figure 5.27. Therefore, the lateral capacity of the pile group at a given deflection level is less than the sum of the individual pile lateral capacities at that deflection. Also, the lateral deflection at a given load is greater than the deflection of an individual pile at the same load per pile. The value of this multiplier is dependent on the location of the pile within the group and the spacing of the pile group. “Front Row” piles are those that push into the soil without any piles ahead of them, and thus are the least affected by the presence of the other piles. “Second Row” piles are affected to a greater extent than the front row piles; “Third and Subsequent Rows” piles are the most affected by the group interaction. The group interaction may be described as the piles in the back pushing the soil forward into the area that is being vacated by the piles in front of them (often referred to as a “shadowing” effect).

Values of  $p$ -multipliers ( $P_m$ ) are provided in Table 5.4 for cyclic loading and static loading.



$p_s$  = p-y Curve for Single Pile

$P_m p_s$  = p-y Curve for Pile in Group

Source: Hannigan et al. (2006)

**Figure 5.27: The p-multiplier ( $P_m$ )**

**Table 5.4: P-Multipliers ( $P_m$ ) for Design of Laterally Loaded Pile Groups**

Soil Type <sup>(1)</sup>	Test Type	Pile Spacing (Cent.-Cent.)	$P_m$ for Rows: 1 2 3+	Reported Lateral Group Efficiencies	Deflection (mm)	Reference
Stiff Clay	Field Study	$3B$	.70 .50 .40	N/A	51	Brown et al. (1987)
Stiff Clay	Field Study	$3B$	.70 .60 .50	N/A	30	Brown et al. (1987)
Medium Clay	Scale Model (Cyclic Load)	$3B$	.60 .45 .40	N/A	600 (at 50 cycles)	Moss (1997)
Clayey Silt	Field Study	$3B$	.60 .40 .40	N/A	25-60	Rollins et al. (1998)
V. Dense Sand	Field Study	$3B$	.80 .40 .30	75%	25	Brown et al. (1998)
M. Dense Sand	Centrifuge Model	$3B$	.80 .40 .30	74%	76	McVay et al. (1995)
M. Dense Sand	Centrifuge Model	$5B$	1.0 .85 .70	95%	76	McVay et al. (1995)
Loose M. Sand	Centrifuge Model	$3B$	.65 .45 .35	73%	76	McVay et al. (1995)
Loose M. Sand	Centrifuge Model	$5B$	1.0 .85 .70	92%	76	McVay et al. (1995)
Loose F. Sand	Field Study	$3B$	.80 .70 .30	80%	25-75	Ruesta and Townsend (1997)

Note: (1) V = very, M = medium, F = fine

Computer programs such as GROUP (Ensoft, 2006) or FB-Pier (BSI, 2003) may be used to analyze the entire group of piles for a given axial, lateral, and moment loading applied to the pile cap. These codes compute the group  $p$ -multipliers by multiplying individual  $p$ -multipliers ( $P_m$ ) and  $p$ - $y$  curves for individual piles. Recent studies (Brown and O'Neill 2003) suggest that a simplified approach to the use of  $p$ -multipliers is suitable for design, particularly when considering that the direction of loading may not be known. A single  $p$ -multiplier equal to the average value of all the pile row  $p$ -multipliers in the group provides a reasonably accurate indication of the overall group deflection and stiffness. The shear and maximum moment distribution in individual piles within the group was found to deviate from the computed average response using the simplified method by no more than 20% in typical cases. The simplified analysis also allows the analysis of a single pile to be used to anticipate the lateral response of a typical pile within the group, with a 20% increase in computed maximum bending moment recommended for design in order to account for variations within the pile group.

Analyses of an individual pile within the group can be performed using a computer code such as LPILE (Ensoft, 2006), but with  $p$ -multipliers applied to the individual  $p$ - $y$  curves to account for group action. Within a group of piles connected to a common cap, a full moment connection to the cap would provide rotational restraint to the top of the pile so that the horizontal translation of the cap is modeled as a lateral shear or displacement at the pile head combined with a slope of zero. The lateral load resistance of the pile group is then equal to the sum of the lateral load resistance of the individual piles.

#### **5.6.4 Structural Capacity**

The structural capacity of CFA piles should be checked in the same manner, and to the same requirements as drilled shafts. While both types of foundations are reinforced, cast-in-place structural elements, some differences exist. Drilled shafts often have larger diameters and consist of non-redundant single shafts designed to support individual columns. On the other hand, CFA piles are typically used in groups with relatively small lateral and bending stresses on a per-pile basis. However, CFA piles can also be used as individual foundations for soundwalls, signs, or light pole structures where the design is dominated by flexure. The structural integrity should be checked for axial loading (including potential uplift loads), as well as bending and shear induced by lateral loading.

The following sections describe the necessary steps for structural analysis and design of CFA piles based on the axial load requirements and bending stresses computed as a result of the lateral analyses using the  $p$ - $y$  method. Note that the geotechnical design of CFA piles is outlined in accordance with allowable stress design (ASD). However, most states use the load and resistance factor design AASHTO specifications (AASHTO, 2006) for the structural design of reinforced concrete members. Structural design of CFA piles is outlined in accordance with LRFD as is typical of structural design of other reinforced concrete members in AASHTO (2006). To compute bending moments in the pile for structural design, the lateral load analyses must include factored load cases.



#### 5.6.4.1 Longitudinal Reinforcement

Reinforcing steel for CFA piles typically consists of two different sections: 1) a top section that consists of a full cage configuration of multiple longitudinal bars and transverse spirals or ties; and 2) a bottom section that consists of a single longitudinal bar along the centerline of the pile that extends the full length of the pile.

An adequate section of steel reinforcement of CFA piles for the purpose of axial uplift loading is often accomplished by the insertion of a single bar down the center of the freshly placed grout or concrete column. Virtually any size bar needed to satisfy the structural requirements can typically be inserted to full depth. High-strength, threaded rods can be used in CFA piles similarly to the use with micropiles.

The top section of reinforcement must extend to a depth that is below the area where large bending moments take place. It is recommended that the depth of full cage reinforcement be set to the inflexion point in the displacement profile (i.e., second point of zero displacement with depth), obtained from lateral load analysis. For instance, the pile shown in Figure 5.23 would require a reinforcing cage extending to approximately 7.5 m (25 ft) below the top of the pile. If this were a pile that extended to a depth of 15 or 18 m (50 or 60 ft) below grade, it would be unnecessary to install a full length cage. When relatively short piles are used and the computed deflection profile does not cross the zero axis at a second point, a full length reinforcing cage should be used.

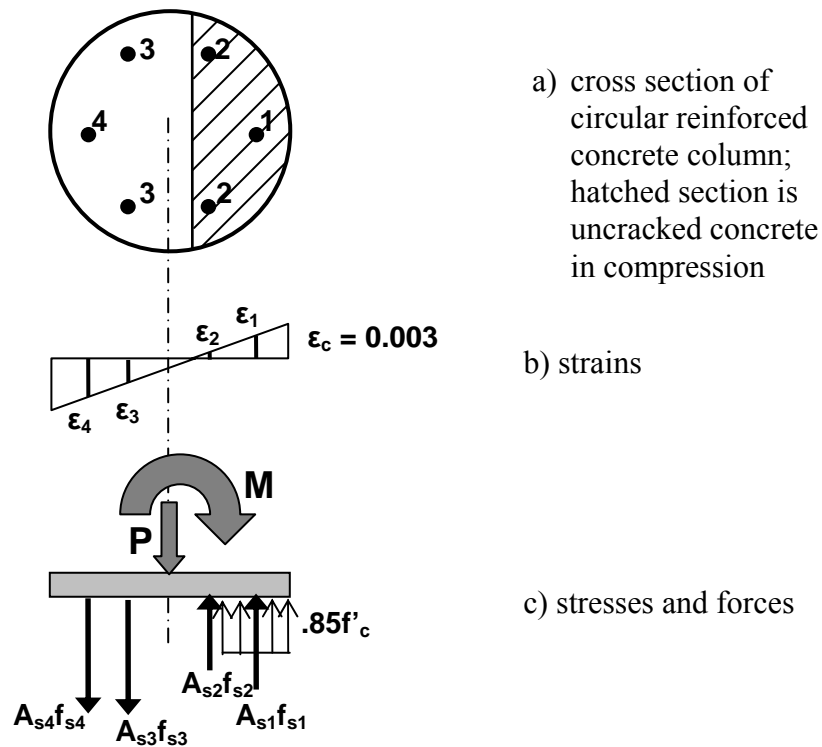
For ease of cage installation with both a top section cage and central bar only, the transverse reinforcement is often not included in approximately the bottom 1.2 m (4 ft) of the cage, and the longitudinal bars are bent inward toward the single bar at the center of the shaft to form a “tapered section” in the cage. In such case, the tapered section should not be counted as part of the cage length to the required minimum depth.

Within the zone where the full cage is installed, the minimum longitudinal reinforcement area should be not less than 1% of the gross concrete area ( $A_g$ ) of the pile. However, in the event that the pile size is larger than necessary to support the computed loads from a structural (not geotechnical) standpoint, then a reduced effective area ( $A_g'$ ) may be used to determine the minimum longitudinal reinforcement and design strength as outlined in the O'Neill and Reese (1999) recommendations for drilled shafts and per section 10.8.4 of the ACI code (ACI, 2004). The reduced effective area ( $A_g'$ ) is the area of concrete sufficient to provide the required axial strength and, in all cases, must be limited to not less than one half of the gross concrete area ( $A_g$ ).

If the reinforcement includes a central bar, this bar must extend throughout the top section cage. If a central bar is used, the area of the central bar may be included in the analysis of structural capacity and minimum requirements of the top cage section.

The design of reinforced concrete piles for bending and axial forces follows procedures used for analysis and design of short columns. Figure 5.28a schematically illustrates the section of a reinforced concrete column loaded parallel to its axis by a compressive force  $P$  and moment  $M$ . The distribution of strains across the cross section at the instant the ultimate load is reached are

shown in Figure 5.28b. The internal forces within the pile, shown in Figure 5.28c, must be in equilibrium with the nominal strength, represented by the combined  $P$  and  $M$ . The internal forces are related to the strains by the modulus. For any of the bars with strains in excess of the yield strain (i.e., equal to the yield strength divided by the elastic modulus), the stress at failure is taken as the yield stress of the bar.



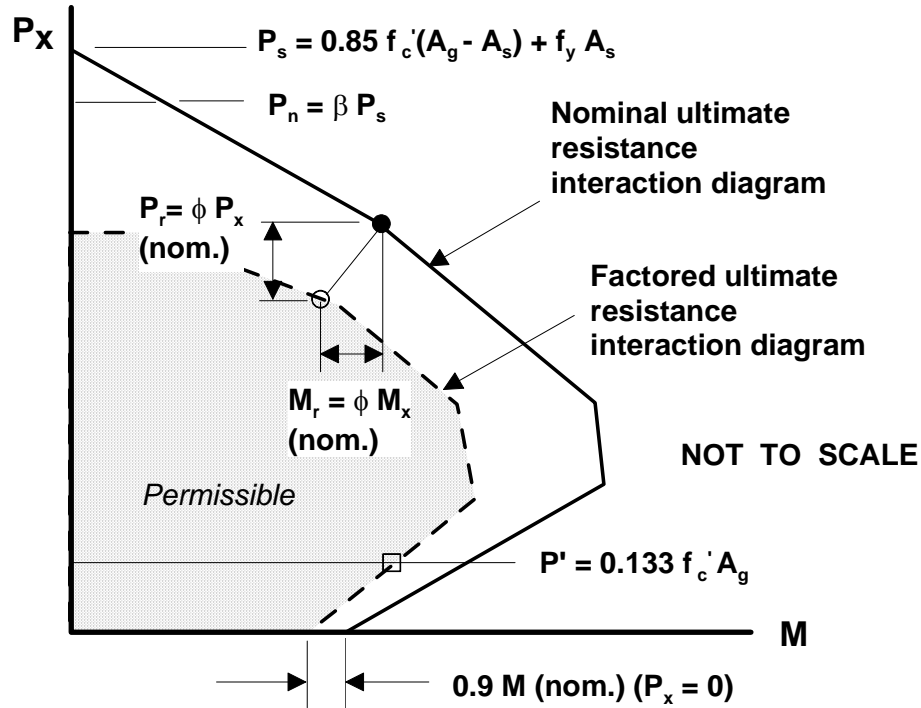
**Figure 5.28: Circular Column (Pile) with Compression Plus Bending**

The analysis of the combinations of  $P$  and  $M$  to produce failure is called a strain compatibility analysis; the plot of these load combinations at failure is an interaction diagram. Details and examples of the calculations involved in the analysis described above is covered in most textbooks on reinforced concrete design.

Satisfactory pile designs are those where all combinations of axial loads and bending moments are contained within the factored ultimate resistance interaction diagram for all critical pile sections, and where the transverse shear requirements are met. The interaction diagram is a plot of all combinations of axial and bending forces on a column that would result in structural yield of the column. The factored interaction diagram would lie inside the interaction diagram of ultimate resistance and are obtained by multiplying the “ultimate” interaction diagram by resistance factors for axial and bending.

To calculate the required amount of longitudinal reinforcement, the interaction diagram must be determined. The maximum bending moment and axial load calculated from the lateral analysis of the pile foundation are compared against the factored interaction diagram. Figure 5.29 shows a typical interaction diagram, both with the nominal and the factored ultimate resistances.

The nominal ultimate resistance interaction diagram, shown as the solid line in Figure 5.29, should be obtained for all critical pile sections. Computer programs for lateral analyses typically include options for generating this interaction diagram at specified pile sections.



Source: O'Neill and Reese (1999)

**Figure 5.29: Example Interaction Diagram for Combined Axial Load and Flexure**

The factored axial resistance (i.e., the intersection of the solid line with the  $P_x$ -axis for axial compressive load only) is obtained as follows:

$$P_n = \beta P_s = \beta [0.85 f_c' (A_g - A_s) + f_y A_s] \quad (\text{Equation 5.55})$$

where:  $P_n$  = nominal ultimate axial resistance;

$f_c'$  = compressive concrete strength at 28-days;

$f_y$  = yield strength of the longitudinal reinforcing steel;

$A_g$  = gross cross-sectional area of concrete;

$A_s$  = cross-sectional area of the reinforcing steel; and

$\beta$  = reduction factor to account for the possibility of small axial load eccentricities.  $\beta = 0.85$  for spiral transverse reinforcement, and  $\beta = 0.80$  for tied transverse reinforcement.

Because resistance factors are different for pure axial and bending, the interaction diagram used for design involves transitional factors for cases with combined axial and bending. A transition point is defined by the axial load  $P'$  in Figure 5.29, which is defined as:

$$P' = 0.133 f_c' A_g \quad (\text{Equation 5.56})$$

The factored resistance interaction diagram (shown as the dashed line in Figure 5.29) is obtained above the  $P'$  line by simultaneously multiplying the nominal ultimate axial resistance ( $P_x$ ) and the nominal ultimate flexural resistance ( $M_x$ ) by a resistance factor ( $\phi$ ),

$$P_r = \phi P_x \quad \text{and} \quad M_r = \phi M_x \quad (\text{Equation 5.57})$$

where  $\phi = 0.75$  for either spiral or tied transverse reinforcement (AASHTO, 2006)

The factored flexural resistance for pure flexure (i.e.,  $P_x = 0$ ) is determined as 0.9 of the nominal ultimate flexural resistance, or  $0.9 M$ . For locations between  $P_x = 0$  and  $P_x = P'$ , the factored resistance is obtained by multiplying the nominal ultimate flexural resistance by a factor linearly interpolated between  $\phi = 0.9$  (for  $P_x = 0$ ) and  $\phi = 0.75$  (for  $P_x = P'$ ). In most cases for CFA piles with large bending moments, bending controls the structural design and the computed combinations of axial forces and bending moments lie close to the  $P_x = 0$  side of the diagram.

#### 5.6.4.2 Shear Reinforcement

The pile design should first be checked to determine if the concrete section has adequate shear capacity without shear reinforcement. The factored shear resistance ( $\phi V_n$ ) of the concrete section can be determined as follows:

$$\phi V_n = \phi V_c A_V \quad (\text{Equation 5.58})$$

Where:  $V_n$  = nominal (computed, unfactored) shear resistance of section;

$\phi$  = capacity reduction factor for shear, usually equal to 0.85;

$A_V$  = cross-sectional area that is effective in resisting shear; and

$V_c$  = concrete shear strength.

The cross-sectional area that is effective in resisting shear can be evaluated for a circular CFA pile as:

$$A_v = B \left[ \frac{B}{2} + 0.58 r_{ls} \right] \quad (\text{Equation 5.59})$$

where

$$r_{ls} = \frac{B}{2} - d_c - \frac{d_b}{2} \quad (\text{Equation 5.60})$$

where:  $r_{ls}$  = radius of the ring formed along the centroids of the longitudinal bars;

$B$  = pile diameter;

$d_c$  = depth of concrete cover; and

$d_b$  = diameter of longitudinal bars.

The concrete shear strength can be estimated as:

$$V_C = \left( 1 + 0.00019 \phi \frac{P}{A_g} \right) \sqrt{f_c'} \quad (f_c' \text{ in psi}) \quad (\text{Equation 5.61a})$$

$$V_C = \left( 0.166 + \phi 0.000032 \frac{P}{A_g} \right) \sqrt{f_c'} \quad (f_c' \text{ in MPa}) \quad (\text{Equation 5.61b})$$

Where  $P$  = axial load and  $A_g$  = gross concrete area.

For a pure bending case (i.e.,  $P_x = 0$ ), this reduces to:  $V_C = \sqrt{f_c'}$  ( $f_c'$  in psi) or  $V_C = 0.166\sqrt{f_c'}$  ( $f_c'$  in MPa).

If the factored shear resistance is greater than the factored shear load for the critical sections (as determined from p-y analyses), the minimum area of transverse reinforcement recommended below is adequate. If the factored shear resistance is less than the factored shear load, then: a) the pile diameter should be increased; or b) the shear reinforcing must be analyzed specifically to ensure that sufficient shear capacity is provided. The latter is likely to be an unusual circumstance for a CFA pile under normal conditions because bending moments associated with high shears are likely to control pile diameter.

If a spiral is used for the transverse reinforcement, the minimum reinforcement ratio ( $\rho$ ) will be determined in accordance with the AASHTO code as:

$$\rho_s = 0.45 \left( \frac{A_g}{A_c} - 1 \right) \left( \frac{f_c'}{f_y} \right) \quad (\text{Equation 5.62})$$

where:  $\rho_s$  = Volume of spiral steel per turn/Volume of concrete core per turn;

Volume of spiral steel per turn = area of bar  $\times \pi \times$  diameter of spiral hoop;

volume per turn of concrete core =  $A_c \times$  pitch of spiral;

$A_c$  = cross-sectional area of concrete inside spiral steel =  $0.25 \times \pi \times$  (core diameter)<sup>2</sup>;

$A$  = gross cross-sectional area of concrete of pile cross section;

$f_c'$  = concrete compressive strength at 28-days; and

$f_y$  = yield strength of the spiral reinforcing steel.

If a tied bar is used for the transverse reinforcement, the minimum requirement is:

- #3 tied bars may be used for cages with longitudinal reinforcing smaller than # 11 bars
- #4 tied bars may be used for cages with longitudinal reinforcing of #11 bars or larger.

The vertical spacing of the tied bars shall not exceed the lesser of:

- the pile diameter; or
- 300 mm (12 in.).

Where the pile with minimum transverse reinforcement has inadequate shear resistance, the pile design may be changed to: (1) a larger diameter pile; (2) higher concrete compressive strength; or (3) transverse reinforcement greater than the minimum to increase the shear resistance. The required area of transverse steel is determined as follows:

$$A_{vs} = \frac{S V_{steel}}{f_y \left[ \frac{B}{2} + 0.58 r_{ls} \right]} \quad \text{(Equation 5.63)}$$

Where:  $A_{vs}$  = required area of transverse steel;

$S$  = longitudinal spacing of the ties (spiral pitch);

$V_{steel}$  = nominal shear resistance of transverse steel (equal to total nominal shear resistance needed less shear resistance provided by concrete);

$f_y$  = yield strength of steel; and

$r_{ls}$  = radius of the ring formed along the centroids of the longitudinal bars on cross section.

### **5.6.5 Concrete or Grout Cover and Cage Centering Devices**

The concrete cover requirements of Section 5.12.3 AASHTO (AASHTO, 2006) apply for CFA piles. For water-to-cement ratios ( $W/C$ ) between 0.40 and 0.50, the minimum cover of concrete or grout over the longitudinal bars must be 75 mm (3 in.) and 100 mm (4 in.) for aggressive environments (e.g., exposure to salt water). The required cover for transverse reinforcement may be less than that required for longitudinal bars by no more than 12 mm (0.5 in.). Transverse reinforcement greater than 13 mm (0.5 in.) would thus necessitate greater cover than longitudinal bars. This is rarely the case for CFA piles, as they typically have transverse reinforcement no greater than 13 mm (0.5 in.).

For  $W/C$  ratios greater than or equal to 0.50, the cover requirements must be increased by a factor of 1.2. For  $W/C$  ratios less than or equal to 0.40, the cover requirements may be decreased by a factor of 0.8. However, low  $W/C$  ratios can pose constructability problems with reinforcement.

Centering devices must be used with CFA pile construction to maintain alignment of the steel reinforcing cages that are being inserted into the freshly placed concrete or grout. The centering devices for full cages are similar to the centering devices used for drilled shaft construction, and most often plastic “wheels” that are installed around the transverse reinforcement. The central longitudinal bar is typically centered with a set of skids such that the arrangement of skids is axis-symmetric around the central bar. Note that the orientation of either wheels or skids must be such that they roll or easily slide, respectively, along the borehole wall without scraping into the soil.

### **5.6.6 Seismic Considerations**

Where seismic loadings govern design, there may be several considerations that influence the design of a deep foundation. A complete discussion of the design of deep foundations for seismic loading is beyond the scope of this manual. However, it is appropriate to summarize herein the major points that may affect the selection and design of CFA piles for projects where seismic loads are significant.

For many transportation structures, design for seismic loading may only include a simple equivalent static analysis of lateral loads at the top of the foundation due to inertial effects on the structure. For such cases, the analysis and design may proceed as outlined in Sections 5.6.2 and 5.6.3. It is possible that seismic loads could include a component of pile uplift load in some cases. If piles are subjected to uplift loading, a full length center bar may be required as described in Section 5.6.4.1.

Where seismic loads and soft ground conditions are present, it may be necessary to consider bending stresses in the pile due to seismically-induced lateral ground movements. The most significant in this case is liquefaction and lateral spreading. Seismically-induced lateral ground movements could produce large bending stresses at great depth below the top of the pile. Therefore, reinforcement may need to be installed at great depths in a CFA pile to ensure that the pile retains axial load capacity during and after the seismic event. A single center bar is not

sufficient in such cases. The use of a continuous steel pipe for reinforcement can provide good flexural capacity and ductility in such cases and may be considered where deep reinforcing cages may be problematic to install.

## 5.7 DOWNDRAG IN CFA PILES

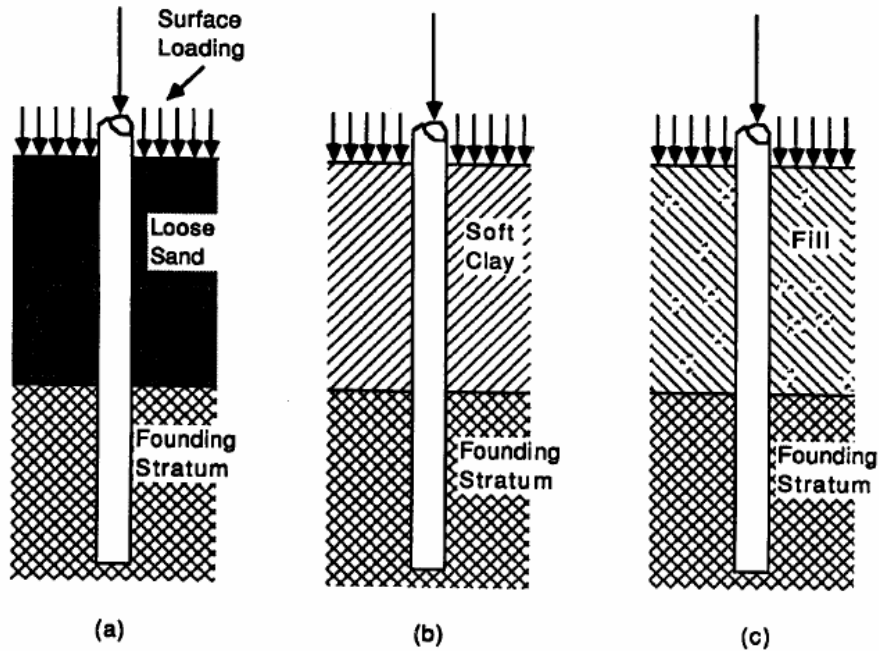
CFA piles will be subjected to a downdrag load (i.e., shear stress reversal) when the soils in contact with the upper portion of the pile move downward relative to the pile. Downdrag loads are fully developed at relatively small displacements, of only approximately 2.5 to 13 mm (0.1 to 0.5 in.). CFA piles behave similarly to drilled shafts in response to downdrag and analysis should be conducted in accordance with the methods of determining the ultimate side-shear values on the CFA piles as recommended herein. One difference with CFA piles is that they will always be used in groups and group behavior for downdrag and uplift may control.

Some examples of cases where downdrag can occur are illustrated in Figure 5.30. Note that overlying loose sand, shown as case (a), may be especially problematic if the loose sand is submerged and is in a seismically active area. A high liquefaction potential, coupled with the limited flexural capacity of CFA piles at great depths may preclude their use. Overlying soft clay, shown as case (b), may only be a problem if a surface load is added or if excess pore pressures exist within the clay following the CFA pile installation to drive the consolidation process. Recently placed fill, shown as case (c), may most commonly be encountered in highway design when an abutment and fill are placed around the CFA columns or the supported column/pier.

The range of forces that may develop against vertical piles when downdrag is occurring is shown schematically in Figure 5.31. The limit-state on the left occurs when the combination of the applied load and downdrag load produces both side-shear and end-bearing resistance failures in the founding stratum. The limit-state on the right occurs when a greater load is applied to the same pile shown on the left. The load on the right has been increased a sufficient amount such that the increased pile deflection is then greater than the settlement of the surrounding soil, and thus the entire pile has now been moved down relative to the soil. In such a case, downdrag no longer acts to load the pile.

Although the limit-state on the right side of Figure 5.31 represents the true ultimate geotechnical limit-state for strength, this condition can only exist when the settlement of the pile exceeds that of the ground surface that may be on the order of several inches to several feet. Therefore, the limit-state on the left side is customarily considered to be the strength limit-state for sustained loads. Downdrag conditions can be such that settlement considerations (i.e., serviceability limit state) rather than geotechnical strength conditions control design. Downdrag forces can add significantly to axial forces within the pile and thus can have a significant effect on pile structural design and material strength requirements.



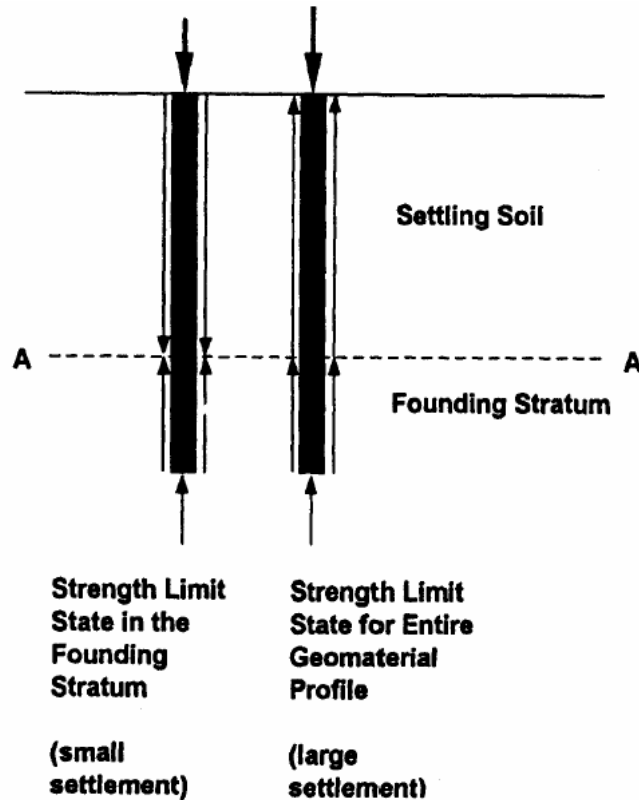


Source: O'Neill and Reese (1999)

**Figure 5.30: Examples of Cases of Downdrag**

The downdrag force should be considered as a permanent load for analysis. This force is the force added to the pile above the neutral plane (defined below) by way of negative (i.e., downward) side-shear. The pile resistance is then the positive (upward) side-shear and end-bearing located below the neutral plane. To correctly differentiate between the downdrag loads and pile resistances, the location of the neutral plane must be determined. The neutral plane is defined at the depth along the pile where there is zero relative movement between the soil and the pile. Therefore, at the neutral plane, there is no load transfer from the soil to the pile.

It may be sufficient to assume that the neutral point lies at the top surface of the strong lower layer in Figure 5.32 if the top layer is relatively weak and causes the downdrag. Note that this assumption is conservative. This condition is shown as details (c) and (d) in Figure 5.32 and is discussed in O'Neill and Reese (1999). Figure 5.32(c) shows the relative movement between the pile and the soil (i.e., negative sign means downdrag). Figure 5.32(d) shows the distribution of resistances along the pile. Better estimates of the neutral point may be obtained with the iterative methodology, as shown in parts (e) and (f) in Figure 5.32. In this case, the neutral point will be located where the end-bearing resistance ( $R_{Bd}$ ) matches that value predicted by static analyses or load-tests. The location of the neutral point may be obtained after only a few trial depths provided that the pile behaves elastically and the load transfer functions are simple.



Source: O'Neill and Reese (1999)

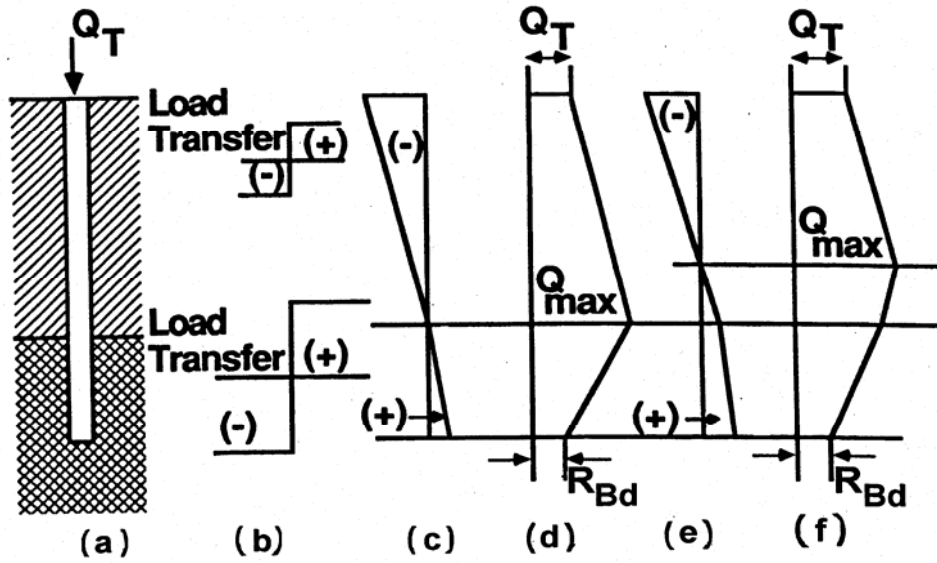
**Figure 5.31: Potential Geotechnical Limit States for Piles Experiencing Downdrag**

When downdrag is anticipated to occur around a pile group, it is usually sufficient for design purposes to use an equivalent pier method where the depth of the pier is the same as for individual piles, and the perimeter of the pier is that of the pile group, as shown in Figure 5.33. The neutral plane may then be determined by the iterative procedure previously described with the equivalent pier dimensions and the equivalent elastic modulus ( $E_e$ ) calculated as follows:

$$E_e = E_c \left( \frac{A_{piles}}{A_{group}} \right) + E_{st} \left( 1 - \frac{A_{piles}}{A_{group}} \right) \quad (\text{Equation 5.64})$$

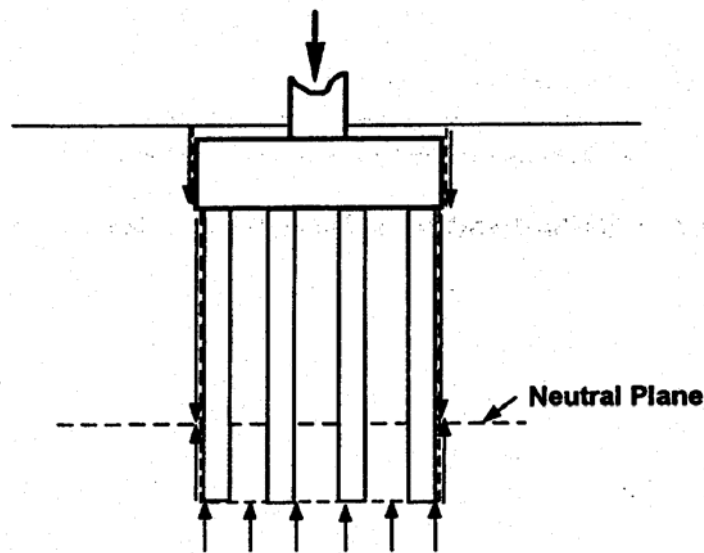
Where:  $E_e$  = average Young's modulus of equivalent pier within the compressible layer;  
 $E_c$  = Young's modulus of pile (concrete or grout);  
 $E_{st}$  = Young's modulus of geomaterial between piles;  
 $A_{piles}$  = cross-sectional area of all the piles in the group; and  
 $A_{group}$  = cross-sectional area of the pile group, not including overhanging cap area.

Note that for typical spacing of 3 pile diameters center-to-center in groups of piles, the downdrag loads occur only around the perimeter of the group, and do not develop against interior piles.



Source: O'Neill and Reese (1999)

Figure 5.32: Mechanics of Downdrag: Estimating the Depth to the Neutral Plane



Source: O'Neill and Reese (1999)

Figure 5.33: Mechanics of Downdrag in a Pile Group

## 5.8 EXAMPLE PROBLEMS: AXIAL CAPACITY OF SINGLE PILES

This section presents two example problems that illustrate the estimation of the axial capacity of CFA piles. The first example is on the estimation of the axial capacity of a conventional CFA pile in cohesive soils. The second example is on the estimation of the axial capacity of conventional CFA and DD piles in cohesionless soils. In these example problems, all quantities are expressed in English units only.

### Problem Statement

Conventional CFA piles of 18 in. nominal diameter are being considered for use to provide support for a highway interchange in a Coastal Plains area. A subsurface investigation, as described in the example problem of Chapter 6 (section 6.7.4, part A), provided information necessary to develop the generalized soil profile at the pier location shown in Figure 5.34. The bottom of the proposed pile cap is at a depth of 4 ft. An allowable stress design (ASD) is to be used with a safety factor of 2.0, as detailed in Chapter 6 (section 6.7.4 Part D). Note that a safety factor of 2.0 is used, as full-scale load-testing will be implemented to verify (or modify if necessary) the pile capacity estimates. Details of the safety factor selection criteria will be presented subsequently in Chapter 6. Provide a hand calculation of the allowable static axial capacity at a pile depth of 60 ft.

### 5.8.1 Conventional CFA Pile in Cohesive Soils

#### Solution

The side-shear resistance ( $R_s$ ) for a pile embedment depth of 60 ft is estimated with the use of the recommended method detailed in Section 5.3.1.1. Note that a spreadsheet solution for the capacity with a range of pile depths is given in Appendix B. The side-shear contributions from the top soil layer (classified as medium gray clay or CH), and the bottom soil layer (classified as stiff to very stiff tan clay or CL to CH) are estimated. The top 5 ft of side-shear is disregarded from the top soil layer estimate, and the bottom 1-diameter (1.5 ft) of side-shear is disregarded from the bottom soil layer estimate, as per the recommended method. Note that if either the bottom of the pile cap (at a depth of 4 ft for this example) or an evaluation of the depth of seasonal moisture change were at a depth in excess of 5 ft, then this larger depth would be discounted from the contribution to the side-shear resistance. From Equation 5.2:

$$R_s = \sum_i^N f_{s,i} \pi D_i L_i = f_{s(\text{Top Layer})} \pi D L_{(\text{Top Layer})} + f_{s(\text{Bottom Layer})} \pi D L_{(\text{Bottom Layer})}$$

where:  $D = 1.5$  ft (the same for both top and bottom layers);

$$L_{(\text{Top Layer})} = 29 \text{ ft} - 5 \text{ ft} = 24 \text{ ft (note the top 5 ft are disregarded for side-shear resistance);}$$

$$L_{(\text{Bottom Layer})} = 60 \text{ ft} - 1.5 \text{ ft} - 29 \text{ ft} = 29.5 \text{ ft (note the bottom 1 diameter or 1.5 ft is disregarded for side-shear resistance);}$$

$f_s = \alpha S_{u,ave}$ ;  $f_s$  is estimated from Equation 5.5 for both the top and bottom layers, as shown below. Note that this will yield an ultimate unit side-shear resistance.

The maximum undrained shear strength,  $S_{u,max}$ , for this profile is 2.5 ksf, which yields a ratio of  $S_{u,max}/P_a \approx 1.25$ . Therefore,  $\alpha = \alpha_{(Top\ Layer)} = \alpha_{(Bottom\ Layer)} = 0.55$ , from Equation 5.6.

$S_{u,ave (Top\ Layer)} = 0.6$  ksf from the idealized soil profile shown in Figure 5.34. Note that the stiffer, desiccated surficial soils (within the top 5 ft zone) were not included in this average in the idealized soil profile.

$S_{u,ave (Bottom\ Layer)} = (1.50 \text{ ksf} + 2.07 \text{ ksf})/2 = 1.79$  ksf from the idealized soil profile shown in Figure 5.34. Note that 2.07 ksf in the above calculation was linearly interpolated at a depth of 58.5 ft (60 ft embedment depth - 1.5 ft exclusion zone at tip).

$$f_s (Top\ Layer) = 0.55 \times (0.60 \text{ ksf}) = 0.33 \text{ ksf}$$

$$f_s (Bottom\ Layer) = 0.55 \times (1.79 \text{ ksf}) = 0.98 \text{ ksf}$$

Then, it results:

$$R_S = (0.33 \text{ ksf}) \times \pi \times (1.5 \text{ ft}) \times (24 \text{ ft}) + (0.98 \text{ ksf}) \times \pi \times (1.5 \text{ ft}) \times (29.5 \text{ ft})$$

$$R_S = 37.3 \text{ kips} + 136.2 \text{ kips} = 173.5 \text{ kips}$$

The end-bearing resistance ( $R_B$ ) for a pile embedment depth of 60 ft is estimated per the recommended method detailed in Section 5.3.1.1. The end-bearing resistance is estimated for the bottom soil layer according to Equation 5.4:

$$R_B = q_p \left( \frac{\pi D^2}{4} \right)$$

where:  $D = 1.5$  ft, the nominal diameter of the pile

$$q_p = N_c^* S_u \text{ from Equation 5.7}$$

$S_{u(ave)} = (2.10 \text{ ksf} + 2.14 \text{ ksf}) / 2 = 2.12 \text{ ksf} = 1.06 \text{ tsf}$  from the idealized soil profile shown in Figure 5.34. The values 2.10 ksf and 2.14 ksf in the above calculation were linearly interpolated at depths of 60 ft (pile tip) and 63 ft (2 diameters below the pile tip), respectively

$N_c^* = 8.71$ , as interpolated from Table 5.1 for an undrained shear strength of 2.12 ksf = 1.06 tsf

$$q_p = (8.71) \times (2.12 \text{ ksf}) = 18.46 \text{ ksf}$$

$$R_B = (18.46 \text{ ksf}) \times (\pi/4) \times (1.5 \text{ ft})^2 = 32.6 \text{ kips}$$

The total axial resistance ( $R_T$ ) for a pile embedment depth of 60 ft is the sum of the side-shear resistance and the end-bearing resistance, according to Equation 5.1:

$$R_T = R_S + R_B = 173.5 \text{ kips} + 32.6 \text{ kips} = 206.1 \text{ kips}$$

Note that this is the ultimate geotechnical axial resistance.

The allowable static axial resistance ( $R_{\text{allowable}}$ ) is obtained in accordance with ASD and a Safety Factor,  $SF = 2.0$ .

$$R_{\text{allowable}} = R_T / SF = (206.1 \text{ kips}) / 2.0 = 103.1 \text{ kips}$$

## 5.8.2 Conventional CFA and Drilled Displacement Piles in Cohesionless Soils

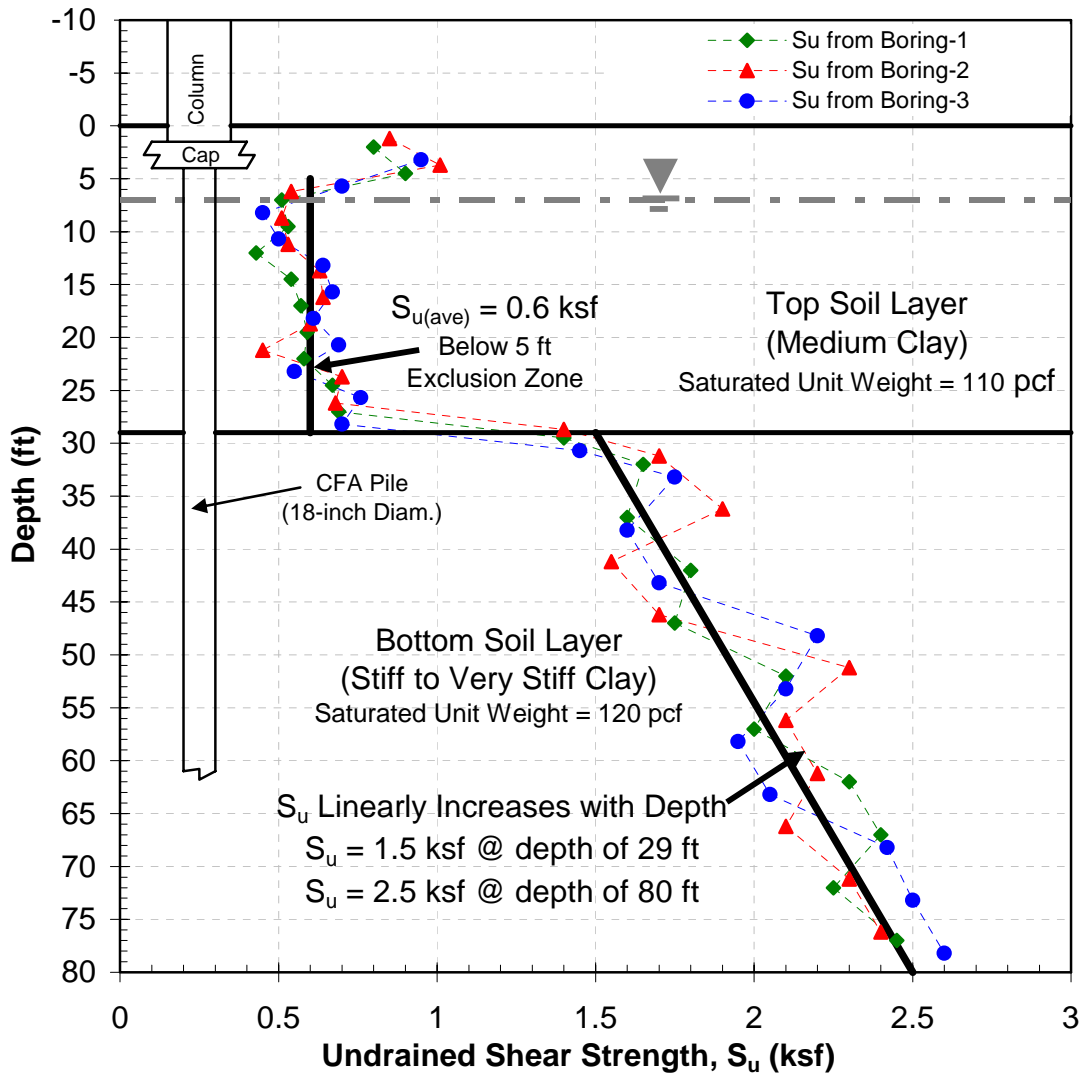
### Problem Statement

Both conventional CFA piles and DD piles, both with a nominal diameter of 18 in., are being considered for use to provide support for a bridge over a small stream within a flood plain. A subsurface investigation provided information to develop the generalized soil profile at the pier location, shown in Figure 5.35, in terms of SPT-N values, soil descriptions, and unit weights. N values are assumed to correspond to 60% hammer efficiency. While the pier location is usually accessible by track-mounted equipment, extreme high tides have been known to bring the water level up to that indicated on the figure. The hydraulic engineer for the project has indicated that potential scour exists at the pier to a depth of 6 ft. The bottom of the proposed pile cap is also proposed at a depth of 6 ft. An ASD is used with a safety factor of 2.5. Details of the safety factor selection criteria will be presented subsequently in Chapter 6. Provide a hand calculation of the ultimate static axial resistance and the allowable static axial resistance for both pile types at a depth of 17 ft in accordance with ASD.

### Solution

Hand solutions for conventional CFA piles and DD piles are presented subsequently, both at a pile depth of 17 ft. Note that spreadsheet solutions of both piles types are given in Appendix B for the capacity with a range of pile depths.

For both pile types, the pile will be divided into 6 segments with the bottom of these segments at depths of 3.25, 5.75, 8.25, 10.75, 13.25, and 17 ft, respectively. These depths correspond to the midpoint between depths of reported SPT-N values. It follows then that the midpoint of each pile segment is at depths of 1.63, 4.5, 7.0, 9.5, 12.0, and 15.1 ft, respectively.

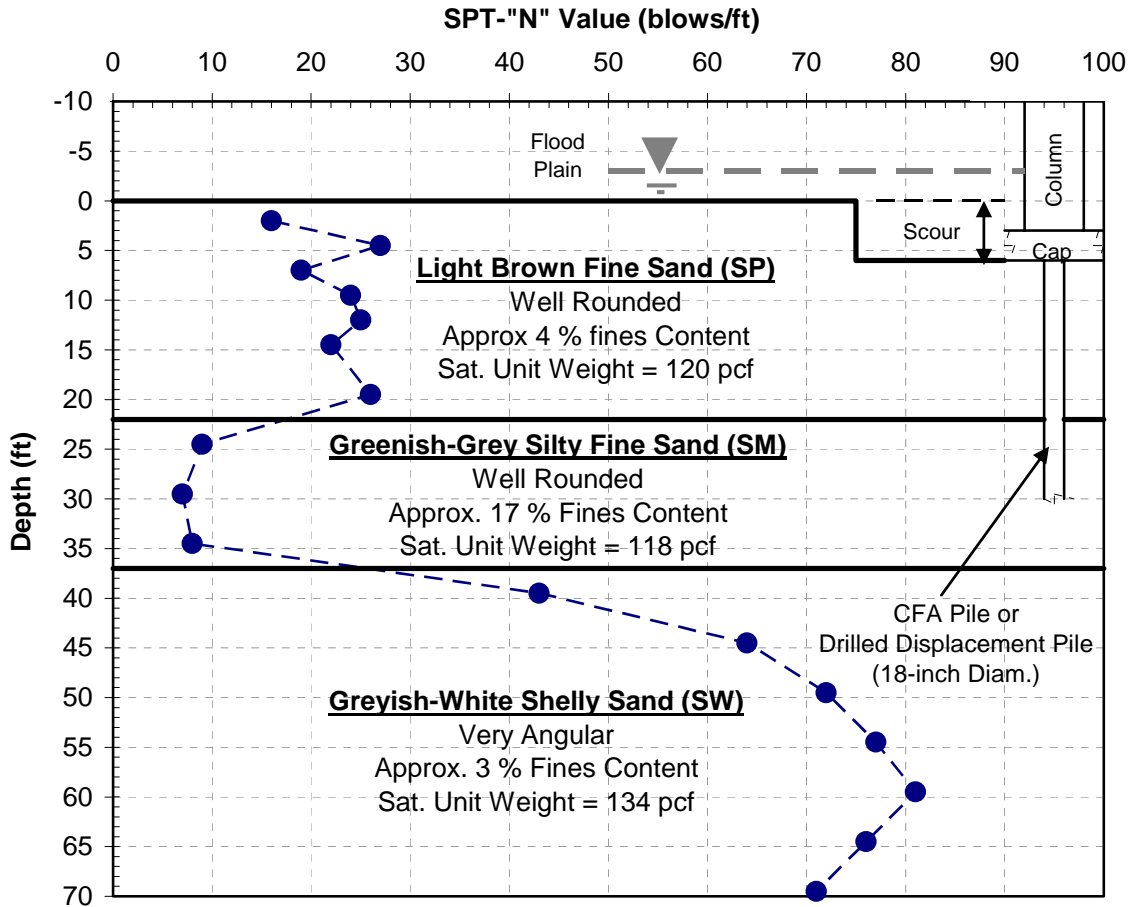


**Figure 5.34: Soil Profile  $S_u$  vs. Depth for Example Problem of CFA Pile in Cohesive Soil**

### Conventional CFA Pile Calculations

The side-shear resistance ( $R_S$ ) for a pile embedment depth of 17 ft is estimated following the recommended method detailed in Section 5.3.2.1. The pile cap and the potential scour both dictate that the side-shear contribution be discounted to a depth of 6 ft. Further, the solution in this example has assumed a worst-case “bed” scour, where the top 6 ft has been disregarded in the calculation of the effective stress distribution and  $\beta$  with depth. Note that if the scour was anticipated to be only “localized”, the top 6 ft do not need to be disregarded in calculating effective stresses and  $\beta$ . From Equation 5.2:

$$R_S = \sum_i^N f_{s,i} \pi D_i L_i$$



**Figure 5.35: Soil Profile SPT-N vs. Depth for Example Problem of CFA Pile and DD Pile in Cohesionless Soil**

For this example with  $N = 6$  pile segments and a constant nominal pile diameter, it results:

$$R_s D \sum_i^6 f_{s,i} L_i$$

where:  $D = 1.5$  ft (the same for both top and bottom layers)

$$f_s = K \sigma_v' \tan \phi = \beta \sigma_v' \text{ from Equations 5.17 and 5.18}$$

and  $\beta = 1.5 - 0.135Z^{0.5}$  (from Equation 5.19) and  $Z$  is the depth to the middle of each pile segment (in ft). Note that  $\beta$  is limited to the following range

$$0.25 < \beta < 1.2, \text{ and}$$

$$\sigma_v' = (\gamma_{sat} - \gamma_{water}) Z = (120 \text{ pcf} - 62.4 \text{ pcf}) Z \text{ (ft)}$$



Pile Segment 1: Disregarded (above scour and pile cap)

Pile Segment 2: Disregarded (above scour and pile cap)

Pile Segment 3:  $f_{s(3)} = (1.2) \times (0.120 - 0.0624 \text{ kcf}) \times (7 - 6 \text{ ft}) = 0.07 \text{ ksf}$  ( $\beta$  limited to 1.2)

Pile Segment 4:  $f_{s(4)} = (1.2) \times (0.120 - 0.0624 \text{ kcf}) \times (9.5 - 6 \text{ ft}) = 0.24 \text{ ksf}$  ( $\beta$  limited to 1.2)

Pile Segment 5:  $f_{s(5)} = [1.5 - 0.135 \times (12 - 6)^{0.5}] \times (0.120 - 0.0624 \text{ kcf}) \times (12 - 6 \text{ ft}) = 0.40 \text{ ksf}$

Pile Segment 6:  $f_{s(6)} = [1.5 - 0.135 \times (15.1 - 6)^{0.5}] \times (0.120 - 0.0624 \text{ kcf}) \times (15.1 - 6 \text{ ft}) = 0.57 \text{ ksf}$

$R_S = \pi (1.5 \text{ ft}) \times \{(0.07 \text{ ksf}) \times [(2.5 \text{ ft} - (6 - 5.75 \text{ ft}))] + (0.24 \text{ ksf}) \times (2.5 \text{ ft}) + (0.40 \text{ ksf}) \times (2.5 \text{ ft}) + (0.57 \text{ ksf}) \times (3.75 \text{ ft})\}$

$$R_S = 18.4 \text{ kips}$$

The end-bearing resistance ( $R_B$ ) for a pile embedment depth of 17 ft is estimated following the recommended method detailed in Section 5.3.2.1. From Equation 5.4:

$$R_B = q_p \left( \frac{\pi D^2}{4} \right)$$

where:  $D$  = 1.5 ft is the nominal diameter of the pile

$q_p$  (ksf) = 0.6  $N_{ave}$  from Equation 5.20

$N_{ave}$  = (22 + 26 blows/ft)/2 = 24 blows/ft, from the  $N$  values at the tip and 5 ft below the tip.

$q_p$  = 0.6  $\times$  (24)  $\times$  (2 ksf/ 1 tsf) = 28.8 ksf

$R_B$  = (28.8 ksf)  $\times$  ( $\pi/4$ )  $\times$  (1.5 ft)<sup>2</sup> = 50.9 kips

The total axial resistance ( $R_T$ ) for a pile embedment depth of 17 ft is the sum of the side-shear resistance and the end-bearing resistance, according to Equation 5.1:

$$R_T = R_S + R_B = 18.4 \text{ kips} + 50.9 \text{ kips} = 69.3 \text{ kips}$$

Note that this is the ultimate geotechnical axial resistance.

The allowable static axial resistance ( $R_{allowable}$ ) is obtained for a Safety Factor, SF = 2.5:

$$R_{allowable} = R_T / SF = 69.3 \text{ kips} / 2.5 = 27.7 \text{ kips}$$

## DD Pile Calculations

The side-shear resistance ( $R_S$ ) for a pile embedment depth of 17 ft is estimated following the recommended method detailed in Section 5.4.2. The pile cap and the potential scour both dictate that the side-shear contribution be discounted to a depth of 6 ft. From Equation 5.2:

$$R_S = \sum_i^N f_{s,i} \pi D_i L_i$$

For this example with  $N = 6$  pile segments and a constant nominal pile diameter is results:

$$R_S = \pi D \sum_i^6 f_{s,i} L_i$$

where:  $D = 1.5$  ft (the same for both top and bottom layers)

$f_s$  (ksf) =  $(0.05 N) (2 \text{ ksf}/1 \text{ tsf}) + W_T$ , from Equation 5.31, and limited to  $N_{60} \leq 50$ .

$W_T = 0$  for 6-pile segments, all lying within the soil layer (silty fine sand). Note that  $f_s$  would be limited to 3.4 ksf for well-rounded and poorly-graded soils, and limited to 4.4 ksf for angular well-graded soils. If the pile segments had been into the last layer (i.e., Shelly sand),  $W_T = 1$  ksf for these angular, well-graded soils. See Section 5.4.2 for details pertaining to the selection of  $W_T$ .

Pile Segment 1: Disregarded (above scour and pile cap)

Pile Segment 2: Disregarded (above scour and pile cap)

Pile Segment 3:  $f_{s(3)} = (0.05) \times (19 \text{ blows/ft}) \times (2 \text{ ksf}/1 \text{ tsf}) + (0 \text{ ksf}) = 1.90 \text{ ksf}$

Pile Segment 4:  $f_{s(4)} = (0.05) \times (24 \text{ blows/ft}) \times (2 \text{ ksf}/1 \text{ tsf}) + (0 \text{ ksf}) = 2.40 \text{ ksf}$

Pile Segment 5:  $f_{s(5)} = (0.05) \times (25 \text{ blows/ft}) \times (2 \text{ ksf}/1 \text{ tsf}) + (0 \text{ ksf}) = 2.50 \text{ ksf}$

Pile Segment 6:  $f_{s(6)} = (0.05) \times (22 \text{ blows/ft}) \times (2 \text{ ksf}/1 \text{ tsf}) + (0 \text{ ksf}) = 2.20 \text{ ksf}$

$$R_S = \pi \times (1.5 \text{ ft}) \times [(1.90 \text{ ksf}) \times (2.5 \text{ ft} - (6 - 5.75 \text{ ft})) + (2.40 \text{ ksf})(2.5 \text{ ft}) + (2.50 \text{ ksf})(2.5 \text{ ft}) + (2.20 \text{ ksf})(3.75 \text{ ft})]$$

$$R_S = 116.7 \text{ kips}$$

The end-bearing resistance ( $R_B$ ) for a pile embedment depth of 17 ft is estimated according to the recommended method detailed in Section 5.4.2. From Equation 5.4:

$$R_B = q_p \left( \frac{\pi D^2}{4} \right)$$

where:  $D = 1.5$  ft, the nominal diameter of the pile

$$q_p (\text{ksf}) = 1.9N_{(ave)} (2 \text{ ksf/1 tsf}) + W_T, \text{ from Equation 5.33 and limited to } N_{60} \leq 50.$$

$N_{ave} = (25 + 22 + 26 + 9) / 4 = 20.5$  blows/ft, from the SPT- $N$  values 6.25 ft above and 10 ft below the tip. Note that  $q_p$  would be limited to 150 ksf for well-rounded and poorly-graded soils and limited to 178 ksf for angular, well-graded soils.

$$q_p = 1.9 \times (20.5) \times (2 \text{ ksf/1 tsf}) + 0 = 77.9 \text{ ksf}$$

$$R_B = (77.9 \text{ ksf}) \times (\pi/4) \times (1.5 \text{ ft})^2 = 137.7 \text{ kips}$$

The total axial resistance ( $R_T$ ) for a pile embedment depth of 17 ft is the sum of the side-shear resistance and the end-bearing resistance according to Equation 5.1:

$$R_T = R_S + R_B = 116.7 \text{ kips} + 137.7 \text{ kips} = 254.4 \text{ kips}$$

Note that this is the ultimate geotechnical axial resistance.

The allowable static axial resistance ( $R_{allowable}$ ) is obtained in for a Safety Factor ( $SF = 2.5$ ).

$$R_{allowable} = RT/SF = 254.4 \text{ kips} / 2.5 = 101.7 \text{ kips}$$

## CHAPTER 6 RECOMMENDED DESIGN METHOD

The purpose of this chapter is to present a step-by-step generalized method for the selection and design of CFA piles.

The process consists of the following design steps:

**Step 1: Initial Design Considerations**

**Step 2: Comparison and Selection of Deep Foundation Alternatives**

**Step 3: Selection of Pile Length and Assessment of Pile Performance under Specified Loads:**

- Calculation of Pile Length
- Verification of Capacity and Performance for Axial and Lateral Loads
- Verification of Pile Group Capacity and Group Settlement Calculations
- Pile Structural Design
- Miscellaneous Considerations

**Step 4: Review of Constructability**

**Step 5: Preparation of Plans and Construction Specifications, Set QC/QA and Load Testing Requirements**

The remainder of this chapter presents an outline of each of the design steps listed above and presents preliminary discussions of the most salient aspects of the design.

### 6.1 STEP 1: INITIAL DESIGN CONSIDERATIONS

The initial design considerations include a review of structure-specific and site-specific conditions for the project that are necessary for any foundation design. In this chapter, attention is focused specifically on those items that establish or preclude suitability of CFA piles for the project. Step 1 is subdivided into several components as described below.

#### 6.1.1 General Structural Foundation Requirements

The first step in the entire process is to determine the general structural requirements for the foundation. Some important considerations include the following:

- Project type: new bridge, replacement bridge, bridge widening, retaining wall, noise wall, sign or light standard. CFA piles may be considered for any of the above.
- Construction sequencing: phased construction or all at once. Neither condition either precludes or favors CFA piles.
- General structure layout and approach grades.
- Surficial site characteristics. A stable working platform is required for CFA pile construction.

- Special design events such as seismic, scour, vessel impact, etc. These factors should be considered in planning the site investigation and can have a significant effect on the selection of CFA piles.
- Possible modifications to the structure that may be desirable for the site under consideration.
- Approximate foundation loads and limitations on deformation.

### **6.1.2 Site Geology and Subsurface Conditions**

A comprehensive review of this component of Step 1 is the subject of other FHWA publications (e.g., “Subsurface Investigations,” document FHWA-HI-97-021, and National Highway Institute [NHI] Workshop on Soils and Foundations, document FHWA-NHI-66-083, and GEC No. 5: “Evaluation of Soil and Rock Properties, document FHWA-IF-02-034 authored by Sabatini et al. [2002]) and will not be repeated here in detail. In general, the components of the site characterization include a review of the site geology and foundation experience in the area, followed by a carefully planned and executed subsurface exploration program. In general, the consideration of CFA piles does not require specialized investigation techniques differing from those used for driven pile foundations. Important considerations for CFA piles include the general site stratigraphy and soil classification, the depth and characteristics of the most likely bearing formation, groundwater conditions, variability, and the presence and extent of unusual geologic features such as solution cavities, boulders, lenses, or layers of hard rock.

The use of cone penetration testing (CPT) is generally considered to be particularly well suited for design procedures used for CFA piles, but especially for drilled displacement (DD) piles. CPT soundings provide a continuous record of a strength measurement that correlates well with CFA and DD pile performance, CPT soundings can generally be performed in soils where CFA or DD piles are to be considered. It is also a very cost-effective tool compared to conventional borings for sounding a large area. Where conditions are such that CFA piles may be considered as a viable foundation alternates, the use of CPT soundings is recommended and encouraged as a part of the exploration program.

## **6.2 STEP 2: COMPARISON AND SELECTION OF DEEP FOUNDATION ALTERNATIVES**

The information from Step 1 must be evaluated and a foundation system selected. Alternatives to deep foundations may be considered, including shallow foundation systems and the potential use of ground improvement techniques to allow the use of shallow foundations. Where deep foundations are required, alternatives include driven piles, drilled shafts, micropiles, and CFA piles including both conventional CFA piles and DD piles. The selection of the optimum deep foundation system for a given project includes consideration of multiple factors and requires experience and judgment on the part of the designer. Table 6.1 outlines many of the considerations involved in the foundation selection process with respect to CFA piles.

**Table 6.1: Design Consideration for Foundation Selection of CFA and DD Piles**

Stratigraphic	Favorable Ground Conditions?	Type of Profile	GWT Location	Other Factors
	Predominantly Clays: favor CFA	Very soft surface may be unfavorable due to poor working platform	If below existing grade, not much of a factor in clays.	Depth to competent material > 30 m (100 ft): not favorable
	Sands: favor DD	Uniform or similar strata: favorable	GWT depth > 3m (10 ft): favorable	Boulders, rock layers or lenses: not favorable
		Highly variable drilling resistance: not favorable	Artesian conditions: not favorable	Good working platform is especially important for DD because DD rigs are usually heavier than CFA
	Cemented soils, weak rock: favor CFA	Highly variable drilling resistance: not favorable	Artesian conditions: not favorable	Boulders, rock layers or lenses: not favorable
	Rock: not favorable for CFA or DD	--	--	--
Structural	Loading Conditions		Other Conditions	
	Approximate maximum ultimate <u>lateral</u> loads per vertical pile (kip) vs. recommended diameter (in.)		<ul style="list-style-type: none"> <li>• Low headroom requirements: may favor CFA piles</li> <li>• Close proximity to existing structures: not favorable to CFA or DD due to potential ground movements during construction</li> <li>• Noise and vibration considerations: may favor CFA or DD piles vs. driven piles</li> <li>• Potential obstructions below grade: not favorable to CFA or DD piles</li> </ul>	
	soft or loose soil: 12 kip - 18" dia. 20 kip - 24" dia. 30 kip - 30" dia. 45 kip - 36" dia.	Stiff or dense soil: 20 kip - 18" dia. 35 kip - 24" dia. 50 kip - 30" dia. 70 kip - 36" dia.		
	Approximate maximum ultimate axial <u>compressive</u> loads per pile (kip) vs. recommended diameter			
400 kip - 18" dia. 700 kip - 24" dia. 1,000 kip - 30" dia. 1,500 kip - 36" dia.				
Special Considerations	Seismic	Scour	Contaminated Spoils	Over Water
	Lateral subsurface soil movements from seismic events produce lateral load conditions not favorable to CFA or DD	Deep scour may result in high moments at depth: not favorable to CFA or DD	Contaminated ground conditions: may favor DD due to avoidance of spoils	Work over water: not favorable to CFA or DD piles
Economic Factors	Qualified Local Subcontractors Available?	Relative Numbers of Piles	Project Size	
	Necessary for CFA or DD	Large numbers of piles: favorable to CFA or DD	Small project with few piles and many moves: may not favor CFA or DD	

The subsequent steps are presented for CFA piles and DD piles. Alternative deep foundation types are described in existing FHWA design manuals for drilled shaft foundations (e.g., FHWA Report No. IF-99-025 by O'Neill and Reese [1999]), for driven pile foundations (e.g., Publication for NHI Course FHWA-NHI-132021 by Hannigan et al. [2006]), and for micropile foundations (e.g., Publication NHI-05-039 by Sabatini et al. [2005]).

### **6.3 STEP 3: SELECT PILE LENGTH AND CALCULATE PERFORMANCE UNDER SPECIFIED LOADS**

#### **6.3.1 Limit States for Design**

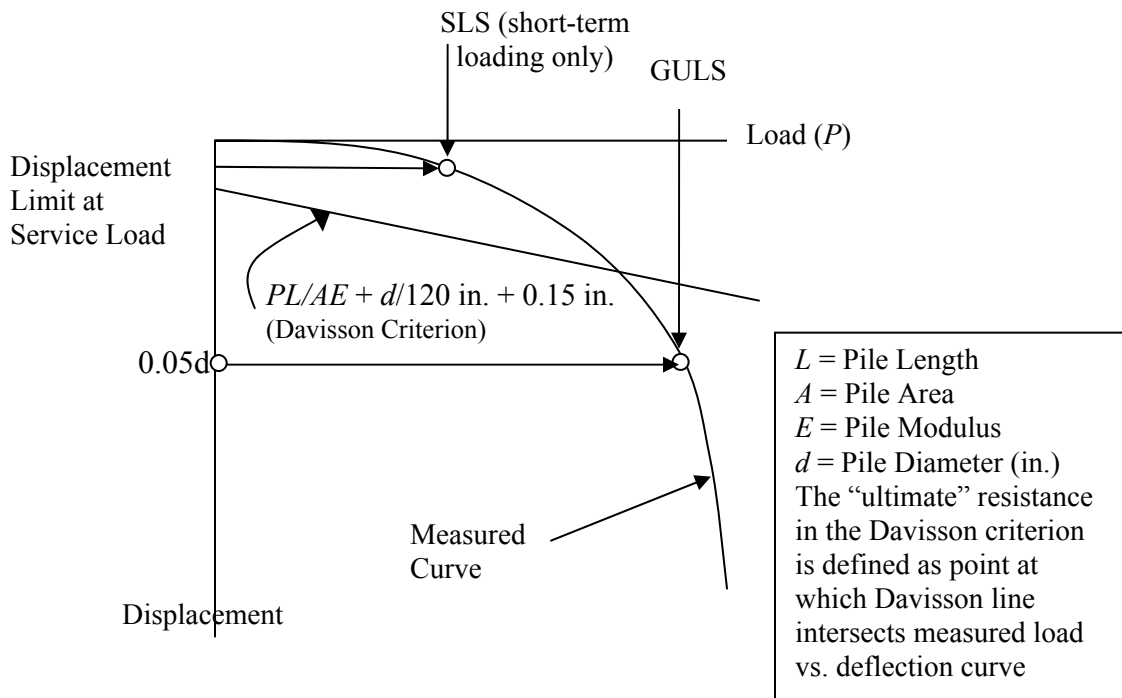
The design method presented is based on an Allowable Stress Design (ASD) for geotechnical conditions, in which a factor of safety is applied to ultimate limit state conditions to obtain allowable resistance values for design. Resistance factors for Load Resistance Factored Design (LRFD) have not been calibrated for geotechnical aspects of CFA pile design. Structural design of the pile is in accordance with LRFD (AASHTO, 2004) as for other reinforced concrete structural elements.

In general, there are three limit state conditions that must be satisfied for design of CFA and other deep foundations:

1. Geotechnical Ultimate Limit State (GULS). The pile should have a load resistance that is greater than the expected loads (service loads) by an adequate margin to provide a required level of safety (safety factor). For axial compressive loads, the GULS is defined as the load resistance at a displacement equal to 5% of the pile diameter in an axial static load test, as shown in Figure 6.1. The Davisson criterion, commonly used for driven piles, and shown for reference in Figure 6.1, will sometimes underestimate the ultimate resistance and is not appropriate for CFA piles. For lateral loads, the GULS may be defined as a push-over failure of the foundation or alternately as some deflection limit at which collapse of the structure above the foundation may occur. Uplift loading conditions and group behavior for axial, rotation, or lateral are additional geotechnical ultimate limit states that may control in some cases. The GULS for preliminary design is determined by calculations, and these calculations may be refined based on site-specific load testing. Note that the GULS is often referenced using the words “capacity” or “failure”, which are a poor choice of words, because no collapse or condition of plunging may exist at the GULS and the pile may have a capacity to support additional loads beyond the GULS. The state of deformation associated with the GULS is not to be confused with deformations at service load levels. The GULS provides a definition of foundation resistance.
2. Service Limit State (SLS). The pile should undergo deformations at service load levels that are within the tolerable limits appropriate for the structure. The actual definition of the service limits should be determined by a rational assessment of the sensitivity of the structure to deformations. Short-term deformations for transient loadings are a function of the mobilization of pile resistance as indicated in Figure 6.1. However, long-term settlements under structural dead loads are a function of

group settlements and should be computed accordingly (as described in Chapter 5). For bridge structures, the serviceability requirements for deformations are in accordance with AASHTO (2002) Section 4.4.7.2.5. Settlements should generally be such that angular distortions between adjacent foundations do not exceed 0.008 in simple spans and 0.004 in continuous spans. It should be noted that only post-construction settlements affect serviceability of the bridge structure. Tolerable movement criteria for lateral displacement should be developed considering the effects of combined lateral and vertical displacements on the structure. AASHTO (2002) Section 4.4.7.2.5 requires that horizontal movements be limited to 25 mm (1 in.) where combined horizontal and vertical movements are possible, and be limited to 38 mm (1.5 in.) when vertical movements are small relative to horizontal movements.

3. Structural Ultimate Limit State (SULS). The pile must have sufficient structural capacity when the pile is subjected to combined axial and flexural loads such that structural yielding of the pile is avoided. The SULS provides a second definition of foundation strength.



**Figure 6.1: GULS and Short-Term SLS for Axial Load on a Single CFA Pile**

Most engineers using ASD methods are familiar with the concept of a factor of safety, which divides the resistance at the GULS to determine an allowable load per pile. The service (unfactored design) loads are compared against the allowable loads per pile to evaluate strength and provide the margin of safety against the limit-state condition (often referred to as “failure”).



For design of CFA piles using ASD, the resistance computed at the GULS is compared with service loads such that:

$$\sum Q_i \leq R / SF \quad (\text{Equation 6.1})$$

Where:

- $Q_i$  = value of service (unfactored) load of type  $i$
- $R$  = computed resistance at GULS
- $SF$  = factor of safety

CFA piles should generally be designed having a factor of safety of at least 2.5. Lower factors of safety are warranted where site-specific load tests are performed and QA/QC systems are used to provide verification that the performance of production piles is reasonably consistent with that of the test pile(s). A factor of safety of 2.0 may be used for design for axial loads provided that the following conditions are met:

1. At least one conventional static load test (per ASTM Standard D1143-81) is performed at the site, to a load exceeding the computed ultimate by 50% or to a load producing displacement equal to 5% of the pile diameter, whichever comes first. Multiple load tests are required where the site extends for a great distance of roadway structure or if, in the judgment of the project geotechnical engineer, the site spans across significant geologic or stratigraphic differences in site conditions. Dynamic or rapid load tests, as described in Chapter 7, may be substituted for some of the conventional static load tests and their results can be correlated to static test or local conditions.
2. Automated monitoring systems are used on production piles to verify that production piles are constructed in a similar way and to achieve similar performance in the test pile(s).
3. The site geology, stratigraphy, and soil properties are not highly variable. Engineering judgment must apply in this instance, and higher factors of safety for design are warranted for conditions with unusual variability in soil properties or geologic conditions. It is acceptable to use a higher factor of safety for some portion of the computed resistance. For example, base resistance or the resistance within some deeper strong layer may be considered as more variable than other portions of the profile that contribute to resistance and therefore, an engineer may apply judgment to assign a higher factor of safety to this portion of the resistance.
4. The site conditions do not pose difficult construction conditions for CFA piles.

Note that load testing and monitoring as described above should be required on all transportation projects constructed using CFA or DD piles. Exceptions may include soundwalls, sign foundations, or similar structures for which the design is not controlled by axial resistance.

It is also important to note that the foundation design engineer should consider the factors of safety cited above as minimum values, and should use a higher factor of safety in any circumstance where there exists concerns for site variability, lack of redundancy, or potentially

difficult construction conditions. An especially critical structure such as a lifeline structure for hurricane evacuation or seismic safety concerns may also warrant a higher safety factor. The values suggested above are for typical conditions and routine projects.

### 6.3.2 Design Procedures

To complete a design, it is necessary to perform static analyses and estimate pile lengths and pile diameters necessary to provide the required compression, lateral, and uplift load capacity. For most routine projects, it is anticipated that the ultimate limit state (capacity) conditions usually control the design of individual CFA piles rather than serviceability (deflection) requirements, therefore, the most efficient approach for design is to check first ultimate limit state conditions and then serviceability. Note that some instances of serviceability may control, such as with large pile groups over a deeper compressible stratum.

In general, smaller diameter and greater length piles tend to be more economical than larger diameter, shorter length piles with similar axial resistance. However, pile diameter is often controlled by lateral shear and bending moment considerations. Lateral load considerations almost never control the length of CFA piles because the soil resistance mobilized to resist lateral loads tends to be within the shallow strata extending to a depth no more than about 10-pile diameters. If significant lateral loads (per pile) are anticipated, the design is accomplished by first performing an initial analysis of lateral loading to define the required diameter and also the depth to the point where calculated bending moments are negligible. This lateral check is followed by static analysis of axial load capacity to define the pile length requirements.

Note that a range of diameters and lengths may be considered for groups of piles, as it is feasible to consider foundations with larger numbers of smaller capacity piles vs. fewer numbers of larger capacity piles. At this stage in the design, it is appropriate to consider a range of pile capacities for possible different group configurations. The procedures described in Chapter 5 are used to perform the analyses associated with determining axial and lateral resistance of various design alternatives.

The recommended procedure for performing a foundation design of CFA or DD piles is outlined below. This outline is developed for the design of a foundation for a structure such as a bridge. A similar procedure for sign foundations or wall components may differ in specifics of some components, but will follow a similar general outline.

- A. Develop Idealized Profile.** Using the borings and geologic descriptions from the site investigation program, group the borings into zones for foundation design according to similarities in the soil profile and properties, and establish idealized geotechnical design profiles for each representative zone at the site. The differing zones should adequately cover the range of conditions at the site, and the designers may develop multiple profiles for each zone to evaluate the possible range of geotechnical (and groundwater) conditions within each identified zone. It may also be necessary to consider several cases of scour associated with different loading conditions. The layers and characterization of soils should be consistent with the methods for estimating axial and lateral load transfer as outlined in Chapter 5 of this document.

**B. Develop Geotechnical Design Parameters.** For each stratum defined in the idealized profiles, evaluate the geotechnical strength and stiffness parameters to establish design parameters for each layer. These may include:

- a. Soil strength parameters such as undrained shear strength and drained friction angle or other measurements, such as SPT- $N_{60}$  values and cone tip resistance. These strength parameters will be used either directly or through correlations to estimate unit side-shear and end-base resistances and to develop p-y curves for lateral loading.
- b. Soil stiffness or modulus and other parameters related to deformation characteristics for use in developing p-y curves for lateral loading and performing settlement analyses of pile groups.
- c. Other soil properties that may be needed for design, such as unit weights and index tests for classification.

Note that the actual values used for design are typically based on judgment and experience along with an understanding of the site geology and potential variability (Sabatini et al., 2002).

**C. Obtain the Loadings for the Foundation.** The design loadings will likely include several cases of both axial and lateral loads. Many different load combinations exist of dead loads, traffic loads, wind loads, etc. Some cases may be combined with scour and some may include extreme event loadings. If downdrag or uplift due to expansive soils is to be considered, these should be noted at this time for inclusion where appropriate into subsequent analysis and design steps. Analyses of the load combinations will reveal the maximum axial and lateral loads imposed to the pile and represent the critical design cases.

**D. Safety Factor(s) for Design.** The safety factors cited in the previous section are suggested for general use in design for strength, and differ depending on the level of site-specific testing and quality control. Large values may be applied in cases where unusual variability in subsurface conditions exist, difficult construction conditions are likely, or if other considerations for the structure dictate. For example, where base resistance contributes a large portion of the axial resistance and the properties of the bearing stratum are quite variable, it may be appropriate to use a significantly greater safety factor on base resistance than side-shear even where a load test is performed.

**E. Select a Trial Design Pile Group to Establish Individual Pile Loads .** The geometry and layout of the pile group, along with the number of piles used to support the foundation loadings will determine individual loads per pile. At this point in the process, experience and/or some preliminary estimates should suggest some reasonable values of nominal axial and lateral resistance for single piles so that an efficient layout can be developed. Engineers are encouraged to evaluate numerous alternatives in the preliminary design stage.

## **F. Select a Trial Design for Individual CFA or Drilled Displacement Piles.**

- a. **Design for Lateral Loading.** Lateral analyses may only be needed if lateral loads are significant. As a guide, lateral shear forces on vertical piles that are less than about 9 to 22 kN (2 to 5 kips) per pile for 460 to 915 mm (18 to 36-in.) diameter piles, would probably not justify lateral analysis at this point in the design process and the designer could skip the lateral analyses and move on to design for axial load. If battered piles are used to resist lateral forces these guidelines apply to the resulting forces transverse to the pile axis and the longitudinal component of the force on the battered pile is considered in design for axial loading.

Select a diameter that is sufficient to provide the necessary nominal lateral load resistance and service load requirements for deflection. Note that when lateral loads are significant, the final design of CFA piles for lateral loading is typically controlled by structural design considerations and the necessary flexural strength and reinforcement. At this point in the design process, it is prudent to consider lateral loading because it may control the pile diameter (but usually not the length). Note that high bending stresses combined with unsupported length due to scour or liquefaction may preclude the use of CFA piles altogether.

A preliminary lateral analysis using a computer code as described in Chapter 5 is warranted at this step in the process. The relative significance of lateral load magnitude is certainly dependent upon soil conditions, and weak surficial soils tend to result in more significant bending moments for a given lateral shear force. Batter piles may also be considered for large lateral forces if downdrag or constructability considerations do not preclude their use, and groups of piles including batter piles are best analyzed using 3-D group analysis programs such as GROUP (Ensoft, 2006) or FB-Pier (BSI, 2003).

The lateral load analysis of a trial pile design should proceed as follows:

- i. Select a trial pile diameter and length (although the design is generally not sensitive to length for CFA piles having length/diameter ratios of 20 or more). Select a trial longitudinal reinforcement. A longitudinal reinforcement with a cross-sectional area of around 1% of the pile cross-sectional area is typically a good initial value to consider. Construct a computer model with p-y curves for the load conditions likely to be most critical for lateral load considerations.
- ii. With the pile modeled as a linear elastic beam, evaluate foundation strength conditions by computing the foundation response of the pile due to service loads multiplied by a factor of at least 2.5 to ensure that the pile embedment into the soil has adequate reserve capacity. Service load deflections or structural strength requirements generally control design, but this “push-over” type analysis is performed to ensure that adequate reserve strength exists with respect to the soil resistance. At the same time, service load and factored load cases can be computed to provide design information that will be used in subsequent steps. Note that there may be several different load combinations to be evaluated, although there

is usually a clearly dominant lateral loading case. This check is to ensure that push-over conditions do not control the design. As mentioned earlier, normally service deflections or structural limit state will control lateral load design. The strength check ensures that the available soil resistance exceeds the structural capacity of the pile in flexure and thus the foundation should have ductility. Note that for analysis of a single pile that will be representative of a group of piles, it is appropriate to include a p-multiplier (less than 1.0) which is equal to the average p-multiplier for the group. The p-multiplier concept is described in Chapter 5 and other references, and is incorporated into most computer programs for lateral analysis using p-y curves.

- iii. Verify that the magnitude and depth of longitudinal reinforcement is adequate for the maximum bending stress computed with the computer program used in step ii. Details of structural design and adequacy are contained in Section 5.6.4. Check to see that the reinforcing design is constructible, as discussed in Section 2.2.2.5.
  - iv. With the pile modeled as a nonlinear reinforced concrete beam, evaluate foundation deflections by computing the foundation response of the pile, or pile cap (when pile groups are used), due to service loads. If the deflections are larger than the service load requirements, the pile diameter may need to be increased (go back to step 3.F.a.i) or the layout changed (go back to step 3.E). If the lateral loads are very high, it may be appropriate to consider batter piles, CFA piles reinforced with steel pipe, or alternative deep foundations.
  - v. Note that if seismic loads are an important component of lateral load considerations, the possibility of subsurface ground movements must be considered, as briefly described in Chapter 5. Although the recommended procedure for design of CFA piles is with ASD using the AASHTO (2002), sections of the AASHTO (2006) design code address issues relating to subsurface ground movements, the effect on pile foundations, and ductility requirements for piles. Subsurface ground movements, which can occur at large depths, may subject CFA piles to significant bending stresses at locations well below the ground surface. Installation of conventional reinforcement in CFA piles may be problematic in such conditions. The use of structural steel pipe or H sections for reinforcement in CFA piles, or selection of alternative deep foundation systems should be considered.
- b. Design for Axial Loading.** After the diameter is selected, determine the length of pile required to provide the necessary axial resistance. Analyses of ultimate axial resistance are performed using the methods outlined in Chapter 5. This step may be a trial and error process. Many engineers may prefer to automate the computations using a spreadsheet or other computer solution that incorporates the methods outlined in Chapter 5. These methods produce profiles with depth of the

nominal and allowable axial resistance for each of the idealized profiles, and loading conditions, and foundation location established for the project. The allowable axial resistance (ultimate axial resistance divided by the factor of safety) is compared to the service loads to ensure that the design meets strength requirements.

- c. At this point it is also prudent to consider constructability, and cost effectiveness of the pile length determined. If the design is problematic from either standpoint, go back to step 3.E and consider an alternative pile layout or alternate deep foundation types.

**G. Pile Group Capacity.** The pile group capacities may be evaluated by hand calculations for simple load conditions and soil layering, as is detailed in Section 5.5.2. However, for pile groups with complex 3-D load conditions or soil layering, the pile group capacity may require analyses using computer codes such as FB-Pier, GROUP, or similar computer-based pile group analysis methods. These tools can be effectively used to optimize foundation layout and load distribution to the piles.

**H. Pile Group Settlements.** For groups of piles subject to sustained permanent loads, long-term settlements in excess of the short-term deformations associated with individual pile load-deflection response (i.e., due to the deeper influence of the pile group) will present a service load condition that should be considered. The group settlement may be evaluated by hand calculations for simple load conditions and soil layering, as is detailed in Section 5.5.3. However, for pile groups with complex 3-D load conditions or soil layering, the pile group capacity may also require computer-based pile group analysis methods. It is noted that the advantages of DD piles in achieving high capacity at shallow depth may be offset by settlement considerations if relatively compressible strata exist at depth. Where downdrag loading is relevant, this should be assessed as outlined in Chapter 5 and design modifications maybe be required. If necessary, longer piles may be required to accommodate settlement or downdrag concerns and the design process may require returning to step 3.E.

**I. Pile Group Lateral Behavior .** The group behavior was taken into account using p-y multipliers during the preliminary analyses of single piles (see step F.a.ii). This may be sufficient for most pile groups, and a sensitivity analysis may be considered to determine primarily the effect of the pile-head fixicity. However, for pile groups with complex soil-pile interaction or cap designs, the pile group lateral capacity may also require computer-based pile group analysis methods.

**J. Structural Design.** After the design has been selected to satisfy considerations of geotechnical strength (GULS) and serviceability (SLS), the final structural design of the piles and pile cap must be completed. This step will involve the final lateral pile analysis or verification and the pile structural design, including reinforcement and grout or concrete material requirements. The structural design for CFA piles is very similar to that of drilled shaft foundations, except for slight differences in properties of grout compared to concrete and the tendency to use a rebar cage that does not extend the full length of the pile. The structural design for the pile is detailed in Section 5.6.4.

## 6.4 STEP 4: CONSTRUCTABILITY REVIEW

An evaluation of constructability is an integral part of the design process and constructability factors should have been considered already in making foundation type selection. A final review of constructability should be performed at this point, including a review of the checklist below for items for evaluating constructability of CFA piles and, if appropriate, DD piles. Note that there are always concerns of some type about constructability, and special concerns should be noted and identified on plan notes and special provisions. It is helpful to highlight these issues to potential bidders so that responsible bids can be prepared and special concerns addressed in the successful bidder's installation plan. A checklist of items to consider follows.

- a. Are pile length and diameters appropriate? Typical CFA pile diameters are typically 0.4 to 0.6 m (16 to 24 in.), and are rarely constructed in excess of 0.9 m (36 in.) in diameter. Typical DD pile diameters are 0.4 to 0.6 m (16 to 24 in.). Lengths of over 30 m (100 ft) are generally undesirable and not optimum.
- b. Can bearing strata be penetrated to depth indicated? Avoid designs that require penetration into hard materials to achieve capacity if the overburden soils may be subject to soil mining or if the bearing stratum is too hard to drill effectively.
- c. Is there a risk of soil mining due to loose water-bearing sands? Avoid CFA in such materials; DD piles may be more effective.
- d. Is there a potential effect on nearby structures? Drilling in close proximity to nearby structures can be risky due to potential subsidence.
- e. Is the rebar cage appropriate? Rebar cage length less than about 12 m (40 ft) is preferable.
- f. Is there a pile cutoff detail? Avoid pile cutoff more than a few feet below the working grade if possible. Deeper cutoff will require casting the pile to the surface and chipping down after the grout or concrete has set.
- g. Is construction sequence is feasible? Consider site access, existing structures, obstructions, pile cap footprint. Avoid installing CFA or DD piles over water. A stable working platform is necessary, especially for DD piles which require larger, heavier rigs than conventional CFA piles.
- h. Are low headroom conditions required? Low headroom working conditions are best if avoided. If it is necessary to use low headroom construction, use smaller piles (usually 0.45 m [18 in.] diameter or less) and smaller working loads per pile to avoid installation problems with small lightweight rigs.
- i. Is there a plan for resolving construction questions prior to production?

## **6.5 STEP 5: PREPARE PLANS AND CONSTRUCTION SPECIFICATIONS, SET QC/QA AND LOAD TESTING REQUIREMENTS**

At this step, general specifications should be reviewed, and project special provisions and plan notes should be developed if needed for incorporation into the project plans and specifications. Guide construction specifications are provided in Chapter 8. Field QC/QA requirements will vary depending on the project type, (e.g., soundwall foundations in favorable soil conditions may have minimal requirements, whereas bridge structure foundations will include extensive monitoring). Load testing requirements should be established, consistent with the design considerations and factor of safety.

## **6.6 EXAMPLE PROBLEM**

### **6.6.1 Introduction**

This example problem is intended to demonstrate the step-by-step design methodology for CFA piles described in the previous sections. In the interest of brevity, the design will focus on the foundation for a single column of one pier, for a single load case. An actual project would utilize the methodology for a variety of foundation locations, additional load cases and alternate subsurface profiles as may occur across the project site for the structure in question. The example problem is developed in English units only.

### **6.6.2 Step 1: Initial Design Considerations**

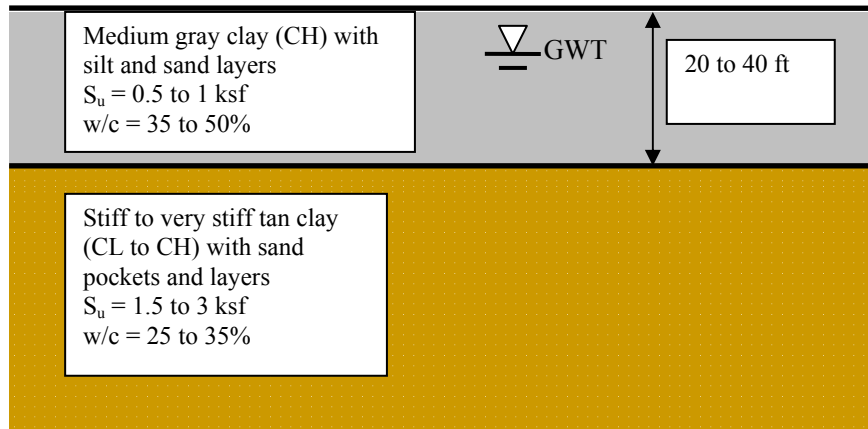
#### **6.6.2.1 General Structural Foundation Requirements**

This project will consist of a series of new bridges to be constructed as a part of an interchange. The layout is such that relatively good access is available and a large number of foundations are required. The magnitude of the axial and lateral loads per each foundation is not unusually large. The working platform is relatively soft in some areas, but suitable for equipment; timber crane mats may be needed.

#### **6.6.2.2 Site Geology and Subsurface Conditions**

The site is in the coastal plains, at a location where relatively soft to medium strength alluvial sediments are present at shallow depths. This soil is predominantly cohesive, but with frequent silt or sand layers. Groundwater is typically present at depths ranging from 6 to 10 ft below existing grade, leaving the cohesive soils in the upper 5 ft, which exhibit a stiffer crust due to desiccation. The shallow sediments are underlain by older, more competent overconsolidated clays of Pleistocene age. The stiff clays extend to depths of engineering significance for this project. The general conditions for the entire site, as indicated by the site investigation, is shown in Figure 6.2. The relatively low strength and high compressibility of the shallow alluvial sediments require that deep foundation support be utilized.





**Figure 6.2: Typical Conditions at the Project Site**

### **6.6.3 Step 2: Comparison and Selection of Deep Foundation Alternatives**

A number of deep foundation alternatives may be considered for this site, including driven piles, drilled shafts, and CFA piles. Because the soils are predominantly clays and no strong bearing stratum is present, deep foundations will derive the majority of capacity from side-shear. This type of profile favors the use of CFA piles, although prestressed concrete piles may be a feasible alternative. Drilled shafts are also a viable alternative, but because of the shallow groundwater and frequent sand layers it is likely that dry hole construction may not be possible and slurry drilling would be required. CFA piles are likely to be very cost-effective in the conditions described in Step 1 and will thus be considered further. The cohesive soils do not favor the use of DD piles as their strength is not appreciably improved from the construction process nor does it benefit from the higher lateral stress attained.

Possible difficulties with the use of CFA piles for this site are:

- If extremely soft organic layers were present within the alluvium, these could pose stability problems with fluid grout. However, no substantial thicknesses (more than a few feet thick) of organics were evident.
- Large lateral loads could be detrimental to CFA piles due to the soft shallow stratum and the limited strength in flexure for these piles.
- Downdrag could be problematic for CFA piles at the abutments, where fill will likely produce significant settlement. This is a consideration for any type of deep foundation, however, and does not preclude the use of CFA piles.

### 6.6.4 Step 3: Select Pile Length and Calculate Performance Under Specified Loads

For this step in the design process, one intermediate bent will be selected and a design developed for the columns at that bent. This bent is to be constructed as a two-column pier, with each column supported by a pile footing. The design will be completed using ASD methods.

Step-By-Step Design Procedure for Axial and Lateral Loads.

6.6.4.A Develop idealized profile. Based on the borings at the intermediate bent location with consideration of nearby borings and engineering judgment, the profile shown in Figure 6.3 is developed for this location. Note that this is the same profile used for one of the examples in Chapter 5.

6.6.4.B Develop geotechnical design parameters. Undrained shear strengths have been obtained based on unconsolidated, undrained triaxial tests, and a design strength profile is developed as shown below. Note that a pile footing is anticipated, with the base of the cap at 4 ft below grade. This elevation will be the top of the pile for analysis purposes.

For settlement considerations of pile groups installed into the deeper stiff clay, this clay is heavily overconsolidated with a recompression index,  $C_r$  of 0.015. The void ratio averages approximately 0.6. Consolidation settlements of the shallow clay will be of interest to parts of the project, but will not directly affect the deep foundation calculations in this example.

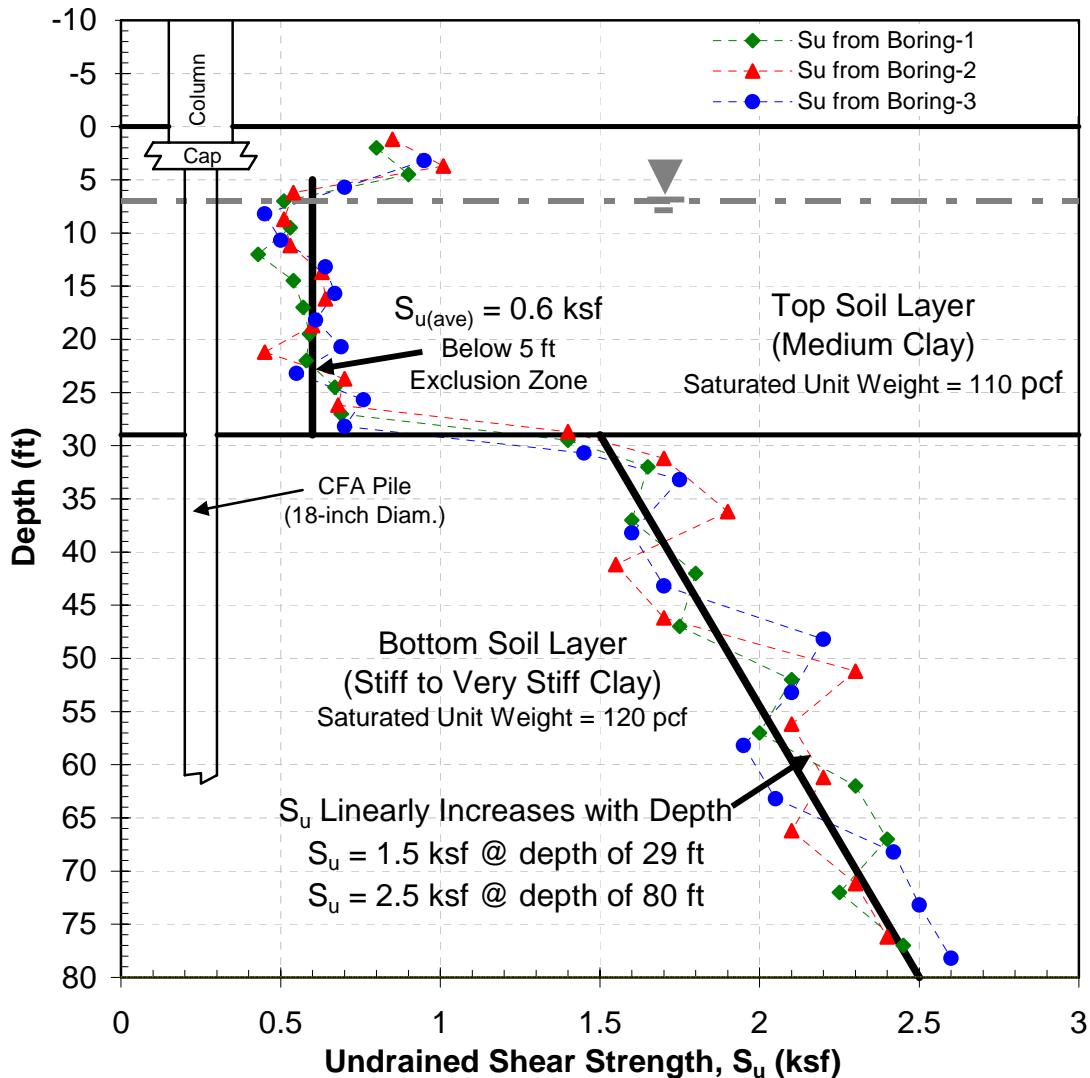
6.6.4.C Obtain the nominal loadings for the foundation. At this interchange, there is no waterway to cause scour and extreme event loadings are not significant. Axial loads are controlled by combined dead load and live load, and lateral loads are produced by wind. Although there are typically a number of load cases to be considered, this simplified problem will consider foundation loads as follows for each of the two columns:

- Group Vertical service load (dead + live) = 500 kips
- Dead Load / Live Load = 2.5
- Horizontal service load (due to wind) = 50 kips
- Overturning moments at the base of the column = 250 ft-kips service loads (transient)

Post-construction axial settlements should not exceed 0.5 in. under service dead loads and lateral deflections at the pile cap should not exceed 0.25 in.

6.6.4.D Establish Factor of Safety for Design. For this project, an extensive field load test program will be developed and used, so that a factor of safety of 2.0 may be used.

6.6.4.E Select a trial design pile group to establish individual pile loads. Several different pile layouts may be used, but as a first trial consider a 5 pile group of 18-in. diameter CFA piles. With piles spaced at 3 diameters on center (i.e., 4.5 ft center-to-center), the layout of such a group is shown in Figure 6.4.



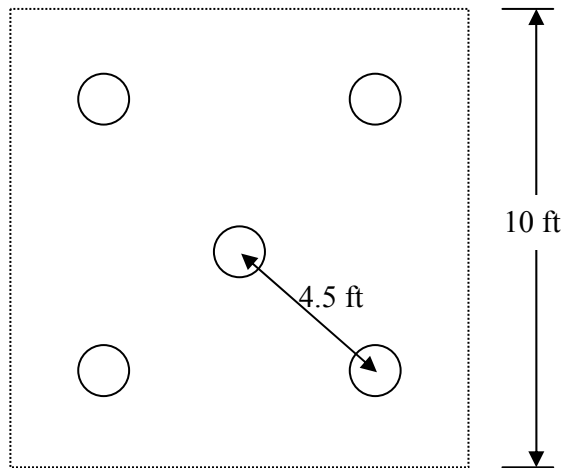
**Figure 6.3: Idealized Soil Profile for Design**

The five-pile layout provides some redundancy in the foundation and distributes the resistance over a broad footprint so that the moment on the column is resisted by axial forces in the piles. A preliminary estimate of individual pile factored loads is as follows:

Axial pile force due to axial column load:

$$500 \text{ kip per column} / 5 \text{ piles} = 100 \text{ kips/pile}$$

The axial pile force ( $F_{pile}$ ) due to the overturning moment on column ( $M_{overturn}$ ) can be computed from static equilibrium as follows: only  $N_{piles} = 4$  piles contribute to moment as the center piles lies along the neutral axis. The distance normal to the neutral axis of the outer four piles ( $d_{pile}$ ) is used for calculation.



**Figure 6.4: Five-Pile Footing Layout**

For static equilibrium about the center of the group, the applied overturning moment must equal the overturning moment resulting from pile axial forces as follows:

$$M_{\text{overturn}} = N_{\text{piles}} \times F_{\text{pile}} \times d_{\text{pile}}$$

$$\text{Load per pile due to moment} = 250 \text{ kip-ft} / [(4 \text{ piles}) \times (4.5 \text{ ft}) (\cos 45^\circ)] = \quad +/ -20 \text{ kips/pile}$$

Cap weight (assume a 2.5-ft thick cap):

$$10 \text{ ft} \times 10 \text{ ft} \times 2.5 \text{ ft} \times 0.15 \text{ kip/ft}^3 / 4 \text{ piles} = 8 \text{ kips/pile}$$

Total axial load per pile =

$$\text{Axial force due to column load} + \text{Load due to moment} + \text{Cap weight} = 100 + 20 + 8 \text{ kips} \\ = 128 \text{ kips/pile}$$

Note that piles at the opposite side of the group are those with the minimum load, and are 40 kips/pile less than the maximum. In some cases, the pile cap may not need to be included in the load.

For design, round off and use 130 kips/pile as the required allowable pile capacity

For lateral loads due to wind, use lateral load per pile = 50 kips/5 piles = 10 kips/pile

6.6.4.F Select a trial design for individual CFA pile. Because lateral loads may control pile diameter, check lateral loading first. Note that combined lateral and axial loading could be evaluated using pile group design software, such as FB-Pier (BSI, 2003) or GROUP (Ensoft, 2006). In many simple cases and in this simple example, an

analysis can be performed on a single pile that is representative of the group behavior. For this example, a single pile is evaluated using LPILE (Ensoft, 2006) to demonstrate the calculation methods and design philosophy. It is obvious that the piles will need to extend for some length into the stiff Pleistocene clay stratum to generate axial resistance; however, the lateral response is unlikely to be affected by this length because the length to diameter ratio for an 18-in. diameter CFA pile will be large. A 40-ft long pile is used for lateral analysis, even though a longer pile will likely be required for axial loading considerations.

a. Design for Lateral Loading

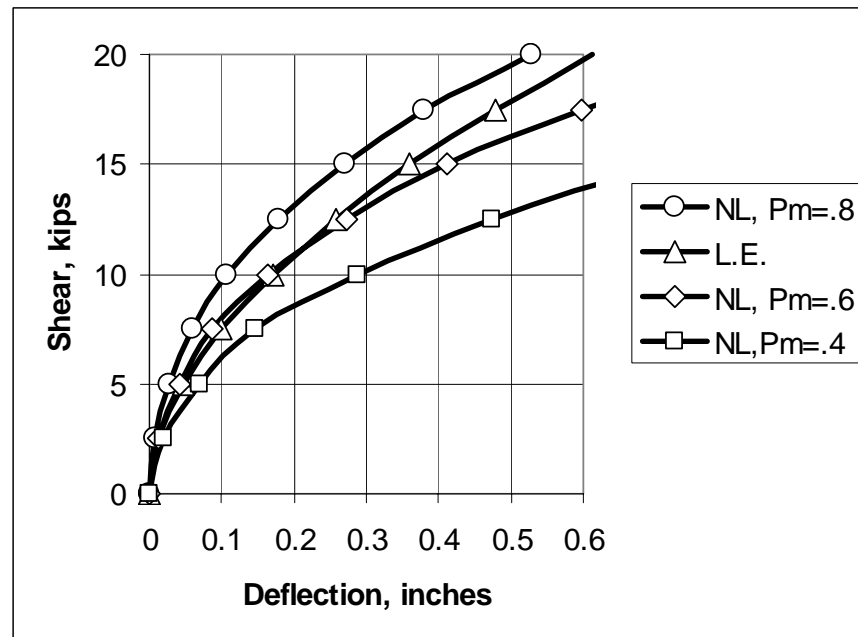
LPILE is used to compute the response of a single linear elastic pile of 18 in. in diameter that extends into the stiff clay stratum for a short distance. Analyses are performed for a range of loads, including loads up to twice the service load of 10 kips per pile, in order to verify that a ductile lateral load vs. deflection response is obtained (e.g., the pile has greater capacity in excess of the design loads with increasing deflection). The top of the pile is assumed to be restrained against rotation; i.e., the pile has a full moment connection and is fixed to the cap by connecting the reinforcement into the cap. The cap will resist rotation because of the rotational stiffness from the axial resistance of the piles. To account for lateral group effects, an average P-multiplier for the pile group is used. P-multipliers range from 0.4 to 0.8 for piles within a group spaced at 3-diameters on center in clay soils (see Section 5.6.3 for a discussion of P-multipliers).

First, a linear elastic analyses (concrete and steel strength are assumed to be linearly elastic with no cracking) with a p-multiplier at the mid-range of 0.6 is performed to verify that the lateral deflections are small and the 18-in. diameter pile has adequate lateral resistance. Subsequently, the model is revised to include nonlinear behavior of the reinforced concrete pile. As a first try, a rebar cage having longitudinal steel equal to at least 1% of the cross-sectional area (i.e.,  $D_s = 2.54 \text{ in.}^2$ ) is used. Six #7 bars provide a total of  $3.6 \text{ in.}^2$  area and are used for subsequent analyses. Grade 60 reinforcement of  $f_y = 60 \text{ ksi}$  and  $f_c' = 4,000 \text{ psi}$  concrete or grout is used for this design. Note that repeated analyses with a range of values are very easy once the basic model is established.

The results of these analyses are illustrated using Figures 6.5 through 6.8. The design engineer can quickly evaluate results graphically on the computer screen and revise the analyses as required without lengthy printouts. The figures are used in this example to illustrate the design process.

The lateral load vs. deflection response shown in Figure 6.5 indicates that the piles in the group should support a lateral shear of 10 kips with a deflection of around 0.2 in. or slightly less at the pile top. The curve for the linear elastic pile case was performed to provide an initial evaluation of soil response without regards to the structural capacity of the pile. The nonlinear analyses should be expected to provide a more realistic estimate of actual pile response. Note that this does not include any potential contribution from the pile cap which is typically bearing against the soil; therefore, this analysis is likely conservative. The actual distribution of forces in the piles in the group may range from around 8 to 12 kips for a displacement of 0.2 in., depending on the row position, and

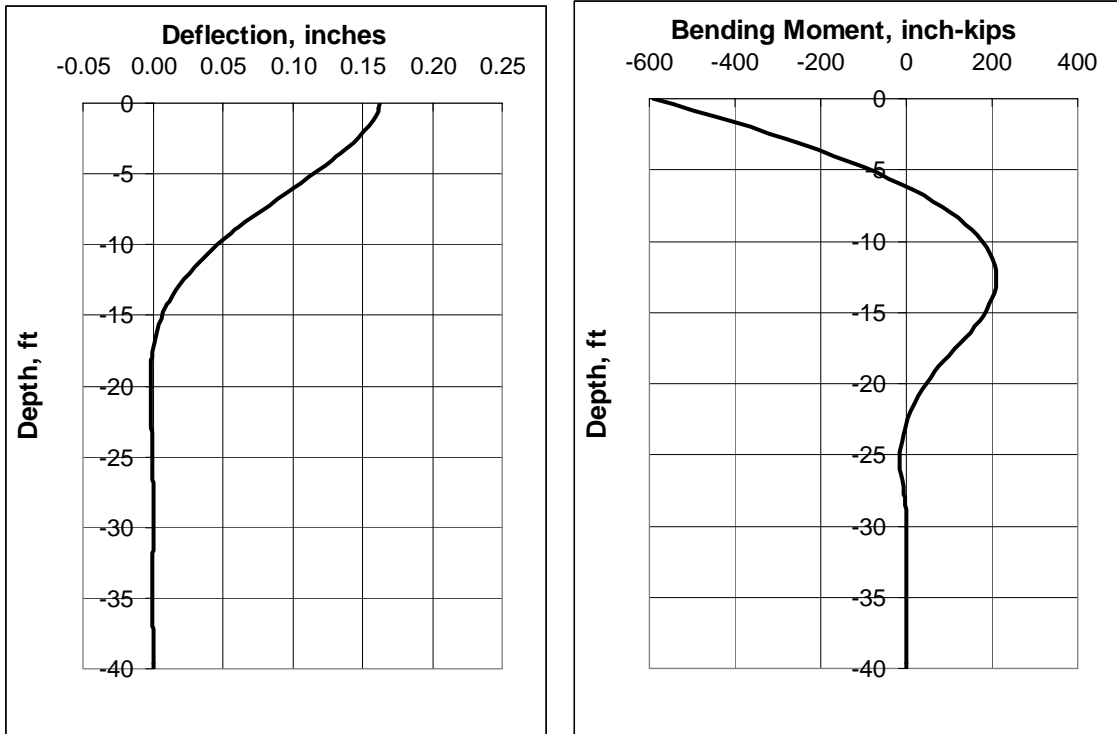
p-multiplier used, as was discussed in Section 5.6.3. The consideration of the average condition is sufficient for this illustration problem.



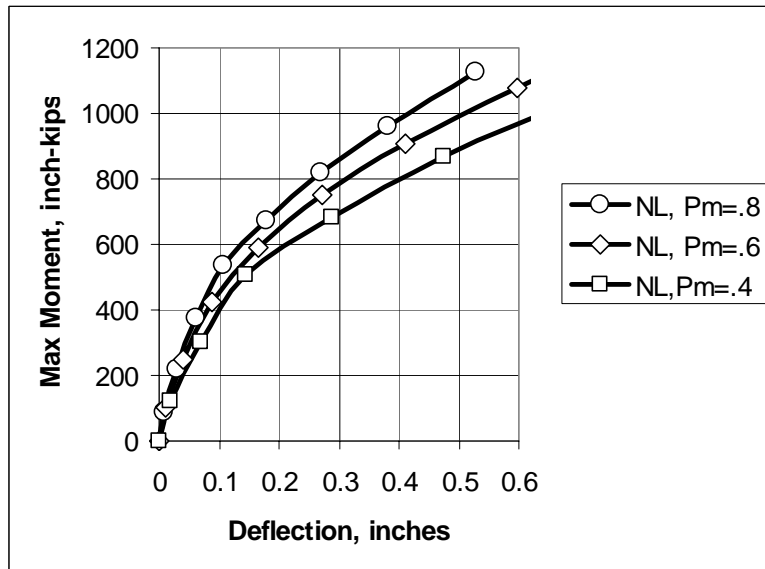
**Figure 6.5: Computed Lateral Load vs. Deflection Response. NL = nonlinear pile behavior, L.E. = linear elastic beam**

The resulting deflection profiles illustrate the length of pile over which the lateral soil resistance is mobilized. Deflection vs. depth for the mid range of the p-multipliers used ( $P_m = 0.6$ ) is shown for a 10 kip lateral load (mid-range from 8 to 12 kips range) in Figure 6.6. This is considered representative of the average pile case. Bending moments in the pile vs. depth for that case are also shown in Figure 6.6. The maximum bending moment occurs at the top of the pile, at the connection to the pile cap. Both deflections and bending moments indicate that depths below 30 ft are relatively unaffected by lateral loads applied at the pile top.

An evaluation of bending moments for the range of lateral loads from 8 to 12 kips corresponds to the range of maximum bending stresses in the piles of the group at a deflection of approximately 0.2 in. Maximum bending moments vs. deflection for the range of p-multiplier values used is illustrated in Figure 6.7. The maximum value for use in design (i.e., for a deflection of 0.2 in.) is around 700 in.-kips. Note that the stiffer pile ( $P_m = 0.8$ ) has the highest moment at a given deflection, because this stiffer pile is supporting a larger share of the lateral load. In any event, it is appropriate to design all of the piles to encompass the maximum possible range of conditions. If the simplified method had been used with calculations performed only for the average p-multiplier of 0.6, the estimated deflection would have been almost the same to that obtained using the row-dependent p-multipliers. The maximum moment would have been calculated at 720 in.-kips, based on the 600 in.-kips for the average pile, with a 20% increase to account for variations in pile stiffness.



**Figure 6.6: Deflection and Bending Moments vs. Depth for Example Problem (lateral load = 10 kips)**



**Figure 6.7: Maximum Bending Moments as a Function of Pile Top Deflection**

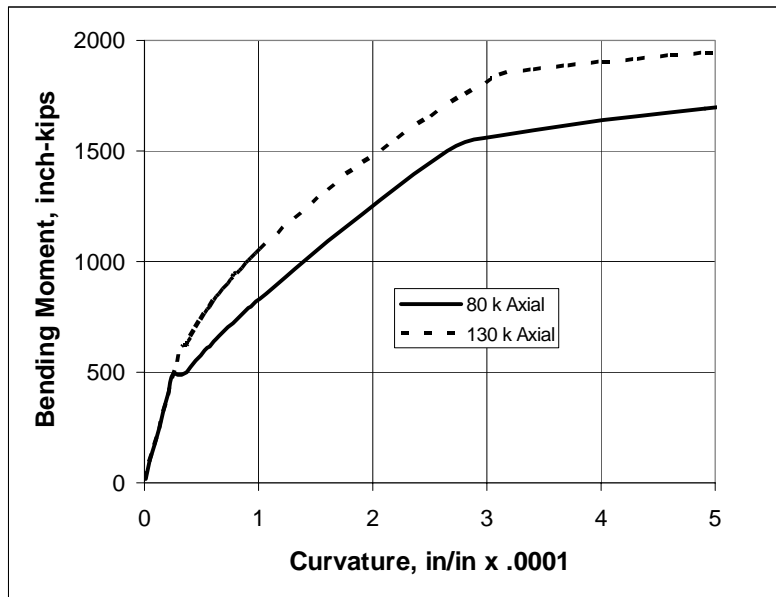
Figure 6.8 shows the moment vs. curvature relationship computed with LPILE for an 18 in.-diameter pile reinforced with 6 #7 bars, and with 3 in. of cover. The range of 80 to 130 kips of axial force encompasses the anticipated range of axial pile loads and provides a structural check on combined axial and flexural responses. This figure

suggests that the maximum bending moments computed in the 700 in.-kip range are well within the factored moment resistance of this pile for purposes of preliminary design. The ultimate moment resistance is in the 1,500 to 1,800 in.-kip range, as is evident by the large increase in curvature with little increase in bending moment (approximate curvature of 0.0003).

At this point, the preliminary evaluation of an 18-in. diameter pile for lateral loads is completed. Before completing a final design considering lateral loads, the design for axial resistance should be performed. Note also that by evaluating a range of lateral loads at this preliminary design stage, it would be easy to re-evaluate lateral load response for pile groups with different numbers of piles or for different loads that may be representative of other foundation cases on the project.

b. Design for Axial Loading

The maximum service loads were determined to be 130 kips per pile. Using a factor of safety of 2.0, the ultimate pile resistance required for this design is 260 kips, corresponding to a tip embedment of 69 ft below grade. Computations of axial resistance with depth for an 18-in. diameter pile in this soil profile were made in Section B.1 of Appendix B. The results of these calculations are reproduced as Figure 6-9. Axial structural capacity was considered in combination with flexure in the previous step.



**Figure 6.8: Bending Moment vs. Curvature for a 18-in. diameter Pile with 6 #7's**

Note that load testing of a pile with similar characteristics and soil conditions is required to utilize the safety factor of 2.0 selected for design. The load test must be designed to test the pile load resistance to at least 390 kips, i.e., 3 times the design load.



c. Consider Constructability and Cost Effectiveness.

The required embedment depth of 69 ft below grade is fairly deep, but well within the range for which CFA piles of this size can be constructed efficiently. It is possible to consider using 24-in. diameter piles of shorter length, for which a 4-pile group could be easily constructed. It is also feasible to increase the design group to a 6-pile arrangement of 18 in. piles to use shorter piles which may require a rig with less torque or crowd.

Another constructability issue to consider is the rebar cage. The calculations for bending moments suggest that a cage needs to extend to a depth of 30 ft, which is within the range of embedment that is relatively easy to construct. Without significant tensile forces or seismic ground motions that could produce significant bending stresses at greater depth, there is no necessity to install a deeper cage. The six bar cage developed in this preliminary design step does not appear to pose a constructability problem.

It may be noted that the great majority of the resistance of the proposed design comes from side-shear, with relatively little contribution from end-bearing resistance. Of most significance is the embedment into the stiff Pleistocene clay stratum, a point which should be made via the project documents so that the inspection team can specifically seek to verify the embedment into the Pleistocene. It generally should be possible to note a change in drilling resistance when this significantly stiffer stratum is encountered below the alluvium.

6.6.4.G Pile Group Capacity. Limiting pile group capacity may be estimated using the block failure concept outlined in Section 5.5.2.1.2. This rarely controls but must be checked. A quick check can be made on the side-shear on the block in the stiff clay stratum only, without even considering the base resistance of the block. The width of the outside of the 5-pile group is 2 times the projected distance from the center pile to the center of the corner piles plus one pile diameter or:

$$2 \times (4.5 \cos 45^\circ) + 1.5 = 7.9 \text{ ft}$$

The group is embedded  $69 - 29 = 40$  ft into the stiff clay. Therefore, the surface area of the block resisting in side-shear is:

$$4 \times 7.9 \times 40 = 1,264 \text{ ft}^2$$

The average undrained shear strength within 29 and 69 ft below grade is 1.9 ksf. Therefore, the side-shear resistance on the block is:

$$1,264 \text{ ft}^2 \times 1.9 \text{ ksf} = 2,402 \text{ kip.}$$

This resistance is substantially larger than the resistance of the 5 individual piles, indicating that block failure of the group does not control. Base resistance can be added if necessary, but this quick check is sufficient to verify the block failure does not control design.

6.6.4.H Pile Group Settlements. Long-term settlements in clay soils resulting from dead load are a consideration, as these sustained loads may result in significant compression or consolidation settlement of the underlying soils. The step-by-step procedure outlined in Section 5.5.3.3 is followed for this calculation.

- a. The depth of the “equivalent footing” is approximately 2/3 of the depth within the stiff clay stratum. Because the pile extends to 69 ft below grade and the stiff clay starts at a depth of 29 ft below grade, the equivalent footing is located at:
- b.  $2/3 \times (69 - 29 \text{ ft}) = 0.67 \times 40 = 56 \text{ ft}$ , or 27 ft into the stiff clay deposit or 56 ft below the ground surface. The side of the equivalent footing for a 5-pile group shown in Figure 6-4 is  $2 \times (4.5 \cos 45^\circ) + 1.5 = 7.9 \text{ ft}$ . Because the DL/LL ratio is 2.5, the sustained dead load (SDL) is the total service load (TSL) times the ratio to the dead load of the total service load or:

$$\text{SDL} = 500 \times 2.5 / (1 + 2.5) = 357 \text{ kips}$$

$$\text{the cap weight is assumed to be} = 10 \times 10 \times 2.5 \times 0.15 = 37.5 \text{ kip}$$

Therefore, the total dead weight causing long-term settlement is 395 kip.

The bearing pressure on the equivalent footing is thus  $395 \text{ kip} / 7.9^2 = 6.33 \text{ ksf}$ .

- c. The soil is divided into 6-ft thick layers below the equivalent footing. The first of three layers will have an effective vertical stress,  $p_o$ , at the center of the layer (or at depth of  $56 + 3 = 59 \text{ ft}$ ) equal to:

$$p_o = \sum_i^6 (\gamma_{soil} z_{soil,i}) - \gamma_w z_w \text{ where:}$$

$$\gamma_{soil} = \text{soil unit weight of layer } i$$

$$z_{soil,i} = \text{soil layer thickness of layer } i$$

$$\gamma_w = \text{unit weight of water}$$

$$z_w = \text{depth below the groundwater table}$$

$$= 29 \text{ ft} \times 0.110 \text{ kcf} + 30 \text{ ft} \times 0.120 \text{ kcf} - 52 \text{ ft} \times 0.0624 \text{ kcf} = 3.55 \text{ ksf}$$

Load spreading at a 1H:2V ratio at the center of the first layer produces a stress change,  $\Delta p$ , of  $395 \text{ k} / (7.9 + 3)^2 = 3.32 \text{ ksf}$  and a final stress,  $p_f = p_o + \Delta p = 3.32 + 3.55 = 6.87 \text{ ksf}$ .

The settlement,  $S$ , of this layer is:

$$S_l = H [(C_r / (1 + e_o)) \log (p_f / p_o)], \text{ where}$$

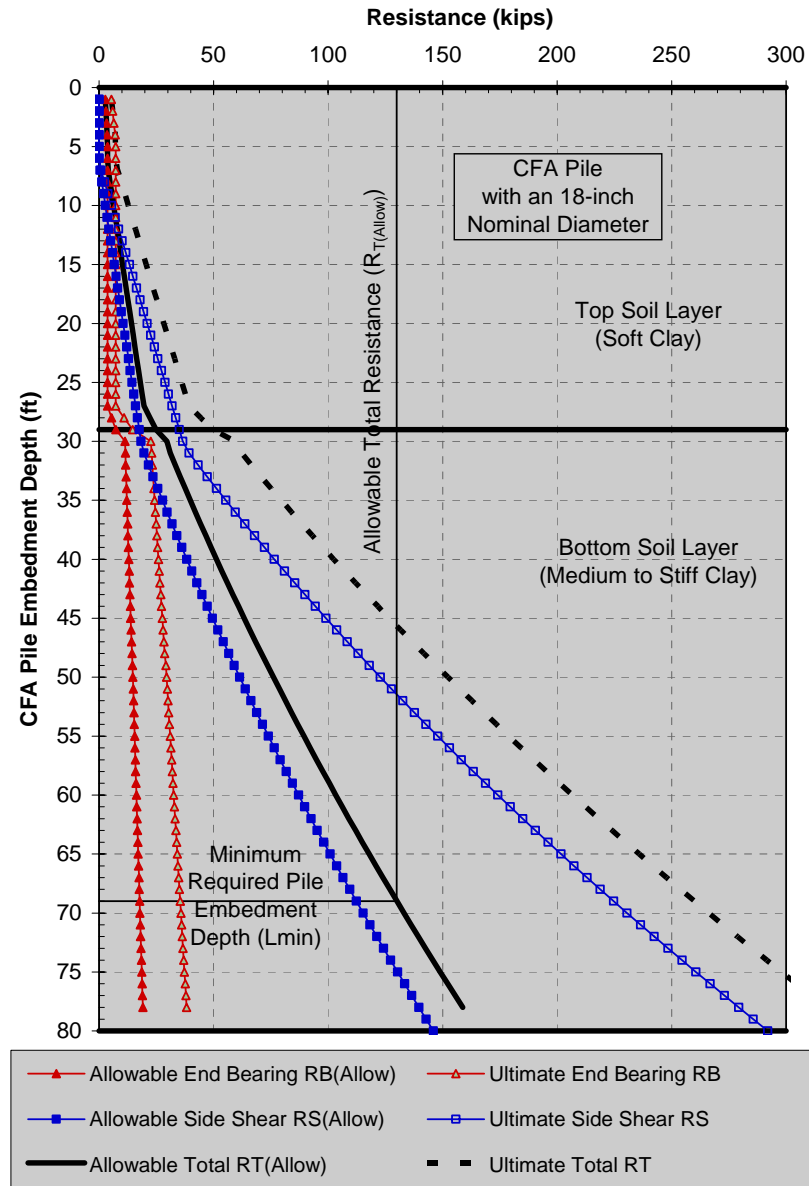
$$H = \text{layer thickness} = 6 \text{ ft} = 72 \text{ in.}$$

$$C_r = \text{recompression index} = 0.015$$

$$e_o = \text{void ratio} = 0.6$$

$$S_l = 72 [(0.015 / 1.6) \log (6.87/3.55)] = 0.19 \text{ in.}$$

For other layers, the computation follows in Table 6.2. Note that the calculation is performed until a depth at which  $\Delta p/p_o < 10\%$



**Figure 6.9: Computed Axial Resistance vs. Depth**

**Table 6.2: Pile Group Settlement Computation**

Layer Number	Depth Interval (ft)	Thickness (in.)	$p_o$ (ksf)	$\Delta p$ (ksf)	$S$ (in.)
1	56 - 62	72	3.55	3.32	0.19
2	62 - 68	72	3.9	1.38	0.09
3	68 - 74	72	4.24	0.75	0.05
4	74 - 80	72	4.59	0.47	0.03
<b>TOTAL:</b>					<b>0.36</b>

Add to the consolidation settlement above the theoretical elastic shortening ( $S_{el}$ ) of the piles acting as a column above the equivalent footing. These piles support a total load of 395 kips with an area equal to that of 5 piles; therefore, using an estimated elastic modulus for the piles of 3,000 ksi, it results

$$S_{el} = (1/2) \times (PL/AE) = 1/2 \times [(395 \text{ kip} \times 56 \text{ ft} \times 12 \text{ in./ft}) / (5 \times 254 \text{ in.}^2 \times 3,000 \text{ ksi})] = 0.04 \text{ in.}$$

Long-term settlements under dead load for this foundation are thereby estimated at no more than  $0.36 + 0.04 = 0.40$  in., or about 0.5 in. It should be noted that a portion of the dead load is applied onto the piles before the pier cap and girder bearing plates are finalized, and the portion of the settlement that occurs during this period will not affect the bridge structure. Therefore, if the long-term settlements due to total dead load appear to be too high, it would be prudent for the design engineer to re-evaluate the settlements to estimate the actual magnitude of the post-construction portion of the total settlement.

6.6.4.I Pile Group Lateral Behavior. Lateral deflections have already been estimated in the previous step (6.6.4.F.a) at less than 0.2 in. for the design lateral loads using appropriate P-multipliers to account for group effects. A full 3-D computer model of the proposed foundation may be analyzed using GROUP (Ensoft, 2006) or FB-Pier (BSI, 2003) or similar software. The use of these sophisticated programs is not necessary for this simple problem but may be a convenience for users who are familiar and efficient in using such software.

6.6.4.J Finalize Structural Design. The design satisfies geotechnical limit states and serviceability limit states. The final sub-step in designing the piles is to finalize the structural design of the pile and select reinforcement. Structural design follows the procedures outlined in Section 5.6.4.

The depth required for the full cage section must first be determined. It was seen in Figure 6.6 that the pile clearly exhibited “long pile” behavior, and the depth to the counter-flexure point in the displacement profile (second point of zero displacement with

depth) was approximately 25 ft. The cage may thus terminate at this depth because the piles are not bearing in weak rock or intermediate geotechnical material (IGM) sockets.

Longitudinal reinforcement was chosen as the recommended minimum of 1%, as has been determined previously in computations of lateral resistance to provide adequate lateral structural resistance. Combined axial force and flexure was considered in the analysis presented in Figure 6.8.

For the maximum computed shear force in any pile, check to determine if the concrete section has adequate shear capacity without shear reinforcement (Chapter 5, Section 5.6.4.2).

With 6 #7's bars and 3-in. cover on the longitudinal reinforcing, the radius of the ring formed by the centroids of the longitudinal bars is (Eq. 5.59):

$$r_{ls} = B/2 - d_c - d_b/2 = 9 - 3 - 0.44 = 5.56 \text{ in.}$$

The area of the cross-section that is effective in resisting shear is (Eq. 5.59):

$$A_v = B[B/2 + 0.5756 \times r_{ls}] = 219 \text{ in.}^2$$

The concrete shear strength using the average axial force of 100 kips is (Eq. 5.61a):

$$\begin{aligned} V_c &= [1 + \phi \times 0.00019 (P/A_g)] \times (f_c')^{0.5} \\ &= [1 + 0.85 \times 0.00019 \times 100,000 / (\pi \times 9^2)] \times (4,000)^{0.5} = 68 \text{ psi} \end{aligned}$$

Note that the maximum shear will likely occur on a front row pile with greater axial force.

Note that ignoring the effect of axial force and computing  $V_c = (f_c')^{0.5}$ , a value of 63 psi is obtained, which is slightly conservative but generally sufficient for design.

The factored shear resistance provided by the concrete is thus:

$$\phi V_n = \phi V_c A_v = 0.85 \times 68 \times 219 / 1,000 \text{ (lb/kip)} = 12.6 \text{ kips} > 12 \text{ kips (max. shear)}$$

Thus, shear reinforcement is not required and the transverse reinforcement can consist of the minimum recommended of #3 ties at 12 in. spacing.

A single center longitudinal bar will extend to the full length of the CFA pile. Because these piles are not subject to uplift forces, the longitudinal bar may be a # 9 bar (minimum size allowed). Note that this bar must extend through the full cage section to the top of the shaft, and would be allowed to contribute to the structural capacity of the top cage section if the design engineer elects to do so in the analyses.

### 6.6.5 Step 4: Constructability Review

Finally, a brief check on constructability issues is provided in a question and answer format:

- a. Are pile length and diameters appropriate? *Yes, 18 in. diameter and less than 70 ft embedded length is within normal sizes.*
- b. Can the bearing strata be penetrated to depth indicated? Avoid designs which require penetration into hard materials to achieve capacity if the overburden soils may be subject to soil mining or if the bearing stratum is too hard to drill effectively. *Yes.*
- c. Is there a risk of soil mining due to loose water-bearing sands? *Yes, if soils are cohesive.*
- d. Is there potential effect on nearby structures? *No.*
- e. Is the rebar cage appropriate? *Yes.*
- f. Is there a pile cutoff detail? *Yes. Avoid pile cutoff more than a few feet below the working grade if possible. Deeper cutoff will require casting the pile to the surface and chipping down after the grout or concrete has set. These piles may be formed to the surface and cut down later. If the contractor chooses to dip the pile down while still fluid, there must be a temporary form provided to prevent cave-ins from contaminating the top of the pile.*
- g. Is construction sequence feasible? *Yes. Consider existing structures, obstructions, pile cap footprint. Avoid installing CFA or DD piles over water. A stable working platform is necessary, especially for DD piles, which require larger, heavier rigs than conventional CFA piles. The working pad may require stabilization; this is worthy of a note on the plans that the surface may be soft.*
- h. Are low headroom conditions required? *No.*
- i. Is there a plan for resolving construction questions prior to production? *Yes. Include pre-construction meeting discussion.*

### 6.6.6 Step 5: Prepare Plans and Construction Specifications, Set Field QC/QA and Load Testing Requirements

These items follow the general work for developing plans and specifications for transportation projects involving deep foundation work. The following two chapters are focused on the aspects of inspection, testing, and specifications for CFA projects. Note that for this example, a load testing program is required because the design relied on the use of a lower factor of safety and because of the increased reliability of a design that must be validated by site-specific load test data.

## **CHAPTER 7    QUALITY CONTROL (QC) / QUALITY ASSURANCE (QA) PROCEDURES**

### **7.1    INTRODUCTION**

Continuous flight auger (CFA) piles have a history of use in the U.S. commercial market but have been used infrequently on public works transportation projects. This under-utilization of a viable technology is at least partly the result of perceived difficulties in quality control on the part of transportation agencies. In addition, the proprietary systems used for the installation of drilled displacement piles are not easily incorporated into traditional design-bid-build delivery systems for public works projects.

The guide specification included in Chapter 8 of this document is performance-based in which the contractor is responsible for the final determination of pile lengths. The approach requires that the contractor provide the quality control and performance measurement parameters necessary to ensure that the owner is provided with the pile capacity and structural integrity that is required for the job. The key for the owner is that the specifications require measurements that provide a reliable indication of performance. With reliable performance indicators, this approach can allow contractors to exercise ingenuity and seek the most cost-effective and timely solutions to achieve the project requirements.

General quality control/quality assurance (QA/QC) practices for deep foundation installation that have been used in the U.S. and abroad are reviewed in this chapter to provide the background for understanding QA/QC issues with CFA piles. Recommended “best practices” for QA/QC for CFA piles on transportation projects are included in each section. The last section summarizes the recommended practices.

### **7.2    THE ROLE OF THE INSPECTOR**

The inspector on a CFA pile project has a significant role in the observation and recording of the contractor’s QA/QC practices. As outlined in this chapter and in the guide specification in Chapter 8, a significant amount of testing, data collection by automated equipment, and manual data will be recorded for pile installation. The inspector will be required to: (a) understand the basic fundamentals of CFA pile installation; (b) verify that good construction practices are followed; and (c) understand the data collected. The inspector may also be collecting manual data, such as is done in much of current commercial practice, to duplicate or to backup the data recorded and submitted by the contractor.

While much of the data collected during pile installation may be recorded by the contractor, the inspector needs to ensure that the data is collected. Many agencies have standard protocols for record keeping and submittals, delineating responsibilities among the contractor and inspector. Some agencies may require that the inspector duplicate some or all manual data collection. The recommended records for pile installation are:

1. Pile location and plumbness;
2. Ground surface elevation;
3. Pile toe (bottom) depth/elevation;
4. Depth/Elevation of top of grout/concrete;
5. Pile length;
6. Auger diameter;
7. Details of the reinforcing steel (number, size, and grade of longitudinal bars, size and spacing of transverse steel; outside diameter and length of cage);
8. Flow cone efflux time and volume of grout placed, or slump and volume of concrete placed;
9. Theoretical volume of excavation (theoretical diameter = diameter of auger);
10. Depth/Elevation to which reinforcing steel was placed;
11. Date/Time of beginning of drilling;
12. Date/Time of completion of drilling;
13. Date/Time grout or concrete was mixed;
14. Date/Time ready-mix grout or concrete truck arrived at project site, and copies of all grout or concrete batch tickets used for the pile construction;
15. Date/Time of beginning of grout or concrete pumping;
16. Date/Time of completion of grout or concrete pumping;
17. Date/Time of placement of reinforcing steel;
18. Weather conditions, including air temperature, at time of grout or concrete placement;
19. Identification of all grout or concrete samples taken from the pile;
20. All other pertinent data relative to the pile installation; and
21. All readings made by the automated measuring and recording equipment to include as a minimum:
  - a. auger rotation vs. depth for every 0.6-m (2-ft) increment, or less, of pile advancement during the drilling process, and during placement of grout or concrete (if auger is rotated during this placement); and
  - b. volume of grout or concrete placed versus depth of outlet orifice for every 0.6-m (2-ft) increment, or less, of pile placed;



- c. Average maximum and minimum pump stroke pressures at ground level for every 0.6-m (2-ft) increment, or less, of pile placed;
- d. Average maximum and minimum pump stroke pressure at or near the auger head for every 0.6-m (2-ft) increment, or less, of pile placed, if directed by the engineer; and
- e. Additionally, the engineer may also specify that the torque and crowd force (downward thrust on auger) measurements be made at every 0.6-m (2-ft) increment, or less, of pile advancement during the drilling process.

### **7.3 PRE-CONSTRUCTION PLANNING**

Effective QA/QC begins with proper planning prior to construction. Under the performance-based specification model, the contractor will be required to submit design calculations, working drawings, a detailed pile installation plan, and a conformance testing plan. The owner and its engineer(s) and inspector(s) will need to review the submittals as part of the project planning process. The owner will also have to provide some level of information for the contractor to perform the design and develop their installation plans.

Owner-controlled design specifications can vary in the amount of design performed by the owner's design engineer and the amount performed by the CFA pile specialty contractor. For the method recommended in Chapter 8, the owner provides preliminary design information. The contractor designs the individual piles and pile cap connections and selects the CFA construction process and equipment.

During the bid process, qualified CFA pile contractors prepare a preliminary CFA pile design based on the owner's preliminary plans and specifications. The submittal design will occur with the bid. Once the contract is awarded, the selected CFA pile contractor prepares detailed CFA pile design calculations and working drawings and submits them for review.

#### **7.3.1 Owner-Supplied Information**

The owner should provide preliminary design information for the contractor during the pre-bid process. The complete list of items will vary according to project and local procedures, but will generally include:

1. plans showing the pile design loadings, minimum pile diameter, pile tip elevation, minimum reinforcement, pile to footing/cap connection design, and pile layout for each footing/cap location;
2. design criteria and requirements, such as design loads and maximum allowable displacements, safety factor;
3. any geotechnical reports for the project containing the results of exploratory borings, test pits, or other subsurface data collected in the vicinity of the pile locations;
4. site information, such as rights-of-way limits, utility locations, site limitation;

5. material requirement for grout/concrete and reinforcement and testing specifications; and
6. requirements for submittal and review of contractor design, working drawing, and construction submittals.

The subsurface conditions expected at the site can significantly impact the contractor's choice of procedures, methods, equipment, the bidding process, and contract administration. The geotechnical report should be a factual document describing the subsurface conditions revealed by the investigation and should be included in the contract special provisions. This report should alert bidders of the subsurface conditions and reduce the potential for differing site conditions construction claims and disputes. By including the report in the contract special provisions, it becomes a legal part of the contract documents.

### **7.3.2 CFA Contractor Experience**

The quality of CFA piles is highly dependent upon the skill of the contractor and the specific crew that is assigned to the project. It is essential that the contractor demonstrate competence to perform the work by providing documentation of successful completion of prior projects of a similar nature to the project being bid. Only experienced contractors will be allowed to perform the work and all contractors will be required to construct a test pile.

For transportation projects, the recommended experience requirements for contractors and their personnel are as follows.

1. The contractor should have completed a minimum of three projects in the two-year period preceding the bid date in which CFA piles were installed successfully under subsurface and project conditions similar to those of the current project;
2. The designated job site supervisor (foreman or crew chief) should have a minimum of three years of experience in the supervision of the installation of CFA piles;
3. Drill rig operators should have a minimum of three years of experience installing CFA piles; and
4. The designated project manager should have a minimum of three years experience with CFA projects of similar size and scope.

The contractor should be required to submit a list of personnel to be used on the project and provide documentation of experience.

### **7.3.3 Design Submittals**

The CFA piles shall be designed by a licensed Professional Engineer (Design Engineer) that is licensed in the state where the project is located. The Design Engineer should have experience in the design of at least three successfully completed CFA pile projects over the past five years with CFA piles of similar capacity to those required for the project.

Revisions to the design due to field conditions will need to be documented through submittals of revised calculations and/or working drawings in the affected portion of the project. It is recommended that the contractor be required to submit as-built drawings upon completion of the pile installation.

#### 7.3.3.1 Design Calculations

Design calculations should include, but not be limited to, the following items:

1. A written summary report that describes the overall CFA pile design;
2. CFA pile structure critical design cross-section(s) including soil/rock strata, piezometric levels, and location, magnitude and direction of applied loads;
3. Design criteria, including soil/rock shear strengths (friction angle and cohesion), unit weights, unit skin friction values, and unit end-bearing values. Any additional subsurface borings, laboratory work, or other subsurface data collected for the design beyond what was provided by the owner;
4. Safety factors used in the design;
5. Seismic design earthquake acceleration coefficient or other seismic design criteria applicable for the geographic area of the project;
6. Design calculation sheets (both static and seismic) with the project number, CFA pile structure location, designation, date of preparation, initials of designer and checker, and page number at the top of each page. An index page should be provided with the design calculations;
7. Design notes including an explanation of any symbols and computer programs used in the design; and
8. Pile to cap/footing calculations.

#### 7.3.3.2 Working Drawings

Working drawings should include, but not be limited to, the following items unless provided in the contract plans:

1. A plan view of the CFA pile structure(s) identifying:
  - a. A reference baseline datum;
  - b. The offset from the construction centerline or baseline to the face of the CFA pile structure at all changes in horizontal alignment;
  - c. Beginning and end station of CFA pile structures;
  - d. CFA pile locations with center-to-center pile spacing;

- e. Right-of-way and permanent or temporary construction easement limits, location of all known active and abandoned existing utilities, adjacent structures or other potential interferences;
  - f. The centerline of any drainage structures or drainage pipes behind, passing through, or passing under the CFA pile structure; and
  - g. Subsurface exploration locations shown on a plan view of the proposed CFA structure alignment with appropriate reference base lines to fix the locations of the explorations relative to the CFA structure.
2. An elevation view of the CFA pile structure(s) identifying:
    - a. CFA pile locations and elevations with vertical and horizontal spacing; and
    - b. Existing and finish grade profiles both behind and in front of the CFA pile structure.
  3. General notes for constructing the CFA piles including construction sequencing or other special construction requirements.
  4. Horizontal and vertical curve data affecting the CFA pile structure and control points, including match lines or other details to relate CFA pile structure stationing to centerline stationing.
  5. A listing of the summary of quantities.
  6. CFA pile typical sections including spacing; diameter; reinforcing bar sizes, locations, and details; centralizers and spacers; and connection details to the substructure footing/pile cap.
  7. Typical details of verification and proof load test piles, including reaction systems.
  8. Details, dimensions, and schedules for all CFA piles and reinforcing steel.

#### **7.3.4 Pile Installation Plan**

The Pile Installation Plan is used by the contractor to demonstrate the acceptability of the equipment, techniques, and source of materials to be used on the project. This plan should include, but not be limited to, the following items:

1. List and sizes of proposed equipment, including drilling rigs, augers and other drilling tools, pumps for grout or concrete, mixing equipment, automated monitoring equipment, and similar equipment to be used in construction, including details of procedures for calibrating equipment as required;
2. Step-by-step description of pile installation procedures;
3. A plan of the sequence of pile installation;

4. Target drilling and grouting parameters (along with acceptable ranges) for pile installation, including auger rotation speed, drilling penetration rates, torque, applied crowd pressures, grout pressures, and grout volume factors;
5. Details of methods of reinforcement placement, including support for reinforcing cages at the top of the pile and methods for centering the cages within the grout or concrete column;
6. Mix designs for all grout or concrete to be used on the project, including slump loss vs. time curves and strength development vs. time curves for mixes with fly ash and/or slag;
7. Equipment and procedures for monitoring and recording auger rotation speed, auger penetration rates, auger depths, and crowd pressures during installation;
8. Equipment and procedures for monitoring and recording grout or concrete pressures and volumes placed during installation;
9. Contingency plans for equipment failures during drilling or grouting operations (grout pump, monitoring equipment, etc.);
10. Procedures for protecting adjacent structures, on or off the right-of-way, that may be adversely affected by foundation construction operations, including a monitoring plan as required in Section 3.1; and
11. Other required submittals shown on the plans or requested by the engineer.

A clearly written pile installation plan can be very effective in reducing misunderstandings between the engineer, inspector, and the CFA pile contractor and can form the basis for solving potential problems before they occur, thus keeping the project on schedule and minimizing claims. The specific time allowance for review and approval should be clearly defined in the contract documents; 14 days is considered suitable for most routine projects. In reviewing the pile contractor's submittal, the key information regarding the equipment that should be scrutinized is:

1. the rated capacity and boom lengths of the drill rig;
2. the torque, rotational speed and down crowd capacity of the drilling machine;
3. the horsepower of the hydraulic power unit used to turn the auger; and
4. the positive displacement piston-ball valve pump, pump stroke displacements, engine horsepower and pump pressures of the grout pump to be used.

With respect to the above parameters, the installation plan should include documentation that the proposed drilling equipment has been demonstrated effective on similar size piles in similar soil conditions.

### 7.3.5 Testing Plan

The testing plan should be a requirement of the contract provided by the owner. The CFA pile contractor should include a plan for constructing and performing the required tests to meet the requirements of the testing plan along with the Pile Installation Plan. The testing program should consist of pre-production static load tests, production static and/or rapid and/or dynamic load tests, and post-installation integrity tests in sufficient quantities to provide the data necessary to demonstrate that the installed piles meet the load and deflection criteria established in the project plans with an appropriate factor of safety.

The intent of the pre-production testing program is to install test piles to establish and/or verify installation means and methods, as well as load capacity. The results of the pre-production test program will then be used during production pile installation to ensure that the contractor is consistently installing acceptable piles (i.e., all production piles are the same as a test pile). The use of automated monitoring equipment provides a means of evaluating each pile for conformance to the installation criteria. Verification load tests and structural integrity tests during construction will be used to verify that the contractor is producing acceptable piles.

Sections 7.4 through 7.6 provide detailed discussions and recommended practices of each of the components of a testing program. The remainder of this section will outline the general requirements for the contractor's pre-construction submittal.

#### 7.3.5.1 Pre-Production Testing

Pre-production load test program will generally consist of a single or multiple static load tests and will depend on the number of piles to be installed, the range of design pile capacities, and the variation of subsurface conditions at the site. Lateral and uplift load tests may be included as well. For very large projects, pre-production testing may include a single static load test supplemented with several piles tested by the rapid load test (RLT) (usually Statnamic<sup>TM</sup>) or dynamic load test (DLT) methods. Performing rapid or dynamic tests during the pre-production testing program will allow these methods to be "calibrated" against static load tests results prior to production pile installation. A discussion of various load test methods is contained in Section 7.6.

Piles installed for pre-production testing (including any reaction piles required for static load testing) should include all construction, monitoring, testing, and inspection requirements of production piles. The results of the installation and testing will be used to:

1. establish target drilling penetration rate(s) for the various subsurface conditions on the site;
2. establish pressure/volume relations for placement of grout/concrete. The grout factor (i.e., ratio of used volume of grout/concrete to theoretical volume for the specified pile size)  $\pm 7.5\%$  that is calculated on the test pile(s) should be used for the installation of the production piles;

3. establish target values for torque and downward thrust or crowd for displacement or partial displacement piles;
4. establish mix design parameters such as grout flow, necessary admixtures, etc.; and
5. evaluate design correlations of side and base resistance with the site specific soil parameters.

Because a major advantage of CFA piles is speed of installation, the pre-production load test program may be performed concurrent with the start of production piles to reduce additional mobilization or delay costs; however, the ability to modify the design based on the results of the load test may be limited in this case. For very large projects, the ability to modify the design based on the pre-production tests may make the separate mobilization for pre-production testing less of cost consideration.

#### 7.3.5.2 Conformance Monitoring and Verification Tests

Conformance monitoring includes the use of automated measuring and recording equipment to confirm the pile installation criteria, integrity testing, and verification tests on production piles to demonstrate that the installed production piles meet the established load-deflection criteria.

##### *Installation Automated Monitoring*

Automated monitoring equipment provides “real time” evaluation of each pile on a project. Section 7.4 outlines the types of equipment and their application. Automated monitoring is a contract requirement. Therefore, the contract documents should outline the data to be collected and submitted. The installation plan should include type of monitoring equipment, manufacturer, data to be collected, current calibration records, and sample data records. As a minimum, the monitoring equipment should have the capability to monitor and record the following:

1. auger rotation;
2. depth of the auger injection point;
3. torque delivered to the auger; and
4. crowd force (downward thrust on auger).

All measurements should be referenced to (or plotted against) the depth of the auger injection point. This can be accomplished with a rotational position indicator on the auger head system and an electronic position indicator on the crane line or boom holding the auger. Torque and thrust load cells should be positioned on the auger head system.

As a minimum, the following automatic measurements should be recorded during the grouting or concreting operation:

1. volume of grout or concrete;
2. maximum and minimum grout or concrete pressure;

3. auger rotation (if rotated); and
4. depth of the injection point.

All measurements should be referenced to (or plotted against) the depth of the auger injection point. This can be accomplished with electronic flowmeters and electronic pressure transducers placed in the grout or concrete pressure line, an electronic position indicator on the crane line or boom holding the auger, and a rotational position indicator on the auger system.

Calibration should be made on all monitoring equipment at the beginning of the project in accordance with the equipment manufacturer's specifications. The values indicated by the monitoring equipment should be within three percent of the manufacturer recommendations.

### *Integrity Testing*

Post-installation integrity tests are valuable in establishing that the contractor's procedures are producing acceptable piles on any given project. The most reliable of the post-installation integrity tests for identifying anomalies within the pile are those that use down-tube instruments, such as the cross-hole sonic (CSL) test, single-hole sonic test, the backscatter gamma test, and the fiber-optic television camera test. However, these types of tests are costly and utilize intrusive tubes, and thus not generally practical for CFA piles of less than 760 mm (30 in.) in diameter. The piles that will include any access tubes should be noted in the test program. Sonic echo tests performed from the pile top are also available to check pile integrity, and may be more practical for routine use to verify the overall structural integrity of the piles in the upper 10 to 20 diameters, though the results may not be as reliable as down-tube tests under certain conditions. Descriptions of tests applicable to CFA piles and a discussion of their use are included in Section 7.5. Piles that have installation records out of specification or that otherwise appear abnormal can be selected for integrity tests or verification load tests to determine if they should be accepted or rejected. Integrity tests along with careful monitoring of installation would then be used to verify pile capacity based on comparison to the pre-production test results. Recommended frequency of integrity testing is given in Section 7.3.3.

### *Verification Testing*

Verification tests should be performed on a minimum of two percent of production piles, or at a greater frequency if required by the engineer. For smaller projects (i.e., less than about 50 piles), a minimum of one or two verification tests should be specified; the actual minimum is dependent upon the variability of site conditions, experience in the area, and other factors as may be considered relevant by the engineer. Verification tests can also be used to determine if a questionable pile should be accepted or rejected. Verification tests can be performed using static load tests, RLTs, or DLTs. Combinations of the various test methods may also be used as appropriate for the project. Section 7.6 includes discussions of common RLTs and DLTs available.

A single pre-production test only demonstrates the performance of the test pile. Performing verification tests periodically throughout production pile installation will verify that the pile installation techniques continue to provide adequate pile capacities. The use of RLTs (e.g.,



Statnamic™) or DLTs (e.g., drop hammer) can often test a large number of piles more efficiently in both time and cost compared to static load test methods. Calibrating the RLT or DLT results with static load test results during the pre-production test program should be part of the testing program, unless comparative tests have been performed on previous projects in similar soil conditions.

#### 7.3.5.3 Materials Testing

Requirements for sampling and testing of grout and concrete materials used on the project should be included in the owner's bid package. The general requirements for materials testing in the State DOT Standard Specifications should be referenced, along with any additional materials testing the contractor is required to perform. Requirements would include the test type and frequency. The tasks for materials testing may be performed solely by the owner, by an independent testing firm working for the contractor, or a combination, and will be addressed in the project specifications. Requirements for grout or concrete testing are discussed in Chapter 4 and in Section 7.4

### 7.4 PERFORMANCE MONITORING AND CONTROL DURING CONSTRUCTION

The construction of continuous flight auger piles is hidden from the view of the operator as well as the inspector. Past practice has emphasized the importance of a skilled operator using visual observations of the drilling and inaccurate estimates of grout/concrete pumped to construct a "good" pile. A skilled operator and experienced CFA contractors are important to achieve a good end result, but the reliance upon visual observations alone is insufficient to provide quality assurance and quality control (QA/QC) for transportation projects. Technology is available to obtain the measurements and feedback needed to: (a) provide operators with information needed to develop judgment and control; and (b) provide inspectors and owners with documentation that the pile was constructed with proper practices in accordance with specifications. Much of the equipment used for this purpose has been described in Chapter 4 of this document. This section will summarize the requirements for performance monitoring and control during construction. Post-construction techniques for integrity and load testing are described in subsequent sections of this chapter.

It is important to remember that automated monitoring should not be viewed as the sole record for CFA pile QA/QC. Critical information that supplements automated monitoring includes: visual record of the completion of the top of the pile, notes of the workmanship of clearing debris and forming the pile top, descriptions of the successes and difficulties in installing the rebar cage, and notes of difficulties encountered and the methods used to resolve any problems. Complementary manual checks of the data collected by the automated equipment should also be performed periodically by the inspector to verify that the equipment is working reliably and accurately. The manual/visual observations outlined in this chapter that are typical of commercial practice in the United States would be appropriate for this task. The level of duplicate data will vary according to the confidence level of the owner agency and the complexity of the project. In the event that the automated equipment malfunctions during production, pile installation should stop until repairs are made.

### 7.4.1 Monitoring and Control of the Drilling Phase

The drilling phase of construction should be controlled to ensure that excessive flighting of soil does not occur with conventional CFA piles and that the appropriate level of soil displacement occurs with drilled displacement piles. The operator and inspector should observe and record the depth of the auger, the speed of the auger, the rate at which the auger penetrates into the ground, and the torque with which the auger is rotated.

There is always some uncertainty as to the proper rate of penetration during construction. The penetration rate will be estimated by the contractor during the design phase and included in the installation plan. Table 7.1 lists some general guidelines for penetration rates that are based on experience. The actual rate to be used can be affected by other factors, such as the pitch on the auger flights. The pre-production installation and testing of piles will either confirm the estimated penetration rate or provide the necessary data to modify the penetration rate to an acceptable value for the production piles. The same construction practices used during installation of successful test piles should be used for all production piles unless there is a significant change in subsurface conditions, such as differing soil types, soils more susceptible to mining, etc.

**Table 7.1: General Guidelines for Auger Penetration Rate for CFA Piles**

Soil Type	Rate of Penetration (Revolutions per Auger Pitch)
Clay soils	2 to 3
Cohesionless soils	1.5 to 2

When penetrating mixed soil profiles, the higher rate of penetration (lower revolutions) should control. For example, in a mix of layers of cohesionless and clay soil, the use of the slower penetration rate appropriate for the clay (2 to 3 revolutions per pitch) could result in excessive flighting of the sand strata. For partial displacement drilled piles, the rate of penetration will affect how much relative displacement occurs, and this parameter has a significant effect on axial resistance. For drilled full displacement piles, the rate of penetration is usually dictated by the need to displace the soil.

In the manual control system that is widely used in commercial construction, the auger speed is predetermined by the gearbox setting, the depth of penetration is monitored by direct observation of the top of the auger in the leads, and the rate of penetration is observed using a stopwatch. These data should be documented in the inspector's notes. **This approach is not sufficientl y accurate fo r transportation projects and sh ould not b e used as the primary means of QA/QC for the drilling process.** These manual observations should be made by the inspector during drilling as a check and/or backup to the automated systems.

The recommended system for transportation projects uses a depth encoder and revolution counter to monitor and display the rate of penetration graphically to the operator in units of revolutions per meter (or foot) of penetration (or meters (or feet) of penetration per revolution), and

simultaneously records this information for plotting after the pile is complete. This system is most often used with hydraulic fixed mast drilling equipment, in which the operator has control of the crowd on the tool, the torque applied, and the speed of revolution (see Figure 7.1). **The cab mounted display and monitoring parameters of the drilling system are required for drilled displacement piles and for CFA piles in non-cohesive soils**. CFA piles may be installed without monitoring and control of the drilling phase only in soils that are demonstrated to be non-caving and not subject to flighting (similar to the contraction of drilled shafts in dry, open holes).

When crane-mounted drilling systems are used instead for CFA piles, the operator has no ability to apply crowd to the auger other than the dead weight of the system. A monitoring system typically used on one of these rigs uses a depth encoder and a clock to monitor the rate of penetration which produce a printed record of depth at various time increments to document the results. The speed of auger rotation is controlled via the gearbox and recorded. This system provides documentation of the operation and a simple visual control. This system does not provide the level of control that should be expected for most transportation projects, but may be acceptable in some cases of non-critical foundations such as soundwalls or other systems installed to shallow depths in favorable (non-caving) soil conditions.



**Figure 7.1: Operator with Cab Mounted Display Used to Control Drilling**

#### **7.4.2 Monitoring and Control of the Grouting/Concreting Phase**

Control of the grouting/concreting phase of construction may be the most important aspect of QA/QC for CFA piles. The obvious objective is that adequate grout or concrete be delivered to the discharge point of the auger at the proper pressure to complete the pile. Poor

grouting/concreting can result in a pile that cannot perform as intended in supporting the structure, including both geotechnical and structural failure.

For the operator to have control and documentation of the operation requires that the pressure and volume be monitored as a function of auger depth. In addition, it is desirable to monitor that the auger is extracted in a slow, continuous manner without excessive or reverse rotation. Upon reaching the required tip elevation, the contractor should establish a flow of concrete or grout with minimal lifting of the auger, typically 150 to 300 mm (6 to 12 in.). After the plug is blown, an initial charge of grout or concrete should be pumped before starting the auger lifting process to develop pressure in the grout or concrete at the bottom of the hole. Some of the initial volume of grout will probably push up the auger flights. The volume of grout/concrete delivered to the lowermost 0.9 to 1.8 m (3 to 6 ft) of pile length should be over-supplied by approximately twice the theoretical volume required to fill the pile for that length.

During the lifting process, the operator must control the lift speed of the auger so that the proper volume of concrete is delivered under sufficient pressure. The auger should be pulled smoothly at a steady speed while grout/concrete is continuously pumped under pressure. Some contractors may slowly rotate the auger in the direction of drilling, while some may pull without rotation. To monitor and control this operation, it is important to observe and document the following: (1) position of the auger tip, (2) lifting speed, (3) volume of grout/concrete that is delivered, and (4) pressure with which the grout/concrete is delivered. In the event that the operator pulls the auger too quickly and the grout/concrete pressure drops below allowable levels, a common practice is to immediately re-drill down 1.5-m (5-ft) below the point where the pressure drop occurred and rebuild the pile from that point up. The operator should be able to observe the pressure drop within seconds and allow the re-drilling and grouting to take place almost immediately.

The manual method of monitoring and documenting the grouting/concrete operation involves the following:

- the position of the auger tip is monitored visually by observing the height of the auger in the leads;
- the lifting speed is controlled by the operator by feel and by observing the height of the auger in the leads while timing the withdrawal using a stopwatch;
- the volume of grout is measured by estimating the volume per stroke of the pump, and by manually counting the pump strokes; and
- the pressure with which the grout is delivered is monitored by a gauge in the line near the pump.

The only means of documenting the operation using the above technique is by the inspector manually recording the observations. The rig operator depends on estimating volumes and manually observing the auger withdrawal, and on signals from the pump operator that the pressure and volume delivered are consistent.

**In general, the simple manual observation and control system described above is not considered to provide sufficient control for transportation projects.** These manual observations can be made by the inspector during grouting/concreting as a check and/or backup to the automated systems. They may be sufficient for non-critical foundations such as soundwalls or other shallow foundations in favorable soil conditions.

The system recommended for transportation projects includes automated monitoring of the auger position; volume of grout/concrete that is delivered; pressure with which it is delivered; and rotation and lifting speed of the auger. Such system should provide the following:

- the position of the auger tip [monitored automatically by a position sensor (shown in Figure 7.2)];
- the volume of grout [measured by an in-line flowmeter (see Figure 7.3) that provides a reliable and accurate measure of the grout/concrete that is delivered in real time];
- the pressure with which the grout/concrete is delivered [monitored using a gauge in the line near the swivel at the top of the auger, or in the auger itself near the tip (latter option is better)];
- the rotation of the auger [monitored by a sensor];
- the lifting speed [controlled by the operator based on real time observation of the control parameters noted above, displayed graphically in the cab of the rig, and compared to target values]; and
- the entire operation [recorded as a part of the documentation process].

There are several methods for providing each of the above measurements, and a variety of different in-cab display systems. Some contractors use electronic monitoring of pressure pulses along with a calibration of volume per pump stroke to determine volume. With the pumps most commonly used, this system is inferior to an in-line flow meter because of possible missed strokes, variable volume per stroke, and other inconsistencies. The pressure in the line can be monitored at a range of locations. The best location is at the tip of the auger inside the auger itself (see Figure 4.20). Although such a system exists, it is not widely available and requires augers equipped with cabling, sensor cutouts, and a means of transmitting the signal through the swivel. The location of the sensor near the swivel at the top of the line is the next best position. The location of pressure sensors in the line near the pump is least effective because of the potential for losses between the measurement point and the auger.

Hydraulic rigs are typically equipped with pressure sensors in the hydraulic lines (see Figure 7.4), which provide feedback and documentation of the torque and crowd force used during drilling. These parameters can be very useful to monitor rig performance and drilling resistance in the soil, particularly for drilled displacement piles. It is quite possible that future research could develop correlations between such drilling parameters and axial resistance of the completed pile.



**Figure 7.2: Depth Encoder Mounted on Crane Boom**



**Figure 7.3: In-line Flowmeter**




**Figure 7.4: Pressure Sensors on Hydraulics to Monitor Rig Forces**

Figure 7.5 shows a display panel mounted outside of the cab of the rig for observation by the inspector. This allows the inspector to make periodic checks of the data being recorded during pile installation. An example of the documentation of a production pile is illustrated in Figure 7.6. Other systems may present the information differently, but similar information should be presented. The top of the data sheet provides project and pile information, and start and finish times. The leftmost column indicates, in a graphical way, the volume of concrete delivered as a function of depth, having a line indicating the target volume. The pile had an over consumption of concrete of 17% above the theoretical volume, which is comparable to a target value of 15% (15 to 20% is typical for CFA piles). Graphical representation of concrete pressures, forces in the rig (measured hydraulic pressures in psi), and rates of lifting and drilling are also provided. Note that a harder layer appears to have been penetrated at depths of around 46 to 54 ft, as indicated by the higher torque and thrust used in attempting to maintain the rotation and drill rate here. At this location, the rotation and drill rates drop slightly.



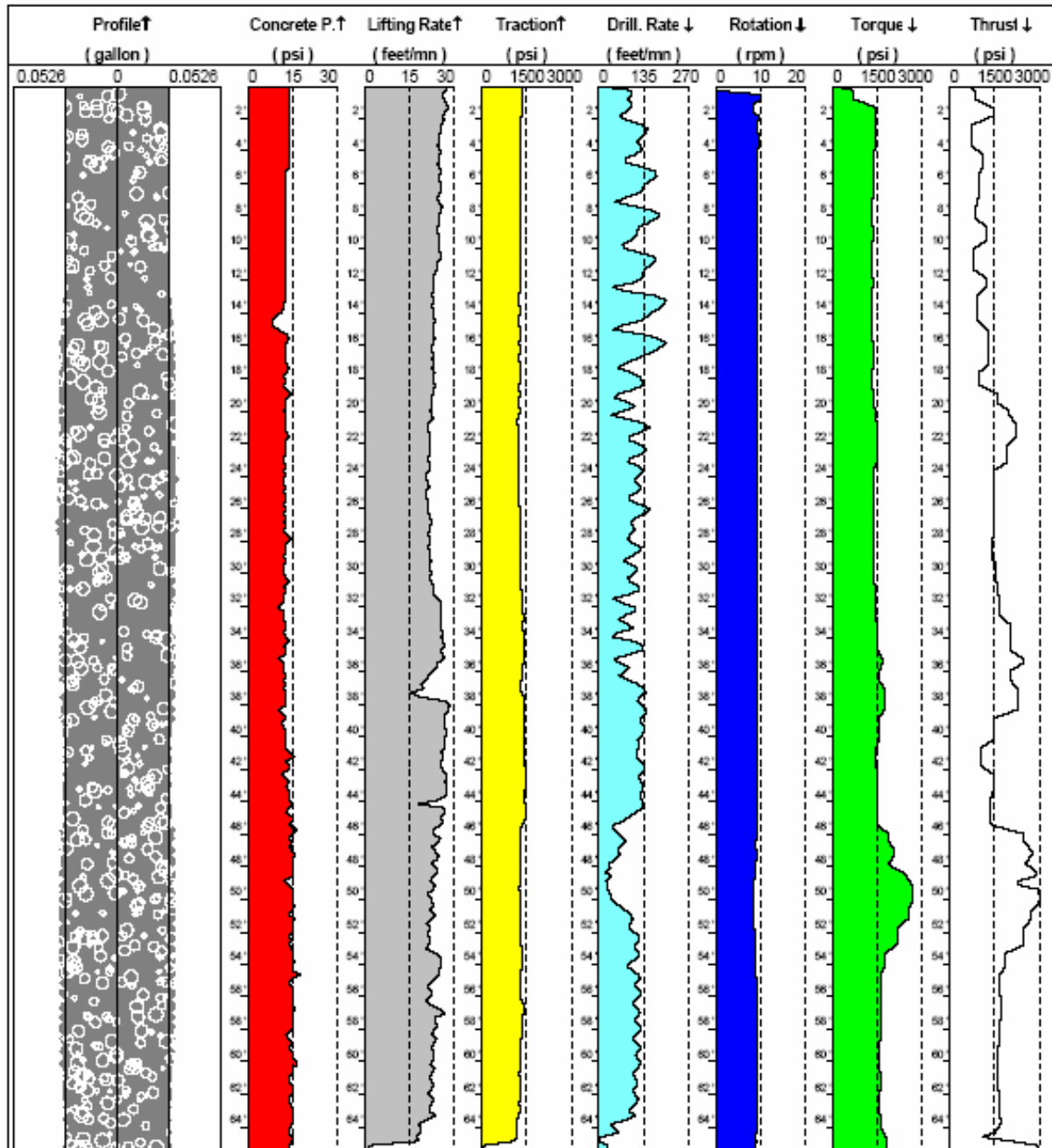
**Figure 7.5: Display Panel for Observation by Inspector**

<b>INSTRUMENTS ET SYSTEMES EN GENIE CIVIL</b> 	<b>MURPHY OIL</b> Continuous Flight Auger Piling		( Contract : 689 )
	Date : 09.27.2001 Begin : 13 h 37 Concrete : 13 h 39 End : 13 h 45	Diameter : 14.02 inch Length : 65.39 ft Volume : 3.03 yds <sup>3</sup> Overconsumption : 17 % Inclination X;Y : -0.2;0.2 °	

1/100

Pile : 91/109

EXTCT W 3.14.3/TARALOG A16e



Original edition

JEAN LUTZ S.A - Juraçon - France - www.jeanlutz.fr

Source: Jean Lutz S.A

Figure 7.6: Example Data Sheet from Project



### 7.4.3 Finishing the Pile Top and Installing Reinforcement

Inspection of the installation of reinforcement and completion of the pile top are not subject to automated monitoring and depend wholly on the observation of the inspector. It is particularly important that the inspector note the point at which grout/concrete appears at the surface relative to the embedment of the tip of the auger. If grout/concrete has pushed far up the auger flights from the tip (more than about 3 m [10 ft]), it may be a sign that the auger has not remained charged with soil. The point at which grout/concrete first appears should be noted and should be relatively consistent from pile to pile. When grout/concrete appears at the surface, it will be no longer possible for the operator to maintain excess positive pressure at the tip because the grout/concrete is now vented to the surface. Therefore, it is particularly important that the volume of flow be consistent to ensure that the auger is not pulled too fast from this point on.

When the auger is removed, it is possible for some soil to spill into the top of the pile and contaminate the grout or concrete. The inspector should observe that the contractor dips out any contamination and finishes the pile with good quality grout or concrete, as shown in Figures 7.7 and 7.8. A small surface casing is normally required to stabilize the top of the hole.



**Figure 7.7: Dipping Grout to Remove Contamination**

Installation of reinforcement should proceed immediately after the pile top is prepared. Reinforcement should be clean and free of rust or contamination, of the size and dimensions indicated on the plans, and equipped with appropriate centering devices. These are normally plastic or sometimes made of mortar or grout. Centering devices should not be made of metal because of potential corrosion and contact with the rebar cage. Welding of the cage is permitted only if weldable reinforcing steel is used; however, this reinforcement is not common in the United States at present.

Reinforcement should be lowered into the fluid grout or concrete by gravity or, if necessary, with an additional gentle push as shown in Figure 7.9. Reinforcement should not be driven, hammered, or vibrated unless specifically permitted by the contract documents; vibration is normally permitted only for fully welded cages. If the cage cannot be placed to the full required depth, the actual installation depth should be recorded and the engineer notified. After installation, the cage should be supported at the ground surface for a sufficient amount of time (typically a few hours, depending on the setting of the grout/concrete mix) to avoid it settling into the pile. The cage is often kept in place by using wire to tie it to timber supports.



**Figure 7.8: Cleaning the Top of a CFA Concrete Pile**

Difficulties in placing the reinforcement may occur if the grout or concrete does not maintain sufficient workability for the duration of time required for placement. In addition, sandy soil profiles can promote rapid dewatering of the grout or concrete in the pile such that reinforcement placement is difficult even with a properly retarded mix. In such cases, anti-washout additives or viscosity modifying admixtures may be helpful in reducing water loss from the grout/concrete. Installation of rebar to depths in excess of 18 m (60 ft) is possible under favorable circumstances, although significant bending stresses rarely occur at such depths for foundation piles.

Most often, piles are connected to a pile cap, with the base of the cap lying below existing construction grade. This below-grade cutoff is typically constructed by excavating for the pile cap, chipping the top of the hardened pile down to the required elevation, and cutting the rebar, as necessary. If the shallow soils are cohesive and the cutoff elevation is within a few feet of the surface, it may be possible to dip the grout/concrete down to the desired depth. In the latter case, a surface casing must be used to maintain a stable hole above the cutoff elevation and prevent surficial soils from sloughing into the fluid grout or concrete and contaminating the top of the pile.



**Figure 7.9: Placement of Reinforcing Cage with Plastic Spacers**

#### **7.4.4 Sampling and Testing of the Grout or Concrete**

Sampling and testing of the grout/concrete are important parts of QA/QC. The samples may be obtained for testing directly by the inspector or by the contractor under the direct supervision of inspectors. The general approach to QA/QC for the grout/concrete is that the mix design and the quality of the mix is the contractor's responsibility and the inspector obtains samples for testing to verify that the requirements for the project are met. Strength tests are the control parameter of most concern for design, while workability is measured in the field to ensure that the construction goes smoothly and that the mix characteristics are consistent.

For concrete, 150 mm (6 in.) diameter by 300-mm (12-in.) high cylinders (ASTM C 31. [ASTM, 2006]) should be made from samples of the mix from the field in the same manner as for per most other cast-in-place concrete construction including drilled shaft construction. Samples should be cured and tested according to ASTM C39 (ASTM, 2006) or the agency's normal procedures. Concrete compressive strength requirements for CFA piles are typically 24 to 31 MPa (3,000 to 4,500 psi) and will be specified according to the project requirements. Typical specifications require a set of at least six samples for each 40 m<sup>3</sup> (about 50 yd<sup>3</sup>) of concrete placed, but no less than one set per day or per batch of concrete, if batch plant operations are started and stopped more than once per day.

For grout, 50 mm (2 in.) cubes are most often used for strength testing, (see Figure 7.10) per ASTM C109 (ASTM, 2006). These are small and easy to handle and transport, and are considered adequate for testing grout without coarse aggregate in the mix. If the grout mix has pea gravel as aggregate, the mix should be considered concrete and thereby tested using cylinders as outlined above. Because grout cubes are small, it is easy for small misalignment in the testing apparatus or uneven surfaces to result in incorrect dimensions and thereby unrepresentative low measured strengths. For this reason and also because the samples are small, it is prudent to make extra samples during field operations so that any discrepancies can be re-evaluated. Some engineers prefer to use 75 mm (3 in.) diameter by 150 mm (6 in.) high or 50 mm (2 in.) diameter by 100 mm (4 in.) high cylinders. In such cases, careful attention is necessary to the relationship between maximum aggregate size and the height-to-diameter ratio of the sample. If the samples are cast using a method or sample different than that used for the mix design, a relationship between the compressive strengths obtained by the methods will be required.

Compressive strength requirements for CFA piles constructed with grout are similar to that for piles constructed with concrete, as noted above. However, it should be noted that the compressive strength of properly tested cubes are slightly higher than that of cylinders with a height-to-diameter ratio of two, therefore, the strength requirement from tests on cubes are typically 10% greater than that of cylinders.

Workability and consistency of concrete are monitored by performing slump tests on samples of the mix at the site. Slump measurements (ASTM C 143, [ASTM, 2006]) should be made on each truck on the project to ensure that consistent mixes are delivered. A slump of approximately 200 +/- 25 mm (8 +/- 1 in.) is typical for CFA piles, as is for drilled shaft placement in wet hole conditions. The relationship of slump loss over time should be established as part of the mix design and included in the approved installation plan. In general, a mix should be developed such that it maintains slump (or flow for grout) for a period of at least two hours for routine projects. The workability as a function of time is highly temperature-dependent and adjustments to the mix may be needed in warm weather. The contractor should place concrete quickly to avoid a decrease in workability over time as the cementitious material hydrates.

The addition of water at the project site should only be permitted through the approved installation plan or with prior approval by the engineer, and only to the extent that the water-cementitious material ratio does not exceed the ratio of the approved design mix. If the slump of the mix as delivered is not suitable, adjustments should be made at the plant unless the project is specifically planned for water to be held back and added at the site. In any case, it is critical that the mix have adequate workability; sometimes it may be necessary for the contractor to adjust the mix with water at the site rather than complete a pile with inadequate workability in the mix. Such practice should be a rare exception and corrections must be made to the operation. If water is added at the site, the inspector should have samples made and/or tests performed after the water has been added and the mix ready for placement.



**Figure 7.10: Cubes for Grout Testing**

Similar to the case of concrete, the workability and consistency of grout must be monitored by performing flow cone tests on samples of the mix at the jobsite. Flow cone measurements should be made on each truck on the job, to ensure that consistent mixes are delivered. As with concrete, water should not be added at the jobsite unless specifically allowed in the project specifications. The preferred practice is that water should not be added at the project site without approval from the project engineer. If the workability of the mix is not suitable as delivered, adjustments should be made at the plant. Nevertheless, it is critical that the mix have adequate workability. Sometimes it may be necessary to adjust the mix with water at the site rather than complete a pile with inadequate workability in the mix. Such practice should be a rare exception and corrections to the grout mix must be made to the operation. Sometimes, grout additives are added at the project site. If so, the specific manufacturer's recommendations must be followed.

ASTM C 939 (ASTM, 2006) or U.S. Army Corps of Engineers CRD 611-94 (USACE, 1994) provide specifications for flow cone testing in which fluid consistency is described according to an efflux time per standard volume (time for a specific volume to flow out of the cone). As the grout mixes used for CFA piles are typically too thick to flow effectively from the standard 12-mm (0.5-in.) outlet specified in these standards, it is common practice to modify the above specifications and use a 19-mm (0.75-in.) opening. This modification can be made by: (a) removing the removable orifice that extends out the bottom of the Corps of Engineers device to leave a 19 mm (0.75 in.) opening; or (b) cutting the flow cone specified in the ASTM standard to modify the outlet diameter. Grouts that are suitable for CFA pile construction typically have a fluid consistency represented by an efflux time of 10 to 25 seconds when tested in accordance with the modifications described above. Grouts that are suitable for CFA pile construction

should maintain fluid consistency within this range for a period of at least two hours, but in no case less than the time required to complete a pile and place reinforcement.

## **7.5 POST-CONSTRUCTION INTEGRITY TESTING**

Post-construction integrity tests are used to supplement the installation monitoring to establish that a contractor's procedures are producing acceptable piles. There are several types of integrity tests that are useful for CFA or drilled displacement piles, most using technologies already in use on transportation projects for drilled shaft foundations. Several references are available that describe a wide variety of integrity test methods in greater detail. Two of these references are O'Neill and Reese (1999) and (DFI (2005).

### **7.5.1 Use of Integrity Testing**

Integrity test methods require careful interpretation, which should be performed by experienced personnel. However, integrity testing personnel cannot always determine whether an anomalous reading is a defect within the pile; therefore, the final decision on acceptability of the pile must be made by the design engineer based on the site specific soil conditions, construction records, the post-installation integrity testing report, and analysis of the possible effect on foundation performance.

As discussed previously, the most reliable means of achieving consistent QA/QC is automated monitoring and control during construction, with documentation of the installation via these measurements. The use of post-construction integrity testing is best utilized to verify that the installation parameters used for control (i.e., penetration speed, grout or concrete pressures and volumes during auger withdrawal) are appropriate for the site-specific project conditions. Integrity tests can also be used to further evaluate piles that did not meet drilling or grouting criteria. Coring of the piles can be used to supplement or to provide a visual check of suspected defects detected by integrity testing.

The necessary frequency of post-construction integrity testing is left to the judgment of the owner and can vary from project to project. A frequency of 10% to 20% of production piles subjected to integrity testing is typical. In addition, all preproduction and verification test piles should be tested. When agencies have little experience with CFA piles, particularly difficult project conditions exist, or project or site conditions give reason to expect problems with pile integrity, integrity testing of more than 20% of production piles may be required. A typical reasonable approach for load-bearing piles is to subject the first 10 to 15 piles to be constructed on a project to integrity tests to establish that the contractor's construction practice at the site is adequate. Thereafter, the frequency of such tests can be set to meet the specified frequency criteria, can be reduced, or even perhaps eliminate further integrity tests if the construction records for the remaining production piles are similar to those of the initial piles that were subjected to integrity tests.

## 7.5.2 Integrity Testing by Surface Methods

The most commonly available, economical, and easily applied type of integrity test is the sonic echo test. The advantage of the method is that a test can be performed rapidly, inexpensively, and without any internal instrumentation or tubes in the pile. In general, the sonic echo test is the recommended method for routine testing of CFA piles of 760 mm (30 in.) diameter or less.

This test is performed by striking the top of the pile with a small instrumented hammer (Figure 7.11, left). A sonic, compressive wave travels down the length of the pile and is reflected by an anomaly in the pile, or the pile tip if the pile is free of defects, and travels back to the top where it is picked up by a receiver on top of the pile. The reflections are used to indicate major changes in cross sectional dimensions or material properties. Wave propagation through the pile is affected by the pile impedance, which is defined mathematically as  $EA/C$ , where  $E$  is the elastic modulus of the pile,  $A$  is the area of the cross section, and  $C$  is the wave propagation velocity, which is related to the elastic modulus and mass density of the pile.

Impedance changes occur where there is a change in cross-sectional area of the pile. A bulge (increase in cross-sectional area) or a neck (reduction in cross-sectional area) can be detected by an increase or decrease, respectively, in impedance of the signal. Changes in impedance also indicate where a change in grout/concrete density occurs, indicating a possible defect in the grout/concrete. Other types of processing are sometimes used to interpret the measurements of reflections including impulse response and impedance logging. Figure 7.11 (right) provides a simplified illustration of the sonic echo test. The displacement record shown in the figure indicates the reflection off the base of a pile of the length,  $L$ , embedded in sound rock. The reflection occurring at a time shorter than  $2L/C$  (i.e., first upward spike of record) suggests an impedance change in the pile above the pile toe.

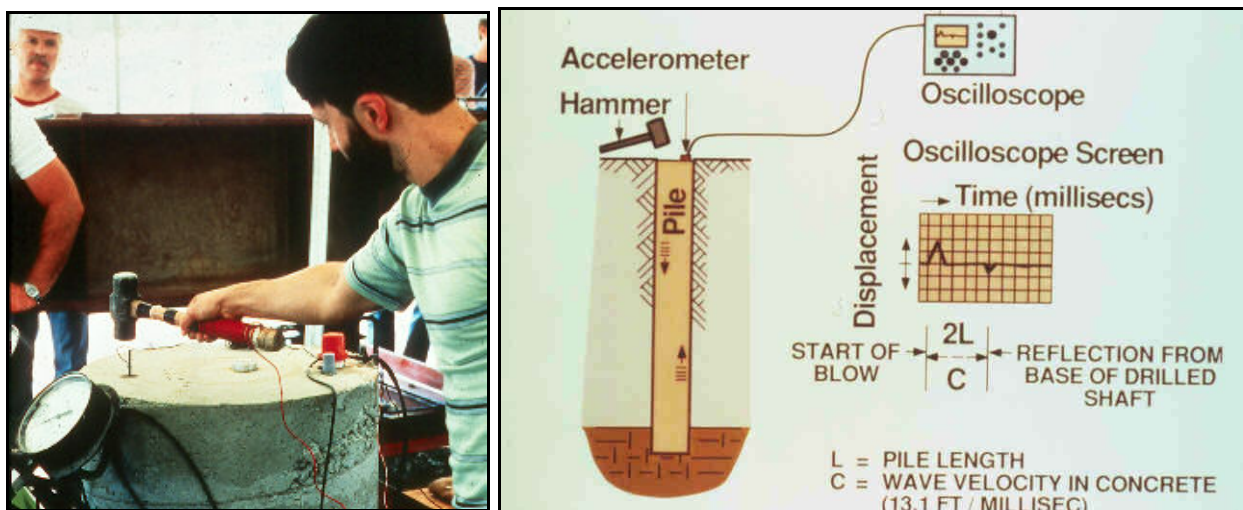
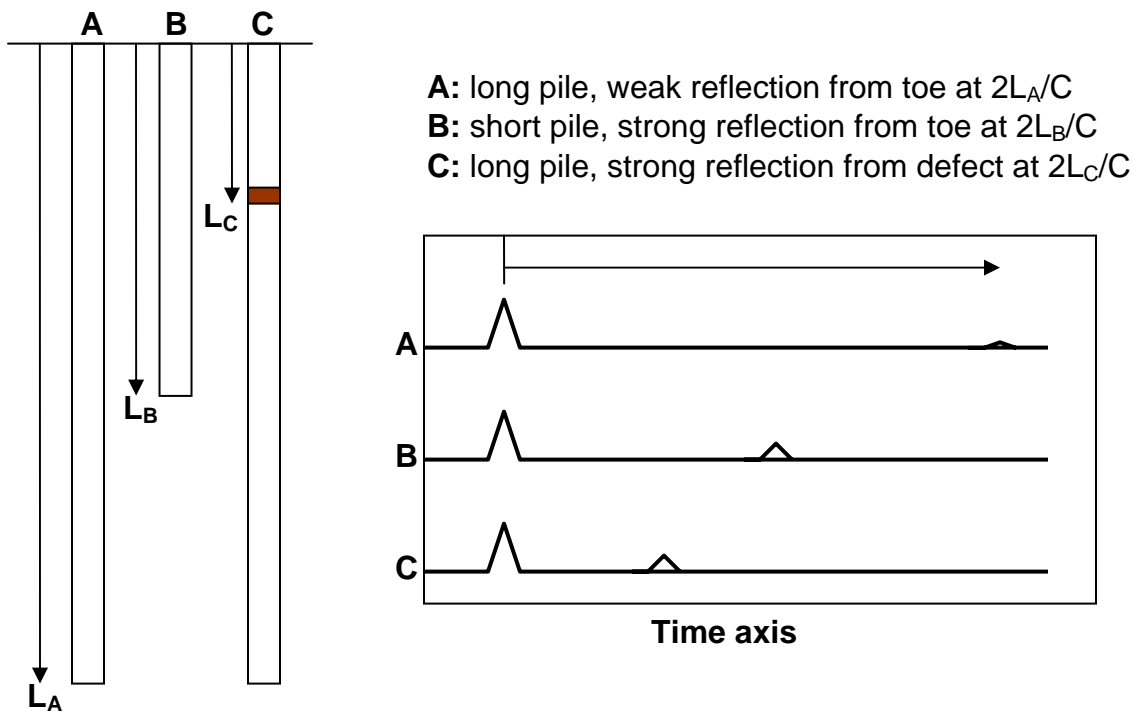


Figure 7.11: Sonic Echo Testing Concept

Although sonic echo testing is an economical and rather simple test, there are some important limitations to consider. As the sound wave travels along the pile, it loses energy and the strength of the reflected signal can become very weak. This means that for very long piles (i.e., depth-to-diameter ratio of greater than 30), the tip of the pile and anomalies or defects occurring at great depths will likely go undetected. Due to the nature of the design of CFA piles, the integrity of the upper 6 m (20 ft) is most critical for structural capacity, particularly for shear and bending moment. As sonic echo testing is more reliable at shallower depths, this limitation is not as significant as for long drilled shafts. This makes testing using sonic echo quite useful for rapidly evaluating a large number of piles. The hypothetical example shown in Figure 7.12 illustrates this concept. The long pile (A) has a weak reflection from the toe that may not be detectable. The short pile (B) has a strong reflection from the toe that is readily detected. Pile C illustrates a long pile containing a defect at a shallow depth. Although the reflection from the toe may be difficult to detect (as for pile A) as would a deep defect, the shallow reflection is readily detected.



**Figure 7.12: Sonic Echo Testing of Long Piles**

Another important limitation of sonic echo testing is that the wave energy is not likely to detect anomalies or defects unless these are large compared to the wave length generated by the impact. Some research indicates that defects that are shorter than 0.25 of the wave length are generally not detected. A typical hammer for sonic echo tests generates a wave length of approximately 1.6 m (5.3 ft), which means that defects or anomalies less than 0.4 m (15- to 16-in.) thick will go undetected. For most CFA pile diameters, this threshold of detection should be appropriate.



### 7.5.3 Integrity Testing using Downhole Techniques

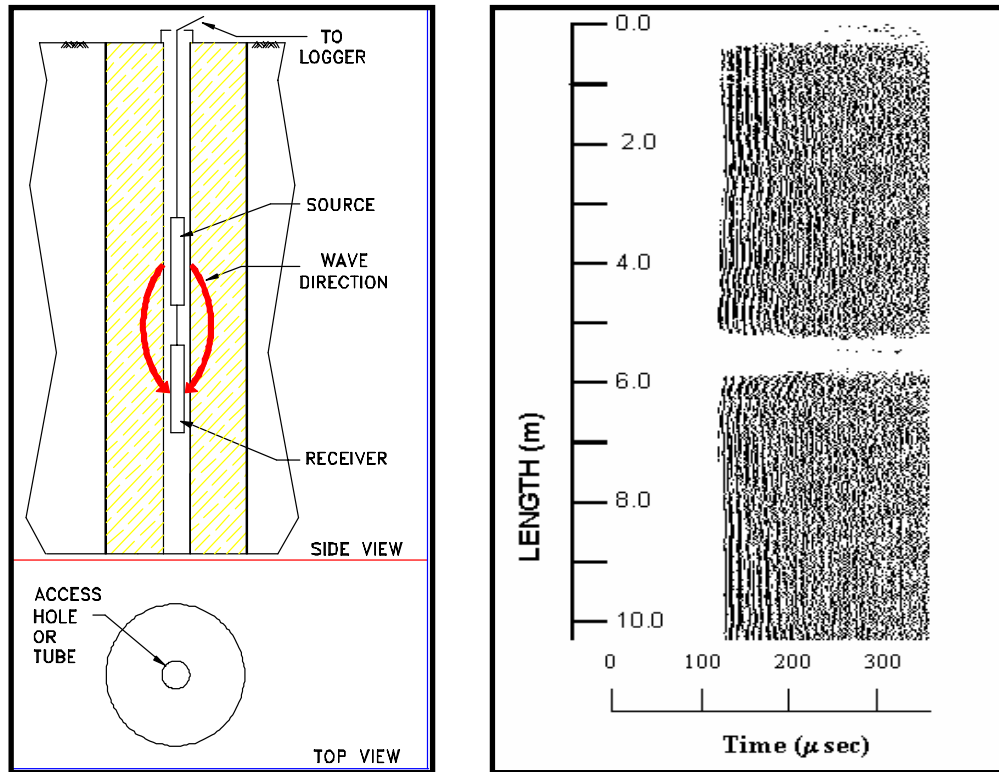
The most reliable of the post-installation integrity tests for identifying anomalies within cast-in-place deep foundations are those that use down-tube instruments, such as the cross-hole sonic logging (CSL) test, single-hole sonic logging (SSL) test, and the backscatter gamma test. However, due to the difficulty and expense of downhole methods on routine projects, these methods are recommended for use on piles where bending moments are unusually high and/or piles larger than 760 mm (30 in.) in diameter are used.

CSL is performed using a source in one tube and a receiver in another to provide a measure of the wave speed of the material between the tubes. A strong signal measurement with an arrival time consistent with the wave speed of good grout/concrete is indicative of sound grout/concrete between the tubes. The SSL test (shown in Figure 7.13) utilizes a source and receiver on the same probe and is intended to sample the wave speed of the material surrounding the tube. The numerous dark lines shown on the time record on the right side of Figure 7.13 represent arrivals of signal energy plotted on a vertical scale of depth vs. time on the horizontal axis. The anomalous lack of dark lines at the 5 to 6 m depth interval represents a delayed arrival time and weak signal between these depths, which may be indicative of a defect in the pile.

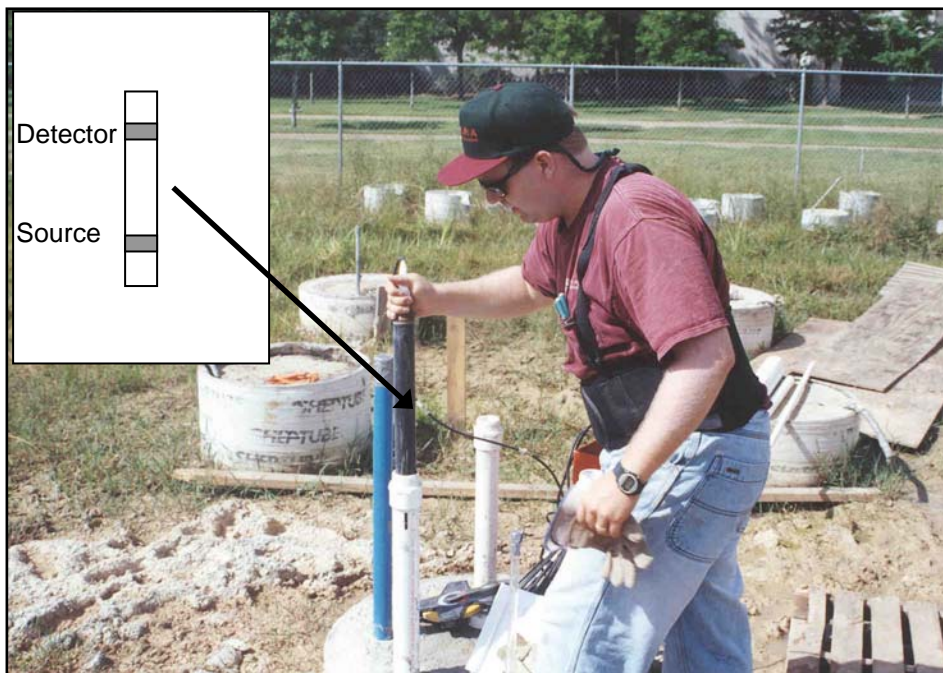
The backscatter gamma test (see Figure 7.14), more commonly referred to as gamma-gamma logging, uses a small radioactive source on one end of the probe to emit gamma photons and a gamma ray detector on the other end. The photon count per unit of time can be calibrated to the grout/concrete density within a radius of about 100 mm (4 in.) around the tube.

To be effective, the access tubes for CSL or backscatter gamma testing should be distributed evenly along the circumference around the reinforcing cage with a spacing of about 0.3 m (1 ft). Tubes should be placed inside the cage to avoid damage during installation. It is recommended that tubes used for CSL tests consist of Schedule 40 steel, because such tubes will remain bonded to the grout or concrete. Polyvinyl chloride (PVC) tubes do not ordinarily remain bonded to the grout or concrete beyond a few days after initial set, and debonding will render the CSL tests ineffective. PVC tubes must be used for backscatter gamma testing because the steel tubes block the gamma photons from penetrating into the surrounding concrete or grout.

These downhole tests all require that the foundation contractor attach appropriate access tubing to the reinforcing steel prior to placing the steel in the grout column. While these tests are frequent with drilled shafts, downhole tests are more difficult to install in CFA piles (because the tubes must be pushed into the fluid grout/concrete). The tubing and instrumentation make downhole tests much more costly in proportion to the total cost of the pile when compared to sonic echo testing. The speed of testing is much slower than sonic echo, which adds to the final cost.



**Figure 7.13: Downhole Single-Hole Sonic Logging (SSL) Concept**



**Figure 7.14: Gamma-Gamma Testing Via Downhole Tube**

## 7.6 LOAD TESTING

Load testing is a very important component for the effective use of CFA piles. Load tests are performed both as pre-production tests and as verification tests as part of the QA/QC of pile production (Figure 7.15). Axial compressive load tests are by far the most common; however, uplift and lateral load test can also be performed as part of a test program when evaluation of either load condition is important. As discussed in Section 7.3.5, both pre-production and verification load tests should be an integral part of transportation projects using CFA piles. A carefully planned and executed load test program can provide the following benefits:

- Site-specific load test data provide verification of design parameters and increases reliability. This reduction in uncertainty may allow the use of lower design factors of safety employed in the ASD methodology.
- The pile load testing program serves to establish the baseline parameters for construction of production piles, particularly with respect to target drilling penetration rate and pressure/volume relations during placement of grout/concrete. Other important parameters such as grout flow and necessary admixtures can be established during the test program.
- The test results can be used to evaluate correlations of side and base resistance with site-specific soil parameters, and to revise or improve the design.

The axial ultimate capacity of individual CFA piles are generally not larger than a few hundred tons. There are several options available in this load range for proof testing of production piles, such as RLT methods (e.g., Statnamic or Fundex systems) or DLT (e.g., drop hammer). Proof testing of CFA piles to confirm nominal axial resistance is generally not detrimental to the structural integrity or geotechnical performance of a sound pile; hence the tested pile may be used for in-service conditions.

Details of axial load testing methods will not be repeated here, although a brief discussion of methods most appropriate for CFA piles is provided. An extensive discussion of axial, uplift, and lateral load testing methods and data interpretation is provided in the following manuals:

- “Static Testing of Deep Foundations” (Kyfor et al., 1992) - FHWA-SA-91-042;
- “Design and Construction of Driven Pile Foundations,” Volumes 1 and 2 (Hannigan et al., 2006) - NHI Course FHWA-NHI-132021;
- “Micropile Design and Construction” (Sabatini et al., 2005) - FHWA NHI-05-039 and
- “Drilled Shafts” (O’Neill and Reese, 1999) - FHWA-IF-99-025

### 7.6.1 Considerations in Planning a CFA Pre-Production Test Pile Program

The objectives of performing a load test program prior to the start of production pile construction are to: (a) provide measurements of site specific values of resistance; (b) correlate these values to construction methods; and (c) verify design assumptions. This is particularly important for

drilled displacement piles where the contractor may be using a proprietary system or tooling for installation. The baseline parameters for drilling rate and concrete or grout placement during the construction of successful test piles are thus established for production piles. For displacement piles, control parameters may also include specific target values of torque and downthrust forces.

In a pre-production pile test program, it is important that test pile locations are selected which are representative of the dominant conditions across the project site. Subsurface information at the specific test pile locations is essential to interpret the results of the installation monitoring and load testing in a meaningful way. In cases of uniform soil and design load conditions, a single test pile may be suitable. In other cases, several test piles may be required to be installed at various locations on the project site.

The axial compressive resistance of CFA piles is normally in a range such that conventional top down static load tests are easy to perform with reaction systems that can be assembled by most contractors. If RLT or DLT methods have been calibrated to local soil and geologic conditions, these alternative methods can offer advantages of speed and economy. On a large project with many piles to be installed, a single control static test supplemented by several RLTs or DLTs on both the control and piles can be a very effective means of achieving a maximum benefit at the least test cost. The additional control static test can provide the reliability of conventional static measurements and the RLT or DLT program can provide the coverage needed to rapidly evaluate a range of conditions that may be encountered. It is always important that a site-specific correlation between static tests and RLTs and/or DLTs be established regardless of project size.

### **7.6.2 Proof Tests on Production Piles**

The relatively modest axial resistance of CFA piles and the availability of rapid and dynamic load test methods make proof load testing of production piles a viable option for QC/QA. Piles may be selected at random or piles of questionable quality can be chosen for proof testing. RLT and DLT methods are quite economical for loads of up to around 5 MN, (450 tons) (Figure 7.16). After RLT or DLT equipment is mobilized to the site, it is usually possible to efficiently test several piles each day.

The use of proof tests on production piles can be planned to provide the increased reliability and lower design factor of safety (or higher design resistance factor) afforded by the inclusion of load testing in the project, and thus can result in significant cost savings.

Axial load tests on production piles are not detrimental to the subsequent performance of the pile so long as the structural capacity of the pile has not been exceeded. Figure 7.17 illustrates the results of two cycles on the same pile, each of which achieved a geotechnical limit on the pile. The first load achieves a geotechnical limit according to the commonly used Davisson criterion. The second load cycle produces a load vs. deflection response that is actually stiffer than the first cycle. In general, the Davisson criterion will provide conservative results. This test result is typical of multiple loadings on a single pile, and the second load cycle is representative of the load deflection response of a pile after a static load test has been conducted. Two observations are made from these data: (a) a load test on a production pile does not adversely affect the ability of the pile to support subsequent loadings; and (b) multiple load tests on a CFA pile can result in

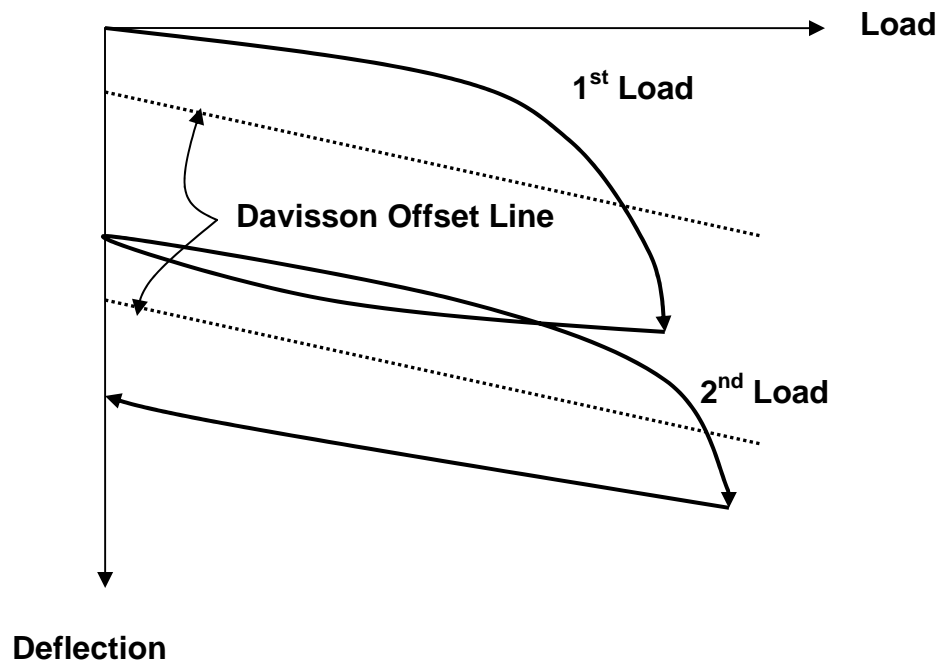
increased pile stiffness in subsequent load cycles. The second aspect can have implications when comparing RLT or DLT methods with a conventional static load test on the same pile, since the pile may provide a stiffer response compared to whichever test method is performed second.



**Figure 7.15: Static Load Test Setup on CFA Piles**



**Figure 7.16: Proof Testing of Production Piles with Statnamic (RLT) Device**



**Figure 7.17: Effect of Multiple Load Cycles on a CFA Pile**

## **7.7 SUMMARY OF RECOMMENDED QC/QA PROCEDURES**

This section provides a summary of recommended QC/QA procedures for use on CFA pile projects and checklists for inspection of CFA piles.

### **7.7.1 Prior to Construction**

The CFA pile inspector must be prepared and should have experience and knowledge of CFA pile construction techniques. Prior to construction the inspector should have and review the following:

- Project plans and specifications;
- Geotechnical report and/or other available subsurface information (often provided on the plans);
- Contractor's approved installation plan;
- Details of load test program or pre-production test pile installations;
- Details of required automated monitoring system and control parameters;
- Details of grout or concrete mix design and sampling and testing requirements; and
- Reinforcing details and methods for pile top finishing and cutoff levels.

### **7.7.2 On-Site Review of Contractor's Equipment**

Upon arrival at the jobsite, the inspector should take the time to thoroughly review the contractor's equipment for compliance with the plans and specifications and approved installation plan. This work includes:

- Check-in with contractor to understand day's planned work and confirm that party responsible for grout/concrete sampling is at site.
- Document auger diameter and length, auger pitch, grout/concrete (each truck immediately when delivered), reinforcing type, and configuration, and centralizers.
- Check calibration of grout/concrete volume monitoring equipment, and other measurement equipment for which calibration is required. Confirm that monitoring equipment is set to record at proper depth intervals as required.
- Check equipment condition and tolerances.

### **7.7.3 During Drilling**

- Confirm that pile location is within horizontal tolerances and pile plumbness is within the range specified.
- Confirm plug placed at auger bit tip.
- Confirm the location of the pile to be constructed, so that relevant subsurface conditions, pile construction requirements (i.e., pile number, embedment depth, cut-off, and batter, if required) can be quickly and accurately referenced.
- Document auger verticality or specified batter, as applicable. Document cuttings and auger advance rate. Confirm for consistency with conditions disclosed in geotechnical report, pile test report, and load test report.
- Confirm removal of excessive cuttings/spoil build-up around auger.
- Monitor behavior of the pile and surrounding ground during construction of test pile foundations. Check for indications of ground subsidence or loss of fluid grout/concrete.

### **7.7.4 During Grout/Concrete Placement**

- Document grout/concrete properties (batch time, temperature, additives, and flow) and those samples that have been obtained for strength testing at the intervals, per project specifications.
- Document the pile grouting/concreting operation, including immediate start of placement and pumping of initial grout/concrete volume and pressure head, and auger withdrawal rates, per approved installation plan. Confirm (from automated monitoring

data and observations) that target minimum grout/concrete factor is attained along the length of the pile. Confirm for consistency with reported conditions disclosed in geotechnical report, test pile report, and load test report.

- Document depth at which grout/concrete return is first observed. Confirm consistency with conditions disclosed in geotechnical report, test pile report, and load test report.
- Should a discontinuity in grout/concrete return or other questionable conditions be observed, inform the contractor of the condition and note the conditions observed on pile logs or data sheets. In some cases, the contractor may re-drill the pile to the full length. Re-drilling the pile to less than the full length to restart the grouting /concreting operation is generally considered unacceptable.
- Confirm continuous and steady auger pull, with slow positive auger rotation if approved in the installation plan, and grout/concrete pumping until auger tip comes out of the ground. Document total volume of grout/concrete pumped, and overall grout/concrete factor. Obtain pile records from automated monitoring equipment.
- Confirm that the pile top is cleared of any debris or contaminated grout or concrete.

#### **7.7.5 During Reinforcement Placement and Pile Top Finishing**

- Document reinforcement installed in pile that is in accordance with specified design.
- Document any installation difficulties, especially since they may be indicative of potential obstructions or undesired inclusions in the pile. In general, the most cost effective and time saving remedial measure is to re-drill and re-grout the pile if suspect conditions are observed.
- Confirm that reinforcing is free of auger spoils or rust prior to insertion.
- Confirm that reinforcing has specified extension above proposed cut-off elevation.
- Confirm that the pile top finishing is performed in a manner consistent with the project requirements, including any forms above grade and tie-off details of the reinforcement.

#### **7.7.6 Post-Installation**

- Check for grout subsidence.
- Inspect pile cut-off.
- Ensure that any post-construction integrity testing or proof load testing is scheduled and performed in a timely manner and that any questionable or rejected piles are noted and the appropriate notification is provided to the owner agency and their engineer.

Additional specific details for each of the items noted above are provided in the project specifications. Guide construction specifications are provided in Chapter 8, which may serve as a preliminary specification for state DOT engineers to use in developing a state-specific CFA pile specification.



# CHAPTER 8 GUIDE CONSTRUCTION SPECIFICATIONS FOR CONTINUOUS FLIGHT AUGER (CFA) PILES

Contractor Performance Based Specifications of CFA Piles

English Units (Metric Units)

(With Commentary)

*Commentary:* Owner-controlled design specifications can vary in the amount of design performed by the Owner's Design Engineer and the amount performed by the CFA Pile Contractor. This guide specification is set up for the Owner-controlled design (Standard Design) method wherein the Owner provides preliminary plans showing the pile design loadings, footing/cap design, and pile layout for each footing/cap location. The Owner also provides related design criteria and requirements, subsurface data, rights-of-way limits, utility locations, site limitations, construction material and testing specifications, and required Contractor working drawing/design and construction submittals and review requirements. The CFA Pile Contractor designs the individual piles and pile cap connections and selects the CFA construction method and equipment. The CFA Pile Contractor prepares a preliminary CFA pile design and a firm cost proposal based on the Owner's preliminary plans and specifications. Once the contract is awarded, the selected CFA Pile Contractor prepares detailed CFA pile design calculations and working drawings and submits them to the Engineer for review.

## 8.1 DESCRIPTION

This work shall consist of constructing CFA piles as shown on the contract plans and approved working drawings and as specified herein. The CFA Pile Contractor is responsible for furnishing all design, materials, products, accessories, tools, equipment, services, transportation, labor and supervision, and manufacturing techniques required for design, installation and testing of CFA piles and pile cap connections for this project.

The CFA Pile Contractor shall design and install CFA piles, including selection of the CFA pile type, diameter, length, pile cap connection, and installation means and methods that will provide the load capacities indicated on the project plans, without damage to existing nearby structures. A minimum diameter will be specified and a minimum length may be specified. The CFA pile load capacities shall be verified by load testing as required, and the pile integrity will be verified by pile integrity tests as required. All piles must meet the test acceptance criteria specified herein.

The imperative mood is used within this specification; for example, when it says, "submit three copies", the CFA Pile Contractor shall submit three copies" is implied.

Sections of this specification are referred to in the text, for example, as “(8.)1.1” to facilitate locating them in this Chapter 8 and allow future renumbering them once the specification is modified according to the Owner’s needs.

### **8.1.1 Definitions**

**CFA Pile:** any foundation that is made by rotating a hollow-stem auger into the ground to the specified pile depth. Grout or concrete is injected through the auger shaft under continuous positive pressure, as the auger is being withdrawn, in order to exert a positive upward pressure on the earth-filled auger flights as well as lateral pressure on the soil surrounding the placed grout or concrete column. Reinforcing steel, as specified, is inserted into the column of fluid grout or concrete following the completion of grout or concrete placement. CFA piles as defined herein include: a) traditional continuous flight auger piles; b) drilled displacement piles intended to install a cast-in-place pile with full displacement and minimal soil spoil; and, c) partial displacement piles which may displace some soil but not act as a full displacement pile.

*Commentary: Many contractors and equipment builders have patented various components of the drilling system for various types of CFA piles, most typically some part of the tooling. As defined within this specification, these various types of piles are all within the broader category of CFA pile; therefore, they would not be considered as “proprietary systems” for bidding purposes. All of the CFA pile systems are generally similar in installation techniques and performance.*

**CFA Pile Contractor:** the firm responsible for performing the CFA pile work.

**Design Engineer:** the Licensed Professional Engineer that designs the CFA piles. The person must meet the experience requirements in Section (8.)1.6.2.

**Engineer:** the Owner’s project engineer, project manager, or other representative.

**Inspector:** the Owner’s field representative on the project site.

**Owner:** agency responsible for the project.

**Plans:** drawings provided by the Owner for bidding purposes.

**Project Manager:** an employee of the CFA Pile Contractor supervising the work and that has a minimum of three years experience with CFA projects of similar size and scope.

**Working Drawings:** drawings submitted by the CFA Pile Contractor. This would include the detailed pile designs.

### **8.1.2 Related Specifications**

*Commentary: Engineer to specify all related specifications from the applicable standard specifications.*

### 8.1.3 Reference Codes and Standards

The following publications form a part of this specification to the extent indicated by the references. The latest publication as of the issue date of this specification shall govern, unless otherwise indicated.

AASHTO Standard Specification for Highway Bridges, current Edition, including current interim specifications.

State Department of Transportation (DOT) Standard Specifications, current Edition, including interim specifications.

*Commentary: Engineer to note any additional publications to be referenced.*

### 8.1.4 Available Information

Available information developed by the Owner, or the Owner's duly authorized representative, include the following items:

1. Plan Set(s) \_\_\_\_, Project No. \_\_\_\_\_, prepared by \_\_\_\_\_, dated \_\_\_\_\_. The plans include the preliminary CFA pile size and length developed for the project, as well as plan view, profile, and typical cross sections for the proposed CFA pile locations.

*Commentary: The Owner should provide preliminary design information for the Contractor as part of the bidding package. The complete list of items will vary according to project and local procedures, but will generally include:*

1. *plans showing the pile design loadings, minimum pile diameter, minimum reinforcement, pile to footing/cap connection design, and pile layout for each footing/cap location. In some cases, the plans may include a minimum pile tip elevation.*
2. *design criteria and requirements, such as minimum safety factors and maximum allowable vertical and horizontal displacements.*

*Refer to Chapter 6 of FHWA Geotechnical Circular No. 8 "Augered Cast-in-Place and Continuous Flight Auger Piles" for detailed guidance on plan information to provide on the preliminary plans.*

2. Geotechnical Report No.(s)\_\_\_\_\_, Project No. \_\_\_\_\_, prepared by \_\_\_\_\_, dated \_\_\_\_\_, included or referenced in the bid documents, containing the results of exploratory borings, observation pits, or other site investigation data obtained in the vicinity of the proposed CFA pile locations.

*Commentary: The subsurface conditions expected can significantly impact the CFA Pile Contractor's choice of procedures, methods, equipment, the bidding process, and contract*

*administration. A geotechnical investigation report should be included in the contract special provisions. This report provides information to bidders of the subsurface conditions and will reduce the potential for differing site conditions construction claims and disputes. By including the geotechnical investigation report in the contract special provisions, it becomes a legal part of the contract documents.*

### **8.1.5 Project Site Survey**

Before bidding the work, the CFA Pile Contractor shall review the available subsurface information and visit the project site to assess the site geometry, equipment access conditions, and locations of existing structures and above-ground facilities.

The CFA Pile Contractor is responsible for field locating and verifying the locations of all utilities shown on the plans prior to starting the Work. The CFA Pile Contractor shall notify the Engineer of any utility locations different from those shown on the plans that may require relocation of foundation elements or modification to the structure design.

***Commentary:** Many public owners have standard specifications or procedures for handling utilities on a project, so this section may not apply or can be modified to include reference to the applicable State DOT specification/procedure. As with any foundation system, the location of active and abandoned underground utilities can have a significant impact on the installation of CFA piles.*

Prior to the start of any CFA pile construction activity, the CFA Pile Contractor and the Engineer shall jointly inspect the site to observe and document the pre-construction condition of the site, existing structures, and utilities.

### **8.1.6 CFA Pile Contractors Experience and Submittal of Experience**

***Commentary:** The quality of CFA piles is highly dependent upon the skill of the CFA Pile Contractor and the specific crew that is assigned to the project. It is essential that the CFA Pile Contractor is competent to perform the work at hand either through providing documentation of successful completion of prior projects of a similar nature to the project being bid, or by directly demonstrating his or her competence by installing a demonstration pile that does not contain defects and has been constructed to at least the diameter and depth shown on the plans.*

#### **8.1.6.1 Experience Requirements**

Listed below are potential CFA Pile Contractors to design, furnish, and install CFA piles for the Owner, based on previous CFA Pile Contractor experience submittals verified and accepted by the Owner:

1. Contractor Name, Mailing Address, Contact Name, Phone Number
2. Contractor Name, Mailing Address, Contact Name, Phone Number
3. Contractor Name, Mailing Address, Contact Name, Phone Number

If the CFA pile work is bid as a subcontract item to a prime contract, the Prime Contractor shall name the intended CFA Pile Contractor at least \_\_\_\_\_ calendar days prior to the beginning of the work for review.

#### 8.1.6.2 Experience Requirements and Submittal

The CFA Pile Contractor shall be experienced in the construction and load testing of CFA piles and shall provide documentation of a minimum of three projects performed in the two-year period preceding the bid date in which CFA piles were installed successfully under subsurface and project conditions similar to those of the current project. The CFA Pile Contractor shall also provide documentation that the designated job site supervisor (foreman or crew chief) has had a minimum of three years of experience in supervision of the installation of CFA piles. Drill rig operators shall be documented to have a minimum of three years experience installing CFA piles.

The CFA Pile Contractor shall assign a Project Manager to supervise the work that has a minimum of three years experience with CFA projects of similar size and scope. The CFA Pile Contractor shall not use consultants or manufacturers' representatives to satisfy the Project Manager requirements of this section. This person may also be the Design Engineer if the Project Manager/Design Engineer is an employee of the CFA Pile Contractor. A Design Engineer that is a Consultant cannot be the Project Manager.

The CFA piles shall be designed by the Design Engineer, a Professional Engineer licensed in the State of \_\_\_\_\_ with experience in the design of at least three successfully completed CFA pile projects over the past five years with CFA piles of similar capacity to those required for the project. The Design Engineer may be either an employee of the CFA Pile Contractor or a separate Consultant Design Engineer meeting the stated experience requirements.

Five copies of the completed project reference list and personnel list shall be submitted by the CFA Pile Contractor at least \_\_\_ calendar days before the planned start of CFA pile construction. The project reference list shall include a brief project description with the project Owner's name and current phone number and load test reports. The personnel list shall identify the CFA Pile Contractor, Project Manager, drill rig operators, and job site supervisor to be assigned to the project. The personnel list shall contain a summary of each individual's experience and be complete enough for the Engineer to determine whether each individual satisfies the required qualifications. The Engineer will approve or reject the CFA Pile Contractor's qualifications within \_\_\_ calendar days after receipt of a complete submission.

The work shall be performed by the personnel listed on the submittals. If personnel changes need to be made during the course of the project, work shall be suspended until the replacement personnel are approved by the Engineer. Additional time required due to incomplete submittals, unacceptable submittals, or obtaining approval of replacement personnel will not be cause for a time extension or delay claims. All costs associated with incomplete, replacement, or unacceptable submittals shall be borne by the CFA Pile Contractor.

### 8.1.7 CFA Pile Design Requirements

The CFA piles shall be designed to meet the specified loading conditions as shown on the contract plans and approved working drawings. The piles shall be designed using the Service Load Design (SLD) procedures contained in Chapters 5 and 6 of FHWA Geotechnical Circular No. 8, “*Augered Cast-in-Place and Continuous Flight Auger Piles*”.

The required geotechnical safety factors/strength factors for SLD shall be in accordance with the FHWA circular, unless otherwise specified. Estimated soil/rock design shear strength parameters, unit weights, applied foundation loadings, special corrosion protection requirements, known utility locations, easements, rights-of-way, and other applicable design criteria will be as shown or listed on the plans, other contract documents, or specified herein. Structural design of any individual CFA pile element not covered in the FHWA manual/circular shall be by the SLD method in conformance with appropriate articles of the most current Edition of the AASHTO Standard Specification for Highway Bridges (i.e., 17<sup>th</sup> Edition as of 2007), including current interim specifications.

#### 8.1.7.1 CFA Pile Design Submittals

At least 60 calendar days before the planned start of CFA pile construction, submit complete design calculations and working drawings to the Engineer for review and approval. Include all details, dimensions, quantities, ground profiles, and cross-sections necessary to construct the CFA piles. Verify the limits of the CFA pile structures and ground survey data before preparing the detailed working drawings.

The working drawings and calculations shall be signed and sealed or stamped by the CFA Pile Contractor’s Design Engineer or by the consultant Design Engineer (if applicable), previously approved by the Engineer. If the CFA Pile Contractor uses a consultant Design Engineer to prepare the design, the CFA Pile Contractor shall have overall contractual responsibility for both the design and construction.

Submit \_\_\_ sets of the working drawings with the initial submission. Drawing sheet size shall be \_\_\_ by \_\_\_. One set will be returned with any indicated corrections. The Engineer will approve or reject the CFA Pile Contractor’s submittal within \_\_\_ calendar days after receipt of a complete submission. If revisions are necessary, make the necessary changes and resubmit \_\_\_ revised sets. When the drawings are approved, furnish \_\_\_ sets and a Mylar sepia set of the approved drawings. The CFA Pile Contractor will not be allowed to begin CFA pile work until the submittal requirements are satisfied and found acceptable by the Engineer. Changes or deviations from the approved submittals must be re-submitted for approval. No adjustments in contract time or delay or impact claims will be allowed due to incomplete submittals.

#### 8.1.7.2 Design Calculations

Design calculations shall include, but not be limited to, the following items:

1. A written summary report which describes the overall CFA pile design.

2. Applicable code requirements and references.
3. CFA pile structure critical design cross-section(s), including soil/rock strata, piezometric levels, and location, magnitude and direction of applied loads.
4. Design criteria, including soil/rock shear strengths (friction angle and cohesion), unit weights, unit skin friction values, and unit end-bearing values. Any additional subsurface borings, laboratory work, or other subsurface data collected for the design shall also be included.
5. Safety factors used in the design.
6. Seismic design earthquake acceleration coefficient or other seismic design criteria applicable for the geographic area of the project.
7. Design calculation sheets (both static and seismic) with the project number, CFA pile structure location, designation, date of preparation, initials of designer and checker, and page number at the top of each page. Provide an index page with the design calculations.
8. Design notes including an explanation of any symbols and computer programs used in the design.

If applicable, requirements for items 2, 5, and 6 will be outlined in the bid package.

#### 8.1.7.3 Working Drawings

The working drawings shall include all information required for the construction and quality control of the piling. Working drawings shall include, but not be limited to, the following items unless provided in the contract plans:

1. A plan view of the CFA pile structure(s) identifying:
  - a. A reference baseline datum.
  - b. The offset from the construction centerline or baseline to the face of the CFA pile structure at all changes in horizontal alignment.
  - c. Beginning and end station of CFA pile structures.
  - d. CFA pile locations with center-to-center pile spacing.
  - e. Right-of-way and permanent or temporary construction easement limits, location of all known active and abandoned existing utilities, adjacent structures or other potential interferences.
  - f. The centerline of any drainage structure or drainage pipe behind, passing through, or passing under the CFA pile structure.

- g. Subsurface exploration locations shown on a plan view of the proposed CFA structure alignment with appropriate reference base lines to fix the locations of the explorations relative to the CFA structure.
2. An elevation view of the CFA pile structure(s) identifying:
    - a. CFA pile locations and elevations with vertical and horizontal spacing; and
    - b. Existing and finished grade profiles both behind and in front of the CFA pile structure.
  3. General notes for constructing the CFA piles including construction sequencing or other special construction requirements.
  4. Horizontal and vertical curve data affecting the CFA pile structure and control points, including match lines or other details to relate CFA pile structure stationing to centerline stationing.
  5. A listing of the summary of quantities.
  6. CFA pile typical sections including spacing, diameter, reinforcing bar sizes, locations, and details; centralizers and spacers; and connection details to the substructure footing/pile cap.
  7. Typical details of verification and proof load test piles, including reaction systems.
  8. Details, dimensions, and schedules for all CFA piles and reinforcing steel.

*Commentary: Submittals procedures shall be coordinated with Owner procedures.*

Revise the drawings when plan dimensions are changed due to field conditions or for other reasons. Within \_\_\_\_ calendar days after completion of the work, submit as-built drawings to the Engineer. Provide revised design calculations signed by the approved Design Engineer for all design changes made during the construction of the CFA piles.

#### **8.1.8 Construction Submittals**

At least 60 calendar days before the planned start of CFA pile construction, submit complete construction submittals to the Engineer for review and comment. The Engineer will review and comment on the CFA Pile Contractor's submittal within \_\_\_\_ calendar days after receipt of a complete submission. If revisions are necessary, make the necessary changes and resubmit. The CFA Pile Contractor will not be allowed to begin CFA pile work until the submittal requirements are satisfied and found acceptable by the Engineer. Changes or deviations from the approved submittals must be re-submitted for approval. No adjustments in contract time or delay claims will be allowed due to incomplete submittals.



#### 8.1.8.1 Pile Installation Plan

The CFA Pile Contractor shall use the Pile Installation Plan to demonstrate, to the satisfaction of the Engineer, the dependability of the equipment, techniques, and source of materials to be used on the project. Reference to successful completion of projects with similar pile sizes in similar soil conditions using the proposed equipment and procedures should be included. The components of the plan shall meet the requirements contained in this specification. This plan shall include, but not be limited to, the following items:

1. List and sizes of proposed equipment, including drilling rigs, augers and other drilling tools, pumps for grout or concrete, mixing equipment, automated monitoring equipment, and similar equipment to be used in construction, including details of procedures for calibrating equipment as required;
2. Step-by-step description of pile installation procedures;
3. A plan of the sequence of pile installation;
4. Target drilling and grouting parameters (along with acceptable ranges) for pile installation, including auger rotation speed, drilling penetration rates, torque, applied crowd pressures, grout pressures, and grout volume factors;
5. Details of methods of reinforcement placement, including support for reinforcing cages at the top of the pile and methods for centering the cages within the grout or concrete column;
6. Mix designs for all grout or concrete to be used on the project, including slump loss vs. time curves and strength development vs. time curves for mixes with fly ash and/or slag;
7. Equipment and procedures for monitoring and recording auger rotation speed, auger penetration rates, auger depths, and crowd pressures during installation;
8. Equipment and procedures for monitoring and recording grout or concrete pressures and volumes placed during installation;
9. Contingency plans for equipment failures during drilling or grouting operations (grout pump, monitoring equipment, etc.);
10. Procedures for protecting adjacent structures, on or off the right-of-way, that may be adversely affected by foundation construction operations, including a monitoring plan as required in Section 3.1; and
11. Other required submittals shown on the plans or requested by the Engineer.

*Commentary: A clearly written pile installation plan can be very effective in reducing misunderstandings between the Engineer and the CFA Pile Contractor and can form the basis for solving potential problems before they occur, thus keeping the project on schedule and minimizing claims. In reviewing the CFA Pile Contractor's submittal, the key information regarding the equipment that should be scrutinized is:*

- (1) the rated capacity and boom lengths of the drill rig;*
- (2) the torque, rotational speed, and crowd capacity on the drilling machine;*
- (3) the horsepower of the hydraulic power unit used to turn the auger; and*
- (4) the positive displacement piston-ball valve pump, pump stroke displacements, engine horsepower and pump pressures of the grout pump to be used.*

*Most CFA piling installed in the United States in the last 30 years has utilized crane-mounted drilling equipment. Crane-mounted rigs have no means of applying crowd onto the auger, and thereby have limited ability to control the rate of penetration and the potential for soil mining, i.e., removal of excess soil during drilling. Crane-mounted rigs should be approved only for non-caving soil conditions after careful consideration of the amount of control the equipment provides on the applied downward pressure and penetration rate during drilling. Conversely, hydraulic rigs provide drilling control systems that allow the use of partial or full displacement piles, allowing more flexibility for the CFA Pile Contractor's installation means and methods to achieve the desired pile capacity. The selection of equipment is ultimately the responsibility of the CFA Pile Contractor*

*Stiff soils or large diameter piles (more than 18 inches [0.45 m]) require special consideration in sizing equipment. The minimum torque supplied should be 30,000 ft-lb (41 m-kN), and the equivalent crowd capacity should be at least 5,000 lb (22 kN). However, this minimum may not be sufficient in many circumstances. The Contractor's plan for sequence of installation should preclude the installation of piles that are within six diameters of each other, center to center, prior to the time that the first pile installed is fully set.*

#### 8.1.8.2 Conformance Testing Plan

Along with the Pile Installation Plan, a specific plan for completing a testing program as outlined in the bid package shall be submitted by the CFA Pile Contractor to the Engineer for review. The program shall consist of pre-production static load tests, production static and/or rapid and/or dynamic load tests, and post-installation integrity tests in sufficient quantities to provide the data necessary to demonstrate that the installed piles meet the load and deflection criteria established in the project plans with an appropriate factor of safety. The complete installation process and equipment used during the pre-production test pile program should be used to install the production piles.

The pre-production test program establishes the baseline parameters for construction of production piles. Verification load tests and structural integrity tests during construction will be used to verify that the CFA Pile Contractor is producing acceptable piles. Pile testing methods and frequencies shall meet the requirements contained in Sections (8.)3.11 and (8.)3.12 of this specification and the appropriate sections of the State DOT Standard Specifications.

The conformance testing program shall meet the requirements as indicated in the bid package and shall include a list of the automated measuring and recording equipment to be utilized during construction. The minimum requirements for automated measuring and recording equipment are contained in Section (8.)3.4 of this specification. The submitted list should include type of equipment, manufacturer, data to be collected, current calibration records, and sample data records.

Sampling and testing of materials used on the project shall also be included in the conformance testing plan. The requirements for materials testing in the State DOT Standard Specifications shall be listed, as well as the requirements for grout or concrete testing included in Section (8.) 3.2 of this specification.

The Conformance Testing Plan will clearly indicate the QA/QC tasks to be performed by the CFA Pile Contractor or its representative, the Inspector, or both.

*Commentary: The intent of the Conformance Testing Program is to assure the Owner that the piles have been installed as designed by the CFA Pile Contractor and that they meet the required load performance criteria. The use of automated measuring and recording equipment provides a means of monitoring each pile for conformance to the installation criteria.*

### **8.1.9 Pre-Construction Meeting**

A pre-construction meeting will be scheduled by the Engineer and held prior to the start of CFA pile construction. The Engineer, prime Contractor, CFA Pile Contractor, Inspectors, excavation Contractor, and Geotechnical Instrumentation Specialist (if applicable) shall attend the meeting. Attendance is highly recommended. The pre-construction meeting will be conducted to clarify the construction requirements for the work, to coordinate the construction schedule activities and identify contractual relationships and delineation of responsibilities among the prime Contractor and various Subcontractors. Main aspects involving multiple subcontractors may include those pertaining with excavation for CFA pile structures, anticipated subsurface conditions, CFA pile installation and testing, CFA pile structure survey control, and site drainage control.

### **8.2 MATERIALS**

All materials shall conform to the pertinent item requirements in the relevant State DOT Standard Specifications, or as otherwise noted.

Portland cement (Types I, II, & III)	Item ____ (Hydraulic Cement), ASTM C 150
Water	Item ____ (Portland Cement Concrete) AASHTO T 26
Fine and coarse aggregate	Item ____ (Portland Cement Concrete), ASTM C 33, ASTM C 87-90, ASTM C 227-90, ASTM C 289-94, ASTM C 295-90, A ASTM C 586-92
Mineral admixtures (Fly Ash)	Item ____ (Concrete Admixtures) ASTM C 618 Class C or F
Water reducing admixtures	Item ____ (Concrete Admixtures) ASTM C 494, ASTM C 1017
Fluidifier (fluidizer)	Item ____ (Grout Admixtures) ASTM C 937, CRD-C 619
Reinforcing steel	Item ____ (Reinforcing Steel), ASTM A 615, ACI 315
Grout flow testing (flow cone)	ASTM C 939, CRD-611-94
Grout cube samples	ASTM C 109
Grout cube testing	ASTM C 109, ASTM C 942
Concrete slump testing	Item ____ (Portland Cement Concrete), ASTM C143
Concrete cylinder samples	Item ____ (Portland Cement Concrete), ASTM C31
Concrete cylinder testing	Item ____ (Portland Cement Concrete), ASTM C 39

Notes:

1. Type III Portland cement shall not be used when the air temperature for the 12 hours following batching will exceed 60° F (15° C).
2. Type B fly ash shall not be used in conjunction with Type II Portland cement.
3. All admixtures must be approved by the \_\_\_\_\_, as specified in Item \_\_\_\_\_. Admixtures shall be stored in accordance with Item \_\_\_\_, Concrete Admixtures.
4. Reinforcing steel item includes the requirements and the assemblies of reinforcing steel.

**Commentary:** *The appropriate sections of each State DOT Standard Specifications should be included under the materials section. A complete generic materials section cannot be provided herein considering the vast combinations of materials and control methods used by individual State DOTs. Some general guidance on grout and concrete is provided in Sections (8.)3.2 and (8.)3.3 of this specification.*

## 8.3 CONSTRUCTION REQUIREMENTS

### 8.3.1 Site Preparation and Protection of Adjacent Structures

#### 8.3.1.1 Site Preparation

Muck, organics, soft clay, or other unsuitable materials encountered within 5 ft (1.5 m) of the ground surface, such material shall be removed or otherwise treated to prevent problems with pile top construction. Excavation of unsuitable surface material and backfilling shall be completed to the Engineer's satisfaction, or as required in the contract documents, prior to the construction of CFA piles. Should more than 5 ft (1.5 m) of unsuitable surface material be encountered, the CFA Pile Contractor shall advise the Engineer immediately and proceed with work as directed by the Engineer. Should the CFA Pile Contractor suspect that any soils that are excavated are contaminated by hydrocarbons, refuse, or other environmentally hazardous material, he or she shall contact the Engineer immediately and proceed with work as directed by the Engineer.

*Commentary: Unsuitable materials should generally be removed to their full depth, or to a depth of 5 ft (1.5 m), whichever is less. The excavation is typically backfilled with soil having a plasticity index of 20 or less compacted to at least 95% of its maximum dry density, as specified by ASTM D 698 (AASHTO T 180), at within 2% of optimum moisture content.*

#### 8.3.1.2 Protection of Adjacent Structures

The CFA Pile Contractor shall be solely responsible for evaluating the need for, design of, and monitoring of measures to prevent damage to adjacent structures or underground utilities, on or off the right-of-way. These measures shall include, but are not limited to, selection of construction methods and procedures that will prevent over-excavation and excessive migration of grout through the ground, monitoring and controlling the vibrations from construction activities (including placement of casings, sheet piling, shoring and similar ancillary features), and protecting utilities.

Structures located within a horizontal distance equal to the planned length of the pile shall be monitored for vertical and horizontal movement in a manner approved by the Engineer within an accuracy of 0.01 in. (0.3 mm). Monitoring of adjacent structures will be done by an independent party working for the CFA Pile Contractor and approved by the Engineer. A monitoring plan, including the locations of measurement points and the frequency of recording measurements shall be submitted to the Engineer for approval as part of the CFA Pile Installation Plan. Monitoring shall begin with a base-line measurement recorded no more than 10 calendar days prior to construction of the pile, any shoring, or similar ancillary features. In addition to monitoring for movement, the condition of the adjacent structure, including cracks and crack widths, before and after construction of the CFA piles, shall be documented by visual inspection, photographs, and/or video. Structures owned by Owner shall be monitored for movement but need not be monitored for condition unless called for on the plans.

As soon as any movements are detected in adjacent structures, the CFA Pile Contractor shall stop construction, notify the Engineer, and take any immediate remedial measures required to prevent damage to the adjacent structures. The CFA Pile Contractor and the Engineer shall then review the current installation procedures. If revisions to the installation procedures are deemed necessary, the CFA Pile Contractor shall submit a revised installation plan for approval by the Engineer before resuming work.

*Commentary: The installation of CFA piles can result in large settlement of the ground surface if the rate of rotation of the auger is high relative to its rate of penetration or over-rotation, especially in loose sandy soils. This action can promote settlement and damage to existing structures near the location of the pile installation. In some soils, the pumping of grout can result in the fracturing of the ground, the traveling of grout in the ground a considerable distance horizontally under pressure, which can lift the ground surface and structures (including buried conduits) founded nearby. Careful monitoring of the movements of adjacent structures and changes in the condition of such structures is necessary in order for the CFA Pile Contractor to know when their procedures are producing ground movements in order and when immediate corrective action needs to be taken during the pile installation. If a soil susceptible to densification is encountered, the penetration rate should be increased or the rate of rotation of auger be reduced. Condition surveys are needed for the evaluation of the effect of the construction process on the serviceability of adjacent structures by the Engineer.*

### **8.3.2 Grout or Concrete**

The grout or concrete property requirements listed to follow in this section shall be determined from samples taken during CFA pile construction as described in Section (8.)3.2.4.

*Commentary: CFA piles have traditionally been constructed in the United States with sand-cement grout. Construction of CFA piles with concrete is now routinely accomplished in the United States and abroad, and has proven to produce acceptable piles when properly specified and constructed. The specifications herein allow for the use of either grout or concrete; however, once a mix design is established through the pile test program it should not be altered.*

*As a guide for strength development, grout and concrete meeting these specifications typically attains 30 % and 70 % of their 28-day compressive strength after 3 and 7 days of curing, respectively. Both grout and concrete mixes may contain pozzolanic additives. The most commonly used is fly ash (ASTM C 618-94; however, finely ground silica flume and blast furnace slag (ASTM 989-94) can also be used. The use of pozzolanic additives results in lower permeability of the hardened concrete and tends to retard the set time of the cement paste, thereby increasing the time that the grout or concrete remains workable. As a consequence of providing a more workable mix, materials such as fly ash, silica flume, and/or slag will probably severely retard the early strength gain of the grout mix, typically until about 10 to 14 days of age. In all cases, the submitted mix design should include strength development vs. time information.*

*Each DOT will likely have local mix designs that are preferred for CFA pile construction (or drilled shafts produced by the wet method), based on performance of local cements and*

*aggregates. Concrete mix design for CFA pile construction should be given special attention. Desirable properties are fluidity, compaction under self weight, resistance to segregation, and controlled set time. Specific guidance on slump and aggregate gradation are provided below.*

#### 8.3.2.1 Mix Design – Grout

The grout shall consist of a mixture of Portland cement fly ash, water, fine aggregate (sand), fluidifier, and if necessary, retarder, which shall be proportioned and mixed so that the grout will exhibit the following properties:

1. All solids shall remain in suspension in the grout without excessive bleed-water.
2. The grout shall be tested for fluid consistency (using a flow cone) in accordance with the modifications made to either ASTM C 939 or the U.S. Army Corps of Engineers specification CRD 611-94 (USACE, 1994), as described below, and shall be obtained as described in Section (8.)3.2.4. Either of these specifications is herein required to have the flow cone outlet modified from a ½ in. (12 mm) diameter outlet to a ¾ in. (19 mm) diameter outlet. A range of acceptable fluid consistency (expressed as efflux time per standard volume as described in the cited specifications) shall be established, and must meet the approval of the Engineer.
3. The grout shall not exhibit shrinkage in excess of 0.15 % in the vertical direction, as tested in accordance with ASTM C 1090, and shall be housed in a 100 % humidity room at a temperature of 68° F to 74° F (20° C to 23° C), or as otherwise specified by the Engineer.
4. Grout samples recovered for strength testing, as described in Section (8.)3.2.4, shall exhibit a minimum compressive strength of \_\_\_\_ psi 28 days after casting, as required by the design.
5. The submitted mix design shall include curves of viscosity loss versus time. In addition, grout shall be designed so as to maintain the range of acceptable fluid consistency for a period of at least 2 hours or longer, if required by the project-specific pile installation plan.
6. Strength development versus time curves/data shall be provided, with data for times beyond 28 days as required for mixes that include fly ash, silica flume, or slag.

**Commentary:** *The grouts used in CFA pile production are typically too thick to flow effectively from the standard ½ in. (12 mm) outlet. The flow cone specified by the U.S. Army Corps of Engineers (CRD 611-94) may be modified by simply taking out the removable ½ in. (12 mm) diameter orifice that extends out the bottom of the device to leave a ¾ in. (19 mm) diameter opening, while a flow cone would need to be custom fabricated to the ASTM C 939 specification with the modified outlet diameter. Grouts acceptable for CFA pile construction typically have a fluid consistency represented by an efflux time of 10 to 25 seconds when tested in accordance with the modifications described herein.*

*Checking the grout flow is considered a quality control tool valued primarily for the purpose of quickly indicating whether the grout currently being tested will most likely conform with grout samples meeting the specified design requirements furnished previously on the project. Should any piles be found inadequate in subsequent testing, a record of grout flow may be valuable in identifying other suspect piles, which may then be subject to further testing at the discretion of the Engineer.*

#### 8.3.2.2 Mix Design – Concrete

The concrete shall consist of a mixture of Portland cement, fly ash, water, coarse aggregate, fine aggregate (sand), water reducers, and if necessary, retarder, which shall be proportioned and mixed so that the concrete will exhibit the following properties:

1. All solids shall remain in suspension in the concrete mix without excessive bleed-water.
2. Concrete samples recovered for slump testing as described in Section (8.)3.2.4, shall exhibit a slump of 8 in.  $\pm$  1 in (200 mm  $\pm$  25 mm) when tested in accordance with ASTM C 143.
3. Concrete samples recovered for strength testing, as described in Section (8.)3.2.4, shall exhibit a compressive strength of \_\_\_\_ psi 28 days after casting, as required by the design.
4. The submitted mix design shall include curves of slump loss versus time.
5. Strength development versus time curves/data shall be provided for mixes that include fly ash, silica fume, or slag.

**Commentary:** *Concrete mix designs appropriate for drilled shafts constructed by the wet method are generally acceptable for use in CFA pile construction, with the notable exception that CFA pile construction may require a greater degree of workability. Greater workability is needed to allow for the concrete to be pumped through the delivery lines and auger, and subsequent insertion of the required reinforcing steel to planned elevation after placement of the concrete. Accordingly, the coarse aggregate for CFA pile construction is typically limited in size to no greater than  $\frac{3}{8}$  in. (9.5 mm). Consideration should be given to the benefit of well rounded aggregate (i.e., pea-gravel).*

*Slump requirements are based on providing the necessary quality of workability for uniform and proper placement throughout the duration of CFA pile construction. A slump range of 8 in.  $\pm$  1 in. (200 mm  $\pm$  25 mm) is suggested. Sampling frequencies for slump measurement are recommended in Section (8.)3.2.4*

*High workability is achieved with proper aggregate gradations, water-cement ratios and appropriate admixtures such as water reducing, with retarding admixtures, and air entraining agents. Angular crushed aggregates are harder to work than similar sized rounded aggregates. To insure against segregation, the sand/cement content should be high compared to the coarse aggregate content. Fly ash can be used to replace some of the Portland cement in many situations, but may result in slower strength development.*



### 8.3.2.3 Field Operations

1. All oil, rust inhibitors, residual drilling slurries and similar foreign materials shall be removed from holding tanks/hoppers, stirring devices, pumps and lines, and all other equipment in contact with the grout or concrete before use.
2. All grout or concrete used shall be batched at a State approved facility, and delivered to the project site. The addition of water at the project site is permitted only with prior approval by the Engineer and only to the extent that the water-cementitious material ratio does not exceed the ratio of the approved design mix.
3. If agitated continuously, the grout or concrete may be held in the ready mix truck for up to 2.5 hours if the air temperature is not greater than 68° F (20° C), or up to 2 hours if the air temperature is between 68° and 100° F (20° and 38° C) if other than Type III Portland cement is used. Grout or concrete shall not be placed if the air temperature exceeds 100° F (38° C) or is less than 39° F (4° C) unless approved procedures for hot (over 100° F [38° C]) or cold weather (less than 39° F [4° C]) placement are followed. Grout or concrete designed with retarders to extend the holding time or placement temperature range shall be placed in accordance with the mix design parameters.
4. A screen with a mesh with openings no larger than ¾ in. (19 mm) for grout, or 4 in. (100 mm) for concrete shall be used between the delivery point from a ready mix truck and the pump, to remove large particles or cement clumps that can clog the grout or concrete injection system.
5. The grout or concrete pump shall be a positive displacement pump with a known volume per stroke that is capable of developing peak pressures of at least 350 psi (2,400 kPa) at the pump. The pump shall be sized appropriately to the pile size such that a smooth, continuous delivery of grout or concrete can be maintained while limiting the pressure variations (particularly the pressure drop) felt by the pile due to the pump strokes. The CFA Pile Contractor shall provide the Engineer with the value of the volume of grout or concrete delivered by each stroke of the pump and shall demonstrate to the Engineer that the actual volume delivered by each stroke of the pump is within 3% of the value provided. The volume per stroke shall be recalibrated when the Engineer suspects that the grout or concrete delivery performance has changed.
6. Automatic measurements shall be made and recorded during the pile construction process as described in Section (8.)3.4 of this specification. All inspection records shall be made as described in Section (8.)3.10 of this specification.
7. The minimum value of grout pressure at the pump outlet or at the top of the auger that is required on the approved working drawings or approved pile installation plan shall be maintained for all grout or concrete placement operations throughout the project.

#### 8.3.2.4 Grout or Concrete Sampling and Testing

Grout or concrete samples for strength testing shall be taken from the discharge at the delivery trucks prior to pumping. Concrete samples shall be cylinders 6 in. (150 mm) diameter by 12 in. (300-mm) high, or sized appropriately for maximum aggregate size according to ASTM C 39. Grout samples shall be 2 in. (50 mm) cubes and shall be subjected to a 10% increase in required compressive strength as compared to cylinder samples.

The CFA Pile Contractor, Testing Agency, or qualified party specified in the contract documents shall make no less than six (6) such samples for each 50 yd<sup>3</sup> (38 m<sup>3</sup>) of grout or concrete placed. No less than six (6) such samples shall be made per working day, or less than six (6) such samples for each mix of grout or concrete produced by the supplier. Concrete or grout cylinders (or alternatively cubes for grout) shall be cured and tested in accordance with the State DOT specifications.

The samples will be tested by \_\_\_\_\_ (Agency's name) for unconfined compressive strength. As a minimum, two (2) samples shall be tested at seven days after sampling; two (2) samples shall be tested at 28 days after sampling; and two (2) samples will be held in reserve. Those samples tested at 28 days after casting shall exhibit a minimum compressive strength as specified in Section (8.)3.2.1 for grout or Section (8.)3.2.2 for concrete.

A grout sample shall be obtained from every truck, and shall be tested for fluid consistency (flow cone) and temperature prior to discharging into the pump hopper. The grout sample shall exhibit the fluid consistency as specified in Section (8.)3.2.1. Alternatively, if a concrete mix is used, a concrete sample shall be obtained from every truck, and shall be tested for slump and temperature prior to discharging into the pump hopper. The concrete sample shall exhibit the slump as specified in Section (8.)3.2.2. Additional samples may be required at the discretion of the Engineer at any time during the grout or concrete placing process to ensure that consistent fluidity/slump is being achieved.

**Commentary:** *Often smaller sized cylinder samples of grout are used and are typically either 3 in. (75 mm) diameter by 6 in. (150 mm) high, or 2 in. (50 mm) diameter by 4 in. (102 mm) high. Smaller sized cylinder samples for grout should only be permitted with prior approval by the Engineer. If the samples are cast using a method or sample different than that used for the mix design, a relationship between the compressive strengths obtained by the methods will need to be established.*

*The type of and frequencies for grout or concrete testing listed in this section are recommended as a minimum requirement. The Engineer may choose to increase the type or frequency of testing in the project specifications or at any time during the construction of the CFA piles. For non-critical foundations, only the Engineer may choose to relax the frequency of grout and concrete sampling and testing.*

*Some State DOTs have standard test procedures and/or frequencies that are not included in the specification when done by State personnel. In such cases, the State DOT should reference their testing manual/procedures and that the testing will be performed by State personnel.*

### **8.3.3 Auger Equipment**

The auger flights shall be continuous from the top of the auger to the bottom tip of the cutting face of the auger, with no gaps or other breaks. Gaps in the flighting are allowed only where auger sections are joined and may not exceed 1 in. (25 mm). The length of any auger brought to the project site shall be such that the auger is capable of installing a pile to a depth that is 20% greater than the depth of the pile shown on the approved working drawings. The auger flighting shall be uniform in diameter throughout its length, and the outside diameter of the auger shall be at least 97% of the design diameter of the pile. Only single helix augers shall be used. The hollow stem of the auger shall be maintained in a clean condition throughout the construction operation. In order to facilitate inspection, the leads shall be clearly marked every 1 ft (0.3 m) along its length so that such marks are visible to the unaided eye from the ground.

*Commentary: The requirements contained in this section are a minimum requirement for CFA piles. The CFA Pile Contractor may propose to use alternative equipment subject to the approval of the Engineer through the Installation Plan submittal process. In general for CFA piles, continuous flight augers that continuously remove soil during drilling are the common type of auger or drilling tool used. Consideration of augers or drilling tools that provide full or partial displacement of the soil during drilling should also be made.*

The bottom of the auger flights and the cutting teeth attached thereto shall be constructed geometrically so that the bottom of the pile will be as flat as feasible. The grout or concrete injection port shall be fitted with a means of sealing it against ingress of water and soil during drilling.

The auger shall be guided at the ground surface by a guide connected to the leads of the CFA piling rig. If the auger is over 40 ft (12 m) long, it shall also be guided by a guide to be located approximately half the length of the auger above the ground-surface guide. Where CFA piles are installed with hydraulic, fixed mast installation platforms, and the stem to which the auger is fixed has an outside diameter 10 in. (250 mm) or greater, a guide above the ground surface is not required. The leads that carry the rotary unit that power the auger should be restrained against rotation by an appropriate mechanism.

The piling rig shall be capable of penetrating the ground without drawing surrounding soils laterally into the pile bore, as is described in Section 3.5. It shall be capable of installing a pile to a depth at least 20% greater than the depth of the piles shown on the approved working drawings.

### **8.3.4 Automatic Measurement and Recording Equipment**

As a minimum, the following automatic measurements shall be made and recorded during the drilling operation:

1. auger rotation;
2. depth of the auger injection point;
3. torque delivered to the auger; and
4. crowd force (downward thrust on auger).

All measurements shall be referenced to (or plotted against) the depth of the auger injection point. This shall be accomplished with a rotational position indicator on the auger head system and an electronic position indicator on the crane line or boom holding the auger. Torque and thrust load cells shall be positioned on the auger head system.

As a minimum, the following automatic measurements shall be made and recorded during the grouting or concreting operation:

1. volume of grout or concrete;
2. maximum and minimum grout or concrete pressure;
3. auger rotation (if rotated); and,
4. depth of the injection point.

All measurements shall be referenced to (or plotted against) the depth of the auger injection point. This shall be accomplished with electronic flowmeters and electronic pressure transducers placed in the grout or concrete pressure line, an electronic position indicator on the crane line or boom holding the auger, and a rotational position indicator on the auger system.

Calibration shall be made on all measuring and recording equipment at the beginning of the project that will demonstrate that the values indicated by the measuring and recording equipment are within 3% of the values indicated. Calibrations shall be performed in accordance with the equipment manufacturer's specifications. All measuring and recording equipment shall also be recalibrated when the Engineer suspects that the drilling and grouting or concreting performance has changed.

***Commentary:** Automated measuring and recording equipment provide real time evaluation of each pile on a project. Piles that have installation records out of specification or that otherwise appear abnormal can be selected for integrity tests or verification load tests to determine if they should be accepted or rejected.*

### **8.3.5 Drilling**

The CFA Pile Contractor shall perform the drilling required for the piling, through whatever materials are encountered, to the dimensions and elevations required by the CFA Pile Contractor's design, as shown on the approved working drawings. Drilling shall not commence until sufficient supply of grout or concrete is present on the project site to complete the pile. The drilling parameters (auger rotation speed, penetration rates, crowd, torque, etc.) for the production piles shall be within the ranges established in the Pile Installation Plan, as verified by the pre-production testing program. The same procedures used to install the test piles shall be used to install production piles.

The center of any pile shall be within 3 in. (75 mm) of the location shown on the approved working drawings in a horizontal plane (i.e., plan-view). The completed pile shall be plumb to within 2%, if vertical, or shall be installed to within 2% of its design batter, as determined by the

angle from the vertical, if planned as a batter pile. Any pile in violation of these tolerances will be subject to review by the Engineer and may be rejected or replaced at the CFA Pile Contractor's expense.

Adjacent piles within six diameters, center to center, of each other shall not be installed until it can be demonstrated by the CFA Pile Contractor that the grout or concrete in the first pile installed is fully set. The grout or concrete should have set enough such that the integrity of the existing pile will not be compromised if drilling the new pile causes mining of soil away from the existing pile.

The auger shall not be extracted from the ground at any time during the construction of a pile in such a way that would result in an open unsupported borehole or inflow of water into the pile borehole. It should become necessary to raise the auger and subsequently re-insert the auger during the pile construction process, the depth of the pile shall be increased and/or other additional measures shall be required as directed by the Engineer.

The auger shall be advanced into the ground at a continuous rate and at a rate of rotation that prevents excess spoil from being transported to the ground surface. The rate of penetration shall be established as a part of the test pile program. Automated monitoring equipment shall be used to verify this target rate of penetration is maintained during construction of production piles.

Pile termination criteria, including refusal criteria, if applicable, will be established during the pre-production test pile program. If refusal is encountered before planned depth is achieved, rotation of the auger shall be stopped, and the CFA Pile Contractor shall inform the Engineer. The CFA Pile Contractor and Engineer shall evaluate the installation data and determine if the established termination criteria have been met, or if other action is required to complete the pile. If an obstruction is encountered and it does not allow the pile to be completed in the planned location, the CFA Pile Contractor shall notify the Engineer and the Design Engineer in order for the Engineer and Design Engineer to determine remedial action.

***Commentary:** The penetration rate should generally be maintained such that the auger advances a depth equal to or greater than the pitch of the auger for every 1.5 to 2 revolutions for cohesionless soils, or 2 to 3 revolutions for cohesive soils. Loose cohesionless soils are more susceptible to mining by the auger flights, and generally call for the more stringent guideline. The intent of this provision is that the piles be constructed to a consistent standard as reflected in the results of the test pile program, and that soil mining be avoided.*

*In general, refusal is defined as a rate of auger penetration of less than 1 ft/minute (0.3 m/minute) with equipment that is appropriate for the project. If correlated with soil boring information, refusal may provide an indication that a strong layer has been reached, but should not be used as the sole criteria for setting pile tip levels for conventional CFA piles. Refusal criteria may be used to set pile tip levels for drilled displacement piles, based on the criteria established and verified to achieve capacity during the pile load testing program.*

### 8.3.6 Placement of Grout or Concrete

The placement of grout or concrete shall commence within 5 minutes after the auger has achieved the planned depth. Grout or concrete shall be pumped through the hollow-stem auger with sufficient pressure (as measured at the top of the auger) as the auger is withdrawn to completely form the pile and fill any soft or porous zones surrounding the pile.

At the beginning of grout or concrete placement the sealing device (plug, or bottom cover plate at the tip of the auger) shall be removed by the application of grout or concrete pressure, or with a central reinforcing bar. As pumping begins, the auger shall be lifted from 6 to 12 in. (0.15 to 0.3 m) to facilitate removal of the sealing device. Care shall be taken to ensure that the auger is lifted only within this specified range to initiate the flow of grout or concrete, and that water inflow and soil movement at or near the base of the auger are minimized. After withdrawing the auger to initiate the flow of grout or concrete, the tip of the auger should be re-inserted to at least the original depth.

The technique and equipment used to initiate and maintain the grout or concrete flow shall be such that a pile of the full design cross-section is obtained from the maximum depth of boring to the final pile cut-off level. The grout or concrete shall be supplied to the pile at a rate during auger withdrawal that ensures that a continuous monolithic shaft of at least the full specified cross-section is formed, and is free from soil inclusions or any grout or concrete segregation.

The auger shall be extracted at a smooth, steady rate while continuously pumping. If rotation of the auger occurs during auger extraction, it shall be positive, i.e. in the same direction as during drilling.

Satisfactory coordination of auger withdrawal with pumping is indicated by maintaining a positive pressure in the grout at the auger tip, and a sufficient volume or pressure of grout or concrete to fill the pile (with a small oversupply of volume). Satisfactory coordination shall be verified using automated monitoring equipment.

The volume of grout or concrete placed as a function of depth shall be measured and recorded at intervals not exceeding 2 ft (0.6 m) using automated monitoring equipment. The magnitude of minimum oversupply (or grout volume factor) appropriate for the site conditions shall be established during the pre-production test pile program and maintained during production pile construction. Inadequate volume pumped over a depth interval of 5 ft (1.5 m) is a basis for rejection of the pile.

*Commentary: Typical grout volume factors range from 1.15 to 1.2 (i.e., 15% to 20% oversupply). In general, a grout volume factor of 1.15 is considered to be a minimum value. Grout factors greater than 1.5 suggest that soil mining or other undesirable installation effects may be occurring. There may be some cases where grout factors greater than 1.5 are acceptable, particularly if integrity and proof tests indicate that the pile meets the performance requirements and if pre-production piles showed similar results.*

The grout/concrete volume factor of the pile shall be within 7.5% of the target volume factor established in the Pile Installation Plan as modified by the results of the pre-production test pile program. Production piles installed outside of this range shall be considered unacceptable piles as listed in Section (8.)3.13.

If placement of grout or concrete is suspended for any reason, such as equipment failure, the pile will need to be re-drilled. The pile may be re-drilled in the same location if the grout or concrete is still fluid enough for the drill rig to penetrate. If the concrete or grout has set, the pile will need to be re-drilled in a new location. The Pile Installation Plan and working drawings will need to be revised by the CFA Pile Contractor to reflect the changes and submitted to the Engineer for approval prior to re-drilling the pile.

*Commentary: During grouting, the auger should be pulled with either no rotation or slow continuous rotation in the direction of drilling. A static pull with no rotation can help maintain a static condition at the base of the auger against which the grout/concrete pressure acts. Some contractors prefer to slowly rotate the auger during withdrawal in order to minimize the risk of having the auger flight stick. In addition, some augers have an off-center discharge plug at the base and slow rotation may help to avoid concentrating the distribution of the grout and pressure to an off-center location within the hole. If rotation is used it must be very slow so that the auger does not tend to conduct the soil on the auger flights to the surface ahead of the auger.*

*The intent of this provision is that the piles be constructed with grout/concrete volumes consistent with the standard as reflected in the results of the pre-production test pile program. The production piles should be installed at the same grout volume factor (within an acceptable range) that was used for the pre-production test pile installation. A pile which is not completed with adequate volume of grout or concrete may be re-drilled at the CFA Pile Contractor's discretion, and this fact recorded on the pile record. The acceptance of a re-drilled pile is at the Engineer's discretion.*

### **8.3.7 Pile Head Finishing and Protection**

Immediately upon completion of placement of the fluid grout or concrete, the CFA Pile Contractor shall remove all excess grout or concrete and spoil from the vicinity of the top of the excavation and place a suitable temporary device within the top of the excavation, extending both above and below the ground surface by at least 1 ft (0.3 m) to keep surface spoil from entering the grout or concrete column before it sets. Immediately upon placement of this temporary device, the CFA Pile Contractor shall remove any and all loose soil that has fallen into the grout or concrete column using the tools and methods contained in the approved Pile Installation Plan, and before the grout or concrete begins its initial set. The temporary device shall be removed without disturbing the natural soil surrounding the top of the pile once the grout or concrete has set.

### **8.3.8 Reinforcing Steel Placement**

Any required reinforcing steel shall be placed as shown on the plans by lowering the steel into the grout or concrete column while it is in a fluid state. The reinforcing steel shall be free of oil,

soil, excessive rust or other deleterious material. The reinforcing steel shall be centered in the excavation by means of plastic or cementitious spacers placed at sufficient intervals along the pile and at sufficient intervals around the steel to keep the steel centered. Metallic spacers shall not be permitted. Centralizer types and spacing are subject to approval by the Engineer. If cages of reinforcing steel are called for on the approved working drawings, the longitudinal bars and lateral reinforcement (spiral or horizontal ties) shall be completely assembled and placed as a unit. Where spiral reinforcement is used, it shall be tied to the longitudinal bars at a spacing not to exceed 1 ft (0.3 m) unless otherwise shown on the plans. Welding of reinforcement is permitted only if weldable reinforcing steel is specified as part of the approved design.

The reinforcing steel shall not be spliced except at locations that are shown on the plans, and the reinforcing steel shall be free of any permanent distortion, such as bars bent by improper pickup. If a pile is required by the Engineer to be lengthened after the steel has been cut and cages have been assembled, the schedule of reinforcing steel (both longitudinal and lateral) shall be extended to the required depth by splicing. Splices should be as close to the bottom of the reinforcing cage as possible. Splicing by welding shall not be permitted unless weldable reinforcing steel is specified as part of the approved design.

The reinforcing steel shall be placed in the grout column immediately after screening the grout or concrete and before the grout or concrete begins to set. The steel may be lowered into the grout or concrete by gravity or pushed gently to final position by hand. The reinforcing steel shall not be vibrated, driven, or otherwise guided into position by mechanical means.

The reinforcing steel shall be held in position at the ground surface within the fluid grout column by supports appropriate for the reinforcement used, which shall remain in place until the grout reaches its initial set, or 24 hours, whichever is longer.

***Commentary:** If the soil profile contains considerable dry or moist sand, it is critical that the cage be placed as soon as possible after placement of grout or concrete, in less than 10 minutes if possible, because the grout or concrete will begin to set very quickly under such conditions. Steel spacers should not be permitted as they may greatly accelerate corrosion of the reinforcing steel, particularly above the ground water table. Centering guides made of steel, such as a wire "basket" or "football" tied at the base of single-rod reinforcement may be used. The time for initial set will vary according to mix design. Mixes with significant amounts of retarders or fluidifiers may require longer than 24 hours to reach initial set under certain conditions (cold weather, for example). The installation plan should include requirements for the duration of reinforcement support.*

### **8.3.9 Pile Cut-Off**

The CFA Pile Contractor shall cut off the tops of piles and square with the pile axis at the elevations indicated on the approved working drawings, by removing fresh grout or concrete from the top of the pile or by cutting off hardened grout or concrete down to the final cutoff point at any time after initial set has occurred. The finished top of pile shall be no more than 1 in. (25 mm) below or 3 in. (75 mm) above the elevation shown on the approved working drawings.



### **8.3.10 Inspection and Records**

The CFA Pile Contractor shall maintain accurate records for each pile constructed. Similar records will be maintained by the Engineer. These records shall show:

1. Pile location;
2. Ground surface elevation (reference grade for pile length);
3. Pile toe (bottom) depth and elevation;
4. Elevation of top of grout or concrete;
5. Pile length;
6. Auger diameter;
7. Details of the reinforcing steel (number, size, and grade of longitudinal bars, size and spacing of transverse steel; outside diameter and length of cage);
8. Flowcone efflux time and volume of grout placed or slump and volume of concrete placed
9. Theoretical volume of drilled hole (theoretical diameter = diameter of auger);
10. Depth to which reinforcing steel was placed;
11. Date/Time of beginning of drilling;
12. Date/Time of completion of drilling;
13. Date/Time grout or concrete was mixed;
14. Date/Time ready-mix grout or concrete truck arrived at project site, and copies of all grout or concrete batch tickets used for the pile construction;
15. Date/Time of beginning of grout or concrete pumping;
16. Date/Time of completion of grout or concrete pumping;
17. Date/Time of placement of reinforcing steel;
18. Weather conditions, including air temperature, at time of grout or concrete placement;
19. Identification of all grout or concrete samples taken from the pile;
20. All other pertinent data relative to the pile installation; and
21. All readings made by the automated measuring and recording equipment to include as a minimum:
  - a. Auger rotation verses depth for every 2 ft (0.6 m) increment, or less, of pile advancement during the drilling process, and during placement of grout or concrete (if auger is rotated during this placement);
  - b. Volume of grout or concrete placed versus depth of outlet orifice for every 2 ft (0.6 m) increment, or less, of pile placed;
  - c. Average maximum and minimum pump stroke pressures at ground level for every 2 ft (0.6 m) increment, or less, of pile placed;

- d. Average maximum and minimum pump stroke pressure at or near the auger head for every 2 ft (0.6 m) increment, or less, of pile placed, if directed by the Engineer; and
- e. Additionally, the Engineer may also specify that torque and crowd force (downward thrust on auger) measurements be made for every 2 ft (0.6 m) increment, or less, of pile advancement during the drilling process.

These data shall be provided to the Engineer within 24 hours of the completion of the pile. Data collected by automated measuring and recording equipment shall be provided in numerical or graphical form.

### **8.3.11 Testing**

Any testing of CFA piles shall conform to the pertinent item requirements in the relevant State DOT's Standard Specifications. If the relevant Standard Specifications do not refer to load testing for CFA piles specifically, the specifications for load testing of deep foundations may be used.

*Commentary: A discussion of testing programs and procedures is contained in Chapter 7 of the FHWA "Geotechnical Circular No. 8 – Augered Cast-in-Place and Continuous Flight Auger Piles". The scope of the testing program for all structures will depend on many factors, including the anticipated loads and the quantity of piles to be installed on the project. For structures that are often referred to as "non-critical structures", such as sound barrier walls, overhead signs, and light/signal pole foundations, the Engineer may not require the same frequency of testing as for bridges and other structures. For example, a qualified contractor that consistently demonstrates proper installation techniques may not need to perform a load test for a lightly loaded pile for a "non-critical" structure. Monitoring records during construction and post-construction integrity testing may provide sufficient confidence for the Owner that the piles will carry the design load.*

#### **8.3.11.1 Pre-Production Testing**

Piles installed for pre-production testing (including any reaction piles required for static load testing) shall include all construction, monitoring, and inspection requirements of production piles. The results of the installation and testing will be used to:

1. Establish target drilling penetration rate for the various subsurface conditions on the site;
2. Establish pressure/volume relations during placement of grout/concrete. The grout factor  $\pm 7.5\%$  calculated for the test pile(s) shall be used for the installation of the production piles;
3. Establish target values for torque and downward thrust or crowd for displacement or partial displacement piles;
4. Establish mix design parameters such as grout flow, necessary admixtures, etc; and

5. Evaluate design correlations of side and base resistance with the site specific soil parameters. Revision of the design by the CFA Pile Contractor may result from these tests, subject to approval by the Engineer.

All of the parameters listed above that are established during the pre-production test pile program will be used to install the production piles.

**Commentary:** *In past practice, the pre-production test program was primarily a load test program which demonstrated that the contractor could properly install a test pile and achieve the desired load capacity of the pile. The intent of the pre-production testing program in this specification is to install test piles to establish and/or verify installation criteria as well as load capacity. The results of the pre-production test program will then be used during production pile installation to ensure that the CFA Pile Contractor is consistently installing acceptable piles (i.e. the production pile is the same as a test pile).*

*Pre-production load tests will generally consist of a single or multiple static load tests, depending on the number of piles to be installed, the range of design pile capacities and the variation of subsurface conditions at the site. For very large projects, pre-production testing may include a single static load test supplemented with several piles tested by the rapid or dynamic load test methods outlined in Section (8.)3.11.2. Performing rapid or dynamic tests during the pre-production testing program will allow these methods to be calibrated against static load tests results prior to production pile installation. The CFA Pile Contractor and the Engineer will be able to best determine the appropriate quantity and level of pre-production testing based on the project conditions.*

*Since a major advantage of CFA piles is speed of installation, the pre-production load test program may be performed concurrent to the start of production piles to reduce additional mobilization or delay costs. This may be sufficient for small to medium sized projects. The ability to modify the design based on the results of the load test may be limited in this case.*

#### 8.3.11.2 Verification Load Testing

Verification tests shall be performed on a minimum of 2% of production piles (and more as required by the Engineer) to demonstrate that the installed production piles meet the established load-deflection criteria. Verification tests can be performed using static load tests, rapid load tests (RLT), or dynamic load tests (DLT). Combinations of the various test methods may also be used as appropriate for the project. RLT and DLT test methods shall conform to the State DOT Standard Specifications or be otherwise approved by the Engineer.

**Commentary:** *A single pre-production test only demonstrates the performance of the test pile. Performing verification tests periodically throughout production pile installation will verify that the pile installation techniques continue to provide adequate pile capacities. The use of RLT (such as Statnamic™ or Fundex systems) or DLT (drop hammer) can often allow testing a large number of piles more efficiently, in terms of time and cost when compared to static load test methods. Calibrating the RLT or DLT tests with static load tests during the pre-production test program may reduce delays associated with analyzing the test data during pile production.*

### 8.3.12 Integrity Testing

Post-installation integrity tests shall be performed on a minimum of 20% of the production piles. Such tests include, but are not limited to, sonic echo tests, impulse-response tests, cross-hole sonic tests, and backscatter gamma tests. Specific integrity test requirements are outlined in the bid documents. Test methods shall conform to the State DOT Standard Specifications or be otherwise approved by the Engineer.

The CFA Pile Contractor shall install access tubes (of a design that is acceptable to the Integrity Testing Firm) to accommodate those tests that require access to the interior of the CFA pile. These tubes shall be secured to the reinforcing steel and capped prior to placing the steel cage in the fluid grout. The piles that will include the access tubes shall be noted on the approved working drawings and in the test program.

The CFA Pile Contractor shall engage an independent Consultant, acceptable to the Engineer, to perform integrity tests and to report the results, with interpretations, to the CFA Pile Contractor and the Engineer.

*Commentary: Post-installation integrity tests are valuable in establishing that a CFA Pile Contractor's procedures are producing acceptable piles on any given project. The most reliable of the post-installation integrity tests for identifying anomalies within the pile are those that use down-tube instruments, such as the cross-hole sonic (CSL) test, single-hole sonic test (SST), the backscatter gamma test, and the fiber-optic television camera test. These tests all require that the CFA Pile Contractor attach appropriate access tubing to the reinforcing steel prior to placing the steel in the grout column. They also require interpretation, which should be performed by independent, experienced, and qualified specialty consultants. It is not always possible to determine whether an anomalous reading is a defect within the pile. The final decision on acceptability of the pile must be made by the Engineer, based on construction records, the post-installation integrity test expert's report, and upon the Engineer's analysis of the possible effect on foundation performance of the potential defect.*

*In order to be effective, access tubes for sonic or backscatter gamma testing should be distributed evenly circumferentially around a reinforcing cage at a frequency of approximately one for every 1 ft (0.3 m) of cage diameter. It is advisable that tubes used for cross-hole sonic tests consist of Schedule 40 steel, because such tubes will remain bonded to the grout. Polyvinyl chloride (PVC) tubes do not ordinarily remain bonded to the grout beyond a few days after grout takes its initial set, and debonding will render the cross-hole sonic tests ineffective. PVC tubes should be used only for backscatter gamma testing unless cross-hole sonic tests will be performed within 72 hours of casting the grout.*

*The necessary frequency of post-construction integrity testing should be outlined in the owner's bid package. In situations when the Owner has little experience with CFA piles, a particularly difficult project is at hand, or the project or site conditions give reason to expect problems with pile integrity, integrity testing of more than 20% of production piles may be required. A typical reasonable approach for load-bearing piles is to subject the first 10 to 15 piles to be constructed to integrity tests to establish that the contractor's construction practice at the site is adequate.*

*Thereafter, the frequency of such tests can be set to meet the 20% criteria, can be reduced, or perhaps eliminated if the construction records for the remaining production piles are similar to those of the initial piles that were subjected to integrity tests.*

### **8.3.13 Unacceptable Piles**

Unacceptable piles are defined as piles that do not meet the project performance criteria with regard to load carrying capacity and deflections. The following items constitute construction conditions would be considered a basis for pile rejection:

1. Piles that are tested using post-installation integrity testing methods and are judged by the Engineer to be unacceptable.
2. Piles subjected to a verification load test where the test indicates the load capacity of the pile does not meet the design load and deflection criteria with an appropriate factor of safety.
3. Piles for which the data from the automated measuring and recording equipment, other recording methods, or the Inspector's records indicate that a defective pile has been installed due to an inadequate penetration rates, grout/concrete volume factors or pressures, or other pile installation parameters that do not meet the criteria established by the pre-production test program.
4. Piles out of position at the ground surface or not within the plumbness or batter limits defined in Section (8.)3.5.
5. Piles in which the top of pile elevation is outside the limits shown on the approved working drawings and described in Section (8.)3.9.
6. Piles in which the grout or concrete strength, and/or grout or concrete factor is less than as designed.
7. Piles in which the reinforcing steel was not inserted as designed.
8. Piles that exhibit any visual evidence of grout or concrete contamination, excessive settlement of grout/concrete, structural damage, or inadequate consolidation of grout/concrete (honeycombing).

Unacceptable piles shall be replaced or repaired at the CFA Pile Contractor's expense, as directed by the Engineer.

**Commentary:** *In addition to the above list, there may be incidents that cause a pile to be unacceptable, such as when lateral communication occurs between piles, or when excessively large grout takes occur. The action taken by the CFA Pile Contractor, Inspector, and Engineer will vary depending on the circumstances. The soil conditions, design load, and other design factors will need to be considered before the pile is rejected or the CFA Pile Contractor is allowed to repair or replace the pile. Options include, but are not limited to, abandoning the pile, switching from grout to concrete, or allow the pile to be grouted to the best of the CFA Pile Contractor's ability and then re-drill the pile after the grout has had its initial set. Judgment on the part of the Engineer and the Design engineer will need to be exercised.*

## **8.4 MEASUREMENT**

CFA pile foundations shall be measured as per pile. Pre-production testing will be measured as a lump sum. Integrity tests and verification load tests will be measured on a per pile basis.

## **8.5 PAYMENT**

The work performed and materials furnished in accordance with this Item and measured as provided under Section (8.)4 (“Measurement”) will be paid for at the unit prices bid under the payment categories listed below.

Payment categories:

1. Per pile accepted by the Engineer.
2. Per pile placed with access tubes for down-hole integrity testing accepted by the Engineer.
3. Per pile for integrity testing on a production pile.
4. Per pile for rapid load test on a production pile.
5. Per pile for dynamic load test on a production pile.
6. Lump sum for pre-production test program as approved by the Engineer.

The quantities to be paid will be the quantities in each category shown on the approved working drawings and as accepted after installation by the Engineer, unless specific changes are required in writing by the Engineer. Unit prices that are bid will apply to the extension of any pile to a depth up to 120% of the depth for that pile that is shown on the approved working drawings when such an increase in depth is required by the Engineer. For such purposes, the length of the pile shall be measured between the top of the grout or concrete and the bottom of the pile. If increases in depth exceeding 120% of the depth shown on the working drawings are required by the Engineer, or if diameters other than those that are shown on the working drawings are required by the Engineer, the unit prices shall be renegotiated for those piles involved.

## CHAPTER 9 REFERENCES

- AASHTO (2002). "Standard Specifications for Highway Bridges," 17th Edition, American Association of State Highway and Transportation Officials, Washington, D.C.
- AASHTO (2006). "LRFD Bridge Design Specifications," 4<sup>th</sup> Edition, American Association of State Highway and Transportation Officials, Washington, D.C.
- ACI (2004). "Building Code Requirements for Reinforced Concrete," American Concrete Institute, Detroit, MI.
- API. (1993). "Recommended Practice for Planning, Designing and Constructing Fixed Offshore Platforms - Working Stress Design," 20th Edition, American Petroleum Institute, Dallas, Texas, pp. 191.
- ASTM (2006). "Annual Book of ASTM Standards," West Conshohocken, PA.
- Brown, D.A., Reese, L.C., and O'Neill, M.W. (1987). "Cyclic lateral loading of a large-scale pile group," *Journal of Geotechnical Engineering*, ASCE, Vol. 113, No. 11, pp.1326–1343.
- Brown, D.A., Morrison, C. and Reese, L.C. (1988). "Lateral Load Behavior of a Pile Group in Sand," *Journal of Geotechnical Engineering*, ASCE, Vol. 114, No. GT11, pp. 1261–1276.
- Brown, D.A. and Drew, C. (2000). "Axial Capacity of Augered Displacement Piles at Auburn University," *Geotechnical Special Publication No. 100*, N. D. Dennis, R. Castelli, and M. W. O'Neill (Eds.), ASCE, August, pp. 397–403.
- Bridge Software Institute (2003). "FB-Pier" Version 3.0. University of Florida, Gainesville, FL.
- Bustamante, M., and Gianceselli, L. (1981). "Portance Réelle et Portance Calculée des Pieux Isolés Sollicités Verticalement," *Revue Francaise de Géotechnique*, No. 16, Presses de l'ENPC, France.
- Bustamante, M., and Gianceselli, L. (1982). "Pile Bearing Capacity by Means of Static Penetrometer CPT," In *Proceedings of the 2nd European Symposium on Penetration Testing*. Amsterdam, pp. 493–500.
- Chin, F.K. (1970). "Estimation of the Ultimate Load of Piles not Carried to Failure," *Proceedings of the Second Southeast Asian Conference on Soil Engineering*, Singapore, Vol. 1, pp. 81–90.
- Clemente, J.L.M., Davie, J.R., and Senapathy, H. (2000). "Design and Load Testing of Augercast Piles in Stiff Clay," *Geotechnical Special Publication No. 100*, Ed. By N. D. Dennis, R. Castelli, and M. W. O'Neill (Eds.), ASCE, August, pp. 398–403.

- Coleman, D.M. and Arcement, B.J. (2002). "Evaluation of Design Methods for Auger Cast Piles in Mixed Soil Conditions," Proceedings of the International Deep Foundations Congress 2002, February 14-16, 2002 Orlando, Florida; M.W. O'Neill and F.C. Townsend (Eds.), ASCE, pp. 1404–1420.
- Collin, J.G. (2004). "Column Supported Embankments - Technical Summary #7. Ground Improvement Methods", FHWA NHI-04-001, October, Federal Highway Administration, Washington, D.C.
- Coyle H. M., and Castello, R. R. (1981). "New Design Correlations for Piles on Sand," Journal of the Geotechnical Engineering Division, ASCE, Vol. 106 No. GT7, pp. 965–986.
- Decourt, L. (2003). "Behaviour of a CFA Pile in a Lateric Clay," Proceedings of the 4<sup>th</sup> International Geotechnical Seminar on Deep Foundations on Bored and Auger Piles, BAP IV, Ghent, Belgium, pp. 301–308.
- DFI (2005). "Manual for Non Destructive Testing and Evaluation of Drilled Shafts", Deep Foundations Institute, Chernauskas, L.E. (Ed.) Hawthorne, NJ.
- Douglas, D. J. (1983). "Discussion on Paper 17-22: Case Histories," Proceeding, Conference on Piling and Ground Treatment, Institution of Civil Engineering, London, pp. 283.
- Fleming, W.G.K. (1995). "The Understanding of Continuous Flight Auger Piling, Its Monitoring and Control," Proceedings, Institution of Civil Engineers Geotechnical Engineering, Vol. 113, July, pp. 157–165. Discussion by R. Smyth-Osbourne and reply, Vol. 119, Oct., 1996, p. 237.
- Frizzi, R.P. and Meyer, M.E. (2000). "Augercast Piles: South Florida Experience," Geotechnical Special Publication No. 100, N. D. Dennis, R. Castelli, and M. W. O'Neill (Eds.), ASCE, August, pp. 382–396.
- Garg, K.G. (1979). "Bored Pile Groups under Vertical Load in Sand," Journal of the Geotechnical Engineering Division, ASCE, Vol. 105, No. GT8, pp. 939–956.
- Gupton, C. and Logan, T. (1984). "Design Guidelines for Drilled Shafts in Weak Rocks in South Florida," Proceedings South Florida Annual ASCE Meeting, ASCE.
- Han, J. and Akins, K. (2002). "Case Studies of Geogrid-Reinforced and Pile-Supported Earth Structures on Weak Foundation Soils," Proceedings of the International Deep Foundation Congress, Geotechnical Special Publication No. 116 - Deep Foundations 2002, M. W. O'Neill and F. C. Townsend (Eds.), ASCE, Orlando, FL, pp. 668–679.
- Hannigan, P.J., Goble, G.G., Likins, G.E., and Rausche, F., R.R. (2006). "Design and Construction of Driven Pile Foundations," Volume I; NHI courses No. 132021 and 132022 Reference Manual, April, 968 p.



- Hetenyi, M. (1946). "Beams on Elastic Foundations," University of Michigan Press, Ann Arbor, MI.
- Kaderabek, T. J., Reynolds, R. T. (1981). "Miami limestone foundation design and construction," *Journal of the Geotechnical Engineering Division, ASCE*, Vol. 127 GT7, July, pp. 859–872.
- Kulhawy, F.H. (1984). "Limiting Tip and Side Resistance: Fact or Fallacy?," *Proceedings of the Symposium on the Analysis and Design of Pile Foundations*. ASCE, San Francisco, CA, pp. 80–98.
- Kyfor, Zenon G., Schnere, Austars R. (1992). "Static Testing of Deep Foundations," Report No. FHWA-SA-91-042, Federal Highway Administration, Washington, D.C.
- McVay, M., Armaghani, B, and Casper, R. (1994). "Design and Construction of Auger-Cast Piles in Florida," *Transportation Research Record 1447, Design and Construction of Auger Cast Piles, and Other Foundation Issues*, Washington, pp. 10–18.
- McVay, M.C., Casper, R., and Shang, T. (1995). "Lateral Response of Three Row Groups in Loose to Dense Sands at 3D and 5D Pile Spacing," *ASCE, Journal of Geotechnical Engineering*, ASCE, Vol. 121, No. 5, pp 436–441.
- Meyerhof, G.G. (1976). "Bearing Capacity and Settlement of Pile Foundations," *Journal of Geotechnical Engineering*, ASCE, Vol. 102, GT3, pp. 195–228.
- Mindess, S., Young, J. F., and Darwin, D. (2003). "Concrete" 2nd Edition, Prentice Hall, Upper Saddle River, NJ, 644 p.
- Moss, R.E.S. (1997). "Cyclic Lateral Loading of Model Pile Groups in Clay Soil: Phase 2B," Masters Thesis, Utah State University.
- Nataraja, M. S., and Cook, B. E. (1983). "Increase in SPT N-Values Due to Displacement Piles," *Journal of the Geotechnical Engineering Division, ASCE*, Vol. 109, No. GT1, pp. 102–113.
- Neely, W. J. (1991) "Bearing Capacity of Auger-Cast Piles in Sand," *Journal of Geotechnical Engineering*, ASCE, Vol. 117, No. 2, pp. 331–345.
- NeSmith, W.M. (2002). "Static Capacity Analysis of Augered, Pressure-Injected Displacement Piles," *Geotechnical Special Publication No. 116*, M. W. O'Neill and F. C. Townsend (Eds.), ASCE, February, Vol. 1, pp. 1088–1097.
- O'Neill, M. W., Ata, A., Vipulanandan, C., and Yin, S. (2002). "Axial Performance of ACIP Piles in Texas Coastal Soils," *Geotechnical Special Publication No. 116*, Ed. by M. W. O'Neill and F. C. Townsend (Eds.), ASCE, February, Vol. 1, pp. 1290–1304.

- O'Neill, M. W., Vipulanandan, C., Ata, A., Tan, F. (1999). "Axial Performance of Continuous-Flight-Auger Piles for Bearing," Final report to the Texas Department of Transportation, Report No. 7-3940-2, August, 254 p.
- O'Neill, M.W. and Reese, L.C. (1999). "Drilled Shafts: Construction Procedures and Design Methods," FHWA Report No. IF-99-025, Federal Highway Administration, Washington, D.C.
- O'Neill, M.W., Vipulanandan, C., and Hassan, K. (2000). "Modeling of Laterally Loaded ACIP Piles in Overconsolidated Clay," Geotechnical Special Publication No. 100, N. D. Dennis, R. Castelli, and M. W. O'Neill (Eds.), ASCE, August, pp. 382–396.
- Peck, R. B., Hanson, W. E., Thornburn, T. H. (1974). "Foundation Engineering", 2nd Edition, Wiley & Sons, New York, NY.
- Ramos, H.R., Antorena, J.A., and McDaniel, G.T. (1994) "Correlations between the Standard Penetration Testing (SPT) and the Measured Shear Strength of Florida Natural Rock, in Proceedings FHWA International Conference on Design and Construction of Deep Foundations, Orlando, FL, pp. 699–711.
- Reese, L. C. (1986). "Behavior of Piles and Pile Groups Under Lateral Load", Publication No. FHWA-RD-85-106, Federal Highway Administration, Washington, D.C.
- Reese, L. C., and O'Neill M. W. (1988). "Drilled Shaft: Construction Procedures and Design Methods," FHWA-HI-88-042, Federal Highway Administration, Washington, D.C.
- Reese, L., Wang, S-T., Arrellaga, J.A., and Hendrix, J. (2006). "LPILE - A Program for the Analysis of Piles and Drilled Shafts Under Lateral Loads." Version 5.0 Plus, ENSOFT, Inc., Houston, TX.
- Reese, L., Wang, S-T., Arrellaga, J.A., and Hendrix, J. (2006). "GROUP - A Program for the Analysis of a Group of Piles Subjected to Axial and Lateral Loading," Version 7.0, ENSOFT, Inc., Houston, TX.
- Rizkallah, V. and Bruns, T. (1988). "Estimation of Pile Bearing Capacity of Cast-in-Place Screwed Piles," Proceedings of the 3rd International Geotechnical Seminar on Deep Foundations on Bored and Auger Piles, BAP III, Ghent, Belgium, pp. 417–424.
- Rollins, K. M., Peterson, K. T., and Weaver, T. J. (1998). "Lateral load behavior of full-scale pile group in clay," *Journal of Geotechnical and Geoenvironmental Engineering*, ASCE, Vol. 124, No. 6, pp. 468-478.
- Ruesta, P.F., and Townsend, F.C. (1997). "Evaluation of laterally loaded pile group at Roosevelt Bridge," *Journal of Geotechnical and Geoenvironmental Engineering*, ASCE, Vol. 123, No. 12, pp. 1153–1161.

- Sabatini, P.J., Tanyu, B., Armour, T., Groneck, P., and Keeley, J. (2005). "Micropile Design and Construction," FHWA NHI-05-039; NHI Course 132078 Reference Manual, December, 436 p.
- Semeraro, M.A. (1982). "Evaluation of and Design Considerations for Drilled Shafts Socketed into Coral and Coquina Limestones," MS Thesis, Massachusetts Institute of Technology, Dept. of Civil and Environmental Engineering.
- Senna R. S., Cintra, J. C. A., Rezende, M. E. B. (1993). "Load Distribution In Bored Pile Groups," In Proceedings of the Second International Geotechnical Seminar on Deep Foundations on Bored and Auger Piles, Ghent, Belgium, Balkema, Rotterdam, pp. 151–154.
- Terzaghi, K. and Peck, R.B. (1967). "Soil Mechanics in Engineering Practice," 2nd Edition, John Wiley & Sons, New York, NY.
- Texas Highway Department (1972). "Foundation Exploration and Design Manual," Bridge Division, 2nd Edition, July.
- Tomlinson, M. J. (1957). "The Adhesion of Piles Driven in Clay Soils," in Proceedings of the 4th International Conference on Soil Mechanics and Foundation Engineering, Vol. 2, 1957, pp. 66–71, Butterworths Scientific Publications, Ltd. London, England.
- Tomlinson, M.J. (1994). "Pile Design and Construction Practice," 4th Edition, E & FN Spon, Chapman and Hall, London, 411 p.
- U.S. Army Corps of Engineers. (1994) "Standard Test Method for Flow of Grout for Preplaced-Aggregate Concrete (Flow Cone Method) (ASTM C 939-94a)," CRD 611–94.
- Viggiani, C. (1993) "Further Experiences with Auger Piles in Naples Area," Proceedings of the 2nd International Geotechnical Seminar on Deep Foundations on Bored and Auger Piles, BAP II, Ghent, Belgium, pp. 445–458.
- Vipulanandan, C., Kim, M.G., and O'Neill, M.W. (2004). "Axial Performance of Continuous Flight Auger Piles for Bearing", Project Report No. 7-3940-2, Texas Department of Transportation, 253 pp.
- Webb, D., Everts, H.J., de Boer, F., and Brons, K.F. (1994). "Bearing Capacity of Piles Influenced by Building Stages," 13th International Conference on Soil Mechanics and Foundation Engineering, Vol. 2, p. 465, Balkema, Rotterdam.
- Wright, S.J. & Reese, L.C. (1979). "Design of Large Diameter Bored Piles," Ground Engineering, Vol. 12, No. 8, pp. 17–51.
- Zelada, G. A., and Stephenson, R. W. (2000). "Design Methods for Auger CIP piles in Compression," New Technological and Design Developments in Deep Foundations, ASCE Geotechnical Special Publication No. 100, N. D. Dennis, R. Castelli and M. W. O'Neill (Eds.), ASCE, August, pp. 418–432.

# APPENDIX A COMPARISONS OF METHODS FOR ESTIMATING THE STATIC AXIAL CAPACITY OF CFA PILES

## A.1 INTRODUCTION

This appendix provides background documentation used to select the recommended method for computing the static axial capacity presented in Chapter 5, and to summarize alternative methods. The methods used for estimating the static axial capacity of continuous flight auger (CFA) piles include methods developed from evaluation of load tests conducted on CFA piles and methods developed for driven piles and drilled shafts. Most of the methods developed specifically for CFA piles are modifications of the methods developed originally for drilled shafts or driven piles, which are based on in-situ soil parameters. Results from four comparative studies, which were conducted to assess the effectiveness of several of these methods, are also presented. The recommendations made in Section 5.3 are based on the main findings of these comparative studies.

The methods for estimating the static axial capacity of CFA piles are commonly separated for cohesive and cohesionless soils. In addition, the axial capacity has two components: the unit side shear capacity ( $f_s$ ) and the bearing unit capacity ( $q_p$ ). The ultimate shear capacity is obtained by integrating the  $f_s$  values along the pile length. The ultimate bearing capacity is obtained by multiplying the  $q_b$  by the pile tip cross sectional area.

In cohesive soils, the static axial capacity of CFA piles is commonly estimated with correlations based on the undrained shear strength ( $S_u$ ) of the soil. The soil undrained shear strength is estimated in the field using in-situ techniques (i.e., SPT or CPT) or in the laboratory (e.g., undrained triaxial tests on undisturbed samples). The ultimate side shear capacity is typically estimated using the “alpha method”, in which the factor  $\alpha$  is dependant on  $S_u$ . In general,  $f_s$  at a given depth is calculated as follows:

$$f_s = \alpha S_u \quad (\text{Equation A-1})$$

The end-bearing unit capacity ( $q_p$ ) is typically estimated by a bearing capacity factor multiplied by  $S_u$ .

In cohesionless soils, the static axial capacity of CFA piles is commonly estimated following an effective stress approach for side shear and in-situ test parameters for the end-bearing resistance. The unit side shear capacity at a given depth is typically calculated as follows:

$$f_s = \beta \sigma_v' \quad (\text{Equation A-2})$$

where  $\beta$  is the beta factor and  $\sigma_v'$  is the vertical effective stress. With  $\beta = K_s \tan \delta$ , where  $K_s$  is the coefficient of lateral earth pressure and  $\delta$  is the pile-to-soil friction angle. Beta factors and end-bearing capacity parameters are correlated with SPT- $N$  values.

Silty soils that cannot be easily classified as cohesive or cohesionless require judgment to evaluate which method is more appropriate for selecting a resistance parameter. If the silty soil is expected to behave in an undrained manner, methods for cohesive soils should be used. Conversely, if the silty soil is expected to behave in a drained manner, methods for cohesionless soils should be used.

Several methods exist that use correlations with in-situ test parameters to estimate side shear and end-bearing capacities in a variety of soil types. These methods are presented in the following sections.

## A.2 METHODS FOR AXIAL CAPACITY OF CFA PILES

The methods presented are introduced in the chronological order they were published.

### A.2.1 Wright and Reese (1979) Method

Wright and Reese (1979) developed a method for predicting the ultimate capacity of drilled shafts and CFA piles in sand. In this method, the average ultimate side shear resistance,  $f_{s\ ave}$ , is calculated as:

$$f_{s\ ave} = \sigma'_{v\ ave} K_s \tan \phi \leq 0.15 \text{ MPa } (\leq 1.6 \text{ tsf}) \quad (\text{Equation A-3})$$

Where  $\sigma'_{v\ ave}$  is the average vertical effective stress along the pile,  $K_s$  is the lateral earth pressure coefficient (assumed to be 1.1), and  $\phi$  is the sand angle of internal friction. The value  $\phi$  is a weighted average of the angle of internal friction of each sand layer along the pile length.

The ultimate end-bearing resistance is calculated as:

$$q_p \text{ (MPa)} = 0.064 N \leq 3.8 \text{ (MPa)} \quad (\text{Equation A-4a})$$

$$q_p \text{ (tsf)} = 0.67 N \leq 40 \text{ (tsf)} \quad (\text{Equation A-4b})$$

where  $N$  is the SPT- $N$  value (blows/0.3 m [1 ft]) near the tip of the pile.

### A.2.2 Douglas (1983) Method

Douglas (1983) developed a method for predicting the capacity of CFA piles based on full scale load test results of 28 CFA piles in sand in the UK and other European countries. The ultimate unite side shear resistance at a given depth is calculated as:

$$f_s = \sigma'_v K_o \tan \phi \quad (\text{Equation A-5})$$

Where  $\sigma'_v$  is the vertical effective stress,  $K_o$  is the lateral earth pressure coefficient (assumed to be 1.0), and  $\phi$  is the sand angle of internal friction. The vertical effective stress is limited for depths greater than 6 or 10 pile diameters in loose and medium dense sands, respectively.

The ultimate capacity was defined occurring at a pile tip displacement of 30 mm (1.2 in.) although the bearing resistance was often observed to mobilize at displacements greater than 100 mm (4 in.). The ultimate end-bearing resistance is calculated from the Dutch Cone point resistance ( $q_c$ ) as:

$$q_p = 0.25 q_c \quad (\text{Equation A-6})$$

### A.2.3 Rizkalla (1988) Method

The Rizkalla (1988) method was developed in Germany to the axial capacity of CFA piles based on the CPT tip resistance ( $q_c$ ). Rizkalla (1988) based his methods on a database of load tests on CFA piles. The method appears to provide conservative predictions for high displacement screw piles.

*Cohesive Soils ( $0.025 \leq S_u \leq 0.2$  MPa)*

The ultimate unit side shear in cohesive soils for a given depth is calculated as:

$$f_s (\text{MPa}) = 0.02 + 0.2 S_u (\text{MPa}) \quad (\text{Equation A-7})$$

The ultimate unit end-bearing resistance, defined occurring at a pile tip displacement of 5% of the pile diameter, is calculated as:

$$q_p (\text{MPa}) = 6 S_u \quad (\text{Equation A-8})$$

$S_u$  can be estimated from the CPT tip resistance ( $q_c$ ) as:

$$S_u = \frac{q_c - \sigma_v}{N_c} \quad (\text{Equation A-9})$$

Where  $\sigma_v$  is the total vertical stress at the tip of the pile, and  $N_c$  is the cone factor, which ranges from 16 to 22. Alternatively,  $S_u$  may be estimated conservatively from unconfined compressive strength ( $q_u$ ), with  $S_u = 0.5 q_u$ , an approach that is commonly used in many methods currently employed in Europe.

*Cohesionless Soils*

In cohesionless soils, the ultimate unit side shear at a given depth is calculated as:

$$f_s = 0.008 q_c (\text{MPa}) \quad (\text{Equation A-10})$$

where  $q_c$  is the CPT tip resistance.

In cohesionless soils, the ultimate unit end-bearing resistance is calculated as:

$$q_p(\text{MPa}) = 0.12 q_c(\text{MPa}) + 0.1 \quad \text{for } q_c \leq 25 \text{ MPa} \quad (\text{Equation A-11})$$

#### A.2.4 Neely (1991) Method

Neely (1991) developed correlations for sandy soils using a database of load tests on 66 CFA piles performed by various researchers. In this method, the effective overburden stress is computed at the mid-depth of the overall pile length. Only one layer of sand is assumed in this method. The average ultimate unit side shear capacity is calculated as follows:

$$f_s = K_s p_o' \tan \delta = \beta p_o' \leq 1.4 \text{ tsf} \quad (\text{Equation A-12})$$

where:

- $f_s$  = average ultimate unit side shear resistance along pile;
- $\beta$  = factor (referred to as the skin friction factor in Neely's method), which is a function of the pile length (see Figure A.1) and is limited to  $\beta \geq 0.2$ ;
- $K_s$  = horizontal earth pressure coefficient;
- $p_o'$  = average vertical effective stress along pile length; and
- $\delta$  = angle of friction at the pile- soil interface.

In this method, the ultimate unit end-bearing resistance for sandy soils is correlated to the SPT- $N$  value near the pile tip. Neely (1991) used load test results from Roscoe (1983) and Van Den Elzen (1979) and equivalent SPT- $N$  values, which were correlated with CPT values employing a the relationship developed by Robertson et al. (1983). The unit end-bearing capacity is calculated as follows:

$$q_p(\text{tsf}) = 1.9 N \leq 75 \text{ tsf} \quad (\text{Equation A-13})$$

where  $N$  is the SPT- $N$  value.

#### A.2.5 Viggiani (1993) Method

Viggiani (1993) developed correlations for cohesionless soils based on load test results on CFA piles and CPT tip resistance,  $q_c$ . The load tests and CPTs were performed near Naples, Italy, where soils are volcanic (mostly pyroclastic). The ultimate unit side shear at a given depth is calculated as:

$$f_s = \alpha \cdot q_c \quad (\text{Equation A-14})$$

$$\alpha = \frac{6.6 + 0.32 q_c(\text{MPa})}{300 + 60 q_c(\text{MPa})}$$

With:

In these cohesionless soils, the ultimate unit end-bearing resistance is calculated as:

$$q_p(\text{MPa}) = q_{c(\text{ave})} \quad (\text{Equation A-15})$$

where  $q_{c(\text{ave})}$  is the average CPT tip resistance calculated in the depth interval of 4 pile diameters above and 4 pile diameters below the pile tip.

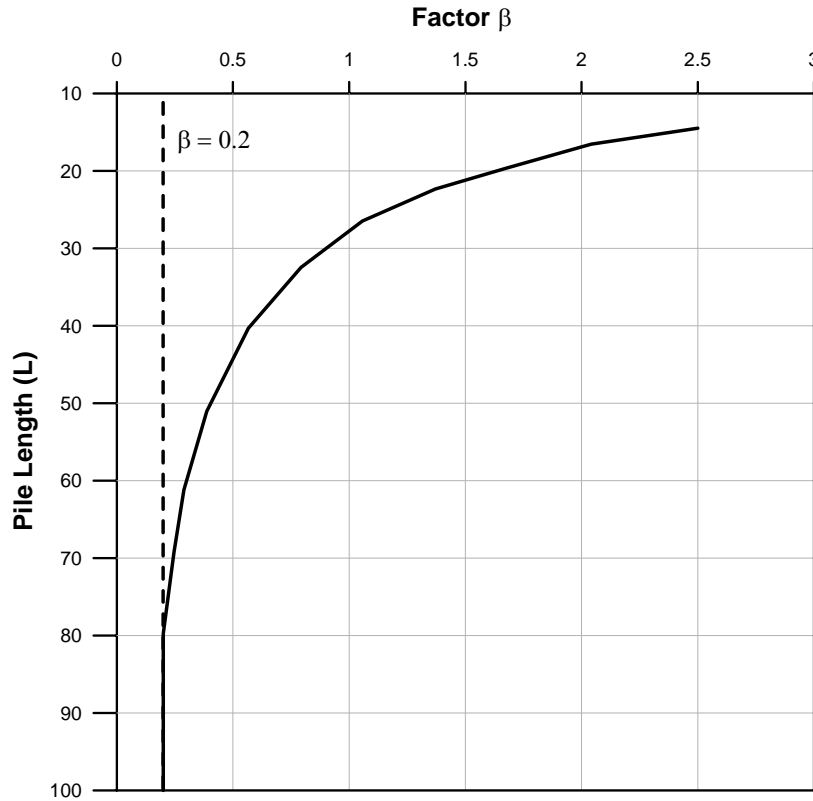


Figure A.1:  $\beta$  Factor vs. Pile Length (Neely, 1991)

### A.2.6 Decourt (1993) Method

Decourt (1993) method was developed for CFA pile in residual soils (silt and silty soils) and was developed from load tests results. This method relies on the apparent shear resistance developed at the maximum torque required to twist a standard penetration test (SPT) split spoon sampler, after it has been driven into the bottom of the borehole. This method relies on the assumption that the influence of SPT dynamic penetration is eliminated during the subsequent twisting of the sampler in place. The ultimate unit side shear capacity for a given pile segment is assumed to be the same as the unit side shear developed during application of the maximum torque, or:

$$f_s = f_s(\text{during maximum torque of SPT spoon}) \quad (\text{Equation A-16})$$



In these soils, the ultimate unit end-bearing resistance is calculated as:

$$q_p = 0.5 K' N_{eq} q_c \leq 25 \text{ (MPa)} \quad \text{(Equation A-17)}$$

where  $K'$  a factor dependent on soil type at the tip of the pile according to:  
 0.10 MPa (clays), 0.12 MPa (clayey silts), 0.14 MPa (sandy silts),  
 and 0.20 MPa (sands); and

$N_{eq}$  average equivalent  $N$  value (blows/ft) from the SPT-torque test near the tip of the pile. It represents a correction factor and is  $N_{eq} = 0.83 T$ , where  $T$  is the torque in (kgf-m) measured in the SPT sampler.

### A.2.7 Clemente et al. (2000) Method

Three CFA test piles were installed in clay soils that ranged from very stiff to hard at three sites in Louisiana, Mississippi, and Texas. Alpha values ( $\alpha$ ) were back-calculated from load test side shear data and compared with  $S_u$  values. This relationship verified the common belief of a decreasing  $\alpha$  with increasing  $S_u$ , as shown below in Figure A.2.

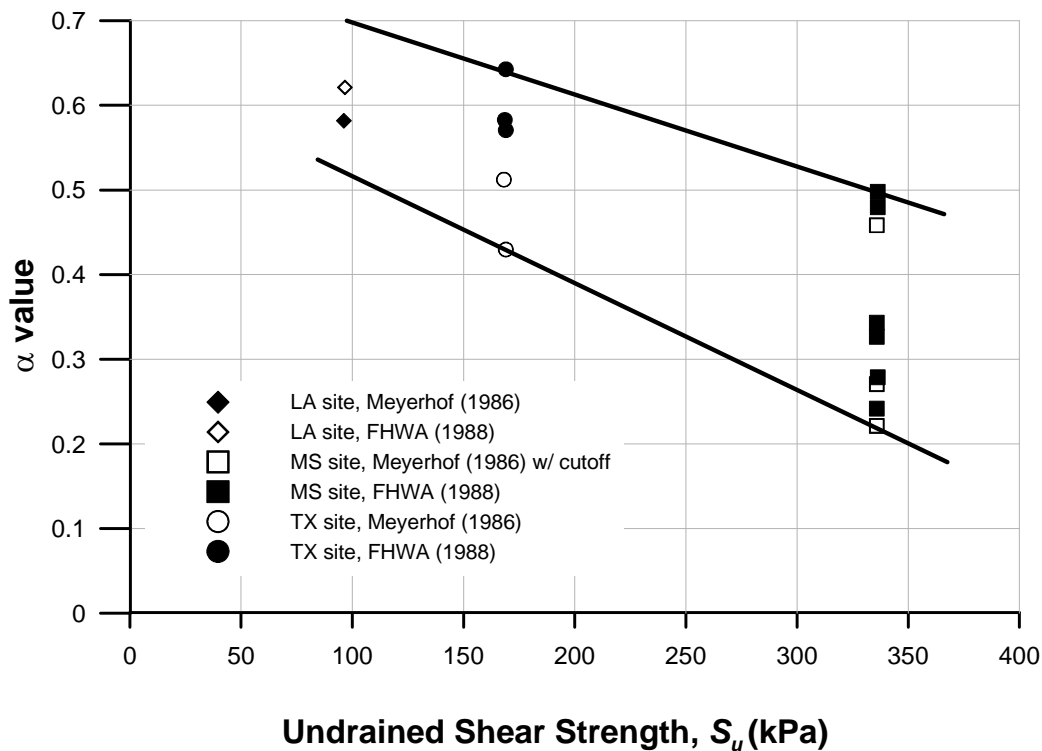


Figure A.2:  $\alpha$  vs. Undrained Shear Strength - Clayey Soils (Clemente et al., 2000)

### A.2.8 Frizzi and Meyer (2000) Method

Frizzi and Meyer (2000) published capacity relationships for CFA piles obtained from over 60 load tests on drilled shafts and CFA piles in the Miami and Fort Thompson limestone formations found in South Florida (Broward and Miami-Dade Counties). Procedures for this method are detailed in Chapter 5.3.

### A.2.9 Zelada and Stephenson (2000) Method

Zelada and Stephenson (2000) studied the results of 43 full-scale compression load tests, five of which were fully instrumented, and ten pull-out tests of CFA piles in sandy soils. They compared the adequacy of various capacity prediction methods. Results of the comparative study by Zelada and Stephenson are detailed in Section A.6.2.

Their study recommended modifications to the  $\beta$  factor and unit tip values of the FHWA 1999 method (O'Neill and Reese, 1999) to reflect their observations of decreased side shear and increased end-bearing in CFA piles when compared to those for drilled shafts. Their method estimates less side shear resistance than the FHWA method and thereby recommends a reduced  $\beta$  factor, only 0.8 of that of the FHWA. Figure A.3 shows the  $\beta$  factor from Zelada and Stephenson's (2000) and from the FHWA 1999 method for comparison. The reduction in the  $\beta$  factor with respect to that of the FHWA method accounts for the reduced soil stress that tends to occur due to soil mining during CFA pile installation. This effect may be more pronounced in clean sands. As discussed in the main text of this document, this effect may be reduced or eliminated by preventing auger over-rotation relative to its penetration rate.

Note that the  $\beta$  factor is also reduced for SPT-N values less than 15, as it is with the FHWA 1999 method. In this method, the expression for  $\beta$  as a function of pile depth is:

for  $N \geq 15$  bpf

$$\beta = 1.2 - 0.11 Z^{0.5} \text{ (ft)} \quad \text{(Equation A-18a)}$$

$$\beta = 1.2 - 0.2 Z^{0.5} \text{ (m)} \quad \text{(Equation A-18b)}$$

for  $N < 15$  bpf

$$\beta = \frac{N}{15} (1.2 - 0.11 Z^{0.5}) \text{ (ft)} \quad \text{(Equation A-18c)}$$

$$\beta = \frac{N}{15} (1.2 - 0.2 Z^{0.5}) \text{ (m)} \quad \text{(Equation A-18d)}$$

The range of  $\beta$  in the Zelada and Stephenson (2000) method is  $0.20 \leq \beta \leq 0.96$ , which takes into account the reduction factor of 0.8.

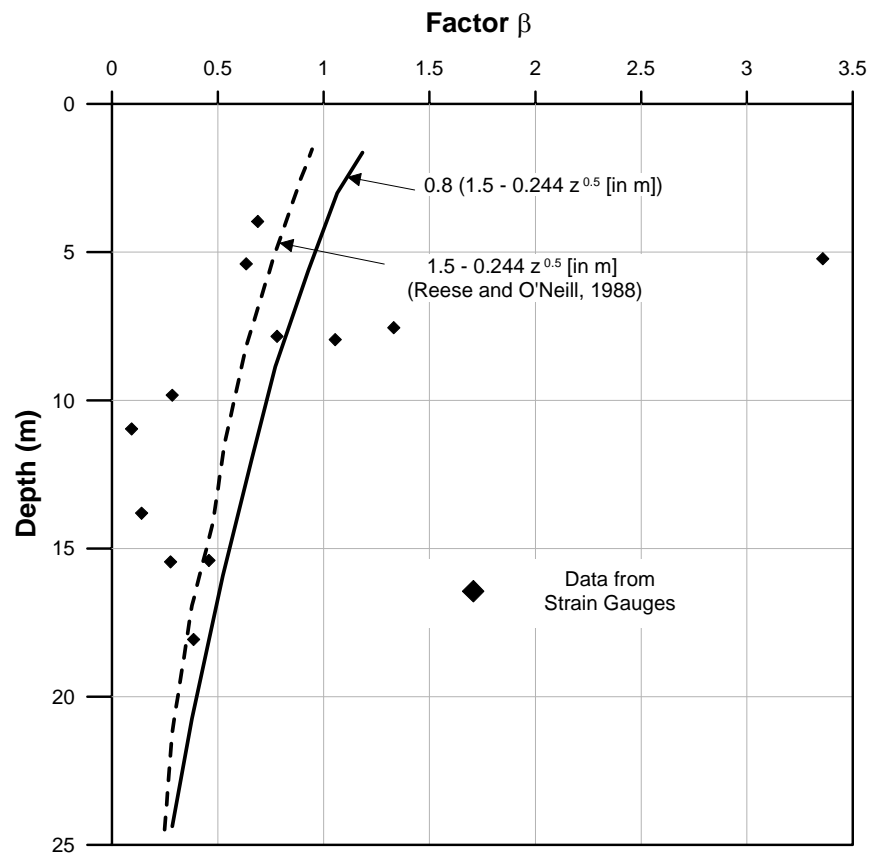
In their analyses, the ultimate end-bearing resistance was defined at a pile tip displacement of 10% of the pile diameter. The ultimate unit end-bearing resistance in this method, which is

based on test data from instrumented CFA load tests in cohesionless soils, is correlated to SPT- $N$  values near the tip of the pile, as follows:

$$q_p \text{ (tsf)} = 1.7 N \leq 75 \text{ tsf} \quad \text{(Equation A-19a)}$$

$$q_p \text{ (MPa)} = 0.16 N \leq 7.2 \text{ MPa} \quad \text{(Equation A-19b)}$$

Note that this correlation gives an ultimate end-bearing resistance that is 2.8 times greater than that estimated with the FHWA method for the same SPT- $N$  value. Figure A.4 shows the recommended  $q_p$  value as a function of SPT- $N$  values and determined from instrumented CFA load tests. The correlation from the FHWA 1999 method for drilled shafts (i.e., “Reese & O’Neill”), the Meyerhof method for driven piles, and the Neely method (1991) for CFA piles are shown for comparison.



Source: Zelada and Stephenson (2000)

**Figure A.3:  $\beta$  Factor vs. depth - Zelada and Stephenson (2000) and FHWA 1999 Methods**

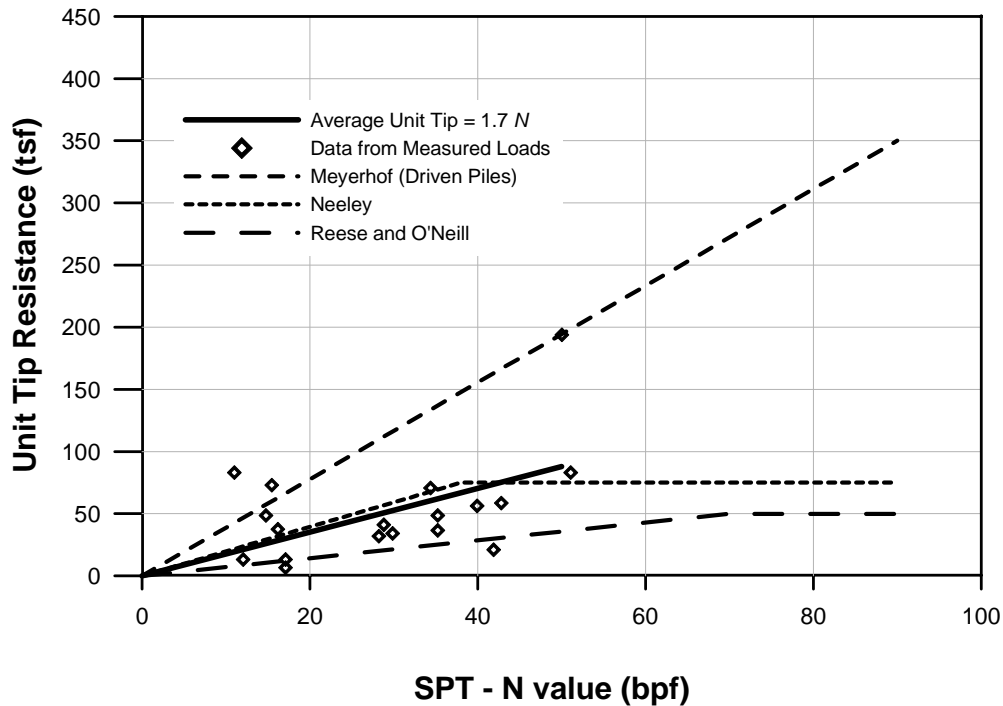
#### A.2.10 Coleman and Arcement (2002) Method

Coleman and Arcement (2002) compared the results of load tests conducted on 32 CFA piles in mixed soil conditions and evaluated the adequacy of various capacity prediction methods. Their study recommended modifications to the  $\alpha$ -factor for cohesive soils and  $\beta$  factor for cohesionless

soils contained in the FHWA 1999 method. Results of the comparison study conducted by Colman and Arcement of several different commonly used methods are detailed in Section A.6.3 of this Appendix and their recommended modifications to the  $\alpha$  and  $\beta$  factors of the FHWA 1999 method are included in Chapter 5.3. Coleman and Arcement did not propose any modifications /methods to estimate the end-bearing resistance.

#### A.2.11 O’Neill et al. (2002) Method

O’Neill et al. (2002) developed a method by analyzing a database on CFA piles data and data from the three fully instrumented load tests performed on CFA piles in geologically diverse sites of coastal Texas in 1999 (O’Neill et al., 1999). These sites are designated as “UH” (over consolidated clay), “Baytown” (mixed soil conditions), and “Rosenburg” (sands). In these three sites, the nominal diameter of the CFA piles was 0.46 m (18 in.) for all piles while the embedment depths were 15.2 m (50 ft), 15.2 m (50 ft), and 9.1 m (30 ft), respectively, for each of these sites.



Source: Zelada and Stephenson (2000)

**Figure A.4: Ultimate Unit End-Bearing Resistance vs. SPT-N values - Zelada and Stephenson (2000) and Other Methods**

Based on the load tests mentioned above, O’Neill et al. (2002) presented a normalized load-settlement curve shown in Figure A.5, which may be suitable for use with CFA piles with similar aspect ratios and in similar geologic formations. Given the ultimate total load ( $Q_t$ ), Figure A.3

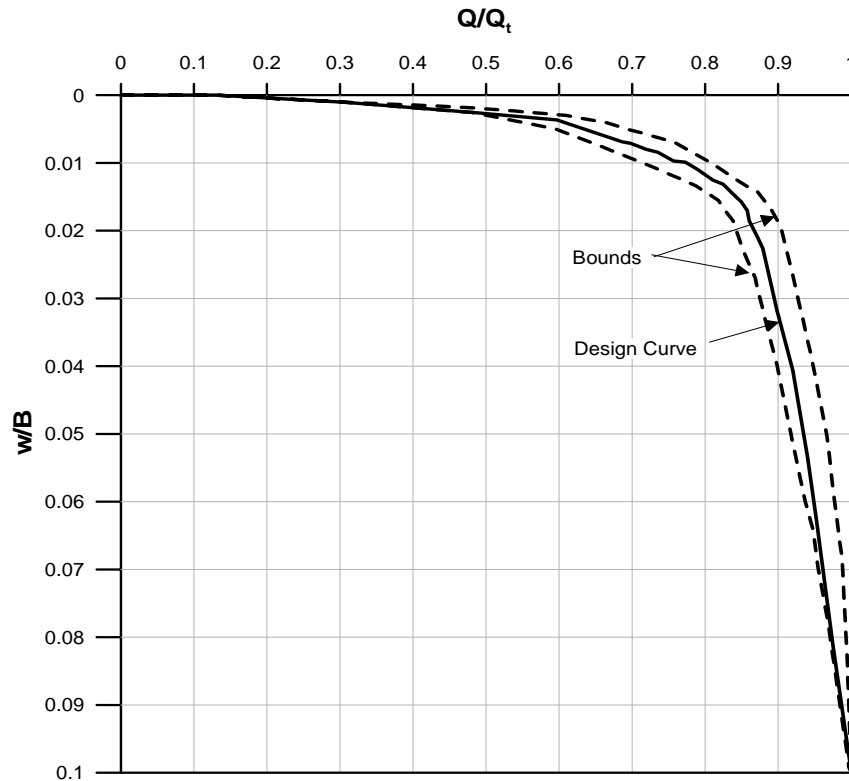
may be used to predict the total load ( $Q$ ) at a given displacement ratio of pile displacement ( $w$ ) to pile diameter ( $B$ ).

### A.3 METHODS FOR AXIAL CAPACITY OF DRILLED SHAFTS APPLICABLE TO CFA PILES

#### A.3.1 TxDOT Method (1972)

##### *Cohesive Soils*

For cohesive soils, this method (developed by Texas Department of Transportation, 1972) uses the undrained shear strength to estimate the side shear resistance and the blow count obtained from the TxDOT Dynamic Cone Penetrometer test to estimate the end-bearing resistance. Although the TxDOT Dynamic Cone Penetrometer is a relatively uncommon test, this method yielded good results for CFA piles in clays (O'Neill et al., 2002). Therefore, this method was recommended as an alternate way of predicting capacities in cohesive soils and the procedures are detailed in Section 5.3.



**Figure A.5: Normalized Load-Settlement Relationship for Design of CFA Piles - Clay Soils of Texas Gulf Coast (O'Neill et al., 2002)**

### *Cohesionless Soils*

For cohesionless soils, this method estimates the ultimate unit side-shear resistance using the blow count from a TxDOT Dynamic Cone Penetrometer ( $N_{TxDOT}$ ) according to the following Equation:

$$f_s (\text{tsf}) = 1.4 \left( \frac{N_{TxDOT}}{80} \right) \quad \text{with } f_s \leq 2.5 (\text{tsf}) \quad (\text{Equation A-20})$$

The ultimate end-bearing resistance in cohesionless soils is also determined using the blow count from the TxDOT Dynamic Cone Penetrometer ( $N_{TxDOT}$ ) as follows:

$$q_p (\text{tsf}) = \frac{N_{TxDOT}}{8.25} \quad (\text{Equation A-21})$$

If the pile diameter is less than 0.6 m (24 in.), the ultimate end-bearing resistance is selected as 4 tsf for cohesionless soils.

### **A.3.2 FHWA 1999 Method**

The FHWA Method, originally proposed by Reese and O'Neill (1988) and latter modified by O'Neill and Reese (1999), has become perhaps the most recognized method for prediction of drilled shaft capacities, and has often been used to determine axial capacity of CFA piles. The comparison studies summarized in Section A.6 of this Appendix consistently show that FHWA method is reliable in estimating CFA pile capacities in both cohesive and cohesionless soils. This method is presented as the recommended method for estimating CFA pile capacity in both cohesive and cohesionless soils. Procedures for this method are presented in Section 5.3.

## **A.4 METHODS FOR DRIVEN PILES APPLICABLE TO CFA PILES**

### **A.4.1 Coyle and Castello (1981) Method**

#### *Cohesive Soils*

Coyle and Castello (1981) recommended the use of Tomlinson's Method (1957) to obtain the average unit side shear capacity of the pile using Equation A-20:

$$f_{Sa} = \alpha \cdot S_{ua} \quad (\text{Equation A-22})$$

where:  $S_{ua}$  = average undrained shear strength along the pile length; and

$\alpha$  = factor that varies from 0.2 to 1.0 and is a function of the average undrained shear strength along the pile length, as shown in Figure A.6.

The ultimate unit end-bearing resistance in cohesive soils is calculated using the following:

$$q_p = 9 \cdot S_u \quad (\text{Equation A-23})$$

### *Cohesionless Soil*

Coyle and Castello (1981) also presented estimates of the ultimate side shear and end-bearing capacities for driven piles in sand based on the sand angle of internal friction and the ratio of pile embedded depth (L) to pile diameter/width (D).

In this method, the ultimate side shear resistance (i.e., maximum skin friction in the original method) can be determined from Figure A.7a, while the ultimate end-bearing resistance (i.e., maximum toe resistance in the original method) can be determined from Figure A.7b. The ultimate end-bearing resistance was limited to 100 tsf for driven piles tipped into sand.

Coyle and Castello (1981) also recommended that the angle of internal friction of the soil ( $\phi$ ) be obtained from Figure A.8, which presents the relationship between SPT  $N$  values and  $\phi$ . Friction angles in this Figure are based on Peck et al. (1974). For the case of silty sands below the water table, and for SPT  $N$  values greater than 15, Coyle and Castello (1981) recommended that SPT  $N$  values be corrected according to the following expression:

$$N' = 15 + 0.5(N - 15) \quad (\text{Equation A-24})$$

The corrected  $N$  value (i.e.,  $N'$ ) can be utilized in the relationship between SPT  $N$  values and  $\phi$  as well as the pile capacity design charts shown in Figure A.7.

#### **A.4.2 American Petroleum Institute (API) (1993) Method**

##### *Cohesive Soils*

The ultimate unit side shear resistance for a pile segment in cohesive soils is calculated using an  $\alpha$  factor as follows:

$$f_s = \alpha S_u \quad (\text{Equation A-25})$$

where:  $S_u$  = undrained shear strength

$\alpha$  = a function of  $S_u$  and the vertical effective stress of the soil (as shown below) and ranges from 0.5 to 1.0

$$\alpha = 0.5/\Psi^{0.5}, \text{ for } \Psi < 1.0$$

$$\alpha = 0.5/\Psi^{0.25}, \text{ for } \Psi \geq 1.0$$

Where  $\Psi = S_u/\sigma_v'$ , and  $\sigma_v'$  = vertical effective stress of the soil at the depth of interest.

For cohesive soils, the ultimate unit end-bearing resistance is calculated as follows:

$$q_p = 9 S_u \quad (\text{Equation A-26})$$

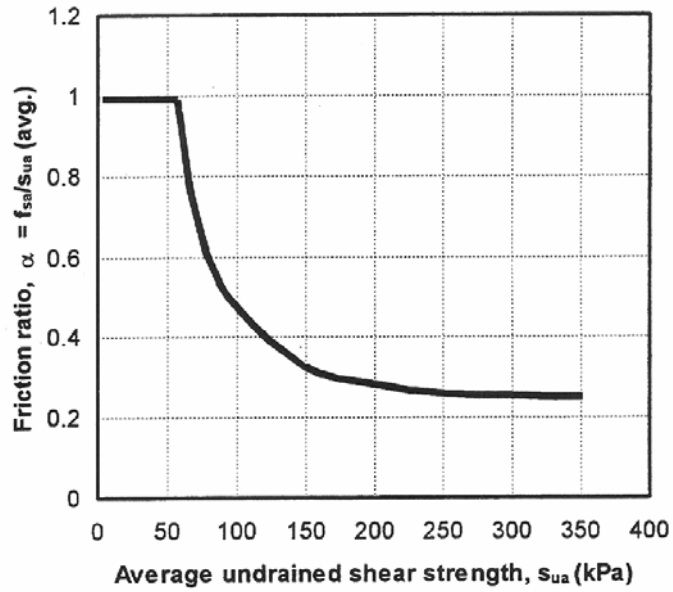


Figure A.6:  $\alpha$  vs. Average Undrained Shear Strength along Pile Length (Coyle and Castello, 1981)

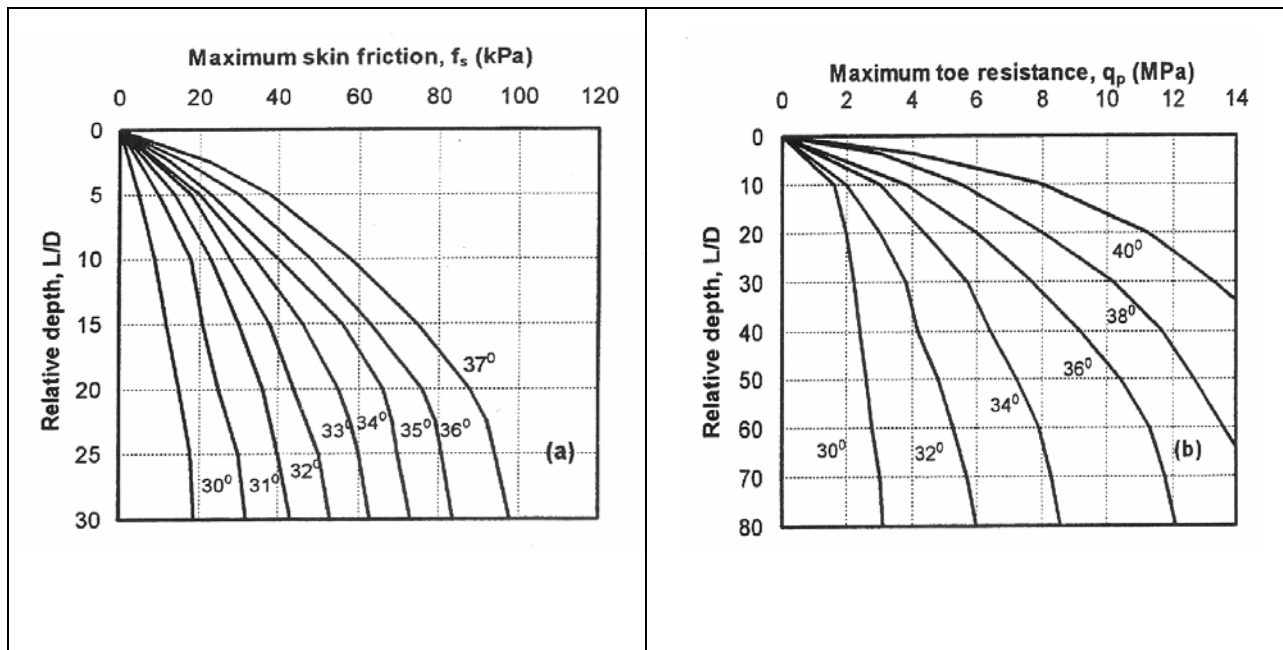
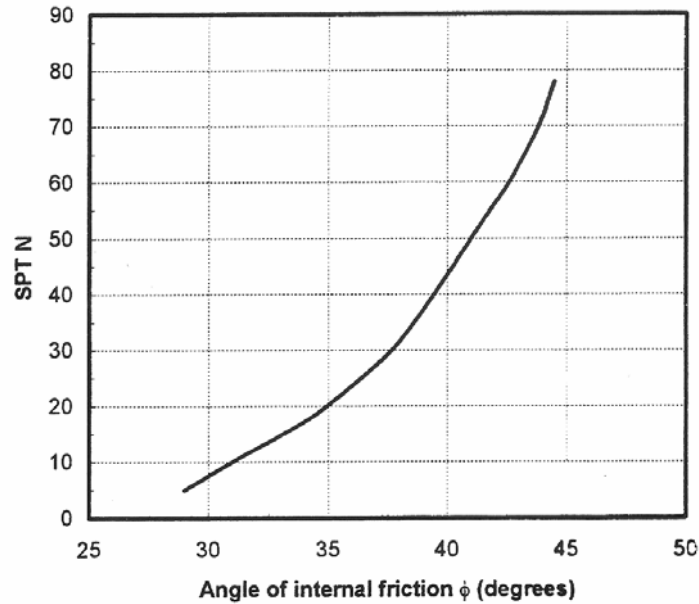


Figure A.7. (a) Unit Side-Shear Capacity and (b) End-Bearing Capacity in Cohesionless Soils (Coyle and Castello, 1981)





**Figure A.8. Relationship between SPT  $N$  Values and  $\phi$  (Coyle and Castello, 1981)**

### *Cohesionless Soils*

The ultimate unit side shear resistance for a pile segment in cohesionless soils is calculated as follows:

$$f_s = K \sigma_v' \tan \delta \quad (\text{Equation A-27})$$

where:  $K$  = horizontal earth pressure coefficient;

$\sigma_v'$  = vertical effective stress of the pile segment

$\delta$  = angle of friction at the pile - soil interface, which may be estimated from Table A.1

The value for  $K$  in is assumed at: a) 0.8 for non-displacement piles and open-ended driven piles; and b) 1.0 for driven piles that have plugged. Therefore, assuming a  $K$  value of 1.0 would be most appropriate for CFA. Table A.1 lists limiting unit side shear resistance (i.e. skin friction), as well as typical values of soil-pile friction angles, which may be used if no other values are available.

The ultimate unit end-bearing resistance in cohesionless soils is calculated as follow:

$$q_p = \sigma_v' N_q \quad (\text{Equation A-28})$$

where:  $\sigma_v'$  = vertical effective stress of the pile segment; and

$N_q$  = bearing capacity factor.

The unit end-bearing resistance for cohesionless soils is limited in the Coyle and Castello (1981) and the API (1993) methods. For driven piles, the soil below the driven pile tip is compacted and highly stressed after driving. It is likely that the limiting unit end-bearing values for CFA is smaller because the effect of overstressing is lacking in CFA piles.

**Table A.1. Soil-Pile Friction Angle, Limiting Unit Side Shear Resistance, and Limiting End-bearing Values (API, 1993)**

Density	Soil Description	Soil-Pile Friction Angle $\delta$ (deg)	Limiting Skin Friction, $f_s$ in kPa (kips/ft <sup>2</sup> )	Bearing Capacity Factor, $N_q$	Limiting Unit End-bearing Values, in MPa (kips/ft <sup>2</sup> )
Very Loose Loose Medium	Sand Sand-Silt Silt	15	47.8 (1.0)	8	1.9 (40)
Loose Medium Dense	Sand Sand-Silt Silt	20	67.0 (1.4)	12	2.9 (60)
Medium Dense	Sand Sand-Silt	25	81.3 (1.7)	20	4.8 (100)
Dense Very Dense	Sand Sand-Silt	30	95.7 (2.0)	40	1.9 (200)
Dense Very Dense	Gravel Sand	35	114.8 (2.4)	50	1.9 (250)

#### **A.5 METHOD FOR DRILLED SHAFTS AND DRIVEN PILES APPLICABLE TO CFA PILES**

Bustamonte and Gianceselli (1981, 1982) reported that the Laboratoire Des Ponts et Chaussée (LPC) in France developed design procedures for use in the design of both driven piles and drilled shafts. This method is referred to as the LPC method. In this method, correlations were developed for cohesive and cohesionless soils based on CPT tip resistance measurements. While the original method uses an average ultimate unit side shear resistance for the entire pile, the technique has also been applied to layered soils where the design charts are utilized for average CPT tip resistances measured at different depths along the pile length. The comparative studies summarized in Section A.6 of this Appendix show that this method is reliable in estimating capacities of CFA pile in both cohesive and cohesionless soils. This method is presented as an alternative for estimating CFA pile capacity in soils when CPT  $q_c$  data is available. The procedures of this method are presented in Section 5.3.

## **A.6 COMPARISON OF DESIGN METHODS FOR AXIAL CAPACITY OF CFA PILES**

Several studies have been conducted in the last few years, between 1994 and 2002, to compare load tests results on CFA piles to capacities predicted by various static analysis methods. These comparisons were made using existing load testing databases and, in some cases, were augmented with additional load test programs. The comparative studies report results according to soil type and for normal construction of CFA piles (i.e., drilled displacement piles were not considered in these studies).

### **A.6.1 Comparison of Five Methods in Predominantly Sandy Soils (McVay et al., 1994)**

McVay et al. (1994) studied the results of 17 full-scale compression load tests and four pullout tests of CFA piles located at 21 different sites throughout Florida. The subsurface soils consisted of sandy soils in for 19 test piles, while clay was predominant in two test piles (both compression tests). The ultimate resistance was evaluated in their study at displacements defined by: (1) the Davisson Criteria; (2) a load corresponding to displacement equal to 2% of the pile diameter; and (3) load corresponding to displacement equivalent to five percent of the pile diameter.

Five methods were evaluated: Wright and Reese (1979), Neely (1991), LPC (1981), original FHWA (Reese and O'Neill, 1988); and Coyle and Castello (1981). In the comparison, the mean and standard deviations of the ratio of the measured ( $Q_{t\ meas}$ ) to predicted ( $Q_{t\ pred}$ ) resistances developed in the McVay et al. (1994) study. These quantities are presented in Table A.2. The study concluded that all methods provided reasonably accurate estimates of total capacity when failure was defined as 5% of the pile diameter displacement. The results for the 5% criteria are illustrated in Figure A.9. This study concluded that the original FHWA method (Reese and O'Neill, 1988) for drilled shafts provided the best prediction for ultimate total pile capacity in sandy soils and this is followed closely by the Wright and Reese Method (1979) for CFA piles in sand.

### **A.6.2 Comparison of Eight Methods in Predominantly Sandy Soils (Zelada and Stephenson, 2000)**

Zelada and Stephenson (2000) studied the results of 43 full-scale compression load tests and ten pullout tests of CFA piles located at 28 sites locations in the United States and Europe. Subsurface soils ranged from medium dense to dense, silty to fine sands. Installed piles that had more than 25 percent of clay along their length were not included in this study.

The ultimate resistance was defined at displacements of 5 to 10% of the pile diameter. The pile diameters ranged from 0.3 to 0.6 m (12 to 24 in.), with the majority within 0.40 to 0.45 m (16 to 18 in.) diameter range. The pile lengths ranged from 7.5 to 21 m (25 to 70 ft), with the majority between 9 and 12 m (30 and 40 ft). All piles were constructed with sand-cement grout, except those reported by Roscoe (1983), which were constructed using concrete.

Eight methods for static capacity were evaluated using this database: Viggiani (1993), Reese and O'Neill (1988), LPC (1981), Wright and Reese (1979), Rizkalla (1988), Coyle and Castello

(1981), Douglas (1983), and Neely (1991). The results of this evaluation for the 5 and 10% of pile diameter as displacement criteria are shown in Table A.3. A summary of results for all tests (both compression and tension) at a pile displacement of 10% of the respective pile diameter is provided in Figure A.10. The Reese and O’Neill (1988) method for drilled shafts provided the best correlation for ultimate total pile capacity in these sandy soils, regardless whether the 5 or 10% of the pile diameter displacement failure criteria was used.

**Table A.2. Total Resistance - Results from Five Methods (McVay et al., 1994)**

Ratio of Predicted to Measured Capacities

Pile No.	Wright			Neely			LPC			FHWA			Coyle			
	Davisson	2% Dia	5% Dia	Davisson	2% Dia	5% Dia	Davisson	2% Dia	5% Dia	Davisson	2% Dia	5% Dia	Davisson	2% Dia	5% Dia	
1	1.71	1.64	1.14	2.15	2.06	1.43	3.00	2.87	2.00	2.00	1.91	1.33	2.50	2.39	1.67	
2	1.30	1.56	1.01	1.82	2.18	1.42	2.01	2.40	1.56	1.49	1.78	1.16	3.33	3.98	2.59	
3	0.92	0.95	0.95	0.95	0.99	0.98	1.11	1.15	1.14	0.99	1.03	1.02	1.43	1.49	1.47	
4	0.81	0.87	0.70	0.86	0.92	0.75	1.47	1.58	1.28	0.94	1.02	0.82	0.79	0.86	0.69	
5	1.55	1.72	1.03	2.54	2.82	1.69	2.30	2.55	1.53	1.64	1.82	1.09	3.14	3.49	2.09	
6	0.77	0.87	0.64	1.69	1.90	1.41	1.15	1.29	0.96	0.89	1.00	0.74	1.32	1.48	1.09	
7	1.04	1.14	0.75	1.72	1.89	1.24	1.52	1.67	1.09	1.18	1.29	0.85	2.23	2.45	1.60	
8	3.10	3.54	1.98	1.51	1.72	0.96	3.49	3.99	2.24	3.16	3.61	2.02	2.44	2.79	1.50	
9	1.01	0.93	0.71	1.66	1.52	1.15	1.83	1.68	1.28	1.30	1.19	0.90	2.73	2.50	1.90	
10	1.06	1.25	0.94	0.69	0.81	0.61	1.42	1.67	1.25	1.16	1.36	1.02	1.24	1.45	1.09	
11	1.19	1.52	1.04	1.18	1.50	1.03	1.21	1.54	1.06	1.19	1.51	1.04	1.75	2.23	1.50	
12	1.24	1.02	1.00	1.43	1.17	1.15	1.25	1.02	1.01	1.32	1.09	1.07	1.10	0.90	0.80	
13	0.66	1.05	0.66	1.28	2.05	1.28	1.06	1.69	1.06	0.86	1.38	0.86	1.70	2.72	1.70	
14	1.13	1.13	1.13	0.97	0.97	0.97	1.41	1.41	1.41	1.06	1.06	1.06	1.51	1.51	1.51	
15	1.46	1.41	0.95	2.19	2.13	1.43	1.99	1.93	1.29	1.46	1.42	0.95	1.77	1.72	1.10	
16	0.89	1.27	0.80	0.87	1.24	0.78	1.07	1.52	0.96	0.79	1.12	0.71	1.13	1.61	1.00	
17	0.75	0.96	0.68	1.38	1.77	1.25	1.08	1.39	0.99	0.87	1.12	0.79	1.59	2.04	1.40	
18	1.46	1.90	1.02	1.99	2.57	1.39	1.84	2.38	1.29	2.00	2.59	1.40	3.68	4.76	2.50	
19	1.26	1.26	0.84	1.18	1.18	0.79	2.03	2.03	1.36	1.58	1.58	1.05	1.34	1.34	0.80	
20	N.A.	N.A.	N.A.	N.A.	N.A.	N.A.	1.18	1.25	1.15	0.98	1.03	0.95	0.92	0.97	0.80	
21	N.A.	N.A.	N.A.	N.A.	N.A.	N.A.	1.40	1.40	1.02	1.42	1.42	1.03	1.18	1.18	0.80	
i	Mean	1.23	1.37	0.95	1.48	1.65	1.14	1.66	1.83	1.28	1.35	1.49	1.04	1.85	2.09	1.40
	St Dev	0.52	0.59	0.29	0.50	0.56	0.28	0.63	0.68	0.32	0.53	0.61	0.28	0.81	1.01	0.50
ii	Mean	1.10	1.24	0.89	1.49	1.70	1.19	1.46	1.64	1.18	1.21	1.36	0.98	1.87	2.14	1.40
	St Dev.	0.26	0.30	0.16	0.50	0.58	0.27	0.38	0.43	0.19	0.31	0.39	0.16	0.93	1.05	0.50

- i. includes both compression and tension piles
- ii. includes compression piles only
- N.A. - not applicable

The accuracy of the eight methods for a given pile diameter was also evaluated. The results from the Zelada and Stephenson (2000) study are presented in Table A.4. These results indicate that, in most cases, the accuracy of the method increased with increasing pile diameter and there was a tendency for better correlation with higher pile length-to-pile diameter ratios. Similar to the findings in the McVay et al. (1994) study, the original FHWA method for drilled shafts provided the best estimate of ultimate total pile capacity, regardless of pile diameter.

Results comparing side shear resistance from Zelada and Stephenson (2000) are provided in Table A.5. Again, according to this study, the Reese and O’Neill (1988) method for drilled shafts provides the best correlation for side shear resistance in these sandy soils, with the LPC (1981) and the Wright and Reese (1979) methods also giving reasonably accurate results.

Results comparing end-bearing unit resistances from the Zelada and Stephenson (2000) study are provided in Table A.6. The comparison indicates that the Viggiani (1993) method overestimated the end-bearing resistance by approximately 50 percent at displacements of 5 and 10% of the pile

diameter. The Neely (1991) method generally provided the best predictions, slightly overestimating and underestimating the end-bearing resistance at displacements of 5 and 10%, respectively. The Coyle and Castello (1981) method overestimated the end-bearing resistance, but the estimates from this method are close to measured values for a displacement of 10% of pile diameter. The remaining five methods underestimated the end-bearing resistance by more than a factor of two, with the exception that the Douglas (1983) method at 5% of the pile diameter.

### **A.6.3 Comparison of Four Methods in Mixed Soil Conditions (Coleman and Arcement, 2002)**

Coleman and Arcement (2002) studied the results of compression load tests conducted on 32 auger-cast piles in mixed soil conditions and performed in accordance with ASTM D 1143. These load tests were conducted at 19 different sites throughout Mississippi and Louisiana during the period of 1985 to 2001.

Several methods for defining CFA failure were considered. It was concluded that while displacements of 5% of the pile diameter was a suitable criterion for large diameter shafts, displacements of 10% of the pile diameter was more appropriate for smaller diameter shafts such as those diameters typical for CFA piles. Therefore, Coleman and Arcement (2002) defined ultimate failure occurs at displacements of 10% of the pile diameter or at the plunging failure, whichever occurred first. In the event that the load was not increased to a level sufficient to cause plunging failure or displacements of ten percent of the pile diameter, the final load obtained was considered ultimate. The pile diameters ranged from 0.36 to 0.6 m (14 to 24 in.) and the pile lengths ranged from 6.1 to 32 m (20 to 105 ft).

Four design methods were evaluated: API (1993), Neely (1991), Coyle and Castello (1981) and FHWA 1999 methods. The results for these design methods are provided in Figure A.11. The API method (1993) gave the best correlation for ultimate total pile capacity in mixed soil conditions and was slightly conservative (i.e., the average ratio of the measured to predicted capacity was 1.03). However, when considering the sites with sandy profiles only, the Neely method (1991) was slightly unconservative (i.e., the average ratio of the measured to predicted capacity was 0.93) and it gave the smallest standard deviation. The FHWA 1999 method (i.e., equivalent to Reese and O'Neill, 1988) was the most conservative and showed a relatively small standard deviation. The Coyle and Castello method (1981) was slightly unconservative and had the highest standard deviation.

Based on this comparison, Coleman and Arcement (2002) recommended a modified FHWA 1999 method because it is widely used and employs factors of side shear resistance (i.e.,  $\alpha$  and  $\beta$  factors) that can easily be modified. Coleman and Arcement reported that the FHWA 1999 method, although conservative, generally appeared reasonable for predicting the end-bearing component for cohesionless soils. Coleman and Arcement did not make recommendations for modifications to the end-bearing resistance provided by the FHWA method, as they believed there was insufficient data to formulate such modifications.

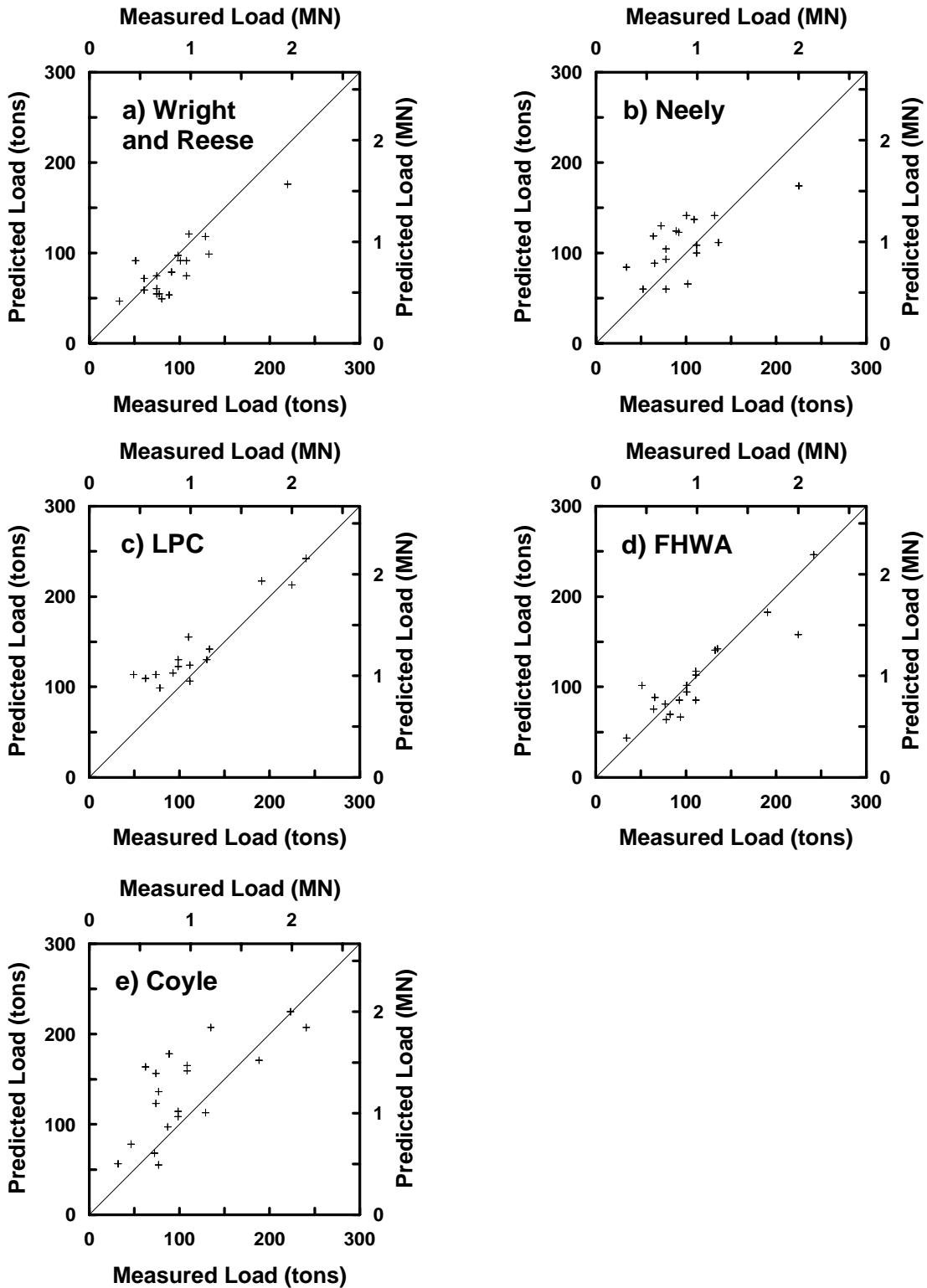
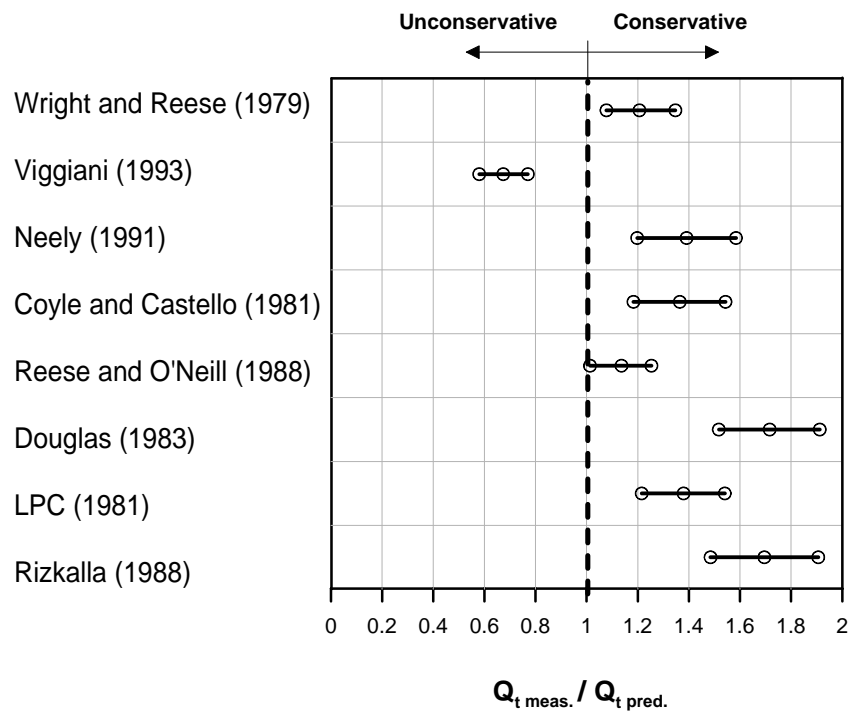


Figure A.9. Summary of Total Resistance – Results from Five Methods (McVay et al., 1994)

**Table A.3. Total Resistance - Results from Eight Methods (Zelada and Stephenson, 2000)**

$Q_{ult}$ Measured / $Q_{ult}$ Predicted Ratios + Standard Deviations (Coefficients of Variation)									
	$Q_{ult}$ Method	Wright & Reese	Viggiani	Neely	Coyle & Castello	Reese & O'Neill	Douglas	LPC	Rizkallah
Comp. Tests Only	5% <i>PD</i>	1.19 ± 0.33	0.54 ± 0.22	1.09 ± 0.41	1.00 ± 0.43	1.10 ± 0.26	1.59 ± 0.45	1.24 ± 0.40	1.45 ± 0.56
	10% <i>PD</i>	1.25 ± 0.47	0.64 ± 0.30	1.31 ± 0.54	1.25 ± 0.52	1.19 ± 0.38	1.72 ± 0.70	1.45 ± 0.55	1.72 ± 0.75
Tens. Tests Only	5% <i>PD</i>	1.20 ± 0.57	0.74 ± 0.25	1.73 ± 0.74	1.54 ± 0.72	1.00 ± 0.42	1.93 ± 0.63	0.91 ± 0.29	1.12 ± 0.56
	10% <i>PD</i>	0.96 ± 0.26	0.86 ± 0.31	1.76 ± 1.12	1.94 ± 0.72	0.82 ± 0.25	1.66 ± 0.54	0.94 ± 0.36	1.49 ± 0.57
All Tests Only	5% <i>PD</i>	1.19 ± 0.38 (0.32)	0.58 ± 0.24 (0.41)	1.21 ± 0.54 (0.45)	1.10 ± 0.54 (0.42)	1.08 ± 0.30 (0.28)	1.65 ± 0.50 (0.30)	1.17 ± 0.40 (0.34)	1.39 ± 0.57 (0.41)
	10% <i>PD</i>	1.21 ± 0.45 (0.38)	0.67 ± 0.30 (0.45)	1.38 ± 0.65 (0.47)	1.36 ± 0.59 (0.44)	1.13 ± 0.38 (0.34)	1.71 ± 0.67 (0.39)	1.37 ± 0.55 (0.40)	1.69 ± 0.72 (0.43)



**Figure A.10. Summary of Total Resistance - Results from Eight Methods (Zelada and Stephenson, 2000)**

**Table A.4. Total Resistances - Results with from Eight Methods (Zelada and Stephenson, 2000)**

Ratios of $Q_{ult}$ measured/ $Q_{ult}$ predicted $\pm$ Standard Deviations (Coefficients of Variation)									
Diam. (in.)	$Q_{ult}$ displ. criteria	Wright and Reese	Viggiani	Neely	Coyle and Castello	Reese and O'Neill	Douglas	LPC	Rizkallah
14	5% PD	1.30 $\pm$ 0.42	0.58 $\pm$ 0.21	1.21 $\pm$ 0.47	0.92 $\pm$ 0.38	1.15 $\pm$ 0.31	1.83 $\pm$ 0.50	1.20 $\pm$ 0.43	1.34 $\pm$ 0.62
	10% PD	1.46 $\pm$ 0.39	0.74 $\pm$ 0.23	1.36 $\pm$ 0.38	1.29 $\pm$ 0.34	1.29 $\pm$ 0.31	2.05 $\pm$ 0.47	1.64 $\pm$ 0.37	1.96 $\pm$ 0.51
16	5% PD	1.10 $\pm$ 0.32	0.58 $\pm$ 0.21	1.25 $\pm$ 0.60	1.31 $\pm$ 0.61	1.01 $\pm$ 0.29	1.48 $\pm$ 0.41	1.10+ 0.34	1.38 $\pm$ 0.50
	10% PD	1.10 $\pm$ 0.32	0.62 $\pm$ 0.31	1.30 $\pm$ 0.74	1.36 + 0.69	0.99 + 0.28	1.50 + 0.47	1.07+ 0.39	1.43 + 0.57
18	5% PD	1.08 $\pm$ 0.26	0.61 + 0.34	1.27 $\pm$ 0.83	1.27 $\pm$ 0.62	1.02 $\pm$ 0.30	1.54 $\pm$ 0.63	1.41+ 0.56	1.68 $\pm$ 0.71
	10% PD								
24	5% PD								
	10% PD	1.12 $\pm$ 0.32	0.41 $\pm$ 0.07	0.79 $\pm$ 0.19	0.73 + 0.22	1.03 $\pm$ 0.30	1.34 $\pm$ 0.35	0.96+ 0.17	1.08 $\pm$ 0.30

\* A minimum of three pile tests per diameter category were required for this statistical analysis.

Note:  $Q_{ult}$ : Ultimate Total Pile Resistance, PD: Pile Displacement as a % of Pile Diameter

**Table A.5. Side Shear Resistance - Results from Eight Methods (Source: Zelada and Stephenson, 2000)**

$Q_{ult}$ measured / $Q_{ult}$ predicted Ratios $\pm$ Standard Deviations							
Wright and Reese	Viggiani	Neely	Coyle and Castello	Reese and O'Neill	Douglas	LPC	Rizkallah
1.09 $\pm$ 0.57	0.83 $\pm$ 0.42	1.50 $\pm$ 0.78	1.94 $\pm$ 1.20	0.92 $\pm$ 0.41	1.81 $\pm$ 0.41	1.05 $\pm$ 0.51	1.39 $\pm$ 0.78



**Table A.6. End-Bearing Resistance—Results from Eight Methods (Zelada and Stephenson, 2000)**

<b>Q<sub>ult</sub> Method</b>	<b>Wright &amp; Reese</b>	<b>Viggiani</b>	<b>Neely</b>	<b>Coyle &amp; Castello</b>	<b>Reese &amp; O’Neill</b>	<b>Douglas</b>	<b>LPC</b>	<b>Rizkallah</b>
5% PD	2.35 ± 2.40	0.43 ± 0.44	0.87 ± 0.88	0.73 ± 0.71	2.47 ± 2.43	1.62 ± 1.59	2.70 ± 2.66	3.01 ± 2.84
10% PD	3.05 ± 2.51	0.56 ± 0.46	1.11 ± 0.92	0.98 ± 0.71	3.26 ± 2.57	2.14 ± 1.69	3.57 ± 2.81	4.01 ± 2.98

Note: Q<sub>ult</sub>: Ultimate Total Pile Resistance, PD: Pile Displacement as a % of Pile Diameter.

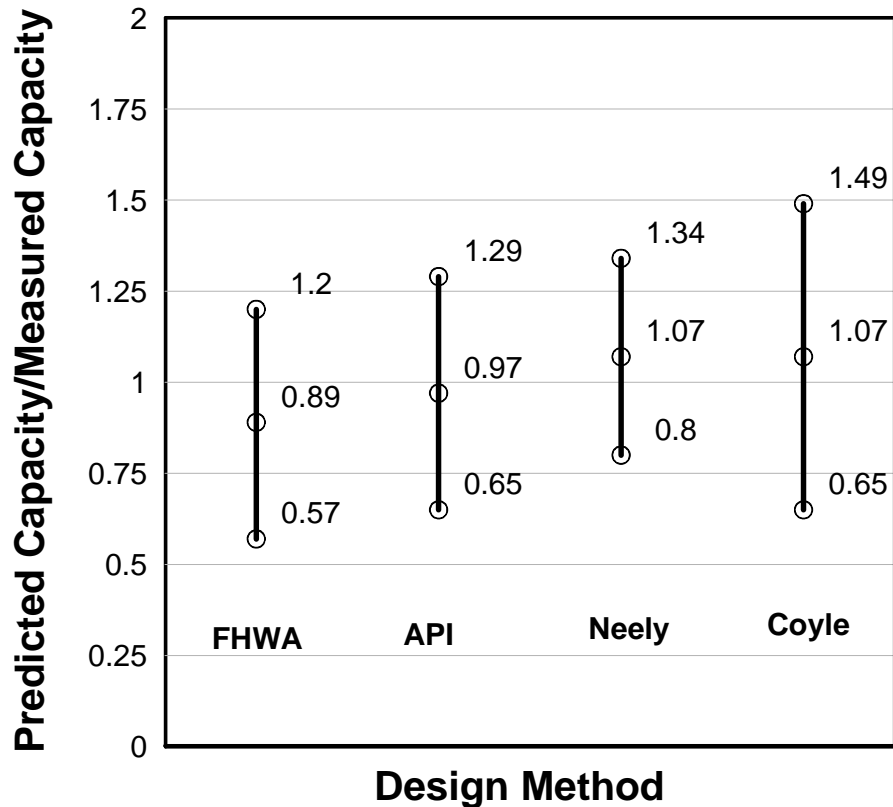
O’Neill et al. (1999) studied the results of 43 load tests performed on CFA piles in coastal Texas. Their study was for mixed soil conditions. Because the available data from CFA piles for sands in coastal Texas were limited, their study was augmented with the database developed by McVay et al (1994) from load tests performed on CFA piles in Florida sands. In addition, three CFA test piles were instrumented and load tested in geologically diverse sites in coastal Texas (O’Neill et al., 2002). These sites were designated as “UH” (over consolidated clay), “Baytown” (mixed soil conditions), and “Rosenburg” (sands). These three sites had CFA piles with a nominal diameter of 0.46 m (18 in.) and had embedment depths of 15.2, 15.2, and 9.1 m (50, 50, and 30 ft), respectively.

#### **A.6.4 Comparison of Seven Methods - Sandy and Clay Soils (O’Neill et al., 1999)**

To investigate the effect of CFA construction on the earth pressure at a given depth, an effective stress cell was placed near the surface at each of the three instrumented CFA piles to monitor the changes in lateral earth pressure during drilling and grouting. Figure A.14 shows the test arrangement and the measured horizontal earth pressures during a typical installation. The increase and the subsequent drop of horizontal earth pressure from the in situ value as the auger tip moves is part of the cell location during the drilling process. The horizontal earth pressure then increased again during grouting to a residual 20 kPa (0.21 tsf) above the in situ value; however, the residual increase in lateral earth pressure at completion was small compared to the approximately 1,500 kPa (15 tsf) of grout pressure that was maintained during auger extraction.

As part of this study, seven methods were evaluated against this database to evaluate their effectiveness in predicting the CFA capacities. These methods include: Wright and Reese (1979), Neely (1991), TxDOT (1972), FHWA 1999 (O’Neill and Reese, 1999), Coyle and Castello (1981), API method (1993), and LPC method (1981). Additionally, O’Neill et al. (2002) later published a normalized load-settlement curve suitable for design of similar diameter, single CFA piles in the geologic formations of the Texas Gulf Coast (as is presented in Section A.2.11 of this Appendix). In their investigation of load-settlement response, O’Neill et al. (2002) reported that although predictions were generally good, they may have been an artifact of compensating errors in the prediction of the side shear resistance. The measured side shear resistances were generally larger than those predicted for the surficial layer to depths of approximately 4 m (13 ft) but they were generally smaller than the values predicted for deeper strata.

For clay soils, the LPC (1981) and the TxDOT (1972) methods gave the closest correlation for ultimate total pile capacity. Their predictions produced average ratios of the measured to measured capacity of 0.98 and 0.86, and had standard deviations of this ratio of 0.35 and 0.33, respectively. The remaining three methods compared similarly, with the FHWA 1999 method being the most conservative (average ratio of the measured to predicted capacity of 1.52, and a standard deviation of this ratio 0.56). The results with the LPC (1981) and the FHWA methods are illustrated in Figure A.15 (a) and (b), respectively.

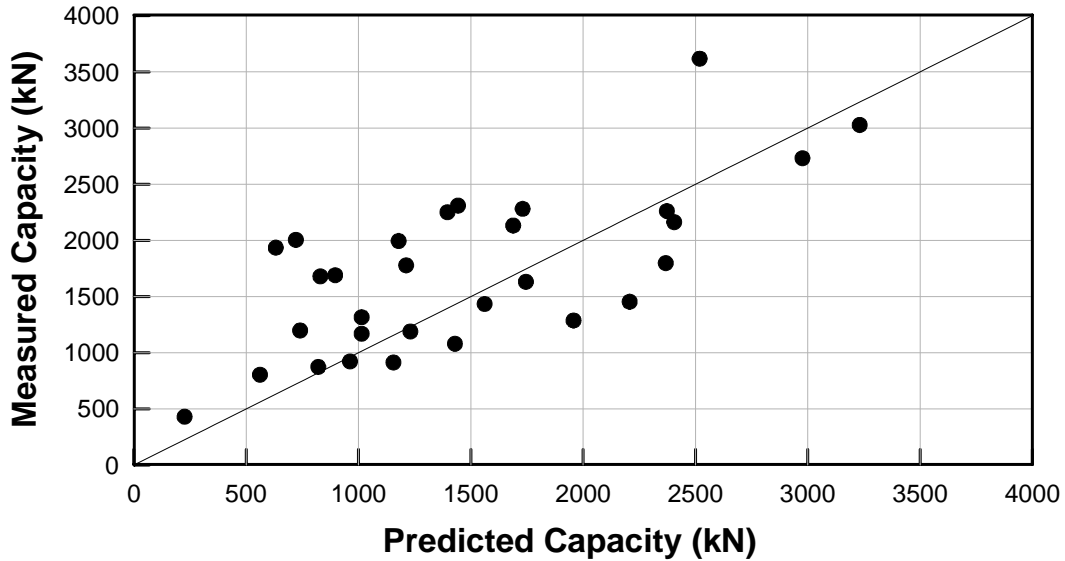


**Figure A.11. Summary of Total Resistance - Results from Four Methods (Coleman and Arcement, 2002)**

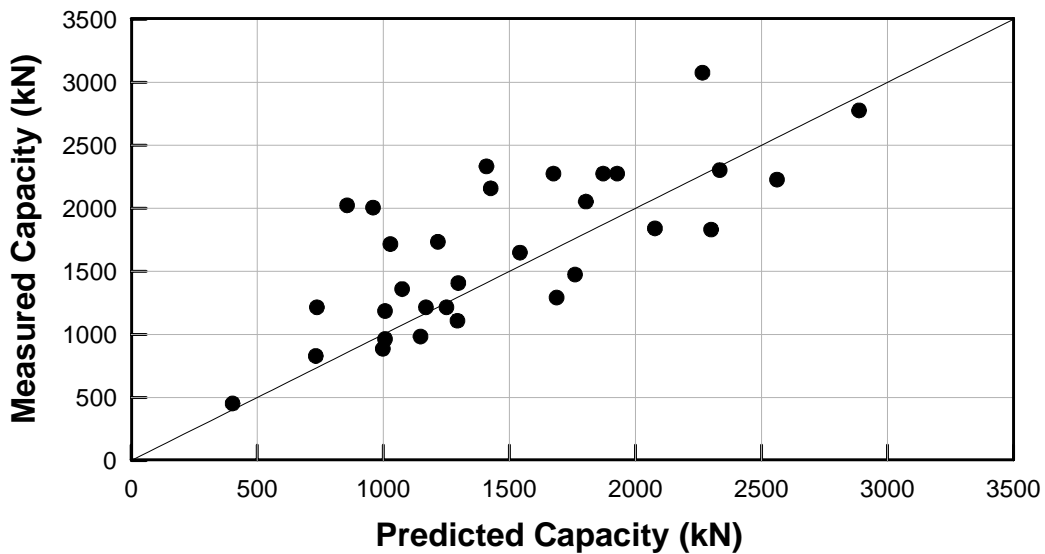
For sandy soils, the LPC (1981) and FHWA 1999 methods gave the best correlation for ultimate total pile capacity; both methods produced an average measured to predicted capacity ratio of 1.02 and had standard deviations of this ratio of 0.34 and 0.27, respectively. The results of the LPC (1981) and the FHWA methods are illustrated in Figure A.15 (c) and (d), respectively.

A comparison of various prediction methods of total capacity for cohesive soils is presented in Figure A.16. In this Figure, the mean and standard deviation of the ratio of the measured total capacity to the predicted total capacity is presented for the various methods. The comparison study conducted by O'Neill et al. (1999) is the only study with profiles consisting of entirely cohesive soils. The results for mixed soil conditions from the O'Neill et al. (1999) and Coleman and Arcement (2002) studies are also shown in Figure A.16.

The results from O'Neill et al. (1999) show that the best method for cohesive soils is the LPC method (1981), followed by the TxDOT (1972) method. However, the LPC Method (1981) requires CPT soundings while the TxDOT (1972) method requires a Dynamic Cone Penetrometer (uncommon to most regions of the U.S.). The remaining three methods all appear to have the same trend, with the FHWA 1999 method being the most conservative. The Coyle and Castello (1981) method generally has the average ratio of measured to predicted total capacity closest to 1.0, but also has the lowest mean of this ratio (i.e., it is most unconservative) for mixed soil conditions (Coleman and Arcement, 2002). In all three methods, the most conservative predictions of total capacity occur for clay soils and mixed soil conditions.



**Figure A.12. Total Capacity - Results From FHWA 1999 Method (Coleman and Arcement, 2002)**



**Figure A.13. Total Capacity Results - Coleman and Arcement (2002) Method**

### A.6.5 Summary of Comparison Study Results for Cohesive Soils

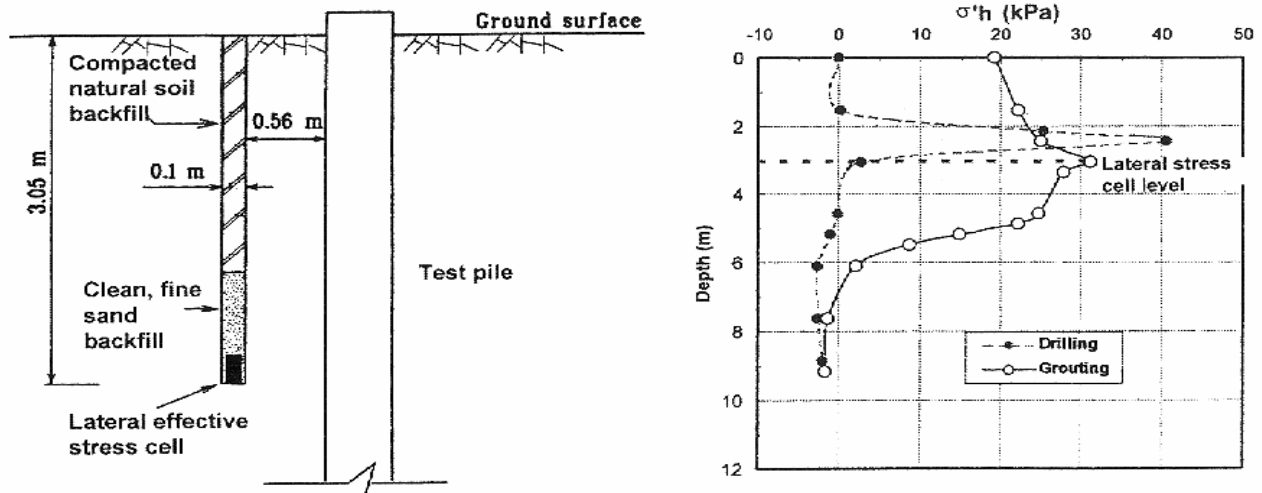


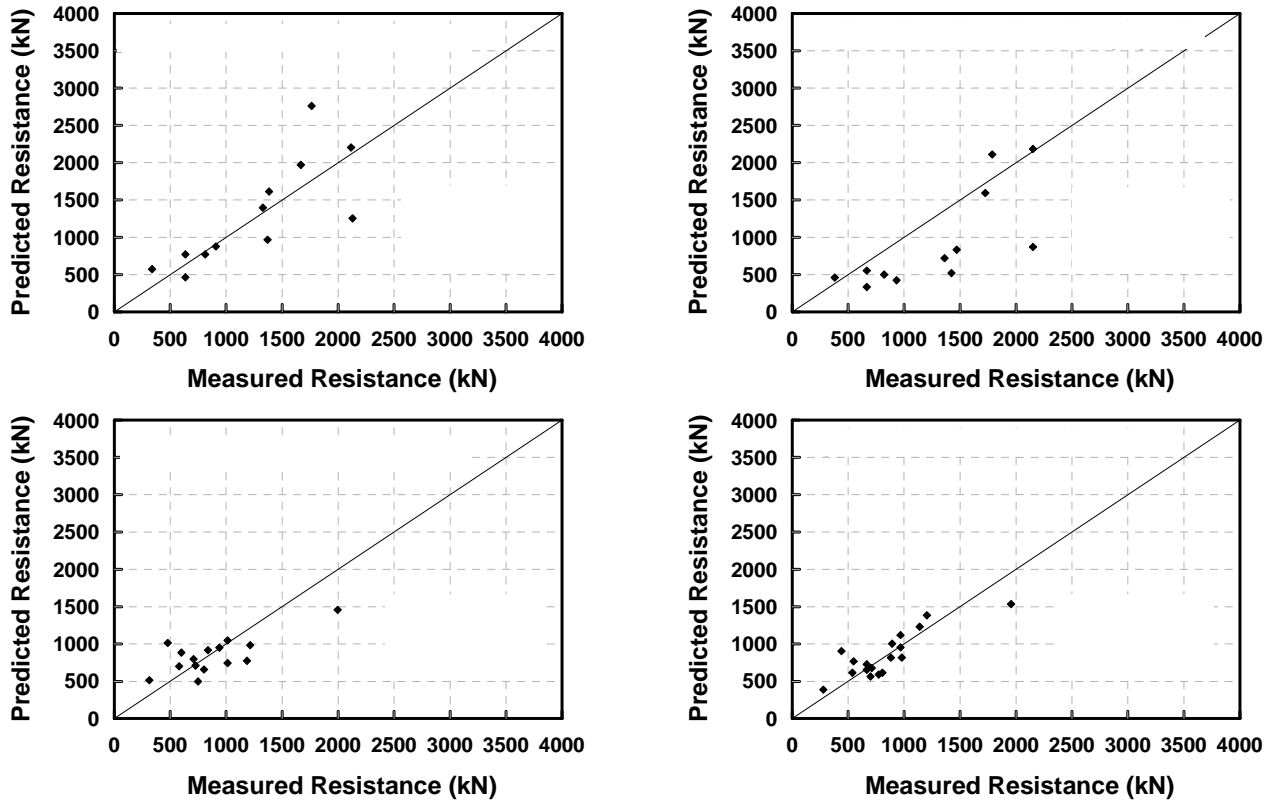
Figure A.14: Effective Lateral Earth Pressure near a CFA Pile during Construction (O'Neill et al., 2002)

### A.6.6 Summary of Comparison Study Results for Cohesionless Soils

A comparison of the mean and range of the measured-to-predicted total capacity ratios for cohesionless soils using various prediction methods is presented in Figure A.17. The mean and the standard deviation of this ratio are presented. The results for mixed soil conditions from Coleman and Arcement (2002) are also presented.

The FHWA 1999 method consistently provides the most accurate method for cohesionless soils in all comparison studies. O'Neill et al. (1999) for sands and Coleman and Arcement (2002) for mixed soils report good average mean ratios for the API method (1993), but also a greater standard deviation than for the FHWA 1999 method. McVay et al. (1994), Zelada and Stephenson (2000), and O'Neill et al. (1999) also found that the Wright and Reese (1979) and LPC (1981) methods provide good results; however, the LPC (1981) method may be occasionally unconservative.

The FHWA 1999 method requires SPT borings for estimating the end-bearing resistance and the pile depth for the side shear component. The LPC Method (1981) requires CPT soundings for estimating both components of resistance. The Wright and Reese (1979) and API (1993) methods require estimation of the lateral earth pressure coefficient ( $K$ ). The Wright and Reese (1979) method requires the internal soil friction angle ( $\phi$ ) and the API (1993) method requires the pile-to-soil interface friction angle ( $\delta$ ).

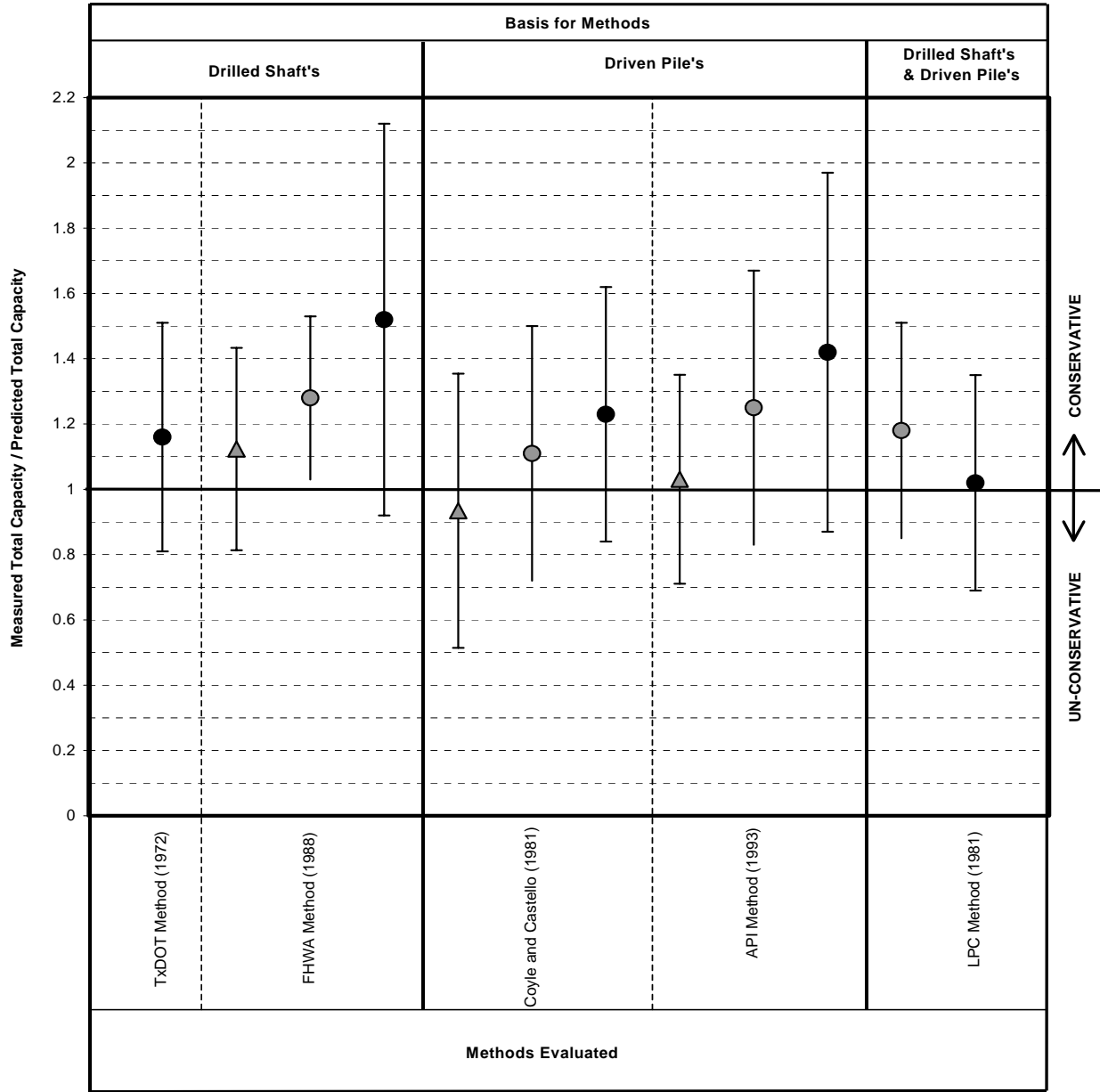


Source: O'Neill et al. (2002)

**Figure A.15. Total Resistance - Results from Four Methods**

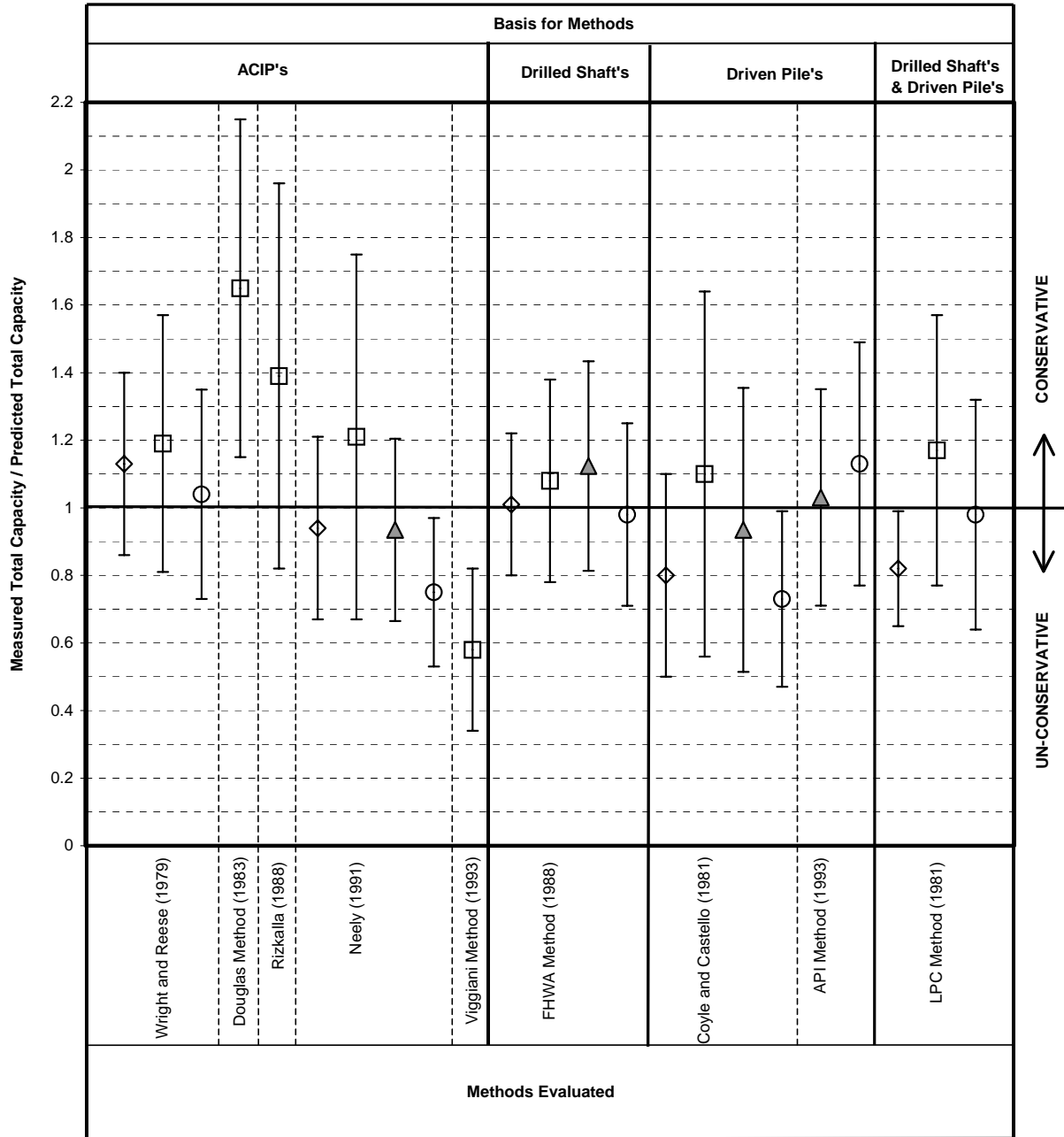
The study by Zelada and Stephenson (2000) for cohesionless soils concluded that the FHWA 1999 method had the best correlation for the side shear capacity, although this method is somewhat unconservative. This study concluded that the FHWA method was conservative for end-bearing resistance. Zelada and Stephenson (2000) recommended modifications to the FHWA 1999 method to reflect the tendency for CFA piles to exhibit less side shear and greater end-bearing resistance in cohesionless soils than that predicted with the FHWA 1999 method. The side shear capacity predicted was reduced by a factor of 0.8, and the end-bearing resistance was increased by a factor of 2.8.

Coleman and Arcement (2002) recommended modifications to the  $\beta$  factor of the FHWA 1999 method for side shear estimation in cohesionless soils (either sandy or silty soils). This was done to reflect the tendency for CFA piles to exhibit greater side shear resistance than the values predicted near the surface and less side shear resistance than that predicted at greater depths.



Predominant Soil Type	Study	Ultimate Capacity Defined at Displacements of
▲ Mixed Soils	Coleman and Arcement (2002)	- 10 % of the Pile Diameter
● Mixed Soils	O'Neill et al. (1999)	- 5 % of the Pile Diameter
● Clay Soils		

**Figure A.16. Comparison of Study Results - Axial Capacity in Cohesive Soils**



Predominant Soil Type	Study	Ultimate Capacity Defined at Displacements of
◇ Sandy Soils	McVay et al (1994)	- 5 % of the Pile Diameter
□ Sandy Soils	Zelada and Stephenson (2000)	- 5 % of the Pile Diameter
▲ Mixed Soils	Coleman and Arcement (2002)	- 10 % of the Pile Diameter
○ Sandy Soils	O'Neill et al. (1999)	- 5 % of the Pile Diameter

**Figure A.17: Comparison of Study Results – Axial Capacity in Cohesionless Soils**

## APPENDIX B. EXAMPLE PROBLEMS: SPREADSHEET SOLUTIONS FOR AXIAL CAPACITY OF SINGLE CFA PILES WITH DEPTH

### B.1 CONVENTIONAL CFA PILE IN COHESIVE SOIL

#### Problem Statement

Conventional CFA piles, 18 inches in nominal diameter, are being considered for use to provide support for a highway interchange in a coastal plains area. A subsurface investigation performed, as described in the Chapter 6 example problem (Section 6.7.4, Part A), provided information necessary to develop the generalized soil profile at the pier location as was shown in Figure 5.32. The bottom of the proposed pile cap is at a depth of 4 ft. An allowable stress design (ASD) is to be used with a safety factor of 2.0, as detailed in Chapter 6 (Section 6.7.4 Part D). Note that a safety factor of 2.0 is used, as full-scale load testing will be implemented to verify (or modify if necessary) the pile capacity estimates. Details of the safety factor selection criteria (ASD) will be presented subsequently in Chapter 6. Loading of the bridge and the proposed foundation layout has determined the axial loads to the individual CFA pile (as detailed in Section 6.7.4 Part E). For an allowable pile capacity of 130 kips, what pile embedment depth should be specified in accordance with ASD?

#### Spreadsheet Solution

The following section presents a spreadsheet solution for the ultimate static axial resistance and the allowable static axial resistance with depth of a single CFA pile in accordance with ASD. Note that a hand calculation of resistance at a pile depth of 60 ft is presented in Section 5.8.1. The recommended method, as detailed in Section 5.3.1.1, for estimating the ultimate resistance of a single CFA pile in cohesive soil was used.

The calculations for an ASD approach are presented in Table B.1. The calculations will be detailed column by column in the section to follow. A graphical presentation of the estimated resistances in accordance with ASD is provided as Figure B.1. It can be seen in this figure that a CFA pile minimum embedment depth of 69 ft is required to provide the specified minimum total allowable resistance of 130 kips, with a safety factor of 2.0 applied to the ultimate resistance.

The following list details the calculations in Table B.1 (column-by-column)

- A. Pile Embedment Depth ( $L$ ) – increments of 1 ft ( $\Delta L$ ) have been chosen for the spreadsheet solution with depth, as it is convenient and customary to provide a required embedment depth, in whole feet (ft). Note that the first whole ft increment with an allowable capacity greater than the required 130 kips should be specified.
- B. Undrained Shear Strength ( $S_u$ ) – provided from the subsurface investigation (from Section 6.7.4, Part A), as was shown in Figure 5.32 at the pier location. The top soil layer (soft clay) was idealized as having constant  $S_u$  with depth, while the bottom soil layer (medium to stiff clay) was idealized as having values of  $S_u$  that increased linearly with depth. Note that the values of  $S_u$  for the bottom soil layer are linearly interpolated from the depth at the mid-point of each of the pile segments.



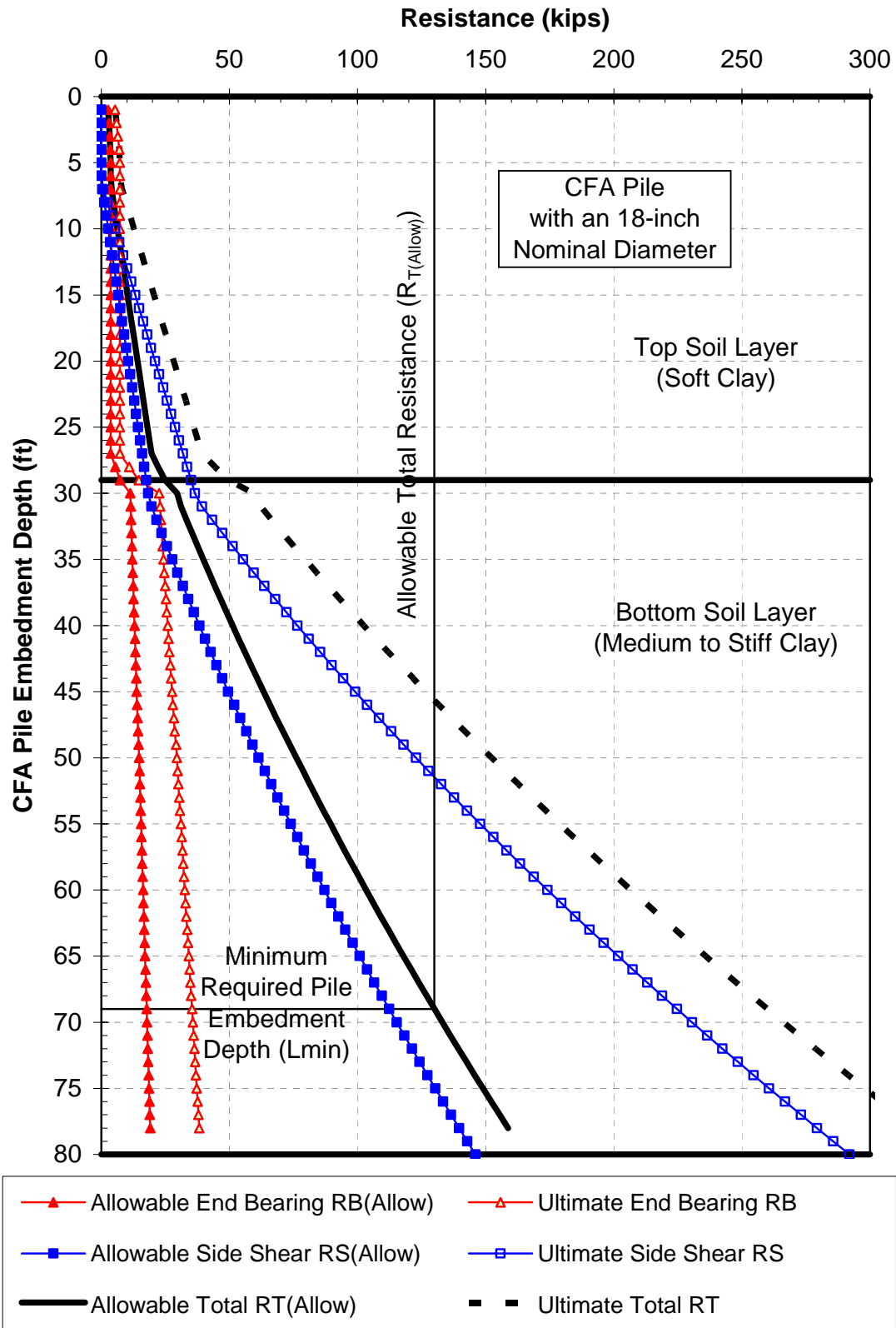
**Table B.1. ASD Example Calculations for 18-inch Diameter - CFA pile in Cohesive Soils**

	SIDE SHEAR RESISTANCE								END BEARING RESISTANCE						TOTAL RESISTANCE	
	A	B	C	D	E	F	G	H	I	J	K	L	M	N	O	P
	Pile Embodiment Depth L (ft)	Undrained Shear Strength $S_u$ (ksf)	Alpha Factor $\alpha$	Ultimate Unit Side Shear $f_s$ (ksf)	Ultimate Side Shear for Pile Segment $\Delta R_s$ (kips)	Ultimate Side Shear $R_s$ (kips)	Safety Factor SF	Allowable Side Shear $R_{S(Allow)}$ (kips)	Average Undrained Shear Strength (2-Diam. Below Tip) $S_{u(ave,2-D)}$ (ksf)	Bearing Capacity Factor $N_c$	Ultimate Unit End Bearing $q_p$ (ksf)	Ultimate End Bearing $R_B$ (kips)	Safety Factor SF	Allowable End Bearing $R_{B(Allow)}$ (kips)	Ultimate Total $R_T$ (kips)	Allowable Total $R_{T(Allow)}$ (kips)
Top Soil Layer (Medium Clay)	1	0.60	0.55	0.33	1.56	0.0	2.0	0.0	0.60	5.07	3.04	5.4	2.0	2.7	5.4	2.7
	2	0.60	0.55	0.33	1.56	0.0	2.0	0.0	0.60	5.57	3.34	5.9	2.0	3.0	5.9	3.0
	3	0.60	0.55	0.33	1.56	0.0	2.0	0.0	0.60	6.08	3.65	6.4	2.0	3.2	6.4	3.2
	4	0.60	0.55	0.33	1.56	0.0	2.0	0.0	0.60	6.59	3.95	7.0	2.0	3.5	7.0	3.5
	5	0.60	0.55	0.33	1.56	0.0	2.0	0.0	0.60	6.84	4.10	7.3	2.0	3.6	7.3	3.6
	6	0.60	0.55	0.33	1.56	0.0	2.0	0.0	0.60	6.84	4.10	7.3	2.0	3.6	7.3	3.6
	7	0.60	0.55	0.33	1.56	0.8	2.0	0.4	0.60	6.84	4.10	7.3	2.0	3.6	8.0	4.0
	8	0.60	0.55	0.33	1.56	2.3	2.0	1.2	0.60	6.84	4.10	7.3	2.0	3.6	9.6	4.8
	9	0.60	0.55	0.33	1.56	3.9	2.0	1.9	0.60	6.84	4.10	7.3	2.0	3.6	11.1	5.6
	10	0.60	0.55	0.33	1.56	5.4	2.0	2.7	0.60	6.84	4.10	7.3	2.0	3.6	12.7	6.3
	11	0.60	0.55	0.33	1.56	7.0	2.0	3.5	0.60	6.84	4.10	7.3	2.0	3.6	14.3	7.1
	12	0.60	0.55	0.33	1.56	8.6	2.0	4.3	0.60	6.84	4.10	7.3	2.0	3.6	15.8	7.9
	13	0.60	0.55	0.33	1.56	10.1	2.0	5.1	0.60	6.84	4.10	7.3	2.0	3.6	17.4	8.7
	14	0.60	0.55	0.33	1.56	11.7	2.0	5.8	0.60	6.84	4.10	7.3	2.0	3.6	18.9	9.5
	15	0.60	0.55	0.33	1.56	13.2	2.0	6.6	0.60	6.84	4.10	7.3	2.0	3.6	20.5	10.2
	16	0.60	0.55	0.33	1.56	14.8	2.0	7.4	0.60	6.84	4.10	7.3	2.0	3.6	22.0	11.0
	17	0.60	0.55	0.33	1.56	16.3	2.0	8.2	0.60	6.84	4.10	7.3	2.0	3.6	23.6	11.8
	18	0.60	0.55	0.33	1.56	17.9	2.0	8.9	0.60	6.84	4.10	7.3	2.0	3.6	25.1	12.6
	19	0.60	0.55	0.33	1.56	19.4	2.0	9.7	0.60	6.84	4.10	7.3	2.0	3.6	26.7	13.3
	20	0.60	0.55	0.33	1.56	21.0	2.0	10.5	0.60	6.84	4.10	7.3	2.0	3.6	28.2	14.1
	21	0.60	0.55	0.33	1.56	22.5	2.0	11.3	0.60	6.84	4.10	7.3	2.0	3.6	29.8	14.9
	22	0.60	0.55	0.33	1.56	24.1	2.0	12.1	0.60	6.84	4.10	7.3	2.0	3.6	31.4	15.7
	23	0.60	0.55	0.33	1.56	25.7	2.0	12.8	0.60	6.84	4.10	7.3	2.0	3.6	32.9	16.5
	24	0.60	0.55	0.33	1.56	27.2	2.0	13.6	0.60	6.84	4.10	7.3	2.0	3.6	34.5	17.2
	25	0.60	0.55	0.33	1.56	28.8	2.0	14.4	0.60	6.84	4.10	7.3	2.0	3.6	36.0	18.0
	26	0.60	0.55	0.33	1.56	30.3	2.0	15.2	0.60	6.84	4.10	7.3	2.0	3.6	37.6	18.8
	27	0.60	0.55	0.33	1.56	31.9	2.0	15.9	0.60	6.84	4.10	7.3	2.0	3.6	39.1	19.6
	28	0.60	0.55	0.33	1.56	33.4	2.0	16.7	0.90	6.84	6.18	10.9	2.0	5.5	44.4	22.2
	29	0.60	0.55	0.33	1.56	35.0	2.0	17.5	1.21	6.84	8.30	14.7	2.0	7.3	49.7	24.8
Bottom Soil Layer (Stiff to Very Stiff Clay)	30	1.51	0.55	0.83	3.91	36.5	2.0	18.3	1.53	8.36	12.79	22.6	2.0	11.3	59.1	29.6
	31	1.53	0.55	0.84	3.96	39.3	2.0	19.6	1.55	8.37	12.97	22.9	2.0	11.5	62.2	31.1
	32	1.55	0.55	0.85	4.01	43.2	2.0	21.6	1.57	8.39	13.16	23.3	2.0	11.6	66.5	33.2
	33	1.57	0.55	0.86	4.07	47.2	2.0	23.6	1.59	8.40	13.34	23.6	2.0	11.8	70.8	35.4
	34	1.59	0.55	0.87	4.12	51.2	2.0	25.6	1.61	8.41	13.53	23.9	2.0	12.0	75.2	37.6
	35	1.61	0.55	0.88	4.17	55.3	2.0	27.7	1.63	8.43	13.72	24.2	2.0	12.1	79.6	39.8
	36	1.63	0.55	0.90	4.22	59.5	2.0	29.7	1.65	8.44	13.90	24.6	2.0	12.3	84.0	42.0
	37	1.65	0.55	0.91	4.27	63.7	2.0	31.8	1.67	8.45	14.09	24.9	2.0	12.5	88.6	44.3
	38	1.67	0.55	0.92	4.32	67.9	2.0	34.0	1.69	8.47	14.28	25.2	2.0	12.6	93.2	46.6
	39	1.69	0.55	0.93	4.37	72.2	2.0	36.1	1.71	8.48	14.47	25.6	2.0	12.8	97.8	48.9
	40	1.71	0.55	0.94	4.42	76.6	2.0	38.3	1.73	8.49	14.66	25.9	2.0	13.0	102.5	51.2

Table B.1. (continued)

A	SIDE SHEAR RESISTANCE							END BEARING RESISTANCE						TOTAL RESISTANCE	
	B	C	D	E	F	G	H	I	J	K	L	M	N	O	P
	Pile Embodiment Depth L (ft)	Undrained Shear Strength $S_u$ (ksf)	Alpha Factor $\alpha$	Ultimate Unit Side Shear $f_s$ (ksf)	Ultimate Side Shear for Pile Segment $\Delta R_s$ (kips)	Ultimate Side Shear $R_s$ (kips)	Safety Factor SF	Allowable Side Shear $R_{S(Allow)}$ (kips)	Average Undrained Shear Strength (2-Diam. Below Tip) $S_{u(ave, 2-D)}$ (ksf)	Bearing Capacity Factor $N_C$	Ultimate Unit End Bearing $q_p$ (ksf)	Ultimate End Bearing $R_B$ (kips)	Safety Factor SF	Allowable End Bearing $R_{B(Allow)}$ (kips)	Ultimate Total $R_T$ (kips)
41	1.73	0.55	0.95	4.47	81.0	2.0	40.5	1.75	8.51	14.85	26.2	2.0	13.1	107.2	53.6
42	1.75	0.55	0.96	4.52	85.4	2.0	42.7	1.76	8.52	15.04	26.6	2.0	13.3	112.0	56.0
43	1.76	0.55	0.97	4.57	89.9	2.0	44.9	1.78	8.54	15.23	26.9	2.0	13.5	116.8	58.4
44	1.78	0.55	0.98	4.62	94.4	2.0	47.2	1.80	8.55	15.42	27.3	2.0	13.6	121.7	60.8
45	1.80	0.55	0.99	4.68	99.0	2.0	49.5	1.82	8.56	15.61	27.6	2.0	13.8	126.6	63.3
46	1.82	0.55	1.00	4.73	103.7	2.0	51.8	1.84	8.58	15.81	27.9	2.0	14.0	131.6	65.8
47	1.84	0.55	1.01	4.78	108.4	2.0	54.2	1.86	8.59	16.00	28.3	2.0	14.1	136.7	68.3
48	1.86	0.55	1.02	4.83	113.1	2.0	56.6	1.88	8.60	16.19	28.6	2.0	14.3	141.8	70.9
49	1.88	0.55	1.04	4.88	117.9	2.0	59.0	1.90	8.68	16.51	29.2	2.0	14.6	147.1	73.6
50	1.90	0.55	1.05	4.93	122.8	2.0	61.4	1.92	8.68	16.69	29.5	2.0	14.7	152.3	76.1
51	1.92	0.55	1.06	4.98	127.7	2.0	63.9	1.94	8.69	16.86	29.8	2.0	14.9	157.5	78.8
52	1.94	0.55	1.07	5.03	132.7	2.0	66.3	1.96	8.69	17.04	30.1	2.0	15.1	162.8	81.4
53	1.96	0.55	1.08	5.08	137.7	2.0	68.8	1.98	8.69	17.21	30.4	2.0	15.2	168.1	84.0
54	1.98	0.55	1.09	5.13	142.7	2.0	71.4	2.00	8.69	17.39	30.7	2.0	15.4	173.4	86.7
55	2.00	0.55	1.10	5.18	147.8	2.0	73.9	2.02	8.70	17.56	31.0	2.0	15.5	178.9	89.4
56	2.02	0.55	1.11	5.23	153.0	2.0	76.5	2.04	8.70	17.74	31.3	2.0	15.7	184.3	92.2
57	2.04	0.55	1.12	5.29	158.2	2.0	79.1	2.06	8.70	17.91	31.7	2.0	15.8	189.9	94.9
58	2.06	0.55	1.13	5.34	163.5	2.0	81.7	2.08	8.70	18.09	32.0	2.0	16.0	195.4	97.7
59	2.08	0.55	1.14	5.39	168.8	2.0	84.4	2.10	8.70	18.26	32.3	2.0	16.1	201.0	100.5
60	2.10	0.55	1.15	5.44	174.1	2.0	87.1	2.12	8.71	18.44	32.6	2.0	16.3	206.7	103.4
61	2.12	0.55	1.16	5.49	179.5	2.0	89.8	2.14	8.71	18.61	32.9	2.0	16.4	212.4	106.2
62	2.14	0.55	1.18	5.54	185.0	2.0	92.5	2.16	8.71	18.79	33.2	2.0	16.6	218.2	109.1
63	2.16	0.55	1.19	5.59	190.5	2.0	95.3	2.18	8.71	18.97	33.5	2.0	16.8	224.0	112.0
64	2.18	0.55	1.20	5.64	196.1	2.0	98.0	2.20	8.72	19.14	33.8	2.0	16.9	229.9	115.0
65	2.20	0.55	1.21	5.69	201.7	2.0	100.8	2.22	8.72	19.32	34.1	2.0	17.1	235.8	117.9
66	2.22	0.55	1.22	5.74	207.4	2.0	103.7	2.24	8.72	19.50	34.5	2.0	17.2	241.8	120.9
67	2.24	0.55	1.23	5.79	213.1	2.0	106.5	2.25	8.72	19.67	34.8	2.0	17.4	247.8	123.9
68	2.25	0.55	1.24	5.84	218.9	2.0	109.4	2.27	8.73	19.85	35.1	2.0	17.5	253.9	127.0
69	2.27	0.55	1.25	5.90	224.7	2.0	112.3	2.29	8.73	20.02	35.4	2.0	17.7	260.1	130.0
70	2.29	0.55	1.26	5.95	230.5	2.0	115.3	2.31	8.73	20.20	35.7	2.0	17.8	266.2	133.1
71	2.31	0.55	1.27	6.00	236.5	2.0	118.2	2.33	8.73	20.38	36.0	2.0	18.0	272.5	136.2
72	2.33	0.55	1.28	6.05	242.4	2.0	121.2	2.35	8.74	20.55	36.3	2.0	18.2	278.8	139.4
73	2.35	0.55	1.29	6.10	248.5	2.0	124.2	2.37	8.74	20.73	36.6	2.0	18.3	285.1	142.5
74	2.37	0.55	1.30	6.15	254.5	2.0	127.3	2.39	8.74	20.91	36.9	2.0	18.5	291.5	145.7
75	2.39	0.55	1.32	6.20	260.7	2.0	130.3	2.41	8.74	21.09	37.3	2.0	18.6	297.9	149.0
76	2.41	0.55	1.33	6.25	266.8	2.0	133.4	2.43	8.75	21.26	37.6	2.0	18.8	304.4	152.2
77	2.43	0.55	1.34	6.30	273.1	2.0	136.5	2.45	8.75	21.44	37.9	2.0	18.9	310.9	155.5
78	2.45	0.55	1.35	6.35	279.3	2.0	139.7	2.47	8.75	21.62	38.2	2.0	19.1	317.5	158.8
79	2.47	0.55	1.36	6.40	285.7	2.0	142.8								
80	2.49	0.55	1.37	6.45	292.0	2.0	146.0								

$S_u$  needed 2-Diameters Below Tip



**Figure B.1. ASD Example for CFA Pile in Cohesive Soils**

- C. Alpha Factor ( $\alpha$ ) – because the ratio of the undrained shear strength to standard atmospheric pressure is less than 1.5 ( $S_u/P_a \leq 1.5$ ), the alpha factor ( $\alpha$ ) is constant at 0.55. Note that for  $S_u/P_a > 1.5$ ,  $\alpha$  would need to be reduced as detailed in Section 5.3.1.1.
- D. Ultimate Unit Side Shear ( $f_s$ ) – the product of columns “C” and “B” ( $f_s = \alpha \cdot S_u$ ).
- E. Ultimate Side Shear for Pile Segment ( $\Delta R_S$ ) – the product of column “D” and the peripheral area of the pile segment ( $\Delta R_S = f_s A_{(peripheral)} = f_s \pi D_{(diameter)} \Delta L$ ).
- F. Ultimate Side Shear ( $R_S$ ) – the sum of the pile segment ultimate side shear values ( $\Sigma \Delta R_S$ ) to the pile embedment depth with the following contributions discounted: The top 5 ft (shaded section in Column “F”), and the bottom section of pile equal in length to one pile diameter (1.5 ft for this example). Discounting of sections at the top and bottom of pile is detailed in Section 5.3.1.1. Note that if an evaluation of the depth of seasonal moisture change were to reveal a depth in excess of 5 ft, then this larger depth would be discounted from contributing to the side shear resistance.
- G. The Safety Factor (SF) – given in problem statement as 2.0.
- H. The Allowable Side Shear Resistance ( $R_{S(Allow)}$ ) - column “F” divided by column “G”.
- I. Average Undrained Shear Strength Below the Pile Tip ( $S_{u(ave,2-D)}$ ) – the average of column “B” from the pile tip to a depth of 2 pile diameters below the pile tip (in this example 3 ft). This is as recommended in Section 5.3.1.1; solutions for the depth of influence of end-bearing typically range from as shallow as 2 diameters above the tip and as deep as 3 to 4 diameters below the tip.
- J. Bearing Capacity Factor ( $N_c^*$ ) – linearly interpolated from the undrained shear strength ( $S_u$ ) of each soil layer from the values listed in Table B.1, because modulus data ( $E_S$ ) was not obtained in the site investigation. Note that the bearing capacity factor has been further reduced for embedment depths less than 3 pile diameters ( $L < 3 D_{(diameter)}$ ) as detailed in Section 5.3.1.1 (shown as shaded section of column “J” in Table 5.3).
- K. Ultimate Unit End-Bearing ( $q_p$ ) – the product of columns “J” and “I” ( $q_p = N_c^* S_{u(ave,2-D)}$ ).
- L. Ultimate End-Bearing ( $R_B$ ) – the product of column “K” and the cross-sectional area of the pile ( $R_B = q_p A_{(cross-section)} = q_p (\pi/4) \cdot D_{(diameter)}^2$ ).
- M. The Safety Factor (SF) – given in problem statement as 2.0. Note that a safety factor of 2.0 is used, as full-scale load testing will be implemented to verify (or modify if necessary) the pile capacity estimates.

- N. The Allowable End-Bearing Resistance ( $R_{B(Allow)}$ ) – Column “L” divided by column “M”.
- O. Ultimate Total Resistance ( $R_T$ ) – sum of columns “F” and “L” ( $R_T = R_S + R_B$ ).
- P. The Allowable Total Resistance ( $R_{T(Allow)}$ ) – sum of columns “H” and “N”. Note this could be calculated as the product of column “O” and the Safety Factor, as only an overall safety factor was specified.

## **B.2 CONVENTIONAL CFA AND DRILLED DISPLACEMENT PILES IN COHESIONLESS SOILS**

### Problem Statement

Both conventional CFA piles and drilled displacement piles, either of which have a nominal diameter of 18 inches, are being considered for use to provide support for a bridge over a small stream within a flood plain. A subsurface investigation performed provided information to develop the generalized soil profile at the pier location, as was shown in Figure 5.33, in terms of *SPT-N* values, soil descriptions, and unit weights. While the pier location is usually accessible by track mounted equipment, extreme high tides have been known to bring the water level up to that of the site. The hydraulic engineer for the project has indicated that potential scour exists at the pier to a depth of 6 ft. The bottom of the proposed pile cap is also proposed at a depth of 6 ft. An allowable stress design (ASD) may be used with a safety factor of 2.5. Note that details of the safety factor selection criteria (ASD) were presented in Chapter 6. Loading of the bridge and the proposed foundation layout has determined an allowable total capacity of 170 kips per pile (in accordance with ASD). What minimum pile embedment depth for both pile types should be specified in accordance with ASD.

### Spreadsheet Solution

The recommended method for estimating the ultimate resistance of a single CFA pile in cohesionless soil was used as detailed in Section 5.3.2.1, and the recommended method for estimating the ultimate resistance of a single drilled displacement pile in cohesionless soil was used as detailed in Section 5.4.2. The calculations for the conventional CFA pile are presented in Table B.2., while the calculations for the drilled displacement pile are presented in Table B.3. All calculations will be detailed column by column in the section to follow.

For the conventional CFA pile, a graphical presentation of the estimated resistances in accordance with ASD is provided as Figure B.2 for the conventional CFA pile, and as Figure B.3 for the drilled displacement pile. It can be seen in these figures that the specified minimum total allowable resistance of 170 kips, with a safety factor of 2.5, may be provided by a conventional CFA pile minimum embedment depth of 62 ft, while a drilled displacement pile minimum embedment depth of only 37 ft is required. Note from the borings near the pier location (Figure 5.33) that a depth of 37 ft corresponds to the transition from soil layer 2 (Silty Fine Sand) to the more competent soil layer 3 (Shelly Sand). Prudence suggests that the embedment depth should

be extended a couple of feet to ensure that the pile is tipped into this more competent soil layer in order to take advantage of the associated greater end-bearing development.

Figure B.4 presents the ultimate resistances of both the conventional CFA pile and the drilled displacement pile with depth to illustrate the capacity advantage that can be realized with a drilled displacement technique in cohesionless soils. For this example, the drilled displacement piles provide a total resistance of approximately 3.5 times (on the average) the total resistance provided by the CFA pile at any given depth.

The following list details the CFA pile calculations in Table B.2 (column-by-column)

- A. *SPT-N* Values – from the subsurface investigation, as was shown in Figure 5.33.
- B. Depth of *SPT-N* Values – from the subsurface investigation, as was shown in Figure 5.33.
- C. Pile Embedment Depth ( $L$ ) – increments ( $\Delta L$ ) have been chosen for the spreadsheet solution such that the division between pile sections lies midway between the reported *SPT-N* values with depth. The pile was segmented in this way mainly for ease in illustrating the recommended method for estimating the end-bearing resistance with *SPT-N* values. However, minor differences in *SPT-N* values obtained within a soil layer type may very well be an artifact of testing inconsistencies as much as soil variation, and even if attributable to soil variation construction of the CFA pile may tend to average out these effects. Alternatively, either simple averages of similar soil types and strengths or a linear fit of the strengths with depth (perhaps from multiple borings) are routinely performed and easily accommodated.
- D. Depth to Mid-Point of Pile Segment ( $L_{(mid)}$ ) – midpoint between pile tip elevation and pile tip elevation from previous segment.
- E. Length of Pile Segment ( $\Delta L$ ) – difference between pile tip elevation and pile tip elevation from previous segment.
- F. Vertical Effective Stress at Mid-Point of Pile Segment ( $\sigma_v'$ ) – total vertical stress minus hydrostatic pressure. Further, the solution in this example has assumed a worst case “bed” scour where the top 6 ft has been discounted (shown as shaded areas in columns “F” and “G”) in calculating both the effective stress distribution and beta factor ( $\beta$ ) with depth. Note that if the scour was anticipated to be only “localized”, the top 6 ft need not be discounted in calculating the effective stress distribution and beta factor ( $\beta$ ).
- G. Beta Factor ( $\beta$ ) – determined as a function of pile embedment depth ( $L$ ) in accordance with Section 5.3.2.1. Note that the  $\beta$  factor for the first and second pile segments were subject to the limitation of 1.2, and the eighth through tenth pile segments were reduced by the ratio of  $N/15$  as these *SPT-N* values were less than 15 (all shown as shaded areas of Column “G”). None of the pile segments were subjected to the lower limit of  $\beta \geq 0.25$ .

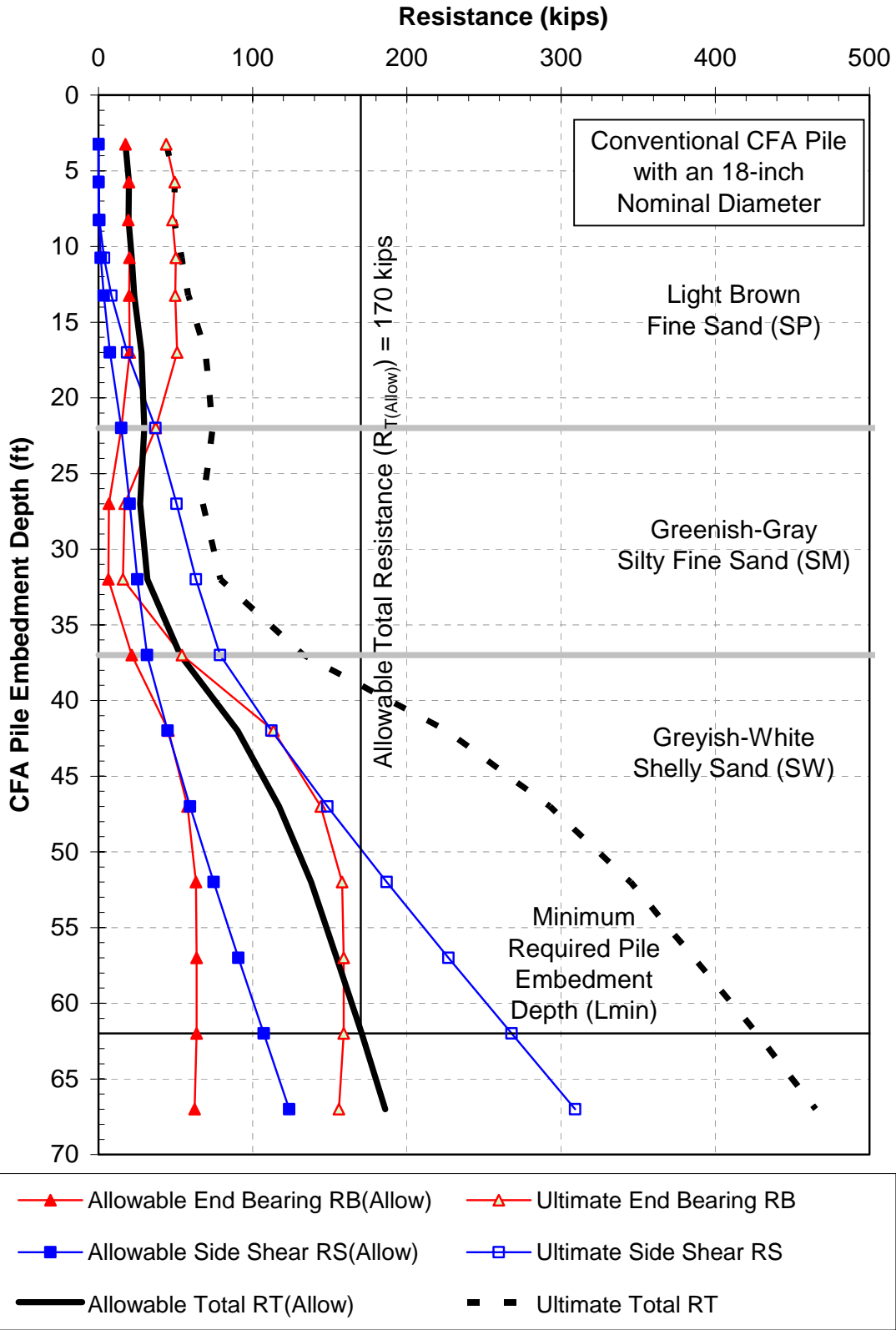
**Table B.2. ASD Example Calculations for 18-inch Diameter CFA Pile in Cohesionless Soils**

	SPT-N Values, PILE DEPTHS and SEGMENT LENGTHS					SIDE SHEAR RESISTANCE							END BEARING RESISTANCE					TOTAL RESISTANCE		
	A	B	C	D	E	F	G	H	I	J	K	L	M	N	O	P	Q	R	S	T
	SPT-N Value	Depth of Reported SPT-N Value	PILE EMBEDMENT DEPTH (Bottom of Pile Segment)	Depth to Mid-Point of Pile Segment	Length of Pile Segment	Vertical Effective Stress at Mid Point of Pile Segment	Beta Factor	Ultimate Unit Side Shear	Ultimate Side Shear for Pile Segment	Ultimate Side Shear	Safety Factor	Allowable Side Shear	Average SPT-N Below Tip		Ultimate Unit End Bearing	Ultimate End Bearing	Safety Factor	Allowable End Bearing	Ultimate Total	Allowable Total
	$SPT-N$ (blows/ft)	$L_{(SPT-N)}$ (ft)	$L$ (ft)	$L_{(mid)}$ (ft)	$\Delta L$ (ft)	$\sigma_v'$ (psf)	$\beta$	$f_s$ (tsf)	$\Delta R_s$ (kips)	$R_s$ (kips)	$SF$	$R_{S(Allow)}$ (kips)	$N_{(ave)}$		$q_p$ (ksf)	$R_B$ (kips)	$SF$	$R_{B(Allow)}$ (kips)	$R_T$ (kips)	$R_{T(Allow)}$ (kips)
Light Brown Fine Sand	16	2.0	3.25	1.63	3.25	0	1.20	0.00	0.0	0.0	2.5	0.0	21	Intentionally Left Blank	24.80	43.8	2.5	17.5	43.8	17.5
	27	4.5	5.75	4.50	2.50	0	1.20	0.00	0.0	0.0	2.5	0.0	23		28.00	49.5	2.5	19.8	49.5	19.8
	19	7.0	8.25	7.00	2.50	58	1.20	0.07	0.8	0.7	2.5	0.3	23		27.20	48.1	2.5	19.2	48.8	19.5
	24	9.5	10.75	9.50	2.50	202	1.25	0.25	3.0	3.7	2.5	1.5	24		28.40	50.2	2.5	20.1	53.9	21.6
	25	12.0	13.25	12.00	2.50	346	1.17	0.40	4.8	8.5	2.5	3.4	24		28.20	49.8	2.5	19.9	58.3	23.3
	22	14.5	17.00	15.13	3.75	526	1.09	0.57	10.1	18.6	2.5	7.4	24		28.80	50.9	2.5	20.4	69.5	27.8
	26	19.5	22.00	19.50	5.00	778	1.00	0.78	18.4	37.0	2.5	14.8	18		21.00	37.1	2.5	14.8	74.1	29.6
Greenish- Grey Silty Fine Sand	9	24.5	27.00	24.50	5.00	1056	0.55	0.58	13.7	50.7	2.5	20.3	8		9.60	17.0	2.5	6.8	67.7	27.1
	7	29.5	32.00	29.50	5.00	1334	0.39	0.53	12.4	63.1	2.5	25.2	8		9.00	15.9	2.5	6.4	79.0	31.6
	8	34.5	37.00	34.50	5.00	1612	0.42	0.67	15.8	78.9	2.5	31.6	26		30.60	54.1	2.5	21.6	133.0	53.2
Greyish-White Shelly Sand	43	39.5	42.00	39.50	5.00	1967	0.72	1.41	33.3	112.2	2.5	44.9	54		64.20	113.5	2.5	45.4	225.7	90.3
	64	44.5	47.00	44.50	5.00	2323	0.66	1.54	36.2	148.5	2.5	59.4	68		81.60	144.2	2.5	57.7	292.7	117.1
	72	49.5	52.00	49.50	5.00	2678	0.61	1.63	38.5	186.9	2.5	74.8	75		89.40	158.0	2.5	63.2	344.9	138.0
	77	54.5	57.00	54.50	5.00	3034	0.56	1.70	40.0	226.9	2.5	90.8	79		90.00	159.0	2.5	63.6	386.0	154.4
	81	59.5	62.00	59.50	5.00	3389	0.51	1.74	40.9	267.9	2.5	107.1	79	90.00	159.0	2.5	63.6	426.9	170.8	
	76	64.5	67.00	64.50	5.00	3745	0.47	1.75	41.2	309.1	2.5	123.6	74	88.20	155.9	2.5	62.3	465.0	186.0	
	71	69.5	72.00	69.50	5.00	4100	0.42	1.74	41.0	350.1	2.5	140.0	SPT-N Values needed at least 2-Diameters Below Tip							

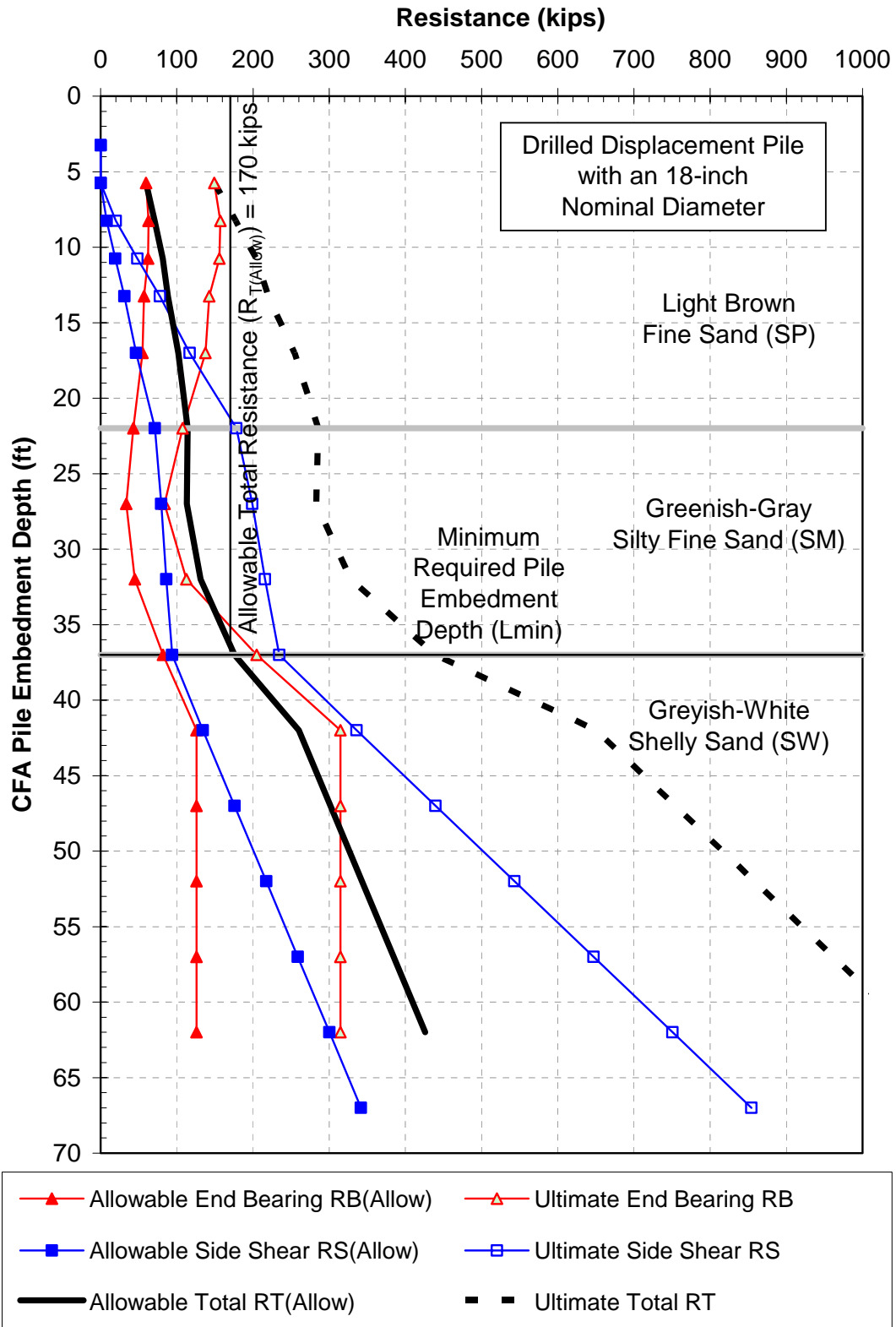
**Table B.3. ASD Example Calculations for 18-inch Diameter Drilled Displacement Pile in Cohesionless Soils**

	SPT-N Values, PILE DEPTHS and SEGMENT LENGTHS					SIDE SHEAR RESISTANCE							END BEARING RESISTANCE					TOTAL RESISTANCE		
	A	B	C	D	E	F	G	H	I	J	K	L	M	N	O	P	Q	R	S	T
	SPT-N Value (blows/ft)	Depth of Reported SPT-N Value $L_{(SPT-N)}$ (ft)	PILE EMBEDMENT DEPTH (Bottom of Pile Segment) $L$ (ft)	Depth to Mid-Point of Pile Segment $L_{(mid)}$ (ft)	Length of Pile Segment $\Delta L$ (ft)	Vertical Effective Stress at Mid-Point of Pile Segment $\sigma'_v$ (psf)	Unit Side Shear Constant $W_s$ (ksf)	Ultimate Unit Side Shear $f_s$ (tsf)	Ultimate Side Shear for Pile Segment $\Delta R_s$ (kips)	Ultimate Side Shear $R_s$ (kips)	Safety Factor $SF$	Allowable Side Shear $R_{S(Allow)}$ (kips)	Average SPT-N Below Tip $N_{(ave)}$ (tsf)	Unit End Bearing Constant $W_T$ (ksf)	Ultimate Unit End Bearing $q_p$ (ksf)	Ultimate End Bearing $R_B$ (kips)	Safety Factor $SF$	Allowable End Bearing $R_{B(Allow)}$ (kisp)	Ultimate Total $R_T$ (kips)	Allowable Total $R_{T(Allow)}$ (kips)
Light Brown Fine Sand	16	2.0	3.25	Not Needed for Drilled Displacement Piles	3.25	Not Needed for Drilled Displacement Piles	0.00	1.60	24.5	0.0	2.50	0.0	SPT-N Values needed Approximately 4-Diameters Above Tip							
	27	4.5	5.75		2.50		0.00	2.70	31.8	0.0	2.50	0.0	22	0	84.36	149.1	2.50	59.6	149.1	59.6
	19	7.0	8.25		2.50		0.00	1.90	22.4	20.1	2.50	8.1	23	0	88.92	157.1	2.50	62.9	177.3	70.9
	24	9.5	10.75		2.50		0.00	2.40	28.3	48.4	2.50	19.4	23	0	88.16	155.8	2.50	62.3	204.2	81.7
	25	12.0	13.25		2.50		0.00	2.50	29.5	77.9	2.50	31.1	21	0	80.56	142.4	2.50	56.9	220.2	88.1
	22	14.5	17.00		3.75		0.00	2.20	38.9	116.7	2.50	46.7	21	0	77.90	137.7	2.50	55.1	254.4	101.8
	26	19.5	22.00		5.00		0.00	2.60	61.3	178.0	2.50	71.2	16	0	60.80	107.4	2.50	43.0	285.5	114.2
Greenish-Grey Silty Fine Sand	9	24.5	27.00	Not Needed for Drilled Displacement Piles	5.00	Not Needed for Drilled Displacement Piles	0.00	0.90	21.2	199.2	2.50	79.7	13	0	47.50	83.9	2.50	33.6	283.2	113.3
	7	29.5	32.00		5.00		0.00	0.70	16.5	215.7	2.50	86.3	17	0	63.65	112.5	2.50	45.0	328.2	131.3
	8	34.5	37.00		5.00		0.00	0.80	18.8	234.6	2.50	93.8	31	0	115.90	204.8	2.50	81.9	439.4	175.7
Greyish-White Shelly Sand	43	39.5	42.00	Not Needed for Drilled Displacement Piles	5.00	Not Needed for Drilled Displacement Piles	1.00	4.30	101.3	335.9	2.50	134.4	47	28	178.00	314.6	2.50	125.8	650.4	260.2
	64	44.5	47.00		5.00		1.00	4.40	103.7	439.5	2.50	175.8	64	28	178.00	314.6	2.50	125.8	754.1	301.6
	72	49.5	52.00		5.00		1.00	4.40	103.7	543.2	2.50	217.3	74	28	178.00	314.6	2.50	125.8	857.8	343.1
	77	54.5	57.00		5.00		1.00	4.40	103.7	646.9	2.50	258.8	77	28	178.00	314.6	2.50	125.8	961.4	384.6
	81	59.5	62.00		5.00		1.00	4.40	103.7	750.6	2.50	300.2	76	28	178.00	314.6	2.50	125.8	1065.1	426.0
	76	64.5	67.00		5.00		1.00	4.40	103.7	854.2	2.50	341.7	SPT-N Values needed Approximately 4-Diameters Below Tip							
	71	69.5	72.00		5.00		1.00	4.40	103.7	957.9	2.50	383.2								

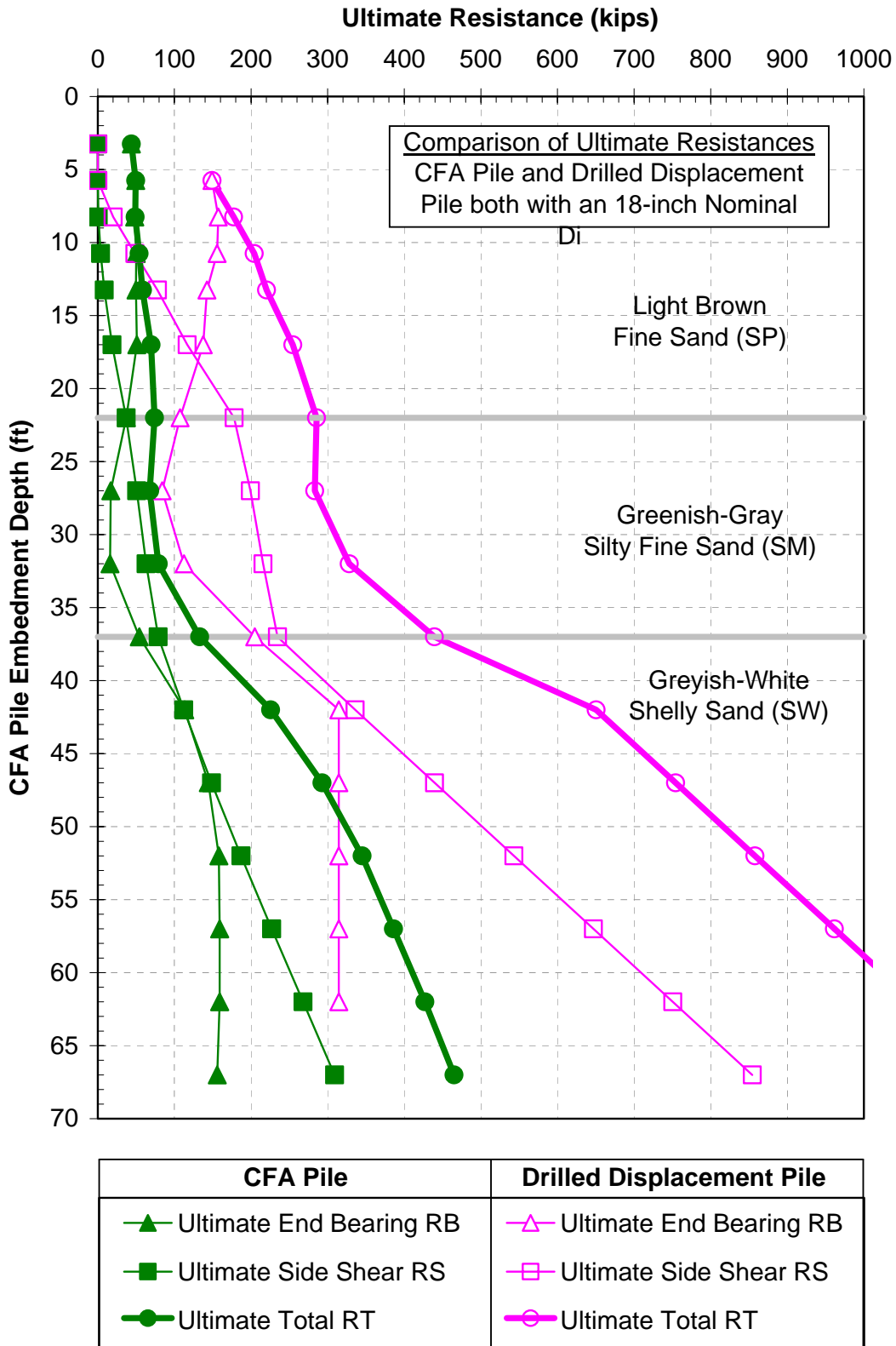




**Figure B.2: ASD Example for CFA Pile in Cohesionless Soils**



**Figure B.3: ASD Example for Drilled Displacement Pile in Cohesionless Soils**



**Figure B.4: Comparison of Ultimate Resistances of 18 inch Diameter CFA Pile and Drilled Displacement Pile for Cohesionless Soil Example**

- H. Ultimate Unit Side Shear ( $f_S$ ) – the product of columns “G” and “F” ( $f_S = \beta \cdot \sigma_v'$ ), note that none of the pile segments exceeded the limit of 2 tsf.
- I. Ultimate Side Shear for Pile Segment ( $\Delta R_S$ ) – the product of column “H” and the peripheral area of the pile segment ( $\Delta R_S = f_S \cdot A_{\text{peripheral}} = f_S \cdot \pi \cdot D_{\text{diameter}} \cdot \Delta L$ ).
- J. Ultimate Side Shear ( $R_S$ ) – the sum of the pile segment ultimate side shear values ( $\Sigma \Delta R_S$ ) to the pile embedment depth.
- K. The Safety Factor (SF) – given in problem statement as 2.5.
- L. The Allowable Side Shear Resistance ( $R_{S(\text{Allow})}$ ) - column “F” divided by column “G”.
- M. Average *SPT-N* Value Below Pile Tip ( $N_{(\text{ave})}$ ) – the average of column “A” from the pile tip to a depth of 2 to 4 pile diameters below the pile tip (in this example 4 to 8 ft), depending upon the frequency of *SPT-N* values with depth and soil layering. Note that the 14<sup>th</sup> and 15<sup>th</sup> pile segments have  $N_{(\text{ave})} > 75$  (shown as shaded areas of column “M”), and the resulting  $q_p$  has been limited as described for column “O”.
- N. Intentionally left Blank – for easy comparison of example calculations of CFA piles (Table B.2) to drilled displacement piles (Table B.3).
- O. Ultimate Unit End-Bearing ( $q_p$ ) – columns “M” multiplied by 0.6 ( $q_p = 0.6 N_{(\text{ave})}$ ) to get  $q_p$  in tsf, and multiplied by 2 to convert units to ksf. Note that the 14<sup>th</sup> and 15<sup>th</sup> pile segments have been subject to the upper limit of 90 ksf (shown as shaded areas of column “O”).
- P. Ultimate End-Bearing ( $R_B$ ) – the product of column “O” and the cross-sectional area of the pile ( $R_B = q_p \cdot A_{(\text{cross-section})} = q_p \cdot (\pi/4) \cdot D_{(\text{diameter})}^2$ ).
- Q. The Safety Factor (SF) – given in problem statement as 2.5.
- R. The Allowable End-Bearing Resistance ( $R_{B(\text{Allow})}$ ) – Column “P” divided by column “Q”.
- S. Ultimate Total Resistance ( $R_T$ ) – sum of columns “J” and “P” ( $R_T = R_S + R_B$ ).
- T. The Allowable Total Resistance ( $R_{T(\text{Allow})}$ ) – sum of columns “L” and “R”. Note this could be calculated as the product of column “S” and the safety factor, as only an overall safety factor was specified.

The following list details the drilled displacement pile calculations in Table B.3 (column-by-column)

The calculations for the static axial capacity of the single drilled displacement pile differs from that for the CFA pile only in the estimation of the ultimate unit side shear and ultimate unit end-bearing resistances. Thus details for the drilled displacement pile calculations (column-by-column) are as described above for the CFA pile, with the following exceptions noted to follow.

- A. Unit Side Shear Constant ( $W_s$ ) – as specified by the recommended method detailed in Section 5.4.2.  $W_s = 0$  ksf for the top two layers (Well rounded, and poorly graded material), and  $W_s = 1$  ksf (0.5 tsf) for the bottom layer (angular, and well graded).
- B. Ultimate Unit Side Shear ( $f_s$ ) – as specified by the recommended method detailed in Section 5.4.2., ( $0.05 \cdot N \cdot (2 \text{ ksf} / 1 \text{ tsf}) + W_s$ ), where  $SPT-N$  is from Column “A” and  $W_s$  is from Column “G”. Note that the 12<sup>th</sup> through the 17<sup>th</sup> pile segments exceeded the limit of 4.4 ksf (2.2 tsf), and thus were set to this limiting value (shown as shaded areas of column “H”).
- C. Average  $SPT-N$  Value Below Pile Tip ( $N_{(ave)}$ ) – the average of column “A” from the pile tip to a depth of approximately 4 pile diameters above and below the pile tip (in this example 4 to 8 ft), depending upon the frequency of  $SPT-N$  values with depth and soil layering. Note that the 12<sup>th</sup> through 15<sup>th</sup> pile segments have  $N_{(ave)} > 50$  (shown as shaded areas of column “M”), and the resulting  $q_p$  will be limited in column “O”.
- D. Unit End-Bearing Constant ( $W_T$ ) – as specified by the recommended method detailed in Section 5.4.2.  $W_s = 0$  ksf for the top two layers (Well rounded, and poorly graded material), and  $W_s = 28$  ksf (14 tsf) for the bottom layer (angular, and well graded).
- E. Ultimate Unit End-Bearing ( $f_s$ ) – as specified by the recommended method detailed in Section 5.4.2., ( $1.9 \cdot N_{(ave)} (2 \text{ ksf} / 1 \text{ tsf}) + W_T$ ), where  $N_{(ave)}$  is from Column “M” and  $W_s$  is from Column “N”. Note that the 11<sup>th</sup> through the 15<sup>th</sup> pile segments exceeded the limit of 178 ksf (89 tsf), and thus were set to this limiting value (shown as shaded areas of column “O”).