

49' BUOY UTILITY  
STERN LOADING  
(BUSL) BOAT  
OPERATOR'S HANDBOOK

U.S. Department  
of Homeland  
Security

United States  
Coast Guard



COMDTINST M16114.22A

---



---

COMDTINST M16114.22A  
July 2006



Commandant  
United States Coast Guard

2100 Second Street, S.W.  
Washington, DC 20593-0001  
Staff Symbol: CG-731  
Phone: (202) 372-2200  
Fax: (202) 372-2909

COMDTNOTE 16114  
05 JANUARY 2009

CANCELLED:  
04 JANUARY 2010

COMMANDANT NOTICE 16114

Subj: CH-1 TO 49 FOOT BUOY UTILITY STERN LOADING BOAT OPERATOR'S HANDBOOK, COMDTINST M16114.22A

1. PURPOSE. This Notice publishes change one to the 49' Buoy Utility Stern Loading (BUSL) Boat Operator's Handbook, COMDTINST 16114.22A.
2. ACTION. Area, district, and sector commanders, commanders of maintenance and logistics commands, Commander Deployable Operations Group, commanding officers of integrated support commands, commanding officers of headquarters units, assistant commandants for directorates, Judge Advocate General and special staff elements at headquarters shall ensure compliance with the provisions of this manual. Internet release is not authorized.
3. DIRECTIVES AFFECTED. None.
4. SUMMARY. Enclosure (1) summarizes the substantial changes throughout the Manual.
5. PROCEDURES. No paper distribution will be made of this Manual. Official distribution will be via the Coast Guard Directive System CD-ROM. An electronic version will be located on the Information and Technology CG-612 CGWEB and WWW website at <http://cgcentral.uscg.mil/> (Once in CG-Central click on the "RESOURCES" Tab and then "Directives".) and <http://cgweb2.comdt.uscg.mil/cgdirectives/welcome.htm>. For personnel who keep a paper copy of the Manual remove and replace the following pages:

Remove

Table of Contents Pages i-xiv  
Pages 2-31 – 2-32  
Pages 2-39 – 2-42

Insert

Table of Contents Pages i-xiv  
Pages 2-31 – 2-32  
Pages 2-39 – 2-42

DISTRIBUTION – SDL No.149

	a	b	c	d	e	f	g	h	i	j	k	l	m	n	o	p	q	r	s	t	u	v	w	x	y	z
A																										
B		1	*			1			1					1												
C									*														*	*	*	
D																				*						
E																		*								
F																										
G																										
H																										

NON-STANDARD DISTRIBUTION LIST: See Page 4

Pages 3-3 – 3-4  
 Pages 3-61 – 3-62  
 Pages 4-3 – 4-4  
 Pages A-1 – A-2  
 Pages A-5 – A-16  
 Pages B-3 – B-4  
 Pages C-5 – C-12  
 Pages C-17 – C-18  
 Pages C-29 – C-30  
 Pages D-3 – D-4  
 Pages E-3 – E-6  
 Pages F-3 – F-4  
 Pages H-3 – H-4  
 Pages Index-1 – Index-5

Pages 3-3 – 3-4  
 Pages 3-61 – 3-62  
 Pages 4-3 – 4-4  
 Pages A-1 – A-2  
 Pages A-5 – A-14  
 Pages B-3 – B-4  
 Pages C-5 – C-12  
 Pages C-17 – C-18  
 Pages C-29 – C-30  
 Pages D-3 – D-4  
 Pages E-3 – E-6  
 Pages F-3 – F-4  
 Pages H-3 – H-4  
 Pages Index-1 – Index-5

6. ENVIRONMENTAL ASPECT AND IMPACT CONSIDERATIONS. Environmental considerations were examined in developing this Manual and were determined to not be applicable.
7. FORMS/REPORT. None.

WAYNE E. JUSTICE/s/  
 Assistant Commandant for Capability

Encl: (1) Summary of changes to the 49 Foot Buoy Utility Stern Loading Boat Operator’s Handbook

NON-STANDARD DISTRIBUTION: Bc: First District (1), Fifth District (1), Seventh District (1), Eighth District (1), Ninth District (1); Ci: STA Burlington (1), STA Saginaw River (1); Cw: ANT Bristol (1), ANT Baltimore (1), ANT Saugerties (1), ANT New York (1), ANT Moriches (1), ANT Cape May (1), ANT Woods Hole (1), ANT Charleston (1), ANT Long Island Sound (1), ANT Muskegon (1), ANT Buffalo (1), ANT Panama City (1), ANT Jacksonville (1), ANT Boston (1), ANT South Portland (1), ANT Southwest Harbor (1), ANT Duluth (1), ANT Detroit (1), ANT Crisfield (1), ANT Mobile (1); Cx: NESU Boston (1), NESU Portsmouth (1), NESU Cleveland (1), NESU New Orleans (1); Cy: Sector Boston (1), Sector Northern New England (1), Sector Southern New England (1), Sector Long Island Sound (1), Sector Delaware Bay (1), Sector Baltimore (1), Sector Mobile (1), Sector Buffalo (1), Sector Detroit (1) Dt: ESU Portsmouth (1) ESU Boston (1), ESU Cleveland (1), ESU New Orleans (1), ESU Miami (1); Eh: ESD Baltimore (1), ESD Cape May (1), ESD Boston (1), ESD Portsmouth (1), ESD South Portland (1), ESD Southwest Harbor (1), ESD New York (1), ESD Long Island Sound (1), ESD Moriches (1), ESD Detroit (1), ESD Buffalo (1), ESD Duluth (1), ESD Grand Haven (1), ESD Mobile (1), ESD Panama City (1), ESD Charleston (1); Er: Sector Field Office Southwest Harbor (1), Sector Field Office Moriches, Sector Field Office Grand Haven (1)

## SUMMARY OF CHANGES

<b>Table of Contents</b>	
<b>Table of Contents</b>	Changed page numbers for chapter 2 following page 2-31. Added section A.4 to chapter 4. Updated Figure 2-14.
<b>Chapter 2</b>	
<b>Article 2.D.2.</b>	Add EPIRB, updated figure 2-14 to show EPIRB on mast.
<b>Article 2.E.10.</b>	Paragraph E.10. Deleted 75 feet of 3/8-inch polypropylene line.
<b>Article 2.E.12.</b>	Paragraph E.12. Updated description of life raft location, securing method, and referenced the ECR initiating this change.
<b>Chapter 3</b>	
<b>Article 3.A.3.</b>	Paragraph A.3. Changed to 300-320.
<b>Article 3.I.17.</b>	Paragraph I.17. Changed to sixteen tie-downs.
<b>Chapter 4</b>	
<b>Article 4.A.1</b>	Paragraph A.1. Updated minimum crewmember definition.
<b>Chapter 5</b>	
<b>Article 5.A.1</b>	Paragraph A.1. Updated operational commander definition.
<b>Appendix A</b>	
<b>Appendix A</b>	Page A-1. Changed page numbers for berthing compartment to page 9, forward peak to page 10, pilothouse to page 11, and main deck to page 12.
<b>Appendix A</b>	Page A-6. Deleted the following items - Auger bit set, bolt cutter (36-inch), cold hand chisel set, crosscut hand saw (with blade guard), electricians tape, electrical insulation tape, electrical workers gloves, electrical workers gloves shells, extension light, fuse puller, hammer (1-pound), hammer (carpenter 1-pound), hand hacksaw frame, hand hacksaw blade, hand metal cutting shears, hose clamps, industrial goggles and/or face shield.
<b>Appendix A</b>	Page A-6. Deleted the following items: wiping rag, wire brush.
<b>Appendix A</b>	A-6. Added the following items: Hand tools (as required for unit ops), pneumatic tools (as required for unit ops), electrical tools (as required for unit ops), personal protective gear (as required for unit ops), AtoN equipment (as required for unit ops).
<b>Appendix A</b>	Page A-7. Deleted the following items: Level (9-inch carpenters), marlinspike (12-inch), tape measure (50-foot), multimeter (fluke), pipe wrench (12-inch strap), plier wrench, pliers, pneumatic wrench, socket wrench set (impact), portable pneumatic drill, putty knife, ratchet brace bit (12-inch), scrub brush, single bit ax, slip joint pliers, socket screwdriver attachment set, socket wrench set case, propane torch kit, terminal hand crimping tool, drill bits, various rain suits (size-L), various rain suits (size-M).

<b>Appendix A</b>	Page A-12. Change to Rescue line throw bag and; Changed picking pennant to alloy picking pennant.
<b>Appendix A</b>	Page A-13. Changed to Rescue line throw bag.

<b>Appendix B</b>	
<b>Appendix B</b>	Page B-3. Added 49 BUSL-A-024 Engineering Exhaust Fan Shutdown Switch dated 08/09/06.

<b>Appendix C</b>	
<b>Appendix C</b>	Page C-5. Deleted wood on dunnage.
<b>Appendix C</b>	Page C-7. Changed to Rescue line throw bag.
<b>Appendix C</b>	Page C-9. Changed to min 30 FT with three wraps on drum. Change to alloy picking pennant.
<b>Appendix C</b>	Page C-11. Changed to AFFF extinguisher.
<b>Appendix C</b>	Page C-17. Changed to Rescue line throw bag.
<b>Appendix C</b>	Page C-18. Changed to Rescue line throw bag.
<b>Appendix C</b>	Page C-29. Added AFFF extinguisher under Storage Cabinet or Port Side.

<b>Appendix D</b>	
<b>Appendix D</b>	Page D-3. Changed to below 280 PSI and above 350 PSI.
<b>Appendix D</b>	Page D-4. Changed to any fuel leak.

<b>Appendix E</b>	
<b>Appendix E</b>	Page E-3. Line item 10.C, added will not close completely.
<b>Appendix E</b>	Page E-4. Line item 12.A, added grade 5 or better mounting bolts.
<b>Appendix E</b>	Page E-4. Line item 14, added needs to be grade 5 or better.
<b>Appendix E</b>	Page E.6. Added line item 11, engine room air dampener will not open with pull cables.

<b>Appendix H</b>	
<b>Appendix H</b>	Page H-3. Deleted - 5/8".
<b>Appendix H</b>	Page H-3. Added with foundry hook on both ends.
<b>Appendix H</b>	Page H-4. Changed a-frame winches and cables (combined) testload to 5000 lbs.

<b>Index</b>	
	Updated index with numerous additions and deletions of page numbers per above changes.

**(This page intentionally left blank.)**



This page intentionally left blank.

COMDTINST M16114.22A  
18 JUL 2006

COMMANDANT INSTRUCTION M16114.22A

Subj: 49 FOOT BUOY UTILITY STERN LOADING BOAT OPERATOR'S HANDBOOK

1. PURPOSE. This Manual provides technical orientation, performance characteristics, and basic operating procedures for the 49 foot Buoy Utility Stern Loading (BUSL) boat. It also standardizes boat outfit, storage and equipment layout.
2. ACTION. Area and district commanders, commanders of maintenance and logistics commands, commanding officers of headquarters units, assistant commandants for directorates, Judge Advocate General, and special staff offices at Headquarters shall ensure adherence to the contents of this Manual at all units which operate and/or maintain a 49 foot BUSL. Internet release authorized.
3. DIRECTIVES AFFECTED. The 49' Buoy Utility Stern Loading (BUSL) Boat Operator's Handbook, COMDTINST M16114.22 is cancelled.
4. DISCUSSION. This Manual contains information necessary to safely and efficiently operate the 49 foot BUSL. The operational capabilities, limitations, and emergency procedures are clearly stipulated. The fittings, outfit list, and physical characteristics of the boat are pictured and described in detail. This Manual is directive in nature and applies to all 49 foot BUSL crews, operational, and supervisory commands.
5. SUMMARY OF CHANGES. This revision provides new policies and procedures, makes modification and clarification to other existing policies, and makes several minor clerical changes. The majority of these changes originated from feedback received from the field. In addition to illustrations that were replaced throughout the Manual, the following major areas of change were made:

- a. Chapter 1, Section B: BUSL STAN Team responsibilities updated.
- b. Chapter 2, Section A: Changes made to reflect accurate characteristics data.
- c. Chapter 2, Section B: Watertight compartments, location, access and egress ladder updated.
- d. Chapter 2, Section E: Addition of paired bits on foredeck, anchor securing points,

DISTRIBUTION – SDL No.145

	a	b	c	d	e	f	g	h	i	j	k	l	m	n	o	p	q	r	s	t	u	v	w	x	y	z	
A																											
B		*	*			2		2	2					10													
C				*			*		*		*												*	*	*		
D																				*							
E								*																			
F																											
G																											
H																											



18 JUN 2006

- e. Chapter 3, Section A: lifering markings, liferaft sea painter boat hook markings. Mathers engine controls, transmission temperature updated.
  - f. Chapter 3, Section D: Engine jacket water heaters, thermostat updated.
  - g. Chapter 3, Section F: Engine jacket water heaters, generator monitoring updated.
  - h. Chapter 3, Section H: Exhaust fan switch location updated.
  - i. Chapter 3, Section I: A-Frame and cross deck manifold locations, winches alloy hook and swivel, chain stopper release assembly updated.
  - j. Chapter 3, Section J: Electronic navigation system, depth sounder, loud hailer, electronic chart system updated.
  - k. Chapter 3, Section N: Portable fire extinguishers updated.
  - l. Chapter 3, Section O: Bilge pump capacity updated.
  - m. Chapter 3, Section S: Potable water system, tank capacity, pressure accumulator tank updated.
  - n. Chapter 4, Introduction: Reference changed.
  - o. Chapter 4, Section A: Minimum crew updated.
  - p. Chapter 4, Section D: Crewmembers, general and note sections changed.
  - q. Chapter 4, Section F: Standards for qualification reference, training underway updated.
  - r. Chapter 4, Section G: Safety equipment modified.
  - s. Chapter 5, Section A: General, reference changed.
  - t. Chapter 5, Section B: Fuel consumption and speed at 10.5 knots updated.
  - u. Chapter 6, Section B: General, reference changed.
  - v. Chapter 6, Section D: Personal protective equipment, operating hydraulic system, and various changes in buoy deck evolution.
  - w. Chapter 6, Section F: Anchoring the boat section updated.
  - x. Chapter 6, Section G: Personnel recovery – new section.
  - y. Chapter 6, Section H: Reduced icebreaking for emergencies only. Added warning regarding keel coolers.
  - z. Chapter 7, Section L and M: New sections added, hydraulic failure, major fuel/lube oil leak.
  - aa. Appendix A: Additions to, and storage of, outfit.
  - bb. Appendix B: Updated ECR List.
  - cc. Appendix C: Exterior pilothouse checklist updated.
  - dd. Appendix E: Restrictive discrepancies – Shaft packing updated.
  - ee. Appendix F: Reduction gear pressures updated.
6. **PROCEDURE.** District, operational, and unit commanders for all units with a 49 foot BUSL shall ensure the procedures and limitations detailed within this Manual are followed. Boat crews shall become familiar with the changes made within this Manual, but are not required to recertify solely based on changes within this revision. Forward any comments, corrections, recommendations, and questions regarding this handbook to the Aid to Navigation Facility Manager in accordance with Section 1.C. of this Manual. Design and structural change requests shall be submitted as outlined in the Naval Engineering Manual, COMDTINST M9000.6 (series).

18 JUN 2006

7. ENVIRONMENTAL ASPECT AND IMPACT CONSIDERATIONS. Environmental considerations were examined in the development of this Instruction and have been determined to be not applicable.
8. FORMS AVAILABILITY. None.

WAYNE E. JUSTICE/s/  
Acting Assistant Commandant for Response

NON-STANDARD DISTRIBUTION: Bb: Atlantic Area (5); Bc: First District (5), Fifth District (5), Seventh District (5), Eighth District (5), Ninth District (5); Cd: Base Mayport (2), Base Detroit; Cg: CEU Miami (1), CEU Providence, CEU Cleveland; Ci: STA Burlington (10), STA Saginaw River (10); Ck: ISC Boston (2), ISC Portsmouth (2), ISC New Orleans (2), ISC Cleveland (2); Cw: ANT Bristol (20), ANT Baltimore (10), ANT Saugerties (10), ANT New York (25), ANT Moriches (15), ANT Cape May (25), ANT Woods Hole (15), STA Burlington (10), ANT Charleston (10), ANT Long Island Sound (25), ANT Muskegon (15), ANT Buffalo (15), ANT Panama City (20), ANT Jacksonville (20), ANT Boston (20), ANT South Portland (30), ANT Southwest Harbor (25), ANT Duluth (10), ANT Detroit (15), STA Saginaw River (8), ANT Crisfield (10), ANT Mobile (15); Cx: NESU Boston (2), MAT Mobile (2), NESU Portsmouth (2), NESU Cleveland (2), NESU New Orleans (2); Cy: Sector Boston (2), Sector Northern New England (2), Sector Southern New England (2), Sector Field Office Southwest Harbor (2), Sector Field Office Moriches (2), Sector Long Island Sound (2), Sector Field Office Atlantic City (2), Sector Baltimore (2), Sector Mobile (2), Sector Buffalo (2), Sector Detroit (2), Sector Field Office Grand Haven (2); Dt: ESU Portsmouth (1) ESU Boston (1), ESU Cleveland (1), ESU New Orleans (1), ESU Miami (1); Eh: ESD Baltimore (1), ESD Cape May (1), ESD Boston (1), ESD Portsmouth (1), ESD South Portland (1), ESD Southwest Harbor (1), ESD New York (1), ESD Long Island Sound (1), ESD Moriches (1), ESD Detroit (1), ESD Buffalo (1), ESD Duluth (1), ESD Grand Haven (1), ESD Mobile (1), ESD Panama City (1), ESD Charleston (1)





## Table of Contents

---

<b>CHAPTER 1 INTRODUCTION.....</b>	<b>1-1</b>
SECTION A. WARNINGS, CAUTIONS, AND NOTES .....	1-3
A.1. General .....	1-3
A.2. Warning.....	1-3
A.3. Caution .....	1-3
A.4. Note.....	1-3
SECTION B. FACILITY MANAGER.....	1-5
B.1. General .....	1-5
SECTION C. CHANGES.....	1-7
C.1. General .....	1-7
C.2. Engineering change requests (ECRs).....	1-7
SECTION D. ACTION.....	1-9
D.1. General .....	1-9
D.2. Configuration control.....	1-9
<b>CHAPTER 2 BOAT CHARACTERISTICS.....</b>	<b>2-1</b>
SECTION A. GENERAL DESCRIPTION .....	2-3
A.1. Design .....	2-3
A.2. Manufacturer.....	2-3
A.3. Missions .....	2-3
A.4. Boat specifications .....	2-3
A.5. Superstructure .....	2-4
A.6. Hull.....	2-4
SECTION B. WATERTIGHT COMPARTMENTS .....	2-9
<i>Aft Voids</i>	
B.1. Access.....	2-12
B.2. Physical characteristics .....	2-12
<i>Lazarette</i>	
B.3. Access.....	2-14
B.4. Physical characteristics .....	2-14
<i>Machinery Space</i>	
B.5. Access.....	2-16
B.6. Physical characteristics .....	2-16
<i>Fuel Tanks</i>	
B.7. Location.....	2-18
B.8. Physical characteristics .....	2-18



*Workshop*

B.9. Access..... 2-20

B.10. Physical characteristics ..... 2-20

*Galley/Mess*

B.11. Access..... 2-22

B.12. Physical characteristics ..... 2-22

*Head*

B.13. Access..... 2-24

B.14. Physical characteristics ..... 2-24

*Berthing Compartment*

B.15. Access..... 2-26

B.16. Physical characteristics ..... 2-26

*Forward Peak/Void*

B.17. Access..... 2-28

B.18. Physical characteristics ..... 2-28

SECTION C. PILOTHOUSE ..... 2-29

C.1. Access..... 2-29

C.2. Physical characteristics ..... 2-29

SECTION D. MAST..... 2-31

D.1. Location ..... 2-31

D.2. Physical characteristics ..... 2-31

SECTION E. DECK EQUIPMENT AND FITTINGS  
(OTHER THAN BUOY HANDLING) ..... 2-35

*Mooring Bitt*

E.1. Location..... 2-37

E.2. Physical characteristics..... 2-37

*Anchor*

E.3. Location..... 2-38

E.4. Physical characteristics..... 2-38

*Hawser Reel*

E.5. Location..... 2-39

E.6. Physical characteristics..... 2-39

*Bits and Chocks*

E.7. Location..... 2-40

E.8. Physical characteristics..... 2-40

*Life Rings*

E.9. Location..... 2-42

E.10. Physical characteristics..... 2-42

*Life Raft*

E.11. Location..... 2-43

E.12. Physical characteristics..... 2-43



<i>Boat Hooks</i>	
E.13. Location.....	2-44
E.14. Physical characteristics.....	2-44
<i>Handrails and Lifelines</i>	
E.15. Location.....	2-46
E.16. Physical characteristics.....	2-46
<i>Grabrails</i>	
E.17. Location.....	2-48
E.18. Physical characteristics.....	2-48
<i>Deck Lockers</i>	
E.19. Location.....	2-50
E.20. Physical characteristics.....	2-50
<i>Emergency Dewatering Pump</i>	
E.21. Location.....	2-52
E.22. Physical characteristics.....	2-52
<b>CHAPTER 3 VESSEL SYSTEMS .....</b>	<b>3-1</b>
SECTION A. PROPULSION SYSTEM .....	3-3
A.1. General.....	3-3
A.2. Engines.....	3-3
A.3. Marine transmission/reduction gear.....	3-3
A.4. Propeller shafts.....	3-4
A.5. Propeller.....	3-4
SECTION B. PROPULSION CONTROL SYSTEM .....	3-7
B.1. General .....	3-7
B.2. Principles of operation .....	3-7
B.3. Engine throttle control.....	3-7
B.4. 585CE actuators .....	3-7
B.5. 813 troll actuator .....	3-8
B.6. Engine control/gauge panels (pilothouse).....	3-8
B.7. Engine control/gauge panel (engine room).....	3-8
B.8. Emergency shutdown controls (main engines) .....	3-9
SECTION C. JACKET WATER COOLING SYSTEM .....	3-13
C.1. General .....	3-13
C.2. Engine-driven cooling water pump.....	3-13
C.3. Coolant reservoir.....	3-13
C.4. Coolant filter .....	3-13
C.5. Thermostat.....	3-13
C.6. Reduction gear/clutch lube oil cooler .....	3-13
C.7. Keel cooler .....	3-13



SECTION D. ENGINE SYSTEMS ..... 3-17

*Engine Lubrication System*

D.1. General ..... 3-18

D.2. Pump and suction screen ..... 3-18

D.3. Spin-on cartridge filter and bypass valve ..... 3-18

D.4. Filter bypass valve ..... 3-18

D.5. Pressure regulating valve ..... 3-18

D.6. Oil cooler bypass valve ..... 3-18

*Engine Crankcase Ventilation System*

D.7. General ..... 3-20

D.8. Air separator filter ..... 3-20

D.9. Air separator body ..... 3-20

*Fuel Oil System*

D.10. General ..... 3-22

D.11. Emergency fuel shutoff valves ..... 3-22

D.12. Duplex fuel oil filter assembly (primary fuel filter) ..... 3-22

D.13. Secondary fuel filter ..... 3-22

*Engine Exhaust System*

D.14. General ..... 3-26

D.15. Piping and mufflers ..... 3-26

D.16. Overboard ports ..... 3-26

*Engine Jacket Water Heaters (Hot Start)*

D.17. General ..... 3-28

D.18. Thermostat ..... 3-28

*Fast Lubricating Oil Change System (FLOCS)*

D.19. General ..... 3-29

D.20. Pan plug adapter ..... 3-29

D.21. Quick-disconnect coupling ..... 3-29

*Engine Starting System*

D.22. General ..... 3-30

D.23. Starter and solenoid ..... 3-30

SECTION E. HYDRAULIC STEERING SYSTEM ..... 3-33

E.1. General ..... 3-33

E.2. Helm pump and conversion block ..... 3-33

E.3. Hydraulic manifold assembly ..... 3-33

E.4. Hydraulic reservoir ..... 3-33

E.5. Hydraulic pump and motor ..... 3-34

E.6. Return oil filter ..... 3-34

E.7. Tiller assembly ..... 3-34

E.8. Rudders ..... 3-34

E.9. Helm pump ..... 3-34

E.10. Electronic chart system (ECS) ..... 3-34



SECTION F. SHIP SERVICE AC GENERATOR.....	3-37
F.1. General.....	3-37
F.2. Diesel engine .....	3-37
F.3. Duplex fuel oil filter assembly (primary fuel filter).....	3-37
F.4. Emergency shutdown control (generator) .....	3-37
F.5. Fuel pump and filter.....	3-37
F.6. Lubrication system .....	3-37
F.7. Jacket water system .....	3-37
F.8. Saltwater system .....	3-38
F.9. Engine jacket water heater (hot start).....	3-38
F.10. Engine exhaust system.....	3-38
F.11. Engine crankcase ventilation system.....	3-38
F.12. Power takeoff (PTO) assembly.....	3-38
F.13. Diesel engine control panel (generator).....	3-38
F.14. Alternator.....	3-39
F.15. Alternator control .....	3-39
F.16. Generator monitoring panel.....	3-39
SECTION G. ELECTRICAL SYSTEMS .....	3-41
G.1. General.....	3-41
G.2. 120-VAC power distribution system .....	3-41
G.3. 24-VDC power distribution system .....	3-43
G.4. Power panels .....	3-45
SECTION H. HEATING, VENTILATION, AND AIR CONDITIONING (HVAC) SYSTEMS.....	3-53
H.1. General.....	3-53
H.2. Machinery space heating and ventilation.....	3-53
H.3. Workshop heating and ventilation .....	3-54
H.4. Galley/mess and head heating and ventilation.....	3-54
H.5. Berthing heating and ventilation.....	3-54
H.6. Pilothouse heating and ventilation .....	3-54
H.7. Lazarette heating and ventilation.....	3-55
H.8. Air conditioning unit condensate drain systems .....	3-55
SECTION I. BUOY HANDLING SYSTEM.....	3-59
I.1. General .....	3-59
I.2. Hydraulic oil reservoir.....	3-59
I.3. Hydraulic pump .....	3-60
I.4. Hydraulic filter (supply).....	3-60
I.5. A-frame manifold .....	3-60
I.6. Cross deck winch manifold .....	3-60
I.7. A-frame winches (port and starboard).....	3-60
I.8. Cross deck winches (port and starboard).....	3-60
I.9. A-frame actuators .....	3-61
I.10. Hydraulic fluid heat exchanger .....	3-61
I.11. Return oil filter .....	3-61
I.12. Local machinery space hydraulic panel .....	3-61





I.13. Buoy console panel (pilothouse) .....	3-61
I.14. P-39 portable hydraulic hand pump .....	3-61
I.15. Filter cart connections .....	3-62
I.16. Chain stopper and roller assembly .....	3-62
I.17. Buoy deck tie-downs .....	3-62
SECTION J. ELECTRONIC NAVIGATION SYSTEM.....	3-69
J.1. General .....	3-69
J.2. AN/SPS-69 navigation radar .....	3-69
J.3. Depth sounder (Raytheon V850).....	3-69
J.4. Differential global positioning system (DGPS) .....	3-69
J.5. VHF radios (Raytheon 201 VHF) .....	3-70
J.6. Loudhailer/ intercom (Raytheon 430).....	3-70
J.7. Electronic compass.....	3-70
J.8. Autopilot system (ComNav Marine 2001).....	3-70
J.9. Electronic chart system (ECS) .....	3-71
SECTION K. MAGNETIC COMPASS.....	3-75
K.1. General .....	3-75
SECTION L. NAVIGATION LIGHTS, SEARCHLIGHTS, FLOODLIGHTS AND SIGNAL DEVICES...	3-77
L.1. Navigation lights .....	3-77
L.2. Searchlights .....	3-77
L.3. Floodlights.....	3-77
L.4. Signal devices.....	3-78
SECTION M. ELECTRICAL ALARM, SAFETY AND WARNING SYSTEMS .....	3-81
M.1. General .....	3-81
M.2. Enunciators.....	3-81
M.3. Loudhailer .....	3-81
SECTION N. FIRE EXTINGUISHING SYSTEMS .....	3-83
N.1. General .....	3-83
N.2. CO <sub>2</sub> cylinders .....	3-83
N.3. Indicator light box.....	3-83
N.4. Audible alarm and rotary beacon.....	3-83
N.5. Switches and remote indicator .....	3-83
N.6. Portable fire extinguishers .....	3-83
SECTION O. BILGE SYSTEM.....	3-85
O.1. General .....	3-85
O.2. Bilge pumps and float switches .....	3-85
O.3. Bilge pump panel .....	3-85
SECTION P. GRAY WATER AND SEWAGE SYSTEMS .....	3-87
P.1. Gray water system .....	3-87
P.2. Sewage system.....	3-87
SECTION Q. DECK WASHDOWN SYSTEM.....	3-91
Q.1. General .....	3-91
Q.2. Strainer .....	3-91



Q.3. Pump and deck washdown fitting .....	3-91
Q.4. Cutoff valve.....	3-91
SECTION R. COMPRESSED AIR SYSTEM .....	3-93
R.1. General .....	3-93
R.2. Air compressor .....	3-93
R.3. Air receiver.....	3-93
R.4. Control valves and switches.....	3-93
R.5. Outlet valves for attaching air hoses .....	3-93
SECTION S. POTABLE WATER SYSTEM .....	3-95
S.1. General.....	3-95
S.2. Potable water tanks .....	3-95
S.3. Service pump .....	3-95
S.4. Pressure (accumulator) tank .....	3-95
S.5. Hot water heater.....	3-95
S.6 Water chiller .....	3-96
S.7. Hose connection .....	3-96
SECTION T. WINDSHIELD WIPERS AND WASHERS .....	3-99
T.1. General .....	3-99
T.2. Pushbutton switches .....	3-99
SECTION U. CATHODIC PROTECTION SYSTEM.....	3-101
U.1. General.....	3-101
U.2. Zinc anodes .....	3-101
<b>CHAPTER 4 CREW REQUIREMENTS.....</b>	<b>4-1</b>
SECTION A. MINIMUM CREW .....	4-3
A.1. General .....	4-3
A.2. Qualified/ certified crewmembers.....	4-3
A.3. Non qualified/certified crewmembers.....	4-3
A.4. ADDITIONAL CREWMEMBERS .....	4-3
SECTION B. COXSWAIN.....	4-5
B.1. General .....	4-5
B.2. Authority and responsibility.....	4-5
B.3. Relief of responsibility .....	4-5
SECTION C. ENGINEER.....	4-7
C.1. General .....	4-7
C.2. Qualifications .....	4-7
C.3. Responsibilities .....	4-7
SECTION D. CREWMEMBERS .....	4-9
D.1. General .....	4-9
D.2. Responsibilities .....	4-9
SECTION E. PASSENGERS.....	4-11
E.1. General .....	4-11
E.2. Passengers .....	4-11



SECTION F. TRAINING ..... 4-13

    F.1. General..... 4-13

    F.2. Standards for qualification ..... 4-13

    F.3. Training underway..... 4-13

SECTION G. SAFETY EQUIPMENT ..... 4-15

    G.1. Personal protective equipment..... 4-15

    G.2. Protective equipment during buoy handling operations ..... 4-15

**CHAPTER 5 OPERATIONAL GUIDELINES .....5-1**

    SECTION A. OPERATING PARAMETERS ..... 5-3

        A.1. General..... 5-3

        A.2. Disabling casualties ..... 5-4

        A.3. Restrictive discrepancies..... 5-4

        A.4. Major discrepancies ..... 5-5

        A.5. Minor discrepancies ..... 5-5

        A.6. Responsibilities ..... 5-5

        A.7. Environmental limits..... 5-7

    SECTION B. PERFORMANCE DATA ..... 5-9

        B.1. Fuel consumption ..... 5-9

        B.2. Seakeeping ..... 5-10

        B.3. Turning..... 5-11

        B.4. Stability ..... 5-12

        B.5. Acceleration ..... 5-12

        B.6. Speed ..... 5-13

        B.7. Deceleration ..... 5-13

**CHAPTER 6 MISSION PERFORMANCE .....6-1**

    SECTION A. STARTING PROCEDURES ..... 6-3

        A.1. Pre-start ..... 6-3

        A.2. Lighting off the generator set..... 6-4

        A.3. Transferring power..... 6-5

        A.4. Starting the engines..... 6-6

        A.5. Energizing equipment ..... 6-7

    SECTION B. UNDERWAY ..... 6-9

        B.1. General ..... 6-9

        B.2. Personal protective gear ..... 6-9

        B.3. Communication ..... 6-9

        B.4. Changing control stations..... 6-9

    SECTION C. HANDLING CHARACTERISTICS..... 6-11

*Turning and Pivoting*

        C.1. General ..... 6-12



C.2. Split throttle turn .....	6-12
C.3. Restricted maneuvering.....	6-13
<i>Head Seas</i>	
C.4. General .....	6-14
C.5. Buoyancy.....	6-14
<i>Beam Seas and Following Seas</i>	
C.6. Operating in beam seas .....	6-15
C.7. Operating in following seas .....	6-15
C.8. White water .....	6-16
<i>Effects of Wind</i>	
C.9. Turning the bow .....	6-17
<i>Effects of Current</i>	
C.10. Vessel stability in current.....	6-18
<i>Station Keeping</i>	
C.11. General .....	6-19
SECTION D. AIDS TO NAVIGATION OPERATIONS.....	6-21
D.1. General.....	6-21
D.2. Personal protective equipment.....	6-21
D.3. Energizing the buoy hydraulic system.....	6-22
D.4. Operating the buoy handling hydraulic system (from the pilothouse) .....	6-23
D.5. Hoisting the buoy .....	6-24
D.6. Pulling chain .....	6-25
D.7. Setting the buoy .....	6-26
D.8. Securing the system .....	6-27
D.9. Standard hand signals.....	6-28
SECTION E. TOWING.....	6-31
E.1. General .....	6-31
E.2. Rigging a vessel for tow .....	6-31
E.3. Affects of wind with vessel in tow .....	6-31
E.4. Tow watch .....	6-31
SECTION F. ANCHORING.....	6-33
F.1. General.....	6-33
F.2. Anchoring the boat .....	6-33
F.3. Weighing anchor.....	6-33
SECTION G. PERSONNEL RECOVERY .....	6-35
G.1. General .....	6-35
G.2. Key issues.....	6-35
SECTION H. ICE CONDITIONS .....	6-37
H.1. General.....	6-37
SECTION I. SECURING PROCEDURES .....	6-39
I.1. Procedures .....	6-39
SECTION J. SECURING PROCEDURES(COLD WEATHER).....	6-41
J.1. Procedures .....	6-41



**CHAPTER 7 EMERGENCY PROCEDURES .....7-1**

SECTION A. STRIKING A SUBMERGED OBJECT ..... 7-3

    A.1. General ..... 7-3

    A.2. Actions ..... 7-3

SECTION B. STEERING CASUALTY ..... 7-5

    B.1. Symptoms ..... 7-5

    B.2. Actions ..... 7-5

SECTION C. REDUCTION GEAR FAILURE ..... 7-7

    C.1. General ..... 7-7

    C.2. Actions ..... 7-7

SECTION D. FIRE IN THE ENGINE ROOM ..... 7-9

    D.1. Symptoms ..... 7-9

    D.2. Actions ..... 7-9

SECTION E. LOSS OF CONTROL OF ENGINE RPM ..... 7-11

    E.1. Actions ..... 7-11

SECTION F. LOSS OF FUEL OIL PRESSURE ..... 7-13

    F.1. Symptoms ..... 7-13

    F.2. Actions ..... 7-13

SECTION G. LOSS OF LUBE OIL PRESSURE ..... 7-15

    G.1. Actions ..... 7-15

SECTION H. MAIN ENGINE HIGH WATER TEMPERATURE ..... 7-17

    H.1. Actions ..... 7-17

    H.2. Keel cooler checks ..... 7-18

    H.3. Jacket water system checks ..... 7-18

SECTION I. GENERATOR EMERGENCY PROCEDURES ..... 7-19

    I.1. General ..... 7-19

    I.2. Generator set jacket water temperature ..... 7-19

    I.3. Generator diesel engine oil pressure ..... 7-19

    I.4. Generator RPMs ..... 7-20

    I.5. Governor failure ..... 7-20

SECTION J. EXCESSIVE SHAFT SEAL LEAKAGE ..... 7-21

    J.1. Actions ..... 7-21

SECTION K. FLOODING ..... 7-23

    K.1. Actions ..... 7-23

SECTION L. BUOY DECK HYDRAULIC FAILURE ..... 7-25

    L.1. General ..... 7-25

    L.2. Actions ..... 7-25

SECTION M. MAJOR FUEL OIL/LUBE OIL LEAK ..... 7-27

    M.1. General ..... 7-27

    M.2. Actions ..... 7-27

Table of Contents





<b>APPENDIX A OUTFIT LIST &amp; STOWAGE PLAN</b>	A-1
<b>APPENDIX B ENGINEERING CHANGE REQUESTS (ECR)</b>	B-1
<b>APPENDIX C MATERIAL INSPECTION CHECKLIST</b>	C-1
<b>APPENDIX D DISABLING CASUALTIES</b>	D-1
<b>APPENDIX E RESTRICTIVE AND MAJOR DISCREPANCIES</b>	E-1
<b>APPENDIX F FULL POWER TRIAL</b>	F-1
<b>APPENDIX G LIST OF ACRONYMS</b>	G-1
<b>APPENDIX H RIGGING EQUIPMENT</b>	H-1
<b>INDEX</b>	Index-1



## List of Figures

2-1	49' BUSL Outboard Profile.....	2-7
2-2	49' BUSL Inboard Profile .....	2-10
2-3	49' BUSL Interior Arrangement .....	2-11
2-4	Aft Voids.....	2-13
2-5	Lazarette.....	2-15
2-6	Machinery Space.....	2-17
2-7	Fuel Tanks.....	2-19
2-8	Workshop.....	2-21
2-9	Galley/Mess .....	2-23
2-10	Head .....	2-25
2-11	Berthing Compartment.....	2-27
2-12	Forward Peak .....	2-28
2-13	Pilothouse (Aft Looking Forward).....	2-30
2-14A	Mast .....	2-32
2-14B	Mast .....	2-33
2-15	Mooring Bitt .....	2-35
2-16	Anchor .....	2-36
2-17	Hawser Reel .....	2-37
2-18	Bits and Chocks .....	2-39
2-19	Life Rings .....	2-40
2-20	Life Raft .....	2-41
2-21	Boat Hooks .....	2-42
2-22	Handrails and Lifelines .....	2-45
2-23	Grabrails.....	2-47
2-24	Deck Lockers .....	2-49
2-25	Emergency Dewatering Pump .....	2-51
3-1	Propulsion System .....	3-5
3-2	Shaft Seal Assembly .....	3-6
3-3	Propulsion Control System (portside from keel to outboard).....	3-9
3-4	Pilothouse Forward Control Console.....	3-10
3-5	Pilothouse Aft Control Console .....	3-10
3-6	Engine Control and Gauge Panel - Machinery Space.....	3-11
3-7	Main Engine Emergency Shutdown Controls - Pilothouse Aft .....	3-12
3-8	Jacket Water Cooling System .....	3-14
3-9	Main Diesel Engine Coolant Reservoir .....	3-15
3-10	Engine Lubrication System.....	3-19
3-11	Engine Crankcase Ventilation System.....	3-21
3-12	Fuel Oil System.....	3-23
3-13	Emergency Actuation Pull Handle.....	3-24
3-14	Engine Exhaust System.....	3-27
3-15	Engine Jacket Water Heaters (Hot Start) .....	3-28
3-16	Fast Lubricating Oil Change System (FLOCS) .....	3-29
3-17	Engine Starting System.....	3-31
3-18	Hydraulic Steering System .....	3-35
3-19	Ship Service AC Generator.....	3-40





3-20	Power Panels .....	3-42
3-21	120-VAC Load Center (LC) 1 .....	3-43
3-22	24-VDC Power Panel (LC2).....	3-46
3-23	120-VAC Engine Room Power Panel (2-4-1) .....	3-46
3-24	120-VAC Galley/Mess Power Panel (2-6-0) .....	3-47
3-25	120-VAC Pilothouse Power Panel (01-7-1).....	3-47
3-26	24-VDC Vital Panel.....	3-48
3-27	Emergency Power Distribution System .....	3-50
3-28	Heating, Ventilation, and Air Conditioning (HVAC) Seawater System.....	3-56
3-29	Heating, Ventilation, and Air Conditioning (HVAC) (Sheet 1 of 2).....	3-57
3-29	Heating, Ventilation, and Air Conditioning (HVAC) (Sheet 2 of 2).....	3-58
3-30	Aft Buoy Console Panel.....	3-63
3-31	Buoy Deck Layout .....	3-64
3-32	Buoy Handling Hydraulic System .....	3-65
3-33	A-Frame Winches (Port and Starboard).....	3-66
3-34	A-Frame Structure .....	3-67
3-35	Cross Deck Winch .....	3-68
3-36	Buoy Handling Hydraulic System Control Panel (Machinery Space).....	3-68
3-37	Furuno Radar Display .....	3-72
3-38	ECS Monitor and Depth Sounder .....	3-72
3-39	DGPS and VHF Radiotelephone.....	3-73
3-40	Loudhailer and VHF Radiotelephone .....	3-73
3-41	Overhead Console (Looking Aft) .....	3-74
3-42	Fluxgate Compass.....	3-74
3-43	Magnetic Compass.....	3-75
3-44	Navigation Lights, Searchlights, Floodlights, and Signal Devices (Plan View).....	3-78
3-45	Navigation Lights, Searchlights, Floodlights, and Signal Devices (Elevation View) .....	3-79
3-46	Central Alarm Panel.....	3-82
3-47	Fire Extinguishing Systems .....	3-84
3-48	Bilge Pump Panel (Pilothouse Forward Console).....	3-86
3-49	Gray Water System .....	3-89
3-50	Sewage System .....	3-90
3-51	Deck Wash Down System.....	3-92
3-52	Compressed Air System.....	3-94
3-53	Potable Water System .....	3-97
3-54	Windshield Wipers and Washers and Pushbutton Control .....	3-100
3-55	Sea Chest and Keel Cooler for Cathodic Protection Zincs .....	3-102
5-1	Fuel Consumption vs. Speed.....	5-9



# Chapter 1 Introduction

## Overview

---

**Introduction** This handbook contains information necessary for the safe and efficient operation of the 49' Buoy Utility Stern Loading (BUSL) boat. It defines operational capabilities, limitations, and emergency procedures. In addition, it shows or describes the fittings, outfit list, and physical characteristics of the boat.

---

**In this chapter** This chapter contains the following sections:

Section	Topic	See Page
A	Warnings, Cautions, and Notes	1-3
B	Facility Manager	1-5
C	Changes	1-7
D	Action	1-9

---



**(This page intentionally left blank.)**



## Section A. Warnings, Cautions, and Notes

---

**A.1. General** The following definitions apply to Warnings, Cautions, and Notes found throughout the handbook.

---

**A.2. Warning** **WARNING**  Operating procedures or techniques that must be carefully followed to avoid personal injury or loss of life.

**A.3. Caution** **CAUTION!** Operating procedures or techniques that must be carefully followed to avoid equipment damage.

**A.4. Note** **NOTE**  An operating procedure or technique essential to emphasize.

---



**(This page intentionally left blank.)**



## Section B. Facility Manager

---

### B.1. General

Commandant (CG-731) is the facility manager for the 49' BUSL. The 49' BUSL is a standard boat as defined in the *Boat Management Manual*, COMDTINST M16114.4 (series) and the *Naval Engineering Manual*, COMDTINST M9000.6 (series). The Boat Forces Center through the 49' BUSL Standardization (STAN) Team provides expertise in all aspects of the boat's operation and maintenance. The 49' BUSL STAN Team reviews the boat, its equipment, crew procedures, operational reports, (casreps, AOPS/TMT, Rigging and Battery Logs etc.) and technical manuals continuously to update this information.

---



**(This page intentionally left blank.)**



## Section C. Changes

---

### C.1. General

COMDT (CG-731) promulgates this handbook and its changes. Submit recommendations for changes to CG-731 via standard letter or electronic mail. The 49' BUSL Standardization Team assumes responsibility for receiving and implementing changes to this handbook. For more information, contact CG-731, Office of Boat Forces, AtoN Boat Facility Manager at (202) 372-2458.

The address for CG-731 is:

Commandant (CG-731)  
U. S. Coast Guard Headquarters  
2100 Second Street S.W.  
Washington, D.C. 20593-0001

---

### C.2. Engineering change requests (ECRs)

All engineering change requests (ECRs) issued since the BUSL has been in service are provided in *Appendix B* of this handbook. ECRs issued after the date of this revision supersede information in this handbook where applicable.

---





**(This page intentionally left blank.)**



## Section D. Action

---

### D.1. General

Operating and supervisory commands and boat crews will comply with the procedures and limitations specified in this publication and any duly issued changes.

---

### D.2. Configuration control

Configuration control for the 49' BUSL is critical for standardization of equipment and safety of operations.

#### NOTE

To maintain fleet wide standardization, unit commanders shall not change or vary the type or location of equipment carried except where noted. Design or structural alterations are prohibited unless specifically authorized by the Office of Naval Engineering, Commandant (CG-45).

#### NOTE

Prototype testing of 49' BUSL configuration changes may only be carried out with the specific authorization of the Office of Naval Engineering, Commandant (CG-45).

---



**(This page intentionally left blank.)**



## Chapter 2 Boat Characteristics

### Overview

---

**Introduction** This chapter describes standard 49' BUSL features. The systems described briefly in this chapter are covered in detail in Chapter 3, *Vessel Systems*.

**NOTE** 

All illustrations in this operator's handbook are for familiarization only. The location of machinery and equipment in these illustrations may not accurately reflect proper placement and installation. Refer to the appropriate blueprint, NE-TIMS, technical publication or enclosure to this handbook for proper placement.

**In this chapter** This chapter contains the following sections:

Section	Topic	See Page
A	General Description	2-3
B	Watertight Compartments	2-9
C	Pilothouse	2-29
D	Mast	2-31
E	Deck Equipment and Fittings (Other Than Buoy Handling)	2-33

---



**(This page intentionally left blank.)**



## Section A. General Description

---

**A.1. Design** The Boat Engineering Branch of the USCG Engineering Logistics Center designed the 49' BUSL (**figure 2-1**).

---

**A.2. Manufacturer** The Coast Guard Yard completed the detailed design and built the initial production 49' BUSL (CG 49403). A total of twenty-six 49' BUSLs were constructed.

---

**A.3. Missions** The 49' BUSL is designed primarily to service aids to navigation within the inland waters of the United States. It is capable and equipped to support multi-mission operations. The 49' BUSL has a 4,500-pound lifting capacity and a 6-inch ice-breaking capability.

---

**A.4. Boat specifications** The following provides a list of all 49' BUSL boat specifications

---

A.4.a. Physical characteristics	Length Overall (LOA):	49' 2 1/4" (14.99 meters)
	Beam (Maximum):	16' 10" (4.9 meters)
	End of Service Draft (Deepest, at the Bottom of the Skegs, Full Load + 2000lbs growth):	5' 6" (1.6 meters)
	Current Draft (Deepest, at the Bottom of the Skegs, Full Load):	5' 4" (1.6 meters)
	Current Draft (Deepest, at the Bottom of the Skegs, Water & Fuel, No Load):	4' 8" (1.4 meters)
	Freeboard at Transom (Maximum):	3' 5" (0.9 meters)
	Highest Fixed Point Above Waterline (with Mast Lowered, Boom Forward, and Preventers Removed):	15' (4.57 meters)
	Highest Unfixed Point Above Waterline:	27' (8.2 meters)
	Hoisting Weight:	71,690 pounds (32,517 kg)
	Propulsion Machinery:	Two Cummins, 6CTA8.3M1 (305 horse power each)
	Reverse Reduction Gear:	Twin-disc, model MG 507A-1, reduction ratio 2.54 to 1
	Propellers:	Twin, fixed pitch, 4-blade, 31-inch diameter, 22-inch pitch
	Generator Rating:	20-kW, single-phase, 120-VAC, 60-Hz unit, operating at 1800 RPM
	Fuel Tank Capacity:	783 gallons (2963liters) at 95%

---



---

Potable Water Capacity:	300 gallons (1135 liters) at 100%
Crew Capacity:	Four crew, three spare/passenger

---

**A.4.b. Operating characteristics**

Maximum Speed:	10.5 knots at 2300 RPM
Cruise Speed:	7 knots
Maximum Range:	400 nautical miles at 10 knots (12 gph @ 2300 rpm equates to 560 NM range)
Endurance:	4 days
Maximum Seas:	6 feet (1.83 meters)
Maximum Towing Capacity	
Bollard Pull:	11,000 lbs (4,950 kg), aft 8,300 lbs (3,735 kg), bow
Maximum Hoisting Capacity (Buoy, Safe Working Load):	4,500 lbs (2,025 kg)
Outside Air Temperature:	0 °F (-18 °C) to 95 °F (35 °C)
Outside Water Temperature (Seawater):	28 °F (-2 °C) to 85 °F (30 °C)
List Limit (Full Load):	Not to exceed ½ degree from vertical
Maximum Sea State for Buoy Operations:	3 feet (0.91 meter)
Maximum Sea State for Transiting:	
No load:	6 feet (1.83 meters)

---

**A.5. Superstructure**

The boat’s deckhouse is made of aluminum plate and sheet and complies with ASTM B209, Alloy 5086-H116. The aluminum deckhouse is joined to the steel main deck using bonded aluminum to steel transition joints. The superstructure contains the steering stations, buoy handling controls, and all electronic navigation systems. The superstructure is fixed to the hull at frame 5, aft and frame 7, forward. The fold-down mast platform is attached to the superstructure at frame 5.

**A.6. Hull**

The hull is made of ASTM A36 steel and is a displacement design with frames numbered from transom to bow. The deepest draft, 5 feet 6 inches, is at the bottom of the two skegs. The propulsion system is a straight drive configuration with the engines and reduction gears close-coupled in the engine room. The propeller shaft runs aft from the reduction gear through the skegs between frames 3 and 4.

---



---

A.6.a. Hull construction

The hull consists of a  $\frac{3}{16}$ -inch bottom/side and  $\frac{1}{4}$ -inch transom shell. The main structural members of the hull are the keel, from the transom to frame 9, and port and starboard girders, positioned second longitudinal from the keel from bulkhead 2 to frame 4A. The hull has a fixed-fender system with rub rails to protect exterior hull surfaces. The rub rails are made of D-shaped rubber for the sides of the hull and dunnage for the transom.

---

A.6.b. Hull reference points

Frames are numbered from transom to bow at 6-foot intervals. Longitudinal spacing is 16 inches.

---





Item	Location
Spray rails	Welded to the hull just above the waterline from the bow to frame 7.
Boat's numbers, a Coast Guard identification stripe with emblem, and "U.S. COAST GUARD" in white letters	Located on each side of the hull between frames 5 and 9. The boat number is displayed on the bow, port and starboard; and aft quarter, port and starboard.
Fixed fenders or "rub rails" (D-shaped)	At deck edge level from stern to bow, and from the transom to bulkhead 5 centered approximately 2 feet 4 inches below the main deck, just above the engine exhaust outlets. The fixed fenders are attached to studs welded to the hull to aid in easy repair or replacement. The transom is protected from the edge of the deck to just above the chine with vertical 4 x 4 lumber which is bolted to a flat bar that is welded to the hull. The fendering material is black rubber.
Overboard discharges for the bilge pumps	At frame 7 on the starboard side of the berthing compartment, workshop, galley and head; frames 4A and 2 on the starboard side of the engine room; and frame 2 of the lazarette.
Depth sounder transducer	Between frames 5 and 6 in the workshop, aft.
Sea suction valves	Between frames 2 and 4A on both sides of the keel in the engine room.
Exhaust ports exit the hull	Just above the waterline between frames 2 and 3 on the port and starboard sides.
The boat's deepest draft	Bottom of the aft ends of the skegs at frame 2.
Propellers	Aft of bulkhead 2 under the lazarette.
Rudder posts	Penetrate the hull forward of bulkhead 1, aft of the propellers.
Draft marks to mark the waterline as measured from the keel	Port and starboard at frames 1 and 9. Forward draft marks reference the bottom of the keel extended and the aft draft marks reference the bottom of the skegs. Draft marks are outlined in weld bead.

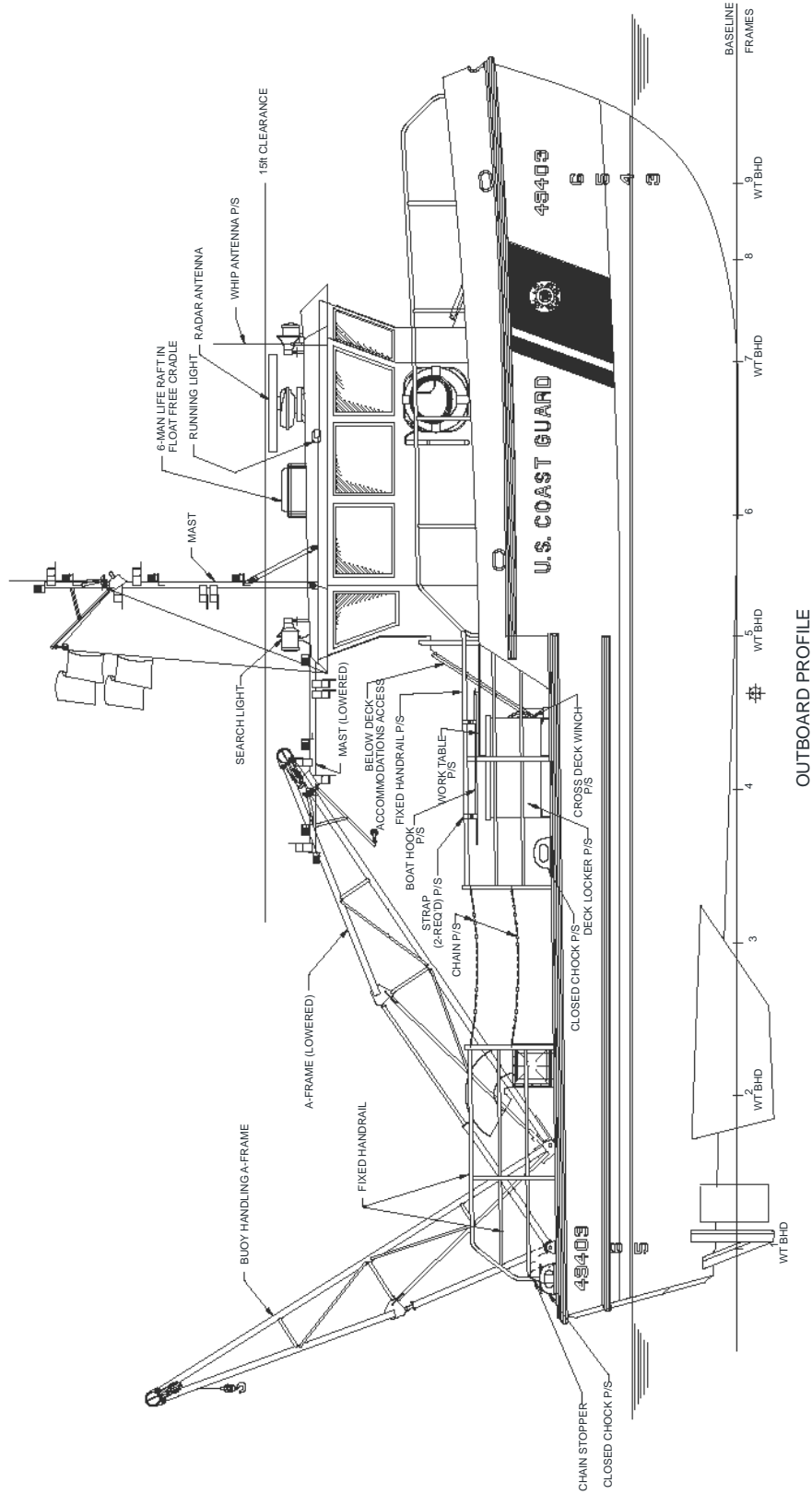

OUTBOARD PROFILE

Figure 2-1  
49' BUSL Outboard Profile



**(This page intentionally left blank.)**



## Section B. Watertight Compartments

---

### Introduction

The 49' BUSL has *nine* main watertight compartments separated by bulkheads: (See figures 2-2 and 2-3.)

1. *Aft Voids* 2. Transom to bulkhead 1.
2. *Lazarette*. Bulkhead 1 to bulkhead 2.
3. *Machinery Space*. Bulkhead 2 to bulkhead 4A.
4. *Fuel Tanks*. Bulkhead 4A to 5.
5. *Workshop, Galley/Mess, and Head*. Bulkhead 5 to 7.
6. *Berthing Compartment*. Bulkhead 7 to 9.
7. *Forepeak*. Bulkhead 9 to bow.
8. *Forward Void*. Bulkhead 9 to bow.

### In this section

This section contains general information regarding the location of/access to and physical characteristics of the following areas of the boat:

Topic	See Page
Aft Voids	2-12
Lazarette	2-14
Machinery Space	2-16
Fuel Tanks	2-18
Workshop	2-20
Galley/Mess	2-22
Head	2-24
Berthing Compartment	2-26
Forepeak/Void	2-28

---

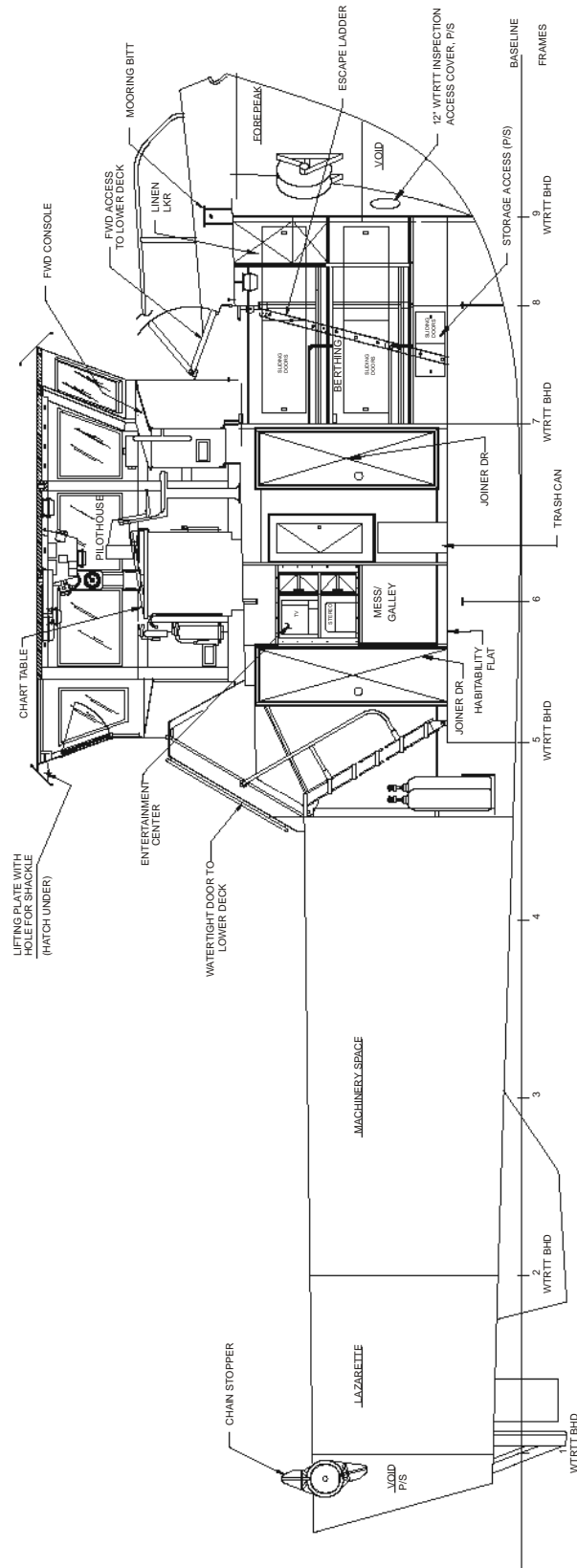

**Figure 2-2**  
**49' BUSL Inboard Profile**

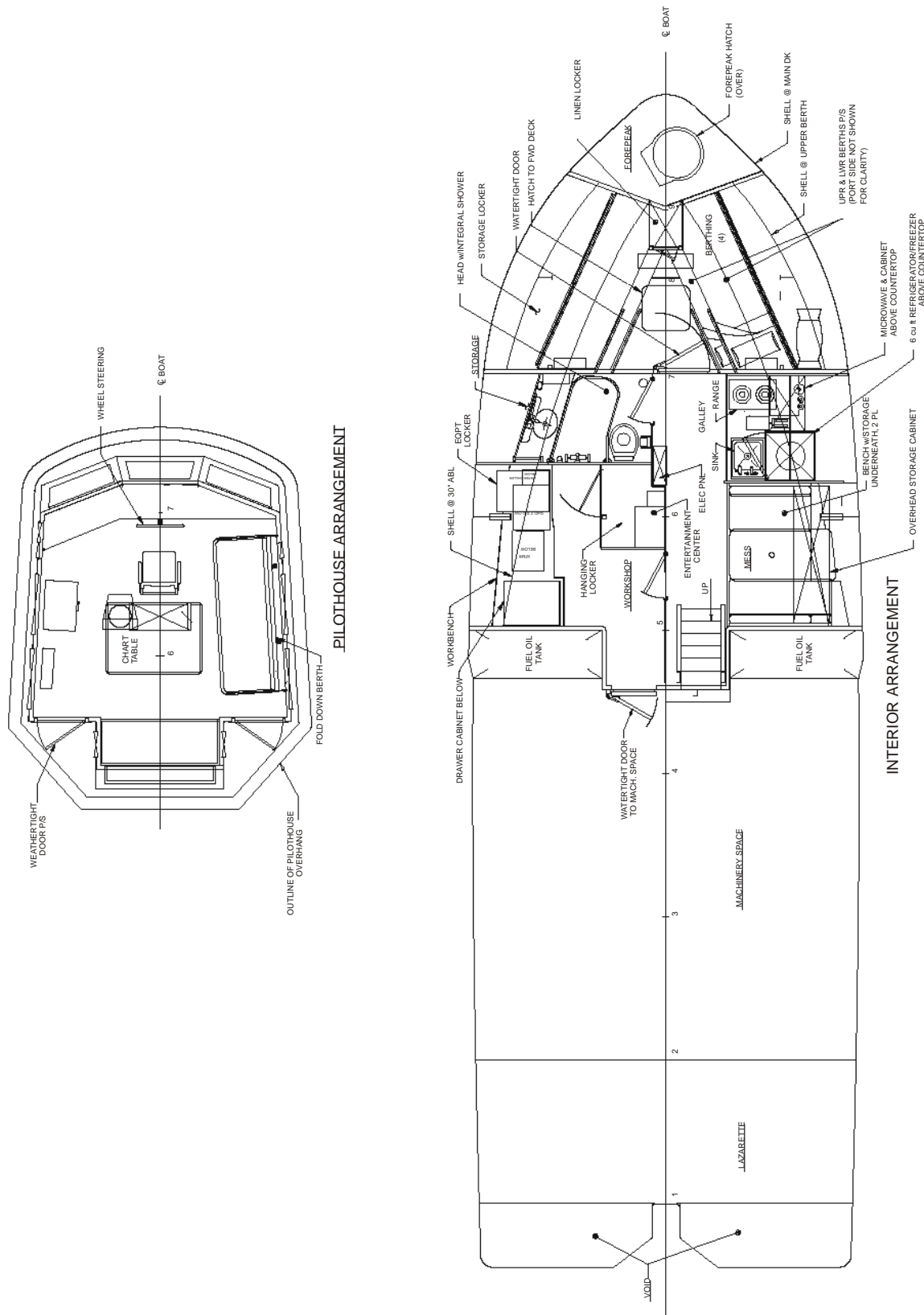

**Figure 2-3**  
**49' BUSL Interior Arrangement (Top View)**



## Aft Voids

---

### B.1. Access

There are two aft voids located from the transom forward to bulkhead 1, the aft bulkhead of the lazarette. They are accessible only through bolted manhole covers that are located inside the lazarette compartment. (See **figure 2-4.**)

---

### B.2. Physical characteristics

The voids serve as buoyancy chambers.

---

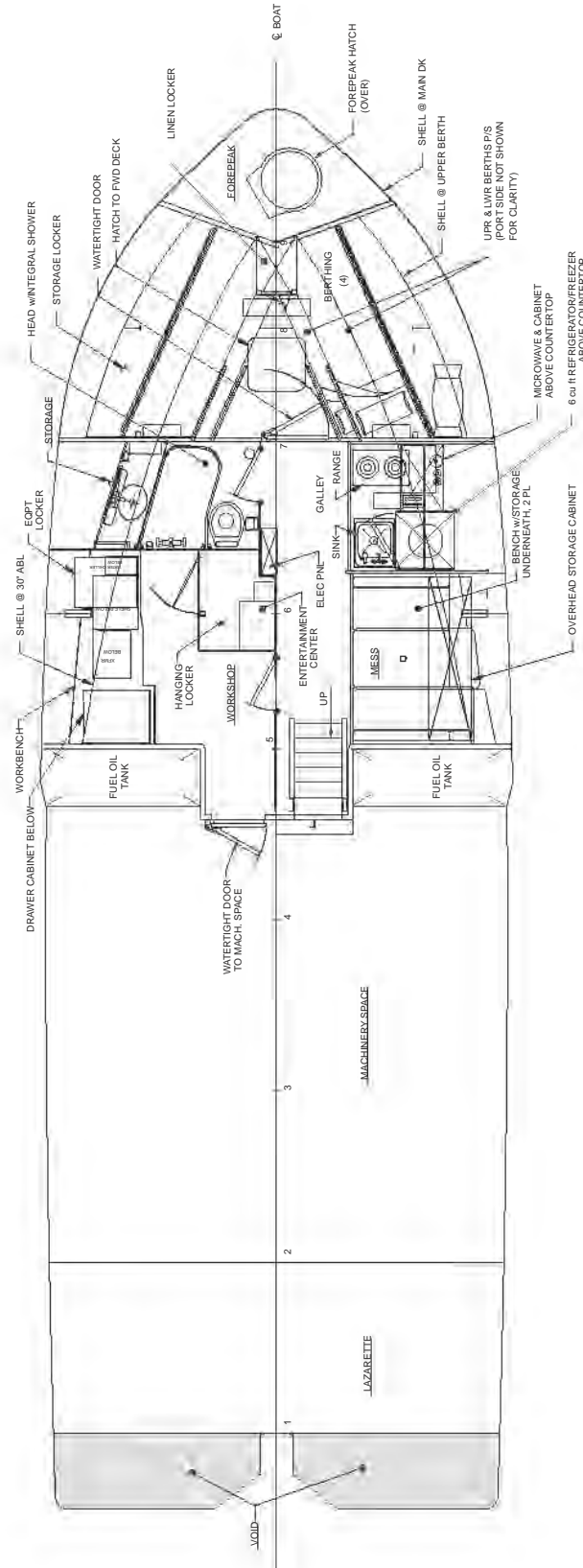

**Figure 2-4**  
**Aft Voids**





## Lazarette

---

### B.3. Access

The lazarette is located below decks, inside the hull between bulkheads 1 and 2. The lazarette is accessible through a flush deck-mounted escape hatch located on the main deck port side aft. (See figure 2-5.)

---

### B.4. Physical characteristics

A permanently installed ladder is located outboard and directly below the hatch. The lazarette hatch is oval with a clear opening of 15 inches by 24 inches. The hatch can be opened from the main deck utilizing a permanently attached handle or from inside the compartment with a permanently attached handle. The hatch cover is aluminum with a steel mounting ring and a stainless steel securing mechanism.

The lazarette is naturally vented. A gooseneck 3-inch vent with an 18-mesh screen and ball check valve provides natural ventilation for the lazarette.

The following major pieces of equipment are located in the lazarette:

- tiller assembly
- sewage holding tank
- sewage discharge pump
- steering gear hydraulic unit
- ship service air compressor and receiver
- A-frame hydraulic manifold

Equipment descriptions are provided in *Chapter 3* of this handbook.

---

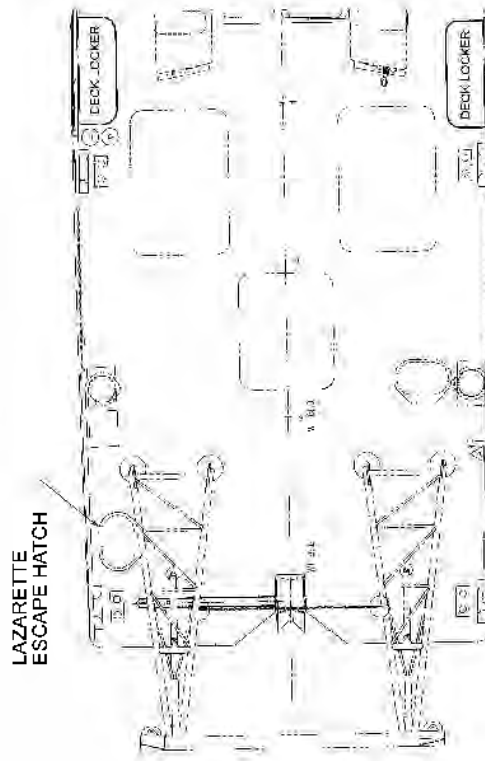
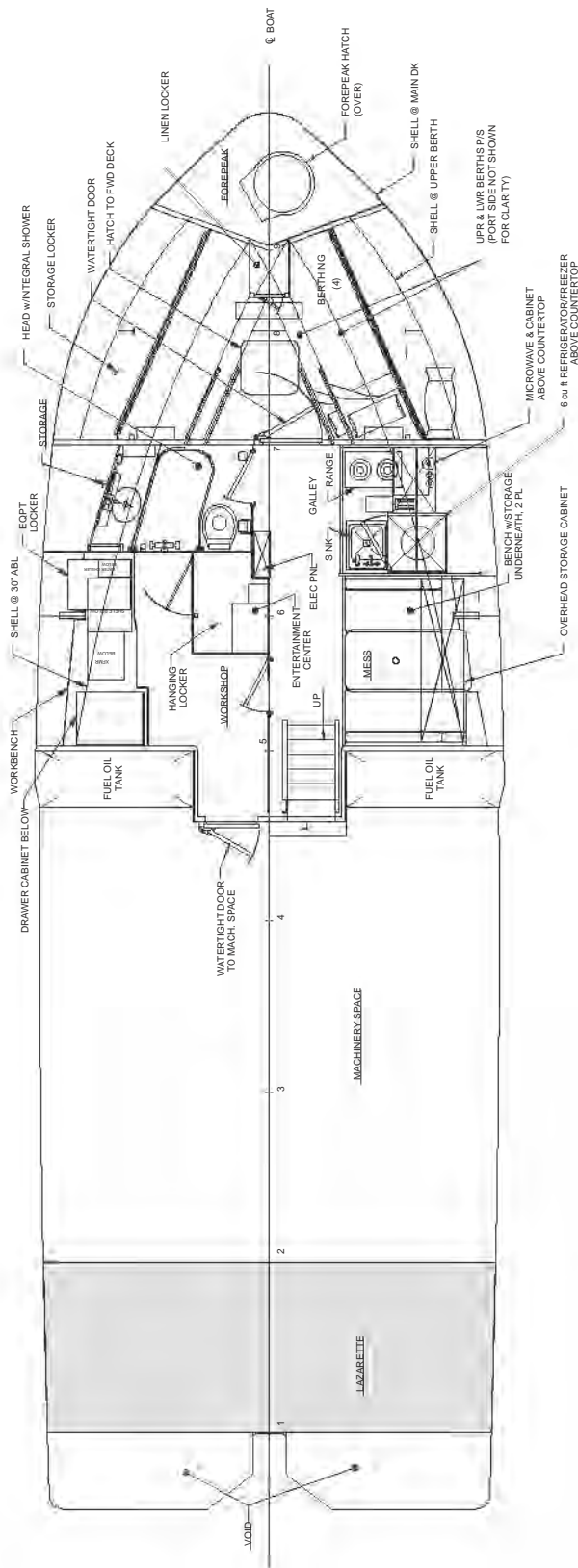

**Figure 2-5**  
**Lazarette**



## Machinery Space

---

### B.5. Access

The machinery space is located below the main deck between bulkheads 2 and 4A. It is normally accessible through a quick-acting watertight door located below the main deck and aft of the workshop, on the approximate centerline of the hull. (See figure 2-6.)

---

### B.6. Physical characteristics

The machinery space door has a clear opening 24 inches wide by 48 inches high. The door is aluminum, mounted in a steel frame.

An escape hatch is located on the main deck just inboard of the machinery space air exhaust on the starboard side. The hatch is oval and has a clear opening of 15 inches by 24 inches. It is aluminum, mounted in a steel ring, and can be opened or closed from the main deck with permanently attached handles.

The machinery space has a natural supply and mechanical exhaust system and is protected from fire by a fixed CO<sub>2</sub> flooding system.

The following pieces of equipment are located in the machinery space:

- port and starboard propulsion engines, gauge panels and associated equipment
- potable water tank
- ship service generator, hydraulic unit and components
- port and starboard propulsion engine fuel filters
- hydraulic oil reservoir
- 120-VAC load center (LC1)
- 24-VDC panel (LC2)
- potable water heater, accumulator, pump
- A/C seawater cooling pump
- deck wash pump and strainer
- battery charger
- engine starting batteries (2 sets)
- reduction gear oil cooler (2)
- cross deck winch hydraulic manifold
- fwd and aft bilge pumps

Equipment descriptions are provided in *Chapter 3* of this handbook.

---

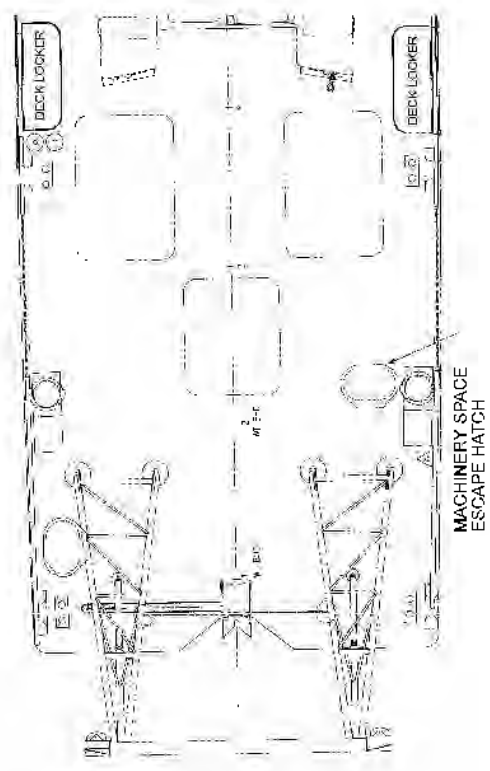
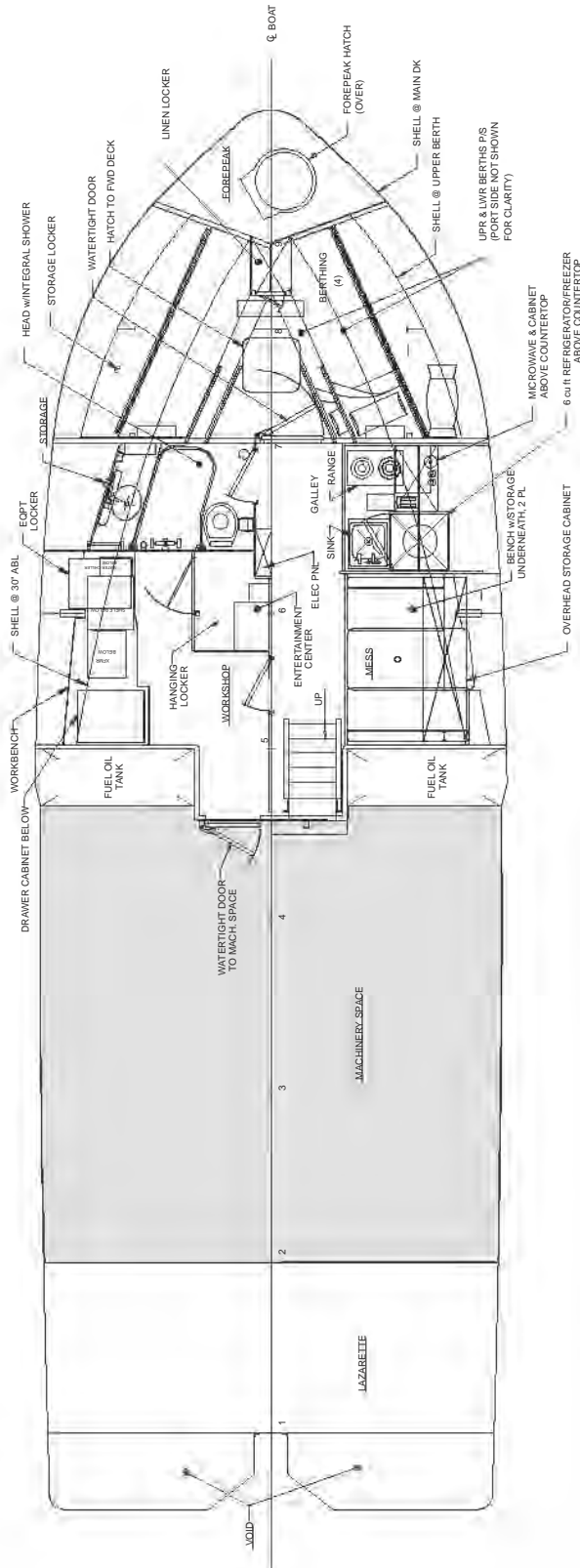

**Figure 2-6**  
**Machinery Space**



## Fuel Tanks

---

### B.7. Location

The fuel tanks are located forward of the machinery space on the port and starboard sides between bulkheads 4A and 5. Access covers are located at bulkhead 4A, inside the machinery space. (See figure 2-7.)

---

### B.8. Physical characteristics

The two fuel tanks have a combined capacity of 783 gallons at 95 percent and feed into a common supply header for both propulsion engines and the diesel generator set.

Each fuel tank is constructed of steel and has a separate 2-inch fill connection, sounding rod, stripping connection, and flameproof vent with 40-mesh screen and inverted ball check valve. Fuel supply and return piping is constructed of stainless steel.

The fill connection, sounding rod, stripping connection and vent are located within a spill containment coaming located above the tanks on the port and starboard side of the main deck, forward of the cross deck winches.

---

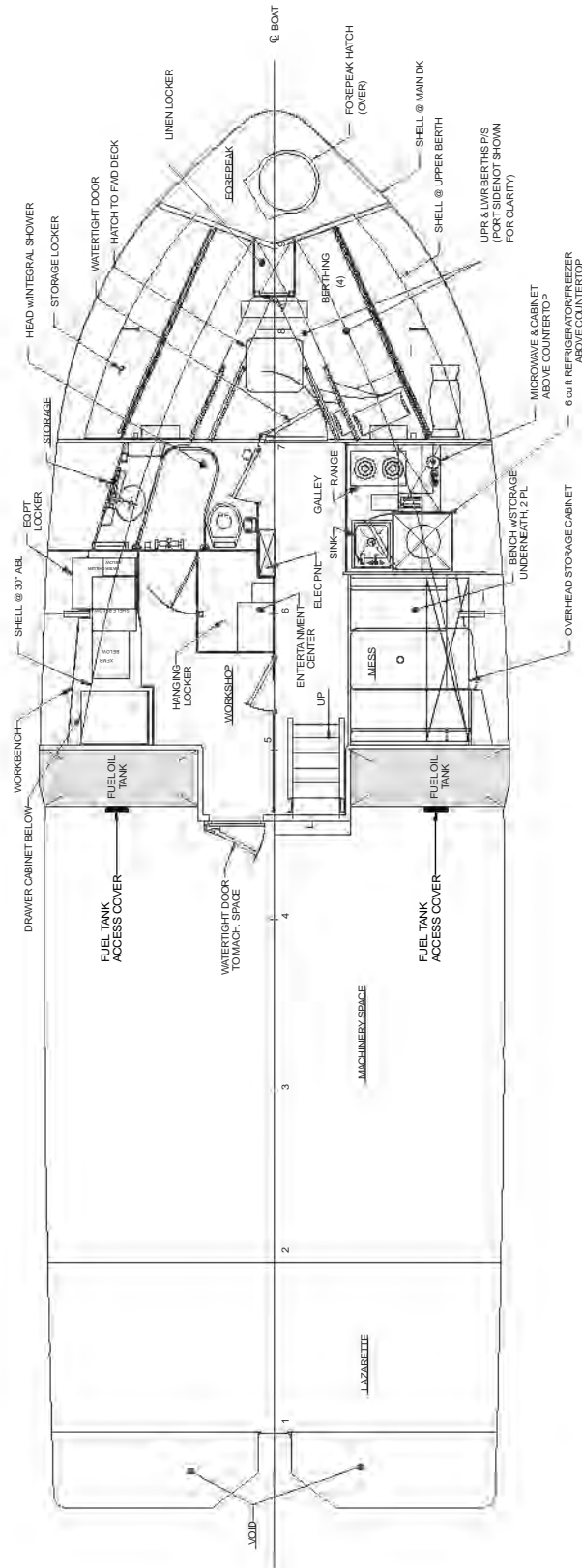

**Figure 2-7**  
**Fuel Tanks**



## Workshop

---

### B.9. Access

The workshop is located below the main deck forward of the machinery space on the port side. Access to this area is through a quick-acting watertight door (QAWTD) accessible from the main deck aft of the pilothouse just starboard of the centerline. **(See figure 2-8.)**

A raised equipment access, 24 inches wide by 24 inches high, is installed on the main deck for equipment access to the workshop.

---

### B.10. Physical characteristics

Workshop equipment and furnishings consist of the following items:

- workbench
- equipment locker
- eye/face washing station
- hanging locker
- water chiller for the galley

The workbench top is capable of supporting 300 pounds and is covered with hardboard, non-sparking dielectric material. There are 120-VAC and 12-VDC outlets adjacent to the workbench.

Eight 2-inch padeyes are provided on the bulkheads of the workshop and are rated at 500 pounds. The padeyes are used to secure aids to navigation equipment during rough weather.

The hanging locker is used to stow rain gear, foul weather jackets, anti-exposure overalls, and personal flotation devices.

---

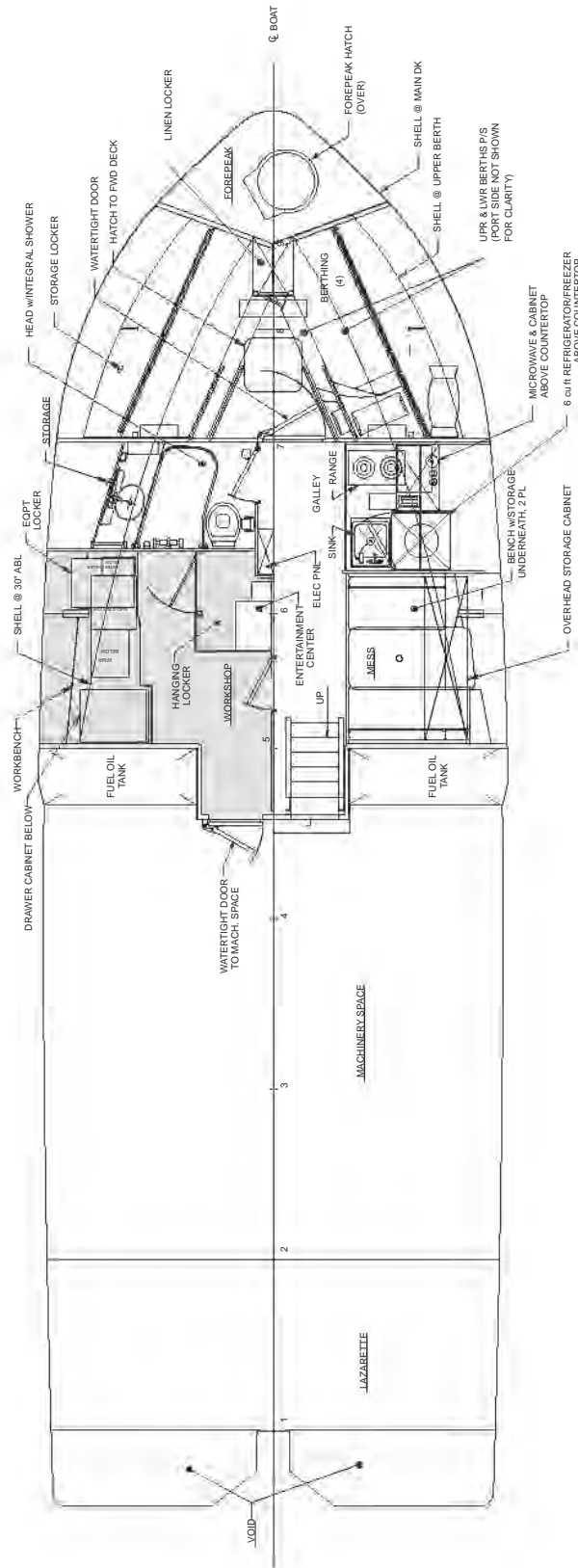

**Figure 2-8**  
**Workshop**





## Galley/Mess

---

### B.11. Access

The galley/mess area is located on the starboard side forward of the machinery space. Access to this area is through a quick-acting watertight door accessible from the main deck aft of the pilothouse just starboard of the centerline. **(See figure 2-9.)**

---

### B.12. Physical characteristics

The following equipment and furnishings are provided in the galley/mess area:

- stainless steel countertop with 16-inch deep sink
- 6-cubic-foot refrigerator/freezer
- two-burner electric range
- microwave oven
- automatic coffee maker
- TV/VCR
- mini-stereo system
- mess table
- bench seats (2) with stowage underneath
- cabinets and shelf over the electric range
- cabinets and drawers under the countertop/sink
- cabinets over the mess deck table

The mess table and bench seating are designed to convert for installing a removable spare berth over the mess table area. A privacy curtain is provided for this removable-storable berth.

---





## Head

---

### B.13. Access

The head is located forward of the workshop on the port side. Access to this area is through a quick-acting watertight door accessible from the main deck aft of the pilothouse just starboard of the centerline. **(See figure 2-10.)**

---

### B.14. Physical characteristics

The head is used as an integral shower. The head consists of the following items:

- a water closet made out of stainless steel
- a lavatory of one-piece vitreous china
- a hand-held shower
- associated fixtures and fittings
- storage space behind the mirror

The shower is mounted on the aft bulkhead of the water closet. The shower pan encompasses the complete floor area of the head. Shower curtains are provided to protect the joiner door to the head and water closet from spray.

---

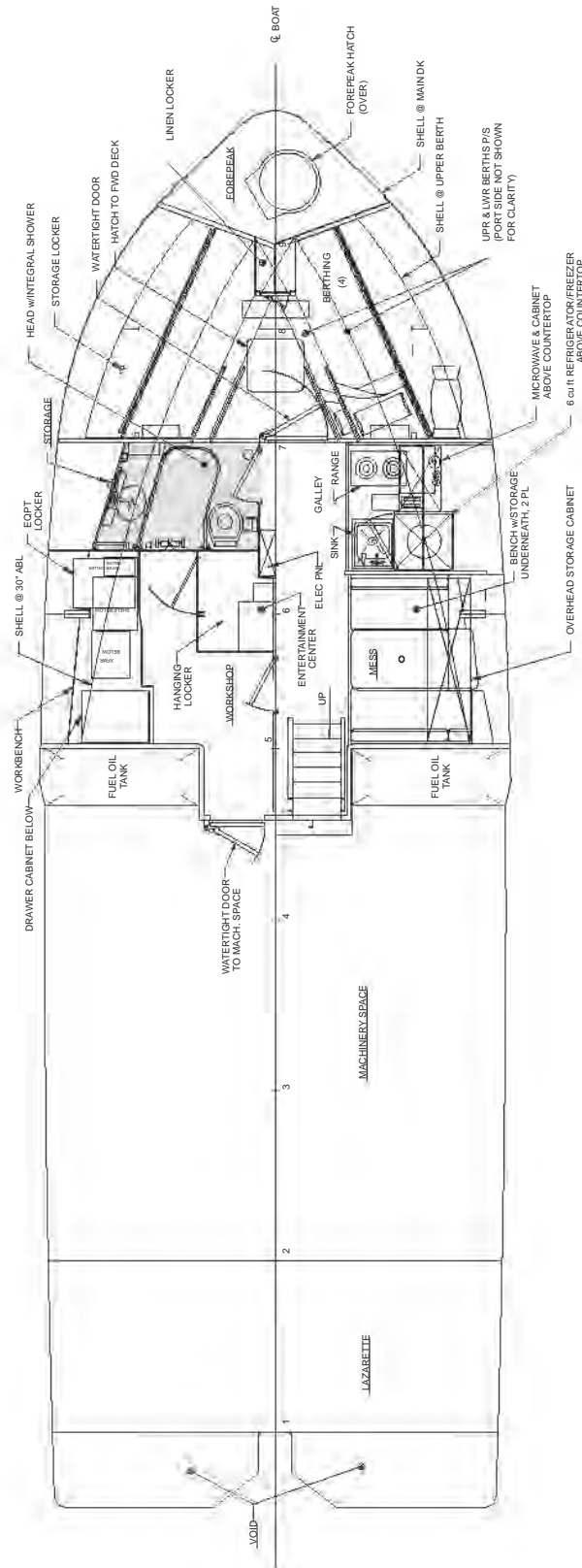

**Figure 2-10**  
**Head**



## Berthing Compartment/Forward Void

---

**B.15. Access** The berthing compartment is located between frames 7 and 9. Access to the berthing area is through a (QAWTD) at bulkhead 7 in the centerline passageway. (See figure 2-11.)

---

**B.16. Physical characteristics** The berthing compartment contains the following equipment and furnishings:

- double-high crew berths (2)
- berth lights (4)
- clothing lockers (4)
- linen locker (1)
- stowage spaces (2) provided below the lower berths
- fluxgate compass mounted below the linen locker
- collapsible emergency egress ladder mounted from the overhead

A quick-acting watertight door, right hand, 24 inches wide by 60 inches high, is installed for transiting to the berthing area.

A watertight hatch, 24 inches wide by 24 inches high, with four individual dogs, aft hinge and constructed of a tinted, translucent LEXAN material, provides egress from the berthing area to the main deck.

The void below the forward peak serves as a buoyancy chamber and is not normally accessible. Two 12 ½-inch diameter bolted manhole covers located at bulkhead 9 provide access for inspection.

---

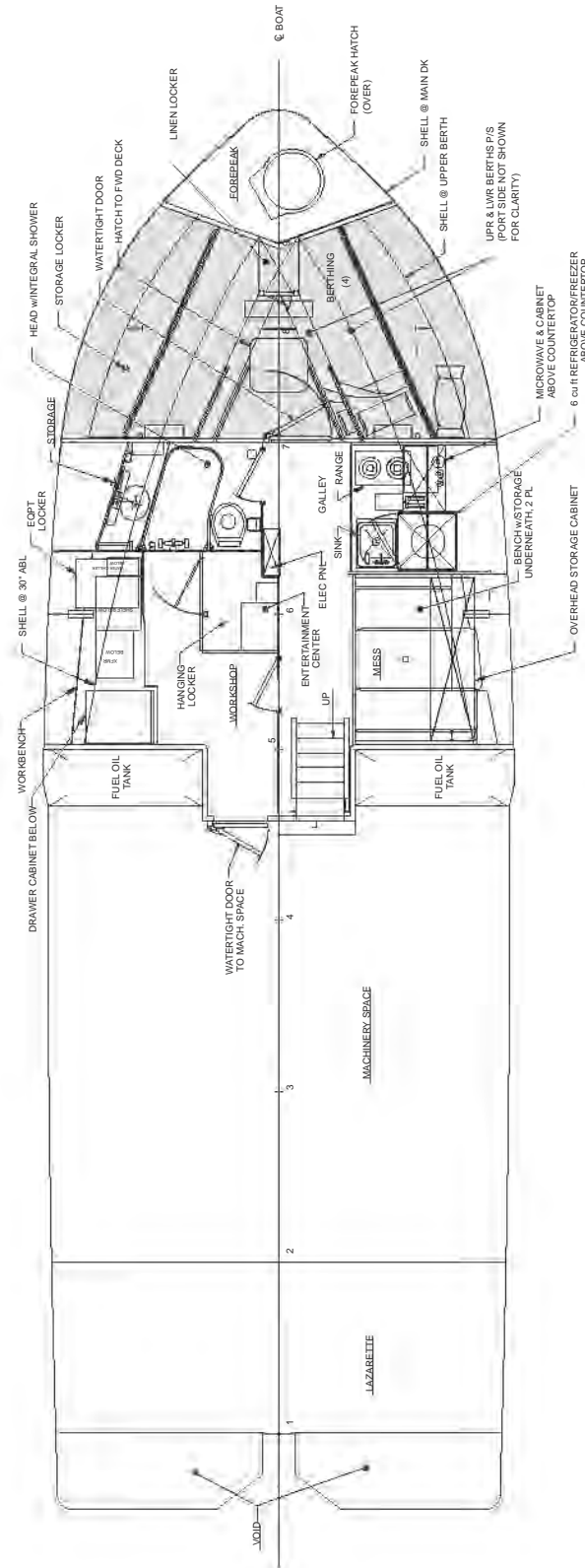

**Figure 2-11**  
**Berthing Compartment**



## Forward Peak

---

### B.17. Access

The forward peak is a storage chamber accessed through a flush deck-mounted escape hatch located on the main deck just forward of bulkhead 9. (See figure 2-12.)

---

### B.18. Physical characteristics

Natural ventilation is provided for the forepeak utilizing a gooseneck vent with an integral ball check valve and 18-mesh bronze or brass wire screen.

One hawser reel is located inside the forepeak, port side forward.

---

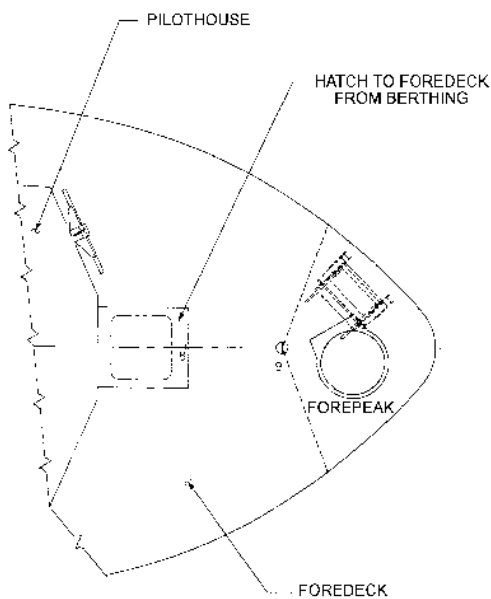

**Figure 2-12**  
**Forward Peak**



## Section C. Pilothouse

---

### C.1. Access

The pilothouse is an aluminum plate and stiffener structure joined to the steel main deck between bulkheads 5A and 7A using explosively bonded aluminum to steel transition joints. Two weather-tight doors with windows, located on the port and starboard side of the aft bulkhead, provide access to the pilothouse from the main deck. (See figure 2-13.)

---

### C.2. Physical characteristics

All (15 total) of the pilothouse windows are fixed except for the middle, side port and starboard windows, and the aft facing buoy deck window, which open. There are four windows on the port and starboard bulkheads of the pilothouse, three on the forward bulkhead and three on the aft bulkhead.

The pilothouse is the central command, control and monitoring station for the boat. Steering, engine and generator operation, A-frame operation and communications, and monitoring systems can be operated or observed from the pilothouse.

A folding bunk and privacy curtain is installed on the starboard side of the pilothouse.

System controls and monitoring will be discussed with description and operation of individual systems in subsequent chapters of this handbook.

---





**Figure 2-13**  
**Pilohouse (Aft Looking Forward)**



## Section D. Mast

---

### D.1. Location

The mast is mounted atop the pilothouse on a hinged fitting and supported by two port and starboard mast support legs that retain the mast in a vertical position utilizing shoulder bolts, nuts, and washers. (See figure 2-14a and 2-14b.)

---

### D.2. Physical characteristics

The mast is constructed of 2 ½-inch schedule 40 pipe. The height of the mast above the pilothouse is 10 feet 7 inches. It is designed to withstand a 60-knot wind speed. A yardarm constructed of 1-inch schedule 40 pipe is welded to the mast. To allow bridge clearance, the mast is capable of being folded by one person without assistance.

Attached to the mast and yardarm are the following components:

- anchor light
  - masthead light
  - restricted maneuvering light (upper)
  - floodlights (2)
  - lower tow light
  - restricted maneuvering light (middle)
  - restricted maneuvering light (lower)
  - EPIRB
  - stern tow light
  - stern light
  - rope pulley (port and starboard side of mast yardarm) with nylon line and snap hooks
  - antenna for AM/FM receiver
  - D-ring for raising and lowering the mast
-

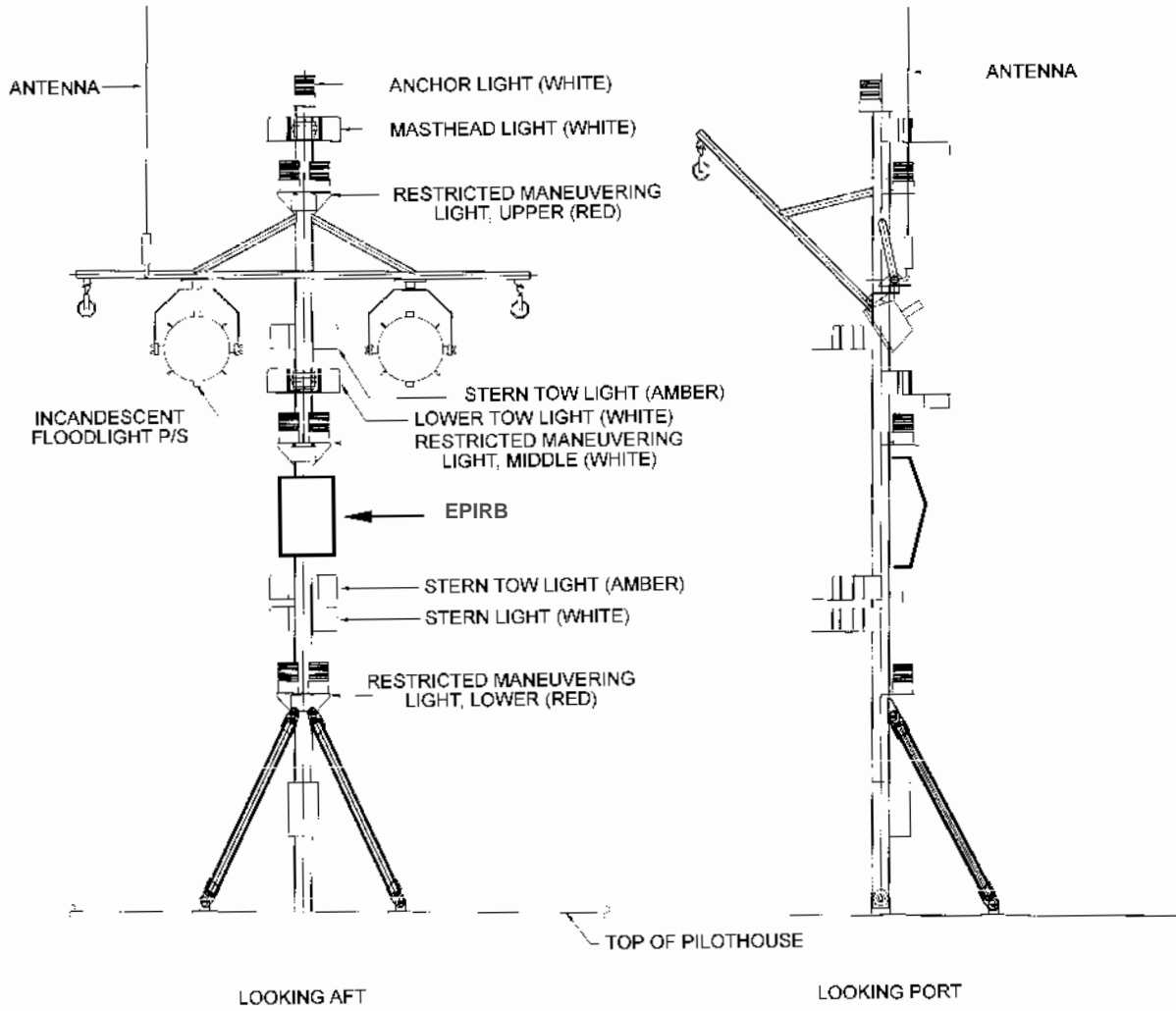

Figure 2-14

Mast



## Section E. Deck Equipment and Fittings (Other than Buoy Handling)

---

### Introduction

This section contains general information regarding the location and physical characteristics of the following deck equipment and fittings (other than buoy handling):

Topic	See Page
Mooring Bitt	2-37
Anchor	2-38
Hawser Reel	2-39
Bits and Chocks	2-40
Life Rings	2-42
Life Raft	2-43
Boat Hooks	2-44
Handrails and Lifelines	2-46
Grabrails	2-48
Deck Lockers	2-50
Emergency Dewatering Pump	2-52

---



**(This page intentionally left blank.)**



## Mooring Bitt

---

**E.1. Location** The mooring bitt is installed on the foredeck centerline, forward of the pilothouse at bulkhead 9. (See figure 2-15.)

---

**E.2. Physical characteristics** The mooring bitt is positioned so that the anchor line can lead through the center of the bull nose from the forepeak to the main deck. The mooring bitt is fabricated from 4-inch schedule 40 stainless steel pipe. A 5-inch long, 1 ¼-inch diameter horizontal member is welded on each side to make up the hawsers or mooring lines. A plug cap is fitted into the top of the mooring bitt.

---



**Figure 2-15**  
**Mooring Bitt**



# Anchor

### E.3. Location

A 60-pound Danforth anchor is stowed on the forward port bulkhead of the pilothouse under the window. The anchor is secured in place with a quick release pin on the shank and two brackets with wing nuts on the stock. (See figure 2-16.)

### E.4. Physical characteristics

The anchor line consists of 300 feet of double-braided nylon line with a minimum circumference of 2 3/4 inches, and 6 feet of 1/2-inch BBB galvanized chain. The anchor line is stowed on the hawser reel inside the forepeak.

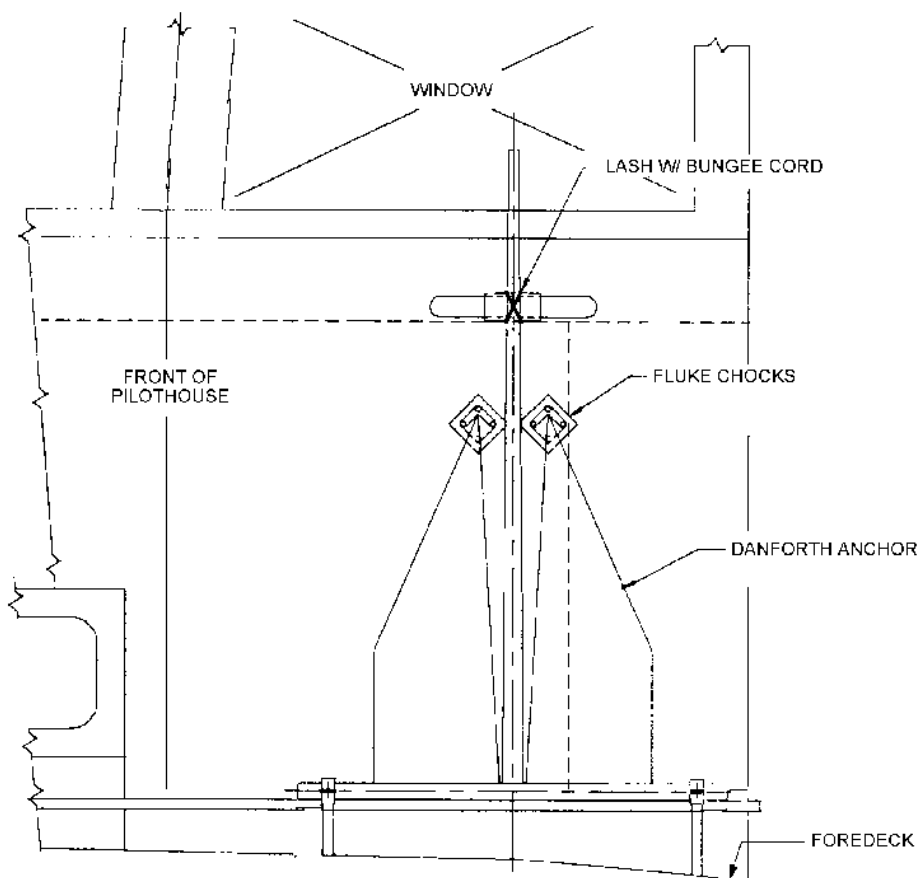

Figure 2-16

Anchor



## Hawser Reel

---

**E.5. Location** One hawser reel is mounted inside the forepeak, port side forward. (See **figure 2-17.**)

---

**E.6. Physical characteristics** The fabricated aluminum hawser reel is 16 inches in diameter and is mounted to allow the anchor line to be retrieved from the main deck without entering the forepeak.

---

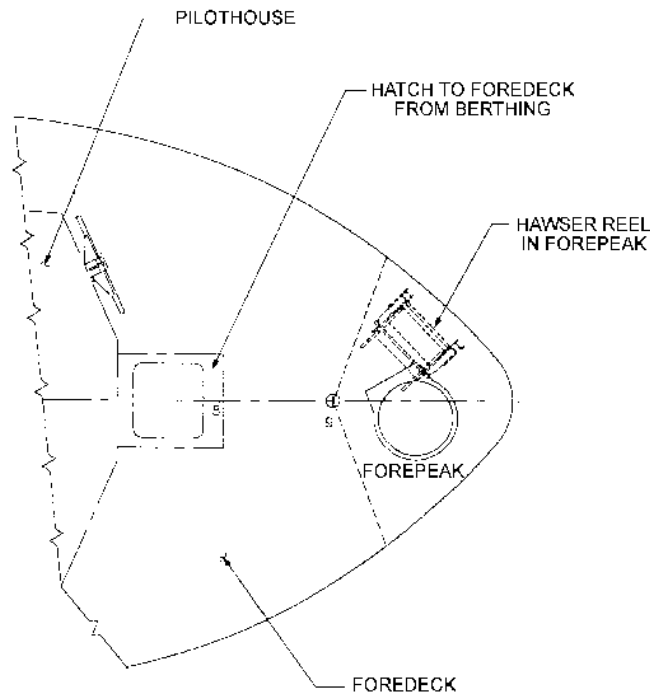

**Figure 2-17**  
**Hawser Reel**





## Bitts and Chocks

---

### E.7. Location

Nine closed chocks and seven double bitts are located around the deck edge of the hull at the following locations: **(See figure 2-18.)**

- One (1) closed chock set into bulwark, centerline at the bow
- One (1) double bitts on main deck, portside forward
- Two (2) closed chocks set into bulwark, port and starboard, forward of the pilothouse doors
- Two (2) closed chocks, port and starboard, side deck near transom
- Two (2) closed chocks, port and starboard, main deck edge, forward of the chain lifelines
- Two (2) double bitts on the foredeck, port and starboard, just aft of the pilothouse doors
- Two (2) double bitts on the main deck, port and starboard, forward of the chain lifelines
- Two (2) double bitts on the main deck, port and starboard, on the side near the transom

---

### E.8. Physical characteristics

The closed chocks are capable of handling a 3 ¼-inch circumference line. The chocks and bitts provide provisions for making up lines to the hull when in port or underway.

---

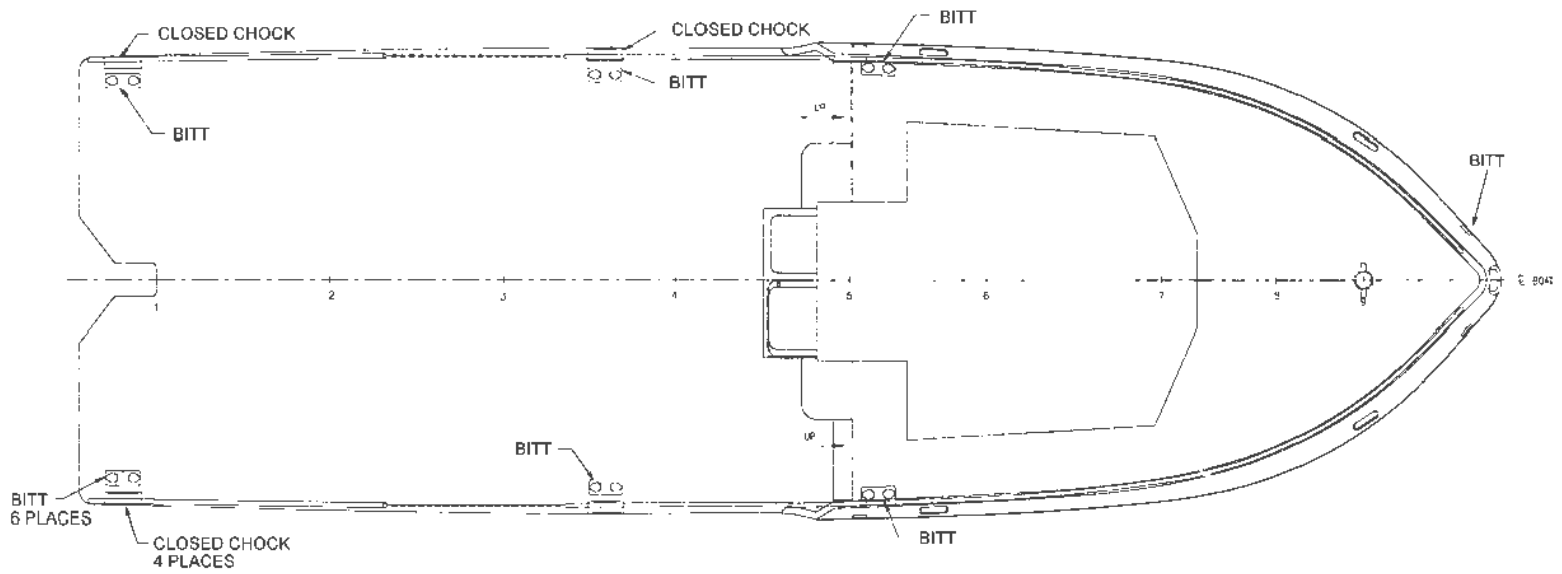

**Figure 2-18**  
**Bitts and Chocks**





## Life Rings

---

**E.9. Location** Two life rings are installed on aluminum brackets on the port and starboard exterior sides of the pilohouse. (See figure 2-19.)

---

**E.10. Physical characteristics** The life rings are the unicellular type; plastic body life rings with 2-inch retro-reflective tape, 30 inches in diameter with an electric, self-lighting, and gravity-activated float light.

---

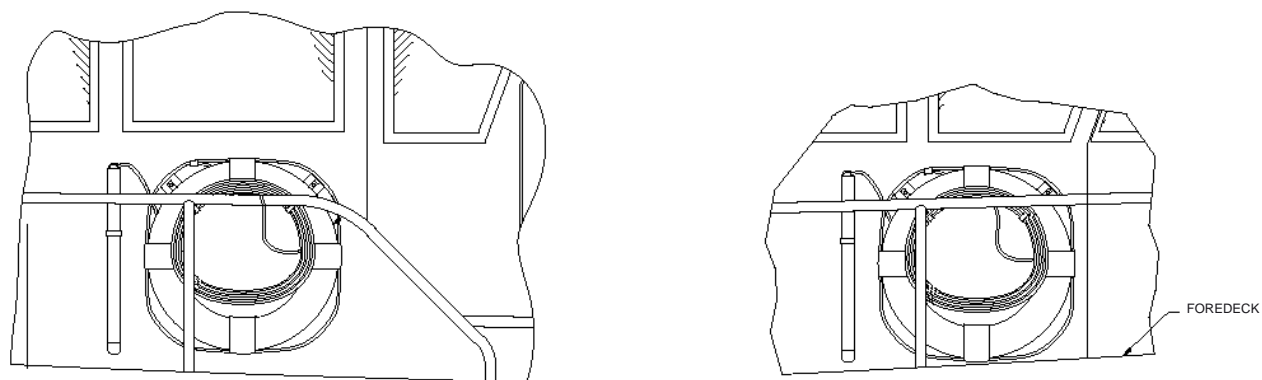

**Figure 2-19**

**Life Rings**



## Life Raft

---

**E.11. Location** One 6-person life raft is stored in a weather-tight, fire-retardant container atop the pilothouse, forward of the mast, in a float-free life raft cradle. (See **figure 2-20.**)

---

**E.12. Physical characteristics** The life raft is secured to the cabin top by the lashing release strap connected to the portside hard point with a shackle and the Hydrostatic unit assembly is connected to the starboard side. For further guidance see ECR 49BUSL-A-022.

---

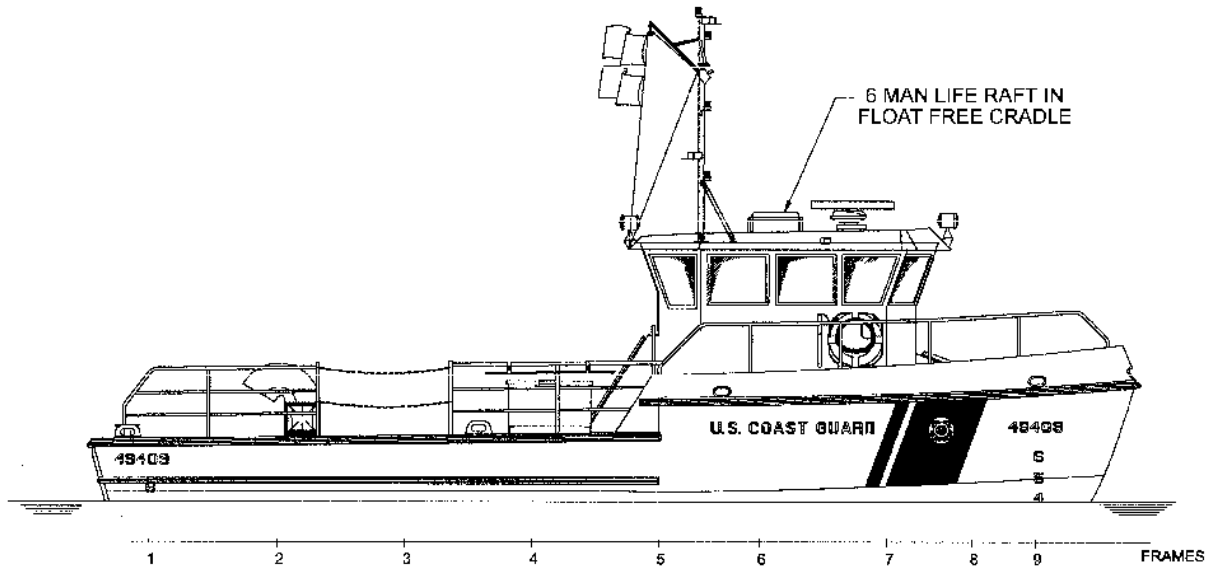

**Figure 2-20**  
**Life Raft**



## Boat Hooks

---

**E.13. Location** Two boat hooks are mounted horizontally port and starboard on the outboard side of the fixed handrails, at the forward end of the buoy deck. (See figure 2-21.)

---

**E.14. Physical characteristics** The boat hooks are fastened to the handrails by a leather strap. The hooks are bronze or brass with wooden handles approximately 10 feet long and shall be engraved with boat's hull number.

---

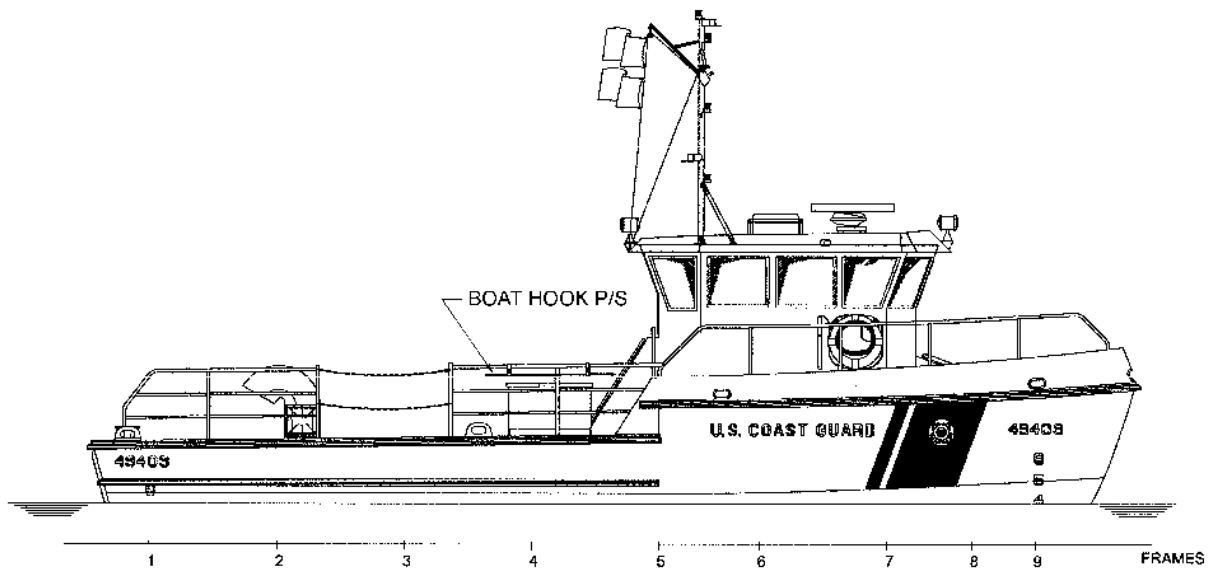

**Figure 2-21**  
**Boat Hooks**



**(This page intentionally left blank.)**



## Handrails and Lifelines

---

### E.15. Location

---

E.15.a. On the foredeck Fixed handrails are installed from bulkhead 5 forward to the bulwark rail on the port and starboard sides. (See figure 2-22.)

---

E.15.b. On the buoy deck Fixed handrails are installed from bulkhead 5 aft approximately 10 feet, allowing for a 6-foot clear opening for buoy deck access and then from the aft chock forward approximately 10 feet. (See figure 2-22.)

---

### E.16. Physical characteristics

---

E.16.a. On the foredeck An 18-inch opening between the port and starboard handrails is provided at the bow. The handrails have one single-top rail 41 inches above the deck. The handrails and stanchions are constructed of 1 ¼-inch schedule 40 pipe.

---

E.16.b. On the buoy deck These fixed handrails have a top rail positioned 41 inches above the deck. The top rail and stanchions are constructed of 1 ¼-inch schedule 40 pipe. Two additional horizontal rails, constructed of ¾-IPS schedule 40 pipe, spaced 15 inches apart, are located below the top rail. The 6-foot opening along the middle of the buoy deck edge, port and starboard sides, is protected by two removable sections of ¼-inch stainless steel chain attached to the stanchions by snap hooks and connect links on one end, and shackles on the other end.

---

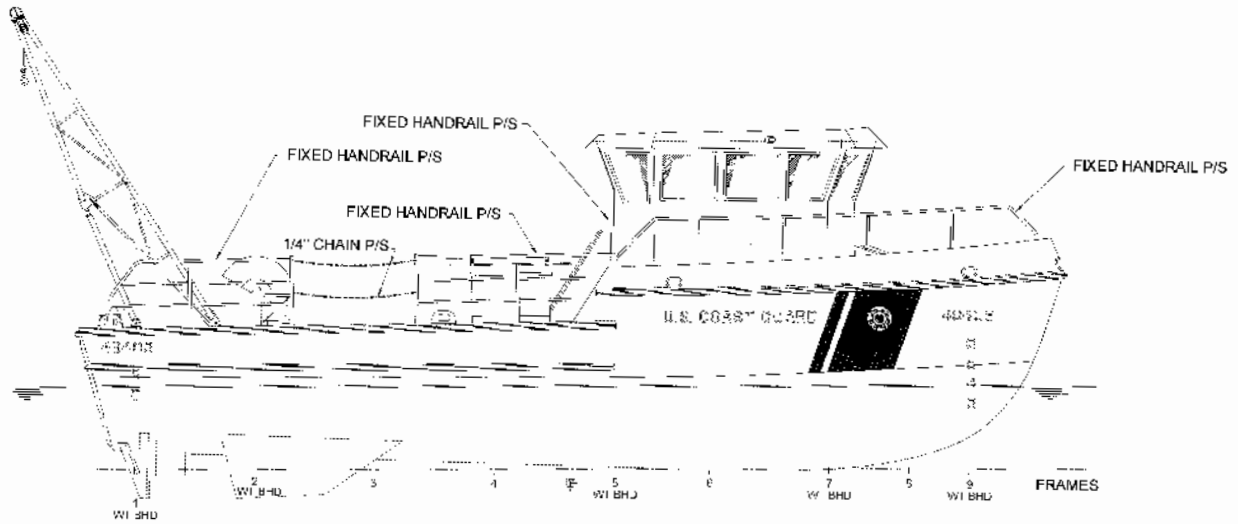

**Figure 2-22**  
**Handrails and Lifelines**





## Grabrails

---

**E.17. Location** The inclined ladder from the main deck aft leading to the mess area is equipped with grabrails. Grabrails are also located between the foredeck and the buoy deck inboard of the port and starboard steps to the pilothouse. There are several other grabrails located inside the pilothouse, workshop, galley/mess, head, and berthing areas for personnel safety. (See **figure 2-23.**)

---

**E.18. Physical characteristics** Composition of interior grabrails differs based upon location and purpose. The grabrails on the weather decks are made from 1 ¼-inch schedule 40 pipe.

---



**Figure 2-23**

**Grabrails**



## Deck Lockers

---

**E.19. Location** Deck lockers are installed port and starboard on the main deck, approximately at bulkhead 4; forward end of the buoy deck. (See figure 2-24.)

---

**E.20. Physical characteristics** The deck lockers are 4 feet long by 1 ½ feet wide by 2 feet high, and have a maximum load rating of 650 pounds. The lockers are made from aluminum with stainless steel stiffeners and hardware, and are bolted to a stainless steel frame 2 inches above the deck. A lid is provided with a lockable hinge. An acetylene and oxygen tank for buoy repair are mounted aft of the port deck locker.

---

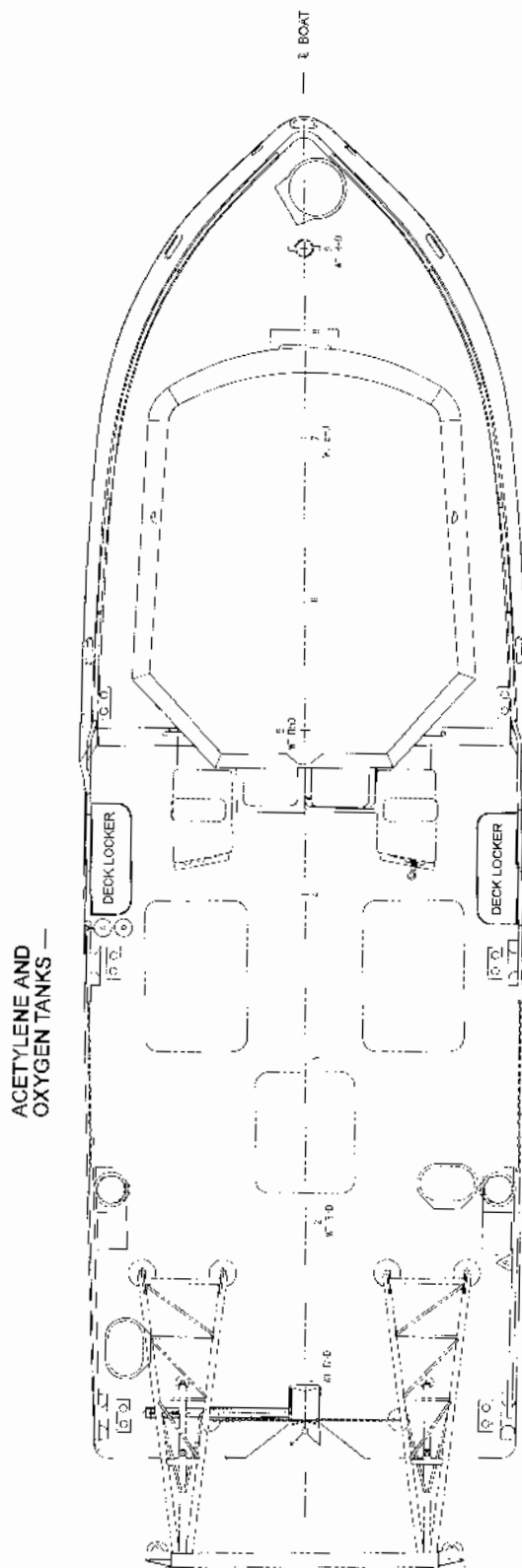

Figure 2-24  
Deck Lockers



## Emergency Dewatering Pump

---

**E.21. Location** The emergency dewatering pump is mounted on the aft pilothouse bulkhead above the equipment access for the workshop, port side of the watertight door leading from the main deck to the mess area. (See figure 2-25.)

---

**E.22. Physical characteristics** The emergency dewatering pump is a gasoline-powered, centrifugal (P-6) type pump, rated at approximately 250 GPM with a dewatering height of 12 feet. A threaded standpipe designed to take suction on the lowest point in the engine room is located adjacent to the starboard fuel tank deck fittings, forward of the buoy deck. The threaded standpipe is equipped with a cap and chain. A suction hose is provided to connect the dewatering standpipe to the pump inlet fitting.

---

**WARNING** 

The P-6 fire fighting capability is intended to only provide personnel protection or to aid in removing survivors from a burning platform.

---



**Figure 2-25**  
**Emergency Dewatering Pump**



**(This page intentionally left blank.)**



## Chapter 3 Vessel Systems

### Overview

---

**Introduction** This chapter discusses the boat's mechanical, electrical, and manual operating systems. It describes basic characteristics and provides information to allow the boat's crew to operate effectively.

---

**In this chapter** This chapter contains the following sections:

Section	Topic	See Page
A	Propulsion System	3-3
B	Propulsion Control System	3-7
C	Jacket Water Cooling System	3-13
D	Engine Systems	3-17
E	Hydraulic Steering System	3-33
F	Ship Service AC Generator	3-37
G	Electrical Systems	3-41
H	Heating, Ventilation, and Air Conditioning (HVAC) Systems	3-53
I	Buoy Handling System	3-59
J	Electronic Navigation System	3-69
K	Magnetic Compass	3-75
L	Navigation Lights, Searchlights, Floodlights, and Signal Devices	3-77
M	Electrical Alarm, Safety, and Warning Systems	3-81
N	Fire Extinguishing Systems	3-83
O	Bilge System	3-85
P	Gray Water and Sewage Systems	3-87
Q	Deck Wash down System	3-91
R	Compressed Air System	3-93
S	Potable Water System	3-95





<b>Section</b>	<b>Topic</b>	<b>See Page</b>
T	Windshield Wipers and Washers	3-99
U	Cathodic Protection System	3-101

---



## Section A. Propulsion System

---

### A.1. General

The propulsion system (**figure 3-1**) is comprised of two marine diesel engines each driving a fixed propeller through a reverse reduction gear and solid, continuous shaft. The propellers are installed for right-hand ahead rotation on the starboard shaft and left-hand ahead rotation on the port shaft.

---

### A.2. Engines

The 49' BUSL is equipped with two Cummins (6CTA 8.3M1) 6-cylinder, turbocharged, and marine diesel engines. The engines are located in the machinery space. Minimum brake horsepower (hp) for each engine is 305 hp at 506 cubic inches (8.3 liters) displacement, 2300 RPM. The lubricating oil system capacity is 23.2 U.S. quarts (22 liters) of 15W-40 oil. The cooling system capacity is approximately 7 gallons. A Mathers Micro Commander Marine Propulsion Control System, utilizing a DC actuator, controls the engines and transmissions. The actuator is mechanically connected to the main engine throttle system for speed control and to the transmission for direction control.

---

### A.3. Marine transmission/reduction gear

The 49' BUSL uses a Twin-Disc Model MG-507-A1 transmission/reduction gear mounted on each engine flywheel housing. The transmission provides for ahead, astern and trolling operations. The reduction ratio is 2.54 to 1 in forward and reverse. Each MG-507-A1 transmission utilizes an independent oil system. The oil system capacity is 1.72 U.S. gallons, conforming to the requirements of MIL-L-2104B, 10W-30 oil. The oil system consists of an oil pump, filter screen, filter and heat exchanger (oil cooler). The heat exchanger uses engine jacket water-cooling at approximately 135 - 185 °F as the cooling median for the transmission oil. The heat exchanger should maintain the oil operating temperature for the transmission at 160 - 210 °F with a maximum temperature of 210 °F.

A selector valve mounted on the rear of the unit is used to hydraulically engage the desired clutch for forward and reverse operation. Normal clutch application pressure is from 300 - 320 PSI with a trolling valve incorporated for trolling in the ahead and astern mode of operation. The selector valve can be manually operated in the event of an electronic failure to the selector valve.

---



---

#### A.4. Propeller shafts

The propeller shafts are hardened stainless steel (Sea Shaft 22 or equivalent) shafts, 2 ½ inches in diameter and approximately 125 inches (10 ½ feet) long. The shaft is attached to the reduction gear utilizing a keyed, 6-bolt flange with a keeper ring set located in a groove between the end of the shaft and the flange. The tapered, threaded and keyed end of the shaft that mounts the propeller is equipped with a plain nut, jam nut and cotter pin hole to retain the propeller to the shaft. Each shaft is housed in a shaft tube, 4 ¾-inch OD with ¼-inch wall thickness, which passes through the skeg. The shaft tube is equipped with a Duramax shaft seal (**figure 3-2**) with a clamp-on adapter for the forward end of the shaft. The shaft seals are supplied with pressurization and flushing water via a valve and flow meter. The aft end of the propeller shaft is supported in the shaft tube by the shaft bearing mounted in the shaft-bearing carrier. The shaft bearing is a Thordon XL marine bearing manufactured from a polymer type material. The shaft bearing is provided with lubrication and flushing water that is into the shaft tube via the pressurization and flushing water at the shaft seal end of the shaft.

---

#### A.5. Propeller

Each 4-bladed propeller is of cast, nickel aluminum bronze material. The propellers are 31 inches in diameter with a 22-inch pitch. Each propeller weighs 128 pounds.

---

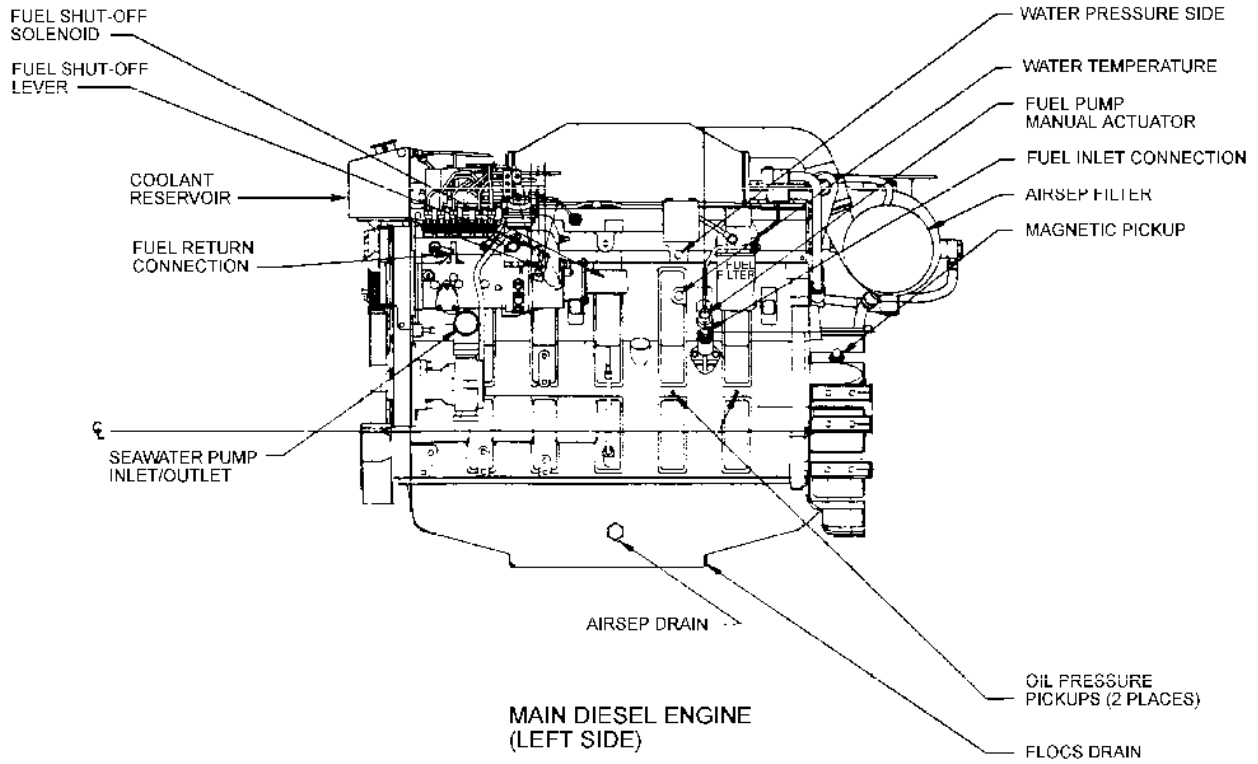

**Figure 3-1**  
**Propulsion System**



**Figure 3-2**  
**Shaft Seal Assembly**



## Section B. Propulsion Control System

---

**B.1. General** The propulsion control system (**figure 3-3**) electronically integrates the control of the main propulsion engines in both the trolling and the fully clutched mode. The engines are normally controlled from the forward pilothouse, station #1, or aft control console, station #2 (**figures 3-4 and 3-5**). The major components of the propulsion control system are the control heads (forward and aft control stations in the pilothouse), troll/non-troll switches, 585CE actuators, one per engine in the main engine room, and one 813 trolling valve actuator.

### CAUTION!

The engine electronic control system is very sensitive to current/voltage fluctuations and surges. Disconnect all components before conducting any welding on the 49' BUSL.

### B.2. Principles of operation

Once the engines are started, control of speed and direction is a function of the 585CE actuators. The 585CE actuators receive an input from the control heads (throttles) of the station in control. The actuator converts the electronic signal into a mechanical output. The mechanical outputs, via push/pull cables, connect to the main engine throttle control and the selector valve on the back of the transmission/reduction gear.

The 813-troll actuator has dual mechanical outputs and is linked via push/pull cables to the trolling valve lever on the back of the transmission. When actuated, the troll/non-troll switch modulates the oil pressure to the clutch ahead and astern clutch plates, allowing the clutch to slip, creating reduced propeller shaft RPM at idle engine RPM.

### B.3. Engine throttle control

Throttle control is located on the forward pilothouse console (**figure 3-4**) for the port and starboard engines between the starboard engine control panel and the depth sounder. Throttle control aft (**figure 3-5**) is located on the aft pilothouse console, outboard of the port engine control panel. An illuminated red light on the control head housing indicates the station with throttle control.

### B.4. 585CE actuators

The actuators are mounted on the hull outboard of each engine. The actuators convert the electrical commands generated by the throttle control into a push/pull mechanical input to the engine governor control and clutch control valve.



---

**B.5. 813 troll actuator**

The troll actuator is located on the overhead aft above the starboard engine 585CE actuator. It has dual mechanical outputs that link to the port and starboard trolling valve levers on the back of the transmission.

---

**B.6. Engine control/gauge panels (pilothouse)**

The pilothouse is equipped with a port and starboard engine control and gauge panel on the forward and aft consoles (**figures 3-4 and 3-5**). Each panel contains the following controls and indicators:

- gear (clutch/transmission) oil pressure gauge
  - jacket water temperature gauge
  - engine start pushbutton
  - engine stop pushbutton
  - panel lamp dimmer rheostat
  - tachometer
  - exhaust temperature gauge
  - engine oil pressure gauge
  - engine oil temperature gauge
  - alternator ammeter
  - troll actuator switch
- 

**B.7. Engine control/gauge panel (engine room)**

The machinery space (engine room) is equipped with engine control and gauge panel located inboard of each main diesel engine (**figure 3-6**). Each panel contains the following controls and indicators:

- engine speed and hour meter
  - engine oil temperature
  - engine oil pressure
  - alternator ammeter
  - gear (clutch/transmission) oil pressure gauge
  - exhaust temperature gauge
  - jacket water temperature
  - engine start pushbutton
  - engine stop pushbutton
  - panel lamp dimmer rheostat
-



**B.8. Emergency shutdown controls (main engines)**

Emergency shutdown pull knobs for the main engines are located on the center of the forward vertical panel on the aft control console in the pilothouse (**figure 3-7**). The top pull knob is for the generator, the center is for the port main engine, and the bottom is for the starboard main engine. Push/pull cables connect the shutdown knobs to the engine remote air shut-off valve to secure air to the engine for emergency shutdown. The generator emergency shutdown will be discussed with the ship service AC generator system.

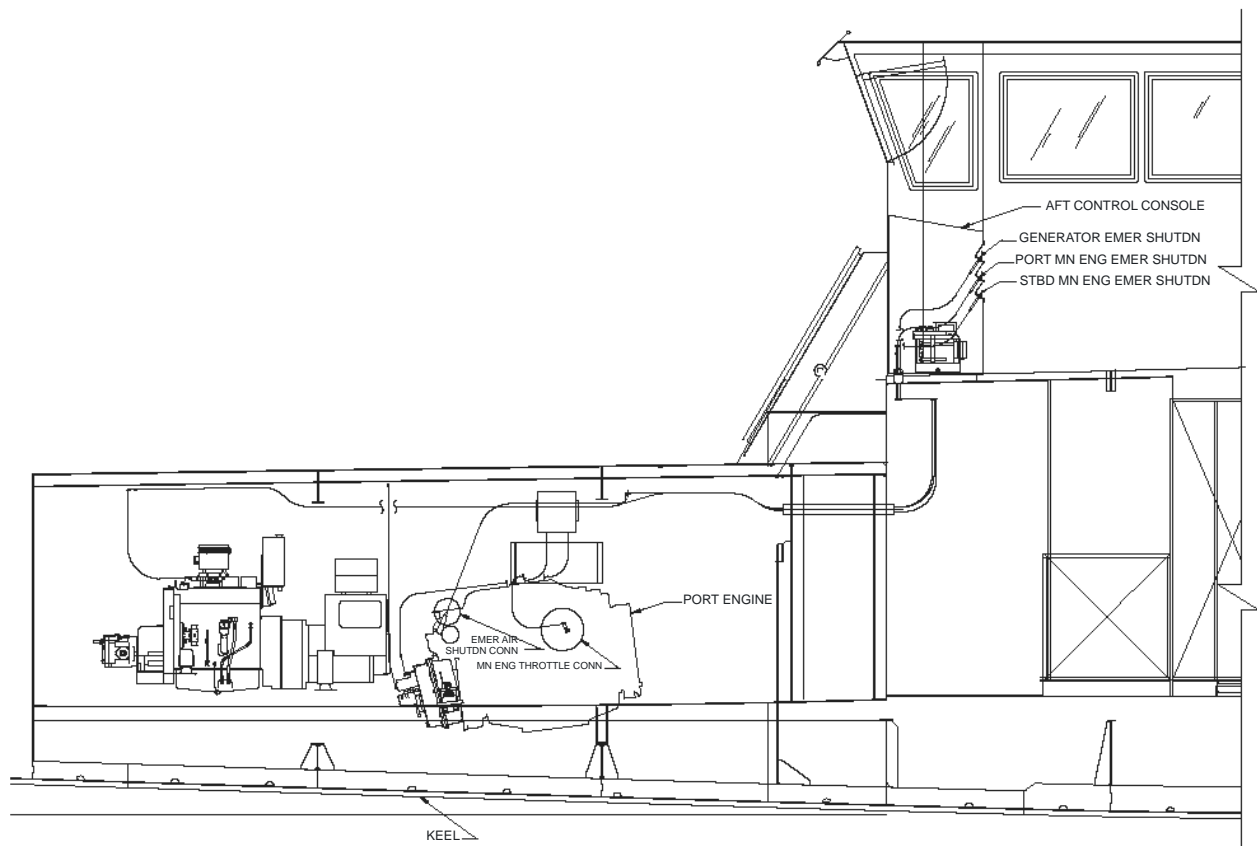

**Figure 3-3**  
**Propulsion Control System**  
**(Portside from keel to outboard)**





Figure 3-4

**Pilotage Forward Control Console**



Figure 3-5

**Pilotage Aft Control Console**



**Figure 3-6**  
**Engine Control and Gauge Panel - Machinery Space**



**Figure 3-7**

**Main Engine Emergency Shutdown Controls - Pilothouse Aft**



## Section C. Jacket Water Cooling System

---

- C.1. General** The jacket water-cooling system (**figure 3-8**) includes the engine-driven cooling water pump, coolant reservoir, coolant filter, thermostat, reduction gear/clutch lube oil cooler and keel cooler.
- 
- C.2. Engine-driven cooling water pump** A belt-driven cooling water pump provides flow of the jacket water through the engine, keel cooler and reduction gear/clutch lube oil cooler. The pump is rated at 75 GPM.
- 
- C.3. Coolant reservoir** The coolant reservoir (**figure 3-9**) provides storage and expansion for a 50-50 water/ethylene-glycol antifreeze mixture for the jacket water-cooling system. A 15-PSI pressure cap is installed in the top of the reservoir for filling and to relieve excessive system pressure.
- 
- C.4. Coolant filter** A cartridge type coolant filter is installed in the jacket water system and must be changed when the engine coolant is changed. The filter is located next to the oil filter on the engine starboard, forward side.
- 
- C.5. Thermostat** The thermostat in the jacket water-cooling system is designed to maintain the jacket water-cooling temperature at 180 - 205 °F. The thermostat should open at approximately 178 °F to permit full flow through the jacket cooling water system.
- 
- C.6. Reduction gear/clutch lube oil cooler** The reduction gear/clutch lube oil cooler is a shell and tube type oil cooler (151 tubes, each ¼ inch in diameter) mounted adjacent to each marine diesel engine and designed to maintain the oil temperature between 150 -210 °F.
- 
- C.7. Keel cooler** Each marine diesel engine has a separate double-stem cooler mounted in a recessed area under the hull. The tubes, 6 per cooler, are approximately 40 inches long and 2 ½ inches in diameter.
-

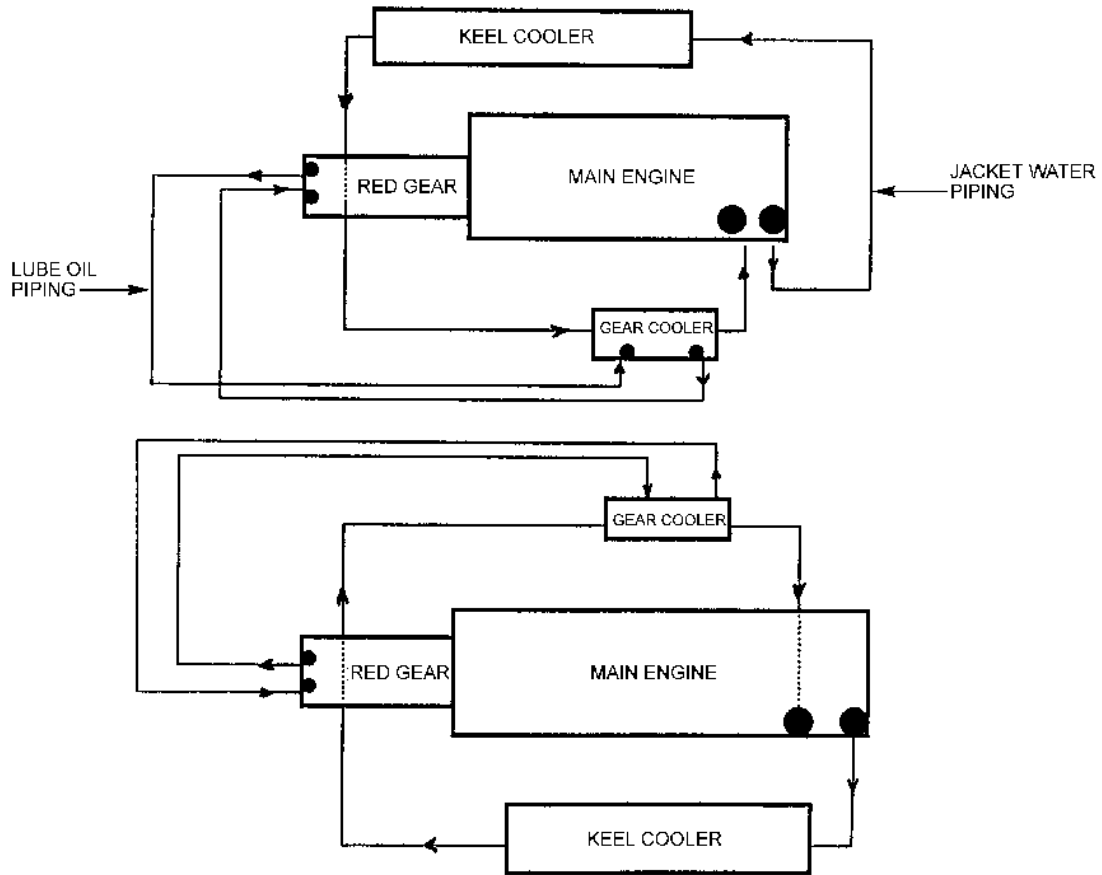

**Cooling System Diagram**

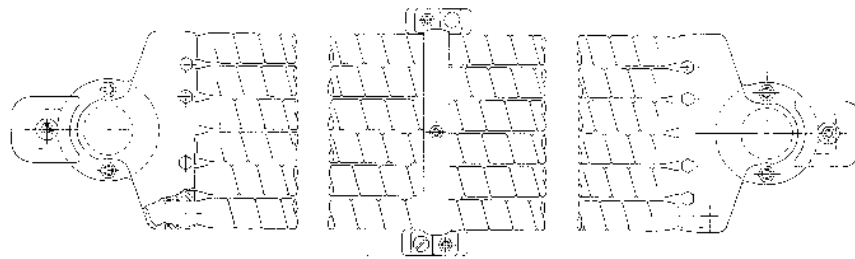

**Keel Cooler (Typical)**

**Figure 3-8  
Jacket Water Cooling System**

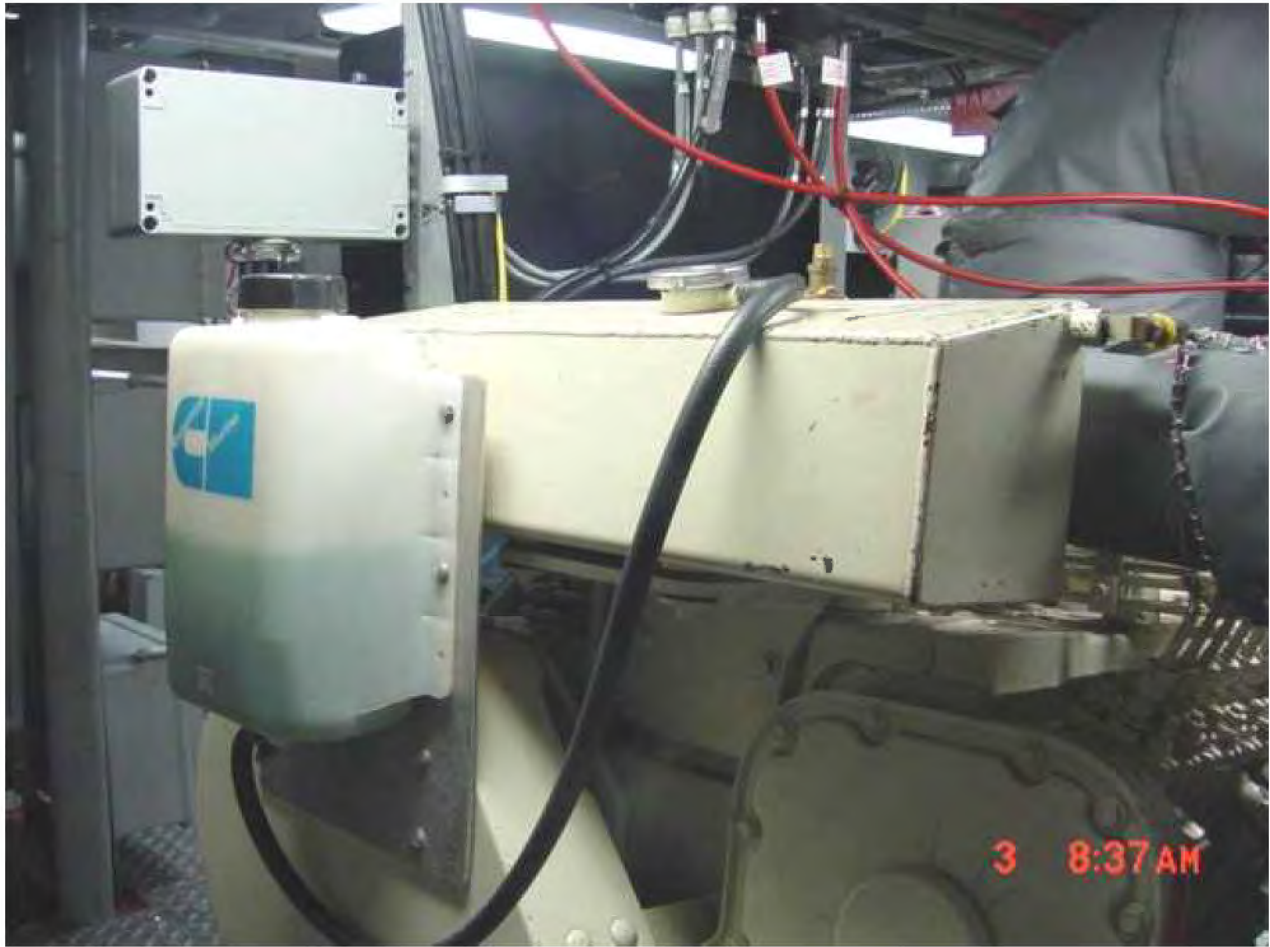

**Figure 3-9**  
**Main Diesel Engine Coolant Reservoir**



**(This page intentionally left blank.)**



## Section D. Engine Systems

---

**Introduction** This section provides information about systems or components that are required for or support the operation of the marine diesel main propulsion engines.

---

**In this section** This section contains the following information:

Topic	See Page
Engine Lubrication System	3-18
Engine Crankcase Ventilation System	3-20
Fuel Oil System	3-22
Engine Exhaust System	3-26
Engine Jacket Water Heaters (Hot Start)	3-28
Fast Lubricating Oil Change System (FLOCS)	3-29
Engine Starting System	3-30

---





## Engine Lubrication System

---

<b>D.1. General</b>	<p>The main diesel engines are equipped with a pressure type, wet sump oil system (<b>figure 3-10</b>). The system consists of:</p> <ul style="list-style-type: none"><li>• pump and suction screen</li><li>• spin-on cartridge filter</li><li>• filter bypass valve</li><li>• pressure regulating valve</li><li>• oil cooler bypass valve</li></ul>
<b>D.2. Pump and suction screen</b>	<p>The generator oil pump, which is gear driven by the engine, takes suction on the sump through an oil screen. The pump creates oil flow through the oil cooler.</p>
<b>D.3. Spin-on cartridge filter and bypass valve</b>	<p>The oil filter is mounted on the engine, starboard side aft of the alternator. It is a spin-on type disposable cartridge filter.</p>
<b>D.4. Filter bypass valve</b>	<p>A bypass valve is provided to divert oil around the filter element should it become clogged.</p>
<b>D.5. Pressure regulating valve</b>	<p>The pressure-regulating valve is located on the discharge side of the oil filter. The valve regulates the engine oil pressure to maintain 30 to 75 PSI throughout the normal engine operating range. The valve is located in the bottom of the oil cooler housing.</p>
<b>D.6. Oil cooler bypass valve</b>	<p>The oil cooler is located on the engine, inboard of the spin-on lube oil filter-mounting flange. The cooler uses jacket water-cooling to cool the engine oil. A thermostatic bypass valve diverts cold oil around the core of the cooler. Oil flows from the cooler to the filter.</p>

---

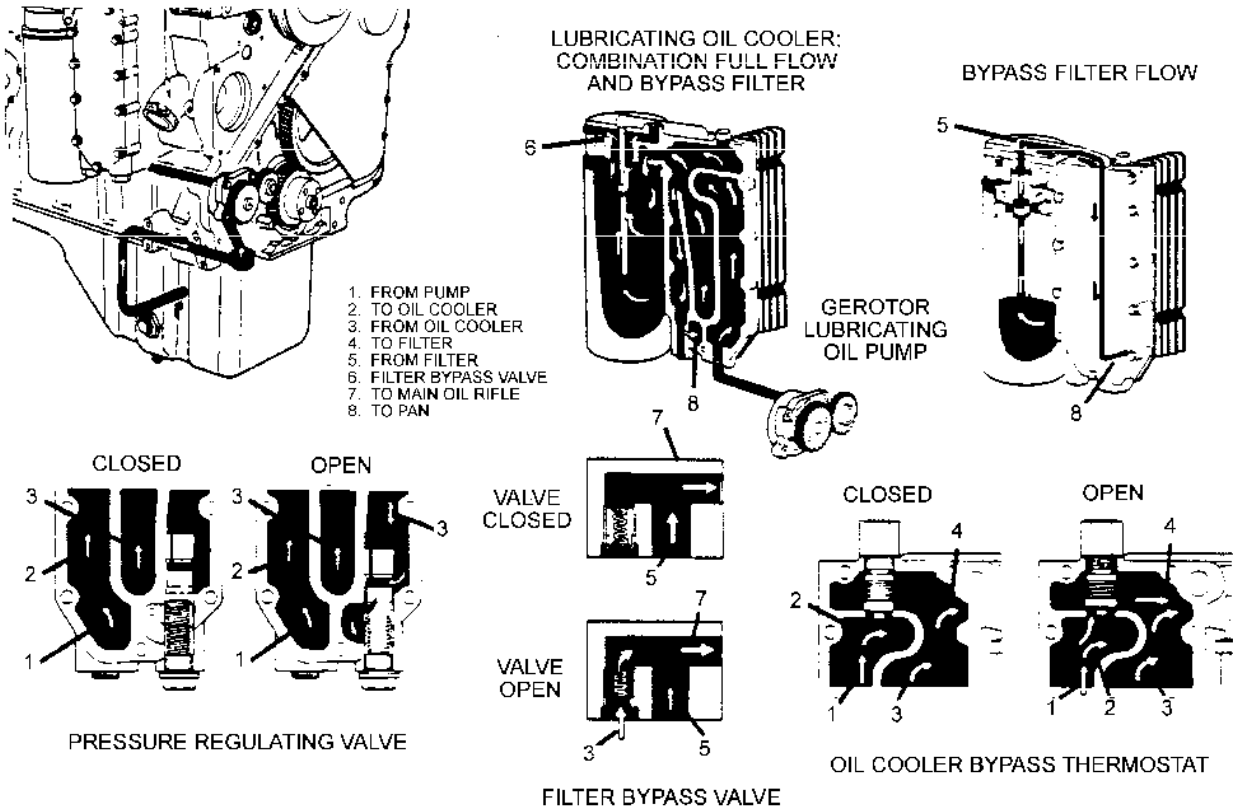

**Figure 3-10**  
**Engine Lubrication System**



## Engine Crankcase Ventilation System

---

**D.7. General** The crankcase ventilation system (**figure 3-11**) routes the fumes produced by the engine oil system back through the engine air intake system.

---

**D.8. Air separator filter** An air separator filter, mounted on the inlet flange for the turbocharger, receives fumes from the engine crankcase via a crankcase regulator and manifold assembly attached to the tappet cover.

---

**D.9. Air separator body** The air separator body is designed to remove oil from the engine oil fumes and return the oil back to the engine oil pan via a check valve and hose connected to the bottom of the air separator and the oil pan.

---

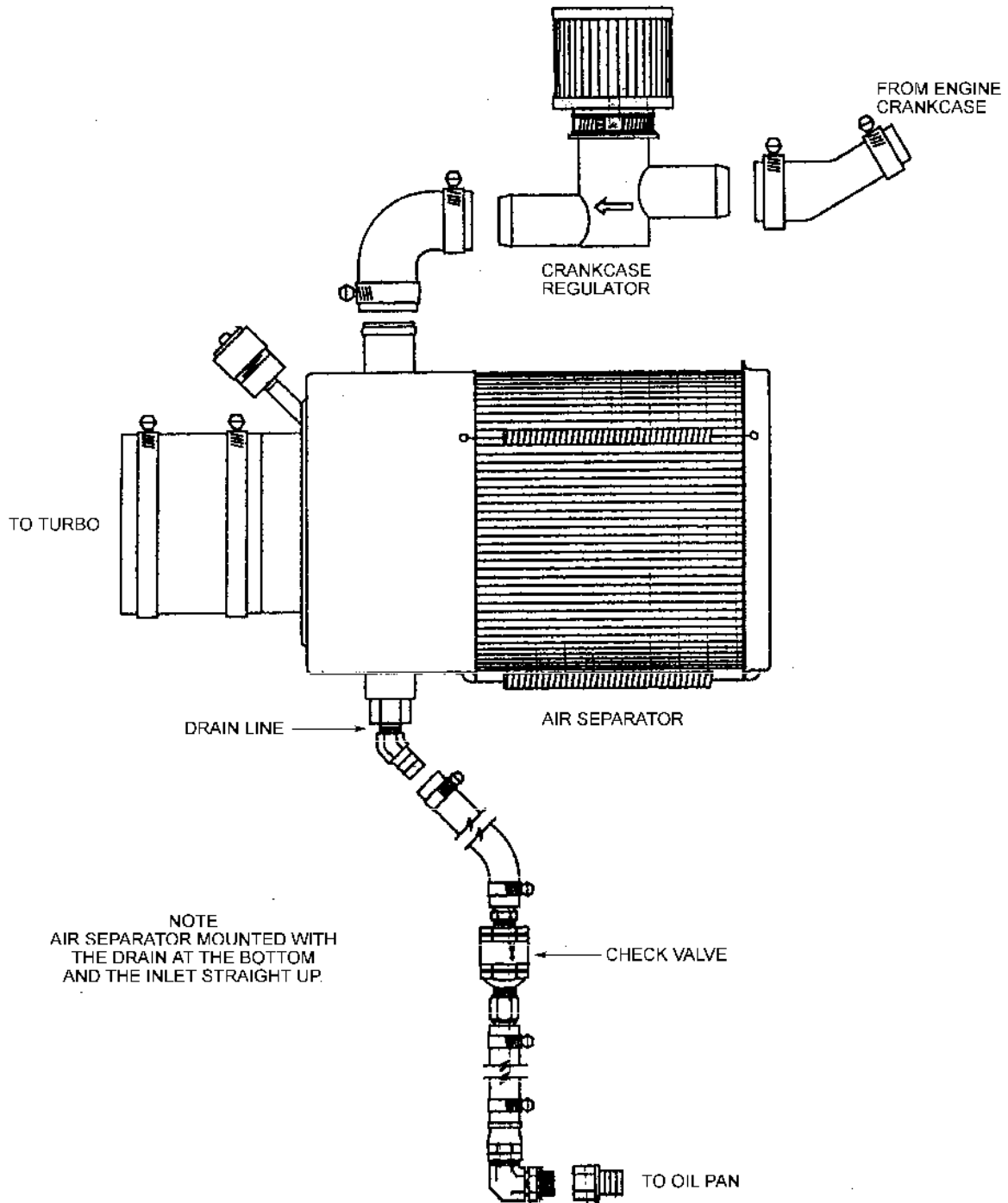

**Figure 3-11**  
**Engine Crankcase Ventilation System**



## Fuel Oil System

---

### D.10. General

The fuel oil system (**figure 3-12**) provides fuel to the main propulsion diesel engines and the ship service generator diesel engines and is composed of:

- emergency fuel shutoff valves
- duplex fuel oil filter assembly
- secondary fuel filter

Fuel is supplied to the engines via a  $\frac{3}{4}$ -inch header from the port and starboard fuel oil service tanks. The fuel flows through an emergency fuel shutoff valve, through the header and off-engine mounted duplex filter to the engine fuel system.

---

### D.11. Emergency fuel shutoff valves

A ball type valve is located in the fuel supply line from each fuel oil tank to the main engine room fuel system header. A pull station located on the main deck adjacent to each fuel oil tank fill connection allows for emergency actuation of the valve. The pull handles are located in small lockers (**figure 3-13**) with snap-lock covers, and labeled for emergency use only.

---

### D.12. Duplex fuel oil filter assembly (primary fuel filter)

Each engine has a dual element fuel filter/separator mounted on a frame assembly, inboard and aft of each main diesel engine. The duplex filter is on the suction side of the engine-driven fuel pump. The filter is rated at 30 microns. The separator portion of the filter is designed to remove large solid particles and to coalesce the small amount of water that falls to the bottom of the filter bowl. A drain plug on the bottom of the filter bowl is provided to remove collected contaminants and water.

---

### D.13. Secondary fuel filter

The secondary fuel filter is mounted on the port side of the engine and filters the fuel from the discharge side of the engine-driven fuel pump, prior to the injectors.

---

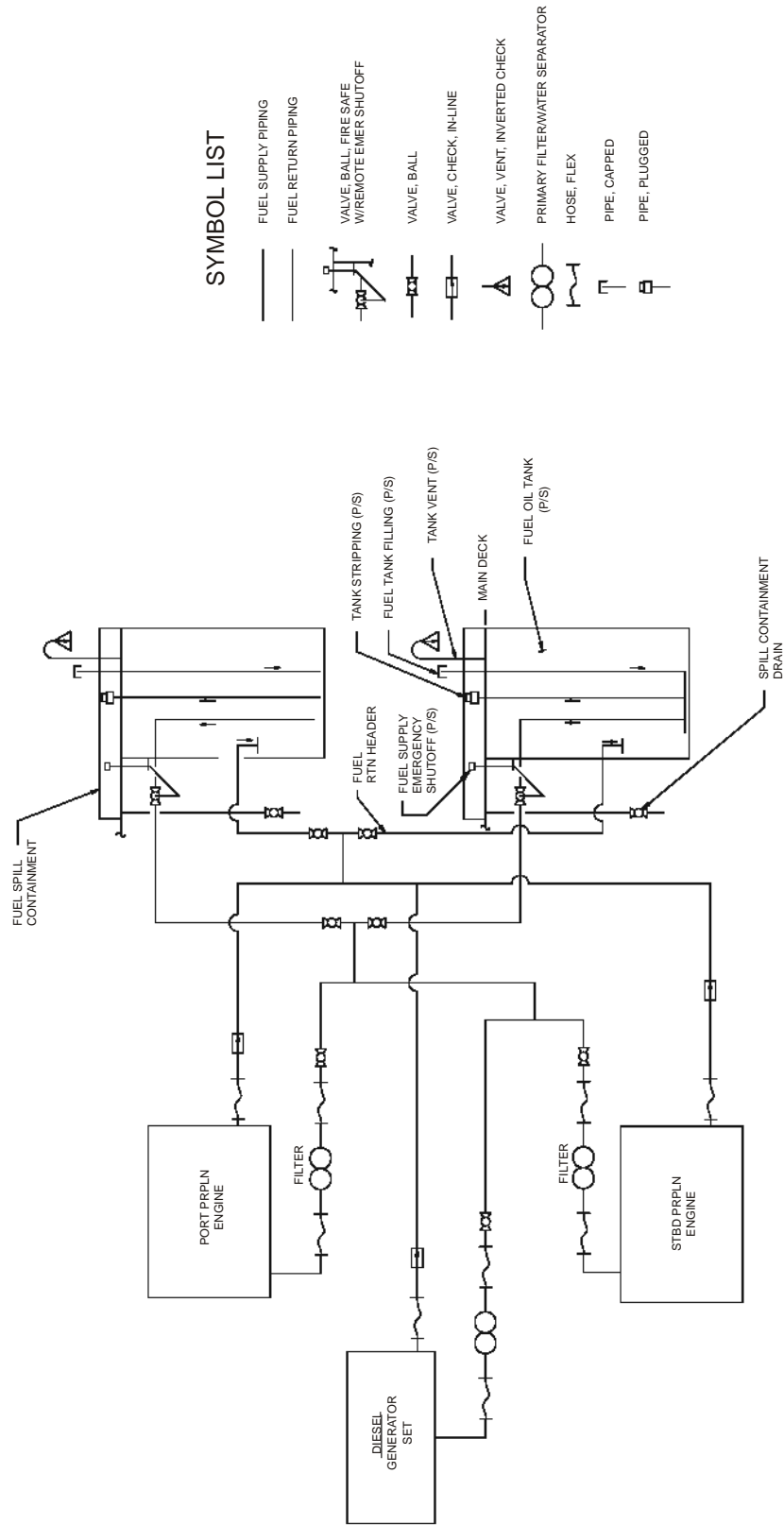

**Figure 3-12**  
**Fuel Oil System**



**Figure 3-13**  
**Emergency Actuation Pull Handle**



**(This page intentionally left blank.)**





## Engine Exhaust System

---

**D.14. General** The main diesel engines each utilize a separate, dry type exhaust system (**figure 3-14**).

---

**D.15. Piping and mufflers** All piping and mufflers of the exhaust system are made from stainless steel, grade 321 or 347. Bellows type, flexible sections are installed between the engine exhaust port and exhaust system piping on the inlet side of the muffler, and also on the outlet side of the muffler for piping that interfaces with the shell penetration points. Resilient pipe hangers are used to support the exhaust system components. Insulation for the exhaust system has a total thickness of 4 inches.

---

**D.16. Overboard ports** The overboard ports for the exhaust system are above the waterline, forward of the engine room aft bulkhead, forward of watertight bulkhead 2. Stainless steel inserts are installed where the exhaust piping penetrates the hull.

---

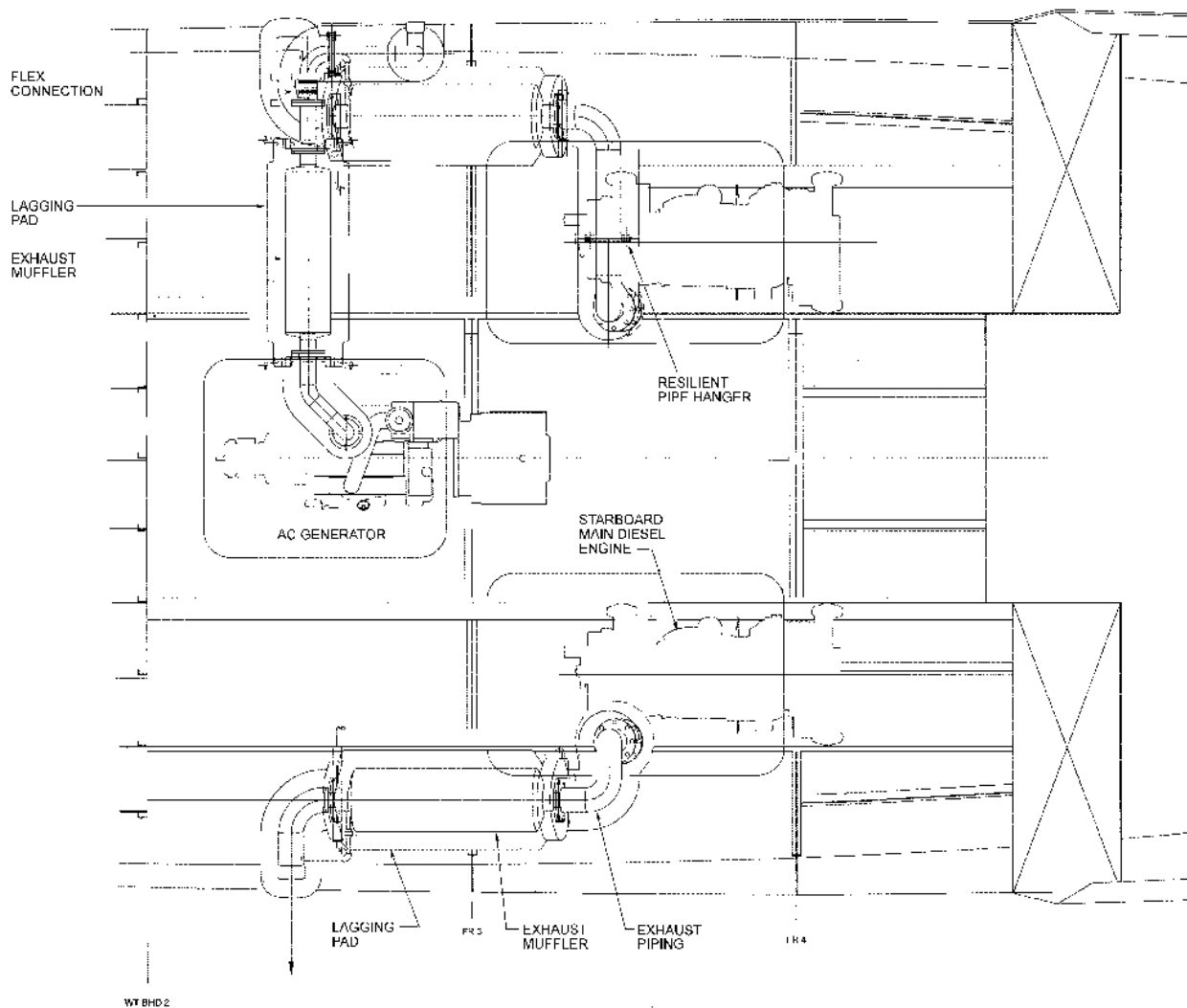

**Figure 3-14**  
**Engine Exhaust System**



## Engine Jacket Water Heaters (Hot Start)

**D.17. General** A 1500-watt, 120-VAC, 60-Hz electric heater is installed in the jacket water system (**figure 3-15**) on each main diesel engine.

**D.18. Thermostat** The heater is controlled by a thermostat that turns the heater *on* if the jacket water temperature drops below 100°F (38°C), and *off* when the temperature reaches 120°F (49°C).

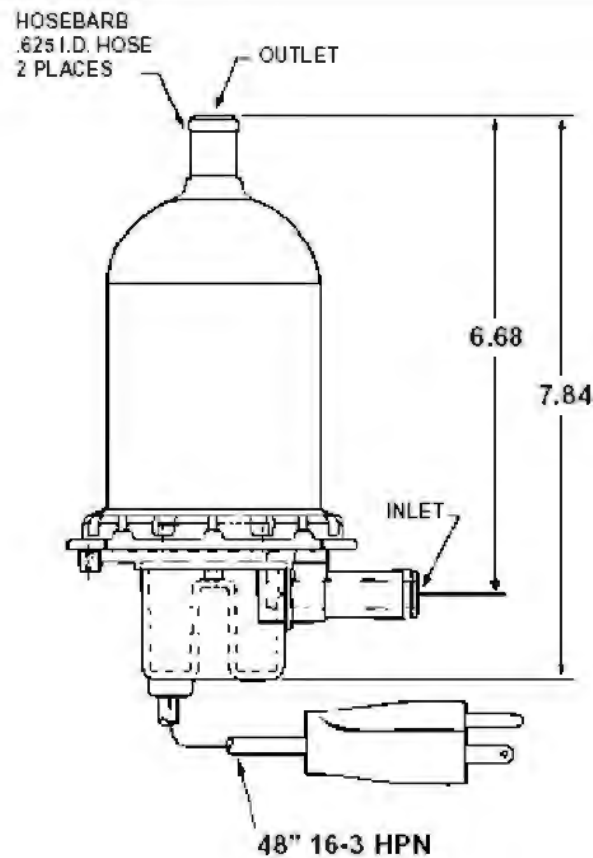

**Figure 3-15**

### Engine Jacket Water Heaters (Hot Start)



## Fast Lubricating Oil Change System (FLOCS)

**D.19. General** The fast lubricating oil change system (FLOCS) (**figure 3-16**) is comprised of engine-mounted hoses and fittings, and a portable oil change cart. The system allows for quick oil changes without the hazard of spilling or dripping oil into the bilge areas.

**D.20. Pan plug adapter** A 90-degree threaded pan plug adapter is installed on the aft face of the oil pan. The adapter connects to a hose assembly that has a spring-loaded, closed, male quick-disconnect coupling on the other end.

**D.21. Quick-disconnect coupling** The quick-disconnect coupling facilitates the connection of the FLOCS pump and hoses to quickly change the engine oil. A similar FLOCS drain is also provided for the transmission.

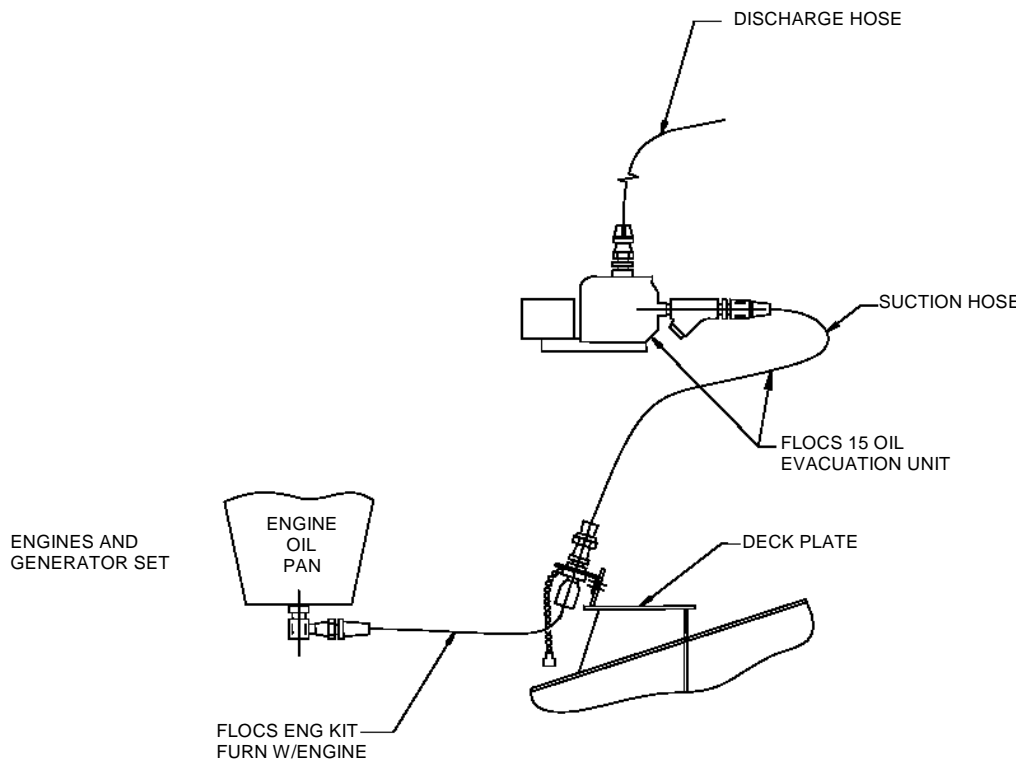

**Figure 3-16**

### Fast Lubricating Oil Change System (FLOCS)



## Engine Starting System

---

### D.22. General

The main engine starting system (**figure 3-17**) is comprised of a 24-VDC heavy duty, ungrounded starter; START pushbutton(s); and a start solenoid for each starter.

---

### D.23. Starter and solenoid

The starter and solenoid are mounted together on the starboard side of the engine, forward and below the engine exhaust outlet flange. A battery bank in the machinery space provides for at least 12 consecutive starts of a main engine without recharging. Main engine starting can be accomplished in the main machinery space at each engine local panel assembly or from the pilothouse on the forward and aft consoles.

---

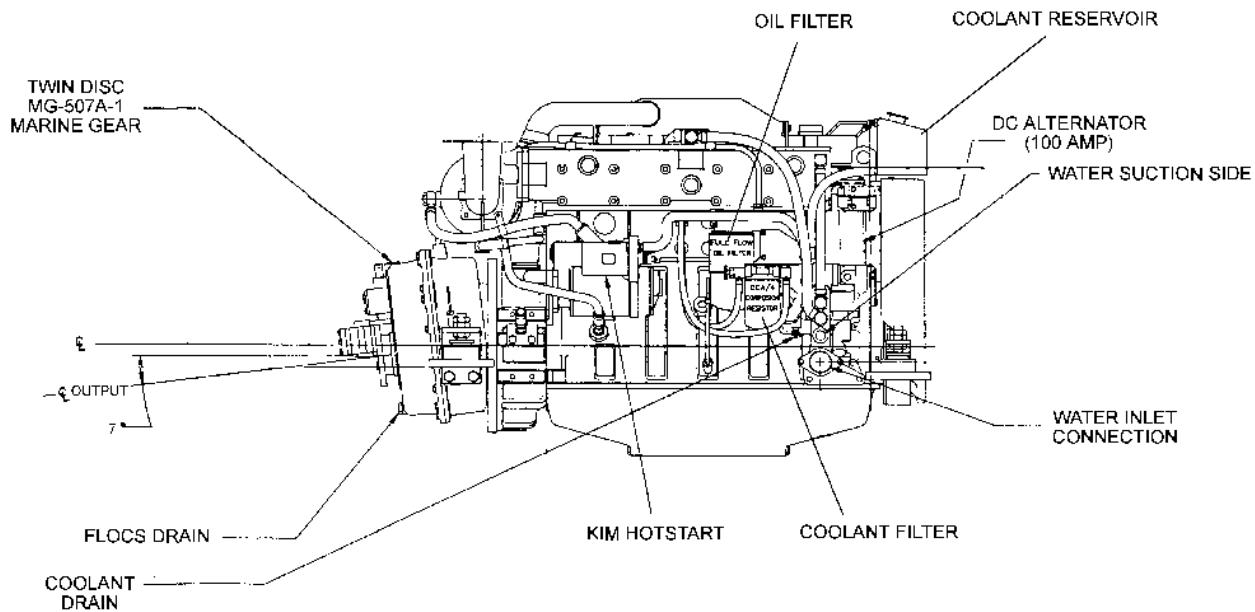

**Figure 3-17**  
**Engine Starting System**



**(This page intentionally left blank.)**



## Section E. Hydraulic Steering System

---

- E.1. General** The power steering system (**figure 3-18**) is hydraulically operated by the wheel at the forward pilothouse position and a follow-up lever mounted on the aft console in the pilothouse. The system is designed to move the rudders from 30 degrees port to 30 degrees starboard in no more than 6 seconds and hold the rudder at any setting, at any speed, in the *ahead* or *astern* position. The hydraulic steering system is made up of two circuits using a common reservoir. The hand-operated manual circuit is the control element and the power circuit provides high-pressure oil to the steering cylinder.
- 
- E.2. Helm pump and conversion block** The helm pump and conversion block are located inside the forward pilothouse console. The helmsman wheel is attached to the helm pump. When the wheel is turned, the helm pump produces hydraulic oil flow to the conversion block. The conversion block (sometimes referred to as the conversion and changeover block) converts the hydraulic oil flow into an electrical signal. The electrical signal is amplified and controls the oil to and from the steering cylinder using the directional control valve on the hydraulic manifold assembly. A lever type (joystick) steering control is located on the aft console in the pilothouse. It is connected in parallel with the forward helm unit. Movement of the handle to port will cause the boat to turn port when the boat is traveling astern.
- 
- E.3. Hydraulic manifold assembly** The hydraulic manifold assembly is located in the lazarette space, adjacent to the reservoir. The hydraulic manifold contains the directional control valve, relief valve, and bypass valve, sequencing valve, lock valve, two-speed valve and orifices to direct and control the fluid flow to the actuating cylinder for the tiller unit.
- 
- E.4. Hydraulic reservoir** The hydraulic reservoir has a capacity of 4.5 gallons and is located in the lazarette space. A 1-gallon expansion/head tank is located in the pilothouse, port side forward. The following hydraulic fluids are compatible for use in the steering system:
- Shell Tellus 32
  - Chevron EP 32
  - Gulf 32 AW
  - Exxon Nutp H32
-





---

**E.5. Hydraulic pump and motor**

The steering system hydraulic pump and motor are located in the lazarette space. The motor is a 1-hp, 24-VDC motor driving a fixed displacement vane pump that will deliver 1 GPM at 1200 RPM. The pump takes suction on the reservoir via a suction strainer that is located inside the 4.5-gallon hydraulic reservoir.

---

**E.6. Return oil filter**

A 25-micron spin-on oil filter in the return line prior to the reservoir filters oil returning from the steering cylinder through the hydraulic manifold assembly.

---

**E.7. Tiller assembly**

The tiller assembly is located in the lazarette and converts the force of the hydraulic cylinder into a port and starboard mechanical movement to position the rudders as commanded from the pilothouse. The actuating cylinder connects to the starboard tiller (bellcrank). A tie bar connects the starboard tiller to the port tiller. A rudder follow-up unit is attached to the port tiller mechanism and transmits rudder position back to the steering electronics and rudder angle indicator.

---

**E.8. Rudders**

The rudders are twin, balanced, spade type rudders manufactured from steel. The rudder stocks (shafts) are fabricated from stainless steel alloy; same alloy used to fabricate the propeller shafts. The rudder shafts pass through a rudder log with a bearing, a lip seal and a thrust bearing at the top of the rudder log, and a bearing at the bottom of the rudder log. The bearings are fabricated from a composite, polymer type material.

---

**E.9. Helm pump**

The helm pump is used for emergency steering. With the steering system secured or in standby, the helm pump pipes directly to the actuating cylinder.

---

**E.10. Electronic chart system (ECS)**

The system uses inputs from the electronic chart system (ECS) to transit a predetermined track line.

---

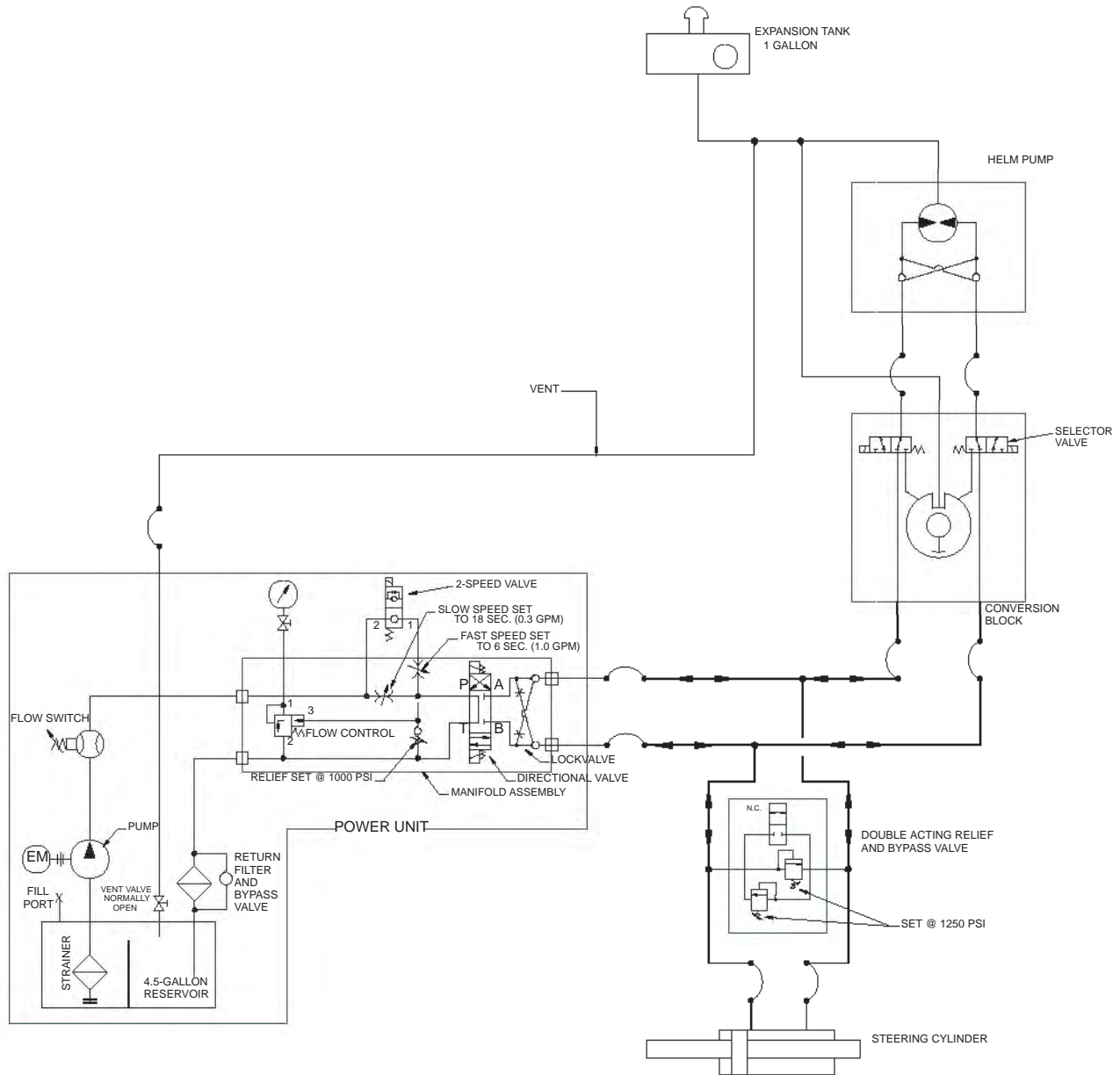

Figure 3-18

Hydraulic Steering System



**(This page intentionally left blank.)**



## Section F. Ship Service AC Generator

<b>F.1. General</b>	The AC generator ( <b>figure 3-19</b> ) set is a 20-kW, single-phase, 120-VAC, 60-Hz unit, operating at 1800 RPM. The generator set is mounted in the machinery space aft, on the centerline.
<b>F.2. Diesel engine</b>	The generator set is powered by a 4-cylinder, 4-cycle, naturally aspirated Cummins diesel engine. The generator is directly coupled to the diesel engine.
<b>F.3. Duplex fuel oil filter assembly (primary fuel filter)</b>	The diesel engine for the generator set has a primary filter mounted on a frame assembly, directly port of the generator set. The duplex filter is on the suction side of the engine-driven fuel pump. The filter is rated at 30 microns. The separator portion of the filter is designed to remove large particles and to coalesce small amounts of water. A drain plug on the bottom of the filter bowl is provided to remove collected contaminants and water.
<b>F.4. Emergency shutdown control (generator)</b>	The generator emergency shutdown control ( <b>figure 3-7</b> ) is located on the center of the forward, vertical panel on the aft control console in the pilothouse. Pulling the generator shutdown knob will mechanically close the remote butterfly valve located between the inlet air separator and intake manifold, thus starving the engine of air.
<b>F.5. Fuel pump and filter</b>	The engine-driven fuel pump and filter are mounted on the engine directly above the oil fill standpipe and cap. The engine-mounted fuel filter (the secondary filter) filters the fuel on the discharge side of the engine-driven fuel pump, prior to the fuel injection pump unit.
<b>F.6. Lubrication system</b>	The engine lubrication system is a self-contained (Use API CC/CD SAE 15W40 or 20W40 good down to 14 F), wet sump system, incorporating a spin-on, full-flow filter and 11.5-quart oil system capacity. The lubrication filter is located on the opposite side of the engine from the lube oil dipstick and filler cap.
<b>F.7. Jacket water system</b>	The jacket water system consists of a reservoir/expansion tank, a pump and a keel cooler. The reservoir, with a 2.1-gallon capacity, requires a 50-50 mixture of freshwater and ethylene glycol antifreeze. The reservoir is fitted with a 15-PSI pressure cap. The centrifugal engine-driven pump pumps the jacket water through the engine and keel cooler. The system is designed to keep the jacket water below 210 °F.



---

**F.8. Saltwater system**

The generator saltwater system provides cooling water to the buoy handling hydraulic oil cooler when the boat is not making headway. The system uses a centrifugal type pump with a neoprene impeller that is mounted on the inboard side of the engine near the oil filler cap and dipstick. The pump is rated at approximately 13.5 GPM at 10 PSI. A suction strainer with a 0.060-inch mesh basket protects the pump from damage.

---

**F.9. Engine jacket water heater (hot start)**

A 1500-watt, 120-VAC, 60-Hz electric heater is installed in the jacket water system for the generator diesel engine. The heater is controlled by a thermostat that turns the heater *on* when the jacket water temperature drops below 100° F, and *off* when the temperature reaches 120° F.

---

**F.10. Engine exhaust system**

The generator engine uses a separate dry type exhaust system. Bellows type flex connections (manufactured from 321 stainless steel) are installed between the engine exhaust port and the exhaust piping system on the inlet side of the muffler, and also on the outlet side of the muffler for piping that interfaces with the shell penetration point. The exhaust is above the waterline port side, forward of the engine room aft bulkhead, forward of watertight bulkhead 2.

---

**F.11. Engine crankcase ventilation system**

The crankcase ventilation system routes the fumes produced by the engine oil system back through the engine air intake system. An air separator filter, mounted on the air intake, receives the fumes from the engine crankcase via a crankcase regulator and manifold assembly attached to the tappet cover. The air separator body is designed to remove oil from the engine oil fumes and return the oil back to the engine oil pan via check valve and hose connected to the bottom of the separator and the oil pan.

---

**F.12. Power takeoff (PTO) assembly**

A power takeoff (PTO) assembly is mounted on the aft end of the engine. The PTO is rated at 28 hp and drives an axial piston hydraulic pump for the buoy handling system rated at 29.5 GPM, and 2150 PSI at 1800 RPM. An electro-magnetic clutch, mounted between the PTO assembly and the pump, provides for pump engagement.

---

**F.13. Diesel engine control panel (generator)**

A control panel located in the machinery space adjacent to the generator set provides the following controls and indicators:

- oil temperature gauge
  - tachometer
  - hourmeter
  - oil pressure gauge
  - jacket water temperature gauge
-



- 
- DC volt meter
  - HEATER ON warning light
  - START-RUN-STOP switch

Additional control and monitoring of the generator set is available from the pilothouse. Individual fault circuit breakers are also mounted on the engine control panel.

---

**F.14.  
Alternator**

The rotor of the alternator is directly coupled to the engine by flexible drive discs. The rotor is supported by pre-lubricated, maintenance free ball bearings. The alternator is cooled by a direct drive centrifugal blower that is an integral part of the alternator. The alternator features a brushless exciter and unit-mounted voltage, frequency and speed governing controls. Anti-condensation heaters are installed on the alternator and maintain the generator air temperature at 5 °F above the temperature outside the enclosure. A white light on the local engine panel illuminates when the heaters are *on*. The heaters de-energize when the generator is operating.

---

**F.15.  
Alternator  
control**

The governor system for the generator senses the electrical load and prime mover (diesel engine) speed and is designed to maintain 60 Hz at plus or minus 0.30 Hz during steady state operation, and a frequency transient tolerance that does not exceed 2.40 Hz. The steady state voltage is automatically regulated at 120 VAC, plus or minus 5 percent (6 volts). Maximum deviation from steady state voltage will not exceed plus or minus 21 VAC.

---

**F.16.  
Generator  
monitoring  
panel**

The generator monitoring panel is located on the aft console in the pilothouse, above the starboard engine control and monitoring panel, and contains the following indicators:

- Hz/RPM
  - AC amperes
  - AC volts
  - phase selector switch
-

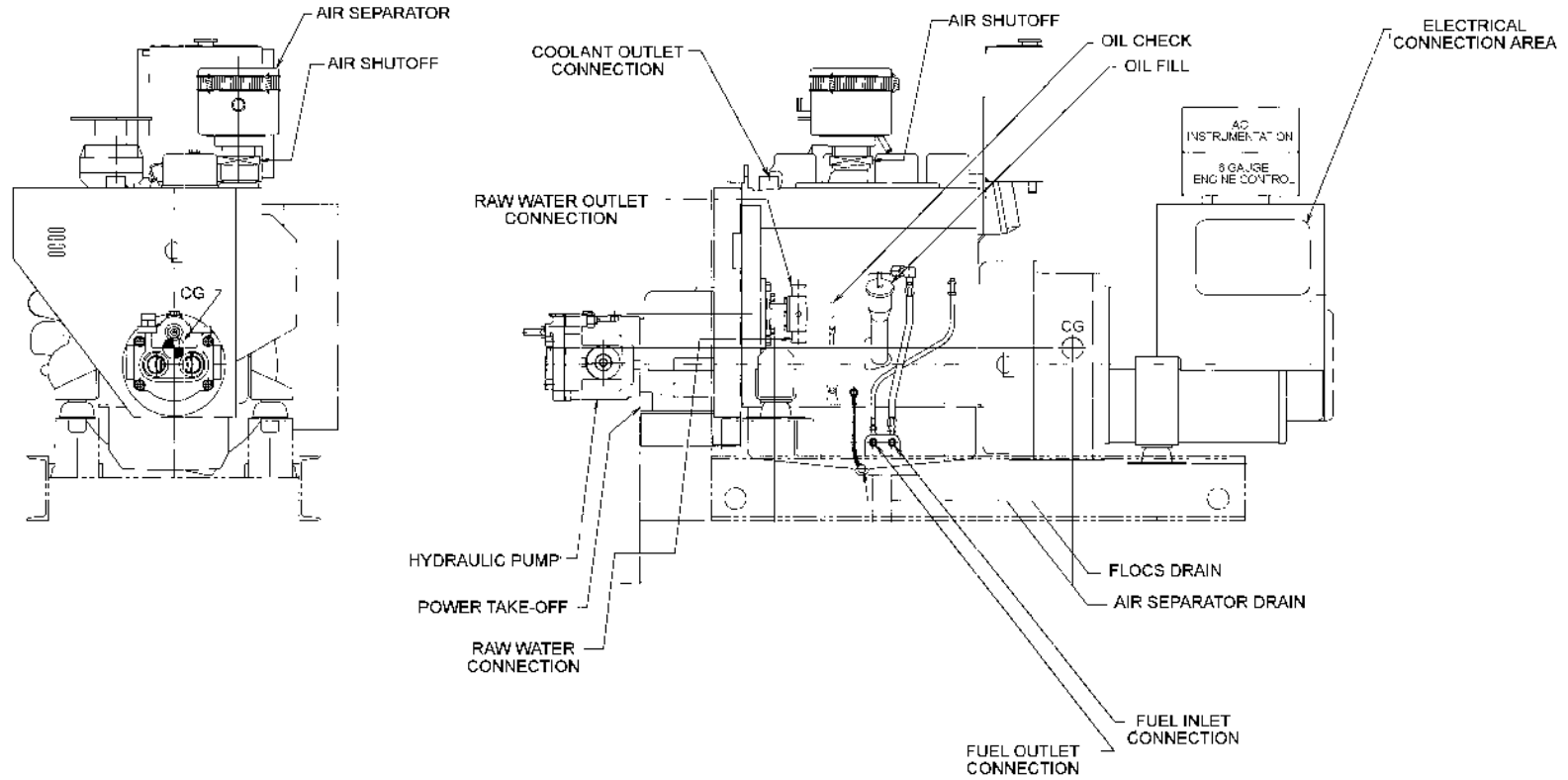

**Figure 3-19**  
**Ship Service AC Generator**



## Section G. Electrical Systems

---

<b>G.1. General</b>	The 49' BUSL electrical system includes both AC and DC power distribution systems from several sources. The power panels for the system are shown in <b>figure 3-20</b> .
<b>G.2 120-VAC power distribution system</b>	AC power is provided from two separate sources: (1) the ship service generator and (2) shore power. The diesel generator circuits and shore power circuits are interlocked to prevent simultaneous operation. The 120-VAC Load Center (LC) 1 is the main distribution point for the 120-VAC power sources.
G.2.a. Ship service generator	The 20-kW, single-phase, 120-VAC, 60-Hz ship service generator is the normal source of power when underway or at anchor. The generator is located in the machinery space aft on the centerline.
G.2.b. Shore power	The shore power receptacle is located on the outside of the pilothouse, forward bulkhead, port side, next to the anchor.
G.2.c. 120-VAC load center (LC)1	<p>The 120-VAC Load Center (LC) 1 (<b>figure 3-21</b>) is located in the machinery space, forward starboard side. When entering the space through the quick-acting watertight door (QAWTD), it is directly to the left. The panel receives inputs from the shore power receptacle or from the ship service generator. The panel contains the following components:</p> <ul style="list-style-type: none"> <li>• shore tie breaker</li> <li>• generator breaker</li> <li>• voltmeter</li> <li>• ammeter</li> <li>• frequency meter</li> <li>• ground detection lights</li> <li>• press-to-test pushbutton</li> <li>• fuses with blown fuse indicators</li> <li>• feeder circuit breakers (3)             <ul style="list-style-type: none"> <li>- to the lighting and power panel (01-7-1) in the pilothouse</li> <li>- to the galley panel (2-6-0) in the galley and mess area</li> <li>- to the machinery panel (2-4-1) located in the engine room</li> </ul> </li> </ul>

---



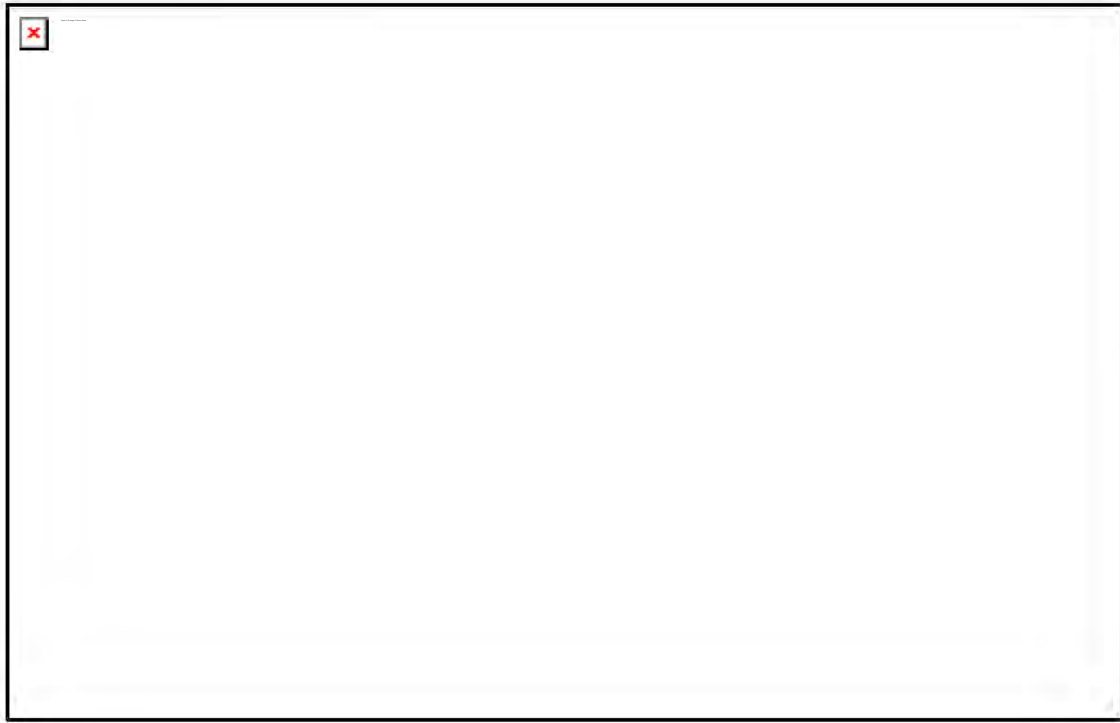

120-VAC POWER

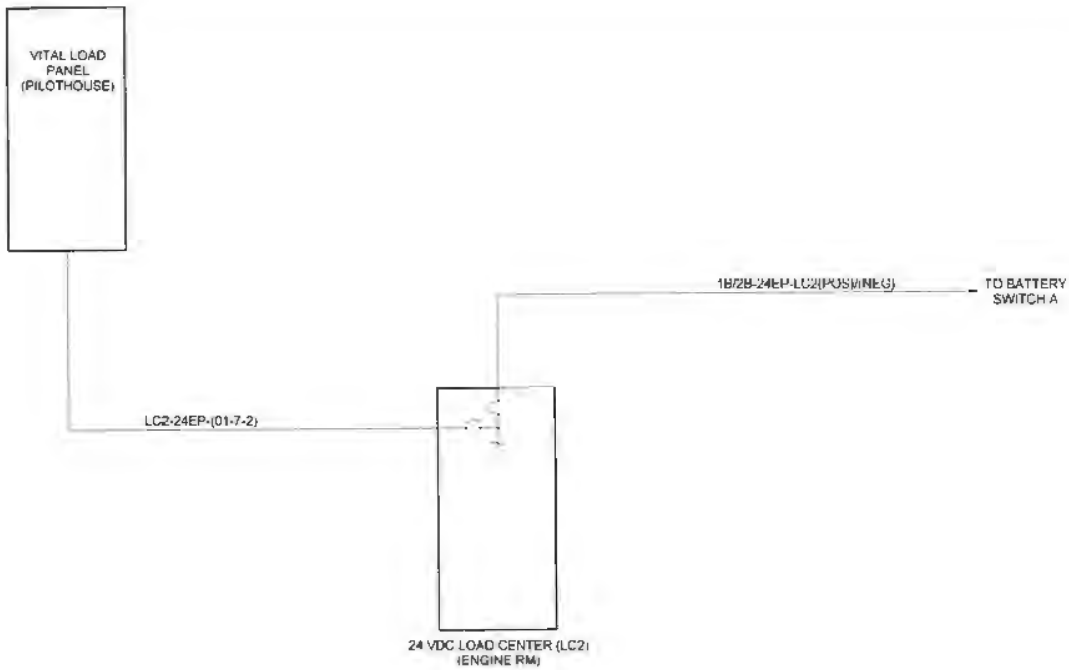

24-VDC POWER

**Figure 3-20**  
**Power Panels**



**Figure 3-21**  
**120-VAC Load Center (LC) 1**

**G.3. 24-VDC  
power  
distribution  
system**

---

The 24-VDC power distribution system is capable of receiving power from three different sources during different boat operating scenarios. The three sources are: (1) ship service alternators (main engine driven), (2) ship service transformer rectifier (battery charger), and (3) vital services battery bank.

---



G.3.a. Ship service alternators

---

The alternators provide power to the 24-VDC power distribution system when one or more main diesel engines are operating. Each of the two alternators is belt driven and air cooled with a solid-state voltage regulator mounted to the back of each alternator. Normal voltage output is 27.8 to 28.2 VDC. Each alternator is capable of operating all DC systems.

---

G.3.b. Ship service transformer rectifier

The ship service transformer rectifier provides power to the 24-VDC power distribution system when both of the main diesel engines are secured and the ship service generator is operating or shore power is available.

---

G.3.c. Vital services battery bank

The vital services battery bank provides power to the 24-VDC power distribution system when both diesel engines are secured and neither shore power nor ship service generator power is available.

---

G.3.d. Battery charger (transformer rectifier)

The battery charger is mounted on the hull in the engine room, outboard of the starboard engine. The battery charger receives 120 VAC from the engine room power panel (2-4-1) and converts it into 24-VDC, 60-amp output. The front of the battery charger is equipped with a DC voltmeter, DC ammeter, and an AC pilot light; AC power available. The unit is capable of supplying 100 percent of the load on the 24-volt distribution system and charging both battery banks at the same time. An interlock is provided to prevent the battery charger from charging the batteries during main engine starting and running, and during ship service generator starting and running.

---

G.3.e. Battery banks

Two separate battery banks, each supplying 24 VDC, are available to shipboard electrical systems. One battery bank is for starting the main diesel engines and ship service diesel generator; the other bank provides emergency power for the boat's 24-VDC power distribution system. Switches can configure each battery bank for vital loads, starting or parallel operation. The battery bank configured for engine start is not charged when a MDE alternator is operating. Because starting batteries supply power to the generator controls, it is recommended battery configuration be changed daily. Each bank is sized to provide the following capabilities:

- At least 12 consecutive starts on one main engine without recharging.
  - 100 percent of the connected vital services on the 24-VDC power distribution system for 30 minutes.
  - Two selector switches are provided to cross-connect the vital battery bank and the starting battery bank if necessary. Normally, the switches are configured to provide power from the starting batteries to the starting terminal board and power from the vital battery bank to the 24-VDC load center. The battery banks for starting and vital 24-VDC services are located in the machinery space, on the centerline below the deck plate.
-



---

G.3.f. 24-VDC power meter and ground fault detection indicator panel

The 24-VDC-power meter and ground fault detection panel is located in the engine room on the bulkhead just aft of LC1. The indicator panel is equipped with a voltmeter, ammeter, push-to-test button for ground detection lights, and ground detection lights for alternator #1, alternator #2, the battery charger and the positive and negative sides of the vital load services bus. Seven fuses with blown fuse indicators are mounted on the front of the panel to protect the fault detection panel circuits. The panel provides visual indicators for determining the status of the 24-VDC power systems.

---

**G.4. Power panels**

The following four primary power panels are provided for power distribution:

- 24-VDC power panel (LC2) (**figure 3-22**)
  - 120-VAC engine room power panel (2-4-1) (**figure 3-23**)
  - 120-VAC galley/mess power panel (2-6-0) (**figure 3-24**)
  - 120-VAC pilothouse power panel (01-7-1) (**figure 3-25**)
- 

G.4.a. 24-VDC power panel

The 24-VDC power panel (LC2) (**figure 3-22**) is located in the engine room, starboard, directly aft of the starboard fuel oil tank. The panel supplies power to the following components:

- pilothouse vital panel
  - steering system HPU
  - port main engine control power
  - CO<sub>2</sub> system
  - engine room/workshop emergency lighting
  - sewage vacuum pump
  - potable water pump
  - buoy handling hydraulic system control
  - A/C condensate pumps #1 and #2
  - main engine control power
-



**Figure 3-22**

**24-VDC Power Panel (LC2)**



**Figure 3-23**

**120-VAC Engine Room Power Panel (2-4-1)**



**Figure 3-24**

**120-VAC Galley/Mess Power Panel (2-6-0)**



**Figure 3-25**

**120-VAC Pilothouse Power Panel (01-7-1)**



G.4.b. 24-VDC vital panel

The 24-VDC vital power panel (**figure 3-26**) is located on the port side of the pilothouse and is fed from a breaker on the 24-VDC panel (LC2) in the engine room. The panel supplies power to the following components:

- bilge pumps
- central alarm panel
- searchlight #1
- searchlight #2
- electric horn
- galley/mess/berthing/pilothouse emergency lights
- navigation lights switch panel
- navigational radar
- loudhailer
- VHF-FM radios
- depthsounder
- magnetic compass light
- window wipers starboard, forward and aft
- window wipers, centerline forward and port forward
- window washers
- autopilot and steering control power
- differential global positioning system (DGPS)



**Figure 3-26**

**24-VDC Vital Panel**



---

G.4.c.  
Emergency  
power  
distribution  
system

The emergency power distribution system (**figure 3-27**) is a subsystem of the 24-VDC power distribution system. The emergency power system is the final source of DC power for vital loads and is fed from the vital services battery bank. The following are considered vital DC loads and are fed from the 24-VDC load center or power distribution panels:

- emergency lighting
- navigational lighting
- navigational equipment
- electronics equipment
- communications equipment
- alarm, warning and shutdown systems
- machinery plant controls and instrumentation

---

G.4.d. 120-VAC  
engine room  
power panel

The 120-VAC engine room power panel (2-4-1) (**figure 3-23**) is located in the engine room, on the hull outboard of the starboard main propulsion engine. Breakers on this panel provide power to the following components:

- hot start, starboard main propulsion engine
  - air compressor
  - hot start, port main propulsion engine
  - deck washdown pump
  - hot start, ship service diesel engine
  - gray water pump
  - hot water heater
  - sewage discharge pump
  - generator heater
  - engine room exhaust fan #1
  - battery charger/power supply
  - engine room exhaust fan #2
  - lazarette heater
  - A/C unit galley
  - A/C unit galley/workshop
  - A/C saltwater cooling pump
-



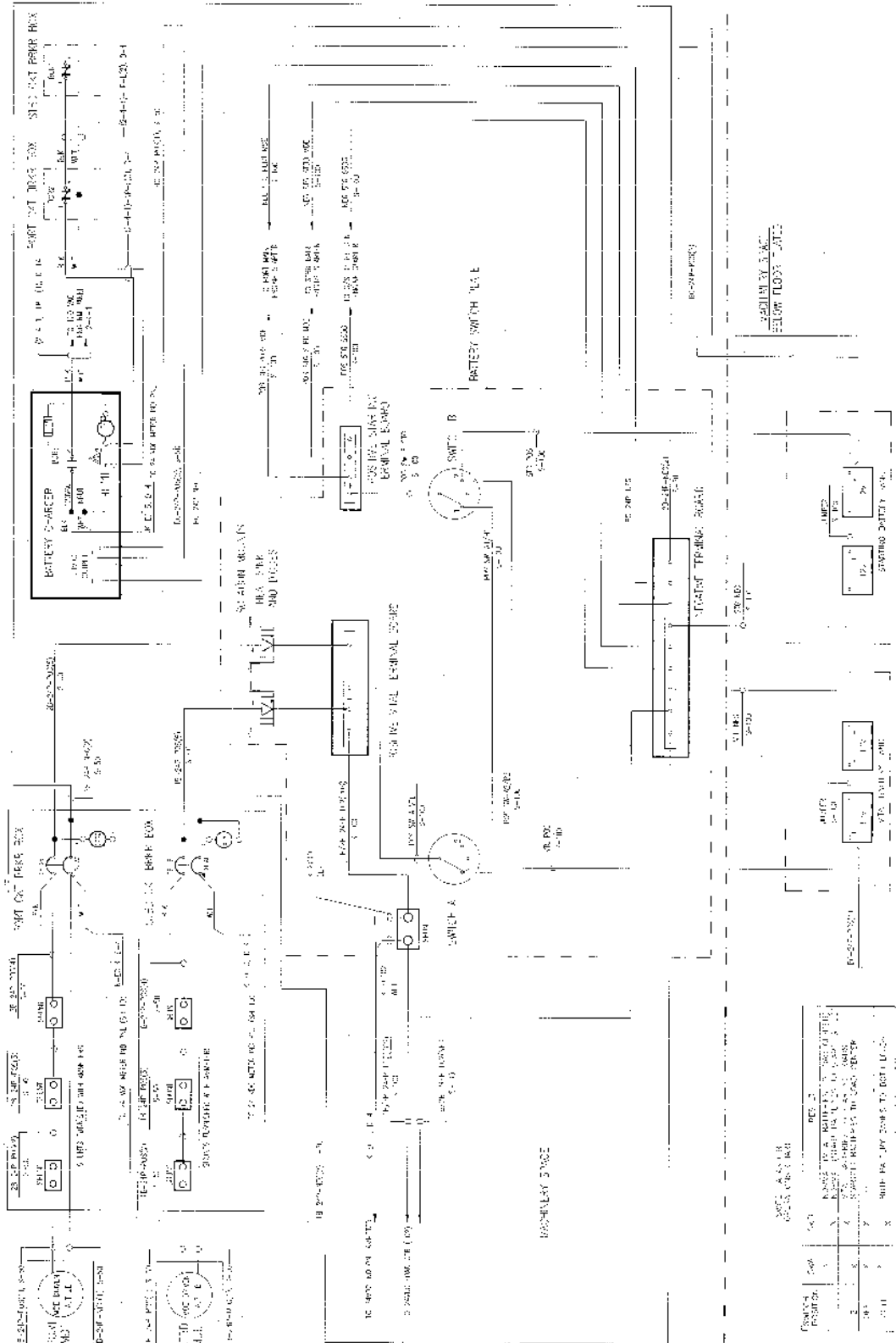

Figure 3-27  
Emergency Power Distribution System



---

G.4.e. 120-VAC galley/mess power panel The 120-VAC galley/mess power panel (2-6-0) (**figure 3-24**) is located on the bulkhead, port side of the center passageway, below decks. Breakers on this panel provide power to the following components:

- workshop heater
- galley range
- galley heater
- berthing area A/C unit
- workshop, engine room and lazarette 120-VAC receptacles
- toaster
- galley/mess 120-VAC receptacles
- coffee maker receptacle
- microwave receptacle
- entertainment center receptacle
- refrigerator receptacle
- water chiller

---

G.4.f. 120-VAC pilothouse power panel The 120-VAC pilothouse power panel (01-7-1) (**figure 3-25**) is located below the forward console, starboard side. Breakers on this panel provide power to the following components:

- window defrost heater #1
  - pilothouse and deck 120-VAC receptacles
  - window defrost heater #2
  - buoy handling hydraulic gauges
  - window defrost heater #3
  - uninterruptible power supply
  - exhaust fan for berthing and head
  - floodlight #1 and #2
  - pilothouse heated window
  - engine room and lazarette lights
  - galley/mess/berthing/pilothouse lights
  - workshop/head/deck lights
  - pilothouse space heater
  - A/C unit pilothouse forward console
  - A/C unit pilothouse aft console
  - berthing space heater
-



**(This page intentionally left blank.)**



## Section H. Heating, Ventilation, and Air Conditioning (HVAC) Systems

<b>H.1. General</b>	Heating and air conditioning ( <b>figures 3-28 and 3-29</b> ) is provided to the pilothouse, workshop, head/shower, berthing and galley/mess area. These spaces are maintained so as not to exceed 80 °F and not to go below 65 °F. The machinery space has only ventilation, no air conditioning. The lazarette and forepeak have only natural ventilation. The heating system is designed to maintain the pilothouse, galley/mess area, workshop and machinery space to 45 °F during unattended, in port operation.
<b>H.2. Machinery space heating and ventilation</b>	No heating is provided for the machinery space. Online equipment underway and in port keeps the space warm. The space has natural supply and mechanical exhaust ventilation.
H.2.a. Machinery space temperature	<p>The machinery space is provided with natural supply and mechanical exhaust ventilation system. The ventilation to the machinery space is designed to keep the space temperature at or below 125 °F while underway, with both main engines and the generator operating. Exhaust airflow will keep the space at or below 104 °F in port when the generator is operating.</p> <p>The machinery space is kept warm, approximately 50 °F in port, by the machinery that is online and generates heat; main engine heaters, ship service generator engine heater, ship service generator heater for generator windings, and battery charger.</p>
H.2.b. Supply ventilation ducts	The machinery space supply/intake ventilation ducts are located on the main deck forward of the cross deck hydraulic winches. The ducts are sized to provide 3000 CFM to the machinery space. Dampers are provided in the intake ventilation ducts to close when the fixed CO <sub>2</sub> flooding system is actuated.
H.2.c. Exhaust ventilation ducts	The machinery space exhaust system consists of exhaust ducts mounted port and starboard on the main deck, just aft of the chain lifelines. A 120-VAC axial, vane type fan provides for exhaust airflow from the machinery space at the rate of 2000 CFM. Dampers are provided in the exhaust ventilation ducts to close when the fixed CO <sub>2</sub> flooding system is actuated. The exhaust duct dampers have manual pull stations adjacent to each duct on the main deck for damper actuation.



---

### **H.3. Workshop heating and ventilation**

A 9000-BTU heat pump unit as part of the direct expansion, refrigerant air conditioning unit, normally heats the workshop. The condenser for the air-conditioning unit is seawater cooled. A centrifugal pump located in the bilge area, port side of the machinery space, provides the seawater. The seawater pump is rated at approximately 15 GPM. The control panel for the air conditioning seawater-cooling pump is located on the forward, port bulkhead in the machinery space.

The reverse cycle operation of this unit is affected as the seawater temperature decreases. At seawater temperatures below 40 °F, the warm air output of this unit decreases proportionately. An electric, forced air heater, operating on 120 VAC and capable of providing 2560 BTU, is mounted on the port bulkhead in the workshop.

---

### **H.4. Galley/mess and head heating and ventilation**

The galley/mess and head area utilizes the same type 9000-BTU heat pump and air conditioning unit that is used for the workshop. Louvered joiner doors between the passageway and workshop, and passageway and head allow for circulation of air. An electric, forced air heater, operating on 120 VAC and capable of providing 2560 BTU, is mounted in the overhead, forward, just starboard of the centerline in the galley area.

An exhaust fan for the head, rated at 100 CFM and 120 VAC, exhausts directly outside the hull through an 18-mesh bronze or brass screen. The fan operates by a switch located on the port bulkhead in the galley.

---

### **H.5. Berthing heating and ventilation**

The berthing area utilizes the same type 9000-BTU heat pump and air conditioning unit utilized by the other spaces below the main deck. The unit is located in the berthing space, below the linen locker. The unit has a supply and return air duct contained in the berthing space, as well as ducting to provide air outlet to the upper berths.

---

### **H.6. Pilothouse heating and ventilation**

The pilothouse uses two 9000 BTU heat pump and air conditioning units. One unit is located in the forward console and one in the aft console. Two centrifugal fans in the forward console ensure a positive and continuous circulation of air. Natural supply and exhaust ducts are also installed for pilothouse ventilation. An electric forced air heater, operating on 120 VAC and capable of providing 3140 BTU is mounted on the starboard side of the chart table in the pilothouse.

---



- 
- H.6.a. Heater/defroster units
- Three 120-VAC forced hot air heater/defroster units are mounted on the overhead in the pilothouse, and provide air to the port and starboard pilothouse windows via air ducts and defroster vents above the windows. The units each have a separate control switch in a common control box. The switches are 3 positions; *fan*, *off*, and *heat* (heat and fan).
- 
- H.6.b. Heated windows
- All of the forward and aft windows in the pilothouse are heated. The  $\frac{3}{8}$ -inch-laminated glass has an integral vinyl heater film. The heated windows operate on 120 VAC and are controlled from an *on/off* control box switch mounted adjacent to the window. A red light on the heated window control box indicates when the heated window is in operation.
- 
- H.7. Lazarette heating and ventilation**
- The lazarette has natural supply and exhaust ventilation utilizing gooseneck vents that terminate port and starboard side on the main deck, aft of bulkhead 2. An electric, forced draft heater, operating on 120 VAC and capable of providing 5120 BTU, provides heating for the lazarette.
- 
- H.8. Air conditioning unit condensate drain systems**
- Condensate from the saltwater cooled A/C units is directed to collection tanks that are automatically pumped overboard.
- 
- H.8.a. Forward A/C unit
- Condensate from the forward A/C unit in the pilothouse and the A/C unit in the berthing compartment drains to a 5-gallon tank in the bilge area, centerline, forward of bulkhead 7. Condensate in the tank is pumped overboard by a 24-VDC centrifugal pump rated at 25 GPM. Level switches mounted in the tank control pump operation.
- 
- H.8.b. Aft A/C unit
- Condensate from the aft A/C unit in the pilothouse and the two A/C units in the workshop area drains to a 5-gallon tank in the bilge area, just starboard of centerline and forward of bulkhead 5. The pump arrangement is identical to that of the forward condensate tank system.
-

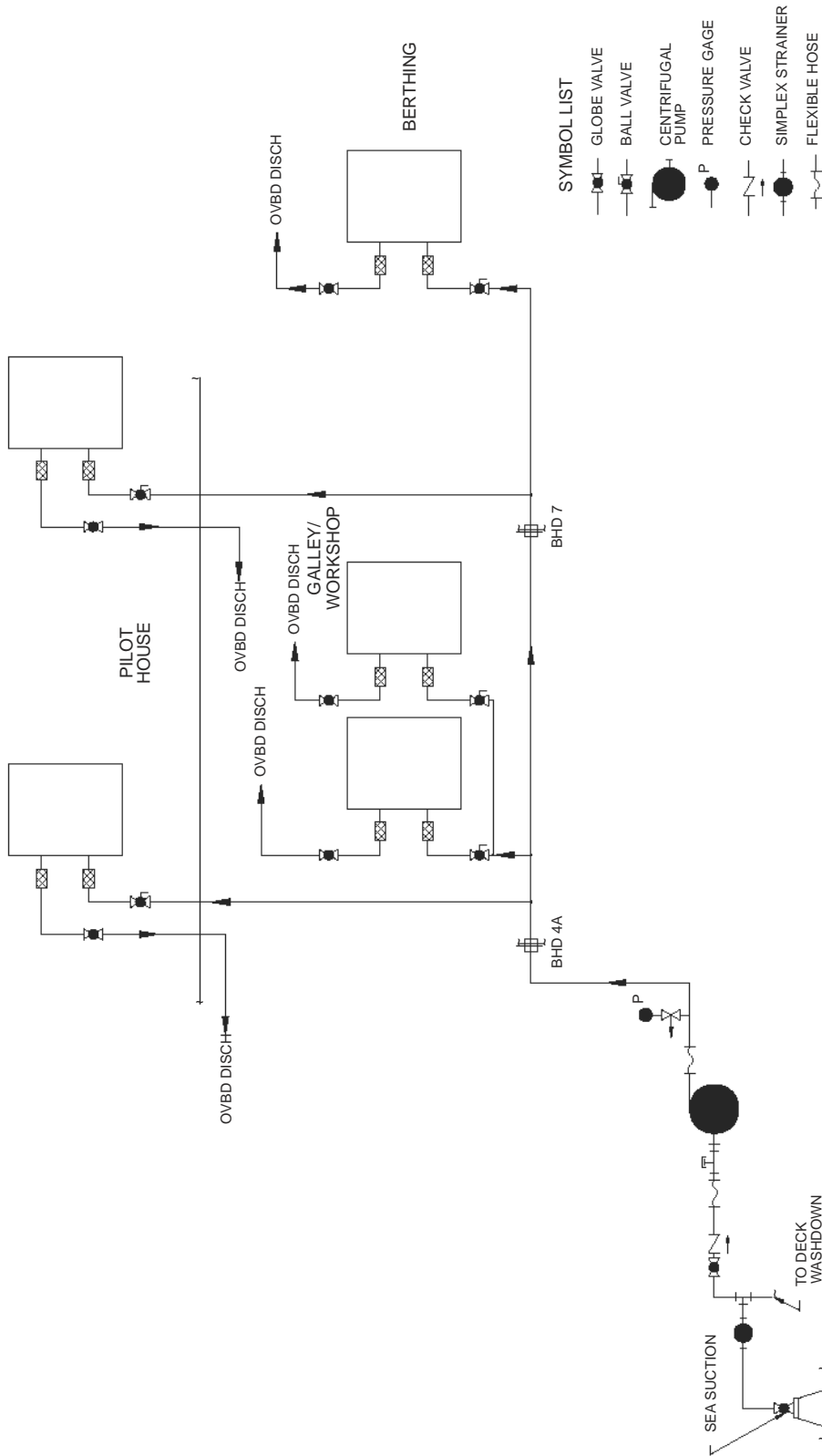

**Figure 3-28**  
**Heating, Ventilation, and Air Conditioning (HVAC) Seawater System**

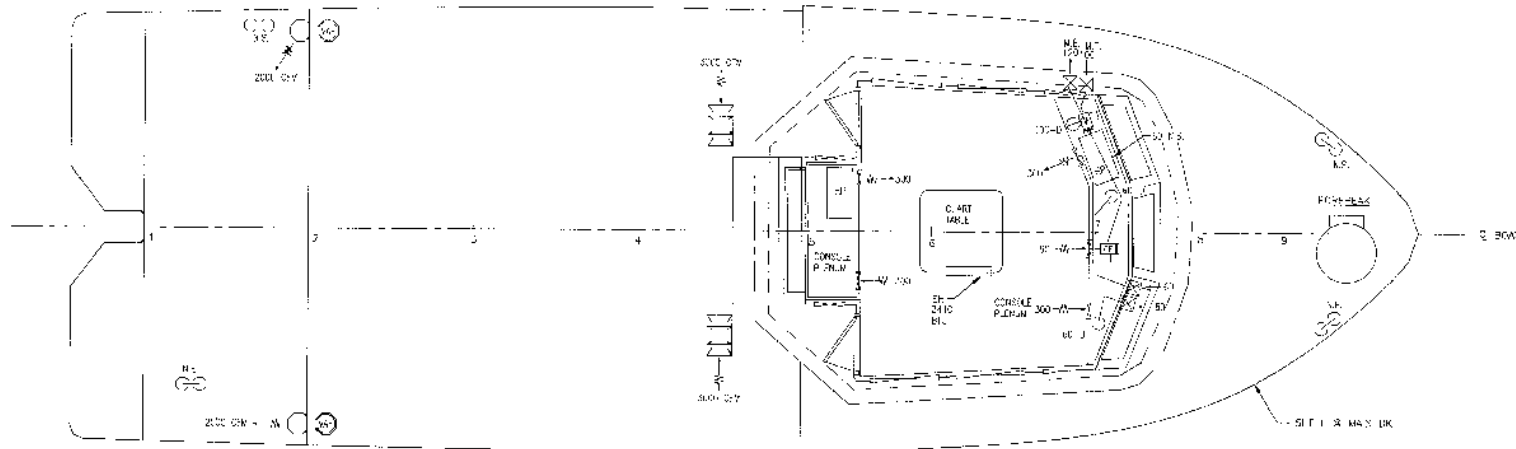

PILOTHOUSE ARRANGEMENT

SYMBOL LIST

- SUPPLY DUCT
- EXHAUST DUCT
- ▷ OUTLET TERMINAL (SUPPLY)
- > INLET TERMINAL (EXHAUST)
- ↗ DUCT UP
- ↘ DUCT DOWN
- ○ VENTILATION GOOSENECK
- ⊗ GOOSENECK DUCT (W/SCREEN)
- HP HEAT PUMP (9000 BTU'S EACH)
- CFM CENTRIFUGAL FAN
- ↻ RETURN AIR
- △ LOUVERED DOOR
- ⊗ VANE AXIAL FAN
- ⊞ DOUBLE-FOODED INTAKE
- NS NATURAL SUPPLY
- NE NATURAL EXHAUST
- EH ELECTRIC HEATER

3-57

**Figure 3-29**  
**Heating, Ventilation, and Air Conditioning (HVAC) System**  
 (Sheet 1 of 2)





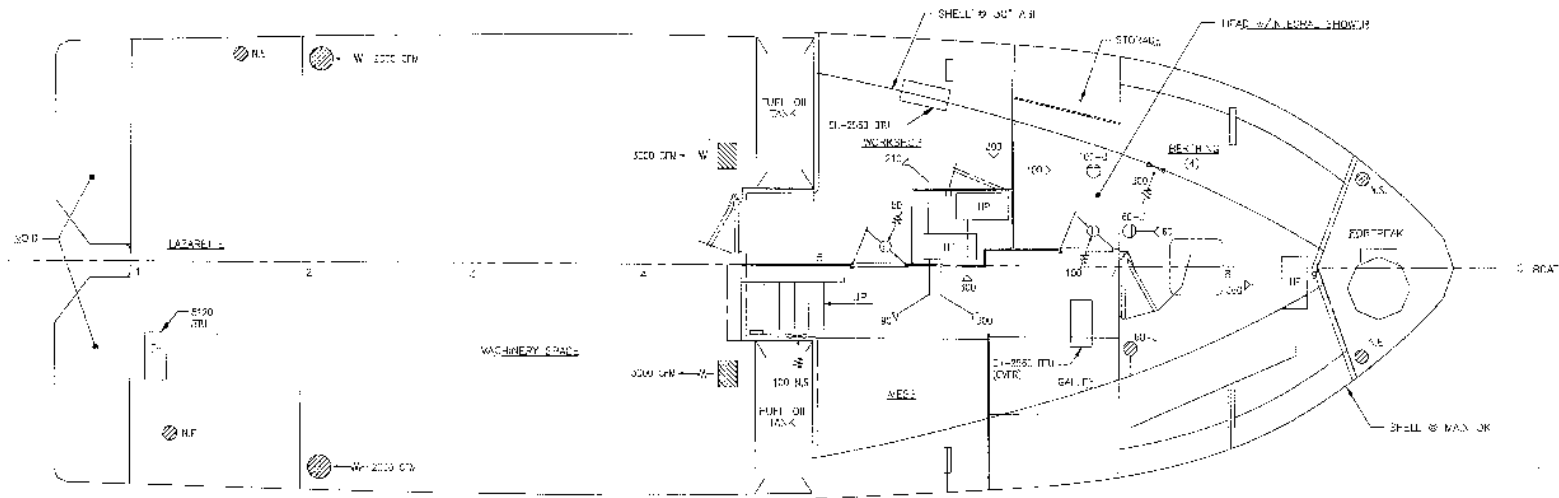

INTERIOR ARRANGEMENT

SYMBOL LIST

- SUPPLY DUCT
- - - EXHAUST DUCT
- ▶ OUTLET TERMINAL (SUPPLY)
- ◀ INLET TERMINAL (EXHAUST)
- ⊙ DUCT UP
- ⊙ DUCT DOWN
- ○ VENTILATION GOOSENECK
- |— GOOSENECK DUCT (W/SCREEN)
- HP HEAT PUMP (9000 BTU'S EACH)
- CFM CENTRIGUAL FAN
- ← RETURN AIR
- △ LOUVERED DOOR
- ⊙ VANE AXIAL FAN
- ⊙ DOUBLE-HOODED INTAKE
- YS NATURAL SUPPLY
- XF NATURAL EXHAUST
- ELECTRIC HEATER

Figure 3-29

Heating, Ventilation, and Air Conditioning (HVAC) System

(Sheet 2 of 2)



## Section I. Buoy Handling System

---

### I.1. General

The buoy handling system consists of the following components:

- A-frame
- port and starboard hoisting winches on the A-frame
- port and starboard A-frame actuators
- two cross deck winches
- notched transom and chain stopper

Control of the buoy handling equipment is from the aft console (buoy console panel) (**figure 3-30**) in the pilothouse. The rated load of the A-frame is 4500 pounds. The buoy deck layout and location of equipment is depicted in **figure 3-31**.

The hydraulic system consists of the following components (**figure 3-32**):

- reservoir
- pump
- filters
- cooler
- control valves
- control consoles
- winches
- actuators

The hydraulic pump creates the fluid flow to operate the buoy handling system equipment. The components of the hydraulic system are designed to direct and control fluid flow to and from the buoy A-frame actuators and winches and the cross deck winches. A diagram of the buoy handling hydraulic system is provided in **figure 3-32**.

### I.2. Hydraulic oil reservoir

The hydraulic oil reservoir is located in the machinery space (engine room) aft of the ship service generator, just port of the centerline. The reservoir has a 55-gallon capacity with a normal operating range of 44 gallons of fluid MIL-H-17672 and a low level alarm set at 30 gallons. A 74-micron wire mesh suction strainer is located on the inlet side of the hydraulic pump.

---



---

**I.3. Hydraulic pump**

The hydraulic pump is an axial piston type pump operating at 29.5 GPM, and 2150 PSI at 1800 RPM. The pump is driven by the ship service generator diesel engine PTO that provides fluid flow to operate the buoy handling hydraulic system.

---

**I.4. Hydraulic filter (supply)**

The hydraulic filter is located on the discharge side of the hydraulic pump. The filter is a spin-on, disposable filter, rated at 10 microns. The filter is mounted on a housing with a bypass valve set at 50 PSID.

---

**I.5. A-frame manifold**

The A-frame hydraulic manifold is located in the lazarette mounted to the overhead near the sewage holding tank. The hydraulic manifold contains three directional control valves, one for each A-frame winch and one that controls the fluid flow to both the port and starboard A-frame actuators.

---

**I.6. Cross deck winch manifold**

The cross deck winch manifold is located in the machinery space (engine room) port side, forward mounted to the overhead. The manifold contains a directional control valve and relief valve to direct and control the fluid flow to each cross deck winch.

---

**I.7. A-frame winches (port and starboard)**

Each A-frame winch (lifting winch) (**figures 3-33 and 3-34**) is a hydraulic motor operating at 2150 PSI and capable of providing a line speed of 0-60 FPM (feet per minute). The hydraulic motor is mechanically coupled to the winch drum through a planetary gear assembly. The drum contains 50 feet of  $\frac{3}{8}$ -inch steel wire rope, with three dead wraps on the drum. An alloy hook and swivel assembly and with a 3000-pound minimum working load and a minimum opening of 1  $\frac{5}{8}$  inches is attached to each wire rope. A hydraulically-released, spring-engaged brake in each winch lifting system will hold the load should hydraulic pressure fail. A manual release feature is provided to release the brakes and carefully lower a suspended load.

---

**I.8. Cross deck winches (port and starboard)**

The port and starboard cross deck winches (**figure 3-35**) are hydraulic motors rated at 3500 PSI and capable of providing a variable line speed of 0-100 FPM. The winches are located port and starboard, forward on the buoy deck. They are fitted with bolted steel cover boxes that provide personnel protection and can be used as workbenches. The cross deck winches have a safe working load of 1500 pounds. Each cross deck winch is equipped with 30 feet of  $\frac{3}{8}$ -inch steel wire rope with three dead wraps on the drum. An alloy hook assembly, similar to the one used on the A-frame winch cable is provided on each cross deck winch cable. The winches are equipped with automatic, hydraulic brakes to stop or hold the load if hydraulic pressure fails. A manual release feature is provided to release the

---



brakes and carefully lower a suspended load.

---

**I.9. A-frame actuators**

The port and starboard actuators are double-acting, cushion-on-end hydraulic cylinders rated at 3500 PSI. Each cylinder has a bore of 3 ¼ inches and a 65-inch stroke. A 2-inch diameter stainless steel rod is attached to the piston and connects the piston to the A-frame assembly.

---

**I.10. Hydraulic fluid heat exchanger**

The hydraulic fluid heat exchanger is located in the return oil line prior to the return oil filter and reservoir. It is mounted on the aft bulkhead centerline in the machinery space (engine room). The ship service diesel generator seawater pump provides water flow to the cooler. The cooler is rated at 20 GPM (hydraulic fluid flow) and has a heat transfer rate of 150 BTU per minute. The cooler is designed to maintain the hydraulic fluid at 105 - 120 °F.

---

**I.11. Return oil filter**

The return oil filter is located prior to the hydraulic reservoir return port in the machinery space (engine room). The spin-on, disposable type filter is rated at 10 microns and has a 15-PSI bypass valve.

---

**I.12. Local machinery space hydraulic panel**

The local machinery space hydraulic panel (**figure 3-36**) is located in the machinery space (engine room) and contains control switches, warning lights and indicators for the buoy handling hydraulic system. The control switches provide for PTO local/remote operation, engage/disengage operations and load/no load operation. Buoy hydraulic supply pressure; buoy hydraulic return pressure and oil temperature gauges are provided as well as low reservoir level, low system pressure and high oil temperature warning lights.

---

**I.13. Buoy console panel (pilothouse)**

The buoy console panel is located on the aft console (**figure 3-30**) in the pilothouse. The panel provides for control of the A-frame winches and actuators, the cross deck winches, and hydraulic pump PTO and clutch operation. Individual controls are provided for each A-frame winch (raise and lower) and cross deck winch (haul-in and payout). A single control (forward and aft) simultaneously directs the operation of both A-frame actuating cylinders.

Gauges are provided for hydraulic oil system pressure and temperature. A summary warning light on the pilothouse central alarm panel will illuminate if the buoy hydraulic oil temperature exceeds 140 °F or the hydraulic system pressure drops below 1600 PSIG.

---



---

**I.14. P-39  
portable  
hydraulic hand  
pump**

The P-39 portable hydraulic hand pump is capable of developing 10,000 PSIG and has an integral reservoir (only 500-700 PSI required). Quick-disconnect fittings at the A-frame and cross deck winch hydraulic motors permit pressurizing the brakes for each winch to allow for emergency lowering or releasing a load. Two hand pumps are required to permit simultaneous actuation of the winch brakes.

---

**I.15. Filter cart  
connections**

Quick-disconnect fittings that interface with the reservoir and the hydraulic system return line provide for connecting a portable, fully equipped filter cart for removing contaminated fluid and water from the system. The filter cart utilizes an electric-driven pump.

---

**I.16. Chain  
stopper and  
roller assembly**

A notched access on the transom provides for the chain stopper and roller (**figure 3-31**). The chain stopper release assembly is manually operated and designed to engage and retain the sinker chain while the buoy is being serviced or repaired. The chain stopper actuating mechanism is located port of the centerline just forward of the transom. A lanyard is attached to the chain stopper and the A-frame port actuating cylinder guard (designed to allow for haul of chain without removing chain from the stopper). The lanyard is used to raise the chain stopper to the *vertical* position after the chain is released. Careful coordination of the hull, A-frame winches and actuating cylinders is required to safely and effectively engage the chain in the chain stopper.

---

**I.17. Buoy deck  
tie-downs**

Sixteen tie-downs are located on the buoy deck and have a safe working load of 4500 pounds. Two bull chain tie-downs are located just forward of the A-frame, port and starboard of centerline on the main deck. The bull chain tie-downs have a safe working load of 12,000 pounds.

---



**Figure 3-30**  
**Aft Buoy Console Panel**



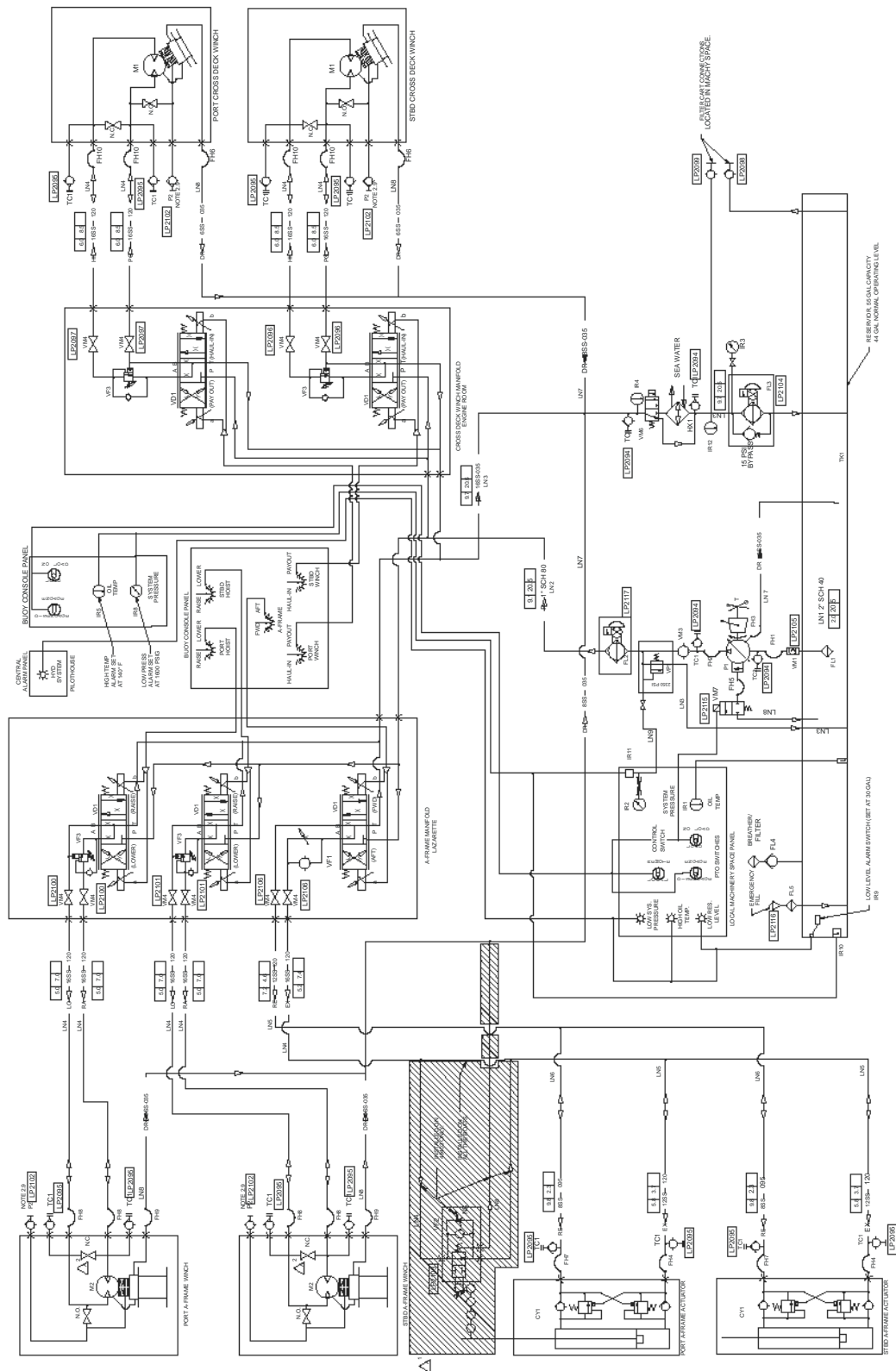

**Figure 3-32**  
**Buoy Handling Hydraulic System**





**Starboard Side**



**Port Side**

**Figure 3-33**

**A-Frame Winches (Port and Starboard)**

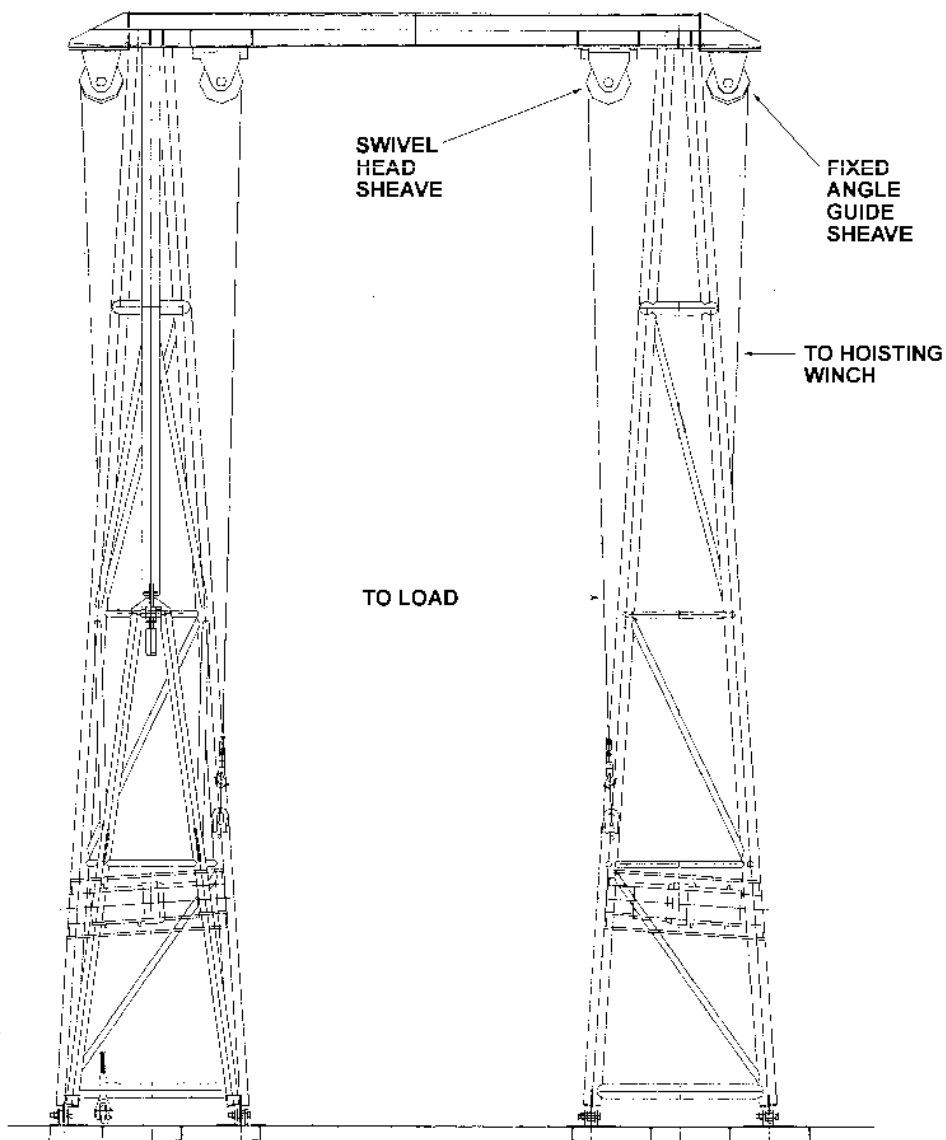

**Figure 3-34**  
**A-Frame Structure**

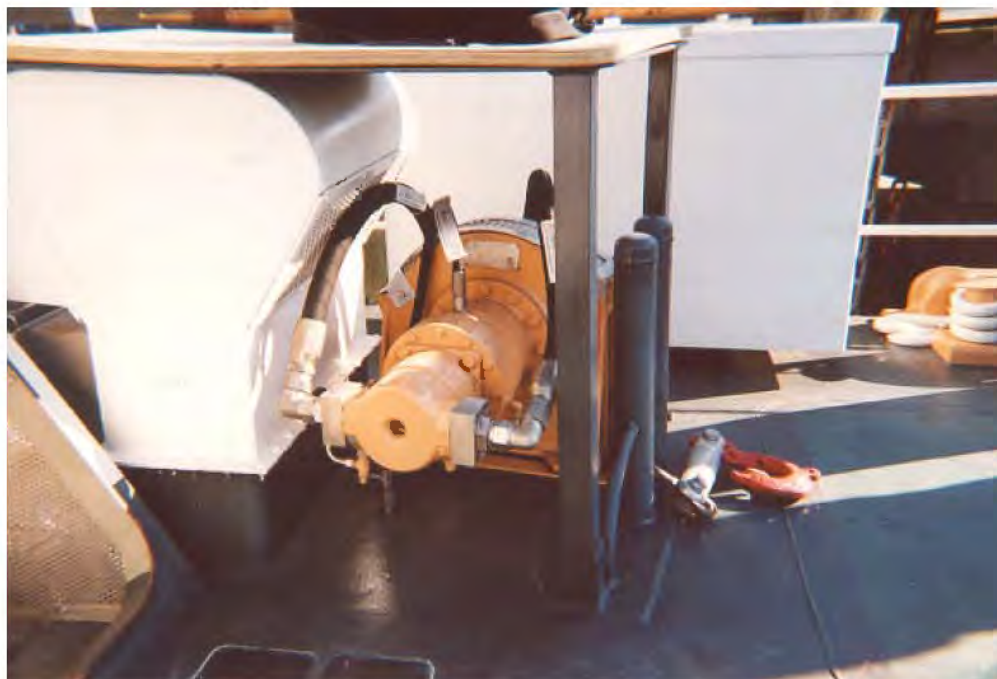

**Figure 3-35**  
**Cross Deck Winch**



**Figure 3-36**  
**Buoy Handling Hydraulic System Control Panel (Machinery Space)**



## Section J. Electronic Navigation System

---

- J.1. General** The electronic navigation system (**figure 3-37 through 3-42**) consists of the following:
- Furuno navigational radar
  - depth sounder
  - differential global positioning system (DGPS)
  - VHF radios
  - loudhailer/intercom
  - electronic compass
  - autopilot system
  - electronic chart system (ECS)
- 
- J.2. Furuno Radar Display** The Furuno Radar Display (**figure 3-37**) unit is mounted on the forward console in the pilothouse, port side of the helmsman wheel. The Furuno antenna and receiver/transmitter unit is mounted on the centerline on top of the pilothouse forward of the life raft cradle. The antenna swing circle is 41 inches. The system requires 24 VDC for operation.
- 
- J.3. Depth sounder (Raytheon V850)** The depth sounder (**figure 3-38**) monitor is mounted on the forward console in the pilothouse, starboard side of the helmsman wheel. A through-hull mounted transducer located forward of frame 5 in the workshop transmits an ultrasonic energy wave into the water, listens for echoes from the ultrasonic wave, and then displays the returning echoes converted into units of depth on the display in the pilothouse. A remote indicator for the depth sounder is located on the aft console in the pilothouse, aft of the main diesel engine throttle controls. The system requires 24 VDC for operation.
- 
- J.4. Differential global positioning system (DGPS)** The DGPS display (**figure 3-39**) is located on the overhead in the pilothouse, just starboard of the centerline. The DGPS antenna is mounted on top of the pilothouse, port side of the centerline and outboard of the Furuno antenna. The DGPS interfaces with the Standard Workstation III (SWIII, runs the ECS and buoy positioning software) and fluxgate compass. The system is capable of providing at least three digits of resolution for latitude and longitude solutions. The system requires 24 VDC for operation.
-



---

**J.5. VHF radios  
(Raytheon 201  
VHF)**

Two VHF receiver/transmitters (radiotelephones) (**figures 3-39, 3-40, and 3-41**) are capable of transmitting on 53 and receiving on 92 Marine VHF radiotelephone channels. The receiver/transmitter units are mounted on the overhead in the pilothouse, one face forward and one aft. A whip antenna for each unit is mounted on top of the pilothouse, forward, outboard, port and starboard side. One of the radios is set to continuously guard channel 13 and one to continuously guard channel 16. The radios operate on 24 VDC.

---

**J.6.  
Loudhailer/  
intercom  
(Raytheon 430)**

The loudhailer/intercom (**figure 3-40**) provides for listening and hailing interior and exterior manned (weather deck) locations. Remote intercom stations in the galley/mess area, berthing space, workshop and machinery space are provided for communications inside the hull. Two exterior loudhailer/listener stations are also provided. Loudhailer microphones are located at the forward and aft consoles. The loudhailer is located on the centerline above the chart table in the pilothouse, convenient to the aft console. The loudhailer operates on 24 VDC.

The loudhailer can also provide nine different navigational sound signals, audible foghorn patterns that correspond to vessel operating conditions.

---

**J.7. Electronic  
compass**

The electronic compass (**figure 3-42**) interfaces with the ComNav Marine 2001 autopilot system (**figure 3-38**). The transmitter (fluxgate compass) is located in the berthing area, below the linen locker. It provides heading information to the autopilot system that also interfaces with the DGPS and SWIII. The compass operates on 24 VDC.

---

**J.8. Autopilot  
system  
(ComNav  
Marine 2001)**

The autopilot system (**figure 3-38**) is capable of steering the vessel under all conditions. The autopilot control display is located on the forward pilothouse console, centerline, directly in front of the helmsman wheel. The autopilot system receives inputs from the electronic compass and ECS systems. The system electronically interfaces the rudder systems and can provide a rudder command signal with a heading accuracy of plus or minus 2 degrees. A rudder angle indicator is located on the forward and aft consoles in the pilothouse. The system operates on 24 VDC.

---



---

**J.9. Electronic chart system (ECS)**

The electronic chart system (ECS) consists of a CPU (SWIII), keyboard, two flat screen monitors, and required power supplies and interface cables. The equipment is located on and under the chart table in the center of the pilothouse. The ECS system utilizes CAPN Voyager Navigational software for navigation and plotting and provides a clear picture of the relative location of navigational aides such as buoys or channel markers. CAPN Voyager combines the Global Positioning System (GPS) and National Oceanographic and Atmospheric Association (NOAA) charts and plotting packages. The ECS interfaces with the DGPS, the Autopilot System and all the navigation sensors except radar. The SWIII also utilizes the Aids to Navigation Information System (ATONIS) for buoy positioning. The ECS system CPU is powered by 120 VAC and utilizes a 1.25-KVA Uninterruptible Power Supply (UPS) receptacle mounted on the chart table in the pilothouse for transfer of power from ship to shore.

---



Figure 3-37

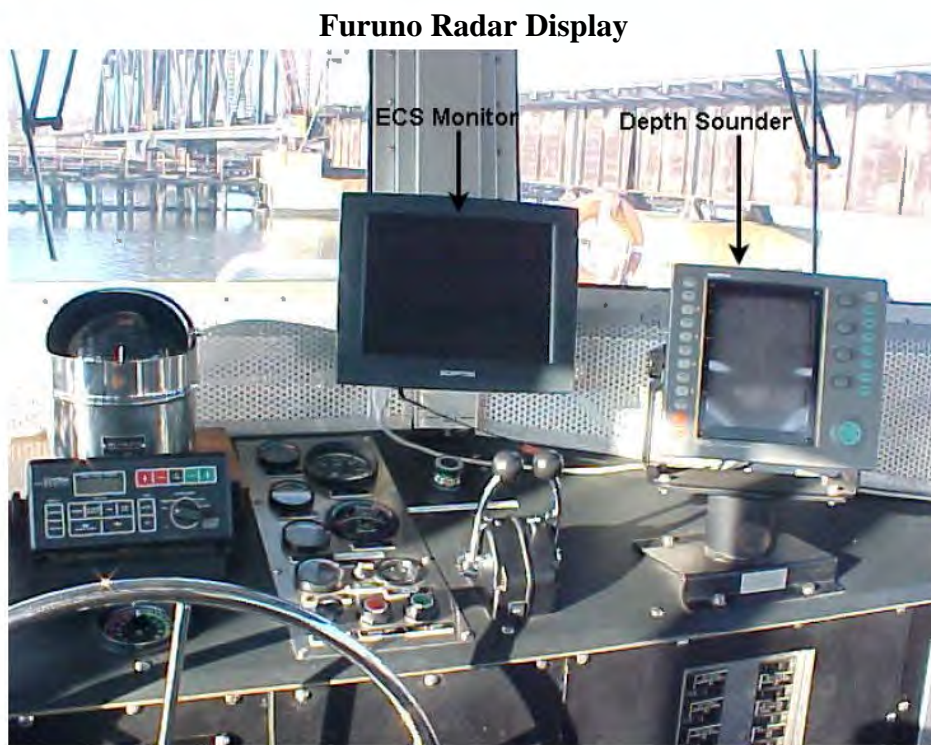

Figure 3-38

**ECS Monitor and Depth Sounder**



Figure 3-39

DGPS and VHF Radiotelephone

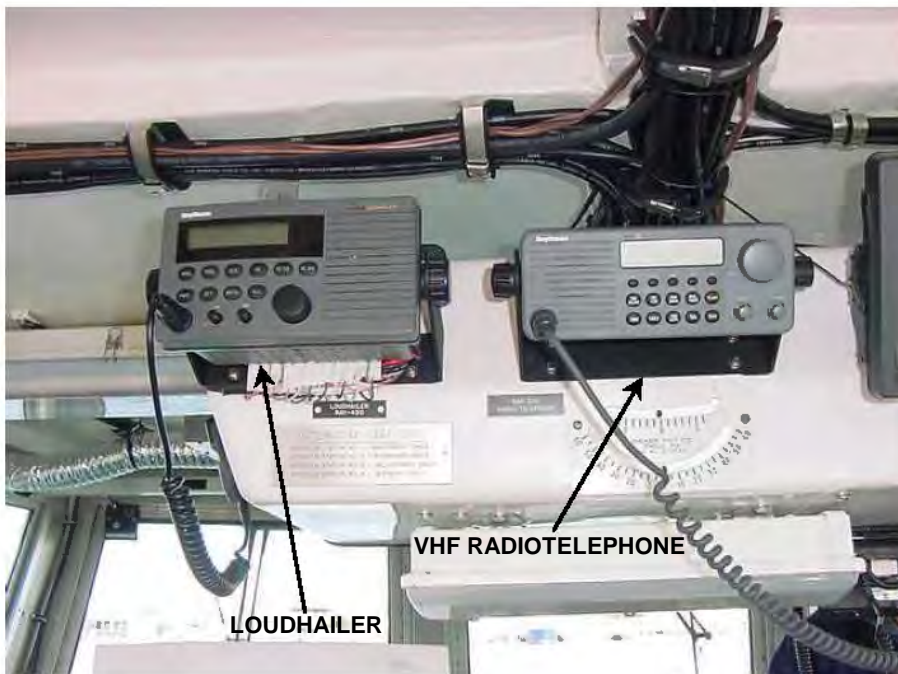

Figure 3-40

Loudhailer and VHF Radiotelephone





**Figure 3-41**

**Overhead Console (Looking Aft)**

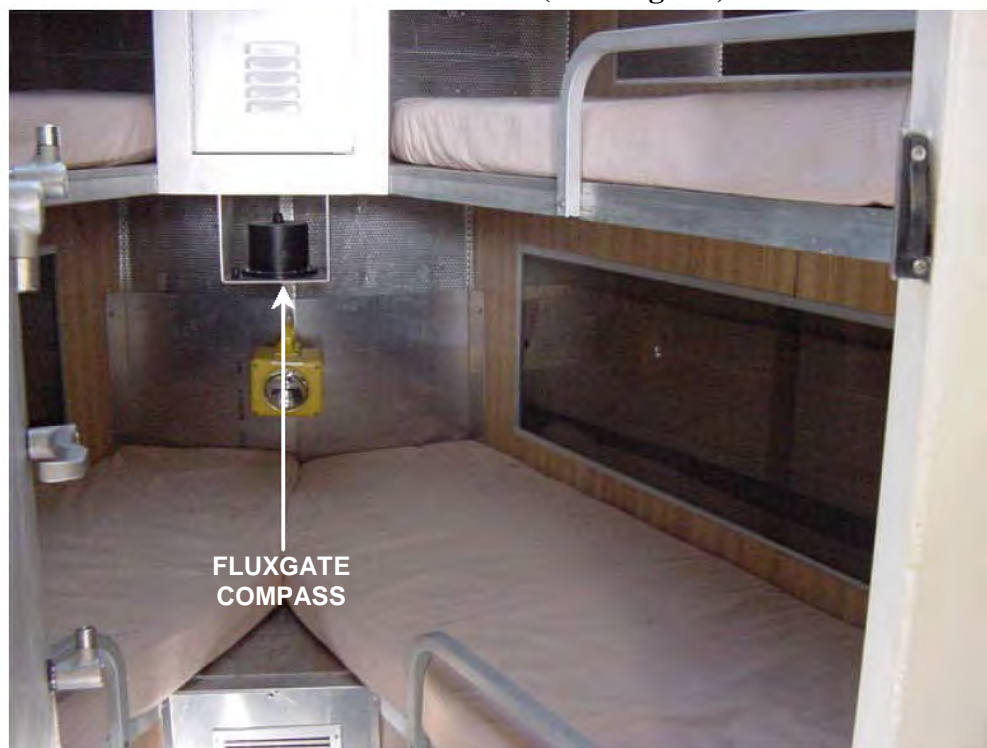

**Figure 3-42**

**Fluxgate Compass**



## Section K. Magnetic Compass

### K.1. General

The magnetic compass (**figure 3-43**) is mounted on the centerline of the forward console in the pilothouse. It is the standby or backup compass used in navigation. The compass has 5-degree increments on a 5-inch card dial, four lubber lines at 90 degrees, and is back lighted. The compass deviation card is installed below the compass and provides the date the compass was last swung and the deviation from the major cardinal points.



**Figure 3-43**  
**Magnetic Compass**



**(This page intentionally left blank.)**



## Section L. Navigation Lights, Searchlights, Floodlights, and Signal Devices

---

### L.1. Navigation lights

The navigation lights (**figures 3-44 and 3-45**) are controlled from a light switch box mounted starboard of centerline, above the chart table in the pilothouse. An 8-position selector switch provides for lighting configurations based upon the boat's operating configuration; underway, anchor, towing astern, towing alongside (inland), buoy operations underway, buoy operations at anchor, towing alongside (International), and off.

The following is a list of installed navigation lights:

- red light - port side of pilothouse
  - green light - starboard side of pilothouse
  - white light (all around) - anchor light, top of the mast
  - white light (forward) - masthead light, second light from top of the mast
  - red light (all around) - restricted maneuvering light (upper), third light from top of the mast
  - amber light (aft) - stern tow light, fourth light from the top of the mast
  - white light (forward) - lower tow light, fifth light from top of the mast
  - white light (all around) - restricted maneuvering light (middle), sixth light from top of the mast
  - amber light (aft) - stern tow light, seventh light from top of the mast
  - white light (aft) - stern light, eighth light from top of the mast
  - red light (all around) - restricted maneuvering light (lower), bottom of mast
- 

### L.2. Searchlights

Two 24-VDC, 500,000-candlepower searchlights (**figures 3-44 and 3-45**) are mounted on top of the pilothouse. One light faces forward and one light faces aft. The lights are capable of illuminating 360 degrees horizontally and 40 degrees vertically. The forward searchlight is controlled from the forward console in the pilothouse and the aft searchlight from the aft console in the pilothouse. The controls allow for *on*, *off*, and *directional* control of the searchlights.

---

### L.3. Floodlights

Two 120-VAC, 150-watt white floodlights (**figures 3-44 and 3-45**) are mounted on the mast yardarm, and provide illumination for the aft deck. Switches on the aft console in the pilothouse operate these floodlights.

---



### L.4. Signal devices

Two horns (**figures 3-44 and 3-45**), one facing forward and one facing aft, are mounted on top of the pilothouse. The horns use 24 VDC and are controlled by pushbuttons on the forward and aft consoles in the pilothouse.

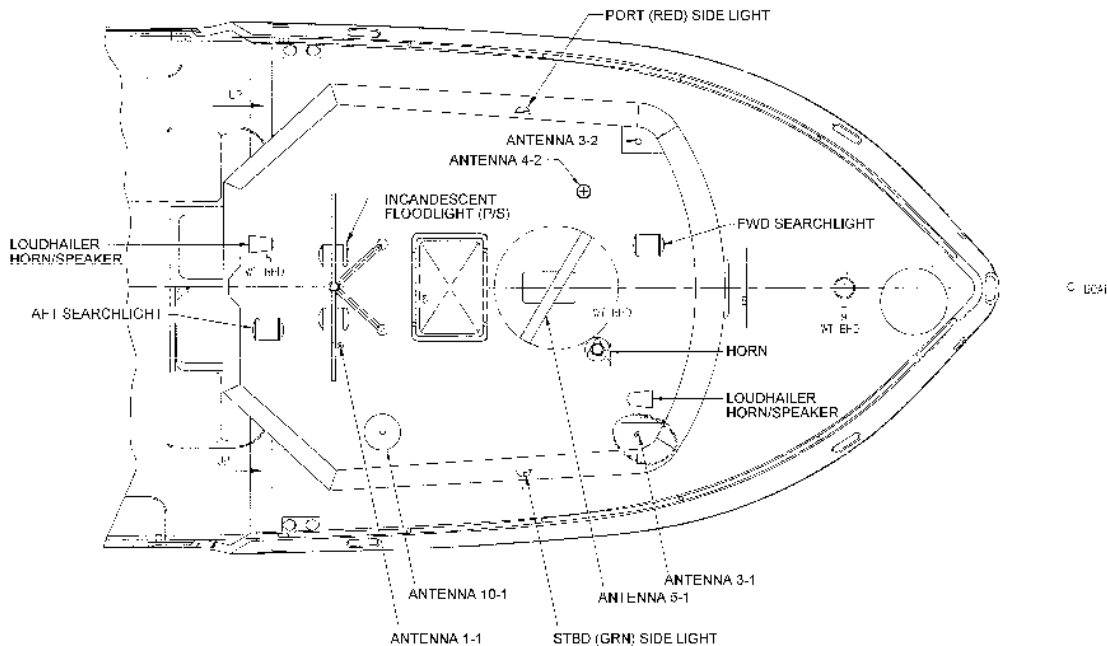

**Figure 3-44**

**Navigation Lights, Searchlights, Floodlights, and Signal Devices (Plan View)**

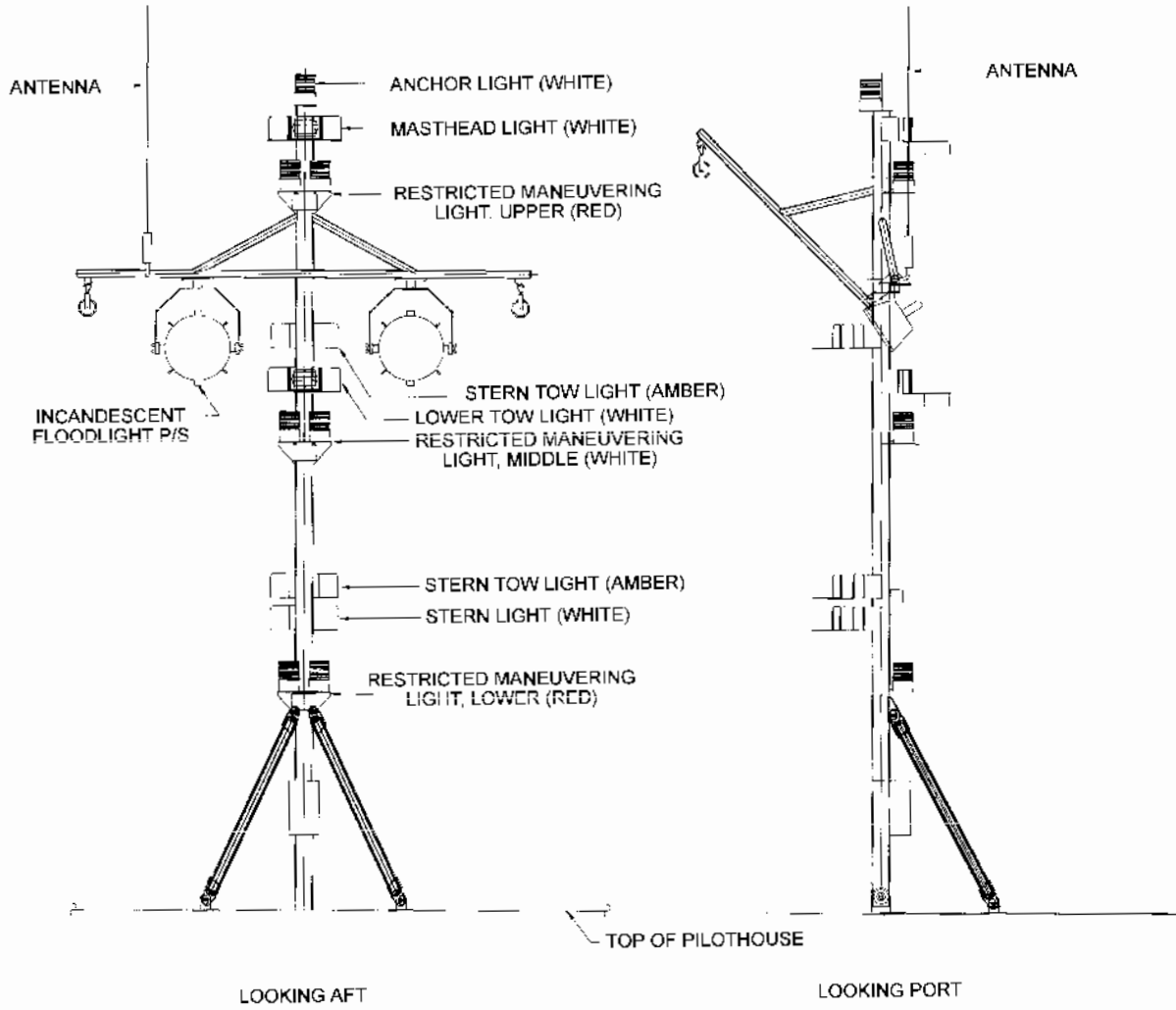

**Figure 3-45**  
**Navigation Lights, Searchlights, Floodlights, and Signal Devices (Elevation View)**



**(This page intentionally left blank.)**



## Section M. Electrical Alarm, Safety, and Warning Systems

---

### M.1. General

A central alarm panel operating on 24-VDC power (**figure 3-46**) is located in the pilothouse, port side forward. RESET, TEST, and ACKNOWLEDGE pushbuttons as well as a POWER-ON light are located on the front of the central alarm panel. Red indicator lights and an audible alarm will announce the following conditions:

- port and starboard engine high jacket water temperature (separate indicator lights)
- port and starboard engine low oil pressure (separate indicator lights)
- port and starboard engine high exhaust temperature (separate indicator lights)
- SSDG high jacket water temperature
- SSDG low oil pressure
- hydraulic power unit alarm
- hydraulic steering alarm
- berthing, galley/mess, lazarette bilge alarms (separate indicator lights)
- engine room aft bilge
- engine room forward bilge
- engine room bilge switch (*auto* mode)
- fire alarms for the engine room, workshop, galley/mess, and berthing area (separate indicator lights)

### M.2. Enunciators

Enunciators (speakers) are located in all accessible spaces to provide an audible alarm when abnormal conditions are sensed.

### M.3. Loudhailer

The alarm panel is connected to the loudhailer for in port unmanned warning of the following conditions.

- Toggle switch must be in the *in port* position.
- Hydraulic system 24 VDC must be secured.
- Loudhailer set for *burglar alarm* becomes active after 5 minutes.

### NOTE

All alarm conditions must be cleared prior to setting in loudhailer alarm mode.







## Section N. Fire Extinguishing Systems

---

- N.1. General** A fixed carbon dioxide (CO<sub>2</sub>) flooding system (**figure 3-47**) is provided to extinguish a fire in the machinery space. The system can be locally actuated by a lever on the CO<sub>2</sub> bottle control head or remotely from a pull station located in the pilothouse on the aft console.
- 
- N.2. CO<sub>2</sub> cylinders** Three 35-pound CO<sub>2</sub> cylinders are designed to dump CO<sub>2</sub> through three nozzles in the machinery space. The cylinders are installed under the inclined ladder in the mess area and slightly forward of the machinery space bulkhead.
- 
- N.3. Indicator light box** An indicator light box outside the machinery space quick-acting watertight door provides status of the CO<sub>2</sub> system as follows:
- red lens - CO<sub>2</sub> pre-discharge
  - red lens - CO<sub>2</sub> discharged
  - white lens - power available
- 
- N.4. Audible alarm and rotary beacon** An audible alarm and rotary beacon will sound and flash in the space to indicate CO<sub>2</sub> pre-discharge and to ensure personnel evacuate the space. A time delay of approximately 30 seconds is provided to allow for space evacuation.
- 
- N.5. Switches and remote indicator** Pressure switches, actuated by discharging CO<sub>2</sub>, will close the machinery space ventilation fire dampers. Electrical switches, actuated by CO<sub>2</sub> will stop the machinery space ventilation fans and shut down the engines. A remote indicator on the aft console in the pilothouse illuminates when the CO<sub>2</sub> system is actuated.
- 
- N.6. Portable fire extinguishers** Three 10-pound PKP and three 5-pound CO<sub>2</sub> hand-held fire extinguishers are provided throughout the boat. Ten-pound PKP extinguishers are located in the workshop, pilothouse, and lazarette. Five-pound CO<sub>2</sub> extinguishers are located in the galley/mess area, pilothouse, and machinery space.
-



**SYMBOL LIST**

	35# CO2 BOTTLE PRESS OPERATED
	35# CO2 BOTTLE CABLE OPERATED
	TIME DELAY
	PRESS SWITCH
	CO2 OPERATED SIREN
	PULL BOX
	FLEXIBLE HOSE
	PIPE CAP
	NOZZLE
	ELECTRICAL CABLE

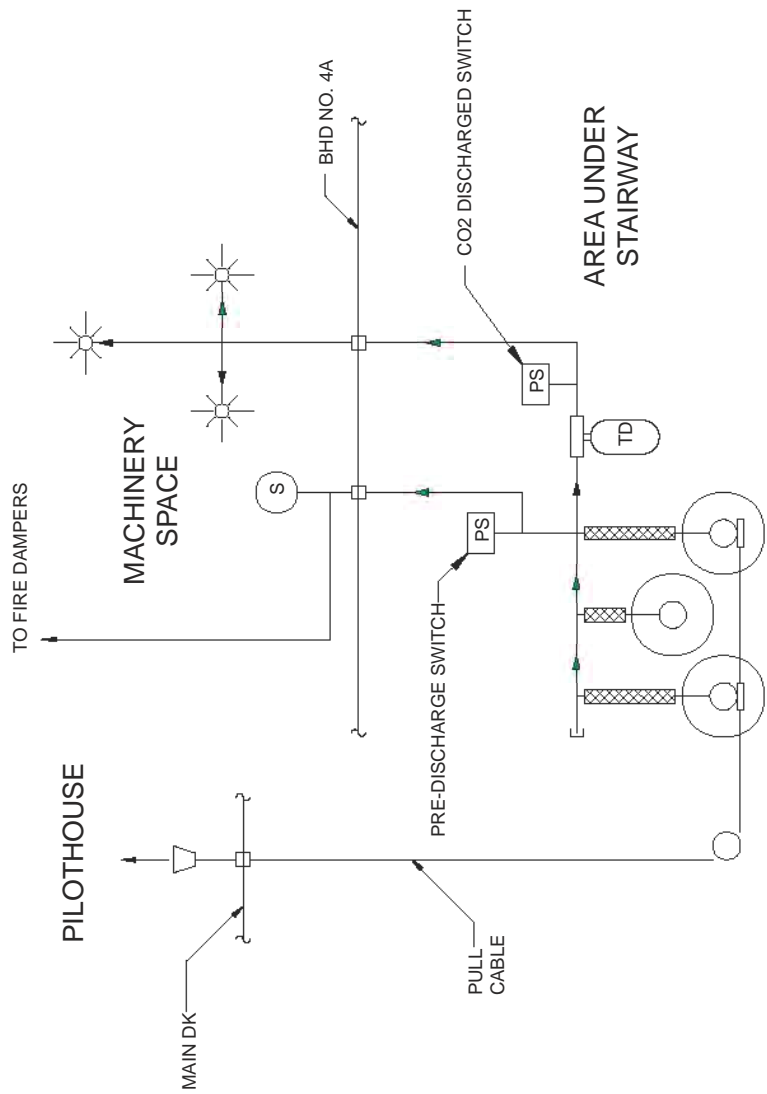

**Figure 3-47**  
**Fire Extinguishing Systems**



## Section O. Bilge System

---

**O.1. General** The bilge system (**figure 3-48**) consists of installed bilge pumps, float switches, and a bilge pump control panel. The system is designed to remove small amounts of water that occur due to condensation, small leaks, or water used to clean decks and other surfaces.

---

**O.2. Bilge pumps and float switches** Each compartment has a fixed, submersible bilge pump that operates on 24 VDC. The machinery space has two bilge pumps, one mounted forward and one aft on the centerline of the bilge. The bilge pumps are rated at approximately 30 GPM at 7 PSI. The bilge pumps' overboard discharges are 1 ¼-inch ID and located 12 inches above the waterline on the starboard side of the hull. A check valve installed in the overboard discharge line prevents backflow through the pump. The float switches are installed to turn the pump *on* when the fluid level is 2 ½ inches deep, and *off* when the level drops to 1 ½ inches deep, with the switch on the control panel in the *automatic* mode.

---

**O.3. Bilge pump panel** The bilge pump panel is located on the port side of the forward control console in the pilothouse. The panel provides switches for *manual* or *automatic* control of the five bilge pumps located in the following areas:

- berthing void
  - galley void
  - engine room forward
  - engine room aft
  - lazarette
-

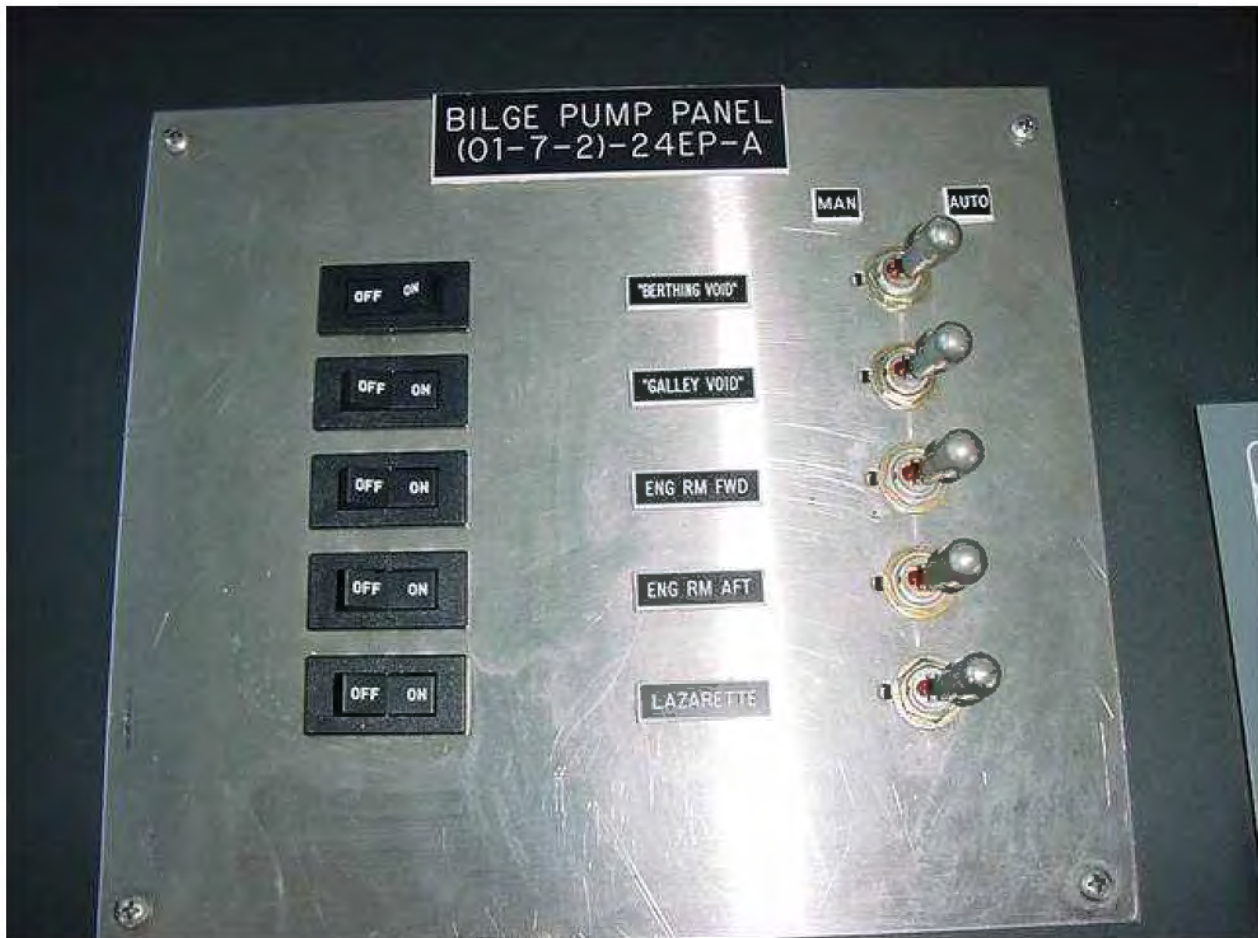

**Figure 3-48**

**Bilge Pump Panel (Pilothouse Forward Console)**



## Section P. Gray Water and Sewage Systems

---

<b>P.1. Gray water system</b>	The gray water system ( <b>figure 3-49</b> ) is designed to receive wastewater from the galley sink, shower drain, and lavatory in the head and discharge it to the sewage holding tank inlet piping.
P.1.a. Gray water holding tank	Water from the galley sink passes through a grease trap and enters the 20-gallon gray water holding tank. Water from the lavatory sink and shower drain goes directly to the 20-gallon gray water holding tank. The tank is located just forward of frame 6, starboard of the centerline below the deck for the galley and mess area.
P.1.b. Level switches	Two level switches in the gray water tank turn the pump <i>on</i> when the tank level reaches 75 percent, and <i>off</i> when the tank level is 15 percent.
P.1.c. Gray water pump	The gray water pump is a 115-VAC, Jabsco macerator type pump rated at 11 GPM. The pump is mounted adjacent to the tank and the tank level switches control its operation. The pump takes suction directly on the gray water tank and discharges to the sewage tank inlet header.
<b>P.2. Sewage system</b>	The sewage system ( <b>figure 3-50</b> ) is designed to receive waste from the vacuum water closet in the head and discharge through the vacuum tank, vacuum pump, and to the sewage-holding tank.
P.2.a. Vacuum tank	The vacuum tank receives waste and potable flushing water from the water closet. Two vacuum switches in the tank will actuate the vacuum pump, turning the pump <i>on</i> when the pressure in the tank reaches 8 inches Hg (vacuum), and <i>off</i> when the pressure is 10 inches Hg (vacuum). The tank is located below deck of the galley/mess area passageway, just aft of frame 6 and approximately 18 inches off centerline, to port.
P.2.b. Vacuum pump	The vacuum pump is a 24-VDC, positive displacement pump rated at 2.5 GPM. The vacuum pump takes suction on the vacuum tank and discharges to the sewage holding tank inlet header. The pump is located just aft of the vacuum tank.

---



---

P.2.c. Sewage holding tank

A 250-gallon sewage-holding tank is located in the lazarette. The tank has three level switches to provide  $\frac{1}{3}$ -,  $\frac{2}{3}$ - and  $\frac{3}{4}$ -full warning lights on the aft console in the pilothouse.

---

P.2.d. Macerator pump

A macerator pump, operating on 120 VAC and rated at 10.8 GPM is designed to pump the contents of the sewage-holding tank to a shore disposal facility. The pump is located adjacent to the tank in the lazarette. The overboard discharge valve for the sewage tank is located on the starboard side, main deck, directly below the machinery space exhaust vent.

---

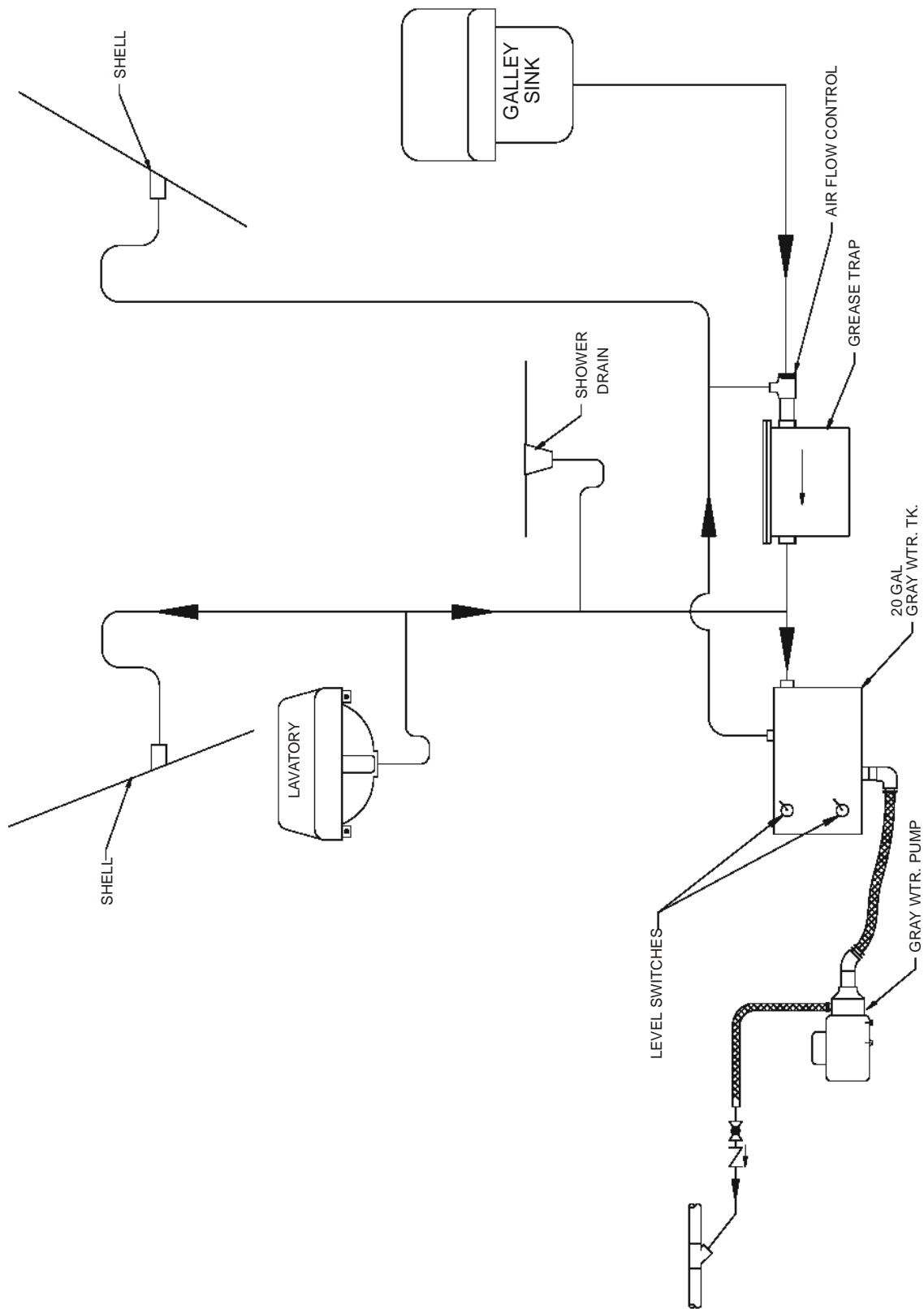

**Figure 3-49**  
**Gray Water System**



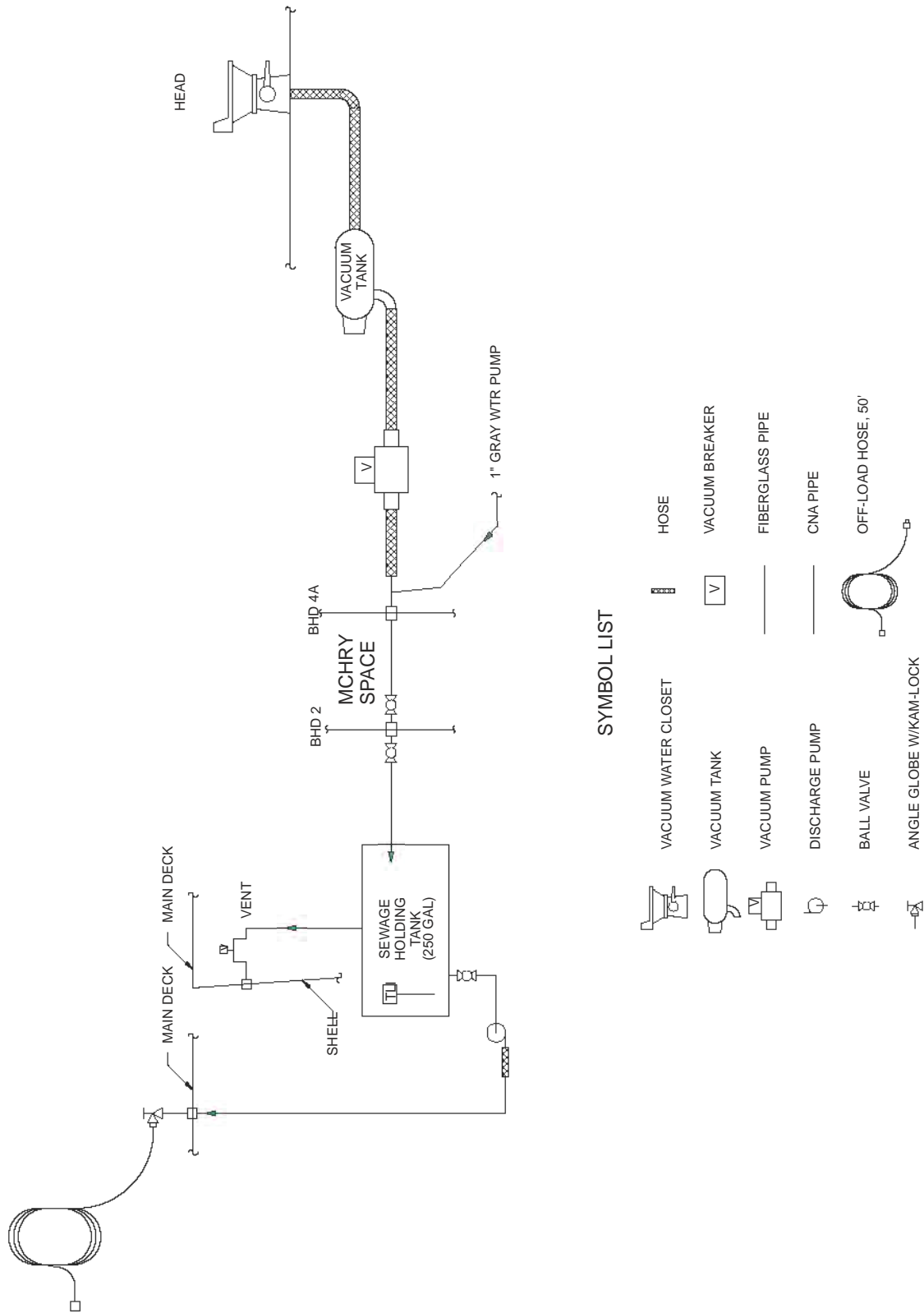

**Figure 3-50**  
**Sewage System**



## Section Q. Deck Washdown System

---

**Q.1. General** The deck wash down system (**figure 3-51**) consists of the following:

- strainer
- pump and deck wash down fitting
- cutoff valve

The system uses saltwater to remove debris from the main deck.

---

**Q.2. Strainer** The pump takes suction through a strainer and discharges to the wash down piping.

---

**Q.3. Pump and deck wash down fitting** The pump is a 120-VAC centrifugal pump rated at 17 GPM and 65 PSI and is located in the machinery space, port side forward. The pump can be controlled locally from the machinery space or from the aft console in the pilothouse.

---

**Q.4. Cutoff valve** A cutoff valve located on the aft, outboard port side of the buoy deck provides for connecting a 50-foot, synthetic reinforced hose. A rack is provided adjacent to the cutoff valve to stow the hose.

---

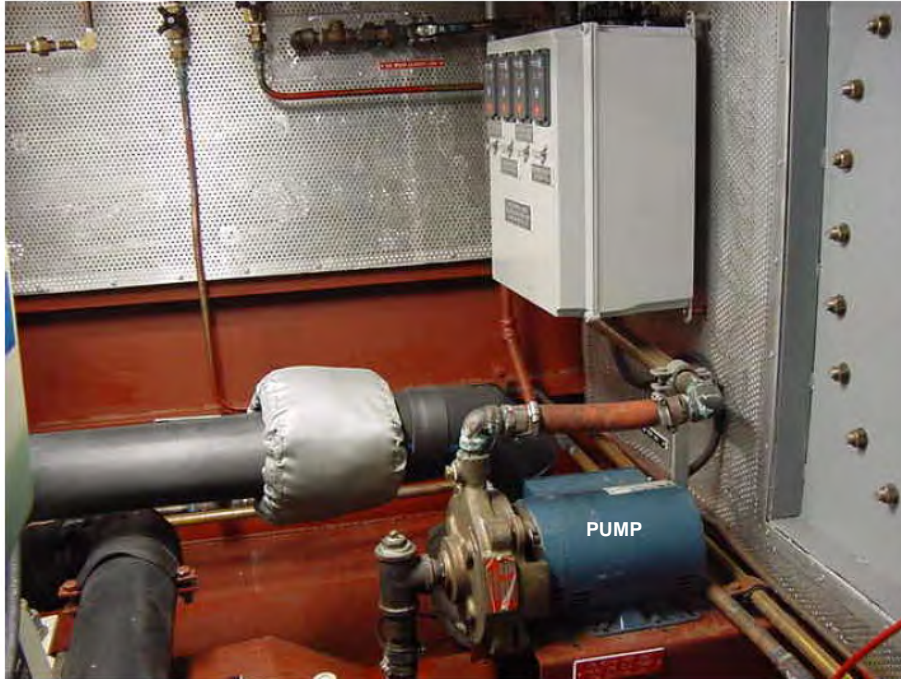

DECK WASHDOWN PUMP IN MACHINERY SPACE

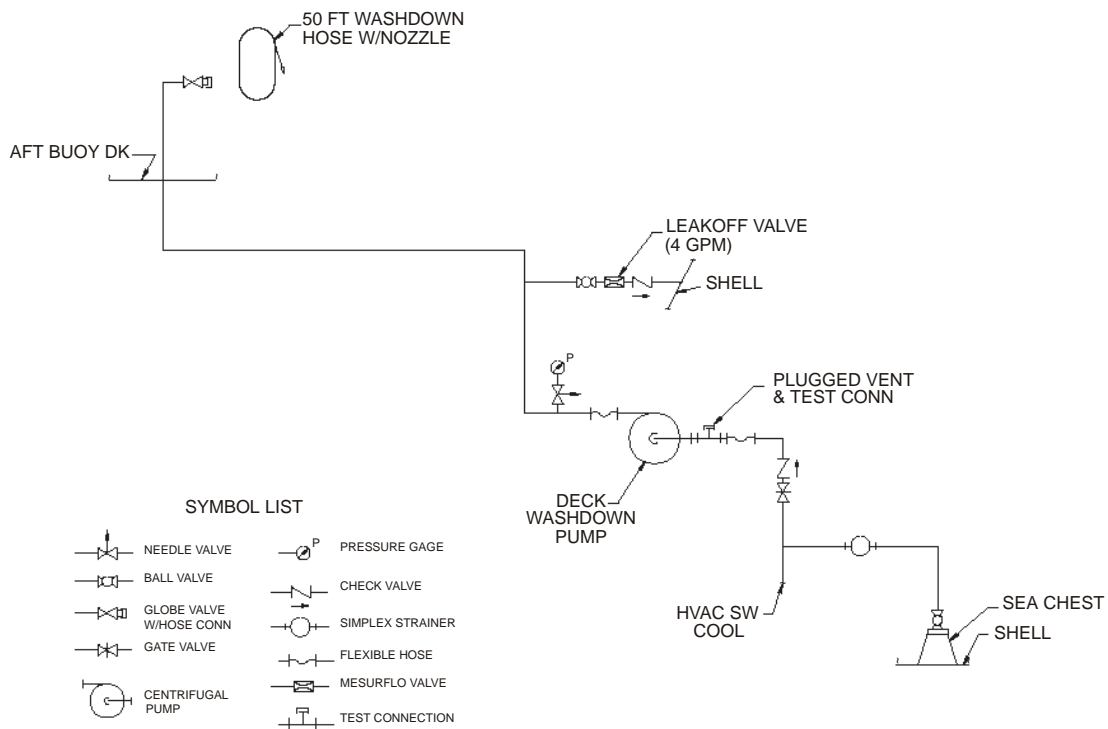

WIRING DIAGRAM

**Figure 3-51**  
**Deck Washdown System**



## Section R. Compressed Air System

---

### R.1. General

A low pressure, compressed air system (**figure 3-52**) is provided for the operation of pneumatic tools and other maintenance activities. The system consists of the following:

- air compressor
  - air receiver
  - control valves and switches
  - outlet valves for attaching air hoses
- 

### R.2. Air compressor

The compressor is a two-stage, reciprocating type air compressor driven by a 120-VAC motor. The air compressor is located inside the lazarette, starboard side. The air compressor is rated at 90 PSI and 10 CFM.

---

### R.3. Air receiver

A 30-gallon air receiver is located in the lazarette adjacent to the air compressor. The air receiver stores the air for the system.

---

### R.4. Control valves and switches

A pressure switch on the receiver will turn the air compressor *on* when the receiver pressure drops below 70 PSI, and *off* when the pressure in the receiver reaches 100 PSI. A relief valve on top of the receiver is set at 125 PSI to prevent over-pressurization.

---

### R.5. Outlet valves for attaching air hoses

A lubricator and filter are located in the lazarette on the receiver discharge line, prior to the hose outlets. Hose outlets are located in the machinery space, workshop, and on the aft deck forward of the buoy deck.

---

### CAUTION!

When the boat is unattended, the air compressor must be secured.

---

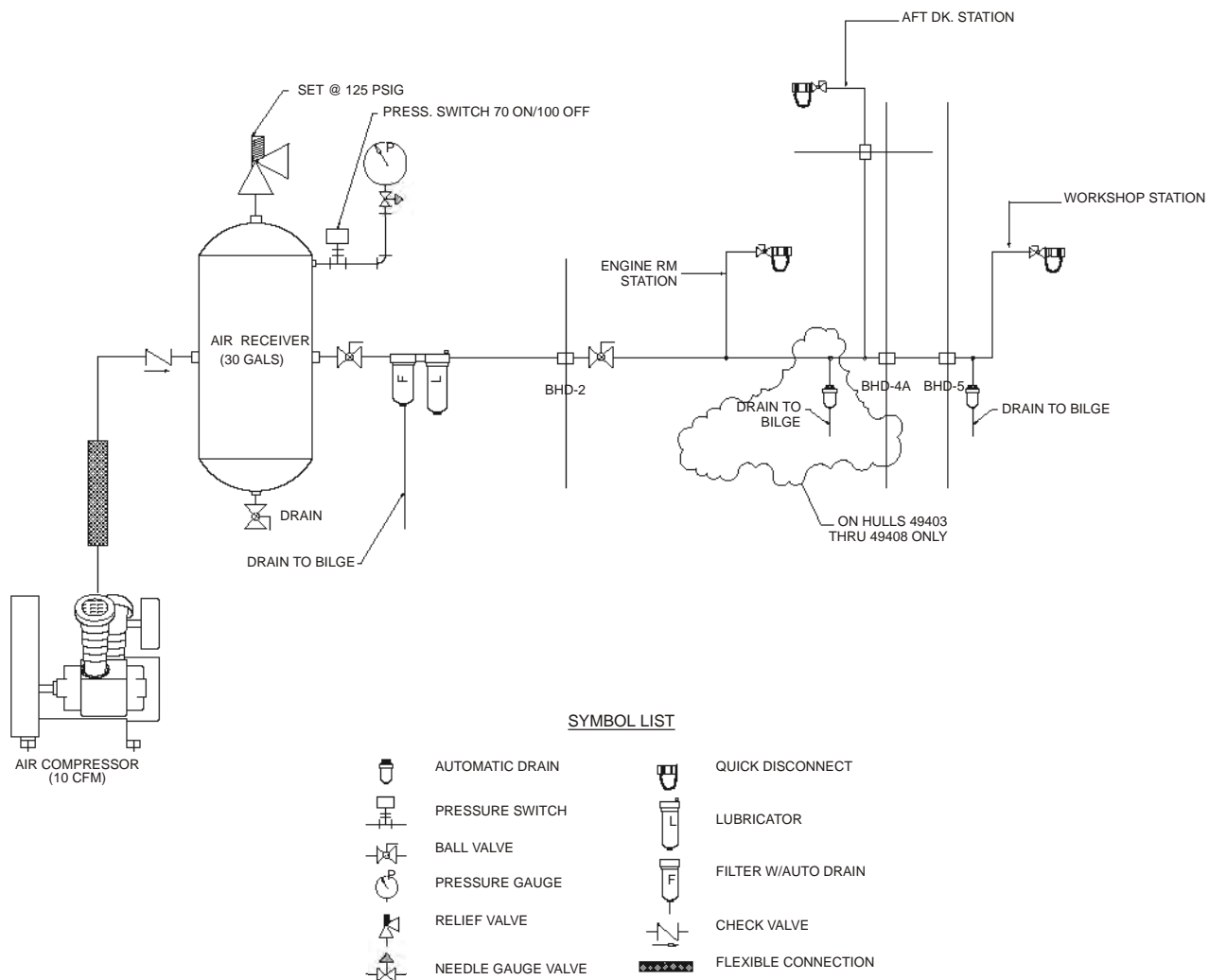

**Figure 3-52**  
**Compressed Air System**



## Section S. Potable Water System

---

### S.1. General

The potable water system (**figure 3-53**) consists of the following:

- potable water tanks
  - service pump
  - pressure tank
  - hot water heater
  - water chiller
  - hose connection
- 

### S.2. Potable water tanks

Two potable water tanks with a combined capacity of 300 gallons are located in the machinery space, aft, port and starboard side. A 1 ½-inch fill connection is located on the port side of the main deck, just forward of bulkhead 2. Protected sight glasses are mounted on both potable water tanks.

---

### S.3. Service pump

The service pump for the potable water system is a belt-driven diaphragm pump, powered by a 24-VDC motor. The pump is located in the machinery space, port side, next to the hot water heater. The pump operates automatically from an internal pressure switch, turning the pump *on* at 20 PSI and *off* at 40 PSI. The pump takes suction on the potable water tanks and discharges to the pressure tank.

---

### S.4. Pressure (accumulator) tank

The pressure (accumulator) tank is a steel shell containing a vinyl bladder with a 20-PSI pre-charge. The pressure tank has a capacity of 0.9 gallons and keeps a positive pressure on the potable water system to reduce pump cycling and prevent pulsations and water hammer. The pressure tank is located on the port side of the machinery space next to the hot water heater.

---

### S.5. Hot water heater

The hot water heater has a 10-gallon capacity and utilizes a submersible 120-VAC-heating element. The thermostat on the heater is set at 120 °F. A relief valve on top of the heater is set at 75 PSI and relieves excessive pressure to the bilge. The heater will automatically shut off if the water temperature in the heater reaches 210 °F. The heater is located in the machinery space next to the pump.

---



---

**S.6 Water chiller**

An electric refrigerated water chiller is installed in the potable water system and provides water at 50 °F and 0.8 GPH to a drinking spigot at the galley sink. The chiller is located in the workshop, behind the shelf located directly under the storage cabinet (directly across from the hanging locker).

---

**S.7. Hose connection**

A 3/4-inch hose connection is located on the main deck adjacent to the fill connection for the potable water tanks. This connection provides freshwater for cleaning and deck wash down when in port.

---

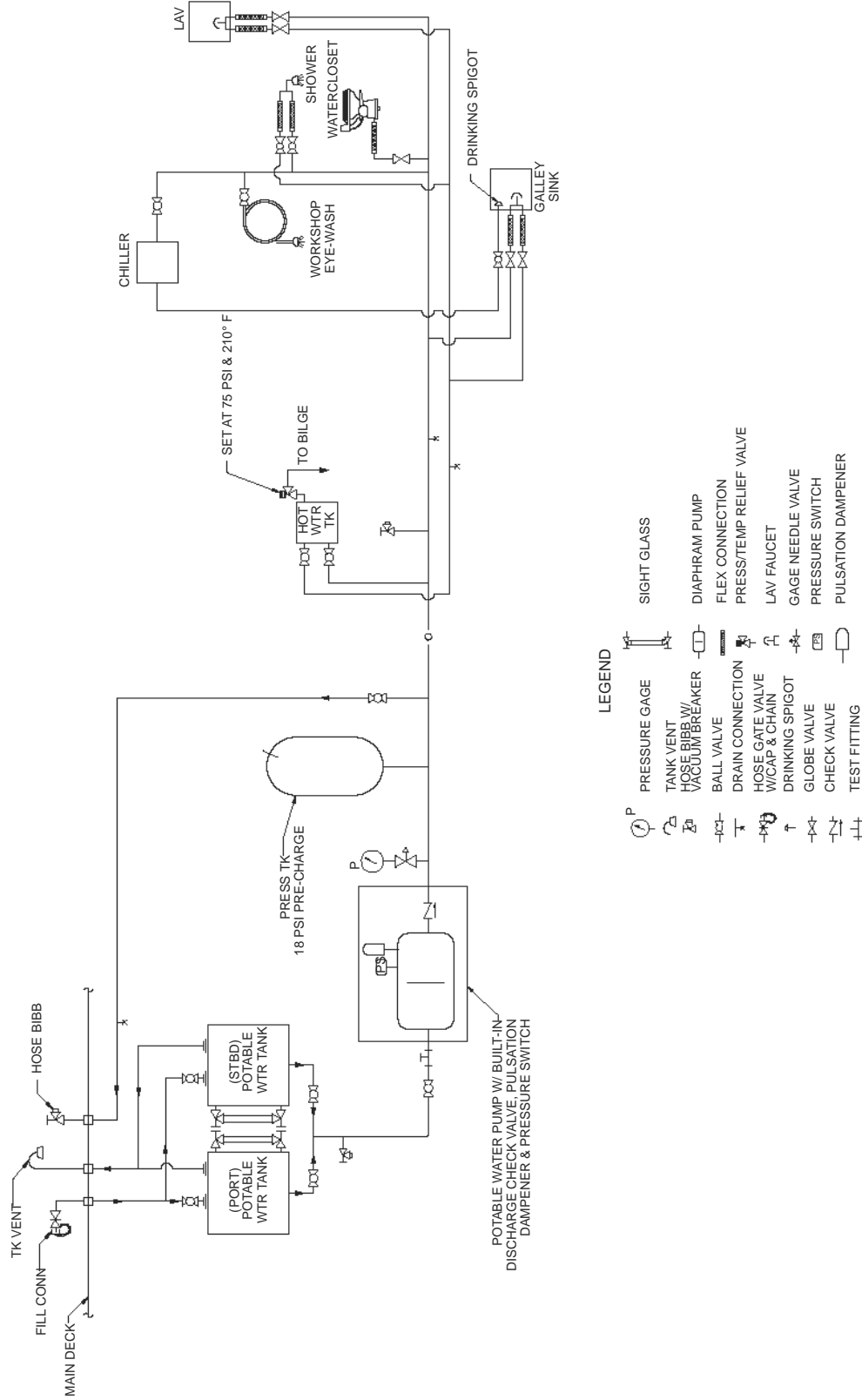

Figure 3-53

Potable Water System





**(This page intentionally left blank.)**



## Section T. Windshield Wipers and Washers

---

**T.1. General** Windshield wipers and washers (**figure 3-54**) are installed on each forward facing window and the aft centerline window. The wipers are variable speed with heated wiper arms and utilize 24-VDC motors. The individual wiper controls are located above the windows.

---

**T.2. Pushbutton switches** Pushbutton switches are located on the fore and aft consoles in the pilothouse and actuate the windshield washers. A reservoir and 24-VDC pump mounted in both the pilothouse forward and aft consoles spray an antifreeze solution on all windows equipped with windshield wipers.

---



**Figure 3-54**

**Windshield Wipers and Washers and Pushbutton Control**



## Section U. Cathodic Protection System

---

**U.1. General** The cathodic protection system (**figure 3-55**) helps to reduce corrosion on exterior hull surfaces and seawater piping systems.

---

**U.2. Zinc anodes** The cathodic protection system installed on the boat consists of sacrificial zinc anodes bolted to studs on the outside of the hull below the waterline. The zinc anodes are located in the following areas:

- one each just aft of frame 8, port and starboard side
  - two in each keel cooler recess
  - two in each sea chest
  - one each between the rudder and hull on the rudder post
  - two on the transom, port and starboard side of the centerline
  - two streamlined zincs forward of midships
-

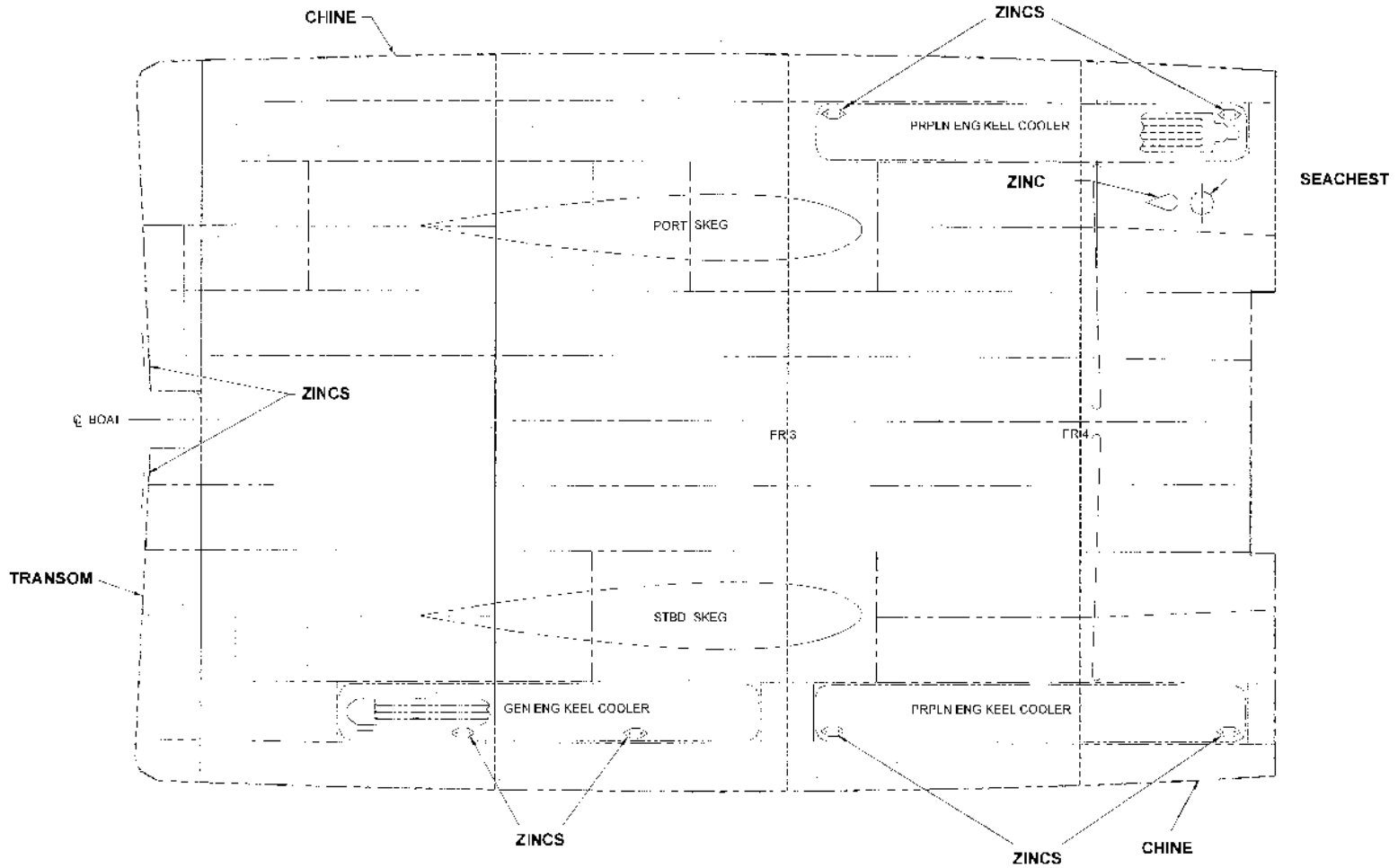

3-102

**Figure 3-55**  
**Seachest and Keel Cooler Cathodic Protection Zincs**



# Chapter 4

## Crew Requirements

### Overview

#### Introduction

The *Boat Operations and Training (BOAT) Manual, COMDTINST M16114.32 Volume I, COMDTINST M16114.33 Volume II* (series) provides minimum standards and guidelines for competence on board the 49' BUSL. Each crewmember should be familiar with the duties of the other crewmembers in addition to his/her own duties. It is important for a crewmember to know and commit to memory all-important characteristics of the boat and its equipment, and which procedures to follow in the event of a casualty. Each crewmember should mentally rehearse the procedures each member of the crew would follow during any operational casualty. Teamwork is the common thread that allows the crew to succeed. Whenever the opportunity is available, the crew should get the boat underway to practice operational and emergency procedures.

#### In this chapter

This chapter contains the following sections:

Section	Topic	See Page
A	Minimum Crew	4-3
B	Coxswain	4-5
C	Engineer	4-7
D	Crewmembers	4-9
E	Passengers	4-11
F	Training	4-13
G	Safety Equipment	4-15



**(This page intentionally left blank.)**



## Section A. Minimum Crew

- 
- A.1. General** The minimum certified crew requirement for the 49 Foot Buoy Utility Stern Loading (BUSL) Boat shall be in accordance with the *U.S. Coast Guard Boat Operations and Training (BOAT) Manual, Volume I, COMDTINST M16114.32 (series)*. Additional crew may be necessary as determined by the nature of the specific mission undertaken.
- 
- A.2. Qualified/certified crewmembers** The certified individuals must include at least one coxswain and one engineer. The third and fourth certified individual crewmember may be an additional coxswain, engineer or a crewmember.
- 
- A.3. Non-qualified/certified crewmember** If the fourth member of the crew is not certified at any position, at a minimum they must have completed Chapter 2 (sections A & B) with the exception of First-Aid of the PQS tasks of the *Boat Operations and Training (BOAT) Manual, COMDTINST M16114.32 Volume I, COMDTINST M16114.33 Volume II (series)*.
- 
- A.4. Additional crewmembers** The nature of the response, local requirements, missions assigned and special operations will dictate the need for additional certified crewmembers.
-





**(This page intentionally left blank.)**



## Section B. Coxswain

---

### B.1. General

The Coast Guard places great trust in each coxswain and his or her ability to accomplish the assigned missions in a safe and professional manner even under adverse conditions. The position of coxswain is one of high regard and great responsibility.

The coxswain is responsible for the boat, its crew, and passengers during every mission. The coxswain assigns and directs all onboard functions during each operation.

---

### B.2. Authority and responsibility

The extent of the authority and responsibility of the coxswain is specified in *United States Coast Guard Regulations*, COMDTINST M5000.3 (series), as follows:

*"The coxswain shall be responsible, in order of precedence, for the safety and conduct of passengers and crew; the safe operation and navigation of the boat assigned; and the completion of the sortie or mission(s) assigned or undertaken pursuant to USCG policy and regulations. An underway coxswain will at all times respond, within the limits of capabilities and legal authority to observed hazards to life or property, and violations of law or regulations."*

The coxswain is the direct representative of the Commanding Officer or Officer-in-Charge and as such, (subject to *Articles 88-89* of the *UCMJ*) has the authority and responsibilities that are independent of rank or seniority in relation to other personnel embarked. The authority and responsibility of the coxswain exist only when the boat is engaged on a specific sortie or mission.

---

### B.3. Relief of responsibility

The only person embarked in the boat who may relieve the coxswain of the responsibility as described above is:

- The Commanding Officer, Officer-in-Charge, Executive Officer, or Executive Petty Officer.
  - A senior officer at the scene of a distress emergency, or other abnormal situation, who exercises authority under the provisions of *USCG Regulations*, whether or not other units are involved.
-



**(This page intentionally left blank.)**



## Section C. Engineer

---

**C.1. General** The position of boat engineer is one of great responsibility. The knowledge and skill of the engineer can make the difference in completing the mission under adverse conditions.

---

**C.2. Qualifications** The boat engineer must be a certified crewmember prior to obtaining certification as a boat engineer since this individual is required to perform duties in both capacities.

---

**C.3. Responsibilities** The primary responsibilities of this position include operational and underway maintenance of the propulsion and auxiliary systems.

The engineer may also serve, if qualified, as:

- senior crewmember,
  - safety observer,
  - A-frame operator,
  - line handler,
  - helmsman,
  - emergency medical technician, or
  - other such duties as may be assigned by the coxswain in support of operational and training sorties or missions.
-



**(This page intentionally left blank.)**



## Section D. Crewmembers

---

**D.1. General** The crewmember is primarily responsible for assisting the coxswain as required during all evolutions or maneuvers, including all buoy-handling operations.

---

**D.2. Responsibilities** The crewmembers may also serve, if qualified, as:

- senior crewmember,
- safety observer,
- A-frame operator,
- line handler,
- towing watch,
- helmsman,
- emergency medical technician, or
- other such duties as may be assigned by the coxswain in support of operational and training sorties or missions.

**NOTE** 

Each break-in crewmember must take the time to study his or her duties in addition to the duties of the other crewmembers since it may be necessary to perform any given duty in the event of an emergency. The *Boat Operations and Training (BOAT) Manual COMDTINST M16114.32 Volume I, COMDTINST M16114.33 Volume II (series)* provides the standards for qualification as coxswain, boat engineer, and crewman aboard the BUSL.

---



**(This page intentionally left blank.)**



## Section E. Passengers

---

### E.1. General

Qualification, certification and assignment as a crewmember on a 49' BUSL require considerable time, effort, and practice. The individual must learn the characteristics of the boat and its missions, as well as the adverse conditions of the sea and the environment in which the boat operates. They should be provided with adequate safety or personal protective equipment based on the mission or situation. At a minimum, each shall wear a properly equipped personal flotation device (PFD).

---

### E.2. Passengers

Since passengers may not have any vessel or equipment knowledge, it is important they receive a basic safety brief prior to getting underway or soon after coming aboard.

### NOTE

The basic safety brief should cover man overboard, abandon ship, and location of life raft.

---





**(This page intentionally left blank.)**



## Section F. Training

---

### F.1. General

Qualification, certification and assignment as a crewmember on a 49' BUSL require considerable time, effort, and practice. The individual must learn the characteristics of the boat and its missions, as well as the adverse conditions of the sea and the environment in which the boat operates. Each break-in crewmember must take the time to study his or her duties in addition to the duties of the other crewmembers since it may be necessary to perform any given duty in the event of an emergency.

---

### F.2. Standards for qualification

The *Boat Operations and Training (BOAT) Manual COMDTINST M16114.32 Volume I, COMDTINST M16114.33 Volume II (series)* provides the standards for qualification as coxswain, engineer, crewmember, and ATON crewmember aboard the 49' BUSL.

### NOTE

Additional AtoN mission-specific training requirements may be required in accordance with local unit training program.

---

### F.3. Training underway

Where staffing permits, additional personnel who have met the requirements set forth in section A.3 of this chapter may participate in underway evolutions in a trainee capacity. To become proficient as a crewmember on any boat, an individual must get underway and practice his or her skills repeatedly.

---



**(This page intentionally left blank.)**



## Section G. Safety Equipment

---

### G.1. Personal protective equipment

During all 49' BUSL operations, crewmembers shall wear personal protective equipment as required by the *Aids to Navigation Manual-Seamanship, COMDTINST M16500.21* (series) and the *Rescue and Survival Systems Manual COMDTINST M10470.10* (series).

### NOTE

The coxswain is responsible for ensuring that all required personal safety equipment is worn, and worn properly.

### G.2. Protective equipment during buoy handling operations

The following equipment shall be available for use during buoy handling operation:

- hard hat with chin strap
- safety toed shoes
- personal floatation device (PFD)
- leather gloves
- eye protection (safety goggles/safety glasses)
- rubber gloves
- rubber apron when handling batteries
- knife
- safety harness
- hearing protection

In addition to the reference above, all crewmembers shall follow the guidelines provided in ATON Deck Supervisor Course.

---



**(This page intentionally left blank.)**



# Chapter 5

## Operational Guidelines

### Overview

---

#### Introduction

This chapter describes how to use the 49' BUSL in the safest and most efficient manner. These policies and performance criteria should be used as guidelines for BUSL operations. Within these guidelines, consider local operating conditions, district regulations, and the skill of the crew to determine how the BUSL's capability is to be used. These factors must be considered prior to each sortie or mission.

---

#### In this chapter

This chapter contains the following sections:

Section	Topic	See Page
A	Operating Parameters	5-3
B	Performance Data	5-9

---



**(This page intentionally left blank.)**



## Section A. Operating Parameters

---

### A.1. General

The readiness of the 49' BUSL shall be continuously monitored to insure that it is capable of unrestricted operations. This monitoring is accomplished through a variety of programs, including daily boat checks, the boat Planned Maintenance System (PMS) schedule, annual engineering inspections, annual Ready for Operations (RFO) evaluations, and biennial Standardization Team Visits.

For the purpose of this section, Operational Commanders are defined as those who exercise direct operational control of a subordinate unit with a standard boat. See *Coast Guard Boat Operations and Training (BOAT) Manual*, COMDTINST M16114.32 *Volume I*, COMDTINST M16114.33 *Volume II* (series).

Operating parameters for the BUSL and crewmembers include the following areas:

- disabling casualties
- restrictive discrepancies
- major discrepancies
- minor discrepancies
- responsibilities
- environmental limits

### A.2. Disabling casualties

Disabling casualties are those that make the boat not serviceable. Appendix D contains a listing of disabling casualties. If a disabling casualty is identified when the boat is moored, the boat shall not get underway until the casualty is corrected.

#### NOTE

The Operational Commander may authorize, in writing, the movement of the boat (for short distances) under its own power only to facilitate haul-outs or corrective maintenance. In the event that the boat sustains a disabling casualty while underway, the boat shall immediately return to the nearest safe mooring, if able. In many cases the boat will require assistance from another vessel.

Disabling casualties shall be reported immediately to the Operational Commander by the most expeditious means; followed by a boat status message as soon as possible but no later than 12 hours after the casualty is discovered. The boat shall be immediately placed in "Charlie" status and repaired. If the casualties cannot be repaired within 48 hours, a CASREP shall be sent within 24 hours of the casualty.

---





**A.3. Restrictive discrepancies**

Restrictive discrepancies are those that restrict the operations of the boat such that it can perform some missions, but not all missions safely. Appendix E contains a listing of restrictive discrepancies.

**A.3.a. Reporting restrictive discrepancies**

Restrictive discrepancies shall be reported to the Operational Commander if the discrepancy cannot be repaired within 1 hour. The boat shall be immediately placed in a "Charlie" status and shall not get underway until the discrepancy is corrected, or a waiver has been received. If the discrepancy cannot be repaired within 48 hours, a CASREP shall be sent within 24 hours of the discrepancy. The Operational Commander is responsible for monitoring the progress of repairs to these discrepancies.

**A.3.b. Waivers**

Boats with restrictive discrepancies shall only be operated if the Operational Commander has issued a written waiver. The waiver shall:

- list the discrepancy
- describe the conditions under which the boat may be operated
- provide concurrence on the measures to be taken to lessen or negate the hazard posed by the discrepancy.

A verbal waiver is authorized, as long as a written waiver follows it up within 4 hours.

**A.3.c. Discrepancy underway**

In the event the boat sustains a restrictive discrepancy while underway, the coxswain should not normally proceed without authorization, unless aborting the mission would increase the level of risk. The situation and recommendations must be effectively communicated to the Operational Commander to allow for prudent risk assessment by all levels.

The reporting procedure is as follows:

Step	Procedure
1	The coxswain shall immediately notify the parent unit with all pertinent information and a recommendation as to whether to continue or abort the mission.
2	The parent unit shall pass along the information pertaining to the casualty, the current mission, and recommendations to the Operational Commander.
3	The Operational Commander shall immediately notify the unit as to whether or not continuing the mission is authorized, and the conditions under which the boat may be operated.



**A.4. Major discrepancies**

Major discrepancies are those that degrade the effectiveness of the boat to perform one or more missions. Appendix E contains a listing of major discrepancies. The occurrence of major discrepancies shall be documented. A plan to correct these discrepancies shall be formulated and carried out. The Operational Commander is responsible for monitoring the status of repairs to these discrepancies.

**A.5. Minor discrepancies**

Minor discrepancies do not affect the operational readiness of the boat. However, a boat with minor discrepancies does not meet the standardization criteria established for the boat. The occurrence and repair of minor discrepancies shall be documented and monitored at the station/unit level.

In the event that the addition of portable equipment, not part of the standard boat outfit, is necessary to meet mission needs, units are authorized to temporarily carry this extra equipment. This authorization is on a case-by-case basis only, and care must be taken to properly secure any extra gear and to ensure it does not interfere with safe egress or the boat's standard outfit/systems. Under no circumstances shall permanent alterations be made to power, stow or in any way accommodate extra equipment.

**A.6. Responsibilities**

The coxswain is always responsible for the safe operation of the boat. The coxswain must decide if the mission warrants subjecting the crew and boat to the danger defined by the mission, weather and sea conditions anticipated.

**A.6.a. Disabling casualty - underway**

In the event that the boat sustains a disabling casualty while underway, the boat shall immediately return to the nearest safe mooring, if able. In many cases the boat will require assistance from another vessel.

**A.6.b. Restrictive discrepancy - underway**

In the event the boat sustains a restrictive discrepancy while underway, the coxswain should not normally proceed without authorization, unless aborting the mission would increase the level of risk. The situation and recommendations must be effectively communicated to the Operational Commander to allow for prudent risk assessment by all levels. The following is the procedure for communicating the discrepancy while underway:

Step	Procedure
1	The coxswain shall immediately notify the parent unit with all pertinent information and a recommendation as to whether to continue or abort the mission.



<b>2</b>	The parent unit shall pass along the information pertaining to the casualty, the current mission, and recommendations to the Operational Commander.
<b>3</b>	The Operational Commander shall immediately notify the unit as to whether or not continuing the mission is authorized, and the conditions under which the boat may be operated.

<b>Casualty/Discrepancy</b>	<b>Consequence</b>	<b>Required Action</b>
<p><b><u>Disabling Casualty</u></b></p> <p>"Boat is not serviceable."</p>	<p>Not authorized to get underway.</p> <p>Notify Operational Commander immediately by the most expeditious means, and follow up by a boat status message.</p>	<p>Assign "Charlie" status to the boat, and commence repairs immediately. Submit CASREP if applicable.</p>
<p><b><u>Restrictive Discrepancy</u></b></p> <p>"Boat and crew cannot perform <u>all</u> missions safely."</p>	<p>Operations restricted.</p> <p>Notify Operational Commander if repairs cannot be made in 1 hour.</p>	<p>Create repair plan and set deadline for completion of repairs. Group/Operational Commander shall monitor progress of repairs. Any operations before restrictive discrepancies are repaired require written waiver (see A.3.b. above) from the Group/Operational Commander. Submit CASREP if applicable.</p>
<p><b><u>Major Discrepancy</u></b></p> <p>"Boat and crew can perform all missions but <u>some</u> degradation in effectiveness or readiness should be expected."</p>	<p>Operations unrestricted.</p> <p>Discrepancy occurrence and repair is documented.</p>	<p>Maintenance plan is carried out. Group/Operational Commander shall monitor status of repairs to the discrepancies.</p>
<p><b><u>Minor Discrepancy</u></b></p> <p>"Boat and crew readiness not affected nor impaired. Boat does not meet standards."</p>	<p>Operations unrestricted.</p> <p>Discrepancy occurrence and repair is documented.</p>	<p>Maintenance plan is carried out. Station CO/OIC monitors completion of maintenance/repair.</p>



**A.7.  
Environmental  
limits**

---

The 49' BUSL is built to operate safely under weather conditions within its design limits. With approval from the Operational Commander, crews may operate the boat in conditions that exceed the environmental limits; however, the coxswain is ultimately responsible and must always make the final determination whether the boat and crew can safely perform the mission.

The following are critical operational and environmental limitations:

- maximum sea state for buoy operation (3 feet)
- maximum sea state for transiting (6 feet)
- up to 4,500-pound lifting capability

**NOTE** 

These limits may be exceeded by approval of the Operational Commander; ONLY after appropriate risk assessment for the situation at hand is made. On-scene conditions provided by the on-scene commander and BUSL coxswain must be considered in the risk assessment process. The coxswain retains the final on-scene decision as to whether or not an action may be safely executed.

---



**(This page intentionally left blank.)**



## Section B. Performance Data

### B.1. Fuel consumption

Fuel consumption and operating range is affected by engine tuning, weather conditions, trim, type of evolution (towing, searching, etc.) and operating area (e.g. shallow water increases resistance, decreases range). Figure 5-1 shows typical fuel consumption at full load condition; 2300 engine RPM at 10.5 knots. The range at 10 knots (full load) is 400 nautical miles.

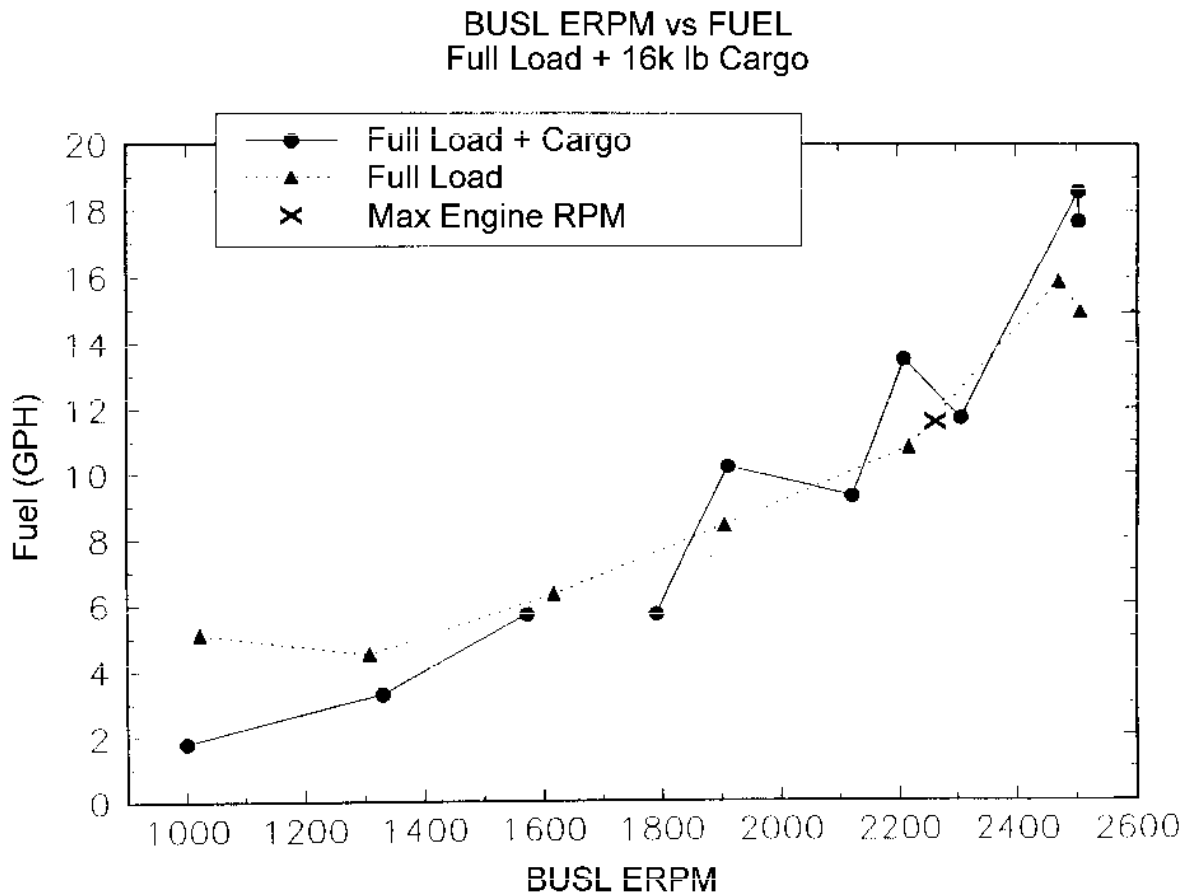

**Figure 5-1**  
**Fuel Consumption vs. Speed**



---

**B.2. Seakeeping** Positioning the vessel with respect to the wind, seas, other craft, and established routes of navigation is essential to prevent damage to the hull or injuries to the crew.

**WARNING** 

The coxswain is responsible for ensuring that all required personal safety equipment is worn, and worn properly.

---

**B.2.a. Operating in beam seas**

Operating with the seas on the beam is more uncomfortable than dangerous when following basic small boat handling guidelines. The danger exists when operations occur in conditions that approach or exceed wind and sea limitations. Use the following techniques to minimize danger:

- Tacking - With large seas on your beam, tack across the seas at a slight angle in a zigzag fashion. This prevents exposure of the beam to heavy swells.
- Changing Course - To change course heading, allow the boat to lose headway, turn the wheel hard over, and apply power to come smartly to the new heading.

**WARNING** 

The position of the boat in relation to a breaking wave crest is critical. Severe wave slap will occur in the area approximately two boat lengths in either direction of the breaking water, however, this area presents less danger of capsizing.

**CAUTION !**

When operating in beam seas, do not allow the boat to become "dead-in-the-water" and be hit broadside by a wave.

---

**B.2.b. Operating in following seas**

Following seas present the greatest dangers to the 49' BUSL. The utility boat does not have the balanced buoyancy or ability to lay-to in a following sea like a motor lifeboat. With the wide, flat stern, large following seas become a serious problem. The operational limitations are the controlling guideline and must be followed at all times. Consider the following points and techniques when operating under these conditions:

- Operation in a following sea involves a risk of surfing on the face of a swell or breaker. This situation is extremely dangerous. Control of the boat may be impossible.
  - Do not power the boat over the crest of a wave and into the trough of the next wave or bury the bow into the back of the next wave.
  - The 49' BUSL has the tendency to slip down the back of the seas, heeling heavily at the bottom of the trough.
-



IF...	THEN...
The boat is being pulled back.	Increase the throttles to gain additional forward momentum.
The boat continues being pulled back.	Be alert for "sluggish" helm response and higher engine RPM (cavitation).
Either situation occurs.	<b>Immediately back off</b> the throttles losing forward momentum, then apply <b>full throttle and rudders</b> and try to kick out of the wave.
<p><b>CAUTION !</b> Carefully observe the seas off the stern to ensure maneuvering room.</p>	
Riding the back of the wave is not possible.	Try to prevent seas from overtaking, breaking under, or breaking over the transom.

**B.2.c. Operating in white water**

If white water is observed overtaking from astern, quickly stop all forward motion and gain sternway before the white water reaches the propellers and rudders. If this is not possible, another option is to come about smartly; present the bow to the sea, and gain sufficient headway to establish rudder and throttle control before the white water reaches the boat. Again, carefully observe the seas off the stern to ensure maneuvering room.

**B.3. Turning**

Turning radius is affected internally by the boat's speed, rudder angle, and hull design and externally by wind, current, and wave action. Refer to *Chapter 6, Section C* of this handbook for methods to plan effective turns. Table 5-1 shows typical rudder-only turning performance.





**Table 5-1  
Turning Performance**

Initial Speed (knots)	Rudder Position (deg)	Engine RPM	Time to Turn 180 deg (sec)	Time to Turn 360 deg (sec)	Tactical Diameter (feet)	Advance at 90 deg (feet)	Transfer at 90 deg (feet)	Turning Speed <sub>avg</sub> at 180 deg (knots)
6.1	10	1250	124	240	781	380	350	5.5
6.3	20	1250	68	133	349	199	177	5.5
5.9	30	1250	55	105	260	150	110	5.5
10.4	10	2300	68	132	726	350	322	9.2
10.4	20	2300	40	74	366	233	190	9.2
9.3	30	2300	28	57	256	180	120	8

**B.4. Stability**

Stability is a measure of a ship or boat's ability to return to its original position when it is disturbed by a force such as winds, heavy seas or rudder angle, and the force is then removed. By virtue of hull design and equipment placement, the BUSL displays positive stability. Positive stability means that the BUSL will return to its original position after being disturbed by an external force.

The positive stability of the BUSL is greatly affected by any additional heavy loads that are placed above the water line. Any buoys that are secured to the buoy deck will have an adverse affect on the reserve stability and righting arm of the BUSL.

The BUSL has a tendency to roll during buoy handling operations as a result of winds or sea state conditions and it may be unsafe to assume that the maximum safe capacity of the A-frame can be achieved.

Ensuring the bilge areas are always free of water, eliminating the free surface affect of liquids in the bilges, and ensuring that topside weather deck freeports are kept free to allow water to drain off the deck are essential to maintaining stability of the BUSL.

**B.5. Acceleration**

The average minimum time for the BUSL to accelerate to full speed is 17 seconds, achieving that speed in 4.3 boat lengths.

**NOTE**

Do not use rapid accelerations from dead-in-the-water (DIW) to full speed except when necessary. This conserves fuel and helps prolong engine life.



---

**B.6. Speed**

At full load, the BUSL achieves 10 knots at 2200 engine RPM, with a fuel rate of approximately 11 GPH. At full load plus cargo (16,000 pounds), the BUSL achieves 10.5 knots at 2300 engine RPM with a fuel rate of approximately 12 GPH.

**NOTE** 

Maximum speed/power should be used only when operationally necessary. Under non-urgent conditions, proceed at cruise speed.

---

**B.7.  
Deceleration**

To decelerate from full ahead to dead-in-the-water (DIW) takes 12 seconds or 2.5 boat lengths.

**CAUTION !**

Use a "crash stop" only when absolutely necessary. Crash stops place significant strain on the propulsion system.

**NOTE** 

There is a four-second delay from full ahead to full astern before the propulsion plant responds to the throttle command.

---



**(This page intentionally left blank.)**



## Chapter 6

# Mission Performance

## Overview

---

### Introduction

The actions and techniques described in this chapter are products of field experience. They are intended to give boat crewmembers information on how the 49' BUSL performs and reacts in various mission scenarios. The information is not intended to provide the "only way" to perform an action or complete a mission. Boat crews should use effective communications and teamwork skills along with this general information to adapt their actions to each unique mission scenario.

Information in this section a

lone does not qualify a crewmember. Observe these procedures and apply skills developed through practice to effectively use the BUSL to perform missions.

---

### In this chapter

This chapter contains the following sections:

Section	Topic	See Page
A	Starting Procedures	6-3
B	Underway	6-9
C	Handling Characteristics	6-11
D	Aids to Navigation Operations	6-21
E	Towing	6-31
F	Anchoring	6-33
G	Personnel Recovery	6-35
H	Ice Conditions	6-37
I	Securing Procedures	6-39
J	Securing Procedures (Cold Weather)	6-41

---



**(This page intentionally left blank.)**



## Section A. Starting Procedures

### A.1. Pre-start

The following procedures must be completed before starting a cold engine, and should be repeated before each mission.

Step	Action
1	Inspect bilges for excessive amounts of water. Look for signs of spilled fuel or oils. Pump and clean as necessary.
2	Sound fuel oil tank. Ensure fuel oil is maintained at 95 percent (783 gallons). Fuel sounding tubes are port and starboard side forward of the buoy deck.
3	<p>Check the following fluid levels:</p> <p><b>CAUTION!</b> Do not open the coolant expansion tank cap on a hot engine.</p> <ul style="list-style-type: none"> <li>• Engine oil level filled to FULL mark.</li> <li>• Reduction gear oil filled at least to FULL mark.</li> </ul> <p><b>NOTE</b> ⚡ Reduction gear oil will normally be above the "H" mark when the reduction gear is not turning. The reduction gear oil level must be checked again with the engine running at low idle. At low idle, the level must be between the "L" and the "H" marks on the dipstick.</p> <ul style="list-style-type: none"> <li>• Check coolant by removing cap and looking into the expansion tank, it should be full. The fluid recovery tank should be 1/4 to 1/2 full.</li> </ul>
4	Ensure air intake is clear and machinery space ventilation flapper is <i>open</i> .
5	Check sea strainers for cleanliness and open sea suction valves.
6	Ensure fuel supply valves are <i>open</i> to fuel tank.
7	Check all belts for proper tension.
8	<p>Ensure all breakers on 120-VAC power panel are <i>on</i> including:</p> <ul style="list-style-type: none"> <li>• LC1</li> <li>• Lighting and power panel (01-7-1)</li> <li>• Galley panel (2-6-0)</li> <li>• Machinery panel (2-4-1)</li> </ul>



Step	Action
9	Ensure all breakers on all 24-VDC power panels are <i>on</i> including: <ul style="list-style-type: none"> <li>• LC2 (Machinery Space)</li> <li>• Pilothouse</li> </ul>

**A.2. Lighting off the generator set**

A.2.a. Preparation

The following procedures must be performed in preparation for generator light off:

**CAUTION !**

Always let the engine cool down before removing the expansion tank coolant pressure cap. Turn the cap slowly and do not open fully until the pressure is relieved. Do not open the cap on a hot engine.

Step	Action
1	Verify the coolant expansion tank level is full.
2	Check the oil level. It should be just below the HIGH level mark on the dipstick.
3	Ensure that the fuel system is aligned to support operation of the diesel generator set.
4	Visually inspect the bottom of the duplex fuel oil filter bowl for the presence of water and sediment. Drain and dispose of as required.
5	Visually inspect the engine for loose or missing components and repair as required.

A.2.b. Light off

The following procedures must be performed to light off the generator set:

**CAUTION !**

Excessive cranking can overheat the starter motor and cause it to fail. Do not crank the engine for more than 30 seconds at a time. If engine fails to start, wait two minutes prior to attempting another start.

Step	Action
1	Hold the START-RUN-STOP switch at the local panel in the START position.



Step	Action
2	If the engine starts, release the switch and verify positive lube oil pressure. Stop the engine immediately if no oil pressure or less than 20 PSI is indicated on the oil pressure gage.
3	Once the engine has started, verify that the oil pressure is 35 - 60 PSI and that the coolant temperature is between 170 and 210 °F during operation.

### A.3. Transferring power

The following procedures must be performed to transfer power from shore to ship and from ship to shore:

**NOTE** ☞ Shore power supply and diesel generator circuits are interlocked to prevent simultaneous operation. This is accomplished using a mechanical interlock.

#### A.3.a. From shore to ship

The following procedures must be performed to transfer power from shore to ship:

Step	Action
1	Ensure the ship service diesel generator is operating.
2	Verify the engine parameters are normal.
3	Verify at the generator local control panel that the generator output is 120 VAC, 60 Hz; that the voltage regulator is in <i>automatic</i> ; and that the generator output breaker is <i>closed</i> .
4	At LC1, <i>open</i> the shore power breaker then <i>close</i> the generator breaker.
5	At LC1, verify readings, frequency, volts, amps, and grounds.
6	At LC1, verify the breakers for the lighting and power panel (01-7-1), the galley panel (2-6-0) and the machinery panel (2-4-1) are closed.
7	Open shore power feed breaker on the pier.
8	Disconnect and stow shore power cable.





A.3.b. From ship to shore The following procedures must be performed to transfer power from ship to shore:

Step	Action
1	Verify shore power is available and capable of handling the boat's in port requirements. The shore tie breaker capacity is 100 amps.
2	Connect the shore power cable to the boat's shore power receptacle.
3	Energize the shore power feeder breaker on the pier.
4	At LC1, verify readings, frequency, volts, amps, and grounds.
5	At LC1, <i>open</i> the generator breaker and <i>close</i> the shore power breaker.
6	With all loads removed from generator set, run for five minutes to cool down. Momentarily position the CONTROL PANEL switch on the local generator control panel to the <i>stop</i> position.

**A.4. Starting the engines**

The following procedures must be performed to start the engines:

Step	Action
1	Set throttle levers to <i>neutral</i> position at all operating stations, select control station, ensure proper fuel system alignment, energize shaft cooling pump, and secure hot starts.
<b>NOTE</b> ⚡	If the 24-VDC vital power panels and START switches are energized from the engine room, the throttle alarms and alarm panel in the pilothouse must be acknowledged before starting the main diesel engines.
<b>NOTE</b> ⚡	During light off, the throttle must be recognized prior to starting the engine.
<b>CAUTION !</b>	Engine will not start without oil pressure (10 PSI minimum).
2	Depress the START button at least three or more times until sufficient oil pressure develops to let the engine start. Do not hold the button. Initial start-up should occur at the local panel.



Step	Action
3	Repeat the previous step for the second engine.
<b>NOTE</b>	There are two banks of batteries connected to two 4-position battery switches. One switch is for vitals, the other for starting. If the engine will not start on BANK 1, switch to BANK 2. If the engine still won't start, switch to BOTH.
4	Visually check the gages in the engine room for proper operation and operating ranges.

**A.5. Energizing equipment** The following steps must be completed prior to getting underway:

Step	Action
1	<i>Close (turn on)</i> all of the remaining breakers on the 24-VDC and 120-VAC power panels.
2	Energize and test all installed electronic components.
3	Conduct operational test on the steering system. Ensure stop-to-stop movement on the rudder angle indicator.
4	When a control station is selected with the throttle levers in <i>neutral</i> , the red STATION ACTIVE light should illuminate.
5	Test throttle operation in <i>forward</i> and <i>reverse</i> .
<b>NOTE</b>	Depressing and holding the STATION ACTIVE button for more than one second disables all control stations; gearboxes return to <i>neutral</i> and engines return to <i>idle</i> . To regain control, place the throttle levers in the <i>neutral</i> position and momentarily depress the STATION ACTIVE button again.
<b>NOTE</b>	The STATION ACTIVE light will flash during station transfer if the throttle position at the new station is not matched to the old station.
6	Repeat steps 3, 4 and 5 at each control station.
7	Ensure gear is properly stowed and watertight integrity is set.
8	Inform coxswain on the status of all engineering and electronic systems and if the boat is ready to get underway.
9	Ensure potable water tank is 95 percent (285 gallons).



<b>Step</b>	<b>Action</b>
10	Ensure sewage tank is less than 1/3 full (83 gallons) or empty.
11	Energize the electronics in the following order: a. Standard Workstation III (log in as user prior to proceeding to next step). b. Energize DGPS. c. Energize the universal marine interface (UMI). d. Energize remaining electronics.



## Section B. Underway

**B.1. General** After getting underway, observe all appropriate machinery gages. If an abnormal condition develops, take corrective action to prevent further damage. Refer to Chapter 7 of this handbook, *C. G. Boat Operations and Training (BOAT) Manual COMDTINST M16114.32 Volume I, COMDTINST M16114.33 Volume II* (series), or the appropriate manufacturer’s technical publication.

**B.2. Personal protective gear** Always observe the requirements of this handbook; *Boat Crew Seamanship Manual*, COMDTINST M16114.5 (series), and *Rescue and Survival Systems Manual*, COMDTINST M10470.10 (series) for wearing protective clothing, personal flotation devices and boat crew signal kits.

**B.3. Communication** Crew communications and coordination is the key to safe operations. Crewmembers should inform the coxswain of their location when moving about the deck. Engine noise can make crew communications difficult on the 49’ BUSL; speak loudly and clearly repeating as necessary until acknowledged.

**B.4. Changing control stations** The following are the steps necessary to change control stations aboard the 49’ BUSL:

Step	Action
1	Place active throttle in <i>neutral</i> position.
2	Select intended helm position.
3	Proceed to the new control station and press the HELM ACTIVATE button to take control of steering from that station.
4	Press the STATION ACTIVE button at the new control station. The red LED light for that station will begin to flash.
<b>NOTE</b>	Nothing will happen if the transfer does not occur. The boat will maintain its course and speed.
5	Move the throttles out of the <i>neutral</i> position to verify control.



**(This page intentionally left blank.)**



## Section C. Handling Characteristics

---

### Introduction

Boat handling is a complex skill that requires extensive knowledge and practical underway experience to build confidence and skill levels. Properly handling a 49' BUSL requires forethought and finesse. Always know the boat's handling features, monitor the prevailing weather conditions, and take into account the vessel's limiting factors.

---

### In this section

This section contains the following information:

Topic	See Page
Turning and Pivoting	6-12
Head Seas	6-14
Beam Seas and Following Seas	6-15
Effects of Wind	6-17
Effects of Current	6-18
Station Keeping	6-19

---



# Turning and Pivoting

## C.1. General

The 49' BUSL rotates in a transverse direction about a vertical axis on its pivot point. The fore and aft location of the pivot point is just forward of amidships when the boat is at rest. As the boat moves ahead or astern, the pivot point moves either forward or aft, respectively. Turning the helm to move the bow port or starboard will cause the stern to swing in the opposite direction. Depending on the position of the pivot point, the stern could swing through a greater distance than the bow at the same angle. The higher the forward speed, the farther the forward movement of the pivot point.

## C.2. Split throttle turn

The split throttle turn is a low-speed maneuver. It is important when changing the boat's heading (to the weather or another vessel) or when moving the bow or stern in a limited area. In either situation, the forces involved must be considered. The rudder can use screw discharge current from the ahead engine to help pivot the stern. Because boats operate more efficiently ahead, some headway may develop.

### C.2.a. Helm amidships

The following procedures should be followed when performing a split throttle turn with helm amidships:

**NOTE** 

The turn described is to *port*. The procedures can be duplicated in an opposite manner for a *starboard* turn.

Step	Action
1	At dead-in-the-water and throttles in <i>neutral</i> , simultaneously clutch <i>ahead</i> with starboard engine, and clutch <i>astern</i> with port engine (keep both engine RPMs the same, though in opposite direction).
2	Note the arcs described by bow and stern as the vessel swings through 360 degrees to determine vessel pivot point.
3	If vessel moved forward (along its centerline) during the rotation, slightly increase astern RPM to compensate.
4	Simultaneously shift throttles so port is clutch <i>ahead</i> and starboard is clutch <i>astern</i> ; note how long it takes to stop and reverse direction of swing.
5	Again check bow and stern arcs as vessel swings through 360



Step	Action
	degrees then stop the swing.
	<p><b>NOTE</b> </p> <div style="border: 2px solid black; padding: 5px;"> <p>At some level of power for each vessel and drive train arrangement, cavitation will occur with split throttles. Know at what throttle settings cavitation occurs. More power will not increase turning ability and might cause temporary loss of maneuverability until cavitation subsides. In critical situations, loss of effective power could leave a vessel vulnerable.</p> </div>

**C.3. Restricted maneuvering**

In restricted maneuvering, some operators choose to use only the throttles, leaving the rudders amidships. This technique can work well but operators should be familiar with combined rudder and propulsion techniques, which may be required in high wind situations, or with vessels alongside.





## Head Seas

---

**C.4. General**      Traveling into head seas normally presents no problems if operations remain within the defined wind and sea limiting factors.

---

**C.5. Buoyancy**      The buoyancy of the wide, flat stern of the 49' BUSL has a greater lifting factor than the bow. When operating at or near the maximum sea-limiting factor, the coxswain must maneuver constantly using both the rudders and main engines to keep the bow from burying into the seas.

---



## Beam Seas and Following Seas

---

**C.6. Operating in beam seas** Operating with the seas on the beam is more uncomfortable than dangerous when following basic small boat handling guidelines. The danger exists when operations occur in conditions that approach or exceed wind and sea limitations. Use the following techniques to minimize danger:

---

C.6.a. Tacking With large seas on the beam, tack across the seas at a slight angle in a zigzag fashion. This prevents exposure of the beam to heavy swells.

---

C.6.b. Changing course To change course heading, allow the boat to lose headway, turn the wheel hard over, and apply power to come smartly to the new heading.

---

**WARNING**  Do not allow the boat to become "dead-in-the-water" and be hit broadside by a wave.

---

**WARNING**  The position of the boat in relation to a breaking wave crest is critical. Severe wave slap will occur in the area approximately two boat lengths in either direction of the breaking water, however, this area presents less danger of capsize.

---

**C.7. Operating in following seas** Following seas present the greatest dangers to the 49' BUSL. The utility boat does not have the balanced buoyancy or ability to lay-to in a following sea like a motor lifeboat. With the wide, flat stern, large following seas become a serious problem. The operational limitations are the controlling guideline and must be followed at all times. Consider the following points and techniques when operating under these conditions:

- Operation in a following sea involves a risk of surfing on the face of a swell or breaker. This situation is extremely dangerous. Control of the boat may be impossible.
  - Do not power the boat over the crest of a wave and into the trough of the next wave or bury the bow into the back of the next wave.
  - The 49' BUSL has a tendency to slip down the back of seas, heeling heavily at the bottom or trough.
-



IF...	THEN...
The boat is being pulled back.	Increase the throttles to gain additional forward momentum.
The boat continues being pulled back.	Be alert for "sluggish" helm response and higher engine RPM (cavitation).
Either situation occurs.	<b>Immediately back off</b> the throttles losing forward momentum, then apply <b>full throttle and rudders</b> and try to kick out of the wave.
<b>CAUTION !</b> Carefully observe the seas off the stern to ensure maneuvering room.	
Riding the back of the wave is not possible.	Try to prevent seas from overtaking, breaking under, or breaking over the transom.

**C.8. White water**

If white water overtaking from astern is observed, quickly stop all forward motion and gain sternway before the white water reaches the propellers and rudders. If this is not possible, another option is to come about smartly; present the bow to the sea, and gain sufficient headway to establish rudder and throttle control before the white water reaches the boat. Again, carefully observe the seas off the stern to ensure maneuvering room.



## Effects of Wind

---

<b>C.9. Turning the bow</b>	The 49' BUSL, with its high cabin area near the bow and low freeboard aft, will tend to ride stern to the wind. The BUSL will make leeway (drift downwind) at a speed proportional to the wind velocity and the amount of sail area.
C.9.a. Restricted maneuvering	In restricted maneuvering situations (ATON operations, alongside, at marinas, piers, wharves, etc.), analyzing the environmental conditions and using them to help rather than hinder operations is the way to deal with the large sail area created by the bow and superstructure.
C.9.b. Towing in winds	Bow into weather towing approaches become very difficult if the wind exceeds 30 knots. Once the wind catches the bow, it can be difficult to turn the bow back up into wind while station keeping. Stern-to approaches often solve this problem.

---



## Effects of Current

---

### **C.10. Vessel stability in current**

One of the environmental forces that affect the vessel is the current. It is important to remember that the Coxswain has no control over the current or any other environmental force. The design of the 49' BUSL, with its high cabin area near the bow, low freeboard aft, twin engines and responsive rudder control, makes it a stable vessel if the Coxswain observes and is aware of existing current conditions. Coxswains should also be familiar with the effects the current might impose on the skegs.

---

#### **C.10.a. Operating in current conditions**

Current will act on the vessel's underwater hull. Current will generally cause a vessel to drift over the ground. A one-knot current may affect the 49' BUSL to the same degree as 30 knots of wind. A strong current will move a vessel upwind.

---

#### **C.10.b. Recognizing current conditions**

The Coxswain and other crewmembers should be aware of existing signs of current flow and where current shear might be present. Large stationary objects such as a breakwater or jetty will cause a major change in the amount and direction of the current. On the downstream side of a jetty or breakwater, the crewmembers should be aware of current eddy. Caution should be taken when in current around floating piers or those with open pile supports. Crewmembers should look for current wake or flow patterns around buoys or piers. When current goes against the wind, the wave pattern will be steeper and closer together. Extreme caution should be taken when operating in conditions where current and wind are funneled one against the other. Tide rips, breaking bars and gorge conditions will make handling the 49' BUSL extremely challenging. Making leeway when drifting downstream (down current) requires a change in approach (actual track vs. intended track) to prevent overshooting your landing.

---



## Station Keeping

---

**C.11. General** Station keeping requires concentration to maintain a constant heading and position. The boat tends to work well with its stern to the wind as the bow tends to "weathervane" downwind. If stern-to station keeping is not an option, the operator must use extra care to counteract environmental factors.

---



**(This page intentionally left blank.)**



## Section D. Aids to Navigation Operations

---

### D.1. General

The 49' BUSL is a stern-loading buoy boat with the buoy deck aft for more space and an A-frame located on the stern. The 49' BUSL has the following operating characteristics:

- A-frame has a working load limit of 4,500 pounds and a cargo capacity of 16,000 pounds.
- Uses an integrated hydraulic buoy handling system consisting of an A-frame with two boom winches that work in unison. In addition, the boat has two deck winches with a working load limit of 1,500 pounds each. The deck winches work independently.
- Is twin screw and has dual steering stations located fore and aft in the pilothouse.
- Can relieve floating aids up to and including a 5- by 11-foot lighted buoy, or up to a third class unlighted buoy. A sinker of 4,000 pounds and up to a 1 1/8-inch chain can be handled.
- Because this boat is stern loading, it must back into the wind or current to work buoys. When making the approach, the A-frame should be in a position to allow easy hook up with the whips depending on size or class of the buoy. The chain stopper should be in the locked position and the cross deck led out to assist in stabilizing the buoy while it is being brought aboard.

Prior to any buoy deck evolution, the Buoy Deck Supervisor (BDS) shall perform daily inspections of all rigging equipment.

---

### D.2. Personal Protective Equipment

The following personal protective equipment shall be worn at all times while the buoy hydraulic system is energized and operating.

- Hard hat with chin strap
- Safety glasses (ANSI Z87.1) rated
- Personal floatation device appropriate for weather conditions
- SAR Vest (may be removed during buoy operations by direction of the CO/OINC and Coxswain.)
- Safety toed boots
- Leather gloves (unless handling lines)
- Knife





**NOTE** ~ Removal of all jewelry (watches, rings etc.) during Buoy deck evolution is mandatory.

**D.3. Energizing the buoy hydraulic system**

Perform the following procedures to properly energize the buoy hydraulic system:

Step	Action
1	On pilothouse aft console, verify selector switches for hydraulic control. <ul style="list-style-type: none"> <li>• LOAD/NO LOAD Switch – NO LOAD</li> <li>• ENGAGE/DISENGAGE Switch – DISENGAGE</li> </ul>
2	Ensure hydraulic oil reservoir capacity is approximately 44 gallons - normal operating level.
3	Perform visual check of hydraulic system components for static leaks and any physical damage to system components (e.g. A-frame, A-frame winches, deck winches, A-frame actuating cylinders, machinery components).
<p><b>NOTE</b> ~ The AC diesel generator set must be in operation to perform power-on pre-start checks of the buoy handling system.</p>	
4	Verify control switches at local machinery space panel. For operational system pre-start checks, position the switches on the local control panel as follows: <ul style="list-style-type: none"> <li>• CONTROL Switch - <i>LOCAL</i></li> <li>• PTO Switch - <i>NO LOAD</i> and <i>DISENGAGE</i></li> </ul>
5	Energize the breaker on LC2, buoy handling hydraulic system control is <i>closed/on</i> .
6	Start the diesel generator set and verify operating parameters.
7	Position PTO switch on local machinery space panel to the <i>ENGAGE</i> position.
8	Verify hydraulic system pressure (2150 PSI) on local pressure gage and visually inspect pressurized system components for leaks.



Step	Action
9	Once system operation has been verified, place PTO switch on local machinery space panel to the <i>NO LOAD, DISENGAGE</i> position and place control switch in <i>remote</i> position.

**D.4. Operating the buoy handling hydraulic system (from the pilothouse)**

Perform the following procedures to properly operate the buoy handling hydraulic system (from the pilothouse):

Step	Action
1	Ensure that all buoy handling controls on the aft console in the pilothouse are in the <i>neutral</i> position.
2	When required, place the switches on the buoy console in the pilothouse to the <i>ENGAGE</i> and <i>LOAD</i> position.
3	Verify system pressure and temperature.
4	Establish communications with buoy deck crew prior to actuating winches or A-frame controls.
5	Perform required system check of cross deck winches, chain stopper, A-frame and winches prior to buoy deck operations.
6	Layout and inspect all gear needed for the operation
7	Perform safety brief prior to buoy operations



### D.5. Hoisting the buoy

**NOTE** 

The following information is the STANDARD evolution for buoy operations with the 49' BUSL.

The boat is maneuvered to the buoy and is maintained in a steady position. When the coxswain is ready, "hook it when you can" is passed. The Buoy Deck Supervisor now has permission to bring the buoy aboard. Perform the procedures in the following order to properly hoist the buoy:

**WARNING** 

Perform safety brief prior to buoy operations.

Step	Action
1	Hook both whips into the buoy utilizing mechanical line reeving device. Lift the buoy until the whips are supporting the weight of the aid.
<p><b>NOTE</b> </p> <p>The hooks should always be placed opposite of each other during the lifts.</p>	
<p><b>CAUTION!</b></p> <p>Do not use weather hitches to mouse the hooks.</p>	
2	Boom forward, snugging the buoy hull into the V-notch. Attach the cross deck to the buoy bail and mouse the hooks.
3	Lift the buoy high enough to clear the chain stopper and boom forward while keeping the cross deck taut. Ensure the load is kept close to the deck. The chain will fair lead into the chain stopper and the chain stopper will automatically engage when the buoy is slacked off or lowered. Ensure stopper is engaged and use a maul to ensure that the chain is properly seated in the chain stopper.
4	Lower the buoy to the deck (the use of buoy saddles or dunnage under the buoy is required).
5	Set the pelican.
6	Gripe the buoy.
7	Disconnect the buoy from the mooring



### D.6. Pulling chain

Perform the following procedures to properly pull chain:

Step	Action
1	Rig the horse collar.
2	Attach cross deck to the mooring chain forward of the pelican hook.
3	Clear the pelican hook from the mooring chain.
4	Use cross deck to pull the chain to short stay.
5	If unable to pull chain using the cross deck, position the boom to pull chain with the whips. Use the cross deck as necessary to set the chain in the stopper. Seat the chain in the stopper each time with a hammer.
<b>NOTE</b> 	When pulling chain with the whips, use a shackle (modeer) to allow a single point pull of chain.
6	Once at short stay, set the chain in the stopper and advise the coxswain.
<b>CAUTION!</b>	Always use the pelican hook when breaking or dragging a sinker. <b>Do not</b> use the chain stopper for this portion of the evolution.
7	If unable to break the sinker from the bottom, clear the whips from the chain, set the pelican, remove the horse collar and trip the stopper. Come ahead on the boat and break the sinker from the bottom.
8	To reset the stopper to the upright position, use the cross deck while the crewman applies tension to the stopper retrieval line.
9	Rig the horse collar and then put the whip hooks into the shackle. Pull the chain until the rock is in sight.
10	Remove the horse collar. Position the boom so that when the sinker is lifted it will clear the stern. Utilize the cross deck to stabilize the sinker while bringing it aboard.
11	Bring the sinker on deck and set it on dunnage and gripe.

**D.7. Setting the buoy**

Perform the procedures in the following order to properly set the buoy:

<b>Step</b>	<b>Action</b>
1	With the sinker and buoy positioned on deck, position the boom until the whips are centered over the sinker. Attach the whips to the sinker's pigtail and mouse the hooks. Attach the cross deck to the chain to assist in stabilizing the load. Set the pelican. Lift the sinker just high enough to clear the chain stopper, keeping equal strain on both whips.
2	Boom aft until the sinker clears the stern.
3	Lead the chain into the chain stopper and slowly lower the sinker over the stern far enough to let it hang below the bottom of the boat. Make sure the chain is set in the chain stopper and that the chain stopper is locked in the upright position.
4	Unhook the whips. Fake the chain and rotten stop it to the bull chain as necessary.
5	Position the boom so that the whips are over the buoy. Attach the cross deck to assist in stabilizing the buoy.
6	Hook whips into the buoy, mouse the hooks, shackle the buoy to the mooring, break the gripes and lift the buoy until it clears the deck, keeping it as close to the deck as possible.
7	Move the buoy over the stern. Lower the buoy until it is one-third into the water keeping the excess chain lashed to the bull chain. Unmouse the hooks and clear the cross deck.
8	Maneuver the boat into position. The Buoy Deck Supervisor will pass "Ready on Deck." On the coxswain's command to "Stand By,"
9	Clear the pelican.
10	Float the buoy.
11	Clear the whips.
12	Upon the coxswain's command to "Set the Buoy," trip the stopper, and the coxswain will pull away.

**D.8. Securing the system**

Perform the following procedures to properly secure the buoy handling system:

<b>Step</b>	<b>Action</b>
1	Stow/retract A-frame winch cables and cross deck winch cables.
2	Position A-frame as dictated by operational considerations.
3	Position all controls at pilothouse buoy handling console in the <i>neutral</i> position.
4	Position switches to <i>NO LOAD</i> and <i>DISENGAGE</i> on the pilothouse console.
5	If required, direct machinery space personnel to place the control switch at local panel to the <i>LOCAL</i> position.
6	De-energize the hydraulic system breaker.



D.9. Standard Hand signals for the 49' BUSL

 <p>A person in a white hard hat, sunglasses, and orange life vest with both arms raised in fists.</p>	 <p>A person in a white hard hat, sunglasses, and orange life vest with both arms raised in fists.</p>	 <p>A person in a white hard hat, sunglasses, and orange life vest with hands clasped in front of the chest.</p>
<p>Avast or stop</p>	<p>Emergency stop</p>	<p>Dog down or Secure</p>
 <p>A person in a white hard hat, sunglasses, and orange life vest pointing forward with the right hand.</p>	 <p>A person in a white hard hat, sunglasses, and orange life vest with the right hand pointing forward.</p>	 <p>A person in a white hard hat, sunglasses, and orange life vest with hands clasped in front of the chest.</p>
<p>Deck Supervisor transfer (After tapping on side of the helmet)</p>	<p>Forward on the A-frame</p>	<p>Aft on the A-frame</p>
 <p>A person in a white hard hat, sunglasses, and orange life vest with hands held flat and parallel to each other.</p>	 <p>A person in a white hard hat, sunglasses, and orange life vest with both index fingers pointing up.</p>	 <p>A person in a white hard hat, sunglasses, and orange life vest with the right index finger pointing up and the left hand pointing to the side.</p>
<p>Forward on the A-frame Keep the load level (Opposite to go aft)</p>	<p>Raise both whips (Opposite to lower)</p>	<p>Raise an individual whip Pointing at the whip to be worked (Opposite to lower)</p>



		<p>In some cases there may be the need for special signals not covered in this chart.</p> <p>The Boom/Crane Operator and the Buoy Deck Supervisor (BDS) must agree upon special signals in advance. These signals shall not conflict with the standard signals.</p>
<p style="text-align: center;"><b>Inhaul on the cross deck</b></p> <p>A waving motion towards yourself Pointing at the cable to be worked</p>	<p style="text-align: center;"><b>Pay out on the cross deck</b></p> <p>A waving motion away from you Pointing at the cable to be worked</p>	





**(This page intentionally left blank.)**



## Section E. Towing

---

**E.1. General** The 49' BUSL has enough power to handle any emergency towing job likely encountered. The coxswain should consider all factors concerning weather, sea state, distance to tow, and size of vessel before attempting each tow.

**CAUTION!**

During normal operations, engines should not overload for more than a few seconds, if at all. Continually overloading the engines shortens the service life of the engines significantly.

**E.2. Rigging a vessel for tow**

The preferred towing technique to utilize with the 49' BUSL is to tow alongside. If necessary to tow from astern, the following guidelines are provided:

The 49' BUSL is not outfitted with a towline or bridle, and therefore, the anchor line, which is a 2 ¾-inch double-braided nylon line, is best utilized for towing. Four rated screw pin shackles, which are provided in the outfit list may assist the crew in making the connection with the distressed vessel.

Two bull chain padeyes with a working load limit (WLL) of 12,000 pounds, located just aft of the buoy deck, are best utilized for rigging the towline.

**NOTE**

Familiarization with the requirements of the *Boat Crew Seamanship Manual*, COMDTINST M16114.5 (series), Chapter 17, Towing, will greatly assist in making the towing evolution a safe and successful operation.

**E.3. Affects of wind with vessel in tow**

The coxswain should be aware of additional affects the wind may have on the 49' BUSL with another vessel in tow. In addition, the coxswain should be aware of substantially increased fuel usage with a large vessel in tow.

**E.4. Tow watch**

The tow watch should be extremely vigilant in observing the condition and ride of the tow. When towing vessels lower than the 49' BUSL transom, or when towing with a long towline, chafing can occur along the transom. The tow watch should closely monitor this and react as necessary.

---



**(This page intentionally left blank.)**



## Section F. Anchoring

---

### F.1. General

The 49' BUSL is fitted with an anchoring system used when the boat must stand by a location or in an emergency.

---

### F.2. Anchoring the boat

A 60 pound Danforth anchor is stowed on the forward, port bulkhead of the pilothouse under the window. The anchor is secured in place with bungee cord. The anchor line consists of 300 feet of 2 ¾ double-braided nylon line and 6 feet of ½-inch BBB galvanized chain with swivel attached. The anchor line is stowed on the hawser reel.

Take the following steps to safely anchor the boat:

#### CAUTION!

When handling the anchor, two crewmembers are recommended.

Step	Action
1	Fair-lead the bight of the anchor line outboard of all deck fittings on the port side; pass the line through the open bullnose, take all slack out of the line and take it to the forward tow bitt with one round turn.
2	While one crewmember tends the anchor line at the forward bitt and as directed by the coxswain, remove the anchor from the bracket on the forward pilothouse bulkhead.
3	As directed by the coxswain, the anchor should be lowered over the side well clear of the boat.
4	Once the anchor is tending <i>up and down</i> , the coxswain should back down until the desired amount of scope is attained and the anchor line is secured.

### F.3. Weighing anchor

Take the following steps to safely weigh anchor:

#### CAUTION!

It is recommended to use two crewmembers to weigh the anchor and tend the bitt.

---



<b>Step</b>	<b>Action</b>
1	Position one crewmember at the bitt and one between the bitt and the bullnose. As the coxswain moves the boat slowly forward, the forward crewmembers take up the slack in the line while maintaining one round turn at the bitt.
2	Once the anchor is at "short stay," the anchor line should be secured at the forward bitt.
3	Crewmembers can then attempt to break the anchor free from the bottom. If unable to do so, the crewmembers shall stand clear of the line while the coxswain moves the boat slowly forward until the anchor breaks free.
4	Once free, the crewmembers can pull the remaining anchor line and the anchor onboard.
5	When the anchor is aboard, the coxswain should take up a stable course so that the crewmembers can stow the anchor and ground tackle.



## Section G. Personnel Recovery

**G.1. General** Person in the water situations are divided into two categories:

1. **Crewmembers:** Individuals from your boat, (reducing the size or your crew for response).
2. **Victims:** Other persons in the water, (allowing use of the full crew).

**G.2. Key issues** Key issues in PIW retrieval include:

Feature	Description
Freeboard	The buoy deck is wide, with relatively low freeboard (40" sides). This is the preferred location for PIW retrieval.
Maneuvering	The boat's speed and ease of handling greatly assist in returning and maneuvering for pickup. Though not appropriate in all conditions, variation of the standard techniques might speed recovery. For instance, by splitting the shafts one ahead and one astern, the 49' BUSL will turn in tight circle to come back on the person in the water.
<b>NOTE</b> 	Because the buoy deck is aft, the person in the water will be in close proximity to the propellers during recovery. Minimize use of the shafts when alongside the person in the water.
Sail Area	With any amount of wind, the high superstructure and shallow draft will cause the boat's stern to turn into the wind with its bow pointed in the direction the wind is blowing (downwind). This condition could cause pickup problems when getting in close.  Carefully assess how to compensate for the wind, seas, currents or any combination of them. PIW recovery should be with the bow into the wind and seas.
Crew Member Recovery	If an injured crewmember is in the water, carefully assess the risk. Exercise extreme caution if necessary to use a swimmer.



**(This page intentionally left blank.)**



## Section H. Ice Conditions

---

### H.1. General

The 49' BUSL is not designed to break ice as a mission and should avoid operations in this capacity. The BUSL can, however, operate through light surface ice up to 6 inches thick if necessary to reach open water or an aid to navigation for emergencies only. Do not exceed 6 knots when operating in ice conditions. In slush conditions, ensure that the seawater cooling system is checked regularly to ensure clogging has not occurred. Operations at high speed (during cold weather) will increase the likelihood of topside icing due to freezing spray.

#### WARNING

Excessive topside icing will greatly affect the boat's stability and righting arm.

#### WARNING

Keel coolers are unprotected and could be damaged when transiting through ice.

#### CAUTION!

Place rudder amidships prior to backing in ice. Encountering ice greater than two inches while backing astern may cause damage to underwater appendages.

#### NOTE

Be aware that freezing spray may seal hatches and scuttles thus limiting immediate or emergency access (i.e. deck box stowage).





**(This page intentionally left blank.)**



## Section I. Securing Procedures

**I.1. Procedures** The following procedures should be repeated after each mission:

Step	Action
1	Secure all electrical and electronic components in the pilothouse.
2	Secure engines using pushbuttons in the pilothouse or engine room following procedures in <i>Chapter 6, Section A.4.</i>
3	Shift electrical load from ship to shore power following procedures in <i>Chapter 6, Section A.3.b</i> of this handbook.
4	Energize equipment breakers in the 120-VAC power panel in the machinery space. Ensure battery charger is operating normally.
5	Secure all breakers in the 24-VDC power panel in the machinery space except for those required to maintain fire, flooding, and lighting systems.
6	Secure start system BATTERY CUTOFF switch.
7	Secure fuel supply valves to engines.
8	Close generator seawater suction valve.
9	Check all machinery fluid levels and refill as necessary.
<p><b>CAUTION!</b> Do not check engine coolant levels until temperature has dropped to 140 °F or below.</p>	
<p><b>NOTE</b> It may be necessary to wait 30 minutes to obtain an accurate reading on engine lube oil levels.</p>	
8	Conduct a visual inspection of the engine room bilges for any obvious abnormalities.
9	Clean engine room bilges and machinery.
10	Sound fuel oil tank and refill to 95 percent (750 gallons).
11	Secure all watertight doors, hatches, and covers. Close all weather-tight doors.
12	If directed, wash the boat down with freshwater.
Step	Action



**NOTE** 

Keeping the boat clean and neat is very important to control corrosion. Maintaining corrosion control is the responsibility of everyone in the crew.

**NOTE** 

The mission is not complete until the boat is ready for the next mission.





## Section J. Securing Procedures (Cold Weather)

**J.1. Procedures** The following procedures should be repeated after each mission when the water temperature reaches 40 degrees F. and below:

Step	Action
1	Secure all electrical and electronic components in the pilothouse.
2	Secure engines using pushbuttons in the pilothouse or engine room following procedures in <i>Chapter 6, Section A.4.</i>
3	Ensure battery charger is operating normally.
4	Secure all breakers in the 24-VDC power panels located in the pilot house and machinery space except for those required to maintain fire, flooding alarm panel, loud hailer, and lighting systems.
5	Secure air compressor circuit breaker on 120 VDC panel in engine room.
6	Ensure all HVAC units are secure.
7	Secure A/C saltwater cooling pump.
8	Shift electrical load from ship to shore power following procedures in <i>Chapter 6, Section A.3.b</i> of this handbook.
9	Secure start system BATTERY CUTOFF switch.
<p><b>CAUTION !</b> Do not check engine coolant levels until temperature has dropped to 140 °F or below.</p>	
<p><b>NOTE</b> It may be necessary to wait 30 minutes to obtain an accurate reading on engine lube oil levels.</p>	
10	Secure fuel supply valves to engines.
11	Close generator seawater suction valve.
12	Check all machinery fluid levels and refill as necessary.
13	Conduct a visual inspection of the engine room bilges for any obvious abnormalities.



Step	Action
14	Clean engine room bilges and machinery.
15	Energize all space heaters.
16	Energize all engine hot starts.
17	Ensure generator heater breaker located in engine room 120-VDC breaker panel is energized.
18	Sound fuel oil tank and refill to 95 percent (750 gallons).
19	Secure all watertight doors, hatches, and covers. Close all weather-tight doors.
20	If directed, wash the boat down with freshwater.
<b>NOTE</b> 	Keeping the boat clean and neat is very important to control corrosion. Maintaining corrosion control is the responsibility of everyone in the crew.
<b>NOTE</b> 	The mission is not complete until the boat is ready for the next mission.



# Chapter 7

## Emergency Procedures

### Overview

#### Introduction

Responding to equipment casualties and emergencies aboard the 49' BUSL should be second nature to all members of the crew. The ability of crewmembers to take immediate action to control emergency situations is critical to prevent a bad situation from getting worse. While every event is different, step-by-step procedures help gain control of the casualty and aid in troubleshooting.

The first step in responding to all casualties is to protect the immediate safety of all crewmembers and to communicate the nature of the casualty to the crewmembers. It is the coxswain's responsibility to keep the station informed of all emergencies encountered during the operation of the boat.

The *Safety & Environmental Health Manual COMDTINST M5100.47* provides additional guidance for a pre-mishap plan, and requirements for reporting mishaps on vessels.

The coxswain and engineer should work together to determine if equipment casualties could be safely repaired while underway. The coxswain must decide whether a casualty has impacted the ability of the boat and crew to complete the mission. The coxswain should not make the decision in a vacuum; input from other crewmembers, especially the engineer, as well as communication with shore side personnel, should be used to determine whether to continue with the mission. The following factors should be considered:

	<b>Factors</b>
1	The safety and physical condition of the crew and vessel.
2	Equipment limitations due to the casualty.
3	Current and forecast weather and sea conditions.
4	The urgency of the mission.



<b>Section</b>	<b>Topic</b>	<b>See Page</b>
A	Striking a Submerged Object	7-3
B	Steering Casualty	7-5
C	Reduction Gear Failure	7-7
D	Fire in the Engine Room	7-9
E	Loss of Control of Engine RPM	7-11
F	Loss of Fuel Oil Pressure	7-13
G	Loss of Lube Oil Pressure	7-15
H	Main Engine High Water Temperature	7-17
I	Generator Emergency Procedures	7-19
J	Excessive Shaft Seal Leakage	7-21
K	Flooding	7-23
L	Buoy Deck Hydraulic Failure	7-25
M	Major Fuel Oil/Lube Oil Leak	7-27



## Section A. Striking a Submerged Object

**A.1. General** Because of the nature of BUSL operations, it is not uncommon for the boat to strike submerged objects or bump the bottom.

**A.2. Actions** Upon striking a submerged object, take the following actions:

Step	Action
1	Reduce engine RPM throttles to <i>neutral</i> , and try to determine what the boat hit; inform the rest of the crew.
2	Check for flooding. Verify status of bilge alarms and physically check areas below the waterline.
3	The engineer and a crewman should proceed to the machinery space to check shafting for damage.
4	The crewman should check all forward compartments for damage. The engineer should check the engine room and lazarette for damage. Make reports to the coxswain.
5	Individually bring up the engine RPMs to determine range and severity of vibration. Also, check shaft seals for leakage.
6	Maintain engine RPMs, 200 RPMs below range of vibration. If vibration is too severe, secure engine and lock shaft.
<b>NOTE</b> 	If possible, the boat should be hoisted to determine extent of damage, especially if there is a vibration.





**(This page intentionally left blank.)**



## Section B. Steering Casualty

**B.1. Symptoms** While steering the boat, the wheel turns sluggishly or steering controls have no effect at all. When a complete loss of steering occurs, the coxswain or helmsman can continue to steer the boat with the engines alone.

**B.2. Actions** When a partial or complete loss of steering control occurs, take the following actions:

**NOTE** Loss of hydraulic oil pump will not affect the use of the manual steering system.

Step	Action
1	Reduce engine RPM to clutch ahead and inform the crew. Ensure the steering station is active. Check steering at both fore and aft stations. Keep engines operating to maintain maneuverability.
2	Check the expansion tank level in the pilothouse and steering gear hydraulic reservoir and components in the lazarette.
3	Check all spaces for presence of hydraulic oil leaks on lines that pass through them.
<p><b>NOTE</b>  If system is intact and pump failure is suspected, using the local control valve may center rudders.</p>	
4	Verify that the steering system HPU breaker on the 24-VDC power panel LC2 in the engine room is <i>closed/on</i> .
5	Verify that the autopilot and steering control power breaker at the 24-VDC power panel in the pilothouse is <i>closed/on</i> .



**(This page intentionally left blank.)**



## Section C. Reduction Gear Failure

**C.1. General** Both the electronic control system and the reduction gear system are activated from the throttle control stations.

**C.2. Actions** If the boat does not respond when the throttle(s) are operated in *forward* and *reverse*, take the following actions:

Step	Action
1	Bring the throttles back to <i>neutral</i> ; ensure the ACTIVE light is lit at the control station in use. Take control at other station and verify throttle operation. If the light is not lit and control cannot be taken, secure the affected engine(s).
2	The engineer should proceed to the machinery space and check throttle control system breakers on the 24-VDC-power panel to ensure the breakers have not tripped.
3	Ensure cables are attached to reduction gear controls.
4	The engineer should remove the deck plates to examine the affected reduction gear and check for oil leaks.
5	Check the reduction gear lube oil level.
6	If no leaks are present and the oil level is full, restart the engine and observe clutch apply pressure (300-320 PSI when the clutch is engaged).
7	If the clutch apply pressure is not sufficient, secure the engine and reduction gear. Allow engine to cool and check jacket water system for the presence of oil.
8	If all mechanical checks have been made, proceed to troubleshooting the electronic controls.
<b>NOTE</b> 	In the event of reduction gear electronic control failure, the reduction gear control valve can be operated manually by disconnecting the push-pull cable and operating the selector valve manually.
9	Attempt to take throttle control at each of the remaining throttle control stations.



10	If the affected transmission will not respond electronically or mechanically to clutch engagement. Secure the effected engine, lock shaft, and proceed to port for repairs.
----	---



---



## Section D. Fire in the Engine Room

**D.1. Symptoms** Signs of smoke coming from the engine room vent and/or an alarm at the central alarm panel in the pilothouse indicate an engine room fire.

**D.2. Actions** In the event of an engine room fire, take the following actions:

Step	Action
1	The coxswain should secure the engines and generator and inform all crewmembers.
2	The engineer should secure the fuel oil by pulling the emergency fuel cutout valves.
3	The engineer should proceed to the machinery space and ensure the engine room watertight door is tightly closed.
4	The engineer should try to determine size and source of fire by looking through the port light in the watertight door. If fire is observed or cause of smoke cannot be determined, notify the coxswain before discharging the CO <sub>2</sub> system.
5	The engineer should energize the CO <sub>2</sub> system by releasing the locking pin and depressing the handle on the CO <sub>2</sub> system actuator or by pulling the ring at the CO <sub>2</sub> bottle. The CO <sub>2</sub> system can also be activated from the aft console in pilot house.
6	Notify the unit once the situation is under control.
<b>NOTE</b> 	There is a 20 to 30-second delay built into the CO <sub>2</sub> system.
7	Keep the engine room secured until towed ashore and secured.
<b>WARNING</b> 	It is extremely dangerous to enter a compartment during or after a fire. After the engine room has been flooded with CO <sub>2</sub> , extensive ventilation is necessary to ensure safety when entering, however, any introduction of oxygen into the compartment may ignite a fire reflash. Keep the space sealed until towed ashore and secured.
8	As much as possible, stay off of the after deck as the heat may have caused structural damage.





**(This page intentionally left blank.)**



## Section E. Loss of Control of Engine RPM

### E.1. Actions

In the event an engine's RPMs cannot be controlled, take the following actions:

Step	Action
1	Ensure the ACTIVE light is lit for the control station in use.
2	Bring the engine control back to <i>clutch ahead</i> .
3	If this fails to control the engine's RPMs, switch to a different control station and attempt to take control.
4	If this fails, push and hold down the engine STOP button for the affected engine.
<p><b>NOTE</b>  Emergency fuel cutout valve actuator handles are located on the main deck at both fuel stations.</p>	
5	If the engine fails to secure, the engineer should proceed to the machinery space and pull the fuel cutoff valve for the affected engine and allow the engine to run out of fuel.
6	If time does not allow for the affected engine to run out of fuel or if the fuel cutoff fails to secure the engine, the coxswain should pull the EMERGENCY AIR SHUTDOWN for the affected engine.
7	Do not restart the engine until the problem has been corrected.
<p><b>WARNING</b>  DO NOT use the CO<sub>2</sub> system to secure the engine. Depleting the fire fighting capabilities of the boat can be dangerous.</p>	





**(This page intentionally left blank.)**



## Section F. Loss of Fuel Oil Pressure

---

**F.1. Symptoms** If a loss of fuel oil pressure occurs, the engine will begin to run rough with a rapid loss of power.

---

**F.2. Actions** In the event of a loss of fuel oil pressure, take the following actions:

Step	Action
1	The coxswain should reduce the affected engine RPMs to <i>clutch ahead</i> .
2	The engineer should proceed to the engine room; look through the port light in the engine room door to ensure that it is safe to enter.
3	If it is safe to enter, check the bilge for any signs of fuel leakage.
4	Check the engine fuel system components for leaks and security. Check the emergency fuel cutout valves to ensure that they are <i>open</i> .
5	Check the primary fuel filters for accumulated sediment and water in the bowls. Shift to off-line filter. Re-prime the system.
6	Check the entire fuel system for obvious leaks; check fuel tank level and check for presence of water in fuel.
7	Restart the engine and check for proper operation.
8	If the problem still persists, secure the engine.

---



**(This page intentionally left blank.)**



## Section G. Loss of Lube Oil Pressure

### G.1. Actions

If the low oil pressure alarm illuminates and sounds at the central alarm panel, take the following actions:

Step	Action
1	The coxswain should reduce the affected engine RPMs to <i>clutch ahead</i> .
<b>CAUTION!</b> If oil pressure drops below 15 PSI, <i>stop</i> the engine.	
2	The engineer should proceed to the engine room; look through the port light in the engine room door to ensure that it is safe to enter.
3	If it is safe to enter, enter the engine room and check the bilge for oil.
4	Check the engine lube oil for quantity and quality and for obvious leaks.
5	Check the jacket water system for the presence of oil.
6	If the cause is not correctable, do not restart the engine.
<b>NOTE</b> In an emergency, oil pressure can be run as low as 5 PSI at idle and 32 PSI at full load.	



**(This page intentionally left blank.)**



## Section H. Main Engine High Water Temperature

### H.1. Actions

If the engine high jacket water alarms illuminate and sound at the central alarm panel, take the following actions:

Step	Action	
1	The coxswain should reduce the affected engine RPMs to <i>clutch ahead</i> .	
2	The engineer should proceed to the engine room, look through the port light in the engine room door and report if steam is present. Also, verify if the affected engine jacket water system is intact.	
3	If steam is present or if the temperature is 205 °F or above, secure the affected engine.	
<p><b>WARNING</b>  If steam is flowing from the expansion tank vent, the engine(s) should be secured and cooled naturally. If the pressure is released when extremely hot by removing the expansion tank cover, the coolant will either flash to steam or boil with a serious potential for injury.</p>		
4	<b>IF ...</b>	<b>THEN ...</b>
	No steam is present.	Enter the engine room and check the bilge and check the brass pipes on the outboard side of the affected engine. The outlet pipe should be warm to hot, and the inlet pipe from the keel cooler, cool.
	Pipe is cool.	The jacket water system for that engine is probably operating normally; the engineer should make initial casualty control checks for the jacket water system.
	Pipe is hot.	The engineer should make casualty control checks for the jacket water system.





### H.2. Keel cooler checks

Take the following action if fouling of the keel cooler is suspected:

Step	Action
1	Have coxswain change direction of vessel from <i>ahead</i> to <i>astern</i> to try to force any temporary fouling off of cooler.
2	Monitor jacket water temperature, and stop engine if temperature continues to rise and keel cooler fouling cannot be cleared.

### H.3. Jacket water system checks

Take the following actions to check the function of the jacket water system:

Step	Action
1	Check the jacket water level. Check the engine and bilge for leakage. Replace fluid if necessary.
<b>WARNING</b>  Anti-freeze is poisonous. Do not inhale the fumes.	
2	Inspect the jacket water pump for normal function.
3	Check lube oil for proper quantity and quality.
4	If jacket water leaks are found, if the pump is inoperative, or if temperature continues to climb, secure the engine.
<b>NOTE</b>  Oil alarms and sensors are directly related to engine temperature. An overheating engine will often set off lube oil alarms.	
<b>CAUTION !</b> If after all efforts have been made at casualty control, including reducing the engine load, the engine temperature does not decrease, secure the engine. The manufacturer recommends shutdown of the engine if the temperature exceeds 220 °F.	



## Section I. Generator Emergency Procedures

### I.1. General

Because the AC generator set is essential to perform mission operations, a generator set alarm or casualty must be quickly ascertained and controlled.

### I.2. Generator set jacket water temperature

In the event the generator set jacket water temperature is equal to or greater than 195 °F (normal 170 - 210 °F), take the following actions:

Step	Action
1	If the temperature is below 200 °F, the engineer should proceed to the engine room and verify valve alignment to the generator set, amperage load, keel cooler vent valve, and condition of jacket water pump serpentine belt.
2	If the engine has reached 220 °F, <i>stop</i> the engine and allow it to cool naturally.
<b>WARNING</b>  Do not attempt to remove the expansion tank cap on a hot engine.	
3	Verify the oil level.
4	Check for damaged or loose hardware for cooling system.
5	If cause cannot be determined, do not attempt to re-start the engine. Inform the unit and return to port.

### I.3. Generator diesel engine oil pressure

In the event the generator diesel engine oil pressure is less than 20 PSI (normal 35 – 60 PSI), take the following actions:

Step	Action
1	The engineer should shut down AC generator set diesel engine.
2	The engineer should proceed to the engine room and check for obvious leaks, check the oil level, and check the expansion tank for the presence of oil in the water.
3	If cause cannot be determined, do not attempt to re-start the engine. Inform the unit and return to port.





**I.4. Generator RPMs**

In the event the generator RPMs fluctuate, runs rough, or will not maintain a stable RPM/frequency, take the following actions:

Step	Action
1	If the generator is loaded, attempt to reduce the load on the generator set, by securing non-essential loads at 120-VAC power panels. Verify that the engine conditions have stabilized.
2	If the engine continues running rough and will not maintain a stable RPM/frequency, check for fuel leaks, shift duplex fuel filter to off-line element, check for water in fuel, and ensure connections to governor are secure.
3	If cause cannot be determined, <i>stop</i> the engine, inform the unit and return to port.

**I.5. Governor failure**

In the event the generator set RPMs indicate 66 Hz or 1980 RPM, suspect the governor has failed and take the following actions:

Step	Action
<p><b>CAUTION !</b> Do not reduce the load on the generator set. Doing so may cause the engine RPMs to increase.</p>	
1	The engineer should proceed to the engine room and check the physical condition of the governor linkage.
2	If cause of excessive RPMs cannot be determined, the coxswain should <i>stop</i> the engine using the remote emergency shutdown.
3	If the engine fails to shut down, <i>close</i> the valves in the fuel supply to the engine and/or plug the air intake system.
4	Do not attempt to re-start the engine. Inform the unit, and if capable, proceed to port under own power.



## Section J. Excessive Shaft Seal Leakage

### J.1. Actions

If the machinery space bilge alarm sounds and upon inspection a shaft seal is found leaking excessively, take the following actions:

Step	Action
1	The engineer should inform the crew of the casualty.
2	The coxswain should place throttles to <i>neutral</i> and secure the affected engine.
<p><b>CAUTION !</b> De-energize the START switch in the engine room to prevent inadvertent starting of the engine while working around the shaft.</p>	
3	The engineer should realign the seal assembly and check to see if the seal clamp has backed off.
4	If the clamp ring remains tight, restart the engine after realignment and roll the shaft. If excessive water continues to leak from the seal, secure the engine and shaft.
5	The engineer should then loosen the seal clamp ring and reposition it in a position that properly compresses the seal bellows.
6	Restart the engine and roll the shaft. If the seal continues to leak excessively, secure the engine.
7	Secure the shaft cooling water pump.
8	Secure the affected shaft with line to prevent rotation and subsequent damage. Perform required damage control to slow the rate of leakage.





**(This page intentionally left blank.)**



## Section K. Flooding

### K.1. Actions

In the event a bilge flooding alarm sounds, maneuver the BUSL into a safe area and take the following actions:

Step	Action
1	The engineer or coxswain will check the control panel to identify the space where flooding is indicated. Push the RESET button to silence the alarm.
<p><b>WARNING</b>  In the event of engine room flooding, secure the generator set before entering the space. If flooding is detected in other spaces, secure the power panels that feed the spaces before entering.</p> <p><b>NOTE</b>  A sounding of the alarm will indicate water in the bilge space.</p>	
2	The engineer and a crewmember will proceed to the flooded space indicated by the control panel, look through the port light in the watertight door and report status to coxswain. If directed, enter the space to investigate.
3	The engineer shall report to the coxswain the extent, cause and corrective actions necessary to control or stop the flooding.
4	The crew will prepare to apply basic casualty control procedures, making ready the damage control kit and dewatering pump as required.
5	The crew shall check the material condition of each compartment, then report the results to the coxswain.
6	After damage has been assessed, the coxswain shall determine whether it is safe to proceed with the mission or return to the unit.
<p><b>CAUTION !</b> The bilge flooding alarm system is designed to notify the crew of an onboard <b>EMERGENCY</b> underway as well as dockside. This system should be confirmed operational prior to and upon return from any missions or sorties.</p>	





**(This page intentionally left blank.)**



## Section L. Buoy Deck Hydraulic failure

**L.1. General** If the hydraulic weight handling system fails during a buoy deck evolution, any suspended gear should be lowered and secured so that if needed the BUSL can maneuver safely.

**L.2. Actions** Upon a hydraulic failure during buoy deck operations, take the following actions:

Step	Action
1	Buoy deck supervisor should evaluate the situation and advise the coxswain.
<b>NOTE</b>  The vessels position should be verified and recorded.	
2	Crewmembers retrieve the P-39 hydraulic hand pumps from the engine room.
3	If the aid is suspended it is advised to re float it and clear it from the boat. If this is impractical, it should be lowered to the deck, griped down and freed from its mooring.
4	If the chain is suspended, ensure that it is set in the pelican hook then lower the chain into the stopper and clear the hooks.
5	If the mooring is suspended, it is advisable to lower and secure it to the deck. If this is impractical, the chain should be secured on deck by the pelican and stopper, the mooring should be lowered over the side, cleared from the lifting hooks, and made ready for letting go if necessary.
6	In the case of a catastrophic failure, the buoy deck crew should immediately clear the deck to evaluate the situation. Any suspended gear should be lowered and secured by the best safest means.
<b>NOTE</b>  If the mooring is still on the bottom and the chain is secured on deck, by the pelican hook and chain stopper, it should be made ready to release so that the boat can maneuver free if needed.	





**(This page intentionally left blank.)**



## Section M. Major Fuel Oil/Lube Oil Leak

**M.1. General** Any **major** flammable oil or fuel leak presents a fire hazard that must be dealt with immediately. Rapid response will greatly reduce the risk of fire.

**M.2. Actions** Upon finding a major fuel oil, lube oil or hydraulic oil leak, take the following actions:

Step	Action
1	Report the leak; size, type, and location immediately to the Pilothouse and secure the affected engine if applicable.
<p><b>WARNING</b> </p> <div style="border: 1px solid black; padding: 5px; margin-left: 40px;">                     When in Restricted Maneuverability, the engineer may secure one MDE but must obtain permission from the Pilothouse prior to securing the SSDG or other MDE.                 </div>	
2	Secure ventilation.
3	Use rags or buckets to control the flow of fuel or oil as well as deflect it away from any hot surface.
4	Isolate the leak locally or remotely by securing the emergency cut-off valves.
5	Break out AFFF fire extinguisher and wash flammable liquid into the bilge covering the liquid to form a vapor barrier.
6	Set fire watch and stand by to evacuate the space in case of fire.
<p><b>NOTE</b> </p> <div style="border: 1px solid black; padding: 5px; margin-left: 40px;">                     If fire ignites, see Section D of this chapter. If the oil leak is buoy hydraulic fluid, see also Section L of this chapter.                 </div>	





**(This page intentionally left blank.)**



# Appendix A

## 49' BUSL Outfit List & Stowage Plan

### Overview

#### Introduction

This appendix is the standard stowage plan for the 49' BUSL outfit. No deviation from this list is authorized, except in the event that the addition of portable equipment, not part of the standard boat outfit, is necessary to meet mission needs. **Authorization is on a case-by-case basis only and care must be taken to properly secure extra gear to ensure it does not interfere with safe egress or the boat's standard outfit/systems. Under no circumstances shall permanent alterations be made.**

The 49' BUSL Machinery Information Catalog Allowance (MICA) provides national stock numbers (NSNs) and ordering information for all outfit list items.

#### In this Appendix

This appendix contains the outfit list and stowage plan for the following areas of the boat:

Area	See Page
Aft Voids	A-3
Lazarette	A-4
Machinery Space (Engine Room)	A-5
Workshop, Galley/Mess, and Head	A-6
Berthing Compartment	A-9
Forward Peak	A-10
Pilothouse	A-11
Main Deck	A-12



**(This page intentionally left blank.)**



## Aft Voids

---

It is not permissible to use voids as storage; therefore, there is no outfitting in the voids.

---



## Lazarette

---

<u>Item</u>	<u>Quantity</u>	<u>Location</u>
Aircraft Cargo Tie Down	1 each	Storage Bin Portside Bulkhead
Boat Fender	4 each	
Industrial Safety Belt	3 each	Storage Bin Portside Bulkhead
Industrial Safety Strap	3 each	Storage Bin Portside Bulkhead
Marine Grapnel (chain and line attached)	1 each	Storage Bin Portside Bulkhead
Safety Helmets (white, yellow, blue and green)	1 each	Storage Bin Portside Bulkhead
Rated Screw Pin Alloy Shackles with ledgeable manufacture markings (1/2 inch to 1 5/8)	6	Storage Bin Portside Bulkhead
Sewage Discharge Jumper Hose	1 each	Storage Bin Portside Deck
Non-Metallic Hose (25' garden hose) Spare	1 each	Storage Bin Portside Deck

---



## Machinery Space (Engine Room)

---

<u>Item</u>	<u>Quantity</u>	<u>Location</u>
Anti-Freeze	2 gallons	Locker
Anti-Freeze Solutions Tester	1 each	Locker
Hand-Operated Lubricating Gun	1 each	Locker
Hand-Operated Oiler	1 each	Locker
Hand-Operated Portable Bilge Pump	1 each	Bilge Area Next To Locker
Oil Viscosity Comparator	1 each	Locker
Portable Eye Wash Station	1 each	Bilge Area Next To Locker
Electrolyte Solution Battery Tester (hydrometer)	1 each	Locker
P-39 Portable Hydraulic Hand Pump	2 each	Bilge Area Port Side

---



## Workshop, Galley/Mess, and Head

---

### Workshop

---

<u>Item</u>	<u>Quantity</u>	<u>Location</u>
Bench & Pipe Vise	1 each	Bench
Dustpan & Brush	1 each	Locker
25-Foot Extension Cord	2 each	Locker
Flashlight (watertight, 2 D-cell)	2 each	Drawer
Sheave Gauge	1 set	Drawer
Survival Vest (properly outfitted)	6 each	Hanging Locker
Boat Pyro (2 MK79 Kits & 12 MK124 Flares)	1 Kit	Hanging Locker
Hand Tools (as required for unit ops)	Various	Drawer
Pneumatic Tools (as required for unit ops)	Various	Drawer
Electrical Tools (as required for unit ops)	Various	Drawer
Personal Protective Gear (as required for unit ops)	Various	Drawer
ATON Equipment (as required for unit ops)	Various	Drawer



---

**Galley/Mess**

---

<u>Item</u>	<u>Quantity</u>	<u>Location</u>
Garbage Can with Cover	1 each	Deck
Electric Toaster	1 each	Galley, Counter
PFD, CG-Approved Type III (various sizes) with PML and Whistle Attached	5 total	Mess Deck, Aft Bench Storage
Blood Born Pathogens PPE Kit	10 each	Mess Deck, Aft Bench Storage
Surface Swimmer's Gear	1 each	Mess Deck, Aft Bench Storage
Wood Scrub Brush	1 each	Galley, Cabinet

---





---

## Head

---

<u>Item</u>	<u>Quantity</u>	<u>Location</u>
Floor Mat (shower)	1 each	Deck
Paper Towel	12 pkg	Behind Mirror
Sanitary Brush	1 each	Bulkhead Hook
Shower Curtain (white vinyl)	2 each	Hanging

---



## Berthing Compartment

---

<u>Item</u>	<u>Quantity</u>	<u>Location</u>
Bed Blanket (wool)	7 each	Linen Locker/On Rack
Bed Sheet (white)	14 each	Linen Locker/On Rack
Bedspread	7 each	Linen Locker/On Rack
Pillow	7 each	Linen Locker/On Rack
Pillowcase (white)	7 each	Linen Locker/On Rack

---



## Forward Peak

---

<u>Item</u>	<u>Quantity</u>	<u>Location</u>
300' of 2 3/4" DBN Line With Chain & Swivel	1 each	Line Reel
1/2" Galvanized Chain and Swivel		
Lead Line Assembly	1 each	Forward Peak

---



## Pilothouse

---

<u>Item</u>	<u>Quantity</u>	<u>Location</u>
General Purpose First Aid Kit	1 each	Bulkhead
Hand-Held Binoculars	1 each	Bulkhead
Binocular Box (wood)	1 each	Starboard Bulkhead Forward
Ship's Bell	1 each	Bulkhead
Walking Cane (lacquer free dead man stick)	1 each	Bulkhead
Manual Reed Type Horn	1 each	Chart Table Storage
Medical Splint & Bandage Kit	1 each	Chart Table Storage
Nautical Slide Rule	1 each	Chart Table Storage
Navigator's Drafting Instrument Set	1 set	Chart Table Storage
Parallel Ruler	1 each	Chart Table Storage
Pencil	1 dozen	Chart Table Storage
Signal Horn	1 each	Chart Table Storage
Stopwatch	1 each	Chart Table Storage
Thermometer	1 each	Chart Table Storage
Wastepaper Basket	1 each	Deck

---



## Main Deck

<u>Item</u>	<u>Quantity</u>	<u>Location</u>
Nonmetallic Hose Assembly (25-foot garden hose)	1 each	Buoy Deck, Port Side Aft Rack
Pelican Hook Assembly ( Grade 8 or better)	1 each	Buoy Deck Bull Chain Padeye
Split Key Hammer	2 each	Starboard Boat Box
Pin Hammer	2 each	Starboard Boat Box
Alloy Picking Pennant ( Grade 8 or better)	1 each	Starboard Boat Box
Gripe Down Chains (Grade 7 or better) with Foundry Hook	8 each	Starboard Boat Box
Ratchet Load Binders (minimum working load limit 5,400 pounds)	8 each	Starboard Boat Box
Shackle (steel/moder/second class)	2 each	Starboard Boat Box
Chain Hook	2 each	Starboard Boat Box
Ball-Diamond-Ball (boat) Dayshape	1 set	Port Boat Box
Cutting & Welding Torch Outfit	1 each	Port Boat Box
Nonmetallic Hose Assembly (fire fighting with nozzle)	1 each	Port Boat Box
Nonmetallic Hose Assembly (P-6 pump suction hose)	1 each	Port Boat Box
Chain Stopper Cheater Bar	1 each	Port Boat Box
Wrecking Bar (24-inch)	1 each	Port Boat Box
DC Kit	1 kt	Port Boat Box
Mechanical Line Reeveing Device	1 each	Port Side Aft Handrail
Rescue Line Throw Bag	1 each	Port/Starboard Aft Handrails



Boat Hook (Stenciled with CG and Boat Number in 1/2" lettering)	1 each	Port/Starboard Aft Handrails
Buoy Scrapper	2 each	Tool Rack, Aft Starboard Deck Box
Shipping & Storage Drum (P-6 pump can)	1 each	Mounted Frame
Portable Pump and Kit (P-6)	1 each	Mounted Frame
Rescue Line Throw Bag	1 each	Port/Starboard Forecastle Handrails
Sledge Hammer (8-pound)	1 each	Starboard Boat Box

---



**(This page intentionally left blank.)**



# Appendix B

## 49' BUSL Engineering Change Requests (ECRs)

### Overview

---

**Introduction** This appendix contains a list of authorized ECRs for the 49' BUSL.

**NOTE**  For a complete breakdown of the Engineering Change Request Number, see the *Naval Engineering Manual*, COMDTINST M9000.6 (series), *Chapter 41*.

---

**In this Appendix** This appendix contains the ECRs for the 49' BUSL.

Topic	See Page
Engineering Change Requests (ECRs)	B-3

---





## Engineering Change Requests (ECRs)

<b>ECR Number</b>	<b>Subject</b>	<b>Date</b>
49BUSL-B-01	BUSL Shaft Bearing	01/30/01
49BUSL-A-02	Hot Start Renewal	08/12/02
49BUSL-A-03	LCD Monitor Installation	04/25/03
49BUSL-A-04	Hydraulic Dehumidifying Filter Installation	06/20/03
49BUSL-A-05	Reduction Gear Lubrication Oil Sender Configuration Standardization	08/04/03
49BUSL-A-06	Replacement of A-frame Winch Counter Balance Valve and Modification of Winch Brakes	10/21/03
49BUSL-A-07	SSDG Alternator Removal	03/15/04
49BUSL-A-08	Hydraulic Case Drain Cooling	05/17/04
49BUSL-B-09	Intermediate Bearing Installation	05/10/04
49BUSL-A-10	Time Delay Relay Installation in Main Engine Starting Circuit	06/02/04
49BUSL-A-11	ATON DGPS Receiver System	11/19/04
49BUSL-A-12	Replacement of AN/SPS-69 Radar System	11/19/04
49BUSL-A-13	AFFF Extinguisher Installation	12/06/04
49BUSL-A-14	Engine Room Deck Plates	12/03/04
49BUSL-A-15	Workshop Watertight Hatch Removal	04/27/05
49BUSL-A-16	Buoy Deck Standardization	01/14/05



49BUSL-C-17	Pneumatic Horn	04/22/05
49BUSL-A-018	Generator Gauge Panel Relocation	04/26/05
49BUSL-A-019	Zinc Upgrade	01/06/05
49BUSL-A-020	FWD Mooring Bitt	01/27/06
49BUSL-A-021	MDE Mounts	01/05/06
49BUSL-A-022	Life Raft	03/07/06
49BUSL-A-023	Winch Brake Mod	05/22/06
49BUSL-A-024	Engine Room Exhaust Fan Shutdown Switch	08/09/06



Appendix B - 49' BUSL Engineering Change Requests (ECRs )

**(This page intentionally left blank.)**



## Appendix C

# 49' BUSL Material Inspection Checklist

## Overview

### Introduction

1. This appendix is meant to be a systematic means to inspect ANY 49' BUSL and to ensure the entire boat is prepared to meet mission demands. Also, this enclosure should be used in conjunction with Appendix A and B.
2. This checklist may be locally reproduced.

### In this Appendix

This appendix contains the Material Inspection Checklist for the 49' BUSL. This inspection list covers the following areas of the boat:

No.	Area	See Page
I.	Hull	C-5
II.	Buoy Deck	C-7
III.	Lazarette	C-11
IV.	Forward Deck	C-13
V.	Forward Peak	C-15
VI.	Exterior Pilothouse	C-17
VII.	Pilothouse Cabin Top	C-19
VIII.	Interior Pilothouse	C-21
IX.	Engine Room	C-25
X.	Workshop	C-29
XI.	Galley/Mess	C-31
XII.	Head	C-35
XIII.	Berthing Compartment	C-37



**(This page intentionally left blank.)**



# Material Inspection Checklist

**Boat number:** \_\_\_\_\_

**Station:** \_\_\_\_\_

**Date:** \_\_\_\_\_

**References:**

- *49' BUSL Operator's Handbook*, COMDTINST M16114.22A
- *Naval Engineering Manual*, COMDTINST M9000.6 (series)
- *Color and Coatings Manual*, COMDTINST M10360.3 (series)
- *Coast Guard Rescue and Survival Systems Manual*, COMDTINST M10470.10 (series)

**Inspection standards:**

The following inspection standards apply to the 49' BUSL boat's hull, superstructure, machinery, equipment, outfit, and all installed systems and accessories:

- Operates smoothly and correctly.
- Free of grease, oil, rust, and corrosion.
- All fluid levels and pressure readings are within tolerances.
- Protective coatings applied correctly and neatly.
- Free of rips, tears, abrasions, and cracks.
- Outfit and equipment correctly installed, adjusted and stowed to specs and design.
- Labels, test dates, and placards properly indicated.
- Free of non-standard/unapproved installations or equipment.
- Maintained according to current manufacturer's guidelines and Commandant Directives.

**Inspection guidelines:**

Inspection requires a minimum of *two* personnel, preferably one Boatswain's Mate and one Machinery Technician, both of who possess extensive 49' BUSL experience and a strong working knowledge of the contents of all references listed above. This material inspection checklist is only applicable to boats in a "Bravo" or "Ready for Sea" condition. Each item on the checklist should be judged against applicable standards and references. Additional discrepancies, uninstalled engineering change requests (ECRs), etc. should be listed.

**Inspected by:** \_\_\_\_\_

**Date:** \_\_\_\_\_

**Inspected by:** \_\_\_\_\_

**Date:** \_\_\_\_\_



**(This page intentionally left blank.)**



# I. Hull

ITEM	SAT	UNSAT	REMARKS
Rubrail			
Paint			
Lettering/Numbering/Decal			
Hull (Visible Surfaces)			
Waterline			
Dunnage			

**REMARKS:** \_\_\_\_\_  
 \_\_\_\_\_  
 \_\_\_\_\_





**(This page intentionally left blank.)**



## II. Buoy Deck

ITEM	SAT	UNSAT	REMARKS
<i>Port</i>			
Fuel Tank Vent			
Fill Pipe			
Stripping Pipe			
Emergency Fuel Shutoff Lever			
Cofferdam and Plugs			
Engine Intake Vent			
Emergency Damper Lever			
Deck Winch			
Cable (30 Ft with 3 wrap's on drum)			
Hook Assembly			
Roller Assembly			
Guard			
Hydraulic Motor			
Hydraulic Hoses			
Rescue Line Throw Bag			
Drop Pump w/Can			
Drop Pump Bracket			
Deck Box			
O <sub>2</sub> /Acetylene Brackets			
Fwd Handrails			
Boat Hook			
Chocks/Cleats			
Safety Chains			
Aft Handrail			
110V Outlet			
Engine Room Exhaust Vent			
Emergency Damper Lever			
Deck Washdown Station			
Deck Hose			
Potable Water Vent			
Potable Water Fill			
Potable Water/Deck Supply			



<b>Port (Cont.)</b>			
A-Frame (Boom)			
Date of Last Weight Test			
<b>Winch</b>			
Cable (Min 50 Ft with 3 wraps on drum)			
Hook Assembly			
Hydraulic Hoses/Piping			
A-Frame Limiting Cables			
Upper Cable Guides			
Ram			
Chain Stopper Assembly			
<b>Starboard</b>			
A-Frame (Boom)			
<b>Winch</b>			
Cable (Min 50 Ft with 3 wraps on drum)			
Hook Assembly			
Hydraulic Hoses/Piping			
A-Frame Proximity Switch			
A-Frame Limiting Cables			
Upper Cable Guides			
Ram			
Aft Safety Chain			
Aft Handrail			
Chock/Cleats			
Sewage Discharge			
Engine Room Exhaust Vent			
Emergency Damper Lever			
110V Outlet			
<b>Engine Room Scuttle</b>			
Hinges			
Gasket			
Knife Edge			
Dogs & Wedges			
Locking Device			
Alignment			
Safety Chains			
Chocks/Cleats			



Fwd Handrails			
<i>Starboard (Cont.)</i>			
Boat Hook			
Deck Box			
Compress Air Supply			
Fuel Tank Vent			
Fill Pipe			
Stripping Pipe			
Emergency Fuel Shutoff Lever			
Cofferdam and Plugs			
Engine Intake Vent			
Emergency Damper Lever			
Deck Winch			
Cable (Min 30 Ft with 3 wraps on drum)			
Hook Assembly			
Roller Assembly			
Guard			
Hydraulic Motor			
Hydraulic Hoses			
Rescue Line Throw Bag			
Deck Padeyes (16 ea)			
Bull Chain Padeyes (2 ea)			
<b><i>Buoy Deck Equipment</i></b>			
Hammers			
Buoy Scraper			
Pelican Hook Assembly			
Gripe Down Chains			
Ratchet Binders			
Alloy Picking Pennant			
Modeer Shackles			
Chain Hooks			
Mooring Lines (4 ea)			
Fenders (4 ea)			

**REMARKS:** \_\_\_\_\_  
 \_\_\_\_\_  
 \_\_\_\_\_



**(This page intentionally left blank.)**



### III. Lazarette

ITEM	SAT	UNSAT	REMARKS
Scuttle			
Hinges			
Gasket			
Knife Edge			
Dogs & Wedges			
Locking Device			
Alignment			
Bulkheads			
Fwd			
Port			
Aft			
Starboard			
Overhead			
Lighting			
Wiring/Stuffing Tubes			
Heater			
Steering Components			
PKP Fire Extinguisher			
Hydraulic Power Unit			
Gage			
Hydraulic Lines			
Air Compressor			
Belt Guard			
Tank			
Gage			
Sewage Tank			
Sewage Discharge Pump			
110V Outlet			
Aft Void Covers			
AFFF Extinguisher			
General Stowage/Cleanliness			
Deck			



Appendix C - 49' BUSL Material Inspection Checklist

Aft Void			
<i>Port</i>			
Covers			
Bulkheads			
Overhead			
Deck			
Paint			
<i>Starboard</i>			
Covers			
Bulkheads			
Overhead			
Deck			
Paint			

**REMARKS:** \_\_\_\_\_  
\_\_\_\_\_  
\_\_\_\_\_



## IV. Forward Deck

ITEM	SAT	UNSAT	REMARKS
Deck Coverings			
Exterior Berthing Hatch			
Forward Handrails			
Chocks			
Cleats			
Forepeak Vent			

**REMARKS:** \_\_\_\_\_  
 \_\_\_\_\_  
 \_\_\_\_\_





**(This page intentionally left blank.)**



## V. Forward Peak

ITEM	SAT	UNSAT	REMARKS
Forepeak Scuttle			
Hinges			
Gasket			
Knife Edge			
Dogs & Wedges			
Locking Device			
Alignment			
Grease Fittings			
Anchor Line (2 3/4 " DBN 300-ft)			
Thimble			
Swivel			
Chain			
Bulkheads			
Fwd			
Port			
Starboard			
Aft			
Deck			

**REMARKS:** \_\_\_\_\_  
 \_\_\_\_\_  
 \_\_\_\_\_



**(This page intentionally left blank.)**



## VI. Exterior Pilothouse

ITEM	SAT	UNSAT	REMARKS
<i>Aft Bulkhead</i>			
Wiring/Stuffing Tubes			
Wiper Motors			
Wiper Arms/Blades			
Windows			
Ships Bell w/Lanyard			
Door Stops/Latches			
Ladder			
Watertight Door			
Hinges			
Gasket			
Knife Edge			
Dogs, Wedges & Rollers			
Locking Device			
Alignment			
<i>Port</i>			
Deck			
Handrails			
Rescue Line Throw Bag			
Bulkhead			
Windows			
Life Ring			
Line			
Stenciling			
Float Light w/Clip			
Date			
<i>Bow</i>			
Anchor (60-lb)			
Shore-Tie			
Windshield Wipers & Washers			
Wire/Stuffing Tubes			
Bulkhead			
<i>Starboard</i>			
Deck			
Handrails			



Rescue Line Throw Bag			
Bulkhead			
Windows			
Life Ring			
Line			
Stenciling			
Float Light w/Clip			
Dated			

**REMARKS:** \_\_\_\_\_  
\_\_\_\_\_  
\_\_\_\_\_



## VII. Pilothouse Cabin Top

ITEM	SAT	UNSAT	REMARKS
Deck			
EPIRB			
Fwd External Speakers			
Radio Antenna P/S			
Horn			
Spotlights (fwd/aft)			
DGPS Antenna			
Running Lights			
Radar Antenna			
Life Raft			
Date			
Life Raft Bracket			
Life Raft Weak Link			
TV Antenna			
Mast			
VHF-FM Radio Antenna			
Nav Lights			
Anchor			
Mast			
Restricted Maneuvering			
Towing			
Wiring/Stuffing Tubes			
Halyards			
Ensigns			
Deck Work Lights			

**REMARKS:** \_\_\_\_\_  
 \_\_\_\_\_  
 \_\_\_\_\_



**(This page intentionally left blank.)**



## VIII. Interior Pilothouse

ITEM	SAT	UNSAT	REMARKS
Overhead			
Insulation			
Wiring			
Labels			
Stuffing Tubes			
Lighting			
Window Heater/Wiper Control			
Fwd			
Port			
Starboard			
Aft			
Heated Window Switches			
Fwd			
Port			
Starboard			
Aft			
Deck Light Switch			
Window Defrosters			
Port			
Starboard			
Fwd Console			
120-Volt Electrical Panel			
Labels			
Depth Finder			
Engine Controls			
Helm			
Rudder Angle Indicator			
Auto Pilot			
Binnacle/Magnetic Compass			
Deviation Table/Date			
Gauges			
Redlined			
Labeled			





Fwd Console (Cont.)			
Horn Electric			
Searchlight Control			
Radar			
Flat Screen Monitor			
Steering Station Control			
Bilge Pump Panel/Labels			
Oily Water Discharge Placard			
Loudhailer Mike			
Under Console			
Wiring			
Bulkhead			
Port Bulkhead			
Hydr Strg Expansion Tank			
Battle Lantern			
Date			
Fwd A/C Unit Control			
DES Speaker			
PKP Extinguisher			
Date			
Alarms Panel			
CO <sub>2</sub> Extinguisher			
Date			
24-Volt Electrical Panel			
Labels			
Pilothouse Light Switch			
Deck Light Switch			
110V Outlet			
Wire Runs			
Window/Latch			
Weather Door Port			
Latch			
Gasket			
Aft Control Console			
Aft A/C Control Unit			
Loudhailer Mike			
Wire Run			
Searchlight Control			



Aft Control Console (Cont.)			
Depth Sounder Display			
Engine Controls			
Gauges			
Redlined			
Labeled			
Helm Control			
Rudder Angle Indicator			
Generator Emergency Stops			
Port Emergency Stops			
Starboard Emergency Stops			
Machinery Space CO <sub>2</sub> Release			
Placard			
Buoy Deck Hydr Control Panel			
Labels			
Port Winch Control			
Starboard Winch Control			
A-Frame Control			
Port Hoist Control			
Starboard Hoist Control			
Window/Latches			
Under Console			
Wiring			
Bulkhead			
Weather Door Starboard			
Latch			
Gasket			
Starboard Bulkhead			
Rack Frame			
Mattress			
Window/Latch			
VHF Speaker			
Chart Table			
Computer			
Flat Screen Monitor			
Keyboard			
CPU			
Mouse			
Computer UPS			



Chart Table (Cont.)			
Drawers/Latches			
Heater			
Hand-Operated Horn			
Charts			
Weems/Slide Rule			
Dividers			
Pencils			
Tide Book			
RPM/Speed/Fuel Curve			
Light List/Coast Pilot			
Overhead			
Loudhailer/Intercom			
VHF-FM Radio			
GPS/DGPS			
Secure VHF-FM Radio			
Nav Light Switch Panel			
Electronics Box			
Helm Chair			
Deck			
Deck Matting			

**REMARKS:** \_\_\_\_\_  
 \_\_\_\_\_  
 \_\_\_\_\_



## IX. Engine Room

ITEM	SAT	UNSAT	REMARKS
<i>Port Forward</i>			
Watertight Door			
Dogs, Wedges & Rollers			
Gasket			
Alignment			
Knife Edge			
Battle Lantern			
Date			
Heat Pump Cooling Pump			
Deck Wash Pump			
Strainer/Valve			
Emergency Intake Shutdown			
Motor Control Center			
Wiring/Stuffing Tubes			
Hydr Winch Control			
Piping			
Potable Water Pressure Gage			
HVAC Cooling Gage			
Deck Washdown Pressure Gage			
Potable Water Pressure Tank			
Hot Water Tank			
#2 Main Engine			
Starter			
Alternator			
Hot Start			
Lube Oil System			
Governor/Linkage			
Cooling System			
Expansion Tanks			
Piping/Lagging			
Exhaust Piping/Lagging			
Exhaust Muffler			
Engine Mounts/Framing			



#2 Main Engine (Cont.)			
Electrical System			
Fuel Oil System			
Fuel Lines			
Shut-Off Valves			
Belt-Guard			
Engine Mounts			
Shaft Seal			
Storage Locker			
Potable Water Tank			
Sight Glass/Valves			
Generator			
Starter			
Hot Start			
Lube Oil System			
Governor/Linkage			
Cooling System			
Expansion Tanks			
Piping/Lagging			
Exhaust Piping/Lagging			
Exhaust Muffler			
Engine Mounts/Framing			
Electrical System			
Fuel Oil System			
Fuel Lines			
Shut-Off Valves			
Belt-Guard			
Engine Mounts			
Central Alarm Remote Switch			
1 MC Speaker			
CO <sub>2</sub> Extinguisher			
Date			
Hydr Tank			
Fill Screen			
Pressure Gage			
Fittings			
Control Panel			
Hydr Gages			



#1 Main Engine			
Hot Start			
Starter			
Alternator			
Lube Oil System			
Governor/Linkage			
Cooling System			
Expansion Tank			
Piping/Lagging			
Exhaust Piping/Lagging			
Exhaust Muffler			
Engine Mounts/Framing			
Electrical System			
Fuel Oil System			
Fuel Lines			
Shut-Off Valves			
Belt Guard			
Engine Mounts			
Shaft Seal			
Battery Charger			
120-Volt Panel			
24-Volt Panel			
Overhead			
Lights			
Wiring Stuffing Tubes			
Smoke Detector			
Bilge			
Deck Plates			
Batteries			
Bilge Switch			
Bilge Pump			
Bilge Alarm			
Pipes/Valves			
Paint			

**REMARKS:** \_\_\_\_\_  
 \_\_\_\_\_  
 \_\_\_\_\_



**(This page intentionally left blank.)**



## X. Workshop

ITEM	SAT	UNSAT	REMARKS
Overhead			
Insulation			
Heater			
Lights			
Junction Boxes/Stuffing Tubes			
Wiring			
Hydr Pipes			
Fwd Bulkhead			
Eyewash Station			
Eyewash Placard			
Pipes/Valves			
Port			
Insulation			
Storage Lockers			
Battle Lantern			
Date			
1MC Speaker			
110V Outlet			
Hearing Protection Storage Box			
Compress Air/Hose Station			
Water Chiller			
Storage Racks			
Shore Power Transformer			
Storage Cabinet			
AFFF Extinguisher			
Starboard Cabinet			
A/C & Heating Unit			
Ducting			
Piping			
Wiring			
PKP Extinguisher			
Dates			
Door Latch			





Aft Bulkhead			
Insulation			
Aft Bulkhead (Cont.)			
Wiring/Stuffing Tubes			
CO <sub>2</sub> Control Panel			
A/C Saltwater Pump Switch			
Deck			
Deck Matting			
Deck Plates			
Bilge			
Wiring			
Stuffing Tubes/Junction Boxes			
Toilet Vacuum Pump			
Vacuum Tank			
Piping/Hoses			
Transducer			
Bilge (paint & corrosion)			
PFD/PYRO/First Aid			
Survival Vest (6 ea)			
Boat Pyrotechnics			
MK-79 Signal Kit (2ea)			
MK-124 Signal Kit (12ea)			
First Aid Kit			

**REMARKS:** \_\_\_\_\_  
 \_\_\_\_\_  
 \_\_\_\_\_



## XI. Galley/Mess

ITEM	SAT	UNSAT	REMARKS
Overhead			
Insulation			
Wire Run			
Stuffing Tubes			
Heater			
Light Fixtures			
Junction Boxes			
Smoke Detector			
Curtain Rail			
1MC Speaker			
Port Bulkhead			
Head Fan Switch			
Light Switch			
110V Outlet			
Battle Lantern			
Date			
CO <sub>2</sub> Fire Extinguisher			
Date			
110-Volt Electrical Panel			
Labels on Breakers			
Entertainment Unit			
TV			
Radio			
Vent			
Light Switch			
110V Outlet			
Starboard Bulkhead			
Upper Cabinets			
Microwave Oven/Bracket			
Toaster			
Refrigerator			
Coffee Maker			
Stove Top			



Starboard Bulkhead (Cont.)			
Sink/Faucet			
Lower Cabinets			
Latches			
Piping/Valves Under Sink			
110V Outlet			
A/C Control			
Central Alarm Remote Switch			
Clock			
Cabinets			
Speakers			
110V Outlet			
Table			
Cushions			
Storage			
Deck			
Deck Matting			
Deck Plates			
Bilge Access Cover			
Ladder			
Engine Room CO <sub>2</sub> System			
Dates of Inspection			
Dates Hydro Stat Inspection			
Bilge			
Wiring			
Stuffing Tubes/Junction Boxes			
Float Switch			
Bilge Alarm Switch			
Grease Trap			
Bilge Pump			
Gray Water Tank			
Macerator Pump/Tank			
Gray Water Pump & Hoses			
A/C Condensation Tank			
Piping/Hoses			
Bilge (paint & corrosion)			



**REMARKS:** \_\_\_\_\_  
\_\_\_\_\_  
\_\_\_\_\_



**(This page intentionally left blank.)**



## XII. Head

ITEM	SAT	UNSAT	REMARKS
Overhead			
Insulation			
Lighting			
Wiring & Stuffing Tubes			
Vent Pipe			
Hydr Pipes			
Curtain Runners			
Curtain			
Forward Bulkhead			
Towel Dispenser			
Port Bulkhead			
Insulation			
Drain Vent Pipe			
Upper Cabinet			
Light			
Mirror			
Sink/Faucet			
Lower Cabinet			
Pipes/Valves			
Aft Bulkhead			
Shower Fixture			
Toilet			
Piping			
Deck			
Deck Matting			
Deck			
Shower Drain			
Door			
Hinges			
Vent			
Latch			



**REMARKS:** \_\_\_\_\_  
\_\_\_\_\_  
\_\_\_\_\_



### XIII. Berthing Compartment

ITEM	SAT	UNSAT	REMARKS
Overhead			
Smoke Detector			
Insulation			
Lighting			
Wiring			
Stuffing Tubes			
Overhead Hatch			
Hinges			
Gasket			
Knife Edge			
Dogs, Wedges and Rollers			
Locking Device			
Egress Ladder			
Fwd Bulkhead			
Linen Locker			
Battle Lantern			
Date			
Fwd Void			
Covers			
Bulkheads			
Overhead			
Deck			
Paint			
Port Side			
Insulation			
Topside Berth			
Stowage Area			
Rack Lights			
Bottom Berth			
Stowage Area			
Rack Lights			
Heater			
Door Stop/Latch			





Starboard Side			
Topside Berth			
Stowage Area			
Rack Lights			
Bottom Berth			
Stowage Area			
Rack Lights			
A/C Unit			
Aft Bulkhead			
Wiring & Stuffing Tubes			
Piping/Insulation			
Valves			
Exhaust Fan Switch			
A/C Control			
110V Outlet			
1MC Speaker			
Thermostat			
Light Switch			
Watertight Door			
Hinges			
Gasket			
Knife Edge			
Dogs, Wedges & Rollers			
Locking Device			
Alignment			
Deck			
Deck Matting			
Deck Plates			
Bilge Hatch			
Hinges			
Gasket			
Knife Edge			
Dogs, Wedges & Rollers			
Locking Device			
Alignment			
Bilge			
Wiring & Stuffing Tubes			
A/C Ducting			
A/C Tank			



Bilge Pump			
Float Switch			
Piping			
Paint			

**REMARKS:** \_\_\_\_\_  
\_\_\_\_\_  
\_\_\_\_\_



**(This page intentionally left blank.)**



## Appendix D

# 49' BUSL Disabling Casualties

### Overview

---

**Introduction** This appendix contains disabling casualties for the 49' BUSL. Refer to *Chapter 5, Section A* of this handbook for steps to follow if any of these casualties occur.

---

**In this appendix** The disabling casualties list covers the following subject areas:

Topic	See Page
Engine Parameters	D-3
Engineering System Components	D-3
Electronic/Navigation	D-3
Safety	D-4
General Material	D-4

---



**(This page intentionally left blank.)**



## Disabling Casualty List

### Engine parameters

- Reduction gear pressure below 280 PSI and above 350 PSI (while engaged).
- Engine lube oil pressure below 30 PSI (at cruising speed).
- Engine fresh water temperature below 140 °F or above 205 °F.

### Engineering system components

- Engine fails to start.
- Uncontrollable overheating.
- Metallic/non-metallic noise: metal on metal/fuel-knock/bearing/clicking.
- Excessive shaft or engine vibration.
- Engine surging/over speed (over 50 RPM).
- Loss of engine governor control.
- Reduction gear fails to engage (forward or reverse).
- Fuel oil dilution 5 percent or above.
- Water in engine lube oil (emulsified white milky oil).
- Lube oil in engine jacket water.
  - More than a light sheen.
  - Floating unmixed lube oil separated from the water.
- Continuous electrical breaker trip.
- Starting batteries won't charge.
- Steering system inoperative.
- Engine motor mounts hardware loose or missing.
- Excessive shaft packing leak:
  - Packing leak while rotating trickle or steady stream.
  - Packing leak while not rotating.

### Electronic/navigation

- No electronic means of signaling distress (i.e., no radio, etc.).
- Electronics won't energize.



---

**Safety**

- Any fuel leak.
- Any lube oil dripping\* on a hot surface (hot surface is defined as a surface greater than 400 °F, even if covered by insulation).
- Electrical arcing and sparking odor of insulation overheating.
- Turbocharger lube oil supply line leaking onto hot surface or not fire rated/fire sleeved.
- Fixed CO<sub>2</sub> flooding system inoperative, PLUS no portable fire extinguishers (unserviceable).
- Emergency alarms inoperative (fire, bilge, lube oil pressure, high water temp).

\* To determine if fuel oil or lube oil dripping is occurring, a clean sheet of paper may be placed under a suspected leak to collect and detect any drops that fall.

---

**General material**

- Hull breach below the waterline
-



# Appendix E

## 49' BUSL Restrictive and Major Discrepancies

### Overview

---

**Introduction** This appendix contains restrictive and major discrepancies for the 49' BUSL. Refer to *Chapter 5, Section A* of this handbook for steps to follow if any of these casualties occur.

---

**In this appendix** This appendix contains the following information:

Topic	See Page
Restrictive Discrepancies	E-3
Major Discrepancies	E-6

---





**(This page intentionally left blank.)**



## Restrictive Discrepancies

### Engine and vessel systems

- 
1. Engine performance:
    - a. Engine RPM less than 2100 RPMs or greater than 2350 RPMs
  2. Leaks more than 15 drops per minute:
    - a. Jacket water
    - b. Lube oil
    - c. Hydraulic oil
    - d. Reduction gear oil
  3. Shaft packing leak:
    - a. Packing leak develops underway but does not meet or exceed disabling criteria, limit RPMs to speed where leak starts
    - b. Contact Operational Commander for waiver to return to an appropriate facility to affect repairs. (See also Section J for Emergency Procedures)
  4. Any lube oil dripping\* (falling onto a surface which is not hot) within ten (10) minutes.
  5. Bilge pumps inoperative.
  6. Bilge system check valves installed improperly or unserviceable.
  7. Inoperative/inaccurate pressure/temperature alarms or gauges.
  8. Any detectable exhaust leaks into machinery space/hull.
  9. Missing exhaust lagging or system blankets.
  10. Failure of any emergency system:
    - a. Fuel shut-off valves do not fully close
    - b. Engine blower shutdown is inoperative (manually from open or enclosed steering)
    - c. Engine room air dampener shutdown system will not close completely
  11. Loose/missing fittings, nuts, bolts, brackets, etc.:
    - a. Missing or loose shafting bolts:
      - 1) Gear output flange
      - 2) Propeller shaft coupling
      - 3) Propeller shaft flange
-



- b. Steering system:
  - 1) Rudder post nuts
  - 2) Steering ram mounts
- 12. Buoy handling equipment inoperative or damaged:
  - a. A-frame actuators and winch hardware, grade 5 or better mounting bolts, hoses, fittings cables
  - b. Cross deck winch hardware, hoses, fittings, and cables
  - c. Chain stopper and roller for physical damage, distortion.
- 13. Buoy handling equipment and rigging gear not inspected:
  - a. Weight handling equipment not of proper grade, that has not been calibrated or pull tested Annually, and material condition that degrades equipment
  - b. Buoy handling system level I inspection/ annually
  - c. Buoy handling system level II inspection/ every four years
- 14. Undersized engine mounting bolts and/or constructed of inferior grade material (needs to be grade 5 or better).
- 15. AC generator inoperative.
- 16. Sea chest valve inoperative (closed).

\* To determine if lube oil is dripping, a clean sheet of paper may be placed under a suspected leak to collect and detect any drops that fall.

---



---

**Boat outfit**

1. Fire extinguishers not secured in brackets, expired weight test.
  2. Mast support bracket hardware loose/missing.
  3. Underweight CO<sub>2</sub> bottle.
  4. CO<sub>2</sub> system pressure switches not operating properly.
  5. Boat pyrotechnics unserviceable/missing.
  6. Missing boat crew survival vest.
  7. Portable dewatering pump kit incomplete/inoperative/missing.
- 

**Electronics/  
navigation**

1. Compass:
    - a. Deviation table missing
    - b. Compass deviation over 5 degrees
    - c. Fluxgate compass inaccurate over 5 degrees
  2. Electronics:
    - a. VHF radio inoperative
    - b. Depth sounder inoperative
    - c. DGPS inoperative
    - d. Radar inoperative
    - e. Electronic Charting System inoperative
    - f. ATONIS/APPS Program inoperative
- 

**General  
materiel and  
safety**

1. Watertight integrity:
    - a. Holes/cracks in a watertight structure
    - b. Cracks through a watertight scuttle/hatch
    - c. Failure of a watertight closure to seal
    - d. Loose dogs/dogging arms on watertight doors/hatches/scuttles
    - e. Any noticeable gap at gasket seams
  2. Stern dunnage missing.
  3. Navigation lights inoperative.
  4. Removal or Alteration to emergency egress route.
  5. Weight handling equipment not of proper grade, that has not been calibrated or pull tested, and material condition that degrades equipment.
  6. A-frame proximity switch inoperative.
-



## Major Discrepancies

### Engine and vessel systems

1. Leaks less than 15 drops per minute:
  - a. Jacket water
  - b. Raw water
  - c. Lube oil
  - d. Hydraulic oil
  - e. Reduction gear oil
2. Any fuel leak (piping/fittings/tank) that drips less than one (1) drop within ten (10) minutes.
3. Bilge pump hoses missing hose clamps.
4. Loose/missing fittings, nuts, bolts, brackets, etc.:
  - a. Hardware on the engines used for attaching equipment
  - b. Battery terminals loose or corroded
  - c. Autopilot pump mounting hardware
  - d. Engine electronic control cables loose or disconnected
5. Flexible hoses and gauge lines used for petroleum based products not either fire rated or fire sleeved (fire sleeve properly banded at both ends).
6. Fluid levels below minimum required.
7. Engine guard's inadequate/missing around moving machinery.
8. Protruding exhaust lagging securing wire.
9. Alternator failure.

### NOTE

There are sufficient redundant systems that this should not be a disabling casualty. Loss of both alternators would not prohibit the boat from performing all of its missions.

10. Any standard boat machinery, with the exception of those listed on the disabling or restrictive list, not operating properly.
11. Engine room air dampener will not open with pull cables.



---

**Boat outfit**

1. Improperly stowed, secured, or inspected equipment:
    - a. Deck locker covers
    - b. All drawers and cabinets in workshop
    - c. Oxygen and acetylene bottles
    - d. Life raft
    - e. Portable dewatering pump
    - f. Survival vest
  2. Hydrostatic testing of fixed/portable cylinders not completed.
  3. Fire extinguisher PMS not recorded on equipment tag or improperly completed.
- 

**Electronics/  
navigation**

1. Compass light inoperative.
  2. Expired deviation table.
  3. Any standard boat electronics, with the exception of those listed on the restrictive list, not operating properly.
- 

**General  
material and  
safety**

1. Watertight integrity:
    - a. Improperly filled holes
    - b. Hardware bolted through a watertight hatch, scuttle, or bulkhead
  2. Scuttle not flush with the deck causing a tripping hazard.
  3. Inability to open or close doors, hatches, or scuttles.
  4. Hatch and scuttle safety locks do not engage when item is in the *open* position.
  5. Missing breaker or open hole in any power distribution panel.
  6. Any standard boat machinery or system, with the exception of those listed on the disabling or restrictive lists, not operating properly.
-



**(This page intentionally left blank.)**



# Appendix F

## 49' BUSL Full Power Trial

### Overview

---

**Introduction** This appendix contains the full power trial requirements for the 49' BUSL to ensure that the boat operates to prescribed standards.

---

**In this appendix** This appendix contains the following information:

Topic	See Page
Conducting a Full Power Trial	F-3

---





**(This page intentionally left blank.)**



## Procedure

### Conducting a full power trial

Follow these procedures when conducting a full power trial:

Step	Procedure
1	Get the boat underway for a 10-minute transit on a relatively straight course. Bring the engine up to full speed.
2	After approximately 8 minutes, check engine speed. Normal engine speed range is 2200-2300 RPM.
3	<p>Check for the following abnormalities, which occasionally occur during the full power trial:</p> <ul style="list-style-type: none"> <li>• Any fuel or lube oil dripping* on a hot surface is a disabling casualty (hot surface is defined as a surface greater than 400 °F, even if covered by insulation)</li> <li>• The turbocharger lube oil supply hose leaking onto a hot surface or not fire rated or fire sleeved is a disabling casualty</li> <li>• A leak from the shaft seal, equivalent to a trickle or steady stream, while rotating is a disabling casualty</li> <li>• Any leak from the shaft seal, in excess of 15 drops per minute, while not turning is a disabling casualty</li> <li>• Any fuel oil drop* falling within 10 minutes, not on a hot surface, is a restrictive discrepancy</li> <li>• Any anti-freeze, lube oil, or hydraulic oil leak greater than 15 drops per minute is a restrictive discrepancy</li> <li>• Any anti-freeze, lube oil, or hydraulic oil leak less than 15 drops per minute is a major discrepancy</li> </ul> <p>* To determine if any oil has dripped, a clean sheet of paper may be placed under a suspected leak for up to ten minutes to collect and detect any drops that fall.</p>



Step	Procedure
4	Check all gauges on the console and record the readings. Refer to the following chart for allowable ranges and results:

Categories	Disabling	Restrictive	Major	Normal	Major	Restrictive	Disabling
Oil Pressure (PSI)	<30			30-70			
Water Temperature (°F)	<140			155-185			>205
Reduction Gear Pressure (PSI)	<280			300-320			>350
Engine Speed (RPM)		<2100		2200-2300		>2350	

5	Return to the mooring. Secure both engines and check all fuel fittings. <ul style="list-style-type: none"> <li>• Any fuel oil leak is a restrictive discrepancy</li> </ul>
---	--



# Appendix G

## List of Acronyms

### Overview

---

**Introduction** This appendix contains a list of the acronyms used throughout the handbook.

---

**In this appendix** This appendix contains the following information:

Topic	See Page
List of Acronyms	G-3

---



**(This page intentionally left blank.)**



<b>ACRONYM</b>	<b>DEFINITION</b>
A/C	Air Conditioning
ATON	Aids to Navigation
BUSL	Buoy Utility Stern Loading
CPU	Central Processing Unit
DGPS	Differential Global Positioning System
DIW	Dead-in-the-Water
ECR	Engineering Change Request
ECS	Electronic Chart System
FLOCS	Fast Lubricating Oil Change System
FPM	Feet Per Minute
GPS	Global Positioning System
HPU	Hydraulic Power Unit
HVAC	Heating, Ventilation, and Air Conditioning
IPS	International Pipe Standard
LC	Load Center
LOA	Length Overall
NATON	National Aids to Navigation
NOAA	National Oceanographic and Atmospheric Association
PFD	Personal Flotation Device
PMS	Planned Maintenance System
PTO	Power Take-Off
QAWTD	Quick-Acting Watertight Door
RFO	Ready for Operations
UMI	Universal Marine Interface
UPS	Uninterrupted Power Supply



**(This page intentionally left blank.)**



# Appendix H

## 49' BUSL Rigging Equipment

### Overview

---

**Introduction**      **This appendix contains a list of rigging equipment and requirement**

---

**In this Appendix**      This appendix contains the following information:

Area	See Page
List and requirements of rigging gear	H-3
Working load limits and test loads	H-4

---





**(This page intentionally left blank.)**



## Buoy Deck Rigging Gear

<u>Item</u>	<u>Requirement</u>
Hoist hooks	A-Frame Alloy steel hook with an opening of 1.75" Cross deck Alloy steel
Swivel assembly	5 ton jaw to jaw
Wire rope	A-Frame 50ft of 3/8" 6x37 IWRC, PRE, XIP, RRL Cross Deck 30ft of 3/8" 6x37 IWRC, PRE, XIP, RRL
Wire rope end fitting	Closed swage socket
Chain gripe down	Alloy steel 5/16" Grade 7 or better with foundry hook on both ends
Hooks grip down	Alloy steel with an opening of 1.06"
Chain over head lifting	Alloy steel Grade 8
Ratchet load binder	Working Load Limit of 5,400 lbs or greater
Snatch block With shackle	4-1/2" sheave diameter Working Load Limit of 4 ton or greater
Bull Chain	Alloy steel 5/8" Grade 8
Pelican Hook	
Modeer shackle	2 <sup>nd</sup> class Federal stock number 4030-01-042-9070
Shackles	Alloy steel with WWL permanently and clearly marked Must be equal to or greater then the job they will perform
Links, Connecters, Rings and other Miscellaneous Hardware	Alloy steel Must be equal to or greater then the job they will perform
Line reeving device	Federal stock number 2040-01-254-5284
Chain Hooks	Federal stock number 5120-00-288-6527
Buoy Scraper	Federal stock number 5110-00-224-9926
Hammer Blacksmith Punch	Federal stock number 5120-00-271-9909
Hammer Sledge 6 lb (Short handle)	Federal stock number 5120-00265-7462

**REMARKS:** \_\_\_\_\_

\_\_\_\_\_

\_\_\_\_\_



## Working Load Limit (WLL) and Test Loads

<u>Item</u>	<u>WLL</u>	<u>Test Load</u>
A-Frame Winches and Cables (Each Whip)	2,250 lbs	
A-Frame Winches and Cables (combined)	4,500 lbs	5,000 lbs
Cross deck Winches and Cables	1,500 lbs	1,875 lbs
Bull Chain pad eyes	12,000 lbs Parallel to deck	15,000 lbs
Grip down pad eyes	4,500 lbs	5,625 lbs

**NOTES:** \_\_\_\_\_  
\_\_\_\_\_  
\_\_\_\_\_



# Index

120-VAC engine room power panel, 3-46  
 120-VAC galley/mess power panel, 3-47, 3-51  
 120-VAC load center, 2-16, 3-41, 3-43  
 120-VAC pilothouse power panel, 3-47  
 120-VAC power distribution system, 3-41  
 120-VAC power panel, 6-3, 6-39, 6-41  
 24-VDC load center, 3-44, 3-49  
 24-VDC power distribution system, 3-43, 3-44, 3-49  
 24-VDC power meter and ground fault detection panel, 3-45  
 24-VDC power panel, 2-16, 3-45, 3-46, 6-4, 6-39, 6-41, 7-5, 7-7  
 585CE actuator, 3-7, 3-8  
 813 troll actuator, 3-7, 3-8

## A

A/C unit, 3-49, 3-51, 3-55  
 acceleration, 5-12  
 accumulator, 3-95  
 acronym, G-1, G-3  
 actuator, 3-7, 3-59, 3-60, 3-61, 7-9, E-3  
 A-frame, 3-59, 3-60, 3-61, 3-62, 3-66, 3-67, 4-7, 4-9, 6-22, 6-23, 6-27, 6-28, E-3  
 A-frame hydraulic manifold, 2-14  
 aft control console, 3-7, 3-9, 3-37  
 aft control stations, 3-7  
 aft voids, 2-9, 2-12, A-1, A-3  
 aids to navigation operations, 6-1, 6-21  
 air compressor, 2-14, 3-49, 3-93  
 air conditioning unit condensate drain systems, 3-55  
 air receiver, 3-93  
 air separator body, 3-20, 3-38  
 air separator filter, 3-20, 3-38  
 alarm, 3-48, 3-49, 3-59, 3-61, 3-81, 3-83  
 alternator, 3-8, 3-18, 3-39, 3-43, 3-44, 3-45, E-5  
 anchor, 2-31, 2-32, 2-35, 2-37, 2-38, 2-39, 6-31, 6-33, 6-34  
 anchoring, 6-1, 6-33  
 autopilot system, 3-69, 3-70, 3-71, 3-72

## B

battery bank, 3-30, 3-43, 3-44, 3-49  
 battery charger, 2-16, 3-43, 3-44, 3-45, 3-49, 3-53  
 beam seas, 5-10, 6-11, 6-15  
 berthing, 3-48, 3-51, 3-53, 3-54, 3-55, 3-70, 3-81, 3-85  
 berthing area, 3-51, 3-54, 3-70, 3-81

berthing compartment, 2-6, 2-9, 2-26, 3-55, A-1, A-15, C-1, C-36  
 bilge, 2-6, 3-29, 3-48, 3-54, 3-55, 3-81, 3-85, 3-95, 5-12, 6-3, 6-39, 7-13, 7-15, 7-17, 7-18, 7-21, 7-23, D-4  
 bilge pump, 2-16, 3-85, E-5  
 bilge pump panel, 3-85, 3-86  
 bilge system, 3-1, 3-85, E-3  
 bitt, 2-35, 2-37, 2-40, 6-33, 6-34  
 boat hooks, 2-35, 2-44  
 boat specifications, 2-3  
 buoy console, 6-23  
 buoy console panel, 3-59, 3-61, 3-63  
 buoy deck, 2-46, 2-48, 2-50, 2-52, 5-12, 6-22, 6-23, 6-24, 6-26, 6-29, 6-31, 6-35 C-1, C-7, C-9, C-23  
 buoy deck supervisor, 6-21, 6-24, 6-26, 6-29  
 buoy handling, 3-38, 3-45, 3-51, 3-59, 3-60, 3-61, 4-3, 4-9, 4-15, 5-12, E-36  
 buoy handling system, 3-1, 3-59, 6-21, 6-22, 6-27  
 buoy handling hydraulic system, 6-22, 6-23  
 buoy handling hydraulic system control panel, 3-68  
 buoy hydraulic system, 6-21, 6-22  
 buoy operation, 5-7  
 buoyancy, 6-14, 6-15  
   bypass valve, 3-18, 3-33, 3-60, 3-61

## C

cartridge filter, 3-18  
 casualties, 7-1  
 casualty, 7-1, 7-17, 7-19, 7-21, 7-23  
 cathodic protection, 3-101  
 cathodic protection system, 3-2, 3-101  
 central alarm panel, 3-48, 3-61, 3-81, 3-82  
 chain stopper, 3-59, 3-62  
 changing course, 5-10, 6-15  
 chocks, 2-35, 2-40, 2-46  
 CO<sub>2</sub> cylinders, 3-83  
 CO<sub>2</sub> flooding system, 3-53  
 CO<sub>2</sub> system, 3-45, 3-83, 7-9  
 compressed air system, 3-1, 3-93, 3-94  
 configuration control, 1-9  
 control console, 3-10  
 control heads, 3-7  
 control station, 6-6, 6-7, 6-9  
 conversion block, 3-33  
 coolant filter, 3-13  
 coolant reservoir, 3-13, 3-15  
 coxswain, 4-1, 4-3, 4-5, 4-7, 4-9, 4-13, 5-4, 5-5, 5-7, 6-9, 6-14, 6-18, 6-24, 6-25, 6-26, 6-31, 6-33, 6-34,



7-1, 7-3, 7-5, 7-9, 7-11, 7-13, 7-15, 7-17, 7-18, 7-20, 7-21, 7-23  
crankcase ventilation system, 3-20, 3-21  
crew, 1-5, 2-4, 2-26, 3-1, 4-1, 4-3, 4-5, 4-13, 5-1, 5-5, 5-6, 5-7, 5-10, 6-1, 6-9, 7-1, 7-3, 7-5, 7-21, 7-23  
crewmember, 4-1, 4-3, 4-7, 4-9, 4-11, 4-13, 4-15, 6-1, 6-9, 6-18, 6-33, 6-34, 6-35, 7-1, 7-9  
cross deck winch, 3-59, 3-60, 3-61, 3-68, E-3  
cross deck winch hydraulic manifold, 2-16  
cross deck winch manifold, 3-60  
current, 6-11, 6-12, 6-18, 6-21, 6-35  
cutoff valve, 3-91

## D

deceleration, 5-13  
deck equipment, 2-1, 2-33  
deck locker, 2-35, 2-50, E-6  
deck washdown, 3-49, 3-91, 3-96  
deck washdown system, 3-1, 3-91, 3-92  
depth sounder, 2-6, 3-7, 3-69, 3-72, E-4  
DGPS, 3-48, 3-69, 3-70, 3-71, 3-73, 6-8, E-4  
diesel engine, 3-3, 3-8, 3-13, 3-18, 3-22, 3-26, 3-28, 3-37, 3-38, 3-39, 3-44  
3-49, 3-60, 3-69  
diesel engine control panel, 3-38  
differential global positioning system, 3-48, 3-69  
disabling casualties, D-1  
disabling casualty, 5-3, 5-5, D-3, F-3  
discrepancy underway, 5-4  
duplex filter, 3-22, 3-37

## E

ECR, 1-7, B-1, B-3  
ECS, 3-34, 3-69, 3-70, 3-71  
electrical alarm, safety and warning systems, 3-1, 3-81  
electrical systems, 3-1, 3-41  
electronic chart system, 3-34, 3-69, 3-71, E-4  
electronic compass, 3-69, 3-70  
electronic navigation system, 3-1, 3-69  
electronics/navigation, D-1, D-3, E-4, E-6  
emergency dewatering pump, 2-33, 2-50, 2-51  
emergency fuel shutoff valve, 3-22  
emergency power distribution system, 3-49  
emergency procedures, 7-1, 7-2, 7-19  
emergency shutdown, 3-9, 3-37  
emergency shutdown control, 3-12, 3-37  
energizing equipment, 6-7  
ENGAGE/DISENGAGE switch, 6-22  
engine, 2-4, 2-6, 2-16, 2-18, 2-29, 2-52, 3-3, 3-7, 3-8, 3-9, 3-13, 3-18, 3-20, 3-22, 3-26, 3-29, 3-30, 3-37,

3-38, 3-39, 3-39, 3-41, 3-43, 3-44, 3-45, 3-48, 3-49, 3-51, 3-53, 3-59, 3-60, 3-61, 3-81, 3-83, 3-85, 6-3, 6-4, 6-5, 6-6, 6-7, 6-9, 6-12, 6-14, 6-16, 6-18, 6-39, 6-41, 6-42, 7-3, 7-5, 7-7, 7-9, 7-11, 7-13, 7-15, 7-17, 7-18, 7-19, 7-20, 7-21, D-1, D-3, E-3, E-5, F-3  
engine control and gauge panel, 3-8, 3-11  
engine crankcase ventilation system, 3-17, 3-38  
engine exhaust system, 3-17, 3-26, 3-27, 3-38  
engine jacket water heater, 3-17, 3-28, 3-38  
engine lubrication system, 3-17, 3-18, 3-19  
engine parameters, D-1, D-3  
engine room, 3-7, 3-8, 3-22, 3-26, 3-38, 3-41, 3-44, 3-45, 3-48, 3-49, 3-51, 3-59, 3-60, 3-61, 3-81, 3-85, 7-3, 7-5, 7-9, 7-13, 7-15, 7-17, 7-19, 7-20, C-1, C-6, C-7, C-24, C-31  
engine RPM, 7-2, 7-11, A-1, A-5  
engine speed, F-3, F-4  
engine starting batteries, 2-16  
engine starting system, 3-17, 3-30, 3-31  
engine systems, 3-1, 3-17  
engine-driven cooling water pump, 3-13  
engineer, 4-1, 4-3, 4-7, 4-13, 7-1, 7-3, 7-7, 7-9, 7-11, 7-13, 7-15, 7-17, 7-19, 7-20, 7-21, 7-23  
engineering change requests, 1-7, B-1, B-3  
engineering system components, D-1, D-3  
enunciators, 3-81  
environmental limits, 5-3, 5-7  
equipment casualties, 7-1  
exhaust ventilation ducts, 3-53

## F

facility manager, 1-5  
fast lubricating oil change system, 3-17 3-29  
filter bypass valve, 3-18  
filter cart connections, 3-62  
fire extinguisher, 3-83, E-4, E-6  
fire extinguishing systems, 3-1, 3-83  
fire in the engine room, 7-2, 7-9  
fittings, 2-1, 2-24, 2-35, 2-52, 6-33, E-3  
float switches, 3-85  
FLOCS, 3-17, 3-29  
flooding, 7-2, 7-3, 7-23  
floodlights, 2-31, 3-1, 3-77, 3-78, 3-79  
fluxgate compass, 3-69, 3-70, 3-74, E-4  
following seas, 5-10, 6-11, 6-15  
forepeak, 2-9, 2-28, 2-37, 2-38  
forward deck, C-1, C-12  
forward peak, A-1, A-12, C-1, C-14  
fuel consumption, 5-9  
fuel filter/separator, 3-22  
fuel filters, 2-16



fuel oil, 3-22, 3-37, 3-45, 6-3, 6-4, 6-39, 6-42  
 fuel oil pressure, 7-2, 7-13  
 fuel oil system, 3-17, 3-22  
 fuel pump, 3-22, 3-37  
 fuel supply valves, 6-3, 6-39  
 fuel tank, 2-4, 2-9, 2-18, 2-52, 6-3  
 full power trial, F-1, F-3

## G

galley, 2-6, 2-9, 2-20, 2-22, 2-48, 3-41, 3-45, 3-47, 3-48, 3-49, 3-51, 3-53, 3-54, 3-70, 3-81, 3-85, 3-87, 3-96  
 galley/mess, 2-9, 2-22, A-1, A-6, A-9, C-1, C-30  
 generator, 2-3, 2-16, 2-18, 2-29, 3-9, 3-37, 3-38, 3-39, 3-39, 3-41, 3-44, 3-49, 3-53, 3-61, 6-4, 6-5, 6-6, 6-23, 6-39, 6-41, 6-42, 7-9, 7-19, 7-20, E-4  
 generator light off, 6-4  
 generator monitoring panel, 3-39  
 generator RPMs, 7-20  
 governor, 3-7, 3-39, 7-20  
 governor failure, 7-20  
 grabrails, 2-35, 2-48, 2-49  
 gray water and sewage systems, 3-1, 3-87  
 gray water holding tank, 3-87  
 gray water pump, 3-49, 3-87  
 gray water system, 3-87

## H

handling characteristics, 6-1, 6-12  
 handrails, 2-33, 2-42, 2-44, 2-46, 2-47  
 hawser reel, 2-28, 2-35, 2-38, 2-39  
 head, 2-6, 2-9, 2-48, 3-7, 3-33, 3-51, 3-53, 3-54, 3-83, 3-87, , A-1, A-6, A-10, C-1, C-30, C-34  
 head seas, 6-12, 6-15  
 heater/defroster units, 3-55  
 heating and ventilation, 3-53, 3-54, 3-55  
 heating, ventilation and air conditioning, 3-1  
 helm, 6-9, 6-12, 6-16  
 helm pump, 3-33, 3-34  
 hose connection, 3-95, 3-96  
 hose outlets, 3-93  
 hot water heater, 3-49, 3-95  
 hull, 2-4, 2-5, 2-6, 2-14, 2-16, 2-40, 2-44, 3-7, 3-13, 3-26, 3-44, 3-49, 3-54, 3-62, 3-69, 3-70, 3-85, 3-101, 5-10, 5-11, 5-12, C-1, C-4  
 HVAC, 3-1, 3-53  
 hydraulic filter, 3-60  
 hydraulic fluid heat exchanger, 3-61  
 hydraulic manifold, 3-33, 3-34, 3-60  
 hydraulic manifold assembly, 3-33, 3-34  
 hydraulic oil reservoir, 2-16, 3-59, 6-22  
 hydraulic pump, 3-34, 3-38, 3-59, 3-60, 3-61

hydraulic pump and motor, 3-34  
 hydraulic reservoir, 3-33, 3-34, 3-61  
 hydraulic steering system, 3-1, 3-33, 3-35

## I

ice conditions, 6-1, 6-37  
 indicator light box, 3-83

## J

jacket water cooling system, 3-1, 3-13, 3-14  
 jacket water system, 3-13, 3-28, 3-37, 3-38, 7-7, 7-15, 7-17, 7-18

## K

keel, 2-5, 2-6  
 keel cooler, 3-13, 3-14, 3-37, 3-101, 7-17, 7-18, 7-19

## L

lazarette, 2-6, 2-9, 2-12, 2-14, 3-33, 3-34, 3-49, 3-51, 3-53, 3-55, 3-60, 3-81, 3-83, 3-85, 3-88, 3-93, 7-3, 7-5, A-1, A-4, C-1, C-10  
 LC1, 2-16  
 LC2, 2-16  
 level switches, 3-55, 3-87, 3-88  
 life raft, 2-35, 2-43  
 life rings, 2-35, 2-42  
 lifelines, 2-35, 2-40, 2-46, 2-47  
 LOAD/NO LOAD switch, 6-22, 6-23  
 loudhailer, 3-48, 3-69, 3-70, 3-73, 3-81  
 loudhailer/intercom, 3-69, 3-70  
 lube oil pressure, 7-2, 7-15, D-3, D-4  
 lubrication system, 3-37

## M

macerator pump, 3-88  
 machinery space, 2-9, 2-16, 2-18, 2-20, 2-22, 3-3, 3-8, 3-11, 3-30, 3-37, 3-38, 3-41, 3-44, 3-53, 3-54, 3-59, 3-60, 3-61, 3-68, 3-70, 3-83, 3-85, 3-88, 3-91, 3-93, 3-95, 6-3, 6-4, 6-22, 6-23, 6-27, 6-39, 6-41, A-1, A-5  
 magnetic compass, 3-1, 3-48, 3-75  
 main engine high water temperature, 7-2, 7-17  
 main propulsion engines, 3-7, 3-17  
 major discrepancies, 5-3, 5-5, 5-6, E-1, E-5  
 major discrepancy, F-3, F-4  
 mast, 2-1, 2-3, 2-4, 2-31, 2-32, 2-33, 2-43, E-4  
 material inspection checklist, C-1, C-2  
 mess, 2-9, 2-22, 2-48, 2-50, 3-41, 3-45, 3-48, 3-51, 3-53, 3-54, 3-70, 3-81, 3-83, 3-87  
 minor discrepancies, 5-3, 5-5, 5-6



mission performance, 6-1  
mooring bitt, 2-35, 2-37  
mufflers, 3-26

## N

navigation lights, 3-1, 3-48, 3-77, 3-78, 3-79, E-4  
navigation radar, 3-69

## O

oil cooler, 3-3, 3-13, 3-18, 3-38  
oil filter, 3-13, 3-18, 3-22, 3-34, 3-37, 3-61  
operating characteristics, 2-4  
operating parameters, 5-1, 5-3  
operational commander, 5-3, 5-4, 5-5, 5-6, 5-7  
operational guidelines, 5-1  
outfit list & stowage plan, A-1  
overboard ports, 3-26

## P

P-39 portable hydraulic hand pump, 3-61  
pan plug adapter, 3-29  
passengers, 4-1, 4-5, 4-11  
performance data, 5-1, 5-9  
personal protective equipment, 4-11, 4-15  
personal protective gear, 6-9  
personnel recovery, 6-1, 6-35  
physical characteristics, 2-3, 2-12, 2-14, 2-16, 2-18, 2-20, 2-22, 2-24, 2-26, 2-28, 2-29, 2-31, 2-37, 2-38, 2-39, 2-40, 2-42, 2-43, 2-44, 2-46, 2-48, 2-50, 2-52  
pilothouse, 2-1, 2-20, 2-22, 2-24, 2-29, 2-30, 2-31, 2-37, 2-38, 2-40, 2-42, 2-43, 2-47, 2-52, 3-7, 3-8, 3-9, 3-30, 3-33, 3-34, 3-37, 3-39, 3-41, 3-45, 3-48, 3-51, 3-53, 3-54, 3-55, 3-59, 3-61, 3-69, 3-70, 3-71, 3-75, 3-77, 3-78, 3-81, 3-83, 3-85, 3-88, 3-91, 3-99, 6-4, 6-21, 6-22, 6-23, 6-28, 6-33, 6-39, 6-41, A-1, A-17, C-1, C-14, C-16, C-18, C-20, C-21  
piping, 3-26, 3-38, 3-87, 3-91, 3-101  
pivoting, 6-12, 6-13  
potable water heater, 2-16  
potable water pump, 3-45  
potable water system, 3-1, 3-95, 3-96  
potable water tank, 2-16, 3-95, 3-96, 6-7  
power panel, 3-41, 3-42, 3-44, 3-45, 3-48, 3-49, 3-51, 6-3, 6-5  
power takeoff (PTO) assembly, 3-38  
pressure regulating valve, 3-18  
pressure switch, 3-83, 3-93, 3-95  
pressure tank, 3-95  
primary fuel filters, 7-13

propeller, 3-3, 3-4, 3-7, 3-34  
propeller shafts, 3-4, 3-34  
propulsion control system, 3-1, 3-3, 3-7, 3-9  
propulsion system, 3-1, 3-3, 3-5  
PTO switch, 6-22, 6-23  
pulling chain, 6-25  
pushbutton switches, 3-99

## Q

quick-acting watertight door, 2-16, 2-20, 2-22, 2-24, 2-26, 3-41, 3-83  
quick-disconnect coupling, 3-29

## R

radio, 3-48, 3-69, 3-70, E-4  
radiotelephone, 3-73  
reduction gear, 2-3, E-3, E-5, F-4  
reduction gear/clutch lube oil cooler, 3-13  
reduction gear controls, 7-7  
reduction gear failure, 7-1, 7-7  
reduction gear oil cooler, 2-16  
remote indicator, 3-69, 3-83  
restricted maneuvering, 6-13, 6-17  
restrictive discrepancies, 5-3, 5-4, 5-5, 5-6, E-1, E-3  
restrictive discrepancy, F-3, F-4  
rigging a vessel for tow, 6-31  
roller assembly, 3-62  
rub rails, 2-5, 2-6  
rudder, 3-33, 3-34, 6-7, 6-12, 6-13, 6-14, 6-16, 6-18, 6-37

## S

safety, D-1, D-4  
safety equipment, 4-1, 4-15  
saltwater cooling pump, 3-49  
seakeeping, 5-10  
searchlights, 3-1, 3-77, 3-78, 3-79  
seawater cooling pump, 2-16, 3-54  
secondary filter, 3-37  
secondary fuel filter, 3-22  
securing procedures, 6-1, 6-39, 6-41  
service pump, 3-95  
setting the buoy, 6-26  
sewage discharge pump, 2-14, 3-49  
sewage holding tank, 2-14, 3-60, 3-87, 3-88  
sewage system, 3-87  
sewage tank, 6-7  
shaft seal, 7-2, 7-3, 7-21  
shaft seal assembly, 3-6  
shaft seal leakage, 7-2, 7-21



ship service AC generator, 3-1, 3-37  
 ship service generator, 3-22, 3-41, 3-44, 3-53, 3-59, 3-60  
 shore power, 3-41, 3-44, 6-5, 6-6, 6-39, 6-41  
 signal devices, 3-1, 3-77, 3-78, 3-79  
 skegs, 2-4, 2-6  
 solenoid, 3-30  
 speed, 5-9, 5-11, 5-12, 5-13, D-3  
 spin-on cartridge filter, 3-18  
 split throttle turn, 6-13  
 stability, 5-12  
 standard workstation III, 3-69, 6-8  
 starter, 3-30  
 starting procedures, 6-1, 6-3  
 station keeping, 6-11, 6-17, 6-19  
 steering casualty, 7-1, 7-5  
 steering gear hydraulic unit, 2-14  
 steering system, 3-33, 3-34, 3-45  
 strainer, 3-91  
 striking a submerged object, 7-1, 7-3  
 suction screen, 3-18  
 suction strainer, 3-34, 3-38, 3-59  
 superstructure, 2-4  
 supply ventilation ducts, 3-53  
 SWIII, 3-69, 3-70, 3-71

## T

tacking, 5-10, 6-15  
 thermostat, 3-13, 3-28, 3-38, 3-95  
 throttle, 3-7, 6-6, 6-7, 6-9, 6-12, 6-13, 6-16, 7-3, 7-7, 7-21  
 tie-downs, 3-62  
 tiller assembly, 2-14, 3-34  
 tow watch, 6-31, 6-35  
 towing, 2-4, 4-9, 5-9, 6-1, 6-17, 6-29  
 training, 4-1, 4-7, 4-9, 4-13  
 transfer power, 6-5, 6-6  
 transferring power, 6-5  
 transformer rectifier, 3-43, 3-44  
 transmission/reduction gear, 3-3, 3-7  
 troll/non-troll switch, 3-7  
 trolling valve actuator, 3-7  
 turning, 5-11, 5-12, 6-12, 6-17

## U

underway, 6-1, 6-7, 6-9, 6-11  
 universal marine interface, 6-8

## V

vacuum pump, 3-45, 3-87  
 vacuum tank, 3-87

## W

waiver, 5-4, 5-6  
 washers, 3-48, 3-99  
 water chiller, 3-51, 3-95, 3-96  
 watertight compartments, 2-1, 2-9  
 white water, 5-11, 6-15  
 winch cables, 6-27  
 winches, 3-53, 3-59, 3-60, 3-61, 3-62, 3-66, 6-21, 6-22, 6-23  
 wind, 5-12, 6-13, 6-14, 6-15, 6-17, 6-18, 6-19, 6-21, 6-31, 6-33, 6-35  
 window wipers, 3-48  
 windshield wipers, 3-99  
 windshield wipers and washers, 3-2, 3-99, 3-100  
 workshop, 2-6, 2-9, 2-16, 2-20, 2-24, 2-48, 2-52, 3-45, 3-49, 3-51, 3-53, 3-54, 3-55, 3-70, 3-81, 3-83, 3-93, 3-96, A-1, A-6, C-1, C-28

## Z

zinc anodes, 3-101



