

**DAHLGREN DIVISION
NAVAL SURFACE WARFARE CENTER**

Dahlgren, Virginia 22448-5100



NSWCDD/TR-98/6

**BEHAVIOR OF LARGE QUANTITIES OF HAZARD
DIVISION 1.2 AMMUNITION IN FIRES**

**W. D. HOUCHINS
WEAPONS SYSTEMS DEPARTMENT**

**M. M. SWISDAK, JR.
INDIAN HEAD DIVISION, NAVAL SURFACE WARFARE CENTER**

**M. J. A. GOULD
UK MINISTRY OF DEFENCE**

FEBRUARY 1999

Approved for public release; distribution is unlimited (February 1999). Other requests shall be referred to Dahlgren Division, Naval Surface Warfare Center, (Code G64), Dahlgren, VA 22448-5100.

19990504 008

DTIC QUALITY INSPECTED 4

REPORT DOCUMENTATION PAGE

Form Approved
OBM No. 0704-0188

Public reporting burden for this collection of information is estimated to average 1 hour per response, including the time for reviewing instructions, search existing data sources, gathering and maintaining the data needed, and completing and reviewing the collection of information. Send comments regarding this burden or any other aspect of this collection of information, including suggestions for reducing this burden, to Washington Headquarters Services, Directorate for Information Operations and Reports, 1215 Jefferson Davis Highway, Suite 1204, Arlington, VA 22202-4302, and to the Office of Management and Budget, Paperwork Reduction Project (0704-0188), Washington, DC 20503.

1. AGENCY USE ONLY (Leave blank)		2. REPORT DATE February 1999	3. REPORT TYPE AND DATES COVERED	
4. TITLE AND SUBTITLE Behavior of Large Quantities of Hazard Division 1.2 Ammunition in Fires			5. FUNDING NUMBERS 9G29DHT01	
6. AUTHOR(s) W. D. Houchins, M. M. Swisdak, Jr., and M. J. A. Gould				
7. PERFORMING ORGANIZATION NAME(S) AND ADDRESS(ES) Naval Surface Warfare Center, Dahlgren Division (Code G64) 17320 Dahlgren Road Dahlgren, VA 22448-5100			8. PERFORMING ORGANIZATION REPORT NUMBER NSWCDD/TR-98/6	
9. SPONSORING/MONITORING AGENCY NAME(S) AND ADDRESS(ES)			10. SPONSORING/MONITORING AGENCY REPORT NUMBER	
11. SUPPLEMENTARY NOTES				
12a. DISTRIBUTION/AVAILABILITY STATEMENT Approved for public release; distribution is unlimited (February 1999). Other requests shall be referred to Dahlgren Division, Naval Surface Warfare Center, (Code G64), Dahlgren, VA 22448-5100.			12b. DISTRIBUTION CODE	
13. ABSTRACT (Maximum 200 words) At present, the quantity-distance (Q-D) requirements for open storage of Hazard Division (HD) 1.2 ammunition are different in the U.S., the United Kingdom (UK), and NATO. In 1989, NATO AC/258 (Group of Experts on the Safety Aspects of Transportation and Storage of Military Ammunition and Explosives) began an effort to review HD 1.2 Q-D requirements with the objective of reconciling the different approaches. However, test data to support the effort were very limited at that time. Therefore, it was recommended that a series of bonfire tests be conducted to characterize the hazards produced by fires involving large stacks of HD 1.2 items. In order to support this effort, the U.S. Department of Defense Explosives Safety Board (DDESB) and the UK Explosives Storage and Transport Committee (ESTC) jointly sponsored a series of bonfire tests using 105mm artillery cartridges and 81mm mortar cartridges. A total of twelve tests were conducted during the period May 1991 through September 1995. This report describes the test program, test and analysis methodologies, and summarizes the results of the tests.				
14. SUBJECT TERMS Hazard Division 1.2 Ammunition M1 105mm Artillery Cartridges M374A2 81mm Mortar Cartridges Inhabited Building Distance (IBD)			15. NUMBER OF PAGES 270	
			16. PRICE CODE	
17. SECURITY CLASSIFICATION OF REPORT UNCLASSIFIED	18. SECURITY CLASSIFICATION OF THIS PAGE UNCLASSIFIED	19. SECURITY CLASSIFICATION OF ABSTRACT UNCLASSIFIED	20. LIMITATION OF ABSTRACT UL	

FOREWORD

This report documents a series of bonfire tests that were conducted on stacks of M1 105mm artillery cartridges and stacks of M374A2 81mm mortar cartridges. The tests were sponsored jointly by the United Kingdom Explosives Storage and Transport Committee (ESTC) and the United States Department of Defense Explosives Safety Board (DDESB). The purpose of the tests was to characterize the hazards associated with accidental fires involving stacks of Hazard Division 1.2 ammunition.

The program was a team effort involving personnel from several facilities. The tests were conducted by the Ordnance Evaluation Branch of the Naval Air Warfare Center, Weapons Division, China Lake, California, under the direction of Mr. C. Halsey. The airblast/temperature measurements and analyses were accomplished under the direction of Mr. K. W. Rye, formerly of the Explosion Damage Branch (R14) of the Naval Surface Warfare Center, Dahlgren Division (NSWCDD), White Oak Detachment. Analyses of the fragmentation data were accomplished by the Weapons Dynamics Branch (G64) of NSWCDD. Overall-program direction and technical guidance were provided by Mr. M. M. Swisdak of the Naval Surface Warfare Center, Indian Head Division; Mr. M. J. A. Gould of the ESTC; and Dr. J. M. Ward of the DDESB Secretariat.

This report has been reviewed by Mr. B. Mohle, Head (Acting), Weapons Dynamics Branch and Mr. S. Collignon, Head, Weapons Evaluation Division.

Approved by:



J. W. WALTERS, Deputy Department Head
Weapons Systems Department

CONTENTS

	<u>Page</u>
BACKGROUND	1
TEST PROGRAM.....	1
TEST ITEMS.....	2
TEST METHOD	4
TEST CONFIGURATIONS	4
INSTRUMENTATION	6
OBSERVATIONS AND RESULTS	7
ANALYSES.....	14
CONCLUSIONS AND DISCUSSION.....	17
REFERENCES	18
APPENDIXES	
A — HD 1.2 TESTING—INSTRUMENTATION RESULTS AND INTERPRETATION.....	A-1
B — FRAGMENT RECOVERY DATA FROM TEST NOS. 7 THROUGH 12.....	B-1
C — ANALYSIS PROCEDURE.....	C-1
DISTRIBUTION	(1)

ILLUSTRATIONS

<u>Figure</u>		<u>Page</u>
1	M1 105MM ARTILLERY CARTRIDGE	3
2	PACKAGING OF M1 105MM ARTILLERY CARTRIDGES.....	3
3	M374A2 81MM MORTAR CARTRIDGE	4
4	CONSTRUCTION OF TEST STANDS	5
5	COMPLETED SETUP FOR TEST NO. 1	5
6	COMPLETED SETUP FOR TEST NO. 4	6
7	APPROXIMATE DISTRIBUTION OF FRAGMENTS AFTER TEST NO. 6.....	10
8	APPROXIMATE DISTRIBUTION OF FRAGMENTS AFTER TEST NO. 12	10
9	WARHEAD FRAGMENTS PRODUCED BY 105MM PROJECTILES LOADED WITH TNT	11
10	WARHEAD FRAGMENTS PRODUCED BY 105MM PROJECTILES LOADED WITH COMPOSITION B.....	11
11	WARHEAD FRAGMENTS PRODUCED BY 81MM MORTAR WARHEADS.....	12
12	APPROXIMATE LOCATIONS OF EXPLOSIONS IN TEST NO. 6	13
13	APPROXIMATE LOCATIONS OF EXPLOSIONS IN TEST NO. 10.....	13
14	APPROXIMATE LOCATIONS OF EXPLOSIONS IN TEST NO. 12.....	13
15	ANALYSIS METHOD	15
16	ESTIMATED RANGES TO EXCEED 1 FRAGMENT PER 600 FT ² VERSUS CURRENT Q-D REQUIREMENTS	16

TABLES

<u>Table</u>		<u>Page</u>
1	HD 1.2 BONFIRE TEST PROGRAM	2
2	GENERAL OBSERVATIONS FOR EACH TEST	8
3	FRAGMENT RECOVERY DATA	9
4	MAXIMUM INDICATED PEAK OVERPRESSURES	12
5	ESTIMATED PORTION OF WARHEAD BODY PIECES RECOVERED	15

BACKGROUND

At present, the quantity-distance (Q-D) requirements for open storage of Hazard Division (HD) 1.2 ammunition are different in the U. S., the United Kingdom (UK), and NATO. A fundamental difference in these systems is the methodology used to establish the Inhabited Building Distance (IBD). In the U. S., an IBD is established for each specific ordnance item (e.g., M1 105mm high explosive cartridge). It is based on the maximum fragment range observed in standard classification tests and it is independent of the quantity of rounds present.^{1,2} The IBD for a stack containing different types of munitions is based solely on the IBD for the item(s) having the largest device-specific IBD; again, independent of the quantity of material present. In contrast, the UK and NATO establish HD 1.2 IBDs based on the total net explosive weight for a stack. Items are classified as either (a) those which produce small fragments of moderate range (HD 1.2*) or (b) those which produce large fragments with considerable range (HD 1.2). Generally, HD 1.2* items are smaller than 60mm caliber. The respective IBDs for HD 1.2* and 1.2 ammunition are defined as follows:

- a. For HD 1.2*, $D1=53Q^{0.18}$ where D1 is the IBD in meters and Q is the Net Explosive Quantity (NEQ) in kilograms. The minimum and maximum limits for D1 are 180m and 410m, respectively.
- b. For HD 1.2, $D2=68Q^{0.18}$ where D2 is the IBD in meters and Q is the NEQ in kilograms. The minimum and maximum limits for D2 are 270m and 560m, respectively.

For HD 1.1 items, the internationally accepted definition for fragment-related IBD is the range at which fragment areal density reduces to 1 lethal fragment per 600 ft². Consideration has been given to using this same criterion for HD 1.2 items. However, sufficient test data to quantify the distribution of fragments from large HD 1.2 events were not available previously. Therefore, in 1989 NATO AC/258 (Group of Experts on the Safety Aspects of Transportation and Storage of Military Ammunition and Explosives) recommended that a series of bonfire tests be conducted to characterize the hazards produced by fires involving large stacks of HD 1.2 items. In order to support this effort, the U. S. Department of Defense Explosives Safety Board (DDESB) and the UK Explosives Storage and Transport Committee (ESTC) jointly sponsored a series of bonfire tests using 105mm artillery cartridges and 81mm mortar cartridges. This report describes the test program, test and analysis methodologies, and summarizes the results of the tests.

Interim results from the test program were presented at recent DDESB Explosives Safety Seminars.^{3,4,5} Additionally, detailed results from the first six tests were published in two technical reports.^{6,7}

TEST PROGRAM

The test program is summarized in Table 1. A total of 12 tests were conducted during the period May 1991 through September 1995. Six tests were conducted using M1 105mm high explosive artillery cartridges that were loaded with TNT explosive as the projectile main fill. Two

tests were conducted using M1 105mm high explosive artillery cartridges that were loaded with Composition B explosive as the projectile main fill. A total of four tests were conducted using 81mm high explosive mortar cartridges. However, one test (test no. 11) was conducted primarily to verify the hazard classification of 81mm mortar cartridges when stored in metal boxes. The posttest recovery and characterization of debris from this test was very limited and, thus, the results were not used in subsequent analyses of fragment hazards.

TABLE 1. HD 1.2 BONFIRE TEST PROGRAM

<u>Test</u>	<u>Date</u>	<u>Test Items</u>	<u>Warhead Fill</u>	<u>Packaging</u>	<u>Pallets</u>	<u>No. of Rounds</u>	<u>Note</u>
1	5-7-91	M1 105mm Artillery Cartridges	TNT	Standard wooden boxes	1	30*	
2	6-24-91	M1 105mm Artillery Cartridges	TNT	Standard wooden boxes	1	30*	
3	7-29-91	M1 105mm Artillery Cartridges	TNT	Standard wooden boxes	1	30*	
4	10-29-91	M1 105mm Artillery Cartridges	TNT	Standard wooden boxes	8	240*	
5	4-29-92	M1 105mm Artillery Cartridges	TNT	Standard wooden boxes	8	240*	
6	10-28-92	M1 105mm Artillery Cartridges	TNT	Standard wooden boxes	27	864*	
7	5-3-94	M1 105mm Artillery Cartridges	Comp B	Standard wooden boxes	3	96*	Nose plugs omitted
8	9-15-94	M374A2 81mm Mortar Cartridges	Comp B	Standard wooden boxes	2	180	
9	5-11-95	M374A2 81mm Mortar Cartridges	Comp B	Metal boxes/plastic sleeves	2	180	
10	5-17-95	M1 105mm Artillery Cartridges	Comp B	Standard wooden boxes	4	128*	
11	9-20-95	M374A2 81mm Mortar Cartridges	Comp B	Metal boxes/plastic sleeves	-	15	Five boxes
12	9-26-95	M374A2 81mm Mortar Cartridges	Comp B	Metal boxes/plastic sleeves	8	720	

* Test nos. 1 through 5 were conducted using pallets of 105mm cartridges that contained 30 rounds (15 boxes) each. Test nos. 6, 7, and 10 were conducted using pallets that contained 32 rounds (16 boxes) each.

TEST ITEMS

The M1 105mm cartridge is a semi-fixed, high explosive artillery round. The general configuration of the assembled cartridge is illustrated in Figure 1. Several variants of the M1 cartridge have been produced with projectiles that contain either TNT or Composition B explosive. The cartridges are normally packaged in wooden boxes for transport and storage. Each box contains two cartridges that are packaged individually in fiberboard sleeves as shown in Figure 2. The cartridges are oriented such that the projectile of one cartridge is adjacent to the propelling charge of the other cartridge (i.e., nose-to-tail arrangement). The boxes are palletized on wooden pallets with 15 or 16 boxes per pallet, depending on their arrangement. The boxes are secured on the pallet using steel banding. With the exception of test no. 7, all of the M1 cartridges that were used in this test program were assembled with aluminum closing plugs (nose plugs) in lieu of live fuzes. The cartridges that were used in test no. 7 were assembled with live fuzes when they were received. The fuzes were removed prior to testing in order to comply with range safety requirements and the fuze well of each projectile was left open.

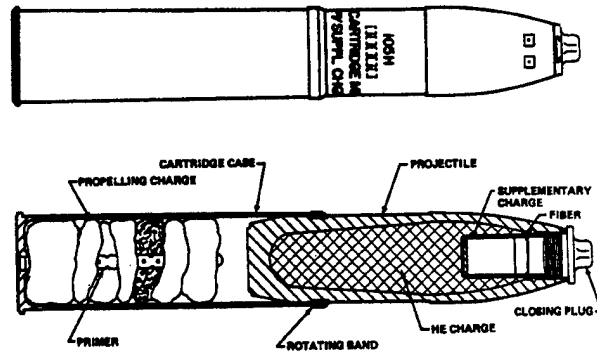

Nominal Characteristics

Projectile Body:	Forged Steel
Projectile Body Weight:	~25.8 lb
Explosive Fill (HE charge):	TNT or Composition B
Explosive Weight (HE charge):	~4.6 lb
Propelling Charge Case:	Spiral Wrap Steel
Propellant:	M1 Propellant
Propellant Weight:	~3 lb
Total Net Explosive Weight	7.773 lb

FIGURE 1. M1 105MM ARTILLERY CARTRIDGE

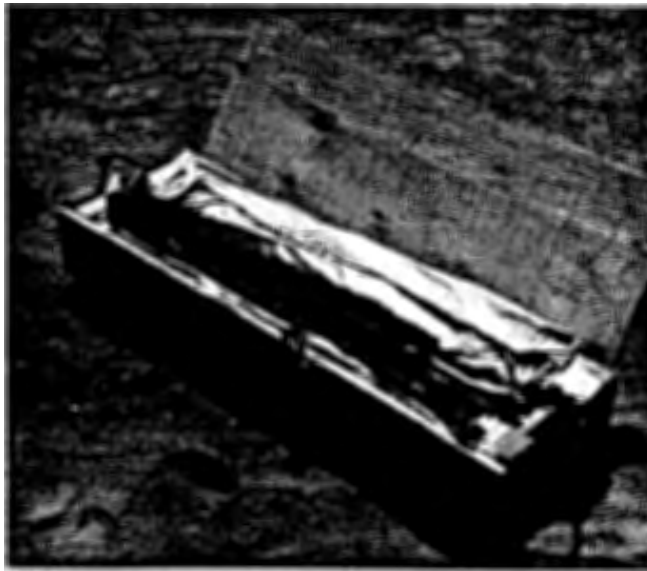
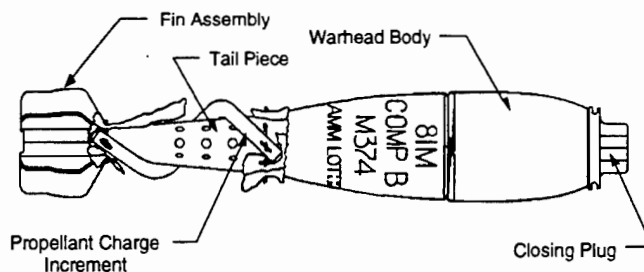

FIGURE 2. PACKAGING OF M1 105MM ARTILLERY CARTRIDGES

The general configuration of the M374A2 mortar cartridge is illustrated in Figure 3. The cartridges are normally packaged in wooden boxes in a manner similar to that for the M1 105mm cartridge, except that each box contains three cartridges. A complete pallet consists of 30 boxes. For test nos. 9, 11, and 12, the cartridges were repackaged in plastic tubes and steel boxes to simulate a packaging configuration that is used in the UK. Aluminum nose plugs were used in lieu of live fuzes for each of the tests of 81mm cartridges.



Nominal Characteristics

Warhead Body:	Forged Steel
Warhead body Weight:	~5.05 lb
Explosive Fill (HE charge):	Composition B
Explosive Weight (HE charge):	~2.1 lb
Tail Piece/Fin Assembly:	Aluminum Alloy
Propellant:	M1 Propellant
Propellant Weight:	~0.3 lb
Total Net Explosive Weight	2.167

FIGURE 3. M374A2 81MM MORTAR CARTRIDGE

TEST METHOD

TEST CONFIGURATIONS

Test nos. 1 through 4 were conducted generally in accordance with the methodology prescribed by the UN Recommendations on the Transport of Dangerous Goods.⁸ The test items were stacked on a steel test stand that provided approximately 30-in. clearance between the bottom of the stack and ground level. The top of the test stand was constructed as shown in Figure 4 to function as a grate. Dried lumber placed beneath the test stand and around the pallet(s) was used as kindling to provide fuel during the initial stages of the test. Four shallow steel troughs containing a small amount of gasoline (less than 5 gal each) were placed around the base of the stack to provide an ignition source for the fire. The gasoline in the troughs was ignited using an electric squib. In order to eliminate ground cratering and burrowing of unexploded test items at the stack site (ground zero), the stack was constructed over a concrete pad. The top of the concrete pad was protected by a steel plate. A typical completed test setup is shown in Figure 5.



FIGURE 4. CONSTRUCTION OF TEST STANDS



FIGURE 5. COMPLETED SETUP FOR TEST NO. 1

The remaining tests were conducted in the same manner except that kindling was only placed directly beneath the test stand as shown in Figure 6. This was done to more realistically simulate an accident scenario in which the test item packaging materials and the energetic components are the primary fuel source for a fire. The use of the steel plate to protect the concrete pad was discontinued after test no. 5.

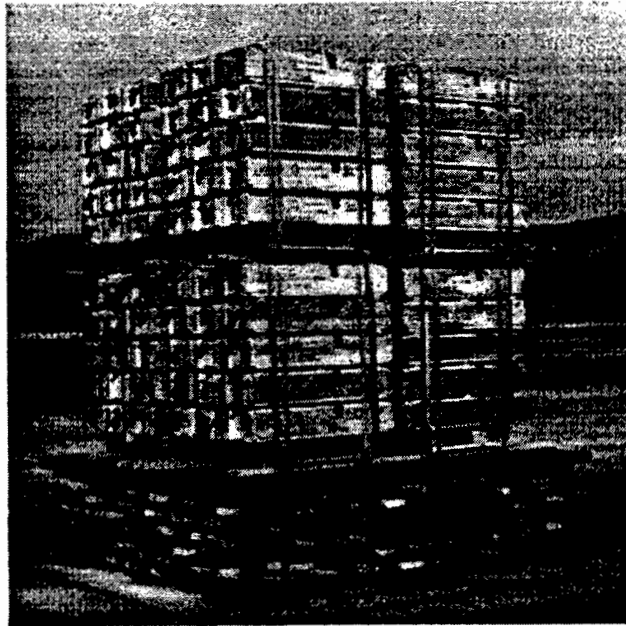

FIGURE 6. COMPLETED SETUP FOR TEST NO. 4

The tests were conducted on a flat, dried lake bed at the Naval Air Warfare Center, China Lake, CA. The area surrounding ground zero was scraped clear of virtually all vegetation to a range of approximately 1300 ft. The vegetation beyond the 1300-ft range consisted of clusters of desert grasses and brush. In order to facilitate recovery of the test item debris, the cleared region was marked with a 10° x 200-ft grid. Recovery of the test item debris was accomplished manually through systematic visual searches of the area by test personnel. The debris that were recovered inside the 200-ft range were not retained for analyses due to their large numbers. However, these debris were segregated according to type (i.e., warhead body piece, cartridge case piece, or miscellaneous) and the total weight of all warhead body pieces was determined. The posttest searches were limited to a range of 2000 ft or less. On-site observations and review of the video records indicated that few, if any, fragments impacted at ranges greater than 2000 ft. Thus, recovery beyond this range was not considered cost effective. Additionally, the likelihood of finding any fragments that might lie in this region was considered low due to the presence of vegetation.

INSTRUMENTATION

The test events were recorded using closed-circuit video systems. Typically, one to three video cameras were positioned approximately 500 ft from the test stack to record the events that occurred within the immediate confines of the fire. Additional video cameras were positioned on hillsides overlooking the test area to record the general location of larger debris as it impacted the ground.

Blast overpressures were measured during test nos. 2 through 12 using pencil-type piezoelectric pressure transducers. The transducers were located along two or three radials at nominal ranges of 50 ft, 70 ft, 100 ft, and 200 ft. The elevation of each pressure transducer was nominally 24 in. above ground level. Commencing with test no. 6, a photodetector was used to record the time at which the larger explosions occurred. This data coupled with the arrival times for the blast data permitted the approximate location of many of the larger reactions to be estimated. Also commencing with test no. 6, type K thermocouples were used to measure temperatures at selected points within each stack. Detailed descriptions of the instrumentation used in each test and the data that were acquired are provided in Appendix A.

OBSERVATIONS AND RESULTS

General observations for each test are summarized in Table 2. Most of the tests produced similar results with respect to fire buildup, onset of test item reactions, levels of test item reactions, and event duration. In most of the tests, the fire developed rapidly following ignition with the entire stack being engulfed within approximately 5 min. Usually the first indications of test item reactions were observed within 10 to 15 min after complete engulfment of the stack. These initial reactions were heard as small pops and/or seen as regions of intense burning within the stack. Most are thought to have been mild deflagrations of propellant charges and/or burning of the explosive fill in some warheads resulting in failure of the nose plug followed by rapid venting of the reaction gases. Most of the debris that were ejected from the bonfire following one of these reactions appeared to have very limited range, less than 100 ft in most instances. The relatively mild initial reactions were followed some time later by a series of much more violent reactions (explosions) that occurred intermittently throughout the remainder of the test, intermingled with additional mild reactions. Each explosion was characterized by abrupt instantaneous expansion of the fire, a loud audible report, low-level air shock, and scattering of burning wood and other debris about the test site. Each of these much more violent reactions was presumed to be the explosion and/or detonation of one or more warheads. Typically the fire would continue to burn at full intensity only until the first few explosions had occurred. It would then begin to die out slowly due to scattering of the stack by each successive explosion. Usually the fire was reduced to broadly scattered smoldering debris in less than one hour. However, in most of the tests, one or more explosions were observed after the fire appeared to be out.

A somewhat different response was observed in test no. 9. The fire buildup and onset of initial mild reactions were similar to that observed in the other tests. However, approximately 26:11 (min:sec) after the fire was lit, an extremely large explosion occurred that completely destroyed the stack and effectively cleared the test pad. No other reactions were observed after that time. A total of 102 warhead bodies were recovered essentially intact after the test, which suggests that 78 warheads were involved in the explosion. Analyses of the blast overpressure data indicated that the yield was equivalent to the detonation of approximately 21 warheads.

TABLE 2. GENERAL OBSERVATIONS FOR EACH TEST

Test No.	Stack Size (Cartridges)	Elapsed Time to Initial Reaction (min:sec)	Elapsed Time to First/Last Explosion (min:sec)	No. of Explosions	No. of Warhead Bodies Recovered Intact	Maximum Observed Fragment Range (ft)
1	30	15:32	18:24 48:53	13	17	1600-1800
2	30	20:22	24:14 42:36	9	21	1600-1800
3	30	20:05	36:48 78:40	11	18*	1400-1600
4	240	18:13	20:48 61:08	66	174	1800-2000
5	240	14:15	18:37 41:13	65	175	3140**
6	864	21:11	25:54 73:39	324*	546	1800-2000
7	96	23:48	31:38 51:58	8	82	1200-1400
8	180	17:03	22:42 41:42	89*	93	1000-1200
9	180	22:18	26:11	1	102	1400-1800
10	128	15:49	19:43 ~241**	39	88	1400-1600
11	15	10:46	16:27 18:43	4	8	800-1000
12	720	18:35	18:35 115:59	177	502	1200-1400

* A 19th projectile body was recovered with only minor damage in the nose region (i.e., small fracture).

** The remaining fragments that were recovered were found at a range less than 1600 ft.

* Based on pressure records, the frequency of explosions was so great at times that the number of explosions could not be determined from visual observation or video records. Some of these events may have been caused by propellant reactions.

** Observed by test personnel after all recording instrumentation was stopped.

Detailed fragment recovery data for test nos. 1 through 6 were reported previously.⁶ Appendix B provides detailed fragment recovery data for tests nos. 7 through 12. The fragment recovery data for each of the tests are summarized in Table 3. Examination of Table 3 indicates that, in general, the fragments having the greatest range were primarily warhead pieces. The exception again is test no. 9 in which pieces of the metal containers contributed significantly to the far-field fragment population. Figures 7 and 8 show the distribution of the fragments that were recovered beyond the 200-ft range for test nos. 6 and 12. These distributions are representative of those for the other tests in that the distribution of fragments with respect to azimuthal angle was relatively uniform. Figures 9 through 11 show some typical warhead fragments that were recovered beyond the 200-ft range. Almost all of the warhead fragments that were produced by the 105mm projectiles that were loaded with TNT explosive appeared to have been produced by explosion (vice detonation) reactions. A significant number of the warhead fragments that were produced by the 81mm mortar warheads and the 105mm projectiles that were loaded with Composition B appeared to have been produced by detonation reactions.

TABLE 3. FRAGMENT RECOVERY DATA

Range Interval (ft)	Test No. 1			Test No. 2			Test No. 3		
	Intact Warheads	Warhead Pieces	Other Debris	Intact Warheads	Warhead Pieces	Other Debris	Intact Warheads	Warhead Pieces	Other Debris
200 - 400	1	10	23	0	9	6	1	8	2
400 - 600	0	9	9	0	1	0	2	7	4
600 - 800	0	6	2	0	6	0	0	8	1
800 - 1000	0	9	0	0	1	0	0	5	0
1000 - 1200	0	7	0	0	3	0	0	5	0
1200 - 1300	0	1	0	0	3	0	0	4	0
1300 - 1400	0	0	0	0	3	0	0	2	0
1400 - 1600	0	0	0	0	4	0	0	3	0
1600 - 1800	0	2	0	0	1	0	0	0	0
1800 - 2000	0	0	0	0	0	0	0	0	0

Range Interval (ft)	Test No. 4			Test No. 5			Test No. 6		
	Intact Warheads	Warhead Pieces	Other Debris	Intact Warheads	Warhead Pieces	Other Debris	Intact Warheads	Warhead Pieces	Other Debris
200 - 400	6	70	471	6	41	283	37	386	2125
400 - 600	3	56	64	1	27	38	9	320	501
600 - 800	0	44	7	0	23	7	4	191	28
800 - 1000	0	27	2	1	30	2	2	212	11
1000 - 1200	1	35	1	0	32	0	0	167	3
1200 - 1300	0	21	0	0	15	0	0	82	1
1300 - 1400	0	3	0	0	1	0	1*	23*	0*
1400 - 1600	0	6	0	0	2	0	0*	13*	0*
1600 - 1800	0	1	0	0	0	0	0*	0*	0*
1800 - 2000	0	1	0	0	0**	0	0*	1*	0*

Range Interval (ft)	Test No. 7			Test No. 8			Test No. 9		
	Intact Warheads	Warhead Pieces	Other Debris	Intact Warheads	Warhead Pieces	Other Debris	Intact Warheads	Warhead Pieces	Other Debris
200 - 400	0	51	116	0	96	47	31	222	1615
400 - 600	0	39	19	1	120	27	18	186	846
600 - 800	2	29	4	1	79	6	15	110	189
800 - 1000	0	7	3	0	25	1	15	43	43
1000 - 1200	0	7	1	0	5	1	9	12	16
1200 - 1300	0	7	0	0	0	0	4	9	4
1300 - 1400	0*	2*	0*	0	0	0	1*	1*	3*
1400 - 1600	0*	0*	0*	- #	- #	- #	1*	2*	4*
1600 - 1800	0*	0*	0*	- #	- #	- #	0*	0*	0*
1800 - 2000	0*	0*	0*	- #	- #	- #	0*	0*	0*

Range Interval (ft)	Test No. 10			Test No. 11			Test No. 12		
	Intact Warheads	Warhead Pieces	Other Debris	Intact Warheads	Warhead Pieces	Other Debris	Intact Warheads	Warhead Pieces	Other Debris
200 - 400	0	161	170	0	8	63	16	388	1212
400 - 600	2	151	62	0	21	11	7	477	396
600 - 800	1	116	12	0	11	8	1	307	148
800 - 1000	0	70	3	1	2	0	1	101	54
1000 - 1200	0	41	0	0	0	0	0	36	12
1200 - 1300	0	11	0	0	0	0	0	20	9
1300 - 1400	0*	4*	0*	- #	- #	- #	0	0	0
1400 - 1600	0*	2*	0*	- #	- #	- #	0	0	0
1600 - 1800	0*	0*	0*	- #	- #	- #	0	0	0
1800 - 2000	0*	0*	0*	- #	- #	- #	0	0	0

* Due to the presence of vegetation beyond the 1300-ft range, recovery was accomplished by thoroughly searching only selected azimuthal sectors. The total azimuthal region searched in tests nos. 6, 7, 9, and 10 were 150°, 90°, 180°, and 220°, respectively.

** One warhead body fragment was recovered at a range of 3140 ft.

"-" indicates area was not searched.

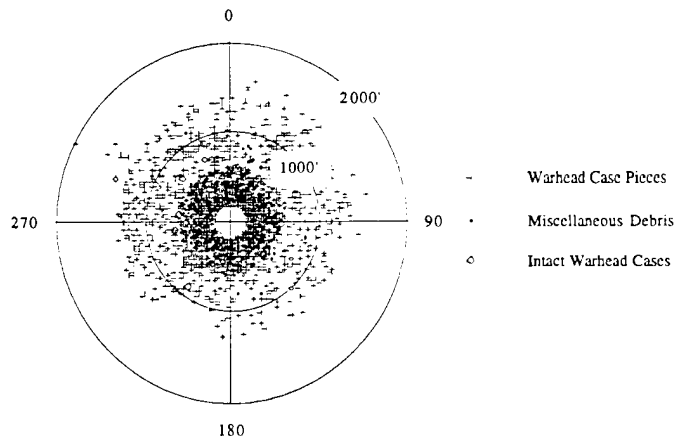

FIGURE 7. APPROXIMATE DISTRIBUTION OF FRAGMENTS AFTER TEST NO. 6

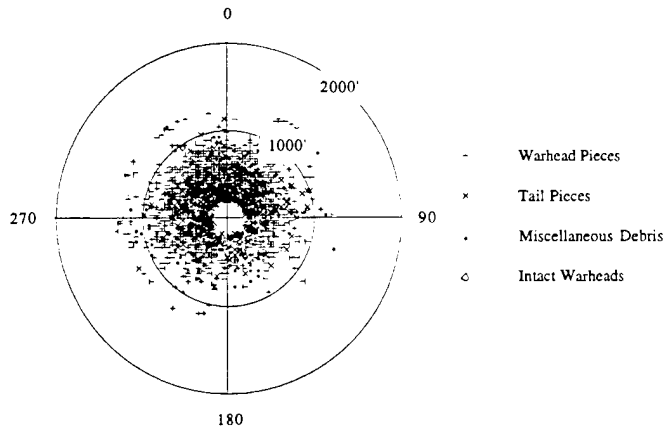

FIGURE 8. APPROXIMATE DISTRIBUTION OF FRAGMENTS AFTER TEST NO. 12

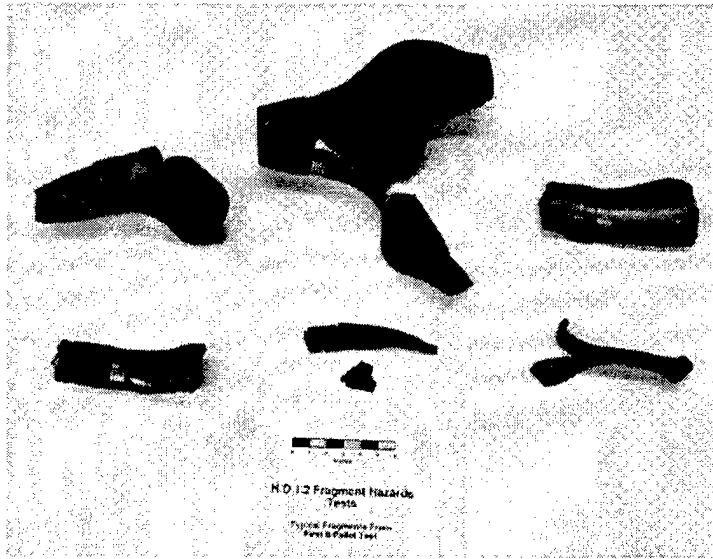

FIGURE 9. WARHEAD FRAGMENTS PRODUCED BY 105MM PROJECTILES LOADED WITH TNT



FIGURE 10. WARHEAD FRAGMENTS PRODUCED BY 105MM PROJECTILES LOADED WITH COMPOSITION B

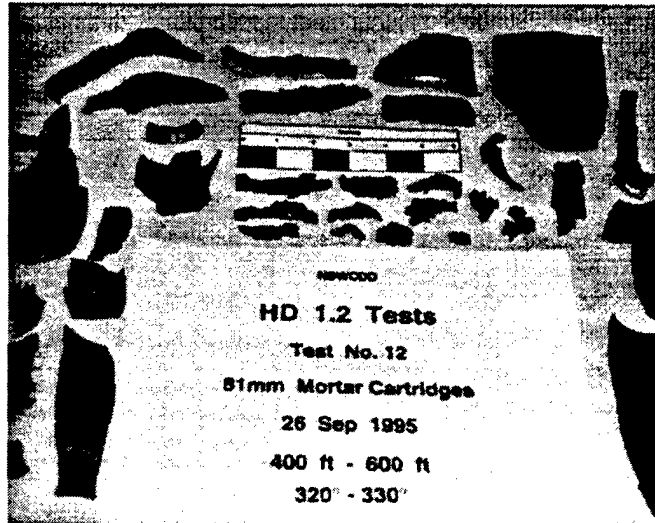

FIGURE 11. WARHEAD FRAGMENTS PRODUCED BY 81MM MORTAR WARHEADS

The maximum blast overpressures that were observed in each test are summarized in Table 4. Figures 12 through 14 show the estimated locations of the explosions in test nos. 6, 10, and 12 based on analyses of the blast time-of-arrival data. It can be seen that most of the estimated locations of the explosions are within 50 ft of the stack location and all are within 150 ft of the stack location. This is consistent with on-site visual observations during each of the tests.

TABLE 4. MAXIMUM INDICATED PEAK OVERPRESSURES

Test	Maximum Indicated Overpressure (psig)			
	50-ft	70-ft	100-ft	200-ft
1	no data	no data	no data	no data
2	no data	1.25	0.66	0.26
3	3.18	1.67	0.86	0.37
4	2.80	1.42	1.08	0.49
5	3.91	1.97	0.62	0.44
6	4.00	3.14	1.35	0.90
7	3.30	1.76	1.31	0.43
8	3.10	1.52	0.81	0.35
9	7.11	3.75	3.19	0.86
10	3.64	1.97	1.38	0.38
11	1.42	0.89	0.67	0.14
12	2.44	3.20	1.09	0.38

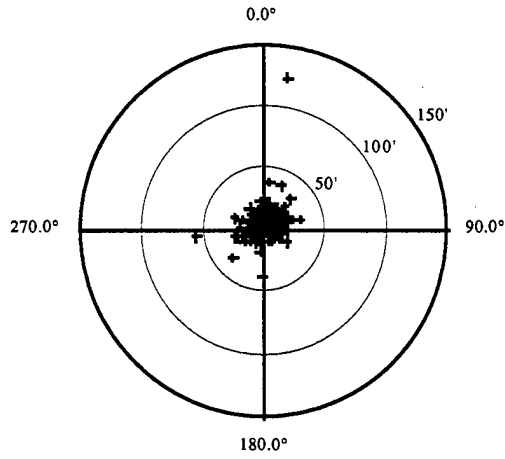

FIGURE 12. APPROXIMATE LOCATIONS OF EXPLOSIONS IN TEST NO. 6

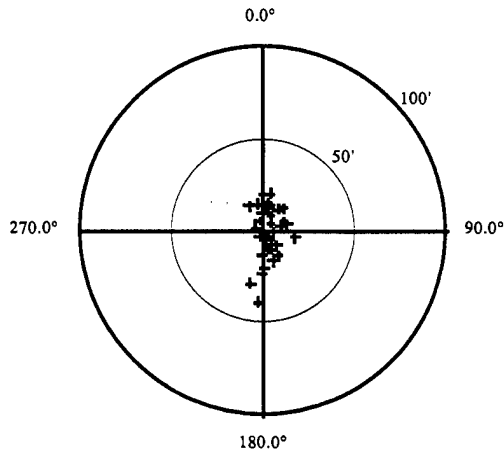

FIGURE 13. APPROXIMATE LOCATIONS OF EXPLOSIONS IN TEST NO. 10

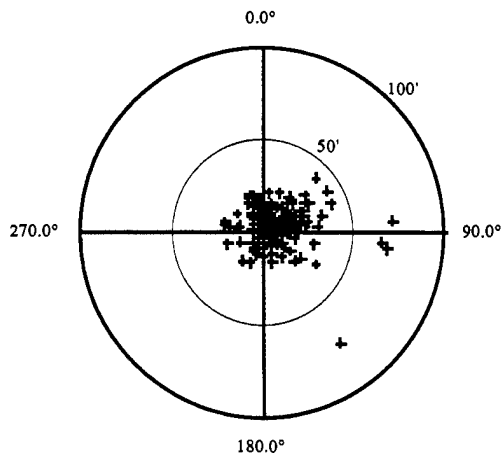

FIGURE 14. APPROXIMATE LOCATIONS OF EXPLOSIONS IN TEST NO. 12

ANALYSES

It appears that the primary hazard associated with these HD 1.2 events is debris. Except for a small region in the immediate vicinity of the fire, air shock and firebrands do not appear to be a major hazard. Therefore, the objective of the following analyses is to use the fragment recovery data acquired from the bonfire tests to predict the fragment hazard that would be produced by fires involving larger stacks of M1 105mm artillery cartridges and M374A2 81mm mortar cartridges. In general, this has been accomplished by extrapolation based on the following observations and assumptions:

- a. The fragment recovery data for these tests have not been subjected to rigorous statistical analyses. However, it appears that the distribution of far-field fragments with respect to azimuthal angle about the stack is fairly random as indicated in Figures 7 and 8. Therefore, it is assumed that the azimuthal distribution of fragments is uniform (i.e., there are no directional effects) and thus fragment areal densities may be assessed as a function of range only.
- b. There are no means to determine the trajectory of a fragment based solely on the range at which it is recovered. Thus, it is not possible to determine the range over which the kinetic energy of each fragment would have exceeded the criterion for a hazardous fragment (i.e., kinetic energy greater than 58 ft-lb). Consequently, each fragment was assumed to constitute a hazardous fragment throughout its entire flight, regardless of its mass or the range at which it was recovered.
- c. Generally, the fragments having the greatest ranges are warhead body pieces. This suggests that warhead explosions and detonations are the primary contributor to far-field fragment hazards. Thus, far-field fragment areal densities are expected to be dependent primarily on the number of warheads that fragment rather than the total number of rounds in the stack. Although, as expected, the number of warheads that fragment does appear to increase relatively proportionately with stack size.
- d. The percentage of warheads that fragment is somewhat variable. However, the highest percentage observed in this test series was approximately 48% (test no. 8).
- e. Based on the analyses of the fragment recovery data outlined in Table 5, it appears that a significant number of fragments may have been missed during most of the posttest visual searches. This suggests that the numbers of fragments actually recovered probably understate the real fragment hazard. Thus, some adjustment of the fragment recovery data is necessary to compensate for fragments that were missed during the recovery process.

The analysis method is outlined schematically in Figure 15. A detailed description of the analysis method, including illustrative sample calculations, is provided in Appendix C.

TABLE 5. ESTIMATED PORTION OF WARHEAD BODY PIECES RECOVERED

	Test No.											
	1	2	3	4	5	6	7	8	9	10	11	12
No. of Cartridges Tested:	30	30	30	240	240	864	96	180	180	128	15	720
No. of Warhead Bodies Recovered Intact:	17	21	18	174	175	546	82	93	102	88	8	502
Indicated No. of Warheads that Fragmented:	13	9	12	66	65	318	14	87	78	40	7	218
Mass of Each Warhead Body (lbm):	25.8	25.8	25.8	25.8	25.8	25.8	25.8	5.05	5.05	25.8	5.05	5.05
Approximate Total Mass of Warhead Body Pieces (lbm):	335	232	310	1703	1677	8204	361	439	394	1032	35	1101
Mass of Warhead Case Pieces Recovered Inside 200-ft (lbm):	118	66	86	754	879	~5400	125	12	13	407	**	365
Indicated Total Mass of Warhead Body Pieces Projected >200-ft (lbm): (Assumes 100% recovery inside 200 ft range)	217	166	224	949	798	2804	236	427	381	625	**	736
Total Mass of Warhead Body Pieces Recovered Beyond 200-ft (lbm)*:	140	153	140	600	613							
Indicated Portion of Warhead Body Pieces Recovered:	0.64	0.92	0.63	0.63	0.77	1.13	0.65	0.31	0.24	0.65	**	0.27

* Adjusted to correct for incomplete search beyond 1300-ft range.

** The mass of the warhead pieces inside the 200-ft range was not determined. Thus the percentage of recovery cannot be estimated.

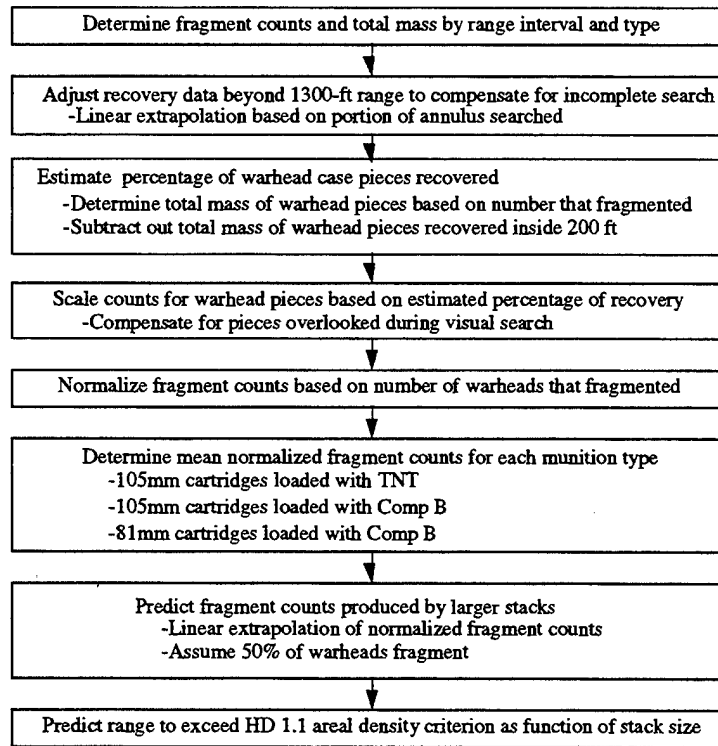

FIGURE 15. ANALYSIS METHOD

Figure 16 shows the predicted ranges to exceed one fragment per 600 ft² based on extrapolation of the test results using the preceding method. The corresponding IBDs established by current Q-D requirements are shown in Figure 16 for comparison. Examination of the results summarized in Figure 16 suggests:

- a. M374A2 81mm cartridges produce a greater fragment hazard than M1 105mm artillery cartridges for stacks of equivalent total net explosive weight (NEW).
- b. M1 105mm cartridges loaded with Composition B explosive produce a slightly greater fragment hazard than M1 105mm cartridges loaded with TNT explosive.
- c. Based on the HD 1.1 fragment areal density criterion, the current U. S. IBD for M374A2 81mm cartridges is conservative for stack sizes up to approximately 1000 lb NEW; however, it appears to be optimistic for larger stacks. Similarly, the U. S. IBD for M1 105mm cartridges is conservative for stack sizes up to approximately 30000 lb NEW, but appears to be optimistic for larger stacks.
- d. Based on the HD 1.1 fragment areal density criterion, the current NATO/UK IBD is conservative for any size stack of M1 artillery cartridges. It appears to be conservative for stacks of M374A2 mortar cartridges with a total NEW less than approximately 2000 lb or greater than approximately 90000 lb; however, it appears to be marginal for stacks of intermediate size.

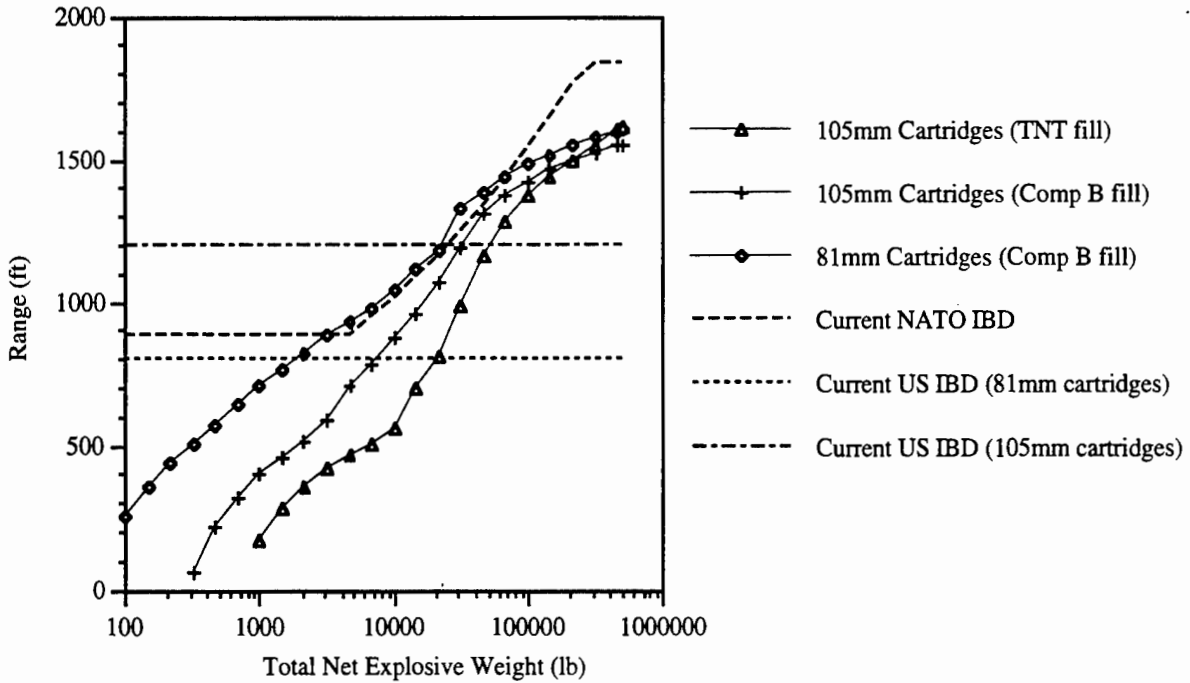

FIGURE 16. ESTIMATED RANGES TO EXCEED 1 FRAGMENT PER 600 FT² VERSUS CURRENT Q-D REQUIREMENTS

CONCLUSIONS AND DISCUSSION

A fire in an open stack of 105mm cartridges or 81mm cartridges typically results in a series of explosions. The first reactions are relatively nonviolent deflagration reactions and are typically observed approximately 10 to 15 min after the stack is completely engulfed in flame. Considerably more violent reactions begin to occur a short time later. The overall duration of the event may range from less than one hour to several hours with the last few explosions occurring after the fire is effectively out.

The most violent reactions are explosions or detonations involving one or more warheads. These reactions often produce relatively large, high-velocity fragments that may have ranges approaching and possibly exceeding 2000 ft. However, not all of the warheads react violently. Some of the warheads burn in a manner that does not fragment the body while others are thrown clear of the fire and do not react. During this test series, the highest percentage of warheads that reacted in a manner that caused fragmentation of the body was approximately 48%.

Fragments are dispersed randomly in azimuthal angle and the fragment density decreases rapidly with range from ground zero. Warhead body fragments are the primary contributor to far-field fragment hazards. Most of the fragments produced by the propellant charges and packaging are limited to a range of roughly 600 ft or less.

Although intact (i.e., live) warheads have been recovered several hundred feet from the stack site, there have been very few occasions in which a warhead was thrown more than 50 ft from the burning stack and then exploded. There have been no instances in which a warhead was thrown more than 150 ft from the fire and then exploded. Thus, it appears that post-impact explosion of lobbed rounds does not contribute appreciably to overall fragment ranges.

The analyses described in the preceding section are based on a relatively limited number of tests. Additionally, the results of the analyses include extrapolations to stack sizes that are several orders of magnitude larger than the stacks were tested under this program. Thus, consideration should be given to the limitations and uncertainties that are inherent in the test data and analysis method when interpreting the results of the analyses, particularly the predicted behavior for very large stacks. However, based on the results summarized in Figure 16:

- a. M374A2 81mm cartridges produce a greater far-field fragment hazard than M1 105mm artillery cartridges for stacks of equivalent total NEW. This effect appears to be due partly to the significant difference in the respective item NEWs. The item NEW of the 105mm cartridge is approximately 3.5 times greater than that of the 81mm cartridge. Thus, for stacks of equivalent total NEW, the number of 81mm warheads expected to fragment is roughly 3.5 times greater than the number of 105mm warheads expected to fragment.
- b. M1 105mm cartridges loaded with Composition B explosive produce a slightly greater fragment hazard than M1 105mm cartridges loaded with TNT explosive. This effect appears to be due primarily to the greater tendency for 105mm warheads loaded with Composition B explosive to detonate relative to 105mm warheads loaded with TNT explosive. This tendency manifests itself as a greater number of fragments of smaller size, particularly at the shorter ranges.
- c. The current U. S. IBD for M374A2 81mm cartridges is conservative for stack sizes up to approximately 1000 lb NEW, but appears to be optimistic for larger stacks.

- d. The U. S. IBD for M1 105mm cartridges is conservative for stack sizes up to approximately 30000 lb NEW, but appears to be optimistic for larger stacks.
- e. The current NATO/UK IBD is conservative any size stack of M1 artillery cartridges assuming that no more than 50% of the warheads in the stack fragment. It appears to be conservative for stacks of M374A2 mortar cartridges with a total NEW less than approximately 2000 lb or greater than approximately 90000 lb; however, it appears to be marginal for stacks of intermediate size.
- f. The ranges at which the fragment areal density is one fragment per 600 ft² become asymptotic with range for very large stacks. This is consistent with the intuitive expectation that there is some maximum range within which all fragments must be contained, regardless of the number of fragments generated.

REFERENCES

1. DoD 6055.9-STD, Department of Defense Ammunition and Explosives Safety Standards, October 1992.
2. NAVSEAINST 8020.8A (Army TB 700-2, Air Force TO 11A-1-47 Defense Logistics Agency DLAR 8220.1), Department of Defense Explosives Hazard Classification Procedures, December 1989.
3. Gould, M. J. A. and Houchins, W. D., "Trials to Determine the Consequences of the Accidental Ignition of Stacks of Hazard Division 1.2 Ammunition," Minutes of the Twenty-Fifth DOD Explosives Safety Seminar, August 1992.
4. Gould, M. J. A. and Houchins, W. D., "Trials to Determine the Consequences of the Accidental Ignition of Stacks of Hazard Division 1.2 Ammunition," Minutes of the Twenty-Sixth DOD Explosives Safety Seminar, August 1994.
5. Houchins, W. D.; Swisdak, M. M.; and Gould, M. J. A.; "Hazard Division 1.2 Open Air Testing - Summary of Results," Minutes of the Twenty-Seventh DOD Explosives Safety Seminar, August 1996.
6. Houchins, W. D., Hazard Division 1.2 Ammunition Bonfire Tests, NSWCDD/TR-93/631, NSWCDD, Dahlgren, VA, July 1995.
7. Swisdak, M. M., Jr. and Rye, K. W., Hazard Division 1.2 Tests - Instrumentation Results and Interpretation, NSWCDD/TR-93/218, NSWCDD, Dahlgren, VA, 9 March 1994.
8. United Nations Recommendations on the Transport of Dangerous Goods, Tests and Criteria, ST/SG/AC.10/11 Current Revision.

APPENDIX A
HD 1.2 TESTING
INSTRUMENTATION RESULTS AND INTERPRETATION

PREPARED BY
MICHAEL M. SWISDAK, JR.
NAVAL SURFACE WARFARE CENTER, INDIAN HEAD DIVISION

HD 1.2 TESTING INSTRUMENTATION RESULTS AND INTERPRETATION

INTRODUCTION

The open-air testing portion of the hazard division (HD) testing effort has now been completed. Table A-1 details the entire testing effort that has been conducted under the HD 1.2 Open-Air Testing Program.

TABLE A-1. HD 1.2 OPEN-AIR TESTING PROGRAM

TEST IDENTIFIER	NUMBER OF PALLETS	BOXES PER PALLET	NUMBER OF ROUNDS	TEST DATE	TEST ITEM	TYPE OF BOX	TYPE OF TEST
1	1	15	30	7-May-91	105 mm/TNT	Wood	External Fire
2	1	15	30	24-Jun-91	105 mm/TNT	Wood	External Fire
3	1	15	30	29-Jul-91	105 mm/TNT	Wood	External Fire
4	8	15	240	29-Oct-91	105 mm/TNT	Wood	External Fire
5	8	15	240	29-Apr-92	105 mm/TNT	Wood	External Fire
6	27	16	864	28-Oct-92	105 mm/TNT	Wood	External Fire
7	3	16	96	3-May-94	105 mm/COMP B*	Wood	External Fire
8	2	30	180	15-Sep-94	81 mm/COMP B	Wood	External Fire
8A			12	8-Sep-94	81 mm/COMP B	Metal	External Fire**
9	2	30	180	11-May-95	81 mm/COMP B	Metal	External Fire
10	4	16	128	17-May-95	105 mm/COMP B	Wood	External Fire
11A			15	20-Sep-95	81 mm/Comp B	Metal	Stack**
11B			15	20-Sep-95	81 mm/Comp B	Metal	External Fire**
12	8	30	720	26-Sep-95	81 mm/COMP B	Metal	External Fire

* tested without nose plugs.

** pseudo-hazard classification tests.

The results of tests 1 through 6 have been previously reported.^{A-1} This appendix will discuss the airblast and temperature data that were obtained on Tests 7, 8, 9, 10, 11B, and 12.

The same instrumentation techniques and equipment described in Reference A-1 were used on the remaining tests (Tests 7, 8, 9, 10, 11B, and 12). Likewise, the analysis procedures for determining event locations and yields were similar to those described and used in Reference A-1. Before discussing the results, these techniques will be briefly summarized.

AIRBLAST

Airblast was measured at four positions along three radial lines using piezoelectric transducers. The transducers were located at nominal ranges of 50 ft, 70 ft, 100 ft, and 200 ft from ground zero. Two fiber optic sensors were employed to sense the light output of each event, thus providing a "zero time" signal. Figure A-1 is a sketch of the field arrangement that was used on all of the tests.

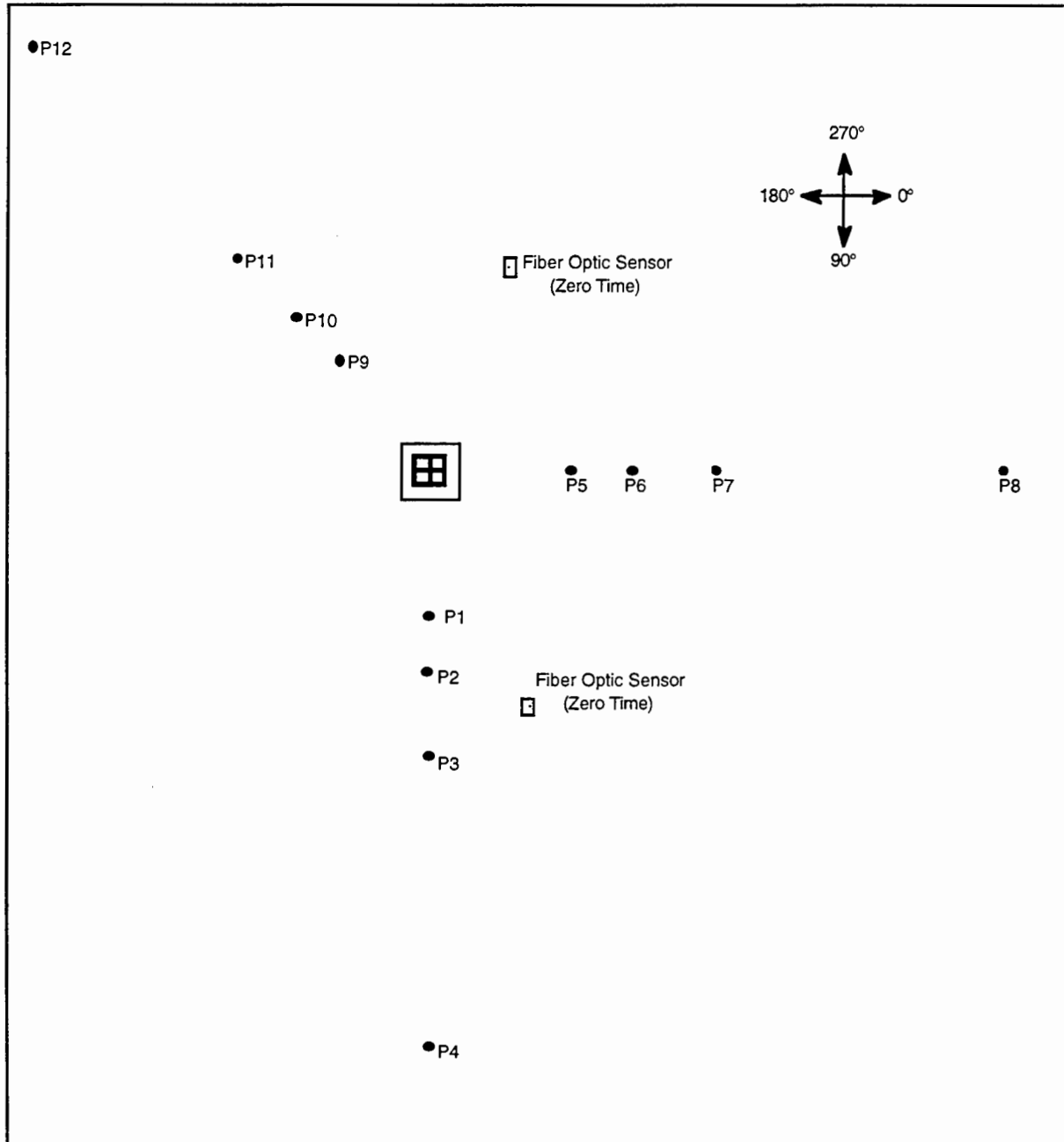

FIGURE A-1. HD 1.2 TEST-FIELD ARRANGEMENT

TEMPERATURE

Temperature measurements were made on each event. Thermocouples were placed inside the fuze wells of selected projectiles, on the exterior of selected projectiles, and on the outside of the pallets (to record the direct flame temperatures). Temperatures were recorded until the stack was disrupted and the thermocouple leads broken.

EVENT TIMES

Event times for each event on each test were determined by two methods. The first relied on an on-site observer to manually note when each event was heard or seen. The second determined the event times from the IRIG time code associated with each pressure-time pulse that was recorded.

EVENT LOCATIONS

Using the airblast pressure pulse arrival times and an iterative procedure, the apparent location of each event was calculated. This procedure is described in Reference A-1. The coordinate system used for the event location computations is shown in Figure A-2.

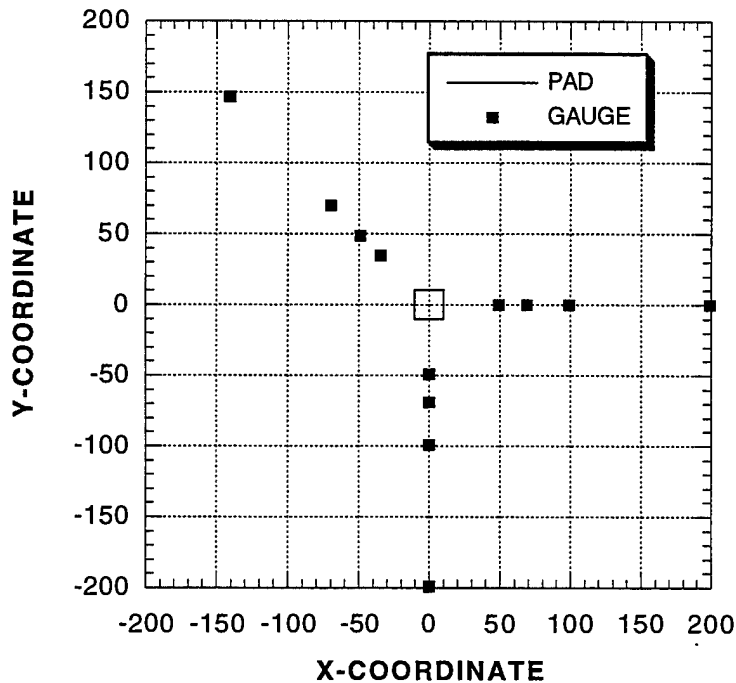

FIGURE A-2. EVENT LOCATION COORDINATE SYSTEM

EVENT YIELDS

Using the airblast pressure pulse magnitudes and the computed event locations, the apparent yield for each event was estimated using the computer code DSC.^{A-2} The computed yields are expressed in terms of a percentage of a complete detonation of one round; i.e., 100% corresponds to a full detonation of one round; 10% would correspond to the airblast produced by the detonation of 10% of the net explosive weight (NEW) present in the round. Yields of over 100% correspond to multiple rounds detonating simultaneously.

PRESENTATION OF DATA

The following sections present the data and analyses that have been collected on each of the six tests. The data are presented in the following sequence for each test: (1) Thermocouple information, (2) Event times, (3) Airblast arrival times and computed event locations, (4) Event location plots, and (5) Airblast peak pressures and computed yields.

TEST 7

3 PALLETS OF 105MM CARTRIDGES

COMPOSITION B

(TESTED WITHOUT NOSE PLUGS)

3 MAY 1994

96 PROJECTILES IN TEST

TABLE A-2. MAXIMUM RECORDED TEMPERATURES

THERMOCOUPLE NUMBER	POSITION	MAXIMUM TEMPERATURE (°C)	RECORD DURATION (minutes)
1	flame beneath bottom right pallet	960	35
2	fuze well--box 4, bottom right pallet	50	35
3	projectile case--box 4, bottom right pallet	50	32
4	flame beneath upper pallet	1100	30
5	fuze well--box 4, upper pallet	560	35
6	projectile case--box 4, upper pallet	50	35
7	fuze well--box 4, bottom left pallet	640	32
8	projectile case--box 4, bottom left pallet	500	31
9	flame beneath bottom left pallet	bad record	

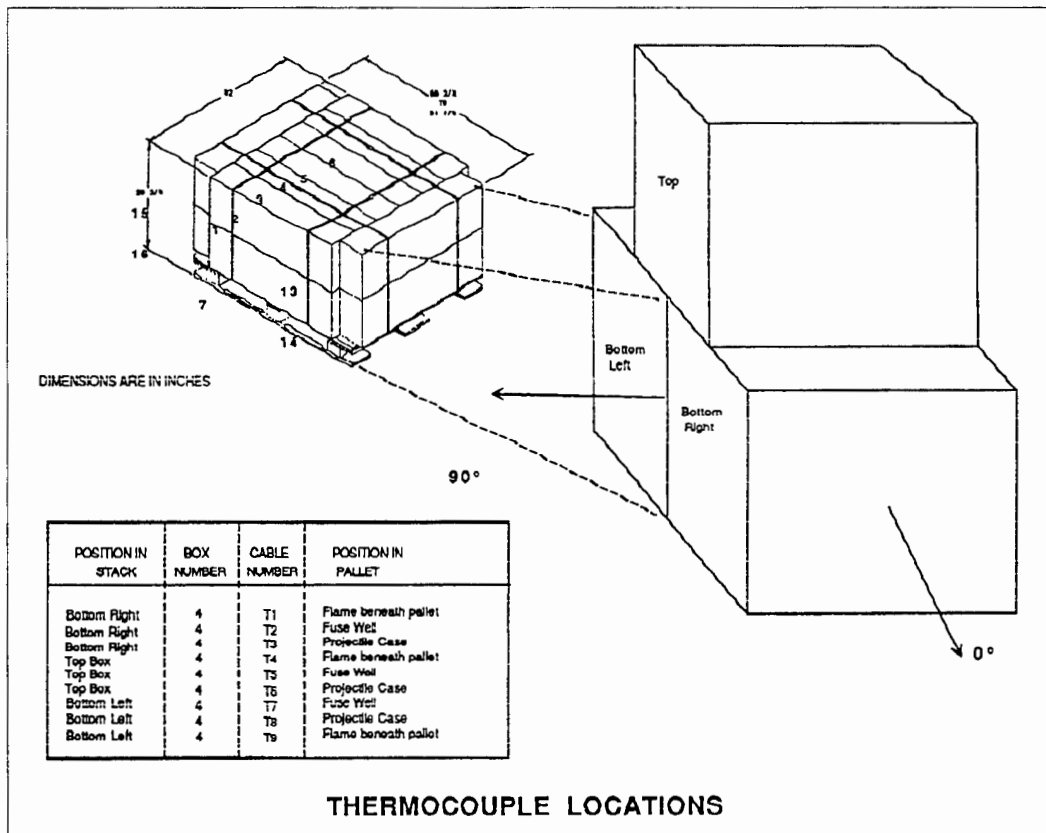

TABLE A-3. EVENT TIMES

Event Number	W.D.H. Event Number	Time Code (h:m:s)	W. D. H Event Time (h:m:s)	Elapsed time: Time Code (m:s)	Elapsed time: W. D. H. (m:s)
	Fire Start		9:07:50		
1	1	09:41:30.6	9:31:38	00:00	00:00
2	2	09:45:36.0	9:35:43	04:05.4	04:05
3	3	09:48:00.8	9:38:08	06:30.2	06:30
4	4	09:49:53.8	9:40:01	08:23.2	08:23
5	5	09:50:00.9	9:40:08	08:30.3	08:30
6	6	09:50:32.8	9:40:40	09:02.2	09:02
7	7	09:53:03.7	9:43:11	11:33.1	11:33
8	8	10:01:49.2	9:51:58	20:18.6	20:20

- Notes: 1. W. D. H. Event Times are the times recorded during the event by on-site observer.
2. Elapsed times are measured from the time of Event 1.

TABLE A-4. AIRBLAST ARRIVAL TIME AND COMPUTED EVENT LOCATIONS

Event Number	TIME OF ARRIVAL (ms)												LOCATION	
	POSITION NUMBER												X0 (ft)	Y0 (ft)
	P1	P2	P3	P4	P5	P6	P7	P8	P9	P10	P11	P12		
1	37.20	54.30	80.30	168.7	40.80	58.30	85.10	173.7	40.20	57.50	83.80	171.9	-2.7	-3.3
2	39.10	56.40	82.50	170.8	39.80	57.60	84.50	173.8	35.70	53.20	79.40	167.4	-3.2	1.1
3	33.00	49.80	76.80	166.1	31.80	49.40	76.30	165.6	25.50	42.70	68.80	156.4	-1.6	4.4
4	32.70	49.60	75.20	163.3	42.80	60.40	87.20	176.8	36.20	53.50	79.60	167.4	-7.7	-5.8
5	31.30	47.80	73.20	160.3	34.80	51.70	77.80	165.8	34.10	51.00	76.60	163.6	-0.6	-2.8
6	37.40	54.40	80.10	168.1	38.90	56.70	83.30	171.9	29.10	45.90	71.70	159.2	-5.5	3.5
7	38.80	55.90	82.10	170.8	31.70	49.10	75.40	164.2	38.40	56.00	82.30	170.2	6.0	2.5
8	34.40	51.20	77.00	164.7	29.40	46.80	73.10	161.2	44.30	61.80	88.20	176.6	9.4	-4.3

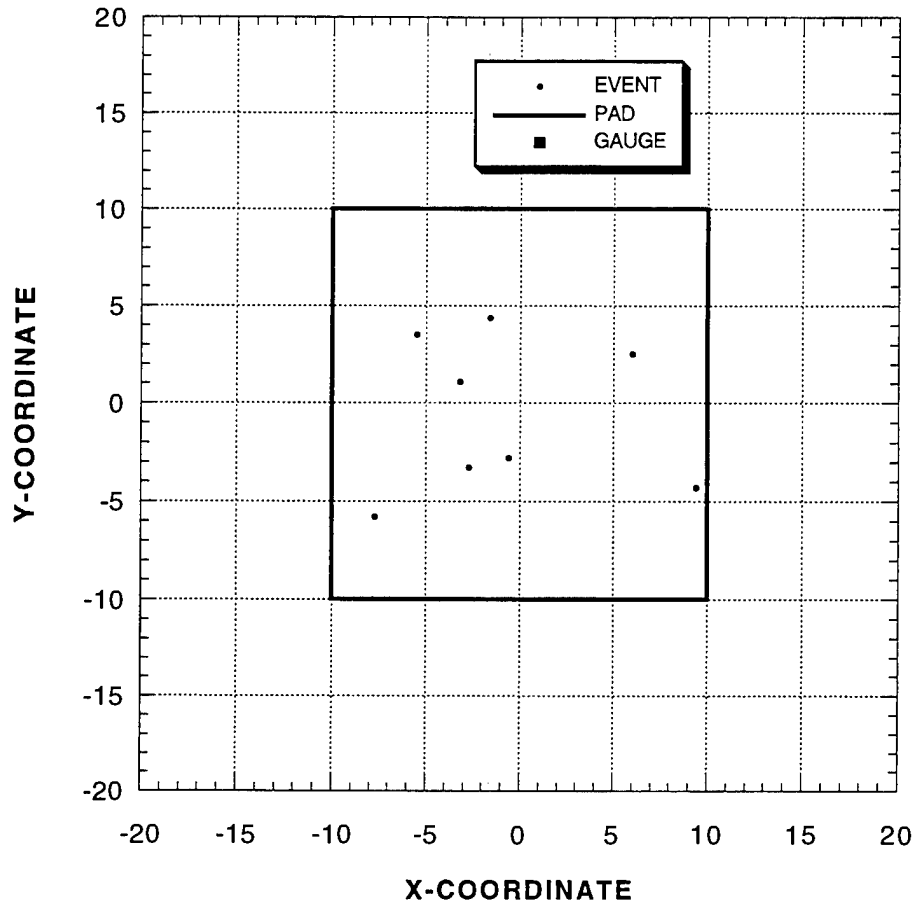

FIGURE A-3. COMPUTED EVENT LOCATIONS

TABLE A-5. AIRBLAST PEAK PRESSURES AND COMPUTED YIELDS

Event Number	PEAK PRESSURE (psi)												YIELD (%)
	POSITION NUMBER												
	P 1	P 2	P 3	P 4	P 5	P 6	P 7	P 8	P 9	P 10	P 11	P 12	
1	1.22	0.75	0.54	0.18	0.59	0.48	0.32	0.11	0.62	0.38	0.26	0.11	40.0
2	0.34	0.19	0.16	0.07	0.36	0.22	0.12	0.07	0.72	0.43	0.31	0.13	9.0
3	0.46	0.77	0.20	0.08	0.33	0.18	0.10	0.06	0.44	0.22	0.17	0.09	10.4
4	1.41	0.72	0.54	0.21	0.44	0.33	0.18	0.11	0.79	0.53	0.37	0.18	37.6
5	3.30	1.76	1.31	0.43	2.32	1.55	0.68	0.33	2.41	1.28	0.97	0.38	77.8
6	1.60	0.85	0.64	0.24	0.71	0.58	0.27	0.15	1.90	0.88	0.68	0.25	152.8
7	1.13	0.53	0.44	0.17	1.22	0.82	0.33	0.16	0.67	0.41	0.36	0.14	65.9
8	1.21	0.63	0.52	0.18	1.03	0.64	0.39	0.14	0.61	0.44	0.34	0.12	48.7

TEST 8

2 PALLETS OF 81MM MORTAR

COMPOSITION B

15 SEPTEMBER 1994

180 PROJECTILES IN TEST

TABLE A-6. MAXIMUM RECORDED TEMPERATURES

THERMOCOUPLE NUMBER	POSITION	MAXIMUM TEMPERATURE (°C)	RECORD DURATION (minutes)
1	fuze well--box 1, bottom left front	540	24.4
2	projectile case--box 1, bottom left front	1050	25.2
3	fuze well--box 2, bottom right back	200	22.8
4	projectile case--box 2, bottom right back	220	22.8
5	external--bottom left front	>1050	25.2
6	flame--between pallets, front	>1050	25.2
7	external--bottom right back	>1050	25.2
8	flame--between pallets, back	bad record	

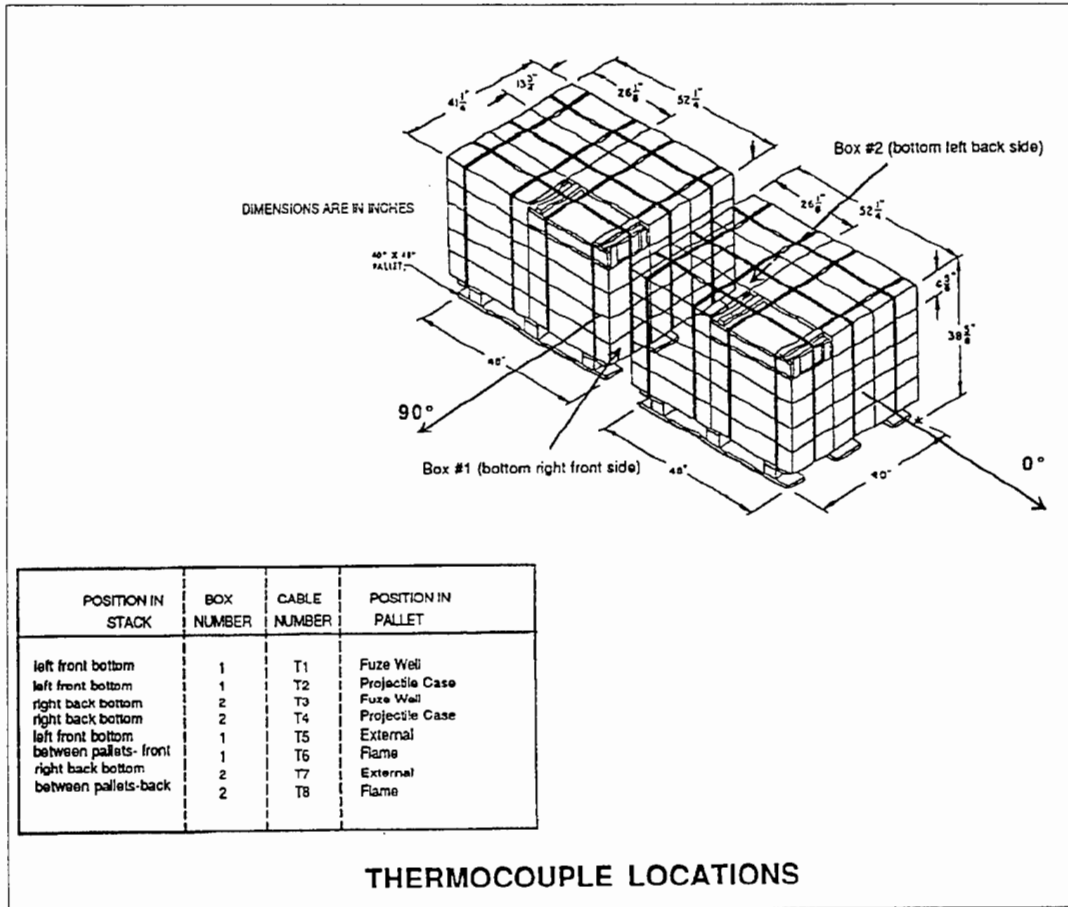

TABLE A-7. EVENT TIMES

Event Number	W.D.H Event Number	Time Code (h:m:s)	W. D. H Event Time (h:m:s)	Elapsed time: Time Code (m:s)	Elapsed time: W. D. H. (m:s)
	Fire Start		9:31:33		
1	1	9:54:13.96	9:54:15	00:00.00	00:00
2	2	9:54:38.19	9:54:39	0:24.23	00:24
3	3	9:54:54.89	9:54:56	0:40.93	00:41
4	4	9:54:59.86	9:55:01	0:45.90	00:46
5		9:55:03.57		0:49.61	
6	5	9:55:20.01	9:55:21	1:06.05	01:06
7		9:55:31.84		1:17.88	
8	6	9:55:32.74	9:55:33	1:18.76	01:18
9	7	9:55:47.08	9:55:48	1:33.12	01:33
10	8	9:55:53.27	9:55:54	1:39.31	01:39
11	9	9:55:59.48	9:56:05	1:45.52	01:50
12	10	9:56:06.80	9:56:07	1:52.84	01:52
13	11	9:56:08.79	9:56:10	1:54.83	01:55
14		9:56:15.74		2:01.78	
15	12	9:56:24.82	9:56:28	2:10.90	02:13
16*		9:56:27.16		2:13.20	
17	13	9:56:35.19	9:56:35	2:21.23	02:20
18	14	9:56:38.78	9:56:40	2:24.82	02:25
19*		9:56:39.27		2:25.31	
20		9:56:42.13		2:28.17	
21	15	9:56:42.51	9:56:45	2:28.55	02:30
22	16	9:56:42.68	9:56:50	2:28.72	02:35
23		9:57:03.94		2:49.98	
24	17	9:57:04.74	9:57:04	2:50.78	02:49
25	18	9:57:05.25	9:57:07	2:51.29	02:52
26	19	9:57:14.84	9:57:16	3:00.88	03:01
27	20	9:57:15.19	9:57:25	3:01.23	03:10
28	21	9:57:24.63	9:57:30	3:10.67	03:15
29	22	9:57:29.64	9:57:34	3:15.68	03:19
30*		9:57:31.40		3:17.44	

TABLE A-7. EVENT TIMES (Continued)

Event Number	W.D.H Event Number	Time Code (h:m:s)	W. D. H Event Time (h:m:s)	Elapsed time: Time Code (m:s)	Elapsed time: W. D. H. (m:s)
31	23	9:57:32.57	9:57:35	3:18.61	03:20
32	24	9:57:44.41	9:57:45	3:30.45	03:30
33	25	9:57:46.21	9:57:47	3:32.25	03:32
34	26	9:57:55.11	9:57:56	3:41.15	03:41
35	27	9:58:04.49	9:58:05	3:50.53	03:50
36		9:58:04.82		3:50.86	
37	28	9:58:08.90	9:58:08	3:54.94	03:53
38	29	9:58:12.76	9:58:12	3:58.80	03:57
39	30	9:58:18.73	9:58:18	4:04.77	04:03
	31		9:58:19		04:04
40	32	9:58:21.64	9:58:22	4:07.68	04:07
41	33	9:58:23.24	9:58:24	4:09.28	04:09
	34		9:58:30		04:15
42	35	9:58:35.72	9:58:36	4:21.76	04:21
43	36	9:58:36.24	9:58:40	4:22.28	04:25
44	37	9:58:38.98	9:58:41	4:25.02	04:26
45		9:58:39.20		4:25.24	
46		9:58:39.77		4:25.81	
47		9:58:44.92		4:30.96	
48		9:58:45.17		4:31.21	
49	38	9:58:48.28	9:59:04	4:34.32	04:49
50	39	9:59:10.26	9:59:11	4:56.30	04:56
51	40	9:59:14.94	9:59:16	5:00.98	05:01
	41		9:59:23		05:08
52	42	9:59:27.04	9:59:28	5:13.08	05:13
53	43	9:59:40.45	9:59:39	5:26.49	05:24
54	44	9:59:46.94	9:59:46	5:32.98	05:31
55	45	10:00:22.12	10:00:18	6:08.16	06:03
56	46	10:00:24.83	10:00:23	6:10.87	06:08
57*	47	10:00:25.50	10:00:25	6:11.54	06:10

TABLE A-7. EVENT TIMES (Continued)

Event Number	W.D.H Event Number	Time Code (h:m:s)	W. D. H Event Time (h:m:s)	Elapsed time: Time Code (m:s)	Elapsed time: W. D. H. (m:s)
58*		10:00:32.98		6:19.02	
59	48	10:00:36.19	10:00:37	6:22.23	06:22
60	49	10:00:39.78	10:00:41	6:25.82	06:26
61	50	10:00:50.96	10:00:51	6:37.00	06:36
62	51	10:00:54.14	10:00:54	6:40.18	06:39
63	52	10:00:59.41	10:00:56	6:45.45	06:41
64	53	10:01:00.83	10:01:00	6:46.87	06:45
	54		10:01:01		06:46
	55		10:01:11		06:56
65	56	10:01:21.32	10:01:22	7:07.36	07:07
	57		10:01:41		07:26
66	58	10:01:47.90	10:01:49	7:33.94	07:34
67	59	10:01:55.23	10:01:57	7:41.27	07:42
68	60	10:01:56.58	10:01:58	7:42.62	07:43
69	61	10:01:59.76	10:02:00	7:45.80	07:45
70	62	10:02:19.63	10:02:20	8:05.67	08:05
71		10:02:21.58		8:07.62	
72	63	10:02:48.44	10:02:49	8:34.48	08:34
73	64	10:02:57.42	10:02:58	8:43.46	08:43
74	65	10:03:00.30	10:03:01	8:46.34	08:46
75	66	10:03:05.43	10:03:06	8:51.47	08:51
76	67	10:03:08.21	10:03:09	8:54.25	08:54
	68		10:03:24		09:09
77	69	10:04:05.00	10:04:06	9:51.04	09:51
78	70	10:04:09.66	10:04:10	9:55.70	09:55
79*		10:04:15.22		10:01.26	
80	71	10:04:19.81	10:04:21	10:05.85	10:06
81	72	10:04:21.19	10:04:22	10:07.23	10:07
82	73	10:04:30.50	10:04:30	10:16.54	10:15
	74		10:04:32		10:17

TABLE A-7. EVENT TIMES (Continued)

Event Number	W.D.H Event Number	Time Code (h:m:s)	W. D. H Event Time (h:m:s)	Elapsed time: Time Code (m:s)	Elapsed time: W. D. H. (m:s)
83	75	10:04:54.02	10:04:55	10:40.06	10:40
84	76	10:05:04.15	10:05:05	10:50.19	10:50
85	77	10:05:06.40	10:05:07	10:52.44	10:52
86	78	10:05:30.43	10:05:31	11:16.47	11:16
87	79	10:05:30.62	10:05:32	11:16.66	11:17
88		10:06:19.62		12:05.66	
89	80	10:06:27.31	10:06:28	12:13.35	12:13
90	81	10:06:38.49	10:06:39	12:24.53	12:24
91	82	10:06:40.88	10:06:42	12:25.92	12:27
92		10:07:46.18		13:32.22	
93	83	10:08:05.23	10:08:05	13:51.27	13:50
94*		10:09:45.89		15:31.93	
95	84	10:13:13.75	10:13:15	18:59.79	19:00
96		10:14:06.82		18:52.86	
97*		10:14:32.56		19:18.60	

Notes: 1. W. D. H. Event Times are the times recorded during the event by on-site observer.

2. Elapsed times are measured from the time of Event 1.

*Propellant event.

TABLE A-8. AIRBLAST ARRIVAL TIME AND COMPUTED EVENT LOCATIONS

Event Number	TIME OF ARRIVAL (ms)												LOCATION	
	POSITION NUMBER												X0 (ft)	Y0 (ft)
	P 1	P 2	P 3	P 4	P 5	P 6	P 7	P 8	P 9	P 10	P 11	P 12		
1	39.64	57.05	83.50	172.5	41.00	58.64	85.46	174.0	34.52	51.00	78.23	163.0	-4.7	2.6
2	29.06	46.62	73.20	162.5	27.54	45.12	72.11	160.8	19.00	34.00		143.0	-1.4	2.7
3	44.20	61.75	88.28	177.4	39.70	57.51	84.10	172.3	29.67	46.70	72.85	159.0	-3.7	9.4
4	41.51	59.14	85.54	174.7	37.80	55.24	82.03	170.5	33.50	52.00	76.00	162.0	-1.2	6.0
5	39.27	56.78	83.33	172.0	43.29	60.67	88.00	175.0	36.00	54.00	80.00	165.0	-5.9	0.7
6	38.05	55.46	81.81	171.0	39.49	57.11	83.89	172.0	36.08	54.60	79.00	166.0	-2.7	0.8
7	39.84	57.63	83.85	173.0	37.35	54.92	81.64	170.0	30.50	49.00	79.55	163.0	-1.5	4.6
8	48.88	66.80	92.40	182.0	32.24	49.68	76.29	164.0	39.00	51.00	87.00	165.0	8.8	13.3
9	43.30	61.05	87.53	177.0	35.07	52.50	79.13	167.0	30.88	47.93	73.00	163.0	1.1	9.4
10	45.96	63.44	89.50	165.0	40.31	57.42	83.00	171.0	23.06	38.83	63.74	147.0	-7.9	10.9
11	38.78	56.34	82.87	173.0	40.33	57.94	84.66	173.0	34.96	52.49		162.5	-4.1	2.6
12	37.24	54.81	81.43	171.0	33.62	51.29	78.46	167.0	29.63	46.63	74.32	158.5	-0.8	4.6
13	40.10	57.56	84.19	174.0	35.98	53.61	80.32	168.0	37.50	54.00		165.0	1.4	4.2
14	41.79	59.55	85.81	175.0	35.84	53.55	80.33	169.0	36.00			165.0	1.2	6.0
15	39.54	57.26	83.62	172.5	41.68	59.30	86.00	174.5	35.00	56.37		163.0	-4.9	2.1
16	37.68	55.31	81.69	171.0	40.00	57.54	84.28	172.5	35.00	54.83		162.0	-3.9	1.2
17	90.00	118.0	144.0		50.75	54.70	69.45	144.5	71.00	80.50		175.0	48.0	66.7
18	40.90	58.63	85.06	174.0	41.61	59.09	85.88	174.0	34.86	51.47	77.86	162.0	-4.6	4.0
19	39.56	57.64	84.44	174.0	37.99	55.59	82.32	170.9	40.53	54.00	84.45	172.6	-1.2	1.7
20	41.22	58.74	85.34	175.0	35.24	52.78	79.50	167.9	36.84	54.60	81.22	162.0	2.3	5.5
21	39.75	57.17	83.66	171.5	44.29	61.40	87.00	177.0	31.92	49.10	75.63	162.0	-8.1	2.4
22	48.05	66.07			47.12	64.03	90.25	177.0	26.00	42.54	68.11	154.0	-9.7	13.2
23	30.89	48.42	74.97	165.0	31.89	49.34	75.99	164.2	24.38	41.56	68.30	153.0	-2.6	2.1
24	24.56	41.25	67.32	156.7	43.66	59.81	85.42	172.6	52.44	64.16	91.78	180.0	2.6	-18.2
25	36.29	53.54	79.74	168.7	36.32	53.55	79.90	167.8	30.17	46.44	71.87	156.0	-3.1	3.3
26	35.28	53.38	79.39	169.0	42.22	61.28	87.28	175.6	34.16	52.48	78.00	162.7	-7.5	-1.6
27	36.98	54.55	81.00	171.0	37.66	53.63	83.39	171.8	36.23	46.33	73.00	157.4	-3.9	3.0
28	48.02	70.40	92.39	165.0	43.72	61.00	87.45	175.3	22.96	39.26	64.59	164.4	-8.8	10.5
29	40.00	63.00	86.00	177.0	37.09	54.32	81.24	169.6	30.00	47.26	72.00	159.0	-1.7	8.9
30	34.89	53.00	79.20	168.0	41.00	58.00	84.81	173.7	30.00	54.00	90.00	165.0	-4.3	-2.5

TABLE A-8. AIRBLAST ARRIVAL TIME AND COMPUTED EVENT LOCATIONS (Continued)

Event Number	TIME OF ARRIVAL (ms)												LOCATION	
	POSITION NUMBER												X0 (ft)	Y0 (ft)
	P 1	P 2	P 3	P 4	P 5	P 6	P 7	P 8	P 9	P 10	P 11	P 12		
31	32.54	50.05	76.54	165.0	39.18	56.63	83.31	171.7	35.76	52.25	78.00	159.0	-4.9	-2.8
32	33.26	50.97	77.37	167.0	37.42	55.04	81.62	169.9	35.00		82.00	172.0	-0.8	-3.6
33	38.49	56.04	82.51	171.0	35.64	53.18	80.02	168.2	30.19	46.93	72.28	158.0	-2.1	5.2
34	39.91	57.45	84.00	174.0	36.90	54.42	81.37	169.2	29.92	46.16	72.00	156.0	-2.9	6.9
35	44.72	62.63	88.70	178.4	42.25	59.68	87.56	174.4	22.35	38.74	64.51	147.0	-9.5	12.7
36	46.90	64.68	90.54	180.0	43.06	60.36	87.05	175.5	35.00	48.00		165.0	-4.2	10.1
37	38.69	56.20	82.62	171.0	36.76	54.48	81.41	169.8	31.47	48.76	78.29	159.0	-2.1	3.9
38	38.23	55.81	82.39	171.0	36.00	54.00	81.59	170.3	31.24	48.15	73.91	159.0	-2.7	4.2
39	35.97	53.30	79.66	168.5	41.84	59.74	86.83	175.2	30.20	47.39	74.21	158.0	-8.5	0.7
40	42.60	60.29	86.60	175.0	32.93	50.50	77.35	166.0	27.00	42.00	69.00	156.0	-0.3	10.5
41	43.21	60.40	86.42	175.0	42.76	60.09	87.62	176.2	18.00	33.00	58.28	144.0	-12.7	12.2
42	34.63	51.89	78.20	168.0	38.12	55.68	82.34	170.6	37.11	53.07	82.18	154.0	-3.4	-0.8
43	33.54	50.89	77.17	165.0	43.82	61.38	88.08	176.4	32.00	48.00	77.76	165.0	-9.2	-3.5
44	38.53	55.91	82.23	171.0	32.80	60.00	75.95	177.0	28.64	45.48	71.95	157.0	-4.5	4.9
45	30.57	47.70	73.66	162.0	32.80	49.70	75.95	165.0	38.00			180.0	5.4	-7.9
46	36.00	53.08	79.05	168.0	30.36	47.88	74.11	161.4	28.35	44.52	70.46	155.9	1.0	4.7
47	41.20	31.00	30.00	105.0	102.0	115.0	138.0		102.0	114.0	135.0		-38.9	-91.6
48	37.08	54.55	80.98	171.0	44.12	60.00	88.14	176.6	31.58	49.99	70.00	161.0	-9.1	1.3
49	1.50	16.05	41.93	130.0	56.60	70.74	94.00	178.0	65.90	84.62	110.0	195.0	-5.0	-47.2
50	42.00	62.00	85.00	174.0	40.49	57.99	84.92	172.2	24.00	42.00	69.00	153.0	-7.0	9.1
51	34.27	51.72	78.27	168.0	40.49	57.99	84.92	173.2	34.00	52.00	75.00	165.0	-5.6	-1.6
52	29.44	46.82	73.15	162.0	40.48	57.69	84.70	171.0	29.17	46.41	72.00	159.0	-7.7	-3.4
53	40.20	57.42	83.29	165.0	42.30	59.55	86.38	174.0	25.09	42.41	67.85	155.0	-9.5	4.6
54	39.80	56.36	82.12	171.0	22.99	40.41	67.02	155.1	51.26	67.87	93.00	177.0	18.0	-0.3
55	38.72	55.91	82.06	171.0	51.00	66.98	93.00	182.0	32.07	49.02	74.88	162.0	-14.5	-0.9
56	42.92	61.37	87.53	177.0	39.87	56.61	83.61	171.0	27.66		70.59	156.0	-4.1	9.6
57	53.79		95.00	180.0	13.00	31.00	57.46	156.0				186.0	28.6	10.3
58	36.01	53.41	80.04	170.0	34.17	51.72	79.19	168.0				180.0	4.6	-2.7
59	39.80	57.37	83.81	172.0	39.29	56.79	83.60	171.9	31.53		74.45	159.0	-4.2	4.5
60	37.72	55.20	81.59	171.0	42.07	59.72	86.75	175.0	30.48		73.00	159.0	-7.7	2.2

TABLE A-8. AIRBLAST ARRIVAL TIME AND COMPUTED EVENT LOCATIONS (Continued)

Event Number	TIME OF ARRIVAL (ms)												LOCATION	
	POSITION NUMBER												X0 (ft)	Y0 (ft)
	P 1	P 2	P 3	P 4	P 5	P 6	P 7	P 8	P 9	P 10	P 11	P 12		
61	39.61	56.84	82.90	171.0	47.89	65.16	92.55	180.0	28.59		71.41	157.0	-13.6	2.2
62	41.66	59.32	85.84	175.0	40.94	58.02	85.14	173.5	25.01		66.74	152.0	-7.4	8.6
63	34.70	52.09	78.52	168.0	43.10	60.56	87.25	175.4	34.94		78.32	163.0	-7.6	-2.5
64	37.61	55.15	81.66	171.0	41.92	59.67	86.52	174.3	29.63		72.43	159.0	-7.6	2.5
65	37.53	55.00	81.45	170.0	35.19	52.79	79.50	168.0				165.0	1.4	1.2
66	38.69	55.69	81.67	171.0	48.93	66.21	91.32	181.7	30.01		72.79	150.0	-15.0	1.7
67	44.38	62.40	87.62	177.0	49.06	66.87	94.00	181.7	26.43		69.81	156.0	-14.3	7.3
68	38.35	55.68	82.06	171.0	42.17	59.73	86.26	174.5	32.42		75.77	162.0	-6.6	1.7
69	40.87	57.75	83.73	172.0	26.32	43.54	69.81	157.6	40.13		82.37	169.0	11.5	4.4
70	38.25	55.98	82.14	171.0	36.80	53.91	80.50	168.3	31.21		73.71	170.0	-0.4	2.7
71	31.54	48.92	75.25	164.0	40.84	58.21	84.65	172.6	35.58		78.00	165.0	-5.5	-5.1
72	40.22	57.56	83.86	172.0	44.67	62.20	89.29	177.5	30.20		72.00	159.0	-9.9	3.5
73	41.94	60.75	86.35	174.0	45.29	63.65	89.83	177.0	28.18		70.81	172.0	-8.6	4.4
74	48.93	65.00	89.92	174.0	15.50	33.00	59.56	148.3	54.04		99.00	185.0	28.3	5.3
75	44.62	62.10	88.19	176.0	47.58	64.42	92.47	180.0	23.54		66.39	153.0	-13.4	8.9
76	43.66	60.97	86.82	175.0	47.68	65.20	91.68	180.7	25.89		68.31	155.0	-13.3	7.0
77	29.36	44.36	69.16	156.0	61.08	78.00	105.0	192.0	43.37		83.62	168.0	-26.2	-20.0
78	38.29	55.73	82.07	171.0	41.15	59.00	85.72	173.7	33.20		77.25	162.0	-5.5	1.7
79	34.41	51.70	77.92	167.0	49.98	67.43	95.00	180.0	41.80		84.11	171.0	-12.8	-8.4
80	49.38	64.78	89.35	175.0	10.00	27.00	53.00	141.0	57.03		99.00	185.0	33.5	5.1
81	44.80	59.38	83.40	170.0	9.00	25.00	51.00	142.0	62.00		105.0	192.0	33.4	-2.8
82	38.40	55.00	81.36	170.0		72.00	101.0	189.0	35.83		78.33	164.5	-21.3	-5.7
83	41.59	59.85	85.75	175.0	42.91	60.49	87.23	175.7	33.71		77.71	163.5	-5.9	4.5
84	42.47	59.84	86.40	175.0	43.96	61.14	88.02	176.2	29.46		72.39	158.0	-8.2	6.4
85	34.68	52.04	78.40	168.0	42.03	59.52	86.11	174.1	36.44		79.55	165.0	-6.0	-2.8
86	41.14	58.55	84.93	174.0	40.85	58.34	84.93	173.0	33.00		76.36	163.0	-4.2	4.7
87	32.78	49.46	75.31	163.0	49.89	67.71	94.50	182.1	34.66		76.84	163.0	-15.6	-7.6
88	35.20	52.32	78.04	165.0	30.24	47.70	74.49	162.0	48.00		97.00	188.0	12.2	-7.6
89	41.30	58.69	84.96	174.0	40.95	58.51	85.21	173.7	30.24		73.06	159.0	-5.6	5.8
90	39.37	56.72	83.02	171.0	42.38	60.20	87.01	175.8	32.23		75.05	162.0	-7.2	2.3

TABLE A-8. AIRBLAST ARRIVAL TIME AND COMPUTED EVENT LOCATIONS (Continued)

Event Number	TIME OF ARRIVAL (ms)												LOCATION	
	POSITION NUMBER												X0 (ft)	Y0 (ft)
	P 1	P 2	P 3	P 4	P 5	P 6	P 7	P 8	P 9	P 10	P 11	P 12		
91	40.73	57.96	84.14	173.0	45.83	63.65	90.44	179.4	29.60		72.03	158.0	-11.4	3.7
92	34.73	52.22	78.65	173.0	47.42	64.98	91.48	179.9	42.42		86.64	174.0	-9.1	-6.5
93	40.10	57.48	83.82	172.0	39.68	57.25	83.82	171.9	34.58		77.91	164.5	-2.9	3.1
94	48.78	64.95	89.96	177.0	17.50	34.58	61.27	149.4	59.00		102.0	189.0	29.0	4.7
95	44.23	59.88	84.81	172.0	13.00	30.20	56.77	159.0	56.24		98.50	183.0	26.2	1.0
96	46.19	62.04	86.79	173.5	17.00	34.34	60.88	149.1	60.00		102.0	188.0	28.3	1.3
97	52.06	69.00	95.00	183.0	21.00	38.07	64.61	152.6	54.08		96.00	182.0	25.7	12.4

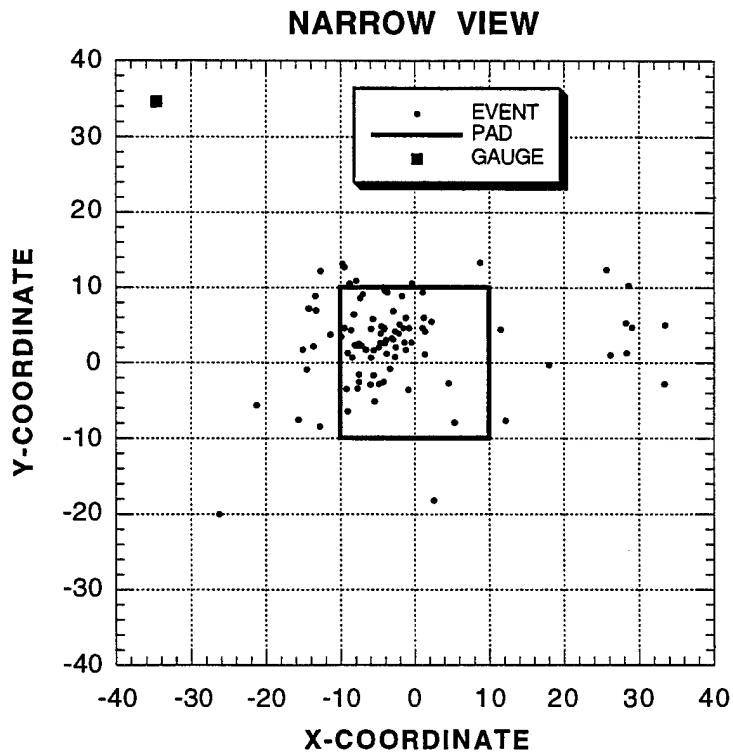
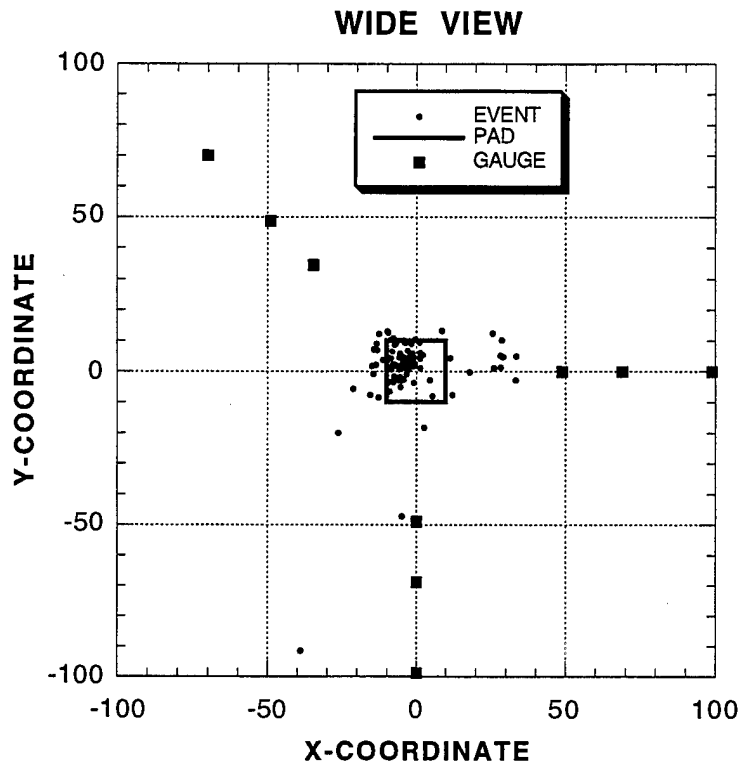

FIGURE A-4. COMPUTED EVENT LOCATIONS

TABLE A-9. AIRBLAST PEAK PRESSURES AND COMPUTED YIELDS

EVENT NUMBER	PEAK PRESSURE (psi)												YIELD (%)
	Position Number												
	P 1	P 2	P 3	P 4	P 5	P 6	P 7	P 8	P 9	P 10	P 11	P 12	
1	0.35	0.27	0.18	0.05	0.35	0.26	0.08	0.05	0.31	0.15	0.04	0.02	1.7
2	0.65	0.45	0.30	0.12	0.56	0.37	0.16	0.09	0.25	0.15		0.04	8.1
3	0.30	0.16	0.10	0.04	0.14	0.12	0.04	0.03	0.37	0.30	0.10	0.12	1.8
4	0.20	0.14	0.08	0.03	0.20	0.12	0.04	0.02	0.07	0.05		0.01	0.2
5	0.19	0.12	0.07	0.02	0.05	0.03	0.02	0.01	0.03	0.02	0.02	0.01	0.6
6	0.35	0.27	0.14	0.04	0.30	0.22	0.08	0.04	0.07	0.04	0.02	0.01	1.0
7	0.14	0.10	0.08	0.04	0.32	0.23	0.09	0.05	0.30	0.13	0.04	0.03	0.7
8	0.13	0.12	0.07	0.02	0.22	0.11	0.04	0.02	0.05	0.04		0.02	0.2
9	0.23	0.18	0.11	0.04	0.40	0.28	0.11	0.04	0.17	0.09	0.04	0.03	1.1
10	0.62	0.36	0.25	0.11	0.80	0.61	0.25	0.18	2.52	1.10	0.25	0.24	38.4
11	0.30	0.23	0.14	0.04	0.18	0.12	0.05	0.03	0.08	0.05	0.02	0.02	0.6
12	0.23	0.14	0.08	0.03	0.26	0.18	0.07	0.04	0.22	0.14	0.05	0.03	0.5
13	0.25	0.15	0.09	0.03	0.23	0.13	0.04	0.03	0.07	0.05		0.01	0.3
14	0.19	0.11	0.06	0.02	0.13	0.08	0.03	0.02	0.05			0.01	0.1
15	0.19	0.12	0.06	0.01	0.06	0.05	0.02	0.01				0.01	0.1
16	0.15	0.11	0.07	0.02	0.05	0.06	0.02	0.01	0.04	0.04	0.01	0.01	0.1
17	0.04	0.04	0.02		0.07	0.08	0.03	0.02	0.08	0.04	0.02	0.02	0.1
18	0.23	0.15	0.09	0.03	0.13	0.10	0.04	0.03	0.14	0.09	0.04	0.04	0.3
19	0.12	0.10	0.04	0.02	0.15	0.09	0.03	0.02	0.05	0.03	0.02	0.01	0.1
20	0.30	0.15	0.08	0.03	0.25	0.18	0.06	0.02	0.13	0.06	0.03	0.02	0.4
21	0.33	0.18	0.11	0.04	0.08	0.06	0.02	0.01	0.13	0.11	0.04	0.08	0.7
22					0.08	0.06	0.03	0.01	0.25	0.13	0.04	0.05	0.2
23	0.55	0.33	0.20	0.05	0.42	0.27	0.10	0.05	0.22	0.14	0.06	0.06	2.7
24	0.91	0.50	0.32	0.11	0.52	0.35	0.17	0.11	0.22	0.18	0.06	0.13	7.0
25	1.73	0.84	0.50	0.19	1.00	0.72	0.30	0.14	1.30	0.75	0.21	0.18	53.7
26	0.27	0.16	0.08	0.03	0.12	0.07	0.03	0.02		0.06	0.04	0.02	0.2
27	0.57	0.29	0.17	0.05	0.25	0.23	0.07	0.05		0.14	0.06	0.05	2.2
28	0.10	0.07	0.03	0.03	0.25	0.24	0.08	0.07	1.63	0.63	0.12	0.15	5.9
29	0.06	0.05	0.05	0.02	0.15	0.11	0.04	0.03	0.13	0.07	0.04	0.03	0.1
30	0.10	0.08	0.04	0.01	0.05	0.04	0.01	0.01	0.12	0.06	0.03	0.02	0.03

TABLE A-9. AIRBLAST PEAK PRESSURES AND COMPUTED YIELDS (Continued)

EVENT NUMBER	PEAK PRESSURE (psi)												YIELD (%)
	Position Number												
	P 1	P 2	P 3	P 4	P 5	P 6	P 7	P 8	P 9	P 10	P 11	P 12	
31	0.56	0.24	0.16	0.05	0.32	0.21	0.08	0.05	0.10	0.07	0.03	0.03	1.4
32	0.25	0.16	0.06	0.04	0.17	0.12	0.05	0.02	0.04	0.03	0.02	0.01	0.2
33	0.51	0.36	0.26	0.13	0.52	0.37	0.18	0.10	1.17	0.51	0.14	0.14	12.7
34	0.31	0.18	0.10	0.04	0.25	0.18	0.06	0.04	0.19	0.12	0.04	0.03	0.7
35	0.15	0.12	0.06	0.04	0.12	0.10	0.04	0.04	0.93	0.38	0.07	0.05	1.1
36	0.15	0.12	0.08	0.03	0.12	0.11	0.04	0.02	0.07	0.03	0.02	0.01	0.2
37	0.40	0.21	0.13	0.05	0.26	0.20	0.07	0.05	0.22	0.11	0.03	0.02	1.1
38	0.41	0.22	0.12	0.07	0.25	0.21	0.08	0.05	0.19	0.10	0.04	0.02	1.3
39	0.63	0.31	0.17	0.06	0.21	0.15	0.05	0.04	0.21	0.14	0.05	0.04	1.9
40	0.32	0.21	0.14	0.04	0.34	0.25	0.10	0.06	0.15	0.06	0.03	0.02	1.3
41	0.50	0.41	0.24	0.17	0.32	0.31	0.13	0.11	3.10	0.97	0.22	0.25	28.4
42	0.95	0.51	0.29	0.11	0.34	0.24	0.10	0.06	0.07	0.06	0.04	0.03	5.9
43	0.34	0.16	0.09	0.04	0.14	0.09	0.04	0.03	0.10	0.07	0.04	0.04	0.4
44	0.27	0.18	0.11	0.04	0.06	0.05	0.02	0.02	0.13	0.11	0.04	0.04	0.4
45	0.18	0.11	0.06	0.02	0.13	0.08	0.03	0.02					0.1
46	1.83	1.09	0.69	0.27	1.28	0.97	0.35	0.22	0.99	0.58	0.15	0.15	84.4
47	0.13	0.15	0.15	0.03	0.06	0.04	0.02			0.02	0.01		0.1
48	0.24	0.18	0.10	0.05	0.10	0.08	0.03	0.02	0.09	0.03	0.03	0.02	0.3
49		1.52	0.46	0.09	0.28	0.19	0.09	0.06	0.17	0.15	0.07	0.06	3.2
50	0.12	0.12	0.06	0.03	0.18	0.13	0.06	0.04	0.30	0.12	0.04	0.03	0.4
51	0.51	0.26	0.16	0.05	0.18	0.14	0.05	0.04	0.05	0.03	0.02	0.01	1.0
52	0.27	0.16	0.11	0.04	0.08	0.07	0.03	0.02	0.11	0.07	0.03	0.02	0.2
53	1.21	0.55	0.33	0.17	0.49	0.35	0.15	0.09	1.32	0.83	0.22	0.20	27.4
54	0.28	0.19	0.12	0.04	0.43	0.25	0.09	0.05	0.06	0.04	0.02	0.02	0.6
55	0.30	0.18	0.13	0.05	0.08	0.06	0.03	0.02	0.25	0.20	0.06	0.05	0.6
56	0.15	0.11	0.07	0.03	0.20	0.13	0.05	0.03	0.26		0.04	0.05	0.4
57	0.06	0.03	0.03	0.01	0.25	0.14	0.04	0.02	0.04			0.02	0.03
58	0.15	0.10	0.06	0.02	0.12	0.06	0.03	0.02	0.02			0.01	0.1
59	0.42	0.28	0.21	0.06	0.34	0.25	0.11	0.07	0.22		0.04	0.03	2.6
60	0.30	0.22	0.12	0.04	0.17	0.12	0.05	0.04	0.08		0.03	0.02	0.7

TABLE A-9. AIRBLAST PEAK PRESSURES AND COMPUTED YIELDS (Continued)

EVENT NUMBER	PEAK PRESSURE (psi)												YIELD (%)
	Position Number												
	P 1	P 2	P 3	P 4	P 5	P 6	P 7	P 8	P 9	P 10	P 11	P 12	
61	0.31	0.22	0.13	0.06	0.11	0.08	0.02	0.02	0.51		0.07	0.06	1.1
62	1.45	1.14	0.70	0.32	1.47	1.13	0.43	0.31	2.60		0.45	0.35	171.5
63	0.80	0.48	0.24	0.06	0.42	0.27	0.11	0.08	0.25		0.10	0.10	5.9
64	2.00	1.26	0.81	0.27	1.20	0.85	0.34	0.25	1.20		0.37	0.35	135.0
65	0.15	0.10	0.06	0.02	0.12	0.07	0.03	0.01					0.1
66	0.40	0.23	0.18	0.08	0.13	0.10	0.04	0.04	0.50		0.13	0.10	2.5
67	0.19	0.12	0.10	0.05	0.09	0.06	0.02	0.02	0.30		0.08	0.06	0.5
68	0.45	0.31	0.18	0.06	0.28	0.21	0.09	0.06	0.33		0.07	0.05	2.3
69	0.70	0.48	0.30	0.10	1.11	0.68	0.22	0.14	0.28		0.10	0.07	12.4
70	0.65	0.40	0.32	0.14	1.01	0.68	0.28	0.15	0.65		0.13	0.14	20.2
71	1.10	0.55	0.35	0.11	0.48	0.33	0.12	0.10	0.15		0.07	0.06	9.2
72	0.32	0.23	0.14	0.04	0.13	0.11	0.04	0.03	0.32		0.05	0.05	0.9
73	0.13	0.10	0.06	0.02	0.07	0.04	0.02	0.02	0.50		0.05	0.05	0.3
74	0.10	0.07	0.05	0.02	0.45	0.18	0.05	0.03	0.05		0.02	0.02	0.1
75	0.15	0.11	0.09	0.04	0.08	0.07	0.03	0.02	0.42		0.10	0.15	1.8
76	0.28	0.21	0.14	0.05	0.12	0.11	0.04	0.03	0.45		0.09	0.08	1.3
77	0.50	0.32	0.18	0.05	0.15	0.11	0.05	0.03	0.25		0.05	0.08	1.4
78	0.35	0.22	0.14	0.06	0.26	0.18	0.07	0.05	0.12		0.04	0.03	1.2
79	0.15	0.10	0.06	0.02	0.05	0.03	0.02	0.01	0.03		0.02	0.02	0.04
80	0.45	0.32	0.23	0.09	2.30	0.70	0.18	0.09	0.20		0.06	0.05	5.0
81	0.40	0.30	0.20	0.07	2.60	0.75	0.17	0.08	0.22		0.09	0.09	4.6
82	0.07	0.05	0.05	0.02					0.20		0.03	0.03	0.1
83	0.11	0.08	0.06	0.03	0.14	0.09	0.04	0.03	0.07		0.03	0.02	0.1
84	0.18	0.14	0.12	0.04	0.17	0.13	0.05	0.03	0.60		0.06	0.06	0.9
85	0.50	0.30	0.19	0.06	0.27	0.19	0.07	0.04	0.10		0.06	0.05	1.8
86	0.45	0.23	0.18	0.05	0.28	0.20	0.08	0.04	0.45		0.07	0.08	2.3
87	0.75	0.45	0.31	0.10	0.33	0.25	0.10	0.09	0.40		0.11	0.11	7.1
88	0.14	0.09	0.06	0.02	0.15	0.08	0.03	0.01	0.02		0.01	0.01	0.03
89	0.50	0.35	0.26	0.09	0.48	0.35	0.13	0.09	0.60		0.14	0.15	8.6
90	0.40	0.27	0.17	0.06	0.32	0.24	0.09	0.06	0.52		0.06	0.06	2.5

TABLE A-9. AIRBLAST PEAK PRESSURES AND COMPUTED YIELDS (Continued)

EVENT NUMBER	PEAK PRESSURE (psi)												YIELD (%)
	Position Number												
	P 1	P 2	P 3	P 4	P 5	P 6	P 7	P 8	P 9	P 10	P 11	P 12	
91	0.52	0.32	0.20	0.06	0.28	0.20	0.08	0.06	1.23		0.10	0.13	6.1
92	0.16	0.11	0.06	0.02	0.08	0.05	0.02	0.02	0.11		0.03	0.03	0.1
93	0.40	0.27	0.15	0.06	0.37	0.25	0.10	0.07	0.37		0.09	0.08	2.8
94	0.11	0.08	0.04	0.01	0.25	0.12	0.03	0.02	0.02		0.02	0.02	0.05
95	0.52	0.36	0.22	0.11	2.00	0.78	0.22	0.11	0.25		0.08	0.08	7.6
96	0.14	0.09	0.05	0.02	0.35	0.18	0.07	0.02	0.05			0.01	0.1
97	0.07	0.04	0.03	0.01	0.20	0.10	0.03	0.02	0.06		0.02	0.02	0.03

TEST 9

2 PALLETS OF 81MM MORTAR

COMPOSITION B

11 MAY 1995

180 PROJECTILES IN TEST

TABLE A-10. MAXIMUM RECORDED TEMPERATURES

THERMOCOUPLE NUMBER	POSITION	MAXIMUM TEMPERATURE (°C)	RECORD DURATION (minutes)
1	fuze well	40	25.8
2	projectile exterior	170	25.8
3	fuze well	260	25.8
4	projectile exterior	354	25.8
5	fuze well	77	25.8
6	projectile exterior	30	25.8
7	between boxes	715	25.8
8	flame outside boxes	bad record	---

TABLE A-11. AIRBLAST ARRIVAL TIME AND COMPUTED EVENT LOCATIONS

Event Number	TIME OF ARRIVAL (ms)												LOCATION	
	POSITION NUMBER												X0 (ft)	Y0 (ft)
	P1	P2	P3	P4	P5	P6	P7	P8	P9	P10	P11	P12		
1	30.75	46.48	71.57	158.7	25.58	41.20	65.39		27.08	42.53	66.67	151.9	2.0	-1.4

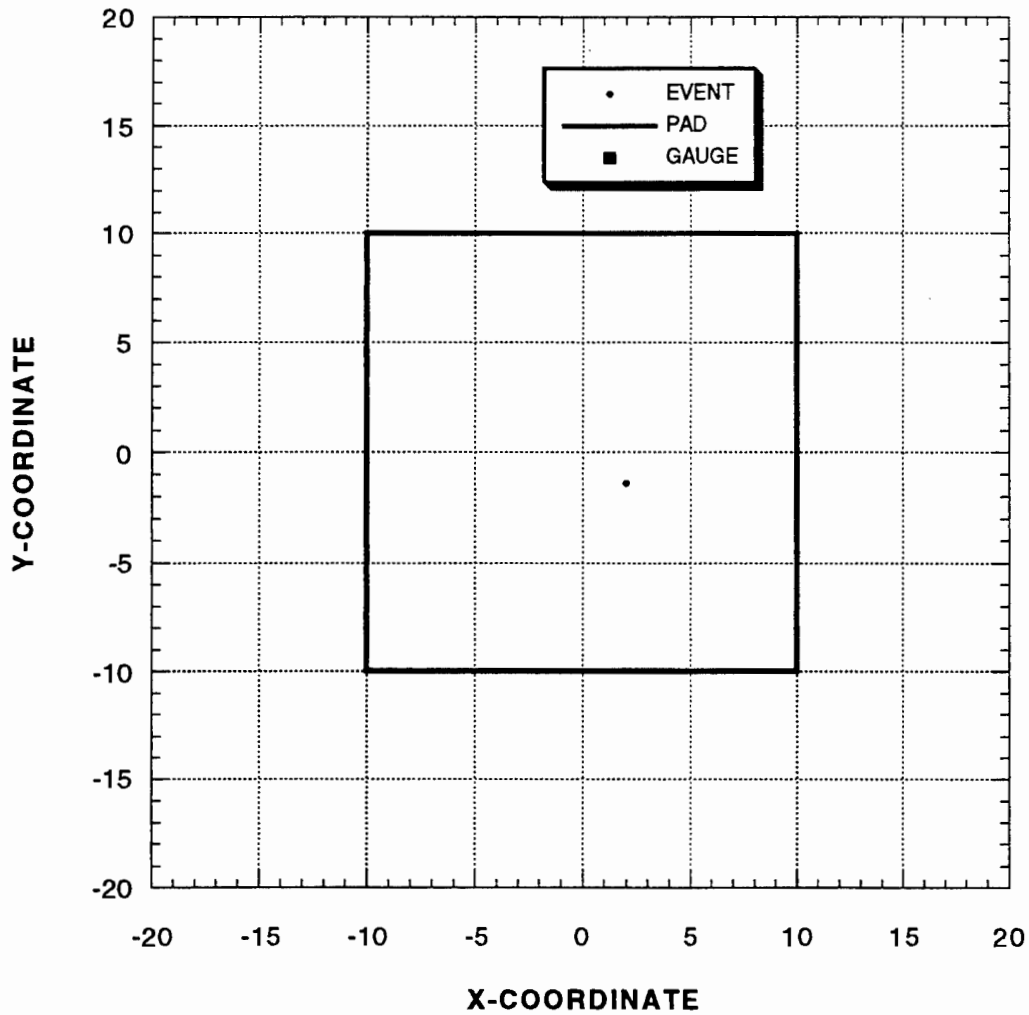

FIGURE A-5. COMPUTED EVENT LOCATIONS

TABLE A-12. AIRBLAST PEAK PRESSURES AND COMPUTED YIELDS

Event Number	PEAK PRESSURE (psi)												YIELD (%)
	P1	P2	P3	P4	P5	P6	P7	P8	P9	P10	P11	P12	
1	4.73	2.60	1.73	0.86	7.11	3.75	2.43		6.54		3.19	0.68	See note

Note: Pressure was produced by the equivalent of 7 boxes (21 rounds) detonating.

TEST 10

4 PALLETS OF 105MM CARTRIDGES

COMPOSITION B

17 MAY 1995

128 PROJECTILES IN TEST

TABLE A-13. MAXIMUM RECORDED TEMPERATURES

THERMOCOUPLE NUMBER	POSITION	MAXIMUM TEMPERATURE (°C)	RECORD DURATION (minutes)
1	fuze well-- bottom left box, right pallet	77	19.6
2	projectile exterior-- bottom left box, right pallet	87	19.6
3	fuze well-- bottom left box, left pallet	33	19.6
4	projectile exterior-- bottom left box, left pallet	30	19.6
5	fuze well-- first box, third row, left pallet	---	---
6	projectile exterior-- first box, third row, left pallet	25	19.6
7	flame between pallets	1223	19.6
8	flame outside pallet, left side	1100	19.6

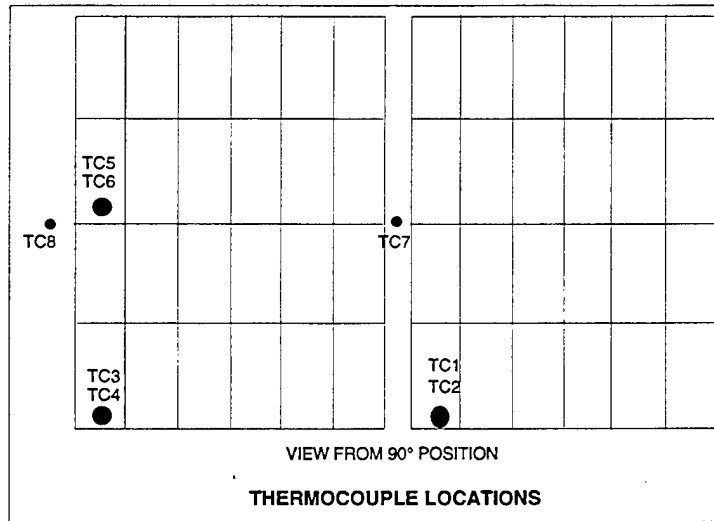

TABLE A-14. EVENT TIMES

Event Number	W.D.H Event Number	Time Code (h:m:s)	W. D. H Event Time (h:m:s)	Elapsed time: Time Code (m:s)	Elapsed time: W. D. H. (h:m:s)
	Fire Start				
1	1	10:11:16.1	10:11:24	00:00.00	0:00:00
2	2	10:13:56.4	10:14:04	2:40.3	0:02:40
3	3	10:14:54.7	10:15:01	3:38.6	0:03:37
4	4	10:15:16.5	10:15:22	4:00.4	0:03:58
5	5	10:16:48.1	10:16:54	5:32.0	0:05:30
6	6	10:17:19.8	10:17:26	6:03.7	0:06:02
7	7	10:17:35.6	10:17:41	6:19.5	0:06:17
8	8	10:17:42.0	10:17:48	6:25.9	0:06:24
9		10:17:43.4		6:27.3	
10	9	10:17:46.6	10:17:53	6:30.5	0:06:29
	10		10:17:56		0:06:32
11	11	10:18:20.0	10:18:26	7:03.9	0:07:02
12	12	10:18:37.6	10:18:43	7:21.5	0:07:19
13	13	10:18:50.2	10:18:56	7:34.1	0:07:32
14	14	10:19:17.9	10:19:23	8:01.8	0:07:59
15	15	10:19:23.8	10:19:30	8:07.7	0:08:06
16	16	10:19:42.5	10:19:48	8:26.4	0:08:24
17	17	10:19:45.1	10:19:51	8:29.0	0:08:27
18	18	10:20:41.6	10:20:47	9:25.5	0:09:23
19	19	10:20:42.4	10:20:49	9:26.3	0:09:25
20	20	10:20:58.8	10:20:57	9:42.7	0:09:33
21	21	10:21:22.3	10:21:27	10:06.2	0:10:03
22	22	10:22:31.1	10:22:37	11:15.0	0:11:13
23	23	10:22:48.2	10:22:54	11:32.1	0:11:30
24	24	10:23:26.6	10:23:33	12:10.5	0:12:09
25	25	10:24:07.0	10:24:13	12:50.9	0:12:49
26	26	10:24:31.2	10:24:37	13:15.1	0:13:13
27	27	10:26:09.9	10:26:15	14:52.8	0:14:51
28	28	10:27:22.9	10:27:31	16:06.8	0:16:07
29	29	10:29:19.4	10:29:26	18:03.3	0:18:02
	30		10:29:27		0:18:03
30	31	10:32:10.6	10:32:17	20:54.5	0:20:53

TABLE A-14. EVENT TIMES (Continued)

Event Number	W.D.H Event Number	Time Code (h:m:s)	W. D. H Event Time (h:m:s)	Elapsed time: Time Code (m:s)	Elapsed time: W. D. H. (h:m:s)
31	32	10:32:17.7	10:32:24	21:01.6	0:21:00
32	33	10:33:50.1	10:33:57	22:34.0	0:22:33
33	34	10:34:06.2	10:34:13	22:50.1	0:22:49
34	35	10:34:14.2	10:34:20	22:58.1	0:22:56
35	36	10:36:41.7	10:36:48	25:25.6	0:25:24
36	37	10:51:58.2	10:51:55	40:42.1	0:40:31
	38		13:47:41		3:36:17
	39		13:52:41		3:41:17

- Notes: 1. W. D. H. Event Times are the times recorded during the event by on-side observer.
2. Elapsed times are measured from the time of Event 1.

TABLE A-15. AIRBLAST ARRIVAL TIME AND COMPUTED EVENT LOCATIONS

Event Number	TIME OF ARRIVAL (ms)												LOCATION	
	POSITION NUMBER												X0 (ft)	Y0 (ft)
	P 1	P 2	P 3	P 4	P 5	P 6	P 7	P 8	P 9	P 10	P 11	P 12		
1	38.24	55.36	81.53	170.8	41.20	59.26	84.05	176.0	39.11	56.40	82.39	169.9	-3.4	-1.4
2	38.31	55.06	81.01	169.7	36.64	53.72	80.82	169.7	33.45	50.38	76.18	164.0	-1.4	2.3
3	30.08	46.99	73.06	162.1	35.77	53.12	79.62	168.9	37.87	55.05	80.95	168.8	-0.7	-6.2
4	33.13	50.13	76.43	165.7	32.30	50.11	76.97	166.7	40.49	57.69	84.36	172.6	3.9	-4.1
5	37.10	53.73	79.43	167.7	46.50	64.79	86.27	181.1	28.00	44.16	69.40	157.1	-13.0	0.8
6	36.16	52.63	78.62	168.0	25.01	42.30	68.65	157.5	46.19	63.64	90.04	178.5	14.1	-2.7
7	34.61	51.41	76.91	166.2	41.83	61.20	87.65	179.3	30.11	47.08	72.17	166.5	-9.8	-2.2
8	27.36	43.84	69.67	158.0	31.73	48.99	75.31	164.3	43.36	60.76	87.25	175.3	5.0	-10.6
9	31.47	48.01	74.04	162.5	27.77	45.11	71.70	156.8	46.47	63.94	90.25	178.7	11.4	-7.5
10	37.86	54.12	81.02	170.4	26.37	44.02	70.69	159.9	46.03	63.33	89.74	177.5	13.0	-1.1

TABLE A-15. AIRBLAST ARRIVAL TIME AND COMPUTED EVENT LOCATIONS (Continued)

Event Number	TIME OF ARRIVAL (ms)												LOCATION	
	POSITION NUMBER												X0 (ft)	Y0 (ft)
	P 1	P 2	P 3	P 4	P 5	P 6	P 7	P 8	P 9	P 10	P 11	P 12		
11	28.80	45.54	71.42	159.9	33.88	51.91	78.35	166.0	40.86	58.66	85.20	174.1	2.4	-9.0
12	37.11	54.10	80.39	174.7	37.38	54.88	81.94	176.3	34.05	51.57	77.89	166.7	-2.8	1.5
13	29.67	46.48	72.41	160.9	35.84	55.79	81.13	173.9	26.13	43.31	69.25	150.9	-9.3	-1.2
14	31.44	48.39	74.39	163.0	43.10	60.49	86.92	177.2	36.99	54.14	80.16	168.5	-7.8	-7.3
15	38.76	55.88	81.97	170.6	34.15	51.60	78.06	167.3	32.68	49.36	75.56	163.8	0.6	3.9
16	39.45	56.18	82.01	170.1	21.08	38.22	64.38	153.5	47.86	65.04	91.12	179.4	18.7	0.2
17	39.58	54.96	79.63	166.5	52.00	73.47	92.46	186.8	26.36	41.64	66.47	153.7	-20.2	0.1
18	32.41	49.47	75.60	164.8	38.40	57.41	81.73	175.4	35.74	52.84	78.69	166.1	-4.6	-4.3
19	31.31	48.20	74.14	163.0	33.99	51.76	78.57	168.3	31.73	48.68	74.29	161.2	-3.0	-1.7
20	39.70	56.45	78.29	171.1	27.53	44.95	71.48	165.8	38.97	59.19	85.20	172.7	8.8	1.2
21	37.29	53.88	79.68	168.1	23.38	40.98	67.75	162.1	47.88	65.13	90.98	178.2	14.6	-2.4
22	44.80	61.62	88.06	176.2	26.70	43.92	70.31	159.5	41.65	58.43	83.80	171.3	12.8	7.8
23	32.96	49.79	75.26	164.4	42.80	61.17	87.83	178.3	32.72	49.59	75.26	161.8	-10.0	-4.0
24	34.51	51.46	77.59	166.9	30.68	48.28	74.68	165.0	44.17	61.75	88.12	175.8	7.6	-4.2
25	21.10	37.64	63.44	152.2	39.44	57.21	83.70	173.4	43.96	60.80	86.33	173.6	-3.7	-17.4
26	47.10	62.45	87.42	174.5	58.60	77.70	104.8	194.5	20.20	34.55	58.96	145.3	-28.8	6.8
27	38.88	56.10	82.51	172.0	32.62	49.71	76.52	164.9	38.59	55.80	81.73	169.5	5.1	2.5
28	30.80	47.37	73.13	162.1	47.90	65.56	92.04	181.5	34.38	51.30	76.95	164.7	-13.8	-8.3
29	24.27	41.26	66.86	155.2	32.95	50.09	75.88	165.0	43.05	60.08	86.42	174.9	3.4	-12.8
30	37.11	53.20	78.20	165.3	53.10	69.96	96.10	185.8	21.95	37.60	62.72	149.6	-24.0	0.8
31	37.46	54.09	79.80	168.2	50.80	69.49	95.90	186.1	33.52	50.56	76.53	164.6	-17.1	-4.6
32	49.40	63.82	87.55	173.7	69.20	87.10	113.2	204.3	22.54	35.40	58.58	144.0	-39.4	3.1
33	34.92	51.46	77.61	166.4	26.28	43.40	69.56	158.0	44.84	61.95	87.80	175.5	12.0	-3.1
34	41.60	58.24	84.37	173.6	26.55	44.03	70.65	160.0	45.27	62.60	88.71	176.5	13.7	2.8
35	28.85	45.00	70.28	158.2	26.77	43.32	69.40	158.1	48.54	65.89	91.98	179.7	12.2	-11.0
36	36.87	53.03	78.41	166.1	19.46	36.73	63.05	151.8	50.39	67.55	93.80	181.9	20.2	-3.8

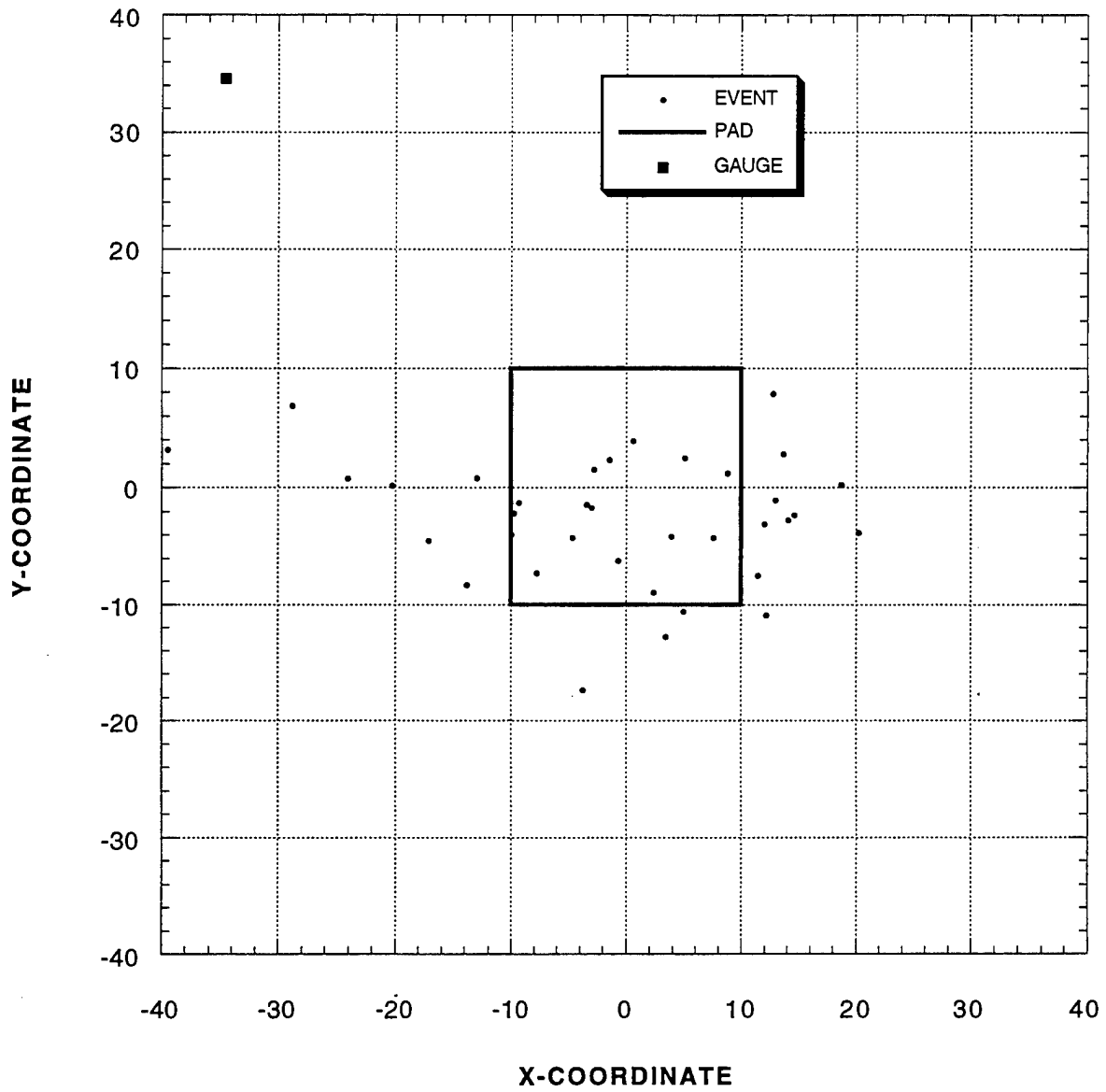

FIGURE A-6. COMPUTED EVENT LOCATIONS

TABLE A-16. AIRBLAST PEAK PRESSURES AND COMPUTED YIELDS

Event Number	PEAK PRESSURE (psi)												YIELD (%)
	POSITION NUMBER												
	P 1	P 2	P 3	P 4	P 5	P 6	P 7	P 8	P 9	P 10	P 11	P 12	
1	0.81	0.55	0.31	0.13	0.57		0.29	0.12	0.85	0.62	0.44	0.12	7.4
2	1.45	1.04	0.65	0.30	0.98			0.20	1.62	1.17	0.99	0.24	53.0
3	1.27	0.83	0.48	0.23	0.91			0.16	0.81	0.71	0.46	0.13	19.8
4	0.81	0.61	0.38	0.18	0.35			0.10	0.30	0.24	0.18	0.08	5.8
5	0.74	0.68	0.38	0.21	0.31			0.11	1.64	1.06	0.67	0.18	17.2
6	0.72	0.50	0.33	0.14	1.04			0.11	0.47	0.38	0.30	0.10	6.3
7	1.34	0.89	0.55	0.24	0.32			0.08	1.04	0.62	0.49	0.14	17.7
8	1.34	0.79	0.49	0.21	0.79			0.14	0.27	0.21	0.19	0.08	15.7
9	0.59	0.44	0.28	0.13	0.92			0.13	0.21	0.17	0.12	0.06	3.6
10	0.36	0.23	0.16	0.07	0.73		0.24	0.09	0.38	0.30	0.23	0.08	1.8
11	1.37	0.66	0.40	0.19	0.61		0.23	0.12	0.28	0.28	0.20	0.05	10.4
12	0.44	0.39	0.25	0.12	0.30		0.20	0.10	0.72	0.50	0.35	0.10	3.7
13	0.47	0.31	0.17	0.10	0.10		0.10	0.04	1.00	0.68	0.46	0.11	3.6
14	0.80	0.56	0.33	0.16	0.24		0.14	0.08	0.57	0.43	0.32	0.10	5.4
15	0.78	0.65	0.44	0.22	0.75		0.36	0.15	1.53	0.91	0.65	0.19	21.8
16	0.55	0.49	0.36	0.18	1.62		0.55	0.17	0.56	0.43	0.35	0.10	9.4
17	0.95	0.65	0.41	0.17	0.13		0.14	0.08	1.17	0.91	0.49	0.13	9.2
18	0.88	0.60	0.36	0.15	0.23		0.13	0.07	0.66	0.44	0.32	0.10	5.4
19	1.35	0.93	0.54	0.30	0.69		0.41	0.17	1.46	1.10	0.83	0.27	38.6
20	0.64	0.53	0.37	0.16	1.09		0.52	0.14	0.46	0.32	0.26	0.09	7.2
21	0.49	0.36	0.25	0.12	0.77		0.28	0.10	0.41	0.35	0.29	0.10	3.6
22	0.36	0.28	0.21	0.12	0.88		0.40	0.15	0.64	0.53	0.41	0.12	7.1
23	0.87	0.68	0.46	0.24	0.39		0.20	0.08	1.19	0.84	0.58	0.17	14.4
24	0.67	0.44	0.26	0.11	0.59		0.24	0.07	0.32	0.22	0.19	0.07	2.6
25	2.14	0.99	0.61	0.26	0.99		0.52	0.24	0.65	0.53	0.40	0.12	49.9
26	0.61	0.47	0.32	0.17	0.19		0.13	0.07	1.94	1.03	0.62	0.15	11.1
27	0.83	0.50	0.37	0.17	1.12		0.48	0.20	0.91	0.68	0.46	0.15	14.2
28	1.15	0.68	0.40	0.18	0.38		0.08	0.12	0.69	0.55	0.38	0.12	10.3
29	1.98	1.24	0.65	0.38	0.97		0.52	0.22	0.93	0.72	0.62	0.20	59.7
30	1.49	1.00	0.78	0.36	0.78		0.52	0.26	3.64	1.97	1.38	0.31	86.3

TABLE A-16. AIRBLAST PEAK PRESSURES AND COMPUTED YIELDS (Continued)

Event Number	PEAK PRESSURE (psi)												YIELD (%)
	POSITION NUMBER												
	P 1	P 2	P 3	P 4	P 5	P 6	P 7	P 8	P 9	P 10	P 11	P 12	
31	0.30	0.20	0.14	0.06	0.12		0.08	0.04	0.66	0.46	0.31	0.08	1.0
32	0.66	0.51	0.35	0.20	0.22		0.20	0.11	1.71	1.01	0.73	0.18	13.2
33	0.78	0.57	0.39	0.18	1.58		0.61	0.23	0.72	0.54	0.49	0.17	17.2
34	0.38	0.28	0.21	0.11	0.77		0.27	0.10	0.35	0.29	0.25	0.08	2.4
35	1.73	1.01	0.63	0.26	2.10		0.79	0.26	0.67	0.51	0.45	0.17	43.8
36	0.85	0.56	0.38	0.19	1.36		0.44	0.14	0.66	0.50	0.46	0.15	13.2

TEST 11B

81MM MORTAR

COMPOSITION B

20 SEPTEMBER 1995

15 PROJECTILES IN TEST

TABLE A-17. EVENT TIMES

Event Number	W.D.H Event Number	Time Code (h:m:s)	W. D. H Event Time (h:m:s)	Elapsed time: Time Code (m:s)	Elapsed time: W. D. H. (m:s)
	Fire Start		12:17:50		
1	1	12:35:00.1	12:34:20	00:00.00	00:00
2	2	12:35:12.0	12:34:32	0:11.9	00:12
3	3	12:35:22.5	12:34:42	0:22.4	00:22
4	4	12:37:15.7	12:36:36	2:15.6	02:16

- Notes: 1. W. D. H. Event Times are the times recorded during the event by on-site observer.
2. Elapsed times are measured from the time of Event 1.

TABLE A-18. AIRBLAST ARRIVAL TIME AND COMPUTED EVENT LOCATIONS

Event Number	TIME OF ARRIVAL (ms)												LOCATION	
	POSITION NUMBER												X0 (ft)	Y0 (ft)
	P 1	P 2	P 3	P 4	P 5	P 6	P 7	P 8	P 9	P 10	P 11	P 12		
1	35.95	52.71	78.32	165.0	36.73	53.90	79.75	166.5	40.04	57.26	83.16	170.3	1.5	-3.0
2	32.80	48.25	74.45	161.7	38.60	55.57	80.41	167.9	34.86	51.90	-	165.0	-2.5	-4.5
3	31.30	47.70	-	159.5	34.70	51.90	77.08	163.3	33.34	50.24	-	162.8	0.3	-3.2
4	49.03	65.36	90.70	176.3	54.98	71.97	97.50	183.7	19.50	36.09	61.70	148.7	-20.2	11.0

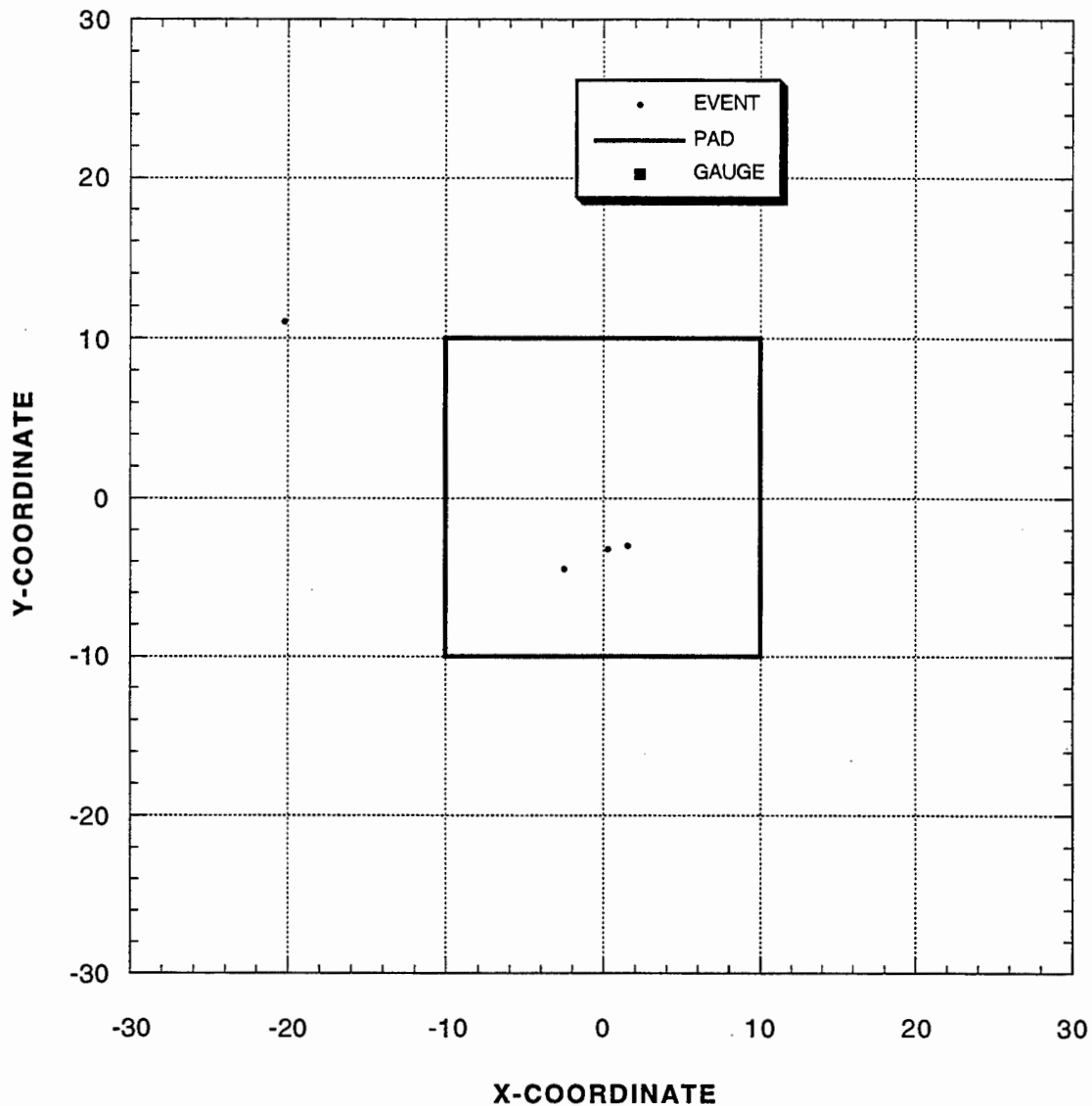

FIGURE A-7. COMPUTED EVENT LOCATIONS

TABLE A-19. AIRBLAST PEAK PRESSURES AND COMPUTED YIELDS

Event Number	PEAK PRESSURE (psi)												YIELD (%)
	Position Number												
	P 1	P 2	P 3	P 4	P 5	P 6	P 7	P 8	P 9	P 10	P 11	P 12	
1	0.49	0.37	0.43	0.06	0.68	-	0.27	0.01	0.59	0.43	0.32	0.07	11.3
2	0.52	0.63	0.44	0.10	0.86	-	0.40	-	0.78	0.67	-	0.12	23.9
3	0.83	0.72	-	0.13	1.42	-	0.67	0.01	1.35	0.89	-	0.14	58.2
4	0.21	0.23	-	0.05	0.33	-	0.17	0.01	1.31	0.59	0.41	0.07	5.4

TEST 12

8 PALLETS OF 81MM MORTAR

COMPOSITION B

26 SEPTEMBER 1995

720 PROJECTILES IN TEST

TABLE A-20. MAXIMUM RECORDED TEMPERATURES

THERMOCOUPLE NUMBER	POSITION	MAXIMUM TEMPERATURE (°C)	RECORD DURATION (min)
1	fuze well	76	18.4
2	projectile surface	160	18.4
3	fuze well	20	18.4
4	projectile surface	No record	No record
9	fuze well	38	19.5
10	projectile surface	32	19.5
11	box exterior	140	18.4
12	box exterior	1230	20.0

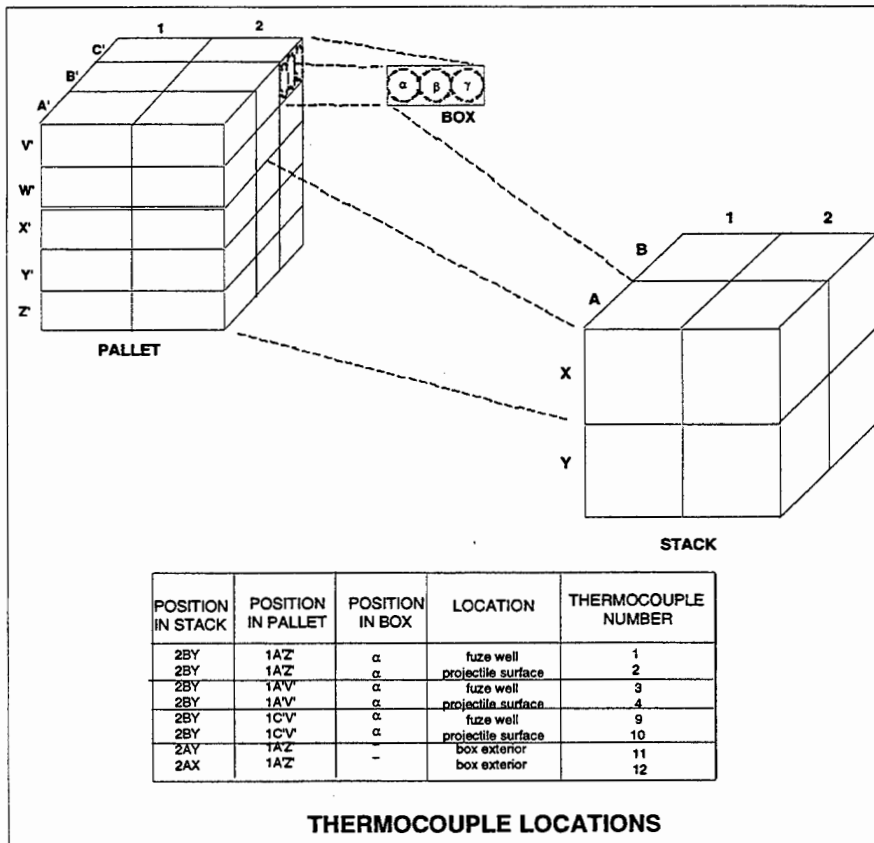

TABLE A-21. EVENT TIMES

Event Number	W.D.H. Event Number	Time Code (h:m:s)	W.D.H. Event Time (h:m:s)	Elapsed time: Time Code (h:m:s)	Elapsed time: W.D.H (h:m:s)
Fire Start		11:00:50			
1		11:19:24.875		0:00:00.000	
2		11:20:05.526		0:00:40.651	
3		11:20:30.409		0:01:05.534	
4		11:20:43.346		0:01:18.471	
5		11:20:44.808		0:01:19.933	
6		11:20:50.204		0:01:25.329	
7		11:20:57.149		0:01:32.274	
8		11:21:24.409		0:01:59.534	
9		11:21:38.503		0:02:13.628	
10		11:21:39.205		0:02:14.330	
11		11:21:53.607		0:02:28.732	
12		11:21:59.096		0:02:34.221	
13		11:22:02.425		0:02:37.550	
14		11:22:05.321		0:02:40.446	
15		11:22:09.832		0:02:44.957	
16		11:22:18.273		0:02:53.398	
17		11:22:30.882		0:03:06.007	
18		11:22:44.483		0:03:19.608	
19		11:22:46.741		0:03:21.866	
20		11:22:48.224		0:03:23.349	
21		11:22:48.409		0:03:23.534	
22		11:22:59.788		0:03:34.913	
23		11:23:06.938		0:03:42.063	
24		11:23:10.423		0:03:45.548	
25		11:23:21.392		0:03:56.517	
26		11:23:26.534		0:04:01.659	
27		11:23:33.482		0:04:08.607	
28		11:23:38.331		0:04:13.456	
29		11:23:45.329		0:04:20.454	
30		11:23:52.653		0:04:27.778	

TABLE A-21. EVENT TIMES (Continued)

Event Number	W.D.H. Event Number	Time Code (h:m:s)	W.D.H. Event Time (h:m:s)	Elapsed time: Time Code (h:m:s)	Elapsed time: W.D.H (h:m:s)
31		11:23:53.502		0:04:28.627	
32		11:23:55.252		0:04:30.377	
33		11:24:07.544		0:04:42.669	
34		11:24:20.178		0:04:55.303	
35		11:24:21.746		0:04:56.871	
36		11:24:25.091		0:05:00.216	
37		11:24:26.492		0:05:01.617	
38		11:24:28.748		0:05:03.873	
39		11:24:33.227		0:05:08.352	
40		11:24:36.866		0:05:11.991	
41		11:24:39.872		0:05:14.997	
42		11:24:40.107		0:05:15.232	
43		11:24:44.640		0:05:19.765	
44		11:24:49.855		0:05:24.980	
45		11:24:51.541		0:05:26.666	
46		11:24:56.300		0:05:31.425	
47		11:24:57.788		0:05:32.913	
48		11:24:58.538		0:05:33.663	
49		11:25:00.230		0:05:35.355	
50		11:25:00.670		0:05:35.795	
51		11:25:03.593		0:05:38.718	
52		11:25:17.393		0:05:52.518	
53		11:25:18.263		0:05:53.388	
54		11:25:19.040		0:05:54.165	
55		11:25:20.047		0:05:55.172	
56		11:25:22.059		0:05:57.184	
57		11:25:33.150		0:06:08.275	
58		11:25:41.406		0:06:16.531	
59		11:25:42.623		0:06:17.748	
60		11:25:43.450		0:06:18.575	

TABLE A-21. EVENT TIMES (Continued)

Event Number	W.D.H. Event Number	Time Code (h:m:s)	W.D.H. Event Time (h:m:s)	Elapsed time: Time Code (h:m:s)	Elapsed time: W.D.H (h:m:s)
61		11:26:02.871		0:06:37.996	
62		11:26:04.501		0:06:39.626	
63		11:26:05.044		0:06:40.169	
64		11:26:05.157		0:06:40.282	
65		11:26:05.183		0:06:40.308	
66		11:26:23.278		0:06:58.403	
67		11:26:33.213		0:07:08.338	
68		11:26:35.074		0:07:10.199	
69		11:26:36.213		0:07:11.338	
70		11:26:37.745		0:07:12.870	
71		11:26:43.870		0:07:18.995	
72		11:26:45.996		0:07:21.121	
73		11:26:59.041		0:07:34.166	
74		11:27:03.513		0:07:38.638	
75		11:27:04.358		0:07:39.483	
76		11:27:31.912		0:08:07.037	
77		11:27:32.055		0:08:07.180	
78		11:27:44.478		0:08:19.603	
79		11:27:50.498		0:08:25.623	
80		11:28:02.909		0:08:38.034	
81		11:28:04.896		0:08:40.021	
82		11:28:19.989		0:08:55.114	
83		11:28:23.288		0:08:58.413	
84		11:28:27.073		0:09:02.198	
85		11:28:36.880		0:09:12.005	
86		11:28:51.386		0:09:26.511	
87		11:29:08.870		0:09:43.995	
88		11:29:18.981		0:09:54.106	
89		11:29:19.891		0:09:55.016	
90		11:29:21.049		0:09:56.174	

TABLE A-21. EVENT TIMES (Continued)

Event Number	W.D.H. Event Number	Time Code (h:m:s)	W.D.H. Event Time (h:m:s)	Elapsed time: Time Code (h:m:s)	Elapsed time: W.D.H (h:m:s)
91		11:29:22.352		0:09:57.477	
92		11:29:23.204		0:09:58.329	
93		11:29:32.103		0:10:07.228	
94		11:29:49.509		0:10:24.634	
95		11:29:52.275		0:10:27.400	
96		11:29:52.765		0:10:27.890	
97		11:29:54.339		0:10:29.464	
98		11:30:01.021		0:10:36.146	
99		11:30:15.801		0:10:50.926	
100		11:30:20.563		0:10:55.688	
101		11:30:27.537		0:11:02.662	
102		11:30:42.775		0:11:17.900	
103		11:30:48.570		0:11:23.695	
104		11:30:49.388		0:11:24.513	
105		11:30:52.468		0:11:27.593	
106		11:30:56.579		0:11:31.704	
107		11:31:08.322		0:11:43.447	
108		11:31:19.928		0:11:55.053	
109		11:31:44.078		0:12:19.203	
110		11:31:54.948		0:12:30.073	
111		11:32:06.278		0:12:41.403	
112		11:32:17.600		0:12:52.725	
113		11:32:31.896		0:13:07.021	
114		11:32:34.323		0:13:09.448	
115		11:33:27.563		0:14:02.688	
116		11:33:28.127		0:14:03.252	
117		11:34:07.980		0:14:43.105	
118		11:34:39.082		0:15:14.207	
119		11:34:41.018		0:15:16.143	
120		11:34:58.558		0:15:33.683	

TABLE A-21. EVENT TIMES (Continued)

Event Number	W.D.H. Event Number	Time Code (h:m:s)	W.D.H. Event Time (h:m:s)	Elapsed time: Time Code (h:m:s)	Elapsed time: W.D.H (h:m:s)
121		11:35:10.904		0:15:46.029	
122		11:35:12.463		0:15:47.588	
123		11:35:37.263		0:16:12.388	
124		11:35:38.462		0:16:13.587	
125		11:36:06.274		0:16:41.399	
126		11:36:28.236		0:17:03.361	
127		11:37:03.523		0:17:38.648	
128		11:37:08.268		0:17:43.393	
129		11:37:24.072		0:17:59.197	
130		11:37:27.315		0:18:02.440	
131		11:37:32.103		0:18:07.228	
132		11:39:18.676		0:19:53.801	
133		11:39:24.337		0:19:59.462	
134		11:39:38.537		0:20:13.662	
135		11:39:40.114		0:20:15.239	
136		11:40:12.640		0:20:47.765	
137		11:40:22.165		0:20:57.290	
138		11:41:58.594		0:22:33.719	
139		11:43:41.650		0:24:16.775	
140		11:45:02.070		0:25:37.195	
141		11:45:06.853		0:25:41.978	
142		11:45:24.313		0:25:59.438	
143		11:45:33.630		0:26:08.755	
144		11:45:34.685		0:26:09.810	
145		11:45:43.265		0:26:18.390	
146		11:46:54.233		0:27:29.358	
147		11:50:07.379		0:30:42.504	
148		11:50:33.296		0:31:08.421	
149		11:50:45.933		0:31:21.058	
150		11:51:05.629		0:31:40.754	

TABLE A-21. EVENT TIMES (Continued)

Event Number	W.D.H. Event Number	Time Code (h:m:s)	W.D.H. Event Time (h:m:s)	Elapsed time: Time Code (h:m:s)	Elapsed time: W.D.H (h:m:s)
151		11:51:08.168		0:31:43.293	
152		11:51:10.459		0:31:45.584	
153		11:52:38.657		0:33:13.782	
154		11:52:41.884		0:33:17.009	
155		11:52:49.094		0:33:24.219	
156		11:52:54.388		0:33:29.513	
157		11:53:51.662		0:34:26.787	
158		11:55:46.748		0:36:21.873	
159		11:56:12.742		0:36:47.867	
160		11:56:44.229		0:37:19.354	
161		11:56:44.281		0:37:19.406	
162		11:56:44.499		0:37:19.624	
163		11:56:33.434		0:37:08.559	
164		11:58:35.137		0:39:10.262	
165		12:00:55.884		0:41:31.009	
166*		12:02:14.000		0:42:49.125	
167*		12:02:18.000		0:42:53.125	
168*		12:02:24.000		0:42:59.125	
169*		12:05:53.000		0:46:28.125	
170*		12:05:54.000		0:46:29.125	
171*		12:16:26.000		0:57:01.125	
172*		12:17:06.000		0:57:41.125	
173*		12:19:05.000		0:59:40.125	
174*		12:22:41.000		1:03:16.125	
175*		12:26:12.000		1:06:47.125	
176*		12:48:32.000		1:29:07.125	
177*		12:56:49.000		1:37:24.125	

Notes: 1. W. D. H. Event Times are times recorded during the event by on-site observer.

2. Elapsed times are measured from the time of Event 1.

*Second tape recorder failed—times are from on-site observer.

TABLE A-22. AIRBLAST ARRIVAL TIME AND COMPUTED EVENT LOCATIONS

Event Number	TIME OF ARRIVAL (ms)												LOCATION	
	POSITION NUMBER												X0 (ft)	Y0 (ft)
	P 1	P 2	P 3	P 4	P 5	P 6	P 7	P 8	P 9	P 10	P 11	P 12		
1	31.98	48.83	74.74	162.8	34.46	57.79	78.18	166.0	41.88	59.47	85.83	174.1	2.0	-7.1
2	39.11	56.27	82.52	174.4	32.46		75.38	161.6	41.87	59.53	85.98	174.6	8.6	1.8
3	38.41	55.47	81.63		31.29	43.30	74.41	161.2	43.43	61.04	87.52	175.9	10.3	0.3
4	34.84	52.18	78.51	167.3	36.25		79.51	168.2	43.68	61.32	87.55	176.3	3.8	-4.8
5	37.03	54.19	80.31	169.5	33.25		77.02	165.0	36.96	54.38	80.52	168.9	3.1	0.8
6	36.12	53.43	79.73	172.4	32.63		74.42	171.6	43.06	60.85	86.61	176.1	5.7	-2.0
7	29.96	46.83	72.68	161.6	34.02		77.03	164.7	42.12	59.75	85.57	174.3	3.3	-8.1
8	41.24	58.13	83.99	173.5	23.36		65.29	152.7	42.99	60.26	86.24	174.2	15.8	4.2
9	22.48	39.82	66.19	155.8	31.74		74.79	162.2	43.31	60.15	86.05	175.4	3.8	-13.3
10	29.58	46.89	73.24	166.0	31.31		74.92	162.2	33.77	51.29	77.55	165.7	1.3	-2.9
11	28.72	45.93	72.12	160.3	36.89		79.29	167.6	46.74	64.72	90.44	179.4	3.5	-11.9
12	34.58	51.88	78.63	167.9	29.95		72.70	159.7	34.60	52.24	78.72	167.3	4.6	0.7
13	34.76	52.01	78.22	167.5	36.08		79.33	167.1	40.68	58.35	84.80	173.5	2.6	-3.5
14	38.64	55.93	82.33	176.1	37.15		80.63	168.5	35.94	53.47	79.87	169.0	0.9	3.0
15	40.21	57.46	83.74	173.5	33.35		77.60	165.0	31.41	49.07	74.87	163.5	1.1	6.0
16	35.39	52.82	79.06	168.4	36.24		79.50	166.6	42.64	60.33	86.80	174.4	3.9	-3.4
17	27.00	43.91	69.83	168.2	31.58		74.41	161.6	51.35	72.27	93.50	183.2	10.6	-12.3
18	33.87	50.93	76.99	167.6	33.52		76.55	164.7	41.71	59.35	85.77	174.3	5.0	-3.9
19	35.79	53.02	79.16	169.8	31.29		73.60	162.2	43.36	61.19	87.66	176.9	8.8	-2.3
20	22.56	38.91	64.38	152.7	29.56		70.55	157.1	44.27	61.66	88.26	176.7	7.1	-14.4
21	27.59	43.67	69.36	159.0	28.93		71.87	159.7	42.17	59.54	85.87	174.1	6.4	-9.3
22	41.83	59.12	85.33	176.8	29.64		72.88	159.7	40.49	57.99	84.29	173.3	10.5	5.5
23	33.00	48.78	74.84		29.11		68.67	157.7					14.5	-8.9
24	34.74	51.41	77.00	165.4	31.42		74.06	160.3	34.25	51.14	76.78	164.1	2.6	0.1
25	44.30	60.28	86.24	178.0	22.50		65.88	153.9	48.24	66.18	91.63	180.5	20.1	4.9
26	33.41	50.54	76.69	167.8	36.67		80.43	167.3	46.74		84.00		3.0	-5.5
27	39.13	55.87	81.54	170.5	25.76		68.32	155.8	43.35	60.98	87.06	175.4	13.4	1.2
28	40.68	57.53	83.25	171.7	24.72		73.65	153.9	42.62	61.89	87.51	174.9	13.5	2.5
29	29.23	46.11	72.05	160.9	33.05		75.64	163.5	40.87	58.37	84.58	172.9	3.4	-7.8
30	40.73	57.80	83.81	173.1	29.38		71.96	159.0	36.68	54.01	80.05	168.3	7.8	5.3

TABLE A-22. AIRBLAST ARRIVAL TIME AND COMPUTED EVENT LOCATIONS (Continued)

Event Number	TIME OF ARRIVAL (ms)												LOCATION	
	POSITION NUMBER												X0 (ft)	Y0 (ft)
	P 1	P 2	P 3	P 4	P 5	P 6	P 7	P 8	P 9	P 10	P 11	P 12		
31	36.47	53.59	79.75	172.0	30.70		74.23	159.7	44.24	62.06	87.67	177.5	10.1	-1.4
32	40.31	56.80	82.47	172.9	23.29		66.15	152.7	44.97	63.13	88.75	178.2	16.9	2.0
33	13.99	27.99	52.79	141.2	40.07		76.96	160.9	69.33	85.87	113.5	202.9	15.0	-37.6
34	40.80	57.98	83.99	177.7	32.94		76.33	163.5	39.41	56.93	83.15	171.6	7.0	4.7
35	34.03	50.39	75.84	163.5	23.73		65.42	151.4	45.15	62.51	88.60	176.7	14.6	-4.3
36	36.20	56.56	84.47		31.64		73.49	161.4	40.76	58.26	84.94	174.5	8.5	1.7
37	33.85	50.84	77.13	167.7	34.88		76.91	166.4	40.51	58.04	84.35	173.2	3.4	-3.6
38	37.45	54.02	80.13	169.7	26.41		69.25	156.4	44.49	64.86	90.45	180.0	14.3	-1.7
39	37.34	54.23	80.26	169.2	31.31		73.67	160.8	35.61	52.62	78.72	167.0	4.5	2.1
40	41.06	57.98	83.90	172.7	23.70		65.36	152.5	40.92	58.29	84.08	172.2	14.4	4.7
41	39.17	55.31	80.45	168.5	22.35		59.00	151.9	44.64	62.57	88.18	176.5	17.6	0.6
42	39.64	56.39	82.22	170.8	23.71		65.47	151.9	33.91	50.72	76.91	165.0	8.0	5.6
43	31.97	48.21	73.86	163.3			76.54	164.0	38.60	55.97	82.16	170.5	1.3	-5.4
44	32.00	49.23	75.41	165.0			77.20	165.0	42.37	60.37	86.61	175.6	4.0	-6.3
45	39.97	57.11	83.13	172.2			74.75	161.4	32.52	49.60	75.33	164.0	2.0	5.4
46	37.91	55.30	81.49	170.9			77.32	165.0	36.09	53.60	79.82	168.4	2.1	1.8
47	44.55	61.66	87.37	176.2	22.33		63.50	150.0	43.63	60.63	86.31	174.1	18.4	7.5
48	36.11	52.62	79.24	170.8			81.38	169.9	41.39	59.99	85.38	175.3	2.3	-3.0
49	44.38	60.94	86.79	178.2	22.26		64.72	151.9	46.62	63.91	89.87	178.5	19.8	6.2
50	31.25	48.44	74.67	164.6	35.99		78.86	166.9	43.38	61.36	87.35	176.5	3.3	-7.6
51	43.61	61.51	86.72	175.9	24.31		66.10	153.0	40.95	57.60	82.57	170.8	14.7	7.9
52	33.61	50.21	75.98	165.0	28.44		70.99	157.0	43.26	60.56	86.74	174.7	9.8	-4.1
53	27.24	43.62	69.50	158.3	32.03		74.47	160.8	44.73	62.67	88.85	177.5	6.3	-11.4
54	34.91	52.05	78.15	168.2	33.96		77.03	163.4	40.31	57.85	94.15	172.5	5.9	-3.4
55	38.77	55.69	81.62	164.0	29.17		72.54	160.2	45.99	63.65	88.56	178.8	11.5	-2.3
56	35.28	52.30	78.40	170.1	23.77		66.80	153.8	34.25	51.67	77.81	165.0	8.4	2.7
57	40.72	57.33	82.57	175.0	25.24		68.21	155.7	46.99	64.43	90.45	179.1	16.4	1.9
58	24.29	40.80	66.67	155.7	32.99		74.92	162.0	52.62	70.19	96.61	186.1	9.4	-17.7
59	52.70	69.44	95.33	187.9	45.11		87.48	174.9	23.78	40.97	67.22	153.8	-6.3	19.0
60	50.16	66.96	92.80	184.0	24.53		61.65	146.2	20.97	34.77	59.11	143.0	5.0	20.8

TABLE A-22. AIRBLAST ARRIVAL TIME AND COMPUTED EVENT LOCATIONS (Continued)

Event Number	TIME OF ARRIVAL (ms)												LOCATION	
	POSITION NUMBER												X0 (ft)	Y0 (ft)
	P 1	P 2	P 3	P 4	P 5	P 6	P 7	P 8	P 9	P 10	P 11	P 12		
61	31.76	48.35	74.00	162.1	29.52		71.82	158.3	41.42	58.89	85.20	173.7	7.5	-5.6
62	39.50	56.58	82.65	172.2	32.86		76.21	162.1	42.99	60.70	85.53	174.9	8.3	1.1
63	69.92	85.81	110.0	139.8	44.19		78.07	159.5	36.65	47.41	69.01	151.3	3.6	20.1
64	45.83	62.84	89.00	177.0	38.77		84.88	170.3	25.42	42.43	68.00	155.7	-5.3	11.6
65	37.21	54.01	79.76	168.0	28.08		69.92	157.0	30.60	47.67	73.09	159.5	3.9	4.5
66	37.04	53.31	79.72	169.3	30.19		72.02	158.9	40.85	58.35	84.28	172.5	8.6	-0.1
67	25.11	42.02	68.26	156.4	34.81		77.30	162.7	49.31	67.17	92.80	183.7	6.6	-15.7
68	35.24	52.48	78.73	167.7	36.72		78.49	167.9	39.54	57.14	83.42	172.0	1.9	-2.6
69	39.18	56.24	83.04	174.3	35.04		76.84	166.9	38.65	56.24	82.62	171.2	4.3	2.5
70	23.08	36.30	61.01	148.1	25.41		63.95	148.1	60.28	76.91	104.2	192.0	20.3	-23.2
71	46.73	63.74	89.85	179.3	27.17		68.28	153.8	32.94	49.27	74.42	162.1	9.6	13.3
72	35.30	52.50	78.71	169.6	44.05		86.04	171.2	40.92	58.40	84.61	173.3	-2.5	-4.5
73	36.57	52.36	77.38	165.0	17.80		59.32	144.9	49.29	66.53	92.27	180.2	21.4	-3.5
74	28.68	45.63	71.67	159.5	36.34		78.18	165.3	44.52	62.33	88.51	176.8	3.3	-10.8
75	35.59	51.61	77.33	168.6	27.42		70.56	157.6	47.17	64.78	91.03	179.9	13.2	-4.1
76	40.84	57.24	83.24	171.8	25.71		68.48	156.0	46.48	63.87	90.05	178.5	15.7	1.4
77	44.59	61.12	86.92	176.6	23.64		66.25	153.0	47.43	64.51	90.57	178.8	19.3	5.6
78	30.49	47.54	73.72	166.6	46.42		88.71	175.2	45.92	64.04	89.34	177.9	-4.5	-11.8
79	28.29	45.42	71.62	161.4	38.24		80.86	168.0	45.33	62.87	88.96	177.3	1.6	-11.4
80	35.19	52.25	78.43	168.0	40.49		83.70	171.3	38.85	56.37	82.74	171.2	-2.0	-3.5
81	30.19	47.31	73.49		43.17		85.71	173.3	48.41	63.53	92.26	181.0	-1.4	-13.5
82	31.43	48.51	74.54	163.2	38.13		81.42	169.2	40.81	58.62	84.95	174.0	-0.2	-7.5
83	30.64	47.87	74.16	164.5	42.21		85.43	173.2					-4.1	-8.5
84	36.39	53.56	79.74	171.0	39.34		83.13	171.1	37.79	55.48	81.89	170.6	-1.3	-1.4
85	33.42	50.49	76.59	166.5	40.94		84.72	172.5	40.59	58.16	84.44	172.9	-2.5	-6.1
86	39.70	56.26	82.67	174.9	41.57		84.63	172.9	35.22	52.77	79.12	167.7	-3.1	2.2
87	25.37	42.67	68.90		43.03		85.08	172.4	52.69	67.30	95.87	182.2	-0.4	-18.7
88	17.14	36.99	59.50	148.6	30.19		70.51	157.0	52.69	72.69	97.14	186.0	11.2	-22.1
89	38.18	55.28	81.35		44.44		88.07	176.3	39.83	57.41	83.83	173.0	-4.9	-3.6
90	34.97	51.62	78.02	167.3	38.46		81.83	169.2	34.09	51.47	77.58	165.7	-3.0	-1.2

TABLE A-22. AIRBLAST ARRIVAL TIME AND COMPUTED EVENT LOCATIONS (Continued)

Event Number	TIME OF ARRIVAL (ms)												LOCATION	
	POSITION NUMBER												X0 (ft)	Y0 (ft)
	P 1	P 2	P 3	P 4	P 5	P 6	P 7	P 8	P 9	P 10	P 11	P 12		
91	36.89	53.88	80.00	169.1	35.71		78.95	166.7	35.71	52.84	79.31	167.5	0.7	0.6
92	28.44	45.53	71.66	160.6	40.21		83.31	170.5	43.71	61.38	87.99	177.7	-0.9	-11.8
93	25.31	41.76	67.49	155.6	29.65		71.45	158.1	48.99	66.43	92.23	181.4	9.9	-14.4
94	18.10	31.11	55.20	142.2	34.48		69.62	153.7	71.75	90.16	114.9	203.7	22.2	-35.9
95	32.83	49.99	76.17	165.0	42.43		86.07	174.3	39.76	57.17	83.22	171.7	-4.8	-6.8
96	44.91	52.11	70.02				131.4		63.00	73.39	93.33	174.5	-58.9	-42.7
97	12.06	4.65	28.57		66.00		97.14	177.7	92.00	109.0	133.3		6.2	-71.3
98	24.31	40.71	66.28	154.3	37.53		79.39	165.7	43.24	60.35	86.17	173.7	0.0	-14.1
99	22.25	38.47	64.07	153.0	31.79		71.53	157.5	60.29	78.10	102.9	194.2	15.8	-23.1
100	38.46	55.63	81.85	172.9	44.01		86.63	174.6	36.35	53.70	79.93	169.8	-4.8	-0.1
101	31.76	48.81	74.99	164.4	39.40		82.41	169.7	40.84	58.27	84.54	173.0	-1.0	-7.0
102	34.61	51.30	77.66	166.7	35.01		78.40	165.0	35.79	53.53	79.62	168.2	0.9	-1.5
103	26.91	43.95	70.03	158.7	38.10		77.71	167.3	47.14	64.82	91.07	179.9	3.4	-13.6
104	23.31	39.09	65.18		34.91		74.82	160.6					10.8	-20.7
105	25.30	37.74	61.17	147.0	26.85		62.22	147.0	69.84	88.89	114.3	205.5	28.7	-29.8
106	41.22	57.43	83.72	175.6	45.21		88.63	177.4	33.09	50.63	76.96	165.0	-7.5	2.8
107	36.06	53.15	79.29	170.5	43.77		86.78	174.7	37.77	55.21	81.58	170.5	-5.1	-3.0
108	19.05	32.38	56.61	143.5	57.27		98.41	184.6	50.45	65.93	89.60	176.4	-17.3	-29.4
109	37.40	54.09	79.80	168.4	26.59		68.93	156.0	46.24	63.92	90.25	178.9	14.2	-2.0
110	31.75	47.34	72.69	160.6	19.68		61.46	147.3	51.97	69.70	95.87	185.0	20.6	-9.6
111	32.41	49.71	75.84	165.1	36.04		79.15	167.0	18.41	36.30	62.50	150.5	-8.6	3.8
112	21.94	39.05	65.28	156.0	37.69		79.44	165.5	53.45	71.87	95.87	187.7	6.1	-20.2
113	29.79	45.30	70.75	165.0	29.77		70.95	159.0					12.9	-11.5
114	47.01	64.00	89.99	178.6	34.07		76.37	162.5	30.95	47.80	73.14	160.6	3.4	12.7
115	34.61	51.93			37.56		80.90	168.7	48.35	66.25		182.0	4.2	-9.3
116	39.08	55.53			48.68		91.66	179.6	39.06	56.39		171.8	-10.5	-5.5
117	36.68	53.75		169.3	44.05		87.63	175.5	35.64	52.98		167.2	-7.2	-2.1
118	29.50	46.65		160.0	49.06		90.79	180.0	46.99	60.31		176.5	-10.2	-15.0
119	42.34	59.22		175.8	47.14		91.21	176.5	30.70	48.04		162.0	-9.9	4.5
120	26.81	43.35	69.20		53.47		95.24	184.3	49.28	66.40	91.47	179.6	-14.2	-21.9

TABLE A-22. AIRBLAST ARRIVAL TIME AND COMPUTED EVENT LOCATIONS (Continued)

Event Number	TIME OF ARRIVAL (ms)												LOCATION	
	POSITION NUMBER												X0 (ft)	Y0 (ft)
	P 1	P 2	P 3	P 4	P 5	P 6	P 7	P 8	P 9	P 10	P 11	P 12		
121	30.55	46.91	73.48	162.0	42.57		85.35	172.9	35.88	52.75	78.54	167.1	-6.5	-7.0
122	27.16	43.60	69.16	159.0	53.76		96.51	182.9	44.82	61.09	86.40	173.4	-15.4	-17.7
123	45.00	61.16	86.96				93.96		33.09	50.57	76.33	165.0	-9.1	4.2
124	42.00	61.74	89.98		40.86		90.00	179.7	32.72	50.22	76.20	165.0	-6.3	5.9
125	35.36	51.89	77.64	166.4	26.03		68.85	154.9	48.39	65.87	92.18	180.9	15.1	-4.7
126	32.79	50.10	76.32	167.2	35.01		78.10	165.0	45.91	63.49	89.78	178.2	6.1	-6.6
127	43.82	60.49	86.74	177.0	50.32		93.97	181.6	31.66	49.05	75.00	163.0	-12.3	3.9
128	42.56	59.61	85.75	175.7	49.39		92.06	180.4	31.05	48.34	74.29	161.9	-11.7	3.8
129	41.27	57.14	85.04						27.50	45.59	75.89		-10.8	3.6
130	40.92	58.05	84.15	176.3	48.81		91.74	179.3	32.34	49.52	75.56	163.2	-10.8	2.6
131	41.97	58.41	84.10						35.08	52.27	82.37	168.8	1.7	4.5
132	29.10	45.40	71.03	158.7	31.51		73.65	160.6	58.61	75.00	101.6	191.6	15.1	-16.8
133	23.45	40.50	66.58	156.0	40.02		81.94	169.0	57.70		98.41	186.0	4.2	-20.4
134	23.94	41.20	67.60	158.7	40.00		81.75	168.9	53.97		98.41	187.3	4.3	-18.9
135	39.14	56.02	82.11	170.2	47.17		90.78	178.2	19.05	35.80	62.22	150.0	-16.0	6.1
136	23.96	41.07	67.23	155.6	39.01		81.27	168.1	58.34	71.75	97.78	189.2	6.0	-20.6
137	36.40	52.53	77.50	165.0	45.79		89.02	175.9	27.69	44.47	70.28	156.8	-12.5	-0.3
138	25.61	41.55	67.26		34.07		74.31	160.6	63.00	79.36	107.3	195.6	16.3	-23.6
139	22.85	39.86	65.98	154.0	39.04		80.95	167.6	53.84	71.32	96.51	186.0	4.5	-20.4
140	48.24	65.12	91.13	181.8	52.74		95.24	184.4	25.36	42.73	68.57	156.2	-15.3	10.2
141	32.74	49.52	75.36	166.7	50.92		93.97	182.0	40.34	57.43	83.38	171.5	-12.9	-10.0
142	30.20	47.09	73.08	161.3	47.10		90.14	178.2	43.61	60.77	86.78	174.0	-8.4	-12.6
143	26.67	43.56	69.49		24.77		67.30	156.0	54.08	72.00	95.87	185.4	15.8	-13.9
144	11.56	7.74	31.54		70.47		105.4	188.8	87.00	100.3	125.7		-8.9	-68.2
145	8.89	4.44	27.94	116.8	67.94		102.2	183.8	83.17	99.68	123.8		-4.7	-65.6
146	25.50	42.73	69.04		43.28		85.77	173.2	55.58	69.84	95.87		-0.2	-19.8
147	20.95	37.40	63.67	153.0	41.78			169.8	55.34	72.80	99.05	187.1	4.1	-23.0
148	31.92	48.50	74.69		30.33			158.7	59.37	76.19	102.9	191.8	19.3	-14.5
149	27.53	44.53	70.46	159.4	32.52			162.0	50.98	68.55	94.60	183.1	9.8	-13.5
150	24.40	41.61	67.92	156.8	42.92			172.9	50.99	68.35	93.97	180.7	0.0	-18.0

TABLE A-22. AIRBLAST ARRIVAL TIME AND COMPUTED EVENT LOCATIONS (Continued)

Event Number	TIME OF ARRIVAL (ms)												LOCATION	
	POSITION NUMBER												X0 (ft)	Y0 (ft)
	P 1	P 2	P 3	P 4	P 5	P 6	P 7	P 8	P 9	P 10	P 11	P 12		
151	34.90	51.17	76.79	165.0	51.12			181.9	32.73	49.34	75.00	162.0	-15.5	-5.1
152	23.12	40.23	66.49	156.0	42.68			172.2	51.54	68.93	94.60	183.3	0.8	-19.4
153	23.30	40.53	66.85	154.9	40.15			168.3	56.63	74.28	99.68	189.9	7.7	-21.2
154	19.05	35.66	61.83	151.1	41.16			168.7	56.28	73.61	99.68	189.2	5.0	-24.8
155	17.78	35.34	61.46	150.0	51.65			180.2	57.78	74.28	99.68	187.9	-5.8	-28.8
156	21.96	38.96	64.66	153.7	38.25			166.8	51.69	69.12	94.60	183.8	4.2	-19.7
157	20.31	37.44	63.44	151.7	37.92			165.0	56.11	73.70	99.68	188.1	7.8	-22.8
158	25.33	42.45	68.50	156.8	38.16			167.3		68.75	94.60	183.7	5.2	-16.7
159	25.85	43.19	68.87	159.0				172.6		66.46	92.56	180.6	1.1	-15.5
160	20.95	37.80	63.60	152.5				160.6		72.22	98.41	185.8	9.4	-21.2
161	13.96	30.00	56.59	144.8				170.4		76.19	105.0	189.3	3.4	-30.9
162	17.77	38.80	64.52	151.1				161.9		80.63	107.3	195.6	15.5	-25.7
163	14.60	30.00	55.06	142.9						80.00	106.0	195.0	9.0	-32.5
164	24.00	41.23	67.41	156.0						64.02	90.32	178.8	-3.0	-17.3
165	28.67	45.23								75.00		190.3	17.5	-16.0

Note: Second tape recorder failed to record—no data beyond Event 165.

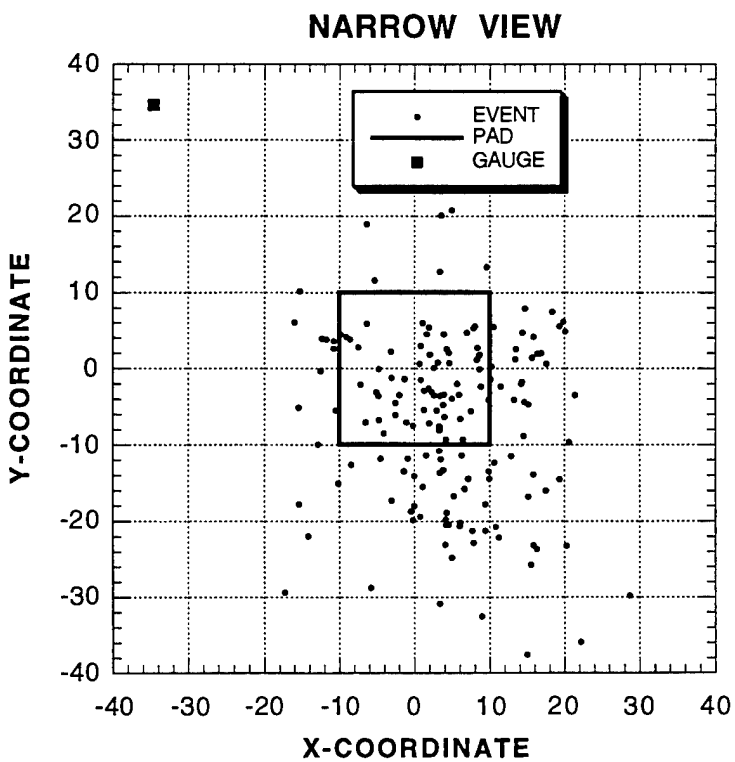
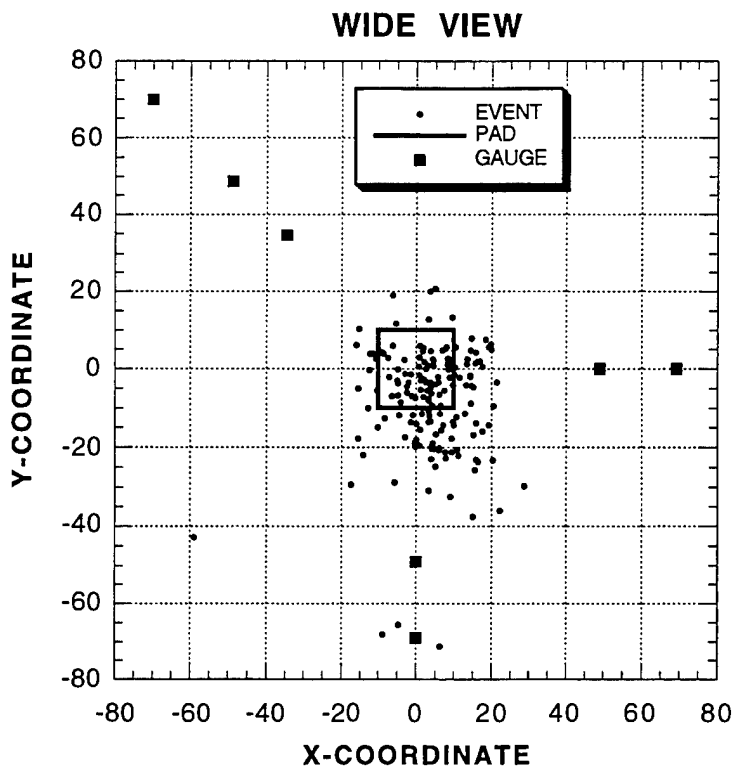

FIGURE A-8. COMPUTED EVENT LOCATIONS

TABLE A-23. AIRBLAST PEAK PRESSURES AND COMPUTED YIELDS

EVENT NUMBER	PEAK PRESSURE (psi)												YIELD (%)
	Position Number												
	P 1	P 2	P 3	P 4	P 5	P 6	P 7	P 8	P 9	P 10	P 11	P 12	
1	1.31	0.82	0.43	0.10	0.89		0.41	0.17	0.30	0.25	0.25	0.08	21.3
2	0.19	0.17	0.10	0.03	0.56		0.23	0.17	0.22	0.16	0.13	0.05	3.9
3	0.33	0.28	0.16		0.65		0.25	0.16	0.21	0.19	0.17	0.06	5.2
4	0.25	0.22	0.12	0.04	0.26		0.13	0.07	0.29	0.21	0.15	0.06	1.5
5	0.42	0.44	0.27	0.08	0.62		0.29	0.14	0.71	0.45	0.33	0.08	12.4
6	0.09	0.10	0.05	0.03	0.08		0.05	0.03	0.08	0.08	0.05	0.02	0.1
7		0.70	0.43	0.07	0.75		0.35	0.18	0.62	0.49	0.43	0.11	25.2
8		0.30	0.19	0.05	1.13		0.36	0.16	0.46	0.32	0.26	0.09	9.9
9		0.17	0.10	0.03	0.20		0.10	0.04	0.14	0.15	0.09	0.04	0.6
10		0.13	0.07	0.03	0.31		0.16	0.08	0.51	0.34	0.22	0.08	3.4
11		0.35	0.18	0.05	0.30		0.15	0.08	0.30	0.21	0.17	0.07	2.8
12	0.13	0.16	0.11	0.04	0.22		0.11	0.05	0.25	0.18	0.14	0.03	0.8
13	0.31	0.28	0.16	0.05	0.42		0.13	0.10	0.36	0.26	0.20	0.07	3.1
14	0.11	0.12	0.07	0.03	0.17		0.07	0.06	0.49	0.35	0.21	0.06	1.6
15	0.31	0.40	0.25	0.06	0.33		0.19	0.12	1.10	0.71	0.49	0.12	16.6
16	0.22	0.22	0.13	0.04	0.26		0.20	0.10	0.20	0.15	0.12	0.05	1.7
17	0.38	0.29	0.12	0.02	0.41		0.26	0.12	0.07	0.06	0.04	0.02	1.9
18	0.66	0.45	0.26	0.04	0.57		0.31	0.16	0.40	0.26	0.23	0.05	8.8
19	0.32	0.27	0.15	0.03	0.45		0.14	0.08	0.15	0.13	0.10	0.03	1.3
20	1.88	1.17	0.50	0.12	1.31		0.76	0.33	0.72	0.51	0.66	0.17	79.2
21	0.44	0.40	0.22	0.05	0.63		0.48	0.24	0.74	0.60	0.40	0.13	26.8
22	0.10	0.11	0.08	0.03	0.45		0.13	0.07	0.27	0.20	0.18	0.05	1.2
23	0.05	0.06	0.02		0.23		0.06	0.03					0.1
24	1.39	1.10	0.59	0.15	1.20		0.62	0.28	1.74	1.20	1.05	0.24	127.5
25	0.13	0.14	0.09	0.02	0.46		0.14	0.09	0.17	0.10	0.11	0.05	0.9
26	0.04	0.05	0.04	0.02	0.07		0.03	0.01	0.07		0.02		0.01
27	0.23	0.30	0.15	0.04	1.48		0.41	0.19	0.32	0.26	0.28	0.10	12.2
28	0.20	0.23	0.11	0.04	1.11		0.35	0.15	0.11	0.09	0.09	0.04	4.1
29	1.21	0.80	0.50	0.09	0.85		0.34	0.16	0.48	0.38	0.37	0.10	23.6
30	0.38	0.45	0.27	0.07	1.00		0.44	0.26	0.72	0.53	0.42	0.10	25.9

TABLE A-23. AIRBLAST PEAK PRESSURES AND COMPUTED YIELDS (Continued)

EVENT NUMBER	PEAK PRESSURE (psi)												YIELD (%)
	Position Number												
	P 1	P 2	P 3	P 4	P 5	P 6	P 7	P 8	P 9	P 10	P 11	P 12	
31	0.19	0.17	0.10	0.03	0.20		0.11	0.08	0.14	0.11	0.10	0.03	0.7
32	0.11	0.14	0.10	0.03	0.53		0.16	0.09	0.14	0.12	0.09	0.04	0.9
33	0.55	0.30	0.13	0.03	0.36		0.14	0.07	0.09	0.09	0.08	0.04	0.8
34	0.08	0.11	0.06	0.02	0.27		0.14	0.06	0.32	0.22	0.19	0.04	1.2
35	0.82	0.69	0.38	0.11	2.44		0.98	0.38	0.80	0.60	0.53	0.14	75.9
36	0.05	0.08	0.03		0.07		0.06	0.06	0.11	0.10	0.07	0.04	0.2
37	0.38	0.32	0.18	0.05	0.14		0.16	0.11	0.29	0.25	0.16	0.06	2.9
38	0.14	0.16	0.08	0.05	0.37		0.23	0.12	0.18	0.15	0.13	0.05	1.9
39	0.77	0.60	0.35	0.09	0.13		0.37	0.20	1.12	0.74	0.60	0.18	37.8
40	0.32	0.42	0.27	0.08	0.08		0.40	0.20	0.46	0.34	0.32	0.11	14.2
41	0.71	0.71	0.40	0.11	0.05		0.58	0.25	0.63	0.53	0.52	0.15	40.1
42	0.63	0.61	0.33	0.09	0.04		0.41	0.18	1.06	0.69	0.72	0.17	40.0
43	0.86	0.74	0.35	0.09			0.22	0.12	0.68	0.49	0.38	0.12	19.5
44	0.27	0.29	0.17	0.04			0.14	0.06	0.23	0.19	0.12	0.03	1.4
45	0.41	0.49	0.31	0.08			0.46	0.21	1.06	0.74	0.60	0.14	35.9
46	0.22	0.30	0.17	0.05			0.08	0.05	0.45	0.31	0.23	0.08	3.1
47	0.38	0.41	0.25	0.08	0.07		0.45	0.20	0.56	0.44	0.40	0.12	18.3
48	0.08	0.08	0.05	0.03			0.04	0.03	0.09	0.07	0.05	0.02	0.1
49	0.19	0.24	0.14	0.04	0.08		0.22	0.10	0.31	0.26	0.20	0.07	3.1
50	0.40	0.32	0.16	0.04	0.04		0.17	0.08	0.28	0.21	0.15	0.05	1.9
51	0.26	0.38	0.23	0.08	0.38		0.40	0.22	0.53	0.43	0.43	0.14	19.0
52	0.82	0.75	0.48	0.10	1.05		0.49	0.19	0.83	0.67	0.44	0.13	36.2
53	1.25	0.72	0.37	0.08	0.79		0.44	0.23	0.33	0.31	0.26	0.10	21.6
54	0.33	0.31	0.19	0.04	0.13		0.09	0.04	0.39	0.28	0.19	0.06	2.2
55	0.20	0.28	0.18	0.05	0.34		0.13	0.08	0.15	0.11	0.10	0.03	1.3
56	0.14	0.20	0.11	0.05	0.62		0.26	0.11	0.40	0.30	0.23	0.07	4.3
57	0.23	0.23	0.14	0.04	0.52		0.27	0.14	0.23	0.19	0.15	0.05	3.4
58	0.51	0.40	0.22	0.05	0.40		0.25	0.11	0.21	0.16	0.15	0.05	3.2
59	0.13	0.14	0.13	0.04	0.42		0.25	0.10	0.58	0.36	0.26	0.06	3.9
60	0.11	0.10	0.07	0.04	0.41		0.23	0.10	0.57	0.32	0.24	0.07	3.2

TABLE A-23. AIRBLAST PEAK PRESSURES AND COMPUTED YIELDS (Continued)

EVENT NUMBER	PEAK PRESSURE (psi)												YIELD (%)
	Position Number												
	P 1	P 2	P 3	P 4	P 5	P 6	P 7	P 8	P 9	P 10	P 11	P 12	
61	1.29	0.82	0.45	0.10	0.97		0.45	0.22	0.55	0.39	0.33	0.09	28.9
62	0.10	0.11	0.08	0.03	0.26		0.13	0.07	0.10	0.10	0.06	0.03	0.4
63	0.10	0.15	0.09	0.14	0.50		0.26	0.14	0.91	0.60	0.62	0.18	19.3
64	0.16	0.21	0.17	0.05	0.45		0.24	0.23	1.20	0.79	0.70	0.12	23.6
65	0.58	0.51	0.32	0.11	1.44		0.65	0.24	1.23	0.77	0.50	0.14	47.3
66	0.66	0.54	0.38	0.07	0.87		0.44	0.17	0.80	0.67	0.42	0.12	26.5
67	0.62	0.47	0.23	0.05	0.36		0.25	0.10	0.18	0.17	0.16	0.04	3.4
68	0.35	0.32	0.16	0.05	0.19		0.11	0.05	0.32	0.26	0.16	0.06	1.9
69	0.13	0.15	0.09	0.04	0.16		0.13	0.07	0.27	0.20	0.15	0.06	1.1
70	0.60	0.70	0.32	0.08	0.89		0.54	0.16	0.31	0.22	0.25	0.10	14.0
71	0.33	0.51	0.32	0.12	1.50		0.57	0.30	1.19	0.82	0.65	0.18	56.8
72	0.17	0.20	0.10	0.03	0.07		0.06	0.04	0.21	0.15	0.11	0.04	0.5
73	0.56	0.59	0.39	0.09	2.21		0.67	0.26	0.70	0.54	0.50	0.17	45.9
74	0.69	0.50	0.29	0.06	0.37		0.17	0.09	0.32	0.23	0.17	0.06	4.3
75	0.21	0.26	0.14	0.04	0.50		0.26	0.10	0.25	0.20	0.16	0.06	2.8
76	0.21	0.24	0.15	0.05	0.71		0.21	0.10	0.31	0.21	0.17	0.06	2.8
77	0.19	0.22	0.14	0.04	0.98		0.23	0.09	0.29	0.19	0.14	0.05	2.5
78	0.16	0.14	0.06	0.02	0.06		0.02	0.03	0.11	0.08	0.06	0.03	0.1
79	0.36	0.34	0.19	0.04	0.34		0.17	0.07	0.15	0.13	0.13	0.05	1.7
80	0.28	0.37	0.23	0.05	0.30		0.16	0.07	0.31	0.24	0.17	0.05	2.7
81	0.08	0.06	0.03		0.09		0.04	0.02	0.05	0.05	0.03	0.01	0.02
82	0.32	0.43	0.20	0.04	0.30		0.19	0.09	0.33	0.25	0.15	0.04	2.9
83	0.10	0.13	0.08	0.02	0.13		0.05	0.03					0.1
84	0.15	0.21	0.11	0.04	0.22		0.10	0.05	0.31	0.24	0.17	0.06	1.2
85	0.21	0.25	0.14	0.05	0.23		0.11	0.07	0.27	0.21	0.16	0.05	1.5
86	0.18	0.17	0.11	0.03	0.16		0.07	0.06	0.35	0.26	0.17	0.05	1.1
87	0.15	0.13	0.06		0.07		0.06	0.02	0.05	0.05	0.03	0.02	0.1
88	0.31	0.26	0.12	0.05	0.42		0.18	0.09	0.10	0.08	0.08	0.04	1.2
89	0.08	0.10	0.06		0.04		0.02	0.02	0.10	0.09	0.06	0.02	0.1
90	0.53	0.55	0.33	0.06	0.63		0.27	0.18	0.95	0.63	0.40	0.16	22.9

TABLE A-23. AIRBLAST PEAK PRESSURES AND COMPUTED YIELDS (Continued)

EVENT NUMBER	PEAK PRESSURE (psi)												YIELD (%)
	Position Number												
	P 1	P 2	P 3	P 4	P 5	P 6	P 7	P 8	P 9	P 10	P 11	P 12	
91	0.45	0.53	0.31	0.07	0.66		0.36	0.23	0.94	0.71	0.48	0.13	28.5
92	0.45	0.41	0.19	0.05	0.27		0.21	0.11	0.13	0.10	0.11	0.04	2.5
93	0.71	0.60	0.30	0.08	0.87		0.40	0.21	0.36	0.34	0.33	0.09	17.5
94	0.44	0.37	0.21	0.04	0.28		0.17	0.07	0.09	0.08	0.07	0.03	0.9
95	0.24	0.30	0.16	0.04	0.23		0.14	0.08	0.33	0.23	0.18	0.05	2.0
96	0.06	0.08	0.06				0.05		0.10	0.06	0.06	0.02	0.2
97	0.21	1.22	0.12		0.05		0.04	0.03	0.04	0.05	0.03		0.1
98	2.37	1.27	0.70	0.16	1.23		0.64	0.33	0.98	0.73	0.64	0.18	94.8
99	0.27	0.32	0.18	0.04	0.29		0.15	0.07	0.10	0.08	0.07	0.03	0.8
100	0.10	0.12	0.07	0.02	0.09		0.05	0.03	0.27	0.15	0.09	0.03	0.2
101	0.50	0.39	0.21	0.04	0.42		0.25	0.15	0.42	0.32	0.22	0.07	7.1
102	0.71	0.60	0.34	0.08	0.49		0.22	0.13	1.11	0.70	0.65	0.16	30.9
103	0.56	0.47	0.22	0.05	0.50		0.20	0.10	0.19	0.18	0.10	0.06	3.4
104	0.08	0.05	0.03		0.09		0.03	0.02					0.01
105	0.41	0.30	0.18	0.05	0.66		0.23	0.12	0.12	0.09	0.08	0.03	1.9
106	0.10	0.13	0.08	0.03	0.07		0.05	0.03	0.42	0.28	0.16	0.04	0.6
107	0.13	0.14	0.07	0.03	0.08		0.04	0.02	0.27	0.17	0.10	0.04	0.3
108	1.52	0.95	0.47	0.08	0.50		0.34	0.17	0.54	0.40	0.36	0.09	23.2
109	0.26	0.26	0.16	0.06	0.95		0.41	0.19	0.26	0.22	0.21	0.06	7.8
110	0.60	0.56	0.33	0.09	1.64		0.59	0.24	0.51	0.31	0.32	0.12	24.4
111	0.13	0.18	0.12	0.05	0.13		0.10	0.05	0.62	0.43	0.31	0.06	2.6
112	0.22	0.19	0.10	0.02	0.27		0.14	0.06	0.09	0.07	0.04	0.03	0.4
113	0.09	0.09	0.04	0.03	0.08		0.03	0.02					0.04
114	0.40	0.56	0.32	0.08	1.29		0.51	0.22	1.25	0.78	0.58	0.16	42.0
115	0.08	0.06			0.10		0.04	0.02	0.06	0.06		0.02	0.03
116	0.07	0.05			0.05		0.02	0.01	0.09	0.06		0.02	0.02
117	0.29	0.29		0.04	0.29		0.17	0.07	0.55	0.31		0.08	3.0
118	0.15	0.13		0.03	0.07		0.04	0.03	0.05	0.05		0.02	0.1
119	0.13	0.16		0.04	0.13		0.07	0.05	0.55	0.33		0.06	1.1
120	0.14	0.10	0.06		0.05		0.02	0.02	0.10	0.08	0.05	0.02	0.1

TABLE A-23. AIRBLAST PEAK PRESSURES AND COMPUTED YIELDS (Continued)

EVENT NUMBER	PEAK PRESSURE (psi)												YIELD (%)
	Position Number												
	P 1	P 2	P 3	P 4	P 5	P 6	P 7	P 8	P 9	P 10	P 11	P 12	
121	0.88	0.71	0.41	0.08	0.98		0.43	0.28	1.02	0.74	0.76	0.17	58.9
122	0.39	0.38	0.20	0.04	0.26		0.16	0.13	0.40	0.28	0.21	0.06	4.9
123	0.05	0.06	0.03				0.01		0.14	0.10	0.07	0.02	0.04
124	0.04	0.03	0.02		0.04		0.02	0.01	0.10	0.06	0.05	0.01	0.01
125	0.64	0.47	0.27	0.07	1.05		0.53	0.18	0.44	0.39	0.26	0.13	17.4
126	0.22	0.26	0.15	0.04	0.42		0.22	0.09	0.43	0.31	0.21	0.06	3.6
127	0.06	0.06	0.03	0.02	0.05		0.04	0.03	0.25	0.15	0.14	0.03	0.2
128	0.15	0.18	0.12	0.04	0.16		0.13	0.07	0.40	0.26	0.25	0.06	1.8
129	0.04	0.03	0.02						0.07	0.06	0.03		0.01
130	0.12	0.13	0.09	0.03	0.09		0.05	0.04	0.46	0.28	0.18	0.05	0.8
131	0.05	0.04	0.03						0.09	0.06	0.05	0.01	0.02
132	0.22	0.15	0.08	0.02	0.27		0.12	0.05	0.12	0.09	0.07	0.03	0.3
133	0.30	0.17	0.10	0.03	0.20		0.12	0.05	0.07		0.05	0.02	0.3
134	0.07	0.06	0.03	0.02	0.09		0.05	0.02	0.03		0.03	0.02	0.03
135	0.14	0.19	0.14	0.04	0.19		0.11	0.07	0.66	0.34	0.20	0.06	1.8
136	0.30	0.16	0.09	0.02	0.22		0.14	0.05	0.08	0.06	0.04	0.02	0.3
137	1.27	0.86	0.56	0.10	0.59		0.36	0.21	2.09	1.13	1.09	0.25	88.1
138	0.15	0.09	0.04		0.15		0.07	0.04	0.06	0.05	0.03	0.02	0.1
139	0.87	0.44	0.25	0.05	0.41		0.21	0.11	0.18	0.16	0.10	0.06	3.3
140	0.16	0.15	0.09	0.03	0.13		0.08	0.03	0.57	0.32	0.20	0.05	0.8
141	0.30	0.22	0.10	0.02	0.16		0.07	0.05	0.29	0.20	0.13	0.04	0.7
142	0.39	0.33	0.14	0.04	0.20		0.10	0.05	0.29	0.21	0.13	0.05	1.3
143	0.08	0.07	0.04		0.14		0.06	0.02	0.06	0.05	0.03	0.02	0.03
144	0.26	0.44	0.07		0.05		0.03	0.01	0.04	0.04	0.02		0.03
145	1.84	3.20	0.47	0.04	0.18		0.16	0.10	0.14	0.13	0.12		3.5
146	0.11	0.07	0.04		0.07		0.04	0.03	0.04	0.04	0.02		0.04
147	0.83	0.45	0.21	0.05	0.41			0.10	0.20	0.17	0.14	0.05	2.8
148	0.08	0.07	0.03		0.10			0.02	0.06	0.08	0.04	0.02	0.05
149	0.77	0.56	0.28	0.06	0.66			0.11	0.23	0.21	0.16	0.07	5.7
150	0.52	0.29	0.15	0.03	0.25			0.06	0.23	0.17	0.14	0.07	1.5

TABLE A-23. AIRBLAST PEAK PRESSURES AND COMPUTED YIELDS (Continued)

EVENT NUMBER	PEAK PRESSURE (psi)												YIELD (%)
	Position Number												
	P 1	P 2	P 3	P 4	P 5	P 6	P 7	P 8	P 9	P 10	P 11	P 12	
151	0.70	0.54	0.32	0.07	0.57			0.16	0.80	0.58	0.45	0.12	19.4
152	0.81	0.46	0.21	0.04	0.41			0.10	0.27	0.24	0.17	0.06	3.8
153	0.15	0.12	0.07	0.02	0.26			0.05	0.10	0.09	0.07	0.03	0.3
154	0.74	0.36	0.17	0.05	0.33			0.07	0.17	0.15	0.10	0.04	1.3
155	0.26	0.14	0.07	0.03	0.05			0.03	0.05	0.05	0.02	0.02	0.1
156	0.92	0.56	0.24	0.06	0.53			0.12	0.29	0.24	0.20	0.07	6.0
157	0.82	0.49	0.23	0.04	0.50			0.11	0.28	0.21	0.17	0.07	4.3
158	0.43	0.31	0.16	0.04	0.36			0.10		0.15	0.10	0.04	1.8
159	0.25	0.19	0.12	0.04				0.06		0.21	0.13	0.06	1.3
160	0.80	0.71	0.39	0.08				0.23		0.31	0.30	0.13	23.2
161	1.37	0.55	0.24	0.05				0.08		0.20	0.15	0.08	3.7
162	0.06	0.10	0.06	0.03				0.06		0.05	0.05	0.02	0.2
163	0.34	0.25	0.14	0.02						0.06	0.05	0.03	0.2
164	0.35	0.24	0.13	0.03						0.13	0.10	0.04	0.6
165	0.16	0.11								0.10		0.03	0.2

Note: Second tape recorder failed to record—no data beyond Event 165.

REFERENCES

- A-1. Swisdak, Michael M., Jr. and Rye, Kent W., "Hazard Division 1.2 Tests--Instrumentation Results and Interpretation," NSWCDD/TR-93-218, 9 March 1994.
- A-2. Porzel, F. B., "Technology Base of the Navy Explosives Safety Improvement Program," Minutes of the 19th DoD Explosives Safety Seminar, Sep 1980.

APPENDIX B
FRAGMENT RECOVERY DATA FOR TEST NOS. 7 THROUGH 12

FRAGMENT RECOVERY DATA FOR TEST NOS. 7 THROUGH 12

TABLE B-1. OBSERVATIONS FROM TEST NO. 7

Test Date: 3 May 1994

Test Items: Three pallets of M1 105mm HE artillery cartridges. Each pallet contained 16 boxes of cartridges (96 cartridges total). Each projectile contained Composition B explosive (main fill) and was assembled with a supplementary charge. The projectiles were received with mechanical time fuzes already installed. The fuze was removed from each projectile prior to the test in order to comply with range safety restrictions and the fuze well was left open.

Weather: Clear skies, approximately 80° F. Winds were N at approximately 7 knots with occasional gusts to 10 knots at the start of the test. Winds diminished to light and variable by the end of the test.

Notes: Mild reactions were observed approximately 23:48 (min:sec) after the start of the test. These reactions appeared to be burning and mild deflagration reactions of some propelling charges. This type of reaction continued to occur intermittently throughout the test. A total of eight major explosions were observed at approximately the following elapsed times following ignition of the fire (min:sec): 31:38, 35:43, 38:08, 40:01, 40:08, 40:40, 43:11, and 51:58.

Following the test, a total of 80 projectile bodies were recovered intact inside the 200-ft range. Twenty-nine of these projectile bodies still contained most or all of the main fill. Two additional projectile bodies were recovered intact beyond the 200-ft range. The total mass of projectile body pieces recovered inside the 200-ft range was 124.6 lb_m.

Fragment recovery was accomplished by visual search of the test area. The entire area between the 200-ft range and the 1300-ft range was searched. Approximately 90° of azimuth was searched between the 1300-ft range and the 2000-ft range. Most of the projectile body fragments were relatively large (>1/4 lb) pieces that appeared to have been produced by explosion (vice detonation) reactions. However, some smaller fragments were recovered that appeared to have been produced by detonation reactions.

NSWCDD/TR-98/6

TABLE B-2. FRAGMENTS RECOVERED BEYOND 200-FT RANGE IN TEST NO. 7

<u>Entry</u>	<u>Range Interval (ft)</u>	<u>Azimuthal Sector (°)</u>	<u>Description</u>	<u>Mass (lb)</u>	<u>Notes</u>	<u>G64 Index No.</u>
1	200 - 400	0 - 10	Warhead Body Piece	7.06		193
2	200 - 400	0 - 10	Cartridge Case Piece	-	Not retained	194
3	200 - 400	10 - 20	Warhead Body Piece	0.1	Rotating Band Piece	138
4	200 - 400	20 - 30	Warhead Body Piece	1.66		205
5	200 - 400	30 - 40	Cartridge Case Piece	-	Not retained	247
6	200 - 400	30 - 40	Cartridge Case Piece	-	Not retained	248
7	200 - 400	40 - 50	Warhead Body Piece	3.26		47
8	200 - 400	40 - 50	Cartridge Case Piece	-	Not retained	48
9	200 - 400	40 - 50	Cartridge Case Piece	-	Not retained	49
10	200 - 400	40 - 50	Cartridge Case Piece	-	Not retained	50
11	200 - 400	40 - 50	Cartridge Case Piece	-	Not retained	51
12	200 - 400	40 - 50	Cartridge Case Piece	-	Not retained	52
13	200 - 400	40 - 50	Cartridge Case Piece	-	Not retained	53
14	200 - 400	40 - 50	Cartridge Case Piece	-	Not retained	54
15	200 - 400	50 - 60	Warhead Body Piece	0.45	Rotating Band Piece	173
16	200 - 400	50 - 60	Cartridge Case Piece	-	Not retained	174
17	200 - 400	50 - 60	Cartridge Case Piece	-	Not retained	175
18	200 - 400	50 - 60	Cartridge Case Piece	-	Not retained	176
19	200 - 400	50 - 60	Cartridge Case Piece	-	Not retained	177
20	200 - 400	50 - 60	Cartridge Case Piece	-	Not retained	178
21	200 - 400	60 - 70	Warhead Body Piece	0.19		207
22	200 - 400	60 - 70	Warhead Body Piece	0.02		208
23	200 - 400	60 - 70	Cartridge Case Piece	-	Not retained	209
24	200 - 400	60 - 70	Cartridge Case Piece	-	Not retained	210
25	200 - 400	60 - 70	Cartridge Case Piece	-	Not retained	211
26	200 - 400	60 - 70	Cartridge Case Piece	-	Not retained	212
27	200 - 400	60 - 70	Cartridge Case Piece	-	Not retained	213
28	200 - 400	60 - 70	Cartridge Case Piece	-	Not retained	214
29	200 - 400	60 - 70	Cartridge Case Piece	-	Not retained	215
30	200 - 400	60 - 70	Cartridge Case Piece	-	Not retained	216
31	200 - 400	60 - 70	Cartridge Case Piece	-	Not retained	217
32	200 - 400	60 - 70	Miscellaneous Debris	-	Not retained	218
33	200 - 400	60 - 70	Miscellaneous Debris	-	Not retained	219
34	200 - 400	70 - 80	Cartridge Case Piece	-	Not retained	249
35	200 - 400	70 - 80	Cartridge Case Piece	-	Not retained	250
36	200 - 400	70 - 80	Cartridge Case Piece	-	Not retained	251
37	200 - 400	70 - 80	Cartridge Case Piece	-	Not retained	252
38	200 - 400	70 - 80	Cartridge Case Piece	-	Not retained	253
39	200 - 400	70 - 80	Cartridge Case Piece	-	Not retained	254
40	200 - 400	70 - 80	Cartridge Case Piece	-	Not retained	255
41	200 - 400	70 - 80	Miscellaneous Debris	-	Not retained	256
42	200 - 400	80 - 90	Warhead Body Piece	0.02		179
43	200 - 400	80 - 90	Warhead Body Piece	0.02		180
44	200 - 400	80 - 90	Warhead Body Piece	0.5		181
45	200 - 400	80 - 90	Cartridge Case Piece	-	Not retained	182
46	200 - 400	80 - 90	Cartridge Case Piece	-	Not retained	183
47	200 - 400	80 - 90	Cartridge Case Piece	-	Not retained	184
48	200 - 400	80 - 90	Cartridge Case Piece	-	Not retained	185
49	200 - 400	80 - 90	Cartridge Case Piece	-	Not retained	186
50	200 - 400	90 - 100	Warhead Body Piece	1.02		93

TABLE B-2. FRAGMENTS RECOVERED BEYOND 200-FT RANGE IN TEST NO. 7 (Continued)

<u>Entry</u>	<u>Range Interval (ft)</u>	<u>Azimuthal Sector (°)</u>	<u>Description</u>	<u>Mass (lb)</u>	<u>Notes</u>	<u>G64 Index No.</u>
51	200 - 400	90 - 100	Warhead Body Piece	2.04		94
52	200 - 400	90 - 100	Warhead Body Piece	0.06		95
53	200 - 400	90 - 100	Warhead Body Piece	0.06		96
54	200 - 400	90 - 100	Warhead Body Piece	0.04		97
55	200 - 400	90 - 100	Warhead Body Piece	0.04		98
56	200 - 400	90 - 100	Warhead Body Piece	0.04		99
57	200 - 400	90 - 100	Warhead Body Piece	0.03		100
58	200 - 400	90 - 100	Warhead Body Piece	0.02		151
59	200 - 400	90 - 100	Warhead Body Piece	0.02		152
60	200 - 400	90 - 100	Warhead Body Piece	0.02		153
61	200 - 400	90 - 100	Warhead Body Piece	0.01		154
62	200 - 400	90 - 100	Warhead Body Piece	0.01		155
63	200 - 400	90 - 100	Warhead Body Piece	0.01		156
64	200 - 400	90 - 100	Cartridge Case Piece	-	Not retained	157
65	200 - 400	90 - 100	Cartridge Case Piece	-	Not retained	158
66	200 - 400	90 - 100	Cartridge Case Piece	-	Not retained	159
67	200 - 400	90 - 100	Cartridge Case Piece	-	Not retained	160
68	200 - 400	90 - 100	Cartridge Case Piece	-	Not retained	161
69	200 - 400	100 - 110	Warhead Body Piece	0.04	Rotating Band Piece	140
70	200 - 400	100 - 110	Warhead Body Piece	0.5		141
71	200 - 400	100 - 110	Cartridge Case Piece	-	Not retained	142
72	200 - 400	100 - 110	Cartridge Case Piece	-	Not retained	143
73	200 - 400	100 - 110	Cartridge Case Piece	-	Not retained	144
74	200 - 400	110 - 120	Warhead Body Piece	0.01		33
75	200 - 400	110 - 120	Cartridge Case Piece	-	Not retained	34
76	200 - 400	110 - 120	Cartridge Case Piece	-	Not retained	35
77	200 - 400	110 - 120	Miscellaneous Debris	-	Not retained	36
78	200 - 400	110 - 120	Miscellaneous Debris	-	Not retained	37
79	200 - 400	110 - 120	Miscellaneous Debris	-	Not retained	38
80	200 - 400	120 - 130	Cartridge Case Piece	-	Not retained	257
81	200 - 400	120 - 130	Cartridge Case Piece	-	Not retained	258
82	200 - 400	120 - 130	Cartridge Case Piece	-	Not retained	259
83	200 - 400	120 - 130	Cartridge Case Piece	-	Not retained	260
84	200 - 400	120 - 130	Cartridge Case Piece	-	Not retained	261
85	200 - 400	130 - 140	Cartridge Case Piece	-	Not retained	262
86	200 - 400	130 - 140	Cartridge Case Piece	-	Not retained	263
87	200 - 400	130 - 140	Miscellaneous Debris	-	Not retained	264
88	200 - 400	140 - 150	Warhead Body Piece	0.01		220
89	200 - 400	140 - 150	Cartridge Case Piece	-	Not retained	221
90	200 - 400	140 - 150	Miscellaneous Debris	-	Not retained	222
91	200 - 400	140 - 150	Miscellaneous Debris	-	Not retained	223
92	200 - 400	140 - 150	Miscellaneous Debris	-	Not retained	224
93	200 - 400	140 - 150	Miscellaneous Debris	-	Not retained	225
94	200 - 400	140 - 150	Miscellaneous Debris	-	Not retained	226
95	200 - 400	150 - 160	Warhead Body Piece	0.13		114
96	200 - 400	150 - 160	Cartridge Case Piece	-	Not retained	115
97	200 - 400	150 - 160	Cartridge Case Piece	-	Not retained	116
98	200 - 400	150 - 160	Cartridge Case Piece	-	Not retained	117
99	200 - 400	150 - 160	Cartridge Case Piece	-	Not retained	118
100	200 - 400	150 - 160	Cartridge Case Piece	-	Not retained	119

NSWCDD/TR-98/6

TABLE B-2. FRAGMENTS RECOVERED BEYOND 200-FT RANGE IN TEST NO. 7 (Continued)

<u>Entry</u>	<u>Range Interval (ft)</u>	<u>Azimuthal Sector (°)</u>	<u>Description</u>	<u>Mass (lb)</u>	<u>Notes</u>	<u>G64 Index No.</u>
101	200 - 400	160 - 170	Warhead Body Piece	0.69		126
102	200 - 400	160 - 170	Warhead Body Piece	0.16		127
103	200 - 400	160 - 170	Warhead Body Piece	0.12		128
104	200 - 400	160 - 170	Warhead Body Piece	0.03		129
105	200 - 400	160 - 170	Cartridge Case Piece	-	Not retained	130
106	200 - 400	160 - 170	Cartridge Case Piece	-	Not retained	131
107	200 - 400	160 - 170	Cartridge Case Piece	-	Not retained	132
108	200 - 400	160 - 170	Miscellaneous Debris	-	Not retained	133
109	200 - 400	160 - 170	Miscellaneous Debris	-	Not retained	134
110	200 - 400	160 - 170	Miscellaneous Debris	-	Not retained	135
111	200 - 400	160 - 170	Miscellaneous Debris	-	Not retained	136
112	200 - 400	160 - 170	Miscellaneous Debris	-	Not retained	137
113	200 - 400	170 - 180	Warhead Body Piece	0.15	Rotating Band Piece	39
114	200 - 400	170 - 180	Cartridge Case Piece	-	Not retained	40
115	200 - 400	170 - 180	Cartridge Case Piece	-	Not retained	41
116	200 - 400	180 - 190	Cartridge Case Piece	-	Not retained	265
117	200 - 400	180 - 190	Miscellaneous Debris	-	Not retained	266
118	200 - 400	180 - 190	Miscellaneous Debris	-	Not retained	267
119	200 - 400	180 - 190	Miscellaneous Debris	-	Not retained	268
120	200 - 400	180 - 190	Miscellaneous Debris	-	Not retained	269
121	200 - 400	190 - 200	Warhead Body Piece	6.67		145
122	200 - 400	190 - 200	Cartridge Case Piece	-	Not retained	146
123	200 - 400	190 - 200	Miscellaneous Debris	-	Not retained	270
124	200 - 400	190 - 200	Miscellaneous Debris	-	Not retained	271
125	200 - 400	200 - 210	Warhead Body Piece	0.25		227
126	200 - 400	200 - 210	Cartridge Case Piece	-	Not retained	228
127	200 - 400	200 - 210	Miscellaneous Debris	-	Not retained	229
128	200 - 400	210 - 220	Warhead Body Piece	2.5		121
129	200 - 400	210 - 220	Cartridge Case Piece	-	Not retained	122
130	200 - 400	210 - 220	Cartridge Case Piece	-	Not retained	123
131	200 - 400	210 - 220	Cartridge Case Piece	-	Not retained	124
132	200 - 400	220 - 230	Warhead Body Piece	0.6		5
133	200 - 400	220 - 230	Warhead Body Piece	0.05		6
134	200 - 400	220 - 230	Warhead Body Piece	0.11		7
135	200 - 400	220 - 230	Cartridge Case Piece	-	Not retained	8
136	200 - 400	230 - 240	Warhead Body Piece	12.29		236
137	200 - 400	230 - 240	Cartridge Case Piece	-	Not retained	237
138	200 - 400	230 - 240	Cartridge Case Piece	-	Not retained	238
139	200 - 400	230 - 240	Miscellaneous Debris	-	Not retained	239
140	200 - 400	240 - 250	Warhead Body Piece	0.3	Rotating Band Piece	78
141	200 - 400	240 - 250	Warhead Body Piece	0.02	Rotating Band Piece	79
142	200 - 400	240 - 250	Cartridge Case Piece	-	Not retained	80
143	200 - 400	240 - 250	Cartridge Case Piece	-	Not retained	81
144	200 - 400	240 - 250	Cartridge Case Piece	-	Not retained	82
145	200 - 400	240 - 250	Miscellaneous Debris	-	Not retained	83
146	200 - 400	240 - 250	Miscellaneous Debris	-	Not retained	84
147	200 - 400	250 - 260	Warhead Body Piece	0.25	Rotating Band Piece	14
148	200 - 400	250 - 260	Cartridge Case Piece	-	Not retained	15
149	200 - 400	260 - 270	Warhead Body Piece	0.09		101
150	200 - 400	260 - 270	Cartridge Case Piece	-	Not retained	102

NSWCDD/TR-98/6

TABLE B-2. FRAGMENTS RECOVERED BEYOND 200-FT RANGE IN TEST NO. 7 (Continued)

<u>Entry</u>	<u>Range Interval (ft)</u>	<u>Azimuthal Sector (°)</u>	<u>Description</u>	<u>Mass (lb)</u>	<u>Notes</u>	<u>G64 Index No.</u>
151	200 - 400	270 - 280	Warhead Body Piece	0.05		187
152	200 - 400	270 - 280	Warhead Body Piece	0.21		188
153	200 - 400	270 - 280	Cartridge Case Piece	-	Not retained	189
154	200 - 400	270 - 280	Miscellaneous Debris	-	Not retained	190
155	200 - 400	280 - 290	Warhead Body Piece	0.07		109
156	200 - 400	280 - 290	Warhead Body Piece	0.09	Rotating Band Piece	110
157	200 - 400	280 - 290	Warhead Body Piece	2.55		111
158	200 - 400	280 - 290	Cartridge Case Piece	-	Not retained	112
159	200 - 400	280 - 290	Cartridge Case Piece	-	Not retained	113
160	200 - 400	290 - 300	Warhead Body Piece	0.01		89
161	200 - 400	290 - 300	Cartridge Case Piece	-	Not retained	90
162	200 - 400	290 - 300	Cartridge Case Piece	-	Not retained	91
163	200 - 400	300 - 310	Cartridge Case Piece	-	Not retained	272
164	200 - 400	300 - 310	Miscellaneous Debris	-	Not retained	273
165	200 - 400	340 - 350	Cartridge Case Piece	-	Not retained	274
166	200 - 400	350 - 360	Cartridge Case Piece	-	Not retained	275
167	200 - 400	350 - 360	Cartridge Case Piece	-	Not retained	276
168	400 - 600	0 - 10	Warhead Body Piece	3.57		88
169	400 - 600	10 - 20	Miscellaneous Debris	0.04		9
170	400 - 600	20 - 30	Warhead Body Piece	0.06	Rotating Band Piece	203
171	400 - 600	30 - 40	Warhead Body Piece	0.02		171
172	400 - 600	40 - 50	Cartridge Case Piece	-	Not retained	277
173	400 - 600	50 - 60	Cartridge Case Piece	-	Not retained	278
174	400 - 600	60 - 70	Warhead Body Piece	0.48		107
175	400 - 600	60 - 70	Warhead Body Piece	0.07		108
176	400 - 600	70 - 80	Warhead Body Piece	0.01		16
177	400 - 600	70 - 80	Warhead Body Piece	0.03		17
178	400 - 600	70 - 80	Warhead Body Piece	0.05		18
179	400 - 600	70 - 80	Warhead Body Piece	0.5		19
180	400 - 600	70 - 80	Warhead Body Piece	0.77		20
181	400 - 600	70 - 80	Cartridge Case Piece	-	Not retained	21
182	400 - 600	70 - 80	Cartridge Case Piece	-	Not retained	22
183	400 - 600	80 - 90	Warhead Body Piece	6.02		147
184	400 - 600	80 - 90	Warhead Body Piece	0.03		148
185	400 - 600	80 - 90	Warhead Body Piece	0.01		149
186	400 - 600	80 - 90	Warhead Body Piece	0.13		150
187	400 - 600	90 - 100	Warhead Body Piece	0.4		23
188	400 - 600	90 - 100	Warhead Body Piece	0.04		24
189	400 - 600	90 - 100	Warhead Body Piece	0.1		25
190	400 - 600	90 - 100	Warhead Body Piece	0.02		26
191	400 - 600	100 - 110	Warhead Body Piece	0.31		57
192	400 - 600	100 - 110	Cartridge Case Piece	-	Not retained	58
193	400 - 600	110 - 120	Warhead Body Piece	0.38		10
194	400 - 600	110 - 120	Warhead Body Piece	0.1		11
195	400 - 600	110 - 120	Warhead Body Piece	0.01		12
196	400 - 600	110 - 120	Cartridge Case Piece	-	Not retained	13
197	400 - 600	120 - 130	Cartridge Case Piece	-	Not retained	279
198	400 - 600	120 - 130	Cartridge Case Piece	-	Not retained	280
199	400 - 600	150 - 160	Cartridge Case Piece	-	Not retained	281
200	400 - 600	160 - 170	Warhead Body Piece	0.94		68

TABLE B-2. FRAGMENTS RECOVERED BEYOND 200-FT RANGE IN TEST NO. 7 (Continued)

<u>Entry</u>	<u>Range Interval (ft)</u>	<u>Azimuthal Sector (°)</u>	<u>Description</u>	<u>Mass (lb)</u>	<u>Notes</u>	<u>G64 Index No.</u>
201	400 - 600	160 - 170	Cartridge Case Piece	-	Not retained	282
202	400 - 600	160 - 170	Cartridge Case Piece	-	Not retained	283
203	400 - 600	180 - 190	Warhead Body Piece	0.02		240
204	400 - 600	180 - 190	Warhead Body Piece	0.01		241
205	400 - 600	180 - 190	Cartridge Case Piece	-	Not retained	284
206	400 - 600	190 - 200	Cartridge Case Piece	-	Not retained	285
207	400 - 600	200 - 210	Warhead Body Piece	0.01		204
208	400 - 600	210 - 220	Warhead Body Piece	0.32		125
209	400 - 600	220 - 230	Miscellaneous Debris	-	Not retained	286
210	400 - 600	230 - 240	Warhead Body Piece	0.04		195
211	400 - 600	230 - 240	Warhead Body Piece	0.06		196
212	400 - 600	230 - 240	Miscellaneous Debris	-	Not retained	197
213	400 - 600	240 - 250	Warhead Body Piece	0.01		74
214	400 - 600	240 - 250	Warhead Body Piece	0.05		75
215	400 - 600	250 - 260	Warhead Body Piece	17.67		230
216	400 - 600	250 - 260	Warhead Body Piece	0.35		231
217	400 - 600	250 - 260	Warhead Body Piece	0.07	Rotating Band Piece	232
218	400 - 600	250 - 260	Cartridge Case Piece	-	Not retained	233
219	400 - 600	250 - 260	Cartridge Case Piece	-	Not retained	234
220	400 - 600	250 - 260	Miscellaneous Debris	-	Not retained	235
221	400 - 600	270 - 280	Warhead Body Piece	0.04		73
222	400 - 600	280 - 290	Warhead Body Piece	0.01		45
223	400 - 600	280 - 290	Warhead Body Piece	0.49		46
224	400 - 600	330 - 340	Warhead Body Piece	4.29		206
225	400 - 600	340 - 350	Warhead Body Piece	0.17		120
226	600 - 800	20 - 30	Warhead Body Piece	0.17		103
227	600 - 800	20 - 30	Warhead Body Piece	0.05	Rotating Band Piece	104
228	600 - 800	40 - 50	Warhead Body Piece	0.09		139
229	600 - 800	70 - 80	Warhead Body Piece	0.34		165
230	600 - 800	70 - 80	Warhead Body Piece	0.04		166
231	600 - 800	70 - 80	Warhead Body Piece	0.76		167
232	600 - 800	80 - 90	Warhead Body Piece	0.75		43
233	600 - 800	80 - 90	Warhead Body Piece	0.15		44
234	600 - 800	90 - 100	Warhead Body Piece	1.58		242
235	600 - 800	90 - 100	Warhead Body Piece	0.11		243
236	600 - 800	100 - 110	Warhead Body Piece	0.21		42
237	600 - 800	110 - 120	Warhead Body Piece	0.04		2
238	600 - 800	160 - 170	Warhead Body Piece	0.31		1
239	600 - 800	180 - 190	Warhead Body Piece	2.66		246
240	600 - 800	190 - 200	Warhead Body Piece	1.74		162
241	600 - 800	190 - 200	Cartridge Case Piece	-	Not retained	163
242	600 - 800	220 - 230	Warhead Body Piece	0.01		70
243	600 - 800	230 - 240	Warhead Body Piece	0.02		3
244	600 - 800	230 - 240	Warhead Body Piece	0.01		4
245	600 - 800	240 - 250	Warhead Body Piece	0.48		86
246	600 - 800	240 - 250	Intact Warhead	-	Not retained	87
247	600 - 800	250 - 260	Warhead Body Piece	0.02		198
248	600 - 800	250 - 260	Warhead Body Piece	0.61		199
249	600 - 800	260 - 270	Warhead Body Piece	0.2		61
250	600 - 800	260 - 270	Warhead Body Piece	0.02		62

TABLE B-2. FRAGMENTS RECOVERED BEYOND 200-FT RANGE IN TEST NO. 7 (Continued)

<u>Entry</u>	<u>Range Interval (ft)</u>	<u>Azimuthal Sector (°)</u>	<u>Description</u>	<u>Mass (lb)</u>	<u>Notes</u>	<u>G64 Index No.</u>
251	600 - 800	260 - 270	Cartridge Case Piece	-	Not retained	63
252	600 - 800	260 - 270	Miscellaneous Debris	-	Not retained	64
253	600 - 800	280 - 290	Warhead Body Piece	0.06		28
254	600 - 800	280 - 290	Cartridge Case Piece	-	Not retained	29
255	600 - 800	290 - 300	Intact Warhead	-	Not retained	287
256	600 - 800	310 - 320	Warhead Body Piece	1.89		31
257	600 - 800	320 - 330	Warhead Body Piece	0.1	Rotating Band Piece	172
258	600 - 800	330 - 340	Warhead Body Piece	0.19		105
259	600 - 800	330 - 340	Warhead Body Piece	0.04		106
260	600 - 800	340 - 350	Warhead Body Piece	0.35		27
261	800 - 1000	50 - 60	Warhead Body Piece	1.94		32
262	800 - 1000	60 - 70	Warhead Body Piece	0.04		71
263	800 - 1000	60 - 70	Cartridge Case Piece	-	Not retained	72
264	800 - 1000	100 - 110	Cartridge Case Piece	-	Not retained	288
265	800 - 1000	110 - 120	Warhead Body Piece	16.08		85
266	800 - 1000	190 - 200	Warhead Body Piece	0.23		77
267	800 - 1000	220 - 230	Warhead Body Piece	0.06		244
268	800 - 1000	220 - 230	Cartridge Case Piece	-	Not retained	245
269	800 - 1000	230 - 240	Warhead Body Piece	0.19		192
270	800 - 1000	290 - 300	Warhead Body Piece	1.63		60
271	1000 - 1200	100 - 110	Warhead Body Piece	0.92		168
272	1000 - 1200	100 - 110	Warhead Body Piece	3.84		169
273	1000 - 1200	100 - 110	Miscellaneous Debris	-	Not retained	170
274	1000 - 1200	110 - 120	Warhead Body Piece	1.49		65
275	1000 - 1200	250 - 260	Warhead Body Piece	0.15		67
276	1000 - 1200	260 - 270	Warhead Body Piece	0.34		56
277	1000 - 1200	270 - 280	Warhead Body Piece	0.1		76
278	1000 - 1200	320 - 330	Warhead Body Piece	2.6		92
279	1200 - 1300	40 - 50	Warhead Body Piece	1.89		201
280	1200 - 1300	40 - 50	Warhead Body Piece	0.54		202
281	1200 - 1300	50 - 60	Warhead Body Piece	0.22		69
282	1200 - 1300	60 - 70	Warhead Body Piece	1.34		55
283	1200 - 1300	70 - 80	Warhead Body Piece	0.21		164
284	1200 - 1300	80 - 90	Warhead Body Piece	0.34		59
285	1200 - 1300	290 - 300	Warhead Body Piece	1.79		66
286	1300 - 1400	290 - 300	Warhead Body Piece	5.35		30
287	1300 - 1400	310 - 320	Warhead Body Piece	0.2		191
288	1000 - 1200	80 - 90	Warhead Body Piece	2.88		289
289	800 - 1000	20 - 30	Warhead Body Piece	2.05		290
290	800 - 1000	20 - 30	Warhead Body Piece	0.98		291
291	800 - 1000	290 - 300	Warhead Body Piece	1.64		292
292	1000 - 1200	170 - 180	Warhead Body Piece	18.75		293
293	1400 - 1600	0 - 10	Warhead Body Piece	12.74		294

TABLE B-3. OBSERVATIONS FROM TEST NO. 8

Test Date: 15 September 1994

Test Items: Two pallets of M374A2 81mm HE mortar cartridges. The items were identified as NSN 1315-00-143-7184 DODIC C236.

Weather: Clear skies, approximately 65° F. Winds were NW at approximately 5-7 knots.

Notes: Mild reactions were observed approximately 17:03 (min:sec) after the start of the test. These reactions appeared to be burning and mild deflagration reactions of some propelling charges. This type of reaction continued to occur intermittently throughout the test. The first large explosion occurred approximately 22:42 (min:sec) after the fire was lit. This initial explosion was followed by a series of explosions that continued until approximately 41:42 (min:sec) into the test. The frequency of explosions was so great at times that the total number of explosions could not be determined from on-site observations.

Following the test, a total of 91 warhead bodies were recovered intact inside the 200-ft range. Seventy-one of these warhead bodies still contained most or all of the main fill. Two additional warhead bodies were recovered intact beyond the 200-ft range. The total mass of warhead body pieces recovered inside the 200-ft range was 11.6 lb_m.

Fragment recovery was accomplished by visual search of the test area. The entire area between the 200-ft range and the 1300-ft range was searched. Most far-field fragments appeared to be pieces of warhead case and tail section. Many of the tail pieces remained essentially intact with a small portion of the aft end of the warhead case still attached. Most warhead case pieces appeared to have been produced by explosion-type reactions; however, a significant portion of the pieces appeared to have been produced by detonations.

NSWCDD/TR-98/6

TABLE B-4. FRAGMENTS RECOVERED BEYOND 200-FT RANGE IN TEST NO. 8

<u>Entry</u>	<u>Range Interval (ft)</u>	<u>Azimuthal Sector (°)</u>	<u>Description</u>	<u>Mass (lb)</u>	<u>Notes</u>	<u>G64 Index No.</u>
1	200 - 400	0 - 10	Warhead Body Piece	0.10		339
2	200 - 400	0 - 10	Warhead Body Piece	0.11		338
3	200 - 400	0 - 10	Warhead Body Piece	0.14		337
4	200 - 400	0 - 10	Miscellaneous Debris	0.09		336
5	200 - 400	0 - 10	Miscellaneous Debris	-	Not retained	346
6	200 - 400	10 - 20	Warhead Body Piece	0.20		247
7	200 - 400	10 - 20	Warhead Body Piece	0.45		246
8	200 - 400	10 - 20	Warhead Body Piece	0.55		245
9	200 - 400	10 - 20	Warhead Body Piece	1.25		244
10	200 - 400	10 - 20	Tail Piece	-	Not retained	243
11	200 - 400	20 - 30	Warhead Body Piece	1.07		168
12	200 - 400	20 - 30	Tail Piece	-	Not retained	167
13	200 - 400	30 - 40	Warhead Body Piece	0.12		26
14	200 - 400	30 - 40	Warhead Body Piece	0.17		25
15	200 - 400	30 - 40	Warhead Body Piece	0.31		24
16	200 - 400	30 - 40	Warhead Body Piece	0.37		23
17	200 - 400	30 - 40	Warhead Body Piece	0.39		22
18	200 - 400	30 - 40	Warhead Body Piece	0.87		21
19	200 - 400	30 - 40	Miscellaneous Debris	-	Not retained	347
20	200 - 400	50 - 60	Warhead Body Piece	0.10		311
21	200 - 400	50 - 60	Warhead Body Piece	0.19		309
22	200 - 400	50 - 60	Warhead Body Piece	0.20		310
23	200 - 400	50 - 60	Warhead Body Piece	0.25		308
24	200 - 400	50 - 60	Warhead Body Piece	0.44		307
25	200 - 400	50 - 60	Warhead Body Piece	1.60		306
26	200 - 400	50 - 60	Tail Piece	-	Not retained	305
27	200 - 400	60 - 70	Warhead Body Piece	0.21		254
28	200 - 400	60 - 70	Warhead Body Piece	0.49		253
29	200 - 400	60 - 70	Warhead Body Piece	2.42		252
30	200 - 400	60 - 70	Tail Piece	-	Not retained	251
31	200 - 400	70 - 80	Warhead Body Piece	0.03		72
32	200 - 400	70 - 80	Warhead Body Piece	0.13		71
33	200 - 400	70 - 80	Warhead Body Piece	0.63		70
34	200 - 400	70 - 80	Tail Piece	-	Not retained	73
35	200 - 400	80 - 90	Warhead Body Piece	0.28		267
36	200 - 400	90 - 100	Warhead Body Piece	0.42		330
37	200 - 400	90 - 100	Warhead Body Piece	0.84		329
38	200 - 400	90 - 100	Warhead Body Piece	1.16		327
39	200 - 400	90 - 100	Warhead Body Piece	2.46		328
40	200 - 400	90 - 100	Warhead Body Piece	0.91	Part of tail piece attached	331
41	200 - 400	90 - 100	Warhead Body Piece	1.14	Part of tail piece attached	332
42	200 - 400	90 - 100	Tail Piece	-	Not retained	326
43	200 - 400	110 - 120	Warhead Body Piece	0.02		27
44	200 - 400	110 - 120	Warhead Body Piece	1.61		28
45	200 - 400	130 - 140	Warhead Body Piece	0.36		176
46	200 - 400	130 - 140	Warhead Body Piece	0.70		174
47	200 - 400	130 - 140	Warhead Body Piece	0.79		175
48	200 - 400	130 - 140	Warhead Body Piece	1.14		173
49	200 - 400	130 - 140	Warhead Body Piece	-	Not retained	172
50	200 - 400	140 - 150	Warhead Body Piece	0.36		296

TABLE B-4. FRAGMENTS RECOVERED BEYOND 200-FT RANGE IN TEST NO. 8 (Continued)

<u>Entry</u>	<u>Range Interval (ft)</u>	<u>Azimuthal Sector (°)</u>	<u>Description</u>	<u>Mass (lb)</u>	<u>Notes</u>	<u>G64 Index No.</u>
51	200 - 400	140 - 150	Warhead Body Piece	0.36		297
52	200 - 400	150 - 160	Warhead Body Piece	0.07		293
53	200 - 400	150 - 160	Warhead Body Piece	0.29		292
54	200 - 400	150 - 160	Warhead Body Piece	0.41		291
55	200 - 400	160 - 170	Warhead Body Piece	0.03		325
56	200 - 400	160 - 170	Warhead Body Piece	0.26		324
57	200 - 400	180 - 190	Warhead Body Piece	0.46		183
58	200 - 400	180 - 190	Warhead Body Piece	0.58		182
59	200 - 400	180 - 190	Warhead Body Piece	1.90		181
60	200 - 400	180 - 190	Tail Piece	-	Not retained	180
61	200 - 400	180 - 190	Miscellaneous Debris	-	Not retained	348
62	200 - 400	180 - 190	Miscellaneous Debris	-	Not retained	349
63	200 - 400	190 - 200	Miscellaneous Debris	-	Not retained	350
64	200 - 400	190 - 200	Miscellaneous Debris	-	Not retained	351
65	200 - 400	200 - 210	Warhead Body Piece	0.32		142
66	200 - 400	200 - 210	Warhead Body Piece	1.65		141
67	200 - 400	210 - 220	Warhead Body Piece	0.29		321
68	200 - 400	210 - 220	Warhead Body Piece	2.53		320
69	200 - 400	220 - 230	Warhead Body Piece	0.57		342
70	200 - 400	220 - 230	Warhead Body Piece	1.65		341
71	200 - 400	220 - 230	Warhead Body Piece	0.88		344
72	200 - 400	220 - 230	Warhead Body Piece	0.94		343
73	200 - 400	220 - 230	Warhead Body Piece	-	Not retained	340
74	200 - 400	220 - 230	Miscellaneous Debris	0.03		345
75	200 - 400	220 - 230	Miscellaneous Debris	-	Not retained	352
76	200 - 400	220 - 230	Miscellaneous Debris	-	Not retained	353
77	200 - 400	230 - 240	Warhead Body Piece	0.55		116
78	200 - 400	230 - 240	Warhead Body Piece	1.09		115
79	200 - 400	230 - 240	Miscellaneous Debris	-	Not retained	354
80	200 - 400	230 - 240	Miscellaneous Debris	-	Not retained	355
81	200 - 400	230 - 240	Miscellaneous Debris	-	Not retained	356
82	200 - 400	240 - 250	Warhead Body Piece	0.24		224
83	200 - 400	240 - 250	Miscellaneous Debris	-	Not retained	357
84	200 - 400	240 - 250	Miscellaneous Debris	-	Not retained	358
85	200 - 400	250 - 260	Warhead Body Piece	0.34		265
86	200 - 400	250 - 260	Warhead Body Piece	0.40		266
87	200 - 400	250 - 260	Miscellaneous Debris	-	Not retained	359
88	200 - 400	260 - 270	Warhead Body Piece	0.20		334
89	200 - 400	260 - 270	Warhead Body Piece	2.32		333
90	200 - 400	260 - 270	Miscellaneous Debris	0.05		335
91	200 - 400	260 - 270	Miscellaneous Debris	-	Not retained	360
92	200 - 400	260 - 270	Miscellaneous Debris	-	Not retained	361
93	200 - 400	260 - 270	Miscellaneous Debris	-	Not retained	362
94	200 - 400	270 - 280	Warhead Body Piece	0.15		161
95	200 - 400	270 - 280	Warhead Body Piece	0.19		160
96	200 - 400	270 - 280	Warhead Body Piece	0.40		158
97	200 - 400	270 - 280	Warhead Body Piece	0.42		157
98	200 - 400	270 - 280	Warhead Body Piece	0.58		159
99	200 - 400	270 - 280	Warhead Body Piece	1.97		156
100	200 - 400	270 - 280	Tail Piece	-	Not retained	162

TABLE B-4. FRAGMENTS RECOVERED BEYOND 200-FT RANGE IN TEST NO. 8 (Continued)

<u>Entry</u>	<u>Range Interval (ft)</u>	<u>Azimuthal Sector (°)</u>	<u>Description</u>	<u>Mass (lb)</u>	<u>Notes</u>	<u>G64 Index No.</u>
101	200 - 400	270 - 280	Tail Piece	-	Not retained	163
102	200 - 400	270 - 280	Tail Piece	-	Not retained	164
103	200 - 400	270 - 280	Miscellaneous Debris	-	Not retained	363
104	200 - 400	270 - 280	Miscellaneous Debris	-	Not retained	364
105	200 - 400	280 - 290	Warhead Body Piece	0.24		2
106	200 - 400	280 - 290	Warhead Body Piece	0.34		4
107	200 - 400	280 - 290	Warhead Body Piece	0.37		1
108	200 - 400	280 - 290	Warhead Body Piece	0.45		3
109	200 - 400	280 - 290	Warhead Body Piece	0.64		5
110	200 - 400	280 - 290	Warhead Body Piece	1.39		6
111	200 - 400	280 - 290	Warhead Body Piece	-	Not retained	8
112	200 - 400	280 - 290	Warhead Body Piece	0.89		7
113	200 - 400	280 - 290	Miscellaneous Debris	-	Not retained	365
114	200 - 400	280 - 290	Miscellaneous Debris	-	Not retained	366
115	200 - 400	290 - 300	Warhead Body Piece	0.25		10
116	200 - 400	290 - 300	Warhead Body Piece	0.83		11
117	200 - 400	290 - 300	Warhead Body Piece	1.10		12
118	200 - 400	290 - 300	Miscellaneous Debris	0.02		9
119	200 - 400	300 - 310	Warhead Body Piece	0.82		210
120	200 - 400	300 - 310	Warhead Body Piece	0.96		209
121	200 - 400	300 - 310	Warhead Body Piece	1.62		207
122	200 - 400	300 - 310	Warhead Body Piece	0.91		208
123	200 - 400	300 - 310	Tail Piece	-	Not retained	206
124	200 - 400	300 - 310	Miscellaneous Debris	-	Not retained	367
125	200 - 400	300 - 310	Miscellaneous Debris	-	Not retained	368
126	200 - 400	300 - 310	Miscellaneous Debris	-	Not retained	369
127	200 - 400	310 - 320	Miscellaneous Debris	-	Not retained	370
128	200 - 400	320 - 330	Warhead Body Piece	0.39		197
129	200 - 400	320 - 330	Miscellaneous Debris	0.01		199
130	200 - 400	320 - 330	Miscellaneous Debris	0.02		198
131	200 - 400	320 - 330	Miscellaneous Debris	-	Not retained	371
132	200 - 400	320 - 330	Miscellaneous Debris	-	Not retained	372
133	200 - 400	320 - 330	Miscellaneous Debris	-	Not retained	373
134	200 - 400	320 - 330	Miscellaneous Debris	-	Not retained	374
135	200 - 400	340 - 350	Warhead Body Piece	0.49		68
136	200 - 400	340 - 350	Tail Piece	-	Not retained	69
137	200 - 400	350 - 360	Warhead Body Piece	0.04		217
138	200 - 400	350 - 360	Warhead Body Piece	0.22		216
139	200 - 400	350 - 360	Warhead Body Piece	0.32		215
140	200 - 400	350 - 360	Warhead Body Piece	0.54		214
141	400 - 600	10 - 20	Warhead Body Piece	0.04		139
142	400 - 600	10 - 20	Warhead Body Piece	0.08		140
143	400 - 600	10 - 20	Warhead Body Piece	0.19		137
144	400 - 600	10 - 20	Warhead Body Piece	0.22		138
145	400 - 600	10 - 20	Warhead Body Piece	0.30		135
146	400 - 600	10 - 20	Warhead Body Piece	0.31		136
147	400 - 600	20 - 30	Warhead Body Piece	0.13		152
148	400 - 600	20 - 30	Warhead Body Piece	0.16		151
149	400 - 600	20 - 30	Warhead Body Piece	0.17		150
150	400 - 600	20 - 30	Warhead Body Piece	-	Not retained	149

TABLE B-4. FRAGMENTS RECOVERED BEYOND 200-FT RANGE IN TEST NO. 8 (Continued)

<u>Entry</u>	<u>Range Interval (ft)</u>	<u>Azimuthal Sector (°)</u>	<u>Description</u>	<u>Mass (lb)</u>	<u>Notes</u>	<u>G64 Index No.</u>
151	400 - 600	30 - 40	Warhead Body Piece	0.19		195
152	400 - 600	30 - 40	Warhead Body Piece	0.36		194
153	400 - 600	30 - 40	Warhead Body Piece	0.37		193
154	400 - 600	40 - 50	Warhead Body Piece	0.14		44
155	400 - 600	50 - 60	Warhead Body Piece	0.07		186
156	400 - 600	50 - 60	Warhead Body Piece	0.32		185
157	400 - 600	50 - 60	Intact Warhead	-	Not retained	184
158	400 - 600	70 - 80	Warhead Body Piece	0.24		295
159	400 - 600	70 - 80	Tail Piece	-	Not retained	294
160	400 - 600	80 - 90	Warhead Body Piece	0.13		242
161	400 - 600	80 - 90	Warhead Body Piece	0.38		241
162	400 - 600	90 - 100	Warhead Body Piece	0.89		201
163	400 - 600	90 - 100	Warhead Body Piece	0.91		202
164	400 - 600	100 - 110	Warhead Body Piece	0.48		304
165	400 - 600	110 - 120	Warhead Body Piece	0.06		166
166	400 - 600	110 - 120	Warhead Body Piece	0.23		165
167	400 - 600	110 - 120	Miscellaneous Debris	-	Not retained	375
168	400 - 600	120 - 130	Miscellaneous Debris	-	Not retained	376
169	400 - 600	120 - 130	Miscellaneous Debris	-	Not retained	377
170	400 - 600	120 - 130	Miscellaneous Debris	-	Not retained	378
171	400 - 600	130 - 140	Warhead Body Piece	0.25		134
172	400 - 600	130 - 140	Warhead Body Piece	0.34		133
173	400 - 600	130 - 140	Tail Piece	-	Not retained	132
174	400 - 600	140 - 150	Warhead Body Piece	0.03		155
175	400 - 600	140 - 150	Warhead Body Piece	0.10		154
176	400 - 600	140 - 150	Warhead Body Piece	0.92		153
177	400 - 600	150 - 160	Warhead Body Piece	0.06		79
178	400 - 600	150 - 160	Warhead Body Piece	0.16		78
179	400 - 600	150 - 160	Warhead Body Piece	0.26		77
180	400 - 600	150 - 160	Warhead Body Piece	1.73		76
181	400 - 600	160 - 170	Warhead Body Piece	0.25		270
182	400 - 600	160 - 170	Warhead Body Piece	0.28		269
183	400 - 600	160 - 170	Tail Piece	-	Not retained	268
184	400 - 600	170 - 180	Warhead Body Piece	0.44		255
185	400 - 600	180 - 190	Warhead Body Piece	0.12		203
186	400 - 600	180 - 190	Warhead Body Piece	0.16		205
187	400 - 600	180 - 190	Warhead Body Piece	0.18		204
188	400 - 600	190 - 200	Warhead Body Piece	0.14		229
189	400 - 600	190 - 200	Warhead Body Piece	0.42		228
190	400 - 600	190 - 200	Warhead Body Piece	1.24		227
191	400 - 600	190 - 200	Tail Piece	-	Not retained	226
192	400 - 600	200 - 210	Warhead Body Piece	0.23		239
193	400 - 600	200 - 210	Warhead Body Piece	0.30		236
194	400 - 600	200 - 210	Warhead Body Piece	0.31		237
195	400 - 600	200 - 210	Warhead Body Piece	0.33		238
196	400 - 600	200 - 210	Warhead Body Piece	0.35		235
197	400 - 600	200 - 210	Warhead Body Piece	0.56		234
198	400 - 600	210 - 220	Warhead Body Piece	0.23		213
199	400 - 600	210 - 220	Warhead Body Piece	0.43		212
200	400 - 600	210 - 220	Tail Piece	-	Not retained	211

TABLE B-4. FRAGMENTS RECOVERED BEYOND 200-FT RANGE IN TEST NO. 8 (Continued)

<u>Entry</u>	<u>Range Interval (ft)</u>	<u>Azimuthal Sector (°)</u>	<u>Description</u>	<u>Mass (lb)</u>	<u>Notes</u>	<u>G64 Index No.</u>
201	400 - 600	220 - 230	Warhead Body Piece	0.01		300
202	400 - 600	220 - 230	Warhead Body Piece	0.07		299
203	400 - 600	220 - 230	Warhead Body Piece	0.30		298
204	400 - 600	220 - 230	Miscellaneous Debris	-	Not retained	379
205	400 - 600	220 - 230	Miscellaneous Debris	-	Not retained	380
206	400 - 600	230 - 240	Warhead Body Piece	0.08		192
207	400 - 600	230 - 240	Warhead Body Piece	0.11		191
208	400 - 600	230 - 240	Warhead Body Piece	0.20		190
209	400 - 600	230 - 240	Warhead Body Piece	0.39		189
210	400 - 600	230 - 240	Warhead Body Piece	0.52		188
211	400 - 600	230 - 240	Warhead Body Piece	-	Not retained	187
212	400 - 600	240 - 250	Warhead Body Piece	0.08		19
213	400 - 600	240 - 250	Warhead Body Piece	0.11		20
214	400 - 600	240 - 250	Warhead Body Piece	0.19		16
215	400 - 600	240 - 250	Warhead Body Piece	0.25		18
216	400 - 600	240 - 250	Warhead Body Piece	0.29		15
217	400 - 600	240 - 250	Warhead Body Piece	0.38		17
218	400 - 600	240 - 250	Warhead Body Piece	0.47		14
219	400 - 600	240 - 250	Miscellaneous Debris	-	Not retained	381
220	400 - 600	250 - 260	Warhead Body Piece	0.01		32
221	400 - 600	250 - 260	Warhead Body Piece	0.06		31
222	400 - 600	250 - 260	Warhead Body Piece	0.29		30
223	400 - 600	260 - 270	Warhead Body Piece	0.06		55
224	400 - 600	260 - 270	Warhead Body Piece	0.06		56
225	400 - 600	260 - 270	Warhead Body Piece	0.10		54
226	400 - 600	260 - 270	Warhead Body Piece	0.18		52
227	400 - 600	260 - 270	Warhead Body Piece	0.19		51
228	400 - 600	260 - 270	Warhead Body Piece	0.19		53
229	400 - 600	260 - 270	Warhead Body Piece	0.34		49
230	400 - 600	260 - 270	Warhead Body Piece	0.49		50
231	400 - 600	260 - 270	Warhead Body Piece	1.11		48
232	400 - 600	260 - 270	Warhead Body Piece	2.20		47
233	400 - 600	270 - 280	Warhead Body Piece	0.03		124
234	400 - 600	270 - 280	Warhead Body Piece	0.09		121
235	400 - 600	270 - 280	Warhead Body Piece	0.12		123
236	400 - 600	270 - 280	Warhead Body Piece	0.15		122
237	400 - 600	270 - 280	Warhead Body Piece	0.21		119
238	400 - 600	270 - 280	Warhead Body Piece	0.28		120
239	400 - 600	270 - 280	Warhead Body Piece	0.80		118
240	400 - 600	270 - 280	Warhead Body Piece	0.89		117
241	400 - 600	270 - 280	Tail Piece	-	Not retained	125
242	400 - 600	270 - 280	Tail Piece	-	Not retained	126
243	400 - 600	280 - 290	Warhead Body Piece	0.01		148
244	400 - 600	280 - 290	Warhead Body Piece	0.03		147
245	400 - 600	280 - 290	Warhead Body Piece	0.13		145
246	400 - 600	280 - 290	Warhead Body Piece	0.14		146
247	400 - 600	280 - 290	Warhead Body Piece	0.17		144
248	400 - 600	280 - 290	Warhead Body Piece	0.81		143
249	400 - 600	290 - 300	Warhead Body Piece	0.02		96
250	400 - 600	290 - 300	Warhead Body Piece	0.03		95

NSWCDD/TR-98/6

TABLE B-4. FRAGMENTS RECOVERED BEYOND 200-FT RANGE IN TEST NO. 8 (Continued)

<u>Entry</u>	<u>Range Interval (ft)</u>	<u>Azimuthal Sector (°)</u>	<u>Description</u>	<u>Mass (lb)</u>	<u>Notes</u>	<u>G64 Index No.</u>
251	400 - 600	290 - 300	Warhead Body Piece	0.11		94
252	400 - 600	290 - 300	Warhead Body Piece	0.24		93
253	400 - 600	290 - 300	Warhead Body Piece	0.45		92
254	400 - 600	290 - 300	Miscellaneous Debris	-	Not retained	382
255	400 - 600	300 - 310	Warhead Body Piece	0.06		86
256	400 - 600	300 - 310	Warhead Body Piece	0.11		85
257	400 - 600	300 - 310	Warhead Body Piece	0.14		84
258	400 - 600	310 - 320	Warhead Body Piece	0.14		179
259	400 - 600	310 - 320	Warhead Body Piece	0.24		178
260	400 - 600	310 - 320	Warhead Body Piece	0.41		177
261	400 - 600	320 - 330	Warhead Body Piece	0.12		290
262	400 - 600	320 - 330	Warhead Body Piece	0.26		289
263	400 - 600	330 - 340	Warhead Body Piece	0.12		288
264	400 - 600	330 - 340	Warhead Body Piece	0.18		287
265	400 - 600	330 - 340	Warhead Body Piece	0.37		286
266	400 - 600	330 - 340	Warhead Body Piece	0.74		285
267	400 - 600	330 - 340	Warhead Body Piece	0.89		283
268	400 - 600	330 - 340	Warhead Body Piece	0.90		284
269	400 - 600	340 - 350	Warhead Body Piece	0.05		58
270	400 - 600	340 - 350	Warhead Body Piece	1.46		57
271	400 - 600	340 - 350	Tail Piece	-	Not retained	59
272	400 - 600	350 - 360	Warhead Body Piece	0.17		46
273	400 - 600	350 - 360	Warhead Body Piece	0.36		45
274	600 - 800	10 - 20	Warhead Body Piece	0.55		258
275	600 - 800	10 - 20	Warhead Body Piece	0.64		257
276	600 - 800	20 - 30	Warhead Body Piece	0.37		29
277	600 - 800	40 - 50	Warhead Body Piece	0.60		230
278	600 - 800	50 - 60	Warhead Body Piece	0.38		264
279	600 - 800	60 - 70	Warhead Body Piece	0.11		262
280	600 - 800	60 - 70	Warhead Body Piece	0.49		261
281	600 - 800	70 - 80	Warhead Body Piece	0.16		250
282	600 - 800	70 - 80	Warhead Body Piece	1.01		249
283	600 - 800	80 - 90	Warhead Body Piece	0.26		35
284	600 - 800	90 - 100	Warhead Body Piece	0.24		240
285	600 - 800	100 - 110	Warhead Body Piece	0.18		200
286	600 - 800	110 - 120	Warhead Body Piece	0.35		279
287	600 - 800	120 - 130	Warhead Body Piece	0.16		37
288	600 - 800	120 - 130	Warhead Body Piece	0.21		36
289	600 - 800	120 - 130	Tail Piece	-	Not retained	38
290	600 - 800	170 - 180	Warhead Body Piece	0.19		171
291	600 - 800	170 - 180	Warhead Body Piece	0.26		170
292	600 - 800	170 - 180	Warhead Body Piece	0.42		169
293	600 - 800	180 - 190	Warhead Body Piece	0.36		322
294	600 - 800	190 - 200	Warhead Body Piece	0.26		81
295	600 - 800	190 - 200	Warhead Body Piece	1.76		80
296	600 - 800	200 - 210	Warhead Body Piece	0.03		275
297	600 - 800	200 - 210	Warhead Body Piece	0.03		276
298	600 - 800	200 - 210	Warhead Body Piece	0.12		274
299	600 - 800	200 - 210	Warhead Body Piece	0.35		273
300	600 - 800	200 - 210	Warhead Body Piece	0.39		272

TABLE B-4. FRAGMENTS RECOVERED BEYOND 200-FT RANGE IN TEST NO. 8 (Continued)

<u>Entry</u>	<u>Range Interval (ft)</u>	<u>Azimuthal Sector (°)</u>	<u>Description</u>	<u>Mass (lb)</u>	<u>Notes</u>	<u>G64 Index No.</u>
301	600 - 800	200 - 210	Warhead Body Piece	0.45		271
302	600 - 800	210 - 220	Warhead Body Piece	0.10		131
303	600 - 800	210 - 220	Warhead Body Piece	0.30		129
304	600 - 800	210 - 220	Warhead Body Piece	0.30		130
305	600 - 800	210 - 220	Warhead Body Piece	0.35		128
306	600 - 800	210 - 220	Warhead Body Piece	0.39		127
307	600 - 800	220 - 230	Warhead Body Piece	0.73		220
308	600 - 800	230 - 240	Warhead Body Piece	0.05		318
309	600 - 800	230 - 240	Warhead Body Piece	0.12		317
310	600 - 800	230 - 240	Warhead Body Piece	0.26		316
311	600 - 800	230 - 240	Warhead Body Piece	0.35		315
312	600 - 800	240 - 250	Warhead Body Piece	0.02		101
313	600 - 800	240 - 250	Warhead Body Piece	0.10		100
314	600 - 800	240 - 250	Warhead Body Piece	0.14		99
315	600 - 800	240 - 250	Warhead Body Piece	0.31		98
316	600 - 800	240 - 250	Intact Warhead	-	Not retained	97
317	600 - 800	240 - 250	Miscellaneous Debris	0.02		102
318	600 - 800	250 - 260	Warhead Body Piece	0.02		112
319	600 - 800	250 - 260	Warhead Body Piece	0.04		111
320	600 - 800	250 - 260	Warhead Body Piece	0.07		110
321	600 - 800	250 - 260	Warhead Body Piece	0.11		109
322	600 - 800	250 - 260	Warhead Body Piece	0.13		108
323	600 - 800	250 - 260	Warhead Body Piece	0.20		107
324	600 - 800	250 - 260	Warhead Body Piece	0.29		106
325	600 - 800	250 - 260	Warhead Body Piece	0.30		105
326	600 - 800	250 - 260	Warhead Body Piece	0.37		104
327	600 - 800	250 - 260	Warhead Body Piece	0.45		103
328	600 - 800	250 - 260	Tail Piece	-	Not retained	113
329	600 - 800	250 - 260	Miscellaneous Debris	-	Not retained	383
330	600 - 800	260 - 270	Warhead Body Piece	0.20		223
331	600 - 800	260 - 270	Warhead Body Piece	0.29		222
332	600 - 800	260 - 270	Warhead Body Piece	0.37		221
333	600 - 800	270 - 280	Warhead Body Piece	0.29		314
334	600 - 800	270 - 280	Warhead Body Piece	0.36		313
335	600 - 800	270 - 280	Warhead Body Piece	0.57		312
336	600 - 800	280 - 290	Warhead Body Piece	0.03		263
337	600 - 800	290 - 300	Warhead Body Piece	0.02		282
338	600 - 800	290 - 300	Warhead Body Piece	0.08		281
339	600 - 800	290 - 300	Warhead Body Piece	0.14		280
340	600 - 800	300 - 310	Warhead Body Piece	0.01		91
341	600 - 800	300 - 310	Warhead Body Piece	0.02		90
342	600 - 800	300 - 310	Warhead Body Piece	0.08		89
343	600 - 800	300 - 310	Warhead Body Piece	0.09		88
344	600 - 800	300 - 310	Warhead Body Piece	0.22		87
345	600 - 800	300 - 310	Miscellaneous Debris	-	Not retained	384
346	600 - 800	310 - 320	Warhead Body Piece	0.29		232
347	600 - 800	310 - 320	Warhead Body Piece	0.30		233
348	600 - 800	310 - 320	Warhead Body Piece	0.31		231
349	600 - 800	320 - 330	Warhead Body Piece	0.13		66
350	600 - 800	320 - 330	Warhead Body Piece	0.17		65

TABLE B-4. FRAGMENTS RECOVERED BEYOND 200-FT RANGE IN TEST NO. 8 (Continued)

<u>Entry</u>	<u>Range Interval (ft)</u>	<u>Azimuthal Sector (°)</u>	<u>Description</u>	<u>Mass (lb)</u>	<u>Notes</u>	<u>G64 Index No.</u>
351	600 - 800	320 - 330	Warhead Body Piece	0.20		64
352	600 - 800	320 - 330	Warhead Body Piece	0.24		63
353	600 - 800	320 - 330	Warhead Body Piece	0.45		60
354	600 - 800	320 - 330	Warhead Body Piece	0.53		61
355	600 - 800	320 - 330	Warhead Body Piece	0.54		62
356	600 - 800	320 - 330	Tail Piece	-	Not retained	67
357	600 - 800	330 - 340	Warhead Body Piece	0.10		319
358	600 - 800	350 - 360	Warhead Body Piece	0.19		260
359	600 - 800	350 - 360	Warhead Body Piece	0.30		259
360	800 - 1000	130 - 140	Warhead Body Piece	0.74		323
361	800 - 1000	170 - 180	Warhead Body Piece	0.51		196
362	800 - 1000	200 - 210	Warhead Body Piece	0.41		256
363	800 - 1000	210 - 220	Warhead Body Piece	0.08		34
364	800 - 1000	210 - 220	Warhead Body Piece	0.28		33
365	800 - 1000	220 - 230	Warhead Body Piece	0.16		219
366	800 - 1000	220 - 230	Warhead Body Piece	0.77		218
367	800 - 1000	230 - 240	Warhead Body Piece	0.04		75
368	800 - 1000	230 - 240	Warhead Body Piece	0.58		74
369	800 - 1000	250 - 260	Warhead Body Piece	0.11		43
370	800 - 1000	250 - 260	Warhead Body Piece	0.14		42
371	800 - 1000	250 - 260	Warhead Body Piece	0.15		41
372	800 - 1000	250 - 260	Warhead Body Piece	0.24		40
373	800 - 1000	250 - 260	Warhead Body Piece	0.85		39
374	800 - 1000	260 - 270	Warhead Body Piece	0.03		303
375	800 - 1000	260 - 270	Warhead Body Piece	0.11		302
376	800 - 1000	260 - 270	Warhead Body Piece	0.12		301
377	800 - 1000	270 - 280	Warhead Body Piece	0.02		83
378	800 - 1000	270 - 280	Warhead Body Piece	0.30		82
379	800 - 1000	280 - 290	Warhead Body Piece	0.45		13
380	800 - 1000	300 - 310	Warhead Body Piece	0.62		114
381	800 - 1000	320 - 330	Warhead Body Piece	0.62		248
382	800 - 1000	350 - 360	Tail Piece	-	Not retained	385
383	1000 - 1200	290 - 300	Warhead Body Piece	0.40		278
384	1000 - 1200	290 - 300	Warhead Body Piece	1.44		277
385	1000 - 1200	310 - 320	Warhead Body Piece	0.38		225

TABLE B-5. OBSERVATIONS FROM TEST NO. 9

Test Date: 11 May 1995

Test Items: Two pallets of M374A2 81mm HE mortar cartridges in UK packaging configuration (i.e., metal boxes containing three cartridges each; cartridges packed individually in plastic sleeves).

Weather: Clear skies, approximately 70° F. Winds were S at approximately 2-4 knots.

Notes: Mild reactions were observed approximately 22:18 (min:sec) after the start of the test. These reactions appeared to be burning and mild deflagration reactions of some propelling charges. This type of reaction continued to occur intermittently throughout the test. A large explosion occurred approximately 26:11 (min:sec) after the fire was lit. The explosion completely destroyed the stack and swept the test pad clear of virtually all debris. No additional reactions were observed after that time.

Following the test, a total of 102 warhead bodies were recovered intact. Seven of the bodies were recovered inside the 200-ft range; the remainder were recovered beyond the 200-ft range. The total mass of warhead body pieces recovered inside the 200-ft range was 12.8 lb_m.

Fragment recovery was accomplished by visual search of the test area. The entire area between the 200-ft range and the 1300-ft range was searched. Due to the presence of relatively dense vegetation beyond the 1300-ft range, recovery at ranges beyond 1300-ft was accomplished by thoroughly searching selected azimuthal sectors. The total azimuthal region searched beyond the 1300-ft range was 180°.

NSWCDD/TR-98/6

TABLE B-6. FRAGMENTS RECOVERED BEYOND 200-FT RANGE IN TEST NO. 9

<u>Entry</u>	<u>Range Interval (ft)</u>	<u>Azimuthal Sector (°)</u>	<u>Description</u>	<u>Mass (lb)</u>	<u>Notes</u>	<u>G64 Index No.</u>
1	200 - 400	0 - 10	Warhead Body Piece	0.10		2165
2	200 - 400	0 - 10	Miscellaneous Debris	0.02		2166
3	200 - 400	0 - 10	Miscellaneous Debris	-	Not retained	9000
4	200 - 400	0 - 10	Miscellaneous Debris	-	Not retained	9001
5	200 - 400	0 - 10	Miscellaneous Debris	-	Not retained	9002
6	200 - 400	0 - 10	Miscellaneous Debris	-	Not retained	9003
7	200 - 400	0 - 10	Miscellaneous Debris	-	Not retained	9004
8	200 - 400	0 - 10	Miscellaneous Debris	-	Not retained	9005
9	200 - 400	0 - 10	Miscellaneous Debris	-	Not retained	9006
10	200 - 400	0 - 10	Miscellaneous Debris	-	Not retained	9007
11	200 - 400	0 - 10	Miscellaneous Debris	-	Not retained	9008
12	200 - 400	0 - 10	Miscellaneous Debris	-	Not retained	9009
13	200 - 400	0 - 10	Miscellaneous Debris	-	Not retained	9010
14	200 - 400	0 - 10	Miscellaneous Debris	-	Not retained	9011
15	200 - 400	0 - 10	Miscellaneous Debris	-	Not retained	9012
16	200 - 400	0 - 10	Miscellaneous Debris	-	Not retained	9013
17	200 - 400	0 - 10	Miscellaneous Debris	-	Not retained	9014
18	200 - 400	0 - 10	Miscellaneous Debris	-	Not retained	9015
19	200 - 400	0 - 10	Miscellaneous Debris	-	Not retained	9016
20	200 - 400	0 - 10	Miscellaneous Debris	-	Not retained	9017
21	200 - 400	0 - 10	Miscellaneous Debris	-	Not retained	9018
22	200 - 400	0 - 10	Miscellaneous Debris	-	Not retained	9019
23	200 - 400	10 - 20	Warhead Body Piece	0.09		2564
24	200 - 400	10 - 20	Warhead Body Piece	0.06		2565
25	200 - 400	10 - 20	Warhead Body Piece	0.05		2566
26	200 - 400	10 - 20	Miscellaneous Debris	-	Not retained	9020
27	200 - 400	10 - 20	Miscellaneous Debris	-	Not retained	9021
28	200 - 400	10 - 20	Miscellaneous Debris	-	Not retained	9022
29	200 - 400	10 - 20	Miscellaneous Debris	-	Not retained	9023
30	200 - 400	10 - 20	Miscellaneous Debris	-	Not retained	9024
31	200 - 400	10 - 20	Miscellaneous Debris	-	Not retained	9025
32	200 - 400	10 - 20	Miscellaneous Debris	-	Not retained	9026
33	200 - 400	10 - 20	Miscellaneous Debris	-	Not retained	9027
34	200 - 400	10 - 20	Miscellaneous Debris	-	Not retained	9028
35	200 - 400	10 - 20	Miscellaneous Debris	-	Not retained	9029
36	200 - 400	10 - 20	Miscellaneous Debris	-	Not retained	9030
37	200 - 400	10 - 20	Miscellaneous Debris	-	Not retained	9031
38	200 - 400	10 - 20	Miscellaneous Debris	-	Not retained	9032
39	200 - 400	20 - 30	Miscellaneous Debris	-	Not retained	9033
40	200 - 400	20 - 30	Miscellaneous Debris	-	Not retained	9034
41	200 - 400	20 - 30	Miscellaneous Debris	-	Not retained	9035
42	200 - 400	20 - 30	Miscellaneous Debris	-	Not retained	9036
43	200 - 400	20 - 30	Miscellaneous Debris	-	Not retained	9037
44	200 - 400	20 - 30	Miscellaneous Debris	-	Not retained	9038
45	200 - 400	20 - 30	Miscellaneous Debris	-	Not retained	9039
46	200 - 400	20 - 30	Miscellaneous Debris	-	Not retained	9040
47	200 - 400	20 - 30	Miscellaneous Debris	-	Not retained	9041
48	200 - 400	20 - 30	Miscellaneous Debris	-	Not retained	9042
49	200 - 400	20 - 30	Miscellaneous Debris	-	Not retained	9043
50	200 - 400	20 - 30	Miscellaneous Debris	-	Not retained	9044

NSWCDD/TR-98/6

TABLE B-6. FRAGMENTS RECOVERED BEYOND 200-FT RANGE IN TEST NO. 9 (Continued)

<u>Entry</u>	<u>Range Interval (ft)</u>	<u>Azimuthal Sector (°)</u>	<u>Description</u>	<u>Mass (lb)</u>	<u>Notes</u>	<u>G64 Index No.</u>
51	200 - 400	20 - 30	Miscellaneous Debris	-	Not retained	9045
52	200 - 400	20 - 30	Miscellaneous Debris	-	Not retained	9046
53	200 - 400	20 - 30	Miscellaneous Debris	-	Not retained	9047
54	200 - 400	20 - 30	Miscellaneous Debris	-	Not retained	9048
55	200 - 400	20 - 30	Miscellaneous Debris	-	Not retained	9049
56	200 - 400	20 - 30	Miscellaneous Debris	-	Not retained	9050
57	200 - 400	20 - 30	Miscellaneous Debris	-	Not retained	9051
58	200 - 400	20 - 30	Miscellaneous Debris	-	Not retained	9052
59	200 - 400	20 - 30	Miscellaneous Debris	-	Not retained	9053
60	200 - 400	20 - 30	Miscellaneous Debris	-	Not retained	9054
61	200 - 400	30 - 40	Warhead Body Piece	0.22		2796
62	200 - 400	30 - 40	Miscellaneous Debris	-	Not retained	9055
63	200 - 400	30 - 40	Miscellaneous Debris	-	Not retained	9056
64	200 - 400	30 - 40	Miscellaneous Debris	-	Not retained	9057
65	200 - 400	30 - 40	Miscellaneous Debris	-	Not retained	9058
66	200 - 400	30 - 40	Miscellaneous Debris	-	Not retained	9059
67	200 - 400	30 - 40	Miscellaneous Debris	-	Not retained	9060
68	200 - 400	30 - 40	Miscellaneous Debris	-	Not retained	9061
69	200 - 400	30 - 40	Miscellaneous Debris	-	Not retained	9062
70	200 - 400	30 - 40	Miscellaneous Debris	-	Not retained	9063
71	200 - 400	30 - 40	Miscellaneous Debris	-	Not retained	9064
72	200 - 400	30 - 40	Miscellaneous Debris	-	Not retained	9065
73	200 - 400	30 - 40	Miscellaneous Debris	-	Not retained	9066
74	200 - 400	30 - 40	Miscellaneous Debris	-	Not retained	9067
75	200 - 400	30 - 40	Miscellaneous Debris	-	Not retained	9068
76	200 - 400	30 - 40	Miscellaneous Debris	-	Not retained	9069
77	200 - 400	30 - 40	Miscellaneous Debris	-	Not retained	9070
78	200 - 400	30 - 40	Miscellaneous Debris	-	Not retained	9071
79	200 - 400	30 - 40	Miscellaneous Debris	-	Not retained	9072
80	200 - 400	30 - 40	Miscellaneous Debris	-	Not retained	9073
81	200 - 400	30 - 40	Miscellaneous Debris	-	Not retained	9074
82	200 - 400	30 - 40	Miscellaneous Debris	-	Not retained	9075
83	200 - 400	30 - 40	Miscellaneous Debris	-	Not retained	9076
84	200 - 400	30 - 40	Miscellaneous Debris	-	Not retained	9077
85	200 - 400	30 - 40	Miscellaneous Debris	-	Not retained	9078
86	200 - 400	30 - 40	Miscellaneous Debris	-	Not retained	9079
87	200 - 400	30 - 40	Miscellaneous Debris	-	Not retained	9080
88	200 - 400	30 - 40	Miscellaneous Debris	-	Not retained	9081
89	200 - 400	40 - 50	Warhead Body Piece	0.24		2881
90	200 - 400	40 - 50	Warhead Body Piece	0.05		2882
91	200 - 400	40 - 50	Warhead Body Piece	0.06		2883
92	200 - 400	40 - 50	Miscellaneous Debris	0.01		2885
93	200 - 400	40 - 50	Miscellaneous Debris	0.03		2884
94	200 - 400	40 - 50	Miscellaneous Debris	-	Not retained	9082
95	200 - 400	40 - 50	Miscellaneous Debris	-	Not retained	9083
96	200 - 400	40 - 50	Miscellaneous Debris	-	Not retained	9084
97	200 - 400	40 - 50	Miscellaneous Debris	-	Not retained	9085
98	200 - 400	40 - 50	Miscellaneous Debris	-	Not retained	9086
99	200 - 400	40 - 50	Miscellaneous Debris	-	Not retained	9087
100	200 - 400	40 - 50	Miscellaneous Debris	-	Not retained	9088

TABLE B-6. FRAGMENTS RECOVERED BEYOND 200-FT RANGE IN TEST NO. 9 (Continued)

<u>Entry</u>	<u>Range Interval (ft)</u>	<u>Azimuthal Sector (°)</u>	<u>Description</u>	<u>Mass (lb)</u>	<u>Notes</u>	<u>G64 Index No.</u>
101	200 - 400	40 - 50	Miscellaneous Debris	-	Not retained	9089
102	200 - 400	40 - 50	Miscellaneous Debris	-	Not retained	9090
103	200 - 400	40 - 50	Miscellaneous Debris	-	Not retained	9091
104	200 - 400	40 - 50	Miscellaneous Debris	-	Not retained	9092
105	200 - 400	40 - 50	Miscellaneous Debris	-	Not retained	9093
106	200 - 400	40 - 50	Miscellaneous Debris	-	Not retained	9094
107	200 - 400	40 - 50	Miscellaneous Debris	-	Not retained	9095
108	200 - 400	40 - 50	Miscellaneous Debris	-	Not retained	9096
109	200 - 400	40 - 50	Miscellaneous Debris	-	Not retained	9097
110	200 - 400	40 - 50	Miscellaneous Debris	-	Not retained	9098
111	200 - 400	40 - 50	Miscellaneous Debris	-	Not retained	9099
112	200 - 400	40 - 50	Miscellaneous Debris	-	Not retained	9100
113	200 - 400	40 - 50	Miscellaneous Debris	-	Not retained	9101
114	200 - 400	40 - 50	Miscellaneous Debris	-	Not retained	9102
115	200 - 400	40 - 50	Miscellaneous Debris	-	Not retained	9103
116	200 - 400	40 - 50	Miscellaneous Debris	-	Not retained	9104
117	200 - 400	40 - 50	Miscellaneous Debris	-	Not retained	9105
118	200 - 400	40 - 50	Miscellaneous Debris	-	Not retained	9106
119	200 - 400	40 - 50	Miscellaneous Debris	-	Not retained	9107
120	200 - 400	40 - 50	Miscellaneous Debris	-	Not retained	9108
121	200 - 400	40 - 50	Miscellaneous Debris	-	Not retained	9109
122	200 - 400	40 - 50	Miscellaneous Debris	-	Not retained	9110
123	200 - 400	40 - 50	Miscellaneous Debris	-	Not retained	9111
124	200 - 400	40 - 50	Miscellaneous Debris	-	Not retained	9112
125	200 - 400	40 - 50	Intact Warhead	5.05		2880
126	200 - 400	50 - 60	Warhead Body Piece	0.09		2851
127	200 - 400	50 - 60	Warhead Body Piece	0.06		2852
128	200 - 400	50 - 60	Tail Piece	0.04		2218
129	200 - 400	50 - 60	Miscellaneous Debris	0.04		2329
130	200 - 400	50 - 60	Miscellaneous Debris	-	Not retained	9113
131	200 - 400	50 - 60	Miscellaneous Debris	-	Not retained	9114
132	200 - 400	50 - 60	Miscellaneous Debris	-	Not retained	9115
133	200 - 400	50 - 60	Miscellaneous Debris	-	Not retained	9116
134	200 - 400	50 - 60	Miscellaneous Debris	-	Not retained	9117
135	200 - 400	50 - 60	Miscellaneous Debris	-	Not retained	9118
136	200 - 400	50 - 60	Miscellaneous Debris	-	Not retained	9119
137	200 - 400	50 - 60	Miscellaneous Debris	-	Not retained	9120
138	200 - 400	50 - 60	Miscellaneous Debris	-	Not retained	9121
139	200 - 400	50 - 60	Miscellaneous Debris	-	Not retained	9122
140	200 - 400	50 - 60	Miscellaneous Debris	-	Not retained	9123
141	200 - 400	50 - 60	Miscellaneous Debris	-	Not retained	9124
142	200 - 400	50 - 60	Miscellaneous Debris	-	Not retained	9125
143	200 - 400	50 - 60	Miscellaneous Debris	-	Not retained	9126
144	200 - 400	50 - 60	Miscellaneous Debris	-	Not retained	9127
145	200 - 400	50 - 60	Miscellaneous Debris	-	Not retained	9128
146	200 - 400	50 - 60	Miscellaneous Debris	-	Not retained	9129
147	200 - 400	50 - 60	Miscellaneous Debris	-	Not retained	9130
148	200 - 400	50 - 60	Miscellaneous Debris	-	Not retained	9131
149	200 - 400	50 - 60	Miscellaneous Debris	-	Not retained	9132
150	200 - 400	50 - 60	Miscellaneous Debris	-	Not retained	9133

NSWCDD/TR-98/6

TABLE B-6. FRAGMENTS RECOVERED BEYOND 200-FT RANGE IN TEST NO. 9 (Continued)

<u>Entry</u>	<u>Range Interval (ft)</u>	<u>Azimuthal Sector (°)</u>	<u>Description</u>	<u>Mass (lb)</u>	<u>Notes</u>	<u>G64 Index No.</u>
151	200 - 400	50 - 60	Miscellaneous Debris	-	Not retained	9134
152	200 - 400	50 - 60	Miscellaneous Debris	-	Not retained	9135
153	200 - 400	50 - 60	Miscellaneous Debris	-	Not retained	9136
154	200 - 400	50 - 60	Miscellaneous Debris	-	Not retained	9137
155	200 - 400	50 - 60	Intact Warhead	5.05		2328
156	200 - 400	60 - 70	Warhead Body Piece	0.46		2904
157	200 - 400	60 - 70	Warhead Body Piece	0.04		2905
158	200 - 400	60 - 70	Tail Piece	0.03		2906
159	200 - 400	60 - 70	Miscellaneous Debris	-	Not retained	9138
160	200 - 400	60 - 70	Miscellaneous Debris	-	Not retained	9139
161	200 - 400	60 - 70	Miscellaneous Debris	-	Not retained	9140
162	200 - 400	60 - 70	Miscellaneous Debris	-	Not retained	9141
163	200 - 400	60 - 70	Miscellaneous Debris	-	Not retained	9142
164	200 - 400	60 - 70	Miscellaneous Debris	-	Not retained	9143
165	200 - 400	60 - 70	Miscellaneous Debris	-	Not retained	9144
166	200 - 400	60 - 70	Miscellaneous Debris	-	Not retained	9145
167	200 - 400	60 - 70	Miscellaneous Debris	-	Not retained	9146
168	200 - 400	60 - 70	Miscellaneous Debris	-	Not retained	9147
169	200 - 400	60 - 70	Miscellaneous Debris	-	Not retained	9148
170	200 - 400	60 - 70	Miscellaneous Debris	-	Not retained	9149
171	200 - 400	60 - 70	Miscellaneous Debris	-	Not retained	9150
172	200 - 400	60 - 70	Miscellaneous Debris	-	Not retained	9151
173	200 - 400	60 - 70	Miscellaneous Debris	-	Not retained	9152
174	200 - 400	60 - 70	Miscellaneous Debris	-	Not retained	9153
175	200 - 400	60 - 70	Miscellaneous Debris	-	Not retained	9154
176	200 - 400	60 - 70	Miscellaneous Debris	-	Not retained	9155
177	200 - 400	60 - 70	Miscellaneous Debris	-	Not retained	9156
178	200 - 400	60 - 70	Miscellaneous Debris	-	Not retained	9157
179	200 - 400	60 - 70	Miscellaneous Debris	-	Not retained	9158
180	200 - 400	60 - 70	Miscellaneous Debris	-	Not retained	9159
181	200 - 400	60 - 70	Miscellaneous Debris	-	Not retained	9160
182	200 - 400	60 - 70	Miscellaneous Debris	-	Not retained	9161
183	200 - 400	60 - 70	Miscellaneous Debris	-	Not retained	9162
184	200 - 400	60 - 70	Miscellaneous Debris	-	Not retained	9163
185	200 - 400	60 - 70	Miscellaneous Debris	-	Not retained	9164
186	200 - 400	60 - 70	Miscellaneous Debris	-	Not retained	9165
187	200 - 400	60 - 70	Miscellaneous Debris	-	Not retained	9166
188	200 - 400	60 - 70	Miscellaneous Debris	-	Not retained	9167
189	200 - 400	60 - 70	Miscellaneous Debris	-	Not retained	9168
190	200 - 400	60 - 70	Miscellaneous Debris	-	Not retained	9169
191	200 - 400	60 - 70	Miscellaneous Debris	-	Not retained	9170
192	200 - 400	60 - 70	Miscellaneous Debris	-	Not retained	9171
193	200 - 400	60 - 70	Miscellaneous Debris	-	Not retained	9172
194	200 - 400	60 - 70	Miscellaneous Debris	-	Not retained	9173
195	200 - 400	60 - 70	Intact Warhead	5.05		2903
196	200 - 400	70 - 80	Warhead Body Piece	0.18		1684
197	200 - 400	70 - 80	Warhead Body Piece	0.01		1685
198	200 - 400	70 - 80	Warhead Body Piece	0.01		1686
199	200 - 400	70 - 80	Tail Piece	0.30		1687
200	200 - 400	70 - 80	Tail Piece	0.04		1688

NSWCDD/TR-98/6

TABLE B-6. FRAGMENTS RECOVERED BEYOND 200-FT RANGE IN TEST NO. 9 (Continued)

<u>Entry</u>	<u>Range Interval (ft)</u>	<u>Azimuthal Sector (°)</u>	<u>Description</u>	<u>Mass (lb)</u>	<u>Notes</u>	<u>G64 Index No.</u>
201	200 - 400	70 - 80	Tail Piece	0.03		1689
202	200 - 400	70 - 80	Miscellaneous Debris	-	Not retained	9174
203	200 - 400	70 - 80	Miscellaneous Debris	-	Not retained	9175
204	200 - 400	70 - 80	Miscellaneous Debris	-	Not retained	9176
205	200 - 400	70 - 80	Miscellaneous Debris	-	Not retained	9177
206	200 - 400	70 - 80	Miscellaneous Debris	-	Not retained	9178
207	200 - 400	70 - 80	Miscellaneous Debris	-	Not retained	9179
208	200 - 400	70 - 80	Miscellaneous Debris	-	Not retained	9180
209	200 - 400	70 - 80	Miscellaneous Debris	-	Not retained	9181
210	200 - 400	70 - 80	Miscellaneous Debris	-	Not retained	9182
211	200 - 400	70 - 80	Miscellaneous Debris	-	Not retained	9183
212	200 - 400	70 - 80	Miscellaneous Debris	-	Not retained	9184
213	200 - 400	70 - 80	Miscellaneous Debris	-	Not retained	9185
214	200 - 400	70 - 80	Miscellaneous Debris	-	Not retained	9186
215	200 - 400	70 - 80	Miscellaneous Debris	-	Not retained	9187
216	200 - 400	70 - 80	Miscellaneous Debris	-	Not retained	9188
217	200 - 400	70 - 80	Miscellaneous Debris	-	Not retained	9189
218	200 - 400	70 - 80	Miscellaneous Debris	-	Not retained	9190
219	200 - 400	70 - 80	Miscellaneous Debris	-	Not retained	9191
220	200 - 400	70 - 80	Miscellaneous Debris	-	Not retained	9192
221	200 - 400	70 - 80	Miscellaneous Debris	-	Not retained	9193
222	200 - 400	70 - 80	Miscellaneous Debris	-	Not retained	9194
223	200 - 400	70 - 80	Miscellaneous Debris	-	Not retained	9195
224	200 - 400	70 - 80	Miscellaneous Debris	-	Not retained	9196
225	200 - 400	70 - 80	Miscellaneous Debris	-	Not retained	9197
226	200 - 400	70 - 80	Miscellaneous Debris	-	Not retained	9198
227	200 - 400	70 - 80	Miscellaneous Debris	-	Not retained	9199
228	200 - 400	70 - 80	Miscellaneous Debris	-	Not retained	9200
229	200 - 400	70 - 80	Miscellaneous Debris	-	Not retained	9201
230	200 - 400	70 - 80	Miscellaneous Debris	-	Not retained	9202
231	200 - 400	70 - 80	Miscellaneous Debris	-	Not retained	9203
232	200 - 400	70 - 80	Miscellaneous Debris	-	Not retained	9204
233	200 - 400	70 - 80	Miscellaneous Debris	-	Not retained	9205
234	200 - 400	70 - 80	Miscellaneous Debris	-	Not retained	9206
235	200 - 400	70 - 80	Miscellaneous Debris	-	Not retained	9207
236	200 - 400	70 - 80	Miscellaneous Debris	-	Not retained	9208
237	200 - 400	70 - 80	Miscellaneous Debris	-	Not retained	9209
238	200 - 400	70 - 80	Miscellaneous Debris	-	Not retained	9210
239	200 - 400	70 - 80	Miscellaneous Debris	-	Not retained	9211
240	200 - 400	70 - 80	Miscellaneous Debris	-	Not retained	9212
241	200 - 400	70 - 80	Miscellaneous Debris	-	Not retained	9213
242	200 - 400	70 - 80	Miscellaneous Debris	-	Not retained	9214
243	200 - 400	70 - 80	Miscellaneous Debris	-	Not retained	9215
244	200 - 400	70 - 80	Miscellaneous Debris	-	Not retained	9216
245	200 - 400	70 - 80	Miscellaneous Debris	-	Not retained	9217
246	200 - 400	70 - 80	Miscellaneous Debris	-	Not retained	9218
247	200 - 400	70 - 80	Miscellaneous Debris	-	Not retained	9219
248	200 - 400	70 - 80	Miscellaneous Debris	-	Not retained	9220
249	200 - 400	70 - 80	Miscellaneous Debris	-	Not retained	9221
250	200 - 400	70 - 80	Miscellaneous Debris	-	Not retained	9222

TABLE B-6. FRAGMENTS RECOVERED BEYOND 200-FT RANGE IN TEST NO. 9 (Continued)

<u>Entry</u>	<u>Range Interval (ft)</u>	<u>Azimuthal Sector (°)</u>	<u>Description</u>	<u>Mass (lb)</u>	<u>Notes</u>	<u>G64 Index No.</u>
251	200 - 400	70 - 80	Miscellaneous Debris	-	Not retained	9223
252	200 - 400	70 - 80	Miscellaneous Debris	-	Not retained	9224
253	200 - 400	70 - 80	Miscellaneous Debris	-	Not retained	9225
254	200 - 400	70 - 80	Miscellaneous Debris	-	Not retained	9226
255	200 - 400	70 - 80	Miscellaneous Debris	-	Not retained	9227
256	200 - 400	70 - 80	Miscellaneous Debris	-	Not retained	9228
257	200 - 400	70 - 80	Miscellaneous Debris	-	Not retained	9229
258	200 - 400	70 - 80	Miscellaneous Debris	-	Not retained	9230
259	200 - 400	70 - 80	Miscellaneous Debris	-	Not retained	9231
260	200 - 400	70 - 80	Miscellaneous Debris	-	Not retained	9232
261	200 - 400	70 - 80	Miscellaneous Debris	-	Not retained	9233
262	200 - 400	70 - 80	Miscellaneous Debris	-	Not retained	9234
263	200 - 400	70 - 80	Miscellaneous Debris	-	Not retained	9235
264	200 - 400	70 - 80	Miscellaneous Debris	-	Not retained	9236
265	200 - 400	70 - 80	Miscellaneous Debris	-	Not retained	9237
266	200 - 400	70 - 80	Miscellaneous Debris	-	Not retained	9238
267	200 - 400	70 - 80	Miscellaneous Debris	-	Not retained	9239
268	200 - 400	70 - 80	Miscellaneous Debris	-	Not retained	9240
269	200 - 400	70 - 80	Miscellaneous Debris	-	Not retained	9241
270	200 - 400	70 - 80	Miscellaneous Debris	-	Not retained	9242
271	200 - 400	70 - 80	Miscellaneous Debris	-	Not retained	9243
272	200 - 400	70 - 80	Miscellaneous Debris	-	Not retained	9244
273	200 - 400	70 - 80	Miscellaneous Debris	-	Not retained	9245
274	200 - 400	70 - 80	Miscellaneous Debris	-	Not retained	9246
275	200 - 400	70 - 80	Miscellaneous Debris	-	Not retained	9247
276	200 - 400	70 - 80	Miscellaneous Debris	-	Not retained	9248
277	200 - 400	70 - 80	Miscellaneous Debris	-	Not retained	9249
278	200 - 400	70 - 80	Miscellaneous Debris	-	Not retained	9250
279	200 - 400	70 - 80	Miscellaneous Debris	-	Not retained	9251
280	200 - 400	70 - 80	Miscellaneous Debris	-	Not retained	9252
281	200 - 400	70 - 80	Miscellaneous Debris	-	Not retained	9253
282	200 - 400	70 - 80	Miscellaneous Debris	-	Not retained	9254
283	200 - 400	70 - 80	Miscellaneous Debris	-	Not retained	9255
284	200 - 400	70 - 80	Miscellaneous Debris	-	Not retained	9256
285	200 - 400	70 - 80	Miscellaneous Debris	-	Not retained	9257
286	200 - 400	70 - 80	Miscellaneous Debris	-	Not retained	9258
287	200 - 400	70 - 80	Miscellaneous Debris	-	Not retained	9259
288	200 - 400	70 - 80	Miscellaneous Debris	-	Not retained	9260
289	200 - 400	70 - 80	Miscellaneous Debris	-	Not retained	9261
290	200 - 400	70 - 80	Miscellaneous Debris	-	Not retained	9262
291	200 - 400	70 - 80	Miscellaneous Debris	-	Not retained	9263
292	200 - 400	70 - 80	Miscellaneous Debris	-	Not retained	9264
293	200 - 400	70 - 80	Miscellaneous Debris	-	Not retained	9265
294	200 - 400	70 - 80	Miscellaneous Debris	-	Not retained	9266
295	200 - 400	70 - 80	Miscellaneous Debris	-	Not retained	9267
296	200 - 400	70 - 80	Miscellaneous Debris	-	Not retained	9268
297	200 - 400	70 - 80	Miscellaneous Debris	-	Not retained	9269
298	200 - 400	70 - 80	Intact Warhead	5.05		1682
299	200 - 400	70 - 80	Intact Warhead	5.05		1683
300	200 - 400	80 - 90	Warhead Body Piece	0.32		2179

TABLE B-6. FRAGMENTS RECOVERED BEYOND 200-FT RANGE IN TEST NO. 9 (Continued)

<u>Entry</u>	<u>Range Interval (ft)</u>	<u>Azimuthal Sector (°)</u>	<u>Description</u>	<u>Mass (lb)</u>	<u>Notes</u>	<u>G64 Index No.</u>
301	200 - 400	80 - 90	Warhead Body Piece	0.28		2180
302	200 - 400	80 - 90	Warhead Body Piece	0.23		2181
303	200 - 400	80 - 90	Warhead Body Piece	0.22		2182
304	200 - 400	80 - 90	Warhead Body Piece	0.12		2183
305	200 - 400	80 - 90	Warhead Body Piece	0.08		2184
306	200 - 400	80 - 90	Warhead Body Piece	0.02		2185
307	200 - 400	80 - 90	Warhead Body Piece	0.01		2186
308	200 - 400	80 - 90	Warhead Body Piece	0.01		2187
309	200 - 400	80 - 90	Warhead Body Piece	0.01		2188
310	200 - 400	80 - 90	Tail Piece	0.43		2191
311	200 - 400	80 - 90	Tail Piece	0.19		2192
312	200 - 400	80 - 90	Tail Piece	0.04		2193
313	200 - 400	80 - 90	Tail Piece	0.03		2194
314	200 - 400	80 - 90	Tail Piece	0.02		2195
315	200 - 400	80 - 90	Tail Piece	0.02		2196
316	200 - 400	80 - 90	Tail Piece	0.01		2197
317	200 - 400	80 - 90	Tail Piece	0.01		2198
318	200 - 400	80 - 90	Tail Piece	0.01		3153
319	200 - 400	80 - 90	Miscellaneous Debris	0.01		2199
320	200 - 400	80 - 90	Miscellaneous Debris	0.01		3154
321	200 - 400	80 - 90	Miscellaneous Debris	0.01		2189
322	200 - 400	80 - 90	Miscellaneous Debris	0.01		2190
323	200 - 400	80 - 90	Miscellaneous Debris	-	Not retained	9270
324	200 - 400	80 - 90	Miscellaneous Debris	-	Not retained	9271
325	200 - 400	80 - 90	Miscellaneous Debris	-	Not retained	9272
326	200 - 400	80 - 90	Miscellaneous Debris	-	Not retained	9273
327	200 - 400	80 - 90	Miscellaneous Debris	-	Not retained	9274
328	200 - 400	80 - 90	Miscellaneous Debris	-	Not retained	9275
329	200 - 400	80 - 90	Miscellaneous Debris	-	Not retained	9276
330	200 - 400	80 - 90	Miscellaneous Debris	-	Not retained	9277
331	200 - 400	80 - 90	Miscellaneous Debris	-	Not retained	9278
332	200 - 400	80 - 90	Miscellaneous Debris	-	Not retained	9279
333	200 - 400	80 - 90	Miscellaneous Debris	-	Not retained	9280
334	200 - 400	80 - 90	Miscellaneous Debris	-	Not retained	9281
335	200 - 400	80 - 90	Miscellaneous Debris	-	Not retained	9282
336	200 - 400	80 - 90	Miscellaneous Debris	-	Not retained	9283
337	200 - 400	80 - 90	Miscellaneous Debris	-	Not retained	9284
338	200 - 400	80 - 90	Miscellaneous Debris	-	Not retained	9285
339	200 - 400	80 - 90	Miscellaneous Debris	-	Not retained	9286
340	200 - 400	80 - 90	Miscellaneous Debris	-	Not retained	9287
341	200 - 400	80 - 90	Miscellaneous Debris	-	Not retained	9288
342	200 - 400	80 - 90	Miscellaneous Debris	-	Not retained	9289
343	200 - 400	80 - 90	Miscellaneous Debris	-	Not retained	9290
344	200 - 400	80 - 90	Miscellaneous Debris	-	Not retained	9291
345	200 - 400	80 - 90	Miscellaneous Debris	-	Not retained	9292
346	200 - 400	80 - 90	Miscellaneous Debris	-	Not retained	9293
347	200 - 400	80 - 90	Miscellaneous Debris	-	Not retained	9294
348	200 - 400	80 - 90	Miscellaneous Debris	-	Not retained	9295
349	200 - 400	80 - 90	Miscellaneous Debris	-	Not retained	9296
350	200 - 400	80 - 90	Miscellaneous Debris	-	Not retained	9297

TABLE B-6. FRAGMENTS RECOVERED BEYOND 200-FT RANGE IN TEST NO. 9 (Continued)

<u>Entry</u>	<u>Range Interval (ft)</u>	<u>Azimuthal Sector (°)</u>	<u>Description</u>	<u>Mass (lb)</u>	<u>Notes</u>	<u>G64 Index No.</u>
351	200 - 400	80 - 90	Miscellaneous Debris	-	Not retained	9298
352	200 - 400	80 - 90	Miscellaneous Debris	-	Not retained	9299
353	200 - 400	80 - 90	Miscellaneous Debris	-	Not retained	9300
354	200 - 400	80 - 90	Miscellaneous Debris	-	Not retained	9301
355	200 - 400	80 - 90	Miscellaneous Debris	-	Not retained	9302
356	200 - 400	80 - 90	Miscellaneous Debris	-	Not retained	9303
357	200 - 400	80 - 90	Miscellaneous Debris	-	Not retained	9304
358	200 - 400	80 - 90	Miscellaneous Debris	-	Not retained	9305
359	200 - 400	80 - 90	Miscellaneous Debris	-	Not retained	9306
360	200 - 400	80 - 90	Miscellaneous Debris	-	Not retained	9307
361	200 - 400	80 - 90	Miscellaneous Debris	-	Not retained	9308
362	200 - 400	80 - 90	Miscellaneous Debris	-	Not retained	9309
363	200 - 400	80 - 90	Miscellaneous Debris	-	Not retained	9310
364	200 - 400	80 - 90	Miscellaneous Debris	-	Not retained	9311
365	200 - 400	80 - 90	Miscellaneous Debris	-	Not retained	9312
366	200 - 400	80 - 90	Miscellaneous Debris	-	Not retained	9313
367	200 - 400	80 - 90	Miscellaneous Debris	-	Not retained	9314
368	200 - 400	80 - 90	Miscellaneous Debris	-	Not retained	9315
369	200 - 400	80 - 90	Miscellaneous Debris	-	Not retained	9316
370	200 - 400	80 - 90	Miscellaneous Debris	-	Not retained	9317
371	200 - 400	80 - 90	Miscellaneous Debris	-	Not retained	9318
372	200 - 400	80 - 90	Miscellaneous Debris	-	Not retained	9319
373	200 - 400	80 - 90	Miscellaneous Debris	-	Not retained	9320
374	200 - 400	80 - 90	Miscellaneous Debris	-	Not retained	9321
375	200 - 400	80 - 90	Miscellaneous Debris	-	Not retained	9322
376	200 - 400	80 - 90	Miscellaneous Debris	-	Not retained	9323
377	200 - 400	80 - 90	Miscellaneous Debris	-	Not retained	9324
378	200 - 400	80 - 90	Miscellaneous Debris	-	Not retained	9325
379	200 - 400	80 - 90	Miscellaneous Debris	-	Not retained	9326
380	200 - 400	80 - 90	Miscellaneous Debris	-	Not retained	9327
381	200 - 400	80 - 90	Miscellaneous Debris	-	Not retained	9328
382	200 - 400	80 - 90	Miscellaneous Debris	-	Not retained	9329
383	200 - 400	80 - 90	Miscellaneous Debris	-	Not retained	9330
384	200 - 400	80 - 90	Miscellaneous Debris	-	Not retained	9331
385	200 - 400	80 - 90	Miscellaneous Debris	-	Not retained	9332
386	200 - 400	80 - 90	Miscellaneous Debris	-	Not retained	9333
387	200 - 400	80 - 90	Miscellaneous Debris	-	Not retained	9334
388	200 - 400	80 - 90	Miscellaneous Debris	-	Not retained	9335
389	200 - 400	80 - 90	Miscellaneous Debris	-	Not retained	9336
390	200 - 400	80 - 90	Miscellaneous Debris	-	Not retained	9337
391	200 - 400	80 - 90	Miscellaneous Debris	-	Not retained	9338
392	200 - 400	80 - 90	Miscellaneous Debris	-	Not retained	9339
393	200 - 400	80 - 90	Miscellaneous Debris	-	Not retained	9340
394	200 - 400	80 - 90	Miscellaneous Debris	-	Not retained	9341
395	200 - 400	80 - 90	Miscellaneous Debris	-	Not retained	9342
396	200 - 400	80 - 90	Miscellaneous Debris	-	Not retained	9343
397	200 - 400	80 - 90	Miscellaneous Debris	-	Not retained	9344
398	200 - 400	80 - 90	Miscellaneous Debris	-	Not retained	9345
399	200 - 400	80 - 90	Miscellaneous Debris	-	Not retained	9346
400	200 - 400	80 - 90	Miscellaneous Debris	-	Not retained	9347

TABLE B-6. FRAGMENTS RECOVERED BEYOND 200-FT RANGE IN TEST NO. 9 (Continued)

<u>Entry</u>	<u>Range Interval (ft)</u>	<u>Azimuthal Sector (°)</u>	<u>Description</u>	<u>Mass (lb)</u>	<u>Notes</u>	<u>G64 Index No.</u>
401	200 - 400	80 - 90	Miscellaneous Debris	-	Not retained	9348
402	200 - 400	80 - 90	Miscellaneous Debris	-	Not retained	9349
403	200 - 400	80 - 90	Miscellaneous Debris	-	Not retained	9350
404	200 - 400	80 - 90	Miscellaneous Debris	-	Not retained	9351
405	200 - 400	80 - 90	Miscellaneous Debris	-	Not retained	9352
406	200 - 400	80 - 90	Miscellaneous Debris	-	Not retained	9353
407	200 - 400	80 - 90	Miscellaneous Debris	-	Not retained	9354
408	200 - 400	80 - 90	Miscellaneous Debris	-	Not retained	9355
409	200 - 400	80 - 90	Miscellaneous Debris	-	Not retained	9356
410	200 - 400	80 - 90	Miscellaneous Debris	-	Not retained	9357
411	200 - 400	80 - 90	Miscellaneous Debris	-	Not retained	9358
412	200 - 400	80 - 90	Miscellaneous Debris	-	Not retained	9359
413	200 - 400	80 - 90	Miscellaneous Debris	-	Not retained	9360
414	200 - 400	80 - 90	Miscellaneous Debris	-	Not retained	9361
415	200 - 400	80 - 90	Miscellaneous Debris	-	Not retained	9362
416	200 - 400	80 - 90	Miscellaneous Debris	-	Not retained	9363
417	200 - 400	80 - 90	Miscellaneous Debris	-	Not retained	9364
418	200 - 400	80 - 90	Miscellaneous Debris	-	Not retained	9365
419	200 - 400	80 - 90	Miscellaneous Debris	-	Not retained	9366
420	200 - 400	80 - 90	Miscellaneous Debris	-	Not retained	9367
421	200 - 400	80 - 90	Miscellaneous Debris	-	Not retained	9368
422	200 - 400	80 - 90	Miscellaneous Debris	-	Not retained	9369
423	200 - 400	80 - 90	Miscellaneous Debris	-	Not retained	9370
424	200 - 400	80 - 90	Miscellaneous Debris	-	Not retained	9371
425	200 - 400	80 - 90	Miscellaneous Debris	-	Not retained	9372
426	200 - 400	80 - 90	Miscellaneous Debris	-	Not retained	9373
427	200 - 400	80 - 90	Miscellaneous Debris	-	Not retained	9374
428	200 - 400	80 - 90	Miscellaneous Debris	-	Not retained	9375
429	200 - 400	80 - 90	Miscellaneous Debris	-	Not retained	9376
430	200 - 400	80 - 90	Miscellaneous Debris	-	Not retained	9377
431	200 - 400	80 - 90	Miscellaneous Debris	-	Not retained	9378
432	200 - 400	80 - 90	Miscellaneous Debris	-	Not retained	9379
433	200 - 400	80 - 90	Miscellaneous Debris	-	Not retained	9380
434	200 - 400	80 - 90	Miscellaneous Debris	-	Not retained	9381
435	200 - 400	90 - 100	Warhead Body Piece	0.52		1937
436	200 - 400	90 - 100	Warhead Body Piece	0.29		1938
437	200 - 400	90 - 100	Warhead Body Piece	0.18		1939
438	200 - 400	90 - 100	Warhead Body Piece	0.09		1940
439	200 - 400	90 - 100	Warhead Body Piece	0.08		1941
440	200 - 400	90 - 100	Warhead Body Piece	0.05		1942
441	200 - 400	90 - 100	Warhead Body Piece	0.02		1943
442	200 - 400	90 - 100	Warhead Body Piece	0.04		1944
443	200 - 400	90 - 100	Warhead Body Piece	0.04		1945
444	200 - 400	90 - 100	Warhead Body Piece	0.04		1946
445	200 - 400	90 - 100	Warhead Body Piece	0.04		1947
446	200 - 400	90 - 100	Warhead Body Piece	0.04		1948
447	200 - 400	90 - 100	Warhead Body Piece	0.03		1949
448	200 - 400	90 - 100	Warhead Body Piece	0.03		1950
449	200 - 400	90 - 100	Warhead Body Piece	0.02		1951
450	200 - 400	90 - 100	Warhead Body Piece	0.02		1952

TABLE B-6. FRAGMENTS RECOVERED BEYOND 200-FT RANGE IN TEST NO. 9 (Continued)

<u>Entry</u>	<u>Range Interval (ft)</u>	<u>Azimuthal Sector (°)</u>	<u>Description</u>	<u>Mass (lb)</u>	<u>Notes</u>	<u>G64 Index No.</u>
451	200 - 400	90 - 100	Warhead Body Piece	0.03		1953
452	200 - 400	90 - 100	Warhead Body Piece	0.02		1954
453	200 - 400	90 - 100	Warhead Body Piece	0.02		1955
454	200 - 400	90 - 100	Warhead Body Piece	0.03		1956
455	200 - 400	90 - 100	Warhead Body Piece	0.02		1957
456	200 - 400	90 - 100	Warhead Body Piece	0.02		1958
457	200 - 400	90 - 100	Warhead Body Piece	0.01		1959
458	200 - 400	90 - 100	Warhead Body Piece	0.01		1960
459	200 - 400	90 - 100	Warhead Body Piece	0.01		1961
460	200 - 400	90 - 100	Warhead Body Piece	0.01		1962
461	200 - 400	90 - 100	Warhead Body Piece	0.01		1963
462	200 - 400	90 - 100	Warhead Body Piece	0.01		1964
463	200 - 400	90 - 100	Warhead Body Piece	0.01		1965
464	200 - 400	90 - 100	Warhead Body Piece	0.01		1966
465	200 - 400	90 - 100	Warhead Body Piece	0.01		1967
466	200 - 400	90 - 100	Warhead Body Piece	0.01		1968
467	200 - 400	90 - 100	Warhead Body Piece	0.01		1969
468	200 - 400	90 - 100	Warhead Body Piece	0.01		1970
469	200 - 400	90 - 100	Warhead Body Piece	0.01		1971
470	200 - 400	90 - 100	Warhead Body Piece	0.01		1972
471	200 - 400	90 - 100	Warhead Body Piece	0.01		1973
472	200 - 400	90 - 100	Warhead Body Piece	0.01		1974
473	200 - 400	90 - 100	Warhead Body Piece	0.01		1975
474	200 - 400	90 - 100	Warhead Body Piece	0.01		1976
475	200 - 400	90 - 100	Warhead Body Piece	0.01		1977
476	200 - 400	90 - 100	Warhead Body Piece	0.01		1978
477	200 - 400	90 - 100	Warhead Body Piece	0.01		1979
478	200 - 400	90 - 100	Warhead Body Piece	0.01		1980
479	200 - 400	90 - 100	Warhead Body Piece	0.01		1981
480	200 - 400	90 - 100	Warhead Body Piece	0.01		1982
481	200 - 400	90 - 100	Warhead Body Piece	0.01		1983
482	200 - 400	90 - 100	Warhead Body Piece	0.01		1984
483	200 - 400	90 - 100	Warhead Body Piece	0.01		1985
484	200 - 400	90 - 100	Warhead Body Piece	0.01		1986
485	200 - 400	90 - 100	Warhead Body Piece	0.01		1987
486	200 - 400	90 - 100	Warhead Body Piece	0.01		1988
487	200 - 400	90 - 100	Warhead Body Piece	0.02		2056
488	200 - 400	90 - 100	Tail Piece	0.18		1996
489	200 - 400	90 - 100	Tail Piece	0.06		1997
490	200 - 400	90 - 100	Tail Piece	0.03		1998
491	200 - 400	90 - 100	Tail Piece	0.02		1999
492	200 - 400	90 - 100	Tail Piece	0.02		2000
493	200 - 400	90 - 100	Tail Piece	0.02		2001
494	200 - 400	90 - 100	Tail Piece	0.02		2002
495	200 - 400	90 - 100	Tail Piece	0.02		2003
496	200 - 400	90 - 100	Tail Piece	0.02		2004
497	200 - 400	90 - 100	Tail Piece	0.01		2005
498	200 - 400	90 - 100	Tail Piece	0.01		2006
499	200 - 400	90 - 100	Tail Piece	0.01		2007
500	200 - 400	90 - 100	Tail Piece	0.01		2008

NSWCDD/TR-98/6

TABLE B-6. FRAGMENTS RECOVERED BEYOND 200-FT RANGE IN TEST NO. 9 (Continued)

<u>Entry</u>	<u>Range Interval (ft)</u>	<u>Azimuthal Sector (°)</u>	<u>Description</u>	<u>Mass (lb)</u>	<u>Notes</u>	<u>G64 Index No.</u>
501	200 - 400	90 - 100	Tail Piece	0.01		2009
502	200 - 400	90 - 100	Tail Piece	0.01		2057
503	200 - 400	90 - 100	Miscellaneous Debris	0.01		2010
504	200 - 400	90 - 100	Miscellaneous Debris	0.01		2011
505	200 - 400	90 - 100	Miscellaneous Debris	0.01		2012
506	200 - 400	90 - 100	Miscellaneous Debris	0.01		2013
507	200 - 400	90 - 100	Miscellaneous Debris	0.01		2014
508	200 - 400	90 - 100	Miscellaneous Debris	0.01		2015
509	200 - 400	90 - 100	Miscellaneous Debris	0.01		2016
510	200 - 400	90 - 100	Miscellaneous Debris	0.01		2017
511	200 - 400	90 - 100	Miscellaneous Debris	0.01		2018
512	200 - 400	90 - 100	Miscellaneous Debris	0.01		1989
513	200 - 400	90 - 100	Miscellaneous Debris	0.01		1990
514	200 - 400	90 - 100	Miscellaneous Debris	0.01		1991
515	200 - 400	90 - 100	Miscellaneous Debris	0.01		1992
516	200 - 400	90 - 100	Miscellaneous Debris	0.01		1993
517	200 - 400	90 - 100	Miscellaneous Debris	0.01		1994
518	200 - 400	90 - 100	Miscellaneous Debris	0.01		1995
519	200 - 400	90 - 100	Miscellaneous Debris	0.01		2019
520	200 - 400	90 - 100	Miscellaneous Debris	-	Not retained	9382
521	200 - 400	90 - 100	Miscellaneous Debris	-	Not retained	9383
522	200 - 400	90 - 100	Miscellaneous Debris	-	Not retained	9384
523	200 - 400	90 - 100	Miscellaneous Debris	-	Not retained	9385
524	200 - 400	90 - 100	Miscellaneous Debris	-	Not retained	9386
525	200 - 400	90 - 100	Miscellaneous Debris	-	Not retained	9387
526	200 - 400	90 - 100	Miscellaneous Debris	-	Not retained	9388
527	200 - 400	90 - 100	Miscellaneous Debris	-	Not retained	9389
528	200 - 400	90 - 100	Miscellaneous Debris	-	Not retained	9390
529	200 - 400	90 - 100	Miscellaneous Debris	-	Not retained	9391
530	200 - 400	90 - 100	Miscellaneous Debris	-	Not retained	9392
531	200 - 400	90 - 100	Miscellaneous Debris	-	Not retained	9393
532	200 - 400	90 - 100	Miscellaneous Debris	-	Not retained	9394
533	200 - 400	90 - 100	Miscellaneous Debris	-	Not retained	9395
534	200 - 400	90 - 100	Miscellaneous Debris	-	Not retained	9396
535	200 - 400	90 - 100	Miscellaneous Debris	-	Not retained	9397
536	200 - 400	90 - 100	Miscellaneous Debris	-	Not retained	9398
537	200 - 400	90 - 100	Miscellaneous Debris	-	Not retained	9399
538	200 - 400	90 - 100	Miscellaneous Debris	-	Not retained	9400
539	200 - 400	90 - 100	Miscellaneous Debris	-	Not retained	9401
540	200 - 400	90 - 100	Miscellaneous Debris	-	Not retained	9402
541	200 - 400	90 - 100	Miscellaneous Debris	-	Not retained	9403
542	200 - 400	90 - 100	Miscellaneous Debris	-	Not retained	9404
543	200 - 400	90 - 100	Miscellaneous Debris	-	Not retained	9405
544	200 - 400	90 - 100	Miscellaneous Debris	-	Not retained	9406
545	200 - 400	90 - 100	Miscellaneous Debris	-	Not retained	9407
546	200 - 400	90 - 100	Miscellaneous Debris	-	Not retained	9408
547	200 - 400	90 - 100	Miscellaneous Debris	-	Not retained	9409
548	200 - 400	90 - 100	Miscellaneous Debris	-	Not retained	9410
549	200 - 400	90 - 100	Miscellaneous Debris	-	Not retained	9411
550	200 - 400	90 - 100	Miscellaneous Debris	-	Not retained	9412

TABLE B-6. FRAGMENTS RECOVERED BEYOND 200-FT RANGE IN TEST NO. 9 (Continued)

<u>Entry</u>	<u>Range Interval (ft)</u>	<u>Azimuthal Sector (°)</u>	<u>Description</u>	<u>Mass (lb)</u>	<u>Notes</u>	<u>G64 Index No.</u>
551	200 - 400	90 - 100	Miscellaneous Debris	-	Not retained	9413
552	200 - 400	90 - 100	Miscellaneous Debris	-	Not retained	9414
553	200 - 400	90 - 100	Miscellaneous Debris	-	Not retained	9415
554	200 - 400	90 - 100	Miscellaneous Debris	-	Not retained	9416
555	200 - 400	90 - 100	Miscellaneous Debris	-	Not retained	9417
556	200 - 400	90 - 100	Miscellaneous Debris	-	Not retained	9418
557	200 - 400	90 - 100	Miscellaneous Debris	-	Not retained	9419
558	200 - 400	90 - 100	Miscellaneous Debris	-	Not retained	9420
559	200 - 400	90 - 100	Miscellaneous Debris	-	Not retained	9421
560	200 - 400	90 - 100	Miscellaneous Debris	-	Not retained	9422
561	200 - 400	90 - 100	Miscellaneous Debris	-	Not retained	9423
562	200 - 400	90 - 100	Miscellaneous Debris	-	Not retained	9424
563	200 - 400	90 - 100	Miscellaneous Debris	-	Not retained	9425
564	200 - 400	90 - 100	Miscellaneous Debris	-	Not retained	9426
565	200 - 400	90 - 100	Miscellaneous Debris	-	Not retained	9427
566	200 - 400	90 - 100	Miscellaneous Debris	-	Not retained	9428
567	200 - 400	90 - 100	Miscellaneous Debris	-	Not retained	9429
568	200 - 400	90 - 100	Miscellaneous Debris	-	Not retained	9430
569	200 - 400	90 - 100	Miscellaneous Debris	-	Not retained	9431
570	200 - 400	90 - 100	Miscellaneous Debris	-	Not retained	9432
571	200 - 400	90 - 100	Miscellaneous Debris	-	Not retained	9433
572	200 - 400	90 - 100	Miscellaneous Debris	-	Not retained	9434
573	200 - 400	90 - 100	Miscellaneous Debris	-	Not retained	9435
574	200 - 400	90 - 100	Miscellaneous Debris	-	Not retained	9436
575	200 - 400	90 - 100	Miscellaneous Debris	-	Not retained	9437
576	200 - 400	90 - 100	Miscellaneous Debris	-	Not retained	9438
577	200 - 400	90 - 100	Miscellaneous Debris	-	Not retained	9439
578	200 - 400	90 - 100	Miscellaneous Debris	-	Not retained	9440
579	200 - 400	90 - 100	Miscellaneous Debris	-	Not retained	9441
580	200 - 400	90 - 100	Miscellaneous Debris	-	Not retained	9442
581	200 - 400	90 - 100	Miscellaneous Debris	-	Not retained	9443
582	200 - 400	90 - 100	Miscellaneous Debris	-	Not retained	9444
583	200 - 400	90 - 100	Miscellaneous Debris	-	Not retained	9445
584	200 - 400	90 - 100	Miscellaneous Debris	-	Not retained	9446
585	200 - 400	90 - 100	Miscellaneous Debris	-	Not retained	9447
586	200 - 400	90 - 100	Miscellaneous Debris	-	Not retained	9448
587	200 - 400	90 - 100	Miscellaneous Debris	-	Not retained	9449
588	200 - 400	90 - 100	Miscellaneous Debris	-	Not retained	9450
589	200 - 400	90 - 100	Miscellaneous Debris	-	Not retained	9451
590	200 - 400	90 - 100	Miscellaneous Debris	-	Not retained	9452
591	200 - 400	90 - 100	Miscellaneous Debris	-	Not retained	9453
592	200 - 400	90 - 100	Miscellaneous Debris	-	Not retained	9454
593	200 - 400	90 - 100	Miscellaneous Debris	-	Not retained	9455
594	200 - 400	90 - 100	Miscellaneous Debris	-	Not retained	9456
595	200 - 400	90 - 100	Miscellaneous Debris	-	Not retained	9457
596	200 - 400	90 - 100	Miscellaneous Debris	-	Not retained	9458
597	200 - 400	90 - 100	Miscellaneous Debris	-	Not retained	9459
598	200 - 400	90 - 100	Miscellaneous Debris	-	Not retained	9460
599	200 - 400	90 - 100	Miscellaneous Debris	-	Not retained	9461
600	200 - 400	90 - 100	Miscellaneous Debris	-	Not retained	9462

TABLE B-6. FRAGMENTS RECOVERED BEYOND 200-FT RANGE IN TEST NO. 9 (Continued)

<u>Entry</u>	<u>Range Interval (ft)</u>	<u>Azimuthal Sector (°)</u>	<u>Description</u>	<u>Mass (lb)</u>	<u>Notes</u>	<u>G64 Index No.</u>
601	200 - 400	90 - 100	Miscellaneous Debris	-	Not retained	9463
602	200 - 400	90 - 100	Miscellaneous Debris	-	Not retained	9464
603	200 - 400	90 - 100	Miscellaneous Debris	-	Not retained	9465
604	200 - 400	90 - 100	Miscellaneous Debris	-	Not retained	9466
605	200 - 400	90 - 100	Miscellaneous Debris	-	Not retained	9467
606	200 - 400	90 - 100	Miscellaneous Debris	-	Not retained	9468
607	200 - 400	90 - 100	Miscellaneous Debris	-	Not retained	9469
608	200 - 400	90 - 100	Miscellaneous Debris	-	Not retained	9470
609	200 - 400	90 - 100	Miscellaneous Debris	-	Not retained	9471
610	200 - 400	90 - 100	Miscellaneous Debris	-	Not retained	9472
611	200 - 400	90 - 100	Miscellaneous Debris	-	Not retained	9473
612	200 - 400	90 - 100	Miscellaneous Debris	-	Not retained	9474
613	200 - 400	90 - 100	Miscellaneous Debris	-	Not retained	9475
614	200 - 400	90 - 100	Miscellaneous Debris	-	Not retained	9476
615	200 - 400	90 - 100	Miscellaneous Debris	-	Not retained	9477
616	200 - 400	90 - 100	Miscellaneous Debris	-	Not retained	9478
617	200 - 400	90 - 100	Miscellaneous Debris	-	Not retained	9479
618	200 - 400	90 - 100	Miscellaneous Debris	-	Not retained	9480
619	200 - 400	90 - 100	Miscellaneous Debris	-	Not retained	9481
620	200 - 400	90 - 100	Miscellaneous Debris	-	Not retained	9482
621	200 - 400	90 - 100	Miscellaneous Debris	-	Not retained	9483
622	200 - 400	90 - 100	Miscellaneous Debris	-	Not retained	9484
623	200 - 400	90 - 100	Miscellaneous Debris	-	Not retained	9485
624	200 - 400	90 - 100	Miscellaneous Debris	-	Not retained	9486
625	200 - 400	90 - 100	Miscellaneous Debris	-	Not retained	9487
626	200 - 400	90 - 100	Miscellaneous Debris	-	Not retained	9488
627	200 - 400	90 - 100	Miscellaneous Debris	-	Not retained	9489
628	200 - 400	90 - 100	Miscellaneous Debris	-	Not retained	9490
629	200 - 400	90 - 100	Miscellaneous Debris	-	Not retained	9491
630	200 - 400	90 - 100	Miscellaneous Debris	-	Not retained	9492
631	200 - 400	90 - 100	Miscellaneous Debris	-	Not retained	9493
632	200 - 400	90 - 100	Miscellaneous Debris	-	Not retained	9494
633	200 - 400	90 - 100	Miscellaneous Debris	-	Not retained	9495
634	200 - 400	90 - 100	Miscellaneous Debris	-	Not retained	9496
635	200 - 400	90 - 100	Miscellaneous Debris	-	Not retained	9497
636	200 - 400	90 - 100	Miscellaneous Debris	-	Not retained	9498
637	200 - 400	90 - 100	Miscellaneous Debris	-	Not retained	9499
638	200 - 400	90 - 100	Miscellaneous Debris	-	Not retained	9500
639	200 - 400	90 - 100	Miscellaneous Debris	-	Not retained	9501
640	200 - 400	90 - 100	Miscellaneous Debris	-	Not retained	9502
641	200 - 400	90 - 100	Miscellaneous Debris	-	Not retained	9503
642	200 - 400	90 - 100	Miscellaneous Debris	-	Not retained	9504
643	200 - 400	90 - 100	Miscellaneous Debris	-	Not retained	9505
644	200 - 400	90 - 100	Miscellaneous Debris	-	Not retained	9506
645	200 - 400	90 - 100	Miscellaneous Debris	-	Not retained	9507
646	200 - 400	90 - 100	Miscellaneous Debris	-	Not retained	9508
647	200 - 400	90 - 100	Miscellaneous Debris	-	Not retained	9509
648	200 - 400	90 - 100	Miscellaneous Debris	-	Not retained	9510
649	200 - 400	90 - 100	Miscellaneous Debris	-	Not retained	9511
650	200 - 400	90 - 100	Miscellaneous Debris	-	Not retained	9512

NSWCDD/TR-98/6

TABLE B-6. FRAGMENTS RECOVERED BEYOND 200-FT RANGE IN TEST NO. 9 (Continued)

<u>Entry</u>	<u>Range Interval (ft)</u>	<u>Azimuthal Sector (°)</u>	<u>Description</u>	<u>Mass (lb)</u>	<u>Notes</u>	<u>G64 Index No.</u>
651	200 - 400	90 - 100	Miscellaneous Debris	-	Not retained	9513
652	200 - 400	90 - 100	Miscellaneous Debris	-	Not retained	9514
653	200 - 400	90 - 100	Miscellaneous Debris	-	Not retained	9515
654	200 - 400	90 - 100	Miscellaneous Debris	-	Not retained	9516
655	200 - 400	90 - 100	Miscellaneous Debris	-	Not retained	9517
656	200 - 400	90 - 100	Miscellaneous Debris	-	Not retained	9518
657	200 - 400	90 - 100	Miscellaneous Debris	-	Not retained	9519
658	200 - 400	90 - 100	Miscellaneous Debris	-	Not retained	9520
659	200 - 400	90 - 100	Miscellaneous Debris	-	Not retained	9521
660	200 - 400	90 - 100	Miscellaneous Debris	-	Not retained	9522
661	200 - 400	90 - 100	Miscellaneous Debris	-	Not retained	9523
662	200 - 400	90 - 100	Miscellaneous Debris	-	Not retained	9524
663	200 - 400	90 - 100	Miscellaneous Debris	-	Not retained	9525
664	200 - 400	90 - 100	Miscellaneous Debris	-	Not retained	9526
665	200 - 400	90 - 100	Miscellaneous Debris	-	Not retained	9527
666	200 - 400	90 - 100	Miscellaneous Debris	-	Not retained	9528
667	200 - 400	90 - 100	Miscellaneous Debris	-	Not retained	9529
668	200 - 400	90 - 100	Miscellaneous Debris	-	Not retained	9530
669	200 - 400	90 - 100	Miscellaneous Debris	-	Not retained	9531
670	200 - 400	90 - 100	Miscellaneous Debris	-	Not retained	9532
671	200 - 400	90 - 100	Miscellaneous Debris	-	Not retained	9533
672	200 - 400	90 - 100	Miscellaneous Debris	-	Not retained	9534
673	200 - 400	90 - 100	Miscellaneous Debris	-	Not retained	9535
674	200 - 400	90 - 100	Miscellaneous Debris	-	Not retained	9536
675	200 - 400	90 - 100	Miscellaneous Debris	-	Not retained	9537
676	200 - 400	90 - 100	Miscellaneous Debris	-	Not retained	9538
677	200 - 400	90 - 100	Miscellaneous Debris	-	Not retained	9539
678	200 - 400	90 - 100	Miscellaneous Debris	-	Not retained	9540
679	200 - 400	90 - 100	Miscellaneous Debris	-	Not retained	9541
680	200 - 400	90 - 100	Miscellaneous Debris	-	Not retained	9542
681	200 - 400	90 - 100	Miscellaneous Debris	-	Not retained	9543
682	200 - 400	90 - 100	Miscellaneous Debris	-	Not retained	9544
683	200 - 400	90 - 100	Miscellaneous Debris	-	Not retained	9545
684	200 - 400	90 - 100	Miscellaneous Debris	-	Not retained	9546
685	200 - 400	90 - 100	Miscellaneous Debris	-	Not retained	9547
686	200 - 400	90 - 100	Miscellaneous Debris	-	Not retained	9548
687	200 - 400	90 - 100	Miscellaneous Debris	-	Not retained	9549
688	200 - 400	90 - 100	Miscellaneous Debris	-	Not retained	9550
689	200 - 400	90 - 100	Miscellaneous Debris	-	Not retained	9551
690	200 - 400	90 - 100	Miscellaneous Debris	-	Not retained	9552
691	200 - 400	90 - 100	Miscellaneous Debris	-	Not retained	9553
692	200 - 400	90 - 100	Miscellaneous Debris	-	Not retained	9554
693	200 - 400	90 - 100	Miscellaneous Debris	-	Not retained	9555
694	200 - 400	90 - 100	Miscellaneous Debris	-	Not retained	9556
695	200 - 400	90 - 100	Miscellaneous Debris	-	Not retained	9557
696	200 - 400	90 - 100	Miscellaneous Debris	-	Not retained	9558
697	200 - 400	90 - 100	Miscellaneous Debris	-	Not retained	9559
698	200 - 400	90 - 100	Intact Warhead	5.05		1934
699	200 - 400	90 - 100	Intact Warhead	5.05		1935
700	200 - 400	90 - 100	Intact Warhead	5.05		1936

TABLE B-6. FRAGMENTS RECOVERED BEYOND 200-FT RANGE IN TEST NO. 9 (Continued)

<u>Entry</u>	<u>Range Interval (ft)</u>	<u>Azimuthal Sector (°)</u>	<u>Description</u>	<u>Mass (lb)</u>	<u>Notes</u>	<u>G64 Index No.</u>
701	200 - 400	100 - 110	Warhead Body Piece	0.31		2418
702	200 - 400	100 - 110	Warhead Body Piece	0.29		2419
703	200 - 400	100 - 110	Warhead Body Piece	0.15		2420
704	200 - 400	100 - 110	Warhead Body Piece	0.02		2421
705	200 - 400	100 - 110	Warhead Body Piece	0.02		2422
706	200 - 400	100 - 110	Warhead Body Piece	0.03		2423
707	200 - 400	100 - 110	Warhead Body Piece	0.01		2424
708	200 - 400	100 - 110	Warhead Body Piece	0.01		2425
709	200 - 400	100 - 110	Warhead Body Piece	0.01		2426
710	200 - 400	100 - 110	Tail Piece	0.19		2428
711	200 - 400	100 - 110	Tail Piece	0.19		2429
712	200 - 400	100 - 110	Tail Piece	0.06		2430
713	200 - 400	100 - 110	Tail Piece	0.03		2431
714	200 - 400	100 - 110	Miscellaneous Debris	0.04		2432
715	200 - 400	100 - 110	Miscellaneous Debris	0.01		2433
716	200 - 400	100 - 110	Miscellaneous Debris	0.01		2427
717	200 - 400	100 - 110	Miscellaneous Debris	-	Not retained	9560
718	200 - 400	100 - 110	Miscellaneous Debris	-	Not retained	9561
719	200 - 400	100 - 110	Miscellaneous Debris	-	Not retained	9562
720	200 - 400	100 - 110	Miscellaneous Debris	-	Not retained	9563
721	200 - 400	100 - 110	Miscellaneous Debris	-	Not retained	9564
722	200 - 400	100 - 110	Miscellaneous Debris	-	Not retained	9565
723	200 - 400	100 - 110	Miscellaneous Debris	-	Not retained	9566
724	200 - 400	100 - 110	Miscellaneous Debris	-	Not retained	9567
725	200 - 400	100 - 110	Miscellaneous Debris	-	Not retained	9568
726	200 - 400	100 - 110	Miscellaneous Debris	-	Not retained	9569
727	200 - 400	100 - 110	Miscellaneous Debris	-	Not retained	9570
728	200 - 400	100 - 110	Miscellaneous Debris	-	Not retained	9571
729	200 - 400	100 - 110	Miscellaneous Debris	-	Not retained	9572
730	200 - 400	100 - 110	Miscellaneous Debris	-	Not retained	9573
731	200 - 400	100 - 110	Miscellaneous Debris	-	Not retained	9574
732	200 - 400	100 - 110	Miscellaneous Debris	-	Not retained	9575
733	200 - 400	100 - 110	Miscellaneous Debris	-	Not retained	9576
734	200 - 400	100 - 110	Miscellaneous Debris	-	Not retained	9577
735	200 - 400	100 - 110	Miscellaneous Debris	-	Not retained	9578
736	200 - 400	100 - 110	Miscellaneous Debris	-	Not retained	9579
737	200 - 400	100 - 110	Miscellaneous Debris	-	Not retained	9580
738	200 - 400	100 - 110	Miscellaneous Debris	-	Not retained	9581
739	200 - 400	100 - 110	Miscellaneous Debris	-	Not retained	9582
740	200 - 400	100 - 110	Miscellaneous Debris	-	Not retained	9583
741	200 - 400	100 - 110	Miscellaneous Debris	-	Not retained	9584
742	200 - 400	100 - 110	Miscellaneous Debris	-	Not retained	9585
743	200 - 400	100 - 110	Miscellaneous Debris	-	Not retained	9586
744	200 - 400	100 - 110	Miscellaneous Debris	-	Not retained	9587
745	200 - 400	100 - 110	Miscellaneous Debris	-	Not retained	9588
746	200 - 400	100 - 110	Miscellaneous Debris	-	Not retained	9589
747	200 - 400	100 - 110	Miscellaneous Debris	-	Not retained	9590
748	200 - 400	100 - 110	Miscellaneous Debris	-	Not retained	9591
749	200 - 400	100 - 110	Miscellaneous Debris	-	Not retained	9592
750	200 - 400	100 - 110	Miscellaneous Debris	-	Not retained	9593

NSWCDD/TR-98/6

TABLE B-6. FRAGMENTS RECOVERED BEYOND 200-FT RANGE IN TEST NO. 9 (Continued)

<u>Entry</u>	<u>Range Interval (ft)</u>	<u>Azimuthal Sector (°)</u>	<u>Description</u>	<u>Mass (lb)</u>	<u>Notes</u>	<u>G64 Index No.</u>
751	200 - 400	100 - 110	Miscellaneous Debris	-	Not retained	9594
752	200 - 400	100 - 110	Miscellaneous Debris	-	Not retained	9595
753	200 - 400	100 - 110	Miscellaneous Debris	-	Not retained	9596
754	200 - 400	100 - 110	Miscellaneous Debris	-	Not retained	9597
755	200 - 400	100 - 110	Miscellaneous Debris	-	Not retained	9598
756	200 - 400	100 - 110	Miscellaneous Debris	-	Not retained	9599
757	200 - 400	100 - 110	Miscellaneous Debris	-	Not retained	9600
758	200 - 400	100 - 110	Miscellaneous Debris	-	Not retained	9601
759	200 - 400	100 - 110	Miscellaneous Debris	-	Not retained	9602
760	200 - 400	100 - 110	Miscellaneous Debris	-	Not retained	9603
761	200 - 400	100 - 110	Miscellaneous Debris	-	Not retained	9604
762	200 - 400	100 - 110	Miscellaneous Debris	-	Not retained	9605
763	200 - 400	100 - 110	Miscellaneous Debris	-	Not retained	9606
764	200 - 400	100 - 110	Miscellaneous Debris	-	Not retained	9607
765	200 - 400	100 - 110	Miscellaneous Debris	-	Not retained	9608
766	200 - 400	100 - 110	Miscellaneous Debris	-	Not retained	9609
767	200 - 400	100 - 110	Miscellaneous Debris	-	Not retained	9610
768	200 - 400	100 - 110	Miscellaneous Debris	-	Not retained	9611
769	200 - 400	100 - 110	Miscellaneous Debris	-	Not retained	9612
770	200 - 400	100 - 110	Miscellaneous Debris	-	Not retained	9613
771	200 - 400	100 - 110	Miscellaneous Debris	-	Not retained	9614
772	200 - 400	100 - 110	Miscellaneous Debris	-	Not retained	9615
773	200 - 400	100 - 110	Miscellaneous Debris	-	Not retained	9616
774	200 - 400	100 - 110	Miscellaneous Debris	-	Not retained	9617
775	200 - 400	100 - 110	Miscellaneous Debris	-	Not retained	9618
776	200 - 400	100 - 110	Miscellaneous Debris	-	Not retained	9619
777	200 - 400	100 - 110	Miscellaneous Debris	-	Not retained	9620
778	200 - 400	100 - 110	Intact Warhead	5.05		2414
779	200 - 400	100 - 110	Intact Warhead	5.05		2415
780	200 - 400	100 - 110	Intact Warhead	5.05		2416
781	200 - 400	100 - 110	Intact Warhead	5.05		2417
782	200 - 400	110 - 120	Warhead Body Piece	0.52		2159
783	200 - 400	110 - 120	Warhead Body Piece	0.22		2160
784	200 - 400	110 - 120	Warhead Body Piece	0.01		2161
785	200 - 400	110 - 120	Warhead Body Piece	0.01		2162
786	200 - 400	110 - 120	Tail Piece	0.20		2163
787	200 - 400	110 - 120	Tail Piece	0.04		2164
788	200 - 400	110 - 120	Miscellaneous Debris	-	Not retained	9621
789	200 - 400	110 - 120	Miscellaneous Debris	-	Not retained	9622
790	200 - 400	110 - 120	Miscellaneous Debris	-	Not retained	9623
791	200 - 400	110 - 120	Miscellaneous Debris	-	Not retained	9624
792	200 - 400	110 - 120	Miscellaneous Debris	-	Not retained	9625
793	200 - 400	110 - 120	Miscellaneous Debris	-	Not retained	9626
794	200 - 400	110 - 120	Miscellaneous Debris	-	Not retained	9627
795	200 - 400	110 - 120	Miscellaneous Debris	-	Not retained	9628
796	200 - 400	110 - 120	Miscellaneous Debris	-	Not retained	9629
797	200 - 400	110 - 120	Miscellaneous Debris	-	Not retained	9630
798	200 - 400	110 - 120	Miscellaneous Debris	-	Not retained	9631
799	200 - 400	110 - 120	Miscellaneous Debris	-	Not retained	9632
800	200 - 400	110 - 120	Miscellaneous Debris	-	Not retained	9633

TABLE B-6. FRAGMENTS RECOVERED BEYOND 200-FT RANGE IN TEST NO. 9 (Continued)

<u>Entry</u>	<u>Range Interval (ft)</u>	<u>Azimuthal Sector (°)</u>	<u>Description</u>	<u>Mass (lb)</u>	<u>Notes</u>	<u>G64 Index No.</u>
801	200 - 400	110 - 120	Miscellaneous Debris	-	Not retained	9634
802	200 - 400	110 - 120	Miscellaneous Debris	-	Not retained	9635
803	200 - 400	110 - 120	Miscellaneous Debris	-	Not retained	9636
804	200 - 400	110 - 120	Miscellaneous Debris	-	Not retained	9637
805	200 - 400	110 - 120	Miscellaneous Debris	-	Not retained	9638
806	200 - 400	110 - 120	Miscellaneous Debris	-	Not retained	9639
807	200 - 400	110 - 120	Miscellaneous Debris	-	Not retained	9640
808	200 - 400	110 - 120	Miscellaneous Debris	-	Not retained	9641
809	200 - 400	110 - 120	Miscellaneous Debris	-	Not retained	9642
810	200 - 400	110 - 120	Miscellaneous Debris	-	Not retained	9643
811	200 - 400	110 - 120	Miscellaneous Debris	-	Not retained	9644
812	200 - 400	110 - 120	Miscellaneous Debris	-	Not retained	9645
813	200 - 400	110 - 120	Intact Warhead	5.05		2156
814	200 - 400	110 - 120	Intact Warhead	5.05		2157
815	200 - 400	110 - 120	Intact Warhead	5.05		2158
816	200 - 400	120 - 130	Warhead Body Piece	0.61		1667
817	200 - 400	120 - 130	Warhead Body Piece	0.29		1668
818	200 - 400	120 - 130	Warhead Body Piece	0.04		1669
819	200 - 400	120 - 130	Warhead Body Piece	0.09		3229
820	200 - 400	120 - 130	Tail Piece	0.04		1671
821	200 - 400	120 - 130	Tail Piece	0.01		1672
822	200 - 400	120 - 130	Miscellaneous Debris	0.05		1673
823	200 - 400	120 - 130	Miscellaneous Debris	0.01		1674
824	200 - 400	120 - 130	Miscellaneous Debris	0.01		1675
825	200 - 400	120 - 130	Miscellaneous Debris	0.04		1670
826	200 - 400	120 - 130	Miscellaneous Debris	-	Not retained	9646
827	200 - 400	120 - 130	Miscellaneous Debris	-	Not retained	9647
828	200 - 400	120 - 130	Miscellaneous Debris	-	Not retained	9648
829	200 - 400	120 - 130	Miscellaneous Debris	-	Not retained	9649
830	200 - 400	120 - 130	Miscellaneous Debris	-	Not retained	9650
831	200 - 400	120 - 130	Miscellaneous Debris	-	Not retained	9651
832	200 - 400	120 - 130	Miscellaneous Debris	-	Not retained	9652
833	200 - 400	120 - 130	Miscellaneous Debris	-	Not retained	9653
834	200 - 400	120 - 130	Miscellaneous Debris	-	Not retained	9654
835	200 - 400	120 - 130	Miscellaneous Debris	-	Not retained	9655
836	200 - 400	120 - 130	Intact Warhead	5.05		1665
837	200 - 400	120 - 130	Intact Warhead	5.05		1666
838	200 - 400	130 - 140	Warhead Body Piece	0.10		1842
839	200 - 400	130 - 140	Warhead Body Piece	0.86		2377
840	200 - 400	130 - 140	Warhead Body Piece	0.17		2378
841	200 - 400	130 - 140	Warhead Body Piece	0.12		2379
842	200 - 400	130 - 140	Warhead Body Piece	0.05		2380
843	200 - 400	130 - 140	Warhead Body Piece	0.03		2381
844	200 - 400	130 - 140	Warhead Body Piece	0.02		2382
845	200 - 400	130 - 140	Tail Piece	-	Not retained	2376
846	200 - 400	130 - 140	Tail Piece	0.06		2383
847	200 - 400	130 - 140	Miscellaneous Debris	-	Not retained	9656
848	200 - 400	130 - 140	Miscellaneous Debris	-	Not retained	9657
849	200 - 400	130 - 140	Miscellaneous Debris	-	Not retained	9658
850	200 - 400	130 - 140	Miscellaneous Debris	-	Not retained	9659

TABLE B-6. FRAGMENTS RECOVERED BEYOND 200-FT RANGE IN TEST NO. 9 (Continued)

<u>Entry</u>	<u>Range Interval (ft)</u>	<u>Azimuthal Sector (°)</u>	<u>Description</u>	<u>Mass (lb)</u>	<u>Notes</u>	<u>G64 Index No.</u>
851	200 - 400	130 - 140	Miscellaneous Debris	-	Not retained	9660
852	200 - 400	130 - 140	Miscellaneous Debris	-	Not retained	9661
853	200 - 400	130 - 140	Miscellaneous Debris	-	Not retained	9662
854	200 - 400	130 - 140	Miscellaneous Debris	-	Not retained	9663
855	200 - 400	130 - 140	Miscellaneous Debris	-	Not retained	9664
856	200 - 400	130 - 140	Miscellaneous Debris	-	Not retained	9665
857	200 - 400	130 - 140	Miscellaneous Debris	-	Not retained	9666
858	200 - 400	130 - 140	Miscellaneous Debris	-	Not retained	9667
859	200 - 400	130 - 140	Intact Warhead	5.05		2372
860	200 - 400	130 - 140	Intact Warhead	5.05		2373
861	200 - 400	130 - 140	Intact Warhead	5.05		2374
862	200 - 400	130 - 140	Intact Warhead	5.05		2375
863	200 - 400	140 - 150	Warhead Body Piece	0.03		2303
864	200 - 400	140 - 150	Warhead Body Piece	0.22		2304
865	200 - 400	140 - 150	Warhead Body Piece	0.23		2305
866	200 - 400	140 - 150	Warhead Body Piece	0.01		2306
867	200 - 400	140 - 150	Tail Piece	0.04		2307
868	200 - 400	140 - 150	Tail Piece	0.01		2308
869	200 - 400	140 - 150	Miscellaneous Debris	-	Not retained	9668
870	200 - 400	140 - 150	Miscellaneous Debris	-	Not retained	9669
871	200 - 400	140 - 150	Miscellaneous Debris	-	Not retained	9670
872	200 - 400	140 - 150	Miscellaneous Debris	-	Not retained	9671
873	200 - 400	140 - 150	Miscellaneous Debris	-	Not retained	9672
874	200 - 400	140 - 150	Miscellaneous Debris	-	Not retained	9673
875	200 - 400	140 - 150	Miscellaneous Debris	-	Not retained	9674
876	200 - 400	140 - 150	Miscellaneous Debris	-	Not retained	9675
877	200 - 400	140 - 150	Miscellaneous Debris	-	Not retained	9676
878	200 - 400	140 - 150	Miscellaneous Debris	-	Not retained	9677
879	200 - 400	140 - 150	Miscellaneous Debris	-	Not retained	9678
880	200 - 400	140 - 150	Miscellaneous Debris	-	Not retained	9679
881	200 - 400	140 - 150	Intact Warhead	5.05		2298
882	200 - 400	140 - 150	Intact Warhead	5.05		2299
883	200 - 400	140 - 150	Intact Warhead	5.05		2300
884	200 - 400	140 - 150	Intact Warhead	5.05		2301
885	200 - 400	140 - 150	Intact Warhead	5.05		2302
886	200 - 400	150 - 160	Warhead Body Piece	0.55		2494
887	200 - 400	150 - 160	Warhead Body Piece	0.06		2495
888	200 - 400	150 - 160	Warhead Body Piece	0.03		2496
889	200 - 400	150 - 160	Warhead Body Piece	0.01		2497
890	200 - 400	150 - 160	Tail Piece	0.19		2498
891	200 - 400	150 - 160	Miscellaneous Debris	-	Not retained	9680
892	200 - 400	150 - 160	Miscellaneous Debris	-	Not retained	9681
893	200 - 400	150 - 160	Miscellaneous Debris	-	Not retained	9682
894	200 - 400	150 - 160	Miscellaneous Debris	-	Not retained	9683
895	200 - 400	150 - 160	Miscellaneous Debris	-	Not retained	9684
896	200 - 400	150 - 160	Miscellaneous Debris	-	Not retained	9685
897	200 - 400	150 - 160	Miscellaneous Debris	-	Not retained	9686
898	200 - 400	150 - 160	Miscellaneous Debris	-	Not retained	9687
899	200 - 400	150 - 160	Miscellaneous Debris	-	Not retained	9688
900	200 - 400	150 - 160	Miscellaneous Debris	-	Not retained	9689

NSWCDD/TR-98/6

TABLE B-6. FRAGMENTS RECOVERED BEYOND 200-FT RANGE IN TEST NO. 9 (Continued)

<u>Entry</u>	<u>Range Interval (ft)</u>	<u>Azimuthal Sector (°)</u>	<u>Description</u>	<u>Mass (lb)</u>	<u>Notes</u>	<u>G64 Index No.</u>
901	200 - 400	150 - 160	Miscellaneous Debris	-	Not retained	9690
902	200 - 400	150 - 160	Miscellaneous Debris	-	Not retained	9691
903	200 - 400	150 - 160	Miscellaneous Debris	-	Not retained	9692
904	200 - 400	150 - 160	Miscellaneous Debris	-	Not retained	9693
905	200 - 400	150 - 160	Miscellaneous Debris	-	Not retained	9694
906	200 - 400	150 - 160	Miscellaneous Debris	-	Not retained	9695
907	200 - 400	150 - 160	Miscellaneous Debris	-	Not retained	9696
908	200 - 400	150 - 160	Miscellaneous Debris	-	Not retained	9697
909	200 - 400	150 - 160	Miscellaneous Debris	-	Not retained	9698
910	200 - 400	150 - 160	Miscellaneous Debris	-	Not retained	9699
911	200 - 400	150 - 160	Miscellaneous Debris	-	Not retained	9700
912	200 - 400	150 - 160	Miscellaneous Debris	-	Not retained	9701
913	200 - 400	150 - 160	Miscellaneous Debris	-	Not retained	9702
914	200 - 400	150 - 160	Miscellaneous Debris	-	Not retained	9703
915	200 - 400	150 - 160	Miscellaneous Debris	-	Not retained	9704
916	200 - 400	150 - 160	Intact Warhead	5.05		2493
917	200 - 400	160 - 170	Warhead Body Piece	0.08		3025
918	200 - 400	160 - 170	Warhead Body Piece	0.03		3026
919	200 - 400	160 - 170	Warhead Body Piece	0.01		3027
920	200 - 400	160 - 170	Tail Piece	-	Not retained	3024
921	200 - 400	160 - 170	Tail Piece	0.07		3028
922	200 - 400	160 - 170	Miscellaneous Debris	0.15		3029
923	200 - 400	160 - 170	Miscellaneous Debris	0.08		3030
924	200 - 400	160 - 170	Miscellaneous Debris	0.04		3031
925	200 - 400	160 - 170	Miscellaneous Debris	0.01		3032
926	200 - 400	160 - 170	Miscellaneous Debris	-	Not retained	9705
927	200 - 400	160 - 170	Miscellaneous Debris	-	Not retained	9706
928	200 - 400	160 - 170	Miscellaneous Debris	-	Not retained	9707
929	200 - 400	160 - 170	Miscellaneous Debris	-	Not retained	9708
930	200 - 400	160 - 170	Miscellaneous Debris	-	Not retained	9709
931	200 - 400	160 - 170	Miscellaneous Debris	-	Not retained	9710
932	200 - 400	160 - 170	Miscellaneous Debris	-	Not retained	9711
933	200 - 400	160 - 170	Miscellaneous Debris	-	Not retained	9712
934	200 - 400	160 - 170	Miscellaneous Debris	-	Not retained	9713
935	200 - 400	160 - 170	Miscellaneous Debris	-	Not retained	9714
936	200 - 400	160 - 170	Miscellaneous Debris	-	Not retained	9715
937	200 - 400	160 - 170	Miscellaneous Debris	-	Not retained	9716
938	200 - 400	160 - 170	Miscellaneous Debris	-	Not retained	9717
939	200 - 400	170 - 180	Warhead Body Piece	0.43		2819
940	200 - 400	170 - 180	Warhead Body Piece	0.11		2820
941	200 - 400	170 - 180	Warhead Body Piece	0.07		2821
942	200 - 400	170 - 180	Warhead Body Piece	0.07		2822
943	200 - 400	170 - 180	Warhead Body Piece	0.02		2823
944	200 - 400	170 - 180	Warhead Body Piece	0.02		2824
945	200 - 400	170 - 180	Warhead Body Piece	0.50		2926
946	200 - 400	170 - 180	Warhead Body Piece	0.01		2929
947	200 - 400	170 - 180	Miscellaneous Debris	-	Not retained	9718
948	200 - 400	170 - 180	Miscellaneous Debris	-	Not retained	9719
949	200 - 400	170 - 180	Miscellaneous Debris	-	Not retained	9720
950	200 - 400	170 - 180	Miscellaneous Debris	-	Not retained	9721

TABLE B-6. FRAGMENTS RECOVERED BEYOND 200-FT RANGE IN TEST NO. 9 (Continued)

<u>Entry</u>	<u>Range Interval (ft)</u>	<u>Azimuthal Sector (°)</u>	<u>Description</u>	<u>Mass (lb)</u>	<u>Notes</u>	<u>G64 Index No.</u>
951	200 - 400	170 - 180	Miscellaneous Debris	-	Not retained	9722
952	200 - 400	170 - 180	Miscellaneous Debris	-	Not retained	9723
953	200 - 400	170 - 180	Miscellaneous Debris	-	Not retained	9724
954	200 - 400	170 - 180	Miscellaneous Debris	-	Not retained	9725
955	200 - 400	170 - 180	Miscellaneous Debris	-	Not retained	9726
956	200 - 400	170 - 180	Miscellaneous Debris	-	Not retained	9727
957	200 - 400	170 - 180	Miscellaneous Debris	-	Not retained	9728
958	200 - 400	170 - 180	Miscellaneous Debris	-	Not retained	9729
959	200 - 400	170 - 180	Miscellaneous Debris	-	Not retained	9730
960	200 - 400	170 - 180	Miscellaneous Debris	-	Not retained	9731
961	200 - 400	170 - 180	Miscellaneous Debris	-	Not retained	9732
962	200 - 400	170 - 180	Miscellaneous Debris	-	Not retained	9733
963	200 - 400	170 - 180	Miscellaneous Debris	-	Not retained	9734
964	200 - 400	170 - 180	Miscellaneous Debris	-	Not retained	9735
965	200 - 400	170 - 180	Intact Warhead	5.05		2817
966	200 - 400	170 - 180	Intact Warhead	5.05		2818
967	200 - 400	180 - 190	Warhead Body Piece	0.86		2636
968	200 - 400	180 - 190	Warhead Body Piece	0.61		2637
969	200 - 400	180 - 190	Warhead Body Piece	0.36		2638
970	200 - 400	180 - 190	Warhead Body Piece	0.20		2639
971	200 - 400	180 - 190	Warhead Body Piece	0.13		2640
972	200 - 400	180 - 190	Warhead Body Piece	0.04		2641
973	200 - 400	180 - 190	Warhead Body Piece	0.34		2642
974	200 - 400	180 - 190	Warhead Body Piece	0.35		2643
975	200 - 400	180 - 190	Warhead Body Piece	0.19		2644
976	200 - 400	180 - 190	Warhead Body Piece	0.05		2645
977	200 - 400	180 - 190	Warhead Body Piece	0.03		2646
978	200 - 400	180 - 190	Warhead Body Piece	0.30		2948
979	200 - 400	180 - 190	Miscellaneous Debris	-	Not retained	9736
980	200 - 400	180 - 190	Miscellaneous Debris	-	Not retained	9737
981	200 - 400	180 - 190	Miscellaneous Debris	-	Not retained	9738
982	200 - 400	180 - 190	Miscellaneous Debris	-	Not retained	9739
983	200 - 400	180 - 190	Miscellaneous Debris	-	Not retained	9740
984	200 - 400	180 - 190	Miscellaneous Debris	-	Not retained	9741
985	200 - 400	180 - 190	Miscellaneous Debris	-	Not retained	9742
986	200 - 400	180 - 190	Miscellaneous Debris	-	Not retained	9743
987	200 - 400	180 - 190	Miscellaneous Debris	-	Not retained	9744
988	200 - 400	180 - 190	Miscellaneous Debris	-	Not retained	9745
989	200 - 400	180 - 190	Miscellaneous Debris	-	Not retained	9746
990	200 - 400	180 - 190	Miscellaneous Debris	-	Not retained	9747
991	200 - 400	180 - 190	Miscellaneous Debris	-	Not retained	9748
992	200 - 400	180 - 190	Miscellaneous Debris	-	Not retained	9749
993	200 - 400	180 - 190	Miscellaneous Debris	-	Not retained	9750
994	200 - 400	180 - 190	Miscellaneous Debris	-	Not retained	9751
995	200 - 400	180 - 190	Miscellaneous Debris	-	Not retained	9752
996	200 - 400	190 - 200	Warhead Body Piece	1.00		2333
997	200 - 400	190 - 200	Warhead Body Piece	0.38		2334
998	200 - 400	190 - 200	Warhead Body Piece	0.29		2335
999	200 - 400	190 - 200	Warhead Body Piece	0.20		2336
1000	200 - 400	190 - 200	Warhead Body Piece	0.13		2337

TABLE B-6. FRAGMENTS RECOVERED BEYOND 200-FT RANGE IN TEST NO. 9 (Continued)

<u>Entry</u>	<u>Range Interval (ft)</u>	<u>Azimuthal Sector (°)</u>	<u>Description</u>	<u>Mass (lb)</u>	<u>Notes</u>	<u>G64 Index No.</u>
1001	200 - 400	190 - 200	Warhead Body Piece	0.07		2338
1002	200 - 400	190 - 200	Warhead Body Piece	0.06		2339
1003	200 - 400	190 - 200	Warhead Body Piece	0.01		2340
1004	200 - 400	190 - 200	Miscellaneous Debris	-	Not retained	9753
1005	200 - 400	190 - 200	Miscellaneous Debris	-	Not retained	9754
1006	200 - 400	190 - 200	Miscellaneous Debris	-	Not retained	9755
1007	200 - 400	190 - 200	Miscellaneous Debris	-	Not retained	9756
1008	200 - 400	190 - 200	Miscellaneous Debris	-	Not retained	9757
1009	200 - 400	190 - 200	Miscellaneous Debris	-	Not retained	9758
1010	200 - 400	190 - 200	Miscellaneous Debris	-	Not retained	9759
1011	200 - 400	190 - 200	Miscellaneous Debris	-	Not retained	9760
1012	200 - 400	190 - 200	Miscellaneous Debris	-	Not retained	9761
1013	200 - 400	190 - 200	Miscellaneous Debris	-	Not retained	9762
1014	200 - 400	190 - 200	Miscellaneous Debris	-	Not retained	9763
1015	200 - 400	190 - 200	Miscellaneous Debris	-	Not retained	9764
1016	200 - 400	190 - 200	Miscellaneous Debris	-	Not retained	9765
1017	200 - 400	190 - 200	Miscellaneous Debris	-	Not retained	9766
1018	200 - 400	190 - 200	Miscellaneous Debris	-	Not retained	9767
1019	200 - 400	190 - 200	Miscellaneous Debris	-	Not retained	9768
1020	200 - 400	190 - 200	Miscellaneous Debris	-	Not retained	9769
1021	200 - 400	190 - 200	Miscellaneous Debris	-	Not retained	9770
1022	200 - 400	190 - 200	Intact Warhead	5.05		2332
1023	200 - 400	200 - 210	Warhead Body Piece	0.25		1713
1024	200 - 400	200 - 210	Warhead Body Piece	0.11		1714
1025	200 - 400	200 - 210	Warhead Body Piece	0.11		1715
1026	200 - 400	200 - 210	Warhead Body Piece	0.09		1716
1027	200 - 400	200 - 210	Warhead Body Piece	0.01		1717
1028	200 - 400	200 - 210	Warhead Body Piece	0.01		1718
1029	200 - 400	200 - 210	Miscellaneous Debris	0.01		1719
1030	200 - 400	200 - 210	Miscellaneous Debris	-	Not retained	9771
1031	200 - 400	210 - 220	Miscellaneous Debris	-	Not retained	9772
1032	200 - 400	210 - 220	Miscellaneous Debris	-	Not retained	9773
1033	200 - 400	210 - 220	Miscellaneous Debris	-	Not retained	9774
1034	200 - 400	210 - 220	Miscellaneous Debris	-	Not retained	9775
1035	200 - 400	210 - 220	Miscellaneous Debris	-	Not retained	9776
1036	200 - 400	210 - 220	Miscellaneous Debris	-	Not retained	9777
1037	200 - 400	210 - 220	Miscellaneous Debris	-	Not retained	9778
1038	200 - 400	210 - 220	Miscellaneous Debris	-	Not retained	9779
1039	200 - 400	210 - 220	Miscellaneous Debris	-	Not retained	9780
1040	200 - 400	210 - 220	Miscellaneous Debris	-	Not retained	9781
1041	200 - 400	210 - 220	Miscellaneous Debris	-	Not retained	9782
1042	200 - 400	210 - 220	Miscellaneous Debris	-	Not retained	9783
1043	200 - 400	210 - 220	Miscellaneous Debris	-	Not retained	9784
1044	200 - 400	210 - 220	Miscellaneous Debris	-	Not retained	9785
1045	200 - 400	210 - 220	Miscellaneous Debris	-	Not retained	9786
1046	200 - 400	210 - 220	Miscellaneous Debris	-	Not retained	9787
1047	200 - 400	210 - 220	Miscellaneous Debris	-	Not retained	9788
1048	200 - 400	220 - 230	Warhead Body Piece	0.03		2545
1049	200 - 400	220 - 230	Warhead Body Piece	0.01		2546
1050	200 - 400	220 - 230	Warhead Body Piece	0.01		2547

NSWCDD/TR-98/6

TABLE B-6. FRAGMENTS RECOVERED BEYOND 200-FT RANGE IN TEST NO. 9 (Continued)

<u>Entry</u>	<u>Range Interval (ft)</u>	<u>Azimuthal Sector (°)</u>	<u>Description</u>	<u>Mass (lb)</u>	<u>Notes</u>	<u>G64 Index No.</u>
1051	200 - 400	220 - 230	Warhead Body Piece	0.01		2548
1052	200 - 400	220 - 230	Tail Piece	0.04		2549
1053	200 - 400	220 - 230	Tail Piece	0.01		2550
1054	200 - 400	220 - 230	Miscellaneous Debris	0.01		2551
1055	200 - 400	220 - 230	Miscellaneous Debris	-	Not retained	9789
1056	200 - 400	220 - 230	Miscellaneous Debris	-	Not retained	9790
1057	200 - 400	220 - 230	Miscellaneous Debris	-	Not retained	9791
1058	200 - 400	220 - 230	Miscellaneous Debris	-	Not retained	9792
1059	200 - 400	220 - 230	Miscellaneous Debris	-	Not retained	9793
1060	200 - 400	220 - 230	Miscellaneous Debris	-	Not retained	9794
1061	200 - 400	220 - 230	Miscellaneous Debris	-	Not retained	9795
1062	200 - 400	220 - 230	Miscellaneous Debris	-	Not retained	9796
1063	200 - 400	220 - 230	Miscellaneous Debris	-	Not retained	9797
1064	200 - 400	220 - 230	Miscellaneous Debris	-	Not retained	9798
1065	200 - 400	220 - 230	Miscellaneous Debris	-	Not retained	9799
1066	200 - 400	220 - 230	Miscellaneous Debris	-	Not retained	9800
1067	200 - 400	220 - 230	Miscellaneous Debris	-	Not retained	9801
1068	200 - 400	220 - 230	Miscellaneous Debris	-	Not retained	9802
1069	200 - 400	220 - 230	Miscellaneous Debris	-	Not retained	9803
1070	200 - 400	220 - 230	Miscellaneous Debris	-	Not retained	9804
1071	200 - 400	220 - 230	Miscellaneous Debris	-	Not retained	9805
1072	200 - 400	220 - 230	Miscellaneous Debris	-	Not retained	9806
1073	200 - 400	220 - 230	Miscellaneous Debris	-	Not retained	9807
1074	200 - 400	220 - 230	Miscellaneous Debris	-	Not retained	9808
1075	200 - 400	220 - 230	Miscellaneous Debris	-	Not retained	9809
1076	200 - 400	220 - 230	Miscellaneous Debris	-	Not retained	9810
1077	200 - 400	220 - 230	Miscellaneous Debris	-	Not retained	9811
1078	200 - 400	220 - 230	Miscellaneous Debris	-	Not retained	9812
1079	200 - 400	220 - 230	Miscellaneous Debris	-	Not retained	9813
1080	200 - 400	220 - 230	Miscellaneous Debris	-	Not retained	9814
1081	200 - 400	220 - 230	Miscellaneous Debris	-	Not retained	9815
1082	200 - 400	220 - 230	Miscellaneous Debris	-	Not retained	9816
1083	200 - 400	220 - 230	Miscellaneous Debris	-	Not retained	9817
1084	200 - 400	230 - 240	Warhead Body Piece	0.33		2703
1085	200 - 400	230 - 240	Warhead Body Piece	0.12		2704
1086	200 - 400	230 - 240	Warhead Body Piece	0.03		2705
1087	200 - 400	230 - 240	Warhead Body Piece	0.06		2706
1088	200 - 400	230 - 240	Warhead Body Piece	0.04		2707
1089	200 - 400	230 - 240	Warhead Body Piece	0.02		2708
1090	200 - 400	230 - 240	Warhead Body Piece	0.02		2709
1091	200 - 400	230 - 240	Warhead Body Piece	0.02		2710
1092	200 - 400	230 - 240	Warhead Body Piece	0.01		2711
1093	200 - 400	230 - 240	Tail Piece	0.13		2712
1094	200 - 400	230 - 240	Tail Piece	0.03		2713
1095	200 - 400	230 - 240	Miscellaneous Debris	0.04		2714
1096	200 - 400	230 - 240	Miscellaneous Debris	0.01		2715
1097	200 - 400	230 - 240	Miscellaneous Debris	-	Not retained	9818
1098	200 - 400	230 - 240	Miscellaneous Debris	-	Not retained	9819
1099	200 - 400	230 - 240	Miscellaneous Debris	-	Not retained	9820
1100	200 - 400	230 - 240	Miscellaneous Debris	-	Not retained	9821

TABLE B-6. FRAGMENTS RECOVERED BEYOND 200-FT RANGE IN TEST NO. 9 (Continued)

<u>Entry</u>	<u>Range Interval (ft)</u>	<u>Azimuthal Sector (°)</u>	<u>Description</u>	<u>Mass (lb)</u>	<u>Notes</u>	<u>G64 Index No.</u>
1101	200 - 400	230 - 240	Miscellaneous Debris	-	Not retained	9822
1102	200 - 400	230 - 240	Miscellaneous Debris	-	Not retained	9823
1103	200 - 400	230 - 240	Miscellaneous Debris	-	Not retained	9824
1104	200 - 400	230 - 240	Miscellaneous Debris	-	Not retained	9825
1105	200 - 400	230 - 240	Miscellaneous Debris	-	Not retained	9826
1106	200 - 400	230 - 240	Miscellaneous Debris	-	Not retained	9827
1107	200 - 400	230 - 240	Miscellaneous Debris	-	Not retained	9828
1108	200 - 400	230 - 240	Miscellaneous Debris	-	Not retained	9829
1109	200 - 400	230 - 240	Miscellaneous Debris	-	Not retained	9830
1110	200 - 400	230 - 240	Miscellaneous Debris	-	Not retained	9831
1111	200 - 400	230 - 240	Miscellaneous Debris	-	Not retained	9832
1112	200 - 400	230 - 240	Miscellaneous Debris	-	Not retained	9833
1113	200 - 400	230 - 240	Miscellaneous Debris	-	Not retained	9834
1114	200 - 400	230 - 240	Miscellaneous Debris	-	Not retained	9835
1115	200 - 400	230 - 240	Miscellaneous Debris	-	Not retained	9836
1116	200 - 400	230 - 240	Miscellaneous Debris	-	Not retained	9837
1117	200 - 400	230 - 240	Miscellaneous Debris	-	Not retained	9838
1118	200 - 400	230 - 240	Miscellaneous Debris	-	Not retained	9839
1119	200 - 400	230 - 240	Miscellaneous Debris	-	Not retained	9840
1120	200 - 400	230 - 240	Miscellaneous Debris	-	Not retained	9841
1121	200 - 400	230 - 240	Miscellaneous Debris	-	Not retained	9842
1122	200 - 400	230 - 240	Miscellaneous Debris	-	Not retained	9843
1123	200 - 400	230 - 240	Miscellaneous Debris	-	Not retained	9844
1124	200 - 400	230 - 240	Miscellaneous Debris	-	Not retained	9845
1125	200 - 400	230 - 240	Miscellaneous Debris	-	Not retained	9846
1126	200 - 400	230 - 240	Miscellaneous Debris	-	Not retained	9847
1127	200 - 400	230 - 240	Miscellaneous Debris	-	Not retained	9848
1128	200 - 400	230 - 240	Miscellaneous Debris	-	Not retained	9849
1129	200 - 400	230 - 240	Miscellaneous Debris	-	Not retained	9850
1130	200 - 400	230 - 240	Miscellaneous Debris	-	Not retained	9851
1131	200 - 400	230 - 240	Miscellaneous Debris	-	Not retained	9852
1132	200 - 400	230 - 240	Miscellaneous Debris	-	Not retained	9853
1133	200 - 400	230 - 240	Miscellaneous Debris	-	Not retained	9854
1134	200 - 400	230 - 240	Miscellaneous Debris	-	Not retained	9855
1135	200 - 400	240 - 250	Warhead Body Piece	0.16		2737
1136	200 - 400	240 - 250	Warhead Body Piece	0.07		2738
1137	200 - 400	240 - 250	Warhead Body Piece	0.04		2739
1138	200 - 400	240 - 250	Warhead Body Piece	0.01		2740
1139	200 - 400	240 - 250	Warhead Body Piece	0.01		2741
1140	200 - 400	240 - 250	Tail Piece	0.04		1902
1141	200 - 400	240 - 250	Tail Piece	0.01		3161
1142	200 - 400	240 - 250	Miscellaneous Debris	0.01		2744
1143	200 - 400	240 - 250	Miscellaneous Debris	0.01		2742
1144	200 - 400	240 - 250	Miscellaneous Debris	0.01		2743
1145	200 - 400	240 - 250	Miscellaneous Debris	-	Not retained	9856
1146	200 - 400	240 - 250	Miscellaneous Debris	-	Not retained	9857
1147	200 - 400	240 - 250	Miscellaneous Debris	-	Not retained	9858
1148	200 - 400	240 - 250	Miscellaneous Debris	-	Not retained	9859
1149	200 - 400	240 - 250	Miscellaneous Debris	-	Not retained	9860
1150	200 - 400	240 - 250	Miscellaneous Debris	-	Not retained	9861

TABLE B-6. FRAGMENTS RECOVERED BEYOND 200-FT RANGE IN TEST NO. 9 (Continued)

<u>Entry</u>	<u>Range Interval (ft)</u>	<u>Azimuthal Sector (°)</u>	<u>Description</u>	<u>Mass (lb)</u>	<u>Notes</u>	<u>G64 Index No.</u>
1151	200 - 400	240 - 250	Miscellaneous Debris	-	Not retained	9862
1152	200 - 400	240 - 250	Miscellaneous Debris	-	Not retained	9863
1153	200 - 400	240 - 250	Miscellaneous Debris	-	Not retained	9864
1154	200 - 400	240 - 250	Miscellaneous Debris	-	Not retained	9865
1155	200 - 400	240 - 250	Miscellaneous Debris	-	Not retained	9866
1156	200 - 400	240 - 250	Miscellaneous Debris	-	Not retained	9867
1157	200 - 400	240 - 250	Miscellaneous Debris	-	Not retained	9868
1158	200 - 400	240 - 250	Miscellaneous Debris	-	Not retained	9869
1159	200 - 400	240 - 250	Miscellaneous Debris	-	Not retained	9870
1160	200 - 400	240 - 250	Miscellaneous Debris	-	Not retained	9871
1161	200 - 400	240 - 250	Miscellaneous Debris	-	Not retained	9872
1162	200 - 400	240 - 250	Miscellaneous Debris	-	Not retained	9873
1163	200 - 400	240 - 250	Miscellaneous Debris	-	Not retained	9874
1164	200 - 400	240 - 250	Miscellaneous Debris	-	Not retained	9875
1165	200 - 400	240 - 250	Miscellaneous Debris	-	Not retained	9876
1166	200 - 400	240 - 250	Miscellaneous Debris	-	Not retained	9877
1167	200 - 400	240 - 250	Miscellaneous Debris	-	Not retained	9878
1168	200 - 400	240 - 250	Miscellaneous Debris	-	Not retained	9879
1169	200 - 400	240 - 250	Miscellaneous Debris	-	Not retained	9880
1170	200 - 400	240 - 250	Miscellaneous Debris	-	Not retained	9881
1171	200 - 400	240 - 250	Miscellaneous Debris	-	Not retained	9882
1172	200 - 400	240 - 250	Miscellaneous Debris	-	Not retained	9883
1173	200 - 400	240 - 250	Miscellaneous Debris	-	Not retained	9884
1174	200 - 400	240 - 250	Miscellaneous Debris	-	Not retained	9885
1175	200 - 400	240 - 250	Miscellaneous Debris	-	Not retained	9886
1176	200 - 400	240 - 250	Miscellaneous Debris	-	Not retained	9887
1177	200 - 400	240 - 250	Miscellaneous Debris	-	Not retained	9888
1178	200 - 400	240 - 250	Miscellaneous Debris	-	Not retained	9889
1179	200 - 400	240 - 250	Miscellaneous Debris	-	Not retained	9890
1180	200 - 400	240 - 250	Miscellaneous Debris	-	Not retained	9891
1181	200 - 400	240 - 250	Miscellaneous Debris	-	Not retained	9892
1182	200 - 400	240 - 250	Miscellaneous Debris	-	Not retained	9893
1183	200 - 400	240 - 250	Miscellaneous Debris	-	Not retained	9894
1184	200 - 400	240 - 250	Miscellaneous Debris	-	Not retained	9895
1185	200 - 400	240 - 250	Miscellaneous Debris	-	Not retained	9896
1186	200 - 400	240 - 250	Miscellaneous Debris	-	Not retained	9897
1187	200 - 400	240 - 250	Miscellaneous Debris	-	Not retained	9898
1188	200 - 400	240 - 250	Miscellaneous Debris	-	Not retained	9899
1189	200 - 400	240 - 250	Miscellaneous Debris	-	Not retained	9900
1190	200 - 400	240 - 250	Miscellaneous Debris	-	Not retained	9901
1191	200 - 400	240 - 250	Miscellaneous Debris	-	Not retained	9902
1192	200 - 400	240 - 250	Miscellaneous Debris	-	Not retained	9903
1193	200 - 400	240 - 250	Miscellaneous Debris	-	Not retained	9904
1194	200 - 400	240 - 250	Miscellaneous Debris	-	Not retained	9905
1195	200 - 400	240 - 250	Miscellaneous Debris	-	Not retained	9906
1196	200 - 400	240 - 250	Miscellaneous Debris	-	Not retained	9907
1197	200 - 400	240 - 250	Miscellaneous Debris	-	Not retained	9908
1198	200 - 400	240 - 250	Miscellaneous Debris	-	Not retained	9909
1199	200 - 400	240 - 250	Miscellaneous Debris	-	Not retained	9910
1200	200 - 400	240 - 250	Miscellaneous Debris	-	Not retained	9911

NSWCDD/TR-98/6

TABLE B-6. FRAGMENTS RECOVERED BEYOND 200-FT RANGE IN TEST NO. 9 (Continued)

<u>Entry</u>	<u>Range Interval (ft)</u>	<u>Azimuthal Sector (°)</u>	<u>Description</u>	<u>Mass (lb)</u>	<u>Notes</u>	<u>G64 Index No.</u>
1201	200 - 400	240 - 250	Miscellaneous Debris	-	Not retained	9912
1202	200 - 400	240 - 250	Miscellaneous Debris	-	Not retained	9913
1203	200 - 400	240 - 250	Miscellaneous Debris	-	Not retained	9914
1204	200 - 400	240 - 250	Miscellaneous Debris	-	Not retained	9915
1205	200 - 400	240 - 250	Miscellaneous Debris	-	Not retained	9916
1206	200 - 400	240 - 250	Miscellaneous Debris	-	Not retained	9917
1207	200 - 400	240 - 250	Miscellaneous Debris	-	Not retained	9918
1208	200 - 400	240 - 250	Miscellaneous Debris	-	Not retained	9919
1209	200 - 400	240 - 250	Miscellaneous Debris	-	Not retained	9920
1210	200 - 400	240 - 250	Miscellaneous Debris	-	Not retained	9921
1211	200 - 400	240 - 250	Miscellaneous Debris	-	Not retained	9922
1212	200 - 400	240 - 250	Miscellaneous Debris	-	Not retained	9923
1213	200 - 400	240 - 250	Miscellaneous Debris	-	Not retained	9924
1214	200 - 400	240 - 250	Miscellaneous Debris	-	Not retained	9925
1215	200 - 400	240 - 250	Miscellaneous Debris	-	Not retained	9926
1216	200 - 400	240 - 250	Miscellaneous Debris	-	Not retained	9927
1217	200 - 400	250 - 260	Warhead Body Piece	0.05		2553
1218	200 - 400	250 - 260	Warhead Body Piece	0.05		2554
1219	200 - 400	250 - 260	Warhead Body Piece	0.04		2555
1220	200 - 400	250 - 260	Warhead Body Piece	0.03		2556
1221	200 - 400	250 - 260	Warhead Body Piece	0.01		2557
1222	200 - 400	250 - 260	Warhead Body Piece	0.01		2558
1223	200 - 400	250 - 260	Warhead Body Piece	0.01		2559
1224	200 - 400	250 - 260	Warhead Body Piece	0.01		2560
1225	200 - 400	250 - 260	Tail Piece	0.02		2561
1226	200 - 400	250 - 260	Miscellaneous Debris	0.01		2562
1227	200 - 400	250 - 260	Miscellaneous Debris	0.01		2563
1228	200 - 400	250 - 260	Miscellaneous Debris	-	Not retained	9928
1229	200 - 400	250 - 260	Miscellaneous Debris	-	Not retained	9929
1230	200 - 400	250 - 260	Miscellaneous Debris	-	Not retained	9930
1231	200 - 400	250 - 260	Miscellaneous Debris	-	Not retained	9931
1232	200 - 400	250 - 260	Miscellaneous Debris	-	Not retained	9932
1233	200 - 400	250 - 260	Miscellaneous Debris	-	Not retained	9933
1234	200 - 400	250 - 260	Miscellaneous Debris	-	Not retained	9934
1235	200 - 400	250 - 260	Miscellaneous Debris	-	Not retained	9935
1236	200 - 400	250 - 260	Miscellaneous Debris	-	Not retained	9936
1237	200 - 400	250 - 260	Miscellaneous Debris	-	Not retained	9937
1238	200 - 400	250 - 260	Miscellaneous Debris	-	Not retained	9938
1239	200 - 400	250 - 260	Miscellaneous Debris	-	Not retained	9939
1240	200 - 400	250 - 260	Miscellaneous Debris	-	Not retained	9940
1241	200 - 400	250 - 260	Miscellaneous Debris	-	Not retained	9941
1242	200 - 400	250 - 260	Miscellaneous Debris	-	Not retained	9942
1243	200 - 400	250 - 260	Miscellaneous Debris	-	Not retained	9943
1244	200 - 400	250 - 260	Miscellaneous Debris	-	Not retained	9944
1245	200 - 400	250 - 260	Miscellaneous Debris	-	Not retained	9945
1246	200 - 400	250 - 260	Miscellaneous Debris	-	Not retained	9946
1247	200 - 400	250 - 260	Miscellaneous Debris	-	Not retained	9947
1248	200 - 400	250 - 260	Miscellaneous Debris	-	Not retained	9948
1249	200 - 400	250 - 260	Miscellaneous Debris	-	Not retained	9949
1250	200 - 400	250 - 260	Miscellaneous Debris	-	Not retained	9950

TABLE B-6. FRAGMENTS RECOVERED BEYOND 200-FT RANGE IN TEST NO. 9 (Continued)

<u>Entry</u>	<u>Range Interval (ft)</u>	<u>Azimuthal Sector (°)</u>	<u>Description</u>	<u>Mass (lb)</u>	<u>Notes</u>	<u>G64 Index No.</u>
1251	200 - 400	250 - 260	Miscellaneous Debris	-	Not retained	9951
1252	200 - 400	250 - 260	Miscellaneous Debris	-	Not retained	9952
1253	200 - 400	250 - 260	Miscellaneous Debris	-	Not retained	9953
1254	200 - 400	250 - 260	Miscellaneous Debris	-	Not retained	9954
1255	200 - 400	250 - 260	Miscellaneous Debris	-	Not retained	9955
1256	200 - 400	250 - 260	Miscellaneous Debris	-	Not retained	9956
1257	200 - 400	250 - 260	Miscellaneous Debris	-	Not retained	9957
1258	200 - 400	250 - 260	Miscellaneous Debris	-	Not retained	9958
1259	200 - 400	250 - 260	Miscellaneous Debris	-	Not retained	9959
1260	200 - 400	250 - 260	Miscellaneous Debris	-	Not retained	9960
1261	200 - 400	250 - 260	Miscellaneous Debris	-	Not retained	9961
1262	200 - 400	250 - 260	Miscellaneous Debris	-	Not retained	9962
1263	200 - 400	250 - 260	Miscellaneous Debris	-	Not retained	9963
1264	200 - 400	250 - 260	Miscellaneous Debris	-	Not retained	9964
1265	200 - 400	250 - 260	Miscellaneous Debris	-	Not retained	9965
1266	200 - 400	250 - 260	Miscellaneous Debris	-	Not retained	9966
1267	200 - 400	250 - 260	Miscellaneous Debris	-	Not retained	9967
1268	200 - 400	250 - 260	Miscellaneous Debris	-	Not retained	9968
1269	200 - 400	250 - 260	Miscellaneous Debris	-	Not retained	9969
1270	200 - 400	250 - 260	Miscellaneous Debris	-	Not retained	9970
1271	200 - 400	250 - 260	Miscellaneous Debris	-	Not retained	9971
1272	200 - 400	250 - 260	Miscellaneous Debris	-	Not retained	9972
1273	200 - 400	250 - 260	Miscellaneous Debris	-	Not retained	9973
1274	200 - 400	250 - 260	Miscellaneous Debris	-	Not retained	9974
1275	200 - 400	250 - 260	Miscellaneous Debris	-	Not retained	9975
1276	200 - 400	250 - 260	Miscellaneous Debris	-	Not retained	9976
1277	200 - 400	250 - 260	Miscellaneous Debris	-	Not retained	9977
1278	200 - 400	250 - 260	Miscellaneous Debris	-	Not retained	9978
1279	200 - 400	250 - 260	Miscellaneous Debris	-	Not retained	9979
1280	200 - 400	250 - 260	Miscellaneous Debris	-	Not retained	9980
1281	200 - 400	250 - 260	Miscellaneous Debris	-	Not retained	9981
1282	200 - 400	250 - 260	Miscellaneous Debris	-	Not retained	9982
1283	200 - 400	250 - 260	Miscellaneous Debris	-	Not retained	9983
1284	200 - 400	250 - 260	Miscellaneous Debris	-	Not retained	9984
1285	200 - 400	250 - 260	Miscellaneous Debris	-	Not retained	9985
1286	200 - 400	250 - 260	Miscellaneous Debris	-	Not retained	9986
1287	200 - 400	250 - 260	Miscellaneous Debris	-	Not retained	9987
1288	200 - 400	250 - 260	Miscellaneous Debris	-	Not retained	9988
1289	200 - 400	250 - 260	Miscellaneous Debris	-	Not retained	9989
1290	200 - 400	250 - 260	Miscellaneous Debris	-	Not retained	9990
1291	200 - 400	250 - 260	Miscellaneous Debris	-	Not retained	9991
1292	200 - 400	250 - 260	Miscellaneous Debris	-	Not retained	9992
1293	200 - 400	250 - 260	Miscellaneous Debris	-	Not retained	9993
1294	200 - 400	250 - 260	Miscellaneous Debris	-	Not retained	9994
1295	200 - 400	250 - 260	Miscellaneous Debris	-	Not retained	9995
1296	200 - 400	250 - 260	Miscellaneous Debris	-	Not retained	9996
1297	200 - 400	250 - 260	Miscellaneous Debris	-	Not retained	9997
1298	200 - 400	250 - 260	Miscellaneous Debris	-	Not retained	9998
1299	200 - 400	250 - 260	Miscellaneous Debris	-	Not retained	9999
1300	200 - 400	250 - 260	Miscellaneous Debris	-	Not retained	10000

TABLE B-6. FRAGMENTS RECOVERED BEYOND 200-FT RANGE IN TEST NO. 9 (Continued)

<u>Entry</u>	<u>Range Interval (ft)</u>	<u>Azimuthal Sector (°)</u>	<u>Description</u>	<u>Mass (lb)</u>	<u>Notes</u>	<u>G64 Index No.</u>
1301	200 - 400	250 - 260	Miscellaneous Debris	-	Not retained	10001
1302	200 - 400	250 - 260	Miscellaneous Debris	-	Not retained	10002
1303	200 - 400	250 - 260	Miscellaneous Debris	-	Not retained	10003
1304	200 - 400	250 - 260	Miscellaneous Debris	-	Not retained	10004
1305	200 - 400	250 - 260	Miscellaneous Debris	-	Not retained	10005
1306	200 - 400	250 - 260	Miscellaneous Debris	-	Not retained	10006
1307	200 - 400	250 - 260	Miscellaneous Debris	-	Not retained	10007
1308	200 - 400	250 - 260	Miscellaneous Debris	-	Not retained	10008
1309	200 - 400	250 - 260	Miscellaneous Debris	-	Not retained	10009
1310	200 - 400	250 - 260	Miscellaneous Debris	-	Not retained	10010
1311	200 - 400	250 - 260	Miscellaneous Debris	-	Not retained	10011
1312	200 - 400	250 - 260	Miscellaneous Debris	-	Not retained	10012
1313	200 - 400	250 - 260	Miscellaneous Debris	-	Not retained	10013
1314	200 - 400	250 - 260	Miscellaneous Debris	-	Not retained	10014
1315	200 - 400	250 - 260	Miscellaneous Debris	-	Not retained	10015
1316	200 - 400	250 - 260	Miscellaneous Debris	-	Not retained	10016
1317	200 - 400	250 - 260	Miscellaneous Debris	-	Not retained	10017
1318	200 - 400	250 - 260	Miscellaneous Debris	-	Not retained	10018
1319	200 - 400	250 - 260	Miscellaneous Debris	-	Not retained	10019
1320	200 - 400	250 - 260	Miscellaneous Debris	-	Not retained	10020
1321	200 - 400	250 - 260	Miscellaneous Debris	-	Not retained	10021
1322	200 - 400	250 - 260	Miscellaneous Debris	-	Not retained	10022
1323	200 - 400	250 - 260	Miscellaneous Debris	-	Not retained	10023
1324	200 - 400	250 - 260	Miscellaneous Debris	-	Not retained	10024
1325	200 - 400	250 - 260	Miscellaneous Debris	-	Not retained	10025
1326	200 - 400	260 - 270	Warhead Body Piece	0.07		2201
1327	200 - 400	260 - 270	Warhead Body Piece	0.04		2202
1328	200 - 400	260 - 270	Warhead Body Piece	0.03		2203
1329	200 - 400	260 - 270	Tail Piece	0.04		2204
1330	200 - 400	260 - 270	Tail Piece	0.02		2205
1331	200 - 400	260 - 270	Tail Piece	0.02		2206
1332	200 - 400	260 - 270	Tail Piece	0.01		2207
1333	200 - 400	260 - 270	Miscellaneous Debris	0.03		2208
1334	200 - 400	260 - 270	Miscellaneous Debris	0.01		2209
1335	200 - 400	260 - 270	Miscellaneous Debris	0.01		2210
1336	200 - 400	260 - 270	Miscellaneous Debris	-	Not retained	10026
1337	200 - 400	260 - 270	Miscellaneous Debris	-	Not retained	10027
1338	200 - 400	260 - 270	Miscellaneous Debris	-	Not retained	10028
1339	200 - 400	260 - 270	Miscellaneous Debris	-	Not retained	10029
1340	200 - 400	260 - 270	Miscellaneous Debris	-	Not retained	10030
1341	200 - 400	260 - 270	Miscellaneous Debris	-	Not retained	10031
1342	200 - 400	260 - 270	Miscellaneous Debris	-	Not retained	10032
1343	200 - 400	260 - 270	Miscellaneous Debris	-	Not retained	10033
1344	200 - 400	260 - 270	Miscellaneous Debris	-	Not retained	10034
1345	200 - 400	260 - 270	Miscellaneous Debris	-	Not retained	10035
1346	200 - 400	260 - 270	Miscellaneous Debris	-	Not retained	10036
1347	200 - 400	260 - 270	Miscellaneous Debris	-	Not retained	10037
1348	200 - 400	260 - 270	Miscellaneous Debris	-	Not retained	10038
1349	200 - 400	260 - 270	Miscellaneous Debris	-	Not retained	10039
1350	200 - 400	260 - 270	Miscellaneous Debris	-	Not retained	10040

NSWCDD/TR-98/6

TABLE B-6. FRAGMENTS RECOVERED BEYOND 200-FT RANGE IN TEST NO. 9 (Continued)

<u>Entry</u>	<u>Range Interval (ft)</u>	<u>Azimuthal Sector (°)</u>	<u>Description</u>	<u>Mass (lb)</u>	<u>Notes</u>	<u>G64 Index No.</u>
1351	200 - 400	260 - 270	Miscellaneous Debris	-	Not retained	10041
1352	200 - 400	260 - 270	Miscellaneous Debris	-	Not retained	10042
1353	200 - 400	260 - 270	Miscellaneous Debris	-	Not retained	10043
1354	200 - 400	260 - 270	Miscellaneous Debris	-	Not retained	10044
1355	200 - 400	260 - 270	Miscellaneous Debris	-	Not retained	10045
1356	200 - 400	260 - 270	Miscellaneous Debris	-	Not retained	10046
1357	200 - 400	260 - 270	Miscellaneous Debris	-	Not retained	10047
1358	200 - 400	260 - 270	Miscellaneous Debris	-	Not retained	10048
1359	200 - 400	260 - 270	Miscellaneous Debris	-	Not retained	10049
1360	200 - 400	260 - 270	Miscellaneous Debris	-	Not retained	10050
1361	200 - 400	260 - 270	Miscellaneous Debris	-	Not retained	10051
1362	200 - 400	260 - 270	Miscellaneous Debris	-	Not retained	10052
1363	200 - 400	260 - 270	Miscellaneous Debris	-	Not retained	10053
1364	200 - 400	260 - 270	Miscellaneous Debris	-	Not retained	10054
1365	200 - 400	260 - 270	Miscellaneous Debris	-	Not retained	10055
1366	200 - 400	260 - 270	Miscellaneous Debris	-	Not retained	10056
1367	200 - 400	260 - 270	Miscellaneous Debris	-	Not retained	10057
1368	200 - 400	260 - 270	Miscellaneous Debris	-	Not retained	10058
1369	200 - 400	260 - 270	Miscellaneous Debris	-	Not retained	10059
1370	200 - 400	260 - 270	Miscellaneous Debris	-	Not retained	10060
1371	200 - 400	260 - 270	Miscellaneous Debris	-	Not retained	10061
1372	200 - 400	260 - 270	Miscellaneous Debris	-	Not retained	10062
1373	200 - 400	260 - 270	Miscellaneous Debris	-	Not retained	10063
1374	200 - 400	260 - 270	Miscellaneous Debris	-	Not retained	10064
1375	200 - 400	260 - 270	Miscellaneous Debris	-	Not retained	10065
1376	200 - 400	260 - 270	Miscellaneous Debris	-	Not retained	10066
1377	200 - 400	260 - 270	Miscellaneous Debris	-	Not retained	10067
1378	200 - 400	260 - 270	Miscellaneous Debris	-	Not retained	10068
1379	200 - 400	260 - 270	Miscellaneous Debris	-	Not retained	10069
1380	200 - 400	260 - 270	Miscellaneous Debris	-	Not retained	10070
1381	200 - 400	260 - 270	Miscellaneous Debris	-	Not retained	10071
1382	200 - 400	260 - 270	Miscellaneous Debris	-	Not retained	10072
1383	200 - 400	260 - 270	Miscellaneous Debris	-	Not retained	10073
1384	200 - 400	260 - 270	Miscellaneous Debris	-	Not retained	10074
1385	200 - 400	260 - 270	Miscellaneous Debris	-	Not retained	10075
1386	200 - 400	260 - 270	Miscellaneous Debris	-	Not retained	10076
1387	200 - 400	260 - 270	Miscellaneous Debris	-	Not retained	10077
1388	200 - 400	260 - 270	Miscellaneous Debris	-	Not retained	10078
1389	200 - 400	260 - 270	Miscellaneous Debris	-	Not retained	10079
1390	200 - 400	260 - 270	Miscellaneous Debris	-	Not retained	10080
1391	200 - 400	260 - 270	Miscellaneous Debris	-	Not retained	10081
1392	200 - 400	260 - 270	Miscellaneous Debris	-	Not retained	10082
1393	200 - 400	260 - 270	Miscellaneous Debris	-	Not retained	10083
1394	200 - 400	260 - 270	Miscellaneous Debris	-	Not retained	10084
1395	200 - 400	260 - 270	Miscellaneous Debris	-	Not retained	10085
1396	200 - 400	260 - 270	Miscellaneous Debris	-	Not retained	10086
1397	200 - 400	260 - 270	Miscellaneous Debris	-	Not retained	10087
1398	200 - 400	260 - 270	Miscellaneous Debris	-	Not retained	10088
1399	200 - 400	260 - 270	Miscellaneous Debris	-	Not retained	10089
1400	200 - 400	260 - 270	Miscellaneous Debris	-	Not retained	10090

TABLE B-6. FRAGMENTS RECOVERED BEYOND 200-FT RANGE IN TEST NO. 9 (Continued)

<u>Entry</u>	<u>Range Interval (ft)</u>	<u>Azimuthal Sector (°)</u>	<u>Description</u>	<u>Mass (lb)</u>	<u>Notes</u>	<u>G64 Index No.</u>
1401	200 - 400	260 - 270	Miscellaneous Debris	-	Not retained	10091
1402	200 - 400	260 - 270	Miscellaneous Debris	-	Not retained	10092
1403	200 - 400	260 - 270	Miscellaneous Debris	-	Not retained	10093
1404	200 - 400	260 - 270	Miscellaneous Debris	-	Not retained	10094
1405	200 - 400	260 - 270	Miscellaneous Debris	-	Not retained	10095
1406	200 - 400	260 - 270	Miscellaneous Debris	-	Not retained	10096
1407	200 - 400	260 - 270	Miscellaneous Debris	-	Not retained	10097
1408	200 - 400	260 - 270	Miscellaneous Debris	-	Not retained	10098
1409	200 - 400	260 - 270	Miscellaneous Debris	-	Not retained	10099
1410	200 - 400	270 - 280	Warhead Body Piece	0.61		3132
1411	200 - 400	270 - 280	Warhead Body Piece	0.34		3133
1412	200 - 400	270 - 280	Warhead Body Piece	0.03		3134
1413	200 - 400	270 - 280	Warhead Body Piece	0.02		3135
1414	200 - 400	270 - 280	Warhead Body Piece	0.01		3136
1415	200 - 400	270 - 280	Tail Piece	0.03		2435
1416	200 - 400	270 - 280	Tail Piece	0.16		3137
1417	200 - 400	270 - 280	Tail Piece	0.13		3138
1418	200 - 400	270 - 280	Tail Piece	0.03		3139
1419	200 - 400	270 - 280	Miscellaneous Debris	0.01		2436
1420	200 - 400	270 - 280	Miscellaneous Debris	0.01		2437
1421	200 - 400	270 - 280	Miscellaneous Debris	-	Not retained	10100
1422	200 - 400	270 - 280	Miscellaneous Debris	-	Not retained	10101
1423	200 - 400	270 - 280	Miscellaneous Debris	-	Not retained	10102
1424	200 - 400	270 - 280	Miscellaneous Debris	-	Not retained	10103
1425	200 - 400	270 - 280	Miscellaneous Debris	-	Not retained	10104
1426	200 - 400	270 - 280	Miscellaneous Debris	-	Not retained	10105
1427	200 - 400	270 - 280	Miscellaneous Debris	-	Not retained	10106
1428	200 - 400	270 - 280	Miscellaneous Debris	-	Not retained	10107
1429	200 - 400	270 - 280	Miscellaneous Debris	-	Not retained	10108
1430	200 - 400	270 - 280	Miscellaneous Debris	-	Not retained	10109
1431	200 - 400	270 - 280	Miscellaneous Debris	-	Not retained	10110
1432	200 - 400	270 - 280	Miscellaneous Debris	-	Not retained	10111
1433	200 - 400	270 - 280	Miscellaneous Debris	-	Not retained	10112
1434	200 - 400	270 - 280	Miscellaneous Debris	-	Not retained	10113
1435	200 - 400	270 - 280	Miscellaneous Debris	-	Not retained	10114
1436	200 - 400	270 - 280	Miscellaneous Debris	-	Not retained	10115
1437	200 - 400	270 - 280	Miscellaneous Debris	-	Not retained	10116
1438	200 - 400	270 - 280	Miscellaneous Debris	-	Not retained	10117
1439	200 - 400	270 - 280	Miscellaneous Debris	-	Not retained	10118
1440	200 - 400	270 - 280	Miscellaneous Debris	-	Not retained	10119
1441	200 - 400	270 - 280	Miscellaneous Debris	-	Not retained	10120
1442	200 - 400	270 - 280	Miscellaneous Debris	-	Not retained	10121
1443	200 - 400	270 - 280	Miscellaneous Debris	-	Not retained	10122
1444	200 - 400	270 - 280	Miscellaneous Debris	-	Not retained	10123
1445	200 - 400	270 - 280	Miscellaneous Debris	-	Not retained	10124
1446	200 - 400	270 - 280	Miscellaneous Debris	-	Not retained	10125
1447	200 - 400	270 - 280	Miscellaneous Debris	-	Not retained	10126
1448	200 - 400	270 - 280	Miscellaneous Debris	-	Not retained	10127
1449	200 - 400	270 - 280	Miscellaneous Debris	-	Not retained	10128
1450	200 - 400	270 - 280	Miscellaneous Debris	-	Not retained	10129

TABLE B-6. FRAGMENTS RECOVERED BEYOND 200-FT RANGE IN TEST NO. 9 (Continued)

<u>Entry</u>	<u>Range Interval (ft)</u>	<u>Azimuthal Sector (°)</u>	<u>Description</u>	<u>Mass (lb)</u>	<u>Notes</u>	<u>G64 Index No.</u>
1451	200 - 400	270 - 280	Miscellaneous Debris	-	Not retained	10130
1452	200 - 400	270 - 280	Miscellaneous Debris	-	Not retained	10131
1453	200 - 400	270 - 280	Miscellaneous Debris	-	Not retained	10132
1454	200 - 400	270 - 280	Miscellaneous Debris	-	Not retained	10133
1455	200 - 400	270 - 280	Miscellaneous Debris	-	Not retained	10134
1456	200 - 400	270 - 280	Miscellaneous Debris	-	Not retained	10135
1457	200 - 400	270 - 280	Miscellaneous Debris	-	Not retained	10136
1458	200 - 400	270 - 280	Miscellaneous Debris	-	Not retained	10137
1459	200 - 400	270 - 280	Miscellaneous Debris	-	Not retained	10138
1460	200 - 400	270 - 280	Miscellaneous Debris	-	Not retained	10139
1461	200 - 400	270 - 280	Miscellaneous Debris	-	Not retained	10140
1462	200 - 400	270 - 280	Miscellaneous Debris	-	Not retained	10141
1463	200 - 400	270 - 280	Miscellaneous Debris	-	Not retained	10142
1464	200 - 400	270 - 280	Miscellaneous Debris	-	Not retained	10143
1465	200 - 400	270 - 280	Miscellaneous Debris	-	Not retained	10144
1466	200 - 400	270 - 280	Miscellaneous Debris	-	Not retained	10145
1467	200 - 400	270 - 280	Miscellaneous Debris	-	Not retained	10146
1468	200 - 400	270 - 280	Miscellaneous Debris	-	Not retained	10147
1469	200 - 400	270 - 280	Miscellaneous Debris	-	Not retained	10148
1470	200 - 400	270 - 280	Miscellaneous Debris	-	Not retained	10149
1471	200 - 400	270 - 280	Miscellaneous Debris	-	Not retained	10150
1472	200 - 400	270 - 280	Miscellaneous Debris	-	Not retained	10151
1473	200 - 400	270 - 280	Miscellaneous Debris	-	Not retained	10152
1474	200 - 400	270 - 280	Miscellaneous Debris	-	Not retained	10153
1475	200 - 400	270 - 280	Miscellaneous Debris	-	Not retained	10154
1476	200 - 400	270 - 280	Miscellaneous Debris	-	Not retained	10155
1477	200 - 400	270 - 280	Miscellaneous Debris	-	Not retained	10156
1478	200 - 400	270 - 280	Miscellaneous Debris	-	Not retained	10157
1479	200 - 400	270 - 280	Miscellaneous Debris	-	Not retained	10158
1480	200 - 400	270 - 280	Miscellaneous Debris	-	Not retained	10159
1481	200 - 400	270 - 280	Miscellaneous Debris	-	Not retained	10160
1482	200 - 400	270 - 280	Miscellaneous Debris	-	Not retained	10161
1483	200 - 400	270 - 280	Miscellaneous Debris	-	Not retained	10162
1484	200 - 400	270 - 280	Miscellaneous Debris	-	Not retained	10163
1485	200 - 400	270 - 280	Miscellaneous Debris	-	Not retained	10164
1486	200 - 400	270 - 280	Miscellaneous Debris	-	Not retained	10165
1487	200 - 400	270 - 280	Miscellaneous Debris	-	Not retained	10166
1488	200 - 400	270 - 280	Miscellaneous Debris	-	Not retained	10167
1489	200 - 400	270 - 280	Miscellaneous Debris	-	Not retained	10168
1490	200 - 400	270 - 280	Miscellaneous Debris	-	Not retained	10169
1491	200 - 400	270 - 280	Miscellaneous Debris	-	Not retained	10170
1492	200 - 400	270 - 280	Miscellaneous Debris	-	Not retained	10171
1493	200 - 400	270 - 280	Miscellaneous Debris	-	Not retained	10172
1494	200 - 400	270 - 280	Miscellaneous Debris	-	Not retained	10173
1495	200 - 400	270 - 280	Miscellaneous Debris	-	Not retained	10174
1496	200 - 400	270 - 280	Miscellaneous Debris	-	Not retained	10175
1497	200 - 400	270 - 280	Miscellaneous Debris	-	Not retained	10176
1498	200 - 400	270 - 280	Miscellaneous Debris	-	Not retained	10177
1499	200 - 400	270 - 280	Miscellaneous Debris	-	Not retained	10178
1500	200 - 400	270 - 280	Miscellaneous Debris	-	Not retained	10179

NSWCDD/TR-98/6

TABLE B-6. FRAGMENTS RECOVERED BEYOND 200-FT RANGE IN TEST NO. 9 (Continued)

<u>Entry</u>	<u>Range Interval (ft)</u>	<u>Azimuthal Sector (°)</u>	<u>Description</u>	<u>Mass (lb)</u>	<u>Notes</u>	<u>G64 Index No.</u>
1501	200 - 400	270 - 280	Miscellaneous Debris	-	Not retained	10180
1502	200 - 400	270 - 280	Miscellaneous Debris	-	Not retained	10181
1503	200 - 400	270 - 280	Miscellaneous Debris	-	Not retained	10182
1504	200 - 400	270 - 280	Miscellaneous Debris	-	Not retained	10183
1505	200 - 400	270 - 280	Miscellaneous Debris	-	Not retained	10184
1506	200 - 400	270 - 280	Miscellaneous Debris	-	Not retained	10185
1507	200 - 400	270 - 280	Miscellaneous Debris	-	Not retained	10186
1508	200 - 400	270 - 280	Miscellaneous Debris	-	Not retained	10187
1509	200 - 400	270 - 280	Miscellaneous Debris	-	Not retained	10188
1510	200 - 400	270 - 280	Miscellaneous Debris	-	Not retained	10189
1511	200 - 400	270 - 280	Miscellaneous Debris	-	Not retained	10190
1512	200 - 400	270 - 280	Miscellaneous Debris	-	Not retained	10191
1513	200 - 400	270 - 280	Miscellaneous Debris	-	Not retained	10192
1514	200 - 400	280 - 290	Warhead Body Piece	0.17		2567
1515	200 - 400	280 - 290	Warhead Body Piece	0.07		2568
1516	200 - 400	280 - 290	Warhead Body Piece	0.04		2569
1517	200 - 400	280 - 290	Warhead Body Piece	0.28		2570
1518	200 - 400	280 - 290	Warhead Body Piece	0.17		2571
1519	200 - 400	280 - 290	Warhead Body Piece	0.08		2572
1520	200 - 400	280 - 290	Warhead Body Piece	0.03		2573
1521	200 - 400	280 - 290	Warhead Body Piece	0.02		2574
1522	200 - 400	280 - 290	Warhead Body Piece	0.01		2575
1523	200 - 400	280 - 290	Warhead Body Piece	0.01		2576
1524	200 - 400	280 - 290	Warhead Body Piece	0.01		2577
1525	200 - 400	280 - 290	Warhead Body Piece	0.07		2921
1526	200 - 400	280 - 290	Warhead Body Piece	0.03		2922
1527	200 - 400	280 - 290	Tail Piece	0.05		2579
1528	200 - 400	280 - 290	Tail Piece	0.03		2580
1529	200 - 400	280 - 290	Tail Piece	0.01		2581
1530	200 - 400	280 - 290	Tail Piece	0.02		2923
1531	200 - 400	280 - 290	Miscellaneous Debris	0.01		2582
1532	200 - 400	280 - 290	Miscellaneous Debris	0.01		2924
1533	200 - 400	280 - 290	Miscellaneous Debris	0.01		2578
1534	200 - 400	280 - 290	Miscellaneous Debris	-	Not retained	10193
1535	200 - 400	280 - 290	Miscellaneous Debris	-	Not retained	10194
1536	200 - 400	280 - 290	Miscellaneous Debris	-	Not retained	10195
1537	200 - 400	280 - 290	Miscellaneous Debris	-	Not retained	10196
1538	200 - 400	280 - 290	Miscellaneous Debris	-	Not retained	10197
1539	200 - 400	280 - 290	Miscellaneous Debris	-	Not retained	10198
1540	200 - 400	280 - 290	Miscellaneous Debris	-	Not retained	10199
1541	200 - 400	280 - 290	Miscellaneous Debris	-	Not retained	10200
1542	200 - 400	280 - 290	Miscellaneous Debris	-	Not retained	10201
1543	200 - 400	280 - 290	Miscellaneous Debris	-	Not retained	10202
1544	200 - 400	280 - 290	Miscellaneous Debris	-	Not retained	10203
1545	200 - 400	280 - 290	Miscellaneous Debris	-	Not retained	10204
1546	200 - 400	280 - 290	Miscellaneous Debris	-	Not retained	10205
1547	200 - 400	280 - 290	Miscellaneous Debris	-	Not retained	10206
1548	200 - 400	280 - 290	Miscellaneous Debris	-	Not retained	10207
1549	200 - 400	280 - 290	Miscellaneous Debris	-	Not retained	10208
1550	200 - 400	280 - 290	Miscellaneous Debris	-	Not retained	10209

NSWCDD/TR-98/6

TABLE B-6. FRAGMENTS RECOVERED BEYOND 200-FT RANGE IN TEST NO. 9 (Continued)

<u>Entry</u>	<u>Range Interval (ft)</u>	<u>Azimuthal Sector (°)</u>	<u>Description</u>	<u>Mass (lb)</u>	<u>Notes</u>	<u>G64 Index No.</u>
1551	200 - 400	280 - 290	Miscellaneous Debris	-	Not retained	10210
1552	200 - 400	280 - 290	Miscellaneous Debris	-	Not retained	10211
1553	200 - 400	280 - 290	Miscellaneous Debris	-	Not retained	10212
1554	200 - 400	280 - 290	Miscellaneous Debris	-	Not retained	10213
1555	200 - 400	280 - 290	Miscellaneous Debris	-	Not retained	10214
1556	200 - 400	280 - 290	Miscellaneous Debris	-	Not retained	10215
1557	200 - 400	280 - 290	Miscellaneous Debris	-	Not retained	10216
1558	200 - 400	280 - 290	Miscellaneous Debris	-	Not retained	10217
1559	200 - 400	280 - 290	Miscellaneous Debris	-	Not retained	10218
1560	200 - 400	280 - 290	Miscellaneous Debris	-	Not retained	10219
1561	200 - 400	280 - 290	Miscellaneous Debris	-	Not retained	10220
1562	200 - 400	280 - 290	Miscellaneous Debris	-	Not retained	10221
1563	200 - 400	280 - 290	Miscellaneous Debris	-	Not retained	10222
1564	200 - 400	280 - 290	Miscellaneous Debris	-	Not retained	10223
1565	200 - 400	280 - 290	Miscellaneous Debris	-	Not retained	10224
1566	200 - 400	280 - 290	Miscellaneous Debris	-	Not retained	10225
1567	200 - 400	280 - 290	Miscellaneous Debris	-	Not retained	10226
1568	200 - 400	280 - 290	Miscellaneous Debris	-	Not retained	10227
1569	200 - 400	280 - 290	Miscellaneous Debris	-	Not retained	10228
1570	200 - 400	280 - 290	Miscellaneous Debris	-	Not retained	10229
1571	200 - 400	280 - 290	Miscellaneous Debris	-	Not retained	10230
1572	200 - 400	280 - 290	Miscellaneous Debris	-	Not retained	10231
1573	200 - 400	280 - 290	Miscellaneous Debris	-	Not retained	10232
1574	200 - 400	280 - 290	Miscellaneous Debris	-	Not retained	10233
1575	200 - 400	280 - 290	Miscellaneous Debris	-	Not retained	10234
1576	200 - 400	280 - 290	Miscellaneous Debris	-	Not retained	10235
1577	200 - 400	280 - 290	Miscellaneous Debris	-	Not retained	10236
1578	200 - 400	280 - 290	Miscellaneous Debris	-	Not retained	10237
1579	200 - 400	280 - 290	Miscellaneous Debris	-	Not retained	10238
1580	200 - 400	280 - 290	Miscellaneous Debris	-	Not retained	10239
1581	200 - 400	280 - 290	Miscellaneous Debris	-	Not retained	10240
1582	200 - 400	280 - 290	Miscellaneous Debris	-	Not retained	10241
1583	200 - 400	280 - 290	Miscellaneous Debris	-	Not retained	10242
1584	200 - 400	280 - 290	Miscellaneous Debris	-	Not retained	10243
1585	200 - 400	280 - 290	Miscellaneous Debris	-	Not retained	10244
1586	200 - 400	280 - 290	Miscellaneous Debris	-	Not retained	10245
1587	200 - 400	280 - 290	Miscellaneous Debris	-	Not retained	10246
1588	200 - 400	280 - 290	Miscellaneous Debris	-	Not retained	10247
1589	200 - 400	280 - 290	Miscellaneous Debris	-	Not retained	10248
1590	200 - 400	280 - 290	Miscellaneous Debris	-	Not retained	10249
1591	200 - 400	280 - 290	Miscellaneous Debris	-	Not retained	10250
1592	200 - 400	280 - 290	Miscellaneous Debris	-	Not retained	10251
1593	200 - 400	280 - 290	Miscellaneous Debris	-	Not retained	10252
1594	200 - 400	280 - 290	Miscellaneous Debris	-	Not retained	10253
1595	200 - 400	280 - 290	Miscellaneous Debris	-	Not retained	10254
1596	200 - 400	280 - 290	Miscellaneous Debris	-	Not retained	10255
1597	200 - 400	280 - 290	Miscellaneous Debris	-	Not retained	10256
1598	200 - 400	280 - 290	Miscellaneous Debris	-	Not retained	10257
1599	200 - 400	280 - 290	Miscellaneous Debris	-	Not retained	10258
1600	200 - 400	280 - 290	Miscellaneous Debris	-	Not retained	10259

TABLE B-6. FRAGMENTS RECOVERED BEYOND 200-FT RANGE IN TEST NO. 9 (Continued)

<u>Entry</u>	<u>Range Interval (ft)</u>	<u>Azimuthal Sector (°)</u>	<u>Description</u>	<u>Mass (lb)</u>	<u>Notes</u>	<u>G64 Index No.</u>
1601	200 - 400	280 - 290	Miscellaneous Debris	-	Not retained	10260
1602	200 - 400	280 - 290	Miscellaneous Debris	-	Not retained	10261
1603	200 - 400	280 - 290	Miscellaneous Debris	-	Not retained	10262
1604	200 - 400	280 - 290	Miscellaneous Debris	-	Not retained	10263
1605	200 - 400	280 - 290	Miscellaneous Debris	-	Not retained	10264
1606	200 - 400	280 - 290	Miscellaneous Debris	-	Not retained	10265
1607	200 - 400	280 - 290	Miscellaneous Debris	-	Not retained	10266
1608	200 - 400	280 - 290	Miscellaneous Debris	-	Not retained	10267
1609	200 - 400	280 - 290	Miscellaneous Debris	-	Not retained	10268
1610	200 - 400	280 - 290	Miscellaneous Debris	-	Not retained	10269
1611	200 - 400	290 - 300	Warhead Body Piece	0.49		2759
1612	200 - 400	290 - 300	Warhead Body Piece	0.18		2760
1613	200 - 400	290 - 300	Warhead Body Piece	0.14		2761
1614	200 - 400	290 - 300	Warhead Body Piece	0.10		2762
1615	200 - 400	290 - 300	Warhead Body Piece	0.01		2763
1616	200 - 400	290 - 300	Warhead Body Piece	0.01		2764
1617	200 - 400	290 - 300	Tail Piece	0.17		2765
1618	200 - 400	290 - 300	Tail Piece	0.04		2766
1619	200 - 400	290 - 300	Tail Piece	0.01		2767
1620	200 - 400	290 - 300	Miscellaneous Debris	-	Not retained	10270
1621	200 - 400	290 - 300	Miscellaneous Debris	-	Not retained	10271
1622	200 - 400	290 - 300	Miscellaneous Debris	-	Not retained	10272
1623	200 - 400	290 - 300	Miscellaneous Debris	-	Not retained	10273
1624	200 - 400	290 - 300	Miscellaneous Debris	-	Not retained	10274
1625	200 - 400	290 - 300	Miscellaneous Debris	-	Not retained	10275
1626	200 - 400	290 - 300	Miscellaneous Debris	-	Not retained	10276
1627	200 - 400	290 - 300	Miscellaneous Debris	-	Not retained	10277
1628	200 - 400	290 - 300	Miscellaneous Debris	-	Not retained	10278
1629	200 - 400	290 - 300	Miscellaneous Debris	-	Not retained	10279
1630	200 - 400	290 - 300	Miscellaneous Debris	-	Not retained	10280
1631	200 - 400	290 - 300	Miscellaneous Debris	-	Not retained	10281
1632	200 - 400	290 - 300	Miscellaneous Debris	-	Not retained	10282
1633	200 - 400	290 - 300	Miscellaneous Debris	-	Not retained	10283
1634	200 - 400	290 - 300	Miscellaneous Debris	-	Not retained	10284
1635	200 - 400	290 - 300	Miscellaneous Debris	-	Not retained	10285
1636	200 - 400	290 - 300	Miscellaneous Debris	-	Not retained	10286
1637	200 - 400	290 - 300	Miscellaneous Debris	-	Not retained	10287
1638	200 - 400	290 - 300	Miscellaneous Debris	-	Not retained	10288
1639	200 - 400	290 - 300	Miscellaneous Debris	-	Not retained	10289
1640	200 - 400	290 - 300	Miscellaneous Debris	-	Not retained	10290
1641	200 - 400	290 - 300	Miscellaneous Debris	-	Not retained	10291
1642	200 - 400	290 - 300	Miscellaneous Debris	-	Not retained	10292
1643	200 - 400	290 - 300	Miscellaneous Debris	-	Not retained	10293
1644	200 - 400	290 - 300	Miscellaneous Debris	-	Not retained	10294
1645	200 - 400	290 - 300	Miscellaneous Debris	-	Not retained	10295
1646	200 - 400	290 - 300	Miscellaneous Debris	-	Not retained	10296
1647	200 - 400	290 - 300	Miscellaneous Debris	-	Not retained	10297
1648	200 - 400	290 - 300	Miscellaneous Debris	-	Not retained	10298
1649	200 - 400	290 - 300	Miscellaneous Debris	-	Not retained	10299
1650	200 - 400	290 - 300	Miscellaneous Debris	-	Not retained	10300

NSWCDD/TR-98/6

TABLE B-6. FRAGMENTS RECOVERED BEYOND 200-FT RANGE IN TEST NO. 9 (Continued)

<u>Entry</u>	<u>Range Interval (ft)</u>	<u>Azimuthal Sector (°)</u>	<u>Description</u>	<u>Mass (lb)</u>	<u>Notes</u>	<u>G64 Index No.</u>
1651	200 - 400	290 - 300	Miscellaneous Debris	-	Not retained	10301
1652	200 - 400	290 - 300	Miscellaneous Debris	-	Not retained	10302
1653	200 - 400	290 - 300	Miscellaneous Debris	-	Not retained	10303
1654	200 - 400	290 - 300	Miscellaneous Debris	-	Not retained	10304
1655	200 - 400	290 - 300	Miscellaneous Debris	-	Not retained	10305
1656	200 - 400	290 - 300	Miscellaneous Debris	-	Not retained	10306
1657	200 - 400	290 - 300	Miscellaneous Debris	-	Not retained	10307
1658	200 - 400	290 - 300	Miscellaneous Debris	-	Not retained	10308
1659	200 - 400	290 - 300	Miscellaneous Debris	-	Not retained	10309
1660	200 - 400	290 - 300	Miscellaneous Debris	-	Not retained	10310
1661	200 - 400	290 - 300	Miscellaneous Debris	-	Not retained	10311
1662	200 - 400	290 - 300	Miscellaneous Debris	-	Not retained	10312
1663	200 - 400	290 - 300	Miscellaneous Debris	-	Not retained	10313
1664	200 - 400	290 - 300	Miscellaneous Debris	-	Not retained	10314
1665	200 - 400	290 - 300	Miscellaneous Debris	-	Not retained	10315
1666	200 - 400	290 - 300	Miscellaneous Debris	-	Not retained	10316
1667	200 - 400	290 - 300	Miscellaneous Debris	-	Not retained	10317
1668	200 - 400	290 - 300	Miscellaneous Debris	-	Not retained	10318
1669	200 - 400	290 - 300	Miscellaneous Debris	-	Not retained	10319
1670	200 - 400	290 - 300	Miscellaneous Debris	-	Not retained	10320
1671	200 - 400	290 - 300	Miscellaneous Debris	-	Not retained	10321
1672	200 - 400	290 - 300	Miscellaneous Debris	-	Not retained	10322
1673	200 - 400	290 - 300	Miscellaneous Debris	-	Not retained	10323
1674	200 - 400	290 - 300	Miscellaneous Debris	-	Not retained	10324
1675	200 - 400	300 - 310	Warhead Body Piece	0.37		2943
1676	200 - 400	300 - 310	Warhead Body Piece	0.09		2944
1677	200 - 400	300 - 310	Warhead Body Piece	0.09		2945
1678	200 - 400	300 - 310	Warhead Body Piece	0.08		2946
1679	200 - 400	300 - 310	Warhead Body Piece	0.02		2947
1680	200 - 400	300 - 310	Miscellaneous Debris	-	Not retained	10325
1681	200 - 400	300 - 310	Miscellaneous Debris	-	Not retained	10326
1682	200 - 400	300 - 310	Miscellaneous Debris	-	Not retained	10327
1683	200 - 400	300 - 310	Miscellaneous Debris	-	Not retained	10328
1684	200 - 400	300 - 310	Miscellaneous Debris	-	Not retained	10329
1685	200 - 400	300 - 310	Miscellaneous Debris	-	Not retained	10330
1686	200 - 400	300 - 310	Miscellaneous Debris	-	Not retained	10331
1687	200 - 400	300 - 310	Miscellaneous Debris	-	Not retained	10332
1688	200 - 400	300 - 310	Miscellaneous Debris	-	Not retained	10333
1689	200 - 400	300 - 310	Miscellaneous Debris	-	Not retained	10334
1690	200 - 400	300 - 310	Miscellaneous Debris	-	Not retained	10335
1691	200 - 400	300 - 310	Miscellaneous Debris	-	Not retained	10336
1692	200 - 400	300 - 310	Miscellaneous Debris	-	Not retained	10337
1693	200 - 400	300 - 310	Miscellaneous Debris	-	Not retained	10338
1694	200 - 400	300 - 310	Miscellaneous Debris	-	Not retained	10339
1695	200 - 400	300 - 310	Miscellaneous Debris	-	Not retained	10340
1696	200 - 400	300 - 310	Miscellaneous Debris	-	Not retained	10341
1697	200 - 400	300 - 310	Miscellaneous Debris	-	Not retained	10342
1698	200 - 400	300 - 310	Miscellaneous Debris	-	Not retained	10343
1699	200 - 400	300 - 310	Miscellaneous Debris	-	Not retained	10344
1700	200 - 400	300 - 310	Miscellaneous Debris	-	Not retained	10345

TABLE B-6. FRAGMENTS RECOVERED BEYOND 200-FT RANGE IN TEST NO. 9 (Continued)

<u>Entry</u>	<u>Range Interval (ft)</u>	<u>Azimuthal Sector (°)</u>	<u>Description</u>	<u>Mass (lb)</u>	<u>Notes</u>	<u>G64 Index No.</u>
1701	200 - 400	300 - 310	Miscellaneous Debris	-	Not retained	10346
1702	200 - 400	300 - 310	Miscellaneous Debris	-	Not retained	10347
1703	200 - 400	300 - 310	Miscellaneous Debris	-	Not retained	10348
1704	200 - 400	300 - 310	Miscellaneous Debris	-	Not retained	10349
1705	200 - 400	300 - 310	Miscellaneous Debris	-	Not retained	10350
1706	200 - 400	300 - 310	Miscellaneous Debris	-	Not retained	10351
1707	200 - 400	300 - 310	Miscellaneous Debris	-	Not retained	10352
1708	200 - 400	300 - 310	Miscellaneous Debris	-	Not retained	10353
1709	200 - 400	300 - 310	Miscellaneous Debris	-	Not retained	10354
1710	200 - 400	300 - 310	Miscellaneous Debris	-	Not retained	10355
1711	200 - 400	300 - 310	Miscellaneous Debris	-	Not retained	10356
1712	200 - 400	300 - 310	Miscellaneous Debris	-	Not retained	10357
1713	200 - 400	300 - 310	Miscellaneous Debris	-	Not retained	10358
1714	200 - 400	300 - 310	Miscellaneous Debris	-	Not retained	10359
1715	200 - 400	300 - 310	Miscellaneous Debris	-	Not retained	10360
1716	200 - 400	300 - 310	Miscellaneous Debris	-	Not retained	10361
1717	200 - 400	300 - 310	Miscellaneous Debris	-	Not retained	10362
1718	200 - 400	300 - 310	Miscellaneous Debris	-	Not retained	10363
1719	200 - 400	300 - 310	Miscellaneous Debris	-	Not retained	10364
1720	200 - 400	300 - 310	Miscellaneous Debris	-	Not retained	10365
1721	200 - 400	310 - 320	Warhead Body Piece	0.01		3175
1722	200 - 400	310 - 320	Miscellaneous Debris	-	Not retained	10366
1723	200 - 400	310 - 320	Miscellaneous Debris	-	Not retained	10367
1724	200 - 400	310 - 320	Miscellaneous Debris	-	Not retained	10368
1725	200 - 400	310 - 320	Miscellaneous Debris	-	Not retained	10369
1726	200 - 400	310 - 320	Miscellaneous Debris	-	Not retained	10370
1727	200 - 400	310 - 320	Miscellaneous Debris	-	Not retained	10371
1728	200 - 400	310 - 320	Miscellaneous Debris	-	Not retained	10372
1729	200 - 400	310 - 320	Miscellaneous Debris	-	Not retained	10373
1730	200 - 400	310 - 320	Miscellaneous Debris	-	Not retained	10374
1731	200 - 400	310 - 320	Miscellaneous Debris	-	Not retained	10375
1732	200 - 400	310 - 320	Miscellaneous Debris	-	Not retained	10376
1733	200 - 400	310 - 320	Miscellaneous Debris	-	Not retained	10377
1734	200 - 400	310 - 320	Miscellaneous Debris	-	Not retained	10378
1735	200 - 400	310 - 320	Miscellaneous Debris	-	Not retained	10379
1736	200 - 400	310 - 320	Miscellaneous Debris	-	Not retained	10380
1737	200 - 400	310 - 320	Miscellaneous Debris	-	Not retained	10381
1738	200 - 400	310 - 320	Miscellaneous Debris	-	Not retained	10382
1739	200 - 400	310 - 320	Miscellaneous Debris	-	Not retained	10383
1740	200 - 400	310 - 320	Miscellaneous Debris	-	Not retained	10384
1741	200 - 400	310 - 320	Miscellaneous Debris	-	Not retained	10385
1742	200 - 400	310 - 320	Miscellaneous Debris	-	Not retained	10386
1743	200 - 400	310 - 320	Miscellaneous Debris	-	Not retained	10387
1744	200 - 400	310 - 320	Miscellaneous Debris	-	Not retained	10388
1745	200 - 400	310 - 320	Miscellaneous Debris	-	Not retained	10389
1746	200 - 400	310 - 320	Miscellaneous Debris	-	Not retained	10390
1747	200 - 400	310 - 320	Miscellaneous Debris	-	Not retained	10391
1748	200 - 400	310 - 320	Miscellaneous Debris	-	Not retained	10392
1749	200 - 400	310 - 320	Miscellaneous Debris	-	Not retained	10393
1750	200 - 400	310 - 320	Miscellaneous Debris	-	Not retained	10394

NSWCDD/TR-98/6

TABLE B-6. FRAGMENTS RECOVERED BEYOND 200-FT RANGE IN TEST NO. 9 (Continued)

<u>Entry</u>	<u>Range Interval (ft)</u>	<u>Azimuthal Sector (°)</u>	<u>Description</u>	<u>Mass (lb)</u>	<u>Notes</u>	<u>G64 Index No.</u>
1751	200 - 400	310 - 320	Miscellaneous Debris	-	Not retained	10395
1752	200 - 400	310 - 320	Miscellaneous Debris	-	Not retained	10396
1753	200 - 400	310 - 320	Miscellaneous Debris	-	Not retained	10397
1754	200 - 400	310 - 320	Miscellaneous Debris	-	Not retained	10398
1755	200 - 400	310 - 320	Miscellaneous Debris	-	Not retained	10399
1756	200 - 400	310 - 320	Miscellaneous Debris	-	Not retained	10400
1757	200 - 400	310 - 320	Miscellaneous Debris	-	Not retained	10401
1758	200 - 400	320 - 330	Warhead Body Piece	0.12		2751
1759	200 - 400	320 - 330	Warhead Body Piece	0.08		2752
1760	200 - 400	320 - 330	Warhead Body Piece	0.05		2753
1761	200 - 400	320 - 330	Warhead Body Piece	0.02		2754
1762	200 - 400	320 - 330	Warhead Body Piece	0.01		2755
1763	200 - 400	320 - 330	Tail Piece	0.02		2756
1764	200 - 400	320 - 330	Tail Piece	0.01		2853
1765	200 - 400	320 - 330	Tail Piece	0.01		2854
1766	200 - 400	320 - 330	Miscellaneous Debris	-	Not retained	10402
1767	200 - 400	320 - 330	Miscellaneous Debris	-	Not retained	10403
1768	200 - 400	320 - 330	Miscellaneous Debris	-	Not retained	10404
1769	200 - 400	320 - 330	Miscellaneous Debris	-	Not retained	10405
1770	200 - 400	320 - 330	Miscellaneous Debris	-	Not retained	10406
1771	200 - 400	320 - 330	Miscellaneous Debris	-	Not retained	10407
1772	200 - 400	320 - 330	Miscellaneous Debris	-	Not retained	10408
1773	200 - 400	320 - 330	Miscellaneous Debris	-	Not retained	10409
1774	200 - 400	320 - 330	Miscellaneous Debris	-	Not retained	10410
1775	200 - 400	320 - 330	Miscellaneous Debris	-	Not retained	10411
1776	200 - 400	320 - 330	Miscellaneous Debris	-	Not retained	10412
1777	200 - 400	320 - 330	Miscellaneous Debris	-	Not retained	10413
1778	200 - 400	320 - 330	Miscellaneous Debris	-	Not retained	10414
1779	200 - 400	320 - 330	Miscellaneous Debris	-	Not retained	10415
1780	200 - 400	320 - 330	Miscellaneous Debris	-	Not retained	10416
1781	200 - 400	330 - 340	Warhead Body Piece	0.20		2315
1782	200 - 400	330 - 340	Warhead Body Piece	0.09		2316
1783	200 - 400	330 - 340	Warhead Body Piece	0.06		2317
1784	200 - 400	330 - 340	Warhead Body Piece	0.04		2318
1785	200 - 400	330 - 340	Warhead Body Piece	0.06		2319
1786	200 - 400	330 - 340	Warhead Body Piece	0.03		2320
1787	200 - 400	330 - 340	Warhead Body Piece	0.04		2321
1788	200 - 400	330 - 340	Tail Piece	0.01		2268
1789	200 - 400	330 - 340	Miscellaneous Debris	0.02		2269
1790	200 - 400	330 - 340	Miscellaneous Debris	-	Not retained	10417
1791	200 - 400	330 - 340	Miscellaneous Debris	-	Not retained	10418
1792	200 - 400	330 - 340	Miscellaneous Debris	-	Not retained	10419
1793	200 - 400	330 - 340	Miscellaneous Debris	-	Not retained	10420
1794	200 - 400	330 - 340	Miscellaneous Debris	-	Not retained	10421
1795	200 - 400	330 - 340	Miscellaneous Debris	-	Not retained	10422
1796	200 - 400	330 - 340	Miscellaneous Debris	-	Not retained	10423
1797	200 - 400	330 - 340	Miscellaneous Debris	-	Not retained	10424
1798	200 - 400	330 - 340	Miscellaneous Debris	-	Not retained	10425
1799	200 - 400	330 - 340	Miscellaneous Debris	-	Not retained	10426
1800	200 - 400	330 - 340	Miscellaneous Debris	-	Not retained	10427

TABLE B-6. FRAGMENTS RECOVERED BEYOND 200-FT RANGE IN TEST NO. 9 (Continued)

<u>Entry</u>	<u>Range Interval (ft)</u>	<u>Azimuthal Sector (°)</u>	<u>Description</u>	<u>Mass (lb)</u>	<u>Notes</u>	<u>G64 Index No.</u>
1801	200 - 400	330 - 340	Miscellaneous Debris	-	Not retained	10428
1802	200 - 400	330 - 340	Miscellaneous Debris	-	Not retained	10429
1803	200 - 400	340 - 350	Warhead Body Piece	0.01		2482
1804	200 - 400	340 - 350	Warhead Body Piece	0.01		2483
1805	200 - 400	340 - 350	Warhead Body Piece	0.01		2484
1806	200 - 400	340 - 350	Warhead Body Piece	0.01		2485
1807	200 - 400	340 - 350	Tail Piece	0.05		2487
1808	200 - 400	340 - 350	Tail Piece	0.01		2488
1809	200 - 400	340 - 350	Miscellaneous Debris	0.01		2489
1810	200 - 400	340 - 350	Miscellaneous Debris	0.01		2486
1811	200 - 400	340 - 350	Miscellaneous Debris	-	Not retained	10430
1812	200 - 400	340 - 350	Miscellaneous Debris	-	Not retained	10431
1813	200 - 400	340 - 350	Miscellaneous Debris	-	Not retained	10432
1814	200 - 400	340 - 350	Miscellaneous Debris	-	Not retained	10433
1815	200 - 400	340 - 350	Miscellaneous Debris	-	Not retained	10434
1816	200 - 400	340 - 350	Miscellaneous Debris	-	Not retained	10435
1817	200 - 400	340 - 350	Miscellaneous Debris	-	Not retained	10436
1818	200 - 400	340 - 350	Miscellaneous Debris	-	Not retained	10437
1819	200 - 400	340 - 350	Miscellaneous Debris	-	Not retained	10438
1820	200 - 400	340 - 350	Miscellaneous Debris	-	Not retained	10439
1821	200 - 400	340 - 350	Miscellaneous Debris	-	Not retained	10440
1822	200 - 400	340 - 350	Miscellaneous Debris	-	Not retained	10441
1823	200 - 400	340 - 350	Miscellaneous Debris	-	Not retained	10442
1824	200 - 400	340 - 350	Miscellaneous Debris	-	Not retained	10443
1825	200 - 400	340 - 350	Miscellaneous Debris	-	Not retained	10444
1826	200 - 400	340 - 350	Miscellaneous Debris	-	Not retained	10445
1827	200 - 400	340 - 350	Miscellaneous Debris	-	Not retained	10446
1828	200 - 400	340 - 350	Miscellaneous Debris	-	Not retained	10447
1829	200 - 400	340 - 350	Miscellaneous Debris	-	Not retained	10448
1830	200 - 400	340 - 350	Miscellaneous Debris	-	Not retained	10449
1831	200 - 400	340 - 350	Miscellaneous Debris	-	Not retained	10450
1832	200 - 400	340 - 350	Miscellaneous Debris	-	Not retained	10451
1833	200 - 400	340 - 350	Miscellaneous Debris	-	Not retained	10452
1834	200 - 400	340 - 350	Miscellaneous Debris	-	Not retained	10453
1835	200 - 400	340 - 350	Miscellaneous Debris	-	Not retained	10454
1836	200 - 400	340 - 350	Miscellaneous Debris	-	Not retained	10455
1837	200 - 400	340 - 350	Miscellaneous Debris	-	Not retained	10456
1838	200 - 400	340 - 350	Intact Warhead	5.05		2481
1839	200 - 400	350 - 360	Tail Piece	0.02		2544
1840	200 - 400	350 - 360	Miscellaneous Debris	-	Not retained	10457
1841	200 - 400	350 - 360	Miscellaneous Debris	-	Not retained	10458
1842	200 - 400	350 - 360	Miscellaneous Debris	-	Not retained	10459
1843	200 - 400	350 - 360	Miscellaneous Debris	-	Not retained	10460
1844	200 - 400	350 - 360	Miscellaneous Debris	-	Not retained	10461
1845	200 - 400	350 - 360	Miscellaneous Debris	-	Not retained	10462
1846	200 - 400	350 - 360	Miscellaneous Debris	-	Not retained	10463
1847	200 - 400	350 - 360	Miscellaneous Debris	-	Not retained	10464
1848	200 - 400	350 - 360	Miscellaneous Debris	-	Not retained	10465
1849	200 - 400	350 - 360	Miscellaneous Debris	-	Not retained	10466
1850	200 - 400	350 - 360	Miscellaneous Debris	-	Not retained	10467

NSWCDD/TR-98/6

TABLE B-6. FRAGMENTS RECOVERED BEYOND 200-FT RANGE IN TEST NO. 9 (Continued)

<u>Entry</u>	<u>Range Interval (ft)</u>	<u>Azimuthal Sector (°)</u>	<u>Description</u>	<u>Mass (lb)</u>	<u>Notes</u>	<u>G64 Index No.</u>
1851	200 - 400	350 - 360	Miscellaneous Debris	-	Not retained	10468
1852	200 - 400	350 - 360	Miscellaneous Debris	-	Not retained	10469
1853	200 - 400	350 - 360	Miscellaneous Debris	-	Not retained	10470
1854	200 - 400	350 - 360	Miscellaneous Debris	-	Not retained	10471
1855	200 - 400	350 - 360	Miscellaneous Debris	-	Not retained	10472
1856	200 - 400	350 - 360	Miscellaneous Debris	-	Not retained	10473
1857	200 - 400	350 - 360	Miscellaneous Debris	-	Not retained	10474
1858	200 - 400	350 - 360	Miscellaneous Debris	-	Not retained	10475
1859	200 - 400	350 - 360	Miscellaneous Debris	-	Not retained	10476
1860	200 - 400	350 - 360	Miscellaneous Debris	-	Not retained	10477
1861	200 - 400	350 - 360	Miscellaneous Debris	-	Not retained	10478
1862	200 - 400	350 - 360	Miscellaneous Debris	-	Not retained	10479
1863	200 - 400	350 - 360	Miscellaneous Debris	-	Not retained	10480
1864	200 - 400	350 - 360	Miscellaneous Debris	-	Not retained	10481
1865	200 - 400	350 - 360	Miscellaneous Debris	-	Not retained	10482
1866	200 - 400	350 - 360	Miscellaneous Debris	-	Not retained	10483
1867	200 - 400	350 - 360	Miscellaneous Debris	-	Not retained	10484
1868	200 - 400	350 - 360	Miscellaneous Debris	-	Not retained	10485
1869	400 - 600	0 - 10	Warhead Body Piece	0.06		1738
1870	400 - 600	0 - 10	Warhead Body Piece	0.04		1739
1871	400 - 600	0 - 10	Warhead Body Piece	0.04		1740
1872	400 - 600	0 - 10	Warhead Body Piece	0.01		1741
1873	400 - 600	0 - 10	Warhead Body Piece	0.01		1742
1874	400 - 600	0 - 10	Warhead Body Piece	0.01		1743
1875	400 - 600	0 - 10	Tail Piece	0.01		1744
1876	400 - 600	0 - 10	Miscellaneous Debris	-	Not retained	10486
1877	400 - 600	0 - 10	Miscellaneous Debris	-	Not retained	10487
1878	400 - 600	0 - 10	Miscellaneous Debris	-	Not retained	10488
1879	400 - 600	0 - 10	Miscellaneous Debris	-	Not retained	10489
1880	400 - 600	0 - 10	Miscellaneous Debris	-	Not retained	10490
1881	400 - 600	0 - 10	Miscellaneous Debris	-	Not retained	10491
1882	400 - 600	0 - 10	Miscellaneous Debris	-	Not retained	10492
1883	400 - 600	0 - 10	Miscellaneous Debris	-	Not retained	10493
1884	400 - 600	0 - 10	Miscellaneous Debris	-	Not retained	10494
1885	400 - 600	0 - 10	Miscellaneous Debris	-	Not retained	10495
1886	400 - 600	0 - 10	Miscellaneous Debris	-	Not retained	10496
1887	400 - 600	0 - 10	Miscellaneous Debris	-	Not retained	10497
1888	400 - 600	0 - 10	Miscellaneous Debris	-	Not retained	10498
1889	400 - 600	0 - 10	Miscellaneous Debris	-	Not retained	10499
1890	400 - 600	0 - 10	Miscellaneous Debris	-	Not retained	10500
1891	400 - 600	0 - 10	Miscellaneous Debris	-	Not retained	10501
1892	400 - 600	10 - 20	Warhead Body Piece	0.43		1870
1893	400 - 600	10 - 20	Warhead Body Piece	0.34		1871
1894	400 - 600	10 - 20	Warhead Body Piece	0.26		1872
1895	400 - 600	10 - 20	Warhead Body Piece	0.12		1873
1896	400 - 600	10 - 20	Warhead Body Piece	0.08		1874
1897	400 - 600	10 - 20	Warhead Body Piece	0.03		1875
1898	400 - 600	10 - 20	Warhead Body Piece	0.01		1876
1899	400 - 600	10 - 20	Warhead Body Piece	0.01		1877
1900	400 - 600	10 - 20	Warhead Body Piece	0.01		1878

TABLE B-6. FRAGMENTS RECOVERED BEYOND 200-FT RANGE IN TEST NO. 9 (Continued)

<u>Entry</u>	<u>Range Interval (ft)</u>	<u>Azimuthal Sector (°)</u>	<u>Description</u>	<u>Mass (lb)</u>	<u>Notes</u>	<u>G64 Index No.</u>
1901	400 - 600	10 - 20	Warhead Body Piece	0.01		1879
1902	400 - 600	10 - 20	Warhead Body Piece	0.01		1880
1903	400 - 600	10 - 20	Warhead Body Piece	0.01		1881
1904	400 - 600	10 - 20	Miscellaneous Debris	0.02		1884
1905	400 - 600	10 - 20	Miscellaneous Debris	0.01		1882
1906	400 - 600	10 - 20	Miscellaneous Debris	0.01		1883
1907	400 - 600	10 - 20	Miscellaneous Debris	-	Not retained	10502
1908	400 - 600	10 - 20	Miscellaneous Debris	-	Not retained	10503
1909	400 - 600	10 - 20	Miscellaneous Debris	-	Not retained	10504
1910	400 - 600	10 - 20	Miscellaneous Debris	-	Not retained	10505
1911	400 - 600	10 - 20	Miscellaneous Debris	-	Not retained	10506
1912	400 - 600	10 - 20	Miscellaneous Debris	-	Not retained	10507
1913	400 - 600	10 - 20	Miscellaneous Debris	-	Not retained	10508
1914	400 - 600	10 - 20	Miscellaneous Debris	-	Not retained	10509
1915	400 - 600	10 - 20	Miscellaneous Debris	-	Not retained	10510
1916	400 - 600	10 - 20	Miscellaneous Debris	-	Not retained	10511
1917	400 - 600	10 - 20	Miscellaneous Debris	-	Not retained	10512
1918	400 - 600	10 - 20	Miscellaneous Debris	-	Not retained	10513
1919	400 - 600	20 - 30	Warhead Body Piece	0.04		1829
1920	400 - 600	20 - 30	Warhead Body Piece	0.02		1830
1921	400 - 600	20 - 30	Warhead Body Piece	0.01		1831
1922	400 - 600	20 - 30	Warhead Body Piece	0.01		1832
1923	400 - 600	20 - 30	Warhead Body Piece	0.01		1833
1924	400 - 600	20 - 30	Warhead Body Piece	0.01		1834
1925	400 - 600	20 - 30	Warhead Body Piece	0.01		1835
1926	400 - 600	20 - 30	Tail Piece	0.02		1837
1927	400 - 600	20 - 30	Tail Piece	0.04		1838
1928	400 - 600	20 - 30	Tail Piece	0.19		1839
1929	400 - 600	20 - 30	Miscellaneous Debris	0.01		1836
1930	400 - 600	20 - 30	Miscellaneous Debris	-	Not retained	10514
1931	400 - 600	20 - 30	Miscellaneous Debris	-	Not retained	10515
1932	400 - 600	20 - 30	Miscellaneous Debris	-	Not retained	10516
1933	400 - 600	20 - 30	Miscellaneous Debris	-	Not retained	10517
1934	400 - 600	20 - 30	Miscellaneous Debris	-	Not retained	10518
1935	400 - 600	20 - 30	Miscellaneous Debris	-	Not retained	10519
1936	400 - 600	20 - 30	Miscellaneous Debris	-	Not retained	10520
1937	400 - 600	20 - 30	Miscellaneous Debris	-	Not retained	10521
1938	400 - 600	20 - 30	Miscellaneous Debris	-	Not retained	10522
1939	400 - 600	20 - 30	Miscellaneous Debris	-	Not retained	10523
1940	400 - 600	20 - 30	Miscellaneous Debris	-	Not retained	10524
1941	400 - 600	20 - 30	Miscellaneous Debris	-	Not retained	10525
1942	400 - 600	20 - 30	Miscellaneous Debris	-	Not retained	10526
1943	400 - 600	20 - 30	Miscellaneous Debris	-	Not retained	10527
1944	400 - 600	20 - 30	Miscellaneous Debris	-	Not retained	10528
1945	400 - 600	20 - 30	Intact Warhead	5.05		3264
1946	400 - 600	30 - 40	Warhead Body Piece	0.03		2151
1947	400 - 600	30 - 40	Warhead Body Piece	0.01		2152
1948	400 - 600	30 - 40	Warhead Body Piece	0.01		2153
1949	400 - 600	30 - 40	Tail Piece	0.07		2154
1950	400 - 600	30 - 40	Miscellaneous Debris	0.01		2155

NSWCDD/TR-98/6

TABLE B-6. FRAGMENTS RECOVERED BEYOND 200-FT RANGE IN TEST NO. 9 (Continued)

<u>Entry</u>	<u>Range Interval (ft)</u>	<u>Azimuthal Sector (°)</u>	<u>Description</u>	<u>Mass (lb)</u>	<u>Notes</u>	<u>G64 Index No.</u>
1951	400 - 600	30 - 40	Miscellaneous Debris	-	Not retained	10529
1952	400 - 600	30 - 40	Miscellaneous Debris	-	Not retained	10530
1953	400 - 600	30 - 40	Miscellaneous Debris	-	Not retained	10531
1954	400 - 600	30 - 40	Miscellaneous Debris	-	Not retained	10532
1955	400 - 600	30 - 40	Miscellaneous Debris	-	Not retained	10533
1956	400 - 600	30 - 40	Miscellaneous Debris	-	Not retained	10534
1957	400 - 600	30 - 40	Miscellaneous Debris	-	Not retained	10535
1958	400 - 600	30 - 40	Miscellaneous Debris	-	Not retained	10536
1959	400 - 600	30 - 40	Miscellaneous Debris	-	Not retained	10537
1960	400 - 600	30 - 40	Miscellaneous Debris	-	Not retained	10538
1961	400 - 600	30 - 40	Miscellaneous Debris	-	Not retained	10539
1962	400 - 600	30 - 40	Miscellaneous Debris	-	Not retained	10540
1963	400 - 600	30 - 40	Miscellaneous Debris	-	Not retained	10541
1964	400 - 600	30 - 40	Miscellaneous Debris	-	Not retained	10542
1965	400 - 600	30 - 40	Miscellaneous Debris	-	Not retained	10543
1966	400 - 600	30 - 40	Miscellaneous Debris	-	Not retained	10544
1967	400 - 600	30 - 40	Miscellaneous Debris	-	Not retained	10545
1968	400 - 600	30 - 40	Miscellaneous Debris	-	Not retained	10546
1969	400 - 600	30 - 40	Miscellaneous Debris	-	Not retained	10547
1970	400 - 600	30 - 40	Miscellaneous Debris	-	Not retained	10548
1971	400 - 600	30 - 40	Miscellaneous Debris	-	Not retained	10549
1972	400 - 600	30 - 40	Miscellaneous Debris	-	Not retained	10550
1973	400 - 600	30 - 40	Miscellaneous Debris	-	Not retained	10551
1974	400 - 600	30 - 40	Miscellaneous Debris	-	Not retained	10552
1975	400 - 600	40 - 50	Warhead Body Piece	0.03		2862
1976	400 - 600	40 - 50	Warhead Body Piece	0.02		2863
1977	400 - 600	40 - 50	Warhead Body Piece	0.01		2864
1978	400 - 600	40 - 50	Warhead Body Piece	0.01		2865
1979	400 - 600	40 - 50	Tail Piece	-	Not retained	2861
1980	400 - 600	40 - 50	Tail Piece	0.43		2866
1981	400 - 600	40 - 50	Tail Piece	0.33		2867
1982	400 - 600	40 - 50	Tail Piece	0.01		2868
1983	400 - 600	40 - 50	Miscellaneous Debris	-	Not retained	10553
1984	400 - 600	40 - 50	Miscellaneous Debris	-	Not retained	10554
1985	400 - 600	40 - 50	Miscellaneous Debris	-	Not retained	10555
1986	400 - 600	40 - 50	Miscellaneous Debris	-	Not retained	10556
1987	400 - 600	40 - 50	Miscellaneous Debris	-	Not retained	10557
1988	400 - 600	40 - 50	Miscellaneous Debris	-	Not retained	10558
1989	400 - 600	40 - 50	Miscellaneous Debris	-	Not retained	10559
1990	400 - 600	40 - 50	Miscellaneous Debris	-	Not retained	10560
1991	400 - 600	40 - 50	Intact Warhead	5.05		2860
1992	400 - 600	50 - 60	Warhead Body Piece	0.09		1804
1993	400 - 600	50 - 60	Warhead Body Piece	0.01		1805
1994	400 - 600	50 - 60	Warhead Body Piece	0.02		1806
1995	400 - 600	50 - 60	Tail Piece	-	Not retained	3265
1996	400 - 600	50 - 60	Miscellaneous Debris	-	Not retained	10561
1997	400 - 600	50 - 60	Miscellaneous Debris	-	Not retained	10562
1998	400 - 600	50 - 60	Miscellaneous Debris	-	Not retained	10563
1999	400 - 600	50 - 60	Miscellaneous Debris	-	Not retained	10564
2000	400 - 600	50 - 60	Miscellaneous Debris	-	Not retained	10565

TABLE B-6. FRAGMENTS RECOVERED BEYOND 200-FT RANGE IN TEST NO. 9 (Continued)

<u>Entry</u>	<u>Range Interval (ft)</u>	<u>Azimuthal Sector (°)</u>	<u>Description</u>	<u>Mass (lb)</u>	<u>Notes</u>	<u>G64 Index No.</u>
2001	400 - 600	50 - 60	Miscellaneous Debris	-	Not retained	10566
2002	400 - 600	50 - 60	Miscellaneous Debris	-	Not retained	10567
2003	400 - 600	50 - 60	Miscellaneous Debris	-	Not retained	10568
2004	400 - 600	50 - 60	Miscellaneous Debris	-	Not retained	10569
2005	400 - 600	60 - 70	Tail Piece	0.03		2150
2006	400 - 600	60 - 70	Miscellaneous Debris	-	Not retained	10570
2007	400 - 600	60 - 70	Miscellaneous Debris	-	Not retained	10571
2008	400 - 600	60 - 70	Miscellaneous Debris	-	Not retained	10572
2009	400 - 600	60 - 70	Miscellaneous Debris	-	Not retained	10573
2010	400 - 600	60 - 70	Miscellaneous Debris	-	Not retained	10574
2011	400 - 600	70 - 80	Warhead Body Piece	0.12		1646
2012	400 - 600	70 - 80	Warhead Body Piece	0.06		3065
2013	400 - 600	70 - 80	Warhead Body Piece	0.08		3066
2014	400 - 600	70 - 80	Warhead Body Piece	0.02		3067
2015	400 - 600	70 - 80	Tail Piece	0.46		3068
2016	400 - 600	70 - 80	Miscellaneous Debris	-	Not retained	10575
2017	400 - 600	70 - 80	Miscellaneous Debris	-	Not retained	10576
2018	400 - 600	70 - 80	Miscellaneous Debris	-	Not retained	10577
2019	400 - 600	70 - 80	Miscellaneous Debris	-	Not retained	10578
2020	400 - 600	70 - 80	Miscellaneous Debris	-	Not retained	10579
2021	400 - 600	70 - 80	Miscellaneous Debris	-	Not retained	10580
2022	400 - 600	70 - 80	Miscellaneous Debris	-	Not retained	10581
2023	400 - 600	70 - 80	Miscellaneous Debris	-	Not retained	10582
2024	400 - 600	70 - 80	Miscellaneous Debris	-	Not retained	10583
2025	400 - 600	70 - 80	Miscellaneous Debris	-	Not retained	10584
2026	400 - 600	70 - 80	Miscellaneous Debris	-	Not retained	10585
2027	400 - 600	70 - 80	Miscellaneous Debris	-	Not retained	10586
2028	400 - 600	70 - 80	Miscellaneous Debris	-	Not retained	10587
2029	400 - 600	70 - 80	Miscellaneous Debris	-	Not retained	10588
2030	400 - 600	70 - 80	Miscellaneous Debris	-	Not retained	10589
2031	400 - 600	70 - 80	Intact Warhead	5.05		3063
2032	400 - 600	70 - 80	Intact Warhead	5.05		3064
2033	400 - 600	80 - 90	Warhead Body Piece	0.26		1815
2034	400 - 600	80 - 90	Warhead Body Piece	0.18		1816
2035	400 - 600	80 - 90	Warhead Body Piece	0.05		1817
2036	400 - 600	80 - 90	Warhead Body Piece	0.03		1818
2037	400 - 600	80 - 90	Tail Piece	0.19		1819
2038	400 - 600	80 - 90	Tail Piece	0.19		1820
2039	400 - 600	80 - 90	Tail Piece	0.17		1821
2040	400 - 600	80 - 90	Tail Piece	0.03		1822
2041	400 - 600	80 - 90	Tail Piece	0.02		1869
2042	400 - 600	80 - 90	Miscellaneous Debris	-	Not retained	10590
2043	400 - 600	80 - 90	Miscellaneous Debris	-	Not retained	10591
2044	400 - 600	80 - 90	Miscellaneous Debris	-	Not retained	10592
2045	400 - 600	80 - 90	Miscellaneous Debris	-	Not retained	10593
2046	400 - 600	80 - 90	Miscellaneous Debris	-	Not retained	10594
2047	400 - 600	80 - 90	Miscellaneous Debris	-	Not retained	10595
2048	400 - 600	80 - 90	Miscellaneous Debris	-	Not retained	10596
2049	400 - 600	80 - 90	Miscellaneous Debris	-	Not retained	10597
2050	400 - 600	80 - 90	Miscellaneous Debris	-	Not retained	10598

NSWCDD/TR-98/6

TABLE B-6. FRAGMENTS RECOVERED BEYOND 200-FT RANGE IN TEST NO. 9 (Continued)

<u>Entry</u>	<u>Range Interval (ft)</u>	<u>Azimuthal Sector (°)</u>	<u>Description</u>	<u>Mass (lb)</u>	<u>Notes</u>	<u>G64 Index No.</u>
2051	400 - 600	80 - 90	Miscellaneous Debris	-	Not retained	10599
2052	400 - 600	80 - 90	Miscellaneous Debris	-	Not retained	10600
2053	400 - 600	80 - 90	Miscellaneous Debris	-	Not retained	10601
2054	400 - 600	80 - 90	Miscellaneous Debris	-	Not retained	10602
2055	400 - 600	80 - 90	Miscellaneous Debris	-	Not retained	10603
2056	400 - 600	80 - 90	Miscellaneous Debris	-	Not retained	10604
2057	400 - 600	90 - 100	Warhead Body Piece	0.05		2933
2058	400 - 600	90 - 100	Tail Piece	0.20		2934
2059	400 - 600	90 - 100	Tail Piece	0.19		2935
2060	400 - 600	90 - 100	Tail Piece	0.05		2936
2061	400 - 600	90 - 100	Miscellaneous Debris	-	Not retained	10605
2062	400 - 600	90 - 100	Miscellaneous Debris	-	Not retained	10606
2063	400 - 600	90 - 100	Miscellaneous Debris	-	Not retained	10607
2064	400 - 600	90 - 100	Miscellaneous Debris	-	Not retained	10608
2065	400 - 600	90 - 100	Miscellaneous Debris	-	Not retained	10609
2066	400 - 600	90 - 100	Miscellaneous Debris	-	Not retained	10610
2067	400 - 600	90 - 100	Miscellaneous Debris	-	Not retained	10611
2068	400 - 600	90 - 100	Miscellaneous Debris	-	Not retained	10612
2069	400 - 600	90 - 100	Miscellaneous Debris	-	Not retained	10613
2070	400 - 600	90 - 100	Miscellaneous Debris	-	Not retained	10614
2071	400 - 600	90 - 100	Miscellaneous Debris	-	Not retained	10615
2072	400 - 600	90 - 100	Miscellaneous Debris	-	Not retained	10616
2073	400 - 600	90 - 100	Miscellaneous Debris	-	Not retained	10617
2074	400 - 600	90 - 100	Miscellaneous Debris	-	Not retained	10618
2075	400 - 600	90 - 100	Miscellaneous Debris	-	Not retained	10619
2076	400 - 600	90 - 100	Miscellaneous Debris	-	Not retained	10620
2077	400 - 600	90 - 100	Intact Warhead	5.05		2932
2078	400 - 600	100 - 110	Warhead Body Piece	0.29		2846
2079	400 - 600	100 - 110	Tail Piece	0.03		2847
2080	400 - 600	100 - 110	Tail Piece	0.02		2848
2081	400 - 600	100 - 110	Miscellaneous Debris	-	Not retained	10621
2082	400 - 600	100 - 110	Miscellaneous Debris	-	Not retained	10622
2083	400 - 600	100 - 110	Miscellaneous Debris	-	Not retained	10623
2084	400 - 600	100 - 110	Miscellaneous Debris	-	Not retained	10624
2085	400 - 600	100 - 110	Miscellaneous Debris	-	Not retained	10625
2086	400 - 600	100 - 110	Miscellaneous Debris	-	Not retained	10626
2087	400 - 600	100 - 110	Miscellaneous Debris	-	Not retained	10627
2088	400 - 600	100 - 110	Miscellaneous Debris	-	Not retained	10628
2089	400 - 600	100 - 110	Miscellaneous Debris	-	Not retained	10629
2090	400 - 600	100 - 110	Intact Warhead	5.05		2845
2091	400 - 600	110 - 120	Miscellaneous Debris	-	Not retained	10630
2092	400 - 600	110 - 120	Miscellaneous Debris	-	Not retained	10631
2093	400 - 600	110 - 120	Miscellaneous Debris	-	Not retained	10632
2094	400 - 600	110 - 120	Miscellaneous Debris	-	Not retained	10633
2095	400 - 600	110 - 120	Miscellaneous Debris	-	Not retained	10634
2096	400 - 600	110 - 120	Intact Warhead	-	Not retained	11412
2097	400 - 600	110 - 120	Intact Warhead	-	Not retained	11413
2098	400 - 600	110 - 120	Intact Warhead	-	Not retained	11414
2099	400 - 600	110 - 120	Intact Warhead	-	Not retained	11415
2100	400 - 600	110 - 120	Intact Warhead	-	Not retained	11416

NSWCDD/TR-98/6

TABLE B-6. FRAGMENTS RECOVERED BEYOND 200-FT RANGE IN TEST NO. 9 (Continued)

<u>Entry</u>	<u>Range Interval (ft)</u>	<u>Azimuthal Sector (°)</u>	<u>Description</u>	<u>Mass (lb)</u>	<u>Notes</u>	<u>G64 Index No.</u>
2101	400 - 600	110 - 120	Intact Warhead	-	Not retained	11417
2102	400 - 600	120 - 130	Tail Piece	0.19		2798
2103	400 - 600	120 - 130	Miscellaneous Debris	-	Not retained	10635
2104	400 - 600	120 - 130	Miscellaneous Debris	-	Not retained	10636
2105	400 - 600	120 - 130	Miscellaneous Debris	-	Not retained	10637
2106	400 - 600	120 - 130	Miscellaneous Debris	-	Not retained	10638
2107	400 - 600	120 - 130	Intact Warhead	5.05		2797
2108	400 - 600	130 - 140	Warhead Body Piece	0.30		1900
2109	400 - 600	130 - 140	Warhead Body Piece	0.15		1901
2110	400 - 600	130 - 140	Miscellaneous Debris	-	Not retained	10639
2111	400 - 600	130 - 140	Miscellaneous Debris	-	Not retained	10640
2112	400 - 600	130 - 140	Miscellaneous Debris	-	Not retained	10641
2113	400 - 600	130 - 140	Miscellaneous Debris	-	Not retained	10642
2114	400 - 600	130 - 140	Miscellaneous Debris	-	Not retained	10643
2115	400 - 600	130 - 140	Intact Warhead	5.05		1898
2116	400 - 600	130 - 140	Intact Warhead	5.05		1899
2117	400 - 600	140 - 150	Warhead Body Piece	1.00		1730
2118	400 - 600	140 - 150	Tail Piece	-	Not retained	1731
2119	400 - 600	140 - 150	Tail Piece	0.19		1733
2120	400 - 600	140 - 150	Intact Warhead	5.05		1732
2121	400 - 600	150 - 160	Warhead Body Piece	1.00		2357
2122	400 - 600	150 - 160	Warhead Body Piece	0.43		2358
2123	400 - 600	150 - 160	Warhead Body Piece	0.17		2359
2124	400 - 600	150 - 160	Warhead Body Piece	0.15		2360
2125	400 - 600	150 - 160	Warhead Body Piece	0.01		2361
2126	400 - 600	150 - 160	Tail Piece	0.45		2362
2127	400 - 600	150 - 160	Tail Piece	0.21		2363
2128	400 - 600	150 - 160	Miscellaneous Debris	-	Not retained	10644
2129	400 - 600	150 - 160	Miscellaneous Debris	-	Not retained	10645
2130	400 - 600	150 - 160	Miscellaneous Debris	-	Not retained	10646
2131	400 - 600	160 - 170	Warhead Body Piece	0.35		2587
2132	400 - 600	160 - 170	Warhead Body Piece	0.29		2588
2133	400 - 600	160 - 170	Warhead Body Piece	0.06		2589
2134	400 - 600	160 - 170	Warhead Body Piece	0.06		2590
2135	400 - 600	160 - 170	Warhead Body Piece	0.30		3034
2136	400 - 600	160 - 170	Miscellaneous Debris	-	Not retained	10647
2137	400 - 600	160 - 170	Miscellaneous Debris	-	Not retained	10648
2138	400 - 600	160 - 170	Miscellaneous Debris	-	Not retained	10649
2139	400 - 600	170 - 180	Warhead Body Piece	0.10		2365
2140	400 - 600	170 - 180	Warhead Body Piece	0.04		2366
2141	400 - 600	170 - 180	Tail Piece	0.26		2367
2142	400 - 600	170 - 180	Miscellaneous Debris	-	Not retained	10650
2143	400 - 600	170 - 180	Miscellaneous Debris	-	Not retained	10651
2144	400 - 600	170 - 180	Miscellaneous Debris	-	Not retained	10652
2145	400 - 600	170 - 180	Intact Warhead	5.05		2364
2146	400 - 600	180 - 190	Warhead Body Piece	0.06		2211
2147	400 - 600	180 - 190	Warhead Body Piece	0.51		2965
2148	400 - 600	180 - 190	Warhead Body Piece	0.70		2966
2149	400 - 600	180 - 190	Warhead Body Piece	0.22		2967
2150	400 - 600	180 - 190	Warhead Body Piece	0.03		2968

TABLE B-6. FRAGMENTS RECOVERED BEYOND 200-FT RANGE IN TEST NO. 9 (Continued)

<u>Entry</u>	<u>Range Interval (ft)</u>	<u>Azimuthal Sector (°)</u>	<u>Description</u>	<u>Mass (lb)</u>	<u>Notes</u>	<u>G64 Index No.</u>
2151	400 - 600	180 - 190	Miscellaneous Debris	-	Not retained	10653
2152	400 - 600	180 - 190	Intact Warhead	5.05		2964
2153	400 - 600	190 - 200	Warhead Body Piece	0.43		2603
2154	400 - 600	190 - 200	Warhead Body Piece	0.12		2604
2155	400 - 600	190 - 200	Warhead Body Piece	0.01		2605
2156	400 - 600	190 - 200	Miscellaneous Debris	0.01		2606
2157	400 - 600	190 - 200	Miscellaneous Debris	-	Not retained	10654
2158	400 - 600	200 - 210	Warhead Body Piece	0.75		2081
2159	400 - 600	200 - 210	Warhead Body Piece	0.14		2082
2160	400 - 600	200 - 210	Warhead Body Piece	0.20		2083
2161	400 - 600	200 - 210	Miscellaneous Debris	-	Not retained	10655
2162	400 - 600	200 - 210	Miscellaneous Debris	-	Not retained	10656
2163	400 - 600	210 - 220	Warhead Body Piece	0.60		2894
2164	400 - 600	210 - 220	Tail Piece	0.18		2895
2165	400 - 600	210 - 220	Miscellaneous Debris	-	Not retained	10657
2166	400 - 600	210 - 220	Miscellaneous Debris	-	Not retained	10658
2167	400 - 600	210 - 220	Miscellaneous Debris	-	Not retained	10659
2168	400 - 600	210 - 220	Miscellaneous Debris	-	Not retained	10660
2169	400 - 600	220 - 230	Warhead Body Piece	0.79		2801
2170	400 - 600	220 - 230	Warhead Body Piece	0.22		2802
2171	400 - 600	220 - 230	Warhead Body Piece	0.01		2803
2172	400 - 600	220 - 230	Warhead Body Piece	0.01		2804
2173	400 - 600	220 - 230	Warhead Body Piece	0.02		2805
2174	400 - 600	220 - 230	Warhead Body Piece	0.01		2806
2175	400 - 600	220 - 230	Miscellaneous Debris	0.01		2807
2176	400 - 600	220 - 230	Miscellaneous Debris	0.01		2808
2177	400 - 600	220 - 230	Miscellaneous Debris	-	Not retained	10661
2178	400 - 600	220 - 230	Miscellaneous Debris	-	Not retained	10662
2179	400 - 600	220 - 230	Miscellaneous Debris	-	Not retained	10663
2180	400 - 600	220 - 230	Miscellaneous Debris	-	Not retained	10664
2181	400 - 600	220 - 230	Miscellaneous Debris	-	Not retained	10665
2182	400 - 600	220 - 230	Miscellaneous Debris	-	Not retained	10666
2183	400 - 600	220 - 230	Miscellaneous Debris	-	Not retained	10667
2184	400 - 600	220 - 230	Miscellaneous Debris	-	Not retained	10668
2185	400 - 600	220 - 230	Miscellaneous Debris	-	Not retained	10669
2186	400 - 600	220 - 230	Miscellaneous Debris	-	Not retained	10670
2187	400 - 600	220 - 230	Miscellaneous Debris	-	Not retained	10671
2188	400 - 600	220 - 230	Miscellaneous Debris	-	Not retained	10672
2189	400 - 600	230 - 240	Warhead Body Piece	0.56		2716
2190	400 - 600	230 - 240	Warhead Body Piece	0.09		2717
2191	400 - 600	230 - 240	Warhead Body Piece	0.38		2718
2192	400 - 600	230 - 240	Warhead Body Piece	0.13		2719
2193	400 - 600	230 - 240	Warhead Body Piece	0.03		2720
2194	400 - 600	230 - 240	Warhead Body Piece	0.02		2721
2195	400 - 600	230 - 240	Warhead Body Piece	0.01		2722
2196	400 - 600	230 - 240	Tail Piece	0.13		2723
2197	400 - 600	230 - 240	Tail Piece	0.12		2724
2198	400 - 600	230 - 240	Tail Piece	0.01		2725
2199	400 - 600	230 - 240	Miscellaneous Debris	0.01		2726
2200	400 - 600	230 - 240	Miscellaneous Debris	-	Not retained	10673

TABLE B-6. FRAGMENTS RECOVERED BEYOND 200-FT RANGE IN TEST NO. 9 (Continued)

<u>Entry</u>	<u>Range Interval (ft)</u>	<u>Azimuthal Sector (°)</u>	<u>Description</u>	<u>Mass (lb)</u>	<u>Notes</u>	<u>G64 Index No.</u>
2201	400 - 600	230 - 240	Miscellaneous Debris	-	Not retained	10674
2202	400 - 600	230 - 240	Miscellaneous Debris	-	Not retained	10675
2203	400 - 600	230 - 240	Miscellaneous Debris	-	Not retained	10676
2204	400 - 600	230 - 240	Miscellaneous Debris	-	Not retained	10677
2205	400 - 600	230 - 240	Miscellaneous Debris	-	Not retained	10678
2206	400 - 600	230 - 240	Miscellaneous Debris	-	Not retained	10679
2207	400 - 600	230 - 240	Miscellaneous Debris	-	Not retained	10680
2208	400 - 600	230 - 240	Miscellaneous Debris	-	Not retained	10681
2209	400 - 600	230 - 240	Miscellaneous Debris	-	Not retained	10682
2210	400 - 600	230 - 240	Miscellaneous Debris	-	Not retained	10683
2211	400 - 600	230 - 240	Miscellaneous Debris	-	Not retained	10684
2212	400 - 600	230 - 240	Miscellaneous Debris	-	Not retained	10685
2213	400 - 600	230 - 240	Miscellaneous Debris	-	Not retained	10686
2214	400 - 600	230 - 240	Miscellaneous Debris	-	Not retained	10687
2215	400 - 600	230 - 240	Miscellaneous Debris	-	Not retained	10688
2216	400 - 600	230 - 240	Miscellaneous Debris	-	Not retained	10689
2217	400 - 600	230 - 240	Miscellaneous Debris	-	Not retained	10690
2218	400 - 600	230 - 240	Miscellaneous Debris	-	Not retained	10691
2219	400 - 600	230 - 240	Miscellaneous Debris	-	Not retained	10692
2220	400 - 600	240 - 250	Warhead Body Piece	0.03		2951
2221	400 - 600	240 - 250	Warhead Body Piece	0.03		2952
2222	400 - 600	240 - 250	Warhead Body Piece	0.04		2953
2223	400 - 600	240 - 250	Warhead Body Piece	0.03		2954
2224	400 - 600	240 - 250	Warhead Body Piece	0.01		2955
2225	400 - 600	240 - 250	Warhead Body Piece	0.01		2956
2226	400 - 600	240 - 250	Tail Piece	0.04		2957
2227	400 - 600	240 - 250	Miscellaneous Debris	0.01		2958
2228	400 - 600	240 - 250	Miscellaneous Debris	-	Not retained	10693
2229	400 - 600	240 - 250	Miscellaneous Debris	-	Not retained	10694
2230	400 - 600	240 - 250	Miscellaneous Debris	-	Not retained	10695
2231	400 - 600	240 - 250	Miscellaneous Debris	-	Not retained	10696
2232	400 - 600	240 - 250	Miscellaneous Debris	-	Not retained	10697
2233	400 - 600	240 - 250	Miscellaneous Debris	-	Not retained	10698
2234	400 - 600	240 - 250	Miscellaneous Debris	-	Not retained	10699
2235	400 - 600	240 - 250	Miscellaneous Debris	-	Not retained	10700
2236	400 - 600	240 - 250	Miscellaneous Debris	-	Not retained	10701
2237	400 - 600	240 - 250	Miscellaneous Debris	-	Not retained	10702
2238	400 - 600	240 - 250	Miscellaneous Debris	-	Not retained	10703
2239	400 - 600	240 - 250	Miscellaneous Debris	-	Not retained	10704
2240	400 - 600	240 - 250	Miscellaneous Debris	-	Not retained	10705
2241	400 - 600	240 - 250	Miscellaneous Debris	-	Not retained	10706
2242	400 - 600	240 - 250	Miscellaneous Debris	-	Not retained	10707
2243	400 - 600	240 - 250	Miscellaneous Debris	-	Not retained	10708
2244	400 - 600	240 - 250	Miscellaneous Debris	-	Not retained	10709
2245	400 - 600	240 - 250	Miscellaneous Debris	-	Not retained	10710
2246	400 - 600	240 - 250	Miscellaneous Debris	-	Not retained	10711
2247	400 - 600	240 - 250	Miscellaneous Debris	-	Not retained	10712
2248	400 - 600	240 - 250	Miscellaneous Debris	-	Not retained	10713
2249	400 - 600	240 - 250	Miscellaneous Debris	-	Not retained	10714
2250	400 - 600	240 - 250	Miscellaneous Debris	-	Not retained	10715

NSWCDD/TR-98/6

TABLE B-6. FRAGMENTS RECOVERED BEYOND 200-FT RANGE IN TEST NO. 9 (Continued)

<u>Entry</u>	<u>Range Interval (ft)</u>	<u>Azimuthal Sector (°)</u>	<u>Description</u>	<u>Mass (lb)</u>	<u>Notes</u>	<u>G64 Index No.</u>
2251	400 - 600	240 - 250	Miscellaneous Debris	-	Not retained	10716
2252	400 - 600	240 - 250	Miscellaneous Debris	-	Not retained	10717
2253	400 - 600	240 - 250	Miscellaneous Debris	-	Not retained	10718
2254	400 - 600	240 - 250	Miscellaneous Debris	-	Not retained	10719
2255	400 - 600	240 - 250	Miscellaneous Debris	-	Not retained	10720
2256	400 - 600	240 - 250	Miscellaneous Debris	-	Not retained	10721
2257	400 - 600	240 - 250	Miscellaneous Debris	-	Not retained	10722
2258	400 - 600	240 - 250	Miscellaneous Debris	-	Not retained	10723
2259	400 - 600	240 - 250	Miscellaneous Debris	-	Not retained	10724
2260	400 - 600	240 - 250	Miscellaneous Debris	-	Not retained	10725
2261	400 - 600	240 - 250	Miscellaneous Debris	-	Not retained	10726
2262	400 - 600	240 - 250	Miscellaneous Debris	-	Not retained	10727
2263	400 - 600	250 - 260	Warhead Body Piece	0.03		2465
2264	400 - 600	250 - 260	Warhead Body Piece	0.02		2466
2265	400 - 600	250 - 260	Warhead Body Piece	0.02		2467
2266	400 - 600	250 - 260	Warhead Body Piece	0.01		2468
2267	400 - 600	250 - 260	Tail Piece	0.17		2469
2268	400 - 600	250 - 260	Tail Piece	0.18		2470
2269	400 - 600	250 - 260	Tail Piece	0.04		2471
2270	400 - 600	250 - 260	Tail Piece	0.03		2472
2271	400 - 600	250 - 260	Tail Piece	0.02		2473
2272	400 - 600	250 - 260	Tail Piece	0.02		2474
2273	400 - 600	250 - 260	Tail Piece	0.02		2475
2274	400 - 600	250 - 260	Tail Piece	0.01		2476
2275	400 - 600	250 - 260	Miscellaneous Debris	-	Not retained	10728
2276	400 - 600	250 - 260	Miscellaneous Debris	-	Not retained	10729
2277	400 - 600	250 - 260	Miscellaneous Debris	-	Not retained	10730
2278	400 - 600	250 - 260	Miscellaneous Debris	-	Not retained	10731
2279	400 - 600	250 - 260	Miscellaneous Debris	-	Not retained	10732
2280	400 - 600	250 - 260	Miscellaneous Debris	-	Not retained	10733
2281	400 - 600	250 - 260	Miscellaneous Debris	-	Not retained	10734
2282	400 - 600	250 - 260	Miscellaneous Debris	-	Not retained	10735
2283	400 - 600	250 - 260	Miscellaneous Debris	-	Not retained	10736
2284	400 - 600	250 - 260	Miscellaneous Debris	-	Not retained	10737
2285	400 - 600	250 - 260	Miscellaneous Debris	-	Not retained	10738
2286	400 - 600	250 - 260	Miscellaneous Debris	-	Not retained	10739
2287	400 - 600	250 - 260	Miscellaneous Debris	-	Not retained	10740
2288	400 - 600	250 - 260	Miscellaneous Debris	-	Not retained	10741
2289	400 - 600	250 - 260	Miscellaneous Debris	-	Not retained	10742
2290	400 - 600	250 - 260	Miscellaneous Debris	-	Not retained	10743
2291	400 - 600	250 - 260	Miscellaneous Debris	-	Not retained	10744
2292	400 - 600	250 - 260	Miscellaneous Debris	-	Not retained	10745
2293	400 - 600	250 - 260	Miscellaneous Debris	-	Not retained	10746
2294	400 - 600	250 - 260	Miscellaneous Debris	-	Not retained	10747
2295	400 - 600	250 - 260	Miscellaneous Debris	-	Not retained	10748
2296	400 - 600	250 - 260	Miscellaneous Debris	-	Not retained	10749
2297	400 - 600	250 - 260	Miscellaneous Debris	-	Not retained	10750
2298	400 - 600	250 - 260	Miscellaneous Debris	-	Not retained	10751
2299	400 - 600	250 - 260	Miscellaneous Debris	-	Not retained	10752
2300	400 - 600	250 - 260	Miscellaneous Debris	-	Not retained	10753

NSWCDD/TR-98/6

TABLE B-6. FRAGMENTS RECOVERED BEYOND 200-FT RANGE IN TEST NO. 9 (Continued)

<u>Entry</u>	<u>Range Interval (ft)</u>	<u>Azimuthal Sector (°)</u>	<u>Description</u>	<u>Mass (lb)</u>	<u>Notes</u>	<u>G64 Index No.</u>
2301	400 - 600	250 - 260	Miscellaneous Debris	-	Not retained	10754
2302	400 - 600	250 - 260	Miscellaneous Debris	-	Not retained	10755
2303	400 - 600	250 - 260	Miscellaneous Debris	-	Not retained	10756
2304	400 - 600	250 - 260	Miscellaneous Debris	-	Not retained	10757
2305	400 - 600	250 - 260	Miscellaneous Debris	-	Not retained	10758
2306	400 - 600	250 - 260	Miscellaneous Debris	-	Not retained	10759
2307	400 - 600	250 - 260	Miscellaneous Debris	-	Not retained	10760
2308	400 - 600	250 - 260	Miscellaneous Debris	-	Not retained	10761
2309	400 - 600	250 - 260	Miscellaneous Debris	-	Not retained	10762
2310	400 - 600	250 - 260	Miscellaneous Debris	-	Not retained	10763
2311	400 - 600	250 - 260	Miscellaneous Debris	-	Not retained	10764
2312	400 - 600	250 - 260	Miscellaneous Debris	-	Not retained	10765
2313	400 - 600	250 - 260	Miscellaneous Debris	-	Not retained	10766
2314	400 - 600	250 - 260	Miscellaneous Debris	-	Not retained	10767
2315	400 - 600	250 - 260	Miscellaneous Debris	-	Not retained	10768
2316	400 - 600	250 - 260	Miscellaneous Debris	-	Not retained	10769
2317	400 - 600	250 - 260	Miscellaneous Debris	-	Not retained	10770
2318	400 - 600	250 - 260	Miscellaneous Debris	-	Not retained	10771
2319	400 - 600	250 - 260	Miscellaneous Debris	-	Not retained	10772
2320	400 - 600	250 - 260	Miscellaneous Debris	-	Not retained	10773
2321	400 - 600	250 - 260	Miscellaneous Debris	-	Not retained	10774
2322	400 - 600	250 - 260	Miscellaneous Debris	-	Not retained	10775
2323	400 - 600	250 - 260	Miscellaneous Debris	-	Not retained	10776
2324	400 - 600	250 - 260	Miscellaneous Debris	-	Not retained	10777
2325	400 - 600	250 - 260	Miscellaneous Debris	-	Not retained	10778
2326	400 - 600	250 - 260	Miscellaneous Debris	-	Not retained	10779
2327	400 - 600	250 - 260	Miscellaneous Debris	-	Not retained	10780
2328	400 - 600	250 - 260	Miscellaneous Debris	-	Not retained	10781
2329	400 - 600	250 - 260	Miscellaneous Debris	-	Not retained	10782
2330	400 - 600	250 - 260	Miscellaneous Debris	-	Not retained	10783
2331	400 - 600	250 - 260	Miscellaneous Debris	-	Not retained	10784
2332	400 - 600	250 - 260	Miscellaneous Debris	-	Not retained	10785
2333	400 - 600	250 - 260	Miscellaneous Debris	-	Not retained	10786
2334	400 - 600	250 - 260	Miscellaneous Debris	-	Not retained	10787
2335	400 - 600	250 - 260	Miscellaneous Debris	-	Not retained	10788
2336	400 - 600	250 - 260	Miscellaneous Debris	-	Not retained	10789
2337	400 - 600	250 - 260	Miscellaneous Debris	-	Not retained	10790
2338	400 - 600	250 - 260	Miscellaneous Debris	-	Not retained	10791
2339	400 - 600	250 - 260	Miscellaneous Debris	-	Not retained	10792
2340	400 - 600	250 - 260	Miscellaneous Debris	-	Not retained	10793
2341	400 - 600	250 - 260	Miscellaneous Debris	-	Not retained	10794
2342	400 - 600	250 - 260	Miscellaneous Debris	-	Not retained	10795
2343	400 - 600	250 - 260	Miscellaneous Debris	-	Not retained	10796
2344	400 - 600	250 - 260	Miscellaneous Debris	-	Not retained	10797
2345	400 - 600	260 - 270	Warhead Body Piece	0.23		3011
2346	400 - 600	260 - 270	Warhead Body Piece	0.09		3012
2347	400 - 600	260 - 270	Warhead Body Piece	0.10		3013
2348	400 - 600	260 - 270	Warhead Body Piece	0.01		3014
2349	400 - 600	260 - 270	Warhead Body Piece	0.06		3015
2350	400 - 600	260 - 270	Warhead Body Piece	0.06		3016

TABLE B-6. FRAGMENTS RECOVERED BEYOND 200-FT RANGE IN TEST NO. 9 (Continued)

<u>Entry</u>	<u>Range Interval (ft)</u>	<u>Azimuthal Sector (°)</u>	<u>Description</u>	<u>Mass (lb)</u>	<u>Notes</u>	<u>G64 Index No.</u>
2351	400 - 600	260 - 270	Warhead Body Piece	0.04		3017
2352	400 - 600	260 - 270	Warhead Body Piece	0.02		3018
2353	400 - 600	260 - 270	Warhead Body Piece	0.01		3019
2354	400 - 600	260 - 270	Warhead Body Piece	0.01		3020
2355	400 - 600	260 - 270	Warhead Body Piece	0.01		3021
2356	400 - 600	260 - 270	Tail Piece	0.03		2076
2357	400 - 600	260 - 270	Tail Piece	0.13		3022
2358	400 - 600	260 - 270	Tail Piece	0.04		3023
2359	400 - 600	260 - 270	Miscellaneous Debris	-	Not retained	10798
2360	400 - 600	260 - 270	Miscellaneous Debris	-	Not retained	10799
2361	400 - 600	260 - 270	Miscellaneous Debris	-	Not retained	10800
2362	400 - 600	260 - 270	Miscellaneous Debris	-	Not retained	10801
2363	400 - 600	260 - 270	Miscellaneous Debris	-	Not retained	10802
2364	400 - 600	260 - 270	Miscellaneous Debris	-	Not retained	10803
2365	400 - 600	260 - 270	Miscellaneous Debris	-	Not retained	10804
2366	400 - 600	260 - 270	Miscellaneous Debris	-	Not retained	10805
2367	400 - 600	260 - 270	Miscellaneous Debris	-	Not retained	10806
2368	400 - 600	260 - 270	Miscellaneous Debris	-	Not retained	10807
2369	400 - 600	260 - 270	Miscellaneous Debris	-	Not retained	10808
2370	400 - 600	260 - 270	Miscellaneous Debris	-	Not retained	10809
2371	400 - 600	260 - 270	Miscellaneous Debris	-	Not retained	10810
2372	400 - 600	260 - 270	Miscellaneous Debris	-	Not retained	10811
2373	400 - 600	260 - 270	Miscellaneous Debris	-	Not retained	10812
2374	400 - 600	260 - 270	Miscellaneous Debris	-	Not retained	10813
2375	400 - 600	260 - 270	Miscellaneous Debris	-	Not retained	10814
2376	400 - 600	260 - 270	Miscellaneous Debris	-	Not retained	10815
2377	400 - 600	260 - 270	Miscellaneous Debris	-	Not retained	10816
2378	400 - 600	260 - 270	Miscellaneous Debris	-	Not retained	10817
2379	400 - 600	260 - 270	Miscellaneous Debris	-	Not retained	10818
2380	400 - 600	260 - 270	Miscellaneous Debris	-	Not retained	10819
2381	400 - 600	260 - 270	Miscellaneous Debris	-	Not retained	10820
2382	400 - 600	260 - 270	Miscellaneous Debris	-	Not retained	10821
2383	400 - 600	260 - 270	Miscellaneous Debris	-	Not retained	10822
2384	400 - 600	260 - 270	Miscellaneous Debris	-	Not retained	10823
2385	400 - 600	260 - 270	Miscellaneous Debris	-	Not retained	10824
2386	400 - 600	260 - 270	Miscellaneous Debris	-	Not retained	10825
2387	400 - 600	260 - 270	Miscellaneous Debris	-	Not retained	10826
2388	400 - 600	260 - 270	Miscellaneous Debris	-	Not retained	10827
2389	400 - 600	260 - 270	Miscellaneous Debris	-	Not retained	10828
2390	400 - 600	260 - 270	Miscellaneous Debris	-	Not retained	10829
2391	400 - 600	260 - 270	Miscellaneous Debris	-	Not retained	10830
2392	400 - 600	260 - 270	Miscellaneous Debris	-	Not retained	10831
2393	400 - 600	260 - 270	Miscellaneous Debris	-	Not retained	10832
2394	400 - 600	260 - 270	Miscellaneous Debris	-	Not retained	10833
2395	400 - 600	260 - 270	Miscellaneous Debris	-	Not retained	10834
2396	400 - 600	260 - 270	Miscellaneous Debris	-	Not retained	10835
2397	400 - 600	260 - 270	Miscellaneous Debris	-	Not retained	10836
2398	400 - 600	260 - 270	Miscellaneous Debris	-	Not retained	10837
2399	400 - 600	260 - 270	Miscellaneous Debris	-	Not retained	10838
2400	400 - 600	260 - 270	Miscellaneous Debris	-	Not retained	10839

TABLE B-6. FRAGMENTS RECOVERED BEYOND 200-FT RANGE IN TEST NO. 9 (Continued)

<u>Entry</u>	<u>Range Interval (ft)</u>	<u>Azimuthal Sector (°)</u>	<u>Description</u>	<u>Mass (lb)</u>	<u>Notes</u>	<u>G64 Index No.</u>
2401	400 - 600	260 - 270	Miscellaneous Debris	-	Not retained	10840
2402	400 - 600	260 - 270	Miscellaneous Debris	-	Not retained	10841
2403	400 - 600	260 - 270	Miscellaneous Debris	-	Not retained	10842
2404	400 - 600	260 - 270	Miscellaneous Debris	-	Not retained	10843
2405	400 - 600	260 - 270	Miscellaneous Debris	-	Not retained	10844
2406	400 - 600	260 - 270	Miscellaneous Debris	-	Not retained	10845
2407	400 - 600	260 - 270	Miscellaneous Debris	-	Not retained	10846
2408	400 - 600	260 - 270	Miscellaneous Debris	-	Not retained	10847
2409	400 - 600	260 - 270	Miscellaneous Debris	-	Not retained	10848
2410	400 - 600	260 - 270	Miscellaneous Debris	-	Not retained	10849
2411	400 - 600	260 - 270	Miscellaneous Debris	-	Not retained	10850
2412	400 - 600	260 - 270	Miscellaneous Debris	-	Not retained	10851
2413	400 - 600	260 - 270	Miscellaneous Debris	-	Not retained	10852
2414	400 - 600	260 - 270	Miscellaneous Debris	-	Not retained	10853
2415	400 - 600	260 - 270	Miscellaneous Debris	-	Not retained	10854
2416	400 - 600	260 - 270	Miscellaneous Debris	-	Not retained	10855
2417	400 - 600	260 - 270	Miscellaneous Debris	-	Not retained	10856
2418	400 - 600	260 - 270	Miscellaneous Debris	-	Not retained	10857
2419	400 - 600	260 - 270	Miscellaneous Debris	-	Not retained	10858
2420	400 - 600	260 - 270	Miscellaneous Debris	-	Not retained	10859
2421	400 - 600	260 - 270	Miscellaneous Debris	-	Not retained	10860
2422	400 - 600	260 - 270	Miscellaneous Debris	-	Not retained	10861
2423	400 - 600	260 - 270	Miscellaneous Debris	-	Not retained	10862
2424	400 - 600	260 - 270	Miscellaneous Debris	-	Not retained	10863
2425	400 - 600	260 - 270	Miscellaneous Debris	-	Not retained	10864
2426	400 - 600	260 - 270	Miscellaneous Debris	-	Not retained	10865
2427	400 - 600	260 - 270	Miscellaneous Debris	-	Not retained	10866
2428	400 - 600	260 - 270	Miscellaneous Debris	-	Not retained	10867
2429	400 - 600	260 - 270	Miscellaneous Debris	-	Not retained	10868
2430	400 - 600	260 - 270	Miscellaneous Debris	-	Not retained	10869
2431	400 - 600	260 - 270	Miscellaneous Debris	-	Not retained	10870
2432	400 - 600	260 - 270	Miscellaneous Debris	-	Not retained	10871
2433	400 - 600	260 - 270	Miscellaneous Debris	-	Not retained	10872
2434	400 - 600	260 - 270	Miscellaneous Debris	-	Not retained	10873
2435	400 - 600	260 - 270	Miscellaneous Debris	-	Not retained	10874
2436	400 - 600	260 - 270	Miscellaneous Debris	-	Not retained	10875
2437	400 - 600	260 - 270	Miscellaneous Debris	-	Not retained	10876
2438	400 - 600	260 - 270	Miscellaneous Debris	-	Not retained	10877
2439	400 - 600	260 - 270	Miscellaneous Debris	-	Not retained	10878
2440	400 - 600	260 - 270	Miscellaneous Debris	-	Not retained	10879
2441	400 - 600	270 - 280	Warhead Body Piece	0.03		2772
2442	400 - 600	270 - 280	Warhead Body Piece	0.01		2773
2443	400 - 600	270 - 280	Warhead Body Piece	0.01		2774
2444	400 - 600	270 - 280	Warhead Body Piece	0.01		2775
2445	400 - 600	270 - 280	Tail Piece	0.05		2776
2446	400 - 600	270 - 280	Tail Piece	0.04		2777
2447	400 - 600	270 - 280	Tail Piece	0.03		2778
2448	400 - 600	270 - 280	Tail Piece	0.02		2779
2449	400 - 600	270 - 280	Tail Piece	0.01		2780
2450	400 - 600	270 - 280	Tail Piece	0.01		2781

TABLE B-6. FRAGMENTS RECOVERED BEYOND 200-FT RANGE IN TEST NO. 9 (Continued)

<u>Entry</u>	<u>Range Interval (ft)</u>	<u>Azimuthal Sector (°)</u>	<u>Description</u>	<u>Mass (lb)</u>	<u>Notes</u>	<u>G64 Index No.</u>
2451	400 - 600	270 - 280	Miscellaneous Debris	-	Not retained	10880
2452	400 - 600	270 - 280	Miscellaneous Debris	-	Not retained	10881
2453	400 - 600	270 - 280	Miscellaneous Debris	-	Not retained	10882
2454	400 - 600	270 - 280	Miscellaneous Debris	-	Not retained	10883
2455	400 - 600	270 - 280	Miscellaneous Debris	-	Not retained	10884
2456	400 - 600	270 - 280	Miscellaneous Debris	-	Not retained	10885
2457	400 - 600	270 - 280	Miscellaneous Debris	-	Not retained	10886
2458	400 - 600	270 - 280	Miscellaneous Debris	-	Not retained	10887
2459	400 - 600	270 - 280	Miscellaneous Debris	-	Not retained	10888
2460	400 - 600	270 - 280	Miscellaneous Debris	-	Not retained	10889
2461	400 - 600	270 - 280	Miscellaneous Debris	-	Not retained	10890
2462	400 - 600	270 - 280	Miscellaneous Debris	-	Not retained	10891
2463	400 - 600	270 - 280	Miscellaneous Debris	-	Not retained	10892
2464	400 - 600	270 - 280	Miscellaneous Debris	-	Not retained	10893
2465	400 - 600	270 - 280	Miscellaneous Debris	-	Not retained	10894
2466	400 - 600	270 - 280	Miscellaneous Debris	-	Not retained	10895
2467	400 - 600	270 - 280	Miscellaneous Debris	-	Not retained	10896
2468	400 - 600	270 - 280	Miscellaneous Debris	-	Not retained	10897
2469	400 - 600	270 - 280	Miscellaneous Debris	-	Not retained	10898
2470	400 - 600	270 - 280	Miscellaneous Debris	-	Not retained	10899
2471	400 - 600	270 - 280	Miscellaneous Debris	-	Not retained	10900
2472	400 - 600	270 - 280	Miscellaneous Debris	-	Not retained	10901
2473	400 - 600	270 - 280	Miscellaneous Debris	-	Not retained	10902
2474	400 - 600	270 - 280	Miscellaneous Debris	-	Not retained	10903
2475	400 - 600	270 - 280	Miscellaneous Debris	-	Not retained	10904
2476	400 - 600	270 - 280	Miscellaneous Debris	-	Not retained	10905
2477	400 - 600	270 - 280	Miscellaneous Debris	-	Not retained	10906
2478	400 - 600	270 - 280	Miscellaneous Debris	-	Not retained	10907
2479	400 - 600	270 - 280	Miscellaneous Debris	-	Not retained	10908
2480	400 - 600	270 - 280	Miscellaneous Debris	-	Not retained	10909
2481	400 - 600	270 - 280	Miscellaneous Debris	-	Not retained	10910
2482	400 - 600	270 - 280	Miscellaneous Debris	-	Not retained	10911
2483	400 - 600	270 - 280	Miscellaneous Debris	-	Not retained	10912
2484	400 - 600	270 - 280	Miscellaneous Debris	-	Not retained	10913
2485	400 - 600	270 - 280	Miscellaneous Debris	-	Not retained	10914
2486	400 - 600	270 - 280	Miscellaneous Debris	-	Not retained	10915
2487	400 - 600	270 - 280	Miscellaneous Debris	-	Not retained	10916
2488	400 - 600	270 - 280	Miscellaneous Debris	-	Not retained	10917
2489	400 - 600	270 - 280	Miscellaneous Debris	-	Not retained	10918
2490	400 - 600	270 - 280	Miscellaneous Debris	-	Not retained	10919
2491	400 - 600	270 - 280	Miscellaneous Debris	-	Not retained	10920
2492	400 - 600	270 - 280	Miscellaneous Debris	-	Not retained	10921
2493	400 - 600	270 - 280	Miscellaneous Debris	-	Not retained	10922
2494	400 - 600	270 - 280	Miscellaneous Debris	-	Not retained	10923
2495	400 - 600	270 - 280	Miscellaneous Debris	-	Not retained	10924
2496	400 - 600	270 - 280	Miscellaneous Debris	-	Not retained	10925
2497	400 - 600	270 - 280	Miscellaneous Debris	-	Not retained	10926
2498	400 - 600	270 - 280	Miscellaneous Debris	-	Not retained	10927
2499	400 - 600	270 - 280	Miscellaneous Debris	-	Not retained	10928
2500	400 - 600	270 - 280	Miscellaneous Debris	-	Not retained	10929

TABLE B-6. FRAGMENTS RECOVERED BEYOND 200-FT RANGE IN TEST NO. 9 (Continued)

<u>Entry</u>	<u>Range Interval (ft)</u>	<u>Azimuthal Sector (°)</u>	<u>Description</u>	<u>Mass (lb)</u>	<u>Notes</u>	<u>G64 Index No.</u>
2501	400 - 600	270 - 280	Miscellaneous Debris	-	Not retained	10930
2502	400 - 600	270 - 280	Miscellaneous Debris	-	Not retained	10931
2503	400 - 600	270 - 280	Miscellaneous Debris	-	Not retained	10932
2504	400 - 600	270 - 280	Miscellaneous Debris	-	Not retained	10933
2505	400 - 600	270 - 280	Miscellaneous Debris	-	Not retained	10934
2506	400 - 600	270 - 280	Miscellaneous Debris	-	Not retained	10935
2507	400 - 600	270 - 280	Miscellaneous Debris	-	Not retained	10936
2508	400 - 600	270 - 280	Miscellaneous Debris	-	Not retained	10937
2509	400 - 600	270 - 280	Miscellaneous Debris	-	Not retained	10938
2510	400 - 600	270 - 280	Miscellaneous Debris	-	Not retained	10939
2511	400 - 600	270 - 280	Miscellaneous Debris	-	Not retained	10940
2512	400 - 600	270 - 280	Miscellaneous Debris	-	Not retained	10941
2513	400 - 600	270 - 280	Miscellaneous Debris	-	Not retained	10942
2514	400 - 600	270 - 280	Miscellaneous Debris	-	Not retained	10943
2515	400 - 600	270 - 280	Miscellaneous Debris	-	Not retained	10944
2516	400 - 600	270 - 280	Miscellaneous Debris	-	Not retained	10945
2517	400 - 600	270 - 280	Miscellaneous Debris	-	Not retained	10946
2518	400 - 600	280 - 290	Tail Piece	0.01		3172
2519	400 - 600	280 - 290	Miscellaneous Debris	-	Not retained	10947
2520	400 - 600	280 - 290	Miscellaneous Debris	-	Not retained	10948
2521	400 - 600	280 - 290	Miscellaneous Debris	-	Not retained	10949
2522	400 - 600	280 - 290	Miscellaneous Debris	-	Not retained	10950
2523	400 - 600	280 - 290	Miscellaneous Debris	-	Not retained	10951
2524	400 - 600	280 - 290	Miscellaneous Debris	-	Not retained	10952
2525	400 - 600	280 - 290	Miscellaneous Debris	-	Not retained	10953
2526	400 - 600	280 - 290	Miscellaneous Debris	-	Not retained	10954
2527	400 - 600	280 - 290	Miscellaneous Debris	-	Not retained	10955
2528	400 - 600	280 - 290	Miscellaneous Debris	-	Not retained	10956
2529	400 - 600	280 - 290	Miscellaneous Debris	-	Not retained	10957
2530	400 - 600	280 - 290	Miscellaneous Debris	-	Not retained	10958
2531	400 - 600	280 - 290	Miscellaneous Debris	-	Not retained	10959
2532	400 - 600	280 - 290	Miscellaneous Debris	-	Not retained	10960
2533	400 - 600	280 - 290	Miscellaneous Debris	-	Not retained	10961
2534	400 - 600	280 - 290	Miscellaneous Debris	-	Not retained	10962
2535	400 - 600	280 - 290	Miscellaneous Debris	-	Not retained	10963
2536	400 - 600	280 - 290	Miscellaneous Debris	-	Not retained	10964
2537	400 - 600	280 - 290	Miscellaneous Debris	-	Not retained	10965
2538	400 - 600	280 - 290	Miscellaneous Debris	-	Not retained	10966
2539	400 - 600	280 - 290	Miscellaneous Debris	-	Not retained	10967
2540	400 - 600	280 - 290	Miscellaneous Debris	-	Not retained	10968
2541	400 - 600	280 - 290	Miscellaneous Debris	-	Not retained	10969
2542	400 - 600	280 - 290	Miscellaneous Debris	-	Not retained	10970
2543	400 - 600	280 - 290	Miscellaneous Debris	-	Not retained	10971
2544	400 - 600	280 - 290	Miscellaneous Debris	-	Not retained	10972
2545	400 - 600	280 - 290	Miscellaneous Debris	-	Not retained	10973
2546	400 - 600	280 - 290	Miscellaneous Debris	-	Not retained	10974
2547	400 - 600	280 - 290	Miscellaneous Debris	-	Not retained	10975
2548	400 - 600	280 - 290	Miscellaneous Debris	-	Not retained	10976
2549	400 - 600	280 - 290	Miscellaneous Debris	-	Not retained	10977
2550	400 - 600	280 - 290	Miscellaneous Debris	-	Not retained	10978

NSWCDD/TR-98/6

TABLE B-6. FRAGMENTS RECOVERED BEYOND 200-FT RANGE IN TEST NO. 9 (Continued)

<u>Entry</u>	<u>Range Interval (ft)</u>	<u>Azimuthal Sector (°)</u>	<u>Description</u>	<u>Mass (lb)</u>	<u>Notes</u>	<u>G64 Index No.</u>
2551	400 - 600	280 - 290	Miscellaneous Debris	-	Not retained	10979
2552	400 - 600	280 - 290	Miscellaneous Debris	-	Not retained	10980
2553	400 - 600	280 - 290	Miscellaneous Debris	-	Not retained	10981
2554	400 - 600	280 - 290	Miscellaneous Debris	-	Not retained	10982
2555	400 - 600	280 - 290	Miscellaneous Debris	-	Not retained	10983
2556	400 - 600	280 - 290	Miscellaneous Debris	-	Not retained	10984
2557	400 - 600	280 - 290	Miscellaneous Debris	-	Not retained	10985
2558	400 - 600	280 - 290	Miscellaneous Debris	-	Not retained	10986
2559	400 - 600	280 - 290	Miscellaneous Debris	-	Not retained	10987
2560	400 - 600	280 - 290	Miscellaneous Debris	-	Not retained	10988
2561	400 - 600	280 - 290	Miscellaneous Debris	-	Not retained	10989
2562	400 - 600	280 - 290	Miscellaneous Debris	-	Not retained	10990
2563	400 - 600	280 - 290	Miscellaneous Debris	-	Not retained	10991
2564	400 - 600	280 - 290	Miscellaneous Debris	-	Not retained	10992
2565	400 - 600	280 - 290	Miscellaneous Debris	-	Not retained	10993
2566	400 - 600	280 - 290	Miscellaneous Debris	-	Not retained	10994
2567	400 - 600	280 - 290	Miscellaneous Debris	-	Not retained	10995
2568	400 - 600	280 - 290	Miscellaneous Debris	-	Not retained	10996
2569	400 - 600	280 - 290	Miscellaneous Debris	-	Not retained	10997
2570	400 - 600	280 - 290	Miscellaneous Debris	-	Not retained	10998
2571	400 - 600	280 - 290	Miscellaneous Debris	-	Not retained	10999
2572	400 - 600	280 - 290	Miscellaneous Debris	-	Not retained	11000
2573	400 - 600	280 - 290	Miscellaneous Debris	-	Not retained	11001
2574	400 - 600	280 - 290	Miscellaneous Debris	-	Not retained	11002
2575	400 - 600	280 - 290	Miscellaneous Debris	-	Not retained	11003
2576	400 - 600	280 - 290	Miscellaneous Debris	-	Not retained	11004
2577	400 - 600	290 - 300	Warhead Body Piece	0.10		3096
2578	400 - 600	290 - 300	Warhead Body Piece	0.08		3097
2579	400 - 600	290 - 300	Warhead Body Piece	0.06		3098
2580	400 - 600	290 - 300	Warhead Body Piece	0.01		3099
2581	400 - 600	290 - 300	Tail Piece	0.03		1711
2582	400 - 600	290 - 300	Tail Piece	0.01		1712
2583	400 - 600	290 - 300	Tail Piece	0.06		3103
2584	400 - 600	290 - 300	Tail Piece	0.03		3104
2585	400 - 600	290 - 300	Tail Piece	0.02		3105
2586	400 - 600	290 - 300	Tail Piece	0.01		3106
2587	400 - 600	290 - 300	Miscellaneous Debris	0.01		3100
2588	400 - 600	290 - 300	Miscellaneous Debris	0.01		3101
2589	400 - 600	290 - 300	Miscellaneous Debris	0.01		3102
2590	400 - 600	290 - 300	Miscellaneous Debris	-	Not retained	11005
2591	400 - 600	290 - 300	Miscellaneous Debris	-	Not retained	11006
2592	400 - 600	290 - 300	Miscellaneous Debris	-	Not retained	11007
2593	400 - 600	290 - 300	Miscellaneous Debris	-	Not retained	11008
2594	400 - 600	290 - 300	Miscellaneous Debris	-	Not retained	11009
2595	400 - 600	290 - 300	Miscellaneous Debris	-	Not retained	11010
2596	400 - 600	290 - 300	Miscellaneous Debris	-	Not retained	11011
2597	400 - 600	290 - 300	Miscellaneous Debris	-	Not retained	11012
2598	400 - 600	290 - 300	Miscellaneous Debris	-	Not retained	11013
2599	400 - 600	290 - 300	Miscellaneous Debris	-	Not retained	11014
2600	400 - 600	290 - 300	Miscellaneous Debris	-	Not retained	11015

NSWCDD/TR-98/6

TABLE B-6. FRAGMENTS RECOVERED BEYOND 200-FT RANGE IN TEST NO. 9 (Continued)

<u>Entry</u>	<u>Range Interval (ft)</u>	<u>Azimuthal Sector (°)</u>	<u>Description</u>	<u>Mass (lb)</u>	<u>Notes</u>	<u>G64 Index No.</u>
2601	400 - 600	290 - 300	Miscellaneous Debris	-	Not retained	11016
2602	400 - 600	290 - 300	Miscellaneous Debris	-	Not retained	11017
2603	400 - 600	290 - 300	Miscellaneous Debris	-	Not retained	11018
2604	400 - 600	290 - 300	Miscellaneous Debris	-	Not retained	11019
2605	400 - 600	290 - 300	Miscellaneous Debris	-	Not retained	11020
2606	400 - 600	290 - 300	Miscellaneous Debris	-	Not retained	11021
2607	400 - 600	290 - 300	Miscellaneous Debris	-	Not retained	11022
2608	400 - 600	290 - 300	Miscellaneous Debris	-	Not retained	11023
2609	400 - 600	290 - 300	Miscellaneous Debris	-	Not retained	11024
2610	400 - 600	290 - 300	Miscellaneous Debris	-	Not retained	11025
2611	400 - 600	290 - 300	Miscellaneous Debris	-	Not retained	11026
2612	400 - 600	290 - 300	Miscellaneous Debris	-	Not retained	11027
2613	400 - 600	290 - 300	Miscellaneous Debris	-	Not retained	11028
2614	400 - 600	290 - 300	Miscellaneous Debris	-	Not retained	11029
2615	400 - 600	290 - 300	Miscellaneous Debris	-	Not retained	11030
2616	400 - 600	290 - 300	Miscellaneous Debris	-	Not retained	11031
2617	400 - 600	290 - 300	Miscellaneous Debris	-	Not retained	11032
2618	400 - 600	290 - 300	Miscellaneous Debris	-	Not retained	11033
2619	400 - 600	290 - 300	Miscellaneous Debris	-	Not retained	11034
2620	400 - 600	290 - 300	Miscellaneous Debris	-	Not retained	11035
2621	400 - 600	290 - 300	Miscellaneous Debris	-	Not retained	11036
2622	400 - 600	290 - 300	Miscellaneous Debris	-	Not retained	11037
2623	400 - 600	290 - 300	Miscellaneous Debris	-	Not retained	11038
2624	400 - 600	290 - 300	Miscellaneous Debris	-	Not retained	11039
2625	400 - 600	290 - 300	Miscellaneous Debris	-	Not retained	11040
2626	400 - 600	290 - 300	Miscellaneous Debris	-	Not retained	11041
2627	400 - 600	290 - 300	Miscellaneous Debris	-	Not retained	11042
2628	400 - 600	290 - 300	Miscellaneous Debris	-	Not retained	11043
2629	400 - 600	290 - 300	Miscellaneous Debris	-	Not retained	11044
2630	400 - 600	290 - 300	Miscellaneous Debris	-	Not retained	11045
2631	400 - 600	290 - 300	Miscellaneous Debris	-	Not retained	11046
2632	400 - 600	300 - 310	Warhead Body Piece	0.05		2522
2633	400 - 600	300 - 310	Warhead Body Piece	0.02		2523
2634	400 - 600	300 - 310	Warhead Body Piece	0.02		2524
2635	400 - 600	300 - 310	Warhead Body Piece	0.01		2525
2636	400 - 600	300 - 310	Warhead Body Piece	0.01		2526
2637	400 - 600	300 - 310	Tail Piece	0.01		2480
2638	400 - 600	300 - 310	Tail Piece	0.12		2527
2639	400 - 600	300 - 310	Tail Piece	0.06		2528
2640	400 - 600	300 - 310	Tail Piece	0.01		2529
2641	400 - 600	300 - 310	Tail Piece	0.03		2675
2642	400 - 600	300 - 310	Miscellaneous Debris	0.01		2530
2643	400 - 600	300 - 310	Miscellaneous Debris	0.01		2531
2644	400 - 600	300 - 310	Miscellaneous Debris	-	Not retained	11047
2645	400 - 600	300 - 310	Miscellaneous Debris	-	Not retained	11048
2646	400 - 600	300 - 310	Miscellaneous Debris	-	Not retained	11049
2647	400 - 600	300 - 310	Miscellaneous Debris	-	Not retained	11050
2648	400 - 600	300 - 310	Miscellaneous Debris	-	Not retained	11051
2649	400 - 600	300 - 310	Miscellaneous Debris	-	Not retained	11052
2650	400 - 600	300 - 310	Miscellaneous Debris	-	Not retained	11053

NSWCDD/TR-98/6

TABLE B-6. FRAGMENTS RECOVERED BEYOND 200-FT RANGE IN TEST NO. 9 (Continued)

<u>Entry</u>	<u>Range Interval (ft)</u>	<u>Azimuthal Sector (°)</u>	<u>Description</u>	<u>Mass (lb)</u>	<u>Notes</u>	<u>G64 Index No.</u>
2651	400 - 600	300 - 310	Miscellaneous Debris	-	Not retained	11054
2652	400 - 600	300 - 310	Miscellaneous Debris	-	Not retained	11055
2653	400 - 600	300 - 310	Miscellaneous Debris	-	Not retained	11056
2654	400 - 600	300 - 310	Miscellaneous Debris	-	Not retained	11057
2655	400 - 600	300 - 310	Miscellaneous Debris	-	Not retained	11058
2656	400 - 600	300 - 310	Miscellaneous Debris	-	Not retained	11059
2657	400 - 600	300 - 310	Miscellaneous Debris	-	Not retained	11060
2658	400 - 600	300 - 310	Miscellaneous Debris	-	Not retained	11061
2659	400 - 600	300 - 310	Miscellaneous Debris	-	Not retained	11062
2660	400 - 600	300 - 310	Miscellaneous Debris	-	Not retained	11063
2661	400 - 600	300 - 310	Miscellaneous Debris	-	Not retained	11064
2662	400 - 600	300 - 310	Miscellaneous Debris	-	Not retained	11065
2663	400 - 600	300 - 310	Miscellaneous Debris	-	Not retained	11066
2664	400 - 600	300 - 310	Miscellaneous Debris	-	Not retained	11067
2665	400 - 600	300 - 310	Miscellaneous Debris	-	Not retained	11068
2666	400 - 600	300 - 310	Miscellaneous Debris	-	Not retained	11069
2667	400 - 600	300 - 310	Miscellaneous Debris	-	Not retained	11070
2668	400 - 600	300 - 310	Miscellaneous Debris	-	Not retained	11071
2669	400 - 600	300 - 310	Miscellaneous Debris	-	Not retained	11072
2670	400 - 600	300 - 310	Miscellaneous Debris	-	Not retained	11073
2671	400 - 600	300 - 310	Miscellaneous Debris	-	Not retained	11074
2672	400 - 600	300 - 310	Miscellaneous Debris	-	Not retained	11075
2673	400 - 600	300 - 310	Miscellaneous Debris	-	Not retained	11076
2674	400 - 600	300 - 310	Miscellaneous Debris	-	Not retained	11077
2675	400 - 600	300 - 310	Miscellaneous Debris	-	Not retained	11078
2676	400 - 600	300 - 310	Miscellaneous Debris	-	Not retained	11079
2677	400 - 600	300 - 310	Miscellaneous Debris	-	Not retained	11080
2678	400 - 600	300 - 310	Miscellaneous Debris	-	Not retained	11081
2679	400 - 600	300 - 310	Miscellaneous Debris	-	Not retained	11082
2680	400 - 600	300 - 310	Miscellaneous Debris	-	Not retained	11083
2681	400 - 600	300 - 310	Miscellaneous Debris	-	Not retained	11084
2682	400 - 600	300 - 310	Miscellaneous Debris	-	Not retained	11085
2683	400 - 600	300 - 310	Miscellaneous Debris	-	Not retained	11086
2684	400 - 600	300 - 310	Miscellaneous Debris	-	Not retained	11087
2685	400 - 600	300 - 310	Miscellaneous Debris	-	Not retained	11088
2686	400 - 600	300 - 310	Miscellaneous Debris	-	Not retained	11089
2687	400 - 600	300 - 310	Miscellaneous Debris	-	Not retained	11090
2688	400 - 600	300 - 310	Miscellaneous Debris	-	Not retained	11091
2689	400 - 600	300 - 310	Miscellaneous Debris	-	Not retained	11092
2690	400 - 600	300 - 310	Miscellaneous Debris	-	Not retained	11093
2691	400 - 600	300 - 310	Miscellaneous Debris	-	Not retained	11094
2692	400 - 600	310 - 320	Warhead Body Piece	0.02		2461
2693	400 - 600	310 - 320	Warhead Body Piece	0.01		2462
2694	400 - 600	310 - 320	Warhead Body Piece	0.01		2463
2695	400 - 600	310 - 320	Warhead Body Piece	0.01		2464
2696	400 - 600	310 - 320	Warhead Body Piece	0.20		3119
2697	400 - 600	310 - 320	Warhead Body Piece	0.08		3120
2698	400 - 600	310 - 320	Warhead Body Piece	0.02		3121
2699	400 - 600	310 - 320	Warhead Body Piece	0.01		3122
2700	400 - 600	310 - 320	Warhead Body Piece	0.01		3123

TABLE B-6. FRAGMENTS RECOVERED BEYOND 200-FT RANGE IN TEST NO. 9 (Continued)

<u>Entry</u>	<u>Range Interval (ft)</u>	<u>Azimuthal Sector (°)</u>	<u>Description</u>	<u>Mass (lb)</u>	<u>Notes</u>	<u>G64 Index No.</u>
2701	400 - 600	310 - 320	Warhead Body Piece	0.01		3124
2702	400 - 600	310 - 320	Warhead Body Piece	0.01		3125
2703	400 - 600	310 - 320	Tail Piece	0.03		3126
2704	400 - 600	310 - 320	Tail Piece	0.01		3127
2705	400 - 600	310 - 320	Tail Piece	0.01		3128
2706	400 - 600	310 - 320	Miscellaneous Debris	0.01		3129
2707	400 - 600	310 - 320	Miscellaneous Debris	0.01		3130
2708	400 - 600	310 - 320	Miscellaneous Debris	0.01		3131
2709	400 - 600	310 - 320	Miscellaneous Debris	-	Not retained	11095
2710	400 - 600	310 - 320	Miscellaneous Debris	-	Not retained	11096
2711	400 - 600	310 - 320	Miscellaneous Debris	-	Not retained	11097
2712	400 - 600	310 - 320	Miscellaneous Debris	-	Not retained	11098
2713	400 - 600	310 - 320	Miscellaneous Debris	-	Not retained	11099
2714	400 - 600	310 - 320	Miscellaneous Debris	-	Not retained	11100
2715	400 - 600	310 - 320	Miscellaneous Debris	-	Not retained	11101
2716	400 - 600	310 - 320	Miscellaneous Debris	-	Not retained	11102
2717	400 - 600	310 - 320	Miscellaneous Debris	-	Not retained	11103
2718	400 - 600	310 - 320	Miscellaneous Debris	-	Not retained	11104
2719	400 - 600	310 - 320	Miscellaneous Debris	-	Not retained	11105
2720	400 - 600	310 - 320	Miscellaneous Debris	-	Not retained	11106
2721	400 - 600	310 - 320	Miscellaneous Debris	-	Not retained	11107
2722	400 - 600	310 - 320	Miscellaneous Debris	-	Not retained	11108
2723	400 - 600	310 - 320	Miscellaneous Debris	-	Not retained	11109
2724	400 - 600	310 - 320	Miscellaneous Debris	-	Not retained	11110
2725	400 - 600	310 - 320	Miscellaneous Debris	-	Not retained	11111
2726	400 - 600	310 - 320	Miscellaneous Debris	-	Not retained	11112
2727	400 - 600	310 - 320	Miscellaneous Debris	-	Not retained	11113
2728	400 - 600	310 - 320	Miscellaneous Debris	-	Not retained	11114
2729	400 - 600	310 - 320	Miscellaneous Debris	-	Not retained	11115
2730	400 - 600	310 - 320	Miscellaneous Debris	-	Not retained	11116
2731	400 - 600	310 - 320	Miscellaneous Debris	-	Not retained	11117
2732	400 - 600	310 - 320	Miscellaneous Debris	-	Not retained	11118
2733	400 - 600	310 - 320	Miscellaneous Debris	-	Not retained	11119
2734	400 - 600	310 - 320	Miscellaneous Debris	-	Not retained	11120
2735	400 - 600	310 - 320	Miscellaneous Debris	-	Not retained	11121
2736	400 - 600	310 - 320	Miscellaneous Debris	-	Not retained	11122
2737	400 - 600	310 - 320	Miscellaneous Debris	-	Not retained	11123
2738	400 - 600	310 - 320	Miscellaneous Debris	-	Not retained	11124
2739	400 - 600	310 - 320	Miscellaneous Debris	-	Not retained	11125
2740	400 - 600	310 - 320	Miscellaneous Debris	-	Not retained	11126
2741	400 - 600	320 - 330	Warhead Body Piece	0.18		1690
2742	400 - 600	320 - 330	Warhead Body Piece	0.05		1691
2743	400 - 600	320 - 330	Warhead Body Piece	0.03		1692
2744	400 - 600	320 - 330	Warhead Body Piece	0.01		1693
2745	400 - 600	320 - 330	Warhead Body Piece	0.01		1694
2746	400 - 600	320 - 330	Warhead Body Piece	0.01		1695
2747	400 - 600	320 - 330	Warhead Body Piece	0.01		1696
2748	400 - 600	320 - 330	Warhead Body Piece	0.01		1697
2749	400 - 600	320 - 330	Warhead Body Piece	0.01		1698
2750	400 - 600	320 - 330	Warhead Body Piece	0.01		1699

NSWCDD/TR-98/6

TABLE B-6. FRAGMENTS RECOVERED BEYOND 200-FT RANGE IN TEST NO. 9 (Continued)

<u>Entry</u>	<u>Range Interval (ft)</u>	<u>Azimuthal Sector (°)</u>	<u>Description</u>	<u>Mass (lb)</u>	<u>Notes</u>	<u>G64 Index No.</u>
2751	400 - 600	320 - 330	Warhead Body Piece	0.02		2896
2752	400 - 600	320 - 330	Tail Piece	0.07		1701
2753	400 - 600	320 - 330	Tail Piece	0.01		1702
2754	400 - 600	320 - 330	Miscellaneous Debris	0.01		1703
2755	400 - 600	320 - 330	Miscellaneous Debris	0.01		1704
2756	400 - 600	320 - 330	Miscellaneous Debris	0.01		1700
2757	400 - 600	320 - 330	Miscellaneous Debris	-	Not retained	11127
2758	400 - 600	320 - 330	Miscellaneous Debris	-	Not retained	11128
2759	400 - 600	320 - 330	Miscellaneous Debris	-	Not retained	11129
2760	400 - 600	320 - 330	Miscellaneous Debris	-	Not retained	11130
2761	400 - 600	320 - 330	Miscellaneous Debris	-	Not retained	11131
2762	400 - 600	320 - 330	Miscellaneous Debris	-	Not retained	11132
2763	400 - 600	320 - 330	Miscellaneous Debris	-	Not retained	11133
2764	400 - 600	320 - 330	Miscellaneous Debris	-	Not retained	11134
2765	400 - 600	320 - 330	Miscellaneous Debris	-	Not retained	11135
2766	400 - 600	320 - 330	Miscellaneous Debris	-	Not retained	11136
2767	400 - 600	320 - 330	Miscellaneous Debris	-	Not retained	11137
2768	400 - 600	320 - 330	Miscellaneous Debris	-	Not retained	11138
2769	400 - 600	320 - 330	Miscellaneous Debris	-	Not retained	11139
2770	400 - 600	320 - 330	Miscellaneous Debris	-	Not retained	11140
2771	400 - 600	320 - 330	Miscellaneous Debris	-	Not retained	11141
2772	400 - 600	320 - 330	Miscellaneous Debris	-	Not retained	11142
2773	400 - 600	320 - 330	Miscellaneous Debris	-	Not retained	11143
2774	400 - 600	320 - 330	Miscellaneous Debris	-	Not retained	11144
2775	400 - 600	320 - 330	Miscellaneous Debris	-	Not retained	11145
2776	400 - 600	320 - 330	Miscellaneous Debris	-	Not retained	11146
2777	400 - 600	320 - 330	Miscellaneous Debris	-	Not retained	11147
2778	400 - 600	320 - 330	Miscellaneous Debris	-	Not retained	11148
2779	400 - 600	320 - 330	Miscellaneous Debris	-	Not retained	11149
2780	400 - 600	320 - 330	Miscellaneous Debris	-	Not retained	11150
2781	400 - 600	320 - 330	Miscellaneous Debris	-	Not retained	11151
2782	400 - 600	330 - 340	Warhead Body Piece	0.72		1909
2783	400 - 600	330 - 340	Warhead Body Piece	0.34		1910
2784	400 - 600	330 - 340	Warhead Body Piece	0.04		1911
2785	400 - 600	330 - 340	Warhead Body Piece	0.05		1912
2786	400 - 600	330 - 340	Warhead Body Piece	0.03		1913
2787	400 - 600	330 - 340	Warhead Body Piece	0.04		1914
2788	400 - 600	330 - 340	Warhead Body Piece	0.03		1915
2789	400 - 600	330 - 340	Warhead Body Piece	0.02		1916
2790	400 - 600	330 - 340	Warhead Body Piece	0.01		1917
2791	400 - 600	330 - 340	Warhead Body Piece	0.01		1918
2792	400 - 600	330 - 340	Warhead Body Piece	0.01		1919
2793	400 - 600	330 - 340	Warhead Body Piece	0.01		1920
2794	400 - 600	330 - 340	Warhead Body Piece	0.01		1921
2795	400 - 600	330 - 340	Warhead Body Piece	0.01		1922
2796	400 - 600	330 - 340	Warhead Body Piece	0.01		1923
2797	400 - 600	330 - 340	Warhead Body Piece	0.04		2599
2798	400 - 600	330 - 340	Warhead Body Piece	0.03		2600
2799	400 - 600	330 - 340	Tail Piece	0.03		1925
2800	400 - 600	330 - 340	Tail Piece	0.02		1926

NSWCDD/TR-98/6

TABLE B-6. FRAGMENTS RECOVERED BEYOND 200-FT RANGE IN TEST NO. 9 (Continued)

<u>Entry</u>	<u>Range Interval (ft)</u>	<u>Azimuthal Sector (°)</u>	<u>Description</u>	<u>Mass (lb)</u>	<u>Notes</u>	<u>G64 Index No.</u>
2801	400 - 600	330 - 340	Tail Piece	0.03		1927
2802	400 - 600	330 - 340	Miscellaneous Debris	0.01		1928
2803	400 - 600	330 - 340	Miscellaneous Debris	0.01		1929
2804	400 - 600	330 - 340	Miscellaneous Debris	0.01		1924
2805	400 - 600	330 - 340	Miscellaneous Debris	-	Not retained	11152
2806	400 - 600	330 - 340	Miscellaneous Debris	-	Not retained	11153
2807	400 - 600	330 - 340	Miscellaneous Debris	-	Not retained	11154
2808	400 - 600	330 - 340	Miscellaneous Debris	-	Not retained	11155
2809	400 - 600	330 - 340	Miscellaneous Debris	-	Not retained	11156
2810	400 - 600	330 - 340	Miscellaneous Debris	-	Not retained	11157
2811	400 - 600	330 - 340	Miscellaneous Debris	-	Not retained	11158
2812	400 - 600	330 - 340	Miscellaneous Debris	-	Not retained	11159
2813	400 - 600	330 - 340	Miscellaneous Debris	-	Not retained	11160
2814	400 - 600	330 - 340	Miscellaneous Debris	-	Not retained	11161
2815	400 - 600	330 - 340	Miscellaneous Debris	-	Not retained	11162
2816	400 - 600	330 - 340	Miscellaneous Debris	-	Not retained	11163
2817	400 - 600	330 - 340	Miscellaneous Debris	-	Not retained	11164
2818	400 - 600	330 - 340	Miscellaneous Debris	-	Not retained	11165
2819	400 - 600	330 - 340	Miscellaneous Debris	-	Not retained	11166
2820	400 - 600	330 - 340	Miscellaneous Debris	-	Not retained	11167
2821	400 - 600	330 - 340	Miscellaneous Debris	-	Not retained	11168
2822	400 - 600	330 - 340	Miscellaneous Debris	-	Not retained	11169
2823	400 - 600	330 - 340	Miscellaneous Debris	-	Not retained	11170
2824	400 - 600	330 - 340	Miscellaneous Debris	-	Not retained	11171
2825	400 - 600	330 - 340	Miscellaneous Debris	-	Not retained	11172
2826	400 - 600	330 - 340	Miscellaneous Debris	-	Not retained	11173
2827	400 - 600	330 - 340	Miscellaneous Debris	-	Not retained	11174
2828	400 - 600	330 - 340	Miscellaneous Debris	-	Not retained	11175
2829	400 - 600	330 - 340	Miscellaneous Debris	-	Not retained	11176
2830	400 - 600	330 - 340	Miscellaneous Debris	-	Not retained	11177
2831	400 - 600	340 - 350	Warhead Body Piece	0.15		2389
2832	400 - 600	340 - 350	Warhead Body Piece	0.26		2390
2833	400 - 600	340 - 350	Warhead Body Piece	0.11		2391
2834	400 - 600	340 - 350	Warhead Body Piece	0.07		2392
2835	400 - 600	340 - 350	Warhead Body Piece	0.02		2393
2836	400 - 600	340 - 350	Warhead Body Piece	0.02		2394
2837	400 - 600	340 - 350	Warhead Body Piece	0.02		2395
2838	400 - 600	340 - 350	Warhead Body Piece	0.02		2396
2839	400 - 600	340 - 350	Warhead Body Piece	0.02		2397
2840	400 - 600	340 - 350	Warhead Body Piece	0.02		2398
2841	400 - 600	340 - 350	Warhead Body Piece	0.02		2399
2842	400 - 600	340 - 350	Warhead Body Piece	0.01		2400
2843	400 - 600	340 - 350	Warhead Body Piece	0.01		2401
2844	400 - 600	340 - 350	Warhead Body Piece	0.01		2402
2845	400 - 600	340 - 350	Warhead Body Piece	0.01		2403
2846	400 - 600	340 - 350	Warhead Body Piece	0.01		2404
2847	400 - 600	340 - 350	Warhead Body Piece	0.32		3186
2848	400 - 600	340 - 350	Tail Piece	0.18		2407
2849	400 - 600	340 - 350	Tail Piece	0.03		2408
2850	400 - 600	340 - 350	Tail Piece	0.01		2409

NSWCDD/TR-98/6

TABLE B-6. FRAGMENTS RECOVERED BEYOND 200-FT RANGE IN TEST NO. 9 (Continued)

<u>Entry</u>	<u>Range Interval (ft)</u>	<u>Azimuthal Sector (°)</u>	<u>Description</u>	<u>Mass (lb)</u>	<u>Notes</u>	<u>G64 Index No.</u>
2851	400 - 600	340 - 350	Miscellaneous Debris	0.02		2410
2852	400 - 600	340 - 350	Miscellaneous Debris	0.01		2411
2853	400 - 600	340 - 350	Miscellaneous Debris	0.01		2405
2854	400 - 600	340 - 350	Miscellaneous Debris	0.01		2406
2855	400 - 600	340 - 350	Miscellaneous Debris	-	Not retained	11178
2856	400 - 600	340 - 350	Miscellaneous Debris	-	Not retained	11179
2857	400 - 600	340 - 350	Miscellaneous Debris	-	Not retained	11180
2858	400 - 600	340 - 350	Miscellaneous Debris	-	Not retained	11181
2859	400 - 600	340 - 350	Miscellaneous Debris	-	Not retained	11182
2860	400 - 600	340 - 350	Miscellaneous Debris	-	Not retained	11183
2861	400 - 600	340 - 350	Miscellaneous Debris	-	Not retained	11184
2862	400 - 600	340 - 350	Miscellaneous Debris	-	Not retained	11185
2863	400 - 600	340 - 350	Miscellaneous Debris	-	Not retained	11186
2864	400 - 600	340 - 350	Miscellaneous Debris	-	Not retained	11187
2865	400 - 600	340 - 350	Miscellaneous Debris	-	Not retained	11188
2866	400 - 600	340 - 350	Miscellaneous Debris	-	Not retained	11189
2867	400 - 600	340 - 350	Miscellaneous Debris	-	Not retained	11190
2868	400 - 600	340 - 350	Miscellaneous Debris	-	Not retained	11191
2869	400 - 600	340 - 350	Miscellaneous Debris	-	Not retained	11192
2870	400 - 600	340 - 350	Miscellaneous Debris	-	Not retained	11193
2871	400 - 600	340 - 350	Miscellaneous Debris	-	Not retained	11194
2872	400 - 600	340 - 350	Miscellaneous Debris	-	Not retained	11195
2873	400 - 600	340 - 350	Miscellaneous Debris	-	Not retained	11196
2874	400 - 600	340 - 350	Miscellaneous Debris	-	Not retained	11197
2875	400 - 600	340 - 350	Miscellaneous Debris	-	Not retained	11198
2876	400 - 600	340 - 350	Miscellaneous Debris	-	Not retained	11199
2877	400 - 600	340 - 350	Miscellaneous Debris	-	Not retained	11200
2878	400 - 600	340 - 350	Miscellaneous Debris	-	Not retained	11201
2879	400 - 600	340 - 350	Miscellaneous Debris	-	Not retained	11202
2880	400 - 600	340 - 350	Miscellaneous Debris	-	Not retained	11203
2881	400 - 600	340 - 350	Miscellaneous Debris	-	Not retained	11204
2882	400 - 600	340 - 350	Miscellaneous Debris	-	Not retained	11205
2883	400 - 600	350 - 360	Warhead Body Piece	0.37		2909
2884	400 - 600	350 - 360	Warhead Body Piece	0.19		2910
2885	400 - 600	350 - 360	Warhead Body Piece	0.07		2911
2886	400 - 600	350 - 360	Warhead Body Piece	0.03		2912
2887	400 - 600	350 - 360	Warhead Body Piece	0.03		2913
2888	400 - 600	350 - 360	Warhead Body Piece	0.02		2914
2889	400 - 600	350 - 360	Warhead Body Piece	0.02		2915
2890	400 - 600	350 - 360	Warhead Body Piece	0.01		2916
2891	400 - 600	350 - 360	Warhead Body Piece	0.01		2917
2892	400 - 600	350 - 360	Warhead Body Piece	0.01		2918
2893	400 - 600	350 - 360	Warhead Body Piece	0.01		2919
2894	400 - 600	350 - 360	Tail Piece	0.04		2920
2895	400 - 600	350 - 360	Miscellaneous Debris	-	Not retained	11206
2896	400 - 600	350 - 360	Miscellaneous Debris	-	Not retained	11207
2897	400 - 600	350 - 360	Miscellaneous Debris	-	Not retained	11208
2898	400 - 600	350 - 360	Miscellaneous Debris	-	Not retained	11209
2899	400 - 600	350 - 360	Miscellaneous Debris	-	Not retained	11210
2900	400 - 600	350 - 360	Miscellaneous Debris	-	Not retained	11211

TABLE B-6. FRAGMENTS RECOVERED BEYOND 200-FT RANGE IN TEST NO. 9 (Continued)

<u>Entry</u>	<u>Range Interval (ft)</u>	<u>Azimuthal Sector (°)</u>	<u>Description</u>	<u>Mass (lb)</u>	<u>Notes</u>	<u>G64 Index No.</u>
2901	400 - 600	350 - 360	Miscellaneous Debris	-	Not retained	11212
2902	400 - 600	350 - 360	Miscellaneous Debris	-	Not retained	11213
2903	400 - 600	350 - 360	Miscellaneous Debris	-	Not retained	11214
2904	400 - 600	350 - 360	Miscellaneous Debris	-	Not retained	11215
2905	400 - 600	350 - 360	Miscellaneous Debris	-	Not retained	11216
2906	400 - 600	350 - 360	Miscellaneous Debris	-	Not retained	11217
2907	400 - 600	350 - 360	Miscellaneous Debris	-	Not retained	11218
2908	400 - 600	350 - 360	Miscellaneous Debris	-	Not retained	11219
2909	400 - 600	350 - 360	Miscellaneous Debris	-	Not retained	11220
2910	400 - 600	350 - 360	Miscellaneous Debris	-	Not retained	11221
2911	400 - 600	350 - 360	Miscellaneous Debris	-	Not retained	11222
2912	400 - 600	350 - 360	Miscellaneous Debris	-	Not retained	11223
2913	400 - 600	350 - 360	Miscellaneous Debris	-	Not retained	11224
2914	400 - 600	350 - 360	Miscellaneous Debris	-	Not retained	11225
2915	400 - 600	350 - 360	Miscellaneous Debris	-	Not retained	11226
2916	400 - 600	350 - 360	Miscellaneous Debris	-	Not retained	11227
2917	400 - 600	350 - 360	Miscellaneous Debris	-	Not retained	11228
2918	400 - 600	350 - 360	Miscellaneous Debris	-	Not retained	11229
2919	600 - 800	0 - 10	Warhead Body Piece	0.90		1723
2920	600 - 800	0 - 10	Warhead Body Piece	0.26		1724
2921	600 - 800	0 - 10	Warhead Body Piece	0.16		1725
2922	600 - 800	0 - 10	Warhead Body Piece	0.11		1726
2923	600 - 800	0 - 10	Warhead Body Piece	0.03		1727
2924	600 - 800	0 - 10	Warhead Body Piece	0.02		1728
2925	600 - 800	0 - 10	Warhead Body Piece	0.01		1729
2926	600 - 800	0 - 10	Warhead Body Piece	0.02		2235
2927	600 - 800	0 - 10	Warhead Body Piece	0.01		2236
2928	600 - 800	0 - 10	Warhead Body Piece	0.01		2237
2929	600 - 800	0 - 10	Miscellaneous Debris	-	Not retained	11230
2930	600 - 800	0 - 10	Miscellaneous Debris	-	Not retained	11231
2931	600 - 800	0 - 10	Miscellaneous Debris	-	Not retained	11232
2932	600 - 800	0 - 10	Miscellaneous Debris	-	Not retained	11233
2933	600 - 800	0 - 10	Miscellaneous Debris	-	Not retained	11234
2934	600 - 800	10 - 20	Warhead Body Piece	0.37		2278
2935	600 - 800	10 - 20	Warhead Body Piece	0.59		2279
2936	600 - 800	10 - 20	Warhead Body Piece	0.05		2280
2937	600 - 800	10 - 20	Warhead Body Piece	0.03		2281
2938	600 - 800	10 - 20	Warhead Body Piece	0.01		2282
2939	600 - 800	10 - 20	Warhead Body Piece	0.01		2283
2940	600 - 800	10 - 20	Miscellaneous Debris	-	Not retained	11235
2941	600 - 800	10 - 20	Miscellaneous Debris	-	Not retained	11236
2942	600 - 800	10 - 20	Miscellaneous Debris	-	Not retained	11237
2943	600 - 800	10 - 20	Miscellaneous Debris	-	Not retained	11238
2944	600 - 800	10 - 20	Miscellaneous Debris	-	Not retained	11239
2945	600 - 800	10 - 20	Miscellaneous Debris	-	Not retained	11240
2946	600 - 800	10 - 20	Miscellaneous Debris	-	Not retained	11241
2947	600 - 800	10 - 20	Miscellaneous Debris	-	Not retained	11242
2948	600 - 800	20 - 30	Warhead Body Piece	0.19		2238
2949	600 - 800	20 - 30	Warhead Body Piece	0.06		2239
2950	600 - 800	20 - 30	Tail Piece	0.34		2240

NSWCDD/TR-98/6

TABLE B-6. FRAGMENTS RECOVERED BEYOND 200-FT RANGE IN TEST NO. 9 (Continued)

<u>Entry</u>	<u>Range Interval (ft)</u>	<u>Azimuthal Sector (°)</u>	<u>Description</u>	<u>Mass (lb)</u>	<u>Notes</u>	<u>G64 Index No.</u>
2951	600 - 800	20 - 30	Tail Piece	0.03		2241
2952	600 - 800	20 - 30	Miscellaneous Debris	-	Not retained	11243
2953	600 - 800	20 - 30	Miscellaneous Debris	-	Not retained	11244
2954	600 - 800	40 - 50	Warhead Body Piece	1.34		2491
2955	600 - 800	40 - 50	Tail Piece	-	Not retained	2490
2956	600 - 800	40 - 50	Tail Piece	0.46		2492
2957	600 - 800	40 - 50	Miscellaneous Debris	-	Not retained	11245
2958	600 - 800	50 - 60	Miscellaneous Debris	-	Not retained	11246
2959	600 - 800	50 - 60	Intact Warhead	-	Not retained	11418
2960	600 - 800	50 - 60	Intact Warhead	-	Not retained	11419
2961	600 - 800	60 - 70	Miscellaneous Debris	-	Not retained	11247
2962	600 - 800	60 - 70	Miscellaneous Debris	-	Not retained	11248
2963	600 - 800	60 - 70	Intact Warhead	-	Not retained	11420
2964	600 - 800	70 - 80	Miscellaneous Debris	-	Not retained	11249
2965	600 - 800	70 - 80	Miscellaneous Debris	-	Not retained	11250
2966	600 - 800	70 - 80	Intact Warhead	-	Not retained	11421
2967	600 - 800	80 - 90	Tail Piece	0.19		2061
2968	600 - 800	80 - 90	Miscellaneous Debris	-	Not retained	11251
2969	600 - 800	80 - 90	Intact Warhead	5.05		2059
2970	600 - 800	80 - 90	Intact Warhead	5.05		2060
2971	600 - 800	90 - 100	Warhead Body Piece	0.62		2079
2972	600 - 800	90 - 100	Miscellaneous Debris	-	Not retained	11252
2973	600 - 800	90 - 100	Miscellaneous Debris	-	Not retained	11253
2974	600 - 800	90 - 100	Miscellaneous Debris	-	Not retained	11254
2975	600 - 800	90 - 100	Miscellaneous Debris	-	Not retained	11255
2976	600 - 800	90 - 100	Miscellaneous Debris	-	Not retained	11256
2977	600 - 800	90 - 100	Intact Warhead	5.05		2078
2978	600 - 800	100 - 110	Tail Piece	0.21		2635
2979	600 - 800	100 - 110	Tail Piece	0.19		2836
2980	600 - 800	100 - 110	Tail Piece	0.18		2837
2981	600 - 800	100 - 110	Miscellaneous Debris	-	Not retained	11257
2982	600 - 800	100 - 110	Miscellaneous Debris	-	Not retained	11258
2983	600 - 800	100 - 110	Miscellaneous Debris	-	Not retained	11259
2984	600 - 800	100 - 110	Miscellaneous Debris	-	Not retained	11260
2985	600 - 800	100 - 110	Intact Warhead	5.05		2832
2986	600 - 800	100 - 110	Intact Warhead	5.05		2833
2987	600 - 800	100 - 110	Intact Warhead	5.05		2834
2988	600 - 800	100 - 110	Intact Warhead	5.05		2835
2989	600 - 800	110 - 120	Tail Piece	0.45		1843
2990	600 - 800	110 - 120	Tail Piece	0.20		1844
2991	600 - 800	110 - 120	Intact Warhead	5.05		3267
2992	600 - 800	120 - 130	Warhead Body Piece	0.04		2535
2993	600 - 800	120 - 130	Miscellaneous Debris	-	Not retained	11261
2994	600 - 800	120 - 130	Intact Warhead	5.05		2532
2995	600 - 800	120 - 130	Intact Warhead	5.05		2533
2996	600 - 800	120 - 130	Intact Warhead	5.05		2534
2997	600 - 800	130 - 140	Tail Piece	0.20		2094
2998	600 - 800	140 - 150	Miscellaneous Debris	-	Not retained	11262
2999	600 - 800	150 - 160	Warhead Body Piece	0.16		3048
3000	600 - 800	150 - 160	Tail Piece	0.21		3049

TABLE B-6. FRAGMENTS RECOVERED BEYOND 200-FT RANGE IN TEST NO. 9 (Continued)

<u>Entry</u>	<u>Range Interval (ft)</u>	<u>Azimuthal Sector (°)</u>	<u>Description</u>	<u>Mass (lb)</u>	<u>Notes</u>	<u>G64 Index No.</u>
3001	600 - 800	160 - 170	Tail Piece	0.21		2292
3002	600 - 800	180 - 190	Warhead Body Piece	0.04		2869
3003	600 - 800	180 - 190	Warhead Body Piece	0.02		2870
3004	600 - 800	180 - 190	Tail Piece	0.46		2871
3005	600 - 800	180 - 190	Tail Piece	0.20		2872
3006	600 - 800	200 - 210	Warhead Body Piece	0.42		2907
3007	600 - 800	200 - 210	Warhead Body Piece	0.11		2908
3008	600 - 800	200 - 210	Tail Piece	0.17		2521
3009	600 - 800	210 - 220	Warhead Body Piece	1.37		2959
3010	600 - 800	210 - 220	Warhead Body Piece	0.19		2540
3011	600 - 800	210 - 220	Tail Piece	0.02		2960
3012	600 - 800	210 - 220	Miscellaneous Debris	-	Not retained	11263
3013	600 - 800	210 - 220	Miscellaneous Debris	-	Not retained	11264
3014	600 - 800	220 - 230	Warhead Body Piece	0.01		2233
3015	600 - 800	220 - 230	Warhead Body Piece	0.16		3254
3016	600 - 800	230 - 240	Warhead Body Piece	0.05		2849
3017	600 - 800	230 - 240	Warhead Body Piece	0.02		2850
3018	600 - 800	230 - 240	Miscellaneous Debris	-	Not retained	11265
3019	600 - 800	230 - 240	Miscellaneous Debris	-	Not retained	11266
3020	600 - 800	230 - 240	Miscellaneous Debris	-	Not retained	11267
3021	600 - 800	230 - 240	Miscellaneous Debris	-	Not retained	11268
3022	600 - 800	230 - 240	Miscellaneous Debris	-	Not retained	11269
3023	600 - 800	230 - 240	Miscellaneous Debris	-	Not retained	11270
3024	600 - 800	230 - 240	Miscellaneous Debris	-	Not retained	11271
3025	600 - 800	230 - 240	Miscellaneous Debris	-	Not retained	11272
3026	600 - 800	230 - 240	Miscellaneous Debris	-	Not retained	11273
3027	600 - 800	240 - 250	Warhead Body Piece	0.57		3072
3028	600 - 800	240 - 250	Warhead Body Piece	0.45		3073
3029	600 - 800	240 - 250	Warhead Body Piece	0.05		3074
3030	600 - 800	240 - 250	Warhead Body Piece	0.10		3075
3031	600 - 800	240 - 250	Warhead Body Piece	0.02		3076
3032	600 - 800	240 - 250	Warhead Body Piece	0.01		3077
3033	600 - 800	240 - 250	Tail Piece	0.02		3051
3034	600 - 800	240 - 250	Tail Piece	0.19		3078
3035	600 - 800	240 - 250	Tail Piece	0.02		3079
3036	600 - 800	240 - 250	Tail Piece	0.07		3262
3037	600 - 800	240 - 250	Miscellaneous Debris	-	Not retained	11274
3038	600 - 800	240 - 250	Miscellaneous Debris	-	Not retained	11275
3039	600 - 800	240 - 250	Miscellaneous Debris	-	Not retained	11276
3040	600 - 800	240 - 250	Miscellaneous Debris	-	Not retained	11277
3041	600 - 800	240 - 250	Miscellaneous Debris	-	Not retained	11278
3042	600 - 800	240 - 250	Miscellaneous Debris	-	Not retained	11279
3043	600 - 800	250 - 260	Warhead Body Piece	0.21		3145
3044	600 - 800	250 - 260	Warhead Body Piece	0.17		3146
3045	600 - 800	250 - 260	Warhead Body Piece	0.11		3147
3046	600 - 800	250 - 260	Warhead Body Piece	0.01		3148
3047	600 - 800	250 - 260	Tail Piece	0.04		3149
3048	600 - 800	250 - 260	Tail Piece	0.03		3150
3049	600 - 800	250 - 260	Tail Piece	0.03		3151
3050	600 - 800	250 - 260	Tail Piece	0.03		3152

NSWCDD/TR-98/6

TABLE B-6. FRAGMENTS RECOVERED BEYOND 200-FT RANGE IN TEST NO. 9 (Continued)

<u>Entry</u>	<u>Range Interval (ft)</u>	<u>Azimuthal Sector (°)</u>	<u>Description</u>	<u>Mass (lb)</u>	<u>Notes</u>	<u>G64 Index No.</u>
3051	600 - 800	250 - 260	Miscellaneous Debris	-	Not retained	11280
3052	600 - 800	250 - 260	Miscellaneous Debris	-	Not retained	11281
3053	600 - 800	250 - 260	Miscellaneous Debris	-	Not retained	11282
3054	600 - 800	250 - 260	Miscellaneous Debris	-	Not retained	11283
3055	600 - 800	250 - 260	Miscellaneous Debris	-	Not retained	11284
3056	600 - 800	250 - 260	Miscellaneous Debris	-	Not retained	11285
3057	600 - 800	250 - 260	Miscellaneous Debris	-	Not retained	11286
3058	600 - 800	250 - 260	Miscellaneous Debris	-	Not retained	11287
3059	600 - 800	260 - 270	Warhead Body Piece	0.16		3081
3060	600 - 800	260 - 270	Warhead Body Piece	0.09		3082
3061	600 - 800	260 - 270	Warhead Body Piece	0.04		3083
3062	600 - 800	260 - 270	Warhead Body Piece	0.02		3084
3063	600 - 800	260 - 270	Warhead Body Piece	0.01		3085
3064	600 - 800	260 - 270	Warhead Body Piece	0.43		3221
3065	600 - 800	260 - 270	Tail Piece	0.19		3086
3066	600 - 800	260 - 270	Tail Piece	0.08		3087
3067	600 - 800	260 - 270	Tail Piece	0.01		3088
3068	600 - 800	260 - 270	Miscellaneous Debris	-	Not retained	11288
3069	600 - 800	260 - 270	Miscellaneous Debris	-	Not retained	11289
3070	600 - 800	260 - 270	Miscellaneous Debris	-	Not retained	11290
3071	600 - 800	260 - 270	Miscellaneous Debris	-	Not retained	11291
3072	600 - 800	260 - 270	Miscellaneous Debris	-	Not retained	11292
3073	600 - 800	260 - 270	Miscellaneous Debris	-	Not retained	11293
3074	600 - 800	260 - 270	Miscellaneous Debris	-	Not retained	11294
3075	600 - 800	260 - 270	Miscellaneous Debris	-	Not retained	11295
3076	600 - 800	260 - 270	Miscellaneous Debris	-	Not retained	11296
3077	600 - 800	260 - 270	Miscellaneous Debris	-	Not retained	11297
3078	600 - 800	260 - 270	Miscellaneous Debris	-	Not retained	11298
3079	600 - 800	260 - 270	Miscellaneous Debris	-	Not retained	11299
3080	600 - 800	260 - 270	Miscellaneous Debris	-	Not retained	11300
3081	600 - 800	260 - 270	Miscellaneous Debris	-	Not retained	11301
3082	600 - 800	270 - 280	Warhead Body Piece	0.28		1573
3083	600 - 800	270 - 280	Warhead Body Piece	0.02		2500
3084	600 - 800	270 - 280	Warhead Body Piece	0.33		3089
3085	600 - 800	270 - 280	Warhead Body Piece	0.07		3090
3086	600 - 800	270 - 280	Warhead Body Piece	0.01		3091
3087	600 - 800	270 - 280	Warhead Body Piece	0.01		3092
3088	600 - 800	270 - 280	Warhead Body Piece	0.01		3093
3089	600 - 800	270 - 280	Warhead Body Piece	0.01		3220
3090	600 - 800	270 - 280	Tail Piece	0.18		3094
3091	600 - 800	270 - 280	Tail Piece	0.03		3095
3092	600 - 800	270 - 280	Tail Piece	0.02		3179
3093	600 - 800	270 - 280	Miscellaneous Debris	-	Not retained	11302
3094	600 - 800	270 - 280	Miscellaneous Debris	-	Not retained	11303
3095	600 - 800	270 - 280	Miscellaneous Debris	-	Not retained	11304
3096	600 - 800	270 - 280	Miscellaneous Debris	-	Not retained	11305
3097	600 - 800	270 - 280	Miscellaneous Debris	-	Not retained	11306
3098	600 - 800	270 - 280	Miscellaneous Debris	-	Not retained	11307
3099	600 - 800	270 - 280	Miscellaneous Debris	-	Not retained	11308
3100	600 - 800	270 - 280	Miscellaneous Debris	-	Not retained	11309

TABLE B-6. FRAGMENTS RECOVERED BEYOND 200-FT RANGE IN TEST NO. 9 (Continued)

<u>Entry</u>	<u>Range Interval (ft)</u>	<u>Azimuthal Sector (°)</u>	<u>Description</u>	<u>Mass (lb)</u>	<u>Notes</u>	<u>G64 Index No.</u>
3101	600 - 800	270 - 280	Miscellaneous Debris	-	Not retained	11310
3102	600 - 800	270 - 280	Miscellaneous Debris	-	Not retained	11311
3103	600 - 800	270 - 280	Miscellaneous Debris	-	Not retained	11312
3104	600 - 800	270 - 280	Miscellaneous Debris	-	Not retained	11313
3105	600 - 800	270 - 280	Miscellaneous Debris	-	Not retained	11314
3106	600 - 800	270 - 280	Miscellaneous Debris	-	Not retained	11315
3107	600 - 800	280 - 290	Warhead Body Piece	0.02		2622
3108	600 - 800	280 - 290	Warhead Body Piece	0.09		3001
3109	600 - 800	280 - 290	Warhead Body Piece	0.24		3002
3110	600 - 800	280 - 290	Warhead Body Piece	0.03		3003
3111	600 - 800	280 - 290	Warhead Body Piece	0.02		3004
3112	600 - 800	280 - 290	Warhead Body Piece	0.01		3005
3113	600 - 800	280 - 290	Warhead Body Piece	0.01		3006
3114	600 - 800	280 - 290	Warhead Body Piece	0.01		3007
3115	600 - 800	280 - 290	Warhead Body Piece	0.01		3008
3116	600 - 800	280 - 290	Warhead Body Piece	0.01		3009
3117	600 - 800	280 - 290	Tail Piece	0.08		3010
3118	600 - 800	280 - 290	Miscellaneous Debris	-	Not retained	11316
3119	600 - 800	280 - 290	Miscellaneous Debris	-	Not retained	11317
3120	600 - 800	280 - 290	Miscellaneous Debris	-	Not retained	11318
3121	600 - 800	280 - 290	Miscellaneous Debris	-	Not retained	11319
3122	600 - 800	280 - 290	Miscellaneous Debris	-	Not retained	11320
3123	600 - 800	280 - 290	Miscellaneous Debris	-	Not retained	11321
3124	600 - 800	280 - 290	Miscellaneous Debris	-	Not retained	11322
3125	600 - 800	280 - 290	Miscellaneous Debris	-	Not retained	11323
3126	600 - 800	280 - 290	Miscellaneous Debris	-	Not retained	11324
3127	600 - 800	280 - 290	Miscellaneous Debris	-	Not retained	11325
3128	600 - 800	280 - 290	Miscellaneous Debris	-	Not retained	11326
3129	600 - 800	280 - 290	Miscellaneous Debris	-	Not retained	11327
3130	600 - 800	280 - 290	Miscellaneous Debris	-	Not retained	11328
3131	600 - 800	280 - 290	Miscellaneous Debris	-	Not retained	11329
3132	600 - 800	280 - 290	Miscellaneous Debris	-	Not retained	11330
3133	600 - 800	290 - 300	Warhead Body Piece	0.41		2980
3134	600 - 800	290 - 300	Warhead Body Piece	0.04		2981
3135	600 - 800	290 - 300	Warhead Body Piece	0.03		2982
3136	600 - 800	290 - 300	Warhead Body Piece	0.01		2983
3137	600 - 800	290 - 300	Warhead Body Piece	0.01		2984
3138	600 - 800	290 - 300	Warhead Body Piece	0.01		2985
3139	600 - 800	290 - 300	Tail Piece	-	Not retained	2979
3140	600 - 800	290 - 300	Miscellaneous Debris	-	Not retained	11331
3141	600 - 800	290 - 300	Miscellaneous Debris	-	Not retained	11332
3142	600 - 800	300 - 310	Warhead Body Piece	0.14		1765
3143	600 - 800	300 - 310	Warhead Body Piece	0.06		1766
3144	600 - 800	300 - 310	Warhead Body Piece	0.06		1767
3145	600 - 800	300 - 310	Warhead Body Piece	0.01		1768
3146	600 - 800	300 - 310	Warhead Body Piece	0.01		1769
3147	600 - 800	300 - 310	Tail Piece	0.03		1770
3148	600 - 800	300 - 310	Tail Piece	0.03		1771
3149	600 - 800	300 - 310	Tail Piece	0.02		1772
3150	600 - 800	300 - 310	Tail Piece	0.02		1773

NSWCDD/TR-98/6

TABLE B-6. FRAGMENTS RECOVERED BEYOND 200-FT RANGE IN TEST NO. 9 (Continued)

<u>Entry</u>	<u>Range Interval (ft)</u>	<u>Azimuthal Sector (°)</u>	<u>Description</u>	<u>Mass (lb)</u>	<u>Notes</u>	<u>G64 Index No.</u>
3151	600 - 800	300 - 310	Tail Piece	0.02		1774
3152	600 - 800	300 - 310	Tail Piece	0.01		1775
3153	600 - 800	300 - 310	Tail Piece	0.03		3228
3154	600 - 800	300 - 310	Miscellaneous Debris	-	Not retained	11333
3155	600 - 800	300 - 310	Miscellaneous Debris	-	Not retained	11334
3156	600 - 800	300 - 310	Miscellaneous Debris	-	Not retained	11335
3157	600 - 800	300 - 310	Miscellaneous Debris	-	Not retained	11336
3158	600 - 800	300 - 310	Miscellaneous Debris	-	Not retained	11337
3159	600 - 800	300 - 310	Miscellaneous Debris	-	Not retained	11338
3160	600 - 800	300 - 310	Miscellaneous Debris	-	Not retained	11339
3161	600 - 800	300 - 310	Miscellaneous Debris	-	Not retained	11340
3162	600 - 800	300 - 310	Miscellaneous Debris	-	Not retained	11341
3163	600 - 800	300 - 310	Miscellaneous Debris	-	Not retained	11342
3164	600 - 800	300 - 310	Miscellaneous Debris	-	Not retained	11343
3165	600 - 800	310 - 320	Warhead Body Piece	0.14		2351
3166	600 - 800	310 - 320	Warhead Body Piece	0.01		2352
3167	600 - 800	310 - 320	Warhead Body Piece	0.01		2353
3168	600 - 800	310 - 320	Warhead Body Piece	0.01		2354
3169	600 - 800	310 - 320	Warhead Body Piece	0.01		2355
3170	600 - 800	310 - 320	Warhead Body Piece	0.01		2356
3171	600 - 800	310 - 320	Miscellaneous Debris	-	Not retained	11344
3172	600 - 800	310 - 320	Miscellaneous Debris	-	Not retained	11345
3173	600 - 800	310 - 320	Miscellaneous Debris	-	Not retained	11346
3174	600 - 800	310 - 320	Miscellaneous Debris	-	Not retained	11347
3175	600 - 800	310 - 320	Miscellaneous Debris	-	Not retained	11348
3176	600 - 800	320 - 330	Warhead Body Piece	0.45		1823
3177	600 - 800	320 - 330	Warhead Body Piece	0.15		1824
3178	600 - 800	320 - 330	Warhead Body Piece	0.09		1825
3179	600 - 800	320 - 330	Warhead Body Piece	0.01		1826
3180	600 - 800	320 - 330	Warhead Body Piece	0.01		1827
3181	600 - 800	320 - 330	Tail Piece	0.01		1828
3182	600 - 800	320 - 330	Miscellaneous Debris	-	Not retained	11349
3183	600 - 800	320 - 330	Miscellaneous Debris	-	Not retained	11350
3184	600 - 800	320 - 330	Miscellaneous Debris	-	Not retained	11351
3185	600 - 800	320 - 330	Miscellaneous Debris	-	Not retained	11352
3186	600 - 800	320 - 330	Miscellaneous Debris	-	Not retained	11353
3187	600 - 800	320 - 330	Miscellaneous Debris	-	Not retained	11354
3188	600 - 800	320 - 330	Miscellaneous Debris	-	Not retained	11355
3189	600 - 800	330 - 340	Warhead Body Piece	0.14		1905
3190	600 - 800	330 - 340	Warhead Body Piece	0.01		1906
3191	600 - 800	330 - 340	Warhead Body Piece	0.25		2127
3192	600 - 800	330 - 340	Warhead Body Piece	0.04		2128
3193	600 - 800	330 - 340	Warhead Body Piece	0.03		2129
3194	600 - 800	330 - 340	Warhead Body Piece	0.02		2130
3195	600 - 800	330 - 340	Warhead Body Piece	0.01		2131
3196	600 - 800	330 - 340	Warhead Body Piece	0.01		2132
3197	600 - 800	330 - 340	Miscellaneous Debris	-	Not retained	11356
3198	600 - 800	330 - 340	Miscellaneous Debris	-	Not retained	11357
3199	600 - 800	330 - 340	Miscellaneous Debris	-	Not retained	11358
3200	600 - 800	330 - 340	Miscellaneous Debris	-	Not retained	11359

NSWCDD/TR-98/6

TABLE B-6. FRAGMENTS RECOVERED BEYOND 200-FT RANGE IN TEST NO. 9 (Continued)

<u>Entry</u>	<u>Range Interval (ft)</u>	<u>Azimuthal Sector (°)</u>	<u>Description</u>	<u>Mass (lb)</u>	<u>Notes</u>	<u>G64 Index No.</u>
3201	600 - 800	330 - 340	Miscellaneous Debris	-	Not retained	11360
3202	600 - 800	330 - 340	Miscellaneous Debris	-	Not retained	11361
3203	600 - 800	330 - 340	Miscellaneous Debris	-	Not retained	11362
3204	600 - 800	340 - 350	Warhead Body Piece	0.12		2293
3205	600 - 800	340 - 350	Warhead Body Piece	0.08		2294
3206	600 - 800	340 - 350	Warhead Body Piece	0.04		2295
3207	600 - 800	340 - 350	Warhead Body Piece	0.11		3035
3208	600 - 800	340 - 350	Warhead Body Piece	0.03		3036
3209	600 - 800	340 - 350	Tail Piece	0.06		2296
3210	600 - 800	340 - 350	Tail Piece	0.03		3037
3211	600 - 800	340 - 350	Miscellaneous Debris	0.04		2297
3212	600 - 800	340 - 350	Miscellaneous Debris	-	Not retained	11363
3213	600 - 800	340 - 350	Miscellaneous Debris	-	Not retained	11364
3214	600 - 800	340 - 350	Miscellaneous Debris	-	Not retained	11365
3215	600 - 800	340 - 350	Miscellaneous Debris	-	Not retained	11366
3216	600 - 800	340 - 350	Miscellaneous Debris	-	Not retained	11367
3217	600 - 800	340 - 350	Miscellaneous Debris	-	Not retained	11368
3218	600 - 800	340 - 350	Miscellaneous Debris	-	Not retained	11369
3219	600 - 800	350 - 360	Warhead Body Piece	0.25		2384
3220	600 - 800	350 - 360	Warhead Body Piece	0.01		2385
3221	600 - 800	350 - 360	Warhead Body Piece	0.01		2386
3222	600 - 800	350 - 360	Warhead Body Piece	0.01		2387
3223	600 - 800	350 - 360	Warhead Body Piece	0.11		2615
3224	600 - 800	350 - 360	Warhead Body Piece	0.06		2616
3225	600 - 800	350 - 360	Warhead Body Piece	0.02		2617
3226	600 - 800	350 - 360	Warhead Body Piece	0.01		2618
3227	600 - 800	350 - 360	Warhead Body Piece	0.01		2619
3228	600 - 800	350 - 360	Tail Piece	0.21		2388
3229	600 - 800	350 - 360	Miscellaneous Debris	-	Not retained	11370
3230	600 - 800	350 - 360	Miscellaneous Debris	-	Not retained	11371
3231	600 - 800	350 - 360	Miscellaneous Debris	-	Not retained	11372
3232	600 - 800	350 - 360	Miscellaneous Debris	-	Not retained	11373
3233	800 - 1000	0 - 10	Warhead Body Piece	0.33		1653
3234	800 - 1000	0 - 10	Warhead Body Piece	0.04		1654
3235	800 - 1000	0 - 10	Tail Piece	0.25		1655
3236	800 - 1000	10 - 20	Warhead Body Piece	1.06		1639
3237	800 - 1000	10 - 20	Warhead Body Piece	1.07		1640
3238	800 - 1000	10 - 20	Tail Piece	0.39		1641
3239	800 - 1000	20 - 30	Warhead Body Piece	0.09		2601
3240	800 - 1000	20 - 30	Warhead Body Piece	0.04		2602
3241	800 - 1000	30 - 40	Warhead Body Piece	0.31		1807
3242	800 - 1000	30 - 40	Warhead Body Piece	0.16		1808
3243	800 - 1000	30 - 40	Warhead Body Piece	0.12		1809
3244	800 - 1000	30 - 40	Warhead Body Piece	0.05		1810
3245	800 - 1000	30 - 40	Warhead Body Piece	0.02		1811
3246	800 - 1000	30 - 40	Warhead Body Piece	0.01		1812
3247	800 - 1000	40 - 50	Warhead Body Piece	0.02		2999
3248	800 - 1000	40 - 50	Miscellaneous Debris	-	Not retained	11374
3249	800 - 1000	40 - 50	Miscellaneous Debris	-	Not retained	11375
3250	800 - 1000	40 - 50	Intact Warhead	5.05		2998

TABLE B-6. FRAGMENTS RECOVERED BEYOND 200-FT RANGE IN TEST NO. 9 (Continued)

<u>Entry</u>	<u>Range Interval (ft)</u>	<u>Azimuthal Sector (°)</u>	<u>Description</u>	<u>Mass (lb)</u>	<u>Notes</u>	<u>G64 Index No.</u>
3251	800 -1000	40 - 50	Intact Warhead	-	Not retained	11422
3252	800 -1000	50 - 60	Warhead Body Piece	1.00		2825
3253	800 -1000	50 - 60	Intact Warhead	-	Not retained	11423
3254	800 -1000	50 - 60	Intact Warhead	-	Not retained	11424
3255	800 -1000	60 - 70	Intact Warhead	-	Not retained	11425
3256	800 -1000	70 - 80	Tail Piece	0.44		2314
3257	800 -1000	80 - 90	Warhead Body Piece	0.09		1647
3258	800 -1000	80 - 90	Miscellaneous Debris	-	Not retained	11376
3259	800 -1000	80 - 90	Miscellaneous Debris	-	Not retained	11377
3260	800 -1000	90 - 100	Tail Piece	0.45		1932
3261	800 -1000	100 - 110	Warhead Body Piece	1.00		2650
3262	800 -1000	100 - 110	Miscellaneous Debris	-	Not retained	11378
3263	800 -1000	100 - 110	Intact Warhead	-	Not retained	11426
3264	800 -1000	110 - 120	Warhead Body Piece	2.52		2682
3265	800 -1000	110 - 120	Warhead Body Piece	0.42		2683
3266	800 -1000	110 - 120	Intact Warhead	5.05		2678
3267	800 -1000	110 - 120	Intact Warhead	5.05		2679
3268	800 -1000	110 - 120	Intact Warhead	5.05		2680
3269	800 -1000	110 - 120	Intact Warhead	5.05		2681
3270	800 -1000	120 - 130	Tail Piece	0.18		1933
3271	800 -1000	120 - 130	Tail Piece	-	Not retained	3174
3272	800 -1000	130 - 140	Tail Piece	-	Not retained	1756
3273	800 -1000	130 - 140	Tail Piece	0.18		1757
3274	800 -1000	140 - 150	Tail Piece	0.20		1813
3275	800 -1000	140 - 150	Intact Warhead	5.05		3266
3276	800 -1000	170 - 180	Intact Warhead	-	Not retained	11427
3277	800 -1000	170 - 180	Intact Warhead	-	Not retained	11428
3278	800 -1000	180 - 190	Intact Warhead	-	Not retained	11429
3279	800 -1000	180 - 190	Intact Warhead	-	Not retained	11430
3280	800 -1000	200 - 210	Warhead Body Piece	1.31		1720
3281	800 -1000	200 - 210	Tail Piece	0.20		1721
3282	800 -1000	230 - 240	Warhead Body Piece	1.86		2133
3283	800 -1000	230 - 240	Warhead Body Piece	0.81		3117
3284	800 -1000	230 - 240	Tail Piece	0.21		2134
3285	800 -1000	240 - 250	Warhead Body Piece	0.07		1803
3286	800 -1000	240 - 250	Warhead Body Piece	0.03		2986
3287	800 -1000	240 - 250	Warhead Body Piece	0.01		2987
3288	800 -1000	240 - 250	Warhead Body Piece	0.10		3219
3289	800 -1000	240 - 250	Warhead Body Piece	0.09		3247
3290	800 -1000	240 - 250	Tail Piece	0.18		2988
3291	800 -1000	240 - 250	Miscellaneous Debris	-	Not retained	11379
3292	800 -1000	250 - 260	Warhead Body Piece	0.36		1761
3293	800 -1000	250 - 260	Warhead Body Piece	0.38		1762
3294	800 -1000	250 - 260	Warhead Body Piece	0.09		3233
3295	800 -1000	250 - 260	Tail Piece	0.40		1763
3296	800 -1000	250 - 260	Miscellaneous Debris	-	Not retained	11380
3297	800 -1000	250 - 260	Miscellaneous Debris	-	Not retained	11381
3298	800 -1000	250 - 260	Miscellaneous Debris	-	Not retained	11382
3299	800 -1000	250 - 260	Miscellaneous Debris	-	Not retained	11383
3300	800 -1000	260 - 270	Warhead Body Piece	0.81		2101

TABLE B-6. FRAGMENTS RECOVERED BEYOND 200-FT RANGE IN TEST NO. 9 (Continued)

<u>Entry</u>	<u>Range Interval (ft)</u>	<u>Azimuthal Sector (°)</u>	<u>Description</u>	<u>Mass (lb)</u>	<u>Notes</u>	<u>G64 Index No.</u>
3301	800 - 1000	260 - 270	Warhead Body Piece	0.04		2102
3302	800 - 1000	260 - 270	Warhead Body Piece	0.02		2103
3303	800 - 1000	260 - 270	Warhead Body Piece	0.37		3225
3304	800 - 1000	260 - 270	Miscellaneous Debris	-	Not retained	11384
3305	800 - 1000	260 - 270	Miscellaneous Debris	-	Not retained	11385
3306	800 - 1000	260 - 270	Miscellaneous Debris	-	Not retained	11386
3307	800 - 1000	270 - 280	Warhead Body Piece	0.02		2826
3308	800 - 1000	270 - 280	Tail Piece	0.02		2827
3309	800 - 1000	280 - 290	Warhead Body Piece	0.44		3162
3310	800 - 1000	280 - 290	Miscellaneous Debris	-	Not retained	11387
3311	800 - 1000	280 - 290	Miscellaneous Debris	-	Not retained	11388
3312	800 - 1000	280 - 290	Miscellaneous Debris	-	Not retained	11389
3313	800 - 1000	280 - 290	Miscellaneous Debris	-	Not retained	11390
3314	800 - 1000	290 - 300	Warhead Body Piece	0.08		2242
3315	800 - 1000	290 - 300	Tail Piece	0.20		2243
3316	800 - 1000	290 - 300	Tail Piece	0.21		2244
3317	800 - 1000	290 - 300	Miscellaneous Debris	-	Not retained	11391
3318	800 - 1000	290 - 300	Miscellaneous Debris	-	Not retained	11392
3319	800 - 1000	290 - 300	Miscellaneous Debris	-	Not retained	11393
3320	800 - 1000	290 - 300	Miscellaneous Debris	-	Not retained	11394
3321	800 - 1000	300 - 310	Warhead Body Piece	0.42		1745
3322	800 - 1000	300 - 310	Miscellaneous Debris	-	Not retained	11395
3323	800 - 1000	310 - 320	Tail Piece	-	Not retained	1664
3324	800 - 1000	320 - 330	Warhead Body Piece	0.15		2648
3325	800 - 1000	320 - 330	Tail Piece	0.05		2995
3326	800 - 1000	330 - 340	Warhead Body Piece	0.05		2629
3327	800 - 1000	330 - 340	Warhead Body Piece	0.03		2630
3328	800 - 1000	340 - 350	Warhead Body Piece	0.17		2974
3329	800 - 1000	340 - 350	Warhead Body Piece	0.10		2975
3330	800 - 1000	340 - 350	Warhead Body Piece	0.08		2976
3331	800 - 1000	340 - 350	Miscellaneous Debris	-	Not retained	11396
3332	800 - 1000	350 - 360	Miscellaneous Debris	-	Not retained	11397
3333	800 - 1000	350 - 360	Miscellaneous Debris	-	Not retained	11398
3334	1000 - 1200	0 - 10	Warhead Body Piece	1.00		2747
3335	1000 - 1200	20 - 30	Warhead Body Piece	0.40		2997
3336	1000 - 1200	30 - 40	Tail Piece	0.20		1755
3337	1000 - 1200	40 - 50	Tail Piece	-	Not retained	2499
3338	1000 - 1200	40 - 50	Miscellaneous Debris	-	Not retained	11399
3339	1000 - 1200	50 - 60	Intact Warhead	-	Not retained	11431
3340	1000 - 1200	60 - 70	Miscellaneous Debris	-	Not retained	11400
3341	1000 - 1200	80 - 90	Intact Warhead	-	Not retained	11432
3342	1000 - 1200	80 - 90	Intact Warhead	-	Not retained	11433
3343	1000 - 1200	90 - 100	Intact Warhead	-	Not retained	11434
3344	1000 - 1200	110 - 120	Miscellaneous Debris	-	Not retained	11401
3345	1000 - 1200	110 - 120	Intact Warhead	-	Not retained	11435
3346	1000 - 1200	170 - 180	Intact Warhead	-	Not retained	11436
3347	1000 - 1200	170 - 180	Intact Warhead	-	Not retained	11437
3348	1000 - 1200	180 - 190	Intact Warhead	-	Not retained	11438
3349	1000 - 1200	180 - 190	Intact Warhead	-	Not retained	11439
3350	1000 - 1200	230 - 240	Tail Piece	0.17		2350

NSWCDD/TR-98/6

TABLE B-6. FRAGMENTS RECOVERED BEYOND 200-FT RANGE IN TEST NO. 9 (Continued)

<u>Entry</u>	<u>Range Interval (ft)</u>	<u>Azimuthal Sector (°)</u>	<u>Description</u>	<u>Mass (lb)</u>	<u>Notes</u>	<u>G64 Index No.</u>
3351	1000 - 1200	240 - 250	Tail Piece	0.20		2758
3352	1000 - 1200	240 - 250	Miscellaneous Debris	-	Not retained	11402
3353	1000 - 1200	250 - 260	Warhead Body Piece	0.42		2893
3354	1000 - 1200	250 - 260	Tail Piece	0.17		3052
3355	1000 - 1200	260 - 270	Warhead Body Piece	0.45		2537
3356	1000 - 1200	260 - 270	Warhead Body Piece	0.23		2538
3357	1000 - 1200	260 - 270	Warhead Body Piece	0.05		2539
3358	1000 - 1200	260 - 270	Tail Piece	0.15		2543
3359	1000 - 1200	260 - 270	Miscellaneous Debris	-	Not retained	11403
3360	1000 - 1200	260 - 270	Miscellaneous Debris	-	Not retained	11404
3361	1000 - 1200	260 - 270	Miscellaneous Debris	-	Not retained	11405
3362	1000 - 1200	260 - 270	Miscellaneous Debris	-	Not retained	11406
3363	1000 - 1200	270 - 280	Miscellaneous Debris	-	Not retained	11407
3364	1000 - 1200	280 - 290	Tail Piece	0.19		2536
3365	1000 - 1200	300 - 310	Warhead Body Piece	2.38		2611
3366	1000 - 1200	300 - 310	Warhead Body Piece	0.38		2612
3367	1000 - 1200	310 - 320	Warhead Body Piece	1.86		2084
3368	1000 - 1200	310 - 320	Warhead Body Piece	0.75		2085
3369	1000 - 1200	320 - 330	Warhead Body Piece	0.50		2977
3370	1000 - 1200	340 - 350	Warhead Body Piece	0.29		2730
3371	1200 - 1300	0 - 10	Warhead Body Piece	0.14		2077
3372	1200 - 1300	20 - 30	Tail Piece	-	Not retained	2058
3373	1200 - 1300	40 - 50	Warhead Body Piece	1.00		2022
3374	1200 - 1300	40 - 50	Warhead Body Piece	1.19		2021
3375	1200 - 1300	80 - 90	Intact Warhead	-	Not retained	11440
3376	1200 - 1300	90 - 100	Intact Warhead	-	Not retained	11441
3377	1200 - 1300	110 - 120	Intact Warhead	-	Not retained	11442
3378	1200 - 1300	170 - 180	Intact Warhead	-	Not retained	11443
3379	1200 - 1300	250 - 260	Tail Piece	0.16		2902
3380	1200 - 1300	270 - 280	Warhead Body Piece	0.08		2649
3381	1200 - 1300	270 - 280	Warhead Body Piece	0.08		2900
3382	1200 - 1300	280 - 290	Warhead Body Piece	0.07		1814
3383	1200 - 1300	290 - 300	Miscellaneous Debris	-	Not retained	11408
3384	1200 - 1300	340 - 350	Warhead Body Piece	0.63		2783
3385	1200 - 1300	340 - 350	Warhead Body Piece	0.04		2784
3386	1200 - 1300	340 - 350	Tail Piece	-	Not retained	2782
3387	1200 - 1300	350 - 360	Warhead Body Piece	0.80		1656
3388	1300 - 1400	80 - 90	Intact Warhead	-	Not retained	11444
3389	1300 - 1400	270 - 280	Tail Piece	0.18		2200
3390	1300 - 1400	270 - 280	Tail Piece	0.18		2596
3391	1300 - 1400	270 - 280	Miscellaneous Debris	-	Not retained	11409
3392	1300 - 1400	320 - 330	Warhead Body Piece	2.57		2050
3393	1400 - 1600	100 - 110	Intact Warhead	-	Not retained	11445
3394	1400 - 1600	260 - 270	Warhead Body Piece	0.09		2620
3395	1400 - 1600	260 - 270	Tail Piece	0.19		2621
3396	1400 - 1600	260 - 270	Miscellaneous Debris	-	Not retained	11410
3397	1400 - 1600	290 - 300	Miscellaneous Debris	-	Not retained	11411
3398	1400 - 1600	300 - 310	Warhead Body Piece	0.41		2937
3399	1400 - 1600	330 - 340	Tail Piece	0.17		2270

TABLE B-7. OBSERVATIONS FROM TEST NO. 10

Test Date: 17 May 1995

Test Items: Four pallets of M1 105mm HE artillery cartridges. Each pallet contained 16 boxes of cartridges (96 cartridges total). Each projectile contained Composition B explosive (main fill) and was assembled with a supplementary charge. The pallets were stacked 2 wide by 1 deep by 2 high.

Weather: Clear skies, approximately 70° F. Winds were N at approximately 4-6 knots with occasional gusts to approximately 8 knots.

Notes: Mild reactions were observed approximately 15:49 (min:sec) after the start of the test. These reactions appeared to be burning and mild deflagration reactions of some propelling charges. This type of reaction continued to occur intermittently throughout the test. The initial reactions were followed by a series of 37 much more violent explosions that began approximately 19:43 (min:sec) after the fire was lit and continued until 94:01 (min:sec) after the fire was lit. Two additional explosions were observed approximately four hours after the fire was lit by personnel maintaining a security watch. The last two explosions occurred after all instrumentation recording systems were turned off.

Following the test, a total of 88 warhead bodies were recovered intact. Eighty-five of the bodies were recovered inside the 200-ft range and three were recovered beyond the 200-ft range. Seventy-eight of the bodies still contained most or all of the main fill. The total mass of warhead body pieces recovered inside the 200-ft range was 407.3 lb_m.

Fragment recovery was accomplished by visual search of the test area. The entire area between the 200-ft range and the 1300-ft range was searched. Due to the presence of relatively dense vegetation beyond the 1300-ft range, recovery at ranges beyond 1300-ft was accomplished by thoroughly searching selected azimuthal sectors. The total azimuthal region searched beyond the 1300-ft range was 220°.

NSWCDD/TR-98/6

TABLE B-8. FRAGMENTS RECOVERED BEYOND 200-FT RANGE IN TEST NO. 10

<u>Entry</u>	<u>Range Interval (ft)</u>	<u>Azimuthal Sector (°)</u>	<u>Description</u>	<u>Mass (lb)</u>	<u>Notes</u>	<u>G64 Index No.</u>
1	200 - 400	0 - 10	Warhead Body Piece	0.21	Rotating band piece	2941
2	200 - 400	0 - 10	Warhead Body Piece	0.10	Rotating band piece	2942
3	200 - 400	0 - 10	Warhead Body Piece	0.05		2938
4	200 - 400	0 - 10	Warhead Body Piece	0.05		2939
5	200 - 400	0 - 10	Warhead Body Piece	0.16		2940
6	200 - 400	0 - 10	Miscellaneous Debris	-	Not retained	9001
7	200 - 400	0 - 10	Miscellaneous Debris	-	Not retained	9002
8	200 - 400	0 - 10	Cartridge Case Piece	-	Not retained	9000
9	200 - 400	10 - 20	Warhead Body Piece	8.55		2115
10	200 - 400	10 - 20	Warhead Body Piece	0.33		2116
11	200 - 400	10 - 20	Warhead Body Piece	0.13		2117
12	200 - 400	10 - 20	Warhead Body Piece	0.21		2118
13	200 - 400	10 - 20	Warhead Body Piece	0.01		2119
14	200 - 400	10 - 20	Cartridge Case Piece	-	Not retained	9003
15	200 - 400	20 - 30	Warhead Body Piece	0.30		3054
16	200 - 400	20 - 30	Warhead Body Piece	0.01		3055
17	200 - 400	20 - 30	Warhead Body Piece	0.01		3056
18	200 - 400	20 - 30	Miscellaneous Debris	-	Not retained	9007
19	200 - 400	20 - 30	Miscellaneous Debris	-	Not retained	9008
20	200 - 400	20 - 30	Cartridge Case Piece	-	Not retained	9004
21	200 - 400	20 - 30	Cartridge Case Piece	-	Not retained	9005
22	200 - 400	20 - 30	Cartridge Case Piece	-	Not retained	9006
23	200 - 400	30 - 40	Warhead Body Piece	0.61		2370
24	200 - 400	30 - 40	Miscellaneous Debris	0.01		2371
25	200 - 400	30 - 40	Miscellaneous Debris	-	Not retained	9011
26	200 - 400	30 - 40	Miscellaneous Debris	-	Not retained	9012
27	200 - 400	30 - 40	Miscellaneous Debris	-	Not retained	9013
28	200 - 400	30 - 40	Cartridge Case Piece	-	Not retained	9009
29	200 - 400	30 - 40	Cartridge Case Piece	-	Not retained	9010
30	200 - 400	40 - 50	Warhead Body Piece	0.30		2322
31	200 - 400	40 - 50	Warhead Body Piece	0.08		2323
32	200 - 400	40 - 50	Warhead Body Piece	3.57		3189
33	200 - 400	40 - 50	Miscellaneous Debris	-	Not retained	9095
34	200 - 400	40 - 50	Miscellaneous Debris	-	Not retained	9096
35	200 - 400	40 - 50	Cartridge Case Piece	-	Not retained	9014
36	200 - 400	40 - 50	Cartridge Case Piece	-	Not retained	9015
37	200 - 400	50 - 60	Warhead Body Piece	2.03		2212
38	200 - 400	50 - 60	Warhead Body Piece	1.15		2213
39	200 - 400	50 - 60	Warhead Body Piece	0.26		2214
40	200 - 400	50 - 60	Warhead Body Piece	0.07		2215
41	200 - 400	50 - 60	Warhead Body Piece	0.07		2216
42	200 - 400	50 - 60	Warhead Body Piece	0.02		2217
43	200 - 400	50 - 60	Miscellaneous Debris	-	Not retained	9097
44	200 - 400	50 - 60	Cartridge Case Piece	-	Not retained	9016
45	200 - 400	60 - 70	Warhead Body Piece	0.22	Rotating band piece	2514
46	200 - 400	60 - 70	Warhead Body Piece	0.78		2511
47	200 - 400	60 - 70	Warhead Body Piece	0.08		2512
48	200 - 400	60 - 70	Warhead Body Piece	0.12		2513
49	200 - 400	60 - 70	Miscellaneous Debris	-	Not retained	9098
50	200 - 400	60 - 70	Miscellaneous Debris	-	Not retained	9099

TABLE B-8. FRAGMENTS RECOVERED BEYOND 200-FT RANGE IN TEST NO. 10 (Continued)

<u>Entry</u>	<u>Range Interval (ft)</u>	<u>Azimuthal Sector (°)</u>	<u>Description</u>	<u>Mass (lb)</u>	<u>Notes</u>	<u>G64 Index No.</u>
51	200 - 400	60 - 70	Cartridge Case Piece	-	Not retained	9017
52	200 - 400	60 - 70	Cartridge Case Piece	-	Not retained	9018
53	200 - 400	60 - 70	Cartridge Case Piece	-	Not retained	9019
54	200 - 400	70 - 80	Warhead Body Piece	13.24		2120
55	200 - 400	70 - 80	Warhead Body Piece	0.29		2121
56	200 - 400	70 - 80	Warhead Body Piece	0.67		2122
57	200 - 400	70 - 80	Warhead Body Piece	0.02		2123
58	200 - 400	70 - 80	Warhead Body Piece	0.01		2124
59	200 - 400	70 - 80	Warhead Body Piece	0.01		2125
60	200 - 400	70 - 80	Miscellaneous Debris	0.01		2126
61	200 - 400	70 - 80	Miscellaneous Debris	-	Not retained	9100
62	200 - 400	70 - 80	Miscellaneous Debris	-	Not retained	9101
63	200 - 400	70 - 80	Miscellaneous Debris	-	Not retained	9102
64	200 - 400	70 - 80	Miscellaneous Debris	-	Not retained	9103
65	200 - 400	70 - 80	Cartridge Case Piece	-	Not retained	9020
66	200 - 400	70 - 80	Cartridge Case Piece	-	Not retained	9021
67	200 - 400	70 - 80	Cartridge Case Piece	-	Not retained	9022
68	200 - 400	80 - 90	Warhead Body Piece	1.19		2271
69	200 - 400	80 - 90	Warhead Body Piece	0.84		2272
70	200 - 400	80 - 90	Warhead Body Piece	0.58		2273
71	200 - 400	80 - 90	Miscellaneous Debris	-	Not retained	9104
72	200 - 400	80 - 90	Miscellaneous Debris	-	Not retained	9105
73	200 - 400	80 - 90	Miscellaneous Debris	-	Not retained	9106
74	200 - 400	80 - 90	Miscellaneous Debris	-	Not retained	9107
75	200 - 400	80 - 90	Cartridge Case Piece	-	Not retained	9023
76	200 - 400	80 - 90	Cartridge Case Piece	-	Not retained	9024
77	200 - 400	90 - 100	Warhead Body Piece	0.37	Rotating band piece	2099
78	200 - 400	90 - 100	Warhead Body Piece	0.53		2095
79	200 - 400	90 - 100	Warhead Body Piece	0.07		2096
80	200 - 400	90 - 100	Warhead Body Piece	0.02		2097
81	200 - 400	90 - 100	Warhead Body Piece	0.09		2098
82	200 - 400	100 - 110	Warhead Body Piece	2.07		1677
83	200 - 400	100 - 110	Warhead Body Piece	0.95		1678
84	200 - 400	100 - 110	Warhead Body Piece	0.01		1679
85	200 - 400	100 - 110	Cartridge Case Piece	0.02		1680
86	200 - 400	110 - 120	Warhead Body Piece	0.17		2748
87	200 - 400	110 - 120	Warhead Body Piece	0.01		2749
88	200 - 400	110 - 120	Miscellaneous Debris	0.01		2750
89	200 - 400	120 - 130	Warhead Body Piece	0.45		2541
90	200 - 400	120 - 130	Warhead Body Piece	0.11		2542
91	200 - 400	120 - 130	Miscellaneous Debris	-	Not retained	9108
92	200 - 400	120 - 130	Miscellaneous Debris	-	Not retained	9109
93	200 - 400	120 - 130	Miscellaneous Debris	-	Not retained	9110
94	200 - 400	120 - 130	Cartridge Case Piece	-	Not retained	9025
95	200 - 400	120 - 130	Cartridge Case Piece	-	Not retained	9026
96	200 - 400	130 - 140	Warhead Body Piece	0.06		2879
97	200 - 400	130 - 140	Miscellaneous Debris	-	Not retained	9111
98	200 - 400	130 - 140	Miscellaneous Debris	-	Not retained	9112
99	200 - 400	140 - 150	Warhead Body Piece	0.10	Rotating band piece	1889
100	200 - 400	140 - 150	Warhead Body Piece	0.08	Rotating band piece	1890

NSWCDD/TR-98/6

TABLE B-8. FRAGMENTS RECOVERED BEYOND 200-FT RANGE IN TEST NO. 10 (Continued)

<u>Entry</u>	<u>Range Interval (ft)</u>	<u>Azimuthal Sector (°)</u>	<u>Description</u>	<u>Mass (lb)</u>	<u>Notes</u>	<u>G64 Index No.</u>
101	200 - 400	140 - 150	Warhead Body Piece	1.79		1885
102	200 - 400	140 - 150	Warhead Body Piece	0.92		1886
103	200 - 400	140 - 150	Warhead Body Piece	0.17		1887
104	200 - 400	140 - 150	Warhead Body Piece	0.05		1888
105	200 - 400	140 - 150	Miscellaneous Debris	-	Not retained	9113
106	200 - 400	140 - 150	Miscellaneous Debris	-	Not retained	9114
107	200 - 400	140 - 150	Miscellaneous Debris	-	Not retained	9115
108	200 - 400	140 - 150	Miscellaneous Debris	-	Not retained	9116
109	200 - 400	140 - 150	Miscellaneous Debris	-	Not retained	9117
110	200 - 400	140 - 150	Cartridge Case Piece	-	Not retained	9027
111	200 - 400	140 - 150	Cartridge Case Piece	-	Not retained	9028
112	200 - 400	140 - 150	Cartridge Case Piece	-	Not retained	9029
113	200 - 400	150 - 160	Warhead Body Piece	5.76		2062
114	200 - 400	150 - 160	Warhead Body Piece	5.16		2063
115	200 - 400	150 - 160	Warhead Body Piece	0.16		2064
116	200 - 400	150 - 160	Warhead Body Piece	0.18		2065
117	200 - 400	150 - 160	Warhead Body Piece	0.01		2066
118	200 - 400	150 - 160	Miscellaneous Debris	-	Not retained	9118
119	200 - 400	150 - 160	Miscellaneous Debris	-	Not retained	9119
120	200 - 400	150 - 160	Miscellaneous Debris	-	Not retained	9120
121	200 - 400	150 - 160	Miscellaneous Debris	-	Not retained	9121
122	200 - 400	150 - 160	Miscellaneous Debris	-	Not retained	9122
123	200 - 400	150 - 160	Miscellaneous Debris	-	Not retained	9123
124	200 - 400	150 - 160	Cartridge Case Piece	-	Not retained	9030
125	200 - 400	150 - 160	Cartridge Case Piece	-	Not retained	9031
126	200 - 400	150 - 160	Cartridge Case Piece	-	Not retained	9032
127	200 - 400	150 - 160	Cartridge Case Piece	-	Not retained	9033
128	200 - 400	160 - 170	Warhead Body Piece	0.09	Rotating band piece	3059
129	200 - 400	160 - 170	Warhead Body Piece	0.70		1908
130	200 - 400	160 - 170	Warhead Body Piece	0.15		3058
131	200 - 400	160 - 170	Miscellaneous Debris	-	Not retained	9124
132	200 - 400	160 - 170	Miscellaneous Debris	-	Not retained	9125
133	200 - 400	160 - 170	Miscellaneous Debris	-	Not retained	9126
134	200 - 400	160 - 170	Cartridge Case Piece	-	Not retained	9034
135	200 - 400	160 - 170	Cartridge Case Piece	-	Not retained	9035
136	200 - 400	160 - 170	Cartridge Case Piece	-	Not retained	9036
137	200 - 400	160 - 170	Cartridge Case Piece	-	Not retained	9037
138	200 - 400	160 - 170	Cartridge Case Piece	-	Not retained	9038
139	200 - 400	160 - 170	Cartridge Case Piece	-	Not retained	9039
140	200 - 400	160 - 170	Cartridge Case Piece	-	Not retained	9040
141	200 - 400	170 - 180	Warhead Body Piece	0.38	Rotating band piece	2930
142	200 - 400	170 - 180	Warhead Body Piece	0.10	Rotating band piece	2931
143	200 - 400	170 - 180	Warhead Body Piece	0.06		2927
144	200 - 400	170 - 180	Warhead Body Piece	0.03		2928
145	200 - 400	170 - 180	Miscellaneous Debris	-	Not retained	9127
146	200 - 400	170 - 180	Cartridge Case Piece	-	Not retained	9041
147	200 - 400	170 - 180	Cartridge Case Piece	-	Not retained	9042
148	200 - 400	170 - 180	Cartridge Case Piece	-	Not retained	9043
149	200 - 400	180 - 190	Warhead Body Piece	0.04		2949
150	200 - 400	180 - 190	Warhead Body Piece	0.01		2950

TABLE B-8. FRAGMENTS RECOVERED BEYOND 200-FT RANGE IN TEST NO. 10 (Continued)

<u>Entry</u>	<u>Range Interval (ft)</u>	<u>Azimuthal Sector (°)</u>	<u>Description</u>	<u>Mass (lb)</u>	<u>Notes</u>	<u>G64 Index No.</u>
151	200 - 400	180 - 190	Miscellaneous Debris	-	Not retained	9128
152	200 - 400	180 - 190	Miscellaneous Debris	-	Not retained	9129
153	200 - 400	180 - 190	Miscellaneous Debris	-	Not retained	9130
154	200 - 400	180 - 190	Miscellaneous Debris	-	Not retained	9131
155	200 - 400	180 - 190	Cartridge Case Piece	-	Not retained	9044
156	200 - 400	190 - 200	Warhead Body Piece	16.89		1861
157	200 - 400	190 - 200	Warhead Body Piece	0.80		1862
158	200 - 400	190 - 200	Warhead Body Piece	0.11		1863
159	200 - 400	190 - 200	Warhead Body Piece	0.05		1864
160	200 - 400	190 - 200	Warhead Body Piece	0.21		1865
161	200 - 400	190 - 200	Cartridge Case Piece	-	Not retained	9045
162	200 - 400	190 - 200	Cartridge Case Piece	-	Not retained	9046
163	200 - 400	190 - 200	Cartridge Case Piece	-	Not retained	9047
164	200 - 400	200 - 210	Warhead Body Piece	0.97		2830
165	200 - 400	200 - 210	Warhead Body Piece	0.01		2831
166	200 - 400	200 - 210	Miscellaneous Debris	-	Not retained	9132
167	200 - 400	200 - 210	Miscellaneous Debris	-	Not retained	9133
168	200 - 400	200 - 210	Cartridge Case Piece	-	Not retained	9048
169	200 - 400	200 - 210	Cartridge Case Piece	-	Not retained	9049
170	200 - 400	200 - 210	Cartridge Case Piece	-	Not retained	9050
171	200 - 400	200 - 210	Cartridge Case Piece	-	Not retained	9051
172	200 - 400	210 - 220	Warhead Body Piece	0.44	Rotating band piece	2633
173	200 - 400	210 - 220	Warhead Body Piece	0.06		2631
174	200 - 400	210 - 220	Warhead Body Piece	0.01		2632
175	200 - 400	210 - 220	Miscellaneous Debris	0.01		2634
176	200 - 400	210 - 220	Miscellaneous Debris	-	Not retained	9134
177	200 - 400	210 - 220	Cartridge Case Piece	-	Not retained	9052
178	200 - 400	220 - 230	Warhead Body Piece	2.95		1849
179	200 - 400	220 - 230	Warhead Body Piece	0.04		1850
180	200 - 400	220 - 230	Warhead Body Piece	0.02		1851
181	200 - 400	220 - 230	Warhead Body Piece	0.02		1852
182	200 - 400	220 - 230	Miscellaneous Debris	0.01		1853
183	200 - 400	220 - 230	Miscellaneous Debris	0.01		1854
184	200 - 400	220 - 230	Miscellaneous Debris	0.01		1855
185	200 - 400	220 - 230	Miscellaneous Debris	0.01		1856
186	200 - 400	220 - 230	Miscellaneous Debris	-	Not retained	9135
187	200 - 400	220 - 230	Miscellaneous Debris	-	Not retained	9136
188	200 - 400	220 - 230	Miscellaneous Debris	-	Not retained	9137
189	200 - 400	220 - 230	Miscellaneous Debris	-	Not retained	9138
190	200 - 400	220 - 230	Cartridge Case Piece	-	Not retained	9053
191	200 - 400	230 - 240	Warhead Body Piece	0.14	Rotating band piece	2266
192	200 - 400	230 - 240	Warhead Body Piece	3.03		2262
193	200 - 400	230 - 240	Warhead Body Piece	0.84		2263
194	200 - 400	230 - 240	Warhead Body Piece	0.12		2264
195	200 - 400	230 - 240	Warhead Body Piece	0.03		2265
196	200 - 400	230 - 240	Miscellaneous Debris	0.02		2267
197	200 - 400	230 - 240	Miscellaneous Debris	-	Not retained	9139
198	200 - 400	230 - 240	Cartridge Case Piece	-	Not retained	9054
199	200 - 400	230 - 240	Cartridge Case Piece	-	Not retained	9055
200	200 - 400	240 - 250	Warhead Body Piece	0.31		3155

TABLE B-8. FRAGMENTS RECOVERED BEYOND 200-FT RANGE IN TEST NO. 10 (Continued)

<u>Entry</u>	<u>Range Interval (ft)</u>	<u>Azimuthal Sector (°)</u>	<u>Description</u>	<u>Mass (lb)</u>	<u>Notes</u>	<u>G64 Index No.</u>
201	200 - 400	240 - 250	Warhead Body Piece	0.09		3156
202	200 - 400	240 - 250	Warhead Body Piece	0.06		3157
203	200 - 400	240 - 250	Warhead Body Piece	0.02		3158
204	200 - 400	240 - 250	Warhead Body Piece	0.01		3159
205	200 - 400	240 - 250	Warhead Body Piece	0.07		3160
206	200 - 400	240 - 250	Miscellaneous Debris	-	Not retained	9140
207	200 - 400	240 - 250	Miscellaneous Debris	-	Not retained	9141
208	200 - 400	240 - 250	Miscellaneous Debris	-	Not retained	9142
209	200 - 400	240 - 250	Cartridge Case Piece	-	Not retained	9056
210	200 - 400	240 - 250	Cartridge Case Piece	-	Not retained	9057
211	200 - 400	250 - 260	Warhead Body Piece	2.98		3140
212	200 - 400	250 - 260	Warhead Body Piece	0.02		3141
213	200 - 400	250 - 260	Warhead Body Piece	0.01		3142
214	200 - 400	250 - 260	Warhead Body Piece	0.01		3143
215	200 - 400	250 - 260	Miscellaneous Debris	-	Not retained	9143
216	200 - 400	250 - 260	Miscellaneous Debris	-	Not retained	9144
217	200 - 400	250 - 260	Miscellaneous Debris	-	Not retained	9145
218	200 - 400	250 - 260	Cartridge Case Piece	-	Not retained	9058
219	200 - 400	250 - 260	Cartridge Case Piece	-	Not retained	9059
220	200 - 400	250 - 260	Cartridge Case Piece	-	Not retained	9060
221	200 - 400	250 - 260	Cartridge Case Piece	-	Not retained	9061
222	200 - 400	250 - 260	Cartridge Case Piece	-	Not retained	9062
223	200 - 400	260 - 270	Warhead Body Piece	16.07		1648
224	200 - 400	260 - 270	Warhead Body Piece	0.22		1649
225	200 - 400	260 - 270	Warhead Body Piece	0.01		1650
226	200 - 400	260 - 270	Warhead Body Piece	0.01		1651
227	200 - 400	260 - 270	Miscellaneous Debris	0.01		1652
228	200 - 400	260 - 270	Miscellaneous Debris	-	Not retained	9146
229	200 - 400	260 - 270	Cartridge Case Piece	-	Not retained	9063
230	200 - 400	260 - 270	Cartridge Case Piece	-	Not retained	9064
231	200 - 400	270 - 280	Warhead Body Piece	0.32	Rotating band piece	2042
232	200 - 400	270 - 280	Warhead Body Piece	9.37		2032
233	200 - 400	270 - 280	Warhead Body Piece	1.50		2033
234	200 - 400	270 - 280	Warhead Body Piece	0.57		2034
235	200 - 400	270 - 280	Warhead Body Piece	0.10		2035
236	200 - 400	270 - 280	Warhead Body Piece	0.04		2036
237	200 - 400	270 - 280	Warhead Body Piece	0.03		2037
238	200 - 400	270 - 280	Warhead Body Piece	0.02		2038
239	200 - 400	270 - 280	Warhead Body Piece	0.01		2039
240	200 - 400	270 - 280	Warhead Body Piece	0.01		2040
241	200 - 400	270 - 280	Warhead Body Piece	0.01		2041
242	200 - 400	270 - 280	Miscellaneous Debris	0.03		2043
243	200 - 400	270 - 280	Miscellaneous Debris	0.01		2044
244	200 - 400	270 - 280	Miscellaneous Debris	-	Not retained	9147
245	200 - 400	270 - 280	Cartridge Case Piece	-	Not retained	9065
246	200 - 400	280 - 290	Warhead Body Piece	0.03	Rotating band piece	2227
247	200 - 400	280 - 290	Warhead Body Piece	10.69		2219
248	200 - 400	280 - 290	Warhead Body Piece	0.21		2220
249	200 - 400	280 - 290	Warhead Body Piece	0.19		2221
250	200 - 400	280 - 290	Warhead Body Piece	0.06		2222

NSWCDD/TR-98/6

TABLE B-8. FRAGMENTS RECOVERED BEYOND 200-FT RANGE IN TEST NO. 10 (Continued)

<u>Entry</u>	<u>Range Interval (ft)</u>	<u>Azimuthal Sector (°)</u>	<u>Description</u>	<u>Mass (lb)</u>	<u>Notes</u>	<u>G64 Index No.</u>
251	200 - 400	280 - 290	Warhead Body Piece	0.03		2223
252	200 - 400	280 - 290	Warhead Body Piece	0.02		2224
253	200 - 400	280 - 290	Warhead Body Piece	0.01		2225
254	200 - 400	280 - 290	Warhead Body Piece	0.01		2226
255	200 - 400	280 - 290	Miscellaneous Debris	-	Not retained	9148
256	200 - 400	280 - 290	Miscellaneous Debris	-	Not retained	9149
257	200 - 400	280 - 290	Miscellaneous Debris	-	Not retained	9150
258	200 - 400	280 - 290	Miscellaneous Debris	-	Not retained	9151
259	200 - 400	280 - 290	Cartridge Case Piece	-	Not retained	9066
260	200 - 400	280 - 290	Cartridge Case Piece	-	Not retained	9067
261	200 - 400	280 - 290	Cartridge Case Piece	-	Not retained	9068
262	200 - 400	280 - 290	Cartridge Case Piece	-	Not retained	9069
263	200 - 400	290 - 300	Warhead Body Piece	1.25		2785
264	200 - 400	290 - 300	Warhead Body Piece	0.01		2786
265	200 - 400	290 - 300	Warhead Body Piece	0.01		2787
266	200 - 400	290 - 300	Miscellaneous Debris	0.01		2788
267	200 - 400	290 - 300	Miscellaneous Debris	0.02		2789
268	200 - 400	290 - 300	Miscellaneous Debris	-	Not retained	9152
269	200 - 400	290 - 300	Cartridge Case Piece	-	Not retained	9070
270	200 - 400	290 - 300	Cartridge Case Piece	-	Not retained	9071
271	200 - 400	290 - 300	Cartridge Case Piece	-	Not retained	9072
272	200 - 400	290 - 300	Cartridge Case Piece	-	Not retained	9073
273	200 - 400	290 - 300	Cartridge Case Piece	-	Not retained	9074
274	200 - 400	290 - 300	Cartridge Case Piece	-	Not retained	9075
275	200 - 400	300 - 310	Warhead Body Piece	0.44		2838
276	200 - 400	300 - 310	Warhead Body Piece	0.31		2839
277	200 - 400	300 - 310	Warhead Body Piece	0.03		2840
278	200 - 400	300 - 310	Warhead Body Piece	0.02		2841
279	200 - 400	300 - 310	Miscellaneous Debris	-	Not retained	9153
280	200 - 400	300 - 310	Cartridge Case Piece	-	Not retained	9076
281	200 - 400	300 - 310	Cartridge Case Piece	-	Not retained	9077
282	200 - 400	300 - 310	Cartridge Case Piece	-	Not retained	9078
283	200 - 400	300 - 310	Cartridge Case Piece	-	Not retained	9079
284	200 - 400	310 - 320	Warhead Body Piece	0.26	Rotating band piece	2859
285	200 - 400	310 - 320	Warhead Body Piece	0.34		2855
286	200 - 400	310 - 320	Warhead Body Piece	0.01		2856
287	200 - 400	310 - 320	Warhead Body Piece	0.01		2857
288	200 - 400	310 - 320	Warhead Body Piece	0.01		2858
289	200 - 400	310 - 320	Cartridge Case Piece	-	Not retained	9080
290	200 - 400	310 - 320	Cartridge Case Piece	-	Not retained	9081
291	200 - 400	310 - 320	Cartridge Case Piece	-	Not retained	9082
292	200 - 400	310 - 320	Cartridge Case Piece	-	Not retained	9083
293	200 - 400	320 - 330	Warhead Body Piece	1.32		3038
294	200 - 400	320 - 330	Warhead Body Piece	0.12		3039
295	200 - 400	320 - 330	Warhead Body Piece	0.07		3040
296	200 - 400	320 - 330	Warhead Body Piece	0.03		3041
297	200 - 400	320 - 330	Warhead Body Piece	0.02		3042
298	200 - 400	320 - 330	Warhead Body Piece	0.02		3043
299	200 - 400	320 - 330	Warhead Body Piece	0.02		3044
300	200 - 400	320 - 330	Warhead Body Piece	0.01		3045

NSWCDD/TR-98/6

TABLE B-8. FRAGMENTS RECOVERED BEYOND 200-FT RANGE IN TEST NO. 10 (Continued)

<u>Entry</u>	<u>Range Interval (ft)</u>	<u>Azimuthal Sector (°)</u>	<u>Description</u>	<u>Mass (lb)</u>	<u>Notes</u>	<u>G64 Index No.</u>
301	200 - 400	320 - 330	Warhead Body Piece	0.01		3046
302	200 - 400	320 - 330	Warhead Body Piece	0.01		3047
303	200 - 400	320 - 330	Cartridge Case Piece	-	Not retained	9084
304	200 - 400	320 - 330	Cartridge Case Piece	-	Not retained	9085
305	200 - 400	330 - 340	Warhead Body Piece	0.06	Rotating band piece	1754
306	200 - 400	330 - 340	Warhead Body Piece	0.10		1749
307	200 - 400	330 - 340	Warhead Body Piece	0.01		1750
308	200 - 400	330 - 340	Warhead Body Piece	0.01		1751
309	200 - 400	330 - 340	Warhead Body Piece	0.01		1752
310	200 - 400	330 - 340	Warhead Body Piece	0.01		1753
311	200 - 400	330 - 340	Cartridge Case Piece	-	Not retained	9086
312	200 - 400	340 - 350	Warhead Body Piece	0.15		2501
313	200 - 400	340 - 350	Warhead Body Piece	0.02		2502
314	200 - 400	340 - 350	Warhead Body Piece	0.01		2503
315	200 - 400	340 - 350	Warhead Body Piece	0.01		2504
316	200 - 400	340 - 350	Warhead Body Piece	0.01		2505
317	200 - 400	340 - 350	Warhead Body Piece	0.01		2506
318	200 - 400	340 - 350	Warhead Body Piece	0.01		2507
319	200 - 400	340 - 350	Warhead Body Piece	0.01		2508
320	200 - 400	340 - 350	Miscellaneous Debris	-	Not retained	9154
321	200 - 400	340 - 350	Cartridge Case Piece	-	Not retained	9087
322	200 - 400	340 - 350	Cartridge Case Piece	-	Not retained	9088
323	200 - 400	340 - 350	Cartridge Case Piece	-	Not retained	9089
324	200 - 400	340 - 350	Cartridge Case Piece	-	Not retained	9090
325	200 - 400	350 - 360	Warhead Body Piece	2.49		2971
326	200 - 400	350 - 360	Warhead Body Piece	0.27		2972
327	200 - 400	350 - 360	Warhead Body Piece	0.01		2973
328	200 - 400	350 - 360	Cartridge Case Piece	-	Not retained	9091
329	200 - 400	350 - 360	Cartridge Case Piece	-	Not retained	9092
330	200 - 400	350 - 360	Cartridge Case Piece	-	Not retained	9093
331	200 - 400	350 - 360	Cartridge Case Piece	-	Not retained	9094
332	400 - 600	0 - 10	Warhead Body Piece	0.11	Rotating band piece	2695
333	400 - 600	0 - 10	Warhead Body Piece	3.40		2690
334	400 - 600	0 - 10	Warhead Body Piece	0.14		2691
335	400 - 600	0 - 10	Warhead Body Piece	0.12		2692
336	400 - 600	0 - 10	Warhead Body Piece	0.06		2693
337	400 - 600	0 - 10	Warhead Body Piece	0.01		2694
338	400 - 600	0 - 10	Miscellaneous Debris	0.01		2696
339	400 - 600	0 - 10	Miscellaneous Debris	-	Not retained	9186
340	400 - 600	10 - 20	Warhead Body Piece	0.38		3070
341	400 - 600	10 - 20	Warhead Body Piece	0.02		3071
342	400 - 600	10 - 20	Miscellaneous Debris	-	Not retained	9187
343	400 - 600	10 - 20	Cartridge Case Piece	-	Not retained	9155
344	400 - 600	20 - 30	Warhead Body Piece	0.01		1903
345	400 - 600	20 - 30	Warhead Body Piece	0.01		1904
346	400 - 600	20 - 30	Miscellaneous Debris	-	Not retained	9188
347	400 - 600	20 - 30	Cartridge Case Piece	-	Not retained	9156
348	400 - 600	30 - 40	Warhead Body Piece	0.37		2457
349	400 - 600	30 - 40	Warhead Body Piece	0.05		2458
350	400 - 600	30 - 40	Warhead Body Piece	0.01		2459

TABLE B-8. FRAGMENTS RECOVERED BEYOND 200-FT RANGE IN TEST NO. 10 (Continued)

<u>Entry</u>	<u>Range Interval (ft)</u>	<u>Azimuthal Sector (°)</u>	<u>Description</u>	<u>Mass (lb)</u>	<u>Notes</u>	<u>G64 Index No.</u>
351	400 - 600	30 - 40	Miscellaneous Debris	0.01		2460
352	400 - 600	30 - 40	Miscellaneous Debris	-	Not retained	9189
353	400 - 600	40 - 50	Warhead Body Piece	0.04	Rotating band piece	2657
354	400 - 600	40 - 50	Warhead Body Piece	0.01		2656
355	400 - 600	50 - 60	Warhead Body Piece	0.14		1659
356	400 - 600	50 - 60	Warhead Body Piece	0.07		1660
357	400 - 600	50 - 60	Warhead Body Piece	0.11		1661
358	400 - 600	50 - 60	Miscellaneous Debris	0.01		1662
359	400 - 600	50 - 60	Miscellaneous Debris	-	Not retained	9190
360	400 - 600	60 - 70	Warhead Body Piece	0.14	Rotating band piece	2345
361	400 - 600	60 - 70	Warhead Body Piece	0.35		2343
362	400 - 600	60 - 70	Warhead Body Piece	0.01		2344
363	400 - 600	60 - 70	Miscellaneous Debris	0.02		2346
364	400 - 600	60 - 70	Miscellaneous Debris	-	Not retained	9191
365	400 - 600	60 - 70	Cartridge Case Piece	-	Not retained	9157
366	400 - 600	70 - 80	Warhead Body Piece	0.05	Rotating band piece	2700
367	400 - 600	70 - 80	Warhead Body Piece	2.27		2699
368	400 - 600	70 - 80	Miscellaneous Debris	-	Not retained	9192
369	400 - 600	70 - 80	Miscellaneous Debris	-	Not retained	9193
370	400 - 600	70 - 80	Miscellaneous Debris	-	Not retained	9194
371	400 - 600	70 - 80	Cartridge Case Piece	-	Not retained	9158
372	400 - 600	80 - 90	Warhead Body Piece	0.12	Rotating band piece	2843
373	400 - 600	80 - 90	Warhead Body Piece	0.01	Rotating band piece	2844
374	400 - 600	80 - 90	Warhead Body Piece	1.44		1866
375	400 - 600	80 - 90	Warhead Body Piece	0.29		1867
376	400 - 600	80 - 90	Warhead Body Piece	0.07		1868
377	400 - 600	80 - 90	Warhead Body Piece	0.10		2842
378	400 - 600	80 - 90	Miscellaneous Debris	-	Not retained	9195
379	400 - 600	90 - 100	Warhead Body Piece	0.04	Rotating band piece	2114
380	400 - 600	90 - 100	Warhead Body Piece	11.37		2106
381	400 - 600	90 - 100	Warhead Body Piece	0.14		2107
382	400 - 600	90 - 100	Warhead Body Piece	0.29		2108
383	400 - 600	90 - 100	Warhead Body Piece	0.37		2109
384	400 - 600	90 - 100	Warhead Body Piece	0.14		2110
385	400 - 600	90 - 100	Warhead Body Piece	0.02		2111
386	400 - 600	90 - 100	Miscellaneous Debris	0.02		2112
387	400 - 600	90 - 100	Miscellaneous Debris	0.01		2113
388	400 - 600	100 - 110	Miscellaneous Debris	-	Not retained	9196
389	400 - 600	110 - 120	Warhead Body Piece	0.05		2969
390	400 - 600	110 - 120	Miscellaneous Debris	-	Not retained	9197
391	400 - 600	120 - 130	Warhead Body Piece	3.91		2254
392	400 - 600	120 - 130	Warhead Body Piece	3.63		2255
393	400 - 600	120 - 130	Warhead Body Piece	0.13		2256
394	400 - 600	120 - 130	Warhead Body Piece	0.03		2257
395	400 - 600	130 - 140	Warhead Body Piece	11.60		3178
396	400 - 600	140 - 150	Warhead Body Piece	0.14	Rotating band piece	1681
397	400 - 600	150 - 160	Warhead Body Piece	6.14		2051
398	400 - 600	150 - 160	Warhead Body Piece	1.70		2052
399	400 - 600	150 - 160	Warhead Body Piece	0.78		2053
400	400 - 600	150 - 160	Warhead Body Piece	0.23		2054

TABLE B-8. FRAGMENTS RECOVERED BEYOND 200-FT RANGE IN TEST NO. 10 (Continued)

<u>Entry</u>	<u>Range Interval (ft)</u>	<u>Azimuthal Sector (°)</u>	<u>Description</u>	<u>Mass (lb)</u>	<u>Notes</u>	<u>G64 Index No.</u>
401	400 - 600	150 - 160	Warhead Body Piece	0.27		2055
402	400 - 600	160 - 170	Warhead Body Piece	0.47		3033
403	400 - 600	170 - 180	Warhead Body Piece	0.13	Rotating band piece	2105
404	400 - 600	170 - 180	Warhead Body Piece	0.24		2104
405	400 - 600	170 - 180	Cartridge Case Piece	-	Not retained	9159
406	400 - 600	180 - 190	Warhead Body Piece	0.01	Rotating band piece	2729
407	400 - 600	180 - 190	Warhead Body Piece	0.12		2727
408	400 - 600	180 - 190	Warhead Body Piece	0.02		2728
409	400 - 600	180 - 190	Intact Warhead	-	Not retained	9218
410	400 - 600	180 - 190	Miscellaneous Debris	-	Not retained	9198
411	400 - 600	190 - 200	Warhead Body Piece	0.32	Rotating band piece	2735
412	400 - 600	190 - 200	Warhead Body Piece	6.93		2731
413	400 - 600	190 - 200	Warhead Body Piece	0.16		2732
414	400 - 600	190 - 200	Warhead Body Piece	0.05		2733
415	400 - 600	190 - 200	Warhead Body Piece	0.17		2734
416	400 - 600	190 - 200	Miscellaneous Debris	0.01		2736
417	400 - 600	190 - 200	Cartridge Case Piece	-	Not retained	9160
418	400 - 600	200 - 210	Warhead Body Piece	0.46		1784
419	400 - 600	200 - 210	Warhead Body Piece	0.10		1785
420	400 - 600	200 - 210	Warhead Body Piece	0.38		1786
421	400 - 600	200 - 210	Miscellaneous Debris	-	Not retained	9199
422	400 - 600	200 - 210	Cartridge Case Piece	-	Not retained	9161
423	400 - 600	200 - 210	Cartridge Case Piece	-	Not retained	9162
424	400 - 600	210 - 220	Warhead Body Piece	0.09		3110
425	400 - 600	210 - 220	Warhead Body Piece	0.90		3111
426	400 - 600	210 - 220	Warhead Body Piece	0.24		3112
427	400 - 600	210 - 220	Warhead Body Piece	0.01		3113
428	400 - 600	210 - 220	Cartridge Case Piece	-	Not retained	9163
429	400 - 600	220 - 230	Warhead Body Piece	0.12	Rotating band piece	3109
430	400 - 600	220 - 230	Warhead Body Piece	2.42		3107
431	400 - 600	220 - 230	Warhead Body Piece	0.14		3108
432	400 - 600	220 - 230	Intact Warhead	-	Not retained	9219
433	400 - 600	220 - 230	Miscellaneous Debris	-	Not retained	9200
434	400 - 600	220 - 230	Miscellaneous Debris	-	Not retained	9201
435	400 - 600	230 - 240	Warhead Body Piece	3.05		2623
436	400 - 600	230 - 240	Warhead Body Piece	0.06		2624
437	400 - 600	230 - 240	Warhead Body Piece	0.06		2625
438	400 - 600	230 - 240	Warhead Body Piece	0.01		2626
439	400 - 600	230 - 240	Warhead Body Piece	0.01		2627
440	400 - 600	230 - 240	Warhead Body Piece	0.01		2628
441	400 - 600	240 - 250	Warhead Body Piece	0.03	Rotating band piece	2091
442	400 - 600	240 - 250	Warhead Body Piece	0.69		2086
443	400 - 600	240 - 250	Warhead Body Piece	0.31		2087
444	400 - 600	240 - 250	Warhead Body Piece	0.06		2088
445	400 - 600	240 - 250	Warhead Body Piece	0.01		2089
446	400 - 600	240 - 250	Warhead Body Piece	0.01		2090
447	400 - 600	240 - 250	Warhead Body Piece	0.03		3211
448	400 - 600	250 - 260	Warhead Body Piece	0.01		1759
449	400 - 600	250 - 260	Warhead Body Piece	0.16		3215
450	400 - 600	250 - 260	Cartridge Case Piece	-	Not retained	9164

NSWCDD/TR-98/6

TABLE B-8. FRAGMENTS RECOVERED BEYOND 200-FT RANGE IN TEST NO. 10 (Continued)

<u>Entry</u>	<u>Range Interval (ft)</u>	<u>Azimuthal Sector (°)</u>	<u>Description</u>	<u>Mass (lb)</u>	<u>Notes</u>	<u>G64 Index No.</u>
451	400 - 600	260 - 270	Warhead Body Piece	0.12		1758
452	400 - 600	260 - 270	Warhead Body Piece	3.54		2067
453	400 - 600	260 - 270	Warhead Body Piece	0.08		2068
454	400 - 600	260 - 270	Warhead Body Piece	0.04		2069
455	400 - 600	260 - 270	Warhead Body Piece	0.02		2070
456	400 - 600	260 - 270	Warhead Body Piece	0.02		2071
457	400 - 600	260 - 270	Warhead Body Piece	0.01		2072
458	400 - 600	260 - 270	Warhead Body Piece	0.01		2073
459	400 - 600	260 - 270	Warhead Body Piece	0.01		2074
460	400 - 600	260 - 270	Warhead Body Piece	0.01		2075
461	400 - 600	260 - 270	Cartridge Case Piece	-	Not retained	9165
462	400 - 600	260 - 270	Cartridge Case Piece	-	Not retained	9166
463	400 - 600	260 - 270	Cartridge Case Piece	-	Not retained	9167
464	400 - 600	270 - 280	Warhead Body Piece	0.92		2768
465	400 - 600	270 - 280	Warhead Body Piece	0.11		2769
466	400 - 600	270 - 280	Warhead Body Piece	0.14		2770
467	400 - 600	270 - 280	Miscellaneous Debris	-	Not retained	9202
468	400 - 600	270 - 280	Cartridge Case Piece	-	Not retained	9168
469	400 - 600	270 - 280	Cartridge Case Piece	-	Not retained	9169
470	400 - 600	280 - 290	Warhead Body Piece	0.03	Rotating band piece	3171
471	400 - 600	280 - 290	Warhead Body Piece	0.88		3163
472	400 - 600	280 - 290	Warhead Body Piece	0.22		3164
473	400 - 600	280 - 290	Warhead Body Piece	0.03		3165
474	400 - 600	280 - 290	Warhead Body Piece	0.02		3166
475	400 - 600	280 - 290	Warhead Body Piece	0.02		3167
476	400 - 600	280 - 290	Warhead Body Piece	0.01		3168
477	400 - 600	280 - 290	Warhead Body Piece	0.01		3169
478	400 - 600	280 - 290	Warhead Body Piece	0.01		3170
479	400 - 600	280 - 290	Miscellaneous Debris	0.01		3173
480	400 - 600	280 - 290	Cartridge Case Piece	-	Not retained	9170
481	400 - 600	280 - 290	Cartridge Case Piece	-	Not retained	9171
482	400 - 600	280 - 290	Cartridge Case Piece	-	Not retained	9172
483	400 - 600	280 - 290	Cartridge Case Piece	-	Not retained	9173
484	400 - 600	290 - 300	Warhead Body Piece	0.09	Rotating band piece	2146
485	400 - 600	290 - 300	Warhead Body Piece	0.09		2139
486	400 - 600	290 - 300	Warhead Body Piece	0.07		2140
487	400 - 600	290 - 300	Warhead Body Piece	0.03		2141
488	400 - 600	290 - 300	Warhead Body Piece	0.03		2142
489	400 - 600	290 - 300	Warhead Body Piece	0.03		2143
490	400 - 600	290 - 300	Warhead Body Piece	0.01		2144
491	400 - 600	290 - 300	Warhead Body Piece	0.01		2145
492	400 - 600	290 - 300	Miscellaneous Debris	-	Not retained	9203
493	400 - 600	290 - 300	Cartridge Case Piece	-	Not retained	9174
494	400 - 600	290 - 300	Cartridge Case Piece	-	Not retained	9175
495	400 - 600	290 - 300	Cartridge Case Piece	-	Not retained	9176
496	400 - 600	290 - 300	Cartridge Case Piece	-	Not retained	9177
497	400 - 600	300 - 310	Warhead Body Piece	5.08		2668
498	400 - 600	300 - 310	Warhead Body Piece	1.06		2669
499	400 - 600	300 - 310	Warhead Body Piece	0.11		2670
500	400 - 600	300 - 310	Warhead Body Piece	0.10		2671

TABLE B-8. FRAGMENTS RECOVERED BEYOND 200-FT RANGE IN TEST NO. 10 (Continued)

<u>Entry</u>	<u>Range Interval (ft)</u>	<u>Azimuthal Sector (°)</u>	<u>Description</u>	<u>Mass (lb)</u>	<u>Notes</u>	<u>G64 Index No.</u>
501	400 - 600	300 - 310	Warhead Body Piece	0.03		2672
502	400 - 600	300 - 310	Warhead Body Piece	0.01		2673
503	400 - 600	300 - 310	Warhead Body Piece	0.01		2674
504	400 - 600	300 - 310	Miscellaneous Debris	-	Not retained	9204
505	400 - 600	300 - 310	Cartridge Case Piece	-	Not retained	9178
506	400 - 600	300 - 310	Cartridge Case Piece	-	Not retained	9179
507	400 - 600	310 - 320	Warhead Body Piece	3.81		2027
508	400 - 600	310 - 320	Warhead Body Piece	0.62		2028
509	400 - 600	310 - 320	Warhead Body Piece	0.01		2029
510	400 - 600	310 - 320	Warhead Body Piece	0.01		2030
511	400 - 600	310 - 320	Warhead Body Piece	0.01		2031
512	400 - 600	310 - 320	Warhead Body Piece	0.15		3209
513	400 - 600	310 - 320	Miscellaneous Debris	-	Not retained	9205
514	400 - 600	310 - 320	Cartridge Case Piece	-	Not retained	9180
515	400 - 600	320 - 330	Warhead Body Piece	2.17		2167
516	400 - 600	320 - 330	Warhead Body Piece	0.53		2168
517	400 - 600	320 - 330	Warhead Body Piece	0.48		2169
518	400 - 600	320 - 330	Warhead Body Piece	0.30		2170
519	400 - 600	320 - 330	Warhead Body Piece	0.22		2171
520	400 - 600	320 - 330	Warhead Body Piece	0.11		2172
521	400 - 600	320 - 330	Warhead Body Piece	0.07		2173
522	400 - 600	320 - 330	Warhead Body Piece	0.05		2174
523	400 - 600	320 - 330	Warhead Body Piece	0.01		2175
524	400 - 600	320 - 330	Warhead Body Piece	0.01		2176
525	400 - 600	320 - 330	Warhead Body Piece	0.01		2177
526	400 - 600	320 - 330	Warhead Body Piece	0.01		2178
527	400 - 600	330 - 340	Warhead Body Piece	0.46		2875
528	400 - 600	330 - 340	Warhead Body Piece	0.40		2876
529	400 - 600	330 - 340	Warhead Body Piece	0.10		2877
530	400 - 600	330 - 340	Warhead Body Piece	0.01		2878
531	400 - 600	330 - 340	Cartridge Case Piece	0.01		738
532	400 - 600	330 - 340	Cartridge Case Piece	-	Not retained	9181
533	400 - 600	330 - 340	Cartridge Case Piece	-	Not retained	9182
534	400 - 600	340 - 350	Warhead Body Piece	0.45		2515
535	400 - 600	340 - 350	Warhead Body Piece	0.31		2516
536	400 - 600	340 - 350	Warhead Body Piece	0.07		2517
537	400 - 600	340 - 350	Warhead Body Piece	0.01		2518
538	400 - 600	340 - 350	Miscellaneous Debris	0.01		2519
539	400 - 600	340 - 350	Miscellaneous Debris	0.01		2520
540	400 - 600	340 - 350	Cartridge Case Piece	-	Not retained	9183
541	400 - 600	340 - 350	Cartridge Case Piece	-	Not retained	9184
542	400 - 600	350 - 360	Warhead Body Piece	0.65		2324
543	400 - 600	350 - 360	Warhead Body Piece	0.42		2325
544	400 - 600	350 - 360	Warhead Body Piece	0.01		2326
545	400 - 600	350 - 360	Warhead Body Piece	0.01		2327
546	400 - 600	350 - 360	Cartridge Case Piece	-	Not retained	9185
547	600 - 800	0 - 10	Warhead Body Piece	3.32		2309
548	600 - 800	0 - 10	Warhead Body Piece	0.25		2310
549	600 - 800	0 - 10	Warhead Body Piece	0.13		2311
550	600 - 800	0 - 10	Warhead Body Piece	0.08		2312

TABLE B-8. FRAGMENTS RECOVERED BEYOND 200-FT RANGE IN TEST NO. 10 (Continued)

<u>Entry</u>	<u>Range Interval (ft)</u>	<u>Azimuthal Sector (°)</u>	<u>Description</u>	<u>Mass (lb)</u>	<u>Notes</u>	<u>G64 Index No.</u>
551	600 - 800	0 - 10	Warhead Body Piece	0.01		2313
552	600 - 800	10 - 20	Warhead Body Piece	0.48		2477
553	600 - 800	10 - 20	Warhead Body Piece	0.16		2478
554	600 - 800	10 - 20	Miscellaneous Debris	0.01		2479
555	600 - 800	10 - 20	Miscellaneous Debris	-	Not retained	9211
556	600 - 800	10 - 20	Miscellaneous Debris	-	Not retained	9212
557	600 - 800	30 - 40	Warhead Body Piece	0.78		2442
558	600 - 800	30 - 40	Warhead Body Piece	0.04		2443
559	600 - 800	30 - 40	Warhead Body Piece	0.01		2444
560	600 - 800	40 - 50	Warhead Body Piece	0.89		3116
561	600 - 800	50 - 60	Warhead Body Piece	1.69		2284
562	600 - 800	70 - 80	Warhead Body Piece	0.12		2613
563	600 - 800	80 - 90	Cartridge Case Piece	-	Not retained	9206
564	600 - 800	90 - 100	Warhead Body Piece	0.09		2697
565	600 - 800	90 - 100	Warhead Body Piece	0.04		2698
566	600 - 800	100 - 110	Warhead Body Piece	0.19		2449
567	600 - 800	100 - 110	Warhead Body Piece	0.01		2450
568	600 - 800	110 - 120	Warhead Body Piece	0.76		2080
569	600 - 800	110 - 120	Intact Warhead	-	Not retained	9220
570	600 - 800	120 - 130	Warhead Body Piece	0.12		2892
571	600 - 800	130 - 140	Warhead Body Piece	0.61		2591
572	600 - 800	130 - 140	Warhead Body Piece	0.06		2592
573	600 - 800	140 - 150	Warhead Body Piece	1.03		2092
574	600 - 800	140 - 150	Warhead Body Piece	0.43		2093
575	600 - 800	140 - 150	Warhead Body Piece	3.39		3217
576	600 - 800	140 - 150	Cartridge Case Piece	-	Not retained	9207
577	600 - 800	150 - 160	Warhead Body Piece	0.06		2647
578	600 - 800	160 - 170	Warhead Body Piece	4.71		2135
579	600 - 800	160 - 170	Warhead Body Piece	0.18		2136
580	600 - 800	160 - 170	Warhead Body Piece	0.03		2137
581	600 - 800	160 - 170	Warhead Body Piece	0.01		2138
582	600 - 800	160 - 170	Cartridge Case Piece	-	Not retained	9208
583	600 - 800	170 - 180	Warhead Body Piece	3.04		2665
584	600 - 800	170 - 180	Warhead Body Piece	1.10		2666
585	600 - 800	170 - 180	Warhead Body Piece	0.05		2667
586	600 - 800	180 - 190	Warhead Body Piece	0.92		3069
587	600 - 800	180 - 190	Cartridge Case Piece	-	Not retained	9209
588	600 - 800	190 - 200	Warhead Body Piece	1.90		2045
589	600 - 800	190 - 200	Warhead Body Piece	1.08		2046
590	600 - 800	190 - 200	Warhead Body Piece	0.79		2047
591	600 - 800	190 - 200	Warhead Body Piece	0.21		2048
592	600 - 800	190 - 200	Warhead Body Piece	0.13		2049
593	600 - 800	200 - 210	Warhead Body Piece	3.47		1787
594	600 - 800	200 - 210	Warhead Body Piece	2.56		1788
595	600 - 800	200 - 210	Warhead Body Piece	0.08		1789
596	600 - 800	200 - 210	Warhead Body Piece	0.06		1790
597	600 - 800	200 - 210	Warhead Body Piece	0.46		2799
598	600 - 800	200 - 210	Warhead Body Piece	0.05		2800
599	600 - 800	220 - 230	Warhead Body Piece	0.79		1930
600	600 - 800	220 - 230	Warhead Body Piece	0.05		1931

TABLE B-8. FRAGMENTS RECOVERED BEYOND 200-FT RANGE IN TEST NO. 10 (Continued)

<u>Entry</u>	<u>Range Interval (ft)</u>	<u>Azimuthal Sector (°)</u>	<u>Description</u>	<u>Mass (lb)</u>	<u>Notes</u>	<u>G64 Index No.</u>
601	600 - 800	220 - 230	Miscellaneous Debris	-	Not retained	9213
602	600 - 800	220 - 230	Miscellaneous Debris	-	Not retained	9214
603	600 - 800	230 - 240	Warhead Body Piece	0.10	Rotating band piece	2456
604	600 - 800	230 - 240	Warhead Body Piece	0.04		2452
605	600 - 800	230 - 240	Warhead Body Piece	0.02		2453
606	600 - 800	230 - 240	Warhead Body Piece	0.01		2454
607	600 - 800	230 - 240	Warhead Body Piece	0.01		2455
608	600 - 800	240 - 250	Warhead Body Piece	0.11	Rotating band piece	1710
609	600 - 800	240 - 250	Warhead Body Piece	2.76		1705
610	600 - 800	240 - 250	Warhead Body Piece	0.20		1706
611	600 - 800	240 - 250	Warhead Body Piece	0.04		1707
612	600 - 800	240 - 250	Warhead Body Piece	0.03		1708
613	600 - 800	240 - 250	Warhead Body Piece	0.02		1709
614	600 - 800	250 - 260	Warhead Body Piece	0.06		2286
615	600 - 800	250 - 260	Warhead Body Piece	0.02		2287
616	600 - 800	250 - 260	Warhead Body Piece	0.02		2288
617	600 - 800	250 - 260	Warhead Body Piece	0.02		2289
618	600 - 800	250 - 260	Warhead Body Piece	0.01		2290
619	600 - 800	250 - 260	Warhead Body Piece	0.01		2291
620	600 - 800	260 - 270	Warhead Body Piece	0.62		2989
621	600 - 800	260 - 270	Warhead Body Piece	0.50		2990
622	600 - 800	260 - 270	Warhead Body Piece	0.23		2991
623	600 - 800	260 - 270	Warhead Body Piece	0.11		2992
624	600 - 800	260 - 270	Warhead Body Piece	0.03		2993
625	600 - 800	260 - 270	Warhead Body Piece	1.89		3216
626	600 - 800	270 - 280	Warhead Body Piece	0.23		2809
627	600 - 800	270 - 280	Warhead Body Piece	0.09		2810
628	600 - 800	270 - 280	Warhead Body Piece	0.03		2811
629	600 - 800	270 - 280	Warhead Body Piece	0.02		2812
630	600 - 800	270 - 280	Warhead Body Piece	0.02		2813
631	600 - 800	270 - 280	Warhead Body Piece	0.01		2814
632	600 - 800	270 - 280	Warhead Body Piece	0.01		2815
633	600 - 800	270 - 280	Warhead Body Piece	0.01		2816
634	600 - 800	270 - 280	Warhead Body Piece	0.26		3231
635	600 - 800	280 - 290	Warhead Body Piece	1.10		2684
636	600 - 800	280 - 290	Warhead Body Piece	0.54		2685
637	600 - 800	280 - 290	Warhead Body Piece	0.12		2686
638	600 - 800	280 - 290	Warhead Body Piece	0.20		2687
639	600 - 800	280 - 290	Warhead Body Piece	0.03		2688
640	600 - 800	280 - 290	Warhead Body Piece	0.02		2689
641	600 - 800	290 - 300	Warhead Body Piece	2.43		2246
642	600 - 800	290 - 300	Warhead Body Piece	1.50		2247
643	600 - 800	290 - 300	Warhead Body Piece	0.80		2248
644	600 - 800	290 - 300	Warhead Body Piece	1.04		2249
645	600 - 800	290 - 300	Warhead Body Piece	0.20		2250
646	600 - 800	290 - 300	Warhead Body Piece	0.11		2251
647	600 - 800	290 - 300	Warhead Body Piece	0.04		2252
648	600 - 800	290 - 300	Warhead Body Piece	0.02		2253
649	600 - 800	300 - 310	Warhead Body Piece	0.70		2790
650	600 - 800	300 - 310	Warhead Body Piece	0.43		2791

TABLE B-8. FRAGMENTS RECOVERED BEYOND 200-FT RANGE IN TEST NO. 10 (Continued)

<u>Entry</u>	<u>Range Interval (ft)</u>	<u>Azimuthal Sector (°)</u>	<u>Description</u>	<u>Mass (lb)</u>	<u>Notes</u>	<u>G64 Index No.</u>
651	600 - 800	300 - 310	Warhead Body Piece	0.20		2792
652	600 - 800	300 - 310	Warhead Body Piece	0.20		2793
653	600 - 800	300 - 310	Warhead Body Piece	0.03		2794
654	600 - 800	300 - 310	Miscellaneous Debris	0.01		2795
655	600 - 800	310 - 320	Warhead Body Piece	0.41		3244
656	600 - 800	310 - 320	Miscellaneous Debris	0.01		1746
657	600 - 800	310 - 320	Cartridge Case Piece	-	Not retained	9210
658	600 - 800	320 - 330	Warhead Body Piece	2.81		1857
659	600 - 800	320 - 330	Warhead Body Piece	0.60		1858
660	600 - 800	320 - 330	Warhead Body Piece	0.05		1859
661	600 - 800	320 - 330	Warhead Body Piece	0.06		1860
662	600 - 800	330 - 340	Warhead Body Piece	1.01		2886
663	600 - 800	330 - 340	Warhead Body Piece	0.39		2887
664	600 - 800	330 - 340	Warhead Body Piece	0.37		2888
665	600 - 800	330 - 340	Warhead Body Piece	0.11		2889
666	600 - 800	330 - 340	Warhead Body Piece	0.14		2890
667	600 - 800	330 - 340	Warhead Body Piece	0.01		2891
668	600 - 800	340 - 350	Warhead Body Piece	3.24		2023
669	600 - 800	340 - 350	Warhead Body Piece	2.43		2024
670	600 - 800	340 - 350	Warhead Body Piece	2.42		2025
671	600 - 800	340 - 350	Warhead Body Piece	0.93		2026
672	600 - 800	350 - 360	Warhead Body Piece	2.03		2607
673	600 - 800	350 - 360	Warhead Body Piece	0.81		2608
674	600 - 800	350 - 360	Warhead Body Piece	0.18		2609
675	600 - 800	350 - 360	Warhead Body Piece	0.09		2610
676	800 -1000	0 - 10	Warhead Body Piece	1.27		2897
677	800 -1000	0 - 10	Warhead Body Piece	0.10		2898
678	800 -1000	0 - 10	Warhead Body Piece	0.05		2899
679	800 -1000	0 - 10	Miscellaneous Debris	-	Not retained	9217
680	800 -1000	10 - 20	Warhead Body Piece	0.04		2676
681	800 -1000	20 - 30	Warhead Body Piece	1.93		1891
682	800 -1000	20 - 30	Warhead Body Piece	0.20		1892
683	800 -1000	30 - 40	Warhead Body Piece	1.90		1795
684	800 -1000	30 - 40	Warhead Body Piece	0.53		1796
685	800 -1000	30 - 40	Warhead Body Piece	0.33		1797
686	800 -1000	30 - 40	Warhead Body Piece	0.05		1798
687	800 -1000	30 - 40	Warhead Body Piece	0.05		1799
688	800 -1000	30 - 40	Warhead Body Piece	0.01		1800
689	800 -1000	50 - 60	Warhead Body Piece	1.60		2341
690	800 -1000	50 - 60	Warhead Body Piece	0.82		2342
691	800 -1000	60 - 70	Warhead Body Piece	1.28		2330
692	800 -1000	70 - 80	Warhead Body Piece	0.25		3114
693	800 -1000	70 - 80	Warhead Body Piece	0.84		3115
694	800 -1000	80 - 90	Warhead Body Piece	0.40		2149
695	800 -1000	90 - 100	Warhead Body Piece	2.20		1897
696	800 -1000	110 - 120	Warhead Body Piece	0.13		2746
697	800 -1000	130 - 140	Warhead Body Piece	0.94		1776
698	800 -1000	140 - 150	Warhead Body Piece	0.80		1848
699	800 -1000	140 - 150	Cartridge Case Piece	-	Not retained	9215
700	800 -1000	150 - 160	Warhead Body Piece	0.01	Rotating band piece	2664

NSWCDD/TR-98/6

TABLE B-8. FRAGMENTS RECOVERED BEYOND 200-FT RANGE IN TEST NO. 10 (Continued)

<u>Entry</u>	<u>Range Interval (ft)</u>	<u>Azimuthal Sector (°)</u>	<u>Description</u>	<u>Mass (lb)</u>	<u>Notes</u>	<u>G64 Index No.</u>
701	800 - 1000	150 - 160	Warhead Body Piece	5.97		2660
702	800 - 1000	150 - 160	Warhead Body Piece	1.22		2661
703	800 - 1000	150 - 160	Warhead Body Piece	0.99		2662
704	800 - 1000	150 - 160	Warhead Body Piece	0.36		2663
705	800 - 1000	170 - 180	Warhead Body Piece	0.07		2925
706	800 - 1000	180 - 190	Warhead Body Piece	1.15		1907
707	800 - 1000	200 - 210	Warhead Body Piece	0.64		3050
708	800 - 1000	210 - 220	Warhead Body Piece	0.93		2701
709	800 - 1000	210 - 220	Warhead Body Piece	0.13		2702
710	800 - 1000	220 - 230	Warhead Body Piece	0.25		2828
711	800 - 1000	220 - 230	Warhead Body Piece	0.28		2829
712	800 - 1000	230 - 240	Warhead Body Piece	4.16		2651
713	800 - 1000	230 - 240	Warhead Body Piece	0.38		2652
714	800 - 1000	230 - 240	Warhead Body Piece	0.24		2653
715	800 - 1000	230 - 240	Warhead Body Piece	0.07		2654
716	800 - 1000	230 - 240	Warhead Body Piece	0.03		2655
717	800 - 1000	230 - 240	Warhead Body Piece	0.10		3204
718	800 - 1000	240 - 250	Warhead Body Piece	1.10		1893
719	800 - 1000	240 - 250	Warhead Body Piece	2.13		1894
720	800 - 1000	240 - 250	Warhead Body Piece	0.02		1895
721	800 - 1000	240 - 250	Warhead Body Piece	0.01		1896
722	800 - 1000	250 - 260	Warhead Body Piece	0.71		2275
723	800 - 1000	250 - 260	Warhead Body Piece	0.69		2276
724	800 - 1000	250 - 260	Warhead Body Piece	0.04		2277
725	800 - 1000	250 - 260	Cartridge Case Piece	-	Not retained	9216
726	800 - 1000	260 - 270	Warhead Body Piece	2.47		1791
727	800 - 1000	260 - 270	Warhead Body Piece	1.90		1792
728	800 - 1000	260 - 270	Warhead Body Piece	1.22		1793
729	800 - 1000	260 - 270	Warhead Body Piece	0.30		1794
730	800 - 1000	270 - 280	Warhead Body Piece	3.09		2228
731	800 - 1000	270 - 280	Warhead Body Piece	0.49		2229
732	800 - 1000	270 - 280	Warhead Body Piece	0.12		2230
733	800 - 1000	270 - 280	Warhead Body Piece	0.09		2231
734	800 - 1000	270 - 280	Warhead Body Piece	0.07		2232
735	800 - 1000	280 - 290	Warhead Body Piece	0.02		2347
736	800 - 1000	280 - 290	Warhead Body Piece	0.02		2348
737	800 - 1000	290 - 300	Warhead Body Piece	1.06		2438
738	800 - 1000	290 - 300	Warhead Body Piece	0.45		2439
739	800 - 1000	290 - 300	Warhead Body Piece	0.06		2440
740	800 - 1000	290 - 300	Warhead Body Piece	0.03		2441
741	800 - 1000	300 - 310	Warhead Body Piece	0.51		2445
742	800 - 1000	300 - 310	Warhead Body Piece	0.52		2446
743	800 - 1000	300 - 310	Warhead Body Piece	0.11		2447
744	800 - 1000	300 - 310	Warhead Body Piece	0.06		2448
745	800 - 1000	310 - 320	Warhead Body Piece	0.21		1840
746	800 - 1000	310 - 320	Warhead Body Piece	1.14		1841
747	800 - 1000	330 - 340	Warhead Body Piece	0.45		3057
748	800 - 1000	350 - 360	Warhead Body Piece	1.20		1642
749	1000 - 1200	0 - 10	Warhead Body Piece	0.71		2593
750	1000 - 1200	0 - 10	Warhead Body Piece	0.37		2594

NSWCDD/TR-98/6

TABLE B-8. FRAGMENTS RECOVERED BEYOND 200-FT RANGE IN TEST NO. 10 (Continued)

<u>Entry</u>	<u>Range Interval (ft)</u>	<u>Azimuthal Sector (°)</u>	<u>Description</u>	<u>Mass (lb)</u>	<u>Notes</u>	<u>G64 Index No.</u>
751	1000 - 1200	10 - 20	Warhead Body Piece	2.34		3060
752	1000 - 1200	10 - 20	Warhead Body Piece	0.12		3061
753	1000 - 1200	20 - 30	Warhead Body Piece	0.47		2509
754	1000 - 1200	20 - 30	Warhead Body Piece	0.16		2510
755	1000 - 1200	30 - 40	Warhead Body Piece	1.02		2961
756	1000 - 1200	30 - 40	Warhead Body Piece	0.58		2962
757	1000 - 1200	30 - 40	Warhead Body Piece	0.05		2963
758	1000 - 1200	40 - 50	Warhead Body Piece	0.82		2901
759	1000 - 1200	50 - 60	Warhead Body Piece	3.02		2658
760	1000 - 1200	50 - 60	Warhead Body Piece	0.22		2659
761	1000 - 1200	60 - 70	Warhead Body Piece	0.14		1657
762	1000 - 1200	60 - 70	Warhead Body Piece	0.04		1658
763	1000 - 1200	70 - 80	Warhead Body Piece	1.90		1734
764	1000 - 1200	80 - 90	Warhead Body Piece	3.26		2020
765	1000 - 1200	90 - 100	Warhead Body Piece	1.42		2368
766	1000 - 1200	90 - 100	Warhead Body Piece	1.60		2369
767	1000 - 1200	90 - 100	Warhead Body Piece	0.52		3236
768	1000 - 1200	100 - 110	Warhead Body Piece	1.65		1801
769	1000 - 1200	120 - 130	Warhead Body Piece	0.56		2412
770	1000 - 1200	120 - 130	Warhead Body Piece	0.29		2413
771	1000 - 1200	160 - 170	Warhead Body Piece	0.07		2451
772	1000 - 1200	170 - 180	Warhead Body Piece	0.84		1760
773	1000 - 1200	210 - 220	Warhead Body Piece	0.70		1777
774	1000 - 1200	230 - 240	Warhead Body Piece	2.11		2100
775	1000 - 1200	240 - 250	Warhead Body Piece	0.16		3080
776	1000 - 1200	250 - 260	Warhead Body Piece	0.24		1643
777	1000 - 1200	250 - 260	Warhead Body Piece	0.04		1644
778	1000 - 1200	260 - 270	Warhead Body Piece	0.21		1845
779	1000 - 1200	260 - 270	Warhead Body Piece	0.12		1846
780	1000 - 1200	270 - 280	Warhead Body Piece	4.58		2258
781	1000 - 1200	270 - 280	Warhead Body Piece	0.60		2259
782	1000 - 1200	270 - 280	Warhead Body Piece	0.45		2260
783	1000 - 1200	270 - 280	Warhead Body Piece	0.08		2261
784	1000 - 1200	280 - 290	Warhead Body Piece	1.61		1747
785	1000 - 1200	280 - 290	Warhead Body Piece	0.10		1748
786	1000 - 1200	290 - 300	Warhead Body Piece	0.83		3144
787	1000 - 1200	320 - 330	Warhead Body Piece	0.53		2349
788	1000 - 1200	340 - 350	Warhead Body Piece	0.24		3263
789	1000 - 1200	350 - 360	Warhead Body Piece	0.26		2595
790	1200 - 1300	30 - 40	Warhead Body Piece	0.38		2771
791	1200 - 1300	80 - 90	Warhead Body Piece	1.59		2745
792	1200 - 1300	90 - 100	Warhead Body Piece	0.41		2331
793	1200 - 1300	250 - 260	Warhead Body Piece	0.24		2597
794	1200 - 1300	250 - 260	Warhead Body Piece	0.16		2598
795	1200 - 1300	260 - 270	Warhead Body Piece	0.42		2585
796	1200 - 1300	280 - 290	Warhead Body Piece	3.16		1722
797	1200 - 1300	290 - 300	Warhead Body Piece	0.73		2970
798	1200 - 1300	300 - 310	Warhead Body Piece	0.13		3053
799	1200 - 1300	320 - 330	Warhead Body Piece	0.22		1645
800	1200 - 1300	330 - 340	Warhead Body Piece	0.55		2996

TABLE B-8. FRAGMENTS RECOVERED BEYOND 200-FT RANGE IN TEST NO. 10 (Continued)

<u>Entry</u>	<u>Range Interval (ft)</u>	<u>Azimuthal Sector (°)</u>	<u>Description</u>	<u>Mass (lb)</u>	<u>Notes</u>	<u>G64 Index No.</u>
801	1300 - 1400	30 - 40	Warhead Body Piece	0.14		1663
802	1300 - 1400	40 - 50	Warhead Body Piece	1.08		2285
803	1300 - 1400	110 - 120	Warhead Body Piece	0.41		2584
804	1300 - 1400	270 - 280	Warhead Body Piece	2.23		1802
805	1400 - 1600	80 - 90	Warhead Body Piece	2.23		2586
806	1400 - 1600	350 - 360	Warhead Body Piece	1.33		2757

TABLE B-9. OBSERVATIONS FROM TEST NO. 11

Test Date: 19 September 1995

Test Items: Five boxes of M374A2 81mm HE mortar cartridges in UK packaging configuration (i.e., metal boxes containing three cartridges each; cartridges packed individually in plastic sleeves). The boxes were arranged in a pyramidal manner with three boxes in the bottom row and two boxes in the top row.

Weather: Clear skies, approximately 90° F. Winds were SSW at approximately 4-5 knots.

Notes: Mild reactions were observed approximately 10:46 (min:sec) after the start of the test. The initial reactions were followed by a series of four much more violent explosions that began approximately 16:27 (min:sec) after the fire was lit and continued until 18:43 (min:sec) after the fire was lit.

Following the test, a total of seven warhead bodies were recovered intact inside the 200-ft range and one was recovered beyond the 200-ft range. The total mass of warhead body pieces recovered inside the 200-ft range was not measured.

TABLE B-10. FRAGMENTS RECOVERED BEYOND 200-FT RANGE IN TEST NO. 11

<u>Entry</u>	<u>Range Interval (ft)</u>	<u>Azimuthal Sector (°)</u>	<u>Description</u>	<u>Mass (lb)</u>	<u>Notes</u>	<u>G64 Index No.</u>
1	200 - 400	0 - 10	Miscellaneous Debris	-	Not retained	
2	200 - 400	0 - 10	Miscellaneous Debris	-	Not retained	
3	200 - 400	10 - 20	Miscellaneous Debris	-	Not retained	
4	200 - 400	20 - 30	Miscellaneous Debris	-	Not retained	
5	200 - 400	20 - 30	Miscellaneous Debris	-	Not retained	
6	200 - 400	20 - 30	Miscellaneous Debris	-	Not retained	
7	200 - 400	20 - 30	Miscellaneous Debris	-	Not retained	
8	200 - 400	30 - 40	Miscellaneous Debris	-	Not retained	
9	200 - 400	30 - 40	Miscellaneous Debris	-	Not retained	
10	200 - 400	30 - 40	Miscellaneous Debris	-	Not retained	
11	200 - 400	30 - 40	Miscellaneous Debris	-	Not retained	
12	200 - 400	30 - 40	Miscellaneous Debris	-	Not retained	
13	200 - 400	40 - 50	Miscellaneous Debris	-	Not retained	
14	200 - 400	40 - 50	Miscellaneous Debris	-	Not retained	
15	200 - 400	40 - 50	Miscellaneous Debris	-	Not retained	
16	200 - 400	50 - 60	Warhead Body Piece	0.01		
17	200 - 400	50 - 60	Miscellaneous Debris	0.01		
18	200 - 400	50 - 60	Miscellaneous Debris	-	Not retained	
19	200 - 400	50 - 60	Miscellaneous Debris	-	Not retained	
20	200 - 400	60 - 70	Miscellaneous Debris	-	Not retained	
21	200 - 400	60 - 70	Miscellaneous Debris	-	Not retained	
22	200 - 400	70 - 80	Warhead Body Piece	0.55		
23	200 - 400	70 - 80	Tail Piece	0.04		
24	200 - 400	80 - 90	Miscellaneous Debris	-	Not retained	
25	200 - 400	80 - 90	Miscellaneous Debris	-	Not retained	
26	200 - 400	80 - 90	Miscellaneous Debris	-	Not retained	
27	200 - 400	80 - 90	Miscellaneous Debris	-	Not retained	
28	200 - 400	80 - 90	Miscellaneous Debris	-	Not retained	
29	200 - 400	90 - 100	Warhead Body Piece	0.24		
30	200 - 400	90 - 100	Miscellaneous Debris	-	Not retained	
31	200 - 400	90 - 100	Miscellaneous Debris	-	Not retained	
32	200 - 400	90 - 100	Miscellaneous Debris	-	Not retained	
33	200 - 400	90 - 100	Miscellaneous Debris	-	Not retained	
34	200 - 400	100 - 110	Miscellaneous Debris	-	Not retained	
35	200 - 400	100 - 110	Miscellaneous Debris	-	Not retained	
36	200 - 400	110 - 120	Miscellaneous Debris	-	Not retained	
37	200 - 400	110 - 120	Miscellaneous Debris	-	Not retained	
38	200 - 400	130 - 140	Miscellaneous Debris	0.01		
39	200 - 400	130 - 140	Miscellaneous Debris	-	Not retained	
40	200 - 400	140 - 150	Warhead Body Piece	0.19		
41	200 - 400	160 - 170	Miscellaneous Debris	-	Not retained	
42	200 - 400	160 - 170	Miscellaneous Debris	-	Not retained	
43	200 - 400	160 - 170	Miscellaneous Debris	-	Not retained	
44	200 - 400	170 - 180	Miscellaneous Debris	0.01		
45	200 - 400	180 - 190	Miscellaneous Debris	0.01		
46	200 - 400	180 - 190	Miscellaneous Debris	-	Not retained	
47	200 - 400	190 - 200	Miscellaneous Debris	-	Not retained	
48	200 - 400	210 - 220	Miscellaneous Debris	-	Not retained	
49	200 - 400	220 - 230	Warhead Body Piece	0.02		
50	200 - 400	220 - 230	Miscellaneous Debris	-	Not retained	

NSWCDD/TR-98/6

TABLE B-10. FRAGMENTS RECOVERED BEYOND 200-FT RANGE IN TEST NO. 11 (Continued)

<u>Entry</u>	<u>Range Interval (ft)</u>	<u>Azimuthal Sector (°)</u>	<u>Description</u>	<u>Mass (lb)</u>	<u>Notes</u>	<u>G64 Index No.</u>
51	200 - 400	230 - 240	Warhead Body Piece	0.01		
52	200 - 400	230 - 240	Miscellaneous Debris	-	Not retained	
53	200 - 400	240 - 250	Miscellaneous Debris	0.01		
54	200 - 400	250 - 260	Tail Piece	0.04		
55	200 - 400	260 - 270	Miscellaneous Debris	0.01		
56	200 - 400	260 - 270	Miscellaneous Debris	-	Not retained	
57	200 - 400	270 - 280	Tail Piece	-	Not retained	
58	200 - 400	270 - 280	Miscellaneous Debris	-	Not retained	
59	200 - 400	300 - 310	Miscellaneous Debris	-	Not retained	
60	200 - 400	300 - 310	Miscellaneous Debris	-	Not retained	
61	200 - 400	300 - 310	Miscellaneous Debris	-	Not retained	
62	200 - 400	300 - 310	Miscellaneous Debris	-	Not retained	
63	200 - 400	310 - 320	Warhead Body Piece	0.01		
64	200 - 400	310 - 320	Miscellaneous Debris	-	Not retained	
65	200 - 400	320 - 330	Warhead Body Piece	0.01		
66	200 - 400	320 - 330	Miscellaneous Debris	0.06		
67	200 - 400	330 - 340	Miscellaneous Debris	-	Not retained	
68	200 - 400	340 - 350	Miscellaneous Debris	-	Not retained	
69	200 - 400	340 - 350	Miscellaneous Debris	-	Not retained	
70	200 - 400	350 - 360	Tail Piece	0.04		
71	200 - 400	350 - 360	Miscellaneous Debris	0.01		
72	400 - 600	0 - 10	Warhead Body Piece	0.07		
73	400 - 600	10 - 20	Miscellaneous Debris	-	Not retained	
74	400 - 600	20 - 30	Miscellaneous Debris	-	Not retained	
75	400 - 600	30 - 40	Warhead Body Piece	0.01		
76	400 - 600	40 - 50	Warhead Body Piece	0.01		
77	400 - 600	40 - 50	Miscellaneous Debris	-	Not retained	
78	400 - 600	50 - 60	Warhead Body Piece	0.20		
79	400 - 600	50 - 60	Warhead Body Piece	0.02		
80	400 - 600	50 - 60	Warhead Body Piece	0.01		
81	400 - 600	50 - 60	Warhead Body Piece	0.03		
82	400 - 600	60 - 70	Warhead Body Piece	0.50		
83	400 - 600	60 - 70	Warhead Body Piece	0.06		
84	400 - 600	80 - 90	Warhead Body Piece	1.44		
85	400 - 600	110 - 120	Tail Piece	0.33		
86	400 - 600	130 - 140	Tail Piece	0.33		
87	400 - 600	150 - 160	Warhead Body Piece	0.33		
88	400 - 600	160 - 170	Miscellaneous Debris	-	Not retained	
89	400 - 600	170 - 180	Miscellaneous Debris	-	Not retained	
90	400 - 600	180 - 190	Miscellaneous Debris	-	Not retained	
91	400 - 600	220 - 230	Warhead Body Piece	0.05		
92	400 - 600	230 - 240	Warhead Body Piece	0.03		
93	400 - 600	230 - 240	Warhead Body Piece	0.01		
94	400 - 600	230 - 240	Warhead Body Piece	0.01		
95	400 - 600	240 - 250	Warhead Body Piece	0.03		
96	400 - 600	240 - 250	Tail Piece	0.03		
97	400 - 600	250 - 260	Warhead Body Piece	0.06		
98	400 - 600	260 - 270	Warhead Body Piece	0.14		
99	400 - 600	300 - 310	Warhead Body Piece	0.01		
100	400 - 600	300 - 310	Warhead Body Piece	0.01		

NSWCDD/TR-98/6

TABLE B-10. FRAGMENTS RECOVERED BEYOND 200-FT RANGE IN TEST NO. 11 (Continued)

<u>Entry</u>	<u>Range Interval (ft)</u>	<u>Azimuthal Sector (°)</u>	<u>Description</u>	<u>Mass (lb)</u>	<u>Notes</u>	<u>G64 Index No.</u>
101	400 - 600	300 - 310	Tail Piece	0.02		
102	400 - 600	320 - 330	Warhead Body Piece	0.37		
103	400 - 600	320 - 330	Miscellaneous Debris	-	Not retained	
104	600 - 800	0 - 10	Miscellaneous Debris	-	Not retained	
105	600 - 800	20 - 30	Miscellaneous Debris	-	Not retained	
106	600 - 800	30 - 40	Warhead Body Piece	0.01		
107	600 - 800	40 - 50	Tail Piece	0.01		
108	600 - 800	90 - 100	Warhead Body Piece	0.11		
109	600 - 800	110 - 120	Miscellaneous Debris	-	Not retained	
110	600 - 800	130 - 140	Warhead Body Piece	0.40		
111	600 - 800	130 - 140	Tail Piece	0.02		
112	600 - 800	140 - 150	Warhead Body Piece	0.36		
113	600 - 800	170 - 180	Tail Piece	0.38		
114	600 - 800	170 - 180	Miscellaneous Debris	-	Not retained	
115	600 - 800	180 - 190	Warhead Body Piece	0.13		
116	600 - 800	200 - 210	Warhead Body Piece	0.02		
117	600 - 800	200 - 210	Warhead Body Piece	0.03		
118	600 - 800	230 - 240	Warhead Body Piece	0.02		
119	600 - 800	240 - 250	Warhead Body Piece	0.02		
120	600 - 800	240 - 250	Tail Piece	0.02		
121	600 - 800	260 - 270	Warhead Body Piece	0.42		
122	600 - 800	300 - 310	Warhead Body Piece	0.23		
123	800 - 1000	20 - 30	Warhead Body Piece	0.31		
124	800 - 1000	50 - 60	Warhead Body Piece	0.03		
125	800 - 1000	110 - 120	Intact Warhead	-	Not retained	

TABLE B-11. OBSERVATIONS FROM TEST NO. 12

Test Date: 26 September 1995

Test Items: Eight pallets of M374A2 81mm HE mortar cartridges in UK packaging configuration (i.e., metal boxes containing three cartridges each; cartridges packed individually in plastic sleeves). The pallets were stacked 2 wide by 2 deep by 2 high.

Weather: Clear skies, approximately 80° F. Winds were light and variable with occasional gusts to approximately 10 knots.

Notes: A series of explosions commenced 18:35 (min:sec) after the fire was lit and continued until 115:59 (min:sec) after the fire was lit. Following the test, 477 warhead bodies were recovered intact inside the 200-ft range and 25 were recovered intact beyond the 200-ft range. The total mass of warhead body pieces recovered inside the 200-ft range was 365 lb_m.

TABLE B-12. FRAGMENTS RECOVERED BEYOND 200-FT RANGE IN TEST NO. 12

<u>Entry</u>	<u>Range Interval (ft)</u>	<u>Azimuthal Sector (°)</u>	<u>Description</u>	<u>Mass (lb)</u>	<u>Notes</u>	<u>G64 Index No.</u>
1	200 - 400	0 - 10	Warhead Body Piece	0.50		952
2	200 - 400	0 - 10	Warhead Body Piece	0.50		953
3	200 - 400	0 - 10	Warhead Body Piece	0.27		954
4	200 - 400	0 - 10	Warhead Body Piece	0.16		955
5	200 - 400	0 - 10	Warhead Body Piece	0.15		956
6	200 - 400	0 - 10	Warhead Body Piece	0.22		957
7	200 - 400	0 - 10	Warhead Body Piece	0.10		958
8	200 - 400	0 - 10	Warhead Body Piece	0.13		959
9	200 - 400	0 - 10	Warhead Body Piece	0.01		960
10	200 - 400	0 - 10	Warhead Body Piece	0.01		961
11	200 - 400	0 - 10	Warhead Body Piece	0.01		962
12	200 - 400	0 - 10	Warhead Body Piece	0.01		963
13	200 - 400	0 - 10	Warhead Body Piece	0.01		964
14	200 - 400	0 - 10	Warhead Body Piece	0.01		965
15	200 - 400	0 - 10	Warhead Body Piece	0.01		966
16	200 - 400	0 - 10	Warhead Body Piece	0.01		967
17	200 - 400	0 - 10	Warhead Body Piece	0.01		968
18	200 - 400	0 - 10	Warhead Body Piece	0.01		969
19	200 - 400	0 - 10	Warhead Body Piece	0.01		970
20	200 - 400	0 - 10	Warhead Body Piece	0.01		971
21	200 - 400	0 - 10	Tail Piece	0.13		972
22	200 - 400	0 - 10	Tail Piece	0.03		973
23	200 - 400	0 - 10	Tail Piece	0.01		974
24	200 - 400	0 - 10	Tail Piece	-	Not retained	9025
25	200 - 400	0 - 10	Tail Piece	-	Not retained	9026
26	200 - 400	0 - 10	Tail Piece	-	Not retained	9027
27	200 - 400	0 - 10	Tail Piece	-	Not retained	9028
28	200 - 400	0 - 10	Tail Piece	-	Not retained	9029
29	200 - 400	0 - 10	Tail Piece	-	Not retained	9030
30	200 - 400	0 - 10	Tail Piece	-	Not retained	9031
31	200 - 400	0 - 10	Tail Piece	-	Not retained	9032
32	200 - 400	0 - 10	Tail Piece	-	Not retained	9033
33	200 - 400	0 - 10	Tail Piece	-	Not retained	9034
34	200 - 400	0 - 10	Miscellaneous Debris	0.01		975
35	200 - 400	0 - 10	Miscellaneous Debris	0.01		976
36	200 - 400	0 - 10	Miscellaneous Debris	0.01		977
37	200 - 400	0 - 10	Miscellaneous Debris	0.01		978
38	200 - 400	0 - 10	Miscellaneous Debris	0.01		979
39	200 - 400	0 - 10	Miscellaneous Debris	0.01		980
40	200 - 400	0 - 10	Miscellaneous Debris	0.01		981
41	200 - 400	0 - 10	Miscellaneous Debris	0.01		982
42	200 - 400	0 - 10	Miscellaneous Debris	-	Not retained	9352
43	200 - 400	0 - 10	Miscellaneous Debris	-	Not retained	9353
44	200 - 400	0 - 10	Miscellaneous Debris	-	Not retained	9354
45	200 - 400	0 - 10	Miscellaneous Debris	-	Not retained	9355
46	200 - 400	0 - 10	Miscellaneous Debris	-	Not retained	9356
47	200 - 400	0 - 10	Miscellaneous Debris	-	Not retained	9357
48	200 - 400	0 - 10	Miscellaneous Debris	-	Not retained	9358
49	200 - 400	0 - 10	Miscellaneous Debris	-	Not retained	9359
50	200 - 400	0 - 10	Miscellaneous Debris	-	Not retained	9360

TABLE B-12. FRAGMENTS RECOVERED BEYOND 200-FT RANGE IN TEST NO. 12 (Continued)

<u>Entry</u>	<u>Range Interval (ft)</u>	<u>Azimuthal Sector (°)</u>	<u>Description</u>	<u>Mass (lb)</u>	<u>Notes</u>	<u>G64 Index No.</u>
51	200 - 400	0 - 10	Miscellaneous Debris	-	Not retained	9361
52	200 - 400	0 - 10	Miscellaneous Debris	-	Not retained	9362
53	200 - 400	0 - 10	Miscellaneous Debris	-	Not retained	9363
54	200 - 400	0 - 10	Miscellaneous Debris	-	Not retained	9364
55	200 - 400	0 - 10	Miscellaneous Debris	-	Not retained	9365
56	200 - 400	0 - 10	Miscellaneous Debris	-	Not retained	9366
57	200 - 400	0 - 10	Miscellaneous Debris	-	Not retained	9367
58	200 - 400	0 - 10	Miscellaneous Debris	-	Not retained	9368
59	200 - 400	0 - 10	Miscellaneous Debris	-	Not retained	9369
60	200 - 400	0 - 10	Miscellaneous Debris	-	Not retained	9370
61	200 - 400	0 - 10	Miscellaneous Debris	-	Not retained	9371
62	200 - 400	0 - 10	Miscellaneous Debris	-	Not retained	9372
63	200 - 400	0 - 10	Miscellaneous Debris	-	Not retained	9373
64	200 - 400	0 - 10	Miscellaneous Debris	-	Not retained	9374
65	200 - 400	10 - 20	Warhead Body Piece	0.50		1452
66	200 - 400	10 - 20	Warhead Body Piece	0.50		1453
67	200 - 400	10 - 20	Warhead Body Piece	0.50		1454
68	200 - 400	10 - 20	Warhead Body Piece	0.80		1455
69	200 - 400	10 - 20	Warhead Body Piece	0.92		1456
70	200 - 400	10 - 20	Warhead Body Piece	0.69		1457
71	200 - 400	10 - 20	Warhead Body Piece	0.55		1458
72	200 - 400	10 - 20	Warhead Body Piece	0.27		1459
73	200 - 400	10 - 20	Warhead Body Piece	0.12		1460
74	200 - 400	10 - 20	Warhead Body Piece	0.08		1461
75	200 - 400	10 - 20	Warhead Body Piece	0.05		1462
76	200 - 400	10 - 20	Warhead Body Piece	0.03		1463
77	200 - 400	10 - 20	Warhead Body Piece	0.02		1464
78	200 - 400	10 - 20	Warhead Body Piece	0.01		1465
79	200 - 400	10 - 20	Warhead Body Piece	0.01		1466
80	200 - 400	10 - 20	Warhead Body Piece	0.01		1467
81	200 - 400	10 - 20	Warhead Body Piece	0.01		1468
82	200 - 400	10 - 20	Warhead Body Piece	0.01		1469
83	200 - 400	10 - 20	Warhead Body Piece	0.01		1470
84	200 - 400	10 - 20	Warhead Body Piece	0.01		1471
85	200 - 400	10 - 20	Warhead Body Piece	0.01		1472
86	200 - 400	10 - 20	Warhead Body Piece	0.01		1473
87	200 - 400	10 - 20	Tail Piece	0.01		1474
88	200 - 400	10 - 20	Tail Piece	-	Not retained	9035
89	200 - 400	10 - 20	Tail Piece	-	Not retained	9036
90	200 - 400	10 - 20	Tail Piece	-	Not retained	9037
91	200 - 400	10 - 20	Tail Piece	-	Not retained	9038
92	200 - 400	10 - 20	Tail Piece	-	Not retained	9039
93	200 - 400	10 - 20	Tail Piece	-	Not retained	9040
94	200 - 400	10 - 20	Tail Piece	-	Not retained	9041
95	200 - 400	10 - 20	Tail Piece	-	Not retained	9042
96	200 - 400	10 - 20	Tail Piece	-	Not retained	9043
97	200 - 400	10 - 20	Miscellaneous Debris	0.01		1475
98	200 - 400	10 - 20	Miscellaneous Debris	0.01		1476
99	200 - 400	10 - 20	Miscellaneous Debris	0.01		1477
100	200 - 400	10 - 20	Miscellaneous Debris	0.01		1478

TABLE B-12. FRAGMENTS RECOVERED BEYOND 200-FT RANGE IN TEST NO. 12 (Continued)

<u>Entry</u>	<u>Range Interval (ft)</u>	<u>Azimuthal Sector (°)</u>	<u>Description</u>	<u>Mass (lb)</u>	<u>Notes</u>	<u>G64 Index No.</u>
101	200 - 400	10 - 20	Miscellaneous Debris	0.01		1479
102	200 - 400	10 - 20	Miscellaneous Debris	0.01		1480
103	200 - 400	10 - 20	Miscellaneous Debris	0.01		1481
104	200 - 400	10 - 20	Miscellaneous Debris	0.01		1482
105	200 - 400	10 - 20	Miscellaneous Debris	-	Not retained	9375
106	200 - 400	10 - 20	Miscellaneous Debris	-	Not retained	9376
107	200 - 400	10 - 20	Miscellaneous Debris	-	Not retained	9377
108	200 - 400	10 - 20	Miscellaneous Debris	-	Not retained	9378
109	200 - 400	10 - 20	Miscellaneous Debris	-	Not retained	9379
110	200 - 400	10 - 20	Miscellaneous Debris	-	Not retained	9380
111	200 - 400	10 - 20	Miscellaneous Debris	-	Not retained	9381
112	200 - 400	10 - 20	Miscellaneous Debris	-	Not retained	9382
113	200 - 400	10 - 20	Miscellaneous Debris	-	Not retained	9383
114	200 - 400	10 - 20	Miscellaneous Debris	-	Not retained	9384
115	200 - 400	10 - 20	Miscellaneous Debris	-	Not retained	9385
116	200 - 400	10 - 20	Miscellaneous Debris	-	Not retained	9386
117	200 - 400	10 - 20	Miscellaneous Debris	-	Not retained	9387
118	200 - 400	10 - 20	Miscellaneous Debris	-	Not retained	9388
119	200 - 400	10 - 20	Miscellaneous Debris	-	Not retained	9389
120	200 - 400	10 - 20	Miscellaneous Debris	-	Not retained	9390
121	200 - 400	10 - 20	Miscellaneous Debris	-	Not retained	9391
122	200 - 400	10 - 20	Miscellaneous Debris	-	Not retained	9392
123	200 - 400	10 - 20	Miscellaneous Debris	-	Not retained	9393
124	200 - 400	10 - 20	Miscellaneous Debris	-	Not retained	9394
125	200 - 400	10 - 20	Miscellaneous Debris	-	Not retained	9395
126	200 - 400	10 - 20	Miscellaneous Debris	-	Not retained	9396
127	200 - 400	10 - 20	Miscellaneous Debris	-	Not retained	9397
128	200 - 400	10 - 20	Miscellaneous Debris	-	Not retained	9398
129	200 - 400	10 - 20	Miscellaneous Debris	-	Not retained	9399
130	200 - 400	10 - 20	Miscellaneous Debris	-	Not retained	9400
131	200 - 400	10 - 20	Miscellaneous Debris	-	Not retained	9401
132	200 - 400	10 - 20	Miscellaneous Debris	-	Not retained	9402
133	200 - 400	10 - 20	Miscellaneous Debris	-	Not retained	9403
134	200 - 400	10 - 20	Miscellaneous Debris	-	Not retained	9404
135	200 - 400	10 - 20	Miscellaneous Debris	-	Not retained	9405
136	200 - 400	10 - 20	Miscellaneous Debris	-	Not retained	9406
137	200 - 400	10 - 20	Miscellaneous Debris	-	Not retained	9407
138	200 - 400	10 - 20	Miscellaneous Debris	-	Not retained	9408
139	200 - 400	20 - 30	Warhead Body Piece	0.50		258
140	200 - 400	20 - 30	Warhead Body Piece	0.50		259
141	200 - 400	20 - 30	Warhead Body Piece	0.27		260
142	200 - 400	20 - 30	Warhead Body Piece	0.16		261
143	200 - 400	20 - 30	Warhead Body Piece	0.10		262
144	200 - 400	20 - 30	Warhead Body Piece	0.04		263
145	200 - 400	20 - 30	Warhead Body Piece	0.12		264
146	200 - 400	20 - 30	Warhead Body Piece	0.06		265
147	200 - 400	20 - 30	Warhead Body Piece	0.02		266
148	200 - 400	20 - 30	Warhead Body Piece	0.01		267
149	200 - 400	20 - 30	Warhead Body Piece	0.01		268
150	200 - 400	20 - 30	Warhead Body Piece	0.01		269

NSWCDD/TR-98/6

TABLE B-12. FRAGMENTS RECOVERED BEYOND 200-FT RANGE IN TEST NO. 12 (Continued)

<u>Entry</u>	<u>Range Interval (ft)</u>	<u>Azimuthal Sector (°)</u>	<u>Description</u>	<u>Mass (lb)</u>	<u>Notes</u>	<u>G64 Index No.</u>
151	200 - 400	20 - 30	Warhead Body Piece	0.01		270
152	200 - 400	20 - 30	Warhead Body Piece	0.01		271
153	200 - 400	20 - 30	Warhead Body Piece	0.01		272
154	200 - 400	20 - 30	Tail Piece	0.03		273
155	200 - 400	20 - 30	Tail Piece	0.02		274
156	200 - 400	20 - 30	Tail Piece	-	Not retained	9044
157	200 - 400	20 - 30	Tail Piece	-	Not retained	9045
158	200 - 400	20 - 30	Tail Piece	-	Not retained	9046
159	200 - 400	20 - 30	Tail Piece	-	Not retained	9047
160	200 - 400	20 - 30	Tail Piece	-	Not retained	9048
161	200 - 400	20 - 30	Tail Piece	-	Not retained	9049
162	200 - 400	20 - 30	Tail Piece	-	Not retained	9050
163	200 - 400	20 - 30	Miscellaneous Debris	0.01		275
164	200 - 400	20 - 30	Miscellaneous Debris	0.01		276
165	200 - 400	20 - 30	Miscellaneous Debris	-	Not retained	9409
166	200 - 400	20 - 30	Miscellaneous Debris	-	Not retained	9410
167	200 - 400	20 - 30	Miscellaneous Debris	-	Not retained	9411
168	200 - 400	20 - 30	Miscellaneous Debris	-	Not retained	9412
169	200 - 400	20 - 30	Miscellaneous Debris	-	Not retained	9413
170	200 - 400	20 - 30	Miscellaneous Debris	-	Not retained	9414
171	200 - 400	20 - 30	Miscellaneous Debris	-	Not retained	9415
172	200 - 400	20 - 30	Miscellaneous Debris	-	Not retained	9416
173	200 - 400	20 - 30	Miscellaneous Debris	-	Not retained	9417
174	200 - 400	20 - 30	Miscellaneous Debris	-	Not retained	9418
175	200 - 400	20 - 30	Miscellaneous Debris	-	Not retained	9419
176	200 - 400	20 - 30	Miscellaneous Debris	-	Not retained	9420
177	200 - 400	20 - 30	Miscellaneous Debris	-	Not retained	9421
178	200 - 400	20 - 30	Miscellaneous Debris	-	Not retained	9422
179	200 - 400	20 - 30	Miscellaneous Debris	-	Not retained	9423
180	200 - 400	20 - 30	Miscellaneous Debris	-	Not retained	9424
181	200 - 400	20 - 30	Miscellaneous Debris	-	Not retained	9425
182	200 - 400	20 - 30	Miscellaneous Debris	-	Not retained	9426
183	200 - 400	20 - 30	Miscellaneous Debris	-	Not retained	9427
184	200 - 400	20 - 30	Miscellaneous Debris	-	Not retained	9428
185	200 - 400	20 - 30	Miscellaneous Debris	-	Not retained	9429
186	200 - 400	20 - 30	Miscellaneous Debris	-	Not retained	9430
187	200 - 400	20 - 30	Miscellaneous Debris	-	Not retained	9431
188	200 - 400	20 - 30	Miscellaneous Debris	-	Not retained	9432
189	200 - 400	20 - 30	Miscellaneous Debris	-	Not retained	9433
190	200 - 400	20 - 30	Miscellaneous Debris	-	Not retained	9434
191	200 - 400	20 - 30	Miscellaneous Debris	-	Not retained	9435
192	200 - 400	20 - 30	Miscellaneous Debris	-	Not retained	9436
193	200 - 400	20 - 30	Miscellaneous Debris	-	Not retained	9437
194	200 - 400	20 - 30	Miscellaneous Debris	-	Not retained	9438
195	200 - 400	20 - 30	Miscellaneous Debris	-	Not retained	9439
196	200 - 400	30 - 40	Warhead Body Piece	0.50		115
197	200 - 400	30 - 40	Warhead Body Piece	0.50		116
198	200 - 400	30 - 40	Warhead Body Piece	0.34		117
199	200 - 400	30 - 40	Warhead Body Piece	0.17		118
200	200 - 400	30 - 40	Warhead Body Piece	0.06		119

TABLE B-12. FRAGMENTS RECOVERED BEYOND 200-FT RANGE IN TEST NO. 12 (Continued)

<u>Entry</u>	<u>Range Interval (ft)</u>	<u>Azimuthal Sector (°)</u>	<u>Description</u>	<u>Mass (lb)</u>	<u>Notes</u>	<u>G64 Index No.</u>
201	200 - 400	30 - 40	Warhead Body Piece	0.04		120
202	200 - 400	30 - 40	Warhead Body Piece	0.02		121
203	200 - 400	30 - 40	Warhead Body Piece	0.23		122
204	200 - 400	30 - 40	Warhead Body Piece	0.02		123
205	200 - 400	30 - 40	Warhead Body Piece	0.02		124
206	200 - 400	30 - 40	Warhead Body Piece	0.01		125
207	200 - 400	30 - 40	Warhead Body Piece	0.01		126
208	200 - 400	30 - 40	Warhead Body Piece	0.01		127
209	200 - 400	30 - 40	Warhead Body Piece	0.01		128
210	200 - 400	30 - 40	Warhead Body Piece	0.01		129
211	200 - 400	30 - 40	Warhead Body Piece	0.01		130
212	200 - 400	30 - 40	Warhead Body Piece	0.01		131
213	200 - 400	30 - 40	Warhead Body Piece	0.01		132
214	200 - 400	30 - 40	Warhead Body Piece	0.01		133
215	200 - 400	30 - 40	Warhead Body Piece	0.01		134
216	200 - 400	30 - 40	Tail Piece	-	Not retained	9051
217	200 - 400	30 - 40	Tail Piece	-	Not retained	9052
218	200 - 400	30 - 40	Tail Piece	-	Not retained	9053
219	200 - 400	30 - 40	Miscellaneous Debris	0.01		135
220	200 - 400	30 - 40	Miscellaneous Debris	0.01		136
221	200 - 400	30 - 40	Miscellaneous Debris	0.01		137
222	200 - 400	30 - 40	Miscellaneous Debris	0.01		138
223	200 - 400	30 - 40	Miscellaneous Debris	-	Not retained	9440
224	200 - 400	30 - 40	Miscellaneous Debris	-	Not retained	9441
225	200 - 400	30 - 40	Miscellaneous Debris	-	Not retained	9442
226	200 - 400	30 - 40	Miscellaneous Debris	-	Not retained	9443
227	200 - 400	30 - 40	Miscellaneous Debris	-	Not retained	9444
228	200 - 400	30 - 40	Miscellaneous Debris	-	Not retained	9445
229	200 - 400	30 - 40	Miscellaneous Debris	-	Not retained	9446
230	200 - 400	30 - 40	Miscellaneous Debris	-	Not retained	9447
231	200 - 400	30 - 40	Miscellaneous Debris	-	Not retained	9448
232	200 - 400	30 - 40	Miscellaneous Debris	-	Not retained	9449
233	200 - 400	30 - 40	Miscellaneous Debris	-	Not retained	9450
234	200 - 400	30 - 40	Miscellaneous Debris	-	Not retained	9451
235	200 - 400	30 - 40	Miscellaneous Debris	-	Not retained	9452
236	200 - 400	30 - 40	Miscellaneous Debris	-	Not retained	9453
237	200 - 400	30 - 40	Miscellaneous Debris	-	Not retained	9454
238	200 - 400	30 - 40	Miscellaneous Debris	-	Not retained	9455
239	200 - 400	30 - 40	Miscellaneous Debris	-	Not retained	9456
240	200 - 400	30 - 40	Miscellaneous Debris	-	Not retained	9457
241	200 - 400	30 - 40	Miscellaneous Debris	-	Not retained	9458
242	200 - 400	30 - 40	Miscellaneous Debris	-	Not retained	9459
243	200 - 400	30 - 40	Miscellaneous Debris	-	Not retained	9460
244	200 - 400	30 - 40	Miscellaneous Debris	-	Not retained	9461
245	200 - 400	30 - 40	Miscellaneous Debris	-	Not retained	9462
246	200 - 400	30 - 40	Miscellaneous Debris	-	Not retained	9463
247	200 - 400	30 - 40	Miscellaneous Debris	-	Not retained	9464
248	200 - 400	30 - 40	Miscellaneous Debris	-	Not retained	9465
249	200 - 400	30 - 40	Miscellaneous Debris	-	Not retained	9466
250	200 - 400	30 - 40	Miscellaneous Debris	-	Not retained	9467

TABLE B-12. FRAGMENTS RECOVERED BEYOND 200-FT RANGE IN TEST NO. 12 (Continued)

<u>Entry</u>	<u>Range Interval (ft)</u>	<u>Azimuthal Sector (°)</u>	<u>Description</u>	<u>Mass (lb)</u>	<u>Notes</u>	<u>G64 Index No.</u>
251	200 - 400	30 - 40	Miscellaneous Debris	-	Not retained	9468
252	200 - 400	30 - 40	Miscellaneous Debris	-	Not retained	9469
253	200 - 400	30 - 40	Miscellaneous Debris	-	Not retained	9470
254	200 - 400	30 - 40	Miscellaneous Debris	-	Not retained	9471
255	200 - 400	30 - 40	Miscellaneous Debris	-	Not retained	9472
256	200 - 400	30 - 40	Miscellaneous Debris	-	Not retained	9473
257	200 - 400	30 - 40	Miscellaneous Debris	-	Not retained	9474
258	200 - 400	30 - 40	Miscellaneous Debris	-	Not retained	9475
259	200 - 400	30 - 40	Miscellaneous Debris	-	Not retained	9476
260	200 - 400	30 - 40	Miscellaneous Debris	-	Not retained	9477
261	200 - 400	30 - 40	Miscellaneous Debris	-	Not retained	9478
262	200 - 400	30 - 40	Miscellaneous Debris	-	Not retained	9479
263	200 - 400	30 - 40	Miscellaneous Debris	-	Not retained	9480
264	200 - 400	30 - 40	Miscellaneous Debris	-	Not retained	9481
265	200 - 400	30 - 40	Miscellaneous Debris	-	Not retained	9482
266	200 - 400	30 - 40	Miscellaneous Debris	-	Not retained	9483
267	200 - 400	30 - 40	Intact Warhead	-	Not retained	9000
268	200 - 400	40 - 50	Warhead Body Piece	0.50		24
269	200 - 400	40 - 50	Warhead Body Piece	0.34		25
270	200 - 400	40 - 50	Warhead Body Piece	0.24		26
271	200 - 400	40 - 50	Warhead Body Piece	0.08		27
272	200 - 400	40 - 50	Warhead Body Piece	0.04		28
273	200 - 400	40 - 50	Warhead Body Piece	0.02		29
274	200 - 400	40 - 50	Warhead Body Piece	0.24		30
275	200 - 400	40 - 50	Warhead Body Piece	0.07		31
276	200 - 400	40 - 50	Warhead Body Piece	0.05		32
277	200 - 400	40 - 50	Warhead Body Piece	0.03		33
278	200 - 400	40 - 50	Warhead Body Piece	0.03		34
279	200 - 400	40 - 50	Warhead Body Piece	0.02		35
280	200 - 400	40 - 50	Warhead Body Piece	0.01		36
281	200 - 400	40 - 50	Warhead Body Piece	0.01		37
282	200 - 400	40 - 50	Warhead Body Piece	0.07		38
283	200 - 400	40 - 50	Tail Piece	0.05		39
284	200 - 400	40 - 50	Tail Piece	0.02		40
285	200 - 400	40 - 50	Tail Piece	0.01		41
286	200 - 400	40 - 50	Tail Piece	-	Not retained	9054
287	200 - 400	40 - 50	Tail Piece	-	Not retained	9055
288	200 - 400	40 - 50	Tail Piece	-	Not retained	9056
289	200 - 400	40 - 50	Tail Piece	-	Not retained	9057
290	200 - 400	40 - 50	Tail Piece	-	Not retained	9058
291	200 - 400	40 - 50	Tail Piece	-	Not retained	9059
292	200 - 400	40 - 50	Tail Piece	-	Not retained	9060
293	200 - 400	40 - 50	Tail Piece	-	Not retained	9061
294	200 - 400	40 - 50	Tail Piece	-	Not retained	9062
295	200 - 400	40 - 50	Tail Piece	-	Not retained	9063
296	200 - 400	40 - 50	Tail Piece	-	Not retained	9064
297	200 - 400	40 - 50	Miscellaneous Debris	0.01		42
298	200 - 400	40 - 50	Miscellaneous Debris	0.01		43
299	200 - 400	40 - 50	Miscellaneous Debris	0.01		44
300	200 - 400	40 - 50	Miscellaneous Debris	0.01		45

NSWCDD/TR-98/6

TABLE B-12. FRAGMENTS RECOVERED BEYOND 200-FT RANGE IN TEST NO. 12 (Continued)

<u>Entry</u>	<u>Range Interval (ft)</u>	<u>Azimuthal Sector (°)</u>	<u>Description</u>	<u>Mass (lb)</u>	<u>Notes</u>	<u>G64 Index No.</u>
301	200 - 400	40 - 50	Miscellaneous Debris	0.01		46
302	200 - 400	40 - 50	Miscellaneous Debris	0.01		47
303	200 - 400	40 - 50	Miscellaneous Debris	-	Not retained	9484
304	200 - 400	40 - 50	Miscellaneous Debris	-	Not retained	9485
305	200 - 400	40 - 50	Miscellaneous Debris	-	Not retained	9486
306	200 - 400	40 - 50	Miscellaneous Debris	-	Not retained	9487
307	200 - 400	40 - 50	Miscellaneous Debris	-	Not retained	9488
308	200 - 400	40 - 50	Miscellaneous Debris	-	Not retained	9489
309	200 - 400	40 - 50	Miscellaneous Debris	-	Not retained	9490
310	200 - 400	40 - 50	Miscellaneous Debris	-	Not retained	9491
311	200 - 400	40 - 50	Miscellaneous Debris	-	Not retained	9492
312	200 - 400	40 - 50	Miscellaneous Debris	-	Not retained	9493
313	200 - 400	40 - 50	Miscellaneous Debris	-	Not retained	9494
314	200 - 400	40 - 50	Miscellaneous Debris	-	Not retained	9495
315	200 - 400	40 - 50	Miscellaneous Debris	-	Not retained	9496
316	200 - 400	40 - 50	Miscellaneous Debris	-	Not retained	9497
317	200 - 400	40 - 50	Miscellaneous Debris	-	Not retained	9498
318	200 - 400	40 - 50	Miscellaneous Debris	-	Not retained	9499
319	200 - 400	40 - 50	Miscellaneous Debris	-	Not retained	9500
320	200 - 400	40 - 50	Miscellaneous Debris	-	Not retained	9501
321	200 - 400	40 - 50	Miscellaneous Debris	-	Not retained	9502
322	200 - 400	40 - 50	Miscellaneous Debris	-	Not retained	9503
323	200 - 400	40 - 50	Miscellaneous Debris	-	Not retained	9504
324	200 - 400	40 - 50	Miscellaneous Debris	-	Not retained	9505
325	200 - 400	40 - 50	Miscellaneous Debris	-	Not retained	9506
326	200 - 400	40 - 50	Miscellaneous Debris	-	Not retained	9507
327	200 - 400	40 - 50	Miscellaneous Debris	-	Not retained	9508
328	200 - 400	40 - 50	Miscellaneous Debris	-	Not retained	9509
329	200 - 400	40 - 50	Miscellaneous Debris	-	Not retained	9510
330	200 - 400	40 - 50	Miscellaneous Debris	-	Not retained	9511
331	200 - 400	40 - 50	Miscellaneous Debris	-	Not retained	9512
332	200 - 400	40 - 50	Miscellaneous Debris	-	Not retained	9513
333	200 - 400	40 - 50	Miscellaneous Debris	-	Not retained	9514
334	200 - 400	40 - 50	Miscellaneous Debris	-	Not retained	9515
335	200 - 400	40 - 50	Miscellaneous Debris	-	Not retained	9516
336	200 - 400	40 - 50	Miscellaneous Debris	-	Not retained	9517
337	200 - 400	40 - 50	Miscellaneous Debris	-	Not retained	9518
338	200 - 400	40 - 50	Intact Warhead	-	Not retained	9001
339	200 - 400	40 - 50	Intact Warhead	-	Not retained	9002
340	200 - 400	50 - 60	Warhead Body Piece	0.50		580
341	200 - 400	50 - 60	Warhead Body Piece	0.50		581
342	200 - 400	50 - 60	Warhead Body Piece	0.29		582
343	200 - 400	50 - 60	Warhead Body Piece	0.23		583
344	200 - 400	50 - 60	Warhead Body Piece	0.13		584
345	200 - 400	50 - 60	Warhead Body Piece	0.35		585
346	200 - 400	50 - 60	Warhead Body Piece	0.10		586
347	200 - 400	50 - 60	Warhead Body Piece	0.15		587
348	200 - 400	50 - 60	Warhead Body Piece	0.12		588
349	200 - 400	50 - 60	Warhead Body Piece	0.03		589
350	200 - 400	50 - 60	Warhead Body Piece	0.01		590

NSWCDD/TR-98/6

TABLE B-12. FRAGMENTS RECOVERED BEYOND 200-FT RANGE IN TEST NO. 12 (Continued)

<u>Entry</u>	<u>Range Interval (ft)</u>	<u>Azimuthal Sector (°)</u>	<u>Description</u>	<u>Mass (lb)</u>	<u>Notes</u>	<u>G64 Index No.</u>
351	200 - 400	50 - 60	Warhead Body Piece	0.01		591
352	200 - 400	50 - 60	Warhead Body Piece	0.01		592
353	200 - 400	50 - 60	Tail Piece	0.01		593
354	200 - 400	50 - 60	Tail Piece	-	Not retained	9065
355	200 - 400	50 - 60	Tail Piece	-	Not retained	9066
356	200 - 400	50 - 60	Tail Piece	-	Not retained	9067
357	200 - 400	50 - 60	Tail Piece	-	Not retained	9068
358	200 - 400	50 - 60	Tail Piece	-	Not retained	9069
359	200 - 400	50 - 60	Tail Piece	-	Not retained	9070
360	200 - 400	50 - 60	Tail Piece	-	Not retained	9071
361	200 - 400	50 - 60	Tail Piece	-	Not retained	9072
362	200 - 400	50 - 60	Miscellaneous Debris	0.01		594
363	200 - 400	50 - 60	Miscellaneous Debris	0.01		595
364	200 - 400	50 - 60	Miscellaneous Debris	0.01		596
365	200 - 400	50 - 60	Miscellaneous Debris	0.01		597
366	200 - 400	50 - 60	Miscellaneous Debris	0.01		598
367	200 - 400	50 - 60	Miscellaneous Debris	-	Not retained	9519
368	200 - 400	50 - 60	Miscellaneous Debris	-	Not retained	9520
369	200 - 400	50 - 60	Miscellaneous Debris	-	Not retained	9521
370	200 - 400	50 - 60	Miscellaneous Debris	-	Not retained	9522
371	200 - 400	50 - 60	Miscellaneous Debris	-	Not retained	9523
372	200 - 400	50 - 60	Miscellaneous Debris	-	Not retained	9524
373	200 - 400	50 - 60	Miscellaneous Debris	-	Not retained	9525
374	200 - 400	50 - 60	Miscellaneous Debris	-	Not retained	9526
375	200 - 400	50 - 60	Miscellaneous Debris	-	Not retained	9527
376	200 - 400	50 - 60	Miscellaneous Debris	-	Not retained	9528
377	200 - 400	50 - 60	Miscellaneous Debris	-	Not retained	9529
378	200 - 400	50 - 60	Miscellaneous Debris	-	Not retained	9530
379	200 - 400	50 - 60	Miscellaneous Debris	-	Not retained	9531
380	200 - 400	50 - 60	Miscellaneous Debris	-	Not retained	9532
381	200 - 400	50 - 60	Miscellaneous Debris	-	Not retained	9533
382	200 - 400	50 - 60	Miscellaneous Debris	-	Not retained	9534
383	200 - 400	50 - 60	Miscellaneous Debris	-	Not retained	9535
384	200 - 400	50 - 60	Miscellaneous Debris	-	Not retained	9536
385	200 - 400	50 - 60	Miscellaneous Debris	-	Not retained	9537
386	200 - 400	50 - 60	Miscellaneous Debris	-	Not retained	9538
387	200 - 400	50 - 60	Miscellaneous Debris	-	Not retained	9539
388	200 - 400	50 - 60	Miscellaneous Debris	-	Not retained	9540
389	200 - 400	50 - 60	Miscellaneous Debris	-	Not retained	9541
390	200 - 400	50 - 60	Miscellaneous Debris	-	Not retained	9542
391	200 - 400	50 - 60	Miscellaneous Debris	-	Not retained	9543
392	200 - 400	50 - 60	Miscellaneous Debris	-	Not retained	9544
393	200 - 400	50 - 60	Miscellaneous Debris	-	Not retained	9545
394	200 - 400	50 - 60	Miscellaneous Debris	-	Not retained	9546
395	200 - 400	50 - 60	Miscellaneous Debris	-	Not retained	9547
396	200 - 400	50 - 60	Miscellaneous Debris	-	Not retained	9548
397	200 - 400	50 - 60	Miscellaneous Debris	-	Not retained	9549
398	200 - 400	50 - 60	Miscellaneous Debris	-	Not retained	9550
399	200 - 400	50 - 60	Miscellaneous Debris	-	Not retained	9551
400	200 - 400	50 - 60	Miscellaneous Debris	-	Not retained	9552

NSWCDD/TR-98/6

TABLE B-12. FRAGMENTS RECOVERED BEYOND 200-FT RANGE IN TEST NO. 12 (Continued)

<u>Entry</u>	<u>Range Interval (ft)</u>	<u>Azimuthal Sector (°)</u>	<u>Description</u>	<u>Mass (lb)</u>	<u>Notes</u>	<u>G64 Index No.</u>
401	200 - 400	50 - 60	Miscellaneous Debris	-	Not retained	9553
402	200 - 400	50 - 60	Miscellaneous Debris	-	Not retained	9554
403	200 - 400	50 - 60	Miscellaneous Debris	-	Not retained	9555
404	200 - 400	50 - 60	Miscellaneous Debris	-	Not retained	9556
405	200 - 400	50 - 60	Miscellaneous Debris	-	Not retained	9557
406	200 - 400	50 - 60	Miscellaneous Debris	-	Not retained	9558
407	200 - 400	50 - 60	Miscellaneous Debris	-	Not retained	9559
408	200 - 400	50 - 60	Miscellaneous Debris	-	Not retained	9560
409	200 - 400	50 - 60	Miscellaneous Debris	-	Not retained	9561
410	200 - 400	50 - 60	Miscellaneous Debris	-	Not retained	9562
411	200 - 400	50 - 60	Miscellaneous Debris	-	Not retained	9563
412	200 - 400	50 - 60	Intact Warhead	-	Not retained	9003
413	200 - 400	60 - 70	Warhead Body Piece	0.22		436
414	200 - 400	60 - 70	Warhead Body Piece	0.12		437
415	200 - 400	60 - 70	Warhead Body Piece	0.07		438
416	200 - 400	60 - 70	Warhead Body Piece	0.11		439
417	200 - 400	60 - 70	Warhead Body Piece	0.06		440
418	200 - 400	60 - 70	Warhead Body Piece	0.04		441
419	200 - 400	60 - 70	Warhead Body Piece	0.01		442
420	200 - 400	60 - 70	Warhead Body Piece	0.01		447
421	200 - 400	60 - 70	Tail Piece	-	Not retained	435
422	200 - 400	60 - 70	Tail Piece	0.02		443
423	200 - 400	60 - 70	Tail Piece	0.02		444
424	200 - 400	60 - 70	Tail Piece	-	Not retained	9073
425	200 - 400	60 - 70	Tail Piece	-	Not retained	9074
426	200 - 400	60 - 70	Tail Piece	-	Not retained	9075
427	200 - 400	60 - 70	Tail Piece	-	Not retained	9076
428	200 - 400	60 - 70	Tail Piece	-	Not retained	9077
429	200 - 400	60 - 70	Tail Piece	-	Not retained	9078
430	200 - 400	60 - 70	Miscellaneous Debris	0.01		445
431	200 - 400	60 - 70	Miscellaneous Debris	0.01		446
432	200 - 400	60 - 70	Miscellaneous Debris	-	Not retained	9564
433	200 - 400	60 - 70	Miscellaneous Debris	-	Not retained	9565
434	200 - 400	60 - 70	Miscellaneous Debris	-	Not retained	9566
435	200 - 400	60 - 70	Miscellaneous Debris	-	Not retained	9567
436	200 - 400	60 - 70	Miscellaneous Debris	-	Not retained	9568
437	200 - 400	60 - 70	Miscellaneous Debris	-	Not retained	9569
438	200 - 400	60 - 70	Miscellaneous Debris	-	Not retained	9570
439	200 - 400	60 - 70	Miscellaneous Debris	-	Not retained	9571
440	200 - 400	60 - 70	Miscellaneous Debris	-	Not retained	9572
441	200 - 400	60 - 70	Miscellaneous Debris	-	Not retained	9573
442	200 - 400	60 - 70	Miscellaneous Debris	-	Not retained	9574
443	200 - 400	60 - 70	Miscellaneous Debris	-	Not retained	9575
444	200 - 400	60 - 70	Miscellaneous Debris	-	Not retained	9576
445	200 - 400	60 - 70	Miscellaneous Debris	-	Not retained	9577
446	200 - 400	60 - 70	Miscellaneous Debris	-	Not retained	9578
447	200 - 400	60 - 70	Miscellaneous Debris	-	Not retained	9579
448	200 - 400	60 - 70	Miscellaneous Debris	-	Not retained	9580
449	200 - 400	60 - 70	Miscellaneous Debris	-	Not retained	9581
450	200 - 400	60 - 70	Miscellaneous Debris	-	Not retained	9582

TABLE B-12. FRAGMENTS RECOVERED BEYOND 200-FT RANGE IN TEST NO. 12 (Continued)

<u>Entry</u>	<u>Range Interval (ft)</u>	<u>Azimuthal Sector (°)</u>	<u>Description</u>	<u>Mass (lb)</u>	<u>Notes</u>	<u>G64 Index No.</u>
451	200 - 400	60 - 70	Miscellaneous Debris	-	Not retained	9583
452	200 - 400	60 - 70	Miscellaneous Debris	-	Not retained	9584
453	200 - 400	60 - 70	Miscellaneous Debris	-	Not retained	9585
454	200 - 400	60 - 70	Miscellaneous Debris	-	Not retained	9586
455	200 - 400	60 - 70	Miscellaneous Debris	-	Not retained	9587
456	200 - 400	60 - 70	Miscellaneous Debris	-	Not retained	9588
457	200 - 400	60 - 70	Miscellaneous Debris	-	Not retained	9589
458	200 - 400	60 - 70	Miscellaneous Debris	-	Not retained	9590
459	200 - 400	60 - 70	Miscellaneous Debris	-	Not retained	9591
460	200 - 400	60 - 70	Miscellaneous Debris	-	Not retained	9592
461	200 - 400	70 - 80	Warhead Body Piece	0.50		341
462	200 - 400	70 - 80	Warhead Body Piece	0.50		342
463	200 - 400	70 - 80	Warhead Body Piece	0.50		343
464	200 - 400	70 - 80	Warhead Body Piece	0.50		344
465	200 - 400	70 - 80	Warhead Body Piece	0.50		345
466	200 - 400	70 - 80	Warhead Body Piece	0.50		346
467	200 - 400	70 - 80	Warhead Body Piece	1.90		347
468	200 - 400	70 - 80	Warhead Body Piece	0.37		348
469	200 - 400	70 - 80	Warhead Body Piece	0.46		349
470	200 - 400	70 - 80	Warhead Body Piece	0.37		350
471	200 - 400	70 - 80	Warhead Body Piece	0.27		351
472	200 - 400	70 - 80	Warhead Body Piece	0.16		352
473	200 - 400	70 - 80	Warhead Body Piece	0.16		353
474	200 - 400	70 - 80	Warhead Body Piece	0.09		354
475	200 - 400	70 - 80	Warhead Body Piece	0.07		355
476	200 - 400	70 - 80	Warhead Body Piece	0.04		356
477	200 - 400	70 - 80	Warhead Body Piece	0.02		357
478	200 - 400	70 - 80	Warhead Body Piece	0.01		358
479	200 - 400	70 - 80	Warhead Body Piece	0.01		359
480	200 - 400	70 - 80	Warhead Body Piece	0.01		360
481	200 - 400	70 - 80	Warhead Body Piece	0.01		361
482	200 - 400	70 - 80	Tail Piece	0.03		362
483	200 - 400	70 - 80	Tail Piece	0.02		363
484	200 - 400	70 - 80	Tail Piece	0.01		364
485	200 - 400	70 - 80	Tail Piece	-	Not retained	9079
486	200 - 400	70 - 80	Tail Piece	-	Not retained	9080
487	200 - 400	70 - 80	Tail Piece	-	Not retained	9081
488	200 - 400	70 - 80	Tail Piece	-	Not retained	9082
489	200 - 400	70 - 80	Tail Piece	-	Not retained	9083
490	200 - 400	70 - 80	Miscellaneous Debris	0.02		365
491	200 - 400	70 - 80	Miscellaneous Debris	0.01		366
492	200 - 400	70 - 80	Miscellaneous Debris	-	Not retained	9593
493	200 - 400	70 - 80	Miscellaneous Debris	-	Not retained	9594
494	200 - 400	70 - 80	Miscellaneous Debris	-	Not retained	9595
495	200 - 400	70 - 80	Miscellaneous Debris	-	Not retained	9596
496	200 - 400	70 - 80	Miscellaneous Debris	-	Not retained	9597
497	200 - 400	70 - 80	Miscellaneous Debris	-	Not retained	9598
498	200 - 400	70 - 80	Miscellaneous Debris	-	Not retained	9599
499	200 - 400	70 - 80	Miscellaneous Debris	-	Not retained	9600
500	200 - 400	70 - 80	Miscellaneous Debris	-	Not retained	9601

NSWCDD/TR-98/6

TABLE B-12. FRAGMENTS RECOVERED BEYOND 200-FT RANGE IN TEST NO. 12 (Continued)

<u>Entry</u>	<u>Range Interval (ft)</u>	<u>Azimuthal Sector (°)</u>	<u>Description</u>	<u>Mass (lb)</u>	<u>Notes</u>	<u>G64 Index No.</u>
501	200 - 400	70 - 80	Miscellaneous Debris	-	Not retained	9602
502	200 - 400	70 - 80	Miscellaneous Debris	-	Not retained	9603
503	200 - 400	70 - 80	Miscellaneous Debris	-	Not retained	9604
504	200 - 400	70 - 80	Miscellaneous Debris	-	Not retained	9605
505	200 - 400	70 - 80	Miscellaneous Debris	-	Not retained	9606
506	200 - 400	70 - 80	Miscellaneous Debris	-	Not retained	9607
507	200 - 400	70 - 80	Miscellaneous Debris	-	Not retained	9608
508	200 - 400	70 - 80	Miscellaneous Debris	-	Not retained	9609
509	200 - 400	70 - 80	Miscellaneous Debris	-	Not retained	9610
510	200 - 400	70 - 80	Miscellaneous Debris	-	Not retained	9611
511	200 - 400	70 - 80	Miscellaneous Debris	-	Not retained	9612
512	200 - 400	70 - 80	Miscellaneous Debris	-	Not retained	9613
513	200 - 400	70 - 80	Miscellaneous Debris	-	Not retained	9614
514	200 - 400	70 - 80	Miscellaneous Debris	-	Not retained	9615
515	200 - 400	80 - 90	Warhead Body Piece	0.50		1251
516	200 - 400	80 - 90	Warhead Body Piece	0.50		1252
517	200 - 400	80 - 90	Warhead Body Piece	1.25		1253
518	200 - 400	80 - 90	Warhead Body Piece	1.46		1254
519	200 - 400	80 - 90	Warhead Body Piece	0.46		1255
520	200 - 400	80 - 90	Warhead Body Piece	0.15		1256
521	200 - 400	80 - 90	Warhead Body Piece	0.07		1257
522	200 - 400	80 - 90	Warhead Body Piece	0.04		1258
523	200 - 400	80 - 90	Warhead Body Piece	0.03		1259
524	200 - 400	80 - 90	Warhead Body Piece	0.07		1260
525	200 - 400	80 - 90	Warhead Body Piece	0.01		1261
526	200 - 400	80 - 90	Warhead Body Piece	0.01		1262
527	200 - 400	80 - 90	Warhead Body Piece	0.01		1263
528	200 - 400	80 - 90	Tail Piece	0.07		1264
529	200 - 400	80 - 90	Tail Piece	-	Not retained	9084
530	200 - 400	80 - 90	Tail Piece	-	Not retained	9085
531	200 - 400	80 - 90	Tail Piece	-	Not retained	9086
532	200 - 400	80 - 90	Tail Piece	-	Not retained	9087
533	200 - 400	80 - 90	Miscellaneous Debris	0.01		1265
534	200 - 400	80 - 90	Miscellaneous Debris	0.01		1266
535	200 - 400	80 - 90	Miscellaneous Debris	0.01		1267
536	200 - 400	80 - 90	Miscellaneous Debris	-	Not retained	9616
537	200 - 400	80 - 90	Miscellaneous Debris	-	Not retained	9617
538	200 - 400	80 - 90	Miscellaneous Debris	-	Not retained	9618
539	200 - 400	80 - 90	Miscellaneous Debris	-	Not retained	9619
540	200 - 400	80 - 90	Miscellaneous Debris	-	Not retained	9620
541	200 - 400	80 - 90	Miscellaneous Debris	-	Not retained	9621
542	200 - 400	80 - 90	Miscellaneous Debris	-	Not retained	9622
543	200 - 400	80 - 90	Miscellaneous Debris	-	Not retained	9623
544	200 - 400	80 - 90	Miscellaneous Debris	-	Not retained	9624
545	200 - 400	80 - 90	Miscellaneous Debris	-	Not retained	9625
546	200 - 400	80 - 90	Miscellaneous Debris	-	Not retained	9626
547	200 - 400	80 - 90	Miscellaneous Debris	-	Not retained	9627
548	200 - 400	80 - 90	Miscellaneous Debris	-	Not retained	9628
549	200 - 400	80 - 90	Miscellaneous Debris	-	Not retained	9629
550	200 - 400	80 - 90	Miscellaneous Debris	-	Not retained	9630

TABLE B-12. FRAGMENTS RECOVERED BEYOND 200-FT RANGE IN TEST NO. 12 (Continued)

<u>Entry</u>	<u>Range Interval (ft)</u>	<u>Azimuthal Sector (°)</u>	<u>Description</u>	<u>Mass (lb)</u>	<u>Notes</u>	<u>G64 Index No.</u>
551	200 - 400	80 - 90	Miscellaneous Debris	-	Not retained	9631
552	200 - 400	80 - 90	Miscellaneous Debris	-	Not retained	9632
553	200 - 400	80 - 90	Miscellaneous Debris	-	Not retained	9633
554	200 - 400	80 - 90	Miscellaneous Debris	-	Not retained	9634
555	200 - 400	80 - 90	Miscellaneous Debris	-	Not retained	9635
556	200 - 400	80 - 90	Miscellaneous Debris	-	Not retained	9636
557	200 - 400	80 - 90	Intact Warhead	-	Not retained	9004
558	200 - 400	90 - 100	Warhead Body Piece	0.31		289
559	200 - 400	90 - 100	Warhead Body Piece	0.16		290
560	200 - 400	90 - 100	Warhead Body Piece	0.12		291
561	200 - 400	90 - 100	Warhead Body Piece	0.16		292
562	200 - 400	90 - 100	Warhead Body Piece	0.11		293
563	200 - 400	90 - 100	Warhead Body Piece	0.06		294
564	200 - 400	90 - 100	Warhead Body Piece	0.05		295
565	200 - 400	90 - 100	Warhead Body Piece	0.02		296
566	200 - 400	90 - 100	Warhead Body Piece	0.01		297
567	200 - 400	90 - 100	Tail Piece	-	Not retained	288
568	200 - 400	90 - 100	Tail Piece	0.02		298
569	200 - 400	90 - 100	Tail Piece	-	Not retained	9088
570	200 - 400	90 - 100	Tail Piece	-	Not retained	9089
571	200 - 400	90 - 100	Miscellaneous Debris	0.02		299
572	200 - 400	90 - 100	Miscellaneous Debris	-	Not retained	9637
573	200 - 400	90 - 100	Miscellaneous Debris	-	Not retained	9638
574	200 - 400	90 - 100	Miscellaneous Debris	-	Not retained	9639
575	200 - 400	90 - 100	Miscellaneous Debris	-	Not retained	9640
576	200 - 400	90 - 100	Miscellaneous Debris	-	Not retained	9641
577	200 - 400	90 - 100	Miscellaneous Debris	-	Not retained	9642
578	200 - 400	90 - 100	Miscellaneous Debris	-	Not retained	9643
579	200 - 400	90 - 100	Miscellaneous Debris	-	Not retained	9644
580	200 - 400	90 - 100	Miscellaneous Debris	-	Not retained	9645
581	200 - 400	90 - 100	Miscellaneous Debris	-	Not retained	9646
582	200 - 400	90 - 100	Miscellaneous Debris	-	Not retained	9647
583	200 - 400	90 - 100	Miscellaneous Debris	-	Not retained	9648
584	200 - 400	90 - 100	Miscellaneous Debris	-	Not retained	9649
585	200 - 400	90 - 100	Miscellaneous Debris	-	Not retained	9650
586	200 - 400	90 - 100	Miscellaneous Debris	-	Not retained	9651
587	200 - 400	90 - 100	Miscellaneous Debris	-	Not retained	9652
588	200 - 400	90 - 100	Miscellaneous Debris	-	Not retained	9653
589	200 - 400	90 - 100	Miscellaneous Debris	-	Not retained	9654
590	200 - 400	90 - 100	Miscellaneous Debris	-	Not retained	9655
591	200 - 400	90 - 100	Miscellaneous Debris	-	Not retained	9656
592	200 - 400	90 - 100	Miscellaneous Debris	-	Not retained	9657
593	200 - 400	90 - 100	Miscellaneous Debris	-	Not retained	9658
594	200 - 400	90 - 100	Miscellaneous Debris	-	Not retained	9659
595	200 - 400	90 - 100	Miscellaneous Debris	-	Not retained	9660
596	200 - 400	90 - 100	Miscellaneous Debris	-	Not retained	9661
597	200 - 400	100 - 110	Warhead Body Piece	0.50		180
598	200 - 400	100 - 110	Warhead Body Piece	0.50		181
599	200 - 400	100 - 110	Warhead Body Piece	0.50		182
600	200 - 400	100 - 110	Warhead Body Piece	0.86		183

NSWCDD/TR-98/6

TABLE B-12. FRAGMENTS RECOVERED BEYOND 200-FT RANGE IN TEST NO. 12 (Continued)

<u>Entry</u>	<u>Range Interval (ft)</u>	<u>Azimuthal Sector (°)</u>	<u>Description</u>	<u>Mass (lb)</u>	<u>Notes</u>	<u>G64 Index No.</u>
601	200 - 400	100 - 110	Warhead Body Piece	0.44		184
602	200 - 400	100 - 110	Warhead Body Piece	0.30		185
603	200 - 400	100 - 110	Warhead Body Piece	0.03		186
604	200 - 400	100 - 110	Warhead Body Piece	0.03		187
605	200 - 400	100 - 110	Warhead Body Piece	0.02		188
606	200 - 400	100 - 110	Warhead Body Piece	0.02		189
607	200 - 400	100 - 110	Tail Piece	-	Not retained	9090
608	200 - 400	100 - 110	Miscellaneous Debris	0.01		190
609	200 - 400	100 - 110	Miscellaneous Debris	-	Not retained	9662
610	200 - 400	100 - 110	Miscellaneous Debris	-	Not retained	9663
611	200 - 400	100 - 110	Miscellaneous Debris	-	Not retained	9664
612	200 - 400	100 - 110	Miscellaneous Debris	-	Not retained	9665
613	200 - 400	100 - 110	Miscellaneous Debris	-	Not retained	9666
614	200 - 400	100 - 110	Miscellaneous Debris	-	Not retained	9667
615	200 - 400	100 - 110	Miscellaneous Debris	-	Not retained	9668
616	200 - 400	100 - 110	Miscellaneous Debris	-	Not retained	9669
617	200 - 400	100 - 110	Miscellaneous Debris	-	Not retained	9670
618	200 - 400	100 - 110	Miscellaneous Debris	-	Not retained	9671
619	200 - 400	100 - 110	Miscellaneous Debris	-	Not retained	9672
620	200 - 400	100 - 110	Miscellaneous Debris	-	Not retained	9673
621	200 - 400	100 - 110	Miscellaneous Debris	-	Not retained	9674
622	200 - 400	100 - 110	Miscellaneous Debris	-	Not retained	9675
623	200 - 400	100 - 110	Miscellaneous Debris	-	Not retained	9676
624	200 - 400	100 - 110	Miscellaneous Debris	-	Not retained	9677
625	200 - 400	100 - 110	Miscellaneous Debris	-	Not retained	9678
626	200 - 400	100 - 110	Miscellaneous Debris	-	Not retained	9679
627	200 - 400	100 - 110	Miscellaneous Debris	-	Not retained	9680
628	200 - 400	100 - 110	Miscellaneous Debris	-	Not retained	9681
629	200 - 400	100 - 110	Miscellaneous Debris	-	Not retained	9682
630	200 - 400	100 - 110	Miscellaneous Debris	-	Not retained	9683
631	200 - 400	100 - 110	Miscellaneous Debris	-	Not retained	9684
632	200 - 400	110 - 120	Warhead Body Piece	0.50		448
633	200 - 400	110 - 120	Warhead Body Piece	0.48		449
634	200 - 400	110 - 120	Warhead Body Piece	0.16		450
635	200 - 400	110 - 120	Warhead Body Piece	0.16		451
636	200 - 400	110 - 120	Warhead Body Piece	0.07		452
637	200 - 400	110 - 120	Tail Piece	0.17		453
638	200 - 400	110 - 120	Tail Piece	-	Not retained	9091
639	200 - 400	110 - 120	Tail Piece	-	Not retained	9092
640	200 - 400	110 - 120	Tail Piece	-	Not retained	9093
641	200 - 400	110 - 120	Tail Piece	-	Not retained	9094
642	200 - 400	110 - 120	Tail Piece	-	Not retained	9095
643	200 - 400	110 - 120	Tail Piece	-	Not retained	9096
644	200 - 400	110 - 120	Miscellaneous Debris	0.04		454
645	200 - 400	110 - 120	Miscellaneous Debris	0.02		455
646	200 - 400	110 - 120	Miscellaneous Debris	0.01		456
647	200 - 400	110 - 120	Miscellaneous Debris	0.01		457
648	200 - 400	110 - 120	Miscellaneous Debris	-	Not retained	9685
649	200 - 400	110 - 120	Miscellaneous Debris	-	Not retained	9686
650	200 - 400	110 - 120	Miscellaneous Debris	-	Not retained	9687

NSWCDD/TR-98/6

TABLE B-12. FRAGMENTS RECOVERED BEYOND 200-FT RANGE IN TEST NO. 12 (Continued)

<u>Entry</u>	<u>Range Interval (ft)</u>	<u>Azimuthal Sector (°)</u>	<u>Description</u>	<u>Mass (lb)</u>	<u>Notes</u>	<u>G64 Index No.</u>
651	200 - 400	110 - 120	Miscellaneous Debris	-	Not retained	9688
652	200 - 400	110 - 120	Miscellaneous Debris	-	Not retained	9689
653	200 - 400	110 - 120	Miscellaneous Debris	-	Not retained	9690
654	200 - 400	110 - 120	Miscellaneous Debris	-	Not retained	9691
655	200 - 400	110 - 120	Miscellaneous Debris	-	Not retained	9692
656	200 - 400	110 - 120	Miscellaneous Debris	-	Not retained	9693
657	200 - 400	110 - 120	Miscellaneous Debris	-	Not retained	9694
658	200 - 400	110 - 120	Miscellaneous Debris	-	Not retained	9695
659	200 - 400	110 - 120	Miscellaneous Debris	-	Not retained	9696
660	200 - 400	110 - 120	Miscellaneous Debris	-	Not retained	9697
661	200 - 400	110 - 120	Miscellaneous Debris	-	Not retained	9698
662	200 - 400	110 - 120	Miscellaneous Debris	-	Not retained	9699
663	200 - 400	110 - 120	Miscellaneous Debris	-	Not retained	9700
664	200 - 400	110 - 120	Miscellaneous Debris	-	Not retained	9701
665	200 - 400	110 - 120	Miscellaneous Debris	-	Not retained	9702
666	200 - 400	110 - 120	Miscellaneous Debris	-	Not retained	9703
667	200 - 400	110 - 120	Miscellaneous Debris	-	Not retained	9704
668	200 - 400	110 - 120	Miscellaneous Debris	-	Not retained	9705
669	200 - 400	110 - 120	Intact Warhead	-	Not retained	9005
670	200 - 400	110 - 120	Intact Warhead	-	Not retained	9006
671	200 - 400	120 - 130	Warhead Body Piece	0.50		466
672	200 - 400	120 - 130	Warhead Body Piece	0.50		467
673	200 - 400	120 - 130	Warhead Body Piece	0.35		468
674	200 - 400	120 - 130	Warhead Body Piece	0.21		469
675	200 - 400	120 - 130	Warhead Body Piece	0.26		470
676	200 - 400	120 - 130	Warhead Body Piece	0.04		471
677	200 - 400	120 - 130	Warhead Body Piece	0.06		472
678	200 - 400	120 - 130	Miscellaneous Debris	-	Not retained	9706
679	200 - 400	120 - 130	Miscellaneous Debris	-	Not retained	9707
680	200 - 400	120 - 130	Miscellaneous Debris	-	Not retained	9708
681	200 - 400	120 - 130	Miscellaneous Debris	-	Not retained	9709
682	200 - 400	120 - 130	Miscellaneous Debris	-	Not retained	9710
683	200 - 400	120 - 130	Miscellaneous Debris	-	Not retained	9711
684	200 - 400	120 - 130	Miscellaneous Debris	-	Not retained	9712
685	200 - 400	120 - 130	Miscellaneous Debris	-	Not retained	9713
686	200 - 400	120 - 130	Miscellaneous Debris	-	Not retained	9714
687	200 - 400	120 - 130	Miscellaneous Debris	-	Not retained	9715
688	200 - 400	120 - 130	Miscellaneous Debris	-	Not retained	9716
689	200 - 400	120 - 130	Miscellaneous Debris	-	Not retained	9717
690	200 - 400	130 - 140	Warhead Body Piece	0.50		330
691	200 - 400	130 - 140	Warhead Body Piece	0.34		331
692	200 - 400	130 - 140	Warhead Body Piece	0.10		332
693	200 - 400	130 - 140	Warhead Body Piece	0.02		333
694	200 - 400	130 - 140	Tail Piece	0.02		335
695	200 - 400	130 - 140	Tail Piece	0.02		336
696	200 - 400	130 - 140	Tail Piece	-	Not retained	9097
697	200 - 400	130 - 140	Tail Piece	-	Not retained	9098
698	200 - 400	130 - 140	Tail Piece	-	Not retained	9099
699	200 - 400	130 - 140	Miscellaneous Debris	0.01		334
700	200 - 400	130 - 140	Miscellaneous Debris	-	Not retained	9718

NSWCDD/TR-98/6

TABLE B-12. FRAGMENTS RECOVERED BEYOND 200-FT RANGE IN TEST NO. 12 (Continued)

<u>Entry</u>	<u>Range Interval (ft)</u>	<u>Azimuthal Sector (°)</u>	<u>Description</u>	<u>Mass (lb)</u>	<u>Notes</u>	<u>G64 Index No.</u>
701	200 - 400	130 - 140	Miscellaneous Debris	-	Not retained	9719
702	200 - 400	130 - 140	Miscellaneous Debris	-	Not retained	9720
703	200 - 400	130 - 140	Miscellaneous Debris	-	Not retained	9721
704	200 - 400	130 - 140	Miscellaneous Debris	-	Not retained	9722
705	200 - 400	130 - 140	Miscellaneous Debris	-	Not retained	9723
706	200 - 400	130 - 140	Miscellaneous Debris	-	Not retained	9724
707	200 - 400	130 - 140	Miscellaneous Debris	-	Not retained	9725
708	200 - 400	130 - 140	Miscellaneous Debris	-	Not retained	9726
709	200 - 400	130 - 140	Miscellaneous Debris	-	Not retained	9727
710	200 - 400	130 - 140	Miscellaneous Debris	-	Not retained	9728
711	200 - 400	130 - 140	Miscellaneous Debris	-	Not retained	9729
712	200 - 400	140 - 150	Warhead Body Piece	0.50		204
713	200 - 400	140 - 150	Warhead Body Piece	0.50		205
714	200 - 400	140 - 150	Warhead Body Piece	0.44		206
715	200 - 400	140 - 150	Warhead Body Piece	0.31		207
716	200 - 400	140 - 150	Warhead Body Piece	0.19		208
717	200 - 400	140 - 150	Warhead Body Piece	0.16		209
718	200 - 400	140 - 150	Warhead Body Piece	0.07		210
719	200 - 400	140 - 150	Warhead Body Piece	0.04		211
720	200 - 400	140 - 150	Warhead Body Piece	0.05		212
721	200 - 400	140 - 150	Warhead Body Piece	0.05		213
722	200 - 400	140 - 150	Tail Piece	0.02		214
723	200 - 400	140 - 150	Tail Piece	-	Not retained	9100
724	200 - 400	140 - 150	Miscellaneous Debris	0.01		215
725	200 - 400	140 - 150	Miscellaneous Debris	-	Not retained	9730
726	200 - 400	140 - 150	Miscellaneous Debris	-	Not retained	9731
727	200 - 400	140 - 150	Miscellaneous Debris	-	Not retained	9732
728	200 - 400	140 - 150	Miscellaneous Debris	-	Not retained	9733
729	200 - 400	140 - 150	Miscellaneous Debris	-	Not retained	9734
730	200 - 400	140 - 150	Miscellaneous Debris	-	Not retained	9735
731	200 - 400	140 - 150	Miscellaneous Debris	-	Not retained	9736
732	200 - 400	140 - 150	Miscellaneous Debris	-	Not retained	9737
733	200 - 400	140 - 150	Miscellaneous Debris	-	Not retained	9738
734	200 - 400	150 - 160	Warhead Body Piece	0.34		698
735	200 - 400	150 - 160	Warhead Body Piece	0.34		699
736	200 - 400	150 - 160	Warhead Body Piece	0.28		700
737	200 - 400	150 - 160	Warhead Body Piece	0.13		701
738	200 - 400	150 - 160	Warhead Body Piece	0.09		702
739	200 - 400	150 - 160	Warhead Body Piece	0.04		703
740	200 - 400	150 - 160	Warhead Body Piece	0.03		704
741	200 - 400	150 - 160	Tail Piece	0.02		705
742	200 - 400	150 - 160	Tail Piece	-	Not retained	9101
743	200 - 400	150 - 160	Tail Piece	-	Not retained	9102
744	200 - 400	150 - 160	Tail Piece	-	Not retained	9103
745	200 - 400	150 - 160	Tail Piece	-	Not retained	9104
746	200 - 400	150 - 160	Tail Piece	-	Not retained	9105
747	200 - 400	150 - 160	Miscellaneous Debris	0.01		706
748	200 - 400	150 - 160	Miscellaneous Debris	0.01		707
749	200 - 400	150 - 160	Miscellaneous Debris	0.01		708
750	200 - 400	150 - 160	Miscellaneous Debris	0.01		709

TABLE B-12. FRAGMENTS RECOVERED BEYOND 200-FT RANGE IN TEST NO. 12 (Continued)

<u>Entry</u>	<u>Range Interval (ft)</u>	<u>Azimuthal Sector (°)</u>	<u>Description</u>	<u>Mass (lb)</u>	<u>Notes</u>	<u>G64 Index No.</u>
751	200 - 400	150 - 160	Miscellaneous Debris	-	Not retained	9739
752	200 - 400	150 - 160	Miscellaneous Debris	-	Not retained	9740
753	200 - 400	150 - 160	Miscellaneous Debris	-	Not retained	9741
754	200 - 400	150 - 160	Miscellaneous Debris	-	Not retained	9742
755	200 - 400	150 - 160	Miscellaneous Debris	-	Not retained	9743
756	200 - 400	150 - 160	Miscellaneous Debris	-	Not retained	9744
757	200 - 400	150 - 160	Miscellaneous Debris	-	Not retained	9745
758	200 - 400	150 - 160	Miscellaneous Debris	-	Not retained	9746
759	200 - 400	150 - 160	Miscellaneous Debris	-	Not retained	9747
760	200 - 400	150 - 160	Miscellaneous Debris	-	Not retained	9748
761	200 - 400	150 - 160	Miscellaneous Debris	-	Not retained	9749
762	200 - 400	150 - 160	Miscellaneous Debris	-	Not retained	9750
763	200 - 400	150 - 160	Miscellaneous Debris	-	Not retained	9751
764	200 - 400	150 - 160	Miscellaneous Debris	-	Not retained	9752
765	200 - 400	150 - 160	Miscellaneous Debris	-	Not retained	9753
766	200 - 400	150 - 160	Miscellaneous Debris	-	Not retained	9754
767	200 - 400	150 - 160	Miscellaneous Debris	-	Not retained	9755
768	200 - 400	160 - 170	Warhead Body Piece	0.68		1431
769	200 - 400	160 - 170	Warhead Body Piece	0.48		1432
770	200 - 400	160 - 170	Warhead Body Piece	0.12		1433
771	200 - 400	160 - 170	Warhead Body Piece	0.15		1434
772	200 - 400	160 - 170	Warhead Body Piece	0.15		1435
773	200 - 400	160 - 170	Warhead Body Piece	0.02		1436
774	200 - 400	160 - 170	Warhead Body Piece	0.02		1437
775	200 - 400	160 - 170	Tail Piece	0.14		1438
776	200 - 400	160 - 170	Tail Piece	-	Not retained	9106
777	200 - 400	160 - 170	Tail Piece	-	Not retained	9107
778	200 - 400	160 - 170	Tail Piece	-	Not retained	9108
779	200 - 400	160 - 170	Miscellaneous Debris	0.01		1439
780	200 - 400	160 - 170	Miscellaneous Debris	0.01		1440
781	200 - 400	160 - 170	Miscellaneous Debris	-	Not retained	9756
782	200 - 400	160 - 170	Miscellaneous Debris	-	Not retained	9757
783	200 - 400	160 - 170	Miscellaneous Debris	-	Not retained	9758
784	200 - 400	160 - 170	Miscellaneous Debris	-	Not retained	9759
785	200 - 400	160 - 170	Miscellaneous Debris	-	Not retained	9760
786	200 - 400	170 - 180	Warhead Body Piece	0.09		250
787	200 - 400	170 - 180	Warhead Body Piece	0.08		251
788	200 - 400	170 - 180	Warhead Body Piece	0.05		252
789	200 - 400	170 - 180	Warhead Body Piece	0.02		253
790	200 - 400	170 - 180	Warhead Body Piece	0.02		254
791	200 - 400	170 - 180	Warhead Body Piece	0.01		255
792	200 - 400	170 - 180	Tail Piece	0.05		256
793	200 - 400	170 - 180	Tail Piece	-	Not retained	9109
794	200 - 400	170 - 180	Tail Piece	-	Not retained	9110
795	200 - 400	170 - 180	Miscellaneous Debris	0.01		257
796	200 - 400	170 - 180	Miscellaneous Debris	-	Not retained	9761
797	200 - 400	170 - 180	Miscellaneous Debris	-	Not retained	9762
798	200 - 400	170 - 180	Miscellaneous Debris	-	Not retained	9763
799	200 - 400	170 - 180	Miscellaneous Debris	-	Not retained	9764
800	200 - 400	170 - 180	Miscellaneous Debris	-	Not retained	9765

TABLE B-12. FRAGMENTS RECOVERED BEYOND 200-FT RANGE IN TEST NO. 12 (Continued)

<u>Entry</u>	<u>Range Interval (ft)</u>	<u>Azimuthal Sector (°)</u>	<u>Description</u>	<u>Mass (lb)</u>	<u>Notes</u>	<u>G64 Index No.</u>
801	200 - 400	170 - 180	Miscellaneous Debris	-	Not retained	9766
802	200 - 400	170 - 180	Miscellaneous Debris	-	Not retained	9767
803	200 - 400	170 - 180	Miscellaneous Debris	-	Not retained	9768
804	200 - 400	170 - 180	Miscellaneous Debris	-	Not retained	9769
805	200 - 400	180 - 190	Warhead Body Piece	0.14		1299
806	200 - 400	180 - 190	Warhead Body Piece	0.01		1300
807	200 - 400	180 - 190	Miscellaneous Debris	-	Not retained	9770
808	200 - 400	180 - 190	Miscellaneous Debris	-	Not retained	9771
809	200 - 400	180 - 190	Miscellaneous Debris	-	Not retained	9772
810	200 - 400	180 - 190	Miscellaneous Debris	-	Not retained	9773
811	200 - 400	180 - 190	Miscellaneous Debris	-	Not retained	9774
812	200 - 400	180 - 190	Miscellaneous Debris	-	Not retained	9775
813	200 - 400	180 - 190	Miscellaneous Debris	-	Not retained	9776
814	200 - 400	180 - 190	Intact Warhead	-	Not retained	9007
815	200 - 400	190 - 200	Warhead Body Piece	0.21		751
816	200 - 400	190 - 200	Warhead Body Piece	0.10		752
817	200 - 400	190 - 200	Warhead Body Piece	0.07		753
818	200 - 400	190 - 200	Warhead Body Piece	0.04		754
819	200 - 400	190 - 200	Warhead Body Piece	0.03		755
820	200 - 400	190 - 200	Tail Piece	-	Not retained	9111
821	200 - 400	190 - 200	Tail Piece	-	Not retained	9112
822	200 - 400	190 - 200	Miscellaneous Debris	0.01		749
823	200 - 400	190 - 200	Miscellaneous Debris	0.01		750
824	200 - 400	190 - 200	Miscellaneous Debris	-	Not retained	9777
825	200 - 400	190 - 200	Miscellaneous Debris	-	Not retained	9778
826	200 - 400	190 - 200	Miscellaneous Debris	-	Not retained	9779
827	200 - 400	190 - 200	Miscellaneous Debris	-	Not retained	9780
828	200 - 400	190 - 200	Miscellaneous Debris	-	Not retained	9781
829	200 - 400	190 - 200	Miscellaneous Debris	-	Not retained	9782
830	200 - 400	190 - 200	Miscellaneous Debris	-	Not retained	9783
831	200 - 400	190 - 200	Miscellaneous Debris	-	Not retained	9784
832	200 - 400	190 - 200	Miscellaneous Debris	-	Not retained	9785
833	200 - 400	190 - 200	Miscellaneous Debris	-	Not retained	9786
834	200 - 400	190 - 200	Miscellaneous Debris	-	Not retained	9787
835	200 - 400	190 - 200	Miscellaneous Debris	-	Not retained	9788
836	200 - 400	190 - 200	Miscellaneous Debris	-	Not retained	9789
837	200 - 400	200 - 210	Warhead Body Piece	0.34		1283
838	200 - 400	200 - 210	Warhead Body Piece	0.37		1284
839	200 - 400	200 - 210	Warhead Body Piece	0.34		1285
840	200 - 400	200 - 210	Warhead Body Piece	0.16		1286
841	200 - 400	200 - 210	Warhead Body Piece	0.11		1287
842	200 - 400	200 - 210	Warhead Body Piece	0.07		1288
843	200 - 400	200 - 210	Warhead Body Piece	0.01		1289
844	200 - 400	200 - 210	Warhead Body Piece	0.01		1290
845	200 - 400	200 - 210	Warhead Body Piece	0.01		1291
846	200 - 400	200 - 210	Warhead Body Piece	0.01		1292
847	200 - 400	200 - 210	Warhead Body Piece	0.01		1293
848	200 - 400	200 - 210	Warhead Body Piece	0.01		1294
849	200 - 400	200 - 210	Tail Piece	-	Not retained	1282
850	200 - 400	200 - 210	Tail Piece	-	Not retained	9113

NSWCDD/TR-98/6

TABLE B-12. FRAGMENTS RECOVERED BEYOND 200-FT RANGE IN TEST NO. 12 (Continued)

<u>Entry</u>	<u>Range Interval (ft)</u>	<u>Azimuthal Sector (°)</u>	<u>Description</u>	<u>Mass (lb)</u>	<u>Notes</u>	<u>G64 Index No.</u>
851	200 - 400	200 - 210	Tail Piece	-	Not retained	9114
852	200 - 400	200 - 210	Tail Piece	-	Not retained	9115
853	200 - 400	200 - 210	Tail Piece	-	Not retained	9116
854	200 - 400	200 - 210	Tail Piece	-	Not retained	9117
855	200 - 400	200 - 210	Miscellaneous Debris	0.01		1295
856	200 - 400	200 - 210	Miscellaneous Debris	0.01		1296
857	200 - 400	200 - 210	Miscellaneous Debris	0.01		1297
858	200 - 400	200 - 210	Miscellaneous Debris	0.01		1298
859	200 - 400	200 - 210	Miscellaneous Debris	-	Not retained	9790
860	200 - 400	200 - 210	Miscellaneous Debris	-	Not retained	9791
861	200 - 400	200 - 210	Miscellaneous Debris	-	Not retained	9792
862	200 - 400	200 - 210	Miscellaneous Debris	-	Not retained	9793
863	200 - 400	200 - 210	Miscellaneous Debris	-	Not retained	9794
864	200 - 400	200 - 210	Miscellaneous Debris	-	Not retained	9795
865	200 - 400	200 - 210	Miscellaneous Debris	-	Not retained	9796
866	200 - 400	200 - 210	Miscellaneous Debris	-	Not retained	9797
867	200 - 400	200 - 210	Miscellaneous Debris	-	Not retained	9798
868	200 - 400	200 - 210	Miscellaneous Debris	-	Not retained	9799
869	200 - 400	200 - 210	Miscellaneous Debris	-	Not retained	9800
870	200 - 400	200 - 210	Miscellaneous Debris	-	Not retained	9801
871	200 - 400	200 - 210	Miscellaneous Debris	-	Not retained	9802
872	200 - 400	200 - 210	Miscellaneous Debris	-	Not retained	9803
873	200 - 400	200 - 210	Miscellaneous Debris	-	Not retained	9804
874	200 - 400	200 - 210	Miscellaneous Debris	-	Not retained	9805
875	200 - 400	200 - 210	Miscellaneous Debris	-	Not retained	9806
876	200 - 400	200 - 210	Miscellaneous Debris	-	Not retained	9807
877	200 - 400	200 - 210	Miscellaneous Debris	-	Not retained	9808
878	200 - 400	200 - 210	Miscellaneous Debris	-	Not retained	9809
879	200 - 400	200 - 210	Miscellaneous Debris	-	Not retained	9810
880	200 - 400	210 - 220	Warhead Body Piece	0.51		1370
881	200 - 400	210 - 220	Warhead Body Piece	0.30		1371
882	200 - 400	210 - 220	Warhead Body Piece	0.32		1372
883	200 - 400	210 - 220	Warhead Body Piece	0.15		1373
884	200 - 400	210 - 220	Warhead Body Piece	0.05		1374
885	200 - 400	210 - 220	Warhead Body Piece	0.12		1375
886	200 - 400	210 - 220	Warhead Body Piece	0.03		1376
887	200 - 400	210 - 220	Tail Piece	0.02		1377
888	200 - 400	210 - 220	Tail Piece	-	Not retained	9118
889	200 - 400	210 - 220	Tail Piece	-	Not retained	9119
890	200 - 400	210 - 220	Tail Piece	-	Not retained	9120
891	200 - 400	210 - 220	Tail Piece	-	Not retained	9121
892	200 - 400	210 - 220	Tail Piece	-	Not retained	9122
893	200 - 400	210 - 220	Tail Piece	-	Not retained	9123
894	200 - 400	210 - 220	Miscellaneous Debris	0.01		1378
895	200 - 400	210 - 220	Miscellaneous Debris	0.01		1379
896	200 - 400	210 - 220	Miscellaneous Debris	0.01		1380
897	200 - 400	210 - 220	Miscellaneous Debris	-	Not retained	9811
898	200 - 400	210 - 220	Miscellaneous Debris	-	Not retained	9812
899	200 - 400	210 - 220	Miscellaneous Debris	-	Not retained	9813
900	200 - 400	210 - 220	Miscellaneous Debris	-	Not retained	9814

NSWCDD/TR-98/6

TABLE B-12. FRAGMENTS RECOVERED BEYOND 200-FT RANGE IN TEST NO. 12 (Continued)

<u>Entry</u>	<u>Range Interval (ft)</u>	<u>Azimuthal Sector (°)</u>	<u>Description</u>	<u>Mass (lb)</u>	<u>Notes</u>	<u>G64 Index No.</u>
901	200 - 400	210 - 220	Miscellaneous Debris	-	Not retained	9815
902	200 - 400	210 - 220	Miscellaneous Debris	-	Not retained	9816
903	200 - 400	210 - 220	Miscellaneous Debris	-	Not retained	9817
904	200 - 400	210 - 220	Miscellaneous Debris	-	Not retained	9818
905	200 - 400	210 - 220	Miscellaneous Debris	-	Not retained	9819
906	200 - 400	210 - 220	Miscellaneous Debris	-	Not retained	9820
907	200 - 400	210 - 220	Miscellaneous Debris	-	Not retained	9821
908	200 - 400	220 - 230	Warhead Body Piece	0.05		1345
909	200 - 400	220 - 230	Warhead Body Piece	0.01		1346
910	200 - 400	220 - 230	Tail Piece	0.05		1347
911	200 - 400	220 - 230	Tail Piece	-	Not retained	9124
912	200 - 400	220 - 230	Tail Piece	-	Not retained	9125
913	200 - 400	220 - 230	Miscellaneous Debris	0.01		1348
914	200 - 400	220 - 230	Miscellaneous Debris	-	Not retained	9822
915	200 - 400	220 - 230	Miscellaneous Debris	-	Not retained	9823
916	200 - 400	220 - 230	Miscellaneous Debris	-	Not retained	9824
917	200 - 400	220 - 230	Miscellaneous Debris	-	Not retained	9825
918	200 - 400	220 - 230	Miscellaneous Debris	-	Not retained	9826
919	200 - 400	220 - 230	Miscellaneous Debris	-	Not retained	9827
920	200 - 400	220 - 230	Miscellaneous Debris	-	Not retained	9828
921	200 - 400	220 - 230	Miscellaneous Debris	-	Not retained	9829
922	200 - 400	220 - 230	Miscellaneous Debris	-	Not retained	9830
923	200 - 400	220 - 230	Miscellaneous Debris	-	Not retained	9831
924	200 - 400	220 - 230	Miscellaneous Debris	-	Not retained	9832
925	200 - 400	220 - 230	Miscellaneous Debris	-	Not retained	9833
926	200 - 400	220 - 230	Miscellaneous Debris	-	Not retained	9834
927	200 - 400	220 - 230	Intact Warhead	-	Not retained	9008
928	200 - 400	230 - 240	Warhead Body Piece	0.50		1623
929	200 - 400	230 - 240	Warhead Body Piece	0.63		1624
930	200 - 400	230 - 240	Warhead Body Piece	0.10		1625
931	200 - 400	230 - 240	Warhead Body Piece	0.03		1626
932	200 - 400	230 - 240	Warhead Body Piece	0.02		1627
933	200 - 400	230 - 240	Warhead Body Piece	0.23		1628
934	200 - 400	230 - 240	Warhead Body Piece	0.01		1629
935	200 - 400	230 - 240	Warhead Body Piece	0.01		1630
936	200 - 400	230 - 240	Warhead Body Piece	0.01		1631
937	200 - 400	230 - 240	Tail Piece	0.02		1632
938	200 - 400	230 - 240	Tail Piece	-	Not retained	9126
939	200 - 400	230 - 240	Tail Piece	-	Not retained	9127
940	200 - 400	230 - 240	Tail Piece	-	Not retained	9128
941	200 - 400	230 - 240	Tail Piece	-	Not retained	9129
942	200 - 400	230 - 240	Miscellaneous Debris	0.01		1633
943	200 - 400	230 - 240	Miscellaneous Debris	0.01		1634
944	200 - 400	230 - 240	Miscellaneous Debris	0.01		1635
945	200 - 400	230 - 240	Miscellaneous Debris	-	Not retained	9835
946	200 - 400	230 - 240	Miscellaneous Debris	-	Not retained	9836
947	200 - 400	230 - 240	Miscellaneous Debris	-	Not retained	9837
948	200 - 400	230 - 240	Miscellaneous Debris	-	Not retained	9838
949	200 - 400	230 - 240	Miscellaneous Debris	-	Not retained	9839
950	200 - 400	230 - 240	Miscellaneous Debris	-	Not retained	9840

TABLE B-12. FRAGMENTS RECOVERED BEYOND 200-FT RANGE IN TEST NO. 12 (Continued)

<u>Entry</u>	<u>Range Interval (ft)</u>	<u>Azimuthal Sector (°)</u>	<u>Description</u>	<u>Mass (lb)</u>	<u>Notes</u>	<u>G64 Index No.</u>
951	200 - 400	230 - 240	Miscellaneous Debris	-	Not retained	9841
952	200 - 400	230 - 240	Miscellaneous Debris	-	Not retained	9842
953	200 - 400	230 - 240	Miscellaneous Debris	-	Not retained	9843
954	200 - 400	230 - 240	Miscellaneous Debris	-	Not retained	9844
955	200 - 400	230 - 240	Miscellaneous Debris	-	Not retained	9845
956	200 - 400	230 - 240	Miscellaneous Debris	-	Not retained	9846
957	200 - 400	230 - 240	Miscellaneous Debris	-	Not retained	9847
958	200 - 400	230 - 240	Miscellaneous Debris	-	Not retained	9848
959	200 - 400	230 - 240	Miscellaneous Debris	-	Not retained	9849
960	200 - 400	230 - 240	Miscellaneous Debris	-	Not retained	9850
961	200 - 400	230 - 240	Miscellaneous Debris	-	Not retained	9851
962	200 - 400	230 - 240	Miscellaneous Debris	-	Not retained	9852
963	200 - 400	230 - 240	Miscellaneous Debris	-	Not retained	9853
964	200 - 400	230 - 240	Miscellaneous Debris	-	Not retained	9854
965	200 - 400	230 - 240	Miscellaneous Debris	-	Not retained	9855
966	200 - 400	230 - 240	Miscellaneous Debris	-	Not retained	9856
967	200 - 400	240 - 250	Warhead Body Piece	1.57		473
968	200 - 400	240 - 250	Warhead Body Piece	0.26		474
969	200 - 400	240 - 250	Warhead Body Piece	0.07		475
970	200 - 400	240 - 250	Warhead Body Piece	0.08		476
971	200 - 400	240 - 250	Warhead Body Piece	0.07		477
972	200 - 400	240 - 250	Warhead Body Piece	0.01		478
973	200 - 400	240 - 250	Warhead Body Piece	0.01		479
974	200 - 400	240 - 250	Warhead Body Piece	0.01		480
975	200 - 400	240 - 250	Warhead Body Piece	0.01		481
976	200 - 400	240 - 250	Tail Piece	0.16		482
977	200 - 400	240 - 250	Tail Piece	0.03		483
978	200 - 400	240 - 250	Tail Piece	0.01		484
979	200 - 400	240 - 250	Tail Piece	-	Not retained	9130
980	200 - 400	240 - 250	Tail Piece	-	Not retained	9131
981	200 - 400	240 - 250	Tail Piece	-	Not retained	9132
982	200 - 400	240 - 250	Tail Piece	-	Not retained	9133
983	200 - 400	240 - 250	Tail Piece	-	Not retained	9134
984	200 - 400	240 - 250	Tail Piece	-	Not retained	9135
985	200 - 400	240 - 250	Tail Piece	-	Not retained	9136
986	200 - 400	240 - 250	Miscellaneous Debris	0.01		485
987	200 - 400	240 - 250	Miscellaneous Debris	0.01		486
988	200 - 400	240 - 250	Miscellaneous Debris	0.01		487
989	200 - 400	240 - 250	Miscellaneous Debris	0.01		488
990	200 - 400	240 - 250	Miscellaneous Debris	-	Not retained	9857
991	200 - 400	240 - 250	Miscellaneous Debris	-	Not retained	9858
992	200 - 400	240 - 250	Miscellaneous Debris	-	Not retained	9859
993	200 - 400	240 - 250	Miscellaneous Debris	-	Not retained	9860
994	200 - 400	240 - 250	Miscellaneous Debris	-	Not retained	9861
995	200 - 400	240 - 250	Miscellaneous Debris	-	Not retained	9862
996	200 - 400	240 - 250	Miscellaneous Debris	-	Not retained	9863
997	200 - 400	240 - 250	Miscellaneous Debris	-	Not retained	9864
998	200 - 400	240 - 250	Miscellaneous Debris	-	Not retained	9865
999	200 - 400	240 - 250	Miscellaneous Debris	-	Not retained	9866
1000	200 - 400	240 - 250	Miscellaneous Debris	-	Not retained	9867

NSWCDD/TR-98/6

TABLE B-12. FRAGMENTS RECOVERED BEYOND 200-FT RANGE IN TEST NO. 12 (Continued)

<u>Entry</u>	<u>Range Interval (ft)</u>	<u>Azimuthal Sector (°)</u>	<u>Description</u>	<u>Mass (lb)</u>	<u>Notes</u>	<u>G64 Index No.</u>
1001	200 - 400	240 - 250	Miscellaneous Debris	-	Not retained	9868
1002	200 - 400	240 - 250	Miscellaneous Debris	-	Not retained	9869
1003	200 - 400	240 - 250	Miscellaneous Debris	-	Not retained	9870
1004	200 - 400	240 - 250	Miscellaneous Debris	-	Not retained	9871
1005	200 - 400	240 - 250	Intact Warhead	-	Not retained	9009
1006	200 - 400	250 - 260	Warhead Body Piece	0.59		88
1007	200 - 400	250 - 260	Warhead Body Piece	0.26		89
1008	200 - 400	250 - 260	Warhead Body Piece	0.13		90
1009	200 - 400	250 - 260	Warhead Body Piece	0.06		91
1010	200 - 400	250 - 260	Warhead Body Piece	0.02		92
1011	200 - 400	250 - 260	Tail Piece	-	Not retained	87
1012	200 - 400	250 - 260	Tail Piece	0.40		93
1013	200 - 400	250 - 260	Tail Piece	-	Not retained	9137
1014	200 - 400	250 - 260	Tail Piece	-	Not retained	9138
1015	200 - 400	250 - 260	Tail Piece	-	Not retained	9139
1016	200 - 400	250 - 260	Tail Piece	-	Not retained	9140
1017	200 - 400	250 - 260	Tail Piece	-	Not retained	9141
1018	200 - 400	250 - 260	Tail Piece	-	Not retained	9142
1019	200 - 400	250 - 260	Tail Piece	-	Not retained	9143
1020	200 - 400	250 - 260	Tail Piece	-	Not retained	9144
1021	200 - 400	250 - 260	Miscellaneous Debris	0.02		94
1022	200 - 400	250 - 260	Miscellaneous Debris	0.01		95
1023	200 - 400	250 - 260	Miscellaneous Debris	0.01		96
1024	200 - 400	250 - 260	Miscellaneous Debris	0.01		97
1025	200 - 400	250 - 260	Miscellaneous Debris	0.01		98
1026	200 - 400	250 - 260	Miscellaneous Debris	-	Not retained	9872
1027	200 - 400	250 - 260	Miscellaneous Debris	-	Not retained	9873
1028	200 - 400	250 - 260	Miscellaneous Debris	-	Not retained	9874
1029	200 - 400	250 - 260	Miscellaneous Debris	-	Not retained	9875
1030	200 - 400	250 - 260	Miscellaneous Debris	-	Not retained	9876
1031	200 - 400	250 - 260	Miscellaneous Debris	-	Not retained	9877
1032	200 - 400	250 - 260	Miscellaneous Debris	-	Not retained	9878
1033	200 - 400	250 - 260	Miscellaneous Debris	-	Not retained	9879
1034	200 - 400	250 - 260	Miscellaneous Debris	-	Not retained	9880
1035	200 - 400	250 - 260	Miscellaneous Debris	-	Not retained	9881
1036	200 - 400	250 - 260	Miscellaneous Debris	-	Not retained	9882
1037	200 - 400	250 - 260	Miscellaneous Debris	-	Not retained	9883
1038	200 - 400	250 - 260	Miscellaneous Debris	-	Not retained	9884
1039	200 - 400	250 - 260	Miscellaneous Debris	-	Not retained	9885
1040	200 - 400	250 - 260	Miscellaneous Debris	-	Not retained	9886
1041	200 - 400	250 - 260	Miscellaneous Debris	-	Not retained	9887
1042	200 - 400	250 - 260	Miscellaneous Debris	-	Not retained	9888
1043	200 - 400	250 - 260	Miscellaneous Debris	-	Not retained	9889
1044	200 - 400	250 - 260	Miscellaneous Debris	-	Not retained	9890
1045	200 - 400	250 - 260	Miscellaneous Debris	-	Not retained	9891
1046	200 - 400	250 - 260	Miscellaneous Debris	-	Not retained	9892
1047	200 - 400	250 - 260	Miscellaneous Debris	-	Not retained	9893
1048	200 - 400	250 - 260	Miscellaneous Debris	-	Not retained	9894
1049	200 - 400	250 - 260	Miscellaneous Debris	-	Not retained	9895
1050	200 - 400	250 - 260	Miscellaneous Debris	-	Not retained	9896

NSWCDD/TR-98/6

TABLE B-12. FRAGMENTS RECOVERED BEYOND 200-FT RANGE IN TEST NO. 12 (Continued)

<u>Entry</u>	<u>Range Interval (ft)</u>	<u>Azimuthal Sector (°)</u>	<u>Description</u>	<u>Mass (lb)</u>	<u>Notes</u>	<u>G64 Index No.</u>
1051	200 - 400	250 - 260	Miscellaneous Debris	-	Not retained	9897
1052	200 - 400	250 - 260	Miscellaneous Debris	-	Not retained	9898
1053	200 - 400	250 - 260	Miscellaneous Debris	-	Not retained	9899
1054	200 - 400	250 - 260	Miscellaneous Debris	-	Not retained	9900
1055	200 - 400	250 - 260	Miscellaneous Debris	-	Not retained	9901
1056	200 - 400	250 - 260	Miscellaneous Debris	-	Not retained	9902
1057	200 - 400	250 - 260	Miscellaneous Debris	-	Not retained	9903
1058	200 - 400	250 - 260	Miscellaneous Debris	-	Not retained	9904
1059	200 - 400	250 - 260	Miscellaneous Debris	-	Not retained	9905
1060	200 - 400	250 - 260	Miscellaneous Debris	-	Not retained	9906
1061	200 - 400	250 - 260	Miscellaneous Debris	-	Not retained	9907
1062	200 - 400	250 - 260	Intact Warhead	-	Not retained	9010
1063	200 - 400	260 - 270	Warhead Body Piece	0.50		605
1064	200 - 400	260 - 270	Warhead Body Piece	0.14		606
1065	200 - 400	260 - 270	Warhead Body Piece	0.03		607
1066	200 - 400	260 - 270	Warhead Body Piece	0.02		608
1067	200 - 400	260 - 270	Warhead Body Piece	0.01		609
1068	200 - 400	260 - 270	Warhead Body Piece	0.02		610
1069	200 - 400	260 - 270	Warhead Body Piece	0.01		611
1070	200 - 400	260 - 270	Warhead Body Piece	0.01		612
1071	200 - 400	260 - 270	Tail Piece	-	Not retained	9145
1072	200 - 400	260 - 270	Tail Piece	-	Not retained	9146
1073	200 - 400	260 - 270	Tail Piece	-	Not retained	9147
1074	200 - 400	260 - 270	Tail Piece	-	Not retained	9148
1075	200 - 400	260 - 270	Tail Piece	-	Not retained	9149
1076	200 - 400	260 - 270	Tail Piece	-	Not retained	9150
1077	200 - 400	260 - 270	Miscellaneous Debris	0.02		613
1078	200 - 400	260 - 270	Miscellaneous Debris	0.02		614
1079	200 - 400	260 - 270	Miscellaneous Debris	0.02		615
1080	200 - 400	260 - 270	Miscellaneous Debris	0.01		616
1081	200 - 400	260 - 270	Miscellaneous Debris	0.01		617
1082	200 - 400	260 - 270	Miscellaneous Debris	0.01		618
1083	200 - 400	260 - 270	Miscellaneous Debris	-	Not retained	9908
1084	200 - 400	260 - 270	Miscellaneous Debris	-	Not retained	9909
1085	200 - 400	260 - 270	Miscellaneous Debris	-	Not retained	9910
1086	200 - 400	260 - 270	Miscellaneous Debris	-	Not retained	9911
1087	200 - 400	260 - 270	Miscellaneous Debris	-	Not retained	9912
1088	200 - 400	260 - 270	Miscellaneous Debris	-	Not retained	9913
1089	200 - 400	260 - 270	Miscellaneous Debris	-	Not retained	9914
1090	200 - 400	260 - 270	Miscellaneous Debris	-	Not retained	9915
1091	200 - 400	260 - 270	Miscellaneous Debris	-	Not retained	9916
1092	200 - 400	260 - 270	Miscellaneous Debris	-	Not retained	9917
1093	200 - 400	260 - 270	Miscellaneous Debris	-	Not retained	9918
1094	200 - 400	260 - 270	Miscellaneous Debris	-	Not retained	9919
1095	200 - 400	260 - 270	Miscellaneous Debris	-	Not retained	9920
1096	200 - 400	260 - 270	Miscellaneous Debris	-	Not retained	9921
1097	200 - 400	260 - 270	Miscellaneous Debris	-	Not retained	9922
1098	200 - 400	260 - 270	Miscellaneous Debris	-	Not retained	9923
1099	200 - 400	260 - 270	Miscellaneous Debris	-	Not retained	9924
1100	200 - 400	260 - 270	Miscellaneous Debris	-	Not retained	9925

NSWCDD/TR-98/6

TABLE B-12. FRAGMENTS RECOVERED BEYOND 200-FT RANGE IN TEST NO. 12 (Continued)

<u>Entry</u>	<u>Range Interval (ft)</u>	<u>Azimuthal Sector (°)</u>	<u>Description</u>	<u>Mass (lb)</u>	<u>Notes</u>	<u>G64 Index No.</u>
1101	200 - 400	260 - 270	Miscellaneous Debris	-	Not retained	9926
1102	200 - 400	260 - 270	Miscellaneous Debris	-	Not retained	9927
1103	200 - 400	260 - 270	Miscellaneous Debris	-	Not retained	9928
1104	200 - 400	260 - 270	Miscellaneous Debris	-	Not retained	9929
1105	200 - 400	260 - 270	Miscellaneous Debris	-	Not retained	9930
1106	200 - 400	260 - 270	Miscellaneous Debris	-	Not retained	9931
1107	200 - 400	270 - 280	Warhead Body Piece	0.92		1381
1108	200 - 400	270 - 280	Warhead Body Piece	0.15		1382
1109	200 - 400	270 - 280	Warhead Body Piece	0.09		1383
1110	200 - 400	270 - 280	Warhead Body Piece	0.08		1384
1111	200 - 400	270 - 280	Warhead Body Piece	0.04		1385
1112	200 - 400	270 - 280	Warhead Body Piece	0.01		1386
1113	200 - 400	270 - 280	Warhead Body Piece	0.01		1387
1114	200 - 400	270 - 280	Warhead Body Piece	0.01		1388
1115	200 - 400	270 - 280	Warhead Body Piece	0.01		1389
1116	200 - 400	270 - 280	Warhead Body Piece	0.01		1390
1117	200 - 400	270 - 280	Tail Piece	0.04		1391
1118	200 - 400	270 - 280	Tail Piece	-	Not retained	9151
1119	200 - 400	270 - 280	Tail Piece	-	Not retained	9152
1120	200 - 400	270 - 280	Tail Piece	-	Not retained	9153
1121	200 - 400	270 - 280	Tail Piece	-	Not retained	9154
1122	200 - 400	270 - 280	Miscellaneous Debris	0.02		1392
1123	200 - 400	270 - 280	Miscellaneous Debris	0.02		1393
1124	200 - 400	270 - 280	Miscellaneous Debris	0.01		1394
1125	200 - 400	270 - 280	Miscellaneous Debris	-	Not retained	9932
1126	200 - 400	270 - 280	Miscellaneous Debris	-	Not retained	9933
1127	200 - 400	270 - 280	Miscellaneous Debris	-	Not retained	9934
1128	200 - 400	270 - 280	Miscellaneous Debris	-	Not retained	9935
1129	200 - 400	270 - 280	Miscellaneous Debris	-	Not retained	9936
1130	200 - 400	270 - 280	Miscellaneous Debris	-	Not retained	9937
1131	200 - 400	270 - 280	Miscellaneous Debris	-	Not retained	9938
1132	200 - 400	270 - 280	Miscellaneous Debris	-	Not retained	9939
1133	200 - 400	270 - 280	Miscellaneous Debris	-	Not retained	9940
1134	200 - 400	270 - 280	Miscellaneous Debris	-	Not retained	9941
1135	200 - 400	270 - 280	Miscellaneous Debris	-	Not retained	9942
1136	200 - 400	270 - 280	Miscellaneous Debris	-	Not retained	9943
1137	200 - 400	270 - 280	Miscellaneous Debris	-	Not retained	9944
1138	200 - 400	270 - 280	Miscellaneous Debris	-	Not retained	9945
1139	200 - 400	270 - 280	Miscellaneous Debris	-	Not retained	9946
1140	200 - 400	270 - 280	Miscellaneous Debris	-	Not retained	9947
1141	200 - 400	270 - 280	Miscellaneous Debris	-	Not retained	9948
1142	200 - 400	270 - 280	Miscellaneous Debris	-	Not retained	9949
1143	200 - 400	270 - 280	Miscellaneous Debris	-	Not retained	9950
1144	200 - 400	270 - 280	Miscellaneous Debris	-	Not retained	9951
1145	200 - 400	270 - 280	Intact Warhead	-	Not retained	9011
1146	200 - 400	270 - 280	Intact Warhead	-	Not retained	9012
1147	200 - 400	270 - 280	Intact Warhead	-	Not retained	9013
1148	200 - 400	280 - 290	Warhead Body Piece	0.02		1636
1149	200 - 400	280 - 290	Warhead Body Piece	0.04		1637
1150	200 - 400	280 - 290	Warhead Body Piece	0.04		1638

TABLE B-12. FRAGMENTS RECOVERED BEYOND 200-FT RANGE IN TEST NO. 12 (Continued)

<u>Entry</u>	<u>Range Interval (ft)</u>	<u>Azimuthal Sector (°)</u>	<u>Description</u>	<u>Mass (lb)</u>	<u>Notes</u>	<u>G64 Index No.</u>
1151	200 - 400	280 - 290	Miscellaneous Debris	-	Not retained	9952
1152	200 - 400	280 - 290	Miscellaneous Debris	-	Not retained	9953
1153	200 - 400	280 - 290	Miscellaneous Debris	-	Not retained	9954
1154	200 - 400	280 - 290	Miscellaneous Debris	-	Not retained	9955
1155	200 - 400	280 - 290	Miscellaneous Debris	-	Not retained	9956
1156	200 - 400	280 - 290	Miscellaneous Debris	-	Not retained	9957
1157	200 - 400	280 - 290	Miscellaneous Debris	-	Not retained	9958
1158	200 - 400	280 - 290	Miscellaneous Debris	-	Not retained	9959
1159	200 - 400	280 - 290	Miscellaneous Debris	-	Not retained	9960
1160	200 - 400	280 - 290	Miscellaneous Debris	-	Not retained	9961
1161	200 - 400	280 - 290	Miscellaneous Debris	-	Not retained	9962
1162	200 - 400	280 - 290	Miscellaneous Debris	-	Not retained	9963
1163	200 - 400	280 - 290	Miscellaneous Debris	-	Not retained	9964
1164	200 - 400	280 - 290	Miscellaneous Debris	-	Not retained	9965
1165	200 - 400	280 - 290	Miscellaneous Debris	-	Not retained	9966
1166	200 - 400	280 - 290	Miscellaneous Debris	-	Not retained	9967
1167	200 - 400	280 - 290	Miscellaneous Debris	-	Not retained	9968
1168	200 - 400	280 - 290	Miscellaneous Debris	-	Not retained	9969
1169	200 - 400	280 - 290	Miscellaneous Debris	-	Not retained	9970
1170	200 - 400	280 - 290	Miscellaneous Debris	-	Not retained	9971
1171	200 - 400	280 - 290	Miscellaneous Debris	-	Not retained	9972
1172	200 - 400	280 - 290	Miscellaneous Debris	-	Not retained	9973
1173	200 - 400	280 - 290	Miscellaneous Debris	-	Not retained	9974
1174	200 - 400	280 - 290	Miscellaneous Debris	-	Not retained	9975
1175	200 - 400	290 - 300	Warhead Body Piece	0.86		1552
1176	200 - 400	290 - 300	Warhead Body Piece	0.52		1553
1177	200 - 400	290 - 300	Warhead Body Piece	0.39		1554
1178	200 - 400	290 - 300	Warhead Body Piece	0.23		1555
1179	200 - 400	290 - 300	Warhead Body Piece	0.26		1556
1180	200 - 400	290 - 300	Warhead Body Piece	0.06		1557
1181	200 - 400	290 - 300	Warhead Body Piece	0.02		1558
1182	200 - 400	290 - 300	Warhead Body Piece	0.01		1559
1183	200 - 400	290 - 300	Warhead Body Piece	0.01		1560
1184	200 - 400	290 - 300	Warhead Body Piece	0.01		1561
1185	200 - 400	290 - 300	Warhead Body Piece	0.01		1562
1186	200 - 400	290 - 300	Warhead Body Piece	0.01		1563
1187	200 - 400	290 - 300	Warhead Body Piece	0.01		1564
1188	200 - 400	290 - 300	Tail Piece	0.18		1565
1189	200 - 400	290 - 300	Tail Piece	-	Not retained	9155
1190	200 - 400	290 - 300	Tail Piece	-	Not retained	9156
1191	200 - 400	290 - 300	Tail Piece	-	Not retained	9157
1192	200 - 400	290 - 300	Tail Piece	-	Not retained	9158
1193	200 - 400	290 - 300	Tail Piece	-	Not retained	9159
1194	200 - 400	290 - 300	Miscellaneous Debris	0.02		1566
1195	200 - 400	290 - 300	Miscellaneous Debris	0.01		1567
1196	200 - 400	290 - 300	Miscellaneous Debris	0.01		1568
1197	200 - 400	290 - 300	Miscellaneous Debris	0.01		1569
1198	200 - 400	290 - 300	Miscellaneous Debris	-	Not retained	9976
1199	200 - 400	290 - 300	Miscellaneous Debris	-	Not retained	9977
1200	200 - 400	290 - 300	Miscellaneous Debris	-	Not retained	9978

NSWCDD/TR-98/6

TABLE B-12. FRAGMENTS RECOVERED BEYOND 200-FT RANGE IN TEST NO. 12 (Continued)

<u>Entry</u>	<u>Range Interval (ft)</u>	<u>Azimuthal Sector (°)</u>	<u>Description</u>	<u>Mass (lb)</u>	<u>Notes</u>	<u>G64 Index No.</u>
1201	200 - 400	290 - 300	Miscellaneous Debris	-	Not retained	9979
1202	200 - 400	290 - 300	Miscellaneous Debris	-	Not retained	9980
1203	200 - 400	290 - 300	Miscellaneous Debris	-	Not retained	9981
1204	200 - 400	290 - 300	Miscellaneous Debris	-	Not retained	9982
1205	200 - 400	290 - 300	Miscellaneous Debris	-	Not retained	9983
1206	200 - 400	290 - 300	Miscellaneous Debris	-	Not retained	9984
1207	200 - 400	290 - 300	Miscellaneous Debris	-	Not retained	9985
1208	200 - 400	290 - 300	Miscellaneous Debris	-	Not retained	9986
1209	200 - 400	290 - 300	Miscellaneous Debris	-	Not retained	9987
1210	200 - 400	290 - 300	Miscellaneous Debris	-	Not retained	9988
1211	200 - 400	290 - 300	Miscellaneous Debris	-	Not retained	9989
1212	200 - 400	290 - 300	Miscellaneous Debris	-	Not retained	9990
1213	200 - 400	290 - 300	Miscellaneous Debris	-	Not retained	9991
1214	200 - 400	290 - 300	Miscellaneous Debris	-	Not retained	9992
1215	200 - 400	290 - 300	Miscellaneous Debris	-	Not retained	9993
1216	200 - 400	290 - 300	Miscellaneous Debris	-	Not retained	9994
1217	200 - 400	290 - 300	Miscellaneous Debris	-	Not retained	9995
1218	200 - 400	290 - 300	Miscellaneous Debris	-	Not retained	9996
1219	200 - 400	290 - 300	Miscellaneous Debris	-	Not retained	9997
1220	200 - 400	290 - 300	Miscellaneous Debris	-	Not retained	9998
1221	200 - 400	290 - 300	Miscellaneous Debris	-	Not retained	9999
1222	200 - 400	290 - 300	Miscellaneous Debris	-	Not retained	10000
1223	200 - 400	290 - 300	Miscellaneous Debris	-	Not retained	10001
1224	200 - 400	290 - 300	Miscellaneous Debris	-	Not retained	10002
1225	200 - 400	290 - 300	Miscellaneous Debris	-	Not retained	10003
1226	200 - 400	290 - 300	Miscellaneous Debris	-	Not retained	10004
1227	200 - 400	290 - 300	Miscellaneous Debris	-	Not retained	10005
1228	200 - 400	290 - 300	Miscellaneous Debris	-	Not retained	10006
1229	200 - 400	290 - 300	Miscellaneous Debris	-	Not retained	10007
1230	200 - 400	290 - 300	Miscellaneous Debris	-	Not retained	10008
1231	200 - 400	290 - 300	Miscellaneous Debris	-	Not retained	10009
1232	200 - 400	300 - 310	Warhead Body Piece	1.62		854
1233	200 - 400	300 - 310	Warhead Body Piece	1.49		855
1234	200 - 400	300 - 310	Warhead Body Piece	0.23		856
1235	200 - 400	300 - 310	Warhead Body Piece	0.12		857
1236	200 - 400	300 - 310	Warhead Body Piece	0.10		858
1237	200 - 400	300 - 310	Warhead Body Piece	0.12		859
1238	200 - 400	300 - 310	Warhead Body Piece	0.07		860
1239	200 - 400	300 - 310	Warhead Body Piece	0.05		861
1240	200 - 400	300 - 310	Warhead Body Piece	0.04		862
1241	200 - 400	300 - 310	Warhead Body Piece	0.03		863
1242	200 - 400	300 - 310	Warhead Body Piece	0.03		864
1243	200 - 400	300 - 310	Warhead Body Piece	0.01		865
1244	200 - 400	300 - 310	Warhead Body Piece	0.01		866
1245	200 - 400	300 - 310	Warhead Body Piece	0.03		867
1246	200 - 400	300 - 310	Warhead Body Piece	0.01		868
1247	200 - 400	300 - 310	Warhead Body Piece	0.01		869
1248	200 - 400	300 - 310	Warhead Body Piece	0.01		870
1249	200 - 400	300 - 310	Tail Piece	-	Not retained	853
1250	200 - 400	300 - 310	Tail Piece	0.02		872

TABLE B-12. FRAGMENTS RECOVERED BEYOND 200-FT RANGE IN TEST NO. 12 (Continued)

<u>Entry</u>	<u>Range Interval (ft)</u>	<u>Azimuthal Sector (°)</u>	<u>Description</u>	<u>Mass (lb)</u>	<u>Notes</u>	<u>G64 Index No.</u>
1251	200 - 400	300 - 310	Tail Piece	-	Not retained	9160
1252	200 - 400	300 - 310	Tail Piece	-	Not retained	9161
1253	200 - 400	300 - 310	Tail Piece	-	Not retained	9162
1254	200 - 400	300 - 310	Tail Piece	-	Not retained	9163
1255	200 - 400	300 - 310	Tail Piece	-	Not retained	9164
1256	200 - 400	300 - 310	Miscellaneous Debris	0.01		873
1257	200 - 400	300 - 310	Miscellaneous Debris	0.01		874
1258	200 - 400	300 - 310	Miscellaneous Debris	0.01		875
1259	200 - 400	300 - 310	Miscellaneous Debris	0.01		876
1260	200 - 400	300 - 310	Miscellaneous Debris	0.01		871
1261	200 - 400	300 - 310	Miscellaneous Debris	-	Not retained	10010
1262	200 - 400	300 - 310	Miscellaneous Debris	-	Not retained	10011
1263	200 - 400	300 - 310	Miscellaneous Debris	-	Not retained	10012
1264	200 - 400	300 - 310	Miscellaneous Debris	-	Not retained	10013
1265	200 - 400	300 - 310	Miscellaneous Debris	-	Not retained	10014
1266	200 - 400	300 - 310	Miscellaneous Debris	-	Not retained	10015
1267	200 - 400	300 - 310	Miscellaneous Debris	-	Not retained	10016
1268	200 - 400	300 - 310	Miscellaneous Debris	-	Not retained	10017
1269	200 - 400	300 - 310	Miscellaneous Debris	-	Not retained	10018
1270	200 - 400	300 - 310	Miscellaneous Debris	-	Not retained	10019
1271	200 - 400	300 - 310	Miscellaneous Debris	-	Not retained	10020
1272	200 - 400	300 - 310	Miscellaneous Debris	-	Not retained	10021
1273	200 - 400	300 - 310	Miscellaneous Debris	-	Not retained	10022
1274	200 - 400	300 - 310	Miscellaneous Debris	-	Not retained	10023
1275	200 - 400	300 - 310	Miscellaneous Debris	-	Not retained	10024
1276	200 - 400	300 - 310	Miscellaneous Debris	-	Not retained	10025
1277	200 - 400	300 - 310	Miscellaneous Debris	-	Not retained	10026
1278	200 - 400	300 - 310	Miscellaneous Debris	-	Not retained	10027
1279	200 - 400	300 - 310	Miscellaneous Debris	-	Not retained	10028
1280	200 - 400	300 - 310	Miscellaneous Debris	-	Not retained	10029
1281	200 - 400	300 - 310	Miscellaneous Debris	-	Not retained	10030
1282	200 - 400	300 - 310	Miscellaneous Debris	-	Not retained	10031
1283	200 - 400	300 - 310	Miscellaneous Debris	-	Not retained	10032
1284	200 - 400	300 - 310	Miscellaneous Debris	-	Not retained	10033
1285	200 - 400	300 - 310	Miscellaneous Debris	-	Not retained	10034
1286	200 - 400	300 - 310	Intact Warhead	-	Not retained	9014
1287	200 - 400	310 - 320	Warhead Body Piece	0.50		48
1288	200 - 400	310 - 320	Warhead Body Piece	0.50		49
1289	200 - 400	310 - 320	Warhead Body Piece	0.08		51
1290	200 - 400	310 - 320	Warhead Body Piece	0.07		52
1291	200 - 400	310 - 320	Warhead Body Piece	0.06		53
1292	200 - 400	310 - 320	Warhead Body Piece	0.05		54
1293	200 - 400	310 - 320	Warhead Body Piece	0.01		55
1294	200 - 400	310 - 320	Warhead Body Piece	0.01		56
1295	200 - 400	310 - 320	Warhead Body Piece	0.01		57
1296	200 - 400	310 - 320	Warhead Body Piece	0.01		58
1297	200 - 400	310 - 320	Warhead Body Piece	0.01		59
1298	200 - 400	310 - 320	Warhead Body Piece	0.01		60
1299	200 - 400	310 - 320	Warhead Body Piece	0.01		61
1300	200 - 400	310 - 320	Warhead Body Piece	0.01		62

NSWCDD/TR-98/6

TABLE B-12. FRAGMENTS RECOVERED BEYOND 200-FT RANGE IN TEST NO. 12 (Continued)

<u>Entry</u>	<u>Range Interval (ft)</u>	<u>Azimuthal Sector (°)</u>	<u>Description</u>	<u>Mass (lb)</u>	<u>Notes</u>	<u>G64 Index No.</u>
1301	200 - 400	310 - 320	Tail Piece	-	Not retained	50
1302	200 - 400	310 - 320	Tail Piece	0.03		69
1303	200 - 400	310 - 320	Tail Piece	0.02		70
1304	200 - 400	310 - 320	Tail Piece	0.02		71
1305	200 - 400	310 - 320	Tail Piece	0.01		72
1306	200 - 400	310 - 320	Tail Piece	0.01		73
1307	200 - 400	310 - 320	Tail Piece	-	Not retained	9165
1308	200 - 400	310 - 320	Tail Piece	-	Not retained	9166
1309	200 - 400	310 - 320	Tail Piece	-	Not retained	9167
1310	200 - 400	310 - 320	Tail Piece	-	Not retained	9168
1311	200 - 400	310 - 320	Tail Piece	-	Not retained	9169
1312	200 - 400	310 - 320	Tail Piece	-	Not retained	9170
1313	200 - 400	310 - 320	Tail Piece	-	Not retained	9171
1314	200 - 400	310 - 320	Tail Piece	-	Not retained	9172
1315	200 - 400	310 - 320	Tail Piece	-	Not retained	9173
1316	200 - 400	310 - 320	Tail Piece	-	Not retained	9174
1317	200 - 400	310 - 320	Tail Piece	-	Not retained	9175
1318	200 - 400	310 - 320	Tail Piece	-	Not retained	9176
1319	200 - 400	310 - 320	Tail Piece	-	Not retained	9177
1320	200 - 400	310 - 320	Miscellaneous Debris	0.15		63
1321	200 - 400	310 - 320	Miscellaneous Debris	0.01		64
1322	200 - 400	310 - 320	Miscellaneous Debris	0.01		65
1323	200 - 400	310 - 320	Miscellaneous Debris	0.01		66
1324	200 - 400	310 - 320	Miscellaneous Debris	0.01		67
1325	200 - 400	310 - 320	Miscellaneous Debris	0.01		68
1326	200 - 400	310 - 320	Miscellaneous Debris	-	Not retained	10035
1327	200 - 400	310 - 320	Miscellaneous Debris	-	Not retained	10036
1328	200 - 400	310 - 320	Miscellaneous Debris	-	Not retained	10037
1329	200 - 400	310 - 320	Miscellaneous Debris	-	Not retained	10038
1330	200 - 400	310 - 320	Miscellaneous Debris	-	Not retained	10039
1331	200 - 400	310 - 320	Miscellaneous Debris	-	Not retained	10040
1332	200 - 400	310 - 320	Miscellaneous Debris	-	Not retained	10041
1333	200 - 400	310 - 320	Miscellaneous Debris	-	Not retained	10042
1334	200 - 400	310 - 320	Miscellaneous Debris	-	Not retained	10043
1335	200 - 400	310 - 320	Miscellaneous Debris	-	Not retained	10044
1336	200 - 400	310 - 320	Miscellaneous Debris	-	Not retained	10045
1337	200 - 400	310 - 320	Miscellaneous Debris	-	Not retained	10046
1338	200 - 400	310 - 320	Miscellaneous Debris	-	Not retained	10047
1339	200 - 400	310 - 320	Miscellaneous Debris	-	Not retained	10048
1340	200 - 400	310 - 320	Miscellaneous Debris	-	Not retained	10049
1341	200 - 400	310 - 320	Miscellaneous Debris	-	Not retained	10050
1342	200 - 400	310 - 320	Miscellaneous Debris	-	Not retained	10051
1343	200 - 400	310 - 320	Miscellaneous Debris	-	Not retained	10052
1344	200 - 400	310 - 320	Miscellaneous Debris	-	Not retained	10053
1345	200 - 400	310 - 320	Miscellaneous Debris	-	Not retained	10054
1346	200 - 400	310 - 320	Miscellaneous Debris	-	Not retained	10055
1347	200 - 400	310 - 320	Miscellaneous Debris	-	Not retained	10056
1348	200 - 400	310 - 320	Miscellaneous Debris	-	Not retained	10057
1349	200 - 400	310 - 320	Miscellaneous Debris	-	Not retained	10058
1350	200 - 400	310 - 320	Miscellaneous Debris	-	Not retained	10059

TABLE B-12. FRAGMENTS RECOVERED BEYOND 200-FT RANGE IN TEST NO. 12 (Continued)

<u>Entry</u>	<u>Range Interval (ft)</u>	<u>Azimuthal Sector (°)</u>	<u>Description</u>	<u>Mass (lb)</u>	<u>Notes</u>	<u>G64 Index No.</u>
1351	200 - 400	310 - 320	Miscellaneous Debris	-	Not retained	10060
1352	200 - 400	310 - 320	Miscellaneous Debris	-	Not retained	10061
1353	200 - 400	310 - 320	Miscellaneous Debris	-	Not retained	10062
1354	200 - 400	310 - 320	Miscellaneous Debris	-	Not retained	10063
1355	200 - 400	310 - 320	Miscellaneous Debris	-	Not retained	10064
1356	200 - 400	320 - 330	Warhead Body Piece	0.50		1203
1357	200 - 400	320 - 330	Warhead Body Piece	0.34		1204
1358	200 - 400	320 - 330	Warhead Body Piece	0.23		1205
1359	200 - 400	320 - 330	Warhead Body Piece	0.18		1206
1360	200 - 400	320 - 330	Warhead Body Piece	0.11		1207
1361	200 - 400	320 - 330	Warhead Body Piece	0.02		1208
1362	200 - 400	320 - 330	Warhead Body Piece	0.10		1209
1363	200 - 400	320 - 330	Warhead Body Piece	0.03		1210
1364	200 - 400	320 - 330	Warhead Body Piece	0.01		1211
1365	200 - 400	320 - 330	Warhead Body Piece	0.01		1212
1366	200 - 400	320 - 330	Warhead Body Piece	0.01		1213
1367	200 - 400	320 - 330	Warhead Body Piece	0.01		1214
1368	200 - 400	320 - 330	Warhead Body Piece	0.01		1215
1369	200 - 400	320 - 330	Warhead Body Piece	0.01		1216
1370	200 - 400	320 - 330	Warhead Body Piece	0.01		1217
1371	200 - 400	320 - 330	Tail Piece	-	Not retained	1201
1372	200 - 400	320 - 330	Tail Piece	-	Not retained	1202
1373	200 - 400	320 - 330	Tail Piece	0.03		1219
1374	200 - 400	320 - 330	Tail Piece	-	Not retained	9178
1375	200 - 400	320 - 330	Tail Piece	-	Not retained	9179
1376	200 - 400	320 - 330	Tail Piece	-	Not retained	9180
1377	200 - 400	320 - 330	Tail Piece	-	Not retained	9181
1378	200 - 400	320 - 330	Tail Piece	-	Not retained	9182
1379	200 - 400	320 - 330	Tail Piece	-	Not retained	9183
1380	200 - 400	320 - 330	Miscellaneous Debris	0.01		1220
1381	200 - 400	320 - 330	Miscellaneous Debris	0.01		1221
1382	200 - 400	320 - 330	Miscellaneous Debris	0.01		1222
1383	200 - 400	320 - 330	Miscellaneous Debris	0.01		1223
1384	200 - 400	320 - 330	Miscellaneous Debris	0.01		1218
1385	200 - 400	320 - 330	Miscellaneous Debris	-	Not retained	10065
1386	200 - 400	320 - 330	Miscellaneous Debris	-	Not retained	10066
1387	200 - 400	320 - 330	Miscellaneous Debris	-	Not retained	10067
1388	200 - 400	320 - 330	Miscellaneous Debris	-	Not retained	10068
1389	200 - 400	320 - 330	Miscellaneous Debris	-	Not retained	10069
1390	200 - 400	320 - 330	Miscellaneous Debris	-	Not retained	10070
1391	200 - 400	320 - 330	Miscellaneous Debris	-	Not retained	10071
1392	200 - 400	320 - 330	Miscellaneous Debris	-	Not retained	10072
1393	200 - 400	320 - 330	Miscellaneous Debris	-	Not retained	10073
1394	200 - 400	320 - 330	Miscellaneous Debris	-	Not retained	10074
1395	200 - 400	320 - 330	Miscellaneous Debris	-	Not retained	10075
1396	200 - 400	320 - 330	Miscellaneous Debris	-	Not retained	10076
1397	200 - 400	320 - 330	Miscellaneous Debris	-	Not retained	10077
1398	200 - 400	320 - 330	Miscellaneous Debris	-	Not retained	10078
1399	200 - 400	320 - 330	Miscellaneous Debris	-	Not retained	10079
1400	200 - 400	320 - 330	Miscellaneous Debris	-	Not retained	10080

NSWCDD/TR-98/6

TABLE B-12. FRAGMENTS RECOVERED BEYOND 200-FT RANGE IN TEST NO. 12 (Continued)

<u>Entry</u>	<u>Range Interval (ft)</u>	<u>Azimuthal Sector (°)</u>	<u>Description</u>	<u>Mass (lb)</u>	<u>Notes</u>	<u>G64 Index No.</u>
1401	200 - 400	320 - 330	Miscellaneous Debris	-	Not retained	10081
1402	200 - 400	320 - 330	Miscellaneous Debris	-	Not retained	10082
1403	200 - 400	330 - 340	Warhead Body Piece	0.50		523
1404	200 - 400	330 - 340	Warhead Body Piece	0.50		524
1405	200 - 400	330 - 340	Warhead Body Piece	0.31		525
1406	200 - 400	330 - 340	Warhead Body Piece	0.14		526
1407	200 - 400	330 - 340	Warhead Body Piece	0.08		527
1408	200 - 400	330 - 340	Warhead Body Piece	0.03		528
1409	200 - 400	330 - 340	Warhead Body Piece	0.02		529
1410	200 - 400	330 - 340	Warhead Body Piece	0.02		530
1411	200 - 400	330 - 340	Warhead Body Piece	0.02		531
1412	200 - 400	330 - 340	Warhead Body Piece	0.02		532
1413	200 - 400	330 - 340	Warhead Body Piece	0.02		533
1414	200 - 400	330 - 340	Warhead Body Piece	0.01		534
1415	200 - 400	330 - 340	Warhead Body Piece	0.01		535
1416	200 - 400	330 - 340	Warhead Body Piece	0.01		536
1417	200 - 400	330 - 340	Warhead Body Piece	0.01		537
1418	200 - 400	330 - 340	Warhead Body Piece	0.01		546
1419	200 - 400	330 - 340	Tail Piece	0.19		538
1420	200 - 400	330 - 340	Tail Piece	0.17		539
1421	200 - 400	330 - 340	Tail Piece	0.05		540
1422	200 - 400	330 - 340	Tail Piece	0.02		541
1423	200 - 400	330 - 340	Tail Piece	0.02		542
1424	200 - 400	330 - 340	Tail Piece	0.02		543
1425	200 - 400	330 - 340	Tail Piece	0.01		544
1426	200 - 400	330 - 340	Tail Piece	0.01		545
1427	200 - 400	330 - 340	Tail Piece	-	Not retained	9184
1428	200 - 400	330 - 340	Tail Piece	-	Not retained	9185
1429	200 - 400	330 - 340	Tail Piece	-	Not retained	9186
1430	200 - 400	330 - 340	Tail Piece	-	Not retained	9187
1431	200 - 400	330 - 340	Tail Piece	-	Not retained	9188
1432	200 - 400	330 - 340	Tail Piece	-	Not retained	9189
1433	200 - 400	330 - 340	Tail Piece	-	Not retained	9190
1434	200 - 400	330 - 340	Tail Piece	-	Not retained	9191
1435	200 - 400	330 - 340	Tail Piece	-	Not retained	9192
1436	200 - 400	330 - 340	Tail Piece	-	Not retained	9193
1437	200 - 400	330 - 340	Tail Piece	-	Not retained	9194
1438	200 - 400	330 - 340	Tail Piece	-	Not retained	9195
1439	200 - 400	330 - 340	Tail Piece	-	Not retained	9196
1440	200 - 400	330 - 340	Tail Piece	-	Not retained	9197
1441	200 - 400	330 - 340	Tail Piece	-	Not retained	9198
1442	200 - 400	330 - 340	Miscellaneous Debris	0.01		547
1443	200 - 400	330 - 340	Miscellaneous Debris	0.01		548
1444	200 - 400	330 - 340	Miscellaneous Debris	0.01		549
1445	200 - 400	330 - 340	Miscellaneous Debris	0.01		550
1446	200 - 400	330 - 340	Miscellaneous Debris	0.01		551
1447	200 - 400	330 - 340	Miscellaneous Debris	0.01		552
1448	200 - 400	330 - 340	Miscellaneous Debris	-	Not retained	10083
1449	200 - 400	330 - 340	Miscellaneous Debris	-	Not retained	10084
1450	200 - 400	330 - 340	Miscellaneous Debris	-	Not retained	10085

TABLE B-12. FRAGMENTS RECOVERED BEYOND 200-FT RANGE IN TEST NO. 12 (Continued)

<u>Entry</u>	<u>Range Interval (ft)</u>	<u>Azimuthal Sector (°)</u>	<u>Description</u>	<u>Mass (lb)</u>	<u>Notes</u>	<u>G64 Index No.</u>
1451	200 - 400	330 - 340	Miscellaneous Debris	-	Not retained	10086
1452	200 - 400	330 - 340	Miscellaneous Debris	-	Not retained	10087
1453	200 - 400	330 - 340	Miscellaneous Debris	-	Not retained	10088
1454	200 - 400	330 - 340	Miscellaneous Debris	-	Not retained	10089
1455	200 - 400	330 - 340	Miscellaneous Debris	-	Not retained	10090
1456	200 - 400	330 - 340	Miscellaneous Debris	-	Not retained	10091
1457	200 - 400	330 - 340	Miscellaneous Debris	-	Not retained	10092
1458	200 - 400	330 - 340	Miscellaneous Debris	-	Not retained	10093
1459	200 - 400	330 - 340	Miscellaneous Debris	-	Not retained	10094
1460	200 - 400	330 - 340	Miscellaneous Debris	-	Not retained	10095
1461	200 - 400	330 - 340	Miscellaneous Debris	-	Not retained	10096
1462	200 - 400	330 - 340	Miscellaneous Debris	-	Not retained	10097
1463	200 - 400	330 - 340	Miscellaneous Debris	-	Not retained	10098
1464	200 - 400	330 - 340	Miscellaneous Debris	-	Not retained	10099
1465	200 - 400	330 - 340	Miscellaneous Debris	-	Not retained	10100
1466	200 - 400	330 - 340	Miscellaneous Debris	-	Not retained	10101
1467	200 - 400	330 - 340	Miscellaneous Debris	-	Not retained	10102
1468	200 - 400	330 - 340	Miscellaneous Debris	-	Not retained	10103
1469	200 - 400	330 - 340	Miscellaneous Debris	-	Not retained	10104
1470	200 - 400	330 - 340	Miscellaneous Debris	-	Not retained	10105
1471	200 - 400	330 - 340	Miscellaneous Debris	-	Not retained	10106
1472	200 - 400	330 - 340	Miscellaneous Debris	-	Not retained	10107
1473	200 - 400	330 - 340	Miscellaneous Debris	-	Not retained	10108
1474	200 - 400	330 - 340	Miscellaneous Debris	-	Not retained	10109
1475	200 - 400	330 - 340	Miscellaneous Debris	-	Not retained	10110
1476	200 - 400	330 - 340	Miscellaneous Debris	-	Not retained	10111
1477	200 - 400	330 - 340	Miscellaneous Debris	-	Not retained	10112
1478	200 - 400	330 - 340	Miscellaneous Debris	-	Not retained	10113
1479	200 - 400	340 - 350	Warhead Body Piece	0.30		829
1480	200 - 400	340 - 350	Warhead Body Piece	0.24		830
1481	200 - 400	340 - 350	Warhead Body Piece	0.09		831
1482	200 - 400	340 - 350	Warhead Body Piece	0.01		832
1483	200 - 400	340 - 350	Warhead Body Piece	0.01		833
1484	200 - 400	340 - 350	Warhead Body Piece	0.05		834
1485	200 - 400	340 - 350	Warhead Body Piece	0.02		835
1486	200 - 400	340 - 350	Warhead Body Piece	0.02		836
1487	200 - 400	340 - 350	Warhead Body Piece	0.01		837
1488	200 - 400	340 - 350	Warhead Body Piece	0.01		838
1489	200 - 400	340 - 350	Warhead Body Piece	0.01		839
1490	200 - 400	340 - 350	Warhead Body Piece	0.01		840
1491	200 - 400	340 - 350	Warhead Body Piece	0.01		841
1492	200 - 400	340 - 350	Warhead Body Piece	0.01		842
1493	200 - 400	340 - 350	Warhead Body Piece	0.01		843
1494	200 - 400	340 - 350	Tail Piece	-	Not retained	828
1495	200 - 400	340 - 350	Tail Piece	0.02		844
1496	200 - 400	340 - 350	Tail Piece	-	Not retained	9199
1497	200 - 400	340 - 350	Tail Piece	-	Not retained	9200
1498	200 - 400	340 - 350	Tail Piece	-	Not retained	9201
1499	200 - 400	340 - 350	Tail Piece	-	Not retained	9202
1500	200 - 400	340 - 350	Tail Piece	-	Not retained	9203

NSWCDD/TR-98/6

TABLE B-12. FRAGMENTS RECOVERED BEYOND 200-FT RANGE IN TEST NO. 12 (Continued)

<u>Entry</u>	<u>Range Interval (ft)</u>	<u>Azimuthal Sector (°)</u>	<u>Description</u>	<u>Mass (lb)</u>	<u>Notes</u>	<u>G64 Index No.</u>
1501	200 - 400	340 - 350	Tail Piece	-	Not retained	9204
1502	200 - 400	340 - 350	Tail Piece	-	Not retained	9205
1503	200 - 400	340 - 350	Tail Piece	-	Not retained	9206
1504	200 - 400	340 - 350	Tail Piece	-	Not retained	9207
1505	200 - 400	340 - 350	Tail Piece	-	Not retained	9208
1506	200 - 400	340 - 350	Miscellaneous Debris	0.01		845
1507	200 - 400	340 - 350	Miscellaneous Debris	0.01		846
1508	200 - 400	340 - 350	Miscellaneous Debris	0.01		847
1509	200 - 400	340 - 350	Miscellaneous Debris	0.01		848
1510	200 - 400	340 - 350	Miscellaneous Debris	0.01		849
1511	200 - 400	340 - 350	Miscellaneous Debris	0.01		850
1512	200 - 400	340 - 350	Miscellaneous Debris	0.01		851
1513	200 - 400	340 - 350	Miscellaneous Debris	0.01		852
1514	200 - 400	340 - 350	Miscellaneous Debris	-	Not retained	10114
1515	200 - 400	340 - 350	Miscellaneous Debris	-	Not retained	10115
1516	200 - 400	340 - 350	Miscellaneous Debris	-	Not retained	10116
1517	200 - 400	340 - 350	Miscellaneous Debris	-	Not retained	10117
1518	200 - 400	340 - 350	Miscellaneous Debris	-	Not retained	10118
1519	200 - 400	340 - 350	Miscellaneous Debris	-	Not retained	10119
1520	200 - 400	340 - 350	Miscellaneous Debris	-	Not retained	10120
1521	200 - 400	340 - 350	Miscellaneous Debris	-	Not retained	10121
1522	200 - 400	340 - 350	Miscellaneous Debris	-	Not retained	10122
1523	200 - 400	340 - 350	Miscellaneous Debris	-	Not retained	10123
1524	200 - 400	340 - 350	Miscellaneous Debris	-	Not retained	10124
1525	200 - 400	340 - 350	Miscellaneous Debris	-	Not retained	10125
1526	200 - 400	340 - 350	Miscellaneous Debris	-	Not retained	10126
1527	200 - 400	340 - 350	Miscellaneous Debris	-	Not retained	10127
1528	200 - 400	340 - 350	Miscellaneous Debris	-	Not retained	10128
1529	200 - 400	340 - 350	Miscellaneous Debris	-	Not retained	10129
1530	200 - 400	340 - 350	Miscellaneous Debris	-	Not retained	10130
1531	200 - 400	340 - 350	Miscellaneous Debris	-	Not retained	10131
1532	200 - 400	340 - 350	Miscellaneous Debris	-	Not retained	10132
1533	200 - 400	340 - 350	Miscellaneous Debris	-	Not retained	10133
1534	200 - 400	340 - 350	Miscellaneous Debris	-	Not retained	10134
1535	200 - 400	350 - 360	Warhead Body Piece	0.37		1316
1536	200 - 400	350 - 360	Warhead Body Piece	0.22		1317
1537	200 - 400	350 - 360	Warhead Body Piece	0.13		1318
1538	200 - 400	350 - 360	Warhead Body Piece	0.06		1319
1539	200 - 400	350 - 360	Warhead Body Piece	0.08		1320
1540	200 - 400	350 - 360	Warhead Body Piece	0.07		1321
1541	200 - 400	350 - 360	Warhead Body Piece	0.07		1322
1542	200 - 400	350 - 360	Warhead Body Piece	0.02		1323
1543	200 - 400	350 - 360	Warhead Body Piece	0.02		1324
1544	200 - 400	350 - 360	Warhead Body Piece	0.01		1325
1545	200 - 400	350 - 360	Warhead Body Piece	0.01		1326
1546	200 - 400	350 - 360	Warhead Body Piece	0.01		1327
1547	200 - 400	350 - 360	Warhead Body Piece	0.01		1328
1548	200 - 400	350 - 360	Warhead Body Piece	0.01		1329
1549	200 - 400	350 - 360	Tail Piece	-	Not retained	1314
1550	200 - 400	350 - 360	Tail Piece	-	Not retained	1315

NSWCDD/TR-98/6

TABLE B-12. FRAGMENTS RECOVERED BEYOND 200-FT RANGE IN TEST NO. 12 (Continued)

<u>Entry</u>	<u>Range Interval (ft)</u>	<u>Azimuthal Sector (°)</u>	<u>Description</u>	<u>Mass (lb)</u>	<u>Notes</u>	<u>G64 Index No.</u>
1551	200 - 400	350 - 360	Tail Piece	0.03		1330
1552	200 - 400	350 - 360	Tail Piece	0.03		1331
1553	200 - 400	350 - 360	Tail Piece	0.03		1332
1554	200 - 400	350 - 360	Tail Piece	0.01		1333
1555	200 - 400	350 - 360	Tail Piece	-	Not retained	9209
1556	200 - 400	350 - 360	Tail Piece	-	Not retained	9210
1557	200 - 400	350 - 360	Tail Piece	-	Not retained	9211
1558	200 - 400	350 - 360	Tail Piece	-	Not retained	9212
1559	200 - 400	350 - 360	Tail Piece	-	Not retained	9213
1560	200 - 400	350 - 360	Tail Piece	-	Not retained	9214
1561	200 - 400	350 - 360	Tail Piece	-	Not retained	9215
1562	200 - 400	350 - 360	Tail Piece	-	Not retained	9216
1563	200 - 400	350 - 360	Miscellaneous Debris	0.01		1334
1564	200 - 400	350 - 360	Miscellaneous Debris	0.01		1335
1565	200 - 400	350 - 360	Miscellaneous Debris	0.02		1336
1566	200 - 400	350 - 360	Miscellaneous Debris	-	Not retained	10135
1567	200 - 400	350 - 360	Miscellaneous Debris	-	Not retained	10136
1568	200 - 400	350 - 360	Miscellaneous Debris	-	Not retained	10137
1569	200 - 400	350 - 360	Miscellaneous Debris	-	Not retained	10138
1570	200 - 400	350 - 360	Miscellaneous Debris	-	Not retained	10139
1571	200 - 400	350 - 360	Miscellaneous Debris	-	Not retained	10140
1572	200 - 400	350 - 360	Miscellaneous Debris	-	Not retained	10141
1573	200 - 400	350 - 360	Miscellaneous Debris	-	Not retained	10142
1574	200 - 400	350 - 360	Miscellaneous Debris	-	Not retained	10143
1575	200 - 400	350 - 360	Miscellaneous Debris	-	Not retained	10144
1576	200 - 400	350 - 360	Miscellaneous Debris	-	Not retained	10145
1577	200 - 400	350 - 360	Miscellaneous Debris	-	Not retained	10146
1578	200 - 400	350 - 360	Miscellaneous Debris	-	Not retained	10147
1579	200 - 400	350 - 360	Miscellaneous Debris	-	Not retained	10148
1580	200 - 400	350 - 360	Miscellaneous Debris	-	Not retained	10149
1581	200 - 400	350 - 360	Miscellaneous Debris	-	Not retained	10150
1582	200 - 400	350 - 360	Miscellaneous Debris	-	Not retained	10151
1583	200 - 400	350 - 360	Miscellaneous Debris	-	Not retained	10152
1584	200 - 400	350 - 360	Miscellaneous Debris	-	Not retained	10153
1585	200 - 400	350 - 360	Miscellaneous Debris	-	Not retained	10154
1586	200 - 400	350 - 360	Miscellaneous Debris	-	Not retained	10155
1587	200 - 400	350 - 360	Miscellaneous Debris	-	Not retained	10156
1588	200 - 400	350 - 360	Miscellaneous Debris	-	Not retained	10157
1589	200 - 400	350 - 360	Miscellaneous Debris	-	Not retained	10158
1590	200 - 400	350 - 360	Miscellaneous Debris	-	Not retained	10159
1591	200 - 400	350 - 360	Miscellaneous Debris	-	Not retained	10160
1592	200 - 400	350 - 360	Miscellaneous Debris	-	Not retained	10161
1593	200 - 400	350 - 360	Miscellaneous Debris	-	Not retained	10162
1594	200 - 400	350 - 360	Miscellaneous Debris	-	Not retained	10163
1595	200 - 400	350 - 360	Miscellaneous Debris	-	Not retained	10164
1596	200 - 400	350 - 360	Miscellaneous Debris	-	Not retained	10165
1597	200 - 400	350 - 360	Miscellaneous Debris	-	Not retained	10166
1598	200 - 400	350 - 360	Miscellaneous Debris	-	Not retained	10167
1599	200 - 400	350 - 360	Miscellaneous Debris	-	Not retained	10168
1600	200 - 400	350 - 360	Miscellaneous Debris	-	Not retained	10169

NSWCDD/TR-98/6

TABLE B-12. FRAGMENTS RECOVERED BEYOND 200-FT RANGE IN TEST NO. 12 (Continued)

<u>Entry</u>	<u>Range Interval (ft)</u>	<u>Azimuthal Sector (°)</u>	<u>Description</u>	<u>Mass (lb)</u>	<u>Notes</u>	<u>G64 Index No.</u>
1601	200 - 400	350 - 360	Miscellaneous Debris	-	Not retained	10170
1602	200 - 400	350 - 360	Miscellaneous Debris	-	Not retained	10171
1603	200 - 400	350 - 360	Miscellaneous Debris	-	Not retained	10172
1604	200 - 400	350 - 360	Miscellaneous Debris	-	Not retained	10173
1605	200 - 400	350 - 360	Miscellaneous Debris	-	Not retained	10174
1606	200 - 400	350 - 360	Miscellaneous Debris	-	Not retained	10175
1607	200 - 400	350 - 360	Miscellaneous Debris	-	Not retained	10176
1608	200 - 400	350 - 360	Miscellaneous Debris	-	Not retained	10177
1609	200 - 400	350 - 360	Miscellaneous Debris	-	Not retained	10178
1610	200 - 400	350 - 360	Miscellaneous Debris	-	Not retained	10179
1611	200 - 400	350 - 360	Miscellaneous Debris	-	Not retained	10180
1612	200 - 400	350 - 360	Miscellaneous Debris	-	Not retained	10181
1613	200 - 400	350 - 360	Miscellaneous Debris	-	Not retained	10182
1614	200 - 400	350 - 360	Miscellaneous Debris	-	Not retained	10183
1615	200 - 400	350 - 360	Miscellaneous Debris	-	Not retained	10184
1616	200 - 400	350 - 360	Intact Warhead	-	Not retained	9015
1617	400 - 600	0 - 10	Warhead Body Piece	0.50		99
1618	400 - 600	0 - 10	Warhead Body Piece	0.44		100
1619	400 - 600	0 - 10	Warhead Body Piece	0.05		101
1620	400 - 600	0 - 10	Warhead Body Piece	0.04		102
1621	400 - 600	0 - 10	Warhead Body Piece	0.04		103
1622	400 - 600	0 - 10	Warhead Body Piece	0.05		104
1623	400 - 600	0 - 10	Warhead Body Piece	0.03		105
1624	400 - 600	0 - 10	Warhead Body Piece	0.01		106
1625	400 - 600	0 - 10	Warhead Body Piece	0.01		107
1626	400 - 600	0 - 10	Warhead Body Piece	0.01		108
1627	400 - 600	0 - 10	Warhead Body Piece	0.01		109
1628	400 - 600	0 - 10	Warhead Body Piece	0.01		110
1629	400 - 600	0 - 10	Warhead Body Piece	0.01		111
1630	400 - 600	0 - 10	Warhead Body Piece	0.01		112
1631	400 - 600	0 - 10	Tail Piece	0.02		113
1632	400 - 600	0 - 10	Tail Piece	0.01		114
1633	400 - 600	0 - 10	Tail Piece	-	Not retained	9217
1634	400 - 600	0 - 10	Tail Piece	-	Not retained	9218
1635	400 - 600	0 - 10	Tail Piece	-	Not retained	9219
1636	400 - 600	0 - 10	Miscellaneous Debris	-	Not retained	10185
1637	400 - 600	0 - 10	Miscellaneous Debris	-	Not retained	10186
1638	400 - 600	0 - 10	Miscellaneous Debris	-	Not retained	10187
1639	400 - 600	0 - 10	Miscellaneous Debris	-	Not retained	10188
1640	400 - 600	0 - 10	Miscellaneous Debris	-	Not retained	10189
1641	400 - 600	0 - 10	Miscellaneous Debris	-	Not retained	10190
1642	400 - 600	0 - 10	Miscellaneous Debris	-	Not retained	10191
1643	400 - 600	0 - 10	Miscellaneous Debris	-	Not retained	10192
1644	400 - 600	0 - 10	Miscellaneous Debris	-	Not retained	10193
1645	400 - 600	0 - 10	Miscellaneous Debris	-	Not retained	10194
1646	400 - 600	0 - 10	Miscellaneous Debris	-	Not retained	10195
1647	400 - 600	0 - 10	Miscellaneous Debris	-	Not retained	10196
1648	400 - 600	0 - 10	Miscellaneous Debris	-	Not retained	10197
1649	400 - 600	0 - 10	Miscellaneous Debris	-	Not retained	10198
1650	400 - 600	10 - 20	Warhead Body Piece	0.50		369

TABLE B-12. FRAGMENTS RECOVERED BEYOND 200-FT RANGE IN TEST NO. 12 (Continued)

<u>Entry</u>	<u>Range Interval (ft)</u>	<u>Azimuthal Sector (°)</u>	<u>Description</u>	<u>Mass (lb)</u>	<u>Notes</u>	<u>G64 Index No.</u>
1651	400 - 600	10 - 20	Warhead Body Piece	0.50		370
1652	400 - 600	10 - 20	Warhead Body Piece	0.50		371
1653	400 - 600	10 - 20	Warhead Body Piece	0.50		372
1654	400 - 600	10 - 20	Warhead Body Piece	0.44		373
1655	400 - 600	10 - 20	Warhead Body Piece	0.41		374
1656	400 - 600	10 - 20	Warhead Body Piece	0.30		375
1657	400 - 600	10 - 20	Warhead Body Piece	0.31		376
1658	400 - 600	10 - 20	Warhead Body Piece	0.24		377
1659	400 - 600	10 - 20	Warhead Body Piece	0.16		378
1660	400 - 600	10 - 20	Warhead Body Piece	0.16		379
1661	400 - 600	10 - 20	Warhead Body Piece	0.12		380
1662	400 - 600	10 - 20	Warhead Body Piece	0.08		381
1663	400 - 600	10 - 20	Warhead Body Piece	0.03		382
1664	400 - 600	10 - 20	Warhead Body Piece	0.02		383
1665	400 - 600	10 - 20	Warhead Body Piece	0.03		384
1666	400 - 600	10 - 20	Warhead Body Piece	0.03		385
1667	400 - 600	10 - 20	Warhead Body Piece	0.01		386
1668	400 - 600	10 - 20	Warhead Body Piece	0.01		387
1669	400 - 600	10 - 20	Warhead Body Piece	0.01		388
1670	400 - 600	10 - 20	Warhead Body Piece	0.01		389
1671	400 - 600	10 - 20	Warhead Body Piece	0.01		390
1672	400 - 600	10 - 20	Warhead Body Piece	0.01		391
1673	400 - 600	10 - 20	Warhead Body Piece	0.01		392
1674	400 - 600	10 - 20	Warhead Body Piece	0.01		393
1675	400 - 600	10 - 20	Warhead Body Piece	0.01		394
1676	400 - 600	10 - 20	Warhead Body Piece	0.01		395
1677	400 - 600	10 - 20	Warhead Body Piece	0.01		396
1678	400 - 600	10 - 20	Warhead Body Piece	0.01		397
1679	400 - 600	10 - 20	Tail Piece	0.04		398
1680	400 - 600	10 - 20	Tail Piece	0.02		399
1681	400 - 600	10 - 20	Tail Piece	0.02		400
1682	400 - 600	10 - 20	Tail Piece	-	Not retained	9220
1683	400 - 600	10 - 20	Tail Piece	-	Not retained	9221
1684	400 - 600	10 - 20	Tail Piece	-	Not retained	9222
1685	400 - 600	10 - 20	Tail Piece	-	Not retained	9223
1686	400 - 600	10 - 20	Tail Piece	-	Not retained	9224
1687	400 - 600	10 - 20	Miscellaneous Debris	0.01		401
1688	400 - 600	10 - 20	Miscellaneous Debris	0.01		402
1689	400 - 600	10 - 20	Miscellaneous Debris	-	Not retained	10199
1690	400 - 600	10 - 20	Miscellaneous Debris	-	Not retained	10200
1691	400 - 600	10 - 20	Miscellaneous Debris	-	Not retained	10201
1692	400 - 600	10 - 20	Miscellaneous Debris	-	Not retained	10202
1693	400 - 600	10 - 20	Miscellaneous Debris	-	Not retained	10203
1694	400 - 600	10 - 20	Miscellaneous Debris	-	Not retained	10204
1695	400 - 600	10 - 20	Miscellaneous Debris	-	Not retained	10205
1696	400 - 600	10 - 20	Miscellaneous Debris	-	Not retained	10206
1697	400 - 600	10 - 20	Miscellaneous Debris	-	Not retained	10207
1698	400 - 600	10 - 20	Miscellaneous Debris	-	Not retained	10208
1699	400 - 600	10 - 20	Miscellaneous Debris	-	Not retained	10209
1700	400 - 600	10 - 20	Miscellaneous Debris	-	Not retained	10210

NSWCDD/TR-98/6

TABLE B-12. FRAGMENTS RECOVERED BEYOND 200-FT RANGE IN TEST NO. 12 (Continued)

<u>Entry</u>	<u>Range Interval (ft)</u>	<u>Azimuthal Sector (°)</u>	<u>Description</u>	<u>Mass (lb)</u>	<u>Notes</u>	<u>G64 Index No.</u>
1701	400 - 600	20 - 30	Warhead Body Piece	0.36		139
1702	400 - 600	20 - 30	Warhead Body Piece	0.18		140
1703	400 - 600	20 - 30	Warhead Body Piece	0.23		141
1704	400 - 600	20 - 30	Warhead Body Piece	0.17		142
1705	400 - 600	20 - 30	Warhead Body Piece	0.23		143
1706	400 - 600	20 - 30	Warhead Body Piece	0.14		144
1707	400 - 600	20 - 30	Warhead Body Piece	0.13		145
1708	400 - 600	20 - 30	Warhead Body Piece	0.04		146
1709	400 - 600	20 - 30	Warhead Body Piece	0.05		147
1710	400 - 600	20 - 30	Warhead Body Piece	0.05		148
1711	400 - 600	20 - 30	Warhead Body Piece	0.03		149
1712	400 - 600	20 - 30	Warhead Body Piece	0.03		150
1713	400 - 600	20 - 30	Warhead Body Piece	0.01		151
1714	400 - 600	20 - 30	Warhead Body Piece	0.01		152
1715	400 - 600	20 - 30	Warhead Body Piece	0.01		153
1716	400 - 600	20 - 30	Warhead Body Piece	0.04		154
1717	400 - 600	20 - 30	Warhead Body Piece	0.02		155
1718	400 - 600	20 - 30	Warhead Body Piece	0.02		156
1719	400 - 600	20 - 30	Warhead Body Piece	0.01		157
1720	400 - 600	20 - 30	Warhead Body Piece	0.01		158
1721	400 - 600	20 - 30	Warhead Body Piece	0.01		159
1722	400 - 600	20 - 30	Warhead Body Piece	0.01		160
1723	400 - 600	20 - 30	Warhead Body Piece	0.01		161
1724	400 - 600	20 - 30	Warhead Body Piece	0.01		162
1725	400 - 600	20 - 30	Warhead Body Piece	0.01		163
1726	400 - 600	20 - 30	Tail Piece	-	Not retained	9225
1727	400 - 600	20 - 30	Miscellaneous Debris	0.01		164
1728	400 - 600	20 - 30	Miscellaneous Debris	-	Not retained	10211
1729	400 - 600	20 - 30	Miscellaneous Debris	-	Not retained	10212
1730	400 - 600	20 - 30	Miscellaneous Debris	-	Not retained	10213
1731	400 - 600	20 - 30	Miscellaneous Debris	-	Not retained	10214
1732	400 - 600	20 - 30	Miscellaneous Debris	-	Not retained	10215
1733	400 - 600	20 - 30	Miscellaneous Debris	-	Not retained	10216
1734	400 - 600	20 - 30	Miscellaneous Debris	-	Not retained	10217
1735	400 - 600	20 - 30	Miscellaneous Debris	-	Not retained	10218
1736	400 - 600	20 - 30	Miscellaneous Debris	-	Not retained	10219
1737	400 - 600	20 - 30	Miscellaneous Debris	-	Not retained	10220
1738	400 - 600	20 - 30	Miscellaneous Debris	-	Not retained	10221
1739	400 - 600	20 - 30	Miscellaneous Debris	-	Not retained	10222
1740	400 - 600	20 - 30	Miscellaneous Debris	-	Not retained	10223
1741	400 - 600	30 - 40	Warhead Body Piece	1.12		1401
1742	400 - 600	30 - 40	Warhead Body Piece	0.64		1402
1743	400 - 600	30 - 40	Warhead Body Piece	0.14		1403
1744	400 - 600	30 - 40	Warhead Body Piece	0.07		1404
1745	400 - 600	30 - 40	Warhead Body Piece	0.07		1405
1746	400 - 600	30 - 40	Warhead Body Piece	0.01		1406
1747	400 - 600	30 - 40	Warhead Body Piece	0.19		1407
1748	400 - 600	30 - 40	Warhead Body Piece	0.03		1408
1749	400 - 600	30 - 40	Warhead Body Piece	0.01		1409
1750	400 - 600	30 - 40	Warhead Body Piece	0.01		1410

TABLE B-12. FRAGMENTS RECOVERED BEYOND 200-FT RANGE IN TEST NO. 12 (Continued)

<u>Entry</u>	<u>Range Interval (ft)</u>	<u>Azimuthal Sector (°)</u>	<u>Description</u>	<u>Mass (lb)</u>	<u>Notes</u>	<u>G64 Index No.</u>
1751	400 - 600	30 - 40	Warhead Body Piece	0.01		1411
1752	400 - 600	30 - 40	Warhead Body Piece	0.01		1412
1753	400 - 600	30 - 40	Warhead Body Piece	0.01		1413
1754	400 - 600	30 - 40	Warhead Body Piece	0.01		1414
1755	400 - 600	30 - 40	Warhead Body Piece	0.01		1415
1756	400 - 600	30 - 40	Warhead Body Piece	0.01		1416
1757	400 - 600	30 - 40	Warhead Body Piece	0.01		1417
1758	400 - 600	30 - 40	Tail Piece	0.02		1418
1759	400 - 600	30 - 40	Tail Piece	0.02		1419
1760	400 - 600	30 - 40	Tail Piece	-	Not retained	9226
1761	400 - 600	30 - 40	Tail Piece	-	Not retained	9227
1762	400 - 600	30 - 40	Tail Piece	-	Not retained	9228
1763	400 - 600	30 - 40	Tail Piece	-	Not retained	9229
1764	400 - 600	30 - 40	Miscellaneous Debris	0.02		1420
1765	400 - 600	30 - 40	Miscellaneous Debris	0.01		1421
1766	400 - 600	30 - 40	Miscellaneous Debris	-	Not retained	10224
1767	400 - 600	30 - 40	Miscellaneous Debris	-	Not retained	10225
1768	400 - 600	30 - 40	Miscellaneous Debris	-	Not retained	10226
1769	400 - 600	30 - 40	Miscellaneous Debris	-	Not retained	10227
1770	400 - 600	30 - 40	Miscellaneous Debris	-	Not retained	10228
1771	400 - 600	30 - 40	Miscellaneous Debris	-	Not retained	10229
1772	400 - 600	30 - 40	Miscellaneous Debris	-	Not retained	10230
1773	400 - 600	30 - 40	Miscellaneous Debris	-	Not retained	10231
1774	400 - 600	30 - 40	Miscellaneous Debris	-	Not retained	10232
1775	400 - 600	30 - 40	Miscellaneous Debris	-	Not retained	10233
1776	400 - 600	30 - 40	Miscellaneous Debris	-	Not retained	10234
1777	400 - 600	30 - 40	Miscellaneous Debris	-	Not retained	10235
1778	400 - 600	30 - 40	Miscellaneous Debris	-	Not retained	10236
1779	400 - 600	30 - 40	Miscellaneous Debris	-	Not retained	10237
1780	400 - 600	40 - 50	Warhead Body Piece	0.44		901
1781	400 - 600	40 - 50	Warhead Body Piece	0.25		902
1782	400 - 600	40 - 50	Warhead Body Piece	0.20		903
1783	400 - 600	40 - 50	Warhead Body Piece	0.25		904
1784	400 - 600	40 - 50	Warhead Body Piece	0.21		905
1785	400 - 600	40 - 50	Warhead Body Piece	0.11		906
1786	400 - 600	40 - 50	Warhead Body Piece	0.09		907
1787	400 - 600	40 - 50	Warhead Body Piece	0.03		908
1788	400 - 600	40 - 50	Warhead Body Piece	0.03		909
1789	400 - 600	40 - 50	Warhead Body Piece	0.01		910
1790	400 - 600	40 - 50	Warhead Body Piece	0.05		911
1791	400 - 600	40 - 50	Warhead Body Piece	0.02		912
1792	400 - 600	40 - 50	Warhead Body Piece	0.02		913
1793	400 - 600	40 - 50	Tail Piece	0.01		914
1794	400 - 600	40 - 50	Tail Piece	-	Not retained	9230
1795	400 - 600	40 - 50	Tail Piece	-	Not retained	9231
1796	400 - 600	40 - 50	Tail Piece	-	Not retained	9232
1797	400 - 600	40 - 50	Tail Piece	-	Not retained	9233
1798	400 - 600	40 - 50	Miscellaneous Debris	0.01		915
1799	400 - 600	40 - 50	Miscellaneous Debris	0.01		916
1800	400 - 600	40 - 50	Miscellaneous Debris	-	Not retained	10238

NSWCDD/TR-98/6

TABLE B-12. FRAGMENTS RECOVERED BEYOND 200-FT RANGE IN TEST NO. 12 (Continued)

<u>Entry</u>	<u>Range Interval (ft)</u>	<u>Azimuthal Sector (°)</u>	<u>Description</u>	<u>Mass (lb)</u>	<u>Notes</u>	<u>G64 Index No.</u>
1801	400 - 600	40 - 50	Miscellaneous Debris	-	Not retained	10239
1802	400 - 600	40 - 50	Miscellaneous Debris	-	Not retained	10240
1803	400 - 600	40 - 50	Miscellaneous Debris	-	Not retained	10241
1804	400 - 600	40 - 50	Miscellaneous Debris	-	Not retained	10242
1805	400 - 600	40 - 50	Miscellaneous Debris	-	Not retained	10243
1806	400 - 600	40 - 50	Miscellaneous Debris	-	Not retained	10244
1807	400 - 600	40 - 50	Miscellaneous Debris	-	Not retained	10245
1808	400 - 600	40 - 50	Miscellaneous Debris	-	Not retained	10246
1809	400 - 600	40 - 50	Miscellaneous Debris	-	Not retained	10247
1810	400 - 600	40 - 50	Miscellaneous Debris	-	Not retained	10248
1811	400 - 600	40 - 50	Miscellaneous Debris	-	Not retained	10249
1812	400 - 600	40 - 50	Miscellaneous Debris	-	Not retained	10250
1813	400 - 600	40 - 50	Miscellaneous Debris	-	Not retained	10251
1814	400 - 600	40 - 50	Miscellaneous Debris	-	Not retained	10252
1815	400 - 600	40 - 50	Miscellaneous Debris	-	Not retained	10253
1816	400 - 600	50 - 60	Warhead Body Piece	0.72		1168
1817	400 - 600	50 - 60	Warhead Body Piece	0.32		1169
1818	400 - 600	50 - 60	Warhead Body Piece	0.43		1170
1819	400 - 600	50 - 60	Warhead Body Piece	0.47		1171
1820	400 - 600	50 - 60	Warhead Body Piece	0.30		1172
1821	400 - 600	50 - 60	Warhead Body Piece	0.22		1173
1822	400 - 600	50 - 60	Warhead Body Piece	0.18		1174
1823	400 - 600	50 - 60	Warhead Body Piece	0.21		1175
1824	400 - 600	50 - 60	Warhead Body Piece	0.08		1176
1825	400 - 600	50 - 60	Warhead Body Piece	0.05		1177
1826	400 - 600	50 - 60	Warhead Body Piece	0.04		1178
1827	400 - 600	50 - 60	Warhead Body Piece	0.03		1179
1828	400 - 600	50 - 60	Warhead Body Piece	0.02		1180
1829	400 - 600	50 - 60	Warhead Body Piece	0.01		1181
1830	400 - 600	50 - 60	Warhead Body Piece	0.04		1182
1831	400 - 600	50 - 60	Warhead Body Piece	0.05		1183
1832	400 - 600	50 - 60	Warhead Body Piece	0.01		1184
1833	400 - 600	50 - 60	Warhead Body Piece	0.01		1185
1834	400 - 600	50 - 60	Warhead Body Piece	0.01		1186
1835	400 - 600	50 - 60	Warhead Body Piece	0.01		1187
1836	400 - 600	50 - 60	Tail Piece	-	Not retained	9234
1837	400 - 600	50 - 60	Miscellaneous Debris	0.01		1188
1838	400 - 600	50 - 60	Miscellaneous Debris	0.01		1189
1839	400 - 600	50 - 60	Miscellaneous Debris	-	Not retained	10254
1840	400 - 600	50 - 60	Miscellaneous Debris	-	Not retained	10255
1841	400 - 600	50 - 60	Miscellaneous Debris	-	Not retained	10256
1842	400 - 600	50 - 60	Miscellaneous Debris	-	Not retained	10257
1843	400 - 600	50 - 60	Miscellaneous Debris	-	Not retained	10258
1844	400 - 600	50 - 60	Miscellaneous Debris	-	Not retained	10259
1845	400 - 600	50 - 60	Miscellaneous Debris	-	Not retained	10260
1846	400 - 600	50 - 60	Miscellaneous Debris	-	Not retained	10261
1847	400 - 600	50 - 60	Miscellaneous Debris	-	Not retained	10262
1848	400 - 600	50 - 60	Miscellaneous Debris	-	Not retained	10263
1849	400 - 600	50 - 60	Miscellaneous Debris	-	Not retained	10264
1850	400 - 600	50 - 60	Miscellaneous Debris	-	Not retained	10265

TABLE B-12. FRAGMENTS RECOVERED BEYOND 200-FT RANGE IN TEST NO. 12 (Continued)

<u>Entry</u>	<u>Range Interval (ft)</u>	<u>Azimuthal Sector (°)</u>	<u>Description</u>	<u>Mass (lb)</u>	<u>Notes</u>	<u>G64 Index No.</u>
1851	400 - 600	50 - 60	Miscellaneous Debris	-	Not retained	10266
1852	400 - 600	50 - 60	Miscellaneous Debris	-	Not retained	10267
1853	400 - 600	60 - 70	Warhead Body Piece	0.50		756
1854	400 - 600	60 - 70	Warhead Body Piece	0.13		757
1855	400 - 600	60 - 70	Warhead Body Piece	0.08		758
1856	400 - 600	60 - 70	Warhead Body Piece	0.04		759
1857	400 - 600	60 - 70	Warhead Body Piece	0.03		760
1858	400 - 600	60 - 70	Warhead Body Piece	0.02		761
1859	400 - 600	60 - 70	Warhead Body Piece	0.02		762
1860	400 - 600	60 - 70	Warhead Body Piece	0.01		763
1861	400 - 600	60 - 70	Warhead Body Piece	0.01		764
1862	400 - 600	60 - 70	Warhead Body Piece	0.01		765
1863	400 - 600	60 - 70	Warhead Body Piece	0.01		766
1864	400 - 600	60 - 70	Warhead Body Piece	0.01		767
1865	400 - 600	60 - 70	Tail Piece	-	Not retained	9235
1866	400 - 600	60 - 70	Miscellaneous Debris	0.01		768
1867	400 - 600	60 - 70	Miscellaneous Debris	-	Not retained	10268
1868	400 - 600	60 - 70	Miscellaneous Debris	-	Not retained	10269
1869	400 - 600	60 - 70	Miscellaneous Debris	-	Not retained	10270
1870	400 - 600	70 - 80	Warhead Body Piece	0.50		1585
1871	400 - 600	70 - 80	Warhead Body Piece	0.50		1586
1872	400 - 600	70 - 80	Warhead Body Piece	0.39		1587
1873	400 - 600	70 - 80	Warhead Body Piece	0.16		1588
1874	400 - 600	70 - 80	Warhead Body Piece	0.09		1589
1875	400 - 600	70 - 80	Warhead Body Piece	0.07		1590
1876	400 - 600	70 - 80	Warhead Body Piece	0.11		1591
1877	400 - 600	70 - 80	Warhead Body Piece	0.02		1592
1878	400 - 600	70 - 80	Warhead Body Piece	0.01		1593
1879	400 - 600	70 - 80	Warhead Body Piece	0.01		1594
1880	400 - 600	70 - 80	Warhead Body Piece	0.01		1595
1881	400 - 600	70 - 80	Warhead Body Piece	0.01		1596
1882	400 - 600	70 - 80	Warhead Body Piece	0.01		1597
1883	400 - 600	70 - 80	Tail Piece	-	Not retained	9236
1884	400 - 600	70 - 80	Tail Piece	-	Not retained	9237
1885	400 - 600	70 - 80	Tail Piece	-	Not retained	9238
1886	400 - 600	70 - 80	Miscellaneous Debris	0.01		1598
1887	400 - 600	70 - 80	Miscellaneous Debris	0.01		1599
1888	400 - 600	70 - 80	Miscellaneous Debris	-	Not retained	10271
1889	400 - 600	70 - 80	Miscellaneous Debris	-	Not retained	10272
1890	400 - 600	70 - 80	Miscellaneous Debris	-	Not retained	10273
1891	400 - 600	70 - 80	Miscellaneous Debris	-	Not retained	10274
1892	400 - 600	70 - 80	Miscellaneous Debris	-	Not retained	10275
1893	400 - 600	70 - 80	Intact Warhead	-	Not retained	9016
1894	400 - 600	80 - 90	Warhead Body Piece	0.21		1539
1895	400 - 600	80 - 90	Warhead Body Piece	0.25		1540
1896	400 - 600	80 - 90	Warhead Body Piece	0.06		1541
1897	400 - 600	80 - 90	Warhead Body Piece	0.24		1542
1898	400 - 600	80 - 90	Warhead Body Piece	0.15		1543
1899	400 - 600	80 - 90	Warhead Body Piece	0.05		1544
1900	400 - 600	80 - 90	Warhead Body Piece	0.04		1545

TABLE B-12. FRAGMENTS RECOVERED BEYOND 200-FT RANGE IN TEST NO. 12 (Continued)

<u>Entry</u>	<u>Range Interval (ft)</u>	<u>Azimuthal Sector (°)</u>	<u>Description</u>	<u>Mass (lb)</u>	<u>Notes</u>	<u>G64 Index No.</u>
1901	400 - 600	80 - 90	Warhead Body Piece	0.03		1546
1902	400 - 600	80 - 90	Warhead Body Piece	0.01		1547
1903	400 - 600	80 - 90	Tail Piece	-	Not retained	1538
1904	400 - 600	80 - 90	Tail Piece	0.07		1548
1905	400 - 600	80 - 90	Tail Piece	-	Not retained	9239
1906	400 - 600	80 - 90	Miscellaneous Debris	-	Not retained	10276
1907	400 - 600	80 - 90	Miscellaneous Debris	-	Not retained	10277
1908	400 - 600	80 - 90	Miscellaneous Debris	-	Not retained	10278
1909	400 - 600	80 - 90	Miscellaneous Debris	-	Not retained	10279
1910	400 - 600	80 - 90	Miscellaneous Debris	-	Not retained	10280
1911	400 - 600	90 - 100	Warhead Body Piece	0.50		74
1912	400 - 600	90 - 100	Warhead Body Piece	0.65		75
1913	400 - 600	90 - 100	Warhead Body Piece	0.27		76
1914	400 - 600	90 - 100	Warhead Body Piece	0.42		77
1915	400 - 600	90 - 100	Warhead Body Piece	0.34		78
1916	400 - 600	90 - 100	Warhead Body Piece	0.06		79
1917	400 - 600	90 - 100	Warhead Body Piece	0.05		80
1918	400 - 600	90 - 100	Warhead Body Piece	0.07		81
1919	400 - 600	90 - 100	Warhead Body Piece	0.03		82
1920	400 - 600	90 - 100	Warhead Body Piece	0.02		83
1921	400 - 600	90 - 100	Warhead Body Piece	0.01		84
1922	400 - 600	90 - 100	Warhead Body Piece	0.01		85
1923	400 - 600	90 - 100	Tail Piece	-	Not retained	9240
1924	400 - 600	90 - 100	Miscellaneous Debris	0.01		86
1925	400 - 600	90 - 100	Miscellaneous Debris	-	Not retained	10281
1926	400 - 600	90 - 100	Miscellaneous Debris	-	Not retained	10282
1927	400 - 600	90 - 100	Miscellaneous Debris	-	Not retained	10283
1928	400 - 600	100 - 110	Warhead Body Piece	0.50		1190
1929	400 - 600	100 - 110	Warhead Body Piece	0.50		1191
1930	400 - 600	100 - 110	Warhead Body Piece	0.50		1192
1931	400 - 600	100 - 110	Warhead Body Piece	0.50		1193
1932	400 - 600	100 - 110	Warhead Body Piece	0.34		1194
1933	400 - 600	100 - 110	Warhead Body Piece	0.31		1195
1934	400 - 600	100 - 110	Warhead Body Piece	0.29		1196
1935	400 - 600	100 - 110	Warhead Body Piece	0.07		1197
1936	400 - 600	100 - 110	Warhead Body Piece	0.04		1198
1937	400 - 600	100 - 110	Tail Piece	-	Not retained	9241
1938	400 - 600	100 - 110	Tail Piece	-	Not retained	9242
1939	400 - 600	100 - 110	Tail Piece	-	Not retained	9243
1940	400 - 600	100 - 110	Miscellaneous Debris	0.01		1199
1941	400 - 600	100 - 110	Miscellaneous Debris	-	Not retained	10284
1942	400 - 600	100 - 110	Miscellaneous Debris	-	Not retained	10285
1943	400 - 600	100 - 110	Miscellaneous Debris	-	Not retained	10286
1944	400 - 600	100 - 110	Miscellaneous Debris	-	Not retained	10287
1945	400 - 600	110 - 120	Warhead Body Piece	0.25		1600
1946	400 - 600	110 - 120	Warhead Body Piece	0.21		1601
1947	400 - 600	110 - 120	Warhead Body Piece	0.14		1602
1948	400 - 600	110 - 120	Warhead Body Piece	0.10		1603
1949	400 - 600	110 - 120	Warhead Body Piece	0.06		1604
1950	400 - 600	110 - 120	Warhead Body Piece	0.02		1605

TABLE B-12. FRAGMENTS RECOVERED BEYOND 200-FT RANGE IN TEST NO. 12 (Continued)

<u>Entry</u>	<u>Range Interval (ft)</u>	<u>Azimuthal Sector (°)</u>	<u>Description</u>	<u>Mass (lb)</u>	<u>Notes</u>	<u>G64 Index No.</u>
1951	400 - 600	110 - 120	Warhead Body Piece	0.01		1606
1952	400 - 600	110 - 120	Warhead Body Piece	0.50		1607
1953	400 - 600	110 - 120	Warhead Body Piece	0.50		1608
1954	400 - 600	110 - 120	Miscellaneous Debris	-	Not retained	10288
1955	400 - 600	110 - 120	Miscellaneous Debris	-	Not retained	10289
1956	400 - 600	110 - 120	Miscellaneous Debris	-	Not retained	10290
1957	400 - 600	120 - 130	Warhead Body Piece	0.38		18
1958	400 - 600	120 - 130	Warhead Body Piece	0.13		19
1959	400 - 600	120 - 130	Warhead Body Piece	0.11		20
1960	400 - 600	120 - 130	Warhead Body Piece	0.02		21
1961	400 - 600	120 - 130	Warhead Body Piece	0.01		22
1962	400 - 600	120 - 130	Miscellaneous Debris	-	Not retained	10291
1963	400 - 600	120 - 130	Miscellaneous Debris	-	Not retained	10292
1964	400 - 600	120 - 130	Miscellaneous Debris	-	Not retained	10293
1965	400 - 600	120 - 130	Miscellaneous Debris	-	Not retained	10294
1966	400 - 600	130 - 140	Warhead Body Piece	0.74		1110
1967	400 - 600	130 - 140	Warhead Body Piece	0.59		1111
1968	400 - 600	130 - 140	Warhead Body Piece	0.21		1112
1969	400 - 600	130 - 140	Warhead Body Piece	0.18		1113
1970	400 - 600	130 - 140	Warhead Body Piece	0.17		1114
1971	400 - 600	130 - 140	Warhead Body Piece	0.20		1115
1972	400 - 600	130 - 140	Warhead Body Piece	0.09		1116
1973	400 - 600	130 - 140	Warhead Body Piece	0.08		1117
1974	400 - 600	130 - 140	Warhead Body Piece	0.01		1118
1975	400 - 600	130 - 140	Tail Piece	0.04		1119
1976	400 - 600	130 - 140	Tail Piece	-	Not retained	9244
1977	400 - 600	130 - 140	Miscellaneous Debris	-	Not retained	10295
1978	400 - 600	130 - 140	Miscellaneous Debris	-	Not retained	10296
1979	400 - 600	140 - 150	Warhead Body Piece	0.24		769
1980	400 - 600	140 - 150	Warhead Body Piece	0.05		770
1981	400 - 600	140 - 150	Warhead Body Piece	0.01		771
1982	400 - 600	140 - 150	Miscellaneous Debris	-	Not retained	10297
1983	400 - 600	140 - 150	Miscellaneous Debris	-	Not retained	10298
1984	400 - 600	140 - 150	Miscellaneous Debris	-	Not retained	10299
1985	400 - 600	140 - 150	Intact Warhead	-	Not retained	9017
1986	400 - 600	150 - 160	Warhead Body Piece	0.51		301
1987	400 - 600	150 - 160	Warhead Body Piece	0.18		302
1988	400 - 600	150 - 160	Warhead Body Piece	0.26		303
1989	400 - 600	150 - 160	Warhead Body Piece	0.19		304
1990	400 - 600	150 - 160	Warhead Body Piece	0.01		305
1991	400 - 600	150 - 160	Miscellaneous Debris	-	Not retained	10300
1992	400 - 600	150 - 160	Miscellaneous Debris	-	Not retained	10301
1993	400 - 600	150 - 160	Intact Warhead	-	Not retained	9018
1994	400 - 600	160 - 170	Warhead Body Piece	0.20		216
1995	400 - 600	160 - 170	Warhead Body Piece	0.14		217
1996	400 - 600	160 - 170	Warhead Body Piece	0.11		218
1997	400 - 600	160 - 170	Warhead Body Piece	0.08		219
1998	400 - 600	160 - 170	Warhead Body Piece	0.07		220
1999	400 - 600	160 - 170	Warhead Body Piece	0.05		221
2000	400 - 600	160 - 170	Warhead Body Piece	0.01		222

NSWCDD/TR-98/6

TABLE B-12. FRAGMENTS RECOVERED BEYOND 200-FT RANGE IN TEST NO. 12 (Continued)

<u>Entry</u>	<u>Range Interval (ft)</u>	<u>Azimuthal Sector (°)</u>	<u>Description</u>	<u>Mass (lb)</u>	<u>Notes</u>	<u>G64 Index No.</u>
2001	400 - 600	160 - 170	Miscellaneous Debris	-	Not retained	10302
2002	400 - 600	160 - 170	Miscellaneous Debris	-	Not retained	10303
2003	400 - 600	160 - 170	Miscellaneous Debris	-	Not retained	10304
2004	400 - 600	170 - 180	Warhead Body Piece	0.35		339
2005	400 - 600	170 - 180	Warhead Body Piece	0.27		340
2006	400 - 600	170 - 180	Tail Piece	-	Not retained	337
2007	400 - 600	170 - 180	Tail Piece	-	Not retained	338
2008	400 - 600	170 - 180	Tail Piece	-	Not retained	9245
2009	400 - 600	170 - 180	Tail Piece	-	Not retained	9246
2010	400 - 600	170 - 180	Miscellaneous Debris	-	Not retained	10305
2011	400 - 600	170 - 180	Miscellaneous Debris	-	Not retained	10306
2012	400 - 600	170 - 180	Miscellaneous Debris	-	Not retained	10307
2013	400 - 600	170 - 180	Miscellaneous Debris	-	Not retained	10308
2014	400 - 600	170 - 180	Miscellaneous Debris	-	Not retained	10309
2015	400 - 600	170 - 180	Miscellaneous Debris	-	Not retained	10310
2016	400 - 600	170 - 180	Miscellaneous Debris	-	Not retained	10311
2017	400 - 600	170 - 180	Miscellaneous Debris	-	Not retained	10312
2018	400 - 600	170 - 180	Miscellaneous Debris	-	Not retained	10313
2019	400 - 600	170 - 180	Intact Warhead	-	Not retained	9019
2020	400 - 600	180 - 190	Warhead Body Piece	1.24		1102
2021	400 - 600	180 - 190	Warhead Body Piece	0.44		1103
2022	400 - 600	180 - 190	Warhead Body Piece	0.37		1104
2023	400 - 600	180 - 190	Warhead Body Piece	0.15		1105
2024	400 - 600	180 - 190	Warhead Body Piece	0.16		1106
2025	400 - 600	180 - 190	Warhead Body Piece	0.07		1107
2026	400 - 600	180 - 190	Warhead Body Piece	0.17		1108
2027	400 - 600	180 - 190	Warhead Body Piece	0.13		1109
2028	400 - 600	180 - 190	Tail Piece	-	Not retained	1101
2029	400 - 600	180 - 190	Tail Piece	-	Not retained	9247
2030	400 - 600	180 - 190	Miscellaneous Debris	-	Not retained	10314
2031	400 - 600	190 - 200	Warhead Body Piece	0.01		286
2032	400 - 600	190 - 200	Warhead Body Piece	0.01		287
2033	400 - 600	190 - 200	Miscellaneous Debris	-	Not retained	10315
2034	400 - 600	200 - 210	Warhead Body Piece	0.56		778
2035	400 - 600	200 - 210	Warhead Body Piece	0.64		779
2036	400 - 600	200 - 210	Warhead Body Piece	0.31		780
2037	400 - 600	200 - 210	Warhead Body Piece	0.12		781
2038	400 - 600	200 - 210	Warhead Body Piece	0.14		782
2039	400 - 600	200 - 210	Warhead Body Piece	0.10		783
2040	400 - 600	200 - 210	Warhead Body Piece	0.12		784
2041	400 - 600	200 - 210	Warhead Body Piece	0.09		785
2042	400 - 600	200 - 210	Warhead Body Piece	0.06		786
2043	400 - 600	200 - 210	Warhead Body Piece	0.04		787
2044	400 - 600	200 - 210	Warhead Body Piece	0.02		788
2045	400 - 600	200 - 210	Warhead Body Piece	0.01		789
2046	400 - 600	200 - 210	Warhead Body Piece	0.01		790
2047	400 - 600	200 - 210	Warhead Body Piece	0.01		791
2048	400 - 600	200 - 210	Miscellaneous Debris	-	Not retained	10316
2049	400 - 600	200 - 210	Miscellaneous Debris	-	Not retained	10317
2050	400 - 600	200 - 210	Miscellaneous Debris	-	Not retained	10318

TABLE B-12. FRAGMENTS RECOVERED BEYOND 200-FT RANGE IN TEST NO. 12 (Continued)

<u>Entry</u>	<u>Range Interval (ft)</u>	<u>Azimuthal Sector (°)</u>	<u>Description</u>	<u>Mass (lb)</u>	<u>Notes</u>	<u>G64 Index No.</u>
2051	400 - 600	200 - 210	Miscellaneous Debris	-	Not retained	10319
2052	400 - 600	210 - 220	Warhead Body Piece	0.50		1040
2053	400 - 600	210 - 220	Warhead Body Piece	0.12		1041
2054	400 - 600	210 - 220	Warhead Body Piece	0.08		1042
2055	400 - 600	210 - 220	Warhead Body Piece	0.12		1043
2056	400 - 600	210 - 220	Warhead Body Piece	0.02		1044
2057	400 - 600	210 - 220	Warhead Body Piece	0.02		1045
2058	400 - 600	210 - 220	Warhead Body Piece	0.01		1046
2059	400 - 600	210 - 220	Warhead Body Piece	0.01		1047
2060	400 - 600	210 - 220	Tail Piece	-	Not retained	9248
2061	400 - 600	210 - 220	Tail Piece	-	Not retained	9249
2062	400 - 600	210 - 220	Tail Piece	-	Not retained	9250
2063	400 - 600	210 - 220	Miscellaneous Debris	0.01		1048
2064	400 - 600	210 - 220	Miscellaneous Debris	0.01		1049
2065	400 - 600	210 - 220	Miscellaneous Debris	-	Not retained	10320
2066	400 - 600	210 - 220	Miscellaneous Debris	-	Not retained	10321
2067	400 - 600	210 - 220	Miscellaneous Debris	-	Not retained	10322
2068	400 - 600	210 - 220	Miscellaneous Debris	-	Not retained	10323
2069	400 - 600	210 - 220	Miscellaneous Debris	-	Not retained	10324
2070	400 - 600	210 - 220	Miscellaneous Debris	-	Not retained	10325
2071	400 - 600	210 - 220	Miscellaneous Debris	-	Not retained	10326
2072	400 - 600	210 - 220	Miscellaneous Debris	-	Not retained	10327
2073	400 - 600	220 - 230	Warhead Body Piece	0.50		626
2074	400 - 600	220 - 230	Warhead Body Piece	0.56		627
2075	400 - 600	220 - 230	Warhead Body Piece	0.09		628
2076	400 - 600	220 - 230	Warhead Body Piece	0.10		629
2077	400 - 600	220 - 230	Warhead Body Piece	0.07		630
2078	400 - 600	220 - 230	Warhead Body Piece	0.06		631
2079	400 - 600	220 - 230	Warhead Body Piece	0.05		632
2080	400 - 600	220 - 230	Warhead Body Piece	0.03		633
2081	400 - 600	220 - 230	Warhead Body Piece	0.04		634
2082	400 - 600	220 - 230	Warhead Body Piece	0.03		635
2083	400 - 600	220 - 230	Warhead Body Piece	0.01		636
2084	400 - 600	220 - 230	Warhead Body Piece	0.03		637
2085	400 - 600	220 - 230	Warhead Body Piece	0.05		638
2086	400 - 600	220 - 230	Warhead Body Piece	0.03		639
2087	400 - 600	220 - 230	Warhead Body Piece	0.01		640
2088	400 - 600	220 - 230	Warhead Body Piece	0.01		641
2089	400 - 600	220 - 230	Warhead Body Piece	0.01		642
2090	400 - 600	220 - 230	Tail Piece	-	Not retained	9251
2091	400 - 600	220 - 230	Miscellaneous Debris	0.01		643
2092	400 - 600	220 - 230	Miscellaneous Debris	-	Not retained	10328
2093	400 - 600	220 - 230	Miscellaneous Debris	-	Not retained	10329
2094	400 - 600	220 - 230	Miscellaneous Debris	-	Not retained	10330
2095	400 - 600	230 - 240	Warhead Body Piece	0.50		941
2096	400 - 600	230 - 240	Warhead Body Piece	0.28		942
2097	400 - 600	230 - 240	Warhead Body Piece	0.36		943
2098	400 - 600	230 - 240	Warhead Body Piece	0.11		944
2099	400 - 600	230 - 240	Warhead Body Piece	0.07		945
2100	400 - 600	230 - 240	Warhead Body Piece	0.05		946

TABLE B-12. FRAGMENTS RECOVERED BEYOND 200-FT RANGE IN TEST NO. 12 (Continued)

<u>Entry</u>	<u>Range Interval (ft)</u>	<u>Azimuthal Sector (°)</u>	<u>Description</u>	<u>Mass (lb)</u>	<u>Notes</u>	<u>G64 Index No.</u>
2101	400 - 600	230 - 240	Warhead Body Piece	0.02		947
2102	400 - 600	230 - 240	Warhead Body Piece	0.01		948
2103	400 - 600	230 - 240	Warhead Body Piece	0.01		949
2104	400 - 600	230 - 240	Warhead Body Piece	0.01		950
2105	400 - 600	230 - 240	Tail Piece	0.02		951
2106	400 - 600	230 - 240	Tail Piece	-	Not retained	9252
2107	400 - 600	230 - 240	Tail Piece	-	Not retained	9253
2108	400 - 600	230 - 240	Miscellaneous Debris	-	Not retained	10331
2109	400 - 600	230 - 240	Miscellaneous Debris	-	Not retained	10332
2110	400 - 600	230 - 240	Miscellaneous Debris	-	Not retained	10333
2111	400 - 600	240 - 250	Warhead Body Piece	0.38		1152
2112	400 - 600	240 - 250	Warhead Body Piece	0.19		1153
2113	400 - 600	240 - 250	Warhead Body Piece	0.06		1154
2114	400 - 600	240 - 250	Warhead Body Piece	0.05		1155
2115	400 - 600	240 - 250	Warhead Body Piece	0.03		1156
2116	400 - 600	240 - 250	Warhead Body Piece	0.07		1157
2117	400 - 600	240 - 250	Warhead Body Piece	0.04		1158
2118	400 - 600	240 - 250	Warhead Body Piece	0.03		1159
2119	400 - 600	240 - 250	Warhead Body Piece	0.02		1160
2120	400 - 600	240 - 250	Warhead Body Piece	0.01		1161
2121	400 - 600	240 - 250	Warhead Body Piece	0.01		1162
2122	400 - 600	240 - 250	Warhead Body Piece	0.01		1163
2123	400 - 600	240 - 250	Warhead Body Piece	0.01		1164
2124	400 - 600	240 - 250	Tail Piece	-	Not retained	1151
2125	400 - 600	240 - 250	Tail Piece	0.04		1165
2126	400 - 600	240 - 250	Tail Piece	0.02		1166
2127	400 - 600	240 - 250	Tail Piece	-	Not retained	9254
2128	400 - 600	240 - 250	Tail Piece	-	Not retained	9255
2129	400 - 600	240 - 250	Tail Piece	-	Not retained	9256
2130	400 - 600	240 - 250	Miscellaneous Debris	0.01		1167
2131	400 - 600	240 - 250	Miscellaneous Debris	-	Not retained	10334
2132	400 - 600	250 - 260	Warhead Body Piece	0.60		1225
2133	400 - 600	250 - 260	Warhead Body Piece	0.25		1226
2134	400 - 600	250 - 260	Warhead Body Piece	0.26		1227
2135	400 - 600	250 - 260	Warhead Body Piece	0.19		1228
2136	400 - 600	250 - 260	Warhead Body Piece	0.16		1229
2137	400 - 600	250 - 260	Warhead Body Piece	0.18		1230
2138	400 - 600	250 - 260	Warhead Body Piece	0.12		1231
2139	400 - 600	250 - 260	Warhead Body Piece	0.13		1232
2140	400 - 600	250 - 260	Warhead Body Piece	0.06		1233
2141	400 - 600	250 - 260	Warhead Body Piece	0.05		1234
2142	400 - 600	250 - 260	Warhead Body Piece	0.04		1235
2143	400 - 600	250 - 260	Warhead Body Piece	0.03		1236
2144	400 - 600	250 - 260	Warhead Body Piece	0.02		1237
2145	400 - 600	250 - 260	Warhead Body Piece	0.01		1238
2146	400 - 600	250 - 260	Warhead Body Piece	0.01		1239
2147	400 - 600	250 - 260	Warhead Body Piece	0.01		1240
2148	400 - 600	250 - 260	Tail Piece	-	Not retained	1224
2149	400 - 600	250 - 260	Tail Piece	-	Not retained	9257
2150	400 - 600	250 - 260	Tail Piece	-	Not retained	9258

NSWCDD/TR-98/6

TABLE B-12. FRAGMENTS RECOVERED BEYOND 200-FT RANGE IN TEST NO. 12 (Continued)

<u>Entry</u>	<u>Range Interval (ft)</u>	<u>Azimuthal Sector (°)</u>	<u>Description</u>	<u>Mass (lb)</u>	<u>Notes</u>	<u>G64 Index No.</u>
2151	400 - 600	250 - 260	Tail Piece	-	Not retained	9259
2152	400 - 600	250 - 260	Miscellaneous Debris	0.01		1241
2153	400 - 600	250 - 260	Miscellaneous Debris	0.01		1242
2154	400 - 600	250 - 260	Miscellaneous Debris	-	Not retained	10335
2155	400 - 600	250 - 260	Miscellaneous Debris	-	Not retained	10336
2156	400 - 600	250 - 260	Miscellaneous Debris	-	Not retained	10337
2157	400 - 600	250 - 260	Miscellaneous Debris	-	Not retained	10338
2158	400 - 600	250 - 260	Miscellaneous Debris	-	Not retained	10339
2159	400 - 600	250 - 260	Miscellaneous Debris	-	Not retained	10340
2160	400 - 600	250 - 260	Miscellaneous Debris	-	Not retained	10341
2161	400 - 600	250 - 260	Miscellaneous Debris	-	Not retained	10342
2162	400 - 600	260 - 270	Tail Piece	-	Not retained	9260
2163	400 - 600	260 - 270	Tail Piece	-	Not retained	9261
2164	400 - 600	260 - 270	Tail Piece	-	Not retained	9262
2165	400 - 600	260 - 270	Tail Piece	-	Not retained	9263
2166	400 - 600	260 - 270	Miscellaneous Debris	-	Not retained	10343
2167	400 - 600	260 - 270	Miscellaneous Debris	-	Not retained	10344
2168	400 - 600	260 - 270	Miscellaneous Debris	-	Not retained	10345
2169	400 - 600	270 - 280	Warhead Body Piece	0.50		1483
2170	400 - 600	270 - 280	Warhead Body Piece	0.50		1484
2171	400 - 600	270 - 280	Warhead Body Piece	0.46		1485
2172	400 - 600	270 - 280	Warhead Body Piece	0.29		1486
2173	400 - 600	270 - 280	Warhead Body Piece	0.27		1487
2174	400 - 600	270 - 280	Warhead Body Piece	0.08		1488
2175	400 - 600	270 - 280	Warhead Body Piece	0.07		1489
2176	400 - 600	270 - 280	Warhead Body Piece	0.09		1490
2177	400 - 600	270 - 280	Warhead Body Piece	0.15		1491
2178	400 - 600	270 - 280	Warhead Body Piece	0.02		1492
2179	400 - 600	270 - 280	Warhead Body Piece	0.01		1493
2180	400 - 600	270 - 280	Warhead Body Piece	0.01		1494
2181	400 - 600	270 - 280	Warhead Body Piece	0.01		1495
2182	400 - 600	270 - 280	Warhead Body Piece	0.01		1496
2183	400 - 600	270 - 280	Warhead Body Piece	0.01		1497
2184	400 - 600	270 - 280	Warhead Body Piece	0.01		1498
2185	400 - 600	270 - 280	Tail Piece	-	Not retained	9264
2186	400 - 600	270 - 280	Tail Piece	-	Not retained	9265
2187	400 - 600	270 - 280	Tail Piece	-	Not retained	9266
2188	400 - 600	270 - 280	Tail Piece	-	Not retained	9267
2189	400 - 600	270 - 280	Miscellaneous Debris	0.01		1499
2190	400 - 600	270 - 280	Miscellaneous Debris	0.01		1500
2191	400 - 600	270 - 280	Miscellaneous Debris	-	Not retained	10346
2192	400 - 600	270 - 280	Miscellaneous Debris	-	Not retained	10347
2193	400 - 600	270 - 280	Miscellaneous Debris	-	Not retained	10348
2194	400 - 600	270 - 280	Miscellaneous Debris	-	Not retained	10349
2195	400 - 600	270 - 280	Miscellaneous Debris	-	Not retained	10350
2196	400 - 600	270 - 280	Miscellaneous Debris	-	Not retained	10351
2197	400 - 600	270 - 280	Miscellaneous Debris	-	Not retained	10352
2198	400 - 600	270 - 280	Miscellaneous Debris	-	Not retained	10353
2199	400 - 600	270 - 280	Intact Warhead	-	Not retained	9020
2200	400 - 600	280 - 290	Warhead Body Piece	0.50		644

NSWCDD/TR-98/6

TABLE B-12. FRAGMENTS RECOVERED BEYOND 200-FT RANGE IN TEST NO. 12 (Continued)

<u>Entry</u>	<u>Range Interval (ft)</u>	<u>Azimuthal Sector (°)</u>	<u>Description</u>	<u>Mass (lb)</u>	<u>Notes</u>	<u>G64 Index No.</u>
2201	400 - 600	280 - 290	Warhead Body Piece	0.50		645
2202	400 - 600	280 - 290	Warhead Body Piece	0.43		646
2203	400 - 600	280 - 290	Warhead Body Piece	0.39		647
2204	400 - 600	280 - 290	Warhead Body Piece	0.23		648
2205	400 - 600	280 - 290	Warhead Body Piece	0.37		649
2206	400 - 600	280 - 290	Warhead Body Piece	0.14		650
2207	400 - 600	280 - 290	Warhead Body Piece	0.11		651
2208	400 - 600	280 - 290	Warhead Body Piece	0.13		652
2209	400 - 600	280 - 290	Warhead Body Piece	0.08		653
2210	400 - 600	280 - 290	Warhead Body Piece	0.06		654
2211	400 - 600	280 - 290	Warhead Body Piece	0.10		655
2212	400 - 600	280 - 290	Warhead Body Piece	0.08		656
2213	400 - 600	280 - 290	Warhead Body Piece	0.02		657
2214	400 - 600	280 - 290	Warhead Body Piece	0.01		658
2215	400 - 600	280 - 290	Warhead Body Piece	0.01		659
2216	400 - 600	280 - 290	Warhead Body Piece	0.04		660
2217	400 - 600	280 - 290	Warhead Body Piece	0.04		661
2218	400 - 600	280 - 290	Warhead Body Piece	0.03		662
2219	400 - 600	280 - 290	Warhead Body Piece	0.02		663
2220	400 - 600	280 - 290	Tail Piece	-	Not retained	9268
2221	400 - 600	280 - 290	Tail Piece	-	Not retained	9269
2222	400 - 600	280 - 290	Miscellaneous Debris	0.03		664
2223	400 - 600	280 - 290	Miscellaneous Debris	-	Not retained	10354
2224	400 - 600	280 - 290	Miscellaneous Debris	-	Not retained	10355
2225	400 - 600	280 - 290	Miscellaneous Debris	-	Not retained	10356
2226	400 - 600	280 - 290	Miscellaneous Debris	-	Not retained	10357
2227	400 - 600	280 - 290	Miscellaneous Debris	-	Not retained	10358
2228	400 - 600	280 - 290	Miscellaneous Debris	-	Not retained	10359
2229	400 - 600	280 - 290	Miscellaneous Debris	-	Not retained	10360
2230	400 - 600	280 - 290	Miscellaneous Debris	-	Not retained	10361
2231	400 - 600	280 - 290	Miscellaneous Debris	-	Not retained	10362
2232	400 - 600	280 - 290	Intact Warhead	-	Not retained	9021
2233	400 - 600	290 - 300	Warhead Body Piece	0.89		319
2234	400 - 600	290 - 300	Warhead Body Piece	0.47		320
2235	400 - 600	290 - 300	Warhead Body Piece	0.39		321
2236	400 - 600	290 - 300	Warhead Body Piece	0.07		322
2237	400 - 600	290 - 300	Warhead Body Piece	0.06		323
2238	400 - 600	290 - 300	Warhead Body Piece	0.02		324
2239	400 - 600	290 - 300	Warhead Body Piece	0.01		325
2240	400 - 600	290 - 300	Warhead Body Piece	0.01		326
2241	400 - 600	290 - 300	Tail Piece	0.01		329
2242	400 - 600	290 - 300	Tail Piece	-	Not retained	9270
2243	400 - 600	290 - 300	Tail Piece	-	Not retained	9271
2244	400 - 600	290 - 300	Tail Piece	-	Not retained	9272
2245	400 - 600	290 - 300	Miscellaneous Debris	0.03		327
2246	400 - 600	290 - 300	Miscellaneous Debris	0.01		328
2247	400 - 600	290 - 300	Miscellaneous Debris	-	Not retained	10363
2248	400 - 600	290 - 300	Miscellaneous Debris	-	Not retained	10364
2249	400 - 600	290 - 300	Miscellaneous Debris	-	Not retained	10365
2250	400 - 600	290 - 300	Miscellaneous Debris	-	Not retained	10366

NSWCDD/TR-98/6

TABLE B-12. FRAGMENTS RECOVERED BEYOND 200-FT RANGE IN TEST NO. 12 (Continued)

<u>Entry</u>	<u>Range Interval (ft)</u>	<u>Azimuthal Sector (°)</u>	<u>Description</u>	<u>Mass (lb)</u>	<u>Notes</u>	<u>G64 Index No.</u>
2251	400 - 600	290 - 300	Miscellaneous Debris	-	Not retained	10367
2252	400 - 600	290 - 300	Miscellaneous Debris	-	Not retained	10368
2253	400 - 600	290 - 300	Miscellaneous Debris	-	Not retained	10369
2254	400 - 600	300 - 310	Warhead Body Piece	0.19		1353
2255	400 - 600	300 - 310	Warhead Body Piece	0.10		1354
2256	400 - 600	300 - 310	Warhead Body Piece	0.02		1355
2257	400 - 600	300 - 310	Warhead Body Piece	0.13		1356
2258	400 - 600	300 - 310	Warhead Body Piece	0.03		1357
2259	400 - 600	300 - 310	Warhead Body Piece	0.03		1358
2260	400 - 600	300 - 310	Warhead Body Piece	0.03		1359
2261	400 - 600	300 - 310	Warhead Body Piece	0.01		1360
2262	400 - 600	300 - 310	Warhead Body Piece	0.01		1361
2263	400 - 600	300 - 310	Warhead Body Piece	0.01		1362
2264	400 - 600	300 - 310	Warhead Body Piece	0.01		1363
2265	400 - 600	300 - 310	Tail Piece	0.05		1364
2266	400 - 600	300 - 310	Tail Piece	0.01		1365
2267	400 - 600	300 - 310	Tail Piece	0.01		1366
2268	400 - 600	300 - 310	Tail Piece	-	Not retained	9273
2269	400 - 600	300 - 310	Tail Piece	-	Not retained	9274
2270	400 - 600	300 - 310	Tail Piece	-	Not retained	9275
2271	400 - 600	300 - 310	Tail Piece	-	Not retained	9276
2272	400 - 600	300 - 310	Tail Piece	-	Not retained	9277
2273	400 - 600	300 - 310	Tail Piece	-	Not retained	9278
2274	400 - 600	300 - 310	Tail Piece	-	Not retained	9279
2275	400 - 600	300 - 310	Tail Piece	-	Not retained	9280
2276	400 - 600	300 - 310	Miscellaneous Debris	0.03		1367
2277	400 - 600	300 - 310	Miscellaneous Debris	0.01		1368
2278	400 - 600	300 - 310	Miscellaneous Debris	0.01		1369
2279	400 - 600	300 - 310	Miscellaneous Debris	-	Not retained	1351
2280	400 - 600	300 - 310	Miscellaneous Debris	-	Not retained	1352
2281	400 - 600	300 - 310	Miscellaneous Debris	-	Not retained	10370
2282	400 - 600	300 - 310	Miscellaneous Debris	-	Not retained	10371
2283	400 - 600	300 - 310	Miscellaneous Debris	-	Not retained	10372
2284	400 - 600	300 - 310	Miscellaneous Debris	-	Not retained	10373
2285	400 - 600	300 - 310	Miscellaneous Debris	-	Not retained	10374
2286	400 - 600	300 - 310	Miscellaneous Debris	-	Not retained	10375
2287	400 - 600	300 - 310	Miscellaneous Debris	-	Not retained	10376
2288	400 - 600	300 - 310	Miscellaneous Debris	-	Not retained	10377
2289	400 - 600	300 - 310	Miscellaneous Debris	-	Not retained	10378
2290	400 - 600	310 - 320	Warhead Body Piece	0.42		804
2291	400 - 600	310 - 320	Warhead Body Piece	0.54		805
2292	400 - 600	310 - 320	Warhead Body Piece	0.34		806
2293	400 - 600	310 - 320	Warhead Body Piece	0.25		807
2294	400 - 600	310 - 320	Warhead Body Piece	0.25		808
2295	400 - 600	310 - 320	Warhead Body Piece	0.31		809
2296	400 - 600	310 - 320	Warhead Body Piece	0.23		810
2297	400 - 600	310 - 320	Warhead Body Piece	0.29		811
2298	400 - 600	310 - 320	Warhead Body Piece	0.08		812
2299	400 - 600	310 - 320	Warhead Body Piece	0.08		813
2300	400 - 600	310 - 320	Warhead Body Piece	0.10		814

TABLE B-12. FRAGMENTS RECOVERED BEYOND 200-FT RANGE IN TEST NO. 12 (Continued)

<u>Entry</u>	<u>Range Interval (ft)</u>	<u>Azimuthal Sector (°)</u>	<u>Description</u>	<u>Mass (lb)</u>	<u>Notes</u>	<u>G64 Index No.</u>
2301	400 - 600	310 - 320	Warhead Body Piece	0.05		815
2302	400 - 600	310 - 320	Warhead Body Piece	0.03		816
2303	400 - 600	310 - 320	Warhead Body Piece	0.02		817
2304	400 - 600	310 - 320	Warhead Body Piece	0.01		818
2305	400 - 600	310 - 320	Warhead Body Piece	0.01		819
2306	400 - 600	310 - 320	Warhead Body Piece	0.01		820
2307	400 - 600	310 - 320	Warhead Body Piece	0.01		821
2308	400 - 600	310 - 320	Warhead Body Piece	0.01		822
2309	400 - 600	310 - 320	Warhead Body Piece	0.01		823
2310	400 - 600	310 - 320	Warhead Body Piece	0.01		824
2311	400 - 600	310 - 320	Warhead Body Piece	0.01		825
2312	400 - 600	310 - 320	Warhead Body Piece	0.01		826
2313	400 - 600	310 - 320	Tail Piece	-	Not retained	803
2314	400 - 600	310 - 320	Tail Piece	0.01		827
2315	400 - 600	310 - 320	Tail Piece	-	Not retained	9281
2316	400 - 600	310 - 320	Tail Piece	-	Not retained	9282
2317	400 - 600	310 - 320	Tail Piece	-	Not retained	9283
2318	400 - 600	310 - 320	Miscellaneous Debris	-	Not retained	10379
2319	400 - 600	310 - 320	Miscellaneous Debris	-	Not retained	10380
2320	400 - 600	310 - 320	Miscellaneous Debris	-	Not retained	10381
2321	400 - 600	310 - 320	Miscellaneous Debris	-	Not retained	10382
2322	400 - 600	310 - 320	Miscellaneous Debris	-	Not retained	10383
2323	400 - 600	310 - 320	Miscellaneous Debris	-	Not retained	10384
2324	400 - 600	310 - 320	Miscellaneous Debris	-	Not retained	10385
2325	400 - 600	310 - 320	Miscellaneous Debris	-	Not retained	10386
2326	400 - 600	310 - 320	Miscellaneous Debris	-	Not retained	10387
2327	400 - 600	310 - 320	Miscellaneous Debris	-	Not retained	10388
2328	400 - 600	310 - 320	Miscellaneous Debris	-	Not retained	10389
2329	400 - 600	310 - 320	Miscellaneous Debris	-	Not retained	10390
2330	400 - 600	320 - 330	Warhead Body Piece	0.50		1503
2331	400 - 600	320 - 330	Warhead Body Piece	0.78		1504
2332	400 - 600	320 - 330	Warhead Body Piece	0.40		1505
2333	400 - 600	320 - 330	Warhead Body Piece	0.42		1506
2334	400 - 600	320 - 330	Warhead Body Piece	0.32		1507
2335	400 - 600	320 - 330	Warhead Body Piece	0.29		1508
2336	400 - 600	320 - 330	Warhead Body Piece	0.23		1509
2337	400 - 600	320 - 330	Warhead Body Piece	0.19		1510
2338	400 - 600	320 - 330	Warhead Body Piece	0.15		1511
2339	400 - 600	320 - 330	Warhead Body Piece	0.11		1512
2340	400 - 600	320 - 330	Warhead Body Piece	0.10		1513
2341	400 - 600	320 - 330	Warhead Body Piece	0.05		1514
2342	400 - 600	320 - 330	Warhead Body Piece	0.08		1515
2343	400 - 600	320 - 330	Warhead Body Piece	0.08		1516
2344	400 - 600	320 - 330	Warhead Body Piece	0.04		1517
2345	400 - 600	320 - 330	Warhead Body Piece	0.04		1518
2346	400 - 600	320 - 330	Warhead Body Piece	0.04		1519
2347	400 - 600	320 - 330	Warhead Body Piece	0.02		1520
2348	400 - 600	320 - 330	Warhead Body Piece	0.02		1521
2349	400 - 600	320 - 330	Warhead Body Piece	0.08		1522
2350	400 - 600	320 - 330	Warhead Body Piece	0.04		1523

TABLE B-12. FRAGMENTS RECOVERED BEYOND 200-FT RANGE IN TEST NO. 12 (Continued)

<u>Entry</u>	<u>Range Interval (ft)</u>	<u>Azimuthal Sector (°)</u>	<u>Description</u>	<u>Mass (lb)</u>	<u>Notes</u>	<u>G64 Index No.</u>
2351	400 - 600	320 - 330	Warhead Body Piece	0.03		1524
2352	400 - 600	320 - 330	Warhead Body Piece	0.02		1525
2353	400 - 600	320 - 330	Warhead Body Piece	0.02		1526
2354	400 - 600	320 - 330	Warhead Body Piece	0.01		1527
2355	400 - 600	320 - 330	Warhead Body Piece	0.01		1528
2356	400 - 600	320 - 330	Warhead Body Piece	0.01		1529
2357	400 - 600	320 - 330	Warhead Body Piece	0.01		1530
2358	400 - 600	320 - 330	Warhead Body Piece	0.01		1531
2359	400 - 600	320 - 330	Warhead Body Piece	0.01		1532
2360	400 - 600	320 - 330	Warhead Body Piece	0.01		1533
2361	400 - 600	320 - 330	Warhead Body Piece	0.01		1534
2362	400 - 600	320 - 330	Tail Piece	-	Not retained	1501
2363	400 - 600	320 - 330	Tail Piece	-	Not retained	1502
2364	400 - 600	320 - 330	Tail Piece	0.06		1536
2365	400 - 600	320 - 330	Tail Piece	-	Not retained	9284
2366	400 - 600	320 - 330	Tail Piece	-	Not retained	9285
2367	400 - 600	320 - 330	Tail Piece	-	Not retained	9286
2368	400 - 600	320 - 330	Tail Piece	-	Not retained	9287
2369	400 - 600	320 - 330	Miscellaneous Debris	0.01		1537
2370	400 - 600	320 - 330	Miscellaneous Debris	0.01		1535
2371	400 - 600	320 - 330	Miscellaneous Debris	-	Not retained	10391
2372	400 - 600	320 - 330	Miscellaneous Debris	-	Not retained	10392
2373	400 - 600	320 - 330	Miscellaneous Debris	-	Not retained	10393
2374	400 - 600	320 - 330	Miscellaneous Debris	-	Not retained	10394
2375	400 - 600	320 - 330	Miscellaneous Debris	-	Not retained	10395
2376	400 - 600	320 - 330	Miscellaneous Debris	-	Not retained	10396
2377	400 - 600	320 - 330	Miscellaneous Debris	-	Not retained	10397
2378	400 - 600	330 - 340	Warhead Body Piece	0.50		714
2379	400 - 600	330 - 340	Warhead Body Piece	0.50		715
2380	400 - 600	330 - 340	Warhead Body Piece	0.49		716
2381	400 - 600	330 - 340	Warhead Body Piece	0.17		717
2382	400 - 600	330 - 340	Warhead Body Piece	0.17		718
2383	400 - 600	330 - 340	Warhead Body Piece	0.11		719
2384	400 - 600	330 - 340	Warhead Body Piece	0.10		720
2385	400 - 600	330 - 340	Warhead Body Piece	0.02		721
2386	400 - 600	330 - 340	Warhead Body Piece	0.01		722
2387	400 - 600	330 - 340	Warhead Body Piece	0.01		723
2388	400 - 600	330 - 340	Warhead Body Piece	0.01		724
2389	400 - 600	330 - 340	Warhead Body Piece	0.01		725
2390	400 - 600	330 - 340	Warhead Body Piece	0.01		726
2391	400 - 600	330 - 340	Warhead Body Piece	0.01		727
2392	400 - 600	330 - 340	Warhead Body Piece	0.01		728
2393	400 - 600	330 - 340	Warhead Body Piece	0.02		729
2394	400 - 600	330 - 340	Warhead Body Piece	0.03		730
2395	400 - 600	330 - 340	Warhead Body Piece	0.01		731
2396	400 - 600	330 - 340	Warhead Body Piece	0.01		732
2397	400 - 600	330 - 340	Warhead Body Piece	0.01		733
2398	400 - 600	330 - 340	Warhead Body Piece	0.01		734
2399	400 - 600	330 - 340	Warhead Body Piece	0.01		735
2400	400 - 600	330 - 340	Warhead Body Piece	0.01		736

TABLE B-12. FRAGMENTS RECOVERED BEYOND 200-FT RANGE IN TEST NO. 12 (Continued)

<u>Entry</u>	<u>Range Interval (ft)</u>	<u>Azimuthal Sector (°)</u>	<u>Description</u>	<u>Mass (lb)</u>	<u>Notes</u>	<u>G64 Index No.</u>
2401	400 - 600	330 - 340	Tail Piece	-	Not retained	9288
2402	400 - 600	330 - 340	Miscellaneous Debris	0.01		737
2403	400 - 600	330 - 340	Miscellaneous Debris	-	Not retained	10398
2404	400 - 600	330 - 340	Miscellaneous Debris	-	Not retained	10399
2405	400 - 600	330 - 340	Miscellaneous Debris	-	Not retained	10400
2406	400 - 600	330 - 340	Miscellaneous Debris	-	Not retained	10401
2407	400 - 600	330 - 340	Miscellaneous Debris	-	Not retained	10402
2408	400 - 600	330 - 340	Miscellaneous Debris	-	Not retained	10403
2409	400 - 600	330 - 340	Miscellaneous Debris	-	Not retained	10404
2410	400 - 600	330 - 340	Miscellaneous Debris	-	Not retained	10405
2411	400 - 600	330 - 340	Miscellaneous Debris	-	Not retained	10406
2412	400 - 600	330 - 340	Miscellaneous Debris	-	Not retained	10407
2413	400 - 600	330 - 340	Miscellaneous Debris	-	Not retained	10408
2414	400 - 600	330 - 340	Miscellaneous Debris	-	Not retained	10409
2415	400 - 600	330 - 340	Intact Warhead	-	Not retained	9022
2416	400 - 600	340 - 350	Warhead Body Piece	2.04		225
2417	400 - 600	340 - 350	Warhead Body Piece	0.55		226
2418	400 - 600	340 - 350	Warhead Body Piece	0.40		227
2419	400 - 600	340 - 350	Warhead Body Piece	0.36		228
2420	400 - 600	340 - 350	Warhead Body Piece	0.31		229
2421	400 - 600	340 - 350	Warhead Body Piece	0.16		230
2422	400 - 600	340 - 350	Warhead Body Piece	0.17		231
2423	400 - 600	340 - 350	Warhead Body Piece	0.02		232
2424	400 - 600	340 - 350	Warhead Body Piece	0.05		233
2425	400 - 600	340 - 350	Warhead Body Piece	0.03		234
2426	400 - 600	340 - 350	Warhead Body Piece	0.02		235
2427	400 - 600	340 - 350	Warhead Body Piece	0.02		236
2428	400 - 600	340 - 350	Warhead Body Piece	0.01		237
2429	400 - 600	340 - 350	Warhead Body Piece	0.01		238
2430	400 - 600	340 - 350	Warhead Body Piece	0.01		239
2431	400 - 600	340 - 350	Warhead Body Piece	0.01		240
2432	400 - 600	340 - 350	Warhead Body Piece	0.01		241
2433	400 - 600	340 - 350	Warhead Body Piece	0.01		242
2434	400 - 600	340 - 350	Warhead Body Piece	0.01		243
2435	400 - 600	340 - 350	Warhead Body Piece	0.01		244
2436	400 - 600	340 - 350	Warhead Body Piece	0.01		245
2437	400 - 600	340 - 350	Warhead Body Piece	0.01		246
2438	400 - 600	340 - 350	Tail Piece	-	Not retained	224
2439	400 - 600	340 - 350	Tail Piece	0.01		247
2440	400 - 600	340 - 350	Tail Piece	-	Not retained	9289
2441	400 - 600	340 - 350	Tail Piece	-	Not retained	9290
2442	400 - 600	340 - 350	Miscellaneous Debris	0.01		248
2443	400 - 600	340 - 350	Miscellaneous Debris	-	Not retained	10410
2444	400 - 600	340 - 350	Miscellaneous Debris	-	Not retained	10411
2445	400 - 600	340 - 350	Miscellaneous Debris	-	Not retained	10412
2446	400 - 600	340 - 350	Miscellaneous Debris	-	Not retained	10413
2447	400 - 600	340 - 350	Miscellaneous Debris	-	Not retained	10414
2448	400 - 600	340 - 350	Miscellaneous Debris	-	Not retained	10415
2449	400 - 600	340 - 350	Miscellaneous Debris	-	Not retained	10416
2450	400 - 600	340 - 350	Miscellaneous Debris	-	Not retained	10417

TABLE B-12. FRAGMENTS RECOVERED BEYOND 200-FT RANGE IN TEST NO. 12 (Continued)

<u>Entry</u>	<u>Range Interval (ft)</u>	<u>Azimuthal Sector (°)</u>	<u>Description</u>	<u>Mass (lb)</u>	<u>Notes</u>	<u>G64 Index No.</u>
2451	400 - 600	340 - 350	Miscellaneous Debris	-	Not retained	10418
2452	400 - 600	350 - 360	Warhead Body Piece	1.09		555
2453	400 - 600	350 - 360	Warhead Body Piece	0.21		556
2454	400 - 600	350 - 360	Warhead Body Piece	0.19		557
2455	400 - 600	350 - 360	Warhead Body Piece	0.16		558
2456	400 - 600	350 - 360	Warhead Body Piece	0.04		559
2457	400 - 600	350 - 360	Warhead Body Piece	0.07		560
2458	400 - 600	350 - 360	Warhead Body Piece	0.05		561
2459	400 - 600	350 - 360	Warhead Body Piece	0.05		562
2460	400 - 600	350 - 360	Warhead Body Piece	0.03		563
2461	400 - 600	350 - 360	Warhead Body Piece	0.02		564
2462	400 - 600	350 - 360	Warhead Body Piece	0.02		565
2463	400 - 600	350 - 360	Warhead Body Piece	0.01		566
2464	400 - 600	350 - 360	Warhead Body Piece	0.03		567
2465	400 - 600	350 - 360	Warhead Body Piece	0.01		568
2466	400 - 600	350 - 360	Warhead Body Piece	0.01		569
2467	400 - 600	350 - 360	Warhead Body Piece	0.01		570
2468	400 - 600	350 - 360	Warhead Body Piece	0.01		571
2469	400 - 600	350 - 360	Warhead Body Piece	0.01		572
2470	400 - 600	350 - 360	Warhead Body Piece	0.01		573
2471	400 - 600	350 - 360	Warhead Body Piece	0.01		574
2472	400 - 600	350 - 360	Warhead Body Piece	0.01		575
2473	400 - 600	350 - 360	Tail Piece	0.05		576
2474	400 - 600	350 - 360	Tail Piece	-	Not retained	9291
2475	400 - 600	350 - 360	Tail Piece	-	Not retained	9292
2476	400 - 600	350 - 360	Tail Piece	-	Not retained	9293
2477	400 - 600	350 - 360	Miscellaneous Debris	0.01		577
2478	400 - 600	350 - 360	Miscellaneous Debris	0.02		578
2479	400 - 600	350 - 360	Miscellaneous Debris	0.01		579
2480	400 - 600	350 - 360	Miscellaneous Debris	-	Not retained	10419
2481	400 - 600	350 - 360	Miscellaneous Debris	-	Not retained	10420
2482	400 - 600	350 - 360	Miscellaneous Debris	-	Not retained	10421
2483	400 - 600	350 - 360	Miscellaneous Debris	-	Not retained	10422
2484	400 - 600	350 - 360	Miscellaneous Debris	-	Not retained	10423
2485	400 - 600	350 - 360	Miscellaneous Debris	-	Not retained	10424
2486	400 - 600	350 - 360	Miscellaneous Debris	-	Not retained	10425
2487	400 - 600	350 - 360	Miscellaneous Debris	-	Not retained	10426
2488	400 - 600	350 - 360	Miscellaneous Debris	-	Not retained	10427
2489	400 - 600	350 - 360	Miscellaneous Debris	-	Not retained	10428
2490	400 - 600	350 - 360	Miscellaneous Debris	-	Not retained	10429
2491	400 - 600	350 - 360	Miscellaneous Debris	-	Not retained	10430
2492	400 - 600	350 - 360	Miscellaneous Debris	-	Not retained	10431
2493	400 - 600	350 - 360	Miscellaneous Debris	-	Not retained	10432
2494	400 - 600	350 - 360	Miscellaneous Debris	-	Not retained	10433
2495	400 - 600	350 - 360	Miscellaneous Debris	-	Not retained	10434
2496	400 - 600	350 - 360	Miscellaneous Debris	-	Not retained	10435
2497	600 - 800	0 - 10	Warhead Body Piece	0.50		413
2498	600 - 800	0 - 10	Warhead Body Piece	0.41		414
2499	600 - 800	0 - 10	Warhead Body Piece	0.39		415
2500	600 - 800	0 - 10	Warhead Body Piece	0.38		416

NSWCDD/TR-98/6

TABLE B-12. FRAGMENTS RECOVERED BEYOND 200-FT RANGE IN TEST NO. 12 (Continued)

<u>Entry</u>	<u>Range Interval (ft)</u>	<u>Azimuthal Sector (°)</u>	<u>Description</u>	<u>Mass (lb)</u>	<u>Notes</u>	<u>G64 Index No.</u>
2501	600 - 800	0 - 10	Warhead Body Piece	0.31		417
2502	600 - 800	0 - 10	Warhead Body Piece	0.09		418
2503	600 - 800	0 - 10	Warhead Body Piece	0.08		419
2504	600 - 800	0 - 10	Warhead Body Piece	0.08		420
2505	600 - 800	0 - 10	Warhead Body Piece	0.08		421
2506	600 - 800	0 - 10	Warhead Body Piece	0.07		422
2507	600 - 800	0 - 10	Warhead Body Piece	0.06		423
2508	600 - 800	0 - 10	Warhead Body Piece	0.07		424
2509	600 - 800	0 - 10	Warhead Body Piece	0.05		425
2510	600 - 800	0 - 10	Warhead Body Piece	0.03		426
2511	600 - 800	0 - 10	Warhead Body Piece	0.03		427
2512	600 - 800	0 - 10	Warhead Body Piece	0.03		428
2513	600 - 800	0 - 10	Warhead Body Piece	0.01		429
2514	600 - 800	0 - 10	Warhead Body Piece	0.01		430
2515	600 - 800	0 - 10	Warhead Body Piece	0.01		431
2516	600 - 800	0 - 10	Warhead Body Piece	0.01		432
2517	600 - 800	0 - 10	Warhead Body Piece	0.01		433
2518	600 - 800	0 - 10	Warhead Body Piece	0.01		434
2519	600 - 800	0 - 10	Tail Piece	-	Not retained	9294
2520	600 - 800	0 - 10	Tail Piece	-	Not retained	9295
2521	600 - 800	0 - 10	Miscellaneous Debris	-	Not retained	10436
2522	600 - 800	0 - 10	Miscellaneous Debris	-	Not retained	10437
2523	600 - 800	0 - 10	Miscellaneous Debris	-	Not retained	10438
2524	600 - 800	10 - 20	Warhead Body Piece	0.07		167
2525	600 - 800	10 - 20	Warhead Body Piece	0.06		168
2526	600 - 800	10 - 20	Warhead Body Piece	0.03		169
2527	600 - 800	10 - 20	Warhead Body Piece	0.02		170
2528	600 - 800	10 - 20	Warhead Body Piece	0.02		171
2529	600 - 800	10 - 20	Warhead Body Piece	0.01		172
2530	600 - 800	10 - 20	Warhead Body Piece	0.01		173
2531	600 - 800	10 - 20	Warhead Body Piece	0.01		174
2532	600 - 800	10 - 20	Warhead Body Piece	0.01		175
2533	600 - 800	10 - 20	Warhead Body Piece	0.01		176
2534	600 - 800	10 - 20	Tail Piece	-	Not retained	165
2535	600 - 800	10 - 20	Tail Piece	-	Not retained	166
2536	600 - 800	10 - 20	Tail Piece	0.07		177
2537	600 - 800	10 - 20	Tail Piece	-	Not retained	9296
2538	600 - 800	10 - 20	Tail Piece	-	Not retained	9297
2539	600 - 800	10 - 20	Tail Piece	-	Not retained	9298
2540	600 - 800	10 - 20	Tail Piece	-	Not retained	9299
2541	600 - 800	10 - 20	Tail Piece	-	Not retained	9300
2542	600 - 800	10 - 20	Miscellaneous Debris	0.01		178
2543	600 - 800	10 - 20	Miscellaneous Debris	0.01		179
2544	600 - 800	10 - 20	Miscellaneous Debris	-	Not retained	10439
2545	600 - 800	10 - 20	Miscellaneous Debris	-	Not retained	10440
2546	600 - 800	10 - 20	Miscellaneous Debris	-	Not retained	10441
2547	600 - 800	10 - 20	Miscellaneous Debris	-	Not retained	10442
2548	600 - 800	20 - 30	Warhead Body Piece	0.25		510
2549	600 - 800	20 - 30	Warhead Body Piece	0.21		511
2550	600 - 800	20 - 30	Warhead Body Piece	0.10		512

NSWCDD/TR-98/6

TABLE B-12. FRAGMENTS RECOVERED BEYOND 200-FT RANGE IN TEST NO. 12 (Continued)

<u>Entry</u>	<u>Range Interval (ft)</u>	<u>Azimuthal Sector (°)</u>	<u>Description</u>	<u>Mass (lb)</u>	<u>Notes</u>	<u>G64 Index No.</u>
2551	600 - 800	20 - 30	Warhead Body Piece	0.08		513
2552	600 - 800	20 - 30	Warhead Body Piece	0.06		514
2553	600 - 800	20 - 30	Warhead Body Piece	0.04		515
2554	600 - 800	20 - 30	Warhead Body Piece	0.02		516
2555	600 - 800	20 - 30	Warhead Body Piece	0.01		517
2556	600 - 800	20 - 30	Warhead Body Piece	0.02		518
2557	600 - 800	20 - 30	Warhead Body Piece	0.01		519
2558	600 - 800	20 - 30	Warhead Body Piece	0.01		520
2559	600 - 800	20 - 30	Miscellaneous Debris	-	Not retained	10443
2560	600 - 800	20 - 30	Miscellaneous Debris	-	Not retained	10444
2561	600 - 800	20 - 30	Miscellaneous Debris	-	Not retained	10445
2562	600 - 800	20 - 30	Miscellaneous Debris	-	Not retained	10446
2563	600 - 800	30 - 40	Warhead Body Piece	0.26		1268
2564	600 - 800	30 - 40	Warhead Body Piece	0.19		1269
2565	600 - 800	30 - 40	Warhead Body Piece	0.17		1270
2566	600 - 800	30 - 40	Warhead Body Piece	0.13		1271
2567	600 - 800	30 - 40	Warhead Body Piece	0.08		1272
2568	600 - 800	30 - 40	Warhead Body Piece	0.15		1273
2569	600 - 800	30 - 40	Warhead Body Piece	0.18		1274
2570	600 - 800	30 - 40	Warhead Body Piece	0.03		1275
2571	600 - 800	30 - 40	Warhead Body Piece	0.02		1276
2572	600 - 800	30 - 40	Warhead Body Piece	0.02		1277
2573	600 - 800	30 - 40	Warhead Body Piece	0.02		1278
2574	600 - 800	30 - 40	Warhead Body Piece	0.01		1279
2575	600 - 800	30 - 40	Warhead Body Piece	0.01		1280
2576	600 - 800	30 - 40	Warhead Body Piece	0.01		1281
2577	600 - 800	30 - 40	Miscellaneous Debris	-	Not retained	10447
2578	600 - 800	30 - 40	Miscellaneous Debris	-	Not retained	10448
2579	600 - 800	40 - 50	Warhead Body Piece	0.50		672
2580	600 - 800	40 - 50	Warhead Body Piece	0.63		673
2581	600 - 800	40 - 50	Warhead Body Piece	0.28		674
2582	600 - 800	40 - 50	Warhead Body Piece	0.20		675
2583	600 - 800	40 - 50	Warhead Body Piece	0.19		676
2584	600 - 800	40 - 50	Warhead Body Piece	0.20		677
2585	600 - 800	40 - 50	Warhead Body Piece	0.22		678
2586	600 - 800	40 - 50	Warhead Body Piece	0.17		679
2587	600 - 800	40 - 50	Warhead Body Piece	0.12		680
2588	600 - 800	40 - 50	Warhead Body Piece	0.09		681
2589	600 - 800	40 - 50	Warhead Body Piece	0.03		682
2590	600 - 800	40 - 50	Warhead Body Piece	0.07		683
2591	600 - 800	40 - 50	Warhead Body Piece	0.01		684
2592	600 - 800	40 - 50	Miscellaneous Debris	-	Not retained	10449
2593	600 - 800	40 - 50	Miscellaneous Debris	-	Not retained	10450
2594	600 - 800	50 - 60	Warhead Body Piece	0.07		490
2595	600 - 800	50 - 60	Warhead Body Piece	0.03		491
2596	600 - 800	50 - 60	Warhead Body Piece	0.03		492
2597	600 - 800	50 - 60	Warhead Body Piece	0.02		493
2598	600 - 800	50 - 60	Tail Piece	-	Not retained	489
2599	600 - 800	50 - 60	Tail Piece	-	Not retained	9301
2600	600 - 800	60 - 70	Warhead Body Piece	0.56		407

NSWCDD/TR-98/6

TABLE B-12. FRAGMENTS RECOVERED BEYOND 200-FT RANGE IN TEST NO. 12 (Continued)

<u>Entry</u>	<u>Range Interval (ft)</u>	<u>Azimuthal Sector (°)</u>	<u>Description</u>	<u>Mass (lb)</u>	<u>Notes</u>	<u>G64 Index No.</u>
2601	600 - 800	60 - 70	Warhead Body Piece	0.18		408
2602	600 - 800	60 - 70	Warhead Body Piece	0.40		409
2603	600 - 800	60 - 70	Warhead Body Piece	0.07		410
2604	600 - 800	60 - 70	Warhead Body Piece	0.03		411
2605	600 - 800	60 - 70	Warhead Body Piece	0.01		412
2606	600 - 800	60 - 70	Miscellaneous Debris	-	Not retained	10451
2607	600 - 800	60 - 70	Miscellaneous Debris	-	Not retained	10452
2608	600 - 800	60 - 70	Miscellaneous Debris	-	Not retained	10453
2609	600 - 800	70 - 80	Warhead Body Piece	0.47		458
2610	600 - 800	70 - 80	Warhead Body Piece	0.19		459
2611	600 - 800	70 - 80	Warhead Body Piece	0.37		460
2612	600 - 800	70 - 80	Warhead Body Piece	0.05		461
2613	600 - 800	70 - 80	Tail Piece	0.18		462
2614	600 - 800	70 - 80	Tail Piece	0.05		463
2615	600 - 800	70 - 80	Tail Piece	-	Not retained	9302
2616	600 - 800	70 - 80	Tail Piece	-	Not retained	9303
2617	600 - 800	70 - 80	Miscellaneous Debris	-	Not retained	10454
2618	600 - 800	70 - 80	Miscellaneous Debris	-	Not retained	10455
2619	600 - 800	70 - 80	Miscellaneous Debris	-	Not retained	10456
2620	600 - 800	80 - 90	Warhead Body Piece	0.50		2
2621	600 - 800	80 - 90	Warhead Body Piece	0.50		3
2622	600 - 800	80 - 90	Warhead Body Piece	0.57		4
2623	600 - 800	80 - 90	Warhead Body Piece	0.06		5
2624	600 - 800	80 - 90	Warhead Body Piece	0.03		6
2625	600 - 800	80 - 90	Warhead Body Piece	0.04		7
2626	600 - 800	80 - 90	Warhead Body Piece	0.01		8
2627	600 - 800	80 - 90	Warhead Body Piece	0.02		9
2628	600 - 800	80 - 90	Tail Piece	0.17		10
2629	600 - 800	80 - 90	Tail Piece	-	Not retained	9304
2630	600 - 800	80 - 90	Tail Piece	-	Not retained	9305
2631	600 - 800	80 - 90	Miscellaneous Debris	-	Not retained	10457
2632	600 - 800	90 - 100	Warhead Body Piece	0.41		1095
2633	600 - 800	90 - 100	Warhead Body Piece	0.30		1096
2634	600 - 800	90 - 100	Warhead Body Piece	0.24		1097
2635	600 - 800	90 - 100	Warhead Body Piece	0.21		1098
2636	600 - 800	90 - 100	Warhead Body Piece	0.16		1099
2637	600 - 800	100 - 110	Warhead Body Piece	0.01		740
2638	600 - 800	100 - 110	Tail Piece	-	Not retained	739
2639	600 - 800	100 - 110	Tail Piece	0.06		741
2640	600 - 800	100 - 110	Tail Piece	-	Not retained	9306
2641	600 - 800	100 - 110	Tail Piece	-	Not retained	9307
2642	600 - 800	100 - 110	Miscellaneous Debris	-	Not retained	10458
2643	600 - 800	100 - 110	Miscellaneous Debris	-	Not retained	10459
2644	600 - 800	110 - 120	Warhead Body Piece	0.43		501
2645	600 - 800	110 - 120	Warhead Body Piece	0.22		502
2646	600 - 800	110 - 120	Warhead Body Piece	0.10		503
2647	600 - 800	110 - 120	Warhead Body Piece	0.07		504
2648	600 - 800	110 - 120	Warhead Body Piece	0.06		505
2649	600 - 800	110 - 120	Tail Piece	0.01		506
2650	600 - 800	110 - 120	Tail Piece	-	Not retained	9308

NSWCDD/TR-98/6

TABLE B-12. FRAGMENTS RECOVERED BEYOND 200-FT RANGE IN TEST NO. 12 (Continued)

<u>Entry</u>	<u>Range Interval (ft)</u>	<u>Azimuthal Sector (°)</u>	<u>Description</u>	<u>Mass (lb)</u>	<u>Notes</u>	<u>G64 Index No.</u>
2651	600 - 800	120 - 130	Warhead Body Piece	0.50		1549
2652	600 - 800	120 - 130	Warhead Body Piece	0.50		1550
2653	600 - 800	120 - 130	Warhead Body Piece	0.09		1551
2654	600 - 800	120 - 130	Tail Piece	-	Not retained	9309
2655	600 - 800	130 - 140	Warhead Body Piece	0.50		306
2656	600 - 800	130 - 140	Warhead Body Piece	0.23		307
2657	600 - 800	130 - 140	Warhead Body Piece	0.02		308
2658	600 - 800	130 - 140	Tail Piece	-	Not retained	9310
2659	600 - 800	130 - 140	Miscellaneous Debris	-	Not retained	10460
2660	600 - 800	140 - 150	Warhead Body Piece	0.13		1450
2661	600 - 800	140 - 150	Warhead Body Piece	0.09		1451
2662	600 - 800	140 - 150	Miscellaneous Debris	-	Not retained	10461
2663	600 - 800	150 - 160	Miscellaneous Debris	-	Not retained	10462
2664	600 - 800	150 - 160	Miscellaneous Debris	-	Not retained	10463
2665	600 - 800	150 - 160	Miscellaneous Debris	-	Not retained	10464
2666	600 - 800	160 - 170	Warhead Body Piece	1.24		277
2667	600 - 800	160 - 170	Tail Piece	0.02		278
2668	600 - 800	160 - 170	Tail Piece	-	Not retained	9311
2669	600 - 800	170 - 180	Miscellaneous Debris	-	Not retained	10465
2670	600 - 800	180 - 190	Warhead Body Piece	0.30		507
2671	600 - 800	180 - 190	Warhead Body Piece	0.22		508
2672	600 - 800	180 - 190	Warhead Body Piece	0.13		509
2673	600 - 800	190 - 200	Warhead Body Piece	0.38		792
2674	600 - 800	190 - 200	Warhead Body Piece	0.17		793
2675	600 - 800	190 - 200	Warhead Body Piece	0.16		794
2676	600 - 800	190 - 200	Tail Piece	0.05		795
2677	600 - 800	190 - 200	Tail Piece	-	Not retained	9312
2678	600 - 800	200 - 210	Warhead Body Piece	0.20		619
2679	600 - 800	200 - 210	Warhead Body Piece	0.08		620
2680	600 - 800	200 - 210	Warhead Body Piece	0.08		621
2681	600 - 800	200 - 210	Warhead Body Piece	0.11		622
2682	600 - 800	200 - 210	Warhead Body Piece	0.04		623
2683	600 - 800	200 - 210	Warhead Body Piece	0.02		624
2684	600 - 800	200 - 210	Warhead Body Piece	0.01		625
2685	600 - 800	200 - 210	Miscellaneous Debris	-	Not retained	10466
2686	600 - 800	200 - 210	Miscellaneous Debris	-	Not retained	10467
2687	600 - 800	210 - 220	Warhead Body Piece	0.19		1028
2688	600 - 800	210 - 220	Warhead Body Piece	0.11		1029
2689	600 - 800	210 - 220	Warhead Body Piece	0.14		1030
2690	600 - 800	210 - 220	Warhead Body Piece	0.03		1031
2691	600 - 800	210 - 220	Miscellaneous Debris	-	Not retained	10468
2692	600 - 800	210 - 220	Miscellaneous Debris	-	Not retained	10469
2693	600 - 800	210 - 220	Miscellaneous Debris	-	Not retained	10470
2694	600 - 800	220 - 230	Warhead Body Piece	0.17		939
2695	600 - 800	220 - 230	Warhead Body Piece	0.06		940
2696	600 - 800	220 - 230	Miscellaneous Debris	-	Not retained	10471
2697	600 - 800	220 - 230	Miscellaneous Debris	-	Not retained	10472
2698	600 - 800	230 - 240	Warhead Body Piece	0.31		313
2699	600 - 800	230 - 240	Warhead Body Piece	0.14		314
2700	600 - 800	230 - 240	Warhead Body Piece	0.05		315

NSWCDD/TR-98/6

TABLE B-12. FRAGMENTS RECOVERED BEYOND 200-FT RANGE IN TEST NO. 12 (Continued)

<u>Entry</u>	<u>Range Interval (ft)</u>	<u>Azimuthal Sector (°)</u>	<u>Description</u>	<u>Mass (lb)</u>	<u>Notes</u>	<u>G64 Index No.</u>
2701	600 - 800	230 - 240	Warhead Body Piece	0.03		316
2702	600 - 800	230 - 240	Warhead Body Piece	0.14		317
2703	600 - 800	230 - 240	Warhead Body Piece	0.07		318
2704	600 - 800	230 - 240	Tail Piece	-	Not retained	312
2705	600 - 800	230 - 240	Tail Piece	-	Not retained	9313
2706	600 - 800	230 - 240	Miscellaneous Debris	-	Not retained	10473
2707	600 - 800	230 - 240	Miscellaneous Debris	-	Not retained	10474
2708	600 - 800	230 - 240	Miscellaneous Debris	-	Not retained	10475
2709	600 - 800	240 - 250	Warhead Body Piece	0.39		1423
2710	600 - 800	240 - 250	Warhead Body Piece	0.08		1424
2711	600 - 800	240 - 250	Warhead Body Piece	0.07		1425
2712	600 - 800	240 - 250	Warhead Body Piece	0.05		1426
2713	600 - 800	240 - 250	Warhead Body Piece	0.04		1427
2714	600 - 800	240 - 250	Warhead Body Piece	0.02		1428
2715	600 - 800	240 - 250	Warhead Body Piece	0.01		1429
2716	600 - 800	240 - 250	Warhead Body Piece	0.01		1430
2717	600 - 800	240 - 250	Tail Piece	-	Not retained	1422
2718	600 - 800	240 - 250	Tail Piece	-	Not retained	9314
2719	600 - 800	240 - 250	Miscellaneous Debris	-	Not retained	10476
2720	600 - 800	250 - 260	Warhead Body Piece	0.36		1302
2721	600 - 800	250 - 260	Warhead Body Piece	0.35		1303
2722	600 - 800	250 - 260	Warhead Body Piece	0.36		1304
2723	600 - 800	250 - 260	Warhead Body Piece	0.21		1305
2724	600 - 800	250 - 260	Warhead Body Piece	0.15		1306
2725	600 - 800	250 - 260	Warhead Body Piece	0.04		1307
2726	600 - 800	250 - 260	Warhead Body Piece	0.04		1308
2727	600 - 800	250 - 260	Warhead Body Piece	0.02		1309
2728	600 - 800	250 - 260	Warhead Body Piece	0.07		1310
2729	600 - 800	250 - 260	Warhead Body Piece	0.05		1311
2730	600 - 800	250 - 260	Warhead Body Piece	0.03		1312
2731	600 - 800	250 - 260	Tail Piece	-	Not retained	1301
2732	600 - 800	250 - 260	Tail Piece	0.01		1313
2733	600 - 800	250 - 260	Tail Piece	-	Not retained	9315
2734	600 - 800	250 - 260	Tail Piece	-	Not retained	9316
2735	600 - 800	260 - 270	Warhead Body Piece	0.50		685
2736	600 - 800	260 - 270	Warhead Body Piece	0.12		686
2737	600 - 800	260 - 270	Warhead Body Piece	0.13		687
2738	600 - 800	260 - 270	Warhead Body Piece	0.08		688
2739	600 - 800	260 - 270	Warhead Body Piece	0.11		689
2740	600 - 800	260 - 270	Warhead Body Piece	0.06		690
2741	600 - 800	260 - 270	Warhead Body Piece	0.02		691
2742	600 - 800	260 - 270	Warhead Body Piece	0.02		692
2743	600 - 800	260 - 270	Warhead Body Piece	0.02		693
2744	600 - 800	260 - 270	Warhead Body Piece	0.02		694
2745	600 - 800	260 - 270	Tail Piece	0.03		695
2746	600 - 800	260 - 270	Tail Piece	-	Not retained	9317
2747	600 - 800	270 - 280	Warhead Body Piece	0.50		1570
2748	600 - 800	270 - 280	Warhead Body Piece	0.63		1571
2749	600 - 800	270 - 280	Warhead Body Piece	0.35		1572
2750	600 - 800	270 - 280	Warhead Body Piece	0.25		1574

TABLE B-12. FRAGMENTS RECOVERED BEYOND 200-FT RANGE IN TEST NO. 12 (Continued)

<u>Entry</u>	<u>Range Interval (ft)</u>	<u>Azimuthal Sector (°)</u>	<u>Description</u>	<u>Mass (lb)</u>	<u>Notes</u>	<u>G64 Index No.</u>
2751	600 - 800	270 - 280	Warhead Body Piece	0.21		1575
2752	600 - 800	270 - 280	Warhead Body Piece	0.19		1576
2753	600 - 800	270 - 280	Warhead Body Piece	0.06		1577
2754	600 - 800	270 - 280	Warhead Body Piece	0.03		1578
2755	600 - 800	270 - 280	Warhead Body Piece	0.03		1579
2756	600 - 800	270 - 280	Warhead Body Piece	0.01		1580
2757	600 - 800	270 - 280	Warhead Body Piece	0.01		1581
2758	600 - 800	270 - 280	Warhead Body Piece	0.01		1582
2759	600 - 800	270 - 280	Warhead Body Piece	0.01		1583
2760	600 - 800	270 - 280	Warhead Body Piece	0.01		1584
2761	600 - 800	270 - 280	Miscellaneous Debris	-	Not retained	10477
2762	600 - 800	270 - 280	Miscellaneous Debris	-	Not retained	10478
2763	600 - 800	280 - 290	Warhead Body Piece	0.33		889
2764	600 - 800	280 - 290	Warhead Body Piece	0.26		890
2765	600 - 800	280 - 290	Warhead Body Piece	0.14		891
2766	600 - 800	280 - 290	Warhead Body Piece	0.07		892
2767	600 - 800	280 - 290	Warhead Body Piece	0.02		893
2768	600 - 800	280 - 290	Warhead Body Piece	0.02		894
2769	600 - 800	280 - 290	Warhead Body Piece	0.02		895
2770	600 - 800	280 - 290	Warhead Body Piece	0.02		896
2771	600 - 800	280 - 290	Warhead Body Piece	0.02		897
2772	600 - 800	280 - 290	Warhead Body Piece	0.02		898
2773	600 - 800	280 - 290	Warhead Body Piece	0.02		899
2774	600 - 800	280 - 290	Tail Piece	-	Not retained	888
2775	600 - 800	280 - 290	Tail Piece	-	Not retained	9318
2776	600 - 800	280 - 290	Tail Piece	-	Not retained	9319
2777	600 - 800	280 - 290	Miscellaneous Debris	0.01		900
2778	600 - 800	280 - 290	Miscellaneous Debris	-	Not retained	10479
2779	600 - 800	280 - 290	Miscellaneous Debris	-	Not retained	10480
2780	600 - 800	290 - 300	Warhead Body Piece	0.12		1078
2781	600 - 800	290 - 300	Warhead Body Piece	0.16		1079
2782	600 - 800	290 - 300	Warhead Body Piece	0.08		1080
2783	600 - 800	290 - 300	Warhead Body Piece	0.10		1081
2784	600 - 800	290 - 300	Warhead Body Piece	0.08		1082
2785	600 - 800	290 - 300	Warhead Body Piece	0.06		1083
2786	600 - 800	290 - 300	Warhead Body Piece	0.03		1084
2787	600 - 800	290 - 300	Warhead Body Piece	0.03		1085
2788	600 - 800	290 - 300	Warhead Body Piece	0.02		1086
2789	600 - 800	290 - 300	Warhead Body Piece	0.01		1087
2790	600 - 800	290 - 300	Warhead Body Piece	0.01		1088
2791	600 - 800	290 - 300	Warhead Body Piece	0.01		1089
2792	600 - 800	290 - 300	Warhead Body Piece	0.01		1090
2793	600 - 800	290 - 300	Warhead Body Piece	0.01		1091
2794	600 - 800	290 - 300	Warhead Body Piece	0.01		1092
2795	600 - 800	290 - 300	Tail Piece	0.02		1093
2796	600 - 800	290 - 300	Tail Piece	0.01		1094
2797	600 - 800	290 - 300	Tail Piece	-	Not retained	9320
2798	600 - 800	290 - 300	Tail Piece	-	Not retained	9321
2799	600 - 800	290 - 300	Miscellaneous Debris	-	Not retained	10481
2800	600 - 800	290 - 300	Miscellaneous Debris	-	Not retained	10482

TABLE B-12. FRAGMENTS RECOVERED BEYOND 200-FT RANGE IN TEST NO. 12 (Continued)

<u>Entry</u>	<u>Range Interval (ft)</u>	<u>Azimuthal Sector (°)</u>	<u>Description</u>	<u>Mass (lb)</u>	<u>Notes</u>	<u>G64 Index No.</u>
2801	600 - 800	300 - 310	Warhead Body Piece	0.22		191
2802	600 - 800	300 - 310	Warhead Body Piece	0.25		192
2803	600 - 800	300 - 310	Warhead Body Piece	0.22		193
2804	600 - 800	300 - 310	Warhead Body Piece	0.08		194
2805	600 - 800	300 - 310	Warhead Body Piece	0.06		195
2806	600 - 800	300 - 310	Warhead Body Piece	0.09		196
2807	600 - 800	300 - 310	Warhead Body Piece	0.02		197
2808	600 - 800	300 - 310	Warhead Body Piece	0.03		198
2809	600 - 800	300 - 310	Warhead Body Piece	0.02		199
2810	600 - 800	300 - 310	Warhead Body Piece	0.01		200
2811	600 - 800	300 - 310	Tail Piece	0.06		201
2812	600 - 800	300 - 310	Tail Piece	-	Not retained	9322
2813	600 - 800	300 - 310	Tail Piece	-	Not retained	9323
2814	600 - 800	300 - 310	Miscellaneous Debris	0.01		202
2815	600 - 800	300 - 310	Miscellaneous Debris	-	Not retained	10483
2816	600 - 800	310 - 320	Warhead Body Piece	0.09		1610
2817	600 - 800	310 - 320	Warhead Body Piece	0.01		1611
2818	600 - 800	310 - 320	Warhead Body Piece	0.16		1612
2819	600 - 800	310 - 320	Warhead Body Piece	0.06		1613
2820	600 - 800	310 - 320	Warhead Body Piece	0.04		1614
2821	600 - 800	310 - 320	Warhead Body Piece	0.07		1615
2822	600 - 800	310 - 320	Warhead Body Piece	0.05		1616
2823	600 - 800	310 - 320	Warhead Body Piece	0.05		1617
2824	600 - 800	310 - 320	Warhead Body Piece	0.03		1618
2825	600 - 800	310 - 320	Warhead Body Piece	0.01		1619
2826	600 - 800	310 - 320	Warhead Body Piece	0.01		1620
2827	600 - 800	310 - 320	Warhead Body Piece	0.01		1621
2828	600 - 800	310 - 320	Warhead Body Piece	0.01		1622
2829	600 - 800	310 - 320	Tail Piece	-	Not retained	1609
2830	600 - 800	310 - 320	Tail Piece	-	Not retained	9324
2831	600 - 800	310 - 320	Miscellaneous Debris	-	Not retained	10484
2832	600 - 800	310 - 320	Miscellaneous Debris	-	Not retained	10485
2833	600 - 800	310 - 320	Miscellaneous Debris	-	Not retained	10486
2834	600 - 800	320 - 330	Warhead Body Piece	0.23		1003
2835	600 - 800	320 - 330	Warhead Body Piece	0.08		1004
2836	600 - 800	320 - 330	Warhead Body Piece	0.06		1005
2837	600 - 800	320 - 330	Warhead Body Piece	0.04		1006
2838	600 - 800	320 - 330	Warhead Body Piece	0.03		1007
2839	600 - 800	320 - 330	Warhead Body Piece	0.03		1008
2840	600 - 800	320 - 330	Warhead Body Piece	0.03		1009
2841	600 - 800	320 - 330	Warhead Body Piece	0.02		1010
2842	600 - 800	320 - 330	Warhead Body Piece	0.02		1011
2843	600 - 800	320 - 330	Warhead Body Piece	0.01		1012
2844	600 - 800	320 - 330	Warhead Body Piece	0.01		1013
2845	600 - 800	320 - 330	Warhead Body Piece	0.01		1014
2846	600 - 800	320 - 330	Warhead Body Piece	0.01		1015
2847	600 - 800	320 - 330	Warhead Body Piece	0.01		1016
2848	600 - 800	320 - 330	Warhead Body Piece	0.01		1017
2849	600 - 800	320 - 330	Warhead Body Piece	0.01		1018
2850	600 - 800	320 - 330	Warhead Body Piece	0.01		1019

NSWCDD/TR-98/6

TABLE B-12. FRAGMENTS RECOVERED BEYOND 200-FT RANGE IN TEST NO. 12 (Continued)

<u>Entry</u>	<u>Range Interval (ft)</u>	<u>Azimuthal Sector (°)</u>	<u>Description</u>	<u>Mass (lb)</u>	<u>Notes</u>	<u>G64 Index No.</u>
2851	600 - 800	320 - 330	Tail Piece	0.01		1020
2852	600 - 800	320 - 330	Tail Piece	-	Not retained	9325
2853	600 - 800	320 - 330	Tail Piece	-	Not retained	9326
2854	600 - 800	320 - 330	Tail Piece	-	Not retained	9327
2855	600 - 800	320 - 330	Miscellaneous Debris	0.01		1021
2856	600 - 800	320 - 330	Miscellaneous Debris	0.01		1022
2857	600 - 800	320 - 330	Miscellaneous Debris	-	Not retained	10487
2858	600 - 800	320 - 330	Miscellaneous Debris	-	Not retained	10488
2859	600 - 800	320 - 330	Miscellaneous Debris	-	Not retained	10489
2860	600 - 800	320 - 330	Miscellaneous Debris	-	Not retained	10490
2861	600 - 800	330 - 340	Warhead Body Piece	0.35		1051
2862	600 - 800	330 - 340	Warhead Body Piece	0.19		1052
2863	600 - 800	330 - 340	Warhead Body Piece	0.25		1053
2864	600 - 800	330 - 340	Warhead Body Piece	0.20		1054
2865	600 - 800	330 - 340	Warhead Body Piece	0.17		1055
2866	600 - 800	330 - 340	Warhead Body Piece	0.25		1056
2867	600 - 800	330 - 340	Warhead Body Piece	0.17		1057
2868	600 - 800	330 - 340	Warhead Body Piece	0.09		1058
2869	600 - 800	330 - 340	Warhead Body Piece	0.06		1059
2870	600 - 800	330 - 340	Warhead Body Piece	0.05		1060
2871	600 - 800	330 - 340	Warhead Body Piece	0.04		1061
2872	600 - 800	330 - 340	Warhead Body Piece	0.04		1062
2873	600 - 800	330 - 340	Warhead Body Piece	0.01		1063
2874	600 - 800	330 - 340	Warhead Body Piece	0.38		1064
2875	600 - 800	330 - 340	Warhead Body Piece	0.18		1065
2876	600 - 800	330 - 340	Warhead Body Piece	0.05		1066
2877	600 - 800	330 - 340	Warhead Body Piece	0.04		1067
2878	600 - 800	330 - 340	Warhead Body Piece	0.06		1068
2879	600 - 800	330 - 340	Warhead Body Piece	0.04		1069
2880	600 - 800	330 - 340	Warhead Body Piece	0.02		1070
2881	600 - 800	330 - 340	Warhead Body Piece	0.02		1071
2882	600 - 800	330 - 340	Warhead Body Piece	0.02		1072
2883	600 - 800	330 - 340	Warhead Body Piece	0.01		1073
2884	600 - 800	330 - 340	Warhead Body Piece	0.01		1074
2885	600 - 800	330 - 340	Warhead Body Piece	0.01		1075
2886	600 - 800	330 - 340	Warhead Body Piece	0.01		1076
2887	600 - 800	330 - 340	Warhead Body Piece	0.01		1077
2888	600 - 800	330 - 340	Tail Piece	-	Not retained	9328
2889	600 - 800	330 - 340	Miscellaneous Debris	-	Not retained	10491
2890	600 - 800	330 - 340	Miscellaneous Debris	-	Not retained	10492
2891	600 - 800	330 - 340	Miscellaneous Debris	-	Not retained	10493
2892	600 - 800	340 - 350	Warhead Body Piece	0.58		1122
2893	600 - 800	340 - 350	Warhead Body Piece	0.42		1123
2894	600 - 800	340 - 350	Warhead Body Piece	0.22		1124
2895	600 - 800	340 - 350	Warhead Body Piece	0.24		1125
2896	600 - 800	340 - 350	Warhead Body Piece	0.10		1126
2897	600 - 800	340 - 350	Warhead Body Piece	0.04		1127
2898	600 - 800	340 - 350	Warhead Body Piece	0.08		1128
2899	600 - 800	340 - 350	Warhead Body Piece	0.06		1129
2900	600 - 800	340 - 350	Warhead Body Piece	0.07		1130

NSWCDD/TR-98/6

TABLE B-12. FRAGMENTS RECOVERED BEYOND 200-FT RANGE IN TEST NO. 12 (Continued)

<u>Entry</u>	<u>Range Interval (ft)</u>	<u>Azimuthal Sector (°)</u>	<u>Description</u>	<u>Mass (lb)</u>	<u>Notes</u>	<u>G64 Index No.</u>
2901	600 - 800	340 - 350	Warhead Body Piece	0.04		1131
2902	600 - 800	340 - 350	Warhead Body Piece	0.03		1132
2903	600 - 800	340 - 350	Warhead Body Piece	0.04		1133
2904	600 - 800	340 - 350	Warhead Body Piece	0.03		1134
2905	600 - 800	340 - 350	Warhead Body Piece	0.02		1135
2906	600 - 800	340 - 350	Warhead Body Piece	0.01		1136
2907	600 - 800	340 - 350	Warhead Body Piece	0.01		1137
2908	600 - 800	340 - 350	Warhead Body Piece	0.01		1138
2909	600 - 800	340 - 350	Warhead Body Piece	0.01		1139
2910	600 - 800	340 - 350	Tail Piece	-	Not retained	1120
2911	600 - 800	340 - 350	Tail Piece	-	Not retained	1121
2912	600 - 800	340 - 350	Tail Piece	-	Not retained	9329
2913	600 - 800	340 - 350	Miscellaneous Debris	0.01		1140
2914	600 - 800	340 - 350	Miscellaneous Debris	0.05		1141
2915	600 - 800	340 - 350	Miscellaneous Debris	-	Not retained	10494
2916	600 - 800	340 - 350	Miscellaneous Debris	-	Not retained	10495
2917	600 - 800	340 - 350	Miscellaneous Debris	-	Not retained	10496
2918	600 - 800	340 - 350	Miscellaneous Debris	-	Not retained	10497
2919	600 - 800	350 - 360	Warhead Body Piece	0.50		984
2920	600 - 800	350 - 360	Warhead Body Piece	0.67		985
2921	600 - 800	350 - 360	Warhead Body Piece	0.21		986
2922	600 - 800	350 - 360	Warhead Body Piece	0.08		987
2923	600 - 800	350 - 360	Warhead Body Piece	0.06		988
2924	600 - 800	350 - 360	Warhead Body Piece	0.05		989
2925	600 - 800	350 - 360	Warhead Body Piece	0.05		990
2926	600 - 800	350 - 360	Warhead Body Piece	0.02		991
2927	600 - 800	350 - 360	Warhead Body Piece	0.04		992
2928	600 - 800	350 - 360	Warhead Body Piece	0.01		993
2929	600 - 800	350 - 360	Warhead Body Piece	0.01		994
2930	600 - 800	350 - 360	Warhead Body Piece	0.01		995
2931	600 - 800	350 - 360	Warhead Body Piece	0.01		996
2932	600 - 800	350 - 360	Warhead Body Piece	0.01		997
2933	600 - 800	350 - 360	Warhead Body Piece	0.01		998
2934	600 - 800	350 - 360	Warhead Body Piece	0.01		999
2935	600 - 800	350 - 360	Tail Piece	0.13		1000
2936	600 - 800	350 - 360	Tail Piece	-	Not retained	9330
2937	600 - 800	350 - 360	Miscellaneous Debris	-	Not retained	10498
2938	600 - 800	350 - 360	Miscellaneous Debris	-	Not retained	10499
2939	600 - 800	350 - 360	Miscellaneous Debris	-	Not retained	10500
2940	600 - 800	350 - 360	Miscellaneous Debris	-	Not retained	10501
2941	600 - 800	350 - 360	Miscellaneous Debris	-	Not retained	10502
2942	600 - 800	350 - 360	Miscellaneous Debris	-	Not retained	10503
2943	600 - 800	350 - 360	Miscellaneous Debris	-	Not retained	10504
2944	600 - 800	350 - 360	Miscellaneous Debris	-	Not retained	10505
2945	600 - 800	350 - 360	Miscellaneous Debris	-	Not retained	10506
2946	600 - 800	350 - 360	Miscellaneous Debris	-	Not retained	10507
2947	600 - 800	350 - 360	Miscellaneous Debris	-	Not retained	10508
2948	600 - 800	350 - 360	Miscellaneous Debris	-	Not retained	10509
2949	600 - 800	350 - 360	Miscellaneous Debris	-	Not retained	10510
2950	600 - 800	350 - 360	Miscellaneous Debris	-	Not retained	10511

NSWCDD/TR-98/6

TABLE B-12. FRAGMENTS RECOVERED BEYOND 200-FT RANGE IN TEST NO. 12 (Continued)

<u>Entry</u>	<u>Range Interval (ft)</u>	<u>Azimuthal Sector (°)</u>	<u>Description</u>	<u>Mass (lb)</u>	<u>Notes</u>	<u>G64 Index No.</u>
2951	600 - 800	350 - 360	Miscellaneous Debris	-	Not retained	10512
2952	600 - 800	350 - 360	Intact Warhead	-	Not retained	9023
2953	800 - 1000	0 - 10	Miscellaneous Debris	-	Not retained	10513
2954	800 - 1000	10 - 20	Warhead Body Piece	0.31		279
2955	800 - 1000	10 - 20	Warhead Body Piece	0.19		280
2956	800 - 1000	10 - 20	Warhead Body Piece	0.16		281
2957	800 - 1000	10 - 20	Warhead Body Piece	0.15		282
2958	800 - 1000	20 - 30	Warhead Body Piece	0.06		1001
2959	800 - 1000	20 - 30	Warhead Body Piece	0.04		1002
2960	800 - 1000	20 - 30	Miscellaneous Debris	-	Not retained	10514
2961	800 - 1000	20 - 30	Miscellaneous Debris	-	Not retained	10515
2962	800 - 1000	30 - 40	Warhead Body Piece	0.14		1245
2963	800 - 1000	30 - 40	Warhead Body Piece	0.14		1246
2964	800 - 1000	30 - 40	Warhead Body Piece	0.05		1247
2965	800 - 1000	30 - 40	Warhead Body Piece	0.03		1248
2966	800 - 1000	30 - 40	Tail Piece	-	Not retained	1243
2967	800 - 1000	30 - 40	Tail Piece	-	Not retained	1244
2968	800 - 1000	30 - 40	Tail Piece	-	Not retained	9331
2969	800 - 1000	30 - 40	Tail Piece	-	Not retained	9332
2970	800 - 1000	30 - 40	Miscellaneous Debris	-	Not retained	10516
2971	800 - 1000	40 - 50	Warhead Body Piece	0.50		403
2972	800 - 1000	40 - 50	Warhead Body Piece	0.21		404
2973	800 - 1000	40 - 50	Warhead Body Piece	0.05		405
2974	800 - 1000	40 - 50	Warhead Body Piece	0.02		406
2975	800 - 1000	40 - 50	Miscellaneous Debris	-	Not retained	10517
2976	800 - 1000	40 - 50	Miscellaneous Debris	-	Not retained	10518
2977	800 - 1000	40 - 50	Miscellaneous Debris	-	Not retained	10519
2978	800 - 1000	50 - 60	Warhead Body Piece	0.19		696
2979	800 - 1000	50 - 60	Warhead Body Piece	0.27		697
2980	800 - 1000	60 - 70	Warhead Body Piece	0.42		934
2981	800 - 1000	60 - 70	Warhead Body Piece	0.36		935
2982	800 - 1000	60 - 70	Warhead Body Piece	0.15		936
2983	800 - 1000	60 - 70	Warhead Body Piece	0.11		937
2984	800 - 1000	60 - 70	Tail Piece	0.13		938
2985	800 - 1000	60 - 70	Tail Piece	-	Not retained	9333
2986	800 - 1000	70 - 80	Warhead Body Piece	0.55		310
2987	800 - 1000	70 - 80	Tail Piece	-	Not retained	309
2988	800 - 1000	70 - 80	Tail Piece	0.32		311
2989	800 - 1000	70 - 80	Tail Piece	-	Not retained	9334
2990	800 - 1000	70 - 80	Tail Piece	-	Not retained	9335
2991	800 - 1000	80 - 90	Tail Piece	0.18		23
2992	800 - 1000	80 - 90	Tail Piece	-	Not retained	9336
2993	800 - 1000	80 - 90	Miscellaneous Debris	-	Not retained	10520
2994	800 - 1000	80 - 90	Miscellaneous Debris	-	Not retained	10521
2995	800 - 1000	80 - 90	Miscellaneous Debris	-	Not retained	10522
2996	800 - 1000	80 - 90	Miscellaneous Debris	-	Not retained	10523
2997	800 - 1000	100 - 110	Warhead Body Piece	0.36		496
2998	800 - 1000	100 - 110	Warhead Body Piece	0.20		497
2999	800 - 1000	100 - 110	Warhead Body Piece	0.13		498
3000	800 - 1000	100 - 110	Warhead Body Piece	0.25		499

NSWCDD/TR-98/6

TABLE B-12. FRAGMENTS RECOVERED BEYOND 200-FT RANGE IN TEST NO. 12 (Continued)

<u>Entry</u>	<u>Range Interval (ft)</u>	<u>Azimuthal Sector (°)</u>	<u>Description</u>	<u>Mass (lb)</u>	<u>Notes</u>	<u>G64 Index No.</u>
3001	800 - 1000	100 - 110	Tail Piece	0.19		500
3002	800 - 1000	110 - 120	Warhead Body Piece	0.38		368
3003	800 - 1000	110 - 120	Tail Piece	-	Not retained	367
3004	800 - 1000	110 - 120	Tail Piece	-	Not retained	9337
3005	800 - 1000	120 - 130	Warhead Body Piece	0.50		283
3006	800 - 1000	120 - 130	Warhead Body Piece	0.50		284
3007	800 - 1000	120 - 130	Warhead Body Piece	0.46		285
3008	800 - 1000	120 - 130	Tail Piece	-	Not retained	9338
3009	800 - 1000	150 - 160	Warhead Body Piece	0.03		249
3010	800 - 1000	190 - 200	Warhead Body Piece	0.20		1400
3011	800 - 1000	210 - 220	Warhead Body Piece	0.36		1337
3012	800 - 1000	210 - 220	Warhead Body Piece	0.08		1338
3013	800 - 1000	210 - 220	Warhead Body Piece	0.01		1339
3014	800 - 1000	210 - 220	Warhead Body Piece	0.01		1340
3015	800 - 1000	210 - 220	Warhead Body Piece	0.01		1341
3016	800 - 1000	210 - 220	Warhead Body Piece	0.01		1342
3017	800 - 1000	210 - 220	Miscellaneous Debris	0.01		1343
3018	800 - 1000	230 - 240	Warhead Body Piece	0.35		600
3019	800 - 1000	230 - 240	Warhead Body Piece	0.17		601
3020	800 - 1000	230 - 240	Warhead Body Piece	0.10		602
3021	800 - 1000	230 - 240	Warhead Body Piece	0.07		603
3022	800 - 1000	230 - 240	Warhead Body Piece	0.04		604
3023	800 - 1000	240 - 250	Warhead Body Piece	0.21		1146
3024	800 - 1000	240 - 250	Warhead Body Piece	0.13		1147
3025	800 - 1000	240 - 250	Warhead Body Piece	0.07		1148
3026	800 - 1000	240 - 250	Miscellaneous Debris	-	Not retained	10524
3027	800 - 1000	250 - 260	Warhead Body Piece	0.57		917
3028	800 - 1000	250 - 260	Warhead Body Piece	0.35		918
3029	800 - 1000	250 - 260	Warhead Body Piece	0.27		919
3030	800 - 1000	250 - 260	Warhead Body Piece	0.08		920
3031	800 - 1000	250 - 260	Warhead Body Piece	0.06		921
3032	800 - 1000	250 - 260	Warhead Body Piece	0.03		922
3033	800 - 1000	250 - 260	Miscellaneous Debris	-	Not retained	10525
3034	800 - 1000	250 - 260	Miscellaneous Debris	-	Not retained	10526
3035	800 - 1000	260 - 270	Warhead Body Piece	0.50		1395
3036	800 - 1000	260 - 270	Warhead Body Piece	0.40		1396
3037	800 - 1000	260 - 270	Warhead Body Piece	0.09		1397
3038	800 - 1000	260 - 270	Warhead Body Piece	0.04		1398
3039	800 - 1000	260 - 270	Miscellaneous Debris	-	Not retained	10527
3040	800 - 1000	260 - 270	Miscellaneous Debris	-	Not retained	10528
3041	800 - 1000	260 - 270	Miscellaneous Debris	-	Not retained	10529
3042	800 - 1000	270 - 280	Warhead Body Piece	0.50		923
3043	800 - 1000	270 - 280	Warhead Body Piece	0.50		924
3044	800 - 1000	270 - 280	Warhead Body Piece	0.50		925
3045	800 - 1000	270 - 280	Warhead Body Piece	0.58		926
3046	800 - 1000	270 - 280	Warhead Body Piece	0.48		927
3047	800 - 1000	270 - 280	Warhead Body Piece	0.26		928
3048	800 - 1000	270 - 280	Warhead Body Piece	0.17		929
3049	800 - 1000	270 - 280	Warhead Body Piece	0.20		930
3050	800 - 1000	270 - 280	Warhead Body Piece	0.12		931

NSWCDD/TR-98/6

TABLE B-12. FRAGMENTS RECOVERED BEYOND 200-FT RANGE IN TEST NO. 12 (Continued)

<u>Entry</u>	<u>Range Interval (ft)</u>	<u>Azimuthal Sector (°)</u>	<u>Description</u>	<u>Mass (lb)</u>	<u>Notes</u>	<u>G64 Index No.</u>
3051	800 - 1000	270 - 280	Warhead Body Piece	0.07		932
3052	800 - 1000	270 - 280	Tail Piece	-	Not retained	9339
3053	800 - 1000	270 - 280	Tail Piece	-	Not retained	9340
3054	800 - 1000	270 - 280	Miscellaneous Debris	0.01		933
3055	800 - 1000	270 - 280	Miscellaneous Debris	-	Not retained	10530
3056	800 - 1000	270 - 280	Miscellaneous Debris	-	Not retained	10531
3057	800 - 1000	280 - 290	Warhead Body Piece	0.12		1441
3058	800 - 1000	280 - 290	Warhead Body Piece	0.07		1442
3059	800 - 1000	280 - 290	Warhead Body Piece	0.19		1443
3060	800 - 1000	280 - 290	Warhead Body Piece	0.04		1444
3061	800 - 1000	280 - 290	Warhead Body Piece	0.04		1445
3062	800 - 1000	280 - 290	Tail Piece	0.03		1446
3063	800 - 1000	280 - 290	Tail Piece	-	Not retained	9341
3064	800 - 1000	290 - 300	Warhead Body Piece	0.08		773
3065	800 - 1000	290 - 300	Warhead Body Piece	0.05		774
3066	800 - 1000	290 - 300	Warhead Body Piece	0.02		775
3067	800 - 1000	290 - 300	Warhead Body Piece	0.04		776
3068	800 - 1000	290 - 300	Warhead Body Piece	0.04		777
3069	800 - 1000	300 - 310	Warhead Body Piece	0.50		882
3070	800 - 1000	300 - 310	Warhead Body Piece	0.42		883
3071	800 - 1000	300 - 310	Warhead Body Piece	0.24		884
3072	800 - 1000	300 - 310	Warhead Body Piece	0.05		885
3073	800 - 1000	300 - 310	Warhead Body Piece	0.03		886
3074	800 - 1000	300 - 310	Warhead Body Piece	0.01		887
3075	800 - 1000	300 - 310	Tail Piece	-	Not retained	881
3076	800 - 1000	300 - 310	Tail Piece	-	Not retained	9342
3077	800 - 1000	310 - 320	Warhead Body Piece	0.06		1038
3078	800 - 1000	310 - 320	Warhead Body Piece	0.05		1039
3079	800 - 1000	320 - 330	Warhead Body Piece	0.36		665
3080	800 - 1000	320 - 330	Warhead Body Piece	0.12		666
3081	800 - 1000	320 - 330	Warhead Body Piece	0.06		667
3082	800 - 1000	320 - 330	Warhead Body Piece	0.02		668
3083	800 - 1000	320 - 330	Intact Warhead	-	Not retained	9024
3084	800 - 1000	330 - 340	Warhead Body Piece	0.50		742
3085	800 - 1000	330 - 340	Warhead Body Piece	0.50		743
3086	800 - 1000	330 - 340	Warhead Body Piece	0.22		744
3087	800 - 1000	330 - 340	Warhead Body Piece	0.04		745
3088	800 - 1000	330 - 340	Warhead Body Piece	0.03		746
3089	800 - 1000	330 - 340	Warhead Body Piece	0.01		747
3090	800 - 1000	330 - 340	Warhead Body Piece	0.01		748
3091	800 - 1000	330 - 340	Tail Piece	-	Not retained	9343
3092	800 - 1000	340 - 350	Warhead Body Piece	0.39		711
3093	800 - 1000	340 - 350	Warhead Body Piece	0.29		712
3094	800 - 1000	340 - 350	Warhead Body Piece	0.09		713
3095	800 - 1000	340 - 350	Tail Piece	-	Not retained	710
3096	800 - 1000	340 - 350	Tail Piece	-	Not retained	9344
3097	800 - 1000	340 - 350	Miscellaneous Debris	-	Not retained	10532
3098	800 - 1000	350 - 360	Warhead Body Piece	0.36		798
3099	800 - 1000	350 - 360	Warhead Body Piece	0.21		799
3100	800 - 1000	350 - 360	Warhead Body Piece	0.26		800

NSWCDD/TR-98/6

TABLE B-12. FRAGMENTS RECOVERED BEYOND 200-FT RANGE IN TEST NO. 12 (Continued)

<u>Entry</u>	<u>Range Interval (ft)</u>	<u>Azimuthal Sector (°)</u>	<u>Description</u>	<u>Mass (lb)</u>	<u>Notes</u>	<u>G64 Index No.</u>
3101	800 - 1000	350 - 360	Warhead Body Piece	0.06		801
3102	800 - 1000	350 - 360	Tail Piece	-	Not retained	797
3103	800 - 1000	350 - 360	Tail Piece	0.18		802
3104	800 - 1000	350 - 360	Tail Piece	-	Not retained	9345
3105	800 - 1000	350 - 360	Tail Piece	-	Not retained	9346
3106	800 - 1000	350 - 360	Miscellaneous Debris	-	Not retained	10533
3107	800 - 1000	350 - 360	Miscellaneous Debris	-	Not retained	10534
3108	800 - 1000	350 - 360	Miscellaneous Debris	-	Not retained	10535
3109	1000 - 1200	0 - 10	Warhead Body Piece	0.05		1050
3110	1000 - 1200	20 - 30	Warhead Body Piece	0.35		553
3111	1000 - 1200	20 - 30	Warhead Body Piece	0.06		554
3112	1000 - 1200	30 - 40	Warhead Body Piece	0.07		1023
3113	1000 - 1200	30 - 40	Warhead Body Piece	0.05		1024
3114	1000 - 1200	30 - 40	Warhead Body Piece	0.04		1025
3115	1000 - 1200	30 - 40	Warhead Body Piece	0.03		1026
3116	1000 - 1200	30 - 40	Warhead Body Piece	0.03		1027
3117	1000 - 1200	40 - 50	Warhead Body Piece	0.48		464
3118	1000 - 1200	40 - 50	Warhead Body Piece	0.01		465
3119	1000 - 1200	40 - 50	Miscellaneous Debris	-	Not retained	10536
3120	1000 - 1200	40 - 50	Miscellaneous Debris	-	Not retained	10537
3121	1000 - 1200	40 - 50	Miscellaneous Debris	-	Not retained	10538
3122	1000 - 1200	50 - 60	Warhead Body Piece	0.53		223
3123	1000 - 1200	60 - 70	Warhead Body Piece	0.14		1100
3124	1000 - 1200	60 - 70	Warhead Body Piece	0.49		1399
3125	1000 - 1200	80 - 90	Warhead Body Piece	0.13		11
3126	1000 - 1200	80 - 90	Miscellaneous Debris	-	Not retained	10539
3127	1000 - 1200	120 - 130	Warhead Body Piece	0.26		300
3128	1000 - 1200	190 - 200	Warhead Body Piece	0.02		1035
3129	1000 - 1200	190 - 200	Warhead Body Piece	0.03		1036
3130	1000 - 1200	190 - 200	Warhead Body Piece	0.01		1037
3131	1000 - 1200	210 - 220	Warhead Body Piece	0.18		1344
3132	1000 - 1200	230 - 240	Warhead Body Piece	0.19		521
3133	1000 - 1200	230 - 240	Warhead Body Piece	0.03		522
3134	1000 - 1200	240 - 250	Tail Piece	0.17		599
3135	1000 - 1200	240 - 250	Tail Piece	-	Not retained	9347
3136	1000 - 1200	250 - 260	Warhead Body Piece	0.08		1142
3137	1000 - 1200	250 - 260	Warhead Body Piece	0.08		1143
3138	1000 - 1200	250 - 260	Warhead Body Piece	0.04		1144
3139	1000 - 1200	250 - 260	Warhead Body Piece	0.03		1145
3140	1000 - 1200	250 - 260	Miscellaneous Debris	-	Not retained	10540
3141	1000 - 1200	250 - 260	Miscellaneous Debris	-	Not retained	10541
3142	1000 - 1200	260 - 270	Warhead Body Piece	0.30		877
3143	1000 - 1200	260 - 270	Warhead Body Piece	0.06		878
3144	1000 - 1200	260 - 270	Warhead Body Piece	0.04		879
3145	1000 - 1200	260 - 270	Warhead Body Piece	0.04		880
3146	1000 - 1200	260 - 270	Miscellaneous Debris	-	Not retained	10542
3147	1000 - 1200	260 - 270	Miscellaneous Debris	-	Not retained	10543
3148	1000 - 1200	270 - 280	Miscellaneous Debris	-	Not retained	10544
3149	1000 - 1200	280 - 290	Warhead Body Piece	0.52		1149
3150	1000 - 1200	280 - 290	Warhead Body Piece	0.24		1150

NSWCDD/TR-98/6

TABLE B-12. FRAGMENTS RECOVERED BEYOND 200-FT RANGE IN TEST NO. 12 (Continued)

<u>Entry</u>	<u>Range Interval (ft)</u>	<u>Azimuthal Sector (°)</u>	<u>Description</u>	<u>Mass (lb)</u>	<u>Notes</u>	<u>G64 Index No.</u>
3151	1000 - 1200	290 - 300	Warhead Body Piece	0.26		772
3152	1000 - 1200	320 - 330	Warhead Body Piece	0.05		669
3153	1000 - 1200	320 - 330	Warhead Body Piece	0.02		670
3154	1000 - 1200	320 - 330	Warhead Body Piece	0.03		671
3155	1000 - 1200	350 - 360	Warhead Body Piece	0.27		1200
3156	1000 - 1200	350 - 360	Tail Piece	-	Not retained	9348
3157	1200 - 1300	20 - 30	Warhead Body Piece	0.07		1249
3158	1200 - 1300	20 - 30	Warhead Body Piece	0.10		1250
3159	1200 - 1300	30 - 40	Warhead Body Piece	0.22		13
3160	1200 - 1300	30 - 40	Warhead Body Piece	0.16		14
3161	1200 - 1300	30 - 40	Warhead Body Piece	0.23		15
3162	1200 - 1300	30 - 40	Warhead Body Piece	0.05		16
3163	1200 - 1300	30 - 40	Tail Piece	-	Not retained	12
3164	1200 - 1300	30 - 40	Tail Piece	0.19		17
3165	1200 - 1300	30 - 40	Tail Piece	-	Not retained	9349
3166	1200 - 1300	30 - 40	Tail Piece	-	Not retained	9350
3167	1200 - 1300	40 - 50	Warhead Body Piece	0.08		983
3168	1200 - 1300	50 - 60	Miscellaneous Debris	-	Not retained	10545
3169	1200 - 1300	80 - 90	Warhead Body Piece	0.50		1
3170	1200 - 1300	100 - 110	Tail Piece	-	Not retained	9351
3171	1200 - 1300	100 - 110	Miscellaneous Debris	-	Not retained	10546
3172	1200 - 1300	260 - 270	Warhead Body Piece	0.10		1447
3173	1200 - 1300	260 - 270	Warhead Body Piece	0.07		1448
3174	1200 - 1300	260 - 270	Warhead Body Piece	0.05		1449
3175	1200 - 1300	290 - 300	Warhead Body Piece	0.37		494
3176	1200 - 1300	290 - 300	Warhead Body Piece	0.24		495
3177	1200 - 1300	290 - 300	Miscellaneous Debris	-	Not retained	10547
3178	1200 - 1300	310 - 320	Warhead Body Piece	0.11		203
3179	1200 - 1300	320 - 330	Warhead Body Piece	0.12		1032
3180	1200 - 1300	320 - 330	Warhead Body Piece	0.14		1033
3181	1200 - 1300	320 - 330	Warhead Body Piece	0.04		1034
3182	1200 - 1300	320 - 330	Miscellaneous Debris	-	Not retained	10548
3183	1200 - 1300	330 - 340	Warhead Body Piece	0.12		1349
3184	1200 - 1300	330 - 340	Warhead Body Piece	0.06		1350
3185	1200 - 1300	340 - 350	Warhead Body Piece	0.07		796

APPENDIX C
ANALYSIS PROCEDURE

ANALYSIS PROCEDURE

The following is a step-by-step description of the procedure by which the results of the bonfire tests, described in this report, were used to predict the fragment hazards produced by larger stacks of M1 105mm artillery cartridges and M374A2 81mm mortar cartridges. Over the course of the program, as more data were acquired and trends were established, the U. S. Department of Defense Explosives Safety Board (DDESB) and UK Explosives Storage and Transport Committee (ESTC) have considered several different methods for analyzing the test results. The procedure described below is based on current direction from both organizations with regard to adjustment of fragment recovery data to compensate for incomplete recovery of fragments and calculation of fragment areal densities using a modified pseudo trajectory-normal method.^{C-1}

- Step 1: Determine the total number of pieces of each type of debris (i.e., intact warhead bodies, warhead body pieces, or other debris) recovered in each range interval.
- Step 2: Determine the total mass of warhead body pieces recovered in each range interval.

- Step 3: Where appropriate, adjust the fragment counts for ranges greater than 1300 ft to compensate for an incomplete search (i.e., less than 360° search). This adjustment is accomplished by multiplying the number of fragments actually recovered by the reciprocal of the portion of the angular region actually searched. An analogous adjustment is applied to the mass data. Table C-1 illustrates this adjustment for test no. 10.

- Step 4: Estimate the total mass of warhead body pieces ($m_{p_{tot}}$) generated during the test as follows:

$$m_{p_{tot}} = (N_t - N_i)m_w$$
 where: N_t = number of cartridges tested
 N_i = number of warhead bodies recovered intact
 m_w = mass of each warhead body

- Step 5: Estimate the mass of warhead body pieces projected more than 200 ft from the stack site ($m_{p_{200+}}$):

$$m_{p_{200+}} = m_{p_{tot}} - m_{p_{200}}$$
 where: $m_{p_{200}}$ = total mass of warhead body pieces recovered inside 200 ft

This assumes that all of the warhead body pieces projected 200 ft or less were found during the posttest search.

- Step 6: Estimate the portion of warhead body pieces projected more than 200 ft that were actually recovered (P_{rec}):

$$P_{rec} = m_{p_{200+}} / m_{p_{tot}}$$

Calculation of the estimated portion of warhead body pieces recovered in each test is outlined in Table C-2.

- Step 7: Scale the fragment counts for warhead body pieces to compensate for pieces that were not found during the posttest recovery process:

$$n_{\text{scaled}} = n_{\text{rec}} / P_{\text{rec}} \quad \text{where: } n_{\text{rec}} = \text{number of warhead body pieces recovered}$$

This adjustment was applied for warhead body pieces only. The recovery data indicate that relatively few pieces of any other debris were recovered beyond a range of 600 ft. Thus, the contribution of these other debris to far-field fragment hazards is minimal and no adjustment appears warranted. Table C-3 illustrates this adjustment for test no. 10.

- Step 8: Sum the fragment counts for each type of debris (i.e., intact warhead bodies, warhead body pieces, and other debris) to determine the total number of fragments in each range interval. These results for test no. 10 are shown in the right-most column of Table C-3.
- Step 9: Normalize the fragment counts for each test based on the number of warheads that fragmented. The normalized fragment counts for test no. 10 are provided in Table C-4.
- Step 10: Determine the mean normalized fragment count for each range interval for each type of munition. The mean normalized fragment counts for the tests of M1 105mm artillery cartridges loaded with Composition B are provided in Table C-5.
- Step 11: For each type of munition, predict the fragment counts that would be produced by larger stacks. It was assumed that 50% of the warheads in a stack would fragment, regardless of the size of the stack. This assumption is thought to be slightly conservative based on the results observed during this series of tests. Thus, the number of fragments expected to fall in any given range interval for any given stack size was calculated as:

$$n_{\text{pred}(i)} = n_{\text{norm}(i)} * N/2 \quad \text{where:}$$

$$n_{\text{pred}(i)} = \text{predicted fragment count for range interval (i)}$$

$$n_{\text{norm}(i)} = \text{normalized fragment count for range interval (i)}$$

$$N = \text{total number of rounds in stack}$$

Table C-6 illustrates the results for a stack of 12865 rounds of M1 105mm cartridges loaded with Composition B explosive. The total net explosive weight (NEW) for a stack this size is 100,000 lb.

- Step 12: For each type of munition and each selected stack size, calculate the areal density of fragments for each range interval. This calculation was performed as follows using a modified pseudo trajectory-normal method:^{C-1}

$$D_{(i)} = (n_{\text{pred}(i)} + (\sum n_{\text{pred}(k)})/3) / A_{(i)} \quad \text{where:}$$

$$D_{(i)} = \text{average areal density for range interval (i)}$$

$$\sum n_{\text{pred}(k)} = \text{sum of fragment counts for range intervals beyond range interval (i)}$$

$$A_{(i)} = \text{area of annulus for range interval (i)}$$

Table C-7 illustrates the results for a stack of M1 105mm cartridges loaded with Composition B explosive with a total NEW of 100,000 lb.

Step 13: For each type of munition and each selected stack size, fit an interpolatory cubic spline to the density-range estimates to determine the range at which the areal density of fragments equals one fragment per 600 ft². Figure C-1 shows the curve fit for a stack of M1 105mm cartridges loaded with Composition B explosive with a total NEW of 100,000 lb and the corresponding interpolated value for the range at which the areal fragment density is one per 600 ft².

TABLE C-1. EXTRAPOLATION OF RECOVERY DATA FROM TEST NO. 10 TO COMPENSATE FOR INCOMPLETE SEARCH BEYOND 1300-FT RANGE

Range Interval (ft)	No. of Pieces Recovered					Portion of Annulus Searched	Zone Multiplier	Extrapolated No. of Pieces				
	Intact Warheads	Warhead Pieces	Nose Plug Pieces	Cartridge Case Pieces	Other Remains			Intact Warheads	Warhead Pieces	Nose Plug Pieces	Cartridge Case Pieces	Other Remains
200 - 400	0	161	14	89	67	360°	1	0	161	14	89	67
400 - 600	2	151	10	32	20	360°	1	2	151	10	32	20
600 - 800	1	116	3	5	4	360°	1	1	116	3	5	4
800 - 1000	0	70	0	2	1	360°	1	0	70	0	2	1
1000 - 1200	0	41	0	0	0	360°	1	0	41	0	0	0
1200 - 1300	0	11	0	0	0	360°	1	0	11	0	0	0
1300 - 1400	0	4	0	0	0	220°	1.64	0	6.56	0	0	0
1400 - 1600	0	2	0	0	0	220°	1.64	0	3.28	0	0	0
1600 - 1800	0	0	0	0	0	220°	1.64	0	0	0	0	0
1800 - 2000	0	0	0	0	0	220°	1.64	0	0	0	0	0

TABLE C-2. ESTIMATED PORTION OF WARHEAD BODY PIECES RECOVERED

	Test No.											
	1	2	3	4	5	6	7	8	9	10	11	12
No. of Cartridges Tested:	30	30	30	240	240	864	96	180	180	128	15	720
No. of Warhead Bodies Recovered Intact:	17	21	18	174	175	546	82	93	102	88	8	502
Indicated No. of Warheads that Fragmented:	13	9	12	66	65	318	14	87	78	40	7	218
Mass of Each Warhead Body (lbm):	25.8	25.8	25.8	25.8	25.8	25.8	25.8	5.05	5.05	25.8	5.05	5.05
Approximate Total Mass of Warhead Body Pieces (lbm):	335	232	310	1703	1677	8204	361	439	394	1032	35	1101
Mass of Warhead Case Pieces Recovered Inside 200-ft (lbm):	118	66	86	754	879	~5400	125	12	13	407	**	365
Indicated Total Mass of Warhead Body Pieces Projected >200-ft (lbm): (Assumes 100% recovery inside 200 ft range)	217	166	224	949	798	2804	236	427	381	625	**	736
Total Mass of Warhead Body Pieces Recovered Beyond 200-ft (lbm)*:	140	153	140	600	613							
Indicated Portion of Warhead Body Pieces Recovered:	0.64	0.92	0.63	0.63	0.77	1.13	0.65	0.31	0.24	0.65	**	0.27

* Adjusted to correct for incomplete search beyond 1300-ft range.

** The mass of the warhead pieces inside the 200-ft range was not determined. Thus, the percentage of recovery cannot be estimated.

TABLE C-3. SCALING OF RECOVERY DATA FROM TEST NO. 10 TO COMPENSATE FOR INCOMPLETE RECOVERY BEYOND 200-FT RANGE

Range Interval (ft)	Extrapolated No. of Pieces					Estimated Portion of Fragments Recovered (Warhead Pieces Only)	Scaled No. of Pieces					Adjusted Total Number of Pieces
	Intact Warheads	Warhead Pieces	Nose Plug Pieces	Cartridge Case Pieces	Other Remains		Intact Warheads	Warhead Pieces	Nose Plug Pieces	Cartridge Case Pieces	Other Remains	
200 - 400	0	161	14	89	67	0.64	0	249.8	14	89	67	419.8
400 - 600	2	151	10	32	20	0.64	2	234.3	10	32	20	298.3
600 - 800	1	116	3	5	4	0.64	1	180.0	3	5	4	193.0
800 - 1000	0	70	0	2	1	0.64	0	108.6	0	2	1	111.6
1000 - 1200	0	41	0	0	0	0.64	0	63.6	0	0	0	63.6
1200 - 1400	0	17.56	0	0	0	0.64	0	27.2	0	0	0	27.2
1400 - 1600	0	3.28	0	0	0	0.64	0	5.1	0	0	0	5.1
1600 - 1800	0	0	0	0	0	0.64	0	0.0	0	0	0	0.0
1800 - 2000	0	0	0	0	0	0.64	0	0.0	0	0	0	0.0

TABLE C-4. NORMALIZED FRAGMENT COUNTS FOR TEST NO. 10

Range Interval (ft)	Adjusted Total Number of Pieces	Normalized Number of Pieces*
200 - 400	419.8	10.49
400 - 600	298.3	7.46
600 - 800	193.0	4.82
800 - 1000	111.6	2.79
1000 - 1200	63.6	1.59
1200 - 1400	27.2	0.68
1400 - 1600	5.1	0.13
1600 - 1800	0.0	0.00
1800 - 2000	0.0	0.00

* (Total Number of Pieces) / (Number of Warheads That Fragmented)

TABLE C-5. NORMALIZED FRAGMENT COUNTS FOR TESTS OF M1 105MM CARTRIDGES LOADED WITH COMPOSITION B EXPLOSIVE

Range Interval (ft)	Normalized Fragment Counts		
	Test No. 7	Test No. 10	Average
200 - 400	12.07	10.49	11.28
400 - 600	4.25	7.46	5.85
600 - 800	2.58	4.82	3.70
800 - 1000	0.96	2.79	1.87
1000 - 1200	0.74	1.59	1.16
1200 - 1400	1.11	0.68	0.90
1400 - 1600	0.30	0.13	0.21
1600 - 1800	0.00	0.00	0.00
1800 - 2000	0.00	0.00	0.00

TABLE C-6. PREDICTED FRAGMENT COUNTS FOR 100,000-LB NEW STACK OF M1 105MM CARTRIDGES LOADED WITH COMPOSITION B EXPLOSIVE

Range Interval (ft)	Average Normalized Fragment Counts	Predicted Fragment Counts for 100,000-lbm NEW (12865 rounds)*	
		Extrapolation of Normalized Counts	Pseudo Trajectory-Normal (PTN) Counts**
200 - 400	11.28	72558	101929
400 - 600	5.85	37643	54467
600 - 800	3.70	23806	32694
800 - 1000	1.87	12046	16919
1000 - 1200	1.16	7489	9866
1200 - 1400	0.90	5766	6220
1400 - 1600	0.21	1363	1363
1600 - 1800	0.00	0	0
1800 - 2000	0.00	0	0

* Based on item NEW of 7.773 lbm, assume 50% of warheads fragment.

** (Number of fragments in range interval)+(number of fragments beyond range interval)/3

TABLE C-7. PREDICTED FRAGMENT AREAL DENSITIES FOR 100,000-LB NEW STACK OF M1 105MM CARTRIDGES LOADED WITH COMPOSITION B EXPLOSIVE

Range Interval (ft)	Area of Annulus (sq ft)	Predicted PTN Counts for 100,000-lbm NEW	Predicted Areal Density for Stack of 100,000-lbm NEW	
			(fragments per sq ft)	(fragments per 600 sq ft)
200 - 400	376991	101929	0.270	162.225
400 - 600	628319	54467	0.087	52.012
600 - 800	879646	32694	0.037	22.301
800 - 1000	1130973	16919	0.015	8.976
1000 - 1200	1382301	9866	0.007	4.282
1200 - 1400	1633628	6220	0.004	2.285
1400 - 1600	1884956	1363	0.001	0.434
1600 - 1800	2136283	0	0.000	0.000
1800 - 2000	2387610	0	0.000	0.000

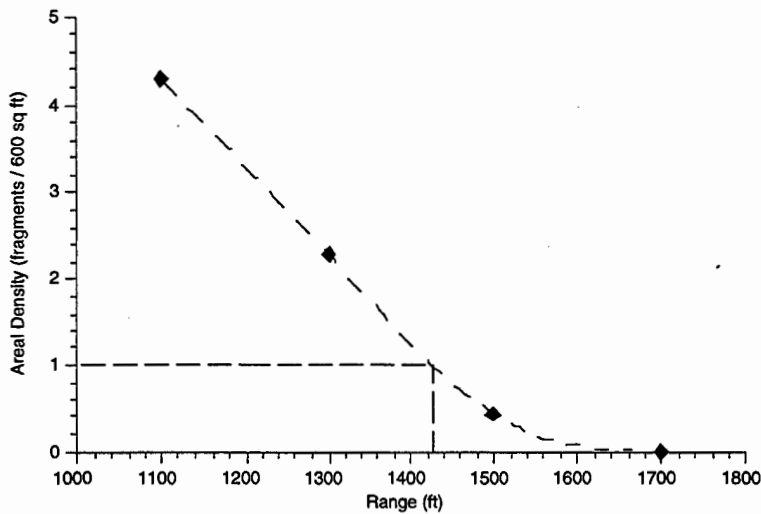

FIGURE C-1. ESTIMATION OF RANGE TO EXCEED AREAL DENSITY OF 1 FRAGMENT PER 600 SQ FT FOR 100,000-LB NEW STACK OF M1 105MM CARTRIDGES LOADED WITH COMPOSITION B EXPLOSIVE

REFERENCE

- C-1. Gould, M. J. A. and Swisdak, M. M., Jr., "The Measurement and Analysis of Explosion Produced Debris And Fragments Following an Accident or a Test Representative of an Accident," PARARI 97 Australian Safety Seminar, October 1997.

DISTRIBUTION

	<u>COPIES</u>		<u>COPIES</u>
DOD ACTIVITIES (CONUS)			
DEFENSE TECHNICAL INFORMATION CENTER 8725 JOHN J KINGMAN RD SUITE 0944 FT BELVOIR VA 22060-6218	1	ATTN CODE LEE DIRECTOR DEFENSE SPECIAL WEAPONS AGENCY 6801 TELEGRAPH ROAD ALEXANDRIA VA 23310-3398	1
DEPUTY UNDER SECRETARY OF DEFENSE (ENVIRONMENTAL SECURITY) PENTAGON ROOM 3E808 WASHINGTON DC 20301-8000	1	ATTN ONR-410 ONR-430 CHIEF OF NAVAL RESEARCH 800 N QUINCY STREET ARLINGTON VA 22217	1 1
ATTN OUSD (A&T) S&TS/M (MELITA) OFFICE OF THE SECRETARY OF DEFENSE PENTAGON ROOM 3B1060 WASHINGTON DC 20301-3080	1	ATTN N411 N411B N411C1 CHIEF OF NAVAL OPERATIONS DEPARTMENT OF THE NAVY WASHINGTON DC 20350-2000	1 1 1
ATTN DDESB-KT (WARD) DDESB-KT (CANADA) CHAIRMAN DEPARTMENT OF DEFENSE EXPLOSIVES SAFETY BOARD 2461 EISENHOWER AVENUE ALEXANDRIA VA 22331-0600	25 1	ATTN N71 N711 N7112 COMMANDER NAVAL ORDNANCE CENTER 23 STRAUSS AVENUE INDIAN HEAD MD 20640-5555	1 1 1
ATTN CODE AQOI DCMC-OI (L JAMES) DEFENSE CONTRACTS MANAGEMENT AGENCY 8725 JOHN J KINGMAN RD SUITE 2533 FT BELVOIR VA 22060-6221	1 1	ATTN SEA-91WM SEA-91WM1 LIBRARY COMMANDER NAVAL SEA SYSTEMS COMMAND 2531 JEFFERSON DAVIS HIGHWAY ARLINGTON VA 22242-5160	1 1 1
ATTN MTOP-SS COMMANDER MILITARY TRAFFIC MANAGEMENT COMMAND 5611 COLUMBIA PIKE FALLS CHURCH VA 22041-5050	1	ATTN CODE 151 CODE 151RU COMMANDING OFFICER NAVAL FACILITIES ENGINEERING COMMAND 200 STOVALL STREET ALEXANDRIA VA 22332-2300	1 1

DISTRIBUTION (Continued)

	<u>COPIES</u>		<u>COPIES</u>
DOD ACTIVITIES (CONUS)			
(Continued)			
ATTN CODE ESC62	1	ATTN CODE 041	1
CODE ESC62 (TANCRETO)	1	CODE 041B	1
CODE ESC62 (HAGER)	1	CODE 044D	1
CODE ESC62 (MURTHA)	1	CODE 044F	1
COMMANDER		CODE 950T	1
NAVAL FACILITIES ENGINEERING		COMMANDER	
SERVICES CENTER		INDIAN HEAD DIVISION	
1100 23RD AVENUE		NAVAL SURFACE WARFARE CENTER	
BUILDING 1100		101 STRAUSS AVENUE	
PORT HUENEME CA 93043-4370		INDIAN HEAD MD 20640-5035	
ATTN TECHNICAL INFORMATION	1	ATTN CODE 672 (RYE)	1
SECTION		CODE 673 (WILSON)	1
COMMANDING OFFICER		LIBRARY	1
NAVAL RESEARCH LABORATORY		COMMANDER	
WASHINGTON DC 20375		NAVAL SURFACE WARFARE CENTER	
ATTN CMC-SD	1	CARDEROCK DIVISION	
DIRECTOR		9500 MACARTHUR BOULEVARD	
MARINE CORPS SAFETY DIVISION		WEST BETHESDA MD 20817-5700	
2405 NAVY ANNEX		ATTN ESO	1
WASHINGTON DC 20380-1555		CODE 405	1
ATTN CODE 473000D	1	COMMANDER	
CODE 473400D	1	NAVAL SURFACE WARFARE CENTER	
CODE 473420D (HALSEY)	1	CRANE DIVISION	
LIBRARY	1	300 HIGHWAY 361	
COMMANDING OFFICER		CRANE IN 47522	
NAVAL AIR WARFARE CENTER/		ATTN TECHNICAL LIBRARY	1
WEAPONS DIVISION		COMMANDING OFFICER	
1 ADMINISTRATION CIRCLE		NAVAL EXPLOSIVE ORDNANCE	
CHINA LAKE CA 93555-6001		DISPOSAL TECHNOLOGY CENTER	
ATTN J JENUS	1	2008 STUMP NECK ROAD	
ASC/WMGB		INDIAN HEAD MD 20640-5070	
102 WEST D STREET		ATTN W RIEDER	1
SUITE 168		AFLC/IGFW	
EGLIN AFB FL 32542-6879		WRIGHT PATTERSON AFB OH	
		45433-5001	

DISTRIBUTION (Continued)

	<u>COPIES</u>		<u>COPIES</u>
DOD ACTIVITIES (CONUS)			
(Continued)			
ATTN SAILE-ESOH (ABRISZ) OFFICE OF THE ASSISTANT SECRETARY OF THE ARMY (INSTALLATIONS, LOGISTICS & ENVIRONMENT) 110 ARMY PENTAGON WASHINGTON DC 20310-0110	1	ATTN AMSTA-AR-AE AMSTA-AR-AEE AMSTA-AR-AEE-BR AMSTA-AR-AEP AMSTA-AR-AES AMSTA-AR-AL AMSTA-AR-ALI AMSTA-AR-QAS	1 1 1 1 1 1 1 1
ATTN DALO-SMA HEADQUARTERS DEPARTMENT OF THE ARMY ROOM 1D567 PENTAGON WASHINGTON DC 20310-0541	1	COMMANDER ARMAMENT RESEARCH DEVELOPMENT AND ENGINEERING CENTER U. S. ARMY ARMAMENT MUNITIONS AND CHEMICAL COMMAND PICATINNY ARSENAL NJ 07806-5000	
ATTN DACS-SF HEADQUARTERS DEPARTMENT OF THE ARMY ROOM 2C717 PENTAGON WASHINGTON DC 20310-0541	1	ATTN SIOAC-DEV SIOAC-ASC DIRECTOR U. S. ARMY DEFENSE AMMUNITION CENTER SAVANNA IL 61074-9639	1 1
ATTN AMCAM-LCP AMCAM-PP AMCSF AMCSF-E AMCSF-X AMXED	1 1 1 1 1 1	ATTN SIOAC-ES SIOAC-ESL SIOAC-EST	1 1 1
COMMANDER U. S. ARMY MATERIEL COMMAND 5001 EISENHOWER AVENUE ALEXANDRIA VA 22333-0001		DIRECTOR U. S. ARMY TECHNICAL CENTER FOR EXPLOSIVES SAFETY SAVANNA IL 61074-9639	
ATTN CSSC1-PR COMMANDER USA SAFETY CENTER FT RUCKER AL 36362-5363	1	ATTN CEWES-SE CEWES-SD-R DIRECTOR US ARMY ENGINEER WATERWAYS EXPERIMENT STATION 3909 HALLS FERRY ROAD VICKSBURG MS 39180-6199	1 1
ATTN LIBRARY COMMANDING GENERAL US ARMY NATICK RESEARCH AND DEVELOPMENT COMMAND NATICK MA 01782	1		

DISTRIBUTION (Continued)

	<u>COPIES</u>		<u>COPIES</u>
DOD ACTIVITIES (CONUS)			
(Continued)			
ATTN AMSMI-SF COMMANDER U. S. ARMY MISSILE COMMAND REDSTONE ARSENAL AL 35898-5130	1	ATTN AFSC/SEP (PRICE) AFSC/SEW AFSC/SEWE AFSC/SEWEC (OLSON) HEADQUARTERS AIR FORCE SAFETY CENTER 9700 AVENUE G SE KIRTLAND AFB NM 87117-5670	1 1 1 1
ATTN CSSD-TC-WS COMMANDER U. S. ARMY SPACE AND STRATEGIC DEFENSE COMMAND PO BOX 1500 HUNTSVILLE AL 35807-3801	1	ATTN MNME (PARSONS) AIR FORCE RESEARCH LABORATORY 2306 PERIMETER ROAD EGLIN AFB FL 32542-5910	1
ATTN AMSRL-WM-TB (FREY) AMSRL-WM-TB (WATSON) AMSRL-WM-TB (STARKENBERG) AMSRL-WM-TB (LOTTERO) COMMANDER US ARMY RESEARCH LABORATORY ABERDEEN PROVING GROUND MD 21005-5066	1 1 1 1	ATTN COLLINS AFDTC/SE 1001 N 2ND STREET SUITE 366 ELGIN AFB FL 32542-6838	1
ATTN AMSIO-DMS (LEAH) COMMANDER INDUSTRIALS OPERATIONS COMMAND ROCK ISLAND IL 61299-6000	1	ATTN PARKER AFDTC/SES 1001 N 2ND STREET SUITE 366 EGLIN AFB FL 32542	1
ATTN CEHNC-ED-CS (LAHOUD) CEHNC-ED-CS-S (ZEHRT) CEHNC-ED-CS-S (FARSOUN) CEHNC-ED-CS-S (SERENA) COMMANDER U. S. ARMY ENGINEERING SUPPORT CENTER PO BOX 1600 HUNTSVILLE AL 35807-4301	1 1 1 1	ATTN C MERRILL AIR FORCE ASTRONAUTICS LABORATORY 10 EAST SATURN EDWARDS AFB CA 93524-7680	1
		ATTN CODE A76 (TECHNICAL LIBRARY) COMMANDING OFFICER CSSDD NSWC 6703 W HIGHWAY 98 PANAMA CITY FL 32407-7001	1

DISTRIBUTION (Continued)

	<u>COPIES</u>		<u>COPIES</u>
NON-DOD ACTIVITIES (CONUS)			
DEPARTMENT OF ENERGY QUALITY VERIFICATION DIVISION WASHINGTON DC 20545	1	ATTN CODE QS (FRAZIER) HEADQUARTERS NATIONAL AERONAUTICS & SPACE ADMINISTRATION 300 E STREET SW WASHINGTON DC 20546	1
ATTN G MEYERS (MAIL STOP EH-53) DEPARTMENT OF ENERGY WASHINGTON DC 20585	1	ATTN AST-200 (REPCHECK) FEDERAL AVIATION ADMINISTRATION OFFICE OF COMMERCIAL SPACE TRANSPORTATION 800 INDEPENDENCE AVE SW WASHINGTON DC 20591	1
ATTN TECHNICAL LIBRARY LOS ALAMOS NATIONAL LABORATORY PO BOX 1663 LOS ALAMOS NM 87545	1	ATTN MARK WALLER BUREAU OF ALCOHOL TOBACCO & FIREARMS PUBLIC SAFETY BRANCH ARSON AND PROGRAMS DIVISION 650 MASSACHUSETTS AVE NW ROOM 5100 WASHINGTON DC 20226	1
ATTN TECHNICAL LIBRARY LAWRENCE LIVERMORE NATIONAL LABORATORY PO BOX 808 LIVERMORE CA 94550	1	WILFRED BAKER ENGINEERING INC 8700 CROWNHILL SUITE 310 PO BOX 6477 SAN ANTONIO TX 78209	1
ATTN A G PAPP MASON & HANGER PO BOX 30020 AMARILLO TX 79177	1	ATTN P BOWLES TECHNICAL LIBRARY SOUTHWEST RESEARCH INSTITUTE PO BOX 28510 6220 CULEBRA ROAD SAN ANTONIO TX 78228-0510	1
ATTN R MAINIERO NIOSH PITTSBURGH RESEARCH CENTER PO BOX 18070 PITTSBURGH PA 15236-0070	1	ATTN P A PERSSON D COLLIS NEW MEXICO INSTITUTE OF MINING AND TECHNOLOGY EMRTC SOCORRO NM 87801	1
ATTN DHM-21 DEPARTMENT OF TRANSPORTATION 400 7TH STREET SW WASHINGTON DC 20590	1		1
INSTITUTE OF MAKERS OF EXPLOSIVES 1120 19TH STREET NW #310 WASHINGTON DC 20036-3605	1		1

DISTRIBUTION (Continued)

	<u>COPIES</u>		<u>COPIES</u>
NON-DOD ACTIVITIES (CONUS)			
(Continued)			
ATTN TECHNICAL LIBRARY	1	INTERNAL	
IIT RESEARCH INSTITUTE			
10 WEST 35TH STREET		B60	3
CHICAGO IL 60616		G606	1
		G64	1
ATTN MS HYL A NAPADENSKY	1	G64 (HOUCHINS)	1
NAPADENSKY ENERGETICS			
HC 3 BOX 458			
LUTSEN MN 55612-9705			
CPIA/JHU			
10630 LITTLE PATUXENT PARKWAY			
SUITE 202			
COLUMBIA MD 21044-3200	1		
THE CNA CORPORATION			
PO BOX 16268			
ALEXANDRIA VA 22302-0268	1		
ATTN GIFT AND EXCHANGE	4		
DIVISION			
LIBRARY OF CONGRESS			
WASHINGTON DC 20540			