



Congestion Mitigation at Railroad-Highway At-Grade Crossings

Final Report 557

Prepared by:

Craig A. Roberts, Ph.D., P.E., Principal Investigator
Jamie Brown-Esplain, Research Engineer
AZTrans: The Arizona Laboratory for Applied Transportation Research
Northern Arizona University
Department of Civil and Environmental Engineering
Flagstaff, AZ 86004-5600

October 2005

Prepared for:

Arizona Department of Transportation
206 South 17th Avenue
Phoenix, Arizona 85007
In cooperation with
U.S. Department of Transportation
Federal Highway Administration

The contents of this report reflect the views of the authors who are responsible for the facts and accuracy of the data presented herein. The contents do not necessarily reflect official views or policies of the Arizona Department of Transportation or the Federal Highway Administration. The report does not constitute a standard, specification, or regulation. Trade or manufacturers' names that appear herein are cited only because they are considered essential to the objectives of the report. The U.S. Government and the State of Arizona do not endorse products or manufacturers.

This ATRC report is available on the Arizona Department of Transportation's Internet site.

Technical Report Documentation Page

1. Report No. FHWA-AZ-05-557		2. Government Accession No.		3. Recipient's Catalog No.	
4. Title and Subtitle Congestion Mitigation at Railroad-Highway At-Grade Crossings				5. Report Date October 2005	
				6. Performing Organization Code	
7. Author Craig A. Roberts, Ph.D., P.E., Principal Investigator Jamie Brown-Esplain, Research Engineer				8. Performing Organization Report No.	
9. Performing Organization Name and Address AZTrans: The Arizona Laboratory for Applied Transportation Research Northern Arizona University Civil and Environmental Engineering Department P.O. Box 15600 Flagstaff, AZ 86011-5600				10. Work Unit No.	
				11. Contract or Grant No. SPR-PL-1(63)557 JPA 02-209 / R0557 15P	
12. Sponsoring Agency Name and Address ARIZONA DEPARTMENT OF TRANSPORTATION 206 S. 17th Avenue, Phoenix, Arizona 85007 ADOT Project Manager: Stephen R. Owen, P.E. *with additional funding support from the City of Flagstaff and Northern Arizona University				13. Type of Report & Period Covered FINAL REPORT March 2003 - November 2005	
				14. Sponsoring Agency Code	
15. Supplementary Notes Prepared in cooperation with the U.S. Department of Transportation, Federal Highway Administration					
16. Abstract – Rapid population growth in Arizona has created several large residential areas that rely on the State highways to provide their primary, daily commuting route. When these commuter routes cross an at-grade railroad crossing, a train passing during peak traffic hours often causes severe congestion. State resources are inadequate to provide flyovers for all of these train crossings and their numbers are forecast to increase. The safety and congestion problems arising from these commuter at-grade crossings are the focus of this research. A study site was selected, train and traffic data were collected, a microscopic traffic simulation model was prepared, and an Early Warning System (EWS) algorithm was developed. The EWS algorithm gives "extra" green time to (train) conflicting traffic movements before the train arrives, taking the time from the other movements. Five cases were studied, each having two to six scenarios. Four major variables were studied: (1) crossing gates down time, (2) length of time the MOEs were collected, (3) conflicting movements traffic volumes, and (4) predicted arrival time error. The EWS algorithm was also successfully programmed into a NEMA controller using Hardware-in-the-Loop to couple it to the simulation model. Four generalizations are tentatively supported by the results but additional site studies are required for verification. First, the complex dynamic interplay of geometrics and train and traffic volumes makes the EWS effectiveness highly site dependent. Second, there must be enough pre-train vehicles present on conflicting movements that derive delay improvement to overcome the increase in delay to the other movements. Third, for safety reasons, an increase in overall intersection delay caused by the EWS may be justified to reduce long queues from backing-up into other intersections or onto freeways. Fourth, rather than control signal timing, the EWS may be used to reduce congestion by alerting drivers with a DMS of a train's imminent arrival so they can take alternate routes. While the EWS was ineffective for the study site, the results may have been confounded by insufficient pre-train queue sizes and lack of a single dominant commuter movement (the study site had strong cross flows). A follow-up study is recommended at a site with more favorable geometry and traffic volumes.					
17. Key Words Microscopic Simulation Models, At-Grade Highway-Railroad Crossings, Railroad Grade Crossings, Preemption, Hardware-in-the-Loop, HIL, VISSIM, CID, DSM, ITS, Model Calibration			18. Distribution Statement Document is available to the U.S. Public through the National Technical Information Service, Springfield, Virginia, 22161		23. Registrant's Seal Not Applicable
19. Security Classification Unclassified	20. Security Classification Unclassified	21. No. of Pages 104	22. Price		

SI* (MODERN METRIC) CONVERSION FACTORS

APPROXIMATE CONVERSIONS TO SI UNITS					APPROXIMATE CONVERSIONS FROM SI UNITS				
Symbol	When You Know	Multiply By	To Find	Symbol	Symbol	When You Know	Multiply By	To Find	Symbol
<u>LENGTH</u>					<u>LENGTH</u>				
in	inches	25.4	millimeters	mm	mm	millimeters	0.039	inches	in
ft	feet	0.305	meters	m	m	meters	3.28	feet	ft
yd	yards	0.914	meters	m	m	meters	1.09	yards	yd
mi	miles	1.61	kilometers	km	km	kilometers	0.621	miles	mi
<u>AREA</u>					<u>AREA</u>				
in ²	square inches	645.2	square millimeters	mm ²	mm ²	square millimeters	0.0016	square inches	in ²
ft ²	square feet	0.093	square meters	m ²	m ²	square meters	10.764	square feet	ft ²
yd ²	square yards	0.836	square meters	m ²	m ²	square meters	1.195	square yards	yd ²
ac	acres	0.405	hectares	ha	ha	hectares	2.47	acres	ac
mi ²	square miles	2.59	square kilometers	km ²	km ²	square kilometers	0.386	square miles	mi ²
<u>VOLUME</u>					<u>VOLUME</u>				
fl oz	fluid ounces	29.57	milliliters	mL	mL	milliliters	0.034	fluid ounces	fl oz
gal	gallons	3.785	liters	L	L	liters	0.264	gallons	gal
ft ³	cubic feet	0.028	cubic meters	m ³	m ³	cubic meters	35.315	cubic feet	ft ³
yd ³	cubic yards	0.765	cubic meters	m ³	m ³	cubic meters	1.308	cubic yards	yd ³
NOTE: Volumes greater than 1000L shall be shown in m ³ .									
<u>MASS</u>					<u>MASS</u>				
oz	ounces	28.35	grams	g	g	grams	0.035	ounces	oz
lb	pounds	0.454	kilograms	kg	kg	kilograms	2.205	pounds	lb
T	short tons (2000lb)	0.907	megagrams (or "metric ton")	mg (or "t")	Mg	megagrams (or "metric ton")	1.102	short tons (2000lb)	T
<u>TEMPERATURE (exact)</u>					<u>TEMPERATURE (exact)</u>				
°F	Fahrenheit temperature	5(F-32)/9 or (F-32)/1.8	Celsius temperature	°C	°C	Celsius temperature	1.8C + 32	Fahrenheit temperature	°F
<u>ILLUMINATION</u>					<u>ILLUMINATION</u>				
fc	foot-candles	10.76	lux	lx	lx	lux	0.0929	foot-candles	fc
fl	foot-Lamberts	3.426	candela/m ²	cd/m ²	cd/m ²	candela/m ²	0.2919	foot-Lamberts	fl
<u>FORCE AND PRESSURE OR STRESS</u>					<u>FORCE AND PRESSURE OR STRESS</u>				
lbf	poundforce	4.45	Newtons	N	N	Newtons	0.225	poundforce	lbf
lbf/in ²	poundforce per square inch	6.89	kilopascals	kPa	kPa	kilopascals	0.145	poundforce per square inch	lbf/in ²

SI is the symbol for the International System of Units. Appropriate rounding should be made to comply with Section 4 of ASTM E380

TABLE OF CONTENTS

EXECUTIVE SUMMARY	1
1. INTRODUCTION	7
1.1. MOTIVATION FOR RESEARCH	7
1.2. SCOPE OF THIS RESEARCH	9
1.3. ORGANIZATION OF THE REPORT	9
2. PROBLEMS WITH AT-GRADE HIGHWAY-RAILROAD CROSSINGS	11
2.1. TRAIN SAFETY	11
2.2. VEHICLE SAFETY	12
2.3. VEHICLE CONGESTION	14
3. SITE SELECTION, GEOMETRICS, AND TRAFFIC	15
3.1. SELECTION OF THE STUDY SITE	15
3.1.1. Railroad Equipment and Operations Used at the Site	15
3.1.2. Traffic Signal Equipment and Operations Used at the Site	19
3.2. SITE GEOMETRICS AND MODIFICATIONS FOR MODEL	22
3.2.1. Current Geometrics at the Study Site	22
3.2.2. Modified Tee Intersection Geometrics Used for the Study	23
3.3. VEHICLE TRAFFIC USED IN THE MODEL	24
3.3.1. Data Collection Procedure	24
3.3.2. Adjustments Made To Data Provided By TDS	26
3.3.3. Data Used in the VISSIM Model For Calibration And Validation	28
3.3.4. Modified Data Used in the VISSIM Model for Study Cases	30
3.4. RAILROAD TRAIN CHARACTERISTICS USED IN THE MODEL	30
4. MODEL DEVELOPMENT	33
4.1. SELECTION OF THE MODELING ENVIRONMENT	33
4.2. VISSIM MODEL CALIBRATION	33
4.2.1. Establishment of Calibration Parameters	34
4.2.2. The Calibration Process	39
4.3. VISSIM MODEL VERIFICATION	39
5. EARLY WARNING SYSTEM (EWS)	41
5.1. EARLY WARNING SYSTEM DESIGN CONSIDERATIONS	41
5.2. EWS DETECTION SUBSYSTEM	41
5.2.1. Radar Detection and Wireless Communication	41
5.2.2. Time Domain Reflectometry (TDR) Detection	42
5.3. EWS PREDICTION SUBSYSTEM	43

5.4.	EWS CONGESTION MITIGATION SUBSYSTEM	44
5.4.1.	Principle of Costs and Benefits	44
5.4.2.	Measurement of Costs versus Benefits	45
5.4.3.	Method to Capture Costs versus Benefits -- Before and After Study	45
5.4.4.	Stochastic Models Require Multiple Runs	45
5.4.5.	Principle of Availability of Vehicles to Receive Benefit	46
5.5.	EWS SAFETY SUBSYSTEM	46
6.	EWS CONGESTION MITIGATION ALGORITHM DEVELOPMENT	49
6.1.	ALGORITHM DEVELOPMENT	49
6.1.1.	EWS Algorithm Logic Concepts	49
6.1.2.	Application of the Algorithm at the Study Site	50
6.1.3.	Limitations Imposed on the Algorithm	51
6.2.	INDEPENDENT ALGORITHM TESTING	52
7.	BEFORE AND AFTER RESULTS	53
7.1.	PARAMETERS USED FOR EWS CONGESTION MITIGATION	53
7.2.	BEFORE AND AFTER CASES STUDIED	53
7.3.	SUMMARY OF RESULTS	57
7.3.1.	Duration Of Gates Down At Crossing	57
7.3.2.	Duration Of MOE Period	60
7.3.3.	Vehicle Traffic Volume Increases On Conflicting Movements	62
7.3.4.	Early and Late Train Arrivals Versus Predicted On-Time Arrival	64
7.3.5.	Impacts on Targeted Queue Lengths	66
8.	HARDWARE-IN-THE-LOOP (HIL) TESTING	69
8.1.	BENEFITS OF HIL TESTING	69
8.2.	METHODOLOGY AND EQUIPMENT	70
8.3.	IMPLEMENTATION USING NEMA TRAFFIC CONTROLLER	71
8.4.	SUMMARY OF RESULTS	73
9.	CONCLUSIONS	75
9.1.	EFFECTIVENESS HIGHLY DEPENDENT ON THE SITE	75
9.2.	VEHICLES MUST BE PRESENT TO USE THE EWS GREEN TIME	76
9.3.	QUEUE LENGTH MAY SUPPORT INCREASED EWS DELAY	76
9.4.	EWS MAY BE USEFUL FOR OTHER PURPOSES	76
10.	RECOMMENDATIONS	77

APPENDIX A. LITERATURE REVIEW	79
A.1. MICROSCOPIC TRAFFIC SIMULATION MODELS	79
A.2. ALGORITHM DEVELOPMENT	81
A.3. HIGHWAY-RAILROAD CROSSING SIGNAL PREEMPTION	82
A.4. HIGHWAY-RAILROAD CROSSING ISSUES	83
A.5. HARDWARE-IN-THE-LOOP SIMULATION	84
APPENDIX B. RAILROAD TRAFFIC DATA COLLECTION	85
B.1. RAILROAD DATA COLLECTION METHODOLOGY	85
B.2. GENERAL CHARACTERISTICS OF RAILROAD TRAFFIC DATA	85
APPENDIX C. EWS CONGESTION MITIGATION ALGORITHM PROGRAMMING	89
C.1. VISSIM MACRO LANGUAGE	89
C.2. SYNOPSIS OF ALGORITHM LOGIC	89
C.2.1. Position of Train Corresponds to Three States	90
REFERENCES	95

LIST OF TABLES

Table 1: Project 557: Technical Advisory Committee Members	10
Table 2: Overview Of Case Attributes	55
Table 3: Overview Of Case Runs	56
Table 4: Train Crossing Summary At The Study Site	86

LIST OF FIGURES

Figure 1: Aerial Photos Of The Study Site	16
Figure 2: Photos Of The At-Grade Crossing At The Study Site.....	17
Figure 3: Photo Of At-Grade Crossing Equipment At The Study Site.....	18
Figure 4: Photo Of The Intersection At The Study Site	22
Figure 5: Vehicle Traffic Data Collection Using Pneumatic Hoses.....	25
Figure 6: Video Cameras Location Map.....	27
Figure 7: “Scissor Lifts” Aided In Obtaining Adequate Video.	28
Figure 8: Study Intersection with Vehicle Movement Controller Numbers.....	30
Figure 9: VISSIM Model Showing Data Collection Points.....	35
Figure 10: VISSIM Model Screen Display Showing Route 66/Enterprise Showing Reduced Speed Areas, Links, And Connectors	36
Figure 11: VISSIM Model Screen Display Showing Enterprise/Butler Showing Reduced Speed Areas, Links, And Connectors	37
Figure 12: VISSIM Model Screen Display Showing Huntington Slip Lane Showing Reduced Speed Area, Links, And Connectors.....	38
Figure 13: Delay For Different Gates Down Durations Using EWS On WB LT	59
Figure 14: Delay For Different Gates Down Durations Using EWS On NB	59
Figure 15: Delay For Different MOE Duration Periods Using EWS On WB LT.....	61
Figure 16: Delay For Different MOE Duration Periods Using EWS On NB.....	61
Figure 17: Delay For Increased Relative Volumes Using EWS On WB LT.....	63
Figure 18: Delay For Increased Relative Volumes Using EWS On NB	63
Figure 19: Delay For Early, Late, And On-Time Arrivals Using EWS On WB LT	65
Figure 20: Delay For Early, Late, And On-Time Arrivals Using EWS On NB	65
Figure 21: Impact On Targeted Queue Using EWS On WB LT	67
Figure 22: Impact On Targeted Queue Using EWS On NB.....	67
Figure 23: Hardware-In-The-Loop Schematic Using McCain-NIATT CID II	70
Figure 24: Econolite Controller--CID II--VISSIM Model Setup	71
Figure 25: Modeled Volumes During Peak 30 Minutes Centered On Train Arrival.....	75
Figure 26: Empirical CDF Of Train Headways At The Study Site	87
Figure 27: Empirical CDF Of Gates-Down At The Study Site	88
Figure 28: NEMA 8-Phase Controller Configuration.....	90

SIGNIFICANT TERMS, ACRONYMS, AND ABBREVIATIONS

ADOT	Arizona Department of Transportation
AM Peak and PM Peak	The peak vehicle traffic flows that typically occur in the morning due to home-to-work trips and in the evening due to work-to-home trips.
Approach	All lanes of traffic moving towards an intersection from one direction.
At-grade Crossing	The intersection of a roadway and a railroad track(s) at the same elevation or grade.
ATRC	Arizona Transportation Research Center: administers the research activity of ADOT and the publication of the results.
<i>AZTrans</i>	The Arizona Laboratory of Transportation, the research unit at Northern Arizona University, Department of Civil and Environmental Engineering that conducted this study.
BNSF	Burlington Northern Santa Fe Railway Company
CDF	Cumulative Distribution Function is the function that gives the cumulative frequency or cumulative probability of a random variable.
CID	Computer Interface Device is a combination of hardware and software that allows an actual traffic signal controller to be linked to a computer and operate as part of a traffic simulation model.
Commuter At-grade Crossing	In this study, an at-grade crossing used by a large number of travelers making daily home-to-work and work-to-home trips.
Conflicting Movement	In this study, a traffic movement that has to cross the railroad track before entering or after leaving a nearby intersection. See “Non-conflicting Moment.”
EWS	Early Warning System – a software or algorithm used to control an intersection’s traffic signal system before a train arrives at a nearby at-grade crossing.
FHWA	Federal Highway Administration
Flyover	When a roadway is grade separated to cross a railroad, by either passing over the railroad or the railroad passing over the roadway.
FRA	Federal Railroad Administration
HIL	Hardware-in-the-Loop simulation refers to a computer simulation in which some of the components of the simulation have been replaced with actual hardware. The hardware is fully functioning, responding to the simulation environment as if it were a real environment.
ITS	Intelligent Transportation System

MOE	Measure of Effectiveness
Movement	A path through an intersection. For this study site (see Figure 8), the principal traffic movements and directionalities are defined as follows: NB: Northbound; SB: Southbound; EB: Eastbound; WB: Westbound LT: Left Turn; RT: Right Turn; TH: (Straight) Through
MUTCD	Manual of Uniform Traffic Control Devices
NEMA	National Electrical Manufacturers Association
Non-conflicting Movement	A traffic movement that does not have to cross the railroad track before entering or after leaving a nearby intersection. See “Conflicting Movement.”
PM	Performance Measure
Preemption Control	The transfer of normal operation of a traffic control signal to a special control mode of operation.
Run	Microscopic traffic simulation software generates a result using several stochastic processes. In order to generate an approximately random number for these processes, a beginning number is used. This beginning number is called a seed and the generation of the results is called a run.
Seed	See “Run.”
TAC	Technical Advisory Committee
TDS	Project sub-consultant, Traffic Data Systems, Inc.
VAP	Vehicle Actuated Programming is the name of the macro language for VISSIM.
VISSIM	A microscopic traffic simulation modeling software originally developed in Germany and maintained in the United States by PTV America, Inc.

EXECUTIVE SUMMARY

Several major Arizona highways are located parallel to active railroads. Population growth in the State has been rapid over the last 40 years and is projected to continue. Most of this growth has occurred in the major cities and towns, pushing them outwards along the State highway routes. This has created many large residential areas that rely on State highways to provide the primary, and often only, daily commuting route.

When these commuter routes cross an at-grade railroad crossing, a train passing during peak traffic hours often causes congestion that delays traffic and may back queues into adjacent intersections or onto freeways, causing operational and safety concerns for the Arizona Department of Transportation (ADOT). Additional contributing factors to the congestion and safety concerns are the increasing traffic on the railroad lines and the increasing number of these types of crossings, which far outstrip the State's ability to provide grade-separated railroad crossings.

The safety and congestion problems arising from these commuter at-grade crossings are the focus of this research for ADOT, which investigates these central issues:

Research Question: Can solutions be applied at a signalized intersection, before a train passes a nearby at-grade highway-railroad crossing, that will mitigate the congestion that will occur after the train has passed? Furthermore, can this be accomplished using a standard traffic signal controller?

Operational Issues

The current organizational and operating systems of the railroad company and the agency that operates adjacent traffic signals have evolved over time, and each may resist change for safety and liability reasons. At an at-grade crossing, the right-of-way corridor is owned by the railway company, which also owns and operates the gates and lights that comprise the active system that alerts drivers to an approaching train. The traffic signal system at the nearby intersection is owned and operated by the city, county, or state agency that owns the roadway. The railroad's warning control system and the traffic signal control system are not integrated, and operate independently.

It is critical for the nearby intersection traffic signal system to know of an approaching train so that it can take appropriate action to reduce safety problems. This is currently done by the railroad control system sending a signal to the traffic signal control system indicating a train is approaching the crossing, and later sending another signal that the train has cleared the crossing. When this signal is received, the traffic signal system operates independently to address the situation by altering its intersection control scheme in a manner known as train preemption, or simply "preemption."

During preemption, the traffic signal control system does four things: (1) it safely interrupts whatever movements are currently timing and gives the green to the movements that are queued across the railroad tracks, (2) it then switches to a sequence that gives green only to non-conflicting movements and withholds green from all conflicting movements while the train passes (a conflicting movement is one that has to cross the railroad track before entering or after leaving the nearby intersection), (3) after the train has passed, it switches to a designated movement (typically the one that is

waiting behind the crossing gates), and (4) lastly, it places a call on another designated movement while releasing control back to the normal cycle sequence.

The train preemption control scheme's primary purpose is safety; congestion mitigation is a secondary goal that occurs only after the train has passed. When vehicle volumes over the at-grade crossing are sufficiently large, and/or when the duration and/or frequency of the passing trains is sufficiently high, the preemption control scheme may be insufficient to clear all of the vehicles. This creates congestion that may cause operational problems for the roadway system. Depending on the geometrics involved, vehicle queues may extend back considerable distances into other intersections, or along freeway ramps onto the freeway itself. In some cases, it can take several cycles for queued vehicles to clear the intersection, causing considerable delay to drivers. The congestion problem is exacerbated if a second train passes before the congestion from the first train clears.

Study Site Geometrics and Traffic

Study site candidates required two primary characteristics: (1) they must be a commuter at-grade crossing and (2) the nearby signalized intersection must be on a State highway. Ideally the site would have severe congestion caused by passing trains. The study site selected was ADOT's Route 66 intersection with Enterprise Road in Flagstaff, Arizona. This site was chosen when the City of Flagstaff became an active secondary sponsor for the research. In retrospect, however, this intersection proved less than ideal due to its unique geometry and traffic patterns.

The study intersection is a "tee" with Route 66 running east-west, and Enterprise Road as the north-south leg that ends at the intersection (see Figure 1). The east-west railroad tracks are parallel to Route 66, and cross Enterprise Road approximately 75 feet south of the intersection. The geometrics of Enterprise were recently upgraded to two northbound left-turn lanes (NB LT) and one northbound right-turn lane (NB RT). The basic Route 66 geometrics were unchanged, consisting of two EB TH (eastbound through) lanes, one EB RT lane, two WB TH (westbound through) lanes, and one WB LT lane. Each of these movements has its own signal head except EB RT, which has its own stacking lane but no signal head.

The normal signal cycle at the intersection has three phases and sequence in this order: (1) WB LT, WB TH, and NB RT; (2) EB TH and EB RT to move also; and (3) NB TH and NB RT. In the standard NEMA controller used at the site, NB RT operates as an overlap with WB LT and also as an overlap with NB LT. It is allowed to do this by giving it its own phase designation, but this phase only operates as an overlap. Right turns on red after stop are allowed for both the NB RT and the EB RT.

The railroad crossing is owned and operated by the Burlington Northern Santa Fe (BNSF) Railway Company. It is an active crossing using advance warning signs, crossbucks, pavement markings, bells, gates, and flashing lights. BNSF's control system sends the signal to the intersection traffic signal control system indicating a train is approaching and another signal indicating the train has cleared the crossing. These signals allow ADOT to begin and end the special train preemption traffic control scheme.

An Early Warning System (EWS) was developed for this study to address the research question. After applying the EWS to the simulation model developed for the study site, it became apparent that the recent geometric improvements to the study site reduced the congestion sufficiently to mask any congestion mitigation improvement potentially attributable to the EWS. The study site simulation was therefore altered to reflect its geometry before the recent construction and restriping. This changed the study site model by (1) reducing the NB LT to only one lane, (2) increasing the length of the EB RT stacking lane by about 25 feet, and (3) reducing the Enterprise Road SB (southbound) lanes leaving the intersection from two to one. The railroad-crossing model was also simplified to two mainline tracks, by eliminating two other infrequently used tracks.

Vehicle traffic data was collected continuously at the site for all movements over a three-day period, including counts and video tape. The railroad (BNSF) was a partner in the research, and provided data of all train traffic at the site for a typical seven-day period.

Traffic Simulation Model Development

The VISSIM traffic simulation model was used in the study for the following four reasons: (1) proven ability to model both train and vehicle traffic, (2) ability to model detailed traffic behavior, (3) ability to modify the model to incorporate intelligent transportation system (ITS) devices, and (4) proven ability to use hardware-in-the-loop (HIL) techniques to test traffic signal controllers. A VISSIM model was prepared for the study site, and was calibrated and validated using two different data sets extracted from the three days of traffic data. Development of the model was the major portion of the research effort, requiring significant study time and resources.

Early Warning System

An ideal EWS would have four characteristics: (1) simple and inexpensive to design, build, and install; (2) easily maintained by existing traffic signal technicians; (3) unilaterally controlled by the highway agency without need for any changes to the railroad control system; and (4) able to retain the time-tested safety aspects of the current at-grade crossing highway and railroad preemption control systems. The EWS developed for this research contains these four characteristics and uses four subsystems to provide (1) detection, (2) prediction, (3) congestion mitigation, and (4) safety.

Conceptually two different types of sensor devices could be used for the detection subsystem: (1) Doppler radar and (2) time domain reflectometry (TDR). The Doppler radar detector has been used for train detection in previous research. It is pole-mounted in a fixed location adjacent to the railroad right-of-way, far from the at-grade crossing. It transmits data about a passing train through wireless transmission to the traffic signal controller cabinet, where a receiver ports the data to the small EWS field-hardened microprocessor computer that contains the other EWS subsystems.

The TDR sensor was recently developed for a different train application as part of a Transportation Research Board (TRB) program for a different train application. It is undergoing field-testing and shows promise, but is as yet unproven for this application. The TDR unit induces an electrical pulse into the rails that travels outward until it encounters the wheels of an approaching train. A portion of the pulse is then reflected

back; the reflected pulse can be analyzed to provide the train's speed and distance. The TDR detector would be located at the crossing itself, and the data transmitted to the nearby traffic signal controller via hardwire or wireless.

The EWS prediction subsystem uses an algorithm to predict the arrival time of the train and its passing duration based on the sensor data. Others have successfully used a simple algorithm, assuming a fixed speed. A fixed speed assumption is valid because the railroad companies strictly enforce train speed limits. The EWS congestion mitigation subsystem is the core of the research and it potentially could decide to take different actions, ranging from using different EWS parameters to aborting the use of the system because of uncertainty for that particular train. The model tested different parameters using an EWS algorithm developed for the study. The algorithm was written in the model's macro language, which required a significant effort to develop and refine. In addition, a third-party expert also was used to review the completed algorithm, which confirmed the accuracy of its logic and code.

The algorithm does not impact the safety of the current, time-tested train preemption control scheme. The algorithm always aborts when a train preemption signal is received. This is the same method currently used by NEMA-compliant traffic signal controllers to preempt the normal control sequence when a train arrives. The algorithm is designed to finish all of its operations just as the train preemption signal is received. However, even if it is not finished, the algorithm will always abort when the train preemption signal is received.

Before/After Study Results

Three measures-of-effectiveness (MOEs) were selected for evaluating the effects of the EWS: (1) delay, (2) travel time, and (3) queues. Of these, delay was the primary reporting MOE. Because of the tee intersection geometrics, two intersection movements (parameters) were available for receiving additional green time before the train arrived: (1) WB LT, which concurrently times WB TH and NB RT and (2) NB LT and NB RT, which time concurrently. The conflicting movements are WB LT, NB LT, and NB RT. Examining these two parameters while varying the other important factors of vehicle traffic flows, train traffic flows, MOE duration period, and train prediction errors, created substantially more cases than resources could accommodate. Therefore, only five cases were selected for testing the EWS. Two to six scenarios were modeled and tested for each case as well as the "no improvements" (before) scenario.

Five major variables were studied by comparing results from the five cases and their multiple scenarios. Crossing gates downtime was varied at three levels: 4.5, 2.6, and 1.5 minutes, based on site train data. MOE results were analyzed at two levels: 15- and 30-minute durations. Conflicting movement vehicle traffic was varied at three levels: actual, twice actual, and three times actual volume. The impact of train arrival prediction error was investigated at three arrival times: 25 seconds early, on-time, and 25 seconds late. Lastly, the impact of the parameters on the queue lengths was examined.

From the perspective of the entire intersection, the overarching before/after results for this site are that the "costs" of the EWS outweigh the "benefits" when intersection delay is considered. The benefits are the savings in delay to the conflicting movements that

receive additional green time, while the costs are the increase in delay to the non-conflicting movements that are the donors of additional green time.

Hardware-in-the-Loop Testing

To test the EWS algorithm, a hardware-in-the-loop technique was used with a NEMA controller. This technique linked an actual NEMA controller containing the EWS algorithm to the traffic simulation model. The algorithm was implemented by linking four of the controller's built-in preemptors. The results verified that a microcomputer inside a traffic signal cabinet could send a signal to a standard NEMA controller that would then initiate the appropriate EWS algorithm routine.

Conclusions and Recommendations

Four generalizations appear to be supported by the study results, but more studies at other sites are needed to conclusively verify or dispute them. The first generalization is that the effectiveness of the Early Warning System is highly dependent on the site geometry, and on the vehicle and train traffic volumes. The relative volumes of individual intersection movements are critical because when a conflicting movement is given "extra" green time by the EWS before the arrival of a train, it "steals" that time from other movements. This complex, dynamic interplay is site dependent.

The second generalization is that vehicles must be available to use the "extra" green time before the train arrives. This may not occur unless there were cycle failures before the train arrives. Without these cycle failures, there may not be enough vehicles in or nearing the queue to use the "extra" green time, especially when the "extra" green time is lengthy.

The third generalization is that reducing long queue lengths for safety purposes may justify an increase in overall intersection delay. This may be especially true if the long queues are backing-up into nearby intersections or onto freeways.

The fourth generalization is that the EWS may also be used in other ways to reduce congestion. One example is to send a warning signal to a DMS (dynamic message sign) that alerts drivers of a train's imminent arrival at the crossing so that they can take an alternate route.

In conclusion, the EWS was ineffective for the study site, but two traffic characteristics may be confounding the results: (1) insufficient pre-train queue lengths for conflicting movements that limit their ability to utilize the "extra" green time; and (2) the lack of a single dominant conflicting flow at the intersection (the study site had fairly balanced cross-flows).

Based on these lessons, a follow-up study is recommended at a new site with favorable geometry and traffic volumes. A multi-phase, incremental study approach should be used that allows termination of the study at the end of any phase that has clearly unfavorable results.

(blank)

1. INTRODUCTION

1.1. MOTIVATION FOR RESEARCH

Arizona's primary railroad system developed along the most accessible and constructible route alignments in advance of its primary highway system. Therefore, when a highway was developed, it was often placed parallel to the existing railroad tracks. The outlying suburban areas in Arizona use the primary highway system for trips to the urban areas for work, school, shopping, and recreation. The rapid growth of the urban areas in Arizona has caused suburban housing areas to be developed outward along highways leading into the urban areas.

Where such highways are parallel to a railroad line, daily commuters on one side of the highway must cross these tracks to reach the highway. The highway is often the primary, and in some cases the only, route available to these commuters to reach the urban areas. These *commuter at-grade crossings* are typically the crossing of the railroad by the feeder road from the housing area to the highway, which may be a two-way, two-lane (TWTL) highway or a four- or more lane, limited access freeway.

As the suburban area fills in, the feeder road--which usually begins as a TWTL road--may be upgraded to more lanes and become surrounded with commercial development. In the absence of a flyover structure (a roadway over- or underpass), the problems associated with at-grade crossings remain, and they typically will get worse as the volumes of vehicle and train traffic continue to increase.

These commuter at-grade crossings cause congestion problems when the volume of traffic crossing the tracks is sufficiently large and/or the frequency of trains is sufficiently high. This is already occurring at various sites in Arizona and is destined to spread to more sites statewide. Continued growth in train traffic is predicted by the railroads and as Arizona's population continues to increase¹, statewide vehicular traffic is also predicted to increase. Arizona's population is projected by the U.S. Census Bureau to

¹ Arizona's statewide population has grown from approximately 1,300,000 in 1960 to 5,100,000 in 2000. The rates of growth each decade beginning with the 1960s through the 1990s are respectively 36%, 53%, 35%, and 40% per decade. During the same 40-year span, the Phoenix-Mesa metro area grew from approximately 725,000 to 3,250,000 and had rates of growth over the four decades of 43%, 54%, 40%, and 45% per decade. Tucson metro area grew from approximately 265,000 in 1960 to 845,000 in 2000 and had rates of growth from the 1960s through the 1990s of 32%, 51%, 25%, and 37%. Yuma metro's growth over this 40-year span was from approximately 46,000 to 160,000 and by decade, the growth rates were 32%, 49%, 18%, and 50% per decade. The Flagstaff metro area grew from approximately 45,000 in 1960 to 122,000 in 2000 and had rates of growth from the 1960s through the 1990s of 14%, 56%, 29%, and 20%. Nationwide from 1990 to 2000, Arizona ranked number 2, behind Nevada, as the fastest growing state by percent population growth. During this same period, Phoenix-Mesa metro area ranked as the 8th top metro growth area by percentage, Tucson ranked 37th, Yuma ranked 3rd, and Flagstaff ranked 69th (CensusScope 2000). Yavapai County, which includes the Prescott valley cities, had population growth from approximately 30,000 in 1960 to 170,000 in 2000 and experienced decade-by-decade growth rates of 27%, 86%, 58%, and 55% per decade over this 40-year span (Arizona Quicklinks 2005).

double from 2000 to 2030 from approximately 5.1 million to 10.7 million (State Interim Population Projections 2005).

ADOT currently has 30 traffic signals on the state highway system that incorporate train preemption. Off the state system, the urban areas in Arizona maintain and control a significantly larger number of such traffic signals. Many of these operate under similar high vehicle and/or train traffic conditions, causing congestion problems.

Additionally, these types of at-grade crossings cause safety problems when the roadway that crosses the railroad leads to/from a nearby signalized roadway intersection. This is usually the case. This specific type of at-grade crossing--the commuter at-grade crossing--is the focus of this research. The congestion and safety problems caused by these commuter at-grade crossings arise from a series of conditions that are briefly listed below and discussed in more detail later in this report.

1. When the roadway crossing the railroad leads to/from a nearby signalized roadway intersection, the right-of-way control systems for the railroad crossing and the roadway intersection act independently. These two control systems can act at cross-purposes to each other, causing safety problems.
2. The organizational and operating systems of the railroad company and the agency operating the traffic signals have evolved over time and resist change for safety and liability reasons. There currently is no technical or jurisdictional option available for the interactive management of the rights-of-way between the at-grade crossing and the roadway intersection.
3. The current method to mitigate the safety problems is for the railroad company to send a signal to the roadway agency when a train is approaching the crossing and another signal once the train has cleared the crossing. The roadway agency uses these signals to independently address the safety problems by altering its intersection control scheme in a manner known as train preemption (or simply *preemption*).
4. The current signalized roadway intersection train preemption control scheme's primary purpose is safety; congestion mitigation is a secondary goal. Congestion mitigation occurs only after the train has passed, in a reactive mode; none occurs in a proactive mode before the train arrives.
5. When the volumes of vehicles crossing the tracks are sufficiently large and/or when the duration and/or frequency of the passing trains is sufficiently high, the signalized intersection preemption traffic control scheme is insufficient to clear all of the vehicles. Therefore, the preemption control scheme delays the clearing of the congestion caused by a train passing for some period of time.
6. This delay in clearing the congestion, if sufficiently long, causes operational problems for the roadway system. Depending on the geometrics involved, when congestion is sufficient, queues of vehicles can back up long distances. The nearby intersection preemption control scheme reduces the possibility of these queues backing up into it. But other intersections, upstream and downstream from the nearby intersection and the railroad crossing, can experience queues backing up into them, causing safety problems.

The safety and congestion problems arising from these commuter at-grade highway-railroad crossings are the focus of the research in this report and give rise to the research question that was investigated.

1.2. SCOPE OF THIS RESEARCH

The primary objective of this study is to investigate these central issues:

Research Question: Can solutions be applied at a signalized intersection, before a train passes a nearby at-grade highway-railroad crossing, that will mitigate the congestion that will occur after the train has passed? Furthermore, can this be accomplished using a standard traffic signal controller?

In order to accomplish this, an initial research workplan was developed and approved by the project's Technical Advisory Committee (TAC). This workplan was modified during the progress of the research as guided by the unfolding results and unforeseen challenges encountered. The TAC also approved these modifications as they occurred.

The final research workplan consisted of the following major tasks:

1. Review work by others that may be useful to this research.
2. Acquire major research equipment and modeling software needed to accomplish the work and train the research staff in its use.
3. Collect geometrics and traffic data at the selected study site.
4. Investigate a site-specific train arrival/prediction model.
5. Develop a microscopic traffic simulation model for the study site.
6. Develop an Early Warning System algorithm to apply congestion mitigation solutions before the train arrives.
7. Using the microscopic traffic simulation model and the EWS algorithm, test the research question using a series of variables and evaluate the results using a series of Measures of Effectiveness.
8. Using hardware-in-the-loop techniques, demonstrate the ability to implement the EWS algorithm using a standard NEMA traffic controller.

The project was formally initiated in March 2003. The initial meeting with the project sponsors and technical advisors was held on May 1, 2003, at ADOT's district office in Flagstaff. The research was actively guided by a Technical Advisory Committee whose members are listed in Table 1.

1.3. ORGANIZATION OF THE REPORT

The report is organized into chapters. Each chapter reports on an element of the research work. If additional detail is deemed relevant, it is included in an Appendix. The organization scheme for chapter topics and location focuses on understanding the outcomes rather than the chronological flow of work.

Table 1: Project 557: Technical Advisory Committee Members

Ken Cooper	ADOT, Roadway Standards
Sam Elters	ADOT, Kingman District Engineer
Chuck Gillick	ADOT, Northern Region Traffic Engineer
John Harper	ADOT, Flagstaff District Engineer
Mike Lessard	ADOT, Traffic Engineering Group
Ann Phillips	ADOT, Traffic Engineering Group
George Wendt	ADOT, Office of Risk Management
Tim Wolfe	ADOT, Transportation Technology Group
Gerry Craig	City of Flagstaff, Traffic Engineer
Steven Hill	City of Flagstaff, Traffic Signals
David Wessel	Flagstaff Metropolitan Planning Organization
Dennis Roberts	City of Kingman, Community Development
Debbie Casson	City of Kingman, Engineering Department
Mike McCallister	BNSF Railway Company
Dan Owsley	BNSF Railway Company
Alan Hansen	Federal Highway Administration

As is typical with most research, many unanticipated challenges were encountered that were not envisioned in the workplan. However, unless these have a direct bearing on the results, they are not reported here. A detailed Table of Contents is given to assist the reader in finding topics of interest.

2. PROBLEMS WITH AT-GRADE HIGHWAY-RAILROAD CROSSINGS

An *at-grade highway-railroad crossing* is one where a highway and railroad intersect on the same plane or grade. This is often simply termed as an “at-grade railroad crossing.” A grade-separated crossing is one where a structure physically separates the two routes, either by the railroad going over the highway or the highway going over the railroad.

An at-grade crossing causes a right-of-way conflict between the highway vehicular traffic and the railroad train traffic. This conflict is similar in concept to a regular intersection between two highways. Where two highways intersect, highway traffic control devices handle the right-of-way control: yield signs, stop signs, or traffic signals. Because a train requires a long distance and time to stop, vehicle traffic is always required to yield right-of-way at an at-grade railroad crossing to a passing train. An analogy using a typical intersection between two roads would be that the railroad acts as the mainline, which always has the right-of-way, and the highway acts as the side road, which has stop control.

Stop control at a railroad crossing can be passive or active. Passive stop control is often the familiar “crossbuck” at the side of the road just before the track crossing plus various additional railroad crossing signs. Often, a typical highway stop or yield sign may also be present. Active stop control usually consists of flashing lights, or flashing lights with gates. In both passive and active control, the vehicular traffic is required to stop and the train is given the right-of-way. Typically, high volumes of vehicular traffic and/or train traffic at an at-grade railroad crossing dictates active stop control using flashing lights with gates.

The first conceptual problem to arise at active control types of crossings is the split jurisdiction within the crossing. All of the railroad control is the jurisdiction of the railway company and all of the highway control is the jurisdiction of the governmental agency that owns the highway. Neither control system relinquishes control to the other system, so there is no technical or jurisdictional option available for an interactive management of the right-of-way at the crossing. What has evolved over time is a set of guidelines adopted by both groups’ industry associations for active crossings. The basic conceptual methodology is that the railroad company's control system will send a signal to the highway agency’s control system when a train is approaching the crossing and another signal once the train has cleared the crossing.

2.1. TRAIN SAFETY

When a vehicle and a train collide, almost invariably the vehicle driver and occupants are injured, often fatally. The train engineer (driver) and train occupants are typically not injured due simply to the physics of the disparity in the mass of the two objects, although there are exceptions. Often, however, the train engineer is emotionally impacted and may be incapable of driving a train again. Typically a train cannot stop within sight distance of an at-grade crossing even when it locks its brakes. This means that when a train engineer first sees a vehicle stalled on the tracks and immediately hits the train brakes (and lays on the whistle), the engineer knows the he will not be able to stop in time but

has to watch as the fully-braking train approaches and then collides with the vehicle, finally coming to a complete stop at a considerable distance beyond the crossing.

In addition to the emotional and possible physical injuries of train personnel, the train traffic on that track and possibly adjacent tracks is halted for a considerable period of time to clear and investigate the collision. Railroads often have little if any ability to route train traffic around the collision site causing all train traffic to come to a halt. The economic impacts of such disruptions on the railroad operations can be large.

The railroad companies have vigorously promoted grade-separated crossings, active at-grade crossing control, and reduced numbers of at-grade crossings with passive control¹. These efforts, aided by the governmental roadway jurisdictions involved, have helped to significantly reduced the number of at-grade crossing collisions over the last several years. For example, between 1990 and 2000, the national number of highway-railroad incidents decreased from 5,715 to 3,502 and the incident rate per million train-miles decreased from 9.39 to 4.84 (Federal Railroad Administration 2001).

Additionally, the railroad companies have improved their active at-grade crossing control systems. The older, but still primary, method used by the railroad companies to gauge when to send a signal to the highway authority indicating that a train is approaching is to locate a sensor on the tracks at a fixed distance from the crossing. One drawback of this method is that the time between when the signal is sent and when the train reaches the crossing varies depending on the speed of the train. This is mostly mitigated because the railroads use strictly enforced train speed limits, however the train can go at a slower speed than the limit. The newer, improved method used by the railroads at some crossings provides the signal at a fixed amount of time before the train reaches the crossing, regardless of train speed.

2.2. VEHICLE SAFETY

The right-of-way control system at the at-grade railroad crossing is installed and operated by the railroad company. At a passive control crossing, the signage is the only right-of-way control system although the train engineer uses his whistle to sound a warning as he approaches a crossing². Additional signage may also be placed at the crossing by the authority that owns the roadway and/or the railroad company.

¹ BNSF announced that in December 2003, it closed its 2,000th highway-rail grade crossing since the beginning of year 2000. During the four-year period from 2000 to 2003, BNSF closed six percent of its grade crossings, in a cooperative effort with landowners and communities along its route to identify unnecessary or redundant grade crossings. BNSF currently has approximately 30,000 at-grade crossings across its 32,500-mile rail network (BNSF Press Release 2004).

² In response to a legislative mandate, FRA has issued a Final Rule on the Use of Locomotive Horns at Highway-Rail Grade Crossings, which requires that locomotive horns be sounded as a warning to highway users at public highway-rail crossings. It takes effect on June 24, 2005; before that, the sounding of horns at public crossings was subject to applicable State laws and railroad rules. The final rule provides an opportunity, not available until now, for thousands of localities nationwide to mitigate the effects of train horn noise by establishing new "quiet zones." The rule also details actions communities with pre-existing "whistle bans" can take to preserve them (Federal Railroad Administration 2005-1).

At active control at-grade crossings, the railroad company is responsible for sensing the approaching train, activating the flashing lights (and gates, if applicable) in sufficient time to notify vehicle traffic not to enter the railroad crossing area until the train has passed. Once the train has passed, the railroad company is responsible for stopping the active warning system devices, which allows the vehicles to cross the railroad crossing.

Typically an active at-grade railroad crossing control system is located in an urban area where the railroad is crossing through the urban area's roadway network. In this situation, active control systems are placed at those at-grade crossings that carry high vehicle and/or train traffic. Often the vehicle roadway crossing the railroad leads to/from a nearby intersection of two roadways. When the volume of vehicle traffic at this nearby intersection is sufficiently high, the intersection right-of-way will be controlled by a vehicle traffic signal control system. This traffic signal control system apportions the right-of-way to vehicles by giving each individual movement the right-of-way (green light) in rotation through a cycle, while simultaneously withholding the right-of-way from the other conflicting movements (red light). Therefore, a driver knows he has the right-of-way when he gets the green light and can safely proceed across the intersection.

Problems arise when a roadway intersection is located near an at-grade railroad crossing because the railroad crossing control system and the roadway intersection control system act independently. An integrated control scheme cannot be used because neither of the two jurisdictions involved relinquishes control to the other. This causes two primary problems. The first is that when sufficient vehicles are waiting to get the green light on the roadway that crosses the railroad and leads to the roadway intersection, the queue that forms will back up across the at-grade railroad crossing. If a train approaches, these vehicles cannot move until they get the green light at the roadway intersection. The second problem is that while the train is passing, the roadway intersection traffic signal system continues to give vehicles the right-of-way to pass through the intersection toward the at-grade railroad crossing. When sufficient vehicles have done this the queue waiting at the at-grade crossing backs up into the roadway intersection.

The method used to mitigate these problems is for the railroad company to send a signal to the roadway agency when a train is approaching the crossing and another signal once the train has cleared the crossing (Federal Highway Administration 2003). The roadway agency uses these signals as inputs to its roadway intersection traffic control scheme to trigger a special control scheme called *preemption*. Conceptually, once the signal of an approaching train is received, the normal rotation of the intersection right-of-way apportionment is interrupted (preempted) and vehicles that may be queued across the at-grade railroad crossing are given the green light to allow them to immediately clear the crossing. Then while the train is passing, the rotation of intersection right-of-way skips those movements that would allow vehicles to approach the train crossing, thereby reducing the likelihood of a queue backing up from the crossing into the intersection. When the signal is received that the train has passed, the right-of-way is first given to a designated movement(s) and then the intersection control scheme is returned to its normal rotation scheme of apportioning the right-of-way. Typically these designated movements are those that were skipped while the train was passing.

2.3. VEHICLE CONGESTION

The roadway intersection located near an at-grade railroad crossing operates under the preemption traffic control scheme in response to the signals it receives from the railway company signaling the approach of a train and later the leaving of the crossing by the train. Once the signal is received that a train is approaching, the sole purpose of the preemption control scheme, both before the train arrives and as it passes, is the safety of the vehicles that might be placed in danger if the traffic control system was not aware of the approaching train. Once the signal is received that the train has cleared the at-grade crossing, the preemption traffic control scheme addresses the congestion that was caused by the train passing. The typical method is to give the right-of-way to those movements that wanted to cross the tracks, but were blocked from doing so while the train was passing.

This scheme works reasonably well to clear the congestion caused by the passing train if the volumes of vehicles that are queued waiting for the train to pass are not too large. However, when these volumes are very large and/or when the frequency of the passing trains is very high, the preemption traffic control scheme is insufficient to clear these large volumes of vehicles. Therefore, the preemption control scheme delays for some period of time the clearing of the congestion caused by the train passing. This delay, if sufficiently long, causes operational problems for the roadway system that the roadway jurisdiction(s) try to address in various ways. Depending on the geometrics involved, when congestion is sufficient, queues of vehicles can back up long distances. The nearby intersection preemption control scheme reduces the possibility of these queues backing up into it. But other intersections, upstream and downstream from the nearby intersection and the railroad crossing, can experience queues backing up into them causing severe safety problems.

One way to address these safety and congestion problems is to eliminate the at-grade crossing by creating a grade-separated crossing, also called a “flyover.” Often this is the preferred method but this solution is very expensive. Additionally, when the railroad is crossing several roadways in an urban roadway network several flyovers may be required. In this situation an area-wide scheme is preferred. This scheme typically designates two or more railroad crossings for flyovers and closes the other crossings.

3. SITE SELECTION, GEOMETRICS, AND TRAFFIC

3.1. SELECTION OF THE STUDY SITE

The investigation of the research question required the selection of an actual site that was experiencing the requisite conditions. Recall that commuter at-grade crossings are defined as having these characteristics:

1. A roadway and railroad intersect on the same plane or grade.
2. The roadway crossing the railroad leads to/from a nearby signalized roadway intersection.
3. Traffic crossing the at-grade highway-railroad crossing have one or more of these characteristics that occur more-or-less concurrently for recurring periods during a year, typically during weekday vehicle AM and/or PM peak periods:
 - a. Vehicle traffic volume is large.
 - b. Train frequency is high.
 - c. Duration the crossing is closed to allow a train(s) to pass is long; this is a function of train length, speed, number of tracks, and frequency of trains.

The term “commuter” is applied to the term “commuter at-grade crossings” because usually the high volume of vehicle traffic is primarily attributed to drivers making home-to-work trips or work-to-home trips. Traffic engineers call these the AM peak period and the PM peak period.

Another requirement for a study site was that it be within the jurisdiction of the Arizona Department of Transportation (ADOT). This meant that a state highway had to be crossed at-grade by the railroad (atypical) and/or that the highway was part of the nearby signalized intersection (typical). The potential study site location was further refined when a secondary sponsor for the research joined the study, the City of Flagstaff.

One potential site that satisfied both ADOT and the City was the intersection of Route 66 and Enterprise Road. The north-south leg of this intersection (Enterprise) was crossed at-grade by the Burlington Northern and Santa Fe (BNSF) Railway’s double mainline tracks. The Enterprise Road crossing is located approximately 75 feet south of the intersection. Additionally, the BNSF also has parallel spur and siding tracks at this crossing for a total of 4 tracks, however the train traffic of interest all occurs on the double-track mainline (see Figure 1).

3.1.1. Railroad Equipment and Operations Used at the Site

“The Federal Railroad Administration was created by the Department of Transportation Act of 1966 (49 U.S.C. 103, Section 3(e)(1)). The purpose of FRA is to: promulgate and enforce rail safety regulations; administer railroad assistance programs; conduct research and development in support of improved railroad safety and national rail transportation policy; provide for the rehabilitation of Northeast Corridor rail passenger service; and consolidate government support of rail transportation activities.” (Federal Railroad Administration 2005-2)

The Secretary of the Department of Transportation has authority over both the Federal Railroad Administration and the Federal Highway Administration (FHWA), the two primary regulatory groups over railroads and highways. State Law governs highway-railroad crossings but typically a State adopts the standards, with modifications to fit state needs, as codified in the Manual on Uniform Traffic Control Devices (MUTCD - Federal Highway Administration 2003). Arizona has adopted the MUTCD, with modification, but none of the modifications significantly alter the standards in the MUTCD that govern at-grade crossings.

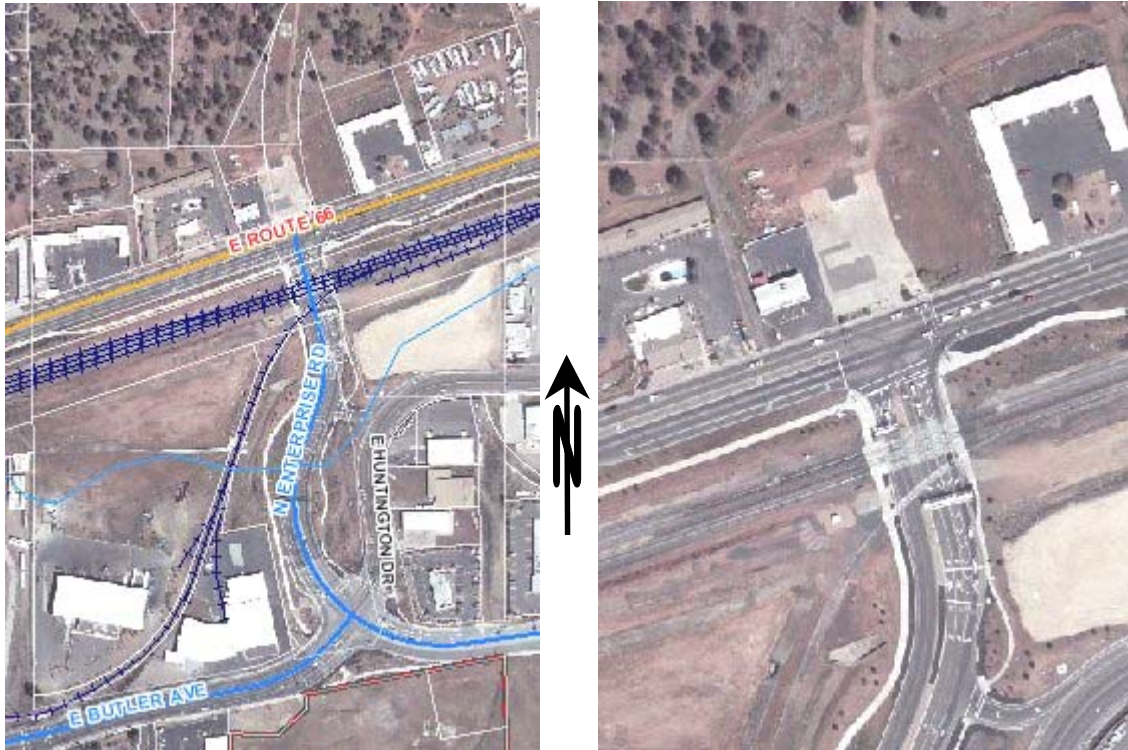

Figure 1: Aerial Photos Of The Study Site

The left photo shows the area surrounding the study site. The study site includes the at-grade crossing of Enterprise Road with the BNSF tracks, and the Route 66/Enterprise "Tee" intersection just to the north of the at-grade crossing. Route 66 and the BNSF Railroad mainline tracks run parallel. The photo at right is a close-up of the study site.

Railway companies own and maintain the tracks, and generally own the property (rights-of-way) to either side of the tracks. At at-grade crossings, they generally install and maintain the tracks, the roadway surface between and around the rails, and traffic control devices on their rights-of-way. While the railway owns the track, the roadway at a crossing is typically owned by a government agency. This roadway agency maintains the road approaching the crossing on either side of tracks.

The Federal Highway Administration is responsible for public grade crossing issues that affect highway safety. FHWA, through the MUTCD, provides guidelines and standards

for the correct design of grade crossings, the assessment of safety at a grade crossing, and appropriate placement of traffic control devices at and on the approach to a grade crossing. These traffic control devices at the study site include circular advance warning signs, crossbucks (the familiar X-shaped signs), pavement markings, and bells, gates, and flashing lights as shown in Figure 2 (Federal Railroad Administration-3, 2005).



Figure 2: Photo Of The At-Grade Crossing At The Study Site

Study site looking south from the Route 66 and Enterprise Rd. intersection to the at-grade highway-railroad crossing. The northbound vehicles on Enterprise Rd., facing the viewer, and the lone southbound vehicle are waiting behind lowered gates as a train passes. All of the red lights on the gates, crossbucks, and overhead gantries are flashing.

Since both the railway company and the roadway agency maintain jurisdiction and responsibility for safety in their own rights-of-way, an at-grade crossing represents the unique condition wherein both have some responsibilities for a common portion of land. Technically, however, the land at the crossing is owned by the railway company and at an active control crossing, they manage and operate the control system and appurtenances involving the crossing itself. This control system is complex and must be compatible with the control systems that the railway company uses to manage its facilities and day-to-day operations up and down the line (see Figure 3). For purposes of this report, it is sufficient to conceptually describe the railway's control system at the crossing and include only those parts that affect the vehicles operating on the roadway.

At the study site, the BNSF Railway Company is responsible for sensing the approaching train and activating the flashing lights and gates in sufficient time to notify vehicle traffic not to enter the railroad crossing area until the train has passed. Once the train has passed, BNSF is responsible for stopping the active warning system devices, which allows the vehicles to cross the railroad crossing.



Figure 3: Photo Of At-Grade Crossing Equipment At The Study Site

Looking east across the at-grade crossing showing the primary active crossing gates and warning lights. The nearside vehicle has just exited the Route 66 and Enterprise Rd. intersection and is heading southbound on Enterprise Rd. The far vehicle is heading northbound toward the intersection.

ADOT manages and operates the control system of the Route 66 and Enterprise Road intersection that lies approximately 75 feet north of the at-grade crossing. Neither the BNSF at-grade control system nor the ADOT signalized intersection control system relinquishes control of its system to the other during the passing of a train. They operate independently, which precludes a joint, interactive control scheme. In order to allow the intersection control system to modify its control scheme during the passing of a train, the standard method (Federal Highway Administration 2003) used nationally is for the railway company to notify the roadway agency. Conceptually the railway crossing system notifies the intersection control system by sending a signal to the roadway agency

when a train is approaching the crossing and another signal once the train has cleared the crossing¹.

At the study site, BNSF operates an advanced type of detection system. This system can provide a signal at a constant time interval before the train arrives rather than at a constant distance from the crossing. ADOT and BNSF have agreed on this constant notification time interval. The constant time interval has a small variance but during an intensive data collection period at the site, the predicted time to crossing was typically within +/- 1 second². The BNSF detection system calculates the speed of the train and predicts the time of arrival at the crossing. It waits until the constant notification time interval remains and then sends the signal to ADOT.

ADOT uses this signal to interrupt its normal operation of the traffic control signal to transfer control to a special control mode of operation called *preemption*. During preemption, the normal sequence of traffic control signal indications are interrupted to avoid entrapment of vehicles on the highway-rail grade crossing by conflicting aspects of the intersection traffic control signals and the highway-rail grade crossing flashing-light signals and gates.

3.1.2. Traffic Signal Equipment and Operations Used at the Site

ADOT manages and operates its intersection traffic control signals in accordance with the MUTCD, as modified for the State of Arizona, including its preemption control mode for at-grade crossings (Traffic Group 2005). At the study site, ADOT uses a NEMA controller³ and cabinet.

¹ The MUTCD specifies a fail-safe type of communications method from the railroad control system to the roadway intersection control system. The preemption feature shall have an electrical circuit of the closed-circuit principle, or a supervised communication circuit between the control circuits of the highway-rail grade crossing warning system and the traffic control signal controller. The traffic control signal controller preemptor shall be activated via the supervised communication circuit or the electrical circuit that is normally energized by the control circuits of the highway-rail grade crossing warning system. The approach of a train to a highway-rail at-grade crossing shall de-energize the electrical circuit or activate the supervised communication circuit, which in turn shall activate the traffic control signal controller preemptor. This shall establish and maintain the preemption condition during the time the highway-rail at-grade crossing warning system is activated, except that when crossing gates exist, the preemption condition shall be maintained until the crossing gates are energized to start their upward movement. When multiple or successive preemptions occur, train activation shall receive first priority. (Federal Highway Administration 2003)

² BNSF gathered information continuously from its crossing equipment recording devices at the study site in support of this study for a 7-day period from 4/26/04 to 5/3/04.

³ At the study site intersection, ADOT uses a NEMA Econolite ASC/2S-2100 controller (Econolite Control Products, Inc. 2005). This is a TS2, Type 2 controller operating in the TS1 environment in a Type 1 Cabinet. ADOT uses an extra Econolite board within the controller to handle its preemption communications and uses the D Plug for all input and output preemptor calls.

ADOT's typical practice for its preemption mode is used at the study site and conceptually consists of the following sequence of events. Specifics given all refer to the study site⁴:

1. Receive the preemption signal from the railroad (BNSF) that indicates the train is approaching the site.
2. Immediately go to the Preemption Track Clearance (TC) Phases (NB LT and NB RT at the study site).
 - a. The designated Preemption TC Phases under ADOT's typical procedures are those movements that potentially can be queued up across the railroad tracks waiting for a green light. (At the study site, these are the NB LT and NB RT movements. Since the intersection is a "tee" intersection, there is no SB leg, which means there are no NB TH, WB RT, or EB LT movements and, of course, no SB movements of any kind.)
 - b. If the green is timing a movement(s) other than the Preemption TC Phases when the preemption signal is received, then this movement(s) will be ended. It will be ended in a safe manner, which means that it will be given a designated preemption minimum amount of green (5 seconds at the study site), followed by a yellow (change interval) and an all-red (clearance interval). These yellow and all-red intervals can be designated specifically for preemption or they can be allowed to default to those used during normal operations (yellow and all-red times used in normal operations are used at the study site). If the minimum amount of green has already elapsed when the preemption signal is received, the movement(s) will immediately proceed to its yellow and all-red.
 - c. If the green is already timing for the movement(s) designated as the Preemption TC Phases, then this movement(s) will continue for the designated length of TC Green time interval, which commences when the preemption signal is received.
 - d. Once the Preemption TC Phases have started timing their green, they will continue in green until the designated TC Green time interval has elapsed.
 - e. Once the TC Green time interval has elapsed, a yellow and an all-red interval will follow. These intervals can be designated as the TC Yellow and TC All-Red intervals or they can be allowed to default to those used

⁴ The nomenclature used throughout this report describing the movements of traffic through an intersection are from the perspective of the direction of traffic. For example, a vehicle that is on the south side of an intersection and traveling north toward the intersection is a NB (northbound) vehicle. This is further refined by designating the direction the vehicle intends to go after it leaves the intersection, e.g., NB LT (northbound left-turn), which could also be called NB to WB (northbound to westbound). In this report, the NB LT type of designation is used. So when a group of vehicles are described as NB, the group includes all vehicles that intend to go NB LT, NB TH (northbound through) and NB RT (northbound right-turn). Similar terms are used for WB (westbound), SB (southbound), and EB (eastbound).

during normal operations (the yellow and all-red times used in normal operations are used at the study site).

3. Go to Preemption Hold Phases (WB TH and EB TH at the study site). These are phases that do not conflict with the passing train. Train conflicting phases are those that would direct vehicles toward the at-grade railroad crossing or away from it while the train is passing (WB LT, EB RT, NB LT, and NB RT at the study site). If any of the Preemption Hold Phases need to be run separately from each other, they will be run in their normal operations sequence, while omitting the train conflicting phases from the sequence. (At the study site the Preemption Hold Phases (WB TH and EB TH) do not conflict with each other so they run simultaneously.) This will continue until the railroad (BNSF) sends the signal indicating the train has left the crossing.
 - a. To insure safe operations, a Minimum Hold Time is designated. This minimum time must be satisfied in addition to receiving the signal from the railroad that the train has left the crossing before control can proceed to the Preemption Exit Phases.
4. Go to Preemption Exit Phases (NB LT and NB RT at the study site) and return to normal operations. Since the signal has returned to its normal operations, these Preemption Exit Phases time their green, yellow, and all-red intervals using their normal operations intervals.
 - a. *Preemption Calls* are also placed on any movement(s) desired (WB LT and WB TH at the study site) as control is returned to normal operations. The normal sequence of movements used in normal operation is observed so the movement(s) that is normally called after the Preemption Exit Phases has finished is what runs next. What the Preemption Calls do is to ensure that the movements that were called will be serviced even if they don't have any vehicles waiting. (For the study site, the normal sequence serves the WB LT and WB TH movements (the Preemption Exit Calls at the study site) after the NB LT and NB RT movements (the Preemption Exit Phases at the site) have run.)

The signal heads are located on overhead cantilevered arms and on the uprights to these arms. There are also two pedestrian crossings: east-west on the south side of the intersection and north-south on the east side of the intersection. These have low pedestrian traffic (see Figure 4).



Figure 4: Photo Of The Intersection At The Study Site

Looking south at the study intersection, which is a “Tee,” the missing leg being on the north side, from where the photo is taken. The intersection signal lights are controlled with a NEMA controller, and signal heads are mounted on side and overhead poles. Route 66 is the east-west roadway running left-to-right in the foreground of the photo. The at-grade railroad crossing can be seen in the background, crossing Enterprise Road.

3.2. SITE GEOMETRICS AND MODIFICATIONS FOR MODEL

3.2.1. Current Geometrics at the Study Site

The study site is the intersection of Route 66 and Enterprise Road in Flagstaff, Arizona. The intersection serves both commuters and tourists as well as commercial vehicular traffic. Although the intersection has four legs, the fourth leg on the north side of the intersection is a driveway into a vacant city-owned lot. There are no traffic signal heads servicing this leg, i.e., SB traffic. Therefore, the intersection is functionally a Tee intersection. This intersection was significantly improved to its current configuration approximately three years before the study began.

The other three legs service significant volumes of vehicular traffic. The EB and WB movements are on Route 66. The normal cross section for Route 66 is five lanes, with two through lanes in each direction and a center common left-turn lane. Both EB and WB directions have two lanes for through movements. EB has a single right turn lane and a long storage lane. WB direction has a single dedicated left turn lane that is essentially of unlimited length due to the center common left-turn lane. Both the WB LT and the EB RT movements lead traffic into Enterprise Road and across the railroad tracks, which are located approximately 75 feet south of the intersection.

Enterprise Road is a north-south connector road that services traffic between the study intersection and the intersection of Butler Avenue and Huntington Road, which lies approximately 800 feet to the south. NB Enterprise Road begins at the intersection of Butler Avenue and Huntington Drive as two lanes. A merging single slip lane from Huntington Drive quickly joins it. As it approaches the study intersection, it widens into a four-lane section containing dual left turn (LT) lanes, a hatched auxiliary lane and one right turn (RT) lane. The dual LT lanes lead vehicles into westbound (WB) Route 66 while the RT lane leads into eastbound Route 66. The southbound Enterprise movement

leaves the study intersection with two lanes. There is approximately a 60-foot storage length between the northbound (NB) stop bar and the railroad crossing.

Route 66 and Enterprise Road have sidewalks on both sides but pedestrian traffic is low. Pedestrian crossings at the study intersection are limited to two: a north-south crossing on the east side and an east-west crossing on the south side.

3.2.2. Modified Tee Intersection Geometrics Used for the Study

The study intersection had significant congestion problems before it was improved in 2002-2003. These problems were substantially reduced by the geometric improvements. Additionally, the close coupling of the two intersections at each end of the Enterprise Road connector caused them to interact with each other, although the timing of their signals is not coordinated.

Substantial efforts were spent modeling the current configuration of the two close-coupled intersections. The modeling software used in the study is VISSIM, which is described in detail in Chapter 4. Models were developed using current vehicle traffic through these intersections. The Early Warning System was initially tested using this configuration. Significant problems developed because of the complexities that occur at the site. It was discovered that while this site qualified as a commuter at-grade crossing, its complexity made it difficult for these reasons:

- The geometric improvements to Route 66/Enterprise Road had already reduced a significant portion of the congestion the EWS was designed to alleviate.
- The close coupling of the two intersections caused an interaction that was most probably confounding results.
- The site was atypical of the site the EWS was designed to help. A typical site would have a feeder road leading across an at-grade crossing to join a main highway. The traffic on the feeder road would be to/from an isolated residential area. The study site consists of two arterials, Route 66 and Butler Avenue, that parallel the railroad tracks on either side. These are cross-connected infrequently, but when they are, significant traffic is exchanged between them. This causes the study intersection to have strong movements in several directions rather than the anticipated primary strong movement to/from a residential area with AM and PM peaks.

It was agreed with the project TAC to attempt to overcome some of these difficulties by modeling a modification of the study site. This modification was used for all testing and results, except traffic volumes were modified in some test cases as described later.

Therefore, the modeled study site had these characteristics:

1. Pre-improvement geometrics: The intersection and at-grade crossing geometrics were modeled using the pre-improvement geometrics. The only improvement on the east-west Route 66 route was to the EB RT storage lane, which was shortened to 360 feet. Enterprise Road had several changes that reduced the cross section at the intersection to one SB lane and two NB lanes, one a LT and the other a RT lane.

2. Simplified at-grade railroad configuration: The current crossing has four tracks: dual mainline tracks, and spur and siding tracks. The spur and siding tracks were eliminated. The dual mainline track was modeled as a single track and the length of a single “long” train was used to simulate the simultaneous crossing of two trains in opposite directions.
3. Eliminated the second close-coupled intersection: The proximity of the second intersection, Butler/Enterprise, caused a “pumping” action that directed traffic at the study intersection in a patterned, but unpredictable way. Additionally, NB Enterprise traffic that might otherwise queue behind the crossing while a train was passing would be interfered with by the needs to keep the Butler/Enterprise intersection clear. However, this varied unpredictably, depending on driver behavior. Therefore, the study intersection was modeled without the Butler/Enterprise intersection. Furthermore, Enterprise was modeled with sufficient length that all queuing traffic was accommodated.

While these modifications did not completely convert the study intersection into the typical commuter at-grade crossing envisioned in the research question, it was a useful compromise. This allowed the real traffic that had been captured at the site and used to calibrate and validate the model to be applied to the modified tee geometrics. This was an important benefit and the alternative was to model both an artificial intersection and artificial traffic. Whereas the artificial intersection would have been much closer to the commuter at-grade crossing envisioned by the research question, the use of artificial traffic would make it difficult to generalize the results to potential field test sites.

3.3. VEHICLE TRAFFIC USED IN THE MODEL

Collecting vehicle traffic at the study site and extracting that needed for modeling was not a trivial task. Three groups were used to collect data on the traffic moving through the two intersections: one to record the traffic counts, one to simultaneously videotape intersection movements, and *AZTrans* supervisory staff. Data was collected for three days from Wednesday, April 23, 2003, through Friday, April 25, 2003.

3.3.1. Data Collection Procedure

AZTrans, in conjunction with Traffic Data Systems (TDS), collected vehicle volume data at the intersections of Route 66 and Enterprise Road, and of Butler Avenue/Enterprise Road and Huntington Drive (see Figure 5). TDS used forty pneumatic hoses to collect 24-hour traffic volume data for three days, beginning 12:00 a.m., Wednesday, April 23, 2003, and ending 11:55 p.m., Friday, April 25, 2003. These tubes consisted of either stubs (tubes extending only to “drip line” of vehicle) or full lane tubes (tubes extending the full length of the lanes being counted). Stubs were used to record the right turn movement on WB Butler and full lane tubes were used in all other lanes. In order to collect data on internal lanes (for example, the innermost lane in a dual left-turn lane within a five-lane section), TDS “jammed” the part of the tube that extended over the outermost lanes, thus collecting data for only the innermost lane.



Figure 5: Vehicle Traffic Data Collection Using Pneumatic Hoses

Looking east at the approaching WB Route 66 traffic at the study intersection of Route 66 and Enterprise Road. Two pneumatic hoses are in place across three lanes of traffic between the two white arrows. One hose spans the two WB TH lanes. The second hose spans all three lanes but is “jammed” for the portion that crosses the two WB TH lanes so it is only recording traffic on the WB LT lane. The recorder box is located behind a small pine tree to the left of the left arrow. Forty pneumatic hoses were used at the study intersection and the nearby intersection of Enterprise Road at Butler Ave. to capture all of the needed traffic flow data over a three-day period.

Additional double pneumatic hoses were placed at three locations: NB Enterprise (north of the Butler-Enterprise intersection and south of the Huntington cutoff), SB Enterprise (south of the Route 66-Enterprise intersection and north of the Butler-Enterprise intersection), and EB Butler (east of the Butler-Enterprise intersection), which collected data on vehicular volume, class, and speed. This field data was used as the benchmark for calibration and validation purposes in the VISSIM model.

TDS checked the recording boxes daily to insure proper operation. One box, recording WB Butler at the Enterprise/Butler intersection, failed on Wednesday morning so the missing data was recollected at this location the following week during the same day and time.

Five camcorders recorded queue lengths from the following three locations: Route 66/Enterprise intersection (Station 1), McDonald’s Restaurant rooftop (Station 2), and

south of the Butler/Enterprise intersection (Station 3). These locations are shown on a map in Figure 6. Station 1, the Route 66 and Enterprise intersection, recorded vehicle queues on EB and WB Route 66. Two wide-angle lens cameras were used to record this vehicle footage at this site. Station 2, from the rooftop of the McDonald's fast food restaurant, captured footage of vehicle queues on EB Butler. Station 3, which was just south of the Butler/Enterprise intersection, recorded queue data on WB Butler, SB Enterprise and SB Huntington.

Camcorder locations at both intersections used "scissor lifts" to elevate the camera platforms above the intersections, 10 feet at Station 1 and 25 feet at Station 3. Traffic footage was collected for 9 hours on Wednesday and Friday and 12 hours on Thursday. The 9 hours recorded are 6:30 a.m. to 9:30 a.m., 11:30 a.m. to 2:30 p.m., and 4:00 p.m. to 7:00 p.m. Mini-DV tapes were used and switched out every 60 minutes, except for Wednesday, when one camcorder utilized 40-minute tapes. Five NAU student research assistants from *AZTrans* and four cameramen from Echo Productions and Bold Eagle were hired to man the cameras in shifts, with supervisory staff from *AZTrans* available onsite for direction (see Figure 7).

3.3.2. Adjustments made to data provided by TDS

Data from the field was organized into a Microsoft EXCEL spreadsheet and aggregated into five-minute totals by TDS and provided to *AZTrans*. These five-minute aggregations listed vehicle counts for nineteen stations plus eleven additional stations with vehicle counts, speeds, and tire configuration for three days of data collection. Using this dataset, *AZTrans* developed heavy vehicle adjustment factors for each five-minute period. After applying the heavy vehicle factor to the data, each five-minute period vehicle count was converted to a flow rate (veh/hr). This vehicle flow rate data was entered into the VISSIM model for nineteen movements and five entry points into the network.

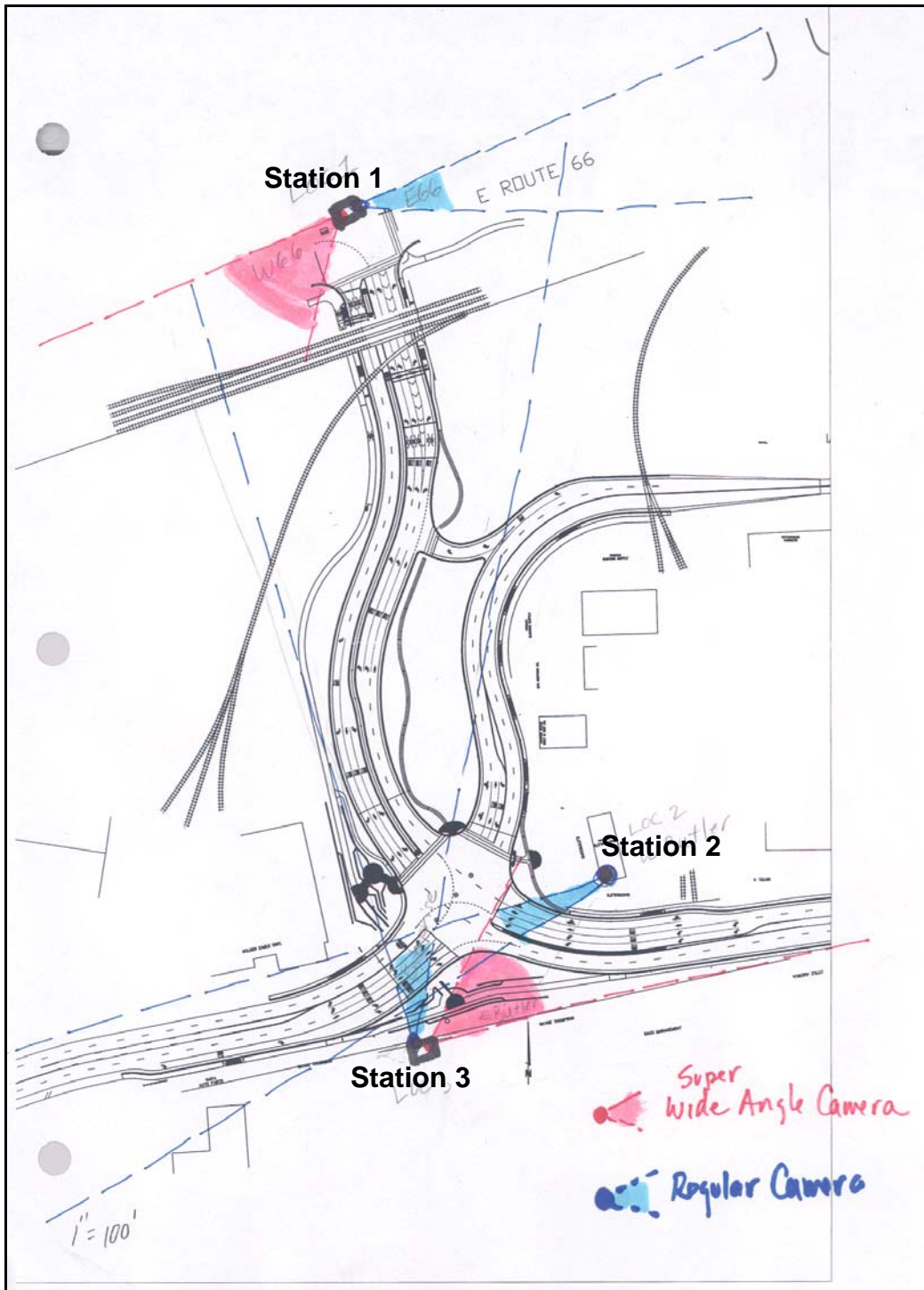

Figure 6: Video Cameras Location Map

Map shows locations of the three video camera stations used to record traffic flow data over the same three-day period that pneumatic hose data was collected. Stations 1 and 3 are located on “scissor lift” platforms, and each uses two cameras. Station 2 uses a single camera located on the roof of a McDonald’s restaurant.



Figure 7: “Scissor Lifts” Aided In Obtaining Adequate Video

Top photo is taken from on top of the McDonalds restaurant, at video camera Station 2, looking west across the Butler Ave--Enterprise Street intersection. The red arrow shows the location of video camera Station 3, which is also shown in the lower right photo. The lower left photo is looking south from the Route 66--Enterprise Road intersection, showing video camera Station 1 in the foreground.

3.3.3. Data Used in the VISSIM Model for Calibration and Validation

AZTrans developed the VISSIM model using the existing geometry with improvements and the volumes obtained from the traffic data collection program. Appropriate time periods were extracted from the data that best represented the desired conditions at the study site. The primary conditions desired were peak vehicle traffic flow coupled with railroad crossing preemption(s) during the same time period. The initial model was developed for the time period from 8:10 a.m. to 9:20 a.m. on Friday, April 25, 2003, for calibration purposes.

In the developing of the VISSIM model, significant data was required beyond vehicular vehicle flows. These included vehicle speed distribution(s), vehicle type(s), routing decisions, and priority rules. Routing decisions are those routes placed in the traffic network that “lead” individual vehicles to their destination, typically through an intersection. Priority rules are used to establish right-of-way for conflicting movements. They are generally used for turning movements, stop signs, and places where vehicles merge. Vehicle speed distributions were set per observed field data, ranging from 25 mph to 40 mph, with the 85th percentile traveling at a set desired speed.

Vehicle classes used in the VISSIM modeling program were identified in European terms. VISSIM is international modeling software originally developed in Germany and several of the terms used in the software reflect European terminology rather than American terminology, however, the functionality is the same (Planung Transport Verkehr AG, 2003). Passenger car types were Car 1 through Car 6 with approximate lengths of 14 feet; Sport Utility Vehicles/Trucks had lengths between 16 and 19 feet; and HGV (Heavy Goods Vehicle) had lengths between 28 and 60 feet. Cars were specified separately from Sport Utility Vehicles/Trucks so that different lengths and color identification could be entered with ease. HGV vehicle types include all heavy vehicles, including buses, that traverse the traffic network. Pedestrian and bicycle movements were omitted from the model because their volumes were insignificant.

Other entered data included speed reduction zones, which were used to replicate speed conditions present in the field. Speed reduction zones were placed in all turning movements at the two intersections where short sections of low speed are typical, such as turning lanes and curves. According to the VISSIM 3.70 User’s Manual, “When approaching a reduced speed area, a vehicle reduces its speed in order to reach its new (slower) speed at the beginning of the reduced speed area. The deceleration process is initiated according to the deceleration value defined. The acceleration at the end of the reduced speed area is determined by the characteristics of the driver-vehicle-unit as well as the original desired speed” (Planung Transport Verkehr AG, 2003, pp. 4-35). Turning movement speeds ranged between 5 and 26 miles per hour, depending on the type of vehicle making the turn.

The Arizona Department of Transportation and the City of Flagstaff provided timing information for the signals in the traffic network. ADOT operates and maintains the signal at the intersection of Route 66 and Enterprise Road while the signal at Butler Avenue/Enterprise Road/Huntington Drive is owned and operated by the City of Flagstaff. This timing information, including normal train preemption, was entered into the VISSIM model.

The intersection of Route 66 and Enterprise Road operates as an actuated uncoordinated intersection. Only one overlap is incorporated at this intersection and operates with both Route 66 WB LT and Enterprise NB LT. The Enterprise NB RT (Movement 8) never runs as a stand-alone phase and operates solely as an overlap. The movements and their phase numbering scheme are shown in Figure 8. Also the in-road detector information was entered for both intersections. Detector information was obtained both from field observations and information provided by the City of Flagstaff.

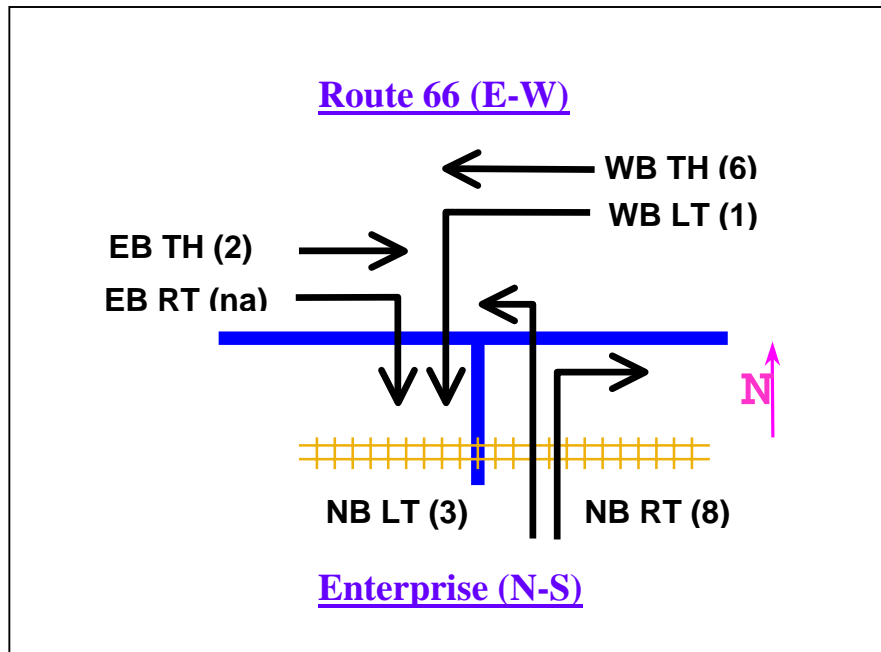

Figure 8: Study Intersection With Vehicle Movement Controller Numbers

The intersection movements are labeled as to direction including their controller movement (phase) number. For example, Northbound Right Turn is movement number 8. EB RT is labeled “na” because while it has an exclusive lane, it doesn’t have a dedicated control phase so it moves concurrently with EB TH (2).

3.3.4. Modified Data Used in the VISSIM Model for Study Cases

As discussed earlier, the two intersections as they exist today were unsatisfactory for study purposes and were modified for the modeling. The modified Tee intersection geometrics used for the study also required modifications to the vehicle data.

The vehicular volume data used in the modified Tee intersection VISSIM model reflects the time from 3:00 p.m. to 6:00 p.m. at the study site. This time represents observed peak hours occurring during the three-day period of data collection. The volumes used in the modified Tee model were obtained by averaging the vehicular volume data collected from Wednesday through Friday, 3:00 p.m. to 6:00 p.m., so as to obtain a representative peak period. A peak hour factor adjustment of 0.984417 was developed from the classification data and was applied to the raw data to obtain the final volumes used in the model.

3.4. RAILROAD TRAIN CHARACTERISTICS USED IN THE MODEL

The congestion experienced by the passing of a train is a function of four primary variables:

- The volume of vehicle traffic crossing the railroad.
- The volume of vehicle traffic using the nearby signalized intersection.

- The duration of railroad crossing gates-down.
- The headway⁵ between trains.

Data was collected by BNSF for a week of all train activity at the study site. The longest duration of a gates-down condition for modeling the site was established at 4.5 minutes (270 seconds), which represents 95% cumulative probability, i.e., the probability that 95% of all gates-down durations will be of this length or less. Similar values were established for the shortest and average gates-down durations of 1.5 minutes (5% cumulative probability) and 2.6 minutes (50% cumulative probability) respectively. In this report, the term “longest” train actually means the longest gates-down duration caused by a train. Similar meanings apply for the “shortest” train and “average” train.

At the double-track study crossing, the “longest train” is actually two trains that cross in opposite directions. The first to cross has not cleared the crossing before the second train starts to cross. Therefore, the gates stay down continuously until both trains have cleared the crossing.

While the headway between trains also effects congestion, it is a more difficult variable to quantify. While this data was collected and analyzed at the study site, its use presents difficulties when coupling with a gates-down duration. For example, it would be a rare event if the longest train was followed by the shortest headway of the next train⁶. While these compound probabilities could possibly have been established by collecting more data, it was decided that this would only add complexity to the modeling that wasn't useful.

Studying the impacts of a single train passing at peak hour conditions was selected as the condition of most interest, and this study is limited to that focus. Detailed statistics and cumulative distribution functions of the railroad headway and gates-down durations are provided in APPENDIX B.

⁵ Headway is the time between successive vehicles (trains), typically measured from the front of the leading vehicle to the front of the following vehicle in seconds.

⁶ What impacts vehicle congestion is the duration of the “gates-down” in combination with the interval until the next “gates-down.” Since the study site is a dual mainline track, an initial “gates-down” duration is caused by a train traveling in one direction. The subsequent “gates-down” duration is caused by a train traveling in either the opposite direction or the same direction.

If the train is traveling in the opposite direction on the parallel track, it could arrive at any time during or after the previous train is at the crossing. If it is traveling in the same direction, on the same track, it is limited by the railway company's control system that governs the flow of train traffic in the same direction on the same track. This is a complex system but conceptually it sets an approximate minimum following headway between trains, which can vary depending on the railroad geometry and crossing control system at the crossing.

(blank)

4. MODEL DEVELOPMENT

4.1. SELECTION OF THE MODELING ENVIRONMENT

The overarching reason to use a model to test the research question is the liabilities associated with direct field-testing. If field-testing were to be performed as the first step of a research investigating changes in intersection traffic control, it would have to be on a trial-and-error basis. Obviously, safety and congestion issues preclude such an approach. For these reasons, researchers use models to test proposed changes, especially new ones, before any field-testing is even contemplated.

Models can be classified in many ways (TRB HCM, 2000, pp. 31-1 to 31-6). One is to vary three dimensions: (a) scale of detail, (b) basis of analysis, and (c) method of analysis. Scale of detail is categorized into (1) large scale, that requires highly aggregated data, (2) small scale, that requires extensive disaggregate data, and (3) middle scale, which is somewhere in between as to the amount of data required. These model scales are called respectively macroscopic, microscopic, and mesoscopic. The basis of analysis can be categorized as (1) theoretical or (2) empirical. And the method of analysis can be categorized as (1) deterministic or (2) stochastic.

It is important to realize that ways of classifying models are not typically an “either-or” situation as much as somewhere along a multi-dimensional continuum (Akcelik & Associates, 2005). For the purposes of exploring the research question, the parameters to be varied and tested require a high degree of detail at a microscopic level. The modeling environment has to be able to extract measures of effectiveness. Due to the variability of both the vehicle and train traffic, a stochastic modeling approach would serve best, in the form of simulation. Most traffic models have elements of both traffic flow/driver behavior theory and reliance on empirical analysis of measured traffic site data for some modeled characteristics.

A microscopic traffic simulation modeling environment was chosen for use in this study. “With advances in computing technology and the ever-increasing power of personal computers, many sophisticated stochastic microscopic simulation models have been developed in the area of transportation engineering. Improved user interfaces have significantly reduced the effort needed to code and interpret the results of these simulations models. As a result, more traffic engineers are relying on microscopic simulation models to analyze complex transportation problems when analytical methods cannot provide satisfactory solutions.” (Tian, et al, 2002, p. 23)

A handful of microscopic traffic simulation modeling environments are available for use and have been carefully examined by the research community. Of these, VISSIM was chosen for four primary reasons: (1) high control over the vehicle-level parameters, (2) ability to use a powerful macro language to program the EWS features, (3) proven ability to use hardware-in-the loop, and (4) an update resolution of several times per second.

4.2. VISSIM MODEL CALIBRATION

“Calibration is necessary because no single model can be expected to be equally accurate for all possible traffic conditions. Even the most detailed microsimulation model still

contains only a portion of all of the variables that affect real-world traffic conditions. Since no single model can include the whole universe of variables, every model must be adapted to local conditions. ... The objective of calibration is to improve the ability of the model to accurately reproduce local traffic conditions.” (Dowling, Skabardonis, and Alexiadis, 2004)

The VISSIM model was calibrated using the current existing geometric configuration at the intersection and the collected data as described in Chapter 3. The collected data from the field served as the benchmark for the calibration process. In order to represent normal traffic conditions, a calibration time period was selected in which there was the greatest number of consecutive five-minute periods where there were no train crossings at the study site. The selected time period for calibration was Friday, April 25, 2003, from 8:10 a.m. to 9:20 a.m.

Once the hourly volumes were entered for their respective movements, three calibration-specific data collection points, as shown in Figure 9, were placed in the traffic network in VISSIM. These points collected output data from the model on mean speed of all vehicles and the number of vehicles. They were placed as close as possible to the locations where the actual pneumatic hoses were located in the field during data collection. VISSIM data collection points consist of a bar that is placed in the cross-section of a link, or roadway. As simulated vehicles cross the data collection bars, designated output information is collected about individual vehicles. It is this output data that is compared to the field data in the calibration/validation process.

4.2.1. Establishment of Calibration Parameters

“The analyst should attempt to keep the set of adjustable parameters as small as possible to minimize the effort required to calibrate them. Whenever practical, the analyst should use observed field data to reflect local conditions. This observed data will serve as the nonadjustable values for certain calibration parameters, thus leaving the set of adjustable parameters to a minimum.” (Dowling, Skabardonis, and Alexiadis, 2004)

Two calibration parameters were selected for manipulation within the VISSIM model. These two calibration parameters are speed at turning movement locations and the two parts, additive and multiplicative, of desired safety distance (car following rule). These calibration parameters were systematically set at different values with each simulation run until the model duplicated the field conditions, within acceptable difference limits.

In order for simulated vehicles to replicate field speeds at locations where speeds are known (in this case, where the double pneumatic hoses were placed), not only were the speeds on the roadways set, but reduced speed areas were incorporated. Reduced speed areas slow down vehicles through its area of application and allow a return to desired speed after the area is traversed. Nineteen reduced speed zones were placed in the traffic network surrounding the study site. Seven were placed at all turning movements (WBLT, WBRT, EBLT, EBRT, NBLT, and NBRT) at the Route 66/Enterprise Road intersection. Eleven were placed at all turning movements (EBLT, EBRT, WBLT, WBRT, NBLT, NBRT, SBLT, and SBRT) at the Butler Avenue/Enterprise Road-Huntington Drive intersection. One was placed on the Huntington Drive slip lane turning movement.

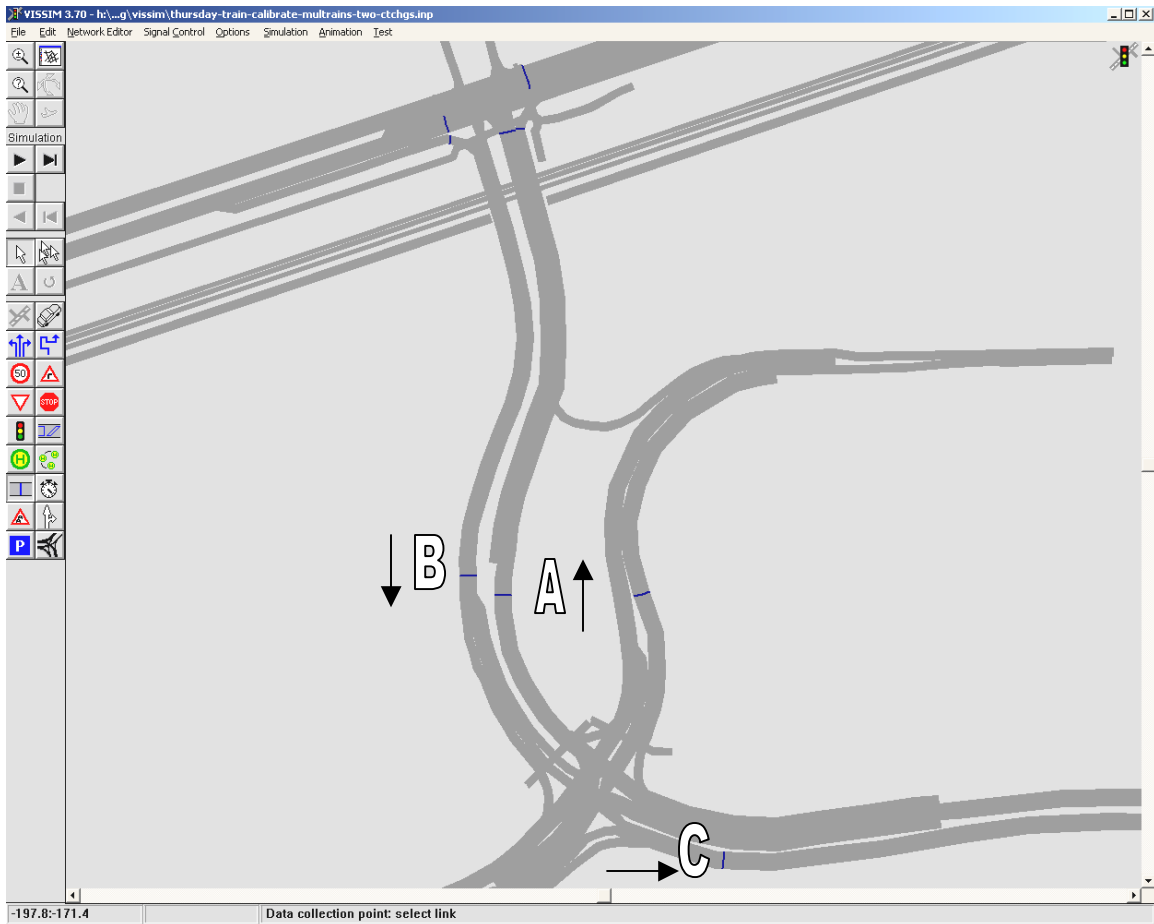

Figure 9: VISSIM Model Showing Data Collection Points

A screenshot from the VISSIM model is shown, with the data collection points used to collect output activity information from the model. Data collection points labeled A, B, and C were used in collecting the field vehicle traffic data. These same locations were used to collect model output activity regarding mean speed and the number of vehicles for use in the calibration of the model.

Figure 10, Figure 11, and Figure 12 on the following pages depict the locations of these reduced speed areas. Without reduced speed areas, the vehicles traverse the intersection at the free flow speed (which ranged from 35-45 miles per hour in this model) and the resulting data in VISSIM reflect unrealistic high speeds through the traffic network. By reducing the speed in which a vehicle can traverse the turning movements, the speeds on all roads reflected more closely the field speed data.

The two parts, additive and multiplicative, of desired safety distance settings (car following rule), control the saturation flow rate of the model. As described in VISSIM software manual, these are model parameters under the Weidemann (1974) psycho-physical driving behavior model, which the VISSIM model uses in its implementation (PTV Planung Transport Verkehr AG, 2003). The saturation flow rate defines the number of vehicles that can free flow through a VISSIM model during one hour.

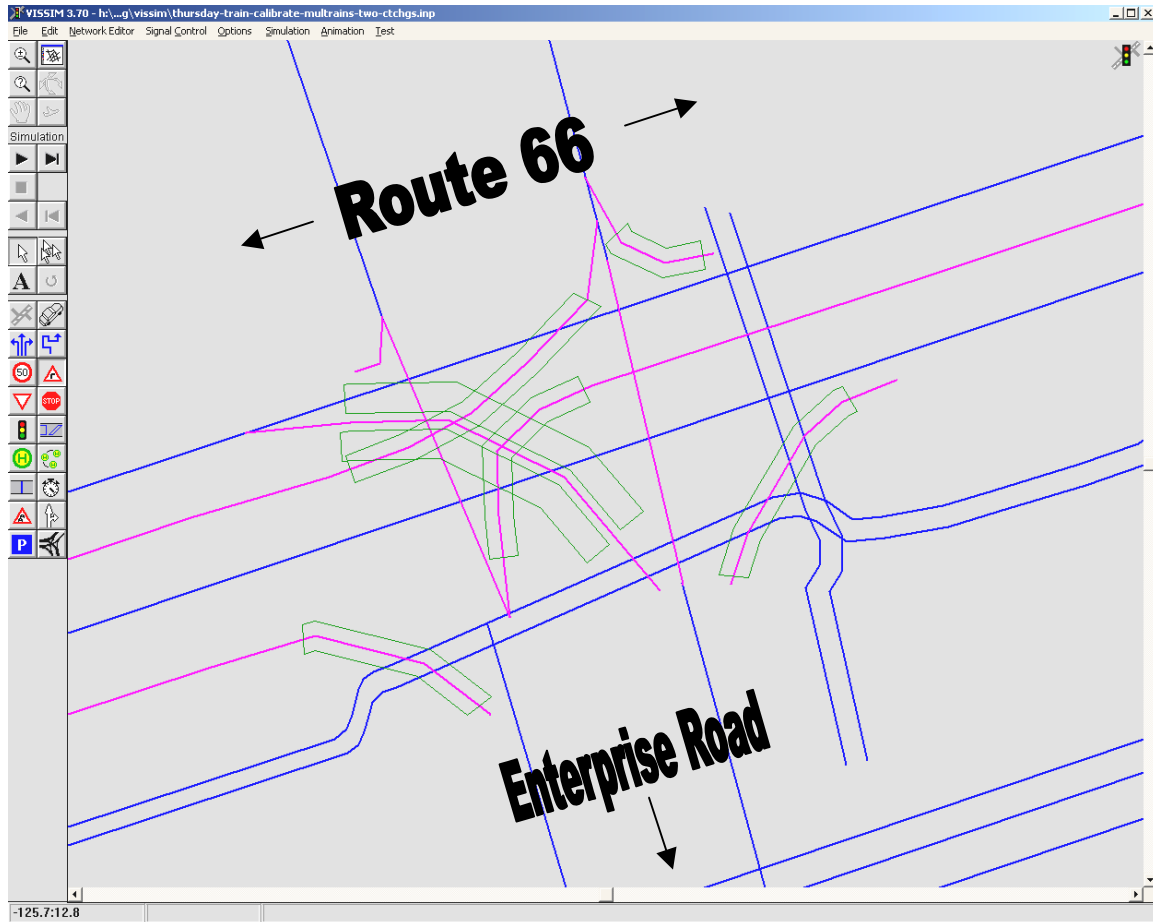

Figure 10: VISSIM Model Screen Display At Route 66 and Enterprise Showing Reduced Speed Areas, Links, And Connectors

A screenshot from the VISSIM model is shown, with the seven reduced speed areas outlined in green. These reduced speed areas are at the intersection of Route 66 and Enterprise Road. The blue lines depict “links” in the model, which serve as roadways (or sidewalk for pedestrians) containing a designated number of lanes. The purple lines are “connectors,” which serve to connect links to one another and are used to model turning movements and changes in the number of lanes (lane additions or drops).

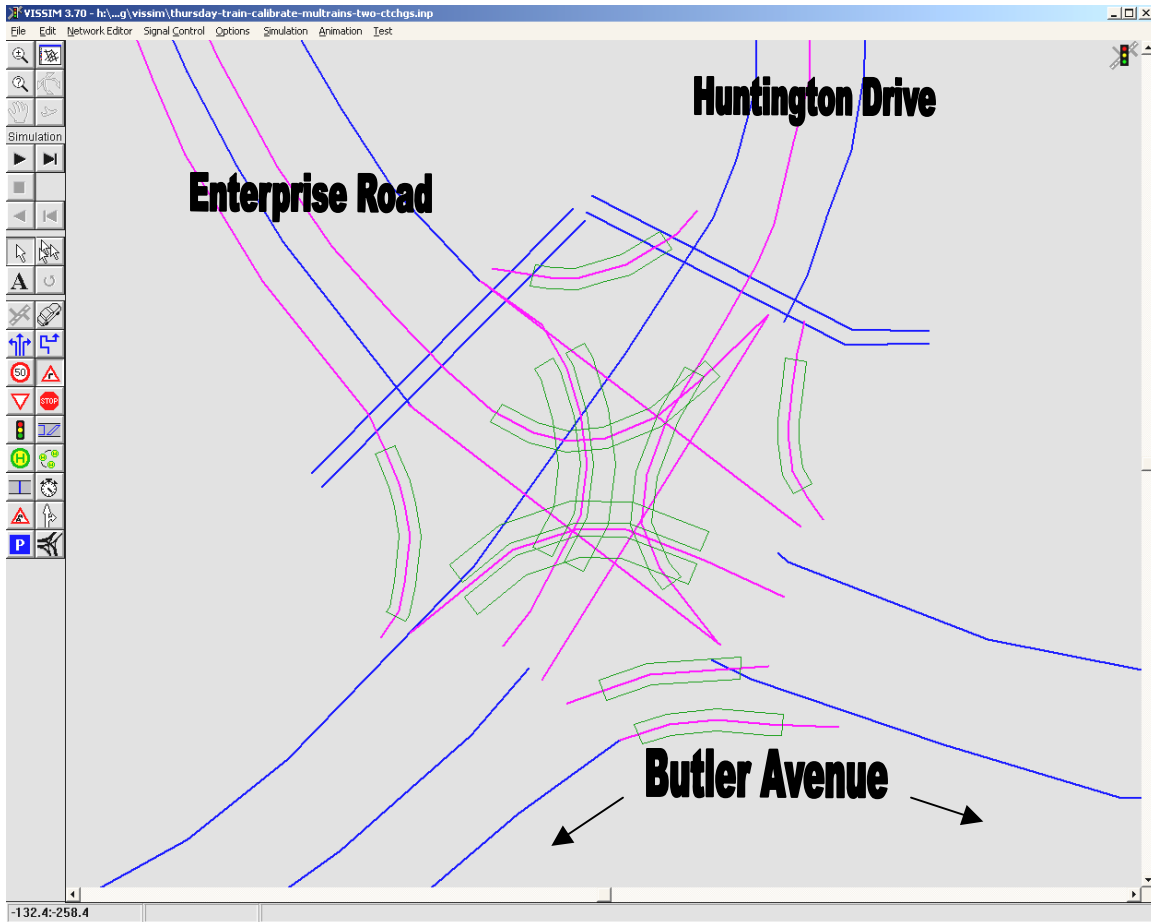

Figure 11: VISSIM Model Screen Display At Enterprise and Butler Showing Reduced Speed Areas, Links, And Connectors

A screenshot from the VISSIM model is shown, indicating the 11 reduced speed areas at the intersection of Butler Avenue/Enterprise Road/Huntington Drive.

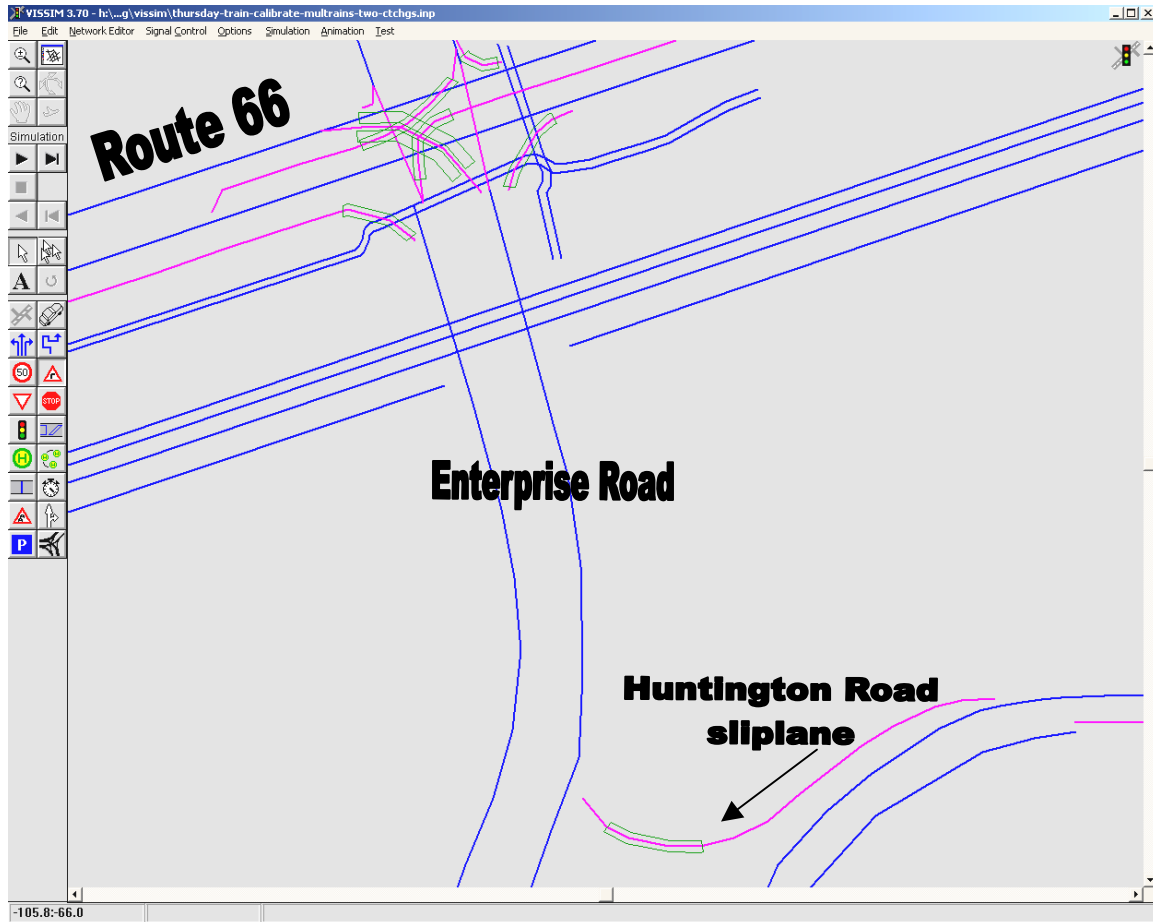

Figure 12: VISSIM Model Screen Display Showing Huntington Slip Lane Showing Reduced Speed Area, Links, And Connectors

A screenshot from the VISSIM model is shown, with the reduced speed area on the slip lane of Huntington Drive, south of the Route 66/Enterprise Road intersection.

4.2.2. The Calibration Process

After all field information, including geometrics and vehicular volume, was entered into the model, five seeds were run in VISSIM and the results (mean speed and number of vehicles) from each seed output were averaged. These averages for simulated vehicles were compared with the values for speed and number of vehicles obtained from field data. The target calibration objective of 10% or less was set for this difference.

Ideally, this target objective could be met at the resolution of 5-minute aggregations; however, this level of data is rarely available and there is little experience in calibrating a model at this resolution. After several unsuccessful attempts, the resolution was changed to 15-minute aggregations. The variability of 5-minute aggregations was large, confounding the attempts to calibrate the model using them.

Twenty-nine iterations were conducted until the target calibration objective was achieved. This calibration was achieved using the 15-minute aggregations. Once the calibration objective was achieved with five seed values, twenty seed values were simulated in VISSIM, which also met the calibration objective.

4.3. VISSIM MODEL VERIFICATION

After the model is calibrated, its ability to generalize for different situations should be validated using a different data set. A second data set for validation was extracted from the field data for this purpose. The validation procedure used twenty seed values and the same model parameters finalized in the calibration process.

The validation data set was for Thursday, April 24, 2003, from 3:50 p.m. to 4:35 p.m., which was also a time period where there were no trains in the traffic network. The validation vehicular data was entered into the calibrated VISSIM model and the results from twenty seeds were collected. This initial run did not meet the target objective of differences of 10% or less. Therefore, the calibration model was adjusted in various ways until, in all cases, the 10% target calibration objective was met. After four attempts, a fully calibrated model was found that also met the validation goal. In other words, the model met the 10% target for both the calibration and validation data sets.

(blank)

5. EARLY WARNING SYSTEM

The research question focuses on taking actions before a train arrives at an at-grade crossing that will mitigate the congestion that occurs after the train passes. The actions to be taken are within the context of the traffic signal control system at the nearby intersection. A proposed solution to address the research question was to design and test an Early Warning System.

5.1. EARLY WARNING SYSTEM DESIGN CONSIDERATIONS

To be of most use, an ideal EWS would conceptually have these features:

1. Simple and inexpensive to design, build, and install.
2. Capable of being maintained by existing maintenance technicians with little or no new training required.
3. Controlled by the highway agency without need for any changes to the railroad control system.
4. Able to maintain the time-tested safety aspects of current at-grade crossing highway and railroad control schemes.

Functionally an ideal EWS would have these components:

1. Detection: Early detection of a train approaching the at-grade crossing.
2. Prediction: Prediction of when the train will arrive at the crossing and how long it will take to clear the crossing.
3. Congestion Mitigation: Changes in the normal intersection traffic control scheme before the train arrives that will reduce the congestion caused by a train after it has passed the crossing.
4. Safety: Minimize the possibility of a vehicle-train collision.

The EWS reported here tests a system that will achieve the ideal features using the components listed above. Each component is itself is a subsystem and a major undertaking. Some components were addressed more fully than others in this research because of problems encountered and resource restraints.

5.2. EWS DETECTION SUBSYSTEM

The EWS detection subsystem conceptually will detect an approaching train at a much greater distance from the crossing than a typical railroad detection system currently does. Additionally, this information must be communicated to the EWS prediction subsystem. The EWS prediction subsystem will require information about both the speed and the length of an approaching train.

5.2.1. Radar Detection and Wireless Communication

A radio frequency (RF) Doppler radar detector has been used for train detection in previous research. Those systems were pioneered by Leonard Ruback at the Texas

Transportation Institute (Ruback 2001, TTI 2005-1). Ruback built systems in his lab from various components and has tested them in the field in various locations. Such an approach could be used; however, with the increasing use of radar speed detectors for ITS and enforcement uses¹, off-the-shelf devices are now more readily available and would simplify the subsystem and make it easier to maintain.

The radar detector would be pole mounted but would be located outside of railroad right-of-way (TTI 2005-2). It would be able to detect a train's presence and speed and send this information to the EWS prediction subsystem. It would also be able to send when the train was no longer detected. The detector would have the ability to induce the train's speed and possibly its length as well. If the length could not be induced by the sensor, it could be calculated by the prediction subsystem from the raw data collected by the detector, i.e., speed, time presence is first detected, and time presence is last detected.

Another component needed for the EWS detection subsystem is a communication system that will send the detected train information to the EWS prediction subsystem. The prediction subsystem is probably best located in the same cabinet as the regular intersection traffic control system. Wireless sending and receiving devices will serve this purpose, when designed for outdoors field use such as in traffic applications. Spread spectrum technologies are one method typically employed. Several vendors offer products in this category using either direct sequence or frequency hopping techniques to produce the spread spectrum output. Spread spectrum equipment operating in the popular unlicensed 900 MHz ISM (Industrial, Scientific, and Medical) band would serve the purpose. These require a transmitter located on the pole with the detector and a receiver located in the intersection traffic control cabinet. Often line-of-sight must be maintained, which may require the use of repeater stations, as would long distances. However, these devices draw low power and can be solar powered.

More than one pole-mounted sensor may be required. For example, a second sensor may be useful closer to the crossing. The data received from this second sensor could be used by the prediction subsystem to recalculate train arrival time and duration. If this has changed sufficiently, the actions taken by the congestion mitigation subsystem could be retimed or aborted.

5.2.2. Time Domain Reflectometry (TDR) Detection

An experimental detection device has been developed under the IDEA² program (TRB IDEA). The original intent of this system was to detect breaks in the railroad tracks. For this purpose, the device was mounted in the cab of the train driver. The device induces an electrical pulse into the rails ahead of the first locomotive axle. This pulse travels

¹ Doppler radar devices are used in photo radar speed and red-light running systems, traffic monitoring systems for use by Traffic Control Centers, and variable message signs that display an approaching motorist of his vehicle speed.

² The Innovations Deserving Exploratory Analysis (IDEA) program provides start-up funding for promising, but unproven, innovations in surface transportation systems. The program is managed by the Transportation Research Board and supported by the Federal Railroad Administration, the Federal Transit Administration, and the Federal Motor Carrier Safety Administration.

forward through the rails until any significant electrical variation is encountered in the track, whereupon a portion of the pulse is reflected back to be received and analyzed at the train. The phase of the returning pulse will indicate if the hazard is a broken rail or track occupation, and the exact amount of time delay will give the distance ahead. If another train is ahead on the same track, the device can constantly calculate the distance and relative approach speed of the second train.

In discussions with the developer of this device, Steven Turner of Analogic Engineering³, he indicated that this detection device might be used for the EWS detection subsystem. For this use, the detection device would be used at a fixed location at the crossing. The TDR detector would constantly sense for an approaching train. When one is detected, the detector would constantly calculate the speed and distance to the approaching train. It could continuously transmit this information and would therefore detect any change in speed that the EWS prediction subsystem could use to change or abort its earlier predictions.

Since the TDR detector would be located at the crossing, communication to the nearby intersection traffic controller cabinet could be hardwired or wireless. However, if the length of the train is also needed, a second TDR detector would have to be installed some distance from the crossing. This second detector would detect the “back” of the train and transmit its data to the first TDR detector, located at the crossing, which would detect the “front” of the train. Since both detectors would be simultaneously giving the distance to the front and back of the train and the distance between the detectors is known, the length of the train can be calculated.

This TDR system, configured for use in a train driver’s cab, is currently undergoing testing at the Transportation Technology Center, Inc. (TTCI) in Pueblo, CO. TTCI focuses on railroad and transit research and operates a laboratory that includes 48 miles of railroad track to test a wide variety of rail components, including rolling stock, track components, signal, and safety devices.

The TDR detection device has not been configured or scheduled for testing for use in the EWS detection subsystem and therefore its usefulness for this application remains unknown. Additionally, since it would be connected directly to the railroad’s tracks, the system would not be controlled by the highway agency but would have to be controlled by the railroad company. But while the TDR detection device needs additional testing before it could be used, it does offer the significant potential benefit of providing continuous speed and distance data whereas a radar detector can only give “spot” speed/length information of the train where the detector is physically located.

5.3. EWS PREDICTION SUBSYSTEM

An EWS prediction subsystem would be a small field-grade microprocessor located in the intersection traffic control cabinet. The data from the EWS detection subsystem would be received by the detection subsystem’s data receiver located in the cabinet and ported to the microprocessor. The microprocessor would contain a clock that would

³ Steven Turner, Analogic Engineering, Inc., Guernsey, WY.

time-stamp incoming data. From this data it could predict the time the train would arrive at the crossing and the time interval before it cleared the crossing from a simple or sophisticated prediction algorithm. A simple approach, and one that has proved successful at other sites (Ruback 2001), is a simple speed versus distance to calculate time of arrival. Depending on the railroad speed limit changes between the detector and the crossing, this method could be within the accuracy needed. Railroad companies strictly enforce their speed limits and trains change speeds slowly.

If a specific site has a complex set of parameters that might affect the speed of a train between the detector and the crossing, a more sophisticated algorithm could be developed to help account for this complexity. Conceptually, this is possible because a significant number of the parameters between the detector and the crossing are fixed, e.g., distances, speed limit change points, spurs, sidings, etc. These fixed parameters make it easier to accurately predict some of the changing variables. For example, if a train occasionally stops before it reaches the crossing, the behavior of a train that does so might have a recognizable pattern of speed changes at specific locations, etc. These speed changes might be detectable by positioning of multiple radar-type detectors at specific points or by using a continuous-type detector. When such a pattern was detected, the arrival prediction could be modified or aborted.

5.4. EWS CONGESTION MITIGATION SUBSYSTEM

The microprocessor used for the EWS prediction subsystem would also contain the EWS congestion mitigation subsystem. Therefore, the predictions needed by the congestion mitigation subsystem would be available to it when needed.

The congestion mitigation subsystem uses the EWS algorithm developed for the specific site. This system conceptually wraps around the EWS safety subsystem. Its purpose is to take actions when a train approaches before the normal train preemption occurs. These actions interrupt the normal traffic signal cycle and allocate the green time differently. If successful, this reallocation of green time before the train arrives will reduce the congestion that typically occurs after the train has passed.

5.4.1. Principle of Costs and Benefits

At the research site, when a train is passing the crossing, the movements and phase numbers that are restricted from moving are WB LT (1), NB RT (8), NB LT (3), and EB RT (na), as shown by Figure 8. Therefore, it is these movements that are the focus of actions taken before the train arrives. Conceptually, this means that “extra” green time is given to these movements before the train arrives and the crossing gates come down.

An important concept that governs giving “extra” green time to any movement is that it must be “stolen” from another movement. For example, in order to interrupt the normal cycle allocations of green and give WB LT (1) some “extra” green, it must be taken (stolen) from other movements in the normal cycle that was interrupted. If in this example, EB TH (2) was green and it was interrupted (cut short) to give WB LT (1), then the “extra” green given to WB LT (1) was “stolen” from EB TH (2).

As a result, more vehicles would be delayed on EB TH (2) when green is “stolen” from it than if the normal cycle would not have been interrupted. This is the cost associated with

giving some “extra” green time to EB LT (1). The benefit is that “extra” green time will reduce the delay for those vehicles that receive it.

5.4.2. Measurement of Costs Versus Benefits

In order for costs to be compared to benefits, a common measurement of both must be taken. These are called Measures of Effectiveness, or, they could be called Performance Measures (PMs). The MOE used must look at the intersection as a whole rather than as individual movements. Three MOEs were selected by the project’s Technical Advisory Committee to be measured and analyzed for the study site.

1. Average Delay measured in seconds per vehicle, using all vehicles to pass through the intersection during a set period of time.
2. Average Travel Time measured in seconds per vehicle, using all vehicles to pass through the intersection during a set period of time.
3. Average Queue length measured in feet, using all vehicles to pass through the intersection during a set period of time.

Two other MOEs were discussed by the TAC and would have been useful except that the VISSIM modeling environment used for the study would not capture them adequately. These were the Number of Cycles to Clear and Stopped Time.

5.4.3. Method to Capture Costs Versus Benefits -- Before and After Study

In order to compare the costs versus the benefits of the EWS congestion mitigation subsystem, a method must be established to do this. This method is typically called a “Before and After” study. This title, while used in this report, is slightly misleading. Technically the method is a “With and Without” study. The Before (Without) analysis models the intersection without using the EWS. The After (With) analysis models the intersection using the EWS.

An important principle is to duplicate exactly the entire modeling environment for both the Before and After analyses, only varying the specific EWS activities in the After analysis. This cannot be done in a field situation because many things change between the Before and After analyses besides the EWS activities. For example, the vehicle traffic changes since this is a stochastic process and is never duplicated exactly from one time to the next. Similarly, train traffic changes, as does a whole host of other factors.

The only way to duplicate the entire environment exactly is to use a model that can duplicate all conditions exactly while changing only those needed for the After analysis. Microscopic simulation traffic models are the tools used for this purpose. One such modeling environment, VISSIM, was used for this study. It allows the capture of the MOEs of both the Before and After analyses and compare them. It is this comparison that yields the costs and benefits.

5.4.4. Stochastic Models Require Multiple Runs

Microscopic traffic simulation models attempt to model the types of variability that actually occur at a site. For example, traffic varies from day to day and hour to hour. A typical peak hour traffic stream on Tuesday of one week, while similar to the traffic on the Tuesday of the following week, is not exactly the same. In fact, variability can be

significant. The model tries to capture this variability so that each time the model is run, it will vary the traffic flow in a definable, but stochastic way.

Any run can be repeated exactly because it depends on an initial starting number, called the “seed.” So if the same seed is used on a second run, it will produce the exact same results and MOEs as the first run. But if a different seed is used, the same model will vary the traffic flow and give different results. The strength of a microscopic simulation model is this variability. It provides a different, but probable, MOE output for each run. This models actual traffic in the field. So a scenario can be tested under different, but probable conditions, using a series of runs.

The MOE from each run, however, is only a snapshot of what is happening. To get a true picture of what is happening, all the runs must be considered together. This can be done in several ways. The most useful is to average the MOEs from a series of runs and use this average MOE for analysis. However, in some cases the maximum and/or minimum value from a series of runs might be useful, for example in evaluating queue length. An accepted minimum number of runs varies from 5 to 10. The primary work done in this study uses 10 runs, but some of the secondary issues were explored with only 5 runs, which conserved resources.

5.4.5. Principle of Availability of Vehicles to Receive Benefit

A subtle but critical principle when dealing with mitigating actions is that something done now will affect something that is forecast to happen in the future. In developing an EWS, the premise is that something is done before a train arrives at a crossing that will relieve congestion that will build up and be present once the train has cleared the crossing.

Simply stated, the EWS attempts to move vehicles through the railroad crossing before the train arrives--vehicles that would normally have to wait until the train passed. The subtle, but necessary, condition for this to happen is that the vehicles that have to wait for the train to pass must arrive at the intersection early enough to be able to use the “extra” green they receive. In other words, unless a heavy volume of vehicles, *which would be held up by the train*, are available to move through the crossing when the EWS is initiated, then the “extra” green given to this movement is not used by a significant number of vehicles. The “extra” green time is not fully used because not enough vehicles are present to use it. This means that vehicles that arrive from right after the EWS has ended, until the train has passed, mainly cause the congestion.

5.5. EWS SAFETY SUBSYSTEM

Safety is the primary objective of the special preemption control scheme currently used at an intersection when a train is passing at a nearby at-grade crossing. This scheme clears the tracks before the train arrives and withholds movement toward the crossing while the train is passing. It is triggered by a preemption signal sent by the railroad to the traffic signal controller.

The traffic signal controller allows other preemptions, like the EWS, but requires each to have a priority assigned to it. The railroad preemption has a priority of one and overrides all other preemption signals as well as all other normal functions of the controller to

address the approaching train. The EWS maintains this safety by not interfering with either the preemption signal from the train or the signal controller's response to it.

If the EWS is already activated when a railroad preemption signal is received, the EWS will be immediately terminated so the preemption control scheme can begin. Likewise if the preemption control scheme is running and the EWS sends a signal to begin, the EWS signal will be ignored until the train has cleared the crossing that the railroad preemption control scheme has finished. These actions are already a part of a standard controller logic and are not changed in any way by the EWS.

Therefore, a key component of the safety subsystem of the EWS is to never interfere with the activation of the train preemption. By keeping this in place, the crossing safety experienced before an EWS is installed is identical after the EWS has been installed and is operating.

Another component of this subsystem is to use the existing logic of a controller to implement the EWS algorithm. This is done by using a linked series of preemptions. These preemptions all have lower priority than the train preemption. By using existing preemption options within the traffic controller, the controller's logic is not changed by the EWS algorithm. Since the controller is using its own logic to implement the EWS algorithm, all of the safeguards that exist within the controller are maintained. For example, when the EWS is initiated, it interrupts a movement. The manner in which it interrupts this movement is part of the existing controller logic, insuring that a minimum green is maintained as well as normal cycle change and clearance intervals for that movement.

(blank)

6. EWS CONGESTION MITIGATION ALGORITHM DEVELOPMENT

6.1. ALGORITHM DEVELOPMENT

The Research Question proposes the concept of taking action before a train arrives using an Early Warning System Congestion Mitigation Subsystem as detailed in Section 5.4. This requires that actions be taken to change the traffic control sequence at the nearby intersection as the train approaches. This is done using an algorithm developed for this purpose.

Ideally the algorithm would be adaptable to any intersection, however to be applied it must be tailored to the specific intersection geometrics and traffic flows. The algorithm will give additional green to “conflicting” movements by taking it from “non-conflicting” movements. A conflicting movement is one that has to cross the railroad track while a non-conflicting movement is one that does not have to cross the tracks. Therefore when a train is passing, the conflicting movements are given a continuous red signal and must wait until the train has passed. The non-conflicting movements are allowed to continue receiving a green signal while the train is passing.

The algorithm gives additional green time to the conflicting movements by interrupting the normal sequence of allocating green time at the intersection. By so doing, it “steals” green time that would normally be given to non-conflicting movements and gives it to conflicting movements. The concept is that the benefit derived from the conflicting movements getting additional green time will offset the costs associated with withholding green time from the non-conflicting movements. Although the non-conflicting movements “lose” green time while the algorithm is running, these movements get “all” the green time as the train passes, since the conflicting movements are given a red signal when the train is passing.

6.1.1. EWS Algorithm Logic Concepts

The algorithm developed for this project is written in the macro language for VISSIM called VAP (Vehicle Actuated Programming). This language allows precise control over the simulated NEMA controller used in the VISSIM simulation. The logic used in programming the algorithm using VAP is detailed in APPENDIX C.

The conceptual sequence of events that the EWS algorithm manages is as follows:

1. Receive Signal: The EWS sensor sends a signal that a train is approaching.
2. Predict Train Arrival Time: The time the train will arrive at the crossing is calculated.
3. Wait Until Appropriate Time: The wait time is calculated by subtracting the time the EWS actions will take from the time before the train is predicted to arrive.
4. Interrupt Normal Signal Operations: At the appropriate time, the traffic movements that are timing at the intersection are interrupted. For safety, they are allowed to run a minimum green time, if they have not already done so, and then are forced to yellow and all red.

5. Start Timing EWS 1 Movement(s): The conflicting movement(s) selected for EWS 1 are allowed to time the specified green, yellow, and all red.
6. Start Timing EWS 2 Movement(s): The conflicting movement(s) selected for EWS 2 are allowed to time the specified green, yellow, and all red.
7. Start Timing EWS 3 Movement(s): The conflicting movement(s) selected for EWS 3 are allowed to time the specified green, yellow, and all red.
8. Start Timing EWS TC Movement(s): The EWS TC movements are allowed to time the specified green time. These Track Clearance Movements are the conflicting movements that queue across the tracks when their light is red.
9. EWS Algorithm Ends: The EWS algorithm can end in one of three ways:
 - a. Train Preemption Occurs: The train reaches the point where it activates the Train Preemption in the traffic signal control system. The Train Preemption interrupts whatever is timing and begins the Train Track Clearance (Train TC) movements. Since the EWS TC movements are the same as the Train TC movements, these movements continue as green. When the EWS TC is interrupted by the Train Preemption, the EWS algorithm is terminated.
 - b. Train Preemption Does Not Occur: If for any reason the Train Preemption fails to occur, the EWS TC movements finish timing their green and then time their yellow and all red. This ends the EWS algorithm.
 - c. Train Preemption Occurs Early: If for any reason the Train Preemption occurs early, during the EWS 1, EWS 2, or EWS 3 timing, the EWS algorithm is terminated.

To summarize, the algorithm has four sequential steps that can time different movements, EWS 1, EWS 2, EWS 3, and EWS TC. If only one group of movements is to be timed, then EWS 2 and EWS 3 are skipped. EWS TC is always used and ends the algorithm unless it is terminated by Train Preemption. Likewise, two groups of movements can be timed (EWS 1 and EWS 2), in which case EWS 3 would be skipped.

6.1.2. Application of the Algorithm at the Study Site

The algorithm anticipates that it will be terminated by the Train Preemption while timing its EWS TC movements. For safety reasons, the Train Preemption will terminate the algorithm whatever it is timing. At the study site (see Figure 8), the intersection is a Tee, which limits the number of conflicting movements as well as non-conflicting movements. The conflicting movements are NB LT (3), NB RT (8), WB LT (1), and EB RT (EB RT has no signal head but does have a dedicated lane) and the non-conflicting movements are WB TH (6) and EB TH (2).

The study site has two potential conflicting movement groups that can be given additional green time:

- WB LT (1); this movement is designated as EWS 1.
- NB LT (3) and NB RT (8); these movements are designated as EWS TC.

6.1.3. Limitations Imposed on the Algorithm

The algorithm concepts are subject to limitations imposed by two primary factors:

1. Train arrival prediction error.
2. NEMA traffic controller logic and capabilities.

The algorithm predicts when the train will arrive at the crossing and uses this to time all of its EWS movements. In essence, it backs up the needed amount of time from when the train is predicted to arrive to begin timing EWS 1. If the predicted arrival time is inaccurate, then the EWS will start at the wrong time. If the train arrives earlier than predicted, the EWS 1 will begin timing too late and won't be finished when the train actually arrives and terminates it. If the train arrives later than predicted, the EWS TC will begin timing too early and will have ended before the train actually arrives. Neither an early or late arriving train is desirable; they will probably occur, however, so the effects of these conditions were studied.

A typical NEMA controller, one that ADOT uses, was designated as the controller to be used in the testing. This is an Econolite ASC/2S-2100. In order to implement the algorithm in this controller, the lower priority preemption calls were used. This places these primary restrictions on the algorithm:

- EWS call must be dropped quickly: The algorithm starts timing EWS 1 by calling Preemption 6. When Preemption 6 is finished, it then calls Preemption 5, which when finished, calls Preemption 4. This is called "linking" preemptions but in order for it to work properly, the call on Preemption 6 must be dropped shortly after it is called. It cannot be a continuous call. This is a minor problem, but one that must be handled outside the controller.
- Fixed timings are required because roadway sensors not available to preemption: The preemption control logic has limitations. One of these limitations is that it cannot "see" the roadway vehicle sensors so the preemptions can only do fixed times. Ideally the roadway vehicle sensors would be used which allows a better response if there were insufficient vehicles available to use the EWS green(s). This would make the algorithm operate more efficiently. Using fixed times can cause severe cost/benefits penalties if too few vehicles are actually available to use the EWS green. The fixed EWS green continues to time without vehicles so no benefit is achieved and all other movements are stopped from timing so they incur costs.
- Status of controller not available to algorithm: The status of what is currently timing in the controller is not available to the algorithm to use in its logic. Therefore, the algorithm must begin a fixed time before the train arrives without regard to what will happen when the controller is interrupted by the start of the EWS. This causes a fluctuation in when the EWS "ends."

For example, assume the EWS 1 is designed to time for a total of 25 seconds (includes green, yellow, and all red) and then go to EWS TC, which is to time a total of 10 seconds of green before the train arrives and terminates the EWS. Based on this, the EWS starts 35 seconds before the train is predicted to arrive.

But what happens with the EWS during that 35 seconds before the train arrives fluctuates depending on what the status of the controller is when the EWS starts.

If the same movement is timing that the EWS 1 wants to call, then it will immediately start to time the EWS 1 and it will terminate 35 seconds later when the train arrives, which is just when it ideally should finish. But if another movement is timing, then it has to shut down this movement first, before it can begin its 35 seconds of timing. If the other movement has just started (worst case), then it will take about 9 seconds to shut it down (5 sec. min green + yellow + all red). Once it is shut down, the 35 seconds begins to time but it will run for only 26 seconds before it is terminated by the train's arrival ($35 - 9 = 26$). If the algorithm "knew" what was happening in the controller, it could start the EWS earlier/later and reduce or eliminate the fluctuation caused by status of the controller sequence when the EWS starts.

- Controller limits algorithm logic complexity: It is easy to envision a complex algorithm logic that would use a series of "what if" conditions to implement a sophisticated solution to the research question. As an example, assume that the roadway vehicle sensors were available to use in the algorithm's logic. A condition could be established that says, "If there are more vehicles queuing up on the EWS TC movements than on the EWS 1 movement, then skip EWS 1 and give even more green time to the EWS TC movements than they would receive otherwise."

6.2. INDEPENDENT ALGORITHM TESTING

Because of the complex nature of the study site, the data, and the programming of the algorithm in the VISSIM macro language (VAP), it was desirable to have an independent expert review the programming logic, parameters, and results. The firm of PTV America was selected, with Kiel Ova performing the work. Mr. Ova has considerable experience in programming VAP,s as well as an excellent knowledge of VISSIM.

Mr. Ova used a program within the VISSIM family, VisVAP 2.15, to independently generate the algorithm VAP code. This was done by mapping the algorithm logic using a highly structured procedure within the VisVAP program. Once this was done, VisVAP generates the VAP code that only requires minor tweaking at that point. This was done and results of the VisVAP generated VAP algorithm was compared to the VAP algorithm.

Minor differences in code writing resulted in some minor differences in outputs. But Mr. Ova noted in his report that, "If the signal timings ...are used for comparison between two different strategies or scenarios, then these inputs are not significant to the research results." (Ova 2005) This is in fact the case for this research.

7. BEFORE AND AFTER RESULTS

7.1. PARAMETERS USED FOR EWS CONGESTION MITIGATION

The modified Tee intersection used for this research, as shown in Figure 8, has two potential conflicting movement groups (parameters) that can be given additional green time before the train arrives:

- WB LT (1), which times NB RT concurrently as an overlap (WB LT/NB RT).
- NB LT (3) and NB RT (8), which time simultaneously (NB LT/NB RT).

Whereas the EB RT is also a conflicting movement and has its own dedicated lane, it does not have its own signal head controlling its movement. It can move either by right-turn-on-red (RTOR) or when the EB TH light is timing. For these reasons, EB RT is not a candidate for additional green time before the train arrives.

7.2. BEFORE AND AFTER CASES STUDIED

After the VISSIM model was calibrated and validated, it was used to study a number of cases. The MOEs for each case can then be compared. Using the modified tee intersection geometrics for all the cases, three case components were identified and the potential variables within each component were also identified.

Case Components

A. Vehicular Traffic Flow Levels

1. Peak Flow
2. Normal Flow
3. Low Flow

B. Train Traffic Flow Levels

1. 1 Train
2. 2 Trains, no gap between
3. 2 Trains, short gap between

C. Train Prediction Variability

1. Train arrives when predicted (on time)
2. Train arrives before predicted (early)
3. Train arrives after predicted (late)

Using these components, 27 study cases are needed to investigate all of the combinations: A (3 variables) x B (3 variables) x C (3 variables). Each of the 27 cases also has a “before” and “after” scenario, ideally requiring 10 runs each. To further expand the complexity, the MOEs can be collected for different time periods, e.g., 15 minutes before to 15 minutes after the train arrives or 7.5 minutes before and after the train arrives.

Each potential case would ideally be studied for the EWS variables discussed in Section 7.1. Each of these EWS variables would need to be studied at various levels. For example, WB LT/NB RT could be given extra green before the train arrives of 20 seconds, or 30 seconds, etc.--likewise for NB LT/NB RT. Even more complex would be studying a mixture of these two parameters, e.g, 20 seconds of WB LT/NB RT followed by 15 seconds of NB LT/NB RT. It was decided to eliminate the mixtures based on available resources.

The number of potential cases had to be reduced to a reasonable number allowing for study resources. Considering that the EWS algorithm would be designed for Peak Flow, it was decided to only study this condition and eliminate normal and low flow. The EWS algorithm might not be effective at these lower flows and if not, the algorithm could be bypassed outside of peak flow time periods based on time-of-day.

The train traffic flow variables were reduced by focusing primarily on the condition of two trains, without a gap in between. Based on train data, as discussed in Section 3.4 and APPENDIX B, this was represented by one long train, which actually models the worst case wherein the first train is just clearing the crossing when the second train arrives at the crossing from the other direction. The condition of two trains with a gap in between, while interesting, was also discarded from the study due to resource limitations. Two other single train conditions were studied, the “average” and the “short” train.

The effect of the train arrival prediction being early or late was studied. In retrospect, the levels used of 25 seconds too early and 25 seconds too late were probably too large to be realistic. It is doubtful that a prediction error would be of this magnitude, but if it were, the EWS would probably be aborted since the results at these levels of prediction error are probably erratic. The abortion could be triggered based on a change in expected speed profile before the EWS has started.

Six cases were ultimately selected for study. The attributes of the six cases studied are detailed in Table 2 along with their case number. Most cases were studied for two EWS parameters: Parameter 1 giving WB LT/NB RT extra green and then separately for Parameter 2 giving NB LT/NB RT extra green. While a combination of these two parameters might yield interesting results, this was not pursued because of resources. However, because of how the EWS algorithm is implemented, it always ends in the train preemption track clearance movements for a few seconds before the train preemption begins, which is identical to Parameter 2. Therefore, when Parameter 1 finishes timing, the EWS always gives a few seconds to Parameter 2 before it is aborted by the train preemption. This results in a de facto small amount of mixture of the two parameters, but not enough to actually study the mixture.

Five possible levels of the EWS parameters were studied for the selected cases. The overview of each case’s variables is shown in Table 3. The final selection of what was studied was also partially guided by the results, as they became known. This choice of cases allowed four major variables to be studied:

- Duration of gates down at crossing. Cases 1, 2, and 3 explore this variable using the “longest” train, “short” train, and “average” train, which have gates down for 4.5, 1.5, and 2.6 minutes respectively. The other factors were held constant for these three cases. The EWS WB LT/NB RT parameter was run at five levels for

each case: 20, 30, 40, 50, and 60 seconds of early green. In addition, the EWS NB LT/NB RT parameter was run for each case at five levels: 20, 30, 40, 50, and 60 seconds of early green.

- Duration of MOE period: Cases 1 and 6 explore this variable using a 30-minute and a 15-minute MOE period over which the MOE statistics are captured. The MOE period is centered on the train arrival at the crossing. EWS WB LT/NB RT parameter was run for each case at five levels: 20, 30, 40, 50, and 60 seconds of early green. In addition, EWS NB LT/NB RT parameter was run for each case at 5 levels: 20, 30, 40, 50, and 60 seconds of early green.
- Volumes at 1X, 2X, and 3X of existing on conflicting movements: Cases 1, 4, and 5 explore increasing vehicle volumes from current volumes (1X) to two times current (2X), to three times current (3X), respectively, for the four conflicting traffic movements: NB LT, NB RT, WB LT, and EB RT. This was done to explore the impact of changing ratios of conflicting to non-conflicting volumes. EWS WB LT/NB RT parameter was run for each case at five levels: 20, 30, 40, 50, and 60 seconds of early green. In addition, EWS NB LT/NB RT parameter was run for each case at five levels: 20, 30, 40, 50, and 60 seconds of early green.
- Early and Late train arrivals versus predicted On-Time arrival: Case 1, 2, 3, and 6 explored this variable. For each case, the effect on the MOEs of the train arriving early by 25 seconds and late by 25 seconds was compared to it arriving on-time. EWS WB LT/NB RT parameter was run for each case at five levels: 20, 30, 40, 50, and 60 seconds of early green. In addition, EWS NB LT/NB RT parameter was run for each case at four levels: 30, 40, 50, and 60 seconds of early green.

Table 2: Overview of Case Attributes

ATTRIBUTE	Overview of Case Attributes					
	FIRST CASE	SECOND CASE	THIRD CASE	FOURTH CASE	FIFTH CASE	SIXTH CASE
	LONGEST TRAIN (4.5 MIN)	SHORT TRAIN (1.5 MIN)	AVERAGE TRAIN (2.6 MIN)	LONGEST TRAIN AT 2X CONFLICT VOLS	LONGEST TRAIN AT 3X CONFLICT VOLS	LONGEST TRAIN AT 15 MIN MOEs
Train Duration at Crossing	4.5	1.5	2.6	4.5	4.5	4.5
Intersection: "Tee" at pre-improvement geometry	✓	✓	✓	✓	✓	✓
Vehicle Flows during PM Peak	✓	✓	✓	✓	✓	✓
Train arrives at 5:00 p.m.	✓	✓	✓	✓	✓	✓
MOEs are TT, Delay, Queues	✓	✓	✓	✓	✓	✓
MOEs duration (min.)-centered on train	30	30	30	30	30	15
Timing is SYNCHRO optimized	✓	✓	✓	✓	✓	✓
VAP Version used	"J"	"J"	"J"	"J"	"J"	"J"
EWS: WB LT (20, 30, 40, 50, 60 sec.)	✓	✓	✓	✓	✓	✓
EWS: NB (20, 30, 40, 50, 60 sec.)	✓	✓	✓	✓	✓	✓
"On-Time" Arrival	✓	✓	✓	✓	✓	✓
"Early by 25 sec."	✓	✓	✓	na	na	✓
"Late by 25 sec."	✓	✓	✓	na	na	✓

Table 3: Overview of Case Runs

Overview of Case Runs						
CASE	FIRST CASE	SECOND CASE	THIRD CASE	FOURTH CASE	FIFTH CASE	SIXTH CASE
	LONGEST TRAIN (4.5 MIN)	SHORT TRAIN (1.5 MIN)	AVERAGE TRAIN (2.6 MIN)	LONGEST TRAIN AT 2X CONFLICT VOLS	LONGEST TRAIN AT 3X CONFLICT VOLS	LONGEST TRAIN AT 15 MIN MOEs
No Improvements	✓	✓	✓	✓	✓	✓
-----On-Time Train Arrival-----						
WB LT Scenario						
20 sec.	✓	✓	✓	✓	✓	✓
30 sec.	✓	✓	✓	✓	✓	✓
40 sec.	✓	✓	✓	✓	✓	✓
50 sec.	✓	✓	✓	✓	✓	✓
60 sec.	✓	✓	✓	✓	✓	✓
NB Scenario						
20 sec.	✓	✓	✓	✓	✓	✓
30 sec.	✓	✓	✓	✓	✓	✓
40 sec.	✓	✓	✓	✓	✓	✓
50 sec.	✓	✓	✓	✓	✓	✓
60 sec.	✓	✓	✓	✓	✓	✓
-----Late by 25 Seconds Train Arrival-----						
WB LT Scenario						
20 sec.	✓	✓	✓	n/a	n/a	✓
30 sec.	✓	✓	✓	n/a	n/a	✓
40 sec.	✓	✓	✓	n/a	n/a	✓
50 sec.	✓	✓	✓	n/a	n/a	✓
60 sec.	✓	✓	✓	n/a	n/a	✓
NB Scenario						
20 sec.	✓	✓	✓	n/a	n/a	✓
30 sec.	✓	✓	✓	n/a	n/a	✓
40 sec.	✓	✓	✓	n/a	n/a	✓
50 sec.	✓	✓	✓	n/a	n/a	✓
60 sec.	✓	✓	✓	n/a	n/a	✓
-----Early by 25 Seconds Train Arrival-----						
WB LT Scenario						
20 sec.	✓	✓	✓	n/a	n/a	✓
30 sec.	✓	✓	✓	n/a	n/a	✓
40 sec.	✓	✓	✓	n/a	n/a	✓
50 sec.	✓	✓	✓	n/a	n/a	✓
60 sec.	✓	✓	✓	n/a	n/a	✓
NB Scenario						
20 sec.	n/a	n/a	n/a	n/a	n/a	n/a
30 sec.	✓	✓	✓	n/a	n/a	✓
40 sec.	✓	✓	✓	n/a	n/a	✓
50 sec.	✓	✓	✓	n/a	n/a	✓
60 sec.	✓	✓	✓	n/a	n/a	✓
✓ = runs complete; n/a = not applicable						

7.3. SUMMARY OF RESULTS

The results of the case MOEs in VISSIM are contained in a series of output files, each having disaggregated data. In order to aggregate this data into useful information, a computer program was developed to accomplish this task. This information was imported into a Microsoft EXCEL spreadsheet, which has been used to develop graphs that show the results.

Graphs are especially useful to show trends. Trends become apparent in the graphs when various levels of a parameter are compared, e.g., using 20, 30, 40, 50, and 60 seconds of EWS green time. Trends also help analyze the comparison of variables on the same graph.

Two of the MOEs, Delay and Travel Time, show essentially the same thing and the shapes of the graphs are identical. Average delay in seconds per vehicle is used to compare results; travel times are not shown because they contain the same information. Therefore, the following sections describe Delay results for the key variable attributes. In addition, queue length MOE results are described for one case in Section 7.3.5.

Overall, the “cost” of the EWS outweighs the “benefits” when the entire intersection is considered. While disappointing, there are useful comparisons that lead to some generalizations as discussed in Chapter 9, but these are not conclusive.

7.3.1. Duration of Gates Down at Crossing

Cases 1, 2, and 3 explore the impact of the duration of time the gates are down when a train passes. The three variables used were 4.5, 1.5, and 2.6 minute durations, which correspond to the actual distribution of times discussed in Section 3.4, and APPENDIX B. These cases are labeled “longest” train, “short” train, and “average” train in the graphs.

Figure 13 shows the trends of different gates down durations when the EWS gave “extra” green to WB LT, which times concurrently with WB TH and NB RT (an overlap). As is expected, the longer the gates remain down from the passing of a single train, the larger the average delay per vehicle. The solid horizontal lines show the delay without using the EWS and the dashed lines show the delay using the EWS.

Ideally, using the EWS would reduce overall intersection delay, but this is not the case. For the longest train, giving 20 seconds of EWS green to the WB LT movement results in a small reduction of overall delay. However, for 30 to 60 seconds of green, the EWS gives more delay than if it weren’t used. For the average train, the results are a bit better, but they are worse for the short train.

Figure 14 shows the trends of different gates down durations when the EWS gave “extra” green to NB LT and NB RT. None of the EWS “extra” green levels results in a reduction in overall intersection delay; in fact, all get worse.

If the standard NEMA hardware controller was more flexible, it might be possible to tailor the amount of EWS green to the duration of the train. The EWS train sensor could provide both the speed of the train and time it takes for the train to pass, which yields a good prediction of the duration of the train. Unfortunately, the standard NEMA

controller only has 6 preemptions and 3 of these are typically used to implement one level of parameter variable. Recall that preemption 1 is reserved for the normal train preemption, which doesn't leave enough unused preemptions to implement another level.

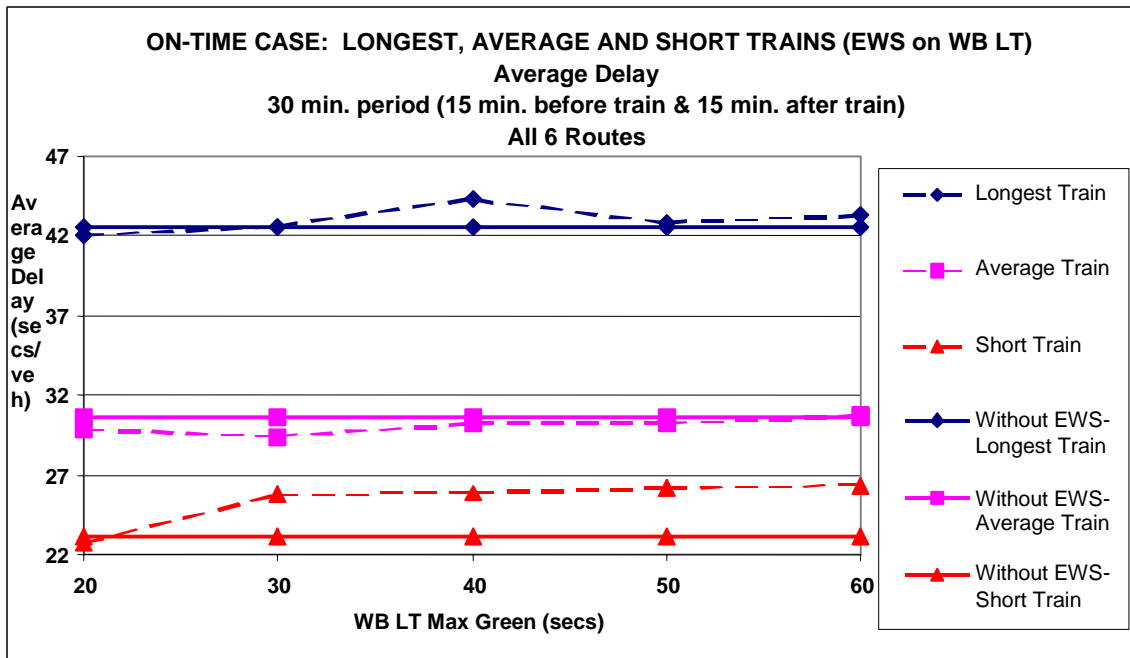

Figure 13: Delay for Different Gates Down Durations Using EWS on WB LT

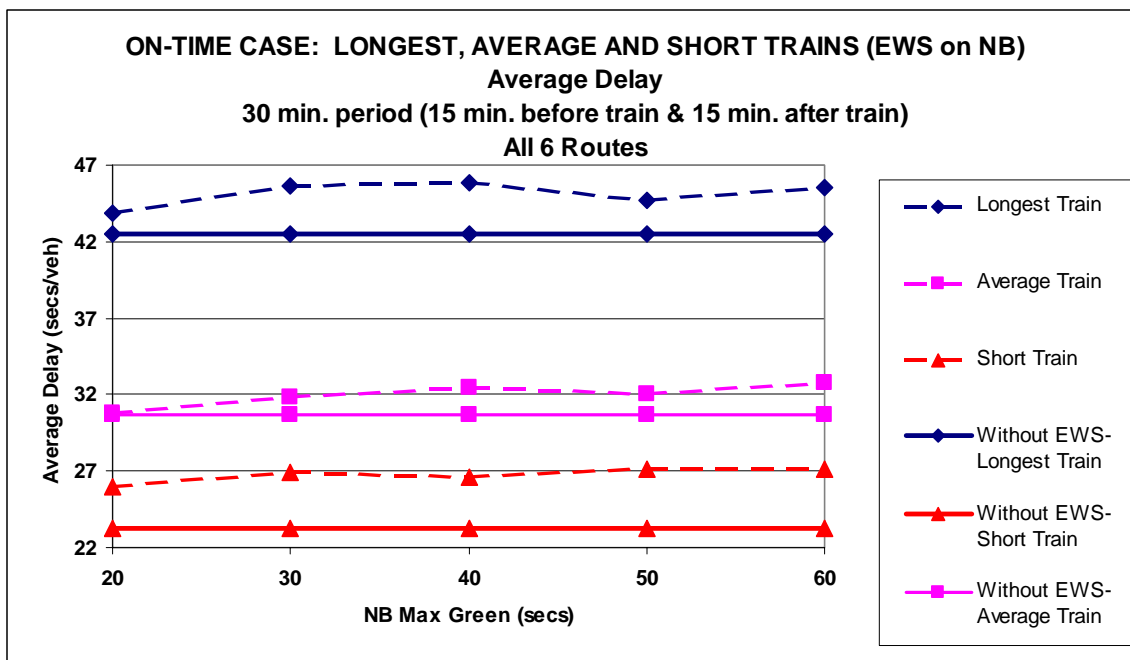

Figure 14: Delay for Different Gates Down Durations Using EWS on NB

7.3.2. Duration of MOE period

Cases 1 and 6 explore the duration of time over which the MOE statistics are collected. This time period length is significant because the longer the MOE period (for a single train passing), the more the results get “washed out” by the normal traffic flows surrounding the time the train passes. Conversely, in a very short MOE period, the disturbance the train causes is magnified. From a practical sense, if the MOE is too short, then the results don’t matter because the overall impact is too small, e.g., in the instance of a 2-minute MOE period. Likewise, it is impractical to have too long of an MOE period because the impact of the EWS is hardly captured at all.

The MOE period of 30 minutes, centered on the arrival of the train at the crossing, was chosen as the most logical choice and was used for all cases except one. Case 6 uses a 15-minute MOE period, which captures the changes from 7.5 minutes before the train arrives until 7.5 minutes after the train arrives.

Figure 15 shows the trends of two different MOE duration lengths when the EWS gave “extra” green to WB LT, which times concurrently the WB TH and NB RT (an overlap). As is expected, the shorter 15-minute period resulted in a larger average delay per vehicle than did the 30-minute period. Since the train has a gates down condition for 4.5 minutes, a great deal of the 15-minute MOE period is involved in dealing with the aftermath of the train passing and the disruptions caused by the EWS before the train arrives. For the 15-minute MOE period, giving 20 or 30 seconds of EWS green to the WB LT movement results in a small reduction of overall delay, but the longer green times do not. For the 30-minute period, the EWS plot seems to shift upwards, perhaps as a result of adding in 15 minutes more of mostly “normal” signal operation.

Figure 16 shows the trends of two different MOE duration lengths when the EWS gave “extra” green to NB LT and NB RT. The shorter 15-minute MOE period appears to “draw down” the basic shape of the EWS parameter trend compared to the 30-minute MOE period.

The MOE period is site specific. It should capture the impact of the EWS but as discussed earlier, it can’t be too long or too short. It depends on how long the passing of a train currently takes to recover, which helps to define the ending time. The starting time for the MOE period should be set such that it catches any impact caused by the EWS before the train arrives.

In retrospect, the 30-minute MOE period was probably too long. Since the EWS typically starts less than a minute or two before the train’s arrival triggers normal train preemption, beginning the MOE 15 minutes before the train arrives appears to be too long. Also, for the existing traffic conditions applied to the modified tee intersection geometrics, ending the MOE 15 minutes after the train arrives may also have been too long. The 15-minute MOE period probably would have been a better choice.

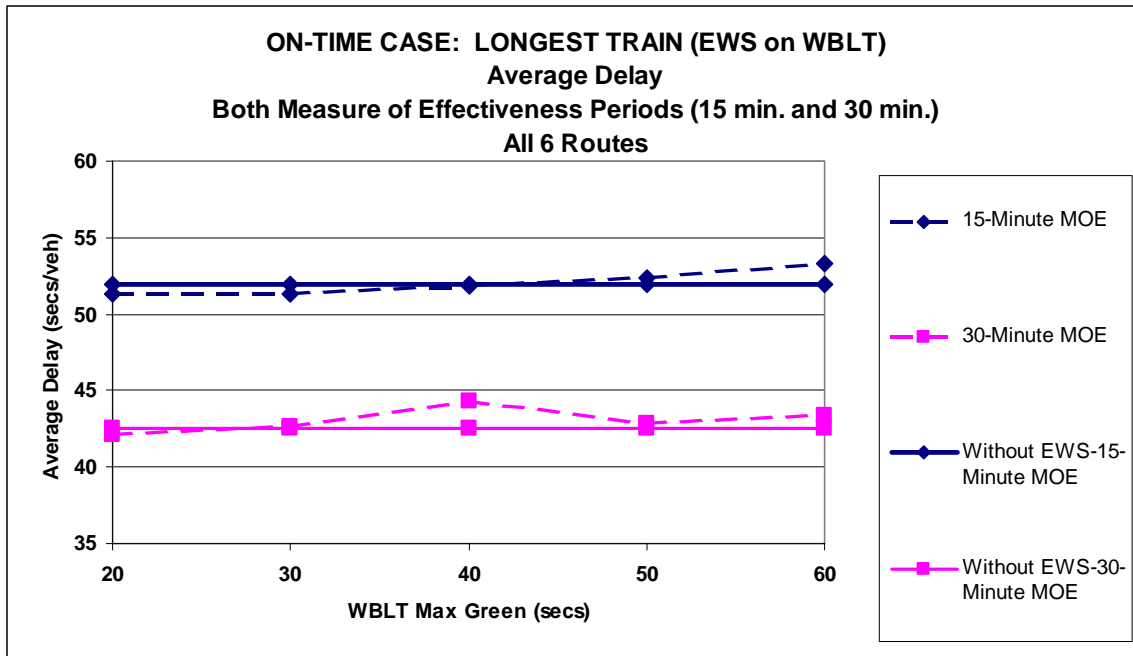

Figure 15: Delay for Different MOE Duration Periods Using EWS on WB LT

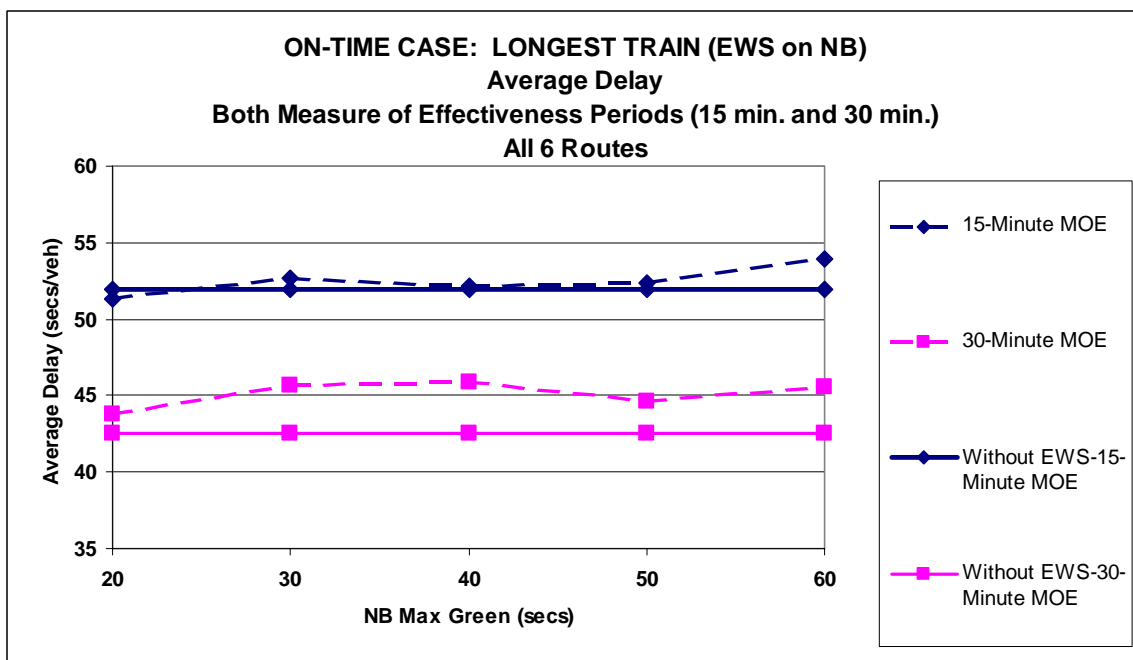

Figure 16: Delay for Different MOE Duration Periods Using EWS on NB

7.3.3. Vehicle Traffic Volume Increases on Conflicting Movements

Cases 1, 4, and 5 explore the impact of increasing the relative vehicle volumes. This was an artificial exercise to try to improve the understanding of relative movement volumes. The four conflicting movements that were increased are NB LT, NB RT, WB LT, and EB RT. Case 4 increased the conflicting movements by a factor of 2, and Case 5 increased them by a factor of 3. While these conflicting movements were increased, the non-conflicting movements were kept at their original volumes: WB TH and EB TH.

Figure 17 shows the impacts of increased conflicting to non-conflicting ratios when the EWS gave “extra” green to WB LT, which times concurrently with WB TH and NB RT (an overlap). While the EWS reduces delay for all values of the EWS parameter, it is not of a significant amount.

Figure 18 shows the impacts of increased conflicting to non-conflicting ratios when the EWS gave “extra” green to NB LT and NB RT. At the lowest level of the EWS parameter, 20 seconds, the EWS appears to depart from its trend. For this exercise, it did not appear useful to explore it further.

The results are not definitive. It was hoped that this exercise would clearly point to a link in the ratio of conflicting to non-conflicting volumes that could be further explored and perhaps some generalized rules developed. But this was not the outcome.

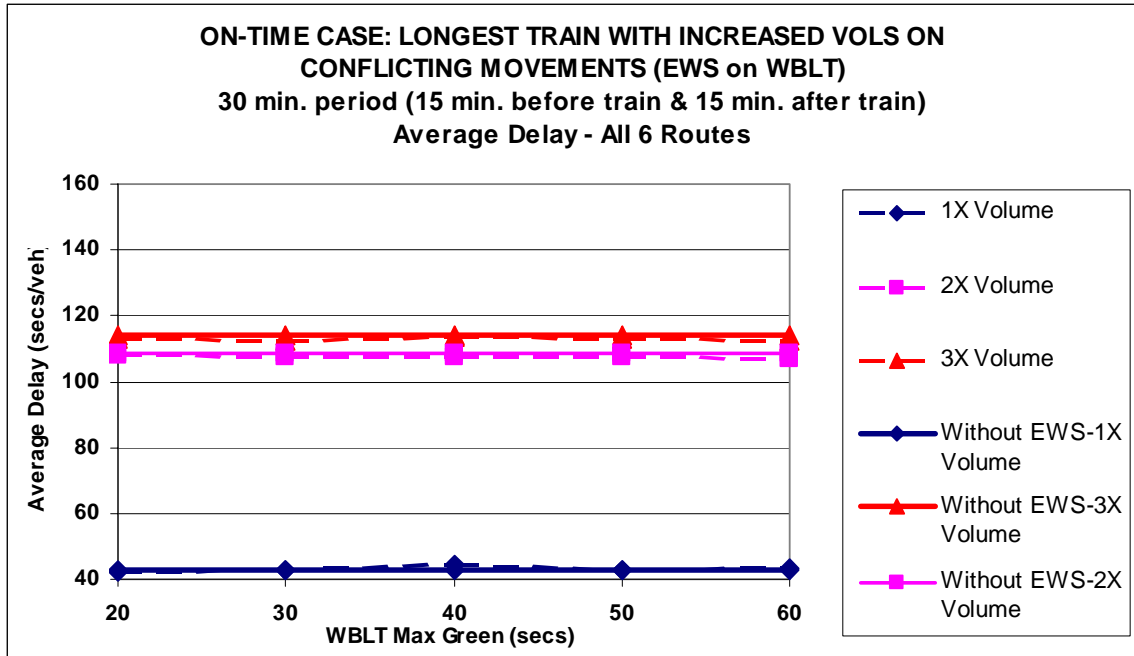

Figure 17: Delay For Increased Relative Volumes Using EWS on WB LT

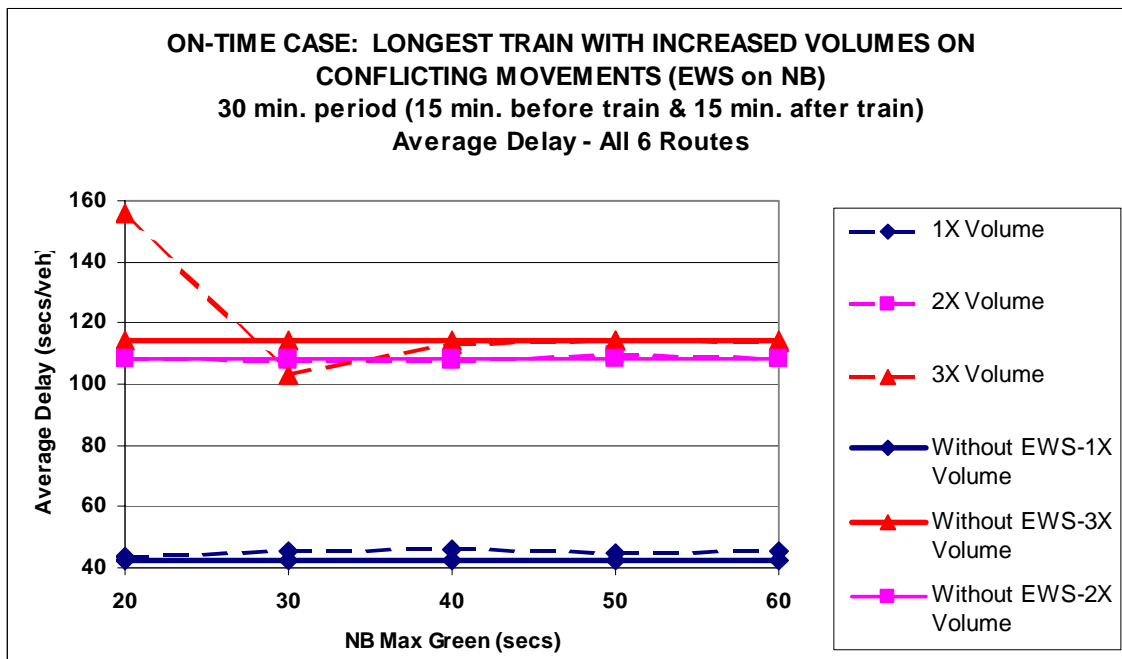

Figure 18: Delay For Increased Relative Volumes Using EWS on NB

7.3.4. Early and Late Train Arrivals Versus Predicted On-Time Arrival

Case 1, 2, 3, and 6 explored the effect on MOEs of the train arriving early by 25 seconds and late by 25 seconds compared to arriving on-time. The results for the four cases do not show a pattern, so only Case 1 is discussed here.

Figure 19 shows the impacts of the longest train arriving 25 seconds early and 25 seconds late when the EWS gave “extra” green to WB LT, which times concurrently with WB TH and NB RT (an overlap). In retrospect, these plus/minus prediction errors of 25 seconds are probably too large for what will actually happen in the field. It is believed that the geometrics of the train and its posted speed limits will make prediction error smaller. But even for these large prediction errors, the impacts are not great, but delay does increase as the amount of EWS green time increases.

Figure 20 shows the impacts of prediction error when the EWS gave “extra” green to NB LT and NB RT. It is important to first note that all of the arrival times, early, on-time, and late, result in longer delay than if no EWS were used. Again, the delay does increase as the amount of EWS green time increases.

The impact of arriving late or early, within reasonable limits, does not seem to have a dramatic effect on the MOEs compared to arriving on-time.

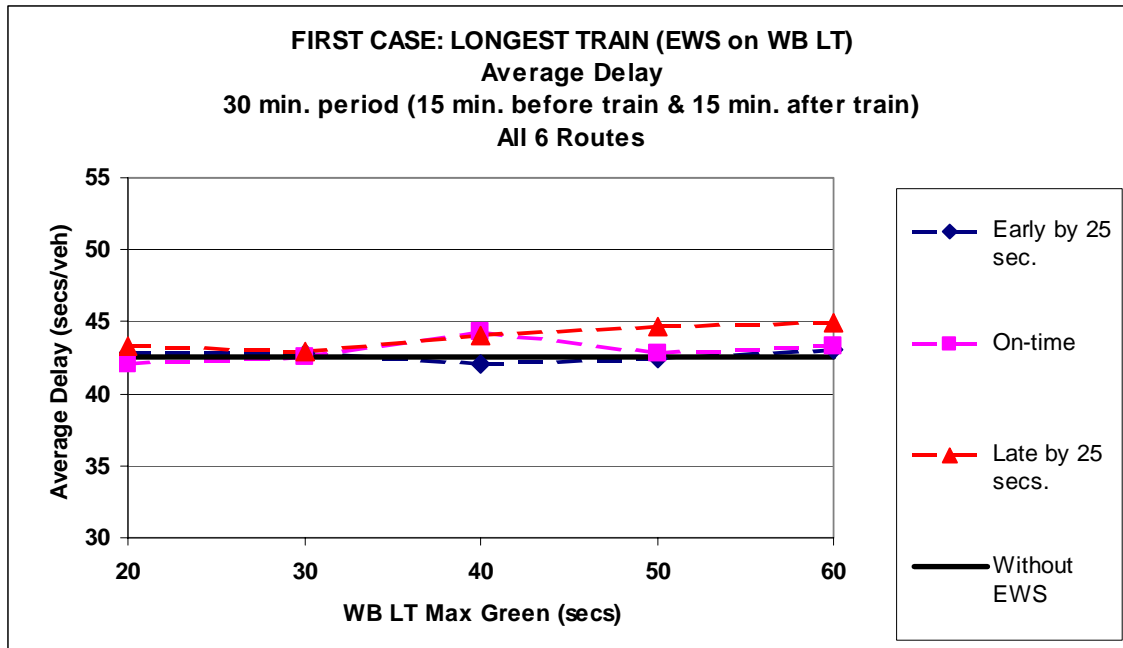

Figure 19: Delay For Early, Late, And On-Time Arrivals Using EWS on WB LT

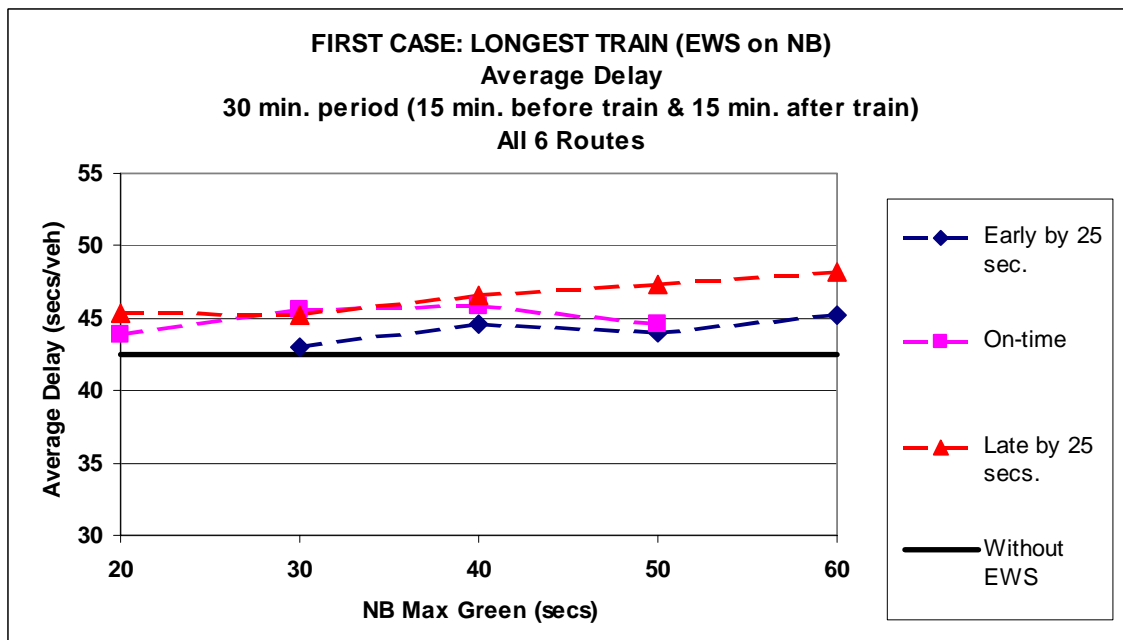

Figure 20: Delay For Early, Late, And On-Time Arrivals Using EWS on NB

7.3.5. Impacts on Targeted Queue Lengths

The research question has a global implication, which has been explored by the cases already discussed. These cases look at impact of the EWS on the overall performance of the intersection when a train passes. These results do not appear to provide useful overall intersection benefits for the study intersection.

Another way to look at the research question is on a micro level wherein a specific movement may be the primary concern. If this were the case, and the “costs” to the overall intersection performance could be borne, then would the EWS significantly reduce the problem on a single targeted movement or perhaps movements? Two single movements at the study intersection were candidates for studying the impact of the EWS on them: WB LT and NB (NB RT and NB LT combined).

Figure 21 shows the impacts on WB LT queue length when the EWS gave “extra” green to WB LT, which times concurrently with WB TH and NB RT (an overlap). The impacts on both the average queue and the maximum queue over the 30-minute MOE period are shown resulting in little improvement.

Figure 22 shows the impacts on NB (NB RT and NB LT combined) queue length when the EWS gave “extra” green to NB LT and NB RT. These results appear to have a more significant improvement. Keep in mind, however, that this improvement comes at a cost to overall intersection delay.

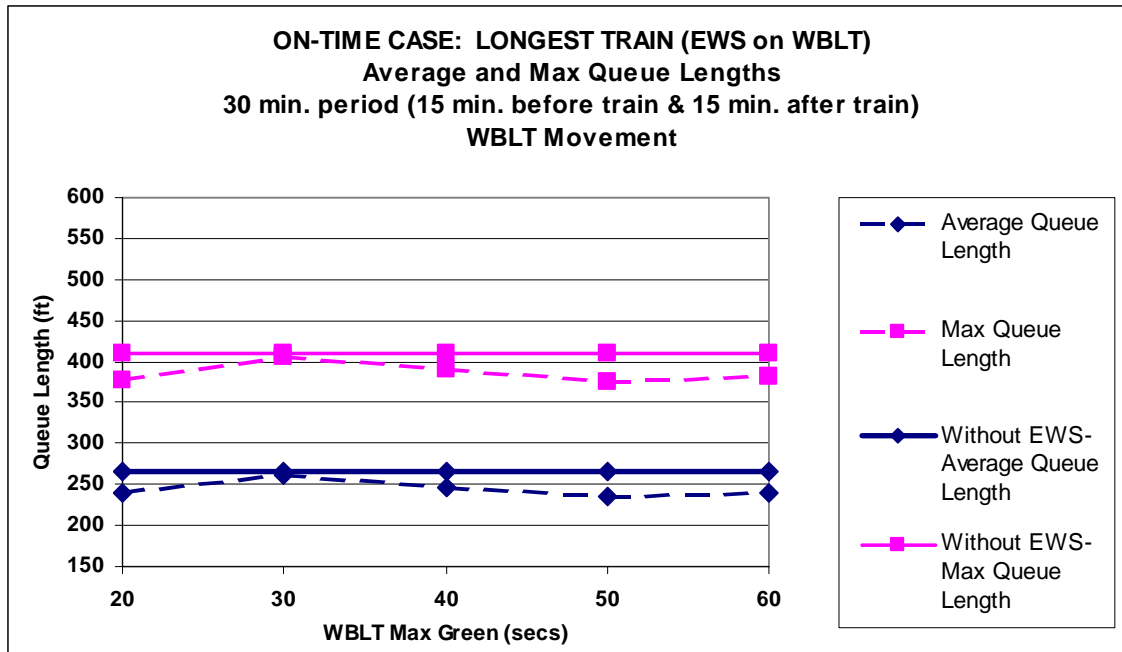

Figure 21: Impact on Targeted Queue Using EWS on WB LT

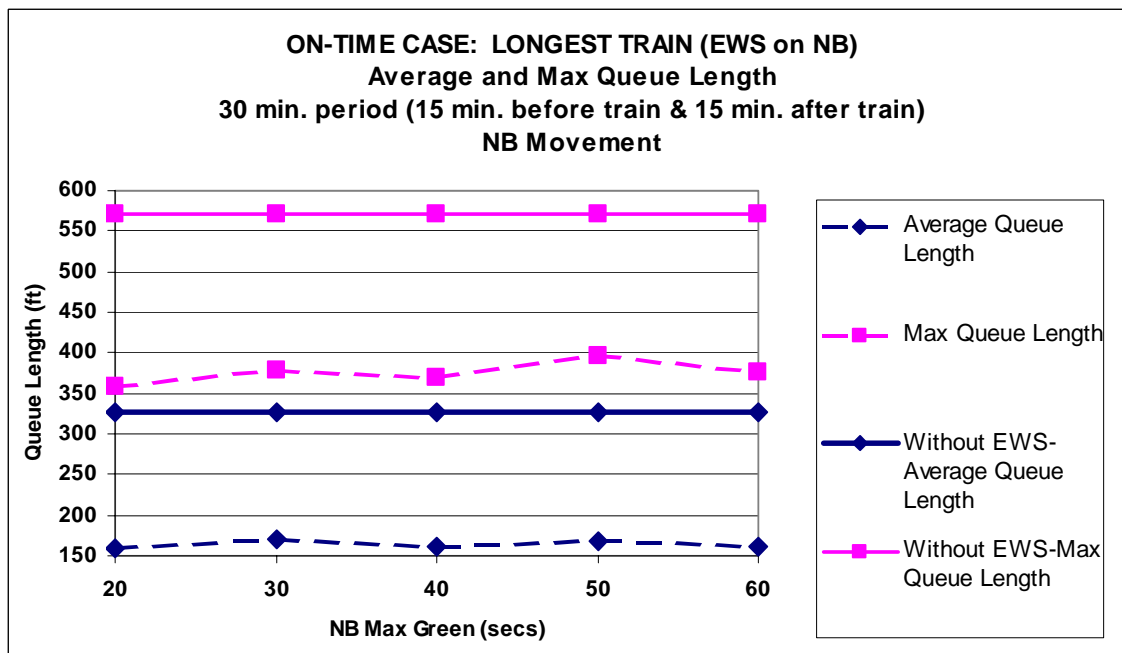

Figure 22: Impact on Targeted Queue Using EWS on NB

(blank)

8. HARDWARE-IN-THE-LOOP (HIL) TESTING

8.1. BENEFITS OF HIL TESTING

“Hardware-in-the-loop simulation refers to a computer simulation in which some of the components of the simulation have been replaced with actual hardware. Hardware-in-the-loop simulation has been successfully used in the aerospace and defense industries for a number of years, and has migrated to the traffic engineering field in the last decade.

“In a hardware-in-the-loop traffic simulation, the traffic control component of the simulation (i.e., the internal controller emulation logic) is replaced with real traffic signal control hardware. The simulation model runs in real time, in other words, one second of simulation takes one second. The simulation model generates detector actuations by modeling simulated vehicles crossing simulated detectors. The simulated detector actuations are then sent to the controller hardware, which reacts to them as it would a real detector actuations by updating phase indications according to the phasing and timing plan programmed in the controller. The phase indications are subsequently read back from the controller hardware to the simulation and assigned to the simulated traffic signals. The simulated vehicles then react to the simulated traffic signals by stopping or departing as appropriate.” (Roelof et al, 2000, pp. 1-2)

Two primary benefits of using HIL are:

- All the benefits of using a microscopic traffic simulation modeling environment apply to HIL. This allows the testing of a strategy’s failure or success without endangering motorists and well before field trials.
- The ability to test a strategy in the actual signal controller hardware itself.

In microsimulation, computer software simulates the traffic signal controller. This simulated controller provides most of the common controller functions and parameters, but today’s traffic controllers are complex and no program currently has all of their functionality. When testing a new algorithm, there is no certainty that something that works in simulation will actually work the same way when installed in an actual controller.

Specifications for National Electrical Manufacturers Association (NEMA) TS-1 and TS-2 traffic signal controllers require all vendors to provide standardized detector inputs and phase outputs, and the vendors compete by offering additional features. This results in numerous control parameters and algorithms being available to the traffic engineer that cannot currently be modeled in any microscopic traffic simulation software. It is these additional features that are often used to try a new technique or algorithm. (Bullock and Catarella, 1998)

An explicit part of this study was to ensure that the resulting algorithm could be installed in a standard NEMA traffic signal controller. HIL coupled to the simulation software provides the capability to test and document this.

8.2. METHODOLOGY AND EQUIPMENT

On State routes, ADOT uses NEMA-standard traffic controllers, running in Type 1 mode. The Flagstaff study site utilizes an Econolite controller, and therefore an Econolite ASC/2S-2100 controller was used for the HIL testing (see also Sec. 3.1.2). The controller and computer were connected using special hardware and software that allows real-time HIL simulation testing. The hardware and software were developed by the National Institute for Advanced Transportation Technology (NIATT) at the University of Idaho and commercialized by McCain Traffic Supply, Inc. This computer interface device is called the McCain-NIATT CID II (“CID II”). The HIL testing was performed according to the CID II operations manual. (McCain Traffic Supply and NIATT, Version 2, circa 2003)

The CID II provides a real-time link between the VISSIM traffic simulation model and the NEMA traffic controllers; it also has the ability to work with Type 170 controllers. The HIL testing was conducted in conjunction with VISSIM 3.70 software. The concept of the HIL is shown in Figure 23.

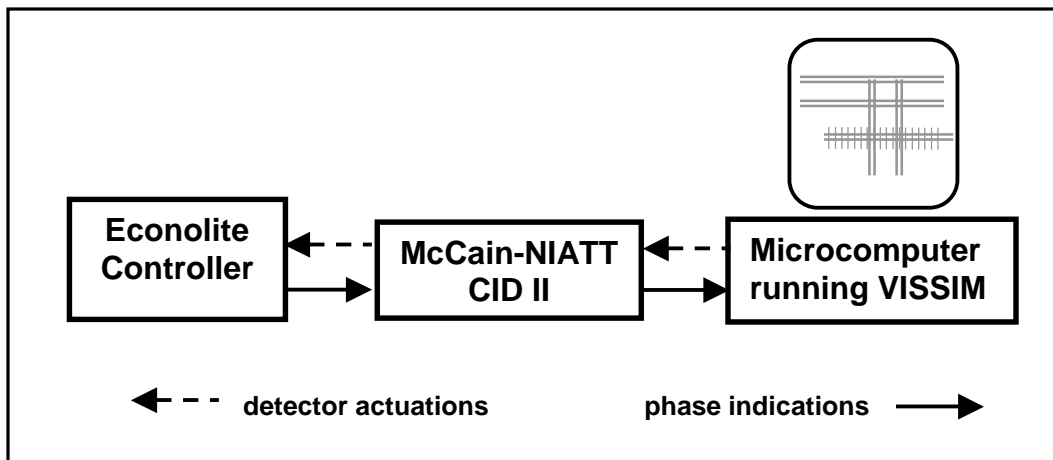

Figure 23: Hardware-In-The-Loop Schematic Using McCain-NIATT CID II

The CID II maps the inputs and outputs between the Econolite controller and the VISSIM simulation model. The CID II Configuration Tool tells VISSIM that an external traffic signal controller governs the intersection simulation. It also maps the Econolite signal controller detector input number to the specific simulated detector location for that movement in the VISSIM model. Likewise, it maps the Econolite signal controller signal head outputs for each movement to the specific VISSIM model simulated movement signal light indication. A photograph of the physical setup of the Econolite ASC/2S-2100 controller coupled to the CID II coupled to the VISSIM model is shown in Figure 24.

After the CID was configured to communicate with the VISSIM software, the input file, which defines all the model parameters, was modified from within so that a real-time HIL simulation could be run in the model. Since the Econolite controller can only run in real time, the simulation parameters in VISSIM were modified so the “Rate of Simulation”

and “Time Steps per Simulation Second” were both set to 1.0, i.e., one second of simulated time equals one second of real time. Normally VISSIM runs much faster than real time, e.g, 10 seconds of simulated time only takes one second of real time.

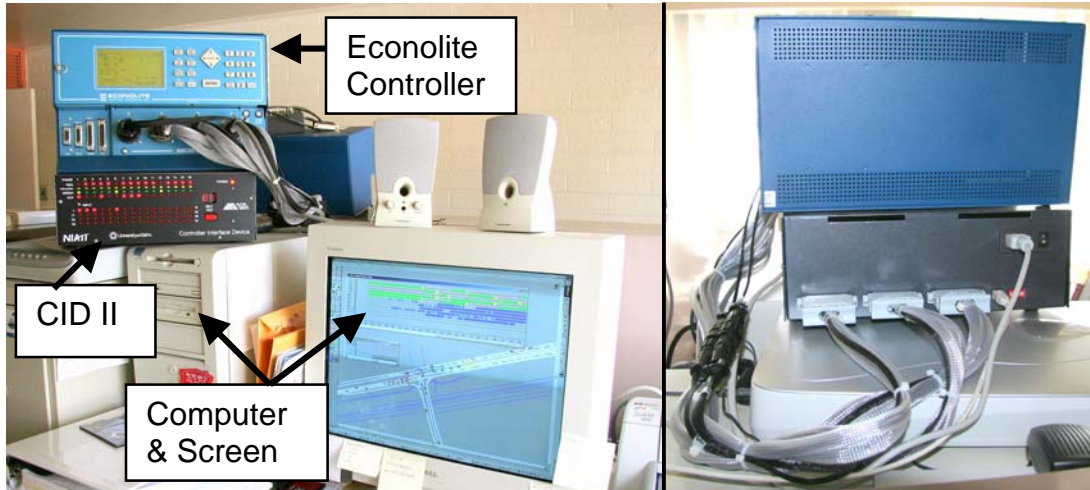

Figure 24: Econolite Controller--CID II--VISSIM Model Setup

Left photo shows all three components. First in the top left of the photo is the Econolite ASC/2S-2100 Controller; the NEMA Type 1 A, B, C, and D plug wires from the front of the controller connect to the back of the second component, the CID II, which is the box just below the controller. A wire connects the back of the CID II to the computer, which is the third component. The right photo shows the backs of the CID II (bottom) and Econolite controller (top). The three bottom rectangular plugs from the back of the CID II are connected to the A, B, C, and D plugs in the front of the controller. The top plug from the CID II connects to the back of the computer with a single wire (USB- type connectors).

8.3. IMPLEMENTATION USING NEMA TRAFFIC CONTROLLER

The Econolite ASC/2S-2100 NEMA controller has 6 standard preemptions, with the highest priority being preemption 1 and the lowest being preemption 6. The EWS algorithm linked four standard preemptions together, preemptions 6, 5, 4, and 3, with each preemption timing a separate leg's movement. A four-leg intersection requires four preemptions to implement the EWS. The EWS triggers preemption 6 to start the EWS. When preemption 6 has finished timing one leg of the EWS algorithm, it calls the next lower preemption to time the next leg. This continues until the last leg is timed by preemption 3. If a train arrives later than predicted and preemption 3 finishes timing, the EWS ends and returns control to the normal signal cycle sequence.

Regardless of what the EWS is doing, when a train arrives at the crossing it always activates preemption 1 immediately. Preemption 1 starts timing the train track clearance movements. If the train arrives at the predicted time, EWS preemption 3 is timing the last leg of the EWS, which are also the track clearance movements. Preemption 1 immediately aborts EWS preemption 3 and continues to time the track clearance

movements for the period of time allocated in the train preemption programming. Once aborted, the EWS does not run again until the next train approaches.

At the study site, only two EWS preemptions are needed because it is a tee intersection. When the EWS is initiated and calls EWS preemption 6, the conflicting WB LT movement is served along with the non-conflicting WB TH and the conflicting NB RT movements. When these movements time out, EWS preemption 6 calls EWS preemption 3, which then serves the conflicting NB LT and NB RT movements (EWS preemptions 5 and 4 are unused). When the train arrives, train preemption 1 is called, which aborts EWS preemption 3 and ends the EWS. Preemption 1 is programmed by ADOT to first serve the movements queued across the tracks. These movements are the NB LT and NB RT, which were already timing under EWS preemption 3, so they continue to time after train preemption 1 interrupts EWS preemption 3. The EWS algorithm is designed to be timing the movements queued across the tracks when the train preemption signal arrives.

If the train arrives earlier than predicted, then the EWS preemption 6 would still be timing WB LT, WB TH, and NB RT. Since the train preemption 1 has priority, EWS preemption 6 would immediately be aborted. Built into the NEMA controller logic is a method of terminating the movement that is timing when a preemption begins and needs to switch to a different movement. The first step is checking whether the movement has received a minimum green time (five seconds for this study). If the answer is "yes," the controller cycles to yellow (change interval), then all red (clearance interval). If not, the green time continues until the minimum is reached, then the yellow and all red intervals are run. The controller has options to use new yellow and all red intervals, or it can use those intervals used in the normal cycle timing.

For the HIL testing, an Econolite ASC/2S-2100 controller was programmed using the same normal cycle and train preemption 1 timing plans as used in the VISSIM-simulated controller. The EWS algorithm for preemptions 6 and 3 was also programmed into the Econolite controller. The HIL simulation was run and the Econolite ASC/2S-2100 NEMA controller accurately timed its programmed EWS, bypassing the VISSIM computer-simulated EWS and thereby proving that the EWS algorithm can be implemented in a standard NEMA controller.

It is important to note one key difference used in the HIL testing from what would be actually implemented in the field. This difference can be most easily understood by comparing the following descriptions of the field and HIL testing methods.

- Field testing of EWS: A small field-hardened microcomputer is located in the controller cabinet and receives the train-approach data from the EWS detector(s). The microcomputer then predicts the train's arrival time at the crossing and at the appropriate time activates the EWS algorithm in the controller by sending a signal to the controller that calls preemption 6.
- HIL simulation testing of EWS: The EWS algorithm and normal controller functions are contained in the Econolite ASC/2S-2100 controller, just as in field testing. However, the prediction of the train's arrival is not used because the simulated EWS train approach detector is positioned in the VISSIM model upstream from the crossing such that it directly activates the EWS when a train

passes over it. Its location corresponds to that needed for a 50 mph train speed, which is assured because this is set as a constant in the VISSIM model.

When programming the controller preemptions, it was noted that the controller did not call a lower preemption directly from a higher preemption while the higher preemption was still receiving a call. This occurred when EWS preemption 6 finished timing, but was still receiving a call from the EWS detector and therefore did not call EWS preemption 3. The EWS detector in the VISSIM model will send a call continuously during the entire time the train is passing. The train is still over the EWS detector and therefore is still sending a EWS preemption 6 call (presence mode), when EWS preemption 6 times out and needs to call for EWS preemption 3. The solution to this problem is to have the detector send a pulse call, rather than a presence call.

Another slight complication was that phase number 8 was used in the VISSIM simulation for the NB RT movement. In a NEMA controller, the even phase numbers are assumed to be through movements and the odd phase numbers are assumed to be left turn movements. Protections exist within the controller logic so even numbered movements will not time concurrently with conflicting odd numbered movements. If the NB RT was designated as phase 8 in an Econolite controller, it could not time concurrently with phase 1, because the controller's logic would interpret these as conflicting movements. Designating NB RT as Overlap D corrected this in the controller. This concurrently times NB RT with phase 1 (WB LT) and phase 3 (NB LT), which duplicated the VISSIM model's use of phase 8 as the NB RT. This works because there are no pedestrian movements in the study model. But at the actual intersection there are pedestrian movements, which makes programming phase 8 as NB RT useful. The Econolite controller could be programmed to override the protections, but this is more complex and was not required to duplicate the VISSIM simulated controller without pedestrian movements.

8.4. SUMMARY OF RESULTS

The HIL configuration shown in Figure 24 tested the VISSIM model using the Econolite ASC/2S-2100 NEMA to perform all normal controller and EWS functions. The EWS testing parameters were a 4.5 minute duration train that triggered the EWS to initially time WB LT (which runs concurrently with WB TH and NB RT) for 30 seconds followed by its yellow and all red intervals. Next, the EWS timed the NB LT and NB RT green; this is aborted when the train gets close enough to the crossing to trigger the train preemption 1. The EWS starts by calling EWS preemption 6, which times the WB LT, WB TH, and NB RT, and then calls EWS preemption 3. EWS preemption 3 times NB LT and NB RT until it is aborted by train preemption 1. Train preemption 1 times its track clearance movements (NB LT and NB RT), then times its hold phases (WB TH and EB TH), then when the train has passed, it times its exit movements (NB LT and NB RT) and places calls on its exit calls (WB LT).

The VISSIM model was first run with the EWS algorithm simulated in the VISSIM model and then run using HIL with the algorithm programmed in the Econolite ASC/2S-2100 controller using preemptions 6 and 3. The run results were compared in two ways:

- The detailed movement timings recorded by the VISSIM software of the simulated EWS were compared with the movement timings of the EWS programmed in the Econolite controller.
- Using a stopwatch, the calls and the timings of the EWS programmed in the Econolite controller were checked against the events happening in the VISSIM model.

Both methods verified that the EWS algorithm can be implemented in the Econolite ASC/2S-2100 NEMA controller. This was one of the parts of the *Research Question* that motivated this study, and it adds general support to using HIL techniques to test any new traffic control scheme before it is a candidate for a field trial.

9. CONCLUSIONS

While these studies were not conclusive, some generalizations appear to be supported by the results, but more studies at other sites would have to be done to conclusively verify or dispute them. This is due to the complexity of the results, which was unanticipated when the project was started. Other confounding factors may be caused by the unique combination of site geometrics, traffic flows, and railroad flows, which may in this case defy an EWS solution.

9.1. EFFECTIVENESS HIGHLY DEPENDENT ON THE SITE

The first general conclusion is that the effectiveness of the EWS is highly dependent on the site, both its geometry and vehicle/train traffic flows. While this is obvious to the problem at hand, it is more complex than it first appears.

One critical factor appears to be the relative flows at the intersection. Giving “extra” green time to an EWS movement reduces that movement’s delay, as expected. This is conditioned on there being vehicles actually available (vehicles waiting, so to speak) to use the “extra” green, which is discussed later. But the cost of giving this “extra” green time is that it is “stolen” from all the other movements. What is complex about this “stolen” time is that it not only steals it from non-conflicting movements, but it also steals it from any conflicting movements except the one receiving the “extra” green time or timing concurrently with it. When it steals from another conflicting movement, this actually reduces the benefit, while stealing from non-conflicting movements increases the costs.

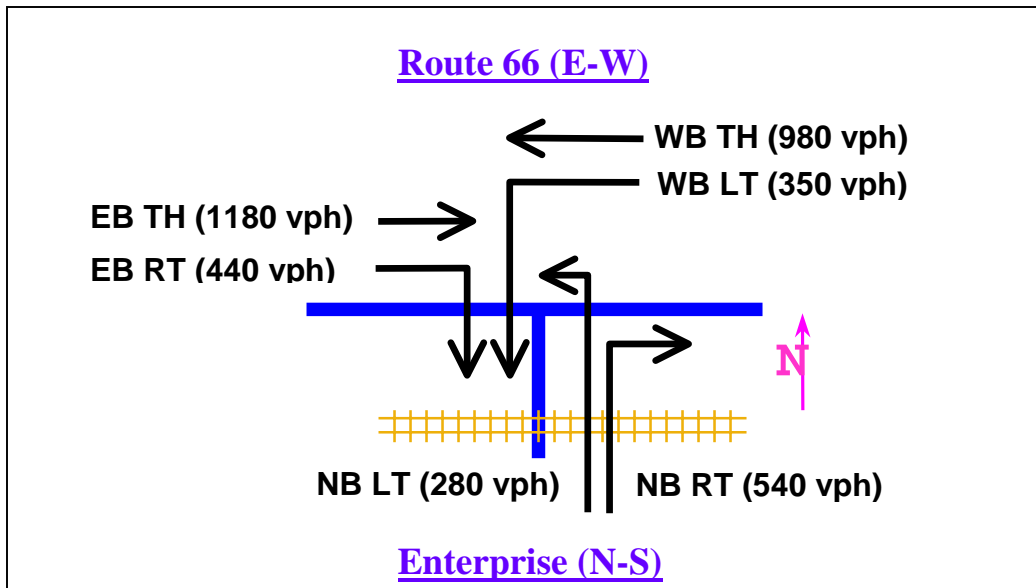

Figure 25: Modeled Volumes During Peak 30 Minutes Centered On Train Arrival

Figure 25 shows the average vehicle flow rates at the study site during the 30-minute period used for the MOEs. What can be seen is the absence of a dominating one-direction flow of traffic that crosses the railroad track. Such a dominating flow was envisioned when the study question was proposed. It is possible that such a site might yield quite different results.

9.2. VEHICLES MUST BE PRESENT TO USE THE EWS GREEN TIME

A presumption at the onset of this study was that if a conflicting movement receives “extra” green time before a train arrived, it would efficiently use it. This may not be the case unless there are cycle failures before the train arrives. Without these cycle failures, there may not be enough vehicles present to effectively use the EWS green when it is displayed. This may especially be true when longer EWS green times are used.

Put another way, the passing train causes the congestion by blocking the conflicting movements. After this occurs, cycle failures occur on the conflicting movements and in severe cases may continue for quite some time. But if this failure hasn’t happened before the train arrives, then the EWS can only “help” those vehicles that are there, which may not be a significant volume.

Special situations may occur at some sites that create cycle failure before the train passes. One such case might be the passing of a second train before the congestion from the first train had cleared the intersection. With the continued projected increase in urban sprawl along highways that parallel a railroad, this may occur more frequently in the future. Such situations might be good candidates for studying the implementation of an EWS.

9.3. QUEUE LENGTH ISSUES MAY SUPPORT INCREASED EWS DELAY

Even if an EWS exacts an increase in overall intersection delay, situations might occur where this is acceptable. Some examples might be where a queue backs up into a neighboring intersection, or overflows from an off-ramp and backs up onto a freeway. In cases such as these, an increase in overall intersection delay might be a reasonable trade-off for increased safety.

9.4. EWS MAY BE USEFUL FOR OTHER PURPOSES

The study has approached the research question focusing on using the EWS detection to take control of the intersection traffic signals. Other related uses may also reduce the congestion caused by a passing train at the intersection. One example is the use of Dynamic Message Signs. The concept is that several components of the EWS could be used to alert upstream drivers, via DMSs, of an approaching train, resulting in a diversion of traffic to alternate routes.

The project TAC discussed this concept in detail for the Flagstaff study site. Flagstaff is currently constructing a Fourth Street railroad flyover upstream of the WB LT movement to the east on Route 66 at Fourth Street. Vehicles approaching the study site intersection from the east and south could be alerted to take the flyover and avoid the at-grade crossing altogether.

10. RECOMMENDATIONS

The Early Warning System appears to be ineffective for the selected study intersection. However, two site traffic characteristics may be confounding the results. One factor is the ability of conflicting movements to use the EWS green time because of less than saturated flow rates at these times; the other is the lack of a dominating, one-way conflicting flow at the intersection. Effectiveness of an EWS when these two potential confounding factors are avoided bears further investigation.

It is recommended that a site be found and studied that has these characteristics:

- One-direction flow through a conflicting movement that highly dominates the overall intersection flows.
- Significant queues at the conflicting movement that can deliver vehicles at near saturation flow rates when it is given EWS green before the train arrives.
- The site should have conditions where use of a Dynamic Message Sign would divert measurable traffic from the intersection.

Because of the cost of a detailed site study, a four-step study approach of a new site is recommended. The first step would entail modeling the intersection using the minimum amount of data needed make the modeling realistic. This would require little field data collection and could possibly rely on existing vehicle traffic flow data and economically collected train data. The primary work tasks would be computer modeling. This would reduce the cost of this step significantly, and while it would not be conclusive if it were successful, it would probably be sufficient to stop the project if it failed.

The second step would upgrade the model to a detailed model. This would require the collection of detailed traffic and train data at the site. This data would be used to calibrate and validate a detailed site model. This model would be used to thoroughly test the EWS at the site.

The third step would involve a test of three of the EWS components. The first component would be the traffic signal controller with an EWS algorithm imbedded, which would be tested using hardware-in-the-loop. The second component would be the EWS sensor(s), which would be installed and tested in the field. The third component would be the DMS. Field trials would be used to test the communication system between it and the intersection, as well as its effectiveness in diverting traffic.

The last step would be a full field test. This would first involve installing and tweaking the system. Once working properly, field measurements of MOEs at the site would need to be collected. The DMS would also be tested at this time. Assuming that the test was successful and the system was left in place, the field technicians servicing the equipment would be trained.

(blank)

APPENDIX A. LITERATURE REVIEW

During this research, a literature search was conducted in five primary areas of interest:

- Microscopic Traffic Simulation Models.
- Algorithm Development.
- Highway-Railroad Crossing Traffic Signal Preemption.
- Highway-Railroad Crossing Issues.
- Hardware-In-The-Loop Simulation.

These references may be of interest to some readers and are listed here. If a reference reports a useful body of work in more than one interest area, it is repeated under each area. Any specific references cited in the text of this report are listed in the subsequent REFERENCES section.

A.1. MICROSCOPIC TRAFFIC SIMULATION MODELS

Arroyo, Bernard J. and Seth Torma. "Micro-simulation Modeling using the VISSIM Software Package." Compendium of Papers at Institute of Transportation Engineers, District 6 Annual Meeting, San Diego, CA, June, 24-28, 2000, 5pp.

Barcelo, Jaime and Jordi Caras. "Methodological Notes on the Calibration and Validation of Microscopic Traffic Simulation Models." National Research Council, Transportation Research Board, 83rd Annual Meeting, Washington, D.C., January 2004, 31 pp.

Bayarri, M.J., James O. Berger, German Molina, Nagui M. Roupail, and Jerome Sacks. "Assessing Uncertainties in Traffic Simulation: A Key Component in Modeling Calibration and Validation." National Research Council, Transportation Research Board, 83rd Annual Meeting, Washington, D.C., January 2004, 32 pp.

Ben-Akiva, Moshe E., Deepak Darda, Mithilesh Jha, Haris N. Koutsopoulos, and Tomer Toledo. "Calibration of Microscopic Traffic Simulation Models with Aggregate Data." National Research Council, Transportation Research Board, 83rd Annual Meeting, Washington, D.C., January 2004, 15 pp.

Bloomberg, Loren and Jim Dale. "Comparison of VISSIM and CORSIM Traffic Simulation Models on a Congested Network." *Transportation Research Record 1727*, Transportation Research Board, National Research Council, Washington, D.C., 2000, pp. 95-100.

Brockfeld, Elmar, Reinhart D. Kuhne, and Peter Wagner. "Calibration and Validation of Microscopic Traffic Flow Models." National Research Council, Transportation Research Board, 83rd Annual Meeting, Washington, D.C., January 2004, 14 pp.

Chu, Lianyu, Henry X. Liu, Jun-Seok Oh, and Will Recker. "A Calibration for Microsimulation Traffic Simulation." National Research Council, Transportation Research Board, 83rd Annual Meeting, Washington, D.C., January 2004, 25 pp.

Cohen, S.L. "An Approach to Calibration and Validation of Traffic Simulation Models." National Research Council, Transportation Research Board, 83rd Annual Meeting, Washington, D.C., January 2004, 15 pp.

Dowling, Richard, Alexander Skabardonis, John Halkias, Gene McHale, and Grant Zammit. "Guidelines for Calibration of Microsimulation Models: Framework and Applications." National Research Council, Transportation Research Board, 83rd Annual Meeting, Washington, D.C., January 2004, 23 pp.

Dowling, Richard, Alexander Skabardonis, and Vassili Alexiadis. Traffic Analysis Toolbox Volume III: Guidelines for Applying Traffic Microsimulation Modeling Software, FHWA-HRT-04-040, Office of Operations, Federal Highway Administration, Washington, D.C., July 2004.

Feng, Yuqi, Joseph Perrin, Jr., and Peter T. Martin. "Bus Priority of SCOOT Evaluated in a VISSIM Simulation Environment." National Research Council, Transportation Research Board, 82nd Annual Meeting, Washington, D.C., 2003. 20 pp.

Gomes, Gabriel, Adolf May, and Roberto Horowitz. "A Microsimulation Model of a Congested Freeway using VISSIM." National Research Council, Transportation Research Board, 83rd Annual Meeting, Washington, D.C., January 2004, 23 pp.

Merritt, Eugene. "Calibration and Validation of CORSIM for Swedish Road Traffic Conditions." National Research Council, Transportation Research Board, 83rd Annual Meeting, Washington, D.C., January 2004, 24 pp.

Ngan, Vikki, Tarek Sayed, and Akmal Abdelfatah. "Evaluation of Transit Signal Priority Strategy Using VISSIM." National Research Council, Transportation Research Board, 83rd Annual Meeting, Washington, D.C., January 2004, 21 pp.

Ni, Daiheng, John D. Leonard, Angshuman Guin, and Billy M. Williams. "A Systematic Approach for Validating Traffic Simulation Models." National Research Council, Transportation Research Board, 83rd Annual Meeting, Washington, D.C., January 2004, 24 pp.

Nsour, S.A., Santiago, A.J. "Comprehensive Plan Development for Testing, Calibration and Validation of CORSIM." Compendium of Technical Papers, Annual Meeting-Institute of Transportation Engineers, Institute of Transportation Engineers, Washington D.C., 1994, 486 pp.

Reinke, David, Richard Dowling, Robert Hranac, and Vassilios Alexiadis. "Development of a High-Level Algorithm Verification and Validation Procedure for Traffic Microsimulation Models." National Research Council, Transportation Research Board, 83rd Annual Meeting, Washington, D.C., January 2004, 22 pp.

Rilett, L. R., Kyu-Ok Kim, and Bryan Raney. "Comparison of Low-Fidelity TRANSIM and High-Fidelity CORSIM Highway Simulation Models with Intelligent Transportation System Data." *Transportation Research Record 1739*, Transportation Research Board, National Research Council, Washington, D.C., 2000, pp. 1-8.

Rilett, L.R., Kim, K-O. "Comparison of TRANSIMS and CORSIM Traffic Signal Simulation Modules." *Transportation Research Record 1748*, Transportation Research Board, National Research Council, Washington, D.C., 2001, pp. 18-25.

Tian, Zong Z., Thomas Urbanik II, Roelof Engelbrecht, and Kevin Balke. "Variations in Capacity and Delay Estimates from Microscopic Traffic Simulation Models." *Transportation Research Record 1802*, Transportation Research Board, National Research Council, Washington, D.C., 2002, pp. 23-31.

Toledo, Tomer and Haris N. Koutsopoulos. "Statistical Validation of Traffic Simulation Models." National Research Council, Transportation Research Board, 83rd Annual Meeting, Washington, D.C., January 2004, 16 pp.

Zang, Li, James Colyar, John Halkias, and Yunlong Zhang. "CORSIM Sensitivity Analysis and its Application in Model Validation and Calibration at Signalized Intersections." National Research Council, Transportation Research Board, 83rd Annual Meeting, Washington, D.C., January 2004, 23 pp.

Zhang, L., Hobeika, A.G., Ghaman, R. "Optimizing Traffic Network Signals Around Railroad Crossings: Model Validations." *Transportation Research Record 1811*, Transportation Research Board, National Research Council, Washington, D.C., 2002, pp. 139-147.

Zhang, Yunlong and Larry E. Owen. "Systematic Validation of a Microscopic Traffic Simulation Program." National Research Council, Transportation Research Board, 83rd Annual Meeting, Washington, D.C., January 2004, 22 pp.

A.2. ALGORITHM DEVELOPMENT

Abbas, M., Bullock, D., Head, L. "Real-Time Offset Transitioning Algorithm for Coordinating Traffic Signals." *Transportation Research Record 1748*, Transportation Research Board, National Research Council, Washington, D.C., 2001, pp. 26-39.

Balke, K.N., Dudek, C.L., Urbanik, T., II. "Development and Evaluation of Intelligent Bus Priority Concept." *Transportation Research Record 1727*, Transportation Research Board, National Research Council, Washington, D.C., 2000, pp. 12-19.

Bullock, Darcy and Tom Urbanik. "Traffic Signal Systems: Addressing Diverse Technologies and Complex User Needs." *Transportation in the New Millennium*, Transportation Research Board, National Research Council, Washington, D.C., 2000, 9 pp.

Cho, Hanseon and Laurence R. Rilett. "Improved Transitional Preemption Strategy For Traffic Signals At Intersections Near Highway-Railway Grade Crossings." National Research Council, Transportation Research Board, 83rd Annual Meeting, Washington, D.C., January 2004, 22 pp.

Cho, Hanseon and Laurence R. Rilett. "Forecasting Train Travel Times At At-Grade Crossings." *Transportation Research Record 1844*, Transportation Research Board, National Research Council, Washington, D.C., 2003, pp. 94-109.

Estes, R. Matthew, Rilett, Laurence R. "Advanced Prediction of Train Arrival and Crossing Times at Highway-Railroad Grade Crossings." *Transportation Research Record 1708*, Transportation Research Board, National Research Council, Washington, D.C., 2000, pp. 68-76.

Janos, Melanie, Furth, Peter G. "Bus Priority with Highly Interruptible Traffic Signal Control: Simulation of San Juan's Avenida Ponce de Leon." *Transportation Research Record 1811*, Transportation Research Board, National Research Council, Washington, D.C., 2002, pp. 157-165.

Liu, Hongchao, Skabardonis, Alexander, Zhang, Wei-bin. "A Dynamic Model for Adaptive Bus Signal Priority." National Research Council, Transportation Research Board, 82nd Annual Meeting, Washington, D.C., January 2003, 20 pp.

Park, Byungkyu "Brian" and Anil Kamarajugadda. "Stochastic Optimization of Traffic Signal at an Isolated Intersection." National Research Council, Transportation Research Board, 83rd Annual Meeting, Washington, D.C., January 2004, 14 pp.

Ruback, L., "Train Notification System Alerts Drivers," *Texas Transportation Researcher*, Vol. 37, Issue 4, Texas Transportation Institute, 2001, pp. 8-9.

Science Applications International Corporation. *Advanced Warning for Railroad Delays in San Antonio: Lessons Learned From The Metropolitan Model Deployment Initiative: A successful Proof of Concept*. Joint Program Office for Intelligent Transportation Systems, U.S. Department of Transportation, Washington, D.C., 2000, 11pp.

A.3. HIGHWAY-RAILROAD CROSSING SIGNAL PREEMPTION

Bullock, D., Morales, J.M., Sanderson, B., Jr. *Evaluation of Emergency Vehicle Signal Preemption on the Route 7 Virginia Corridor*. FHWA-RD-99-070, Final Report, Federal Highway Administration, July 1999, 28 pp.

Jacobson, M.S. "An Investigation of Traffic Signal Preemption at Railroad-Highway Grade Crossings." In the Compendium: *Graduate Student Papers on Advanced Surface Transportation Systems*, Editor C.L. Dudek, Texas Transportation Institute, College Station, TX, August 1997, pp. 37.

Lucas, David E., Mirchandani, Pitu B., Head, K. Larry. "Testing Real-Time Control Strategies Using Client/Server Architecture via the Internet." National Research Council, Transportation Research Board, 79th Annual Meeting, Washington, D.C., January 2000, 18pp.

Marshall, Peter S., Berg, William D. "Evaluation of Railroad Preemption Capabilities of Traffic Signal Controllers." *Transportation Research Record 1254*, Transportation Research Board, National Research Council, Washington, D.C., 1990, pp. 44-49.

Nelson, E.J., Bullock, D. "Impact of Emergency Vehicle Preemption on Signalized Corridor Operation: An Evaluation." *Transportation Research Record 1727*, Transportation Research Board, National Research Council, Washington, D.C., 2000, pp. 1-11.

Seyfried, R.K. "Timing of Traffic Signal Preemption at Intersections Near Highway-Railway Grade Crossings." Compendium of Technical Papers, Annual Meeting-Institute of Transportation Engineers, Institute of Transportation Engineers, Chicago, IL, August 19-22, 2001, 22pp.

Sunkari, S.R., Beasley, P.S., Urbanik, T., II, Fambro, D.B. "Model to Evaluate the Impacts of Bus Priority on Signalized Intersections." *Transportation Research Record 1494*, Transportation Research Board, National Research Council, Washington, D.C., 1995, pp. 117-123.

Traffic Engineering Council Committee TENC-4M-35. *Preemption of Traffic Signals At or Near Railroad Grade Crossings with Active Warning Devices; A Recommended Practice of the Institute of Transportation Engineers*. Institute of Transportation Engineers, Washington D.C., 1997, 32pp.

Venglar, S. *Advanced Intersection Controller Response to Railroad Preemption*. High-Speed Rail IDEA Program Project Final Report, Transportation Research Board, Washington D.C., December 2001, 35 pp.

Venglar, S.P.; Jacobson, M.S.; Sunkari, S.R.; Engelbrecht, R.J.; Urbanik, T, II. *Guide for Traffic Signal Preemption Near Railroad Grade Crossing*. FHWA/TX-01/1439-9, Texas Transportation Institute, 2000, 64 pp.

A.4. HIGHWAY-RAILROAD CROSSING ISSUES

Alroth, W.A., Mansel, D.M., Siques, J.T., "Design Considerations for Pre-Signals at Highway-Railroad Grade Crossings." Enhancing Transportation Safety in the 21st Century ITE International Conference, Institute of Transportation Engineers, Kissimmee, FL, March 28-31, 1999, pp. 8.

Austin, R.D. and Carson, J.L. "An Alternative Accident Prediction Model for Highway-Rail Interfaces." *Accident Analysis and Prevention*, Elsevier Science, Ltd., Vol: 34 No: 1, January 2002, pp. 31-42.

Bullough, John D., Boyce, Peter R., Bierman, Andrew, Hunter, Claudia M., Conway, Kathryn M., Nakata, Akiko, Figueiro, Mariana G. "Traffic Control Devices, Visibility, and Rail-Highway Grade Crossings." *Transportation Research Record 1754*, Transportation Research Board, National Research Council, Washington, D.C., 2001, pp. 42-47.

Eck, Ronald W., Russell, Eugene R., Coleman III, Fred. "Railroad-Highway Grade Crossings: A Look Forward." *Transportation in the New Millennium*, Transportation Research Board, 2000, 7pp.

Engelbrecht, R. "Researchers Recommend 'quick fix' for Safer Rail Crossings." *Texas Transportation Researcher*, Texas Transportation Institute, 2001, Vol. 37, 6pp.

Gent, Steve J., Logan, Scott, Evans, David. "Automated-Horn Warning System for Highway-Railroad Grade Crossings: Evaluation at Three Crossings in Ames, Iowa." *Transportation Research Record 1708*, Transportation Research Board, National Research Council, Washington, D.C., 2000, pp. 77-82.

Khawani, V. "'Second Train Coming' Warning Sign Demonstration Project." *Transportation Research Record 1762*, Transportation Research Board, National Research Council, Washington, D.C., 2001, pp. 32-36.

A.5. HARDWARE-IN-THE-LOOP SIMULATION

Abbas, M., Bullock, D., Head, L. “Real-Time Offset Transitioning Algorithm for Coordinating Traffic Signals.” *Transportation Research Record 1748*, Transportation Research Board, National Research Council, Washington, D.C., 2001, pp. 26-39.

Abdel-Rahim, Ahmed, Zhen Li, and Michael Kyte. “Hardware-in-the-Loop Simulation: What’s the Difference?” National Research Council, Transportation Research Board, 83rd Annual Meeting, Washington, D.C., January 2004, 15 pp.

Balke, K.N., Dudek, C.L., Urbanik, T., II. “Development and Evaluation of Intelligent Bus Priority Concept.” *Transportation Research Record 1727*, Transportation Research Board, National Research Council, Washington, D.C., 2000, pp. 12-19.

Bullock, Darcy and Alison Catarella. “A Real-Time Simulation Environment for Evaluating Traffic Signal Systems.” *Transportation Research Record 1634*, Transportation Research Board, National Research Council, Washington, D.C., 1998, pp. 130-135.

Koonce, Peter J., Thomas Urbanik II, and Darcy Bullock. “Evaluation of Diamond Interchange Signal Controller Settings by Using Hardware-in-the-Loop Simulation.” *Transportation Research Record 1683*, Transportation Research Board, National Research Council, Washington, D.C., 1999, pp. 59-66.

Lucas, David E., Pitu B. Mirchandani, and K. Larry Head. “Remote Simulation to Evaluate Real-Time Traffic Control Strategies.” *Transportation Research Record 1727*, Transportation Research Board, National Research Council, Washington, D.C., 2000, pp. 95-100.

Roelof, Engelbrecht, J., Kevin N. Balke, Steven P. Venglar, and Srinivasa R. Sunkari. “Recent Applications of Hardware-in-the-loop Traffic Simulation.” Compendium of Papers at Institute of Transportation Engineers Meeting, Nashville, TN, August 6-9, 2000, 14pp.

APPENDIX B. RAILROAD TRAFFIC DATA COLLECTION

The Burlington Northern Santa Fe Railway Company provided invaluable assistance to the project by having its representatives serve on the Technical Advisory Committee, who provided guidance and insight into BNSF operations. Additionally, BNSF helped collect data regarding rail traffic at the study site.

B.1. RAILROAD DATA COLLECTION METHODOLOGY

BNSF uses an advanced type of detection system at the study site. This system allows them to record all events occurring on the tracks at the crossing. The system records over itself when the memory is full in a continuous loop process. BNSF retrieved the recorded events several times during the data collection period in order to build a complete record.

Data was collected for a week from April 26, 2004, until May 3, 2004. Several log files were collected and provided the *AZTrans* research team. Due to the volume of the data, *AZTrans* wrote a data extraction program in order to analyze the data.

B.2. GENERAL CHARACTERISTICS OF RAILROAD TRAFFIC DATA

There are four tracks at the study site. These are numbered 1 through 4. Tracks 1 and 2 are the mainline tracks. Track 3 is a siding track, meaning that both ends are attached to the mainline whereas a spur track only has one end attached to the mainline. Track 4 is a spur track, but since this track always uses a flagman and crosses the road at a diagonal several feet away from the other three tracks, it has no crossing island detector and therefore is not included in the summary statistics. The traffic of interest to the research was that occurring on the double mainline tracks 1 and 2.

Table 4 summarizes the crossing data for a continuous seven-day period.

The train data was used to construct cumulative distribution functions (CDFs) of two variables: headways and crossing gates-down durations. Data regarding tracks 3 and 4 were omitted from the data since these do not represent typical operations. Of interest were the mainline tracks 1 and 2. A train at the crossing on either of these tracks brings down the gates and closes the crossing to roadway vehicle traffic. Therefore, what is important is the combined effect that these two mainline tracks have on the crossing. These effects are captured in the CDFs shown in Figure 26 and Figure 27.

The CDF of the gates-down durations (Figure 27) were used to establish realistic values for use in modeling the crossings. The duration of the longest train was established as 4.5 minutes, which is approximately the value at which 95% of all trains passing will be at this value or less. This was the primary gates-down time used in the modeling cases and it represents the probable worst case at the study site.

Also of interest was checking what effect a short and average gates-down duration would have on the modeling cases. These times were established as 1.5 minutes for the shortest train (gates-down duration), in which case approximately 5% of all trains passing are at this value or less. The average train (gates-down duration) was established as 2.6 minutes, the approximate value at which 50% of all trains will be at this value or less.

Table 4: Train Crossing Summary At The Study Site

	HEADWAYS AHEAD				GATES DOWN DURATION		
	Tracks 12	Track 1	Track 2	Track 3	Tracks 1234	Tracks 1 & 2	Tracks 1 & 2 Omit Duals
	(min.)	(min.)	(min.)	(min.)	(min.)	(min.)	(min.)
mean	35.49	38.06	33.27	520.10	2.54	2.81	2.57
median	23.42	25.68	22.43	69.02	2.50	2.58	2.53
std dev	31.61	36.59	26.42	999.96	1.99	1.97	0.83
min	6.97	8.77	6.97	4.35	0.07	0.70	0.70
max	346.47	346.47	150.28	4098.85	39.65	39.65	11.10
n	567	263	304	19	601	519	473

Number of simultaneous (dual) crossings	
track 12	46
track 23	2
track 13	1

Train Crossing Summary Statistics; BNSF at Enterprise Rd.; Flagstaff, AZ; Sample was collected Monday 4/26/04 (14:00) through Monday 5/03/04 (14:00). The crossing has two mainline tracks (Track 1 and Track 2), a siding track (Track 3), and a spur track (Track 4).

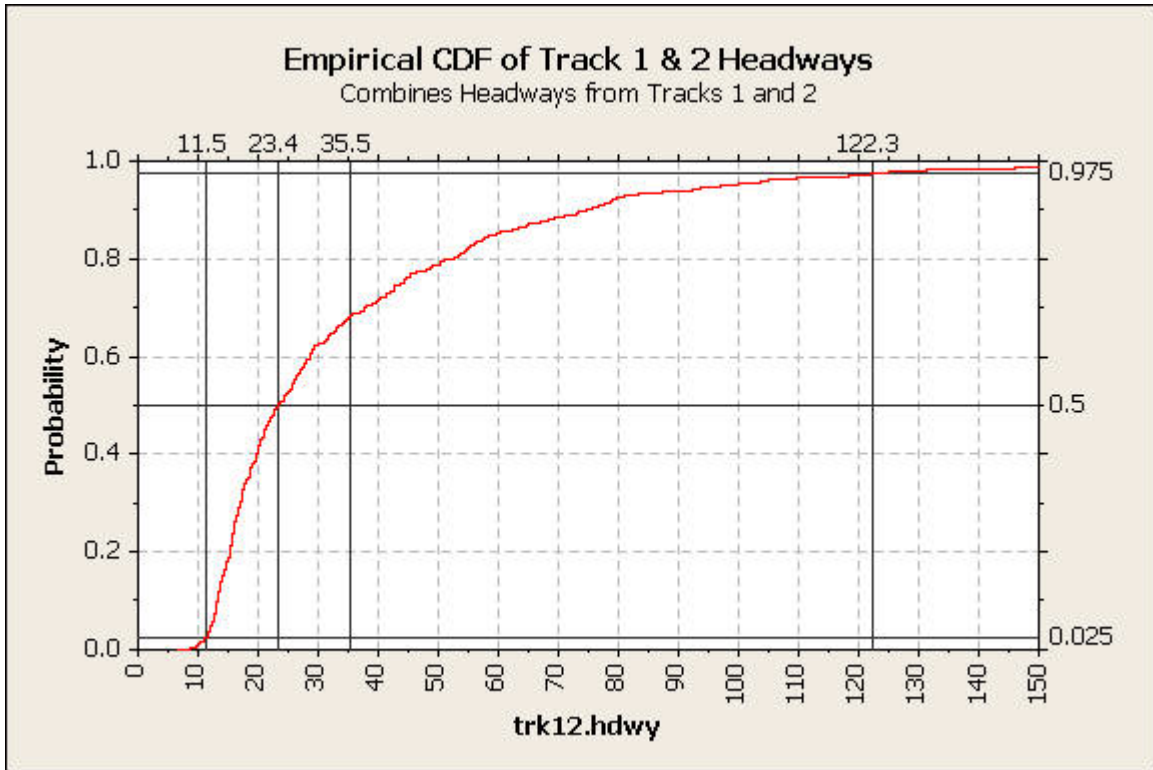

Figure 26: Empirical CDF of Train Headways at the Study Site

Empirical Cumulative Distribution Function of the headways (in seconds) between trains crossing the study site crossing on either of the two mainline tracks 1 and 2 during the week of 4/26/04 (14:00) through Monday 5/03/04 (14:00). The headway values shown across the top of the graph are for the $Pr[X \leq 0.025] = 11.5$, $Pr[X \leq 0.50] = 23.4$, the mean ($\mu = 35.5$), and $Pr[X \leq 0.975] = 122.3$.

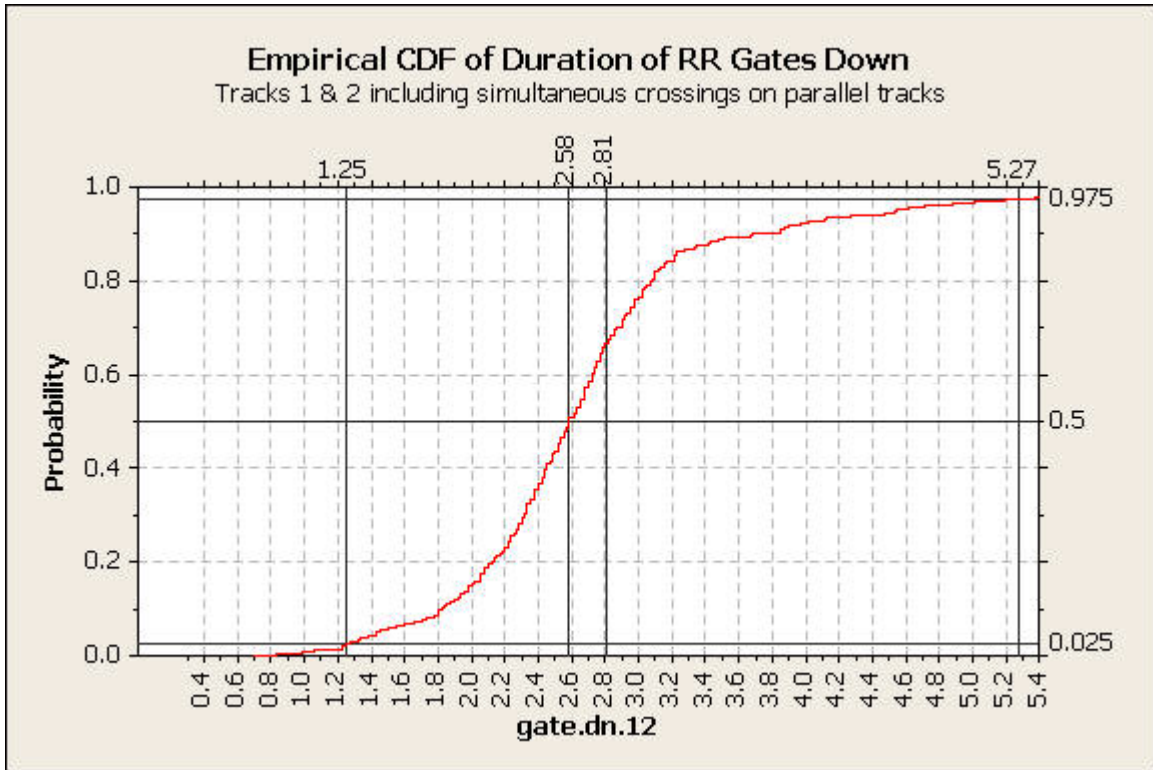

Figure 27: Empirical CDF of Gates-Down at the Study Site

Empirical Cumulative Distribution Function of the durations (in minutes) of the gates being down at the study site crossing caused by a train passing on either of the two mainline tracks 1 and 2 during the week of 4/26/04 (14:00) through Monday 5/03/04 (14:00). The duration values shown across the top of the graph are for the $Pr[X \leq 0.025] = 1.25$, $Pr[X \leq 0.50] = 2.58$, the mean ($\mu = 2.81$), and $Pr[X \leq 0.975] = 5.27$.

APPENDIX C. EWS CONGESTION MITIGATION ALGORITHM PROGRAMMING

The VISSIM software used to develop the microscopic traffic simulation model was chosen for four primary reasons:

1. Proven hardware-in-the-loop software and hardware had been developed for only two microscopic traffic simulation model softwares, CORSIM and VISSIM.
2. The resolution of VISSIM is finer than that available for CORSIM. This allows updating at several times per second versus a single time per second, which was typical of most other microscopic traffic simulation softwares.
3. The parameters available in VISSIM for modeling actual traffic behavior are more extensive than those available in CORSIM.
4. VISSIM has an easier macro language available for developing non-standard methods of traffic control within the model than does CORSIM.

C.1. VISSIM MACRO LANGUAGE

VAP (Vehicle Actuated Programming) is an optional add-on module of VISSIM for the simulation of programmable, phase or stage based, traffic actuated signal controls. The control logic is described in a text file using a simple programming language. During VISSIM simulations or in the test mode, VAP interprets the control logic commands and creates the signal control commands for the VISSIM network. At the same time, various detector variables reflecting the current traffic situation are retrieved from the simulation and processed in the logic. (PTV Planung Transport Verkehr AG 2003)

VAP allowed the modification of the model such that substitute logic could be used instead of using the normal NEMA signalized intersection traffic control logic. This substitute logic is the Early Warning System (EWS) logic. The VAP also allowed for parameters used in the EWS logic to be varied to seek optimized scenarios.

C.2. SYNOPSIS OF ALGORITHM LOGIC

The Early Warning System algorithm was written in the VAP macro language. Provided here is a synopsis of the logic used in the VAP program. The following description assumes the reader is familiar with the normal operations and terminology of (1) a microscopic traffic simulation model, specifically VISSIM, (2) computer programming methods, and (3) a NEMA traffic signal controller.

The description was written by the computer programmer and uses first person case, which while not normally used in a technical report, was left unchanged here for clarity. The color “amber” is used here, which is standard in the VISSIM programming, where elsewhere in this report the more common American term “yellow” is used. Also, programmer phrases and jargon are often used instead of complete, grammatical sentences.

The following description assumed the early warning option has been turned on.

C.2.1. Position of Train Corresponds to Three States

The program has three states that correspond directly with the position of a train as reported by VISSIM. An overview is described next, followed by detailed descriptions.

NORMAL OPERATION: The train has not yet hit the EW (early warning) detector so the VAP will behave as a "standard" NEMA controller, i.e., running free, actuated, and without peds (pedestrians). The EW detector is located on the train tracks upstream of the crossing at a known distance.

PREEMPTION: The VAP performs the five major tasks of regular preemption in response to the train hitting the PREE (preemption) detector. The PREE detector is located on the train tracks upstream of the crossing, between the crossing and the EW detector.

EARLY WARNING: If required, early warning modules are run until completion or the start of preemption.

Note on selected terms used in the synopsis:

- **Movements** are referred to as phases.
- **Section:** Both rings and their 8 phases are divided into 2 sections. Section 1 contains phases 1, 2, 5 and 6. Section 2 contains phases 3, 4, 7, and 8 (see Figure 28).

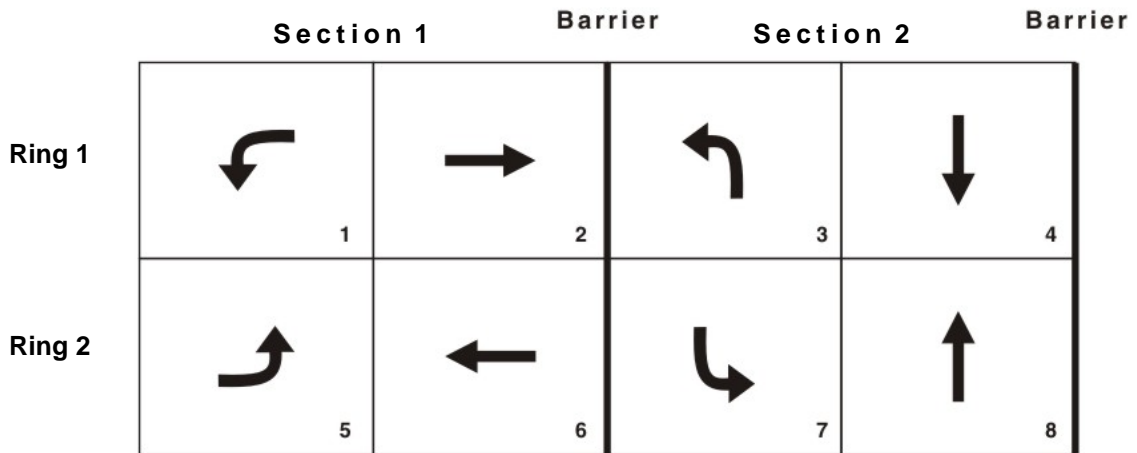

Figure 28: NEMA 8-Phase Controller Configuration

- **Dead Zone or Phase:** Because the VAP is configurable, it is possible that an entire Section of a ring be turned off. For example, if Phases 1 and 2 of Section 1 were turned off, the program would refer to this logically as the Ring 1 Section 1 Dead Phase.

C.2.1.1. Details of NORMAL OPERATION

- Handling green lights.
 1. Are any green lights ready to change?
 - This is determined individually. A green light is ready if the section it's in is dead, (see above), or it's been green longer than the minimum and has either gapped out or has been on longer than the maximum.
 2. Should a ready green light jump within its section?
 - If one of the phases 1, 3, 5 or 7 are ready and there is a call on the next phase, start to switch. For example, if 3 is ready and there's a call on 4 change 3 to amber along with any overlap of 3. Note that this happens individually as well. Ring 1 will jump within its section regardless of Ring 2's readiness.
 3. If the other ring isn't ready, CAN a ring single jump within its section as above?
 - For example, if 3 is ready but Ring 2 isn't, 3 will switch along with its' overlap regardless of a call on 4. Note that Ring 2 may not be ready because it has jumped in Item 2 above.
 - 4a. If both rings are ready we have a cross-barrier jump, so determine where we're going.
 - We are wrapping. If both rings in the next section are dead, our destination lies in the current section. In effect we jump both barriers. This case happens during preemption when only 2 & 6 are active. For example, if 2 is wrapping 1, then 2 is tested for calls. The first with a call is the destination. In the absence of calls, the first active phase is chosen. Note that when wrapping there is always a destination. (See 4b below.)
 - No wrapping. The next section is not entirely dead. If 2 & 6's destinations lie in section 2, in the case of 6, first 7 and then 8 will be tested for calls. When not wrapping a destination need not be determined here. Providing there are no calls on 7 or 8, ring 2's destination will remain in limbo for now; 6 will still switch however, along with its overlap.
 - 4b. Which of one ring, the other, or both need to go amber?
 - We are wrapping. If a phase is wrapping to itself nothing is done, as in 2 & 6 during preemption. Otherwise the phase and its overlap switch.
 - No wrapping. The current phase of a ring is not turned amber if it matches an overlap of the destinations of either ring. If it's going to be green, it will stay green. (It is left to the person who configures the specific phases for an intersection to avoid yellow traps.) The same kind of check is made for a phase's overlap, if any. If the overlap matches either of the destinations or their overlaps, it stays green.

During the above logic, the amount of time a phase will stay amber is computed from the longest of the two times. A dead phase counts as 0 for this calculation.

- Handling amber lights and green lights crossing the barrier for amber lengths of time.
 1. Is the phase switching by itself within a section?
 - If the phase has been amber for more than the amber time, switch it to red along with its overlap.
 2. Are the rings crossing a barrier?
 - If both rings have waited for the amber time calculated above, switch them if their current state is amber.
- Handling clear timers.
 1. Single jump within section?
 - A destination is always known in this case. If the time has expired, turn it green along with the overlap, if any.
 2. Barrier crossing? This case is complicated by the possibility that one or both of the destinations aren't known.
 - Find a destination for any ring that doesn't know yet. This is done by checking lowest to highest for first calls and then activity. Say if neither 3 nor 4 have calls, it goes to the first that's enabled.
 - Switch to green the destinations if not dead. If the light is already green this doesn't hurt.

C.2.1.2. Details of PREEMPTION

The train has hit the PREE detector.

- Truncating non-conflicting phases.
 1. Does a green light need to go amber? A green light is shut down only if it's not a track clearance phase or one of their overlaps, and one or more of the same aren't green. In that case the appropriate truncation green time is given. For example, if the clearance phases are 3 and 8 with 1 as an overlap, but 3 is not green, all greens will be shutting down.
 2. Does an amber need to go red? Give the correct truncating amber time and go red.
 3. Is a current red phase done waiting? Wait for the appropriate time and signal done.
 4. If all the waiting is done in 1, 2, and 3 above, turn the track clearance phases to green and transition to track clearance running.
 5. NOTE: In the above shut down process overlaps, use their time and not that of their parent. They are also shut down separately.

- Clear conflicting phases.
 1. Are the green lights finished? The track clearance phases will remain green until the track clear time has expired or they have both gapped out. This feature allows the input of a min, a max, and an extension. The study site controller cannot use these features so the track clearance phases remain green for a constant amount of time by setting min = max.
 2. Are the amber lights done?
 3. Are the red lights done? Transition to non-conflict running.
- Run non-conflicting phases.
 1. The program does this by making only the hold phases active and then returning to normal operation. The transition to shutting down non-conflicting phases is handled by VISSIM reporting that the train has hit the outgoing detector.
- Shutting down non-conflicting phases.
 1. The shut down process is a mirror of the truncating non-conflicts above with one exception. The time given to greens is the normal minimum. The transition is handled by restoring the normally active phases and turning the exit phases and their overlaps green.
- Exit phase.
 1. The same normal operation logic is used to determine when the two exit phases are done. They must be above the minimum and either above the max or gapped out. If an exit phase is the same as a resume phase or their overlaps, they'll stay green. Regardless, the transition back to normal operation is done with the two resume phases as destinations and the exit phases amber waiting. [*Note*: this forces the resume phase(s) to run after the Exit phases have finished. These resume phases mimic the Exit Calls used in a controller. This is not strictly the way an actual controller works because it places exit calls. These calls mean that these phases will be called, but only in their normal rotation. The normal rotation continues from the Exit phases and those phases having an exit call may or may not be the next phases in the normal rotation. However, at the study site the exit call phases are the next phases in the normal rotation after the Exit phases. If another site were to be used, this feature should be changed.]

C.2.1.3. Details of EARLY WARNING

1. Is there an active EW module that needs starting?
 - A module is active if it has one or two phases to run. EW_TC should always be active. It will need starting if there is a call on either of its phases or the call sensitivity is turned off.

2. If a module is to start, gracefully shut down current phases.
 - The shut down logic is consistent with that of preemption except that a minimum EW green time is used. Amber and clear times are the normal times.
3. Run each module that is to run.
 - The logic involved is the same as normal operation. The differences lie in the EW times used and the fact that phases are known in advance. The program basically loops, finishing one module and looking for the next until the EW_TC module ends or the train (preemption) cuts it all short. The same logic used in Item 1 above is used to tell if a module is to run. Should the train preemption not occur, normal operation is resumed on the EW resume phases.

REFERENCES

- Akcelik & Associates. Traffic Models, Retrieved July 15, 2005, from <http://www.aattraffic.com/TrafficModels.htm>.
- Arizona Quicklinks. Yavapai County, Arizona, U.S. Census Bureau, U.S. Department of Commerce. Retrieved June 15, 2005, from <http://quickfacts.census.gov/qfd/states/04/04025.html>.
- BNSF Press Release. "BNSF Closes 2,000th Grade Crossing as Part of Safety Program", January 19, 2004. Retrieved June 15, 2005, from http://www.bnsf.com/employees/communications/bnsf_today/2004/01/2004-01-19-b.html.
- Bullock, Darcy and Alison Catarella. "A Real-Time Simulation Environment for Evaluating Traffic Signal Systems." *Transportation Research Record 1634*, Transportation Research Board, National Research Council, Washington, D.C., 1998, pp. 130-135.
- CensusScope. Arizona Population Growth, 1960-2000, Social Science Data Analysis Network, University of Michigan, Source 2000 U.S. Census. Retrieved June 15, 2005, from <http://www.censuscope.org>.
- Dowling, Richard, Alexander Skabardonis, and Vassili Alexiadis. Traffic Analysis Toolbox Volume III: Guidelines for Applying Traffic Microsimulation Modeling Software, FHWA-HRT-04-040, Office of Operations, Federal Highway Administration, Washington, D.C., July 2004.
- Econolite Control Products, Inc. ASC/2S Series; NEMA TS2 Actuated Controllers. Retrieved 16 June, 2005, from <http://www.econolite.com/pdf/controllers/asc2s.pdf>.
- Federal Highway Administration. Manual of Uniform Traffic Control Devices, Part 8. Traffic Controls for Highway-Rail Grade Crossings, U.S. Department of Transportation, 2003. Retrieved June 15, 2005, from <http://mutcd.fhwa.dot.gov/>.
- Federal Railroad Administration. Railroad Safety Statistics; Annual Report 2000, U.S. Department of Transportation, July 2001. Retrieved June 15, 2005, from <http://safetydata.fra.dot.gov/OfficeofSafety/Default.asp>.
- Federal Railroad Administration-1. Summary regarding Federal Register, April 27, 2005, 49 CFR Parts 222 and 229, Use of Locomotive Horns at Highway-RailGrade Crossings; Final Rule. Retrieved June 15, 2005, from <http://safetydata.fra.dot.gov/OfficeofSafety/Default.asp>.
- Federal Railroad Administration-2. About The Federal Railroad Administration, U.S. Department of Transportation. Retrieved June 16, 2005, from <http://www.fra.dot.gov/us/content/2>.
- Federal Railroad Administration-3. Highway-Rail Crossing Program, U.S. Department of Transportation. Retrieved June 16, 2005, from <http://www.fra.dot.gov/us/content/86>.
- McCain Traffic Supply and NIATT. MCCAIN-NIATT CID II Users Manual, Version 2.0 including extra VISSIM Chapter 5, circa 2003.

Ova, Kiel. Memo summarizing a review of VAP logic for SPR 557-Railroad Cooperative Signal Control Research, PTV America, 7/25/05.

PTV Planung Transport Verkehr AG. Users Manual VISSIM 3.7, North America Distributors: Innovative Transportation Concepts, Inc., Corvallis, OR, 2003.

Roelof, Engelbrecht, J., Kevin N. Balke, Steven P. Venglar, and Srinivasa R. Sunkari. "Recent Applications of Hardware-in-the-loop Traffic Simulation." Compendium of Papers at Institute of Transportation Engineers Meeting, Nashville, TN, August 6-9, 2000, 14pp.

Ruback, L. "Train Notification System Alerts Drivers," *Texas Transportation Researcher*, Vol. 37, Issue 4, Texas Transportation Institute, 2001, pp. 8-9.

State Interim Population Projections. U.S. Census Bureau, U.S. Department of Commerce. Retrieved June 15, 2005, from <http://www.census.gov/population/www/projections/projectionsagesex.html>.

Tian, Zong Z., Thomas Urbanik II, Roelof Engelbrecht, and Kevin Balke. "Variations in Capacity and Delay Estimates from Microscopic Traffic Simulation Models." *Transportation Research Record 1802*, Transportation Research Board, National Research Council, Washington, D.C., 2002, pp. 23-31.

Traffic Group. Traffic Engineering Standards, Intermodal Transportation Division, Arizona Department of Transportation. Retrieved June 16, 2005, from <http://www.dot.state.az.us/highways/traffic/Standards.asp>.

Turner, Steven. Discussions with Analogic Engineering, Inc., PO Box 873, 320 W. Whalen, Guernsey, WY 82214, analogic@prairieweb.com, phone (307) 836-3108.

[TRB IDEA] New IDEAS for High-Speed Rail; Annual Progress Report. Transportation Research Board, National Research Council, Washington, D.C., 2005, pp. 50. Retrieved July 1, 2005, from http://gulliver.trb.org/publications/sp/hsr-idea_report_jan2005.pdf.

[TTI 2005-1] Texas Transportation Institute. "Sensor Evaluation," TransLinkTrain Monitoring Project, TransLink Research Center, Texas Transportation Institute, College Station, Texas. Retrieved July 1, 2005, from http://railview.tamu.edu/Sensor_Evaluation.htm.

[TTI 2005-2] Texas Transportation Institute. "Sensor Evaluation," TransLinkTrain Monitoring Project, TransLink Research Center, Texas Transportation Institute, College Station, Texas. Retrieved July 1, 2005, from http://railview.tamu.edu/Station_Design.htm.