

TEXAS DEPARTMENT OF TRANSPORTATION
AVIATION DIVISION
125 EAST 11TH, AUSTIN, TX 78704-2483 (MAILING)
(512) 416-4500 FAX: (512) 416-4510 1-800-687-4568

FARM AND RANCH AIRSTRIPS

HOW TO BUILD YOUR OWN AIRSTRIP

Texas Department of Transportation, Aviation Division

GOVERNOR
Rick Perry

AVIATION ADVISORY BOARD

Bill Knowles.....Chairman
Blair A. Bisbey.....Vice-Chairman
James Schwertner.....Member
Corky C. Pedger.....Member
Gordon Richardson.....Member
Col.Charles E.Powell,USAF(Ret)....Member

DIRECTOR
David S. Fulton

OFFICE LOCATION

150 East Riverside Drive
5th Floor, South Tower
Austin, Texas 78704

MAILING ADDRESS

125 E 11th Street
Austin, Texas 78701-2483

PHONE NUMBERS

(512) 416-4500
(512) 416-4510 (FAX)
1-800-68-PILOT

INTRODUCTION

The Texas Department of Transportation, Aviation Division has prepared the following material to assist the rancher, farmer or other private aircraft owner who wishes to construct his own personal or private-use landing strip.

Although there are design manuals covering the development of public airports, information for developing limited use airstrips suitable for the small aircraft used on ranches and farms is not readily available. About 1200, or two-thirds, of all airports and airstrips in Texas are privately owned. In this publication, we will discuss the development of such airstrips which, when properly constructed and maintained, can have virtually the same degree of safety to be found on public use airports.

Experience indicates that the farmer or rancher who uses his airplane regularly often lands at a variety of well developed public use airports with paved runways, and usually has a good idea how to scale down the standards for his farm or ranch airstrip and still retain the necessary safety factors. Therefore, the information in this publication is general in nature and does not cover every condition which may be encountered. However, when used as a guide, and combined with common sense and good judgment, this booklet should prove a useful guide for the improvement or construction of a safe and adequate private landing strip.

David S. Fulton
Director

CONTENTS

Introduction3
Site Selection6
Soil Characteristics.....9
Landing Strip Development.....9
Landing Strip Preparations.....11
Weather Considerations.....11
Seeding and Fertilizing.....12
Wind Indicators and Airport Identifiers.....12
Lighting15
Hangar and Aircraft Parking Area.....15
Aircraft Shelters or Hangars.....18
Structural Requirements.....18
Maintenance Practices.....18
The Aviation Division Can Help.....20
Giving Notice to the FAA.....22
Listing of Manufacturers.....23
 Runway Lighting.....23
 Texas Hangar Manufacturers.....23
 Hangar Manufacturers in Other States.....24
 Windsock Manufacturers.....25
Appendix 4.....25

LIST OF ILLUSTRATIONS

Prevailing Winds in Texas, Figure 1.....7
Runway/Landing Strip Requirements, Figure 2.....8
Farm-Ranch Landing Strip Layout, Figure 3.....10
Landing Strip Marking and Panel Construction, Figure 4.....13
Markings, Figure 5.....14
Segmented Circle and Wind Cone Standards, Figure 6.....16
Strip Lighting Layout, Figure 7.....17
Unit Hangar for Small Aircraft, Figure 8.....19
Tie Downs, Figure 9.....21

SITE SELECTION

The first step in constructing an airstrip is to determine where to locate it. Chances are that your choice of a site for the airstrip is limited to one or two of the more suitable areas on your property. Undoubtedly, the thought has occurred to you how convenient, useful and practical it would be if you could fly to and from your property, land there, or even operate from your residence on the property.

Although convenience is an important factor, it should not dictate that the landing strip chosen be located close to the dwelling area. It may often be possible to select a suitable ridge or plateau which although more removed from such buildings, would still provide the desired convenience, especially if it were possible to taxi the airplane up to the dwellings. Certainly, access to a road or highway would increase the usefulness and convenience of the airstrip.

The prevailing winds in Texas are illustrated in Figure 1. All other factors being equal, it is best to align the strip into the prevailing wind. In some locations the strong wind velocities may not necessarily be from the direction of the area prevailing wind.

At such sites it is good practice to also include an area for a cross wind landing strip. The two landing strips do not have to connect, but it should be possible to taxi from one strip to the other. The length of a cross wind landing strip seldom has to be more than 50 percent of the primary strip length.

The terrain in the selected area obviously must be sufficiently flat and large enough to accommodate the physical layout of the landing strip and perhaps a small building area without too much grading and other construction. The land selected should have natural drainage to insure freedom from standing water or muddy soft spots. Gentle slopes are permissible.

The more level the ground, except in areas having insufficient drainage, the less will be the cost of the construction. Where a less favorable close-in area is being considered, the additional cost of construction must be weighed against the convenience of access to the buildings.

PREVAILING WINDS
TEXAS

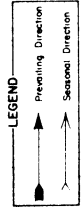
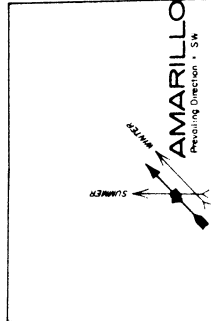

DATA DERIVED FROM
 LOCAL CLIMATOLOGICAL DATA
 U.S. Department of Commerce
 Weather Bureau

TXDOT AVIATION
PREVAILING WINDS IN TEXAS

FIG. 1

RUNWAY & LANDING STRIP NOMOGRAPH

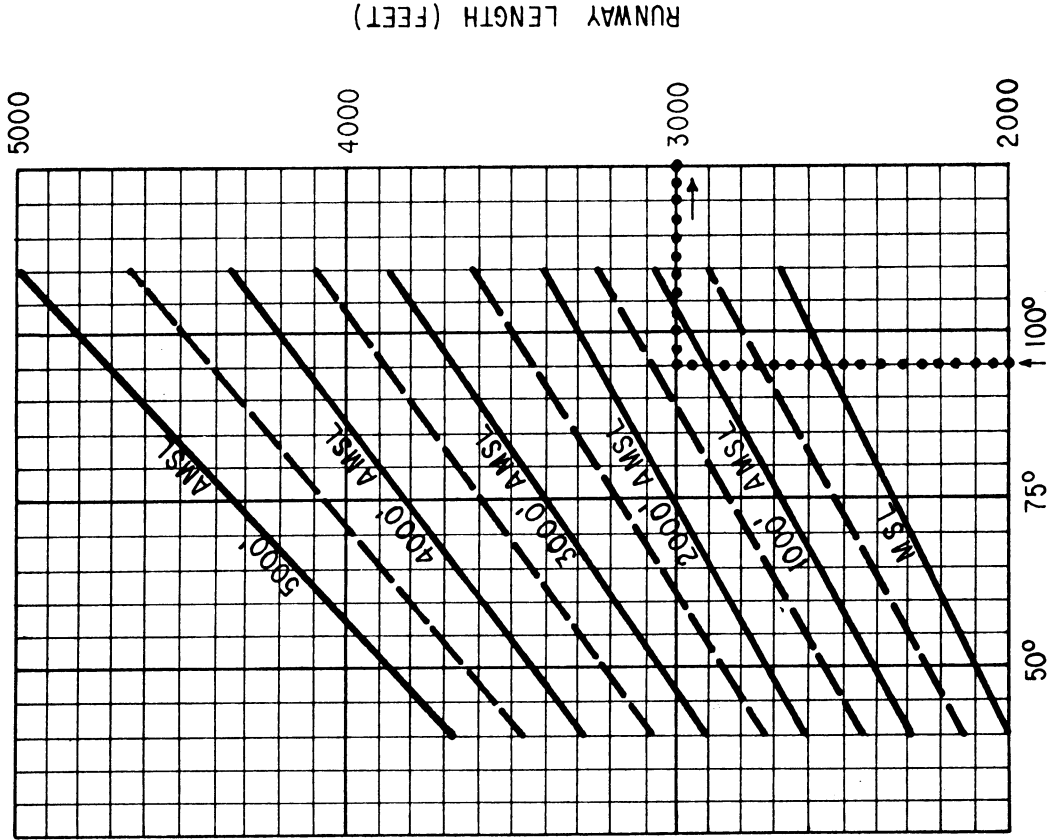

Example :

Normal Max. Temp. 95°F.
 Airport Elev. (AMSL) 1250
 Runway Length (paved) 3000'
 Landing Strip Length* 3200'

AMSL = Above Mean Sea Level

* Landing Strip Length & Width is generally 100' longer at each end and twice the width of the proposed Runway respectively.

TxDOT AVIATION
RUNWAY/LANDING STRIP REQUIREMENTS

AVERAGE MAXIMUM TEMPERATURE
(°F), HOTTEST MONTH OF YEAR

BASIC UTILITY
STAGE I

FIG. 2

SOIL CHARACTERISTICS

Stability of the soil is important, especially during inclement weather.

In general, the more sandy the soil, commensurate with its ability to produce turf, the more stable will be the landing strip. Clay soils absorb excessive moisture during wet weather and tend to become quagmires of instability. A stable soil may reduce the need for heavy grading.

On sandy soils with good drainage, where there is well established turf, it is possible to operate in all types of weather as the soil, even when containing a high degree of moisture, will support the weight of an aircraft. With heavy clay soils, on the other hand, it is necessary to provide steeper lateral slopes by grading and other means for more rapid runoff and for diverting off site drainage.

LANDING STRIP DEVELOPMENT

The most important part of the airport is the landing strip or that area used for landing and taking off of aircraft. Although lateral clearances of 200 feet from the centerline of the strip to the fence line are provided on many public airports, an unfenced, open area landing strip for private use could be only 75 feet in width. If the landing strip is fenced or runs through wooded areas, it would be safer to provide from 100 to 200 feet for width.

The minimum length landing strip being advocated now is approximately 3,200 feet. It could be shortened slightly in some cases where small light aircraft will be used, and lengthened where greater elevations, grades and temperatures are involved. For exact requirements for areas of different elevation, see Figure 2. Turf surfaces create more wheel drag than do the pavements from which most pilots normally operate. The increased wheel drag requires a longer takeoff run and, correspondingly, a need for a longer strip. The maximum longitudinal grade recommended for landing strips on small airports is 2%. It is desirable not to exceed this grade because of the inherent drag on takeoff, and the difficulty of using the full length of a strip with an extreme grade on landing.

The landing strip must have safe approaches even if it is intended for use only during daylight hours. This feature is illustrated in Figure 3.

Basically, the requirement is that no structure or obstacle penetrate the approach path of landing aircraft. This means that there should be no structure or obstacle in the approaches to the airstrip higher than one foot for every 20 feet horizontally from the runway ends. Lateral clearance to trees or structures is not as critical, but any hills or sharply rising ground adjacent to the beginning of the landing strip can cause wind shifts that could be hazardous to the pilot.

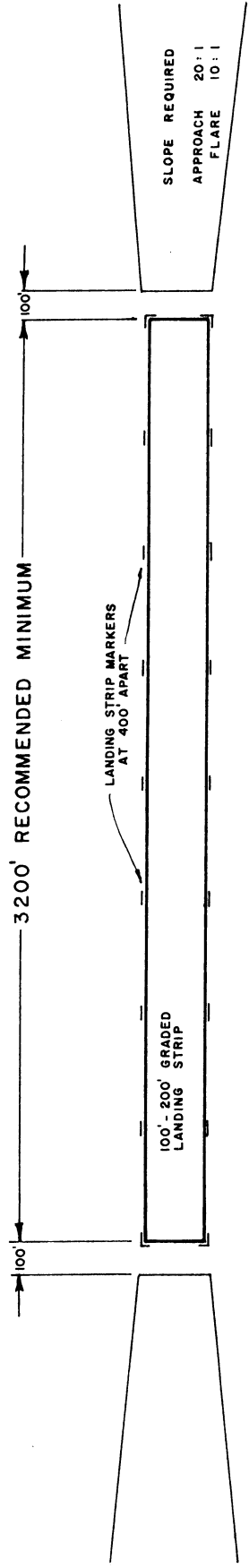

MINIMUM GRADED LANDING STRIP

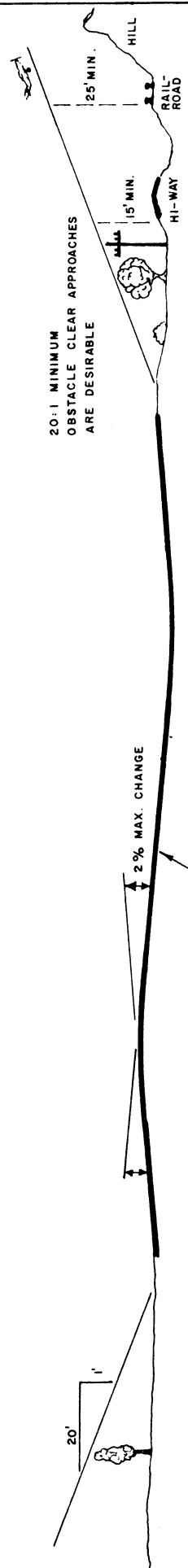

NOTE: AVOID EXCESSIVE AND ABRUPT GRADE CHANGES WITHOUT ROUNDING OFF THE PROFILE (VERTICAL CURVE).

GRADE LIMITATIONS & APPROACH CLEARANCES

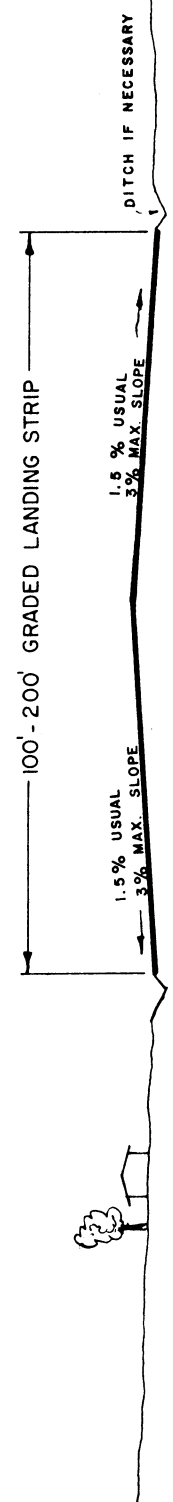

TYPICAL SECTION

NOTE: SOME LANDING STRIPS MAY NOT NEED GRADING.

TxDOT AVIATION
FARM-RANCH
LANDING STRIP LAYOUT

FIG. 3

If the area selected for the landing strip has little variation in elevation throughout its entire length, very little grading will be required. Many private use airports are located on grazing areas of a pasture which have merely been bladed to smooth the surface and to permit proper drainage. The decision as to the degree or type of improvement needed for such a landing strip depends on the soil, weight and type of the aircraft, and the climate. As a minimum, however, the following initial preparations should be undertaken first:

LANDING STRIP PREPARATIONS

1. Clear the entire area of any trees, rocks, brush, fences, structures or rubble which will be hazardous to aircraft operations. The rots of large trees should be grubbed to at least 12 inches below the surface.
2. Fill all low areas in which water collects.
3. Eliminate all sharp breaks in the surface grade and remove any high humps or mounds.
4. Small ditches should be filled and smoothed out.
5. Any ridges remaining along old fence rows should be flattened and the soil spread to blend with the surrounding areas.
6. Armadillo, gopher and other wild animal burrows must be filled with soil and compacted firmly. If there is a sign of considerable activity by burrowing animals, frequent inspections of the landing area become mandatory. Holes and burrows have been the cause of bent propellers and broken nose struts.
7. Large ditches should be diverted so that in the event of heavy rains, large volumes of water will not cross the landing strip and erode it. It may be necessary to install a drainage pipe to carry the water under the strip.
8. If any obstructions such as trees, poles and electric or telephone lines exist beyond the ends of the landing strip which could interfere with the safe operation of aircraft, try to have them removed, relocated, lowered, placed underground, or at least marked and/or lighted. If the obstructions are trees, they could possibly be topped if removal is impossible.

WEATHER CONSIDERATIONS

Some form of stabilization may be necessary for heavier aircraft, and especially those of the tricycle gear variety. The minimum stabilizing effort would be to grade the strip raising the center approximately 6 inches to provide faster drainage. If that is not sufficient, then the placing of 3 to 6 inches of top soil and reseeding the strip will complete the job. There are other more costly stabilization methods. The most familiar would be the construction of pavement similar to that of any farm-to-market road.

SEEDING AND FERTILIZING

After grading preparations of the new strip have been completed, turfing is advisable to prevent erosion and dust. Due to the wide variation in soils and climatic conditions throughout the state, it is impossible to list here the type of seed and fertilizer to be used on each site. The grass selected, however, should be of a type which will produce a deep root system and form a good top mat.

In most areas of Texas, Bermuda grass is quite suitable for airport use. It thrives in high temperatures, and its rapid summer growth, together with its low creeping habit, makes it an excellent turf species for traffic areas as well as other areas of the airport. It does well on a wide range of soils and is highly resistant to abrasion. When properly fertilized it recovers rapidly from damage. For dust control or occasional use it may be grown over a region extending almost to the western boundary of the Texas Panhandle on deep sandy soils. By aid of irrigation, it may be used throughout the southern arid zone at elevations below 5,000 feet.

Seed and planting material of Bermuda grass is readily available. Its propagation is economical and may be accomplished by seeding, sprigging, sodding or top soil planting. Bermuda grass is extremely variable and several selected strains are superior for airport use to the ordinary commercial types. When speed is an important factor in the establishment of this grass from seed, hulled seed may be used since the germination of the unhulled seed is usually slow. Your local Agricultural Agent should be contacted for details peculiar to the individual sites.

WIND INDICATORS AND AIRPORT IDENTIFIERS

Airports and airstrips which do not have pavement are extremely difficult to identify from the air, particularly by anyone who has never seen the airport before. Boundary markers are important as they serve to identify the landing strip from several miles away.

To mark the landing strip, panels may be constructed and located in accordance with the details shown on the Landing Strip Marking and Panel Construction Layout sheet, Figures 4 and 5. Old tires may be half buried horizontally with half the casing walls above the ground, and located each 300 feet or so to outline the landing area. When the sidewalls of the tires are painted a bright color (white, orange, yellow, etc.) they do an adequate job of marking. If the landing strip is fenced, a painted tire may be hung on each fence post, thereby creating a very easily identified boundary outline of the strip from the air.

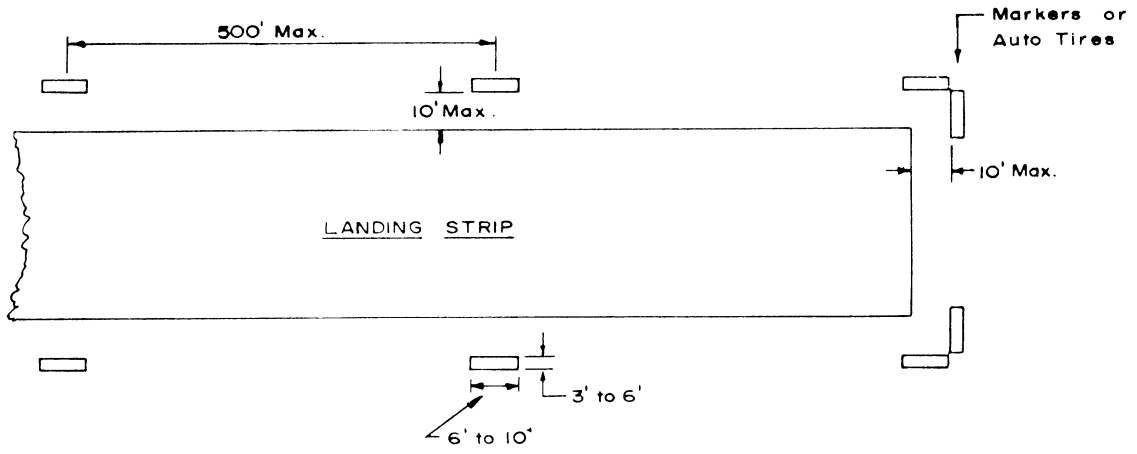

LANDING STRIP MARKING

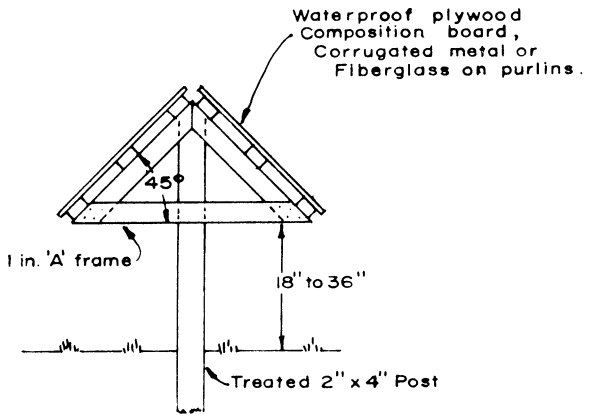

Half section 36" Pipe

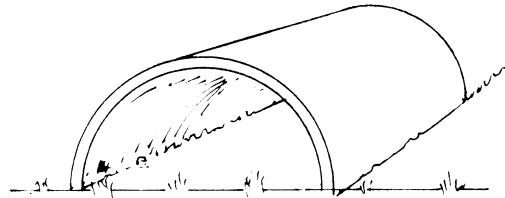

ALTERNATE SUGGESTION:
Aggregate Concrete planks
on the ground.

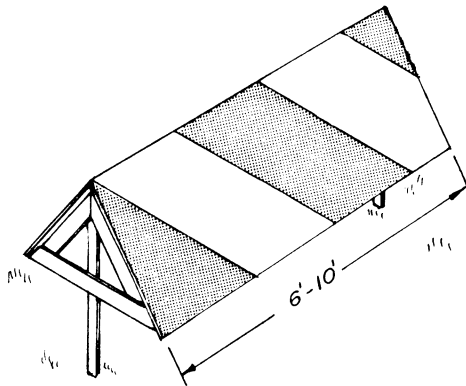

TxDOT AVIATION
LANDING STRIP MARKING AND PANEL CONSTRUCTION

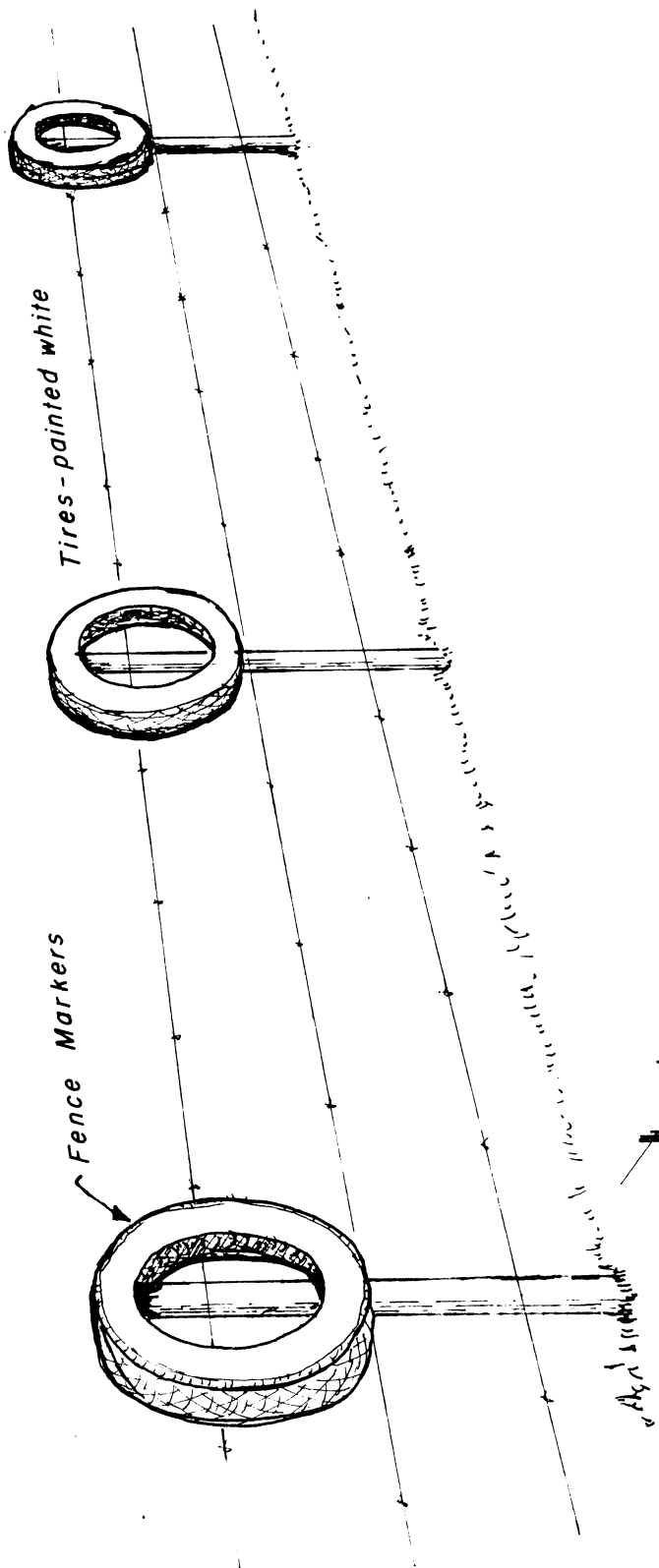

MARKINGS

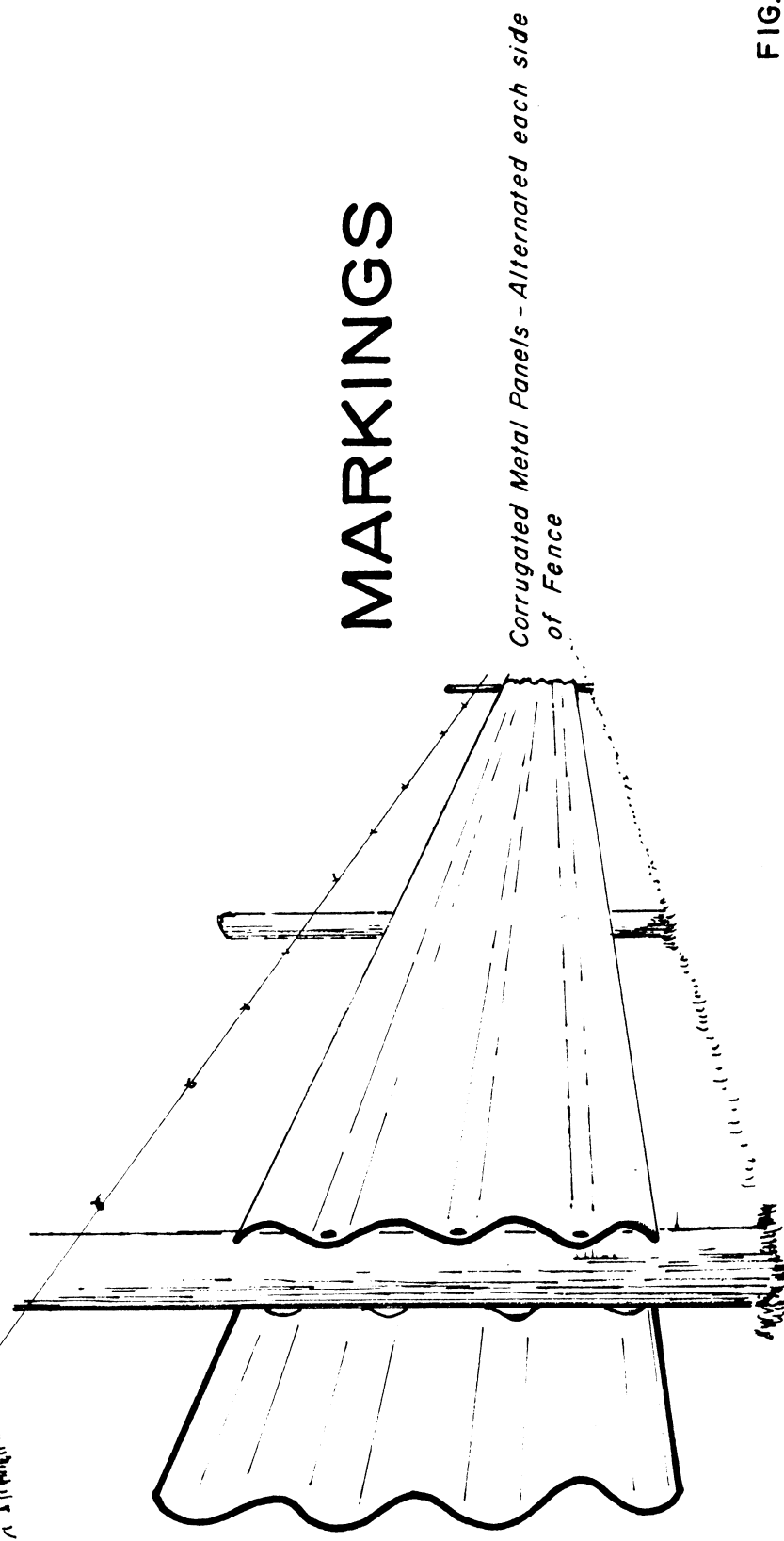

FIG. 5

Another identifier is a segmented circle which may be made up of any of several types of material as illustrated in Figure 6. This circle marks the location of the wind cone. The segmented circle is a standard requirement for many public airports and is very desirable on any airstrip that will be used at times by others, including the occasional cross country pilot who may experience an enroute emergency such as severe weather or mechanical difficulties.

A standard 8-foot windsock is basic and can be purchased from a number of suppliers. Some of them are listed in the back of this booklet. The segmented circle and windsock should be placed where the best prevailing wind indication may be obtained without interference from trees, buildings and hills.

LIGHTING

The practice of using single engine aircraft at night is becoming widespread, and the installation of lighting fixtures will increase the usability of the airport. There are a number of inexpensive low intensity lighting fixtures on the market, any of which would serve very well. Some suppliers are listed in the back of the booklet. The cost of installation generally is approximately one-third of the cost of the material, and depends on how the cable is installed underground, by trenching or by a motor grader. On most public airports there is usually a free-standing lighted wind indicator and beacon. Similar light fixtures, wind cone, and tetrahedron can be produced locally, however, it is more economical to purchase some supplies directly from manufacturers. Figure 7 illustrates some of the fixtures that are available.

HANGAR AND AIRCRAFT PARKING AREA

There is often no need to have an area laid out for hangars or for the parking of aircraft for the owner's use. In most cases the owner's aircraft is taxied for hangaring to one of the several buildings used in farming or ranching. Some designation of such areas should be made, however, if guests or visitors may have occasion to use the airport. The best reason for parking aircraft away from the landing area is that in the event a pilot loses control of his aircraft, no parked aircraft adjacent to the landing area would be in jeopardy. No aircraft should be parked closer than 100 feet from the centerline of the landing strip. It is likewise recommended that any and all buildings be at least 150 feet from the landing strip centerline.

NOTE

Circle could also be outlined with large flat stones painted white or yellow. Sterilize area to discourage vegetation growth.

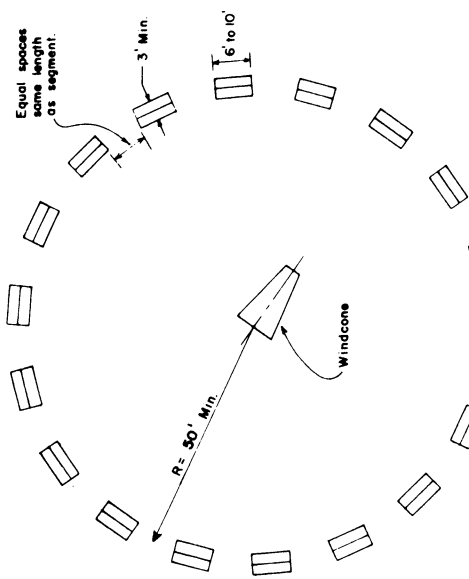

SEGMENTED CIRCLE

(Not to scale)

Galvanized or Aluminum sheets

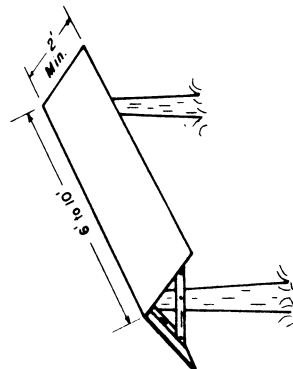

Segmented Circle or Landing Strip Markers

(Not to scale)

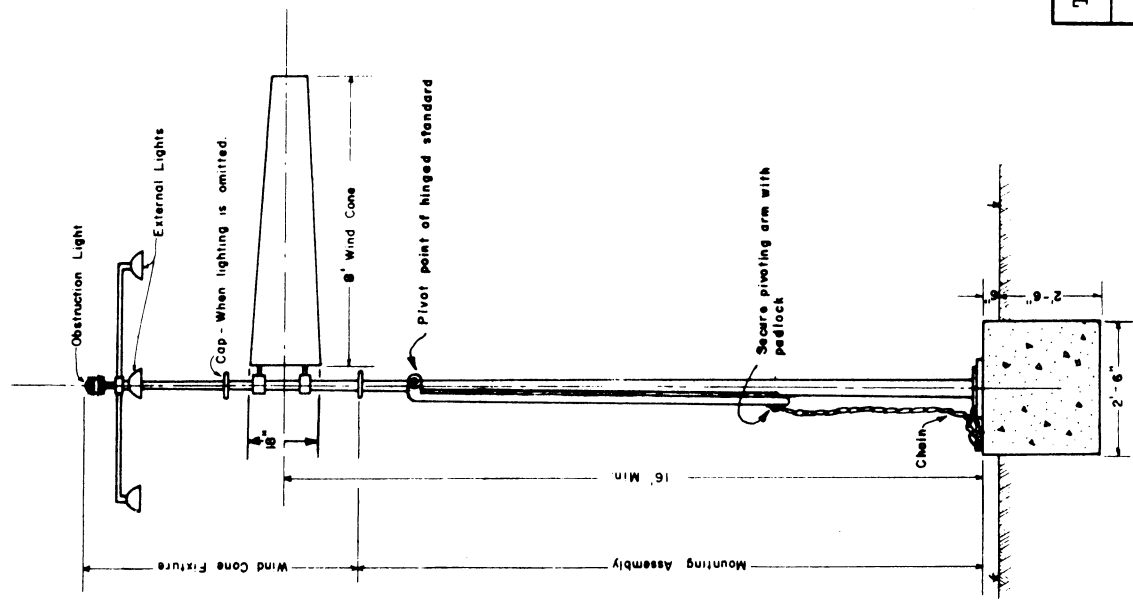

TYPICAL WIND CONE

(Not to scale)

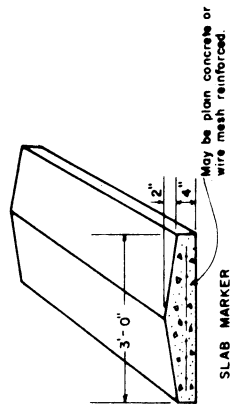

TxDOT AVIATION

SEGMENTED CIRCLE
AND
WIND CONE STANDARD

WIND CONE STANDARD

FIG. 6

AIRCRAFT SHELTERS OR HANGARS

It is advisable that your aircraft be stored under a roof to protect it from the sun, hail, and severe winds. Most aircraft users provide such shelter for their valuable equipment. The storage can be an open type structure similar to that shown in Figure 8, or a single "T" also illustrated. The structure must be sufficiently strong to withstand winds up to 70 miles per hour. This would pose few problems to most farmers and ranchers since other ranch buildings are also usually built to this strength.

STRUCTURAL REQUIREMENTS

The specific determination as to the type of structural material and hangar configuration is limited only by the number of excellent designs now available. All basic types of hangars are obtainable in a variety of sizes and types to fit most needs and preferences.

The structural features of any hangar selected should rate high on the following points:

1. Complete protection of aircraft from the elements.
2. Fireproof (resistant) structure.
3. Maintenance free.
4. Bird proof (a serious and messy problem).
5. Safety, accommodate aircraft (tail and all).
6. Attractive design...fits into environment.
7. Easy to operate doors.
8. Windproof structure.
9. Security...can be locked securely...tamper proof.

Before the doors are constructed, be sure that the type used is based on a proven design and large enough to permit easy removal of aircraft.

MAINTENANCE PRACTICES

We have previously indicated the desirability of seeding grasses and providing vegetative cover for unpaved landing strips to reduce dust and increase stability.

Where the soil has difficulty supporting vegetation it may be necessary to fertilize a width of approximately 25 feet along the middle of the landing strip to encourage a denser growth of turf. One application each season should be sufficient. Some landing strips, particularly those having gramma and other bunch grasses, tend to get rough from blowing soil and the washing away of soil from around the grass roots. Since blading would destroy the grass, rolling the surface with a flat wheel roller during the period when moisture is adequate becomes necessary. The roller will push the grass bunches into the ground and the strip will become fairly smooth.

TXDOT AVIATION
UNIT HANGAR FOR SMALL AIRCRAFT

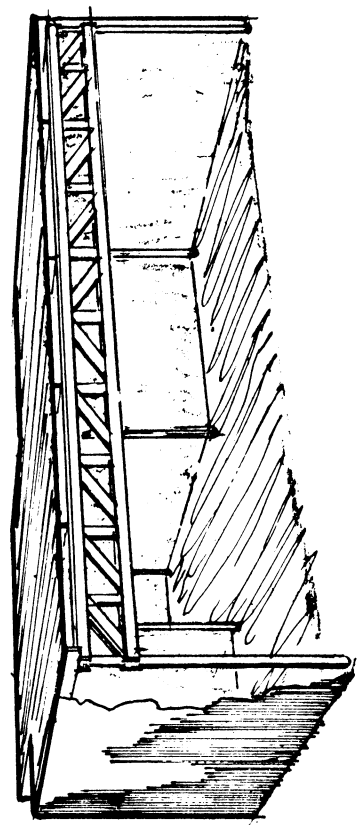
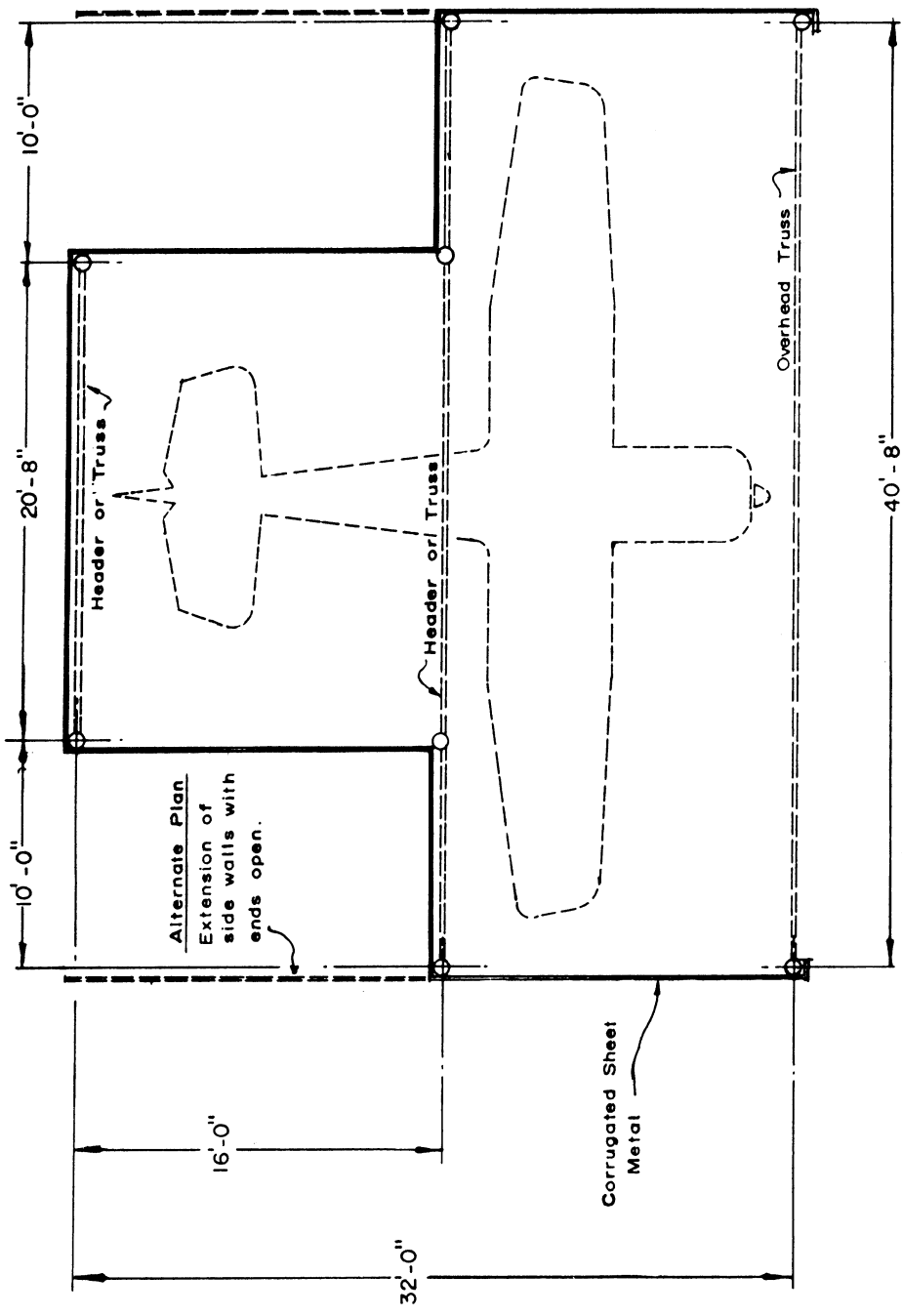

FIG. 8

On newly graded areas, particularly those with some slope, erosion is always a problem, but it is most serious just before the establishment of an adequate stand of grass. As the new grading consolidates and the grass becomes well established, erosion will diminish provided the old eroded areas have been repaired and properly maintained. Gullies created by erosion should be filled and compacted to prevent enlargement. These repaired areas should be reseeded immediately.

On the flatter areas of the landing strip, low spots may develop or aircraft wheels may cause rutting that will collect water. Not only will standing water tend to kill the grass, it will be absorbed by the soil and lead to additional rutting. These low areas, after being discovered, should be filled with good topsoil.

Proper mowing is a necessity if a good turf is to be established and maintained. It is important that troublesome weeds be kept mowed, not just to prevent their coming to seed, but to prevent their smothering the shorter and more tender grasses. Timely mowings will not only control weeds but will encourage the growth and binding of grass plants. Also, the clippings from frequent mowings are shorter and can be left to provide mulch and return nutrients to the soil. The ideal procedure is to maintain grass at about a three to five inch height by mowing as frequently as necessary rather than at set periods of time. Under certain extremely dry conditions and during the dormant season, it may require mowing to reduce the hazard of fire.

The runway lights should not present any serious maintenance problem, particularly if the cable is buried. It is a good practice to keep spare light bulbs and a section of cable on hand. In sandy soil, gopher activity sometimes becomes a problem, and it is necessary to either eradicate the animals or bury the cable to depths of two feet to prevent them from chewing the insulation off the cable.

THE AVIATION DIVISION CAN HELP

The Texas Department of Transportation, Aviation Division administers the development of city, county and other publicly owned airports that request state assistance (up to 90 percent of project cost). In carrying out this program, we find it possible to extend engineering and operational guidance in helping to solve problems that owners of non-public airports may have. Within the time that is available to the personnel of the Department, we will attempt to help any airstrip owner or prospective airport developer on any phase of development or maintenance.

TIE DOWNS

Discarded Aircraft
Tire 600' x 6
Imbedded

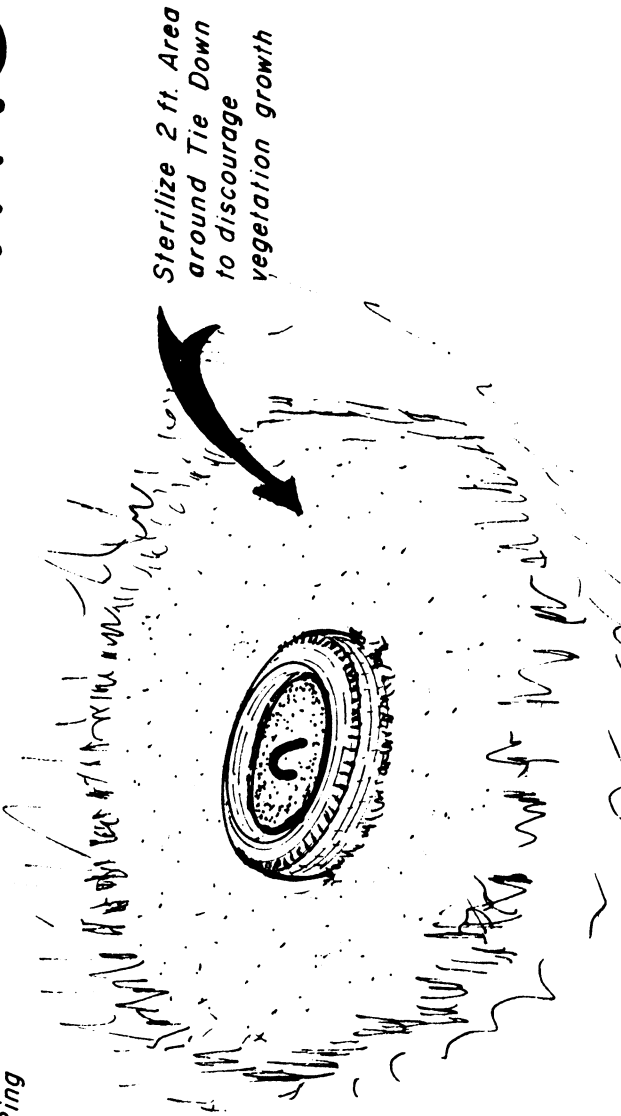
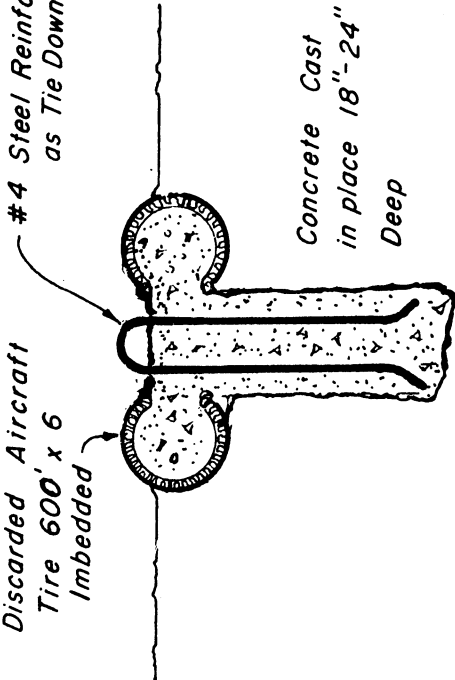

Eye could be welded
closed for strength



Steel Screw in Tie Down
Stakes - Available at
most Pet supply houses
& kennels

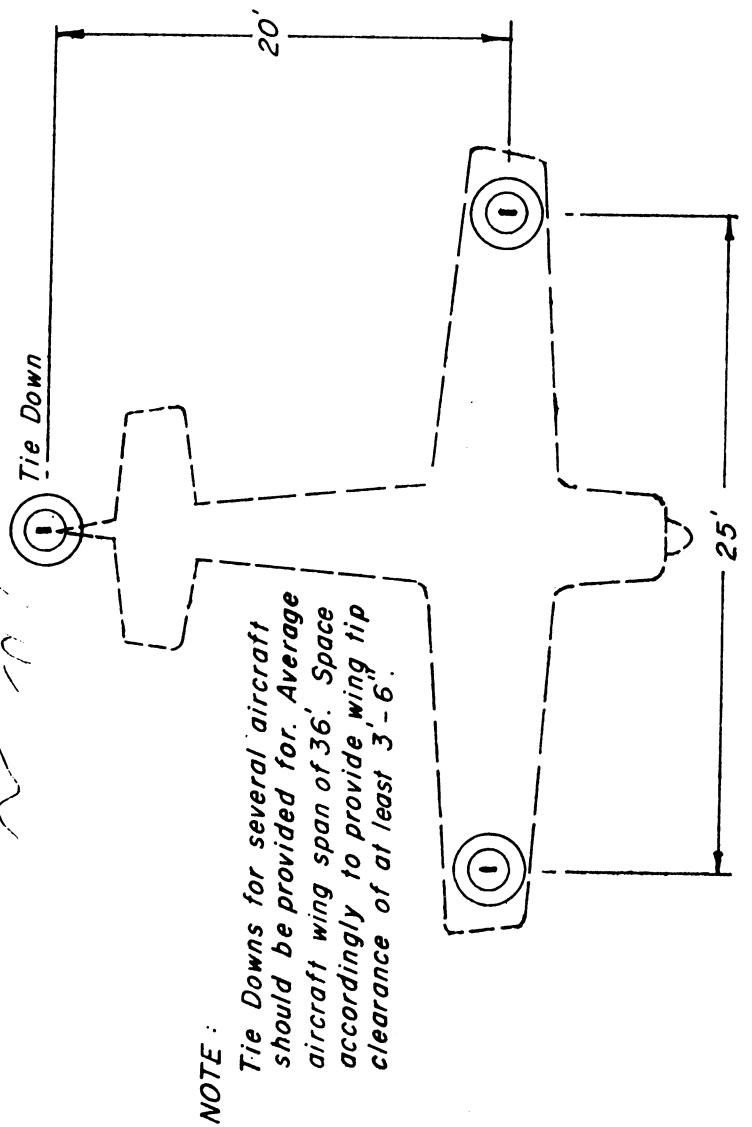

GIVING NOTICE TO THE FAA

Any person proposing to establish, alter or deactivate a landing strip or area is required to give prior notice to the Federal Aviation Administration. This notice is accomplished through the submission of FAA Form 7480-1, which may be obtained by contacting our office at the addresses listed in the front of this book.

The applicable Federal Aviation Regulation is FAR Part 157. It states that anyone proposing to build a personal or private use airport (used solely under VFR conditions, located more than 20 nautical miles from an airport for which an instrument approach procedure is authorized and located more than five nautical miles from any airport open to the public) must submit FAA Form 7480-1 at least 30 days before work is to begin.

The owner may at the same time request that his farm and ranch strip be shown on FAA sectional charts with a notation as to the nature of the strip...private, cattle on field, etc.

DISCLAIMER: Texas Department of Transportation, Aviation Division does not endorse any product or service listed, nor does TxDOT vouch for any of the listed vendors. TxDOT provides this partial list as a public service to our clients.

RUNWAY LIGHTING MANUFACTURERS AND SUPPLIERS
March 2003

Airport Lighting Co.
108 Fairgrounds Drive
Manlius, NY 13104-2416
(315) 682-6460
(315) 682-6469 FAX

Julian A. McDermott Corp.
1639 Stephen Road
Ridgewood, NY 11385
(718) 456-3606
(718) 381-0229 FAX
Website:
www.mddermottlight.com

Crouse-Hinds Airport Lighting
Products
1200 Kennedy Road
Windsor, CT 06095
(203) 683-4300

Manairco, Inc.
P.O. Box 111
28 Mansfield Industrial Park
P.O. Box 111
Mansfield, OH 44901
(419) 524-2121
(800) 524-2121

Honeywell Aerospace Electronic
Systems
2162 Union Place
Simi Valley, CA 93065
(805) 581-5591
(805) 581-5032 FAX
www.honeywellaerospace.com

Siemens Airfield Solutions
Ghanna Parkway
P. O. Box 30829
Columbus, OH 43230
(614) 861-1304
(614) 864-2069 FAX

TEXAS HANGAR MANUFACTURERS
March 2003

American Steel Buildings, Inc.
P. O. Box 14244
Houston, TX 77221
(713) 433-5661
(713) 433-0847

Mesco Metal Buildings Corp.
P.O. Box 20
400 N. Kimball Avenue
South Lake, TX 76092
(817) 488-329-2326
(817) 329-2329 FAX

Boyd Industries, Inc.
P.O. Box 315
Boyd, TX 76023
(940) 433-2315
(940) 433-8440 FAX

Midwest Metallic
7321 Fairview
Houston, TX 77041
(713) 466-7788
(713) 466-3195 FAX

Delta Industrial Construction
P.O. Drawer 20115
Beaumont, TX 77720
(409) 842-3326
(409) 842-4049 FAX

Robert S. Henry Company
P.O. Box 8629
Houston, TX 77249
(713) 227-0105
(713) 227-0610 FAX

HANGAR MANUFACTURERS IN OTHER STATES
March 2003

Fulfab, Inc.
1525-A Whipple Avenue, SW
Canton, OH 44710
(330) 477-7211
(800) 274-0144
(330) 478-3863 FAX

Varco-Pruden
3200 Players Club Circle
Memphis, TN 38125
(901) 749-9305
(901) 748-9322 FAX

Behlen Manufacturing Company
4035 E. 23rd Street
Columbus, NE 68601
(402) 563-3111
(800) 563-7405
www.behlenmfg.com

Building Technologies
5550 Peachtree Parkway
Technology Parkway
Summit Bldg. A., 6th Floor
Norcross, GA 30092-2595
(404) 662-1111
(404) 662-1184 FAX

Butler Manufacturing Company
1540 Genessee Street
Kansas City, MO 64102
(816) 968-3000
(816) 968-3740 FAX

Erect-A-Tube, Inc.
P.O. Box 100
701 W. Park Street
Harvard, IL 60033
(815) 943-4091
(800) 624-9219
www.erect-a-tube.com

WINDSOCK MANUFACTURERS
March 2003

Airtex Products
259 Lower Morrisville Road
Fallsington, PA 19054
(215) 295-4115
(800) 394-1247
(215) 295-4417 FAX

Safety-Flag Company of America
P.O. Box 1088
Pawtucket, RI 02862
(401) 722-0900
(401) 722-0912 FAX
www.safetyflag.com

Wag-Aero
P.O. Box 181
Lyons, WI 53148
(262) 763-7595
(800) 558-6868

ADDITIONAL ADDRESS LIST OF
CERTIFIED AIRPORT LIGHTING EQUIPMENT MANUFACTURERS
March 2003

Avtech Corp.
3400 Wallingford Avenue N.
Seattle, WA 98103-9095
(206) 695-8000
(206) 695-8011 FAX
E-Mail: info@avtcorp.com
Website: www.avtcorp.com

BF Goodrich/Godfrey Engineering
3051 Pine Street
Clearwater FL 33763-0914
(727) 799-4919
(727) 724-0212 FAX

Carsonite International Corp.
1301 Hot Springs Road
Carson City, NV 89706
(702) 883-5104
(800) 648-7974

Cegeloc Projedts, Ltd.
Boughton Road
Rugby CV21 IBU
England
44(788) 542144, ext. 3281
44(788) 560767 FAX

Crouse-Hinds Joy Molded Products
4758 Washington Street
La Grange, NC 28551
(252) 566-3014
(252) 566-9337 FAX

DeVore Aviation Corporation
6104 Jefferson N.E.
Albuquerque, NM 87109-3410
(505) 345-8713
(505) 344-3835 FAX

Electro Fiber Optics Corp.
56 Hudson Street
Northboro, MA 01532
(508) 393-3753
(505) 344-3835 FAX

FlexStake, Inc.
2150 Andrea Lane #C
Ft. Myers, FL 33912
(941) 481-3539
(941) 482-3539 FAX

Hubbell Lighting Inc.
2000 Electric Way
Christiansburg, VA 24073-2500
(540) 382-6111
(540) 382-1526 FAX
Website: www.hubbell-ltg.com

Hughey & Phillips, Inc.
P.O. Box 2167
Simi Valley, CA 93062-2167
(805) 581-5591
(805) 581-5032 FAX

Jaquith Industries, Inc.
East Brighton & Glen Avenues
P.O. Box 780
Syracuse, NY 13205
(315) 475-5700
(317) 478-5707 FAX
E-Mail: bschai@jaquith.com

E-Mail: bschai@jaquith.com
Website: www.jaquith.com
Litebeams, Inc.
223 West Palm Avenue
Burbank, CA 91502
(818) 843-2711
(818) 843-2794 FAX
E-Mail: bschai@jaquith.com
Website: www.jaquith.com

Maria Miranda Co.
8275 San Leandro Street
Oakland, CA 94621
(510) 635-6551

Multi-Electric Manufacturing, Inc.
4223-43 West Lake Street
Chicago, IL 60624-1787
(773) 722-1900
(773) 722-5694 FAX
E-Mail: Sales@multielectric.com

Olson Industries, Inc.
P.O. Box 758
East Hwy 20 Star Route 4
Atkinson, NE 68713
(402) 925-5090
(402) 925-5499
E-Mail: hchr@inetnebr.com

Standard Signs, Inc.
3190 East 65th Street
Cleveland, OH 44127
(316) 341-5611
(316) 341-0652 FAX
Website: www.lumacurve.com

TWR Lighting, Inc.
4300 Windfern Road STE 100
Houston TX 77041-8943
(713) 973-6905
(713) 973-9352

Universe, Inc.
1833 West Hovey Avenue
Normal IL 617761-4315
(309) 454-5665
(309) 452-2521 FAX

Vomar International, Inc.
166441 Roscoe Place
P.O. Box 2637
Sepulveda, CA 91343
(818) 894-7174