

MoDOT

Research, Development and Technology

University of Missouri-Rolla

RDT 04-010

Evaluation of Bridge Approach Slabs, Performance and Design

RI 02-033

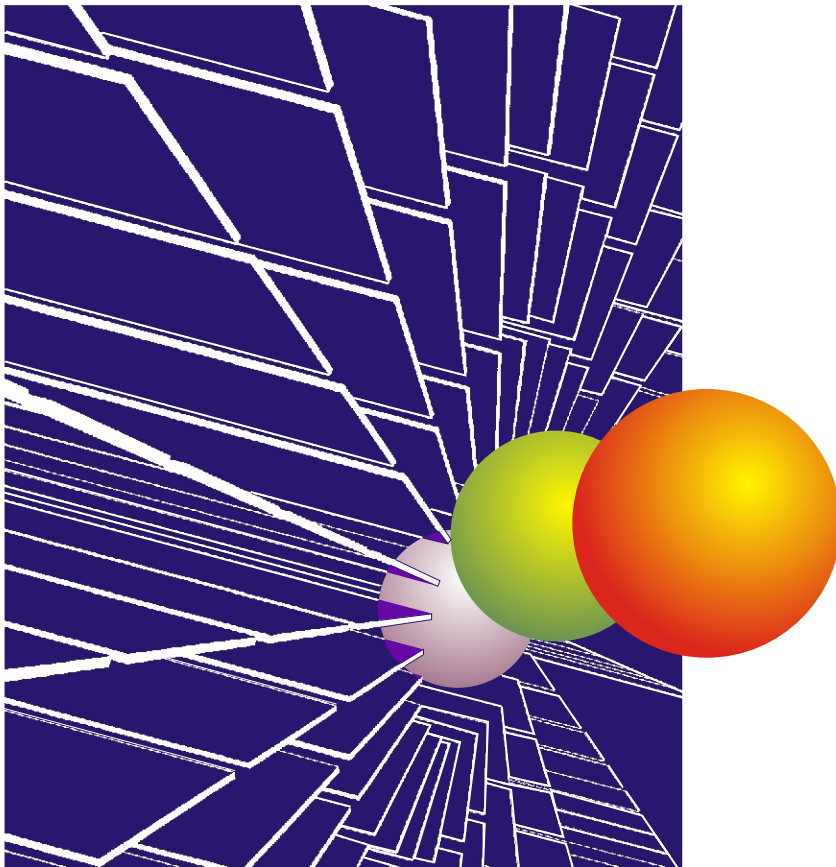

April, 2004

FINAL PROJECT REPORT

RDT 04-010

Research Investigation RI 02-033

Evaluation of Bridge Approach Slabs, Performance and Design

Prepared by:

Dr. Ronaldo Luna, PE,
Associate Professor

Jonathan L Robison, PE
Graduate Student

Andrew J. Wilding
Graduate Student

*Department of Civil, Architectural and Environmental Engineering
University of Missouri-Rolla
Rolla, MO 65401*

Date Submitted: April 2004

The opinions, findings, and conclusions expressed in this publication are those of the principal investigators and the Missouri Department of Transportation; Research, Development and Technology. They are not necessarily those of the U.S. Department of Transportation, Federal Highway Administration. This report does not constitute a standard regulation.

TECHNICAL REPORT DOCUMENTATION PAGE

1. Report No. <p style="text-align: center;">RDT 04-010</p>	2. Government Accession No.	3. Recipient's Catalog No.	
4. Title and Subtitle <p style="text-align: center;">Evaluation of Bridge Approach Slabs, Performance and Design</p>	5. Report Date <p style="text-align: center;">April 2004</p>		
	6. Performing Organization Code <p style="text-align: center;">University of Missouri - Rolla</p>		
7. Author(s) <p style="text-align: center;">Ronaldo Luna, PhD, PE</p>	8. Performing Organization Report No. <p style="text-align: center;">RDT 04-010 RI02-033</p>		
9. Performing Organization Name and Address <p style="text-align: center;">Department of Civil, Architectural and Environmental Engineering 130 Butler-Carlton Hall, University of Missouri – Rolla Rolla, MO 65409-0030</p>	10. Work Unit No.		
	11. Contract or Grant No. <p style="text-align: center;">RI02-033</p>		
12. Sponsoring Agency Name and Address <p style="text-align: center;">Missouri Department of Transportation Research, Development and Technology Division P. O. Box 270, Jefferson City, MO 65102</p>	13. Type of Report and Period Covered <p style="text-align: center;">Final Report</p>		
	14. Sponsoring Agency Code <p style="text-align: center;">MoDOT</p>		
15. Supplementary Notes <p style="text-align: center;">The investigation was conducted in cooperation with the U. S. Department of Transportation, Federal Highway Administration.</p>			
16. Abstract <p>The design changes in the 1990s to bridge approaches resulted in approach slabs of about 8m in length supported at one end on the bridge abutment and at the other by a sleeper beam resting on the embankment. These slabs have not performed adequately due primarily to excessive deformation of the foundation and fill soils under the slab and sleeper beam. Survey questionnaires were administered for resident engineers in MoDOT and neighboring states to assess overall performance. Two bridge sites were selected for more detailed study of the deformation mechanisms. Analyses involving modeling using a finite element method program were conducted using soil properties obtained from drilling, sampling and laboratory testing at the study sites. Conclusions and recommendations are in the following categories: initiating programmatic instrumentation and monitoring plans for approach embankments; enhanced drilling, sampling and analysis at locations of future embankments; geosynthetic reinforcement of the embankment; staged construction; separating grading and paving contract; abutment and drainage details; and improved compaction specifications.</p>			
17. Key Words <p>Geotechnical, Survey, Maintenance, Bridge Approach Slabs, Design, Construction, Maintenance, Performance Monitoring.</p>		18. Distribution Statement <p>No restrictions. This document is available to the public through National Technical Information Center, Springfield, Virginia 22161</p>	
19. Security Classification (of this report) <p style="text-align: center;">Unclassified</p>	20. Security Classification (of this page) <p style="text-align: center;">Unclassified</p>	21. No. of Pages <p style="text-align: center;">106</p>	22. Price

EXECUTIVE SUMMARY

This research project report summarizes the activities and results of the work performed by the University of Missouri-Rolla. The performance of several bridge approach slabs was undertaken based on preliminary work completed by the technical advisory group, bridge approach slabs task force.

The existing design as modified in the early 1990s was reviewed and the available methods to mitigate this common problem in bridge engineering were researched in the literature. A summary of the recent developments in this field are shown in Appendix A. Two surveys were conducted, first one administered to resident engineers within the state and the other to transportation officials of the neighboring states. The findings show that this problem is prevalent throughout the Midwest and that a solution has not been reached at a regional level. Many states are currently performing or have recently completed research efforts towards this end. The response to the Resident Engineer's survey within the state of Missouri is summarized graphically by geographic location with the aid of a Geographic Information System (GIS). At least 15% of the recently completed bridge approach slabs have performed unsatisfactorily to the point that remediation was required.

Two bridge sites were selected in the state of Missouri to investigate and analyze in more detail as case studies. Detailed subsurface characterization of existing bridge embankments utilizing the new design were carried out. It consisted of drilling and sampling of boreholes and cone penetrometer tests. This allowed for the subsurface characterization of these two sites. Explorations were advanced at each site and provided data to model the common characteristics of the embankment and to further analyze the deformations.

Both hand calculations and finite element analysis were carried out for these bridge sites. The deformation ranged from 0.03 to 0.6 m for the northern site in Livingston County. However, only the deformations that occurred after the construction of the slab are structurally important. The calculated deformations experienced by the bridge approach slab are much smaller than the figures shown above but still unacceptable. For the southern bridge (A-5690) only 0.08 m were calculated using the finite element analyses. The actual deformation from the end of construction to the current conditions has not been measured with time, therefore, no comparisons can be made between predicted and measured data. One of the salient recommendations to MoDOT is to start a programmatic approach to instrument and monitor deformations of select earth structures to be able to calibrate and compare with analytical techniques (i.e., settlement calculations, finite element method, etc.)

After evaluating the different solutions available and given the design and construction practice at MoDOT, it is recommended that means to stiffen the embankment be investigated. This will make the transition to the very unyielding bridge less abrupt and reduce the compressibility of the embankment fill. A reinforced soil embankment is proposed as a solution for the embankments that are at least 10-feet high. This reinforcement should be extended 60 feet away from the abutment. Compressibility of the foundation soils should be evaluated on a case-by-case basis based on additional boreholes completed before design behind the bridge abutment. An implementation plan and milestones are recommended in this report.

ACKNOWLEDGEMENTS

The work presented in this report was the product of many collaborators at the Missouri Department of Transportation and the University of Missouri-Rolla. The authors would like to thank Tom Fennessey, in the Soils & Geology Group at MoDOT, for his efforts as technical liaison and his efforts to see this work move to implementation in the Department. A special group of individuals from MoDOT, herein referred to as the “bridge approach slabs task force” were also a big part of this project and played a major role during the project. The individuals associated with this task force are: Dennis Bryant, Carl Callahan, Dennis Heckman, Tom Fennessey, Mike Fritz, Alan Miller, and Rob Lauer. Their comments and suggestions to the research work are very much appreciated.

The financial support from the Missouri Department of Transportation via Task Order RI02-033 is also acknowledged. Thanks also go to the UMR University Transportation Center for the matching funds provided for this research project to support graduate students.

TABLE OF CONTENTS

Section	Page
Executive Summary	ii
Acknowledgements	iii
List of Figures	v
List of Tables	vi
1. Introduction	1
2. Objectives	2
3. Present Technical Conditions	3
4. Technical Approach	6
5. Results and Discussion	17
6. Conclusions	32
7. Recommendations	33
8. Principal Investigator and Project Members	36
9. Implementation Plan	36
10. Bibliography	39
Appendices:	
A. Review of Literature – Available Mitigation Measure	43
B. Field Explorations (Boreholes & CPT logs) and Laboratory Results	65
C. Numerical Modeling (PLAXIS) Results	89

LIST OF FIGURES

Figure	Caption Description	Page
1.1	Br. A5934, Rte. 21 Crossing the Little Black River in Southeast Missouri.	1
1.2	MoDOT Post-1993 Bridge Approach Design, after Bowders, et al. (2002)	2
3.1	Typical Cross-Section of a Bridge Abutment in Longitudinal Direction	3
3.2	Typical Cross-Section Showing an Earth Plug within Rock Fill Embankment	3
3.3	Standard Design Drawings for the Bridge Approach Slab (a) longitudinal cross-section, and (b) plan view (MODOT, 2000)	5
4.1	Location of Selected Case Study Bridge Sites	9
4.2	Site Plan for Explorations for Bridge A-6031, US 36, Livingston County	11
4.3	Subsurface Cross-Sections for Bridge A-6031, US 36, Livingston County	12
4.4	Site Plan for Explorations for Bridge A-5690, MO 19, Crawford County	14
4.5	Subsurface Cross-Sections for Bridge A-5690, MO 19, Crawford County	15
5.1	Resident Engineers' Survey Statewide Results Chart	17
5.2	Surficial Materials Map of Missouri – source: MoDNR	18
5.3	Map showing the results of RE survey over Surficial Materials Map	19
5.4	Br. A6031 East Abutment Side View Design	23
5.5	Bridge A6031, Livingston County Rte. 36	24
5.6	Representation of Bridge Approach Sleeper Beam and Loading for PLAXIS Model	25
5.7	High Bound Total Displacement Shadings Br. A6031	28
5.8	High & Low Bound Displacement Curves East Abutment Embankment Br. A6031	29
5.9	A6031 Low Bound Vertical Deflection Curve Showing “Structurally Important Deflection”	30
5.10	(a) Deformed mesh results of Bridge A-5690 in Crawford County. (b) Contours of deformations for the loaded bridge approach slab on the top of embankment	31

LIST OF TABLES

Table	Caption Description	Page
4.1	RE's Survey Distributed in November 2002	7
5.1	Summary of Survey to Neighboring States	20
5.2	Pocket Penetrometer and Torvane Shear Strength Data Foundation Soil, Br. A6031 East Abutment	24
5.3	Material Parameters, Low Bound	26
5.4	Material Parameters, High Bound	27

1. INTRODUCTION

The problem often referred to as the “bump at the end of the bridge,” is well known in the highway engineering community. This discontinuity in grade caused by differential settlement is sometimes dramatic (see Figure 1.1). It can result in driver distraction and discomfort, and it can impair safety as well as cause automobile damage. Nationwide this problem is estimated to affect 25% of all bridges (approximately 150,000 bridges) resulting in expenditures of at least \$100 million per year (Briaud, et al., 1997). Missouri is certainly not immune to this problem. In a recent survey of statewide geotechnical problems, Missouri Department of Transportation (MoDOT) geologists and engineers ranked the settlement of bridge approaches second only to slope instability in order of importance (Bowders, et al., 2002).



Figure 1.1- Br. A5934, Rte. 21 Crossing the Little Black River in Southeast Missouri.

To expand on the findings of the Bowders, et al., (2002) study, MoDOT and the University of Missouri-Rolla initiated research project RI02-033, “Evaluation of Bridge Approach Slabs, Performance and Design”. The objectives of the research project were as follows: to establish and relate a thorough understanding of the components of the bridge approach problem, to evaluate the performance of the current MoDOT bridge approach product (including both design and construction), and to suggest possible actions or design changes to lessen the potential for problematic behavior on future projects.

In order to appreciate the causes of the failures occurring at bridge ends, an introduction to the mechanics of the approach is warranted. In 1993, MoDOT adopted a “sleeper” beam and approach pavement design as shown in Figure 1.2. The end abutment of the bridge rests on a deep foundation driven to rock or other unyielding bearing strata. The approach slab is supported on one end by the abutment and by the concrete sleeper beam on the other end. The sleeper beam rests atop the bridge end embankment. This design results in one structural member being supported by two very different foundation systems.

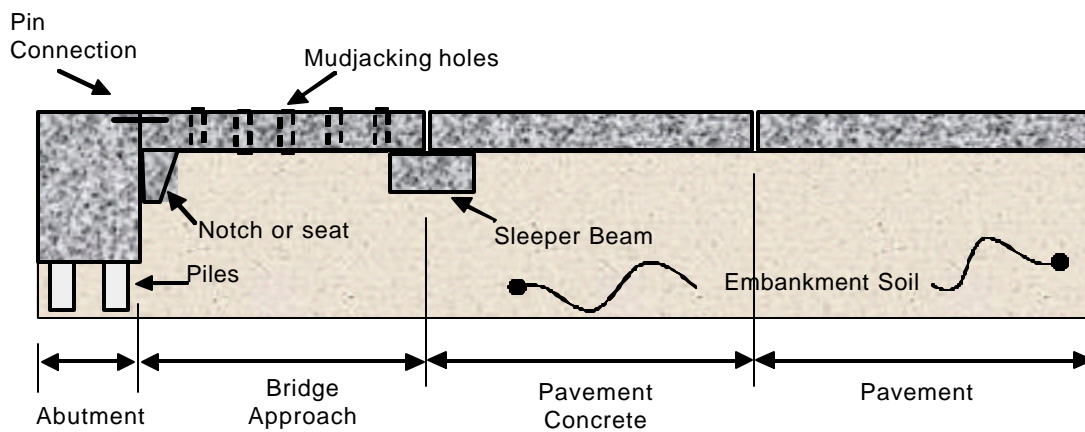

Figure 1.2 - MoDOT Post-1993 Bridge Approach Design, after Bowders, et al. (2002).

2. OBJECTIVES

The overall objective of this research project was to identify and quantify the failure mechanisms recently observed at the bridge approach slabs supported on approach embankments. Two bridge sites were selected for detailed study of the performance and involved subsurface investigations and analysis reported herein. The final objective was to provide recommendations related to the design and construction of bridge approach slabs for possible implementation by MoDOT. During the course of the research project an additional objective was introduced, which was to conduct a survey to assess the performance of the bridge approach slabs. The MoDOT resident engineers and subsequently representatives in the neighboring states were sent a survey questionnaire administered via email.

3. PRESENT TECHNICAL CONDITIONS

The present technical conditions were evaluated using the standards and specifications for Missouri bridges. For a few specific bridges the actual design plans for the project were used for the evaluation. For example, Figure 3.1 shows a typical cross-section of a bridge abutment in the longitudinal direction. The seat-type abutments are typically supported on piles to a firm strata and tied back to a deadman anchor at the base to restrain movement in the lateral direction. The embankment fill is typically shown as a Class “C” (shot rock fill) and occasionally a clay plug is shown in the drawings to facilitate pile driving through this rockfill embankments, as shown in Figure 3.2.

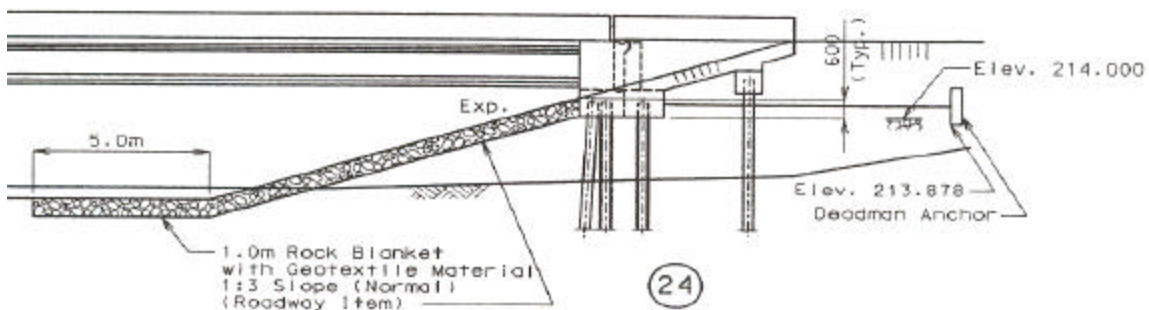
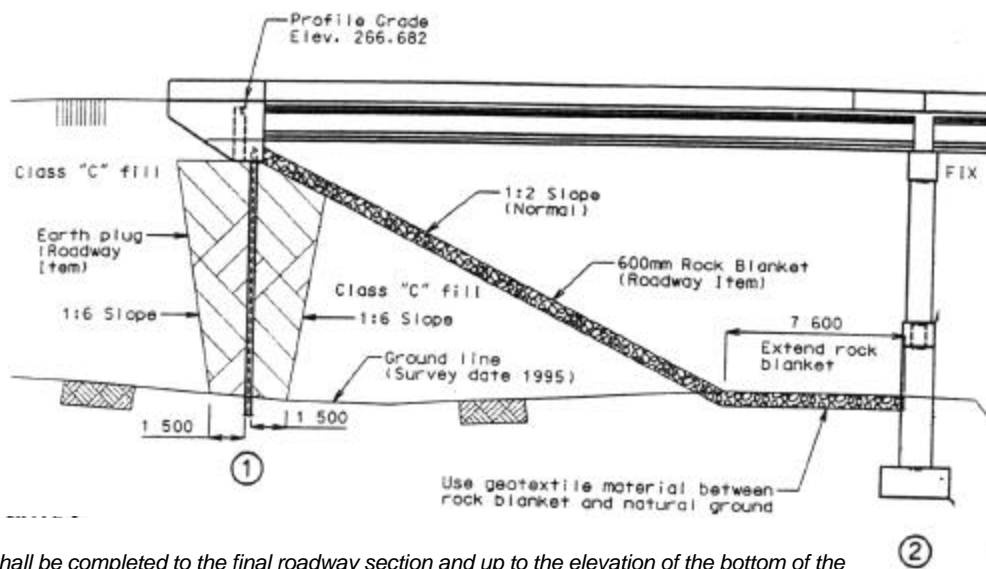

Figure 3.1 - Typical Cross-section of a bridge abutment in longitudinal direction



Note:

Roadway fill shall be completed to the final roadway section and up to the elevation of the bottom of the concrete beam within the limits of the structure and for not less than 8 meters in back of the fill falling within the embankment section

Figure 3.2 - Typical Cross-section showing an earth plug within rock fill embankment

An evaluation of the current design was made based on several meetings with MoDOT personnel, such as the progress report meetings, and by telephone conversation and inspection of the bridge plans. The bridge approach slab (BAS) was designed to span as a one-way slab from the notch at the abutment to the sleeper beam (i.e., from a unyielding pile supported abutment to a shallow footing support on the embankment) unsupported at the wing walls. The bridge approach slab is 8m long and 30cm thick. The sleeper beam runs the entire width of the BAS lane and is 50cm thick. Drainage material is placed below the entire slab and a perforated pipe along the sleeper beam with an invert elevation at the bottom of the sleeper beam (see Figure 3.3a). It was determined that the bridge approach slab was designed to bridge the 8 meter span from the abutment to the sleeper slab, assuming a void would develop below the entire slab. A standard bridge approach slab drawing is available on the MoDOT Bridge Standards Website, http://www.modot.state.mo.us/business/standard_drawings/approachslab.htm. Figure 3.3a shows this similar layout without a skew that is shown in typical drawings.

Since the design anticipates the development of a void, a grid of holes through the bridge approach slab were incorporated in the design to mudjack the slab back to designed elevation. The grid of mudjacking holes is shown in the plan view for the bridge approach slab in Figure 3.3(b). The holes are spaced at about 2.0 by 2.5 meters on center. Mudjacking of the slabs is the responsibility of the maintenance operations and is typically done with a lean mix of sand and cement. Slabs are sometimes mudjacked by a contractor using specialized materials for pumping, such as foam. One of the name brands of this pressurized foam is called Uretek®, which requires a different size of hole for the application of the stabilizing slab pumping. Different holes have to be drilled in addition to the cast-in-place holes for the use of the Uretek® product. When excessive compression of the embankment structure is observed compaction grouting of the subgrade has been the corrective measure of choice. The compaction grouting is performed to both raise the BAS and stabilize the embankment soil mass with its cementitious properties of the grout.

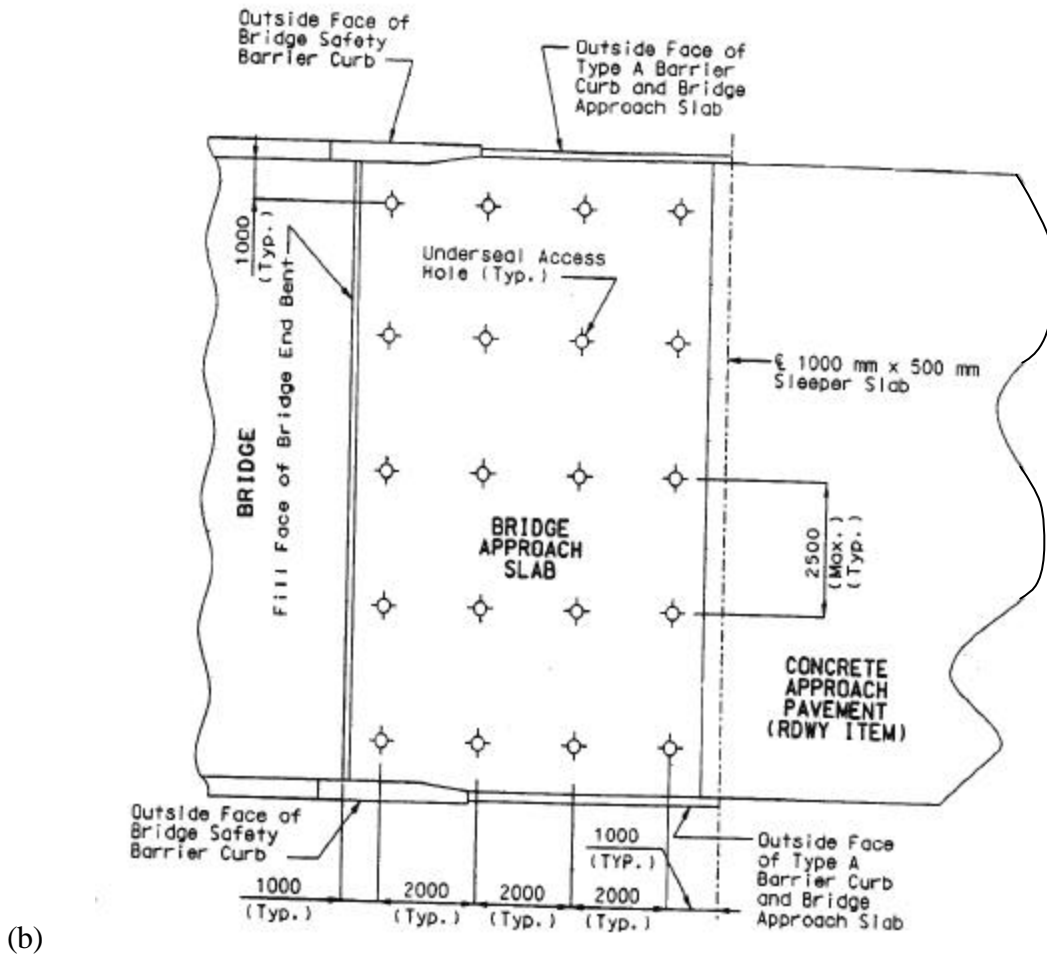
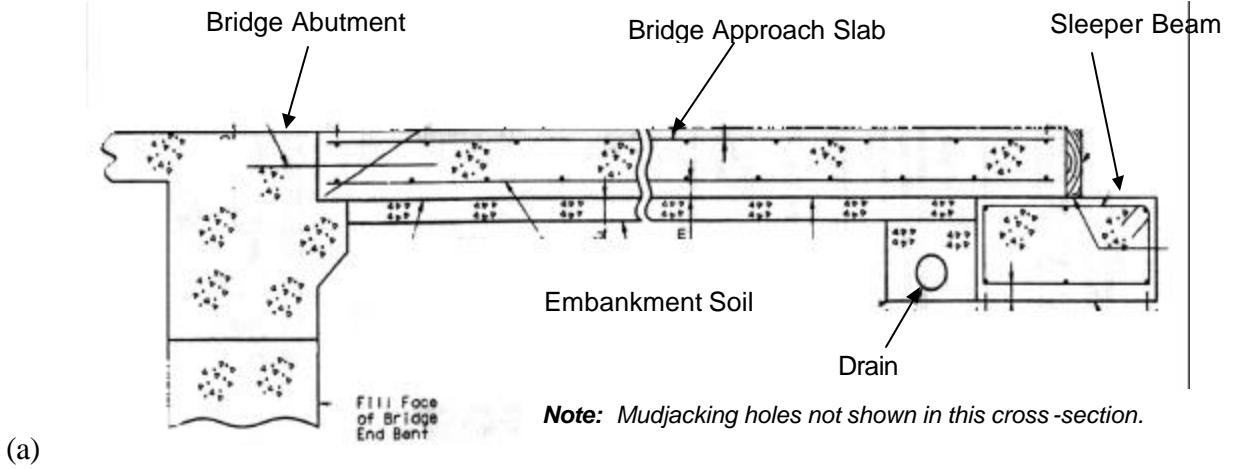

Figure 3.3 – Standard Design Drawings for the Bridge Approach Slab (a) longitudinal cross-section, and (b) plan view (MODOT, 2000)

4. TECHNICAL APPROACH

4.1 General

The aim of this project was to identify the performance of the BAS and examine the failures throughout the state. Once these mechanisms are identified and studied, a number of potential mitigation measures were studied and prioritized for implementation into a revised design or a new approach to the construction. Emphasis was paid to the soil-structure interaction and this transition location from the unyielding pile supported bridge structure to the softer support at the embankment. The first task in the research approach was to examine the existing technical conditions (Section 3.) followed by a literature review of this common problem in bridge structures. These tasks were followed by a survey questionnaire of MoDOT Resident Engineers (RE) and additional questions to neighboring states Departments of Transportation. Based on the data collected, two sites were selected for detailed study, one in Livingston County and the other in Crawford County. The intent of these two case studies was to collect embankment soil properties and analyze the deformation trends of the embankments where the sleeper beam and BAS are supported. Construction staging and sequence were also taken into account.

4.2 Literature Review

A literature review of the traditional problem of the bump-at-the-end of the bridge was conducted and several mitigation measures were studied. A narrative description of this effort is contained in Appendix A. Reference will be made to this appendix later in this report where specific mitigation measures are discussed as they apply to the state of Missouri and the current design of the BAS.

4.3 Development of Resident Engineer's Survey

A brief survey questionnaire was developed in consultation with the MoDOT task force. The intent was to make the survey as simple and brief as possible so that it yielded considerable response rate. The REs were asked to evaluate the performance of the bridges they were familiar with and assign a designation to that level of performance. The survey as distributed in November 2002 is included in Table 4.1

Table 4.1 – RE’s survey distributed in November 2002

<p>Bridge Approach- Resident Engineer Survey</p> <p>The primary goal of this project is to evaluate the performance of the current bridge approach design. This survey will serve to help identify and quantify bridge approach slab problems throughout the state.</p> <p>Please attempt to fill out this survey for all bridges built out of your office from the mid-1990's to the present using the current bridge approach design. Please be as complete as possible...Thank you, your help is appreciated.</p> <p><u>Survey Designation-</u></p> <ol style="list-style-type: none"> 1. No visible problem: approach slabs are functioning without any noticeable defect. 2. Some differential movement: noticeable differential movement at approach(s)-bridge interface, no corrective action required. 3. Problematic movement: bridge approach has moved enough to require corrective action (or is in need of corrective action). 					
Year Complete	Name	Route	County	Survey Designation	Remarks - (Thoughts on cause of problem).

4.4 Survey Administration

The survey was distributed electronically to all the resident engineers by means of the MoDOT email network. The kind assistance of Dennis Bryant, Construction, was provided for this survey, which yielded a good response rate of 33%. Additionally, a series of questions were also sent to DOTs at neighboring states. The results of the survey are presented and discussed in Section 5 of this report.

4.5 Bridge Approach Movement Mechanisms

There are a number of modes of failure that may occur at the abutment. This section will identify the most common causes of embankment movement and provide tools for predicting embankment deformation. Causes of bridge approach movement include compression of the embankment fill material during and immediately following grading operations, settlement or the creation of voids beneath the sleeper beam and approach slab due to the embankment fill not being constructed properly, such as, having drainage problems or being composed of a poorly compacted material. Improper compaction practices or the use of soils subject to volume change may lead to consolidation, shrinkage, or heaving

embankment soils. Embankment soil may be lost to erosion or it may move laterally out from beneath the roadway due to improper design and/or construction methods. Additionally, the foundation soils may undergo consolidation and/or secondary compression resulting in excessive settlement. The following list is a summary of the topics researched in more detail in the work by Robison (2003) in Chapter 4 of his thesis:

- Compression of Embankment Soil
- Water Intrusion Induced Compression
- Local Settlement - Subgrade Failure
- Soil Volume Change due to Moisture Content Change
- Construction Methods
- Primary Compression of Foundation Soil
- Secondary Compression of Foundation Soil
- Erosion And Lateral Spreading Of Embankment Material

4.6 Evaluation of Performance – Two Case Study Bridge Sites

The original scope of work included the investigation of two bridge sites that have different levels of performance. The selection process of these sites was comprehensive and based on the existing information at MoDOT. Some examples of the information available at the time of the study are listed below:

- Pre- and Post-construction subsurface exploration data for four bridges with approach slab. The post-construction subsurface data was of special interest considering this data is not common for a regular bridge development project (Bridge Designations: A-4145, A-4993, A-6182, and A-5865).
- Bridge plans with bridge layout and borehole data for the 33 bridges selected by the task force.

After careful consideration of all the information collected by the researchers and task force, it was considered appropriate to select the two sites for post-construction embankment fill characterization and

further study. These sites were located one in northern and the other in southern Missouri as shown in Figure 4.1.

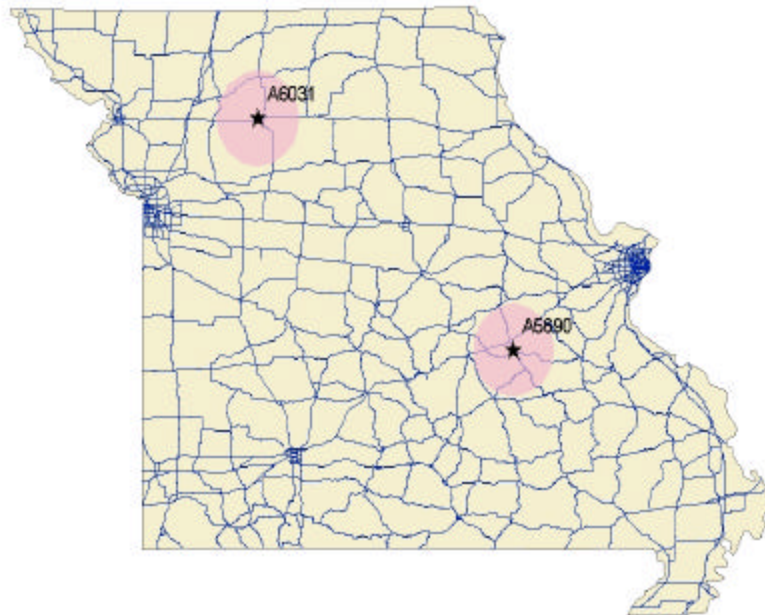

Figure 4.1 – Location of Selected Case Study Bridge Sites

Bridge A-6031, Route 36, Livingston Co., reasons for selection:

1. Good documentation of construction, Resident Engineer and District Geologist cooperative
2. Extensive soil reports were available for this site due compressible foundation soils
3. Site located in Northern Missouri - deep soft natural soil deposits, friction piles
4. Problem appears to be consolidation of foundation soils and fill placement.

Bridge A-5690, Route 19, Crawford County, reasons for selection:

1. Easy access to site and construction records
2. Better performance than other site, but still some indication of settlement.
3. Site in south central Missouri - shallow rock, rocky clay fills
4. Problem appears to be construction method/ high PI/ dirt plug

For both of the selected bridge sites the following information was collected: plans, soil reports, construction information, and initial settlement calculations. A decision to perform additional subsurface investigations (boreholes and seismic CPT) at these locations was made in early 2003.

4.7 Subsurface Investigations

The purpose of the subsurface investigations at the two case study sites was to characterize the soil materials below the bridge approach slabs. The extent of the investigations was focused primarily on the embankment soils. However, some explorations did go beyond the bottom of the embankment. Available subsurface data from the original design of the bridge structure were used to determine the soil profile conditions below the embankments. MoDOT materials staff conducted standard penetration testing with sampling, Atterberg limit tests, pocket penetrometer tests, and rock coring. Borehole logs, CPT logs and a summary of the laboratory test results are presented in Appendix B.

For the northern bridge site (A-6031), due to the presence of compressible deposits, a special foundation investigation was originally conducted in 1999 by MoDOT, which incorporated handheld pocket penetrometer and torvane shear tests, and consolidated drained direct shear tests. The special foundation report also included consolidation tests and predicted 0.11 meters of foundation settlement at station 14+187 14.5m Rt taking up to 9 months with half the settlement occurring in 2 months. A boring at 14+257.1 15.36 m Rt was used to predict 0.23 meters of settlement taking up to 2 years and 5 months for half of the settlement. This research project generated data that complemented the previous subsurface information available by completing four boreholes and two piezocone soundings. The personnel of the MoDOT Soils & Geology division carried out the field investigations during the winter of 2003. The locations of the boreholes and piezocones are shown in Figure 4.2. The embankment soils of this bridge approach embankment consisted of lean to fat clay with some sand and gravel mixed in. The piezocone soundings were able to penetrate to a depth beyond the bottom of the embankment until they reached refusal on deeper sand deposits. Subsurface cross-sections of the approach embankments (A-A' and B-B') for both ends of the bridge are shown in Figure 4.3, which were the basis for the models developed for the deformation analysis.

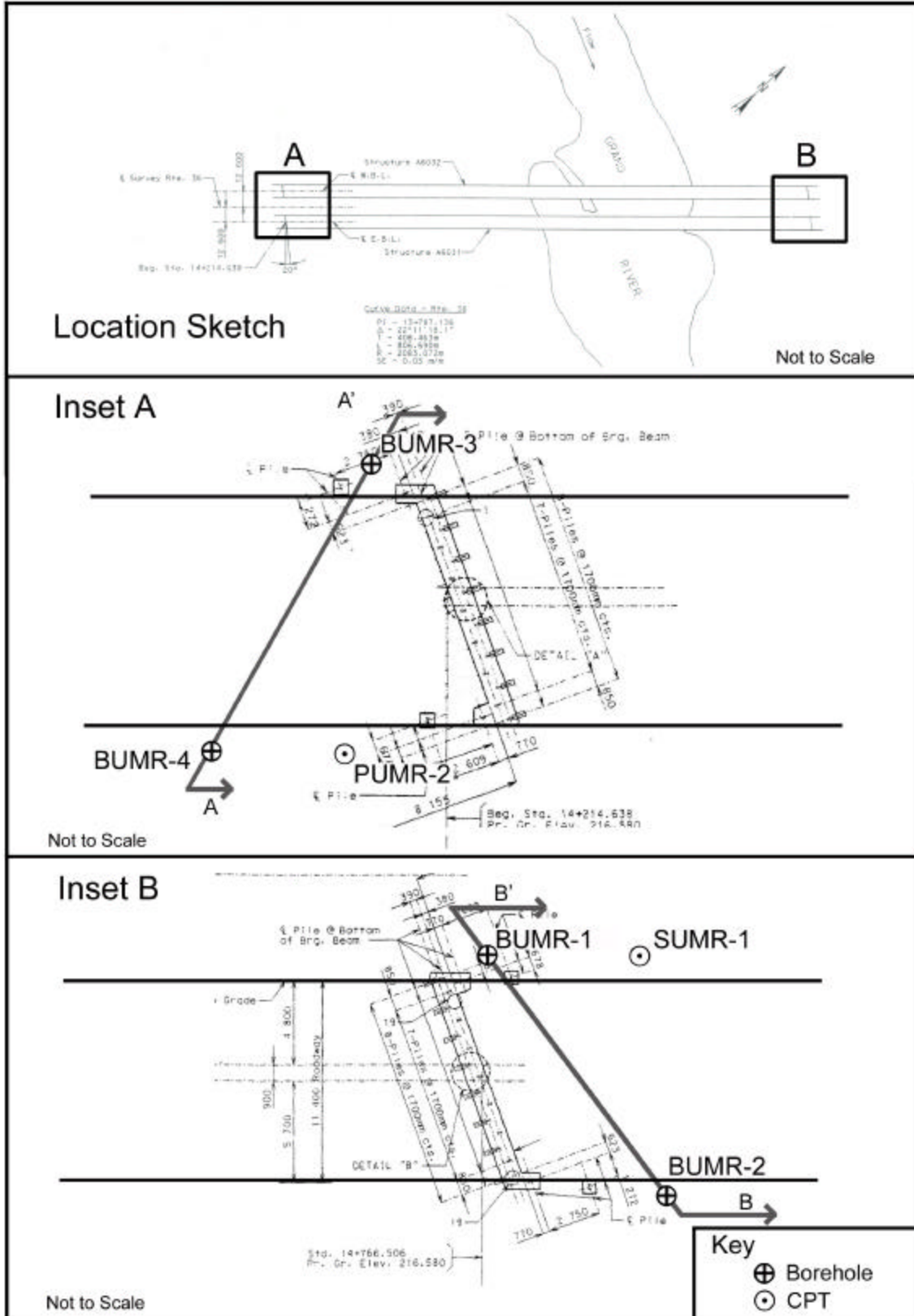
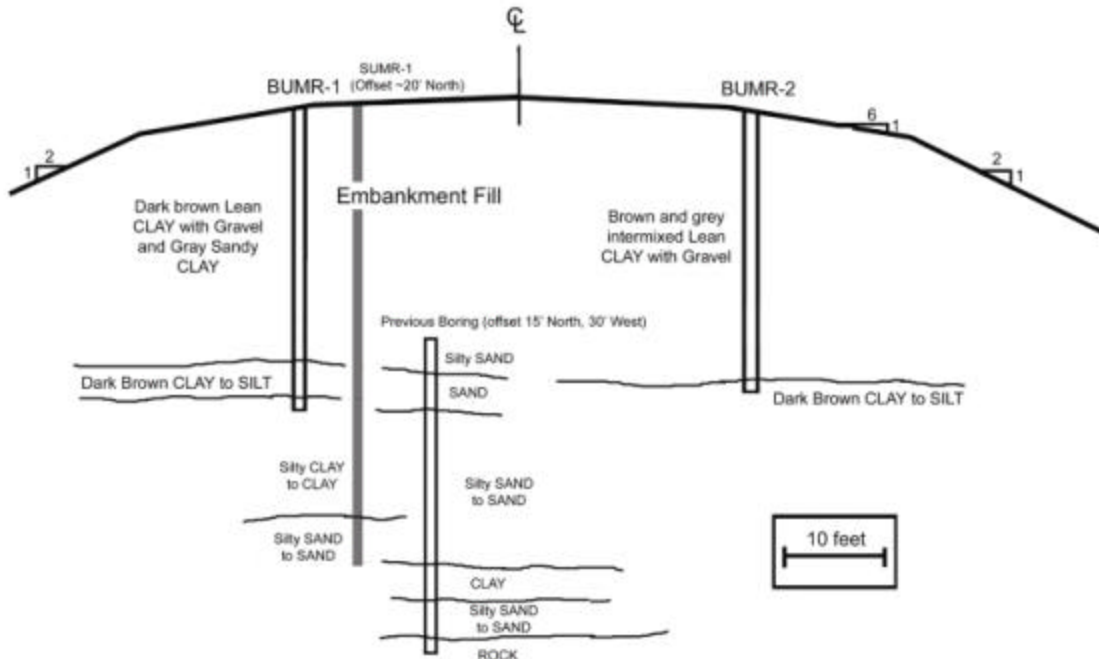
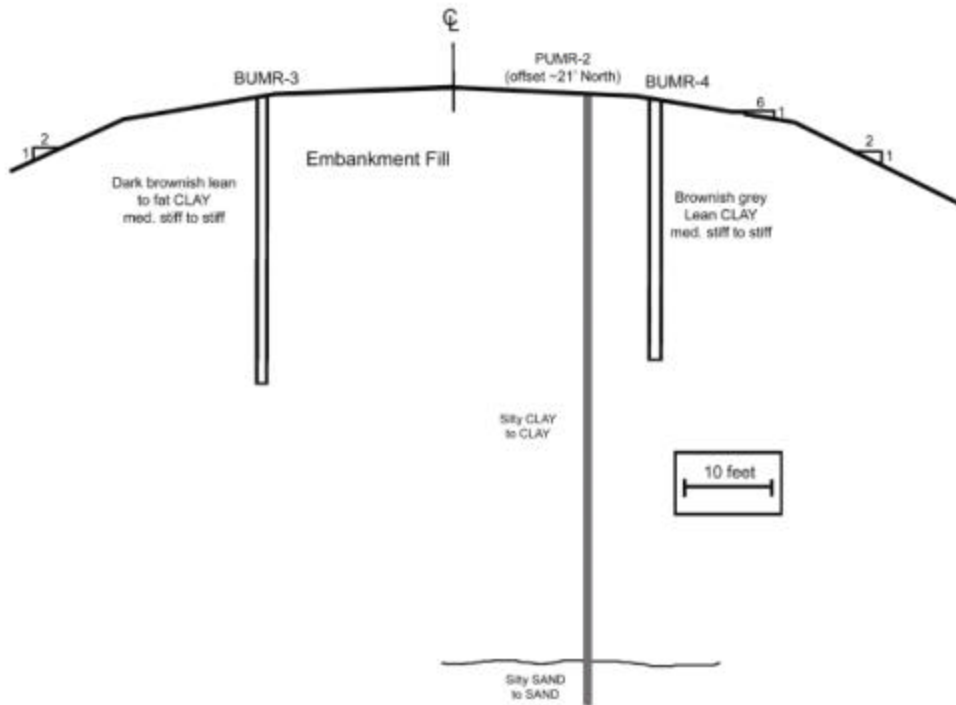

Figure 4.2 – Site Plan for Explorations for Bridge A-6031, US 36, Livingston County



Cross-section B-B' (see figure 4.2 for plan view)



Cross-section A-A' (see figure 4.2 for plan view)

Figure 4.3 – Subsurface Cross-Sections for Bridge A-6031, US 36, Livingston County

For the southern bridge site (A-5690), a conventional foundation investigation was conducted due to the presence of relatively competent foundation conditions. MoDOT also conducted this geotechnical work for the original roadway and bridge design. This research project added to the previous subsurface information available by completing four boreholes and three piezocone soundings. The personnel of the MoDOT Soils & Geology division carried out the field investigations during the spring of 2003. The locations of the boreholes and piezocones are shown in Figure 4.4. The embankment soils of this bridge approach embankment consisted of lean to fat reddish brown clay with gravel. In the northern embankment the fill material was much more sandy within the clay matrix. The piezocone soundings were able to penetrate to a depth beyond the bottom of the embankment until they reached refusal on deeper sand deposits. Subsurface cross-sections of the approach embankments (A-A' and B-B') for both ends of the bridge are shown in Figure 4.5. These cross-sections were the basis for the models developed for the deformation analysis.

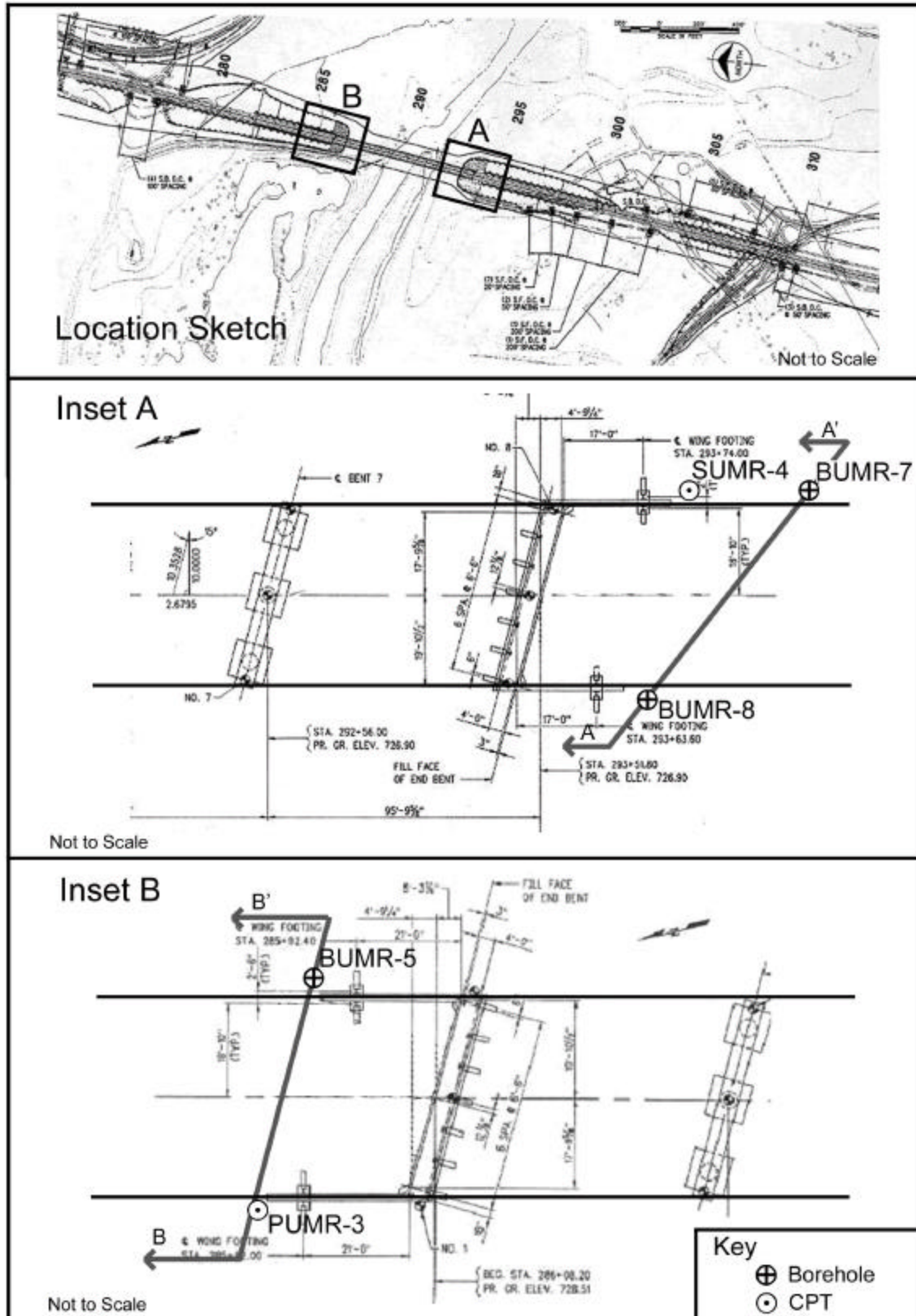

Figure 4.4 – Site Plan for Explorations for Bridge A-5690, MO 19, Crawford County

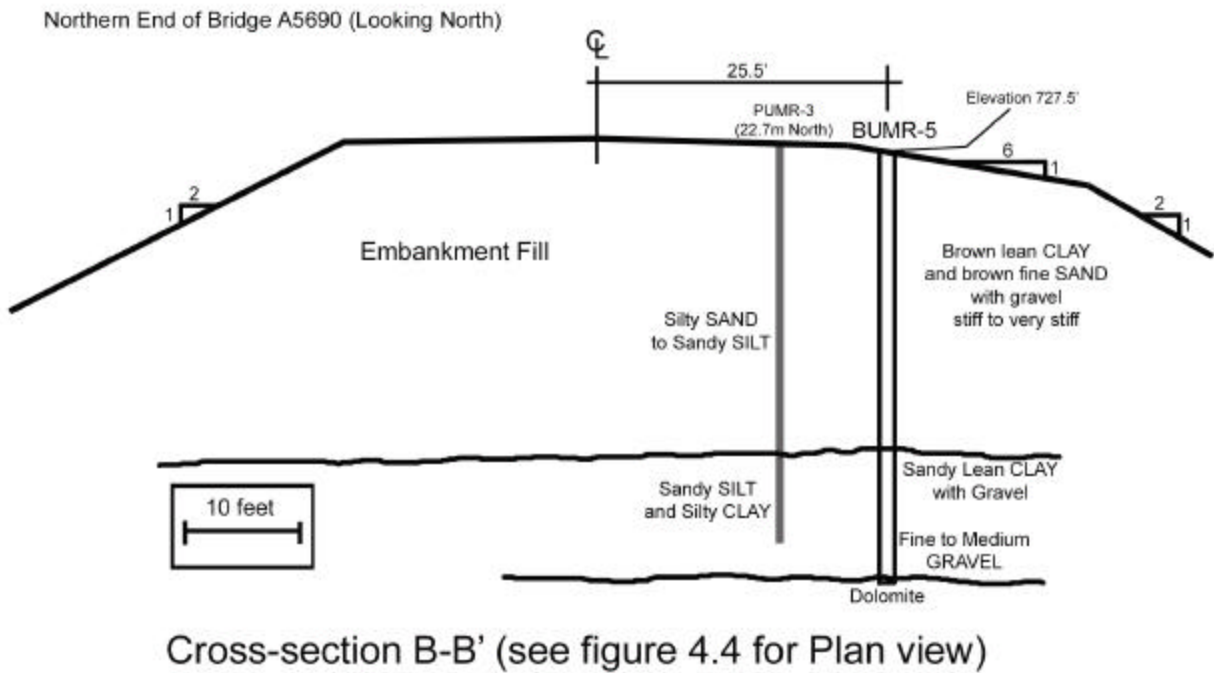
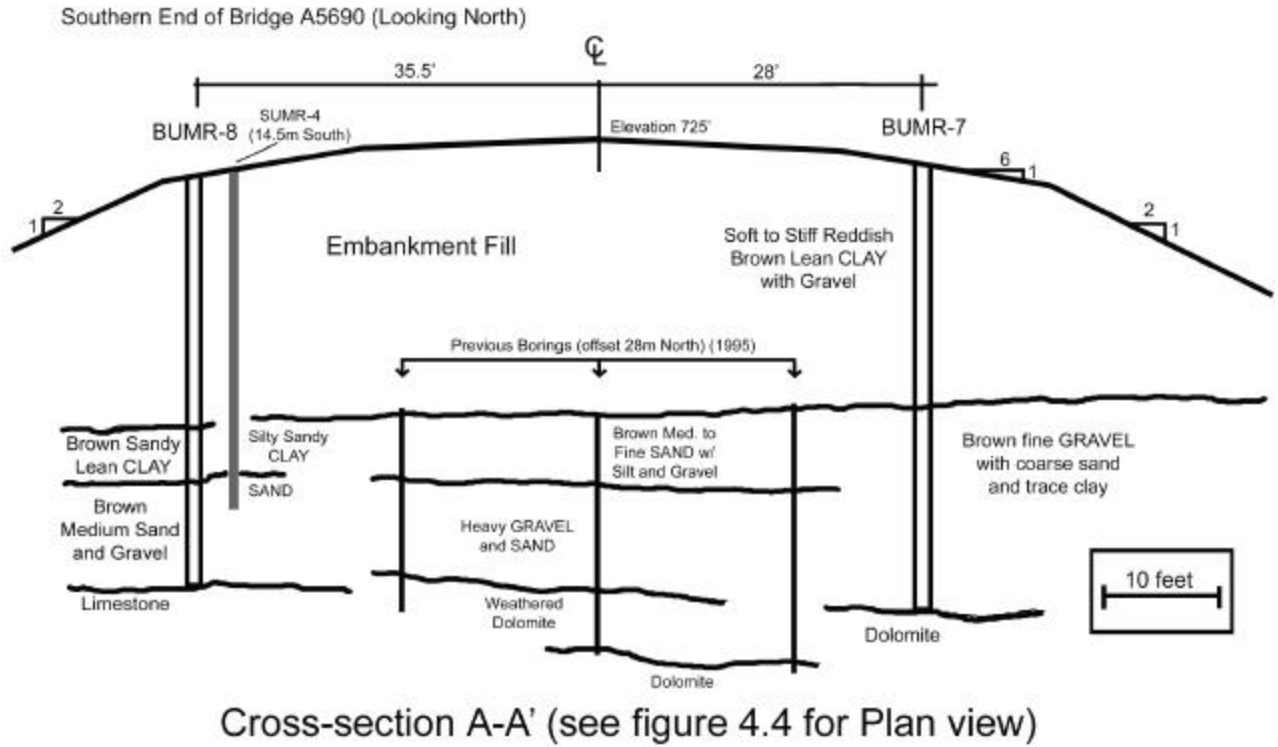

Figure 4.5 – Subsurface Cross-Sections for Bridge A-5690, MO 19, Crawford County

4.8 Numerical Deformation Analyses

To get a better understanding of the deformation characteristics of embankments and their construction sequence a numerical model of each case study was performed. The material properties were obtained from the subsurface investigations and correlations by other researchers. The numerical models were performed using the finite element method (FEM) as implemented in the program PLAXIS.

PLAXIS was originally developed beginning in 1987 at the Technical University of Delft for use in finite element modeling of the highly compressible soft soils of the lowlands of Holland. Since this time PLAXIS development has advanced to the point where many geotechnical studies could be evaluated using this user-friendly program. In 1998 the first Windows version was released followed in 2001 with the appearance of the PLAXIS 3D Tunnel program. According to Brinkgreve (2002) the main goal of PLAXIS is to “provide a tool for practical analysis to be used by geotechnical engineers who are not necessarily numerical specialists.”

PLAXIS offers the user a great deal of features and flexibility in modeling. Brinkgreve (2002) notes, “PLAXIS version 8 is a finite element package intended for the two-dimensional analysis of deformation and stability in geotechnical engineering. Geotechnical applications require advanced constitutive models for the simulation of the non-linear, time-dependent and anisotropic behavior of soils and/or rock. In addition, since soil is a multi-phase material, special procedures are required to deal with hydrostatic and non-hydrostatic pore pressures in the soil. PLAXIS has special features to deal with various aspects of complex geotechnical structures.” The Mohr-Coulomb analysis mode was used for this project with both drained and undrained analysis for the respective soil layers. In order to conduct this analysis some familiarity with soil mechanics principles is necessary. In Section 5.3 of this report, the results of the deformation analyses are presented for each bridge approach slab case study.

5. RESULTS AND DISCUSSION

5.1 Results of the BAS Surveys – Resident Engineers

Fourteen of the 43 RE offices responded to the survey resulting in a response rate of 33%. Data from 185 bridges was collected and returned by the RE offices. Possible causes of the problem suggested by the Resident Engineers include: large fill heights, gumbo foundation soil (high organic content), insufficient or improper subgrade compaction, seismic activity, heavy truck loads dynamically impacting the approach, and water undermining the sleeper beam. These suggested causes are very similar to information available from other states and surveys.

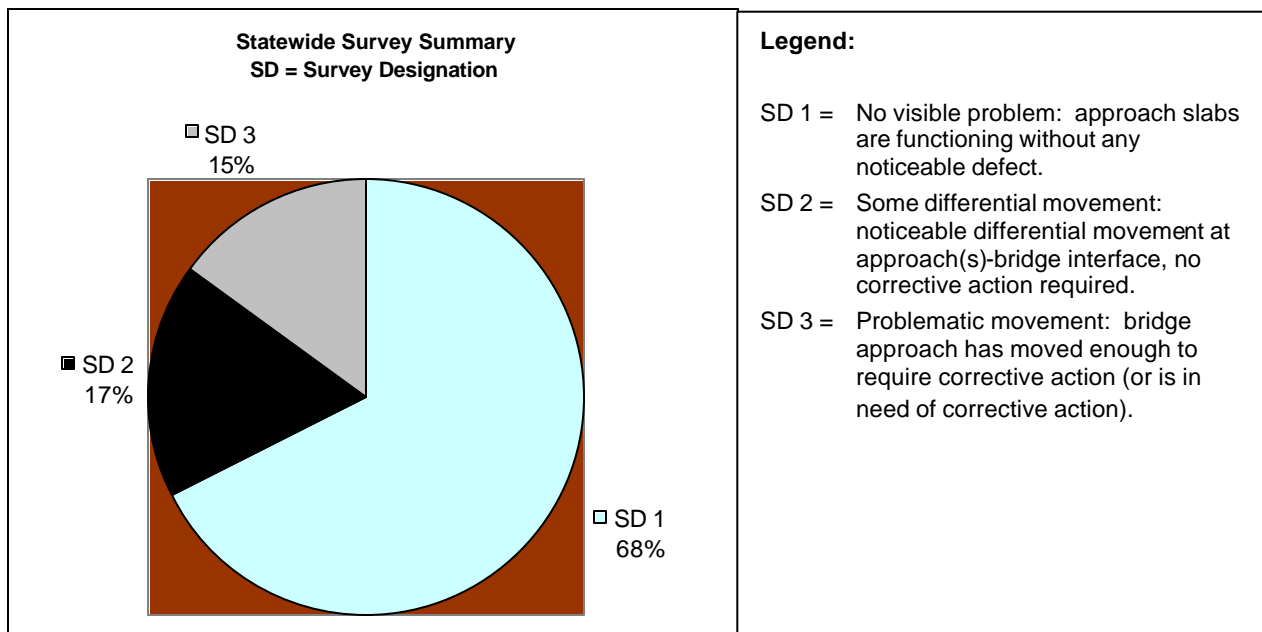

Figure 5.1 – Resident Engineers’ Survey Statewide Results Chart.

It is clear from Figure 5.1 that bridge approach movement is a problem in Missouri. Data regarding the extent of the problem prior to the 1993 design change is not known to exist, so it is difficult to tell if the 1993 change was an improvement. Clearly the design is not functioning at what could be considered an acceptable level of performance.

The survey response data of the individual offices were plotted using a Geographical Information System (GIS) and the Missouri surficial materials map shown in Figure 5.2 to see if any correlations

between soil types, depth to rock, or etc... could be made. This map layout is presented as Figure 5.2 and it also shows the four general geologic regions by name.

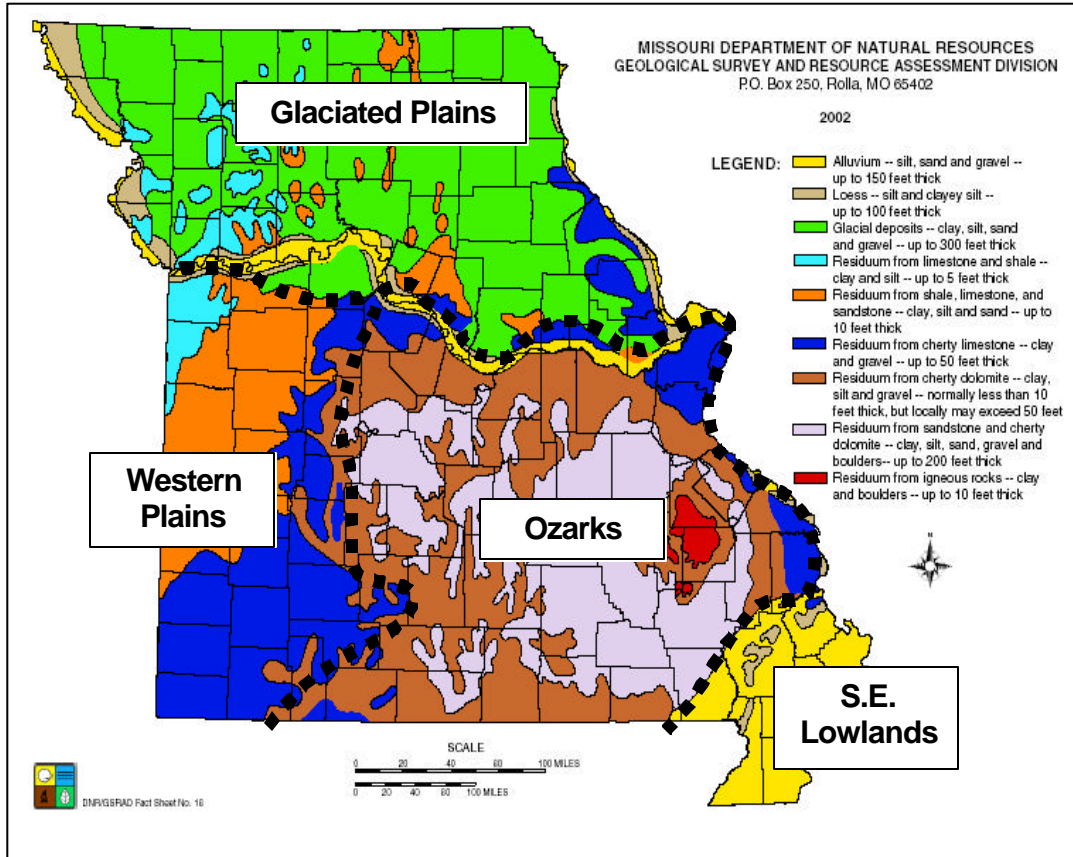

Figure 5.2 – Surficial Materials Map of Missouri – source: MO Department of Natural Resources

It is apparent from Figure 5.3 that, as expected, bridge approach settlement is a statewide problem. Interesting to note is the concentration of gray (survey designation 3) in the pie charts in East-South-Central areas of the state. This band of unusually poor performance seems to be bounded by St. Louis in the East, Poplar Bluff in the South, Rolla in the West, and Columbia in the North. All of these offices have construction projects in the shallow, rocky clay areas of the Missouri Ozarks. Often these clays are highly plastic but they are not usually treated when used as construction materials by MoDOT. Also, because of the amount of rock present in the soils, it is often not possible to test fill compaction with the nuclear gauge (the standard MoDOT compaction test method).

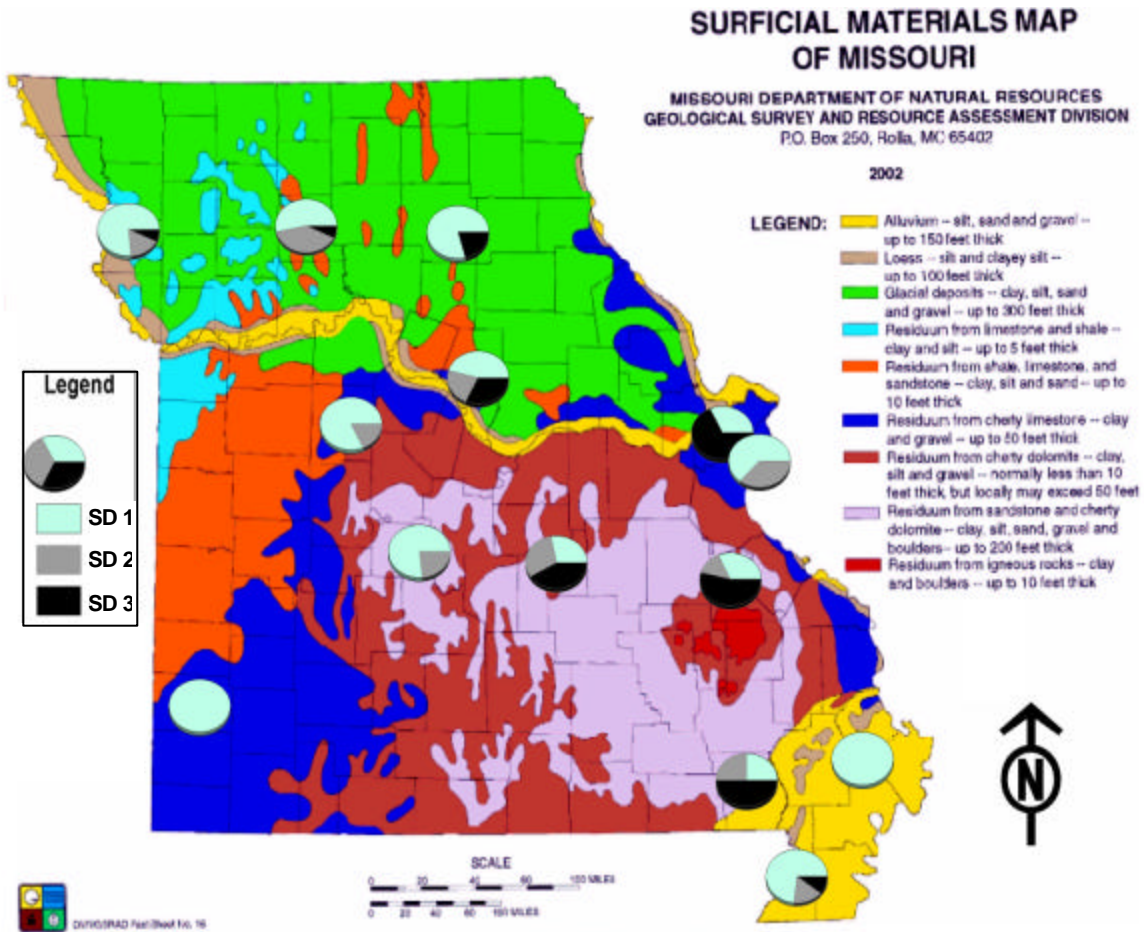

Figure 5.3 – Map showing the results of RE survey over Surficial Materials Map

5.2 Results of the BAS Surveys – Neighboring States

The response to the survey administered by Mr. Bill Strossner (FHWA) was very successful, every neighboring state responded to the questionnaire. It was evident that the BAS problem is prevalent in the Midwest. Several states have taken a proactive approach to study the problem. The mitigation measures vary, but are repeated in application, such as flowable fill, select fill, pile-supported sleeper beam, construction sequencing, mudjacking, and asphalt overlays. A summary of what was learned from the Neighboring states is presented in Table 5.1. The most recent publication found on these mitigation measures of neighboring states was from the State of Illinois (Stark, et al., 1995).

Table 5.1 – Summary of Survey to Neighboring States

<p>1 Is the bump-at-the-end-of-the-bridge a problem in your state? If Yes, to what degree? (Low,med, or high)</p> <p>AR Yes, Medium</p> <p>IA Yes, Medium to High</p> <p>IL Yes, Low to High</p> <p>KY Yes, Medium</p> <p>NE Yes, High at one time</p> <p>TN Yes, Low</p> <p>OK Yes, High to Low</p>
<p>2 Has your state conducted a study on this issue? If yes, please provide a reference/contact.</p> <p>AR Yes, Dr. Jack Gazin (501)569-2498 jack.gazin@ahtd.state.ar.us</p> <p>IA Yes, Study currently underway by Dr. David J. White (515) 294-1463</p> <p>IL No. However, our efforts found (Stark & Olson, 1995, University of Illinois -Champaign)</p> <p>KY Yes, David Allen at the University of Kentucky Transportation Center</p> <p>NE No. However, our efforts found (Tardos & Benak, 1989; Univ. of Nebraska)</p> <p>TN No.</p> <p>OK Yes, Dave Gridner, ODOT Planning & Research Division (405) 521-2536</p>
<p>3 How do your maintenance personnel take care of the problem?</p> <p>AR AHTD current method for repairs is a foam injection process "URETEK" using 1.5 to 20 psf when BAS is used.</p> <p>IA Grouting under the approach slab and asphalt overlay.</p> <p>IL Typically, a contract is let for a bituminous resurfacing through the depressed area. Raveling of the overlay limits is a problem with this repair method, unless butt joints can be cut into the existing pavement.</p> <p>KY Usually by just wedging with asphalt.</p> <p>NE Case by case.</p> <p>TN Despite the use of approach pavements on practically all bridges, settlement of the roadway fills occur, due either to incomplete compaction or subsidence of the existing ground under fills. Approach pavements just act to mitigate bumps in most cases.</p> <p>OK They fill the bump in with asphalt, mudjack, replace the slab or do nothing depending on the location and severity.</p>
<p>4 Does your state have a reinforced concrete bridge approach slab at the abutment?</p> <p>AR Yes, details enclosed.</p> <p>IA Yes.</p> <p>IL Yes, the present design is a 30-foot long, 15-inch thick reinforced approach tied to the abutment.</p> <p>KY Yes, not used at all bridges.</p> <p>NE Yes.</p> <p>TN Yes.</p> <p>OK Yes.</p>

Table 5.1 – Summary of Survey to Neighboring States (continued)

<p>5 Does your state use select imported granular material behind the abutment and into the approach embankment? If Yes, what type of material?</p>
<p>AR No.</p>
<p>IA Yes, Porous backfill (pea gravel) around subdrain. Granular backfill (sand) to subgrade level. Modified subbase (basically gravel) beneath pavement.</p>
<p>IL Yes, the abutment backfill is CA7, a 1-inch topsize crushed aggregate with few fines.</p>
<p>KY Yes, less than 10% passing Number 200 sieve - No shale.</p>
<p>NE Yes.</p>
<p>TN Yes, Class "A" grading D.</p>
<p>OK Yes, less than 10% passing Number 200 sieve - No shale. Flowable backfill is used between the wingwalls to the depth of the wingwalls.</p>
<p>6 Are there any other mitigation (fix) methods used with the approach embankment settles and the bridge does not?</p>
<p>AR Yes, see item No. 3.</p>
<p>IA Yes, we replace the approach slab and are trying to investigate other potential mitigations .</p>
<p>IL Yes, Mudjacking has been successful on some occasions. There is a concern that with integral abutment bridges the grout may stiffen to abutment and not allow temperature induced movement.</p>
<p>KY No.</p>
<p>NE Yes, since 1996 we have been using grade beam (sleeper slab) on piles or deep foundations.</p>
<p>TN Yes, approach pavements, which ease the transitions. When settlement occurs, asphalt wedges are used to fill the resulting dip.</p>
<p>OK --</p>
<p>7 Are there any other design features or construction techniques employed in your state to mitigate or minimize the bump-at-the-end-of-the-bridge" ?</p>
<p>AR Yes, backfill behind backwall with flowable fill</p>
<p>IA Yes, Recently, the width of the "pavement notch" was increased on the abutment and the amount of reinforcement steel has also been increased. Research project is currently underway.</p>
<p>IL Not at this time. However, we are thinking of longer approach slabs.</p>
<p>KY No.</p>
<p>NE</p>
<p>TN Not at present. Tighter compaction requirements are needed.</p>
<p>OK Yes, avoid tall abutments and slopes steeper that 3H:1V. Also, place a bench on the 3:1 slope to add stability.</p>

5.3 Results of Deformation Analyses

5.3.1 Input Parameters Common to Both Cases

MoDOT and UMR have conducted field and laboratory characterization of the two bridge embankment soils. This post-construction field program includes drilling, sampling, and in-situ testing (SPT, Shelby tube, and CPT explorations). Initial soil reports and plan balance areas made for the original design and construction process have been reviewed, so the basic composition of both fills is known. These fills were both constructed of CL material (inorganic clays of low to medium plasticity). NAVFAC (1986) and Kulhawy and Mayne (1990) give average strength and modulus parameters for a typical engineered CL fill. The parameters used are modulus of elasticity ($E = 1.03E^4$ kPa), Poisson's ratio ($\nu = 0.35$), apparent cohesion ($c = 86$ kPa), internal angle of friction ($\phi = 28^\circ$), and permeability ($k = 10E^{-9}$ m/s).

In addition to the soil models, the properties of the structural elements supported by the soil must be determined. The beam in Figure 5.6 was used to approximate the bridge approach sleeper beam for the embankments modeled in PLAXIS. This program requires the input of an axial stiffness (EA) and a flexural rigidity (EI) for a plate loading. The beam input parameters are $EI = 2.6E^5$ kNm²/m, and $EA = 1.2E^7$ kN. Once these structural properties are determined, the loading of the plate must be estimated. A truck loading of H-20 (40 kip) will fit on the approach slab, AASHTO (1996). It is assumed that the soil settles out from beneath the approach slab and so the slab is forced to span a void from the abutment to the sleeper beam (commonly observed if embankment is built rapidly). The ultimate loading or increase in stress felt by the approach embankment then is a combination of one half of the approach slab, the self-weight of the sleeper beam, and the traffic loading. This maximum estimated to be 56 kPa. Part of this load is static permanent and part is temporary, however the maximum possible load of traffic load was considered in this estimate. More details on when the loading is place are presented in the following cases analyzed.

5.3.2. Analysis of Bridge A6031, Livingston County US 36

Construction work on job J2P0476C in Livingston County began in August of 2000 and ended in November of 2002. The project included the construction of bridges and embankments to widen 8.9 kilometers of the existing two-lane US 36 to four lanes with paving to be completed under a different contract in the summer of 2003. The twin bridges A6031 and A6032 were built to span the Grand River flood plain. Both bridges are approximately 550 meters long and rely on a combination of driven H pile and drilled pier foundations with their end abutments founded on H piling. The east abutment (bent 24) approach of Bridge A6031 has experienced the worst settlement (almost 2") of the four approaches and will be emphasized for this case study. Figure 5.4 is the plan drawing of the east abutment and Figure 5.5 is a photograph of Bridge A6031 taken from the east abutment.

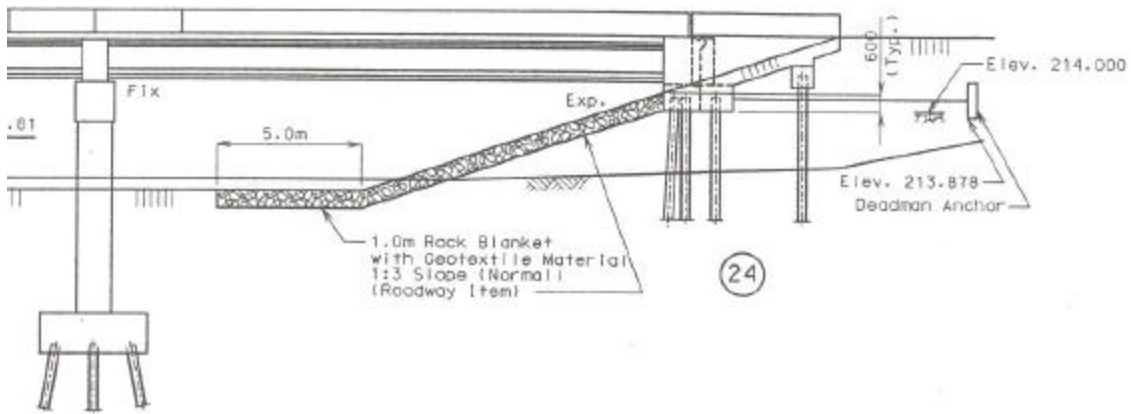

Figure 5.4 - Br. A6031 East Abutment Side View Design.

The east abutment embankment fill of approximately five meters depth was constructed between 11-30-00 and 12-09-00. The sleeper beam and slab were not built until the following year, being constructed between 8-29-01 and 9-13-01. This allowed for an interlude of nine months for compression to occur before the placement of the roadway.



Figure 5.5 - Bridge A6031, Livingston County Rte. 36.

The soil conditions for this site are typical of the Northern Missouri glaciated plains region. The topography is gently rolling upland dissected by the broad, nearly level flood plain of the Grand River. Soil investigations revealed till, loess, and residual soils, consisting primarily of stiff to very stiff lean to fat clays. The foundation soil beneath the east abutment of Bridge A6031 consists of a combination of clay, silt, and sand layers.

Table 5.2- Pocket Penetrometer and Torvane Shear Strength Data
Foundation Soil, Br. A6031 East Abutment.

Depth (m)	PP $\left(\frac{kg}{cm^2}\right)$	S_u (kPa)	TV $\left(\frac{kg}{cm^2}\right)$	S_u (kPa)
0.5	0.75	38	0.2	20
1	0.9	45	0.75	75
2	0.5	25	0.2	20
2.5	0.75	38	0.2	20
4.25	0.5	25	0.15	15
5.5	0.5	25	0.1	10
15	2.25	110	--	--
16.5	3.5	175	--	--
18	4.5+	225+	--	--
19.5	4.5+	225+	--	--
21	4.5+	225+	--	--

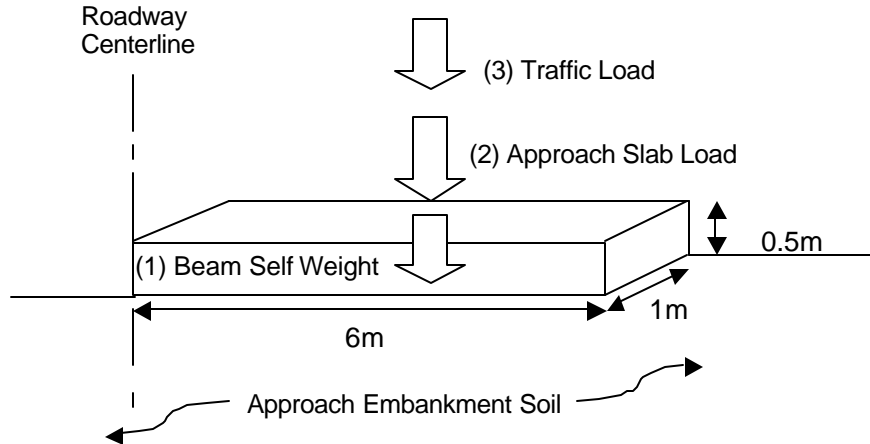

Figure 5.6- Representation of Bridge Approach Sleeper Beam and Loading for PLAXIS Model.

The ultimate load discussed in section 5.3.1 and shown in Figure 5.6 were used for initial PLAXIS runs to determine the stability of the approach embankment. With no stability problems noted, a long-term consolidation loading was needed that would not include the transient truck loading. For this long term consolidation loading a distributed pressure of 25kPa was calculated to represent the sleeper beam weight and one half of the approach slab weight. Based on construction records, four stages were used for the calculation phase; (1) construction of the embankment (10 days), (2) waiting period of 270 days, (3) construction of the bearing beam and approach slab (15 days), and (4) consolidation for 10 years.

Numerous computer runs were made in PLAXIS varying Young's modulus (E), cohesion (c), angle of internal friction (ϕ), and permeability. Select results presented in Tables 5.3 and 5.4 are designated as "low bound" (LB) and "high bound" (HB), respectively. The high and low bound refer to the relative values of the strength and compressibility parameters. The clay layers were modeled as undrained and the sand layers were modeled as drained for all runs. Drained runs using consolidation data developed by MoDOT for the original design were made to look at overall stability; no stability problems were noted. The values of S_u from the PP and TV tests (Table 5.2) were used for the undrained low bound runs. Values of S_u derived from the SPT testing (Hara, et al, 1974) were used for the high bound runs.

Table 5.3 - Material Parameters, Low Bound.

<i>Mohr-Coulomb Model, Soil Input Parameters</i>		1 new embankment	2 bc- upper clay layer	3 scsl- upper sand layer	4 gc-lower clay layer	5 scsd-lower sand layer
Type		Drained	Undrained	Drained	Undrained	Drained
g_{unsat}	[kN/m ³]	19.00	16.00	16.00	16.00	17.00
g_{sat}	[kN/m ³]	20.00	18.00	18.00	18.00	21.00
k_x	[m/day]	4.4E-4	1.81E-5	0.900	1.81E-5	0.900
k_y	[m/day]	4.4E-4	1.81E-5	0.900	1.81E-5	0.900
e_{init}	[-]	0.500	0.700	1.000	0.700	1.000
c_k	[-]	1E15	1E15	1E15	1E15	1E15
E_{ref}	[kN/m ²]	10300.000	5400.00	2100.00	16600.00	8700.00
n	[-]	0.350	0.350	0.200	0.350	0.200
G_{ref}	[kN/m ²]	3814.815	2000.00	875.00	6148.15	3625.00
E_{oed}	[kN/m ²]	16530.86	8666.67	2333.333	26641.98	9666.67
c_{ref}	[kN/m ²]	86.00	25.00	0.20	110.00	0.20
f	[°]	28.00	0.00	30.00	0.00	37.00
y	[°]	0.00	0.00	0.00	0.00	3.00
E_{inc}	[kN/m ² /m]	0.00	0.00	320.00	0.00	0.00
y_{ref}	[m]	0.000	0.000	4.000	0.00	0.00
$R_{inter.}$	[-]	0.65	1.00	1.00	1.00	0.7

(Note: see Figure 4.3 for location of soil layers 1 thru 5.)

Table 5.4 - Material Parameters, High Bound.

<i>Mohr-Coulomb Model, Soil Input Parameters</i>		1 new embankment	2 bc- upper clay layer	3 scsl- upper sand layer	4 gc-lower clay layer	5 scsd-lower sand layer
Type		Drained	Undrained	Drained	Undrained	Drained
g_{unsat}	[kN/m ³]	19.00	16.00	16.00	16.00	17.00
g_{sat}	[kN/m ³]	20.00	18.00	18.00	18.00	21.00
k_x	[m/day]	4.4E-4	1.81E-5	0.900	1.81E-5	0.900
k_y	[m/day]	4.4E-4	1.81E-5	0.900	1.81E-5	0.900
e_{init}	[-]	0.500	0.700	1.000	0.700	1.000
c_k	[-]	1E15	1E15	1E15	1E15	1E15
E_{ref}	[kN/m ²]	10300.00	10700.00	5700.00	24100.00	15400.00
n	[-]	0.350	0.350	0.200	0.350	0.200
G_{ref}	[kN/m ²]	3814.82	3962.96	2375.00	8925.93	6416.67
E_{oed}	[kN/m ²]	16530.86	17172.84	6333.33	38679.01	17111.11
c_{ref}	[kN/m ²]	86.00	210.00	0.20	520.00	0.20
f	[°]	28.00	0.00	34.00	0.00	40.00
y	[°]	0.00	0.00	0.00	0.00	3.00
E_{inc}	[kN/m ² /m]	0.00	0.00	220.00	0.00	0.00
y_{ref}	[m]	0.000	0.000	4.000	0.000	0.000
$R_{\text{inter.}}$	[-]	0.65	1.00	1.00	1.00	0.70

(Note: see Figure 4.3 for location of soil layers 1 thru 5.)

The displacement along the centerline of the embankment was computed to be 0.6 m for the low bound parameters and 0.25 m for the high bound parameters. It should be noted that this is the total deformation of the embankment including initial compression and consolidation that occurs before the construction of the approach pavement. This total displacement is not representative of the settlement of the roadway or any differential observed in the field. Figure 5.7 illustrates soil displacement within the embankment for the high bound condition.

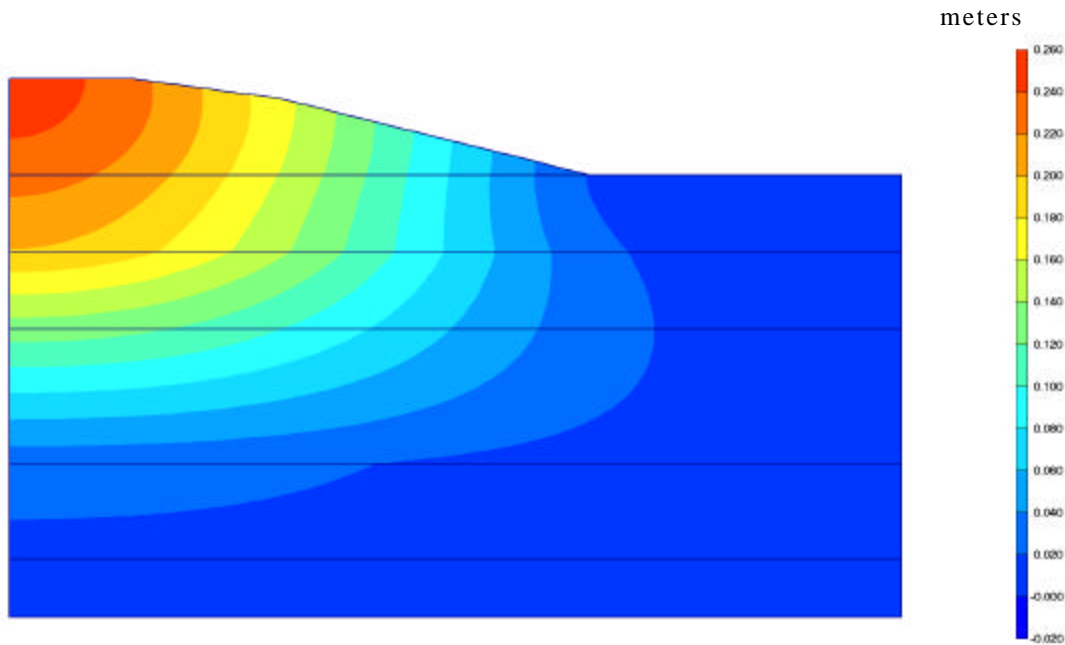

Figure 5.7- High Bound Total Displacement Shadings Br. A6031.

The relative lack of sophistication of the input data when compared to the tool used to model the abutment should be mentioned. The predicted displacements, particularly in reference to the timing of construction operations are instructive, but not as accurate as they would be if high quality input data was available. This lack of accuracy is illustrated by the range between the high bound and low bound curves (Figure 5.8). As anticipated, the majority of deformations occur during the initial embankment construction. See Appendix C for complete PLAXIS generated reports from the individual runs.

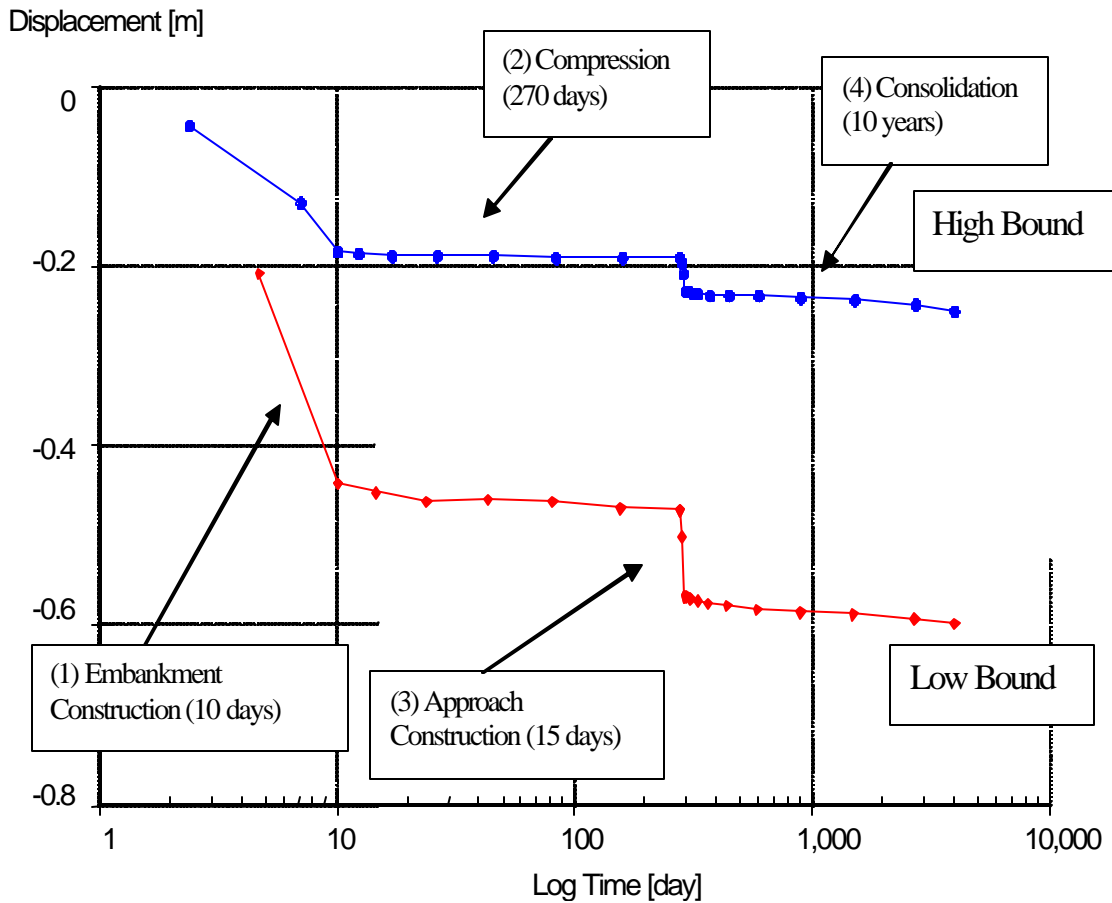

Figure - 5.8- High & Low Bound Displacement Curves East Abutment Embankment Br. A6031

The deflections that are generally noted by construction and maintenance personnel are generally differential settlements between the pile supported abutment and embankment supported approach. These deformations occur following the construction of the approach slab. These settlements are structurally important deflections and designated as delta, using the symbol δ . The concept of structurally important deflections is emphasized in Figure 5.9, the calculated low bound curve.

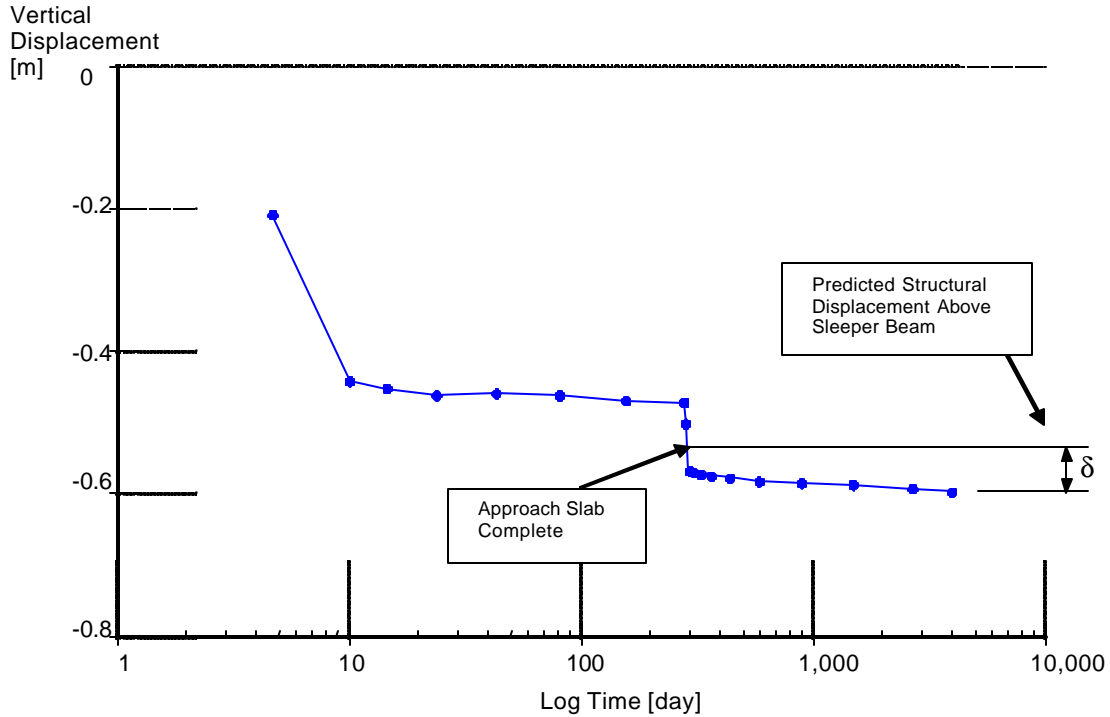

Figure 5.9 - A6031 Low Bound Vertical Deflection Curve Showing “Structurally Important Deflection”

The time at which the approach slab is complete or, put another way, the moment the final roadway grade is in place, is estimated to be half way or approximately seven days through the approach slab construction phase based on construction records. The displacement (δ) then is equal to one half of the approach construction settlements and the 10-year consolidation settlement. This yields a structurally important deflection on the order of 0.07 meters for the low bound condition. Field survey observations taken at the joint above the sleeper beam by MoDOT construction forces indicate that after two years δ is equal to two inches or 0.05 meters relative to the bridge abutment.

5.3.3. Analysis of Bridge A-5690, Crawford County, MO 19

Similar analyses was carried out for the A-5690 bridge located in southern Missouri on Route 19 crossing the Meramec River south of Cuba, MO. Instead of repeating all the steps shown for the other case study only the salient points are mentioned in this section. The approach embankment was not symmetrical

making this case dissimilar to the one in Livingston County. The finite element mesh developed for this model is presented in Figure 5.10 (a & b), notice the non-symmetrical embankment. The total deformation of the embankment soils and structural elements was about 8 cm from the time the embankment was topped off to when the first wheel load was applied. Obviously, this deformation cannot be observed in the field due to the sequence of construction and time when the bridge approach slab was built. About half of this deformation can be attributed to the post slab construction deformations. The depression observed on this bridge was moderate, actually the driveability is quite well when compared to the other bridges.

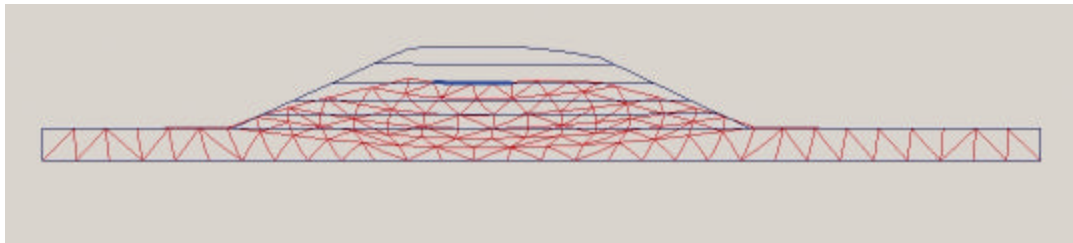

NOTE: Deformations are exaggerated 50 times for the purpose of presentation only.

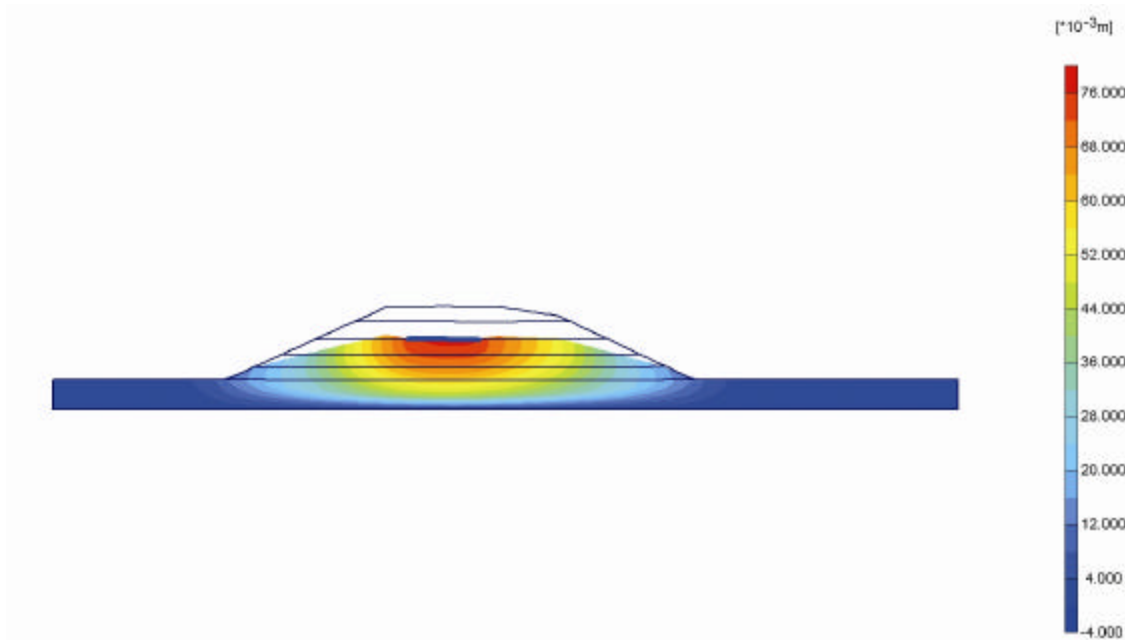

Figure 5.10 (a) Deformed mesh results of Bridge A-5690 in Crawford County. (b) Contours of deformations for the loaded bridge approach slab on the top of embankment.

6. CONCLUSIONS

This one-year project brought to light several issues regarding the transition between the bridge and the embankment earth structure. Some of the conclusions are more factual than others given the nature and complexity of the problem, which involves multiple design aspects in this transition component of the bridge.

The first conclusion came in agreement with the studies made by the MoDOT BAS task force, which was that Missouri's current bridge approach slabs are not performing at an acceptable level. Data from 185 bridges statewide indicates that 15% of bridges built with the current design have required or are in need of repair. A further 17% of this sample has exhibited noticeable differential movement. Clearly, some modification to existing design and construction procedures is required. Neighboring states also have the same kind of problems and they have several ways to mitigate the problem. Any recommendations implemented by MoDOT should be shared with the neighboring states.

There are several means to reduce the occurrence of the "bump at the end of the bridge" phenomena and approach embankment design options are available and well documented. They range from costly to relatively inexpensive and from complicated to simple. Geotechnical (soil mechanics) techniques can be used to predict when the potential for a problem exists. The various means of reducing the settlement of the embankments need to be established on a case-by-case basis as determined by the design interactions between the geotechnical engineers and the bridge designers.

This research project used modern numerical methods to determine the embankment settlement and it compared well with the general observed conditions. The use of typical geotechnical data for input parameters results in useful but relatively large ranges of the predicted settlement due to the inability of assessing modulus and related deformation parameters. The low bound structurally important deflections predicted for bridges A6031 (0.07m) and A5834 (0.03m) are reasonable and compare well with field measurements. The use of numerical analysis allows for design scenarios where staged construction can be evaluated.

The construction sequence has a significant effect on the final performance of the embankment and bridge approach slab. If the BAS is built with the bridge contract, the embankment will not have enough time to compress or settle. The construction of the slab should be delayed as much as possible to avoid the consequences of not meeting grade. Stiffening of the embankment by select means (flowable fill, select crushed rock, geosynthetics, grouting, etc.) will tend to make the embankment less compressible. The objective is to have more compatible stiffness between the bridge and the embankment. The abutment could be made less stiff as well, but this would require shallow foundations.

7. RECOMMENDATIONS

After the evaluation of the performance and deformations of the embankments, a series of recommendations have been selected for implementation by MoDOT. The recommendations are not in any particular order or ranking. Economic analysis was not within the scope of work, the evaluation was limited to technical considerations of the available construction practices in the Midwest. The following recommendations address both design and construction issues.

7.1 Design of New Bridges Approaches

The bridge approach slab is a rigid structural element that will deform abruptly if the foundation materials yield. The bridge approach slab should be treated as another structural element of the bridge that requires a foundation. However, the foundation soils are man-made as bridge approach embankments that need to be designed in close collaboration with geotechnical and bridge staff. The following are some recommended guidelines for design:

- Exploratory boreholes should be designated about 30-50 feet away from the planned location of the abutment to investigate the foundation soils under the approach embankment. If the embankments are anticipated to be in excess of 10-ft in height, a subsurface investigation should be undertaken to assess stability and compressibility behavior of the foundation soils below the proposed embankments. This subsurface investigation should consist of boreholes with adequate sampling of the existing foundation soils to determine the engineering soil properties.

- Where possible the slopes of soil embankment should be flattened to 2.5H:1V, which tends to increase stability and reduce deformations of the embankment. A select material (low in fines content) should be used for abutment embankments. If the proposed embankment material is plastic (having a PI greater than 15-20) treatment of the soil or alternate borrow sources should be considered. How far back the select fill will extend will be project specific and required further design, but most likely between 50 and 100 feet.
- For approach embankments higher than 10-ft in height a geosynthetic reinforced backfill behind the abutments should reduce the lateral loads on the bridge structure, add confinement of the fill soils and increase the stiffness of the embankment. This should result in more compatible stiffnesses between the earth structure and bridge. Additionally, a layered system with the geosynthetic inclusions (e.g., 18 inches lifts) will demand proper attention in the construction of the approach embankment. If these layers of geosynthetics are pay-items the contractor will be aware of the importance of this bridge component.
- If gaps are still present between the wingwall and abutment a flowable fill or geofoam could be used to fill the gap. Both of these options have cementitious properties and in the long-term will tend not add large load to the wing walls and abutments if the remainder of the approach embankment behind the abutment has been reinforced.
- It is recommended to reassess the structural requirements of the steel rods into the anchor deadman behind the seat-type abutments and evaluate if they can be replaced with a reinforced soil system. The experience during construction is that they interrupt the earthwork operations and that working around them is troublesome. It is not clear why this anchoring system is necessary and if it would still be the case with a reinforced soil embankment.
- The sleeper slab drain should be placed at an elevation below the bottom of the sleeper beam and specify at least 2' of crushed or shot rock beneath the sleeper beam and approach slab.

- Compression of foundation soils must be anticipated and considered in design. If the proposed foundation soils are prone to consolidation then surcharging, replacement, wick drains, stone columns, rammed aggregate piers, or other options should be considered.
- Where the fills are not high and the foundation soils are competent, such as in rock cuts or firm ground, the approach pavement system should be less stringent.

7.2 Abutment details:

- The abutment should be designed such that no overhangs or notches are present. This makes it very difficult to adequately compact the backfill material below these overhangs. When the material immediately below these overhangs is not well compacted it starts creating a void that is very difficult to observe in maintenance and subsequently it gets inundated with water to worsen the situation and increase the migration of fines. Different means of supporting the bridge approach slab need to be identified in order to have a straight backfill wall.
- Consider shallow bridge foundations when competent ground is at a shallow elevation. This will make the bridge foundation less expensive and more deformation compatible with the embankment earth structure.

7.3 Construction of New Bridge Approaches

- **Earthwork Construction Sequence:** Construction should be staged to allow the approach embankment and foundation soils time to compress prior to BAS and pavement construction. For fills greater than 10-ft in height special specifications should be written into the plans. The concrete bridge approach slab should be built at the same time as the pavement, that is, several months after the embankment is topped off. An additional layer of fill above the final grade of the bottom of the bridge approach slab should be compacted at the time of the initial embankment construction. This additional layer provides a small surcharge load and additional confinement for better compaction of

the layer below. When it is time to construct the bridge approach slab this material should be removed and the appropriate drainage material be placed, if not already in place.

- **Instrumentation & Monitoring:** Settlement should be monitored with embankment instrumentation prior to pavement construction for fills that are in excess of 10-ft. This may require having a survey crew periodically spot check the elevation at some monuments 50 ft away from the bridge abutment. An indication of when the embankment stops settling should be apparent.
- **Review grading inspection procedures.** (1) The compaction criteria of at least 95% should be maintained for the entire height of the approach embankment under the bridge approach slab, sleeper beam and pavement concrete, that is about 60-80 feet away from the abutment. (2) MoDOT should consider other grading inspection procedures for soils currently considered “too rocky to test”. MoDOT should consider the use of a stiffness gauge instead of a density only criteria that uses physical and nuclear densometers.

8. PRINCIPAL INVESTIGATOR AND PROJECT MEMBERS

Principal Investigator: Dr. Ronaldo Luna, University of Missouri-Rolla

Graduate Students: Jonathan L. Robison, University of Missouri-Rolla (SCI Engineering, Inc.)
Andrew J. Wilding, University of Missouri-Rolla

9. IMPLEMENTATION PLAN

9.1 Objectives:

Implementation of the recommendations from this project will result in the following outcomes:

1. Improved performance of bridge approach slabs with respect to settlement.
2. Increased likelihood of success and expanded impact of future research projects.
3. Provide a smoother ride and transition from the embankment to the bridge.
4. Reduced life-cycle costs for the bridge approach slab – reduced maintenance costs.

The question of how to proceed to accomplish these implementation objectives follows.

9.2 Proposed Implementation Process

The proposed recommendations in section 7 of this report should follow a process that demonstrates that the changes to design and construction will perform adequately. Therefore, a series of steps are presented as a proposed implementation process.

- a.** Come to a consensus that stiffening of the embankment fill and controlled foundation soil settlements are the solution to be implemented.
- b.** Stiffening of the embankment will be accomplished by reinforcing the soils with geosynthetics (e.g., geotextiles) – providing lateral support, confinement and a layered earthwork operations.
- c.** Design the construction sequence (timeline) of the embankment construction, geotextile patterns and seams, drainage layer, settlement monitoring and bridge approach slab construction.
- d.** Design a prototype approach embankment for a future bridge abutment providing all design details and specifications. This design should involve constructability and cost evaluation.
- e.** Select a bridge structure where this design can be implemented. The approach embankment near the abutment should be at least 10 feet high. Preferably, this should involve twin bridges where one bridge is reinforced and the other not. This would allow for comparison to the construction issues and performance of deformations.
- f.** Install settlement plates and survey monuments for the continuous monitoring of the deformations. The settlement plate should be installed at the bottom of the embankment to separate the compressibility of the embankment and the foundation soils. This exercise will be the basis for developing the instrumentation and monitoring plan for approach embankments near the abutment (those that support bridge approach slabs).
- g.** Most of the movement of the embankment will tend to happen in the first 6 months of the construction and it is in this period that the embankment should be closely monitored until it stops moving.
- h.** Once the performance of the new bridge approach embankment is acceptable after being

subjected to traffic, then revisions to the current design and specifications should be implemented.

9.3 Milestones

Four (4) milestones are anticipated in the proposed implementation process. The actual dates or time intervals between the milestones are not provided and will require input from MoDOT and reviewers.

- 1) Once the consensus of stiffening of the approach embankments via geosynthetic reinforcement is reached, then MoDOT will have a well-defined direction to solve this problem. The collaboration between Soils & Geology, Bridge, and Design (Project Development) divisions is very important.
- 2) Complete the design prototype for a reinforced approach embankment greater than 10-ft high.
- 3) Construct the proposed demonstration approach embankment project including reinforced and non-reinforced performance evaluation. This milestone will be reached at least one season after the embankment is constructed.
- 4) Develop design and construction specifications for use in standard construction.

9.4 Business Units Affected.

The following units will be impacted by the successful implementation of the findings:

<u>Unit</u>	<u>Contact</u>
Materials	
• Geotechnical	Mike Fritz, Tom Fennessey
• Pavements	John Donahue
Construction	Dennis Bryant
Design	
• Bridge Development	Dennis Heckman
Maintenance	
RD&T	Carl Callahan, Patricia Lemongelli

10. BIBLIOGRAPHY

- AASHTO (1996). *Standard Specifications for Highway Bridges*, 16th Edition, pp. 760.
- Abu-Hejleh, N., Zornberg, J.G., Wang, T., Watcharamonthein, J. (2003). “Design Assessment of Founders-Meadows GRS Abutment Structure.” *Proc.*, 82nd Annual TRB Meeting.
- Barden, L., Madedor, A.O., Sides, G.R. (1969). “Volume Change Characteristics of Unsaturated Clay.” *J. Soil Mech. and Foundations Div.*, ASCE, 96 No. SM4, pp. 1171.
- Bardet, J. (1997). *Experimental Soil Mechanics*, Prentice-Hall, Inc.
- Bowders, J., Loehr, E., Luna, R., Petry, T.M. (2002). “Determination and Prioritization of MoDOT Geotechnical Related Problems with Emphasis on Effectiveness of Designs for Bridge Approach Slabs and Pavement Edge Drains.” MoDOT Project Report R199-029, Missouri Dept. of Transportation.
- Bowles, J.E. (1988). *Foundation Analysis and Design*, McGraw-Hill.
- Briaud, J.L., James, R.W., Hoffman, S.B. (1997). “Synthesis of Highway Practice 234- Settlement of Bridge Approaches (The Bump at the End of the Bridge).” National Academy Press, Washington, D.C.
- Brinkgrave, R.B.J. (2002). “Plaxis 2D- Version 8.” A.A. Balkeema Publishers.
- Brown, R.W. (1996). *Practical Foundation Engineering Handbook*, McGraw-Hill.
- Brylawski, E., Poh, C. C., O’Malley, E.S. (1994). “Settlement Measurements of 50 ft. High Embankments at the Chesapeake and Delaware Canal Bridge.” *Vertical and Horizontal Deformations of Foundations and Embankments Vol. 2*, ASCE.
- Chapra, S.C., Canale, R.P. (1998). *Numerical Methods for Engineers*, McGraw-Hill.
- Felio, G.Y., Bauer, G.E. (1994). “Settlement and Deformation Response of a Bridge Footing on a Sloped Fill.” *Vertical and Horizontal Deformations of Foundations and Embankments Vol. 2*, ASCE.
- Fleming, P.R., Rogers, C.D.F., Frost, M.W. (2001). “Assessment of a Performance Specification Approach for Pavement Foundations.” *Proc. 80th Annual TRB Meeting*.
- Fox, Nathaniel S., Wissman, Kord J. (2001). “Design and Analysis of Short Aggregate Piers Used to Reinforce Soil for Foundation Support.” Geopier Foundation Company Technical Paper No. 2.
- Hara, A., Ohta, T. Niwa, M., Tanaka, S., Banno, T. (1974). “Shear Modulus and Shear Strength of Cohesive Soils.” *Soils and Foundations*, Vol. 14, No. 3, pp. 1-12.
- Hoppe, Edward J. (1999). “Final Report- Guidelines for the Use, Design, and Construction of Bridge Approach Slabs.” Virginia Transportation Research Council.
- Houston, Sandra L., Walsh, Kenneth D. (1993). “Comparison of Rock Correction Methods for Compaction of Clayey Soils.” *J. Geotechnical Eng.*, ASCE, Vol. 119 No. 4 pp. 763.

- Kulhawy, F.H., Mayne, P. W. (1990). *Manual on Estimating Soil Properties for Foundation Design*, Cornell University Geotechnical Engineering Group, Electric Power Research Institute.
- Lambe, T.W., Whitman, R.V. (1969). *Soil Mechanics*, John Wiley and Sons.
- Lawton, F.M., Lester, M.D. (1964). “Settlement of Rockfill Dams.” *8th ICOLD Congress*, Edinburgh, Q.31, R.2, 111, pp. 599-613.
- Lenke, L.R., McKeen, R.G., Grush, M.P. (2003). “Laboratory Investigation of the GeoGauge for Compaction Control.” *Proc. 82nd Annual TRB Meeting*.
- Lin, Q.L., Wong, I.H. (1999). “Use of Deep Cement Mixing to Reduce Settlements at Bridge Approaches.” *J. Geotechnical and Geoenvironmental Eng.*, ASCE, Vol. 125, No. 4, pp 309.
- Mayne, P.W., Kemper, J.B. (1988). “Profiling OCR in Stiff Clays by CPT and SPT.” *Geotechnical Testing J.*, ASTM, Vol. 11, No. 2, pp. 139-147.
- Miller, G.A., Maraleetharan, K.K., Lim, Y.Y. (2001). “Wetting-Induced Settlement of Compacted Fill Embankments.” *Proc. 80th Annual TRB Meeting*.
- Missouri Highways and Transportation Commission (1999). *Missouri Standard Specifications for Highway Construction*, pp. 88.
- Monley, Gregory J., Wu, Jonathan T.H. (1993). “Tensile Reinforcement Effects on Bridge-Approach Settlement.” *J. Geotechnical Eng.*, ASCE, Vol. 119, No. 4, pp. 749.
- NAVFAC- Naval Facilities Engineering Command Soil Mechanics Design Manual 7.01 (updated 1986).
- Nazarian, S., Yuan, D., Arellano, M. (2001). “Compaction Quality Control of Soils Using Wave Propagation Techniques.” *Proc. 80th Annual TRB Meeting*.
- Noornay, I., Sweet, J., Smith, I. (1992). “Deformations of Fill Slopes Caused by Wetting.”, *Stability and Performance of Slopes and Embankments*, Vol. 2, ASCE.
- Nunnally, S. W. (1998). *Construction Methods and Management*, Prentice-Hall, Inc.
- O’Flaherty, C.A., (2002). *Highways- The Location, Design, Construction, & Maintenance of Pavements*, Butterworth-Heinemann.
- Ohya, S., Imai, T., Matsubara, M. (1982). “Relationship Between N Value by SPT and LLT Pressuremeter Results.” *Proc., 2nd European Symposium on Penetration Testing*, Vol. 1, Amsterdam, pp. 125-130.
- Peck, R.B., Hanson, W.E., Thornburn, T.G. (1974). *Foundation Engineering*, 2nd Edition, John Wiley and Sons, pp. 514.
- Petry, T.M., Little, D.N. (2002). “Review of Stabilization of Clays and Expansive Soils in Pavements and Lightly Loaded Structures-History, Practice, and Future.” *J. of Materials in Civil Engineering*, ASCE, Vol. 14, No. 6, pp. 447.
- PLAXIS Version 8 Material Models Manual (2002). *Software Support Manual*

PLAXIS Company.

Price, J.T., Sherman, W. F. (1986). “Geotextiles Eliminate Approach Slab Settlement.” *Public Works*, January.

Robison, J.L., (2003), “Discussion and Analysis of Differential Settlement of Missouri Bridge Approach Embankments”, MS Thesis Civil Engineering, University of Missouri-Rolla, 118pp.

Sargand, S.M., Masada, T., Engle, R. (1999). “Spread Footing Foundation for Highway Bridge Applications.” *J. Geotechnical and Geoenvironmental Eng.*, ASCE, Vol. 125, No. 5, pp. 373.

Saville, V.B., Davis, W.C. (1962). *Geology and Soils Manual*, Missouri State Highway Commission.

Sew, G.S., Chin, T.Y. (2001). “Geotechnical Solutions for High Speed Track Embankment- A Brief Overview.” Technical Seminar Talk, PWI Annual Convention.

Sherard, J.L., Woodward, R.J., Gizienski, S.F., Clevenger, W.A. (1963). *Earth and Earth-Rock Dams*, John Wiley and Sons.

Speedie, M.G. (1970). “Dam Behaviour Measurements.” ANCOLD Bulletin No. 30, March, pp. 27-35.

Stark, T.D., Olson, S.M., and Long, J.H., “Differential movement at the Embankment/Structure Interface – Mitigations and Rehabilitation”, Project No. IAV-HI, FY03, Illinois Transportation Research Center, IDOT.

Steinberg, M. (1998). *Geomembranes and the Control of Expansive Soils in Construction*, McGraw-Hill.

Stroud, M.A. (1974). “The SPT in Insensitive Clays and Soft Rocks.” *Proc. European Symposium on Penetration Testing*, Vol. 2.2, Stockholm.

Tadros, M.K., Benak, J.V. (1989). “Bridge Abutment and Approach Slab Settlement phase 1 Final Report.” University of Nebraska- Nebraska Department of Roads.

Taylor, D.W. (1948). *Fundamentals of Soil Mechanics*, John Wiley and Sons.

Terzaghi, K., Peck, R.B. (1967). *Soil Mechanics in Engineering Practice*, 2nd Edition, John Wiley and Sons.

Thacker, J., McMillen, M.P. (2000). “Collapsible Soils can be Remedied if Found in Time.” *Horizons*, SCI Engineering, Inc. Company Publication, September.

Thomas, H.H., (1976). *The Engineering of Large Dams*, John Wiley and Sons.

Walkinshaw, J.L. (1978). “Survey of bridge movements in the western United States.” *Transportation Research Record 678*, Washington, D.C., 6-11.

White, D.J., Wissman, K., Barnes, A.G., Gaul, A.J. (2002). “Embankment Support: A Comparison of Stone Column and Rammed Aggregate Pier Soil Reinforcement.” *Proc. 81st Annual TRB Meeting*.

Winkerton, H.F., Fang, H-Y (1975). *Foundation Engineering Handbook*, Van Nostrand Reinhold Company, Inc.

Wu, J.T.H., Lee, K.Z.Z., Ketchart, K. (2003). “A Review of Case Histories on GRS Bridge-Supporting Structures with Flexible Facing.” *Proc. 82nd Annual TRB Meeting*.

Yoder, E.J., Witzak, M.W. (1975). *Principles of Pavement Design*, John Wiley and Sons.

Zaman, Musharraf, Gopalasingam, Arumugam, Laguros, Joakim G. (1991). “Consolidation Settlement of Bridge Approach Foundation.” *J. Geotechnical Eng.*, ASCE, Vol. 117, No. 2 pp. 219.

Appendix A

REVIEW OF LITERATURE - AVAILABLE MITIGATION MEASURES

There is a large amount of literature available on the subject of bridge approach problems. Some of the literature reviewed and referenced for this work concentrate on surveys of various state agencies and statistical representations of current design, construction, and maintenance practices. Other reports focus on individual case studies and the methods used to correct anticipated problems.

It is important to keep in mind a few principles as this subject is investigated. Some amount of differential settlement at bridge ends is practically unavoidable. The different mechanisms of settlement are well known and documented and may be individually remediated, however a combination of these problems is nearly always at work. An approach slab will not change the amount of the embankment settlement that will ultimately develop. The approach slab is strictly a tool to lessen the severity of the bump; without it a dramatic grade differential may develop. Figure A.1 from Hoppe (1999) illustrates the settlement of the approach slab. Note the potential contribution of both the fill material and the foundation soil.

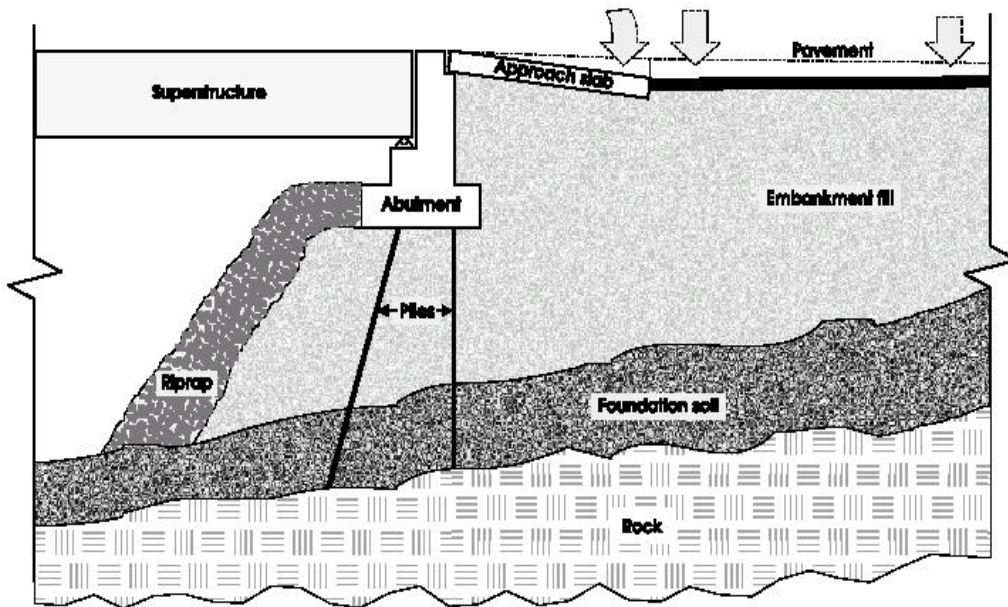

Figure A.1- Typical Approach/Abutment with Settlement, Hoppe (1999).

If some amount of settlement is inevitable, how much is acceptable? In a recent study, Briaud, et al., (1997) recommends a maximum allowable slope differential of 1/200. This corresponds to a maximum settlement differential of 1.5 inches on an approach slab of 25 feet. Even this level may be unacceptable, particularly if the loss of material beneath the slab results in the structural failure of the paving haunch (notch) or in problems with guardrail or other bridge end appurtenances, or if the dip in the roadway creates a dynamic loading situation, thereby magnifying the problem and negatively impacting the bridge itself.

It is impossible to overstate the importance of the soil exploration program to the ultimate success of any geotechnical design. Clearly, if soil behavior cannot be reliably predicted, then anything built of soil or bearing on soil is inherently of questionable soundness. If soil behavior may be clearly defined and quantified through exploration and laboratory testing, it may be controlled or its effects remediated through a variety of procedures.

In some cases, conventional engineered solutions such as pre-loading the embankment, or removing or treating unsuitable foundation soil, or even just a change in the timing of construction operations may reduce the eventual approach movement to an acceptable level. More involved procedures may be employed such as pre-cambered approaches, mechanical or pneumatic sleeper jacking, approach fill stiffening with geotextiles, pre-formed grout holes, temporary paving, lightweight fills, or pile-supported embankments.

A.1 CONSTRUCTION STAGING, INSTRUMENTATION, AND PERFORMANCE SPECIFICATIONS

A number of procedures exist that will reduce differential settlement at bridge abutments assuming its cause is some sort of soil compression of either the embankment fill material or the foundation soils.

A simple method of applying a consolidation load to the soil prior to the construction of the bridge approach would be to enforce a time period of waiting between embankment construction and approach slab construction. Many projects are let in stages with the grading and bridges first, followed by the paving in a later contract. If the approach system was let in conjunction with the paving instead of the bridge a good deal of settlement would have occurred prior to paving and could be corrected for during the construction of the approach.

Instrumentation of fills should be implemented any time a substantial consolidation settlement is anticipated. Instrumentation could be as simple as a construction survey program to periodically check witness plates, or more elaborate instruments as suggested by Brylawski, et al., (1994), (Figure A2). In this case, horizontal inclinometers and liquid settlement tubes with pneumatic pressure sensors were used to track the settlement of the approach embankments in a particularly poor soil.

Since the contractor is the most familiar with his equipment and preferred technique perhaps he could be required to produce a quality control plan for the construction of all of the bridge approach components (subject to DOT approval), after the job is awarded. This procedure could be developed as a performance-based specification to contractually specify a maximum differential settlement over a certain time period and give the owner some recourse if the approach fails. Nunnally (1998) defines a performance-based specification as a specification

that “specifies only the end result to be achieved and leaves to the contractor the choice of equipment and method.” The approach lends itself well to a warranty required type of operation. If the contractor is allowed to build the approach embankment according to his own plan with the knowledge that he had to guarantee his work, he would likely take much greater care to build it correctly. In his study of performance specification use for pavement foundations in the United Kingdom, Fleming, et al., (2001) asserts that the use of a performance specification for pavement foundations would provide assurance of the ‘as-constructed’ performance of the pavement foundation.

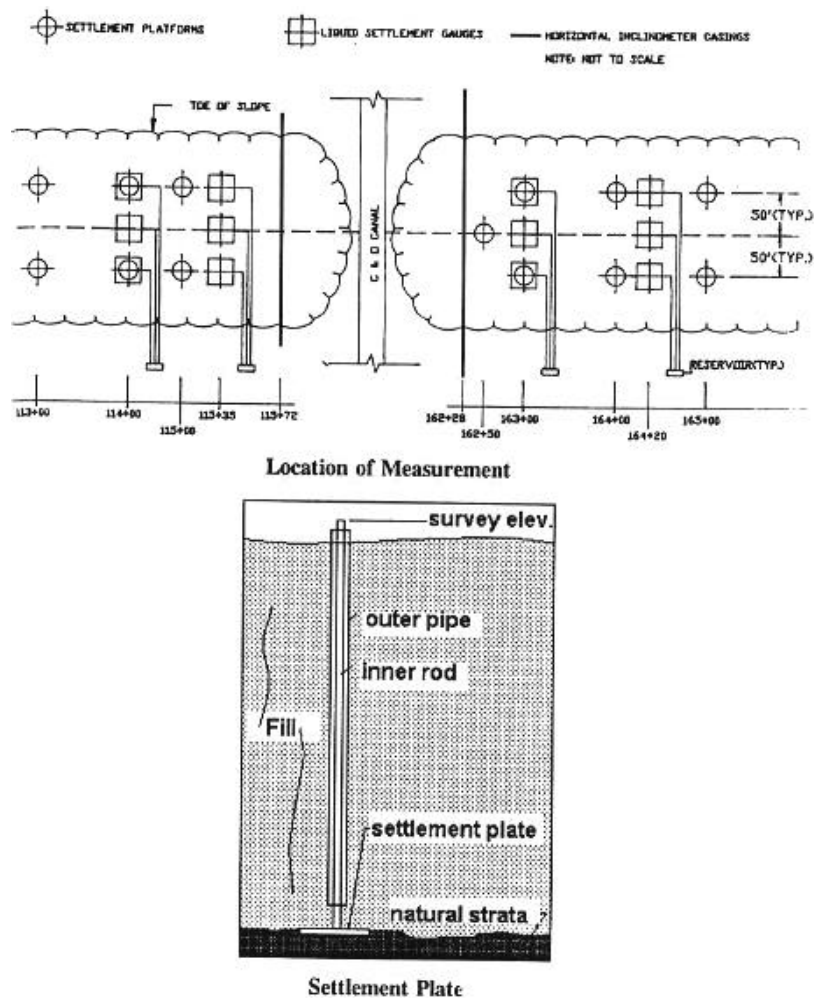

Figure A.2 – Chesapeake & Delaware Canal Bridge Instrumentation Layout, after Brylawski, et al., (1994).

A.2 PRECOMPRESSION AND LIGHTWEIGHT FILLS

According to Bowles (1988), precompression may be used to accomplish two major goals; to eliminate settlements that would otherwise occur after the structure is built and to improve the shear strength of the subsoil by increasing the density, reducing the void ratio, and decreasing the water content. Bowles states that precompression is “a relatively inexpensive, effective method to improve poor foundation soils in advance of construction of permanent facilities”.

A reduction in the increase in pressure felt by a foundation soil due to embankment construction will also decrease settlement potential. Loading may be reduced through the use of lightweight fills such as lightweight aggregate, expanded polystyrene, lightweight concrete, or others. If expanded polystyrene is considered, the potential problem of uplift or flotation should be examined for any water crossing (Figure A.3), (Sew, et al., 2001).

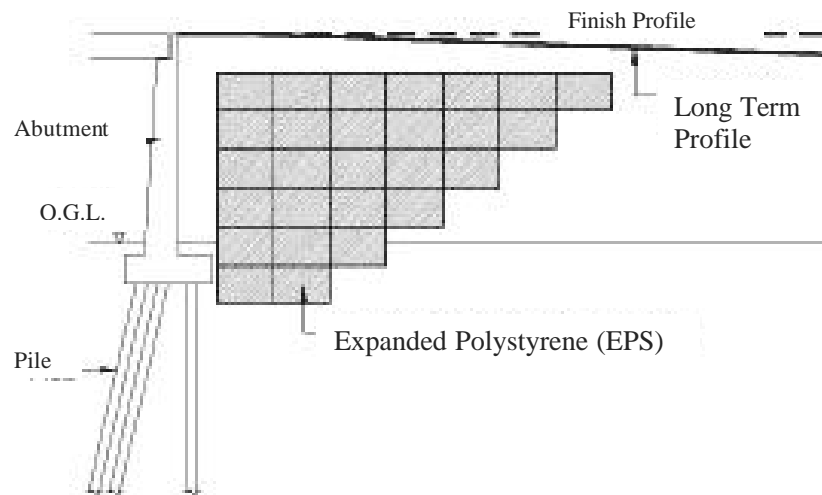

Figure A.3- Expanded Polystyrene at Bridge Abutment after Sew, et al., (2001).

A.3 FOUNDATION SOIL CONSOLIDATION SETTLEMENT ABATEMENT

If a foundation soil is found to be prone to consolidation, a number of methods exist to lessen the potential settlement. In addition to the staging and preloading options mentioned previously, several options are available to shorten the drainage path thereby hastening the consolidation process. These options include wick drains, stone columns, rammed aggregate piers, and others. More elaborate efforts may be required in very poor soils to prevent unacceptable levels of settlement.

Wick drains and stone columns are both effective methods to decrease the time required for consolidation. Rammed aggregate piers may be used to substantially improve the soil stiffness while at the same time reducing the drainage path (Fox, 2001). Iowa has used both stone columns and rammed aggregate piers to support embankments. In his study, White, et al., (2002) notes that the rammed aggregate pier supported embankment settled significantly less than the stone column supported fill (5.4cm vs. 19.5cm under 6m of fill). Iowa is currently experimenting with the use of rammed aggregate piers to reduce settlement at bridge approaches.

There are several options available to improve a site with very poor foundation soils. Deep cement mixing columns have been successfully used to reduce total and differential settlements from a soft clay foundation at a bridge approach (Figure A.4), (Lin, et al., 1999).

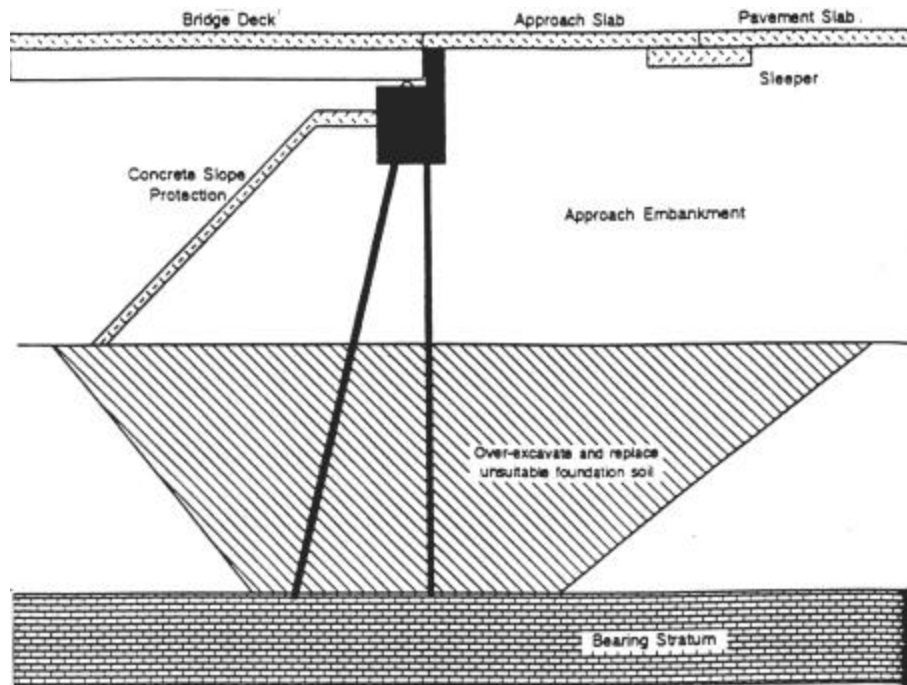

Figure A.5- Over-excavation of Unsuitable Deposits, Tadros and Benak (1989).

Pile supported embankment may be specified in extreme cases to enhance transition smoothness, (Sew, 2001), (Figure A.6). The piles support a high-strength geotextile stiffened fill and require an in depth soil exploration program and settlement analysis.

This solution does have its drawbacks. The piles are driven into the foundation soil prior to its consolidation. As the soil consolidates and moves downward relative to the pile, a negative skin friction is developed (Bowles, 1988). This friction imposes an additional load on the pile and must be accounted for in design. Winterkorn and Fang (1975) provide a method for the estimation of down-drag potential.

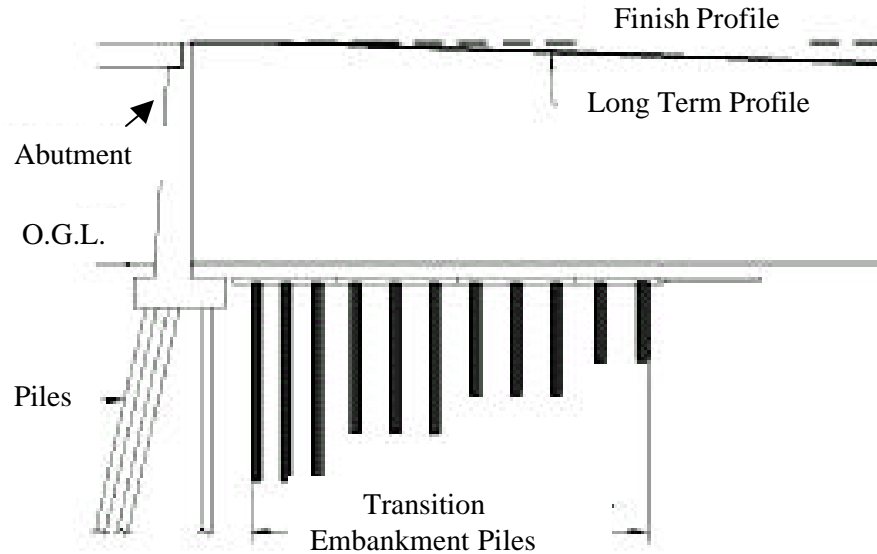

Figure A.6- Piled Embankment with Transition Piles after Sew, et al., (2001).

A.4 PRE-CAMBERED APPROACH SYSTEMS

If the approach pavement settlement cannot be controlled with economical means a pre-cambered roadway approach may be specified. In his 1999 report for the Virginia Department of Transportation, Hoppe (1999) recommends this solution, “Where practical, implement pre-cambering of bridge approaches at up to a 1/125 longitudinal gradient... to accommodate the differential settlement that will inevitably occur between a structure constructed on deep foundations and adjoining earthworks.”

The pre-cambered design utilizes a paving notch similar to the current MoDOT standard design. A concrete slab is supported by this notch and is effectively hinged at this point and allowed to move radially (Figure A.7). Above the slab is placed base courses and flexible pavement. Obviously, the flexible pavement over the slab will absorb some movement below it but not a great extent. The pre-cambered approach system then requires an accurate assessment

of settlement potential. Assuming that such assessment is possible, this solution should be considered. The pre-cambered approach design could be specified in situations where time is not available for more conventional settlement remediation i.e. preloading, wick drains, etc...

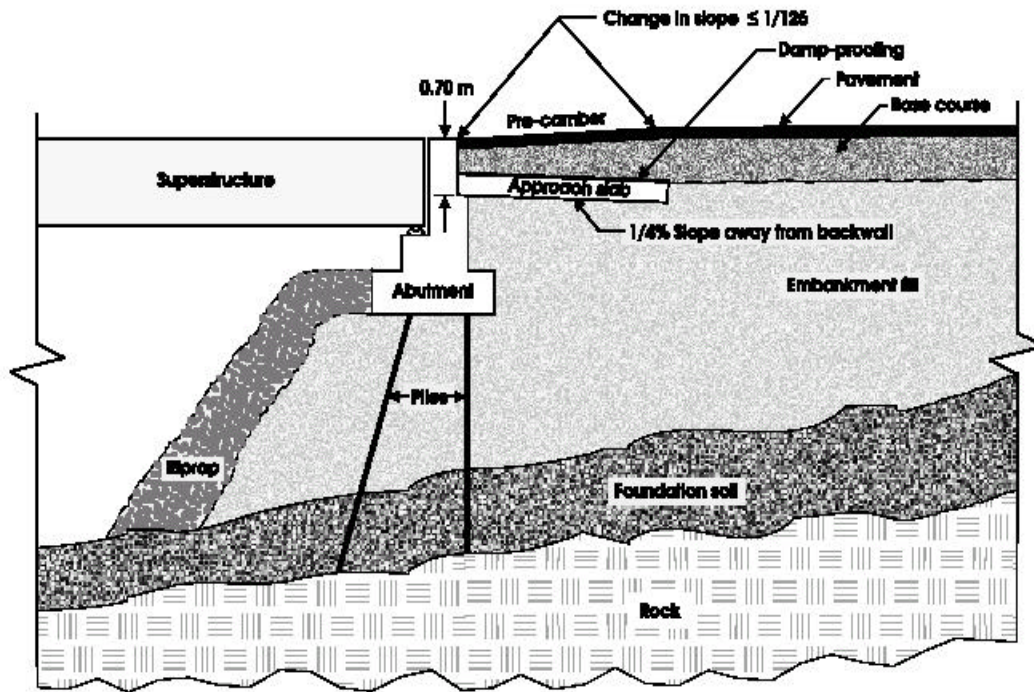

Figure A.7- Pre-Cambered Approach Design, Hoppe (1999).

A.5 APPROACH FILL STIFFENING

The use of a geotextile reinforcement increases the modulus of elasticity of the fill. This helps distribute traffic loads over a larger area and decreases subsequent approach settlements. The Wyoming Department of Transportation has had success with this method. According to Price and Sherman (1986), no repair has been required on any of the bridge approaches supported by embankments built with fabric reinforced soil (FRS) walls (Figure A.8).

Monley, et al., (1991) recommends including a collapsible inclusion between the tensile reinforced approach fill and the abutment wall. This addition helps to mobilize the tensile resistance of the reinforcement and decrease stress on the abutment wall during compaction operations. Monley asserts that overall, the addition of the collapsible inclusion results in smaller, more uniform deformations.

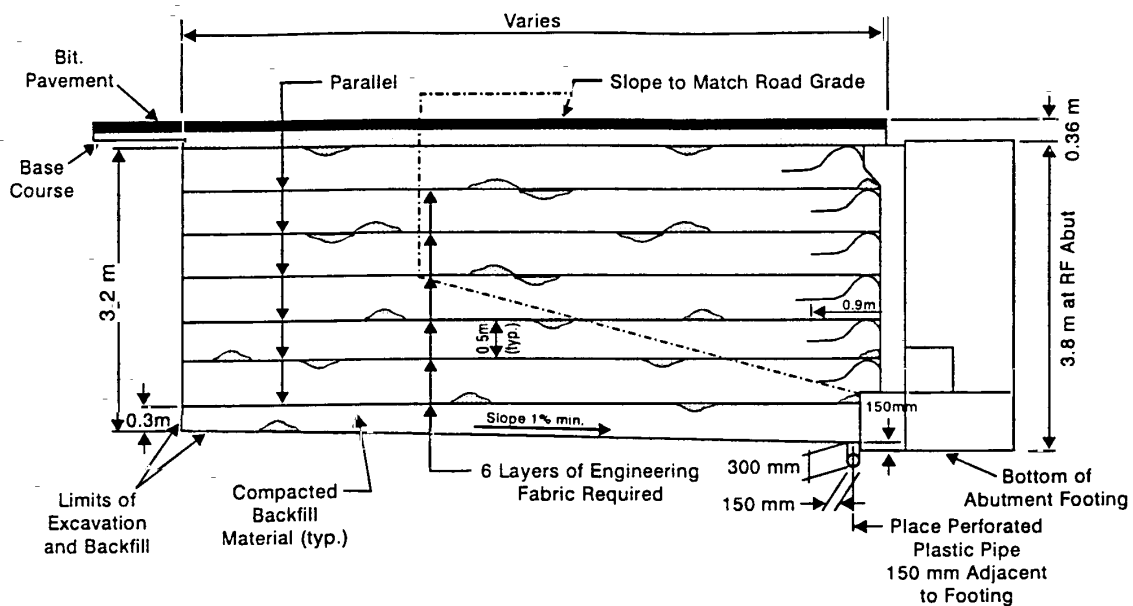

Figure A.8- Wyoming DOT Geo-Fabric Reinforced Soil Walls, Briaud, et al., (1997).

A.6 REINFORCED SOIL SUPPORTED SHALLOW FOUNDATIONS

Recent advances in geosynthetic materials and designs have led to a number of noteworthy bridge projects involving the use of shallow footings to support the end abutment and approach structures. Colorado has implemented these designs at a few locations with good

performance results. Worldwide this design has been used in various forms in Austria, Australia, France, Japan, and Italy (Wu, et al., 2003).

Abu-Hejleh, et al., (2003) investigated the use of a geosynthetic-reinforced soil (GRS) system to support shallow footings in the Denver, Colorado area (Figures A.9 and A.10). Completed in 1999, this project on the Founders/Meadows Parkway supports the shallow footings of a two-span six-lane bridge as well as the adjoining earthworks. Abu-Hejleh reports the following performance related information: “the monitored movements of the Founders/Meadows structure were smaller than those anticipated in the design or allowed by performance requirements, post construction movements became negligible after an in-service period of 1 year, and there was no evidence of the ‘bump at the bridge’ problem after 35 months in service.”

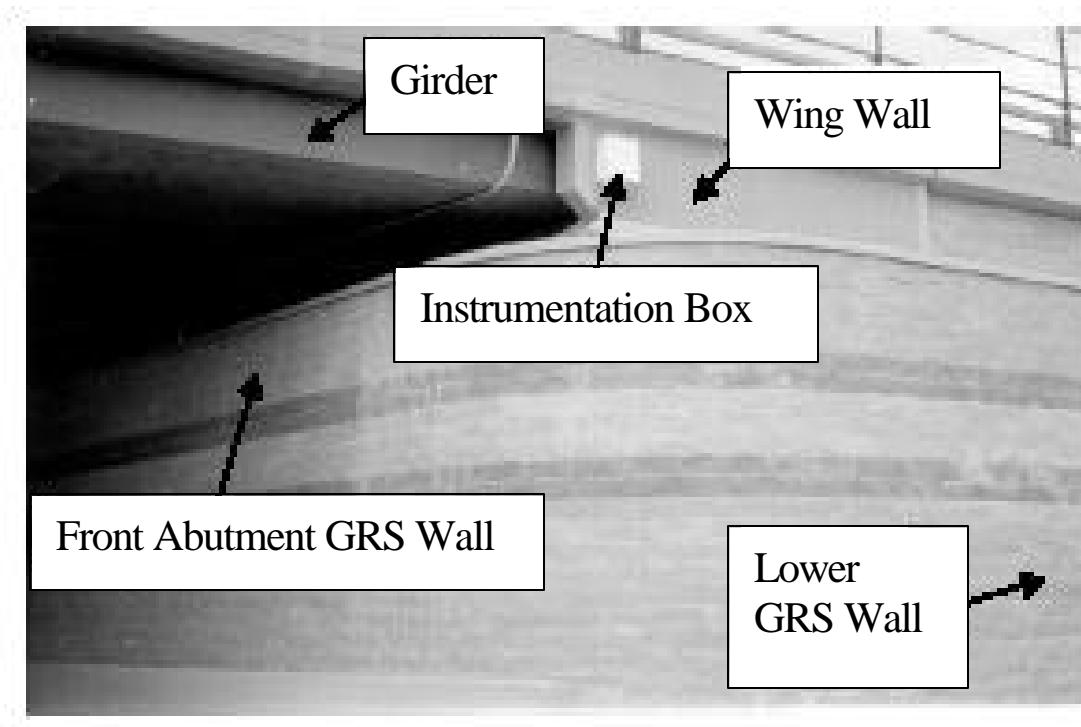

Figure A.9 - View of the SE side of the Founders/Meadows GRS Abutment Structure, after Abu Hejleh, et al., (2003).

GRS systems have many advantages. Wu, et al., (2003) notes that, “GRS structures are typically more ductile, more flexible (hence more tolerant to differential settlement), more adaptable to low quality backfill, easier to construct, requires less over-excavation, and more economical” than more conventional construction.

As can be seen from Figure A.10, the supporting engineered soil fill is resting on solid rock. This allows for absolute surety of foundation conditions for the construction personnel. This would offer a degree of assurance to the structural designer that the spread footings would, in fact, be able to support the loading without undue settlement.

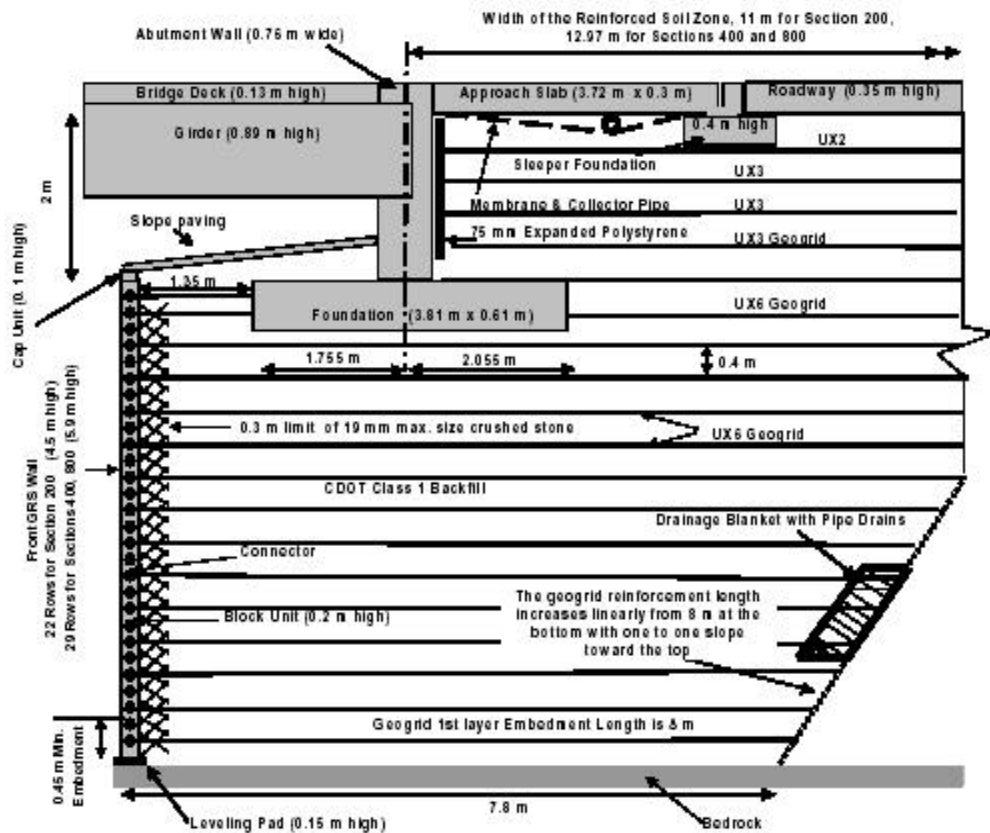

Figure A.10- Typical Cross Section through the Front and Abutment GRS Walls, Abu Hejleh, et al., (2003).

Other designs have been implemented that do not require excavation to rock. These rely on a firm soil layer to support the GRS reinforced soil mass. A good example of this is the Black Hawk bridge abutment located in Colorado shown in Figure A.11. This project also incorporated several preloading cycles on each footing that were greater than the design load and sustained for a number of minutes (Wu, et al., 2003). Wu notes that after the first few cycles of preloads, the observed settlement reduced to negligible amounts. Subsequent service settlements were less than ½ inch.

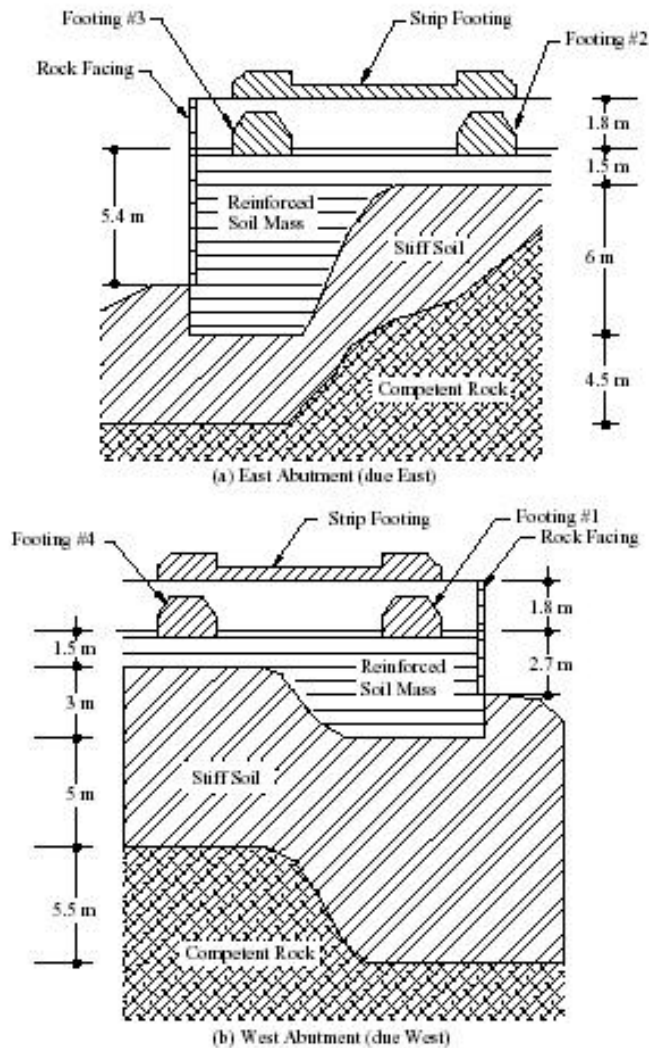

Figure A.11- Footings and Foundations of Black Hawk Abutment, Wu, et al., (2003).

A.7 TRADITIONAL SOIL SUPPORTED SHALLOW FOUNDATIONS

Traditional spread footing design for the bridge abutments may be considered in competent ground. Standard geotechnical design practice is to allow settlements of one inch or less in footings supporting structures. Several studies confirm the practicality of shallow foundation design for bridge support.

Walkinshaw (1978) reviewed field performance of 35 bridges in western states that were supported on spread footings. He states that poor riding quality did not result until settlement exceeded 2.5 inches. In his study, Sargand (1999) concludes that, “Overall, the current study demonstrated that spread footings could be used successfully to support the highway bridge structures on both cohesionless and cohesive soils...” Felio (1994) documents a successful implementation of a shallow foundation on a sloped fill, and the instrumentation requirements of a spread footing for a bridge end abutment (Figure A.12). If spread footings were used, then the approach and end bent would settle together and the differential settlement problem would thus be alleviated.

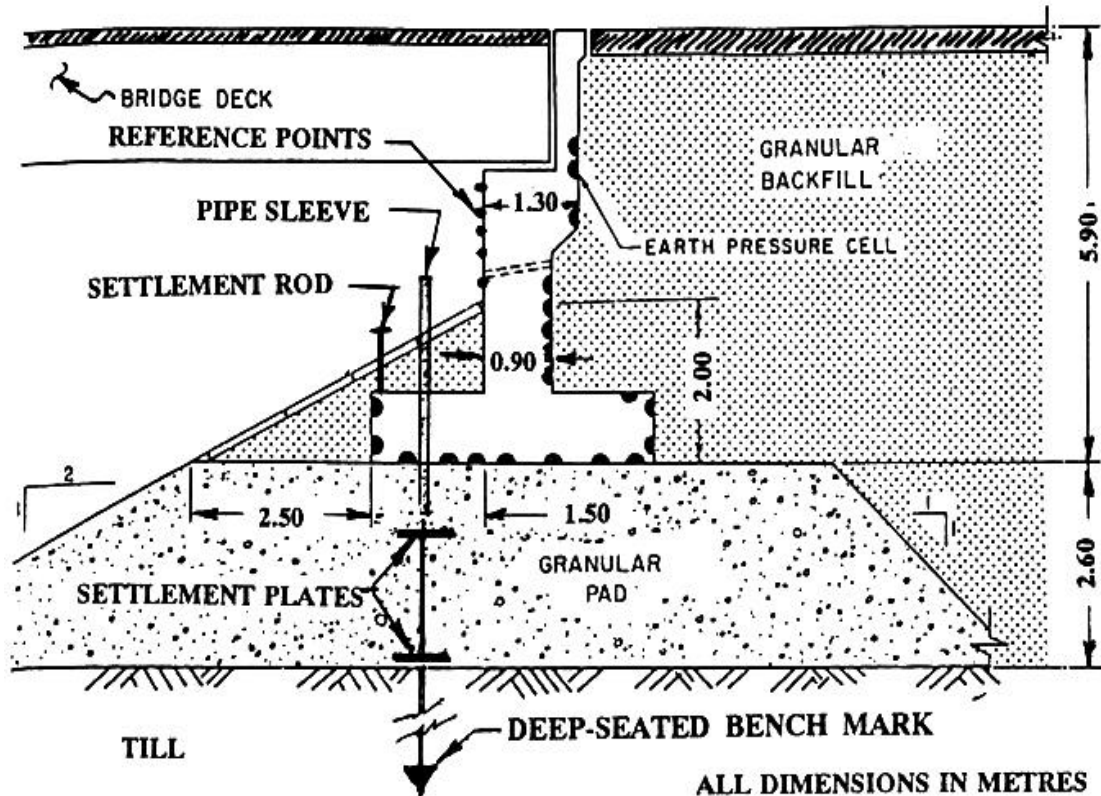

Figure A.12- Shallow Footing with Instrumentation, Felio (1994).

A.8 PREFORMED GROUT HOLES

If the designer must presuppose the settlement of the approach, then grout holes may be left in the pavement to facilitate mudjacking operations. This option is currently the standard design for MoDOT approach systems (Figure A.13). Mudjacking is designed to fill voids beneath the slab and will, in some cases, lift the approach slab. However, to raise the sleeper and approach pavement, additional holes have to be drilled through the sleeper or the jacking apparatus must be inserted deep within the embankment. Mudjacking is reasonably effective if settlement is complete. If settlement is not complete the slab may have to be pumped multiple times, and the process is inconvenient for the traveling public.

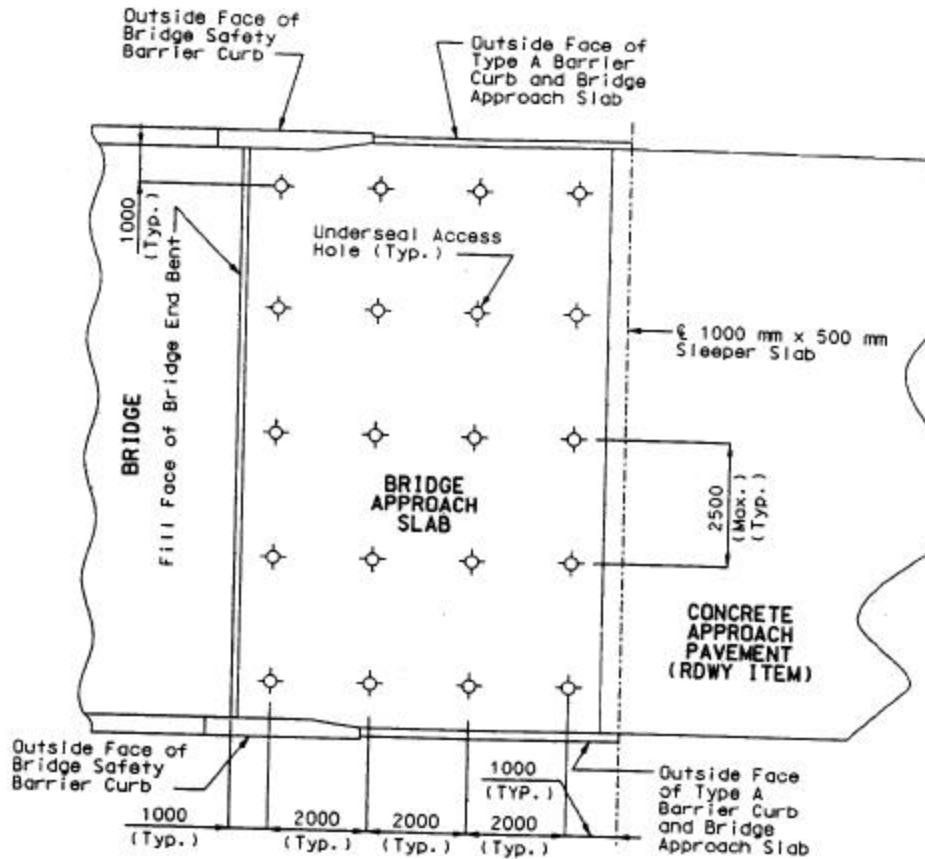

Figure A.13- MoDOT Standard Approach Slab Design Plan View.

Deep compaction grouting has also been used on some MoDOT bridges recently. In this method, grout is pumped deep within the embankment to stabilize and lift the entire fill. Initial reports of effectiveness are good. However the long-term success of this procedure for highway bridge abutment embankments is still being evaluated and the method is considered quite costly.

A.9 DRAINAGE AND LATERAL MOVEMENT

Positive drainage must be ensured without erosion of fill material. Maryland Department of Transportation's (Maryland DOT) standard abutment design taken from Briaud, et al., (1997), incorporates a number of features to provide this (Figure A.14). Select drainable fill is placed

both beneath the approach pavement and next to the top of the embankment. Also the fill is sloped to drain and partially covered with a geotextiles. A small concrete sleeper is placed to ensure water moves to the drainage pipe inlet, and the drain is located at the base of the column or just above finished ground line.

Some fills exhibit a tendency to move laterally (shove). To remedy this problem abutments may be keyed directly into the rock strata (if shallow enough), and act as a retaining system. If bedrock is relatively deep, a full height closed abutment founded on piling may be considered or a mechanically stabilized abutment system might be necessary. The Maryland DOT's full cantilever abutment design incorporates a full height retaining wall as well as several specialized water draining features. Contrast this with the MoDOT sleeper drain located too high to remove water from beneath the sleeper beam (Figure A.15). It is important to note that the drain needs to be sloped properly to carry water away from the center of the embankment.

A.10 MECHANICAL AND PNEUMATIC SLEEPER JACKING

Mechanical and pneumatic sleeper jacking are similar. Both rely on a pre-built lifting system to raise or lower the approach grade (see Figure A.16). The ability to lower the slab could be important if the approach is constructed on top of an expansive soil. Mechanical and pneumatic sleeper jacking are mentioned by Tadros and Benak, (1989).

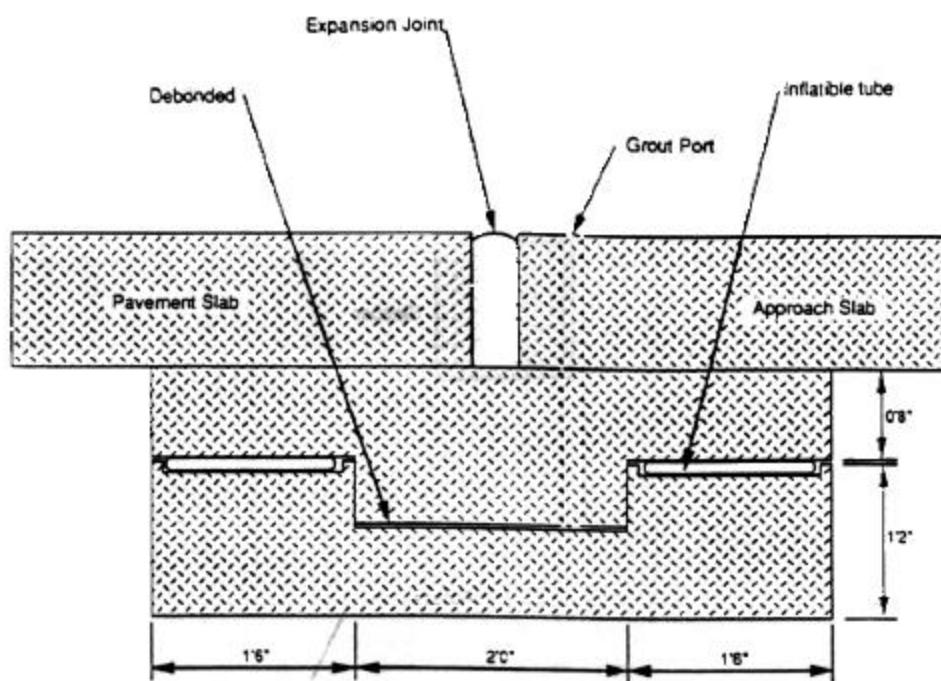

Figure A.16- Pneumatic Adjustable Sleeper, Tadros and Benak (1989).

A.11 TEMPORARY PAVING

If a project has to be completed and open to traffic without time for surcharging or other methods, then temporary paving may be considered. To successfully use this method, approach settlement should be calculated accurately and time factors should be derived as well from a thorough investigation of the foundation and fill materials. Without these precautions, the

permanent pavement may be placed only to fail as consolidation or other compression processes continue.

A.12 ROADWAY PAVEMENT DESIGN

Prior to the introduction of the concrete bridge approach slab, the approach to the bridge was simply the typical asphalt or concrete pavement section. It is possible that this design would be effective when combined with surcharges and/or other measures to lessen foundation soil consolidation settlements and if the fill beneath the pavement is competent. If the approach is constructed of asphalt and problems occur, the asphalt surface may be milled up and replaced with a leveling course.

APPENDIX B

**FIELD EXPLORATIONS (Boreholes and CPTs)
AND LABORATORY RESULTS**

DEPTH M FT	BLOWS ON SAMPLER	N	q _u	w _N	LL	PI	Symbol	DESCRIPTION	q _u	2	3	4	5
									N ⌀10	20	30	40	50
5	PUSH				69	41		Dark Brownish, lean CLAY, scattered gravel seams, moist, medium stiff.					
	2-4-4	8	(1.5)	35	76	41							
10	PUSH		(1.5)		80	53							
	2-9-7	16		37				Gray SANDY CLAY to silt with gray fine grained sand partings, moist, stiff to very stiff.					
	PUSH												
15	6-6-5	11		18	19	NP							
	PUSH												
	3-3-2	5		21									
20	PUSH												
	6-9-13	22	(3.0)	21				Dark brown and gray mottled lean CLAY, moist, stiff.					
	PUSH				37	15							
25	2-2-3	5	(1.1)	26				Dark Brown and gray mottled lean CLAY to SILT, with fine grained sand partings, moist, soft to medium stiff.					
	PUSH				31	11							
	5-5-6	11	(1.0)	13				Brown, fine grained SAND, dry, medium dense.					
								END OF BORING @ 29.5 FT.					

LOG OF BORING: NORTHERN SITE GPJ, U.MO ROLLA GDT, 12/17/03

DATE HOLE	STARTED	COMPLETED
	3-4-03	3-4-03
ELEVATION TOP OF HOLE (FT)	216.50	
ELEVATION GROUND WATER (FT)		
LOCATION	Route US 36 over the Grand River Sta 14+773.1, 6.7' RT	
NAME OF DRILLER	Dodds	
DRILLING EQUIPMENT	CME 850	
WATER CONTENT IN PERCENT	q. () PENETROMETER	
N BLOWS FROM S. P. T.	LL LIQUID LIMIT IN %	
UNCOMPAED COMPRESSIVE STRENGTH T.S.F.	PL PLASTIC LIMIT IN %	
WATER TABLE OR PHREATIC LEVEL	PI PLASTICITY INDEX IN %	



UNIVERSITY OF MISSOURI-ROLLA
DEPARTMENT OF CIVIL ENGINEERING
GEOTECHNICAL ENGINEERING

Northern Site Bridge No. A-6031
Livingston County, Missouri

APPROVED

JOB No. **RI02-033**

BORING No.

1 OF 1 SHEETS

BUMR-1

DEPTH M FT	BLOWS ON SAMPLER	N	q _u	w _N	LL	PI	Symbol	DESCRIPTION	q _u	2	3	4	5	
									N @10	20	30	40	50	
5	PUSH		(1.8)	33	58	32		Brown and gray intermix lean CLAY, moist, medium stiff to stiff.						
	2-2-3	5	(1.0)	33										
	PUSH				68	36								
10	2-4-5	9	(1.3)	33										
	PUSH													
	3-4-5	9	(1.8)	30	68	40								
15	PUSH				62	33								
	4-10-12	22	(3.2)	31										
	PUSH													
20	5-1-17	18	(3.0)	18										
	19-8-12	20	(4.0)	20										
25	PUSH				37	15								
	2-3-3	6	(1.0)	24										
	1-3-4	7	(1.3)	27	32	11			Brown lean CLAY to silt with mottles, moist, medium stiff.					
								END OF BORING @ 28 FT.						

LOG OF BORING: NORTHERN SITE GSP.U MO ROLLA GDT 12/17/03

DATE HOLE	STARTED	COMPLETED
	3-4-03	3-4-03
ELEVATION TOP OF HOLE (FT)	216.40	
ELEVATION GROUND WATER (FT)		
LOCATION	Route US 36 over the Grand River Sta 14+778.7, 19.8' RT	
NAME OF DRILLER	Dodds	
DRILLING EQUIPMENT	CME 850	
WATER CONTENT IN PERCENT	S. () PENETROMETER	
BLOWS FROM S. P. T.	LL LIQUID LIMIT IN %	
UNCONFINED COMPRESSIVE STRENGTH T.S.F.	PL PLASTIC LIMIT IN %	
WATER TABLE OR PHREATIC LEVEL	PI PLASTICITY INDEX IN %	



UNIVERSITY OF MISSOURI-ROLLA
DEPARTMENT OF CIVIL ENGINEERING
GEOTECHNICAL ENGINEERING

Northern Site Bridge No. A-6031
Livingston County, Missouri

APPROVED	JOB No. R102-033	BORING No.
	1 OF 1 SHEETS	BUMR-2

DEPTH M FT	BLOWS ON SAMPLER	N	q _u	w _N	LL	PI	Symbol	DESCRIPTION	q _u w				
									1	2	3	4	5
									N	20	30	40	50
	PUSH		(0.8)	32	50	23	[Cross-hatched symbol]	Dark brownish gray, mottled lean CLAY, moist, medium stiff to stiff (FILL).					
	2-4-4	8	(1.0)	28									
5	PUSH		(1.8)	26	67	37							
	3-5-5	10	(1.8)	29									
	PUSH		(1.5)	33	70	31							
10	3-3-5	8	(3.5)	27									
	PUSH		(1.0)	31									
	3-4-5	9	(1.0)	31									
15	PUSH		(2.3)	31	57	28							
	3-6-7	13	(3.5)	27				[Diagonal hatched symbol]	Dark gray, mottled lean CLAY, moist, very stiff.				
	PUSH		(2.0)	34	78	44							
20	4-6-9	15	(4.5)	29	62	32							
	PUSH		(2.3)	22	49	21							
	2-5-8	13	(3.3)	25	52	23							
25	4-4-7	11	(1.5)	24	45	20							
	3-3-5	8	(1.0)	26	47	25	[Diagonal hatched symbol]	Light tannish gray, lean CLAY, with iron stained mottles, scattered medium grained sand, moist, medium stiff to stiff.					
								END OF BORING @ 29.5 FT.					

LOG OF BORING: NORTHERN SITE, GPJ, UMO ROLLA, GOT 12/17/03

DATE HOLE	STARTED	COMPLETED
	3-4-03	3-4-03
ELEVATION TOP OF HOLE (FT)	216.40	
ELEVATION GROUND WATER (FT)		
LOCATION	Route US 36 over the Grand River Sta 14+199.8, 19.7' RT	
NAME OF DRILLER	DRILLING EQUIPMENT	
Dodds	CME 850	
w	WATER CONTENT IN PERCENT	s
N	BLOWS FROM S.P.T.	LL
q _u	UNCONFINED COMPRESSIVE STRENGTH T.S.F.	PL
▼	WATER TABLE OR PHREATIC LEVEL	PI
		() PENETROMETER
		LIQUID LIMIT IN %
		PLASTIC LIMIT IN %
		PLASTICITY INDEX IN %



UNIVERSITY OF MISSOURI-ROLLA
DEPARTMENT OF CIVIL ENGINEERING
GEOTECHNICAL ENGINEERING

Northern Site Bridge No. A-6031
Livingston County, Missouri

APPROVED	JOB No. RI02-033	BORING No.
	1 OF 1 SHEETS	BUMR-4

DEPTH M FT	BLOWS ON SAMPLER	N	q _u	w _N	LL	PI	Symbol	DESCRIPTION	q _u	2	3	4	5
									N @10	20	30	40	50
	PUSH		(1.0)	15				Brown fine SAND, and brown lean CLAY with gravel, very stiff to stiff.					
	8-18-15	33		13				No recovery					
5	PUSH			16									
	18-12-6	18		16									
	PUSH		(1.0)	16									
10	4-5-4	9		17	15	NP							
	7-8-10	18	(0.5)	17				Brown lean CLAY, trace sand with gravel @ 14' to 14.7'.					
15	15-13-21	34		14	15	NP							
	8-8-9	17	(0.5)	18									
20	22-30-23	53		12	17	NP							
	10-12-11	23		13									
25													
	PUSH							No recovery					
30	1-3-3	6	(0.1)	26	29	10		Brown to gray lean SANDY CLAY, soft.					
	PUSH		(1.3)	27				Gray to brown lean CLAY, trace sand and gravel, soft.					
	2-3-15	18	(0.2)	18									
35	29-28-26	54		30				Fine to medium grained GRAVEL, very dense.					
	50/2.4"							DOLOMITE, moderately hard. END OF BORING @ 38 FT.					

LOG OF BORING SOUTHERN SITE GRU U MO ROLLA GDT 12/17/03

DATE HOLE	STARTED	5-5-03	COMPLETED	5-5-03
ELEVATION TOP OF HOLE (FT)	727.50			
ELEVATION GROUND WATER (FT)	722.0			
LOCATION	Route 19 over Meramec River Sta 285+83, 25.5' LT			
NAME OF DRILLER	Lamberson		DRILLING EQUIPMENT	
			Falling 1500	
w _c	WATER CONTENT IN PERCENT	q _u	PENETROMETER	
N	BLOWS FROM S. P. T.	LL	LIQUID LIMIT IN %	
q _u	UNCONFINED COMPRESSIVE STRENGTH T.S.P.	PL	PLASTIC LIMIT IN %	
W	WATER TABLE OR PHREATIC LEVEL	PI	PLASTICITY INDEX IN %	



UNIVERSITY OF MISSOURI-ROLLA
DEPARTMENT OF CIVIL ENGINEERING
GEOTECHNICAL ENGINEERING

Northern Site Bridge No. A-5690
Crawford County, Missouri

APPROVED	JOB No. R102-0033	BORING No.
	1 OF 1 SHEETS	BUMR-5

DEPTH M FT	BLOWS ON SAMPLER	N	q _u	w _N	LL	PI	Symbol	DESCRIPTION	q _u 1 2 3 4 5					
									1	2	3	4	5	
	2-2-4	6	(1.0)	20				Reddish lean CLAY, with gravel, soft to medium stiff.	⊗	■	●			
	6-3-3	6	(0.5)	16	49	29		Brown lean CLAY, with gravel, soft to medium stiff.	■	●				
5	PUSH		(1.0)	27										
	1-3-5	8	(1.5)	42					⊗	■				
10	PUSH		(1.0)	49										
	5-7-6	13	(1.8)	25	65	41			⊗	■				
15	5-10-8	18	(1.3)	32					■	⊗				
	3-16-11	27	(1.3)	28	58	37			■					
20														
	4-5-6	11	(0.5)					Brown fine GRAVEL with coarse sand, trace clay, dense.	■	⊗				
25	3-2-3	5							⊗					
	2-9-18	27	(0.5)	21					■					
30	7-15-14	29	(4.5)	15						●				
	3-4-20	24												
35	9-24 1/4"													
	50 FT. 2"							DOLOMITE, moderately hard. END OF BORING @ 38 FT.						

LOG OF BORING SOUTHERN SITE GPJ UMO ROLLA GDT 12/17/03

DATE HOLE	STARTED	COMPLETED	 <p>UNIVERSITY OF MISSOURI-ROLLA DEPARTMENT OF CIVIL ENGINEERING GEOTECHNICAL ENGINEERING</p> <p>Northern Site Bridge No. A-5690 Crawford County, Missouri</p>
ELEVATION TOP OF HOLE (FT)	5-6-03	5-6-03	
ELEVATION GROUND WATER (FT)	725.00		
LOCATION	717.4		
NAME OF DRILLER	Route 19 over Meramec River Sta 294+07, 26' LT		<p>APPROVED</p> <p>JOB No. RI02-0033</p> <p>BORING No. BUMR-7</p>
DRILLING EQUIPMENT	Falling 1500		
WATER CONTENT IN PERCENT	S. () PENETROMETER		
N BLOWS FROM S.P.T.	LL LIQUID LIMIT IN %		
q _u UNCONFINED COMPRESSIVE STRENGTH T.S.F.	PL PLASTIC LIMIT IN %		
WATER TABLE OR PHREATIC LEVEL	PI PLASTICITY INDEX IN %		

DEPTH M FT	BLOWS ON SAMPLER	N	q _u	w _N	LL	PI	Symbol	DESCRIPTION	q _u ■ 1 2 3 4 5					
									w ●	N ⊗10	20	30	40	50
	1-30-23	53	(2.0)	18				Brown lean CLAY, gravelly, stiff moist.						
	1-3-3	6	(2.0)	21	53	31		Reddish brown lean CLAY, with gravel, stiff, moist.						
5	5-11-8	19	(2.0)	19										
	4-5-5	10	(2.0)	23										
10	4-5-7	12	(2.0)	25										
	3-4-5	9	(2.0)	25										
15	3-4-5	9	(3.0)	33	75	48								
	11-8-9	17	(1.5)	25				Dark brown sandy lean CLAY, with cobbles and sand, stiff moist.						
20	11-11-6	17	(3.0)	22										
	3-2-1	3	(0.5)	22	21	5		Brown sandy lean CLAY, medium stiff, moist.						
25	PUSH		(0.5)											
	11-14-6	20		16				Brown medium SAND and GRAVEL, loose to medium dense, wet.						
30				17										
	18-8-5	13		17										
35	80/5"			21				LIMESTONE moderately hard.						

END OF BORING @ 37.9 FT.

LOG OF BORING, SOUTHERN SITE GPJ, U.MO. ROLLA, G07-12/17/03

DATE HOLE		STARTED	5-11-03	COMPLETED	5-11-03
ELEVATION TOP OF HOLE (FT)		725.00			
ELEVATION GROUND WATER (FT)		716.6			
LOCATION Route 19 over Meramec River Sta 293+77, 23' RT					
NAME OF DRILLER Barnett		DRILLING EQUIPMENT Versa Drill 4000 TR			
APPROVED		JOB No.	RI02-0033	BORING No.	
		1 OF 1 SHEETS		BUMR-8	



UNIVERSITY OF MISSOURI-ROLLA
DEPARTMENT OF CIVIL ENGINEERING
GEOTECHNICAL ENGINEERING

Northern Site Bridge No. A-5690
Crawford County, Missouri

*Soil behavior type and SPT based on data from UBC-1983

Hogentogler & Co

Operator: sheri
Sounding: sumr1
Cone Used: 680tc

CPT Date/Time: 03-25-03 00:19
Location: sumr-1
Job Number: spr03bds

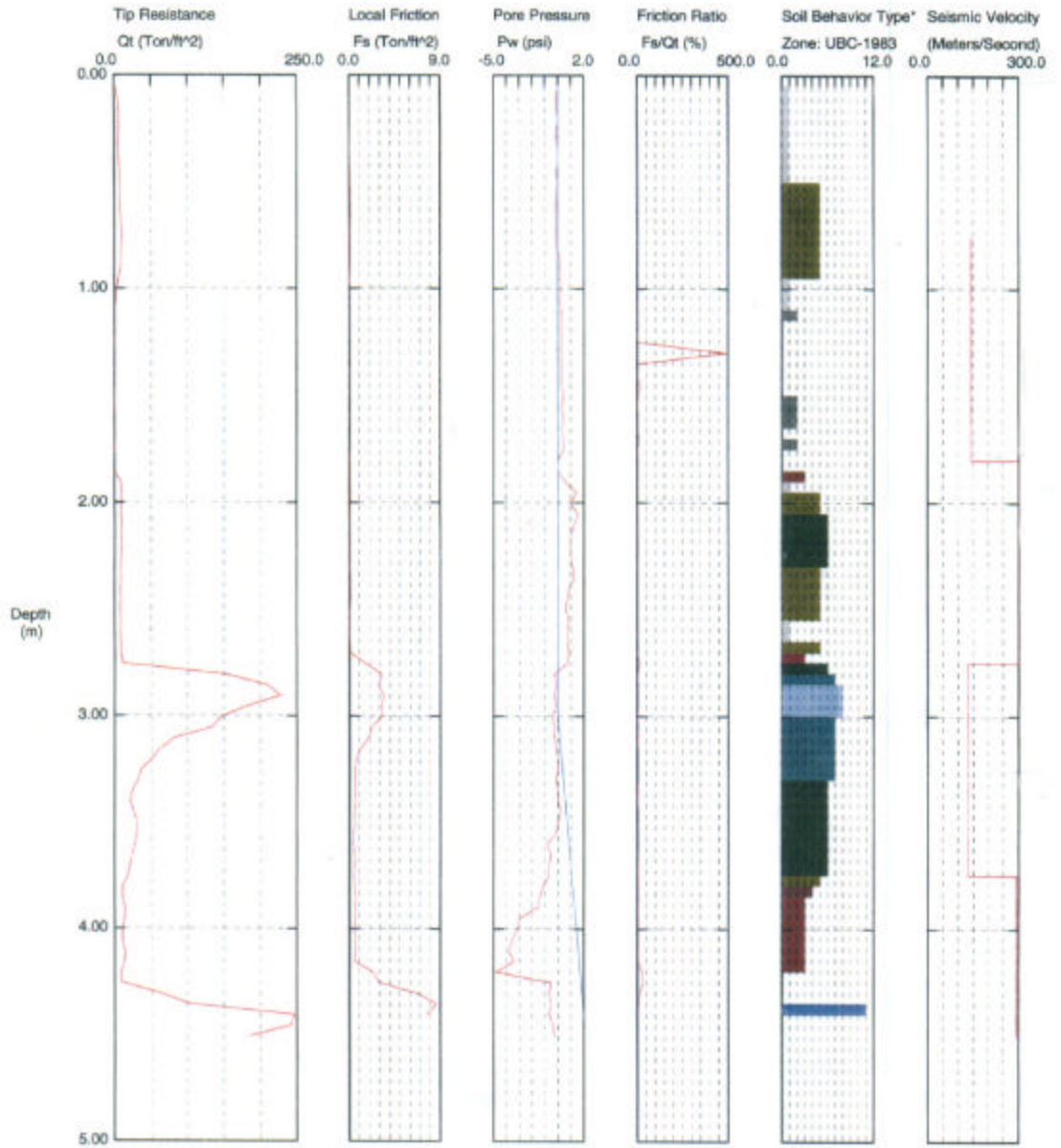

Maximum Depth = 4.50 meters

Depth Increment = 0.05 meters

- | | | | |
|--------------------------|-----------------------------|----------------------------|--------------------------------|
| 1 sensitive fine grained | 4 silty clay to clay | 7 silty sand to sandy silt | 10 gravelly sand to sand |
| 2 organic material | 5 clayey silt to silty clay | 8 sand to silty sand | 11 very stiff fine grained (*) |
| 3 clay | 6 sandy silt to clayey silt | 9 sand | 12 sand to clayey sand (*) |

*Soil behavior type and SPT based on data from UBC-1983

Hogentogler & Co

Operator: sheri
Sounding: sumr11
Cone Used: 680tc

CPT Date/Time: 03-25-03 01:07
Location: sumr-1
Job Number: spr03bds

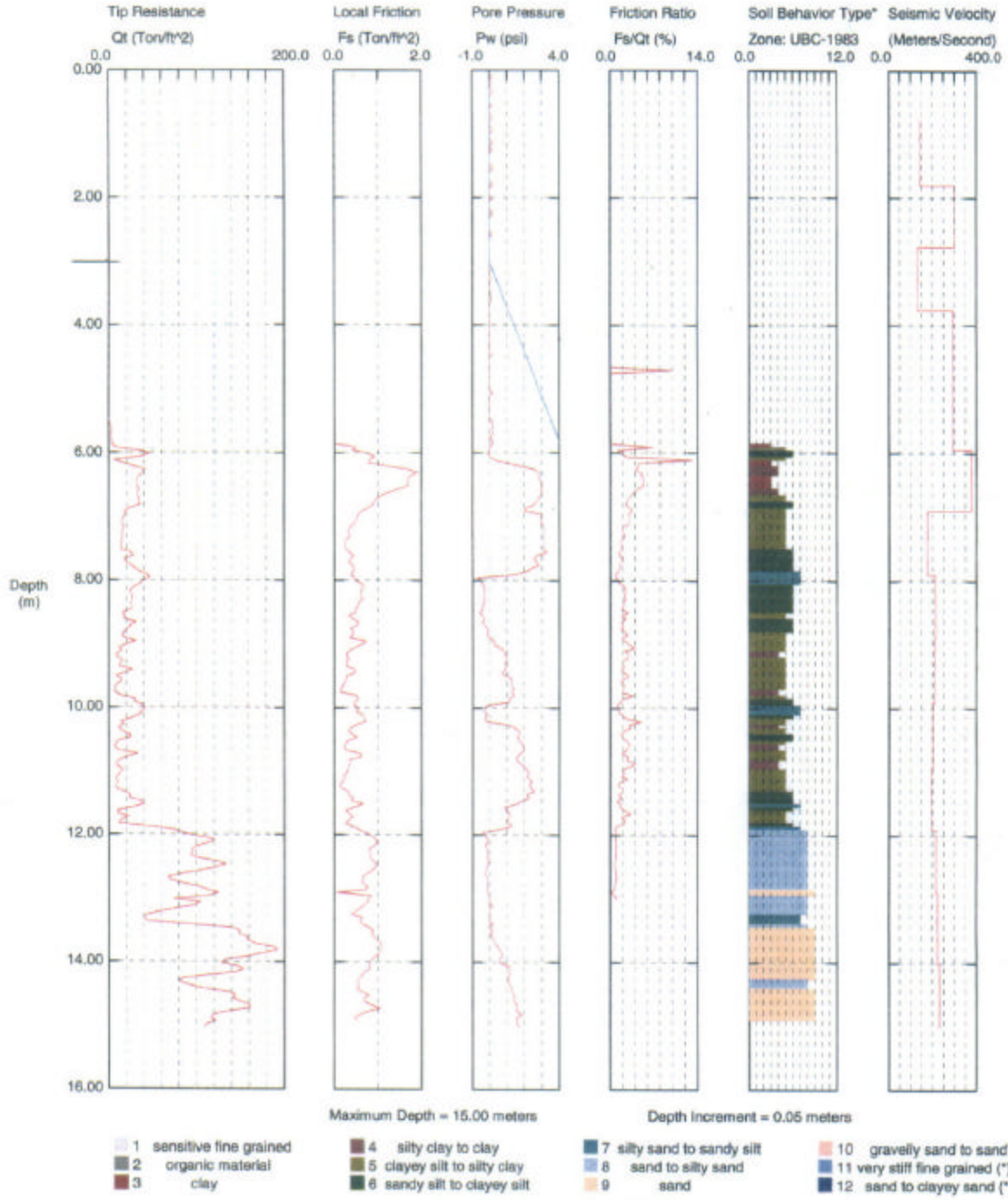

Hogentogler & Co

Operator: sheri
 Sounding: a60312
 Cone Used: 680tc

CPT Date/Time: 03-20-03 20:12
 Location: pumr-2
 Job Number: spr03bds

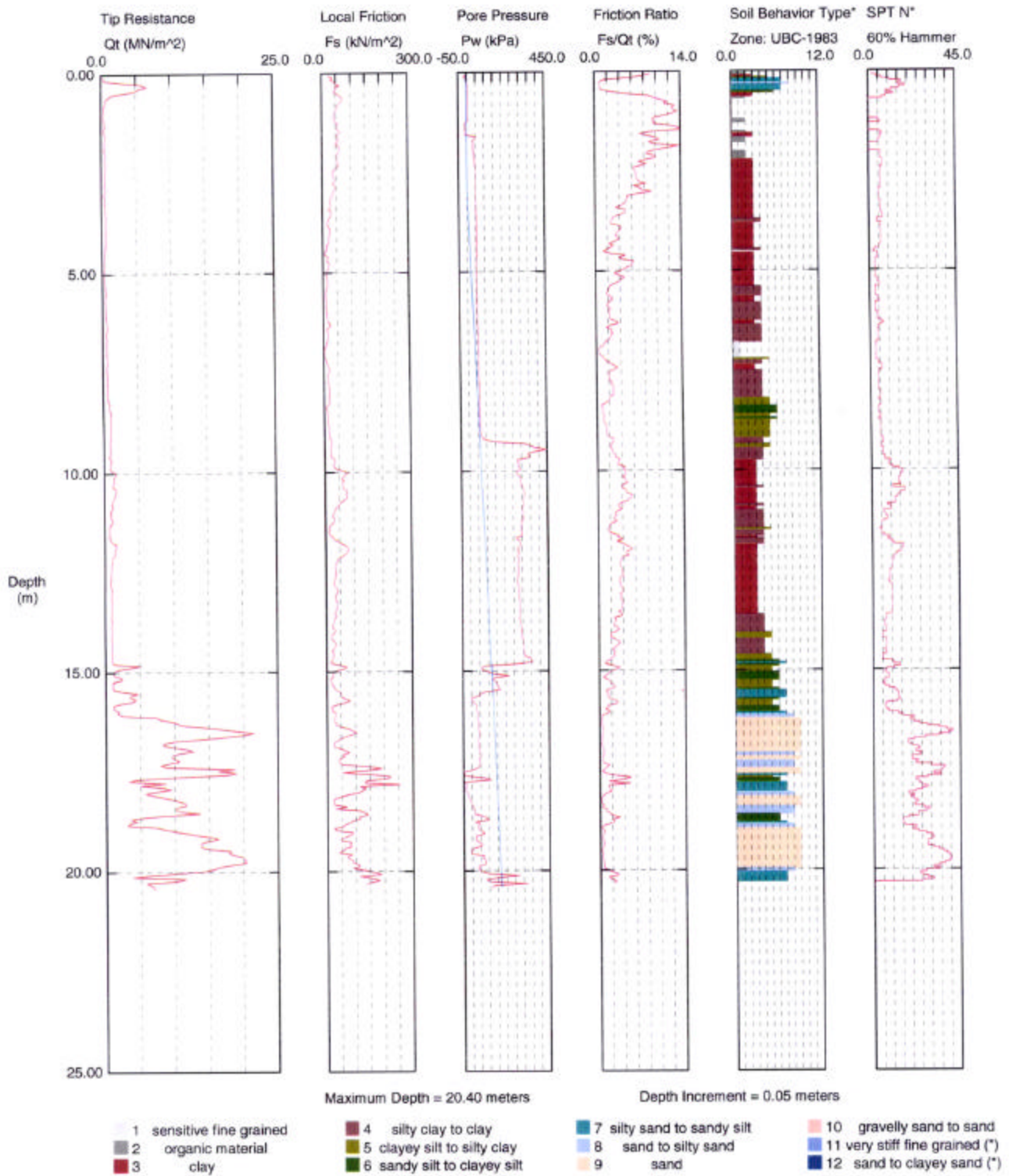

*Soil behavior type and SPT based on data from UBC-1983

MoDOT/UMR

Operator: Kevin McLain
 Sounding: pumr3bb
 Cone Used: DSA0854

CPT Date/Time: 9/3/2003 11:34:38 AM
 Location: PUMR3b N. side meramec
 Job Number: R2a0

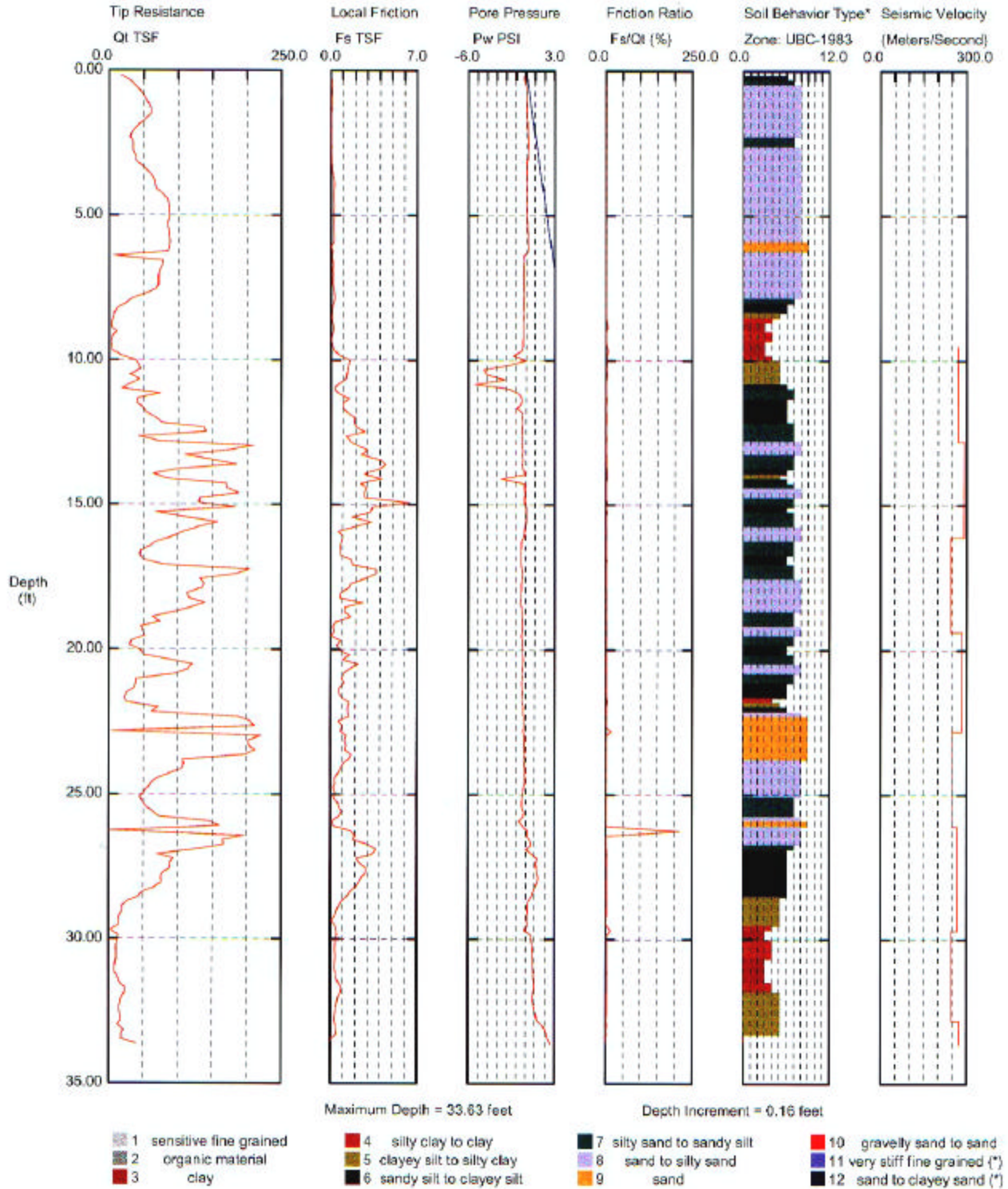

*Soil behavior type and SPT based on data from UBC-1983

MoDOT/UMR

Operator: Kevin McLain
 Sounding: sumr4
 Cone Used: DSA0854

CPT Date/Time: 9/2/2003 4:25:55 PM
 Location: sumr4
 Job Number: R2a0

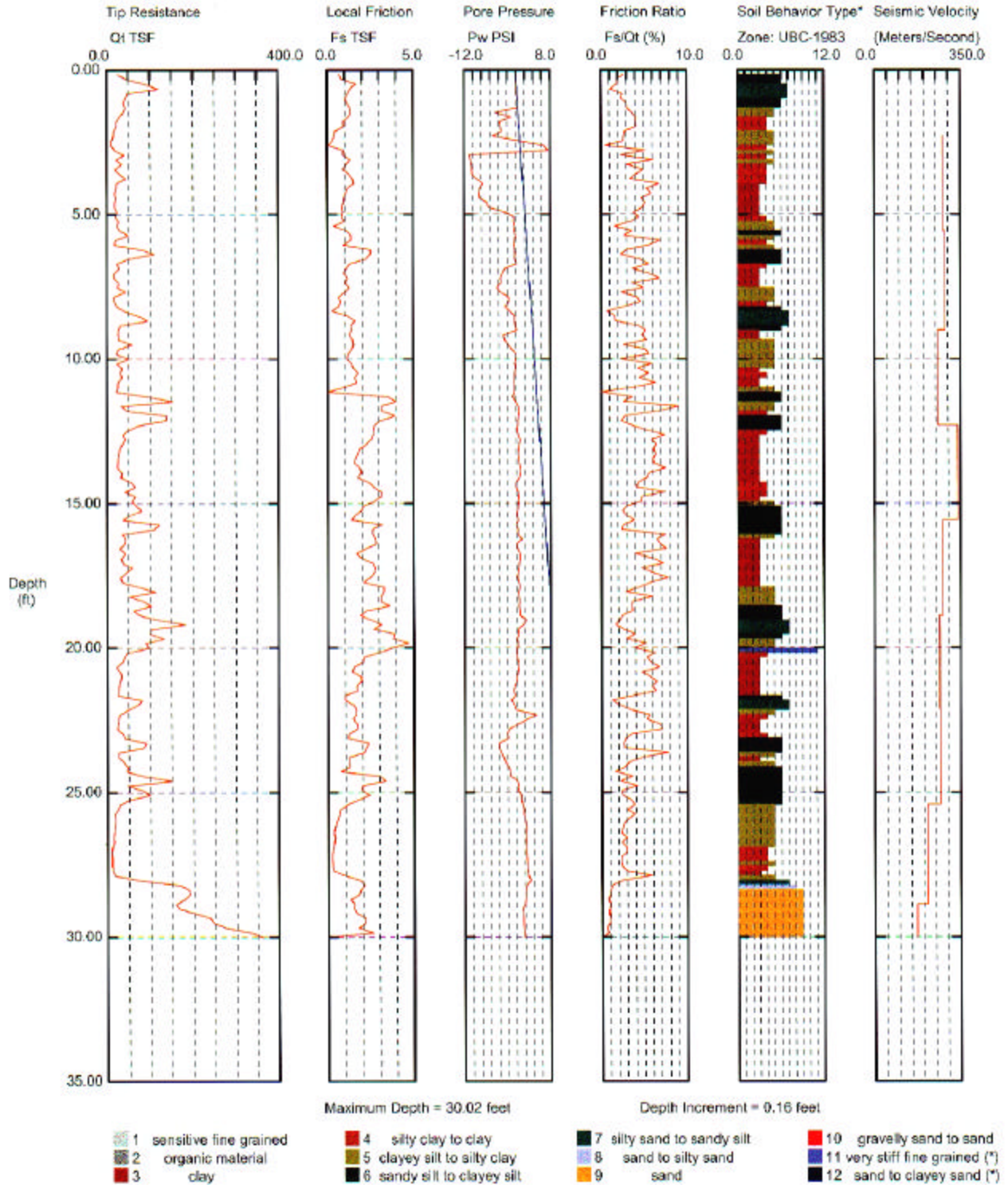

Borehole	Depth	Liquid Limit	Plastic Limit	Plasticity Index	Maximum Size (mm)	%<#200 Sieve	Classification	Water Content (%)	Dry Density (pcf)	Saturation (%)	Void Ratio
BUMR-1	5.0	69	27	41							
BUMR-1	7.0	76	35	41				35.0			
BUMR-1	8.5	80	27	53							
BUMR-1	10.0							37.4			
BUMR-1	14.0	19	NP	NP				17.9			
BUMR-1	17.5							21.4			
BUMR-1	21.0							20.7			
BUMR-1	22.5	37	22	15							
BUMR-1	24.5							25.7			
BUMR-1	26.0	31	20	11							
BUMR-1	28.0							13.1			
BUMR-2	4.0	58	26	32				33.4			
BUMR-2	6.0							32.5			
BUMR-2	7.5	68	32	36							
BUMR-2	9.5							32.9			
BUMR-2	13.0	68	28	40				30.0			
BUMR-2	14.5	62	29	33							
BUMR-2	16.5							30.5			
BUMR-2	20.0							17.6			
BUMR-2	21.5							19.6			
BUMR-2	23.0	37	22	15							
BUMR-2	25.0							23.6			
BUMR-2	26.5	32	21	11				26.5			
BUMR-3	5.0	54	24	30				24.0			
BUMR-3	7.0							29.1			
BUMR-3	10.5	69						29.8			
BUMR-3	12.0	63	32	31				26.8			
BUMR-3	12.5	79	32	46							
BUMR-3	14.0							28.9			
BUMR-3	15.5	56	28	28				32.6			
BUMR-3	16.5	64	32	32				31.3			
BUMR-3	19.0	60						29.0			
BUMR-3	21.0							26.1			
BUMR-3	22.5	55	25	30				30.8			
BUMR-3	24.5	67	22	45				26.4			
BUMR-3	26.0	41	21	20				23.1			
BUMR-3	28.0	46	19	27				27.0			
BUMR-3	29.5	53	24	28				31.3			
BUMR-4	0.0	50	27	23				32.3			
BUMR-4	2.0							28.1			
BUMR-4	3.5	67	30	37				26.1			
BUMR-4	5.5							28.9			

UIS LAB SUMMARY, NORTHERN SITE BRIDGE, U.MO ROLLA, GDT, 12/17/03



UNIVERSITY OF MISSOURI-ROLLA
DEPARTMENT OF CIVIL ENGINEERING
GEOTECHNICAL ENGINEERING

Summary of Laboratory Results

Project: Northern Site Bridge No. A-6031
Location: Livingston County, Missouri
Job No.: RI02-033

Borehole	Depth	Liquid Limit	Plastic Limit	Plasticity Index	Maximum Size (mm)	%<#200 Sieve	Classification	Water Content (%)	Dry Density (pcf)	Saturation (%)	Void Ratio
BUMR-4	7.0	70	39	31				32.6			
BUMR-4	9.0							27.3			
BUMR-4	12.5							30.9			
BUMR-4	14.0	57	29	28				31.3			
BUMR-4	16.0							26.5			
BUMR-4	17.5	62	30	32				33.6			
BUMR-4	18.0	78	34	44							
BUMR-4	19.5							28.9			
BUMR-4	21.0	52	29	23				22.0			
BUMR-4	21.5	49	28	21							
BUMR-4	23.0							25.4			
BUMR-4	24.5	45	24	20							
BUMR-4	26.5							23.8			
BUMR-4	28.5	47	22	25				26.4			

US LAB SUMMARY NORTHERN SITE GPJ U MO ROLLA GDT 12/17/03



UNIVERSITY OF MISSOURI-ROLLA
DEPARTMENT OF CIVIL ENGINEERING
GEOTECHNICAL ENGINEERING

Summary of Laboratory Results

Project: Northern Site Bridge No. A-6031

Location: Livingston County, Missouri

Job No.: RI02-033

Borehole	Depth	Liquid Limit	Plastic Limit	Plasticity Index	Maximum Size (mm)	%<#200 Sieve	Classification	Water Content (%)	Dry Density (pcf)	Saturation (%)	Void Ratio
BUMR-5	0.0							15.0			
BUMR-5	2.0							13.0			
BUMR-5	4.3							16.3			
BUMR-5	7.0							15.6			
BUMR-5	9.0	15	NP	NP				17.3			
BUMR-5	12.0							16.9			
BUMR-5	15.0	15	NP	NP				14.0			
BUMR-5	18.0							17.9			
BUMR-5	20.0	17	NP	NP				11.7			
BUMR-5	23.0							13.2			
BUMR-5	28.0	29	19	10				26.3			
BUMR-5	30.0							27.4			
BUMR-5	32.0							18.1			
BUMR-5	35.0							30.0			
BUMR-7	0.0							19.6			
BUMR-7	2.5	49	20	29				15.8			
BUMR-7	5.0							27.2			
BUMR-7	7.0							41.9			
BUMR-7	10.0							49.3			
BUMR-7	11.5	65	24	41				24.7			
BUMR-7	15.0							31.8			
BUMR-7	18.0	58	21	37				27.8			
BUMR-7	28.0							21.3			
BUMR-7	31.0							15.1			
BUMR-8	0.0							18.3			
BUMR-8	2.5	53	22	31				21.2			
BUMR-8	5.0							18.6			
BUMR-8	7.5							22.7			
BUMR-8	10.0							25.3			
BUMR-8	12.5							24.8			
BUMR-8	15.0	75	27	48				33.4			
BUMR-8	17.5							25.1			
BUMR-8	20.0							21.5			
BUMR-8	22.5	21	16	5				21.6			
BUMR-8	27.5							15.8			
BUMR-8	30.0							16.8			
BUMR-8	32.5							16.8			
BUMR-8	35.0							21.0			

US LAB SUMMARY SOUTHERN SITE.GPJ U.MO.ROLLA.GDT 7/27/03



UNIVERSITY OF MISSOURI-ROLLA
DEPARTMENT OF CIVIL ENGINEERING
GEOTECHNICAL ENGINEERING

Summary of Laboratory Results

Project: **Southern Site Bridge No. A-5690**
 Location: **Crawford County, Missouri**
 Job No.: **RI02-0033**

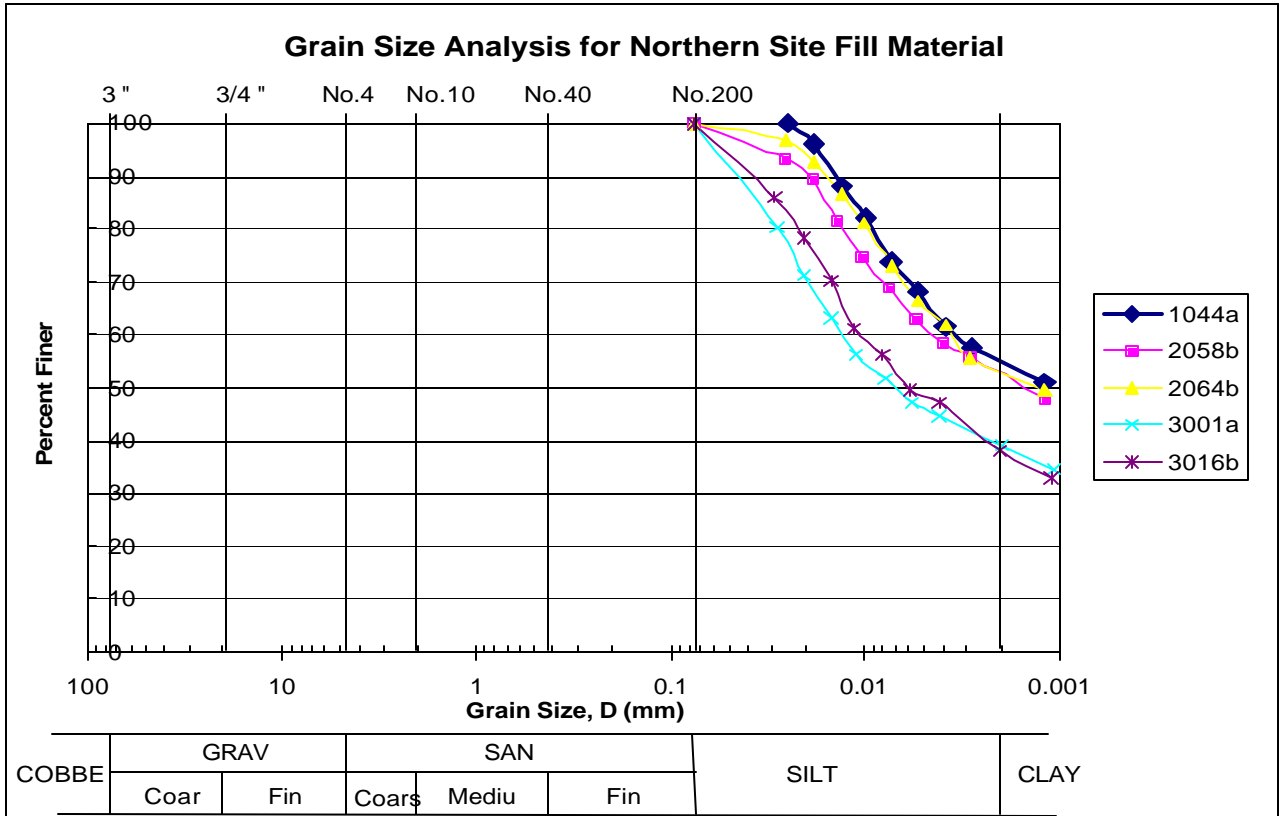
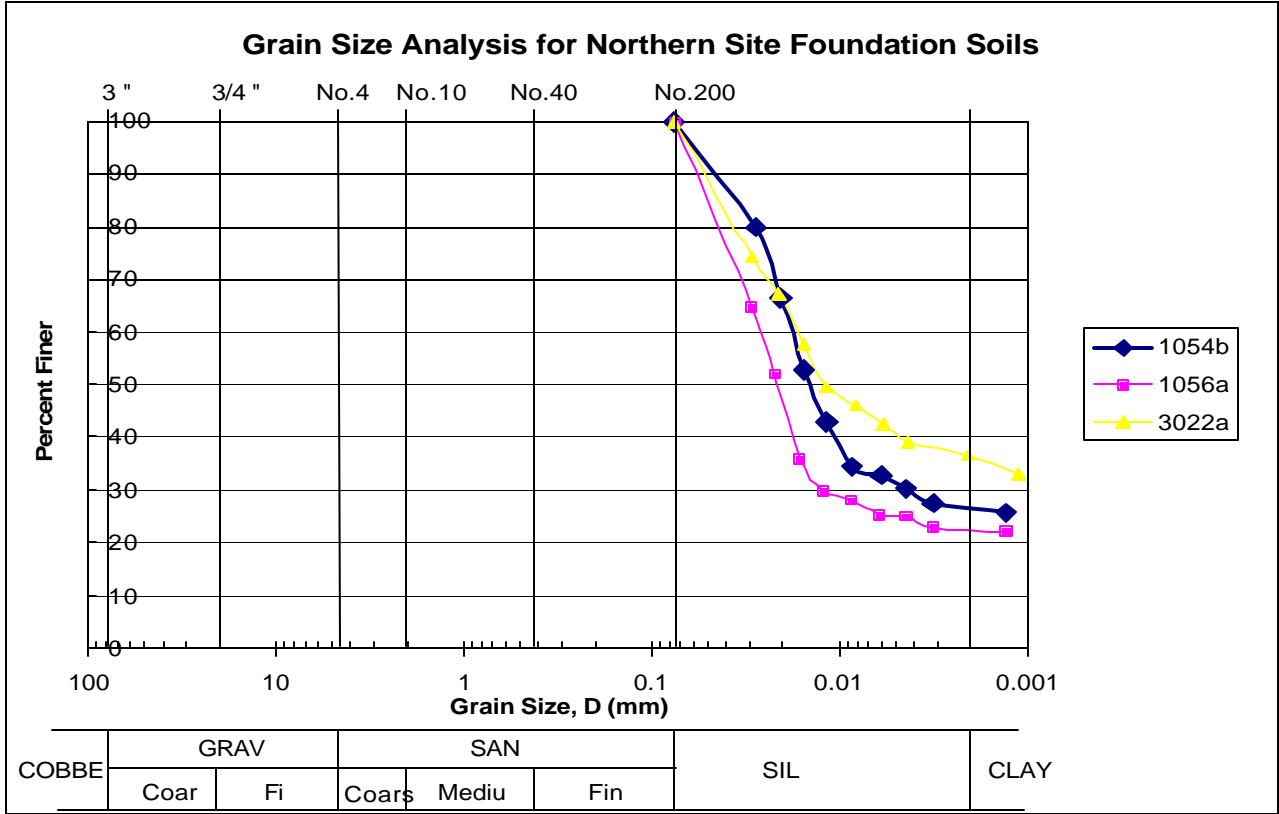

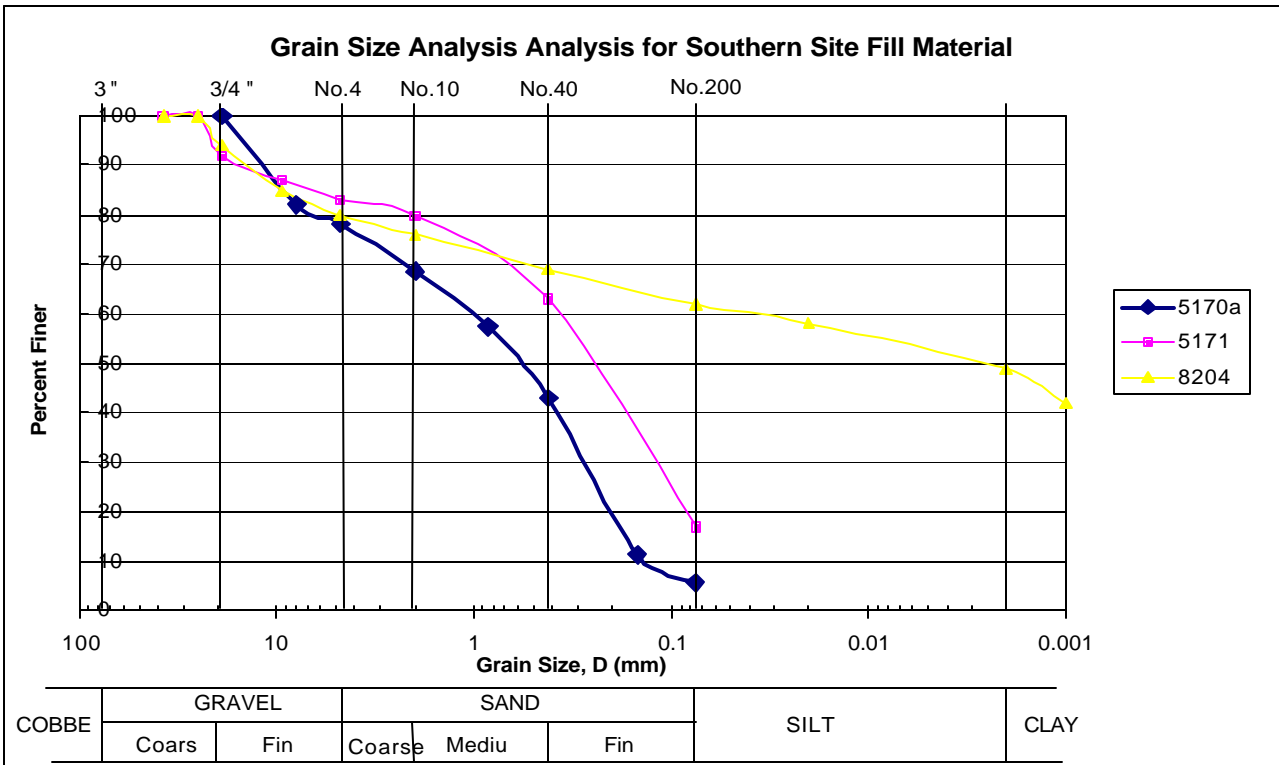
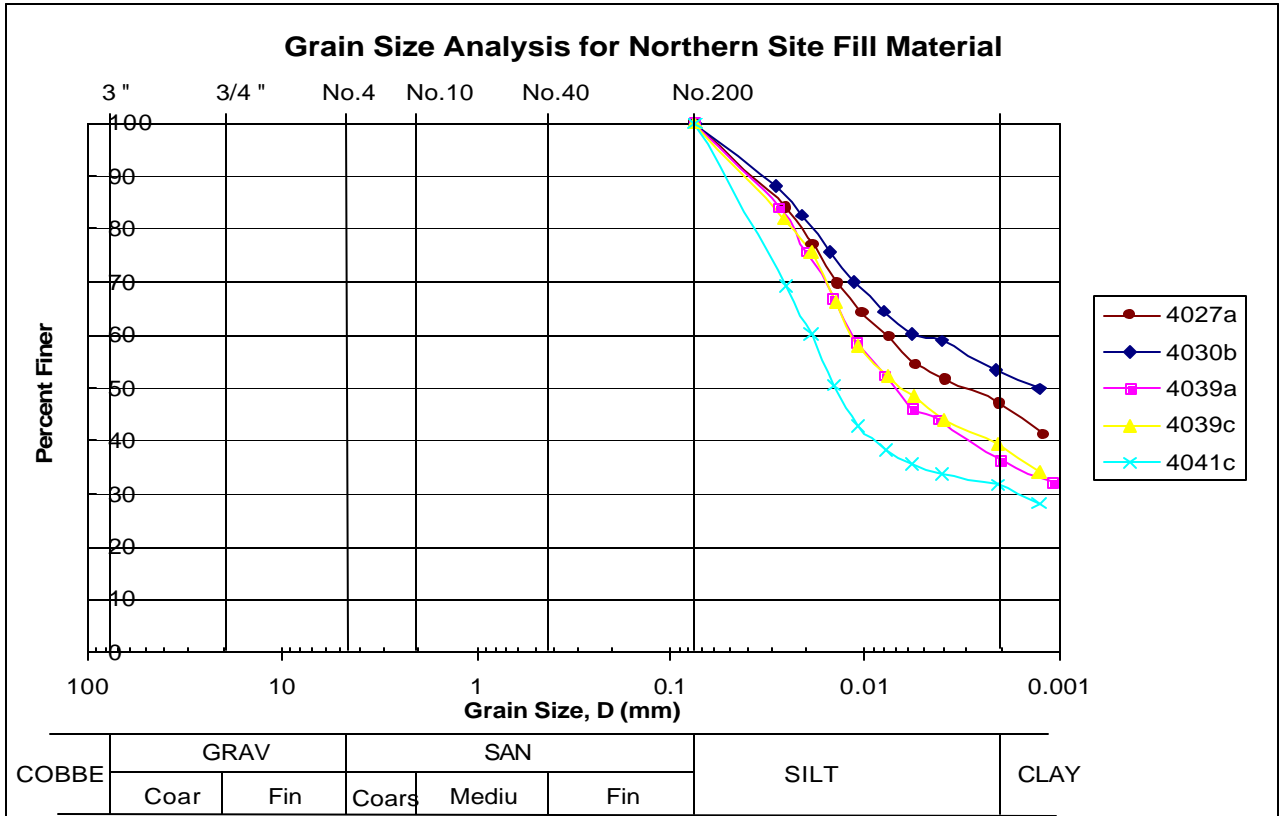

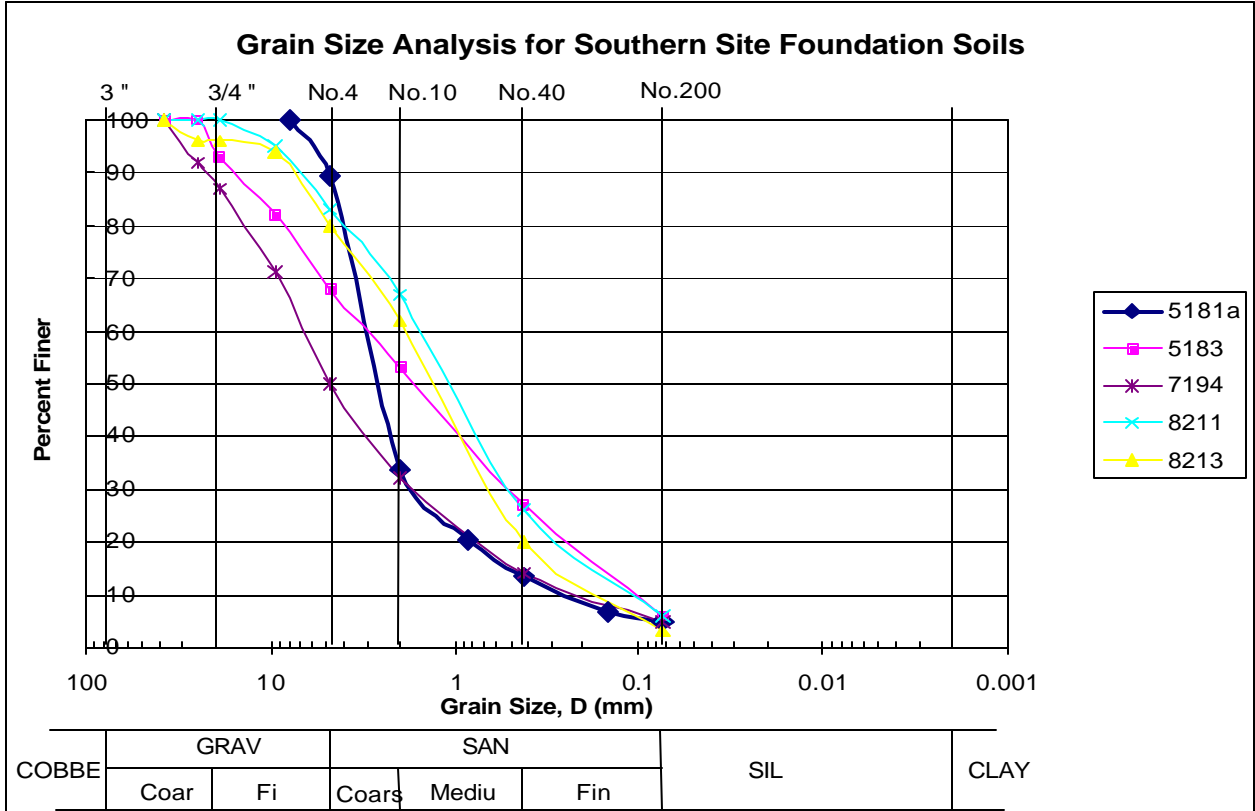

Sample Information

Borehole ID: BUMR-2
 Sample #: 58
 Depth: 4.5'
 Water Content: 33.40%

Description:

Brownish gray, moist medium stiff silty CLAY.

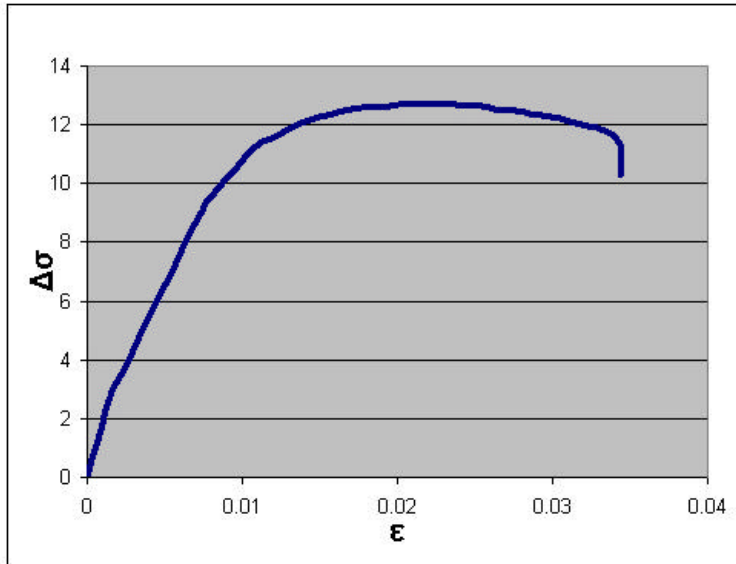

Su =	12.71 psi
E =	1325 psi

Sample Information

Borehole ID: BUMR-2
 Sample #: 62
 Depth: 12'
 Water Content: 34.00%

Description:

Dark Gray, moist, medium stiff silty CLAY with trace of organics.

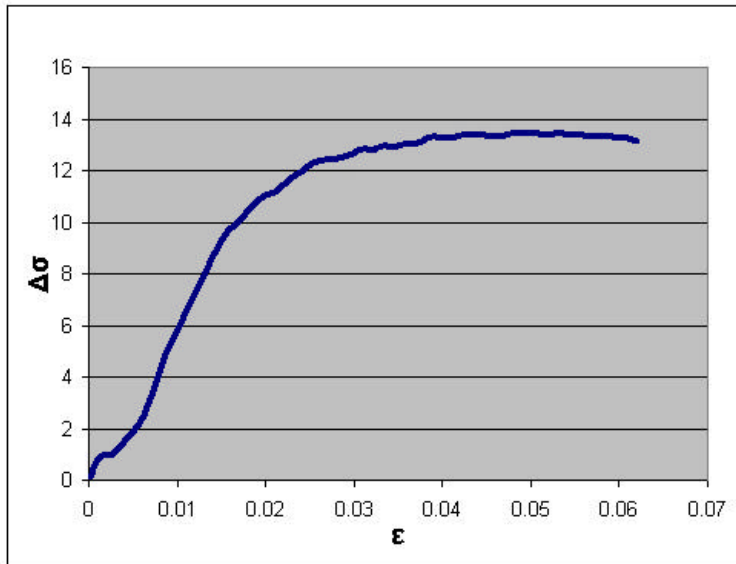

Su =	13.51 psi
E =	592.4 psi

Sample Information

Borehole ID:	BUMR-3
Sample #:	4
Depth:	8.5'
Water Content:	26.00%

Description:

Dark grey CLAY with light gray mottled lean clay, moist medium stiff to stiff.

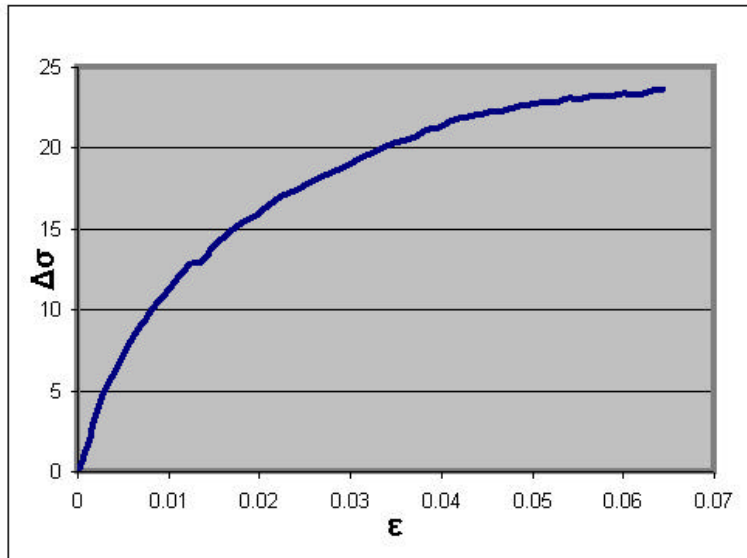

Su =	23.65 psi
E =	1084.8 psi

Sample Information

Borehole ID:	BUMR-4
Sample #:	33
Depth:	10.5
Water Content:	32.00%

Description:

Dark brownish gray lean mottled CLAY, moist medium stiff to stiff.

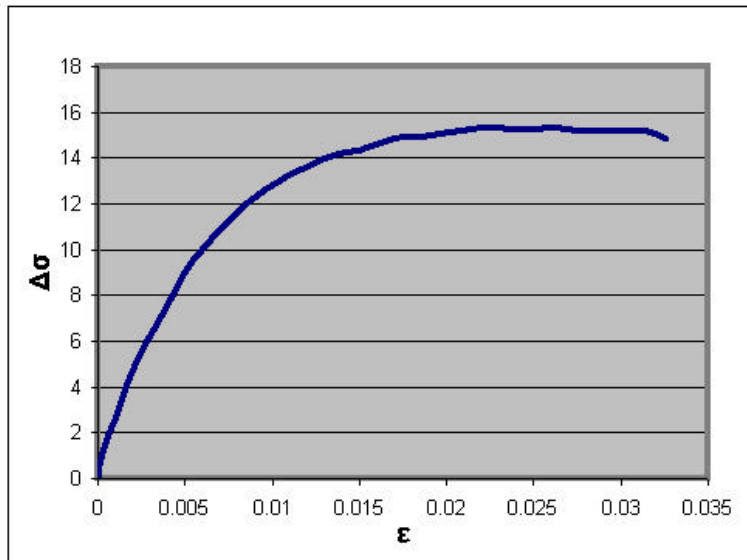

Su =	15.38 psi
E =	1898.2 psi

Sample Information

Borehole ID:	BUMR-5
Sample #:	181
Depth:	31'
Water Content:	23.50%

Description:
 Light grey with brown mottles silty sandy CLAY.

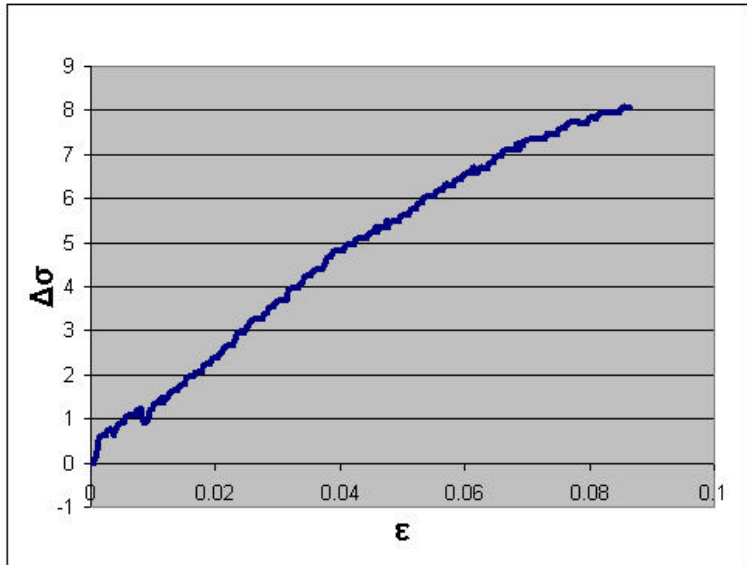

Su =	8.06 psi
E =	121.79 psi

Sample Information

Borehole ID:	BUMR-1
Sample #:	54
Depth:	23.5'
Water Content:	22.70%

Description:
 Light brownish gray, moist, medium stiff to stiff silty CLAY

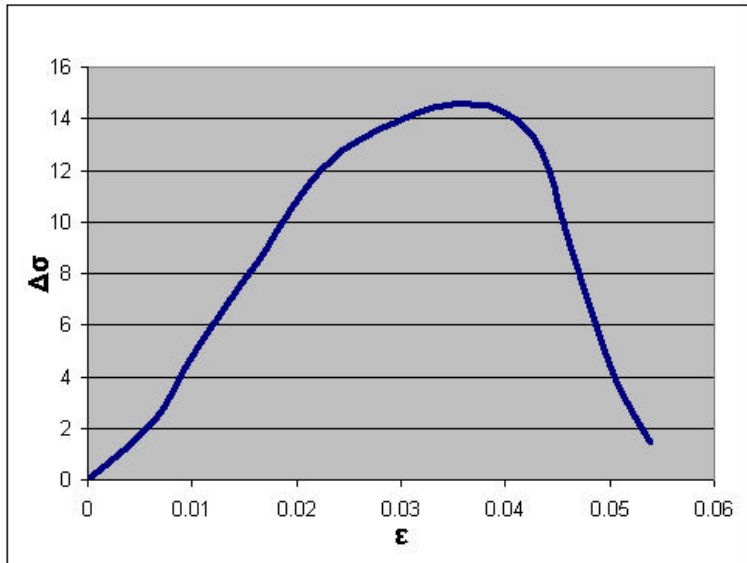

Su =	14.55 psi
E =	511.51 psi

Sample Information

Borehole ID: BUMR-3
 Sample #: 22
 Depth: 30.5
 Water Content: 31.80%

Description:

Light grayish brown, soft, moist silty CLAY.

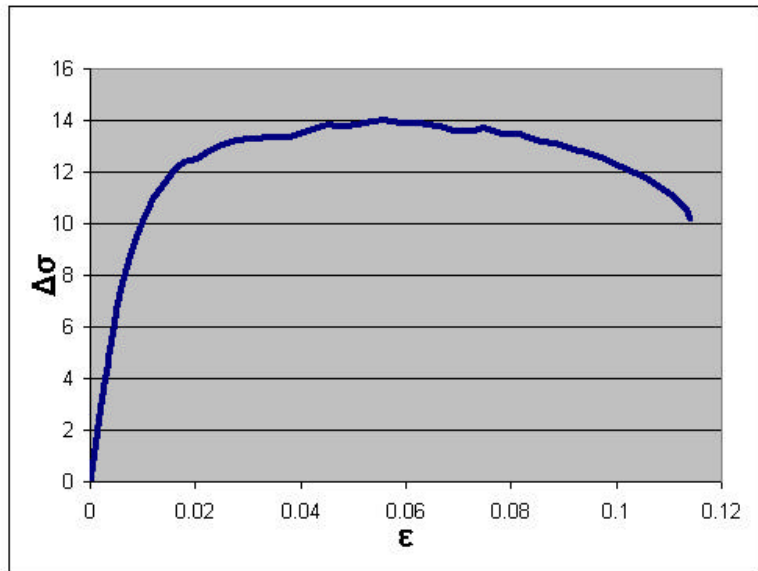

Su =	14 psi
E =	1294.2 psi

Sample Information

Borehole ID: BUMR-4
 Sample #: 27
 Depth: 5'
 Water Content: 27.90%

Description:

Dark brownish gray silty CLAY, moist medium stiff to stiff.

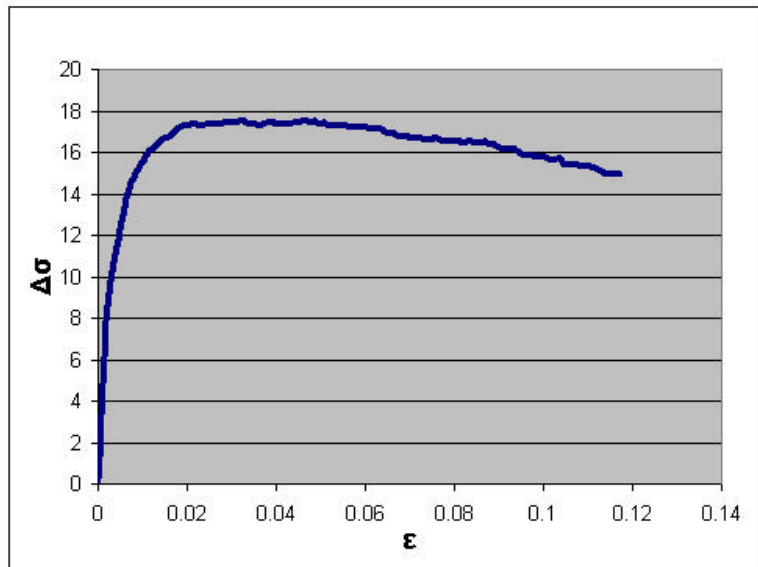

Su =	17.55 psi
E =	3510.6 psi

Sample Information

Borehole ID: BUMR-4
 Sample #: 41
 Depth: 26'
 Water Content: 23.10%

Description:

Dark brownish gray, med stiff to stiff moist silty CLAY w/ brown mottling.

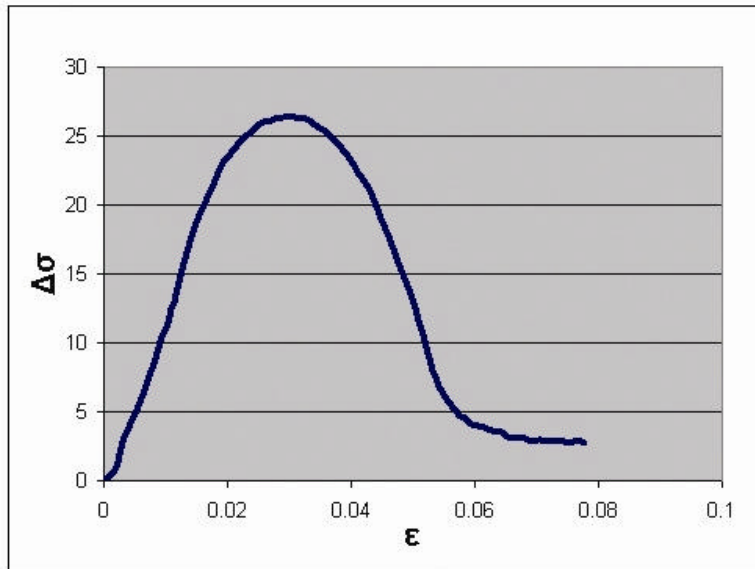

Su =	26.39 psi
E =	1147.2 psi

Sample Information

Borehole ID: BUMR-3
 Sample #: 16
 Depth: 24'
 Water Content: 32.10%

Description:

Dark greyish brown with light brown streaks, medium stiff to stiff, moist silty CLAY.

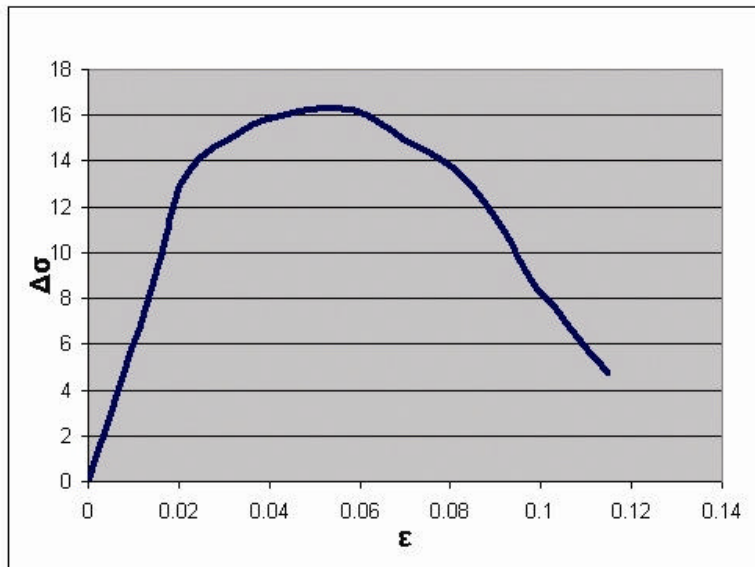

Su =	16.3 psi
E =	600 psi

Appendix C

NUMERICAL MODELING (PLAXIS) RESULTS

PLAXIS[®] DETAIL REPORT

Upper Bound Case – A-6031

Table of Contents

1. General Information.....	C-2
2. Geometry.....	C-2
3. Loads & boundary conditions	C-3
4. Material data	C-4
5. Results for phase 4	C-5

1. General Information

Table [1] Units

Type	Unit
Length	m
Force	kN
Time	day

Table [2] Model dimensions

	min.	max.
X	0.000	43.000
Y	0.000	28.000

Table [3] Model

Model	Plane strain
Element	15-Noded

2. Geometry

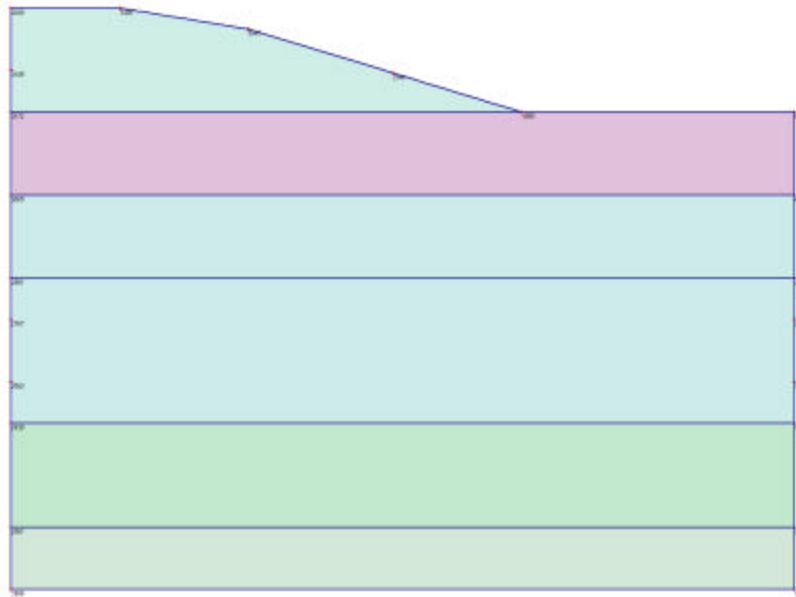

Fig. 1 Plot of geometry model with significant nodes

3. Loads & boundary conditions

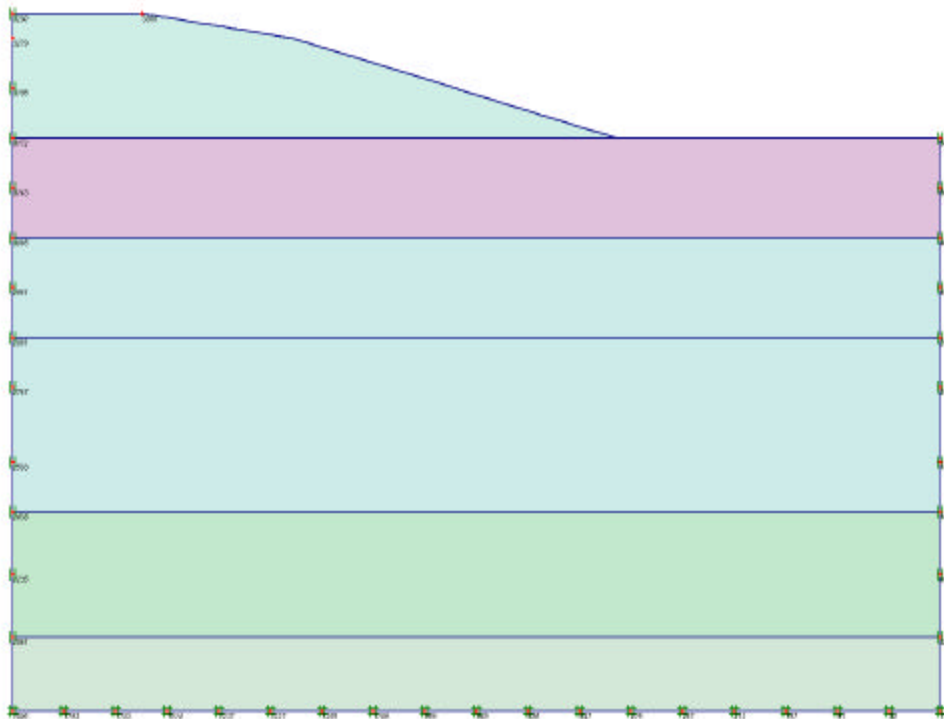

Fig. 2 Plot of geometry with loads & boundary conditions

4. Material data

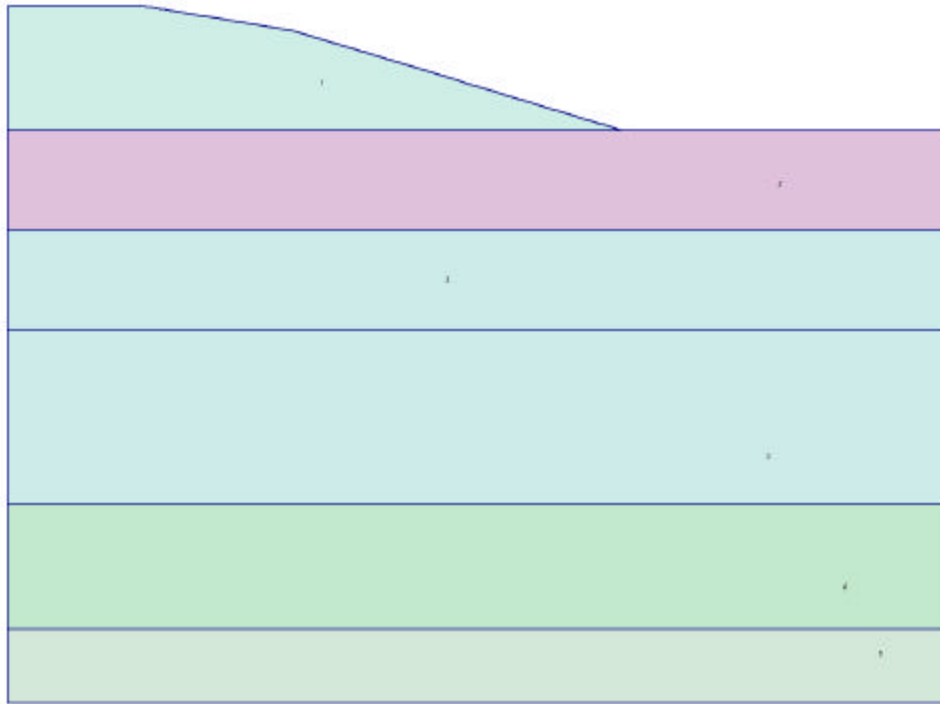

Fig. 3 Plot of geometry with material data sets

Table [5] Soil data sets parameters

<i>Mohr-Coulomb</i>		1	2	3
		new embankment	bc	scsl
Type		Drained	Undrained	Drained
g_{unsat}	[kN/m ³]	19.00	16.00	16.00
g_{sat}	[kN/m ³]	20.00	18.00	18.00
k_x	[m/day]	0.000	0.000	0.900
k_y	[m/day]	0.000	0.000	0.900
e_{init}	[-]	0.500	0.700	1.000
c_k	[-]	1E15	1E15	1E15
E_{ref}	[kN/m ²]	10300.000	10700.000	5700.000
n	[-]	0.350	0.350	0.200
G_{ref}	[kN/m ²]	3814.815	3962.963	2375.000
E_{oed}	[kN/m ²]	16530.864	17172.840	6333.333
c_{ref}	[kN/m ²]	86.00	210.00	0.20
j	[°]	28.00	0.00	34.00
γ	[°]	0.00	0.00	0.00
E_{inc}	[kN/m ² /m]	0.00	0.00	220.00
y_{ref}	[m]	0.000	0.000	4.000
$c_{increment}$	[kN/m ² /m]	0.00	0.00	0.00
$T_{str.}$	[kN/m ²]	0.00	0.00	0.00
$R_{inter.}$	[-]	0.65	1.00	1.00
Interface Permeability		Neutral	Neutral	Neutral

<i>Mohr-Coulomb</i>		4 gc	5 scsd
Type		Undrained	Drained
g_{unsat}	[kN/m ³]	16.00	17.00
g_{sat}	[kN/m ³]	18.00	21.00
k_x	[m/day]	0.000	0.900
k_y	[m/day]	0.000	0.900
e_{init}	[-]	0.700	1.000
c_k	[-]	1E15	1E15
E_{ref}	[kN/m ²]	24100.000	15400.000
n	[-]	0.350	0.200
G_{ref}	[kN/m ²]	8925.926	6416.667
E_{oed}	[kN/m ²]	38679.012	17111.111
c_{ref}	[kN/m ²]	520.00	0.20
j	[°]	0.00	40.00
γ	[°]	0.00	3.00
E_{inc}	[kN/m ² /m]	0.00	0.00
y_{ref}	[m]	0.000	0.000
$c_{increment}$	[kN/m ² /m]	0.00	0.00
$T_{str.}$	[kN/m ²]	0.00	0.00
$R_{inter.}$	[-]	1.00	0.70
Interface permeability		Neutral	Neutral

Table [6] Beam data sets parameters

No.	Identification	EA [kN/m]	EI [kNm ² /m]	W [kN/m/m]	n [-]	Mp [kNm/m]	Np [kN/m]
1	sb	1.2E7	2.6E5	0.00	0.00	1E15	0.00

5. Results for phase 4

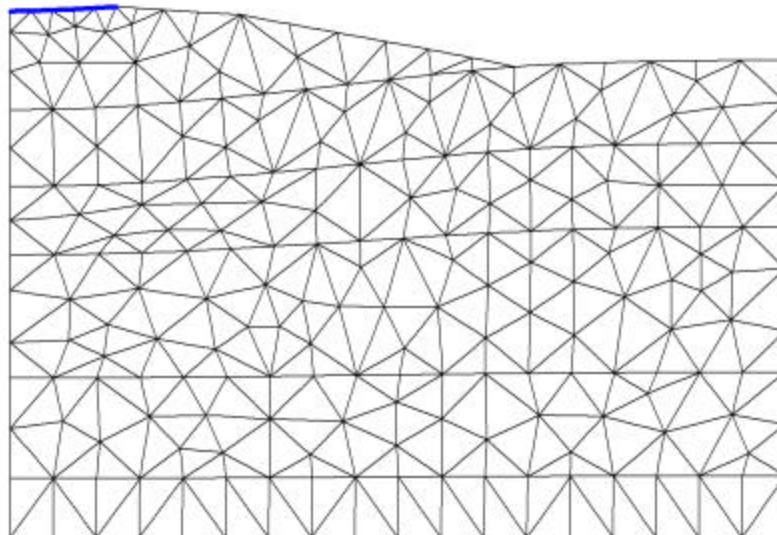

Fig. 4 Plot of deformed mesh - step no: 24 - (phase: 4)

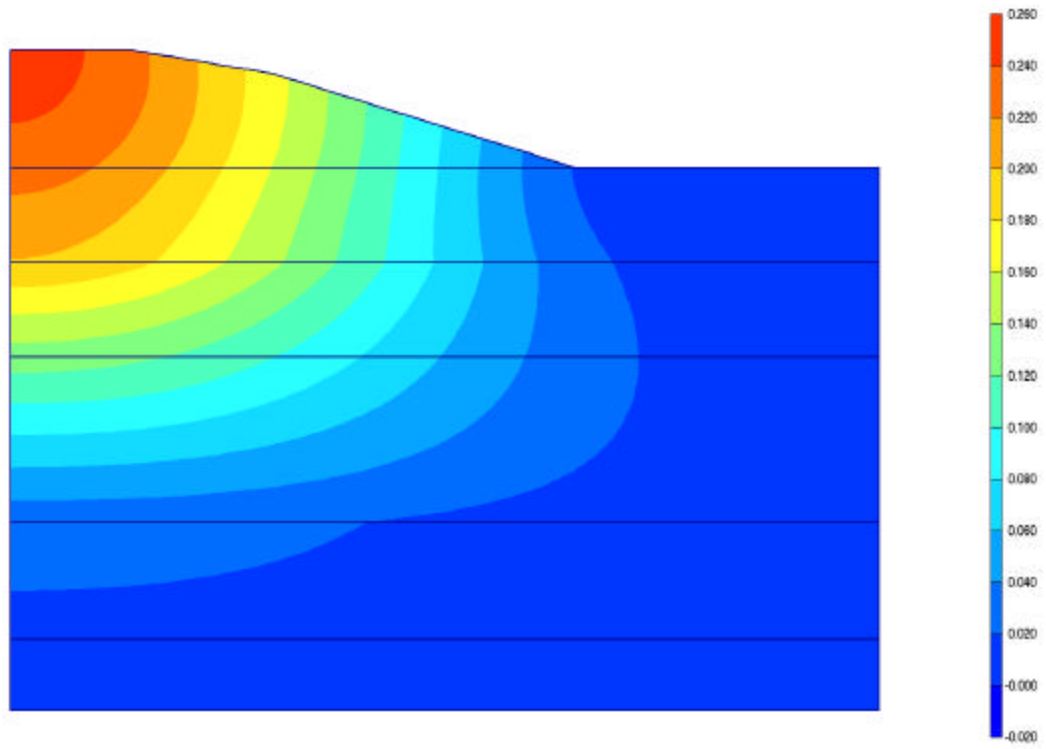

Fig. 5 Plot of total displacements (shadings) - step no: 24 - (phase: 4)

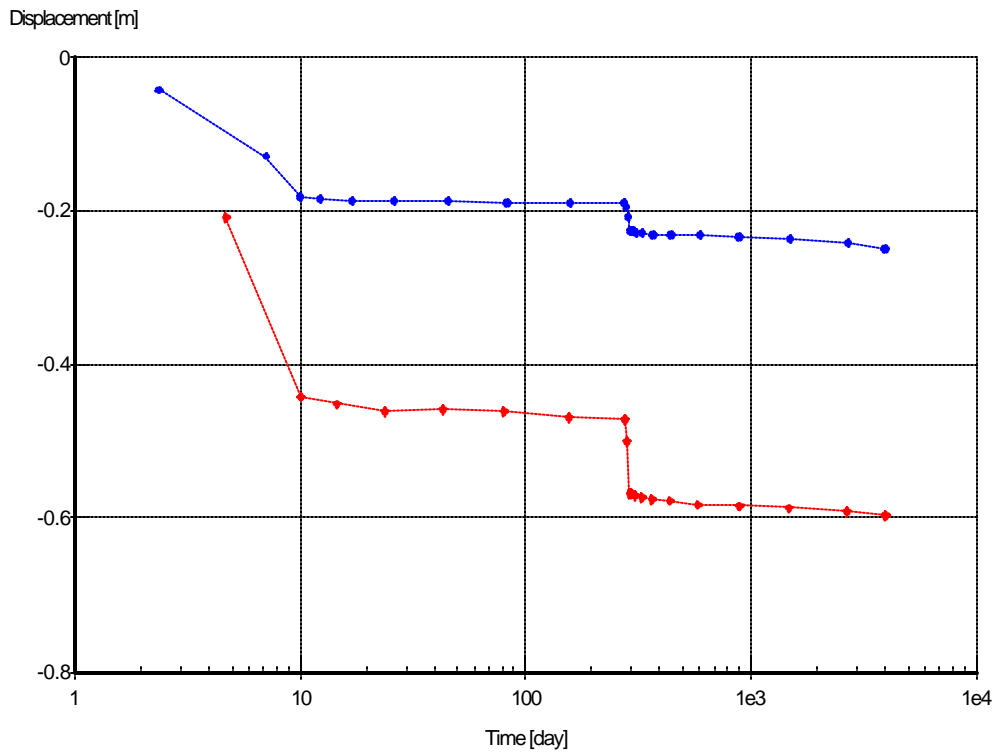

Fig. 6

PLAXIS[®] DETAIL REPORT

Lower Bound Case – A-6031

Table of Contents

1. General Information.....	C-7
2. Geometry.....	C-7
3. Loads & boundary conditions	C-8
4. Material data	C-9
5. Results for phase 4	C-10

1. General Information

Table [1] Units

Type	Unit
Length	m
Force	kN
Time	day

Table [2] Model dimensions

	min.	max.
X	0.000	43.000
Y	0.000	28.000

Table [3] Model

Model	Plane strain
Element	15-Noded

2. Geometry

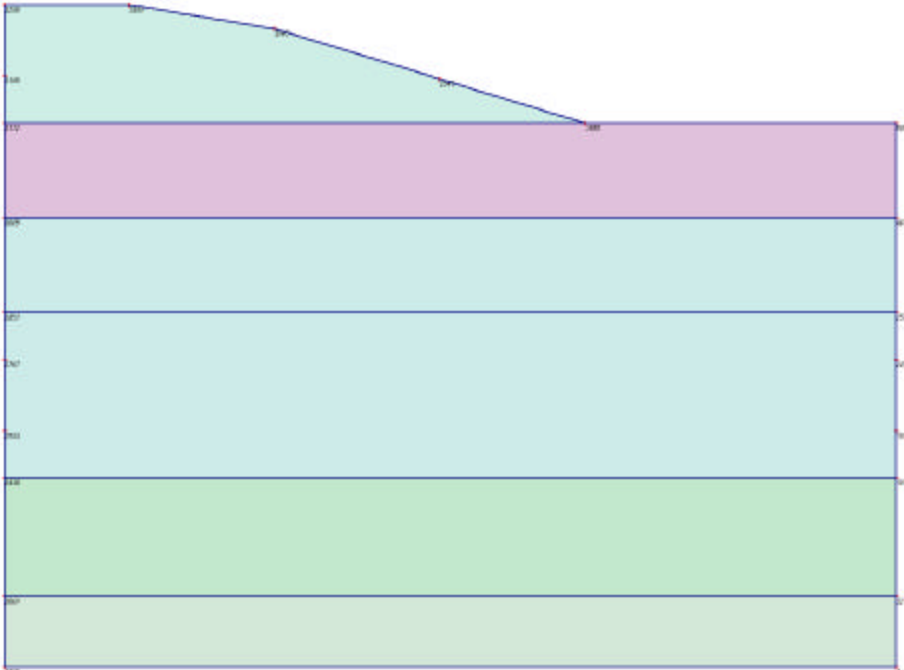

Fig. 1 Plot of geometry model with significant nodes

3. Loads & boundary conditions

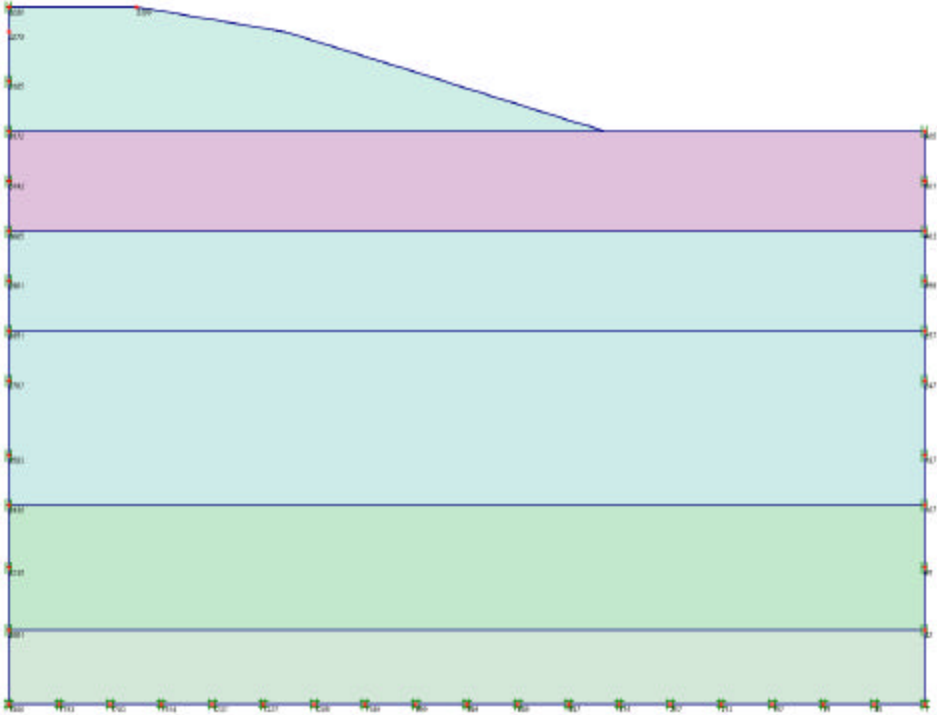

Fig. 2 Plot of geometry with loads & boundary conditions

4. Material data

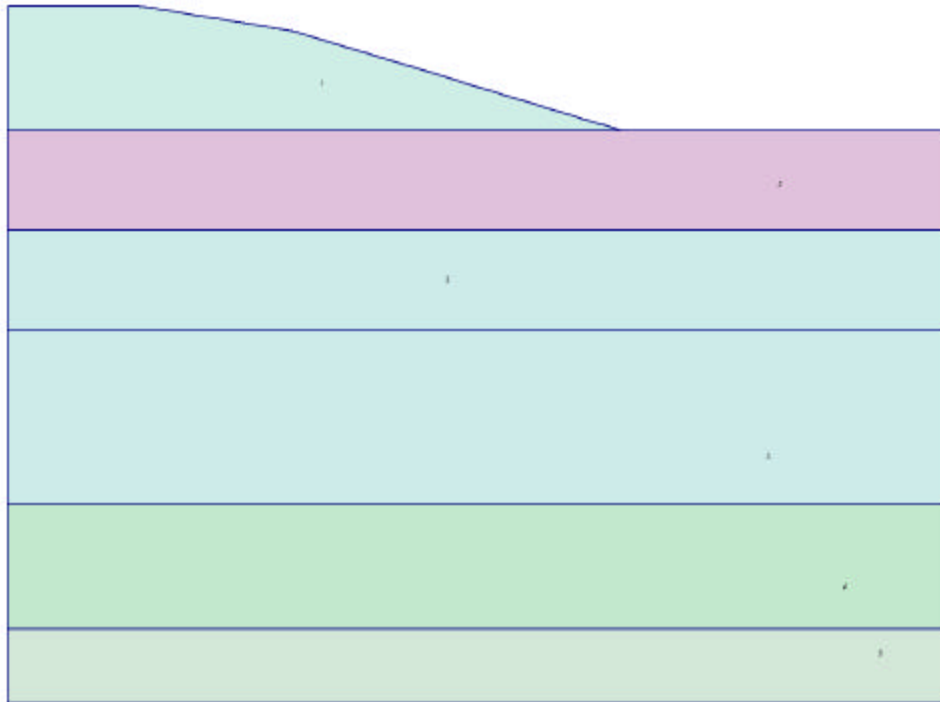

Fig. 3 Plot of geometry with material data sets

Table [6] Soil data sets parameters

<i>Mohr-Coulomb</i>		1	2	3
		new embankment	bc	scsl
Type		Drained	Undrained	Drained
g_{unsat}	[kN/m ³]	19.00	16.00	16.00
g_{sat}	[kN/m ³]	20.00	18.00	18.00
k_x	[m/day]	0.000	0.000	0.900
k_y	[m/day]	0.000	0.000	0.900
e_{init}	[-]	0.500	0.700	1.000
c_k	[-]	1E15	1E15	1E15
E_{ref}	[kN/m ²]	10300.000	5400.000	2100.000
n	[-]	0.350	0.350	0.200
G_{ref}	[kN/m ²]	3814.815	2000.000	875.000
E_{oed}	[kN/m ²]	16530.864	8666.667	2333.333
c_{ref}	[kN/m ²]	86.00	25.00	0.20
j	[°]	28.00	0.00	30.00
γ	[°]	0.00	0.00	0.00
E_{inc}	[kN/m ² /m]	0.00	0.00	320.00
y_{ref}	[m]	0.000	0.000	4.000
$c_{\text{increment}}$	[kN/m ² /m]	0.00	0.00	0.00
$T_{\text{str.}}$	[kN/m ²]	0.00	0.00	0.00
$R_{\text{inter.}}$	[-]	0.65	1.00	1.00
Interface permeability		Neutral	Neutral	Neutral

<i>Mohr-Coulomb</i>		4	5
		gc	scsd
Type		Undrained	Drained
g_{unsat}	[kN/m ³]	16.00	17.00
g_{sat}	[kN/m ³]	18.00	21.00
k_x	[m/day]	0.000	0.900
k_y	[m/day]	0.000	0.900
e_{init}	[-]	0.700	1.000
c_k	[-]	1E15	1E15
E_{ref}	[kN/m ²]	16600.000	8700.000
n	[-]	0.350	0.200
G_{ref}	[kN/m ²]	6148.148	3625.000
E_{oed}	[kN/m ²]	26641.975	9666.667
c_{ref}	[kN/m ²]	110.00	0.20
j	[°]	0.00	37.00
γ	[°]	0.00	3.00
E_{inc}	[kN/m ² /m]	0.00	0.00
y_{ref}	[m]	0.000	0.000
$c_{\text{increment}}$	[kN/m ² /m]	0.00	0.00
$T_{\text{str.}}$	[kN/m ²]	0.00	0.00
$R_{\text{inter.}}$	[-]	1.00	0.70
Interface permeability		Neutral	Neutral

Table [7] Beam data sets parameters

No.	Identification	EA [kN/m]	EI [kNm ² /m]	W [kN/m/m]	n [-]	Mp [kNm/m]	Np [kN/m]
1	Sb	1.2E7	2.6E5	0.00	0.00	1E15	0.00

5. Results for phase 4

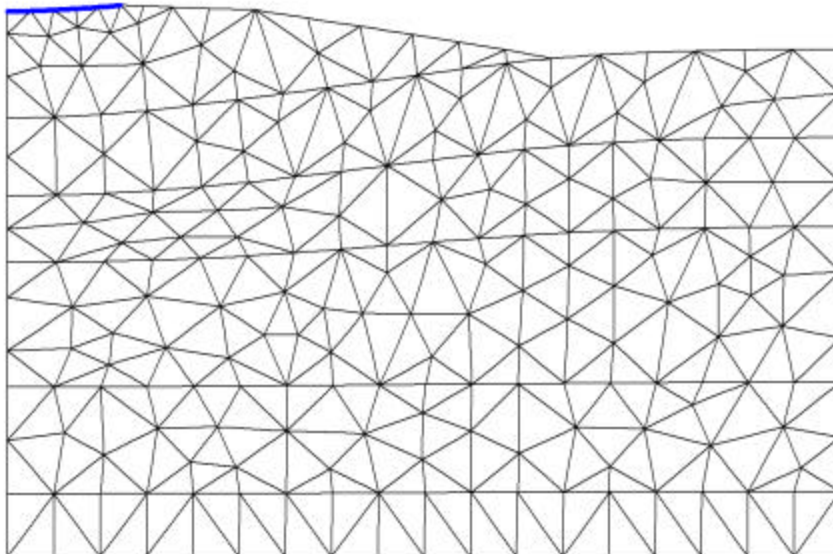

Fig. 4 Plot of deformed mesh - step no: 20 - (phase: 4)

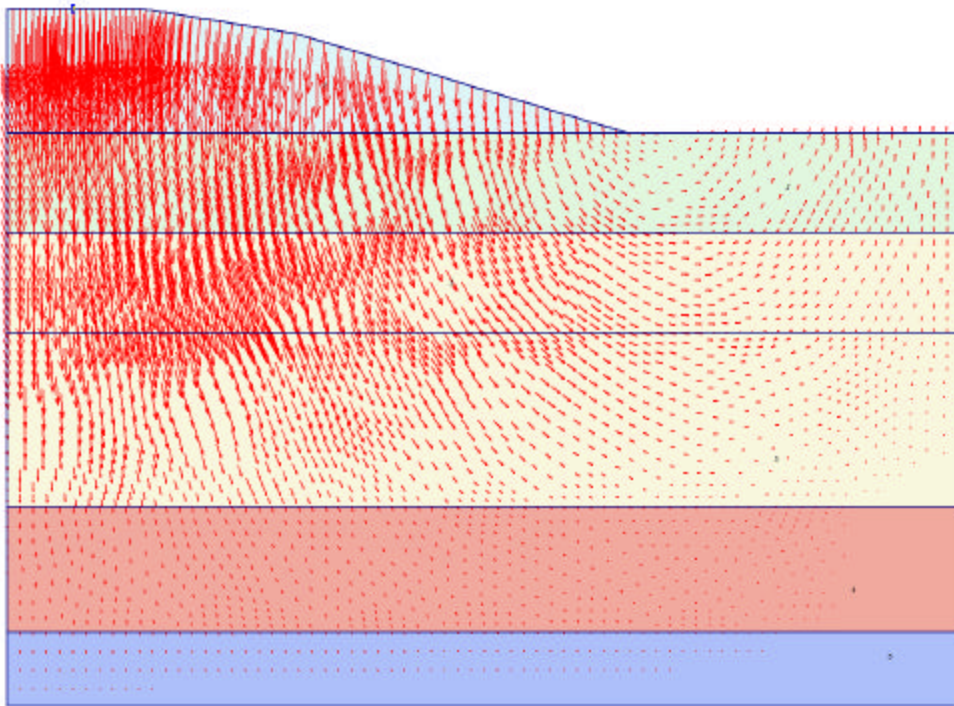

Fig. 5 Plot of total displacements (arrows) - step no: 20 - (phase: 4)

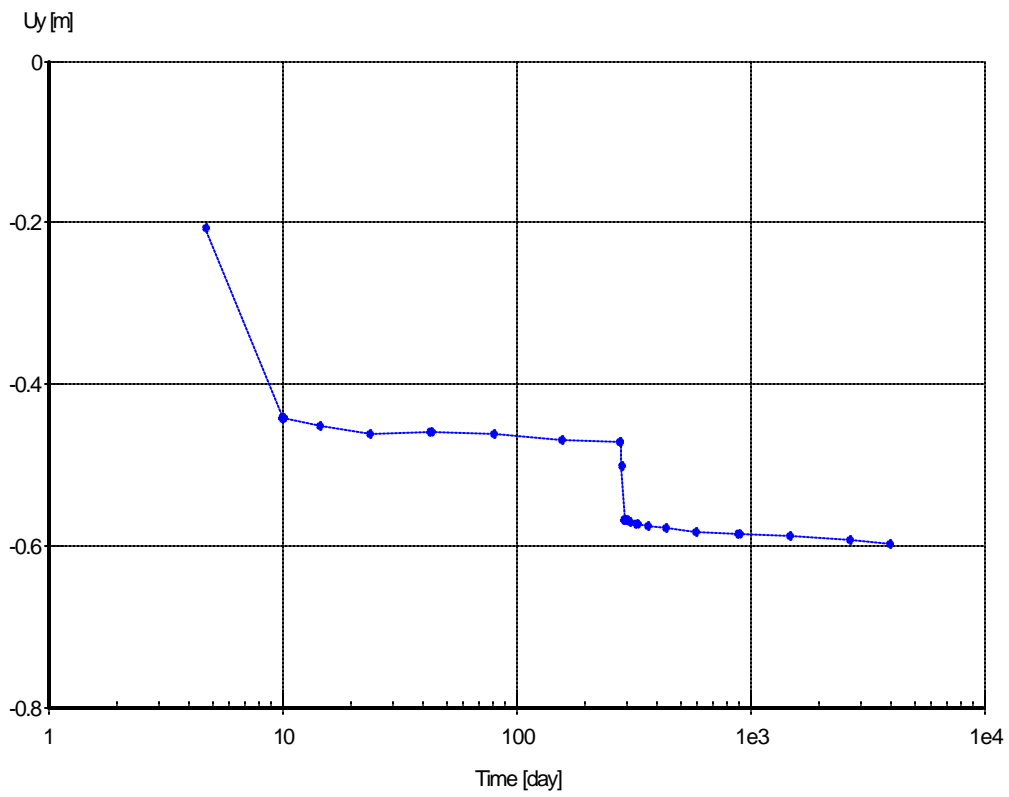

Fig. 6

PLAXIS[®] DETAIL REPORT

Case – A-5690

Table of Contents

1. General Information.....	101
2. Geometry.....	101
3. Structures	102
4. Loads & boundary conditions	102
5. Mesh data	104
6. Material data	104
7. Calculation phases.....	105

1. General Information

Table [1] Units

Type	Unit
Length	m
Force	kN
Time	day

Table [2] Model dimensions

	min.	max.
X	0.000	105.000
Y	0.000	12.000

Table [3] Model

Model	Plane strain
Element	15-Noded

2. Geometry

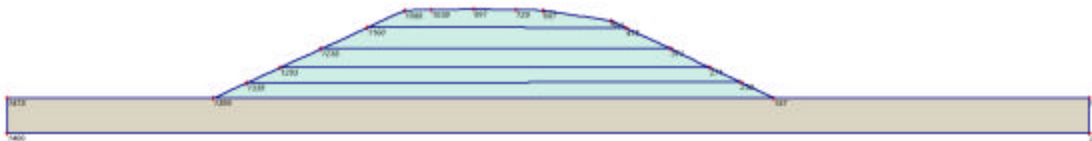

Fig. 1 Plot of geometry model with significant nodes

Table [4] Table of significant nodes

Node no.	x-coord.	y-coord.	Node no.	x-coord.	y-coord.
1466	0.000	0.000	1039	41.199	11.939
20	105.000	0.000	729	49.399	11.939
1	105.000	3.400	1339	23.214	4.869
1478	0.000	3.400	239	71.173	4.932
1359	20.000	3.400	1293	26.511	6.376
1088	38.600	11.900	271	68.182	6.352
897	45.300	12.000	1238	30.418	8.161
687	52.000	11.900	371	64.341	8.175
503	58.600	10.900	415	60.095	10.190
187	74.400	3.400	1160	34.941	10.228

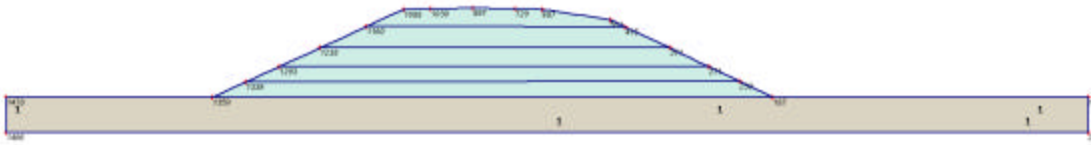

Fig. 2 Plot of geometry model with cluster numbers

Table [5] Table of clusters

Cluster no.	Nodes
1	1466, 20, 1, 1478, 1359, 187.
2	1359, 187, 1339, 239.
3	1339, 239, 1293, 271.
4	1293, 271, 1238, 371.
5	1238, 371, 415, 1160.
6	1088, 897, 687, 503, 1039, 729, 415, 1160.

3. Structures

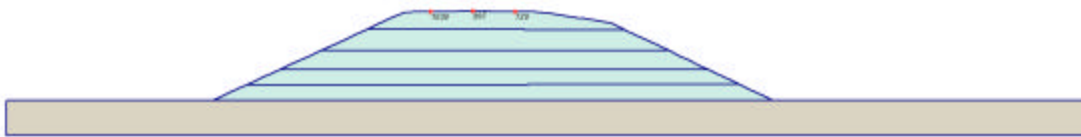

Fig. 3 Plot of geometry model with structures

Table [6] Beams

Plate no.	Data set	Length [m]	Nodes
1	Plate	8.201	1039, 897, 729.

4. Loads & boundary conditions

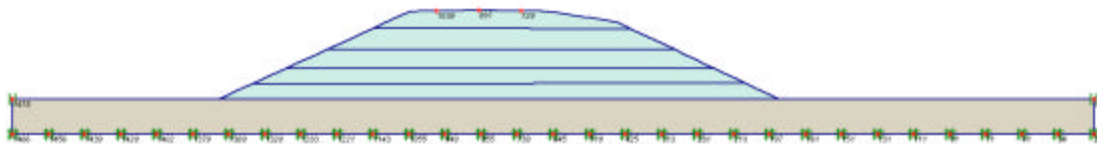

Fig. 4 Plot of geometry with loads & boundary conditions

Table [7] Node fixities

Node no.	Sign	Horizontal	Vertical	Node no.	Sign	Horizontal	Vertical
1466	#	Fixed	Fixed	519	#	Fixed	Fixed
20	#	Fixed	Fixed	425	#	Fixed	Fixed
1456	#	Fixed	Fixed	313	#	Fixed	Fixed
1439	#	Fixed	Fixed	281	#	Fixed	Fixed
1429	#	Fixed	Fixed	213	#	Fixed	Fixed
1402	#	Fixed	Fixed	197	#	Fixed	Fixed
1379	#	Fixed	Fixed	161	#	Fixed	Fixed
1369	#	Fixed	Fixed	151	#	Fixed	Fixed
1329	#	Fixed	Fixed	131	#	Fixed	Fixed
1283	#	Fixed	Fixed	111	#	Fixed	Fixed
1221	#	Fixed	Fixed	91	#	Fixed	Fixed
1143	#	Fixed	Fixed	71	#	Fixed	Fixed
1055	#	Fixed	Fixed	41	#	Fixed	Fixed
949	#	Fixed	Fixed	34	#	Fixed	Fixed
855	#	Fixed	Fixed	1		Fixed	Free
739	#	Fixed	Fixed	1478		Fixed	Free
645	#	Fixed	Fixed				

Table [8] Distributed loads A

Loads no.	First node	qx [kN/m/m]	qy [kN/m/m]	Last node	qx [kN/m/m]	qy [kN/m/m]
1	897			729		
2	1039			897		

5. Mesh data

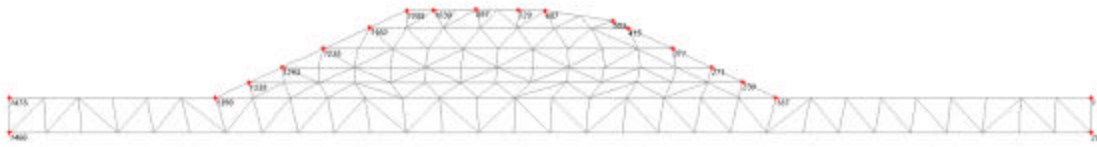

Fig. 5 Plot of the mesh with significant nodes

Table [9] Numbers, type of elements, integrations

Type	Type of element	Type of integration	Total no.
Soil	15-noded	12-point Gauss	169
Plate	5-node line	4-point Gauss	4

6. Material data

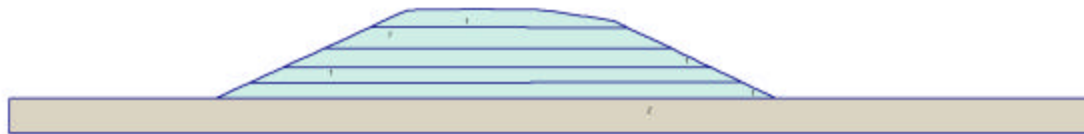

Fig. 6 Plot of geometry with material data sets

Table [10] Soil data sets parameters

<i>Mohr-Coulomb</i>		1	2
		Silty Sand	Silty Clay
Type		Drained	Undrained
g_{unsat}	[kN/m ³]	17.00	17.50
g_{sat}	[kN/m ³]	18.00	23.20
k_x	[m/day]	0.000	0.000
k_y	[m/day]	0.000	0.000
e_{init}	[-]	1.000	1.000
c_k	[-]	1E15	1E15
E_{ref}	[kN/m ²]	17000.000	8000.000
n	[-]	0.300	0.350
G_{ref}	[kN/m ²]	6538.462	2962.963
E_{oed}	[kN/m ²]	22884.615	12839.506
c_{ref}	[kN/m ²]	50.27	64.64
j	[°]	34.00	32.00
γ	[°]	0.00	0.00
E_{inc}	[kN/m ² /m]	0.00	0.00
γ_{ref}	[m]	0.000	0.000
$c_{\text{increment}}$	[kN/m ² /m]	0.00	0.00
$T_{\text{str.}}$	[kN/m ²]	0.00	0.00
$R_{\text{inter.}}$	[-]	0.66	1.00
Interface permeability		Neutral	Neutral

Table [11] Beam data sets parameters

No.	Identification	EA [kN/m]	EI [kNm ² /m]	w [kN/m/m]	n [-]	Mp [kNm/m]	Np [kN/m]
1	Plate	1.2E7	2.6E5	0.00	0.00	1E15	0.00

7. Calculation phases

Table [12] List of phases

Phase	Ph-No.	Start phase	Calculation type	Load input	First step	Last step
Initial phase	0	0		-	0	0
<Phase 1>	1	0	Consolidation	Ultimate time	1	2
<Phase 2>	2	1	Consolidation	Ultimate time	3	4
<Phase 3>	3	2	Consolidation	Ultimate time	5	6
<Phase 4>	4	3	Consolidation	Ultimate time	7	8
<Phase 5>	5	4	Consolidation	Ultimate time	9	10
<Phase 8>	8	5	Consolidation	Ultimate time	11	12
<Phase 7>	7	8	Consolidation	Minimum pore pressure	13	18

Table [13] Staged construction info

Ph-No.	Active clusters	Inactive clusters	Active beams	Active geotextiles	Active anchors
0	1.	2, 3, 4, 5, 6.			

Table [14] Control parameters 1

Ph-No.	Additional steps	Reset displacements to zero	Ignore undrained behaviour	Delete intermediate steps
1	250	No	No	No
2	250	No	No	No
3	250	No	No	No
4	250	No	No	No
5	250	No	No	No
8	250	No	No	No
7	250	No	No	No

Table [15] Control parameters 2

Ph-No.	Iterative procedure	Tolerated error	Over relaxation	Max. iteratio ns	Desired min.	Desired max.	Arc-Length control
1	Standard	0.010	1.200	50	6	15	Yes
2	Standard	0.010	1.200	50	6	15	Yes
3	Standard	0.010	1.200	50	6	15	Yes
4	Standard	0.010	1.200	50	6	15	Yes
5	Standard	0.010	1.200	50	6	15	Yes
8	Standard	0.010	1.200	50	6	15	Yes
7	Standard	0.010	1.200	50	6	15	Yes

Table [16] Incremental multipliers (input values)

Ph-No.	Displ.	Contr. A	Contr. B	Load A	Load B	Weight	Accel	Time	s-f
0	0.0000	0.0000	0.0000	0.0000	0.0000	0.0000	0.0000	0.0000	0.0000
1	0.0000	0.0000	0.0000	0.0000	0.0000	0.0000	0.0000	10.0000	0.0000
2	0.0000	0.0000	0.0000	0.0000	0.0000	0.0000	0.0000	10.0000	0.0000

Ph-No.	Displ.	Contr. A	Contr. B	Load A	Load B	Weight	Accel	Time	s-f
3	0.0000	0.0000	0.0000	0.0000	0.0000	0.0000	0.0000	10.0000	0.0000
4	0.0000	0.0000	0.0000	0.0000	0.0000	0.0000	0.0000	10.0000	0.0000
5	0.0000	0.0000	0.0000	0.0000	0.0000	0.0000	0.0000	10.0000	0.0000
8	0.0000	0.0000	0.0000	0.0000	0.0000	0.0000	0.0000	10.0000	0.0000
7	0.0000	0.0000	0.0000	0.0000	0.0000	0.0000	0.0000	2530808. 8200	0.0000

Table [17] Total multipliers - input values

Ph-No.	Displ.	Contr. A	Contr. B	Load A	Load B	Weight	Accel	Time	s-f
0	1.0000	0.0000	0.0000	1.0000	1.0000	1.0000	0.0000	0.0000	1.0000
1	1.0000	0.0000	0.0000	1.0000	1.0000	1.0000	0.0000	10.0000	1.0000
2	1.0000	0.0000	0.0000	1.0000	1.0000	1.0000	0.0000	20.0000	1.0000
3	1.0000	0.0000	0.0000	1.0000	1.0000	1.0000	0.0000	30.0000	1.0000
4	1.0000	0.0000	0.0000	1.0000	1.0000	1.0000	0.0000	40.0000	1.0000
5	1.0000	0.0000	0.0000	1.0000	1.0000	1.0000	0.0000	50.0000	1.0000
8	1.0000	0.0000	0.0000	1.0000	1.0000	1.0000	0.0000	60.0000	1.0000
7	1.0000	0.0000	0.0000	1.0000	1.0000	1.0000	0.0000	1153087 7.3000	1.0000

Table [18] Total multipliers - reached values

Ph-No.	Displ.	Contr. A	Contr. B	Load A	Load B	Weight	Accel	Time	s-f
0	1.0000	0.0000	0.0000	1.0000	1.0000	1.0000	0.0000	0.0000	1.0000
1	1.0000	0.0000	0.0000	1.0000	1.0000	1.0000	0.0000	10.0000	1.0000
2	1.0000	0.0000	0.0000	1.0000	1.0000	1.0000	0.0000	20.0000	1.0000
3	1.0000	0.0000	0.0000	1.0000	1.0000	1.0000	0.0000	30.0000	1.0000
4	1.0000	0.0000	0.0000	1.0000	1.0000	1.0000	0.0000	40.0000	1.0000
5	1.0000	0.0000	0.0000	1.0000	1.0000	1.0000	0.0000	50.0000	1.0000
8	1.0000	0.0000	0.0000	1.0000	1.0000	1.0000	0.0000	60.0000	1.0000
7	1.0000	0.0000	0.0000	1.0000	1.0000	1.0000	0.0000	1153087 7.3000	1.0000