



RESEARCH

2009-17

Subsurface Drainage Manual for Pavements in Minnesota



Take the



steps...

Research...Knowledge...Innovative Solutions!

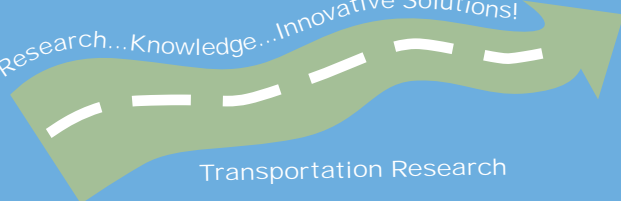

Transportation Research

Technical Report Documentation Page

1. Report No. MN/RC 2009-17	2.	3. Recipients Accession No.	
4. Title and Subtitle Subsurface Drainage Manual for Pavements in Minnesota		5. Report Date June 2009	
		6.	
7. Author(s) Caleb N. Arika, Dario J. Canelon, John L. Nieber		8. Performing Organization Report No.	
9. Performing Organization Name and Address Department of Bioproducts and Biosystems Engineering University of Minnesota Biosystems and Agricultural Engineering Building 1390 Eckles Avenue St. Paul, Minnesota 55108		10. Project/Task/Work Unit No.	
		11. Contract (C) or Grant (G) No. (c) 89261 (wo) 10	
12. Sponsoring Organization Name and Address Minnesota Department of Transportation 395 John Ireland Boulevard Mail Stop 330 St. Paul, Minnesota 55155		13. Type of Report and Period Covered Final Report	
		14. Sponsoring Agency Code	
15. Supplementary Notes http://www.lrrb.org/PDF/200917.pdf			
16. Abstract (Limit: 250 words) A guide for evaluation of highway subsurface drainage needs and design of subsurface drainage systems for highways has been developed for application to Minnesota highways. The guide provides background information on the benefits of subsurface drainage, methods for evaluating the need for subsurface drainage at a given location, selection of the type of drainage system to use, design of the drainage system, guidelines on how to construct/install the subsurface drainage systems for roads, and guidance on the value of maintenance and how to maintain such drainage systems.			
17. Document Analysis/Descriptors Pavement subsurface drainage, drainage equations, drainage system construction/installation, drainage system maintenance, cost/benefits of subsurface drainage systems		18. Availability Statement No restrictions. Document available from: National Technical Information Services, Springfield, Virginia 22161	
19. Security Class (this report) Unclassified	20. Security Class (this page) Unclassified	21. No. of Pages 194	22. Price

Subsurface Drainage Manual for Pavements in Minnesota

Final Report

Prepared by

Caleb N. Arika
Dario J. Canelon
John L. Nieber

Department of Bioproducts and Biosystems Engineering
University of Minnesota

June 2009

Published by

Minnesota Department of Transportation
Research Services Section
Transportation Bldg.
395 John Ireland Boulevard, Mail Stop 330
St. Paul, Minnesota 55155-1899

This report represents the results of research conducted by the authors and does not necessarily represent the views or policies of the Minnesota Department of Transportation and/or the University of Minnesota. This report does not contain a standard or specified technique.

The authors and the Minnesota Department of Transportation and/or the University of Minnesota do not endorse products or manufacturers. Trade or manufacturers' names appear herein solely because they are considered essential to this report.

Acknowledgments

We wish to thank the Minnesota Local Road Research Board (LRRB) and its Research Implementation Committee (RIC), and the Minnesota Department of Transportation (Mn/DOT), for their financial support which made the development of this important resource a reality. The Technical Advisory Panel (TAP), which steered the project, was extremely helpful in sharing their knowledge, expertise, and experience in the use of subsurface drainage systems for transportation related pavement structures. We appreciate the assistance of the following people who served on the TAP:

Dan Sauve, Clearwater County HWY Dept./RIC Member (Technical Liaison)

Alan Rindels, Mn/DOT, RSS (Administrative Liaison)

Chuck Howe, Mn/DOT Geology

Gabe Guevara, Mn/DOT Maintenance Operations

Joel Ulring, Wadena County

Stephen Schnieder, Nobles County

Kevin Muellerleile, Mn/DOT RSS

Andrea Hendrickson, Mn/DOT

Tracy Schimdt, Mn/DOT Aeronautics

Finally, we wish to thank Ms. Angela Gorham, E.I.T., for assisting with the final edits of the document.

Table of Contents

Chapter 1 OVERVIEW	1
1.0 INTRODUCTION	1
1.1 PURPOSE OF THE MANUAL.....	2
1.2 SCOPE OF THE MANUAL.....	2
1.3 ORGANIZATION AND USE OF THE MANUAL	2
1.4 DOCUMENTATION	3
1.4.1. Definitions.....	3
1.5 DISCLAIMER	4
Chapter 2 SUBSURFACE DRAINAGE SYSTEMS FOR PAVEMENT STRUCTURES	5
2.0 INTRODUCTION	5
2.1 PURPOSE OF SUBSURFACE DRAINAGE	6
2.2 EFFECTS OF MOISTURE ON PAVEMENTS	7
2.3 SOURCES OF MOISTURE.....	8
2.4 QUANTIFYING NET INFLOW BY SOURCE	9
2.4.1. Infiltration	10
2.4.2. Groundwater	11
2.4.3. Capillary Action and Water Vapor Movement.....	12
2.4.4. Spring Thaw.....	13
2.5 DRAINAGE NEED ANALYSIS	13
2.5.1. Subsurface Drainage Needs Analysis.....	14
2.5.2. Subsurface Drainage: Purpose and Approach.....	14
2.5.3. Percent Drained.....	15
2.5.4. Percent Saturation	16
2.5.5. Quantity of Free Water to be Drained.....	16
2.5.6. Factors Increasing Potential for Moisture-Related Pavement Damage	17
2.5.7. Subgrade Type, Strength and Condition.....	17
2.5.8. Type and Condition of Pavement	18
2.5.9. Traffic Loading.....	19
2.6 PAVEMENT GEOMETRY.....	20
2.6.1. Longitudinal Grades.....	20
2.6.2. Subsurface Geometry.....	22
2.7 OTHER FACTORS WHICH DETERMINE THE NEED FOR DRAINAGE	22
2.7.1. Existing Pavements.....	23
2.7.2. New Pavements.....	23
2.7.3. Site Conditions.....	23
2.8 TYPES OF SUBSURFACE DRAINAGE SYSTEMS.....	24
2.8.1. Influence of Type of Base Materials on Pavement Drainage	29
2.8.2. Index Properties of Materials.....	29
2.8.3. Performance Characteristics	30
2.8.4. Types and Specification of Base Materials.....	35
2.8.5. Positive Drainage of the Permeable Base	35

2.8.6.	Longitudinal Drains	35
2.8.7.	Transverse and Horizontal Drains	38
2.8.8.	Drainage Blankets.....	39
2.8.9.	Interceptor Drains	42
2.8.10.	Well Systems	44
2.9	TYPES OF PAVEMENTS AND DRAINAGE REQUIREMENTS.....	45
2.9.1.	Rigid Pavements	46
2.9.2.	Permeable Base in Rigid Pavement Design.....	46
2.9.3.	Flexible Pavements	47
2.9.4.	Stabilized Bases in the FAA Rigid Pavement Design	47
2.10	DESIGN OF SUBSURFACE DRAINAGE SYSTEMS	48
2.10.1.	Pavements with a Permeable Base System.....	49
2.11	CONSTRUCTION AND MAINTENANCE OF SUBSURFACE DRAINAGE SYSTEMS.....	49
2.12	ECONOMICS OF SUBSURFACE DRAINAGE	49
Chapter 3	SELECTION OF SUBSURFACE DRAINAGE SYSTEMS	51
3.0	INTRODUCTION	51
3.1	DRAIN OR NOT DRAIN?.....	51
3.1.1.	Quantitative Evaluation of Drainage Needs	52
3.1.2.	Traffic Loading.....	52
3.1.3.	Factors Influencing Amount of Free Water Entering the Pavement.....	53
3.1.4.	Factors Increasing Potential for Moisture-Related Pavement Damage	53
3.2	DESIGN CONSIDERATIONS	53
3.3	RECOMMENDATIONS.....	54
3.3.1.	New PCC Pavements	55
3.3.2.	Site Conditions.....	55
3.3.3.	Design Considerations	55
3.3.4.	Recommendations for PCC Pavements	55
3.4	GUIDELINES FOR ASSESSING THE NEED FOR PAVEMENT SUBSURFACE DRAINAGE SYSTEMS.....	56
3.4.1.	Permanent International Association Of Road Congresses (PIARC).....	58
3.5	SUBSURFACE DRAINAGE DESIGN ALTERNATIVES	59
3.5.1.	Guidelines for Selection of Drainage Systems	60
3.6	RECOMMENDED SUBSURFACE DRAINAGE DESIGN ALTERNATIVES.....	61
3.6.1.	Subsurface Drainage Systems for Flexible Pavements.....	62
3.6.2.	Subsurface Drainage Systems for Flexible Pavements.....	65
3.6.3.	Permeable Base Layer.....	65
3.6.4.	Daylighted Base Sections	66
3.6.5.	Aggregate Separator Layer	66
3.7	REHABILITATION DESIGN	68
3.8	SEQUENCE OF STEPS FOR SELECTION OF ALTERNATIVE SUBSURFACE DRAINAGE DESIGNS.....	69
3.9	EVALUATING SUBSURFACE DRAINAGE NEEDS FOR EXISTING PAVEMENTS.....	69

Chapter 4	DESIGN OF SUBSURFACE DRAINAGE SYSTEMS.....	71
4.0	DRAINAGE NEEDS ANALYSIS	71
4.1	SOURCE OF PAVEMENT DISTRESS	73
4.1.1.	Traffic Loads.....	73
4.1.2.	Site Conditions.....	73
4.2	SOURCES AND QUANTITY OF WATER.....	76
4.2.1.	Infiltration	76
4.2.2.	Groundwater	79
4.2.3.	Spring Thaw.....	82
4.3	DATA REQUIREMENTS FOR SUBSURFACE DRAINAGE DESIGN	85
4.3.1.	Roadway Geometry	86
4.3.2.	Climatological Data	89
4.3.3.	Other Considerations	90
4.4	DESIGN OF SUBSURFACE SYSTEMS: TIME-TO-DRAIN	91
4.4.1.	Computation Procedures for Time-To-Drain.....	91
4.5	DESIGN OF SELECT SUBSURFACE DRAINAGE SYSTEM COMPONENTS	97
4.5.1.	Permeable Base.....	97
4.5.2.	Thickness and Permeability of the Permeable Base.	97
4.5.3.	Design of Unstabilized Permeable Base.....	100
4.5.4.	Design of Stabilized Permeable Base	101
4.5.5.	Full-Depth AC Pavements	101
4.5.6.	Subsurface Drainage Systems for Rigid Pavements.....	101
4.5.7.	JPCP without Dowels	101
4.5.8.	JPCP and JRCP with Dowels.....	102
4.5.9.	Jointed PCC Pavements	103
4.5.10.	CRCP	103
4.5.11.	Design of Edgedrain Collector System with Outlet Pipe.....	104
4.5.12.	Edge Drain Capacity and Outlet Spacing	105
4.5.13.	Design of Discharge/Outlets and Collector Pipes.....	106
4.5.14.	Influence of Road Geometrics on Locating Collector Pipes	107
4.5.15.	Locating Outlets.....	108
4.5.16.	Provisions for Outlets in Cold Climate.....	109
4.5.17.	Longitudinal Edgedrains.....	110
4.5.18.	Pipe Edgedrains	110
4.5.19.	Prefabricated Geocomposite Edgedrains	113
4.5.20.	Aggregate Trench Drain	114
4.5.21.	Headwalls.....	114
4.5.22.	Design of Separator and Filters.....	114
4.5.23.	Geotextiles	115
4.6	INTERCEPTION OF GROUNDWATER	120
4.7	APPLICATIONS OF MODELING IN DESIGN OF SUBSURFACE DRAINAGE SYSTEMS.....	122
4.7.1.	MnDRAIN	122
4.7.2.	DRIP	122
4.7.3.	DRIP Capabilities	122

4.8	DESIGN PROCEDURES FOR PERMEABLE BASES IN THE FAA RIGID PAVEMENTS (HALL, 2005)	123
Chapter 5	CONSTRUCTION.....	124
5.0	INTRODUCTION	124
5.1	CONSTRUCTION OF PERMEABLE BASE SYSTEMS	124
5.1.1.	Sequence of Construction Operations.....	124
5.2	CONSTRUCTION OF FILTER/SEPARATOR LAYER	125
5.3	CONSTRUCTION OF EDGEDRAINS FOR NEW PAVEMENTS	125
5.4	INSTALLATION / RETROFITTING OF PIPE EDGEDRAINS.....	126
5.5	SUBSURFACE DRAINS.....	127
5.5.1.	Materials	127
5.5.2.	Construction Requirements.....	127
5.5.3.	Excavation.....	127
5.5.4.	Laying Drains.....	128
5.5.5.	Backfill.....	128
5.5.6.	Drain Outlets.....	129
Chapter 6	MAINTENANCE.....	133
6.0	INTRODUCTION	133
6.1	MAINTENANCE PROGRAM	137
6.1.1.	Inspection and Monitoring.....	138
6.1.2.	Preventive Maintenance.....	138
6.1.3.	Repair.....	140
6.1.4.	Continuous Monitoring and Feedback.....	140
6.2	MAINTENANCE CURRENT PRACTICE	141
Chapter 7	COST ESTIMATION: ECONOMIC ANALYSIS	143
7.0	INTRODUCTION	143
7.1	LIFE-CYCLE COST ANALYSIS.....	143
7.2	ECONOMIC INDICATORS	143
7.3	POTENTIAL INCREASE IN MAINTENANCE COSTS.....	144
	REFERENCES	148
Appendix A: OUTLINE: RECOMMENDED PROCEDURES FOR SELECTION, DESIGN, CONSTRUCTION AND MAINTENANCE OF SUBSURFACE DRAINAGE SYSTEMS		
Appendix B: DESIGN PLANS, CHARTS AND TABLES		
Appendix C: ACRONYMS		
Appendix D: EXAMPLES		

List of Tables

Table 2.1. Pavement distresses caused by poor subsurface drainage and the appropriate drainage solutions	8
Table 2.2. AASHTO drainage recommendations for time to drain from 100 to 50 percent of the drainable water	15
Table 2.3. Pavement rehabilitation manual guidance for time to drain from 100 to 85 percent saturation	16
Table 2.4. Ranking site conditions for AC and PCC pavements	24
Table 2.5. Typical values of soil permeability	31
Table 2.6. Typical values of soil permeability, apparent specific gravity and effective porosity	32
Table 2.7. Normal subsurface drainage design practices for each pavement type	47
Table 3.1. Comparison of cost-effectiveness of drained and undrained pavements	53
Table 3.2. Ranking design conditions for AC pavements	54
Table 3.3. Ranking for site conditions for AC and PCC pavements	54
Table 3.4. Recommendations for subsurface drainage in AC pavements	54
Table 3.5. Ranking design conditions for PCC pavements	55
Table 3.6. Recommendations for subsurface drainage in PCC pavements	56
Table 3.7. Criteria for permeable bases in Minnesota	57
Table 3.8. Recommended allowable number of trucks per day for climatic conditions and erodibility of subbase	58
Table 3.9. Guidelines for drainage of non-doweled jointed PCC pavements	59
Table 3.10. Recommended levels of subdrainage based on site conditions for flexible pavements	64
Table 4.1. Guidelines for selection of heave rate or frost susceptibility classification for use in Figure 4.8	84
Table 4.2. The Time-to-Drain Calculation Form	96 to 97
Table 4.3: Recommended levels of subdrainage based on site conditions for non-doweled JPCP	102
Table 4.4. Recommended levels of subdrainage based on site conditions for doweled JPCP and JRCP	103
Table 4.5. Aggregate separator layer gradation	115
Table 4.6. The U.S. standard sieve size openings in the geotextile range	117
Table 4.7. Summary of the design criteria for selection and adoption of geotextiles	119
Table 5.1. Conveyance for circular pipes (K)	126
Table 5.2. Mn/DOT specifications for fine filter aggregate material	128

List of Figures

Figure 2.1. Sources of moisture reaching subsurface of the pavement system	9
Figure 2.2a. Lateral (gravity) flow of groundwater towards the roadway.....	11
Figure 2.2b. Flow of water from a confined (artesian) aquifer source	12
Figure 2.3. Variation in resilient modulus with moisture content for various soils.....	17
Figure 2.4. Points of entrance of water into the highway pavement structural sections.....	21
Figure 2.5. Paths of flow of surface and subsurface water in Portland cement concrete pavement structural section.....	22
Figure 2.6. Typical undrained AC pavement section	24
Figure 2.7. Typical undrained PCC pavement section	25
Figure 2.8. Typical full-depth asphalt concrete pavement.....	25
Figure 2.9. Types of subsurface drainage designs for AC pavements used by the States	27
Figure 2.10. Types of subsurface drainage designs for PCC pavements used by the States	27
Figure 2.11. Longitudinal interceptor drain used to cut off seepage and lower the groundwater table.....	28
Figure 2.12. Symmetrical longitudinal drains used to lower the groundwater table and to collect water infiltrating the pavement	28
Figure 2.13. Multiple interceptor drain installation for groundwater control.....	29
Figure 2.14. Chart for estimating coefficient of permeability of granular drainage and filter materials	34
Figure 2.15. Longitudinal collector drain used to remove water seeping into pavement structural section	36
Figure 2.16. Multiple, multipurpose longitudinal drain installation	37
Figure 2.17. Transverse drains on super-elevated curve.....	38
Figure 2.18. Transverse interceptor drain installation in roadway cut with alignment perpendicular to existing contours	39
Figure 2.19. Applications of horizontal drainage blankets	40
Figure 2.20. Applications of horizontal drainage blankets	41
Figure 2.21. Drainage blanket (wedge) on cut slope drained by longitudinal collector drain	41
Figure 2.22. Drainage blanket beneath side hill fill outletted by collector drain.....	42
Figure 2.23. Illustration of ground water flow along a sloping impervious layer toward a roadway	43
Figure 2.24. Illustration of the effect of an interceptor drain on the drawdown of the ground water table.....	43
Figure 2.25. A typical section of drainage trench at Towle slide	44
Figure 2.26. A typical sand drainage well installation.....	45
Figure 3.1. Types of subsurface drainage designs for AC pavements used by the States	62
Figure 3.2. Types of subsurface drainage designs for PCC pavements used by the States	63
Figure 3.3. Profile of typical AC pavement cross section	64
Figure 3.4. The recommended design of AC pavement with a permeable base.....	65
Figure 3.5. The recommended design of PCC pavement with a permeable base.....	66
Figure 3.6. Typical AC pavement with a daylighted base.....	67
Figure 3.7. Concept of separation of permeable base and subgrade.....	67

Figure 3.8. Concept of drainage promoted by the separator layer.....	68
Figure 4.1. Outline of the design steps for subsurface drainage system for highway pavement.....	72
Figure 4.2. Two-Year, one-hour rainfall intensity in Minnesota.....	74
Figure 4.3. The maximum depth of frost penetration (inches) in Minnesota.....	75
Figure 4.4. Averages of the maximum soil frost depths recorded at Mn/DOT monitoring stations in Minnesota counties, 1998-2008.....	76
Figure 4.5. Crack layout - plan view.....	78
Figure 4.6. Crack layout - sectional view.....	79
Figure 4.7. Chart for determining flow rate into horizontal permeable base.....	81
Figure 4.8. Chart for estimating design inflow rate of melt water from ice lenses.....	83
Figure 4.9. Summary of results of standard laboratory freezing tests performed by the U.S. Army COE between 1950 and 1970.....	85
Figure 4.10. Typical cross sections for crowned and superelevated pavement sections.....	87
Figure 4.11. Roadway geometry.....	88
Figure 4.12. Frozen soil profile of St. Louis County, Minnesota 2004-2005.....	90
Figure 4.13. Time factors for drainage of saturated layers.....	93
Figure 4.14. Time factor for 50 percent drainage, for various values of S_f	94
Figure 4.15. Chart for estimating maximum depth of flow caused by steady inflow.....	98
Figure 4.16. Framework for application of guidelines for permeable base design for new constructions.....	99
Figure 4.17. Typical AC pavement with pipe edgedrains.....	104
Figure 4.18. Typical AC pavement with geocomposite edgedrains.....	105
Figure 4.19. Nomograph for selection of perforated pipe diameters and outlet spacing, with use of nomograph illustrated in the example provided.....	107
Figure 4.20. Recommended detail for subsurface drainage outlet pipe and marker.....	108
Figure 4.21. Permeable base section with longitudinal edgedrains.....	111
Figure 4.22. Permeable base section with longitudinal edgedrains wrapped in geotextile.....	111
Figure 4.23. Nonerrodible dense-graded base sections with pipe edgedrains.....	112
Figure 4.24. Typical (a) components of prefabricated fin drains, and (b) installation of prefabricated fin drain in trench.....	112
Figure 4.25. A typical cross-section of pavement with pipe edgedrain.....	113
Figure 4.26. A typical cross-section of pavement with prefabricated edgedrain.....	113
Figure 4.27. A typical cross-section filter formation.....	117
Figure 4.28. A schematic presentation of the gradient ratio test.....	118
Figure 4.29. Chart for determining rate of flow into an interceptor drain.....	121
Figure 5.1. Placement of geotextile around edgedrain.....	125
Figure 5.2. Design plans for precast concrete headwall with removable rodent screen.....	130
Figure 6.1. Vegetative material removed from an edgedrain system.....	133
Figure 6.2. Rodent's nest.....	134
Figure 6.3. Crushed pipe.....	134
Figure 6.4. Crushed pipe.....	135
Figure 6.5. Hidden outlet pipe.....	135
Figure 6.6. Painted arrow as a reference marker.....	136
Figure 6.7. Excessive erosion at the outlet pipe.....	136
Figure 6.8. Large outlet pipe headwall.....	137

Figure 6.9. Video camera approaching edgedrain	138
Figure 6.10. Pipe flushing unit.....	139
Figure 6.11. Construction and maintenance inspection form	141
Figure 7.1. Relationship between fatigue life and water content.....	145
Figure 7.2. Decrease in fatigue life due to increase in water content	146
Figure 7.3. Increase in construction costs due to increase in water content	147
Figure A-1. Outline of recommended procedures for selection, design, construction and maintenance of subsurface drainage system for highway pavements	A-1 to A-4
Figure A-2. Outline of recommended procedures for selection, design, construction and maintenance of subsurface drainage system for highway pavements	A-5
Figure B-1. Cross-section of edgedrain	B-1
Figure B-2. Drintile and lawn sump box installation.....	B-2
Figure B-3. Detail connection of PE drain pipe to storm sewer	B-3
Figure B-4. PE drain pipe placement.....	B-4
Figure B-5. Typical combination subsurface drainage systems in bituminous pavement.....	B-5
Figure B-6. Cross-section of a typical subcut drain type.....	B-6
Figure B-7. Typical PAB drain and their positioning.....	B-7
Figure B-8. Subsurface drainage systems: pavement edgedrain, pavement edgedrain Type I, permeable base, and permeable aggregate base type I	B-8
Figure B-9. Typical edgedrain and discharge plan	B-9

Executive Summary

Many paved and unpaved roadways in the United States are subjected to problems associated with excess water within the foundation structure of the roadway. This excess water originates from water infiltrating along the roadway surface or along the shoulders, groundwater seeping in from upslope areas, high water in roadway ditches, groundwater rising up from beneath the roadway, or from thawing ice lenses formed during periods of extreme cold. The excessive wetness of the roadway foundation leads to a weakening of the roadway foundation and, eventually, failure of the surface, whether it is paved or unpaved. The national economic cost of pavement damage as a result of excess water is estimated in tens of millions of dollars annually. While surface drainage practices do help to alleviate some of the problems associated with excess water conditions, the principal way of handling the problem is to use subsurface drainage.

As the result of over 50 years of research on subsurface drainage for roadways, many products have been made available for construction and installation of subsurface drainage systems and guidelines have been developed for system design, construction, and maintenance. Some aspects of subsurface drainage system design include a preliminary assessment of whether or not subsurface drainage is necessary at a given location, determination of the source of excess water if it exists at all, determination of the type of drain to install, longitudinal or transverse or both, determination of the required capacity of the drainage system to reduce the excess water conditions, design of the filter material to prevent subsurface erosion of roadway foundation material, and design of the drain outlets. Sets of procedures have been developed for performing the required quantitative analysis associated with these design aspects. The calculations are conducted using charts, tables, and nomographs, and, in some cases, with publicly available computer modeling software. This drainage manual provides some examples of the types of calculations required for system design.

The construction and installation of subsurface drainage systems needs to be conducted with great care to be assured of a positive outcome. One of the leading causes of failure in subsurface drainage systems is inadequate care in the construction and installation phases of a project. Care needs to be taken to assure the proper alignment of drains, proper outletting of drains, and adequate compaction of backfill for drain trenches. It is essential to make sure that construction equipment does not cause misalignment or damage to the drain. Care also needs to be taken by construction inspectors to make sure that the finished product meets the specifications. The contractor is responsible for making sure that the drains are properly installed.

The maintenance of subsurface drains is an essential step in protecting the investment represented by the system. Not only is the capital cost of the drainage system at risk, but the roadway pavement is as well, because a drainage system operating inadequately will lead to moisture damage to the road. The cost of that damage is several orders of magnitude higher than the cost of a good maintenance program. A sound maintenance program involves periodic inspections of drains and cleanout of drains that are plugged.

A nationwide survey of subsurface drainage costs indicated the costs to be as large as 10% of roadway costs. However, an informal survey for Minnesota county highways indicated that the cost is only about 2% of total highway construction costs. Even so, the cost of subsurface

drainage systems can be compared to the financial benefits of such systems, as it is related to highway longevity, by applying life cycle cost analysis. Examples of cost/benefits of subsurface drainage systems are given for illustration of the value of those systems.

Foreword

Administrators, practicing engineers, and researchers concerned with transportation structures often have to deal with highway problems for which much information is already, either in documented form or in undocumented experience and practice. However, this information is commonly fragmented, scattered, and under evaluated. In many cases, pertinent information to the solution of even a simple problem remains unknown to individuals responsible for solving the problem. Consequently, information gained from valuable experience may be overlooked, and due consideration not given to the recommended practices for solving or alleviating the problem.

Development of a manual such as this is being undertaken here. It is an attempt to initiate the process of collecting, evaluating, and synthesizing available information, and presenting it in forms readily accessible to personnel who may need references while seeking solutions for existing highway-drainage related problems.

The manual being developed is not intended to replace or ignore personal and professional experience of practicing engineers, but rather is intended to help reduce uncertainties in drainage needs assessment, design, construction, cost benefit analysis, and systems maintenance.

Ultimately, this drainage manual is intended to be a resource that practitioners will turn to for assistance in making decisions about the design, construction, and maintenance of subsurface drainage systems.

If we can clearly show the cost benefits of subsurface drainage, then practitioners will have an incentive to use the manual to assess drainage for their own situation. Our hope is to provide a tool that is efficient for their use.

Development of this manual has often referred to the reference manual by the ERES Consultants, INC. (ERES, 1999). Where proper citation of the publication is omitted in the body of the manual, the intention is not to ignore crediting the source, but in the interest of brevity and avoiding excessive citations.

Chapter 1 OVERVIEW

1.0 INTRODUCTION

Water accumulating excessively in pavement layers contributes to problems which may cause premature failure of the structure, and unsafe operating conditions for motorized traffic. Prompt removal of such accumulations is essential to avoid roadway surfaces which are hazardous to traffic due to increased skid potential and weakening of the structural integrity of the pavement (White, 2001). Problems attributable to water presence in pavement layers occur in all regions and across the climates of United States. A study conducted by the National Cooperative Highway Research Program (NCHRP) estimated that excess water reduces the life expectancy of pavement systems by more than half (Christopher and McGuffey, 1997). Cedergren (1974a) predicted a reduction of 50% in the pavement service life if a pavement base is saturated as little as 10% of the time.

Many state agencies recognize that water in pavements is not desirable. However, there is no common philosophy on how to reduce the effects of this problem (Christopher and McGuffey, 1997). An assortment of strategies, ranging from complete sealing of the pavement, together with incorporating low permeable base with no drainage, to incorporating a fully drainable pavement section with permeable base and edge drains are considered, often at the discretion of the practicing engineer, manager, or other responsible personnel.

Installation of subsurface drainage systems is of immense benefit to the life and performance of a pavement. However, their application is far rarer than it ought to be. Some of the reasons for the low frequency of adoption are probably due to the difficulty of determining the need for drainage in a particular location and the cost benefit ratio of drainage. This is true even though the benefits of inclusion of subsurface drainage systems in pavements are well documented. Several reports have been published that provide guidance to designers of subsurface drainage systems. Also, workshops are provided at the national level within the Federal Highway Administration (FHWA) framework to provide education to practitioners on the design and maintenance of subsurface drainage systems for pavements. However, there does appear to be a need for information provided to local practitioners containing guidance on how to assess the need for drainage and to design, construct, and maintain pavement subsurface drainage systems. Currently, no such user-friendly guide exists for pavement subsurface drainage systems for the state of Minnesota

Water entering the pavement and adjacent highway components has many sources. The largest, and often overlooked, source of “free” water (water not bound by any form of energy or potential) entering the structural section is atmospheric precipitation, which supplies surface water in form of rain, snow, hail, condensing mist, dew, or melting ice (Cedergren et al., 1973a,b). Pavement designers need to consider the entire profile and cross section of the highway, and the surface and subsurface drainage systems that are to be used for the operation and structural integrity of the overall facility (Ridgeway, 1982). Water reaches the structural section by infiltrating through cracks in the pavement surface, the shoulders, side ditches, from

melting the ice layer in the frost area during the thawing cycle, “free” water from pavement base, high ground water table, and condensation of water vapor (Ridgeway, 1982).

Subsurface drainage is the process through which artificial underground water drains, which may be piped or pipeless, are used for the purpose of removing excess water. The primary goal of this type of drainage is to improve properties of the subsoil and base materials for improved performance of supported structures, such as highway or airfield pavements.

Design and construction of highway pavements and associated systems in Minnesota, including drainage, are guided by the Mn/DOT Standards Specifications for Construction (Mn/DOT, 2005). All State and Federal Aid construction contracts awarded in Minnesota stipulate that these standard specifications be adopted for application in the design and construction of transportation drainage systems.

The present manual was developed with the purpose of guiding design engineers and pavement managers in Minnesota in the selection, design, and installation of sub-surface drainage systems. It is recommend that engineers reference the Mn/DOT Standards Specifications for Construction during applications of the manual (Mn/DOT, 2005).

1.1 PURPOSE OF THE MANUAL

This manual is intended to provide guidance to practicing engineers in the state of Minnesota in the design, installation, or retrofitting of subsurface drainage systems in new and existing transportation pavements.

1.2 SCOPE OF THE MANUAL

To address effectively all problems of pavement performance and reasons for their premature failure, it is necessary for design engineers to take into account factors and conditions which are likely to affect life and performance of the pavements. However, this is difficult to achieve because of the large number and diversity of factors, as well as their interactions, which are responsible for pavement failure. Design manuals could be of great benefit to engineers in addressing pavements problems.

This manual presents the methods and procedures to be applied in assessing subsurface drainage needs in pavements, selection of appropriate drainage systems, and implementation of recommended designs. It also provides guidelines for design, construction, and maintenance of subsurface drainage systems, for both new and existing pavements. Discussions and procedures on evaluation of cost effectiveness of subsurface drainage systems have also been provided.

1.3 ORGANIZATION AND USE OF THE MANUAL

General format and coverage of the manual will be presented in this section. The design concepts are generally based on the American Association of State Highway and Transportation Officials

(AASHTO) Model Drainage Manual (AASHTO, 1999). Most aspects of literature review on drainage solutions to pavement problems are discussed in chapter 2 of the manual.

Chapter 2 – Overview of subsurface drainage

Chapter 3 – Selection of subsurface drainage systems

Chapter 4 – Design of subsurface drainage systems

Chapter 5 – Construction of subsurface drainage systems

Chapter 6 – Maintenance of subsurface drainage systems

Chapter 7 – Economic analysis

Recommendations on pertinent data required, where and how to obtain the data, how to record, present, analyze, and apply the data in seeking solutions to pavement drainage problems are included.

Users of this manual can, at their discretion, apply the manual by studying it chapter by chapter in the presented order, or in any order that best suits their specific needs. Whereas reading some of the chapters, especially those presenting the theory and background of subsurface drainage, can be a long, tedious, and time consuming exercise, it is recommended that those lacking “sufficient” knowledge and experience of the subject matter to review the manual in totality and in the sequence of its presentation.

1.4 DOCUMENTATION

Documentation is an important part of the design or analysis of any hydraulic structure. The documentation is an important record that should contain all information regarding the structure, its location, and the location of markers which will enable responsible parties to locate the structure (for purposes of inspection, maintenance, renovations, or replacement) with ease. Appropriate documentation of the design of any hydraulic facility is an essential part of these or other functionally related engineering constructions for many of the following reasons (AASHTO, 1999):

- Public safety
- Justification of expenditure of public funds
- Future reference by engineers when improvements, changes, or rehabilitations are made to the highway facilities
- Information leading to the development of defense in matters of litigation
- Public information

It is sometimes necessary to refer to plans, specifications, and analyses long after actual construction has been completed. In the event of a failure due to a flood, documentation permits evaluation of performance of the structure to determine if it performed as anticipated or to establish the cause of the unexpected behavior. Identification of factors contributing to the failure will facilitate avoidance of recurring damage.

1.4.1. Definitions

The definitions of various terminologies used in the course of documenting the design of subsurface drainage systems are based on recommendations in the AASHTO Model Drainage

Manual (1999). Chapter 4.0 of the aforementioned publication provides details and descriptions of basic types of documentation, agencies practices related to the documentation, storage and preservation of records, and documentation procedures.

1.5 DISCLAIMER

This manual is intended as a guide to solving pavement problems associated with subsurface drainage water. In no way should this be taken to imply applicability in all conditions. The authors shall not be responsible for problems arising from use of this manual for specifying of designs, construction, or maintenance of pavement subsurface drainage systems.

Chapter 2 SUBSURFACE DRAINAGE SYSTEMS FOR PAVEMENT STRUCTURES

2.0 INTRODUCTION

This chapter presents an overview of pavement subsurface drainage systems and their potential benefits to the life and performance of the pavement. The discussions and literature reviews presented focus on the need for these systems and their design, construction, and maintenance.

Research and past practice have shown the detrimental effects of inadequate subsurface drainage, thus emphasizing the importance of subsurface drainage systems, on transportation systems. Despite the documented benefits of subsurface drainage systems, there are controversies regarding the benefits of some systems, such as permeable bases, longitudinal edgedrains, transverse drains, daylighted permeable bases, and retrofitting edgedrains to existing pavements. The results of a survey conducted by Harrigan reported high failure rates of constructed subsurface drainage systems, showing that only one-third of the edgedrains in existing pavements are functioning properly (2002).

Studies of damage in asphalt concrete (AC) pavements due to moisture confirm that the strength and moduli of AC mixtures can be adversely affected by the presence of moisture (Cedergren, 1973b). Pumping of fines from pavement subgrade materials is one of the primary distress mechanisms observed in Portland Cement Concrete (PCC) pavement, which occur under conditions of excessive “free” water, heavy wheel loads, and erodible base, and results in voids beneath the pavement slab (FHWA, 1992).

Knowledge of the sources of moisture in the pavement subsurface layers is critical in the design of subsurface drainage systems. Since it is not easy to stop moisture from reaching the pavement base layers by joint sealing or other methods, installing new or reconstructed pavements provide excellent opportunities for incorporating drainable pavement systems to remove any surface water which cannot be prevented from entering the pavement structure. These pavement systems consist of (FHWA, 1992):

- Permeable base
- Separator layer
- Edgedrains
- Transverse drains

An important consideration in use of drainage systems is that they be cost-effective. Cost-effectiveness is possible if the benefits of subsurface drainage systems outweigh the cost of their installation and maintenance.

Problems associated with rapid deterioration and unsatisfactory performance of pavement systems are, in many instances, directly related to the accumulation of excessive moisture in subgrade and granular layers when the system is properly designed but does not have subsurface

drainage. Proper design, construction, and maintenance of the drainage systems should take the following into consideration:

- Sources of moisture in pavement, and how to stop moisture from reaching the pavement subsurface
- Distresses that are caused or accelerated by excessive moisture in pavement systems
- Types and components of drainage systems
- Identifying the benefits and risks of providing subsurface pavement drainage

2.1 PURPOSE OF SUBSURFACE DRAINAGE

An important component of pavement design is determining the need for incorporation of a drainage system in new and/or existing pavement structures. The key factors determining the need for subsurface drainage may be categorized as (ERES, 1999):

- Traffic loads, which include volume and weight (axle)
- Factors influencing the amount of free water entering the pavement system, which include:
 - climatic factors of rainfall and temperature (freezing and thawing)
 - ground water
 - roadway geometry
 - pavement type and condition
- Factors that increase potential for moisture-related pavement damage, such as:
 - subgrade type, strength, and condition
 - type of pavement material used
 - design features such as pavement thickness, shoulder design, etc.

Accumulation of moisture introduced into the pavement subgrade from any of the sources can adversely affect pavement performance, leading to accelerated pavement deterioration. Pavement problems associated with infiltrated water may fall into three categories (ERES, 1998; ERES, 1999):

- Softening of the pavement layers and subgrade by becoming saturated and remaining so for prolonged periods
- Degradation of the quality of pavement and subgrade material due to interaction with moisture
- Loss of bonding between pavement layers due to saturation with moisture

Likewise, failures occurring due to groundwater and seepage may be classified into two categories (Cedergren, 1973b):

- Those causing piping or erosion failures
- Those caused by uncontrolled seepage patterns leading to saturation, internal flooding, excessive uplift, or excessive seepage forces

2.2 EFFECTS OF MOISTURE ON PAVEMENTS

Moisture related problems in pavements can be minimized when designers of the structure make conscious efforts to keep the base, sub-base, subgrade, and other susceptible paving materials from becoming saturated or exposed to constant high moisture levels. Three effective approaches to controlling or reducing pavement problems are:

- To provide adequate cross slopes and longitudinal slopes to quickly drain moisture from pavement surface, thereby minimizing infiltration into the pavement structure
- To use material and design features, such as stabilized cement (CTB) or lean concrete bases (LCB) in Portland cement concrete, also known as PCC pavement, that are not sensitive to the effects of moisture
- To remove moisture that enters the pavement system promptly

For effective control of moisture related problems in pavements over the life of the pavement, it often is necessary to employ these approaches in combination (ERES, 1999).

Table 2.1. Pavement distresses caused by poor subsurface drainage and the appropriate drainage solutions (ERES, 1999).

	Distresses Affected by Subsurface Drainage	Other Design Features Affecting the Performance	Effective Drainage
AC Pavement on Granular Base	Fatigue cracking	Structural design (thickness of asphalt bound layers)	Edgedrains, permeable base*
	Rutting	Structural design, AC mix design	
	AC stripping	AC mix design	Permeable base*
Full-Depth AC Pavement	Transverse crack deterioration	Structural design	Permeable base*
	Fatigue cracking	Structural design	Edgedrains, permeable base*
	Rutting	Structural design, AC mix design	
	AC stripping	AC mix design	Permeable base*
JPCP	Pumping & faulting	Dowel, base type, widened slab	Edgedrains, permeable base*
	Slab cracking	Slab thickness, joint spacing, PCC strength, tied PCC shoulder, base type	Permeable base*, edgedrains
	D-cracking	Aggregate type and gradation, mix design	Daylighting, edgedrains, permeable base*
JRCP/CRCP	Crack deterioration	Steel design, slab thickness, base type	Edgedrains
	D-cracking	Aggregate type and gradation, mix design	Daylighting, edgedrains

**With edgedrain or daylighting*

Section 2502.1 of the Mn/DOT Standard Specifications for Construction details the recommended design and construction of subsurface drains for all transportation pavements required in the interception, carrying off, and safe discharge of subsurface water (2005).

2.3 SOURCES OF MOISTURE

An important component of design and installation of an effective pavement subsurface drainage system is the knowledge and understanding of the sources of moisture reaching the subsurface layers of the pavement structure. Designers should be knowledgeable about the various sources of water in the structure for them to identify the best methods for preventing the moisture from entering the system or removing it once it has entered the system (ERES, 1999). The moisture in

the pavement subgrade may come from many sources, as is illustrated in Figure 2.1. The main source of water infiltrating into pavement structural sections is generally from precipitation (Moulton, 1980).

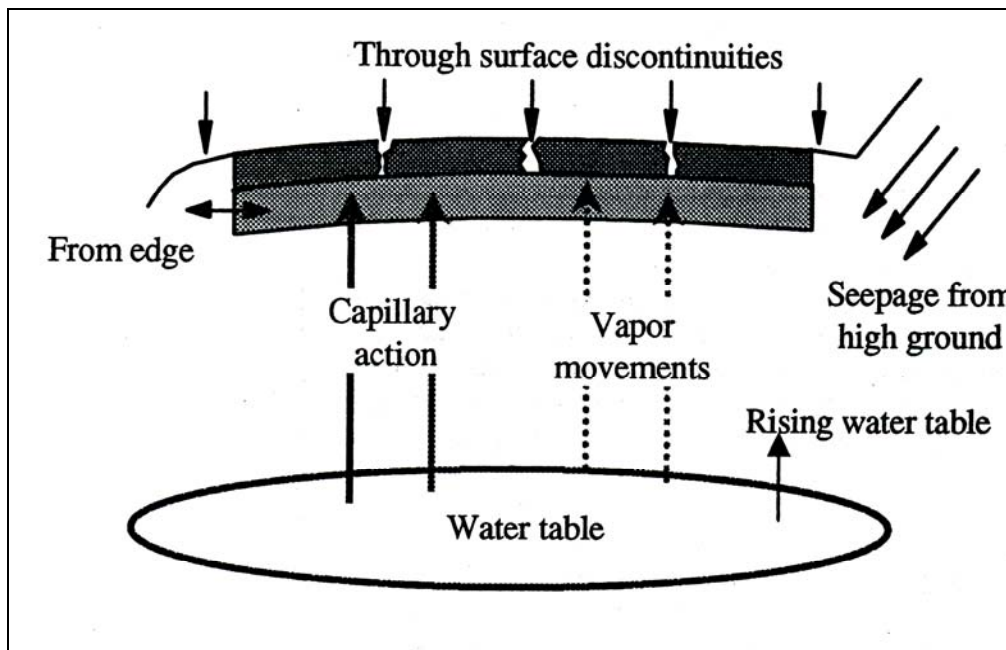

Figure 2.1. Sources of moisture reaching subsurface of the pavement system (ERES, 1999).

2.4 QUANTIFYING NET INFLOW BY SOURCE

During the design process of the pavement drainage system, the design net inflow, q_n , should include inflow from all possible sources. The major sources of inflow include surface infiltration, inflows from gravity drainage of groundwater, artesian sources from below the pavement, and melt water from thawing ice lenses (FHWA, 1992). Discussion on these sources, and the methods of computing design inflow rates are presented in the following sections.

When considering all the important probable combinations of inflows and outflows, the following relationship for computing net design inflow is important:

$$q_n = q_i + q_g + q_m + q_a \quad (2.1)$$

where

q_n = the design net inflow

q_i = the inflow from infiltration

q_g = the inflow from gravity flow of groundwater

q_m = the inflow from melt water from thawing ice lenses

q_a = the inflow from an artesian source below the pavement

Each of these sources will be discussed in the sections to follow, and details of calculations are presented in Chapter 4.

There are two types of hydraulic design approaches used in the design of pavement drainage systems. They are known as the steady-state flow approach and the time-to-drain approach (FHWA, 1992; FHWA, 1994).

Both of these have a part to play in the design even though the time-to-drain approach is preferred (FHWA, 1992). This preference is due to the fact that the steady-state approach requires estimates of the inflows from the various sources, one of these being the infiltration source. The first problem with quantifying the infiltration flux is in estimating the design rainfall rate. Hydraulic engineers have not agreed on the proper selection of the storm frequency and the time of concentration (storm duration), which are required for estimation of a design rainfall. The second problem is estimating the portion of rainfall that enters the pavement. However, putting these concerns aside, it is appropriate to consider both analyses for the design of the drainage system.

The steady-state flow analysis assumes that constant flows from the various sources are entering the pavement structure. The drainage system, including the drainable base course, as well as the drain and drain outlet, is designed to enable removal of this flow without allowing the base to become saturated.

The Time-to-Drain analysis considers the situation where the base becomes saturated due to some design rainfall event, and determines the capacity of the drainage system necessary to remove this excess water within a desired period of time. Whichever of these two analyses yields the maximum required drainage capacity will be the result that is selected for the design. The design procedure using both of these approaches will be outlined in Chapter 4. For now, the components of the water sources will be presented.

2.4.1. Infiltration, q_i

Water arriving at the pavement surface would infiltrate into the subgrade layers through surface discontinuities such as joints, cracks, shoulder edges and any other defects in the pavement surface. Studies have shown surface infiltration to be the single largest source of moisture-related problems in PCC pavements (FHWA, 1994). Hagen and Cochran (1995) discovered that 40 percent of rainfall enters the pavement. Although AC pavements lack joints, their surface cracks, longitudinal cold joints that crack, and pavement edges provide pathways for water to infiltrate the pavement structure.

Pavement infiltration (cu ft/day/sq ft of pavement) is the volume of water entering through a specified area of pavement, and can be determined by either the infiltration ratio method or the crack infiltration method (FHWA, 1992). Of these two methods, the Crack Infiltration method is preferred because parameters can be estimated more easily and with greater confidence (Moulton, 1980).

2.4.2. Groundwater, q_g , q_a

The seasonal fluctuations of the water table can be a significant source of water moving into pavement sections. Although this flow varies with season, the rate of change in flow is sufficiently small so one can justifiably treat the flow as steady-state.

Two possible sources of groundwater which should be considered during design of subsurface drainage systems are gravity drainage, which is water moving laterally towards the pavement section (see Figure 2.2a), and artesian flow, which is upward flow from confined aquifers (see Figure 2.2b) (Moulton, 1980).

While it is feasible in some situations to intercept all of the groundwater flowing towards the pavement structure, in many instances it will not be possible, especially with regard to water originating from an artesian aquifer system. When some, but not all, of the groundwater is intercepted, it is necessary to include seepage from this source while designing pavement drainage.

The contribution of water flow to the pavement from these two sources of groundwater can be estimated using information about hydraulic conductivity of the underlying soil and the water pressures in the soil alongside the road and in the confined aquifer.

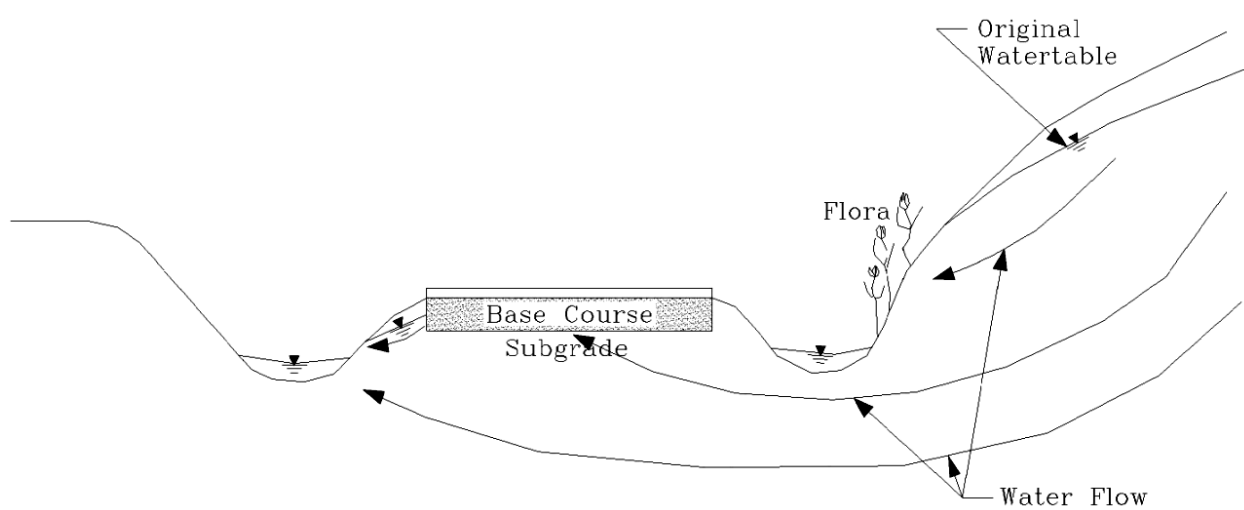

Figure 2.2a. Lateral (gravity) flow of groundwater towards the roadway.

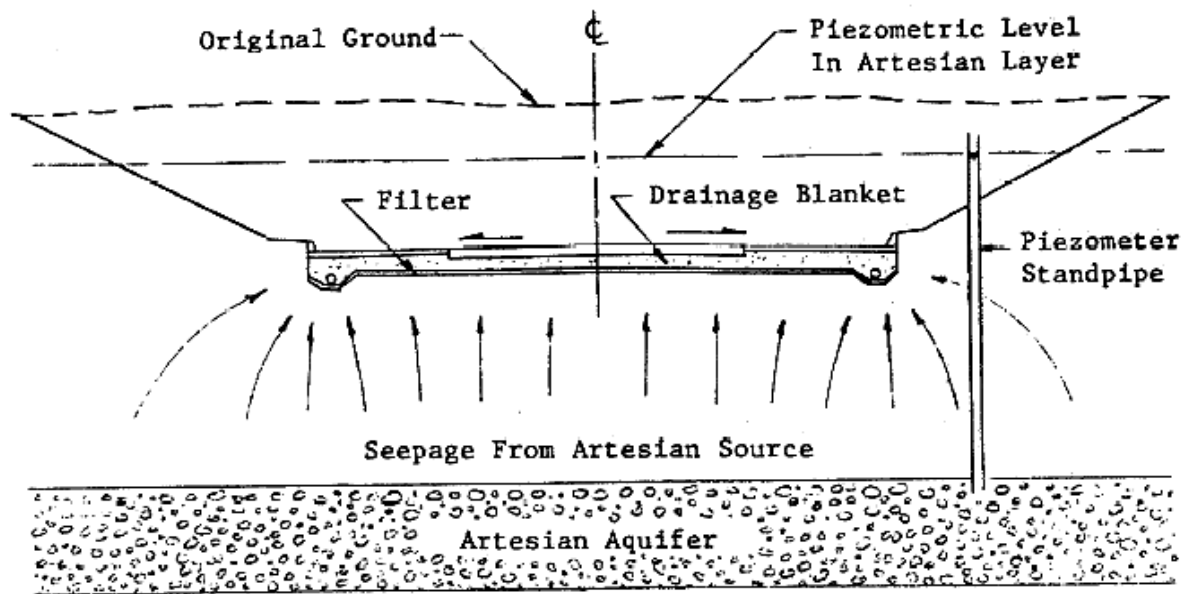

Figure 2.2b. Flow of water from a confined (artesian) aquifer source (Moulton, 1980).

2.4.3. Capillary Action and Water Vapor Movement

Capillary action causes moisture to rise from the water table, transporting this to the pavement structure. The height of water rise due to capillary action varies, depending on the grain size of the soil. This may range between 3.9 to 7.9 ft for sandy soils, 10 to 20 ft for silty soils, and 20 ft or more for clayey soils (Janssen and Dempsey, 1980; Peck et al., 1975).

Temperature gradients in the subgrade would cause water present in the air voids of the subgrade to migrate and condense within the pavement foundation materials (ERES, 1999). The volume of free water produced in the pavement structure is typically insignificant compared to other sources, and does not present problems to the pavement except under certain extreme circumstances, such as in the case of AC pavements in desert areas, which have hot days and cold nights (Hindermann, 1968). Condensation generated from the heating and cooling cycle can cause stripping in these pavements. The Minnesota climatic conditions are not favorable for this type of water movement. Therefore, under most local conditions, vapor movement is not an important consideration in design of pavement structures, hence pavement subsurface drainage systems.

Capillary action and vapor flow contribute to the formation of ice within pavement foundation materials. Therefore, these processes are contributory to the volume of water present during the spring thaw, q_m .

2.4.4. Spring Thaw, q_m

Moisture emanating from spring thaw may lead to accelerated moisture-related damage, especially in pavements constructed with or on top of frost susceptible materials (ERES, 1999). In a study conducted in Minnesota, Hagen and Cochran (1995) showed that spring thaw flows can be almost equivalent to a major rainfall event.

Because most base, subbase, and subgrade materials are known to be susceptible to freeze-thaw damage, potential damage can be avoided if adequate subsurface drainage is provided, or by treating the material to reduce susceptibility to moisture, or if both steps are taken (NCHRP, 1974).

The amount of ice accumulating in a highway subgrade as a result of frost action is dependent upon the frost susceptibility of the subgrade soil, availability of groundwater to feed the growth of ice lenses, and the severity and duration of subfreezing temperatures (Moulton, 1980). The movement of water by seepage from the thawing soil is a function of thawing rate, permeability of the thawed soil, the effectiveness of the pavement drainage system, and the loading imposed by the overlying pavement structure and vehicular traffic.

2.5 DRAINAGE NEED ANALYSIS

Key questions which must be addressed to accurately establish whether drainage is needed for a given pavement system are:

- How much free water is permeating the pavement subbase and base layers?
- Is the continued presence of this water within the structure detrimental to the performance and life of the structure given current and potential pavement loading?
- Can this water be removed timely and cost effectively?

Certain pavement surface distress problems occur only under poor subsurface drainage conditions (Lee et al., 2002). Subsurface drainage is required when conditions exist that can cause prolonged exposure of the pavement structure to excess moisture, resulting in accelerated pavement deterioration under existing levels of traffic loading (ERES, 1999). There are many factors responsible for the onset and progression of moisture-related pavement deterioration. Before deciding if installation of drainage systems will have the desired positive effect on pavement performance, it is necessary to conduct a comprehensive evaluation of these factors.

The condition of the pavement and shoulder surface give a good indication as to whether a subsurface drainage system is needed. Critical indicators include pavement surface distress, such as premature rutting, cracking, faulting, increasing roughness, wetness in pavement, and other factors affecting pavement performance. While the positive influence of subsurface drainage systems on pavement performance is not in question, it may not always be necessary and cost-effective to adopt them (ERES, 1999). There are no universally accepted criteria for evaluating site factors to assess the need for subsurface drainage. Resources suggested by Lee et al. and the criteria and guidelines used by different state highway agencies (SHAs) and design consultants, may be used in evaluating the surface conditions of the pavement and shoulder at given site to determine need for subsurface drainage (Lee et al., 2002; ERES, 1999).

The key factors determining the need for subsurface drainage may be categorized as (ERES, 1999):

- Traffic loads, which includes volume and weight (axle)
- Factors that determine the amount of free water infiltrating the pavement, which include climatic factors of rainfall, freezing and thawing, water table, roadway geometry, and pavement type and condition
- Factors that increase potential for moisture-related pavement damage, such as traffic loads, subgrade type, strength and condition, type of pavement material used, and design features

These factors may also be classified into two groups, known as external and internal (Carpenter et al., 1981). External drainage factors are the local site conditions which regulate the supply of moisture to the pavement, while the internal factors are the pavement material and base/subgrade properties whose interaction with moisture influences performance of the pavement over time.

2.5.1. Subsurface Drainage Needs Analysis

Drainage needs analysis is conducted for the purpose of establishing the potential for the pavement structure being negatively impacted by the presence of water and to assess whether provision of a drainage system would have significant effects on the life and performance of the pavement. The guidelines for assessing subsurface drainage needs have been divided into three categories (ERES, 1999):

- existing pavements
- newly constructed AC pavements
- newly constructed PCC pavements

Pertinent questions to ask in assessing the need for drainage in a pavement structure are:

- Will the supply of water at or adjacent to the site affect normal performance of the structure?
- Will the time required to drain the water by natural drainage be excessive?

2.5.2. Subsurface Drainage: Purpose and Approach

To minimize potential moisture damage to a pavement structure, the permeable base must drain accumulated water in as short a time as possible. The best parameter for determining the performance of a permeable base is the time-to-drain method (FHWA, 1992). This is a good standard because it meets the needs of pavement drainage. The U.S. Army Corps of Engineers has developed a design approach that considers both the time-to-drain and the storage capabilities of the permeable base (FHWA, 1992).

Two design standards are recommended for determining the time-to-drain, known as AASHTO percent drained (50 percent) and percent saturation (85 percent) (ERES, 1999; FHWA, 1992).

The time-to-drain approach assumes that when a rainfall event occurs when water infiltrates the pavement until the permeable base is saturated, excess runoff will not enter the pavement section after it is saturated, but will instead flow off the pavement surface, or when excess water will drain out of the saturated base after the storm ends.

It is assumed that rainfall water which has infiltrated the pavement surface into the permeable base will drain into the outlet ditches either through edgedrains or by daylighting. Engineers must therefore design permeable bases to drain this water relatively quickly, preventing the pavement from being damaged during traffic loading. Time-to-drain is the best known parameter for determining performance of a permeable base. The design approach that considers both the time-to-drain and the storage capabilities of the permeable base, developed by the U.S. Army Corps of Engineers are valuable procedures designers should consider (USACOE, 1988).

2.5.3. *Percent Drained*

Some recommendations for determining the time to drain 50 percent of drainable water from a saturated base material are provided in Table 2.2. The complete recommendations are in the AASHTO Guide for Design of Pavement Structures, Vol 2, Appendix DD (ERES, 1999). One of the limitations of this approach is that it does not consider the water retained by the effective porosity as a quality of the material.

Table 2.2. AASHTO drainage recommendations for time to drain from 100 to 50 percent of the drainable water (FHWA, 1994; AASHTO, 1985).

Quality of Drainage	Time-to-Drain
Excellent	2 hours
Good	1 day
Fair	7 days
Poor	1 month
Very Poor	Does not drain

For interstate highways and freeways, it is suggested that 50 percent of the drainable water be drained within 2 hours. However, for pavements carrying very high volumes of traffic, a criterion of draining 50 percent of drainable water in 1 hour is suggested (ERES, 1999).

The time-to-drain, t , is determined using equation:

$$t = T \times m \times 24 \quad (2.2)$$

where

- t = time-to-drain a specified percent (e.g. 50%) of drainable water, hrs
- T = time factor
- m = "m" factor, days

2.5.4. Percent Saturation

Guidance for the quality of drainage based on 85 percent saturation is provided in Table 2.3 (ERES, 1987). The 85 percent saturation method considers both the water that can drain and the water retained by the effective porosity quality of the material (ERES, 1999).

Table 2.3. Pavement rehabilitation manual guidance for time to drain from 100 to 85 percent saturation (ERES, 1987; FHWA, 1994).

Quality of Drainage	Time-to-Drain
Excellent	Less than 2 hours
Good	2 to 5 hours
Fair	5 to 10 hours
Poor	Greater than 10 hours
Very Poor	Much greater than 10 hours

2.5.5. Quantity of Free Water to be Drained

An important step in establishing the need for drainage in a pavement structure is the determination of quantities of free water to be removed from the system. This is typically the amount of water from different sources which may eventually enter the pavement system. The most important sources of water reaching the pavement subgrade sections are:

- Infiltration (rainfall, surface snow melt)
- Groundwater (gravity flow and artesian flow)
- Capillary action (due to rise from groundwater table)
- Ice melt (thawing ice lenses in subgrade)
- Vapor movement (not significant problem in most design projects)

2.5.6. Factors Increasing Potential for Moisture-Related Pavement Damage

The main factors influencing potential for moisture related pavement damage are the volume and loads of traffic, type of the subgrade base material, type of pavement, and the design features. The evaluation of these factors is discussed below.

2.5.7. Subgrade Type, Strength and Condition

Subgrade type, strength, and permeability are important factors influencing the decision on the need for subsurface drainage because support provided to pavement by the subgrade is critical to the pavement's performance (Laguros et al., 1998). Resilient modulus (M_R), which is a measure of stiffness of subgrade soils, varies significantly with moisture content of the material. Resilient modulus of silty clay subgrade can drop by 50 percent or more under saturated conditions, compared to that under dry conditions (ERES, 1999). Some studies have illustrated the relationship between M_R and degree of saturation of soils, with M_R dropping significantly with increasing levels of saturation (Cedergren et al., 1973; Thompson and Robnett, 1976). This relationship is shown in Figure 2.3.

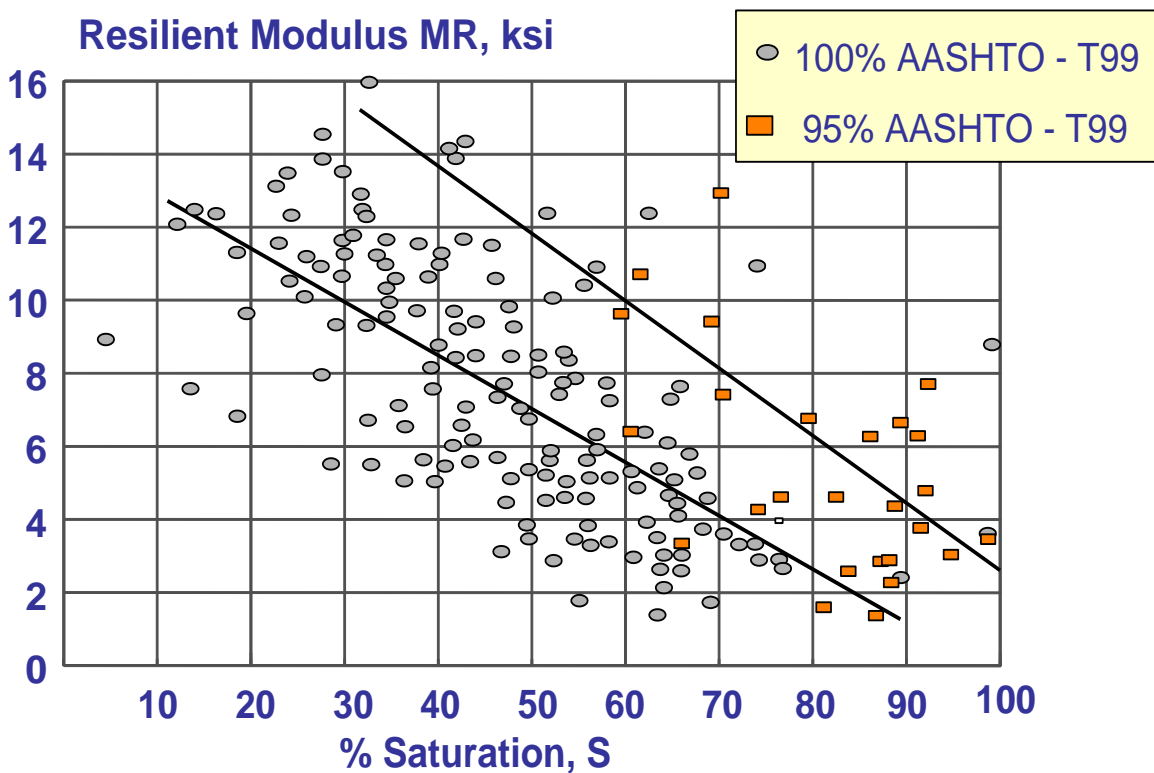

Figure 2.3. Variation in resilient modulus with moisture content for various soils (Thompson and Robnett, 1976).

The fundamental material properties are an important aid to classifying materials and helping to predict how they will perform, particularly with respect to their ability to transmit the flow of water. The index properties of subgrade materials are those which help in identifying and

classifying the material, which may also be important indicators of material performance. These are primarily those properties which exert an influence on seepage phenomena, and include:

- The grain size characteristics, determined following the standard methods for particle size analysis (ASTM, 1978)
- Plasticity characteristics, or Atterberg limits
- Soil classification or performance characteristics, which are properties that control the flow of subsurface water. These include (Moulton, 1980):
 - coefficient of permeability, k
 - the effective porosity (yield capacity), n'
 - the frost susceptibility of the material

The type of material used in construction of pavements has a direct influence on the need for subsurface drainage, as well as on the level of drainage required to improve performance of the pavement (ERES, 1999). Unbound or untreated base or subbase layers are more susceptible to moisture presence in the pavements. An increase in saturation level results in significant decreases in load-bearing capacity of AASHTO granular materials (Dempsey et al., 1982; Haynes and Yoder, 1963). When PCC pavements have excessive moisture, they may suffer loss of support and reduced load-bearing capacity due to loss of pumping and erosion of fines in the base and subbase. The damages in untreated aggregate material may be minimized by treatment with AC or Portland cement which will decrease the influence of moisture on the material. Increasing the content of these stabilizers to about 8 percent will render the base or subbase material to a non-erodible state (ERES, 1999). Some design features have significant influence on the extent of moisture related damage to pavements. For example, widened truck traffic lane slab (18 inches) can effectively keep wheel loads away from longitudinal edges to significantly reduce the critical stresses and deflections that affect faulting and cracking in PCC pavements (ERES, 1999). Full-width paving has been found effective in keeping wheel loads away from the area weakened by water infiltrating the AC pavement structure through lane-shoulder joint.

The coefficient of permeability can be determined by in-situ measurement, laboratory testing, theoretical analysis, and empirical methods.

The recommended method for determination of the coefficient of permeability is by in-situ measurements.

2.5.8. Type and Condition of Pavement

Type and condition of pavement is an important factor influencing decisions on the need, for subsurface drainage. The joints in PCC pavements, when not properly sealed, allow for surface water to flow into the pavement. Cracks which develop in AC pavement with aging allow water to infiltrate into the pavement structure. Longitudinal construction joints between paving lanes and the shoulder also provide conduits for water to infiltrate in AC pavements (Moulton, 1980).

2.5.9. Traffic Loading

The total traffic volume and weight is an important factor in the life and performance of a pavement. The volume and weight of traffic expected on the pavement is a key factor in pavement structural design as well as assessment of pavement subsurface drainage needs. Many of the moisture-related pavement distresses can be accelerated by high volumes of heavy traffic loads (ERES, 1999). There are a large number of factors influencing susceptibility of pavements to moisture-related damage. Most notable are traffic loads, subgrade characteristics, design features, and the properties of the pavement material (ERES, 1999). Moisture-related pavement distress can be accelerated by high volumes of heavy traffic loads (ERES, 1999).

Various studies have reported on the superiority of pavements with subsurface drainage in load carrying ability over those with no drainage. Based on investigations of several pavements, Cedergren et al. (1973) reported that pavements which are free of excess moisture can carry heavier traffic loads and larger volumes than similar ones containing excess water.

An important part of the design process is the estimation of cumulative traffic loading expected on the pavement during its design life. Procedures for calculating estimated single axel load (ESAL) are described in the AASHTO Design Guide (AASHTO, 1963)

A combination of different types of vehicles with different gross weights, axle types, and axle weight distributions must be converted into a standard measure, known as the 8.99 ton ESAL, which is the standard traffic loading designation currently used in most design procedures (Christopher and McGuffey, 1997). Parameters required to obtain accurate information on traffic loading include the average daily truck traffic (ADTT), or the percentage of trucks in the traffic stream, vehicle type classification, growth rates, the current mean vehicle type equivalency factors, and the truck equivalency factor growth rate. The best source of this information for any given project design is the on-site traffic count and weight.

The recommended minimum design period for both AC and PCC pavements is 20 years. However, a longer design period (up to 40 years for high-type pavements) would provide some insurance in the near term against unanticipated increases in traffic that could shorten service life.

The total number of ESALs is computed by multiplying the mean truck equivalency factors by the number of trucks in each class and then adding these together. In case a mean truck factor is not available in each truck equivalency class, equation 2.3 can be used to provide an approximate ESAL value (ERES, 1998)

$$ESAL = ADT \times PTRKS \times GF \times DD \times LD \times TF \times 365 \quad (2.3)$$

Where

- ESAL = Number of 8.99 ton ESAL applications over design period
- ADT = Initial two-way average daily traffic, vehicles per day
- PTRKS = Percentage of heavy trucks (FHWA class 5 or greater)
- GF = $[(1+g)^n - 1]/g$, (where g rate/100 and is not zero)

g	= $[(1 + g_{tv}) * (1 + g_{tf})] - 1$
g_{tv}	= Growth rate of traffic volume
g_{tf}	= Growth rate of truck factor
DD	= Directional distribution of truck traffic (decimal)
LD	= Lane distribution of trucks in design lane (decimal)
TF	= Average current truck equivalency factor for all trucks, ESALs/truck

2.6 PAVEMENT GEOMETRY

The geometry of a highway plays an important part in the design of a pavement drainage system. Therefore, good geometric designs which facilitate surface drainage of a pavement and median in both the transverse and longitudinal directions is an important design consideration.

Comprehensive guidelines on geometric design to provide adequate surface drainage are described in the AASHTO manual (AASHTO, 1990; Johnson and Chang, 1984; Anderson and Reed, 1998). A well designed pavement would provide for a system that has an effective method of preventing surface water from infiltrating into the pavement system. A pavement which does not allow moisture to stay on its surface for long would prevent the moisture from entering the pavement base layers through cracks, joints, or pavement surface infiltration. This can be accomplished by providing adequate cross slopes and longitudinal slopes to quickly drain moisture from the pavement surface.

An example of a typical pavement constructed in this manner is one with crowned sections having transverse slopes ranging from 1.5 to 2.5 percent for the surface layer and 3.5 to 6 percent for the shoulders (Yu et al., 1998).

Figure 2.4 illustrates recommended cross sections for various pavement designs (see page 21).

2.6.1. Longitudinal Grades

A requirement in design of subsurface drainage systems is a set of roadway cross-sections showing the original ground and the gross features (i.e. cut and fill slopes, ditches, etc.) of the proposed construction. It is also desirable to have a topographic map of the highway corridor upon which the final highway alignment has been superimposed. This map should be of a large enough scale (100 or 200 scale) that features pertinent to surface and subsurface drainage, such as streams, lakes, and the seasonally wet areas above the highway, can be clearly identified.

The flow of water across the surface of a paved roadway is controlled to a large extent, by the longitudinal grade of the roadway, g , and its cross slope, S_c . Figures 2.4 and 2.5 illustrate paths of water movement in the pavement surface and subsurface, and possible routes the water would follow in permeating the subbase (see pages 21 and 22). The length of the flow path, L , can be expressed in equation:

$$L = W \sqrt{1 + \left(\frac{g}{S_c}\right)^2} \quad (2.4)$$

where

- W = the width of the drainage layer
- g = longitudinal grade of the roadway
- S_c = roadway cross slope

The slope of the flow path, S, can be evaluated using the expression:

$$S = W\sqrt{S_c^2 + g^2} \quad (2.5)$$

After the determination of the various combinations of longitudinal and transverse grades to be encountered on the project at hand, the data should be tabulated in a form convenient for the calculation of L and S required in the design and analysis. An anomaly with the equation for determination of the flow path, L, is that whenever the transverse grade approaches zero, the length of the flow path given by equation (2.4) approaches infinity. In practice, the relationship between longitudinal and transverse grades will be a local one, and length of the flow path will be governed by the grades of adjacent sections of roadway and/or the distance to the nearest transverse drain.

Another anomaly is that if either the cross slope or the longitudinal grade is varying with the stationing along the roadway, the flow path cannot be linear, but will be curved as shown in Figure 2.5.

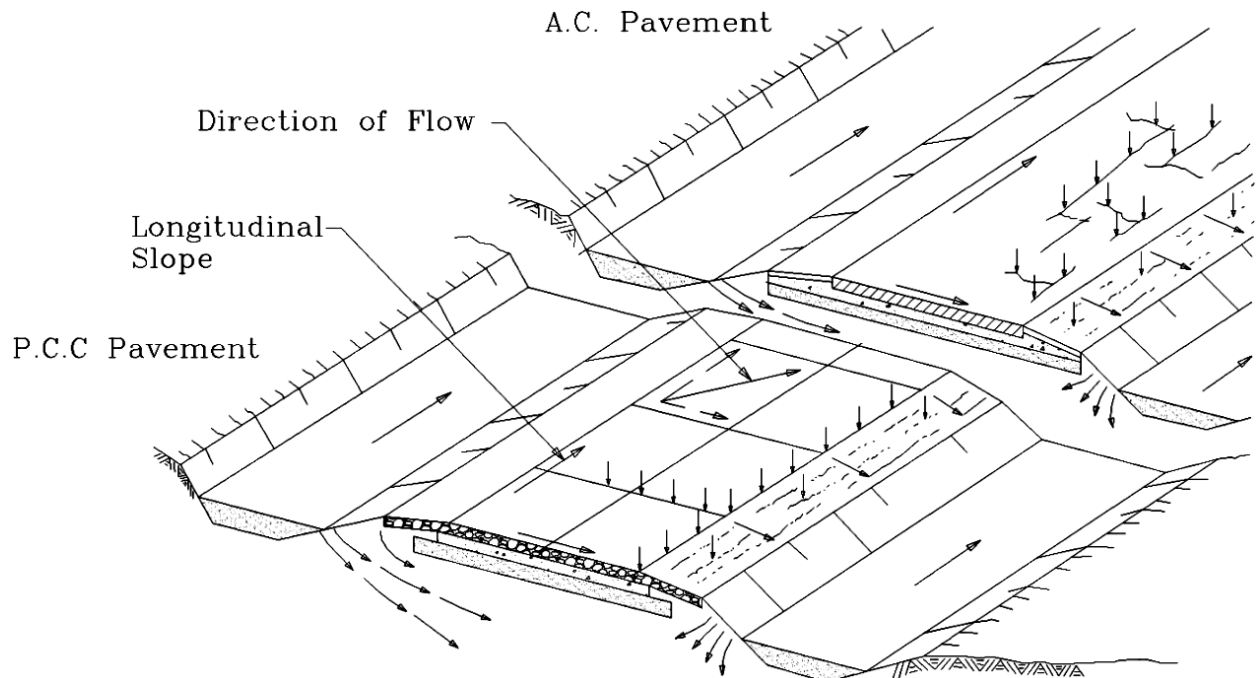

Figure 2.4. Points of entrance of water into the highway pavement structural sections (redrawn from Cedergren, 1973a).

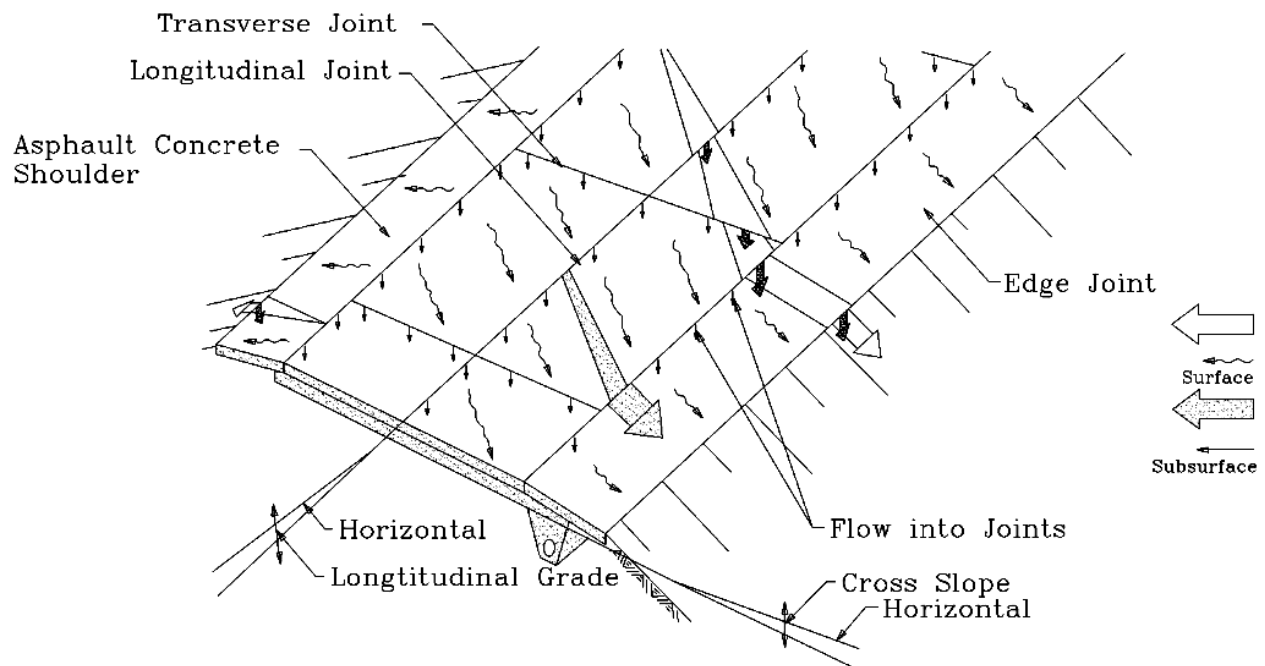

Figure 2.5. Paths of flow of surface and subsurface water in Portland cement concrete pavement structural section (redrawn from Cedergren, 1973a).

2.6.2. *Subsurface Geometry*

It is necessary to establish as accurately as possible the nature and limits, especially the subsurface boundaries, of the flow domain. To accomplish this would require a thorough and detailed exploration and geologic evaluation of the subsurface, leading to the development of soil and rock profiles, as well as to define the prevailing groundwater conditions. A good subsurface exploration is a vital part of the basic design procedure for highways. There are agricultural and geological maps available for many parts of the United States that can be used while planning the subsurface exploration program. Various methods which can be used for this subsurface exploration and sampling are described in detail in many publications (AASHTO, 1978; Hvorslev, 1949; NCHRP, 1976).

2.7 ***OTHER FACTORS WHICH DETERMINE THE NEED FOR DRAINAGE***

Other factors which should be considered when assessing the need for subsurface drainage are:

- Topography, which can affect the longitudinal grade and cross slope of the roadway, and hence affect removal of excess water
 - Functional class and location: pavements which typically carry high-volume and heavy traffic have higher potential for moisture-related damage. Subsurface drainage systems are often necessary for improved pavement performance and longer life (ERES, 1999)
1. Cost: provision of subsurface drainage can increase the overall cost of construction and maintenance, which must be offset by increased service life and reductions in maintenance and rehabilitation costs. According to Cole (1996), inclusion of the

subsurface drainage system in a pavement can increase initial bid costs by as much as 24 percent. Both initial and life cycle costs are important factors in assessing the cost-effectiveness of subsurface drainage (ERES, 1999).

A survey conducted (ERES, 1996) to determine States' views on the importance of the various factors used in determining subsurface drainage needs ranked these factors in terms in order of importance (1 being most important, and 9 being least important) as:

1. Subgrade type
2. Functional classification
3. traffic level
4. design life
5. topography
6. life cycle cost
7. location (urban vs. rural)
8. amount of rainfall
9. initial cost

2.7.1. Existing Pavements

To determine if subsurface drainage is required in an existing pavement, a drainage survey must be conducted which will provide information on the condition of the pavement (ERES, 1999). It is through such surveys that the extent of current moisture-related damage, as well as the presence of key factors that cause moisture related damage to the pavement, can be determined. Drainage evaluation, which involves a distress survey and examination of critical factors that influence moisture condition in a pavement, is a proven way of assessing subsurface drainage needs (ERES, 1999).

2.7.2. New Pavements

At the present, there are no universal criteria for assessing the need for subsurface drainage of new AC pavements (ERES, 1999). Different States and agencies have adopted distinct criteria and guidelines, which fall into two categories. These are site conditions and design considerations.

2.7.3. Site Conditions

Factors falling under this category are those which may be used to determine the overall site drain ability, or condition rating, as is presented in Table 2.4. The site conditions that influence drain ability are subgrade permeability, at grade/on fill versus cut section, freeze or no freeze area, and wet or dry.

Table 2.4. Ranking site conditions for AC and PCC pavements (ERES, 1999).

		SUBGRADE PERMEABILITY					
		>30 m/day		4 to 30 m/day		<3 m/day	
		At grade/ fill	Cut section	At grade/ fill	Cut section	At grade/ fill	Cut section
No-freeze	Dry	Good	Good	Fair	Fair	Fair	
	Wet		Fair			Fair	Poor
Freeze	Dry	Fair	Poor	Poor	Poor	Poor	
	Wet	Poor		Poor			

2.8 TYPES OF SUBSURFACE DRAINAGE SYSTEMS

Early pavement designs did not incorporate subsurface drainage systems, an example of which is shown in Figures 2.6 through 2.8. Pavement without subsurface drainage has water which enters the base and subbase layers and is trapped there. The subgrade and shoulder back-fill are fine-grained soils, acting as barriers which prevent water from exiting, hence resulting in the system filling with water over time. This condition is commonly known as “bathtub” or “trench”. If this water does not find a way out of the pavement structure, pavement problems are likely to be manifested. Construction of pavements without providing a subsurface drainage system may be acceptable in areas with special conditions, such as areas where coarse-grained subgrade is present, which allows water to drain vertically through the subgrade (ERES, 1999).

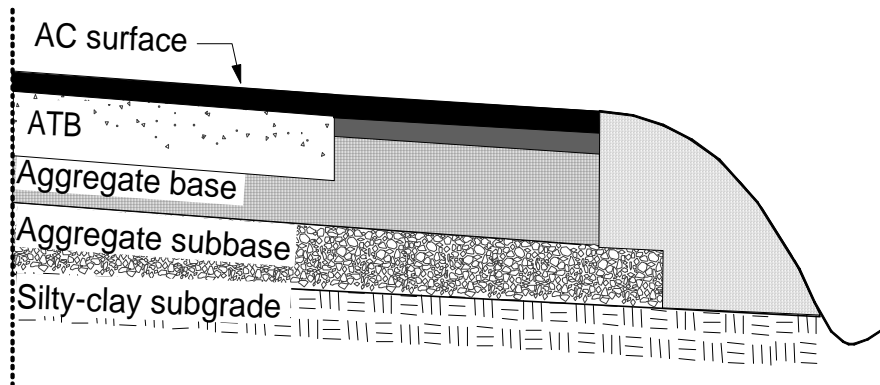

Figure 2.6. Typical undrained AC pavement section (ERES, 1999).

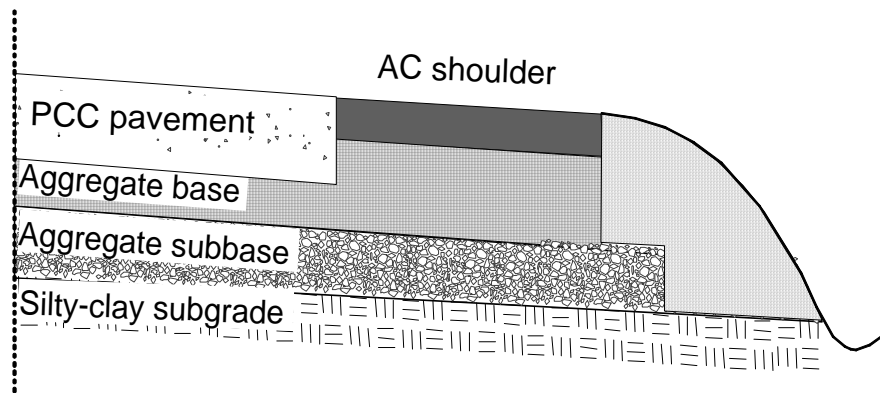

Figure 2.7. Typical undrained PCC pavement section (ERES, 1999).

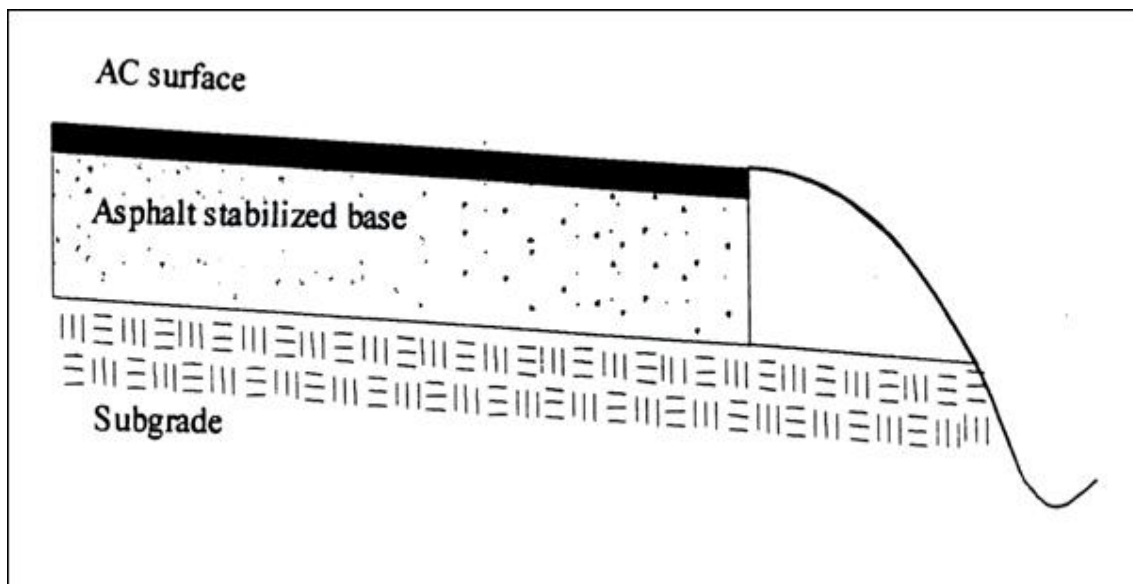

Figure 2.8. Typical full-depth asphalt concrete pavement (ERES, 1999).

Groundwater control systems are drainage systems designed to remove and/or control the flow of groundwater, while infiltration control systems are designed to remove water that seeps into the pavement structural section. There are situations where both subdrainage systems may be required to control water from both sources (Moulton, 1980). Subsurface drainage systems are commonly identified in terms of their location and geometry (ERES, 1999). In this classification, subsurface drainage systems are typically divided into five distinct types. These are longitudinal edgedrains, transverse and horizontal drains, permeable bases, drainage blankets, and well systems. Highway subsurface drainage systems can be classified according to the source of the subsurface water they are designed to control, the function they perform, and their location and geometry.

Well designed subsurface drainage systems are capable of performing different functions, including interception or cutoff of the seepage from above an impervious boundary, draw-down of the water table, and collection of flow from other drainage systems (Moulton, 1980).

Even though they are commonly designed to serve one function, subsurface drainage systems may be expected to serve other functions, such as an interceptor drain, used to cut off side-flow, and as a means to draw down the water table.

A typical, well-designed drainable pavement system should consist of the following design elements and features:

- Full-width permeable base, or non-erodible base under the AC- or PCC-surfaced pavement
- A separator layer under the permeable base to prevent contamination from the subgrade materials
- Longitudinal edgedrains with closely spaced outlets, or edgedrains ‘daylighting’ directly into a side ditch

Designs which do not incorporate these combinations of features cannot be expected to function properly (ERES, 1999).

Infiltration

The most commonly used approaches to address surface infiltration water for new construction are daylighted dense-graded or permeable bases and permeable bases with longitudinal edgedrains. For existing pavements, retrofit edgedrains are the common means of improving drainage of existing pavements (ERES, 1999).

Results of a survey of 40 US state highway agencies (SHA) on the use and current design of subsurface drainage systems show extensive use of permeable base in AC and PCC pavements (ERES, 1996; ERES, 1999). Figures 2.9 and 2.10 show a breakdown on use of different subsurface drainage systems for different types of pavements. The realization of the importance of drainage to pavement performance has led to a trend where older pavement not originally provided with subsurface drainage is being retrofitted with drainage features such as longitudinal edgedrains (ERES, 1999). The functions of different types of subsurface drainages systems are illustrated in Figures 2.11 through 2.13.

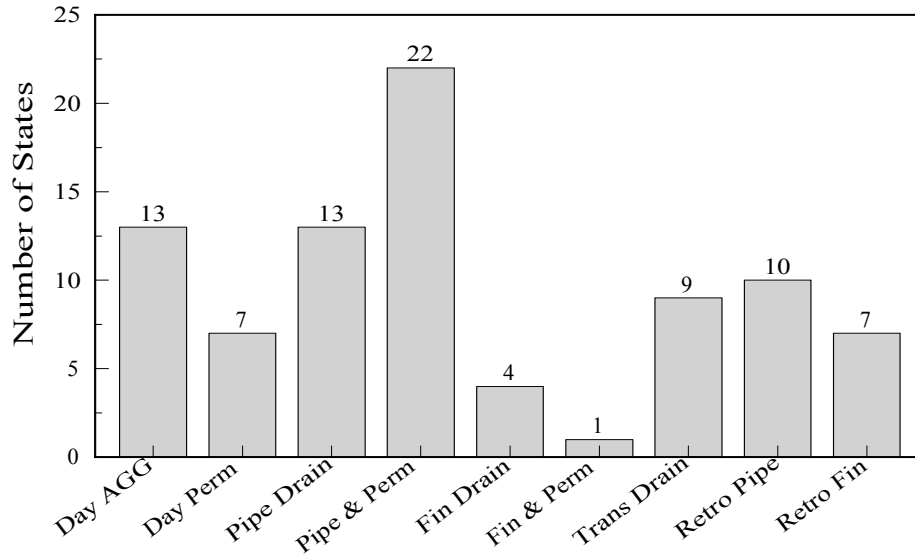

Figure 2.9. Types of subsurface drainage designs for AC pavements used by the States (ERES, 1996).

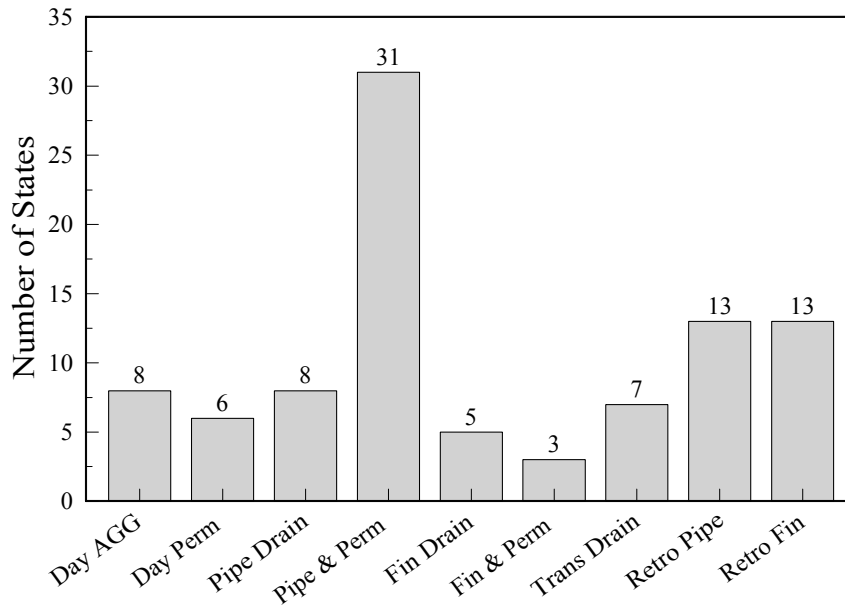

Figure 2.10. Types of subsurface drainage designs for PCC pavements used by the States (ERES 1996).

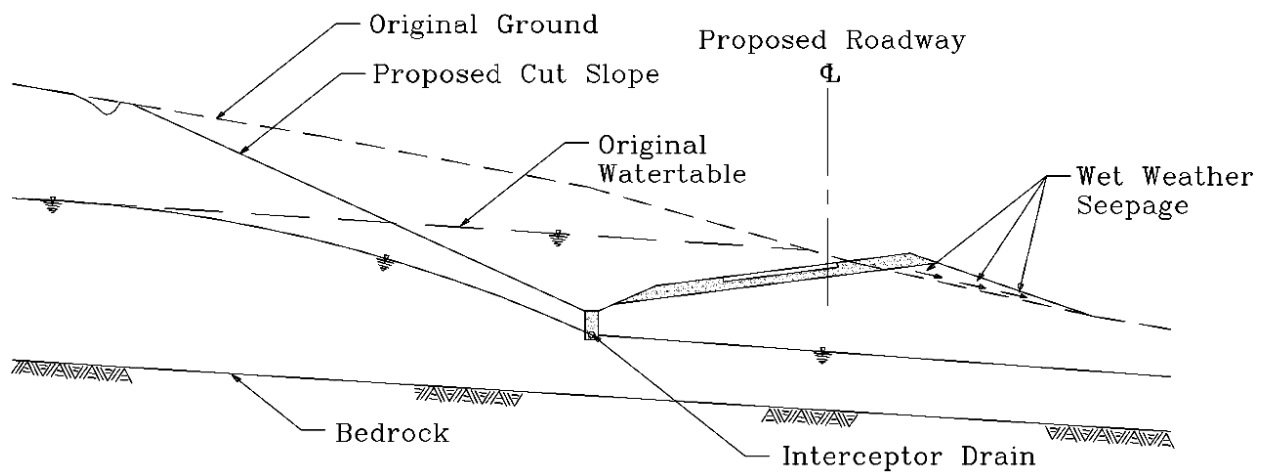

Figure 2.11. Longitudinal interceptor drain used to cut off seepage and lower the groundwater table (redrawn from: Moulton, 1980).

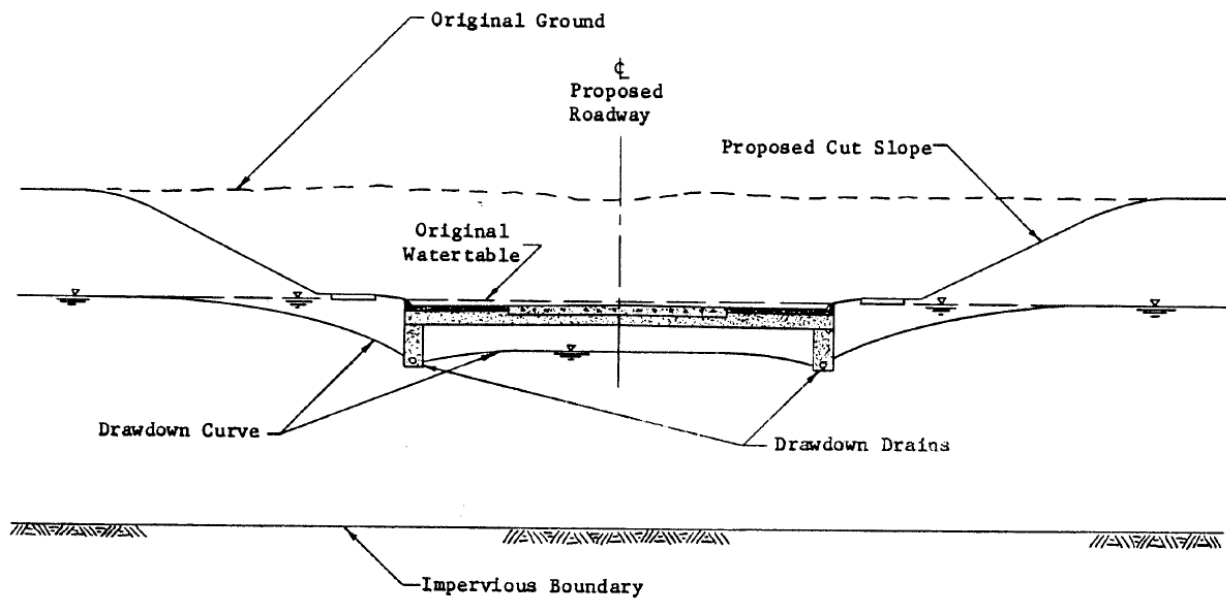

Figure 2.12. Symmetrical longitudinal drains used to lower the groundwater table and to collect water infiltrating the pavement (Moulton, 1980).

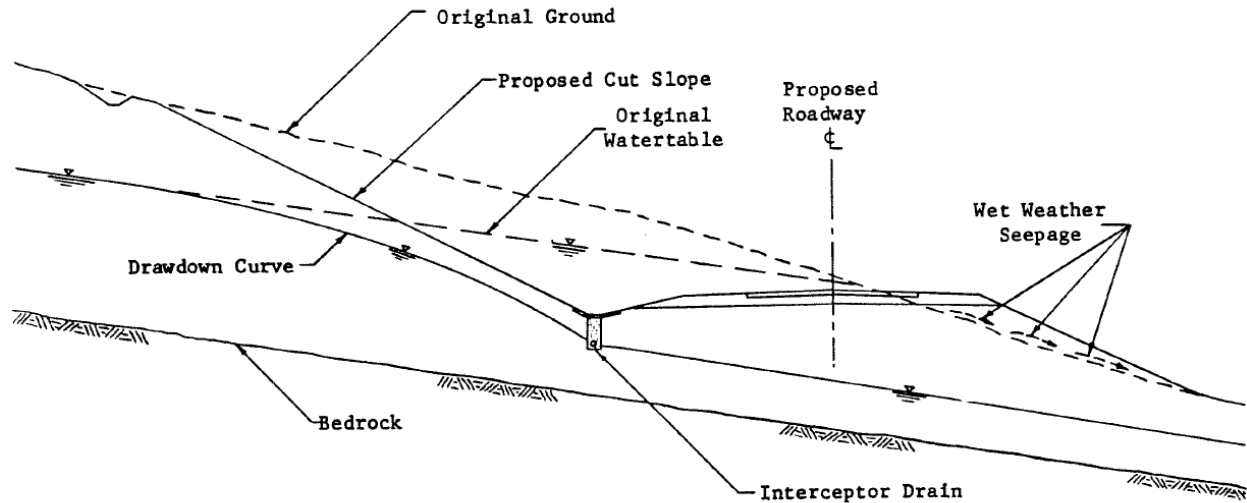

Figure 2.13. Multiple interceptor drain installation for groundwater control (Moulton, 1980).

2.8.1. Influence of Type of Base Materials on Pavement Drainage

Constructed structures, including highway pavement, depend on the base or foundation elements for support. Past construction of highway pavements had the base course whose primary function was to provide uniform support. Without adequate drainage, water entered the base and resulted in failure of the pavement due to pumping and erosion. Permeable bases, which are open graded base materials (OGBM), and have recently replaced the impermeable bases, rapidly drain infiltrated water from pavement structures. Permeable bases are used to provide three main functions (FHWA, 1994). First, the base must be permeable enough so the base course can drain within the design period. Second, the base must be stable enough to support pavement construction operations. Finally, the base course must have enough stability to provide necessary support for the pavement structure.

2.8.2. Index Properties of Materials

In assembling pertinent data for the analysis and design of subsurface drainage, the pertinent index properties we are primarily concerned with are those properties which exert an influence on seepage phenomena. These include the grain size characteristics, plasticity characteristics (Atterberg limits), and soil classification.

The grain size characteristics of the natural soils within the flow domain, either in cuts or fills, can be determined by taking representative samples from the sites, and subjecting them to grain size analysis using standard test methods (ASTM, 1978). Carrying out this analysis is particularly important in locations where it is anticipated that protective filters may be required to prevent finer soil particles from being washed or "pumped" into drainage layers (Moulton, 1980). For granular materials to be used in base, subbase, drainage blankets, filters, etc., it is considered highly desirable that representative samples of the actual construction materials be subjected to grain size analysis. However, it is recognized that this may not always be practical, and it may be necessary to work from the specified gradation limits for these materials.

It is recommended that sufficient laboratory data be developed for representative soil samples from the project site to permit classification determination of useful data for the classification of these soils.

2.8.3. Performance Characteristics

There is a wide range of engineering properties of materials with which we must be concerned in highway design. For the design of subsurface drainage systems, of most concern are those properties that control the flow of subsurface water. The data required for analysis and design of the subsurface drainage systems are:

- the coefficient of permeability, k
- the effective porosity (yield capacity), n'
- the frost susceptibility of the material
- data on other performance characteristics which govern these parameters
 - the grain size distribution
 - the packing (dry density, void ratio, porosity)
 - the mineralogical composition
 - the nature of the permeant
 - the degree of saturation

For engineering design, the method most recommended for determination of the coefficient of permeability is the in-situ measurements. The coefficient of permeability which is obtained for compacted drainage layers after they are in place cannot be considered a design function.

When field evaluation of the coefficient of permeability is not feasible, use of laboratory determinations is highly recommended, particularly for fill materials, bases, subbases, and other drainage layers.

There is a problem associated with determining the coefficient of permeability for coarse granular materials. This is because flow in the material under natural conditions may become non-laminar, even at low hydraulic gradients, invalidating Darcy's Law. Cedergren (1977) has described an alternative procedure and correction factors which can be used to establish the true Darcy permeability. The method involves performing the laboratory tests under small hydraulic gradients that ensure laminar flow, and then applying a correction factor to evaluate the coefficient of permeability in turbulent flow at greater hydraulic gradients than used in the tests.

Although field or laboratory procedures are considered desirable methods for the determination of coefficient of permeability, in practice it is often necessary for the designer to estimate the coefficient of permeability empirically. There are several approaches available for conducting these estimations, though they all depend upon some kind of correlation between the coefficient of permeability and properties such as grain size characteristics, dry density, and porosity or void ratio. One method which has been used with some success utilizes a relationship between permeability, specific surface, and porosity (NYDOT, 1973). Tables 2.5 and 2.6 show a set of typical set values of the coefficient of permeability and a general indication of the degree of permeability as a function of the grain size characteristics of the material.

Table 2.5. Typical values of soil permeability (Carsel and Parrish, 1988; Domenico and Schwartz, 1990; Rawls et al., 1992).

Soil Type	Saturated Hydraulic Conductivity, Ks (ft/day)	Effective Porosity (mean)
Gravel	84 to 8400	0.42
Coarse Sand	0.24 to 1700	0.28
Medium Sand	0.12 to 140	0.3
Fine Sand	0.048 to 58	0.32
Loamy Sand	12	0.4
Sandy Loam	3.6	0.41
Loam	0.72	0.43
Silt, Loess	0.002 to 58	-
Silt Loam	0.36	0.49
Till	0.55 to 2.9	-
Clay	0.0012 to 2.9	0.39
Sandy Clay Loam	0.9	0.33
Silty Clay Loam	0.07	0.43
Clay Loam	0.2	0.39
Sandy Clay	0.1	0.32
Silty Clay	0.02	0.42
Limestone	0.29 to 5,660	-
Limestone, Dolomitic	0.00024 to 1.7	0.001 - 0.05
Sandstone	1.7 to 8.4	0.005-0.1
Siltstone	0.0036 to 2.9	-
Shale	0.0005 to 2.9	0.005-0.05

Table 2.6. Typical values of soil permeability, apparent specific gravity and effective porosity (Hansen et al., 1979; James 1988).

Soil Texture	Representative Saturated Hydraulic Conductivity, Ks (ft/day)	Range Saturated Hydraulic Conductivity, Ks (ft/day)	Effective Porosity (%)
Sandy	4	2 to 20	0.23
Sandy Loam	2	1 to 6	0.22
Loam	1	0.6 to 1.6	0.16
Clay Loam	0.6	0.2 to 1.2	0.13
Silty Clay	0.2	0.02 to 0.4	0.11
Clay	0.4	0.1 to 0.8	0.09

As has already been emphasized, it is very important in the analysis of subsurface drainage systems to be able to estimate the coefficient of permeability of granular drainage and filter materials. A tool has been developed to help in this regard (Figure 2.14). The chart was developed by correlating statistically the measured coefficients of permeability for a large number of samples with those properties known to exert an influence on permeability (Barber and Sawyer, 1952; Chu et al., 1955). According to the test results, the most significant properties are the effective grain size, D_{10} , the porosity, n , and the percent passing the No. 200 sieve, P_{200} , and are known to explain over 91 percent of the variation in the coefficient of permeability (Moulton, 1980). The prediction equation derived from the correlation is given by

$$k = \frac{6.214 \times 10^5 (D_{10})^{1.478} (n)^{6.654}}{(P_{200})^{0.597}} \text{ (ft/day)} \quad (2.6)$$

This equation should be used with caution, particularly at the high or low values, as data was not sufficient in these extremities for reliable determinations. For ease and convenience, a conversion has been made in the chart, replacing the porosity parameter with dry density.

In many instances a new pavement layer will be overlaid onto an existing distressed pavement. In such cases the exiting distressed pavement will serve as the base course for the new overlay pavement. In the design of subsurface drainage systems the effective permeability of the distressed pavement should be taken into account since it will usually have a significant amount of cracking (secondary porosity) associated with the distressed condition, or it will be specified to fracture the existing pavement prior to placing the overlay. Retrofitted edgedrains placed alongside the existing pavement will collect water not only from the original base course (base material underlying the existing pavement) and the subgrade material, but also from the fracture existing pavement.

As with a normal edgedrain design, it is necessary to estimate the hydraulic conductivity and the effective porosity of the base course (in this case the existing pavement). The hydraulic

conductivity can be estimated from knowing the average width of fractures in and the thickness of the existing pavement. The orientation of fractures will be important also, with those running directly across the road and perpendicular to the edgedrains, being the most effective at draining the base materials. Fractures running along the road (parallel to the edgedrains) will be the least effective, unless they are directly connected to fractures running toward the edgedrains.

The hydraulic conductivity of a block of fractured pavement (concrete or asphalt) can be estimated by assuming that the flow in a single fracture is similar to the flow between two parallel plates. Then if we assume that the fractures are all aligned in the same direction, and that they are at a uniform spacing, the equivalent hydraulic conductivity of a length of fractured pavement flow is given by (Zimmerman and Bodvarsson, 1996)

$$K_f = 3,600 \frac{gb^3}{\nu S} \quad (2.7)$$

where K_f is the equivalent saturated hydraulic conductivity (in/hr), b is the mean width of fractures (in), S is the spacing between fractures (in), g is the acceleration of gravity (ft/sec^2), and ν is the kinematic viscosity of water (ft^2/sec). This is the saturated hydraulic conductivity facing in the direction of the fractures. Of course, fractured pavement will not have only one fracture direction, as it generally fractures both longitudinally along the pavement and transversely to the pavement. The above equation can be used to estimate the equivalent hydraulic conductivity in each of the fracture directions, transverse and longitudinal. It should be noted that the equivalent hydraulic conductivity of the fractured pavement will be a very large value, and can easily exceed the hydraulic conductivity of typical base course materials.

As an example calculation of the hydraulic conductivity of a fractured pavement, consider an existing concrete pavement with transverse fractures having an average width of 0.1 inch (0.0083 ft) and average spacing of 3 ft. The equivalent saturated hydraulic conductivity in the transverse direction is then

$$K_f = 3,600 \frac{gb^3}{\nu S} = 3,600 \frac{(32.2 \text{ ft}/\text{sec}^2)(0.0083 \text{ ft})^3}{(1.07 \times 10^{-5} \text{ ft}^2/\text{sec})(3 \text{ ft})} = 49,556 \text{ ft}/\text{day}$$

This example shows that the factor limiting drainage from the distressed pavement will not be the pavement permeability, but rather the resistance to entry into the drains, and the resistance to flow within the drains.

While the permeability of the distressed pavement can be extremely high, it is important that fractures have a continuous path in the direction perpendicular to the drain orientation, although it is not essential that the fracture pathway be on a straight line. Fractures that have a longitudinal orientation will be completely ineffective at moving water to edgedrains, unless they are able to intersect with fractures that have a transverse orientation.

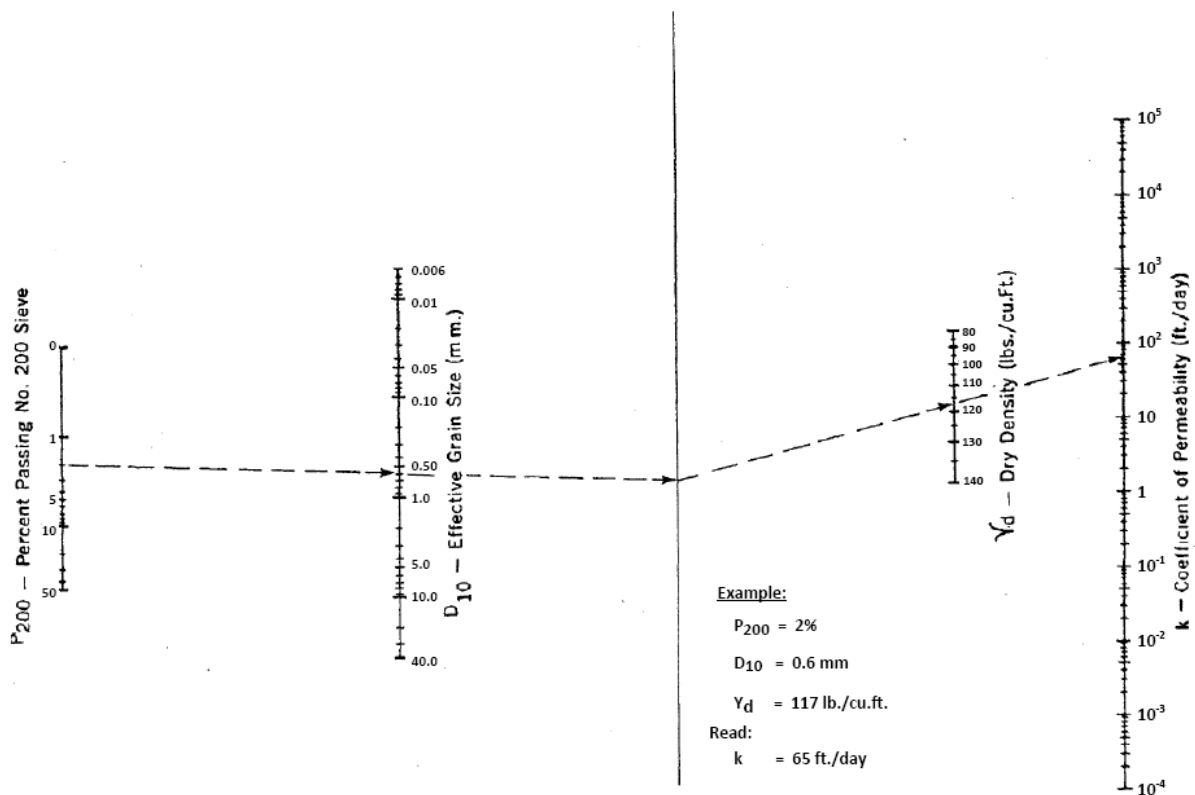

Figure 2.14. Chart for estimating coefficient of permeability of granular drainage and filter materials (Moulton, 1980; NYDOT, 1973).

With the problem of frost action, the designer providing subsurface drainage during periods of thawing requires knowledge of frost susceptibility of the subgrade soils and the depth of frost penetration (Moulton, 1980). It is critical that melt water from thawing ice masses be removed as rapidly as possible by suitable drainage layers in order to prevent the saturation of the pavement structural section. This is considered to be an essential factor in limiting both the duration and magnitude of the reduction in supporting power of the subgrade, base, and subbase during periods of spring thaw (Cedergren, 1973a; Cedergren, 1974a).

2.8.4. Types and Specification of Base Materials

There are two main permeable base materials: stabilized and unstabilized. Both materials should consist of durable, crushed, angular aggregate, passing number 4 sieve, with few or no fines (FHWA, 1994). These should meet the FHWA requirements for a Class B aggregate in accordance with the AASHTO M 283-83 (FHWA, 1994), Coarse Aggregate of Highway and Airport Construction. The aggregates should meet the AASHTO T 96-87 specifications for durability to abrasion wear due to freeze-thaw in accordance with AASHTO T 104.

For Minnesota the above specification for an unstabilized base is represented by the following gradation for percent passing: 1", 100%; ¾", 65-100%; 3/8", 35-70%; No. 4, 20-45%; No. 10, 8-25%; No. 40, 2-10%; No. 200, 0-3%. For the stabilized base a representative gradation for percent passing is given by: 1 ½", 100%; 1", 95-100%; ½", 25-60%; No. 4, 0-10%; No. 8, 0-5%. As can be seen from these two gradations, the gradation for the stabilized material is much coarser.

The main difference between the two types of base materials is in the size of the constituent aggregates. Unstabilized materials contain high content of finer size aggregates, which provide stability through increased aggregate interlock. This however, results in lower material permeability. Unstabilized permeable bases generally have a coefficient of permeability in the range of 1,000 to 3,000 feet per day (Moulton, 1980). The permeability of this material is approximately 1,400 ft/day. Because stabilized base materials achieve stability through treatment with asphalt or concrete additives, the aggregates can have a larger size, leading to higher permeabilities than those of the unstabilized materials. The permeability of this gradation is approximately 6,800 ft/day.

During construction, for the base to provide required stability for the equipment and activities, it is recommended that the coefficient of uniformity of the unstabilized permeable base courses be greater than 4 (Moulton, 1980).

2.8.5. Positive Drainage of the Permeable Base

Permeable bases beneath pavement must be provided with positive drainage, usually in the form of longitudinal edgedrains with outlet pipes (FHWA, 1994). A drainage alternative often used is daylighting the permeable base into ditches. However, this has proved ineffective over the long run because the daylighted layers often get clogged by roadway debris and vegetation.

The type of subsurface drainage system an engineer is likely to select depends, to a larger extent, on the three selection criteria suggested by Moulton (1980) above.

2.8.6. Longitudinal Drains

Longitudinal drains are normally located parallel to the roadway centerline, with both horizontal and vertical alignments. This type of drainage usually includes a trench of substantial depth, a collector pipe, and a protective filter of some kind, or it may be less elaborate. Examples of types

of longitudinal drains commonly used in control of seepage and groundwater are shown in Figures 2.15 and 2.16.

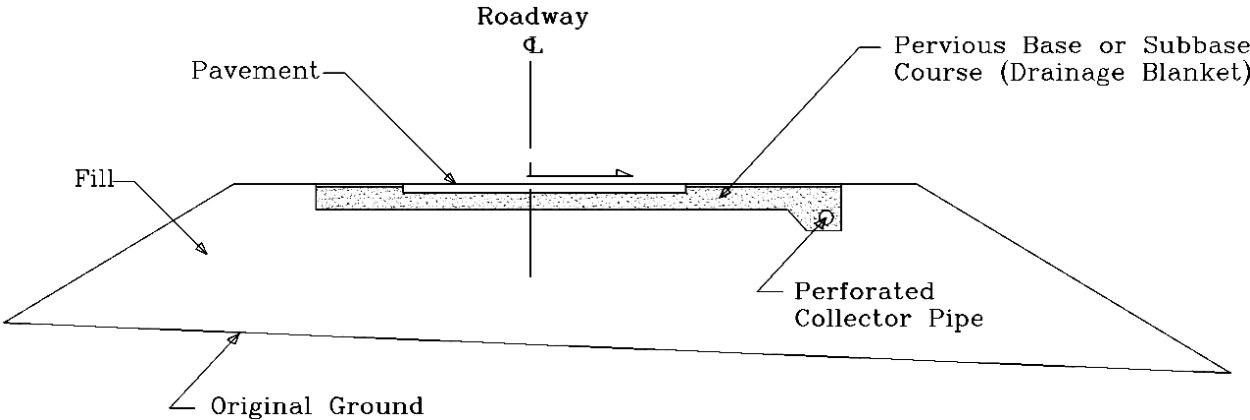

Figure 2.15. Longitudinal collector drain used to remove water seeping into pavement structural section (redrawn from: Moulton, 1980).

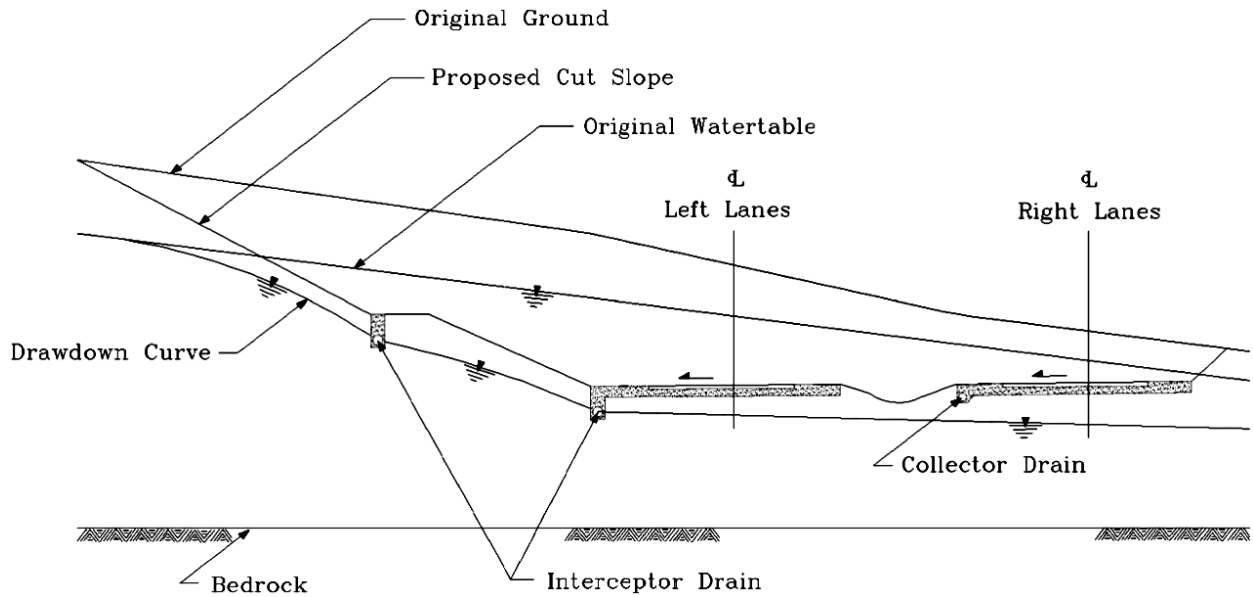

Figure 2.16. Multiple, multipurpose longitudinal drain installation (redrawn from: Moulton, 1980).

Sometimes, a multiple drain installation is needed for control of water under certain situations. Figure 2.16 shows an example where a multiple longitudinal drain in a section of an expressway cut in a wet hillside. In order to intercept the flow and draw down the water table below the left cut slope, it was necessary to use two lines of relatively deep longitudinal drains.

In addition to intercepting water flowing from the hill slope, the interceptor drain beneath the left shoulder of the left lanes drains any water that may enter the base or subbase of the left lanes from infiltration or frost action. The shallow collector drain along the left edge of the right lanes performs this same function.

In many cases it is not possible to compact the subgrade material to desired specification. These materials are then removed and other more suitable material is transported in to replace it. The resulting backfilled subcuts are then susceptible to the 'bathtub effect', meaning that water will accumulate in the volume of replaced materials. It is important to provide drainage for these subcuts. The drainage of subcuts can be accomplished with longitudinal drains if the subcuts are continuous along the pavement, or the drains might be placed on a transverse angle to the pavement if the subcut's volumes are localized. The design of drains for longitudinal subcuts follows the same procedures used for longitudinal edgedrains. For more localized subcut situations the design of the drains can follow the procedures used for transverse drains.

2.8.7. Transverse and Horizontal Drains

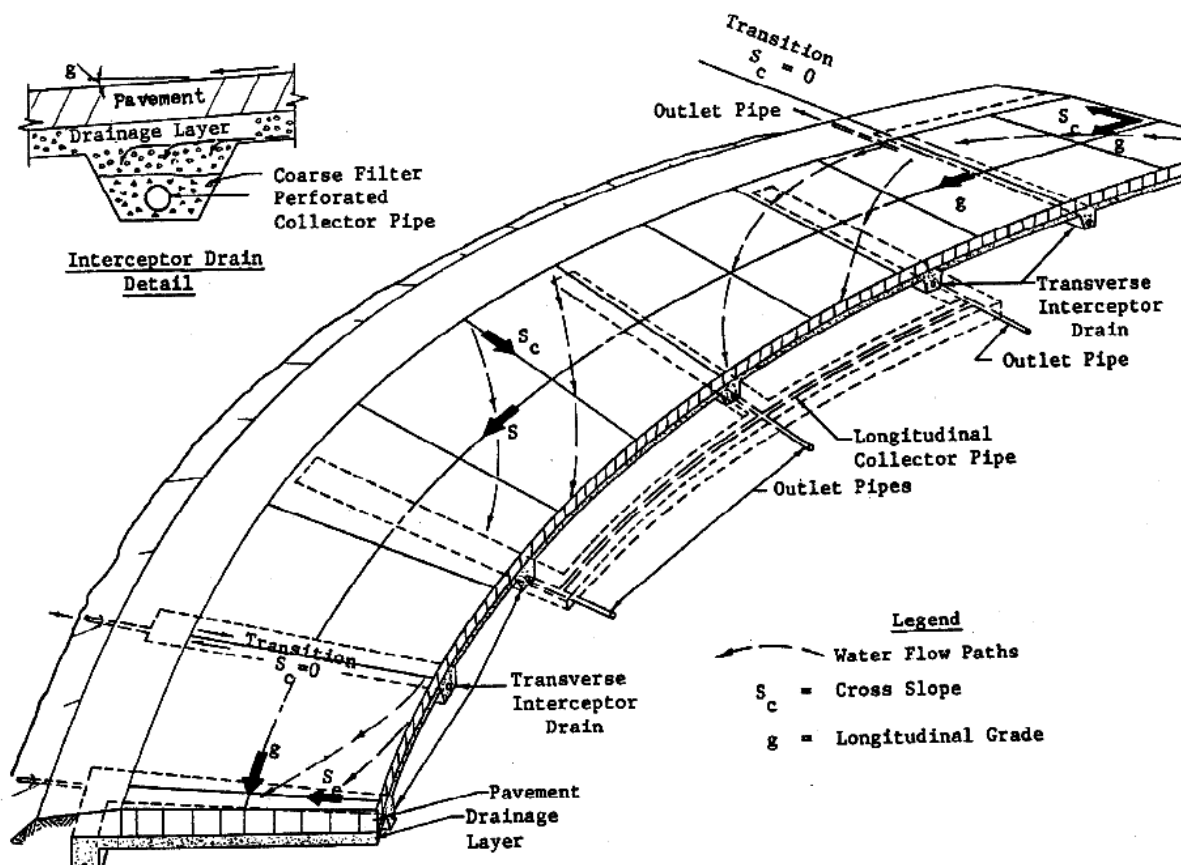

Figure 2.17. Transverse drains on super-elevated curve (Moulton, 1980).

Transverse drains are a class of subsurface drains that run laterally beneath the roadway. The common placement of these drains is at right angles to the roadway centerline, although they may be skewed in some cases, creating what is often referred to as the "herringbone" pattern (Moulton, 1980). This type of drainage system is often used at pavement joints to drain infiltration and groundwater which may be in the bases and subbases. Transverse drains may be used in conjunction with a horizontal drainage blanket and longitudinal collector drain system, which provides an effective means for rapid removal of water from the pavement section.

Transverse drains may involve a trench, collector pipe, and protective filter, as shown in Figure 2.17, or they can consist of simple "french drains" (shallow trenches filled with open graded aggregate), although this is not generally recommended. The degree of sophistication employed in the designs of this type of drainage system depends on the source of the subsurface water and the function of the drain. This type of drain is especially effective when used in situations where the general direction of the groundwater flow tends to be parallel to the roadway (common when the roadway is cut more or less perpendicular to the existing contours). This application is

illustrated in Figure 2.18. The need to exercise caution in the use of transverse drains in areas of seasonal frost is exemplified in certain locations where pavements undergo a general frost heaving, except where transverse drains were installed, leading to poor riding quality during winter months (Moulton, 1980).

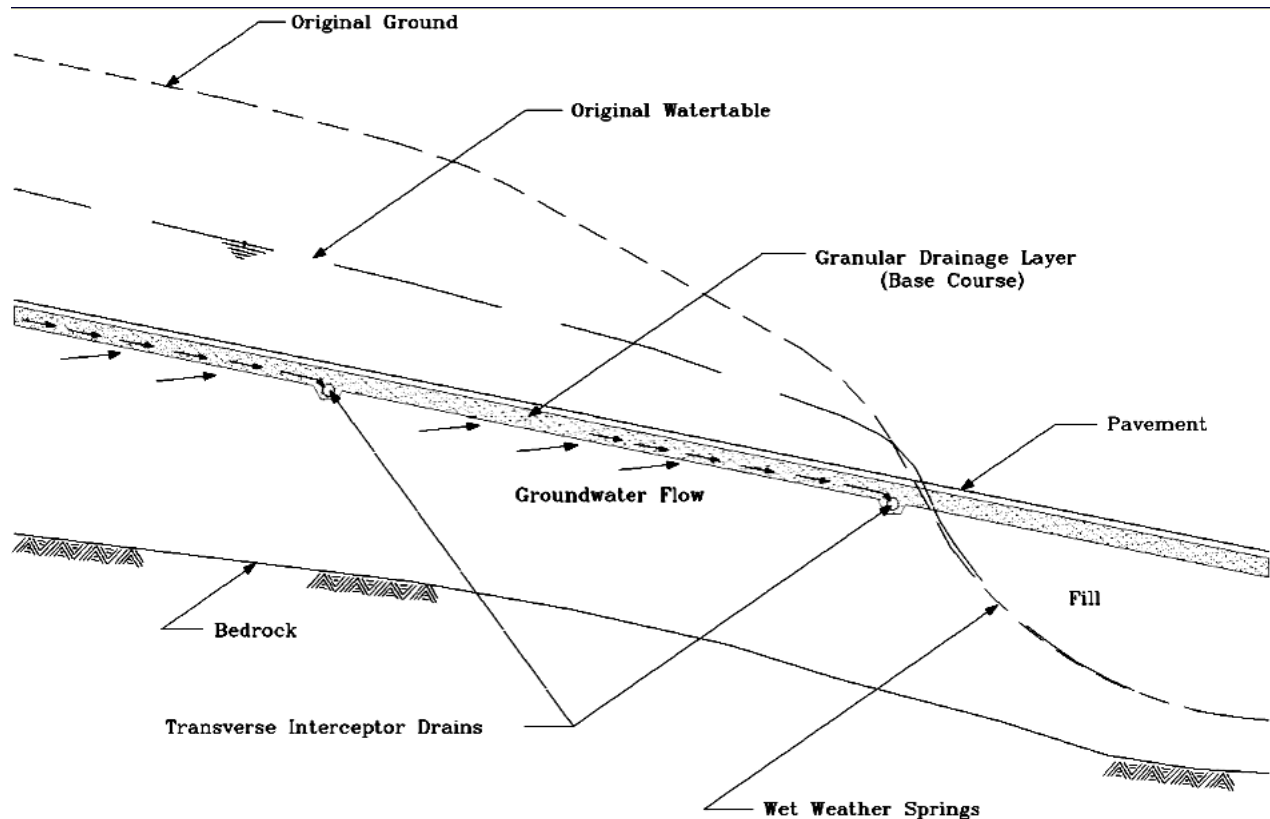

Figure 2.18. Transverse interceptor drain installation in roadway cut with alignment perpendicular to existing contours (redrawn from Moulton, 1980).

Horizontal drains consist of nearly horizontal pipes drilled into cut slopes or side hill fills to tap springs and relieve pore water pressures.

2.8.8. Drainage Blankets

Drainage blanket is a term generally applied to a very permeable layer whose width and length in flow direction is large relative to its thickness. These drainage systems, if properly designed, can be used for effective control of both groundwater and infiltration (Moulton, 1980). The horizontal drainage blanket can be placed beneath or serve as an integral part of a pavement structure to remove infiltrated water or to remove groundwater from both gravity and artesian sources. To function as drainage blankets, the systems must be specifically designed and constructed to do so. They must be designed with adequate thickness of material with a very high coefficient of permeability, a positive outlet for the water collected, and, in some instances, the use of one or more protective filter layers (Cedergren, 1973a; Cedergren, 1974a).

Types and applications of horizontal drainage blanket systems are shown in Figures 2.19 through 2.22 (Moulton, 1980). In Figure 2.19 a horizontal blanket drain used in connection with shallow longitudinal collector drains to control both infiltration and the flow of groundwater from an artesian source. In Figure 2.20 a horizontal blanket drain is used to remove water that has seeped into the pavement by infiltration alone. An outlet has been provided by "daylighting" the drainage blanket. However, it should be noted that it is not uncommon for this type of outlet to become clogged and cease to function effectively. A more positive means of out-letting the drainage blanket would be to use the longitudinal drain as shown dashed in the illustration. Drainage blankets can be used effectively to control the flow of groundwater from cut slopes and beneath side hill fills, as illustrated in Figures 2.21 and 2.22. When the drainage blanket is used in connection with a longitudinal drain, this will help improve the surface stability (relieve sloughing) of cut slopes by preventing the development of a surface of seepage.

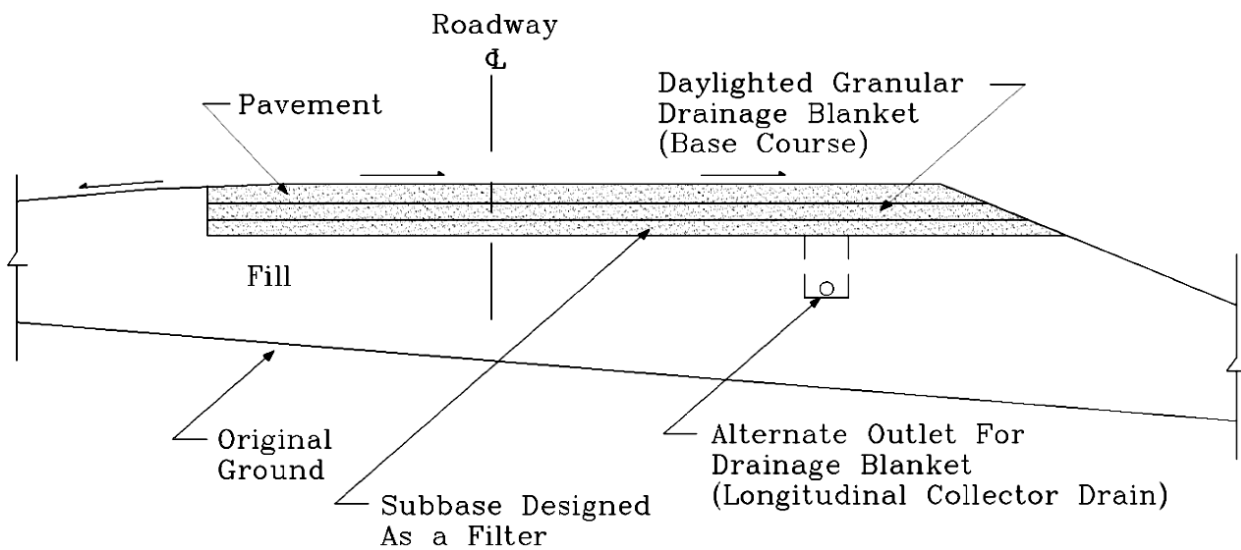

Figure 2.19. Applications of horizontal drainage blankets (redrawn from Moulton, 1980).

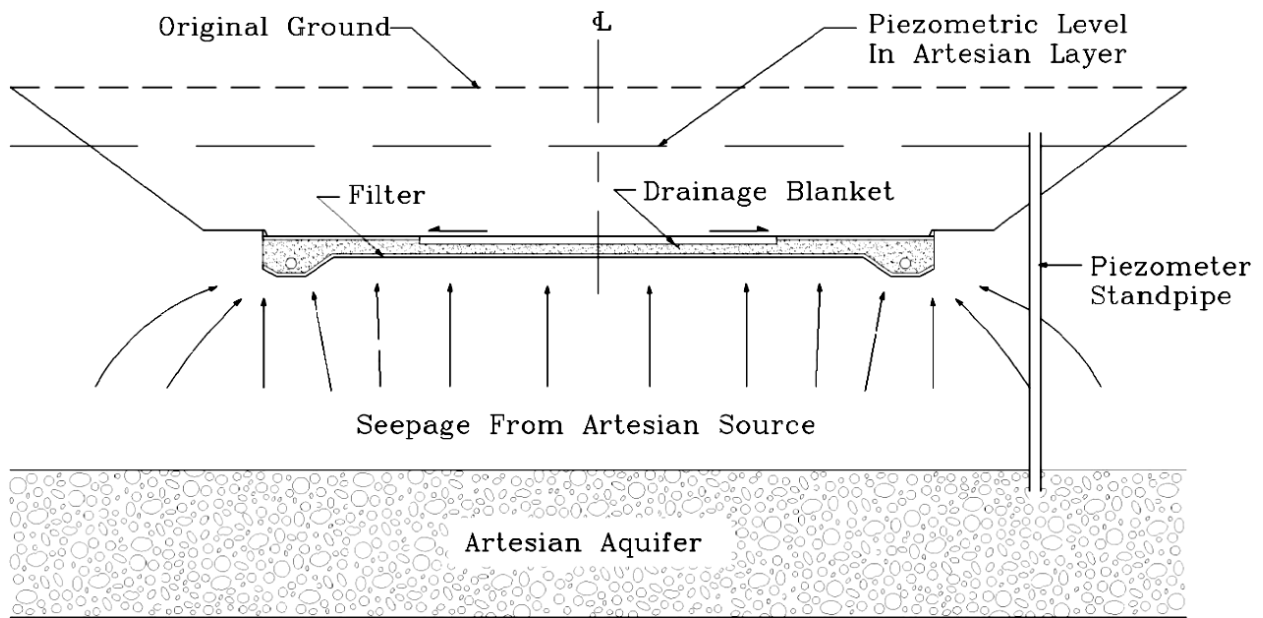

Figure 2.20. Applications of horizontal drainage blankets (redrawn from: Moulton, 1980).

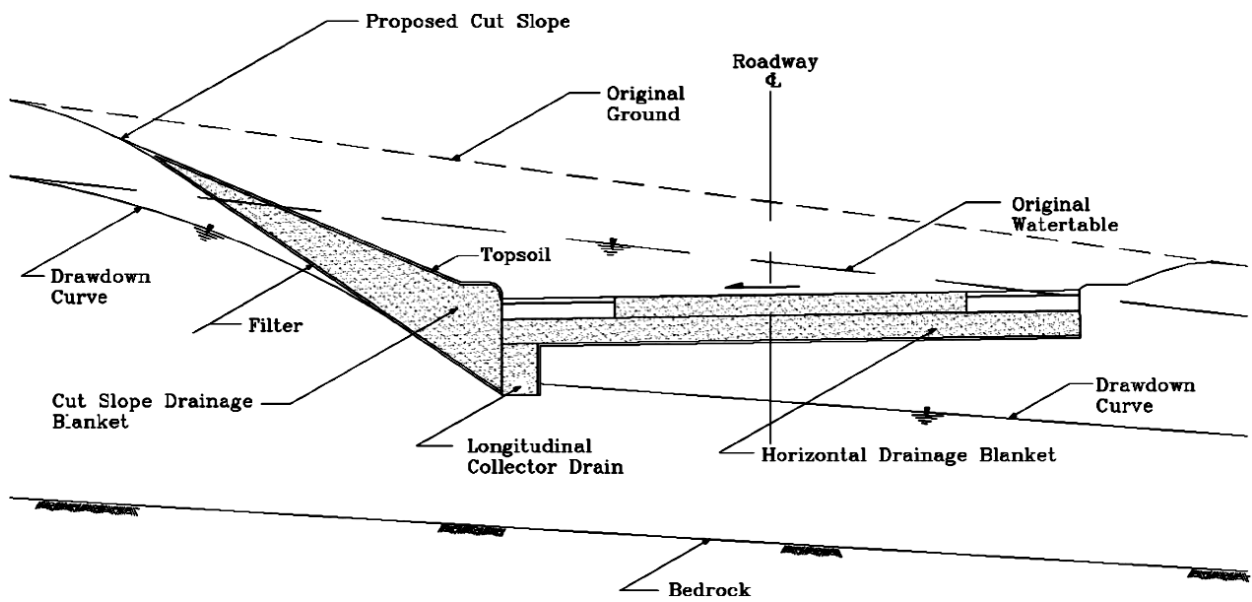

Figure 2.21. Drainage blanket (wedge) on cut slope drained by longitudinal collector drain (redrawn from Moulton, 1980).

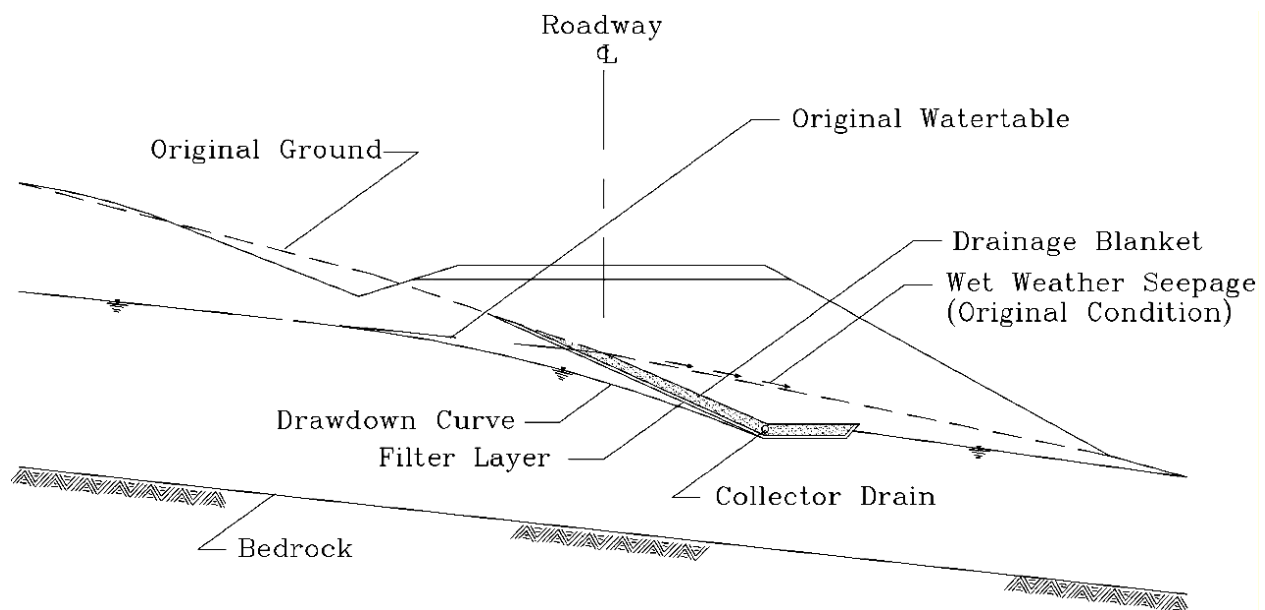

Figure 2.22. Drainage blanket beneath side hill fill outletted by collector drain (redrawn from: Moulton, 1980).

2.8.9. *Interceptor Drains*

In many instances hillslopes along the side of roadways can have ground water seeping from higher ground, which leads to instability of the hillslope in many instances. This ground water is also a source of water for the pavement foundation. An illustration of a field situation near a pavement section with hillslope seepage is shown on Figure 2.23. The soil profile has a bottom boundary layer which is considered to be effectively impervious. The ground water flow toward the highway shows that the water table intersects with the hillslope surface near the road ditch, and ground water is seeping through the slope into the ditch. In addition, ground water is flowing beneath the road and entering into the subgrade and base course material.

Placing an interceptor drain upgradient from the ditch, or beneath the ditch itself, can help to control the hillslope seepage and decrease or even eliminate the flow beneath the roadway, thus removing the source of water from entering into the pavement foundation. An illustration of the situation with an interceptor drain is shown in Figure 2.24. There it is seen that the water table is drawn down by the interceptor drain to the level of the drain. The water table down gradient of the interceptor drain may rise up above the level of the drain due to seepage flowing under the drain.

The design of an interceptor drain requires an estimate of the hydraulic conductivity of the hillslope soil, k , the thickness of the saturated zone for the ground water, which is shown as

height H in Figure 2.23, the slope of the bottom boundary of the soil profile, S , and the height of the drain above the impermeable boundary, H_0 . If we want to prevent ground water from entering into the subgrade and base course material, then the interceptor drain needs to be placed at an elevation below the elevation of those foundation layers, as shown in Figure 2.24.

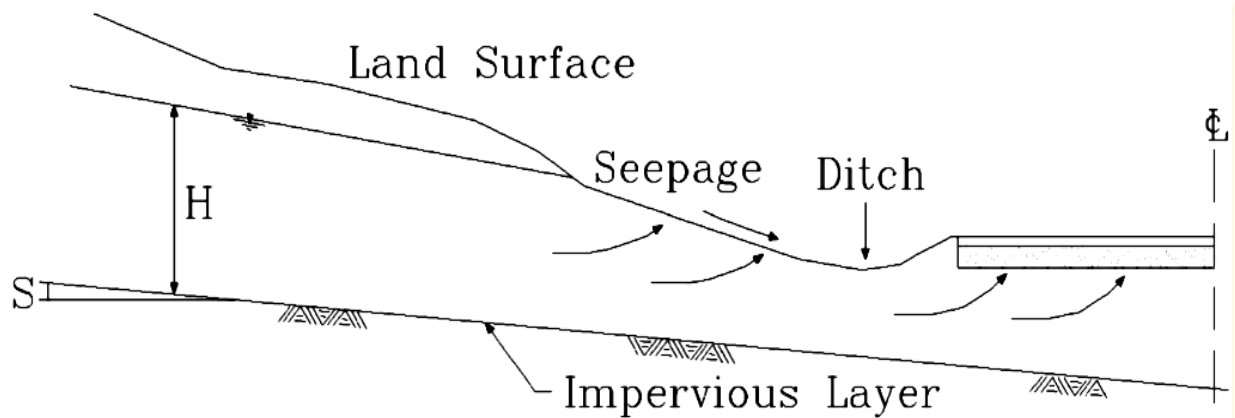

Figure 2.23. Illustration of ground water flow along a sloping impervious layer toward a roadway. Ground water seeps through the slope where the water table intersects the land slope, and ground water flows beneath the pavement while also entering the pavement foundation materials.

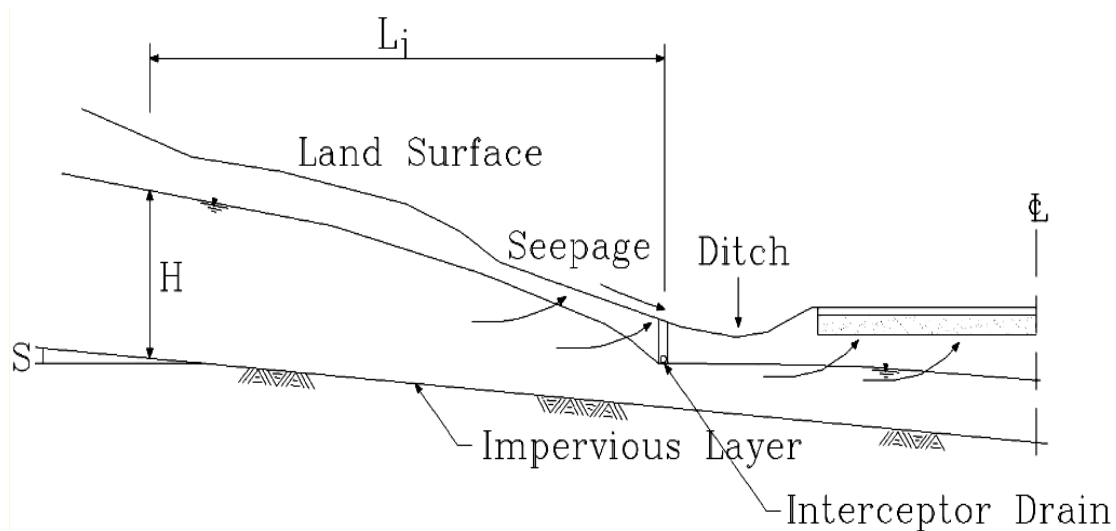

Figure 2.24. Illustration of the effect of an interceptor drain on the drawdown of the ground water table.

2.8.10. Well Systems

Under certain conditions, such as potentially troublesome highway slopes, systems of vertical wells can be used to control the flow of groundwater and relieve pore water pressures. When necessary, these systems are pumped for temporal lowering of the water table during construction, or may otherwise be allowed to overflow for the relief of artesian pressures (Moulton, 1980). A common practice is to provide them with some collection system, such as tunnels, drilled-in pipe outlets, or horizontal drains, so they can be drained freely at the bottom.

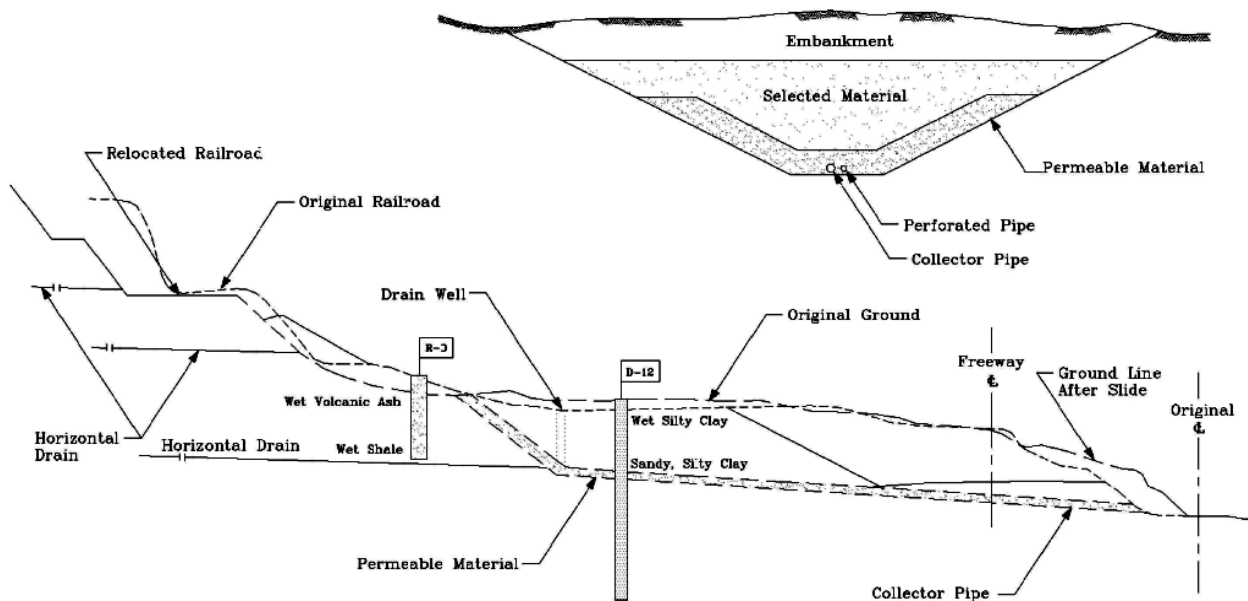

Figure 2.25. A typical section of drainage trench at Towle slide (redrawn from: Moulton, 1980; Smith and Cedergren, 1963).

Figures 2.25 and 2.26 show typical well drainage systems that can be used in the stabilization of wet slopes.

The sand filled vertical wells in Figure 2.26 can be used for accelerated drainage of soft and compressible foundation materials which are undergoing consolidation as a result of the application of a surface loading (Barron, 1948; Cedergren, 1977).

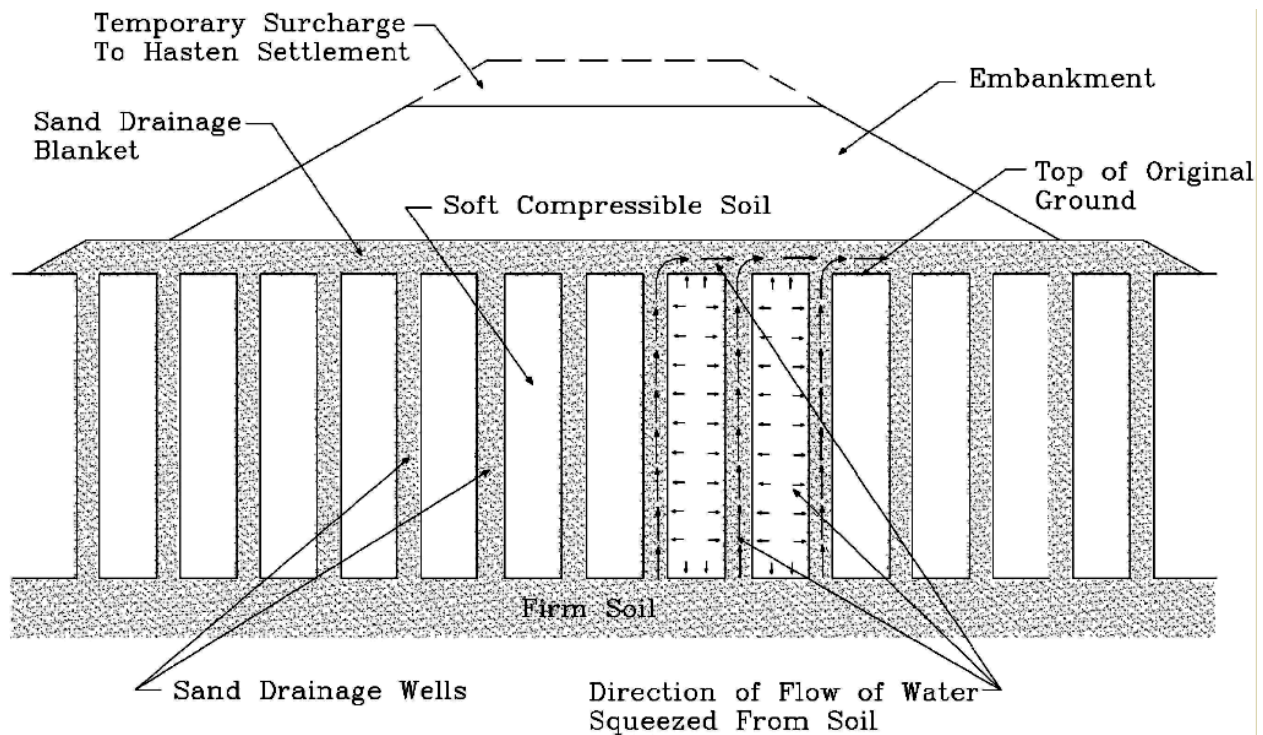

Figure 2.26. A typical sand drainage well installation (redrawn from Moulton, 1980).

2.9 TYPES OF PAVEMENTS AND DRAINAGE REQUIREMENTS

Hard surfaced pavements typically fall into two categories: flexible and rigid pavements. Drainage requirements are unique for each of these types of pavement. Concrete, or rigid, pavements generally have lower permeability than asphalt pavements, and will more effectively impede water infiltration into the subgrade layer.

The common types of pavements constructed in the USA fall under the categories are shown below (ERES, 1999).

- **Rigid Pavements**
 - Jointed plain concrete pavement (JPCP)
 - Jointed reinforced concrete pavement (JRCP)
 - Continuously reinforced concrete pavement (CRCP)
 - PCC rehabilitation

- **Flexible pavements**
 - Conventional asphalt concrete (AC)
 - Full-depth AC
 - AC rehabilitation

2.9.1. Rigid Pavements

These are pavements surfaced with concrete materials, such as PCC. Because pumping is highly prevalent in these types of pavements under certain conditions, design and installation of subsurface drainage system should take these factors into consideration. To avoid pumping and blowing problems, initial pavement design should adopt design procedures to minimize the problem. These include the use of good base-course materials, as well as insuring proper design of pavement slab. Proper pavement slab design considerations would include design for provision of subsurface drainage systems to ensure water entering the subgrade material is drained at a rate equal to, or faster than, inflow rate.

2.9.2. Permeable Base in Rigid Pavement Design

The Federal Aviation Administration (FAA) design procedures manual has not addressed the permeable base layers directly. During the design of airport pavement, the structural contribution of permeable base layers is ignored because they are relatively weak. A shortfall in the adoption of these systems in rigid airport pavements is the lack of clear consensus on their best location within the typical pavement section (FHWA, 1992). In many projects, construction specifications for the permeable base layers are developed by modifying existing guide specifications, such as Items P-401 or 402 for ATPB and Item P-304 for CTP. Experience has shown that the open-graded nature of these materials prevents the application of conventional techniques for performing mix designs and specifying their construction (FHWA, 1992).

Although there is ample evidence supporting the idea that well designed and constructed stabilized and permeable bases help rigid pavements achieve their long-term performance goals, short- and long-term performance deficiencies, such as early cracking and base pumping, can occur when the primary functions of the base layer are not fully considered when incorporating them into the pavement structure (FHWA, 1992).

Some examples of such misapplications include:

- Selecting the wrong base type for a given application. Certain base types are more effective than others for a given application. For example, permeable bases are most effective when there is a need to rapidly remove water from within a pavement structure
- Increasing stabilized base thickness to reduce PCC layer thickness.
- Increasing stabilized base strength to achieve construction expediency.
- Increasing permeability of permeable bases without properly balancing stability- or durability-related issues.

It is important to take into consideration the mounting evidence of increasing occurrence of early-age cracking in rigid pavements when they are constructed over certain types of stabilized and permeable bases. The design engineer should be aware that under certain situations, some qualities of permeable bases, in combination with other rigid pavement design, materials, and construction factors, are primary causes for such cracking (FHWA, 1992).

2.9.3. Flexible Pavements

Flexible pavements are those surfaced with bituminous, or asphalt, materials. Accumulation of water beneath a flexible pavement experiencing overloading would lead to failure, normally in the form of rutting and shoving. Pavement design should include drainage provision to maintain a water free subbase during the life of the structure.

Table 2.7. Normal subsurface drainage design practices for each pavement type (ERES, 1999).

PAVEMENT TYPE	DRAINAGE INCLUDED IN DESIGN				
	Yes	No	Some	N/A	Total
Conventional AC	16	13	8	0	37
Full-Depth AC	8	12	8	9	37
JPCP	21	5	3	7	36
JRCP	9	5	2	21	37
CRCP	8	4	1	23	36
AC Rehabilitation	4	17	16	0	37
PCC Rehabilitation	8	8	16	5	37

2.9.4. Stabilized Bases in the FAA Rigid Pavement Design

The FAA requires that stabilized base layers (CTB, LCB, or ATB) in all new rigid pavements be designed to accommodate aircraft weighing 100,000 lb (45,250 kg) or more (Hall, 2005). Until recently, the FAA AC 150/5370-10A has provided standards for the construction of airports in the United States. In this guide, specifications for the CTB, LCB, and ATB layers are referred to as Items P-304, P-306, and P-401, respectively.

Two aspects are recommended in the design procedure of PCC drainage layers. First, the minimum prescribed thickness of the stabilized base layer is 4 in (102 mm). Second, follow the FAA design procedure, which considers load stresses alone in determining PCC layer thickness.

Design specifications for the different stabilized base layers are provided by Hall as (2005):

- The Cement Treated Base (Item P-304) layer mixture design specifications are based on strength and durability criteria. The minimum 7-day compressive strength of 750 psi (5,171 kPa) is suggested. According to the 1991 specification, a bond-breaking layer which is normally placed between the PCC layer and CTB is not required. However, in AC 150/5370-10B, a bond-breaking layer is recommended.
 - The mixture design of Lean Concrete Base (Item P-306) in the FAA's guide specifications are based on the criteria that compressive strength be a minimum of between 500 and 750 psi (3,448 and 5,171 kPa), specified at 7- and 28-days, respectively. However, due to possible detrimental effects of high strength bases, the

P-306 guide specification suggests an upper limit of 1,200 psi (8,274 kPa), which may be imposed as an optional requirement.

2.10 DESIGN OF SUBSURFACE DRAINAGE SYSTEMS

The primary factors to consider in developing design alternatives for both new construction and rehabilitation are:

- Traffic- cumulative heavy axle loading measured over the life of a pavement is a necessary factor in the design for subsurface drainage system. This is indicative of potential for damage to the pavement structure from axle loading. Total traffic volume must be accounted for in the geometric design of the roadway.
- Soil characteristics are key factors influencing design features for reduced moisture damage. Strength, deformation, gradation, and permeability properties of the subgrade soil influence pavement design and the need for subsurface drainage.
- Climatic conditions such as rainfall, snow, ice, frost penetration, cyclic freezing and thawing, and daily and seasonal temperature cycling all influence subgrade soil and pavement layers, and are therefore important in selection of alternate designs. Pavements located in regions with little or no rainfall and no freeze-thaw will not require subsurface drainage.
- Construction considerations- there is need for an assessment to determine the time required for initial construction, the period before major rehabilitation is necessary, and the frequency of future maintenance. These are important, especially for urban roadways and other high-volume routes, where traffic control is costly and lane closure time must be minimized.
- Cost comparisons- federal and state agencies recognize the need for assessing all costs of a highway improvement over a certain design analysis period rather than comparing only the initial costs of construction of different alternatives. Economic analysis which compares major costs of a highway improvement over a chosen analysis period must consider initial construction costs, maintenance costs, rehabilitation costs, and road user costs.
- Maintainability of the system and expected performance should be considered.

These primary factors are of paramount importance in an engineering analysis of design alternatives. However, there is need to consider additional factors that are specific to subsurface drainage, including:

- Type of construction (new or a rehabilitation of an existing structure)
- How similar subsurface drainage designs in the area are performing
- Success of local contractors in constructing drainage design alternatives
- Characteristics of surface drainage
- Type of pavement and other design features
- The quality of local materials
- Condition of the Pavement for retrofitting edgedrain design
- Topography

It is therefore critical to consider the interrelationship between subsurface drainage, other design features, and specific pavement performance if optimal pavement design is to be obtained.

2.10.1. Pavements with a Permeable Base System

When determining the appropriateness of using the Permeable Aggregate Base (PAB) concept, Mn/DOT (1994b) guidelines recommends that the following variables are especially important and should be given consideration:

- The Estimated Single Axle Loads (ESALs) of heavy truck traffic volumes and loads
- Type of subgrade soil
- Pavement type
- Pavement functional classification

2.11 CONSTRUCTION AND MAINTENANCE OF SUBSURFACE DRAINAGE SYSTEMS

The importance of subsurface drainage systems for improved pavement performance has been confirmed in various studies. According to Cedergren (1988), all important pavements should have internal drainage, because it eliminates damage, increases pavement life, and has also proved to be cost effective. During the past number of decades, there has been an increase in loadings due to traffic, with a doubling every ten years (ERES, 1999). This has resulted in higher observed incidents of accelerated pavement damage due to moisture. This is responsible for reported increases in the number of states adopting subsurface drainage systems (Yu et al., 1998).

Usefulness of the subsurface drainage system depends on their performance. Experience has shown that many of the systems do not perform up to expectations due to instances of poor design, construction, and/or maintenance (ERES, 1999). Criteria for excellent drainage require that the permeable aggregate base (PAB) layer be able to remove at least 50 percent of the drainable water from the pavement structural section in less than two to three hours after cessation of the precipitation event (Mn/DOT, 1994a). To perform optimally, the subsurface drainage systems need to be designed, constructed, and maintained with high standards. It is good practice to have surfaces on which drainage materials are placed well compacted, stable, dry, free from loose material, and completed to true line and grade (Moulton, 1980). On completion of construction of these drainage systems, inspection should be conducted to verify that these conditions have been met. Necessary measures should be taken to prevent the intrusion of foreign material into any portion of the drainage system due to construction operations and natural rainfall events during and immediately following construction.

2.12 ECONOMICS OF SUBSURFACE DRAINAGE

A number of studies have reported on the cost-effectiveness of subsurface drainage systems in addressing accelerated moisture related pavement deterioration problems. A study by Smith et al. (1990) comparing cost and performance data found that addition of a permeable base to be cost-effective. Results of the study claim a minimum increase in AC pavement life of 4 years through use of a permeable base, and a 50 percent increase in life of PCC pavement. Accurate comparison of costs of different materials would require one to consider the real cost of the material in the pavement on a yield basis.

A general recommendation in the incorporation of subsurface drainage systems is that their total costs should never exceed 2% of the total costs of installation of the pavement structure.

Chapter 3 SELECTION OF SUBSURFACE DRAINAGE SYSTEMS

3.0 INTRODUCTION

In the past, pavement design methods gave greater consideration to establishing a good paving platform, which often outweighed drainage considerations (Mn/DOT, 1994b). Because pavements are commonly subject to moisture-related problems, many engineers are convinced that subsurface drainage design criteria and principles should be part of pavement structural design and construction. It is believed that better, more economical pavements can be designed and constructed if these criteria and principles become an integral part of the pavement design, construction, and maintenance (Christopher and McGuffey, 1997). However, pavement subsurface drainage, which is one of the elements of pavement design, should not be used to reduce reliance on other pavement requirements, such as thickness or strength of the subgrade (FHWA, 1994).

The first important step in the design of subsurface drainage systems is to establish the need for drainage of the structure. Procedures for this determination are described later in this manual.

- Once the need for subsurface drainage has been established, the designer must then determine what type of drainage system is best suited for the conditions of the project under consideration. Since the cost of the pavement project will increase when any drainage system is included, the selected drainage system must be cost-effective to result in sufficient improvements in pavement performance, as well as reduced need for maintenance and rehabilitation costs, in order to justify the increased pavement construction costs (ERES, 1999). There are many types of subsurface drainage systems to choose from. To identify the design best suited for a given project, each alternative system must be evaluated for its effects on pavement performance and cost. The AASHTO Informational Guide on Project Procedures for developing design alternatives provides the primary factors for consideration in the selection of alternative designs (AASHTO, 1963). Although these factors apply to the overall pavement, they give a good indication of the important factors that need to be considered when selecting subsurface drainage design alternatives. These factors are described in section 2.10.

The need for adequate drainage has been repeatedly demonstrated. For example, when concrete slabs were removed during pavement reconstruction, or interceptor trenches constructed for the unbound concrete overlay, these revealed free water beneath the slab, even when there was no rain for weeks previously (Mn/DOT, 1994b).

3.1 DRAIN OR NOT DRAIN?

An important consideration in the design of pavements is the potential need for incorporation of a drainage system in the structure. This can be determined through evaluation of the pavement section, or when considered for a new project, by characterizing site conditions. Evaluation of

the pavement or site conditions may be conducted by obtaining quantitative or qualitative information on the key factors affecting drainage of the structure or area.

3.1.1. Quantitative Evaluation of Drainage Needs

In this analysis, the design engineer will need to conduct survey(s) of the site, taking measurements of all parameters which characterize the key factors affecting drainage conditions of the site. This shall include calculating traffic loading, computing net moisture inflow into the subbase layer, determining required roadway geometry, and determining the type of soil in the subgrade..

The key factors determining the need for subsurface drainage may be categorized as (ERES, 1999):

- Traffic loads, which includes volume and weight (axle)
- Factors that determine the amount of free water entering the pavement, which include:
 - climatic factors of rainfall and temperature (freezing and thawing)
 - groundwater table
 - roadway geometry
 - pavement type and condition
- Factors that increase potential for moisture-related pavement damage, such as:
 - traffic loads
 - subgrade type, strength and condition
 - type of pavement material used
 - design features

Studies conducted on conventional flexible pavements at test tracks indicate that the rate of damage in a saturated pavement structure can be as much as 200 times that rate in a dry pavement structure (Barenberg and Thompson, 1970; Cedergren, 1973a; Cedergren, 1974a).

3.1.2. Traffic Loading

One of the key factors in structural design of pavement is the traffic loading expected on it, in which both volume and weight must be considered. Increased traffic loads are known to be responsible for a majority of moisture related stresses. Table 3.1 offers an example of data comparison between drained and undrained section on highway I-5 near Sacramento, California (ERES, 1999). According to the study, the pavement constructed with effective edgedrains resulted in an increase in construction cost of 5%, resulted in a 90% increase in the life of the pavement in the drained section compared to that of the undrained section.

Table 3.1. Comparison of cost-effectiveness of drained and undrained pavements (ERES, 1999).

	UNDRAINED PAVEMENT	DRAINED PAVEMENT
Faulting (ESALs, millions)	21	45
Transverse cracking (ESALs, millions)	40	40
Transverse spalling (ESALs, millions)	40	48
Cost, C (\$)	487,000	513,400
Life (critical ESALs), L	21	40
% increase in cost, C	5 Percent	
% increase in life, L	90 Percent	
Cost-Effective?	Not determined	Yes

3.1.3. Factors Influencing Amount of Free Water Entering the Pavement

The following are the key factors determining the quantity of ‘free’ water available to enter the pavement subgrade layers:

- **Climatic factors of rainfall and temperature:** The amount of water reaching the pavement surface depends on the rainfall characteristics (amount, intensity, etc.) at the pavement location. Temperature affects the freezing and thawing cycles.
- **Groundwater:** For any given pervious base material, the depth of the ground water table beneath pavement structure is normally inversely proportional to the quantity of water flowing into the pavement subbase layers.
- **Roadway geometry:** Factors such as slope, length, aspect
- **Pavement type and condition:** Pavement type (pervious or impervious), age, and condition all influence the amount of water flowing into the subsurface layers.

Design of pavement subsurface drainage systems need to take these factors into consideration.

3.1.4. Factors Increasing Potential for Moisture-Related Pavement Damage

Pavement problems due to moisture are exacerbated by various factors including:

- traffic loads (weight and volume)
- subgrade type (strength and condition)
- type of pavement material used
- design features

3.2 DESIGN CONSIDERATIONS

This category comprises design conditions which have an impact on drainability of AC pavement. Some of the conditions are:

- Type of construction (full-width paving or other)
- Traffic volume (low, medium, or high)

When combined, these factors can be used to determine an overall design rating useful in assessing the need for subsurface drainage. Table 3.2 presents the overall drainage ratings.

Table 3.2. Ranking design conditions for AC pavements (ERES, 1999).

TRAFFIC CLASS ¹	FULL-WIDTH PAVING	OTHER PAVING TYPES
Low Traffic (Less than 3 million ESALs)	Good*	Fair
Medium Traffic (3 to 15 million ESALs)	Fair	Poor
High Traffic (>15 million ESALs)	Poor	Poor

¹ Traffic class – 20-year Design Lane Cumulative Traffic (Million Equivalent Single Axle Loads, ESALs)

* Pavements with “Good” ranking mean that drainage is not necessary, while those with “Poor” ranking must have drainage incorporated

Table 3.3. Ranking for site conditions for AC and PCC pavements (ERES, 1999).

		Subgrade Permeability					
		>100 ft/day		10 to 100 ft/day		<10 ft/day	
		At Grade/Fill	Cut Section	At Grade/Fill	Cut Section	At Grade/Fill	Cut Section
No-Freeze	Dry	Good*	Good	Good	Fair	Fair	
	Wet		Fair	Fair		Poor	
Freeze	Dry	Fair	Poor	Poor	Poor		
	Wet	Poor			Poor		

* Pavements with “Good” ranking mean that drainage is not necessary, while those with “Poor” ranking must have drainage incorporated

3.3 RECOMMENDATIONS

Table 3.4 presents recommendations on the possibility of using subsurface drainage based on the assessment of new AC pavements according to rankings presented in Tables 3.3 and 3.4.

Table 3.4: Recommendations for subsurface drainage in AC pavements (ERES, 1999).

		SITE RANKINGS (SUBGRADE/CLIMATE)		
		Good	Fair	Poor
Design Rankings (Traffic/Design)	Good	Not Recommended	Feasible*	Feasible
	Fair	Feasible	Recommended	Recommended
	Poor	Feasible	Recommended	Recommended

* For “feasible” the soils/materials engineer should consider the following (ERES, 1999):

- Past performance and experience of the pavement
- The anticipated quality of paving aggregate

- *Availability of materials*
- *Modification needed to improve the gradeline drainage with respect to existing water table*
- *Additional costs and anticipated increase in service life due to inclusion of the permeable bases*

3.3.1. *New PCC Pavements*

Currently, there are no universally recognized criteria for assessing subsurface drainage needs for new PCC pavements (ERES, 1999). The criteria and guidelines for assessing the need for subsurface drainage in PCC pavements are the same categories described for the AC pavement and therefore are assumed to be site conditions and design considerations.

3.3.2. *Site Conditions*

The site conditions that influence drainability of PCC pavements are similar to those for the AC pavements. The site conditions can be ranked as shown in Table 3.3.

3.3.3. *Design Considerations*

There are three main design conditions which are known to influence durability of PCC pavements (ERES, 1999). These are shoulder type (tied PCC or other), presence or absence of dowels, and traffic class (low, medium, or high). Again, as was discussed for AC pavements, these factors are combined to determine an overall design condition rating to be used in assessing the need for subsurface drainage. Design condition ratings are presented in Table 3.5.

Table 3.5. Ranking design conditions for PCC pavements (ERES, 1999).

TRAFFIC CLASS	TIED PCC SHOULDER OR WIDENED LANE		OTHER SHOULDER TYPE	
	Dowels	No Dowels	Dowels	No Dowels
Low Traffic (Less than 4.5 million ESALs)	Good	Good	Good	Fair
Medium Traffic (4.5 to 20 million ESALs)	Good	Fair	Fair	Poor
High Traffic (>20 million ESALs)	Fair	Poor	Poor	Poor

** Pavements with “Good” ranking mean that drainage is not necessary, while those with “Poor” ranking must have drainage incorporated*

3.3.4. *Recommendations for PCC Pavements*

For the PCC pavements, assessment for subsurface drainage needs is conducted using the combination of site and design conditions, which are shown in Tables 3.3 and 3.5. The recommendations are presented in Table 3.6.

Table 3.6. Recommendations for subsurface drainage in PCC pavements (ERES, 1999).

		SITE RANKINGS (SUBGRADE/CLIMATE)		
		Good	Fair	Poor
Design Rankings (Traffic/Design)	Good	Not Recommended	Not Recommended	Feasible
	Fair	Not Recommended	Feasible*	Recommended
	Poor	Feasible	Recommended	Recommended

* Use same guidelines as outlined for AC pavements

3.4 GUIDELINES FOR ASSESSING THE NEED FOR PAVEMENT SUBSURFACE DRAINAGE SYSTEMS

Not all state DOTs have complete guidelines for assessing pavement subsurface drainage needs. Mn/DOT developed a set of guidelines for providing subsurface drainage (ERES, 1999). These were developed following a 2-year effort, and include procedures for assessing the need for drainage. Several factors are considered to determine whether subsurface drainage is required or not, including the presence of heavy truck traffic volumes and loads, in terms of ESALs, subgrade soil type and its susceptibility to moisture-related pavement deterioration, pavement type, and functional class (ERES, 1999).

The guidelines require that the following elements be provided for in a subsurface drainage system (Mn/DOT, 1994a; Mn/DOT, 1994b):

- A permeable drainage layer
- A filter or separator layer
- A collector system comprising of a longitudinal edgedrain and, if required, interceptor drains
- Discharge pipe and headwall
- Adequate ditch depth, especially in rural areas

The Mn/DOT established guidelines in determining where and when PAB should be given consideration for incorporation into a given pavement section. Various physical parameters should be considered, including subgrade soil type (plastic/non-granular vs granular), roadway system (interstate and non-interstate), pavement type (concrete, bituminous full depth, bituminous aggregate base), and traffic levels (20 year design lane BESALs and CESALs) (Mn/DOT, 1994a).

The guidelines developed by Mn/DOT are shown in Table 3.7. At the time these guidelines were developed, there was no known national or Minnesota-based research to help establish the cost-effectiveness of PAB designs (Mn/DOT, 1994a). The recommendations were based somewhat on national and local experience, but primarily on the consensus of the technical committee responsible for developing these guidelines (Mn/DOT, 1994a).

Table 3.7. Criteria for permeable bases in Minnesota (Mn/DOT, 1994).

SURFACE TYPE	ROADWAY TYPE	SUBGRADE SOIL TYPE							
		Plastic/Non-granular				Granular ^D			
		Traffic Class ¹				Traffic Class			
		VH	H	M	L	VH	H	M	L
Concrete	Interstate	R ²	R	NA	NA	R	R/AR	NA	NA
	Non-Interstate	R	R	R	AR	R	R/AR	NR	NR
Bituminous Full-Depth	Interstate	R	R	NA	NA	R	R/AR	NA	NA
	Non-Interstate	R	R	R	AR	R	R/AR	NR	NR
Bituminous Aggregate Base	Interstate	R	AR	NA	NA	R	AR	NA	NA
	Non-Interstate	R	AR	NR	NR	R	AR	NR	NR

¹Traffic Classes are shown below.

Traffic Class	20-year Design Lane Traffic Level (millions)	
	BESALs ²	CESALs
VH (Very High)	> 10	> 15
H (High)	3 - 10	4.5 - 15
M (Medium)	1 - 3	1.5 - 4.5
L (Low)	< 1	<1.5

² **Legend**

- R = Recommended
- NA = Not applicable (see note B).
- AR = As recommended (see note A).
- NR = Not recommended.
- R/AR = See note C below.
- BESALs = Bituminous ESALs
- CESALs = Concrete ESALs

Notes to Table 3.7:

- A. For AR, the district soils/materials engineer should consider the feasibility of providing drainage by reviewing:
 - Past pavement performance and experience
 - Types of distress
 - Anticipated paving aggregate quality
 - Availability of materials
 - Gradeline modification needed to improve gradeline drainage with respect to the in place water table
 - Cost differential and anticipated increase in service life through the use of permeable bases
- B. NA applies to the interstate traffic classes M and L. Interstate has only VH and H traffic classes.
- C. R/AR means recommended if granular material has between 12 and 20% passing the #200 (0.075-mm) sieve and as recommended if the granular material has 12% or less passing the #200 (0.075-mm) sieve.
- D. Granular subgrade is a subgrade in which the upper 2.95ft or more has 20% or less passing the #200 (0.075-mm) sieve.
- E. Open-graded aggregate bases or permeable asphalt-treated base is allowed for concrete pavement. Only permeable asphalt-treated base is used for asphalt pavements.

3.4.1. Permanent International Association Of Road Congresses (PIARC)

The PIARC approach for assessing drainage needs in concrete pavements was developed from data recorded following an international survey of over 100 concrete pavement sections in 26 countries, including the United States (PIARC, 1987; Ray, 1981; Ray and Christory, 1989; Ray et al., 1985). An important issue raised by this approach is that selecting a drainage system should be considered together with other choices that affect performance. An example is given for jointed concrete pavement, in which the approach proposes optimization that will lead to selection of design features from among the following choices (ERES, 1999):

- Type of load transfer
- Subbase and shoulder material erodibility class
- Drainage system
- Sealed or non-sealed joints

The approach by Ray et al. (1985) recommends maximum allowable traffic for nondoweled jointed concrete pavements, based on subbase erodibility rating and traffic as shown in Table 3.8.

Table 3.8. Recommended allowable number of trucks per day for climatic conditions and erodibility of subbase (Ray et al., 1985 as cited by ERES, 1999).

CLIMATE, NUMBER OF RAINY DAYS PER YEAR	SUBBASE ERODIBILITY GRADING					
	12 to 8		8 to 5		5	
	Truck Axle Weight, tons					
	14.3	9.9 - 11	14.3	9.9 - 11	14.3	9.9 - 11
Harsh, 150 days	150	300	300	750	750	2000
Average, 50 to 150 days	300	750	750	2000	2000	2000
Favorable, 50 days	750	2000	2000	5000	2000	5000

By incorporating information reflecting the evolution of practices in various countries over the past 15 years, Christory (1990) developed guidelines for drainage of non-doweled jointed PCC pavements which are shown in Table 3.9. The traffic levels in this table are in terms of heavy commercial vehicles (legal axle weights of 13 metric tons) as follows:

- High: > 750 CV/d
- Medium: 150 to 750 CV/d
- Low: < 150 CV/d

The surface water exposure time given in Table 3.9 refers to the number of days during which water is present on the surface, and is classified as follows:

- High: > 150 days
- Medium: 50 to 150 days
- Low: < 50 days

Table 3.9. Guidelines for drainage of non-doweled jointed PCC pavements (Christory, 1990).

	Heavy (> 750 CV/d)			Medium (150 to 750 CV/d)			Light (< 150 CV/d)		
Time during which water is present on surface Design provisions	high > 150 d	medium 50 to 150 d	low <50 d	high > 150 d	medium 50 to 150 d	low < 50 d	high > 150 d	medium 50 to 150 d	low < 50 d
Interface drainage (type)	I or IIa	I or IIa	I or IIb	I or IIa or IIb	I or IIb*	optional			-
Material of base and shoulder (erodibility class)	A	A or B	B	B	B or C	C	C or D	C or D	D or E
Sealing of joint	yes	Yes	yes	yes	optional with B or C	Optional			

* Subject to verification of stresses in concrete with filter layer which will actually be used.

1. - Drainage -

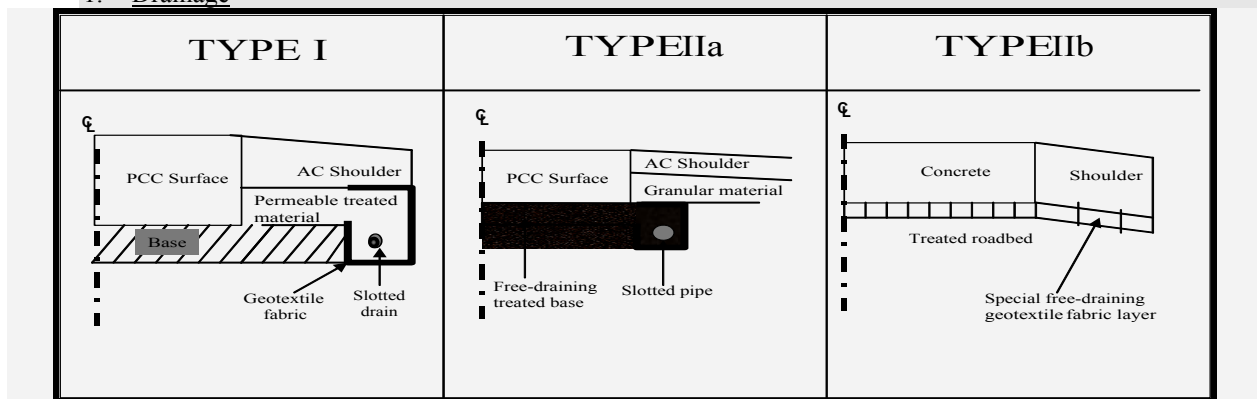

2. Materials and erodibility classes:

- A: Lean concrete with 8 percent cement; bituminous concrete with 6 percent asphalt cement.
- B: Cement treated granular material with 5 percent cement manufacturer in plant.
- C: Cement-treated granular material with 3.5 percent cement manufactured in plant: bitumen treated granular material with 3 percent asphalt cement.
- D: Granular material treated in place with 2.5 percent cement, treated soils.
- E: Untreated granular material.

3.5 SUBSURFACE DRAINAGE DESIGN ALTERNATIVES

Currently, there is no perfect method suited for selecting alternative designs for every project. It is therefore necessary for professional engineering judgment to be applied to each project. This requires that local practice, past experience, and policy dictate the types of alternative designs selected for comparison (ERES, 1999). There are slight differences between approaches used in

selecting alternative designs for new and reconstruction projects from those for selecting alternatives for rehabilitation projects.

Recommended alternatives for new and reconstruction designs include pavements with different subsurface drainage designs, and those without. Subsurface drainage system should therefore be considered a design feature which is a necessary inclusion in a given design to enable the pavement to meet or exceed its design life. The following are broad classes of alternatives which may be considered for new or reconstructed pavement designs (ERES, 1999):

- Pavement types without drainage
- Types of AC and PCC pavements with a partial drainage system (e.g. permeable shoulders with longitudinal drains and outlets)
- Different types of AC or PCC pavements with full drainage system (e.g. permeable base, longitudinal drains, and outlets).

There are a large number of designs falling under these categories. The following procedures shall guide design engineers to select and design the most suitable system for pavements the existing and potential local conditions which may contribute to moisture impacting the life and performance of the pavement

3.5.1. Guidelines for Selection of Drainage Systems

The practice of use of permeable Aggregate Base (PAB) drainage systems for both flexible and rigid pavements is well accepted in Minnesota because of the strong support provided by FHWA, the development of “new” concepts which promote rapid pavement drainage and which can be applied easily, and a concerted effort to prolong pavement life (Mn/DOT, 1994b).

According to the guidelines for application and design of PAB and associated drainage systems under highway pavements, an adequate subsurface drainage system for collection, conveyance, and disposal of surface infiltration and spring thaw moisture in a timely manner is vital to the stability and performance of the total pavement system(Mn/DOT, 1994a).

Selection of alternative designs for comparison in a given project requires a considerable amount of professional engineering judgment to be applied in each project (ERES, 1999). In most situations, local practice, past experience, and policy will dictate the types of alternate designs selected for comparison. The approach used for selecting alternative designs for comparison of subsurface drainage design for new design and reconstruction differs somewhat from those used in selecting alternatives for rehabilitation design.

When selecting subsurface drainage designs for comparison and incorporation into new or reconstruction projects, it is important to include alternative pavements with different subsurface drainage designs, as well as those without subsurface drainage provisions. Subsurface drainage systems should, therefore, be considered as any other design feature, such as dowels or higher quality AC surface, which must be considered during the design to ensure pavement design life is met or even exceeded (ERES, 1999). For new and reconstructed pavements, the following drainage alternatives should be considered:

- Different pavement types without any subsurface drainage

- Different types of pavements (AC and PCC) with a partial drainage system (permeable shoulders with longitudinal drains and outlets)
- Different types of pavements (AC or PCC), with full drainage system (permeable base, longitudinal drains, outlets)

Subsurface drainage is considered a design feature for new pavements in Minnesota that "...will act as a reliability factor for material life..." and ensure that the pavement's life is extended through the projected design life (Mn/DOT, 1994). Since selection of the appropriate drainage design involves comparing alternative types, in this situation we can include a type of flexible pavement with subsurface drainage, a flexible pavement without drainage, and a PCC pavement with drainage. In such states as California, where the current policy is so stringent that drainage is required in most instances, the alternatives selected for comparison should all contain designs of different pavement types (AC and PCC) with different types of drainage (CALTRANS, 1995).

3.6 RECOMMENDED SUBSURFACE DRAINAGE DESIGN ALTERNATIVES

There are many alternative design drainage options to solve problems associated with excess moisture in both new and reconstructed pavement structures. A survey was conducted which asked states to identify, among the following listed types of subsurface drainage, which ones they used for AC and PCC pavements. The survey results show the prevalence of permeable base with a longitudinal pipe drain among most US states, including Minnesota (see Figure 3.1). Results showed (Figures 3.1 and 3.2) the highest rate of adoption being the permeable base and longitudinal pipe drains (ERES, 1996; ERES, 1999). The definition of these abbreviations for the indicated drains are listed below.

- Daylighted dense-graded base (Day AGG)
- Daylighted permeable base (Day Perm)
- Longitudinal pipe drains only (Pipe Drain)
- Permeable base with a longitudinal pipe drain (Pipe & Perm)
- Fin drains only (Fin Drain)
- Fin drains with a permeable base (Fin & Perm)
- Transverse drains (used in conjunction with the others on steep downward grades - Trans Design)

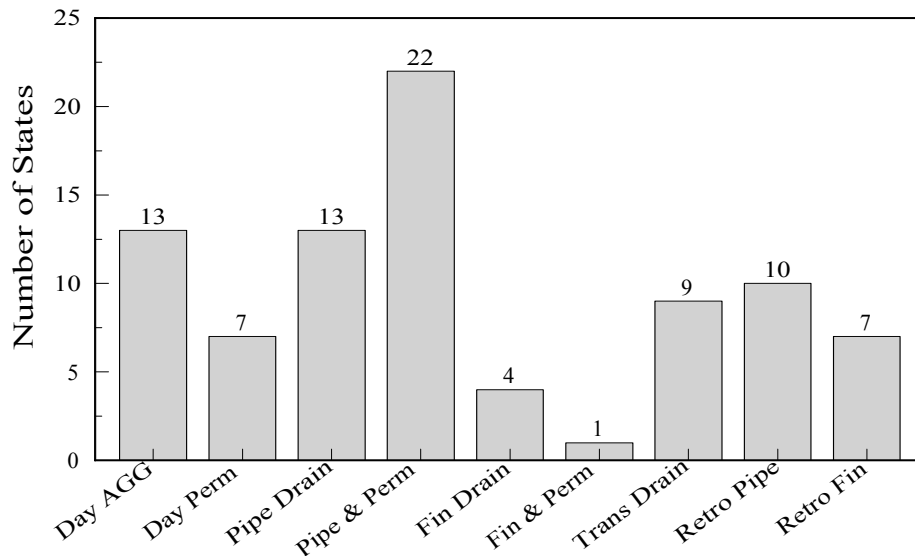

Figure 3.1. Types of subsurface drainage designs for AC pavements used by the States (ERES, 1996).

3.6.1. Subsurface Drainage Systems for Flexible Pavements

There are many types of flexible pavements. The most common types used in the US are the hot asphalt (HMA) mixes. Flexible pavements such as bituminous surface treatments (BSTs) are considered by most agencies to be a form of maintenance. HMA mix types differ from each other mainly in maximum aggregate size, aggregate gradation and asphalt binder content/type. The dense-graded HMA in most flexible pavement sections is the most common HMA pavement material in the US.

The predominant procedure used for flexible pavement design in the US is the AASHTO design procedure (AASHTO, 1993).

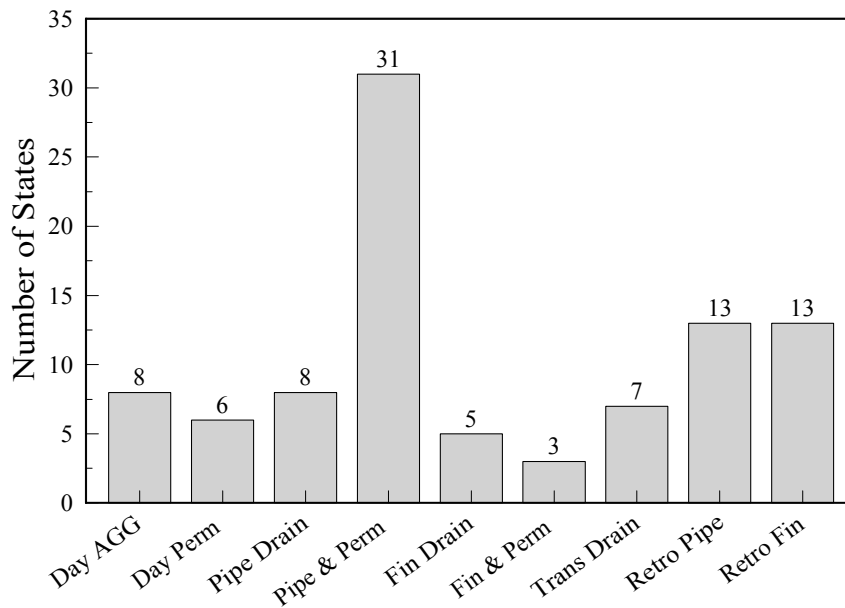

Figure 3.2. Types of subsurface drainage designs for PCC pavements used by the States (ERES 1996).

Pavements which are surfaced with bituminous (or asphalt) materials are commonly referred to as flexible because the total pavement structure bends or deflects due to traffic loads. The structure of this type of pavement is generally composed of several layers of materials which can accommodate the flexing. This type of pavement is generally constructed with the following elements:

- Surface course- this is the top layer which comes in contact with traffic. It may be composed of one or several different hot mix asphalt (HMA) sublayers.
- Base course- this is the layer directly below the HMA layer, which generally consists of stabilized or unstabilized aggregate
- Subbase course- this layer or layers between the base course and the subgrade. It is not always a necessary inclusion. This layer functions primarily as structural support but can also minimize the intrusion of fines from the subgrade into the pavement structure, improve drainage, minimize frost action damage, and provide a working platform for construction.

The NCHRP 1-34 study, which investigated the effectiveness of subsurface drainage in prolonging service life of pavements, came up with recommendations on the use of subsurface drainage and other pavement design features to minimize the effects of moisture on pavement performance (Yu et al., 1998b).

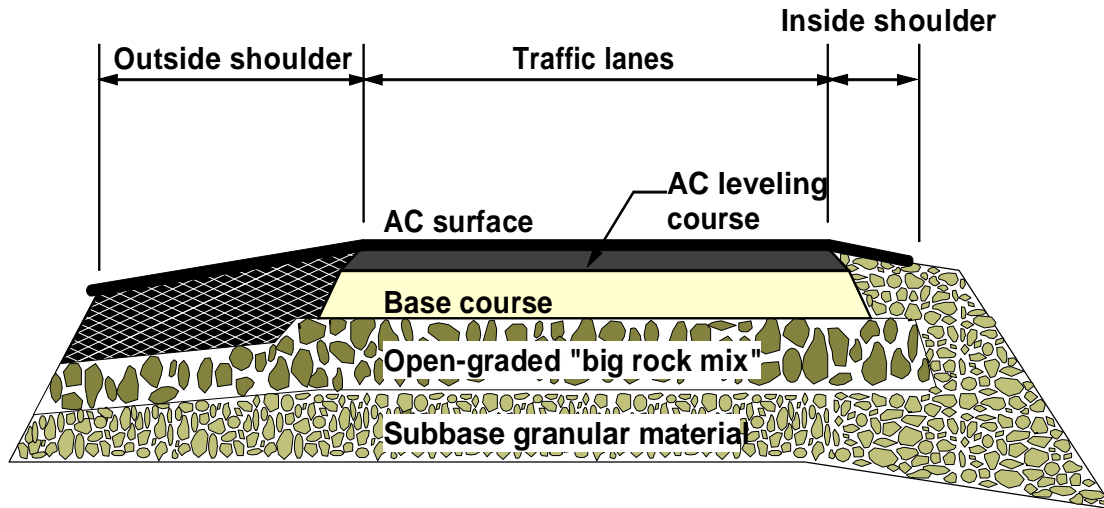

Figure 3.3. Profile of typical AC pavement cross section.

The general recommendations for flexible pavements, which should first be evaluated using a life cycle costing analysis for specific projects, are contained in Table 3.10.

Table 3.10. Recommended levels of subdrainage based on site conditions for flexible pavements.

Design Traffic million ESALs	Subgrade Type	Subsurface Drainage Recommendations
0.5 – 1	All	Baseline adequate
1 – 2	Coarse- grained	Baseline adequate
1 – 2	Fine- grained	Utilize non-moisture sensitive materials
2 – 4	All	Utilize non-moisture sensitive materials
4 – 12	Coarse- grained	Utilize non-moisture sensitive materials
4 – 12	All	Utilize non-moisture sensitive materials, or permeable base
> 12	All	Utilize non-moisture sensitive materials, or permeable base

Notes: Recommendations are based on rutting and fatigue and durability factors. Recommendations are valid for all climatic regions. The baseline is a non-drained pavement structure without any positive subdrainage features. It may, however, include design features that prevent water from entering the pavement structure.

3.6.2. Subsurface Drainage Systems for Flexible Pavements

A recommended subsurface drainage system for an asphalt concrete (AC) pavement should possess the following basic elements:

- A permeable base layer (permeability > 984.25 ft/day)
- A dense-graded aggregate separator layer, usually a DGAB
- An edgedrain collector system with an outlet pipe and headwall; alternatively, the permeable base can be daylighted directly into the ditch
- A roadside channels/ditch with adequate depth, or a storm drain connected to the outlets

3.6.3. Permeable Base Layer

New pavements that are designed and constructed with a drainage layer involve construction of a permeable base layer, which is usually placed beneath the lowest layer in the pavement structure. A separator layer is usually placed directly beneath the permeable base layer to prevent fines from the underlying materials from penetrating into the permeable base, or vice versa. The separator layer is either a dense-graded aggregate material or a Geotextile (ERES, 1999). The longitudinal edgedrains, outlets, and ditches are the mechanisms for draining the permeable base of infiltrated water. Figures 3.4 and 3.5 illustrate typical AC and PCC pavements designs. Design and construction procedures for permeable base layer are presented in Chapters 4 and 5.

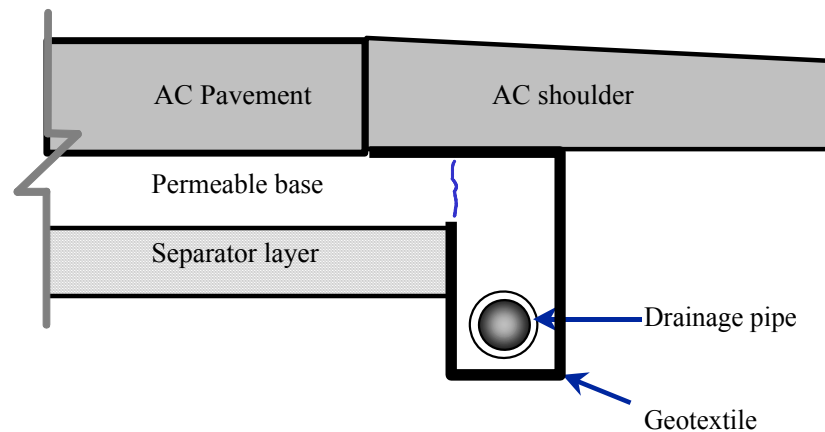

Figure 3.4. The recommended design of AC pavement with a permeable base (ERES, 1999).

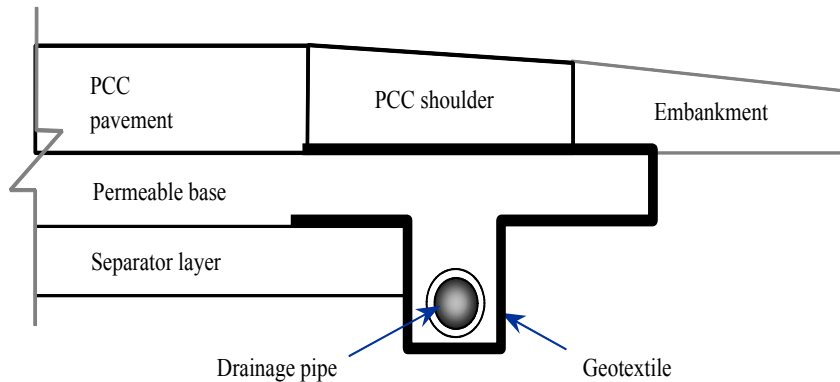

Figure 3.5. The recommended design of PCC pavement with a permeable base (ERES, 1999).

Many state highway agencies (SHAs) use permeable base comprising of open-graded base material to rapidly drain infiltrated water from the pavement structure. The function of a permeable base in both AC and PCC pavements is to intercept and remove any water entering the pavement structure relatively quickly, thus preventing its entry into the lower pavement structure and causing a weakness there (ERES, 1999). A properly designed and constructed permeable base should have the following properties (Cedergren, 1986):

- Sufficient permeability for the layer to drain within the design time period
- Contain sufficient air void space to prevent pumping, and erosion of fines when the pavement is under heavy axle loads, thus preventing general pavement weakening
- The base course must be stable enough to support the pavement during construction operation and must not cause premature distress of the surface layer
- The base course must have enough stability to provide the necessary support for the pavement over its entire design life
- It must provide a dry base to minimize moisture-related distresses in the layers above it, such as D-cracking in PCC pavements and stripping in AC pavements

3.6.4. Daylighted Base Sections

Daylighting of the permeable base (e.g., Figure 3.6) is not often constructed because of concerns of silting up of the daylighted openings. In such situations, longitudinal edgedrains and outlets are common alternatives to daylighting (ERES, 1999). It has also been noted that with shallow ditches, daylighting may result in flooding of the permeable base. Some limited data on performance of this design have shown positive results (Yu et al., 1998a).

3.6.5. Aggregate Separator Layer

The properties of an appropriate separator layer (Figure 3.7) must be known for given pavement conditions. The following descriptions of the properties of aggregate and geotextile separator layers, as well their effects on performance of pavements as were provided by Moulton (1980).

The aggregate separator layer is usually made of a dense-graded aggregate with very low permeability, making it suitable for most of the functions outlined below. An appropriate aggregate separator layer must have the following physical properties (FHWA, 1994a). It must consist of durable, crushed angular aggregate material, which has good mechanical interlock. It

should also meet the requirements for a class C aggregate in accordance with *AASHTO M 283-83, Coarse Aggregate for Highway and Airport Construction*. The L.A. abrasion wear of aggregate separator layer materials should not exceed 50 percent, as determined by AASHTO T 96-87. Also, the soundness percent loss of the aggregate should not exceed the 12 or 18 percent requirements for a class C aggregate, as specified in AASHTO M 283-83, determined by the sodium sulfate or magnesium sulfate tests, respectively, in AASHTO T 104 - 86. Lastly, the aggregate separator layer should meet the requirements for a 50 CBR subbase as recommended by the U.S. Army Corp of Engineers (U.S. Army COE, 1992).

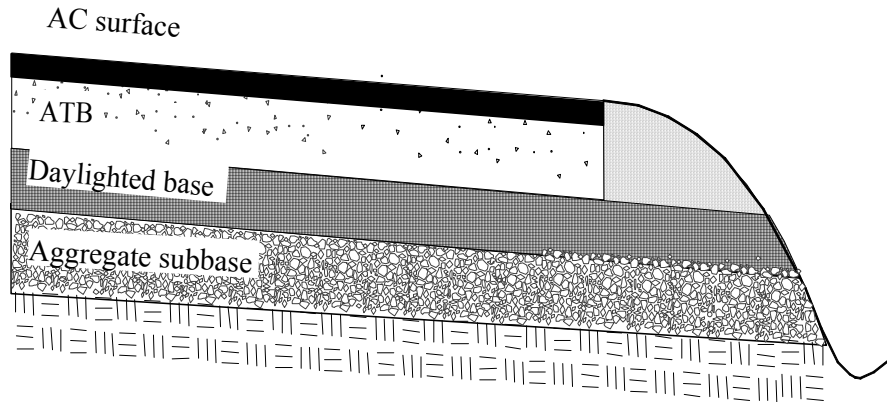

Figure 3.6. Typical AC pavement with a daylighted base (ERES, 1999).

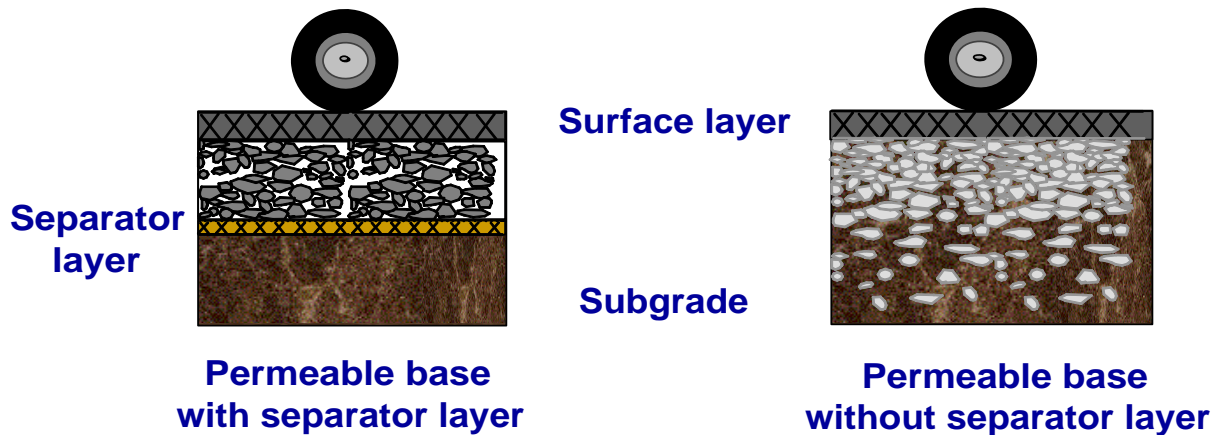

Figure 3.7. Concept of separation of permeable base and subgrade (Holtz et al., 1998).

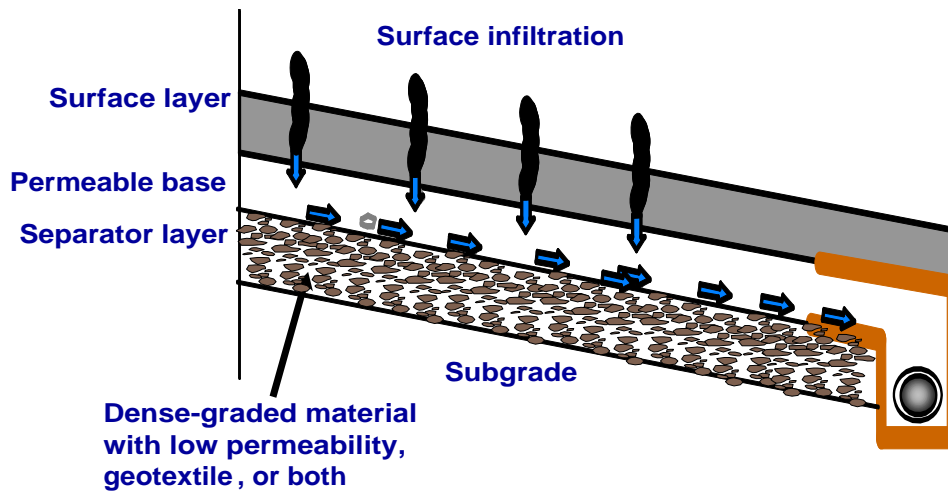

Figure 3.8. Concept of drainage promoted by the separator layer (ERES, 1999).

When an adequate granular separation layer is included, it provides a firm foundation for constructing the drainage layer as well as adding strength to the existing pavement structure. Although the separator cannot be a substitute for a strong subgrade, when its thickness is increased, it can be used over a soft, wet, fine-grained soil (ERES, 1999). A weak subgrade (CBR less than 6), would require mechanical or chemical stabilization to provide a suitable construction platform (Laguros and Miller, 1998). Because of its low permeability, a dense-graded aggregate can easily deflect water (Figure 3.8) that has infiltrated the pavement structural section to the edgedrains or pavement edge.

3.7 REHABILITATION DESIGN

The decision to provide drainage in existing pavements will often be made after moisture-related distresses have been observed. Retrofitting pavements may not always be the solution. For example, it is possible to decide not to install an edgedrain in a given pavement if the distress is significant and it is probably too late for the edgedrain to make a difference (ERES, 1999). It is essential that engineering analysis precede any rehabilitation design to determine whether drainage will reduce the acceleration of the observed distresses or reduce moisture accelerated distress.

In the case where the distressed pavements is to be rehabilitated with an overlay while leaving the distressed pavement in place, the distressed pavement will take the place of the base course layer. If longitudinal drains are to be used, they should be designed to work with the distressed pavement as the drainable layer for water removal from the subsurface. As such, it is important that the distressed pavement layer, should have sufficient fractures to provide continuity between individual fractures running longitudinally along and transversely across the pavement. As shown in section 2.8.3, when the pavement is fractured, even with thin fractures, the equivalent hydraulic conductivity of the fracture network is extremely high, and not a limiting factor to the transmission of water through the layer.

3.8 SEQUENCE OF STEPS FOR SELECTION OF ALTERNATIVE SUBSURFACE DRAINAGE DESIGNS

When it has been determined that there is need for subsurface drainage, the design engineer has the task of deciding on the most appropriate alternative design to adopt for the pavement project at hand. Section 3.5 and Appendix A present guides to aid in arriving at the best alternative for adoption in rehabilitation projects. Appendix B contains plans of design systems commonly used in transportation infrastructure systems in Minnesota. For new projects, selection of the drainage system goes hand in hand with overall project design. In this section, we shall address selection of design alternatives for adoption in rehabilitation (retrofitting) projects.

3.9 EVALUATING SUBSURFACE DRAINAGE NEEDS FOR EXISTING PAVEMENTS

Conducting drainage evaluation starts with a visual inspection of the pavement, or future location of a new pavement, following the procedures described in literature (Nichols, 1998; SHRP, 1993). During this inspection, the following drainage-related questions should be answered:

2. What are the depths of the ditches?
3. Is the flowline beneath the top of the subgrade?
4. Are ditch lines clear of standing water?
5. Are the ditch lines and pavement edge free of vegetation?
6. Does moisture stand in the joints or cracks immediately following rainfall?
 - a. Is there any evidence of pumping?
 - b. Does water stand at the outer edge of the shoulder?
 - c. Is there any evidence that water may pond on the shoulder?
7. Are the outlets to surface drainage clearly marked, easily found, clear of debris, and set at the proper elevation above the ditch line?
8. Are inlets clear and set at proper elevations, with adequate cross slope on the pavement surface to get water to the pavement edge?
9. Is the condition of joint sealants or crack sealants good, and will sealant prevent water from entering the pavement?

Survey visual observation data may be recorded in a form such as provided in Chapter 4 in Figure 4.2.

The purpose of assessing drainage need analysis is to establish the potential for the pavement structure being negatively impacted by the presence of water, and to determine whether the provision of a drainage system would have significant effects on the life and performance of the pavement. Key indicators of drainage needs are:

- The supply of water at or adjacent to the site has affected or may affect normal performance of the pavement structure
- The time required to drain the water by natural drainage is too long

In summary, the guidelines for assessing subsurface drainage needs have been divided into three categories (ERES, 1999). These are existing pavements, newly constructed AC, and newly constructed PCC pavements.

For existing pavements, a drainage survey must be conducted to determine the condition of the pavement (ERES, 1999). The surveys would determine the extent of current moisture-related damage and discover the presence or absence of key factors likely to cause moisture related damage to the pavement. Drainage evaluation involves surveys and examination of critical factors that influence moisture conditions in a pavement (ERES, 1999).

The following parameters will be quantified to aid in selection of drainage system design alternatives.

- Traffic- selection of alternative design to consider those best suited for expected total volume of traffic and cumulative axle loadings over the life of a pavement.
- Soil Characteristics- strength, deformation, gradation, and permeability properties of the subgrade soil are important
- Climate- design adopted should be able to handle the amount of water under given rainfall-, snow-, ice melt- quantity and rates, and also perform as per design under the expected temperature fluctuations for the area
- Construction considerations- time required for initial construction, period before major rehabilitation is required, and frequency of future maintenance are important, particularly for urban roadways and high volume routes
- Cost comparisons- economic analysis comparing the major costs of highway improvement over a chosen analysis period must consider initial costs and maintenance costs

Chapter 4 DESIGN OF SUBSURFACE DRAINAGE SYSTEMS

4.0 DRAINAGE NEEDS ANALYSIS

One of the critical factors determining the validity of a designed subsurface drainage system is the accuracy and completeness of the data upon which design computations are based. The parameters required for designing subsurface drainage systems can be estimated from readily available climatic, soil, and topographic data. From the available information engineers must make every effort to develop input data that is as realistic as possible while preserving an appropriate measure of conservatism (Moulton, 1980).

Data required for analysis and design of subsurface drainage can be grouped into four general categories, which are:

- the geometry of the flow domain
- the properties of the materials
- the climatological data, and
- other

Recommendation for installation of a subsurface drainage system will be made if upon survey of the project site records there is a presence of any of the following conditions (ERES, 1999):

- Moisture related distress (attributed to moisture, and not any other factor), including stripping, rutting and fatigue cracking in AC pavements, or pumping, faulting and D-cracking in PCC pavement
- Pavement longitudinal slope is near zero percent (-0.5 – 0.5 percent)
- The pavement section is located in a cut
- Notable obvious signs of poor drainage, such as standing water in ditches or cattails, willows, or other wetland vegetation

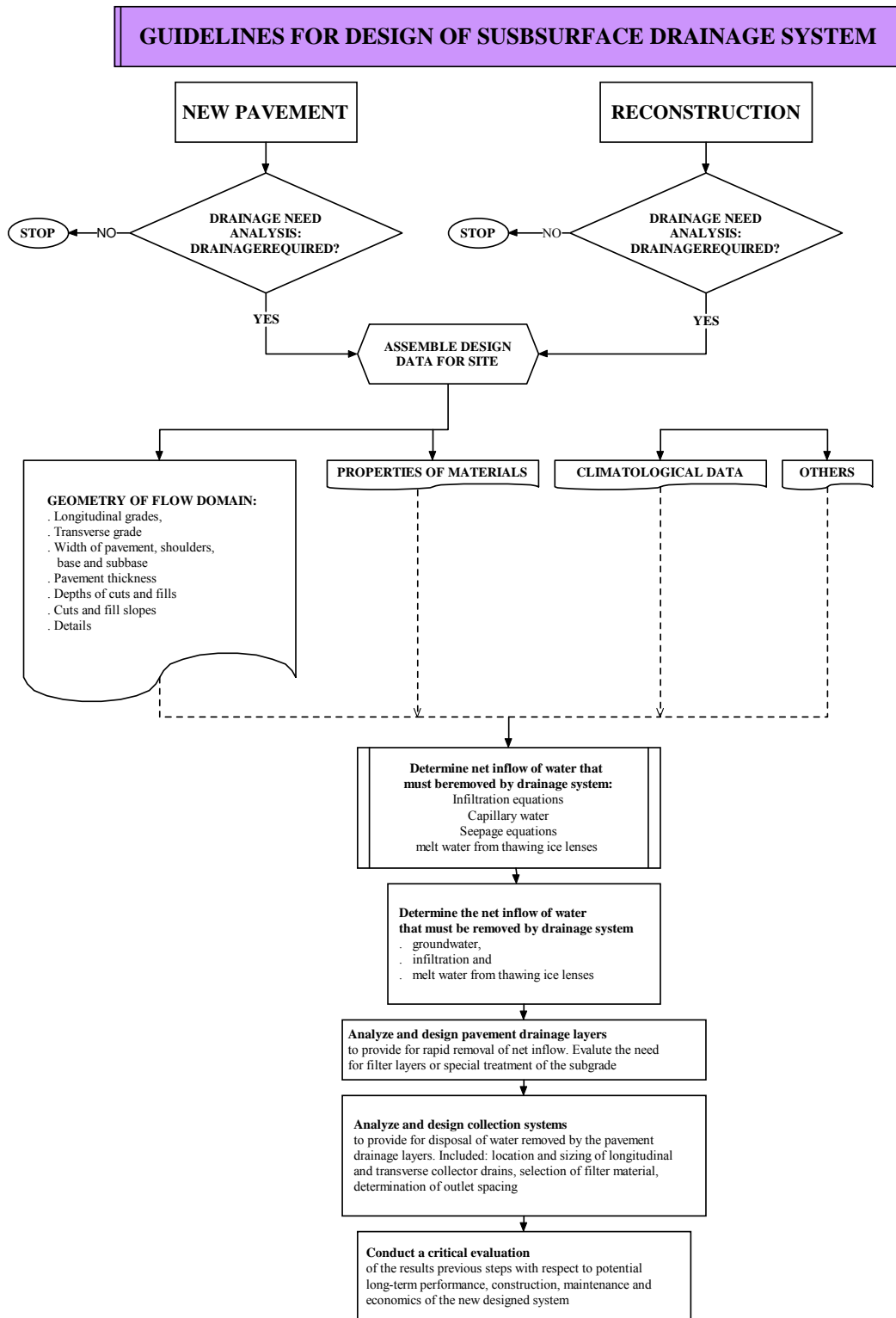

Figure 4.1. Outline of the design steps for subsurface drainage system for highway pavement.

4.1 SOURCE OF PAVEMENT DISTRESS

Designers of pavement structures should make informed decisions on the need for inclusion of subsurface drainage systems. The key factors in the determining the need for subsurface drainage may be categorized as (ERES, 1999):

- Traffic loads, which includes volume and weight (axle)
- Factors that determine the amount of free water entering the pavement, which include:
 - roadway geometry
 - climatic factors of rainfall and temperature (freezing and thawing)
 - ground water table
 - pavement type and condition
- factors that increase potential for moisture-related pavement damage, such as:
 - traffic loads
 - subgrade type, strength, and condition
 - type of pavement material used
 - design features

4.1.1. Traffic Loads

For any pavement design, it is critical to have an accurate enough figure of the expected loading the pavement has to support. This is equivalent to the total ESAL, which is evaluated using equation 2.10.

4.1.2. Site Conditions

The climatological data provide an important insight into the fundamental source of all subsurface water and the potentially adverse effects of frost action. In the design of subsurface drainage systems, climatic data is important in evaluating the potential for moisture presence in the base and subgrade of the structure. Key required data include precipitation and the depth of frost penetration, which are discussed below.

Precipitation

An understanding of the frequency, intensity, and duration of precipitation in the project area is necessary. A reasonable correlation exists between fluctuations in groundwater level and infiltration of rainfall into pavement sections, and is dependent more upon duration of rainfall than intensity or frequency (Moulton, 1980).

Precipitation data may be availed through the United States National Weather Service, which publishes records of precipitation in a variety of forms. Maps which show rainfall intensity as a function of frequency and duration can be obtained, an example of which is the 2-Year, 1-hour rainfall intensity shown in Figure 4.2.

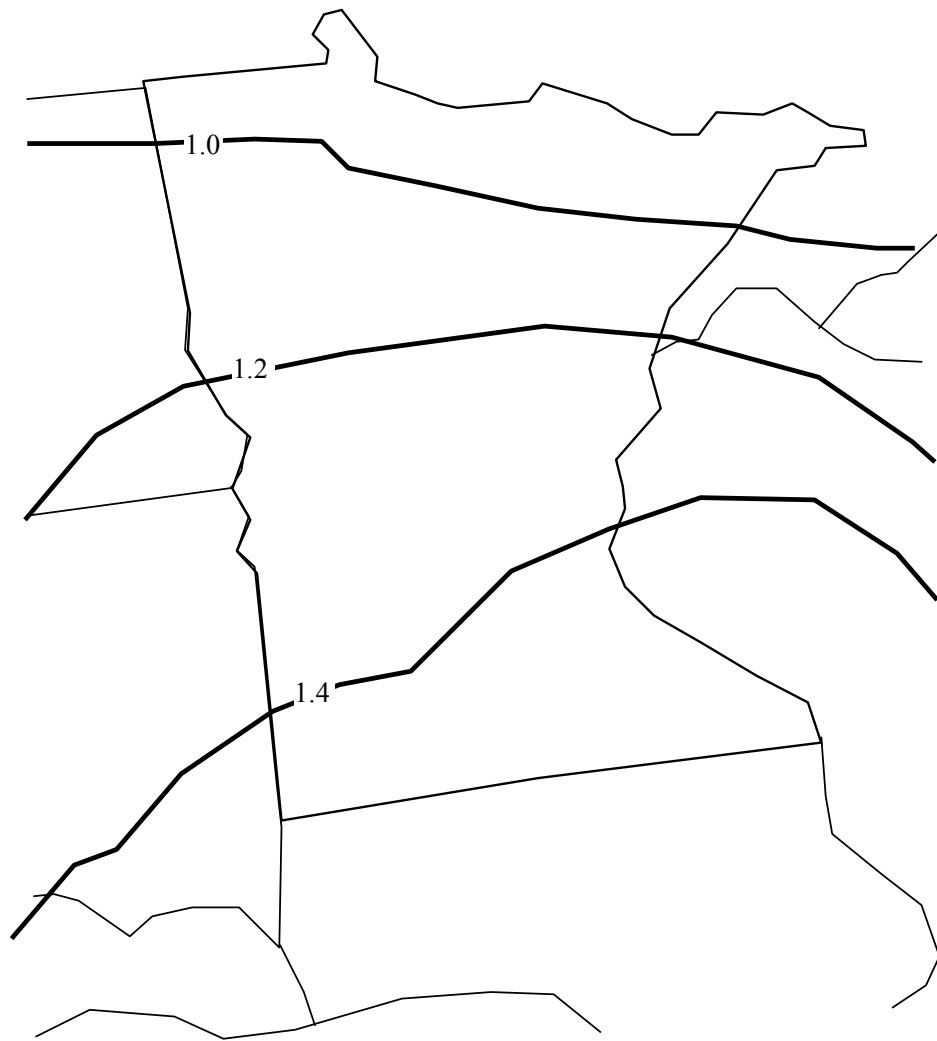

Figure 4.2. Two-Year, one-hour rainfall intensity in Minnesota (ERES, 1999).

Depth of Frost Penetration

Knowledge on the depth to which freezing temperatures may penetrate into the pavement or underlying subgrade can be helpful in assessing the seriousness of possible frost action. This information may be derived using theoretical relationships which have been developed permitting a reasonably reliable prediction of frost depth based upon air or pavement freezing indices and the thermal properties of the pavement elements and the subgrade (Aldrich, 1956; Johnson, 1952; Moulton, 1968; NCHRP, 1974). The modified Berggren equation appears to be the most reliable of these formulas (Aldrich, 1956; Moulton, 1968).

Maps which give average or maximum depths of frost penetration may be helpful (Figures 4.3 and 4.4), but should be used with caution because the extreme variations in frost depth can occur as a function of elevation and latitude (Moulton, 1968). The most ideal data would be the well

kept records of accurately measured depths of frost penetration, which would provide the best source of frost depth data. With advances in record keeping and computing, accurate weather records and the use of the digital computer permit reliable individual predictions of local frost penetration to be made with relative ease and speed (FHWA, 1992)

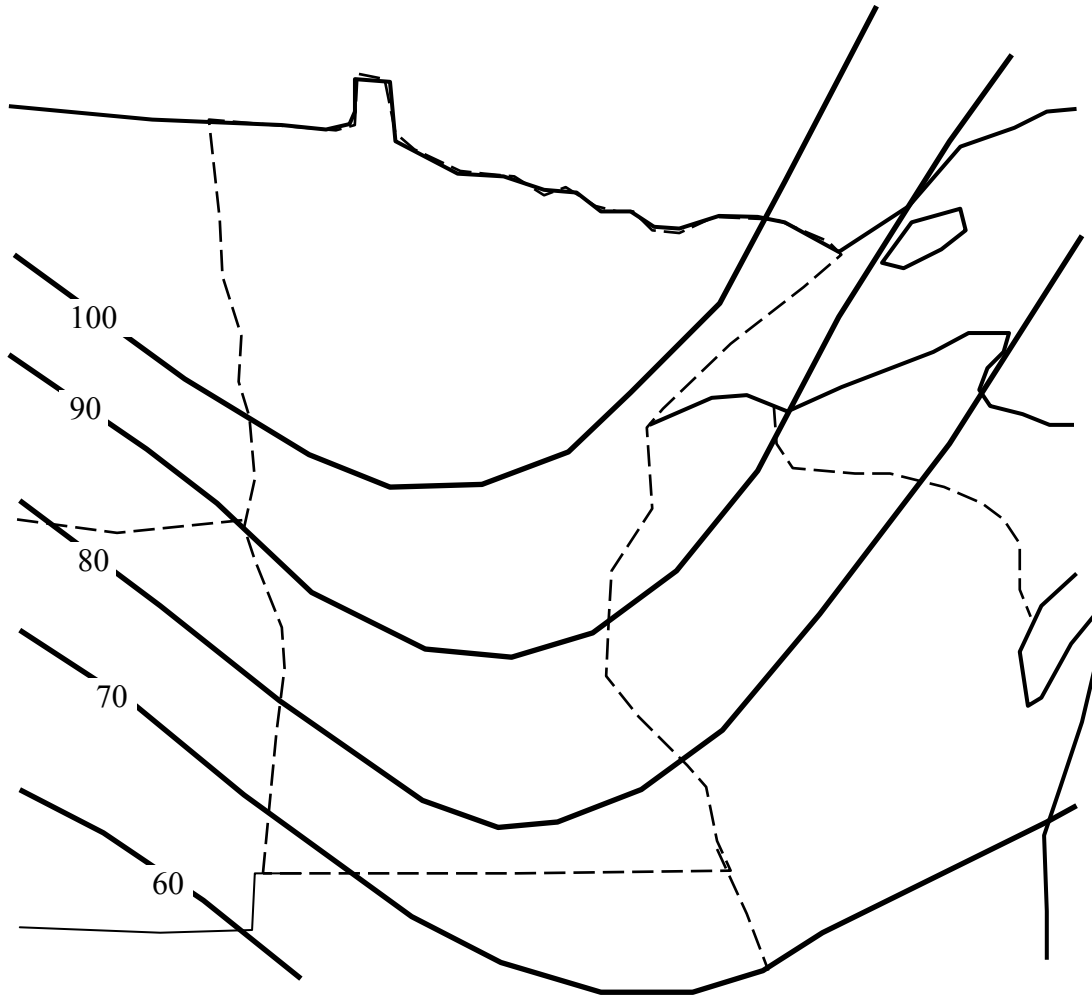

Figure 4.3. The maximum depth of frost penetration (inches) in Minnesota (Sowers and Sowers, 1961).

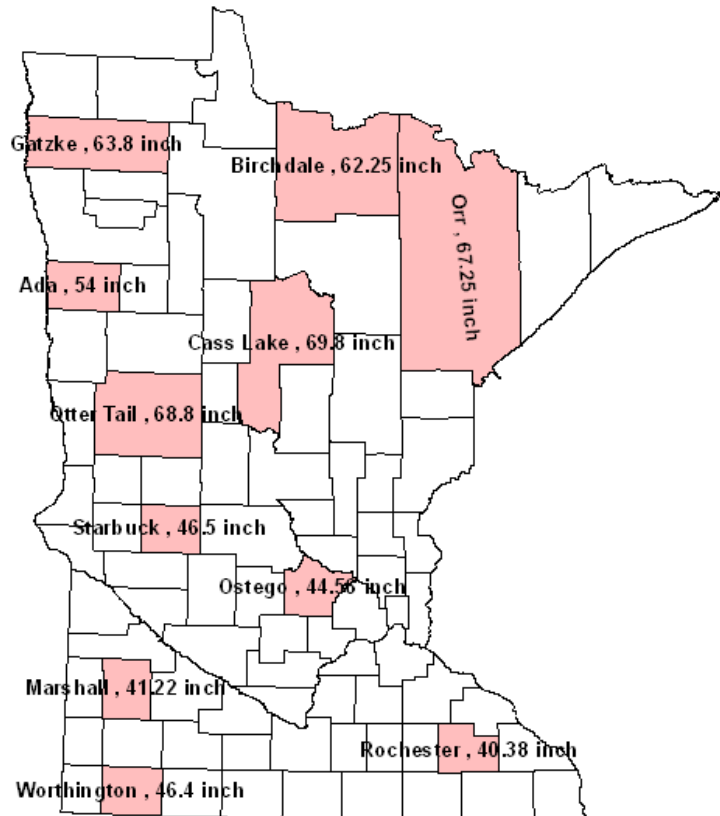

Figure 4.4. Averages of the maximum soil frost depths recorded at Mn/DOT monitoring stations in Minnesota counties, 1998-2008 (http://www.mrr.dot.state.mn.us/research/seasonal_load_limits/thawindex/frost_thaw_graphs.asp).

4.2 SOURCES AND QUANTITY OF WATER

4.2.1. Infiltration

Water arriving at the pavement surface may infiltrate into the subgrade layers through surface discontinuities such as joints, cracks, shoulder edges and any other defects in the pavement surface. Studies have shown surface infiltration to be the single largest source of moisture-related problems in PCC pavements (FHWA, 1994). Hagen and Cochran discovered that 40 percent of rainfall enters the pavement (1995).

The amount of water infiltrating into one square foot of pavement (cu ft/day/sq ft) can be determined by two methods (FHWA, 1992). These are known as infiltration ratio and the crack infiltration method, which are discussed below.

Infiltration Ratio

In this method, a design rainfall and an infiltration ratio are selected. Based on these parameters, the pavement infiltration (q) is determined using equation 4.1.

$$q_i = C.R \left[\frac{1}{12} \right] (ft/in) \times 24(hr/day) \times (1 ft \times 1 ft) \quad (4.1)$$

Equation 4.1 can be simplified to:

$$q_i = 2C.R \quad (4.2)$$

where

- q_i = Pavement infiltration, cu ft/day/sq. ft of pavement
- C = Infiltration ratio
- R = Rainfall rate, in/hr

The infiltration ratio, C, is the portion of rainfall entering the pavement through joints and cracks. For design guidance, a range of infiltration coefficient values of 0.33 to 0.50, and 0.50 to 0.67 have been suggested for asphalt concrete pavements and Portland cement concrete pavements, respectively (FHWA, 1992). For simplicity, it is suggested that designers adopt an infiltration coefficient of 0.50. In the design of drainage systems, it is important that engineers select a design storm whose frequency and duration will provide an adequate design. The 2-year frequency, 1-hour duration storm is usually suggested (FHWA, 1992). Figure 4.2 provides generalized rainfall intensities for a 2-year frequency, 1-hour duration rainfall. However, current and detailed information for some regions in the United States can be found in the NOAA publication NWS-35 (NOAA, 1973; NOAA, 1977). An example of this method is shown in Appendix D (see Example 4.1).

Crack Infiltration

The crack infiltration method has been referred to in some publications as the preferred method of design for pavement infiltration (FHWA, 1992; Moulton, 1980). Crack infiltration may be computed using equation 4.3.

$$q_i = I_c \left[\frac{N_c}{W} + \frac{W_c}{WC_s} \right] + k_p \quad (4.3)$$

where

- q_i = Pavement infiltration, cu ft/day/sq ft
- I_c = Crack infiltration rate, cu ft/day/ft of crack
- N_c = Number of longitudinal joints or cracks
- W_c = Length of contributing transverse joints or cracks, ft
- C_s = Spacing of contributing transverse joints or cracks, ft
- W = Width of permeable base, ft
- k_p = Pavement permeability, cu ft/day/sq ft

To avoid the problem of selecting the design storm and infiltration ratio, a crack infiltration rate of 2.4 cu ft/day/ft is suggested by Moulton (1980). However, engineers need to bear in mind that this value is based on a minimal amount of research data.

The number of longitudinal cracks is dependent on the pavement geometry, which is a factor of the number of contributing traffic lanes and the uniform cross slope or crowned pavement.

The number of longitudinal joints or cracks can be estimated from the following relation as (FHWA, 1992):

$$N_c = N + 1 \quad (4.4)$$

where

- N_c = The number of longitudinal cracks
- N = The number of contributing traffic lanes

On super-elevated sections, where the uppermost crack or joint may not intercept very much flow, this method of estimating the number of cracks may yield very conservative values.

Engineers have to use judgment when determining the number of longitudinal cracks in a given highway section. In an example of a road consisting of two traffic lanes with a uniform cross slope (not crowned), the number of contributing traffic lanes would be two, while the number of longitudinal joints or cracks would be three. This is illustrated in Figures 4.5 and 4.6.

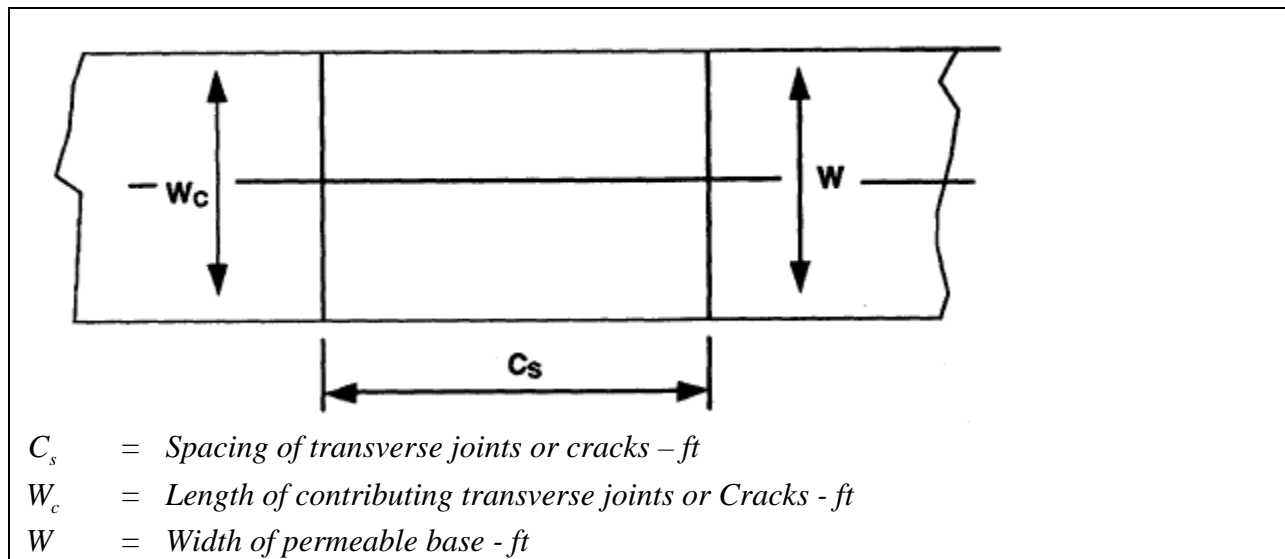

Figure 4.5. Crack layout - plan view (ERES, 1999).

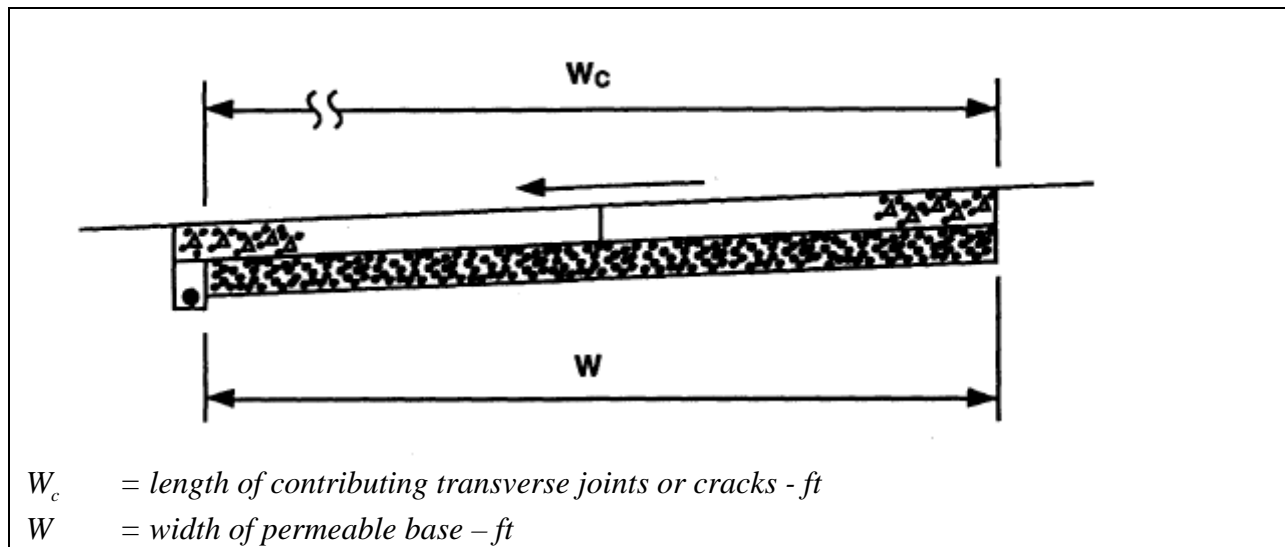

Figure 4.6. Crack layout - sectional view (ERES, 1999).

In the design of infiltration into new PCC pavement, it is suggested that the transverse crack spacing (C_s) be taken as the regular transverse joint spacing and as anticipated average transverse crack spacing for new, continuously reinforced concrete pavement (FHWA, 1992; Moulton, 1980).

Since pavement permeability (K_p) represents the flow through the uncracked pavements, its value would be zero for concrete and densely compacted hot mix asphalt pavements. The crack infiltration method provides engineers with a flexible method for modeling pavement infiltration. Some examples of this method is shown in Appendix D (see Examples 4.2-4.4).

4.2.2. Groundwater, q_g, q_a

The flow of groundwater into the pavement structure by gravity flow is illustrated in Chapter 2 in Figure 2.2. The lateral flow of groundwater toward the pavement structure is driven by the relatively higher water table to the side of the roadway. Some of this lateral flow will be intercepted by the roadway ditch, if it exists, or by an interceptor drain, which will be examined later. Some will enter directly into the base of the road and some may pass by the roadway structure, depending on the geometry of the cross-section. In the design for gravity drainage, the average inflow rate, q_g , can be estimated using the chart given in Figure 4.7 (Moulton, 1980).

The first step in the computations will be to determine the "radius of influence" or distance of drawdown influence, which, for practical purposes, can be estimated by means of the expression:

$$L_i = 3.8(H - H_o) \quad (4.5)$$

where L_i is the influence distance (ft), and $(H - H_o)$ is the drawdown (ft).

The evaluated value of L_i is used with Figure 4.7 to determine the total quantity of upward flow, q_g , into the drainage blanket. The average inflow rate (q_g) can then be computed from the relationship

$$q_g = \frac{q_2}{0.5W} \quad (4.6)$$

q_g is the design inflow rate from gravity drainage (cu. ft/day/sq. ft of drainage layer), q_2 is the total upward flow into one half of the drainage blanket (cubic feet/day/linear foot of roadway and W is the width of the drainage layer (feet). Although the solution given in Figure 4.7 is based on a symmetrical configuration of gravity flow, very little error is introduced if the flow conditions are not exactly symmetrical because of roadway cross slope, variation in depth of the impervious boundary, etc. Under these conditions, the use of average values of H , H_o and L_i in Figure 4.7 will be satisfactory. The lateral flow, q_1 (cu.ft/day/lineal foot of roadway), to the longitudinal edgedrain shown in Figure 4.7 is calculated from

$$q_1 = K(H - H_o)^2 / 2L_i \quad (4.7)$$

where K = soil hydraulic conductivity (ft/day). An example showing these calculations is located in Appendix D (see Example 4.5).

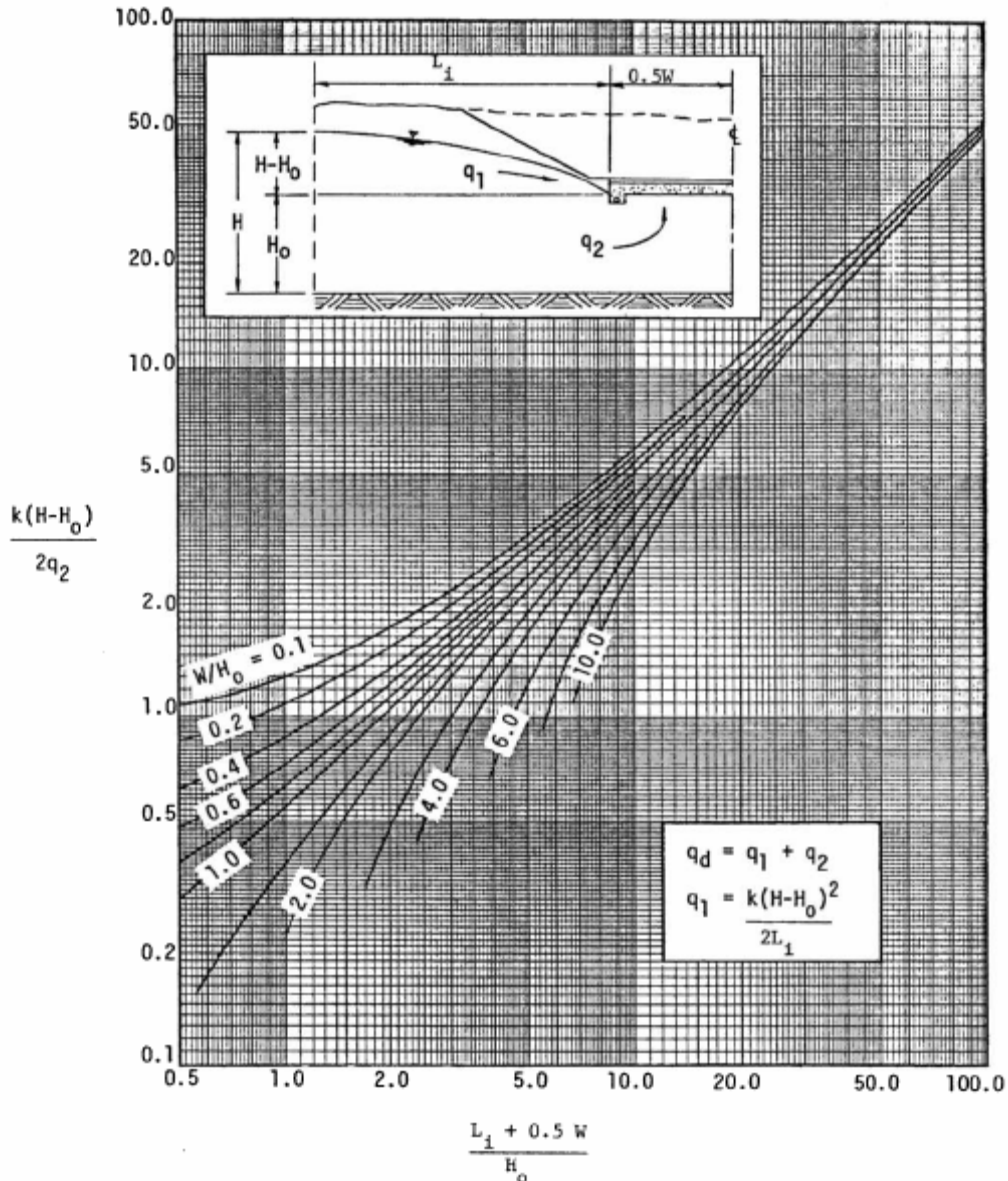

Figure 4.7. Chart for determining flow rate into horizontal permeable base (Moulton, 1977; Moulton, 1979; Moulton, 1980).

Flow from underlying confined aquifers can also be a source of water to the pavement structure. This situation is illustrated in Chapter 2 in Figure 2.3. The upward flux to the pavement structure can be estimated if the pressure in the confined aquifer is known or can be estimated. The upward flux, q_a , is calculated using

$$q_a = K \frac{H_a}{D} \quad (4.8)$$

where q_a is the upward artesian flow (cu.ft/day/lineal foot of roadway), H_a is the height which water will stand in a well installed in the confined aquifer above the elevation of the pavement

base course, and D is the thickness of soil material between the aquifer and the base course. An example showing the calculations to obtain q_a is located in Appendix D (see Example 4.6).

4.2.3. Spring Thaw, q_m

Moisture emanating from spring thaw may lead to accelerated moisture-related damage, especially in pavements constructed with or over frost susceptible materials (ERES, 1999). In their study conducted in Minnesota, Hagen and Cochran (1995) showed that spring thaw flows can be almost equivalent to a major rain event.

Because most base, subbase, and subgrade materials are known to be susceptible to freeze-thaw damage, potential damage can be avoided if adequate subsurface drainage is provided, or by treating the material to reduce susceptibility to moisture, or both (NCHRP, 1974).

The amount of ice accumulating in a highway subgrade as a result of frost action is dependent upon the frost susceptibility of the subgrade soil, availability of groundwater to feed the growth of ice lenses, and the severity and duration of subfreezing temperatures (Moulton, 1980). The movement of water by seepage from the thawing soil is a function of thawing rate, permeability of the thawed soil, the effectiveness of the pavement drainage system, and the loading imposed by the overlying pavement structure and vehicular traffic. The design inflow rate estimates can be made by appropriate use of Figure 4.8.

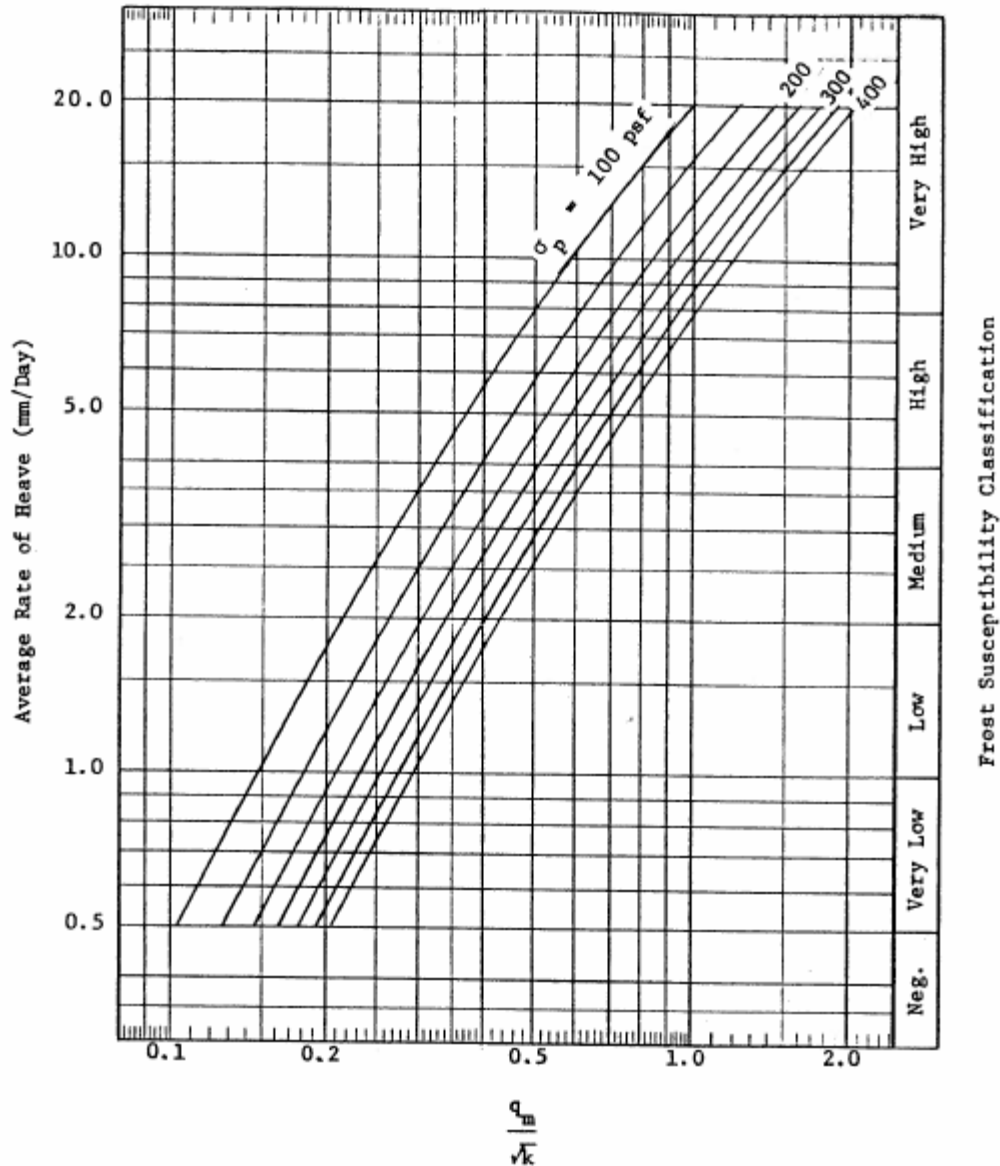

Figure 4.8. Chart for estimating design inflow rate of melt water from ice lenses (Moulton, 1980).

The q_m as determined from Figure 4.8 involves use of a value of laboratory heave rate or the frost susceptibility classification shown in Table 4.1. Since the results of laboratory freezing tests on specific soils are rarely available, the selection of a heave rate for use in Figure 4.8 depends upon the exercise of experience and judgment, which may be based on observations of frost action in local soils. In lieu of this experience and judgment, the conservative guidelines presented in Table 4.1 are recommended (Moulton, 1980). Example 4.7 in Appendix D shows a solution to a problem involving spring thaw flow.

Table 4.1. Guidelines for selection of heave rate or frost susceptibility classification for use in Figure 4.8 (Moulton, 1980).

Unified Classification		Percent <0.00079 inches	Heave Rate inch/day	Frost Susceptibility Classification
Soil Type	Symbol			
Gravels and Sandy Gravels	GP	0.0157	0.118	Medium
	GW	0.028 - 0.039	0.012-0.039	Negl. to Low
		0.039-0.059	0.039-0.138	Low to Medium
		0.059-.175	0.138-0.079	Medium
Silty and Sandy Gravels	GP-GM	.079-0.118	0.039-0.12	Low to Medium
	GW-GM	0.118-0.276	0.118-0.177	Medium to High
	GM			
Clayey and Silty Gravels	GW-GC	0.165	0.098	Medium
	GW-GC	0.591	0.197	High
	GC	0.591-1.181	0.098-0.197	Medium to High
Sands and Gravely Sands	SP	0.039-0.079	0.031	Very Low
	SW	0.079	0.118	Medium
Silty and Gravely Sands	SP-SM, SW-SM, SM	0.059-0.079	.008-0.06	Negl. to Low
		0.079-197	0.06-0.26	Low to High
		0.197-0.354	0.263-0.35	High to Very High
		0.354-0.866	0.354-0.217	
Clayey and Silty Sands	SM-SC	0.374-1.378	0.217-0.276	High
	SC			
Silts and Organic Silts	ML-OL , ML	0.906-1.299	0.043-0.551	Low to Very High
		1.299-1.772	0.551-0.984	Very High
		1.772-2.559	0.984	Very High
Clayey Silts	ML-CL	2.362-2.953	0.512	Very High
Gravely and Sandy Clays	CL	1.496-2.559	0.276-00.394	High to Very High
Lean Clays	CL	2.559	0.197	High
	CL-OL	1.181-2.756	0.157	High
Fat Clays	CH	2.362	0.031	Very Low

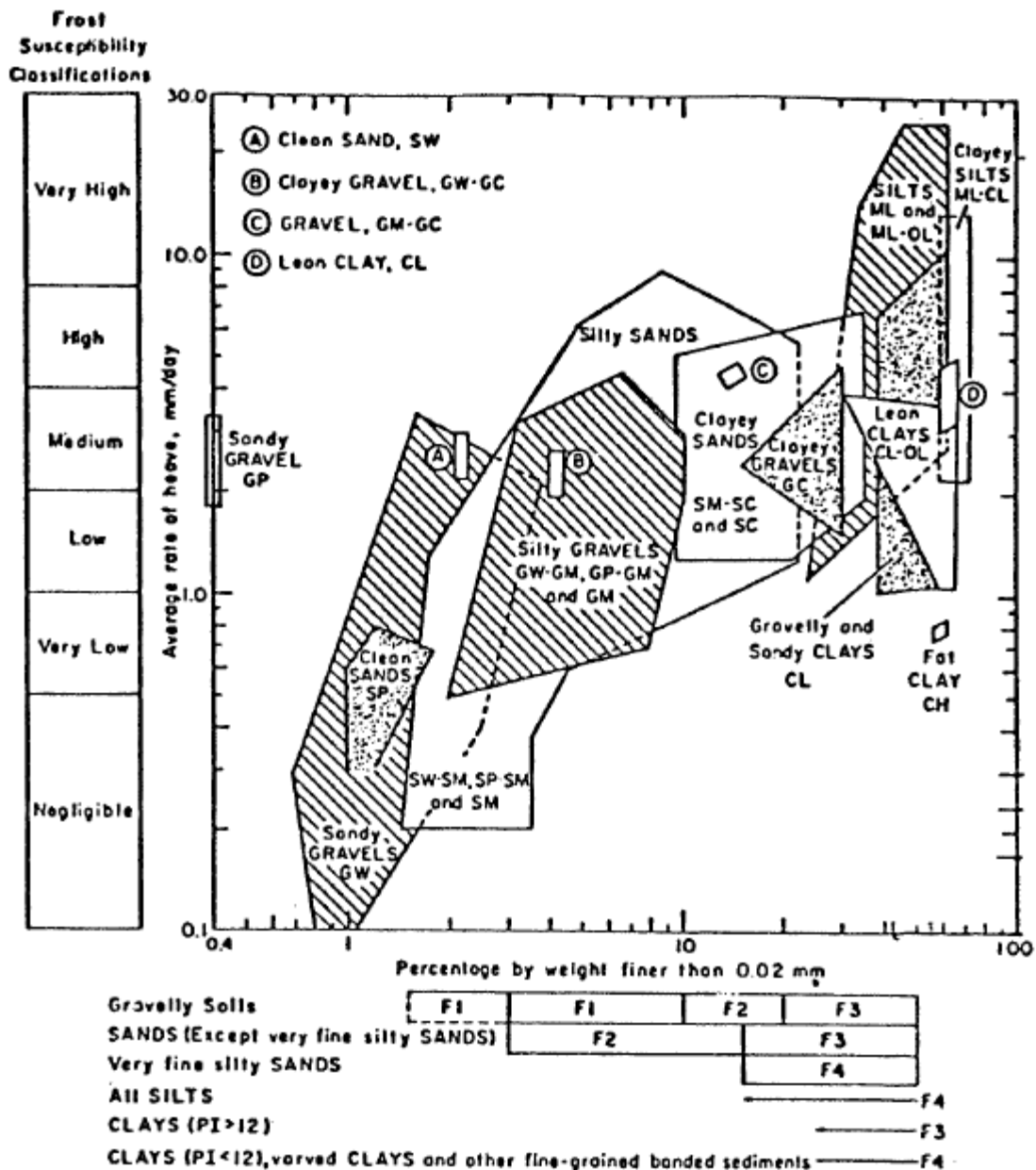

Figure 4.9. Summary of results of standard laboratory freezing tests performed by the U.S. Army COE between 1950 and 1970 (Haley, 1963).

4.3 DATA REQUIREMENTS FOR SUBSURFACE DRAINAGE DESIGN

It is important to note that data requirements for design of drainage systems will vary depending on whether the system is a retrofit in an existing pavement, or installations in a new pavement are to be constructed, or if it is a re-construction. In the situation where an existing pavement is experiencing drainage problems, the most common type of drainage system used for retrofits have been pipe edgedrains placed in geotextile wrapped trenches (Mathis, 1990). Retrofit longitudinal edgedrains can be grouped into three basic types known as pipe edgedrains,

prefabricated geocomposite edgedrains (PGED), or fin drains, and aggregated trenches, or French drains (ERES, 1999).

The discussion in the following sections will focus on subsurface drainage design requirements for both new and existing pavement systems.

4.3.1. Roadway Geometry

Because many of the geometric design features of a highway (e.g., Figure 4.10) can exert some influence on the analysis and design of subsurface drainage, the designer should be armed with as much information as possible on these features before undertaking the work (Moulton, 1980). Important resources to have at hand are sufficiently detailed profiles and cross-sections, which permit assembly of the following data for each section of roadway under consideration:

- Longitudinal grades
- Transverse grades (including super-elevation)
- Widths of pavement and shoulder surface, and the base and subbase
- Required thickness of pavement elements based on normal structural design practice for the particular area under consideration
- Depths of cuts and fills
- Recommended cut and fill slopes
- Details of ditches and other surface drainage facilities

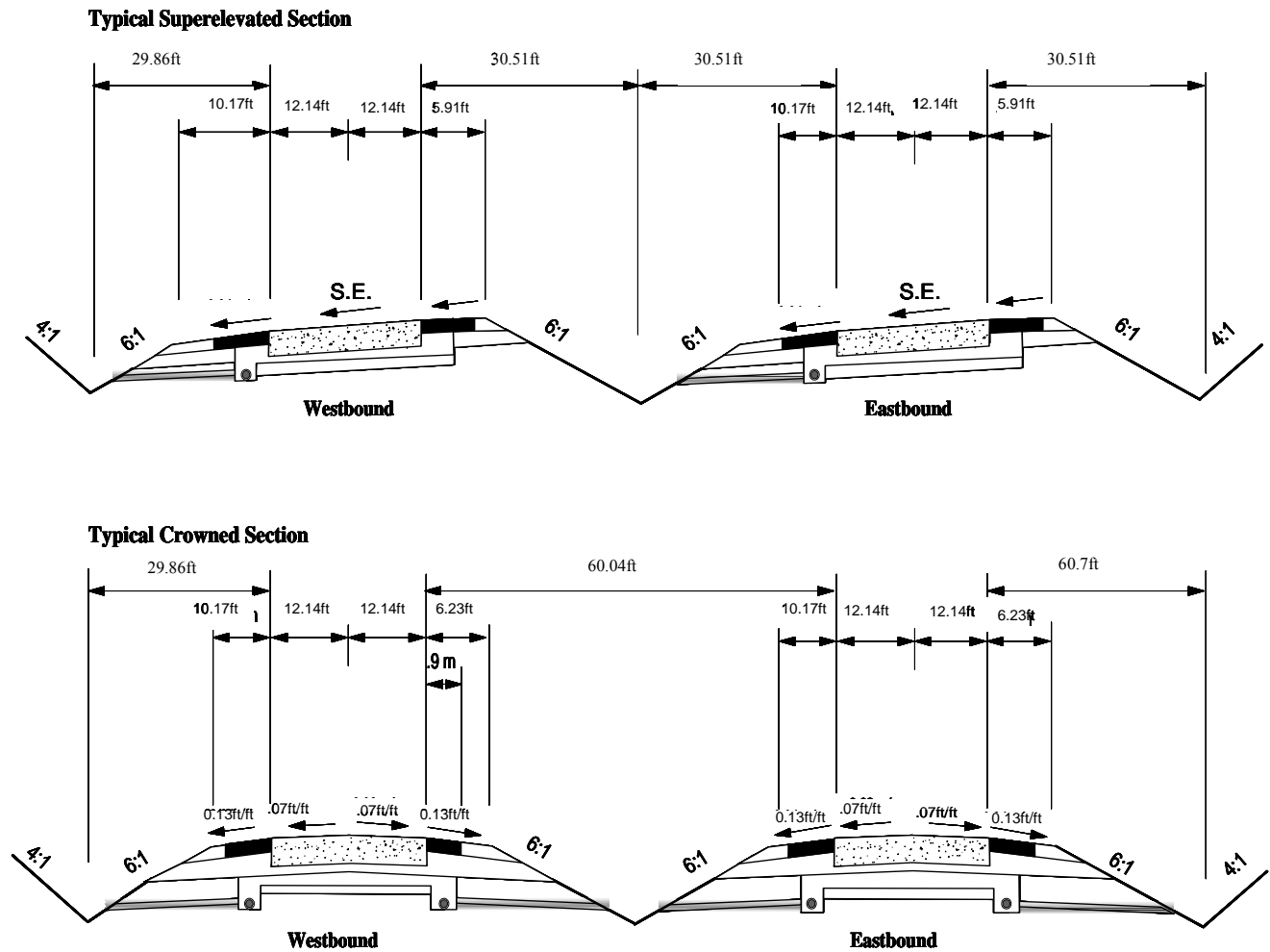

Figure 4.10. Typical cross sections for crowned and superelevated pavement sections (ERES, 1999).

During the design of a permeable base, it is critical to use the true slope and length of the permeable layer. The true or resultant slope (S_R , Figure 4.11) of the flow path is usually determined by combining the longitudinal slope with the pavement cross slope (S_X) using the equation below (Carpenter et al., 1981).

$$S_R = (S^2 + S_x^2)^{\frac{1}{2}} \quad (4.9)$$

where

- S_R = Resultant slope, ft/ft
- S = Longitudinal slope ft/ft
- S_X = Cross-slope, ft/ft

The recommended minimum cross-slope of the permeable base should be taken as 0.02 ft/ft (FHWA, 1994).

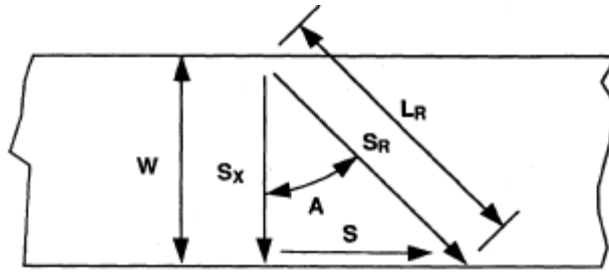

Figure 4.11. Roadway geometry (ERES, 1999).

The resultant length, L_R , of the flow path can then be evaluated using equation 4.10 (ERES, 1999):

$$L_R = W \left[1 + \left(\frac{S}{S_x} \right)^2 \right]^{0.5} \quad (4.10)$$

where

- L_R = Resultant length of base, ft/ft.
- W = Width of permeable base, ft/ft.

The orientation of the flow path can be determined by using equation 4.11 (ERES, 1999).

$$\tan(A) = \frac{S}{S_x} \quad (4.11)$$

where A is the angle between roadway cross-slope and resultant slope.

The length of the flow path should never be less than the pavement width (FHWA, 1994).

Example 4.8 in Appendix D demonstrates these calculations.

Pavement Geometry

Geometry and the path of water flow in pavements can be determined from the geometric design features of the pavement and other related subsurface drainage geometry. The rate of outflow of infiltrated water from the pavement structure can be evaluated from such design factors as longitudinal profile and the cross slope of the pavement layers. The designer needs to obtain detailed information on profiles and cross-sections of the pavement to permit the assembly of the longitudinal grades, transverse grades, widths of pavement and shoulder surface, base, and subbase, and the minimum outlet ditch depth for each section of the roadway under consideration (ERES, 1999). This information can also be obtained from a detailed set of cross-sections (Cedergren, 1977).

4.3.2. Climatological Data

Precipitation

An understanding of the frequency, intensity, and duration of precipitation in an area is not necessary for the detailed design of highway subsurface drainage, but is helpful in defining the seriousness of the problem and in devising solutions (Moulton, 1980). Groundwater problems are noted to occur with more frequency in areas with high rainfall, where fluctuations in groundwater seem to correlate with the amount of precipitation.

Studies have reported that infiltration of rainfall into pavement sections is more dependent upon the duration of rainfall than its intensity or frequency (Ridgeway, 1976).

The United States National Weather Service maps, which show rainfall intensity as a function of frequency and duration, are valuable sources of precipitation information to designers. Figure 4.2 is a typical map of 2-year, 1-hour frequency precipitation rates for Minnesota which Cedergren has recommended as the basis for computing infiltration rates into pavement structural sections (1974a). Hourly precipitation data may be obtained from a recording station nearby the project construction site.

Depth of Frost Penetration

There is need for indication on the depth to which freezing temperatures may penetrate into the pavement or underlying subgrade to enable engineers to assess the seriousness of possible frost action. Predictive relationships have already been presented in Table 1 and Figure 4.8. Theoretical relationships which have been developed can permit predictions of frost depth based upon air or pavement freezing indices and the thermal properties of the pavement elements and the subgrade (Aldrich, 1956; Johnson, 1952; Moulton, 1968; NCHRP, 1974). The availability of accurate weather records and the use of the digital computer permit reliable individual predictions of local frost penetration to be made relatively easily and quickly (Moulton, 1968). Maps providing information on the average or maximum depths of frost penetration are available for Minnesota as is shown in Figure 4.4. Maps of dynamic frost depth and thaw depth during the year are also available in Minnesota for several locations. Figure 4.12 shows an example of the data available from such a site.

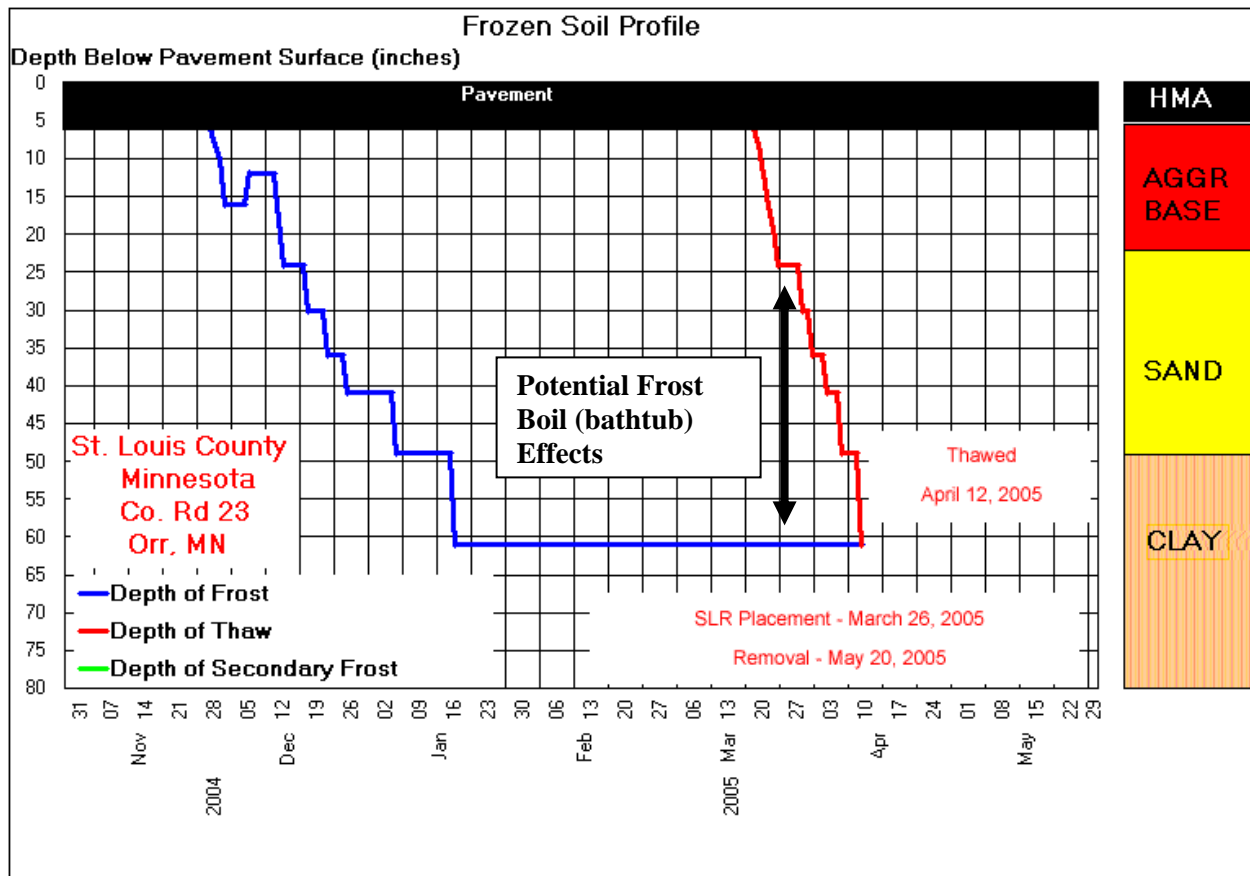

Figure 4.12. Frozen soil profile of St. Louis County, Minnesota 2004-2005.

More charts for other locations in the State are available at http://www.mrr.dot.state.mn.us/research/seasonal_load_limits/thawindex/frost/historical/fs_stouis_2004_2005.asp. Also shown is the frost boil effect brought about when liquid water produced during thawing gets backed up by the underlying material that is still frozen.

4.3.3. Other Considerations

Besides assembling the detailed data required in the design of the subsurface drainage systems, attention should be given to a number of considerations that may have either a direct or indirect influence on the design of subsurface drainage. These include the impact of the proposed subdrainage system would have on the existing regime and other aspects of design, the sequence of construction operations, and the economic factors associated with design and construction of highway subsurface drainage.

The designer should consider what effect the proposed subsurface drainage might have on the potential uses of groundwater and the consequences of redirecting the surface and subsurface flow of water. For example, in the process of lowering the watertable by means of highway subdrainage, the water level in nearby wells could be lowered or the wells may even dry up. Although it might not be possible to avoid such occurrences, these possibilities should be explored and given consideration in right-of-way negotiations. It is also possible that outlets from subsurface drainage systems may direct water away from existing watercourses, causing

minor flooding and/or erosion if appropriate consideration is not given to this matter. Frequently, it is desirable to control the sequence of construction operations so that subsurface drainage is installed as an early operation, or as the work progresses, in order that subsequent construction operations can be conducted "in-the-dry". On the other hand, under some circumstances, it may be better to control the timing of the installation of subsurface drainage until all work that could result in damage to drainage materials has been completed (see Chapter 5).

4.4 DESIGN OF SUBSURFACE SYSTEMS: TIME-TO-DRAIN

It is assumed that rainfall water which has infiltrated the pavement surface into the permeable base will drain into the outlet ditches either through edgedrains or by daylighting. Drainage systems provided for removal of this water must therefore drain relatively quickly in order to prevent the pavement from being damaged during traffic loading. The time-to-drain design approach considers both the flow capacity and the storage capacity of the permeable base.

AASHTO 50-Percent Drained: Some recommendations for determining time to drain 50 percent of drainable water from a saturated base material are provided in Table 2.3.

85 Percent Saturation: Guidance for the quality of drainage based on 85 percent saturation is provided in Table 2.4 (ERES, 1987). The 85 percent saturation method considers both the water that can drain and the water retained by the effective porosity quality of the material (ERES, 1999).

The goal of drainage is to remove all drainable water in the pavement subbase layer as quickly as possible. For Interstate highways and freeways, it is suggested that 50 percent of the drainable water be drained within 2 hours. However, for highest class roads carrying very high volumes of traffic, a criterion of draining 50 percent of drainable water in 1 hour is suggested (ERES, 1999). It is important to remember that this is only a target value, and that the goal of drainage is to remove all drainable water as quickly as possible.

The time to drain, t , is determined using equation:

$$t = T \times m \times 24 \tag{4.12}$$

where

- t = Time-to-Drain a specified percentage of drainable water, hrs
- T = Time Factor
- m = "m" factor, days

4.4.1. Computation Procedures for Time-To-Drain

Step 1: Identify/determine the following parameters for the permeable base:

- S_R - resultant slope
- L_R - resultant length
- H - base thickness
- K - hydraulic conductivity

N_e - drainable porosity

K and N_e represent the rate and amount of water that will drain from the base. N_e may be determined from the conventional porosity (N) equation:

$$N = \left(1 - \frac{\gamma_d}{\gamma_s} \right) \quad (4.13)$$

where

γ_d = Dry bulk density (lb/cu.ft)
 γ_s = Particle density of the solid grains, usually about 165 lb/cu.ft

Drainable porosity N_e , which is equal to the ratio of the volume of water that drains under gravity from a soil sample to the total volume of the soil sample (WL), can be determined from the relation:

$$N_e = N \times WL \quad (4.14)$$

where

N = Porosity of material
 WL = The ratio of volume of water drained

Step 2: Calculate the slope factor, S_1 and the m factor using the equations:

$$S_1 = \frac{L_R S_R}{H} \quad (4.15)$$

The m factor is determined by the following equation:

$$m = \frac{N_e L_R^2}{KB} \quad (4.16)$$

where

N_e = Effective porosity
 L_R = Resultant length, ft
 B = Thickness of base, ft.

Often, engineers will use one degree of drainage (such as 50% drained) to quickly estimate the time to drain. For such cases, Figure 4.13 is inconvenient to use. By selecting a time factor for one degree of drainage for multiple values of slope factors, a simplified chart, such as given in Figure 4.14 based on 50 percent drained, can be developed.

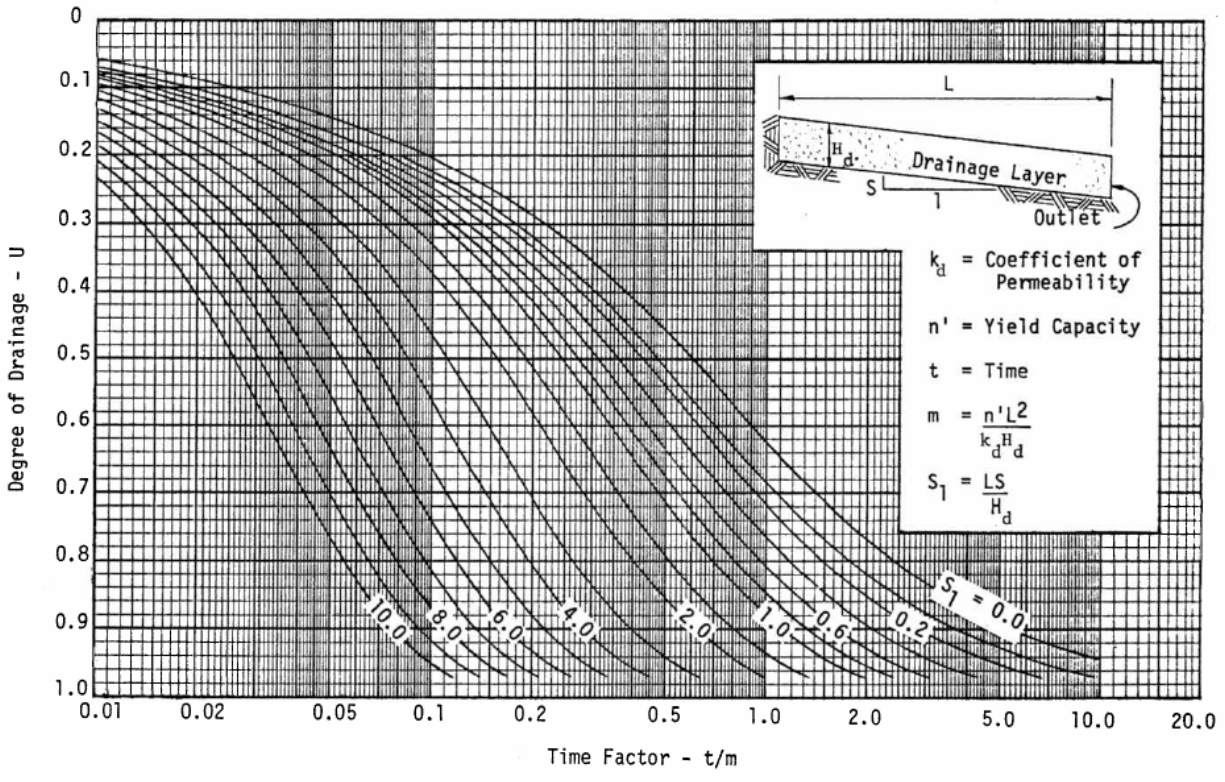

Figure 4.13. Time factors for drainage of saturated layers (ERES, 1999; FHWA, 1992; Moulton, 1980).

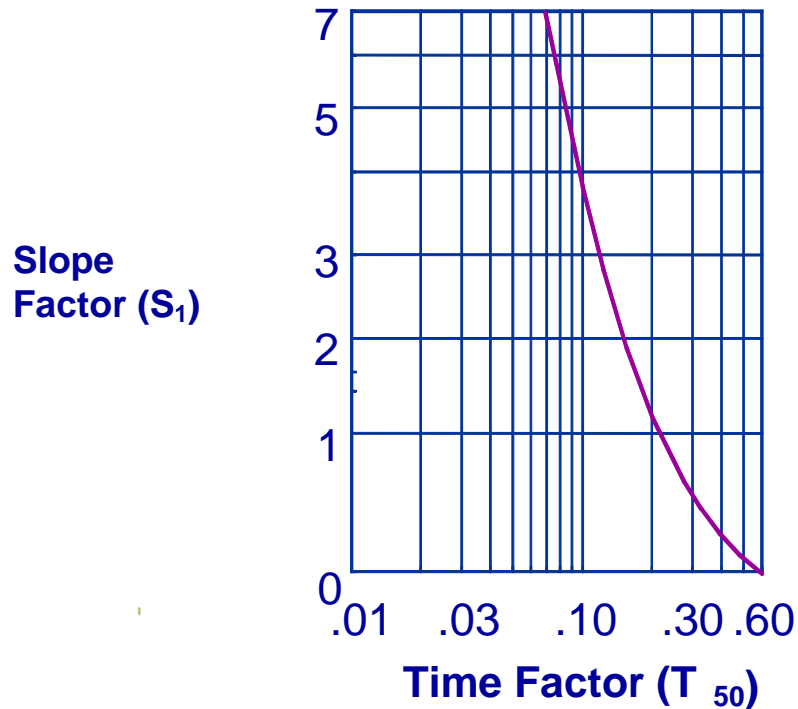

Figure 4.14. Time factor for 50 percent drainage, for various values of S_1 (ERES, 1999).

An alternative means of calculating the Time-to-Drain quickly and accurately is by use of the computer program DRIP (Wyatt et al., 1998). An example showing the calculation of the time-to-drain is located in Appendix D (see Example 4.9). The design procedure for the method is outlined below.

Design Procedure

Many engineers recommend evaluating the drainage for a range of drainage conditions rather than a single standard. In this situation, the time-to-drain is calculated over a range of 10 to 90 percent drained water. This makes it possible to bring into consideration the sensitivity to drainage as the design is finalized.

Table 4.2 shows the form designed for use in calculating the time to drain for the different degrees of drainage. The form can be completed by adopting the following procedures:

The first step in the design is to compute all design parameters.

- Determine the base thickness (B) and the hydraulic conductivity (K).
- Determine the roadway geometry measures of resultant length (LR), and resultant slope (SR).
- Calculate porosity (N), and the effective porosity (N_e) of the base material.
- Evaluate the slope factor (S_1) of the permeable base using equation 4.15.

$$S_1 = \frac{L_R \times S_R}{B}$$

Determine the m factor using equation 4.16.

$$m = \frac{N_e L_R^2}{kB}$$

With the obtained parametric values, the form can then be completed

Column 1 (Percent Drained) may be assigned any value from the range 0.1 to 0.9, which represents the percent of water (U) to be drained from the base.

The Time Factor (T), can be determined and entered in Column 2 by first calculating the slope factor (**S₁**), **then with** respective percent drained (U) entered in column 1, time factor (T) is selected from Figure 4.13.

The Time-to-Drain to be entered in Column 3 can be calculated using equation 4.12.

$$t = T \times m \times 24$$

Use the T value entered in column 2.

If the design being conducted is based on percent drained, it will be complete at this point. Drainage relationship can be determined if time to drain is plotted in a graph against the percent drained. However, in the case where the design criteria is based on percent saturation, the columns 4 to 6 must be completed.

Column 4 (Drained Water) can be evaluated using equation:

$$\text{Drained water} = N_e \times U = N_e \times \text{Column 1}$$

Column 5: Calculate the volume of water (**V_w**) in the base.

It is known that **V_v** = N.

$$\text{Then } V_w = (N - \text{Drained water}) = (N - \text{Column 4})$$

Column 6: Percent Saturation (**S**) can be evaluated using the expression:

$$S = (V_w / N) \times 100 = (\text{Column 5} / N) \times 100$$

If the time to drain (Column 3) is plotted against the percent saturation (Column 6), the drainage relationship is obvious.

Table 4.2. The Time-to-Drain Calculation Form (U.S. Army COE, 1988).

Pavement Section	
Pavement Section _____	
Properties of Base Course	
Resultant Slope, S_R _____	ft/ft
Resultant Length, L_R _____	ft
Base Thickness, H _____	ft
Coefficient of Permeability, k _____	ft/day
Slope Factor, $S_1 = (L_R \times S_H)/H =$ _____	
Porosity (N)	
Dry Density, γ_d _____	pcf
Bulk Specific Gravity, G_{sb} _____	
Porosity (N) or Volume of Voids (V_v) _____	
$N = (1 - (\gamma_d / (62.4 \times G_{sb}))) =$ _____	
Effective Porosity (N_e)	
Types of Fines _____	
Percent of Fines _____	
Effective Size D_{10} _____	
Estimated Water Loss, (WL) _____	Percent
Effective Porosity, $N_e = N \times WL =$ _____	
Calculate "m" factor	
$M = (N_e \times L_R^2) / (k \times H) =$ _____	

Table 4.2. The Time-to-Drain Calculation Form (cont'd.).

(1)	(2)	(3)	(4)	(5)	(6)
U	Time Factor (T)	Time to Drain (Hours) (2) x m x 24	Water Drained (1) x N _e	Water Retained (V _w) N - (4)	Percent Saturation (S) ((5) / N) x 100
.1					
.2					
.3					
.4					
.5					
.6					
.7					
.8					
.9					

4.5 DESIGN OF SELECT SUBSURFACE DRAINAGE SYSTEM COMPONENTS

4.5.1. Permeable Base

The permeable base's aggregate material should have good mechanical interlock. This is possible if the base is made from crushed material. Both unstabilized and stabilized permeable base material should consist of durable, crushed, angular aggregate with essentially no fines smaller than No. 200 sieve material. The FHWA recommends that only crushed stone be used in permeable bases (FHWA, 1992). In accordance with AASHTO M 283-83, it is recommended that the aggregate for the permeable base should at the very least meet the requirements for a Class B Coarse Aggregate for Highway and Airport Construction. The gradations representing the stabilized bases and the unstabilized bases for Minnesota were discussed in section 2.8.4.

Different states have different requirements. However, most states require 100% crushed stone, so that the permeable base material is sufficiently stable for construction equipment to work on without significant displacement (FHWA, 1992).

4.5.2. Thickness and Permeability of the Permeable Base.

Once the design inflow rate, q_n , has been computed following the procedures described in section 2.4, it is relatively easy to determine the thickness, H_d , and permeability, k_d , of the drainage layer required to transmit the inflow to a suitable outlet (FHWA, 1992).

The recommended minimum thickness of the permeable base so as to overcome any construction variances and to provide an adequate hydraulic conduit to transmit the water to the edgedrain is 4 inches (FHWA, 1992).

Use of Figure 4.15 permits determination of the maximum depth of flow, H_m , in a drainage layer when values of the design inflow rate, the permeability of the drainage layer, the length of the

flow path, L , and the slope of the drainage layers, S , along the flow path are known. It is also possible to determine the required coefficient of permeability of the drainage layer if the maximum depth of flow and the other parameters are known. Figure 4.15 was developed with the assumption of steady inflow uniformly distributed across the surface of the pavement section.

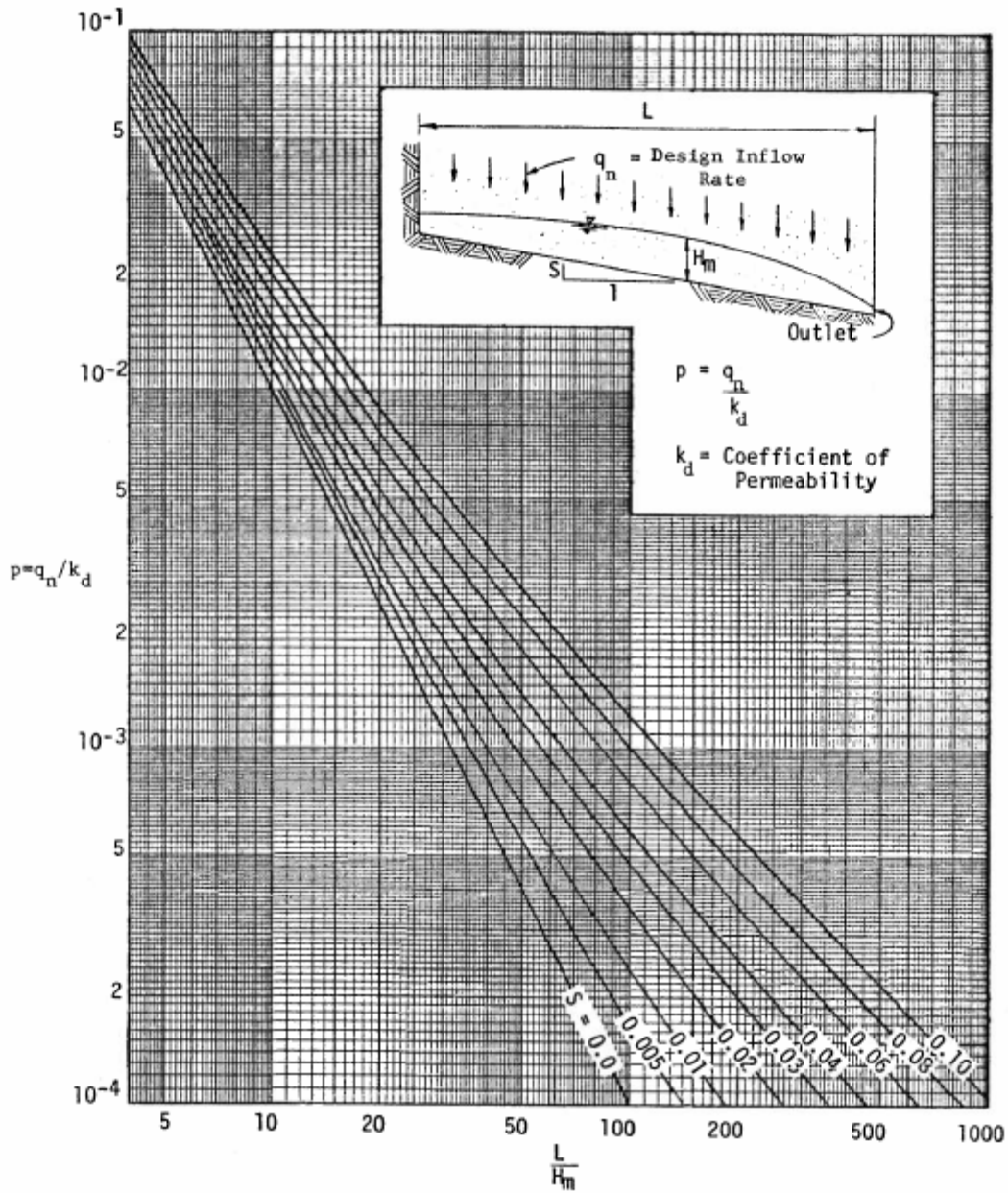

Figure 4.15. Chart for estimating maximum depth of flow caused by steady inflow (FHWA, 1992).

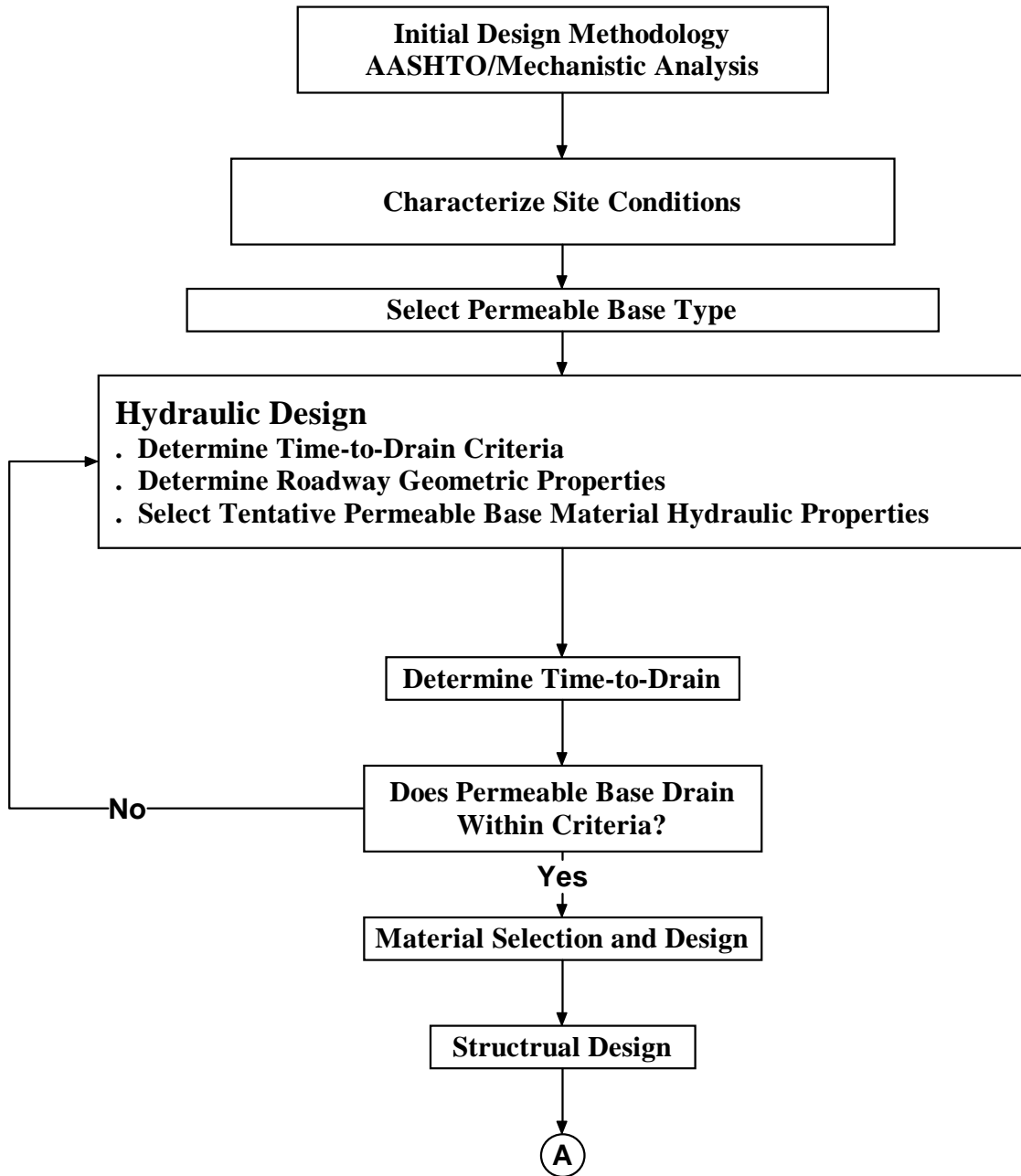

Figure 4.16. Framework for application of guidelines for permeable base design for new constructions (ERES, 1999).

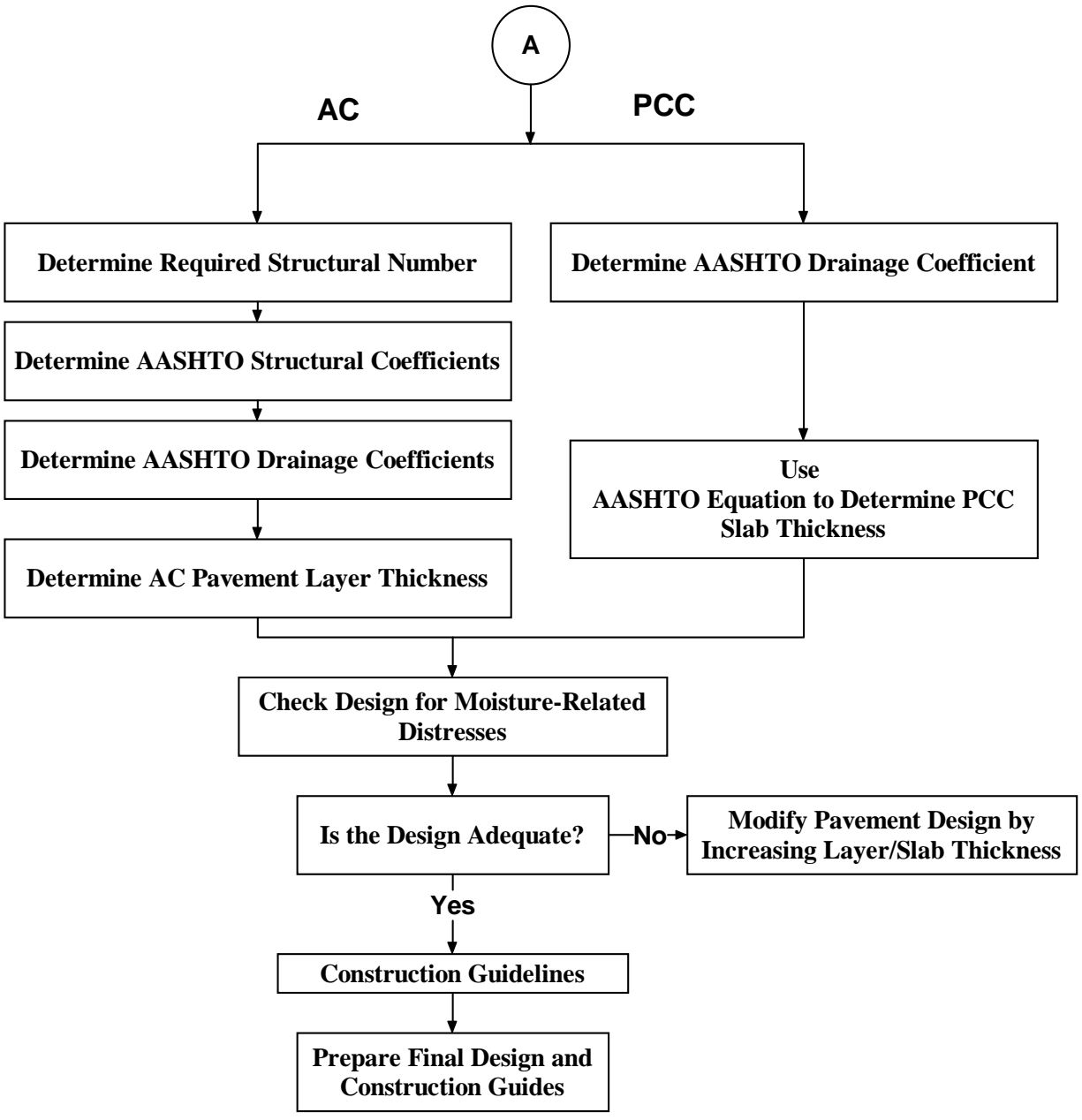

Figure 4.16. Framework for application of guidelines for permeable base design for new constructions, cont'd (ERES, 1999).

4.5.3. Design of Unstabilized Permeable Base

SHA's that use unstabilized permeable bases have developed a gradation that represents a careful trade-off of constructability/stability and permeability. Unstabilized materials contain smaller size aggregate to provide stability through increased aggregate interlock. However, this results in lower permeability. To provide stability sufficient for paving equipment, unstabilized aggregate should be composed of 100 percent crushed stone. This, however, is not part of

pavement construction practices of Minnesota. A general recommendation for unstabilized materials is that they should have a hydraulic conductivity on the order of 1,000 to 3,000 feet per day.

4.5.4. Design of Stabilized Permeable Base

The design and construction of stabilized permeable bases utilize open-graded aggregate material which is stabilized with asphalt cement or Portland cement. The permeable base is stabilized to provide a stable working platform without appreciably affecting the permeability of the material. The stabilizer is used primarily to provide stability of the permeable base during construction. The base material is also designed to ensure high permeability. This criteria is met in the additional requirement of limiting the amount of material passing the No. 200 sieve from 0 to 2 percent, and also by limiting the amount of material passing the No. 8 sieve, thus ensuring a large effective diameter (D_{10}) of the material. A suitable measure of the permeability is the coefficient of permeability, which should be greater than 3,000 feet per day.

4.5.5. Full-Depth AC Pavements

A full-depth AC pavement normally consists of an AC surface binder and course on top of an AC-treated base placed directly on the subgrade. Introducing an unstabilized permeable base will alter the design to be more like a conventional AC pavement than a full-depth AC. Thus, to maintain the full-depth pavements design, a practical design would be to use a combination of a dense-graded hot mix AC under an asphalt-treated permeable base and an AC surface layer with edgedrains. This type of pavement would require construction of an adequate foundation.

4.5.6. Subsurface Drainage Systems for Rigid Pavements

Almost all rigid pavements are made with PCC. This guide shall discuss on subsurface drainage systems for PCC pavements only. Rigid pavements are differentiated into three major categories by their means of crack control. These are the JPCP, JRCP, and CRCP.

4.5.7. JPCP without Dowels

JPCP is the most common type of the rigid pavements. Cracks in this pavement are controlled by dividing the pavement into individual slabs separated by contraction joints. Slabs are typically one lane wide and between 12 ft and 20 ft long. JPCP does not use any reinforcing steel but does use dowel bars and tie bars.

The recommendations for providing subsurface drainage for non-doweled JPCP, which are based primarily on limiting joint faulting, are summarized in Table 4.3. The recommendations show that the baseline non-drained JPCP will perform well up to a point, but will require good subsurface drainage at higher traffic levels to obtain desirable performance. It is also apparent that climate has a major effect on the performance of non-doweled JPCP, with effects being more severe in wet freeze areas than dry no-freeze areas. There is a critical traffic level beyond which non-doweled JPCP pavement is not feasible. In wet freeze areas rigid ESALs greater than or equal to 6 million, JPCP non-doweled pavement is not feasible even with an erosion resistant

base or a permeable base due to excessive joint faulting. This ESALs figure is higher in dry and no-freeze areas.

Table 4.3: Recommended levels of subdrainage based on site conditions for non-doweled JPCP.

Design Traffic million ESALs	Climate	Subdrainage Recommendations
<1.5 million	All	Baseline Adequate
1.5 – 3	Dry No-freeze	Baseline Adequate
1.5 – 3	Wet Freeze	Non-erosion Base (LCB)
3 – 6	Dry No-freeze	Baseline Adequate
3 – 6	All	Non-erosion Base (LCB), or Permeable Base
6 – 18	Dry No-freeze	Non-erosion Base (LCB), or Permeable Base
> 6	Wet Freeze	None adequate, must add dowels or other design features
<p><i>Notes: Recommendations are based primarily on meeting 2.5 (0.1 inch) maximum joint faulting criteria. Valid for all subgrade types. Baseline is a non-drained pavement structure without any positive subdrainage features. It may however, include design features that prevent water from entering the pavement structure.</i></p>		

4.5.8. JPCP and JRCP with Dowels

JRCP controls cracks by dividing the pavement into individual slabs separated by contraction joints. However, slabs much longer (as long as 15 m) than JPCP slabs are used. JRCP uses reinforcing steel within each slab to control within-slab cracking. This type of pavement is not commonly used in Minnesota due to some long-term performance problems (Muench et al., 2006).

Table 4.4 show recommendations for doweled JPCP and JRCP, which is based primarily on joint faulting. Studies and analysis of the field performance data of properly doweled pavements reveal no significant improvement of a permeable base on joint faulting. Because of this, permeable bases are recommended only for pavements with high traffic (greater than 18 million ESALs).

Table 4.4. Recommended levels of subdrainage based on site conditions for doweled JPCP and JRCP.

Design Traffic, million ESALs	Subdrainage Recommendations
1.5 - 3	Baseline Adequate
3 – 6	Baseline Adequate
6 - 18	Baseline Adequate
> 18	Non-erodible (LCB), or Permeable Base
<p><i>Notes: Recommendations are based primarily on meeting 2.5 mm (0.1 inch) maximum joint faulting criteria. They are valid for all climatic regions and all subgrade types. Baseline is a non-drained pavement structure without any positive subdrainage features. It may, however, include design features that prevent water from entering the pavement structure.</i></p>	

4.5.9. Jointed PCC Pavements

The recommended subsurface drainage system for JCP should possess basic elements which include a permeable base layer, a dense-graded aggregate separator layer, an edgedrain collector system with an outlet pipe and headwall or the permeable base can be daylighted directly into the ditch, and roadside channels or ditches with adequate depth or a storm drain connected to the outlets(ERES, 1999).

Various studies have shown that in situations where moisture damage is serious and prevalent, providing drainage systems improves performance of PCC pavements (Ray et al., 1985; Forsyth et al., 1987; Ray and Christory, 1989; Smith et al., 1990). Further improvement in the long-term performance of these pavements can be realized by inclusion of other design features, such as dowels, short joint spacing, and sealed joints (Ray, 1981; Ray et al., 1985; PIARC, 1987; Ray et al., 1989; Ray, 1990; Smith et al., 1998).

Lean concrete base and asphalt concrete pavement are effective nonerodible base layers recommended for PCC pavements. Providing dowels and a nonerodible base of the PIARC type I design may be effective for JCP pavements (ERES, 1999).

4.5.10. CRCP

CRCP uses reinforcing steel rather than contraction joints for crack control. Cracks are typically held tightly together by the underlying reinforcing steel.

PIARC type I drainage is recommended, preferably with an AC interlayer over a cement-treated base, for CRCP. To date, there are no comprehensive studies proving the effectiveness of permeable bases under CRCP. Furthermore, there are several concerns regarding their use.

One of the most significant concerns is intrusion of PCC mix into the permeable base and bonding between the PCC surface and treated permeable base. The higher potential for contamination of the permeable base for CRCP is another problem because this type of pavement generally experiences higher deflections.

4.5.11. Design of Edgedrain Collector System with Outlet Pipe

Edgedrains are perhaps the most effective subsurface drainage systems for removing water infiltrating joints and cracks in PCC pavements (Jeffcoat et al., 1992). Since the effectiveness of any system can be highly site specific, it is essential that careful evaluation of site conditions be carried out when considering retrofitting edgedrains because addition of edgedrains in areas with highly erodible subgrade or base material may accelerate erosion problems. This is due to the fact that the fines can be lost through the edgedrains (Gulden, 1983).

The longitudinal edgedrains, when used in existing pavements, just like those installed during initial construction, can be grouped into three basic types known as pipe edgedrains, PGED or “fin drains,” and aggregate trenches or “French drains.”

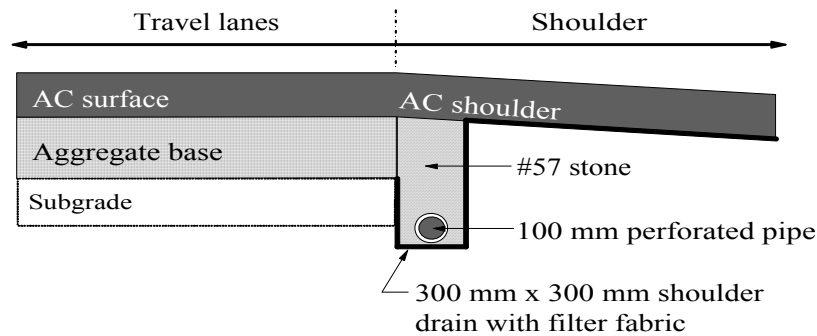

Figure 4.17. Typical AC pavement with pipe edgedrains (ERES, 1999).

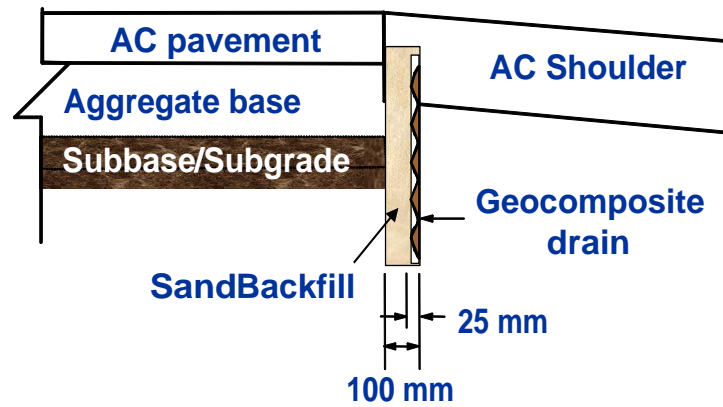

Figure 4.18. Typical AC pavement with geocomposite edgedrains (ERES, 1999).

For specific details on the design and location of these components, refer to Appendix B in this document (Chapters 6-8, ERES, 1999).

Providing an AC layer of adequate thickness above the permeable base is essential for obtaining good performance (Yu et al., 1998b). Dense-graded bases that are daylighted have been determined not suitable for providing drainage to newly constructed or reconstructed AC pavements. However, daylighting of the dense-graded bases will provide positive drainage, and would hence be far superior to bathtub design (Kersten and Skok, 1968).

Another advantage of DGAB is that a daylighted permeable base is able to breathe, thus preventing buildup of water vapor pressures under the AC surface from hydrogenesis (Fehsenfeld, 1988). Asphalt concrete pavements with granular bases are particularly susceptible to hydrogenesis, which can lead to stripping (Hindermann, 1968).

4.5.12. Edge Drain Capacity and Outlet Spacing

The goal of installing subsurface drainage systems in pavement structures is to remove water entering the base and subgrade layers as quickly as possible. It is imperative that the edgedrain capacity should be designed so as not to be an impediment to the removal. A common recommendation is that the capacity of the edgedrain system should always increase as the water flows through the system (FHWA, 1992). This would be accomplished if the combination of edgedrain capacity and outlet spacing are adequate to handle the design flows.

The required pipe capacity and outlet spacing can be determined by one of three design approaches (FHWA, 1992). These are the pavement infiltration discharge rate (q_i), permeable base discharge rate, and time-to-drain discharge rate. The engineer needs to select the design approach that meets the field conditions. The design pipe flow for this approach is determined by the following equation.

$$Q_p = q_i WL \quad (4.17)$$

where

Q = Design flow rate for pipe flow, cu ft/day

- q_i = Pavement infiltration, cu ft/day/sq ft
- W = Width of permeable base, ft
- L = Outlet spacing, ft

To determine the required pipe flow, the design discharge rate from the permeable base need to be adjusted. The resulting equation is:

$$Q_p = k S_R H L \cos(A) \quad (4.18)$$

where

- Q_p = Design flow rate for pipe flow, cu ft/day
- k = Coefficient of permeability, ft/day
- S_R = Resultant slope, ft/ft
- H = Thickness of base, ft
- L = Outlet spacing, ft
- A = Angle between roadway cross slope and resultant slope

In the time to drain discharge rate approach, the edgedrain system is required to be capable of handling the flow generated by draining the permeable base (FHWA, 1992). The pipe flow rate is determined by the equation below.

$$Q_p = (WLN_eU) \left(\frac{1}{t_D} \right) \times 24 \quad (4.19)$$

where

- Q_p = Design flow rate for pipe flow, cu ft/day
- W = Width of permeable base, ft
- L = Outlet spacing, ft
- H = Thickness of base, ft
- N_e = Effective porosity, %
- U = Percent drained, expressed as a decimal
- t_D = Drainage time period, hours

4.5.13. Design of Discharge/Outlets and Collector Pipes

For a subsurface drainage system to function properly, suitable collector pipes and adequate outlet systems are vital (Cedergren, 1974a). These components of the subsurface drainage system need to be designed to handle all water accumulating in the subgrade. Appropriate slotted or perforated pipes should be placed along lower outer edges and at other suitable locations as required to prevent entrapment of water in the drainage systems (Cedergren, 1974a). A nomograph developed by the FHWA for easy determination of collector pipe diameters and spacing outlets is presented in Figure 4.19 (FHWA, 1973). An example is provided within the body of the figure to illustrate use of the nomograph.

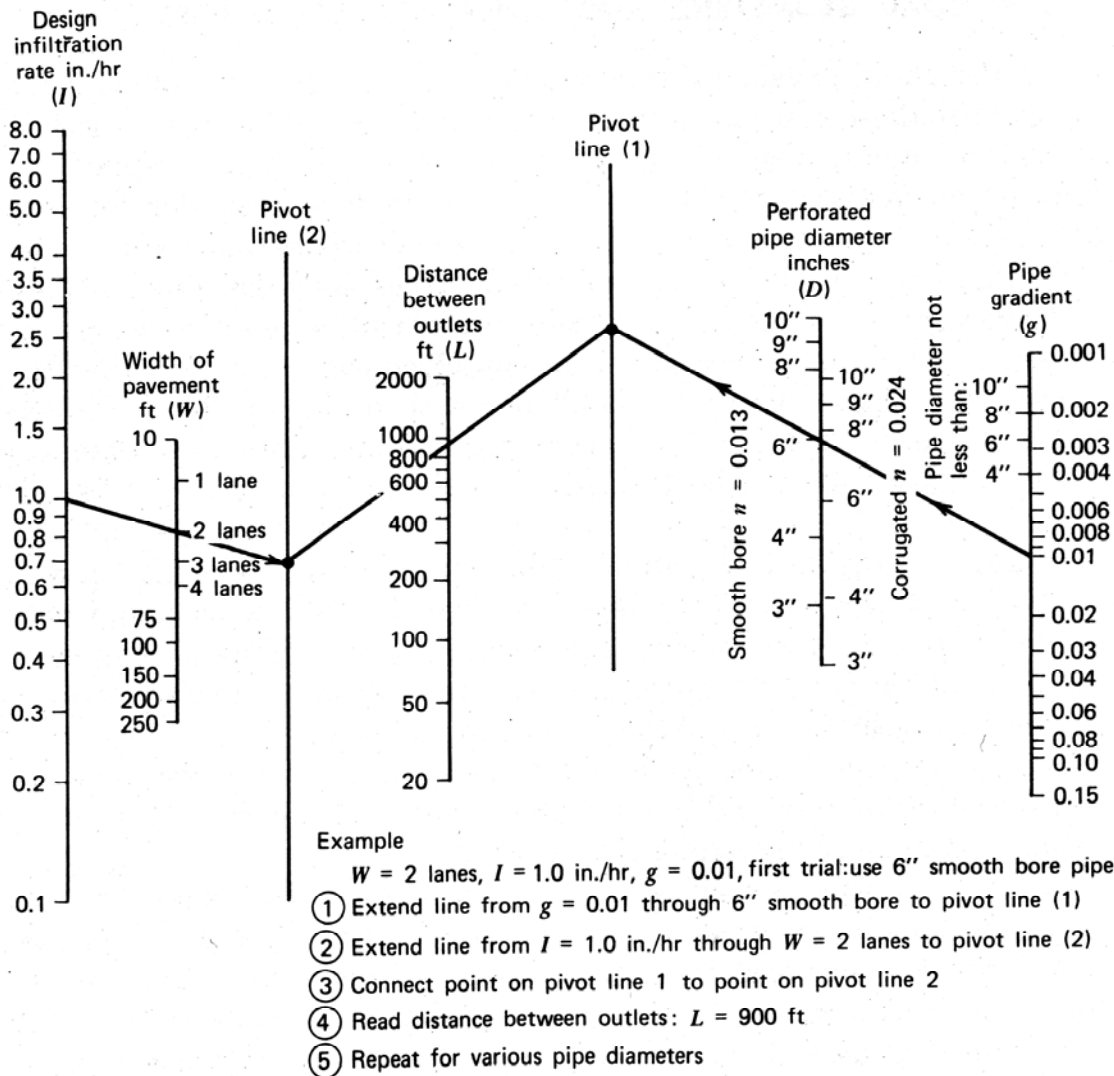

Figure 4.19. Nomograph for selection of perforated pipe diameters and outlet spacing, with use of nomograph illustrated in the example provided (FHWA, 1973).

4.5.14. Influence of Road Geometrics on Locating Collector Pipes

The designer of pavement-drainage systems is required to try visualizing the systems in three-dimensions and to identify any special situations in which water could be trapped by unusual geometrics, or where water may meander for long distances before reaching an outlet. These special locations, such as reverse super-elevated curves, long sustained grades, and sag vertical curves, require special attention (Cedergren, 1974a). Cedergren (1974) suggests a criterion to be followed in examining plans for locating collector pipes, whether they are longitudinal drains, transverse interceptor drains, or supplemental collector drains. The criterion recommends that seepage should not exceed a maximum distance of 150 to 200 feet (45.72 to 60.96 meters) without a collector drain.

4.5.15. Locating Outlets

When locating outlet pipes for subsurface drainage systems, designers should examine the topography for any off ramps, structures, or features, natural or man-made, which can interfere with free gravity flow from the system. Where this may occur, special provisions should be made, such as using longer spacing between outlets, use of sumps and pumping outlets, or utilizing existing sewer or surface-water sumps and pumps for removal of seepage from subsurface drainage systems (Cedergren, 1974a). In all cases, it is recommended that outlets be located high enough on the slopes of ditches so that free gravity flow is assured. Flap gates may be incorporated with the outlets in areas where large flood flows often occur and where there may be high water levels in ditches, sometimes rising above the exit pipes.

In the selection of material, the designer needs to take into consideration the local conditions, especially for pipes. Pipe material should be compatible to the local conditions so that the pipe will not corrode, rust, disintegrate, or be attacked by the chemical content of the soil, water, or foreign matter (Cedergren, 1974a). It is recommended that standard ASTM or AASHTO or federal or other agency specifications be used.

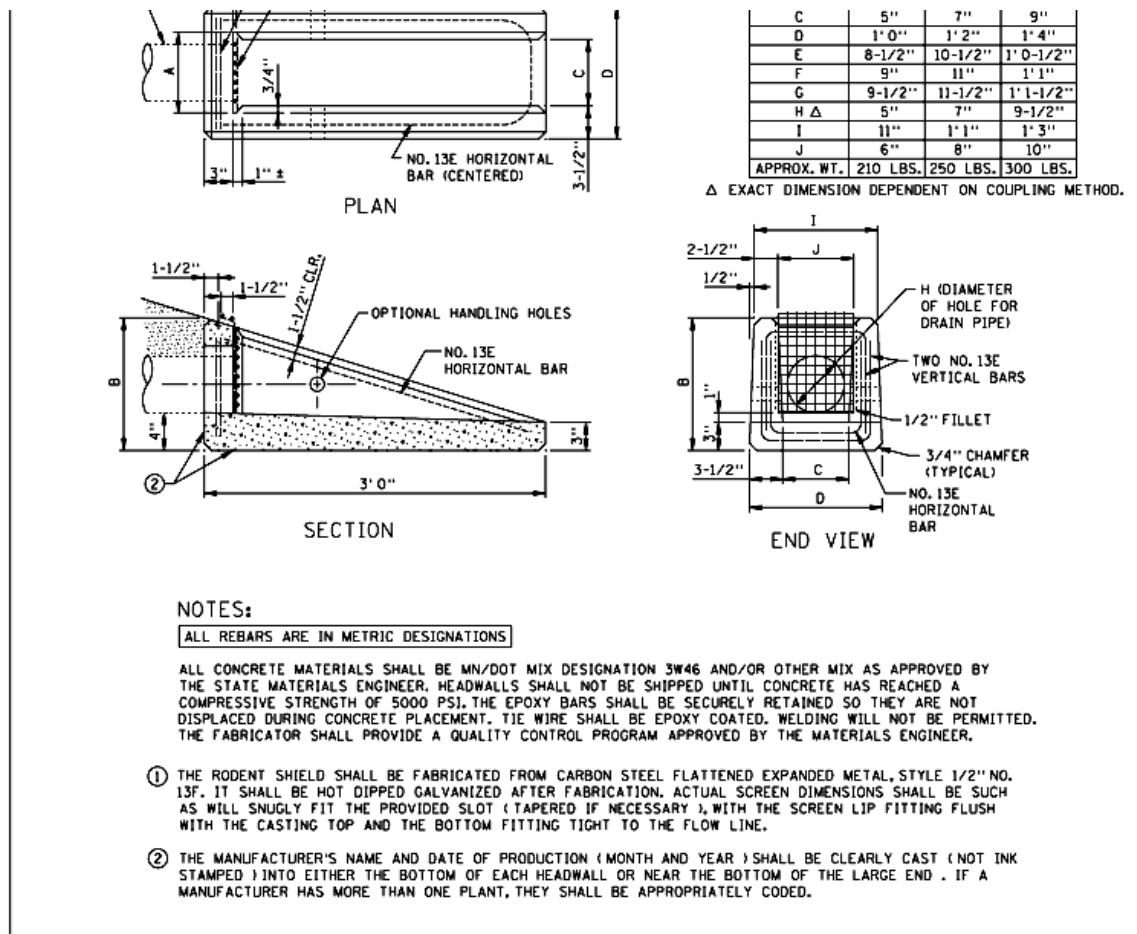

Figure 4.20. Recommended detail for subsurface drainage outlet pipe and marker (Mn/DOT, 1994a).

Drainage outlets are generally provided at suitable intervals in the collection system to convey the received water to a suitable and safe exit point. A commonly used collector is a pipe, not necessarily perforated, which is placed in a ditch backfilled with low permeability soil.

An important consideration in the design of the outlet system is to prevent piping along the outlet pipe, usually by utilizing suitable backfill materials and proper placement and compaction procedures. In case there is a lack of suitable materials, use of cutoff collars or other similar devices may be suitable substitutes.

The topographic and geometric features of a highway and the overall drainage pattern adjacent to the highway, are some of the key factors which dictate the location of the placement of the outlets. Whereas selection of correct outlet spacing is governed by analysis and design considerations, this actual spacing may be controlled by the availability of suitable outlet points permitting free and unobstructed exit of the water without generating drainage problems on adjacent property or other parts of the highway system.

The size of the longitudinal collector pipes is dependent upon the outlet spacing. An important feature of an outlet is its exit point, which must be well protected from all hazards. Protection would generally consist of a combination of screens. The screens are generally adequate to prevent small animals or birds from nesting or depositing debris in the pipes.

The screens should be designed to be displaced outward under a small head of water. This feature will provide protection against an internal stoppage should debris or soil from any source accumulate at the outlet. Where high flows are expected to occur in the outfall ditches, flap valves can be utilized to prevent backflow or deposition of debris.

Installation of outlet markers is mandatory to provide short and long term protection, and also for the outlets to be more easily located by maintenance personnel. The post should contain a suitable identification, and be placed immediately adjacent to the outlet, extending approximately 24 to 30 inches above the ground.

Whereas posts are for the purpose of locating and identifying outlets, there are concerns regarding their being potential hazard to motorists. It is suggested that light metal poles be selected in lieu of heavier wooden posts in locations with high motorist hazards. Other consideration would be concreted headwalls constructed flush with the slope to protect the outlets.

Other important considerations during selection of type of outlet protection include availability, cost, climate, especially in terms of potential frost action, potential for corrosion/attack, ease of installation, and anticipated maintenance requirements and costs.

4.5.16. Provisions for Outlets in Cold Climate

Freezing may affect normal functioning of collector pipes and flap gates. The designer should place collector pipes below the depth of frost penetration in cold climate regions, and when feasible, have outlets discharge into manholes, box structures, or other protective facilities. The

outlets should have flap gates to keep cold air out of their ends, with the gates designed to minimize sticking when water freezes in the inverted outlet pipes (Cedergren, 1974a).

4.5.17. Longitudinal Edgedrains

Longitudinal edgedrains are a key element in conveying free water which may have collected in the drainable pavement system. An important component of design and installation of longitudinal edgedrains is that the network must have the necessary hydraulic capacity to handle water being discharged from the permeable base (FHWA, 1992). To ensure there are no weak links in the drainage system, each element of the system should increase in capacity as the water moves toward the outlet. There are three basic types of edgedrains, which are known as the aggregate trench or French drain, the pipe edgedrain, and the prefabricated geocomposite edgedrain (PGED) or fin drain.

Both the aggregate trench edgedrain and the geocomposite fin drains are often not recommended because they have a low hydraulic capacity and an inability to be cleaned (FHWA, 1992).

Conventional pipe edgedrains are recommended because they have relatively high flow capacity and are easy to maintain (FHWA, 1992). There are two particularly important conditions that affect the successful use of longitudinal edge drains in existing pavements (Ridgeway, 1982). First, the edge support for the pavement must not be damaged when the drain is installed. Second, the material that is adjacent to the drain and needs to be drained must be sufficiently permeable to allow free water that is causing the problem to reach the longitudinal drain.

4.5.18. Pipe Edgedrains

Pipe edgedrains consist of flexible metallic or plastic pipes placed in a permeable aggregate trench. They are typically used on projects with high flow requirements (e.g., pavements on permeable bases).

Most State Highway Agencies (SHA's) use flexible, corrugated polyethylene (CPE) or smooth, rigid polyvinyl chloride (PVC) pipe (FHWA, 1992). One of the important design requirements is that pipes conform to the appropriate State or AASHTO specifications. When using CPE piping, the Corrugated Polyethylene Drainage Tubing or AASHTO Specification M 252 is suggested while the AASHTO Class PC 50 PVC Pipe (specification M 278) is recommended for PVC piping (FHWA, 1992). For situations where the pipe is to be installed in trenches that are backfilled with asphalt-stabilized permeable material (ASPM), the pipe must be capable of withstanding the temperature of the ASPM. One type of piping suggested for use when ASPM is used as a trench backfill is the PVC 90' electric plastic conduit, EPC-40 or EPC-80, which conform to the requirements of the National Electrical Manufacturers Association (NEMA) Specification TC-2 (FHWA, 1992).

There are different designs of pipe edgedrains which have been used in the past. The most frequently recommended design for use with permeable bases is shown in Figures 4.21 and 4.22. In this design, pipe drains are placed in an aggregate trench partially wrapped with a geotextile, with the fabric used for protecting against the loss of fines from the surrounding soils.

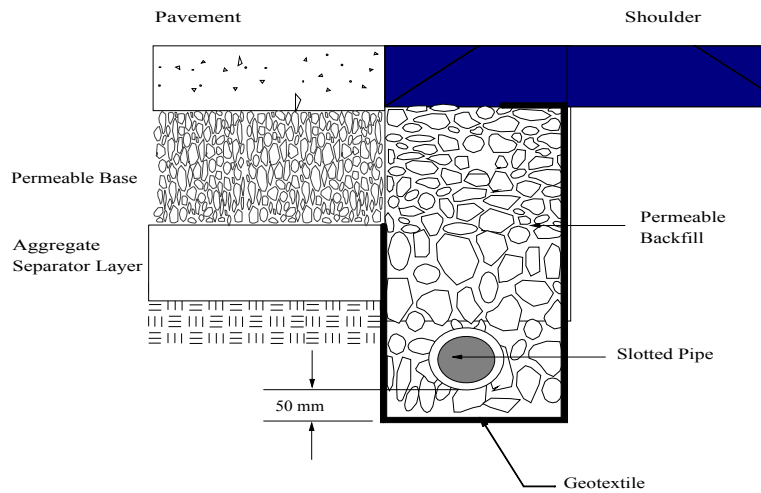

Figure 4.21. Permeable base section with longitudinal edgedrains.

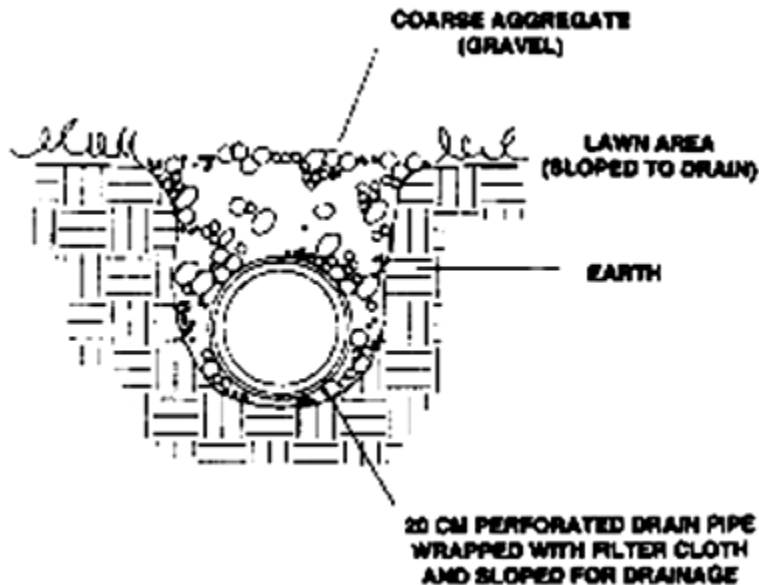

Figure 4.22. Permeable base section with longitudinal edgedrains wrapped in geotextile.

Other variant designs that have been used in the past for pavement subsurface drainage include pipe drains in a completely wrapped trench and pipe drains in a nonwrapped trench (ERES, 1999). The first design has the entire edgedrain trench encapsulated with geotextile. This design is not recommended where fast drainage rate is required because the geotextile inhibits free flow of water from the base into the drain, and clogging has also been a problem with the design. The second design has the edgedrain trench backfilled with a filter aggregate, with no geotextile used, making it a drain with a much lower degree of permeability, low hydraulic capacity, and the potential for clogging.

Pipe edgedrains are installed in some states in conjunction with nonerrodible dense-graded base. The stabilized dense-graded base provides strong, uniform support, and deflects water along the top of the base. A typical design for edgedrains in a dense-graded base is shown in Figure 4.23.

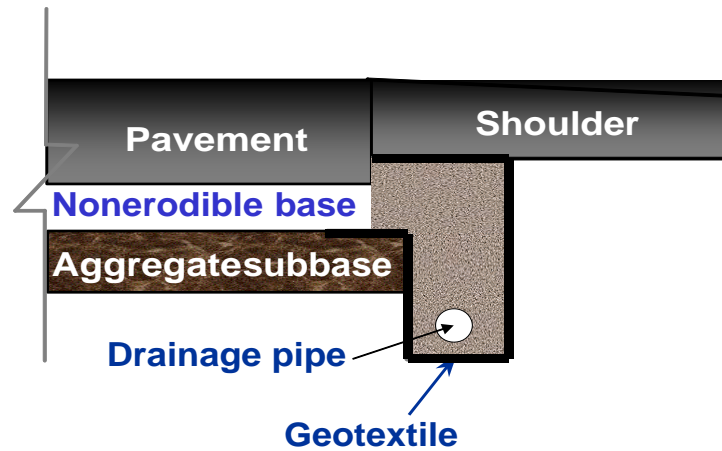

Figure 4.23. Nonerrodible dense-graded base sections with pipe edgedrains.

The main function of a pavement edge drain is to collect water from the pavement subbase layers and convey it through outlet pipes to the surface drainage system (Zubair, 1997). Earlier edge drain designs used clay and concrete pipes. These have been replaced with perforated corrugated metal or plastic pipes. Development of the prefabricated edge drains (PFEDs) or geotextile fin drains, seen in Figure 4.24, have made the work of retrofitting existing pavements much easier (Zubair, 1997). The PFEDs have been determined to be among the easiest to place, and have a relatively low cost when compared to conventional pipe edge drains. Examples determining the required removal rate of water for an edgedrain is located in Appendix D (Examples 4.10 and 4.11).

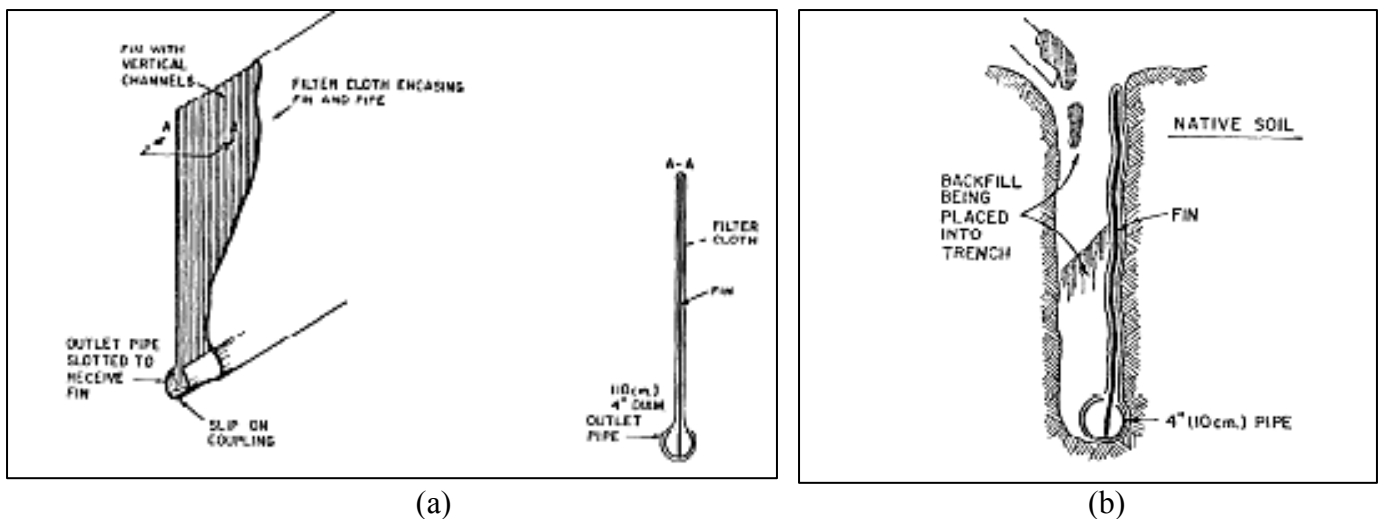

Figure 4.24. Typical (a) components of prefabricated fin drains, and (b) installation of prefabricated fin drain in trench (Healey and Long, 1972; ERES, 1999).

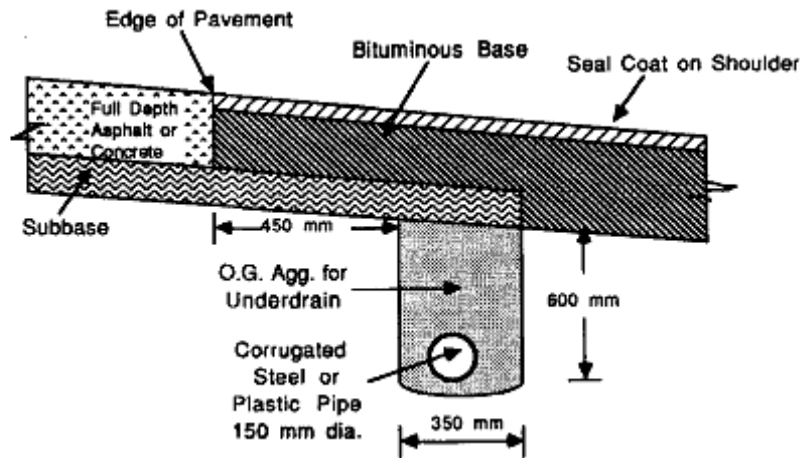

Figure 4.25. A typical cross-section of pavement with pipe edgedrain (ERES, 1999).

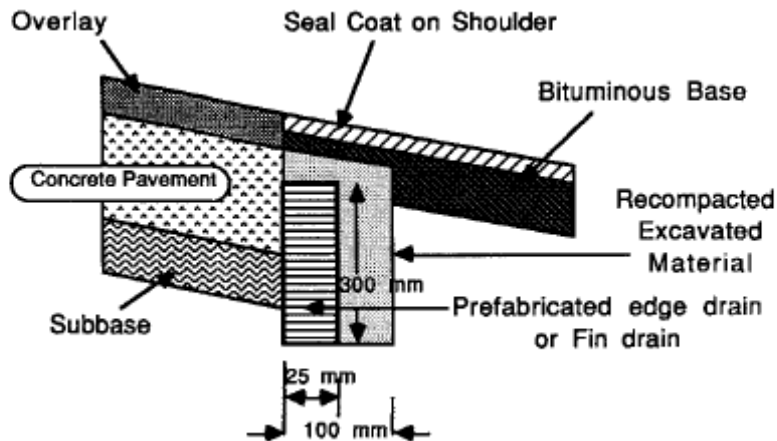

Figure 4.26. A typical cross-section of pavement with prefabricated edgedrain (ERES, 1999).

4.5.19. Prefabricated Geocomposite Edgedrains

Geocomposite drains, also known as fin drains, consist of a plastic drainage core wrapped in geotextile. The main advantage of this type of design is that they are easy to install and are substantially cheaper than any other types of drains (ERES, 1999). Because they are fully wrapped in geotextile, they are prone to clogging and soil retention problems, just as geotextile-wrapped pipe edgedrains are. Further, most geocomposite drains do not provide adequate hydraulic capacity and cannot be maintained. For these reasons, geocomposite drains are not recommended for new design, but may be used for retrofit projects where the hydraulic

requirements are low. Development of new geocomposites with increased hydraulic capacities might make geocomposite drains a more attractive alternative in the future.

4.5.20. Aggregate Trench Drain

This is a type of drain comprised of a trench filled with a permeable backfill material that is placed along the edge of the pavement to intercept water draining from the pavement structure. Often referred to as a French drain, it does not contain an edgedrain pipe, but rather relies on the slope within the trench to move water. The use of aggregate trench drains is not recommended because of low hydraulic capacity and the fact that they cannot be cleaned.

4.5.21. Headwalls

Headwalls perform the following functions in subsurface drainage systems:

- Protection of the outlet pipe from damage due to mowing
- Prevention of slope erosion
- Provide aid in the location of outlet pipe for future maintenance operations

It is recommended that they be installed in all outlets for subsurface drainage systems.

4.5.22. Design of Separator and Filters

The separator layer is an essential component of pavement structures which is located between the pavement's permeable base and the subbase or subgrade. This is provided to keep subgrade soil particles from contaminating the permeable base. Studies and experience have shown that where the stabilized material is not subject to saturation or high pressures for an extended period of time, a separator layer may not be needed over stabilized subbases or subgrades (FHWA, 1992). The separator layer may be made from aggregate material or geotextile (ERES, 1999; FHWA, 1994). A separator layer is not a substitute for a strong subgrade. Besides protecting the permeable base from contamination by fines infiltrating from underlying layers, other key functions of an aggregate separator are necessary (FHWA, 1994). First, the separator layer must be strong enough to provide a stable working platform during construction of the permeable base. Most SHA's use a dense graded aggregate base for the aggregate separator layer, which should be strong enough to support the paving operations. Second, the gradation of the aggregate separator layer must be carefully selected to prevent fines from pumping up from this layer into the permeable base. Last, the aggregate separator layer should have a low permeability, as the layer acts as a shield to deflect infiltrated water over to the edgedrain.

The separator consists of a layer of granular soil whose gradation and other characteristics must satisfy established filter criteria. A number of different types of drainage fabrics and mats have become available and have been used to protect the pavement base (Calhoun, 1972; Calhoun et al., 1971; Cedergren, 1974b; Steward et al., 1977). In making a choice between aggregate filters and drainage fabric, a careful evaluation of the history of performance, availability, and economy must be taken into consideration.

Design and construction of the aggregate separator layer must meet the following requirements for the aggregate separator layer and subgrade interface:

- D_{15} (Separator Layer) $\leq 5 D_{85}$ (Subgrade) - (this is a filtration requirement)
- D_{50} (Separator Layer) $\leq 25 D_{50}$ (Subgrade) – (a uniformity requirement)

where

D_x is the size at which "X" percent of the particles, by weight, are smaller than that size.

The relation $D_{15} \leq 5 D_{85}$ means that the requirement specifications is for the material to have component of size D_{85} be less than or equal to 5 times of size D_{15} .

It is recommended that the aggregate separator layer be constructed using durable, crushed, angular aggregate material. The aggregate material should have good mechanical interlock, and should meet the requirements for a Class C Aggregate in accordance with AASHTO M 283-83 Coarse Aggregate for Highway and Airport Construction. The abrasion wear should not exceed 50 percent, as determined by AASHTO T 96-87, and the soundness percent loss should not exceed the requirements for a Class C Aggregate as specified in AASHTO M 283-83.

An aggregate gradation that meets the gradation requirements outlined above is presented in Table 4.5.

Table 4.5. Aggregate separator layer gradation (FHWA, 1992).

Sieve Size	Percent passing
1-1/2"	100
3/4"	95-100
No. 4	50-80
No. 40	20-35
No. 200	5-12

4.5.23. Geotextiles

Instead of using aggregate separator layers, some SHA's use geotextiles (FHWA, 1994). There are particular conditions in the subgrade material which require use of geotextiles mainly because the aggregate layers will not work. One such situation is where the subgrades have a high percentage of fines (FHWA, 1992). When used, the geotextile should have enough strength to survive the construction phase. During installation of geotextiles, care should be taken to ensure they are not damaged during construction.

The primary functions of Geotextiles are filtration, drainage, separation and reinforcement. It is critical that during construction of the base course materials should be placed with care to ensure the integrity of the separator layer is maintained (FHWA, 1992). This will avoid damage or displacement, which can impact on the performance of the geotextile layer. Because the principal advantage of a geotextile is its filtration capability, it will allow any rising water, due to capillary

action or a rising water table, to enter the permeable base and to rapidly drain out to the edgedrain system.

When used in the retention of fine materials, geotextiles should have pore openings sized to retain larger soil particles to facilitate soil bridging action, and at the same time allow smaller soil particles to pass through the geotextile without clogging the fabric (FHWA, 1992). A general recommendation is that a large number of openings should be provided in case there is some clogging. In such cases, additional openings should be available to drain the water.

Sometimes, small amounts of fines will pass through the geotextile into the permeable base, initiating formation of a soil filter zone adjacent to the geotextile. Larger soil particles are retained by the geotextile, causing a bridging action to form. A zone called the soil bridge network is formed (see Figure 4.27). Immediately behind this zone, another one forms where finer soil particles are trapped. This is called a filter cake, and has a much lower permeability.

For geotextiles to perform their intended functions, they, as with other elements of highway design, must be appropriately engineered. The apparent opening size (AOS), which is the U.S. standard sieve number whose opening size is closest to the geotextile opening size, is a standard design parameter applied in the selection of these systems. The AOS value is an index test used in identifying the largest opening size of the geotextile, and is less valid for thick, nonwoven geotextiles with smaller sieve size openings (FHWA, 1992). The method commonly used in determining the opening size is by sieving single-size glass beads through the geotextile in accordance with ASTM D-475 1. The endpoint in determining the geotextile AOS is reached by repeating the test with successively coarser sized glass beads until less than 5 percent, by weight, passes through the geotextile. The AOS number of the fabric is the sieve size number before the 5-percent limit is exceeded. This opening size is also referred to as the apparent opening size or 95 percent opening size. Table 4.6 shows the opening size for the U.S. standard sieve sizes in the geotextile range.

So that any vertically draining water is not impeded by the geotextile, it is important that the geotextile has a permeability several times greater than that of the subgrade (FHWA, 1992).

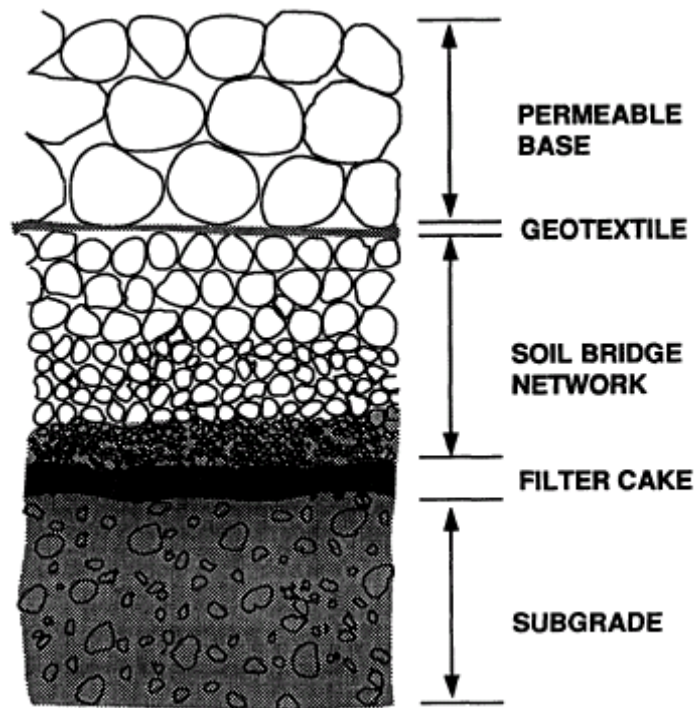

Figure 4.27. A typical cross-section filter formation (ERES, 1999).

Table 4.6. The U.S. standard sieve size openings in the geotextile range (FHWA, 1992).

Sieve Number	Sieve Opening (mm)
30	0.600
40	0.425
50	0.300
60	0.250
70	0.212
100	0.150
200	0.075

Although there is no direct relationship between the AOS number and permeability, they both are related to the density and manufacturing method of the geotextile. Clogging is a potential problem that design engineers must take into consideration. A performance test that has gained wide acceptance is to measure the soil clogging potential of the geotextile, which is known as the gradient ratio test. This test ratio is the ratio of the hydraulic gradient through the geotextile and 1 inch of the soil immediately adjacent to the material to the hydraulic gradient over the next 2 inches of soil between 1 inch and 3 inches from the geotextile. It involves direct measurements

of the soil and geotextile system's clogging and retention potential. This relationship is expressed in the following equation:

$$GR = \frac{i_f}{i_g} \quad (4.20)$$

where

- GR = Gradient ratio
- i_f = Hydraulic gradient of geotextile and 1 inch of soil
- i_g = Hydraulic gradient between 1 inch and 3 inches of soil

This relationship is illustrated schematically in Figure 4.28. The gradient ratio will rise when soil particles get trapped in the geotextile, and it will if soil particles pass through the geotextile. The general criteria recommended in using this ratio for selection and design of the geotextiles is given by the U.S. Army COE as:

$$GR \leq 3$$

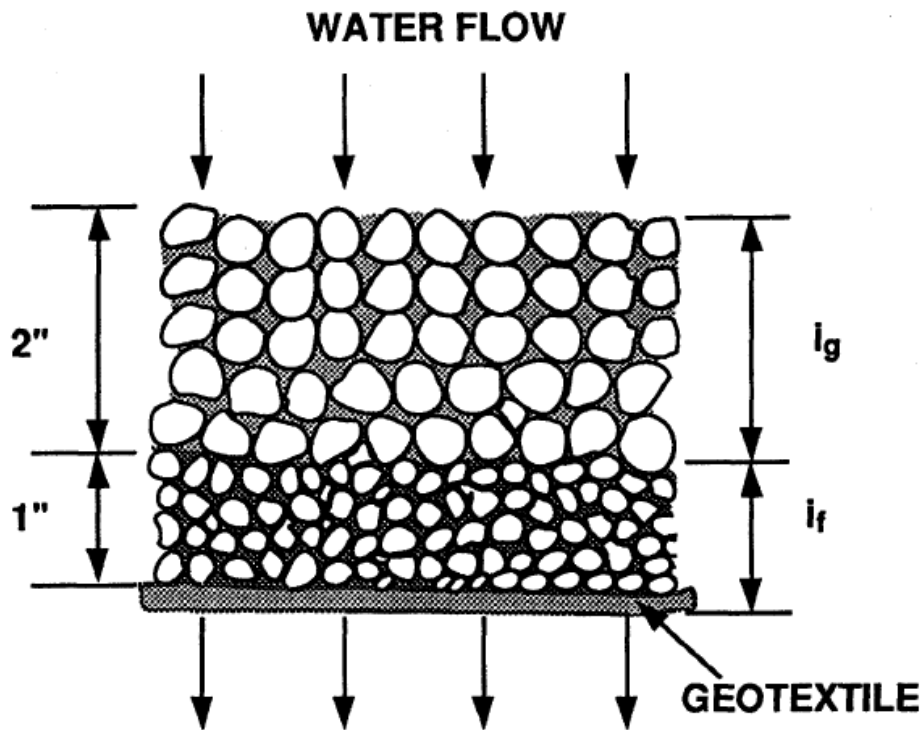

Figure 4.28. A schematic presentation of the gradient ratio test (ERES, 1999).

The guidelines or design criteria for selecting Geotextiles are summarized in Table 4.7.

Table 4.7. Summary of the design criteria for selection and adoption of geotextiles (FHWA, 1992).

I. SOIL RETENTION CRITERIA

<i>Less than 50% Passing No. 200 Sieve</i>		
Steady-State Flow	Dynamic Flow	
AOS* $O_{95} \leq B D_{85}$	Can Move	Cannot Move
$CU \leq 2$ or ≥ 8 $B = 1$ $2 \leq CU \leq 4$ $B = 0.5 CU$ $4 \leq CU \leq 8$ $B = 8/CU$	$O_{95} \leq D_{15}$	$O_{50} \leq 0.5 D_{85}$

<i>Greater than 50% Passing No. 200 Sieve</i>		
Steady-State Flow	Dynamic Flow	
Woven	Non-woven	
$O_{95} \leq D_{85}$	$O_{95} \leq 1.8 D_{85}$	$O_{50} \leq 0.5 D_{85}$
AOS No. (fabric) \geq No. 50 Sieve		

II. PERMEABILITY CRITERIA

A. Critical / Severe Application	B. Less Critical / Severe Applications (with Clean Medium to Coarse Sands and Gravels)
$k(\text{fabric}) \geq 10 k(\text{soil})$	$k(\text{fabric}) \geq k(\text{soil})$

III. CLOGGING CRITERIA

A. Critical / Severe Application	B. Less Critical / Severe Applications
Select fabrics meeting Criteria I, II, IIB, and perform soil/fabric filtration tests before specifying. Suggested performance test methods: Gradient Ratio ≤ 3	1. Select fabric with maximum opening size possible (lowest AOS number)
	2. Effective Open Area Qualifiers: Woven fabrics: Percent Open Area $\geq 4\%$ Non-Woven fabrics: Porosity $\geq 30\%$
	3. Additional Qualifier (Optional): $O_{95} \geq 3 D_{15}$
	4. Additional Qualifier (Optional): $O_{15} \geq 3 D_{15}$

* AOS = Apparent opening size, the US standard sieve number whose opening size is closest to the geotextile opening size.

CU = Coefficient of uniformity

O_{95} = Apparent geotextile opening equivalent to sieve size allowing less than 5 percent by weight of glass beads through

D_{85} = 85 % by weight smaller than particle size diameter D, in inches

k = Coefficient of permeability

4.6 INTERCEPTION OF GROUNDWATER

To minimize detrimental effects of water in the pavement structural system, it is important to install subsurface drainage systems which will effectively drain the water. There has been a growing awareness of the need for effective drainage systems. Most of the drainage emphasis has been on the removal of moisture that infiltrates through the surface of the pavement and water that enters from below into the base course. However, it has long been recognized that the control of groundwater at some distance away from the pavement is an essential part of any effective highway subsurface drainage system (Cedergren, 1974a). One has a choice in the handling of groundwater. Either it can be drained at the point of the roadway foundation material, or it may be removed prior to reaching the foundation. The latter alternative will be the better one in cases where groundwater is a significant contributor to the source of water in the base materials.

The most common groundwater control systems are the interceptor drains, which are illustrated in Chapter 2 by Figures 2.11 and 2.13.

An illustration of a field situation near a pavement section with hillslope seepage is shown in Chapter 2 by Figure 2.23. The soil profile has a bottom boundary layer which is considered to be effectively impervious. The ground water flow toward the highway shows that the water table intersects with the hillslope surface near the road ditch, and ground water seeps through the slope into the ditch. In addition, ground water is flowing beneath the road and entering into the subgrade and base course material.

Placing an interceptor drain upgradient from the ditch, or beneath the ditch itself, can help to control the hillslope seepage and decrease or even eliminate the flow beneath the roadway, thus removing the source of the water entering into the pavement foundation. An illustration of the situation with an interceptor drain is shown in Chapter 2 by Figure 2.24. It is seen there that the water table is drawn down by the interceptor drain to the level of the drain.

The design of an interceptor drain requires an estimate of the hydraulic conductivity of the hillslope soil (K), the thickness of the saturated zone for the ground water (height H in Chapter 2, in Figure 2.11), the slope of the bottom boundary of the soil profile (S), and the height of the drain above the impermeable boundary (H_0). If we want to prevent ground water from entering into the subgrade and base course material, then the interceptor drain needs to be placed at an elevation below that of those foundation layers, as was shown in Chapter 2 by Figure 2.24.

The sizing of the interceptor drain is determined from the calculation of the rate of ground water collected by the drain. This flow can be calculated using the charts in Figure 4.29 (Moulton, 1980). An example using this figure is in Appendix D (see Example 4.12). We should reiterate that it is important that the drain be free flowing with no backpressure as the design chart is based on the assumption that the drain is free flowing.

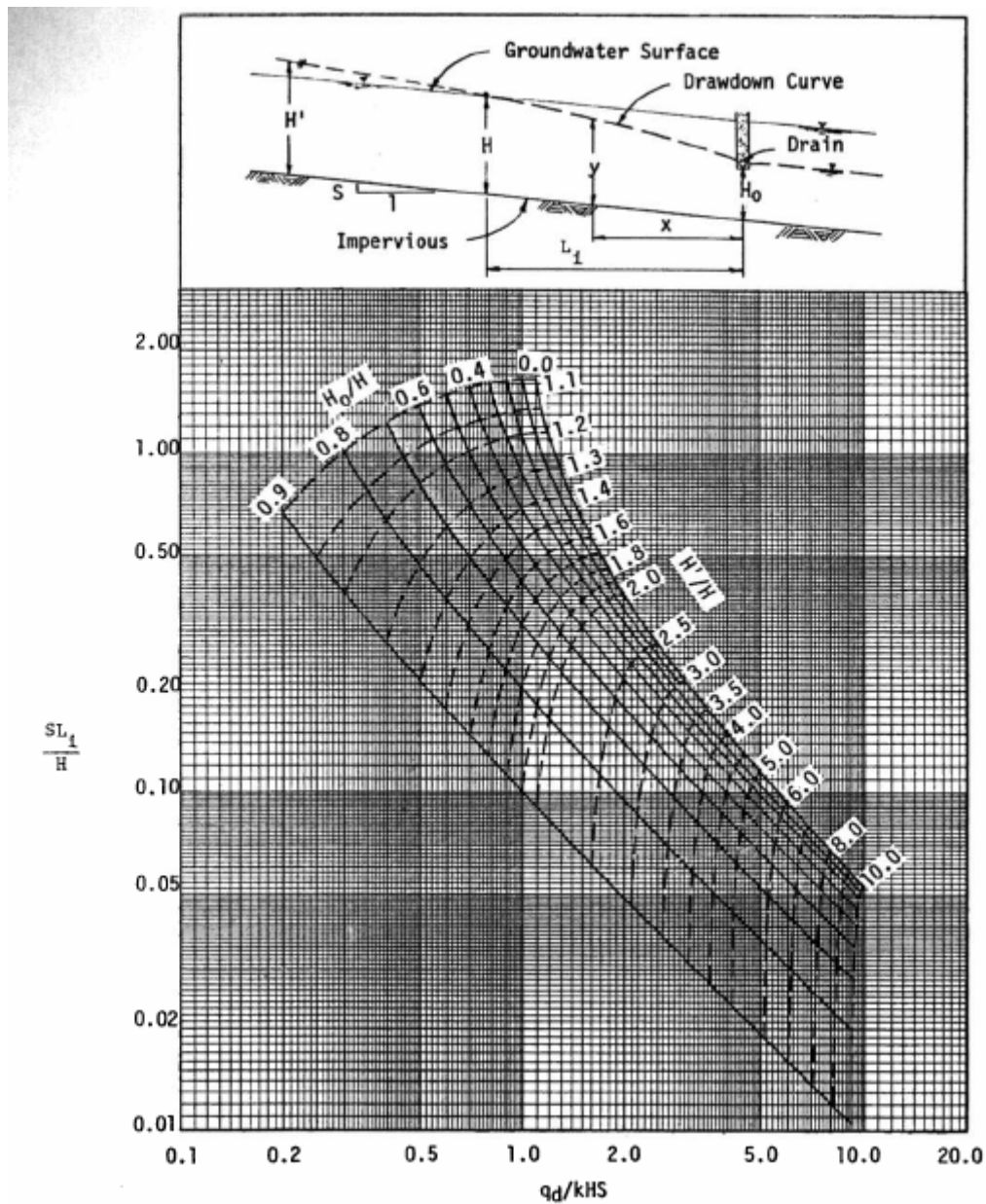

Figure 4.29. Chart for determining rate of flow into an interceptor drain (Moulton, 1980).

It should be noted that the deeper the drain placement, the smaller the value of H_0 is, and the higher the discharge to the drain will be. If the drain is placed at the bottom of the soil profile, directly on top of the impervious boundary, then the drain will collect all of the groundwater and then none will then flow beneath the roadway. Of course, it is only necessary to drop the water

table below the elevation of the subgrade and it is therefore not necessary to place the drain at such large depth.

4.7 APPLICATIONS OF MODELING IN DESIGN OF SUBSURFACE DRAINAGE SYSTEMS

4.7.1. MnDRAIN

Mndrain is software for evaluating the effectiveness of edge drains. It is primarily a tool for assessment of design decisions and not for providing design decisions (Voller, 2002). It is recommended that once the designer has completed the design of an adopted subsurface drainage system, evaluation of the effectiveness of the system be carried out using MnDRAIN.

4.7.2. DRIP

For many years, engineers have needed a concise and user-friendly microcomputer program that replicates the subsurface drainage design procedures. A microcomputer program titled “Drainage Requirements in Pavements (DRIP) Version1.0” has been developed by Applied Research Associates, Inc. under a contract from the FHWA (contract No. DTFH61-95-C-00008) (Mallela et al., 2002).

4.7.3. DRIP Capabilities

The DRIP ‘Roadway Geometrics Calculations’ feature enables a user to compute the length and slope of the true drainage path based on the longitudinal and transverse grade of the roadway, as well as the width of the underlying base material. The user can perform these calculations for the two commonly encountered roadway cross-sections, known as the crowned and superelevated, or uniform slope, sections.

Using this software, one can perform calculations to obtain effective grain sizes (D_x), total and effective porosities, coefficient of uniformity and gradation, and coefficient of permeability by entering information on gradation. It is possible to produce plots of the gradations on semi-log and FHWA power 45 templates.

Total moisture infiltrating the pavement structure from rainfall and meltwater can be computed using the ‘Inflow Calculations’ program option. The surface infiltration calculations can be performed using two different approaches—the infiltration ratio approach and the crack infiltration approach. Computations for meltwater rate can be performed for a variety of soil types and pavement cross-section depths.

The program offers two permeable base design options, depth-of-flow and time-to drain, by which a user can design an open-graded base that can handle the inflow entering the pavement structure.

The program’s Separator Layer Design option allows the user to design two types of separator layers. These are the geotextile and aggregate separator layers. Based on the gradations of the

proposed permeable base and the subgrade being designed, the program can be used to verify whether a separation layer is required or not.

The Edgedrain Design program option allows for design of either geocomposite of fin drains or pipe edgedrains. Calculations can be performed for edgedrain capacity as well as the outlet spacing required.

4.8 DESIGN PROCEDURES FOR PERMEABLE BASES IN THE FAA RIGID PAVEMENTS (HALL, 2005)

Permeable base layers are not directly addressed in the current FAA design procedure. However, they are allowed in airfield rigid pavement construction. The structural contribution of permeable base layers is ignored in the design process since they are relatively weak. There is also no clear consensus on the best location of these layers within the typical section. The construction specifications for these layers are typically developed by modifying existing guide specifications, such as Items P-401 or 402 for ATPB and Item P-304 for CTPB. However, the open-graded nature of these materials prevents the application of conventional techniques for performing mix designs and specifying their construction. For example, the ATPB mix designs often are specified on the basis of a gradation and the percent binder content. Permeability, an important consideration for this base type, is seldom specified or monitored. Furthermore, field compaction of the mixtures is achieved using method specifications. Acceptance of the mixture is done on the basis of thickness. Considerable empiricism is used to specify and construct these mixes, some of which is unavoidable until further research is done.

Stabilized and Permeable Bases and Early-Age Rigid Pavement Performance

There is ample evidence to support the notion that well designed and constructed stabilized and permeable bases help rigid pavements achieve their long-term performance goals. However, when the primary functions of the base layer are not fully considered when incorporating them into the pavement structure, short- and long-term performance deficiencies, such as early cracking and base pumping, can occur.

Chapter 5 CONSTRUCTION

5.0 INTRODUCTION

This section addresses the construction phase of the design and installation of subsurface drainage systems as solutions to drainage related problems in pavements. The types of drainage systems, as well as methods of installation, differs depending on whether the work is being done on new pavement construction projects or as a rehabilitation of existing structures.

New construction projects would normally be designed to include permeable bases for protection of the pavement structure from failure due to subsurface moisture-related distresses. These systems would drain at rates meeting design requirements. On the other hand, existing pavement experiencing very poor subsurface drainage conditions are most commonly retrofitted with edgedrains. The most common reason for installing retrofit edgedrains has been to address the pumping of fines and joint faulting problems in PCC pavements (ERES, 1999).

The process of designing a pavement with a permeable base consists of two main components. First, a permeable base must have the hydraulic capacity to drain the pavement structure within an acceptable time and, second, the whole pavement structure must have the structural integrity to withstand the expected traffic loading over time.

5.1 CONSTRUCTION OF PERMEABLE BASE SYSTEMS

Performance and life of subsurface drainage systems depend on both the care taken during construction and maintenance as well as the validity of their design (FHWA, 1994). For this to occur, it is recommended that plans and specifications include specific requirements with respect to construction activities, thus insuring completed subsurface drainage systems will function as designed. Necessary maintenance operations should be anticipated and design features should be included which will facilitate these activities (FHWA, 1994).

5.1.1 Sequence of Construction Operations

The most important elements in the long term satisfactory performance of a subsurface drainage system are systematic and timely construction practices, accompanied by appropriate quality control testing and inspection. Adequate preparations of the foundation and subgrade must be accomplished before initiating construction of the system. These preparations include insuring that sufficient materials required for the construction of the system are available, that it is possible to construct some of the self-contained sections of the system in a timely manner, and to provide adequate protection against damage to or contamination of the system. A recommended general sequence of construction operations for a subsurface drainage system should follow the pattern of first preparing the subgrade and/or foundation, then excavating the collector and outlet pipe trenches, placing the bedding material and installing the perforated pipe in collector trenches, installing the outlet pipes in their appropriate trenches (bedding aggregate not required), placing and compacting the collection and outlet trench backfill in compliance with

construction plans and specifications, placing and compacting the base drainage layer with underlying filter aggregate or filter fabric as necessary, and finally installing the outlet appurtenances and markers (Moulton, 1980).

5.2 CONSTRUCTION OF FILTER/SEPARATOR LAYER

A separator layer is usually a layer of soil, fabric, or other paving material which is typically placed below the permeable base layer to perform several important functions. The main functions of a separator layer are to ensure the finer subgrade materials do not pump into the permeable base when the pavement is subjected to heavy traffic loads, to prevent the penetration of aggregates into the permeable base layer of the subgrade and to prevent the intrusion of subgrade soils up into the permeable base, to provide a stable foundation for the construction of the permeable base, and to act as a shield to deflect infiltrated water over to the edgedrain

For the separator layer to perform satisfactorily over the long term, various combinations of materials have been used for its construction, including dense-graded aggregate, which is the most commonly used, asphalt chip seals, dense-graded asphalt concrete, geotextiles, and cement-treated granular material (FHWA, 1994a).

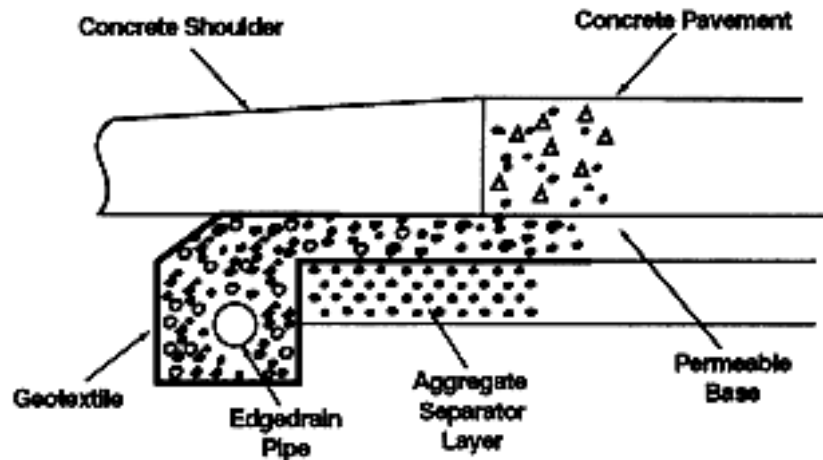

Figure 5.1. Placement of geotextile around edgedrain.

5.3 CONSTRUCTION OF EDGEDRAINS FOR NEW PAVEMENTS

There are different basic designs of edgedrains in use, including longitudinal edgedrains for permeable bases and longitudinal edgedrains for nonerrodible dense-graded bases.

Nonerrodible dense-graded base as used here refers to a stabilized aggregate base material such as a LCB or AC base. The longitudinal edgedrains with conventional unstabilized, dense-graded

bases are not recommended because they cannot move water effectively and because of loss of fines and subsequent clogging of the drains (ERES, 1999).

The edgedrains being installed must be properly designed. These would have the necessary hydraulic capacity to handle water being discharged from the pavement structure, as well as that infiltrating through the lane-shoulder joint. The elements of the drainage system will increase in capacity as the water moves toward the outlet, thus ensuring no weak links exist in the system (FHWA, 1990). A well designed system would possess the combination of pipe diameter and outlet spacing, able to provide adequate drainage capacity to handle the design flows. There should be sufficient inlet points into the edgedrain pipes, strategically placed to accommodate the inflow (Hassan and White, 1996).

Table 5.1 shows pipe conveyance values for various pipe sizes for the minimum recommended grade. For ease in maintenance a minimum pipe diameter of 100 mm (4 in) is recommended.

Table 5.1. Conveyance for circular pipes (K).

Pipe Diameter (in)	Pipe Conveyance, ft ³ /day*	
	Smooth Pipe (n = 0.012)	Corrugated Pipe (n = 0.024)
3	4,900	2,450
4	10,557	5,279
6	31,120	15,560

*Pipe conveyances computed using minimum recommended grade of 0.35%.

5.4 INSTALLATION / RETROFITTING OF PIPE EDGEDRAINS

Correct line and grade are critical to proper functioning of edgedrains. It is critical that outlet pipe in the trench is placed correctly, avoiding high or low spots in the trench. The trench backfill material must be compacted properly to prevent future maintenance problems with early deterioration of the shoulder. Another critical part of edgedrain installation is to ensure there is no water entrapment. This can be avoided only when the outlet pipe or concrete headwall are constructed to grade so the pipe drains has proper slope.

Another problem which may occur when flexible plastic tubing is used for the outlet pipe is pipe curling. Properly installed concrete headwalls should solve this problem. This is also the reason installation of rigid pipe outlet is also recommended.

The following section offers Mn/DOT recommended procedures for installation of subsurface drainage systems. This has been acquired from section 2502 of Mn/DOT Standard Specifications for Construction (Mn/DOT, 2005).

5.5 SUBSURFACE DRAINS

This section discusses procedures for construction of subsurface drains, using plant-fabricated pipe and appurtenant materials, which are installed to collect and discharge water infiltrating into the pavement system (pavement edge drain), collect and discharge water accumulated in the bottom of a granular-backfilled subcut (subcut drain), and to cut off or intercept ground water flowing toward the roadway (cut-off drain).

Subsurface drains include all materials used to collect ground water and conduct it to a discharge point either at a structure or on a side slope. The typical system will include a drain pipe, geotextiles, metal oversleeves, radial connecting pipe, discharge pipe, precast concrete headwalls, and rodent screens.

5.5.1. Materials

The pipe for the drain, which can include the edge drain, centerline drain, or interceptor drains, needs to be perforated to facilitate water entry. In contrast, the outlet piping, which conducts collected water to the outlet facility, should be nonperforated, and should be thermoplastic (TP) piping material. For all pipe materials, fittings used in connecting multiple lengths of pipe should be of the same material as the pipe.

5.5.2. Construction Requirements

The following general guidelines should be followed, but if special needs apply to the conditions at a specific location the design engineer can specify the alternative requirements.

5.5.3. Excavation

In general, the trench should be excavated at a constant depth so that the bottom of the trench follows the grade of the road. The depth of the trench should be such that the top of the installed drain pipe will be no less than 2 inches below the bottom of the base course layer, while also accommodating a bedding material beneath the pipe that has depth equal to the diameter of the pipe. The width of the trench should be equal to three times the pipe diameter. For perforated pipes the bed material should be fine filter aggregate, the specifications of which are given in Table 5.2, while for nonperforated pipes the bed material can be acquired from material encountered in the trench excavation. The bed should be shaped so the pipe fits snugly onto it. It is recommended that the shaping of the bed material be such as to fit at least the lower 30% of the outside circumference of the pipe.

Any rock greater than 1 inch encountered within the excavation should be removed to a minimum width as specified above, and to a minimum depth of one pipe diameter below the pipe.

Table 5.2. Mn/DOT specifications for fine filter aggregate material.

Sieve size	Percent Passing
9 mm (3/8 inch)	100
4.74 mm (#4)	90-100
2.00 mm (#10)	45-90
0.425 mm (#40)	5-35
0.075 mm (#200)	0-3

5.5.4. Laying Drains

Drains shall be laid carefully to line and grade, with uniform bearing throughout and with the perforations down unless otherwise directed.

All perforated pipe shall be wrapped with geotextile that is factory seamed or produced as a continuous knit weave. The fabric seam shall be placed at the top of the pipe (opposite the perforations). Where seams are necessary at fittings or connectors, the adjoining geotextiles shall be mechanically fastened, or overlapped a minimum of 150 mm (6 in).

Pipe sections shall be joined securely with the appropriate coupling bands or fittings. Solvent type joints shall be cemented unless otherwise specified. Upgrade ends of all subdrain pipe shall be closed with suitable caps. All junctions and turns shall be made with wyes or bends and be suitable for cleaning and inspection.

Where a drain connects with a structure or catch basin, the contractor shall make a suitable and secure connection through the wall of the structure. Unless otherwise specified, drainage outlets to the surface shall terminate at a standard precast concrete headwall.

5.5.5. Backfill

After the drain pipe is placed into the trench, the backfill material, which is generally sand or gravel, is filled in over the pipe. A chute should be used to place the backfill material into the trench to reduce impact of the backfill material onto the pipe. Once a minimum of 6 inches of backfill has been placed over the pipe the backfill should be compacted. A vibratory wheel compactor can be used for this purpose. For perforated pipes the backfill material should be fine filter aggregate, similar to that described in Table 5.2, up to at least 6 inches above the pipe. For elevations above that, the backfill material can be acquired from materials encountered during the excavation of the trench. For nonperforated pipes the material for the entire backfill can be acquired from materials extracted during the excavation of the trench.

5.5.6. Drain Outlets

Precast Concrete Headwall

Pavement drains will outlet to the side ditch through a discharge pipe and it is important to protect that discharge pipe from being damaged by mowing operations, vehicles driving off the shoulder, and entry of rodents. To protect outlets for drain pipes it is recommended that precast concrete headwalls be used (Figure 5.2). The uppermost point of the headwall is placed flush with the slope of the outlet ditch, and should be at a minimum downward grade of 2% so as not to back discharge water. The discharge pipe outlets through the concrete headwall at an elevation of 12 inches or more above ditch grades whenever possible, with the absolute minimum being 6 inches, and this elevation then determines the position of the headwall on the sideslope. The earthen side slopes adjacent to the headwall should be shaped to conform to the sides and toe of the headwall. All soils around and under the concrete headwall outlet should be compacted to minimize future movement.

**Precast Concrete
Headwall
In Slope**

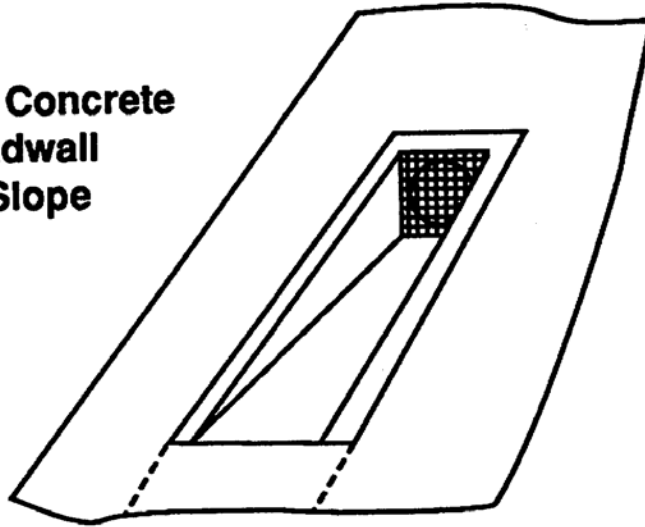

Side View

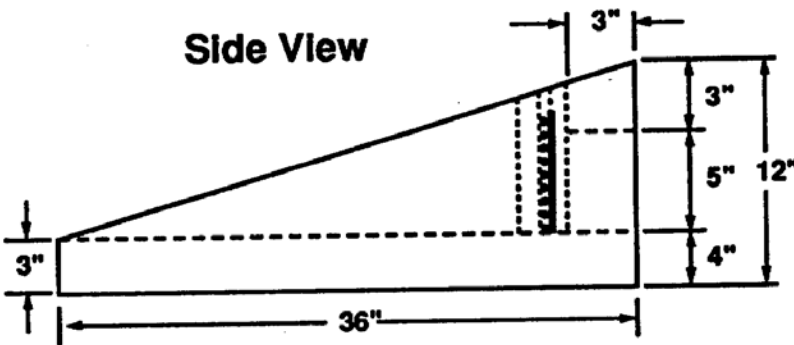

**Slotted
Headwall
Detail**

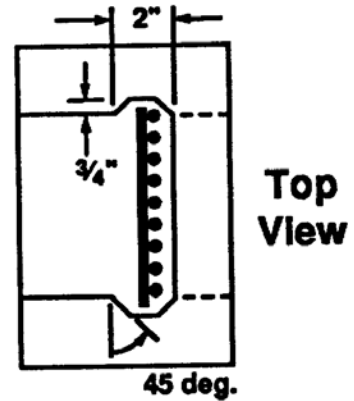

Top View

Front View

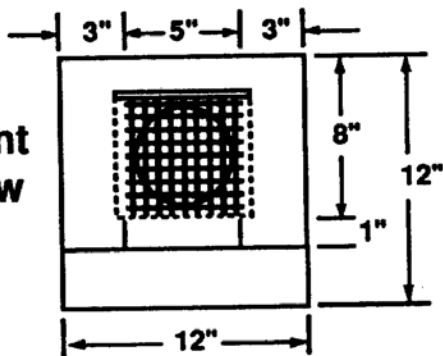

**Rodent
Shield**

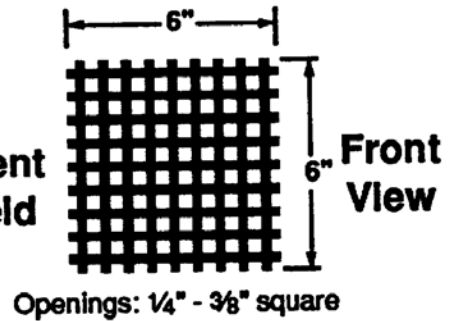

Front View

Figure 5.2. Design plans for precast concrete headwall with removable rodent screen (FHWA, 1992).

Discharge Pipe

The discharge pipe to the drain outlet should be constructed concurrently with the drains and be laid at roughly right angles to the roadway centerline. The discharge pipe should be fully inserted and coupled to the headwall, and should be secure enough so that small movements of the headwall will not cause separation. Suggested ways of securing this connection are to use 3A grout, a rubber gasket on the pipe, a rubber or plastic gasket cast into the headwall, or by solvent or gasket joint into a thermal plastic coupling securely cast into the headwall. The connection between the drain pipe and the discharge pipe will be at a right angle and should be made through a radial coupling having a minimum radius of 12 inches. This type of connection will provide easy access for probes, cleaners, and video cameras.

The trench for the discharge pipe along with the backfill material was described above. In the case of the discharge pipe, however, the grade should have a minimum of 2%.

Turf Establishment

Upon completion of the construction of the outlets, the soil overlying the outlet drain and the soil surrounding the headwall will be disturbed and exposed, subject to rainfall impact erosion. Stabilization of the exposed soil is important to prevent erosion around the drainage facility. To stabilize the exposed soil, seeds, or sod and an erosion control blanket should be applied to the soil. In many cases the construction of the road will involve more than just the installation of the outlet drain and the entire slope will have exposed soil. In that case, seeds or sod and erosion control blankets will again be required to stabilize the ditch surfaces.

Marking Outlet Locations

Outlet locations along the road should be permanently marked for the purpose of finding outlets for maintenance monitoring. A suggested method for the permanent marking is to use 6 by 18 inch strip of white marking tape. The tape should be placed at the outside edge of the bituminous shoulder, at right angles to the roadway. The tape can be rolled into the shoulder while the bituminous is still hot during construction. When two runs of drain pipe come together at a low point and discharge via a "Y" to a single outlet, there should be two markers placed side-by-side at 6 inch spacing. In the case where there is no bituminous shoulder, the location should be marked with tape on the bituminous pavement or by spraying a strip of white paint strip on concrete pavements.

Inspection and Cleanout

After completion of installation of the drainage pipe, the discharge pipe, and the headwalls, the installation should be checked to make sure that the systems are viable. Pipes crushed during construction are a common occurrence, and this will lead to later failures of the drainage function. The contractor should be responsible for any crushed, damaged, or misaligned pipes or misaligned headwalls. A suggested method of inspection is to use a probe mounted on the end of a flexible fiberglass rod. To be effective for the inspection the probe should be 4 inches long and have a diameter of one nominal pipe size smaller than the drain pipe that is being inspected. The

inspection should be conducted through the discharge pipe, radius connection, and at least 3 feet into the main drainage line to verify that it is open and operative.

Chapter 6 MAINTENANCE

6.0 INTRODUCTION

Maintenance of pavement subsurface drainage systems is an essential practice for the long-term success of drainage systems and, subsequently, pavements (Ray and Christory, 1989; Christory, 1990; Fleckenstein et al., 1991, 1994). Maintenance is tightly linked to both design and construction of pavements. Therefore, support from both stages is necessary for an effective maintenance program (U.S. DOT, 2002).

According to Baumgardner (2002) most of the State highway agencies that have constructed subsurface drainage systems recognize that maintenance is a problem. The most common maintenance problems are vegetative growth around the pipe outlets, rodent's nests, mowing clippings, and sediment collecting on rodent screens at the headwall.

An example of vegetative material removed from an edge drain is shown in Figure 6.1, while an edge drain pipe blocked by a rodent's nest is shown in Figure 6.2.



Figure 6.1. Vegetative material removed from an edgedrain system (Baumgardner, 2002).



Figure 6.2. Rodent's nest (Baumgardner, 2002).

Figure 6.3 and Figure 6.4 show examples of crushed pipes. These pipes were probably crushed during construction of the subsurface drainage system.

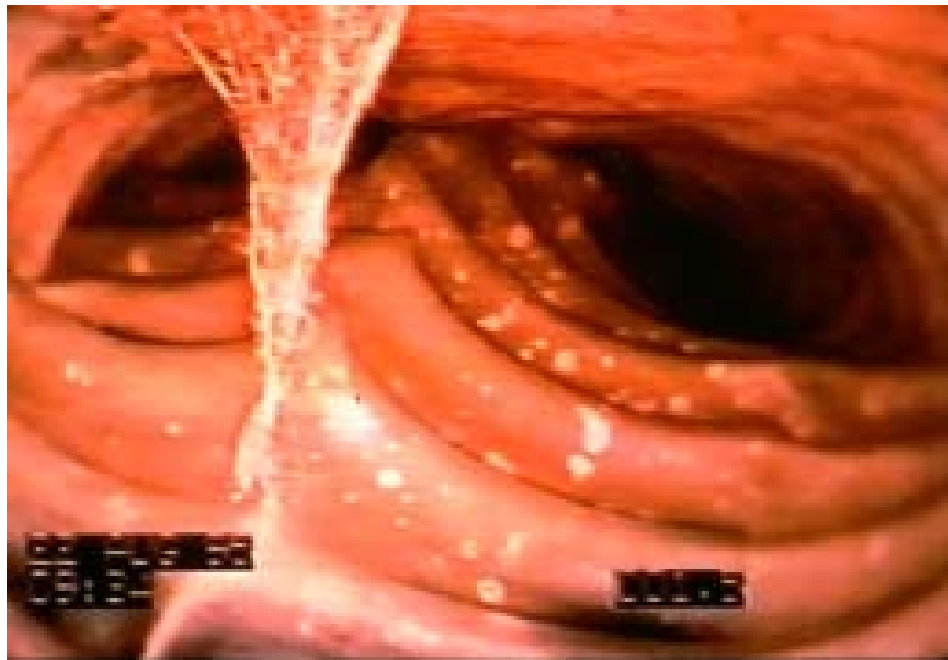

Figure 6.3. Crushed pipe (Baumgardner, 2002).

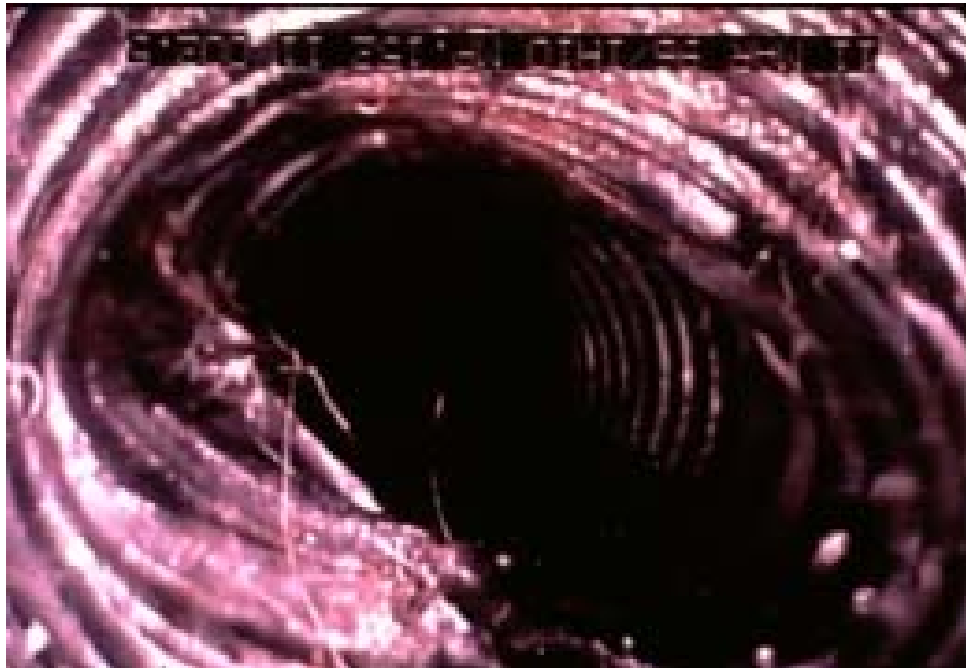

Figure 6.4. Crushed pipe (Baumgardner, 2002).

Figure 6.5 is an example of a typical outlet pipe hidden due to vegetative growth, while Figure 6.6 shows a pavement marker to indicate the location of an outlet.



Figure 6.5. Hidden outlet pipe (Baumgardner, 2002).



Figure 6.6. Painted arrow as a reference marker (Baumgardner, 2002).

Figure 6.7 present an example of excessive erosion at an edge drain outlet, while Figure 6.8 shows an outlet protected with a headwall.



Figure 6.7. Excessive erosion at the outlet pipe (Baumgardner, 2002).



Figure 6.8. Large outlet pipe headwall (Baumgardner, 2002).

6.1 MAINTENANCE PROGRAM

A maintenance program comprises of several phases. The most effective maintenance programs use a five-phase approach, the steps to which are listed below (U.S. DOT, 2002):

1. Routine inspection and monitoring
2. Routine preventive maintenance
3. Spot detection of problems
4. Repair
5. Continued monitoring and feedback

However, because of different reasons, such as budget constraints, and shortsighted economics, most state DOT maintenance programs use only the phases of spot detection and repair, although inspection, in conjunction with preventive maintenance, has proven to be many times more cost effective (a \$3 to \$4 return on each \$1 invested) than detection and repair programs (Geoffroy, 1996; Ridgeway, 1982).

In a survey carried out by U.S.DOT (2002) several respondents noted that program managers may not be aware that the lack of subsurface drainage maintenance has a delayed effect on pavement performance and, therefore, on future system costs.

According to U.S. DOT (1992), program managers often do not have adequate information with which to plan overall allocation of funds within their transportation facilities. A strong commitment from the general office to fund standard subsurface drainage maintenance is needed to prevent the loss of drainage and subsequent premature failure of a costly pavement.

A brief description of the above mentioned phases presented in the following sections.

6.1.1. Inspection and Monitoring

The inspection phase of maintenance provides important data on the effectiveness of drainage elements and the need for further maintenance (U.S. DOT, 2002). This phase includes visual inspection and effectiveness testing. Visual inspection consists of inventorying outflow following storm events and assessing outlet condition. Outflow inventories generally are qualitative (e.g. high, moderate, low, and no flow).

Visual inspection can be significantly enhanced though the use of video cameras (see Figure 6.9). These cameras have proven to be effective tools for identifying fine buildup and other potential blockages in drainage pipes (Steffles et al., 1991; Daleiden and Peirce, 1997). Ahmed and White (1993) have proposed a system of inspection for transportation agencies that includes visual and video camera inspection techniques. Training in the use of video equipment has been part of FHWA Demonstration Project 87. Demonstrations have been performed in 27 states (Daleiden and Peirce, 1997).



Figure 6.9. Video camera approaching edgedrain (Baumgardner, 2002).

6.1.2. Preventive Maintenance

U.S. DOT identified the following preventive maintenance actions that help ensure good subsurface drainage system performance (1990):

- Clean and seal joints and cracks.
- Clean and verify grade of outlet ditches.

- Clean catch basins and other discharge points.
- Clean outlet screen and area around headwalls.

Although the effectiveness of joint seals in preventing the ingress of surface water has proven to be short-lived, over the long-term the seals are still effective in preventing the wash-in of particulates that can clog the drainage system (Ridgey, 1982; McGhee, 1995). Guidelines for joint sealing are reviewed by McGhee and detailed by U.S.DOT, the American Concrete Pavement Association, and Strategic Highway Research Program (McGhee, 1995; U.S. DOT 1990b; ACPA, 1993; SHRP, 1993).

According to Wells' and Nokes' survey results, some states have installed cleanouts to aid in flushing of subsurface drainage systems, and some states require a minimum pipe size of 3 inch to allow for flushing (1993). Most require wide curves for outlet connections to facilitate insertion of a flushing unit (Figure 6.10).



Figure 6.10. Pipe flushing unit (Baumgardner, 2002).

One of the detriments to an effective strategy for maintaining pavement subsurface drainage systems is the inability to locate outlets for visual inspection and maintenance (U.S. DOT, 2002). One way to avoid this is to install reference markers and permanent concrete headwalls, as shown in Figures 4.6 and 4.8. More than 20,000 prefabricated headwall outlets were reported to have been installed in 1993 by the 20 states responding.

6.1.3. Repair

It is generally accepted that once pavement damage from blocked subsurface drainage is visible, the damage is irreversible and the pavement life has been shortened. For this reason, any problems observed, no matter how minor in appearance, should be addressed immediately to confine them to a localized area (Ray and Christory, 1989).

Usually, both pipes and outlets are accessible for maintenance, but aggregate and filters can be maintained only by removing costly surface materials. Damaged or nonfunctional outlets, clogged outlets, buried outlets, deposits at outlets, and water above outlets need prompt attention, because distress in pavement is imminent, and it is often too late for maintenance to help. When blockage is apparent in the drain line, flushing may be performed. However, if flushing is not successful, the drain line may require replacement (U.S. DOT, 2002).

6.1.4. Continuous Monitoring and Feedback

Monitoring is a continuous improvement process, especially for pavement sections that did not perform as well as intended. However, improvements are achieved only through providing feedback to the design and construction groups. Maintenance should provide inspection results along with performance indicators to both design and construction for review. In addition to this, information on the performance of treatments and costs to apply them should be fed into the Department of Transportation's pavement management, maintenance management, and cost accounting systems (U.S. DOT, 2002).

Different methodologies for pavement management and maintenance strategies are reviewed by Geoffroy and Zimmerman and ERES (Geoffroy, 1996; Zimmerman and ERES, 1995). FHWA is currently considering video inspection as a potential pavement management systems tool. A training program for maintenance staff on subsurface drainage strategies and their importance to long-term pavement performance should also be a part of the feedback process.

Figure 6.11 shows an example of an inspection form used during construction and also for maintenance purposes by the Kentucky Department of Transportation (U.S. DOT, 2002).

ROUTE	MILEPOST	DIRECTION	LOCATION & OUTLET TYPE	OUTLET	COVER MATER.	SCREEN CONDITION	SILT	FLOW	DITCHLINE DRAINAGE	SURFACE DISTRESS	FIELD NOTES	FILM ROLL # & PHOTO
				1. CLEAN 2. PT. COVER. 3. COVER. 4. PLUGGED	1. GRAV. 2. DIRT. 3. VEG. 4. CON.	1. NONE 2. OPEN 3. PT. OPEN 4. BLOCK	1. NONE 2. SLIGHT 3. MOD. 4. SEV.	1. YES 2. NO	1. GOOD 2. POOR	1. POT HOLE 2. STAINING 3. OUT 4. CL 5. CON. JT. 6. SHOULDER		

ROUTE	MILEPOST	DIRECTION	PIPE TYPE 1. FLEX. 2. RIGID	<table border="0"> <tr> <td>1. SAG</td> <td>8. BACKFILL IN PIPE</td> </tr> <tr> <td>2. SAG W/ STANDING WATER</td> <td>9. SEPARATION AT COUPLING</td> </tr> <tr> <td>3. SAG W/ SILTATION</td> <td>10. RIF IN PIPE</td> </tr> <tr> <td>4. COMPRESSED COUPLING</td> <td>11. COMPRESSED PANEL</td> </tr> <tr> <td>5. COMPRESSED PIPE</td> <td>12. COMPRESSED AND SILETED PANEL</td> </tr> </table>						1. SAG	8. BACKFILL IN PIPE	2. SAG W/ STANDING WATER	9. SEPARATION AT COUPLING	3. SAG W/ SILTATION	10. RIF IN PIPE	4. COMPRESSED COUPLING	11. COMPRESSED PANEL	5. COMPRESSED PIPE	12. COMPRESSED AND SILETED PANEL	VIDEO TAPE
				1. SAG	8. BACKFILL IN PIPE															
2. SAG W/ STANDING WATER	9. SEPARATION AT COUPLING																			
3. SAG W/ SILTATION	10. RIF IN PIPE																			
4. COMPRESSED COUPLING	11. COMPRESSED PANEL																			
5. COMPRESSED PIPE	12. COMPRESSED AND SILETED PANEL																			
A	B	C	D	E	F	COMMENTS														

Figure 6.11. Construction and maintenance inspection form (U.S., DOT, 2002).

6.2 MAINTENANCE CURRENT PRACTICE

The results of a survey carried out by the Department of Transportation indicate the following (U.S. DOT, 2002):

- Many respondents have little information on the maintenance activities of their agencies and many agencies have more than one policy, depending on the responsible individuals in each maintenance jurisdiction. Most respondents agreed that maintenance of the outlets is the single most important maintenance task that contributes to long-term performance of pavement subsurface drainage systems. However, locating the outlets was noted as a problem. Of 33 agencies that reported using edge-drains, 39% use posts to locate outlets, 9% use markers on the pavement, 9% stake the location or use the headwall, and 21% reported having no markers system. The remaining 22% did not provide a response. Outlets that are crushed, plugged, or under water, poor grades on the outlet pipe, and plugged rodent screens were cited as problems leading to system failures.
- Only nine states indicated that they have a program for periodic subsurface drainage maintenance inspection. Most states require a yearly inspection of the outlet condition. Some have follow-up actions, depending on findings of the inspection. Ditch cleaning, pipe flushing, and total replacement are actions states take based on inspections. Many

respondents indicated that many maintenance groups select their own maintenance strategies with little central control (i.e., with little uniformity of application of technology).

- One concern expressed by the designers is that there is insufficient control over the flow of money into maintenance activities and, therefore, the designers cannot predict whether any maintenance will get done. For this reason, design level decisions may not be the most appropriate for evaluating actual maintenance capabilities.
- All designers surveyed expressed the importance of maintenance to pavement subsurface drainage systems. However, there appears to be a lack of confidence that maintenance support will be consistent and can be relied upon when design decisions are made. Most designers expressed a desire for training of maintenance staff, and some also expressed a desire for more basic research in the maintenance area.

Chapter 7 COST ESTIMATION: ECONOMIC ANALYSIS

7.0 INTRODUCTION

Cost estimation is a very important issue in subsurface drainage systems for pavements. This enables us make decisions on the choice of best alternative when evaluating different design approaches, construction techniques, and maintenance programs for a specific subsurface drainage project. The costs associated with maintenance of the subsurface drainage system are an important component of the lifetime cost of a pavement.

Subsurface drainage systems constitute an important part in the total cost of pavements. However, they are a very cost-effective measure because they will contribute to a longer lifetime of the pavement. The estimation of costs for a subsurface drainage system can be performed by considering it as an integral part of the total cost of the pavement (as well as costs for design, construction, maintenance, etc.), or can be done separately, as a separate project from the pavement structure. Because of the investment needed for installing any pavement, a life-cycle cost analysis (LCCA) is required in order to help making the best economical decision.

7.1 LIFE-CYCLE COST ANALYSIS

LCCA is an analysis technique that builds on the well-founded principles of economic analysis to evaluate the overall long term economic efficiency between competing alternative investment options (U.S. DOT, 1998). LCCA is an award procedure commonly used for designing and building highway pavement projects (Gransberg and Molenaar, 2004). According to Scott, a LCCA should be accomplished for all pavement designs (2003). Costs in the analysis have to include future maintenance, repairs, rehabilitations, user expenses from the loss of usage, and initial cost.

There are computer programs available to perform life-cycle cost analysis, such as RealCost, which is a Microsoft Excel 2000 based workbook that was developed for cost evaluation of pavement rehabilitation alternatives. In the following, a brief description of the economics indicators included in a LCCA is presented, based on those presented by the U.S. DOT (1998).

7.2 ECONOMIC INDICATORS

The most common indicators available for the analysis include the benefit/cost (B/C) ratios, the internal rate of return (IRR), the net present value (NPV), and the equivalent uniform annual costs (EUAC). Many of these indicators are thoroughly discussed in OMB (1992).

Benefit/cost analysis or ratio represents the net discounted benefits of an alternative divided by net discounted costs. B/C ratios greater than 1.0 indicate that benefits exceed cost. The B/C ratio approach is generally not recommended for pavement analysis because of the difficulty in sorting out benefits and costs for use in developing B/C ratios.

Internal Rate of Return, primarily used in private industry, represents the discount rate necessary to make discounted cost and benefits equal. While the IRR does not generally provide an acceptable decision criterion, it does provide useful information, particularly when budgets are constrained or there is uncertainty about the appropriate discount rate.

Net present value, also called net present worth, is the discounted monetary value of expected net benefits. NPV is computed by assigning monetary values to benefits and costs, discounting future benefits (PV_{benefits}) and costs (PV_{costs}) using an appropriate discount rate, and subtracting the sum total of discounted costs from the sum total of discounted benefits. Programs with a positive NPV value increase social resources and are generally preferred, whereas programs with negative NPV should generally be avoided. NPV is considered to be the economic efficiency indicator of choice.

The basic formula for computing NPV is:

$$NPV = PV_{\text{benefits}} - PV_{\text{costs}} \quad (7.1)$$

Because the benefits of keeping the roadway above some predetermined terminal service ability level are the same for all design alternatives, the benefits component drops out and the formula reduces to:

$$NPV = \text{Initial Cost} + \sum_{k=1}^n \text{Rehab Cost}_k \left[\frac{1}{(1+i)^{n_k}} \right] \quad (7.2)$$

where

i is the discount rate (fraction)

n is the year of expenditure

Equivalent uniform annual cost represents the NPV of all discounted cost and benefits of an alternative as if they were to occur uniformly throughout the analysis period. EUAC is a very useful indicator when budgets are established in an annual basis. A common way of determining EUAC is first to determine the NPV, and then convert it to EUAV using the following formula:

$$EUAC = NPV \left[\frac{1(1+i)^n}{(1+i)^n - 1} \right] \quad (7.3)$$

7.3 *POTENTIAL INCREASE IN MAINTENANCE COSTS*

If the subsurface drainage system is not installed correctly, or is not well maintained, excess water will not be properly removed from the pavement. If this happens, the lifetime of the pavement will be reduced and/or the maintenance cost to prevent this reduction will increase. The increase in maintenance costs of the pavement, due to the potential excess water, can be calculated as a fraction of the increase of construction costs of the pavement.

Arika et al proposed that the increase of construction cost could be estimated in a preliminary way by estimating the decrease in fatigue life of the road due to the increase in water content in the subgrade material (2006). Then it will be possible to determine the actual lifetime of the road and the time when the road needs to be replaced. The construction cost of the pavement will increase, in the long range, because it will be replaced earlier than expected. This approach is developed next.

From Otto and Nieber (2005), cited by Arika et al. (2005), it can be observed that the fatigue life of the road decreases consistently when the water content of it increases (see Figure 7.1). In other words, any relative increase in water content of the road can be associated with a relative decrease in fatigue life of the road (see Figure 7.2).

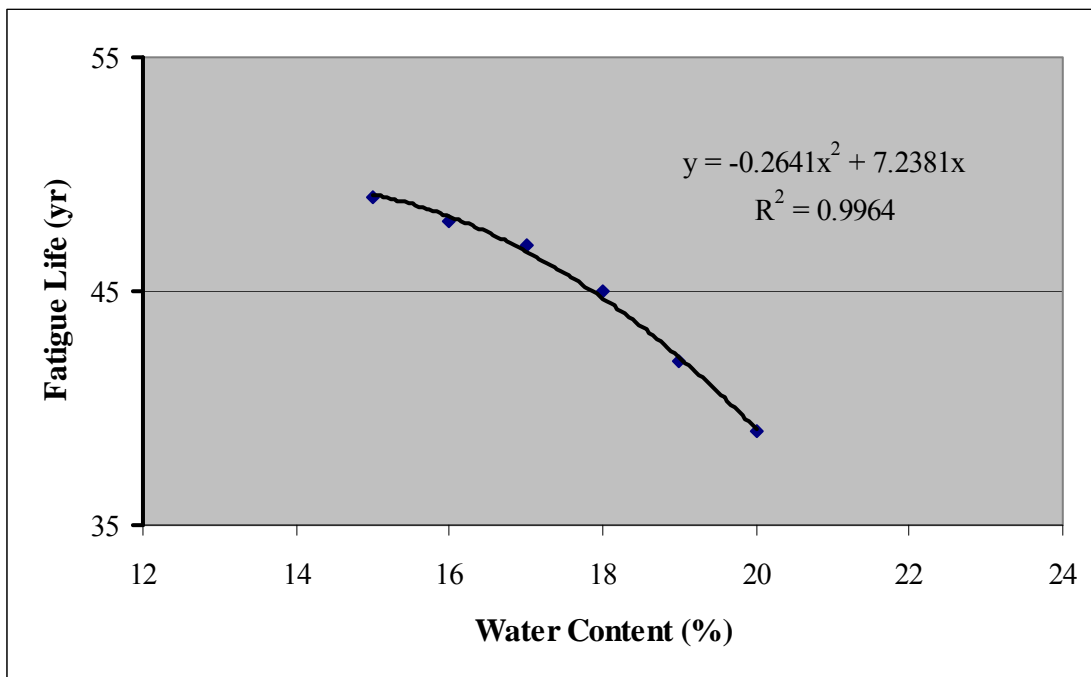

Figure 7.1. Relationship between fatigue life and water content (Arika et al, 2006).

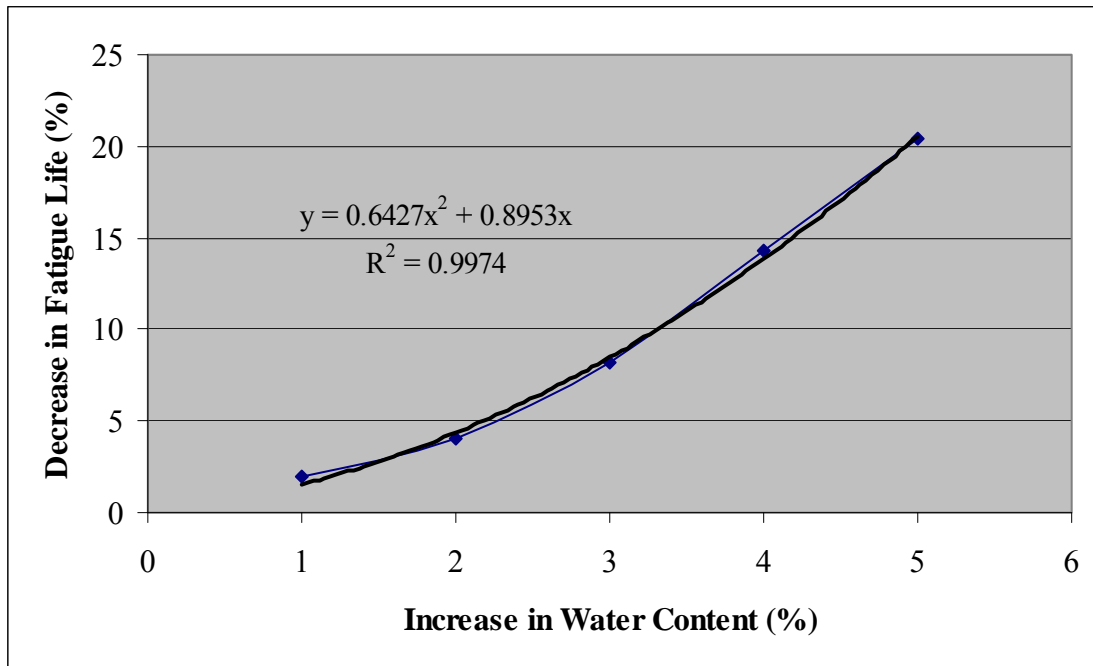

Figure 7.2. Decrease in fatigue life due to increase in water content (Arika et al, 2006).

Using LCCA, it is possible to calculate the annual construction cost of the road along its lifecycle. So, if the decrease in fatigue life of the road, from Fig. 7.2, is associated with a similar decrease in its lifecycle, it would be possible to calculate a new EUAC and, therefore, the increase in the construction cost of the road. In other words, if the lifecycle decreases, the EUAC will increase and the annual construction cost of the road will also increase, as is shown in Figure 7.3.

For example, an increase of water content of 5% will decrease the fatigue life of the road and, therefore, in its lifecycle, by about 20%. For a normal lifecycle of 20 years, the reduced lifecycle would then be around 16 years. Using a market discount rate (i) of 0.07, the new EUAC will be 0.1062, instead of 0.0944, representing an increase in construction costs of about 12.5%. For an increase of water content of 8%, the new lifecycle will be about 10.5 years (from Figure 7.2), and the increase in the construction cost will be about 32% (from Figure 7.3).

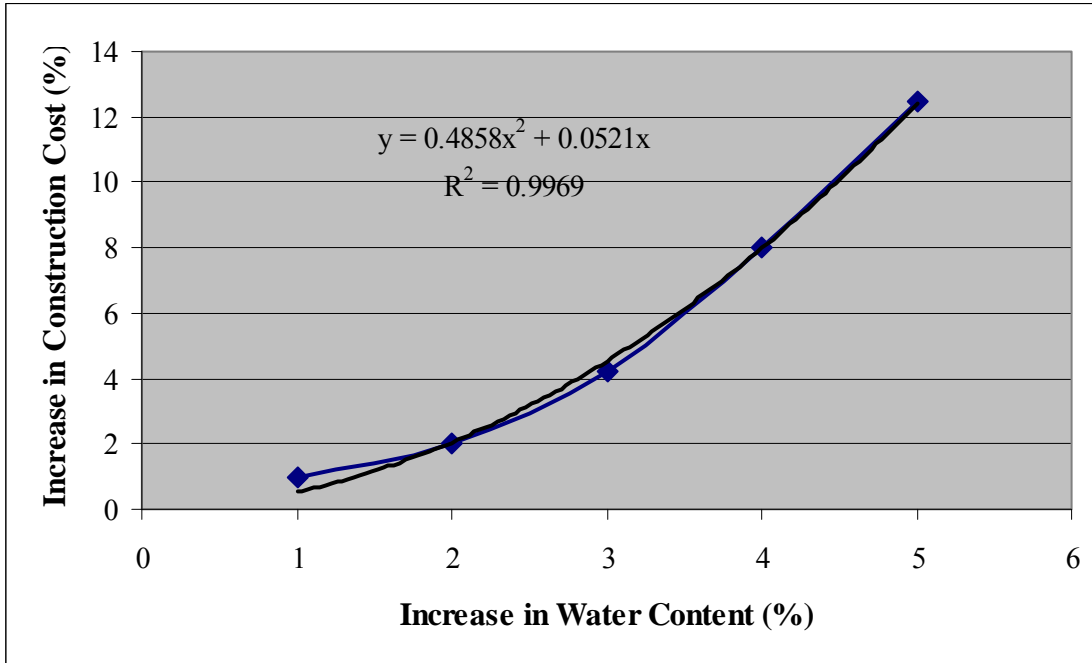

Figure 7.3. Increase in construction costs due to increase in water content (Arika et al, 2006).

REFERENCES

- AASHTO. 1963. An Informational Guide on Project Procedures (Green Book). Design Standards for Highways FHPM 6-2-1-1. AASHTO, American Association of State Highway and Transportation Officials.
- AASHTO, A.A.o.S.H.a.T.O. 1978. Manual on Foundation Investigations, Washington, D. C.
- AASHTO, A.A.o.S.H.a.T.O. 1999. Model Drainage Manula (Metric Edition). AASHTO, Washington, D.C.
- Aldrich, H.P. 1956. Frost Penetration Below Highway and Airfield Pavements Bulletin No. 135. Highway Research Board, Washington, D. C.
- ASTM, A.S.f.T.M. 1978. Standard method for particle-size analysis of soils Annual Book of ASTM Standards, Part 19. American Society for Testing Materials, Philadelphia, PA.
- Barber, E.S., and C.L. Sawyer. 1952. Highway Subdrainage. Public Roads 26:251-268.
- Barenberg, E.J., and O.O. Thompson. 1970. Behavior and performance of flexible pavements in the University of Illinois Pavement Test Track Highway Engineering Series No. 36. Illinois Cooperative Highway Research Program Series No. 108, Urbana, IL.
- Barron, R.A. 1948. Consolidation of Fine Grained Soils by Drain Wells Rutledge, P. Transactions, American Society of Civil Engineers 113.
- Calhoun, C.C., Jr. 1972. Development of Design Criteria and Acceptance Specifications for Plastic Filter Cloths Technical Report S-72-7. U. S. Army Waterways Experiment Station.
- Calhoun, C.C., Jr., J.R. Compton, and W.E. Strohm. 1971. Performance of Plastic Filter Cloths as a Replacement for Granular Filter Materials, Highway Research Record No. 373. Highway Research Board, Washington, D. C.
- Carpenter, S.H., J.A. Arman, B.J. Dempsey, and H. S. 1981. A Pavement Moisture Accelerated Distress (MAD) Indentification System FHWA/RD-81/079. Federal Highway Administration, Washington, DC.
- Carsel, R.F., and R.S. Parrish. 1988. Variation within texture classes of soil water characteristics. Water Resource Res. 24:755-769.
- Cedergren, H.R. 1973a. Development of Guidelines for the Design of Subsurface Drainage Systems for Highway Pavement Structural Section. FHWA-RD-73-14. Office of Research, Federal Highway Administration, Washington , D.C.
- Cedergren, H.R. 1973b. Development of Guidelines for the Desgin of Subsurface Drainage Systems for Highway Pavement Structural Section. FHWA-RD-73-14. Office of Research, Federal Highway Administration, Washington , D.C.
- Cedergren, H.R. 1974a. Drainage of Highway and airfield pavements Wiley, New York.
- Cedergren, H.R. 1974b. Drainage of Highway and Airfield Pavements, John Wiley and Sons, New York.
- Cedergren, H.R. 1977. Seepage, Drainage and Flow Nets John Wiley and Sons, New York.
- Cedergren, H.R. 1988. Why all Important Pavements should be well Drainage Transportation Research Record 1188. Transportation Research Board, Washington , D.C.
- Cedergren, H.R., J.A. Arman, and K.H. O'Brien. 1973. Development of Guidelines for the Desing of Subsurface Drainage Systems for Highway Pavement Structural Sections FHWA-RD-73-14. Federal Highway Adminstration, Washington, D.C.

- Christopher, B.R., and V.C. McGuffey. 1997. Pavement Subsurface Drainage Systems Synthesis of Highway Practice 239. Transport Research Board: National Research Council, Washington, DC. (ed.) 1990. Sixth International Symposium on Concrete Roads., Madrid, Spain.
- Chu, T.Y., D.T. Davidson, and A.E. Wickstrom. 1955. Permeability test for Sands ASTM Special Technical Publication No. 1.63,. American Society for Testing Materials, Philadelphia, PA.
- Dempsey, B.J., S.H. Carpenter, and M.I. Darter. 1982. Improving Subdrainage and Shoulders of Existing Pavements - State of the Art FHWA/RD-81/077. Federal Highway Administration, Washington, D.C.
- Domenico, P.A., and F.W. Schwartz. 1990. Physical and Chemical Hydrogeology John Wiley and Sons, New York, NY.
- ERES. 1996. Performance of Subsurface Pavement Drainage. Interim Report. TRB, National Research Council, Washington, DC.
- ERES. 1998. Evaluation of Unbonded Portland Cement Concrete Overlays. Final Report, NCHRP 10-41. Transportation Research Board, Washington, DC.
- ERES. 1999. Pavement Subsurface Drainage Design. Reference Manual ERES Project No. 99-035-E1. U.S. Dept. of Transportation, Federal Highway Administration, National Highway Institute., McLean, Va.
- ERES CONSULTANS, I. 1998. Pavement Subsurface Drainage Design FHWA DTFH61-95-C-00003. National Highway Institute
Federal Highway Administration, Champaign, IL.
- FHWA, D.P. 1992. Drainable Pavement Systems, Participant Notebook Publication FHWA-SA-92-008. FHWA, United States Department of Transportation, Washington, D.C.
- FHWA, F.H.A. 1973. Final Report for the Project for Development of Guidelines for the Design of Subsurface Drainage Systems for Highway Structural Sections, Washington, D.C.
- FHWA, F.H.A. 1994. Drainable Pavement Systems - Participant Notebook. Demonstration Project 87: FHWA-SA-92-008. Office of Technology Applications and Office of Engineering, FHWA.
- Geoffroy, D.N. 1996. Synthesis of Highway Practice 223: Cost-effective Preventive Pavement Maintenance. Transport Research Board, National Research Council, Washington, D.C.
- Gulden, W. 1983. Experience in Georgia with Drainage of Jointed Concrete Pavements Transportation Research Record 1440. Transportation Research Board, Washington, D.C.
- Hagen, M.G., and G.R. Cochran. 1995. Comparison of Pavement Drainage Systems. MN/RD-98/28. Minnesota Department of Transportation, Maplewood, MN.
- Haley, J.F. 1963. Frost Considerations in Highway Pavement Design: Eastern United States Highway Research Record No. 33. Highway Research Board, Washington, D. C.,.
- Hall, J.W., Jag. Mallela, and Kelly L. Smith., 2005. A Design and Construction Guide: Stabilized and Drainable Base for Rigid Pavements Report IPRF-01-G-002-02-1(G). Innovative Pavement Research Foundation (IPRF) and Federal Aviation Administration (FAA), Skokie, IL.
- Hansen, V.E., O.A. Israelson, and G. Stingham. 1979. Irrigation Principles and Practice John Wiley & Son, Inc., New York, NY.
- Harrigan, E.T. 2002. Performance of Subsurface Pavement Drainage ; NCHRP RESEARCH RESULTS DIGEST 268. TRB - National Cooperative Highway Research Program.

- Haynes, J.A., and E.J. Yoder. 1963. Effect of Repeated Loading on Gravel and Crushed Stone Base Materials Used in the AASHTO Road Test Highway Research Record 39. Highway Research Board, Washington, D.C.
- Healey, K.A., and R.P. Long. 1972. Prefabricated Filter-Fin for Subsurface Drains. J. Irrigation and Drainage Division of ASCE IR 4.
- Hindermann, W.L. 1968. The Swing to Full-Depth information series No. 146. Asphalt Institute, Lexington, KY.
- Hvorslev, M.J. 1949. Subsurface Exploration and Sampling of Soils for Civil Engineering Purposes. Engineering Foundation, New York, N. Y.
- James, L.G. 1988. Principles of Farm Irrigation System Design John Wiley & Sons, New York, NY.
- Jeffcoat, H.H., F.A. Kilpatrick, J.B. Atkins, and J.A. Pearman. 1992. EFFECTIVENESS OF HIGHWAY EDGEDRAINS: Experimental Project No. 12, Concrete Pavement Drainage Rehabilitation 92-4147. USDOT, Federal Highway Administration, Washington, D.C.
- Johnson, A.W. 1952. Frost Action in Roads and Airfields, A Review of Literature Special Report No. 1. Highway Research Board, Washington, D. C.
- Lee, M., B. Brooks, and D. Spivey. 2002. Wapa Asphalt Pavement Guide [Online]. Available by Washington Asphalt Pavement Association, Inc.
http://www.asphaltwa.com/wapa_web/modules/11_guidance/11_surface_distress.htm#stripping.
- Mallela, J., G. Larson, T. Wyatt, J. Hall, and W. Barker. 2002. USER'S GUIDE FOR DRAINAGE REQUIREMENTS IN PAVEMENTS – DRIP 2.0 MICROCOMPUTER PROGRAM. ERES Consultants, A Division of Applied Research Associates, Inc. Funded by Federal Highway Administration, Champaign, IL. (ed.) 1990. Virginia Pavement Drainage Workshop, Williamsburgh, VA. Virginia Department of Transportation.
- Mn/DOT. 1994a. Permeable Aggregate Base Drainage Systems - Design Guidelines. Materials Engineers Committee, Minnesota Department of Transportation, St Paul, MN.
- Mn/DOT. 1994b. Permeable Aggregate Base Drainage Systems - Guidelines Development. Materials Engineers Committee, Minnesota Department of Transportation, St Paul, MN.
- Mn/DOT. 2005. Standard Specifications for Construction. 2005 ed. Minnesota Department of Transportation, St. Paul, Mn.
- Moulton, L.K. 1968. Prediction of the Depth of Frost Penetration in West Virginia for Pavement Design Purposes, West Virginia University, Morgantown, West Virginia.
- Moulton, L.K. 1977. Groundwater, Seepage and Flow Nets. 2nd ed. John Wiley and Sons, New York, (ed.) 1979. 58th Annual Meeting of the Transportation Research Board, Washington, D. C.
- Moulton, L.K. 1980. Highway Subsurface Drainage Design - FHWA-TS-80-224 FHWA-TS-80-224. Office of Research and Development, Federal Highway Administration, Washington, D.C.
- Muench, S.T., J.P. Mahoney, and L.M. Pierce. 2006. WSDOT Pavement Guide [Online]. Available by WSDOT, Washington State Department of Transportation
<http://training.ce.washington.edu/WSDOT/>.
- NCHRP, N.C.H.R.P. 1974. Roadway Design in Seasonal Frost Areas Highway Research Program Synthesis of Practice No. 26. Transportation Research Board, Washington, D. C.

- NCHRP, N.C.H.R.P. 1976. Aquisition and Use of Geotechnical Information Synthesis of Practice No. 33. Highway Research Board, Washington, D. C.
- NOAA, N.O.a.A.A. 1973. Precipitation Frequency Atlas of Westerg United States, NOAA Atlas No.2. U.S. Government Printing Office,, Washington DC 20402.
- NOAA, N.O.a.A.A. 1977. Five to 60 Minute Precipitation Frequency for Eastern and Central United States NTIS No. PB 272 112. National Weather Service, NWS HYDRO-35, 5285 Port Royal Road, Springfield, VA 22161.
- NYDOT, S.o.N.Y.D.o.T. 1973. Test Procedures for Specific Surface Anbalysis Soil Test Procedures STP-1. Soil Mechanics Bureau, New York, NY.
- Peck, R.B., W.E. Hanson, and T.H. Thornburn. 1975. Foundation Engineering. 2nd ed. John Wiley and Sons, NeW York.
- PIARC. 1987. Combating Concrete Pavement Slab Pumping—State of the Art and Recommendations. PIARC Technical Committee on Concrete Roads.
- Rawls, W.J., L.R. Ahuja, D.L. Brakensiek, and A. Shirmohammadi, (eds.) 1992. Soil water movement and infiltration. Handbook of Hydrology. McGraw Hill.
- Ray, M. 1981. A European synthesis on drainage, subbase, erodibility, and load transfer in concrete pavements, Proceedings of the 2nd International Conference on Concrete Pavement Design, April 14-16, Purdue University, IN.
- Ray, M. and J.P. Christory. 1989. Combating concrete pavement slab pumping - state of the art and recommendations, Proceedings of the 4th International Conference on Concrete Pavement Design and Rehabilitation, April 18-20, Purdue University, IN.
- Ray, M., J.P. Christory and J.P. Poilane. 1985. Drainage and erodibility: International seminar on synthesis and new research results related to field performance, Proceedings of the 3rd International Conference on Concrete Pavement Design and Rehabilitation, April 23-25, Purdue University, IN.
- Ridgeway, H.H. 1976. Infiltration of water through the pavement surface Transportation Research Record No. 616. Transportation Research Board, Waashington, D.C.
- Ridgeway, H.H. 1982. Pavement Subsurface Drainage Systems Synthesis of Highway Practice 96. NCHRP Synthesis of Highway Practice, Tansportation Research board, National Research COuncil, Washington, DC.
- Smith, J.W., and H.R. Cedergren. 1963. Cut slope design and landslides, Special Technical Publication No. 322. American Society for Testing Materials, Philadelphia, PA.
- Smith, K.D., A.L. Mueller, M.I. Darter, and D.G. Peshkin. 1990. Performance of Jointed Concrete Pavements, Volume II - Evaluation and Modification of CONcrete Pavement Desing and Analysis Models. Federal Highway Administration, McLean, VA.
- Sowers, G.B., and G.F. Sowers. 1961. Introductory Soil Mechanics and Foundations Macmillan Company, New York, NY.
- Steward, J., R. Williamson, and M. J. 1977. Guidelines for Use of Fabrics in Construction and Maintenance of Low Volume Roads Report No. FHWA-TS-78-205,. Federal Highway Administration, Washington, D. C.
- U.S. Army COE. 1988. Technical Guidance for Design of the Subsurface Drainage for Military Pavements (Draft) 39 180-063 1. Waterways Experiment Station (GP-T),, Vicksburg, MS.
- Voller, V.R. 2002. MNDRAIN Drainage Design Software - alpha version. User Manual.
- White, L.a.M.Z. 2001. A Simplified Model for Pavement Drainage. The International Journal of Geomechanics 1:65–82.

- Wyatt, T., W. Barker, and J. Hall. 1998. Drainage Requirements in Pavements: User Manual FHWA-SA-96-070. Federal highway Administration, Washington, DC.
- Yu, H.T., L. Khazanovich, S.P. Rao, M.I. Darter, and H. Von Quintus. 1998. Guidelines for Subsurface Drainage Based on Performance. NCHRP 1-34 Final Report. NCHRP 1-34. National Cooperative Highway Research Program (NCHRP), Washington, D. C.
- Yu, H.T., L. Khazanovich, S.P. Rao, M.I. Darter, and H.V. Quintus. 1998b. Guidelines for Subsurface Drainage Based on Performance. NCHRP 1-34 Final Report. National Cooperative Highway Research Program., Washington, D.C.
- Zimmerman, R.W. and G.S. Bodvarsson, 1996. Hydraulic conductivity of rock fractures, *Transport in Porous Media*, 23: 1-30.
- Zubair, A., T. D. White, and T. Kuczek. 1997. Comparative Field Performance of Subdrainage Systems. *J. Irrigation and Drainage Engineering*. 123:194-201.

Appendix A

OUTLINE: RECOMMENDED PROCEDURES FOR SELECTION, DESIGN, CONSTRUCTION AND MAINTENANCE OF SUBSURFACE DRAINAGE SYSTEMS

**DESIGN OF SUBSURFACE DRAINAGE SYSTEMS:
RETROFITTING EXISTING PAVEMENT STRUCTURES**

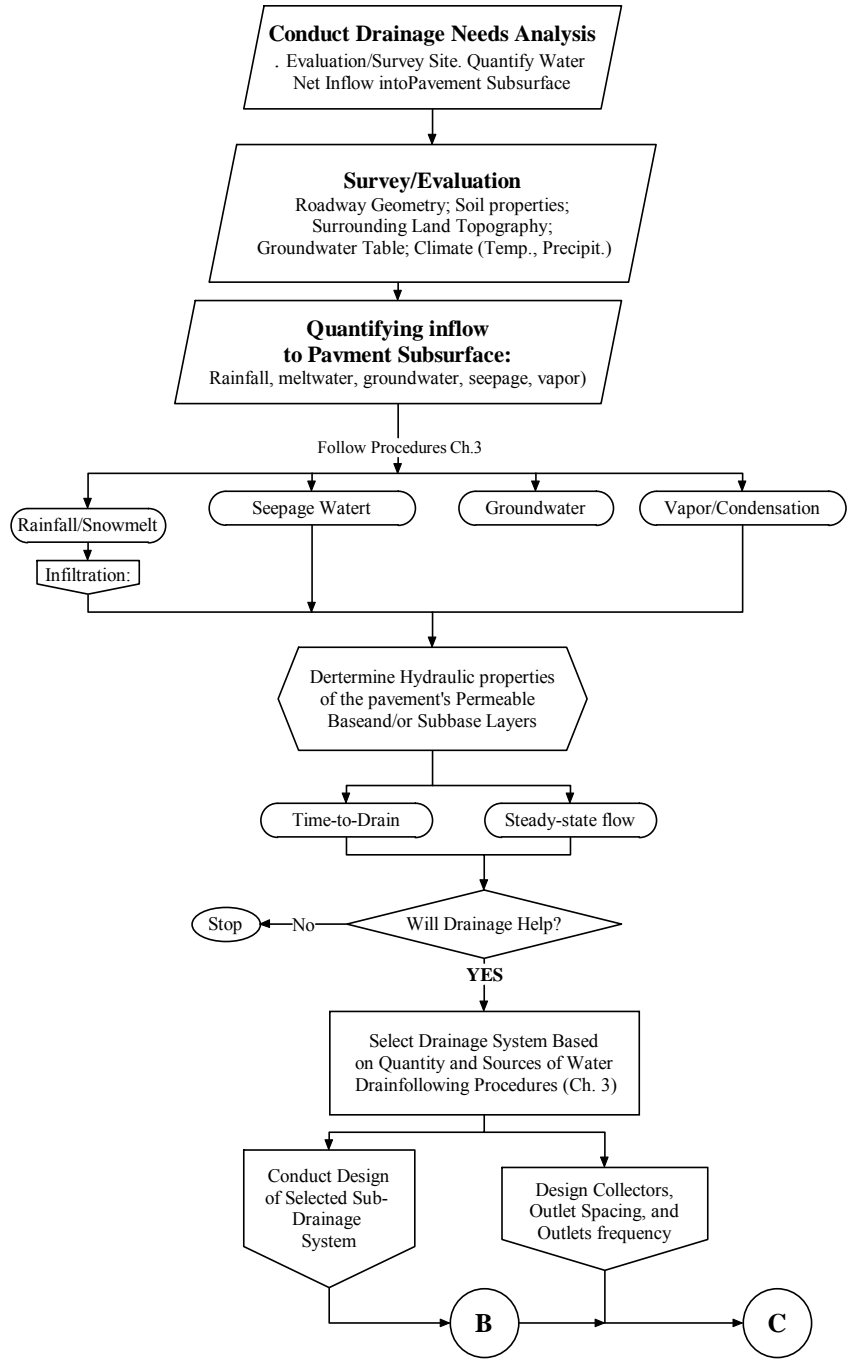

Figure A-1. Outline of recommended procedures for selection, design, construction and maintenance of subsurface drainage system for highway pavements.

**DESIGN OF SUBSURFACE DRAINAGE SYSTEMS: RETROFITTING
EXISTING PAVEMENT STRUCTURES**

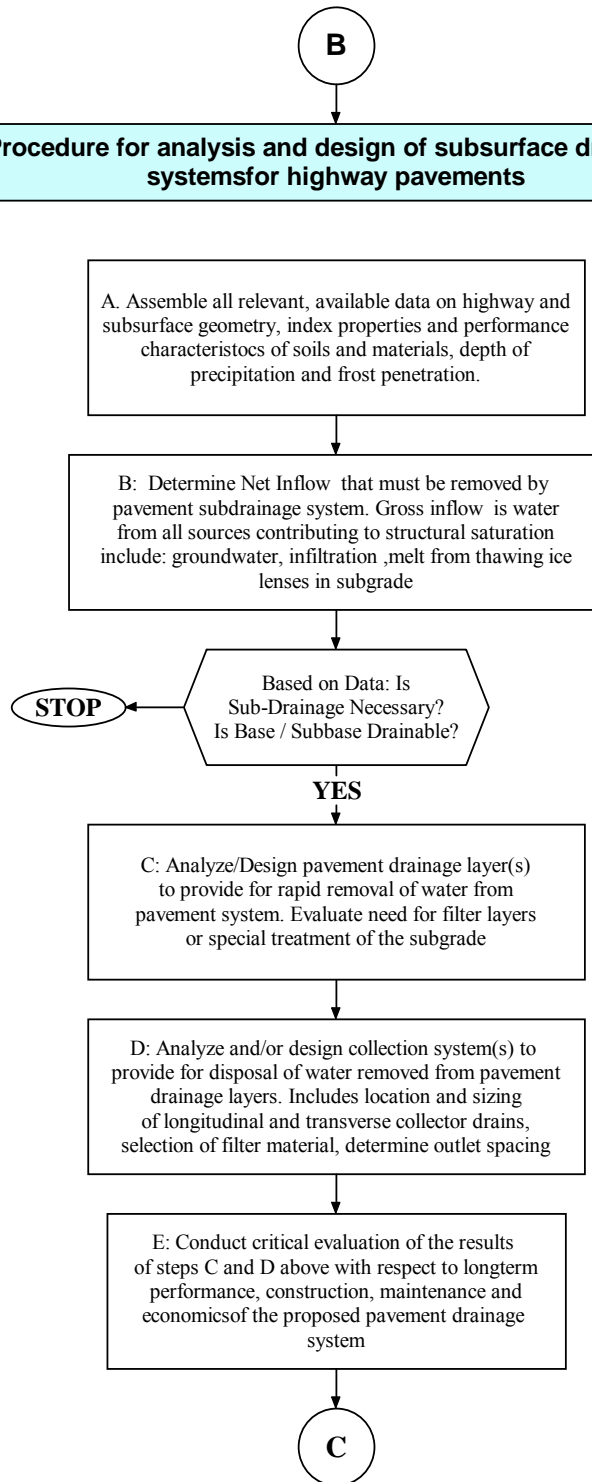

Figure A-1. Outline of recommended procedures for selection, design, construction and maintenance of subsurface drainage system for highway pavements (cont'd).

C

Construction of subsurface drainage systems for highway pavements

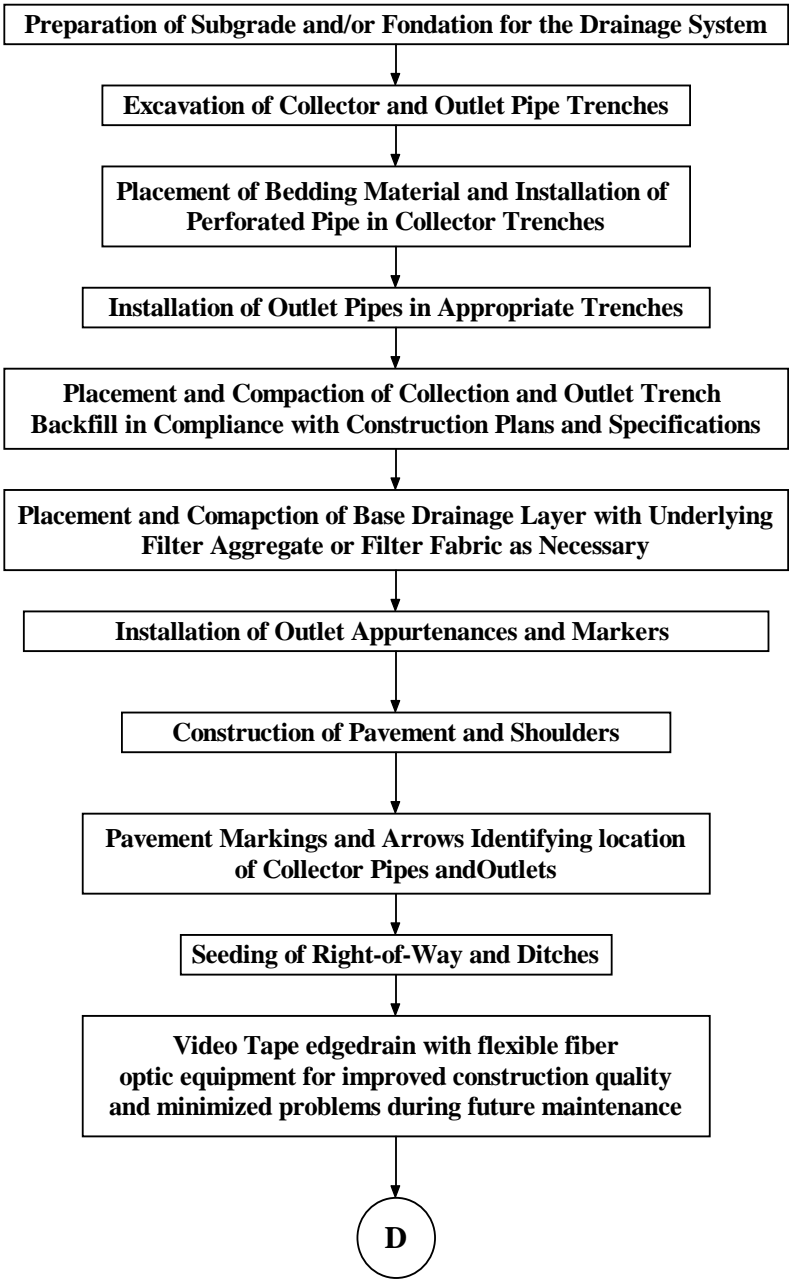

Figure A-1. Outline of recommended procedures for selection, design, construction and maintenance of subsurface drainage system for highway pavements (cont'd).

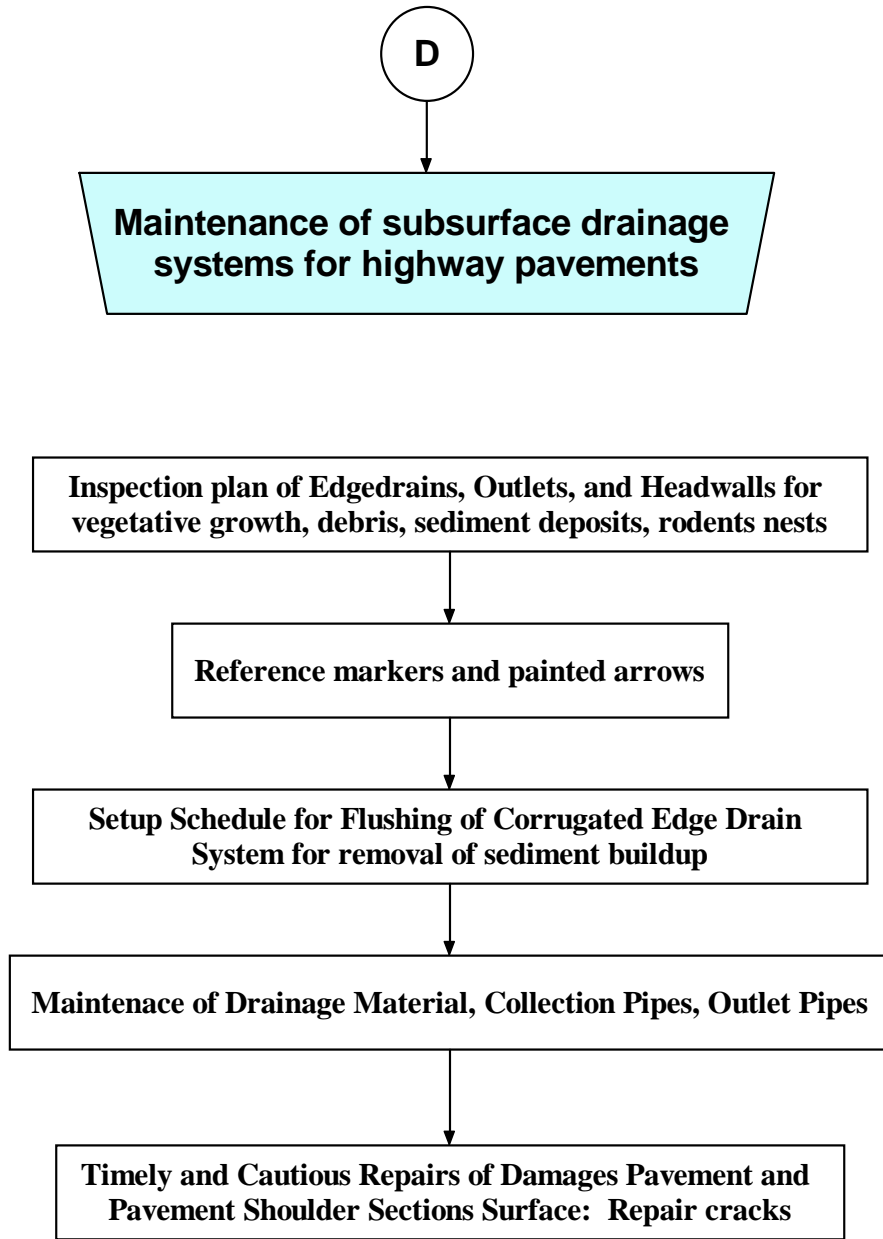

Figure A-1. Outline of recommended procedures for selection, design, construction and maintenance of subsurface drainage system for highway pavements (cont'd).

**DESIGN OF SUBSURFACE DRAINAGE SYSTEMS FOR
NEW CONSTRUCTIONS (PAVEMENT STRUCTURES)**

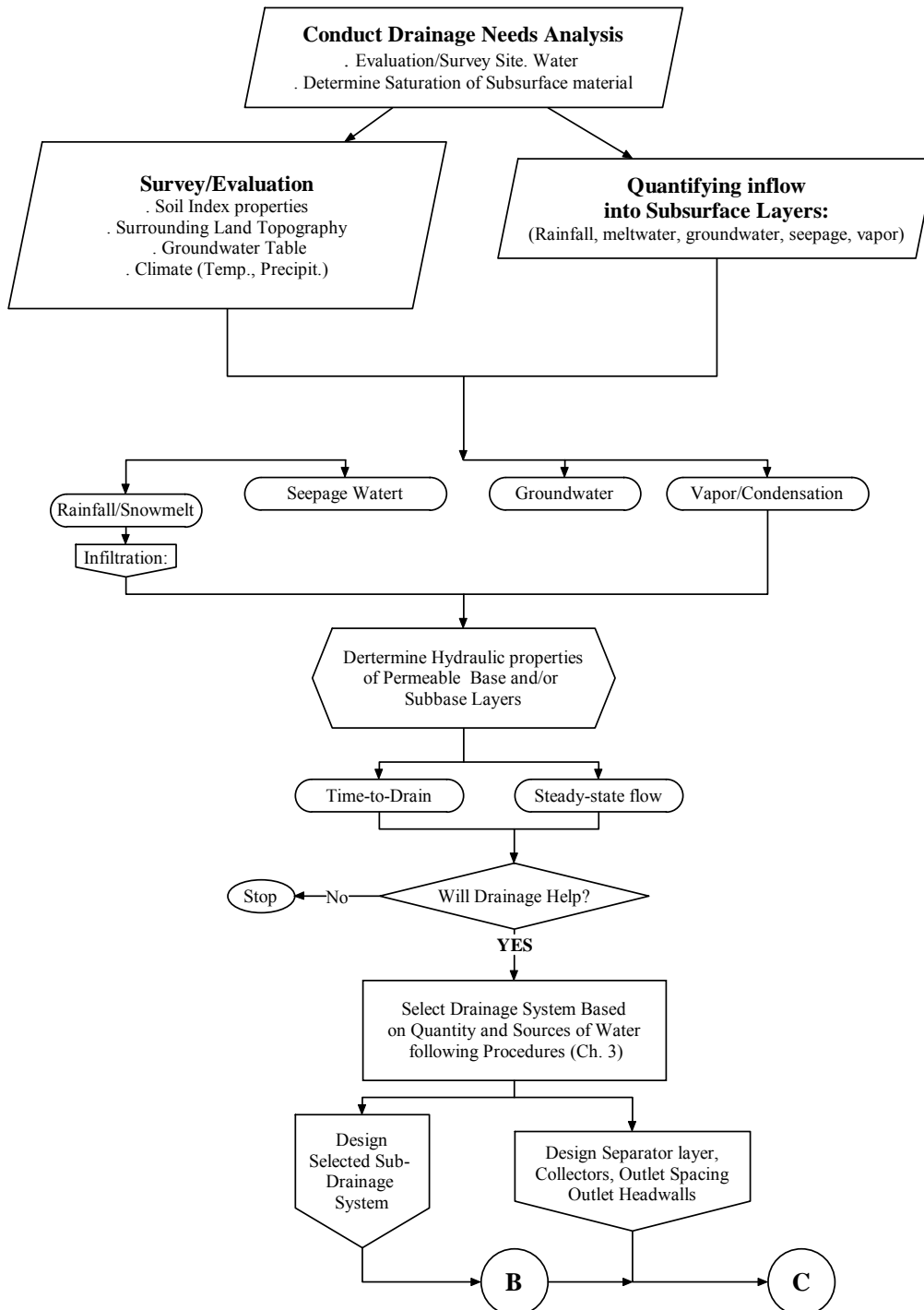

Figure A-2. Outline of recommended procedures for selection, design, construction and maintenance of subsurface drainage system for highway pavements.

For sections B, C and D of the flow diagram, refer to Figure A-1 above.

Appendix B

DESIGN PLANS, CHARTS AND TABLES

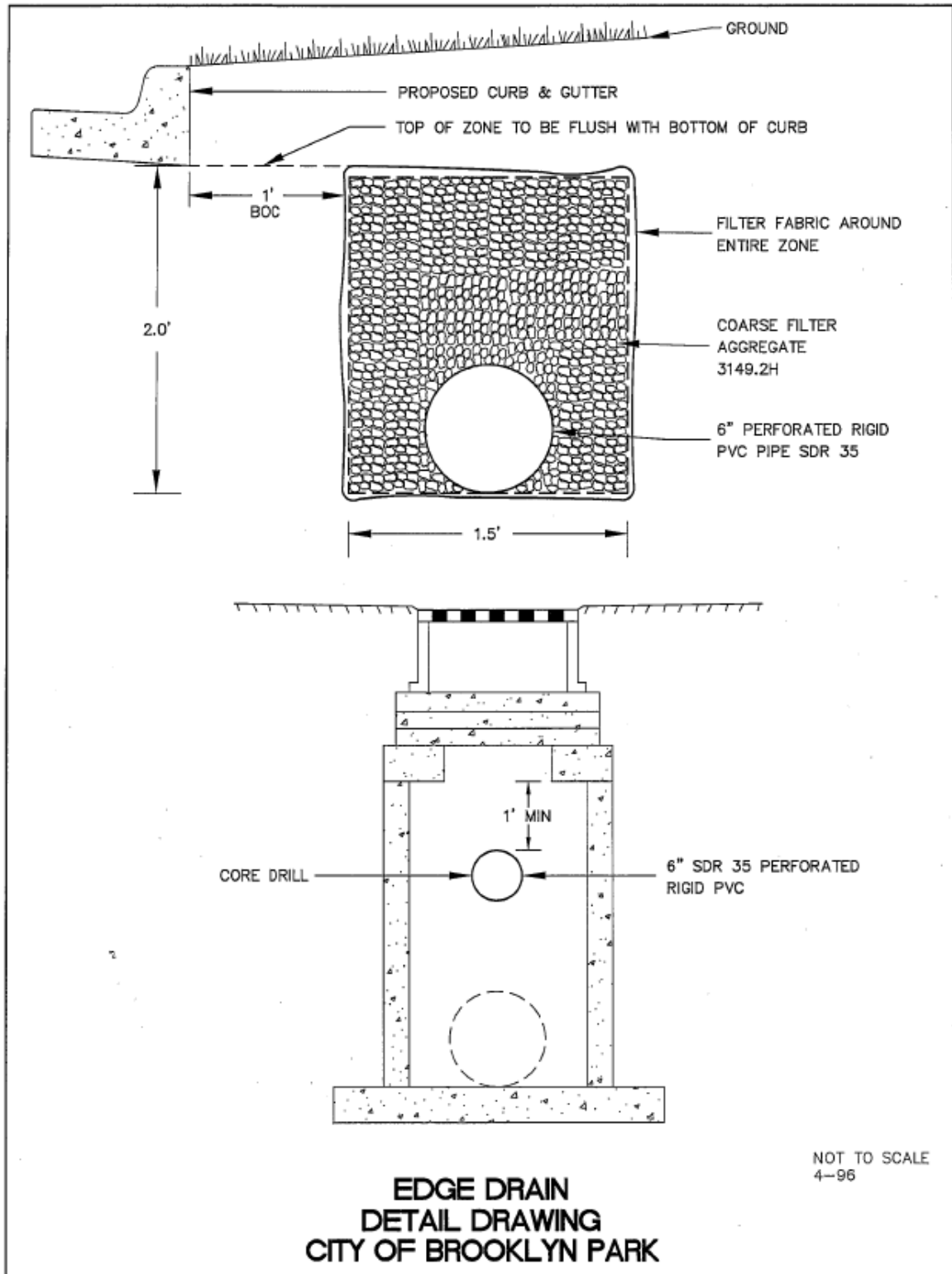

Figure B-1. Cross-section of edgedrain (Mn/DOT, 1994b).

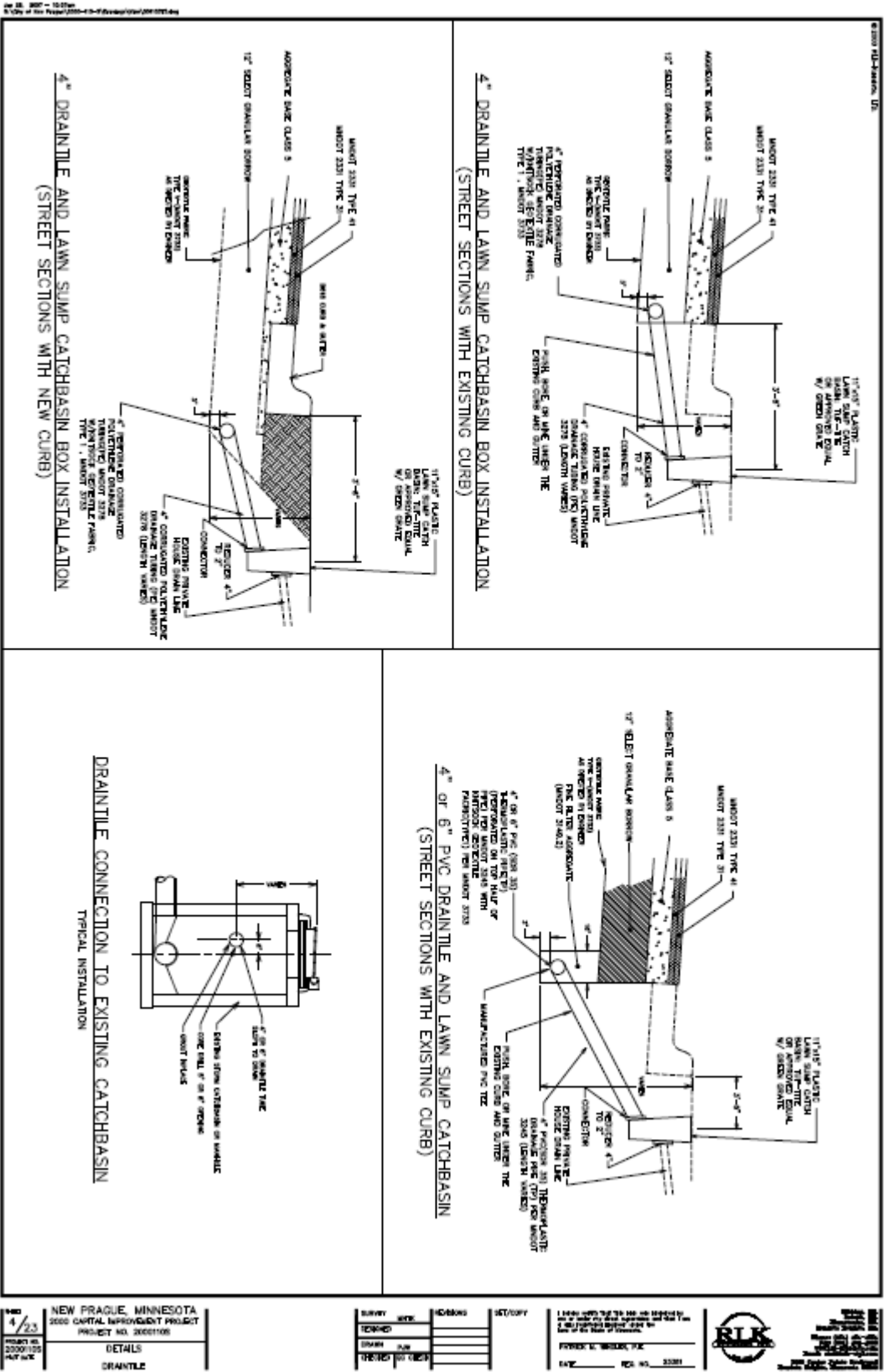

Figure B-2. Draintile and lawn sump box installation (Mn/DOT, 1994b).

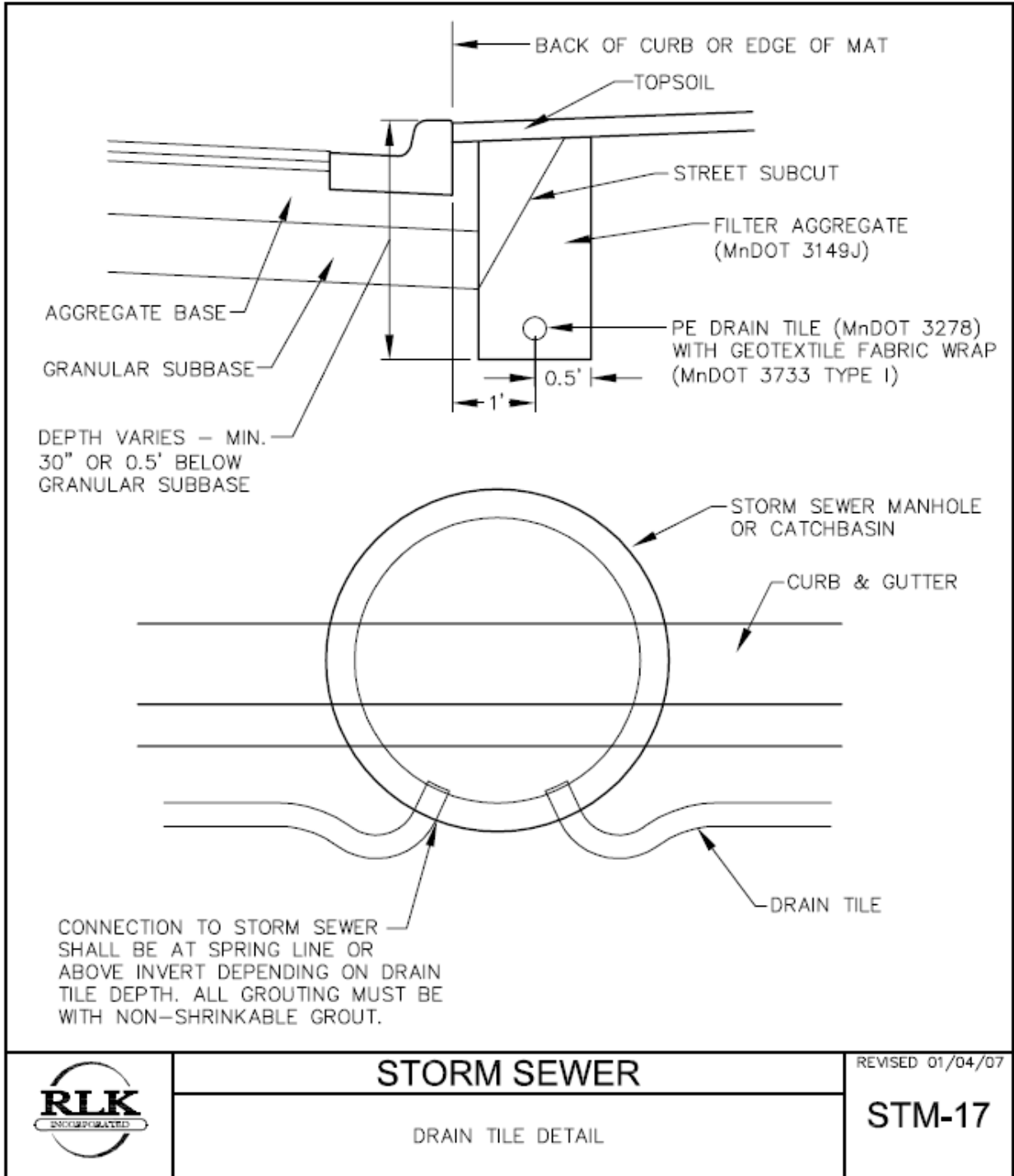

Figure B-3. Detail connection of PE drain pipe to storm sewer (Mn/DOT, 1994b).

PE PIPE DRAIN 28' TO 48' LT.										PE PIPE DRAIN 25' TO 55' RT.									
STA.	OFFSET	ELEV.	TO STA.	OFFSET	ELEV.	GRADE	SIZE	NOTES		STA.	OFFSET	ELEV.	TO STA.	OFFSET	ELEV.	GRADE	SIZE	NOTES	
84500	38' L.	1303.94	84500	38' L.	1303.94	-0.34K	8" x 300'			84500	38' RT.	1303.94	84500	38' RT.	1303.94	-0.34K	8" x 300'		
84500	38' L.	1305.18	84500	38' L.	1305.50	-0.34K	8" x 300'			84500	38' RT.	1303.94	84500	38' RT.	1303.94	-0.34K	8" x 300'	CONNECT INTO M.H. STA. 84436 54' RT. = 1201.50	
84500	28' L.	1201.50	84500	39' L.	1201.31	-0.19K	8" x 300'			84500	39' RT.	1201.50	84500	39' RT.	1201.50	-0.24K	8" x 300'	CONNECT INTO M.H. STA. 84436 54' RT. = 1201.50	
84500	39' L.	1197.31	84500	34' L.	1198.50	-0.19K	8" x 300'			84500	39' RT.	1200.71	84500	38' RT.	1198.58	-0.24K	8" x 300'		
84500	39' L.	1197.31	84500	34' L.	1198.50	-0.19K	8" x 300'			84500	39' RT.	1200.71	84500	38' RT.	1198.58	-0.24K	8" x 300'		
84500	34' L.	1195.50	84500	38' L.	1191.38	-0.33K	8" x 420'			84500	38' RT.	1198.58	84500	33' RT.	1189.18	-0.57K	8" x 318'		
74500	38' L.	1197.38	74500	38' L.	1189.14	-0.75K	8" x 300'			74500	38' RT.	1189.14	74500	34' RT.	1187.81	-0.33K	8" x 324'	MINIMUM 8" DIA. DUAL-WALL PE PIPE DRAIN 30' TO 40' LT. TO BE INSTALLED UNDER ROAD APPROACHES. PERFORATED PE PIPE DRAIN BEHIND ROAD APPROACHES. SURFACE INLET STA. 74500 34' RT. = 1187.81	
74500	38' L.	1186.14	74500	34' L.	1188.68	-0.55K	8" x 61'	DUAL-WALL PE PIPE DRAIN 30' TO 40' LT. TO BE INSTALLED UNDER ROAD APPROACHES. PERFORATED PE PIPE DRAIN BEHIND ROAD APPROACHES. SURFACE INLET STA. 74500 34' RT. = 1187.81		74500	34' RT.	1187.81	74500	34' RT.	1187.81	-0.33K	8" x 324'	DUAL-WALL PE PIPE DRAIN 30' TO 40' LT. TO BE INSTALLED UNDER ROAD APPROACHES. PERFORATED PE PIPE DRAIN BEHIND ROAD APPROACHES. SURFACE INLET STA. 74500 34' RT. = 1187.81	
74500	48' L.	1186.33	74500	41' L.	1186.71	-0.38K	8" x 461'	DUAL-WALL PE PIPE DRAIN 30' TO 40' LT. TO BE INSTALLED UNDER ROAD APPROACHES. PERFORATED PE PIPE DRAIN BEHIND ROAD APPROACHES. SURFACE INLET STA. 74500 34' RT. = 1187.81		74500	40' RT.	1186.08	74500	40' RT.	1186.38	-0.30K	8" x 381'	DUAL-WALL PE PIPE DRAIN 30' TO 40' LT. TO BE INSTALLED UNDER ROAD APPROACHES. PERFORATED PE PIPE DRAIN BEHIND ROAD APPROACHES. SURFACE INLET STA. 74500 34' RT. = 1187.81	
74500	41' L.	1186.41	74500	39' L.	1186.97	-0.56K	8" x 80'	MINIMUM 8" DIA. DUAL-WALL PE PIPE DRAIN 30' TO 40' LT. TO BE INSTALLED UNDER ROAD APPROACHES. PERFORATED PE PIPE DRAIN BEHIND ROAD APPROACHES. SURFACE INLET STA. 74500 34' RT. = 1187.81		74500	39' RT.	1186.24	74500	39' RT.	1186.65	-0.41K	8" x 130'	MINIMUM 8" DIA. DUAL-WALL PE PIPE DRAIN 30' TO 40' LT. TO BE INSTALLED UNDER ROAD APPROACHES. PERFORATED PE PIPE DRAIN BEHIND ROAD APPROACHES. SURFACE INLET STA. 74500 34' RT. = 1187.81	
74500	39' L.	1186.97	74500	40' L.	1187.85	-0.88K	8" x 684'	F & T 8" SURFACE INLET STA. 84500 40' L.		74500	39' RT.	1186.24	74500	39' RT.	1186.65	-0.41K	8" x 130'	MINIMUM 8" DIA. DUAL-WALL PE PIPE DRAIN 30' TO 40' LT. TO BE INSTALLED UNDER ROAD APPROACHES. PERFORATED PE PIPE DRAIN BEHIND ROAD APPROACHES. SURFACE INLET STA. 74500 34' RT. = 1187.81	
84500	40' L.	1187.85	84500	34' L.	1187.78	-0.07K	8" x 130'	CONNECT TO 8" SURFACE INLET STA. 84500 40' L.		84500	39' RT.	1186.24	84500	39' RT.	1186.65	-0.41K	8" x 130'	MINIMUM 8" DIA. DUAL-WALL PE PIPE DRAIN 30' TO 40' LT. TO BE INSTALLED UNDER ROAD APPROACHES. PERFORATED PE PIPE DRAIN BEHIND ROAD APPROACHES. SURFACE INLET STA. 74500 34' RT. = 1187.81	
84500	34' L.	1187.78	84500	30' L.	1190.67	+0.89K	8" x 300'	END & CAP 8" PE PIPE DRAIN STA. 84500 30' L.		84500	30' RT.	1190.26	84500	29' RT.	1190.26	-0.28K	8" x 484'	END & CAP 8" PE PIPE DRAIN STA. 84500 29' RT.	
TOTALS 8" PERFORATED PE PIPE DRAIN --- 2457' 8" DUAL-WALL PE PIPE DRAIN --- 1165' 8" CS PIPE DRAIN --- 10' 8" DUAL-WALL PERFORATED PE PIPE DRAIN --- 80' 8" SURFACE INLET --- 2										TOTALS 8" PERFORATED PE PIPE DRAIN --- 2707' 8" CS PIPE DRAIN --- 300' 8" DUAL-WALL PERFORATED PE PIPE DRAIN --- 120'									

TILE CROSSINGS									
STATION	ELEV.	TO STATION	ELEV.	FURNISH & INSTALL	F & T HICKENBOTTOM	NOTES			
87500 28' RT.	EXISTING	87500 30' LT.	EXISTING	10' x 14" CE PIPE DRAIN	48' LT. = 48' RT.	CONNECT TO 8" PE PIPE DRAIN TO EXISTING TILE OUTLET			
TOTALS									
10' x 14" CE PIPE DRAIN --- 130'									
REMOVE TILE --- 54'									
8" SURFACE INLET --- 1									
8" HICKENBOTTOM --- 1									

TILE LINES TO HICKENBOTTOMS									
STATION	ELEV.	TO STATION	ELEV.	FURNISH & INSTALL	GRADE	F & T HICKENBOTTOM	NOTES		
74500 38' RT.	EXISTING	74500 38' RT.	---	10' x 14" CE PIPE DRAIN	-0.8K	---	CONNECT TO 8" PE PIPE DRAIN TO EXISTING TILE OUTLET		
TOTALS									
10' x 14" CE PIPE DRAIN --- 10'									

GENERAL NOTES

- ALL EXISTING TILE SHOWN ON PLAN SHALL BE LOCATED BY CONTRACTOR. (INCIDENTAL TO PE PIPE DRAIN)
- ALL PE PIPE DRAIN OUTLETS SHALL HAVE RODENT GUARDS. (INCIDENTAL TO PE PIPE DRAIN)
- ALL CS PIPE DRAIN OUTLETS SHALL HAVE RODENT GUARDS. (INCIDENTAL TO PE PIPE DRAIN)
- ALL CONNECTIONS SHALL BE GROTTED.
- ALL BROKEN TILE ON PROJECT SHALL BE REPAIRED EVEN IF NOT SHOWN ON PLAN.
- ALL TIES AND CONNECTORS SHALL BE INCIDENTAL.
- 8" APPROVED HICKENBOTTOM SURFACE INLETS SHALL BE WRAPPED IN GEOTEXTILE. (INCIDENTAL TO SURFACE INLET)
- 8" APPROVED HICKENBOTTOM SURFACE INLETS SHALL HAVE 1 1/2" ROOF FLASHING A MINIMUM OF 2' AROUND SURFACE INLET. (INCIDENTAL TO SURFACE INLET)
- PERFORATED PE PIPE DRAIN WITHIN 25' OF CENTERLINE OF ROADWAY AND PE PIPE DRAIN THRU ROAD APPROACHES THE BOTTOM 1 FOOT SHALL BE BACKFILLED WITH 3/4" DIA. (APPROX. 6 C.V.) AND THE REMAINING (2.5' TO 5.0') SHALL BE BACKFILLED WITH 3/4" DIA. 2.2 PINE FILTER AGGREGATE (APPROX. 45 C.V.). BACKFILL SHALL BE INCIDENTAL TO PE PIPE DRAIN.
- PERFORATED PE PIPE DRAIN BEYOND 25' OF CENTERLINE OF ROADWAY SHALL BE BACKFILLED WITH EXCAVATED MATERIAL.
- ALL SURFACE INLETS SHALL HAVE A FLAT PERFORATED GRATE COVER. (INCIDENTAL TO SURFACE INLET)
- ALL SURFACE INLETS SHALL BE INSTALLED A MINIMUM OF 1' ABOVE FINISHED GRADE (FOR EROSION CONTROL) AND CUT TO FINISHED GRADE WHEN PERMANENT EROSION CONTROL (EOD) IS IN PLACE.

TILE PLAN

Certified By *[Signature]* No. 21557.Dats. *[Signature]* S.A.P. 74-635-07 BR. 74543 Sheet 30 of 60 Sheets

Figure B-4. PE drain pipe placement (Mn/DOT, 1994b).

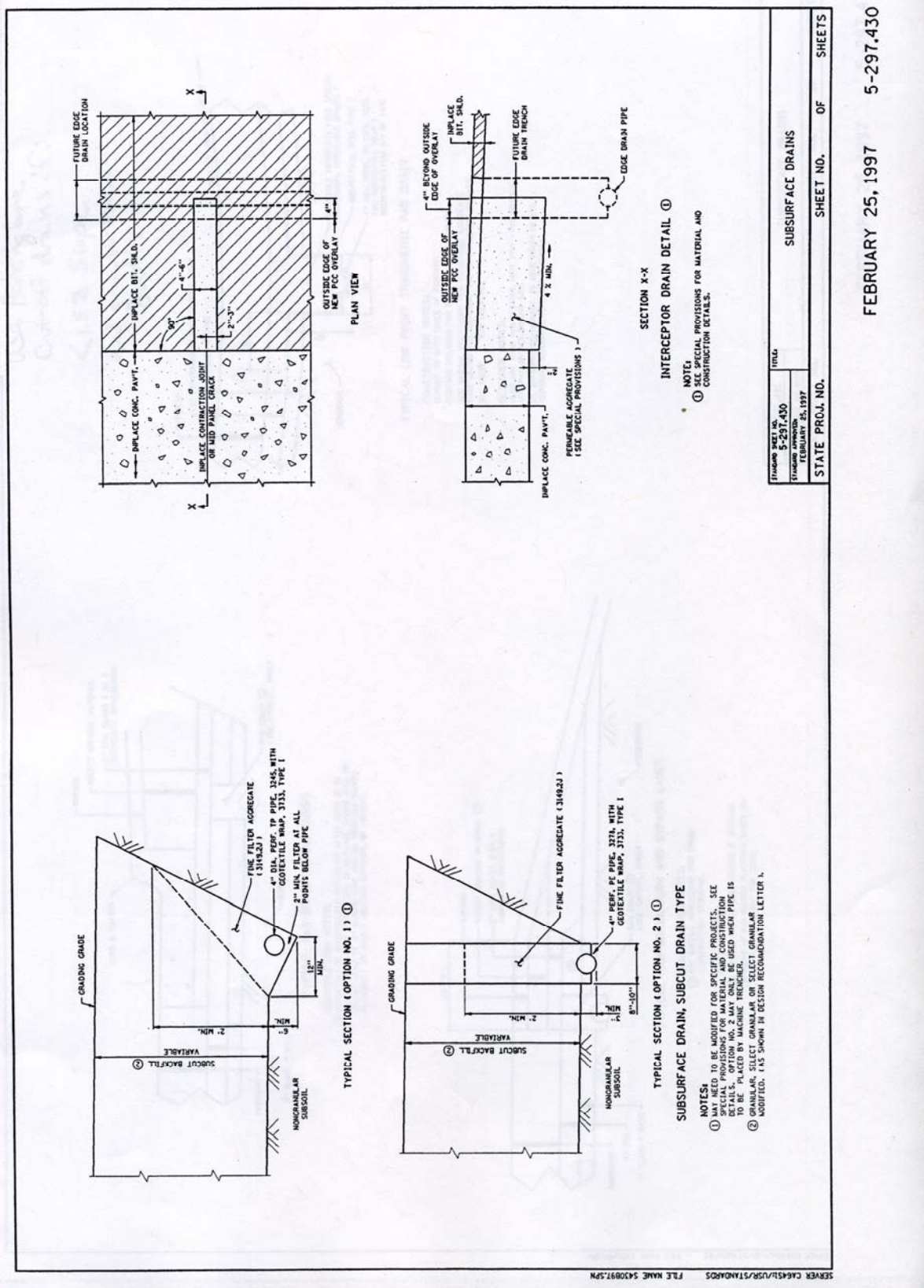

STANDARD SHEET NO.	TOTAL
5-297.430	
STANDARD APPROVED	
FEBRUARY 25, 1997	
STATE PROJ. NO.	SHEET NO. OF SHEETS

FEBRUARY 25, 1997 5-297.430

Figure B-6. Cross-section of a typical subcut drain type (Mn/DOT, 1994b).

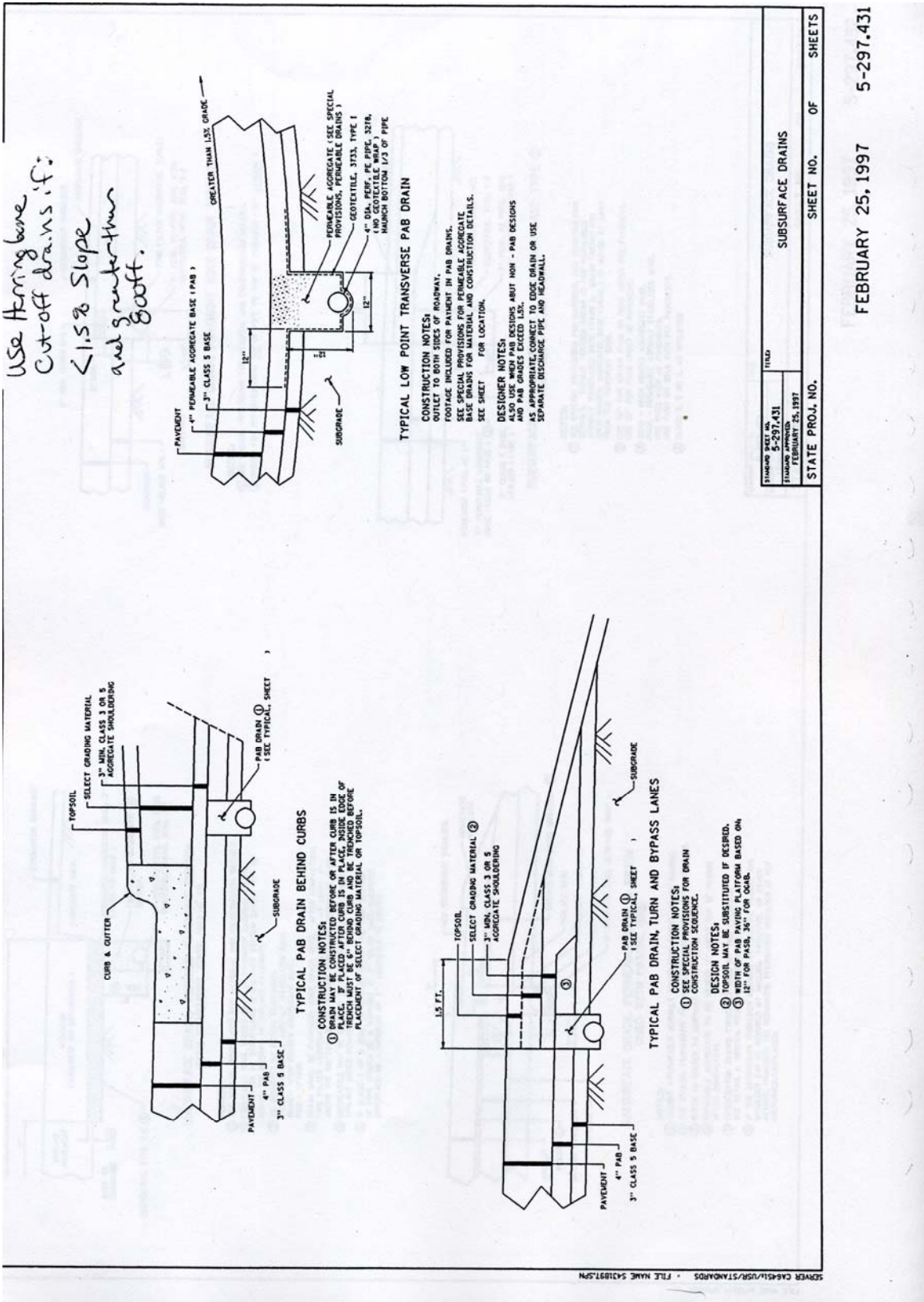

Figure B-7. Typical PAB drain and their positioning (Mn/DOT, 1994b).

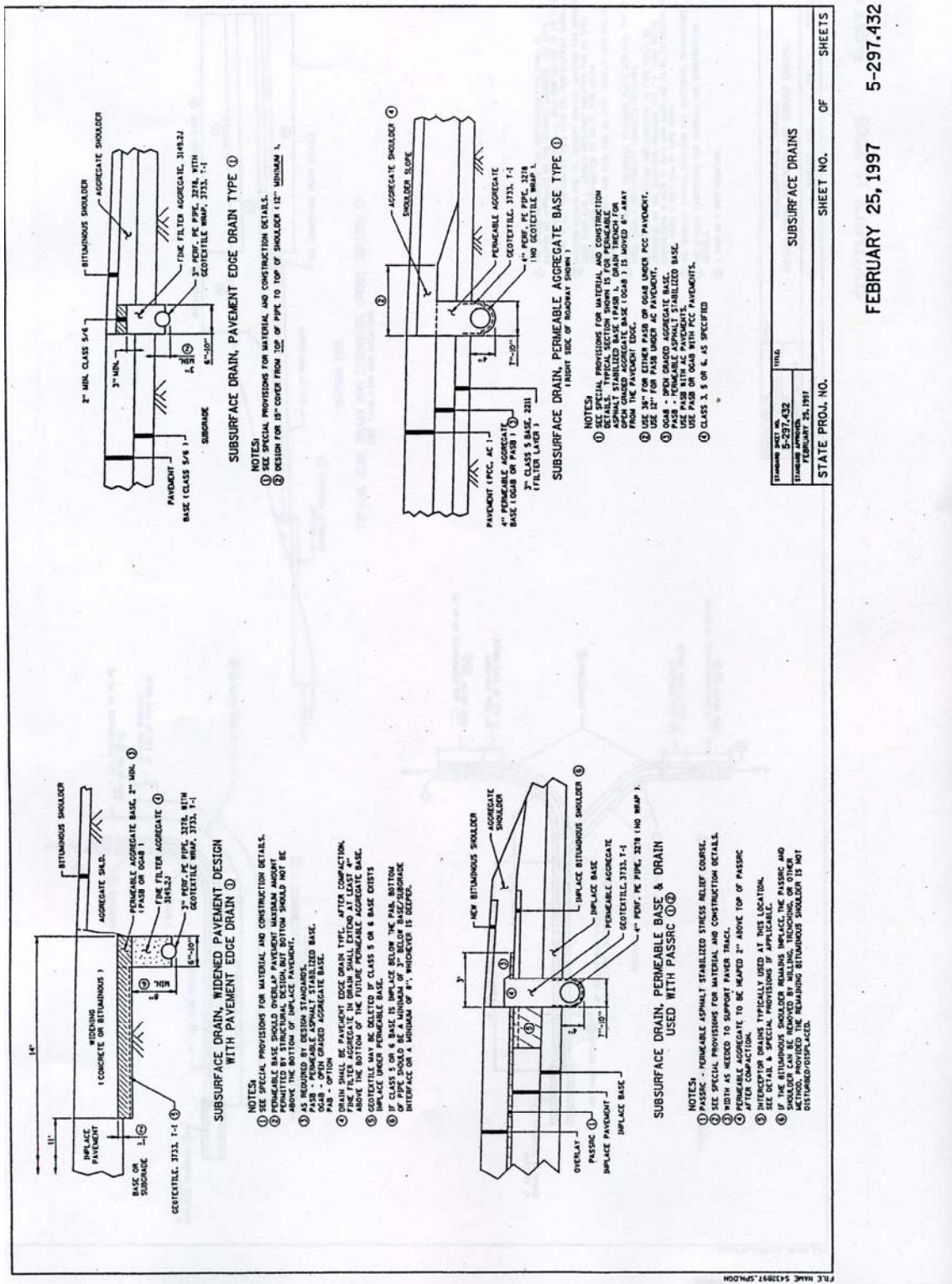

Figure B-8. Subsurface drainage systems: pavement edgedrain, pavement edgedrain Type I, permeable base, and permeable aggregate base type I (Mn/DOT, 1994b).

STANDARD SPEC. IN USE	1976G
STANDARD SPEC. NO.	5-297,432
ISSUED	FEBRUARY 25, 1997
STATE PROJ. NO.	
SHEET NO.	OF
SUBSURFACE DRAINS	

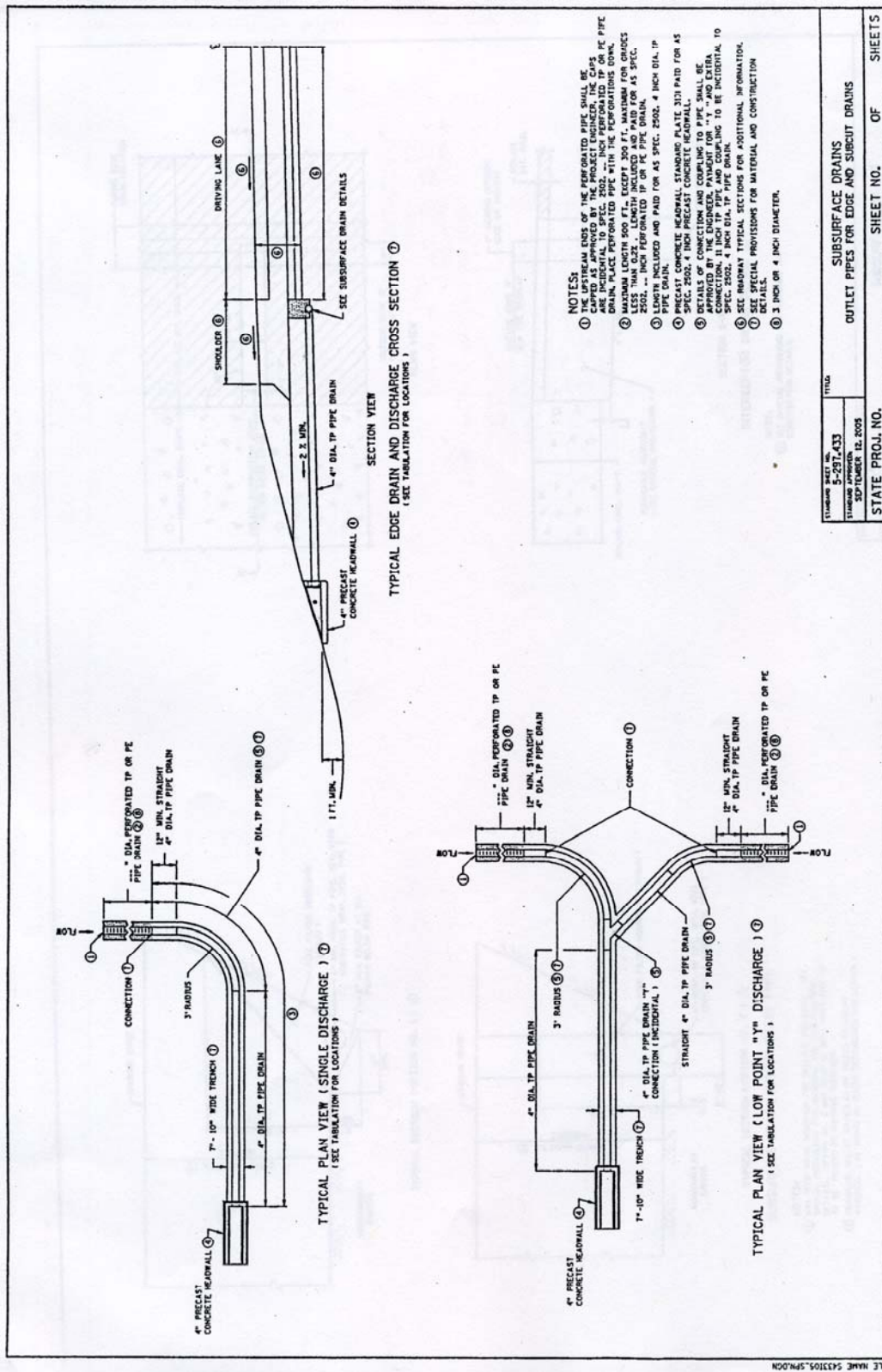

Figure B-9. Typical edgedrain and discharge plan (Mn/DOT, 1994b).

Appendix C

ACRONYMS

Acronyms

AASHTO – American Association of State Highway and Transportation Officials
AB – Aggregate Base
ACB – Asphalt Concrete Base
ADTT – Average daily truck traffic
AS – Asphalt Subbase
ASTM – American Society for Testing and Materials
ATB – Asphalt Treated Base
ATPB – Asphalt Treated Permeable Base
CFD – Cubic feet per day
CRCP – Continuously reinforced concrete pavement
CTB – Cement Treated Base
CTPB – Cement treated Permeable Base
ESAL – Estimated single axel load
FAA – Federal Aviation Administration
FHWA – Federal Highway Administration
GB – Granular Base
HMA – Hot Mix Asphalt
JPCP – Jointed plain concrete pavement
JRCP – Jointed reinforced concrete pavement
LCB – Lean Concrete Base
LRRB – Local Road Research Board
LTPP – Long Term Pavement Performance
Mn/DOT – Minnesota Department of Transportation
NCHRP – National Cooperative Highway Research Program
OGBM – Open graded base materials
OGFC – Open-Graded Friction Course
PATB – Permeable Asphalt Treated Base
PCC – Portland Cement Concrete
PCF – Pounds per cubic feet
PSF – Pounds per square feet
SHA – State Highways Agency

Appendix D

EXAMPLES

Example 4.1: Infiltration ratio method

The infiltration ratio method is illustrated by the following example problem:

Given a rainfall intensity (R) for Duluth, Minnesota of 1.2 inches/hour, and Infiltration ratio (C) of 0.5, determine the pavement infiltration (qi).

Solution

R = 1.2 inches/hour

C = 0.5

Substituting into the infiltration ratio equation (Equation 4.2):

$$q_i = 2CR = 2 \times 0.5 \times 1.2 = 1.2 \text{ cu ft/day/sq ft}$$

$$q_i = 1.2 \text{ cu ft/day/sq ft}$$

Thus, if the pavement is 15 ft wide, the drainage flow required per linear foot of pavement is (1.2 cu ft/day/sq.ft)(15 ft) = 18 cu ft/day/ft. This amount of water would need to be carried by the permeable base and the edgedrain.

Example 4.2: Crack Infiltration method

Given a highway consisting of two 12-foot lanes of PCC pavement with 10-ft AC shoulders on either side, or a uniform un-crowned cross slope, with the width of the permeable base being the same as the PCC pavement. The transverse joint spacing is 20 feet. Determine infiltration into this pavement.

Known:

Crack infiltration rate (I_c) = 2.4 cu ft/day/ft of crack

Number of contributing lanes (N) = 2

Length of transverse contributing joints or cracks (W_c) = 24 ft

Spacing of transverse joints or cracks (C_s) = 20 ft

Width of permeable base (W) = 24 ft

Pavement permeability (k_p) = 0

Solution

Determine the number of contributing cracks:

$$N_c = N + 1 = (2 + 1) = 3$$

By substituting in equation 4.3

$$q_i = I_c \left[\frac{N_c}{W} + \frac{W_c}{WC_s} \right] + k_p$$

$$q_i = 2.4 \left[\frac{3}{24} + \frac{24}{24 \times 20} \right] + 0$$

$$q_i = 2.4 (0.125 + 0.05) = 2.4 \times 0.175 = 0.42$$

$q_i = 0.42 \text{ cu ft/day/sq ft}$

The permeable base discharge is then determined using the equation:

$$q_d = q_i L_R$$

where

q_d = Permeable base discharge rate, cu ft/day/ft of base

q_i = Pavement infiltration, cu ft/day/sq ft

L_R = Resultant length of base, ft

This discharge, q_d , represents flow from a lineal foot of the road permeable base into the edgedrain system.

Example 4.3: Crack Infiltration method

A section of a new Portland cement concrete pavement has two 12ft traffic lanes with 10ft dense graded bituminous concrete shoulders. Given transverse pavement joints placed at 20ft intervals, what is the infiltration through the uncracked pavement surface?

K_p can be assumed to be insignificant, $k_p = 0$. Then, assuming I_c of 2.4 cfd/f, $N_C = (N + 1) = 3$, $C_S = 20'$; $W_C = 44'$ ft and $W = 24$ ft

$$q_i = 2.4 \left[\frac{3}{24} + \frac{44}{24(20)} \right] = 0.52 \text{ cfd / sf or } 0.5 \text{ cfd/sf.}$$

Example 4.4: Crack Infiltration method

Given a new bituminous concrete pavement for two lanes in a divided 4 lane expressway. If the highway has traffic lanes which are 12 ft wide, with a 4 ft inside shoulder and a 10 ft outside shoulder. Then, assuming for "normal" cracking; $N_C = 3$; $C_S = 40'$; $W_C = 38'$; and $W = 24'$. If $I_C = 2.4$, and assuming $K_p = 0$. then infiltration (q_i) into the pavement can be evaluated as:

$$q_i = 2.4 \left[\frac{3}{24} + \frac{38}{24(40)} \right] = 0.395 \text{ cfd / sf or } 0.4 \text{ cfd/sf.}$$

Example 4.5: Gravity flow of groundwater

Consider the roadway described in Example 4.2. The permeable base is assumed to be the same with of the pavement plus shoulders. Determine the flow of groundwater.

Known:

Width of the roadway (W) = 44 ft

Depth of impermeable boundary (H_o) = 5 ft

Water table elevation with drawdown (H) = 15 ft

Hydraulic conductivity of soil (K) = 3 ft/day

Solution

The influence length (L_i) is estimated from equation 4.5 to be = $3.8(H - H_o) = 3.8(15-5) = 38$ ft.

This then gives the ratio $(\frac{W}{H_o}) = (\frac{44}{10}) = 4.4$, and $(\frac{L_i + 0.5W}{H_o}) = (\frac{38 + 22}{5}) = 12$. From Figure

4.7, entering the abscissa with 12, going vertically to the ratio of 4.4, yields an approximate value of $(K \frac{(H - H_o)}{2q_2}) = 5.5$. The value of $q_2 = (K \frac{(H - H_o)}{2(5.5)}) = ((3.0) \frac{(15 - 5)}{2(5.5)}) = 4.09$

cu.ft./day/lineal foot. This value of q_2 is used in designing the drain and the thickness of the permeable base. The value of $q_g = (\frac{q_2}{0.5W}) = (\frac{4.09}{22}) = 0.18$ cu.ft./day/sq.ft.

The lateral flow of groundwater directly into the drain is q_1 which is computed from

$q_1 = K(H - H_o)^2 / 2L_i = \frac{(3.0)(15 - 5)^2}{2(38)} = 3.95$ cu.ft./day/lineal foot. This portion of the flow does

not pass through the permeable base, but flows directly into the drain.

Example 4.6: Artesian flow of groundwater

Consider the roadway given in Example 4.2. The confined aquifer lies at a depth of 20 feet below the base course, and a nearby well in the aquifer has a static water level elevation of 962 ft. The elevation of the base of the base course at the location is 957 feet.

Known:

Static water level in artesian aquifer relative to base course elevation (H_a) = 962 ft – 957 ft = 5 ft

Hydraulic conductivity of the soil layer confining the aquifer (K) = 0.1 ft/day

Solution:

The upward flow of water to the base course is calculated from equation 4.8 as

$$q_a = K \frac{H_a}{D} = (0.1) \left(\frac{5.0}{20} \right) = 0.025 \text{ cu.ft./day/lineal foot}$$

Example 4.7: Determining moisture from spring thaw

Given a concrete pavement which is 9 inches thick, with a 6 inch thick granular subbase designed as a drainage layer overlying a silty subgrade soil, determine the spring thaw flow if:

* the soil has 39 percent of its particles finer than 0.0008 inches (0.02 mm) and is classified as an ML soil under the Unified Soil Classification system

*the groundwater and temperature conditions at the pavement site are both conducive to frost action.

Assuming the coefficient of permeability, k , of the thawed subgrade soil is 0.05 feet per day, unit weights of 150 pcf and 125 pcf for the pavement and subbase, respectively:

The value of $\sigma_p = 150(9/12) + 125(6/12) = 175$ psf.

The heave rate for this soil can be estimated from Table 2.

0.2 by interpolation as $14 + (6/12)11 = 0.77$ in./day (20 mm/day). Entering Figure 4.8 with a heave rate of 20 mm/day, and $\sigma_p = 175$ psf, yields $q_m / \sqrt{k} = 1.32$. Therefore, $q_m = 1.32 / \sqrt{0.05} = 0.295$ or 0.3 cfd

It should be noted that the subgrade soil in this example had very high frost heave susceptibility.

Example 4.8: Calculation of resultant slope and slope orientation

Known:

Give a pavement with the following:

Longitudinal slope (S) = 0.02 ft/ft

Cross slope (S_x) = 0.02 ft/ft

Width of permeable base (W) = 24 ft

What is the resultant slope, length, and flow path orientation for this pavement?

Solution:

Substituting into Equation 4.1 for the resultant slope:

$$S_R = (S^2 + S_x^2)^{1/2} = (0.02^2 + 0.02^2)^{1/2} = 0.02828$$

$$S_R = 0.02828 \text{ ft/ft}$$

Substituting into Equation 2 for the resultant length:

$$L_R = W \left(1 + \left(\frac{S}{S_x} \right)^2 \right)^{1/2} = 24 \times \left(1 + \left(\frac{0.02}{0.02} \right)^2 \right)^{1/2} = 33.94$$

$$L_R = 33.94 \text{ ft}$$

Substituting into Equation 4.3 for orientation of the flow path:

$$\tan(A) = \frac{S}{S_x} = \frac{0.02}{0.02} = 1$$

$$\text{Angle (A)} = 45^\circ$$

The flow path will be on a line 45 degrees from a line perpendicular to the centerline of the road.

Example 4.9: Calculation of time-to-drain

Known:

A Roadway Geometry has the following dimensions:

Resultant slope (SR) = 0.02 ft/ft

Resultant length (LR) = 24 ft

Base thickness (H) = 0.5 ft

The Permeable Base Material:

Effective porosity (Ne) = 0.25

Hydraulic conductivity (K) = 2000 ft/day

Find:

The time to drain (t) for 50 percent drainage of the permeable base.

Solution:

First the slope factor is calculated,

$$S_1 = \frac{L_R S_R}{B} = \frac{24 \times 0.02}{B} = 0.96$$

Entering Figure 4.13 with the slope factor, select a time factor (T50) of 0.245.

Calculate the “m” factor:

$$m = \frac{N_e L_R^2}{KB} = \frac{0.25 \times (24)^2}{2000 \times 0.5} = \frac{144}{1000} = 0.144 \text{ days}$$

Calculate the time to drain (t):

$$t = T_{50} \times m \times 24 = 0.245 \times 0.144 \times 24 = 0.85 \text{ hrs}$$

The required time to drain for 50 percent drainage is 0.85 hours.

Note that the rate of inflow into the pavement does not enter into the design calculations. This is because, theoretically, the time to drain does not start until after the design storm has stopped.

Example 4.10.

Given a hypothetical PCC pavement designed with a permeable base drainage width of 24 ft, determine the design pavement discharge rate required to be removed by edge drains using the pavement infiltration discharge rate method.

Solution

A pavement infiltration rate of $0.4 \text{ ft}^3/\text{day}/\text{ft}^2$ is selected for the PCC pavement. The design pavement discharge rate is calculated as follows:

$$q_d = q_i W = (0.4 \text{ ft}^3/\text{day}/\text{ft}^2)(24 \text{ ft}) = 9.6 \text{ ft}^3/\text{day}/\text{ft}$$

The spacing between outlets for this system can be determined once the capacity of the drain is computed. This is done in Example 4.11.

Example 4.11.

A PCC pavement is being designed for a collector road. The proposed pavement section consists of a 0.5 ft permeable base with a coefficient of permeability of 1,500 ft/day. The resultant slope is 0.020 ft/ft, and the angle between the roadway cross slope and the resultant slope is 10° . The longitudinal edgedrain is 4 inches on a slope of 0.004 ft/ft. Given these conditions, determine the design pavement discharge rate using the permeable base discharge rate approach, and determine the spacing of drain outlets

Solution

For this structure design pavement discharge rate can be determined as follows:

$$q_p = kS_R H \cos(A) = (1,500 \text{ ft}/\text{day})(0.02 \text{ ft}/\text{ft})(0.5 \text{ ft})\cos(10^\circ) = 14.8 \text{ ft}^3/\text{day}/\text{ft}$$

The flow capacity of an edgedrain, which is a circular pipe, can be determined by Manning's equation assuming the pipe is flowing full with no back pressure:

$$Q = \frac{53.2}{n} D^{8/3} S^{1/2}$$

where

Q	=	Pipe capacity, ft^3/day .
n	=	Manning's roughness coefficient.
D	=	Pipe diameter, inches.
S	=	Longitudinal slope, ft/ft.

The flow capacity is also just equal to

$$Q = q_d L$$

thereby allowing us to compute the outlet spacing L .

The following are suggested values of Manning's roughness coefficient (FHWA, 1994):

Smooth pipe:	n	=	0.012
Corrugated pipe:	n	=	0.024

For this example we use the corrugated pipe ($n=0.024$). The flow capacity of the pipe is then

$$Q = \frac{53.2}{0.024} (4)^{8/3} (0.004)^{1/2} = 5,647 \text{ ft}^3/\text{day}$$

The spacing between the outlets is then

$$L = \frac{Q}{q_d} = \frac{5,647}{14.8} = 382 \text{ ft}$$

We get the same result if we use the nomograph given in Figure 4.19.

For the required discharge given in Example 4.10, the spacing is

$$L = \frac{Q}{q_d} = \frac{5,647}{9.6} = 570 \text{ ft}$$

Example 4.12: Calculation of flow rate to interceptor drain

Find the flow rate to the interceptor drain.

Known

Height of the water table upgradient of the drain is (H) = 10 ft.

Slope of the bottom boundary of soils (S) = 0.04 ft/ft

Height of the drain above the impermeable barrier (H_o) = 4 ft

Hydraulic conductivity of the soil (K) = 2 ft/day

Solution

First, we calculate the length of influence (L_i)

$$L_i = 3.8(H - H_o) = 3.8(10-4) = 22.8 \text{ ft}$$

The ratio $\left(\frac{H_o}{H}\right) = \left(\frac{4}{10}\right) = 0.4$

The ratio $(\frac{SL_i}{H}) = (\frac{(0.04)(22.8)}{10}) = 0.091$

Using these ratios on Figure 4.29 we get $(\frac{q_d}{KHS}) = 5.5$, and this result leads to

$$q_d = (5.5)(K)(H)(S) = (5.5)(2)(10)(0.04) = 4.4 \text{ cu.ft/day/lineal foot of interceptor drain}$$

With this flow rate we can determine the required diameter and the grade for the interceptor drain.