

# Field Evaluation of Compaction Monitoring Technology: Phase II



**Final Report**  
**March 2006**

**Sponsored by**  
the Iowa Department of Transportation  
(CTRE Project 04-171)



**IOWA STATE**  
**UNIVERSITY**

## **About the PGA**

The mission of the Partnership for Geotechnical Advancement is to increase highway performance in a cost-effective manner by developing and implementing methods, materials, and technologies to solve highway construction problems in a continuing and sustainable manner.

## **Disclaimer Notice**

The contents of this report reflect the views of the authors, who are responsible for the facts and the accuracy of the information presented herein. The opinions, findings and conclusions expressed in this publication are those of the authors and not necessarily those of the sponsors.

The sponsors assume no liability for the contents or use of the information contained in this document. This report does not constitute a standard, specification, or regulation.

The sponsors do not endorse products or manufacturers. Trademarks or manufacturers' names appear in this report only because they are considered essential to the objective of the document.

## **Non-discrimination Statement**

Iowa State University does not discriminate on the basis of race, color, age, religion, national origin, sexual orientation, gender identity, sex, marital status, disability, or status as a U.S. veteran. Inquiries can be directed to the Director of Equal Opportunity and Diversity, (515) 294-7612.

**Technical Report Documentation Page**

<b>1. Report No.</b>	<b>2. Government Accession No.</b>	<b>3. Recipient's Catalog No.</b>	
<b>4. Title and Subtitle</b> Field Evaluation of Compaction Monitoring Technology: Phase II		<b>5. Report Date</b> March 2006	
		<b>6. Performing Organization Code</b>	
<b>7. Author(s)</b> David J. White, Mark J. Thompson, Kari Jovaag, Edward J. Jaselskis, Vernon R. Schaefer, E. Thomas Cackler		<b>8. Performing Organization Report No.</b> CTRE Project 04-171	
<b>9. Performing Organization Name and Address</b> Center for Transportation Research and Education Iowa State University 2901 South Loop Drive, Suite 3100 Ames, IA 50010-8634		<b>10. Work Unit No. (TRAIS)</b>	
		<b>11. Contract or Grant No.</b>	
<b>12. Sponsoring Organization Name and Address</b> Iowa Department of Transportation 800 Lincoln Way Ames, IA 50010		<b>13. Type of Report and Period Covered</b> Final Report	
		<b>14. Sponsoring Agency Code</b>	
<b>15. Supplementary Notes</b> Visit <a href="http://www.ctre.iastate.edu">www.ctre.iastate.edu</a> for color PDF files of this and other research reports.			
<b>16. Abstract</b> <p>This report documents an extensive field program carried out to identify the relationships between soil engineering properties, as measured by various in situ devices, and the results of machine compaction monitoring using prototype compaction monitoring technology developed by Caterpillar Inc. Primary research tasks for this study include the following: (1) experimental testing and statistical analyses to evaluate machine power in terms of the engineering properties of the compacted soil (e.g., density, strength, stiffness) and (2) recommendations for using the compaction monitoring technology in practice.</p> <p>The compaction monitoring technology includes sensors that monitor the power consumption used to move the compaction machine, an on-board computer and display screen, and a GPS system to map the spatial location of the machine. In situ soil density, strength, and stiffness data characterized the soil at various stages of compaction. For each test strip or test area, in situ soil properties were compared directly to machine power values to establish statistical relationships. Statistical models were developed to predict soil density, strength, and stiffness from the machine power values. Field data for multiple test strips were evaluated. The <math>R^2</math> correlation coefficient was generally used to assess the quality of the regressions.</p> <p>Strong correlations were observed between averaged machine power and field measurement data. The relationships are based on the compaction model derived from laboratory data. Correlation coefficients (<math>R^2</math>) were consistently higher for thicker lifts than for thin lifts, indicating that the depth influencing machine power response exceeds the representative lift thickness encountered under field conditions. Caterpillar Inc. compaction monitoring technology also identified localized areas of an earthwork project with weak or poorly compacted soil. The soil properties at these locations were verified using in situ test devices. This report also documents the steps required to implement the compaction monitoring technology evaluated.</p>			
<b>17. Key Words</b> compaction monitoring—intelligent compaction—earthwork construction— machine energy—quality control/quality assurance—soil compaction		<b>18. Distribution Statement</b> No restrictions.	
<b>19. Security Classification (of this report)</b> Unclassified.	<b>20. Security Classification (of this page)</b> Unclassified.	<b>21. No. of Pages</b> 457	<b>22. Price</b> NA





# **FIELD EVALUATION OF COMPACTION MONITORING TECHNOLOGY: PHASE II**

**Final Report  
March 2006**

## **Principal Investigator**

David J. White, Assistant Professor  
Department of Civil, Construction, and Environmental Engineering, Iowa State University

## **Co-Principal Investigators**

E. Thomas Cackler, Director  
Partnership for Geotechnical Advancement

Edward J. Jaselskis, Associate Professor  
Vernon R. Schaefer, Professor

Department of Civil, Construction, and Environmental Engineering, Iowa State University

## **Research Assistant**

Mark J. Thompson

## **Authors**

David J. White, Mark J. Thompson, and Kari Jovaag

Preparation of this report was financed in part through funds provided by the Iowa Department of Transportation through its research management agreement with the Center for Transportation Research and Education, CTRE Project 04-171.

A report from  
**Center for Transportation Research and Education**

**Iowa State University**  
2901 South Loop Drive, Suite 3100  
Ames, IA 50010-8634  
Phone: 515-294-8103  
Fax: 515-294-0467  
[www.ctre.iastate.edu](http://www.ctre.iastate.edu)



## TABLE OF CONTENTS

ACKNOWLEDGMENTS .....	XXI
EXECUTIVE SUMMARY .....	XXIII
INTRODUCTION .....	1
Phase I Summary .....	1
Phase II .....	2
Project Scope .....	2
Research Objectives.....	3
RESEARCH METHODOLOGY .....	4
Test Project Objectives .....	4
In Situ Test Measurements .....	5
Moisture and Density .....	5
Soil Strength and Stiffness.....	5
Evaluating Machine Power as a Compaction Indicator.....	6
TEST PROJECTS .....	7
Test Project 1: Caterpillar Edwards Demonstration Arena (2/7/05-2/18/05).....	7
Project Description .....	7
Material Properties.....	15
Compaction Monitor Machine Power Output .....	21
In Situ Measurement Values and Single-Parameter Regressions.....	40
Variability of Measured Properties.....	133
Multiple Linear Regression Analysis .....	142
Repeatability of Machine Power Measurements .....	160
Project Observations .....	163
Test Project 2: Caterpillar Edwards Outdoor Facility (5/16/05–5/18/05) .....	165
Project Description .....	165
Material Properties.....	170
Compaction Monitor Machine Power Output .....	172
In Situ Measurement Values and Single-Parameter Regressions.....	178
Regression Analysis.....	178
Project Observations .....	188
Test Project 3: TH 14 Field Demonstration Project (7/18/05–7/21/05) .....	189
Project Description .....	189
Compaction Monitoring Mapping Locations .....	190
Project Observations .....	200
SUMMARY AND CONCLUSIONS .....	201
Summary .....	201
Conclusions.....	201
RECOMMENDATIONS .....	205
Guidelines for Using Compaction Monitoring Technology in Practice.....	205

Calibrating Machine Power to Engineering Soil Properties.....	205
Identifying Variation and Non-Uniformity in Compacted Fill.....	205
Implementation of Compaction Monitoring Technology into QC/QA Specifications....	206
Method, End Result, and Performance-Based Specifications .....	206
Recommendations for Future Research .....	207
Statistical Framework for QC/QA Using Compaction Monitoring Technology .	207
Statistical Analysis Routines .....	208
Laboratory Evaluation of Strength-Stiffness-Moisture-Energy Relationships....	209
REFERENCES .....	211
NOTATIONS.....	212
APPENDIX A. PROJECT 1 IN SITU TEST DATA .....	213
APPENDIX B. PROJECT 1 MOISTURE CONTENTS BY NONDESTRUCTIVE METHODS .....	309
APPENDIX C. PROJECT 1 DCP PROFILES.....	337
APPENDIX D. PROJECT 1 PLT LOAD-DEFLECTION CURVES .....	377
APPENDIX E. PROJECT 2 IN SITU TEST DATA.....	383
APPENDIX F. PROJECT 2 DCP PROFILES.....	413
APPENDIX G. PROJECT 3 IN SITU TEST DATA .....	427

## LIST OF FIGURES

Figure 1. Caterpillar Inc. compaction monitoring system .....	1
Figure 2. Placement of soil in excavated and stabilized test strip pit .....	9
Figure 3. In situ soil mixing using (a) road reclaimer or (b) tiller .....	10
Figure 4. Moisture and density determination using nuclear moisture-density gauge for 0 roller passes.....	11
Figure 5. Soil compaction using prototype CP-533 static padfoot roller .....	11
Figure 6. In situ test measurement of soil properties.....	12
Figure 7. Stiffness and modulus determination using GeoGauge .....	12
Figure 8. Strength and stiffness determination using Clegg impact hammer (left) and PFWD (right) .....	13
Figure 9. Strength determination using DCP .....	13
Figure 10. TDR moisture sensor .....	14
Figure 11. Duff moisture sensor .....	14
Figure 12. Excavation of drive core for density and moisture determination .....	15
Figure 13. Topsoil, particle size distribution, and Proctor moisture-density curve.....	17
Figure 14. Fill clay, particle size distribution, and Proctor moisture-density curve.....	18
Figure 15. Till, particle size distribution, and Proctor moisture-density curve .....	19
Figure 16. Sand, particle size distribution, and Proctor curve with minimum and maximum density from relative density test .....	20
Figure 17. Topsoil, strip 1 compaction monitor views (30 x 24 m viewing area).....	22
Figure 18. Topsoil, strip 2 compaction monitor views (30 x 24 m viewing area).....	23
Figure 19. Topsoil, strip 3 compaction monitor views (30 x 24 m viewing area).....	24
Figure 20. Topsoil, strip 4 compaction monitor views (30 x 24 m viewing area).....	25
Figure 21. Topsoil, strip 5 compaction monitor views (30 x 24 m viewing area).....	26
Figure 22. Topsoil, strip 6 compaction monitor views (30 x 24 m viewing area).....	27
Figure 23. Fill clay, strip 1 compaction monitor views (30 x 24 m viewing area).....	28
Figure 24. Fill clay, strip 2 compaction monitor views (30 x 24 m viewing area).....	29
Figure 25. Fill clay, strip 3 compaction monitor views (30 x 24 m viewing area).....	30
Figure 26. Edwards till, strip 1 compaction monitor views (30 x 24 m viewing area) .....	31
Figure 27. Edwards till, strip 2 compaction monitor views (30 x 24 m viewing area) .....	32
Figure 28. Edwards till, strip 3 compaction monitor views (30 x 24 m viewing area) .....	33
Figure 29. Edwards till, strip 4 compaction monitor views (30 x 24 m viewing area) .....	34
Figure 30. Edwards till, strip 6 compaction monitor views (30 x 24 m viewing area) .....	35
Figure 31. Sand, strip 1 compaction monitor views (30 x 24 m viewing area).....	36
Figure 32. Sand, strip 2 compaction monitor views (30 x 24 m viewing area).....	37
Figure 33. Sand, strip 3 compaction monitor views (30 x 24 m viewing area).....	38
Figure 34. Sand, strip 4 compaction monitor views (30 x 24 m viewing area).....	39
Figure 35. Measurement locations and influence areas affecting net power-soil property correlations.....	41
Figure 36. Observed variation in machine power and dry unit weight per pass (topsoil).....	42
Figure 37. Comparison of averages of all machine power data versus ten points.....	42
Figure 38. Topsoil, strip 1: net power–dry unit weight correlation.....	44
Figure 39. Topsoil, strip 1: net power–CIV correlation .....	45
Figure 40. Topsoil, strip 1: net power–DCP index correlation.....	46
Figure 41. Topsoil, strip 1: net power–GeoGauge modulus correlation .....	47

Figure 42. Topsoil, strip 1: net power–PFWD modulus correlation .....	48
Figure 43. Topsoil, strip 2: net power–dry unit weight correlation.....	49
Figure 44. Topsoil, strip 2: net power–DCP index correlation.....	50
Figure 45. Topsoil, strip 2: net power–GeoGauge modulus correlation .....	51
Figure 46. Topsoil, strip 2: net power–PFWD modulus correlation .....	52
Figure 47. Topsoil, strip 3: net power–dry unit weight correlation.....	53
Figure 48. Topsoil, strip 3: net power–CIV correlation .....	54
Figure 49. Topsoil, strip 3: net power–DCP index correlation.....	55
Figure 50. Topsoil, strip 3: net power–GeoGauge modulus correlation .....	56
Figure 51. Topsoil, strip 3: net power–PFWD modulus correlation .....	57
Figure 52. Topsoil, strip 4: net power–dry unit weight correlation.....	58
Figure 53. Topsoil, strip 4: net power–CIV correlation .....	59
Figure 54. Topsoil, strip 4: net power–DCP index correlation.....	60
Figure 55. Topsoil, strip 4: net power–GeoGauge modulus correlation .....	61
Figure 56. Topsoil, strip 4: net power–PFWD modulus correlation .....	62
Figure 57. Topsoil, strip 5: net power–dry unit weight correlation.....	63
Figure 58. Topsoil, strip 5: net power–CIV correlation .....	64
Figure 59. Topsoil, strip 5: net power–DCP index correlation.....	65
Figure 60. Topsoil, strip 5: net power–GeoGauge modulus correlation .....	66
Figure 61. Topsoil, strip 5: net power–PFWD modulus correlation .....	67
Figure 62. Topsoil, strip 6: net power–dry unit weight correlation.....	68
Figure 63. Topsoil, strip 6: net power–CIV correlation .....	69
Figure 64. Topsoil, strip 6: net power–DCP index correlation.....	70
Figure 65. Topsoil, strip 6: net power–GeoGauge modulus correlation .....	71
Figure 66. Topsoil, strip 6: net power–PFWD modulus correlation .....	72
Figure 67. Topsoil, net power–coefficient of subgrade reaction correlation.....	73
Figure 68. Fill clay, strip 1: net power–dry unit weight correlation.....	74
Figure 69. Fill clay, strip 1: net power–CIV correlation .....	75
Figure 70. Fill clay, strip 1: net power–DCP index correlation.....	76
Figure 71. Fill clay, strip 1: net power–GeoGauge modulus correlation .....	77
Figure 72. Fill clay, strip 1: net power–PFWD modulus correlation .....	78
Figure 73. Fill clay, strip 2: net power–dry unit weight correlation.....	79
Figure 74. Fill clay, strip 2: net power–CIV correlation .....	80
Figure 75. Fill clay, strip 2: net power–DCP index correlation.....	81
Figure 76. Fill clay, strip 2: net power–GeoGauge modulus correlation .....	82
Figure 77. Fill clay, strip 2: net power–PFWD modulus correlation .....	83
Figure 78. Fill clay, strip 3: net power–dry unit weight correlation.....	84
Figure 79. Fill clay, strip 3: net power–CIV correlation .....	85
Figure 80. Fill clay, strip 3: net power–DCP index correlation.....	86
Figure 81. Fill clay, strip 3: net power–GeoGauge modulus correlation .....	87
Figure 82. Fill clay, strip 3: net power–PFWD modulus correlation .....	88
Figure 83. Fill clay, net power–coefficient of subgrade reaction correlation.....	89
Figure 84. Edwards till, strip 1: net power–dry unit weight correlation.....	90
Figure 85. Edwards till, strip 1: net power–CIV correlation .....	91
Figure 86. Edwards till, strip 1: net power–DCP index correlation .....	92
Figure 87. Edwards till, strip 1: net power–GeoGauge modulus correlation .....	93
Figure 88. Edwards till, strip 1: net power–PFWD modulus correlation .....	94
Figure 89. Edwards till, strip 2: net power–dry unit weight correlation.....	95

Figure 90. Edwards till, strip 2: net power–CIV correlation .....	96
Figure 91. Edwards till, strip 2: net power–DCP index correlation .....	97
Figure 92. Edwards till, strip 2: net power–GeoGauge modulus correlation .....	98
Figure 93. Edwards till, strip 2: net power–PFWD modulus correlation .....	99
Figure 94. Edwards till, strip 3: net power–dry unit weight correlation.....	100
Figure 95. Edwards till, strip 3: net power–DCP index correlation .....	101
Figure 96. Edwards till, strip 3: net power–GeoGauge modulus correlation .....	102
Figure 97. Edwards till, strip 3: net power–PFWD modulus correlation .....	103
Figure 98. Edwards till, strip 4: net power–dry unit weight correlation.....	104
Figure 99. Edwards till, strip 4: net power–DCP index correlation .....	105
Figure 100. Edwards till, strip 5: net power–dry unit weight correlation.....	106
Figure 101. Edwards till, strip 5: net power–CIV correlation .....	107
Figure 102. Edwards till, strip 5: net power–DCP index correlation .....	108
Figure 103. Edwards till, strip 5: net power–GeoGauge modulus correlation .....	109
Figure 104. Edwards till, strip 5: net power–PFWD modulus correlation .....	110
Figure 105. Edwards till, strip 6: net power–dry unit weight correlation.....	111
Figure 106. Edwards till, strip 6: net power–CIV correlation .....	112
Figure 107. Edwards till, strip 6: net power–DCP index correlation .....	113
Figure 108. Edwards till, strip 6: net power–GeoGauge modulus correlation .....	114
Figure 109. Edwards till, strip 6: net power–PFWD modulus correlation .....	115
Figure 110. Edwards till, net power–coefficient of subgrade reaction correlation .....	116
Figure 111. Sand, strip 1: net power–dry unit weight correlation .....	117
Figure 112. Sand, strip 1: net power–DCP index correlation.....	118
Figure 113. Sand, strip 1: net power–GeoGauge modulus correlation.....	119
Figure 114. Sand, strip 1: net power–PFWD modulus correlation.....	120
Figure 115. Sand, strip 2: net power–dry unit weight correlation .....	121
Figure 116. Sand, strip 2: net power–DCP index correlation.....	122
Figure 117. Sand, strip 2: net power–GeoGauge modulus correlation.....	123
Figure 118. Sand, strip 2: net power–PFWD modulus correlation.....	124
Figure 119. Sand, strip 3: net power–dry unit weight correlation .....	125
Figure 120. Sand, strip 3: net power–DCP index correlation.....	126
Figure 121. Sand, strip 3: net power–GeoGauge modulus correlation.....	127
Figure 122. Sand, strip 3: net power–PFWD modulus correlation.....	128
Figure 123. Sand, strip 4: net power–dry unit weight correlation .....	129
Figure 124. Sand, strip 4: net power–DCP index correlation.....	130
Figure 125. Sand, strip 4: net power–GeoGauge modulus correlation.....	131
Figure 126. Sand, strip 4: net power–PFWD modulus correlation.....	132
Figure 127. Topsoil, strip 1: distribution plots for net power and dry density per pass .....	134
Figure 128. Fill clay, strip 1: distribution plots for net power and dry density per pass .....	135
Figure 129. Edwards till, strip 1: distribution plots for net power and dry density per pass.....	136
Figure 130. Sand, strip 1: distribution plots for net power and dry density per pass .....	137
Figure 131. Dry density data (squares) and predictions (lines) using a laboratory-derived compaction model.....	143
Figure 132. Topsoil, 20 cm lift (Strips 2, 4, 6) .....	145
Figure 133. Topsoil, 30 cm lift (Strips 1, 3, 5) .....	146
Figure 134. Fill clay, 25 cm lift (Strips 1, 2, 3) .....	147
Figure 135. Till, 15 cm lift (Strips 1, 3, 6).....	148
Figure 136. Till, 25 cm lift (Strips 2, 4, 5).....	149

Figure 137. Sand, 25 cm lift (Strips 1, 4) .....	150
Figure 138. Sand, 36 cm lift (Strips 2, 3) .....	151
Figure 139. Topsoil, both lift thicknesses (Strips 1, 2, 3, 4, 5, 6).....	154
Figure 140. Edwards till, both lift thicknesses (Strips 1, 2, 3, 4, 5, 6) .....	155
Figure 141. Sand, both lift thicknesses (Strips 1, 2, 3, 4).....	156
Figure 142. Topsoil, fill clay, till; multiple regression predictions .....	159
Figure 143. Topsoil, strip 1: variability and repeatability of net power along length of test strip.....	161
Figure 144. Fill clay, strip 1: variability and repeatability of net power along length of test strip.....	161
Figure 145. Till, strip 1: variability and repeatability of net power along length of test strip ....	162
Figure 146. Sand, strip 1: variability and repeatability of net power along length of test strip ..	162
Figure 147. Excavation of test strip .....	166
Figure 148. Placement of fill in test strip.....	166
Figure 149. Moisture conditioning of test soils prior to placement in strips .....	167
Figure 150. In situ soil mixing using a road reclaimer .....	167
Figure 151. CP-533 vibratory padfoot roller .....	168
Figure 152. Soil compaction using CP-533 vibratory padfoot roller .....	168
Figure 153. Excavated trench for roller identification of a soft spot.....	169
Figure 154. Saturated soil for roller identification of wet/weak spot.....	169
Figure 155. CA6, particle size distribution and Proctor moisture density curve.....	171
Figure 156. Edwards till, particle size distribution and Proctor moisture-density curve .....	172
Figure 157. CA6, strip 1 compaction monitor views (30 x 24 m viewing area) .....	173
Figure 158. CA6, strip 2 compaction monitor views (30 x 24 m viewing area) .....	174
Figure 159. Edwards till, strip 1 compaction monitor views (30 x 24 m viewing area) .....	175
Figure 160. Edwards till, strip 2 compaction monitor views (30 x 24 m viewing area) .....	176
Figure 161. Screen capture of net power after 8 roller passes over till, strip 2 .....	177
Figure 162. Net power for 8th pass over till, strip 2 showing soft and wet spots .....	178
Figure 163. CA6: regressions using averaged net power, dry unit weight, and DCP index .....	179
Figure 164. Edwards till, strip 1: net power–dry unit weight correlation.....	180
Figure 165. Edwards till, strip 1: net power–DCP index correlation .....	181
Figure 166. Edwards till, strip 2: net power–dry unit weight correlation.....	182
Figure 167. Edwards till, strip 2: net power–DCP index correlation .....	183
Figure 168. CA6, strip 1: net power–dry unit weight correlation .....	184
Figure 169. CA6, strip 1: net power–DCP index correlation .....	185
Figure 170. CA6, strip 2: net power–dry unit weight correlation .....	186
Figure 171. CA6, strip 2: net power–DCP index correlation .....	187
Figure 172. Test roller used for quality assurance.....	190
Figure 173. EB STA 365–385: (a) compaction monitor view (view area 165 x 132 m), (b) photo of rutting at point 4.....	192
Figure 174. Proof rolling result at EB STA 365–285: (a) pt 1, (b) pt 2, (c) pt 3, (d) pt 5.....	192
Figure 175. Field measurements: (a) DCP profiles and moisture contents, (b) FMO device.....	193
Figure 176. Compaction monitor view at County 55 (viewing area 137 x 110 m) .....	194
Figure 177. DCP strength profiles at County 55, subgrade .....	194
Figure 178. Compaction monitor view of WB STA 345–360 (viewing area 473x 376 m).....	195



Figure 179. Plate load test setup and performance .....	196
Figure 180. DCP profiles from WB STA 345–360 at PLT locations .....	197
Figure 181. Weak linear correlation between CMV and energy for sand .....	197
Figure 182. Scatterplots of field measurement results versus net power.....	198
Figure 183. Scatterplots of field measurement results versus CMV .....	199
Figure 184. Conceptual data analysis approach to define a quality statement .....	208
Figure C.1. Kickapoo topsoil, strip 1 .....	338
Figure C.2. Kickapoo topsoil, strip 1 .....	339
Figure C.3. Kickapoo topsoil, strip 2.....	340
Figure C.4. Kickapoo topsoil, strip 2.....	341
Figure C.5. Kickapoo topsoil, strip 3.....	342
Figure C.6. Kickapoo topsoil, strip 3.....	343
Figure C.7. Kickapoo topsoil, strip 4.....	344
Figure C.8. Kickapoo topsoil, strip 4.....	345
Figure C.9. Kickapoo topsoil, strip 5.....	346
Figure C.10. Kickapoo topsoil, strip 5.....	347
Figure C.11. Kickapoo topsoil, strip 6.....	348
Figure C.12. Kickapoo topsoil, strip 6.....	349
Figure C.13. Kickapoo Fill Clay, strip 1.....	350
Figure C.14. Kickapoo Fill Clay, strip 1.....	351
Figure C.15. Kickapoo Fill Clay, strip 2.....	352
Figure C.16. Kickapoo Fill Clay, strip 2.....	353
Figure C.17. Kickapoo Fill Clay, strip 3.....	354
Figure C.18. Kickapoo Fill Clay, strip 3.....	355
Figure C.19. Edwards till, strip 1 .....	356
Figure C.20. Edwards till, strip 1 .....	357
Figure C.21. Edwards till, strip 2.....	358
Figure C.22. Edwards till, strip 2.....	359
Figure C.23. Edwards till, strip 3.....	360
Figure C.24. Edwards till, strip 3.....	361
Figure C.25. Edwards till, strip 4.....	362
Figure C.26. Edwards till, strip 4.....	363
Figure C.27. Edwards till, strip 5.....	364
Figure C.28. Edwards till, strip 5.....	365
Figure C.29. Edwards till, strip 6.....	366
Figure C.30. Edwards till, strip 6.....	367
Figure C.31. Kickapoo sand, strip 1 .....	368
Figure C.32. Kickapoo sand, strip 1 .....	369
Figure C.33. Kickapoo sand, strip 2 .....	370
Figure C.34. Kickapoo sand, strip 2 .....	371
Figure C.35. Kickapoo sand, strip 3 .....	372
Figure C.36. Kickapoo sand, strip 3 .....	373
Figure C.37. Kickapoo sand, strip 4 .....	374
Figure C.38. Kickapoo sand, strip 4 .....	375
Figure D.1. Plate bearing test results for Kickapoo topsoil.....	378
Figure D.2. Plate bearing test results for Kickapoo Fill Clay.....	379
Figure D.3. Plate bearing test results for Edwards till.....	380
Figure D.4. Plate bearing test results for Kickapoo sand.....	381

Figure F.1. CA-6, strip 1, lift 1 .....	414
Figure F.2. CA-6, strip 1, lift 1 .....	415
Figure F.3. CA-6, strip 1, lift 2 .....	416
Figure F.4. CA-6, strip 1, lift 2 .....	417
Figure F.5. CA-6, strip 1, lift 3 .....	418
Figure F.6. CA-6, strip 1, lift 3 .....	419
Figure F.7. CA-6, strip 2, lift 3 .....	420
Figure F.8. CA-6, strip 2, lift 3 .....	421
Figure F.9. Edwards till, strip 3 .....	422
Figure F.10. Edwards till, strip 3 .....	423
Figure F.11. Edwards till, strip 4 .....	424
Figure F.12. Edwards till, strip 4 .....	425

## LIST OF TABLES

Table 1. Summary of Phase II test projects .....	7
Table 2. Pilot Project 1 testing program .....	8
Table 3. Pilot Project 1 testing materials .....	16
Table 4. Summary of regression $R^2$ values for scatterplots .....	43
Table 5. Summary of regression $R^2$ values for scatterplots of averaged data .....	43
Table 6. Topsoil: summary of net power and spot measurement averages, standard deviations, and coefficients of variation .....	138
Table 7. Fill clay: summary of net power and spot measurement averages, standard deviations, and coefficients of variation .....	139
Table 8. Edwards till: summary of net power and spot measurement averages, standard deviations, and coefficients of variation .....	140
Table 9. Sand: summary of net power and spot measurement averages, standard deviations, and coefficients of variation .....	141
Table 10. Summary of $R^2$ for linear and multiple regression analyses (per soil and lift).....	152
Table 11. Summary of $R^2$ for multiple linear regression analyses (per soil).....	157
Table 12. Summary of $R^2$ for unified (cohesive soils) multiple linear regression analysis.....	160
Table 13. Pilot Project 2 testing program .....	165
Table 14. Pilot Project 2 testing materials .....	170
Table 15. Summary of compaction monitoring mapping trials .....	191
Table 16. Machine power for WB STA 345–360, sand .....	196
Table 17. CMV history for WB STA 345–360, sand .....	196
Table A.1. Moisture and density summary of Kickapoo topsoil, strip 1, 0 roller passes .....	214
Table A.2. Stiffness and strength summary of Kickapoo topsoil, strip 1, 0 roller passes .....	214
Table A.3. Moisture and density summary of Kickapoo topsoil, strip 1, 1 roller pass .....	214
Table A.4. Stiffness and strength summary of Kickapoo topsoil, strip 1, 1 roller pass .....	215
Table A.5. Moisture and density summary of Kickapoo topsoil, strip 1, 2 roller passes .....	215
Table A.6. Stiffness and strength summary of Kickapoo topsoil, strip 1, 2 roller passes .....	215
Table A.7. Moisture and density summary of Kickapoo topsoil, strip 1, 4 roller passes .....	216
Table A.8. Stiffness and strength summary of Kickapoo topsoil, strip 1, 4 roller passes .....	216
Table A.9. Moisture and density summary of Kickapoo topsoil, strip 1, 8 roller passes .....	216
Table A.10. Stiffness and strength summary of Kickapoo topsoil, strip 1, 8 roller passes .....	217
Table A.11. Moisture and density summary of Kickapoo topsoil, strip 2, 0 roller passes .....	217
Table A.12. Stiffness and strength summary of Kickapoo topsoil, strip 2, 0 roller passes .....	217
Table A.13. Moisture and density summary of Kickapoo topsoil, strip 2, 1 roller pass .....	218
Table A.14. Stiffness and strength summary of Kickapoo topsoil, strip 2, 1 roller pass .....	218
Table A.15. Moisture and density summary of Kickapoo topsoil, strip 2, 2 roller passes .....	219
Table A.16. Stiffness and strength summary of Kickapoo topsoil, strip 2, 2 roller passes .....	219
Table A.17. Moisture and density summary of Kickapoo topsoil, strip 2, 4 roller passes .....	220
Table A.18. Stiffness and strength summary of Kickapoo topsoil, strip 2, 4 roller passes .....	220
Table A.19. Moisture and density summary of Kickapoo topsoil, strip 2, 8 roller passes .....	221
Table A.20. Stiffness and strength summary of Kickapoo topsoil, strip 2, 8 roller passes .....	221
Table A.21. Moisture and density summary of Kickapoo topsoil, strip 3, 0 roller passes .....	222
Table A.22. Stiffness and strength summary of Kickapoo topsoil, strip 3, 0 roller passes .....	222
Table A.23. Moisture and density summary of Kickapoo topsoil, strip 3, 1 roller pass .....	223
Table A.24. Stiffness and strength summary of Kickapoo topsoil, strip 3, 1 roller pass .....	223







Table A.169. Moisture and density summary of Kickapoo sand, strip 2, 8 roller passes.....	298
Table A.170. Stiffness and strength summary of Kickapoo sand, strip 2, 8 roller passes.....	298
Table A.171. Moisture and density summary of Kickapoo sand, strip 3, 0 roller passes.....	299
Table A.172. Stiffness and strength summary of Kickapoo sand, strip 3, 0 roller passes.....	299
Table A.173. Moisture and density summary of Kickapoo sand, strip 3, 1 roller pass.....	300
Table A.174. Stiffness and strength summary of Kickapoo sand, strip 3, 1 roller pass.....	300
Table A.175. Moisture and density summary of Kickapoo sand, strip 3, 2 roller passes.....	301
Table A.176. Stiffness and strength summary of Kickapoo sand, strip 3, 2 roller passes.....	301
Table A.177. Moisture and density summary of Kickapoo sand, strip 3, 4 roller passes.....	302
Table A.178. Stiffness and strength summary of Kickapoo sand, strip 3, 4 roller passes.....	302
Table A.179. Moisture and density summary of Kickapoo sand, strip 3, 8 roller passes.....	303
Table A.180. Stiffness and strength summary of Kickapoo sand, strip 3, 8 roller passes.....	303
Table A.181. Moisture and density summary of Kickapoo sand, strip 4, 0 roller passes.....	304
Table A.182. Stiffness and strength summary of Kickapoo sand, strip 4, 0 roller passes.....	304
Table A.183. Moisture and density summary of Kickapoo sand, strip 4, 1 roller pass.....	305
Table A.184. Stiffness and strength summary of Kickapoo sand, strip 4, 1 roller pass.....	305
Table A.185. Moisture and density summary of Kickapoo sand, strip 4, 2 roller passes.....	306
Table A.186. Stiffness and strength summary of Kickapoo sand, strip 4, 2 roller passes.....	306
Table A.187. Moisture and density summary of Kickapoo sand, strip 4, 4 roller passes.....	307
Table A.188. Stiffness and strength summary of Kickapoo sand, strip 4, 4 roller passes.....	307
Table A.189. Moisture and density summary of Kickapoo sand, strip 4, 8 roller passes.....	308
Table A.190. Stiffness and strength summary of Kickapoo sand, strip 4, 8 roller passes.....	308
Table B.1. NDE moisture summary of Kickapoo topsoil, strip 1, 1 roller pass.....	310
Table B.2. NDE moisture summary of Kickapoo topsoil, strip 1, 2 roller passes.....	310
Table B.3. NDE moisture summary of Kickapoo topsoil, strip 1, 4 roller passes.....	311
Table B.4. NDE moisture summary of Kickapoo topsoil, strip 1, 8 roller passes.....	311
Table B.5. NDE moisture summary of Kickapoo topsoil, strip 2, 4 roller passes.....	312
Table B.6. NDE moisture summary of Kickapoo topsoil, strip 2, 8 roller passes.....	312
Table B.7. NDE moisture summary of Kickapoo topsoil, strip 2, 12 roller passes.....	313
Table B.8. NDE moisture summary of Kickapoo topsoil, strip 3, 2 roller passes.....	313
Table B.9. NDE moisture summary of Kickapoo topsoil, strip 3, 4 roller passes.....	314
Table B.10. NDE moisture summary of Kickapoo topsoil, strip 3, 8 roller passes.....	314
Table B.11. NDE moisture summary of Kickapoo topsoil, strip 4, 8 roller passes.....	315
Table B.12. NDE moisture summary of Kickapoo topsoil, strip 5, 4 roller passes.....	315
Table B.13. NDE moisture summary of Kickapoo topsoil, strip 5, 8 roller passes.....	316
Table B.14. NDE moisture summary of Kickapoo fill clay, strip 1, 4 roller passes.....	316
Table B.15. NDE moisture summary of Kickapoo fill clay, strip 1, 8 roller passes.....	317
Table B.16. NDE moisture summary of Kickapoo fill clay, strip 2, 1 roller pass.....	318
Table B.17. NDE moisture summary of Kickapoo fill clay, strip 2, 2 roller passes.....	318
Table B.18. NDE moisture summary of Kickapoo fill clay, strip 2, 4 roller passes.....	319
Table B.19. NDE moisture summary of Kickapoo fill clay, strip 2, 8 roller passes.....	319
Table B.20. NDE moisture summary of Edwards till, strip 1, 0 roller passes.....	320
Table B.21. NDE moisture summary of Edwards till, strip 1, 1 roller pass.....	320
Table B.22. NDE moisture summary of Edwards till, strip 1, 2 roller passes.....	321
Table B.23. NDE moisture summary of Edwards till, strip 1, 4 roller passes.....	321
Table B.24. NDE moisture summary of Edwards till, strip 1, 8 roller passes.....	322
Table B.25. NDE moisture summary of Edwards till, strip 2, 0 roller passes.....	322
Table B.26. NDE moisture summary of Edwards till, strip 2, 1 roller pass.....	323

Table B.27. NDE moisture summary of Edwards till, strip 2, 2 roller passes .....	323
Table B.28. NDE moisture summary of Edwards till, strip 2, 4 roller passes .....	324
Table B.29. NDE moisture summary of Edwards till, strip 2, 8 roller passes .....	324
Table B.30. NDE moisture summary of Edwards till, strip 3, 1 roller pass .....	325
Table B.31. NDE moisture summary of Edwards till, strip 3, 2 roller passes .....	325
Table B.32. NDE moisture summary of Edwards till, strip 3, 4 roller passes .....	326
Table B.33. NDE moisture summary of Edwards till, strip 3, 8 roller passes .....	326
Table B.34. NDE moisture summary of Edwards till, strip 4, 8 roller passes .....	327
Table B.35. NDE moisture summary of Edwards till, strip 5, 4 roller passes .....	327
Table B.36. NDE moisture summary of Edwards till, strip 5, 8 roller passes .....	328
Table B.37. NDE moisture summary of Kickapoo sand, strip 1, 0 roller passes .....	328
Table B.38. NDE moisture summary of Kickapoo sand, strip 1, 1 roller pass .....	329
Table B.39. NDE moisture summary of Kickapoo sand, strip 1, 4 roller passes .....	329
Table B.40. NDE moisture summary of Kickapoo sand, strip 1, 8 roller passes .....	330
Table B.41. NDE moisture summary of Kickapoo sand, strip 2, 1 roller pass .....	330
Table B.42. NDE moisture summary of Kickapoo sand, strip 2, 2 roller passes .....	331
Table B.43. NDE moisture summary of Kickapoo sand, strip 2, 4 roller passes .....	331
Table B.44. NDE moisture summary of Kickapoo sand, strip 2, 8 roller passes .....	332
Table B.45. NDE moisture summary of Kickapoo sand, strip 3, 0 roller passes .....	332
Table B.46. NDE moisture summary of Kickapoo sand, strip 3, 1 roller pass .....	333
Table B.47. NDE moisture summary of Kickapoo sand, strip 3, 2 roller passes .....	333
Table B.48. NDE moisture summary of Kickapoo sand, strip 3, 4 roller passes .....	334
Table B.49. NDE moisture summary of Kickapoo sand, strip 3, 8 roller passes .....	334
Table B.50. NDE moisture summary of Kickapoo sand, strip 4, 0 roller passes .....	335
Table B.51. NDE moisture summary of Kickapoo sand, strip 4, 1 roller pass .....	335
Table B.52. NDE moisture summary of Kickapoo sand, strip 4, 2 roller passes .....	336
Table B.53. NDE moisture summary of Kickapoo sand, strip 4, 8 roller passes .....	336
Table E.1. Moisture and density summary of CA-6 sand, strip 1, lift 1, 0 roller passes .....	384
Table E.2. Stiffness and strength summary of CA-6 sand, strip 1, lift 1, 0 roller passes .....	384
Table E.3. Moisture and density summary of CA-6 sand, strip 1, lift 1, 1 roller pass .....	385
Table E.4. Stiffness and strength summary of CA-6 sand, strip 1, lift 1, 1 roller pass .....	385
Table E.5. Moisture and density summary of CA-6 sand, strip 1, lift 1, 2 roller passes .....	386
Table E.6. Stiffness and strength summary of CA-6 sand, strip 1, lift 1, 2 roller passes .....	386
Table E.7. Moisture and density summary of CA-6 sand, strip 1, lift 1, 4 roller passes .....	387
Table E.8. Stiffness and strength summary of CA-6 sand, strip 1, lift 1, 4 roller passes .....	387
Table E.9. Moisture and density summary of CA-6 sand, strip 1, lift 2, 0 roller passes .....	388
Table E.10. Stiffness and strength summary of CA-6 sand, strip 1, lift 2, 0 roller passes .....	388
Table E.11. Moisture and density summary of CA-6 sand, strip 1, lift 2, 1 roller pass .....	389
Table E.12. Stiffness and strength summary of CA-6 sand, strip 1, lift 2, 1 roller pass .....	389
Table E.13. Moisture and density summary of CA-6 sand, strip 1, lift 2, 2 roller passes .....	390
Table E.14. Stiffness and strength summary of CA-6 sand, strip 1, lift 2, 2 roller passes .....	390
Table E.15. Moisture and density summary of CA-6 sand, strip 1, lift 2, 4 roller passes .....	391
Table E.16. Stiffness and strength summary of CA-6 sand, strip 1, lift 2, 4 roller passes .....	391
Table E.17. Moisture and density summary of CA-6 sand, strip 1, lift 2, 8 roller passes .....	392
Table E.18. Stiffness and strength summary of CA-6 sand, strip 1, lift 2, 8 roller passes .....	392
Table E.19. Moisture and density summary of CA-6 sand, strip 1, lift 3, 0 roller passes .....	393
Table E.20. Stiffness and strength summary of CA-6 sand, strip 1, lift 3, 0 roller passes .....	393
Table E.21. Moisture and density summary of CA-6 sand, strip 1, lift 3, 1 roller pass .....	394



Table E.22. Stiffness and strength summary of CA-6 sand, strip 1, lift 3, 1 roller pass .....	394
Table E.23. Moisture and density summary of CA-6 sand, strip 1, lift 3, 2 roller passes .....	395
Table E.24. Stiffness and strength summary of CA-6 sand, strip 1, lift 3, 2 roller passes .....	395
Table E.25. Moisture and density summary of CA-6 sand, strip 1, lift 3, 4 roller passes .....	396
Table E.26. Stiffness and strength summary of CA-6 sand, strip 1, lift 3, 4 roller passes .....	396
Table E.27. Moisture and density summary of CA-6 sand, strip 1, lift 3, 8 roller passes .....	397
Table E.28. Stiffness and strength summary of CA-6 sand, strip 1, lift 3, 8 roller passes .....	397
Table E.29. Moisture and density summary of CA-6 sand, strip 2, lift 3, 0 roller passes .....	398
Table E.30. Stiffness and strength summary of CA-6 sand, strip 2, lift 3, 0 roller passes .....	398
Table E.31. Moisture and density summary of CA-6 sand, strip 2, lift 3, 1 roller pass .....	399
Table E.32. Stiffness and strength summary of CA-6 sand, strip 2, lift 3, 1 roller pass .....	399
Table E.33. Moisture and density summary of CA-6 sand, strip 2, lift 3, 2 roller passes .....	400
Table E.34. Stiffness and strength summary of CA-6 sand, strip 2, lift 3, 2 roller passes .....	400
Table E.35. Moisture and density summary of CA-6 sand, strip 2, lift 3, 4 roller passes .....	401
Table E.36. Stiffness and strength summary of CA-6 sand, strip 2, lift 3, 4 roller passes .....	401
Table E.37. Moisture and density summary of CA-6 sand, strip 2, lift 3, 8 roller passes .....	402
Table E.38. Stiffness and strength summary of CA-6 sand, strip 2, lift 3, 8 roller passes .....	402
Table E.39. Moisture and density summary of CA-6 sand, strip 2, lift 3, 12 roller passes .....	403
Table E.40. Stiffness and strength summary of CA-6 sand, strip 2, lift 3, 12 roller passes .....	403
Table E.41. Moisture and density summary of Edwards till, strip 3, 0 roller passes .....	404
Table E.42. Stiffness and strength summary of Edwards till, strip 3, 0 roller passes.....	404
Table E.43. Moisture and density summary of Edwards till, strip 3, 1 roller pass.....	405
Table E.44. Stiffness and strength summary of Edwards till, strip 3, 1 roller pass.....	405
Table E.45. Moisture and density summary of Edwards till, strip 3, 2 roller passes .....	406
Table E.46. Stiffness and strength summary of Edwards till, strip 3, 2 roller passes.....	406
Table E.47. Moisture and density summary of Edwards till, strip 3, 4 roller passes .....	407
Table E.48. Stiffness and strength summary of Edwards till, strip 3, 4 roller passes.....	407
Table E.49. Moisture and density summary of Edwards till, strip 3, 8 roller passes .....	408
Table E.50. Stiffness and strength summary of Edwards till, strip 3, 8 roller passes.....	408
Table E.51. Moisture and density summary of Edwards till, strip 4, 0 roller passes .....	409
Table E.52. Stiffness and strength summary of Edwards till, strip 4, 0 roller passes.....	409
Table E.53. Moisture and density summary of Edwards till, strip 4, 1 roller pass.....	410
Table E.54. Stiffness and strength summary of Edwards till, strip 4, 1 roller pass.....	410
Table E.55. Moisture and density summary of Edwards till, strip 4, 8 roller passes .....	411
Table E.56. Stiffness and strength summary of Edwards till, strip 4, 8 roller passes.....	411
Table G.1. GPS coordinates of WB mainline sand.....	428
Table G.2. Stiffness and strength summary of WB mainline sand.....	428
Table G.3. Nuclear gauge moisture and density summary of WB mainline sand.....	429
Table G.4. GPS coordinates of EB mainline sand, 0 passes.....	429
Table G.5. Stiffness and strength summary of EB mainline sand, 0 passes.....	430
Table G.6. GPS coordinates of EB mainline sand, 4 passes.....	430
Table G.7. Stiffness and strength summary of EB mainline sand, 4 passes.....	431



## **ACKNOWLEDGMENTS**

The Highway Division of the Iowa Department of Transportation (Iowa DOT) sponsored Phase II of this study. Thanks also go to the Federal Technology and Innovation Program of the Federal Highway Administration (FHWA). In-kind and matched support was provided by Caterpillar Inc. (CAT), the Iowa Association of General Contractors, Iowa State University's Center for Transportation Research and Education (CTRE), the Asphalt Paving Association of Iowa, and the Iowa DOT. Numerous people assisted the authors in identifying projects for testing, refining research tasks, and providing review comments. Some of the contributors are listed below. Their support is greatly appreciated.

From CAT, Paul Corcoran, Tom Congdon, Donald Hutchen, Allen DeClerk, Glen Feather, Dean Potts, and Tom Walters provided assistance in developing pilot project test plans and assisted with field testing. John Adam, Sandra Larson, and Mark Dunn of the Iowa DOT and Max Grogg of the FHWA provided helpful input in developing this research program through the Partnership for Geotechnical Advancement at CTRE. Guidance with intellectual property issues was provided by Ken Kirkland of the Iowa State University Research Foundation. The authors would like to acknowledge the assistance of Isaac Drew, Lifeng Li, Matt Veenstra, Allison Moyer, Heath Gieselmann, Mohamed Mekkawy, and Muhannad Suleiman for providing assistance with field testing.



## **EXECUTIVE SUMMARY**

Recent developments in real-time compaction monitoring technologies for earthwork operations provide 100% inspection data, compared to the relatively small number of isolated spot checks with conventional post-process measurements. In practice, with the results provided in real-time, compaction processes can potentially be managed and controlled to improve quality, reduce rework, maximize productivity, and minimize construction costs. This report documents results from an extensive field program carried out to identify relationships between the soil engineering properties measured by various in situ devices and the machine compaction monitoring results using prototype compaction monitoring technology developed by Caterpillar Inc.

### **Research Summary**

The compaction monitoring technology evaluated in this study is comprised of internal sensors installed on the roller to monitor the power consumption used to move the machine, an on-board computer and ruggedized display screen, and a global positioning satellite (GPS) system to map the spatial location of the roller. Primary research tasks for the Phase II study include the following: (1) performing experimental testing and statistical analyses to evaluate machine power in terms of the engineering properties of the compacted soil (e.g., density, strength, stiffness) and (2) developing recommendations for using the compaction monitoring technology in practice. For this study, data were collected at three test sites. The first two projects (February and May 2005) were conducted at Caterpillar Inc. facilities near Peoria, Illinois, and involved constructing and testing relatively uniform test strips using different soil types, moisture contents, and lift thicknesses. The data collected facilitated linear and multiple linear regression analyses with moisture content, lift thickness, and soil type as regression parameters. The third test site (June 2005) was conducted at an earthwork construction project for the TH 14 bypass near Janesville, Minnesota. For the third project, the ability of the compaction monitoring technology to identify localized areas of weak or poorly compacted soil was demonstrated by mapping select locations of the project and comparing to the test rolling.

For all test projects, in situ testing of soil density (nuclear moisture-density gauge), strength (dynamic cone penetrometer, Clegg impact hammer), and stiffness (GeoGauge, portable falling weight deflectometer, plate load test) provided data to characterize the soil at various stages of compaction (i.e., roller passes). For each test strip (i.e., uniform soil type and moisture content) or test area (variable conditions), in situ soil properties were compared directly to machine power values to establish statistical relationships. Using a physical model developed from laboratory compaction energy, dry unit weight, and moisture content measurements as a basis, statistical models were developed to predict soil density, strength, and stiffness from the machine power values. Field data for multiple test strips (i.e., multiple moisture contents, lift thicknesses, and/or soil types) were evaluated. The  $R^2$  correlation coefficient was generally used to assess the quality of the regressions.

The established research objectives were achieved because the testing methods and operation generated data usable for evaluating machine power in terms of soil compaction measures. Machine power and field measurements were collected at various levels of compaction, including soft, intermediate, and hard materials. Also, using a variety of in situ testing devices to characterize soil density, strength, and stiffness facilitated multiple interpretations about machine

power response, not just the conventional approach of determining relative compaction. Future research to investigate compaction monitoring technology may use similar testing procedures, but will isolate other variables affecting machine-soil response (e.g., speed, slope, acceleration, turning radius, etc.).

## Research Conclusions

Some of the significant conclusions drawn from the Phase II research are as follows:

- Using averaged machine power and field measurement data, strong correlations ( $R^2 \geq 0.9$ ) were developed to characterize the machine-soil interaction. These correlations (models) were initially derived from laboratory compaction data relating compaction energy, moisture content, and dry unit weight. The final models for each combination of soil type, lift thickness, and test device show that machine power is statistically significant in predicting various soil properties. Since the initial physical model was derived from moisture-density relationships, predictions of dry unit weight were often more accurate than predictions of soil strength or stiffness. The complexity of soil strength and stiffness requires the use of a more complicated physical model. Nevertheless, by incorporating moisture content and moisture-energy (i.e., machine power) interaction terms into the regressions, high correlations were achieved and indicate the promise of using such compaction monitoring technology as a tool for earthwork quality control.
- The compaction monitoring technology identified “wet” and “soft” spots incorporated into a test strip, evidenced by relatively high net power values observed at these locations and displayed on the compaction monitor. The difference in net power observed between these locations and the rest of the test strip was considerable; this observation reflects the extreme conditions (i.e., high lift thickness and moisture content) built into the strip design. Future testing may be required to determine and quantify the roller’s sensitivity to these changes in moisture content and soil lift thickness that result from variations in construction operations (e.g., fill placement, moisture conditioning, existing site conditions) for a wider range of soil types and larger test areas.
- The compaction monitoring technology may identify areas of weak or poorly compacted soil with real-time readings and 100% coverage. Two-dimensional spatial mapping trials conducted at the TH 14 bypass earthwork pilot project showed that in situ test measurements and proof rolling verified the compaction monitoring output for cohesive subgrade soils, but showed less certainly in some areas for fine sandy soils.
- The research program revealed that a single in situ test point does not provide a high level of confidence in representing the average soil engineering property values over a given area. Rather, variation always exists, and several samples must be tested to determine the soil properties with any confidence. In the case of comparing compaction monitoring output to field measurements, soil property variations and the influence area of the measurement must be considered.
- Investigating the influence of lift thickness on the machine power output data provided important insight into the factors affecting machine-soil response. The summary of  $R^2$  values for multiple linear regression analyses per soil showed that correlation coefficients for thicker lifts were consistently higher than for the thin lifts. The relative change in  $R^2$  values between thin and thick lifts suggests that the depth influencing machine power

response exceeds representative lift thicknesses encountered in field conditions. While the depth to a stabilized base (e.g., any soil layer with differing stiffness properties) affects the field measurements to some degree, the measurement influence depth affects the roller response (higher weight and contact area than in situ test devices) to a greater extent than the conventional tests.

## **Recommendations for Implementation**

Compaction monitoring technology has been documented to give compaction results in real-time with 100% roller coverage. Machine power output was evaluated in this study using experimental and statistical methods. Relating the technology output to more conventional soil parameters and making the technology more accessible will ultimately benefit both government transportation agencies and earthwork contractors. Transportation agencies (project owners) will have the opportunity to specify the use of compaction monitoring technology in earthwork projects for which achieving compaction and soil uniformity is critical to performance. Earthwork contractors may find the technology advantageous considering construction productivity, reliability, and the safety of field personnel.

Most existing earthwork specifications use relative compaction and moisture content as acceptance criteria. Although machine power is related to relative compaction, strong regressions were identified using soil stiffness values. As a result, new acceptance criteria must be developed by transportation agencies to define quality in terms of compaction monitoring output. This effort, which is a leap from density-based quality criteria to strength/stiffness-based quality criteria, may take considerable time to identify target values, especially for cohesive soils where stiffness is highly dependent on moisture content. Moreover, compaction monitoring technology currently does not eliminate the need for soil moisture control during earthwork construction. Field personnel must still perform field measurements to verify that moisture conditioning operations meet the specification limits.

Continued research on compaction monitoring technologies is necessary to better understand and refine the systems. Regarding implementation, however, transportation agencies must also begin to participate in developing guidelines for using compaction monitoring technology in earthwork construction. Such participation will make specification development more efficient and more widely accepted and will also accelerate technology deployment. Because compaction monitoring technologies are relatively new in the United States and transportation agencies and contractors are generally unfamiliar with the state of the technology, manufacturers of compaction monitoring technology are expediting involvement by candidly demonstrating the fundamental workings, advantages, and disadvantages of the systems. This technology transfer can promote confidence in both the technology and the manufacturers' products.

Short-term objectives for implementing compaction monitoring technology into earthwork construction should focus on (1) evaluating the technology from the perspective of geotechnical and materials uniformity and performance, (2) demonstrating that the technology will provide for the construction of higher quality earth structures and pavement systems, and (3) documenting the cost savings associated with using compaction monitoring technology over conventional earthwork practices. Immediate efforts should focus on pilot projects to verify and document the reported benefits (maximized productivity, improved compaction and uniformity of pavement

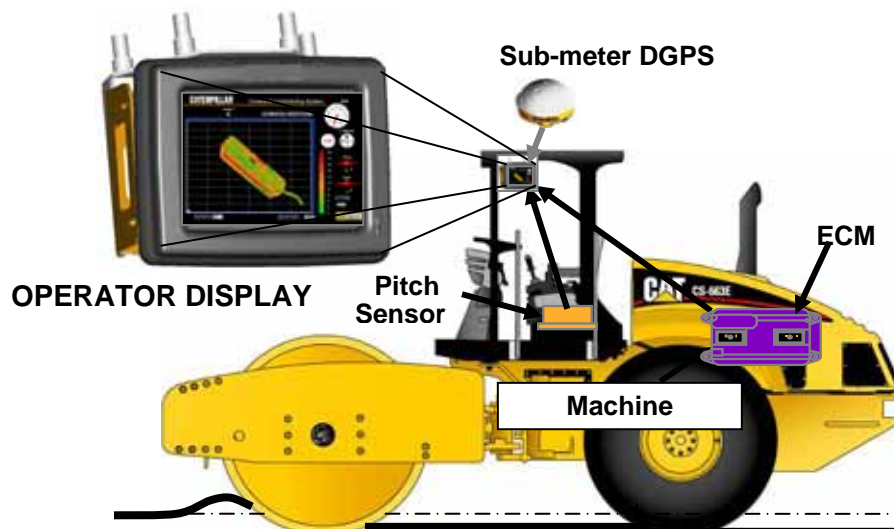
materials, identification of weak areas, and reduction in highway repair costs, etc.) using data to support any conclusions. Large-scale pilot projects that use side-by-side conventional compaction operations and compaction monitoring technology may provide the information needed to accomplish these tasks. The long-term performance of these constructed facilities should also be monitored to collect information about the effectiveness of compaction monitoring technologies.



## INTRODUCTION

### Phase I Summary

Phase I was initiated in 2003 to begin evaluating a compaction monitoring technology developed by Caterpillar Inc. The technology was comprised of an instrumented prototype padfoot roller to monitor changes in machine power output resulting from soil compaction and the corresponding changes in machine-soil interaction. The roller, diagrammed in Figure 1, is additionally fitted with a global positioning system (GPS), such that coverage (i.e., history of the roller location) and machine power are mapped and viewed in real-time during compaction operations. The specific objectives of Phase I included the following: (1) a literature review of current compaction monitoring technologies, (2) data collection using the compaction monitoring system and in situ testing devices for comparing machine power with physical soil properties (e.g., density, strength, stiffness), (3) an identification of modifications to be made to the technological and communication systems, and (4) identification of the benefits to contractors and owners of using the technology.



**Figure 1. Caterpillar Inc. compaction monitoring system**

The Phase I report summarized preliminary analyses of data collected during pilot studies at Caterpillar Inc. facilities in Peoria, Illinois, and on an actual earthwork project in West Des Moines, Iowa. At the sites, in situ tests were conducted using conventional and currently accepted practices to evaluate the technology. The field measurements of soil density, moisture content, strength, and stiffness showed a high level of promise for the technology output (machine power) to indicate soil compaction.

The significant research findings from Phase I (White et al. 2004) are summarized as follows:

- Multiple linear regression analyses were performed using machine power and various field measurements (nuclear moisture and density, dynamic cone penetrometer [DCP] index, Clegg impact value [CIV]). The  $R^2$  values of the models indicated that compaction

energy accounts for more variation in dry unit weight than DCP index or Clegg impact values.

- Incorporating moisture content in the regression analyses improved model  $R^2$  values for DCP index and CIV, indicating the influence of moisture content on strength and stiffness.
- The compaction monitoring technology showed a high level of promise for use as a quality control/quality assurance (QC/QA) tool, but was demonstrated for a relatively narrow range of field conditions.

The results of this proof-of-concept study provided evidence that machine power may reliably indicate soil compaction with the advantages of 100% coverage and real-time results. Additional field trials were recommended, however, to expand the range of correlations to other soil types, roller configurations, lift thicknesses, and moisture contents. The observed promise for using such compaction monitoring technology in earthwork QC/QA practices also required the development of guidelines for its use, considering a statistical framework for analyzing the near-continuous data.

## **Phase II**

### *Project Scope*

This report summarizes experimental testing programs, field measurements, and statistical analyses performed to evaluate the compaction monitoring technology developed by Caterpillar Inc. For Phase II, three test sites were studied. The first two sites involved constructing and testing relatively uniform test strips of varying soil types, lift thicknesses, and moisture contents. Data collected during these projects facilitated regression analyses and the development of relationships relating machine power to more conventional measures of soil density, strength, and stiffness. The third pilot project was conducted at an active earthwork project (TH 14 near Janesville, Minnesota) to exercise the mapping capabilities of the compaction monitoring system, verify the ability of the technology to identify areas of weak or poorly compacted soil, and demonstrate the benefits of the technology for earthwork contractors and project owners.

Based on Phase II observations and results, recommendations regarding technology deployment and use are provided. While this report does not include ready-to-implement specifications, the insight gained by the authors in performing the research is shared. Nevertheless, such recommendations address the key elements of any such specifications, which include (1) calibrating machine power values to physical test measurements, (2) linking the data collected for varying soil types and moisture contents, (3) identifying variation and soil non-uniformity from compaction monitoring data, and (4) developing a statistical framework for defining quality using compaction monitoring technologies.

## *Research Objectives*

The following research objectives were established for Phase II:

- Investigate machine power for the full range of soil compaction, from an uncompacted state to nearly full compaction (i.e., 100% compaction).
- Describe the change in machine power observed during compaction in terms of soil density, strength, stiffness, and moisture content for a wide range of field conditions.
- Use laboratory data to derive a relationship between energy, density, and moisture content that can be used to relate machine power data to field measurements. Evaluate the models and document the significant model parameters.
- Evaluate the mapping capabilities of the compaction monitoring technology by compacting select areas of an earthwork project and identifying areas of poorly compacted soil.
- Document recommendations for implementing the technology in earthwork QC/QA practices.

## RESEARCH METHODOLOGY

### Test Project Objectives

The principle concept of using machine drive power as an indicator of a soil's physical properties has its origin in various mathematical models of vehicle-terrain interaction (see Bekker 1969). The net power ( $P_n$ ) required to propel the machine through the uncompacted layer of fill can be represented as follows,

$$P_n = P_g - WV \left( \sin \theta + \frac{a}{g} \right) + (mV + b) \quad (1)$$

where  $W$  is the roller weight,  $a$  is acceleration of the machine,  $g$  is acceleration of gravity,  $\theta$  is the slope angle,  $V$  is the roller velocity, and  $m$  and  $b$  are machine internal loss coefficients specific to a particular machine. Here,  $P_g$  represents the gross power needed to move the machine. A portion of the gross power is the power associated with sloping grade, machine accelerations, and internal machine losses and must be accounted for, such that  $P_n$  only represents the machine power associated with changes in soil physical parameters (i.e., density, strength, and stiffness)

Phase II research efforts build on the findings from Phase I to include a more comprehensive evaluation of machine power considering the following influences: (1) state of soil compaction, (2) soil type, (3) lift thickness, and (4) moisture content. The experimental testing plan for the current phase was designed to isolate and control each of these compaction parameters; the presentation of machine power and field measurement data in the following report sections reflects these objectives.

Test Projects 1 and 2 were conducted at the Caterpillar Inc. Edwards facilities near Peoria, Illinois. Uniform test strips with lengths of about 15 m were constructed, compacted using the prototype CP-533 padfoot roller, and tested using in situ testing devices. In doing this, machine power data was collected approximately every 20 cm along the strip; ten test points (for field measurements) were established at 1.5 m intervals in the center of the roller width. Since GPS coordinates were collected with compaction monitoring data and each soil property measurement, the field measurements were paired with the spatially nearest machine power values. For each test strip, such measurements were collected and analyzed for the uncompacted material (zero passes) and the following one, two, four, and eight passes of the roller. Characteristics of the compacted fill, defined using machine power and conventional measures of soil density, strength, and stiffness, are available for the full range of soil compaction states. The results of test projects provide a statistically robust dataset that can evaluate machine net power as an indicator of soil compaction.

The following objectives were established for Test Projects 1 and 2:

- Describe the change in machine net power observed during soil compaction in terms of soil density, strength, and stiffness. As each strip consisted of soil at one nominal moisture content and one lift thickness, conditions that isolate the factors affecting

compaction, decreasing machine power was correlated with increasing density, strength, and stiffness.

- Describe the variability observed in the measured soil properties based on compaction monitoring data and field measurement results. Document the difference in regressions from pairs of isolated point measurements and distributions/averages of data.
- Using a laboratory-derived model relating dry density, moisture content, and compaction energy, combine the data from various test strips (of differing moisture content) to evaluate soil property predictions based on net power and moisture content.

Test Project 3 was conducted on an earthwork project for construction of the TH 14 bypass around Janesville, Minnesota. At this project site, compaction monitoring technology was applied to a CP-533 padfoot roller and a CS-563 smooth drum roller (both vibratory). The CS-563 was additionally fitted with the Geodynamik system to monitor compaction meter value (CMV) (Geodynamik). The objectives of this project were to begin demonstrating the capabilities and benefits of compaction monitoring technology to contractors and project owners (e.g., transportation agencies). Highway subgrade was compacted; the mapping features of the system were evaluated by spot checking localized areas identified as soft or poorly compacted.

## **In Situ Test Measurements**

### *Moisture and Density*

The nuclear moisture-density gauge was incorporated into the testing program to provide a rapid measurement of density and moisture. Drive core and bag samples were additionally collected after the final roller pass (generally eight passes) to determine oven moisture contents and verify soil density onsite in the Iowa State University Mobile Concrete Laboratory. The drive core samples were taken in the top 5 to 10 cm below padfoot penetration, whereas nuclear tests averaged measurements over the top 10 to 20 cm.

### *Soil Strength and Stiffness*

Soil strength and stiffness was determined using the Clegg impact hammer, DCP (surface measurement only), GeoGauge (GG), portable falling weight deflectometer (PFWD), and plate load tests (PLT). CIVs are empirically related to California bearing ratio (CBR), and the test can reportedly simulate penetration of a roller pad/foot. In testing the compacted soil, two CIV values were collected at each point and averaged. DCP tests were performed to develop strength profiles with depth. CBR profiles derived from DCP measurements for the various pilot projects are found in Appendices C and F. DCP index values at the soil surface were used in regressions with machine power, as soil properties at the surface most strongly affect machine-soil interaction. The GeoGauge device determined in situ deformation properties of soil, giving both soil stiffness and elastic modulus. GG stiffness and GG modulus are related through a linear relationship, such that only the GG modulus was used in performing statistical analyses. The PFWD is equipped with a load sensor and geophone and determines applied load and plate deflection for a 300 mm steel plate. The result of this test is elastic modulus.

## **Evaluating Machine Power as a Compaction Indicator**

The compaction monitoring system generates near-continuous spatial data based on GPS location information and sensor measurements that indicate machine drive power. During soil compaction operations, the data is collected, displayed in the roller cab, and stored for later viewing and data retrieval. The machine power data may be viewed using the Caterpillar Inc. Compaction Viewer software. From within the Compaction Viewer program, the raw data may be exported to Microsoft Excel for manipulation and analysis. Data extraction from the compaction software is the first step in quantitatively evaluating machine power as a compaction indicator.

For this study, only the machine power data collected within the limits of the test strips and the performance of field spot measurements were analyzed. The data outside the limits of the test strips were thus disregarded. Using simple algorithms, the pertinent data were sorted to separate the sequential data into the number of roller passes (i.e., first pass, second pass, etc.). Generally, about 65 to 75 data points were collected for each pass of a 15 m to 18 m long test strip. As the roller was operated at a relatively constant speed, these data are equally spaced along the strip at about a 0.2 m interval. Having the machine power data organized by soil type, strip number, and pass number, statistical analysis functions were performed, including calculation of averages and standards of deviation.

Field spot measurements were paired with spatially nearest machine power values based on GPS location information. For each of the ten test points established along the test strips, the following data were available for developing scatter plots and regressions: net power, moisture content, dry unit weight, CIV, DCP index, GG modulus, PFWD modulus, and PLT coefficient of subgrade reaction. As the test strips were regarded as uniform, field measurements were also averaged for each roller pass, and the averages of machine power and measures of soil density, strength, and stiffness were correlated.

The analysis data and results for each pilot project are detailed in the respective report sections, with data supporting the rationale for using various analysis methods.

## TEST PROJECTS

Three test projects were completed in 2005 to evaluate Caterpillar Inc. compaction monitoring technology applied to two rollers for a wide range of field conditions. The objectives unique to each project are described in the respective report sections. A summary of pilot projects and project parameters is provided in Table 1.

**Table 1. Summary of Phase II test projects**

Experimental testing parameters		Test project No. 1	Test project No. 2	Test project No. 3
Roller	CP-533 static padfoot	x		
	CP-533 vibratory padfoot		x	x
	CS-563 smooth drum			x
Soil type	ML	x		
	CL	x	x	x
	SW-SM	x		
	SM		x	x
Fill condition	Variable moisture content	x	x	
	Variable lift thickness	x	x	
	Highway subgrade/subbase			x
Machine parameters	Machine power	x	x	x
	CMV			x

### Test Project 1: Caterpillar Edwards Demonstration Arena (2/7/05-2/18/05)

#### *Project Description*

Test Project 1 was conducted at the indoor Caterpillar Inc. Edwards Demonstration Arena from February 7–18, 2005. The testing program used four soils, variable moisture content, and variable loose lift thickness and was designed to include a relatively wide yet representative range of field conditions encountered during earthwork construction operations. In all, 19 test strips were constructed, compacted using a CP-533 static padfoot roller, and tested. The testing schedule is provided in Table 2.

**Table 2. Pilot Project 1 testing program**

<b>Soil Type</b>	<b>Strip #</b>	<b>Loose lift thickness (cm)</b>	<b>Moisture content (%)</b>	<b>Moisture deviation <sup>a</sup> (%)</b>
Topsoil	1	30	8	-11
	2	20	8	-11
	3	30	16	-3
	4	20	16	-3
	5	30	12	-7
	6	20	12	-7
Fill clay	1	25	24	+4
	2	25	16	-4
	3	25	20	0
Till	1	15	8	-4
	2	25	8	-4
	3	15	16	+4
	4	25	16	+4
	5	25	12	0
	6	15	12	0
Sand	1	25	5	-4
	2	36	5	-4
	3	36	10	+1
	4	25	10	+1

<sup>a</sup> Moisture deviation from optimum, based on standard Proctor test ( $w - w_{opt}$ )

Within the indoor facility, two parallel test pits were established. The existing Edwards till of the arena was excavated, and the pit bases were stabilized with liberal compaction to create a relatively uniform and stable base. With the exception of DCP measurements, the engineering properties of the stabilized bases were not determined using in situ test methods. Testing materials (topsoil, fill clay, till, and sand) were placed in the pits (see Figure 2) and mixed in situ with a road reclaimer (see Figure 3) or tiller to achieve uniform, relatively homogeneous soil conditions. The specified moisture content was verified by drying soil samples using a microwave. The moisture was accepted for testing, provided the moisture content was within about 2% of the desired moisture for each strip. Water and/or wet soil were added to test strips containing soil too dry for testing. Soil too wet for testing was air-dried and occasionally mixed.





**Figure 2. Placement of soil in excavated and stabilized test strip pit**



(a)



(b)

**Figure 3. In situ soil mixing using (a) road reclaimer or (b) tiller**

For testing the soil, ten test points were established at 1.5 m intervals in the center of the strip, between the paths of the roller tires. At these points, the density and moisture content of the uncompacted soil were determined using a nuclear moisture-density gauge (see Figure 4). Following the first pass of the roller over the strip (see Figure 5), in situ test measurements of density, moisture content, strength, and stiffness were obtained at each test point (see Figure 6). Laser positioning measurements were additionally collected to facilitate later correlations of field measurement results with machine power data. Considering the relative influence of soil disturbance on test results and the tests' sensitivity to soil disturbance, the order in which tests

were performed was determined as follows: (1) nuclear moisture and density, (2) GeoGauge (Figure 7), (3) PFWD (Figure 8), (4) Clegg impact (Figure 8), (5) DCP (Figure 9), and (6) time domain reflectometry (TDR) (Figure 10) and Duff (Figure 11) moisture sensing equipment. A single plate load test was conducted at the end of the test strip next to the tenth test point. Following subsequent passes of the CP-533 padfoot roller (e.g., one, two, four, eight), the same measurements were obtained for the increasingly compact material. Following the final roller pass, drive core samples were excavated for a direct measurement of density and moisture (Figure 12).



**Figure 4. Moisture and density determination using nuclear moisture-density gauge for 0 roller passes**



**Figure 5. Soil compaction using prototype CP-533 static padfoot roller**



**Figure 6. In situ test measurement of soil properties**



**Figure 7. Stiffness and modulus determination using GeoGauge**





**Figure 8. Strength and stiffness determination using Clegg impact hammer (left) and PFWD (right)**



**Figure 9. Strength determination using DCP**



**Figure 10. TDR moisture sensor**



**Figure 11. Duff moisture sensor**



**Figure 12. Excavation of drive core for density and moisture determination**

### *Material Properties*

Evaluating the applicability of compaction monitoring technology to various material types was an important aspect of the current research effort. As a result, the first pilot project involved compaction and field testing of four soils. Topsoil, fill clay, till, and sand were acquired from Kickapoo and Edwards, Illinois. The first three soils (topsoil, fill clay, and till) were fine-grained with moderate plasticity. The sand was well-graded and nonplastic.

Moisture-density tests were performed following ASTM D 698 (Moisture-Density Relations of Soils and Soil-Aggregate Mixtures Using 5.5 lb Rammer and 12 in. Drop) and ASTM D 1557 (Moisture-Density Relations of Soils and Soil-Aggregate Mixtures Using 10 lb Rammer and 18 in. Drop), more commonly referred to as Standard and Modified Proctor compaction tests, respectively. In performing these tests, test method A (4 in. mold and material passing a No. 4 sieve) was used, and an automated mechanical rammer was provided for compaction. A relative density compaction test was also performed with the cohesionless sand material in accordance with ASTM D 4253 (Maximum Index Density and Unit Weight of Soils Using a Vibratory Table) and ASTM D 4254 (Minimum Index Density and Unit Weight of Soils and Calculation of Relative Density).

Soil classifications and engineering properties of the testing materials are provided in Table 3. Particle size distribution curves and Proctor moisture-density relationships are provided in Figure 13 through Figure 16 for the four soils of Test Project 1.

**Table 3. Pilot Project 1 testing materials**

Soil Property	Kickapoo topsoil	Kickapoo fill clay	Edwards till	Kickapoo sand
USCS:	---	---	---	---
Symbol	ML	CL	CL	SW-SM
Name	Silt	Lean clay with sand	Sandy lean clay	Well graded sand with silt
$G_s$	2.65	2.85	2.75	2.70
$F_{200}$ (%)	92	79	68	7
LL (PI)	38 (13)	47 (22)	29 (12)	NP
Standard Proctor:	---	---	---	---
$\gamma_{d, \max}$ (kN/m <sup>3</sup> ) <sup>a</sup>	15.8	17.4	18.4	18.3
$w_{opt}$ (%) <sup>a</sup>	20	16	13	---
Modified Proctor:	---	---	---	---
$\gamma_{d, \max}$ (kN/m <sup>3</sup> ) <sup>b</sup>	17.2	18.1	19.9	18.8
$w_{opt}$ (%) <sup>b</sup>	15	14	7	---
Relative Density:	---	---	---	---
$\gamma_{d, \max}$ (kN/m <sup>3</sup> ) <sup>c</sup>	---	---	---	18.3
$\gamma_{d, \min}$ (kN/m <sup>3</sup> ) <sup>c</sup>	---	---	---	15.1

<sup>a</sup> Based on standard Proctor test

<sup>b</sup> Based on modified Proctor test

<sup>c</sup> Based on relative density test

1 kN/m<sup>3</sup> = 6.36 lb/ft<sup>3</sup>



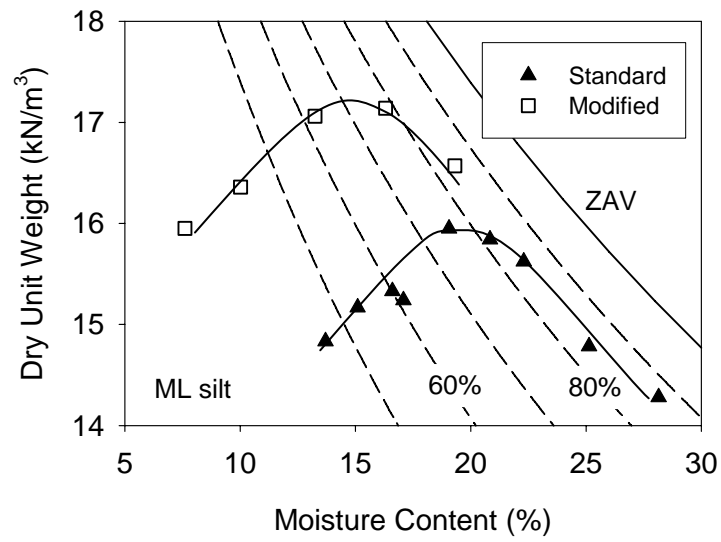
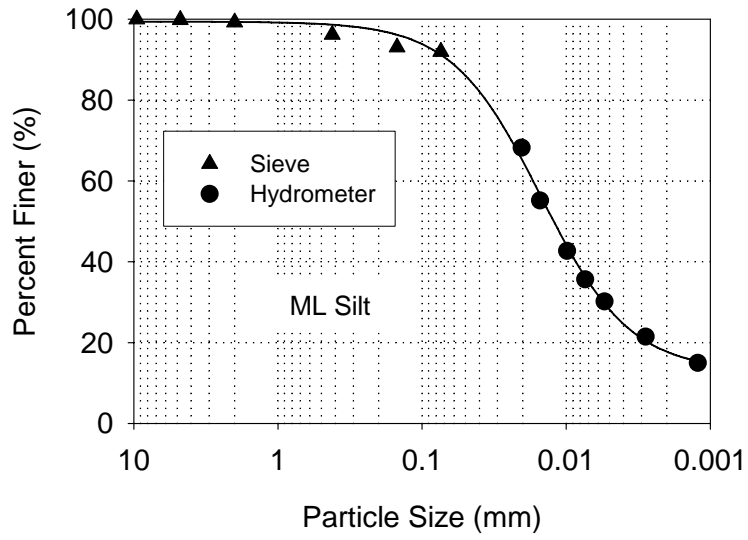
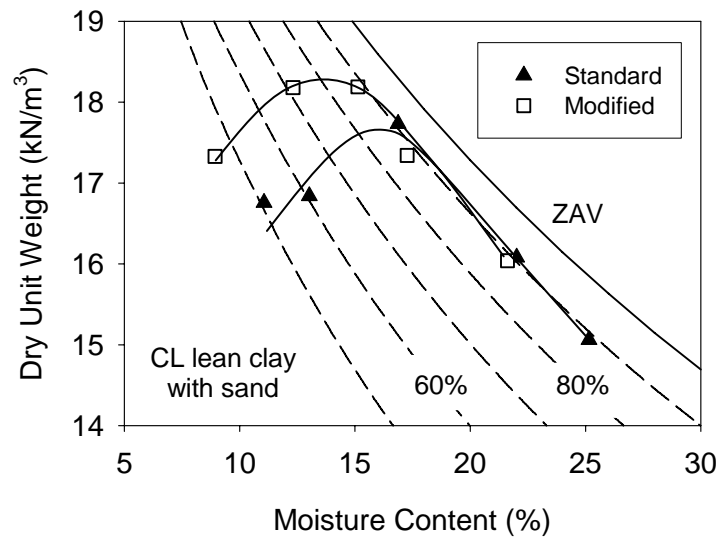
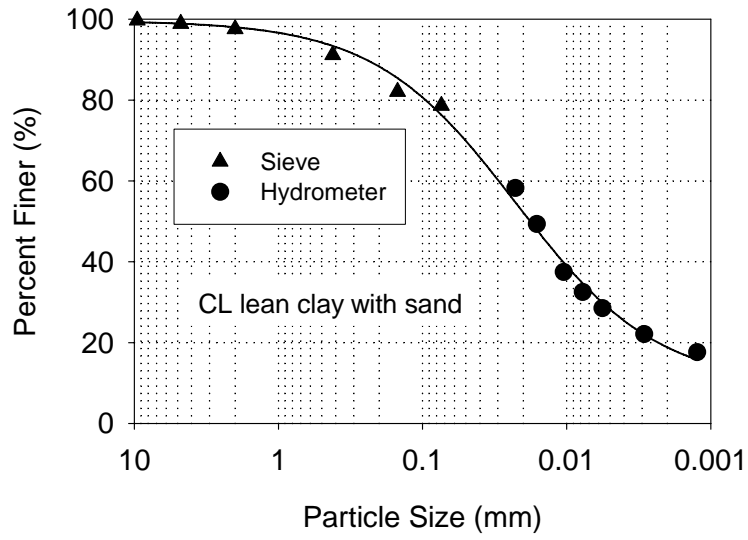
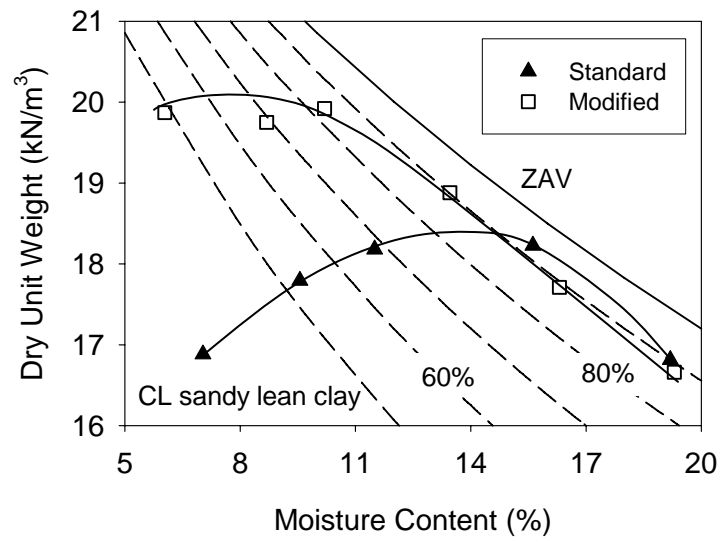
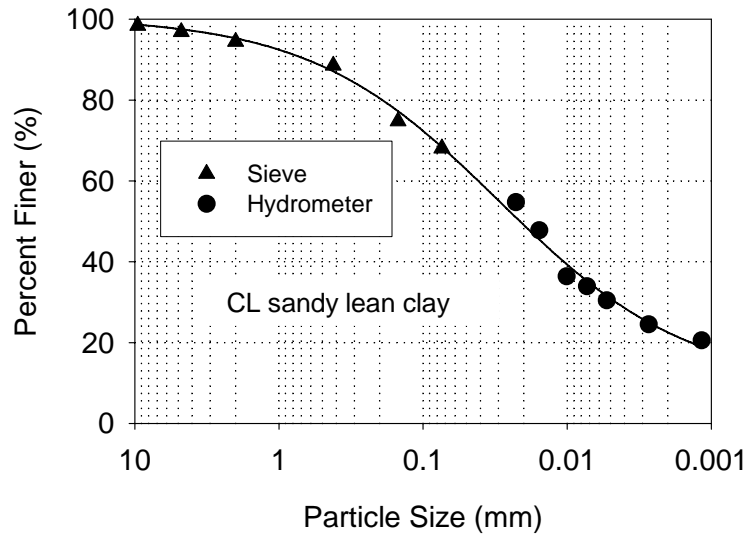


Figure 13. Topsoil, particle size distribution, and Proctor moisture-density curve



**Figure 14. Fill clay, particle size distribution, and Proctor moisture-density curve**



**Figure 15. Till, particle size distribution, and Proctor moisture-density curve**



### *Compaction Monitor Machine Power Output*

Compaction monitor machine power output is summarized from Figure 17 to Figure 34 using screen captures from the compaction software. In each figure (one per test strip, sorted by soil type), six screen captures are provided. The coverage maps provide the spatial location history of the roller, indicating the number of roller passes that have occurred within the viewing area limits (30 x 24 m). Screen captures were obtained after one, two, and eight roller passes. This information is seen in the color changes following each roller pass and the reference scale found immediately adjacent to the viewing area. The approximate locations of the test areas are outlined with a white box. Machine power maps provide the quantitative machine response corresponding to the respective roller pass (again, presented for one, two, and eight roller passes). Following the first roller pass, cell colors are mostly red or orange. With an increased number of roller passes and soil compaction, cell colors transition from orange (high power) to yellow to green (low power). Based on the power reference scale, the observed color changes indicate that less machine drive power is required to propel the roller over the compacted material with increasing roller passes.

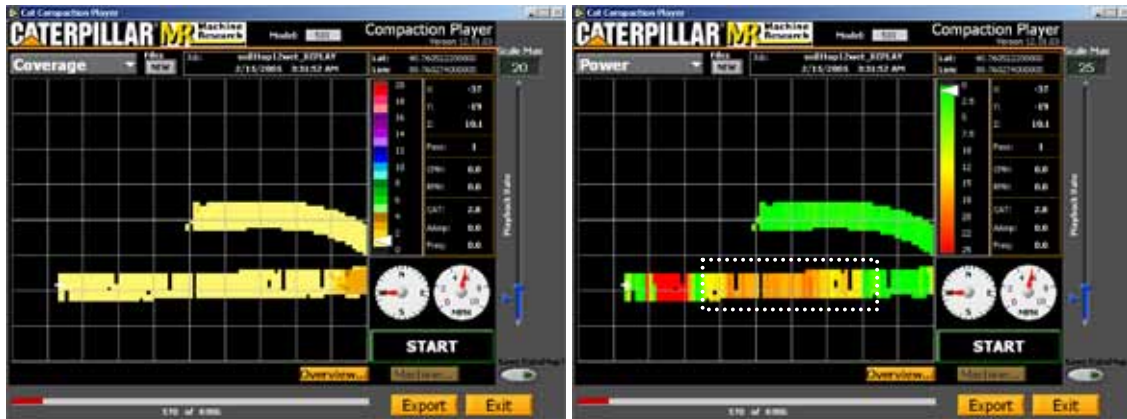
Pilot Project 1 was conducted indoors, and GPS data were replaced with a laser-based location system. Several screen captures show “holes.” These missing data are attributed to blind spots and occasionally poor resolution of the indoor laser positioning system.

During compaction operations, a roller operator may use either the coverage or power map (or both). Monitoring roller coverage can assist an operator in applying uniform compaction effort to a large area of fill; the coverage map may simply suggest that a change in rolling pattern be made. Alternatively, monitoring machine power may optimize compaction operations by displaying areas of soft, weak, or poorly compacted material, evidenced by red cells observed on the on-board monitor.

COVERAGE MAPS

MACHINE POWER

Pass 1



Pass 2



Pass 8

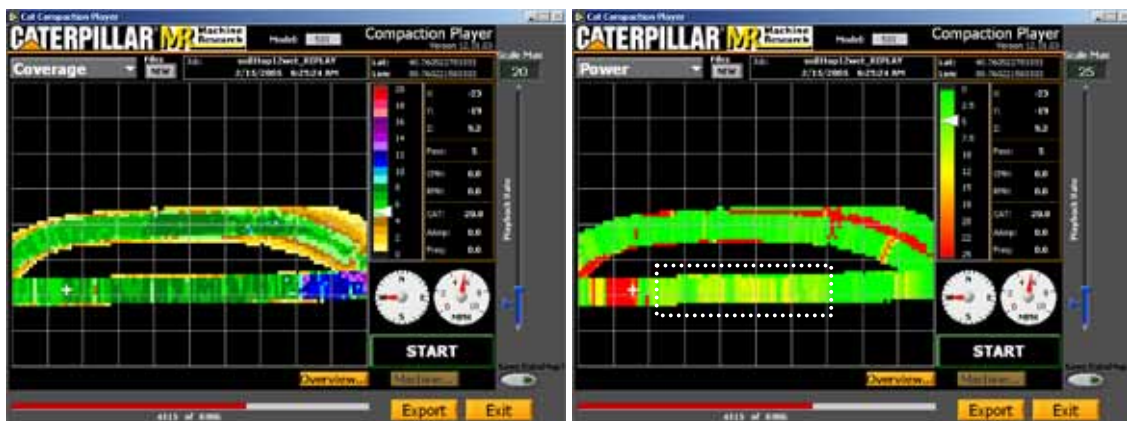


Figure 17. Topsoil, strip 1 compaction monitor views (30 x 24 m viewing area)

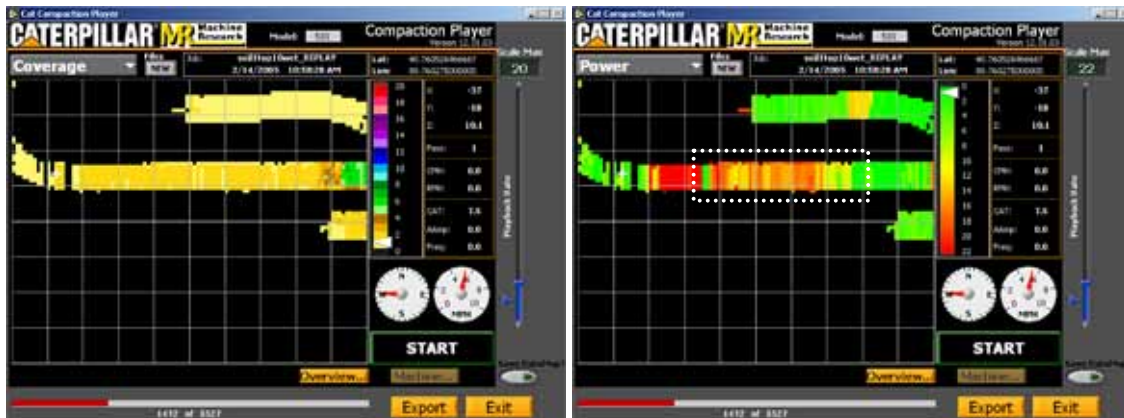
COVERAGE MAPS

MACHINE POWER

Pass 1



Pass 2



Pass 8



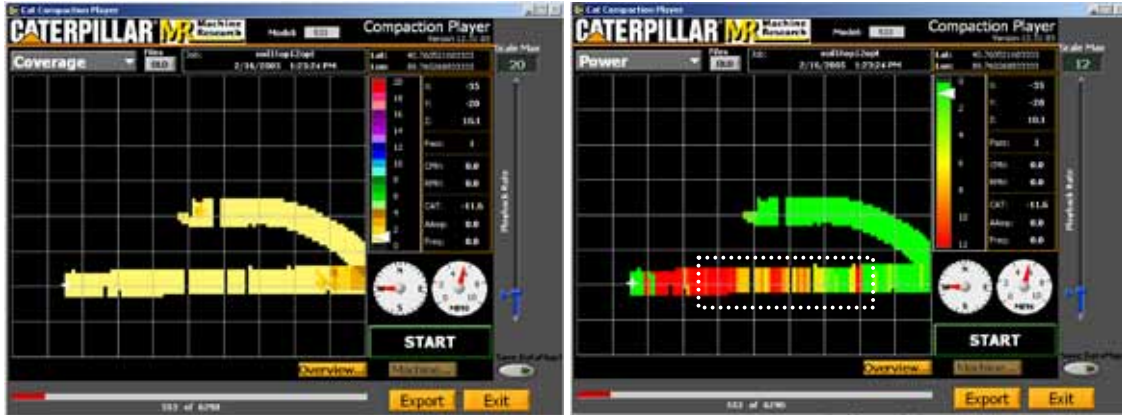
Figure 18. Topsoil, strip 2 compaction monitor views (30 x 24 m viewing area)



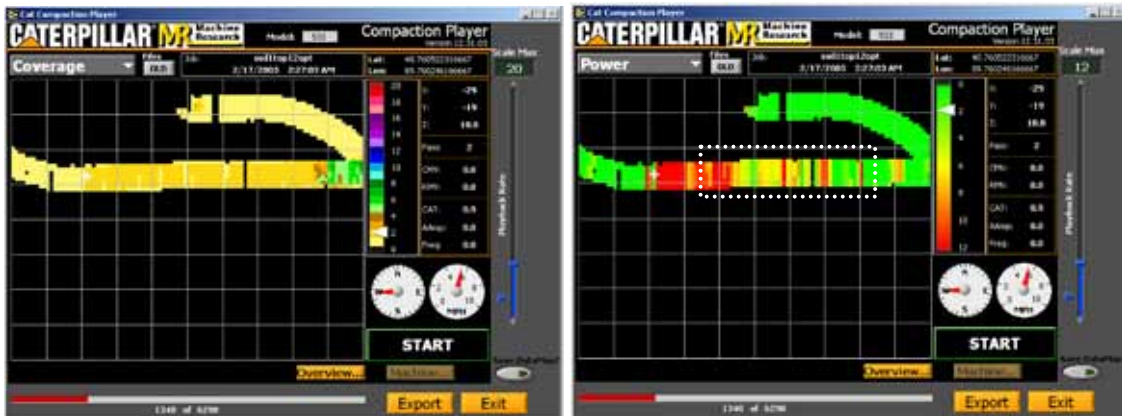
COVERAGE MAPS

MACHINE POWER

Pass 1



Pass 2



Pass 8



Figure 19. Topsoil, strip 3 compaction monitor views (30 x 24 m viewing area)



COVERAGE MAPS

MACHINE POWER

Pass 1



Pass 2



Pass 8

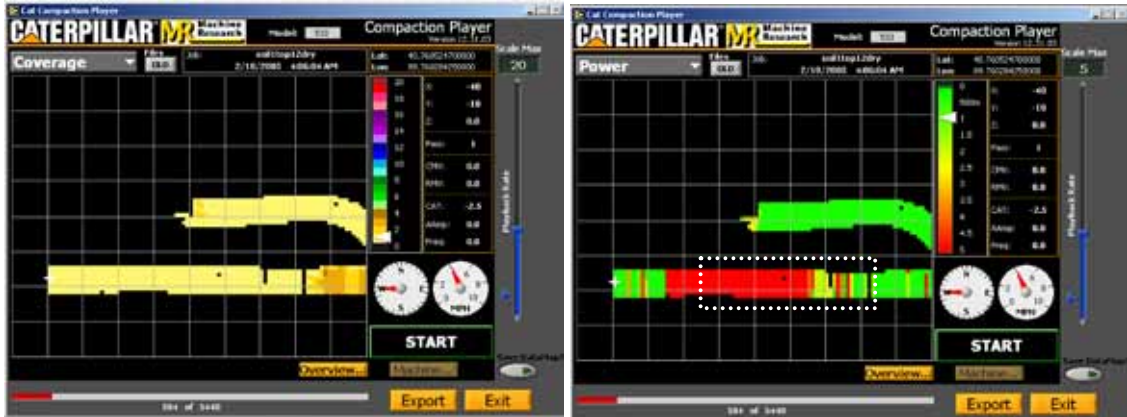


Figure 20. Topsoil, strip 4 compaction monitor views (30 x 24 m viewing area)

COVERAGE MAPS

MACHINE POWER

Pass 1



Pass 2



Pass 8

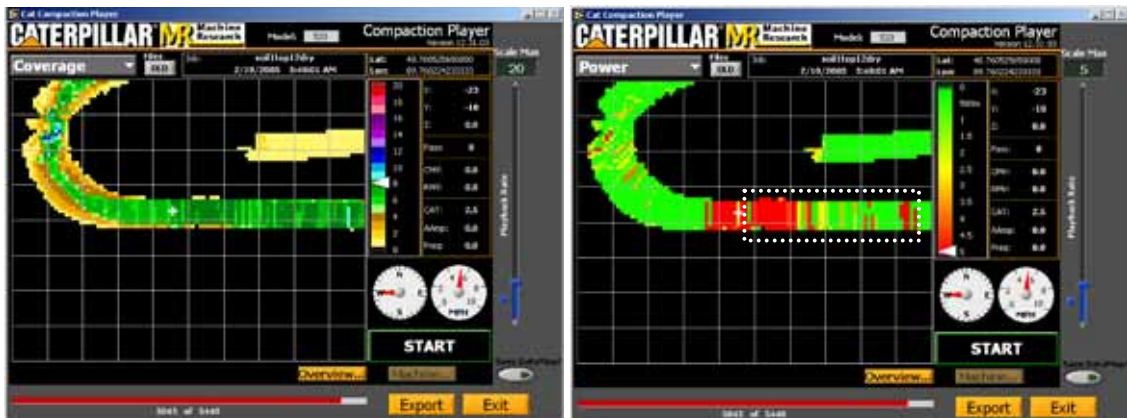


Figure 21. Topsoil, strip 5 compaction monitor views (30 x 24 m viewing area)



COVERAGE MAPS

MACHINE POWER

Pass 1



Pass 2



Pass 8



Figure 22. Topsoil, strip 6 compaction monitor views (30 x 24 m viewing area)



COVERAGE MAPS

MACHINE POWER

Pass 1



Pass 2



Pass 8



Figure 24. Fill clay, strip 2 compaction monitor views (30 x 24 m viewing area)



COVERAGE MAPS

MACHINE POWER

Pass 1



Pass 2



Pass 8

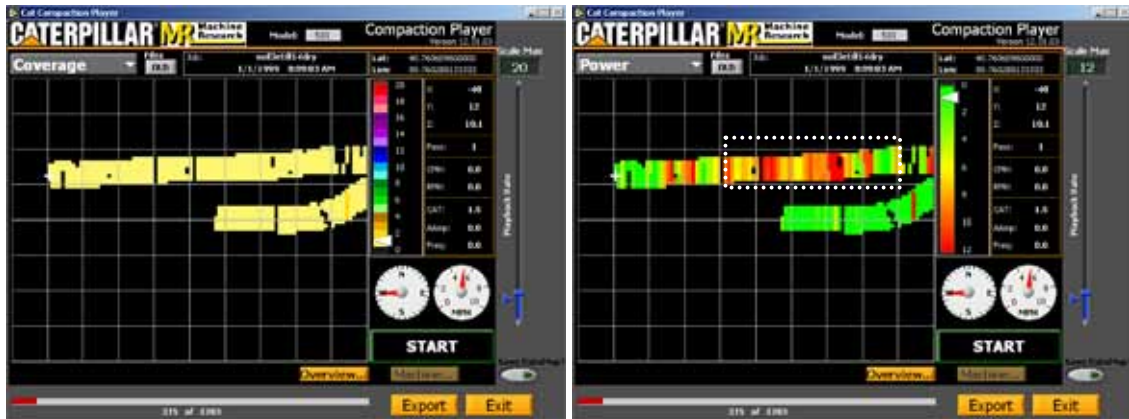


Figure 25. Fill clay, strip 3 compaction monitor views (30 x 24 m viewing area)

COVERAGE MAPS

MACHINE POWER

Pass 1



Pass 2



Pass 8

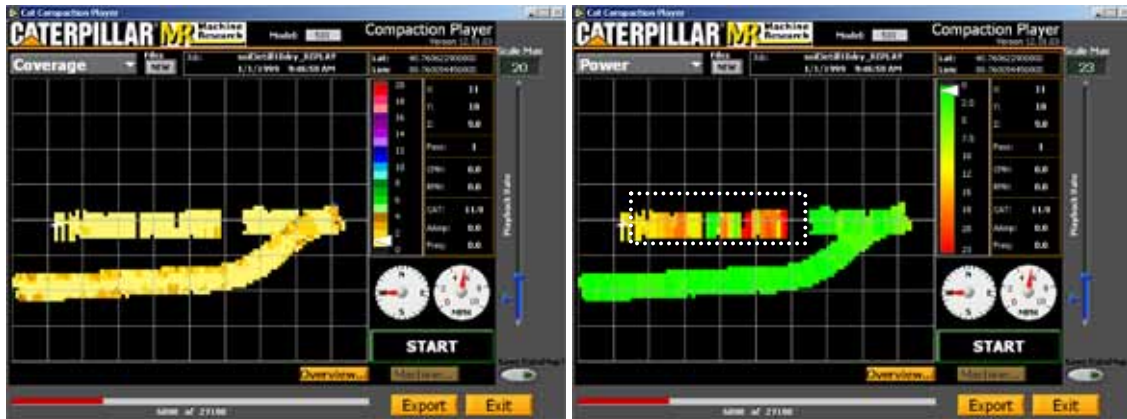


Figure 26. Edwards till, strip 1 compaction monitor views (30 x 24 m viewing area)

COVERAGE MAPS

MACHINE POWER

Pass 1



Pass 2



Pass 8



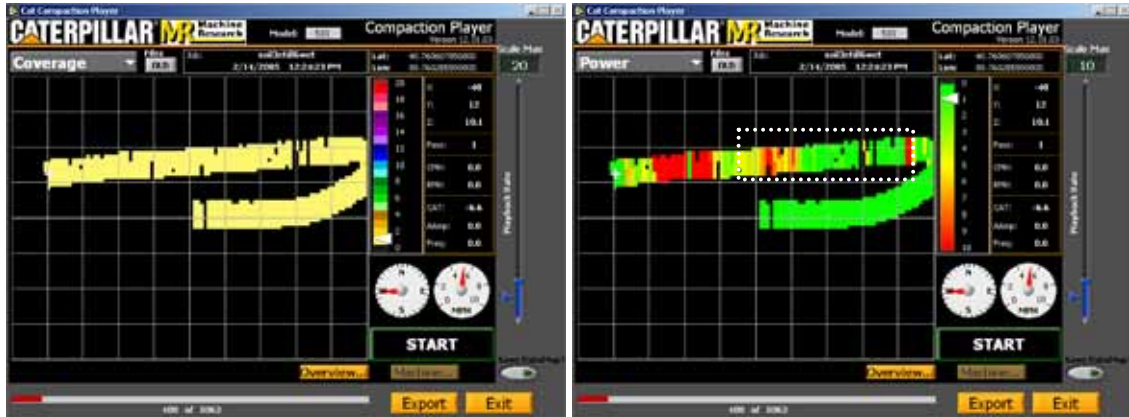
Figure 27. Edwards till, strip 2 compaction monitor views (30 x 24 m viewing area)



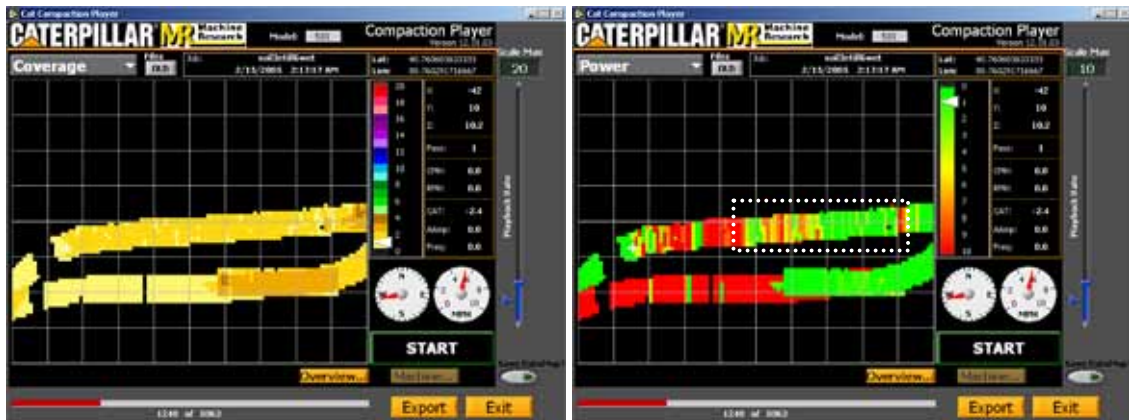
COVERAGE MAPS

MACHINE POWER

Pass 1



Pass 2



Pass 8

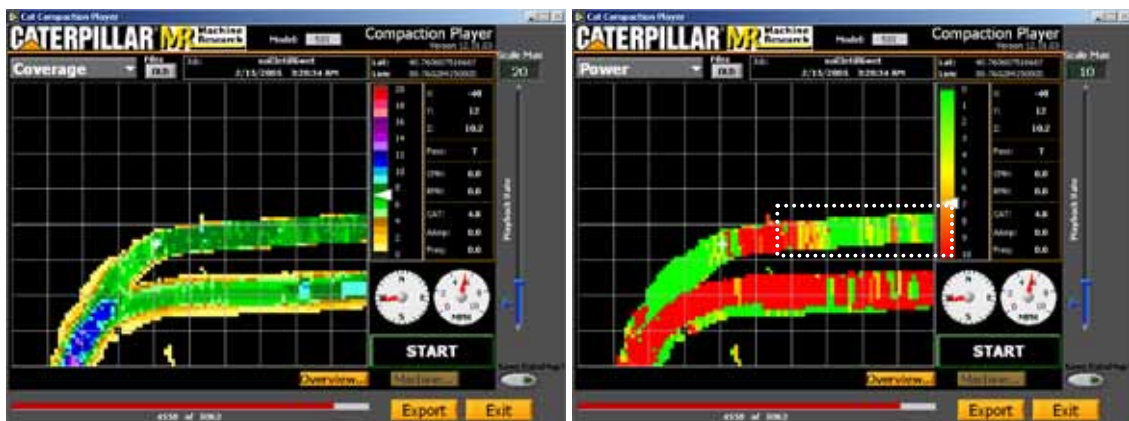
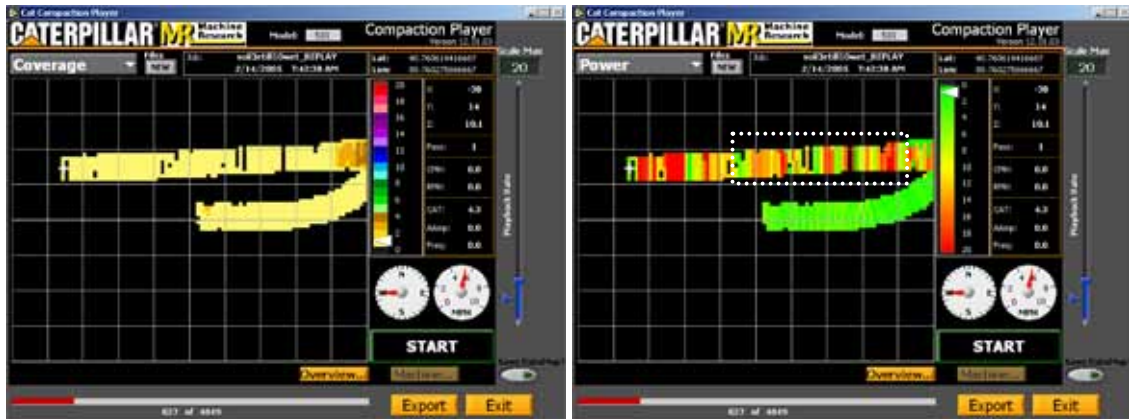


Figure 28. Edwards till, strip 3 compaction monitor views (30 x 24 m viewing area)

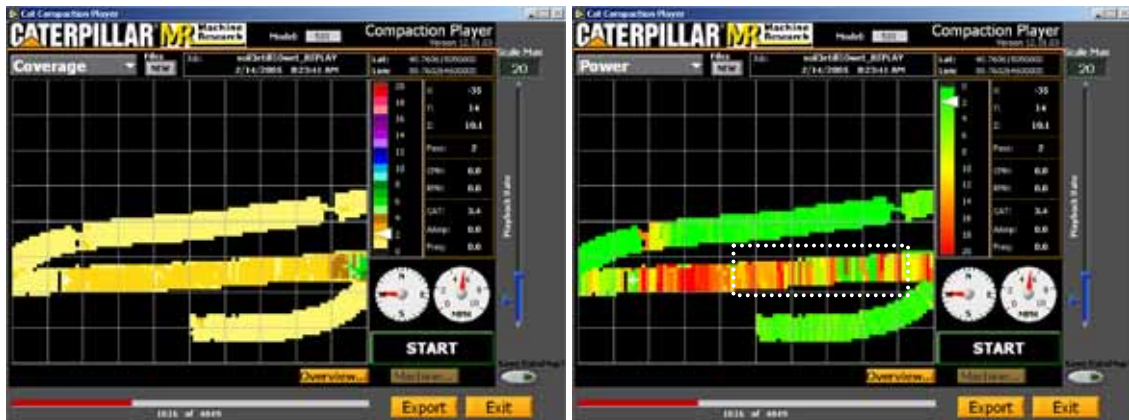
COVERAGE MAPS

MACHINE POWER

Pass 1



Pass 2



Pass 8

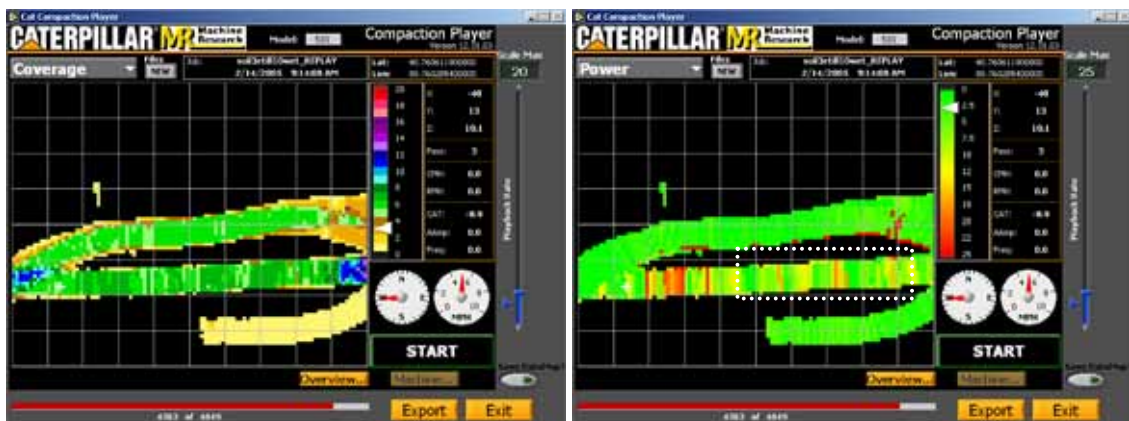


Figure 29. Edwards till, strip 4 compaction monitor views (30 x 24 m viewing area)

COVERAGE MAPS

MACHINE POWER

Pass 1



Pass 2



Pass 8



Figure 30. Edwards till, strip 6 compaction monitor views (30 x 24 m viewing area)



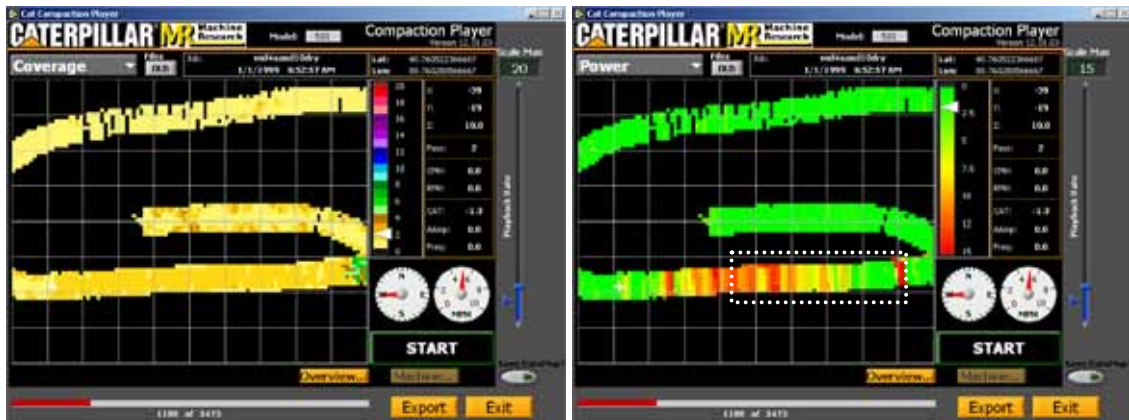
COVERAGE MAPS

MACHINE POWER

Pass 1



Pass 2



Pass 8

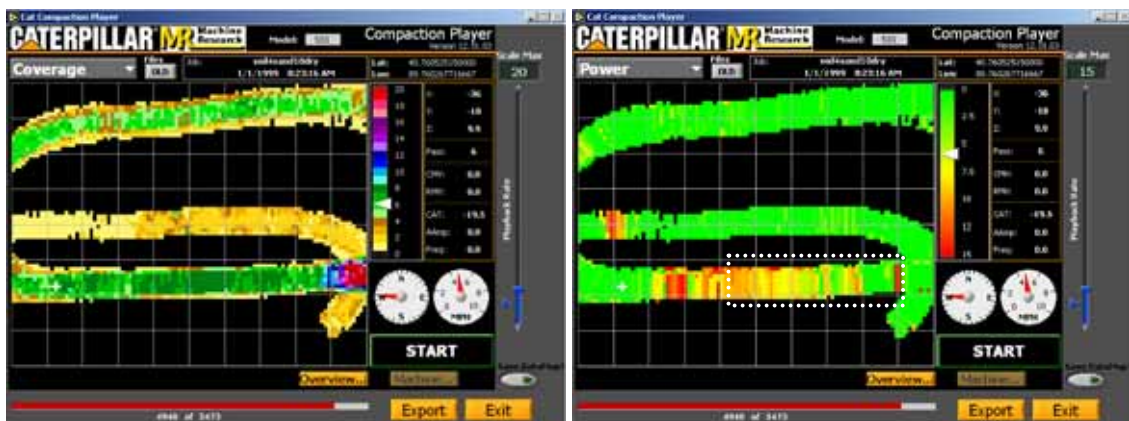
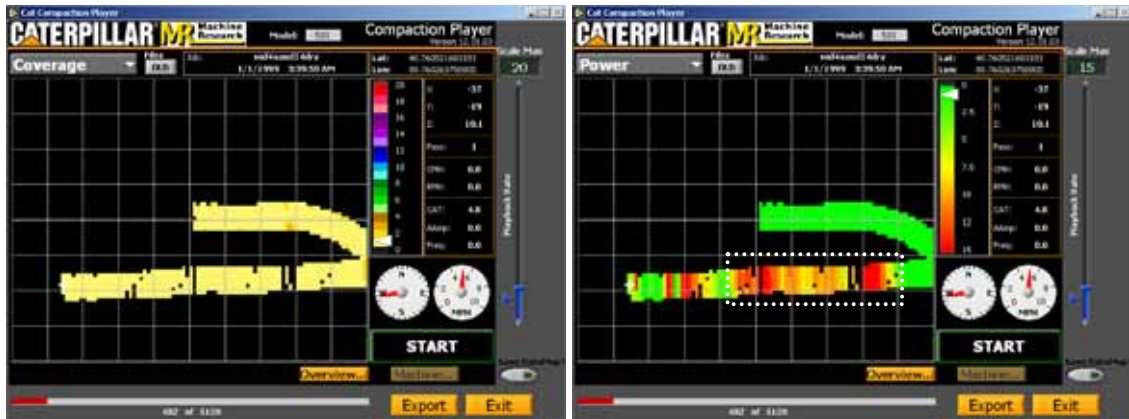


Figure 31. Sand, strip 1 compaction monitor views (30 x 24 m viewing area)

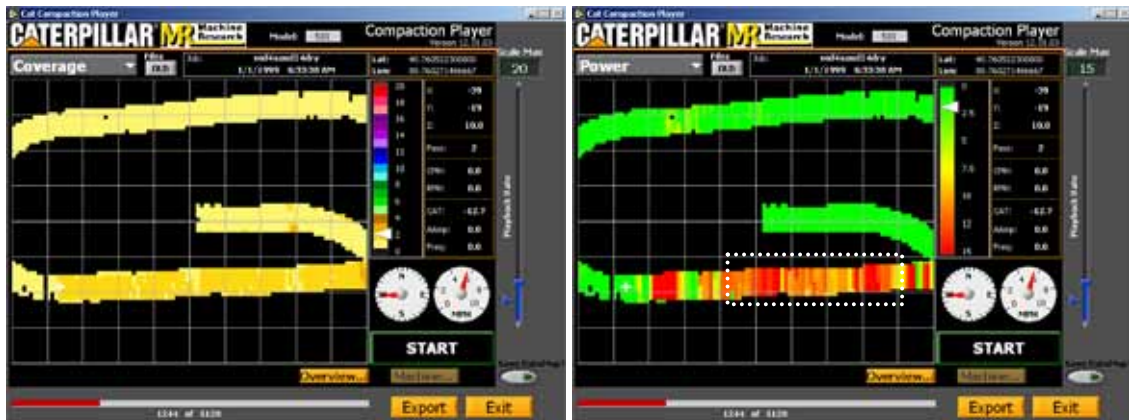
COVERAGE MAPS

MACHINE POWER

Pass 1



Pass 2



Pass 8

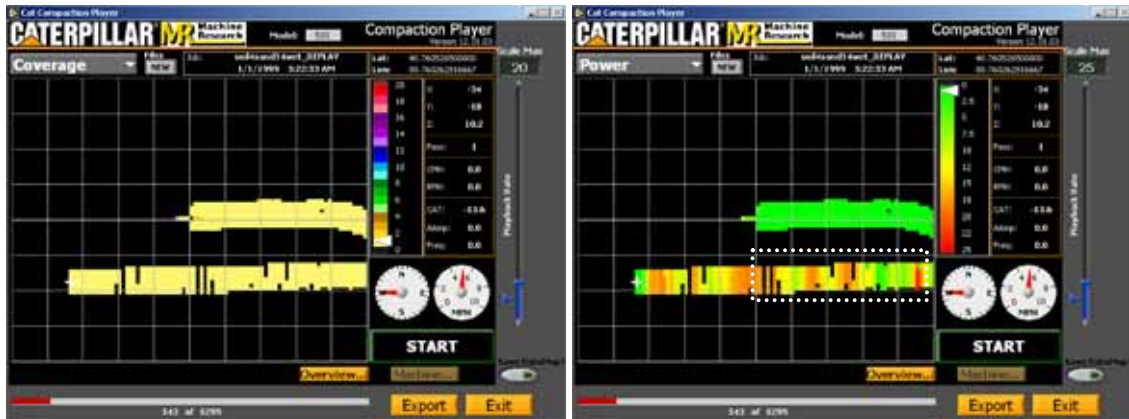


Figure 32. Sand, strip 2 compaction monitor views (30 x 24 m viewing area)

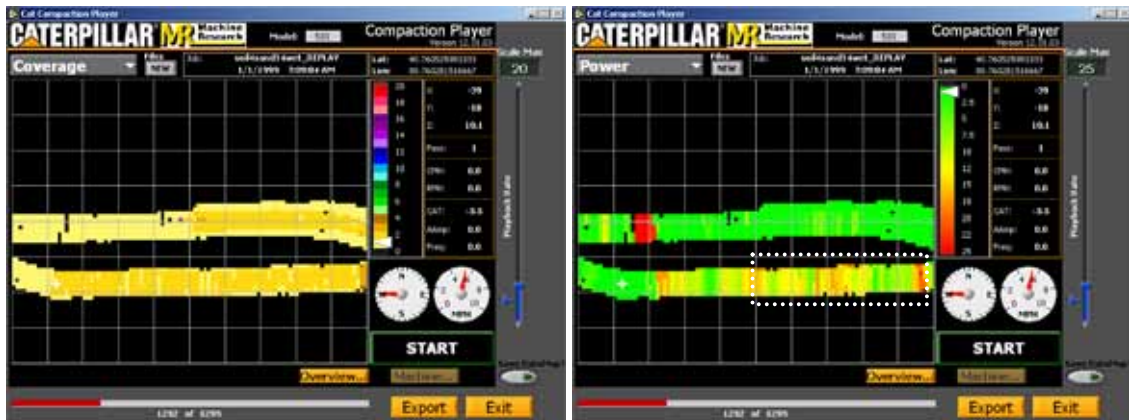
COVERAGE MAPS

MACHINE POWER

Pass 1



Pass 2



Pass 8

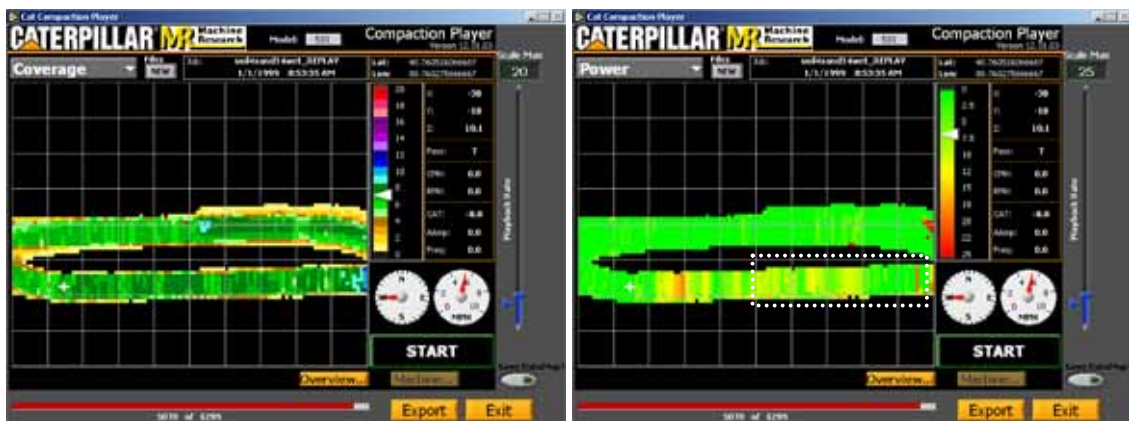


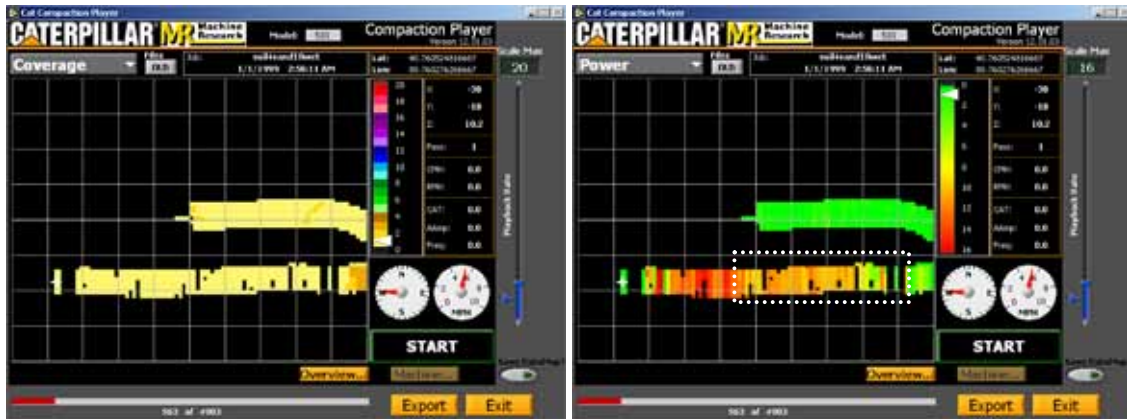
Figure 33. Sand, strip 3 compaction monitor views (30 x 24 m viewing area)



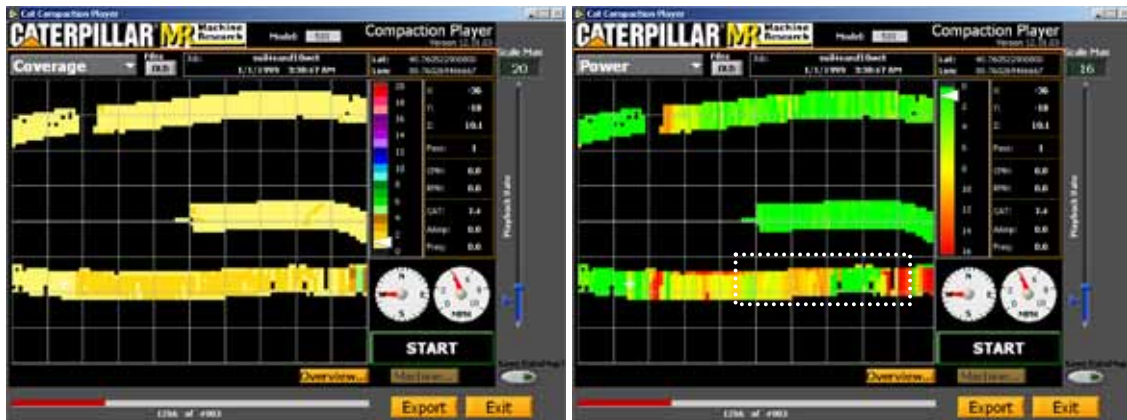
COVERAGE MAPS

MACHINE POWER

Pass 1



Pass 2



Pass 8



Figure 34. Sand, strip 4 compaction monitor views (30 x 24 m viewing area)

### *In Situ Measurement Values and Single-Parameter Regressions*

Conventional measures of soil density, strength, and stiffness were collected concurrent with the machine power data on test strips of varying soil type, moisture content, and initial lift thickness. The raw data are provided in Appendix A. From this dataset, compaction curves showing changes in measurement values with the increasing number of roller passes were observed for nearly all in situ test devices and the machine power values. After eight roller passes, the dry unit weight of the soil had often approached full compaction (indicated by only a small increase in density from the subsequent pass). Compaction was also supported by roller walk-out and the leveling off of a decrease in the machine power values.

All data were initially plotted against the location/length along each test strip. In doing this, the general trends and potential correlations were observed for machine power and in situ measurements. In some cases, the variation in machine power observed for a single roller pass was supported by the field measurements to indicate inherent variability in the soil. Nevertheless, considerable variability in machine power was observed that cannot be explained by soil variability alone; coefficients of variation (COV) for net power, determined for each roller pass, ranged from 6% to 128%. These plots also aided identification of statistical outliers. While all statistical outliers remained in the dataset for performing regression analyses, physically-prohibitive data (i.e., negative power) were simply removed from the dataset.

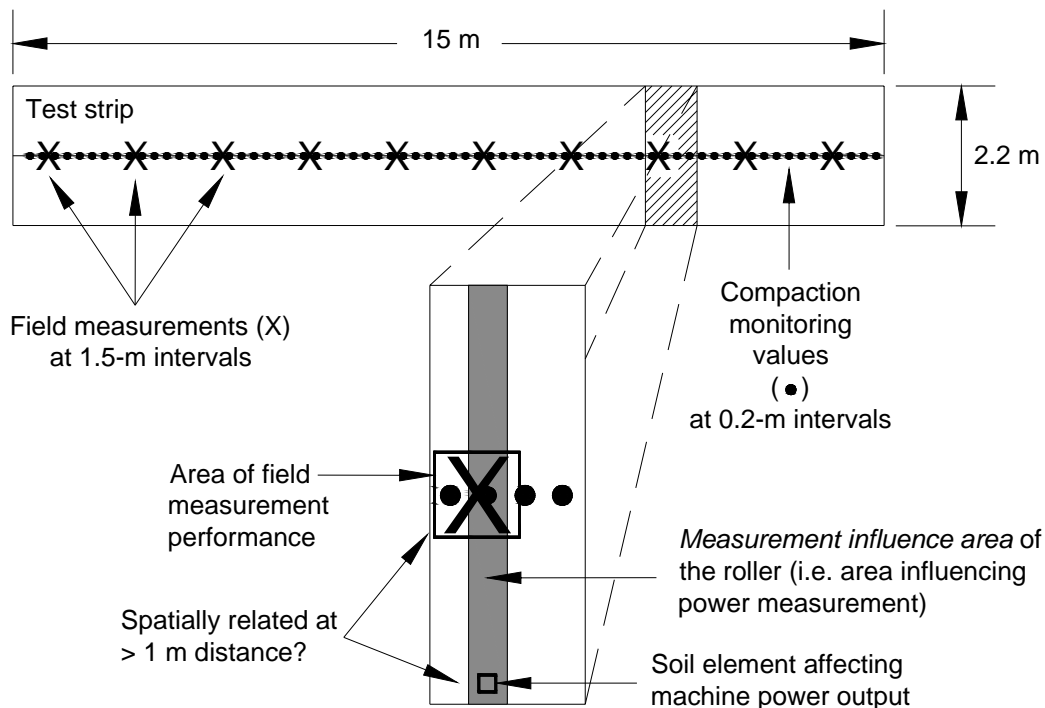
Boxplots were created for all measurements and displayed with the roller pass. Boxplots display the quartiles (e.g., 25th, 50th (median), and 75th percentiles) and the minimum and maximum observations of a data group. The length of the box represents the interquartile range (distance between 25th and 75th percentiles), and the horizontal line within the box represents the sample median. The vertical lines extend from the largest or smallest value within 1.5 times the interquartile range. Observations outside this range are represented by circular data points. In addition to showing the compaction curve, boxplots indicate the variability in machine power, with several observations shown outside the interquartile range for all test strips and roller passes.

Using the field measurements and spatially nearest machine power values, scatterplots were created for each test strip. Because in situ tests were performed at ten locations after one, two, four, and eight roller passes, these scatterplots were comprised of roughly 40 data points. For each test device, these plots show relationships between the measured soil property and machine power. Soil density, CIV,  $E_{GG}$ ,  $E_{PFWD}$ , and  $k_{PLT}$  show a negative relationship with net power; the DCP index shows a positive relationship. Unless an obvious nonlinear relationship was observed, a linear trendline and 95% confidence intervals were provided. Some scatter was evident in nearly all of the scatterplots; in some cases, the scatter was considerable and resulted in non-significant regression slopes. Possible sources of error in these scatter plots include (1) inherent soil variation, (2) location measurement error, (3) rear wheel-soil interaction at a different location from the location measurement, (4) machine measurement error, and (5) test device/measurement error.

This testing program reveals that a single test point does not provide a high level of confidence in representing the average material characteristics. Rather, variation always exists, and several samples must be tested to determine the soil properties with any confidence. In the case of



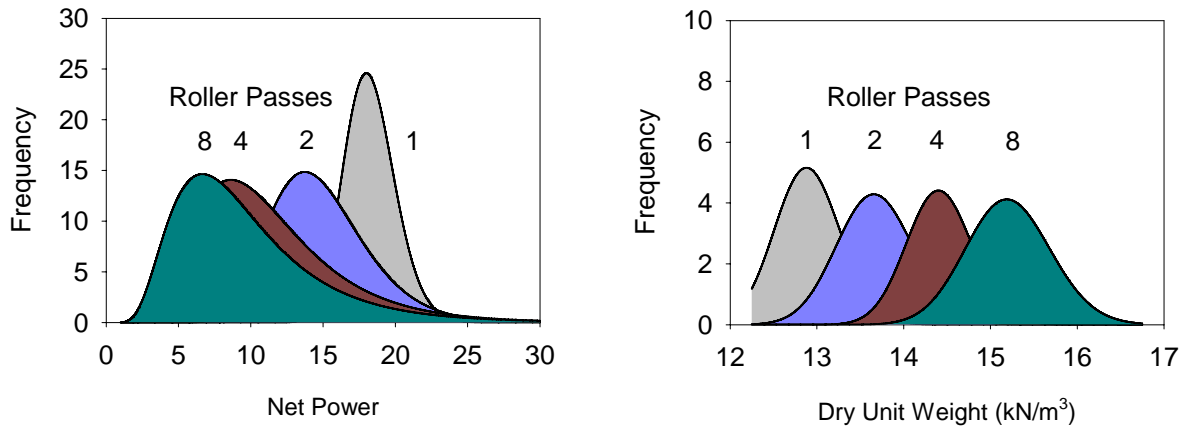
comparing compaction monitoring output to field measurements, soil property variation and measurement influence area must be considered. The soil along the entire width of the roller affects the machine power values calculated from machine measurements. These output values, however, correspond to discrete points based on GPS location information. The field measurements were also assumed to represent the material properties at discrete points. The spatially nearest net power values were then paired with field measurements; the distance between the measurements in the longitudinal direction of the strip ranged up to half of the distance between roller measurements. As a result, soil located over one meter away from the field measurement, a distance at which the soil properties may not be spatially related, influenced the scatterplot regressions (see Figure 35). These issues of spatial variation in the soil and measurement error are particularly important for developing effective specifications involving calibration procedures.



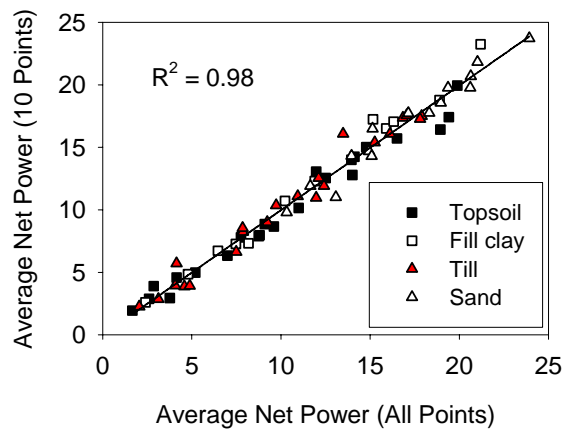
**Figure 35. Measurement locations and influence areas affecting net power-soil property correlations**

An alternative method for relating compaction monitoring data to measures of soil compaction is to incorporate soil variability into the analysis. For this, the distribution of machine power is compared to the distribution of soil density, strength, and stiffness over a finite area. In this case, the area over which data is examined is the area of the test strips (roller width multiplied by strip length). A characterization of measurement variability is shown in Figure 36 and presented with more detail in the following section. In recognizing that the test strips were constructed to be as uniform as may be expected under real field conditions and that multiple tests must be performed to find an engineering parameter representative of the tested soil, averaged machine power and field measurement values were used to create a second series of scatterplots. Using averages of power and field measurement data clearly minimizes the observed scatter in these relationships.

These new plots were comprised of only four data points (one data point for each roller pass, followed by field measurements). Further, averages of machine power were determined using only the net power values spatially nearest to the field measurement locations. To justify this measure, the correlation between averages using all the power data (65 to 75 points) and ten power values is shown in Figure 37. The correlation coefficient was nearly a unity.



**Figure 36. Observed variation in machine power and dry unit weight per pass (topsoil)**



**Figure 37. Comparison of averages of all machine power data versus ten points**

Soil modulus determined from the GG and PFWD, as well as coefficients of subgrade reaction determined from PLTs, generally show a curvilinear relationship with averaged net power. While some GG, PFWD, and PLT data show a linear relation to machine power, examination of the entire group of scatter plots provided justification for using a power-function regression. In many cases, the scatterplots comprised of all 40 data points helped support curvilinear relationships between soil stiffness and machine power.

The correlation coefficients ( $R^2$ ) for the regressions using spatially nearest and averaged data are presented in Table 4 and Table 5, respectively. Although the  $R^2$  values are generally high for the averaged data, the regressions are limited by the number of data used in developing the relationships (generally three to four points). The plots of raw data versus strip location, the

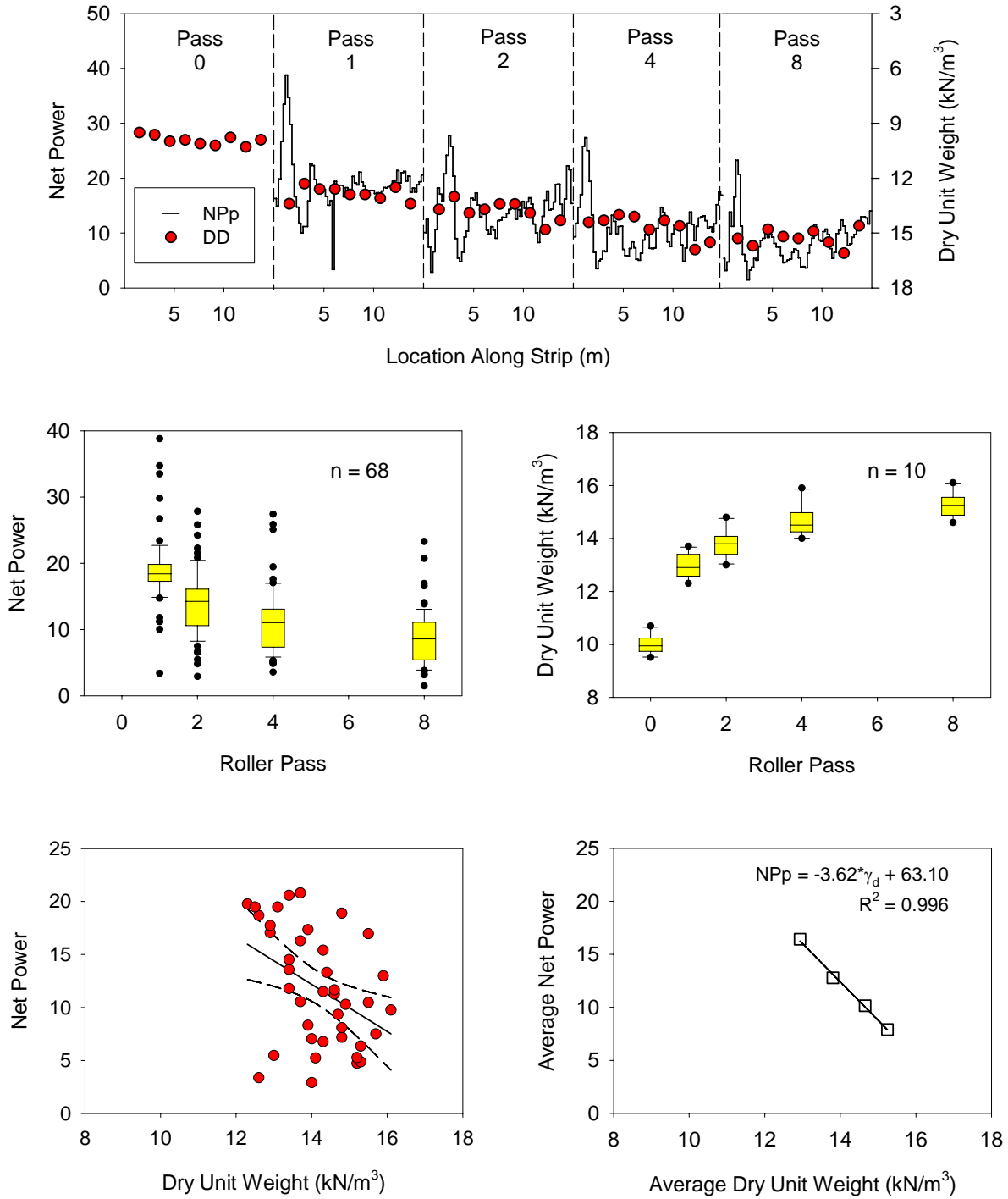
boxplots, and both scatter plots are provided from Figure 38 to Figure 126 for each test strip and field measurement device.

**Table 4. Summary of regression  $R^2$  values for scatterplots**

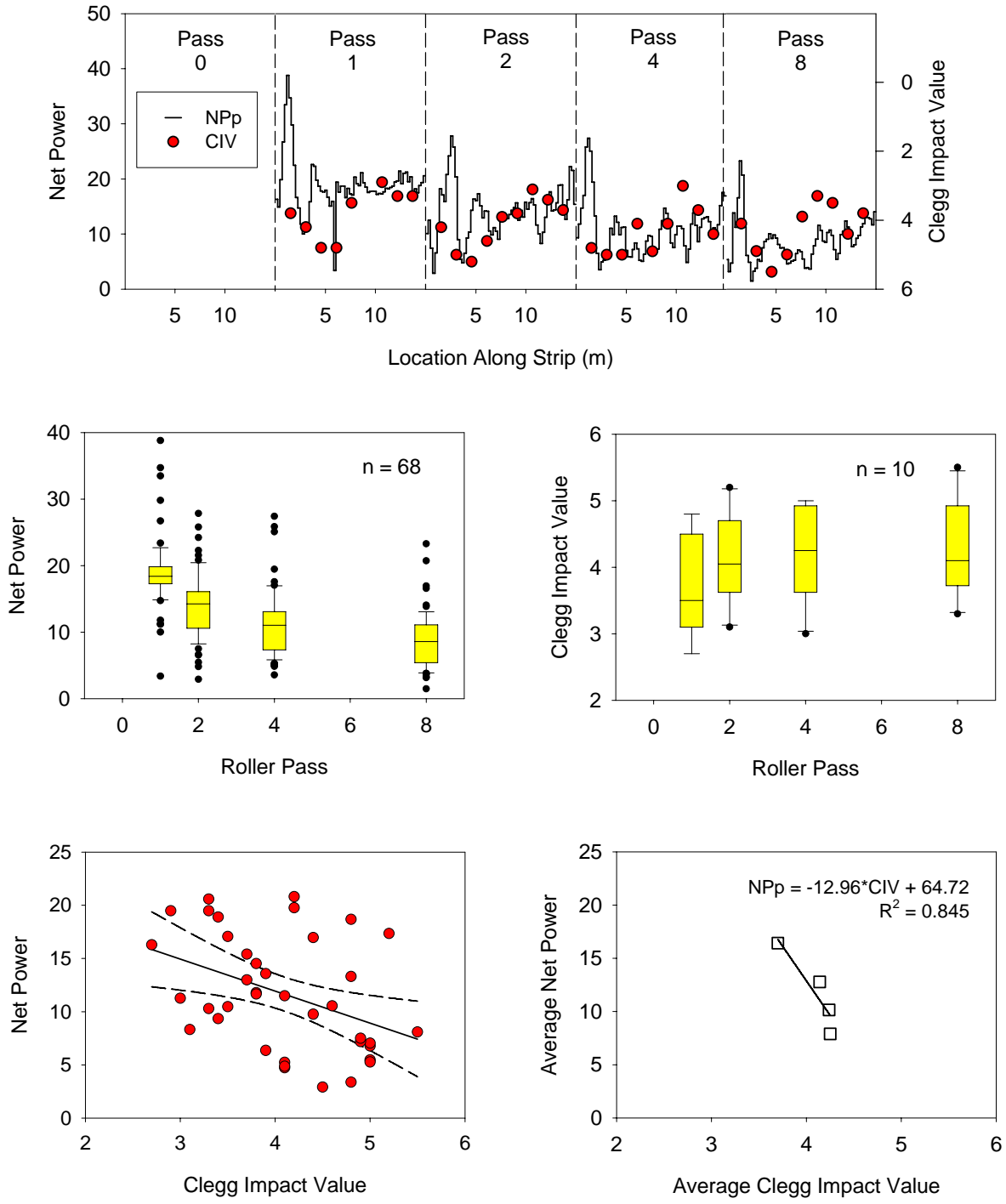
Soil type	Strip	$\gamma_d$	CIV	DCPI	$E_{GG}$	$E_{PFWD}$	$k_{PLT}$
Topsoil	1	0.17	0.16	0.06	0.00	0.00	---
	2	0.47	---	0.37	0.52	0.18	---
	3	0.72	0.68	0.56	0.59	0.35	---
	4	0.70	0.51	0.57	0.40	0.68	---
	5	0.31	0.21	0.10	0.30	0.20	---
	6	0.63	0.57	0.40	0.35	0.56	---
Fill clay	1	0.40	0.00	0.12	0.07	0.05	---
	2	0.38	0.54	0.33	0.28	0.29	---
	3	0.27	0.12	0.04	0.03	0.05	---
Till	1	0.64	0.69	0.71	0.65	0.71	---
	2	0.48	0.75	0.51	0.55	0.59	---
	3	0.29	---	0.23	0.02	0.00	---
	4	0.18	---	0.00	---	---	---
	5	0.23	0.27	0.27	0.39	0.17	---
	6	0.04	0.00	0.31	0.12	0.07	---
Sand	1	0.20	---	0.02	0.17	0.00	---
	2	0.09	---	0.00	0.03	0.00	---
	3	0.43	---	0.61	0.28	0.28	---
	4	0.30	---	0.51	0.21	0.17	---

**Table 5. Summary of regression  $R^2$  values for scatterplots of averaged data**

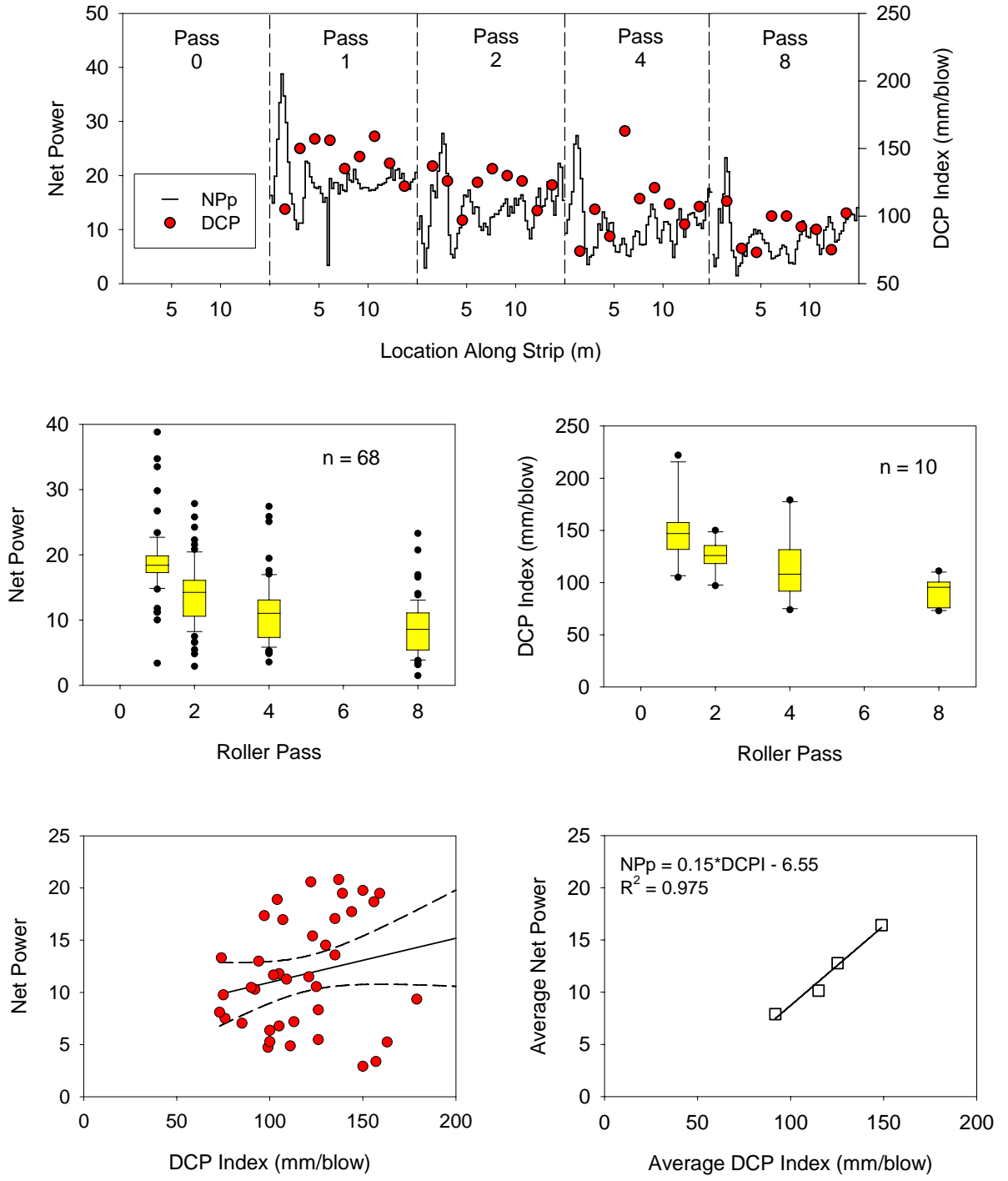
Soil type	Strip	$\gamma_d$	CIV	DCPI	$E_{GG}$	$E_{PFWD}$	$k_{PLT}$
Topsoil	1	0.99	0.85	0.98	---	0.56	0.56
	2	0.98	---	1.00	0.99	---	0.8
	3	0.94	0.96	0.88	0.98	0.77	0.99
	4	0.93	0.74	0.92	1.00	0.97	0.94
	5	0.98	0.97	0.97	0.76	0.76	0.78
	6	0.91	0.99	0.99	0.99	0.89	---
Fill clay	1	0.94	---	0.99	0.95	0.60	---
	2	0.89	0.99	0.74	0.99	0.98	0.82
	3	0.67	0.83	---	---	0.32	0.68
Till	1	0.90	0.88	0.95	0.97	0.95	---
	2	0.83	0.97	0.77	0.96	0.97	---
	3	0.78	---	0.98	---	---	---
	4	0.80	---	---	---	---	---
	5	0.98	0.99	1.00	1.00	1.00	---
	6	0.56	---	0.78	0.94	---	---
Sand	1	0.61	---	---	---	---	---
	2	---	---	---	---	---	---
	3	0.88	---	0.93	0.87	0.96	---
	4	0.99	---	0.99	0.98	---	---



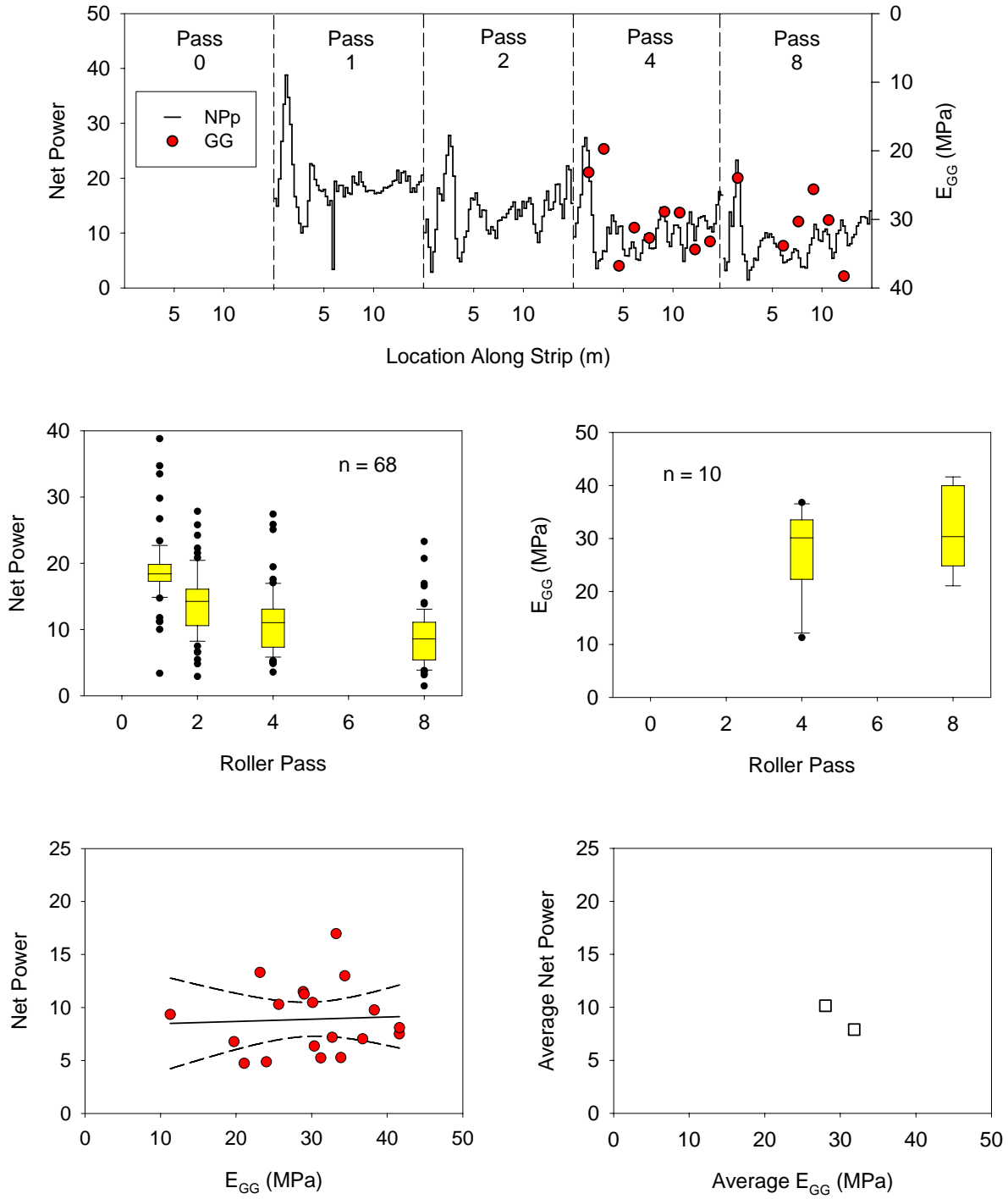
**Figure 38. Topsoil, strip 1: net power–dry unit weight correlation**



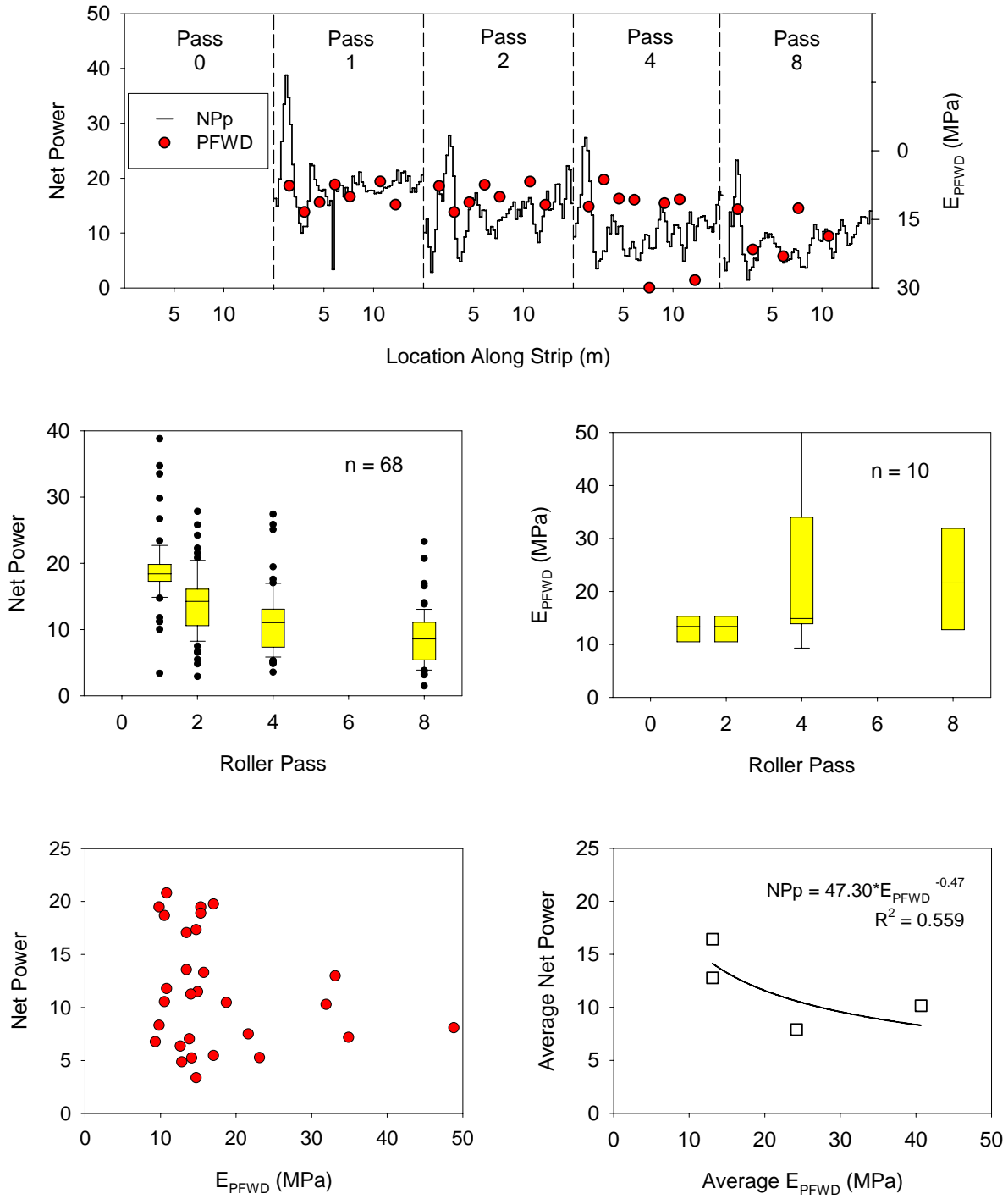
**Figure 39. Topsoil, strip 1: net power–CIV correlation**



**Figure 40. Topsoil, strip 1: net power–DCP index correlation**

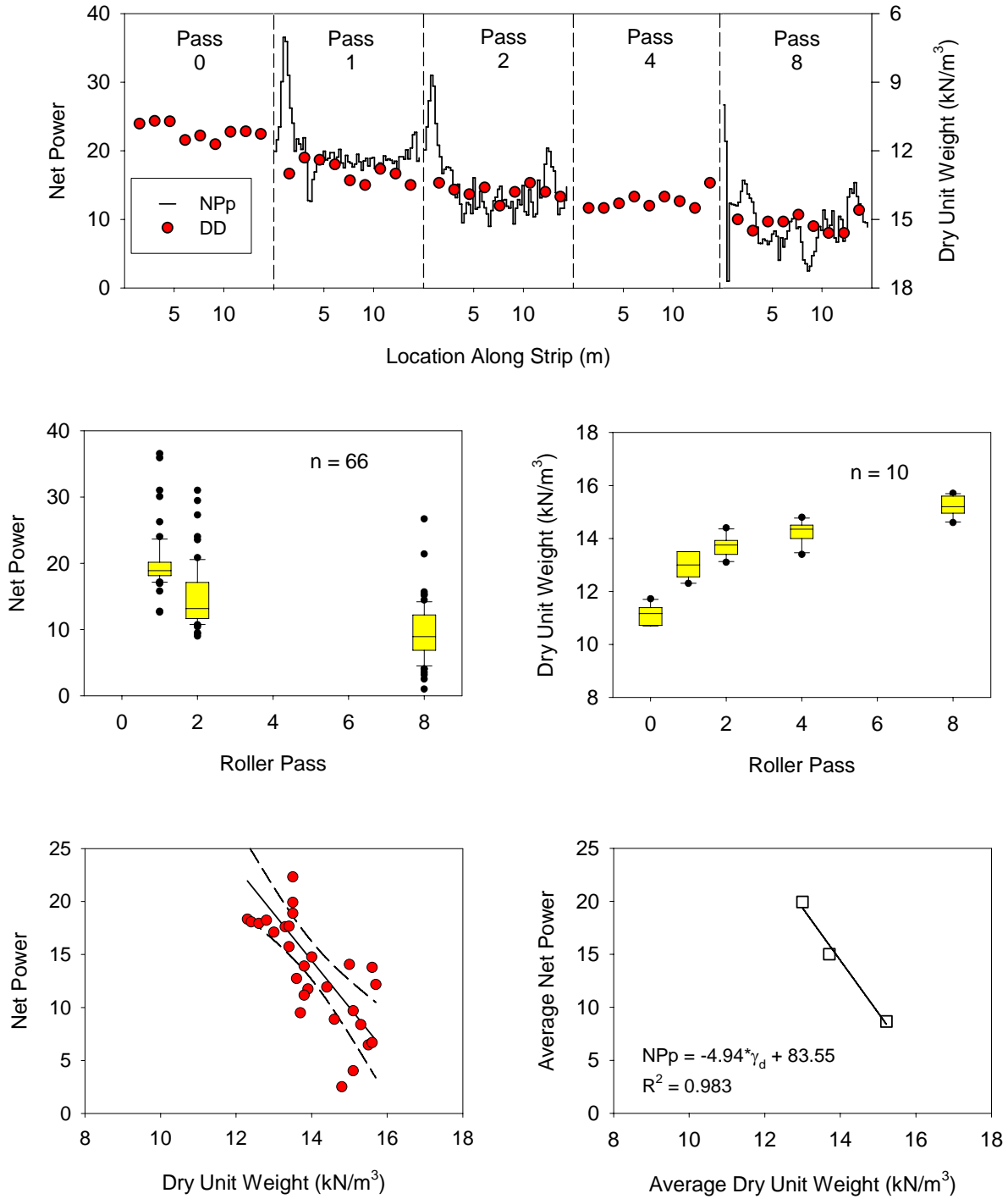


**Figure 41. Topsoil, strip 1: net power–GeoGauge modulus correlation**

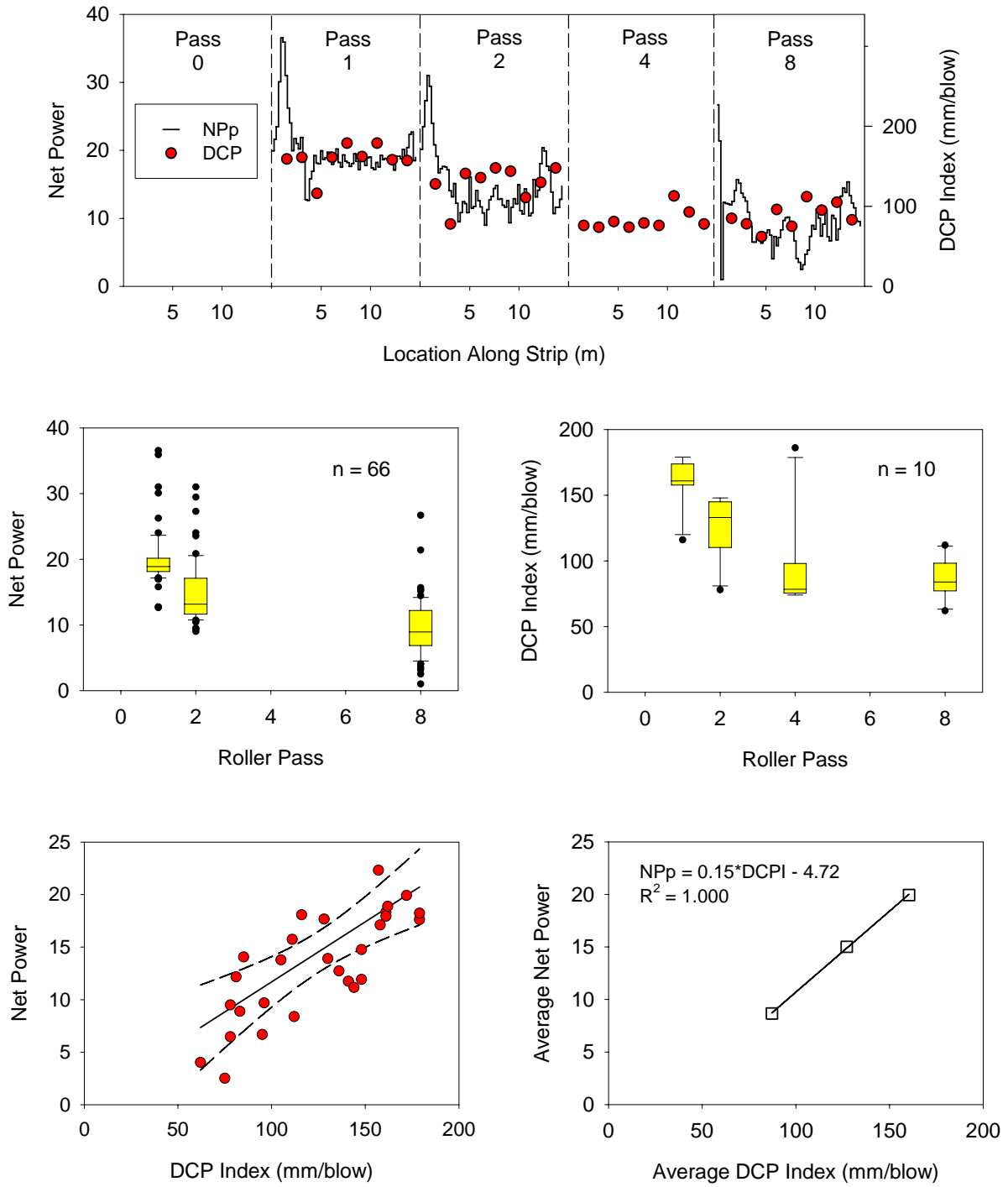


**Figure 42. Topsoil, strip 1: net power–PFWD modulus correlation**

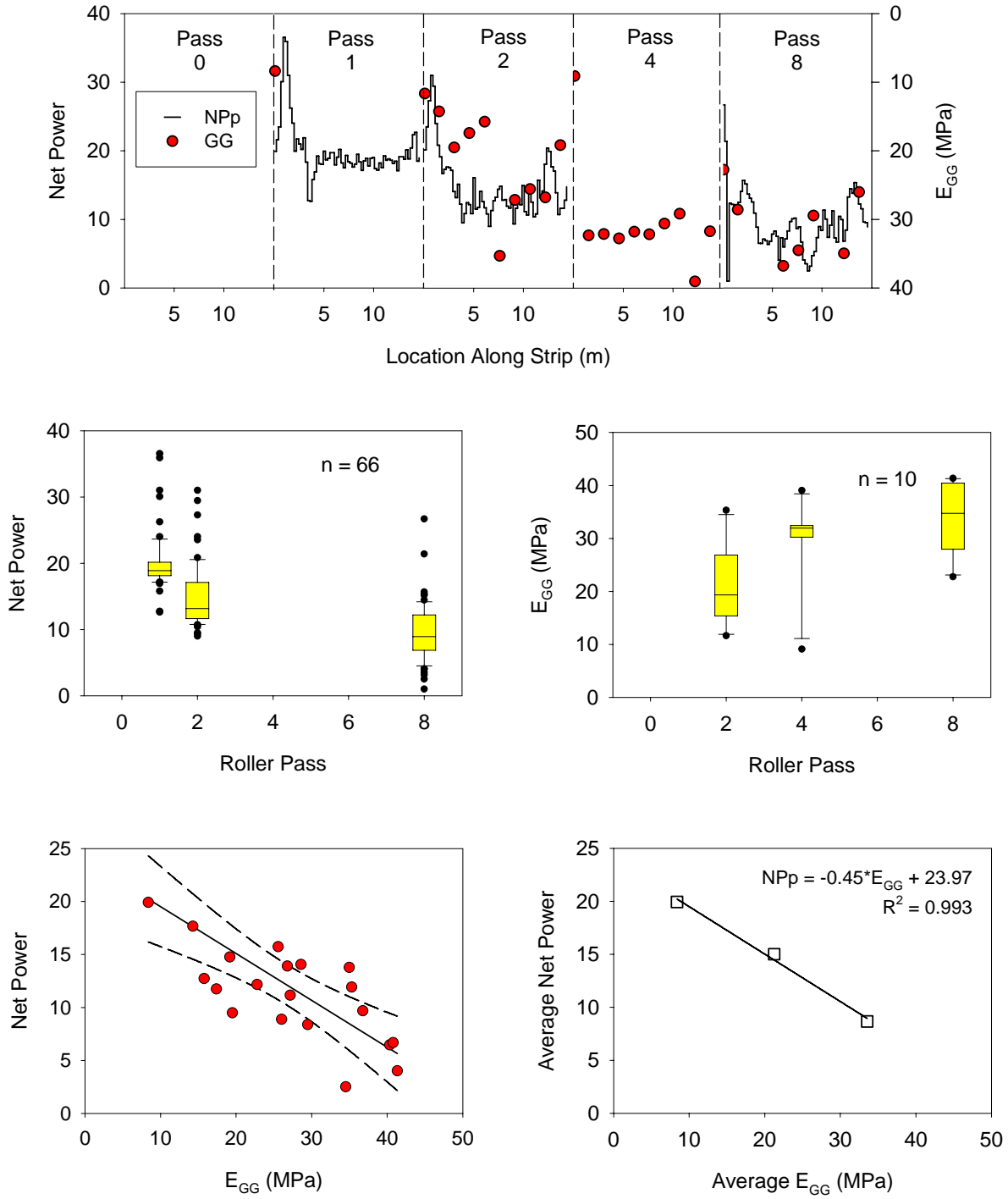




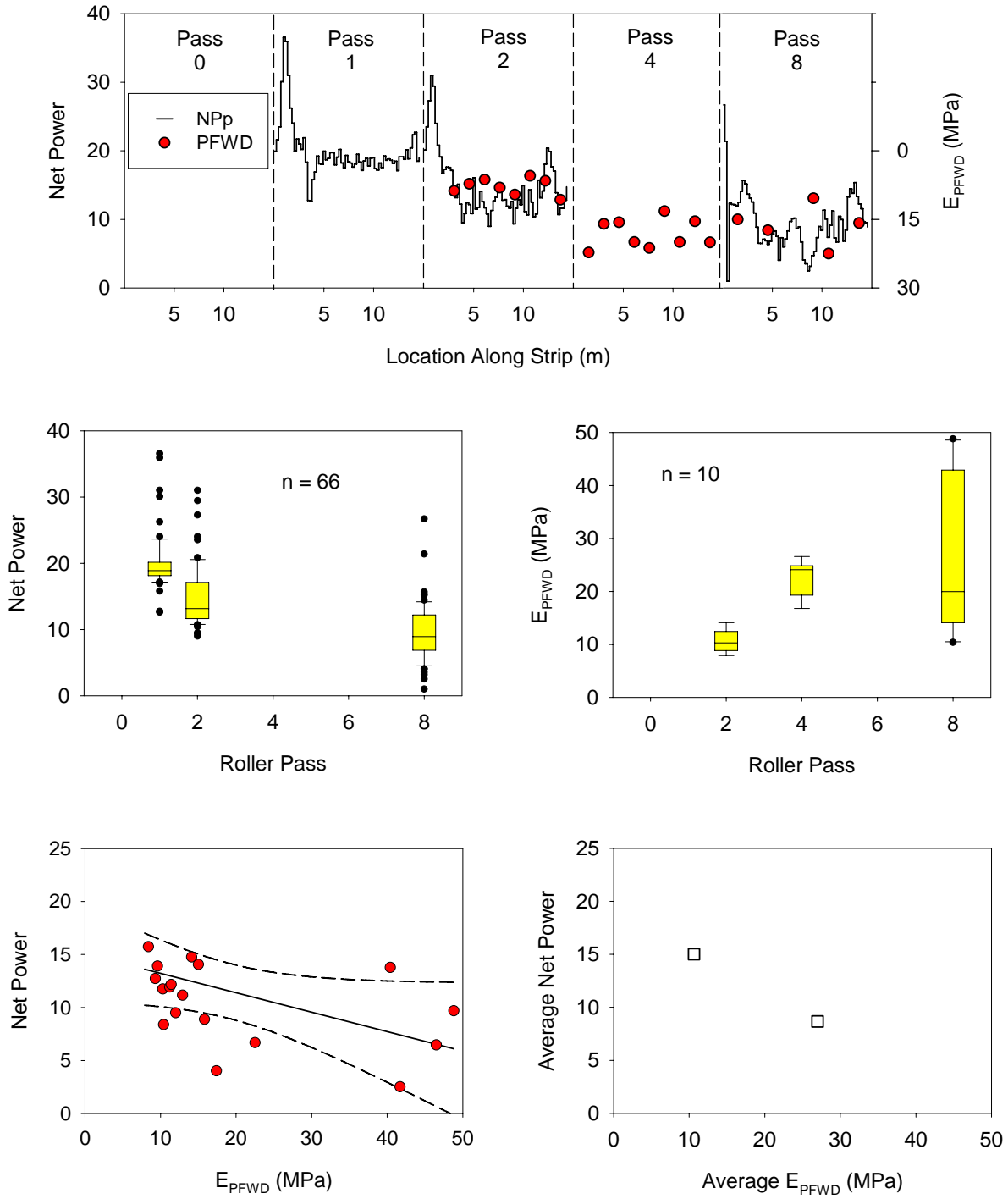
**Figure 43. Topsoil, strip 2: net power–dry unit weight correlation**



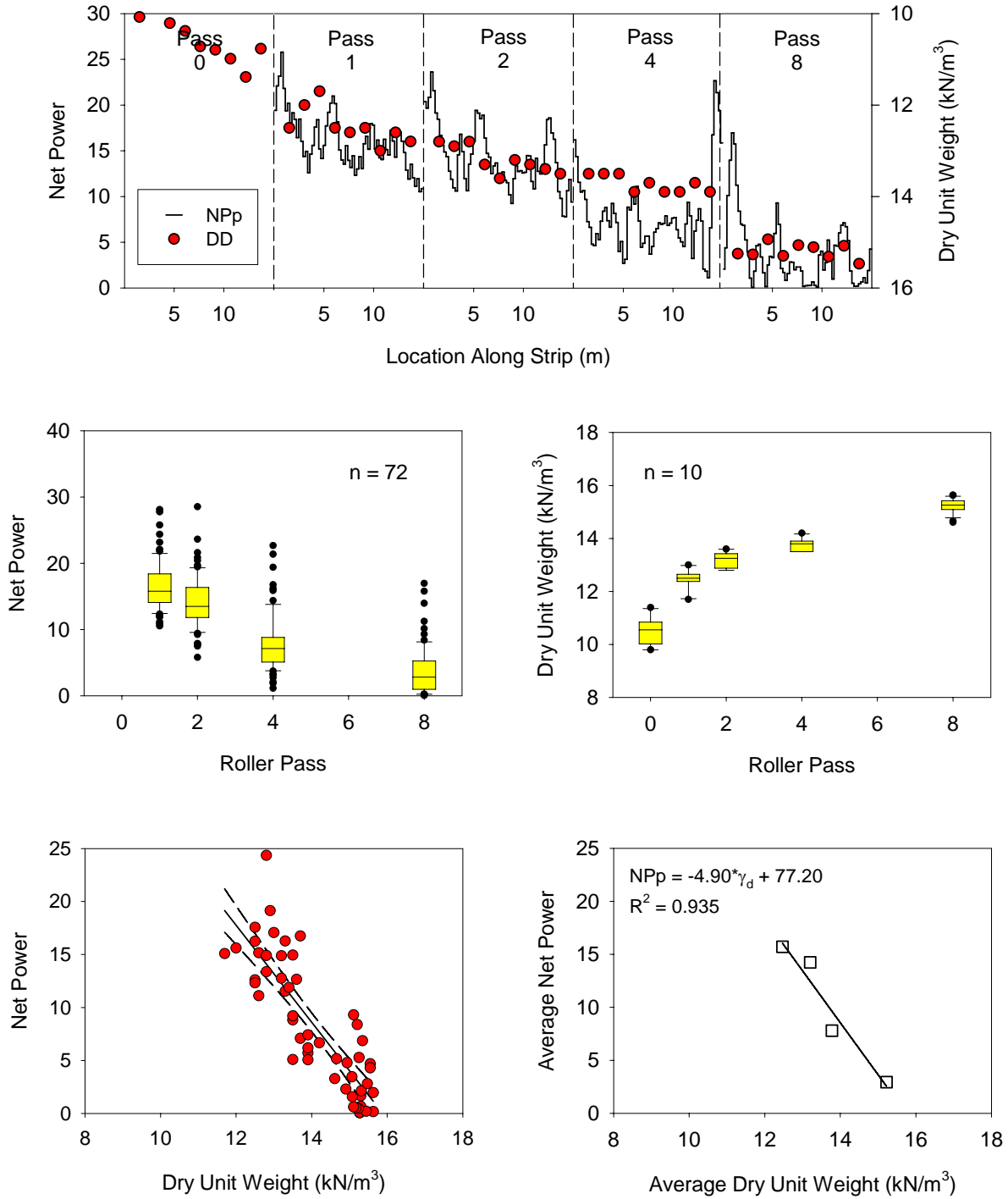
**Figure 44. Topsoil, strip 2: net power–DCP index correlation**



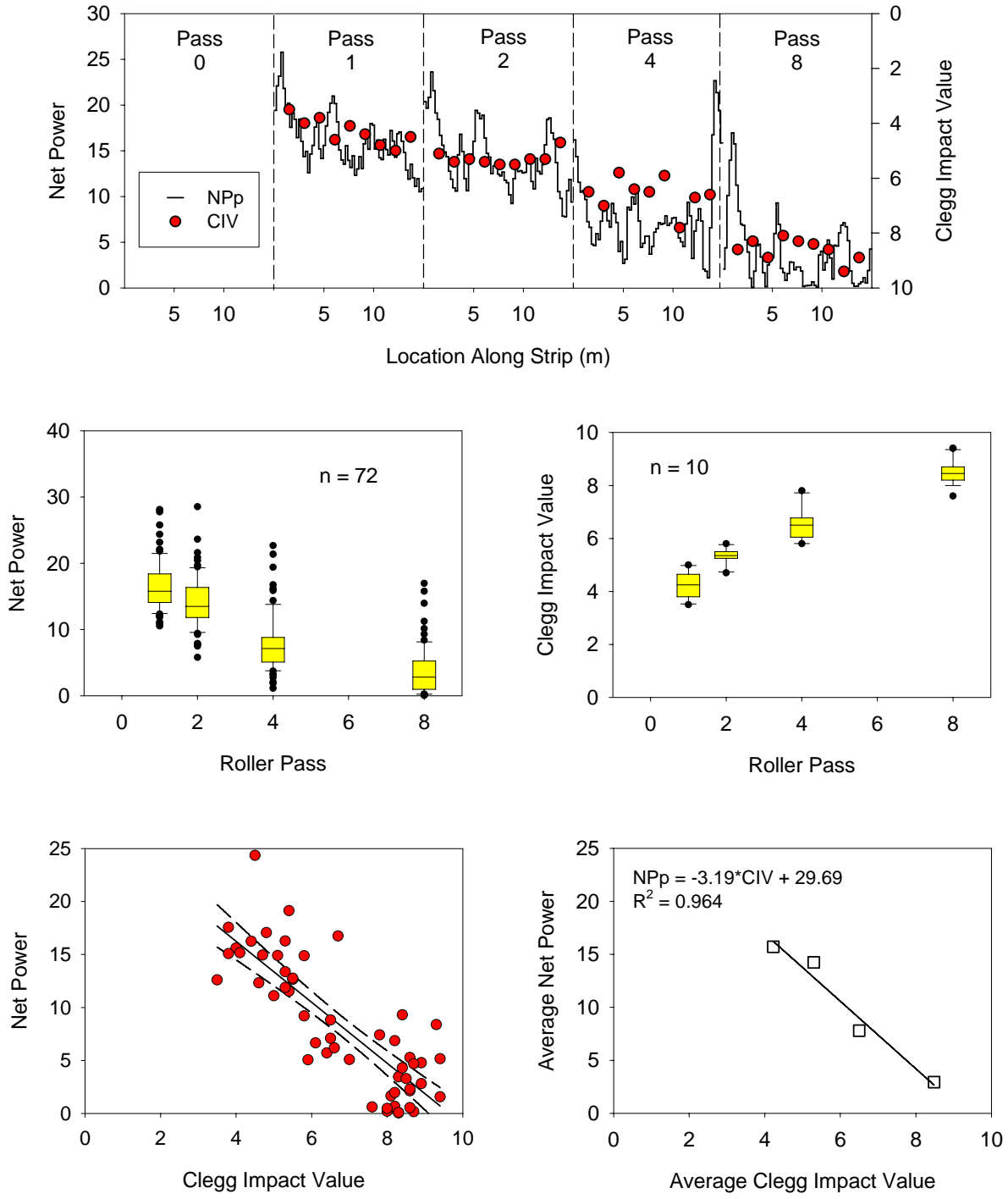
**Figure 45. Topsoil, strip 2: net power–GeoGauge modulus correlation**



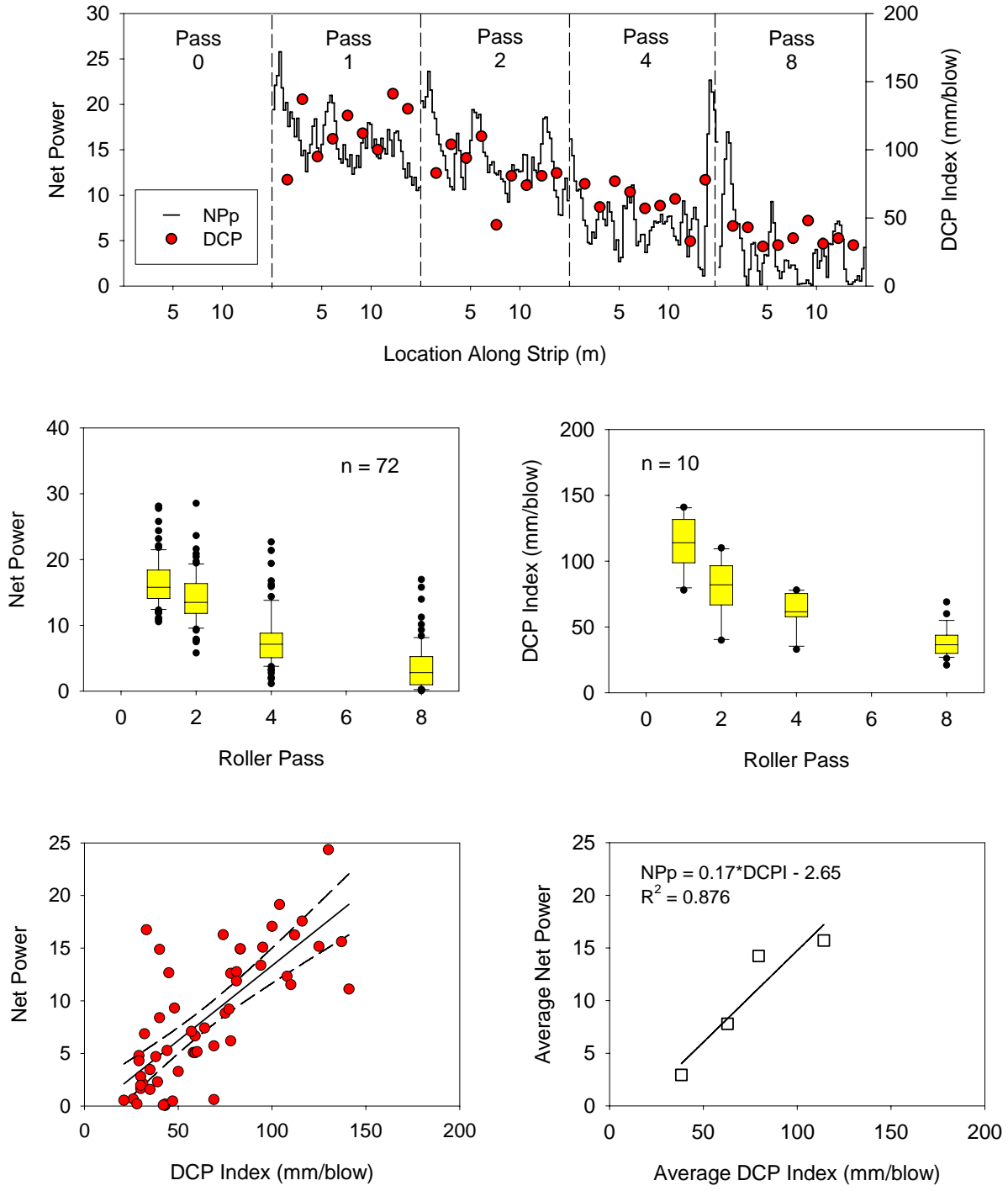
**Figure 46. Topsoil, strip 2: net power–PFW modulus correlation**



**Figure 47. Topsoil, strip 3: net power–dry unit weight correlation**

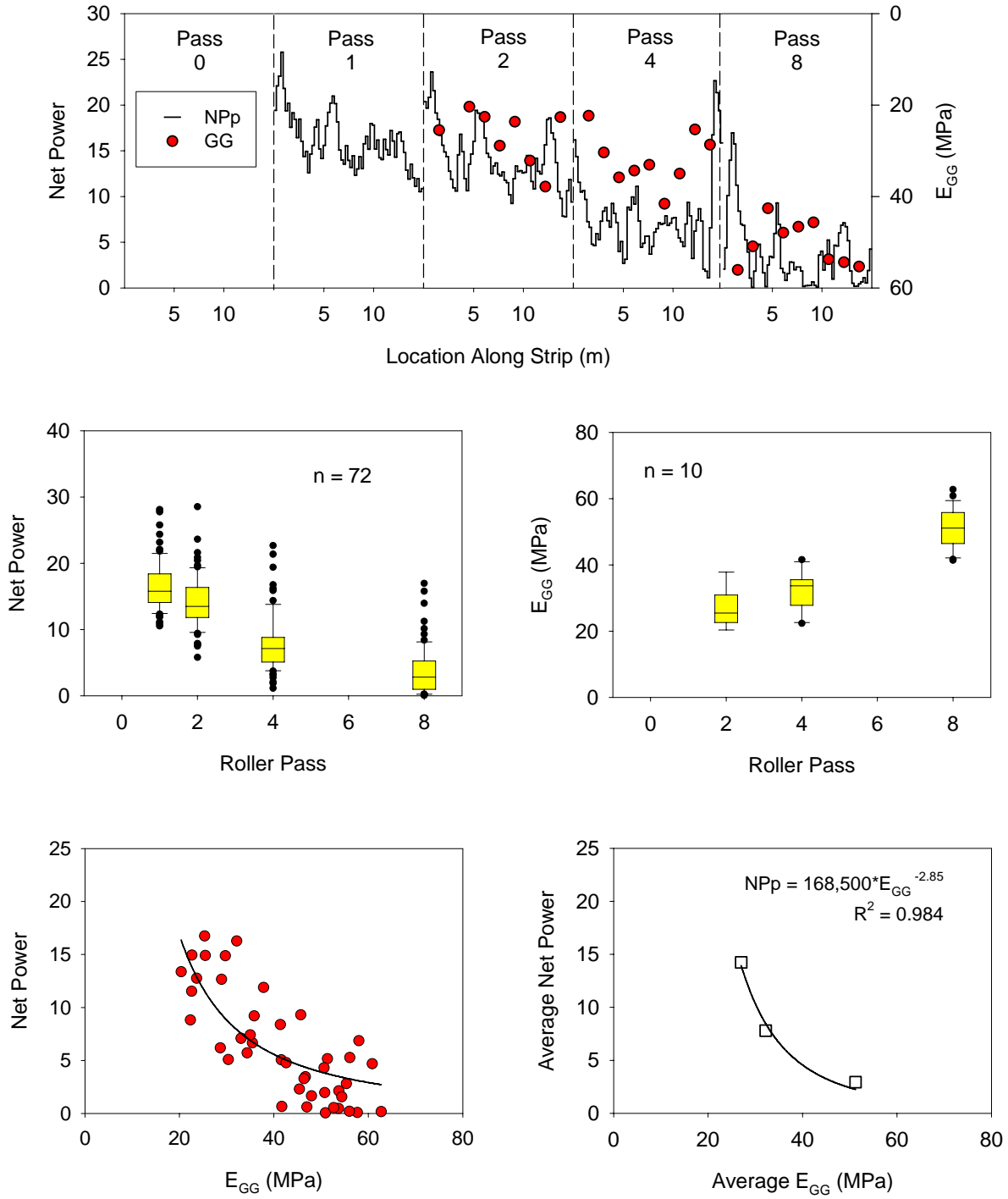


**Figure 48. Topsoil, strip 3: net power-CIV correlation**

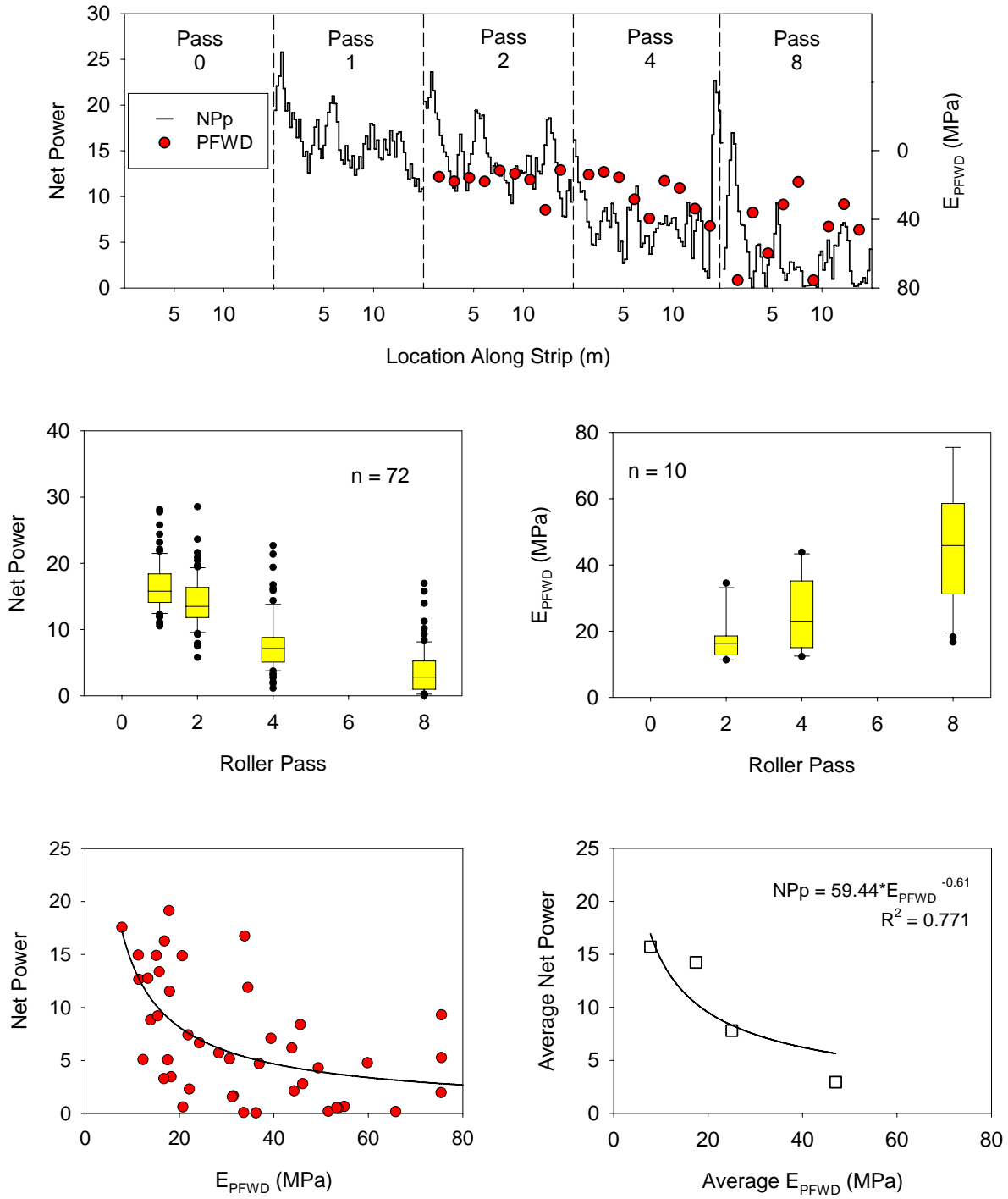


**Figure 49. Topsoil, strip 3: net power–DCP index correlation**

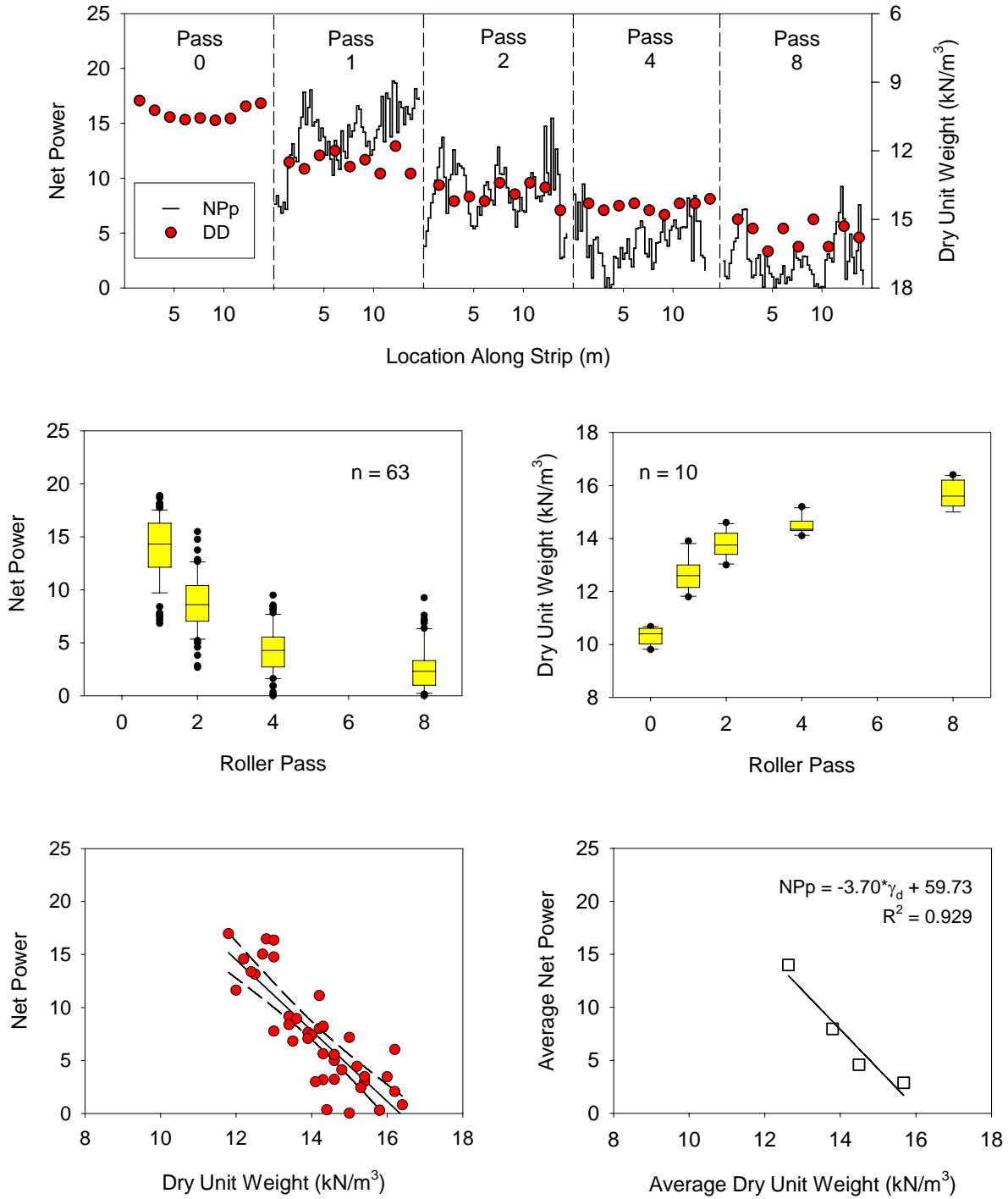




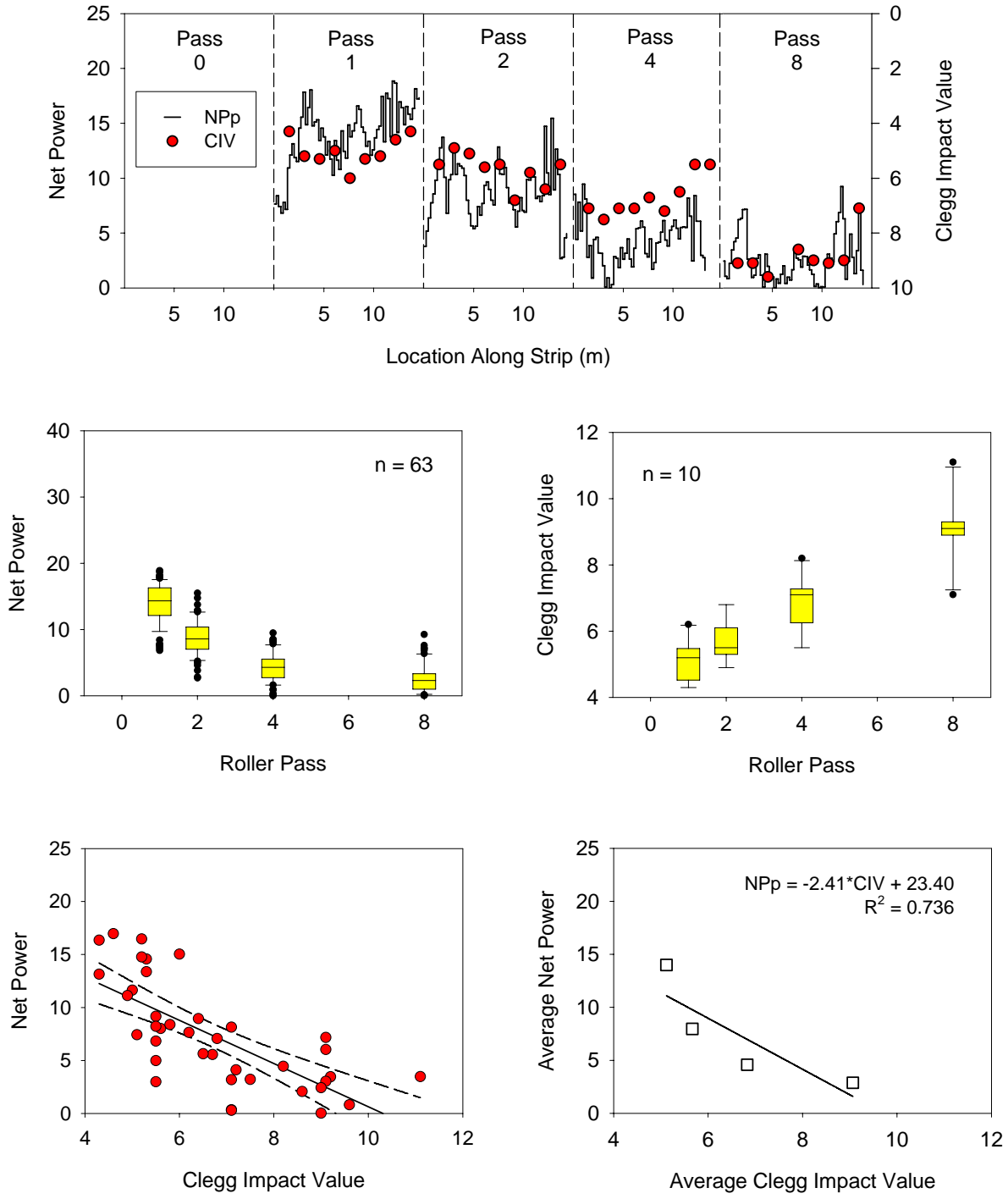
**Figure 50. Topsoil, strip 3: net power-GeoGauge modulus correlation**



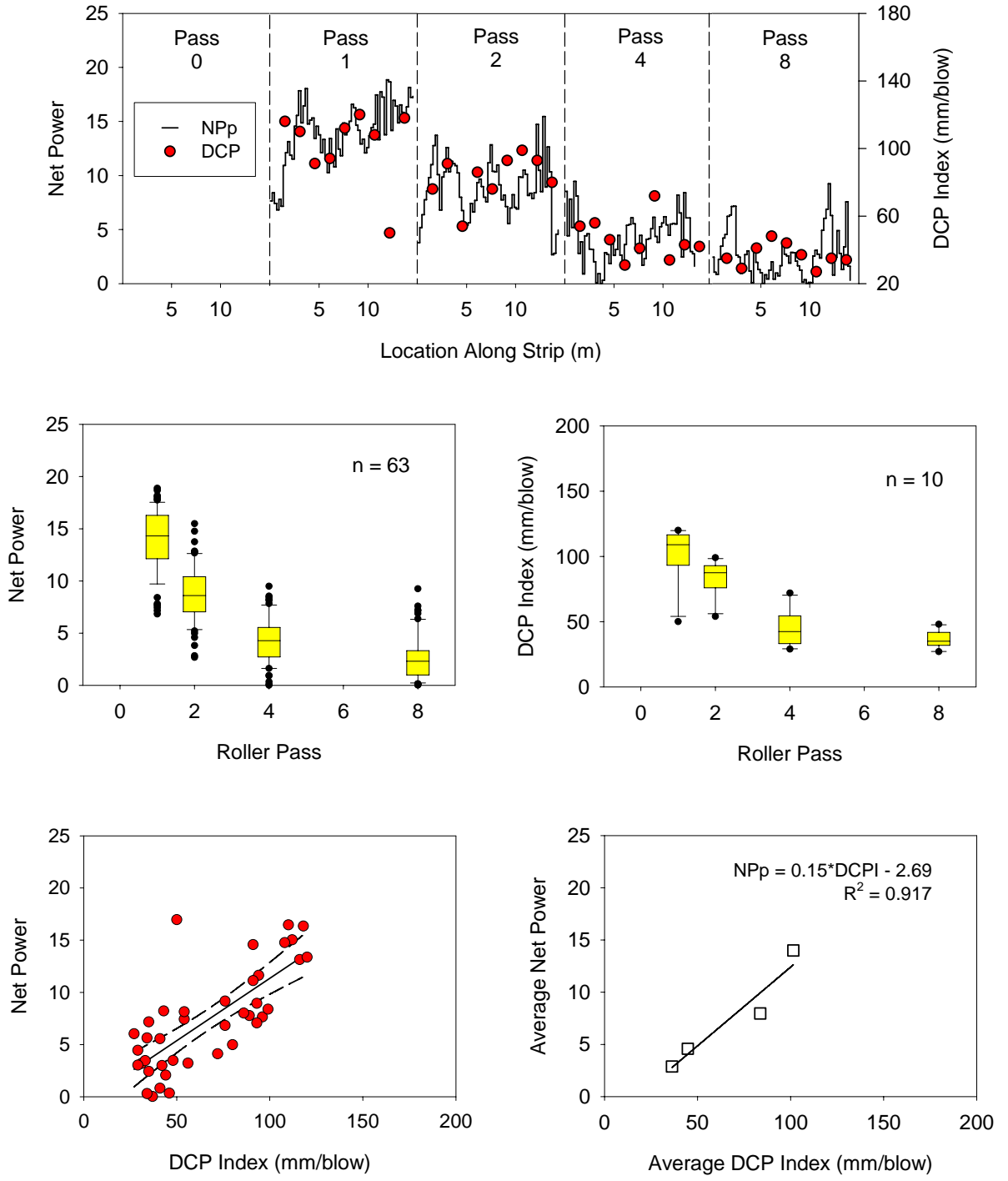
**Figure 51. Topsoil, strip 3: net power–PFWD modulus correlation**



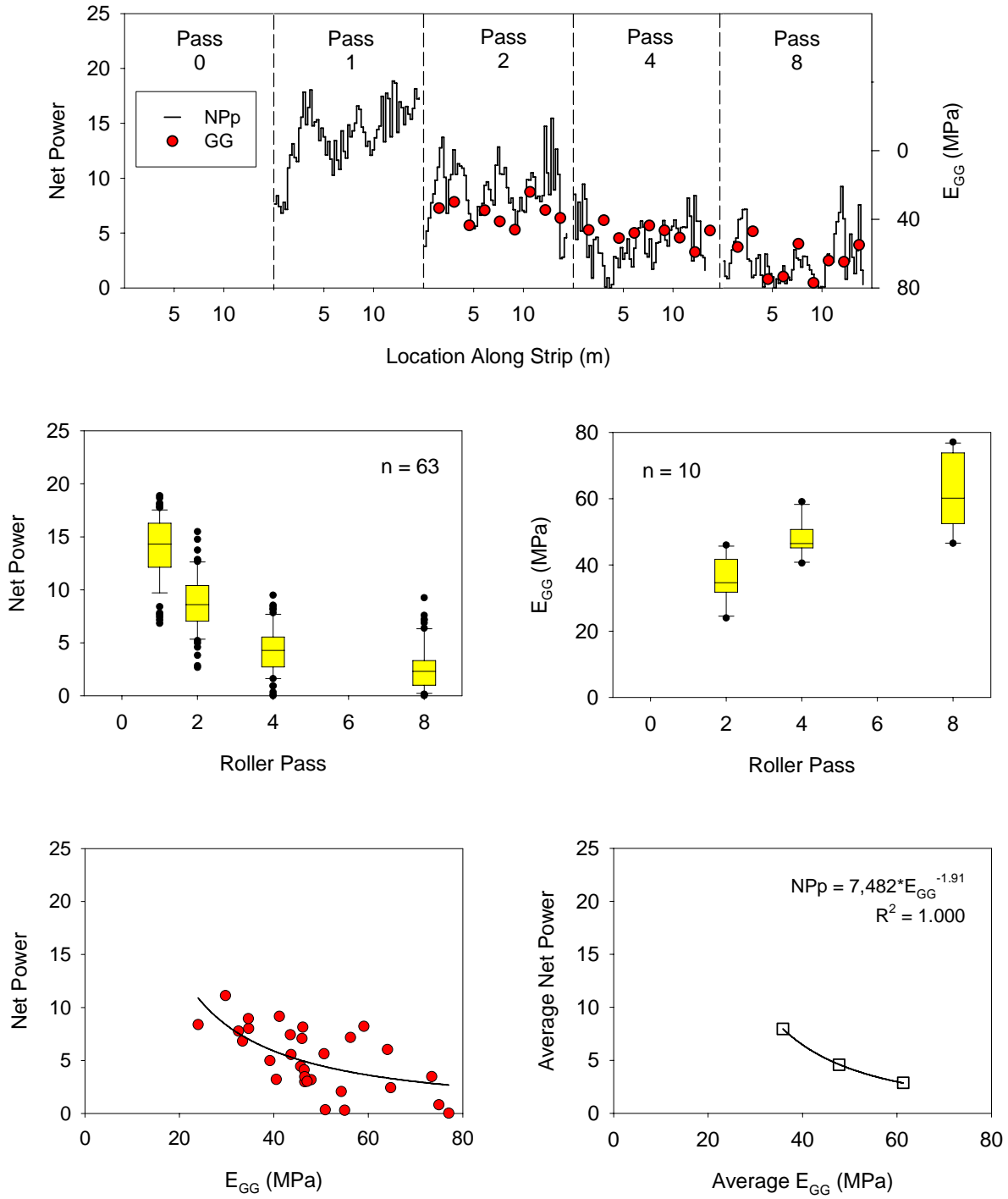
**Figure 52. Topsoil, strip 4: net power–dry unit weight correlation**



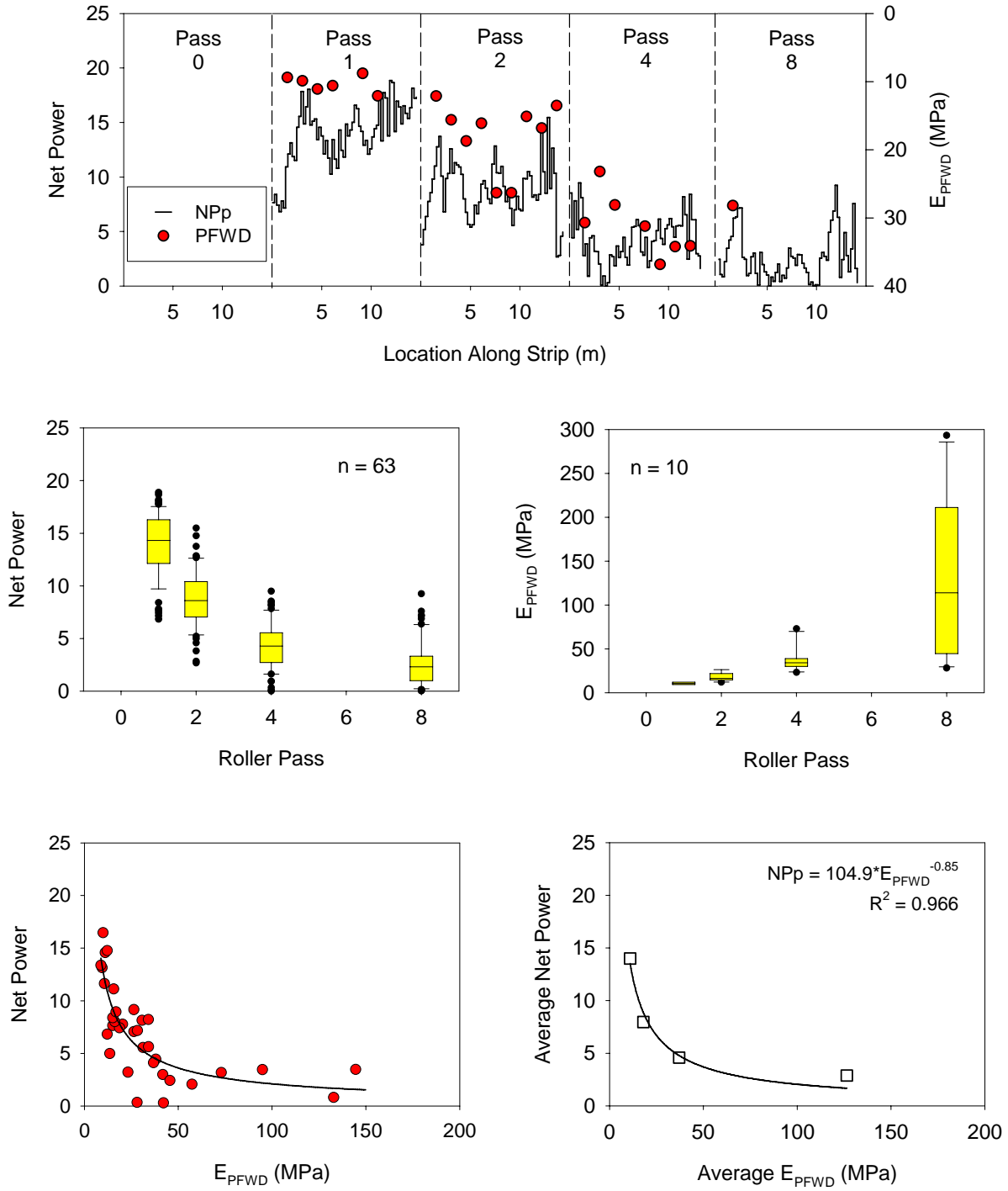
**Figure 53. Topsoil, strip 4: net power–CIV correlation**



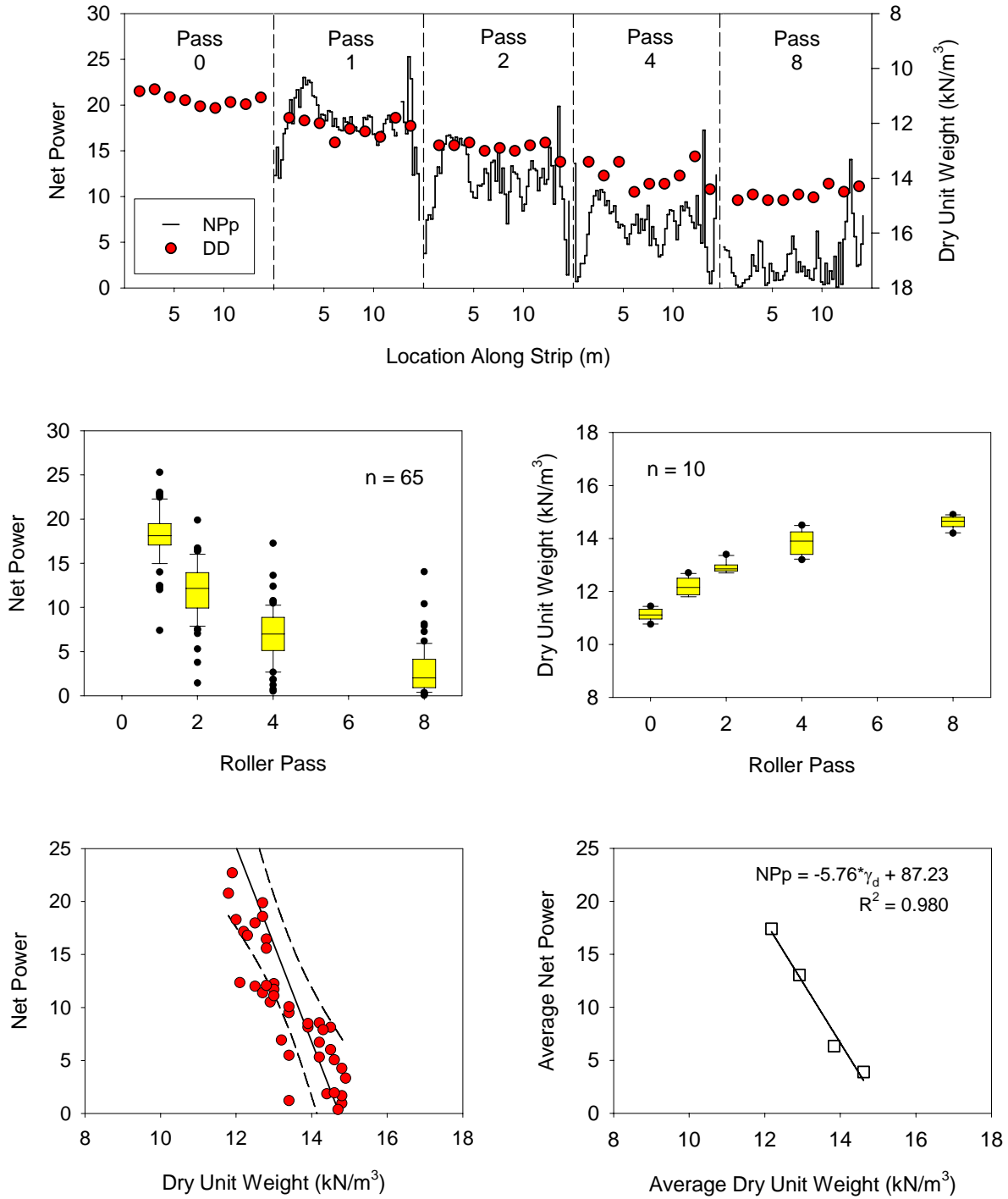
**Figure 54. Topsoil, strip 4: net power–DCP index correlation**



**Figure 55. Topsoil, strip 4: net power–GeoGauge modulus correlation**

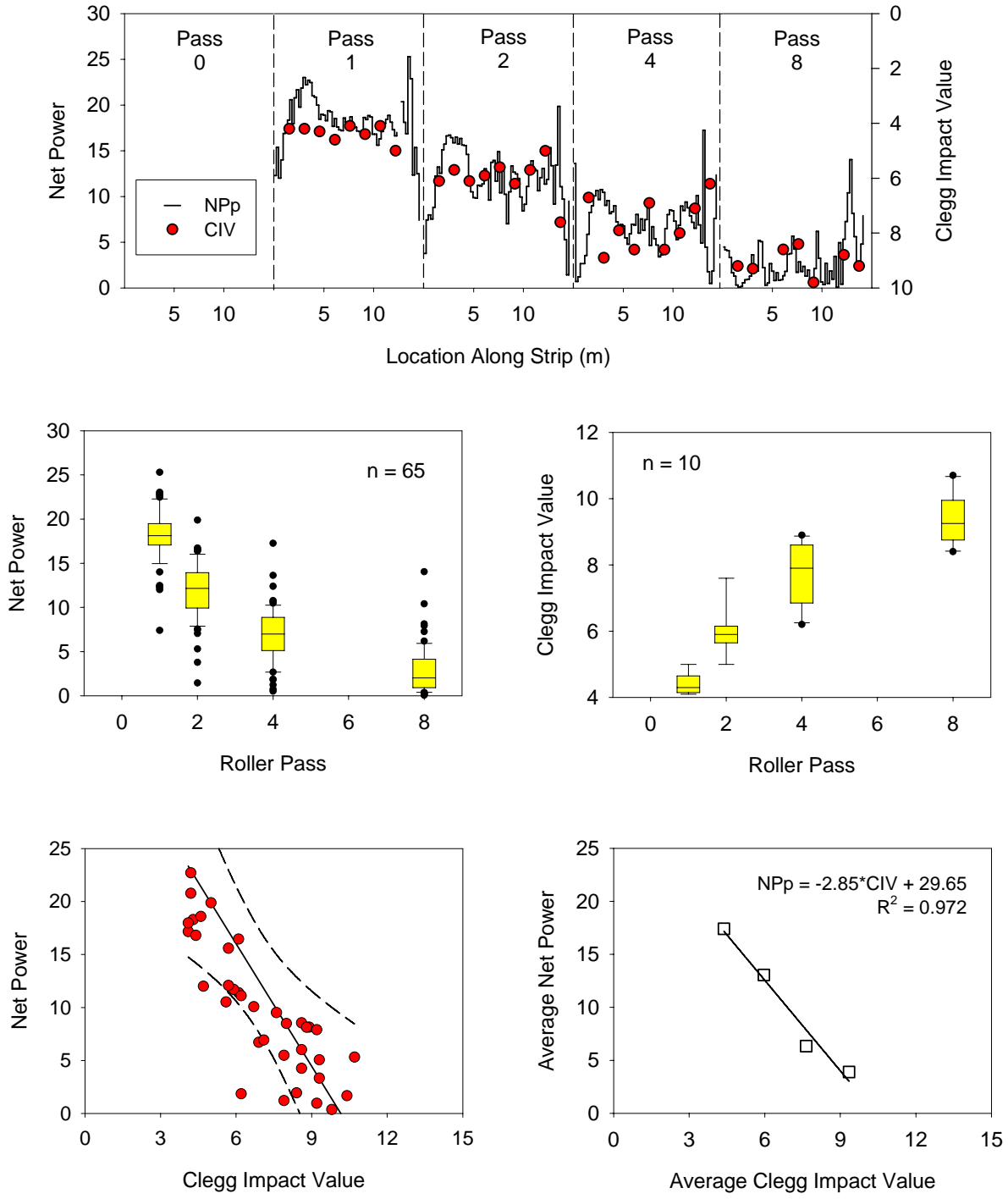


**Figure 56. Topsoil, strip 4: net power–PFWD modulus correlation**

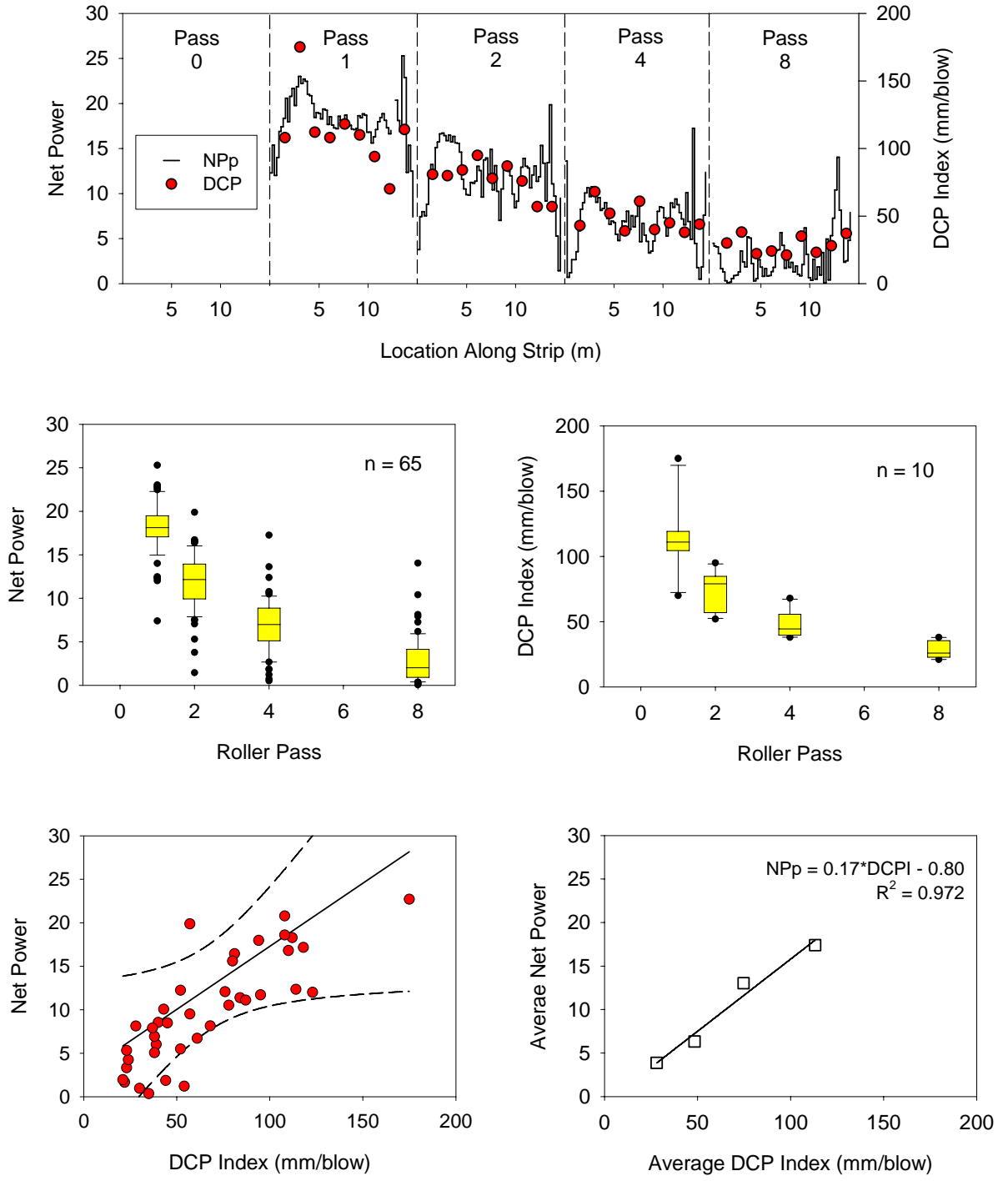


**Figure 57. Topsoil, strip 5: net power–dry unit weight correlation**

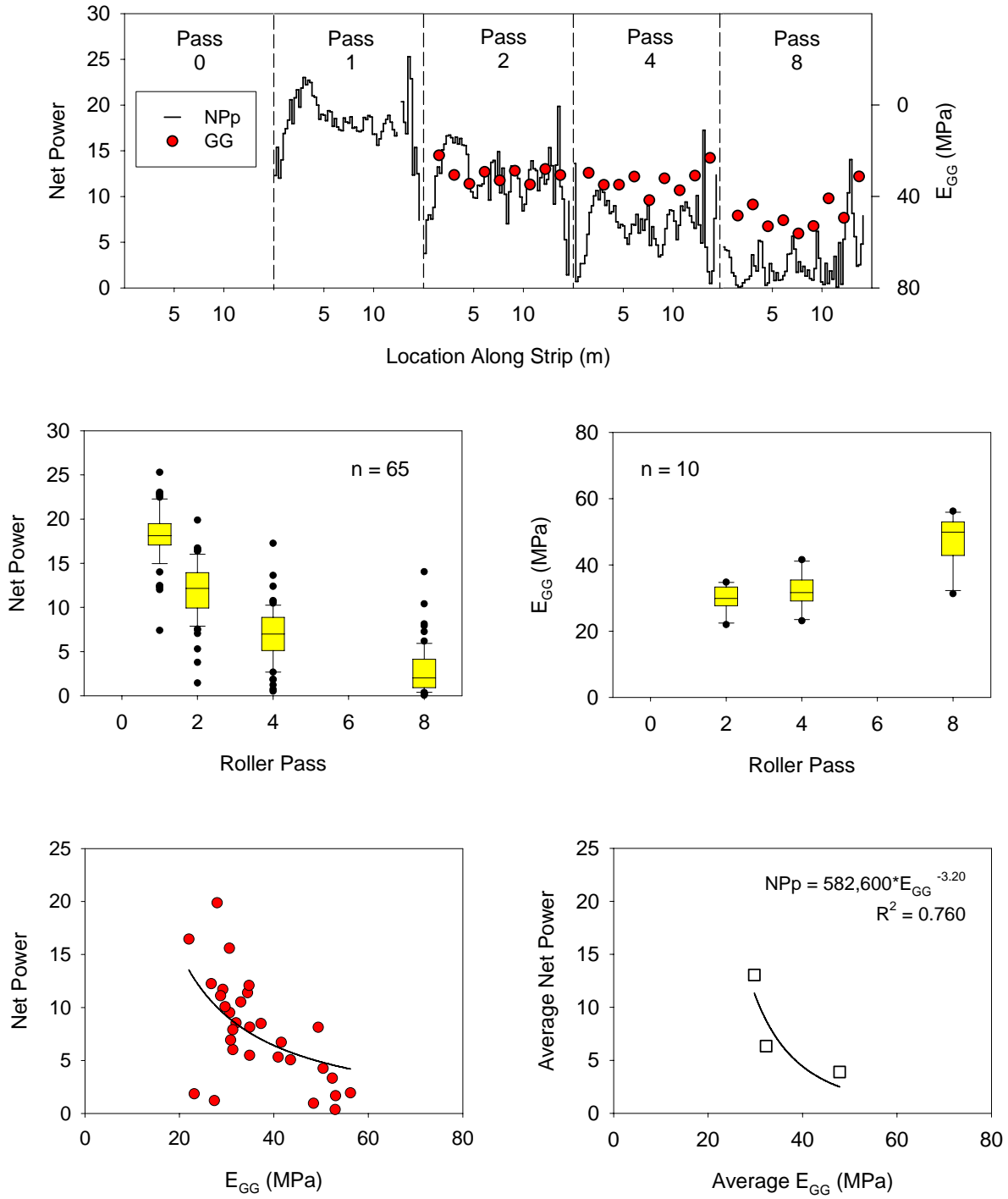




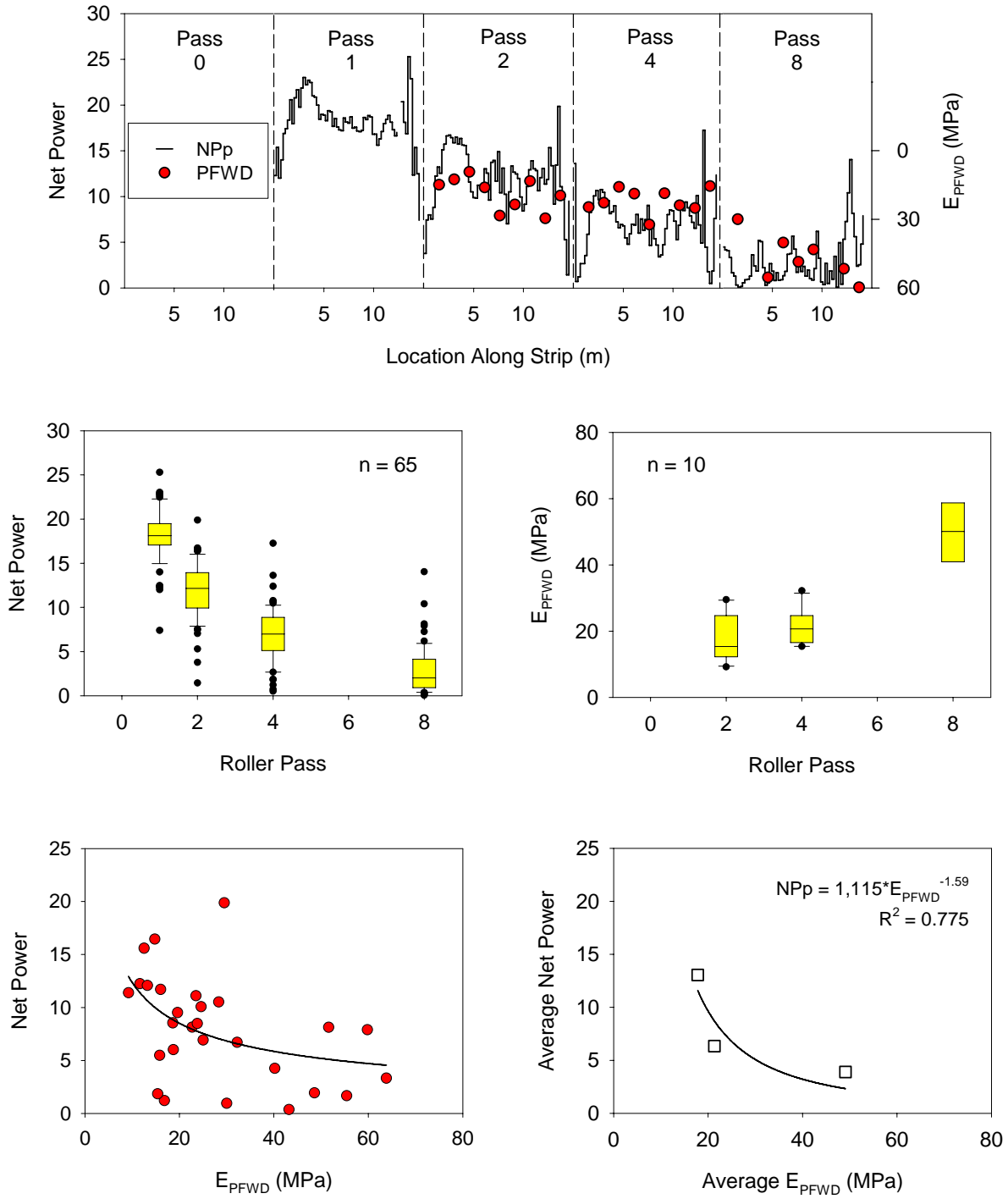
**Figure 58. Topsoil, strip 5: net power–CIV correlation**



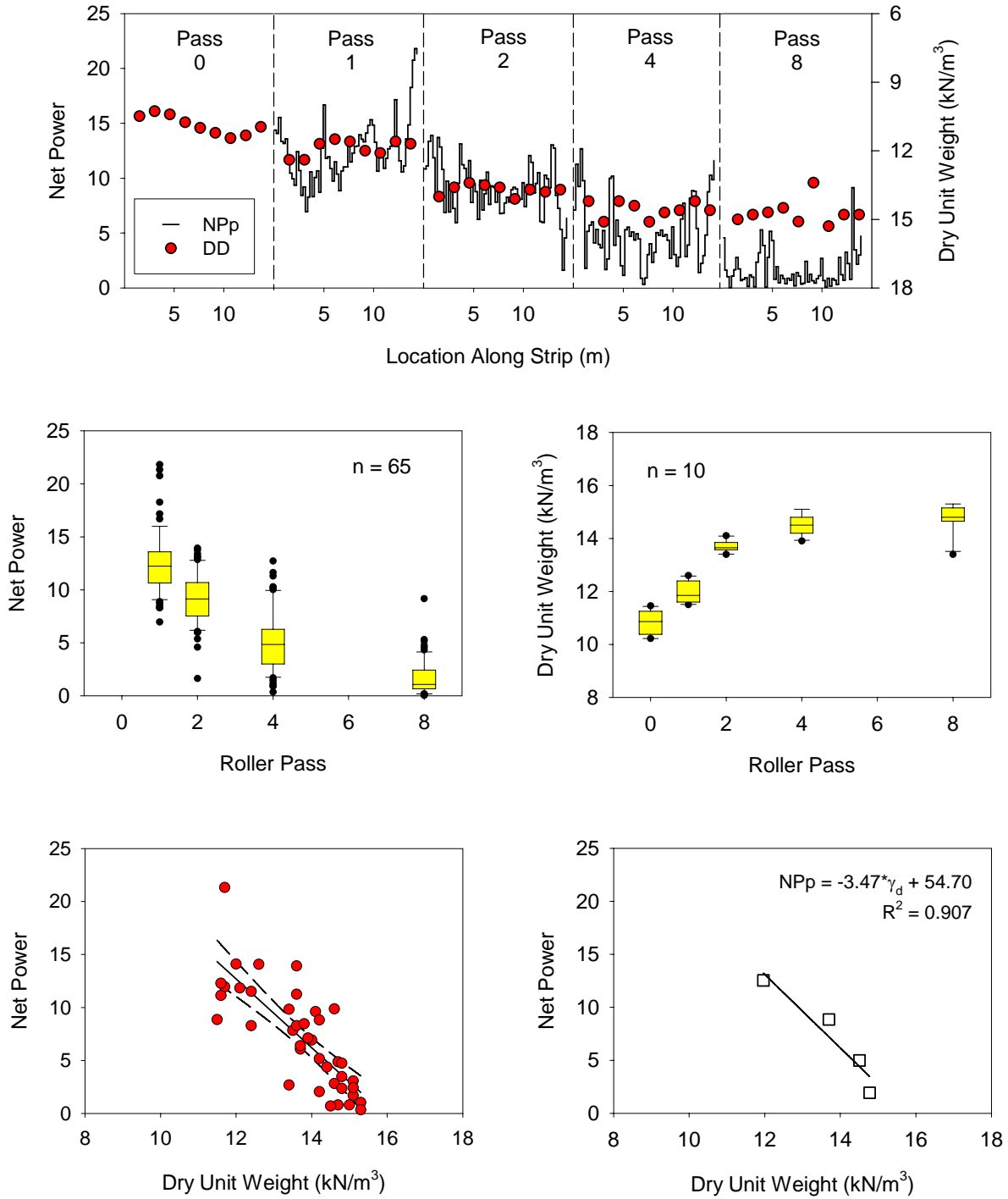
**Figure 59. Topsoil, strip 5: net power–DCP index correlation**



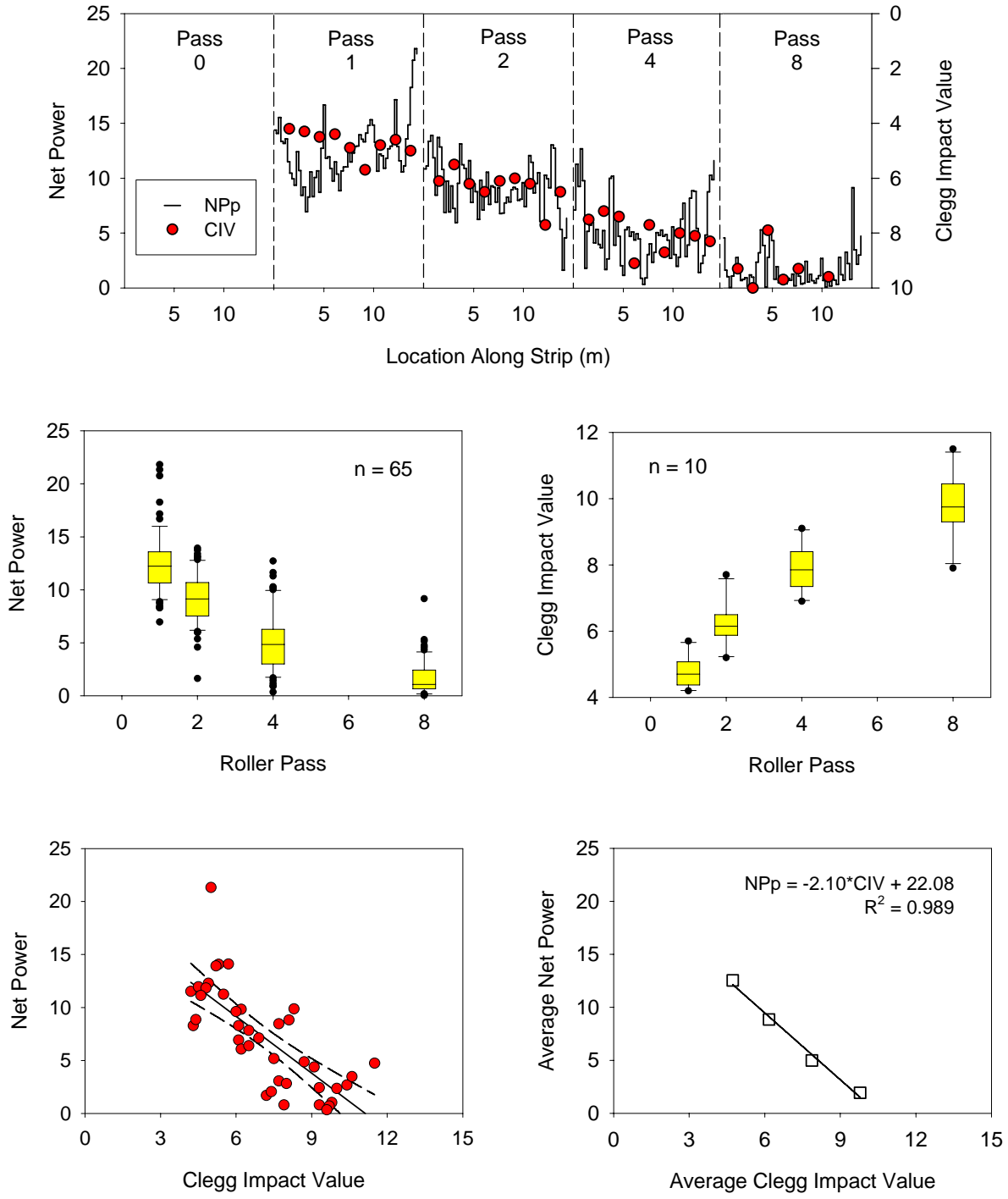
**Figure 60. Topsoil, strip 5: net power–GeoGauge modulus correlation**



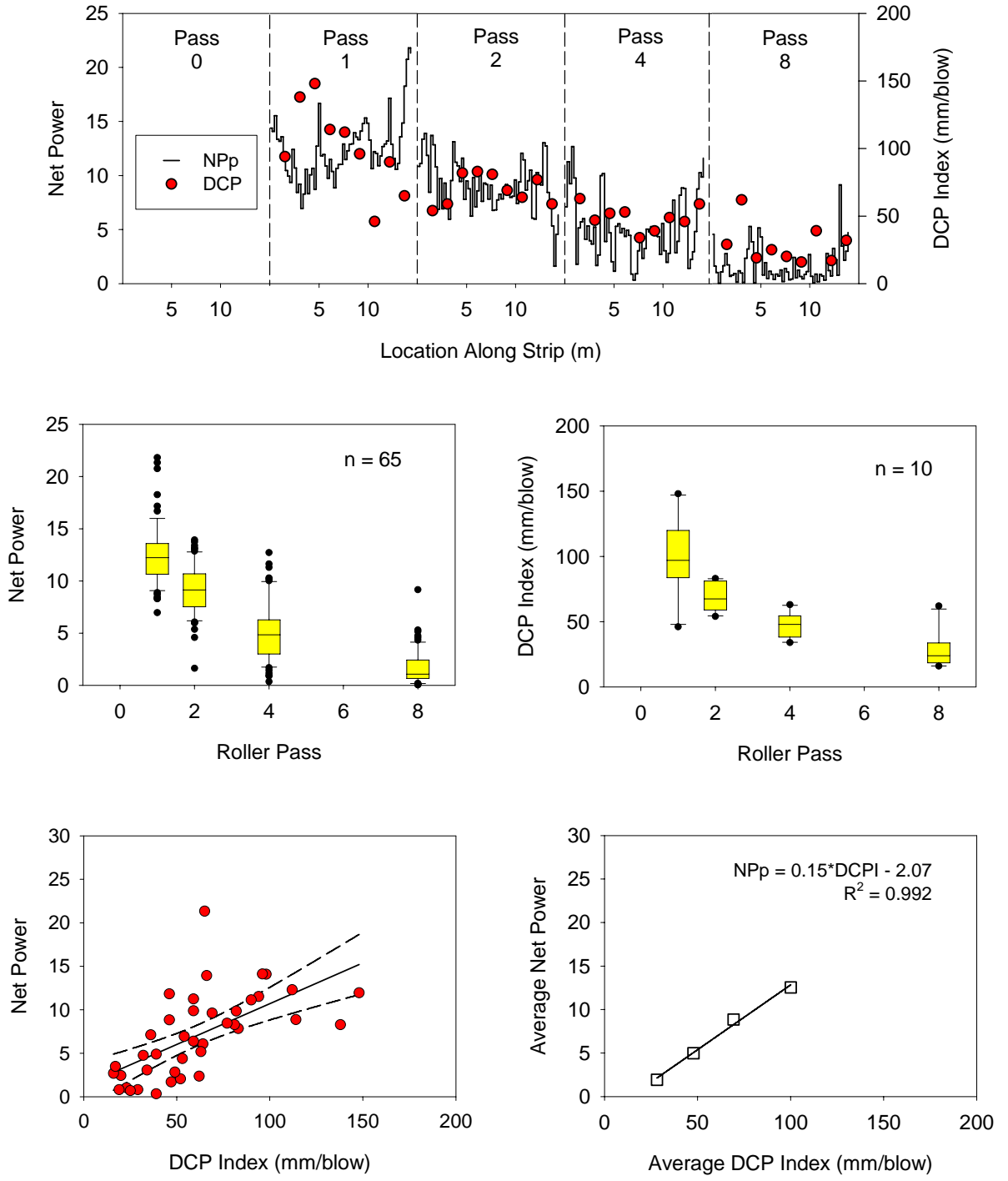
**Figure 61. Topsoil, strip 5: net power–PFWD modulus correlation**



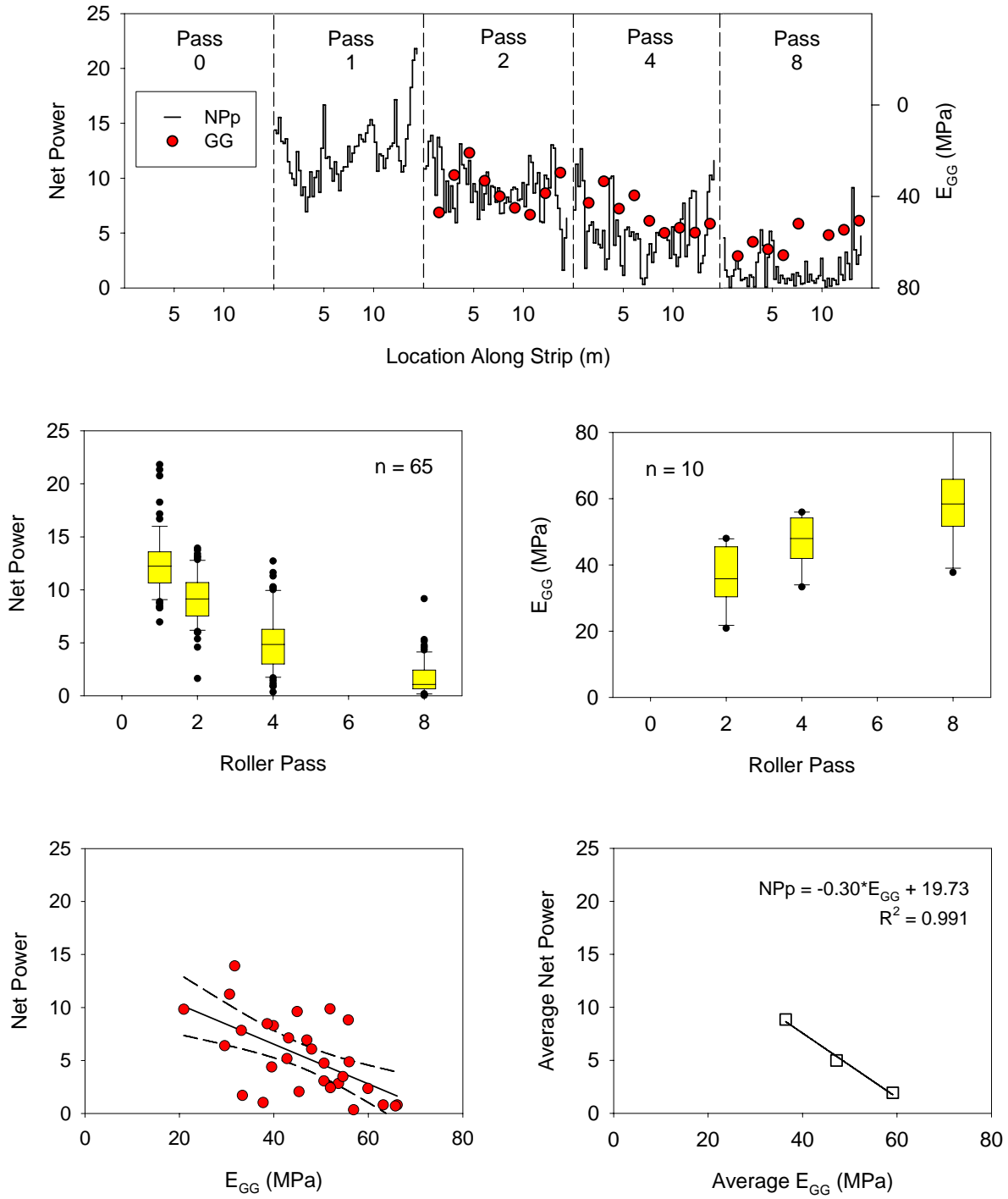
**Figure 62. Topsoil, strip 6: net power–dry unit weight correlation**



**Figure 63. Topsoil, strip 6: net power–CIV correlation**

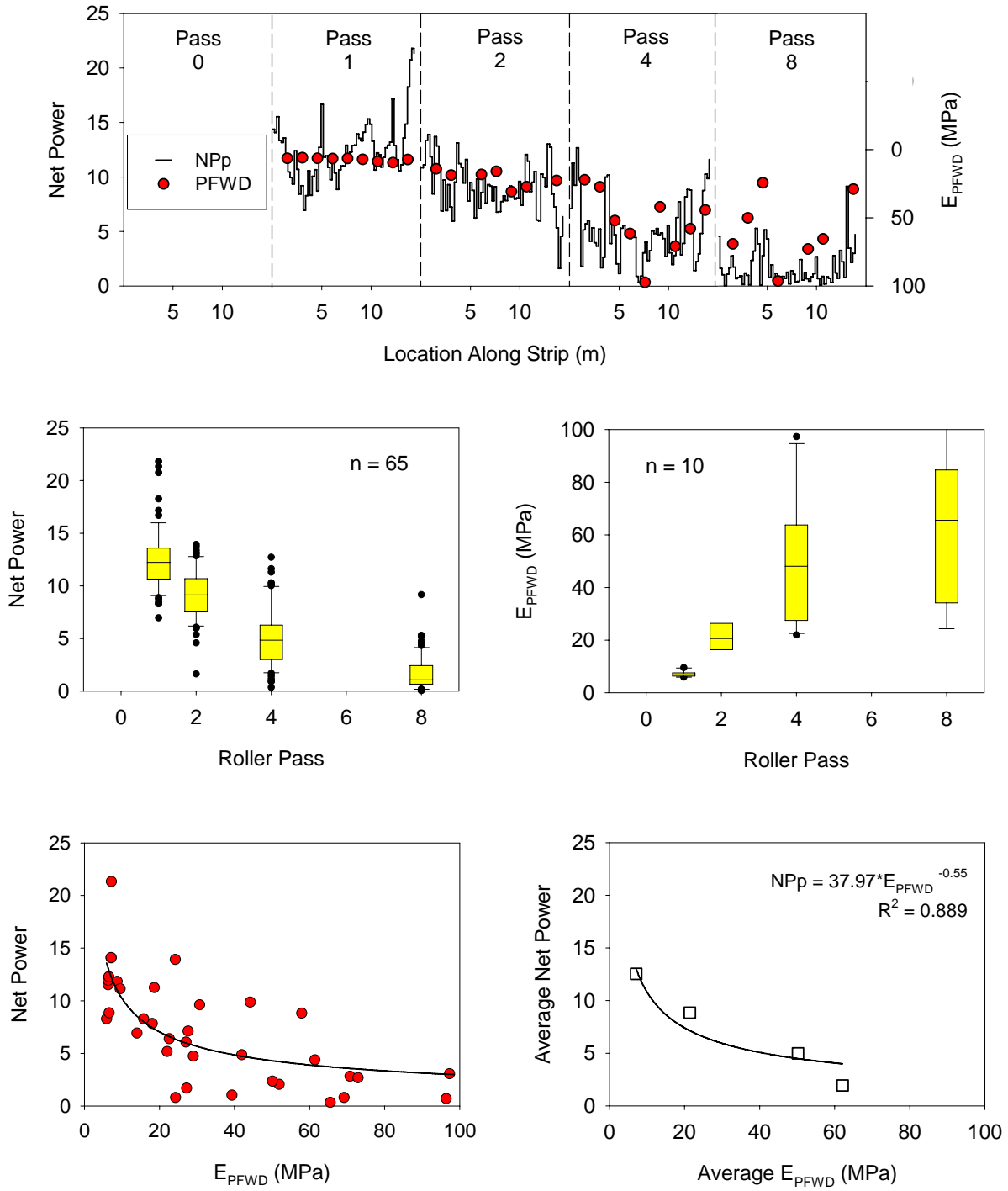


**Figure 64. Topsoil, strip 6: net power–DCP index correlation**

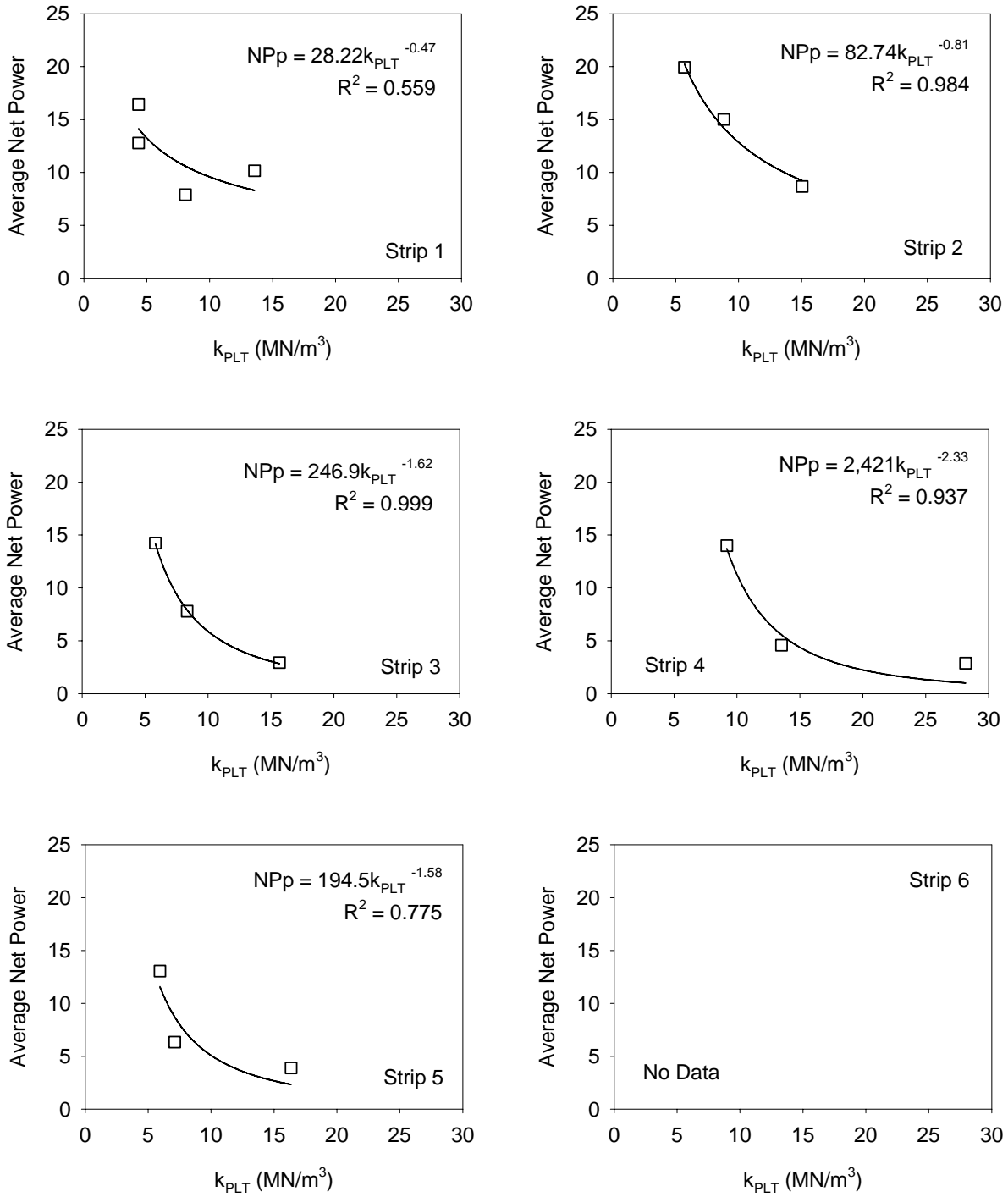


**Figure 65. Topsoil, strip 6: net power–GeoGauge modulus correlation**

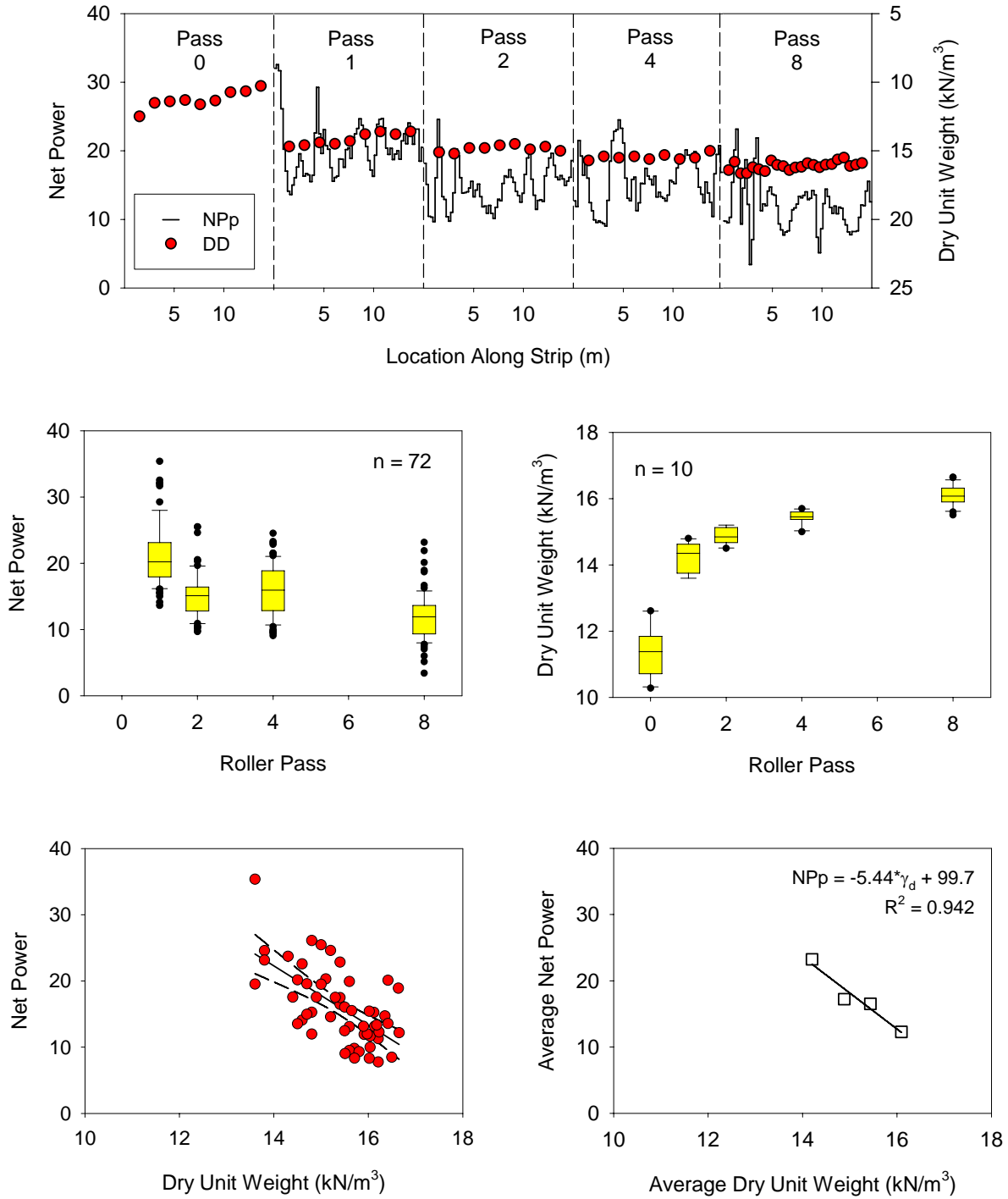




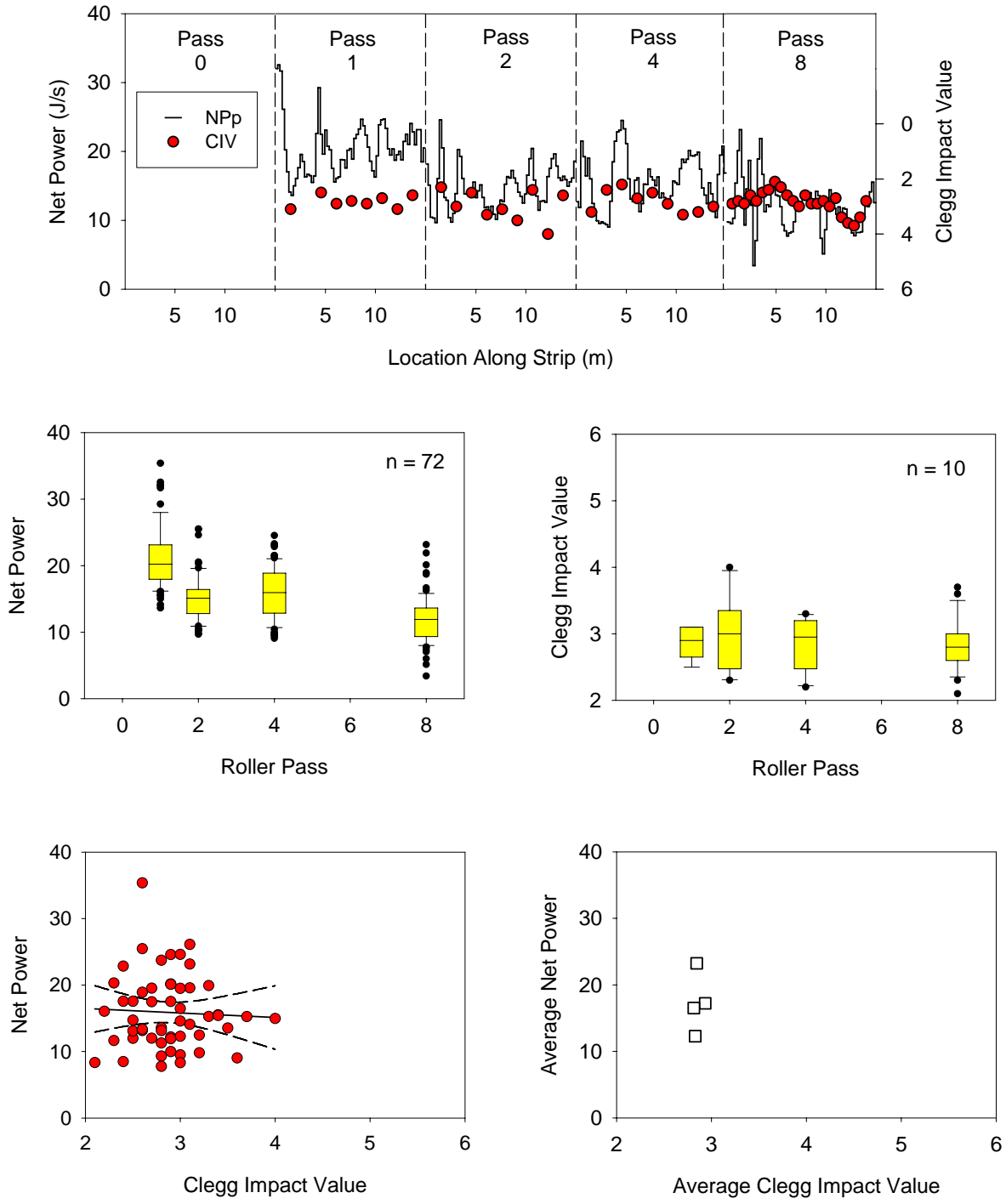
**Figure 66. Topsoil, strip 6: net power–PFWD modulus correlation**



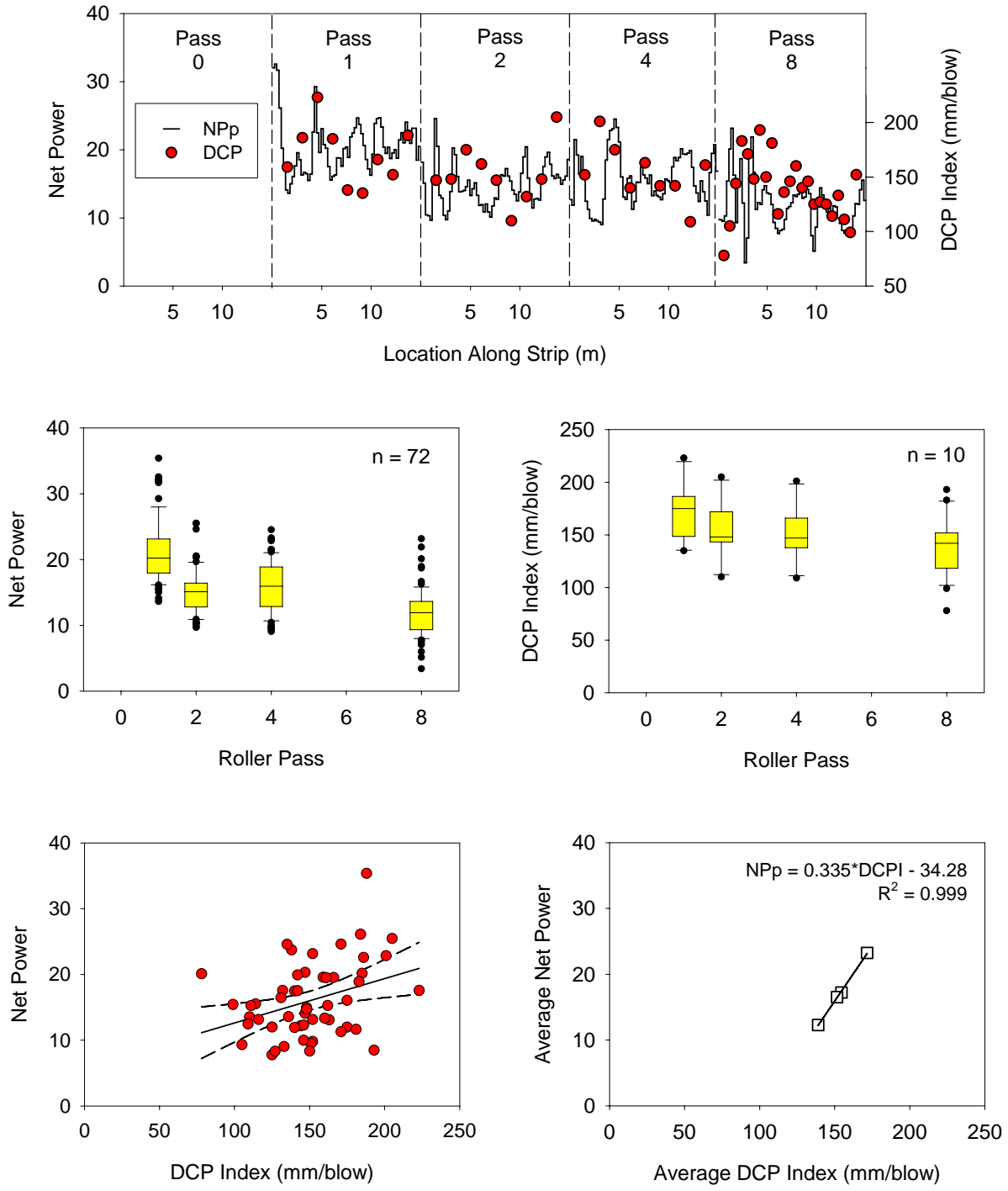
**Figure 67. Topsoil, net power–coefficient of subgrade reaction correlation**



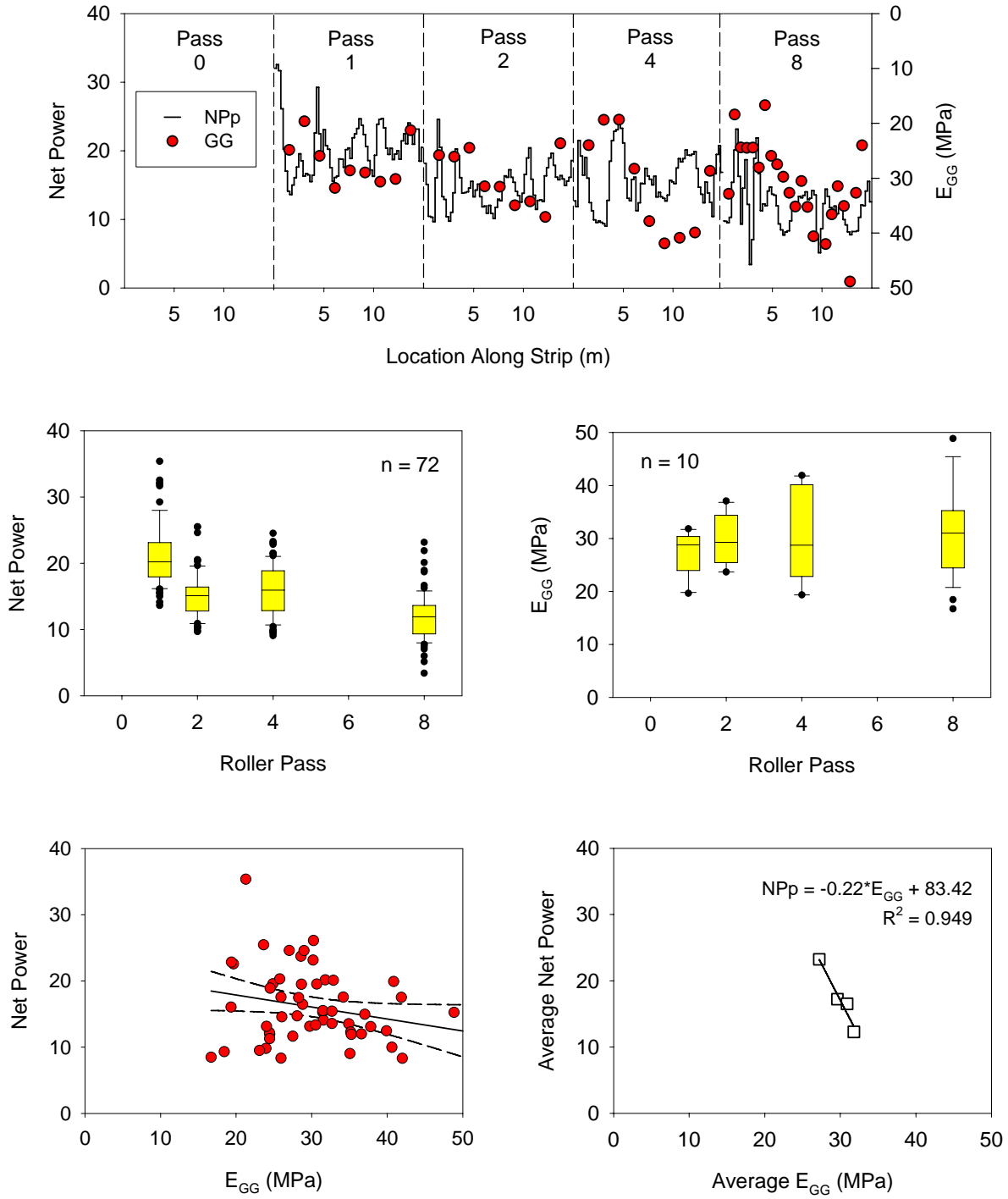
**Figure 68. Fill clay, strip 1: net power–dry unit weight correlation**



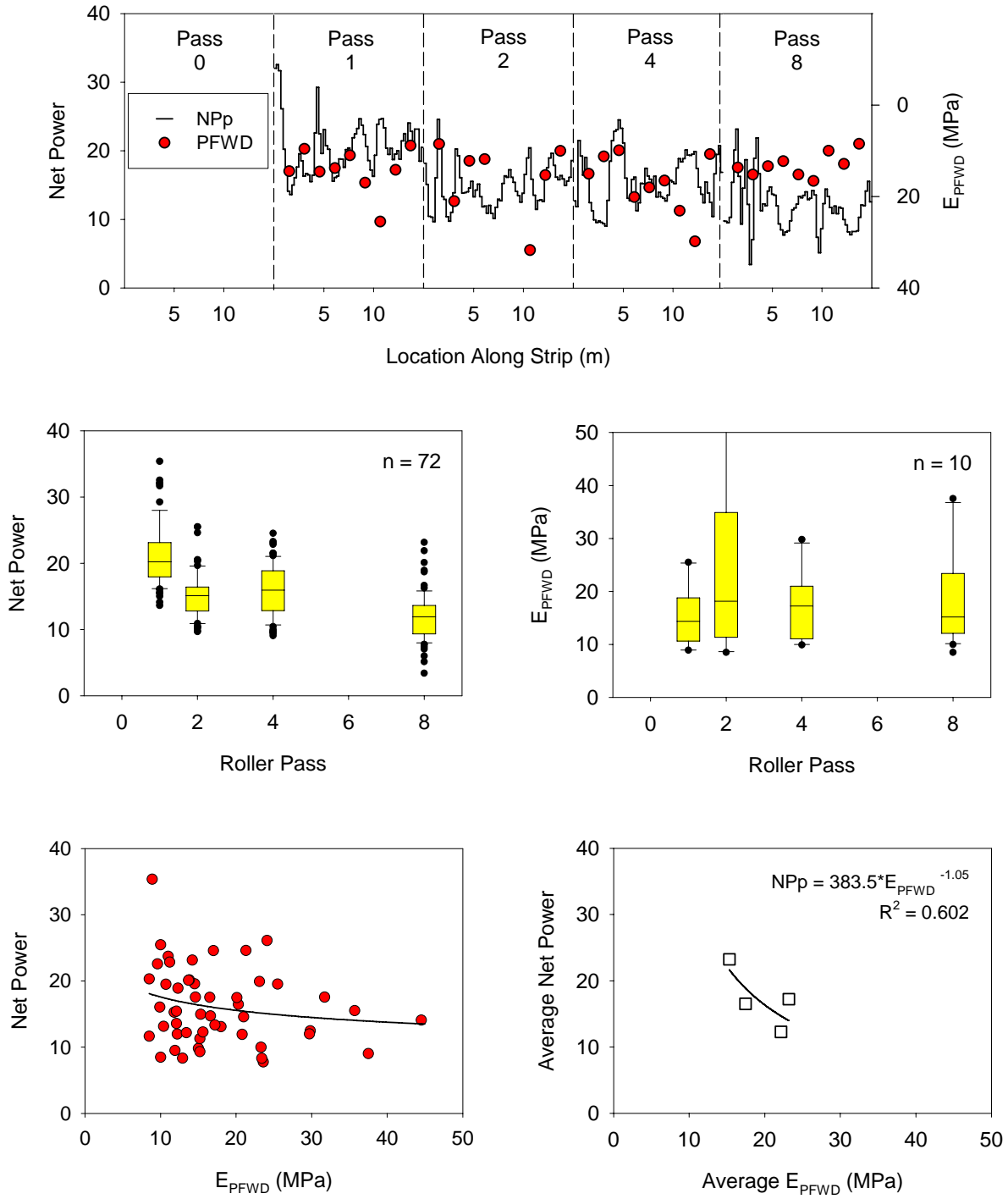
**Figure 69. Fill clay, strip 1: net power–CIV correlation**



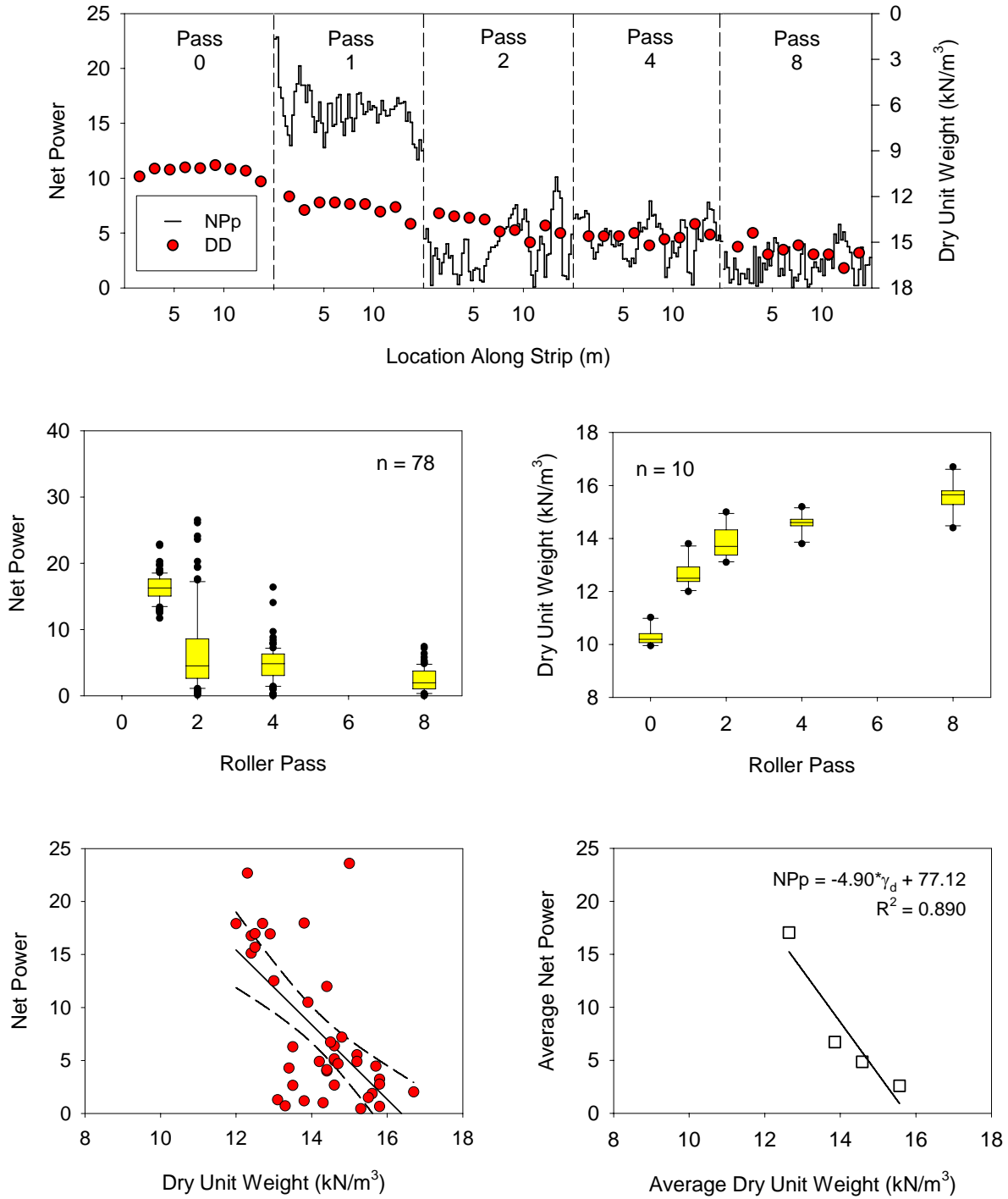
**Figure 70. Fill clay, strip 1: net power-DCP index correlation**



**Figure 71. Fill clay, strip 1: net power–GeoGauge modulus correlation**

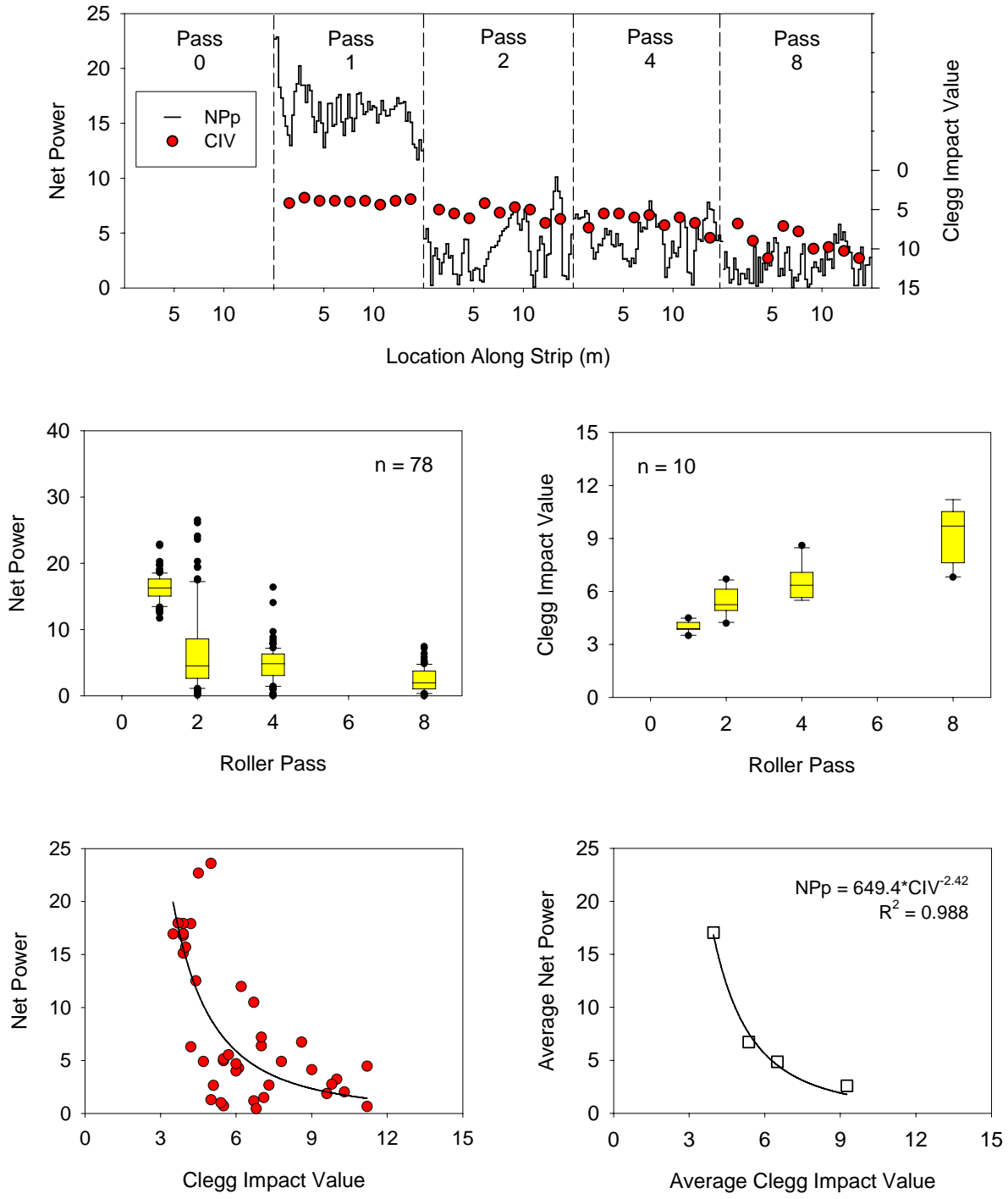


**Figure 72. Fill clay, strip 1: net power–PFWD modulus correlation**

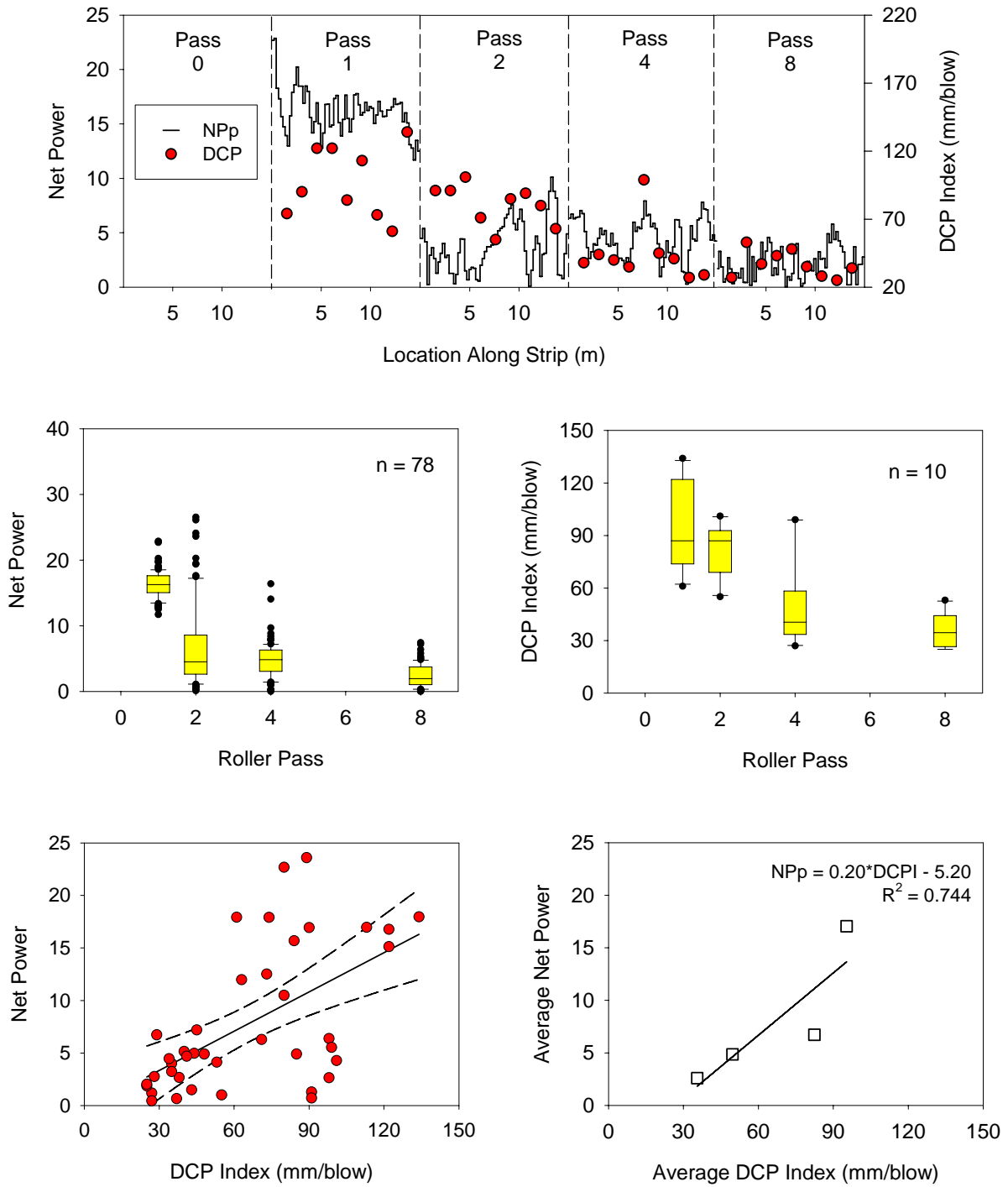


**Figure 73. Fill clay, strip 2: net power–dry unit weight correlation**

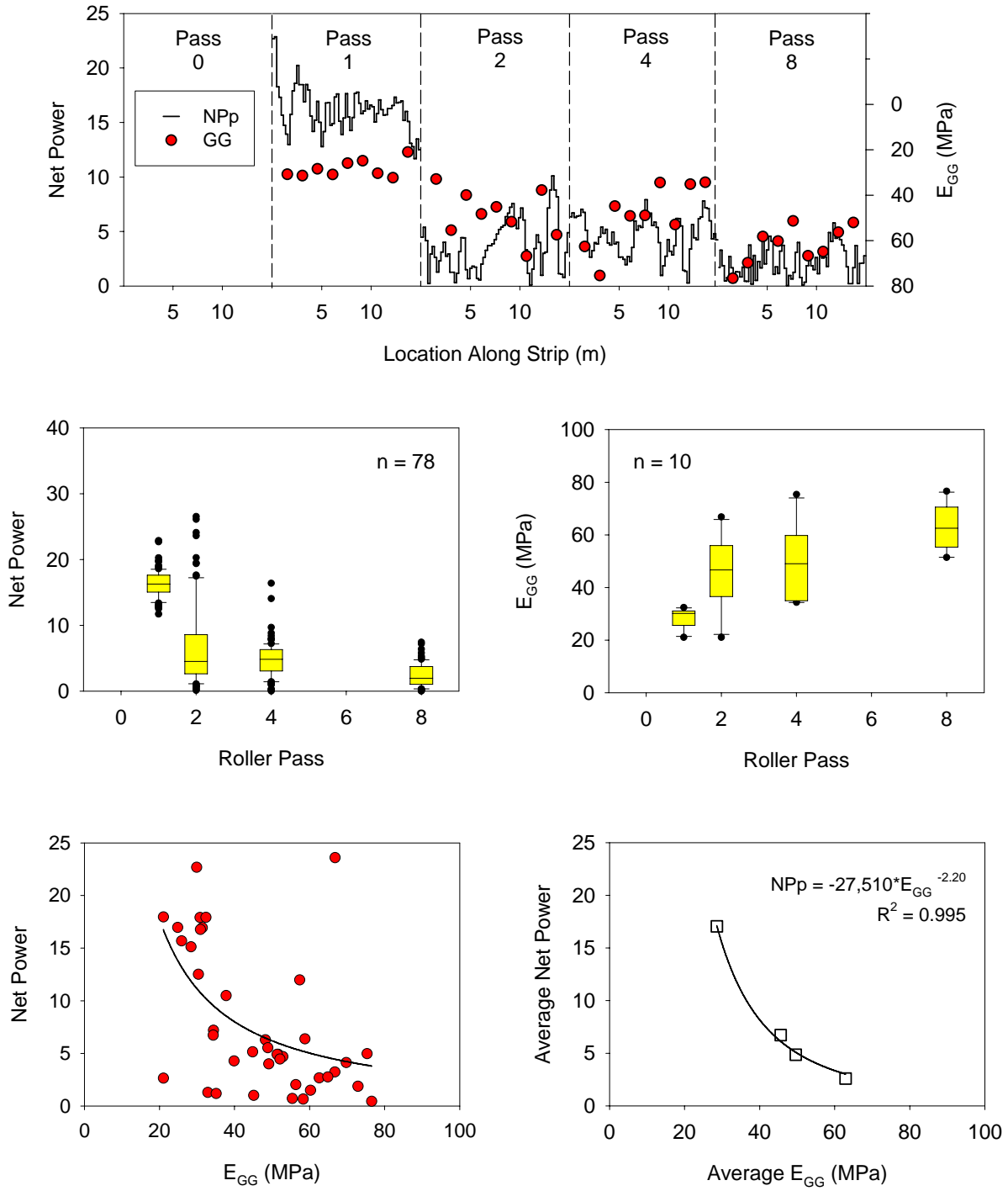




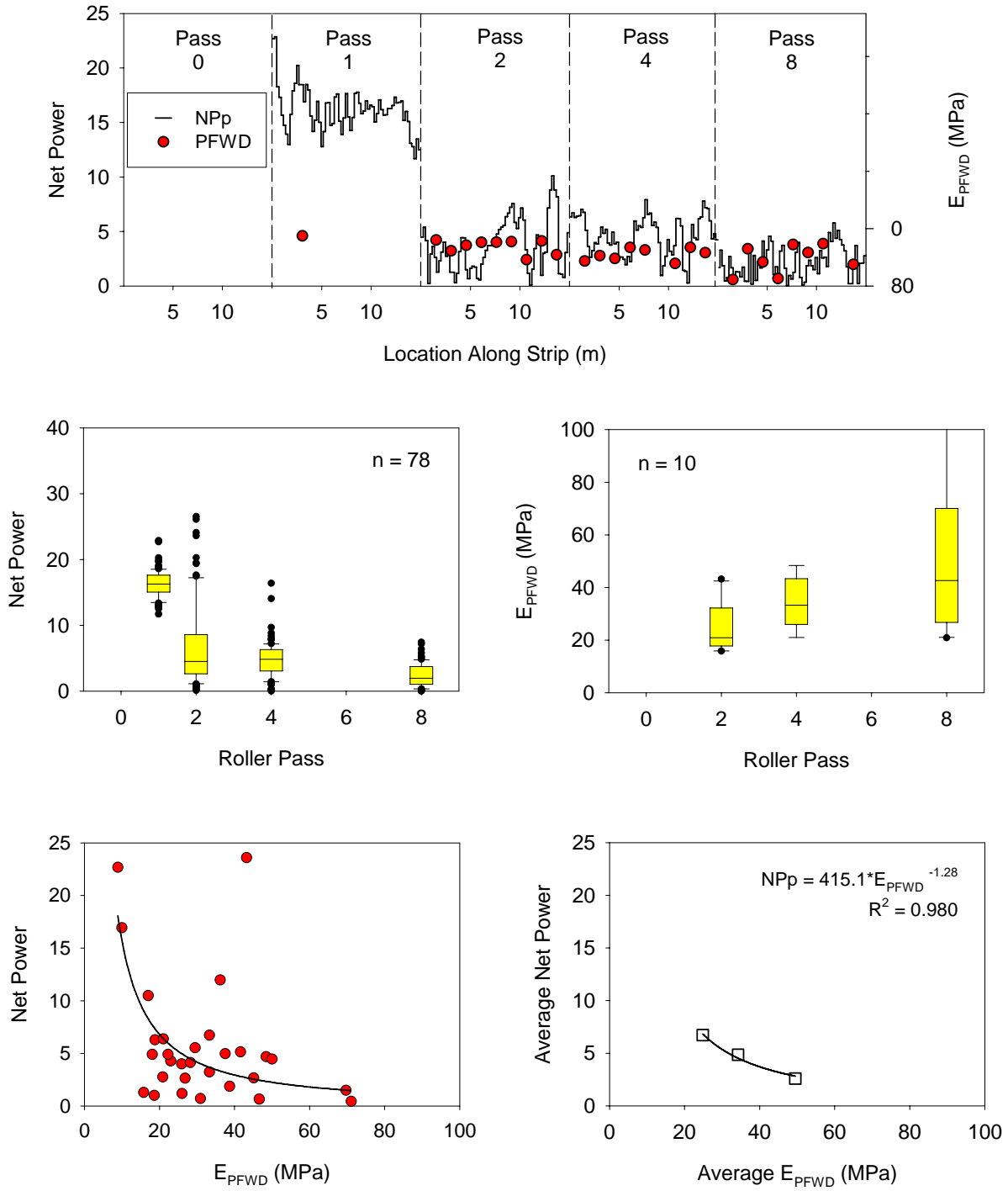
**Figure 74. Fill clay, strip 2: net power–CIV correlation**



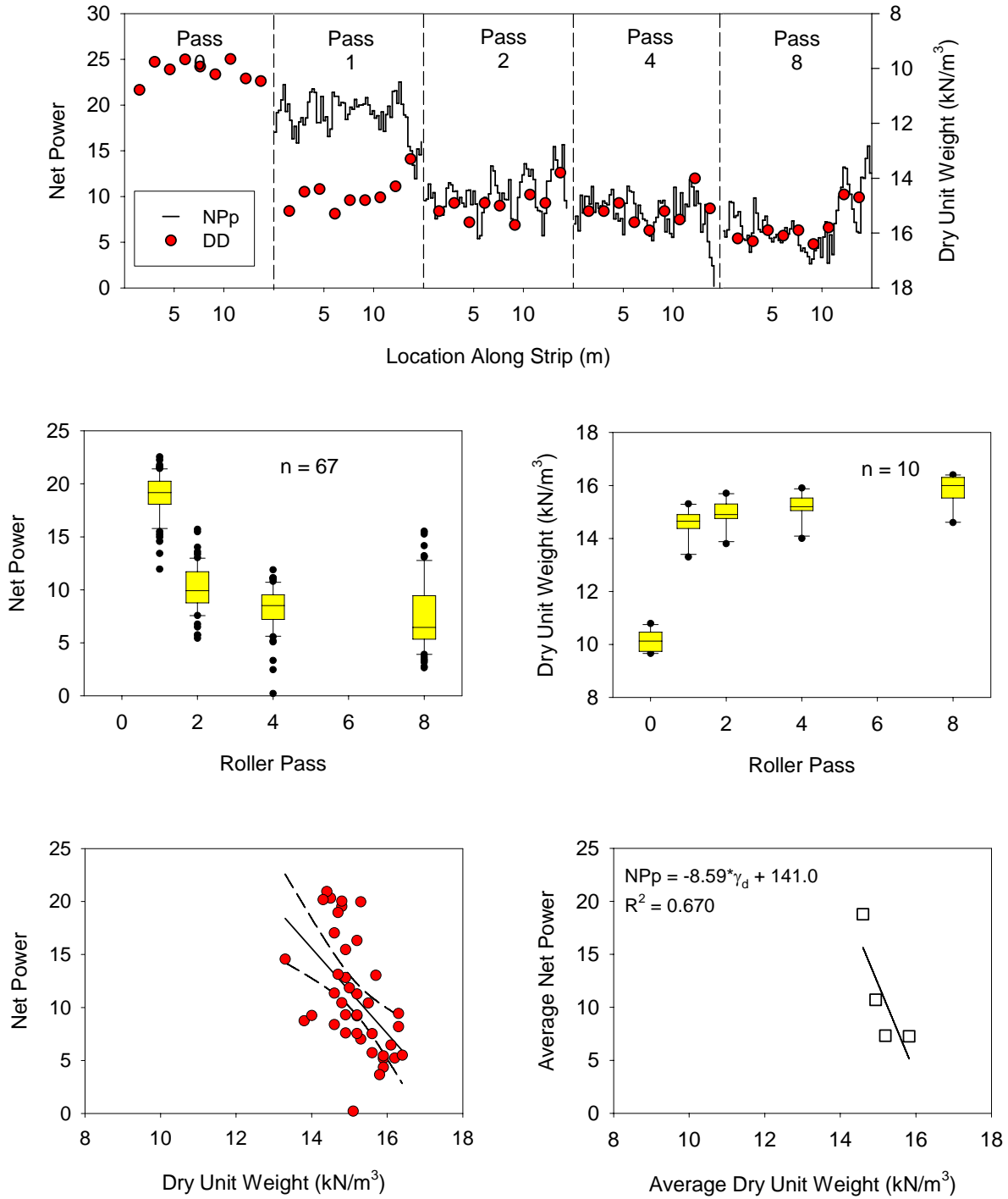
**Figure 75. Fill clay, strip 2: net power–DCP index correlation**



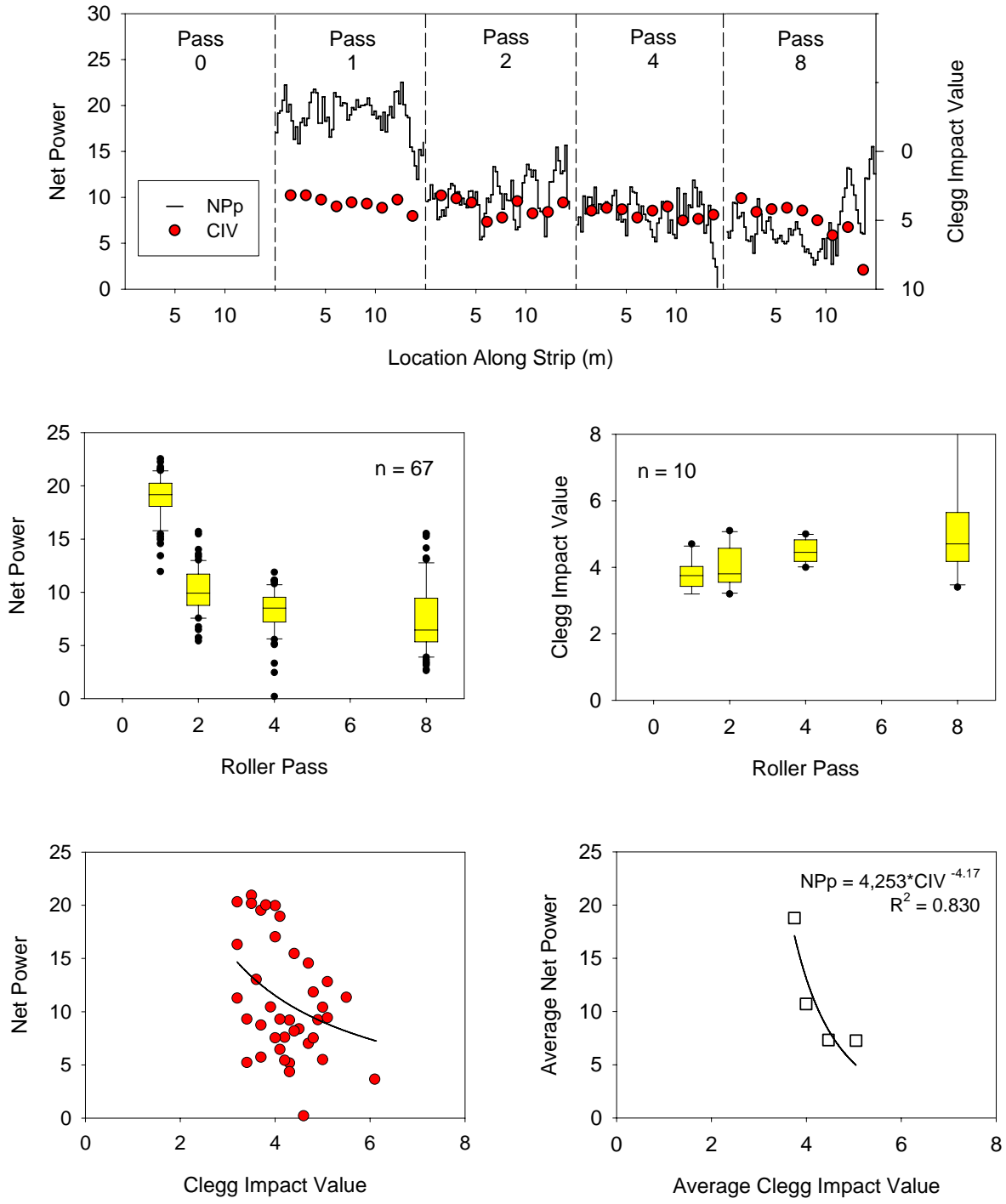
**Figure 76. Fill clay, strip 2: net power–GeoGauge modulus correlation**



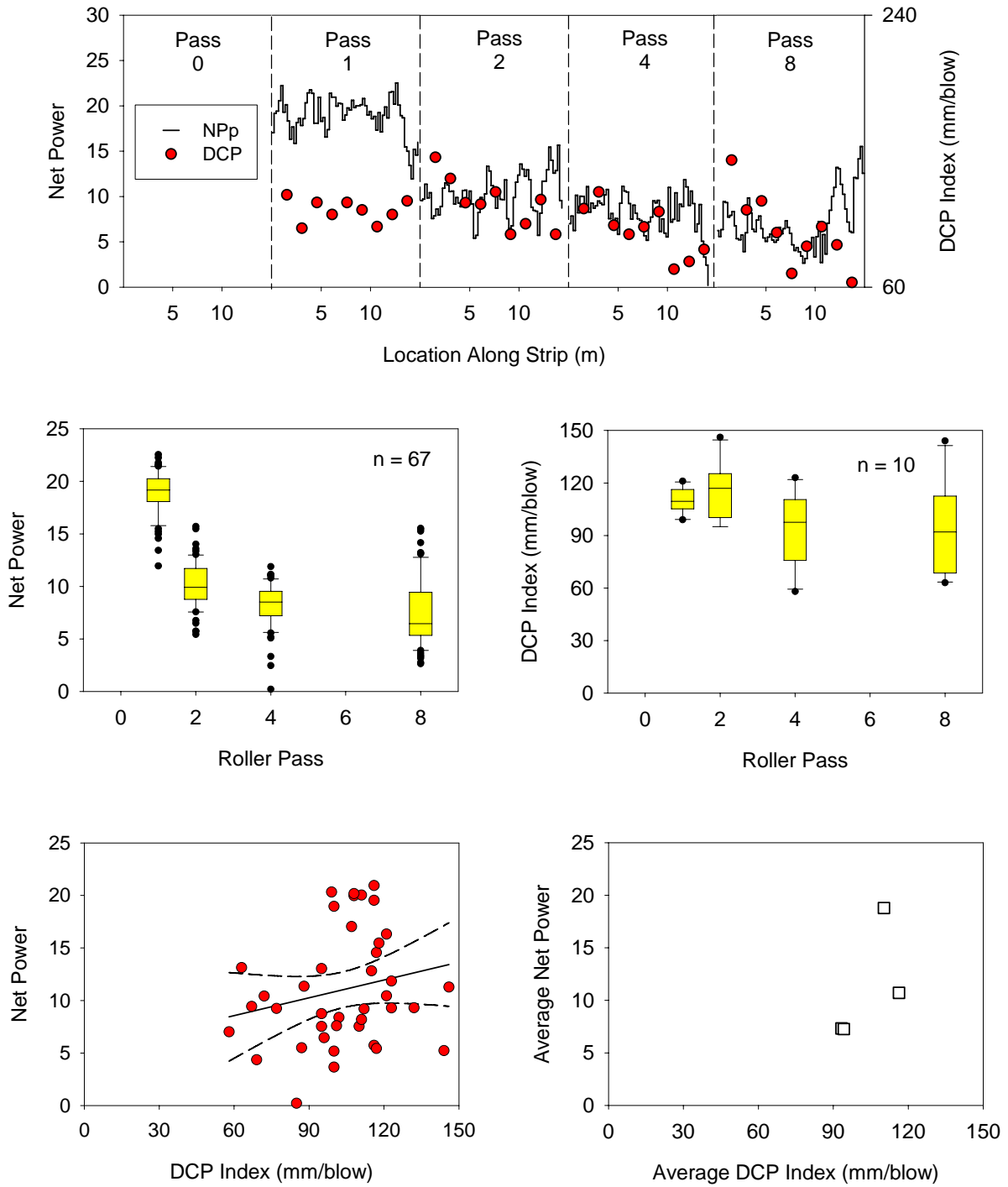
**Figure 77. Fill clay, strip 2: net power–PFWD modulus correlation**



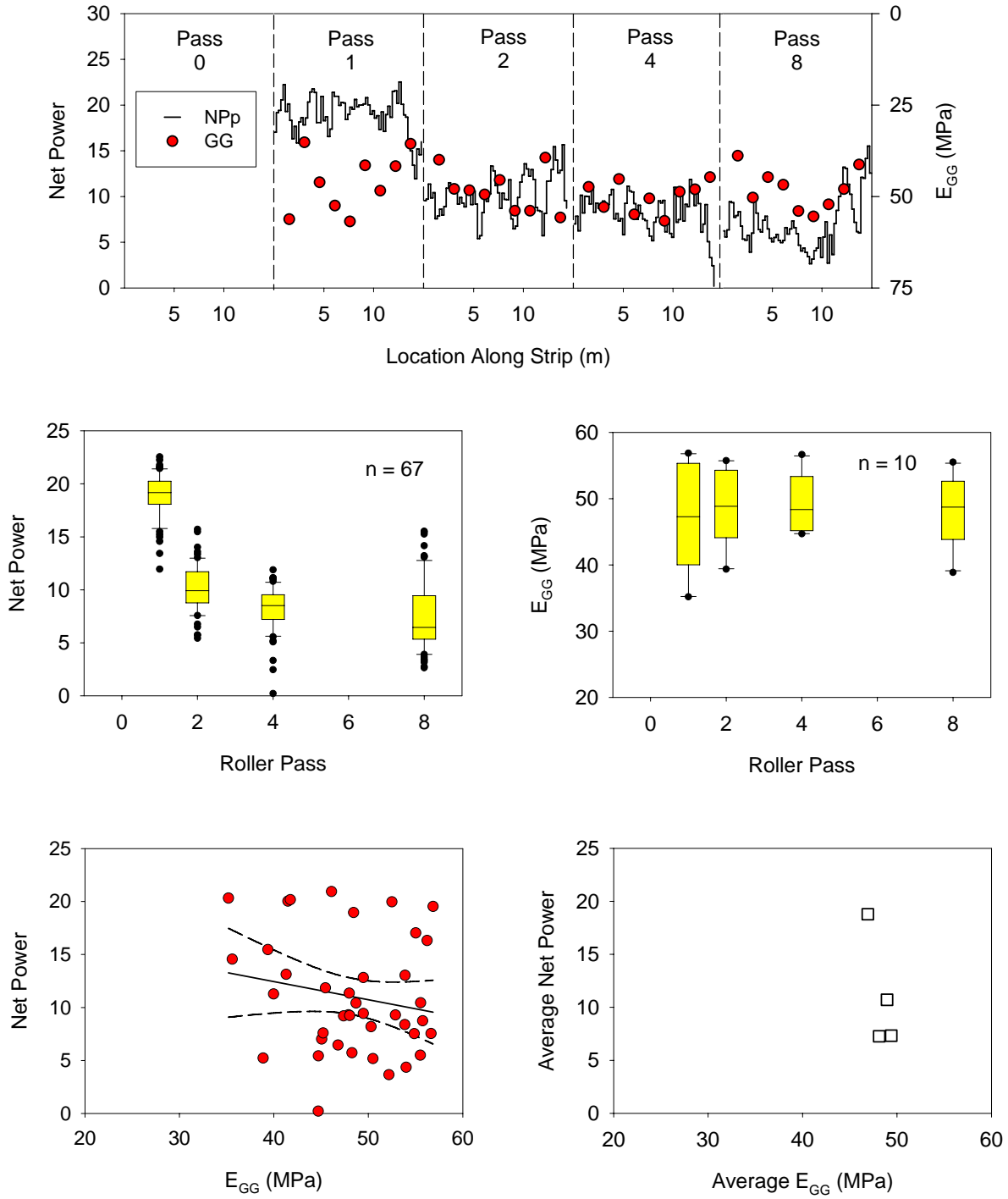
**Figure 78. Fill clay, strip 3: net power–dry unit weight correlation**



**Figure 79. Fill clay, strip 3: net power–CIV correlation**

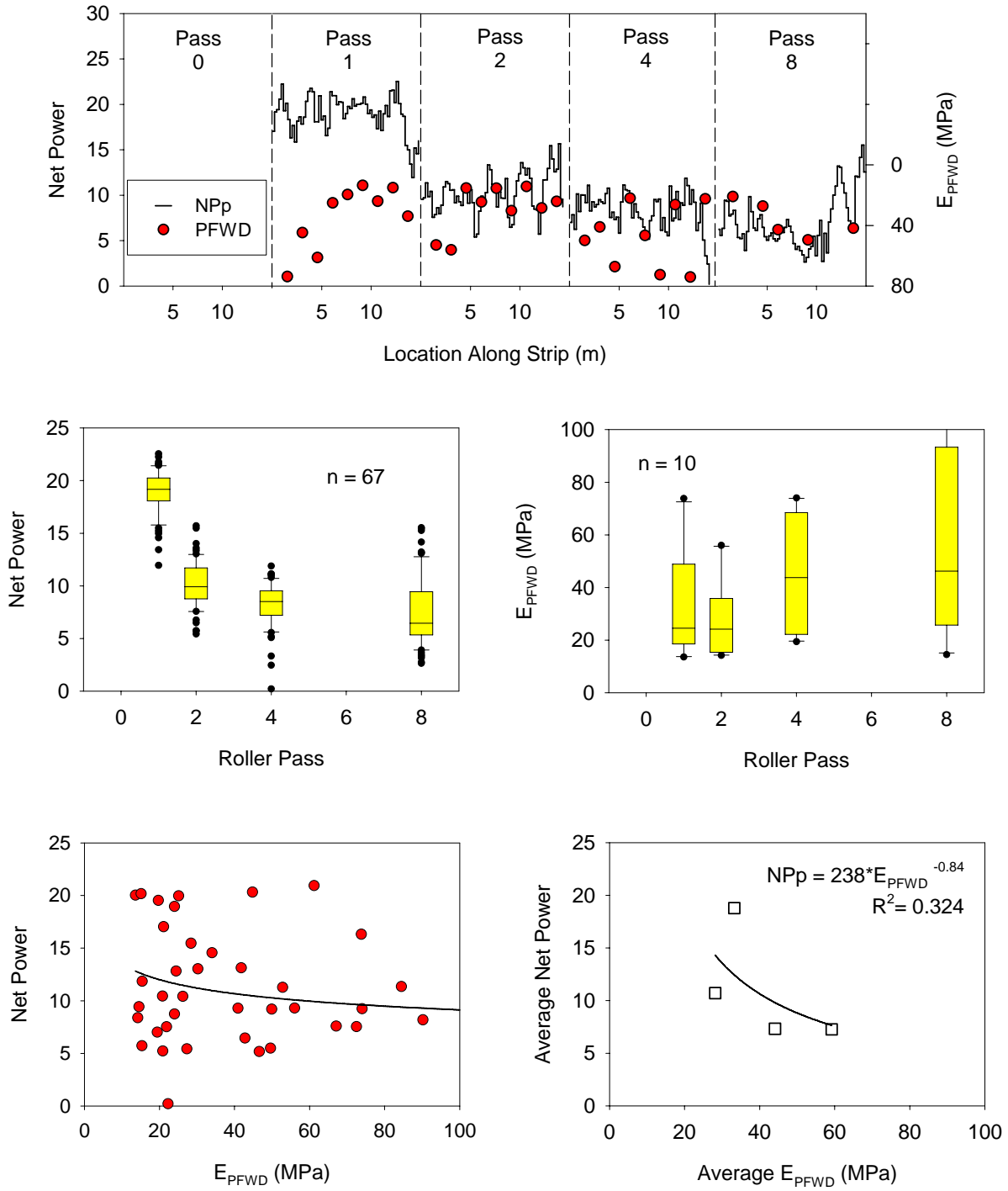


**Figure 80. Fill clay, strip 3: net power-DCP index correlation**

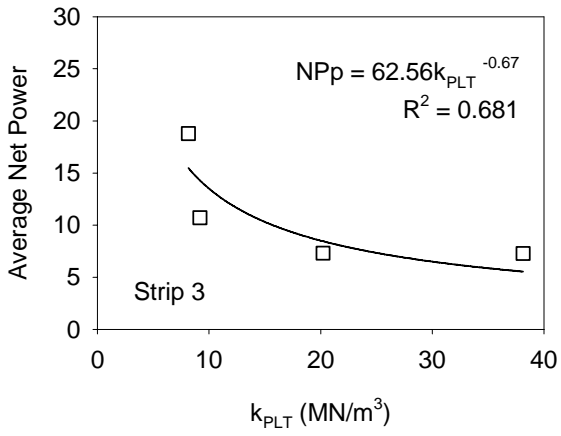
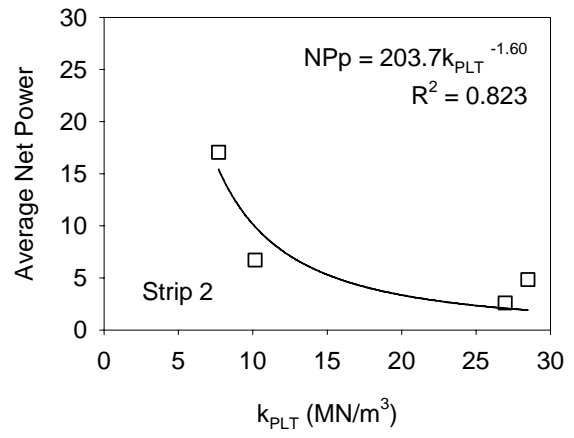
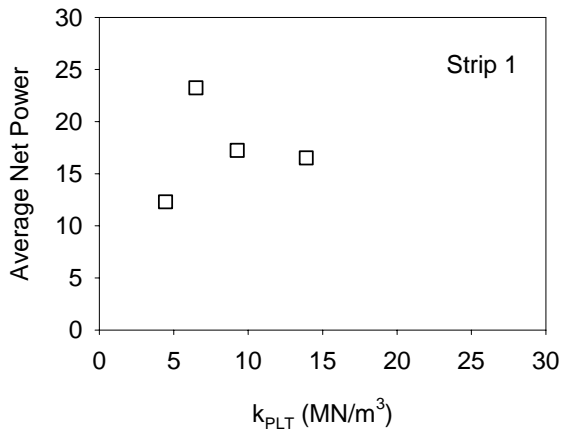


**Figure 81. Fill clay, strip 3: net power-GeoGauge modulus correlation**

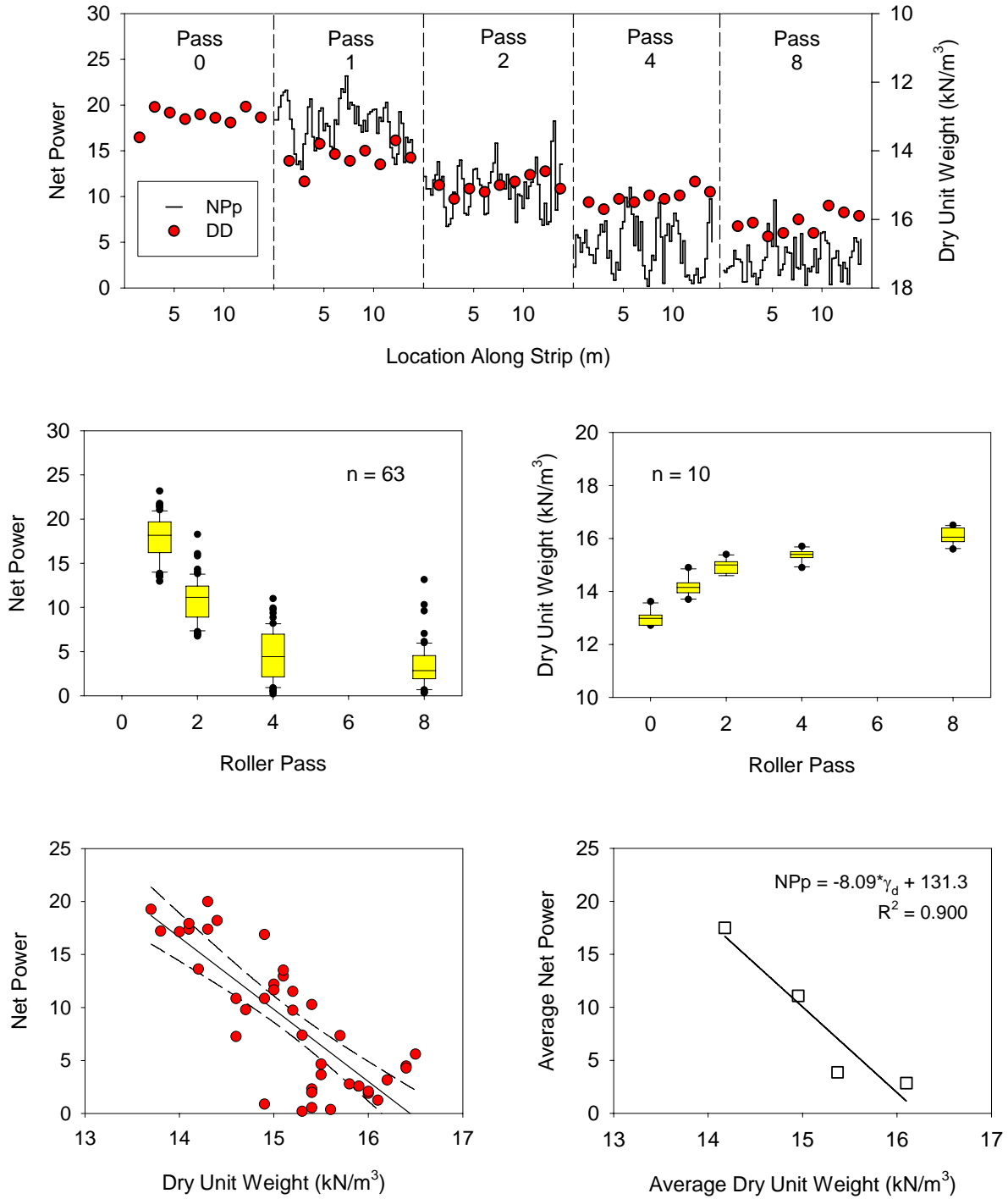




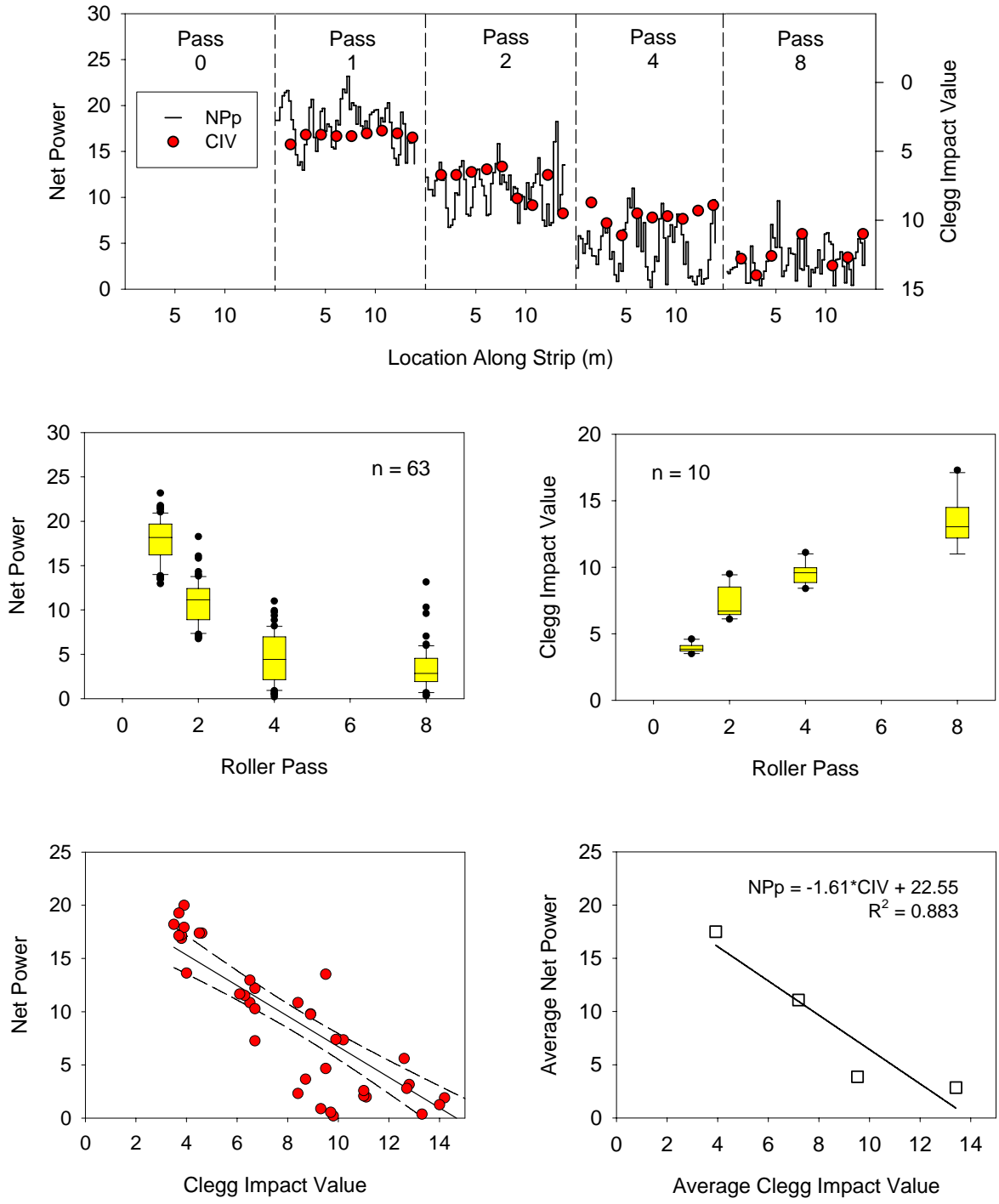
**Figure 82. Fill clay, strip 3: net power–PFWD modulus correlation**



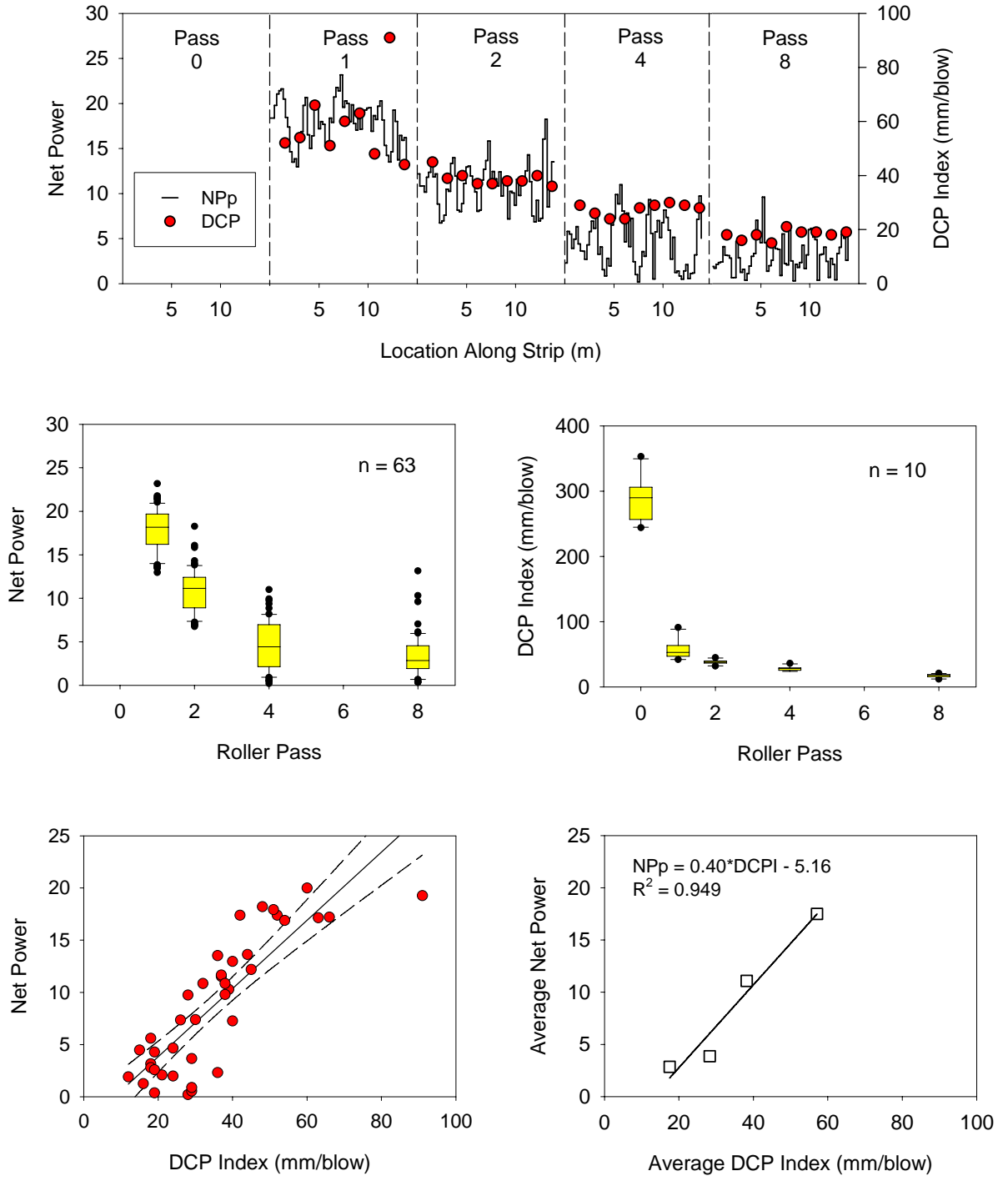
**Figure 83. Fill clay, net power–coefficient of subgrade reaction correlation**



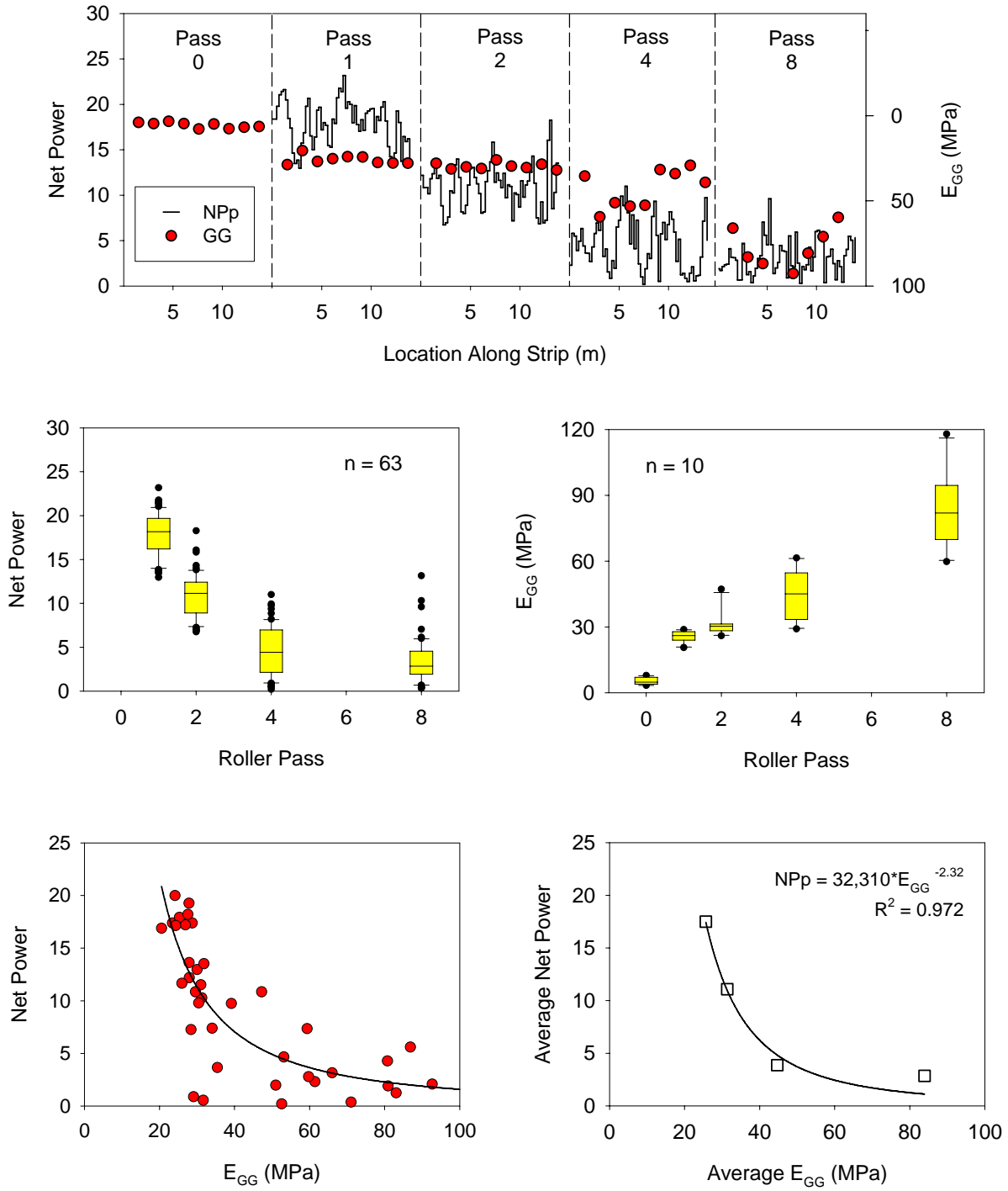
**Figure 84. Edwards till, strip 1: net power–dry unit weight correlation**



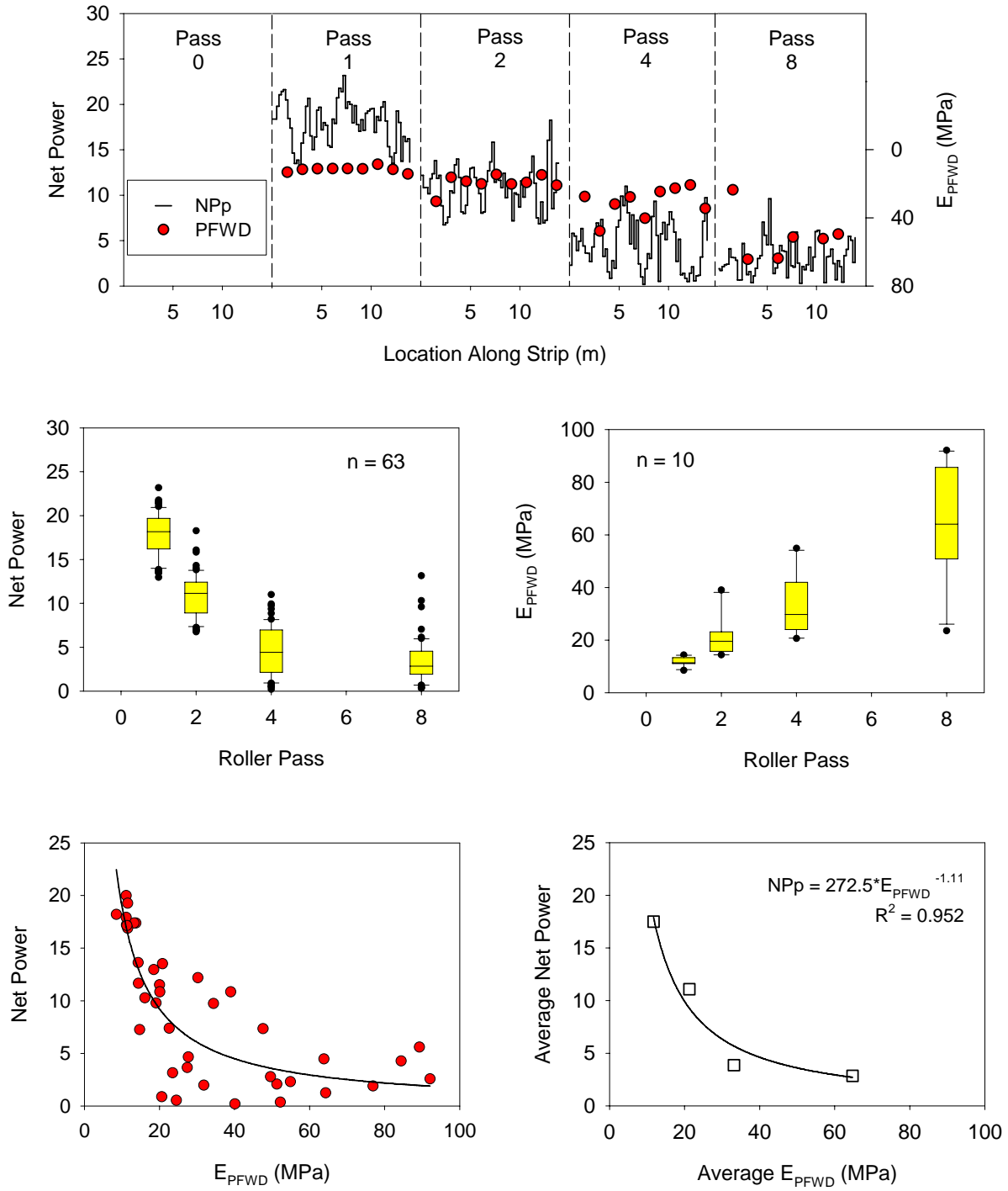
**Figure 85. Edwards till, strip 1: net power–CIV correlation**



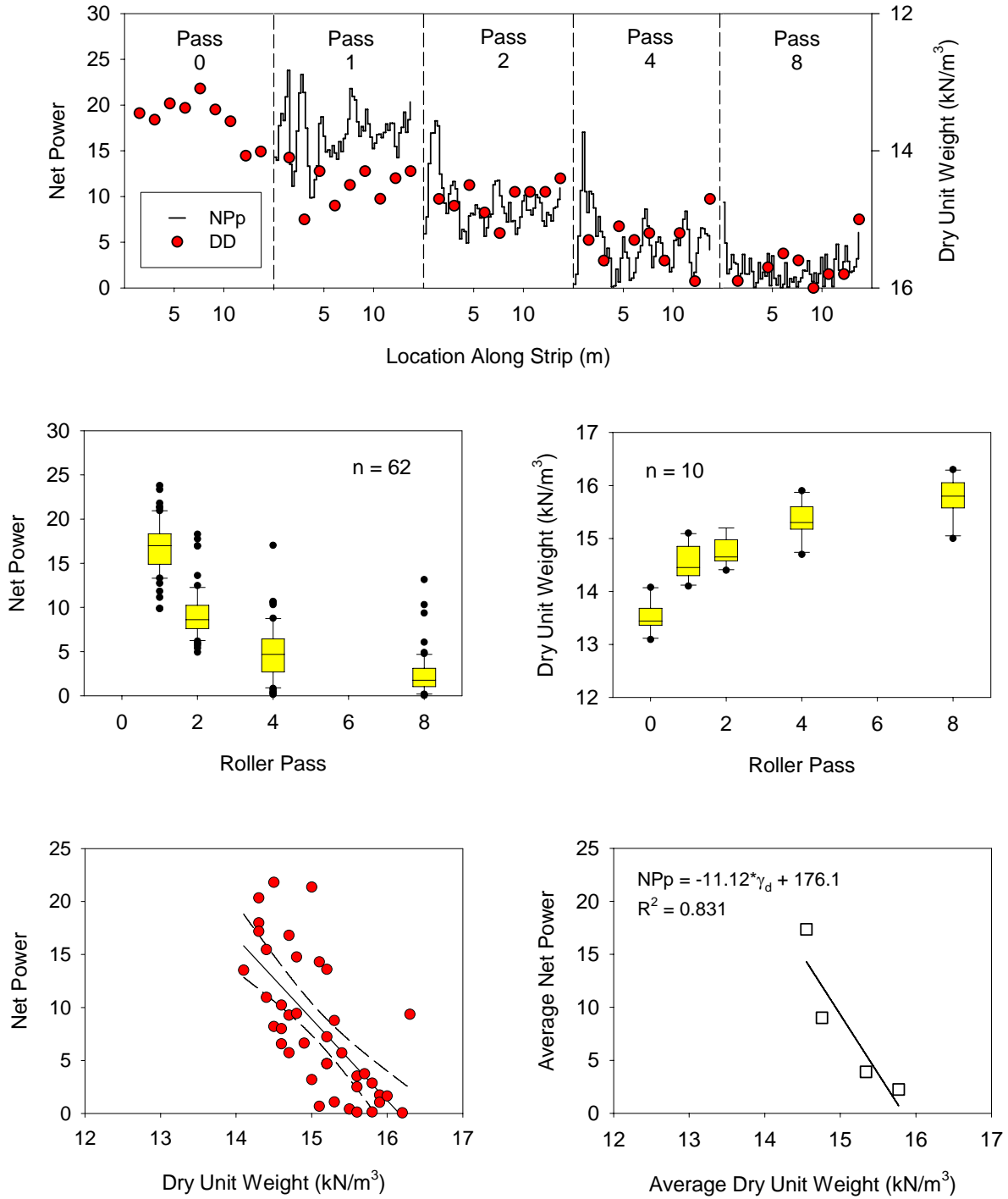
**Figure 86. Edwards till, strip 1: net power–DCP index correlation**



**Figure 87. Edwards till, strip 1: net power–GeoGauge modulus correlation**

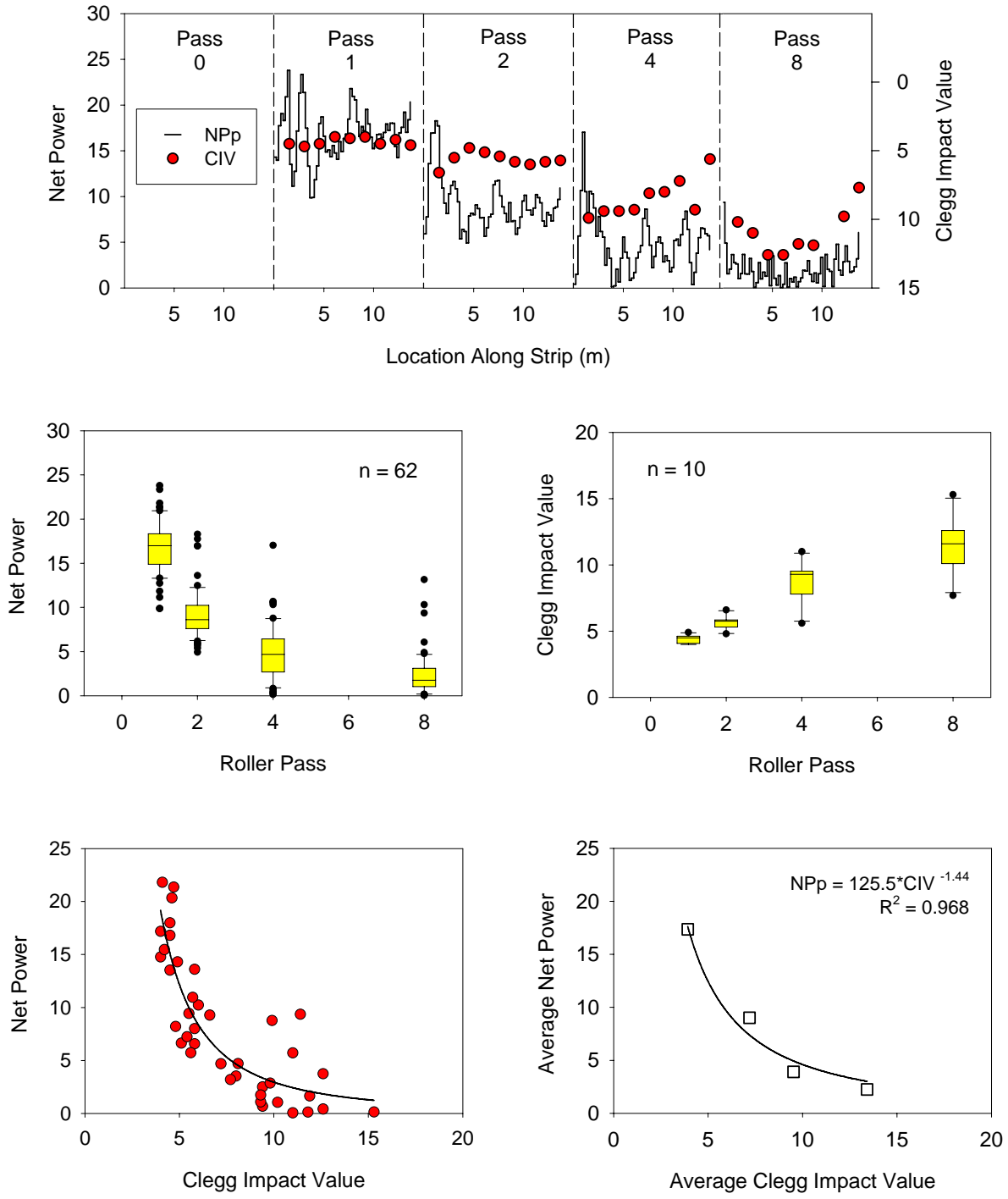


**Figure 88. Edwards till, strip 1: net power–PFWD modulus correlation**

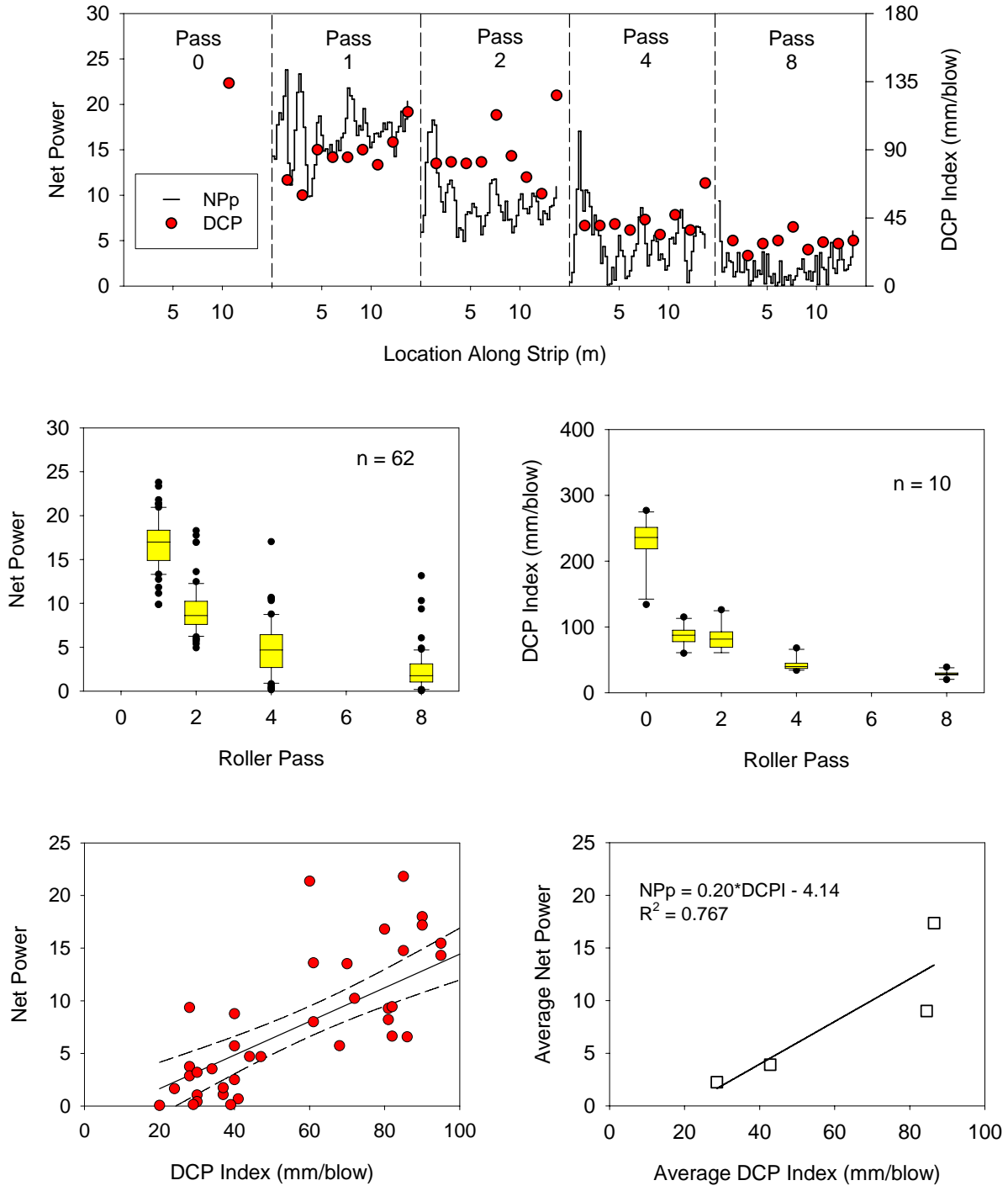


**Figure 89. Edwards till, strip 2: net power–dry unit weight correlation**

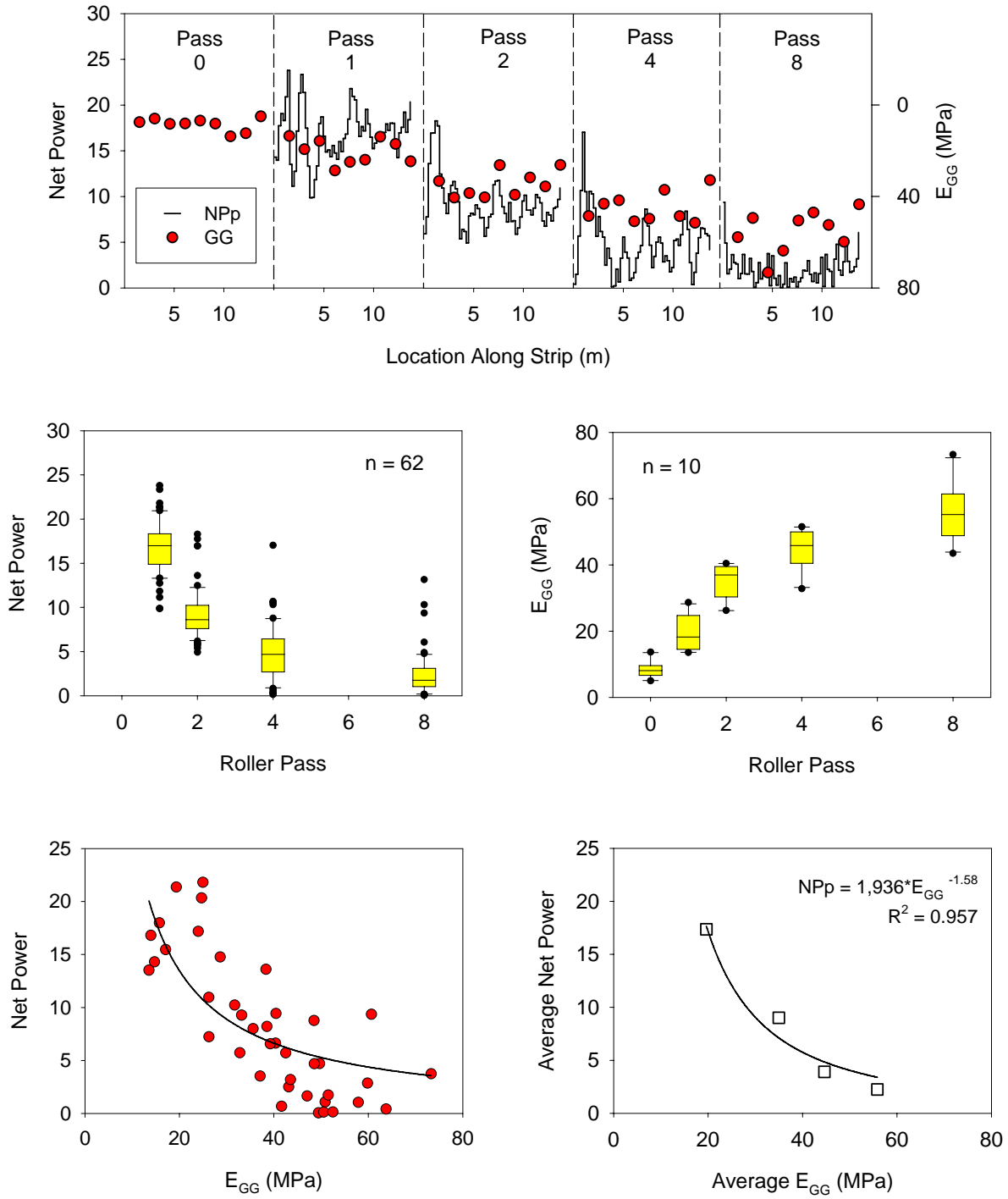




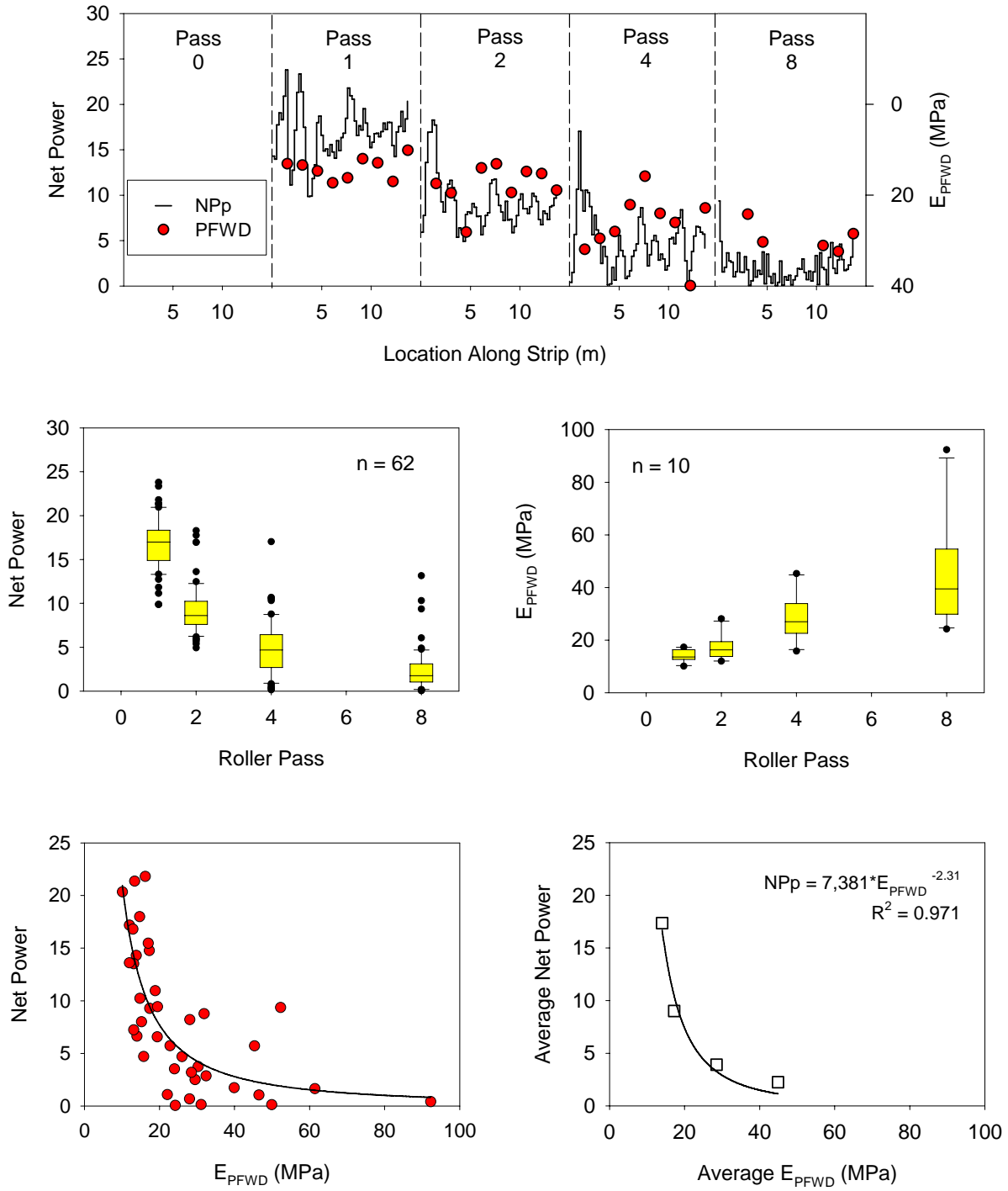
**Figure 90. Edwards till, strip 2: net power–CIV correlation**



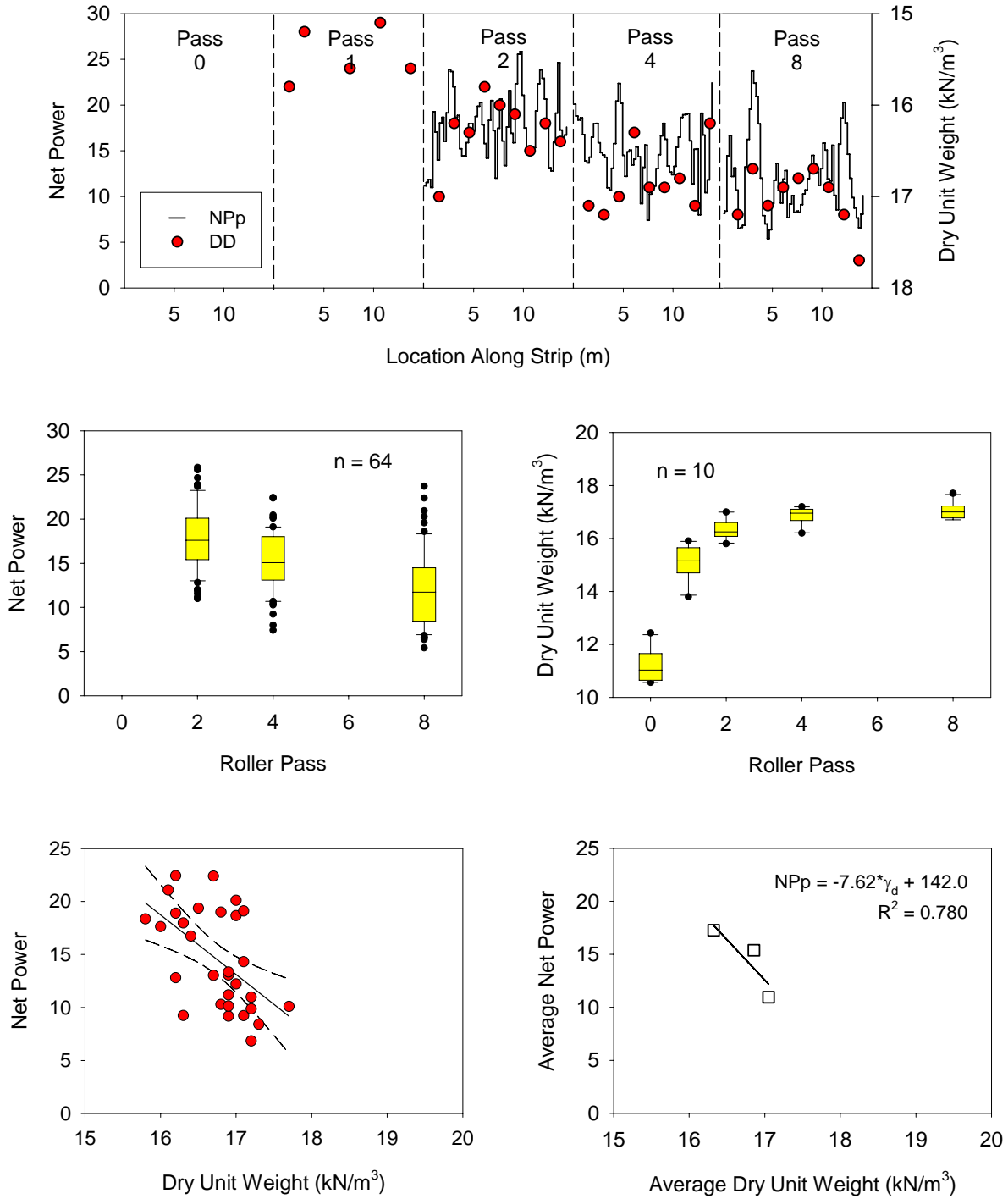
**Figure 91. Edwards till, strip 2: net power–DCP index correlation**



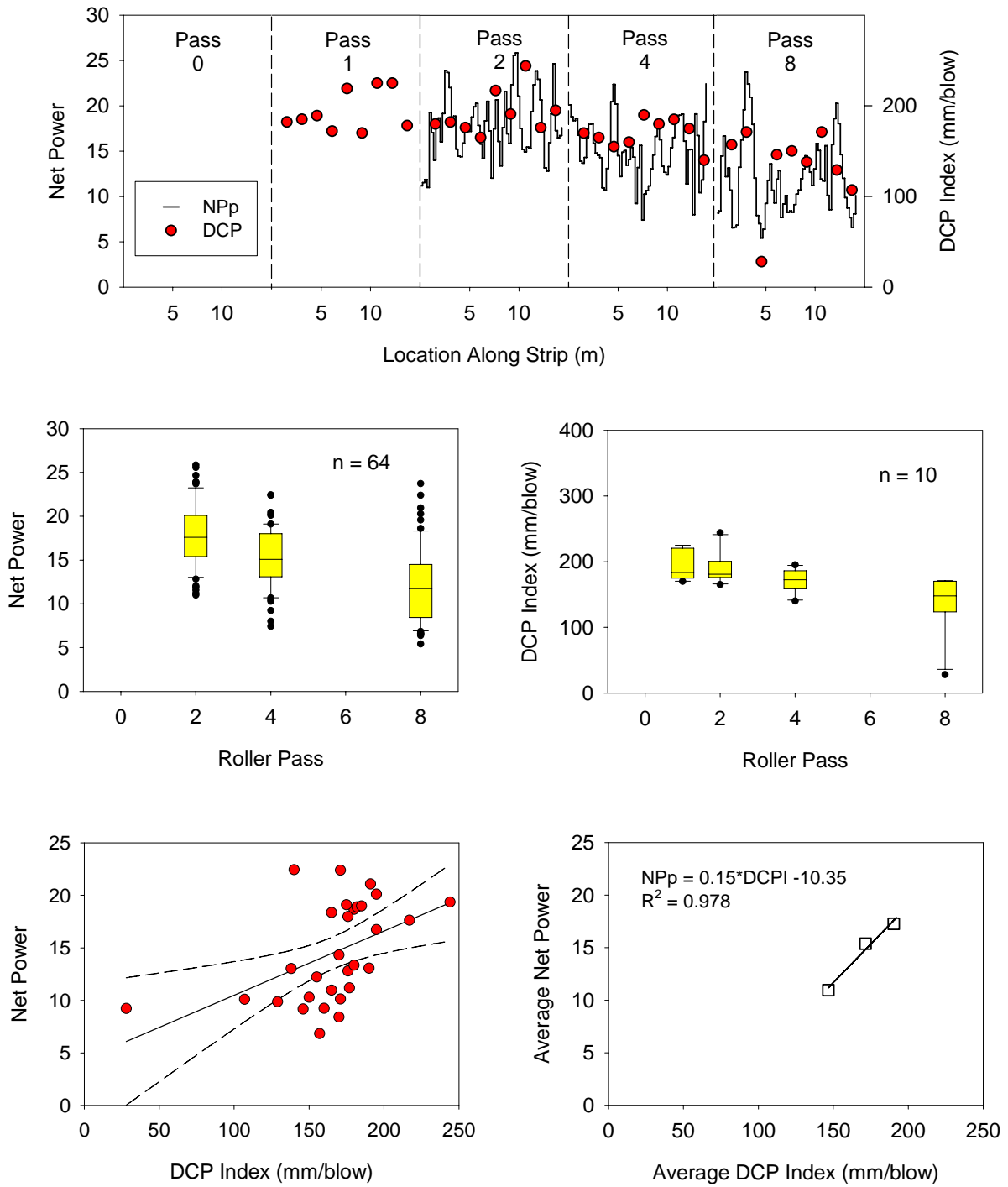
**Figure 92. Edwards till, strip 2: net power–GeoGauge modulus correlation**



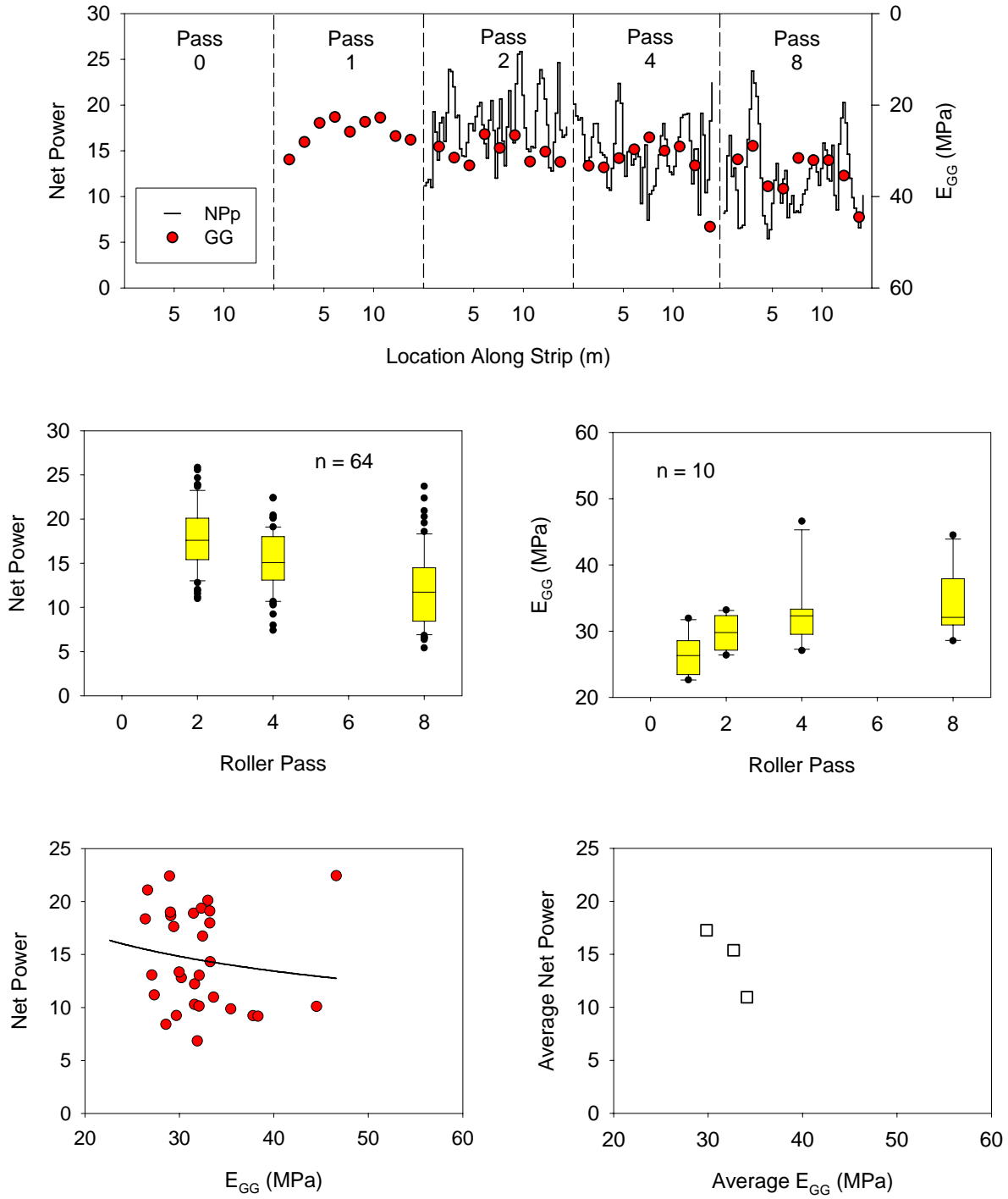
**Figure 93. Edwards till, strip 2: net power–PFWD modulus correlation**



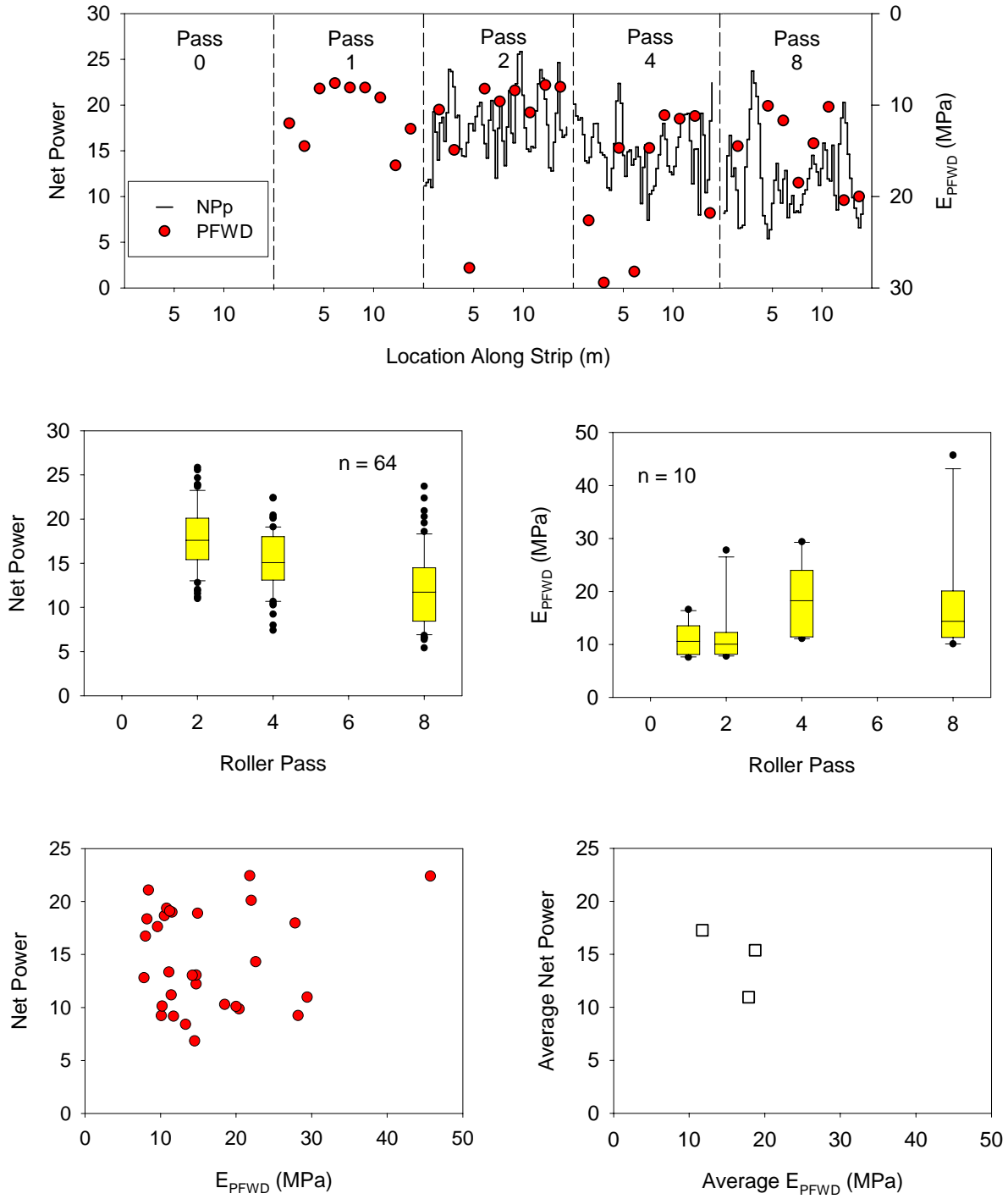
**Figure 94. Edwards till, strip 3: net power–dry unit weight correlation**



**Figure 95. Edwards till, strip 3: net power–DCP index correlation**

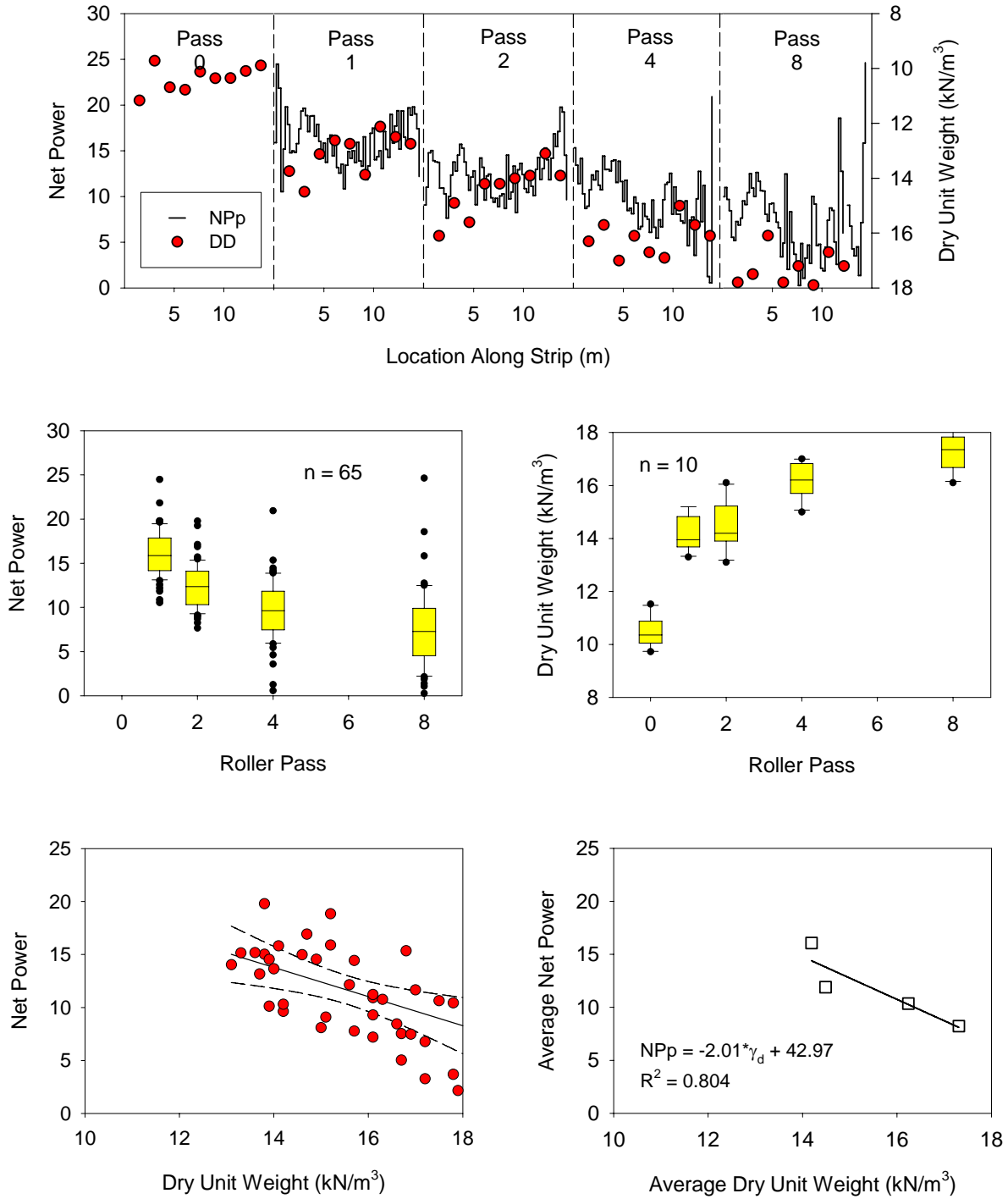


**Figure 96. Edwards till, strip 3: net power-GeoGauge modulus correlation**

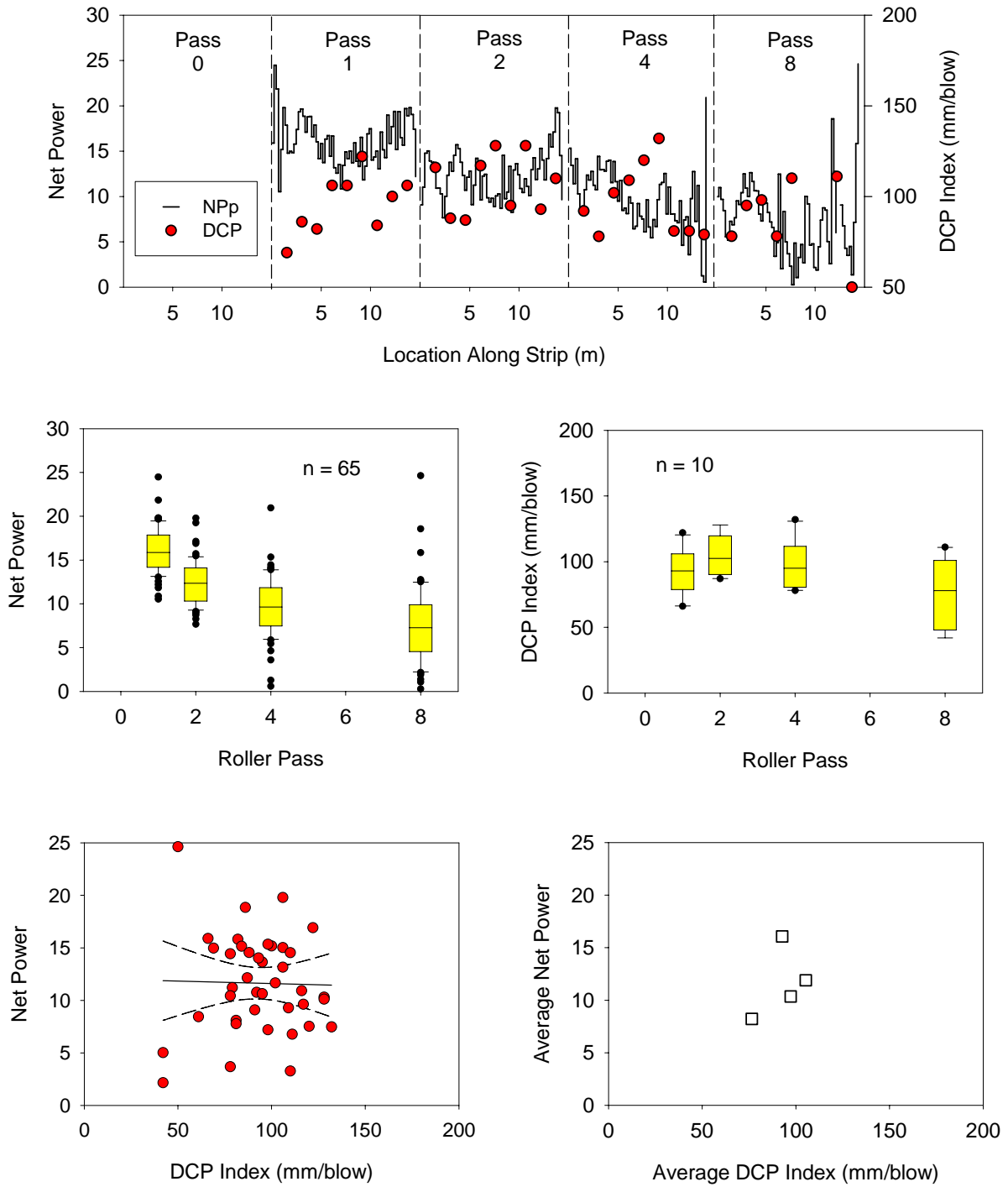


**Figure 97. Edwards till, strip 3: net power–PFWD modulus correlation**

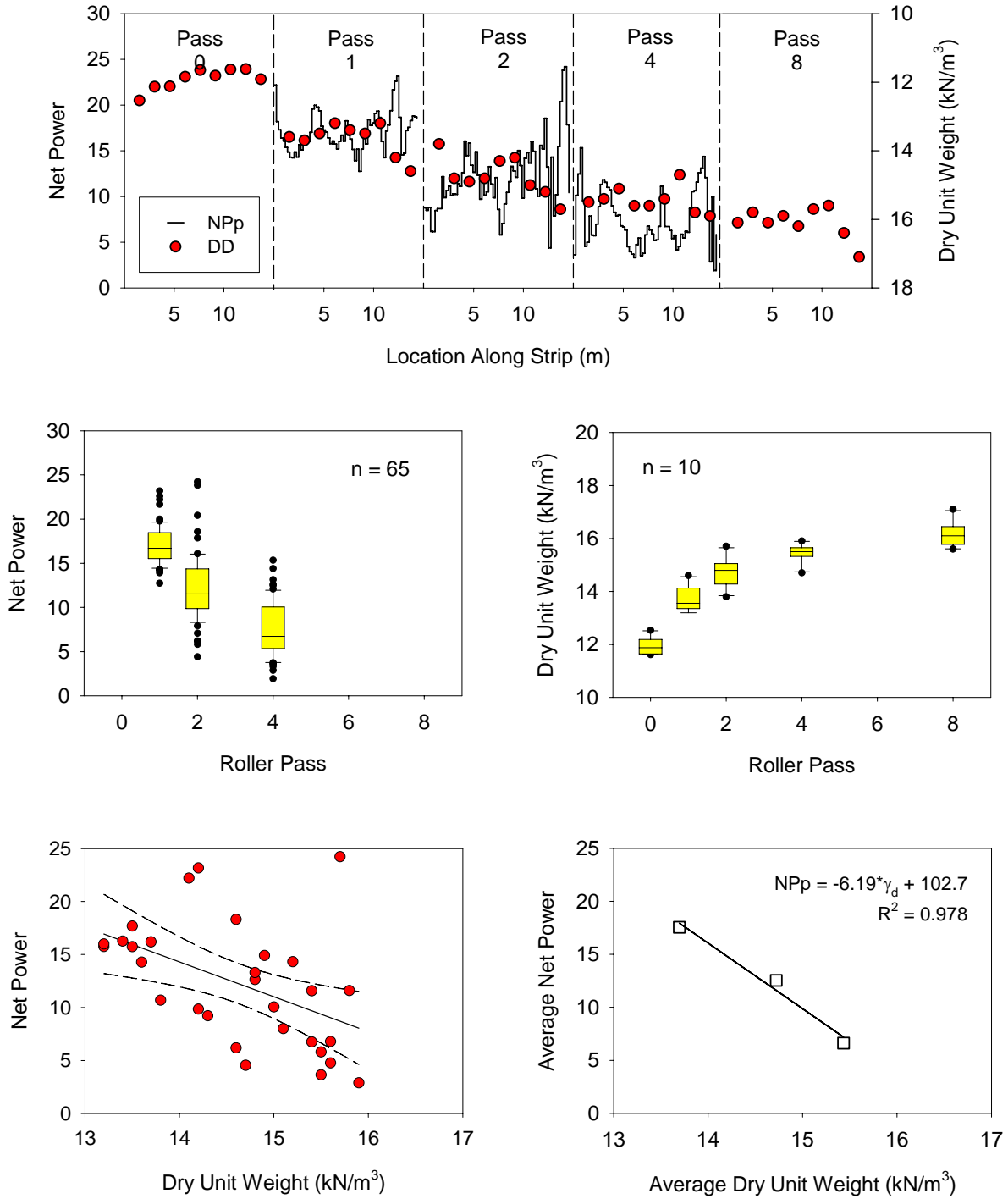




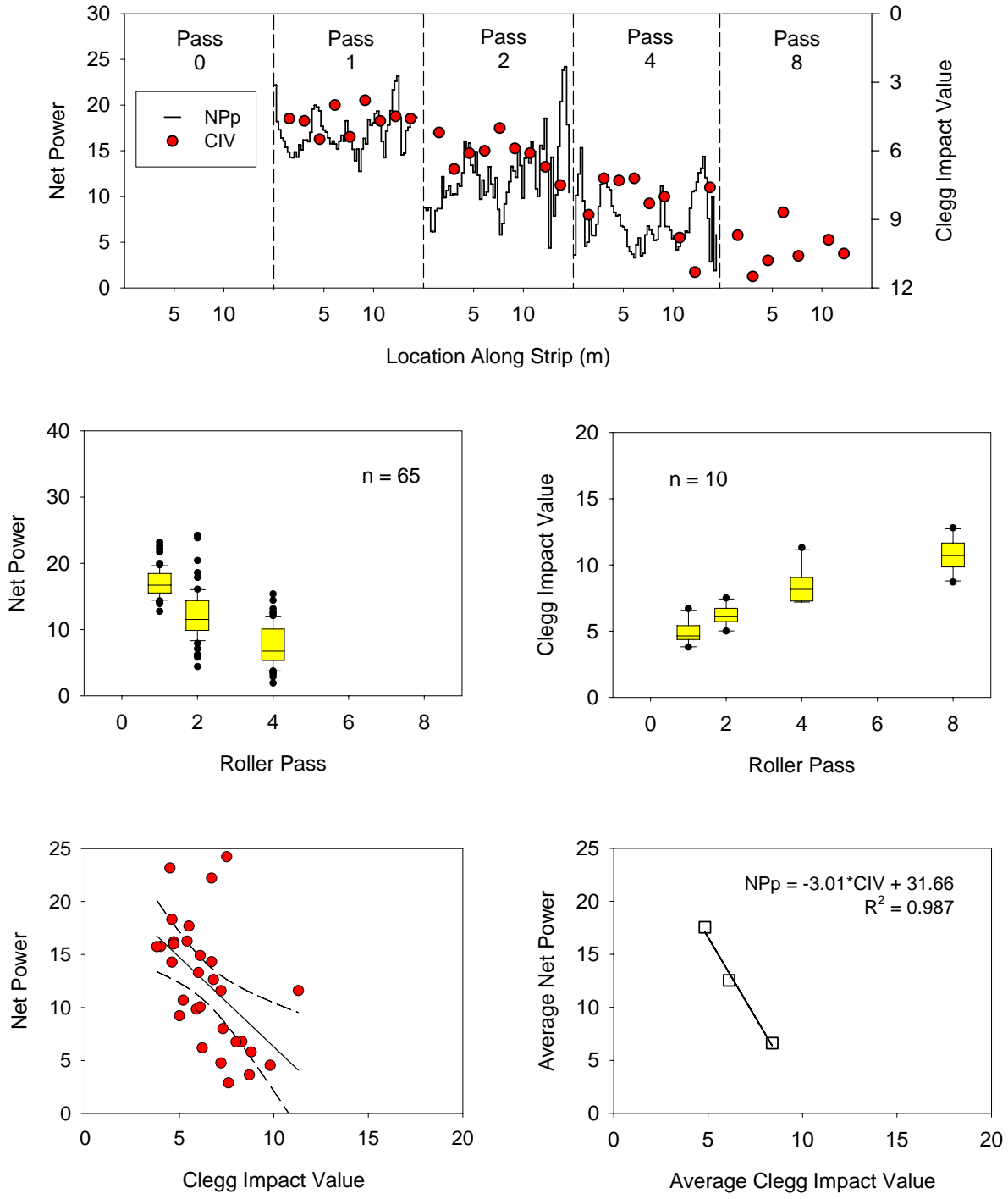
**Figure 98. Edwards till, strip 4: net power–dry unit weight correlation**



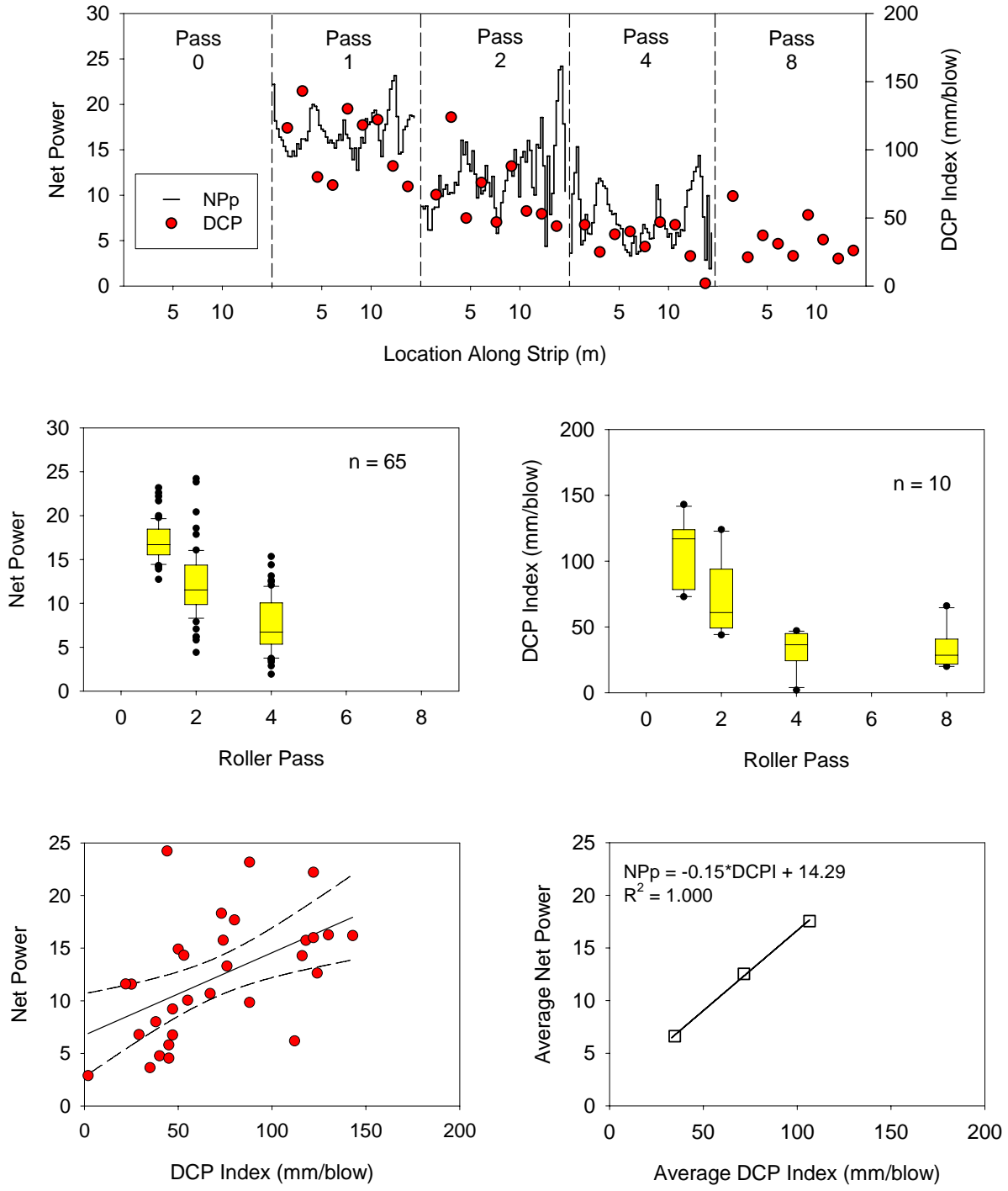
**Figure 99. Edwards till, strip 4: net power–DCP index correlation**



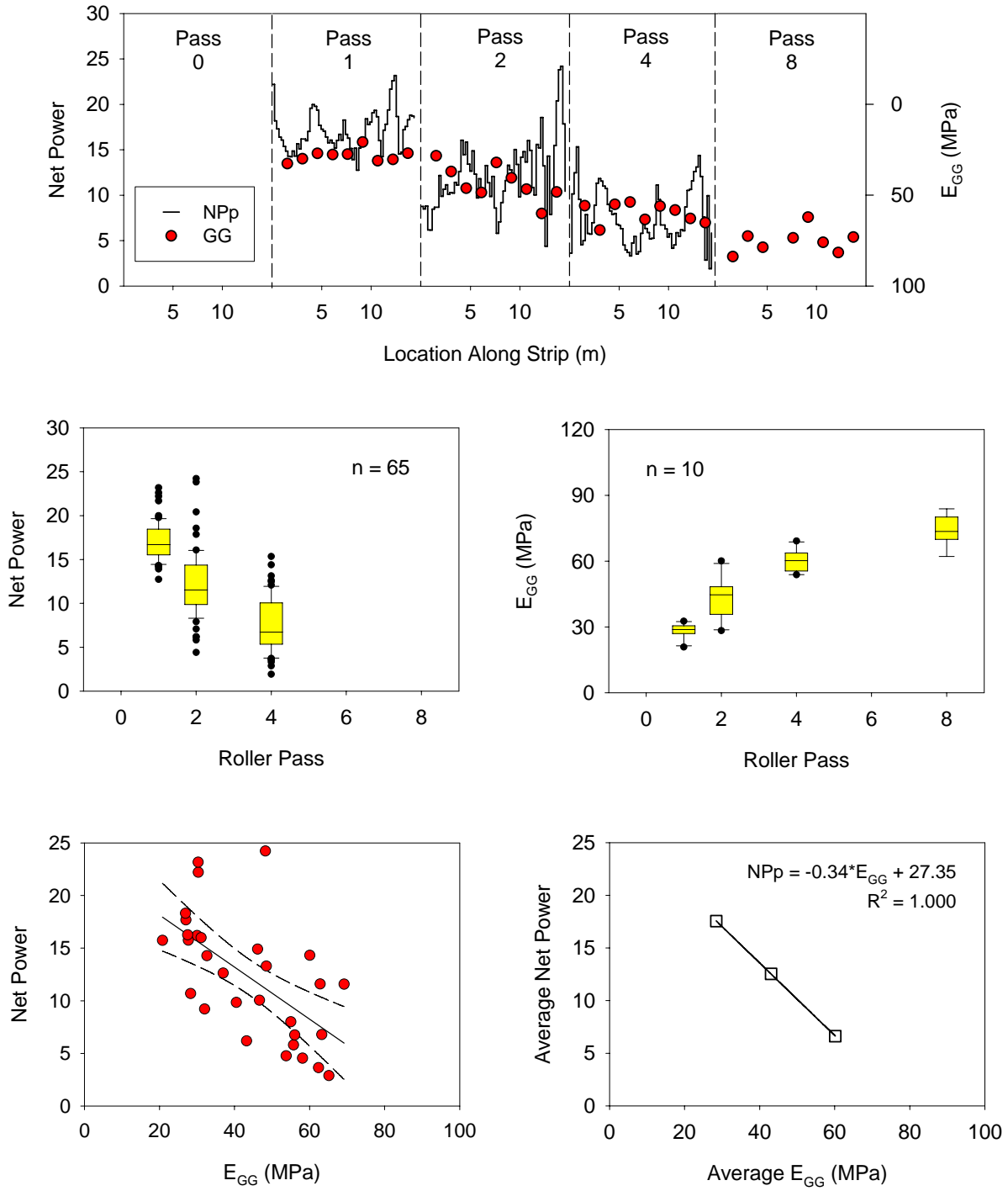
**Figure 100. Edwards till, strip 5: net power–dry unit weight correlation**



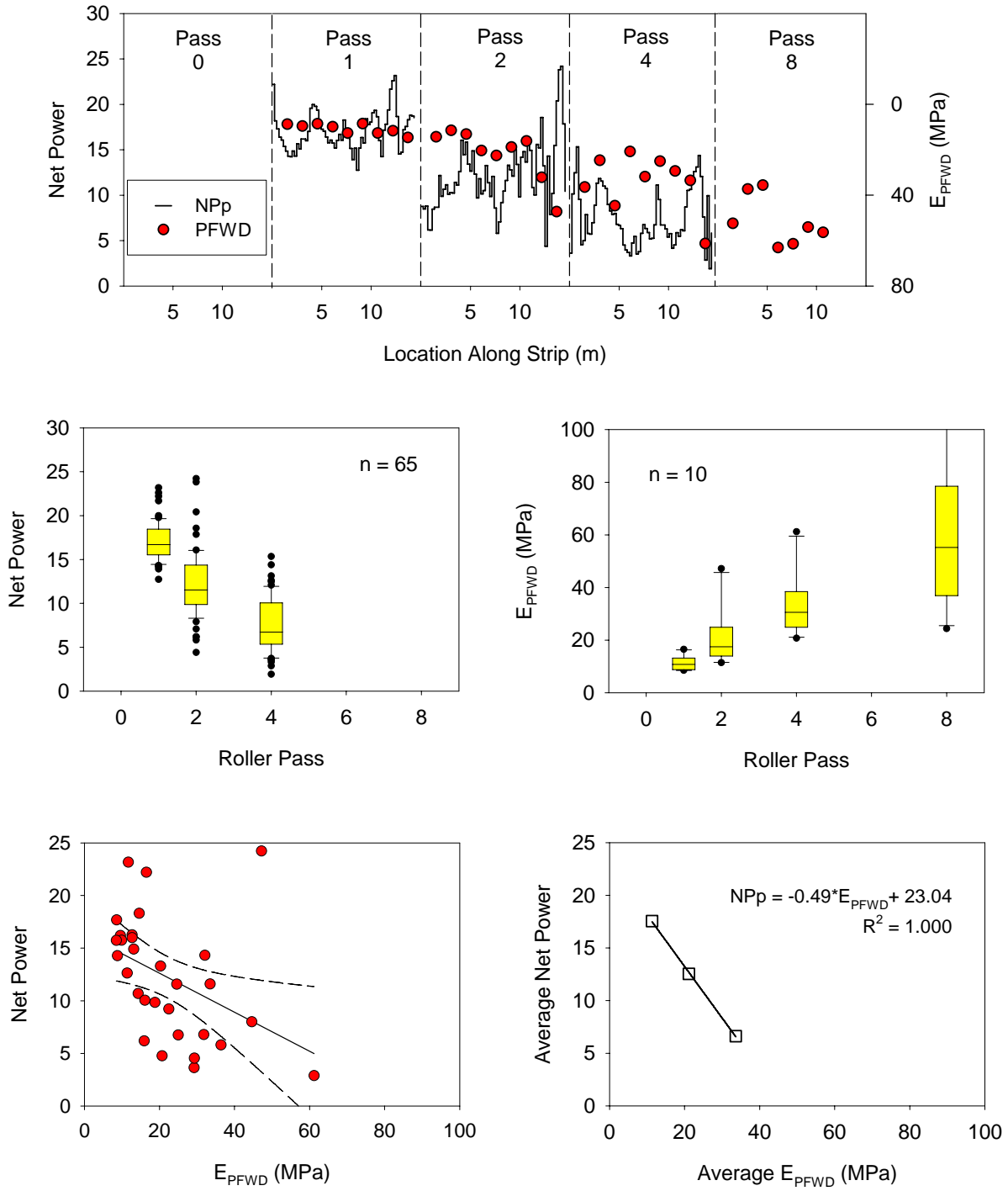
**Figure 101. Edwards till, strip 5: net power–CIV correlation**



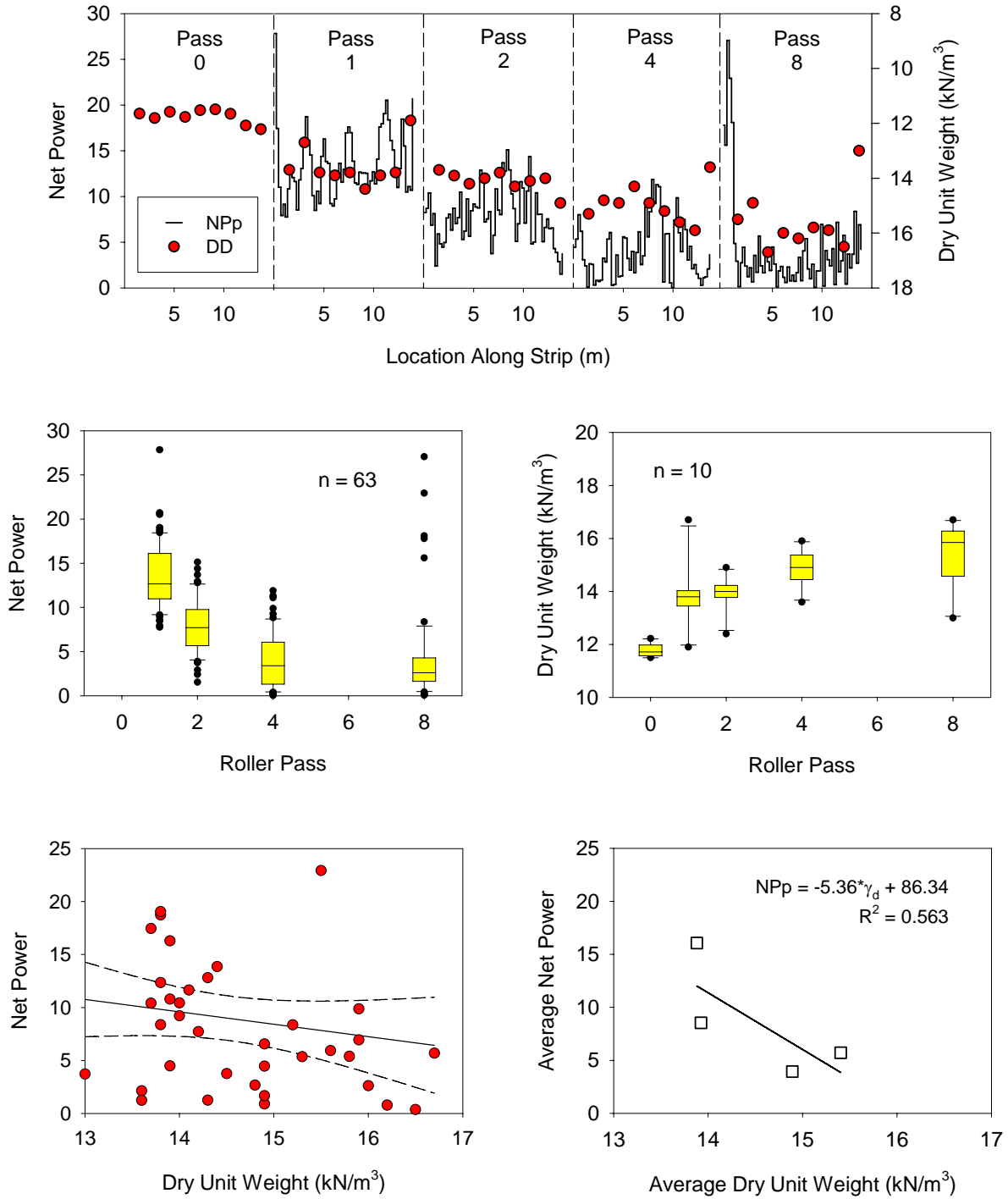
**Figure 102. Edwards till, strip 5: net power–DCP index correlation**



**Figure 103. Edwards till, strip 5: net power–GeoGauge modulus correlation**

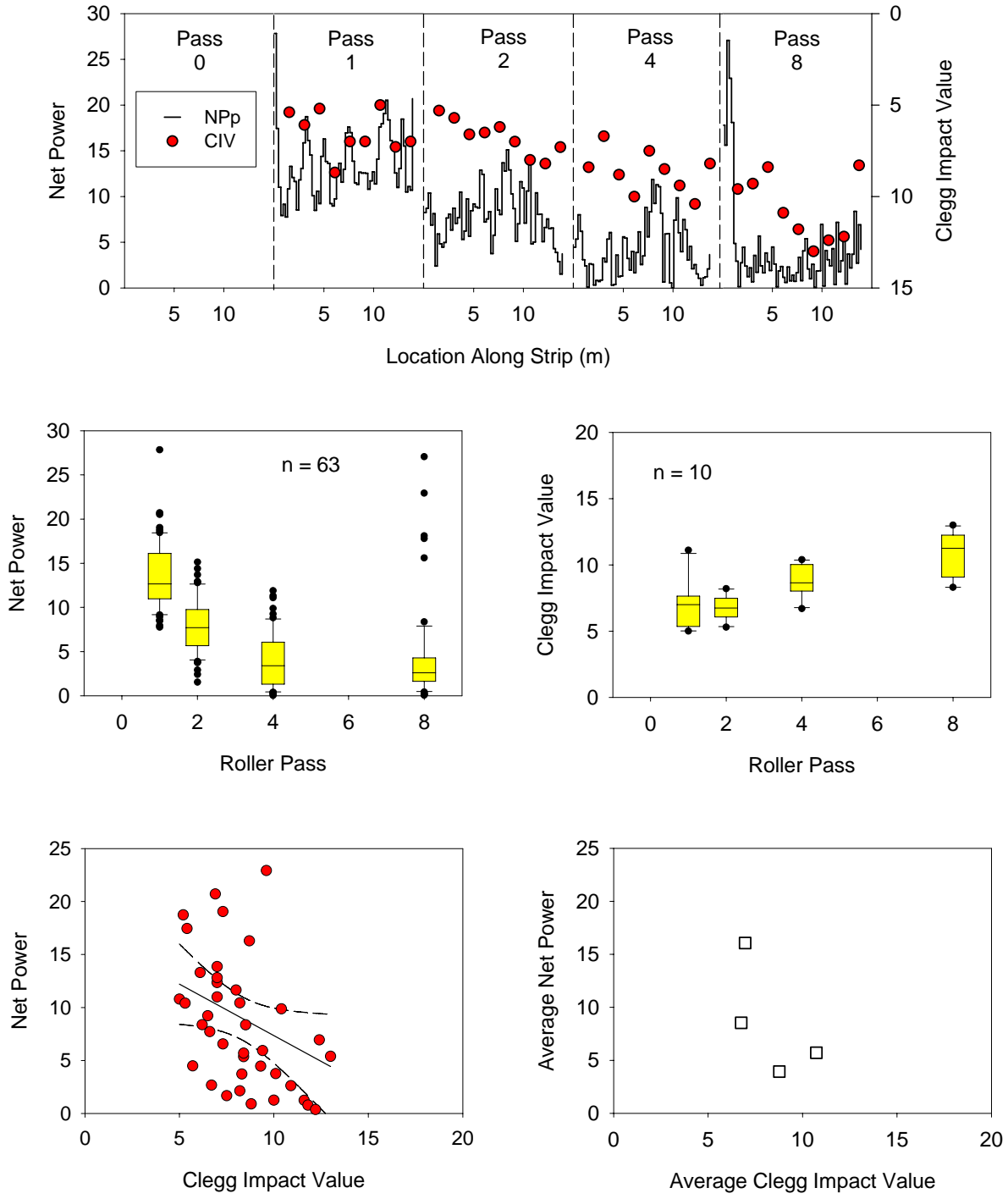


**Figure 104. Edwards till, strip 5: net power–PFWD modulus correlation**

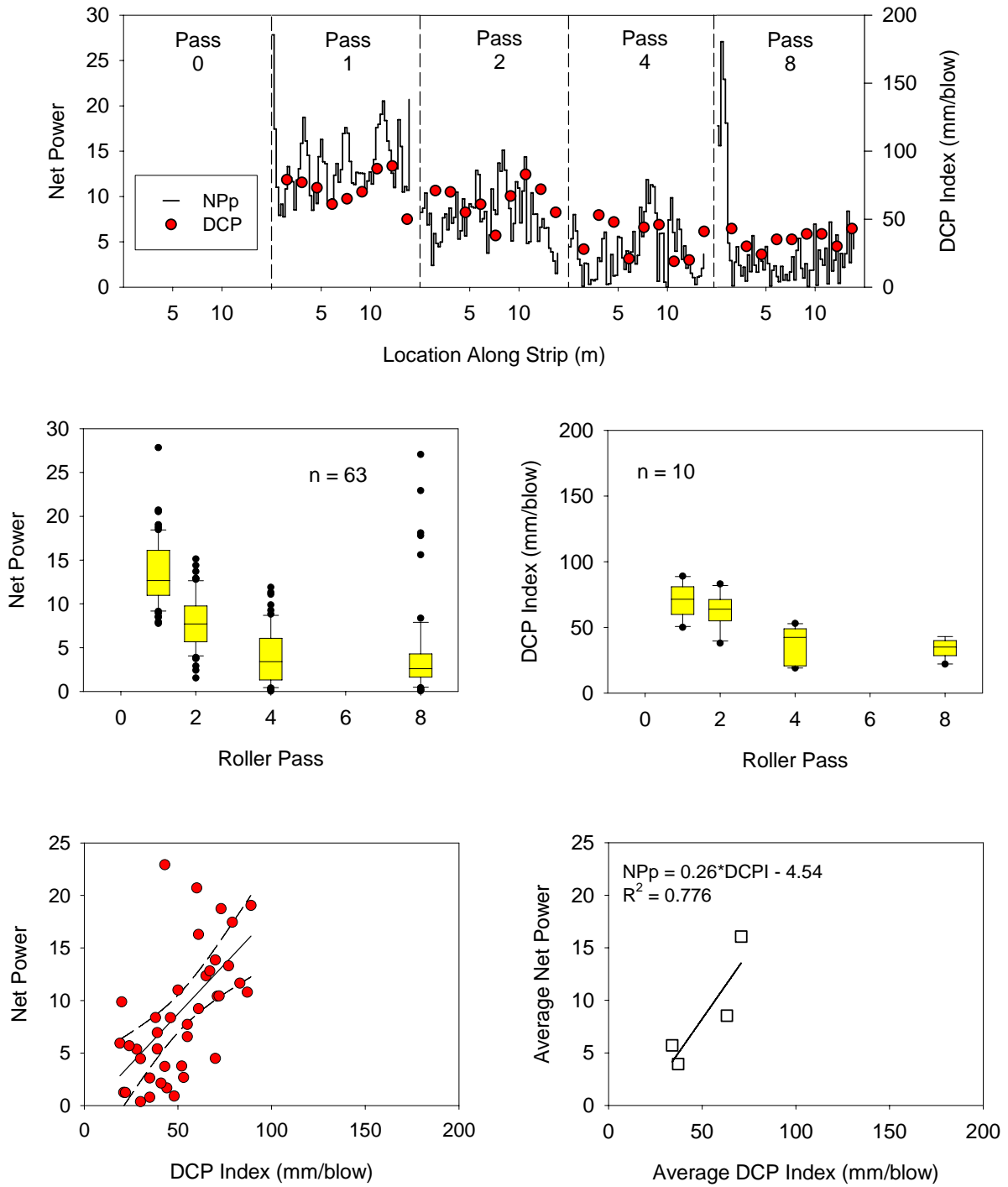


**Figure 105. Edwards till, strip 6: net power–dry unit weight correlation**

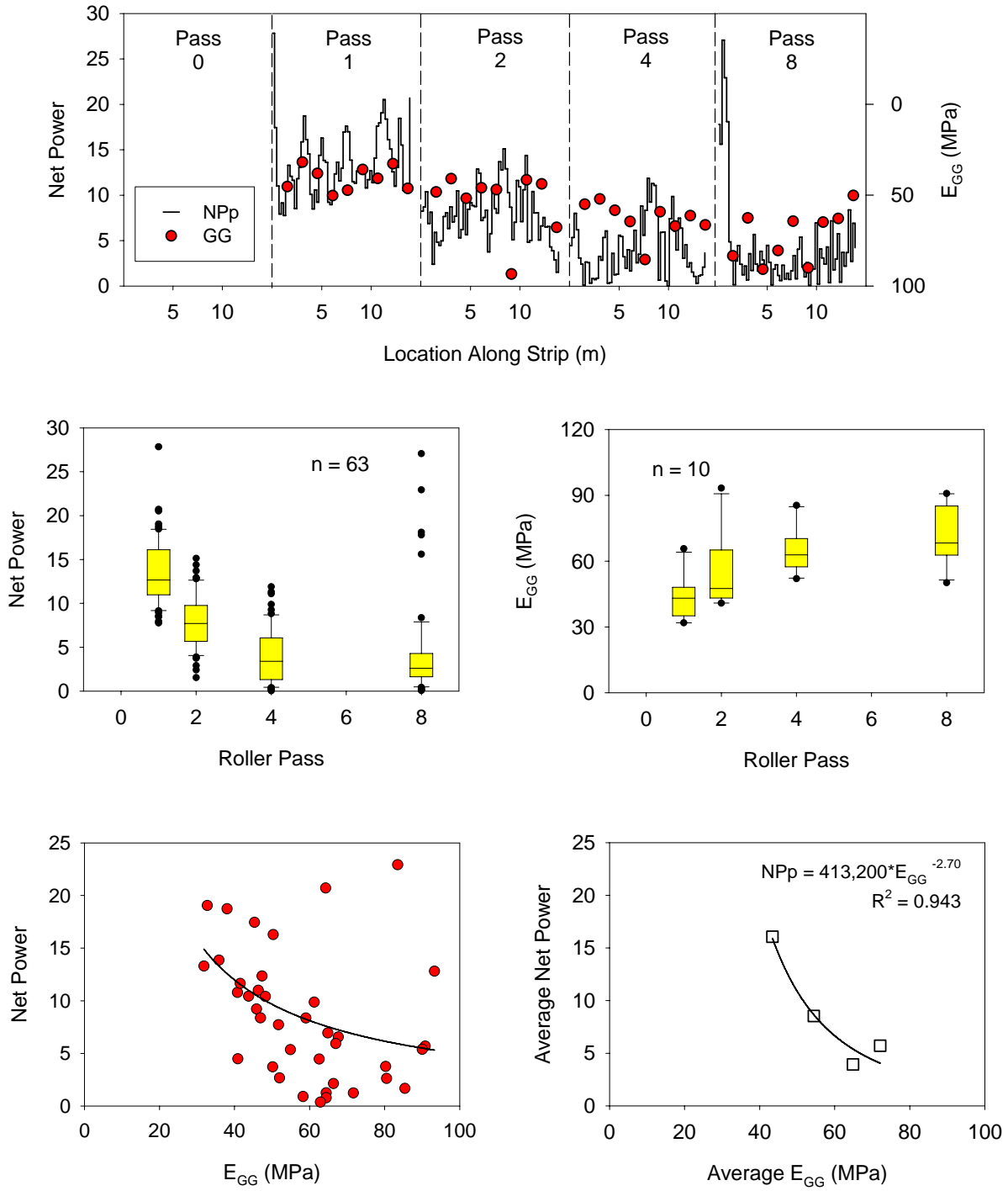




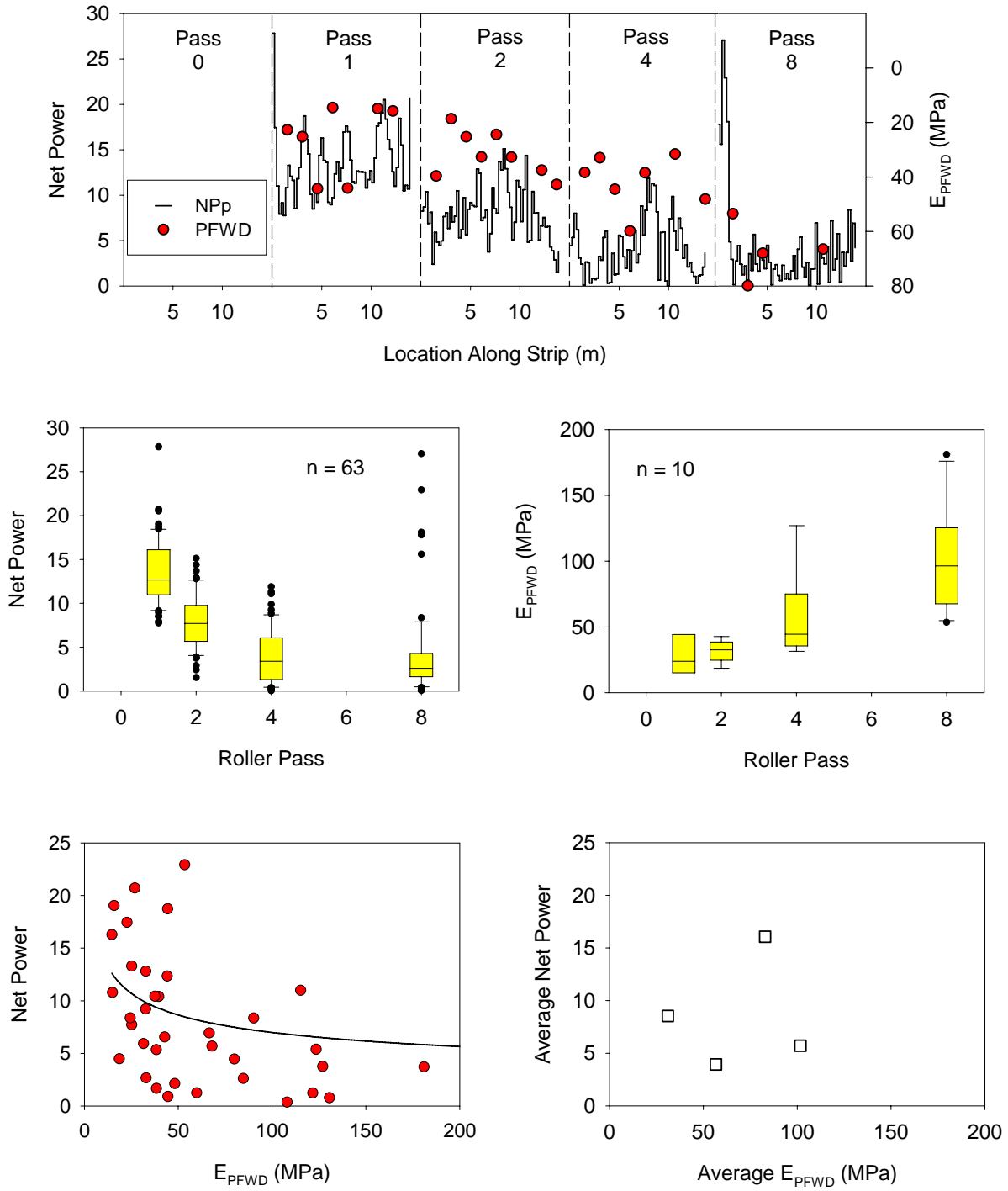
**Figure 106. Edwards till, strip 6: net power–CIV correlation**



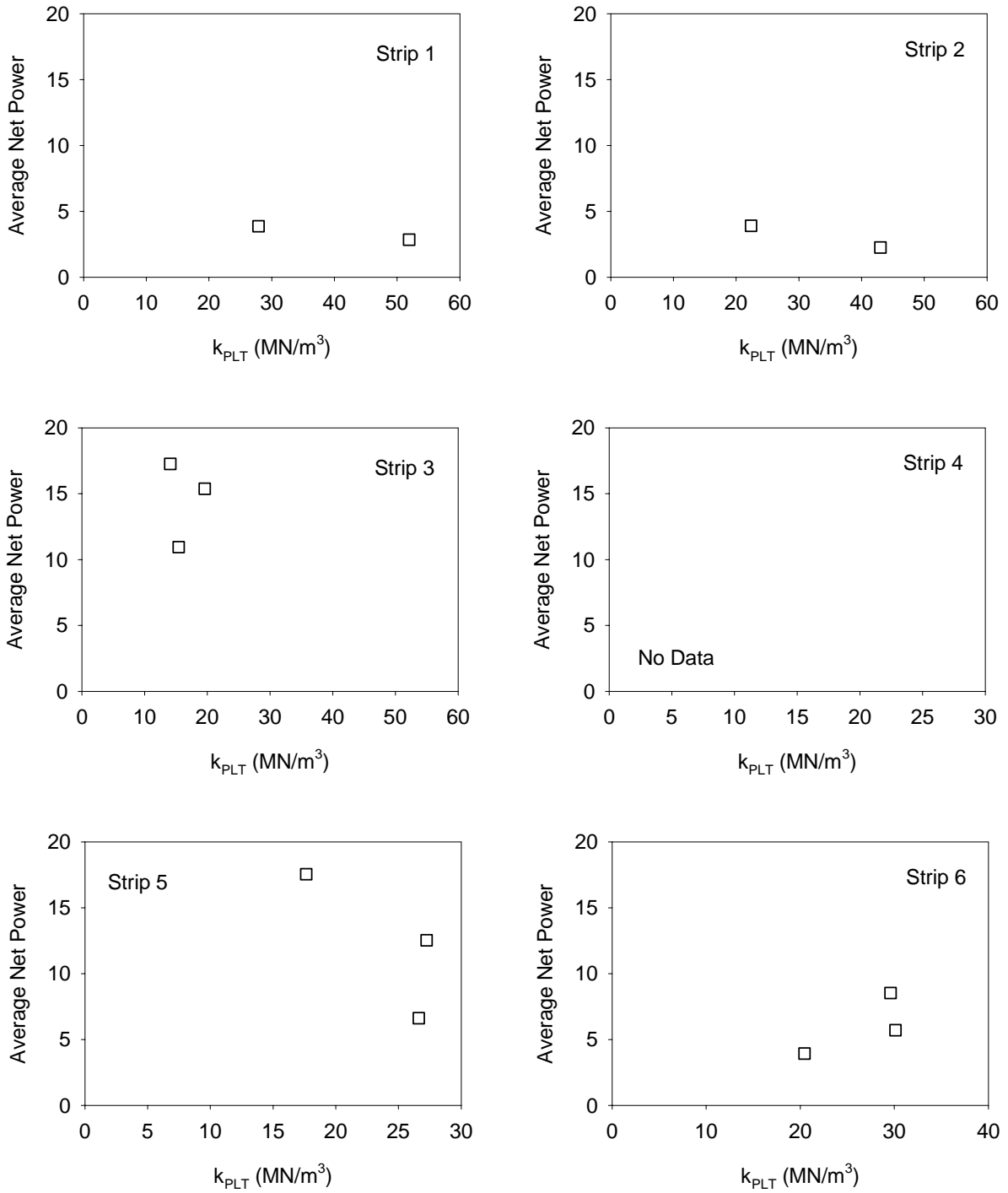
**Figure 107. Edwards till, strip 6: net power-DCP index correlation**



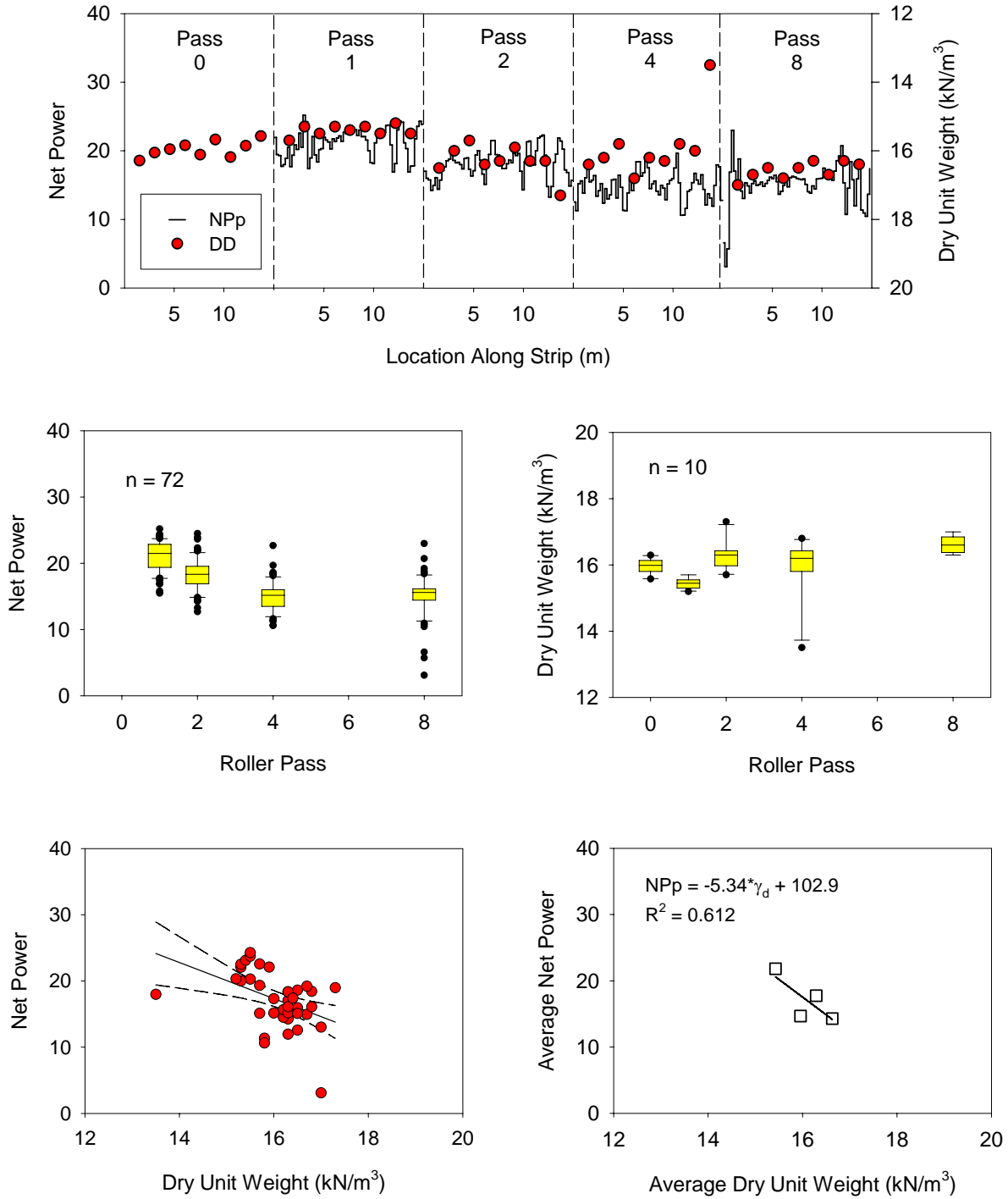
**Figure 108. Edwards till, strip 6: net power–GeoGauge modulus correlation**



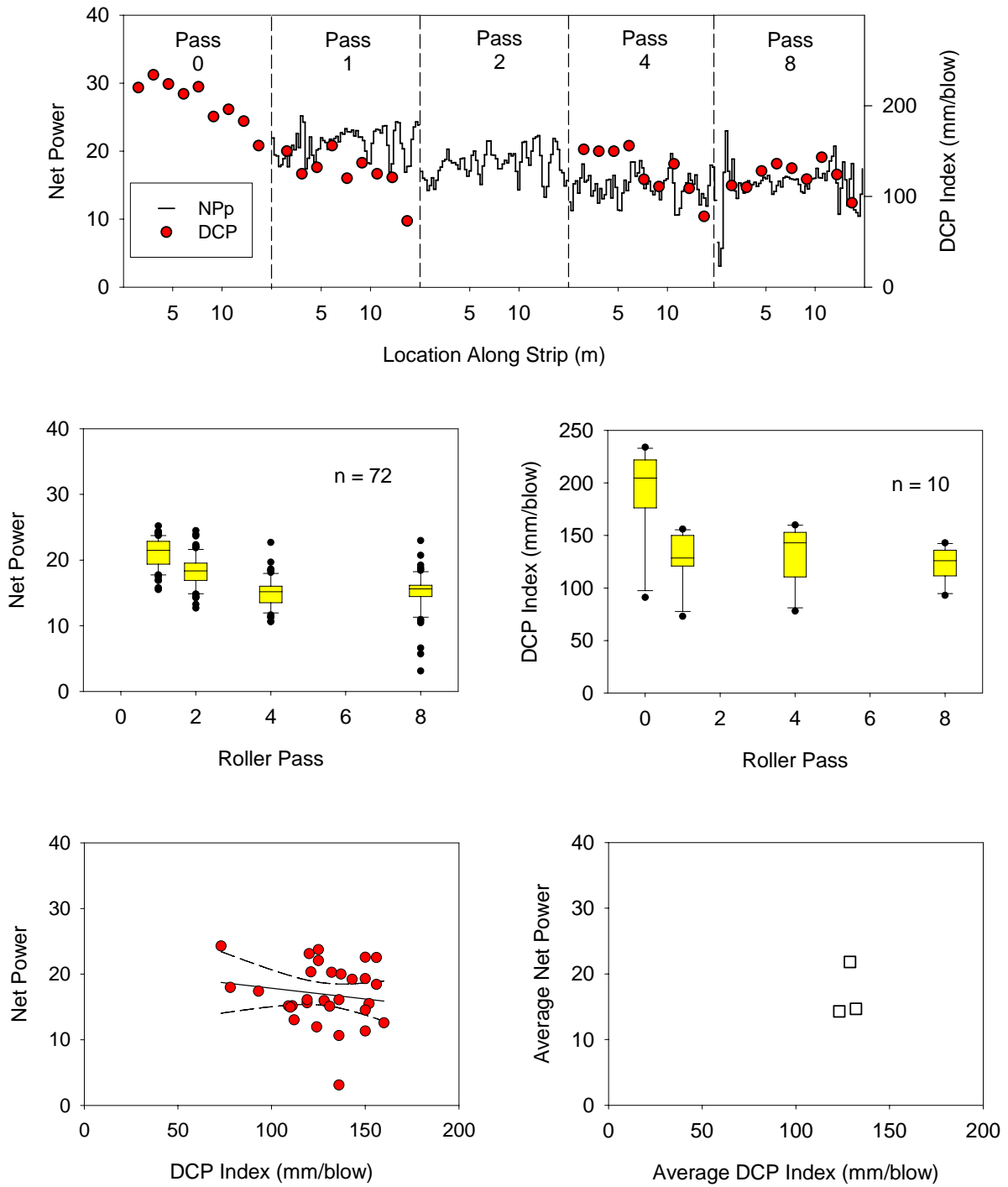
**Figure 109. Edwards till, strip 6: net power-PFWD modulus correlation**



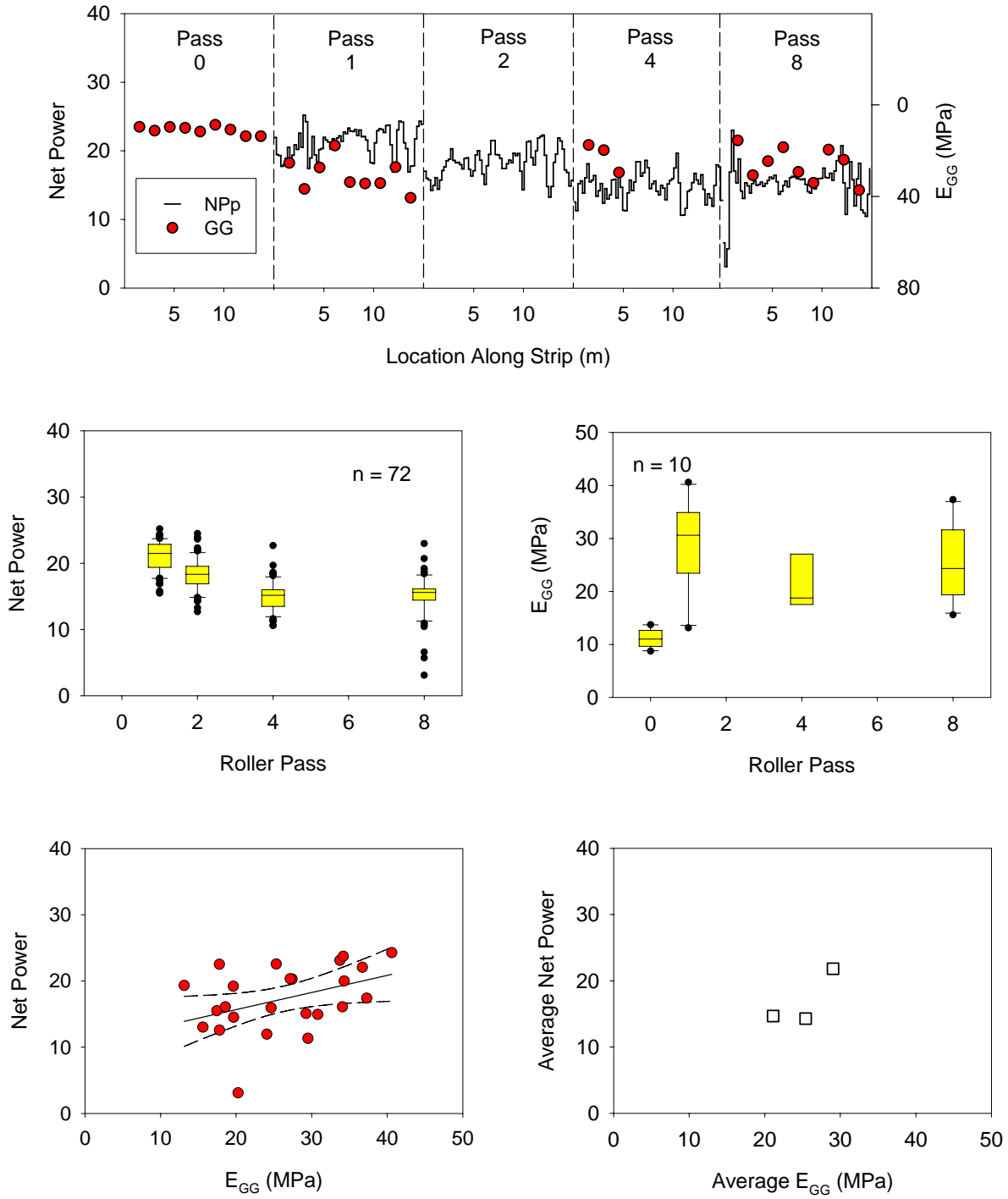
**Figure 110. Edwards till, net power–coefficient of subgrade reaction correlation**



**Figure 111. Sand, strip 1: net power–dry unit weight correlation**

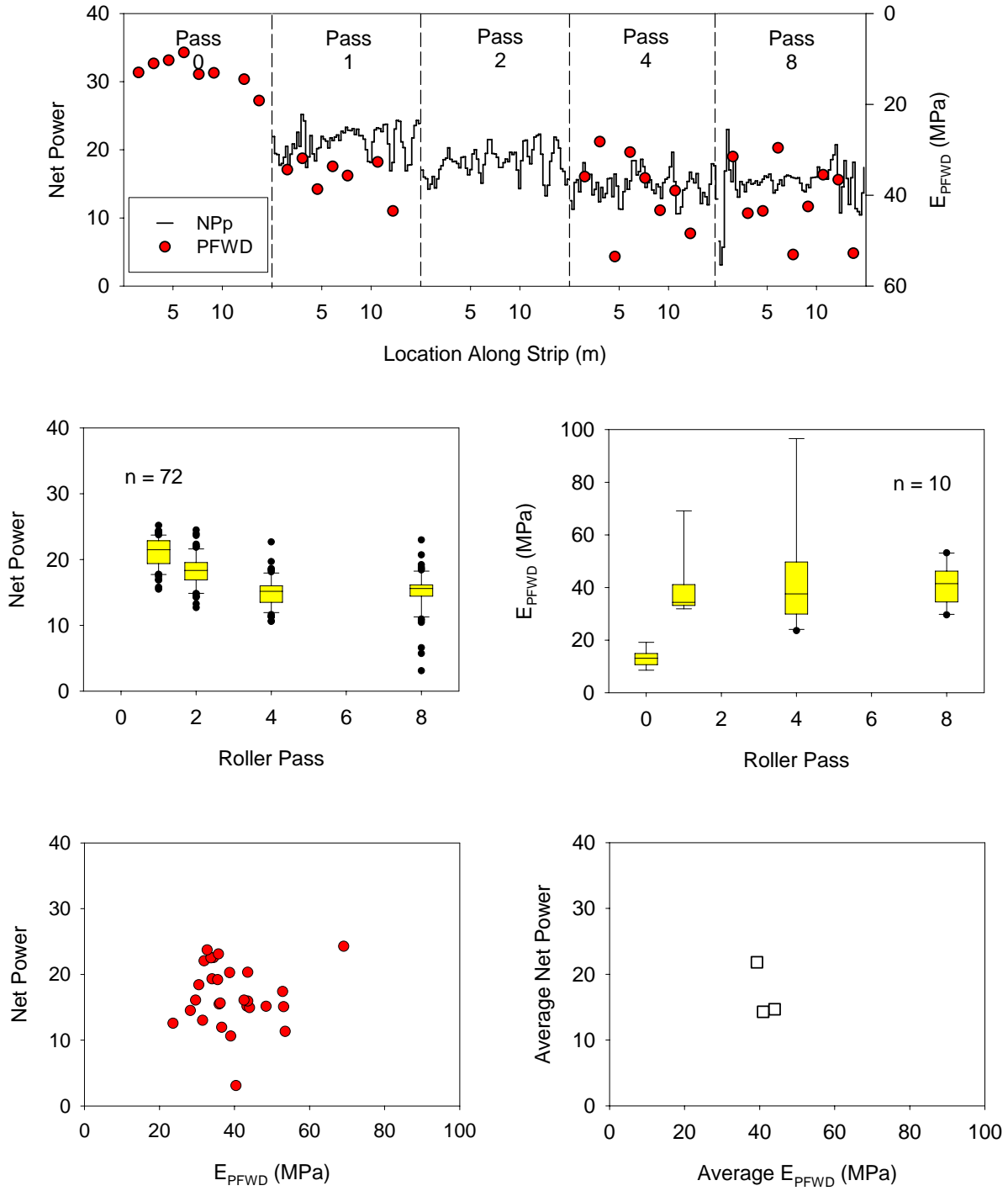


**Figure 112. Sand, strip 1: net power–DCP index correlation**

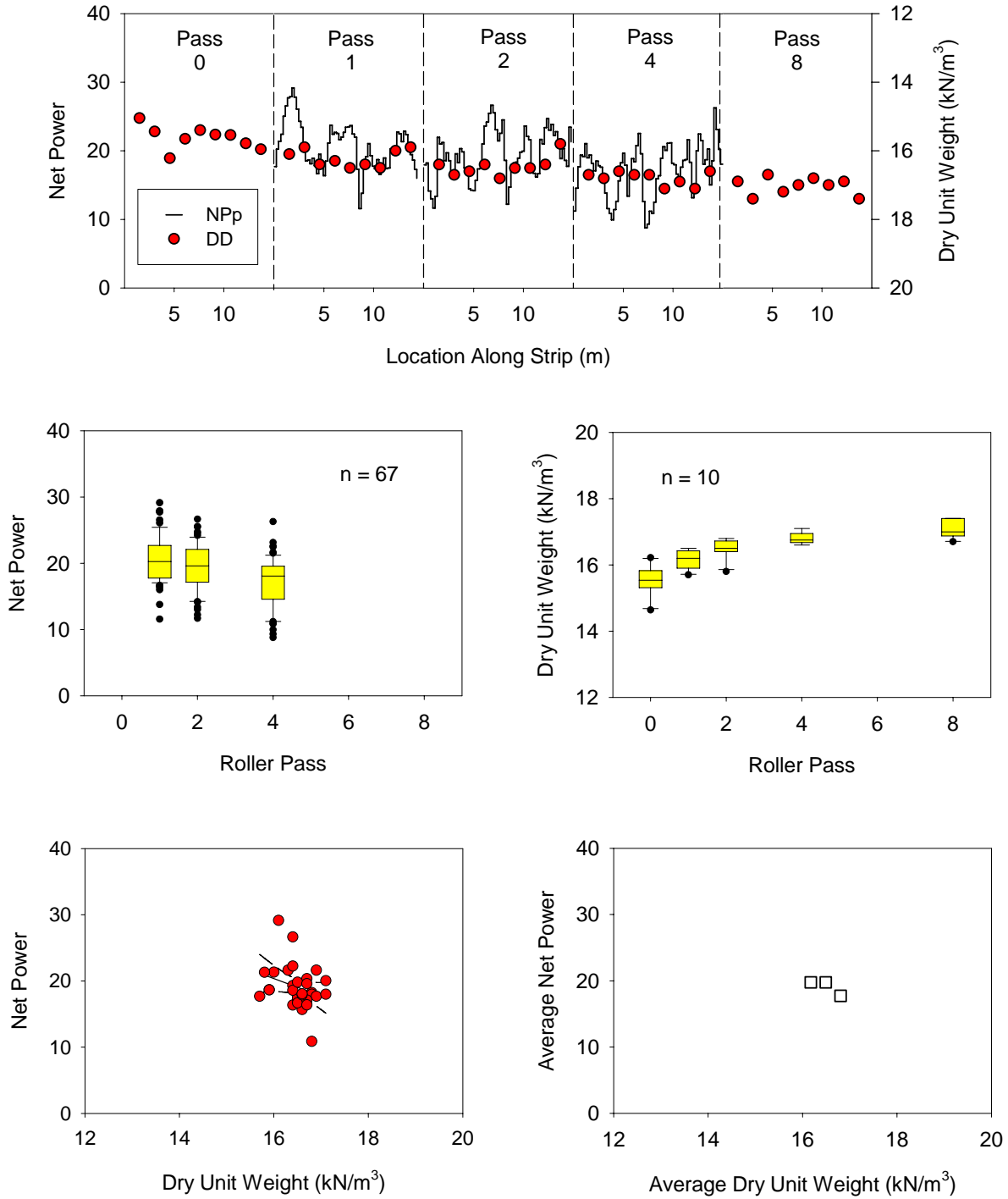


**Figure 113. Sand, strip 1: net power-GeoGauge modulus correlation**

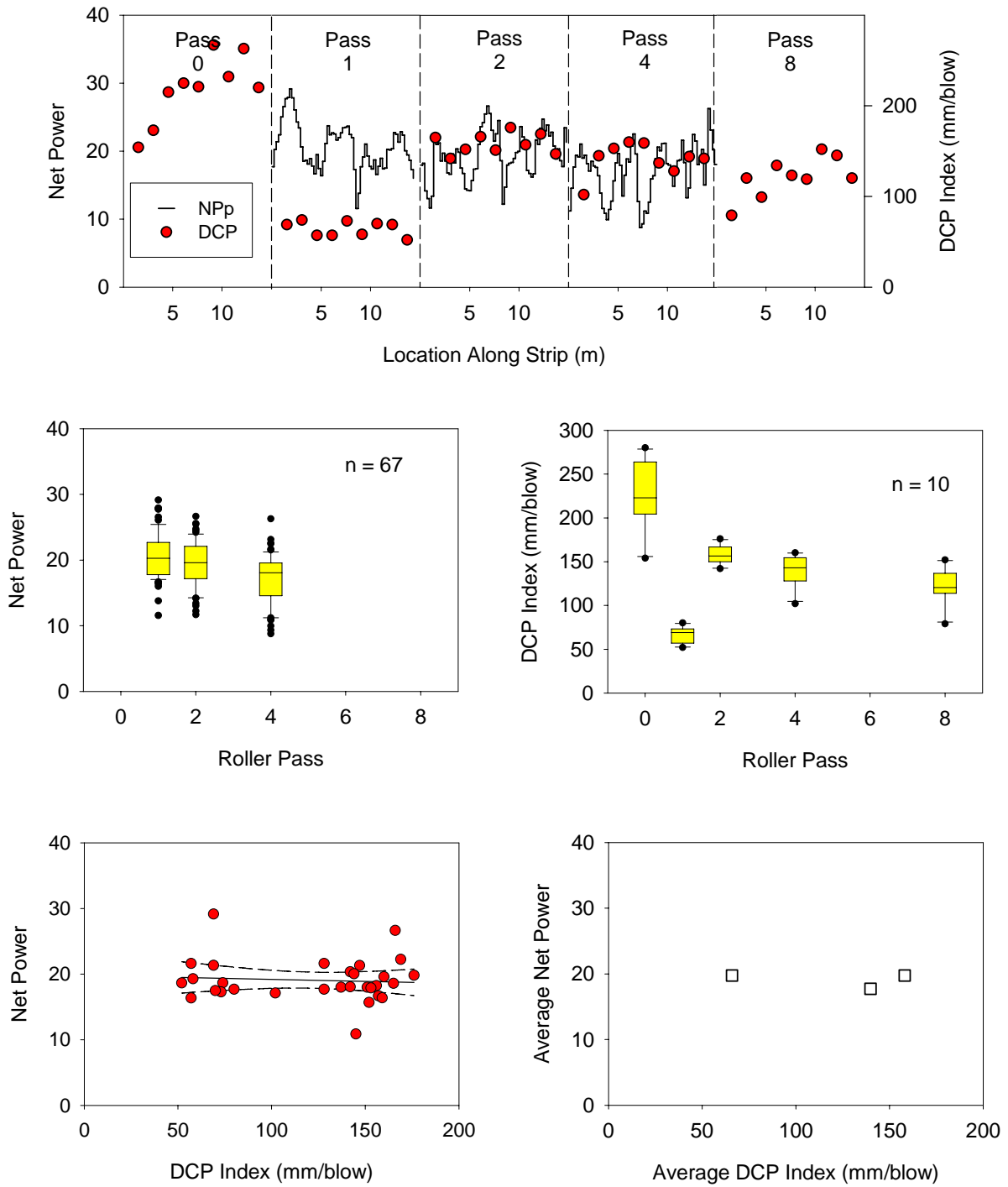




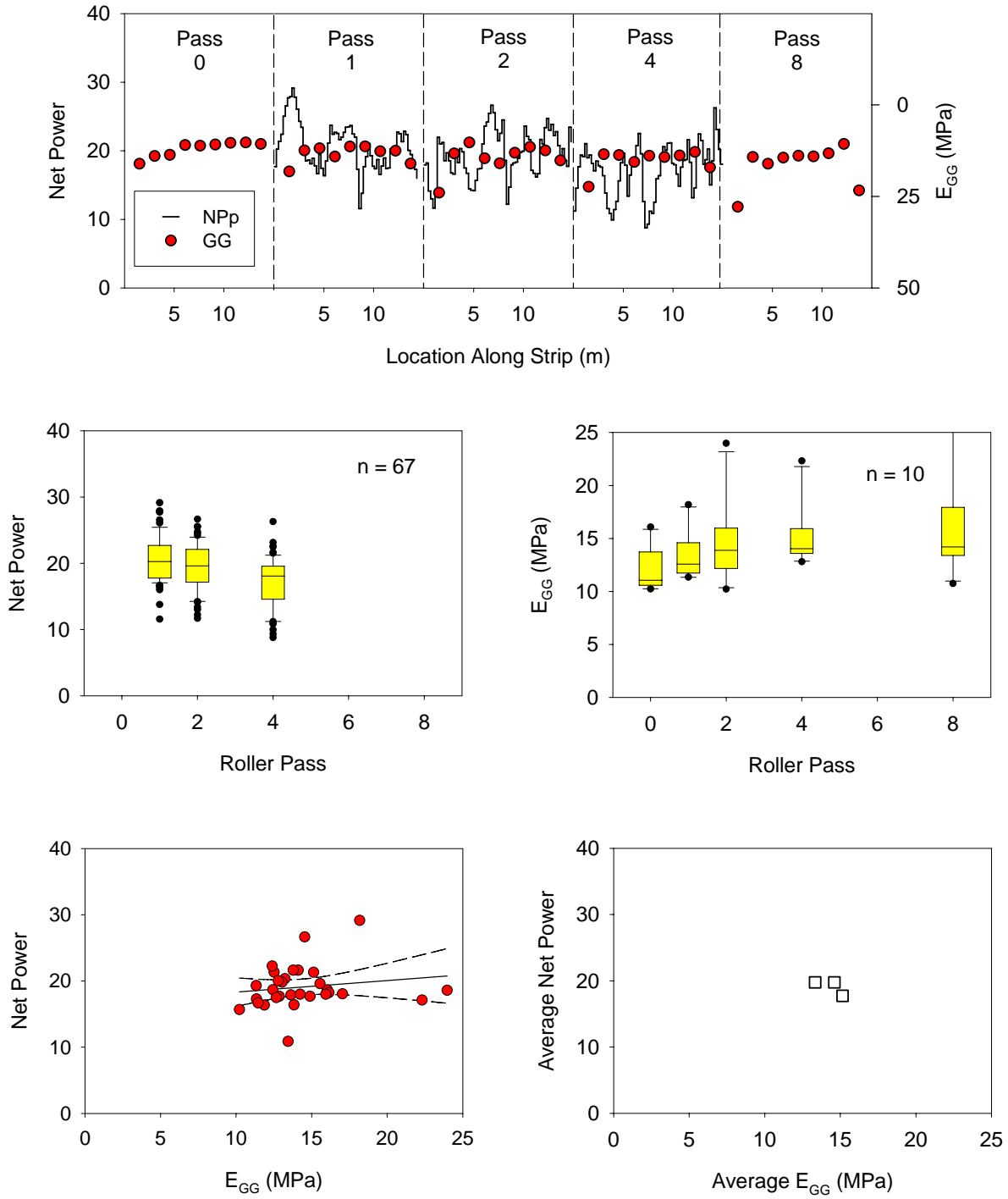
**Figure 114. Sand, strip 1: net power–PFWD modulus correlation**



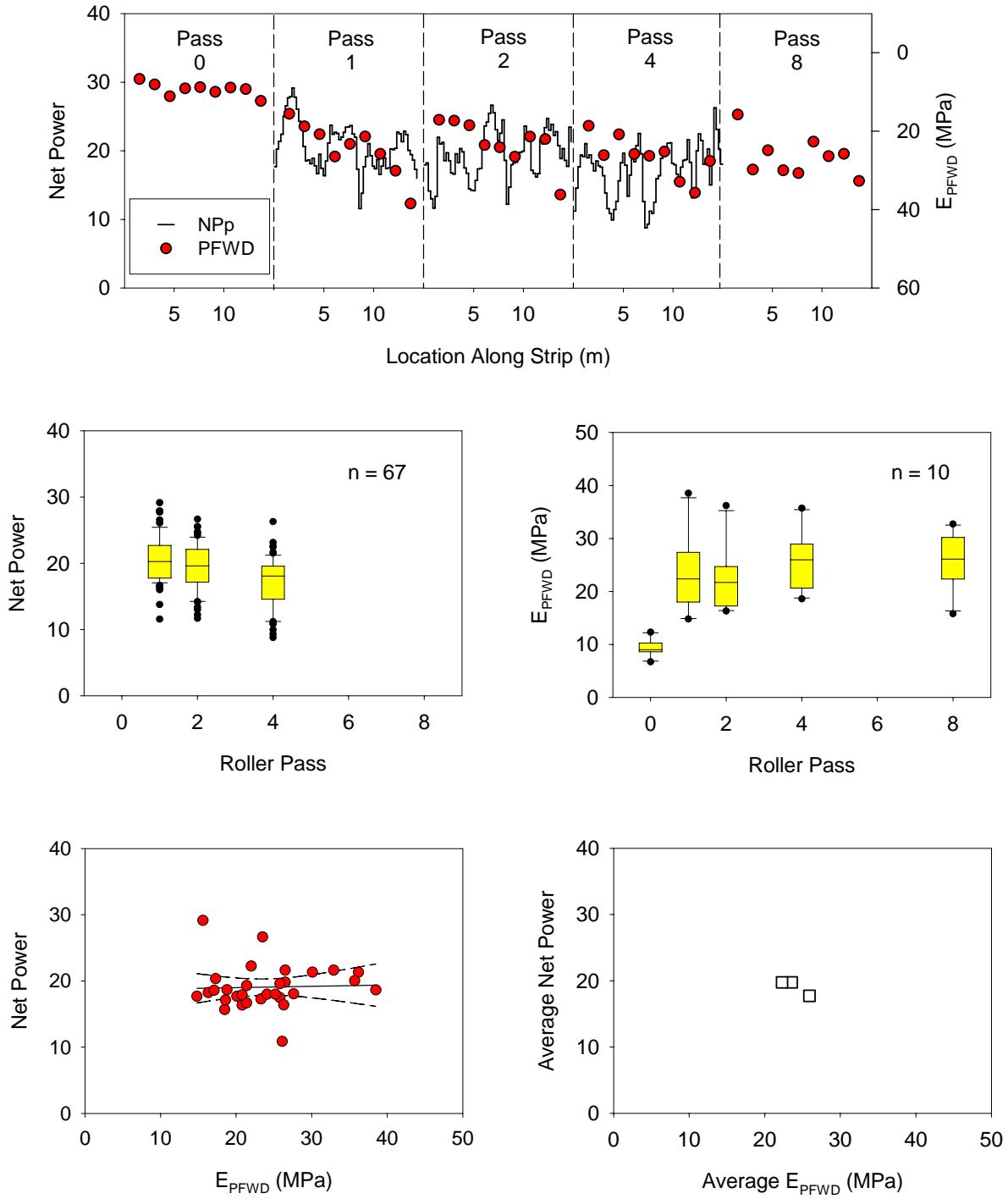
**Figure 115. Sand, strip 2: net power–dry unit weight correlation**



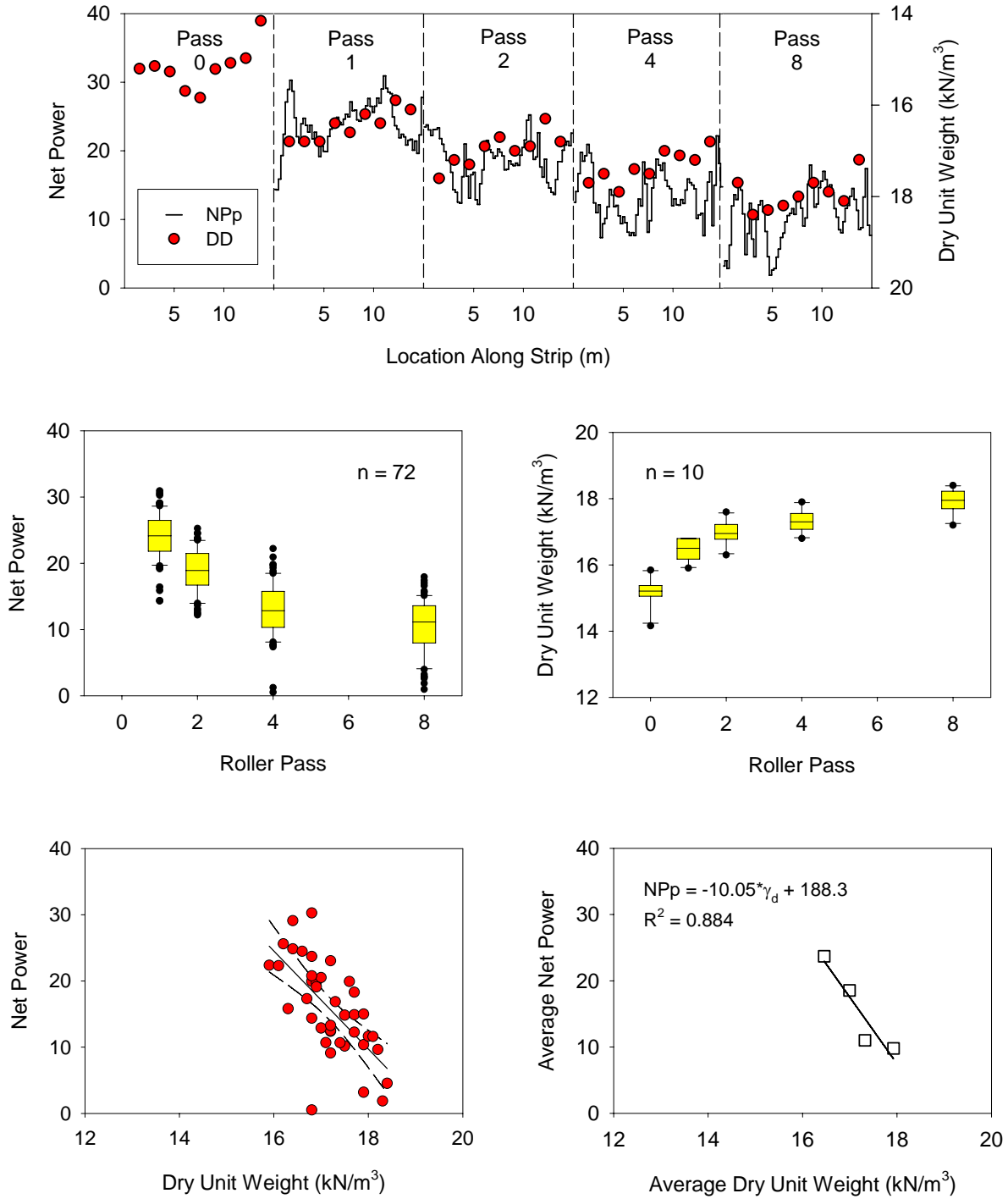
**Figure 116. Sand, strip 2: net power–DCP index correlation**



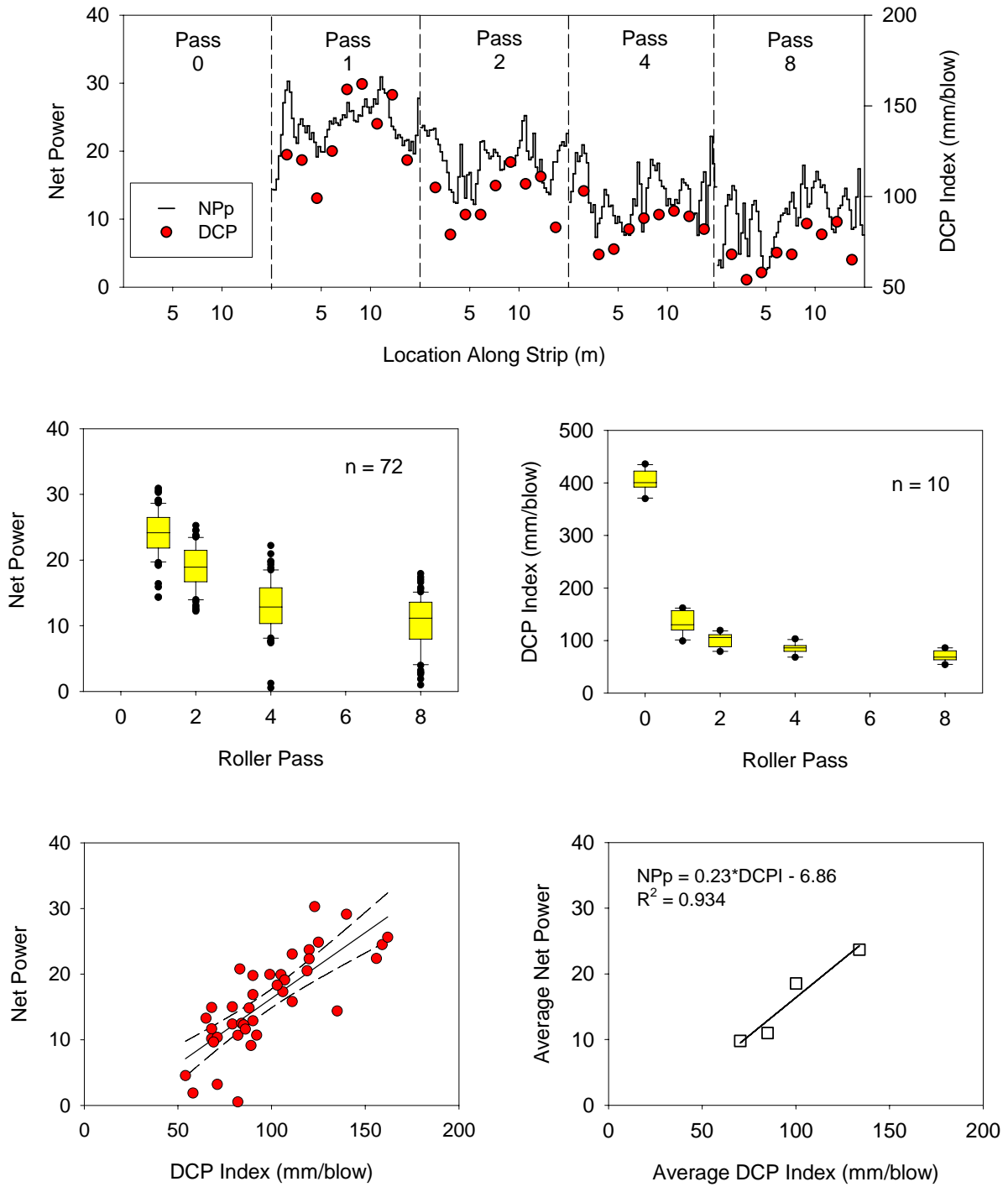
**Figure 117. Sand, strip 2: net power-GeoGauge modulus correlation**



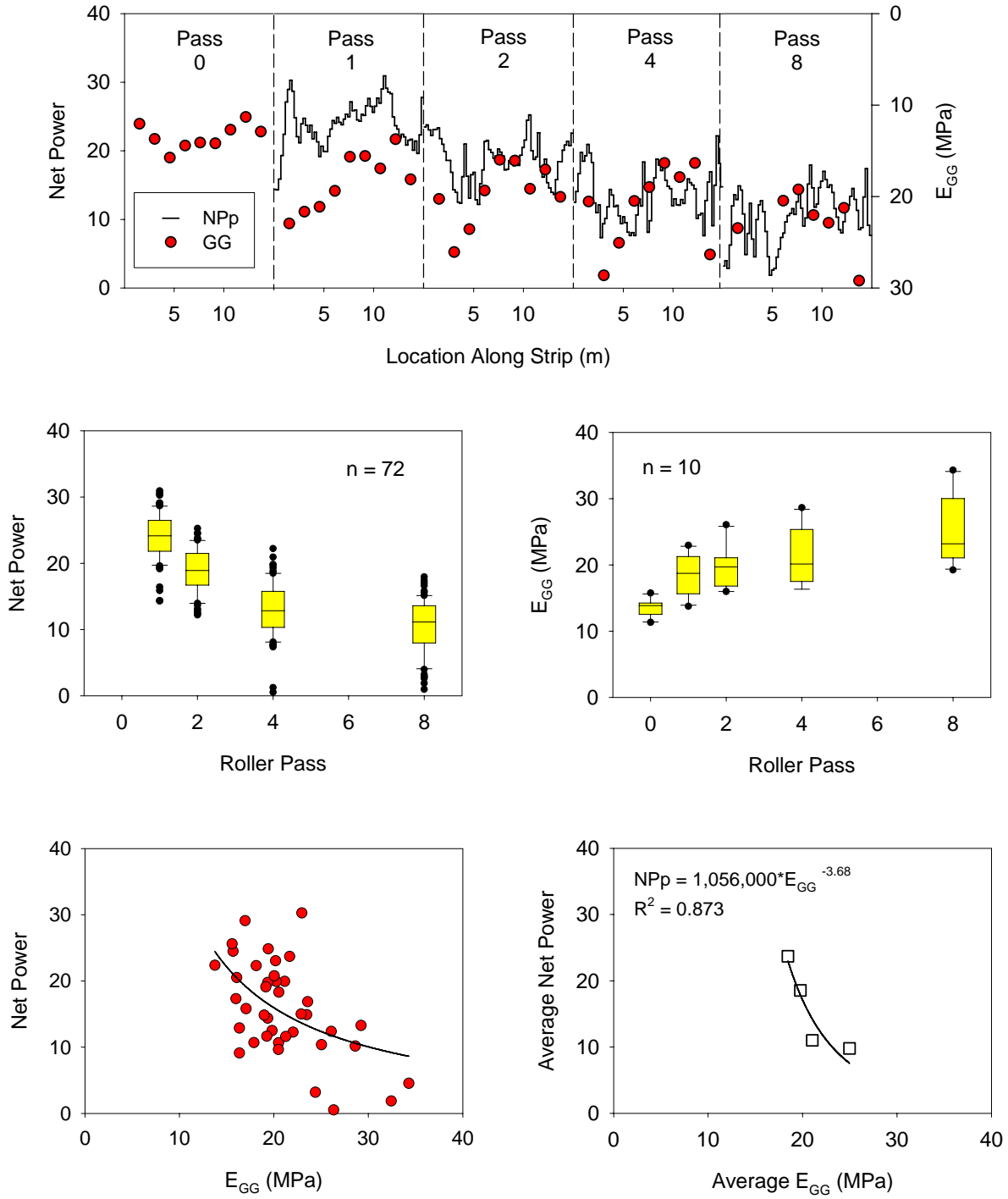
**Figure 118. Sand, strip 2: net power–PFWD modulus correlation**



**Figure 119. Sand, strip 3: net power–dry unit weight correlation**

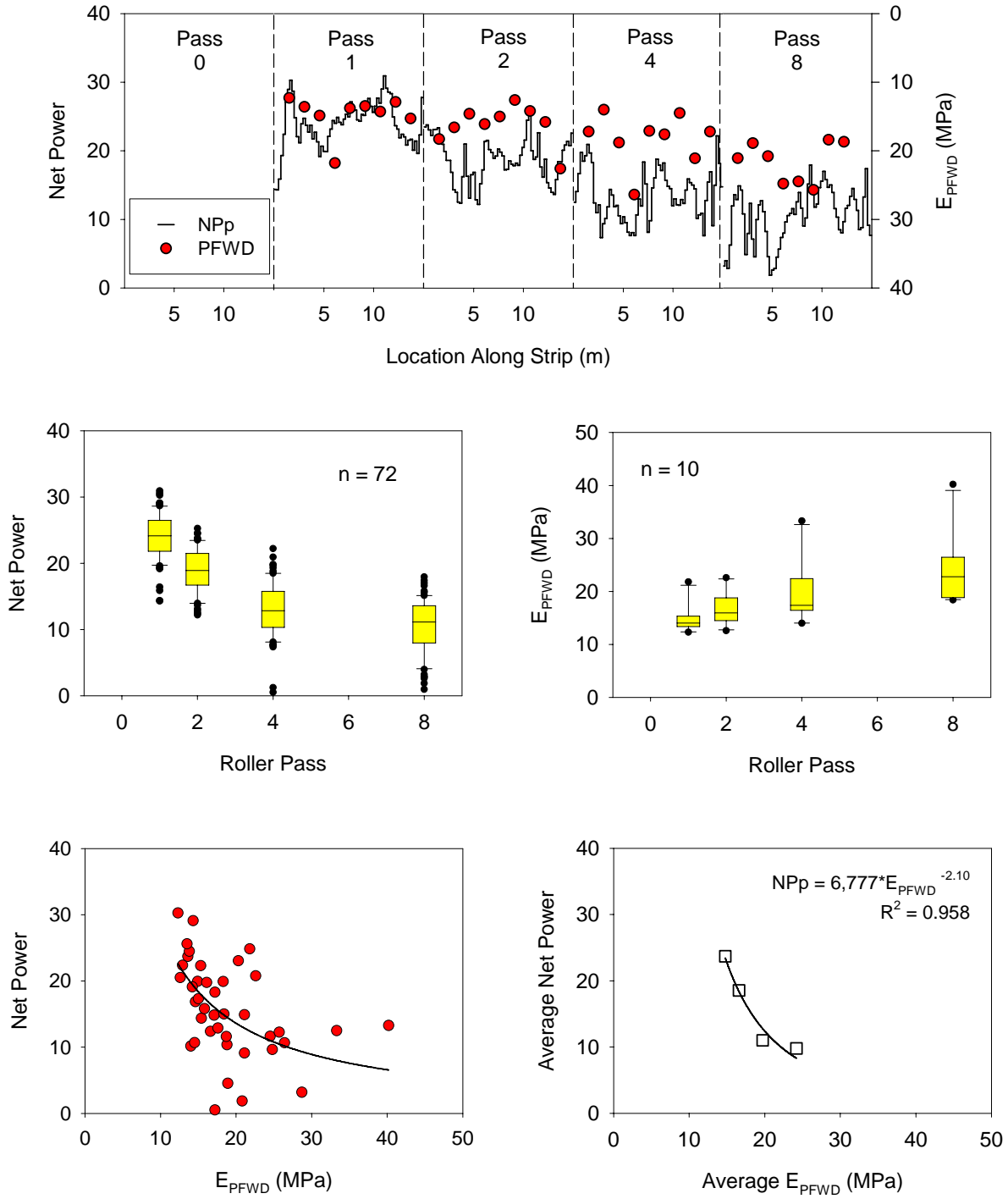


**Figure 120. Sand, strip 3: net power–DCP index correlation**

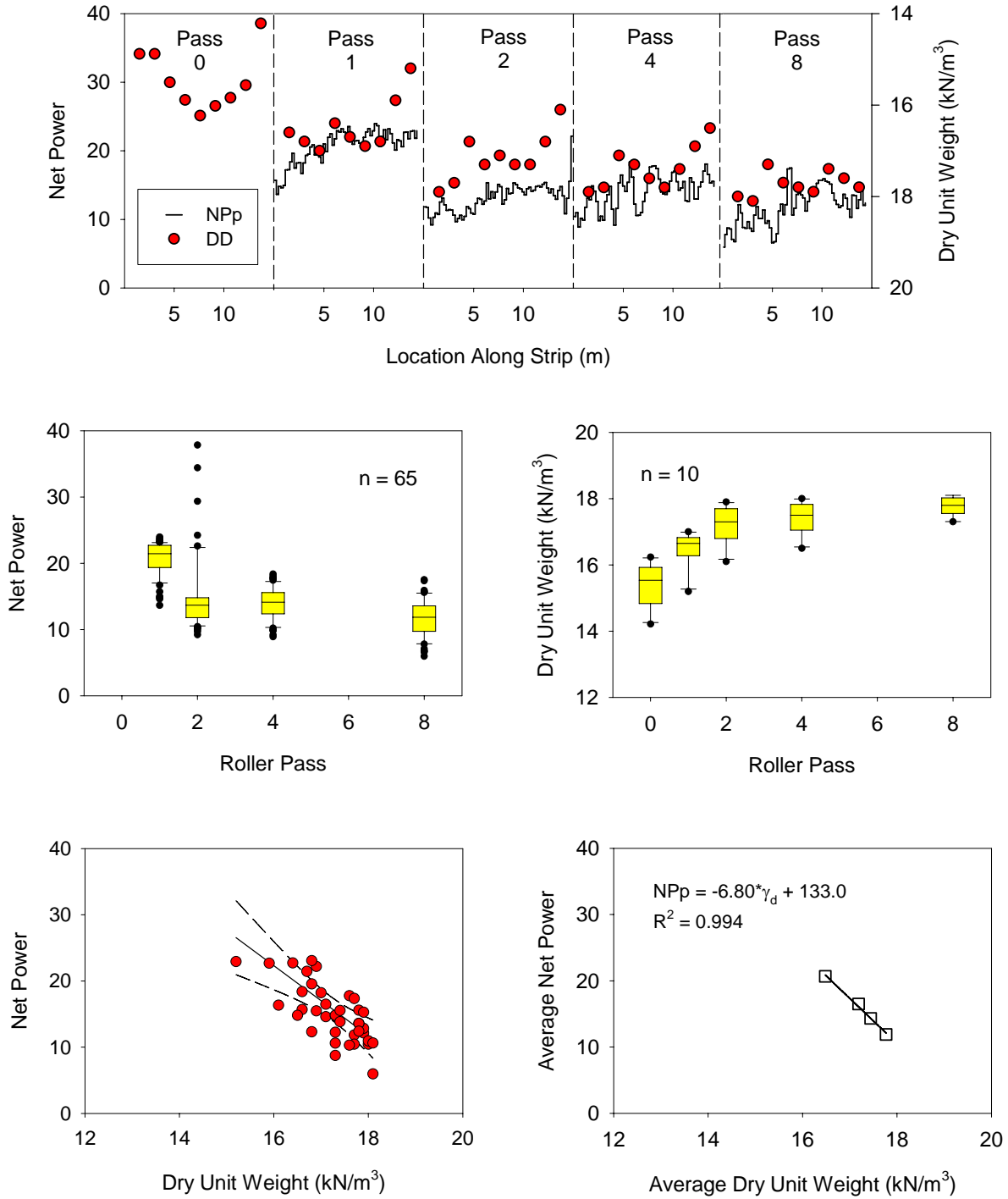


**Figure 121. Sand, strip 3: net power-GeoGauge modulus correlation**

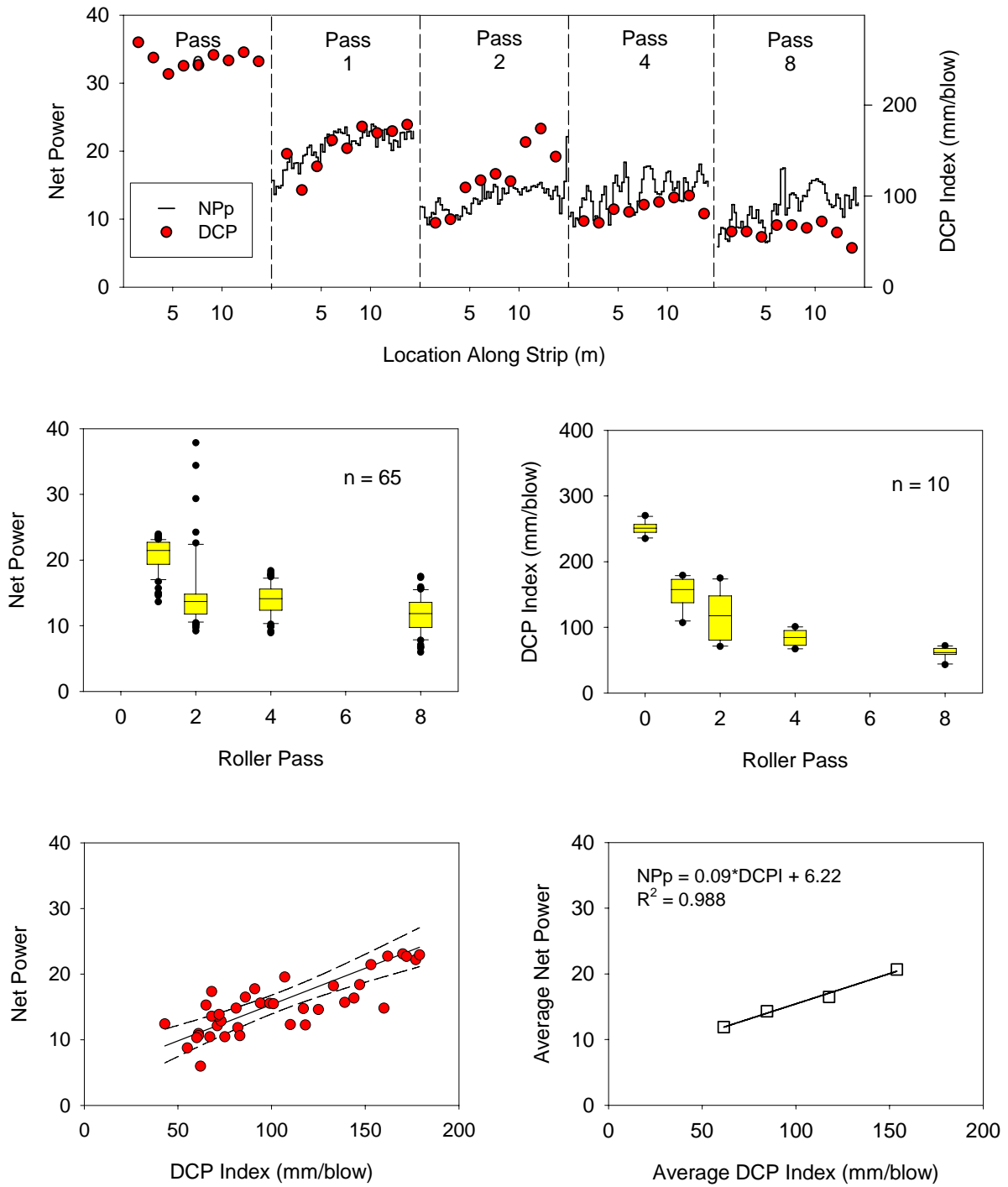




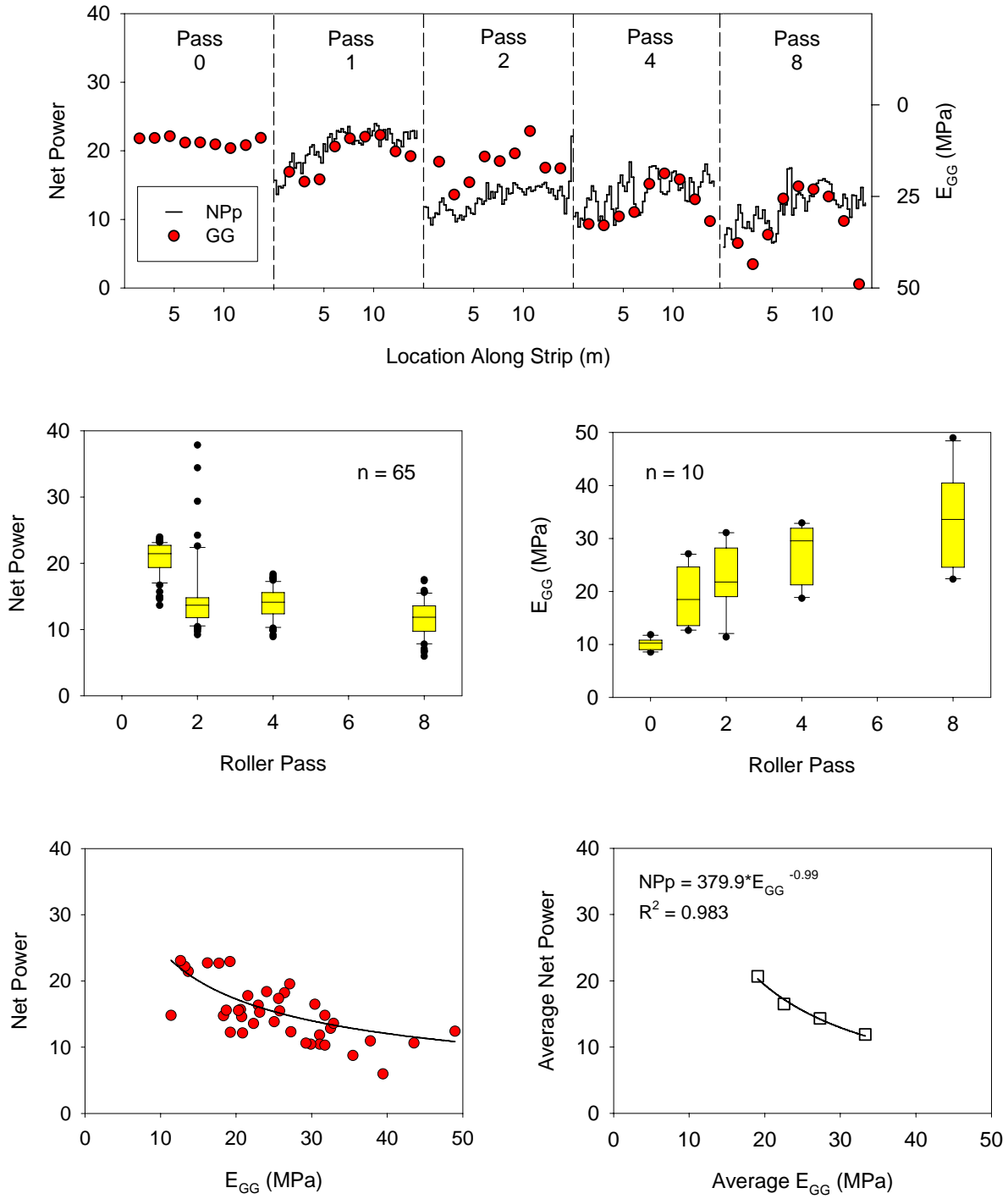
**Figure 122. Sand, strip 3: net power–PFWD modulus correlation**



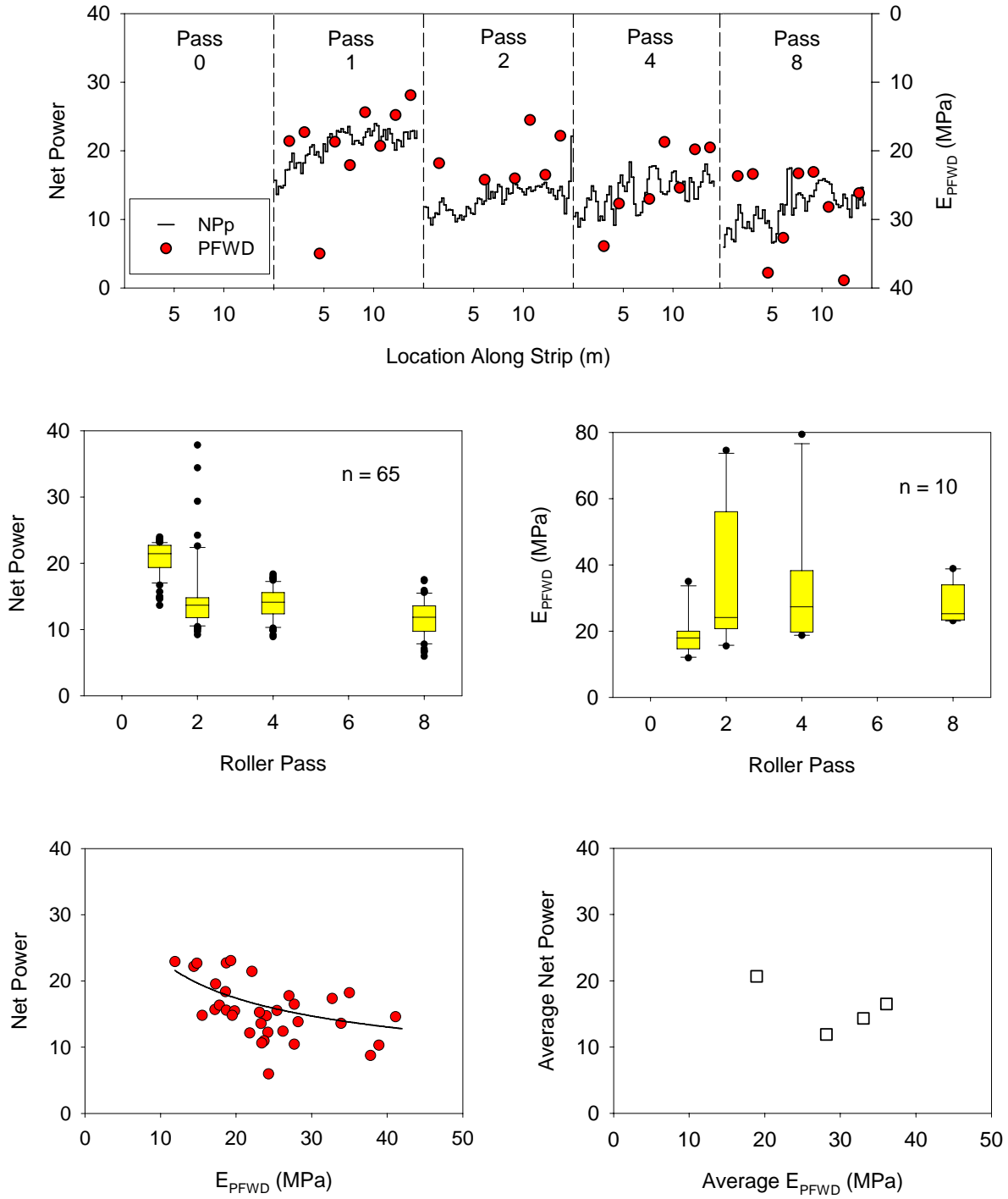
**Figure 123. Sand, strip 4: net power–dry unit weight correlation**



**Figure 124. Sand, strip 4: net power–DCP index correlation**



**Figure 125. Sand, strip 4: net power-GeoGauge modulus correlation**



**Figure 126. Sand, strip 4: net power–PFWD modulus correlation**

### *Variability of Measured Properties*

To begin characterizing the variability of measured properties using compaction monitoring technology and in situ test devices, distribution plots of net power and dry unit weight were developed per roller pass for strip 1 of each soil (see Figure 127 to Figure 130). In most cases, the mean machine power values decreased with increasing roller passes, while the mean dry unit weight increased with more roller passes. Furthermore, the relative variability between soil types was observed, where till and sand materials provided a wider range of machine power values than topsoil or fill clay. The variability in dry unit weight was nearly constant with compaction and consistent between soil types.

Averages ( $\mu$ ) of the field measurements and machine power values are summarized from Table 6 to Table 9. Standard deviations ( $\sigma$ ) and COV values ( $\sigma / \mu$ ) are also provided to show the relative variability associated with the testing devices and to illustrate how the variability changes with increasing roller passes. In general, dry unit weight exhibits the lowest variability, with COV ranging from 1% to 8%. Soil modulus (GG and PFWD) exhibits the highest variability, with COV ranging from 8% to 163%. This difference has been noted to be a challenge in using stiffness-based measurements to establish quality earthwork construction.

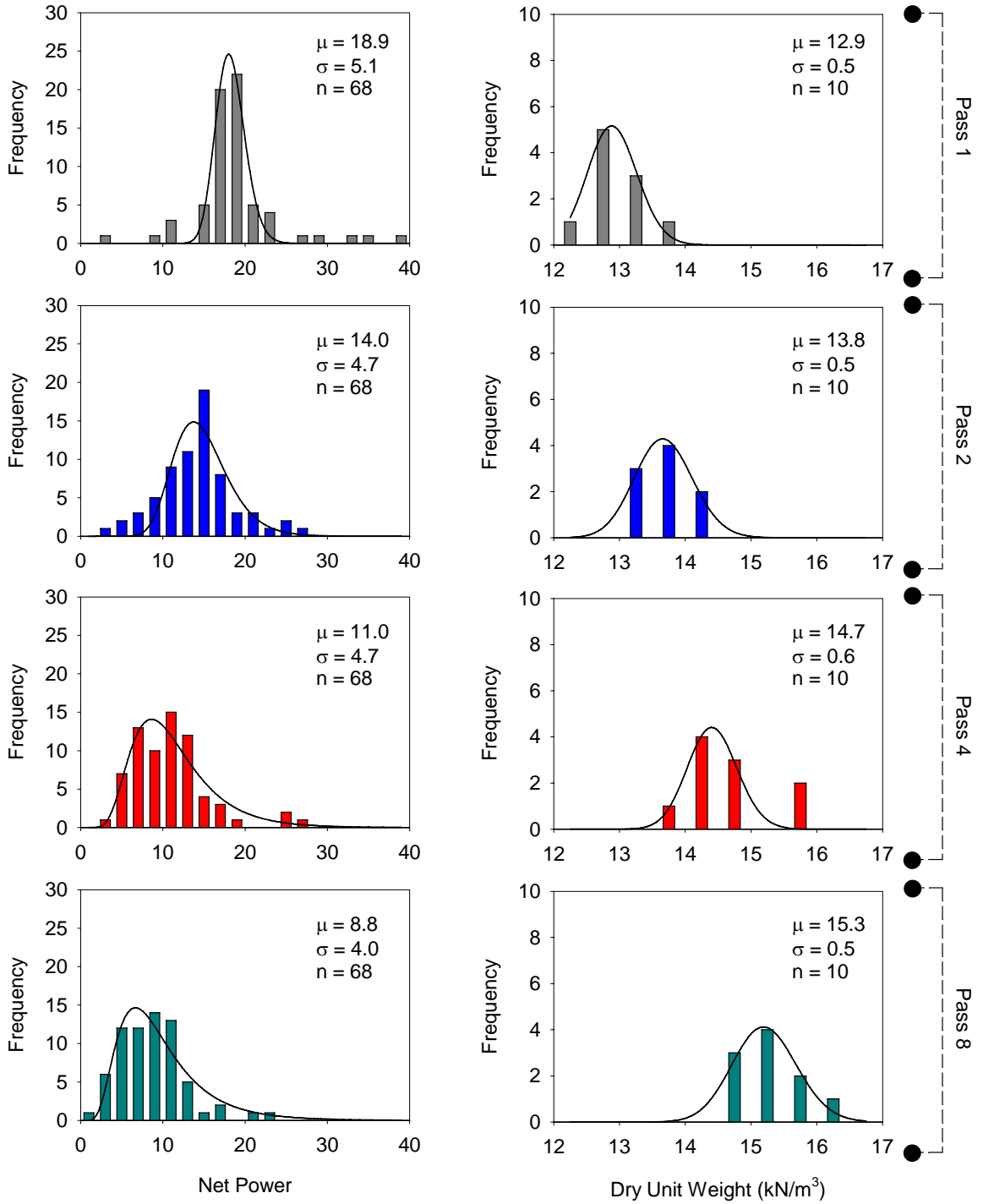


Figure 127. Topsoil, strip 1: distribution plots for net power and dry density per pass

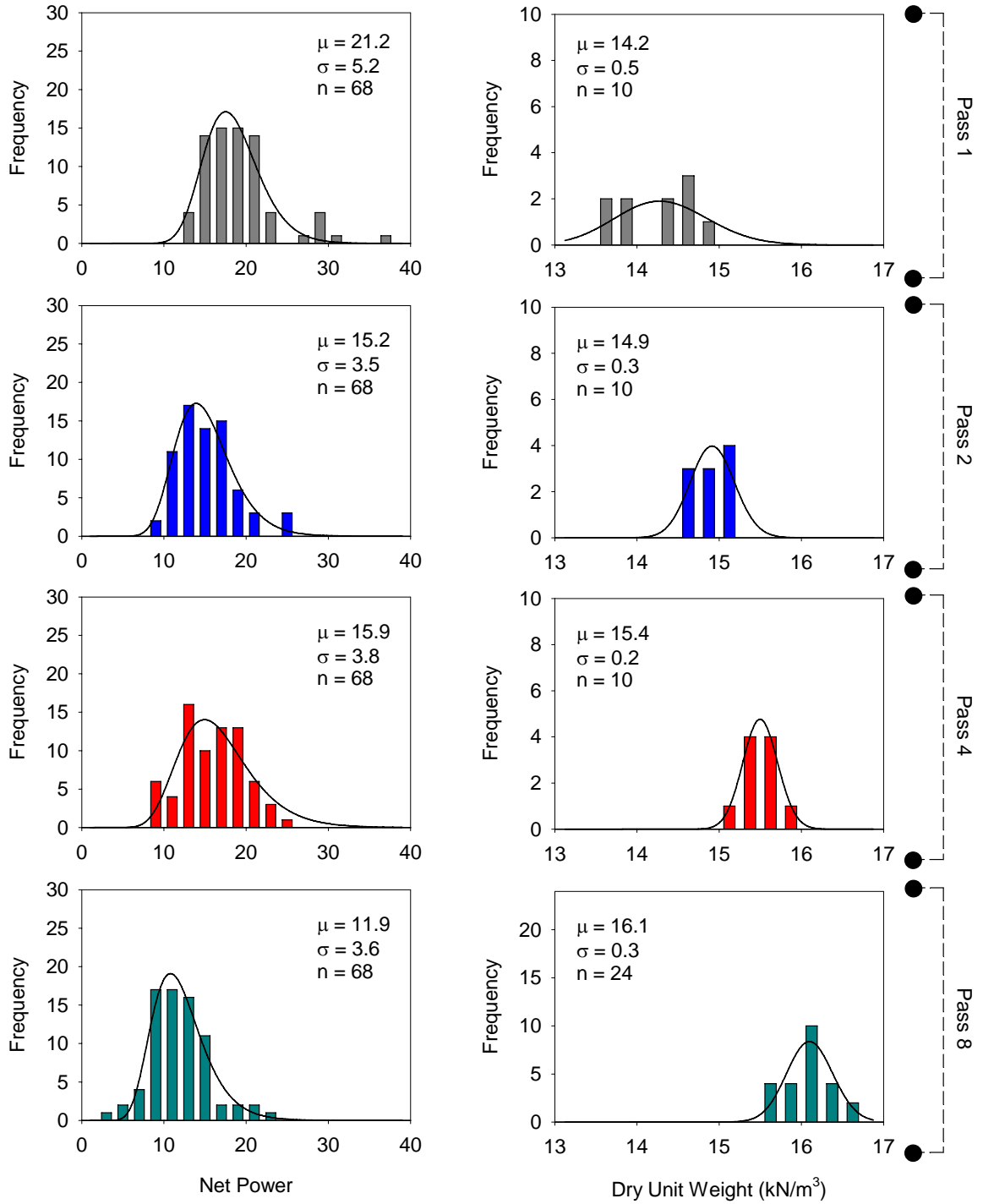


Figure 128. Fill clay, strip 1: distribution plots for net power and dry density per pass



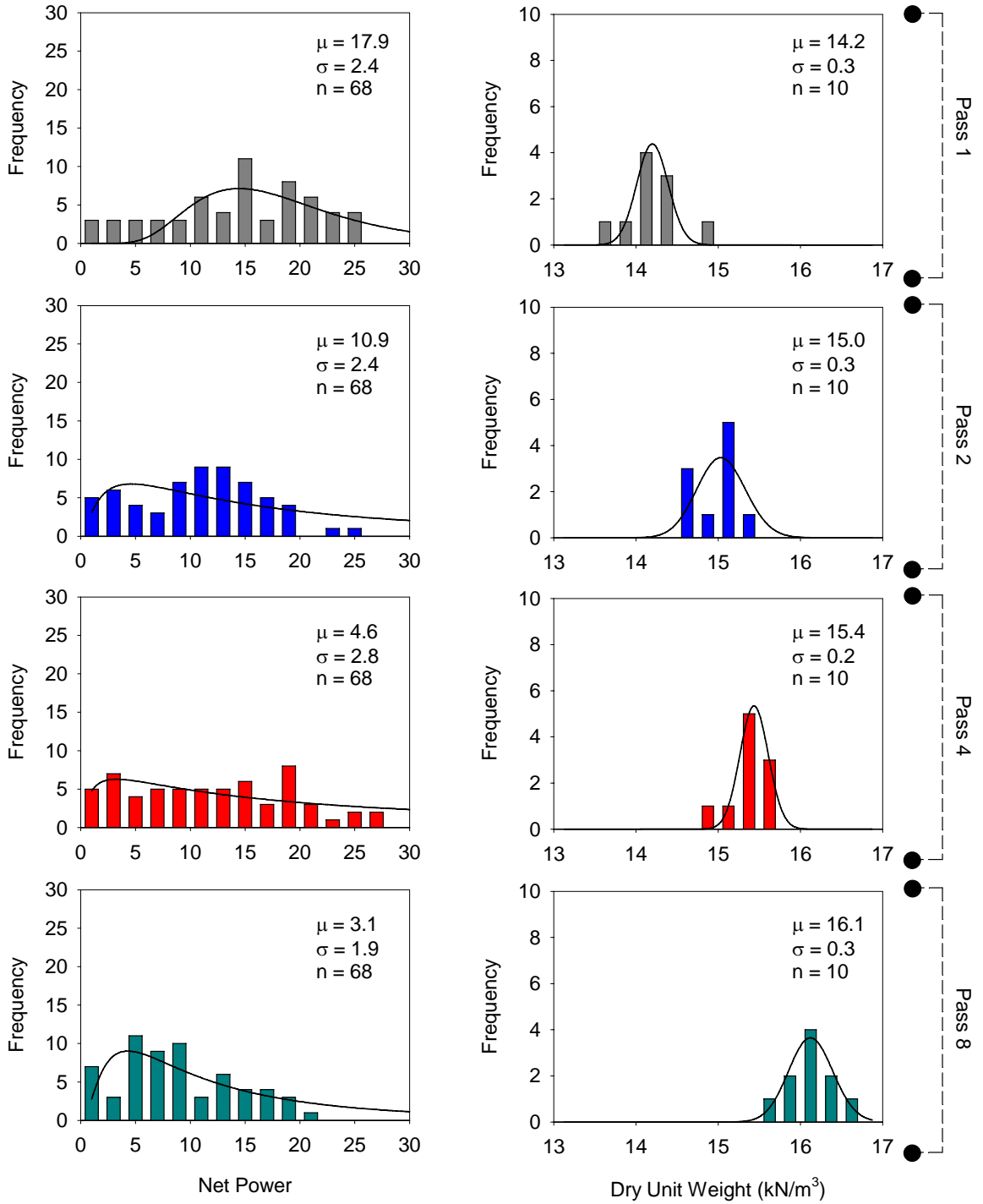


Figure 129. Edwards till, strip 1: distribution plots for net power and dry density per pass

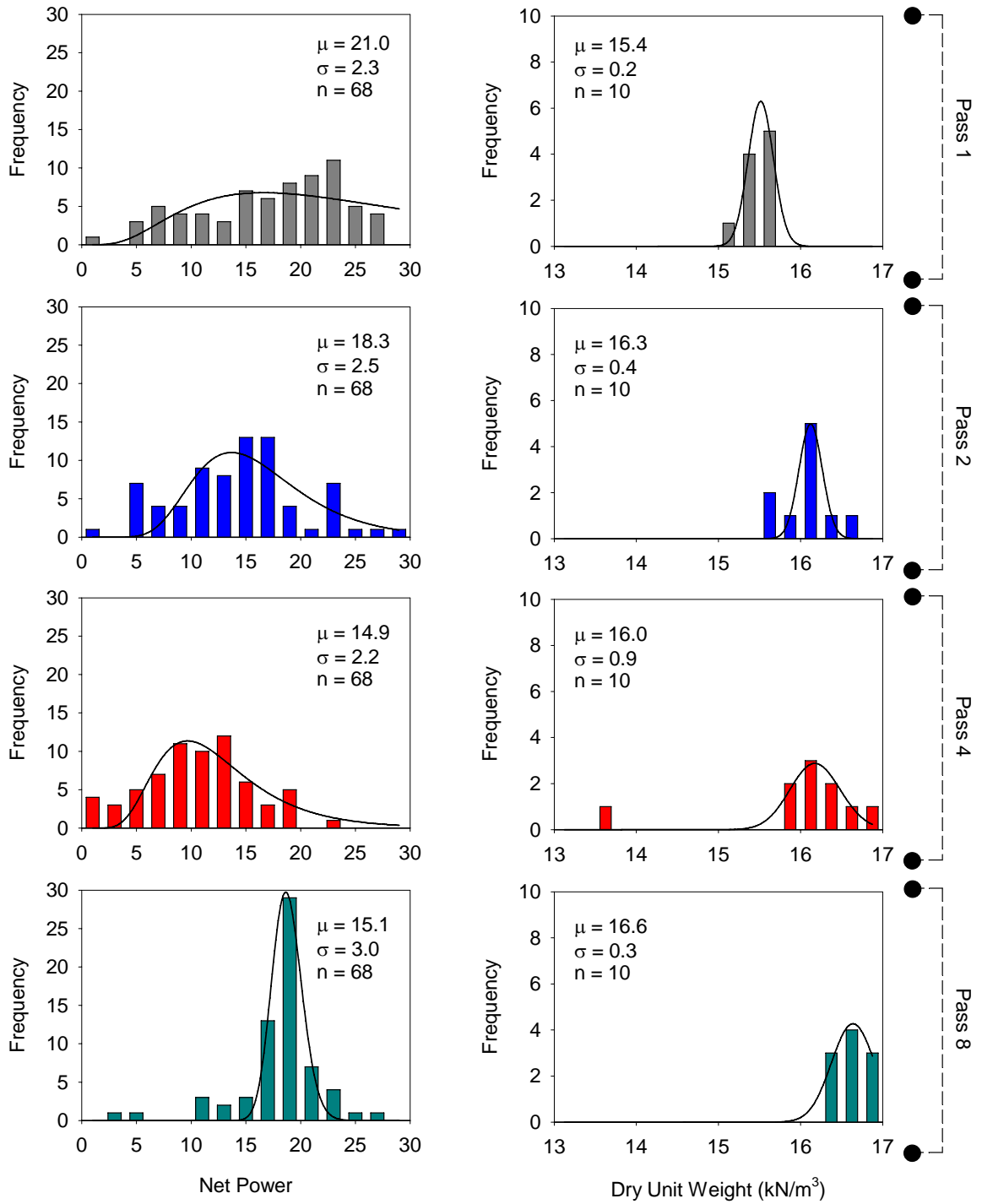


Figure 130. Sand, strip 1: distribution plots for net power and dry density per pass

**Table 6. Topsoil: summary of net power and spot measurement averages, standard deviations, and coefficients of variation**

Strip	Pass	NPp			$\gamma_d$ (kN/m <sup>3</sup> )			w (%)			CIV			DCPI (mm/b)			E <sub>GG</sub> (MPa)			E <sub>PFWD</sub> (MPa)		
		$\mu$	$\sigma$	COV	$\mu$	$\sigma$	COV	$\mu$	$\sigma$	COV	$\mu$	$\sigma$	COV	$\mu$	$\sigma$	COV	$\mu$	$\sigma$	COV	$\mu$	$\sigma$	COV
1	0	---	---	---	10.00	0.34	0.03	19.5	1.04	0.05	---	---	---	---	---	---	---	---	---	---	---	---
	1	18.94	5.09	0.27	12.93	0.46	0.04	23.0	1.31	0.06	3.7	0.76	0.21	149	30.78	0.21	---	---	---	13	2.76	0.21
	2	14.01	4.69	0.33	13.80	0.50	0.04	22.7	1.30	0.06	4.1	0.68	0.17	125	15.36	0.12	---	---	---	13	2.76	0.21
	4	11.00	4.70	0.43	14.65	0.59	0.04	23.0	1.65	0.07	4.2	0.71	0.17	115	32.77	0.28	28.0	7.82	0.28	41	66.47	1.63
	8	8.75	4.03	0.46	15.25	0.45	0.03	23.2	1.69	0.07	4.3	0.70	0.16	92	13.11	0.14	32	7.56	0.24	24	12.70	0.52
2	0	---	---	---	11.11	0.37	0.03	17.0	0.77	0.05	---	---	---	---	---	---	---	---	---	---	---	---
	1	19.89	4.09	0.21	13.00	0.45	0.03	22.0	1.49	0.07	---	---	---	160	17.70	0.11	---	---	---	---	---	---
	2	14.78	4.64	0.31	13.71	0.35	0.03	21.7	1.52	0.07	---	---	---	127	22.30	0.18	21	7.27	0.34	11	2.08	0.20
	4	60.64	3.37	0.06	14.26	0.39	0.03	23.1	1.18	0.05	---	---	---	93	34.82	0.37	30	7.80	0.26	22	3.41	0.15
	8	9.60	4.21	0.44	15.22	0.39	0.03	22.2	1.10	0.05	---	---	---	87	14.91	0.17	34	6.55	0.20	27	15.46	0.57
3	0	---	---	---	10.50	0.52	0.05	15.5	0.72	0.05	---	---	---	---	---	---	---	---	---	---	---	---
	1	16.51	3.68	0.22	12.47	0.38	0.03	19.1	0.63	0.03	4.2	0.48	0.11	114	19.81	0.17	---	---	---	---	---	---
	2	14.11	3.99	0.28	13.20	0.28	0.02	18.7	0.72	0.04	5.3	0.28	0.05	80	22.49	0.28	27	5.60	0.21	17	6.68	0.38
	4	7.76	4.15	0.54	13.78	0.23	0.02	18.8	0.96	0.05	6.5	0.59	0.09	63	13.31	0.21	32	5.63	0.17	25	11.02	0.44
	8	3.76	3.64	0.97	15.22	0.30	0.02	17.6	0.00	0.06	---	---	---	38	---	---	51	---	---	47	---	---
4	0	---	---	---	10.33	0.32	0.03	14.9	0.98	0.07	---	---	---	---	---	---	---	---	---	---	---	---
	1	13.95	2.89	0.21	12.63	0.59	0.05	17.2	1.09	0.06	5.1	0.63	0.12	102	20.81	0.21	---	---	---	11	2.11	0.19
	2	8.80	2.66	0.30	13.80	0.50	0.04	17.9	1.00	0.06	5.7	0.58	0.10	84	12.94	0.15	36	6.65	0.19	18	4.92	0.27
	4	4.15	2.00	0.48	14.49	0.33	0.02	17.6	0.91	0.05	6.8	0.85	0.12	45	13.05	0.29	48	5.01	0.11	37	13.63	0.37
	8	2.61	2.18	0.84	15.67	0.51	0.03	17.2	1.32	0.08	9.1	0.96	0.11	36	6.48	0.18	61	11.24	0.18	127	89.68	0.71
5	0	---	---	---	11.12	0.23	0.02	12.4	0.85	0.07	---	---	---	---	---	---	---	---	---	---	---	---
	1	19.41	11.17	0.58	12.18	0.32	0.03	15.6	1.34	0.09	4.4	0.29	0.07	113	26.33	0.23	---	---	---	---	---	---
	2	11.98	3.25	0.27	12.92	0.22	0.02	16.2	0.85	0.05	6.0	0.71	0.12	75	14.42	0.19	30	3.84	0.13	18	7.12	0.40
	4	7.00	3.01	0.43	13.84	0.47	0.03	15.6	1.16	0.07	7.7	0.92	0.12	48	10.08	0.21	32	5.19	0.16	21	5.28	0.25
	8	2.86	2.63	0.92	14.61	0.24	0.02	15.1	1.04	0.07	9.3	0.74	0.08	28	6.54	0.23	48	7.41	0.15	49	11.06	0.23
6	0	---	---	---	10.81	0.45	0.04	13.8	0.57	0.04	---	---	---	---	---	---	---	---	---	---	---	---
	1	12.51	2.94	0.24	11.96	0.41	0.03	16.2	0.78	0.05	4.7	0.48	0.10	100	30.52	0.30	---	---	---	---	---	---
	2	9.09	2.37	0.26	13.70	0.20	0.01	15.9	0.69	0.04	6.2	0.67	0.11	69	10.70	0.15	36	8.75	0.24	24	1.06	0.38
	4	5.20	2.92	0.56	14.51	0.39	0.03	15.6	0.72	0.05	7.9	0.67	0.08	48	9.51	0.20	47	7.58	0.16	43	9.08	0.41
	8	1.67	1.66	0.99	14.77	0.56	0.04	15.8	0.72	0.05	9.8	0.96	0.10	28	13.89	0.49	59	12.27	0.21	49	17.66	0.37

**Table 7. Fill clay: summary of net power and spot measurement averages, standard deviations, and coefficients of variation**

Strip	Pass	NPP			$\gamma_d$ (kN/m <sup>3</sup> )			w (%)			CIV			DCPI (mm/b)			E <sub>GG</sub> (MPa)			E <sub>PFWD</sub> (MPa)		
		$\mu$	$\sigma$	COV	$\mu$	$\sigma$	COV	$\mu$	$\sigma$	COV	$\mu$	$\sigma$	COV	$\mu$	$\sigma$	COV	$\mu$	$\sigma$	COV	$\mu$	$\sigma$	COV
1	0	---	---	---	11.40	0.75	0.07	14.9	1.02	0.07	---	---	---	---	---	---	---	---	---	---	---	---
	1	21.19	5.20	0.25	14.20	0.48	0.03	21.4	3.19	0.15	2.8	0.22	0.08	172	26.86	0.16	27.2	4.16	0.15	15	5.59	0.36
	2	15.16	3.46	0.23	14.88	0.25	0.02	22.4	1.67	0.07	2.9	0.54	0.18	155	25.78	0.17	29.6	4.80	0.16	23	15.92	0.69
	4	15.91	3.75	0.24	15.44	0.20	0.01	22.2	0.96	0.04	2.8	0.38	0.13	152	25.31	0.17	30.9	8.69	0.28	17	6.22	0.36
	8	11.90	3.56	0.30	---	---	---	21.0	---	---	2.8	---	---	139	---	---	31.8	---	---	22	---	---
2	0	---	---	---	10.29	0.33	0.03	11.3	0.81	0.07	---	---	---	---	---	---	---	---	---	---	---	---
	1	16.32	2.04	0.12	12.64	0.48	0.04	14.8	1.41	0.10	4.0	0.31	0.08	95	25.29	0.27	28.6	3.59	0.13	---	---	---
	2	6.47	6.29	0.97	13.86	0.62	0.04	15.0	1.56	0.10	5.4	0.75	0.14	82	15.09	0.18	45.6	13.28	0.29	25	9.27	0.37
	4	4.78	2.60	0.54	14.58	0.36	0.02	15.2	1.04	0.07	6.5	0.98	0.15	50	26.42	0.53	49.6	13.43	0.27	34	9.48	0.28
	8	2.40	1.73	0.72	15.57	0.59	0.04	14.8	1.62	0.11	9.3	1.57	0.17	36	9.85	0.28	62.9	8.65	0.14	49	28.77	0.58
3	0	---	---	---	10.14	0.38	0.04	14.8	1.47	0.10	---	---	---	---	---	---	---	---	---	---	---	---
	1	18.89	2.11	0.11	14.60	0.55	0.04	18.5	1.19	0.06	3.8	0.45	0.12	110	7.30	0.07	46.9	8.21	0.18	33	20.43	0.61
	2	10.23	2.20	0.22	14.94	0.52	0.04	18.2	0.88	0.05	4.0	0.63	0.16	116	16.03	0.14	48.9	6.01	0.12	28	14.89	0.53
	4	8.18	2.15	0.26	15.19	0.50	0.03	18.3	1.09	0.06	4.5	0.37	0.08	93	20.14	0.22	49.4	4.23	0.09	44	21.55	0.49
	8	7.47	3.21	0.43	15.82	0.65	0.04	18.3	1.17	0.06	5.0	1.47	0.29	94	25.29	0.27	48.1	5.35	0.11	59	36.57	0.62

**Table 8. Edwards till: summary of net power and spot measurement averages, standard deviations, and coefficients of variation**

Strip	Pass	NPp			$\gamma_d$ (kN/m <sup>3</sup> )			w (%)			CIV			DCPI (mm/b)			E <sub>GG</sub> (MPa)			E <sub>PFWD</sub> (MPa)		
		$\mu$	$\sigma$	COV	$\mu$	$\sigma$	COV	$\mu$	$\sigma$	COV	$\mu$	$\sigma$	COV	$\mu$	$\sigma$	COV	$\mu$	$\sigma$	COV	$\mu$	$\sigma$	COV
1	0	---	---	---	12.99	0.27	0.02	6.8	0.58	0.09	---	---	---	287	34.13	0.12	5.4	1.63	0.30	---	---	---
	1	17.89	2.42	0.14	14.18	0.34	0.02	8.3	0.75	0.09	3.9	0.35	0.09	57	14.25	0.25	25.7	2.57	0.10	12	1.65	0.14
	2	10.94	2.43	0.22	14.95	0.25	0.02	8.6	0.57	0.07	7.2	1.22	0.17	38	3.33	0.09	31.4	5.84	0.19	21	7.65	0.36
	4	4.59	2.77	0.60	15.37	0.21	0.01	8.5	0.45	0.05	9.5	0.79	0.08	28	3.43	0.12	44.7	12.07	0.27	33	11.25	0.34
	8	3.13	1.86	0.59	16.10	0.30	0.02	8.2	0.37	0.05	13.4	1.90	0.14	18	2.55	0.15	83.9	16.97	0.20	65	21.49	0.33
2	0	---	---	---	13.53	0.30	0.02	7.0	0.42	0.06	---	---	---	231	38.29	0.17	8.5	2.67	0.32	---	---	---
	1	16.84	2.92	0.17	14.55	0.33	0.02	8.6	0.42	0.05	4.4	0.30	0.07	87	14.92	0.17	19.7	5.46	0.28	14	2.28	0.16
	2	9.23	2.84	0.31	14.76	0.27	0.02	8.3	0.43	0.05	5.6	0.49	0.09	85	20.64	0.24	35.0	5.46	0.16	17	4.66	0.27
	4	4.88	3.14	0.64	15.34	0.30	0.02	7.8	0.54	0.07	8.7	1.52	0.17	43	9.58	0.22	44.6	6.28	0.14	29	8.73	0.31
	8	2.06	1.65	0.80	15.77	0.37	0.02	7.6	0.41	0.05	11.4	2.01	0.18	29	4.84	0.17	55.8	8.95	0.16	45	20.71	0.46
3	0	---	---	---	11.19	0.61	0.05	11.4	1.49	0.13	---	---	---	---	---	---	---	---	---	---	---	---
	1	---	---	---	15.09	0.66	0.04	18.0	1.57	0.09	---	---	---	192	22.11	0.12	26.3	3.14	0.12	11	3.19	0.29
	2	17.80	3.56	0.20	16.32	0.38	0.02	16.3	0.53	0.03	---	---	---	190	23.62	0.12	29.8	2.51	0.08	12	6.04	0.51
	4	15.26	3.32	0.22	16.86	0.33	0.02	16.7	1.06	0.06	---	---	---	172	17.00	0.10	32.7	5.35	0.16	19	6.98	0.37
	8	11.98	4.21	0.35	17.05	0.30	0.02	17.4	1.11	0.06	---	---	---	147	21.49	0.15	34.1	4.92	0.14	18	10.48	0.59
4	0	---	---	---	10.47	0.57	0.05	13.6	1.21	0.09	---	---	---	---	---	---	---	---	---	---	---	---
	1	16.11	2.64	0.16	14.19	0.67	0.05	15.5	0.99	0.06	---	---	---	93	18.11	0.20	---	---	---	---	---	---
	2	12.41	2.54	0.20	14.49	0.92	0.06	15.3	1.09	0.07	---	---	---	105	16.33	0.16	---	---	---	---	---	---
	4	9.74	3.42	0.35	16.24	0.63	0.04	14.7	0.84	0.06	---	---	---	97	18.70	0.19	---	---	---	---	---	---
	8	7.87	7.36	0.94	17.31	0.65	0.04	15.0	1.21	0.08	---	---	---	77	26.76	0.35	---	---	---	---	---	---
5	0	---	---	---	11.96	0.32	0.03	9.5	0.65	0.07	---	---	---	---	---	---	---	---	---	---	---	---
	1	17.05	2.16	0.13	13.70	0.45	0.03	10.7	1.71	0.16	4.8	0.82	0.17	107	25.41	0.24	28.4	3.31	0.12	11	2.75	0.24
	2	12.12	3.80	0.31	14.72	0.53	0.04	11.1	0.60	0.05	6.1	0.74	0.12	72	28.17	0.39	43.1	9.13	0.21	21	10.89	0.51
	4	7.49	3.08	0.41	15.44	0.36	0.02	11.4	0.96	0.08	8.4	1.32	0.16	35	9.73	0.28	60.1	5.12	0.09	34	11.80	0.35
	8	---	---	---	16.15	0.43	0.03	10.9	0.82	0.07	10.8	1.20	0.11	33	15.18	0.46	74.3	6.79	0.09	65	37.75	0.58
6	0	---	---	---	11.77	0.24	0.02	9.9	1.31	0.13	---	---	---	---	---	---	---	---	---	---	---	---
	1	13.49	3.71	0.27	13.88	1.24	0.09	11.1	1.12	0.10	7.0	1.84	0.26	71	12.73	0.18	43.4	10.05	0.23	83	118.0	1.42
	2	7.85	2.99	0.38	13.92	0.64	0.05	10.9	0.93	0.09	6.8	0.91	0.14	63	12.36	0.20	54.4	16.41	0.30	31	7.95	0.26
	4	4.07	3.10	0.76	14.89	0.67	0.05	9.8	0.80	0.08	8.8	1.18	0.14	37	13.73	0.37	64.9	10.65	0.16	57	31.96	0.56
	8	4.14	5.30	1.28	15.40	1.22	0.08	10.5	0.94	0.09	10.7	1.72	0.16	34	7.38	0.22	72.1	13.50	0.19	102	38.73	0.38

**Table 9. Sand: summary of net power and spot measurement averages, standard deviations, and coefficients of variation**

Strip	Pass	NPp			$\gamma_d$ (kN/m <sup>3</sup> )			w (%)			CIV			DCPI (mm/b)			E <sub>GG</sub> (MPa)			E <sub>PFWD</sub> (MPa)		
		$\mu$	$\sigma$	COV	$\mu$	$\sigma$	COV	$\mu$	$\sigma$	COV	$\mu$	$\sigma$	COV	$\mu$	$\sigma$	COV	$\mu$	$\sigma$	COV	$\mu$	$\sigma$	COV
1	0	---	---	---	15.96	0.22	0.01	5.3	0.52	0.10	---	---	---	193	42.77	0.22	11.1	1.71	0.15	13	3.10	0.24
	1	21.02	2.27	0.11	15.43	0.17	0.01	8.1	0.51	0.06	---	---	---	129	23.56	0.18	29.0	8.62	0.30	39	11.73	0.30
	2	18.31	2.45	0.13	16.29	0.41	0.03	6.6	0.53	0.08	---	---	---	---	---	---	---	---	---	---	---	---
	4	14.93	2.23	0.15	15.96	0.90	0.06	7.8	0.96	0.12	---	---	---	132	26.83	0.20	---	---	---	44	22.09	0.50
	8	15.09	3.01	0.20	16.63	0.26	0.02	6.9	0.39	0.06	---	---	---	123	15.03	0.12	25.4	7.19	0.28	41	7.98	0.19
2	0	---	---	---	15.52	0.45	0.03	7.5	8.24	1.09	---	---	---	225	39.68	0.18	12.1	1.96	0.16	9	1.55	0.17
	1	20.62	3.44	0.17	16.17	0.29	0.02	7.8	0.58	0.07	---	---	---	66	9.22	0.14	13.3	2.20	0.17	24	7.11	0.30
	2	19.37	3.50	0.18	16.49	0.31	0.02	7.1	0.74	0.10	---	---	---	158	10.67	0.07	14.6	3.81	0.26	22	5.95	0.27
	4	17.14	3.70	0.22	16.81	0.19	0.01	7.2	0.52	0.07	---	---	---	140	17.37	0.12	15.1	2.80	0.18	26	5.39	0.21
	8	---	---	---	17.07	0.24	0.01	6.4	0.64	0.10	---	---	---	121	20.99	0.17	16.2	5.27	0.33	26	5.13	0.20
3	0	---	---	---	15.18	0.45	0.03	8.2	0.76	0.09	---	---	---	405	20.78	0.05	13.5	1.29	0.10	---	---	---
	1	23.93	3.54	0.15	16.46	0.33	0.02	10.7	0.75	0.07	---	---	---	134	20.41	0.15	18.5	2.98	0.16	15	2.66	0.18
	2	18.96	3.32	0.18	16.99	0.36	0.02	10.4	1.22	0.12	---	---	---	100	13.51	0.13	19.8	3.17	0.16	17	3.01	0.18
	4	13.08	4.20	0.32	17.32	0.33	0.02	7.8	0.52	0.07	---	---	---	85	10.15	0.12	21.0	4.24	0.20	20	5.92	0.30
	8	10.33	4.07	0.39	17.93	0.33	0.02	9.9	0.78	0.08	---	---	---	70	10.52	0.15	25.0	5.20	0.21	24	6.60	0.27
4	0	---	---	---	15.37	0.67	0.04	8.3	0.54	0.06	---	---	---	251	9.43	0.04	10.0	1.05	0.10	---	---	---
	1	20.64	2.48	0.12	16.48	0.55	0.03	10.2	0.62	0.06	---	---	---	154	22.91	0.15	19.1	5.37	0.28	19	6.34	0.33
	2	15.13	6.76	0.45	17.19	0.54	0.03	10.3	0.56	0.05	---	---	---	118	35.21	0.30	22.6	6.02	0.27	36	21.27	0.59
	4	13.95	2.47	0.18	17.44	0.49	0.03	10.5	0.70	0.07	---	---	---	85	11.80	0.14	27.3	5.34	0.20	33	18.87	0.57
	8	11.65	2.75	0.24	17.77	0.27	0.02	10.8	0.79	0.07	---	---	---	62	8.13	0.13	33.3	9.23	0.28	28	6.14	0.22

## *Multiple Linear Regression Analysis*

### Laboratory Study

A laboratory compaction study was performed to investigate and model the relationships between compaction energy, moisture content, and dry unit weight. The model would ideally be simple and would predict dry unit weight for any combination of moisture content and compaction energy. For the study, soil type (Edwards till, western Iowa loess, Peoria proving grounds (PPG) till, weathered shale, central Iowa till), compaction energy (355, 592, 987, and 2,693 kJ/m<sup>3</sup>), and moisture content (varying by soil type) were controlled; additionally, the dry weight for each combination of soil type, energy level, and moisture content was determined using Proctor tests. The density-moisture-energy relationships for each soil type were modeled separately, however, because of the differing physical properties of the soils.

Moisture-density relationships at each level of compaction energy are bell-shaped, with dry unit weight initially increasing with increasing moisture, followed by decreasing dry unit weight. This trend was observed at each energy level with the caveat that increasing compaction energy for a given soil produced a higher maximum dry density at lower optimum moisture content. The relationship between dry unit weight and moisture content for a given soil type and energy level was modeled using a quadratic function, as shown in Equation 2. At this time, more complex models have not been considered due to the relatively small amount of data (about 5 points for each soil type). Further, log transformations on dry unit weight or moisture content did not produce linear models or improve the model fit.

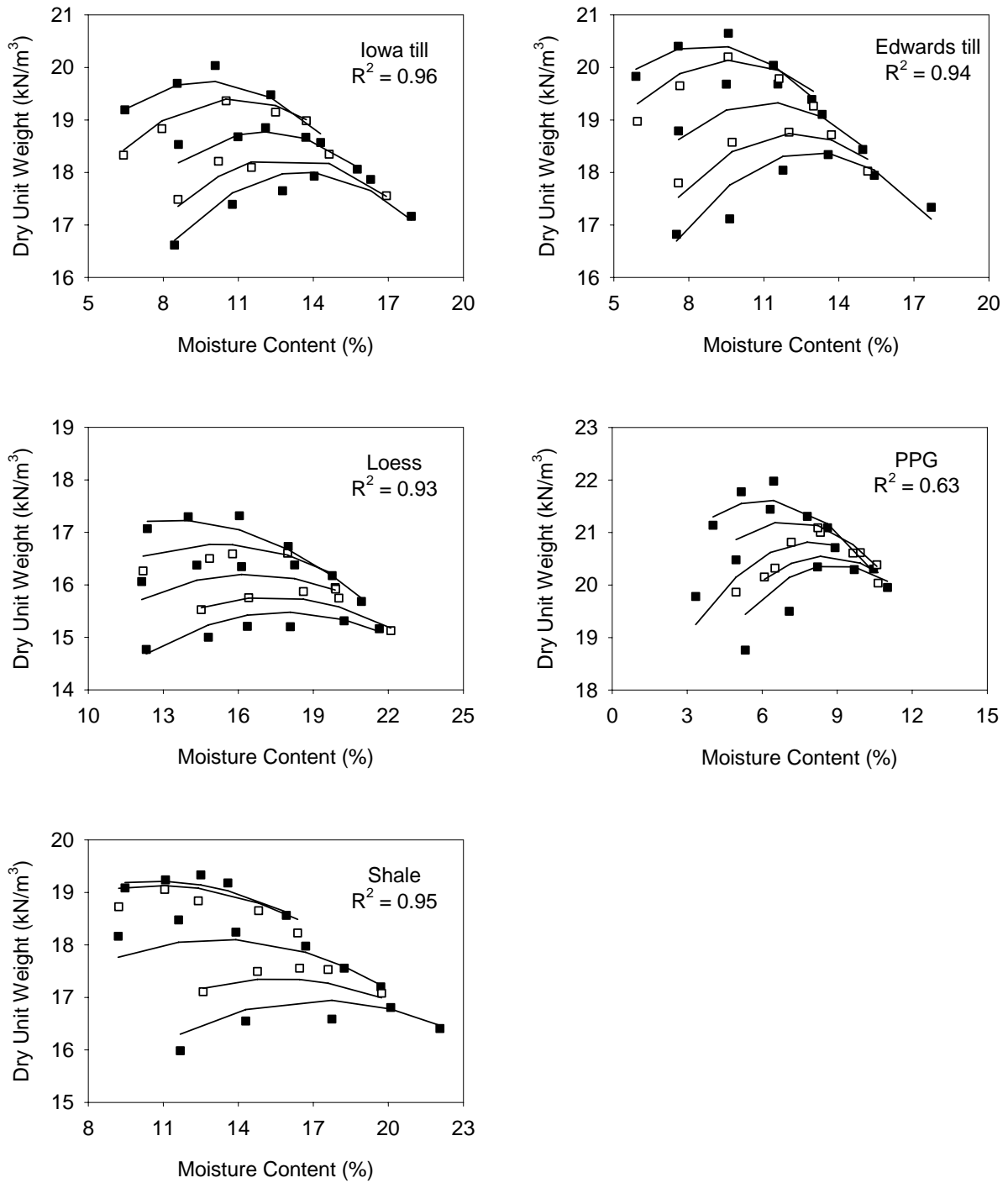
$$\gamma_d = b_0 + b_1 w + b_2 w^2 \quad (2)$$

Energy was initially incorporated into the model as a classification variable. This model contained the following 15 parameters: intercept, slope, and the quadratic term for moisture content at each of the 5 energy levels. Restricted models using a common slope, quadratic term, or both were compared using fit statistics (e.g., AIC) and F-tests. These tests indicated that either a common slope or a common quadratic term may be used, but not both. A model with separate slopes and a common quadratic term was eventually chosen due to a preference to fix the higher order parameter. This model had the following 11 parameters: intercept and slope for moisture content at each of the five energy levels, and one quadratic term.

The five intercepts and five slopes were then plotted against energy to observe any consistent relationships. The intercepts and the slopes could be modeled reasonably well using a quadratic function. Using the log of energy did not result in a linear relationship or improve the model fit. Incorporating the quadratic relationships of the moisture content intercepts and slopes into a model with energy gave the following seven-parameter model:

$$\gamma_d = b_0 + b_1 E + b_2 E^2 + b_3 w + b_4 w^2 + b_5 E w + b_6 E^2 w \quad (3)$$

where  $\gamma_d$  = dry unit weight,  $E$  = compaction energy,  $w$  = moisture content, and  $b_0$  through  $b_6$  are the regression coefficients. Graphs of the data with the fitted model for each soil type are given in Figure 131. The coefficient estimates for the fitted model are also given in the figure.



**Figure 131. Dry density data (squares) and predictions (lines) using a laboratory-derived compaction model**



Using the same number of soils (five), moisture contents (four), and energy levels (five), additional laboratory compaction studies were performed to identify the relationships between soil strength/stiffness and compaction energy and moisture content. The shear strength and secant modulus were determined for samples prepared at each combination of compaction energy and moisture content. The relationship between shear strength and energy for a given moisture content and soil type was adequately described by a quadratic model. To simplify the models, a common quadratic term that could be used for all moisture contents of a soil type was investigated. No consistent relationship was observed between the slope or intercept and moisture content. Therefore, a simple model based on quadratic relationships could not predict shear strength from energy and moisture content. A consistent relationship between secant modulus and energy at each moisture content was not observed. Furthermore, insufficient data were available for evaluating more complex models requiring additional parameters.

Attempts at predicting soil strength and stiffness from compaction energy and moisture content were unsuccessful. The inability to use a simple, consistent model may be explained as follows:

- The relationships are complex, and simple models may not be adequate.
- Soil strength and stiffness properties are strongly influenced by small changes in moisture. Variability in moisture content observed within a nominal moisture range obscured a general pattern.
- Soil strength and stiffness may not be adequately predicted from compaction energy and moisture content alone; additional variables may be needed.

Results using relatively simple relationships, although inconclusive in this study, provide a framework for evaluating the factors affecting the strength and stiffness of the compacted fill.

### Field Study

The previous laboratory study showed that dry unit weight could be modeled reasonably well using compaction energy and moisture content. A simple, consistent model could not be derived for strength or stiffness; however, some quadratic relationships were observed. Equation 3 was thus used to model all field measurements of soil density, strength, and stiffness with machine (net) power indicating compaction energy delivered to the soil. Statistically non-significant ( $p$  value  $> 0.05$ ) variables were removed from the model. The resulting relationships thus varied, depending on soil type and lift thickness. The final models were generally simpler than Equation 2, usually with less than four regression parameters. Still, about one half of the  $R^2$  values exceeded 0.80.

Using averaged net power (10 points) and field measurement values (nuclear density, CIV, DCP index, GG modulus, PFWD modulus, and PLT coefficient of subgrade reaction), the models, separated by soil type and lift thickness, are presented from Figure 132 to Figure 138. A summary of  $R^2$  values for multiple regression analyses (per soil and lift thickness) is presented in Table 10. Exactly one half of the models show a linear relationship between net power and the various field measurements; the other half show that moisture and net power-moisture interaction terms are significant.

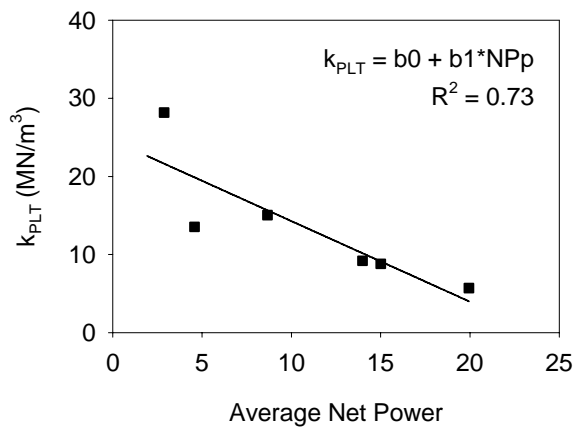
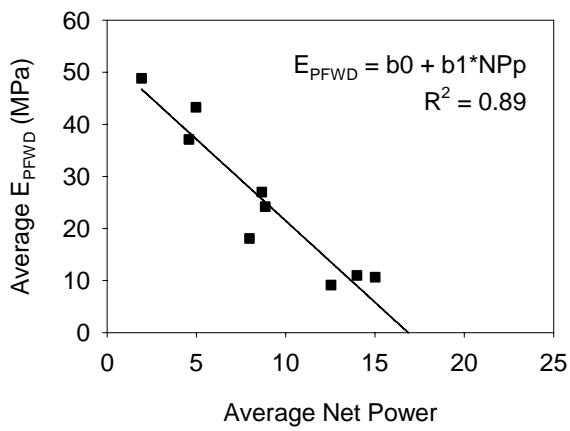
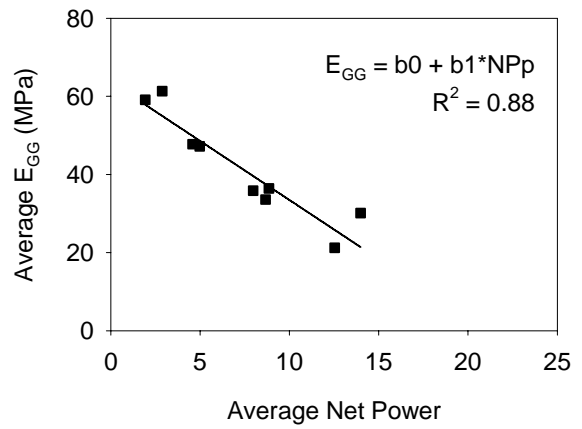
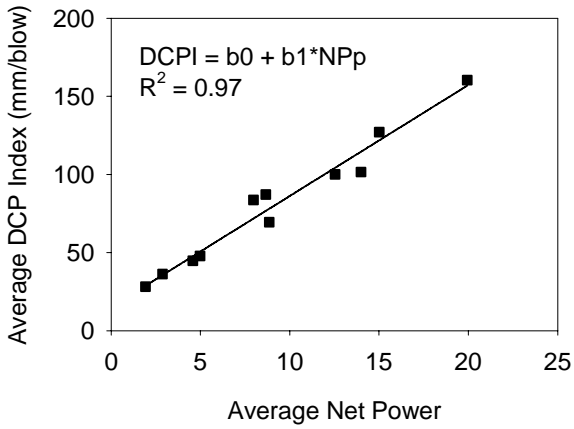
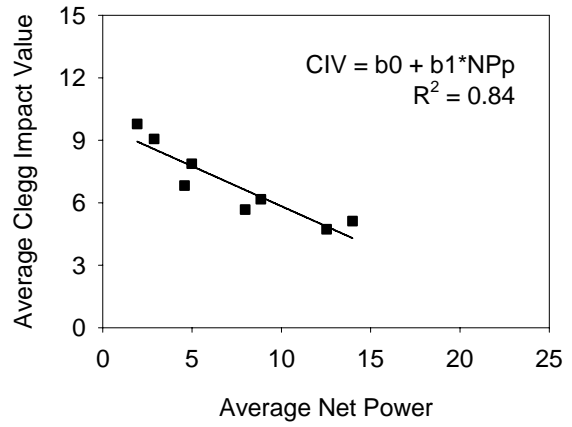
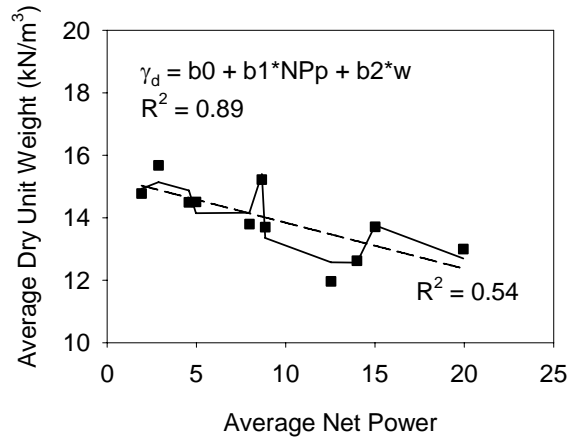


Figure 132. Topsoil, 20 cm lift (Strips 2, 4, 6)

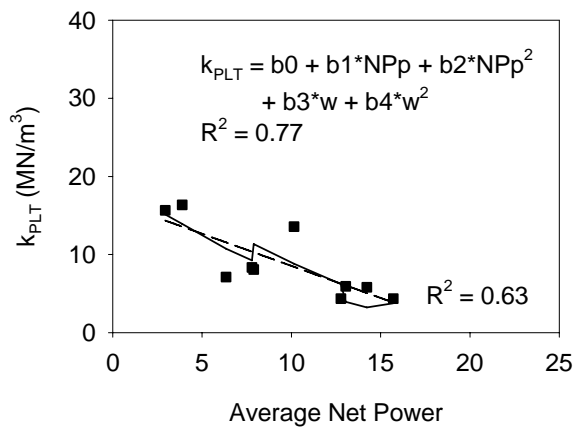
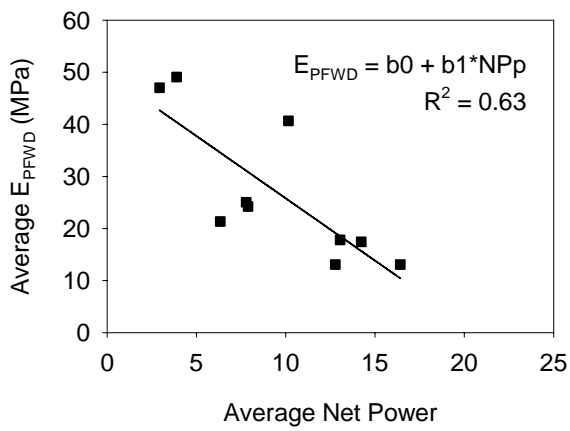
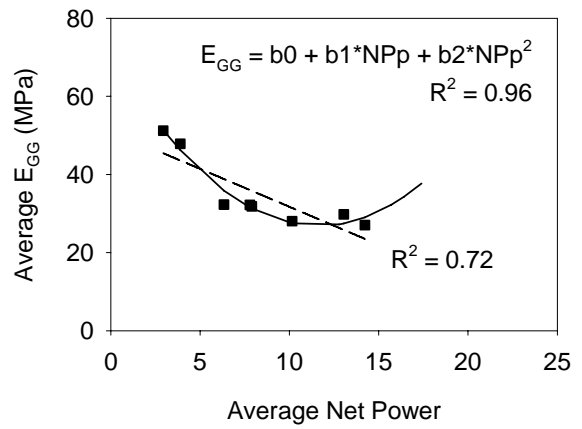
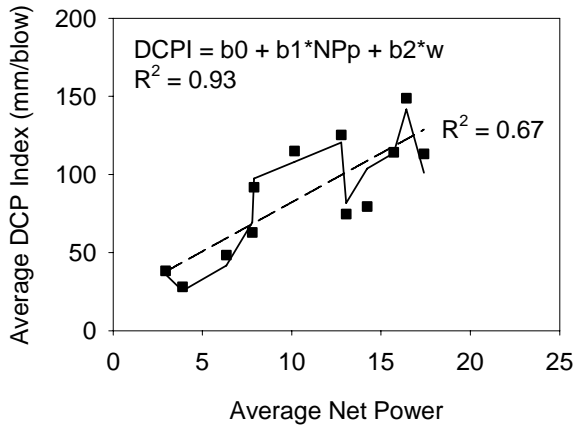
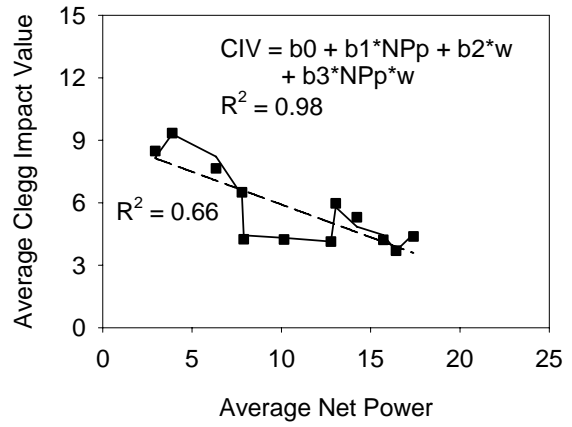
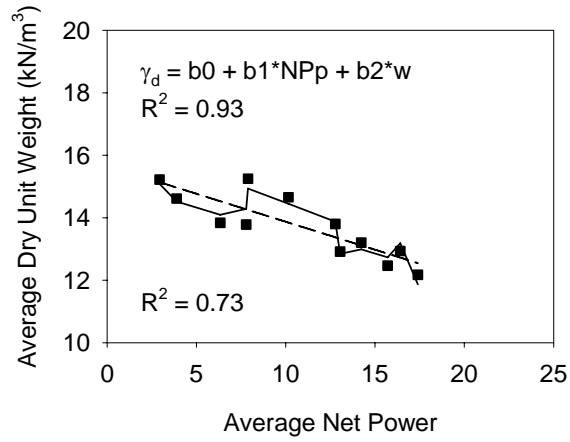
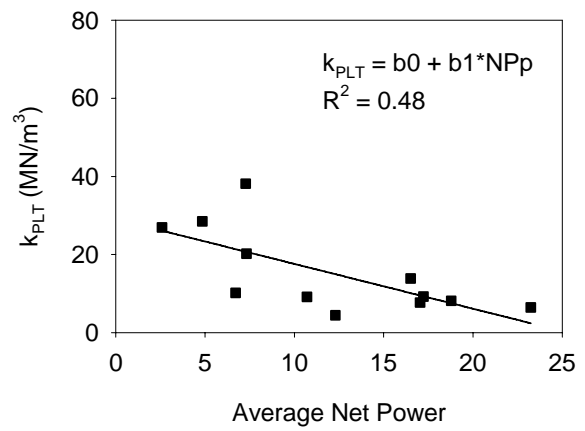
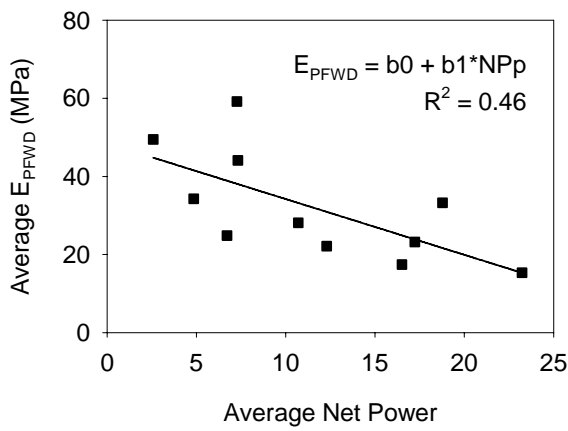
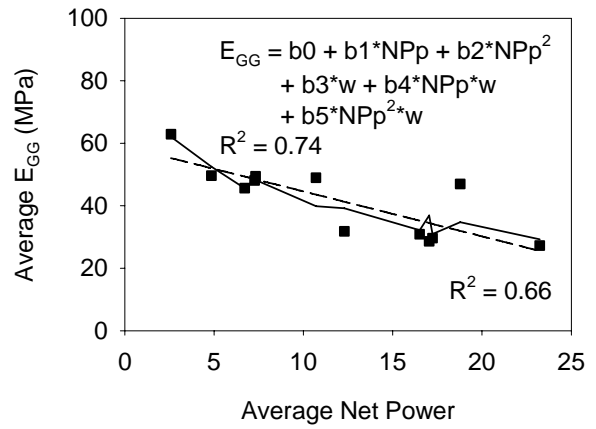
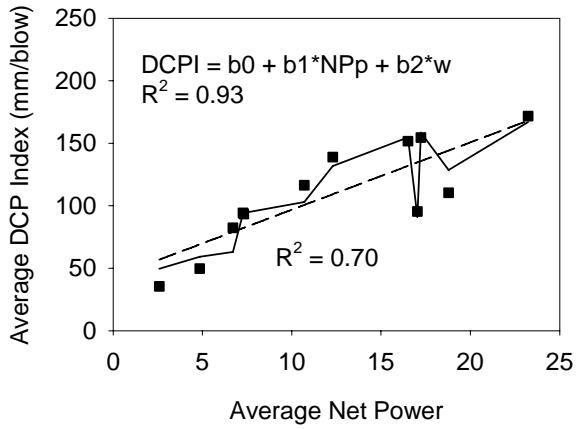
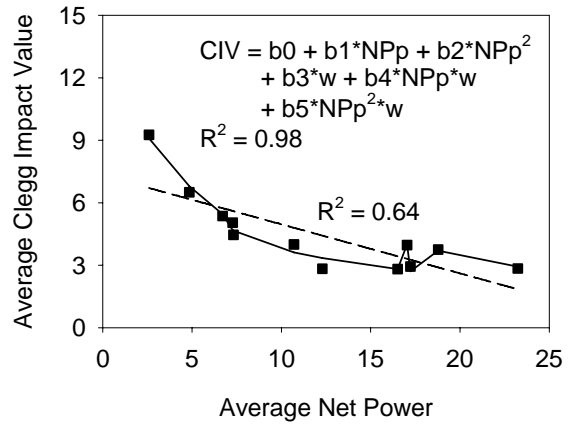
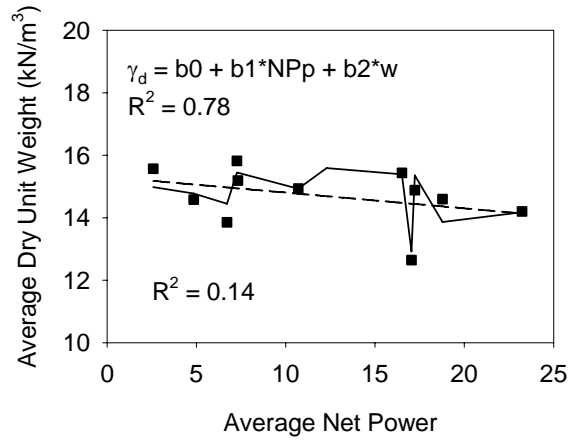
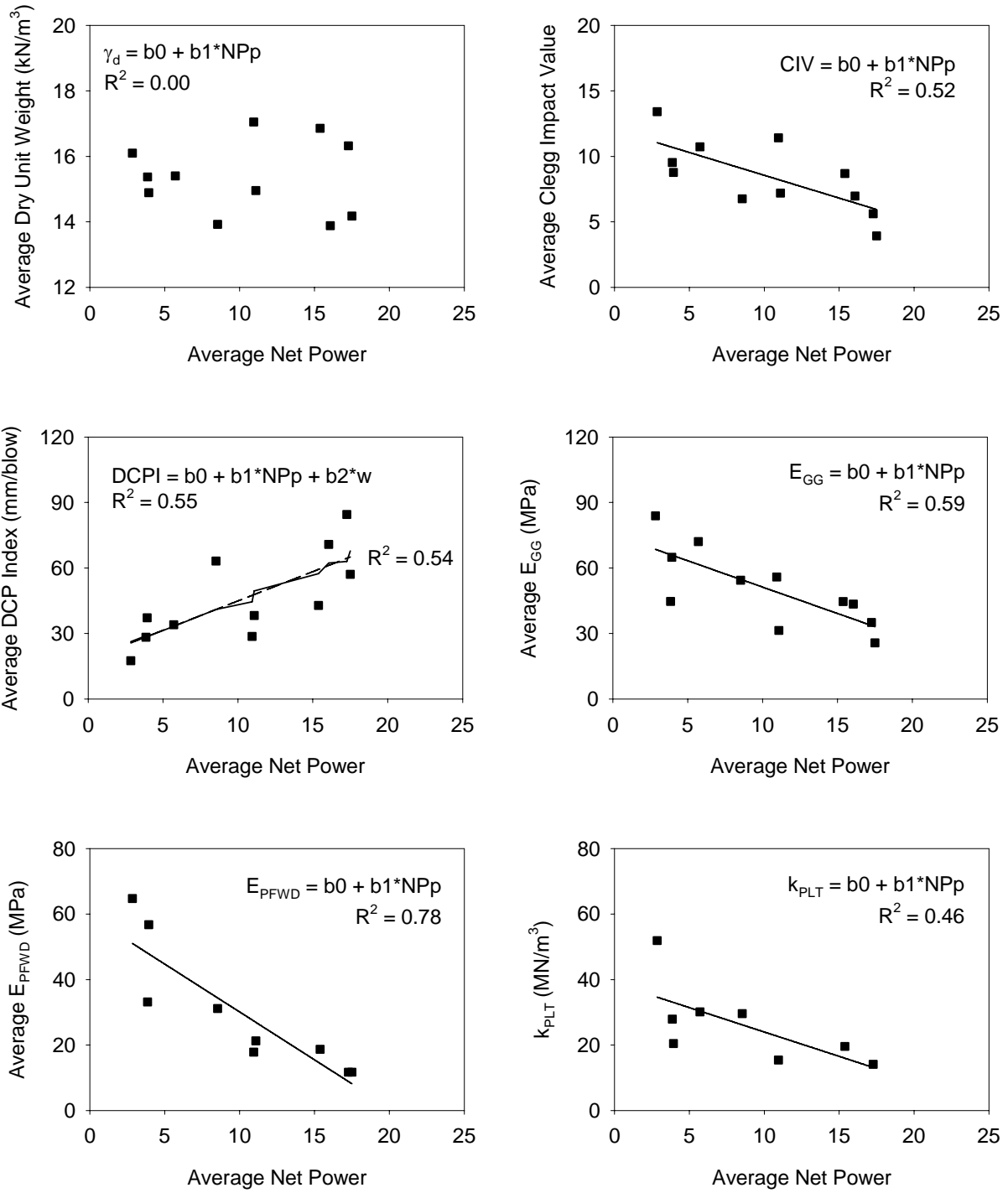


Figure 133. Topsoil, 30 cm lift (Strips 1, 3, 5)



**Figure 134. Fill clay, 25 cm lift (Strips 1, 2, 3)**



**Figure 135. Till, 15 cm lift (Strips 1, 3, 6)**

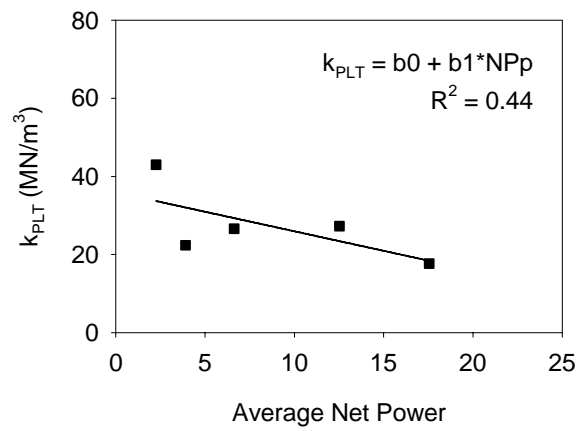
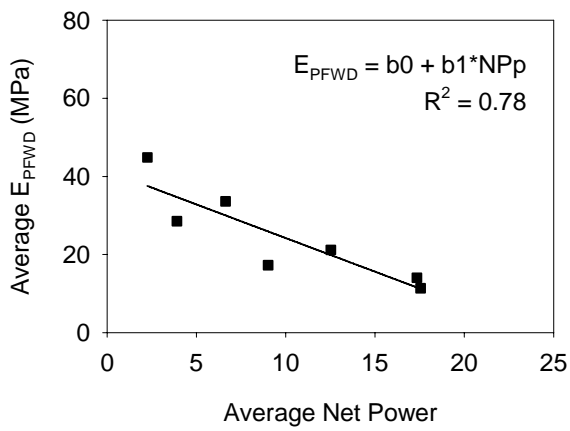
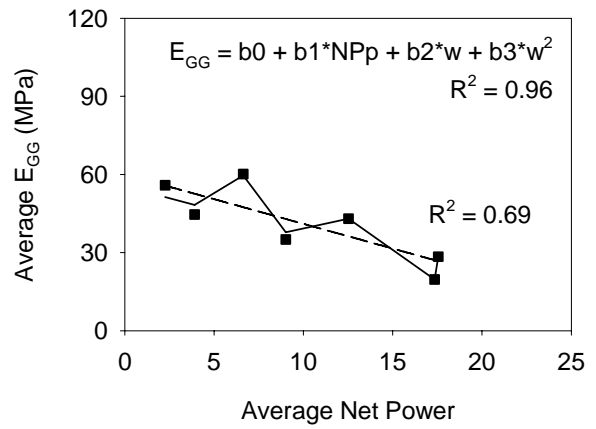
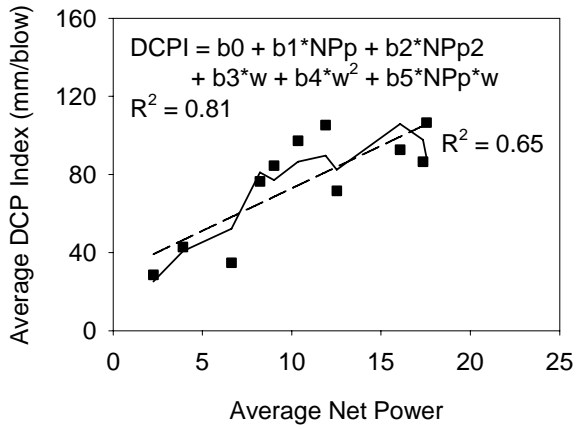
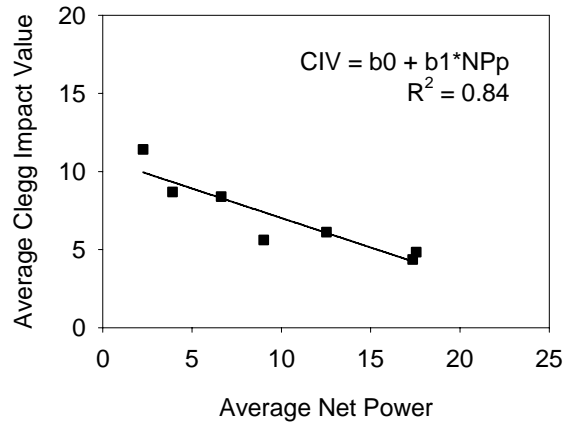
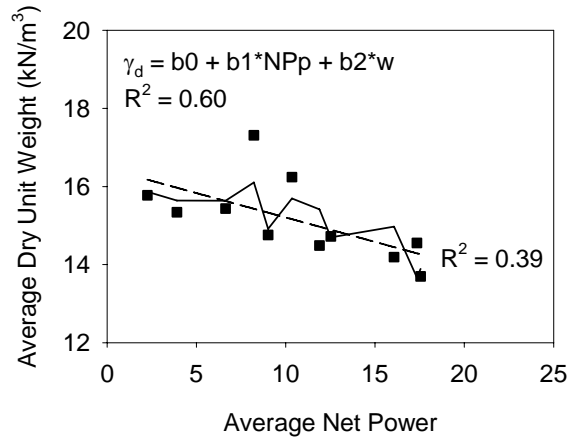
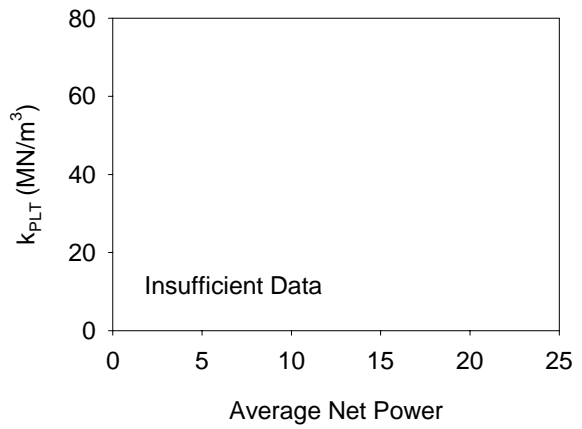
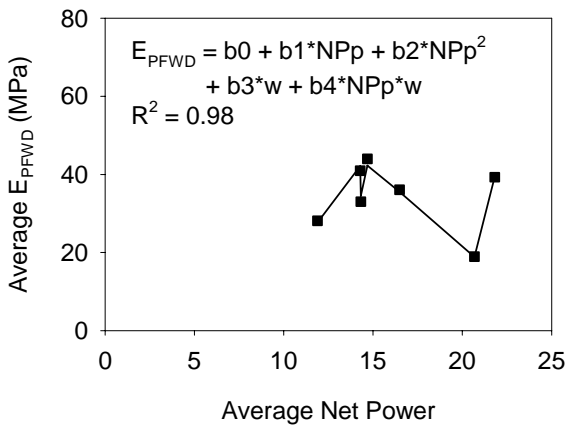
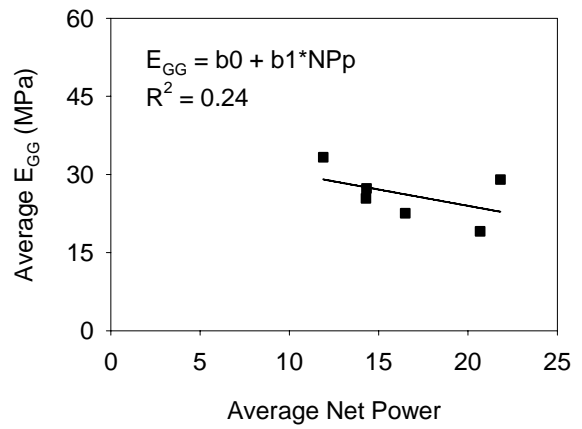
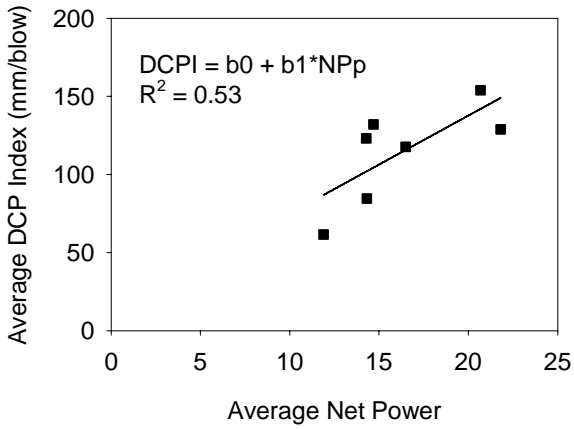
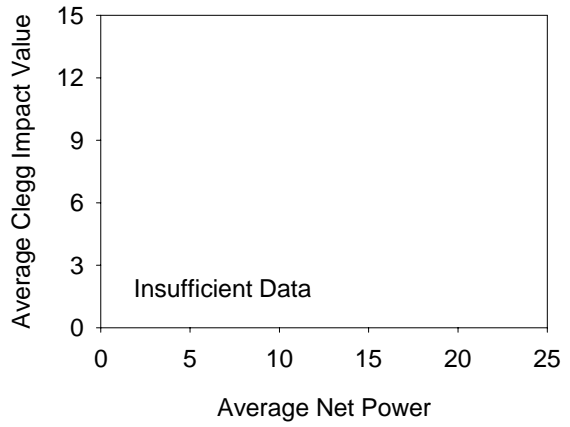
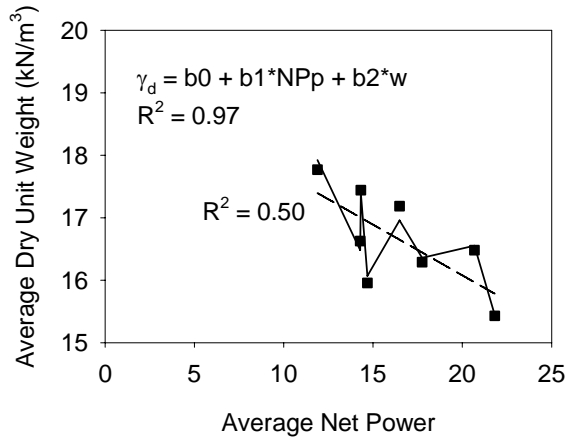


Figure 136. Till, 25 cm lift (Strips 2, 4, 5)



**Figure 137. Sand, 25 cm lift (Strips 1, 4)**

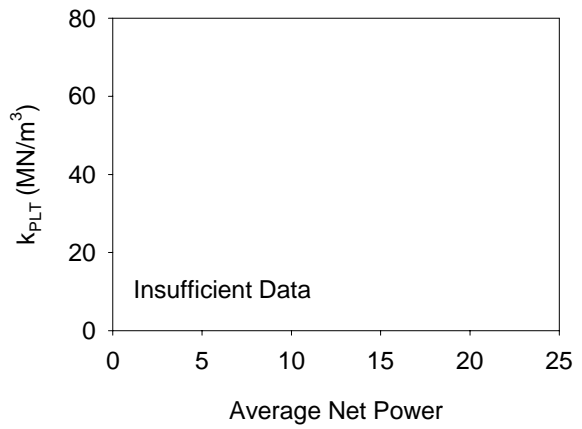
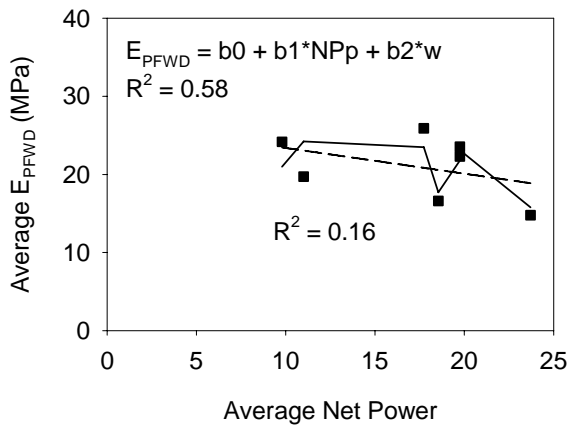
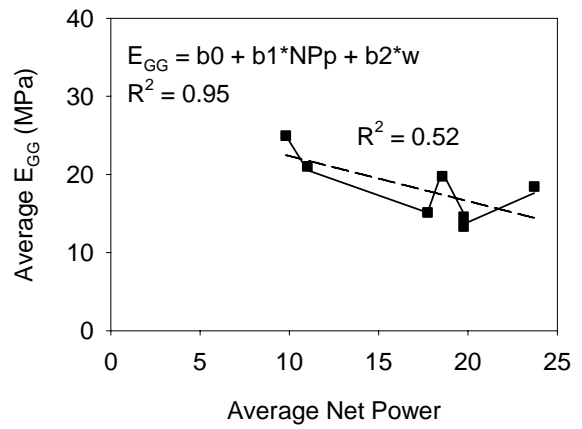
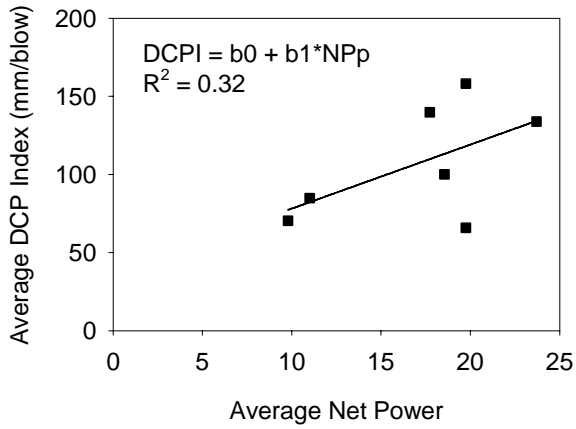
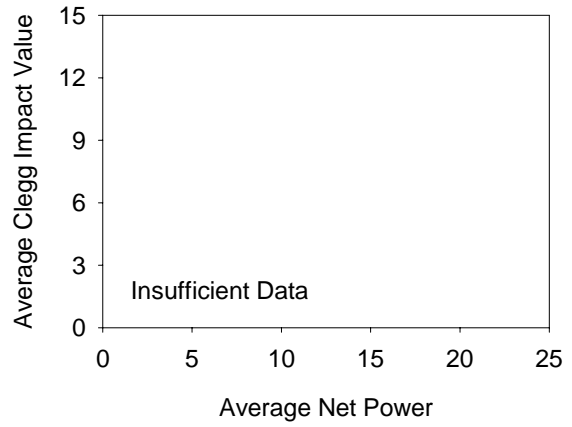
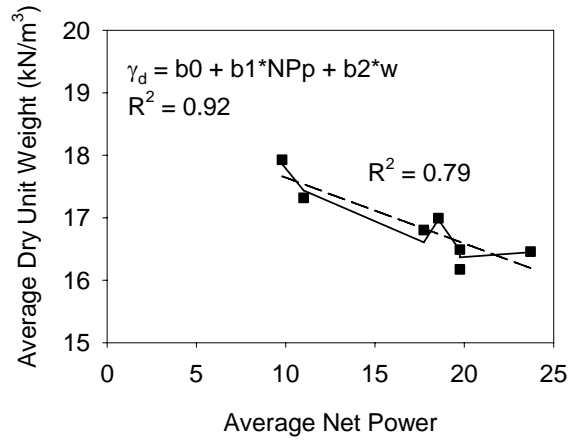


Figure 138. Sand, 36 cm lift (Strips 2, 3)



**Table 10. Summary of R<sup>2</sup> for linear and multiple regression analyses (per soil and lift)**

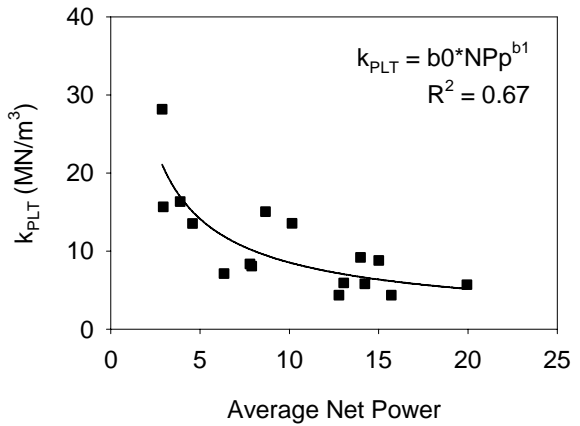
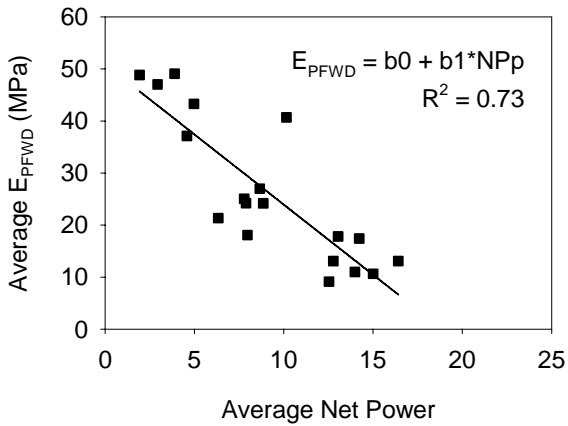
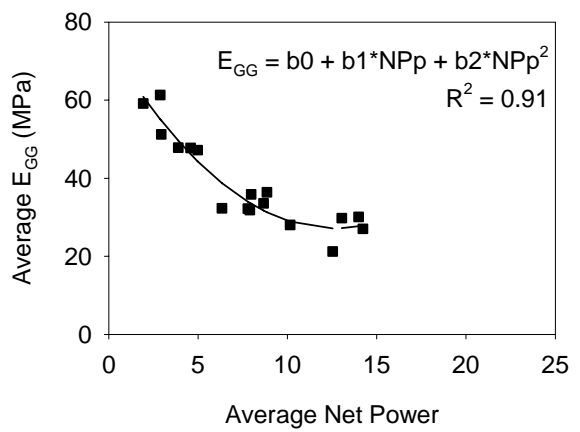
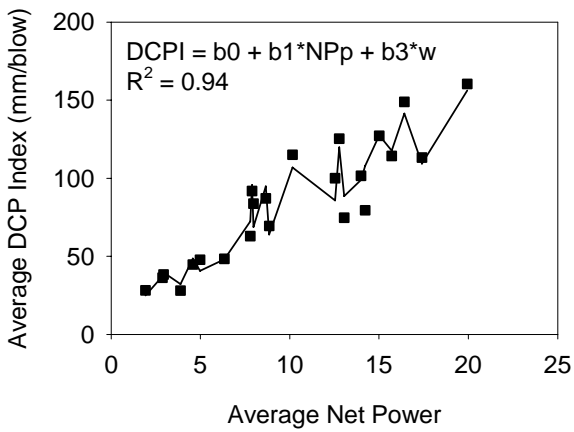
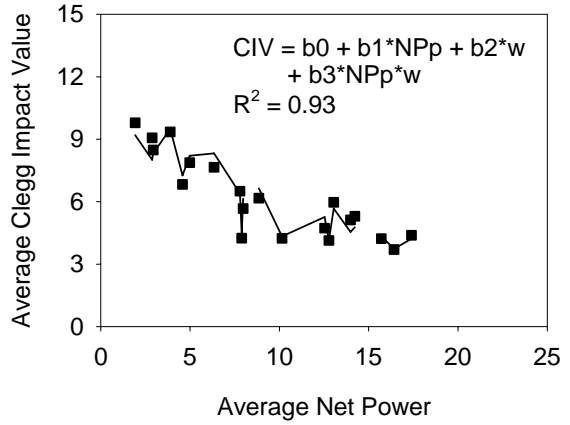
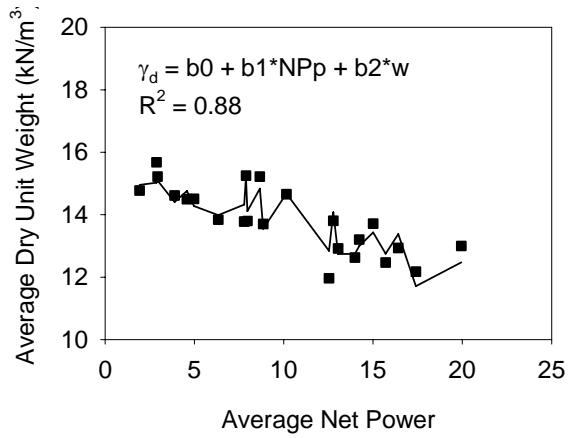
Soil type	Lift thickness	Moisture contents	Soil property	R <sup>2</sup>	
				Linear <sup>a</sup>	Multiple linear <sup>b</sup>
Topsoil	20-cm	8, 12, 16 %	$\gamma_d$	0.54	0.89
			CIV	0.84	---
			DCPI	0.97	---
			E <sub>GG</sub>	0.88	---
			E <sub>PFW</sub>	0.89	---
			k <sub>PLT</sub>	0.73	---
	30-cm	8, 12, 16 %	$\gamma_d$	0.73	0.93
			CIV	0.66	0.98
			DCPI	0.67	0.93
			E <sub>GG</sub>	0.72	0.96
			E <sub>PFW</sub>	0.63	---
			k <sub>PLT</sub>	0.63	0.77
Fill clay	25-cm	16, 20, 24 %	$\gamma_d$	0.14	0.78
			CIV	0.64	0.98
			DCPI	0.70	0.93
			E <sub>GG</sub>	0.66	0.74
			E <sub>PFW</sub>	0.46	---
			k <sub>PLT</sub>	0.48	---
Till	15-cm	8, 12, 16 %	$\gamma_d$	0.00	---
			CIV	0.52	---
			DCPI	0.54	0.55
			E <sub>GG</sub>	0.59	---
			E <sub>PFW</sub>	0.78	---
			k <sub>PLT</sub>	0.46	---
	25-cm	8, 12, 16 %	$\gamma_d$	0.39	0.60
			CIV	0.84	---
			DCPI	0.65	0.81
			E <sub>GG</sub>	0.69	0.96
			E <sub>PFW</sub>	0.78	---
			k <sub>PLT</sub>	0.44	---
Sand	25-cm	5, 10 %	$\gamma_d$	0.50	0.97
			CIV	---	---
			DCPI	0.53	---
			E <sub>GG</sub>	0.24	---
			E <sub>PFW</sub>	0.04	0.98
			k <sub>PLT</sub>	---	---
	36-cm	5, 10 %	$\gamma_d$	0.79	0.92
			CIV	---	---
			DCPI	0.32	---
			E <sub>GG</sub>	0.52	0.95
			E <sub>PFW</sub>	0.16	0.58
			k <sub>PLT</sub>	---	---

<sup>a</sup> Includes N<sub>Pp</sub>; <sup>b</sup> includes N<sub>Pp</sub>, w, and N<sub>Pp</sub>-w interaction terms

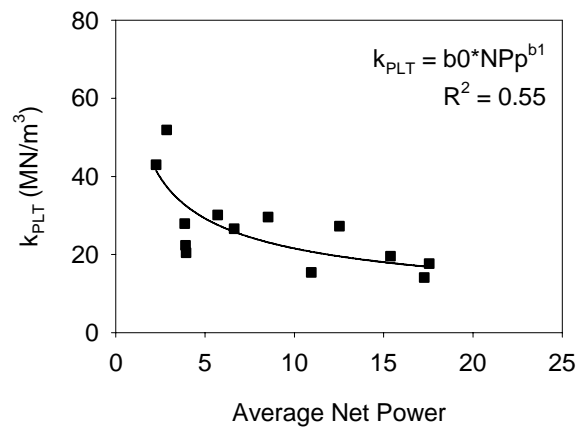
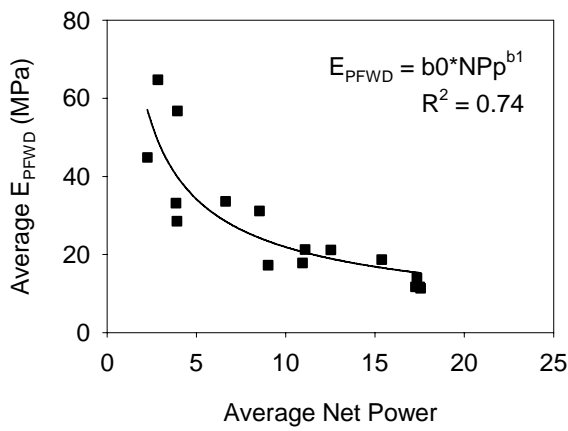
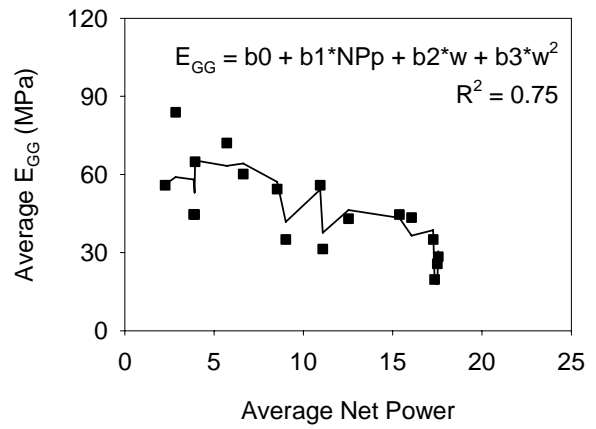
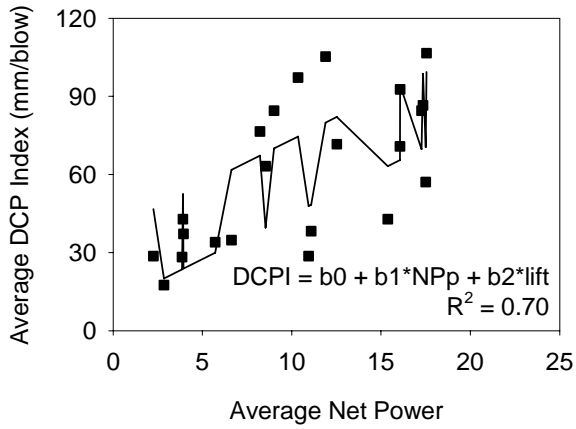
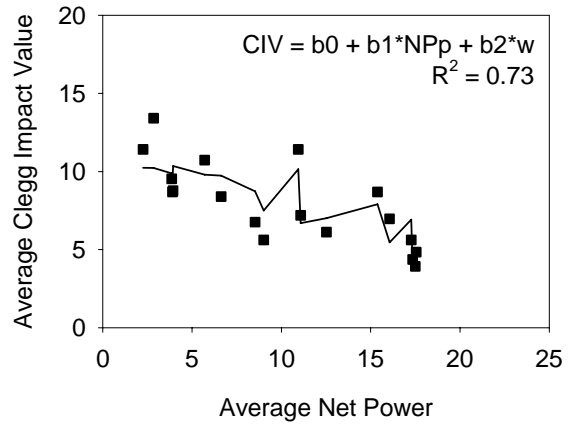
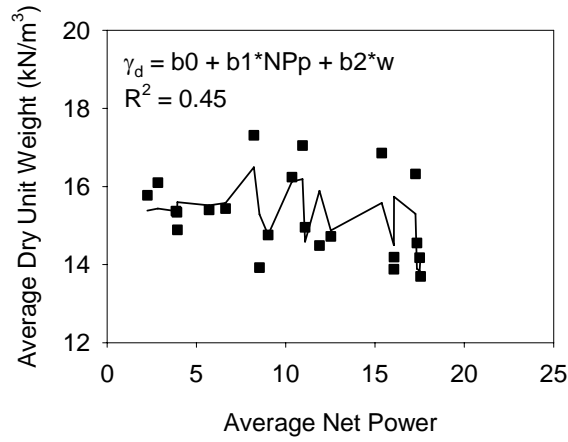
\* Referencing regressions from Figure 132 to Figure 138

Further analyses followed an incremental approach to achieving a more unified compaction model. After incorporating variable moisture into the model, data from multiple lift thicknesses and then soil types were combined. As the model complexity increased due to incorporation of additional parameters, correlation coefficients generally decreased.

The next analysis was performed after combining all the data for each soil type, thus incorporating two lift thicknesses for topsoil, till, and sand materials (fill clay test strips were constructed using only one lift thickness). As lift thickness was another variable affecting the machine power-soil property relationships, this parameter was added to the model. Again, only statistically significant variables were included in the final models for each field measurement. The models and  $R^2$  values for each soil are presented from Figure 139 to Figure 141. A summary of  $R^2$  values for multiple linear regression analyses (per soil) is presented in Table 11. The lift thickness variable was found to be significant in only three models (DCP index in till, GG modulus in sand, and PFW modulus in sand).



**Figure 139. Topsoil, both lift thicknesses (Strips 1, 2, 3, 4, 5, 6)**



**Figure 140. Edwards till, both lift thicknesses (Strips 1, 2, 3, 4, 5, 6)**

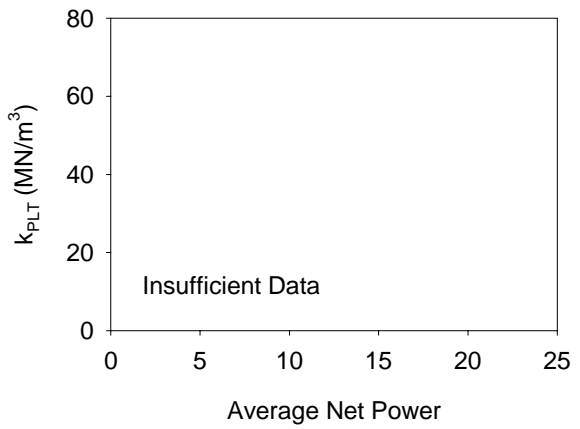
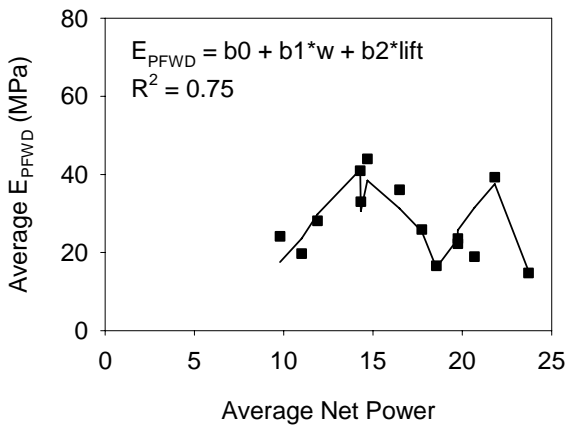
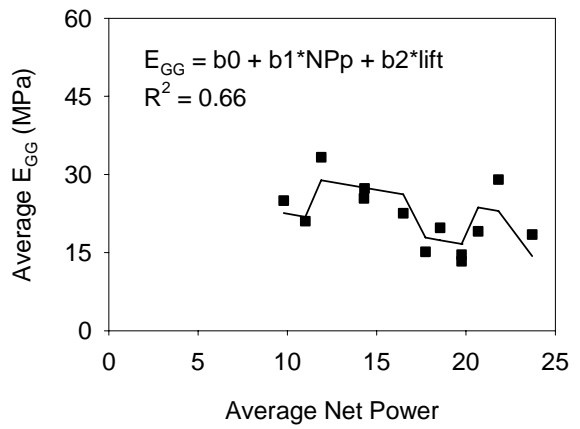
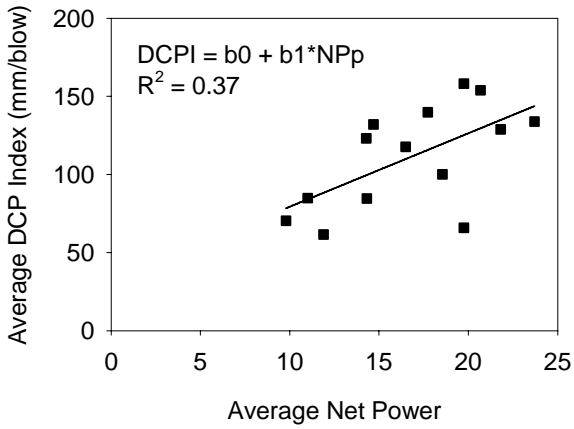
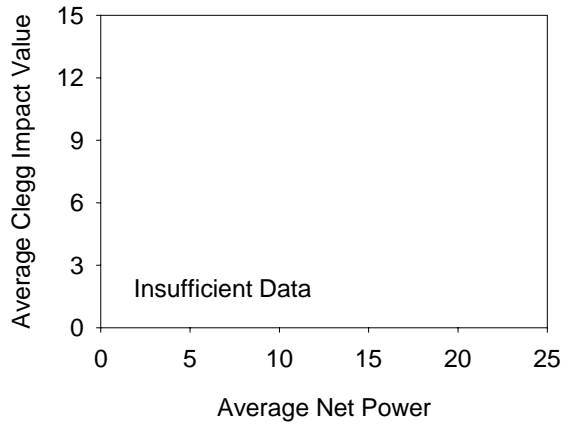
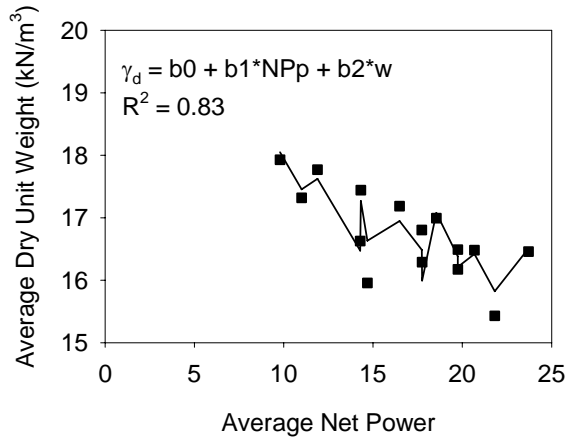


Figure 141. Sand, both lift thicknesses (Strips 1, 2, 3, 4)

**Table 11. Summary of R<sup>2</sup> for multiple linear regression analyses (per soil)**

Soil type	Moisture contents	Lift thickness (cm)	Soil property	R <sup>2</sup>		
				Thin lift	Thick lift	Both*
Topsoil	8, 12, 16 %	20, 30	$\gamma_d$	0.89	0.93	0.88
			CIV	0.84 <sup>a</sup>	0.98	0.93
			DCPI	0.97 <sup>a</sup>	0.93	0.94
			E <sub>GG</sub>	0.88 <sup>a</sup>	0.96	0.91
			E <sub>PFWD</sub>	0.89 <sup>a</sup>	0.63 <sup>a</sup>	0.73 <sup>a</sup>
			k <sub>PLT</sub>	0.73 <sup>a</sup>	0.77	0.67 <sup>a</sup>
Fill clay <sup>b</sup>	16, 20, 24 %	25	$\gamma_d$	---	0.78	0.78
			CIV	---	0.98	0.98
			DCPI	---	0.93	0.93
			E <sub>GG</sub>	---	0.74	0.74
			E <sub>PFWD</sub>	---	0.46 <sup>a</sup>	0.46 <sup>a</sup>
			k <sub>PLT</sub>	---	0.48 <sup>a</sup>	0.48 <sup>a</sup>
Till	8, 12, 16 %	15, 25	$\gamma_d$	0.00 <sup>a</sup>	0.60	0.45
			CIV	0.52 <sup>a</sup>	0.84 <sup>a</sup>	0.73
			DCPI	0.55	0.81	0.70
			E <sub>GG</sub>	0.59 <sup>a</sup>	0.96	0.75
			E <sub>PFWD</sub>	0.78 <sup>a</sup>	0.78 <sup>a</sup>	0.74 <sup>a</sup>
			k <sub>PLT</sub>	0.46 <sup>a</sup>	0.44 <sup>a</sup>	0.55 <sup>a</sup>
Sand	5, 10 %	25, 36	$\gamma_d$	0.97	0.92	0.83
			CIV	---	---	---
			DCPI	0.53 <sup>a</sup>	0.32 <sup>a</sup>	0.37 <sup>a</sup>
			E <sub>GG</sub>	0.24 <sup>a</sup>	0.95	0.66
			E <sub>PFWD</sub>	0.98	0.58	0.75
			k <sub>PLT</sub>	---	---	---

<sup>a</sup> Includes NPp term only (linear or power relationships)

<sup>b</sup> Includes test strips with only one lift thickness

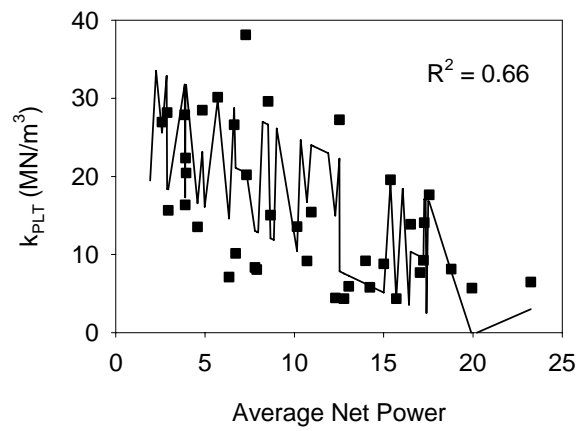
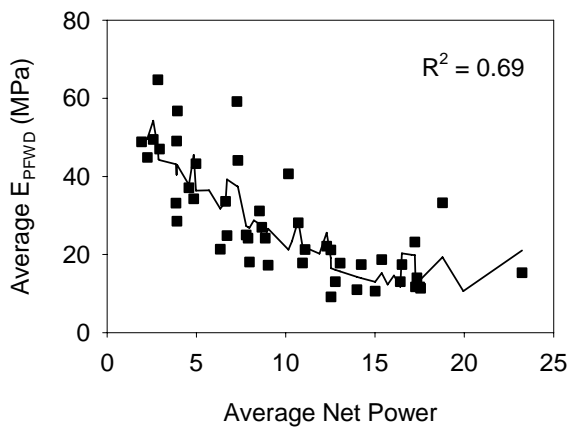
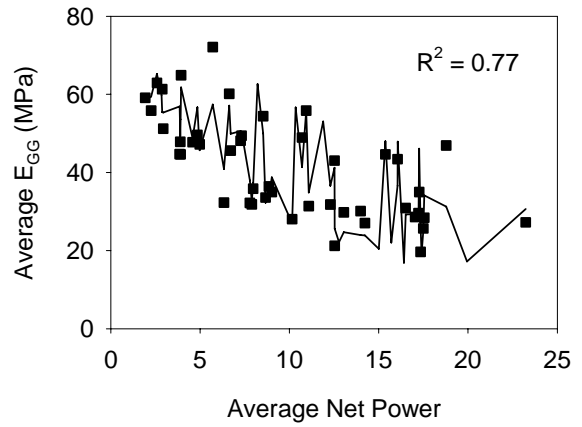
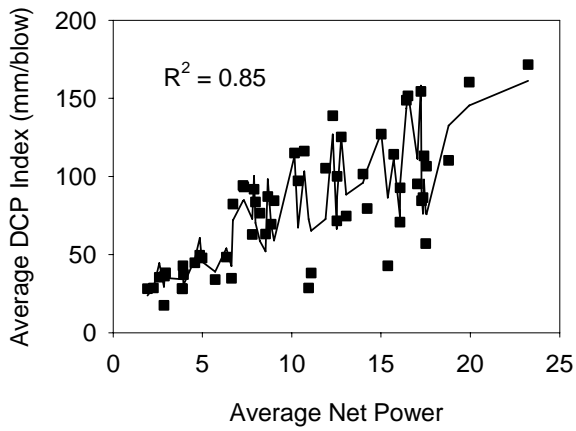
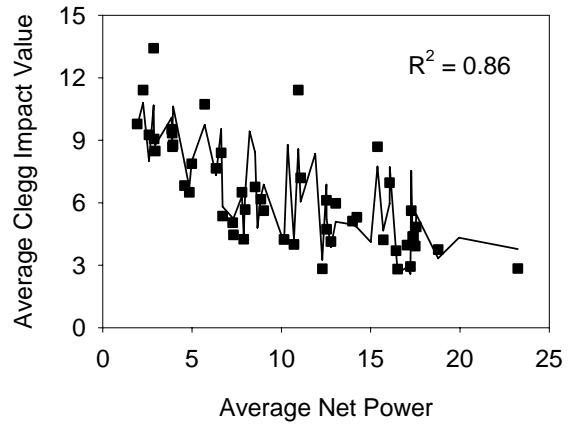
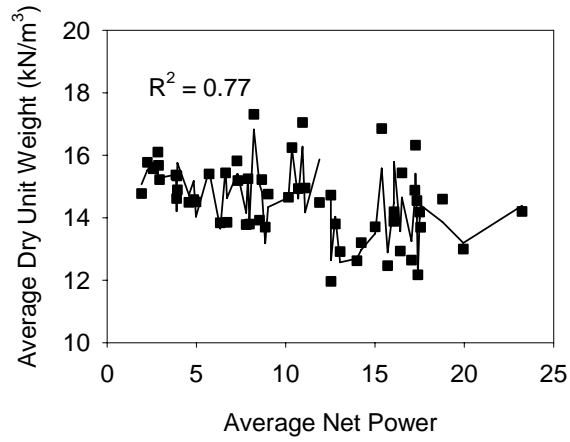
\* Referencing regressions from Figure 139 to Figure 141

A final analysis was performed after combining all the cohesive soil data (topsoil, fill clay, and till). The ability to predict physical soil properties from machine (net) power and moisture without calibrating the regressions for each soil type would influence the implementation and use of the compaction monitoring technology. In this case, the soil fines content (percent of soil particles smaller than 0.075 mm, F<sub>200</sub>) and plasticity index (PI) were used as indices to represent soil type quantitatively. Each of these soil parameters has been shown to influence soil compaction. As a result, these parameters became variables in the regression model for predicting soil density, strength, and stiffness, as follows:

$$P = b_0 + b_1 E + b_2 E^2 + b_3 w + b_4 w^2 + b_5 E w + b_6 E^2 w + b_7 F_{200} + b_8 PI \quad (4)$$

where P = soil property (e.g., density, CIV, DCP index, etc.), E = compaction energy, w = moisture content, F<sub>200</sub> = fines content, PI = plasticity index, and b<sub>0</sub> through b<sub>8</sub> are the regression coefficients. Only statistically significant terms were included in the final regression models. These models are presented in Figure 142. A summary of significant regression parameters and

corresponding  $R^2$  values is provided in Table 12. For each field testing device (nuclear density, Clegg impact hammer, DCP, GG, PFWD, and PLT), net power and PI were significant. The soil fines content was significant for all regressions except the PFWD modulus.  $R^2$  values for the various test devices ranged from 0.66 to 0.86, indicating surprisingly accurate prediction, given the sensitivity of soil compaction to soil type. Furthermore, higher  $R^2$  values (0.77 to 0.86) were observed for prediction of dry unit weight and soil strength (CIV and DCP index) than for soil stiffness ( $E_{GG}$ ,  $E_{PFWD}$ , and  $k_{PLT}$ ) ( $R^2$  from 0.66 to 0.77). This observation was anticipated; characterizing soil stiffness is relatively complicated, and the variation in stiffness measurements is greater than that of soil density or strength. These regressions may be further explored using additional soil indices as regression parameters, including effective particle size and gradation coefficients.



**Figure 142. Topsoil, fill clay, till; multiple regression predictions**



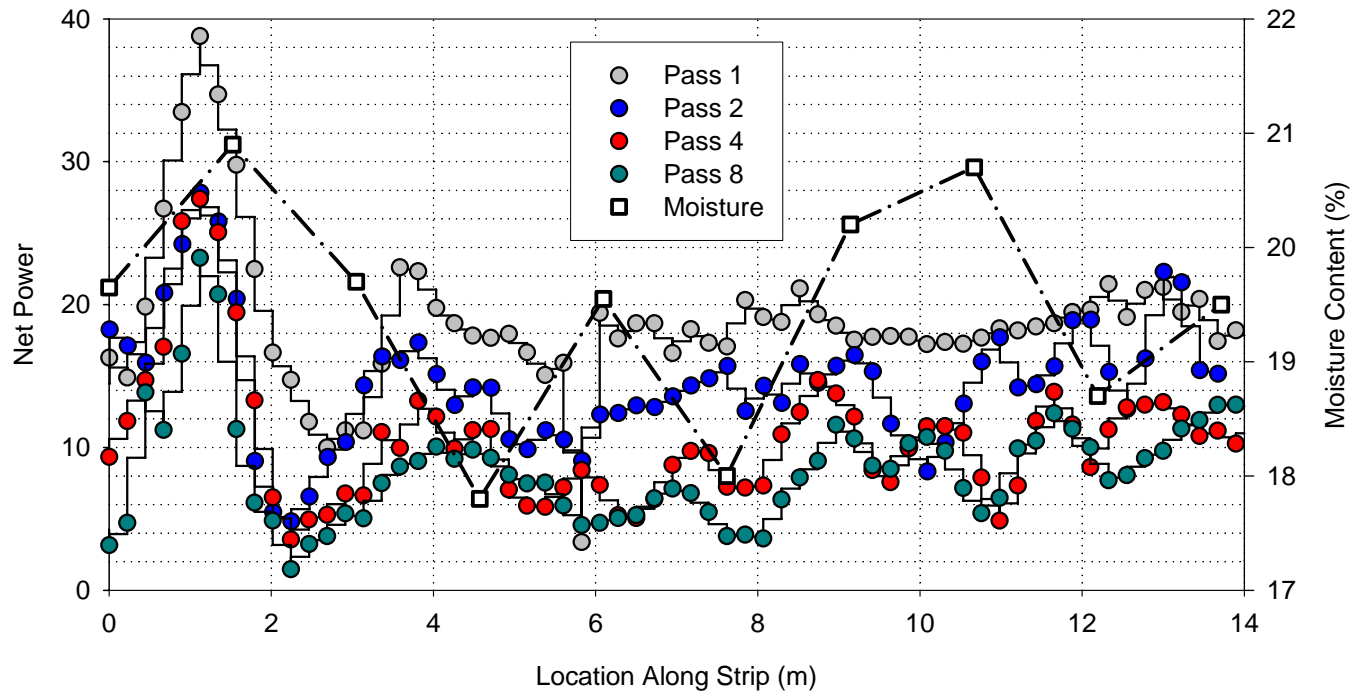
**Table 12. Summary of  $R^2$  for unified (cohesive soils) multiple linear regression analysis**

<b>Dependent variable</b>	<b>Model parameters</b>	<b><math>R^2</math></b>
$\gamma_d$	NPp, $NPp^2$ , w, $NPp*w$ , $F_{200}$ , PI	0.77
CIV	NPp, $NPp^2$ , w, $w^2$ , $NPp*w$ , $F_{200}$ , PI	0.86
DCPI	NPp, $NPp^2$ , w, $w^2$ , $NPp*w$ , $F_{200}$ , PI	0.85
$E_{GG}$	NPp, $NPp^2$ , w, $w^2$ , $F_{200}$ , PI	0.77
$E_{PFWD}$	NPp, $NPp^2$ , PI	0.69
$k_{PLT}$	NPp, $F_{200}$ , PI	0.66

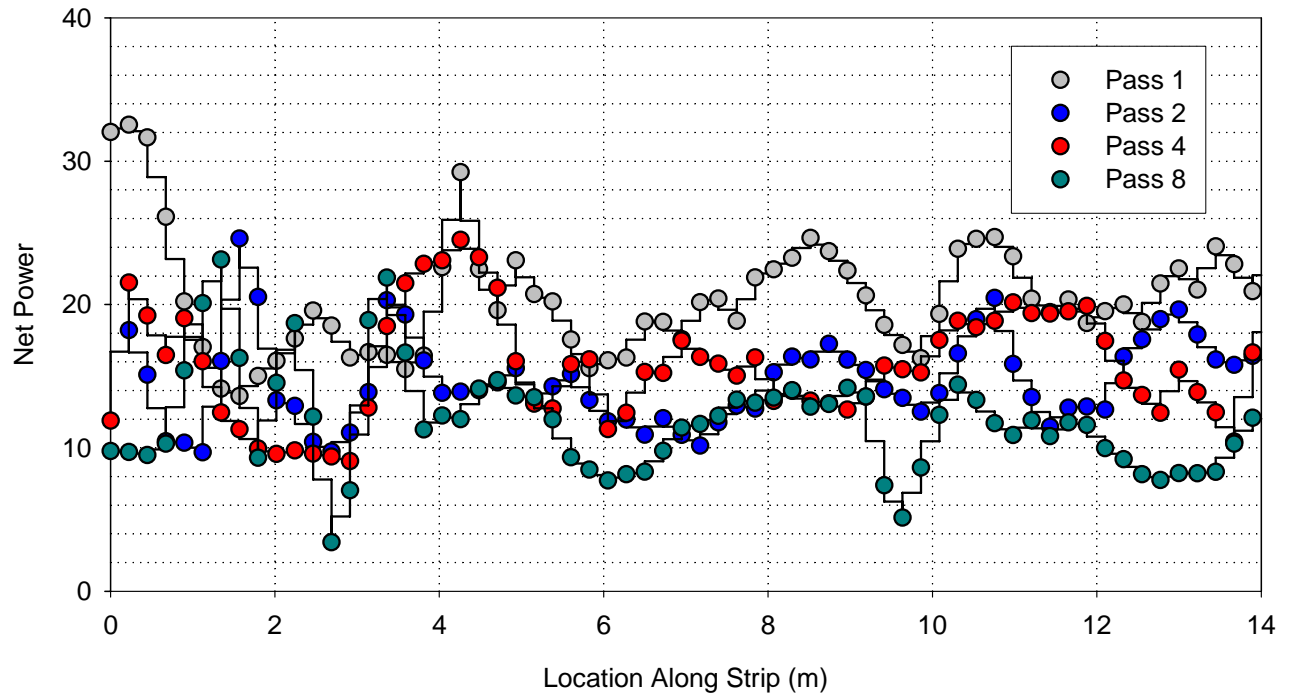
\* Referencing regressions in Figure 142

### *Repeatability of Machine Power Measurements*

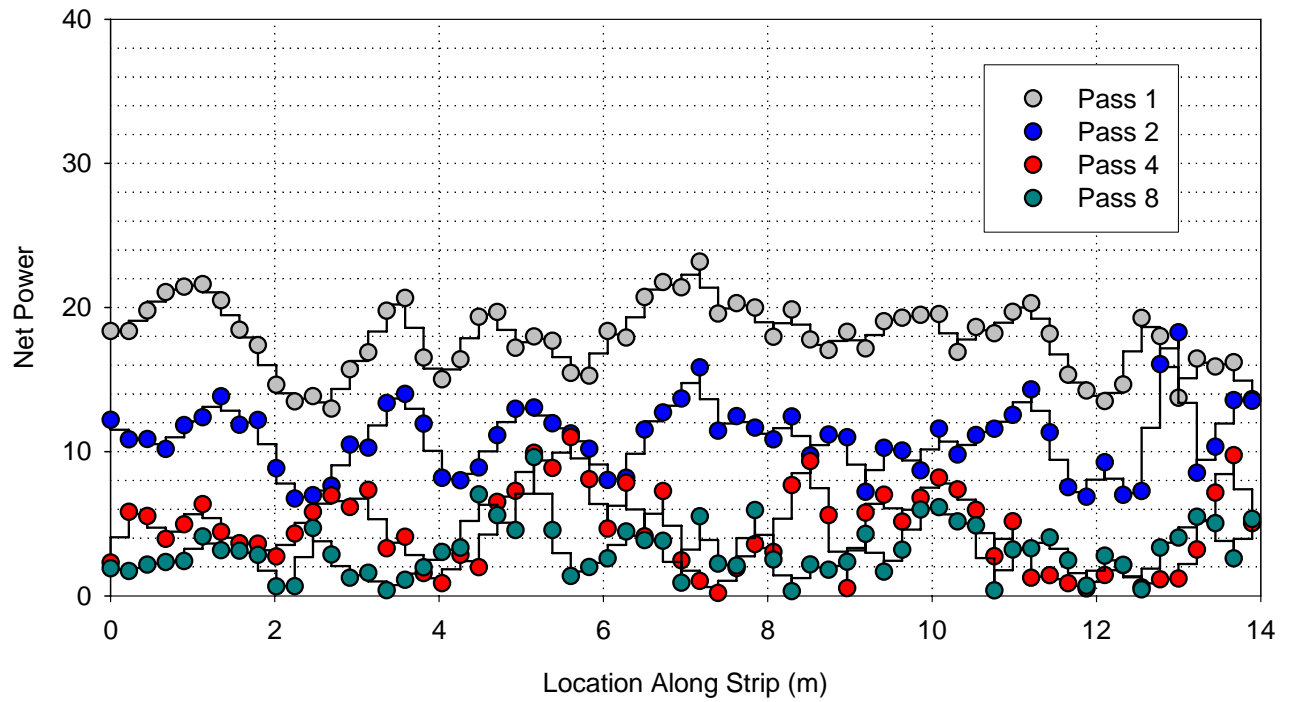
Variations in machine power were observed for all test strips (along the length of the test strips). Initially, the sensitivity of the measurement might be questioned, given the relatively low variation in some of the field measurements, such as dry unit weight (others were highly variable). The machine power output per pass, however, indicates that machine power patterns are repeatable. Figure 143 shows net power versus the measurement location in relation to the strip length for one, two, four, and eight roller passes over the topsoil (strip 1). The high machine power values observed about one meter from the beginning of the test strip, corresponding to a slightly wet soil condition, were seen with each roller pass. As the strip variability increased with compaction, even relatively small changes in power along the strip were observed with subsequent roller passes. To show the repeatability of machine power, net power measurements are also presented for fill clay, till, and sand from Figure 144 to Figure 146.



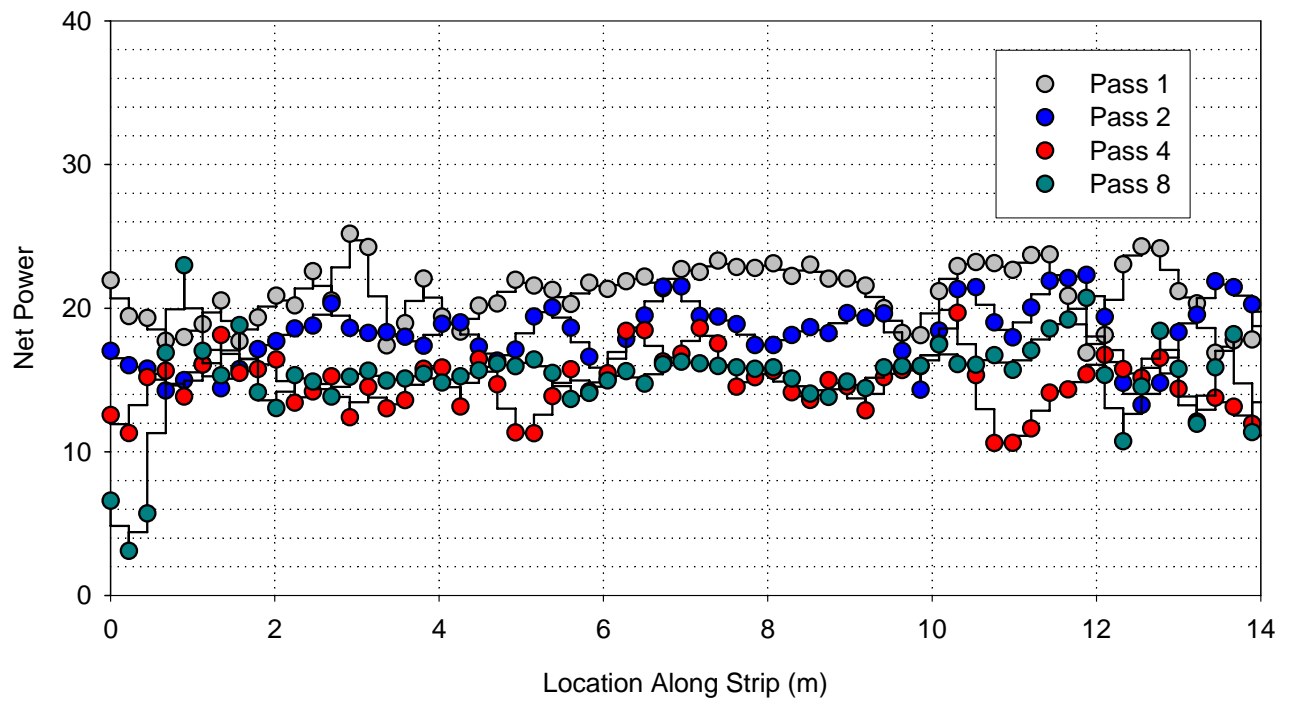
**Figure 143. Topsoil, strip 1: variability and repeatability of net power along length of test strip**



**Figure 144. Fill clay, strip 1: variability and repeatability of net power along length of test strip**



**Figure 145. Till, strip 1: variability and repeatability of net power along length of test strip**



**Figure 146. Sand, strip 1: variability and repeatability of net power along length of test strip**

## *Project Observations*

In Test Project 1, 19 test strips with varying soil type, moisture content, and lift thickness were constructed, compacted, and tested using field measurement devices. Furthermore, field measurements were generally obtained on the uncompacted material and following one, two, four, and eight roller passes. The following observations were made from the test results:

- This testing method facilitated the evaluation of natural variability in soil properties in a “uniform” soil and the variability associated with each measurement device, including machine power measurements (i.e., measurement error). Variability was expressed using standards of deviation, COV, and distribution plots of the measurements. Soil density and moisture content exhibited the lowest variation. Machine power and soil stiffness measurements, however, exhibited considerable variation, with COV exceeding 100%. This result was also anticipated, since machine power measurements are sensitive to machine response (in addition to soil response), and soil stiffness is affected by many factors other than moisture content or percent compaction.
- The testing plan as a whole provided sufficient variation in soil type, moisture content, and lift thickness to produce meaningful correlations between machine power and soil engineering properties. Separate regressions were developed for each in situ testing device, relating machine power to measures of soil density, strength, and stiffness for the full range of soil compaction (e.g., compaction curve). These initial relationships verify that machine power is an indicator of soil engineering properties. For each test strip and testing device, the correlations show either linear (nuclear density, DCP index, CIV) or power-function (GG and PFWF modulus) relationships over the compaction curve.
- In recognizing that the quality of correlation depends on the range over which observations are related, the relatively poor correlations observed in sand (compared to the three cohesive soils) are explained by the difficulty in compacting the material. Compared to strips containing cohesive soil, the change in machine power for increasing roller passes was relatively small (Figure 111 to Figure 126 and Table 9). The range in soil properties observed at an uncompacted state and following eight roller passes was also small. These data thus provided data clusters that can be combined between test strips of different moisture contents to facilitate a regression. The inability to produce significant correlations also indicates that static compaction using a padfoot roller is not the appropriate construction equipment for achieving high compaction in cohesionless material.
- By using averaged machine power and field measurement data, strong correlations were developed to characterize the machine-soil interaction. These correlations (i.e., models) were initially derived from laboratory compaction data relating compaction energy, moisture content, and dry unit weight. The final models for each combination of soil type, lift thickness, and test device showed that net power is statistically significant in predicting physical soil properties. Since the initial model was derived from density data, predictions of dry unit weight were often more accurate than predictions of soil strength or stiffness. The complexity of soil strength and stiffness requires that a more complex model be used. Nevertheless, by incorporating moisture content and moisture-energy interaction terms (i.e., machine power) into the regressions, high correlation was achieved, which indicates the promise of using such compaction monitoring technology as a tool for earthwork QC/QA.

- Investigating the influence of lift thickness on the machine power output data provided a somewhat obvious but important insight into the factors affecting machine-soil response. The summary of  $R^2$  values for multiple linear regression analyses per soil (Table 11) showed that correlation coefficients for the thick lift were consistently higher than for the thin lift. The relative change in  $R^2$  values between thin and thick lifts suggests that the depth that influences machine power response exceeds the representative lift thicknesses encountered in field conditions. While the depth to a stabilized base (i.e., any soil layer with differing stiffness properties) affects the field measurements to some degree, the measurement influence depth affects the roller response (higher weight and contact area than in situ test devices) to a greater extent than the conventional tests. Still, the measurement influence depth would presumably be less for a static padfoot roller than for a vibratory roller. By combining all of the data within each soil type, intermediate  $R^2$  values (i.e., between thin and thick) were observed.
- Eventually, all of the cohesive soil data were combined, and models were fitted for each test device. In this analysis, soil fines content and plasticity index were used to represent soil type quantitatively. Predictions of soil density, strength, and stiffness using machine power, moisture content, and soil index parameters resulted in  $R^2$  values ranging from 0.66 to 0.86. Plasticity index and fines content were statistically significant in predictions for most of the test device measurements. The sand was nonplastic, and using a plasticity index equal to zero produced relatively weak correlations. Because plasticity index was significant in all regressions, data collected in the sand material were not included in the final models. Developing separate machine power-soil property relationships based on soil classification groups (e.g., gravels, sands, silts, and clays) may be adequate for specifying the use of the technology for various projects and soil types. As datasets relating machine power to soil properties become more populated with results from various soils within a classification range, these preliminary recommendations may be justified.
- A major finding from Test Project 1 is that the testing methods and operations generate usable data for evaluating machine power in terms of measures of soil compaction. Machine power and field measurements should be collected at various levels of compaction, including both soft, intermediate, and hard materials. Secondly, using the entire suite of in situ testing devices to characterize soil density, strength, and stiffness facilitates multiple interpretations about machine power response to compaction than just dry unit weight. Future research to investigate compaction monitoring technology may use similar testing procedures, but should isolate other variables affecting machine-soil response (e.g., speed, slope, etc.).

## Test Project 2: Caterpillar Edwards Outdoor Facility (5/16/05–5/18/05)

### *Project Description*

Test Project 2 was conducted at the Caterpillar Inc. Edwards outdoor facility from May 15–18, 2005. Similar to Test Project 1, Test Project 2 involved the construction and testing of soil strips. This project evaluated compaction monitoring technology applied to a CP-533 vibratory padfoot roller. For soil compaction, the roller was operated in the vibratory mode at the high (~1.8 mm) amplitude setting with a vibration frequency of about 32 Hz. Data were collected using the roller on four test strips. The testing program is provided in Table 13.

**Table 13. Pilot Project 2 testing program**

Soil type	Strip #	Loose lift thickness (cm)	Moisture content (%)	Moisture deviation <sup>b</sup> (%)
CA6 <sup>a</sup>	1	27	8	0
	2	21	9	+1
Till	1	32	14	+1
	2	Variable	Variable	---

<sup>a</sup> Illinois DOT gradation

<sup>b</sup> Moisture deviation from optimum, based on standard Proctor test ( $w - w_{opt}$ )

Prior to May 2005, internal power loss in the roller was estimated to be proportional to roller speed. The loss equaled a constant value multiplied by ground speed. Between February and May of 2005 (Pilot Projects 1 and 2), this internal loss correction procedure was modified. For Test Project 2 (May), a new algorithm determined the internal loss using a linear regression equation comprised of a slope and an intercept. This regression equation was still a function of ground speed. Additionally, machine (net) power calibration changed, such that a net power value of zero indicates the level of compaction observed on the calibration surface (often a stabilized haul road). Therefore, the calibration coefficients between Pilot Projects 1 and 2 are different, and combining datasets from the projects may offer a false sense of correlation.

At the test site, two pits were excavated (Figure 147) and filled with testing materials (Figure 148). After moisture conditioning of the soil (Figure 149) to about optimum moisture content, the material was mixed in situ using a road reclaimer to create a uniform soil condition (Figure 150). Soil was then compacted using the CP-533 vibratory padfoot roller (Figure 151 and Figure 152). Following each roller pass, GPS coordinates were obtained at each test location using a rover that worked off of a local base station unit. In situ tests were performed following 1, 2, 4, 8, and 12 roller passes. Field measurements included nuclear moisture and density, strength using the DCP, and stiffness using the PLT.

For the last test strip (Edwards till, strip 2), two points along the strip were designed to vary from the other eight test points in soil stiffness and moisture content. A “soft” spot was created by excavating a narrow trench in the direction perpendicular to the strip (Figure 153) and backfilling the trench with loose soil. A “wet” spot was also created by saturating the test point with water (Figure 154). Following one and eight passes of the roller, these points were tested to

obtain soil strength/stiffness properties and determine whether the compaction monitoring technology could identify such localized soft or weak areas.



**Figure 147. Excavation of test strip**



**Figure 148. Placement of fill in test strip**



**Figure 149. Moisture conditioning of test soils prior to placement in strips**



**Figure 150. In situ soil mixing using a road reclaimer**





**Figure 151. CP-533 vibratory padfoot roller**



**Figure 152. Soil compaction using CP-533 vibratory padfoot roller**



**Figure 153. Excavated trench for roller identification of a soft spot**



**Figure 154. Saturated soil for roller identification of wet/weak spot**

## Material Properties

Selection of testing materials for the second test project reflected the use and evaluation of compaction monitoring technology applied to a vibratory padfoot roller. Edwards till, acquired from the same source as the soil used for Test Project 1, was again used for testing. Additionally, CA6 (Illinois DOT gradation) was used. This base material is coarse-grained with a low plasticity and is suitable for compaction using vibratory techniques.

Moisture-density tests were performed following ASTM D 698 (Moisture-Density Relations of Soils and Soil-Aggregate Mixtures Using 5.5 lb Rammer and 12 in. Drop) and ASTM D 1557 (Moisture-Density Relations of Soils and Soil-Aggregate Mixtures Using 10 lb Rammer and 18 in. Drop), more commonly referred to as Standard and Modified Proctor compaction tests, respectively. Test Method A (4 in. mold and material passing a No. 4 sieve) was used for Edwards till, and test Method C (6 in. mold and material passing a 3/4 in. sieve) was used for CA6. An automated mechanical rammer was provided for compaction in both tests.

Soil classifications and engineering properties of the testing materials are provided in Table 14. Particle size distribution curves and Proctor moisture-density relationships are provided in Figure 155 and Figure 156 for CA6 and till, respectively.

**Table 14. Pilot Project 2 testing materials**

Soil property	CA6	Edwards till
USCS:	---	---
Symbol	SM	CL
Name	Silty sand with gravel	Sandy lean clay
$G_s$	---	2.75
$F_{200}$ (%)	31	68
LL (PI)	19 (3)	29 (12)
Standard Proctor:	---	---
$\gamma_{d, \max}$ (kN/m <sup>3</sup> ) <sup>a</sup>	20.1	18.4
$w_{opt}$ (%) <sup>a</sup>	11	13
Modified Proctor:	---	---
$\gamma_{d, \max}$ (kN/m <sup>3</sup> ) <sup>b</sup>		19.9
$w_{opt}$ (%) <sup>b</sup>		7

<sup>a</sup> Based on standard Proctor test

<sup>b</sup> Based on modified Proctor test

1 kN/m<sup>3</sup> = 6.36 lb/ft<sup>3</sup>

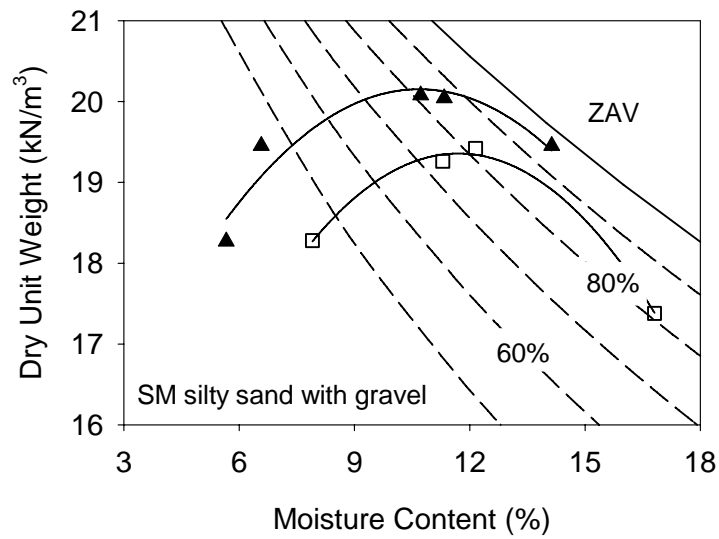
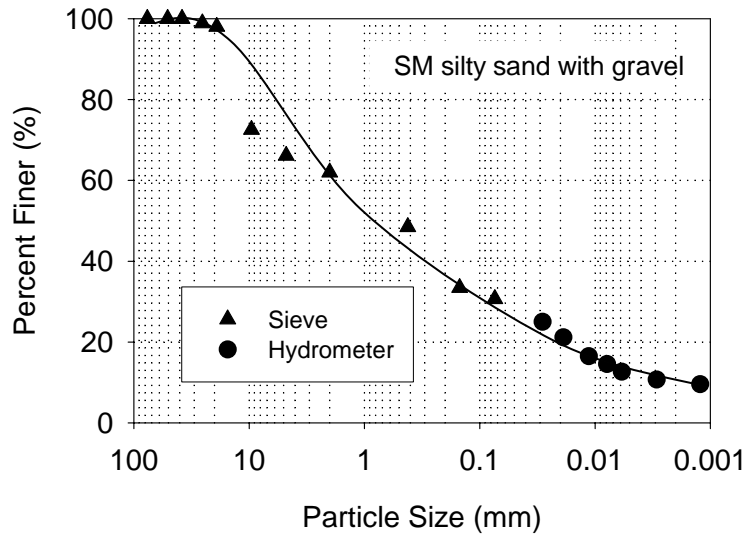
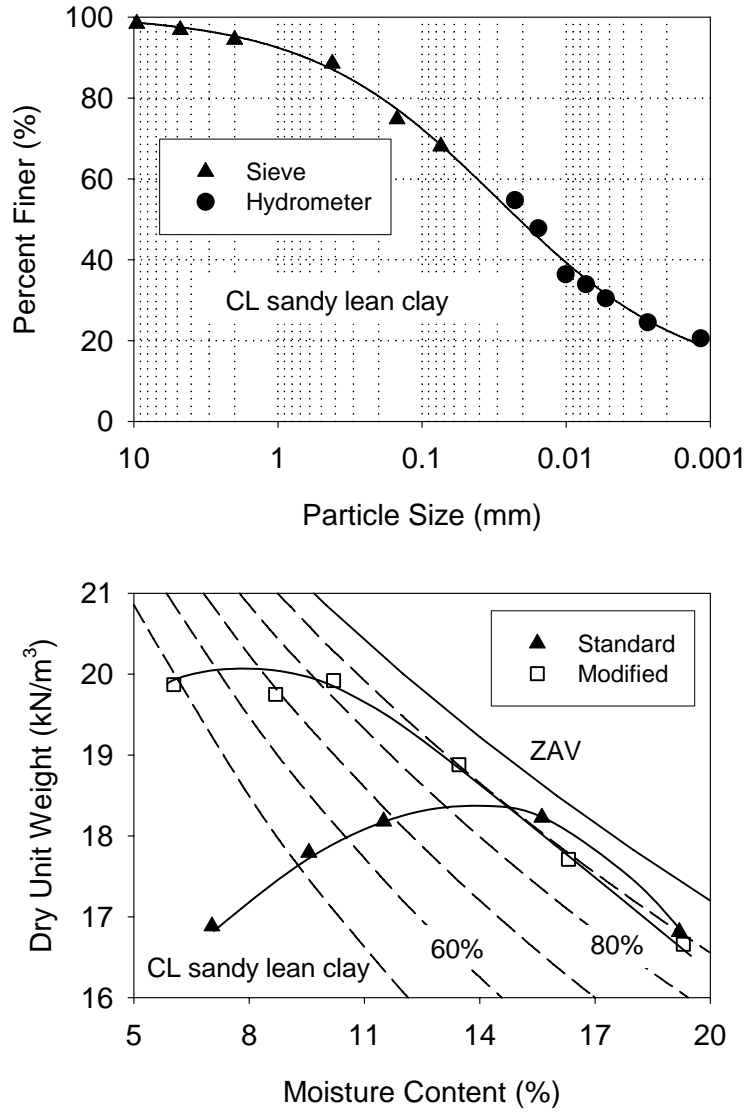


Figure 155. CA6, particle size distribution and Proctor moisture density curve



**Figure 156. Edwards till, particle size distribution and Proctor moisture-density curve**

*Compaction Monitor Machine Power Output*

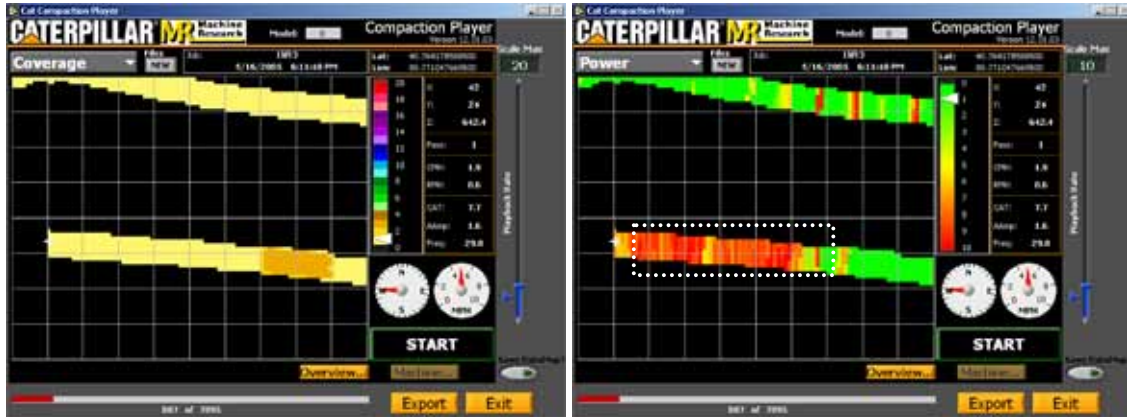
Compaction monitor power output for Pilot Project 2 is summarized from Figure 157 to Figure 160 using screen captures from the Caterpillar Inc. Compaction Player software program. In each figure (one per test strip, sorted by soil type), six screen captures are provided, as were provided for Test Project 1.



COVERAGE MAPS

MACHINE POWER

Pass 1



Pass 2



Pass 8

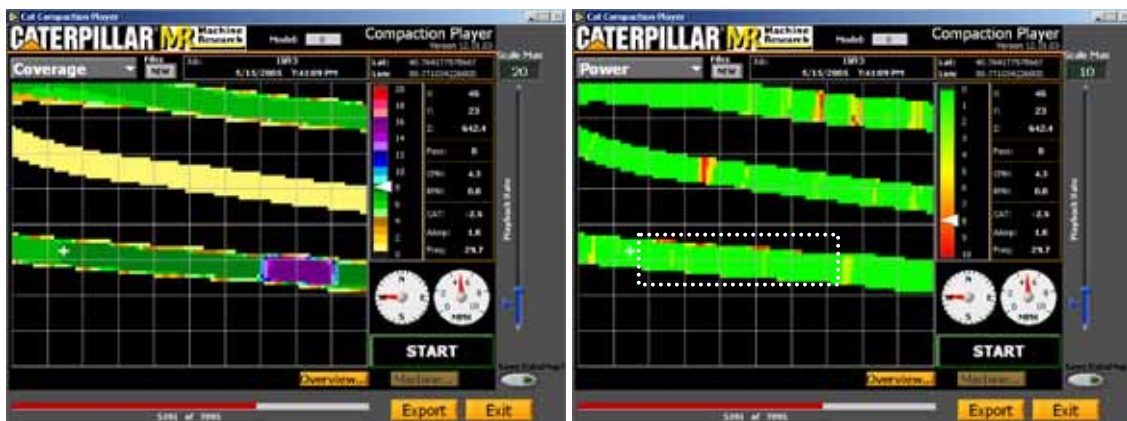


Figure 157. CA6, strip 1 compaction monitor views (30 x 24 m viewing area)

COVERAGE MAPS

MACHINE POWER

Pass 1



Pass 2



Pass 8

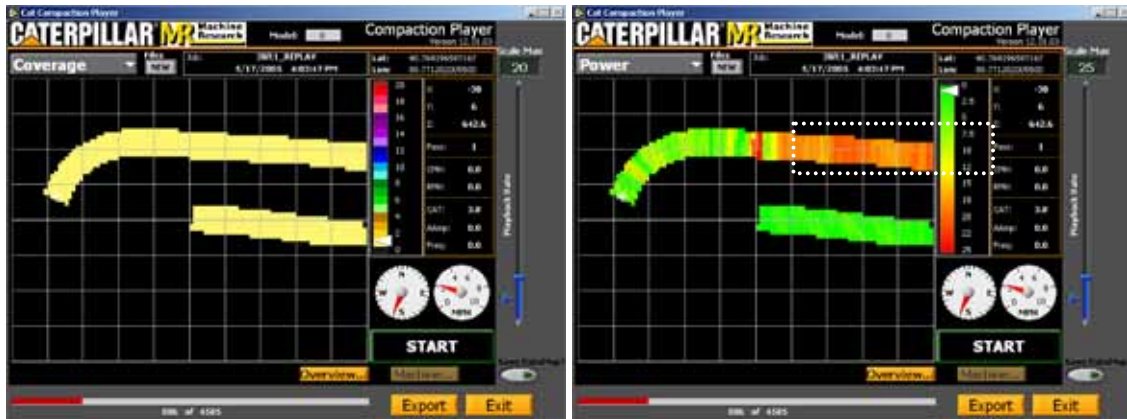


Figure 158. CA6, strip 2 compaction monitor views (30 x 24 m viewing area)

COVERAGE MAPS

MACHINE POWER

Pass 1



Pass 2



Pass 8

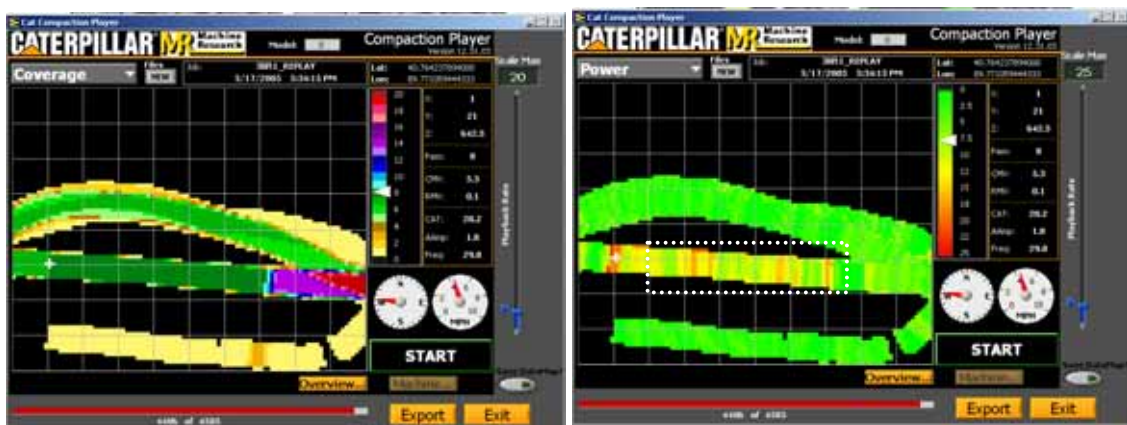


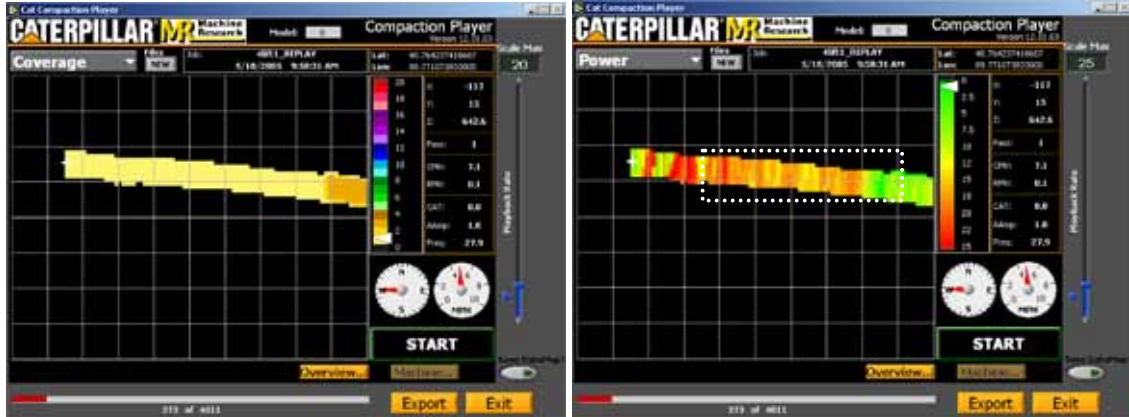
Figure 159. Edwards till, strip 1 compaction monitor views (30 x 24 m viewing area)



COVERAGE MAPS

MACHINE POWER

Pass 1



Pass 2



Pass 8

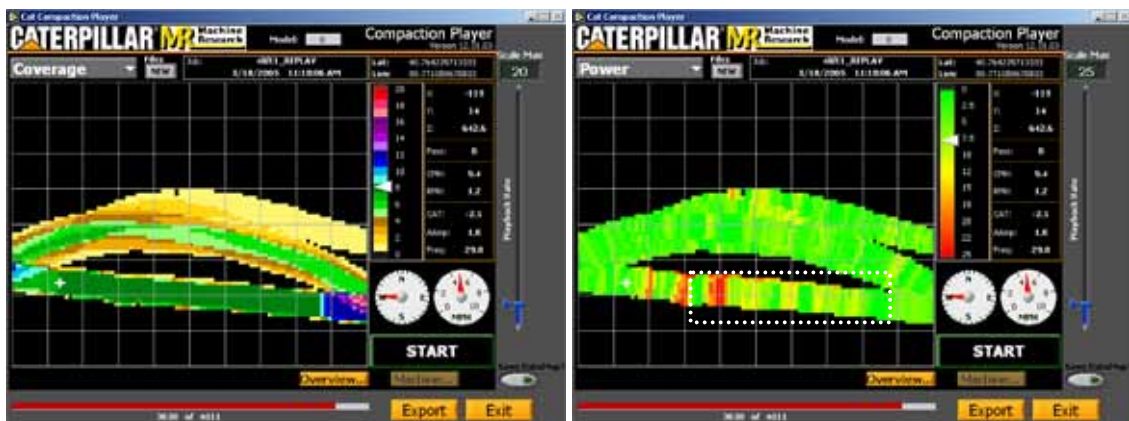


Figure 160. Edwards till, strip 2 compaction monitor views (30 x 24 m viewing area)

Net power data for Edwards till, strip 2 are shown to demonstrate the ability of the compaction monitoring technology to identify localized areas of poorly compacted or weak soil. The artificial “soft” and “wet” spots appear in the Compaction Player program as red and yellow areas, respectively, indicating low compaction (Figure 161). The quantitative data for the eighth roller pass is shown in Figure 162 to better illustrate the influences of lift thickness and moisture content on soil compaction and to illustrate how compaction monitoring technology may be used to identify such conditions in the field for implementing corrective measures.

Data at the “soft” spot showed two machine power spikes. The first power increase corresponds to the roller drum passing over the loosely backfilled trench; the second power increase corresponds to the rear wheels passing over this soft soil. Two separate machine power spikes were observed because the trench length (in the direction of the test strip) was less than the drum-to-wheel distance (3.0 m) of the CP-533 roller. The second machine power spike occurs approximately 3 m after the first spike, providing support that the second spike, in fact, is caused by the rear wheels. At the “wet” spot, machine power increased only once and then decreased. The water at this location was not localized, but rather weakened the adjacent soil in both directions of the strip. Thus, the rear wheels entered the “wet” spot prior to the drum leaving the “wet” spot. In Figure 162, the “wet” spot appears to be about 3 m long (from about 7 to 10 m). This exercise shows the need for incorporating a data correction algorithm into the compaction monitor software to account for machine-soil interaction occurring at both the drum and rear wheel locations (currently, machine power is assigned to only the drum location).

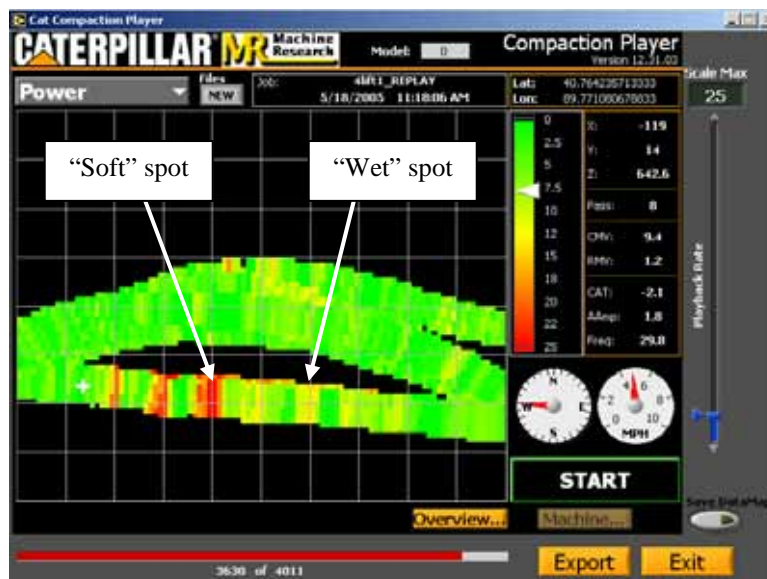
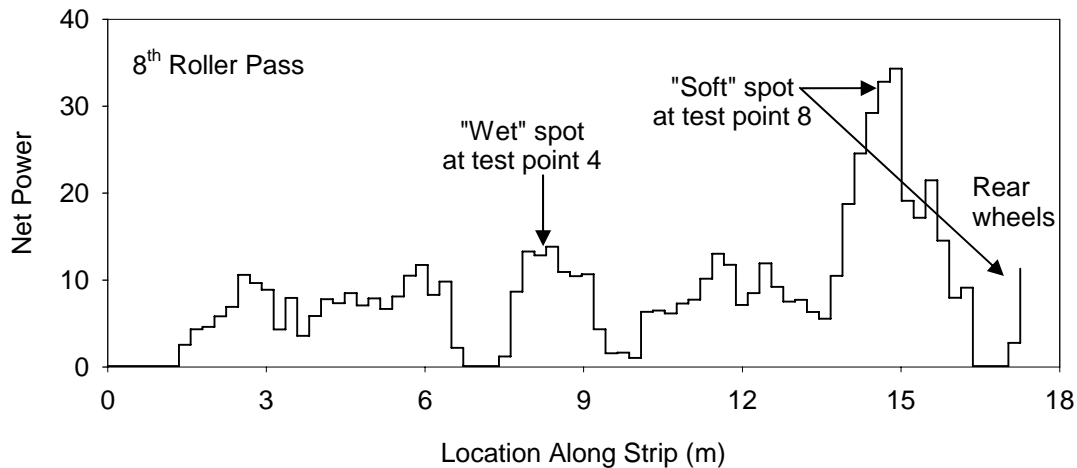


Figure 161. Screen capture of net power after 8 roller passes over till, strip 2



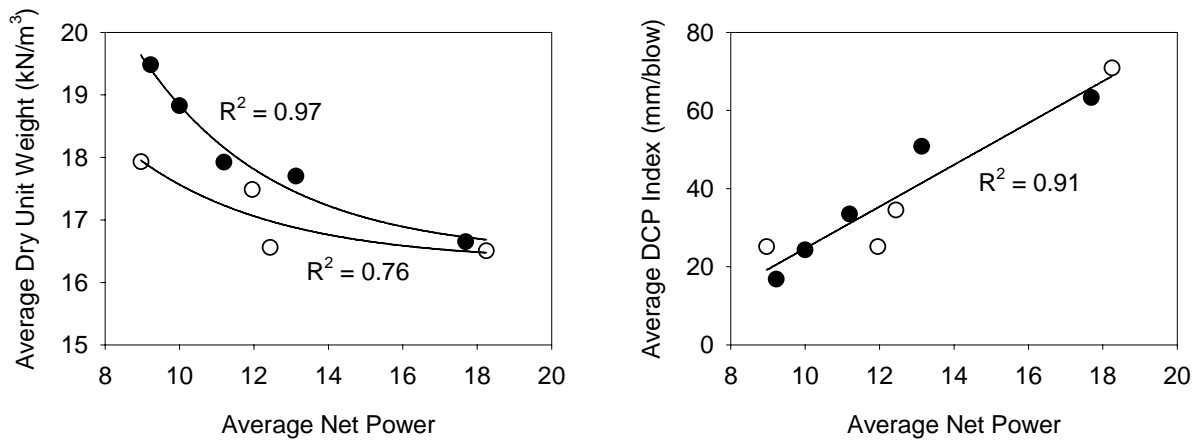
**Figure 162. Net power for 8th pass over till, strip 2 showing soft and wet spots**

### *In Situ Measurement Values and Single-Parameter Regressions*

The net power data and field measurements for Test Project 2 are provided from Figure 164 to Figure 171 for each test strip and field measurement device (nuclear density and DCP). Presentation of the data follows that of test project No. 1; raw data versus strip location, boxplots, and scatterplots using raw and averaged data are also provided.

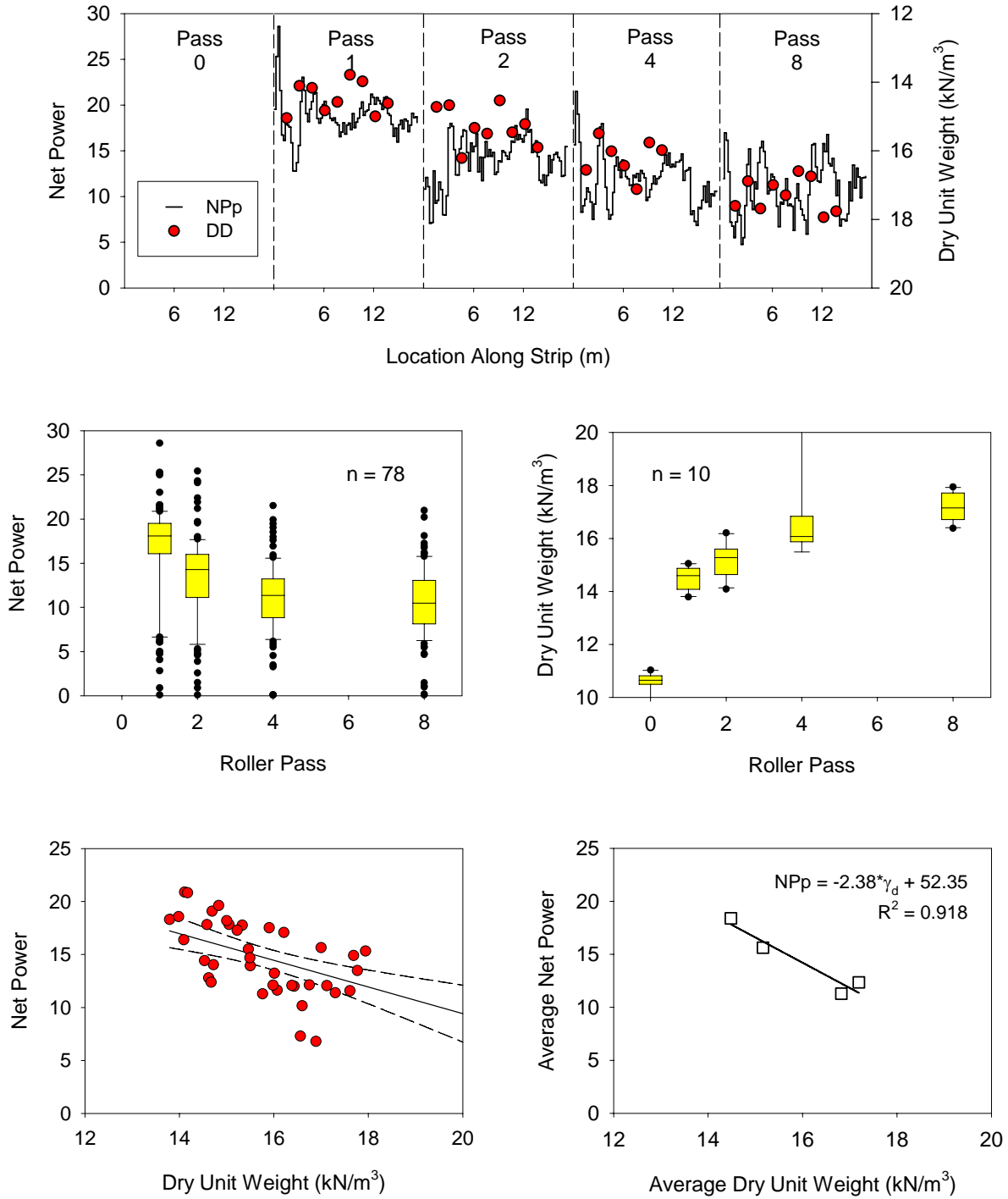
### *Regression Analysis*

Given the limited number of test strips and the relatively narrow range of moisture contents (within 1% of optimum), the data collected during Test Project 2 was insufficient to perform comprehensive multiple linear regression analyses. The averaged data from CA6 test strips are shown in Figure 163. Machine power predicts both dry unit weight and DCP index reasonably well. Correlation coefficients ( $R^2$ ) from regressions using exponential curves for dry unit weight range from 0.76 to 0.97, while the  $R^2$  value for the power-DCP index regression is 0.91 using a linear regression. These correlations suggest that both dry unit weight and soil strength properties, for this particular soil type, can be predicted from the machine net power. Moisture content, however, is required to predict the dry unit weight of different strips. Too little variation in moisture content between strips was observed to use in the regression analysis.

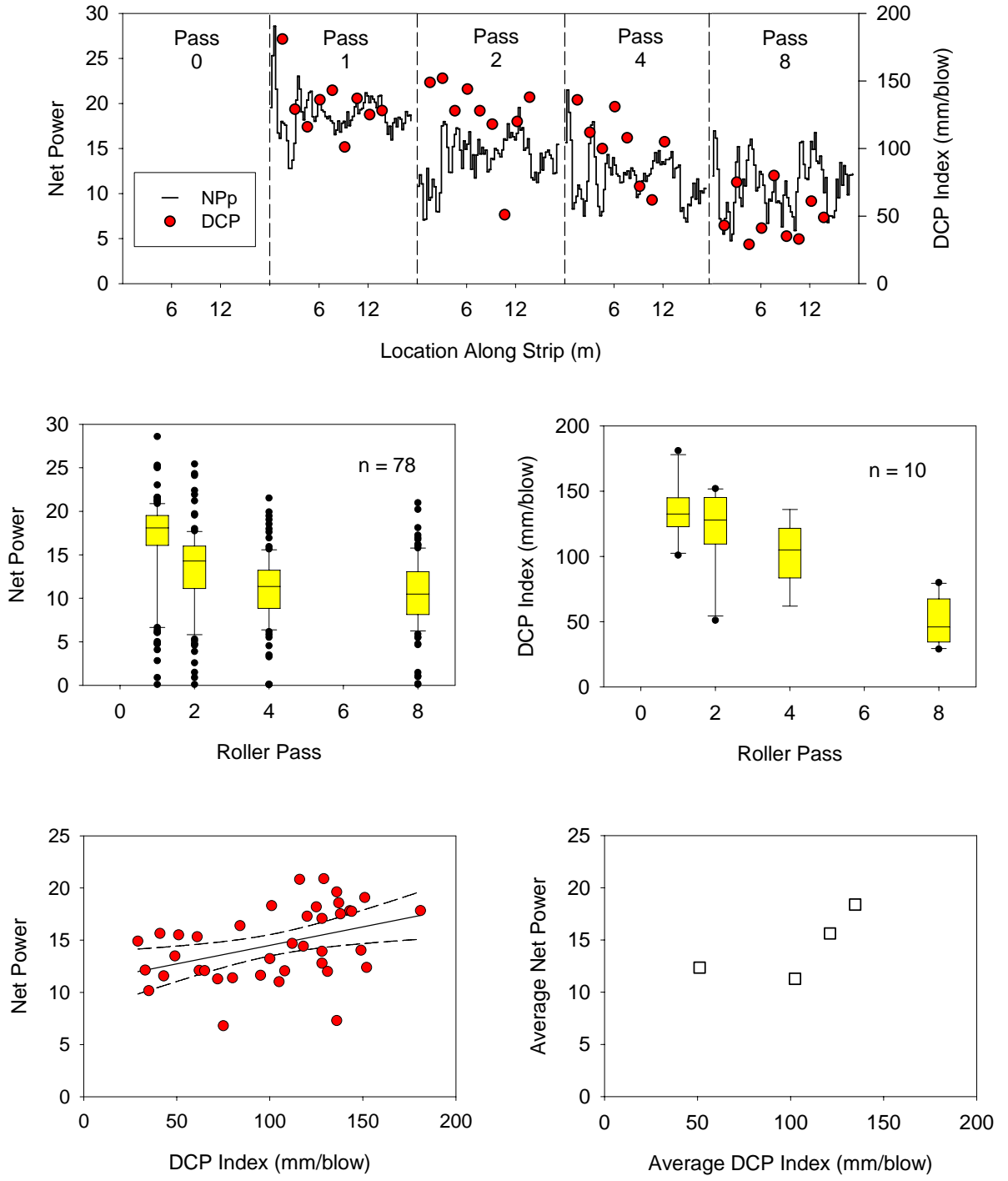


**Figure 163. CA6: regressions using averaged net power, dry unit weight, and DCP index**

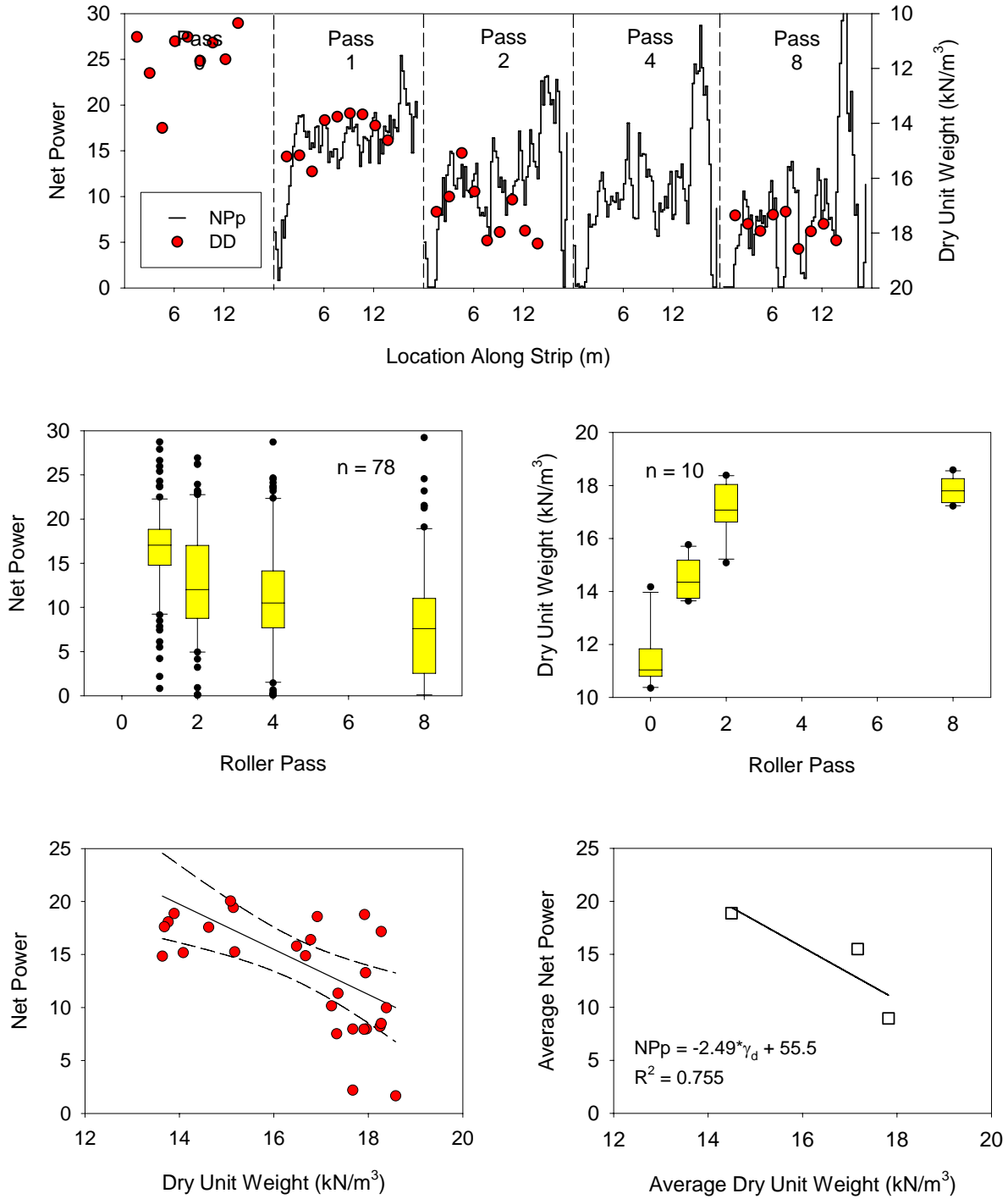
As strip 2 in Edwards till was modified to provide “soft” and “wet” spots, the mean density and strength were biased and did not reflect representative strip characteristics. Thus, averaged data from strips 1 and 2 (till) were not combined to provide another net power regression. Still, the relationships between net power, dry unit weight, and DCP index are provided from Figure 164 to Figure 165 to show the promise of predicting soil properties from machine power.



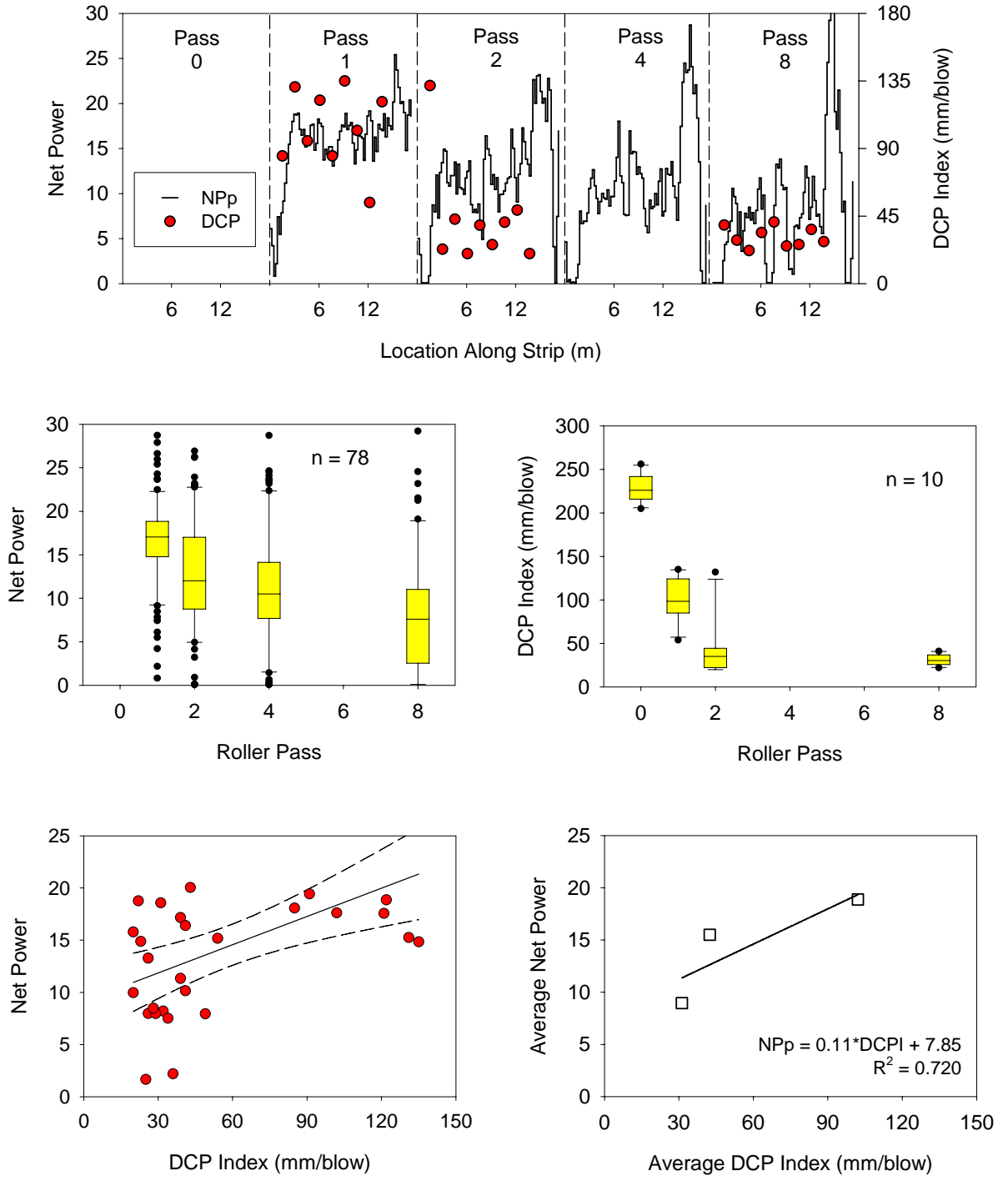
**Figure 164. Edwards till, strip 1: net power–dry unit weight correlation**



**Figure 165. Edwards till, strip 1: net power–DCP index correlation**

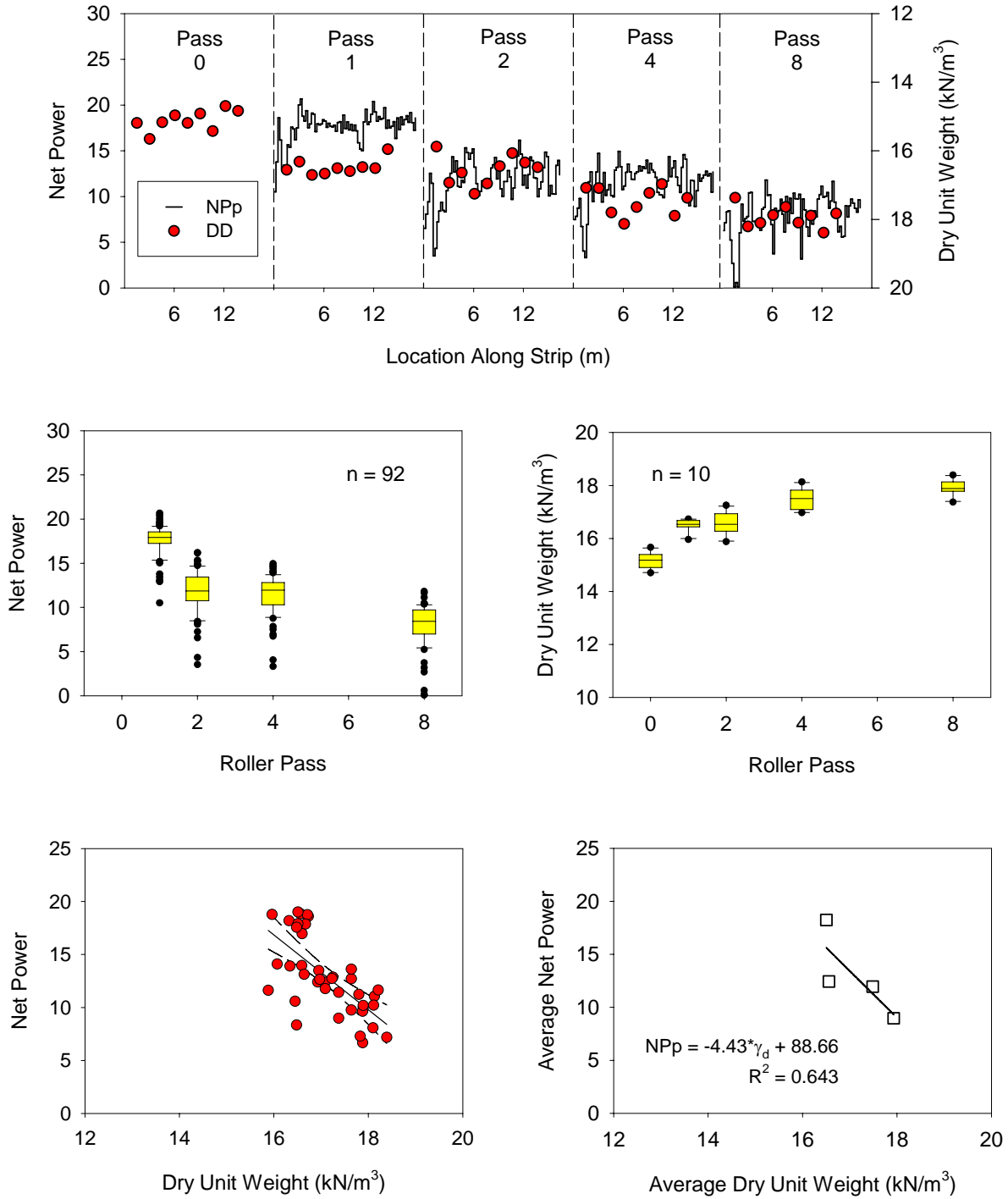


**Figure 166. Edwards till, strip 2: net power–dry unit weight correlation**

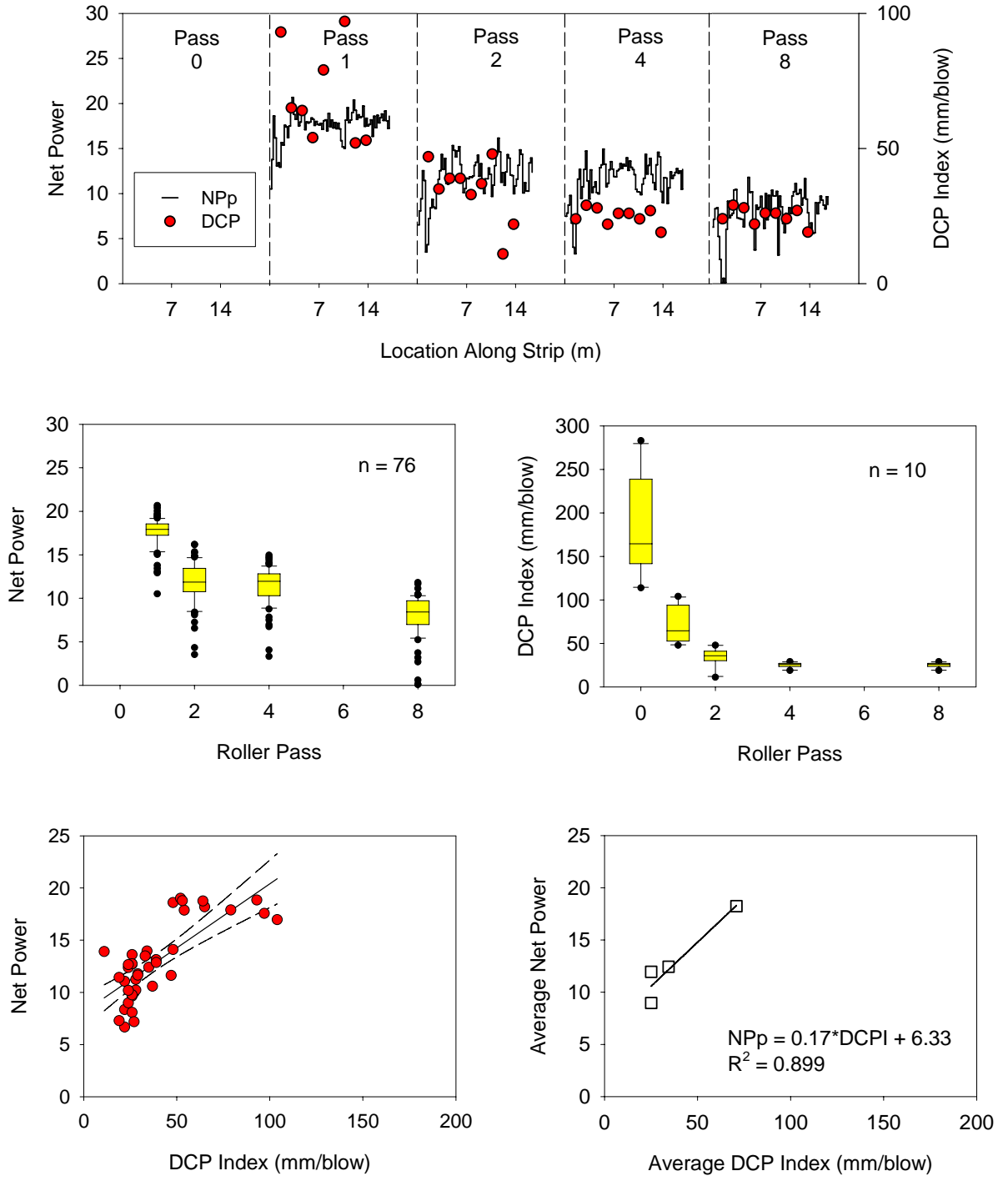


**Figure 167. Edwards till, strip 2: net power–DCP index correlation**

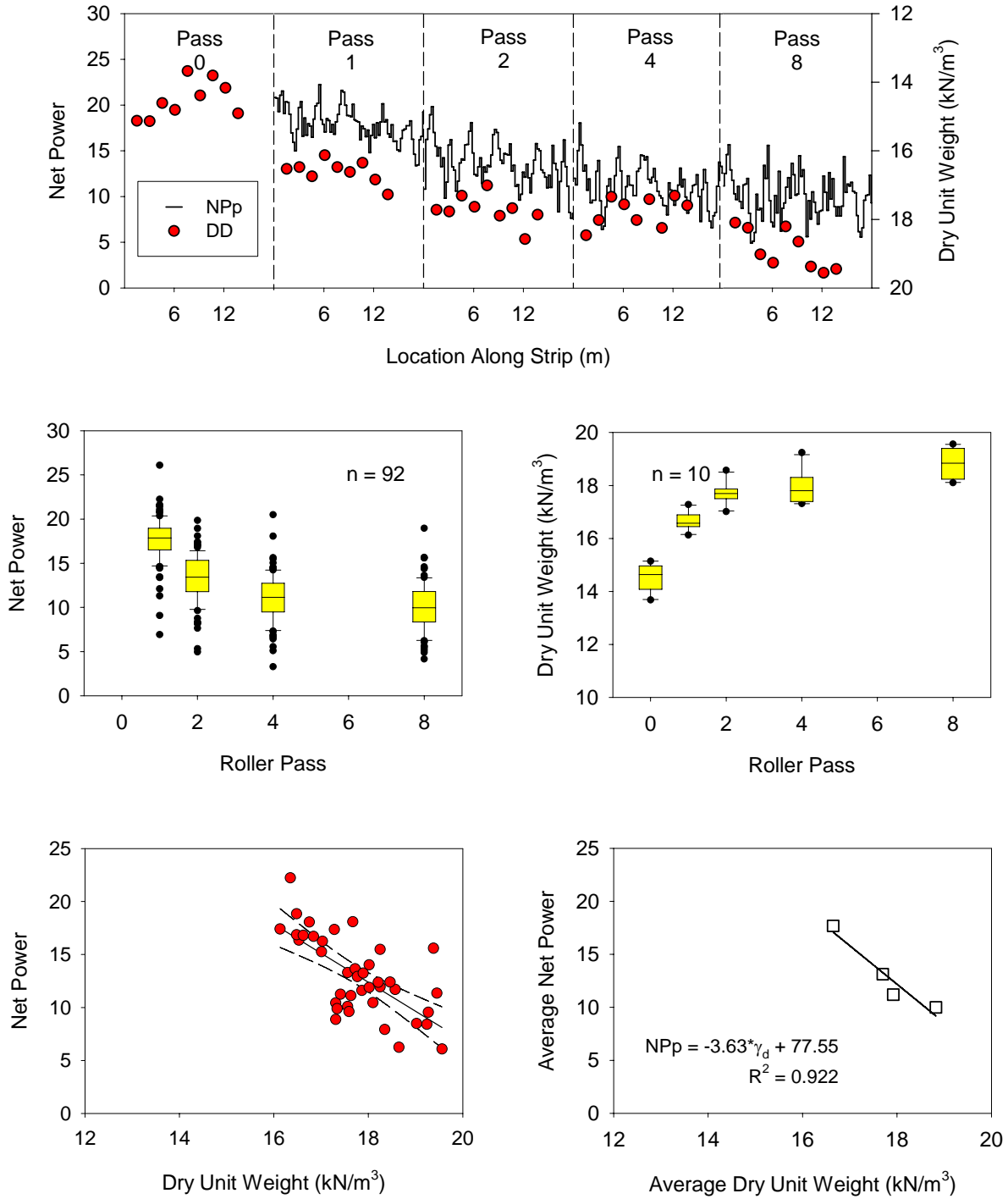




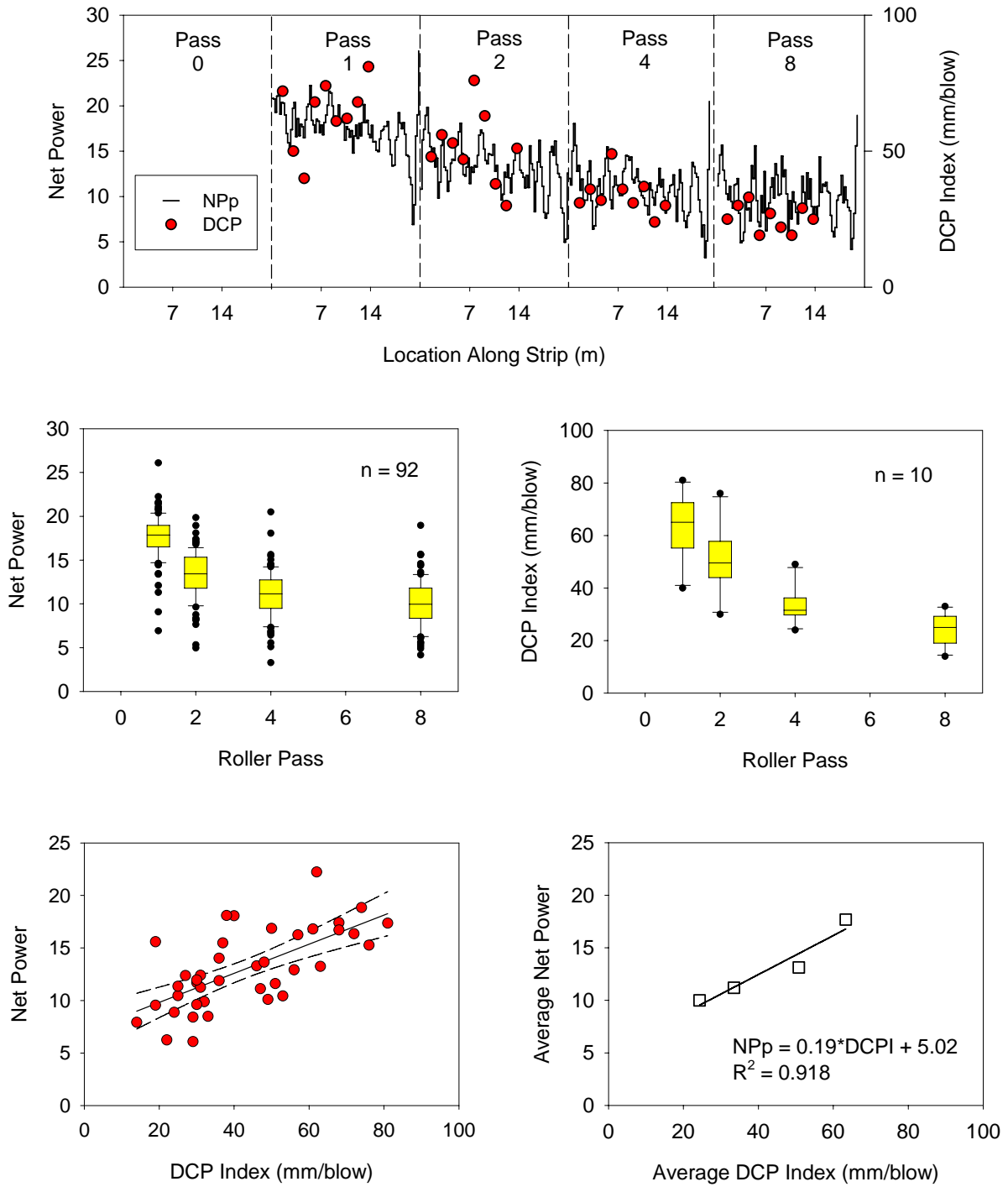
**Figure 168. CA6, strip 1: net power–dry unit weight correlation**



**Figure 169. CA6, strip 1: net power–DCP index correlation**



**Figure 170. CA6, strip 2: net power–dry unit weight correlation**



**Figure 171. CA6, strip 2: net power–DCP index correlation**

## *Project Observations*

Similar findings were observed during this project as for Test Project 1, as follows:

- Machine power was related to soil density and strength using a nuclear gauge and DCP test, respectively. These relationships were developed for two soil types (Edwards till and CA6) at two moisture contents for the full range of soil compaction.  $R^2$  values for single-strip regressions ranged from 0.64 to 0.92 for dry unit weight and from 0.72 to 0.92 for DCP index.
- Little variation in moisture content was observed between the two test strips for each soil, such that moisture content was a non-significant parameter in regressions developed using combined data. Machine net power predicted dry unit weight reasonably well for separate CA6 strips, while a linear relationship was observed for combined CA6 data.
- The compaction monitoring technology identified artificial “wet” and “soft” spots incorporated into strip 2 of Edwards till material, evidenced by relatively high net power values observed at these locations and red displayed on the compaction monitor. The difference in net power observed between these locations and the rest of the test strip was considerable; this observation reflects the extreme conditions (i.e., high lift thickness and moisture content) built into the strip design. Realistically, a backfilled trench and an isolated, completely saturated location could be encountered in the field. Future testing may be required to determine and quantify the roller sensitivity to these changes in moisture content and soil lift thickness resulting from variation in construction operations (e.g., fill placement, moisture conditioning, existing site conditions) for a wider range of soil types and for two-dimensional areas.
- The machine-soil interaction at both drum and rear wheel locations affect the machine power values that are currently applied to soil at only the drum location. A data correction algorithm may be incorporated into the compaction monitor software to account for these observed effects and to improve the precision of the compaction monitoring system.

### **Test Project 3: TH 14 Field Demonstration Project (7/18/05–7/21/05)**

#### *Project Description*

Test Project 3, conducted from July 18–21, 2005, was comprised of a series of compaction monitoring mapping trials to demonstrate the ability of the compaction monitoring technology to indicate the level of soil compaction achieved with the prototype rollers and identify localized areas of the TH 14 bypass near Janesville, Minnesota, that may be poorly compacted. For this project, two rollers (CP-533 vibratory padfoot and CS-563 f vibratory smooth drum) were used to collect data. In addition to machine power measurements, the CS-563 was fitted with the Geodynamik system to determine a CMV (Geodynamik). Some field measurements of soil density, strength, and stiffness were collected to verify the compaction monitoring system output. The specific objectives of the pilot project were as follows:

- Demonstrate the compaction monitoring technology with a transportation agency (Minnesota DOT) and earthwork contractors and discuss the role of such technology in construction and quality management.
- Using the compaction monitoring technology, map select areas of the project. Using in situ testing devices, determine the soil properties of localized weak spots identified by the roller.
- Compare the two following compaction monitoring systems: Geodynamik CMV and Caterpillar Inc. machine power.
- Evaluate compaction monitoring technology under actual field conditions. Previous pilot projects were conducted under controlled conditions at Caterpillar Inc. facilities near Peoria, Illinois.
- Demonstrate the use of in situ testing methods (e.g., DCP, Clegg impact test, PFWD) with an emphasis on using soil properties from these conventional tests to calibrate and evaluate machine power measurements.

Test rolling at the TH 14 project serves as acceptance testing for the constructed subgrade. The test roller, shown in Figure 172, is comprised of a 267 kN (60 kip) load pulled on a rubber-tired trailer to give a target contact pressure. To ensure quality, rutting observed using the test roller is limited to about 1.9 cm (0.75 in.). To evaluate whether compaction monitoring technology might also identify a weak subgrade susceptible to poor performance, several areas of the project were mapped using the prototype roller and then test rolled.



**Figure 172. Test roller used for quality assurance**

*Compaction Monitoring Mapping Locations*

This section provides details on the compaction monitoring mapping trials and the field measurements at select locations of the project site. A summary of the testing program is provided in Table 15. The trials that include paired machine power-soil property measurements are described in the following sections.

**Table 15. Summary of compaction monitoring mapping trials**

Project ID	Date	Data file name	Roller	Operator	Soil type	Station	Location	Spot tests
---	7/18	563MankatoCal	CS-563	Tom C.	---	---	Rt 33	---
---	7/18	533MankatoCal	CP-533	Tom C.	---	---	Rt 33	---
1	7/19	EB14-362b	CS-563	Tom R.	Clay	362-385	EB ML14	DCP, w%
2	7/19	WB14-362b	CS-563	Tom R.	Clay	362-385	WB ML14	---
3	7/19	EB719_am	CS-563	Tom R.	Sand	345-360	EB ML14	DCP, PFWD, w%
4	7/19	EB719_am2	CS-563	Tom R.	Sand	345-360	EB ML14	---
5	7/19	EB719_pm	CS-563	Tom R.	Sand	345-360	EB ML14	DCP, PFWD, w%
6	7/19	479eastbnd	CP-533	Tom C.	Clay	479-485	EB ML14	DCP, w%
7	7/19	Cr55proof	CP-533	Tom C.	Clay	---	Cty Rd 55	DCP
8	7/19	Cr55proof2	CP-533	Tom C.	Clay	---	Cty Rd 55	DCP
9	7/19	Cr55proof3	CP-533	Brian M.	Clay	---	Cty Rd 55	---
10	7/20	Westboxsouth	CP-533	Tom W.	Clay	340-345	EB ML14	---
11	7/20	Southatcure	CP-533	Tom W.	Clay	285-300	EB ML 14	DCP
12	7/20	Eb14-418	CP-533	ISU	Clay	418-436	EB ML 14	DCP-2
13	7/20	---	CS-563	---	Sand	345-360	WB ML14	DCP, PFWD, CIV, GG, PLT, nuclear gauge

Location 1: EB STA 365–385, Proof Roll in Subgrade Material

The compaction monitoring data collected on the Eastbound (EB) mainline from station (STA) 365 to 385 using the CP-533 is shown in Figure 173(a) as a screen capture from the Caterpillar Inc. Compaction Viewer program. The data show that a reference level of soil compaction corresponding to the calibration surface is achieved for most of the test area, evidenced by largely green cells applied to the compacted area. Several sections of the subgrade, however, are shown to have lower stability by yellow or red pixels in the compaction monitor viewer. The entire area was then test rolled, and rutting was observed (see Figure 173(b) and Figure 174). Five test points were established. Points 1, 2, and 4 showed considerable rutting; Point 5 showed minimal rutting. These specific locations were tested for soil strength using the DCP and for moisture content using the field moisture oven (FMO). DCP profiles for the test points are shown in Figure 175(a). The moisture content was about 23% near point 4 and about 12% near point 5. The wet-of-optimum moisture contents near point 4 are likely responsible for low stability, and the areas shown by compaction monitoring technology require additional compaction.





(a)

(b)

Figure 173. EB STA 365–385: (a) compaction monitor view (view area 165 x 132 m), (b) photo of rutting at point 4



(a)



(b)

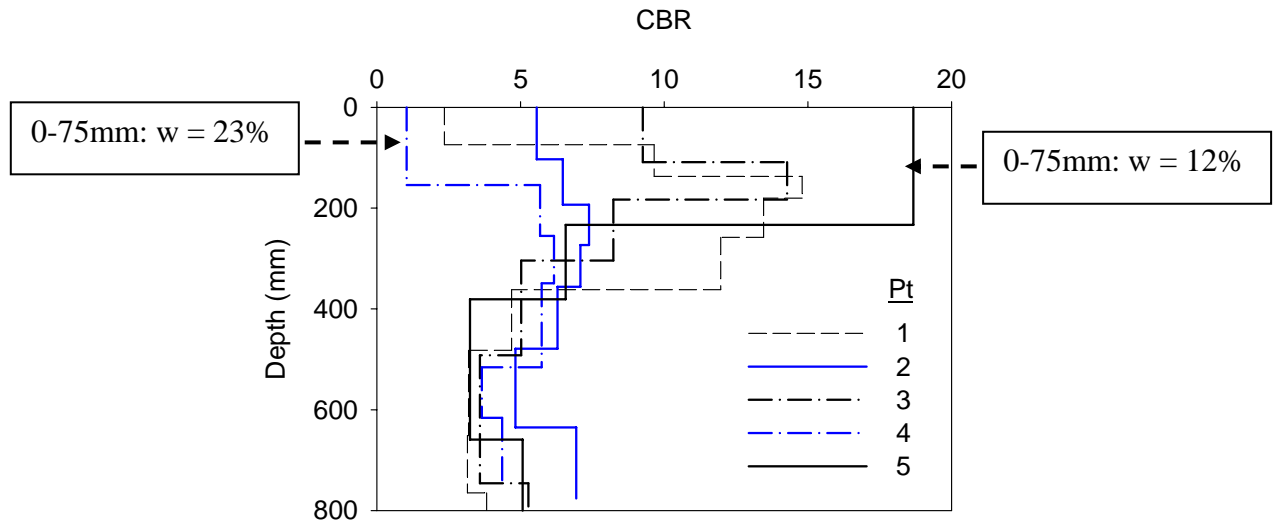


(c)



(d)

Figure 174. Proof rolling result at EB STA 365–285: (a) pt 1, (b) pt 2, (c) pt 3, (d) pt 5



(a)



(b)

Figure 175. Field measurements: (a) DCP profiles and moisture contents, (b) FMO device

Location 7: County 55, Subgrade

The ability of Caterpillar’s compaction monitoring technology to identify areas of poorly compacted soil was also illustrated at County 55. As shown through compaction monitoring data in Figure 176 and DCP profiles in Figure 177, weak or poorly compacted soil near point 1 is indicated by yellow and red pixels in the compaction monitoring viewer. High-strength soil near point 3 is shown to have achieved compaction, as indicated by green pixels in the compaction monitoring viewer and the high soil strength. DCP testing confirmed the existence of localized areas of lower stability that matched the machine power results.

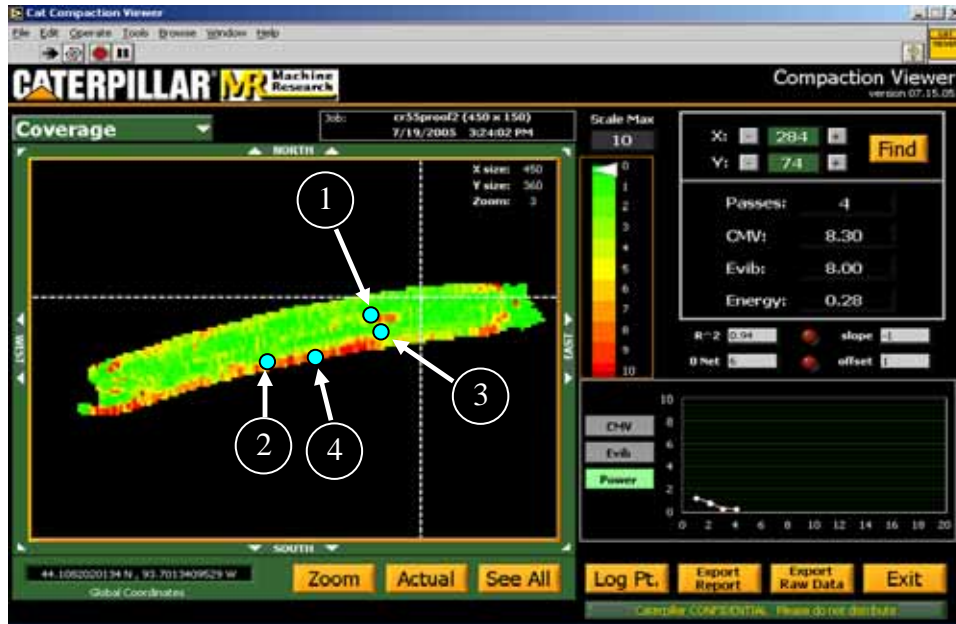


Figure 176. Compaction monitor view at County 55 (viewing area 137 x 110 m)

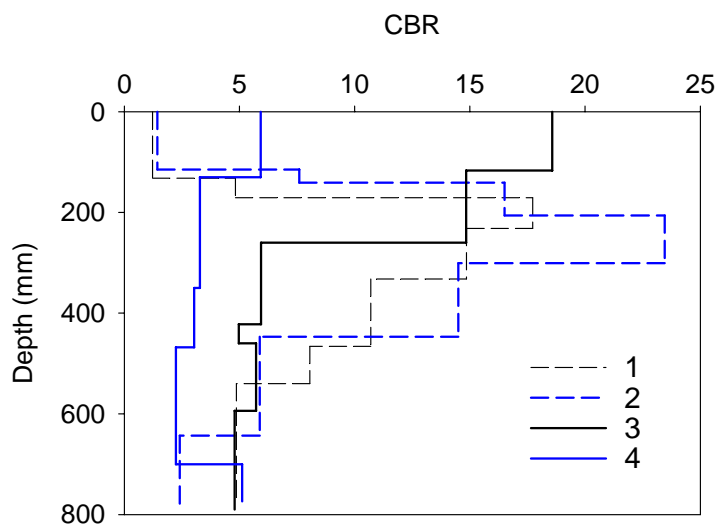
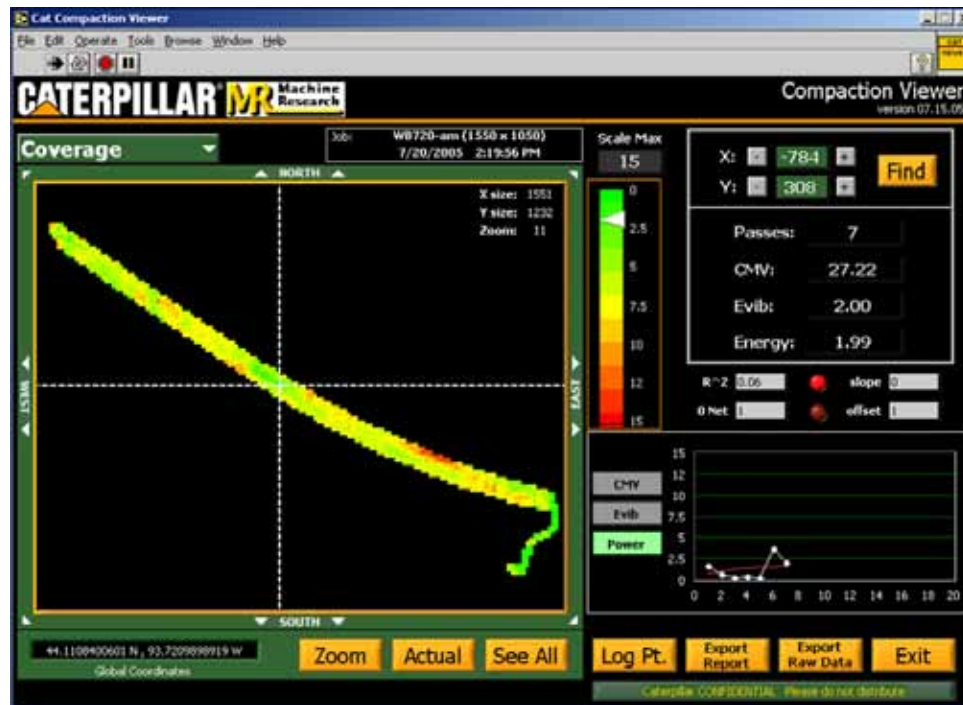


Figure 177. DCP strength profiles at County 55, subgrade

Location 13: WB STA 345-360, Sand

During compaction operations of sand material using the CS-563 roller along the Westbound (WB) mainline from STA 345 to 360, soil density, moisture content, strength, and stiffness were determined using in situ testing devices at ten randomly spaced test points. The compaction monitor view of the tested area is shown in Figure 178, and field measurement data are summarized in Appendix G.



**Figure 178. Compaction monitor view of WB STA 345–360 (viewing area 473x376 m)**

Machine power data from the roller and field measurements from in situ testing devices varied over the test area. Compaction monitoring data at ten test points are provided in Table 16 and Table 17 for machine power and CMV, respectively. Two of the test points (1 and 2) exhibited considerably different soil characteristics. Soil strength and stiffness at these locations were determined using DCP and PLT, respectively. PLT setup and performance is shown in Figure 179. DCP profiles and PLT load-deflection relationships at the two test points are provided in Figure 180. From these tests, both soil strength and stiffness are observed to be higher at point 10 than at point 1. Interestingly, the unload-reload modulus values are comparable for tests performed at each location.

**Table 16. Machine power for WB STA 345–360, sand**

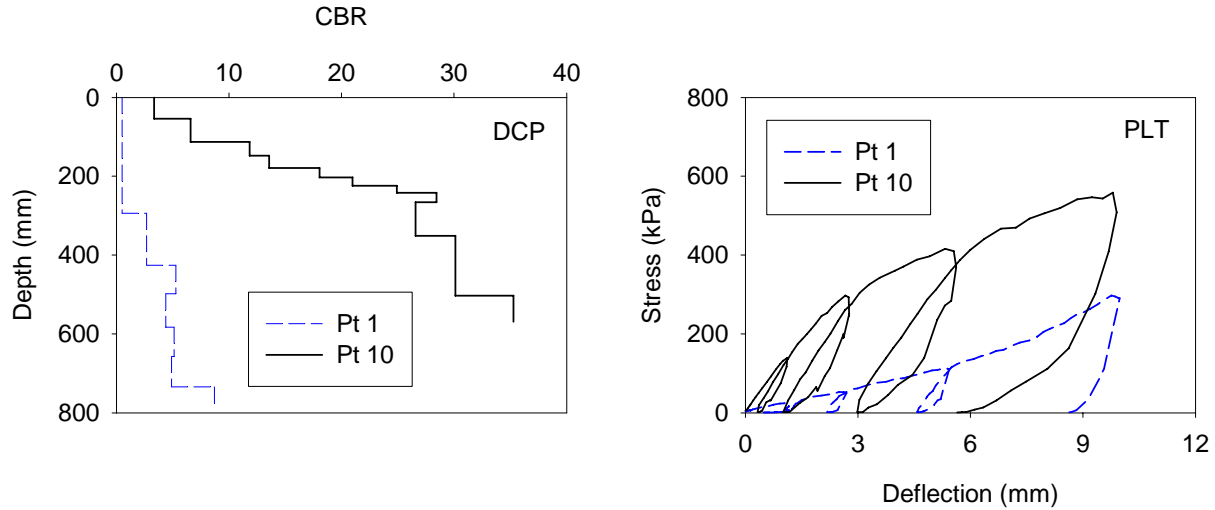
Location point	Energy				
	Pass 1	Pass 2	Pass 3	Pass 4	Pass 5
1	---	---	---	---	---
2	11.80	9.49	6.76	---	---
3	10.91	8.50	7.88	---	---
4	7.042	3.83	4.46	5.83	4.46
5	8.26	6.81	6.08	---	---
6	7.50	9.44	7.62	5.90	7.60
7	10.11	8.40	5.44	9.51	---
8	9.10	11.63	9.32	9.64	8.68
9	7.17	6.94	6.14	---	---
10	3.55	1.19	0.77	1.54	4.46

**Table 17. CMV history for WB STA 345–360, sand**

Location point	CMV				
	Pass 1	Pass 2	Pass 3	Pass 4	Pass 5
1	---	---	---	---	---
2	2.60	4.33	6.47	---	---
3	6.60	6.93	5.10	---	---
4	6.26	6.99	6.53	8.24	7.72
5	13.10	10.52	14.67	---	---
6	10.10	7.14	8.29	15.69	18.24
7	22.78	31.38	25.72	32.20	---
8	20.20	17.50	20.59	19.45	19.78
9	19.50	25.26	34.73	---	---
10	30.66	37.59	16.10	39.07	24.39

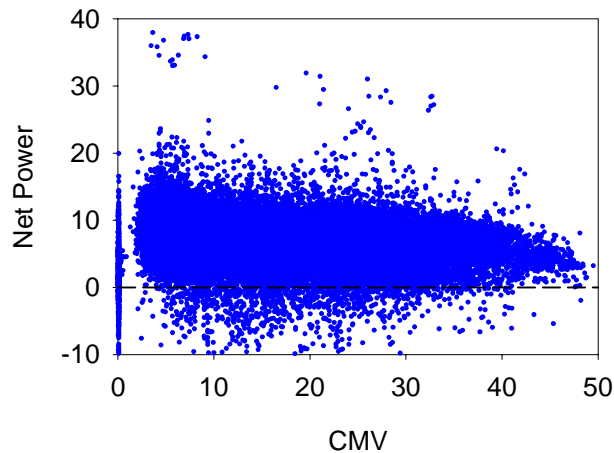


**Figure 179. Plate load test setup and performance**



**Figure 180. DCP profiles from WB STA 345–360 at PLT locations**

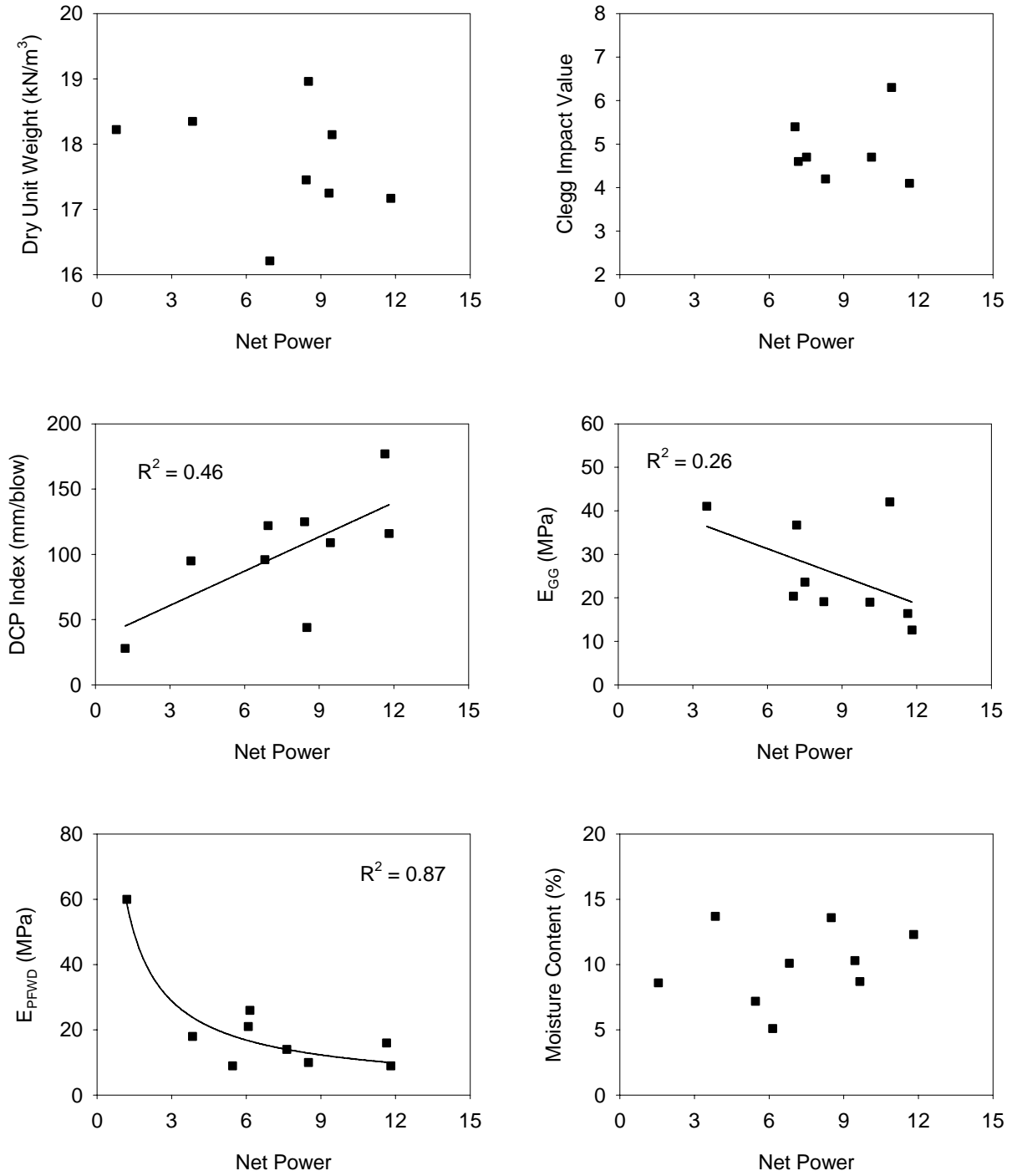
Soil stiffness (CMV) measurements were observed to show a weak relation to machine power, with the coefficient of correlation equal to about 0.04 (see Figure 181).



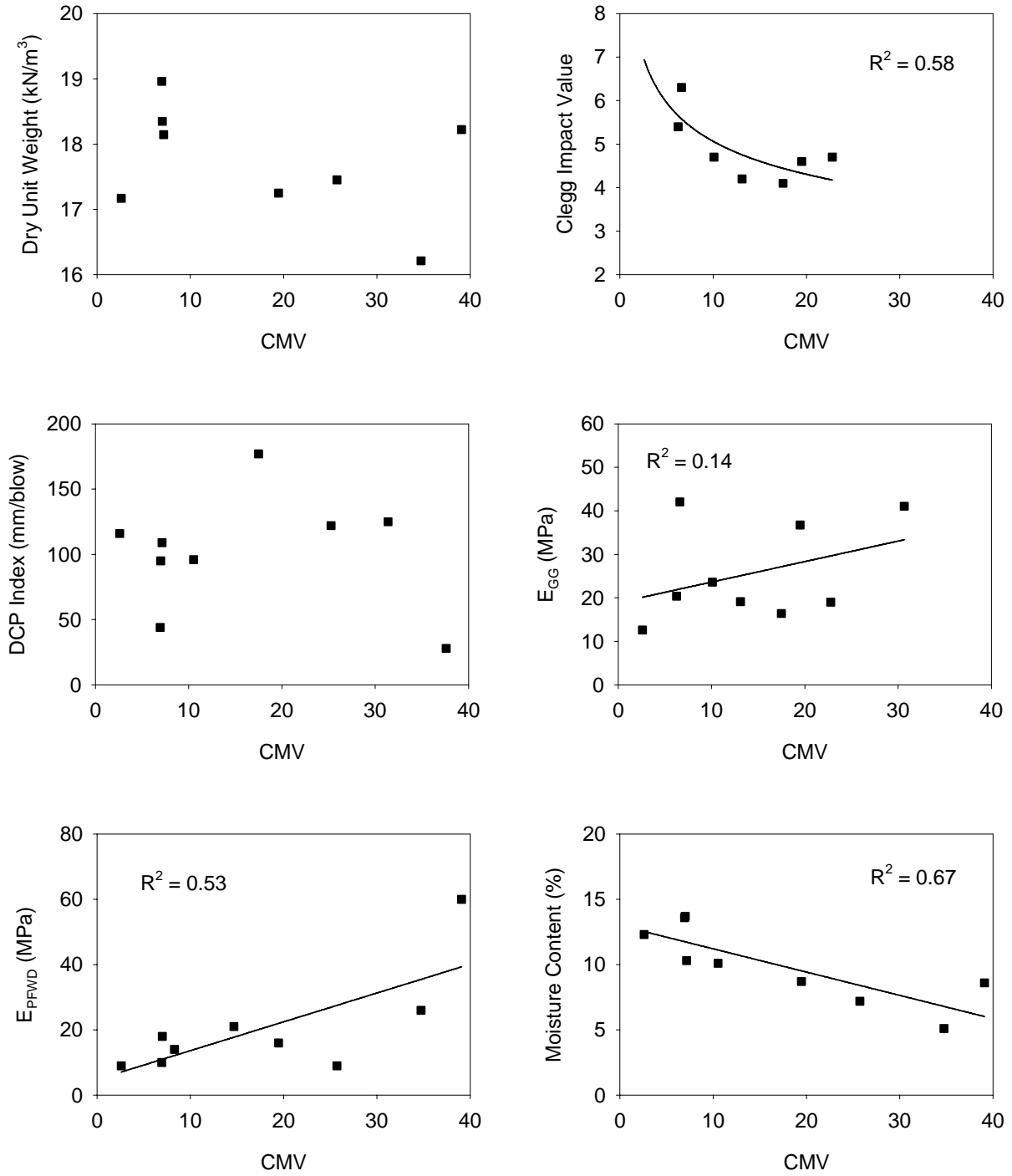
**Figure 181. Weak linear correlation between CMV and energy for sand**

Scatterplots comparing field measurements (dry unit weight, CIV, DCP index, GG modulus, PFWD modulus, and moisture content) to compaction monitoring data are provided in Figure 182 and Figure 183 for machine power and Geodynamik CMV, respectively. Generally, the relationships are statistically weak and/or strongly influenced by one or two points. In many cases, the models were not significant (i.e., the linear model did not provide a better prediction of the field measurement than the overall mean) and thus are not shown. Furthermore, insufficient data were available to use averaging techniques for reducing random variability.





**Figure 182. Scatterplots of field measurement results versus net power**



**Figure 183. Scatterplots of field measurement results versus CMV**



### *Project Observations*

The following observations were made from Test Project 3 on TH 14 near Janesville, Minnesota:

- Bringing compaction monitoring technology to field projects of transportation agencies helps to transfer the technology to those organizations, which will benefit in the future.
- Caterpillar Inc. compaction monitoring technology may identify areas of weak or poorly compacted soil with real-time readings and 100% coverage. Mapping trials were conducted using two instrumented rollers and in situ testing devices to verify compaction monitoring output. Insufficient data were collected to quantify the reliability of spatial data.
- Monitoring machine power during soil compaction may provide an alternative to test rolling subgrade for assuring a quality subgrade resistant to rutting.
- Compaction monitoring technology may not accurately indicate soil compaction (i.e., density, strength, or stiffness) for cohesionless materials that do not compact at the soil surface, as shown at WB STA 345–360. Clean sands often lack sufficient confining pressure and base friction to achieve high density immediately under the roller.
- Geodynamik CMV measurements derived from sensors installed on a CS-563 roller were weakly correlated with machine power for sand.
- Geodynamik CMV measurements were negatively correlated with moisture content (i.e., high moisture content gives low CMV), with an  $R^2$  value of 0.67 to support the influence of moisture on soil stiffness.

## SUMMARY AND CONCLUSIONS

### Summary

The Caterpillar Inc. compaction monitoring technology is comprised of internal sensors installed on a roller to monitor machine power and a GPS system to map spatial location and history of the roller. Primary research tasks involved (1) performing experimental testing and statistical analyses to evaluate machine power in terms of soil compaction and the properties of compacted soil (e.g., density, strength, stiffness), and (2) developing recommendations for using the compaction monitoring technology in practice. For this second-phase study, data were collected at three test projects. The first two projects were conducted at Caterpillar Inc. facilities near Peoria, Illinois, and were comprised of constructing and testing uniform test strips with varying soil types, moisture contents, and lift thicknesses. The third test project was conducted at an earthwork construction project on TH 14 near Janesville, Minnesota. For this final project, the ability of the compaction monitoring technology to identify localized areas of weak soil was demonstrated by mapping select locations of the project.

In situ testing of soil density (nuclear moisture-density gauge), strength (DCP, Clegg impact hammer), and stiffness (GG, PFWD, PLT) provided data to characterize the soil at various stages (i.e., passes) of compaction. For each test strip (i.e., single soil type and moisture content), in situ soil properties were compared directly to machine power to show that machine power indicates changes in soil properties and machine-soil response indicative of soil compaction. Using a relationship between compaction energy, dry unit weight, and moisture content derived from laboratory data, the field data for multiple test strips (i.e., multiple moisture contents, lift thicknesses, and/or soil types) were evaluated. Soil density, strength, and stiffness were predicted from machine power, particularly when moisture content was included as a regression parameter. Correlation coefficients ( $R^2$ ) were generally used to assess the quality of the regressions.

The established research objectives were achieved because the testing methods and operation generated usable data for evaluating machine power in terms of measures of soil compaction. Machine power and field measurements were collected at various levels of compaction, including both soft, intermediate, and hard materials. Also, using the various in situ testing devices to characterize soil density, strength, and stiffness facilitated multiple interpretations of the machine power response to compaction than just the effect of soil density. Future research to investigate compaction monitoring technology may use similar testing procedures, but should to isolate other variables affecting machine-soil response (e.g., speed, slope, etc.).

### Conclusions

Conclusions based on Test Project 1 are as follows:

- This testing method facilitated the evaluation of natural variability in the soil properties of a “uniform” soil and the variability associated with each measurement device, including machine power measurements (i.e., measurement error). Variability was expressed using standards of deviation, coefficients of variation, and distribution plots of

the measurements. Soil density and moisture content exhibited the lowest variation. Machine power and soil stiffness measurements, however, exhibited considerable variation, with COV exceeding 100%. This result was anticipated, since machine power measurements are sensitive to machine response (in addition to soil response) and soil stiffness is affected by many factors other than moisture content or percent compaction.

- The testing plan, as a whole, provided sufficient variation in soil type, moisture content, and lift thickness to produce meaningful correlations between machine power and soil engineering properties. Separate regressions were developed for each in situ testing device, relating machine power to measures of soil density, strength, and stiffness for the full range of soil compaction (e.g., compaction curve). These initial relationships verify that machine power is an indicator of soil engineering properties. For each test strip and testing device, the correlations show either linear (nuclear density, DCP index, CIV) or power-function (GG and PFW modulus) relations over the compaction curve.
- In recognizing that the quality of correlation depends on the range over which observations are related, the relatively poor correlations observed in sand (compared to the three cohesive soils) are explained by the difficulty in compacting the material. Compared to strips containing cohesive soil, the change in machine power for increasing roller passes was relatively small (Figure 111 to Figure 126, Table 9). The range in soil properties observed at an uncompacted state and following eight roller passes was also small. These data thus provided data clusters that may be combined between test strips of different moisture contents to facilitate a regression. The inability to produce significant correlations also indicates that static compaction using a padfoot roller is not the appropriate construction method for achieving high compaction in cohesionless material.
- By using averaged machine power and field measurement data, strong correlations were developed to characterize the machine-soil interaction. These correlations (i.e., models) were initially derived from laboratory compaction data relating compaction energy, moisture content, and dry unit weight. The final models for each combination of soil type, lift thickness, and test device showed that net power is statistically significant in predicting physical soil properties. Since the initial model was derived from density data, predictions of dry unit weight were often more accurate than predictions of soil strength or stiffness. The complexity of soil strength and stiffness requires that a more complicated model be used. Nevertheless, by incorporating moisture content and moisture-energy interaction (i.e., machine power) terms into the regressions, a high correlation was achieved, which indicates the promise of using such compaction monitoring technology as a tool for earthwork QC/QA.
- Investigating the influence of lift thickness on the machine power output data provided somewhat obvious but important insight into the factors affecting machine-soil response. The summary of  $R^2$  values for multiple linear regression analyses per soil (Table 11) showed that correlation coefficients for the thick lift were consistently higher than for the thin lift. The relative change in  $R^2$  values between thin and thick lifts suggests that the depth influencing the machine power response exceeds representative lift thicknesses encountered in field conditions. While the depth to a stabilized base (e.g., any soil layer with differing stiffness properties) affects the field measurements to some degree, the measurement influence depth affects the roller (higher weight and contact area than in situ test devices) response to a greater extent than the conventional tests. Still, the measurement influence depth would presumably be less for a static padfoot roller than for a vibratory roller. By combining all of the data within each soil type, intermediate  $R^2$

values (i.e., between thin and thick) were observed.

- Eventually, all of the cohesive soil data were combined, and models were fitted for each test device. In this analysis, soil fines content and plasticity index were used to quantitatively represent soil type. Predictions of soil density, strength, and stiffness using machine power, moisture content, and soil index parameters resulted in  $R^2$  values ranging from 0.66 to 0.86. Plasticity index and fines content were statistically significant in predictions for most of the test device measurements. The sand was nonplastic, and using a plasticity index equal to zero produced relatively weak correlations. Because plasticity index was significant in all regressions, data collected in the sand material were not included in the development of the final models. Developing separate machine power-soil property relationships based on soil classification groups (e.g., gravels, sands, silts, and clays) may be adequate for specifying the use of the technology for various projects and soil types. As datasets relating machine power to soil properties become more populated with results from various soils within a classification range, these preliminary recommendations may be justified.
- A major finding from Test Project 1 is that the testing methods and operation generate usable data for evaluating machine power in terms of measures of soil compaction. Machine power and field measurements should be collected at various levels of compaction, including both soft, intermediate, and hard materials. Secondly, using the entire suite of in situ testing devices to characterize soil density, strength, and stiffness facilitates multiple interpretations of the machine power response to compaction than just dry unit weight. Future research to investigate compaction monitoring technology may use similar testing procedures, but should isolate other variables affecting machine-soil response (e.g., speed, slope, etc.).

Conclusions based on Test Project 2 are as follows:

- Machine power was related to soil density and strength using a nuclear gauge and DCP testing, respectively. These relationships were developed for two soil types (Edwards till and CA6) at two moisture contents for the full range of soil compaction.  $R^2$  values for single-strip regressions ranged from 0.64 to 0.92 for dry unit weight and from 0.72 to 0.92 for DCP index.
- Little variation of moisture content was observed between the two test strips for each soil, such that moisture content was a non-significant parameter in regressions developed using the combined data. Machine net power predicted dry unit weight reasonably well for separate CA6 strips, while a linear relationship was observed for combined CA6 data.
- The compaction monitoring technology identified artificial “wet” and “soft” spots incorporated into strip 2 of the Edwards till material, evidenced by relatively high net power values observed at these locations and red displayed on the compaction monitor. The difference in net power observed between these locations and the rest of the test strip was considerable; this observation reflects the extreme conditions (i.e., high lift thickness and moisture content) built into the strip design. Realistically, a backfilled trench and an isolated, completely saturated location could be encountered in the field. Future testing may be required to determine and quantify the roller sensitivity to these changes in moisture content and soil lift thickness resulting from variation in construction operations (e.g., fill placement, moisture conditioning, existing site conditions) for a wider range of soil types and for two-dimensional areas.

- The machine-soil interaction at both drum and rear wheel locations affect the machine power values, which are currently applied to soil at only the drum location. A data correction algorithm may be incorporated into the compaction monitor software to account for these observed effects and improve the precision of the compaction monitoring system.

Conclusions based on Test Project 3 are as follows:

- Bringing compaction monitoring technology to field projects of transportation agencies helps to transfer the technology to those organizations, which will benefit in the future.
- Caterpillar Inc. compaction monitoring technology may identify areas of weak or poorly compacted soil with real-time readings and 100% coverage. Mapping trials were conducted using two instrumented rollers and in situ testing devices to verify compaction monitoring output. Insufficient data were collected to quantify the reliability of spatial data.
- Monitoring machine power during soil compaction may provide an alternative to test rolling subgrade for assuring a quality subgrade resistant to rutting.
- Compaction monitoring technology may not accurately indicate soil compaction (i.e., density, strength, or stiffness) for cohesionless materials that do not compact at the soil surface, as shown at WB STA 345–360. Clean sands often lack sufficient confining pressure and base friction to achieve a high density immediately under the roller.
- Geodynamik CMV measurements derived from sensors installed on a CS-563 roller were weakly correlated with machine power for sand.
- Geodynamik CMV measurements were negatively correlated with moisture content (i.e., high moisture content gives low CMV), with an  $R^2$  value of 0.67 to support the influence of moisture on soil stiffness.

## RECOMMENDATIONS

### Guidelines for Using Compaction Monitoring Technology in Practice

#### *Calibrating Machine Power to Engineering Soil Properties*

For earthwork construction, calibrating machine power to the engineering properties of a soil may closely resemble the testing operations used during this study. A test strip or section may be constructed with relatively uniform soil conditions. Machine power would be monitored during compaction of the test section, and in situ testing would occur after several passes (e.g., 1, 2, 4, 8, and 12). From the obtained data, relationships between net power and soil physical properties may be evaluated, and a target compaction monitor value may be determined. Furthermore, the variation in each measurement may be evaluated to establish the confidence in the regression and target compaction parameters for the soil type. Variable moisture may also be included in the test section to determine the influence of moisture content on soil engineering properties and machine power. This characterization of machine-soil interaction would then be used to evaluate quality over the larger production area. A pass/fail statement may be developed for specifications using compaction monitoring technology, provided the statement addresses the inherent variation of soil properties and the measurement error associated with both the compaction monitoring technology and in situ test methods. A conceptual approach to defining quality using compaction monitoring technology is presented later in this chapter.

The distance between consecutive net power measurements of the Caterpillar Inc. compaction monitoring technology is approximately 0.2 m. Consequently, each non-redundant value represents an area 0.2 m long and about 2 m wide (roller width). Recognizing that soil underneath the rear roller axle also influences the net power measurement, the measurement influence area also includes the contact area of the rear roller wheels. For correlation development and acceptance analysis, it is important to understand how compaction monitoring data should be interpreted spatially relative to in situ spot test measurements. To assess this relationship, correlations may be calculated between individual spot test measurements and averages of machine power data taken from “windows” of various widths around the corresponding spot test location. This analysis may be incorporated into the calibration procedure for determining whether individual or, more likely, average machine power values are used for quality assurance/acceptance. Spatial analysis techniques may also be used to (1) define the number and spatial pattern of spot tests required for calibration, (2) develop recommendations for acceptance testing, and (3) better understand the implications of variable-control intelligent compaction systems.

#### *Identifying Variation and Non-Uniformity in Compacted Fill*

The observed variation in material properties can generally be attributed to inherent variability in the soil and/or measurement variability and error. Regardless of whether these sources of variation are separated into components, care must be taken to ensure that individual components of variation do not bias the overall variation (e.g., measurement error mistaken for soil variability). In evaluating the quality of compacted fill using compaction monitoring technology and the derived linear relationship between net power and dry unit weight, for example, the

relatively wide range of machine power values should not necessarily be interpreted as variable soil density. The compaction monitoring technology, at this time, is subject to variable readings caused by either sensitivity of the roller instrumentation or the physical machine-soil interaction.

The inherent variability of material cannot alone be used as a specification limit. This source of variation must be determined by testing the soil, which consequently introduces a second source of variation (e.g., measurement error). In developing specifications, these sources of variability must be closely examined to ensure that testing variation is accounted for and integrated into QC/QA target values. Future research may indicate the appropriate level of testing needed to identify the “true” soil property value and establish confidence in the correlations between machine power and in situ soil properties.

## **Implementation of Compaction Monitoring Technology into QC/QA Specifications**

Using compaction monitoring technology to evaluate the quality of earthwork construction changes the process of QC/QA, including the measurement processes, types of field verification, the target results for the field measurements, and responsibility levels for contractors and project owners. As described in the following sections, compaction monitoring technology may be implemented in various types of specifications.

### *Method, End Result, and Performance-Based Specifications*

#### Method Specification

A method specification would require developing a standard protocol for accepting the roller on the project in accordance with some predetermined size-weight-shape criteria and the operations of the roller (e.g., working speed, number of passes, documentation protocol). The process could include a test strip approach that measures the compaction effort related to some measure of soil compaction (e.g., stiffness or percent compaction). This approach would specify a minimum number of roller passes over all areas to be compacted per soil type. A color-coded coverage map of the project would be produced by the contractor to demonstrate that the correct number of passes has been applied. If the contractor can show that complete coverage with the minimum number of passes has been obtained, the specification requirements will have been met.

#### End Result Specification

An end result specification would require that the soil to be compacted into an acceptable condition which is then assessed on a pass/fail criterion. The end-result target, determined from the machine power calibration procedure, would be specified as a function of percent compaction (or achieving a minimum soil modulus or strength) and the machine power. Compliance with the end result specification would require rigorous in situ spot testing by direct measurement during calibration of the machine value and less rigorous in situ spot testing during the quality assurance testing. Many alternative in situ spot test measurement techniques exist, and the repeatability/reproducibility of the test methods and state DOT experience need to be considered.

As part of establishing the specification criteria, a target soil modulus, for example, would be established with a calibration procedure to correlate machine values with the “proving” tests, which would provide a direct measure of soil modulus. The calibration procedure would be performed at the beginning of the project to establish the minimum machine value that meets the desired in situ modulus. The contractor would be required to provide a color-coded map of the project showing that the machine power values (as specified by to-be-determined mean, standard deviation criteria) have been obtained consistently throughout the project limits. Another acceptance criterion would be a measure of soil uniformity (COV).

### Performance-Based Specification

A performance specification stipulates how the earthwork should act under conditions likely to be encountered in service. The advantages of a performance specification approach are that (1) performance relationships can be identified from appropriate performance parameters, (2) higher performance specifications can be applied for more heavily loaded areas, and (3) greater flexibility in construction operations and materials can be provided, as long as performance requirements are met. Some disadvantages of performance-based specifications are (1) the needs for a greater level of soil understanding, especially in the long term, (2) the need for testing in the laboratory to establish design target values (e.g., resilient modulus), and (3) the need for extensive trials to gain confidence in the robustness of the specification.

The performance-based specification would require more field and laboratory work and more time for development than either the method or end result specifications. The best measure of performance is the ultimate service life of the roadway structure. The first assumption that must be made is that material properties can be measured that relate directly to a predicted service life. At this time, it appears that the best way to predict performance is through laboratory measurement of resilient modulus, as evidenced by the move to a mechanistic-empirical pavement design methodology. Therefore, any effort to develop performance-based specifications must include a thorough investigation of how roller-generated data measurements relate to the laboratory resilient modulus testing of in situ samples from the compacted roadway material.

If a valid correlation between laboratory resilient modulus and machine-generated data can be obtained, the color-coded project map may be used for acceptance and may show that the contractor has obtained the minimum modulus that relates to performance criteria consistently throughout the project.

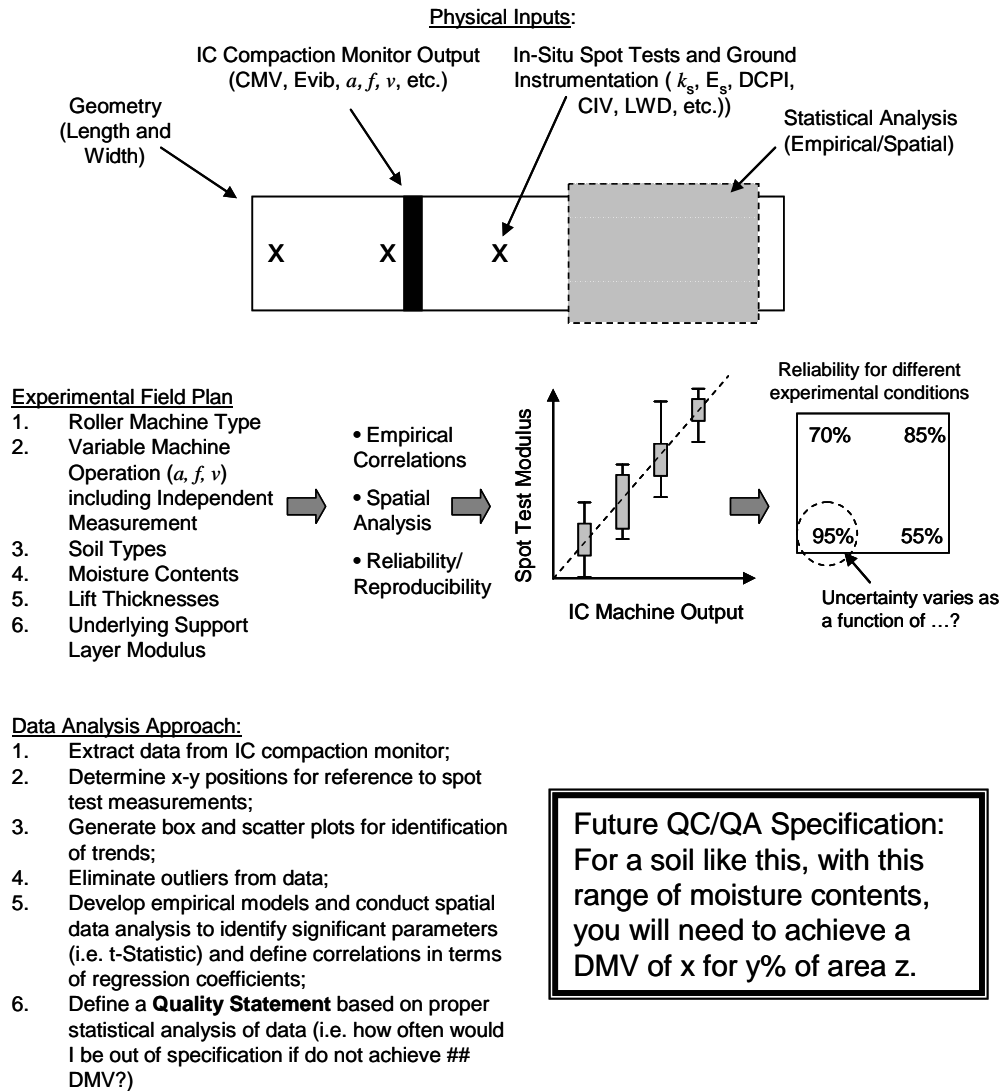
### Recommendations for Future Research

#### *Statistical Framework for QC/QA Using Compaction Monitoring Technology*

With regards to developing the machine-soil property calibration relationships, regression models will consist of single-regression analyses (e.g., plotting net power versus dry unit weight or modulus) and multiple-regression analyses (e.g., including moisture content as a second parameter along with net power). Figure 184 shows a conceptual approach to analyzing machine power and field measurements, including simple empirical correlations, spatial analysis relationships, and reliability concepts. Validating this approach, however, will require



concentrated spot testing over relatively large test sections. These test sections will provide further insight into the variation of compacted soil and the level of confidence that may be expected from machine-spot test measurements in the field.



**Figure 184. Conceptual data analysis approach to define a quality statement**

### Statistical Analysis Routines

Transportation agencies will need tools (software packages, for example) to manage and analyze relatively large quantities of compaction monitoring data collected during an earthwork construction project. These agencies may prefer data transfer and documentation that utilizes geographic information systems (GIS). As each state may have different procedures for data management and analysis, however, a roller manufacturer might not develop these engines. Rather, the analysis framework may be developed by state or private institutions. Alternatively, such analysis routines may be incorporated into compaction software by a manufacturer to

increase the autonomy of intelligent construction equipment. Advanced algorithms might analyze compaction monitoring data on the fly and signal subsequent compaction (or other parallel construction) operations. Thus, the need for roller operators to make such decisions on machine control would be reduced or potentially eliminated.

#### *Laboratory Evaluation of Strength-Stiffness-Moisture-Energy Relationships*

As documented, attempts at predicting laboratory strength and stiffness during this study were generally unsuccessful. The inability to develop a simple, consistent model is explained as follows:

- The relationships are complex, and simple models may not be adequate.
- Soil strength and stiffness properties are strongly influenced by even small changes in moisture. Variability in moisture content observed within a nominal moisture range obscured a general pattern.
- Soil strength and stiffness may not be predicted adequately from compaction energy and moisture content alone; additional variables may be needed.

Additional laboratory studies may be conducted to evaluate the relationships between soil strength, stiffness, moisture, and energy. Another study may use larger sample sizes to determine whether any of the aforementioned possibilities apply. Furthermore, alternative strength/stiffness tests may be used to obtain the deformation behavior of soil subjected to stress conditions observed during construction and long-term performance.



## REFERENCES

Geodynamik. 2005. Our Products. Stockholm, Sweden: Geodynamik.  
[http://www.geodynamik.com/languages/english/index\\_gb.html](http://www.geodynamik.com/languages/english/index_gb.html).

International Society for Soil Mechanics and Geotechnical Engineering (ISSMGE), Technical Committee 3. 2005. Specification: Geotechnics for Pavements in Transportation Infrastructure, Roller-Integrated Continuous Compaction Control (CCC), Technical Contractual Provisions – Recommendations. International Society for Soil Mechanics and Geotechnical Engineering.

Forschungsgesellschaft Straße, Schiene, Verkehr [Road, Rail, and Traffic Research Association, Austria]. 1993. Kontinuierlicher walzenintegrierter Verdichtungsnachweis [Continuous roll-integrated compression]. Richtlinien für Verkehr und Strassenwesen. RVS 8S.02.6.

1994. Tienrakennustiden yleiset laatuvaatimukset ja tyselitykset [General quality specifications and work descriptions in road constructions. Formation level and road base.]. Helsinki, Finland: Tielaitos.

White, D., E. Jaselskis, V. Schaefer, T. Cackler, I. Drew, and L. Li. 2004. Field Evaluation of Compaction Monitoring Technology: Phase I. Final Report. Iowa DOT Project TR-495. Ames, IA: Center for Transportation Research and Education, Iowa State University.

1994. Yttackande packningskontroll Metodbeskrivning. 603.

ZTVE-StB 94. 29 July 1994. Zusätzliche Technische Vertragsbedingungen und Richtlinien für Erdarbeiten im Strassenbau [Additional technical guidelines for earthwork in road construction]. FGSV599.

## NOTATIONS

a	=	machine acceleration
b	=	regression coefficient
CBR	=	California bearing ratio
CIV	=	Clegg impact value
CMV	=	compaction meter value
COV	=	coefficient of variation
DCP	=	dynamic cone penetrometer
E	=	soil modulus
E	=	energy
F <sub>200</sub>	=	percent finer than 0.075 mm
FMO	=	field moisture oven
g	=	acceleration of gravity
GG	=	GeoGauge
GPS	=	global positioning system
IC	=	intelligent compaction
k	=	coefficient of subgrade reaction
n	=	number of observations (i.e., data points)
NPp	=	net power
PFWD	=	portable falling weight deflectometer
P <sub>g</sub>	=	gross power
PI	=	plasticity index
PLT	=	plate load test
QA	=	quality assurance
QC	=	quality control
R <sup>2</sup>	=	correlation coefficient
V	=	roller velocity
w	=	soil gravimetric moisture content
w <sub>v</sub>	=	soil volumetric moisture content
W	=	roller weight
γ <sub>d</sub>	=	soil dry unit weight
μ	=	mean
σ	=	standard deviation

**APPENDIX A. PROJECT 1 IN SITU TEST DATA**

**Table A.1. Moisture and density summary of Kickapoo topsoil, strip 1, 0 roller passes**

Test point	Coordinates (m)			Nuclear gauge (kN/m <sup>3</sup> , %)						Drive core (kN/m <sup>3</sup> , %)	
	X	Y	Z	$\gamma_d^1$	$w_g^1$	$\gamma_d^2$	$w_g^2$	$\gamma_d$	$w_g$	$\gamma_d$	$w_g$
1	-5.73	6.44	-0.11	10.7	19.8	10.7	19.5	10.7	19.7	---	---
2	-5.88	4.85	-0.12	9.7	18.4	9.3	23.4	9.5	20.9	---	---
3	-5.93	3.47	-0.13	9.9	17.7	9.3	21.7	9.6	19.7	---	---
4	-5.96	1.87	-0.14	9.9	17.4	10.1	18.2	10.0	17.8	---	---
5	-5.95	0.35	-0.16	10.1	18.4	9.7	20.7	9.9	19.6	---	---
6	-5.91	-1.10	-0.17	10.0	18.7	10.2	17.3	10.1	18.0	---	---
7	-5.91	-2.66	-0.18	10.4	19.0	10.1	21.4	10.2	20.2	---	---
8	-5.89	-4.14	-0.19	9.9	20.4	9.7	21.0	9.8	20.7	---	---
9	-5.80	-5.74	-0.20	10.6	17.1	10.0	20.3	10.3	18.7	---	---
10	-5.80	-7.26	-0.18	10.2	19.1	9.6	19.9	9.9	19.5	---	---

**Table A.2. Stiffness and strength summary of Kickapoo topsoil, strip 1, 0 roller passes**

Test point	Clegg impact test			Geogauge		DCP	FWD: E (MPa)				
	CIV <sup>1</sup>	CIV <sup>2</sup>	CIV	M	S	DCPI	1	2	3	4	
1	---	---	---	---	---	---	---	---	---	---	---
2	---	---	---	---	---	---	---	---	---	---	---
3	---	---	---	---	---	---	---	---	---	---	---
4	---	---	---	---	---	---	---	---	---	---	---
5	---	---	---	---	---	---	---	---	---	---	---
6	---	---	---	---	---	---	---	---	---	---	---
7	---	---	---	---	---	---	---	---	---	---	---
8	---	---	---	---	---	---	---	---	---	---	---
9	---	---	---	---	---	---	---	---	---	---	---
10	---	---	---	---	---	---	---	---	---	---	---

**Table A.3. Moisture and density summary of Kickapoo topsoil, strip 1, 1 roller pass**

Test point	Coordinates (m)			Nuclear gauge (kN/m <sup>3</sup> , %)						Drive core (kN/m <sup>3</sup> , %)	
	X	Y	Z	$\gamma_d^1$	$w_g^1$	$\gamma_d^2$	$w_g^2$	$\gamma_d$	$w_g$	$\gamma_d$	$w_g$
1	-5.70	6.95	-0.22	14.1	23.3	13.3	23.3	13.7	23.3	---	---
2	-5.51	4.57	-0.27	13.9	20.4	12.9	21.9	13.4	21.2	---	---
3	-5.59	2.95	-0.26	12.4	25.0	12.2	24.7	12.3	24.9	---	---
4	-5.53	1.22	-0.29	12.2	20.6	12.9	21.1	12.6	20.9	---	---
5	-5.53	0.54	-0.30	12.5	22.1	12.6	23.0	12.6	22.6	---	---
6	-5.53	-0.52	-0.30	12.7	22.4	13.1	24.3	12.9	23.4	---	---
7	-5.51	-2.52	-0.31	12.6	22.2	13.2	21.9	12.9	22.1	---	---
8	-5.49	-4.48	-0.32	13.0	23.9	13.2	24.0	13.1	24.0	---	---
9	-5.46	-5.93	-0.32	12.4	23.2	12.6	25.3	12.5	24.3	---	---
10	-5.46	-7.26	-0.30	13.2	23.7	13.6	23.1	13.4	23.4	---	---

**Table A.4. Stiffness and strength summary of Kickapoo topsoil, strip 1, 1 roller pass**

Test point	Clegg impact test			Geogauge		DCP	FWD: E (MPa)			
	CIV <sup>1</sup>	CIV <sup>2</sup>	CIV	M	S	DCPI	1	2	3	4
1	2.7	---	2.7	---	---	222	5.2	5.8	6.3	---
2	3.8	---	3.8	---	---	105	9.1	15.7	12.8	10.8
3	4.2	---	4.2	---	---	150	17.3	27.7	21.9	17.0
4	4.8	---	4.8	---	---	157	24.2	21.5	17.0	14.7
5	4.8	---	4.8	---	---	156	7.0	9.0	9.6	10.5
6	3.5	---	3.5	---	---	135	19.0	15.6	13.8	13.4
7	---	---	---	---	---	144	6.9	7.8	7.6	---
8	2.9	---	2.9	---	---	159	14.7	11.2	10.1	9.8
9	3.3	---	3.3	---	---	139	35.2	22.4	16.3	15.3
10	3.3	---	3.3	---	---	122	5.0	6.2	6.1	---

**Table A.5. Moisture and density summary of Kickapoo topsoil, strip 1, 2 roller passes**

Test point	Coordinates (m)			Nuclear gauge (kN/m <sup>3</sup> , %)						Drive core (kN/m <sup>3</sup> , %)	
	X	Y	Z	$\gamma_d^1$	$w_g^1$	$\gamma_d^2$	$w_g^2$	$\gamma_d$	$w_g$	$\gamma_d$	$w_g$
1	-5.68	6.26	-0.20	13.5	22.5	14.4	21.2	14.0	21.9	---	---
2	-5.66	4.95	-0.26	14.0	20.3	13.4	25.1	13.7	22.7	---	---
3	-5.64	3.57	-0.27	13.2	21.8	12.7	22.1	13.0	22.0	---	---
4	-5.63	1.89	-0.27	14.1	19.8	13.6	22.7	13.9	21.3	---	---
5	-5.66	0.22	-0.30	14.1	21.0	13.4	22.6	13.7	21.8	---	---
6	-5.67	-1.13	-0.31	13.2	23.1	13.6	25.0	13.4	24.1	---	---
7	-5.71	-2.79	-0.31	13.3	24.6	13.6	26.5	13.4	25.6	---	---
8	-5.70	-4.10	-0.32	13.9	22.0	13.8	24.6	13.9	23.3	---	---
9	-5.67	-5.75	-0.33	14.6	21.6	15.0	22.0	14.8	21.8	---	---
10	-5.65	-7.12	-0.32	14.0	23.2	14.5	22.0	14.3	22.6	---	---

**Table A.6. Stiffness and strength summary of Kickapoo topsoil, strip 1, 2 roller passes**

Test point	Clegg Impact Test			Geogauge		DCP	FWD: E (MPa)			
	CIV <sup>1</sup>	CIV <sup>2</sup>	CIV	M	S	DCPI	1	2	3	4
1	4.5	---	4.5	---	---	150	5.2	5.8	6.3	---
2	4.2	---	4.2	---	---	137	9.1	15.7	12.8	10.8
3	5.0	---	5.0	---	---	126	17.3	27.7	21.9	17.0
4	5.2	---	5.2	---	---	97	24.2	21.5	17.0	14.7
5	4.6	---	4.6	---	---	125	7.0	9.0	9.6	10.5
6	3.9	---	3.9	---	---	135	19.0	15.6	13.8	13.4
7	3.8	---	3.8	---	---	130	6.9	7.8	7.6	---
8	3.1	---	3.1	---	---	126	14.7	11.2	10.1	9.8
9	3.4	---	3.4	---	---	104	35.2	22.4	16.3	15.3
10	3.7	---	3.7	---	---	123	5.0	6.2	6.1	---



**Table A.7. Moisture and density summary of Kickapoo topsoil, strip 1, 4 roller passes**

Test point	Coordinates (m)			Nuclear gauge (kN/m <sup>3</sup> , %)						Drive core (kN/m <sup>3</sup> , %)	
	X	Y	Z	$\gamma_d^1$	$w_g^1$	$\gamma_d^2$	$w_g^2$	$\gamma_d$	$w_g$	$\gamma_d$	$w_g$
1	-5.85	6.98	-0.23	14.6	22.5	14.7	22.8	14.7	22.7	---	---
2	-5.67	5.25	-0.26	14.3	24.4	14.5	22.5	14.4	23.5	---	---
3	-5.60	3.95	-0.27	14.6	22.3	14.0	20.7	14.3	21.5	---	---
4	-5.65	2.23	-0.28	14.3	20.6	13.6	22.7	14.0	21.7	---	---
5	-5.65	0.90	-0.30	14.1	21.0	14.2	23.0	14.1	22.0	---	---
6	-5.64	-0.78	-0.32	14.8	22.8	14.8	22.2	14.8	22.5	---	---
7	-5.59	-3.12	-0.32	14.4	24.9	14.3	25.7	14.3	25.3	---	---
8	-5.56	-4.75	-0.33	14.7	25.1	14.4	27.1	14.6	26.1	---	---
9	-5.68	-5.36	-0.34	16.0	21.8	15.8	20.4	15.9	21.1	---	---
10	-5.48	-7.10	-0.33	15.3	23.9	15.7	23.2	15.5	23.6	---	---

**Table A.8. Stiffness and strength summary of Kickapoo topsoil, strip 1, 4 roller passes**

Test point	Clegg Impact Test			Geogauge		DCP	FWD: E (MPa)			
	CIV <sup>1</sup>	CIV <sup>2</sup>	CIV	M	S	DCPI	1	2	3	4
1	3.4	---	3.4	11.28	1.52	179	2.9	---	---	---
2	4.8	---	4.8	23.15	3.12	74	24.4	21.1	17.1	15.7
3	5.0	---	5.0	19.72	2.66	105	5.5	8.8	8.9	9.3
4	5.0	---	5.0	36.76	4.96	85	13.1	15.1	14.4	13.8
5	4.1	---	4.1	31.20	4.21	163	10.8	15.0	14.6	14.1
6	4.9	---	4.9	32.70	4.41	113	13.4	37.7	49.5	34.9
7	4.1	---	4.1	28.88	3.89	121	27.7	22.8	17.8	14.9
8	3.0	---	3.0	29.01	3.91	109	14.2	13.2	13.1	14.0
9	3.7	---	3.7	34.39	4.64	94	11.0	19.7	26.8	33.1
10	4.4	---	4.4	33.22	4.48	107	417.9	179.9	206.0	216.3

**Table A.9. Moisture and density summary of Kickapoo topsoil, strip 1, 8 roller passes**

Test point	Coordinates (m)			Nuclear gauge (kN/m <sup>3</sup> , %)						Drive core (kN/m <sup>3</sup> , %)	
	X	Y	Z	$\gamma_d^1$	$w_g^1$	$\gamma_d^2$	$w_g^2$	$\gamma_d$	$w_g$	$\gamma_d$	$w_g$
1	-5.76	6.57	-0.22	15.5	22.7	14.9	22.6	15.2	22.7	15.1	23.5
2	-5.73	4.90	-0.27	15.2	23.0	15.3	23.1	15.3	23.1	16.1	23.0
3	-5.71	3.57	-0.29	15.4	21.3	16.1	19.7	15.7	20.5	---	---
4	-5.72	1.88	-0.30	14.6	25.2	15.0	23.0	14.8	24.1	15.1	23.4
5	-5.68	0.52	-0.32	15.3	22.2	15.1	23.0	15.2	22.6	15.4	23.7
6	-5.63	-1.14	-0.34	14.9	24.7	15.6	23.8	15.3	24.3	15.4	23.5
7	-5.61	-2.80	-0.34	14.8	26.8	14.9	25.5	14.9	26.2	15.2	25.0
8	-5.57	-4.12	-0.35	15.4	23.6	15.6	23.7	15.5	23.7	15.5	23.6
9	-5.52	-5.78	-0.35	15.8	21.8	16.4	19.9	16.1	20.9	15.8	23.3
10	-5.50	-7.04	-0.34	14.7	22.7	14.4	26.0	14.6	24.4	---	---

**Table A.10. Stiffness and strength summary of Kickapoo topsoil, strip 1, 8 roller passes**

Test point	Clegg Impact Test			Geogauge		DCP	FWD: E (MPa)			
	CIV <sup>1</sup>	CIV <sup>2</sup>	CIV	M	S	DCPI	1	2	3	4
1	4.1	---	4.1	21.08	2.84	99	11.4	9.1	8.6	---
2	4.1	---	4.1	23.99	3.24	111	11.9	14.1	14.3	12.8
3	4.9	---	4.9	41.60	5.61	76	23.8	33.2	29.2	21.6
4	5.5	---	5.5	41.62	5.61	73	33.5	44.2	47.8	48.8
5	5.0	---	5.0	33.88	4.57	100	18.1	22.7	23.4	23.1
6	3.9	---	3.9	30.34	4.09	100	9.4	13.1	12.6	12.6
7	3.3	---	3.3	25.65	3.46	92	26.9	27.2	28.8	31.9
8	3.5	---	3.5	30.13	4.06	90	12.4	14.3	15.2	18.7
9	4.4	---	4.4	38.29	5.16	75	231.3	1571.0	---	---
10	3.8	---	3.8	---	---	102	4.8	6.9	---	---

**Table A.11. Moisture and density summary of Kickapoo topsoil, strip 2, 0 roller passes**

Test point	Coordinates (m)			Nuclear gauge (kN/m <sup>3</sup> , %)						Drive core (kN/m <sup>3</sup> , %)	
	X	Y	Z	$\gamma_d^1$	$w_g^1$	$\gamma_d^2$	$w_g^2$	$\gamma_d$	$w_g$	$\gamma_d$	$w_g$
1	-5.98	6.42	-0.10	10.7	17.4	10.7	16.3	10.7	16.9	---	---
2	-5.94	4.90	-0.12	10.8	15.3	10.8	17.4	10.8	16.4	---	---
3	-5.80	3.30	-0.10	10.9	17.0	10.5	20.2	10.7	18.6	---	---
4	-5.70	1.84	-0.11	10.7	15.3	10.7	18.3	10.7	16.8	---	---
5	-5.72	0.34	-0.12	11.5	17.9	11.5	15.8	11.5	16.9	---	---
6	-5.66	-1.12	-0.13	11.2	16.6	11.5	16.4	11.3	16.5	---	---
7	-5.59	-2.66	-0.13	11.4	17.2	12.0	16.3	11.7	16.8	---	---
8	-5.54	-4.10	-0.13	11.1	17.2	11.2	15.8	11.2	16.5	---	---
9	-5.62	-5.67	-0.14	11.2	16.0	11.2	17.5	11.2	16.8	---	---
10	-5.67	-7.22	-0.12	11.2	17.0	11.4	19.6	11.3	18.3	---	---

**Table A.12. Stiffness and strength summary of Kickapoo topsoil, strip 2, 0 roller passes**

Test point	Clegg Impact Test			Geogauge		DCP	FWD: E (MPa)			
	CIV <sup>1</sup>	CIV <sup>2</sup>	CIV	M	S	DCPI	1	2	3	4
1	---	---	---	---	---	---	---	---	---	---
2	---	---	---	---	---	---	---	---	---	---
3	---	---	---	---	---	---	---	---	---	---
4	---	---	---	---	---	---	---	---	---	---
5	---	---	---	---	---	---	---	---	---	---
6	---	---	---	---	---	---	---	---	---	---
7	---	---	---	---	---	---	---	---	---	---
8	---	---	---	---	---	---	---	---	---	---
9	---	---	---	---	---	---	---	---	---	---
10	---	---	---	---	---	---	---	---	---	---

**Table A.13. Moisture and density summary of Kickapoo topsoil, strip 2, 1 roller pass**

Test point	Coordinates (m)			Nuclear gauge (kN/m <sup>3</sup> , %)						Drive core (kN/m <sup>3</sup> , %)	
	X	Y	Z	$\gamma_d^1$	$w_g^1$	$\gamma_d^2$	$w_g^2$	$\gamma_d$	$w_g$	$\gamma_d$	$w_g$
1	-6.01	6.38	-0.22	13.1	20.5	13.9	18.7	13.5	19.6	---	---
2	-6.00	4.92	-0.23	13.0	22.5	13.0	22.0	13.0	22.3	---	---
3	-5.86	3.10	-0.25	12.3	24.5	12.2	23.1	12.3	23.8	---	---
4	-5.48	1.83	-0.22	12.6	23.8	12.3	19.9	12.4	21.9	---	---
5	-5.51	0.38	-0.23	12.5	23.9	12.7	23.8	12.6	23.9	---	---
6	-5.52	-1.28	-0.22	13.0	20.4	13.6	19.7	13.3	20.1	---	---
7	-5.54	-2.66	-0.26	13.5	22.5	13.5	23.2	13.5	22.9	---	---
8	-5.68	-4.06	-0.25	12.6	23.6	13.1	23.3	12.8	23.5	---	---
9	-5.68	-5.79	-0.24	13.6	19.7	12.5	22.9	13.0	21.3	---	---
10	-5.66	-7.28	-0.24	13.2	22.9	13.8	19.8	13.5	21.4	---	---

**Table A.14. Stiffness and strength summary of Kickapoo topsoil, strip 2, 1 roller pass**

Test point	Clegg Impact Test			Geogauge		DCP	FWD: E (MPa)			
	CIV <sup>1</sup>	CIV <sup>2</sup>	CIV	M	S	DCPI	1	2	3	4
1	---	---	---	8.39	1.13	172	4.8	4.1	---	---
2	---	---	---	---	---	159	6.1	7.9	---	---
3	---	---	---	---	---	161	---	---	---	---
4	---	---	---	---	---	116	5.2	5.1	---	---
5	---	---	---	---	---	161	6.8	6.6	---	---
6	---	---	---	---	---	179	5.6	---	---	---
7	---	---	---	---	---	162	15.8	16.4	---	---
8	---	---	---	---	---	179	5.2	6.8	---	---
9	---	---	---	---	---	158	7.6	6.4	---	---
10	---	---	---	---	---	157	---	---	---	---

**Table A.15. Moisture and density summary of Kickapoo topsoil, strip 2, 2 roller passes**

Test point	Coordinates (m)			Nuclear gauge (kN/m <sup>3</sup> , %)						Drive core (kN/m <sup>3</sup> , %)	
	X	Y	Z	$\gamma_d^1$	$w_g^1$	$\gamma_d^2$	$w_g^2$	$\gamma_d$	$w_g$	$\gamma_d$	$w_g$
1	-5.82	5.78	-0.25	13.1	25.2	13.2	24.5	13.1	24.9	---	---
2	-5.57	4.11	-0.22	13.5	21.3	13.3	24.8	13.4	23.1	---	---
3	-5.56	2.70	-0.21	13.9	22.0	13.5	20.7	13.7	21.4	---	---
4	-5.67	1.08	-0.23	14.2	22.5	13.6	19.9	13.9	21.2	---	---
5	-5.66	-0.38	-0.22	13.7	19.2	13.5	20.0	13.6	19.6	---	---
6	-5.62	-1.83	-0.25	14.5	22.0	14.2	21.6	14.4	21.8	---	---
7	-5.39	-3.36	-0.24	14.0	22.6	13.5	23.4	13.8	23.0	---	---
8	-5.70	-4.80	-0.26	13.1	20.9	13.8	21.8	13.4	21.4	---	---
9	-5.54	-6.48	-0.26	14.2	19.6	13.4	21.1	13.8	20.4	---	---
10	-5.38	-7.77	-0.23	14.6	20.2	13.4	21.6	14.0	20.9	---	---

**Table A.16. Stiffness and strength summary of Kickapoo topsoil, strip 2, 2 roller passes**

Test point	Clegg Impact Test			Geogauge		DCP	FWD: E (MPa)			
	CIV <sup>1</sup>	CIV <sup>2</sup>	CIV	M	S	DCPI	1	2	3	4
1	---	---	---	11.64	1.57	108	10.7	14.4	10.3	7.9
2	---	---	---	14.26	1.92	128	9.0	8.2	7.9	---
3	---	---	---	19.51	2.63	78	12.8	17.9	13.1	12.0
4	---	---	---	17.40	2.35	141	14.6	13.6	11.4	10.3
5	---	---	---	15.76	2.13	136	20.4	13.7	10.4	9.3
6	---	---	---	35.30	4.76	148	12.9	13.4	12.0	11.2
7	---	---	---	27.17	3.66	144	25.7	24.5	16.3	12.9
8	---	---	---	25.57	3.45	111	9.2	9.1	8.5	8.4
9	---	---	---	26.78	3.61	130	11.2	11.3	10.2	9.6
10	---	---	---	19.18	2.59	148	22.5	21.3	16.3	14.1

**Table A.17. Moisture and density summary of Kickapoo topsoil, strip 2, 4 roller passes**

Test point	Coordinates (m)			Nuclear gauge (kN/m <sup>3</sup> , %)						Drive core (kN/m <sup>3</sup> , %)	
	X	Y	Z	$\gamma_d^1$	$w_g^1$	$\gamma_d^2$	$w_g^2$	$\gamma_d$	$w_g$	$\gamma_d$	$w_g$
1	-5.76	6.39	-0.24	15.0	21.5	14.6	23.1	14.8	22.3	---	---
2	-5.90	5.06	-0.25	14.5	22.5	14.5	21.9	14.5	22.2	---	---
3	-5.88	3.43	-0.24	14.5	23.5	14.4	22.8	14.5	23.2	---	---
4	-5.83	2.01	-0.26	14.1	22.0	14.4	20.8	14.3	21.4	---	---
5	-5.59	0.34	-0.26	14.0	25.3	14.0	24.3	14.0	24.8	---	---
6	-5.70	-1.39	-0.26	14.5	21.4	14.3	22.8	14.4	22.1	---	---
7	-5.49	-2.74	-0.26	13.9	23.5	14.0	22.7	14.0	23.1	---	---
8	-5.49	-4.03	-0.26	14.0	25.9	14.3	23.9	14.2	24.9	---	---
9	-5.52	-5.70	-0.27	14.8	23.2	14.3	23.6	14.5	23.4	---	---
10	-5.50	-7.09	-0.25	13.6	23.1	13.2	25.1	13.4	24.1	---	---

**Table A.18. Stiffness and strength summary of Kickapoo topsoil, strip 2, 4 roller passes**

Test point	Clegg Impact Test			Geogauge		DCP	FWD: E (MPa)			
	CIV <sup>1</sup>	CIV <sup>2</sup>	CIV	M	S	DCPI	1	2	3	4
1	---	---	---	9.11	1.23	186	6.3	5.8	---	---
2	---	---	---	32.32	4.36	76	25.3	41.7	33.5	26.6
3	---	---	---	32.14	4.33	74	15.7	24.4	22.6	19.8
4	---	---	---	32.76	4.42	81	33.1	34.3	24.8	19.4
5	---	---	---	31.79	4.29	74	66.4	58.3	36.8	24.1
6	---	---	---	32.18	4.34	79	9.1	9.7	27.0	25.5
7	---	---	---	30.61	4.13	76	62.1	44.2	24.2	16.8
8	---	---	---	29.18	3.94	113	22.4	38.7	29.2	24.1
9	---	---	---	39.05	5.27	93	52.1	37.2	23.9	19.2
10	---	---	---	31.74	4.28	78	63.0	52.1	34.2	24.2

**Table A.19. Moisture and density summary of Kickapoo topsoil, strip 2, 8 roller passes**

Test point	Coordinates (m)			Nuclear gauge (kN/m <sup>3</sup> , %)						Drive core (kN/m <sup>3</sup> , %)	
	X	Y	Z	$\gamma_d^1$	$w_g^1$	$\gamma_d^2$	$w_g^2$	$\gamma_d$	$w_g$	$\gamma_d$	$w_g$
1	-5.91	5.51	-0.24	15.5	22.3	15.9	19.8	15.7	21.1		
2	-5.88	4.05	-0.24	15.3	20.9	14.6	25.0	15.0	23.0		
3	-5.84	2.45	-0.24	15.4	22.5	15.6	20.0	15.5	21.3		
4	-5.72	0.91	-0.25	15.2	21.9	15.0	21.3	15.1	21.6		
5	-5.72	-0.26	-0.26	14.4	24.5	15.8	20.4	15.1	22.5		
6	-5.78	-2.00	-0.28	15.0	22.7	14.6	23.6	14.8	23.2		
7	-5.76	-3.32	-0.27	15.3	22.6	15.2	22.7	15.3	22.7		
8	-5.74	-4.81	-0.27	15.7	22.1	15.6	20.6	15.6	21.4		
9	-5.75	-6.32	-0.28	15.8	20.3	15.4	22.3	15.6	21.3		
10	-5.65	-7.78	-0.28	14.4	24.1	14.8	24.8	14.6	24.5		

**Table A.20. Stiffness and strength summary of Kickapoo topsoil, strip 2, 8 roller passes**

Test point	Clegg Impact Test			Geogauge		DCP	FWD: E (MPa)			
	CIV <sup>1</sup>	CIV <sup>2</sup>	CIV	M	S	DCPI	1	2	3	4
1	---	---	---	22.77	3.07	81	15.6	14.8	12.8	11.4
2	---	---	---	28.59	3.85	85	29.3	20.6	18.9	15.0
3	---	---	---	40.33	5.44	78	102.3	95.8	65.2	46.5
4	---	---	---	41.34	5.58	62	22.2	23.0	19.1	17.4
5	---	---	---	36.78	4.96	96	78.1	91.5	67.7	48.8
6	---	---	---	34.51	4.65	75	34.2	69.1	60.6	41.7
7	---	---	---	29.47	3.97	112	5.5	9.1	9.7	10.4
8	---	---	---	40.78	5.50	95	72.3	64.2	36.2	22.5
9	---	---	---	34.97	4.72	105	65.8	71.8	52.7	40.4
10	---	---	---	26.03	3.51	83	32.0	26.1	19.6	15.8

**Table A.21. Moisture and density summary of Kickapoo topsoil, strip 3, 0 roller passes**

Test point	Coordinates (m)			Nuclear gauge (kN/m <sup>3</sup> , %)						Drive core (kN/m <sup>3</sup> , %)	
	X	Y	Z	$\gamma_d^1$	$w_g^1$	$\gamma_d^2$	$w_g^2$	$\gamma_d$	$w_g$	$\gamma_d$	$w_g$
1	-5.61	6.64	-0.08	9.8	16.5	9.9	16.5	9.8	16.5	---	---
2	-5.47	5.14	-0.08	10.2	13.5	9.9	16.7	10.1	15.1	---	---
3	-5.23	3.65	-0.11	9.9	16.2	9.7	15.3	9.8	15.8	---	---
4	-5.25	2.28	-0.15	10.4	13.2	10.0	14.9	10.2	14.1	---	---
5	-5.20	0.79	-0.14	10.4	16.4	10.4	16.1	10.4	16.3	---	---
6	-5.12	-0.73	-0.14	10.7	13.7	10.8	16.6	10.7	15.2	---	---
7	-5.19	-2.47	-0.13	10.8	16.0	10.8	15.4	10.8	15.7	---	---
8	-5.20	-3.98	-0.15	10.7	14.7	11.3	14.8	11.0	14.8	---	---
9	-5.21	-5.36	-0.15	11.1	15.7	11.7	15.7	11.4	15.7	---	---
10	-5.49	-7.05	-0.14	10.6	16.1	10.9	15.2	10.8	15.7	---	---

**Table A.22. Stiffness and strength summary of Kickapoo topsoil, strip 3, 0 roller passes**

Test point	Clegg Impact Test			Geogauge		DCP	FWD: E (MPa)				
	CIV <sup>1</sup>	CIV <sup>2</sup>	CIV	M	S	DCPI	1	2	3	4	
1	---	---	---	---	---	---	---	---	---	---	---
2	---	---	---	---	---	---	---	---	---	---	---
3	---	---	---	---	---	---	---	---	---	---	---
4	---	---	---	---	---	---	---	---	---	---	---
5	---	---	---	---	---	---	---	---	---	---	---
6	---	---	---	---	---	---	---	---	---	---	---
7	---	---	---	---	---	---	---	---	---	---	---
8	---	---	---	---	---	---	---	---	---	---	---
9	---	---	---	---	---	---	---	---	---	---	---
10	---	---	---	---	---	---	---	---	---	---	---

**Table A.23. Moisture and density summary of Kickapoo topsoil, strip 3, 1 roller pass**

Test point	Coordinates (m)			Nuclear gauge (kN/m <sup>3</sup> , %)						Drive core (kN/m <sup>3</sup> , %)	
	X	Y	Z	$\gamma_d^1$	w <sub>g</sub> <sup>1</sup>	$\gamma_d^2$	w <sub>g</sub> <sup>2</sup>	$\gamma_d$	w <sub>g</sub>	$\gamma_d$	w <sub>g</sub>
1	-5.66	5.01	-0.21	12.4	20.8	12.6	16.8	12.5	18.8	---	---
2	-5.57	3.30	-0.23	12.4	18.0	12.6	18.7	12.5	18.4	---	---
3	-5.77	1.91	-0.26	12.0	17.7	12.0	22.2	12.0	20.0	---	---
4	-5.61	0.50	-0.23	11.4	20.0	11.9	18.8	11.7	19.4	---	---
5	-5.63	-1.19	-0.23	12.2	20.5	12.8	16.1	12.5	18.3	---	---
6	-5.53	-2.60	-0.24	12.4	18.6	12.8	19.1	12.6	18.9	---	---
7	-5.52	-4.04	-0.23	12.7	19.5	12.2	18.9	12.5	19.2	---	---
8	-5.57	-5.56	-0.21	12.8	18.2	13.2	18.4	13.0	18.3	---	---
9	-5.35	-7.02	-0.20	12.4	19.5	12.7	19.9	12.6	19.7	---	---
10	-5.53	-8.55	-0.17	12.9	21.3	12.7	18.2	12.8	19.8	---	---

**Table A.24. Stiffness and strength summary of Kickapoo topsoil, strip 3, 1 roller pass**

Test point	Clegg Impact Test			Geogauge		DCP	FWD: E (MPa)			
	CIV <sup>1</sup>	CIV <sup>2</sup>	CIV	M	S	DCPI	1	2	3	4
1	4.2	3.3	3.8	---	---	116	6.6	8.3	7.9	7.8
2	3.0	4.0	3.5	---	---	78	6.3	7.4	7.3	---
3	4.7	3.2	4.0	---	---	137	6.8	6.9	6.9	---
4	3.9	3.7	3.8	---	---	95	7.1	6.7	6.7	---
5	5.2	4.0	4.6	---	---	108	11.1	11.4	10.5	---
6	4.4	3.8	4.1	---	---	125	10.0	8.9	8.0	---
7	4.5	4.2	4.4	---	---	112	5.7	6.5	6.9	---
8	5.0	4.5	4.8	---	---	100	10.7	9.5	9.0	---
9	5.4	4.6	5.0	---	---	141	16.4	18.2	12.9	---
10	5.2	3.7	4.5	---	---	130	33.4	65.6	44.2	---



**Table A.25. Moisture and density summary of Kickapoo topsoil, strip 3, 2 roller passes**

Test point	Coordinates (m)			Nuclear gauge (kN/m <sup>3</sup> , %)						Drive core (kN/m <sup>3</sup> , %)	
	X	Y	Z	$\gamma_d^1$	$w_g^1$	$\gamma_d^2$	$w_g^2$	$\gamma_d$	$w_g$	$\gamma_d$	$w_g$
1	-5.89	4.62	-0.24	12.9	18.7	13.5	16.6	13.2	17.7	---	---
2	-5.55	2.95	-0.28	12.7	19.1	12.9	18.7	12.8	18.9	---	---
3	-5.41	1.40	-0.27	12.8	19.1	13.1	17.3	12.9	18.2	---	---
4	-5.42	-0.03	-0.26	12.8	19.9	12.8	20.0	12.8	20.0	---	---
5	-5.41	-1.50	-0.27	13.5	18.4	13.1	19.8	13.3	19.1	---	---
6	-5.44	-3.08	-0.26	13.6	19.2	13.7	17.6	13.6	18.4	---	---
7	-5.39	-4.47	-0.26	13.2	19.6	13.3	19.1	13.2	19.4	---	---
8	-5.38	-6.09	-0.23	13.1	19.2	13.5	19.5	13.3	19.4	---	---
9	-5.38	-7.61	-0.24	13.5	18.3	13.2	17.5	13.4	17.9	---	---
10	-5.33	-8.95	-0.16	13.4	19.2	13.5	18.1	13.5	18.7	---	---

**Table A.26. Stiffness and strength summary of Kickapoo topsoil, strip 3, 2 roller passes**

Test point	Clegg Impact Test			Geogauge		DCP	FWD: E (MPa)			
	CIV <sup>1</sup>	CIV <sup>2</sup>	CIV	M	S	DCPI	1	2	3	4
1	5.5	6.0	5.8	29.71	4.01	40	23.0	27.3	23.5	20.6
2	5.8	4.3	5.1	25.48	3.44	83	22.6	23.4	18.7	15.1
3	4.6	6.1	5.4	---	---	104	21.5	24.2	19.9	17.8
4	5.3	5.3	5.3	20.36	2.75	94	18.0	20.3	17.3	15.7
5	5.0	5.7	5.4	22.57	3.04	110	12.3	27.5	22.6	17.9
6	5.4	5.6	5.5	28.90	3.90	45	14.4	16.0	12.8	11.4
7	4.6	6.3	5.5	23.64	3.19	81	11.8	18.5	13.3	13.3
8	5.6	4.9	5.3	32.12	4.33	74	22.3	21.4	20.1	16.8
9	5.5	5.1	5.3	37.82	5.10	81	43.4	50.0	40.4	34.5
10	4.3	5.1	4.7	22.63	3.05	83	12.3	12.8	12.3	11.3

**Table A.27. Moisture and density summary of Kickapoo topsoil, strip 3, 4 roller passes**

Test point	Coordinates (m)			Nuclear gauge (kN/m <sup>3</sup> , %)						Drive core (kN/m <sup>3</sup> , %)	
	X	Y	Z	$\gamma_d^1$	$w_g^1$	$\gamma_d^2$	$w_g^2$	$\gamma_d$	$w_g$	$\gamma_d$	$w_g$
1	-5.60	5.09	-0.24	14.4	16.5	14.0	18.3	14.2	17.4	---	---
2	-5.50	3.57	-0.25	13.0	18.3	13.9	17.6	13.5	18.0	---	---
3	-5.52	2.16	-0.27	13.7	17.7	13.4	18.4	13.5	18.1	---	---
4	-5.42	0.50	-0.28	13.1	20.0	14.0	19.5	13.5	19.8	---	---
5	-5.32	-0.89	-0.26	13.8	19.5	13.9	21.1	13.9	20.3	---	---
6	-5.35	-2.46	-0.27	14.0	20.0	13.5	19.3	13.7	19.7	---	---
7	-5.33	-4.06	-0.27	14.0	18.9	13.9	18.7	13.9	18.8	---	---
8	-5.28	-5.70	-0.25	13.5	18.2	14.3	17.9	13.9	18.1	---	---
9	-5.28	-7.18	-0.25	13.7	20.0	13.7	18.7	13.7	19.4	---	---
10	-5.26	-8.58	-0.20	13.4	18.8	14.3	17.8	13.9	18.3	---	---

**Table A.28. Stiffness and strength summary of Kickapoo topsoil, strip 3, 4 roller passes**

Test point	Clegg Impact Test			Geogauge		DCP	FWD: E (MPa)			
	CIV <sup>1</sup>	CIV <sup>2</sup>	CIV	M	S	DCPI	1	2	3	4
1	5.6	6.5	6.1	35.45	4.78	59	21.7	32.2	29.2	24.2
2	7.3	5.7	6.5	22.32	3.01	75	16.8	13.2	14.0	13.9
3	6.6	7.3	7.0	30.36	4.09	58	10.3	12.4	12.3	12.3
4	5.5	6.0	5.8	35.82	4.83	77	16.5	19.8	17.4	15.4
5	6.1	6.6	6.4	34.33	4.63	69	42.4	42.0	33.8	28.3
6	6.6	6.4	6.5	33.06	4.46	57	62.8	75.5	44.7	39.4
7	6.0	5.7	5.9	41.56	5.61	59	24.3	24.4	20.2	17.5
8	8.7	6.9	7.8	34.99	4.72	64	40.5	34.2	26.3	21.8
9	6.7	6.7	6.7	25.32	3.42	33	52.9	52.6	44.1	33.8
10	6.0	7.1	6.6	28.66	3.86	78	58.6	66.3	56.0	43.8

**Table A.29. Moisture and density summary of Kickapoo topsoil, strip 3, 8 roller passes**

Test point	Coordinates (m)			Nuclear gauge (kN/m <sup>3</sup> , %)						Drive core (kN/m <sup>3</sup> , %)	
	X	Y	Z	$\gamma_d^1$	$w_g^1$	$\gamma_d^2$	$w_g^2$	$\gamma_d$	$w_g$	$\gamma_d$	$w_g$
0 ft	-5.63	5.12	-0.24	97.5	17.4	96.1	16.8	96.8	17.1	99.0	19.4
2	-5.64	4.51	-0.25	99.0	16.7	95.2	18.6	97.1	17.7	101.0	19.2
4	-5.64	3.87	-0.25	95.9	18.4	98.4	17.0	97.2	17.7	101.8	19.9
6	-5.59	3.22	-0.26	95.5	18.1	94.7	17.4	95.1	17.8	96.3	19.2
8	-5.55	2.69	-0.28	97.4	17.3	97.3	17.9	97.4	17.6	97.8	19.5
10	-5.47	2.07	-0.30	95.0	17.6	96.8	16.0	95.9	16.8	98.2	19.3
12	-5.50	1.43	-0.29	95.4	16.3	96.9	16.8	96.2	16.6	100.5	19.6
14	-5.53	0.84	-0.28	96.9	17.7	98.0	15.9	97.5	16.8	101.1	19.4
16	-5.43	0.18	-0.27	95.4	17.9	96.5	18.0	96.0	18.0	95.1	18.9
18	-5.44	-0.37	-0.26	95.7	18.3	101.2	16.4	98.5	17.4	96.6	19.3
20	-5.36	-1.04	-0.27	97.2	17.0	92.6	18.3	94.9	17.7	97.8	18.0
22	-5.30	-1.57	-0.27	97.7	17.9	101.3	17.7	99.5	17.8	101.8	17.7
24	-5.25	-2.20	-0.27	97.9	17.3	96.9	18.4	97.4	17.9	100.1	19.4
26	-5.21	-2.72	-0.27	96.3	18.3	98.1	18.4	97.2	18.4	99.7	19.2
28	-5.29	-3.40	-0.27	98.1	18.1	100.9	16.9	99.5	17.5	94.9	19.1
30	-5.27	-3.95	-0.27	94.2	18.1	91.8	19.7	93.0	18.9	90.8	19.3
32	-5.16	-4.61	-0.26	97.0	19.1	100.9	19.3	99.0	19.2	102.5	18.7
34	-5.21	-5.20	-0.25	96.4	16.3	98.9	17.3	97.7	16.8	99.4	19.5
36	-5.54	-5.86	-0.25	93.1	18.2	93.4	18.7	93.3	18.5	101.0	18.5
38	-5.23	-6.60	-0.23	97.5	17.5	99.1	18.0	98.3	17.8	101.5	19.0
40	-5.50	-7.01	-0.25	97.3	19.0	96.6	16.1	97.0	17.6	98.3	19.6
42	-5.51	-7.61	-0.24	97.5	18.0	95.6	17.6	96.6	17.8	100.0	19.2
44	-5.47	-8.30	-0.20	96.6	16.6	101.3	16.0	99.0	16.3	100.2	19.7
46	-5.46	-8.83	-0.18	98.1	17.4	94.3	17.1	96.2	17.3	100.4	19.7

**Table A.30. Stiffness and strength summary of Kickapoo topsoil, strip 3, 8 roller passes**

Test point	Clegg Impact Test			Geogauge		DCP	FWD: E (MPa)			
	CIV <sup>1</sup>	CIV <sup>2</sup>	CIV	M	S	DCPI	1	2	3	4
0 ft	9.6	9.0	9.3	41.38	5.58	40	50.5	67.5	55.1	45.6
2	8.5	8.6	8.6	56.08	7.56	44	140.0	114.6	89.3	75.5
4	8.4	8.1	8.3	50.92	6.87	43	57.7	52.5	42.8	36.2
6	8.9	8.8	8.9	42.61	5.75	29	74.0	86.1	81.3	59.8
8	8.1	8.0	8.1	47.93	6.46	30	29.6	49.0	37.4	31.4
10	8.2	8.4	8.3	46.65	6.29	35	19.6	22.9	19.1	18.2
12	8.6	8.2	8.4	45.69	6.16	48	98.2	110.6	90.8	75.5
14	8.4	8.7	8.6	53.74	7.25	31	---	69.1	55.2	44.3
16	9.4	9.3	9.4	54.38	7.33	35	35.4	52.3	38.8	31.2
18	9.6	8.2	8.9	55.35	7.47	30	68.9	74.0	56.7	46.1
20	8.2	9.0	8.6	45.41	6.12	39	26.5	25.1	23.4	22.1
22	8.9	8.5	8.7	62.73	8.46	43	135.3	120.6	83.3	65.8
24	7.5	8.9	8.2	41.65	5.62	26	34.1	59.8	59.1	54.9
26	7.9	8.7	8.3	57.69	7.77	42	29.6	31.6	47.4	33.6
28	7.7	8.6	8.2	50.78	6.85	30	51.2	92.7	89.9	75.4
30	10.1	6.8	8.5	46.38	6.25	50	24.6	20.1	18.4	16.7
32	9.2	8.2	8.7	60.83	8.20	38	56.2	56.1	44.7	36.9
34	7.3	9.0	8.2	58.02	7.82	32	125.7	142.6	123.2	100.4
36	8.9	9.8	9.4	51.35	6.93	60	43.5	41.3	38.1	30.6
38	8.8	7.1	8.0	55.98	7.55	28	197.8	95.2	70.1	51.5
40	8.9	7.0	8.0	53.69	7.24	47	30.8	60.0	62.0	53.6
42	7.8	9.3	8.6	52.66	7.10	21	77.1	97.2	87.4	53.3
44	8.2	8.6	8.4	50.63	6.83	29	51.1	80.5	65.1	49.4
46	8.0	7.1	7.6	46.97	6.34	69	40.1	38.9	27.1	20.7

**Table A.31. Moisture and density summary of Kickapoo topsoil, strip 4, 0 roller passes**

Test point	Coordinates (m)			Nuclear gauge (kN/m <sup>3</sup> , %)						Drive core (kN/m <sup>3</sup> , %)	
	X	Y	Z	$\gamma_d^1$	$w_g^1$	$\gamma_d^2$	$w_g^2$	$\gamma_d$	$w_g$	$\gamma_d$	$w_g$
1	-5.45	5.09	-0.20	10.4	17.4	10.1	15.2	10.3	16.3	---	---
2	-5.35	3.57	-0.23	9.9	16.4	9.7	16.4	9.8	16.4	---	---
3	-5.34	2.18	-0.25	10.4	13.5	10.1	13.6	10.2	13.6	---	---
4	-5.37	0.72	-0.26	10.5	14.7	10.6	12.9	10.5	13.8	---	---
5	-5.19	-1.04	-0.29	10.7	13.4	10.6	14.7	10.6	14.1	---	---
6	-5.27	-2.41	-0.26	10.7	14.5	10.4	15.4	10.6	15.0	---	---
7	-5.29	-3.98	-0.26	10.9	14.1	10.4	15.3	10.7	14.7	---	---
8	-5.25	-5.36	-0.25	10.5	14.5	10.7	15.2	10.6	14.9	---	---
9	-5.25	-7.35	-0.20	10.0	15.4	10.1	14.8	10.1	15.1	---	---
10	-5.28	-8.51	-0.16	10.0	15.3	9.8	16.1	9.9	15.7	---	---

**Table A.32. Stiffness and strength summary of Kickapoo topsoil, strip 4, 0 roller passes**

Test point	Clegg Impact Test			Geogauge		DCP	FWD: E (MPa)				
	CIV <sup>1</sup>	CIV <sup>2</sup>	CIV	M	S	DCPI	1	2	3	4	
1	---	---	---	---	---	---	---	---	---	---	---
2	---	---	---	---	---	---	---	---	---	---	---
3	---	---	---	---	---	---	---	---	---	---	---
4	---	---	---	---	---	---	---	---	---	---	---
5	---	---	---	---	---	---	---	---	---	---	---
6	---	---	---	---	---	---	---	---	---	---	---
7	---	---	---	---	---	---	---	---	---	---	---
8	---	---	---	---	---	---	---	---	---	---	---
9	---	---	---	---	---	---	---	---	---	---	---
10	---	---	---	---	---	---	---	---	---	---	---

**Table A.33. Moisture and density summary of Kickapoo topsoil, strip 4, 1 roller pass**

Test point	Coordinates (m)			Nuclear gauge (kN/m <sup>3</sup> , %)						Drive core (kN/m <sup>3</sup> , %)	
	X	Y	Z	$\gamma_d^1$	$w_g^1$	$\gamma_d^2$	$w_g^2$	$\gamma_d$	$w_g$	$\gamma_d$	$w_g$
1	-5.46	5.33	-0.27	13.6	15.7	14.1	15.2	13.9	15.5	---	---
2	-5.44	3.48	-0.32	12.2	17.3	12.9	15.9	12.5	16.6	---	---
3	-5.48	1.98	-0.33	13.4	15.9	12.2	16.1	12.8	16.0	---	---
4	-5.41	0.60	-0.37	12.7	18.1	11.6	19.7	12.2	18.9	---	---
5	-5.41	-0.89	-0.36	12.0	16.4	12.0	16.7	12.0	16.6	---	---
6	-5.35	-2.59	-0.35	12.4	18.2	13.1	16.5	12.7	17.4	---	---
7	-5.41	-3.96	-0.33	12.1	18.4	12.7	18.3	12.4	18.4	---	---
8	-5.42	-5.46	-0.33	12.5	19.0	13.5	17.3	13.0	18.2	---	---
9	-5.41	-7.12	-0.27	11.8	17.7	11.9	17.4	11.8	17.6	---	---
10	-5.36	-8.38	-0.23	13.0	19.0	12.9	16.1	13.0	17.6	---	---

**Table A.34. Stiffness and strength summary of Kickapoo topsoil, strip 4, 1 roller pass**

Test point	Clegg Impact Test			Geogauge		DCP	FWD: E (MPa)			
	CIV <sup>1</sup>	CIV <sup>2</sup>	CIV	M	S	DCPI	1	2	3	4
1	6.5	5.9	6.2	---	---	96	8.5	12.1	14.7	15.1
2	4.8	3.8	4.3	---	---	116	3.5	7.4	8.7	9.4
3	6.0	4.3	5.2	---	---	110	6.4	8.9	9.5	9.9
4	5.4	5.2	5.3	---	---	91	6.3	9.1	9.9	11.1
5	4.2	5.8	5.0	---	---	94	3.4	9.2	9.8	10.6
6	5.9	6.0	6.0	---	---	112	6.4	8.7	8.2	---
7	4.7	5.8	5.3	---	---	120	6.7	8.1	8.1	8.8
8	5.7	4.7	5.2	---	---	108	12.8	13.1	12.0	12.1
9	3.5	5.6	4.6	---	---	50	6.3	6.7	7.1	---
10	4.9	3.7	4.3	---	---	118	5.6	6.9	7.2	---

**Table A.35. Moisture and density summary of Kickapoo topsoil, strip 4, 2 roller passes**

Test point	Coordinates (m)			Nuclear gauge (kN/m <sup>3</sup> , %)						Drive core (kN/m <sup>3</sup> , %)	
	X	Y	Z	$\gamma_d^1$	$w_g^1$	$\gamma_d^2$	$w_g^2$	$\gamma_d$	$w_g$	$\gamma_d$	$w_g$
1	-5.48	4.49	-0.30	12.9	18.2	13.1	18.8	13.0	18.5	---	---
2	-5.34	2.91	-0.33	13.7	16.8	13.3	17.9	13.5	17.4	---	---
3	-5.35	1.55	-0.34	14.2	16.9	14.2	15.3	14.2	16.1	---	---
4	-5.33	-0.11	-0.36	14.5	17.2	13.5	17.2	14.0	17.2	---	---
5	-5.33	-1.50	-0.36	14.4	17.3	14.0	18.2	14.2	17.8	---	---
6	-5.37	-3.12	-0.35	13.9	18.9	12.9	18.5	13.4	18.7	---	---
7	-5.59	-4.67	-0.34	14.6	16.9	13.3	19.9	13.9	18.4	---	---
8	-5.65	-6.20	-0.31	13.1	19.1	13.7	20.3	13.4	19.7	---	---
9	-5.63	-7.68	-0.27	14.1	16.9	13.1	17.7	13.6	17.3	---	---
10	-5.67	-9.11	-0.23	15.4	15.0	13.9	20.0	14.6	17.5	---	---

**Table A.36. Stiffness and strength summary of Kickapoo topsoil, strip 4, 2 roller passes**

Test point	Clegg Impact Test			Geogauge		DCP	FWD: E (MPa)			
	CIV <sup>1</sup>	CIV <sup>2</sup>	CIV	M	S	DCPI	1	2	3	4
1	---	---	---	32.50	4.38	89	14.3	15.8	18.4	20.3
2	5.3	5.7	5.5	33.38	4.50	76	14.8	13.1	12.0	12.1
3	5.0	4.8	4.9	29.76	4.01	91	13.4	22.4	18.0	15.6
4	4.9	5.3	5.1	43.49	5.87	54	25.9	21.5	20.0	18.7
5	5.6	5.6	5.6	34.65	4.67	86	17.7	15.9	15.4	16.1
6	5.5	5.5	5.5	41.15	5.55	76	50.8	36.0	30.7	26.3
7	8.5	5.0	6.8	45.95	6.20	93	34.8	39.5	31.2	26.3
8	4.6	7.0	5.8	23.96	3.23	99	17.2	20.7	17.6	15.1
9	8.5	4.2	6.4	34.59	4.66	93	19.4	22.6	19.2	16.8
10	7.2	3.8	5.5	39.17	5.28	80	23.0	21.2	16.2	13.5

**Table A.37. Moisture and density summary of Kickapoo topsoil, strip 4, 4 roller passes**

Test point	Coordinates (m)			Nuclear gauge (kN/m <sup>3</sup> , %)						Drive core (kN/m <sup>3</sup> , %)	
	X	Y	Z	$\gamma_d^1$	$w_g^1$	$\gamma_d^2$	$w_g^2$	$\gamma_d$	$w_g$	$\gamma_d$	$w_g$
1	-5.78	5.17	-0.29	15.1	19.1	15.4	18.1	15.2	18.6	---	---
2	-5.71	3.61	-0.32	14.3	17.3	14.3	17.4	14.3	17.4	---	---
3	-5.83	1.88	-0.35	15.0	16.8	14.2	17.0	14.6	16.9	---	---
4	-5.78	0.46	-0.36	14.4	17.2	14.4	14.8	14.4	16.0	---	---
5	-5.75	-0.90	-0.38	14.6	17.5	14.0	16.1	14.3	16.8	---	---
6	-5.72	-2.66	-0.36	14.7	18.4	14.6	16.5	14.6	17.5	---	---
7	-5.77	-4.07	-0.34	14.7	16.9	14.8	17.7	14.8	17.3	---	---
8	-5.75	-5.64	-0.32	14.5	18.2	14.2	18.1	14.3	18.2	---	---
9	-5.71	-7.05	-0.29	14.4	17.5	14.1	19.7	14.3	18.6	---	---
10	-5.64	-8.37	-0.25	13.9	18.6	14.3	18.9	14.1	18.8	---	---

**Table A.38. Stiffness and strength summary of Kickapoo topsoil, strip 4, 4 roller passes**

Test point	Clegg Impact Test			Geogauge		DCP	FWD: E (MPa)			
	CIV <sup>1</sup>	CIV <sup>2</sup>	CIV	M	S	DCPI	1	2	3	4
1	7.8	8.6	8.2	45.66	6.16	29	80.7	54.9	43.3	38.0
2	7.3	6.8	7.1	46.13	6.22	54	75.7	62.0	46.0	30.7
3	6.9	8.1	7.5	40.51	5.46	56	21.4	30.6	26.0	23.2
4	6.6	7.6	7.1	50.90	6.86	46	33.1	40.9	33.1	28.1
5	6.6	7.6	7.1	47.88	6.46	31	186.2	143.1	98.6	72.9
6	6.2	7.2	6.7	43.62	5.88	41	63.4	46.4	36.8	31.2
7	5.7	8.7	7.2	46.41	6.26	72	60.5	60.8	46.9	36.8
8	5.7	7.3	6.5	50.64	6.83	34	41.9	45.1	38.3	34.2
9	5.3	5.7	5.5	59.07	7.97	43	80.6	85.6	52.1	34.1
10	5.8	5.1	5.5	46.52	6.27	42	77.4	59.2	50.8	41.8



**Table A.39. Moisture and density summary of Kickapoo topsoil, strip 4, 8 roller passes**

Test point	Coordinates (m)			Nuclear gauge (kN/m <sup>3</sup> , %)						Drive core (kN/m <sup>3</sup> , %)	
	X	Y	Z	$\gamma_d^1$	$w_g^1$	$\gamma_d^2$	$w_g^2$	$\gamma_d$	$w_g$	$\gamma_d$	$w_g$
1	-5.76	4.31	-0.31	16.3	15.4	15.6	15.8	16.0	15.6	15.4	18.1
2	-5.70	2.76	-0.35	15.1	16.8	14.9	17.8	15.0	17.3	0.3	17.8
3	-5.86	1.48	-0.36	14.9	18.9	15.8	17.4	15.4	18.2	15.7	18.0
4	-5.73	-0.23	-0.37	16.3	16.2	16.5	14.3	16.4	15.3	15.7	17.6
5	-5.80	-1.92	-0.37	15.3	17.0	15.6	17.0	15.4	17.0	15.7	18.0
6	-5.80	-3.29	-0.36	16.3	17.9	16.1	16.1	16.2	17.0	16.6	16.8
7	-5.76	-4.54	-0.34	15.3	19.0	14.8	19.3	15.0	19.2	16.6	18.3
8	-5.67	-6.32	-0.31	15.9	17.9	16.6	16.9	16.2	17.4	15.1	18.4
9	-5.61	-7.48	-0.29	15.2	19.8	15.4	18.1	15.3	19.0	16.4	17.9
10	-5.20	-9.05	-0.23	16.2	15.6	15.4	16.4	15.8	16.0	16.5	19.6

**Table A.40. Stiffness and strength summary of Kickapoo topsoil, strip 4, 8 roller passes**

Test point	Clegg Impact Test			Geogauge		DCP	FWD: E (MPa)			
	CIV <sup>1</sup>	CIV <sup>2</sup>	CIV	M	S	DCPI	1	2	3	4
1	8.4	9.9	9.2	46.52	6.27	33	159.6	129.8	111.1	94.9
2	10.9	7.3	9.1	56.20	7.58	35	23.9	22.9	25.6	28.2
3	9.5	8.7	9.1	47.06	6.35	29	199.8	236.3	231.1	209.1
4	9.0	10.1	9.6	74.96	10.11	41	95.7	138.5	131.4	132.8
5	10.5	11.6	11.1	73.42	9.90	48	219.9	187.8	165.6	144.5
6	8.0	9.1	8.6	54.27	7.32	44	144.5	103.4	79.8	57.3
7	8.4	9.6	9.0	77.03	10.39	37	108.3	196.4	307.3	293.3
8	9.0	9.2	9.1	64.05	8.64	27	266.0	272.5	245.1	217.3
9	9.0	8.9	9.0	64.73	8.73	35	60.4	58.3	49.0	45.5
10	6.8	7.4	7.1	55.00	7.42	34	116.7	87.7	61.3	42.1

**Table A.41. Moisture and density summary of Kickapoo topsoil, strip 5, 0 roller passes**

Test point	Coordinates (m)			Nuclear gauge (kN/m <sup>3</sup> , %)						Drive core (kN/m <sup>3</sup> , %)	
	X	Y	Z	$\gamma_d^1$	$w_g^1$	$\gamma_d^2$	$w_g^2$	$\gamma_d$	$w_g$	$\gamma_d$	$w_g$
1	-5.32	5.26	-0.08	11.1	12.4	10.9	14.3	11.0	13.4	---	---
2	-5.10	3.49	-0.15	10.7	14.1	10.9	12.4	10.8	13.3	---	---
3	-5.13	2.07	-0.14	10.8	12.1	10.7	14.3	10.8	13.2	---	---
4	-5.52	0.41	-0.17	11.0	12.5	11.1	13.2	11.1	12.9	---	---
5	-5.41	-0.98	-0.17	11.2	13.3	11.2	12.6	11.2	13.0	---	---
6	-5.54	-2.58	-0.16	11.2	13.2	11.5	12.1	11.4	12.7	---	---
7	-5.72	-4.00	-0.17	11.5	10.4	11.4	13.2	11.4	11.8	---	---
8	-5.45	-5.63	-0.16	11.1	11.7	11.3	11.2	11.2	11.5	---	---
9	-5.64	-6.80	-0.12	11.2	11.7	11.4	12.5	11.3	12.1	---	---
10	-5.55	-8.30	-0.10	11.1	10.1	11.1	11.6	11.1	10.9	---	---

**Table A.42. Stiffness and strength summary of Kickapoo topsoil, strip 5, 0 roller passes**

Test point	Clegg Impact Test			Geogauge		DCP	FWD: E (MPa)			
	CIV <sup>1</sup>	CIV <sup>2</sup>	CIV	M	S	DCPI	1	2	3	4
1	---	---	---	---	---	---	---	---	---	---
2	---	---	---	---	---	---	---	---	---	---
3	---	---	---	---	---	---	---	---	---	---
4	---	---	---	---	---	---	---	---	---	---
5	---	---	---	---	---	---	---	---	---	---
6	---	---	---	---	---	---	---	---	---	---
7	---	---	---	---	---	---	---	---	---	---
8	---	---	---	---	---	---	---	---	---	---
9	---	---	---	---	---	---	---	---	---	---
10	---	---	---	---	---	---	---	---	---	---

**Table A.43. Moisture and density summary of Kickapoo topsoil, strip 5, 1 roller pass**

Test point	Coordinates (m)			Nuclear gauge (kN/m <sup>3</sup> , %)						Drive core (kN/m <sup>3</sup> , %)	
	X	Y	Z	$\gamma_d^1$	$w_g^1$	$\gamma_d^2$	$w_g^2$	$\gamma_d$	$w_g$	$\gamma_d$	$w_g$
1	-5.66	5.00	-0.19	12.6	14.9	12.5	14.5	12.5	14.7	---	---
2	-5.61	3.44	-0.23	11.6	16.7	11.9	15.9	11.8	16.3	---	---
3	-5.59	1.98	-0.24	12.2	15.5	11.6	17.0	11.9	16.3	---	---
4	-5.65	0.40	-0.27	11.7	18.4	12.3	16.9	12.0	17.7	---	---
5	-5.72	-1.35	-0.24	12.6	14.8	12.7	13.4	12.7	14.1	---	---
6	-5.74	-2.78	-0.23	12.1	17.2	12.3	15.4	12.2	16.3	---	---
7	-5.80	-4.16	-0.22	12.3	14.9	12.3	14.5	12.3	14.7	---	---
8	-5.86	-5.48	-0.22	12.3	14.4	12.6	15.3	12.5	14.9	---	---
9	-5.74	-6.88	-0.21	11.5	17.4	12.1	16.9	11.8	17.2	---	---
10	-5.97	-8.24	-0.17	11.7	14.4	12.4	13.0	12.1	13.7	---	---

**Table A.44. Stiffness and strength summary of Kickapoo topsoil, strip 5, 1 roller pass**

Test point	Clegg Impact Test			Geogauge		DCP	FWD: E (MPa)			
	CIV <sup>1</sup>	CIV <sup>2</sup>	CIV	M	S	DCPI	1	2	3	4
1	4.9	4.5	4.7	---	---	123	3.7	5.2	7.1	---
2	4.4	4.0	4.2	---	---	108	3.4	5.4	6.8	---
3	3.6	4.8	4.2	---	---	175	4.5	6.9	6.7	---
4	4.9	3.7	4.3	---	---	112	4.2	6.6	7.9	---
5	5.3	3.8	4.6	---	---	108	4.6	5.9	7.0	---
6	4.5	3.7	4.1	---	---	118	6.1	6.0	---	---
7	5.0	3.7	4.4	---	---	110	---	---	---	---
8	4.4	3.8	4.1	---	---	94	3.5	6.3	7.9	---
9	4.8	5.1	5.0	---	---	70	38.7	45.0	34.7	---
10	---	---	---	---	---	114	3.3	12.5	13.3	---

**Table A.45. Moisture and density summary of Kickapoo topsoil, strip 5, 2 roller passes**

Test point	Coordinates (m)			Nuclear gauge (kN/m <sup>3</sup> , %)						Drive core (kN/m <sup>3</sup> , %)	
	X	Y	Z	$\gamma_d^1$	$w_g^1$	$\gamma_d^2$	$w_g^2$	$\gamma_d$	$w_g$	$\gamma_d$	$w_g$
1	-5.67	4.39	-0.22	13.2	15.9	12.8	17.2	13.0	16.6	---	---
2	-5.46	2.74	-0.27	12.5	17.8	13.2	16.8	12.8	17.3	---	---
3	-5.39	1.33	-0.26	12.3	18.7	13.2	15.5	12.8	17.1	---	---
4	-5.46	-0.32	-0.28	12.6	17.0	12.9	16.9	12.7	17.0	---	---
5	-5.46	-1.67	-0.26	13.3	14.9	12.6	17.8	13.0	16.4	---	---
6	-5.41	-3.05	-0.25	12.8	16.6	13.0	15.6	12.9	16.1	---	---
7	-5.35	-4.72	-0.25	13.5	14.6	12.6	16.6	13.0	15.6	---	---
8	-5.40	-6.17	-0.23	13.2	14.5	12.4	17.8	12.8	16.2	---	---
9	-5.80	-7.85	-0.18	12.9	13.3	12.5	15.5	12.7	14.4	---	---
10	-5.32	-8.94	-0.20	13.2	16.0	13.7	15.5	13.4	15.8	---	---

**Table A.46. Stiffness and strength summary of Kickapoo topsoil, strip 5, 2 roller passes**

Test point	Clegg Impact Test			Geogauge		DCP	FWD: E (MPa)			
	CIV <sup>1</sup>	CIV <sup>2</sup>	CIV	M	S	DCPI	1	2	3	4
1	---	---	---	26.73	3.60	52	7.6	10.9	11.1	11.6
2	5.3	6.9	6.1	21.98	2.96	81	8.3	14.1	15.6	14.8
3	6.7	4.6	5.7	30.57	4.12	80	20.2	18.2	14.0	12.5
4	5.4	6.7	6.1	34.41	4.64	84	2.9	7.1	8.5	9.2
5	6.8	4.9	5.9	29.18	3.93	95	9.2	15.2	16.1	16.0
6	6.4	4.7	5.6	32.97	4.45	78	26.6	46.5	36.4	28.3
7	7.9	4.5	6.2	28.71	3.87	87	12.6	23.0	25.1	23.5
8	5.3	6.1	5.7	34.75	4.69	76	17.8	18.4	14.2	13.2
9	4.6	5.4	5.0	28.00	3.78	57	21.9	33.3	29.3	29.5
10	5.9	9.3	7.6	30.65	4.13	57	21.4	25.7	23.0	19.6

**Table A.47. Moisture and density summary of Kickapoo topsoil, strip 5, 4 roller passes**

Test point	Coordinates (m)			Nuclear gauge (kN/m <sup>3</sup> , %)						Drive core (kN/m <sup>3</sup> , %)	
	X	Y	Z	$\gamma_d^1$	$w_g^1$	$\gamma_d^2$	$w_g^2$	$\gamma_d$	$w_g$	$\gamma_d$	$w_g$
1	-5.50	5.00	-0.19	13.0	18.9	13.7	15.0	13.4	17.0	---	---
2	-5.45	3.43	-0.24	13.6	16.8	13.2	17.1	13.4	17.0	---	---
3	-5.62	1.82	-0.26	13.6	15.6	14.2	16.4	13.9	16.0	---	---
4	-5.47	0.39	-0.27	13.1	18.5	13.6	14.9	13.4	16.7	---	---
5	-5.45	-1.06	-0.25	14.5	15.5	14.5	14.0	14.5	14.8	---	---
6	-5.53	-2.47	-0.24	14.3	15.8	14.0	14.2	14.2	15.0	---	---
7	-5.64	-4.20	-0.23	14.0	14.7	14.3	14.0	14.2	14.4	---	---
8	-5.56	-5.62	-0.23	14.0	14.8	13.7	14.4	13.9	14.6	---	---
9	-5.78	-7.06	-0.20	12.9	15.9	13.5	16.7	13.2	16.3	---	---
10	-5.78	-8.46	-0.18	15.8	13.9	13.0	13.9	14.4	13.9	---	---

**Table A.48. Stiffness and strength summary of Kickapoo topsoil, strip 5, 4 roller passes**

Test point	Clegg Impact Test			Geogauge		DCP	FWD: E (MPa)			
	CIV <sup>1</sup>	CIV <sup>2</sup>	CIV	M	S	DCPI	1	2	3	4
1	8.2	7.5	7.9	27.41	3.70	54	25.7	20.3	17.3	16.8
2	7.4	6.0	6.7	29.66	4.00	43	26.8	33.2	28.4	24.6
3	9.8	7.9	8.9	34.87	4.70	68	14.9	24.7	23.9	22.7
4	7.9	7.8	7.9	34.83	4.70	52	24.6	20.4	17.3	15.8
5	8.8	8.4	8.6	31.28	4.22	39	13.4	17.7	18.5	18.7
6	5.5	8.2	6.9	41.57	5.61	61	25.9	59.8	37.8	32.2
7	8.6	---	8.6	32.00	4.32	40	12.8	21.2	19.1	18.6
8	9.1	6.9	8.0	37.27	5.03	45	22.8	27.6	25.6	23.8
9	7.9	6.2	7.1	30.84	4.16	38	24.4	33.5	29.4	25.0
10	6.6	5.7	6.2	23.11	3.12	44	12.0	16.9	15.3	15.4

**Table A.49. Moisture and density summary of Kickapoo topsoil, strip 5, 8 roller passes**

Test point	Coordinates (m)			Nuclear gauge (kN/m <sup>3</sup> , %)						Drive core (kN/m <sup>3</sup> , %)	
	X	Y	Z	$\gamma_d^1$	$w_g^1$	$\gamma_d^2$	$w_g^2$	$\gamma_d$	$w_g$	$\gamma_d$	$w_g$
1	-5.65	4.63	-0.21	15.0	14.8	14.8	15.6	14.9	15.2	15.7	16.6
2	-5.66	2.99	-0.25	14.8	15.6	14.7	18.0	14.8	16.8	15.6	16.9
3	-5.66	1.60	-0.26	14.5	14.4	14.6	15.5	14.6	15.0	15.0	16.2
4	-5.56	0.04	-0.26	14.5	17.8	15.2	16.0	14.8	16.9	15.4	16.7
5	-5.56	-1.72	-0.25	14.9	13.6	14.7	16.3	14.8	15.0	15.1	15.9
6	-5.58	-3.03	-0.25	14.3	15.1	15.0	14.4	14.6	14.8	15.5	15.9
7	-5.58	-4.77	-0.24	14.5	14.5	14.9	14.3	14.7	14.4	13.9	16.0
8	-5.67	-6.78	-0.19	14.3	14.9	14.1	15.3	14.2	15.1	15.4	15.3
9	-5.62	-7.50	-0.19	14.3	14.9	14.7	13.6	14.5	14.3	14.3	15.2
10	-5.72	-8.90	-0.18	14.6	14.2	14.0	13.0	14.3	13.6	15.7	15.3

**Table A.50. Stiffness and strength summary of Kickapoo topsoil, strip 5, 8 roller passes**

Test point	Clegg Impact Test			Geogauge		DCP	FWD: E (MPa)			
	CIV <sup>1</sup>	CIV <sup>2</sup>	CIV	M	S	DCPI	1	2	3	4
1	10.0	8.5	9.3	52.37	7.06	23	59.0	84.8	72.9	63.8
2	9.4	8.9	9.2	48.41	6.53	30	25.9	37.3	34.1	30.0
3	8.8	9.7	9.3	43.52	5.87	38	32.0	51.8	44.2	---
4	9.8	10.9	10.4	53.06	7.16	22	69.9	81.6	67.4	55.4
5	8.4	8.8	8.6	50.40	6.80	24	42.8	59.3	48.6	40.2
6	7.0	9.8	8.4	56.22	7.58	21	62.3	72.7	51.8	48.6
7	8.6	11.0	9.8	52.96	7.14	35	29.2	46.4	48.1	43.2
8	7.9	13.5	10.7	40.90	5.52	23	49.3	64.6	55.5	---
9	8.3	9.2	8.8	49.38	6.66	28	62.4	66.9	59.5	51.6
10	7.8	10.6	9.2	31.28	4.22	37	60.2	75.6	68.6	59.8

**Table A.51. Moisture and density summary of Kickapoo topsoil, strip 6, 0 roller passes**

Test point	Coordinates (m)			Nuclear gauge (kN/m <sup>3</sup> , %)						Drive core (kN/m <sup>3</sup> , %)	
	X	Y	Z	$\gamma_d^1$	$w_g^1$	$\gamma_d^2$	$w_g^2$	$\gamma_d$	$w_g$	$\gamma_d$	$w_g$
1	-5.28	4.72	-0.19	10.3	13.8	10.1	13.9	10.2	13.9	---	---
2	-5.33	3.37	-0.20	10.4	12.6	10.6	14.9	10.5	13.8	---	---
3	-5.34	1.73	-0.25	10.5	12.5	10.1	15.3	10.3	13.9	---	---
4	-5.46	0.19	-0.25	10.4	13.0	10.4	14.1	10.4	13.6	---	---
5	-5.39	-1.31	-0.25	10.9	12.1	10.6	13.9	10.8	13.0	---	---
6	-5.54	-2.89	-0.25	11.0	12.8	11.0	13.0	11.0	12.9	---	---
7	-5.40	-4.06	-0.24	11.2	14.3	11.3	13.6	11.2	14.0	---	---
8	-5.39	-5.50	-0.21	11.2	13.5	11.7	13.8	11.5	13.7	---	---
9	-5.40	-7.02	-0.19	11.5	14.8	11.2	15.0	11.3	14.9	---	---
10	-5.54	-8.38	-0.17	10.9	14.8	11.1	13.5	11.0	14.2	---	---

**Table A.52. Stiffness and strength summary of Kickapoo topsoil, strip 6, 0 roller passes**

Test point	Clegg Impact Test			Geogauge		DCP	FWD: E (MPa)			
	CIV <sup>1</sup>	CIV <sup>2</sup>	CIV	M	S	DCPI	1	2	3	4
1	---	---	---	---	---	---	---	---	---	---
2	---	---	---	---	---	---	---	---	---	---
3	---	---	---	---	---	---	---	---	---	---
4	---	---	---	---	---	---	---	---	---	---
5	---	---	---	---	---	---	---	---	---	---
6	---	---	---	---	---	---	---	---	---	---
7	---	---	---	---	---	---	---	---	---	---
8	---	---	---	---	---	---	---	---	---	---
9	---	---	---	---	---	---	---	---	---	---
10	---	---	---	---	---	---	---	---	---	---

**Table A.53. Moisture and density summary of Kickapoo topsoil, strip 6, 1 roller pass**

Test point	Coordinates (m)			Nuclear gauge (kN/m <sup>3</sup> , %)						Drive core (kN/m <sup>3</sup> , %)	
	X	Y	Z	$\gamma_d^1$	$w_g^1$	$\gamma_d^2$	$w_g^2$	$\gamma_d$	$w_g$	$\gamma_d$	$w_g$
1	-5.48	5.10	-0.24	12.8	16.6	12.4	13.9	12.6	15.3	---	---
2	-5.48	3.39	-0.27	12.2	17.4	12.7	16.1	12.4	16.8	---	---
3	-5.47	1.99	-0.31	12.1	14.5	12.7	14.9	12.4	14.7	---	---
4	-5.49	0.04	-0.45	11.6	16.7	11.9	15.7	11.7	16.2	---	---
5	-5.51	-1.11	-0.32	11.5	16.2	11.5	16.2	11.5	16.2	---	---
6	-5.53	-2.51	-0.32	11.3	16.9	11.8	14.7	11.6	15.8	---	---
7	-5.56	-4.24	-0.30	11.9	16.8	12.1	16.2	12.0	16.5	---	---
8	-5.58	-5.66	-0.28	12.3	16.1	11.9	17.5	12.1	16.8	---	---
9	-5.61	-7.39	-0.24	11.9	16.9	11.4	16.9	11.6	16.9	---	---
10	-5.64	-8.85	-0.19	11.6	17.4	11.7	16.9	11.7	17.2	---	---

**Table A.54. Stiffness and strength summary of Kickapoo topsoil, strip 6, 1 roller pass**

Test point	Clegg Impact Test			Geogauge		DCP	FWD: E (MPa)			
	CIV <sup>1</sup>	CIV <sup>2</sup>	CIV	M	S	DCPI	1	2	3	4
1	5.7	4.8	5.3	---	---	98	7.6	---	7.1	8.4
2	3.8	4.5	4.2	---	---	94	3.4	---	6.3	9.9
3	4.0	4.5	4.3	---	---	138	2.8	4.5	5.9	---
4	4.1	4.8	4.5	---	---	148	2.8	5.0	6.3	---
5	3.9	4.8	4.4	---	---	114	2.8	5.0	6.6	---
6	4.1	5.7	4.9	---	---	112	3.2	4.9	6.5	---
7	6.8	4.6	5.7	---	---	96	2.8	5.5	7.1	---
8	4.9	4.6	4.8	---	---	46	6.2	7.2	8.7	---
9	4.8	4.3	4.6	---	---	90	5.7	---	9.5	---
10	4.4	5.5	5.0	---	---	65	2.5	5.0	7.2	---



**Table A.55. Moisture and density summary of Kickapoo topsoil, strip 6, 2 roller passes**

Test point	Coordinates (m)			Nuclear gauge (kN/m <sup>3</sup> , %)						Drive core (kN/m <sup>3</sup> , %)	
	X	Y	Z	$\gamma_d^1$	$w_g^1$	$\gamma_d^2$	$w_g^2$	$\gamma_d$	$w_g$	$\gamma_d$	$w_g$
1	-5.70	4.37	-0.27	13.6	16.8	13.5	16.5	13.6	16.7	---	---
2	-5.67	2.76	-0.32	14.1	16.0	13.8	15.3	14.0	15.7	---	---
3	-5.79	1.42	-0.34	13.3	16.8	14.0	16.4	13.6	16.6	---	---
4	-5.84	-0.25	-0.35	13.1	16.6	13.7	14.8	13.4	15.7	---	---
5	-5.79	-1.74	-0.34	13.6	16.3	13.5	17.3	13.5	16.8	---	---
6	-5.74	-3.11	-0.32	13.5	15.7	13.8	15.7	13.6	15.7	---	---
7	-5.81	-4.56	-0.32	14.3	15.0	13.8	16.6	14.1	15.8	---	---
8	-5.75	-6.19	-0.28	13.9	16.7	13.4	16.3	13.7	16.5	---	---
9	-5.85	-7.88	-0.23	13.9	15.6	13.7	15.4	13.8	15.5	---	---
10	-5.69	-9.10	-0.18	13.9	15.1	13.4	14.0	13.7	14.6	---	---

**Table A.56. Stiffness and strength summary of Kickapoo topsoil, strip 6, 2 roller passes**

Test point	Clegg Impact Test			Geogauge		DCP	FWD: E (MPa)			
	CIV <sup>1</sup>	CIV <sup>2</sup>	CIV	M	S	DCPI	1	2	3	4
1	5.0	5.3	5.2	31.70	4.28	66	35.0	26.6	24.2	22.4
2	6.5	5.6	6.1	46.99	6.34	54	14.5	379.8	14.0	14.3
3	5.3	5.7	5.5	30.62	4.13	59	12.5	20.2	18.6	17.6
4	5.8	6.5	6.2	20.89	2.82	82	28.2	56.5	---	40.8
5	7.7	5.2	6.5	33.10	4.46	83	19.4	19.1	18.1	17.9
6	6.1	6.0	6.1	39.89	5.38	81	17.0	17.0	15.8	16.0
7	6.0	5.9	6.0	44.93	6.06	69	21.9	34.7	30.7	29.2
8	5.9	6.5	6.2	47.98	6.47	64	28.9	28.7	27.1	25.0
9	6.9	8.5	7.7	38.58	5.20	77	42.0	---	---	34.5
10	7.7	5.3	6.5	29.59	3.99	59	10.8	22.5	22.6	---

**Table A.57. Moisture and density summary of Kickapoo topsoil, strip 6, 4 roller passes**

Test point	Coordinates (m)			Nuclear gauge (kN/m <sup>3</sup> , %)						Drive core (kN/m <sup>3</sup> , %)	
	X	Y	Z	$\gamma_d^1$	$w_g^1$	$\gamma_d^2$	$w_g^2$	$\gamma_d$	$w_g$	$\gamma_d$	$w_g$
1	-5.59	5.15	-0.26	14.1	17.2	13.8	17.2	13.9	17.2	---	---
2	-5.70	3.71	-0.29	14.8	15.1	13.7	16.5	14.2	15.8	---	---
3	-5.64	1.94	-0.33	15.0	15.2	15.2	15.6	15.1	15.4	---	---
4	-5.87	0.39	-0.34	14.7	15.1	13.8	16.3	14.2	15.7	---	---
5	-5.56	-0.88	-0.33	13.7	17.6	15.2	13.8	14.4	15.7	---	---
6	-5.83	-2.33	-0.35	15.3	15.2	14.9	15.9	15.1	15.6	---	---
7	-5.82	-3.86	-0.33	14.5	17.1	15.0	13.5	14.7	15.3	---	---
8	-5.67	-5.43	-0.30	14.3	17.1	14.9	13.7	14.6	15.4	---	---
9	-5.78	-6.97	-0.27	14.4	17.1	14.0	14.2	14.2	15.7	---	---
10	-5.85	-8.64	-0.21	14.6	13.9	14.5	14.6	14.6	14.3	---	---

**Table A.58. Stiffness and strength summary of Kickapoo topsoil, strip 6, 4 roller passes**

Test point	Clegg Impact Test			Geogauge		DCP	FWD: E (MPa)			
	CIV <sup>1</sup>	CIV <sup>2</sup>	CIV	M	S	DCPI	1	2	3	4
1	6.9	6.9	6.9	43.10	5.81	36	24.7	29.1	27.6	25.5
2	7.2	7.8	7.5	42.77	5.77	63	8.6	21.7	22.0	22.3
3	7.1	7.3	7.2	33.35	4.50	47	21.2	29.4	27.2	25.6
4	7.4	7.4	7.4	45.31	6.11	52	44.7	56.9	51.9	47.1
5	9.7	8.4	9.1	39.51	5.33	53	27.7	70.6	61.4	61.1
6	7.1	8.3	7.7	50.62	6.83	34	116.0	122.3	97.3	77.3
7	10.2	7.1	8.7	55.93	7.54	39	15.7	44.7	41.9	39.2
8	8.3	7.6	8.0	53.69	7.24	49	37.1	70.6	70.8	56.4
9	6.5	9.7	8.1	55.77	7.52	46	66.6	78.4	57.9	42.8
10	6.4	10.1	8.3	51.90	7.00	59	68.0	60.8	44.2	35.6

**Table A.59. Moisture and density summary of Kickapoo topsoil, strip 6, 8 roller passes**

Test point	Coordinates (m)			Nuclear gauge (kN/m <sup>3</sup> , %)						Drive core (kN/m <sup>3</sup> , %)	
	X	Y	Z	$\gamma_d^1$	$w_g^1$	$\gamma_d^2$	$w_g^2$	$\gamma_d$	$w_g$	$\gamma_d$	$w_g$
1	-5.66	4.66	-0.26	15.6	16.6	15.0	15.0	15.3	15.8	15.4	16.5
2	-5.66	3.09	-0.30	14.8	16.4	15.2	15.7	15.0	16.1	13.8	16.6
3	-5.67	1.60	-0.34	15.2	14.8	14.4	16.2	14.8	15.5	13.4	16.3
4	-5.83	-0.20	-0.34	14.7	16.3	14.8	15.7	14.7	16.0	15.3	16.0
5	-5.93	-1.76	-0.34	13.9	17.6	15.0	15.2	14.5	16.4	16.4	15.7
6	-5.71	-3.22	-0.32	15.3	16.0	14.9	15.0	15.1	15.5	15.0	15.5
7	-5.79	-4.90	-0.31	13.3	16.6	13.4	17.7	13.4	17.2	15.9	16.2
8	-5.71	-6.31	-0.28	15.7	15.1	14.9	15.6	15.3	15.4	---	15.9
9	-5.89	-8.23	-0.23	14.8	14.9	14.9	17.0	14.8	16.0	---	15.9
10	-5.97	-9.03	-0.18	14.8	14.1	14.9	14.7	14.8	14.4	---	15.6

**Table A.60. Stiffness and strength summary of Kickapoo topsoil, strip 6, 8 roller passes**

Test point	Clegg Impact Test			Geogauge		DCP	FWD: E (MPa)			
	CIV <sup>1</sup>	CIV <sup>2</sup>	CIV	M	S	DCPI	1	2	3	4
1	9.5	10.1	9.8	37.74	5.09	23	47.1	43.7	39.3	36.5
2	9.1	9.4	9.3	66.10	8.91	29	62.3	101.5	69.2	60.7
3	8.2	11.8	10.0	59.93	8.08	62	30.5	46.0	50.1	45.1
4	7.1	8.6	7.9	63.16	8.52	19	18.1	23.1	24.3	25.4
5	9.1	10.2	9.7	65.74	8.87	25	127.8	115.0	96.4	81.4
6	10.0	8.5	9.3	51.97	7.01	20	98.9	81.6	---	45.2
7	7.8	13.0	10.4	84.41	11.38	16	69.1	---	72.9	60.7
8	9.0	10.2	9.6	56.89	7.67	39	41.5	78.7	65.5	56.7
9	10.4	10.7	10.6	54.60	7.36	17	68.5	123.6	112.3	---
10	8.5	14.5	11.5	50.65	6.83	32	17.4	33.5	29.0	27.9

**Table A.61. Moisture and density summary of Kickapoo Fill Clay, strip 1, 0 roller passes**

Test point	Coordinates (m)			Nuclear gauge (kN/m <sup>3</sup> , %)						Drive core (kN/m <sup>3</sup> , %)	
	X	Y	Z	$\gamma_d^1$	$w_g^1$	$\gamma_d^2$	$w_g^2$	$\gamma_d$	$w_g$	$\gamma_d$	$w_g$
1	-5.49	5.01	-0.08	12.8	17.1	12.5	13.1	12.6	15.1	---	---
2	-5.30	3.49	-0.12	12.7	12.5	12.3	14.0	12.5	13.3	---	---
3	-5.09	2.19	-0.13	11.5	15.5	11.6	14.2	11.5	14.9	---	---
4	-5.04	0.56	-0.13	11.7	12.7	11.1	17.8	11.4	15.3	---	---
5	-4.98	-0.88	-0.14	11.4	14.4	11.2	18.2	11.3	16.3	---	---
6	-5.05	-2.40	-0.15	11.4	16.5	11.9	13.2	11.6	14.9	---	---
7	-5.13	-3.88	-0.15	11.2	15.5	11.5	14.5	11.3	15.0	---	---
8	-5.20	-5.30	-0.14	10.6	14.1	10.8	15.0	10.7	14.6	---	---
9	-4.99	-6.98	-0.10	10.8	13.2	10.5	13.9	10.7	13.6	---	---
10	-4.88	-8.61	-0.08	10.0	15.1	10.6	17.9	10.3	16.5	---	---

**Table A.62. Stiffness and strength summary of Kickapoo Fill Clay, strip 1, 0 roller passes**

Test point	Clegg Impact Test			Geogauge		DCP	FWD: E (MPa)				
	CIV <sup>1</sup>	CIV <sup>2</sup>	CIV	M	S	DCPI	1	2	3	4	
1	---	---	---	---	---	---	---	---	---	---	---
2	---	---	---	---	---	---	---	---	---	---	---
3	---	---	---	---	---	---	---	---	---	---	---
4	---	---	---	---	---	---	---	---	---	---	---
5	---	---	---	---	---	---	---	---	---	---	---
6	---	---	---	---	---	---	---	---	---	---	---
7	---	---	---	---	---	---	---	---	---	---	---
8	---	---	---	---	---	---	---	---	---	---	---
9	---	---	---	---	---	---	---	---	---	---	---
10	---	---	---	---	---	---	---	---	---	---	---

**Table A.63. Moisture and density summary of Kickapoo Fill Clay, strip 1, 1 roller pass**

Test point	Coordinates (m)			Nuclear gauge (kN/m <sup>3</sup> , %)						Drive core (kN/m <sup>3</sup> , %)	
	X	Y	Z	$\gamma_d^1$	$w_g^1$	$\gamma_d^2$	$w_g^2$	$\gamma_d$	$w_g$	$\gamma_d$	$w_g$
1	-5.75	5.11	-0.19	14.8	20.6	14.9	22.7	14.8	21.7	---	---
2	-5.64	3.53	-0.22	14.9	22.1	14.5	21.9	14.7	22.0	---	---
3	-5.74	2.08	-0.24	14.6	22.8	14.7	22.2	14.6	22.5	---	---
4	-5.55	0.54	-0.24	14.6	2.0	14.1	22.9	14.4	12.5	---	---
5	-5.52	-0.80	-0.26	14.5	22.0	14.5	22.3	14.5	22.2	---	---
6	-5.50	-2.31	-0.27	14.6	22.8	14.0	22.7	14.3	22.8	---	---
7	-5.46	-4.01	-0.29	13.5	23.3	14.2	23.7	13.8	23.5	---	---
8	-5.39	-5.30	-0.29	13.4	22.0	13.7	23.5	13.6	22.8	---	---
9	-5.31	-7.07	-0.29	14.1	21.6	13.4	22.4	13.8	22.0	---	---
10	-5.40	-8.67	-0.24	13.5	23.0	13.7	21.7	13.6	22.4	---	---

**Table A.64. Stiffness and strength summary of Kickapoo Fill Clay, strip 1, 1 roller pass**

Test point	Clegg Impact Test			Geogauge		DCP	FWD: E (MPa)			
	CIV <sup>1</sup>	CIV <sup>2</sup>	CIV	M	S	DCPI	1	2	3	4
1	3.0	3.2	3.1	30.24	4.08	184	54.5	40.3	27.4	24.1
2	3.1	3.0	3.1	24.85	3.35	159	28.4	22.7	17.9	14.5
3	---	---	---	19.65	2.65	186	20.8	18.8	13.6	9.6
4	2.7	2.3	2.5	25.94	3.50	223	31.2	31.2	20.0	14.6
5	2.5	3.2	2.9	31.81	4.29	185	37.5	29.1	17.9	13.8
6	2.8	---	2.8	28.59	3.86	138	16.1	12.9	11.9	11.0
7	2.9	---	2.9	28.98	3.91	135	27.3	30.4	22.2	17.0
8	2.7	---	2.7	30.66	4.14	166	42.8	67.7	42.7	25.5
9	3.2	3.0	3.1	30.18	4.07	152	52.6	22.9	17.2	14.2
10	2.6	2.6	2.6	21.28	2.87	188	10.8	9.5	9.0	8.9

**Table A.65. Moisture and density summary of Kickapoo Fill Clay, strip 1, 2 roller passes**

Test point	Coordinates (m)			Nuclear gauge (kN/m <sup>3</sup> , %)						Drive core (kN/m <sup>3</sup> , %)	
	X	Y	Z	$\gamma_d^1$	$w_g^1$	$\gamma_d^2$	$w_g^2$	$\gamma_d$	$w_g$	$\gamma_d$	$w_g$
1	-5.82	4.46	-0.21	14.9	21.9	15.6	20.8	15.2	21.4	---	---
2	-5.31	2.86	-0.23	14.9	24.3	15.3	21.3	15.1	22.8	---	---
3	-5.74	1.56	-0.24	15.3	19.9	15.0	20.1	15.2	20.0	---	---
4	-5.73	-0.05	-0.26	14.7	24.1	14.9	24.1	14.8	24.1	---	---
5	-5.81	-1.71	-0.26	14.8	23.7	14.9	22.0	14.8	22.9	---	---
6	-5.70	-2.93	-0.30	14.7	25.5	14.4	25.4	14.6	25.5	---	---
7	-5.60	-4.61	-0.29	14.3	21.9	14.7	21.6	14.5	21.8	---	---
8	-5.56	-5.89	-0.31	15.1	23.7	14.7	23.5	14.9	23.6	---	---
9	-5.61	-7.53	-0.28	14.8	19.9	14.5	21.6	14.7	20.8	---	---
10	-5.50	-9.11	-0.23	14.8	22.2	15.2	20.6	15.0	21.4	---	---

**Table A.66. Stiffness and strength summary of Kickapoo Fill Clay, strip 1, 2 roller passes**

Test point	Clegg Impact Test			Geogauge		DCP	FWD: E (MPa)			
	CIV <sup>1</sup>	CIV <sup>2</sup>	CIV	M	S	DCPI	1	2	3	4
1	3.3	2.6	3.0	27.05	3.65	171	45.7	35.3	27.0	21.3
2	2.5	2.0	2.3	25.79	3.48	147	12.0	10.0	9.1	8.5
3	2.8	3.1	3.0	26.05	3.51	148	47.8	32.4	25.5	21.0
4	2.3	2.6	2.5	24.45	3.30	175	27.4	18.7	14.8	12.2
5	4.0	2.6	3.3	31.47	4.24	162	36.9	22.5	15.1	11.8
6	4.0	2.2	3.1	31.54	4.25	147	109.4	94.8	62.2	44.5
7	3.8	3.1	3.5	34.91	4.71	110	139.8	104.3	74.4	55.5
8	2.5	2.3	2.4	34.20	4.61	132	158.0	---	51.7	31.7
9	3.8	4.1	4.0	37.04	5.00	148	55.5	24.2	18.0	15.3
10	2.5	2.6	2.6	23.63	3.19	205	30.3	17.5	12.2	10.0

**Table A.67. Moisture and density summary of Kickapoo Fill Clay, strip 1, 4 roller passes**

Test point	Coordinates (m)			Nuclear gauge (kN/m <sup>3</sup> , %)						Drive core (kN/m <sup>3</sup> , %)	
	X	Y	Z	$\gamma_d^1$	$w_g^1$	$\gamma_d^2$	$w_g^2$	$\gamma_d$	$w_g$	$\gamma_d$	$w_g$
1	-5.90	5.00	-0.21	15.4	21.9	15.4	23.8	15.4	22.9	---	---
2	-5.89	3.47	-0.24	15.7	21.2	15.7	21.4	15.7	21.3	---	---
3	-5.81	1.99	-0.24	15.3	23.1	15.5	21.4	15.4	22.3	---	---
4	-5.67	0.89	-0.24	15.3	23.3	15.6	20.4	15.5	21.9	---	---
5	-5.83	-1.01	-0.28	15.4	22.7	15.3	23.6	15.4	23.2	---	---
6	-5.51	-2.50	-0.28	15.5	22.1	15.8	21.3	15.6	21.7	---	---
7	-5.41	-3.95	-0.29	15.4	23.3	15.2	22.3	15.3	22.8	---	---
8	-5.38	-5.50	-0.29	15.5	21.7	15.7	21.4	15.6	21.6	---	---
9	-5.61	-6.99	-0.28	15.6	21.5	15.3	20.0	15.5	20.8	---	---
10	-5.32	-8.52	-0.25	14.8	25.9	15.3	21.9	15.0	23.9	---	---

**Table A.68. Stiffness and strength summary of Kickapoo Fill Clay, strip 1, 4 roller passes**

Test point	Clegg Impact Test			Geogauge		DCP	FWD: E (MPa)			
	CIV <sup>1</sup>	CIV <sup>2</sup>	CIV	M	S	DCPI	1	2	3	4
1	2.4	3.6	3.0	28.80	3.88	131	10.0	31.0	28.2	20.3
2	3.6	2.7	3.2	23.96	3.23	152	11.6	26.0	23.0	15.0
3	2.6	2.2	2.4	19.37	2.61	201	16.7	19.0	14.6	11.2
4	2.2	2.1	2.2	19.34	2.61	175	23.3	16.2	12.0	9.9
5	2.5	2.9	2.7	28.27	3.81	140	54.2	50.4	30.8	20.1
6	2.6	2.3	2.5	37.82	5.10	163	42.4	37.2	24.6	18.0
7	2.8	3.0	2.9	41.88	5.65	142	48.5	26.1	19.0	16.5
8	3.2	3.3	3.3	40.86	5.51	142	69.7	---	32.9	23.1
9	3.6	2.8	3.2	39.90	5.38	109	101.9	65.0	42.0	29.8
10	3.0	2.9	3.0	28.65	3.86	161	14.8	14.1	11.9	10.7

**Table A.69. Moisture and density summary of Kickapoo Fill Clay, strip 1, 8 roller passes**

Test point	Coordinates (m)			Nuclear gauge (kN/m <sup>3</sup> , %)						Drive core (kN/m <sup>3</sup> , %)	
	X	Y	Z	$\gamma_d^1$	$w_g^1$	$\gamma_d^2$	$w_g^2$	$\gamma_d$	$w_g$	$\gamma_d$	$w_g$
0 ft	-5.67	5.22	-0.22	98.4	24.3	100.2	19.8	99.3	22.1	99.3	24.4
2	-5.66	4.63	-0.25	103.7	20.7	105.2	19.1	104.5	19.9	100.1	24.1
4	-5.59	4.03	-0.26	99.8	18.8	101.4	21.2	100.6	20.0	99.6	22.9
6	-5.52	3.39	-0.24	105.5	20.4	106.4	20.2	106.0	20.3	101.0	23.3
8	-5.47	2.80	-0.24	104.9	20.9	106.8	19.5	105.9	20.2	101.0	24.2
10	-5.47	2.18	-0.26	103.0	22.2	103.3	20.0	103.2	21.1	98.3	24.0
12	-5.52	1.47	-0.28	104.3	20.4	103.8	18.7	104.1	19.6	98.0	24.3
14	-5.47	0.45	-0.30	105.8	19.0	104.2	19.0	105.0	19.0	98.0	24.4
16	-5.51	-0.17	-0.26	100.1	23.6	99.9	23.7	100.0	23.7	99.3	24.4
18	-5.47	-0.81	-0.29	102.4	21.9	101.8	20.2	102.1	21.1	99.8	24.0
20	-5.45	-1.44	-0.30	102.8	22.4	102.6	22.1	102.7	22.3	99.0	24.2
22	-5.44	-2.63	-0.29	104.7	19.2	104.3	20.0	104.5	19.6	97.7	23.8
24	-5.29	-3.27	-0.29	103.8	21.0	102.7	21.6	103.3	21.3	97.7	24.3
26	-5.22	-3.81	-0.29	102.6	21.0	103.4	21.5	103.0	21.3	98.1	24.2
28	-5.21	-4.52	-0.28	100.1	22.0	102.4	19.7	101.3	20.9	99.0	23.9
30	-5.29	-5.16	-0.29	102.6	20.3	101.6	21.0	102.1	20.7	98.4	24.1
32	-5.24	-5.68	-0.30	103.8	19.5	102.6	20.3	103.2	19.9	100.7	22.7
34	-5.31	-6.36	-0.31	100.7	22.5	103.3	19.8	102.0	21.2	99.6	23.6
36	-5.33	-6.92	-0.29	101.7	21.2	101.6	22.1	101.7	21.7	97.5	24.8
38	-5.32	-7.37	-0.31	99.1	22.5	100.0	22.0	99.6	22.3	97.5	24.4
40	-5.39	-8.08	-0.29	99.4	22.4	98.0	22.1	98.7	22.3	102.8	21.9
42	-5.36	-8.65	-0.27	103.0	21.7	102.2	22.5	102.6	22.1	101.7	22.7
44	---	---	---	102.5	21.2	101.4	20.8	102.0	21.0	99.2	24.0
46	---	---	---	100.5	20.4	101.9	20.5	101.2	20.5	97.2	25.2



**Table A.70. Stiffness and strength summary of Kickapoo Fill Clay, strip 1, 8 roller passes**

Test point	Clegg Impact Test			Geogauge		DCP	FWD: E (MPa)			
	CIV <sup>1</sup>	CIV <sup>2</sup>	CIV	M	S	DCPI	1	2	3	4
0 ft	2.7	3.2	3.0	23.10	3.12	151	14.8	16.2	15.7	11.9
2	3.0	2.7	2.9	32.86	4.43	78	13.1	32.7	33.5	13.7
4	2.9	2.7	2.8	18.43	2.49	105	35.4	29.8	20.0	15.2
6	2.6	3.2	2.9	24.41	3.29	144	27.1	22.2	15.6	13.4
8	2.1	3.0	2.6	24.50	3.30	183	33.9	32.9	18.3	12.3
10	2.9	2.7	2.8	24.44	3.30	171	20.1	25.3	20.7	15.2
12	2.5	2.4	2.5	28.09	3.79	148	26.7	27.8	21.8	16.6
14	2.5	2.3	2.4	16.70	2.25	193	40.4	24.4	13.9	10.0
16	2.0	2.2	2.1	25.94	3.50	150	20.7	19.5	16.9	12.9
18	2.3	2.2	2.3	27.51	3.71	181	16.1	12.3	9.7	8.5
20	2.4	2.7	2.6	29.75	4.01	116	19.5	14.0	11.5	10.4
22	2.6	3.0	2.8	32.69	4.41	136	16.3	14.3	13.0	12.1
24	2.5	3.4	3.0	35.18	4.74	146	35.0	27.2	20.7	15.6
26	2.8	2.4	2.6	30.53	4.12	160	31.0	28.7	20.2	17.2
28	3.4	2.4	2.9	35.25	4.75	140	45.6	40.2	28.7	20.8
30	2.9	2.9	2.9	40.61	5.48	146	44.2	36.1	30.6	23.3
32	2.6	2.9	2.8	62.21	5.69	125	50.4	40.5	30.1	23.6
34	3.1	2.8	3.0	42.00	5.66	127	42.1	40.6	29.3	23.4
36	2.6	2.7	2.7	36.60	4.94	125	50.3	51.2	---	29.7
38	3.3	3.4	3.4	31.48	4.24	114	31.4	40.5	28.9	35.7
40	3.4	3.8	3.6	35.08	4.73	133	100.0	75.5	51.8	37.5
42	3.7	3.7	3.7	48.85	6.59	111	87.7	113.8	109.9	118.4
44	3.6	3.1	3.4	32.69	4.41	99	34.9	22.2	14.8	12.1
46	2.9	2.7	2.8	24.01	3.24	152	8.9	9.4	8.7	---

**Table A.71. Moisture and density summary of Kickapoo Fill Clay, strip 2, 0 roller passes**

Test point	Coordinates (m)			Nuclear gauge (kN/m <sup>3</sup> , %)						Drive core (kN/m <sup>3</sup> , %)	
	X	Y	Z	$\gamma_d^1$	$w_g^1$	$\gamma_d^2$	$w_g^2$	$\gamma_d$	$w_g$	$\gamma_d$	$w_g$
1	3.63	4.97	0.01	10.2	10.9	9.8	11.4	10.0	11.2	---	---
2	3.70	3.46	-0.02	10.6	13.1	10.8	12.1	10.7	12.6	---	---
3	4.16	2.26	-0.01	10.4	11.3	10.0	11.9	10.2	11.6	---	---
4	4.39	0.86	0.02	10.4	9.5	10.1	11.9	10.2	10.7	---	---
5	4.60	-0.74	0.01	9.9	13.5	10.2	11.4	10.1	12.5	---	---
6	4.54	-2.26	-0.01	10.3	10.8	10.0	11.2	10.1	11.0	---	---
7	4.68	-3.51	-0.03	9.9	12.6	10.0	10.9	10.0	11.8	---	---
8	4.79	-5.28	-0.01	10.3	11.1	10.1	10.8	10.2	11.0	---	---
9	4.02	-6.91	0.01	10.4	10.5	10.2	11.7	10.3	11.1	---	---
10	4.61	-8.59	0.05	10.9	10.0	11.1	9.8	11.0	9.9	---	---

**Table A.72. Stiffness and strength summary of Kickapoo Fill Clay, strip 2, 0 roller passes**

Test point	Clegg Impact Test			Geogauge		DCP	FWD: E (MPa)				
	CIV <sup>1</sup>	CIV <sup>2</sup>	CIV	M	S	DCPI	1	2	3	4	
1	---	---	---	---	---	---	---	---	---	---	---
2	---	---	---	---	---	---	---	---	---	---	---
3	---	---	---	---	---	---	---	---	---	---	---
4	---	---	---	---	---	---	---	---	---	---	---
5	---	---	---	---	---	---	---	---	---	---	---
6	---	---	---	---	---	---	---	---	---	---	---
7	---	---	---	---	---	---	---	---	---	---	---
8	---	---	---	---	---	---	---	---	---	---	---
9	---	---	---	---	---	---	---	---	---	---	---
10	---	---	---	---	---	---	---	---	---	---	---

**Table A.73. Moisture and density summary of Kickapoo Fill Clay, strip 2, 1 roller pass**

Test point	Coordinates (m)			Nuclear gauge (kN/m <sup>3</sup> , %)						Drive core (kN/m <sup>3</sup> , %)	
	X	Y	Z	$\gamma_d^1$	$w_g^1$	$\gamma_d^2$	$w_g^2$	$\gamma_d$	$w_g$	$\gamma_d$	$w_g$
1	3.84	5.09	-0.08	12.4	16.4	12.2	15.2	12.3	15.8	---	---
2	3.92	3.70	-0.07	12.0	19.7	12.1	13.9	12.0	16.8	---	---
3	4.04	2.06	-0.06	13.3	13.4	12.5	13.9	12.9	13.7	---	---
4	3.99	0.62	-0.07	13.0	16.0	11.8	14.8	12.4	15.4	---	---
5	4.05	-0.77	-0.07	12.6	15.6	12.1	15.3	12.4	15.5	---	---
6	4.06	-2.47	-0.08	12.7	16.0	12.3	16.4	12.5	16.2	---	---
7	4.08	-3.88	-0.09	12.9	14.5	12.1	15.2	12.5	14.9	---	---
8	4.25	-5.56	-0.08	13.2	13.8	12.7	13.0	13.0	13.4	---	---
9	4.35	-6.97	-0.07	12.8	13.8	12.5	15.1	12.7	14.5	---	---
10	4.50	-8.68	-0.03	14.2	12.7	13.3	11.7	13.8	12.2	---	---

**Table A.74. Stiffness and strength summary of Kickapoo Fill Clay, strip 2, 1 roller pass**

Test point	Clegg Impact Test			Geogauge		DCP	FWD: E (MPa)			
	CIV <sup>1</sup>	CIV <sup>2</sup>	CIV	M	S	DCPI	1	2	3	4
1	4.9	4.0	4.5	29.90	4.64	80	9.4	9.7	9.2	8.9
2	4.2	4.2	4.2	30.82	4.16	74	3.6	5.6	6.9	---
3	3.6	3.3	3.5	31.42	4.24	90	10.7	9.9	10.2	10.0
4	4.3	3.5	3.9	28.42	3.83	122	3.8	5.9	7.3	---
5	4.3	3.4	3.9	30.90	4.17	122	4.7	6.4	7.3	---
6	4.3	3.6	4.0	25.91	3.49	84	6.2	6.9	7.5	---
7	3.9	3.9	3.9	24.84	3.35	113	5.4	7.0	7.1	---
8	4.4	4.4	4.4	30.38	4.10	73	3.6	5.5	6.6	---
9	4.1	3.6	3.9	32.37	4.37	61	9.9	10.9	10.6	---
10	3.6	3.8	3.7	21.03	2.84	134	3.4	8.3	9.3	---

**Table A.75. Moisture and density summary of Kickapoo Fill Clay, strip 2, 2 roller passes**

Test point	Coordinates (m)			Nuclear gauge (kN/m <sup>3</sup> , %)						Drive core (kN/m <sup>3</sup> , %)	
	X	Y	Z	$\gamma_d^1$	$w_g^1$	$\gamma_d^2$	$w_g^2$	$\gamma_d$	$w_g$	$\gamma_d$	$w_g$
1	3.92	4.32	-0.09	13.9	15.5	13.1	15.9	13.5	15.7	---	---
2	4.02	3.20	-0.08	12.8	15.2	13.5	15.7	13.1	15.5	---	---
3	4.02	1.49	-0.08	13.5	15.2	13.1	15.4	13.3	15.3	---	---
4	4.12	0.22	-0.07	13.3	16.9	13.4	16.4	13.4	16.7	---	---
5	4.01	-1.48	-0.08	13.7	16.4	13.2	17.2	13.5	16.8	---	---
6	4.14	-2.91	-0.10	13.9	15.8	14.7	14.5	14.3	15.2	---	---
7	4.24	-4.60	-0.10	14.6	14.6	13.8	15.1	14.2	14.9	---	---
8	4.20	-5.90	-0.08	15.1	14.3	15.0	14.0	15.0	14.2	---	---
9	4.34	-7.02	-0.08	13.8	14.6	14.0	14.4	13.9	14.5	---	---
10	4.27	-9.04	-0.05	13.7	12.2	15.2	10.3	14.4	11.3	---	---

**Table A.76. Stiffness and strength summary of Kickapoo Fill Clay, strip 2, 2 roller passes**

Test point	Clegg Impact Test			Geogauge		DCP	FWD: E (MPa)			
	CIV <sup>1</sup>	CIV <sup>2</sup>	CIV	M	S	DCPI	1	2	3	4
1	5.6	4.5	5.1	21.03	2.84	98	42.4	50.6	40.1	26.8
2	4.5	5.4	5.0	32.91	4.44	91	17.3	15.7	15.7	15.8
3	5.2	5.7	5.5	55.41	7.47	91	55.0	52.5	40.4	30.9
4	5.2	7.0	6.1	39.88	5.38	101	28.0	36.0	28.2	23.0
5	4.0	4.4	4.2	48.24	6.51	71	32.1	---	21.9	18.8
6	6.0	4.8	5.4	45.10	6.08	55	29.0	20.8	19.5	18.6
7	4.6	4.8	4.7	51.65	6.97	85	23.0	19.7	18.7	18.1
8	5.2	4.8	5.0	66.77	9.01	89	75.1	71.5	55.0	43.2
9	6.1	7.2	6.7	37.73	5.09	80	24.9	19.4	18.2	17.0
10	6.9	5.4	6.2	57.38	7.74	63	35.1	36.6	42.2	36.2

**Table A.77. Moisture and density summary of Kickapoo Fill Clay, strip 2, 4 roller passes**

Test point	Coordinates (m)			Nuclear gauge (kN/m <sup>3</sup> , %)						Drive core (kN/m <sup>3</sup> , %)	
	X	Y	Z	$\gamma_d^1$	$w_g^1$	$\gamma_d^2$	$w_g^2$	$\gamma_d$	$w_g$	$\gamma_d$	$w_g$
1	4.22	5.20	-0.10	15.2	14.1	13.9	14.0	14.6	14.1	---	---
2	4.25	3.74	-0.09	15.0	14.8	14.3	15.5	14.6	15.2	---	---
3	4.34	2.32	-0.09	13.8	16.7	15.5	15.5	14.6	16.1	---	---
4	4.36	0.69	-0.08	15.3	15.3	14.0	15.9	14.6	15.6	---	---
5	4.42	-0.80	-0.10	13.8	16.9	15.0	16.2	14.4	16.6	---	---
6	4.45	-2.36	-0.10	15.4	16.0	15.1	14.7	15.2	15.4	---	---
7	4.52	-3.88	-0.11	14.0	16.3	15.5	15.5	14.8	15.9	---	---
8	4.56	-5.30	-0.10	13.9	14.3	15.4	14.5	14.7	14.4	---	---
9	4.31	-6.98	-0.07	13.9	15.6	13.7	15.3	13.8	15.5	---	---
10	4.64	-8.59	-0.04	15.2	12.9	13.9	13.3	14.5	13.1	---	---

**Table A.78. Stiffness and strength summary of Kickapoo Fill Clay, strip 2, 4 roller passes**

Test point	Clegg Impact Test			Geogauge		DCP	FWD: E (MPa)			
	CIV <sup>1</sup>	CIV <sup>2</sup>	CIV	M	S	DCPI	1	2	3	4
1	7.5	6.4	7.0	58.79	7.93	98	35.9	31.8	24.9	21.0
2	5.7	8.9	7.3	62.57	8.44	38	48.0	84.2	57.5	45.1
3	4.8	6.1	5.5	75.32	10.16	44	54.7	66.7	48.3	37.5
4	6.0	4.9	5.5	44.82	6.04	40	40.9	54.5	50.3	41.6
5	5.8	6.2	6.0	49.11	6.62	35	33.5	28.4	23.9	25.9
6	5.4	6.0	5.7	48.86	6.59	99	58.5	42.6	35.1	29.5
7	5.9	8.0	7.0	34.38	4.64	45	26.8	24.3	24.7	---
8	5.5	6.4	6.0	52.87	7.13	41	88.0	67.8	48.7	48.4
9	8.0	5.4	6.7	35.12	4.74	27	26.3	28.2	26.8	26.0
10	8.5	8.6	8.6	34.30	4.63	29	59.5	44.8	38.1	33.3

**Table A.79. Moisture and density summary of Kickapoo Fill Clay, strip 2, 8 roller passes**

Test point	Coordinates (m)			Nuclear gauge (kN/m <sup>3</sup> , %)						Drive core (kN/m <sup>3</sup> , %)	
	X	Y	Z	$\gamma_d^1$	$w_g^1$	$\gamma_d^2$	$w_g^2$	$\gamma_d$	$w_g$	$\gamma_d$	$w_g$
1	3.79	4.73	-0.09	15.9	14.5	15.3	14.9	15.6	14.7	16.2	15.9
2	3.92	3.36	-0.09	15.9	15.8	14.7	16.6	15.3	16.2	16.0	16.1
3	4.07	1.46	-0.09	14.1	16.7	14.6	17.0	14.4	16.9	15.0	16.9
4	3.96	0.01	-0.08	15.2	16.2	16.5	15.3	15.8	15.8	17.4	16.0
5	4.11	-1.31	-0.09	15.9	15.5	15.1	17.4	15.5	16.5	16.0	17.4
6	4.32	-2.89	-0.10	14.8	15.5	15.6	14.3	15.2	14.9	15.2	17.3
7	4.19	-4.61	-0.10	16.1	14.5	15.5	14.4	15.8	14.5	15.5	16.5
8	4.55	-6.30	-0.07	15.3	13.1	16.3	13.7	15.8	13.4	16.5	15.6
9	4.61	-7.58	-0.06	16.7	13.9	16.6	13.6	16.7	13.8	16.7	14.0
10	4.74	-9.02	-0.03	15.6	12.2	15.7	10.9	15.7	11.6	16.2	12.5

**Table A.80. Stiffness and strength summary of Kickapoo Fill Clay, strip 2, 8 roller passes**

Test point	Clegg Impact Test			Geogauge		DCP	FWD: E (MPa)			
	CIV <sup>1</sup>	CIV <sup>2</sup>	CIV	M	S	DCPI	1	2	3	4
1	11.3	7.9	9.6	72.89	9.83	25	85.8	60.7	46.7	38.7
2	6.6	7.0	6.8	76.56	10.33	27	38.2	111.5	84.2	71.1
3	9.9	8.1	9.0	69.78	9.41	53	31.0	32.1	29.9	28.2
4	10.2	12.1	11.2	58.27	7.86	37	46.1	54.6	52.6	46.6
5	7.0	7.2	7.1	60.24	8.12	43	97.7	110.9	89.7	69.7
6	6.3	9.2	7.8	51.38	6.93	48	16.4	32.1	24.7	22.3
7	9.6	10.4	10.0	66.75	9.00	35	42.7	35.7	34.0	33.3
8	10.6	9.0	9.8	64.86	8.75	28	16.5	27.5	23.4	20.9
9	10.6	9.9	10.3	56.32	7.60	25	120.6	159.5	136.2	114.1
10	10.0	12.3	11.2	52.09	7.02	34	32.6	66.8	60.4	50.0

**Table A.81. Moisture and density summary of Kickapoo Fill Clay, strip 3, 0 roller passes**

Test point	Coordinates (m)			Nuclear gauge (kN/m <sup>3</sup> , %)						Drive core (kN/m <sup>3</sup> , %)	
	X	Y	Z	$\gamma_d^1$	$w_g^1$	$\gamma_d^2$	$w_g^2$	$\gamma_d$	$w_g$	$\gamma_d$	$w_g$
1	3.56	5.35	0.02	10.4	14.0	10.5	14.7	10.5	14.4	---	---
2	3.71	3.68	0.03	10.6	15.7	11.0	14.8	10.8	15.3	---	---
3	3.59	2.36	0.03	10.3	14.7	9.2	17.6	9.8	16.2	---	---
4	3.70	0.62	0.03	9.6	17.7	10.5	15.2	10.0	16.5	---	---
5	3.84	-0.85	0.00	9.2	18.1	10.2	15.1	9.7	16.6	---	---
6	3.91	-2.40	0.00	9.8	13.4	10.0	15.2	9.9	14.3	---	---
7	3.87	-3.83	0.00	10.9	12.9	9.6	15.6	10.2	14.3	---	---
8	3.96	-5.42	0.01	9.6	14.0	9.7	15.1	9.7	14.6	---	---
9	4.13	-6.88	-0.03	10.4	11.8	10.4	11.3	10.4	11.6	---	---
10	4.43	-8.47	0.01	10.6	14.6	10.4	15.1	10.5	14.9	---	---

**Table A.82. Stiffness and strength summary of Kickapoo Fill Clay, strip 3, 0 roller passes**

Test point	Clegg Impact Test			Geogauge		DCP	FWD: E (MPa)			
	CIV <sup>1</sup>	CIV <sup>2</sup>	CIV	M	S	DCPI	1	2	3	4
1	---	---	---	---	---	---	---	---	---	---
2	---	---	---	---	---	---	---	---	---	---
3	---	---	---	---	---	---	---	---	---	---
4	---	---	---	---	---	---	---	---	---	---
5	---	---	---	---	---	---	---	---	---	---
6	---	---	---	---	---	---	---	---	---	---
7	---	---	---	---	---	---	---	---	---	---
8	---	---	---	---	---	---	---	---	---	---
9	---	---	---	---	---	---	---	---	---	---
10	---	---	---	---	---	---	---	---	---	---

**Table A.83. Moisture and density summary of Kickapoo Fill Clay, strip 3, 1 roller pass**

Test point	Coordinates (m)			Nuclear gauge (kN/m <sup>3</sup> , %)						Drive core (kN/m <sup>3</sup> , %)	
	X	Y	Z	$\gamma_d^1$	$w_g^1$	$\gamma_d^2$	$w_g^2$	$\gamma_d$	$w_g$	$\gamma_d$	$w_g$
1	4.11	5.38	-0.05	15.0	17.6	14.2	19.4	14.6	18.5	---	---
2	4.16	3.71	-0.04	15.6	19.1	14.7	20.7	15.2	19.9	---	---
3	4.17	2.00	-0.04	14.2	20.2	14.9	18.6	14.5	19.4	---	---
4	4.17	0.68	-0.05	14.2	21.6	14.7	19.4	14.4	20.5	---	---
5	4.36	-0.90	-0.05	15.1	17.4	15.5	17.7	15.3	17.6	---	---
6	4.46	-2.29	-0.06	14.6	17.5	15.1	18.3	14.8	17.9	---	---
7	4.57	-3.75	-0.07	14.7	18.0	14.9	19.7	14.8	18.9	---	---
8	4.58	-5.40	-0.08	14.8	16.7	14.6	17.7	14.7	17.2	---	---
9	4.55	-6.75	-0.06	13.9	19.3	14.6	17.6	14.3	18.5	---	---
10	4.76	-8.43	-0.01	13.3	16.7	13.4	16.9	13.3	16.8	---	---

**Table A.84. Stiffness and strength summary of Kickapoo Fill Clay, strip 3, 1 roller pass**

Test point	Clegg Impact Test			Geogauge		DCP	FWD: E (MPa)			
	CIV <sup>1</sup>	CIV <sup>2</sup>	CIV	M	S	DCPI	1	2	3	4
1	4.6	3.3	4.0	55.02	7.42	107	26.6	30.8	27.6	21.1
2	3.7	2.7	3.2	56.23	7.58	121	33.1	105.1	91.0	73.8
3	3.6	2.8	3.2	35.19	4.75	99	80.6	76.0	61.2	44.8
4	4.0	2.9	3.5	46.11	6.22	116	42.4	66.3	78.9	61.2
5	4.5	3.5	4.0	52.50	7.08	108	34.9	37.5	29.7	25.1
6	3.9	3.5	3.7	56.85	7.67	116	10.9	18.9	20.2	19.7
7	3.8	3.7	3.8	41.49	5.60	111	9.2	15.6	14.6	13.6
8	4.6	3.6	4.1	48.44	6.53	100	17.7	30.8	29.7	24.0
9	3.9	3.1	3.5	41.74	5.63	108	11.9	19.7	17.5	15.1
10	5.1	4.2	4.7	35.60	4.80	117	17.5	---	46.5	34.0



**Table A.85. Moisture and density summary of Kickapoo Fill Clay, strip 3, 2 roller passes**

Test point	Coordinates (m)			Nuclear gauge (kN/m <sup>3</sup> , %)						Drive core (kN/m <sup>3</sup> , %)	
	X	Y	Z	$\gamma_d^1$	$w_g^1$	$\gamma_d^2$	$w_g^2$	$\gamma_d$	$w_g$	$\gamma_d$	$w_g$
1	3.76	4.63	-0.07	15.0	18.1	14.5	19.8	14.8	19.0	---	---
2	3.91	2.79	-0.07	15.1	18.0	15.3	20.0	15.2	19.0	---	---
3	4.02	1.50	-0.07	15.0	18.0	14.8	17.3	14.9	17.7	---	---
4	4.03	-0.08	-0.08	15.5	19.7	15.6	18.8	15.6	19.3	---	---
5	4.10	-1.52	-0.08	14.9	18.6	15.0	19.0	14.9	18.8	---	---
6	4.13	-3.03	-0.08	15.3	17.7	14.6	19.6	15.0	18.7	---	---
7	4.14	-4.77	-0.11	15.6	18.2	15.7	17.6	15.7	17.9	---	---
8	4.21	-6.11	-0.09	14.9	17.1	14.2	19.5	14.6	18.3	---	---
9	4.24	-7.36	-0.09	15.1	16.2	14.8	17.5	14.9	16.9	---	---
10	4.43	-8.93	-0.07	13.6	17.1	14.0	16.6	13.8	16.9	---	---

**Table A.86. Stiffness and strength summary of Kickapoo Fill Clay, strip 3, 2 roller passes**

Test point	Clegg Impact Test			Geogauge		DCP	FWD: E (MPa)			
	CIV <sup>1</sup>	CIV <sup>2</sup>	CIV	M	S	DCPI	1	2	3	4
1	3.4	4.3	3.9	55.54	7.49	121	39.5	32.9	23.6	20.8
2	2.9	3.4	3.2	39.96	5.39	146	36.3	71.3	63.4	52.8
3	3.0	3.7	3.4	47.90	6.46	132	27.6	45.7	70.2	56.0
4	4.4	3.0	3.7	48.27	6.51	116	13.5	16.1	15.4	15.3
5	5.5	4.6	5.1	49.46	6.67	115	28.2	41.4	28.5	24.4
6	4.6	5.0	4.8	45.47	6.13	123	8.9	17.7	18.4	15.4
7	2.6	4.5	3.6	53.89	7.27	95	64.9	52.6	37.1	30.2
8	3.8	5.1	4.5	53.86	7.26	102	11.6	14.2	14.6	14.2
9	3.6	5.1	4.4	39.36	5.31	118	36.3	47.0	34.3	28.4
10	3.4	4.0	3.7	55.74	7.52	95	27.8	38.3	29.4	24.0

**Table A.87. Moisture and density summary of Kickapoo Fill Clay, strip 3, 4 roller passes**

Test point	Coordinates (m)			Nuclear gauge (kN/m <sup>3</sup> , %)						Drive core (kN/m <sup>3</sup> , %)	
	X	Y	Z	$\gamma_d^1$	$w_g^1$	$\gamma_d^2$	$w_g^2$	$\gamma_d$	$w_g$	$\gamma_d$	$w_g$
1	3.72	5.35	-0.06	15.8	16.7	14.8	18.1	15.3	17.4	---	---
2	4.12	3.74	-0.07	15.5	19.6	15.0	20.0	15.2	19.8	---	---
3	4.18	2.04	-0.05	15.0	18.4	15.3	18.7	15.2	18.6	---	---
4	4.31	0.56	-0.07	14.7	19.6	15.2	20.8	14.9	20.2	---	---
5	4.37	-1.02	-0.07	15.1	17.8	16.1	17.2	15.6	17.5	---	---
6	4.37	-2.64	-0.08	16.1	18.8	15.7	18.9	15.9	18.9	---	---
7	4.51	-4.19	-0.10	15.0	17.0	15.3	17.0	15.2	17.0	---	---
8	4.43	-5.58	-0.09	15.0	18.2	16.0	17.9	15.5	18.1	---	---
9	4.33	-7.12	-0.08	13.9	18.4	14.1	19.0	14.0	18.7	---	---
10	4.47	-8.72	-0.06	15.9	16.3	14.4	18.2	15.1	17.3	---	---

**Table A.88. Stiffness and strength summary of Kickapoo Fill Clay, strip 3, 4 roller passes**

Test point	Clegg Impact Test			Geogauge		DCP	FWD: E (MPa)			
	CIV <sup>1</sup>	CIV <sup>2</sup>	CIV	M	S	DCPI	1	2	3	4
1	3.9	5.5	4.7	45.07	6.08	58	21.8	24.7	22.1	19.4
2	4.6	3.9	4.3	47.39	6.39	112	34.3	66.2	70.3	49.9
3	3.8	4.4	4.1	52.87	7.13	123	45.1	65.3	45.9	40.9
4	3.9	4.4	4.2	45.20	6.10	101	26.7	94.7	94.6	67.1
5	5.0	4.5	4.8	54.87	7.40	95	40.8	43.8	29.0	21.9
6	4.3	4.2	4.3	50.50	6.81	100	59.5	72.0	59.1	46.6
7	3.6	4.3	4.0	56.65	7.64	110	11.2	114.6	102.3	72.5
8	6.0	4.0	5.0	48.70	6.57	72	45.8	34.4	30.6	26.2
9	6.6	3.2	4.9	48.03	6.48	77	54.2	88.4	82.6	74.0
10	4.7	4.5	4.6	44.69	6.03	85	29.9	34.4	28.5	22.3

**Table A.89. Moisture and density summary of Kickapoo Fill Clay, strip 3, 8 roller passes**

Test point	Coordinates (m)			Nuclear gauge (kN/m <sup>3</sup> , %)						Drive core (kN/m <sup>3</sup> , %)	
	X	Y	Z	$\gamma_d^1$	$w_g^1$	$\gamma_d^2$	$w_g^2$	$\gamma_d$	$w_g$	$\gamma_d$	$w_g$
1	4.11	4.85	-0.07	16.4	17.5	16.2	19.0	16.3	18.3	16.0	21.1
2	4.12	3.09	-0.08	16.0	20.4	16.4	19.3	16.2	19.9	15.6	22.3
3	4.18	1.76	-0.07	16.5	19.1	16.1	19.1	16.3	19.1	16.1	21.4
4	4.20	-0.02	-0.08	16.3	18.2	15.4	19.8	15.9	19.0	16.2	20.3
5	4.32	-1.64	-0.09	16.0	19.4	16.2	18.6	16.1	19.0	16.2	21.3
6	4.15	-3.09	-0.08	16.2	18.5	15.6	19.0	15.9	18.8	16.4	20.5
7	4.16	-4.64	-0.09	16.3	16.4	16.5	17.2	16.4	16.8	16.5	19.6
8	4.25	-5.96	-0.09	15.6	17.8	16.0	16.5	15.8	17.2	16.2	19.5
9	4.40	-7.36	-0.08	14.7	18.7	14.4	18.9	14.6	18.8	16.6	18.4
10	4.59	-9.04	-0.05	15.0	15.4	14.4	17.1	14.7	16.3	---	16.1

**Table A.90. Stiffness and strength summary of Kickapoo Fill Clay, strip 3, 8 roller passes**

Test point	Clegg Impact Test			Geogauge		DCP	FWD: E (MPa)			
	CIV <sup>1</sup>	CIV <sup>2</sup>	CIV	M	S	DCPI	1	2	3	4
1	4.7	5.4	5.1	49.47	6.67	67	4.7	8.8	12.9	14.5
2	3.7	3.0	3.4	38.87	5.23	144	39.0	37.1	26.8	20.9
3	5.0	3.8	4.4	50.29	6.78	111	187.5	131.1	110.5	90.2
4	3.9	4.4	4.2	44.71	6.03	117	23.4	35.6	29.8	27.3
5	4.8	3.4	4.1	46.79	6.31	96	67.0	80.5	61.1	42.8
6	3.4	5.1	4.3	54.00	7.28	69	102.1	147.3	118.9	102.5
7	5.8	4.2	5.0	55.50	7.49	87	43.1	92.1	64.9	49.6
8	4.7	7.4	6.1	52.18	7.04	100	42.9	113.8	155.0	117.6
9	5.2	5.8	5.5	47.98	6.47	88	52.7	83.6	91.6	84.5
10	8.6	8.6	8.6	41.29	5.57	63	33.5	74.2	49.6	41.8

**Table A.91. Moisture and density summary of Edwards till, strip 1, 0 roller passes**

Test point	Coordinates (m)			Nuclear gauge (kN/m <sup>3</sup> , %)						Drive core (kN/m <sup>3</sup> , %)	
	X	Y	Z	$\gamma_d^1$	$w_g^1$	$\gamma_d^2$	$w_g^2$	$\gamma_d$	$w_g$	$\gamma_d$	$w_g$
1	4.95	4.82	-0.02	12.5	7.9	13.0	6.9	12.7	7.4	---	---
2	4.91	3.66	0.00	13.5	5.3	13.7	6.8	13.6	6.1	---	---
3	5.04	2.24	0.00	12.7	7.4	12.8	6.3	12.7	6.9	---	---
4	5.06	0.76	0.02	12.9	6.2	12.9	6.5	12.9	6.4	---	---
5	4.95	-0.85	0.02	13.3	6.3	12.9	7.1	13.1	6.7	---	---
6	5.12	-2.38	0.00	13.0	7.1	12.9	6.4	12.9	6.8	---	---
7	5.15	-3.98	0.04	13.2	6.9	12.9	7.5	13.0	7.2	---	---
8	5.11	-5.60	0.03	13.3	6.5	13.1	7.6	13.2	7.1	---	---
9	5.17	-7.06	0.03	12.9	6.8	12.6	8.3	12.7	7.6	---	---
10	8.23	-16.70	1.10	13.0	5.1	13.1	6.4	13.0	5.8	---	---

**Table A.92. Stiffness and strength summary of Edwards till, strip 1, 0 roller passes**

Test point	Clegg Impact Test			Geogauge		DCP	FWD: E (MPa)			
	CIV <sup>1</sup>	CIV <sup>2</sup>	CIV	M	S	DCPI	1	2	3	4
1	---	---	---	3.86	0.52	252	3.4	4.5	6.6	9.2
2	---	---	---	3.99	0.54	244	4.2	4.4	6.6	8.7
3	---	---	---	4.66	0.63	287	2.9	4.6	6.4	8.8
4	---	---	---	3.32	0.45	258	3.0	---	6.3	8.0
5	---	---	---	4.68	0.63	293	---	---	---	---
6	---	---	---	7.82	1.05	260	---	---	---	---
7	---	---	---	4.95	0.67	302	---	---	---	---
8	---	---	---	7.67	1.03	301	---	---	---	---
9	---	---	---	6.77	0.91	319	---	---	---	---
10	---	---	---	6.41	0.86	353	---	---	---	---

**Table A.93. Moisture and density summary of Edwards till, strip 1, 1 roller pass**

Test point	Coordinates (m)			Nuclear gauge (kN/m <sup>3</sup> , %)						Drive core (kN/m <sup>3</sup> , %)	
	X	Y	Z	$\gamma_d^1$	$w_g^1$	$\gamma_d^2$	$w_g^2$	$\gamma_d$	$w_g$	$\gamma_d$	$w_g$
1	5.05	5.44	-0.13	13.9	8.8	14.3	7.8	14.1	8.3	---	---
2	5.20	3.82	-0.08	14.7	7.5	14.0	8.9	14.3	8.2	---	---
3	5.25	2.49	-0.07	14.8	6.8	15.0	7.5	14.9	7.2	---	---
4	5.11	0.68	-0.06	13.8	8.0	13.7	10.0	13.8	9.0	---	---
5	5.22	-0.72	-0.06	14.2	8.1	14.1	7.8	14.1	8.0	---	---
6	5.22	-2.12	-0.05	14.6	8.2	14.0	9.2	14.3	8.7	---	---
7	5.13	-3.64	-0.06	14.0	9.1	13.9	9.3	14.0	9.2	---	---
8	5.24	-5.20	-0.05	14.5	7.5	14.3	7.6	14.4	7.6	---	---
9	5.32	-6.95	-0.05	13.8	8.2	13.5	10.7	13.7	9.5	---	---
10	5.49	-8.40	-0.06	14.2	7.5	14.2	8.1	14.2	7.8	---	---

**Table A.94. Stiffness and strength summary of Edwards till, strip 1, 1 roller pass**

Test point	Clegg Impact Test			Geogauge		DCP	FWD: E (MPa)			
	CIV <sup>1</sup>	CIV <sup>2</sup>	CIV	M	S	DCPI	1	2	3	4
1	4.8	4.4	4.6	23.46	3.16	42	5.1	13.6	13.6	13.7
2	4.3	4.6	4.5	28.75	3.88	52	2.3	7.5	11.2	13.2
3	3.7	3.9	3.8	20.58	2.78	54	2.6	7.4	9.7	11.5
4	3.8	3.8	3.8	26.90	3.63	66	2.6	7.0	9.5	11.2
5	4.0	3.7	3.9	25.35	3.42	51	---	8.2	9.5	11.1
6	3.5	4.3	3.9	24.14	3.26	60	2.6	8.0	10.0	11.1
7	3.3	4.1	3.7	24.32	3.28	63	2.9	8.9	10.4	11.3
8	3.2	3.8	3.5	27.56	3.72	48	---	6.8	7.3	8.5
9	3.6	3.7	3.7	27.85	3.76	91	2.3	9.4	11.0	11.5
10	4.3	3.7	4.0	27.89	3.76	44	3.8	10.6	12.6	14.3

**Table A.95. Moisture and density summary of Edwards till, strip 1, 2 roller passes**

Test point	Coordinates (m)			Nuclear gauge (kN/m <sup>3</sup> , %)						Drive core (kN/m <sup>3</sup> , %)	
	X	Y	Z	$\gamma_d^1$	$w_g^1$	$\gamma_d^2$	$w_g^2$	$\gamma_d$	$w_g$	$\gamma_d$	$w_g$
1	4.73	5.43	-0.14	14.6	10.1	14.6	9.7	14.6	9.9	---	---
2	4.80	3.86	-0.12	15.2	7.9	14.8	8.6	15.0	8.3	---	---
3	4.79	2.24	-0.09	15.5	7.6	15.2	8.0	15.4	7.8	---	---
4	4.81	0.75	-0.09	15.1	8.3	15.1	8.2	15.1	8.3	---	---
5	4.93	-0.91	-0.09	15.1	8.9	15.3	7.5	15.2	8.2	---	---
6	5.00	-2.33	-0.08	15.3	7.6	14.7	9.3	15.0	8.5	---	---
7	4.88	-3.65	-0.07	14.9	9.0	14.9	8.4	14.9	8.7	---	---
8	4.73	-5.28	-0.08	14.8	8.0	14.5	9.8	14.7	8.9	---	---
9	4.94	-6.92	-0.07	14.8	7.6	14.5	9.1	14.6	8.4	---	---
10	4.96	-8.31	-0.08	15.2	8.4	15.0	9.3	15.1	8.9	---	---

**Table A.96. Stiffness and strength summary of Edwards till, strip 1, 2 roller passes**

Test point	Clegg Impact Test			Geogauge		DCP	FWD: E (MPa)			
	CIV <sup>1</sup>	CIV <sup>2</sup>	CIV	M	S	DCPI	1	2	3	4
1	6.1	6.8	6.5	47.22	6.37	32	20.1	47.6	43.7	39.0
2	7.0	6.3	6.7	27.93	3.77	45	13.3	36.4	31.6	30.2
3	7.4	6.0	6.7	31.24	4.21	39	14.3	18.2	23.3	16.1
4	6.9	6.1	6.5	30.03	4.05	40	10.0	18.6	17.9	18.5
5	6.3	6.2	6.3	31.02	4.18	37	9.8	20.9	20.0	20.0
6	5.6	6.5	6.1	25.97	3.50	37	5.5	12.3	13.3	14.4
7	9.5	7.3	8.4	29.58	3.99	38	14.3	20.6	20.0	20.1
8	9.1	8.6	8.9	30.46	4.11	38	10.9	16.4	18.3	19.1
9	6.9	6.4	6.7	28.41	3.83	40	5.9	13.7	13.9	14.7
10	7.4	11.5	9.5	31.85	4.30	36	9.6	20.9	21.2	20.8

**Table A.97. Moisture and density summary of Edwards till, strip 1, 4 roller passes**

Test point	Coordinates (m)			Nuclear gauge (kN/m <sup>3</sup> , %)						Drive core (kN/m <sup>3</sup> , %)	
	X	Y	Z	$\gamma_d^1$	$w_g^1$	$\gamma_d^2$	$w_g^2$	$\gamma_d$	$w_g$	$\gamma_d$	$w_g$
1	4.74	5.70	-0.08	15.8	6.8	15.1	8.9	15.4	7.9	---	---
2	4.60	4.16	-0.05	15.5	8.0	15.6	8.0	15.5	8.0	---	---
3	4.63	2.59	-0.04	15.8	8.2	15.5	8.4	15.7	8.3	---	---
4	4.72	1.11	-0.04	15.5	8.5	15.4	8.5	15.4	8.5	---	---
5	4.72	-0.28	-0.03	15.6	8.9	15.4	8.2	15.5	8.6	---	---
6	4.65	-1.82	-0.02	15.2	9.2	15.5	9.1	15.3	9.2	---	---
7	4.99	-3.29	-0.02	15.4	8.5	15.5	8.1	15.4	8.3	---	---
8	5.35	-4.80	0.01	15.0	8.9	15.6	8.2	15.3	8.6	---	---
9	5.09	-6.10	-0.01	14.8	8.7	14.9	9.3	14.9	9.0	---	---
10	5.72	-7.94	0.00	14.9	9.2	15.5	9.1	15.2	9.2	---	---

**Table A.98. Stiffness and strength summary of Edwards till, strip 1, 4 roller passes**

Test point	Clegg Impact Test			Geogauge		DCP	FWD: E (MPa)			
	CIV <sup>1</sup>	CIV <sup>2</sup>	CIV	M	S	DCPI	1	2	3	4
1	9.2	7.6	8.4	61.42	8.28	36	53.7	65.7	51.2	54.9
2	10.2	7.1	8.7	35.42	4.78	29	15.7	26.6	26.3	27.4
3	11.0	9.3	10.2	59.34	8.00	26	47.7	59.8	51.0	47.6
4	10.5	11.7	11.1	51.01	6.88	24	19.8	32.9	31.8	31.8
5	10.3	8.6	9.5	53.13	7.16	24	14.4	24.1	27.5	27.7
6	10.2	9.3	9.8	52.56	7.09	28	22.8	50.5	43.7	40.1
7	10.0	9.4	9.7	31.65	4.27	29	15.1	28.6	24.8	24.5
8	9.8	10.0	9.9	34.02	4.59	30	11.8	27.4	23.8	22.6
9	10.1	8.4	9.3	29.11	3.93	29	11.3	18.7	19.5	20.6
10	9.2	8.6	8.9	39.14	5.28	28	10.4	32.5	33.7	34.4

**Table A.99. Moisture and density summary of Edwards till, strip 1, 8 roller passes**

Test point	Coordinates (m)			Nuclear gauge (kN/m <sup>3</sup> , %)						Drive core (kN/m <sup>3</sup> , %)	
	X	Y	Z	$\gamma_d^1$	$w_g^1$	$\gamma_d^2$	$w_g^2$	$\gamma_d$	$w_g$	$\gamma_d$	$w_g$
1	4.99	5.82	-0.08	16.0	8.8	16.0	7.9	16.0	8.4	---	8.8
2	4.99	4.22	-0.04	16.1	7.9	16.3	8.5	16.2	8.2	---	---
3	5.01	2.67	-0.03	15.9	8.5	16.4	8.3	16.1	8.4	---	7.8
4	5.03	0.89	-0.03	16.4	7.5	16.7	8.9	16.5	8.2	---	7.7
5	5.30	-0.67	-0.01	16.8	7.1	16.0	8.8	16.4	8.0	---	8.2
6	5.14	-2.06	-0.01	15.8	8.2	16.3	7.6	16.0	7.9	---	7.8
7	5.13	-3.58	-0.01	16.5	7.7	16.3	8.2	16.4	8.0	---	7.9
8	4.91	-5.22	-0.01	15.3	8.3	15.9	8.0	15.6	8.2	---	8.4
9	5.46	-6.51	0.00	16.1	7.6	15.4	8.7	15.8	8.2	---	8.0
10	5.11	-8.09	-0.02	16.3	8.3	15.6	10.1	15.9	9.2	---	8.2

**Table A.100. Stiffness and strength summary of Edwards till, strip 1, 8 roller passes**

Test point	Clegg Impact Test			Geogauge		DCP	FWD: E (MPa)			
	CIV <sup>1</sup>	CIV <sup>2</sup>	CIV	M	S	DCPI	1	2	3	4
1	15.9	12.5	14.2	80.90	10.91	12	85.3	104.0	87.5	76.9
2	14.2	11.4	12.8	66.02	8.90	18	18.1	23.8	22.7	23.5
3	12.9	15.0	14.0	83.06	11.20	16	66.5	84.1	66.9	64.3
4	12.2	13.0	12.6	86.89	11.72	18	118.9	128.9	---	89.3
5	16.1	14.6	15.4	100.13	13.50	15	76.8	84.9	72.4	63.8
6	10.6	11.4	11.0	92.70	12.50	21	32.7	77.4	61.0	51.3
7	16.2	18.3	17.3	80.76	10.89	19	86.8	128.8	103.9	84.4
8	14.4	12.2	13.3	71.07	9.59	19	50.5	70.8	59.2	52.2
9	10.3	15.1	12.7	59.74	8.06	18	30.5	63.5	53.2	49.6
10	12.5	9.5	11.0	117.89	15.90	19	117.3	134.7	109.8	92.1



**Table A.101. Moisture and density summary of Edwards till, strip 2, 0 roller passes**

Test point	Coordinates (m)			Nuclear gauge (kN/m <sup>3</sup> , %)						Drive core (kN/m <sup>3</sup> , %)	
	X	Y	Z	$\gamma_d^1$	$w_g^1$	$\gamma_d^2$	$w_g^2$	$\gamma_d$	$w_g$	$\gamma_d$	$w_g$
1	4.59	5.60	0.07	13.5	6.8	13.4	8.5	13.4	7.7	---	---
2	4.68	4.07	0.10	13.8	5.3	13.1	7.5	13.5	6.4	---	---
3	4.70	2.54	0.12	13.6	6.5	13.5	7.2	13.5	6.9	---	---
4	4.80	1.10	0.11	13.2	6.8	13.4	6.6	13.3	6.7	---	---
5	4.80	-0.37	0.14	13.3	6.8	13.5	7.1	13.4	7.0	---	---
6	4.86	-2.06	0.14	13.2	6.6	13.0	8.1	13.1	7.4	---	---
7	4.89	-3.46	0.14	13.5	6.5	13.3	6.3	13.4	6.4	---	---
8	4.93	-4.92	0.15	13.2	8.1	14.0	6.6	13.6	7.4	---	---
9	4.83	-6.39	0.14	14.1	6.7	14.1	6.9	14.1	6.8	---	---
10	4.90	-7.98	0.10	14.2	6.9	13.8	7.5	14.0	7.2	---	---

**Table A.102. Stiffness and strength summary of Edwards till, strip 2, 0 roller passes**

Test point	Clegg Impact Test			Geogauge		DCP	FWD: E (MPa)			
	CIV <sup>1</sup>	CIV <sup>2</sup>	CIV	M	S	DCPI	1	2	3	4
1	---	---	---	8.75	1.18	231	3.5	4.5	6.3	8.3
2	---	---	---	7.51	1.01	250	2.4	9.6	7.5	8.6
3	---	---	---	5.98	0.81	277	2.7	4.6	6.4	---
4	---	---	---	8.28	1.12	218	---	---	---	---
5	---	---	---	8.10	1.09	255	---	---	---	---
6	---	---	---	6.88	0.93	241	---	---	---	---
7	---	---	---	8.16	1.10	249	---	---	---	---
8	---	---	---	13.71	1.85	134	---	---	---	---
9	---	---	---	12.32	1.66	231	---	---	---	---
10	---	---	---	5.02	0.68	219	---	---	---	---

**Table A.103. Moisture and density summary of Edwards till, strip 2, 1 roller pass**

Test point	Coordinates (m)			Nuclear gauge (kN/m <sup>3</sup> , %)						Drive core (kN/m <sup>3</sup> , %)	
	X	Y	Z	$\gamma_d^1$	$w_g^1$	$\gamma_d^2$	$w_g^2$	$\gamma_d$	$w_g$	$\gamma_d$	$w_g$
1	3.99	5.63	0.00	15.3	6.8	14.8	8.5	15.1	7.7	---	---
2	3.99	4.01	0.01	14.2	8.3	14.1	8.8	14.1	8.6	---	---
3	4.33	2.54	0.04	15.0	8.1	15.0	8.0	15.0	8.1	---	---
4	4.37	1.07	0.03	14.3	8.4	14.3	8.8	14.3	8.6	---	---
5	4.44	-0.55	0.05	15.0	8.0	14.6	9.1	14.8	8.6	---	---
6	4.48	-2.01	0.05	14.4	9.0	14.6	8.8	14.5	8.9	---	---
7	4.58	-3.45	0.04	14.3	8.7	14.3	8.8	14.3	8.8	---	---
8	4.56	-5.18	0.07	15.0	8.8	14.3	9.4	14.7	9.1	---	---
9	4.78	-6.64	0.05	14.5	8.6	14.3	8.6	14.4	8.6	---	---
10	4.96	-8.10	0.03	14.7	8.0	13.9	9.5	14.3	8.8	---	---

**Table A.104. Stiffness and strength summary of Edwards till, strip 2, 1 roller pass**

Test point	Clegg Impact Test			Geogauge		DCP	FWD: E (MPa)			
	CIV <sup>1</sup>	CIV <sup>2</sup>	CIV	M	S	DCPI	1	2	3	4
1	5.1	4.7	4.9	14.73	1.99	95	3.4	11.0	12.6	13.8
2	4.0	4.9	4.5	13.55	1.83	70	5.6	11.9	12.4	13.1
3	4.4	4.9	4.7	19.35	2.61	60	4.2	10.2	12.4	13.4
4	4.6	4.4	4.5	15.76	2.12	90	7.1	14.6	14.6	14.7
5	4.2	3.8	4.0	28.62	3.86	85	5.2	15.0	16.7	17.3
6	4.4	3.8	4.1	24.96	3.37	85	4.6	16.3	16.8	16.2
7	3.9	4.0	4.0	23.98	3.23	90	3.2	16.0	12.5	12.0
8	4.9	4.0	4.5	13.94	1.88	80	8.1	11.3	12.0	12.9
9	4.3	4.1	4.2	17.07	2.30	95	3.4	11.5	19.8	17.0
10	4.7	4.4	4.6	24.67	3.33	115	---	8.7	9.6	10.1

**Table A.105. Moisture and density summary of Edwards till, strip 2, 2 roller passes**

Test point	Coordinates (m)			Nuclear gauge (kN/m <sup>3</sup> , %)						Drive core (kN/m <sup>3</sup> , %)	
	X	Y	Z	$\gamma_d^1$	$w_g^1$	$\gamma_d^2$	$w_g^2$	$\gamma_d$	$w_g$	$\gamma_d$	$w_g$
1	4.22	5.11	0.01	15.4	7.2	15.1	8.5	15.2	7.9	---	---
2	4.34	3.53	0.02	14.8	8.6	14.7	8.0	14.7	8.3	---	---
3	4.48	2.24	0.04	14.8	8.3	14.9	7.8	14.8	8.1	---	---
4	4.47	0.82	0.04	14.2	8.4	14.8	9.3	14.5	8.9	---	---
5	4.52	-0.86	0.03	15.1	8.5	14.8	9.2	14.9	8.9	---	---
6	4.54	-2.73	0.06	15.1	7.5	15.2	8.2	15.2	7.9	---	---
7	4.69	-4.03	0.06	14.7	8.6	14.5	7.5	14.6	8.1	---	---
8	4.73	-5.72	0.07	14.6	8.1	14.7	8.5	14.6	8.3	---	---
9	4.82	-6.96	0.05	14.4	8.8	14.7	9.1	14.6	9.0	---	---
10	4.89	-8.20	0.02	14.4	7.8	14.4	8.1	14.4	8.0	---	---

**Table A.106. Stiffness and strength summary of Edwards till, strip 2, 2 roller passes**

Test point	Clegg Impact Test			Geogauge		DCP	FWD: E (MPa)			
	CIV <sup>1</sup>	CIV <sup>2</sup>	CIV	M	S	DCPI	1	2	3	4
1	6.3	5.3	5.8	38.33	5.17	61	12.3	11.2	10.9	12.0
2	6.3	6.8	6.6	33.18	4.47	81	5.7	14.3	16.2	17.4
3	5.8	5.2	5.5	40.44	5.45	82	10.5	19.1	19.9	19.5
4	4.6	4.9	4.8	38.53	5.20	81	9.7	29.7	27.6	28.1
5	5.5	4.7	5.1	40.36	5.44	82	6.8	12.7	13.5	14.0
6	5.2	5.5	5.4	26.26	3.54	113	6.5	10.2	11.8	13.1
7	6.1	5.4	5.8	39.23	5.29	86	4.9	16.9	18.4	19.4
8	5.4	6.5	6.0	31.70	4.28	72	10.7	17.2	15.0	14.8
9	5.5	6.0	5.8	35.61	4.66	61	8.9	14.1	14.7	15.2
10	5.8	5.6	5.7	26.21	3.53	126	7.7	22.4	20.6	18.9

**Table A.107. Moisture and density summary of Edwards till, strip 2, 4 roller passes**

Test point	Coordinates (m)			Nuclear gauge (kN/m <sup>3</sup> , %)						Drive core (kN/m <sup>3</sup> , %)	
	X	Y	Z	$\gamma_d^1$	$w_g^1$	$\gamma_d^2$	$w_g^2$	$\gamma_d$	$w_g$	$\gamma_d$	$w_g$
1	3.88	4.94	0.03	15.4	8.7	15.5	8.9	15.4	8.8	---	---
2	4.09	3.45	0.03	15.3	7.9	15.3	7.0	15.3	7.5	---	---
3	3.65	2.29	0.05	15.8	6.9	15.3	8.9	15.6	7.9	---	---
4	4.54	0.81	0.06	15.2	8.9	15.0	8.0	15.1	8.5	---	---
5	4.10	-0.55	0.08	15.4	7.5	15.3	7.6	15.3	7.6	---	---
6	4.26	-2.28	0.09	15.3	8.2	15.2	7.8	15.2	8.0	---	---
7	4.73	-3.91	0.08	15.7	6.6	15.4	8.6	15.6	7.6	---	---
8	4.77	-5.05	0.09	15.3	6.3	15.2	7.6	15.2	7.0	---	---
9	4.85	-6.73	0.07	15.8	7.6	15.9	7.2	15.9	7.4	---	---
10	4.94	-8.01	0.04	14.8	7.7	14.7	8.5	14.7	8.1	---	---

**Table A.108. Stiffness and strength summary of Edwards till, strip 2, 4 roller passes**

Test point	Clegg Impact Test			Geogauge		DCP	FWD: E (MPa)			
	CIV <sup>1</sup>	CIV <sup>2</sup>	CIV	M	S	DCPI	1	2	3	4
1	10.6	11.3	11.0	42.49	5.73	40	36.3	48.9	47.8	45.3
2	10.1	9.6	9.9	48.48	6.54	40	28.2	34.5	32.5	31.9
3	9.3	9.5	9.4	43.15	5.82	40	14.0	23.7	27.3	29.5
4	11.1	7.6	9.4	41.62	5.61	41	47.9	39.9	32.8	28.0
5	8.4	10.1	9.3	50.85	6.86	37	16.5	23.0	21.8	22.1
6	8.5	7.7	8.1	49.68	6.70	44	4.9	10.7	13.9	15.8
7	8.0	8.0	8.0	37.08	5.00	34	40.8	33.6	27.3	24.0
8	7.5	6.8	7.2	48.56	6.55	47	11.5	24.1	25.8	26.0
9	9.6	8.9	9.3	51.50	6.95	37	44.6	51.3	44.9	39.9
10	5.5	5.7	5.6	32.80	4.42	68	20.0	26.4	24.5	22.8

**Table A.109. Moisture and density summary of Edwards till, strip 2, 8 roller passes**

Test point	Coordinates (m)			Nuclear gauge (kN/m <sup>3</sup> , %)						Drive core (kN/m <sup>3</sup> , %)	
	X	Y	Z	$\gamma_d^1$	$w_g^1$	$\gamma_d^2$	$w_g^2$	$\gamma_d$	$w_g$	$\gamma_d$	$w_g$
1	4.23	5.54	0.01	16.3	7.0	16.3	7.7	16.3	7.4	---	7.3
2	4.21	3.99	0.03	15.9	6.9	16.0	7.4	15.9	7.2	---	7.8
3	4.56	2.51	0.05	16.3	7.4	16.0	7.2	16.2	7.3	---	7.7
4	4.64	1.09	0.05	15.5	7.4	16.0	7.0	15.7	7.2	15.5	7.9
5	4.86	-0.47	0.06	15.6	7.2	15.4	8.0	15.5	7.6	15.4	7.6
6	4.83	-1.90	0.06	15.7	8.7	15.5	7.1	15.6	7.9	---	7.5
7	4.84	-3.67	0.07	16.2	7.6	15.8	7.9	16.0	7.8	---	7.9
8	4.82	-5.40	0.08	15.8	7.3	15.8	7.7	15.8	7.5	---	7.6
9	4.81	-6.60	0.07	15.8	8.7	15.8	8.4	15.8	8.6	15.5	7.8
10	5.18	-8.03	0.05	15.0	7.9	14.9	7.5	15.0	7.7	16.1	7.9

**Table A.110. Stiffness and strength summary of Edwards till, strip 2, 8 roller passes**

Test point	Clegg Impact Test			Geogauge		DCP	FWD: E (MPa)			
	CIV <sup>1</sup>	CIV <sup>2</sup>	CIV	M	S	DCPI	1	2	3	4
1	12.2	10.5	11.4	60.65	8.18	28	93.2	73.5	56.8	52.3
2	10.1	10.3	10.2	57.88	7.81	30	53.5	58.4	54.6	46.5
3	11.3	10.7	11.0	49.44	6.67	20	13.4	20.6	22.5	24.2
4	13.1	12.1	12.6	73.31	9.89	28	51.1	39.0	32.0	30.3
5	13.6	11.6	12.6	63.77	8.60	30	67.6	131.1	112.4	92.3
6	11.3	12.2	11.8	50.54	6.82	39	38.9	63.5	54.0	49.9
7	12.5	11.3	11.9	47.06	6.35	24	45.6	65.7	69.6	61.4
8	14.5	16.1	15.3	52.51	7.08	29	18.0	34.5	33.1	31.1
9	8.9	10.6	9.8	59.82	8.07	28	43.1	39.7	35.8	32.4
10	7.7	7.7	7.7	43.51	5.87	30	7.3	22.0	27.7	28.5

**Table A.111. Moisture and density summary of Edwards till, strip 3, 0 roller passes**

Test point	Coordinates (m)			Nuclear gauge (kN/m <sup>3</sup> , %)						Drive core (kN/m <sup>3</sup> , %)	
	X	Y	Z	$\gamma_d^1$	$w_g^1$	$\gamma_d^2$	$w_g^2$	$\gamma_d$	$w_g$	$\gamma_d$	$w_g$
1	4.30	5.39	0.07	11.4	14.9	11.8	12.6	11.6	13.8	---	---
2	4.30	3.87	0.01	11.7	11.7	13.2	10.1	12.4	10.9	---	---
3	4.44	2.43	0.02	11.9	16.0	10.9	9.7	11.4	12.9	---	---
4	4.75	0.72	0.07	10.5	13.8	11.5	13.1	11.0	13.5	---	---
5	4.92	-0.73	0.09	10.6	9.4	10.7	10.0	10.7	9.7	---	---
6	5.02	-2.21	0.08	10.4	11.2	10.7	11.0	10.6	11.1	---	---
7	5.08	-3.72	0.11	11.3	11.2	10.9	10.9	11.1	11.1	---	---
8	5.13	-5.24	0.13	10.6	9.9	10.9	9.2	10.8	9.6	---	---
9	5.31	-6.77	0.10	11.6	10.8	12.0	9.8	11.8	10.3	---	---
10	5.44	-8.32	0.16	10.5	10.5	10.7	11.9	10.6	11.2	---	---

**Table A.112. Stiffness and strength summary of Edwards till, strip 3, 0 roller passes**

Test point	Clegg Impact Test			Geogauge		DCP	FWD: E (MPa)				
	CIV <sup>1</sup>	CIV <sup>2</sup>	CIV	M	S	DCPI	1	2	3	4	
1	---	---	---	---	---	---	---	---	---	---	---
2	---	---	---	---	---	---	---	---	---	---	---
3	---	---	---	---	---	---	---	---	---	---	---
4	---	---	---	---	---	---	---	---	---	---	---
5	---	---	---	---	---	---	---	---	---	---	---
6	---	---	---	---	---	---	---	---	---	---	---
7	---	---	---	---	---	---	---	---	---	---	---
8	---	---	---	---	---	---	---	---	---	---	---
9	---	---	---	---	---	---	---	---	---	---	---
10	---	---	---	---	---	---	---	---	---	---	---

**Table A.113. Moisture and density summary of Edwards till, strip 3, 1 roller pass**

Test point	Coordinates (m)			Nuclear gauge (kN/m <sup>3</sup> , %)						Drive core (kN/m <sup>3</sup> , %)	
	X	Y	Z	$\gamma_d^1$	$w_g^1$	$\gamma_d^2$	$w_g^2$	$\gamma_d$	$w_g$	$\gamma_d$	$w_g$
1	4.56	5.50	-0.09	15.5	18.3	16.2	18.6	15.9	18.5	---	---
2	4.62	3.87	-0.10	15.3	18.1	16.2	18.7	15.8	18.4	---	---
3	4.69	2.20	-0.09	15.1	19.9	15.2	18.6	15.2	19.3	---	---
4	4.74	0.88	-0.09	14.4	21.5	14.4	18.4	14.4	20.0	---	---
5	4.84	-0.76	-0.06	13.6	19.6	13.9	19.3	13.8	19.5	---	---
6	4.91	-2.08	-0.08	15.6	16.5	15.7	16.1	15.6	16.3	---	---
7	5.02	-3.73	-0.05	14.7	17.2	15.1	15.7	14.9	16.5	---	---
8	5.12	-5.37	-0.04	15.0	17.9	15.1	16.9	15.1	17.4	---	---
9	5.19	-6.73	-0.02	14.8	18.7	14.8	19.6	14.8	19.2	---	---
10	5.33	-8.38	0.02	15.5	15.4	15.6	15.2	15.6	15.3	---	---

**Table A.114. Stiffness and strength summary of Edwards till, strip 3, 1 roller pass**

Test point	Clegg Impact Test			Geogauge		DCP	FWD: E (MPa)			
	CIV <sup>1</sup>	CIV <sup>2</sup>	CIV	M	S	DCPI	1	2	3	4
1	1.7	---	1.7	29.94	4.04	176	25.0	26.0	17.3	13.2
2	---	---	---	31.94	4.31	182	24.6	27.2	18.1	12.0
3	2.0	---	2.0	28.10	3.79	185	9.2	23.9	18.6	14.5
4	2.0	2.1	2.1	23.93	3.23	189	16.3	12.5	9.2	8.2
5	2.4	2.1	2.3	22.63	3.05	172	6.0	8.6	7.8	7.6
6	2.0	---	2.0	25.87	3.49	219	11.5	10.1	9.1	8.1
7	---	---	---	23.70	3.20	170	8.1	7.5	7.8	8.1
8	---	---	---	22.78	3.07	225	5.9	6.0	6.8	9.2
9	---	---	---	26.79	3.61	225	19.0	36.1	25.6	16.6
10	---	---	---	27.59	3.72	178	9.8	15.9	13.8	12.6

**Table A.115. Moisture and density summary of Edwards till, strip 3, 2 roller passes**

Test point	Coordinates (m)			Nuclear gauge (kN/m <sup>3</sup> , %)						Drive core (kN/m <sup>3</sup> , %)	
	X	Y	Z	$\gamma_d^1$	$w_g^1$	$\gamma_d^2$	$w_g^2$	$\gamma_d$	$w_g$	$\gamma_d$	$w_g$
1	4.55	5.49	-0.10	16.7	16.9	17.0	16.9	16.9	16.9	---	---
2	4.58	3.86	-0.11	17.4	15.2	16.7	16.2	17.0	15.7	---	---
3	4.71	2.17	-0.10	16.3	15.5	16.1	16.5	16.2	16.0	---	---
4	4.95	0.90	-0.10	16.1	16.6	16.4	16.6	16.3	16.6	---	---
5	4.83	-0.83	-0.07	15.8	16.4	15.8	17.9	15.8	17.2	---	---
6	4.92	-2.44	-0.09	16.4	15.6	15.7	17.8	16.0	16.7	---	---
7	4.97	-3.80	-0.06	16.1	15.3	16.1	15.9	16.1	15.6	---	---
8	5.08	-5.15	-0.04	16.2	18.5	16.8	14.2	16.5	16.4	---	---
9	5.33	-6.78	-0.02	16.3	15.7	16.1	16.7	16.2	16.2	---	---
10	5.66	-8.11	-0.01	16.3	15.0	16.4	16.6	16.4	15.8	---	---

**Table A.116. Stiffness and strength summary of Edwards till, strip 3, 2 roller passes**

Test point	Clegg Impact Test			Geogauge		DCP	FWD: E (MPa)			
	CIV <sup>1</sup>	CIV <sup>2</sup>	CIV	M	S	DCPI	1	2	3	4
1	---	---	---	27.33	3.69	177	17.4	14.1	12.9	11.4
2	---	---	---	29.08	3.92	180	14.1	11.8	10.8	10.5
3	---	---	---	31.49	4.25	182	62.1	48.8	27.3	14.9
4	---	---	---	33.20	4.48	176	82.9	60.8	42.1	27.8
5	---	---	---	26.38	3.56	165	11.1	9.8	8.5	8.2
6	---	---	---	29.40	3.96	217	16.9	10.5	9.5	9.6
7	---	---	---	26.62	3.59	191	4.2	5.6	6.1	8.4
8	---	---	---	32.33	4.36	244	14.6	14.9	12.3	10.8
9	---	---	---	30.19	4.07	176	9.2	8.9	8.2	7.8
10	---	---	---	32.45	4.38	195	7.0	6.5	7.0	8.0



**Table A.117. Moisture and density summary of Edwards till, strip 3, 4 roller passes**

Test point	Coordinates (m)			Nuclear gauge (kN/m <sup>3</sup> , %)						Drive core (kN/m <sup>3</sup> , %)	
	X	Y	Z	$\gamma_d^1$	$w_g^1$	$\gamma_d^2$	$w_g^2$	$\gamma_d$	$w_g$	$\gamma_d$	$w_g$
1	4.35	5.35	-0.11	17.0	17.1	16.9	18.1	17.0	17.6	---	---
2	4.54	3.67	-0.10	17.4	16.2	16.8	17.8	17.1	17.0	---	---
3	4.50	2.75	-0.09	17.3	17.0	17.1	17.1	17.2	17.1	---	---
4	4.49	1.13	-0.07	17.2	15.7	16.7	16.5	17.0	16.1	---	---
5	4.76	-0.52	-0.06	16.5	19.2	16.1	19.0	16.3	19.1	---	---
6	4.86	-1.94	-0.06	16.8	16.6	17.0	14.7	16.9	15.7	---	---
7	4.94	-3.27	-0.06	16.5	16.1	17.4	15.2	16.9	15.7	---	---
8	5.02	-4.87	-0.04	16.8	16.1	16.8	17.1	16.8	16.6	---	---
9	5.07	-6.29	-0.02	17.4	15.1	16.9	17.0	17.1	16.1	---	---
10	5.55	-7.82	0.00	16.1	16.0	16.4	16.2	16.2	16.1	---	---

**Table A.118. Stiffness and strength summary of Edwards till, strip 3, 4 roller passes**

Test point	Clegg Impact Test			Geogauge		DCP	FWD: E (MPa)			
	CIV <sup>1</sup>	CIV <sup>2</sup>	CIV	M	S	DCPI	1	2	3	4
1	---	---	---	33.01	4.45	195	27.4	45.2	30.1	22.0
2	---	---	---	33.25	4.48	170	44.7	43.9	32.7	22.6
3	---	---	---	33.61	4.53	165	49.5	81.5	42.6	29.4
4	---	---	---	31.60	4.26	155	30.8	24.7	19.0	14.7
5	---	---	---	29.67	4.00	160	36.7	46.4	38.2	28.2
6	---	---	---	27.08	3.65	190	23.3	20.9	16.3	14.7
7	---	---	---	29.97	4.04	180	18.9	14.2	11.7	11.1
8	---	---	---	29.04	3.92	185	13.0	16.1	13.0	11.5
9	---	---	---	33.20	4.48	175	23.3	19.6	13.6	11.2
10	---	---	---	46.60	6.28	140	24.0	36.0	27.2	21.8

**Table A.119. Moisture and density summary of Edwards till, strip 3, 8 roller passes**

Test point	Coordinates (m)			Nuclear gauge (kN/m <sup>3</sup> , %)						Drive core (kN/m <sup>3</sup> , %)	
	X	Y	Z	$\gamma_d^1$	$w_g^1$	$\gamma_d^2$	$w_g^2$	$\gamma_d$	$w_g$	$\gamma_d$	$w_g$
1	4.38	5.33	-0.12	17.3	17.8	17.4	17.8	17.3	17.8	16.9	17.4
2	4.50	3.70	-0.12	17.2	17.3	17.2	17.4	17.2	17.4	17.2	17.3
3	4.80	2.40	-0.12	16.5	18.7	16.8	17.7	16.7	18.2	17.2	17.1
4	4.67	0.73	-0.10	17.4	16.9	16.7	16.6	17.1	16.8	17.2	17.1
5	4.75	-0.89	-0.09	16.7	19.8	17.2	17.9	16.9	18.9	17.1	16.9
6	4.85	-2.21	-0.10	16.9	17.1	16.8	17.6	16.8	17.4	17.4	15.8
7	4.95	-3.86	-0.09	16.3	17.9	17.1	16.9	16.7	17.4	17.2	17.3
8	4.99	-5.22	-0.05	17.1	18.9	16.7	18.0	16.9	18.5	17.0	17.6
9	5.07	-6.91	-0.02	17.4	16.7	16.9	17.4	17.2	17.1	17.3	17.4
10	5.28	-8.22	0.00	17.5	14.8	17.8	14.9	17.7	14.9	17.5	16.1

**Table A.120. Stiffness and strength summary of Edwards till, strip 3, 8 roller passes**

Test point	Clegg Impact Test			Geogauge		DCP	FWD: E (MPa)			
	CIV <sup>1</sup>	CIV <sup>2</sup>	CIV	M	S	DCPI	1	2	3	4
1	---	---	---	28.57	3.85	170	34.7	22.6	16.6	13.3
2	---	---	---	31.90	4.30	157	14.5	17.7	15.8	14.5
3	---	---	---	28.95	3.90	171	51.8	71.0	54.4	45.7
4	---	---	---	37.79	5.10	28	11.9	12.9	11.0	10.1
5	---	---	---	38.31	5.17	146	5.5	8.1	10.8	11.7
6	---	---	---	31.59	4.26	150	21.9	20.2	17.3	18.5
7	---	---	---	32.08	4.33	138	14.8	14.5	14.0	14.2
8	---	---	---	32.07	4.32	171	6.6	13.8	4.6	10.2
9	---	---	---	35.44	4.78	129	68.2	40.8	27.6	20.4
10	---	---	---	44.52	6.00	107	26.7	33.7	26.0	20.0

**Table A.121. Moisture and density summary of Edwards till, strip 4, 0 roller passes**

Test point	Coordinates (m)			Nuclear gauge (kN/m <sup>3</sup> , %)						Drive core (kN/m <sup>3</sup> , %)	
	X	Y	Z	$\gamma_d^1$	$w_g^1$	$\gamma_d^2$	$w_g^2$	$\gamma_d$	$w_g$	$\gamma_d$	$w_g$
1	4.24	6.32	-0.02	11.7	13.8	11.4	14.7	11.5	14.3	---	---
2	4.39	4.71	-0.07	10.9	13.2	11.4	13.3	11.2	13.3	---	---
3	4.56	3.24	-0.08	9.5	15.5	9.9	14.3	9.7	14.9	---	---
4	4.70	1.78	-0.06	10.5	12.1	10.9	13.4	10.7	12.8	---	---
5	4.86	0.18	-0.05	10.7	11.0	10.8	13.4	10.8	12.2	---	---
6	5.07	-1.31	-0.07	10.2	12.9	10.0	13.7	10.1	13.3	---	---
7	5.06	-2.85	-0.08	10.3	17.6	10.4	14.0	10.4	15.8	---	---
8	5.20	-4.12	-0.08	10.5	13.0	10.2	15.9	10.4	14.5	---	---
9	5.36	-5.83	-0.02	10.2	10.7	10.0	13.6	10.1	12.2	---	---
10	5.43	-7.40	0.00	9.9	11.7	9.8	14.2	9.9	13.0	---	---

**Table A.122. Stiffness and strength summary of Edwards till, strip 4, 0 roller passes**

Test point	Clegg Impact Test			Geogauge		DCP	FWD: E (MPa)				
	CIV <sup>1</sup>	CIV <sup>2</sup>	CIV	M	S	DCPI	1	2	3	4	
1	---	---	---	---	---	---	---	---	---	---	---
2	---	---	---	---	---	---	---	---	---	---	---
3	---	---	---	---	---	---	---	---	---	---	---
4	---	---	---	---	---	---	---	---	---	---	---
5	---	---	---	---	---	---	---	---	---	---	---
6	---	---	---	---	---	---	---	---	---	---	---
7	---	---	---	---	---	---	---	---	---	---	---
8	---	---	---	---	---	---	---	---	---	---	---
9	---	---	---	---	---	---	---	---	---	---	---
10	---	---	---	---	---	---	---	---	---	---	---

**Table A.123. Moisture and density summary of Edwards till, strip 4, 1 roller pass**

Test point	Coordinates (m)			Nuclear gauge (kN/m <sup>3</sup> , %)						Drive core (kN/m <sup>3</sup> , %)	
	X	Y	Z	$\gamma_d^1$	$w_g^1$	$\gamma_d^2$	$w_g^2$	$\gamma_d$	$w_g$	$\gamma_d$	$w_g$
1	4.34	6.30	-0.16	15.4	15.8	14.9	18.2	15.2	17.0	---	---
2	4.46	4.62	-0.20	14.3	15.5	14.8	14.8	14.6	15.2	---	---
3	4.56	3.28	-0.21	15.1	15.3	15.2	15.8	15.2	15.6	---	---
4	4.69	1.59	-0.19	14.2	15.4	14.0	17.7	14.1	16.6	---	---
5	4.80	0.23	-0.19	13.6	17.0	13.9	16.9	13.7	17.0	---	---
6	4.97	-1.43	-0.18	14.0	14.8	13.6	14.2	13.8	14.5	---	---
7	5.07	-3.14	-0.18	15.1	14.3	14.3	14.2	14.7	14.3	---	---
8	5.17	-4.51	-0.18	13.6	14.8	13.0	15.3	13.3	15.1	---	---
9	5.26	-5.88	-0.15	13.9	14.6	13.2	15.0	13.6	14.8	---	---
10	5.37	-7.26	-0.12	14.1	14.8	13.5	16.0	13.8	15.4	---	---

**Table A.124. Stiffness and strength summary of Edwards till, strip 4, 1 roller pass**

Test point	Clegg Impact Test			Geogauge		DCP	FWD: E (MPa)			
	CIV <sup>1</sup>	CIV <sup>2</sup>	CIV	M	S	DCPI	1	2	3	4
1	---	---	---	---	---	66	---	---	---	---
2	---	---	---	---	---	69	---	---	---	---
3	---	---	---	---	---	86	---	---	---	---
4	---	---	---	---	---	82	---	---	---	---
5	---	---	---	---	---	106	---	---	---	---
6	---	---	---	---	---	106	---	---	---	---
7	---	---	---	---	---	122	---	---	---	---
8	---	---	---	---	---	84	---	---	---	---
9	---	---	---	---	---	100	---	---	---	---
10	---	---	---	---	---	106	---	---	---	---

**Table A.125. Moisture and density summary of Edwards till, strip 4, 2 roller passes**

Test point	Coordinates (m)			Nuclear gauge (kN/m <sup>3</sup> , %)						Drive core (kN/m <sup>3</sup> , %)	
	X	Y	Z	$\gamma_d^1$	$w_g^1$	$\gamma_d^2$	$w_g^2$	$\gamma_d$	$w_g$	$\gamma_d$	$w_g$
1	4.34	6.35	-0.15	14.9	15.4	15.3	17.2	15.1	16.3	---	---
2	4.29	4.69	-0.19	16.5	13.8	15.7	14.9	16.1	14.4	---	---
3	4.60	3.30	-0.20	15.1	15.6	14.7	15.4	14.9	15.5	---	---
4	4.74	1.65	-0.18	15.2	15.3	16.1	14.6	15.6	15.0	---	---
5	4.87	0.27	-0.17	14.2	15.4	14.2	15.7	14.2	15.6	---	---
6	5.02	-1.41	-0.17	13.8	15.2	14.5	16.0	14.2	15.6	---	---
7	5.11	-3.11	-0.17	14.4	14.7	13.7	14.7	14.0	14.7	---	---
8	5.20	-4.47	-0.17	14.0	14.2	13.7	14.5	13.9	14.4	---	---
9	5.26	-5.86	-0.14	13.0	17.6	13.1	17.7	13.1	17.7	---	---
10	5.31	-7.58	-0.11	14.3	13.6	13.5	14.4	13.9	14.0	---	---

**Table A.126. Stiffness and strength summary of Edwards till, strip 4, 2 roller passes**

Test point	Clegg Impact Test			Geogauge		DCP	FWD: E (MPa)			
	CIV <sup>1</sup>	CIV <sup>2</sup>	CIV	M	S	DCPI	1	2	3	4
1	---	---	---	---	---	91	---	---	---	---
2	---	---	---	---	---	116	---	---	---	---
3	---	---	---	---	---	88	---	---	---	---
4	---	---	---	---	---	87	---	---	---	---
5	---	---	---	---	---	117	---	---	---	---
6	---	---	---	---	---	128	---	---	---	---
7	---	---	---	---	---	95	---	---	---	---
8	---	---	---	---	---	128	---	---	---	---
9	---	---	---	---	---	93	---	---	---	---
10	---	---	---	---	---	110	---	---	---	---

**Table A.127. Moisture and density summary of Edwards till, strip 4, 4 roller passes**

Test point	Coordinates (m)			Nuclear gauge (kN/m <sup>3</sup> , %)						Drive core (kN/m <sup>3</sup> , %)	
	X	Y	Z	$\gamma_d^1$	$w_g^1$	$\gamma_d^2$	$w_g^2$	$\gamma_d$	$w_g$	$\gamma_d$	$w_g$
1	4.43	6.32	-0.15	16.9	16.0	16.7	16.9	16.8	16.5	---	---
2	4.61	4.73	-0.18	16.2	14.0	16.4	14.9	16.3	14.5	---	---
3	4.72	3.30	-0.18	15.4	14.6	16.1	16.1	15.7	15.4	---	---
4	4.86	1.70	-0.17	17.0	16.0	17.0	14.5	17.0	15.3	---	---
5	5.03	0.15	-0.16	16.4	13.3	15.8	13.4	16.1	13.4	---	---
6	5.01	-1.31	-0.17	17.0	15.1	16.4	14.7	16.7	14.9	---	---
7	5.11	-2.73	-0.18	16.7	15.4	17.1	14.1	16.9	14.8	---	---
8	5.23	-4.43	-0.17	15.3	13.7	14.8	14.5	15.0	14.1	---	---
9	5.27	-5.80	-0.14	15.7	15.5	15.7	12.8	15.7	14.2	---	---
10	5.37	-7.14	-0.11	16.2	14.1	16.1	15.1	16.1	14.6	---	---

**Table A.128. Stiffness and strength summary of Edwards till, strip 4, 4 roller passes**

Test point	Clegg Impact Test			Geogauge		DCP	FWD: E (MPa)			
	CIV <sup>1</sup>	CIV <sup>2</sup>	CIV	M	S	DCPI	1	2	3	4
1	---	---	---	---	---	98	---	---	---	---
2	---	---	---	---	---	92	---	---	---	---
3	---	---	---	---	---	78	---	---	---	---
4	---	---	---	---	---	102	---	---	---	---
5	---	---	---	---	---	109	---	---	---	---
6	---	---	---	---	---	120	---	---	---	---
7	---	---	---	---	---	132	---	---	---	---
8	---	---	---	---	---	81	---	---	---	---
9	---	---	---	---	---	81	---	---	---	---
10	---	---	---	---	---	79	---	---	---	---

**Table A.129. Moisture and density summary of Edwards till, strip 4, 8 roller passes**

Test point	Coordinates (m)			Nuclear gauge (kN/m <sup>3</sup> , %)						Drive core (kN/m <sup>3</sup> , %)	
	X	Y	Z	$\gamma_d^1$	$w_g^1$	$\gamma_d^2$	$w_g^2$	$\gamma_d$	$w_g$	$\gamma_d$	$w_g$
1	4.42	5.52	-0.18	16.7	17.1	16.6	16.1	16.6	16.6	18.1	15.7
2	4.53	3.92	-0.20	17.7	16.0	17.9	15.6	17.8	15.8	17.6	16.2
3	4.65	2.45	-0.19	17.6	15.0	17.4	15.6	17.5	15.3	17.4	16.9
4	4.89	0.98	-0.18	16.4	17.2	15.8	16.1	16.1	16.7	17.0	15.5
5	4.84	-0.80	-0.17	17.6	15.2	18.0	14.2	17.8	14.7	17.8	15.3
6	4.90	-1.95	-0.17	17.3	15.5	17.1	15.3	17.2	15.4	17.4	16.1
7	5.27	-3.51	-0.17	17.5	13.8	18.2	12.5	17.9	13.2	---	---
8	5.39	-4.89	-0.17	16.2	14.8	17.3	14.4	16.7	14.6	15.6	30.2
9	5.12	-6.44	-0.13	17.2	14.1	17.2	14.9	17.2	14.5	17.9	15.5
10	5.25	-7.98	-0.10	18.6	12.6	17.7	13.9	18.2	13.3	18.3	14.7

**Table A.130. Stiffness and strength summary of Edwards till, strip 4, 8 roller passes**

Test point	Clegg Impact Test			Geogauge		DCP	FWD: E (MPa)			
	CIV <sup>1</sup>	CIV <sup>2</sup>	CIV	M	S	DCPI	1	2	3	4
1	---	---	---	---	---	61	---	---	---	---
2	---	---	---	---	---	78	---	---	---	---
3	---	---	---	---	---	95	---	---	---	---
4	---	---	---	---	---	98	---	---	---	---
5	---	---	---	---	---	78	---	---	---	---
6	---	---	---	---	---	110	---	---	---	---
7	---	---	---	---	---	42	---	---	---	---
8	---	---	---	---	---	42	---	---	---	---
9	---	---	---	---	---	111	---	---	---	---
10	---	---	---	---	---	50	---	---	---	---

**Table A.131. Moisture and density summary of Edwards till, strip 5, 0 roller passes**

Test point	Coordinates (m)			Nuclear gauge (kN/m <sup>3</sup> , %)						Drive core (kN/m <sup>3</sup> , %)	
	X	Y	Z	$\gamma_d^1$	$w_g^1$	$\gamma_d^2$	$w_g^2$	$\gamma_d$	$w_g$	$\gamma_d$	$w_g$
1	4.10	6.12	0.02	12.6	8.2	12.1	10.1	12.3	9.2	---	---
2	4.05	4.90	0.00	12.6	9.0	12.4	10.1	12.5	9.6	---	---
3	4.27	3.42	-0.02	12.1	8.4	12.1	8.9	12.1	8.7	---	---
4	4.52	1.54	-0.02	12.4	8.2	11.9	9.7	12.1	9.0	---	---
5	4.50	0.37	-0.01	12.0	8.9	11.7	9.0	11.8	9.0	---	---
6	4.70	-1.27	-0.03	11.8	10.6	11.5	10.4	11.6	10.5	---	---
7	4.72	-2.87	-0.02	12.1	9.7	11.5	10.8	11.8	10.3	---	---
8	4.89	-4.26	-0.02	11.8	9.1	11.4	10.7	11.6	9.9	---	---
9	4.99	-5.82	0.04	11.7	9.2	11.5	9.4	11.6	9.3	---	---
10	5.21	-7.24	0.04	12.3	9.1	11.6	11.4	11.9	10.3	---	---

**Table A.132. Stiffness and strength summary of Edwards till, strip 5, 0 roller passes**

Test point	Clegg Impact Test			Geogauge		DCP	FWD: E (MPa)				
	CIV <sup>1</sup>	CIV <sup>2</sup>	CIV	M	S	DCPI	1	2	3	4	
1	---	---	---	---	---	---	---	---	---	---	---
2	---	---	---	---	---	---	---	---	---	---	---
3	---	---	---	---	---	---	---	---	---	---	---
4	---	---	---	---	---	---	---	---	---	---	---
5	---	---	---	---	---	---	---	---	---	---	---
6	---	---	---	---	---	---	---	---	---	---	---
7	---	---	---	---	---	---	---	---	---	---	---
8	---	---	---	---	---	---	---	---	---	---	---
9	---	---	---	---	---	---	---	---	---	---	---
10	---	---	---	---	---	---	---	---	---	---	---



**Table A.133. Moisture and density summary of Edwards till, strip 5, 1 roller pass**

Test point	Coordinates (m)			Nuclear gauge (kN/m <sup>3</sup> , %)						Drive core (kN/m <sup>3</sup> , %)	
	X	Y	Z	$\gamma_d^1$	$w_g^1$	$\gamma_d^2$	$w_g^2$	$\gamma_d$	$w_g$	$\gamma_d$	$w_g$
1	4.33	6.21	-0.07	14.7	11.5	13.4	12.3	14.1	11.9	---	---
2	4.45	4.51	-0.10	13.6	11.2	13.7	12.7	13.6	12.0	---	---
3	4.57	3.05	-0.11	14.0	11.3	13.3	11.4	13.7	11.4	---	---
4	4.66	1.65	-0.11	13.7	11.1	13.3	11.8	13.5	11.5	---	---
5	4.85	0.18	-0.11	13.0	11.1	13.4	1.8	13.2	6.5	---	---
6	4.95	-1.37	-0.11	13.7	13.5	13.1	11.6	13.4	12.6	---	---
7	5.06	-2.89	-0.11	13.0	11.0	13.9	10.5	13.5	10.8	---	---
8	5.23	-4.44	-0.09	13.6	10.1	12.8	10.4	13.2	10.3	---	---
9	5.22	-5.85	-0.05	14.5	9.7	13.9	10.6	14.2	10.2	---	---
10	5.30	-7.37	-0.04	14.2	9.7	15.0	10.6	14.6	10.2	---	---

**Table A.134. Stiffness and strength summary of Edwards till, strip 5, 1 roller pass**

Test point	Clegg Impact Test			Geogauge		DCP	FWD: E (MPa)			
	CIV <sup>1</sup>	CIV <sup>2</sup>	CIV	M	S	DCPI	1	2	3	4
1	6.3	7.0	6.7	30.33	4.09	122	14.7	22.9	18.8	16.5
2	4.7	4.5	4.6	32.62	4.40	116	5.4	8.4	8.5	8.8
3	5.2	4.1	4.7	30.03	4.05	143	7.2	10.5	9.8	9.6
4	5.9	5.0	5.5	27.04	3.65	80	6.0	7.5	8.6	8.6
5	4.2	3.8	4.0	27.69	3.73	74	8.6	9.5	9.8	9.9
6	6.3	4.5	5.4	27.48	3.71	130	22.7	17.4	14.6	12.7
7	3.8	3.8	3.8	20.79	2.80	118	12.5	8.7	7.9	8.5
8	4.5	4.9	4.7	31.09	4.19	122	15.8	17.7	15.3	12.7
9	5.2	3.8	4.5	30.30	4.09	88	5.7	9.9	11.2	11.7
10	4.7	4.5	4.6	26.92	3.63	73	12.6	15.8	15.6	14.6

**Table A.135. Moisture and density summary of Edwards till, strip 5, 2 roller passes**

Test point	Coordinates (m)			Nuclear gauge (kN/m <sup>3</sup> , %)						Drive core (kN/m <sup>3</sup> , %)	
	X	Y	Z	$\gamma_d^1$	$w_g^1$	$\gamma_d^2$	$w_g^2$	$\gamma_d$	$w_g$	$\gamma_d$	$w_g$
1	4.27	5.54	-0.08	15.0	10.6	14.1	11.1	14.6	10.9	---	---
2	4.42	3.97	-0.11	13.4	12.3	14.2	11.3	13.8	11.8	---	---
3	4.61	2.41	-0.11	15.0	12.4	14.6	11.0	14.8	11.7	---	---
4	4.77	1.13	-0.11	14.7	10.8	15.2	10.5	14.9	10.7	---	---
5	4.86	-0.29	-0.09	15.3	11.1	14.3	9.5	14.8	10.3	---	---
6	5.05	-1.88	-0.11	14.8	10.7	13.9	11.5	14.3	11.1	---	---
7	5.09	-3.45	-0.11	13.9	12.4	14.5	11.7	14.2	12.1	---	---
8	5.25	-5.05	-0.09	15.4	10.3	14.6	10.9	15.0	10.6	---	---
9	5.23	-6.54	-0.05	15.0	10.9	15.3	11.1	15.2	11.0	---	---
10	5.28	-7.78	-0.03	15.4	10.7	15.9	10.4	15.7	10.6	---	---

**Table A.136. Stiffness and strength summary of Edwards till, strip 5, 2 roller passes**

Test point	Clegg Impact Test			Geogauge		DCP	FWD: E (MPa)			
	CIV <sup>1</sup>	CIV <sup>2</sup>	CIV	M	S	DCPI	1	2	3	4
1	6.2	6.1	6.2	43.18	5.82	112	26.9	20.2	18.7	15.9
2	4.5	5.8	5.2	28.31	3.82	67	11.2	18.1	15.3	14.3
3	7.5	6.0	6.8	36.97	4.99	124	8.0	12.2	12.2	11.4
4	6.7	5.4	6.1	46.17	6.23	50	10.5	15.0	13.4	13.1
5	6.1	5.9	6.0	48.46	6.54	76	22.3	22.3	21.3	20.3
6	5.5	4.4	5.0	32.03	4.32	47	18.9	18.4	25.2	22.5
7	6.8	5.0	5.9	40.48	5.46	88	13.7	22.8	20.3	18.8
8	6.1	6.0	6.1	46.64	6.29	55	16.6	20.0	17.4	16.1
9	7.3	6.0	6.7	60.07	8.10	53	29.9	48.9	39.0	32.1
10	7.5	7.5	7.5	48.23	6.50	44	55.6	66.5	56.1	47.2

**Table A.137. Moisture and density summary of Edwards till, strip 5, 4 roller passes**

Test point	Coordinates (m)			Nuclear gauge (kN/m <sup>3</sup> , %)						Drive core (kN/m <sup>3</sup> , %)	
	X	Y	Z	$\gamma_d^1$	$w_g^1$	$\gamma_d^2$	$w_g^2$	$\gamma_d$	$w_g$	$\gamma_d$	$w_g$
1	4.29	6.21	-0.07	15.8	13.0	15.2	13.7	15.5	13.4	---	---
2	4.55	4.40	-0.11	15.6	11.5	15.4	12.2	15.5	11.9	---	---
3	4.73	3.13	-0.11	15.2	12.1	15.5	11.1	15.4	11.6	---	---
4	4.82	1.71	-0.10	15.1	11.9	15.1	11.4	15.1	11.7	---	---
5	4.98	0.02	-0.10	15.5	11.6	15.6	11.3	15.6	11.5	---	---
6	4.87	-1.19	-0.12	15.1	12.2	16.2	10.7	15.6	11.5	---	---
7	5.02	-3.08	-0.11	15.9	10.0	14.9	10.2	15.4	10.1	---	---
8	5.18	-4.26	-0.12	14.8	10.5	14.5	10.3	14.7	10.4	---	---
9	5.29	-6.04	-0.06	15.7	10.4	15.9	10.0	15.8	10.2	---	---
10	5.41	-7.22	-0.05	15.8	11.6	16.0	11.3	15.9	11.5	---	---

**Table A.138. Stiffness and strength summary of Edwards till, strip 5, 4 roller passes**

Test point	Clegg Impact Test			Geogauge		DCP	FWD: E (MPa)			
	CIV <sup>1</sup>	CIV <sup>2</sup>	CIV	M	S	DCPI	1	2	3	4
1	9.6	7.8	8.7	62.39	8.41	35	27.5	30.9	31.8	29.2
2	10.0	7.5	8.8	55.72	7.51	45	15.2	51.8	42.4	36.4
3	7.5	6.9	7.2	69.17	9.33	25	30.5	40.6	30.3	24.6
4	6.5	8.0	7.3	55.01	7.42	38	81.3	73.3	57.5	44.6
5	6.2	8.1	7.2	53.77	7.25	40	5.9	19.9	20.9	20.7
6	8.9	7.6	8.3	63.25	8.53	29	47.1	48.4	39.9	31.8
7	8.6	7.4	8.0	56.03	7.56	47	4.8	21.4	23.0	25.0
8	9.5	10.0	9.8	58.12	7.84	45	37.8	49.9	36.2	29.3
9	10.4	12.2	11.3	62.82	8.47	22	48.0	41.8	40.4	33.5
10	7.4	7.8	7.6	65.13	8.78	2	68.1	104.7	77.1	61.2

**Table A.139. Moisture and density summary of Edwards till, strip 5, 8 roller passes**

Test point	Coordinates (m)			Nuclear gauge (kN/m <sup>3</sup> , %)						Drive core (kN/m <sup>3</sup> , %)	
	X	Y	Z	$\gamma_d^1$	$w_g^1$	$\gamma_d^2$	$w_g^2$	$\gamma_d$	$w_g$	$\gamma_d$	$w_g$
1	4.91	5.59	-0.08	16.4	11.6	16.8	11.6	16.6	11.6	17.8	11.5
2	4.78	3.99	-0.12	16.2	10.8	15.9	10.2	16.1	10.5	---	---
3	4.85	2.79	-0.12	16.3	10.3	15.4	12.4	15.8	11.4	18.0	12.2
4	5.10	1.41	-0.11	16.3	10.7	15.8	12.6	16.1	11.7	17.5	12.0
5	5.14	-0.27	-0.10	16.0	11.3	15.9	11.5	15.9	11.4	18.2	11.6
6	5.21	-1.79	-0.12	16.2	11.2	16.1	11.9	16.2	11.6	18.3	11.4
7	5.42	-3.49	-0.12	15.9	10.9	15.6	10.7	15.7	10.8	17.5	11.5
8	5.29	-4.54	-0.11	15.2	9.2	16.1	10.2	15.6	9.7	15.6	12.1
9	5.50	-6.33	-0.07	15.9	11.0	16.8	11.3	16.4	11.2	17.8	10.4
10	5.41	-8.20	-0.04	16.7	8.6	17.5	10.1	17.1	9.4	19.0	11.1

**Table A.140. Stiffness and strength summary of Edwards till, strip 5, 8 roller passes**

Test point	Clegg Impact Test			Geogauge		DCP	FWD: E (MPa)			
	CIV <sup>1</sup>	CIV <sup>2</sup>	CIV	M	S	DCPI	1	2	3	4
1	9.4	13.2	11.3	67.23	9.07	22	64.2	37.3	25.8	24.4
2	9.2	10.2	9.7	83.80	11.30	66	106.3	81.9	66.1	52.4
3	11.7	11.3	11.5	72.59	9.79	21	53.7	51.1	43.5	37.3
4	11.3	10.3	10.8	78.71	10.61	37	110.0	80.7	67.6	35.6
5	9.0	8.4	8.7	---	---	31	89.5	93.0	78.9	63.1
6	10.6	10.5	10.6	73.55	9.92	22	24.1	87.3	75.2	61.4
7	12.5	13.0	12.8	62.14	8.38	52	81.1	75.3	65.0	54.1
8	7.4	12.3	9.9	75.94	10.24	34	61.4	71.4	59.1	56.4
9	7.9	13.1	10.5	81.59	11.00	20	184.4	197.0	168.1	140.0
10	12.5	11.7	12.1	73.04	9.85	26	83.9	155.0	140.9	124.6

**Table A.141. Moisture and density summary of Edwards till, strip 6, 0 roller passes**

Test point	Coordinates (m)			Nuclear gauge (kN/m <sup>3</sup> , %)						Drive core (kN/m <sup>3</sup> , %)	
	X	Y	Z	$\gamma_d^1$	$w_g^1$	$\gamma_d^2$	$w_g^2$	$\gamma_d$	$w_g$	$\gamma_d$	$w_g$
1	4.64	5.69	-0.19	11.5	10.2	12.4	10.0	11.9	10.1	---	---
2	4.65	4.01	-0.21	11.5	16.5	11.8	10.0	11.6	13.3	---	---
3	4.34	2.31	-0.20	11.7	7.9	11.9	8.8	11.8	8.4	---	---
4	3.64	0.53	0.15	11.4	9.2	11.7	10.3	11.6	9.8	---	---
5	4.49	0.84	-0.22	12.0	8.7	11.6	10.4	11.8	9.6	---	---
6	4.47	-0.68	-0.26	11.6	10.0	11.5	8.7	11.5	9.4	---	---
7	4.88	-2.21	-0.24	11.3	10.8	11.7	8.7	11.5	9.8	---	---
8	4.88	-3.39	-0.24	11.6	10.1	11.8	8.2	11.7	9.2	---	---
9	4.92	-5.30	-0.16	12.4	8.4	11.8	10.0	12.1	9.2	---	---
10	5.03	-6.29	-0.15	12.2	10.5	12.2	10.5	12.2	10.5	---	---

**Table A.142. Stiffness and strength summary of Edwards till, strip 6, 0 roller passes**

Test point	Clegg Impact Test			Geogauge		DCP	FWD: E (MPa)				
	CIV <sup>1</sup>	CIV <sup>2</sup>	CIV	M	S	DCPI	1	2	3	4	
1	---	---	---	---	---	---	---	---	---	---	---
2	---	---	---	---	---	---	---	---	---	---	---
3	---	---	---	---	---	---	---	---	---	---	---
4	---	---	---	---	---	---	---	---	---	---	---
5	---	---	---	---	---	---	---	---	---	---	---
6	---	---	---	---	---	---	---	---	---	---	---
7	---	---	---	---	---	---	---	---	---	---	---
8	---	---	---	---	---	---	---	---	---	---	---
9	---	---	---	---	---	---	---	---	---	---	---
10	---	---	---	---	---	---	---	---	---	---	---

**Table A.143. Moisture and density summary of Edwards till, strip 6, 1 roller pass**

Test point	Coordinates (m)			Nuclear gauge (kN/m <sup>3</sup> , %)						Drive core (kN/m <sup>3</sup> , %)	
	X	Y	Z	$\gamma_d^1$	$w_g^1$	$\gamma_d^2$	$w_g^2$	$\gamma_d$	$w_g$	$\gamma_d$	$w_g$
1	4.45	5.62	-0.27	16.6	11.1	16.9	11.0	16.7	11.1	---	---
2	4.73	4.08	-0.27	14.0	11.1	13.5	10.6	13.7	10.9	---	---
3	4.77	2.47	-0.27	12.6	12.5	12.9	12.1	12.7	12.3	---	---
4	4.69	0.95	-0.29	14.2	10.8	13.4	11.2	13.8	11.0	---	---
5	4.73	-0.51	-0.31	14.2	10.5	13.7	9.1	13.9	9.8	---	---
6	4.78	-1.97	-0.31	14.1	11.5	13.6	11.8	13.8	11.7	---	---
7	4.88	-3.50	-0.30	14.4	10.3	14.5	10.5	14.4	10.4	---	---
8	4.90	-5.13	-0.25	14.1	9.7	13.7	9.9	13.9	9.8	---	---
9	4.97	-6.57	-0.21	14.2	11.1	13.4	10.9	13.8	11.0	---	---
10	5.04	-8.17	-0.20	12.0	12.6	11.7	14.3	11.9	13.5	---	---

**Table A.144. Stiffness and strength summary of Edwards till, strip 6, 1 roller pass**

Test point	Clegg Impact Test			Geogauge		DCP	FWD: E (MPa)			
	CIV <sup>1</sup>	CIV <sup>2</sup>	CIV	M	S	DCPI	1	2	3	4
1	10.9	11.3	11.1	65.63	8.85	57	19.6	74.1	65.3	137.4
2	5.2	5.6	5.4	45.33	6.11	79	25.7	27.4	24.8	22.7
3	6.1	6.1	6.1	31.85	4.30	77	20.9	35.8	29.8	25.2
4	5.1	5.3	5.2	38.01	5.13	73	30.5	73.3	50.0	44.3
5	8.7	8.7	8.7	50.33	6.79	61	8.4	12.5	13.3	14.6
6	6.3	7.6	7.0	47.33	6.38	65	164.3	118.0	85.7	44.1
7	6.7	7.2	7.0	35.87	4.84	70	56.2	217.0	456.6	395.1
8	5.1	4.8	5.0	40.80	5.50	87	5.3	12.5	14.4	14.9
9	7.6	7.0	7.3	32.73	4.41	89	8.4	10.6	13.5	15.8
10	7.1	6.9	7.0	46.31	6.25	50	21.8	115.6	125.5	115.2

**Table A.145. Moisture and density summary of Edwards till, strip 6, 2 roller passes**

Test point	Coordinates (m)			Nuclear gauge (kN/m <sup>3</sup> , %)						Drive core (kN/m <sup>3</sup> , %)	
	X	Y	Z	$\gamma_d^1$	$w_g^1$	$\gamma_d^2$	$w_g^2$	$\gamma_d$	$w_g$	$\gamma_d$	$w_g$
1	4.43	4.99	-0.26	12.3	12.6	12.4	13.9	12.4	13.3	---	---
2	4.56	3.73	-0.26	13.6	11.5	13.9	10.6	13.7	11.1	---	---
3	4.54	2.23	-0.27	13.6	10.5	14.1	10.1	13.9	10.3	---	---
4	4.58	0.69	-0.29	14.3	10.5	14.2	11.0	14.2	10.8	---	---
5	4.73	-0.83	-0.31	14.1	10.7	13.9	10.7	14.0	10.7	---	---
6	4.81	-2.45	-0.28	13.9	11.2	13.8	10.6	13.8	10.9	---	---
7	4.91	-4.05	-0.27	14.1	9.5	14.5	10.1	14.3	9.8	---	---
8	5.01	-5.64	-0.22	13.9	11.0	14.2	11.8	14.1	11.4	---	---
9	5.10	-7.08	-0.21	14.1	10.5	13.9	11.1	14.0	10.8	---	---
10	5.17	-8.29	-0.19	14.4	11.2	15.3	9.3	14.9	10.3	---	---

**Table A.146. Stiffness and strength summary of Edwards till, strip 6, 2 roller passes**

Test point	Clegg Impact Test			Geogauge		DCP	FWD: E (MPa)			
	CIV <sup>1</sup>	CIV <sup>2</sup>	CIV	M	S	DCPI	1	2	3	4
1	6.6	7.2	6.9	64.29	8.67	60	24.5	35.0	30.5	26.9
2	5.4	5.2	5.3	48.23	6.50	71	52.1	76.9	59.8	39.6
3	5.8	5.6	5.7	40.85	5.51	70	12.2	13.5	17.7	18.6
4	6.4	6.8	6.6	51.71	6.97	55	37.3	29.5	26.4	25.2
5	5.9	7.0	6.5	45.88	6.19	61	39.4	42.9	36.8	32.6
6	6.5	5.9	6.2	46.91	6.33	38	12.8	20.9	23.0	24.4
7	7.6	6.3	7.0	93.31	12.58	67	23.5	27.6	29.1	32.7
8	8.6	7.4	8.0	41.51	5.60	83	---	---	---	---
9	8.0	8.3	8.2	43.75	5.90	72	50.9	42.2	41.4	37.5
10	7.7	6.9	7.3	67.66	9.12	55	60.2	53.8	48.2	42.7

**Table A.147. Moisture and density summary of Edwards till, strip 6, 4 roller passes**

Test point	Coordinates (m)			Nuclear gauge (kN/m <sup>3</sup> , %)						Drive core (kN/m <sup>3</sup> , %)	
	X	Y	Z	$\gamma_d^1$	$w_g^1$	$\gamma_d^2$	$w_g^2$	$\gamma_d$	$w_g$	$\gamma_d$	$w_g$
1	4.53	5.48	-0.24	14.8	10.5	14.2	11.9	14.5	11.2	---	---
2	4.71	4.06	-0.26	15.6	10.8	15.0	11.0	15.3	10.9	---	---
3	4.84	2.69	-0.25	14.8	8.6	14.8	9.4	14.8	9.0	---	---
4	4.76	1.02	-0.28	14.8	9.7	14.9	9.4	14.9	9.6	---	---
5	4.72	-0.49	-0.30	14.0	9.7	14.5	10.1	14.3	9.9	---	---
6	4.85	-2.09	-0.30	14.9	9.5	14.9	9.2	14.9	9.4	---	---
7	5.03	-3.71	-0.27	14.9	9.6	15.4	9.0	15.2	9.3	---	---
8	5.08	-5.01	-0.25	15.6	9.0	15.7	9.8	15.6	9.4	---	---
9	5.18	-6.61	-0.20	16.3	8.8	15.4	9.4	15.9	9.1	---	---
10	5.52	-7.91	-0.19	13.6	10.1	13.6	11.2	13.6	10.7	---	---

**Table A.148. Stiffness and strength summary of Edwards till, strip 6, 4 roller passes**

Test point	Clegg Impact Test			Geogauge		DCP	FWD: E (MPa)			
	CIV <sup>1</sup>	CIV <sup>2</sup>	CIV	M	S	DCPI	1	2	3	4
1	9.6	10.6	10.1	80.27	10.83	52	15.9	173.3	152.1	127.0
2	9.0	7.7	8.4	54.89	7.40	28	87.7	64.3	51.7	38.3
3	6.3	7.1	6.7	52.01	7.07	53	56.5	41.0	37.4	32.9
4	9.6	8.0	8.8	58.24	7.85	48	59.9	75.2	---	44.5
5	11.4	8.5	10.0	64.43	8.69	21	92.7	91.1	83.7	59.8
6	8.5	6.4	7.5	85.39	11.52	44	46.9	56.0	---	38.4
7	8.0	8.9	8.5	59.03	7.96	46	26.1	80.1	102.9	90.2
8	10.8	7.9	9.4	66.97	9.03	19	34.2	29.5	---	31.5
9	12.9	7.8	10.4	61.24	8.26	20	---	---	---	---
10	7.2	9.2	8.2	66.38	8.95	41	83.8	71.5	53.5	48.1



**Table A.149. Moisture and density summary of Edwards till, strip 6, 8 roller passes**

Test point	Coordinates (m)			Nuclear gauge (kN/m <sup>3</sup> , %)						Drive core (kN/m <sup>3</sup> , %)	
	X	Y	Z	$\gamma_d^1$	$w_g^1$	$\gamma_d^2$	$w_g^2$	$\gamma_d$	$w_g$	$\gamma_d$	$w_g$
1	4.62	5.00	-0.24	13.7	13.3	13.5	11.4	13.6	12.4	14.9	10.2
2	4.93	3.71	-0.22	15.3	11.1	15.6	10.3	15.5	10.7	16.2	11.9
3	4.86	2.05	-0.25	14.5	9.6	15.4	10.9	14.9	10.3	16.0	10.6
4	4.84	0.56	-0.28	16.5	10.0	16.9	10.9	16.7	10.5	16.9	10.4
5	4.84	-1.04	-0.31	16.0	8.6	16.1	9.9	16.0	9.3	16.7	10.0
6	4.91	-2.57	-0.28	15.8	11.4	16.6	10.3	16.2	10.9	16.4	10.0
7	4.82	-4.04	-0.27	16.2	9.9	15.4	10.4	15.8	10.2	16.8	9.7
8	5.02	-5.61	-0.22	15.8	9.9	15.9	9.4	15.9	9.7	---	---
9	5.08	-6.95	-0.20	16.4	9.4	16.5	9.6	16.5	9.5	16.2	9.8
10	5.41	-8.13	-0.19	13.1	11.2	12.9	11.7	13.0	11.5	15.9	9.6

**Table A.150. Stiffness and strength summary of Edwards till, strip 6, 8 roller passes**

Test point	Clegg Impact Test			Geogauge		DCP	FWD: E (MPa)			
	CIV <sup>1</sup>	CIV <sup>2</sup>	CIV	M	S	DCPI	1	2	3	4
1	9.0	14.2	11.6	71.65	9.66	22	166.4	166.3	145.3	121.7
2	10.9	8.3	9.6	83.49	11.26	43	52.8	75.8	---	53.5
3	9.9	8.7	9.3	62.57	8.44	30	92.4	102.2	92.1	79.9
4	8.1	8.7	8.4	90.81	12.25	24	95.9	103.5	83.8	68.0
5	9.2	12.5	10.9	80.53	10.86	35	76.6	82.5	81.8	84.7
6	10.3	13.3	11.8	64.40	8.68	35	173.6	172.7	152.3	130.6
7	12.1	13.8	13.0	89.99	12.14	39	112.9	140.3	133.0	123.5
8	12.5	12.2	12.4	64.85	8.75	39	111.0	102.7	88.0	66.5
9	13.8	10.6	12.2	62.88	8.48	30	173.4	137.0	125.1	108.0
10	8.6	7.9	8.3	50.17	6.77	43	248.1	228.9	208.1	181.0

**Table A.151. Moisture and density summary of Kickapoo sand, strip 1, 0 roller passes**

Test point	Coordinates (m)			Nuclear gauge (kN/m <sup>3</sup> , %)						Drive core (kN/m <sup>3</sup> , %)	
	X	Y	Z	$\gamma_d^1$	$w_g^1$	$\gamma_d^2$	$w_g^2$	$\gamma_d$	$w_g$	$\gamma_d$	$w_g$
1	-5.45	5.80	0.04	16.3	6.3	15.8	6.0	16.0	6.2	---	---
2	-5.36	4.36	0.03	16.1	5.0	16.5	5.4	16.3	5.2	---	---
3	-5.31	2.86	0.03	16.2	5.8	15.9	6.6	16.1	6.2	---	---
4	-5.24	1.47	0.00	15.9	4.6	16.0	4.7	16.0	4.7	---	---
5	-5.11	-0.15	0.00	15.8	5.8	15.9	5.5	15.8	5.7	---	---
6	-4.94	-1.48	-0.01	16.3	4.6	15.9	6.1	16.1	5.4	---	---
7	-4.89	-3.01	-0.02	15.6	5.2	15.7	4.6	15.7	4.9	---	---
8	-4.79	-4.60	0.00	16.2	4.9	16.1	5.3	16.2	5.1	---	---
9	-4.79	-5.96	0.01	15.9	5.0	15.8	5.3	15.9	5.2	---	---
10	-4.61	-7.57	0.04	15.6	5.0	15.6	5.0	15.6	5.0	---	---

**Table A.152. Stiffness and strength summary of Kickapoo sand, strip 1, 0 roller passes**

Test point	Clegg Impact Test			Geogauge		DCP	FWD: E (MPa)			
	CIV <sup>1</sup>	CIV <sup>2</sup>	CIV	M	S	DCPI	1	2	3	4
1	---	---	---	12.31	1.66	91	5.7	12.7	15.1	15.4
2	---	---	---	9.55	1.29	220	2.7	6.9	6.9	13.0
3	---	---	---	11.23	1.51	234	2.8	5.8	9.2	11.0
4	---	---	---	9.66	1.30	224	3.3	6.4	9.3	10.3
5	---	---	---	10.00	1.35	213	3.1	5.0	6.6	8.6
6	---	---	---	11.70	1.58	221	2.9	5.9	10.1	13.4
7	---	---	---	8.74	1.18	188	2.9	5.3	9.2	13.1
8	---	---	---	10.79	1.46	196	6.3	8.2	10.3	---
9	---	---	---	13.69	1.85	183	2.8	5.4	9.9	14.5
10	---	---	---	13.65	1.84	156	4.2	8.7	14.4	19.2

**Table A.153. Moisture and density summary of Kickapoo sand, strip 1, 1 roller pass**

Test point	Coordinates (m)			Nuclear gauge (kN/m <sup>3</sup> , %)						Drive core (kN/m <sup>3</sup> , %)	
	X	Y	Z	$\gamma_d^1$	$w_g^1$	$\gamma_d^2$	$w_g^2$	$\gamma_d$	$w_g$	$\gamma_d$	$w_g$
1	-5.44	5.80	-0.06	15.8	8.4	15.5	8.5	15.7	8.5	---	---
2	-5.26	3.93	-0.07	15.8	8.2	15.6	7.2	15.7	7.7	---	---
3	-5.13	2.64	-0.08	15.7	6.8	15.0	8.5	15.3	7.7	---	---
4	-5.01	1.05	-0.10	15.4	8.1	15.5	7.8	15.5	8.0	---	---
5	-5.04	-0.31	-0.10	15.2	8.8	15.3	7.8	15.3	8.3	---	---
6	-4.95	-1.29	-0.09	15.5	8.4	15.3	8.2	15.4	8.3	---	---
7	-4.80	-2.56	-0.08	15.6	7.6	15.0	8.2	15.3	7.9	---	---
8	-4.84	-4.33	-0.10	15.7	6.9	15.3	8.2	15.5	7.6	---	---
9	-4.73	-5.98	-0.08	15.1	9.8	15.2	8.8	15.2	9.3	---	---
10	-4.82	-7.19	-0.08	15.4	8.6	15.5	7.8	15.5	8.2	---	---

**Table A.154. Stiffness and strength summary of Kickapoo sand, strip 1, 1 roller pass**

Test point	Clegg Impact Test			Geogauge		DCP	FWD: E (MPa)			
	CIV <sup>1</sup>	CIV <sup>2</sup>	CIV	M	S	DCPI	1	2	3	4
1	---	---	---	13.12	1.77	150	5.1	19.0	28.1	34.0
2	---	---	---	25.33	3.42	150	4.6	17.8	27.1	34.4
3	---	---	---	36.72	4.95	125	4.5	15.9	26.1	31.9
4	---	---	---	27.41	3.70	132	1.6	11.2	30.0	38.7
5	---	---	---	17.80	2.40	156	3.2	17.0	27.2	33.7
6	---	---	---	33.74	4.55	120	6.5	21.7	30.1	35.7
7	---	---	---	34.31	4.63	137	---	---	---	---
8	---	---	---	34.20	4.61	125	3.1	15.4	24.8	32.7
9	---	---	---	27.16	3.66	121	4.0	23.8	35.6	43.5
10	---	---	---	40.60	5.48	73	9.0	41.6	61.1	69.1

**Table A.155. Moisture and density summary of Kickapoo sand, strip 1, 2 roller passes**

Test point	Coordinates (m)			Nuclear gauge (kN/m <sup>3</sup> , %)						Drive core (kN/m <sup>3</sup> , %)	
	X	Y	Z	$\gamma_d^1$	$w_g^1$	$\gamma_d^2$	$w_g^2$	$\gamma_d$	$w_g$	$\gamma_d$	$w_g$
1	-5.63	5.46	-0.04	16.5	6.7	16.2	6.5	16.3	6.6	---	---
2	-5.36	3.47	-0.05	16.4	5.5	16.6	5.4	16.5	5.5	---	---
3	-5.30	2.20	-0.06	15.6	6.5	16.4	6.3	16.0	6.4	---	---
4	-5.22	0.76	-0.08	15.8	6.8	15.7	7.6	15.7	7.2	---	---
5	-5.16	-0.77	-0.08	16.6	5.9	16.2	6.6	16.4	6.3	---	---
6	-5.11	-2.14	-0.09	16.5	6.7	16.1	7.4	16.3	7.1	---	---
7	-5.07	-3.82	-0.08	16.2	6.7	15.6	6.8	15.9	6.8	---	---
8	-5.04	-5.02	-0.10	16.5	5.6	16.0	7.1	16.3	6.4	---	---
9	-4.91	-6.64	-0.08	16.3	6.7	16.2	7.3	16.3	7.0	---	---
10	-5.02	-7.87	-0.09	17.2	7.0	17.4	7.2	17.3	7.1	---	---

**Table A.156. Stiffness and strength summary of Kickapoo sand, strip 1, 2 roller passes**

Test point	Clegg Impact Test			Geogauge		DCP	FWD: E (MPa)				
	CIV <sup>1</sup>	CIV <sup>2</sup>	CIV	M	S	DCPI	1	2	3	4	
1	---	---	---	---	---	---	---	---	---	---	---
2	---	---	---	---	---	---	---	---	---	---	---
3	---	---	---	---	---	---	---	---	---	---	---
4	---	---	---	---	---	---	---	---	---	---	---
5	---	---	---	---	---	---	---	---	---	---	---
6	---	---	---	---	---	---	---	---	---	---	---
7	---	---	---	---	---	---	---	---	---	---	---
8	---	---	---	---	---	---	---	---	---	---	---
9	---	---	---	---	---	---	---	---	---	---	---
10	---	---	---	---	---	---	---	---	---	---	---

**Table A.157. Moisture and density summary of Kickapoo sand, strip 1, 4 roller passes**

Test point	Coordinates (m)			Nuclear gauge (kN/m <sup>3</sup> , %)						Drive core (kN/m <sup>3</sup> , %)	
	X	Y	Z	$\gamma_d^1$	$w_g^1$	$\gamma_d^2$	$w_g^2$	$\gamma_d$	$w_g$	$\gamma_d$	$w_g$
1	-5.49	6.18	-0.04	16.7	7.6	16.4	7.7	16.5	7.7	---	---
2	-5.37	4.48	-0.05	16.2	8.3	16.7	7.6	16.4	8.0	---	---
3	-5.47	3.19	-0.06	16.5	6.4	15.9	7.6	16.2	7.0	---	---
4	-5.28	1.44	-0.09	15.9	7.0	15.8	8.0	15.8	7.5	---	---
5	-5.23	0.10	-0.09	17.0	6.6	16.6	6.8	16.8	6.7	---	---
6	-5.12	-1.58	-0.09	16.7	6.4	15.7	8.7	16.2	7.6	---	---
7	-5.15	-2.83	-0.11	16.0	7.3	16.6	6.5	16.3	6.9	---	---
8	-5.07	-4.31	-0.10	16.1	7.8	15.5	10.2	15.8	9.0	---	---
9	-5.02	-5.73	-0.11	16.2	7.9	15.8	8.2	16.0	8.1	---	---
10	-4.99	-7.33	-0.10	14.3	10.1	12.8	9.5	13.5	9.8	---	---

**Table A.158. Stiffness and strength summary of Kickapoo sand, strip 1, 4 roller passes**

Test point	Clegg Impact Test			Geogauge		DCP	FWD: E (MPa)			
	CIV <sup>1</sup>	CIV <sup>2</sup>	CIV	M	S	DCPI	1	2	3	4
1	---	---	---	17.82	2.40	160	15.1	14.9	19.0	23.6
2	---	---	---	17.45	2.35	152	4.2	17.8	28.2	35.9
3	---	---	---	19.68	2.65	150	3.7	14.0	21.9	28.2
4	---	---	---	29.51	3.98	150	7.2	51.0	58.1	53.5
5	---	---	---	---	---	156	3.6	14.0	23.6	30.5
6	---	---	---	---	---	119	3.3	20.0	29.5	36.2
7	---	---	---	---	---	111	7.8	24.9	35.5	43.3
8	---	---	---	---	---	136	4.0	20.5	31.6	39.0
9	---	---	---	---	---	109	6.2	29.4	41.1	48.4
10	---	---	---	---	---	78	11.2	87.8	102.9	101.3

**Table A.159. Moisture and density summary of Kickapoo sand, strip 1, 8 roller passes**

Test point	Coordinates (m)			Nuclear gauge (kN/m <sup>3</sup> , %)						Drive core (kN/m <sup>3</sup> , %)	
	X	Y	Z	$\gamma_d^1$	$w_g^1$	$\gamma_d^2$	$w_g^2$	$\gamma_d$	$w_g$	$\gamma_d$	$w_g$
1	-5.42	5.73	-0.12	16.9	6.7	17.0	7.2	17.0	7.0	---	---
2	-5.49	4.10	-0.12	17.0	7.0	16.9	6.5	17.0	6.8	---	---
3	-5.38	2.84	-0.12	16.7	5.9	16.7	6.7	16.7	6.3	---	---
4	-5.34	1.16	-0.15	16.6	6.4	16.4	7.6	16.5	7.0	---	---
5	-5.40	-0.40	-0.15	17.1	6.1	16.6	7.4	16.8	6.8	---	---
6	-5.44	-2.08	-0.19	16.7	6.8	16.3	7.7	16.5	7.3	---	---
7	-5.25	-3.83	-0.19	16.4	7.5	16.3	6.8	16.3	7.2	---	---
8	-5.13	-5.18	-0.15	16.9	5.8	16.5	7.1	16.7	6.5	---	---
9	-5.10	-6.87	-0.16	16.3	6.4	16.3	6.5	16.3	6.5	---	---
10	-4.99	-8.28	-0.17	16.4	6.8	16.4	8.2	16.4	7.5	---	---

**Table A.160. Stiffness and strength summary of Kickapoo sand, strip 1, 8 roller passes**

Test point	Clegg Impact Test			Geogauge		DCP	FWD: E (MPa)			
	CIV <sup>1</sup>	CIV <sup>2</sup>	CIV	M	S	DCPI	1	2	3	4
1	---	---	---	20.25	2.73	136	4.5	22.7	32.8	40.4
2	---	---	---	15.60	2.10	112	3.8	16.1	24.6	31.5
3	---	---	---	30.81	4.16	110	3.4	23.4	35.2	44.0
4	---	---	---	24.63	3.32	128	2.7	18.7	33.6	43.5
5	---	---	---	18.58	2.51	136	19.2	19.1	23.8	29.6
6	---	---	---	29.26	3.95	131	50.1	33.6	43.8	53.1
7	---	---	---	34.08	4.60	119	2.8	19.2	32.9	42.5
8	---	---	---	19.64	2.65	143	3.0	19.2	28.9	35.5
9	---	---	---	24.05	3.24	124	3.4	18.9	29.7	36.6
10	---	---	---	37.29	5.03	93	3.2	26.7	42.6	52.8

**Table A.161. Moisture and density summary of Kickapoo sand, strip 2, 0 roller passes**

Test point	Coordinates (m)			Nuclear gauge (kN/m <sup>3</sup> , %)						Drive core (kN/m <sup>3</sup> , %)	
	X	Y	Z	$\gamma_d^1$	$w_g^1$	$\gamma_d^2$	$w_g^2$	$\gamma_d$	$w_g$	$\gamma_d$	$w_g$
1	-5.88	5.94	0.15	14.6	4.1	14.7	4.5	14.6	4.3	---	---
2	-5.90	4.47	0.11	14.8	5.3	15.3	4.7	15.0	5.0	---	---
3	-5.91	2.92	0.11	15.4	5.4	15.5	5.3	15.4	5.4	---	---
4	-6.01	1.36	0.10	16.2	5.1	16.2	5.0	16.2	5.1	---	---
5	-5.69	-0.20	0.11	15.6	5.6	15.8	5.1	15.7	5.4	---	---
6	-5.60	-1.73	0.13	15.6	5.0	15.2	6.6	15.4	5.8	---	---
7	-5.57	-3.25	0.12	15.7	4.4	15.3	5.2	15.5	4.8	---	---
8	-5.42	-4.75	0.11	15.8	4.2	15.3	5.0	15.5	4.6	---	---
9	-5.32	-6.18	0.10	15.7	4.6	15.9	3.7	15.8	4.2	---	---
10	-5.14	-7.75	0.09	15.9	4.9	16.0	57.0	16.0	31.0	---	---

**Table A.162. Stiffness and strength summary of Kickapoo sand, strip 2, 0 roller passes**

Test point	Clegg Impact Test			Geogauge		DCP	FWD: E (MPa)			
	CIV <sup>1</sup>	CIV <sup>2</sup>	CIV	M	S	DCPI	1	2	3	4
1	---	---	---	12.69	1.71	280	2.8	5.7	6.8	8.8
2	---	---	---	16.07	2.17	154	5.4	4.9	7.8	6.7
3	---	---	---	13.98	1.89	173	2.7	4.6	6.3	8.1
4	---	---	---	13.64	1.84	215	4.1	7.2	9.4	11.1
5	---	---	---	10.96	1.48	225	6.1	5.7	6.8	9.1
6	---	---	---	11.14	1.50	221	6.0	5.9	6.9	8.8
7	---	---	---	10.81	1.46	267	5.5	5.7	7.2	10.0
8	---	---	---	10.37	1.40	232	10.3	7.4	7.4	8.9
9	---	---	---	10.23	1.38	263	6.0	5.9	7.2	9.3
10	---	---	---	10.65	1.44	220	3.1	10.4	10.8	12.3

**Table A.163. Moisture and density summary of Kickapoo sand, strip 2, 1 roller pass**

Test point	Coordinates (m)			Nuclear gauge (kN/m <sup>3</sup> , %)						Drive core (kN/m <sup>3</sup> , %)	
	X	Y	Z	$\gamma_d^1$	$w_g^1$	$\gamma_d^2$	$w_g^2$	$\gamma_d$	$w_g$	$\gamma_d$	$w_g$
1	-5.57	6.34	0.02	15.7	7.7	15.6	8.8	15.7	8.3	---	---
2	-5.67	4.55	0.01	16.1	8.5	16.1	8.6	16.1	8.6	---	---
3	-5.49	2.90	0.02	15.9	8.0	16.0	7.0	15.9	7.5	---	---
4	-5.10	1.32	0.00	16.3	7.1	16.5	5.9	16.4	6.5	---	---
5	-5.27	-0.07	-0.01	16.4	7.7	16.1	8.2	16.3	8.0	---	---
6	-5.24	-1.83	0.02	16.6	7.5	16.5	7.9	16.5	7.7	---	---
7	-5.13	-3.21	0.02	16.4	7.8	16.4	9.1	16.4	8.5	---	---
8	-5.01	-4.85	0.01	16.6	6.8	16.4	8.6	16.5	7.7	---	---
9	-5.01	-6.15	0.00	15.7	8.8	16.3	7.3	16.0	8.1	---	---
10	-5.06	-7.59	0.00	15.8	8.4	16.0	7.1	15.9	7.8	---	---

**Table A.164. Stiffness and strength summary of Kickapoo sand, strip 2, 1 roller pass**

Test point	Clegg Impact Test			Geogauge		DCP	FWD: E (MPa)			
	CIV <sup>1</sup>	CIV <sup>2</sup>	CIV	M	S	DCPI	1	2	3	4
1	---	---	---	12.85	1.73	80	3.4	8.6	12.1	14.8
2	---	---	---	18.18	2.45	69	5.4	10.0	13.2	15.6
3	---	---	---	12.43	1.68	74	4.0	9.9	15.4	18.8
4	---	---	---	11.87	1.60	57	5.4	12.2	17.4	20.8
5	---	---	---	14.11	1.90	57	5.5	18.1	22.8	26.5
6	---	---	---	11.35	1.53	73	2.9	12.5	18.7	23.3
7	---	---	---	11.33	1.53	58	3.1	11.5	17.1	21.4
8	---	---	---	12.66	1.71	70	3.4	14.1	21.1	25.8
9	---	---	---	12.51	1.69	69	5.2	19.8	26.3	30.1
10	---	---	---	16.03	2.16	52	7.6	26.0	34.0	38.5



**Table A.165. Moisture and density summary of Kickapoo sand, strip 2, 2 roller passes**

Test point	Coordinates (m)			Nuclear gauge (kN/m <sup>3</sup> , %)						Drive core (kN/m <sup>3</sup> , %)	
	X	Y	Z	$\gamma_d^1$	$w_g^1$	$\gamma_d^2$	$w_g^2$	$\gamma_d$	$w_g$	$\gamma_d$	$w_g$
1	-5.87	5.90	0.05	16.9	6.7	16.7	6.2	16.8	6.5	---	---
2	-5.78	4.20	0.04	16.1	7.3	16.7	6.1	16.4	6.7	---	---
3	-5.69	2.70	0.04	16.8	6.0	16.7	7.1	16.7	6.6	---	---
4	-5.48	1.23	0.03	16.7	5.9	16.5	6.4	16.6	6.2	---	---
5	-5.31	-0.21	0.00	16.2	7.2	16.6	7.0	16.4	7.1	---	---
6	-5.27	-2.03	0.02	16.6	6.6	17.0	7.0	16.8	6.8	---	---
7	-5.26	-3.18	0.01	16.4	8.0	16.6	7.0	16.5	7.5	---	---
8	-5.22	-4.76	0.01	16.5	7.2	16.5	6.9	16.5	7.1	---	---
9	-5.22	-6.38	0.01	16.3	7.9	16.5	7.5	16.4	7.7	---	---
10	-5.14	-7.95	-0.01	15.6	9.5	15.9	7.9	15.8	8.7	---	---

**Table A.166. Stiffness and strength summary of Kickapoo sand, strip 2, 2 roller passes**

Test point	Clegg Impact Test			Geogauge		DCP	FWD: E (MPa)			
	CIV <sup>1</sup>	CIV <sup>2</sup>	CIV	M	S	DCPI	1	2	3	4
1	---	---	---	16.14	2.18	156	11.8	11.0	13.5	16.3
2	---	---	---	23.96	3.23	165	11.6	14.8	14.3	17.1
3	---	---	---	13.23	1.78	142	2.7	9.2	13.5	17.3
4	---	---	---	10.22	1.38	152	13.7	12.4	15.1	18.5
5	---	---	---	14.54	1.96	166	4.1	15.3	19.9	23.5
6	---	---	---	15.93	2.15	151	24.8	20.0	20.9	24.1
7	---	---	---	13.03	1.76	176	5.6	16.2	21.8	26.5
8	---	---	---	11.46	1.54	157	3.2	10.6	16.4	21.4
9	---	---	---	12.39	1.67	169	3.2	10.6	16.8	22.0
10	---	---	---	15.13	2.04	147	10.3	27.0	32.1	36.2

**Table A.167. Moisture and density summary of Kickapoo sand, strip 2, 4 roller passes**

Test point	Coordinates (m)			Nuclear gauge (kN/m <sup>3</sup> , %)						Drive core (kN/m <sup>3</sup> , %)	
	X	Y	Z	$\gamma_d^1$	$w_g^1$	$\gamma_d^2$	$w_g^2$	$\gamma_d$	$w_g$	$\gamma_d$	$w_g$
1	-5.77	5.88	0.02	17.0	7.1	16.8	7.2	16.9	7.2	---	---
2	-5.64	4.40	0.02	16.8	6.7	16.7	6.1	16.7	6.4	---	---
3	-5.79	2.87	0.02	16.9	6.7	16.6	7.2	16.8	7.0	---	---
4	-5.74	1.34	0.02	16.7	6.7	16.6	6.5	16.6	6.6	---	---
5	-5.68	-0.29	0.02	16.7	7.9	16.6	7.1	16.7	7.5	---	---
6	-5.50	-2.02	0.03	16.7	7.9	16.7	8.3	16.7	8.1	---	---
7	-5.46	-3.45	0.01	17.2	7.2	17.0	7.5	17.1	7.4	---	---
8	-5.33	-4.79	0.00	16.9	7.8	16.9	7.7	16.9	7.8	---	---
9	-5.42	-6.53	0.00	17.0	6.8	17.2	6.8	17.1	6.8	---	---
10	-5.34	-7.96	0.00	16.6	6.8	16.5	7.5	16.6	7.2	---	---

**Table A.168. Stiffness and strength summary of Kickapoo sand, strip 2, 4 roller passes**

Test point	Clegg Impact Test			Geogauge		DCP	FWD: E (MPa)			
	CIV <sup>1</sup>	CIV <sup>2</sup>	CIV	M	S	DCPI	1	2	3	4
1	---	---	---	14.89	2.01	128	4.0	11.2	16.1	20.1
2	---	---	---	22.31	3.01	102	4.4	12.5	16.0	18.6
3	---	---	---	13.44	1.81	145	3.7	15.6	22.3	26.1
4	---	---	---	13.62	1.84	153	2.7	9.9	16.2	20.8
5	---	---	---	15.55	2.10	160	7.1	16.9	21.8	25.8
6	---	---	---	13.83	1.87	159	6.2	15.7	22.4	26.3
7	---	---	---	14.23	1.92	137	3.5	14.9	20.7	25.2
8	---	---	---	13.78	1.86	128	6.2	21.3	27.6	32.9
9	---	---	---	12.79	1.73	144	4.5	23.5	30.1	35.7
10	---	---	---	17.04	2.30	142	3.1	13.0	20.9	27.6

**Table A.169. Moisture and density summary of Kickapoo sand, strip 2, 8 roller passes**

Test point	Coordinates (m)			Nuclear gauge (kN/m <sup>3</sup> , %)						Drive core (kN/m <sup>3</sup> , %)	
	X	Y	Z	$\gamma_d^1$	$w_g^1$	$\gamma_d^2$	$w_g^2$	$\gamma_d$	$w_g$	$\gamma_d$	$w_g$
1	-6.02	5.78	0.03	17.1	6.3	17.6	5.3	17.4	5.8	---	---
2	-6.02	4.14	0.03	17.0	5.7	16.9	5.7	16.9	5.7	---	---
3	-5.90	2.43	0.03	17.4	5.5	17.3	7.3	17.4	6.4	---	---
4	-5.73	1.24	0.02	16.7	6.9	16.7	7.3	16.7	7.1	---	---
5	-5.65	-0.15	0.02	17.1	6.0	17.2	6.2	17.2	6.1	---	---
6	-5.52	-1.70	0.03	17.1	6.3	16.9	6.7	17.0	6.5	---	---
7	-5.50	-3.13	0.02	17.0	6.9	16.6	7.7	16.8	7.3	---	---
8	-5.47	-4.59	0.01	17.1	7.3	16.9	7.0	17.0	7.2	---	---
9	-5.42	-6.13	0.00	16.7	7.8	17.2	5.4	16.9	6.6	---	---
10	-5.33	-8.27	0.00	17.2	5.6	17.5	5.4	17.4	5.5	---	---

**Table A.170. Stiffness and strength summary of Kickapoo sand, strip 2, 8 roller passes**

Test point	Clegg Impact Test			Geogauge		DCP	FWD: E (MPa)			
	CIV <sup>1</sup>	CIV <sup>2</sup>	CIV	M	S	DCPI	1	2	3	4
1	---	---	---	13.43	1.81	121	4.3	10.2	15.8	21.2
2	---	---	---	27.85	3.76	79	4.4	10.5	13.6	15.8
3	---	---	---	14.27	1.92	120	7.4	19.6	24.6	29.8
4	---	---	---	16.11	2.17	99	6.6	15.1	21.3	24.9
5	---	---	---	14.44	1.95	134	4.5	17.1	25.3	30.0
6	---	---	---	13.95	1.88	123	5.6	18.0	25.3	30.7
7	---	---	---	14.11	1.90	119	3.5	12.1	17.5	22.7
8	---	---	---	13.28	1.79	152	4.8	13.5	20.2	26.4
9	---	---	---	10.73	1.45	145	4.6	14.4	20.1	25.8
10	---	---	---	23.42	3.16	120	12.5	24.7	28.6	32.7

**Table A.171. Moisture and density summary of Kickapoo sand, strip 3, 0 roller passes**

Test point	Coordinates (m)			Nuclear gauge (kN/m <sup>3</sup> , %)						Drive core (kN/m <sup>3</sup> , %)	
	X	Y	Z	$\gamma_d^1$	$w_g^1$	$\gamma_d^2$	$w_g^2$	$\gamma_d$	$w_g$	$\gamma_d$	$w_g$
1	-5.66	6.07	0.09	15.1	8.1	15.4	8.3	15.2	8.2	---	---
2	-5.57	4.43	0.13	15.5	7.4	15.0	8.7	15.2	8.1	---	---
3	-5.47	2.95	0.14	15.1	8.7	15.2	9.8	15.2	9.3	---	---
4	-5.48	1.47	0.13	15.3	8.0	15.3	8.9	15.3	8.5	---	---
5	-5.31	-0.10	0.11	15.6	9.0	15.8	8.9	15.7	9.0	---	---
6	-5.29	-1.66	0.10	15.9	8.8	15.8	9.2	15.8	9.0	---	---
7	-5.24	-3.24	0.11	15.3	6.8	15.2	8.8	15.2	7.8	---	---
8	-5.24	-4.65	0.14	15.0	7.1	15.1	7.9	15.1	7.5	---	---
9	-5.15	-6.23	0.12	15.1	6.3	14.8	7.8	15.0	7.1	---	---
10	-5.07	-7.69	0.12	14.2	6.8	14.1	7.7	14.2	7.3	---	---

**Table A.172. Stiffness and strength summary of Kickapoo sand, strip 3, 0 roller passes**

Test point	Clegg Impact Test			Geogauge		DCP	FWD: E (MPa)			
	CIV <sup>1</sup>	CIV <sup>2</sup>	CIV	M	S	DCPI	1	2	3	4
1	---	---	---	14.01	1.89	370	7.8	5.7	5.6	---
2	---	---	---	12.06	1.63	422	3.1	4.5	6.8	---
3	---	---	---	13.72	1.85	398	2.7	4.7	6.3	10.6
4	---	---	---	15.76	2.12	401	---	---	---	---
5	---	---	---	14.44	1.95	400	---	---	---	---
6	---	---	---	14.11	1.90	424	---	---	---	---
7	---	---	---	14.19	1.91	421	---	---	---	---
8	---	---	---	12.70	1.71	396	---	---	---	---
9	---	---	---	11.32	1.53	436	---	---	---	---
10	---	---	---	12.92	1.74	380	---	---	---	---

**Table A.173. Moisture and density summary of Kickapoo sand, strip 3, 1 roller pass**

Test point	Coordinates (m)			Nuclear gauge (kN/m <sup>3</sup> , %)						Drive core (kN/m <sup>3</sup> , %)	
	X	Y	Z	$\gamma_d^1$	$w_g^1$	$\gamma_d^2$	$w_g^2$	$\gamma_d$	$w_g$	$\gamma_d$	$w_g$
1	-5.37	5.91	-0.03	16.8	10.9	16.8	10.7	16.8	10.8	---	---
2	-5.33	4.24	0.01	17.0	10.3	16.6	10.7	16.8	10.5	---	---
3	-5.29	2.84	0.01	16.6	10.6	16.9	10.5	16.8	10.6	---	---
4	-5.26	1.19	0.00	16.8	10.9	16.7	10.8	16.8	10.9	---	---
5	-5.23	-0.18	-0.01	16.7	11.0	16.1	11.9	16.4	11.5	---	---
6	-5.19	-1.84	-0.02	16.6	12.0	16.5	11.6	16.6	11.8	---	---
7	-5.15	-3.50	-0.01	16.3	9.7	16.1	11.2	16.2	10.5	---	---
8	-5.10	-4.86	0.01	16.2	11.8	16.5	10.5	16.4	11.2	---	---
9	-5.04	-6.22	-0.01	16.0	9.3	15.7	10.3	15.9	9.8	---	---
10	-4.97	-7.89	-0.02	16.0	9.1	16.1	9.4	16.1	9.3	---	---

**Table A.174. Stiffness and strength summary of Kickapoo sand, strip 3, 1 roller pass**

Test point	Clegg Impact Test			Geogauge		DCP	FWD: E (MPa)			
	CIV <sup>1</sup>	CIV <sup>2</sup>	CIV	M	S	DCPI	1	2	3	4
1	---	---	---	19.35	2.61	135	5.1	9.4	12.8	15.4
2	---	---	---	22.96	3.10	123	4.0	8.1	10.4	12.3
3	---	---	---	21.67	2.92	120	17.3	21.1	14.6	13.6
4	---	---	---	21.13	2.85	99	4.3	8.8	12.5	14.9
5	---	---	---	19.40	2.62	125	17.6	25.3	22.8	21.8
6	---	---	---	15.67	2.11	159	4.4	8.2	11.3	13.8
7	---	---	---	15.58	2.10	162	4.3	8.5	11.8	13.5
8	---	---	---	16.95	2.29	140	4.5	10.0	12.7	14.3
9	---	---	---	13.75	1.85	156	3.3	7.4	10.9	12.9
10	---	---	---	18.13	2.44	120	5.9	11.0	13.5	15.3

**Table A.175. Moisture and density summary of Kickapoo sand, strip 3, 2 roller passes**

Test point	Coordinates (m)			Nuclear gauge (kN/m <sup>3</sup> , %)						Drive core (kN/m <sup>3</sup> , %)	
	X	Y	Z	$\gamma_d^1$	$w_g^1$	$\gamma_d^2$	$w_g^2$	$\gamma_d$	$w_g$	$\gamma_d$	$w_g$
1	-5.37	5.83	-0.02	17.3	9.3	17.1	10.3	17.2	9.8	---	---
2	-5.36	4.11	0.01	17.4	9.3	17.7	9.1	17.6	9.2	---	---
3	-5.32	2.75	0.02	16.9	10.4	17.4	11.4	17.2	10.9	---	---
4	-5.31	1.40	0.01	17.2	8.7	17.5	10.1	17.3	9.4	---	---
5	-5.31	-0.30	-0.01	16.8	10.1	17.1	11.2	16.9	10.7	---	---
6	-5.28	-1.65	-0.02	16.7	12.3	16.7	13.6	16.7	13.0	---	---
7	-5.25	-3.32	-0.02	17.1	10.3	17.0	11.3	17.0	10.8	---	---
8	-5.23	-4.67	0.00	16.8	10.6	17.0	10.8	16.9	10.7	---	---
9	-5.20	-6.35	-0.01	16.0	10.5	16.6	10.9	16.3	10.7	---	---
10	-5.16	-7.73	-0.02	16.8	8.4	16.7	8.7	16.8	8.6	---	---

**Table A.176. Stiffness and strength summary of Kickapoo sand, strip 3, 2 roller passes**

Test point	Clegg Impact Test			Geogauge		DCP	FWD: E (MPa)			
	CIV <sup>1</sup>	CIV <sup>2</sup>	CIV	M	S	DCPI	1	2	3	4
1	---	---	---	20.18	2.72	111	5.4	12.6	17.2	20.3
2	---	---	---	20.26	2.73	105	7.1	12.7	16.0	18.3
3	---	---	---	26.07	3.52	79	6.6	12.5	14.9	16.6
4	---	---	---	23.57	3.18	90	5.9	9.5	12.7	14.6
5	---	---	---	19.35	2.61	90	4.9	9.5	13.1	16.1
6	---	---	---	15.98	2.15	106	3.7	9.0	12.4	15.0
7	---	---	---	16.06	2.17	119	9.0	8.7	10.3	12.6
8	---	---	---	19.15	2.58	107	3.1	7.8	11.3	14.2
9	---	---	---	17.05	2.30	111	3.7	9.4	13.4	15.8
10	---	---	---	20.04	2.70	83	10.1	18.5	20.9	22.6

**Table A.177. Moisture and density summary of Kickapoo sand, strip 3, 4 roller passes**

Test point	Coordinates (m)			Nuclear gauge (kN/m <sup>3</sup> , %)						Drive core (kN/m <sup>3</sup> , %)	
	X	Y	Z	$\gamma_d^1$	$w_g^1$	$\gamma_d^2$	$w_g^2$	$\gamma_d$	$w_g$	$\gamma_d$	$w_g$
1	-5.49	5.90	-0.03	17.3	12.1	17.1	11.7	17.2	11.9	---	---
2	-5.46	4.22	-0.01	17.2	10.4	18.1	10.2	17.7	10.3	---	---
3	-5.43	2.83	0.00	17.3	10.9	17.6	11.7	17.5	11.3	---	---
4	-5.39	1.15	0.00	17.9	9.8	17.9	10.3	17.9	10.1	---	---
5	-5.35	-0.21	-0.02	17.6	10.5	17.3	12.0	17.4	11.3	---	---
6	-5.26	-3.26	-0.02	17.3	11.4	17.6	11.6	17.5	11.5	---	---
7	-5.21	-4.64	-0.02	16.8	10.6	17.2	10.5	17.0	10.6	---	---
8	-5.11	-6.33	-0.02	17.2	11.0	17.0	10.6	17.1	10.8	---	---
9	-5.03	-7.70	-0.03	17.0	10.8	17.5	8.6	17.2	9.7	---	---
10	-4.96	-9.44	-0.02	16.6	10.2	17.0	10.1	16.8	10.2	---	---

**Table A.178. Stiffness and strength summary of Kickapoo sand, strip 3, 4 roller passes**

Test point	Clegg Impact Test			Geogauge		DCP	FWD: E (MPa)			
	CIV <sup>1</sup>	CIV <sup>2</sup>	CIV	M	S	DCPI	1	2	3	4
1	---	---	---	19.80	2.67	84	10.9	24.4	30.2	33.3
2	---	---	---	20.53	2.77	103	4.1	10.0	14.2	17.2
3	---	---	---	28.62	3.86	68	4.2	8.6	11.4	14.0
4	---	---	---	25.05	3.38	71	6.4	13.0	16.6	18.8
5	---	---	---	20.49	2.76	82	10.9	19.4	24.3	26.4
6	---	---	---	18.97	2.56	88	4.9	11.3	14.1	17.1
7	---	---	---	16.34	2.20	90	2.6	9.5	14.6	17.6
8	---	---	---	17.88	2.41	92	3.2	8.2	11.7	14.5
9	---	---	---	16.34	2.20	89	6.6	15.2	18.9	21.1
10	---	---	---	26.33	3.55	82	3.1	10.2	14.2	17.2

**Table A.179. Moisture and density summary of Kickapoo sand, strip 3, 8 roller passes**

Test point	Coordinates (m)			Nuclear gauge (kN/m <sup>3</sup> , %)						Drive core (kN/m <sup>3</sup> , %)	
	X	Y	Z	$\gamma_d^1$	$w_g^1$	$\gamma_d^2$	$w_g^2$	$\gamma_d$	$w_g$	$\gamma_d$	$w_g$
1	-5.26	6.13	-0.03	18.1	8.9	17.7	11.2	17.9	10.1	18.1	9.3
2	-5.19	4.36	0.00	17.8	10.1	17.6	10.6	17.7	10.4	18.0	8.7
3	-5.13	2.75	0.01	18.5	9.3	18.3	10.5	18.4	9.9	19.2	9.3
4	-5.07	1.38	0.00	18.2	10.1	18.3	10.6	18.3	10.4	18.4	9.3
5	-5.02	-0.30	-0.01	18.1	10.6	18.2	10.3	18.2	10.5	18.0	9.2
6	-4.97	-1.66	-0.03	18.2	10.4	17.8	10.8	18.0	10.6	17.9	9.6
7	-4.91	-3.32	-0.02	17.8	10.1	17.6	10.7	17.7	10.4	18.8	9.1
8	-4.84	-4.72	-0.01	17.8	9.5	17.9	9.1	17.9	9.3	16.9	8.6
9	-4.78	-6.05	-0.01	18.0	8.4	18.2	8.3	18.1	8.4	17.1	8.2
10	-4.74	-7.76	-0.02	17.4	8.6	17.1	9.0	17.2	8.8	17.2	7.7

**Table A.180. Stiffness and strength summary of Kickapoo sand, strip 3, 8 roller passes**

Test point	Clegg Impact Test			Geogauge		DCP	FWD: E (MPa)			
	CIV <sup>1</sup>	CIV <sup>2</sup>	CIV	M	S	DCPI	1	2	3	4
1	---	---	---	24.39	3.29	71	10.0	23.1	27.0	28.7
2	---	---	---	23.47	3.17	68	10.0	17.0	19.5	21.1
3	---	---	---	34.29	4.62	54	13.6	18.7	18.3	18.9
4	---	---	---	32.43	4.37	58	10.9	17.8	19.2	20.8
5	---	---	---	20.48	2.76	69	7.6	17.0	21.1	24.8
6	---	---	---	19.24	2.59	68	5.7	16.7	21.2	24.5
7	---	---	---	22.04	2.97	85	7.5	23.2	23.8	25.7
8	---	---	---	22.89	3.09	79	4.5	14.1	13.9	18.4
9	---	---	---	21.25	2.87	86	---	11.5	15.8	18.7
10	---	---	---	29.22	3.94	65	15.0	48.9	44.1	40.2



**Table A.181. Moisture and density summary of Kickapoo sand, strip 4, 0 roller passes**

Test point	Coordinates (m)			Nuclear gauge (kN/m <sup>3</sup> , %)						Drive core (kN/m <sup>3</sup> , %)	
	X	Y	Z	$\gamma_d^1$	$w_g^1$	$\gamma_d^2$	$w_g^2$	$\gamma_d$	$w_g$	$\gamma_d$	$w_g$
1	-5.61	6.02	-0.02	14.6	8.7	14.8	8.8	14.7	8.8	---	---
2	-5.51	4.38	-0.02	14.6	8.1	15.1	7.2	14.9	7.7	---	---
3	-5.55	2.86	-0.03	15.0	8.4	14.8	7.9	14.9	8.2	---	---
4	-5.49	1.40	-0.03	15.5	8.1	15.6	8.4	15.5	8.3	---	---
5	-5.30	-0.13	-0.02	16.0	9.0	15.8	9.7	15.9	9.4	---	---
6	-5.28	-1.54	-0.02	16.3	8.5	16.1	9.4	16.2	9.0	---	---
7	-5.39	-3.26	-0.02	16.1	7.5	16.0	8.7	16.0	8.1	---	---
8	-5.42	-4.83	-0.02	15.7	8.1	15.9	8.3	15.8	8.2	---	---
9	-5.39	-6.24	-0.01	15.8	8.1	15.3	8.6	15.6	8.4	---	---
10	-5.30	-7.73	0.00	14.5	7.2	13.9	8.1	14.2	7.7	---	---

**Table A.182. Stiffness and strength summary of Kickapoo sand, strip 4, 0 roller passes**

Test point	Clegg Impact Test			Geogauge		DCP	FWD: E (MPa)			
	CIV <sup>1</sup>	CIV <sup>2</sup>	CIV	M	S	DCPI	1	2	3	4
1	---	---	---	10.39	1.40	252	17.2	25.0	27.0	28.8
2	---	---	---	9.13	1.23	270	---	---	---	---
3	---	---	---	9.03	1.22	253	3.9	4.2	6.3	8.0
4	---	---	---	8.53	1.15	235	---	---	---	---
5	---	---	---	10.27	1.39	244	---	---	---	---
6	---	---	---	10.25	1.38	245	---	---	---	---
7	---	---	---	10.78	1.45	256	2.7	4.3	6.2	10.7
8	---	---	---	11.81	1.59	250	---	---	---	---
9	---	---	---	10.97	1.48	259	---	---	---	---
10	---	---	---	9.02	1.22	249	---	---	---	---

**Table A.183. Moisture and density summary of Kickapoo sand, strip 4, 1 roller pass**

Test point	Coordinates (m)			Nuclear gauge (kN/m <sup>3</sup> , %)						Drive core (kN/m <sup>3</sup> , %)	
	X	Y	Z	$\gamma_d^1$	$w_g^1$	$\gamma_d^2$	$w_g^2$	$\gamma_d$	$w_g$	$\gamma_d$	$w_g$
1	-5.66	6.09	-0.07	16.5	10.7	16.6	10.2	16.6	10.5	---	---
2	-5.64	4.39	-0.08	16.7	9.8	16.6	9.8	16.6	9.8	---	---
3	-5.68	2.71	-0.10	16.6	10.0	17.0	10.3	16.8	10.2	---	---
4	-5.66	1.36	-0.11	17.1	9.4	16.8	11.1	17.0	10.3	---	---
5	-5.62	-0.35	-0.10	16.3	10.9	16.5	10.9	16.4	10.9	---	---
6	-5.58	-1.70	-0.10	16.7	11.4	16.7	11.1	16.7	11.3	---	---
7	-5.53	-3.39	-0.09	17.2	9.3	16.6	10.1	16.9	9.7	---	---
8	-5.49	-4.74	-0.08	17.1	9.5	16.4	10.1	16.8	9.8	---	---
9	-5.42	-6.44	-0.08	16.0	10.2	15.9	11.1	15.9	10.7	---	---
10	-5.39	-7.82	-0.06	15.6	8.8	14.7	9.6	15.2	9.2	---	---

**Table A.184. Stiffness and strength summary of Kickapoo sand, strip 4, 1 roller pass**

Test point	Clegg Impact Test			Geogauge		DCP	FWD: E (MPa)			
	CIV <sup>1</sup>	CIV <sup>2</sup>	CIV	M	S	DCPI	1	2	3	4
1	---	---	---	20.57	2.77	139	6.7	12.5	15.0	17.2
2	---	---	---	24.03	3.24	147	4.7	12.7	16.1	18.6
3	---	---	---	27.08	3.65	107	4.7	10.7	14.8	17.3
4	---	---	---	26.41	3.56	133	15.2	37.7	35.1	35.0
5	---	---	---	16.20	2.19	162	4.5	11.6	15.8	18.7
6	---	---	---	13.66	1.84	153	5.6	14.0	15.7	22.1
7	---	---	---	13.21	1.78	177	2.7	8.3	11.9	14.4
8	---	---	---	12.65	1.71	170	5.3	14.1	17.3	19.3
9	---	---	---	17.73	2.39	172	4.7	10.8	13.2	14.8
10	---	---	---	19.19	2.59	179	5.7	10.7	11.6	11.9

**Table A.185. Moisture and density summary of Kickapoo sand, strip 4, 2 roller passes**

Test point	Coordinates (m)			Nuclear gauge (kN/m <sup>3</sup> , %)						Drive core (kN/m <sup>3</sup> , %)	
	X	Y	Z	$\gamma_d^1$	$w_g^1$	$\gamma_d^2$	$w_g^2$	$\gamma_d$	$w_g$	$\gamma_d$	$w_g$
1	-5.86	6.10	-0.07	17.5	10.4	17.9	9.6	17.7	10.0	---	---
2	-5.88	4.43	-0.09	18.2	10.1	17.6	10.9	17.9	10.5	---	---
3	-5.87	2.74	-0.10	17.6	10.0	17.8	11.1	17.7	10.6	---	---
4	-5.86	1.38	-0.11	16.9	10.2	16.6	10.8	16.8	10.5	---	---
5	-5.82	-0.28	-0.10	17.2	10.6	17.3	10.7	17.3	10.7	---	---
6	-5.76	-1.66	-0.10	16.7	11.4	17.6	10.8	17.1	11.1	---	---
7	-5.66	-3.34	-0.09	17.5	10.0	17.0	11.1	17.3	10.6	---	---
8	-5.60	-4.68	-0.09	17.8	8.4	16.7	10.2	17.3	9.3	---	---
9	-5.51	-6.46	-0.08	16.4	10.0	17.1	10.2	16.8	10.1	---	---
10	-5.48	-7.86	-0.06	15.9	9.3	16.2	9.6	16.1	9.5	---	---

**Table A.186. Stiffness and strength summary of Kickapoo sand, strip 4, 2 roller passes**

Test point	Clegg Impact Test			Geogauge		DCP	FWD: E (MPa)			
	CIV <sup>1</sup>	CIV <sup>2</sup>	CIV	M	S	DCPI	1	2	3	4
1	---	---	---	31.04	4.19	82	22.2	44.8	49.6	52.9
2	---	---	---	20.85	3.62	71	6.7	16.0	19.2	21.8
3	---	---	---	31.07	4.19	75	22.8	63.4	64.3	65.6
4	---	---	---	27.24	3.67	110	---	59.0	71.6	74.6
5	---	---	---	19.24	2.59	118	3.7	14.5	19.8	24.2
6	---	---	---	20.73	2.80	125	15.0	39.7	41.9	41.1
7	---	---	---	18.33	2.47	117	7.3	15.6	20.5	24.0
8	---	---	---	11.38	1.53	160	2.9	8.3	12.3	15.5
9	---	---	---	22.74	3.07	175	6.5	16.7	20.7	23.5
10	---	---	---	22.93	3.09	144	6.7	16.5	17.6	17.8

**Table A.187. Moisture and density summary of Kickapoo sand, strip 4, 4 roller passes**

Test point	Coordinates (m)			Nuclear gauge (kN/m <sup>3</sup> , %)						Drive core (kN/m <sup>3</sup> , %)	
	X	Y	Z	$\gamma_d^1$	$w_g^1$	$\gamma_d^2$	$w_g^2$	$\gamma_d$	$w_g$	$\gamma_d$	$w_g$
1	-5.98	6.08	-0.08	17.9	10.9	18.1	11.1	18.0	11.0	---	---
2	-5.99	4.40	-0.09	17.9	10.1	18.0	11.3	17.9	10.7	---	---
3	-5.96	2.68	-0.11	18.0	9.9	17.7	11.4	17.8	10.7	---	---
4	-5.90	1.31	-0.12	17.3	10.6	16.9	11.6	17.1	11.1	---	---
5	-5.85	-0.39	-0.11	17.4	10.2	17.2	11.9	17.3	11.1	---	---
6	-5.79	-1.74	-0.11	17.7	10.1	17.6	11.0	17.6	10.6	---	---
7	-5.72	-3.45	-0.09	17.8	9.2	17.7	8.8	17.8	9.0	---	---
8	-5.62	-4.80	-0.08	17.5	11.0	17.2	11.4	17.4	11.2	---	---
9	-5.50	-6.52	-0.08	17.0	9.5	16.9	10.4	16.9	10.0	---	---
10	-5.38	-7.95	-0.06	16.6	10.0	16.3	9.8	16.5	9.9	---	---

**Table A.188. Stiffness and strength summary of Kickapoo sand, strip 4, 4 roller passes**

Test point	Clegg Impact Test			Geogauge		DCP	FWD: E (MPa)			
	CIV <sup>1</sup>	CIV <sup>2</sup>	CIV	M	S	DCPI	1	2	3	4
1	7.2	8.2	7.7	29.89	4.03	67	16.0	27.4	27.4	27.7
2	6.5	6.5	6.5	32.50	4.38	73	18.4	49.6	50.9	51.4
3	6.7	7.3	7.0	32.89	4.44	71	13.3	26.9	30.4	33.9
4	5.1	5.1	5.1	30.43	4.10	86	6.3	16.9	23.0	27.7
5	5.8	5.6	5.7	29.24	3.94	83	22.4	60.4	67.7	79.4
6	4.9	5.6	5.3	21.55	2.91	91	12.3	19.2	22.4	27.0
7	5.9	5.5	5.7	18.70	2.52	94	3.7	10.7	15.3	18.7
8	5.2	5.6	5.4	20.32	2.74	99	8.1	17.9	21.7	25.4
9	6.0	5.6	5.8	25.76	3.47	101	5.3	13.4	17.1	19.8
10	7.0	5.8	6.4	31.74	4.28	81	10.0	19.5	18.9	19.5

**Table A.189. Moisture and density summary of Kickapoo sand, strip 4, 8 roller passes**

Test point	Coordinates (m)			Nuclear gauge (kN/m <sup>3</sup> , %)						Drive core (kN/m <sup>3</sup> , %)	
	X	Y	Z	$\gamma_d^1$	$w_g^1$	$\gamma_d^2$	$w_g^2$	$\gamma_d$	$w_g$	$\gamma_d$	$w_g$
1	-5.84	6.00	-0.08	18.2	10.3	18.0	10.7	18.1	10.5	17.7	8.8
2	-5.86	4.29	-0.09	18.2	10.1	17.8	11.8	18.0	11.0	17.7	9.0
3	-5.86	2.90	-0.11	18.0	10.8	18.2	10.8	18.1	10.8	17.7	9.1
4	-5.86	1.52	-0.12	17.3	11.0	17.2	11.4	17.3	11.2	17.8	9.2
5	-5.83	-0.19	-0.11	17.9	10.9	17.5	11.7	17.7	11.3	17.7	8.9
6	-5.82	-1.58	-0.11	17.8	11.7	17.8	10.4	17.8	11.1	17.8	7.9
7	-5.82	-3.26	-0.09	17.9	10.6	17.8	11.2	17.9	10.9	17.4	8.7
8	-5.80	-4.65	-0.09	17.5	11.0	17.3	11.6	17.4	11.3	17.8	8.4
9	-5.75	-6.35	-0.08	17.6	11.1	17.7	11.2	17.6	11.2	17.3	9.0
10	-5.71	-8.02	-0.05	17.9	8.0	17.7	9.3	17.8	8.7	17.3	8.5

**Table A.190. Stiffness and strength summary of Kickapoo sand, strip 4, 8 roller passes**

Test point	Clegg Impact Test			Geogauge		DCP	FWD: E (MPa)			
	CIV <sup>1</sup>	CIV <sup>2</sup>	CIV	M	S	DCPI	1	2	3	4
1	7.6	8.1	7.9	39.44	5.32	62	8.0	17.8	21.4	24.3
2	6.9	7.8	7.4	37.77	5.09	61	5.3	12.2	18.4	23.7
3	7.7	7.2	7.5	43.55	5.87	61	4.1	13.0	19.6	23.4
4	7.1	8.1	7.6	35.45	4.78	55	11.1	21.5	26.1	37.8
5	7.1	7.0	7.1	25.63	3.46	68	10.8	31.7	31.5	32.7
6	7.5	6.0	6.8	22.29	3.01	68	5.2	12.4	17.8	23.3
7	7.0	6.4	6.7	23.11	3.12	65	5.9	13.7	18.9	23.1
8	7.2	6.7	7.0	25.04	3.38	72	9.2	19.1	24.0	28.2
9	6.9	7.0	7.0	31.74	4.28	60	13.5	30.3	35.1	38.9
10	7.2	6.5	6.9	48.97	6.60	43	14.2	22.1	24.5	26.2

**APPENDIX B. PROJECT 1 MOISTURE CONTENTS BY NONDESTRUCTIVE  
METHODS**

**Table B.1. NDE moisture summary of Kickapoo topsoil, strip 1, 1 roller pass**

Test point	Duff (% $\text{, kN/m}^3$ )		TDR (%)			
	$w_v$	$\gamma_t$	$w_v^1$	$w_v^2$	$w_v^3$	$w_v$
1	---	---	37.1	37.1	---	37.1
2	---	---	33.3	32.4	---	32.9
3	---	---	30.2	32.4	---	31.3
4	---	---	25.5	25.9	---	25.7
5	---	---	31.2	29.4	---	30.3
6	---	---	23.6	30.5	---	27.1
7	---	---	28.7	29.8	---	29.3
8	---	---	36.4	33.4	---	34.9
9	---	---	27.5	29.2	---	28.4
10	---	---	32.2	33.9	---	33.1

**Table B.2. NDE moisture summary of Kickapoo topsoil, strip 1, 2 roller passes**

Test point	Duff (% $\text{, kN/m}^3$ )		TDR (%)			
	$w_v$	$\gamma_t$	$w_v^1$	$w_v^2$	$w_v^3$	$w_v$
1	---	---	37.3	37.7	---	37.5
2	---	---	33.4	36.3	---	34.9
3	---	---	34.4	32.9	---	33.7
4	---	---	29.4	32.5	---	31.0
5	---	---	33.1	35.7	---	34.4
6	---	---	34.4	35.3	---	34.9
7	---	---	35.7	36.1	---	35.9
8	---	---	35.9	34.9	---	35.4
9	---	---	35.7	35.3	---	35.5
10	---	---	34.9	36.9	---	35.9

**Table B.3. NDE moisture summary of Kickapoo topsoil, strip 1, 4 roller passes**

Test point	Duff (% $\text{, kN/m}^3$ )		TDR (%)			
	$w_v$	$\gamma_t$	$w_v^1$	$w_v^2$	$w_v^3$	$w_v$
1	---	---	---	---	---	---
2	---	---	38.6	39.3	---	39.0
3	---	---	39.3	41.2	---	40.3
4	---	---	37.4	37.1	---	37.3
5	---	---	33.7	36.0	---	34.9
6	---	---	35.1	36.6	---	35.9
7	---	---	35.2	39.8	---	37.5
8	---	---	33.8	38.0	---	35.9
9	---	---	33.2	32.6	---	32.9
10	---	---	37.5	37.3	---	37.4

**Table B.4. NDE moisture summary of Kickapoo topsoil, strip 1, 8 roller passes**

Test point	Duff (% $\text{, kN/m}^3$ )		TDR (%)			
	$w_v$	$\gamma_t$	$w_v^1$	$w_v^2$	$w_v^3$	$w_v$
1	44.1	18.5	41.4	40.3	---	40.9
2	40.0	18.4	40.0	40.6	---	40.3
3	---	18.7	37.6	34.2	---	35.9
4	40.8	18.6	35.9	39.2	---	37.6
5	24.6	17.7	38.7	38.6	---	38.7
6	40.0	18.2	---	---	---	---
7	16.4	16.7	---	---	---	---
8	35.1	17.3	---	---	---	---
9	---	---	---	---	---	---
10	31.2	17.6	---	---	---	---



**Table B.5. NDE moisture summary of Kickapoo topsoil, strip 2, 4 roller passes**

Test point	Duff (% $\gamma_t$ , kN/m <sup>3</sup> )		TDR (%)			
	w <sub>v</sub>	$\gamma_t$	w <sub>v</sub> <sup>1</sup>	w <sub>v</sub> <sup>2</sup>	w <sub>v</sub> <sup>3</sup>	w <sub>v</sub>
1	---	---	40.2	38.1	---	39.2
2	---	---	37.5	37.6	---	37.6
3	---	---	34.6	37.9	---	36.3
4	---	---	36.7	31.4	---	34.1
5	---	---	39.5	39.8	---	39.7
6	---	---	40.1	36.6	---	38.4
7	---	---	40.4	39.3	---	39.9
8	---	---	41.8	40.3	---	41.1
9	---	---	40.2	40.5	---	40.4
10	---	---	39.0	36.9	---	38.0

**Table B.6. NDE moisture summary of Kickapoo topsoil, strip 2, 8 roller passes**

Test point	Duff (% $\gamma_t$ , kN/m <sup>3</sup> )		TDR (%)			
	w <sub>v</sub>	$\gamma_t$	w <sub>v</sub> <sup>1</sup>	w <sub>v</sub> <sup>2</sup>	w <sub>v</sub> <sup>3</sup>	w <sub>v</sub>
1	---	---	40.8	41.1	---	41.0
2	---	---	41.3	40.7	---	41.0
3	---	---	37.5	41.5	---	39.5
4	---	---	38.9	41.2	---	40.1
5	---	---	40.3	40.9	---	40.6
6	---	---	36.4	41.5	---	39.0
7	---	---	41.3	43.0	---	42.2
8	---	---	35.0	43.5	---	39.3
9	---	---	37.5	41.3	---	39.4
10	---	---	41.3	39.1	---	40.2

**Table B.7. NDE moisture summary of Kickapoo topsoil, strip 2, 12 roller passes**

Test point	Duff (% $\text{, kN/m}^3$ )		TDR (%)			
	$w_v$	$\gamma_t$	$w_v^1$	$w_v^2$	$w_v^3$	$w_v$
1	43.0	19.0	41.8	41.6	---	41.7
2	35.5	18.9	40.3	38.4	---	39.4
3	36.4	18.7	41.4	41.4	---	41.4
4	33.0	18.7	38.5	40.2	---	39.4
5	37.2	18.5	40.6	39.7	---	40.2
6	38.8	19.0	41.9	41.8	---	41.9
7	41.5	18.9	39.2	40.4	---	39.8
8	51.0	19.2	41.0	42.7	---	41.9
9	36.0	19.0	41.5	41.7	---	41.6
10	32.5	17.7	40.3	39.3	---	39.8

**Table B.8. NDE moisture summary of Kickapoo topsoil, strip 3, 2 roller passes**

Test point	Duff (% $\text{, kN/m}^3$ )		TDR (%)			
	$w_v$	$\gamma_t$	$w_v^1$	$w_v^2$	$w_v^3$	$w_v$
1	---	---	26.4	30.1	---	28.3
2	---	---	24.5	28.1	---	26.3
3	---	---	21.6	29.0	---	25.3
4	---	---	24.3	28.8	---	26.6
5	---	---	24.4	27.5	---	26.0
6	---	---	27.7	30.6	---	29.2
7	---	---	27.4	29.6	---	28.5
8	---	---	27.2	31.6	---	29.4
9	---	---	30.5	30.8	---	30.7
10	---	---	27.9	31.4	---	29.7

**Table B.9. NDE moisture summary of Kickapoo topsoil, strip 3, 4 roller passes**

Test point	Duff (% $\text{, kN/m}^3$ )		TDR (%)			
	$w_v$	$\gamma_t$	$w_v^1$	$w_v^2$	$w_v^3$	$w_v$
1	---	---	29.3	29.8	---	29.6
2	---	---	28.7	31.7	---	30.2
3	---	---	27.7	30.1	---	28.9
4	---	---	31.6	31.9	---	31.8
5	---	---	32.7	32.9	---	32.8
6	---	---	28.8	33.7	---	31.3
7	---	---	28.8	33.6	---	31.2
8	---	---	33.6	31.2	---	32.4
9	---	---	30.0	32.2	---	31.1
10	---	---	25.3	34.3	---	29.8

**Table B.10. NDE moisture summary of Kickapoo topsoil, strip 3, 8 roller passes**

Test point	Duff (% $\text{, kN/m}^3$ )		TDR (%)			
	$w_v$	$\gamma_t$	$w_v^1$	$w_v^2$	$w_v^3$	$w_v$
0 ft	20.6	---	32.3	34.0	---	33.2
2	14.6	---	34.0	32.1	---	33.1
4	11.2	---	31.7	34.6	---	33.2
6	14.0	---	32.2	31.8	---	32.0
8	15.9	---	34.7	35.0	---	34.9
10	13.7	---	34.3	33.7	---	34.0
12	18.6	---	33.7	33.8	---	33.8
14	17.5	---	29.4	34.0	---	31.7
16	14.3	---	34.4	34.1	---	34.3
18	16.2	---	31.6	33.4	---	32.5
20	11.2	---	34.5	34.5	---	34.5
22	14.6	---	37.1	35.2	---	36.2
24	20.9	---	36.9	32.2	---	34.6
26	21.9	---	34.3	34.2	---	34.3
28	20.1	---	34.3	35.7	---	35.0
30	12.6	---	32.2	33.7	---	33.0
32	17.2	---	35.6	33.7	---	34.7
34	14.8	---	33.8	28.3	---	31.1
36	12.4	---	31.0	35.1	---	33.1
38	15.9	---	33.4	37.0	---	35.2
40	11.2	---	35.2	33.7	---	34.5
42	17.0	---	35.0	36.7	---	35.9
44	12.9	---	32.4	35.9	---	34.2
46	17.2	---	35.8	33.8	---	34.8

**Table B.11. NDE moisture summary of Kickapoo topsoil, strip 4, 8 roller passes**

Test point	Duff (% $\text{, kN/m}^3$ )		TDR (%)			
	$w_v$	$\gamma_t$	$w_v^1$	$w_v^2$	$w_v^3$	$w_v$
1	20.6	18.4	---	---	---	---
2	34.3	19.4	---	---	---	---
3	31.6	18.9	---	---	---	---
4	31.6	19.8	---	---	---	---
5	38.4	20.3	---	---	---	---
6	24.6	19.5	---	---	---	---
7	31.6	19.9	---	---	---	---
8	29.4	19.5	---	---	---	---
9	27.5	18.1	---	---	---	---
10	24.6	19.4	---	---	---	---

**Table B.12. NDE moisture summary of Kickapoo topsoil, strip 5, 4 roller passes**

Test point	Duff (% $\text{, kN/m}^3$ )		TDR (%)			
	$w_v$	$\gamma_t$	$w_v^1$	$w_v^2$	$w_v^3$	$w_v$
1	---	---	22.9	25.7	---	24.3
2	---	---	21.0	25.1	---	23.1
3	---	---	22.0	23.7	---	22.9
4	---	---	22.9	26.5	---	24.7
5	---	---	26.2	24.5	---	25.4
6	---	---	23.4	25.0	---	24.2
7	---	---	23.5	23.4	---	23.5
8	---	---	21.0	25.9	---	23.5
9	---	---	19.1	23.6	---	21.4
10	---	---	18.5	21.0	---	19.8

**Table B.13. NDE moisture summary of Kickapoo topsoil, strip 5, 8 roller passes**

Test point	Duff (% $\text{, kN/m}^3$ )		TDR (%)			
	$w_v$	$\gamma_t$	$w_v^1$	$w_v^2$	$w_v^3$	$w_v$
1	---	---	24.8	30.0	---	27.4
2	---	---	25.1	28.4	---	26.8
3	---	---	27.0	24.1	---	25.6
4	---	---	30.5	30.1	---	30.3
5	---	---	25.6	29.0	---	27.3
6	---	---	27.9	28.1	---	28.0
7	---	---	23.2	25.7	---	24.5
8	---	---	25.3	26.4	---	25.9
9	---	---	22.2	26.0	---	24.1
10	---	---	22.1	29.4	---	25.8

**Table B.14. NDE moisture summary of Kickapoo fill clay, strip 1, 4 roller passes**

Test point	Duff (% $\text{, kN/m}^3$ )		TDR (%)			
	$w_v$	$\gamma_t$	$w_v^1$	$w_v^2$	$w_v^3$	$w_v$
1	---	---	43.5	43.3	---	43.4
2	---	---	44.1	44.8	---	44.5
3	---	---	41.0	41.7	---	41.4
4	---	---	43.6	42.1	---	42.9
5	---	---	45.0	43.8	---	44.4
6	---	---	40.8	43.2	---	42.0
7	---	---	42.5	43.5	---	43.0
8	---	---	43.6	42.6	---	43.1
9	---	---	42.1	44.6	---	43.4
10	---	---	40.8	42.8	---	41.8

**Table B.15. NDE moisture summary of Kickapoo fill clay, strip 1, 8 roller passes**

Test point	Duff (% $\gamma_t$ , kN/m <sup>3</sup> )		TDR (%)			
	w <sub>v</sub>	$\gamma_t$	w <sub>v</sub> <sup>1</sup>	w <sub>v</sub> <sup>2</sup>	w <sub>v</sub> <sup>3</sup>	w <sub>v</sub>
0 ft	40.8	19.1	42.0	44.4	---	43.2
2	50.4	19.1	41.9	41.6	---	41.8
4	47.2	19.1	44.3	41.8	---	43.1
6	44.5	19.1	43.2	42.6	---	42.9
8	46.2	19.5	44.7	42.0	---	43.4
10	46.2	18.5	43.8	43.9	---	43.9
12	35.1	18.1	43.0	43.8	---	43.4
14	46.5	19.4	43.5	41.8	---	42.7
16	43.0	18.6	42.2	44.8	---	43.5
18	30.3	19.0	---	42.6	---	42.6
20	44.8	18.6	45.2	42.6	---	43.9
22	53.8	19.2	39.6	43.6	---	41.6
24	43.7	18.8	42.8	45.0	---	43.9
26	58.9	18.9	45.0	42.4	---	43.7
28	54.9	18.8	44.2	41.0	---	42.6
30	33.4	18.5	43.2	45.4	---	44.3
32	43.0	19.0	42.0	42.7	---	42.4
34	34.3	18.7	43.8	44.4	---	44.1
36	52.2	19.2	35.6	40.0	---	37.8
38	36.8	0.0	44.4	41.7	---	43.1
40	43.7	19.2	43.5	42.2	---	42.9
42	51.0	19.9	42.3	42.1	---	42.2
44	52.7	19.2	40.7	43.0	---	41.9
46	---	---	45.4	---	---	45.4

**Table B.16. NDE moisture summary of Kickapoo fill clay, strip 2, 1 roller pass**

Test point	Duff (% $\gamma_t$ , kN/m <sup>3</sup> )		TDR (%)			
	w <sub>v</sub>	$\gamma_t$	w <sub>v</sub> <sup>1</sup>	w <sub>v</sub> <sup>2</sup>	w <sub>v</sub> <sup>3</sup>	w <sub>v</sub>
1	---	---	---	---	---	---
2	---	---	---	---	---	---
3	---	---	---	---	---	---
4	---	---	---	---	---	---
5	---	---	---	---	---	---
6	---	---	---	---	---	---
7	---	---	---	---	---	---
8	---	---	---	---	---	---
9	---	---	---	---	---	---
10	---	---	---	---	---	---

**Table B.17. NDE moisture summary of Kickapoo fill clay, strip 2, 2 roller passes**

Test point	Duff (% $\gamma_t$ , kN/m <sup>3</sup> )		TDR (%)			
	w <sub>v</sub>	$\gamma_t$	w <sub>v</sub> <sup>1</sup>	w <sub>v</sub> <sup>2</sup>	w <sub>v</sub> <sup>3</sup>	w <sub>v</sub>
1	---	---	---	---	---	---
2	---	---	---	---	---	---
3	---	---	---	---	---	---
4	---	---	---	---	---	---
5	---	---	---	---	---	---
6	---	---	---	---	---	---
7	---	---	---	---	---	---
8	---	---	---	---	---	---
9	---	---	---	---	---	---
10	---	---	---	---	---	---

**Table B.18. NDE moisture summary of Kickapoo fill clay, strip 2, 4 roller passes**

Test point	Duff (% $\gamma_t$ , kN/m <sup>3</sup> )		TDR (%)			
	w <sub>v</sub>	$\gamma_t$	w <sub>v</sub> <sup>1</sup>	w <sub>v</sub> <sup>2</sup>	w <sub>v</sub> <sup>3</sup>	w <sub>v</sub>
1	---	---	---	---	---	---
2	---	---	---	---	---	---
3	---	---	---	---	---	---
4	---	---	---	---	---	---
5	---	---	---	---	---	---
6	---	---	---	---	---	---
7	---	---	---	---	---	---
8	---	---	---	---	---	---
9	---	---	---	---	---	---
10	---	---	---	---	---	---

**Table B.19. NDE moisture summary of Kickapoo fill clay, strip 2, 8 roller passes**

Test point	Duff (% $\gamma_t$ , kN/m <sup>3</sup> )		TDR (%)			
	w <sub>v</sub>	$\gamma_t$	w <sub>v</sub> <sup>1</sup>	w <sub>v</sub> <sup>2</sup>	w <sub>v</sub> <sup>3</sup>	w <sub>v</sub>
1	19.8	---	---	---	---	---
2	13.5	---	---	---	---	---
3	11.3	---	---	---	---	---
4	15.7	---	---	---	---	---
5	12.1	---	---	---	---	---
6	14.5	---	---	---	---	---
7	11.3	---	---	---	---	---
8	13.9	---	---	---	---	---
9	12.6	---	---	---	---	---
10	13.4	---	---	---	---	---



**Table B.20. NDE moisture summary of Edwards till, strip 1, 0 roller passes**

Test point	Duff (% $\text{, kN/m}^3$ )		TDR (%)			
	$w_v$	$\gamma_t$	$w_v^1$	$w_v^2$	$w_v^3$	$w_v$
1	---	---	10.4	8.6	---	9.5
2	---	---	10.2	10.9	---	10.6
3	---	---	9.3	9.0	---	9.2
4	---	---	9.2	8.2	---	8.7
5	---	---	7.8	8.8	---	8.3
6	---	---	8.4	9.3	---	8.9
7	---	---	8.6	9.3	---	9.0
8	---	---	9.2	8.8	---	9.0
9	---	---	8.7	10.5	---	9.6
10	---	---	10.9	9.1	---	10.0

**Table B.21. NDE moisture summary of Edwards till, strip 1, 1 roller pass**

Test point	Duff (% $\text{, kN/m}^3$ )		TDR (%)			
	$w_v$	$\gamma_t$	$w_v^1$	$w_v^2$	$w_v^3$	$w_v$
1	---	---	16.6	17.1	---	16.9
2	---	---	16.1	16.9	---	16.5
3	---	---	16.2	17.3	---	16.8
4	---	---	17.6	17.5	---	17.6
5	---	---	18.5	17.4	---	18.0
6	---	---	17.7	16.9	---	17.3
7	---	---	17.4	19.9	---	18.7
8	---	---	16.3	15.8	---	16.1
9	---	---	16.3	16.4	---	16.4
10	---	---	14.2	16.8	---	15.5

**Table B.22. NDE moisture summary of Edwards till, strip 1, 2 roller passes**

Test point	Duff (% $\text{, kN/m}^3$ )		TDR (%)			
	$w_v$	$\gamma_t$	$w_v^1$	$w_v^2$	$w_v^3$	$w_v$
1	---	---	19.7	20.0	---	19.9
2	---	---	19.1	19.2	---	19.2
3	---	---	18.5	20.5	---	19.5
4	---	---	19.1	19.6	---	19.4
5	---	---	18.8	18.7	---	18.8
6	---	---	19.1	19.3	---	19.2
7	---	---	19.1	19.6	---	19.4
8	---	---	19.9	20.9	---	20.4
9	---	---	20.1	19.6	---	19.9
10	---	---	17.8	19.2	---	18.5

**Table B.23. NDE moisture summary of Edwards till, strip 1, 4 roller passes**

Test point	Duff (% $\text{, kN/m}^3$ )		TDR (%)			
	$w_v$	$\gamma_t$	$w_v^1$	$w_v^2$	$w_v^3$	$w_v$
1	---	---	20.4	20.2	---	20.3
2	---	---	20.7	20.5	---	20.6
3	---	---	21.5	21.7	---	21.6
4	---	---	20.1	20.8	---	20.5
5	---	---	20.3	20.4	---	20.4
6	---	---	19.8	20.9	---	20.4
7	---	---	20.9	20.0	---	20.5
8	---	---	19.7	20.3	---	20.0
9	---	---	19.5	19.8	---	19.7
10	---	---	19.2	19.5	---	19.4

**Table B.24. NDE moisture summary of Edwards till, strip 1, 8 roller passes**

Test point	Duff (% $\text{, kN/m}^3$ )		TDR (%)			
	$w_v$	$\gamma_t$	$w_v^1$	$w_v^2$	$w_v^3$	$w_v$
1	---	---	19.6	23.3	---	21.5
2	---	---	21.0	19.4	---	20.2
3	---	---	22.0	21.2	---	21.6
4	---	---	21.7	22.3	---	22.0
5	---	---	22.2	22.2	---	22.2
6	---	---	21.7	21.3	---	21.5
7	---	---	23.0	22.8	---	22.9
8	---	---	22.6	22.7	---	22.7
9	---	---	22.6	22.1	---	22.4
10	---	---	21.1	22.3	---	21.7

**Table B.25. NDE moisture summary of Edwards till, strip 2, 0 roller passes**

Test point	Duff (% $\text{, kN/m}^3$ )		TDR (%)			
	$w_v$	$\gamma_t$	$w_v^1$	$w_v^2$	$w_v^3$	$w_v$
1	---	---	11.5	11.4	---	11.5
2	---	---	13.1	10.3	---	11.7
3	---	---	9.6	12.4	---	11.0
4	---	---	10.2	10.3	---	10.3
5	---	---	10.0	10.8	---	10.4
6	---	---	8.7	10.4	---	9.6
7	---	---	10.7	8.6	---	9.7
8	---	---	14.1	11.0	---	12.6
9	---	---	10.8	13.4	---	12.1
10	---	---	11.1	11.8	---	11.5

**Table B.26. NDE moisture summary of Edwards till, strip 2, 1 roller pass**

Test point	Duff (% $\text{, kN/m}^3$ )		TDR (%)			
	$w_v$	$\gamma_t$	$w_v^1$	$w_v^2$	$w_v^3$	$w_v$
1	---	---	16.8	16.0	---	16.4
2	---	---	16.1	15.2	---	15.7
3	---	---	18.2	18.7	---	18.5
4	---	---	16.6	17.8	---	17.2
5	---	---	16.6	18.4	---	17.5
6	---	---	14.4	16.7	---	15.6
7	---	---	16.9	17.5	---	17.2
8	---	---	17.8	17.3	---	17.6
9	---	---	15.8	17.1	---	16.5
10	---	---	16.7	16.6	---	16.7

**Table B.27. NDE moisture summary of Edwards till, strip 2, 2 roller passes**

Test point	Duff (% $\text{, kN/m}^3$ )		TDR (%)			
	$w_v$	$\gamma_t$	$w_v^1$	$w_v^2$	$w_v^3$	$w_v$
1	---	---	18.8	14.1	---	16.5
2	---	---	18.2	19.4	---	18.8
3	---	---	19.3	19.2	---	19.3
4	---	---	17.5	18.6	---	18.1
5	---	---	19.6	17.8	---	18.7
6	---	---	14.9	18.7	---	16.8
7	---	---	16.7	17.9	---	17.3
8	---	---	18.4	18.5	---	18.5
9	---	---	18.5	18.5	---	18.5
10	---	---	15.7	17.9	---	16.8

**Table B.28. NDE moisture summary of Edwards till, strip 2, 4 roller passes**

Test point	Duff (% $\text{, kN/m}^3$ )		TDR (%)			
	$w_v$	$\gamma_t$	$w_v^1$	$w_v^2$	$w_v^3$	$w_v$
1	---	---	20.0	20.3	---	20.2
2	---	---	19.6	19.8	---	19.7
3	---	---	20.0	19.9	---	20.0
4	---	---	19.4	19.5	---	19.5
5	---	---	19.4	18.7	---	19.1
6	---	---	19.8	19.5	---	19.7
7	---	---	19.0	17.3	---	18.2
8	---	---	18.4	18.6	---	18.5
9	---	---	20.7	21.5	---	21.1
10	---	---	18.0	15.1	---	16.6

**Table B.29. NDE moisture summary of Edwards till, strip 2, 8 roller passes**

Test point	Duff (% $\text{, kN/m}^3$ )		TDR (%)			
	$w_v$	$\gamma_t$	$w_v^1$	$w_v^2$	$w_v^3$	$w_v$
1	---	---	20.2	21.2	---	20.7
2	---	---	21.2	18.5	---	19.9
3	---	---	20.4	19.4	---	19.9
4	---	---	20.5	21.4	---	21.0
5	---	---	20.6	20.4	---	20.5
6	---	---	19.8	20.2	---	20.0
7	---	---	21.5	21.1	---	21.3
8	---	---	18.7	20.6	---	19.7
9	---	---	18.1	20.2	---	19.2
10	---	---	19.9	20.5	---	20.2

**Table B.30. NDE moisture summary of Edwards till, strip 3, 1 roller pass**

Test point	Duff (% $\text{, kN/m}^3$ )		TDR (%)			
	$w_v$	$\gamma_t$	$w_v^1$	$w_v^2$	$w_v^3$	$w_v$
1	---	---	38.4	35.9	---	37.2
2	---	---	39.6	39.4	---	39.5
3	---	---	39.3	37.0	---	38.2
4	---	---	36.1	35.7	---	35.9
5	---	---	34.6	32.2	---	33.4
6	---	---	33.1	35.2	---	34.2
7	---	---	32.1	36.4	---	34.3
8	---	---	35.8	34.1	---	35.0
9	---	---	32.5	37.2	---	34.9
10	---	---	34.9	30.9	---	32.9

**Table B.31. NDE moisture summary of Edwards till, strip 3, 2 roller passes**

Test point	Duff (% $\text{, kN/m}^3$ )		TDR (%)			
	$w_v$	$\gamma_t$	$w_v^1$	$w_v^2$	$w_v^3$	$w_v$
1	---	---	37.3	37.0	---	37.2
2	---	---	37.7	37.3	---	37.5
3	---	---	36.1	36.4	---	36.3
4	---	---	37.4	35.7	---	36.6
5	---	---	36.6	36.1	---	36.4
6	---	---	36.9	32.9	---	34.9
7	---	---	35.8	35.0	---	35.4
8	---	---	36.6	36.7	---	36.7
9	---	---	37.3	37.2	---	37.3
10	---	---	38.5	35.4	---	37.0

**Table B.32. NDE moisture summary of Edwards till, strip 3, 4 roller passes**

Test point	Duff (% $\text{, kN/m}^3$ )		TDR (%)			
	$w_v$	$\gamma_t$	$w_v^1$	$w_v^2$	$w_v^3$	$w_v$
1	---	---	38.8	37.8	---	38.3
2	---	---	38.2	39.0	---	38.6
3	---	---	37.8	38.5	---	38.2
4	---	---	37.7	38.3	---	38.0
5	---	---	40.3	37.5	---	38.9
6	---	---	37.9	33.7	---	35.8
7	---	---	38.2	39.1	---	38.7
8	---	---	37.1	35.1	---	36.1
9	---	---	40.2	36.8	---	38.5
10	---	---	35.6	32.2	---	33.9

**Table B.33. NDE moisture summary of Edwards till, strip 3, 8 roller passes**

Test point	Duff (% $\text{, kN/m}^3$ )		TDR (%)			
	$w_v$	$\gamma_t$	$w_v^1$	$w_v^2$	$w_v^3$	$w_v$
1	44.8	20.3	37.2	39.2	---	38.2
2	58.5	20.7	37.6	38.9	---	38.3
3	55.9	20.7	38.5	38.6	---	38.6
4	52.5	20.5	38.4	38.9	---	38.7
5	58.5	20.9	36.9	37.1	---	37.0
6	58.5	20.6	37.2	38.6	---	37.9
7	56.4	20.7	39.1	38.8	---	39.0
8	58.0	20.7	39.6	38.3	---	39.0
9	57.1	20.5	38.2	38.1	---	38.2
10	5.3	---	---	---	---	---

**Table B.34. NDE moisture summary of Edwards till, strip 4, 8 roller passes**

Test point	Duff (% $\text{, kN/m}^3$ )		TDR (%)			
	$w_v$	$\gamma_t$	$w_v^1$	$w_v^2$	$w_v^3$	$w_v$
1	28.4	20.0	33.7	35.4	---	34.6
2	33.4	20.0	33.7	35.8	---	34.8
3	31.2	20.5	33.3	37.0	---	35.2
4	38.4	20.4	33.1	37.9	---	35.5
5	52.5	20.1	34.3	31.3	---	32.8
6	30.7	19.4	38.7	33.5	---	36.1
7	38.8	20.1	37.1	34.8	---	36.0
8	18.0	19.7	35.6	32.7	---	34.2
9	41.5	20.5	37.5	34.6	---	36.1
10	24.1	19.8	39.6	36.5	---	38.1

**Table B.35. NDE moisture summary of Edwards till, strip 5, 4 roller passes**

Test point	Duff (% $\text{, kN/m}^3$ )		TDR (%)			
	$w_v$	$\gamma_t$	$w_v^1$	$w_v^2$	$w_v^3$	$w_v$
1	---	---	28.2	24.1	---	26.2
2	---	---	23.0	29.6	---	26.3
3	---	---	27.4	23.8	---	25.6
4	---	---	22.7	26.4	---	24.6
5	---	---	21.8	23.5	---	22.7
6	---	---	26.4	---	---	26.4
7	---	---	28.5	22.0	---	25.3
8	---	---	22.9	22.3	---	22.6
9	---	---	25.7	23.5	---	24.6
10	---	---	24.8	23.1	---	24.0



**Table B.36. NDE moisture summary of Edwards till, strip 5, 8 roller passes**

Test point	Duff (% $\text{, kN/m}^3$ )		TDR (%)		
	$w_v$	$\gamma_t$	$w_v^1$	$w_v^2$	$w_v$
1	---	---	27.8	27.6	27.7
2	---	---	25.4	24.6	25.0
3	---	---	28.2	22.7	25.5
4	---	---	25.4	25.2	25.3
5	---	---	27.0	24.9	26.0
6	---	---	27.0	26.0	26.5
7	---	---	25.9	21.3	23.6
8	---	---	27.0	25.3	26.2
9	---	---	30.0	22.8	26.4
10	---	---	---	---	---

**Table B.37. NDE moisture summary of Kickapoo sand, strip 1, 0 roller passes**

Test point	Duff (% $\text{, kN/m}^3$ )		TDR (%)		
	$w_v$	$\gamma_t$	$w_v^1$	$w_v^2$	$w_v$
1	---	---	10.2	9.5	9.9
2	---	---	10.4	10.4	10.4
3	---	---	9.5	9.3	9.4
4	---	---	8.7	8.2	8.5
5	---	---	8.9	8.1	8.5
6	---	---	10.2	9.4	9.8
7	---	---	8.3	8.1	8.2
8	---	---	9.6	9.7	9.7
9	---	---	8.9	8.9	8.9
10	---	---	8.7	8.2	8.5

**Table B.38. NDE moisture summary of Kickapoo sand, strip 1, 1 roller pass**

Test point	Duff (% $\text{, kN/m}^3$ )		TDR (%)		
	$w_v$	$\gamma_t$	$w_v^1$	$w_v^2$	$w_v$
1	---	---	11.5	11.7	11.6
2	---	---	---	---	---
3	---	---	8.0	7.9	8.0
4	---	---	9.5	9.1	9.3
5	---	---	9.5	9.5	9.5
6	---	---	10.9	10.1	10.5
7	---	---	9.3	9.6	9.5
8	---	---	9.9	9.6	9.8
9	---	---	9.5	9.4	9.5
10	---	---	---	---	---

**Table B.39. NDE moisture summary of Kickapoo sand, strip 1, 4 roller passes**

Test point	Duff (% $\text{, kN/m}^3$ )		TDR (%)		
	$w_v$	$\gamma_t$	$w_v^1$	$w_v^2$	$w_v$
1	---	---	12.3	12.0	12.2
2	---	---	12.3	11.5	11.9
3	---	---	10.1	8.7	9.4
4	---	---	11.2	11.7	11.5
5	---	---	9.8	11.4	10.6
6	---	---	11.3	11.5	11.4
7	---	---	10.8	10.8	10.8
8	---	---	10.8	10.5	10.7
9	---	---	10.0	8.6	9.3
10	---	---	---	---	---

**Table B.40. NDE moisture summary of Kickapoo sand, strip 1, 8 roller passes**

Test point	Duff (% $\text{, kN/m}^3$ )		TDR (%)		
	$w_v$	$\gamma_t$	$w_v^1$	$w_v^2$	$w_v$
1	---	---	11.9	11.0	11.5
2	---	---	9.7	9.8	9.8
3	---	---	11.8	11.6	11.7
4	---	---	11.2	11.0	11.1
5	---	---	12.0	12.8	12.4
6	---	---	10.0	---	10.0
7	---	---	11.3	11.6	11.5
8	---	---	11.5	9.5	10.5
9	---	---	12.5	12.8	12.7
10	---	---	---	---	---

**Table B.41. NDE moisture summary of Kickapoo sand, strip 2, 1 roller pass**

Test point	Duff (% $\text{, kN/m}^3$ )		TDR (%)		
	$w_v$	$\gamma_t$	$w_v^1$	$w_v^2$	$w_v$
1	---	---	12.9	13.1	13.0
2	---	---	13.1	12.5	12.8
3	---	---	11.2	12.4	11.8
4	---	---	11.3	11.0	11.2
5	---	---	9.2	10.5	9.9
6	---	---	11.1	11.3	11.2
7	---	---	10.8	12.1	11.5
8	---	---	11.8	11.2	11.5
9	---	---	11.1	11.0	11.1
10	---	---	10.7	9.8	10.3

**Table B.42. NDE moisture summary of Kickapoo sand, strip 2, 2 roller passes**

Test point	Duff (% $\text{, kN/m}^3$ )		TDR (%)		
	$w_v$	$\gamma_t$	$w_v^1$	$w_v^2$	$w_v$
1	---	---	12.4	11.8	12.1
2	---	---	13.9	10.5	12.2
3	---	---	12.3	11.5	11.9
4	---	---	10.1	11.7	10.9
5	---	---	11.2	11.2	11.2
6	---	---	12.4	12.1	12.3
7	---	---	11.6	11.9	11.8
8	---	---	11.8	11.8	11.8
9	---	---	11.6	11.4	11.5
10	---	---	10.6	10.8	10.7

**Table B.43. NDE moisture summary of Kickapoo sand, strip 2, 4 roller passes**

Test point	Duff (% $\text{, kN/m}^3$ )		TDR (%)		
	$w_v$	$\gamma_t$	$w_v^1$	$w_v^2$	$w_v$
1	---	---	12.1	13.0	12.6
2	---	---	12.9	13.8	13.4
3	---	---	11.6	10.7	11.2
4	---	---	11.1	11.1	11.1
5	---	---	10.8	11.2	11.0
6	---	---	12.1	11.6	11.9
7	---	---	12.2	12.1	12.2
8	---	---	12.1	11.4	11.8
9	---	---	12.1	11.9	12.0
10	---	---	9.8	11.9	10.9

**Table B.44. NDE moisture summary of Kickapoo sand, strip 2, 8 roller passes**

Test point	Duff (% $\text{, kN/m}^3$ )		TDR (%)		
	$w_v$	$\gamma_t$	$w_v^1$	$w_v^2$	$w_v$
1	---	---	12.5	12.1	12.3
2	---	---	13.0	12.4	12.7
3	---	---	11.6	11.9	11.8
4	---	---	12.2	12.1	12.2
5	---	---	11.9	11.6	11.8
6	---	---	12.5	12.2	12.4
7	---	---	12.5	11.8	12.2
8	---	---	12.5	12.2	12.4
9	---	---	11.7	12.2	12.0
10	---	---	11.2	11.9	11.6

**Table B.45. NDE moisture summary of Kickapoo sand, strip 3, 0 roller passes**

Test point	Duff (% $\text{, kN/m}^3$ )		TDR (%)		
	$w_v$	$\gamma_t$	$w_v^1$	$w_v^2$	$w_v$
1	---	---	15.1	12.4	13.8
2	---	---	15.4	15.6	15.5
3	---	---	13.9	16.0	15.0
4	---	---	14.9	16.0	15.5
5	---	---	16.5	15.9	16.2
6	---	---	17.4	18.4	17.9
7	---	---	12.3	16.5	14.4
8	---	---	14.9	13.9	14.4
9	---	---	13.6	14.2	13.9
10	---	---	10.3	9.7	10.0

**Table B.46. NDE moisture summary of Kickapoo sand, strip 3, 1 roller pass**

Test point	Duff (% $\text{, kN/m}^3$ )		TDR (%)		
	$w_v$	$\gamma_t$	$w_v^1$	$w_v^2$	$w_v$
1	---	---	19.2	19.1	19.2
2	---	---	20.1	20.5	20.3
3	---	---	21.5	22.2	21.9
4	---	---	21.2	20.6	20.9
5	---	---	18.5	19.7	19.1
6	---	---	20.0	19.6	19.8
7	---	---	17.0	18.1	17.6
8	---	---	18.8	17.9	18.4
9	---	---	16.8	16.1	16.5
10	---	---	18.1	17.6	17.9

**Table B.47. NDE moisture summary of Kickapoo sand, strip 3, 2 roller passes**

Test point	Duff (% $\text{, kN/m}^3$ )		TDR (%)		
	$w_v$	$\gamma_t$	$w_v^1$	$w_v^2$	$w_v$
1	---	---	20.5	20.9	20.7
2	---	---	21.1	20.3	20.7
3	---	---	22.0	21.8	21.9
4	---	---	22.0	22.0	22.0
5	---	---	20.8	21.6	21.2
6	---	---	22.9	21.0	22.0
7	---	---	18.4	19.3	18.9
8	---	---	19.0	19.4	19.2
9	---	---	18.9	19.1	19.0
10	---	---	17.0	18.5	17.8

**Table B.48. NDE moisture summary of Kickapoo sand, strip 3, 4 roller passes**

Test point	Duff (% $\text{, kN/m}^3$ )		TDR (%)		
	$w_v$	$\gamma_t$	$w_v^1$	$w_v^2$	$w_v$
1	---	---	19.4	23.1	21.3
2	---	---	21.5	21.8	21.7
3	---	---	23.2	22.6	22.9
4	---	---	21.9	22.7	22.3
5	---	---	22.1	22.4	22.3
6	---	---	22.6	22.4	22.5
7	---	---	20.9	20.3	20.6
8	---	---	20.9	21.1	21.0
9	---	---	19.2	19.6	19.4
10	---	---	20.2	20.0	20.1

**Table B.49. NDE moisture summary of Kickapoo sand, strip 3, 8 roller passes**

Test point	Duff (% $\text{, kN/m}^3$ )		TDR (%)		
	$w_v$	$\gamma_t$	$w_v^1$	$w_v^2$	$w_v$
1	---	---	22.8	23.0	22.9
2	---	---	22.5	23.5	23.0
3	---	---	24.2	23.1	23.7
4	---	---	23.1	22.9	23.0
5	---	---	21.2	21.1	21.2
6	---	---	22.5	22.6	22.6
7	---	---	19.8	20.4	20.1
8	---	---	20.3	20.6	20.5
9	---	---	19.7	19.5	19.6
10	---	---	18.9	20.5	19.7

**Table B.50. NDE moisture summary of Kickapoo sand, strip 4, 0 roller passes**

Test point	Duff (% $\text{, kN/m}^3$ )		TDR (%)		
	$w_v$	$\gamma_t$	$w_v^1$	$w_v^2$	$w_v$
1	---	---	12.0	13.9	13.0
2	---	---	13.6	13.7	13.7
3	---	---	15.0	12.8	13.9
4	---	---	13.9	12.9	13.4
5	---	---	15.4	15.2	15.3
6	---	---	16.6	16.2	16.4
7	---	---	15.0	13.2	14.1
8	---	---	15.3	17.6	16.5
9	---	---	14.3	14.0	14.2
10	---	---	10.6	12.0	11.3

**Table B.51. NDE moisture summary of Kickapoo sand, strip 4, 1 roller pass**

Test point	Duff (% $\text{, kN/m}^3$ )		TDR (%)		
	$w_v$	$\gamma_t$	$w_v^1$	$w_v^2$	$w_v$
1	---	---	20.2	16.7	18.5
2	---	---	17.5	20.9	19.2
3	---	---	18.7	20.8	19.8
4	---	---	18.7	16.9	17.8
5	---	---	18.5	19.1	18.8
6	---	---	19.0	21.0	20.0
7	---	---	19.5	17.5	18.5
8	---	---	19.9	18.7	19.3
9	---	---	16.2	17.6	16.9
10	---	---	13.7	14.9	14.3



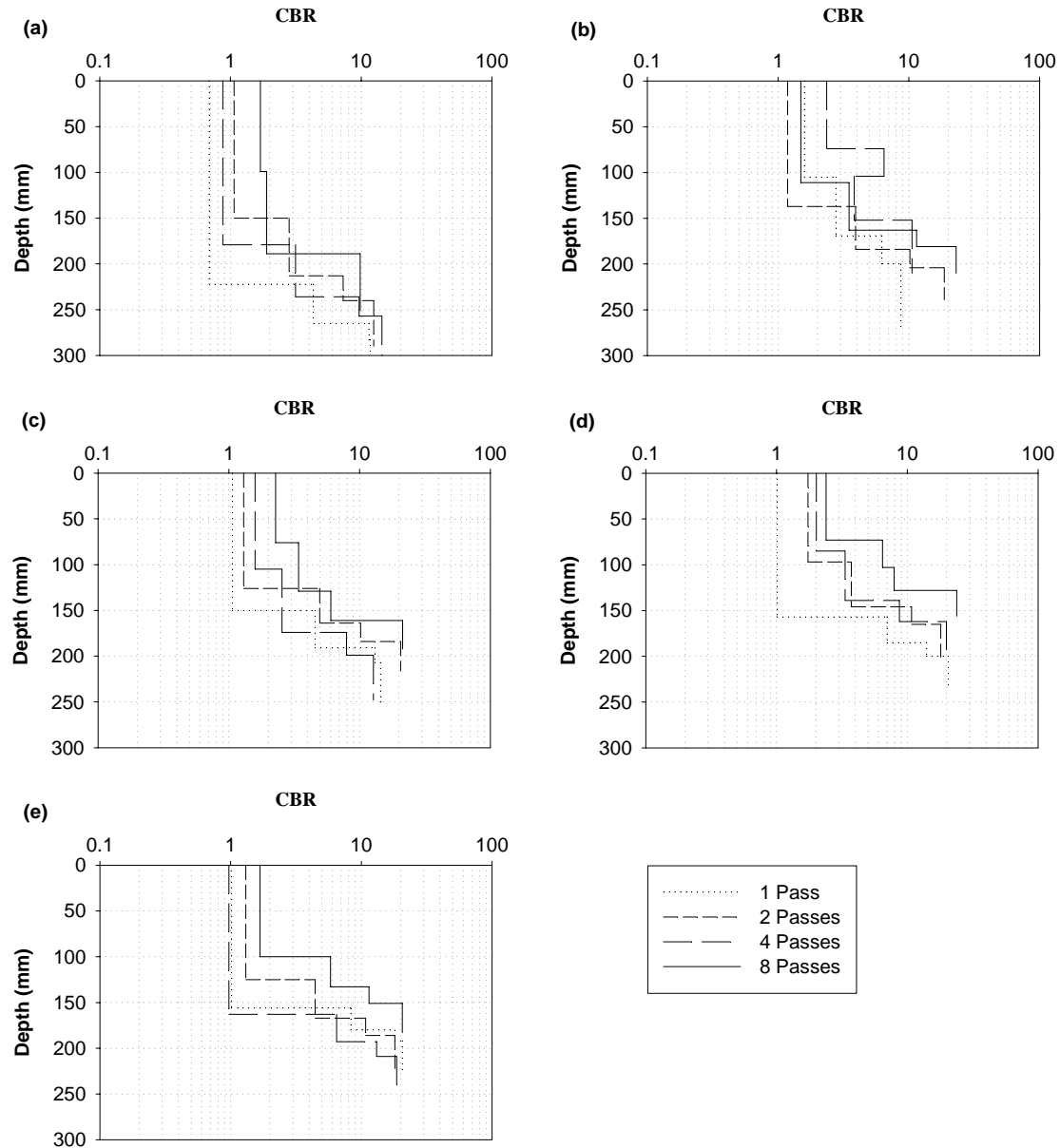
**Table B.52. NDE moisture summary of Kickapoo sand, strip 4, 2 roller passes**

Test point	Duff (% $\text{, kN/m}^3$ )		TDR (%)		
	$w_v$	$\gamma_t$	$w_v^1$	$w_v^2$	$w_v$
1	---	---	20.3	20.0	20.2
2	---	---	22.2	19.2	20.7
3	---	---	20.2	21.2	20.7
4	---	---	19.6	19.8	19.7
5	---	---	20.0	21.2	20.6
6	---	---	18.2	20.1	19.2
7	---	---	20.2	18.2	19.2
8	---	---	18.4	19.0	18.7
9	---	---	19.6	19.4	19.5
10	---	---	19.0	19.6	19.3

**Table B.53. NDE moisture summary of Kickapoo sand, strip 4, 8 roller passes**

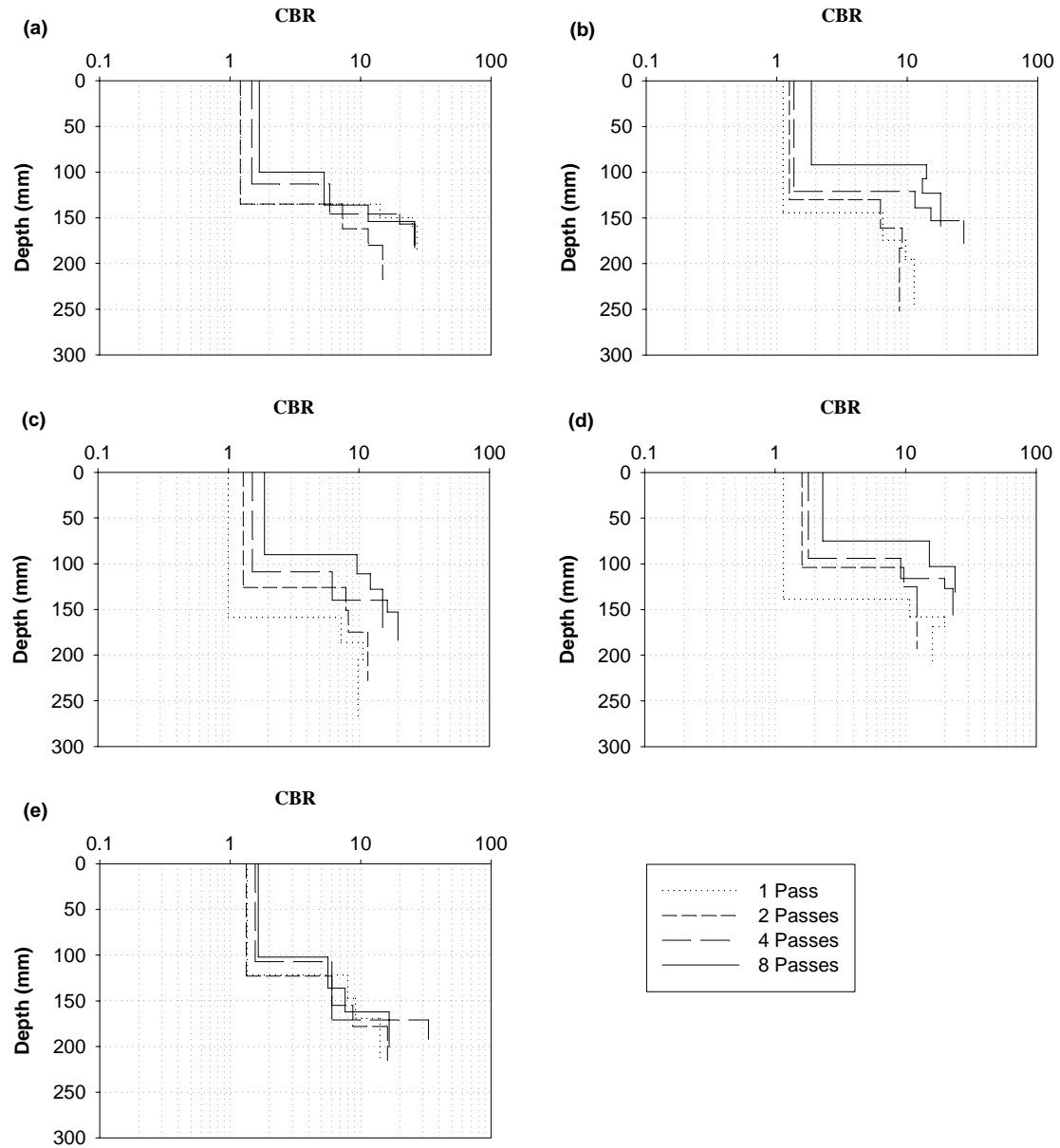
Test point	Duff (% $\text{, kN/m}^3$ )		TDR (%)		
	$w_v$	$\gamma_t$	$w_v^1$	$w_v^2$	$w_v$
1	---	---	21.4	22.6	22.0
2	---	---	20.2	21.5	20.9
3	---	---	22.7	21.4	22.1
4	---	---	21.3	21.0	21.2
5	---	---	21.0	21.1	21.1
6	---	---	20.5	19.3	19.9
7	---	---	20.8	21.6	21.2
8	---	---	20.3	20.2	20.3
9	---	---	21.3	20.1	20.7
10	---	---	21.2	20.6	20.9

**APPENDIX C. PROJECT 1 DCP PROFILES**



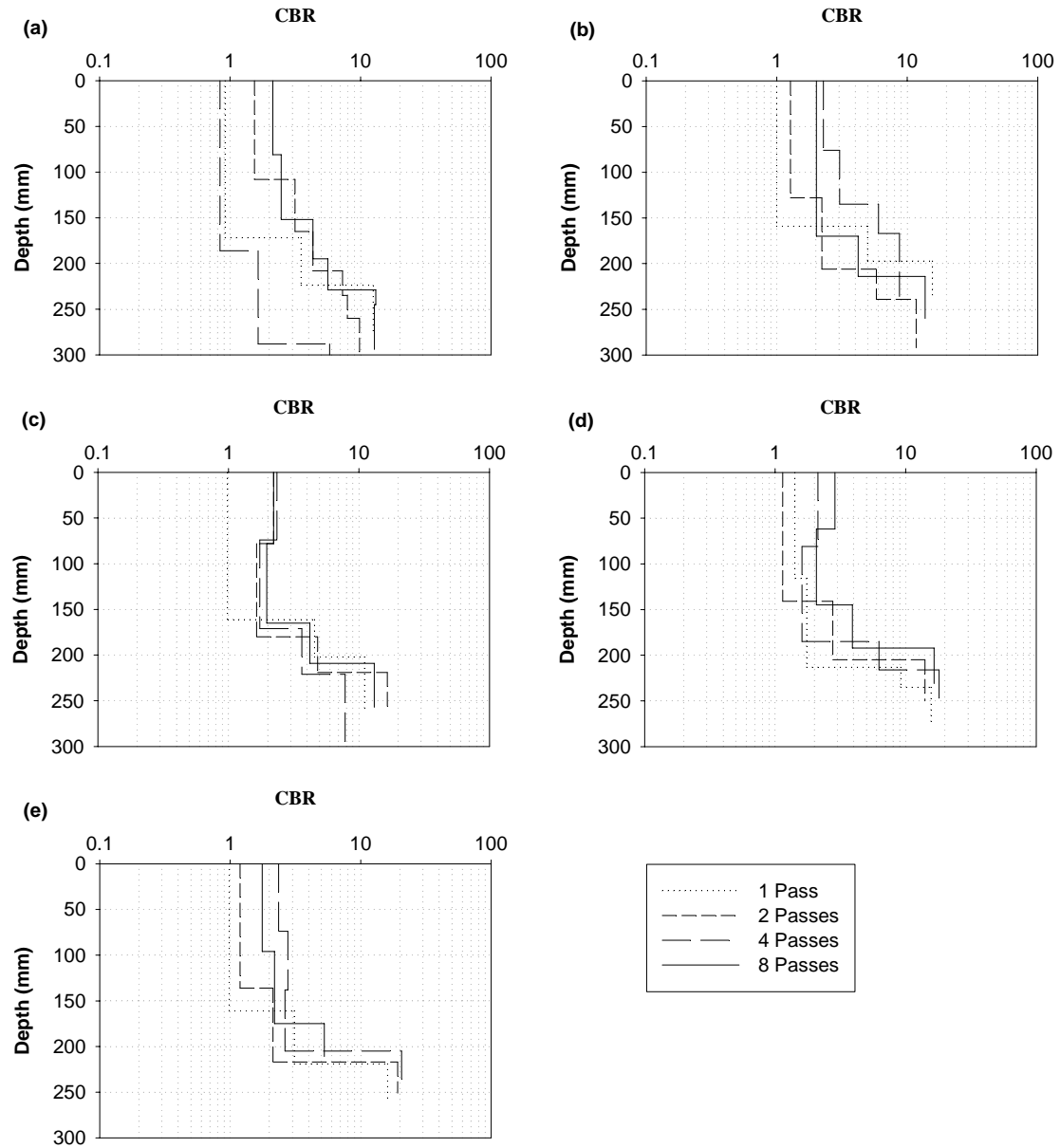
**Figure C.1. Kickapoo topsoil, strip 1**

**(a) Pt 1; (b) Pt 2; (c) Pt 3; (d) Pt 4; (e) Pt 5**



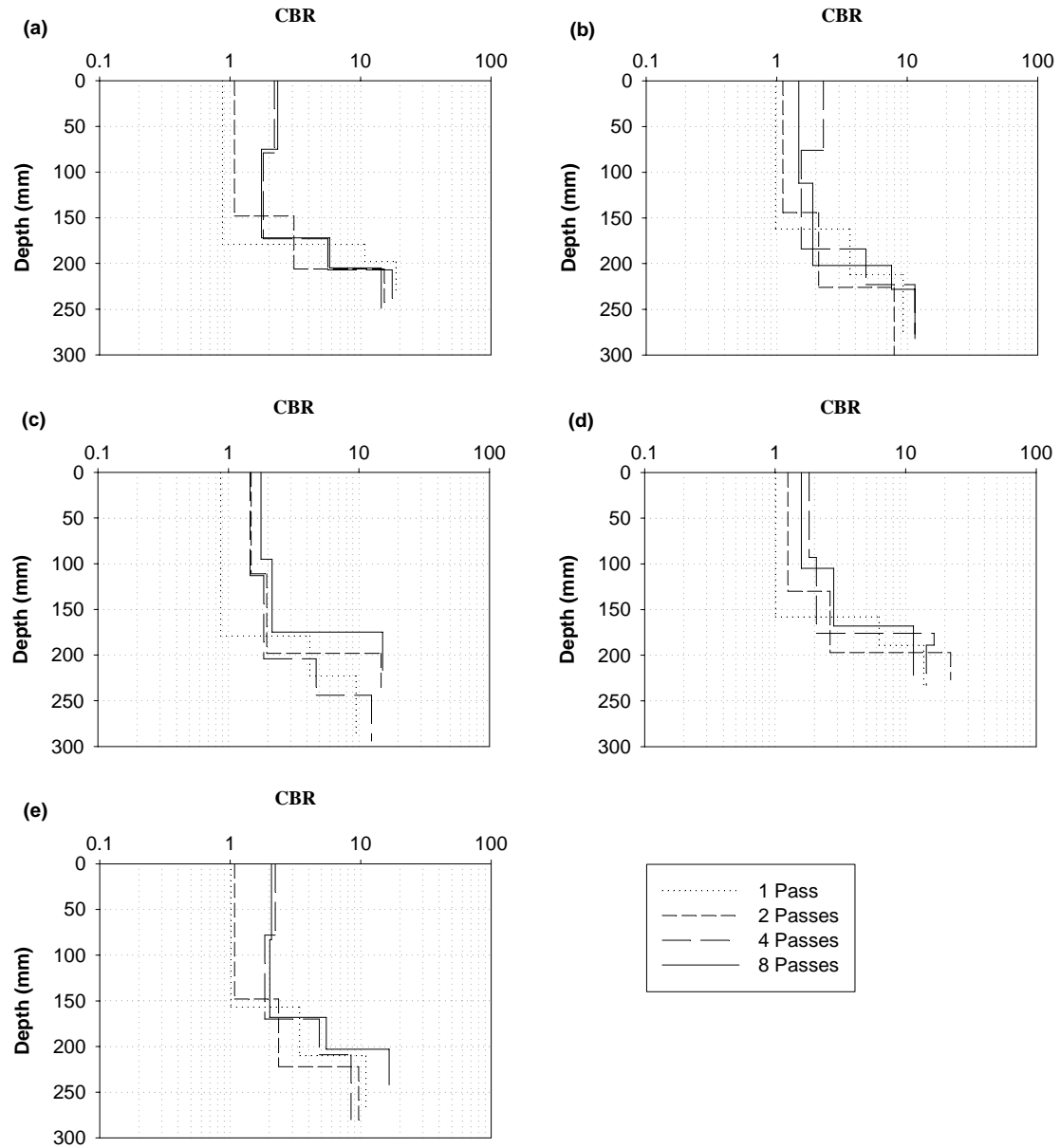
**Figure C.2. Kickapoo topsoil, strip 1**

**(a) Pt 6; (b) Pt 7; (c) Pt 8; (d) Pt 9; (e) Pt 10**



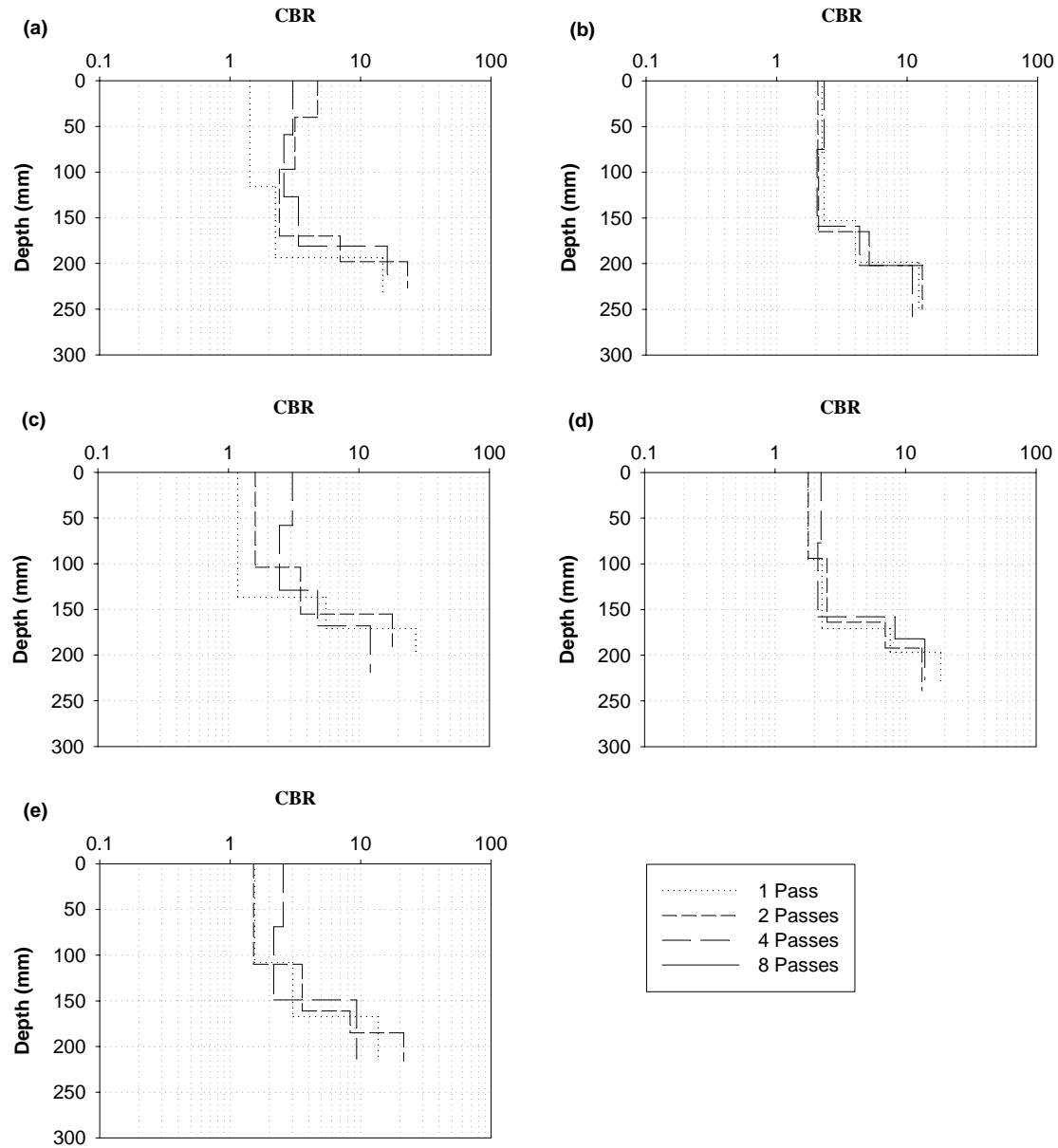
**Figure C.3. Kickapoo topsoil, strip 2**

**(a) Pt 1; (b) Pt 2; (c) Pt 3; (d) Pt 4; (e) Pt 5**



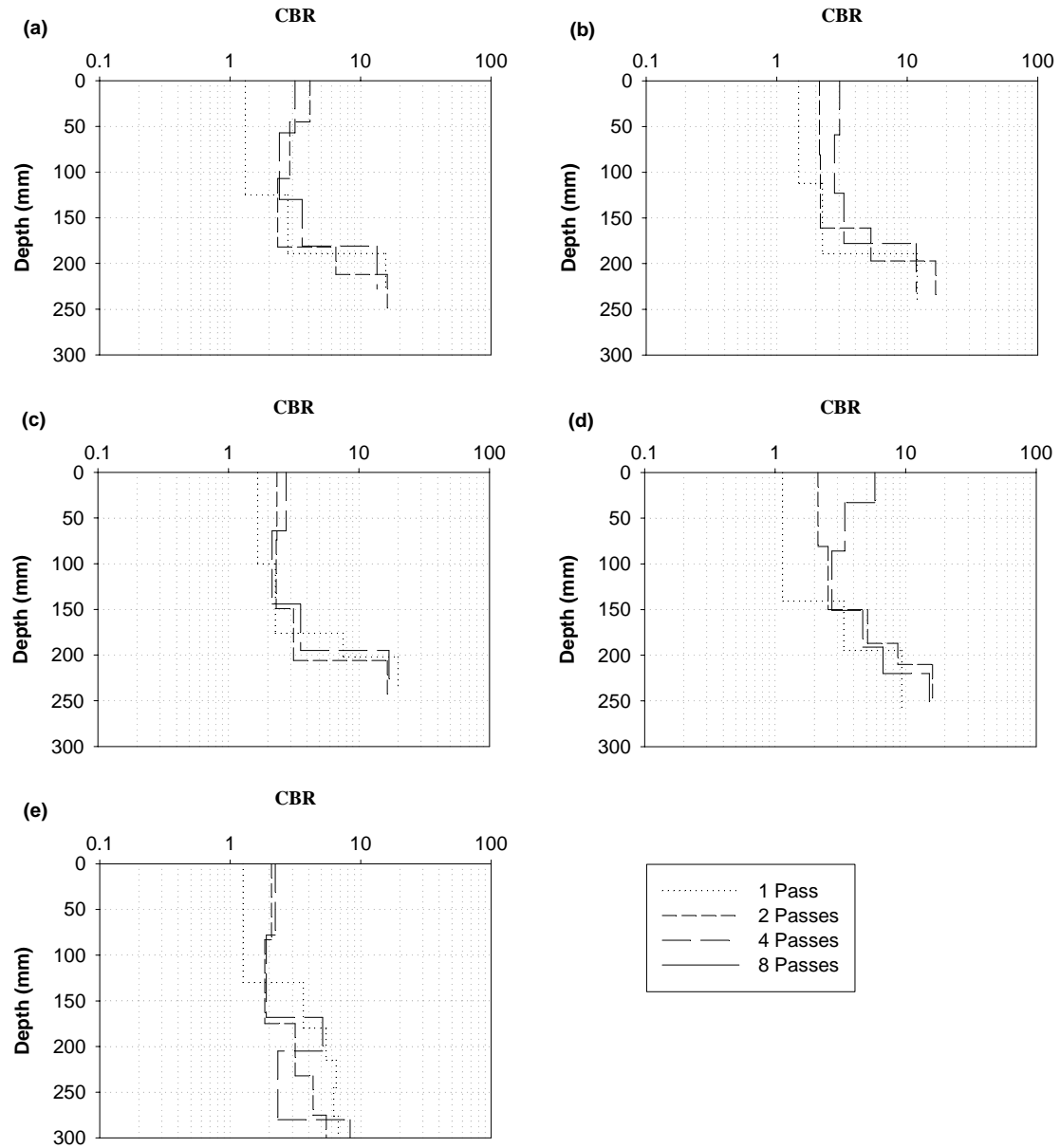
**Figure C.4. Kickapoo topsoil, strip 2**

**(a) Pt 6; (b) Pt 7; (c) Pt 8; (d) Pt 9; (e) Pt 10**



**Figure C.5. Kickapoo topsoil, strip 3**

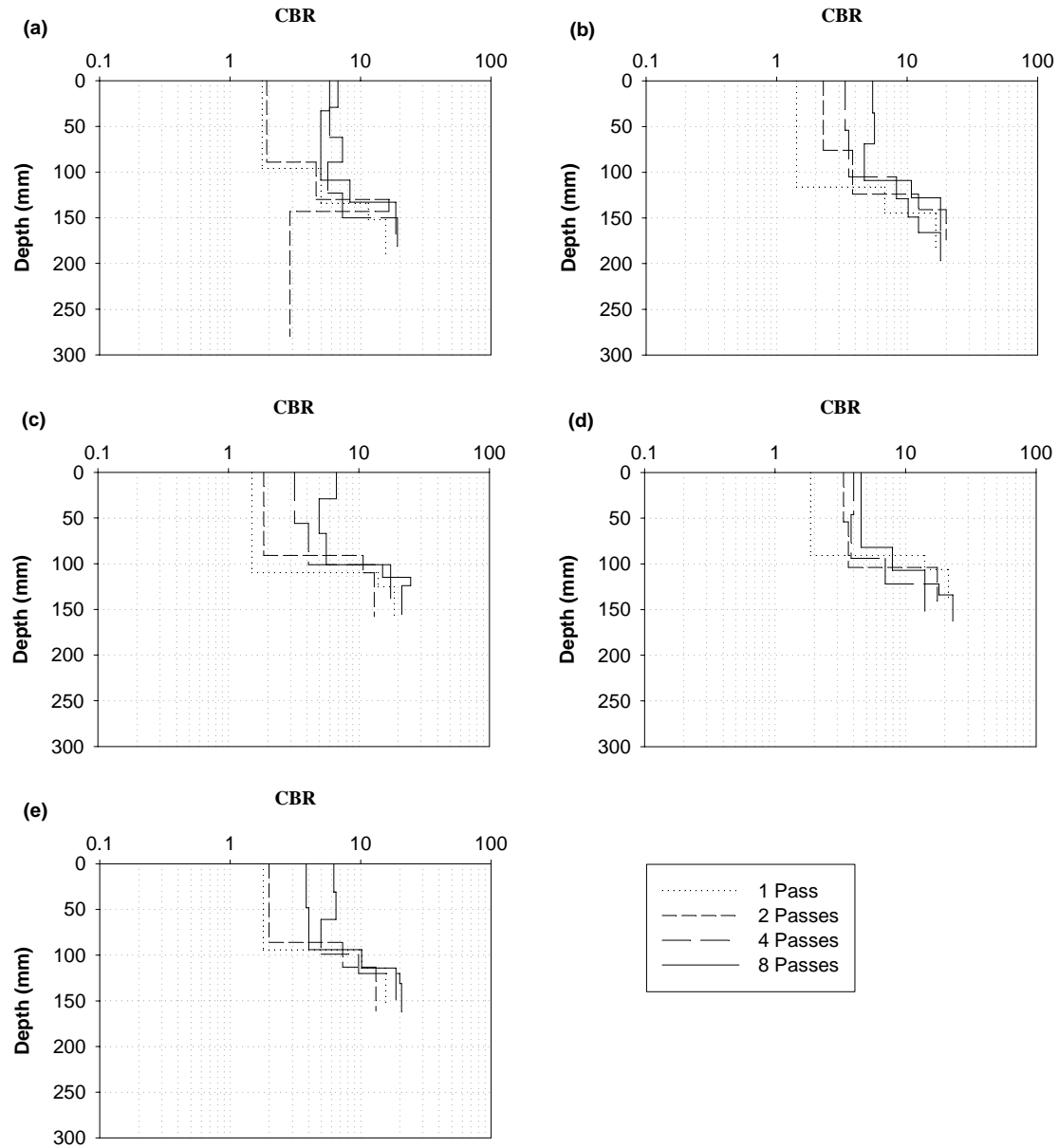
**(a) Pt 1; (b) Pt 2; (c) Pt 3; (d) Pt 4; (e) Pt 5**



**Figure C.6. Kickapoo topsoil, strip 3**

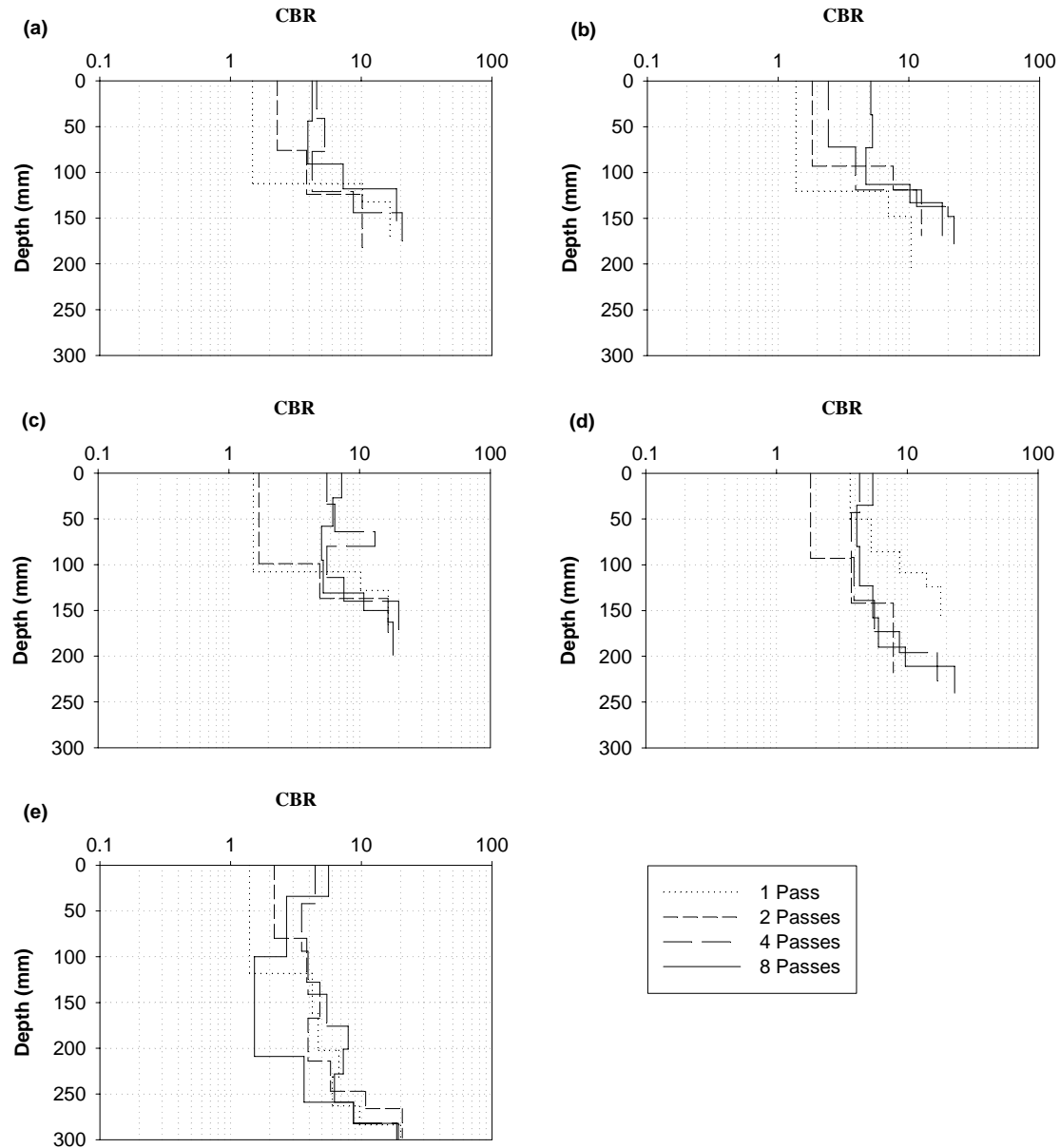
**(a) Pt 6; (b) Pt 7; (c) Pt 8; (d) Pt 9; (e) Pt 10**





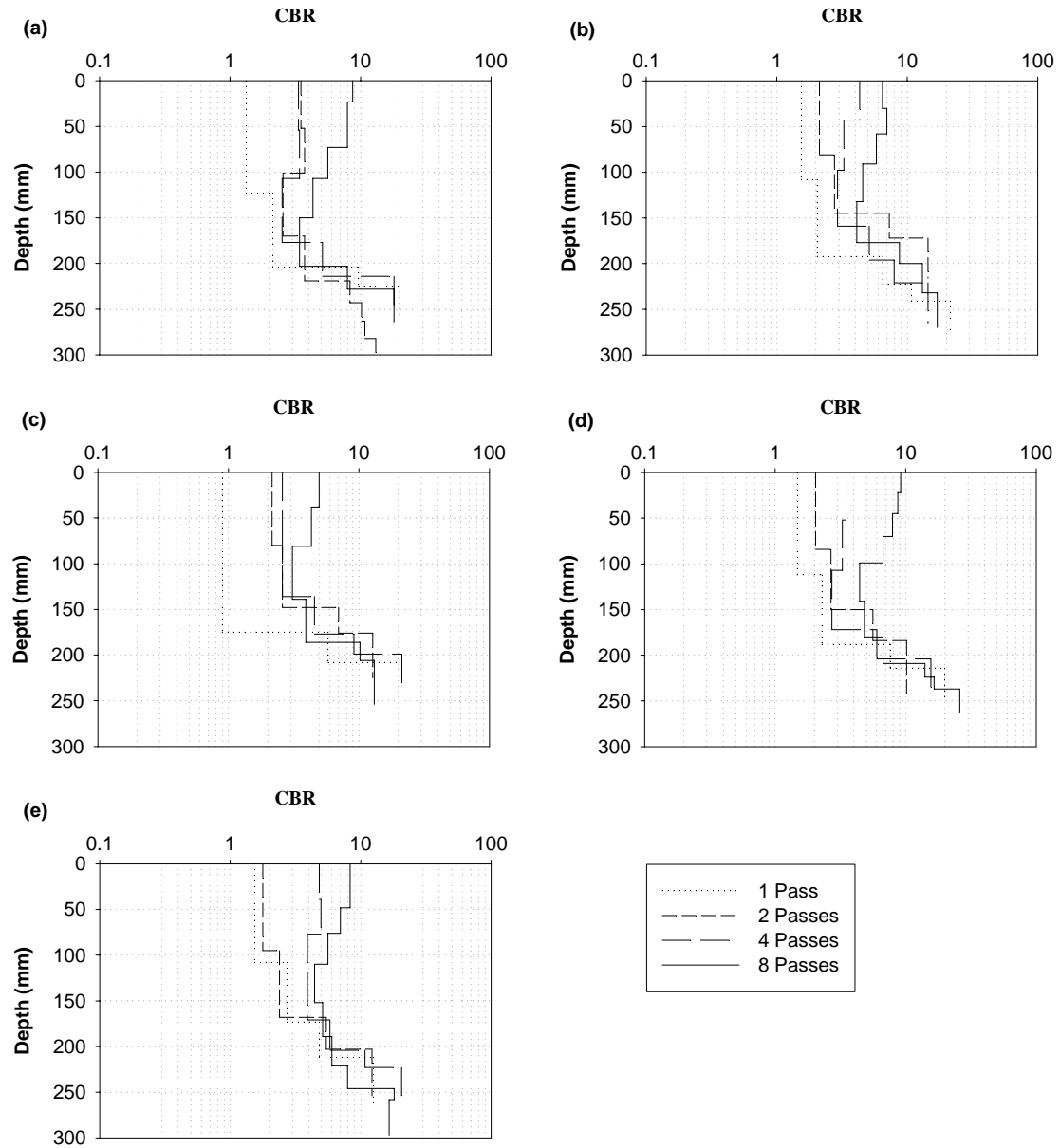
**Figure C.7. Kickapoo topsoil, strip 4**

**(a) Pt 1; (b) Pt 2; (c) Pt 3; (d) Pt 4; (e) Pt 5**



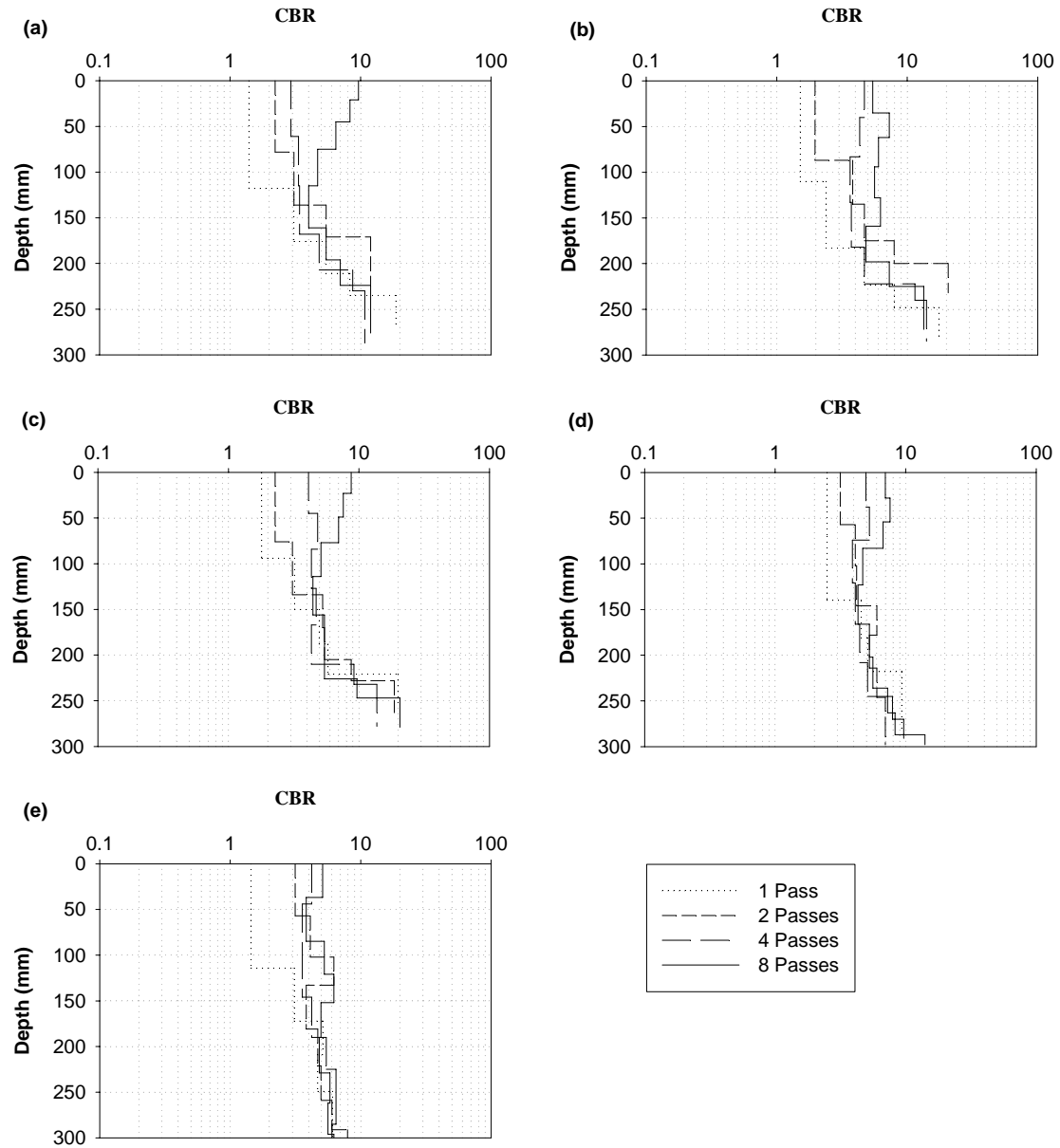
**Figure C.8. Kickapoo topsoil, strip 4**

**(a) Pt 6; (b) Pt 7; (c) Pt 8; (d) Pt 9; (e) Pt 10**



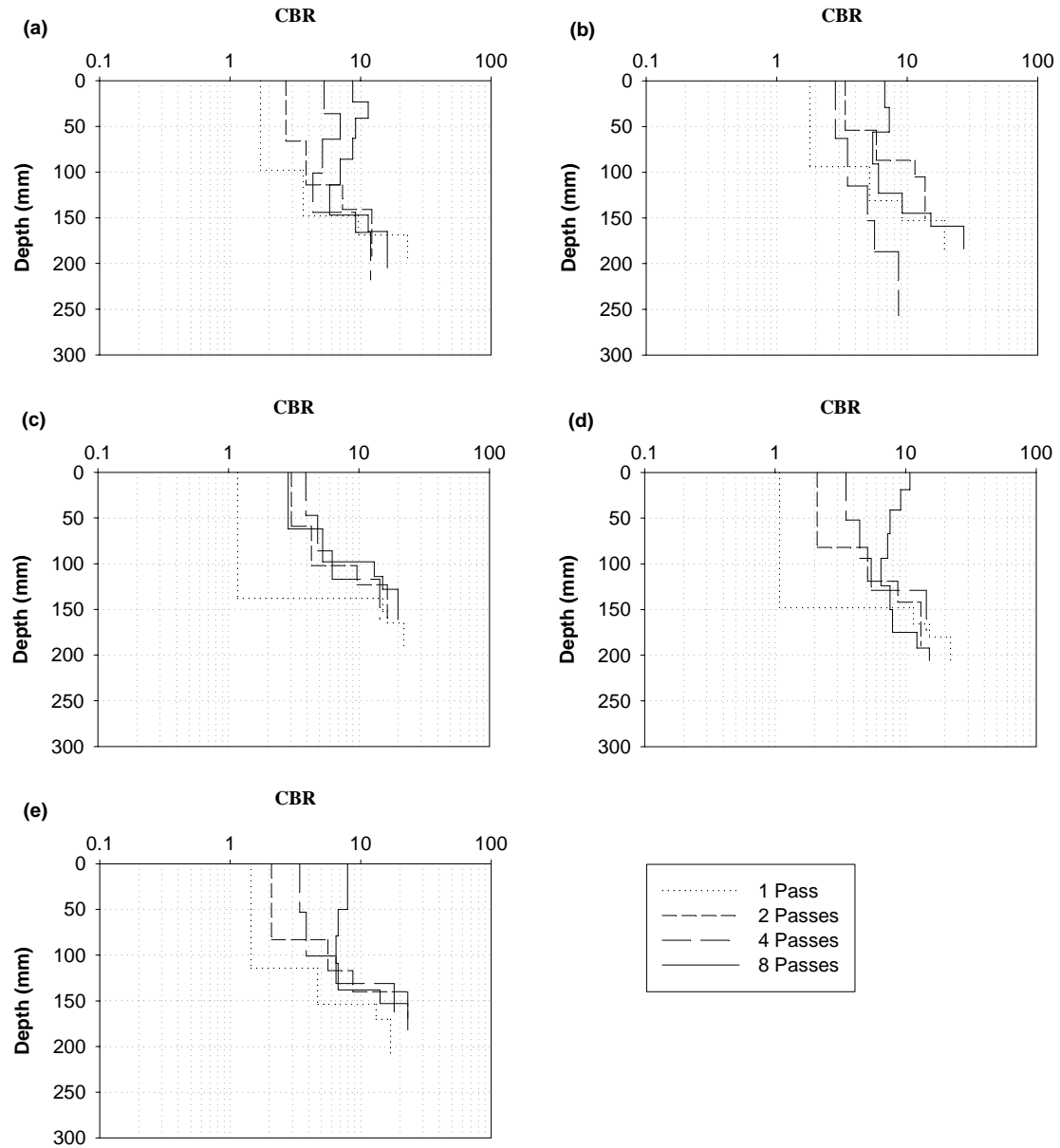
**Figure C.9. Kickapoo topsoil, strip 5**

**(a) Pt 1; (b) Pt 2; (c) Pt 3; (d) Pt 4; (e) Pt 5**



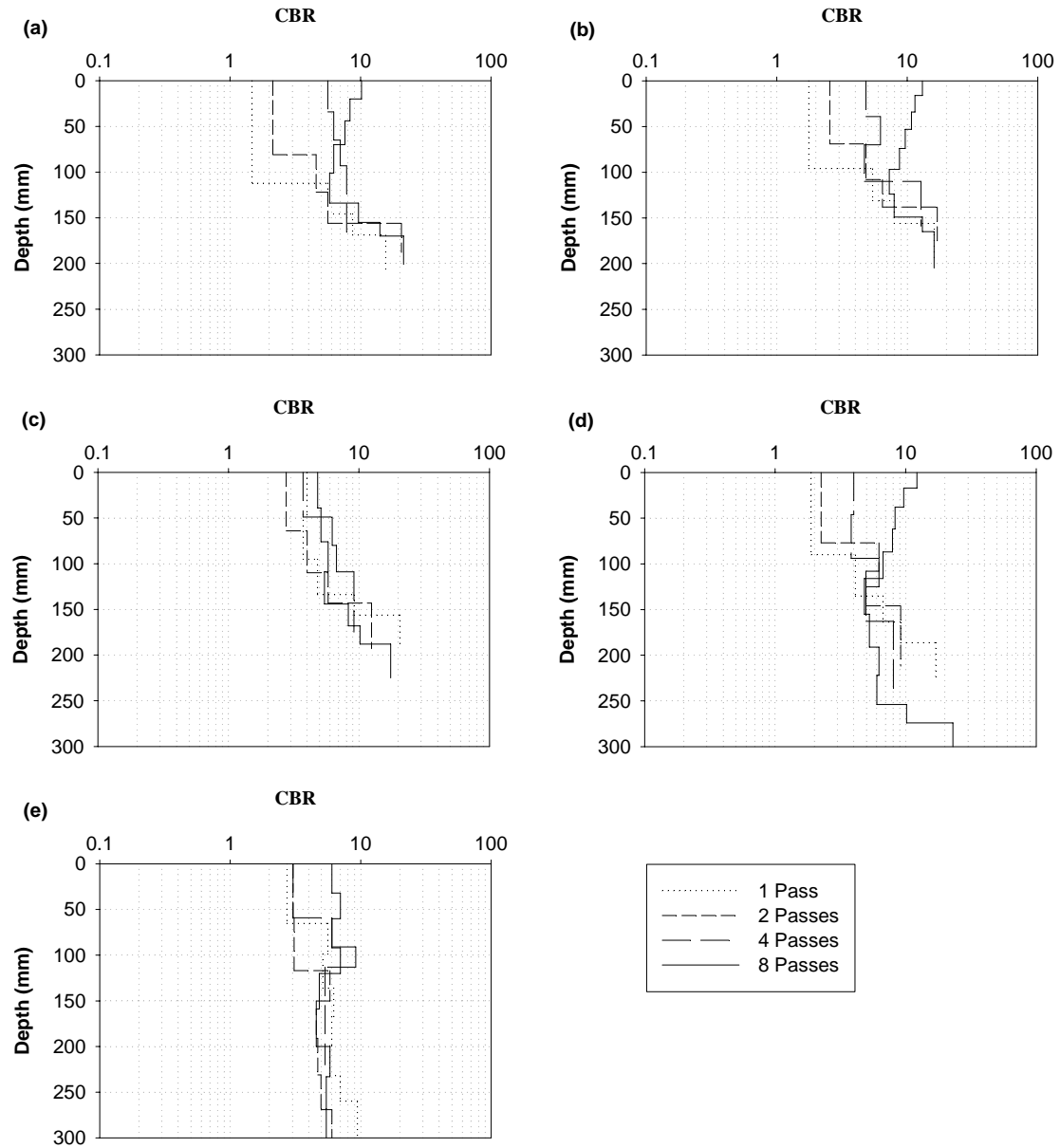
**Figure C.10. Kickapoo topsoil, strip 5**

**(a) Pt 6; (b) Pt 7; (c) Pt 8; (d) Pt 9; (e) Pt 10**



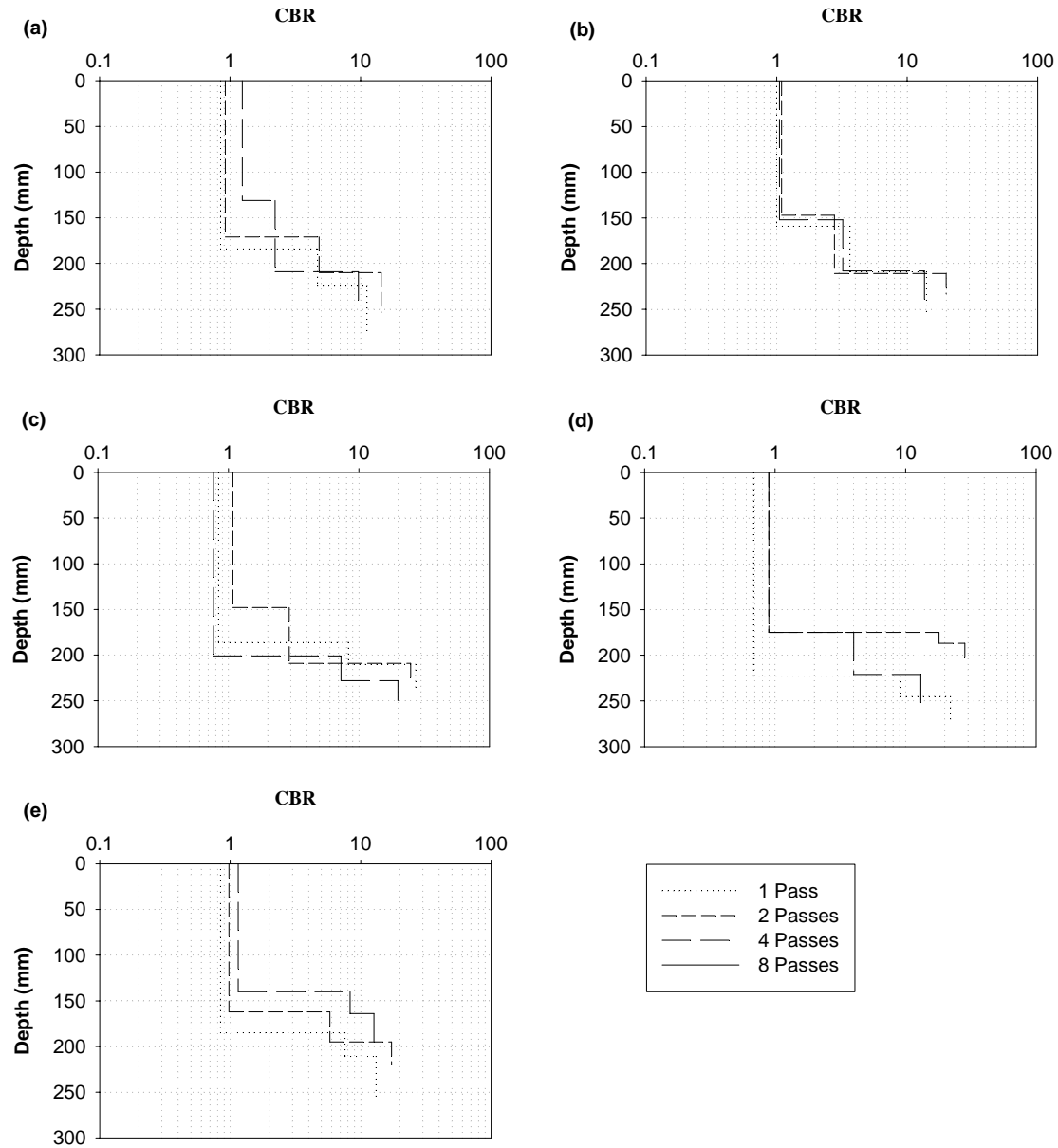
**Figure C.11. Kickapoo topsoil, strip 6**

**(a) Pt 1; (b) Pt 2; (c) Pt 3; (d) Pt 4; (e) Pt 5**



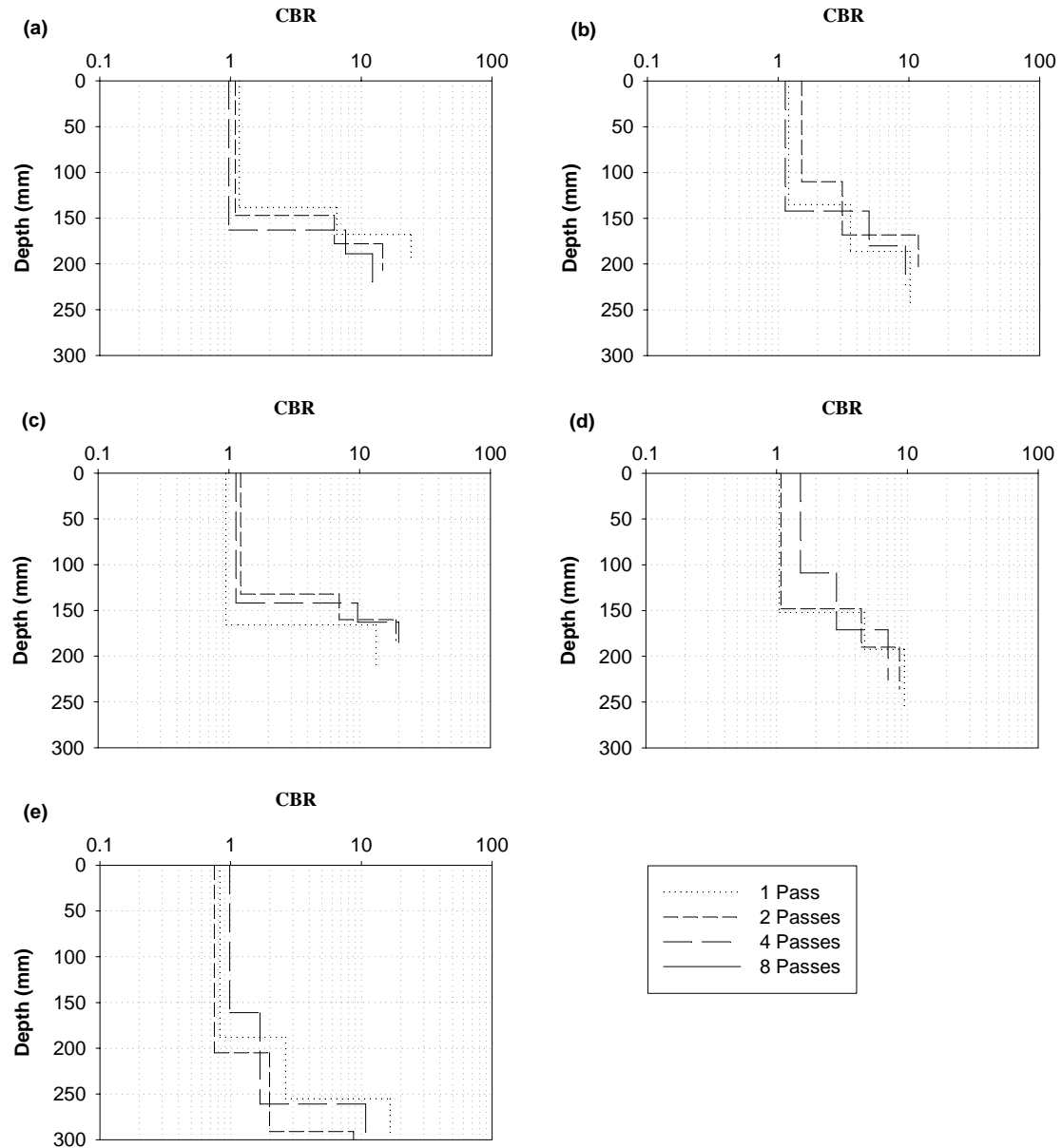
**Figure C.12. Kickapoo topsoil, strip 6**

**(a) Pt 6; (b) Pt 7; (c) Pt 8; (d) Pt 9; (e) Pt 10**



**Figure C.13. Kickapoo Fill Clay, strip 1**

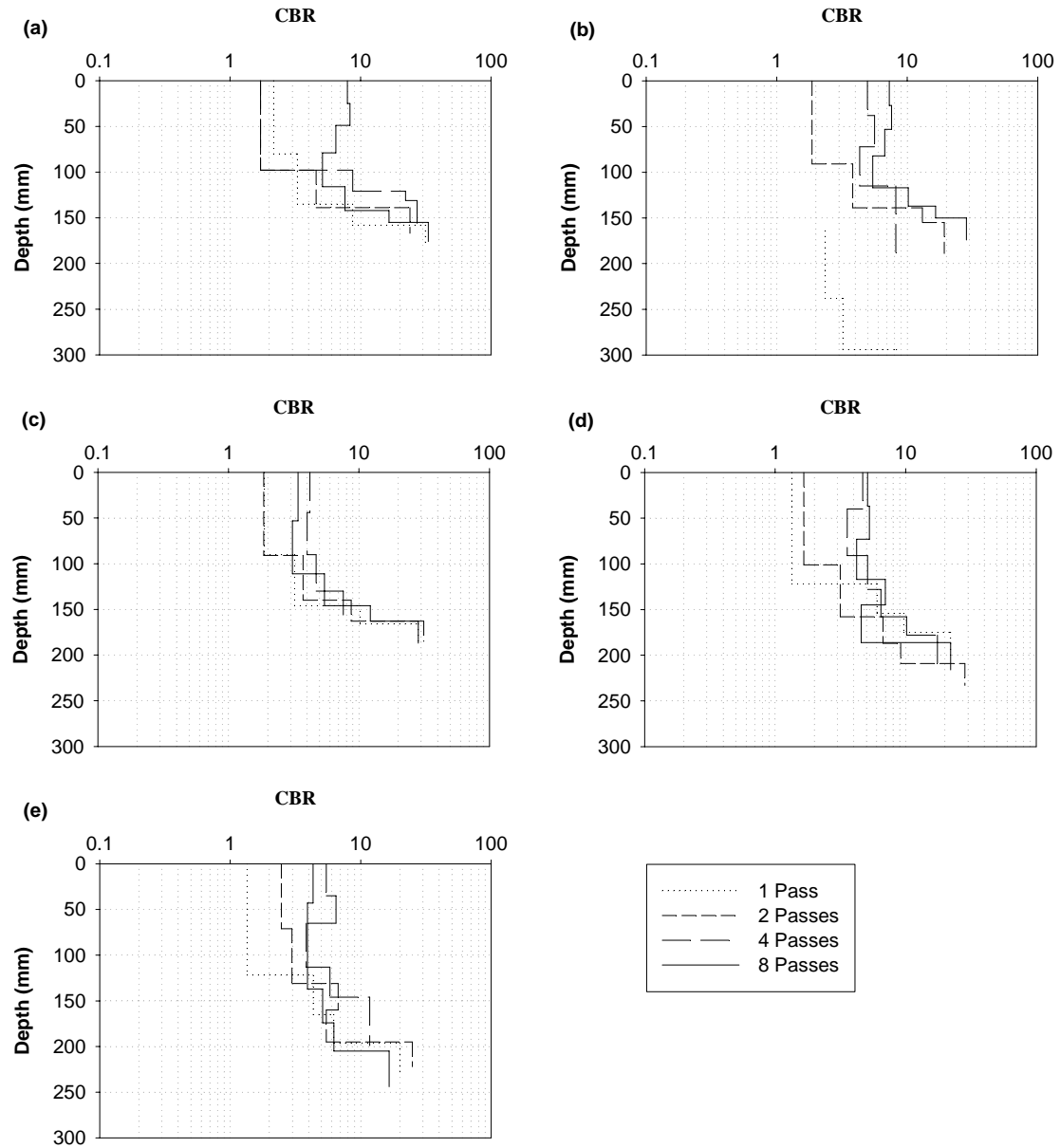
**(a) Pt 1; (b) Pt 2; (c) Pt 3; (d) Pt 4; (e) Pt 5**



**Figure C.14. Kickapoo Fill Clay, strip 1**

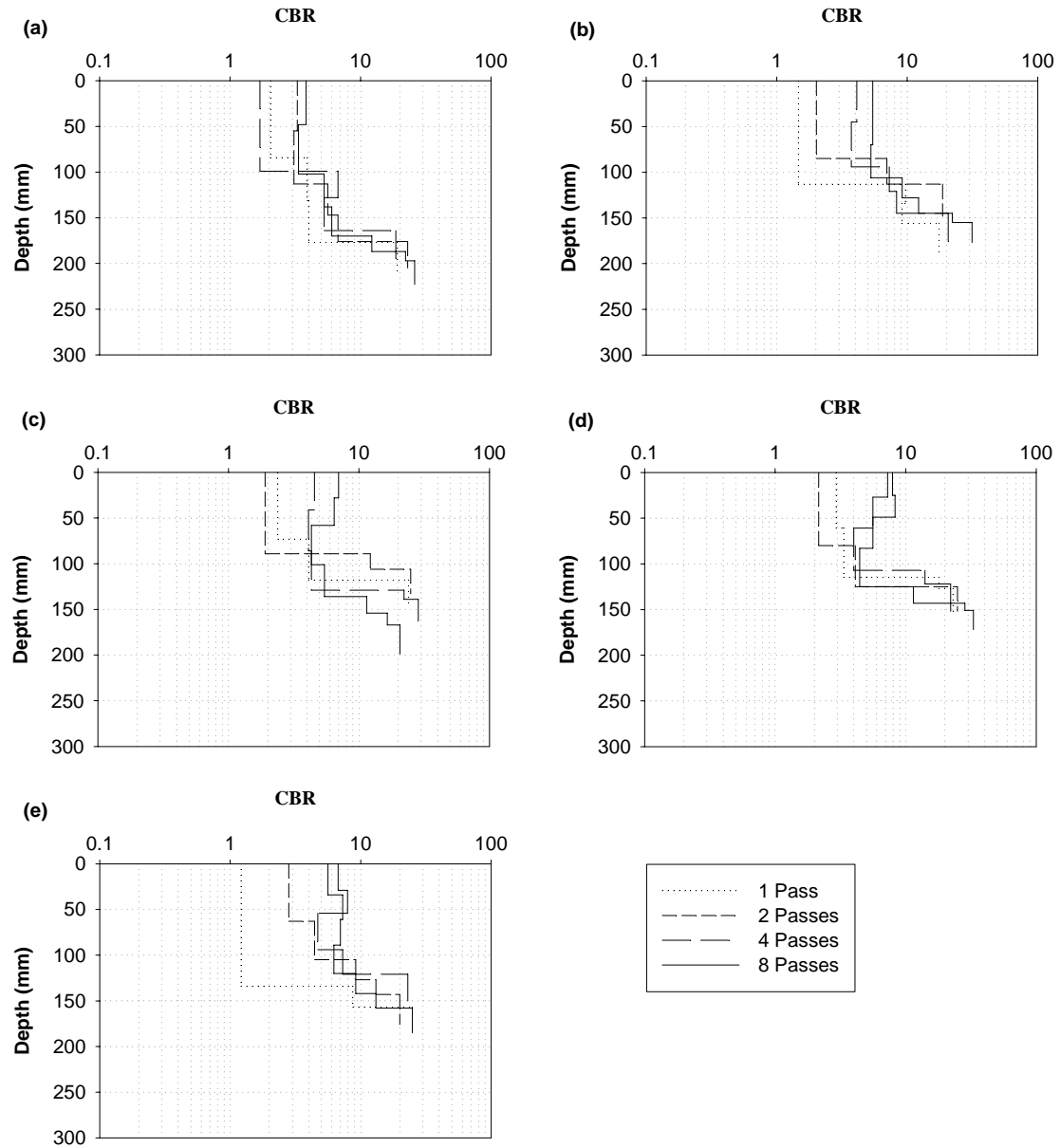
**(a) Pt 6; (b) Pt 7; (c) Pt 8; (d) Pt 9; (e) Pt 10**





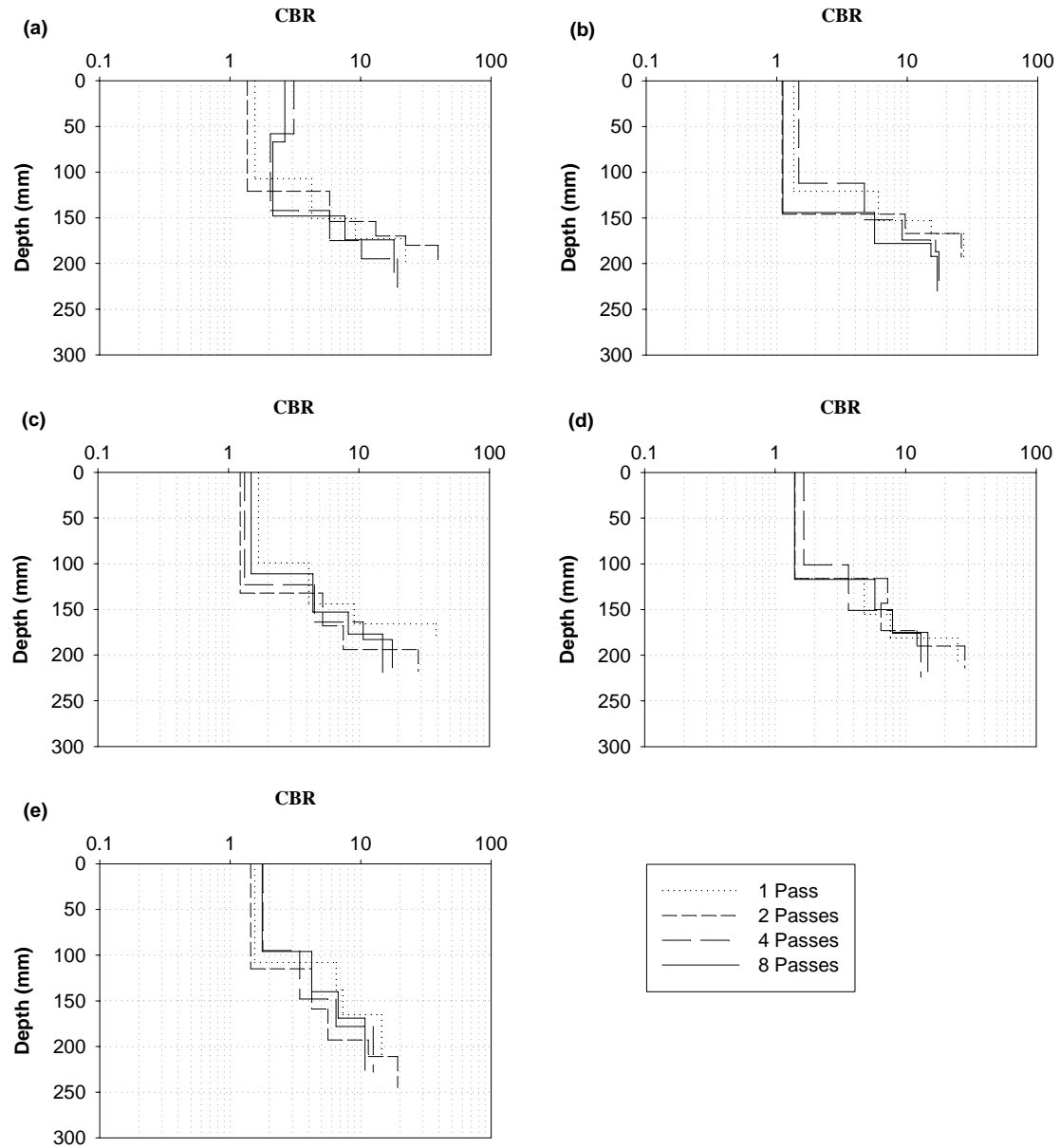
**Figure C.15. Kickapoo Fill Clay, strip 2**

**(a) Pt 1; (b) Pt 2; (c) Pt 3; (d) Pt 4; (e) Pt 5**



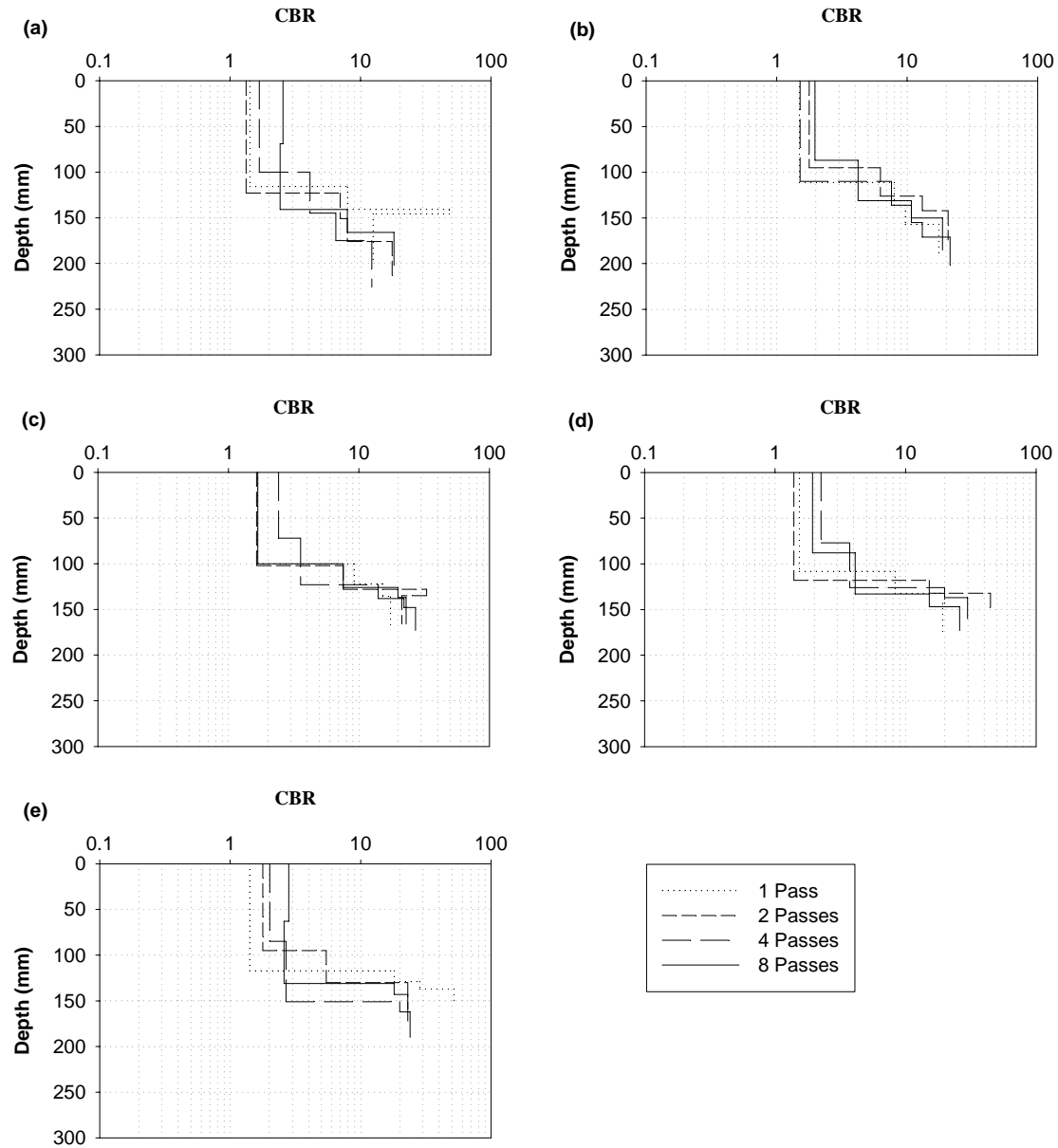
**Figure C.16. Kickapoo Fill Clay, strip 2**

**(a) Pt 6; (b) Pt 7; (c) Pt 8; (d) Pt 9; (e) Pt 10**



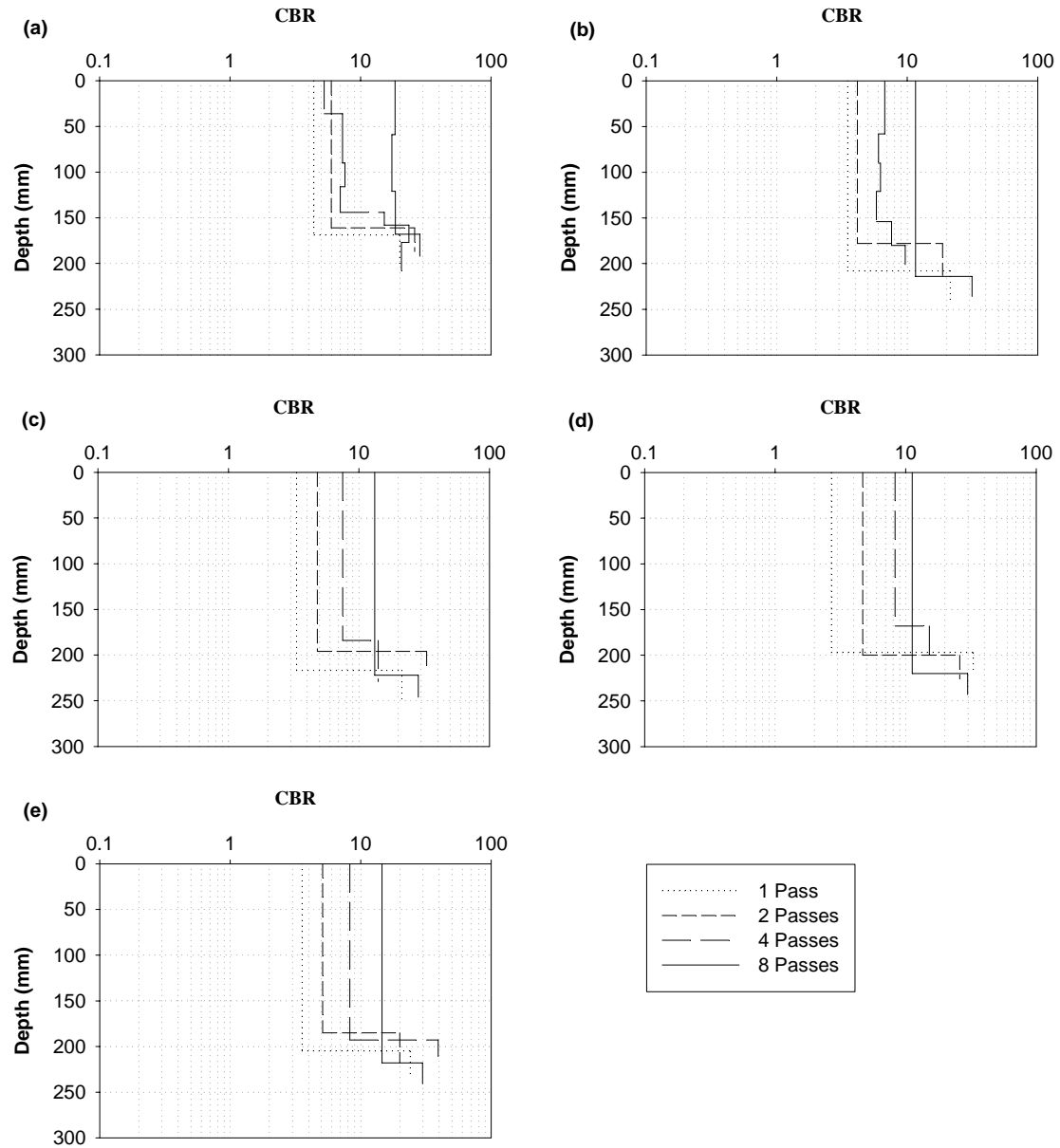
**Figure C.17. Kickapoo Fill Clay, strip 3**

**(a) Pt 1; (b) Pt 2; (c) Pt 3; (d) Pt 4; (e) Pt 5**



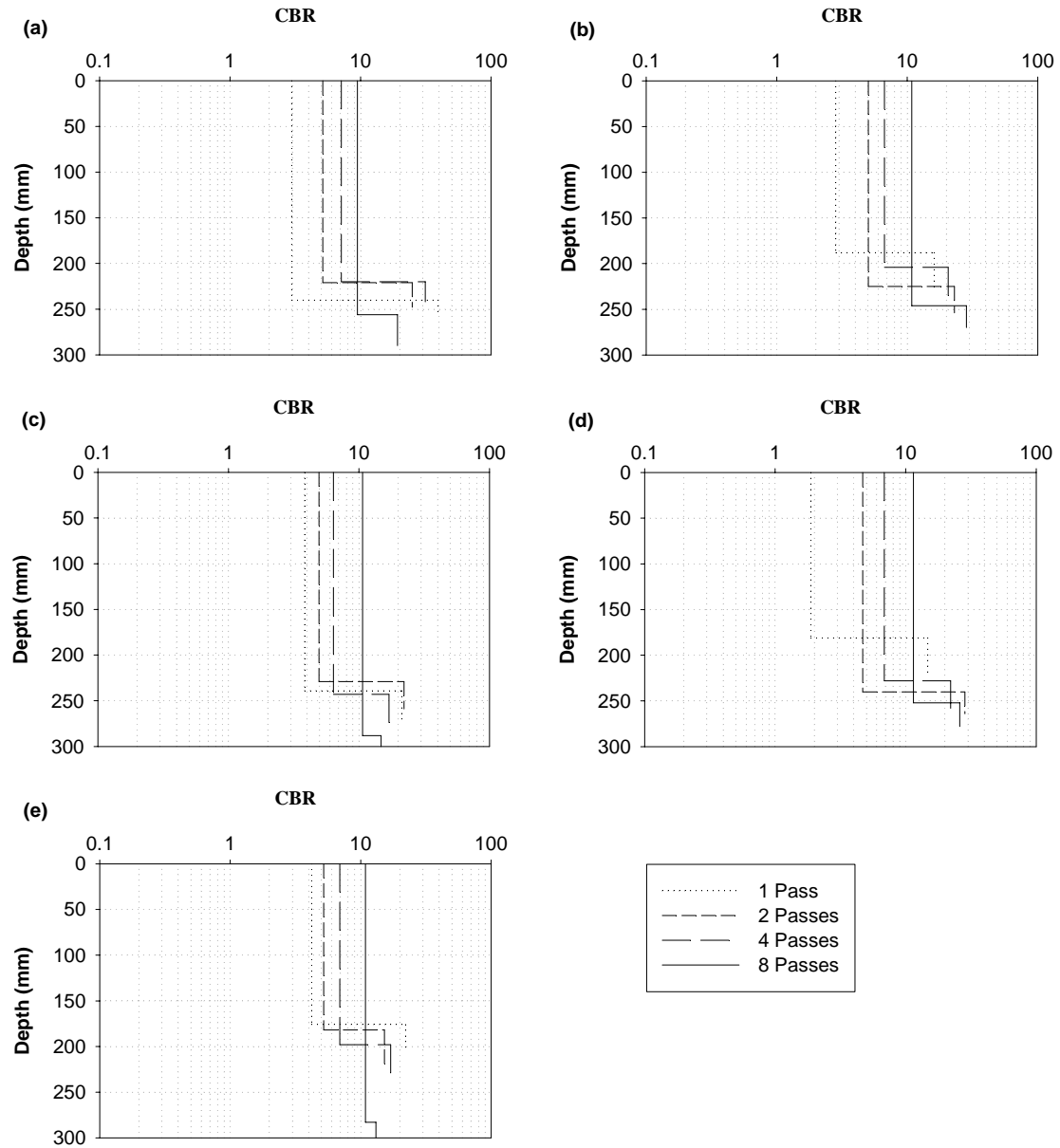
**Figure C.18. Kickapoo Fill Clay, strip 3**

**(a) Pt 6; (b) Pt 7; (c) Pt 8; (d) Pt 9; (e) Pt 10**



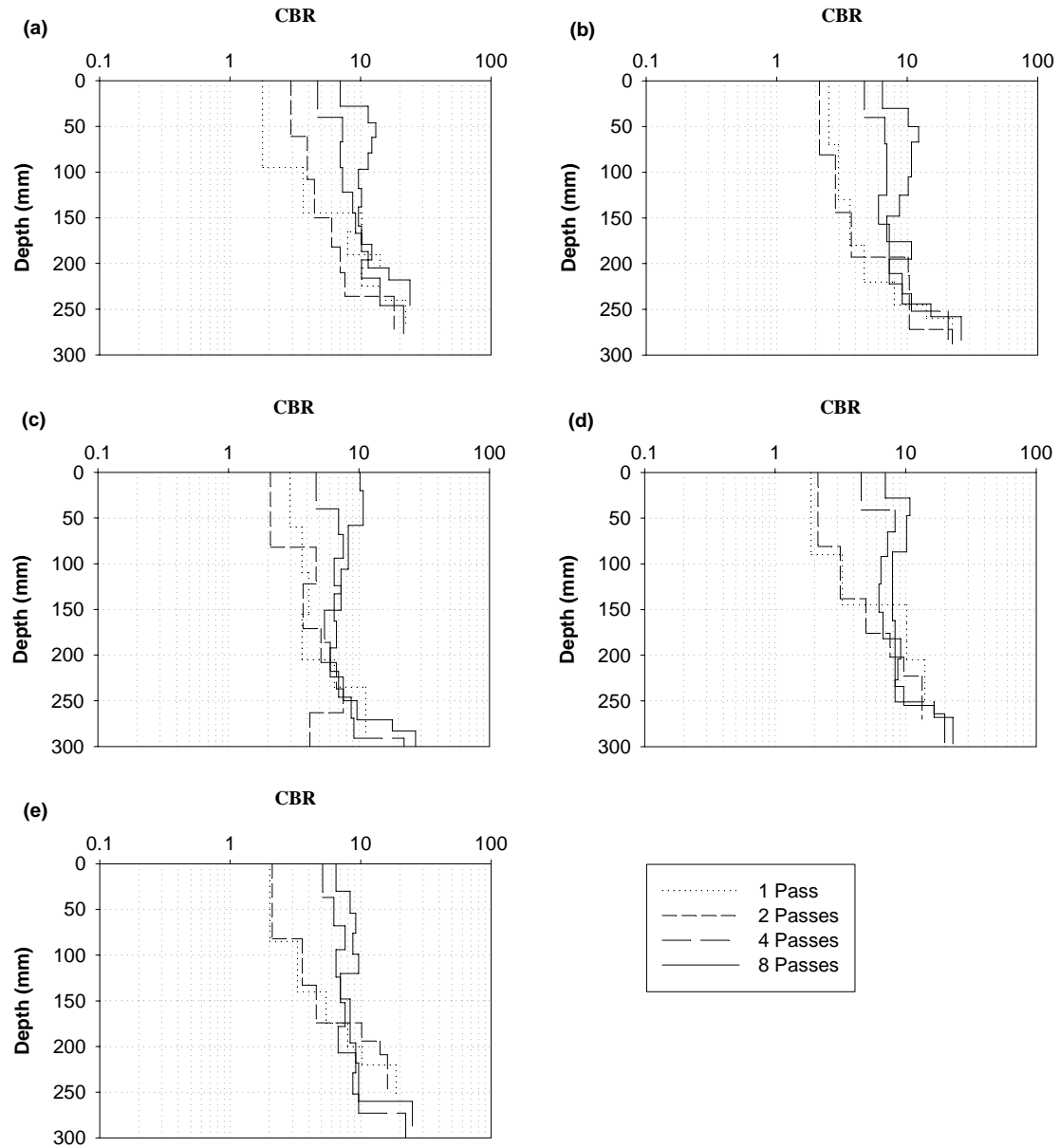
**Figure C.19. Edwards till, strip 1**

**(a) Pt 1; (b) Pt 2; (c) Pt 3; (d) Pt 4; (e) Pt 5**



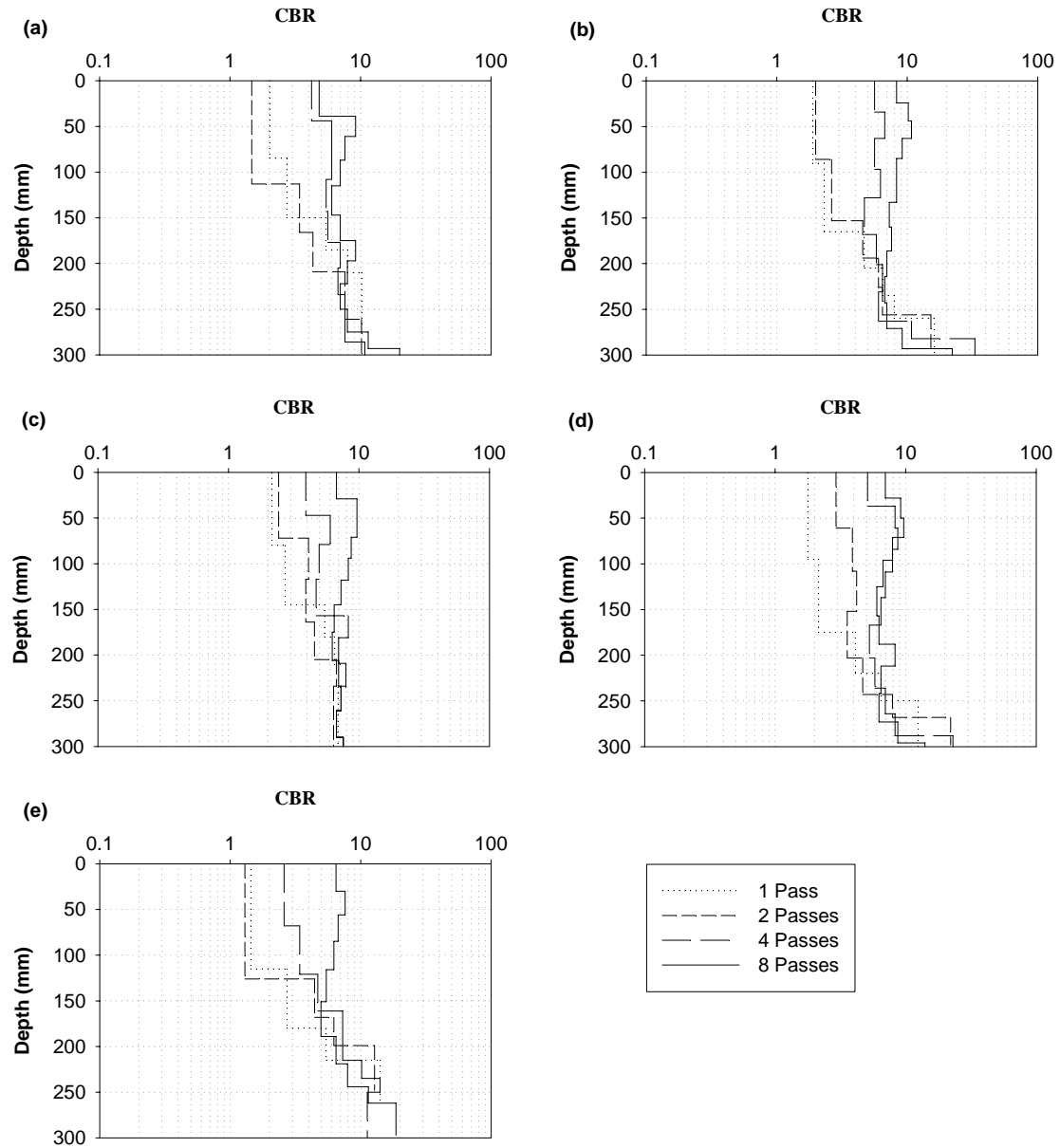
**Figure C.20. Edwards till, strip 1**

**(a) Pt 6; (b) Pt 7; (c) Pt 8; (d) Pt 9; (e) Pt 10**



**Figure C.21. Edwards till, strip 2**

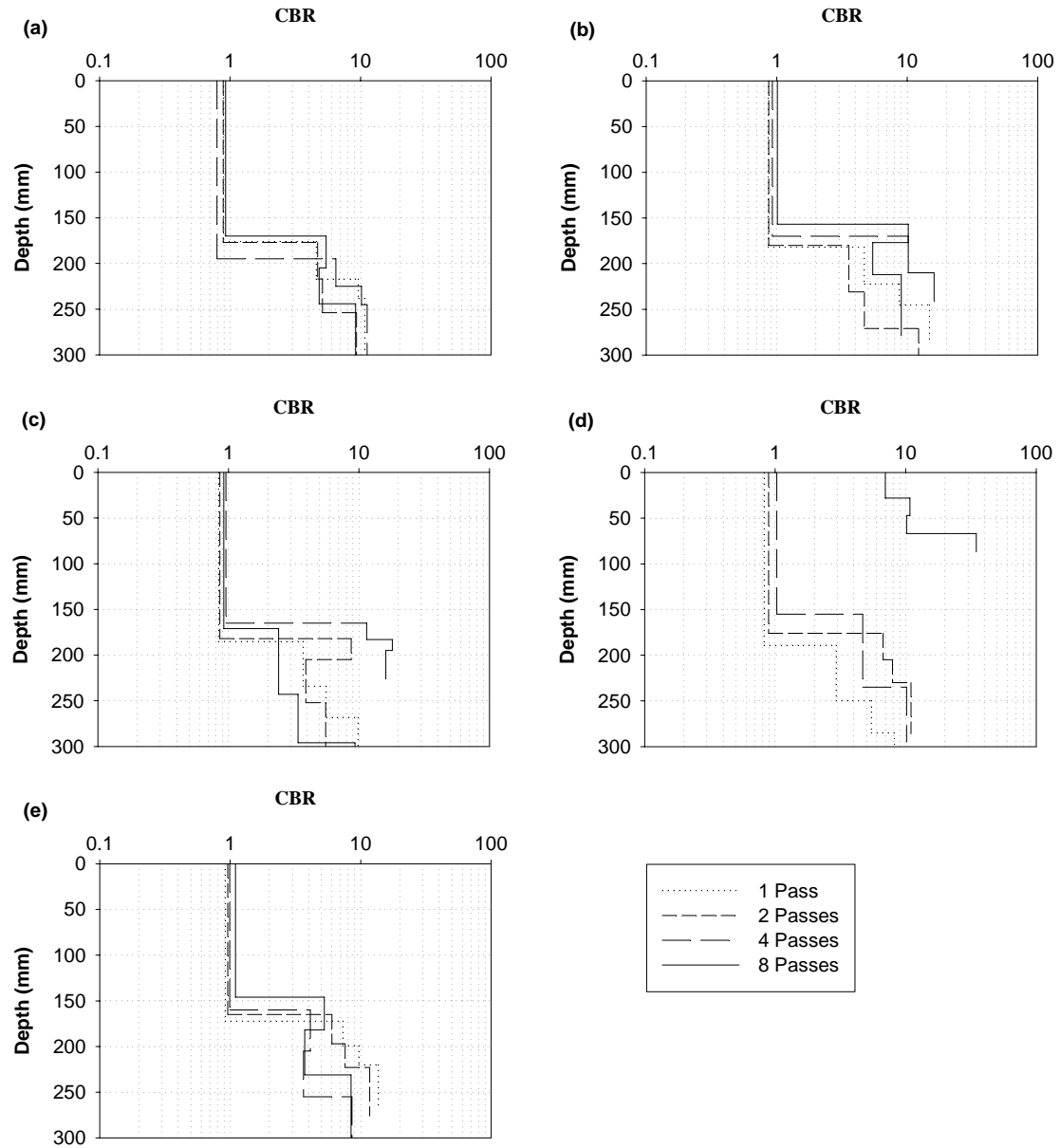
**(a) Pt 1; (b) Pt 2; (c) Pt 3; (d) Pt 4; (e) Pt 5**



**Figure C.22. Edwards till, strip 2**

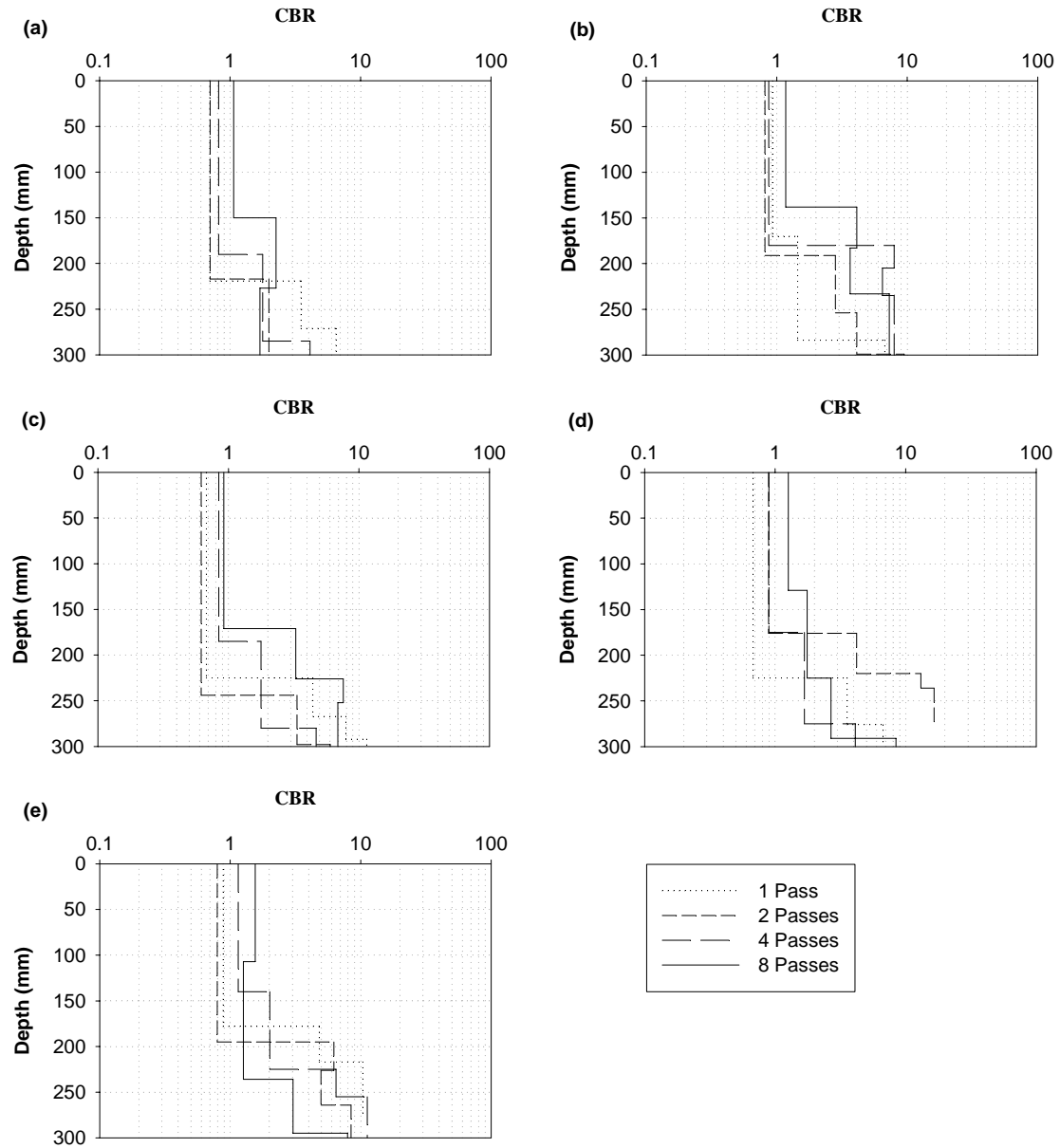
**(a) Pt 6; (b) Pt 7; (c) Pt 8; (d) Pt 9; (e) Pt 10**





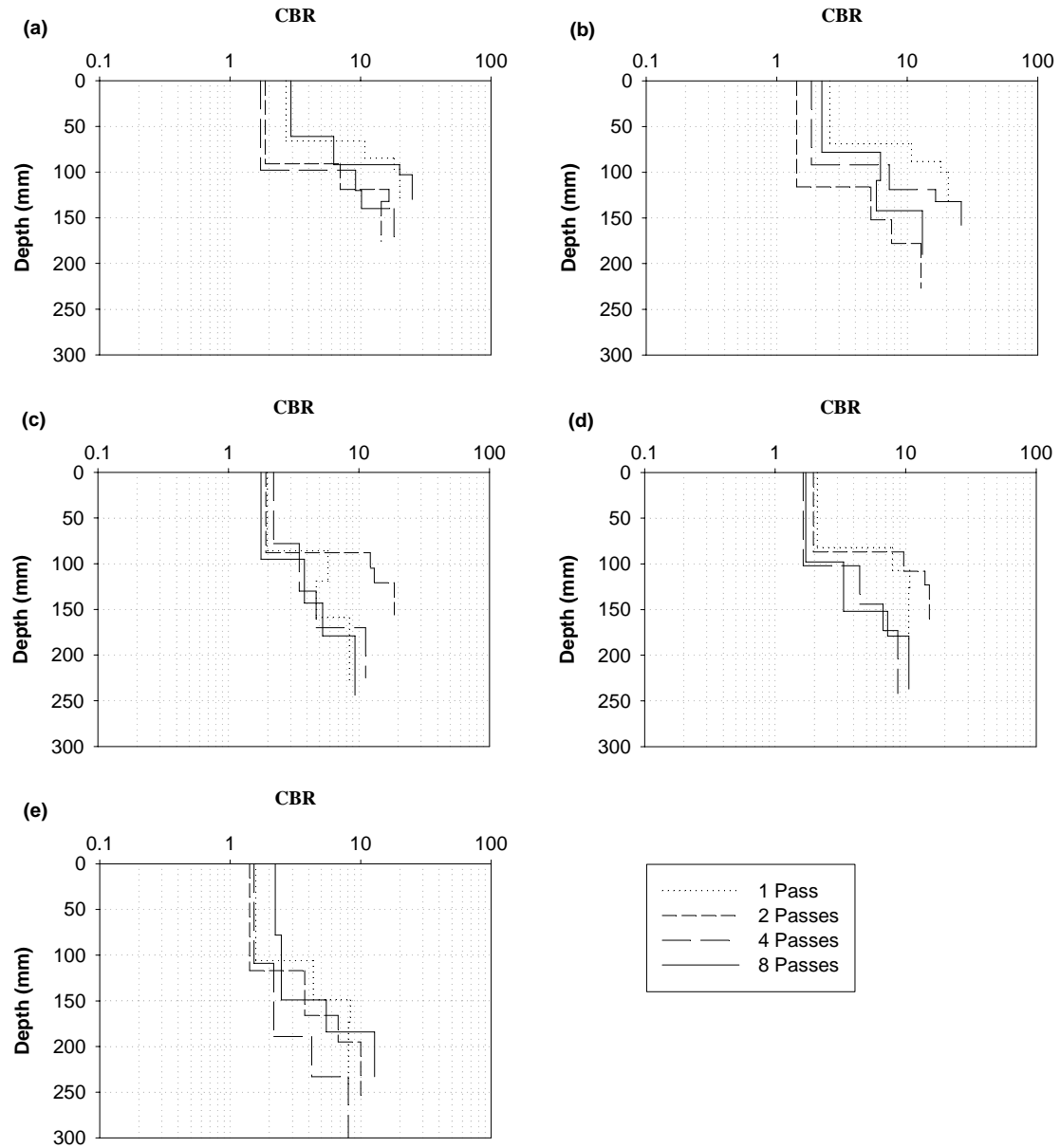
**Figure C.23. Edwards till, strip 3**

**(a) Pt 1; (b) Pt 2; (c) Pt 3; (d) Pt 4; (e) Pt 5**



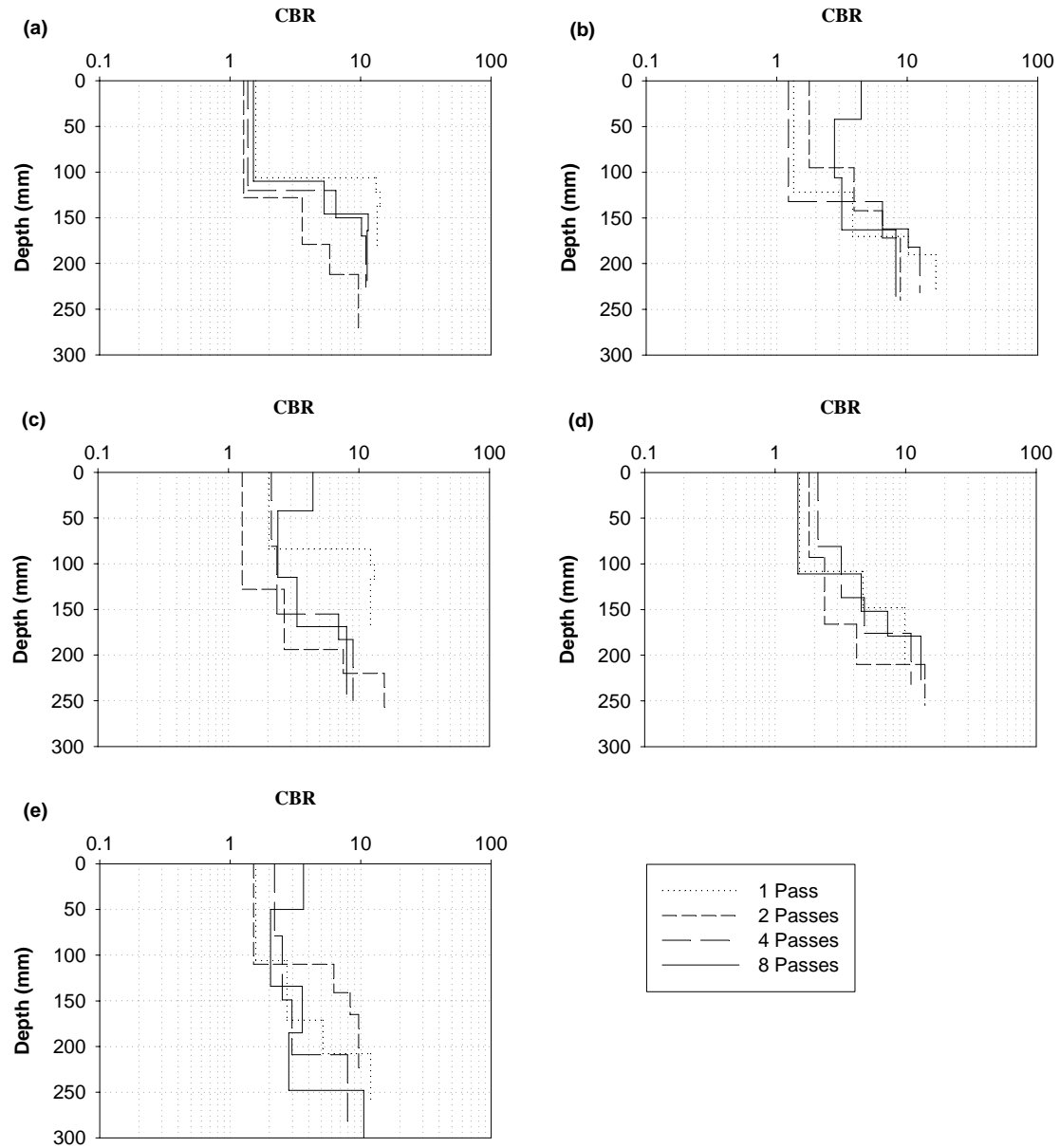
**Figure C.24. Edwards till, strip 3**

**(a) Pt 6; (b) Pt 7; (c) Pt 8; (d) Pt 9; (e) Pt 10**



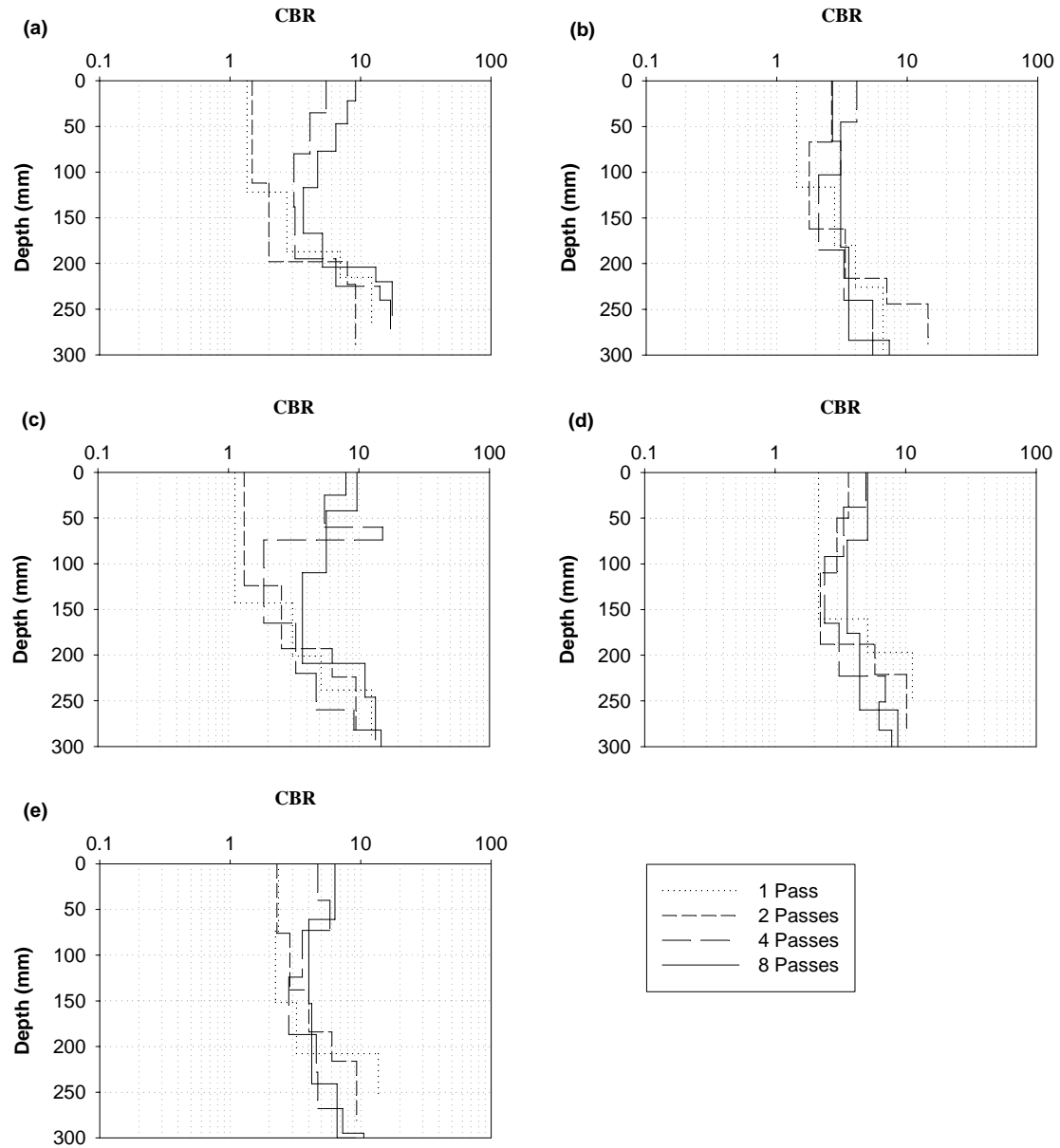
**Figure C.25. Edwards till, strip 4**

**(a) Pt 1; (b) Pt 2; (c) Pt 3; (d) Pt 4; (e) Pt 5**



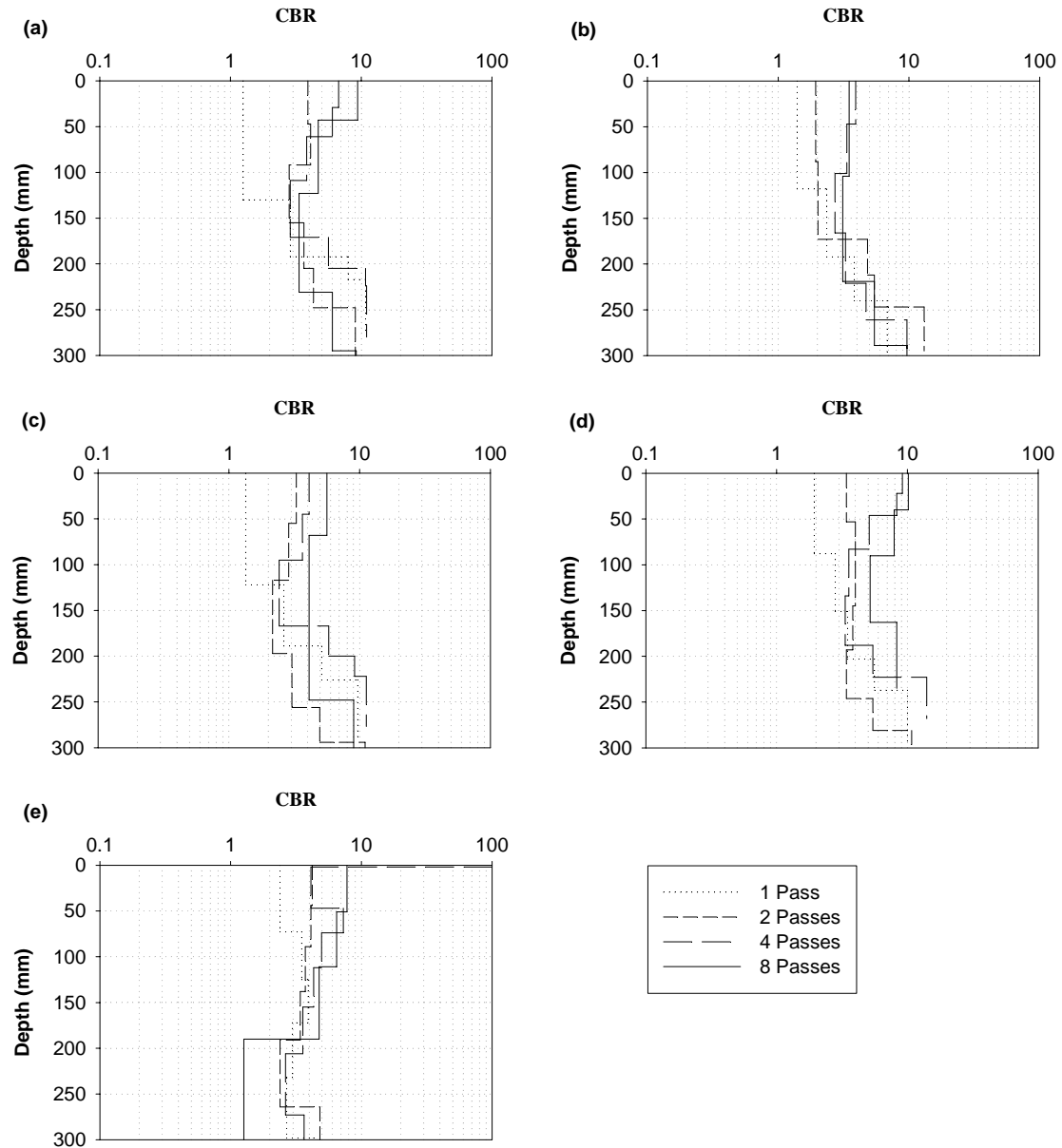
**Figure C.26. Edwards till, strip 4**

**(a) Pt 6; (b) Pt 7; (c) Pt 8; (d) Pt 9; (e) Pt 10**



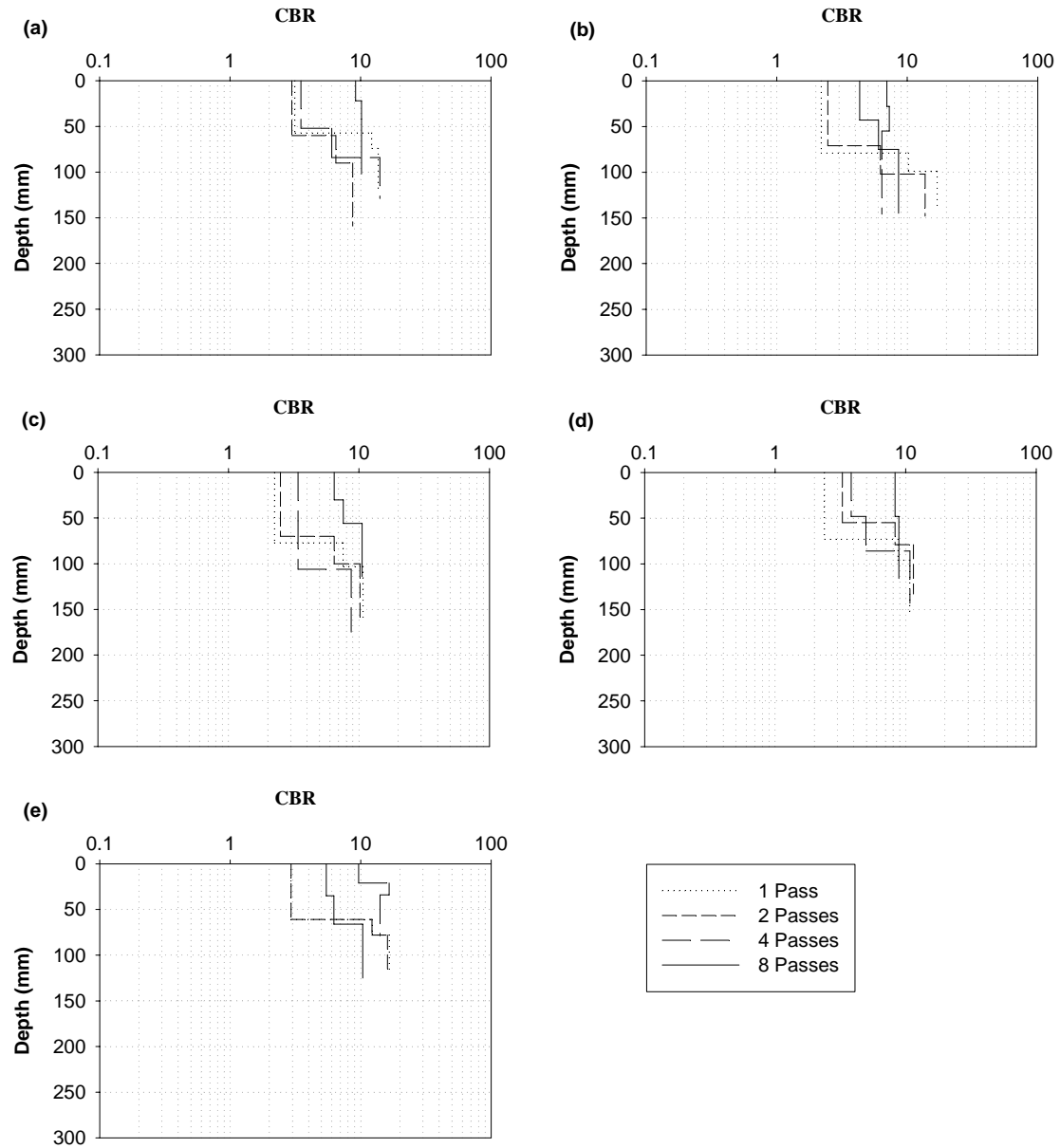
**Figure C.27. Edwards till, strip 5**

**(a) Pt 1; (b) Pt 2; (c) Pt 3; (d) Pt 4; (e) Pt 5**



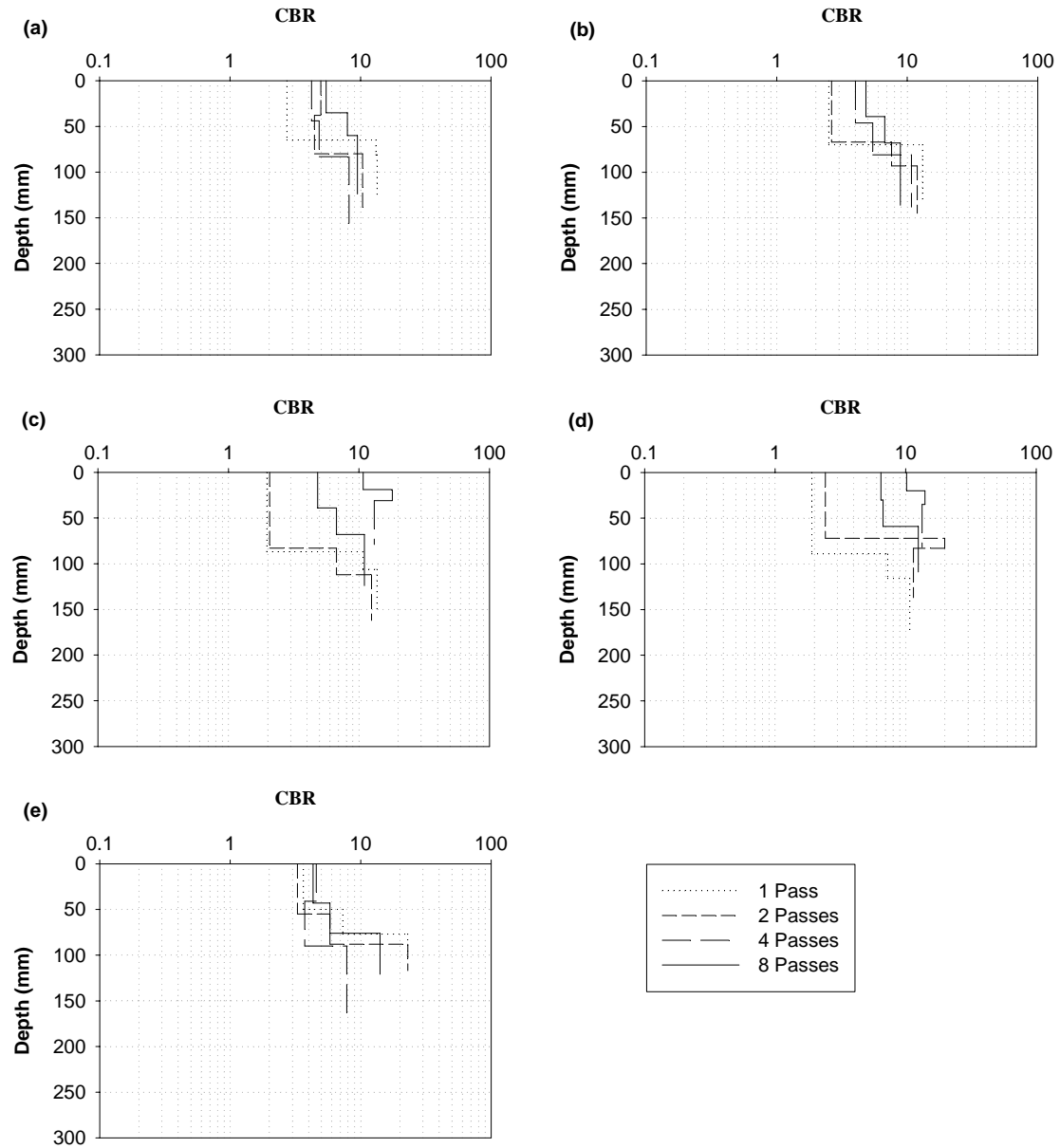
**Figure C.28. Edwards till, strip 5**

**(a) Pt 6; (b) Pt 7; (c) Pt 8; (d) Pt 9; (e) Pt 10**



**Figure C.29. Edwards till, strip 6**

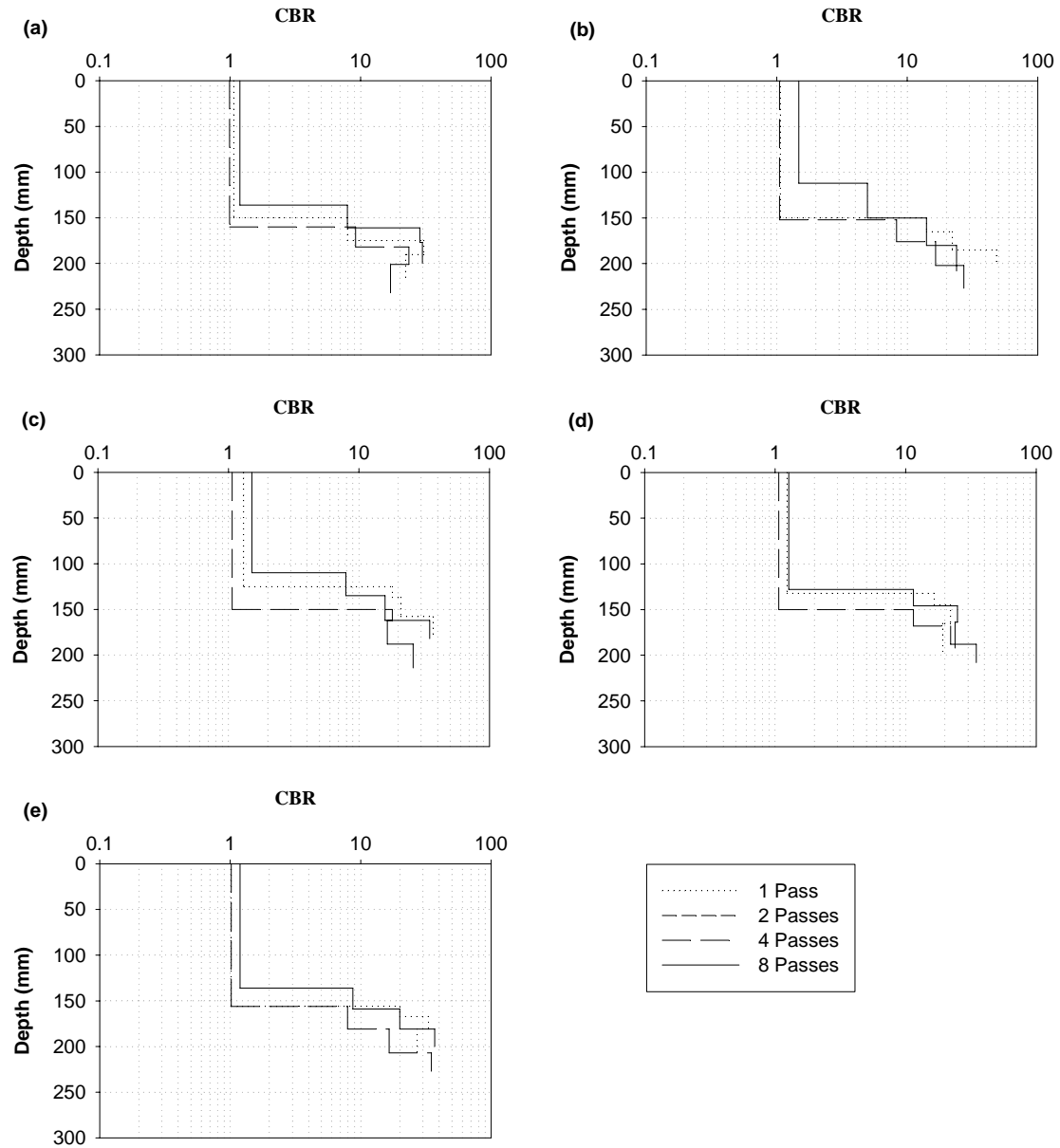
**(a) Pt 1; (b) Pt 2; (c) Pt 3; (d) Pt 4; (e) Pt 5**



**Figure C.30. Edwards till, strip 6**

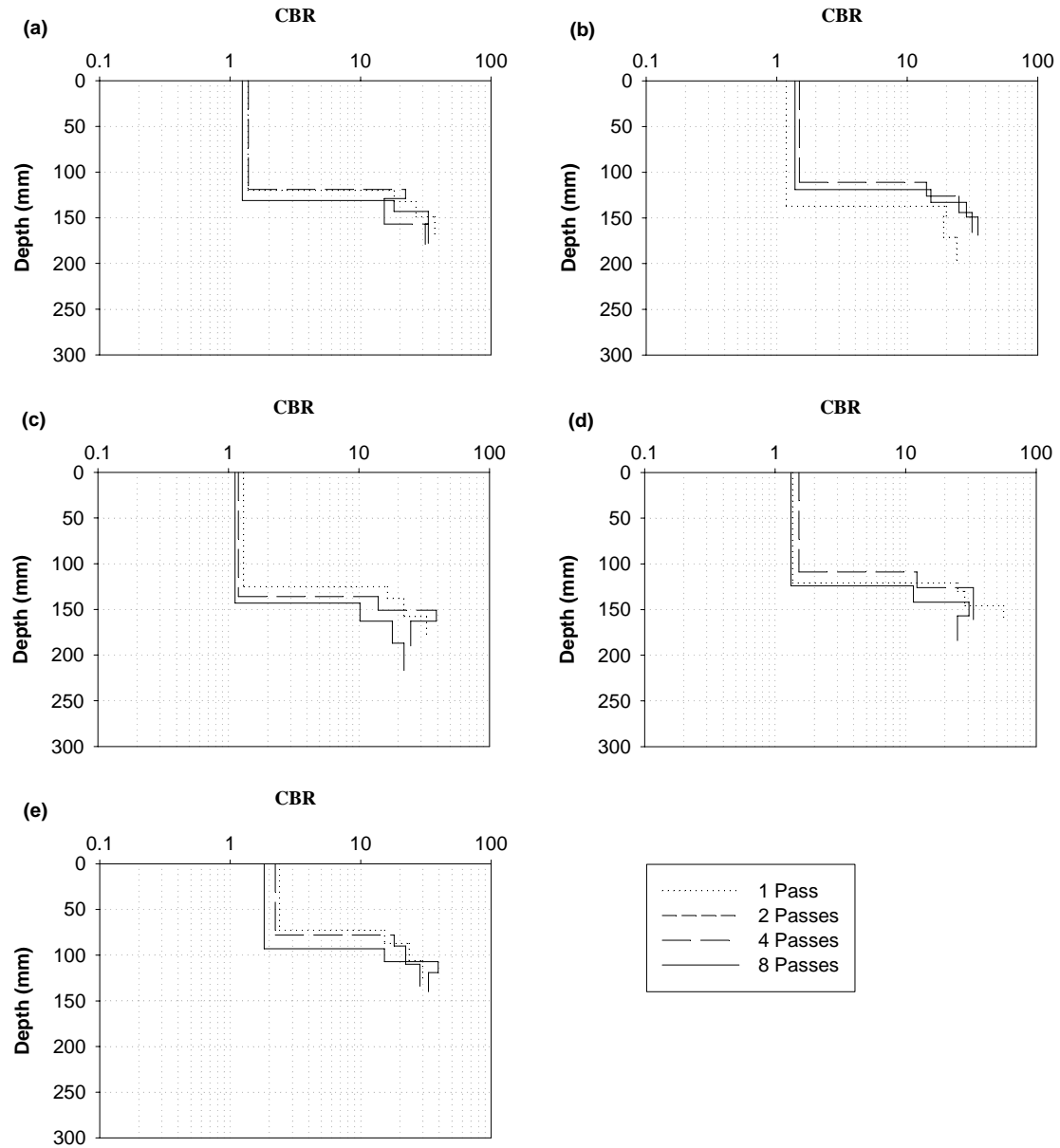
**(a) Pt 6; (b) Pt 7; (c) Pt 8; (d) Pt 9; (e) Pt 10**





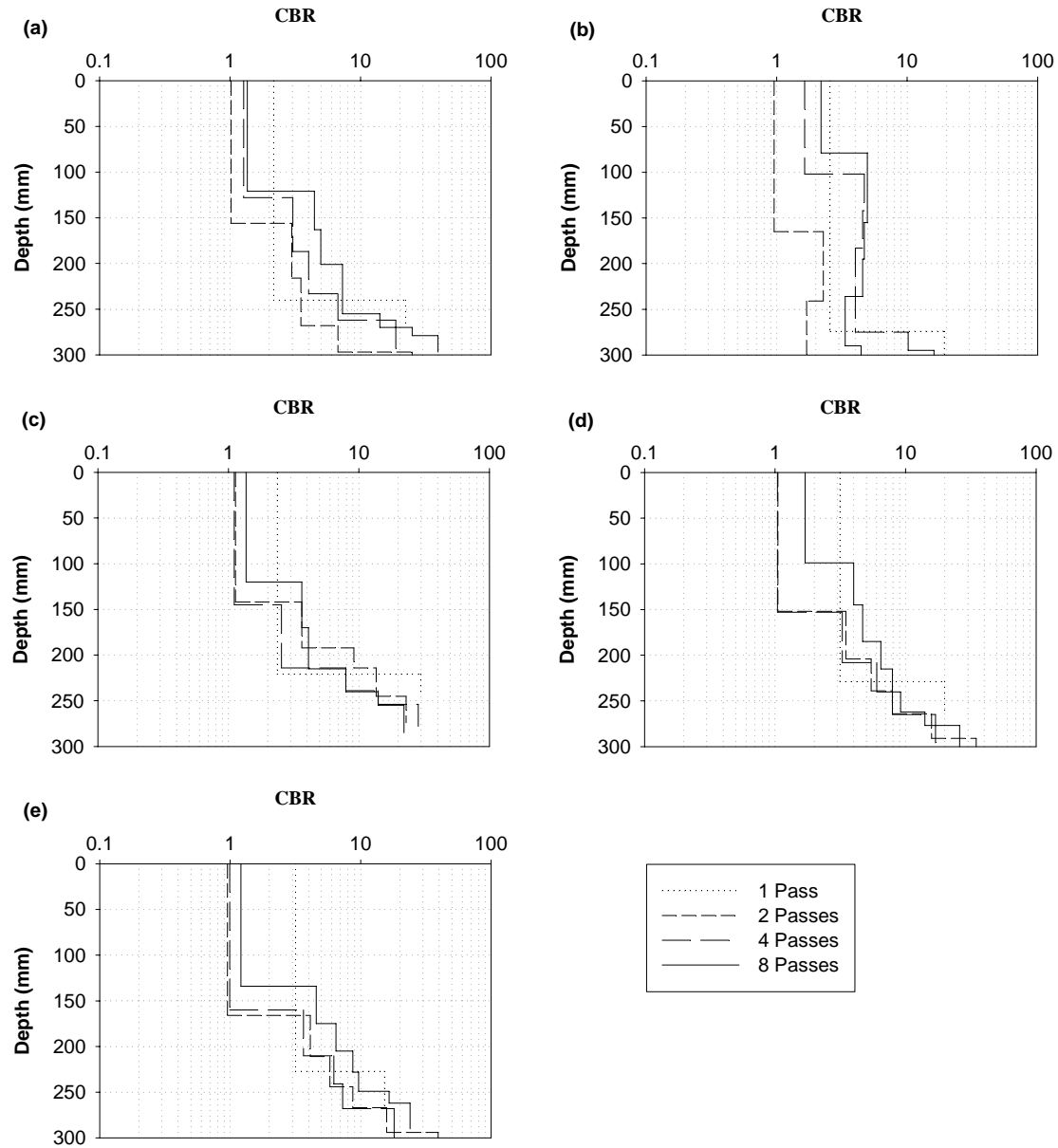
**Figure C.31. Kickapoo sand, strip 1**

**(a) Pt 1; (b) Pt 2; (c) Pt 3; (d) Pt 4; (e) Pt 5**



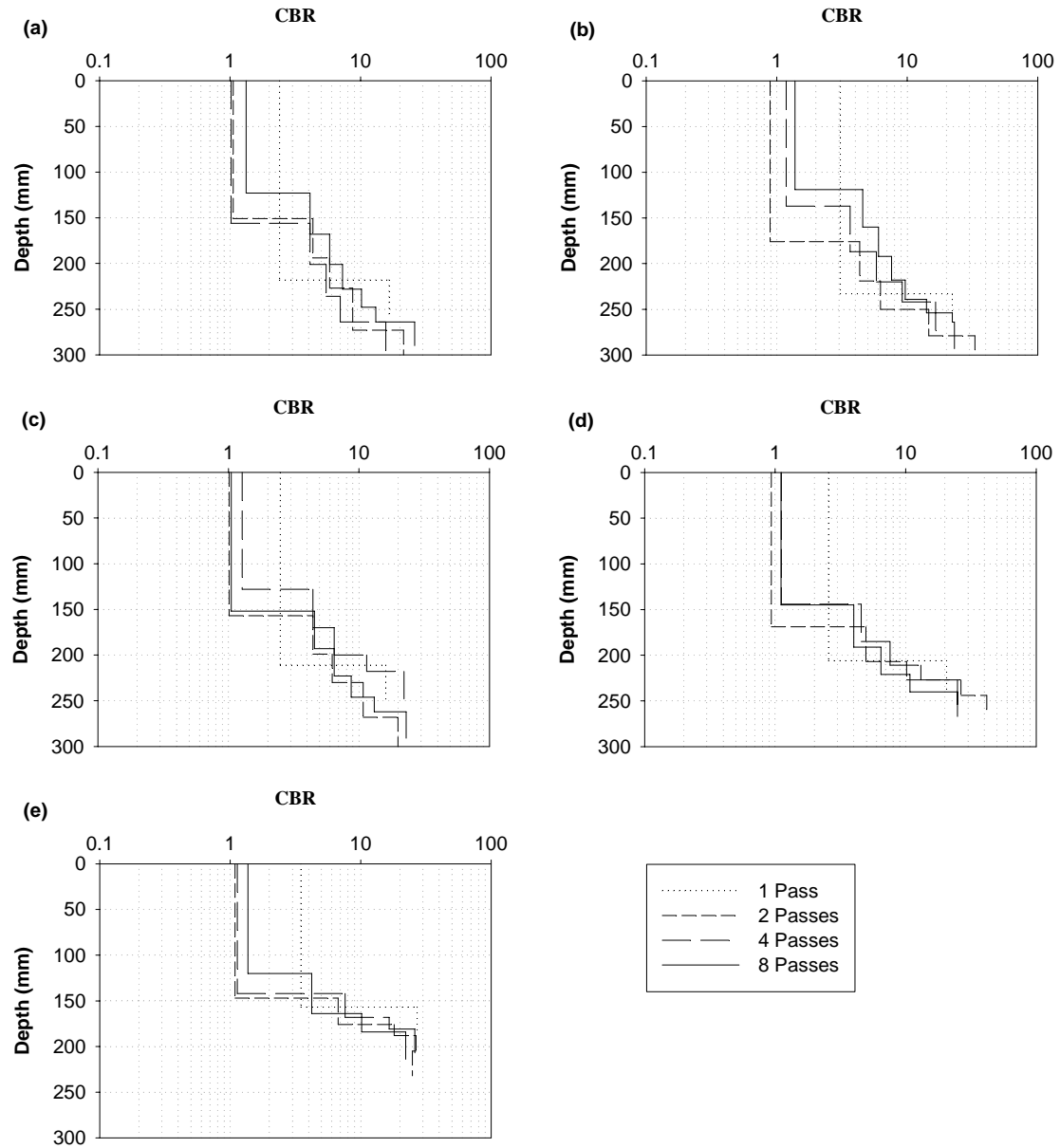
**Figure C.32. Kickapoo sand, strip 1**

**(a) Pt 6; (b) Pt 7; (c) Pt 8; (d) Pt 9; (e) Pt 10**



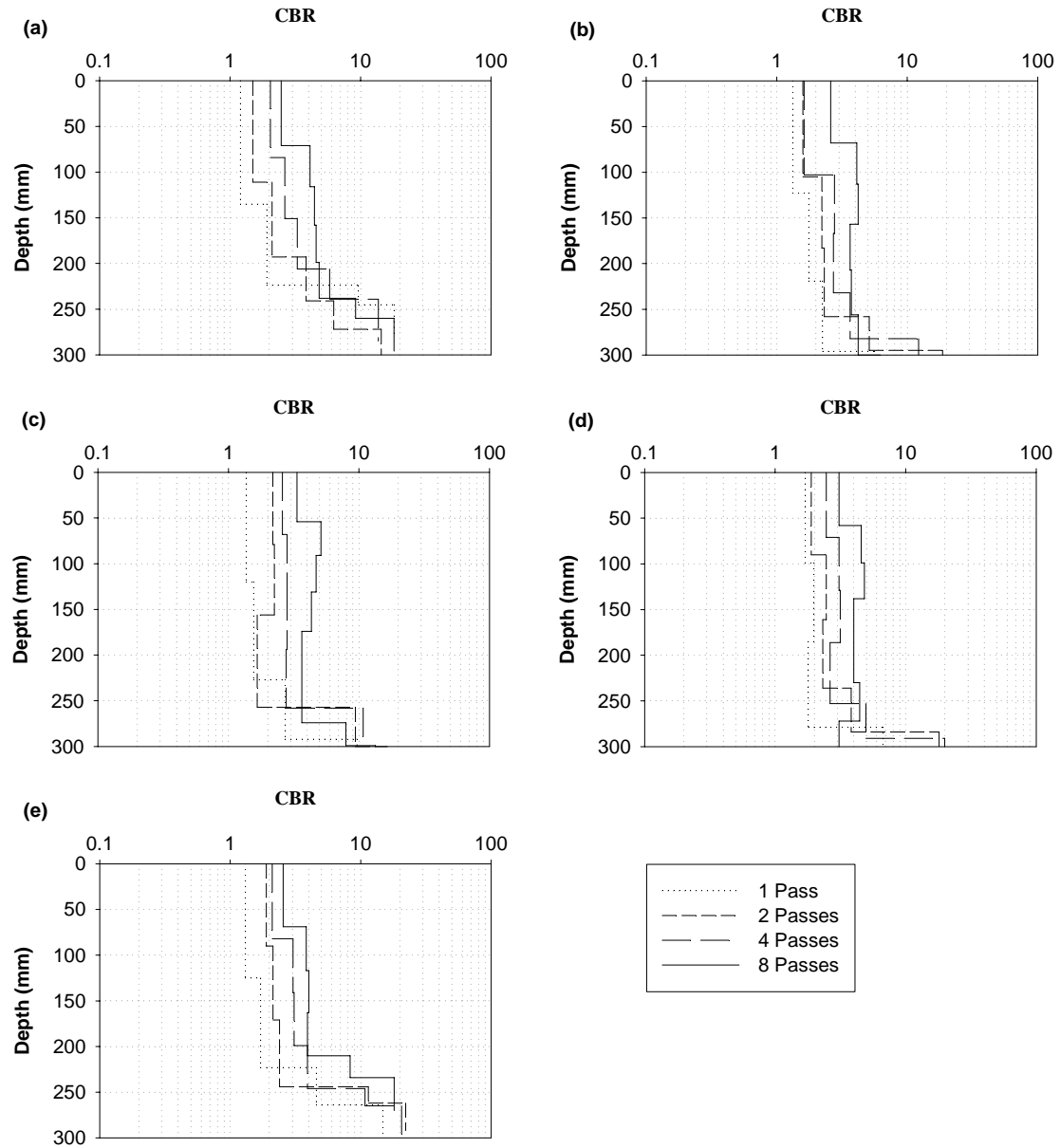
**Figure C.33. Kickapoo sand, strip 2**

**(a) Pt 1; (b) Pt 2; (c) Pt 3; (d) Pt 4; (e) Pt 5**



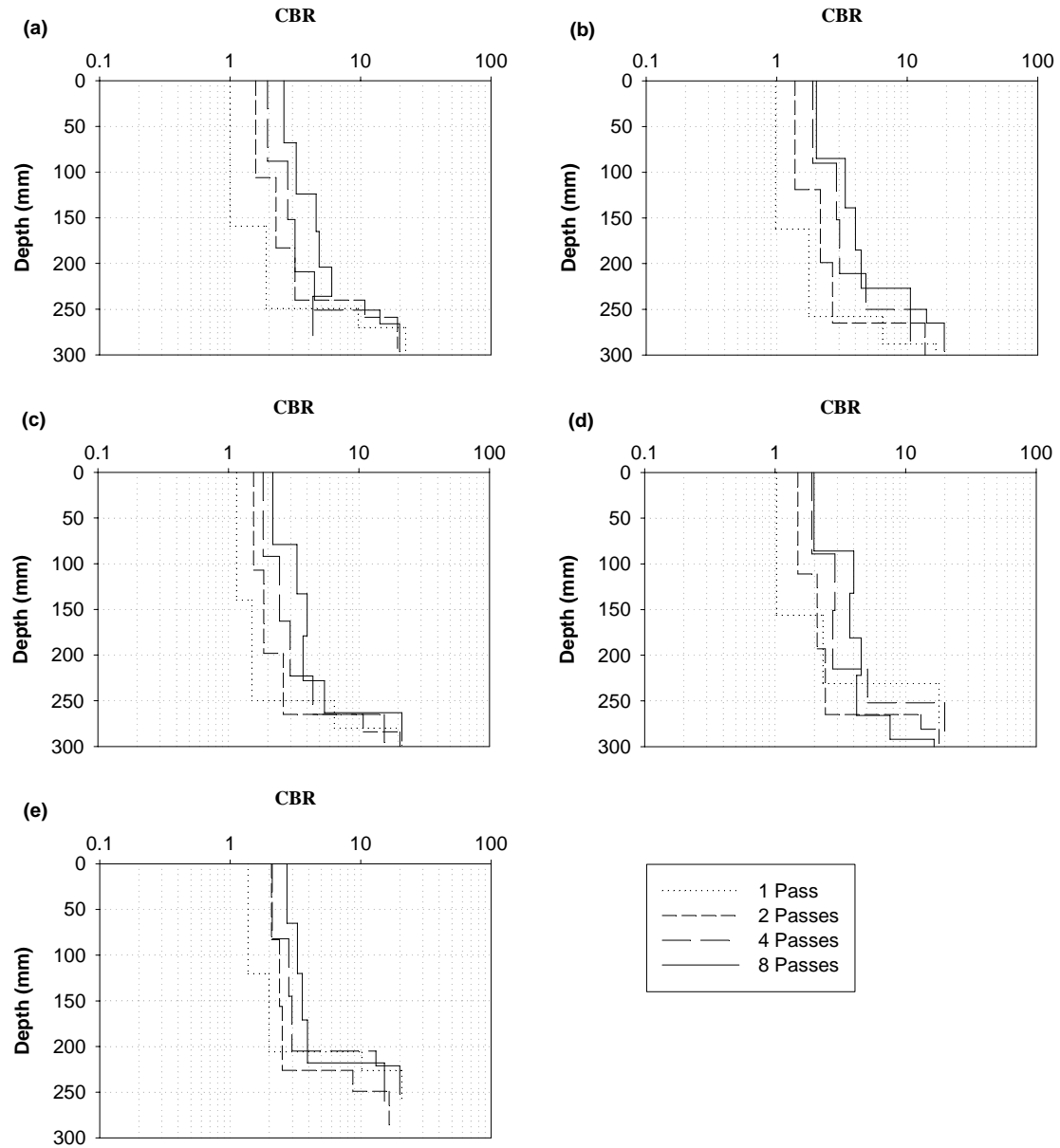
**Figure C.34. Kickapoo sand, strip 2**

**(a) Pt 6; (b) Pt 7; (c) Pt 8; (d) Pt 9; (e) Pt 10**



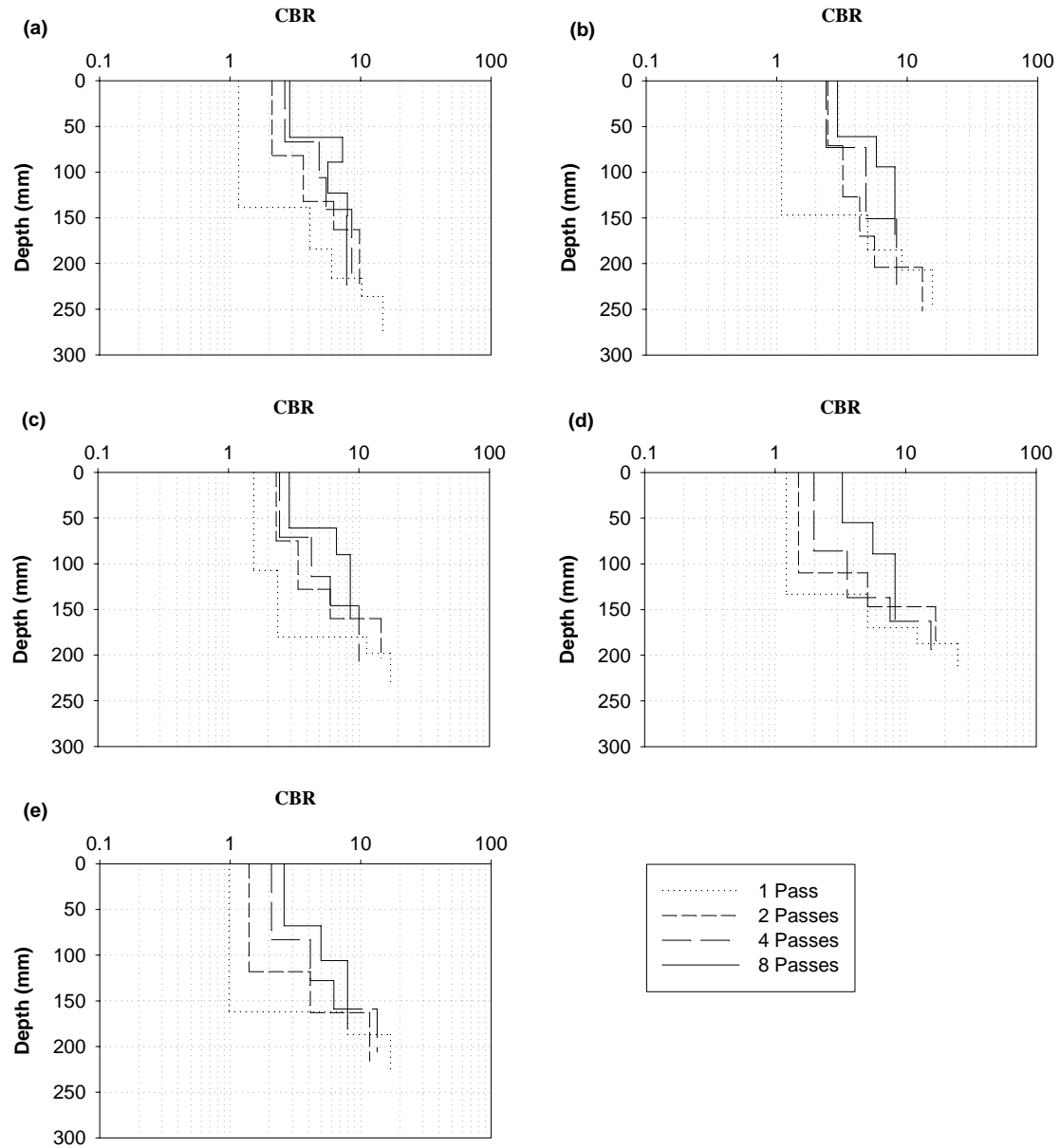
**Figure C.35. Kickapoo sand, strip 3**

**(a) Pt 1; (b) Pt 2; (c) Pt 3; (d) Pt 4; (e) Pt 5**



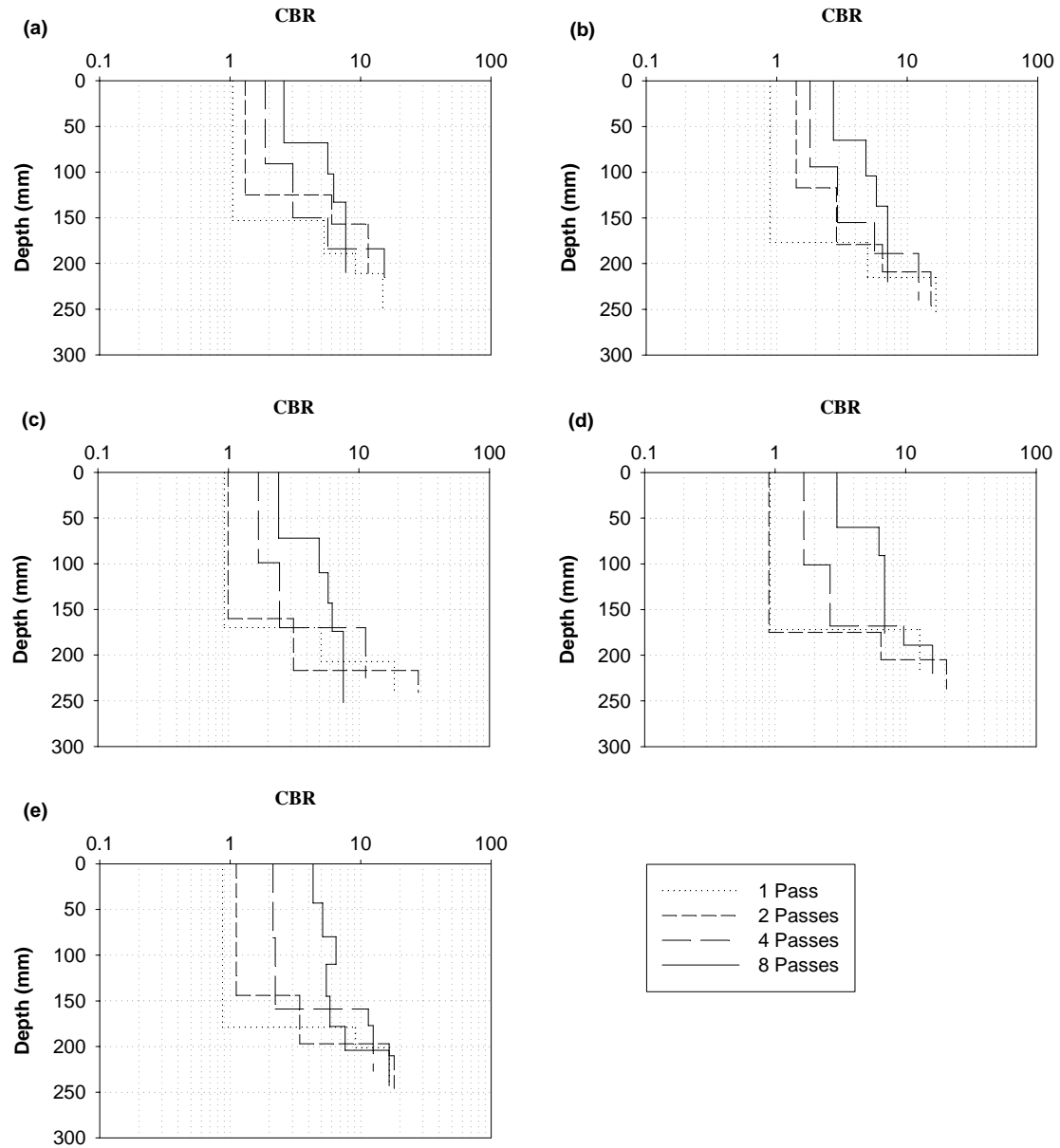
**Figure C.36. Kickapoo sand, strip 3**

**(a) Pt 6; (b) Pt 7; (c) Pt 8; (d) Pt 9; (e) Pt 10**



**Figure C.37. Kickapoo sand, strip 4**

**(a) Pt 1; (b) Pt 2; (c) Pt 3; (d) Pt 4; (e) Pt 5**



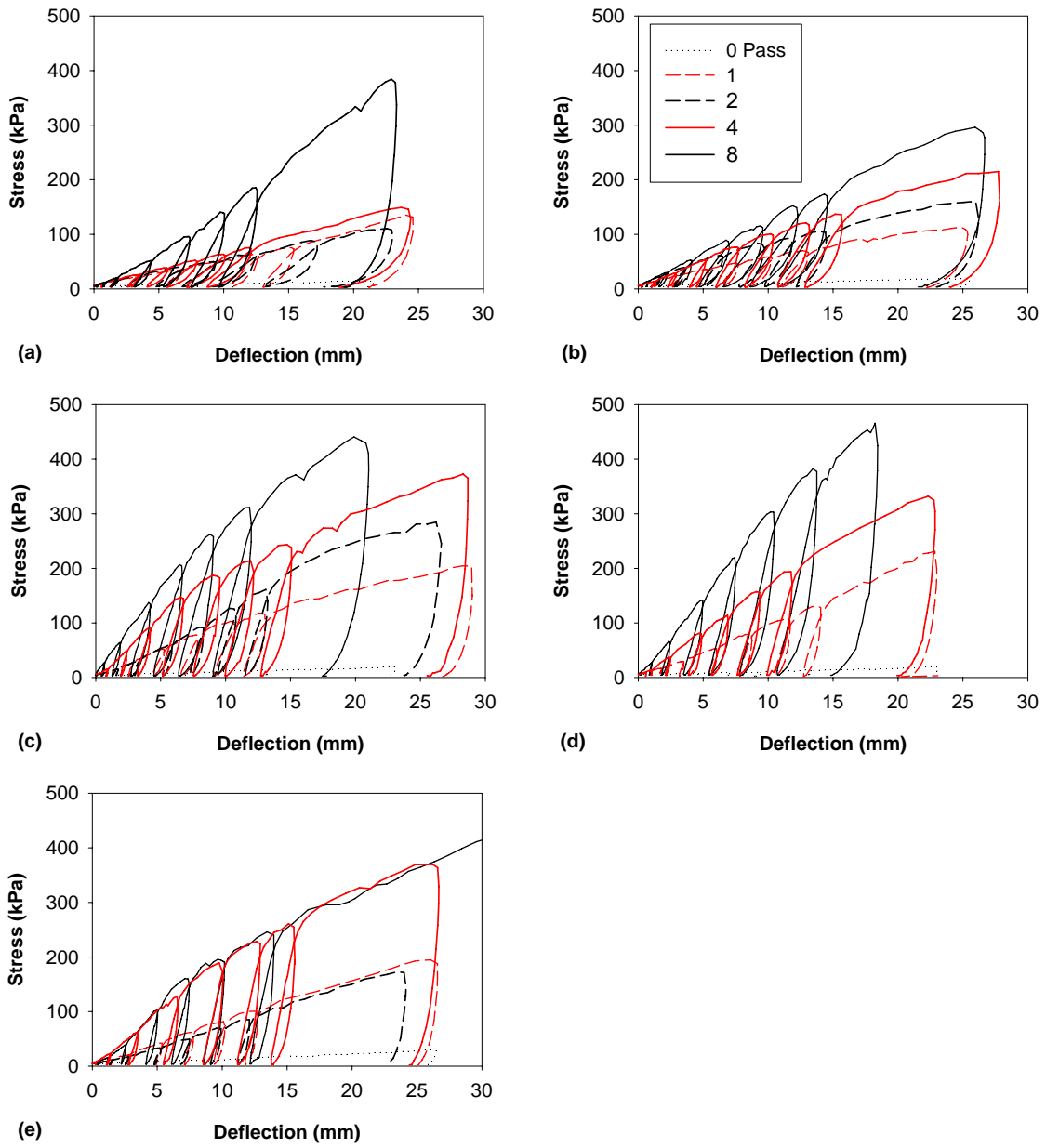
**Figure C.38. Kickapoo sand, strip 4**

**(a) Pt 6; (b) Pt 7; (c) Pt 8; (d) Pt 9; (e) Pt 10**



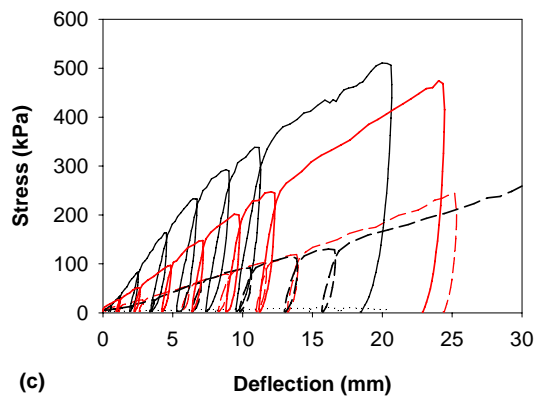
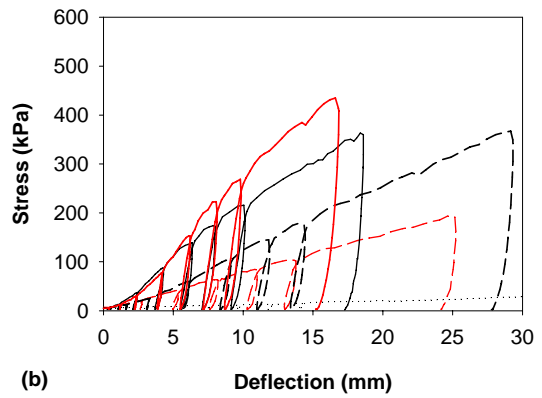
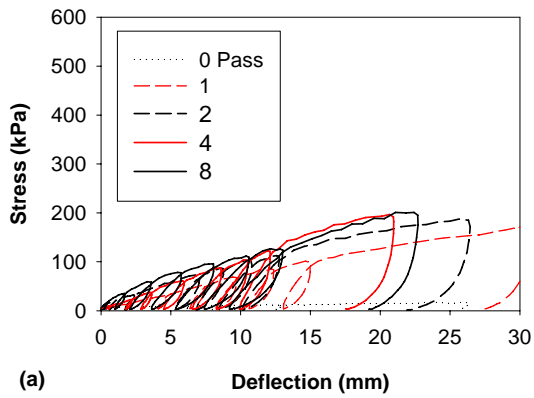


**APPENDIX D. PROJECT 1 PLT LOAD-DEFLECTION CURVES**



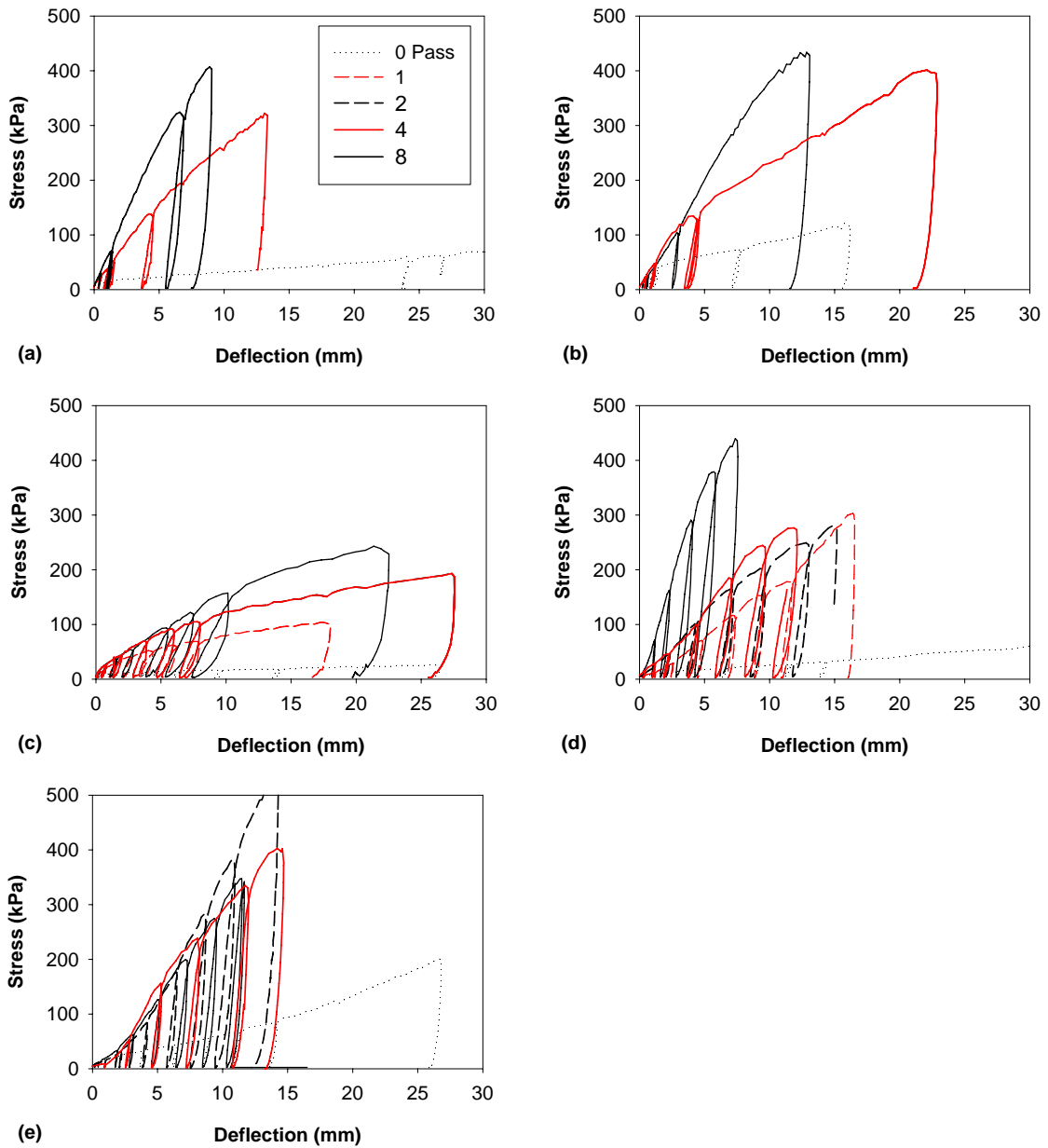
**Figure D.1. Plate bearing test results for Kickapoo topsoil**

**(a) strip 1; (b) strip 2; (c) strip 3; (d) strip 4; (e) strip 5**



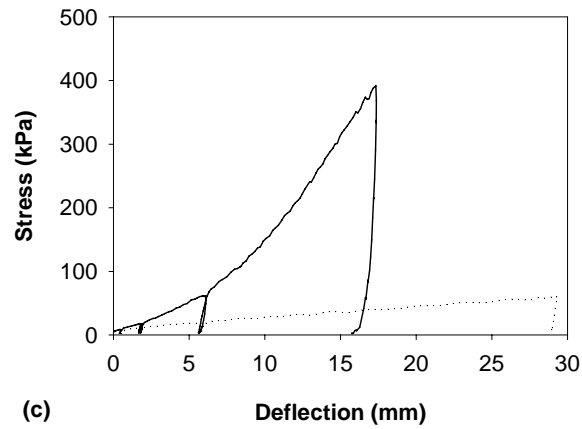
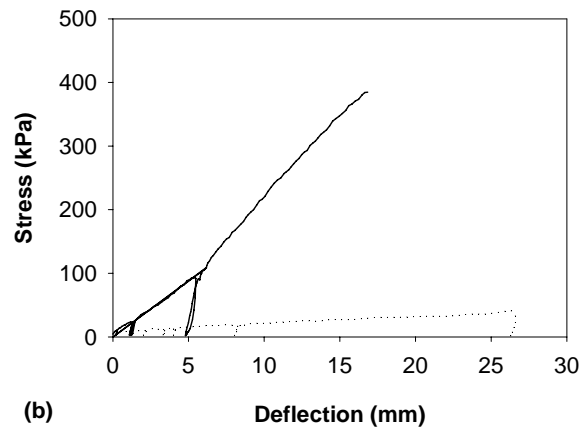
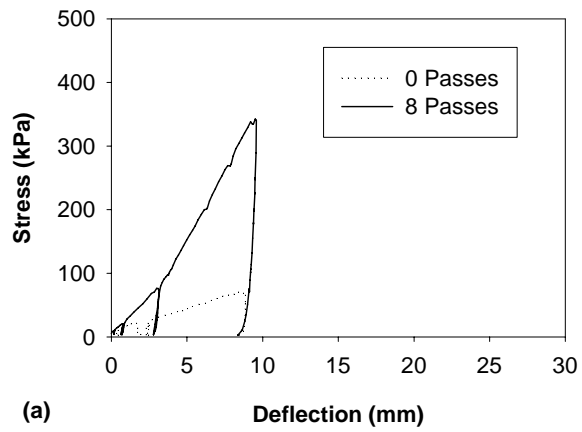
**Figure D.2. Plate bearing test results for Kickapoo Fill Clay**

**(a) strip 1; (b) strip 2; (c) strip 3**



**Figure D.3. Plate bearing test results for Edwards till**

**(a) strip 1; (b) strip 2; (c) strip 3; (d) strip 5; (e) strip 6**



**Figure D.4. Plate bearing test results for Kickapoo sand**

**(a) strip 2; (b) strip 3; (c) strip 4**



**APPENDIX E. PROJECT 2 IN SITU TEST DATA**



**Table E.1. Moisture and density summary of CA-6 sand, strip 1, lift 1, 0 roller passes**

Test point	Coordinates			Nuclear gauge (kN/m <sup>3</sup> , %)						Oven
	X	Y	Z	$\gamma_d^1$	$w_g^1$	$\gamma_d^2$	$w_g^2$	$\gamma_d$	$w_g$	$w_g$
1	---	---	---	15.49	6.5	15.44	7.3	15.47	6.9	---
2	---	---	---	15.44	7.6	14.91	9.2	15.17	8.4	---
3	---	---	---	15.52	7.6	15.55	7.7	15.54	7.7	---
4	---	---	---	15.94	7.2	15.80	7.6	15.88	7.4	---
5	---	---	---	15.52	7.4	15.54	7.7	15.54	7.6	---
6	---	---	---	15.88	6.9	15.72	7.3	15.80	7.1	---
7	---	---	---	16.31	8.2	16.20	8.2	16.26	8.2	---
8	---	---	---	16.46	8.1	16.37	8.2	16.42	8.2	---
9	---	---	---	15.79	7.8	15.79	7.2	15.79	7.5	---
10	---	---	---	16.01	8.1	16.07	8.6	16.04	8.4	---

**Table E.2. Stiffness and strength summary of CA-6 sand, strip 1, lift 1, 0 roller passes**

Test point	Geogauge		DCP	Portable FWD		
	M	S	DCPI	Force (kN)	$\delta$ ( $\mu\text{m}$ )	E (MPa)
1	---	---	284	---	---	---
2	---	---	250	---	---	---
3	---	---	264	---	---	---
4	---	---	250	---	---	---
5	---	---	200	---	---	---
6	---	---	184	---	---	---
7	---	---	223	---	---	---
8	---	---	90	---	---	---
9	---	---	150	---	---	---
10	---	---	78	---	---	---

**Table E.3. Moisture and density summary of CA-6 sand, strip 1, lift 1, 1 roller pass**

Test point	Coordinates			Nuclear gauge (kN/m <sup>3</sup> , %)						Oven
	X	Y	Z	$\gamma_d^1$	$w_g^1$	$\gamma_d^2$	$w_g^2$	$\gamma_d$	$w_g$	$w_g$
1	---	---	---	16.93	9.3	16.82	8.2	16.89	8.8	---
2	---	---	---	16.84	8.7	16.38	9.2	16.62	9.0	---
3	---	---	---	16.02	9.3	15.65	9.0	15.83	9.2	---
4	---	---	---	17.75	7.7	16.62	9.2	17.19	8.5	---
5	---	---	---	16.40	9.4	16.60	8.6	16.51	9.0	---
6	---	---	---	16.23	9.5	15.77	10.7	16.01	10.1	---
7	---	---	---	16.95	9.1	16.51	10.4	16.73	9.8	---
8	---	---	---	16.54	9.2	15.76	10.7	16.15	10.0	---
9	---	---	---	17.44	8.6	16.64	8.5	17.04	8.6	---
10	---	---	---	16.70	9.8	16.57	9.3	16.64	9.6	---

**Table E.4. Stiffness and strength summary of CA-6 sand, strip 1, lift 1, 1 roller pass**

Test point	Geogauge		DCP	Portable FWD		
	M	S	DCPI	Force (kN)	$\delta$ ( $\mu\text{m}$ )	E (MPa)
1	36.52	4.93	77	---	---	---
2	31.04	4.19	75	---	---	---
3	30.54	4.12	76	---	---	---
4	51.09	5.54	63	---	---	---
5	37.80	5.10	77	---	---	---
6	37.10	5.00	62	---	---	---
7	42.37	5.71	72	---	---	---
8	34.71	4.68	69	---	---	---
9	32.50	4.38	75	---	---	---
10	39.30	5.30	62	---	---	---

**Table E.5. Moisture and density summary of CA-6 sand, strip 1, lift 1, 2 roller passes**

Test point	Coordinates			Nuclear gauge (kN/m <sup>3</sup> , %)						Oven
	X	Y	Z	$\gamma_d^1$	$w_g^1$	$\gamma_d^2$	$w_g^2$	$\gamma_d$	$w_g$	$w_g$
1	-76.0	5.0	518.64	17.19	8.2	17.25	8.2	17.22	8.2	---
2	-72.0	4.0	518.79	16.95	8.4	16.56	8.7	16.76	8.6	---
3	-67.0	4.0	518.69	16.82	9.7	17.12	9.8	16.98	9.8	---
4	-62.0	4.0	518.62	17.61	8.3	17.39	8.9	17.50	8.6	---
5	-57.0	3.0	518.62	16.46	9.9	17.19	8.7	16.82	9.3	---
6	-52.0	2.0	518.49	17.19	8.9	16.87	9.6	17.03	9.3	---
7	-47.0	2.0	518.52	16.79	9.0	16.75	8.7	16.78	8.9	---
8	-42.0	1.0	518.44	17.55	9.3	17.58	8.8	17.56	9.1	---
9	-37.0	1.0	518.32	17.63	9.5	17.80	9.7	17.72	9.6	---
10	-32.0	0.0	518.38	17.80	9.4	17.39	8.2	17.59	8.8	---

**Table E.6. Stiffness and strength summary of CA-6 sand, strip 1, lift 1, 2 roller passes**

Test point	Geogauge		DCP	Portable FWD		
	M	S	DCPI	Force (kN)	$\delta$ ( $\mu\text{m}$ )	E (MPa)
1	---	---	36	---	---	---
2	48.28	6.51	41	---	---	---
3	50.57	6.82	40	---	---	---
4	52.74	7.11	48	---	---	---
5	54.51	7.35	30	---	---	---
6	---	---	43	---	---	---
7	---	---	32	---	---	---
8	---	---	33	---	---	---
9	---	---	40	---	---	---
10	---	---	38	---	---	---

**Table E.7. Moisture and density summary of CA-6 sand, strip 1, lift 1, 4 roller passes**

Test point	Coordinates			Nuclear gauge (kN/m <sup>3</sup> , %)						Oven
	X	Y	Z	$\gamma_d^1$	$w_g^1$	$\gamma_d^2$	$w_g^2$	$\gamma_d$	$w_g$	$w_g$
1	-79.0	5.0	518.87	16.70	9.7	16.79	8.8	16.75	9.3	6.4
2	-74.0	4.0	518.68	17.70	8.5	17.83	8.6	17.77	8.6	7.4
3	-69.0	3.0	518.67	17.34	8.3	17.22	9.2	17.28	8.8	6.3
4	-64.0	3.0	518.57	18.44	7.2	18.14	8.0	18.30	7.6	5.3
5	-59.0	2.0	518.44	17.14	9.5	17.30	8.6	17.22	9.1	6.7
6	-55.0	2.0	518.45	17.12	8.5	17.01	9.1	17.08	8.8	8.4
7	-51.0	2.0	518.42	16.98	9.3	17.50	8.8	17.25	9.1	9.4
8	-46.0	2.0	518.36	18.14	8.1	18.36	8.6	18.25	8.4	7.7
9	-41.0	2.0	518.30	17.50	9.2	17.06	10.2	17.28	9.7	9.7
10	-35.0	1.0	518.29	16.45	10.9	16.49	10.6	16.48	10.8	5.1

**Table E.8. Stiffness and strength summary of CA-6 sand, strip 1, lift 1, 4 roller passes**

Test point	Geogauge		DCP	Portable FWD		
	M	S	DCPI	Force (kN)	$\delta$ ( $\mu\text{m}$ )	E (MPa)
1	---	---	32	---	---	---
2	---	---	36	---	---	---
3	---	---	34	---	---	---
4	---	---	34	---	---	---
5	---	---	29	---	---	---
6	---	---	40	---	---	---
7	---	---	40	---	---	---
8	---	---	55	---	---	---
9	---	---	46	---	---	---
10	---	---	42	---	---	---

**Table E.9. Moisture and density summary of CA-6 sand, strip 1, lift 2, 0 roller passes**

Test point	Coordinates			Nuclear gauge (kN/m <sup>3</sup> , %)						Oven
	X	Y	Z	$\gamma_d^1$	$w_g^1$	$\gamma_d^2$	$w_g^2$	$\gamma_d$	$w_g$	$w_g$
1	---	---	---	15.52	8.0	15.71	5.3	15.61	6.7	---
2	---	---	---	15.17	6.8	14.92	7.4	15.05	7.1	---
3	---	---	---	14.73	7.1	14.64	7.6	14.69	7.4	---
4	---	---	---	15.87	7.1	15.91	7.0	15.90	7.1	---
5	---	---	---	15.50	6.5	15.03	7.7	15.27	7.1	---
6	---	---	---	15.25	6.5	15.19	6.6	15.22	6.6	---
7	---	---	---	14.69	6.0	14.88	6.7	14.78	6.4	---
8	---	---	---	15.43	6.8	15.47	6.8	15.46	6.8	---
9	---	---	---	15.50	8.5	15.91	6.3	15.71	7.4	---
10	---	---	---	14.97	5.9	14.89	6.6	14.94	6.3	---

**Table E.10. Stiffness and strength summary of CA-6 sand, strip 1, lift 2, 0 roller passes**

Test point	Geogauge		DCP	Portable FWD		
	M	S	DCPI	Force (kN)	$\delta$ ( $\mu\text{m}$ )	E (MPa)
1	---	---	220	---	---	---
2	---	---	253	---	---	---
3	---	---	265	---	---	---
4	---	---	253	---	---	---
5	---	---	257	---	---	---
6	---	---	220	---	---	---
7	---	---	286	---	---	---
8	---	---	236	---	---	---
9	---	---	192	---	---	---
10	---	---	246	---	---	---

**Table E.11. Moisture and density summary of CA-6 sand, strip 1, lift 2, 1 roller pass**

Test point	Coordinates			Nuclear gauge (kN/m <sup>3</sup> , %)						Oven
	X	Y	Z	$\gamma_d^1$	$w_g^1$	$\gamma_d^2$	$w_g^2$	$\gamma_d$	$w_g$	$w_g$
1	-98.0	9.0	519.38	16.76	6.3	16.87	6.7	16.82	6.5	---
2	-94.0	9.0	519.30	16.75	8.2	16.70	8.1	16.73	8.2	---
3	-89.0	8.0	519.35	17.23	8.1	16.92	8.3	17.08	8.2	---
4	-84.0	7.0	---	16.24	10.4	16.29	10.9	16.27	10.7	---
5	-79.0	7.0	---	16.13	8.2	16.04	7.7	16.09	8.0	---
6	-74.0	6.0	---	16.70	8.7	16.76	7.4	16.73	8.1	---
7	-69.0	6.0	519.22	16.79	8.8	15.98	8.0	16.38	8.4	---
8	-64.0	5.0	519.06	15.91	8.7	16.45	9.6	16.18	9.2	---
9	-59.0	5.0	519.03	16.82	8.4	16.59	8.2	16.71	8.3	---
10	-54.0	4.0	519.16	16.16	8.5	16.07	7.5	16.12	8.0	---

**Table E.12. Stiffness and strength summary of CA-6 sand, strip 1, lift 2, 1 roller pass**

Test point	Geogauge		DCP	Portable FWD		
	M	S	DCPI	Force (kN)	$\delta$ ( $\mu\text{m}$ )	E (MPa)
1	---	---	71	---	---	---
2	---	---	49	---	---	---
3	---	---	65	---	---	---
4	---	---	52	---	---	---
5	---	---	48	---	---	---
6	---	---	50	---	---	---
7	---	---	66	---	---	---
8	---	---	65	---	---	---
9	---	---	54	---	---	---
10	---	---	62	---	---	---

**Table E.13. Moisture and density summary of CA-6 sand, strip 1, lift 2, 2 roller passes**

Test point	Coordinates			Nuclear gauge (kN/m <sup>3</sup> , %)						Oven
	X	Y	Z	$\gamma_d^1$	$w_g^1$	$\gamma_d^2$	$w_g^2$	$\gamma_d$	$w_g$	$w_g$
1	-96.0	7.0	519.402	17.30	8.7	18.25	7.0	17.78	7.9	---
2	-91.0	7.0	519.372	18.13	6.4	17.36	7.6	17.75	7.0	---
3	-85.0	7.0	519.252	17.55	8.0	16.95	9.7	17.25	8.9	---
4	-81.0	7.0	519.303	17.74	7.0	17.04	9.2	17.39	8.1	---
5	-76.0	7.0	519.245	16.16	9.1	16.04	9.8	16.10	9.5	---
6	-71.0	7.0	519.231	17.44	7.6	17.22	8.2	17.33	7.9	---
7	-67.0	7.0	519.076	17.30	8.4	17.06	8.6	17.19	8.5	---
8	-62.0	6.0	519.017	17.06	7.7	16.54	7.5	16.81	7.6	---
9	-62.0	7.0	518.998	17.53	9.2	17.26	8.1	17.41	8.7	---
10	-56.0	6.0	518.962	16.89	7.5	16.97	7.8	16.93	7.7	---

**Table E.14. Stiffness and strength summary of CA-6 sand, strip 1, lift 2, 2 roller passes**

Test point	Geogauge		DCP	Portable FWD		
	M	S	DCPI	Force (kN)	$\delta$ ( $\mu\text{m}$ )	E (MPa)
1	---	---	32	---	---	---
2	---	---	46	---	---	---
3	---	---	37	---	---	---
4	---	---	37	---	---	---
5	---	---	37	---	---	---
6	---	---	42	---	---	---
7	---	---	35	---	---	---
8	---	---	50	---	---	---
9	---	---	39	---	---	---
10	---	---	42	---	---	---

**Table E.15. Moisture and density summary of CA-6 sand, strip 1, lift 2, 4 roller passes**

Test point	Coordinates			Nuclear gauge (kN/m <sup>3</sup> , %)						Oven
	X	Y	Z	$\gamma_d^1$	$w_g^1$	$\gamma_d^2$	$w_g^2$	$\gamma_d$	$w_g$	$w_g$
1	-99.0	9.0	519.44	18.21	8.2	18.30	8.1	18.25	8.2	---
2	-95.0	9.0	519.33	17.42	8.3	17.30	8.2	17.36	8.3	---
3	-89.0	8.0	519.23	17.75	8.8	17.59	8.6	17.67	8.7	---
4	-83.0	7.0	519.27	18.13	7.9	17.72	8.3	17.92	8.1	---
5	-79.0	7.0	519.25	17.47	8.6	17.17	8.8	17.33	8.7	---
6	-74.0	6.0	519.17	17.45	7.4	16.97	9.3	17.22	8.4	---
7	-68.0	6.0	519.21	18.80	7.6	18.35	8.0	18.58	7.8	---
8	-64.0	5.0	519.06	17.83	8.1	18.03	8.0	17.94	8.1	---
9	-59.0	4.0	519.06	17.63	8.3	17.70	7.7	17.67	8.0	---
10	-54.0	4.0	519.03	18.30	8.0	18.24	8.3	18.27	8.2	---

**Table E.16. Stiffness and strength summary of CA-6 sand, strip 1, lift 2, 4 roller passes**

Test point	Geogauge		DCP	Portable FWD		
	M	S	DCPI	Force (kN)	$\delta$ ( $\mu\text{m}$ )	E (MPa)
1	---	---	32	---	---	---
2	---	---	39	---	---	---
3	---	---	29	---	---	---
4	---	---	22	---	---	---
5	---	---	34	---	---	---
6	---	---	41	---	---	---
7	---	---	25	---	---	---
8	---	---	26	---	---	---
9	---	---	36	---	---	---
10	---	---	28	---	---	---



**Table E.17. Moisture and density summary of CA-6 sand, strip 1, lift 2, 8 roller passes**

Test point	Coordinates			Nuclear gauge (kN/m <sup>3</sup> , %)						Oven
	X	Y	Z	$\gamma_d^1$	$w_g^1$	$\gamma_d^2$	$w_g^2$	$\gamma_d$	$w_g$	
1	-95.0	9.0	519.41	17.45	7.8	17.48	7.1	17.47	7.5	6.5
2	-91.0	8.0	519.30	17.63	7.5	17.91	7.0	17.77	7.3	6.0
3	-86.0	7.0	519.33	17.94	7.4	18.05	7.6	18.00	7.5	7.1
4	-81.0	7.0	519.33	18.33	7.3	17.72	8.7	18.03	8.0	6.9
5	-76.0	7.0	519.26	17.37	9.4	17.67	8.7	17.53	9.1	8.5
6	-71.0	6.0	519.23	18.39	7.3	18.22	7.6	18.32	7.5	6.5
7	-66.0	5.0	519.19	18.77	7.8	18.00	7.0	18.39	7.4	8.6
8	-62.0	5.0	519.13	18.03	7.2	17.75	7.2	17.89	7.2	8.2
9	-57.0	4.0	519.15	18.68	7.4	18.02	7.8	18.35	7.6	10.1
10	-52.0	4.0	519.10	18.98	6.6	18.30	8.2	18.65	7.4	6.6

**Table E.18. Stiffness and strength summary of CA-6 sand, strip 1, lift 2, 8 roller passes**

Test point	Geogauge		DCP	Portable FWD		
	M	S	DCPI	Force (kN)	$\delta$ ( $\mu\text{m}$ )	E (MPa)
1	---	---	12	---	---	---
2	---	---	35	---	---	---
3	---	---	23	---	---	---
4	---	---	21	---	---	---
5	---	---	21	---	---	---
6	---	---	26	---	---	---
7	---	---	28	---	---	---
8	---	---	29	---	---	---
9	---	---	27	---	---	---
10	---	---	17	---	---	---

**Table E.19. Moisture and density summary of CA-6 sand, strip 1, lift 3, 0 roller passes**

Test point	Coordinates			Nuclear gauge (kN/m <sup>3</sup> , %)						Oven
	X	Y	Z	$\gamma_d^1$	$w_g^1$	$\gamma_d^2$	$w_g^2$	$\gamma_d$	$w_g$	$w_g$
1	---	---	---	15.68	9.8	15.06	6.6	15.38	8.2	---
2	---	---	---	15.27	5.7	15.10	6.5	15.19	6.1	---
3	---	---	---	15.77	6.5	15.54	6.7	15.66	6.6	---
4	---	---	---	15.35	6.4	15.00	6.7	15.17	6.6	---
5	---	---	---	15.22	6.5	14.70	7.9	14.97	7.2	---
6	---	---	---	15.57	5.9	14.81	6.3	15.19	6.1	---
7	---	---	---	14.89	5.7	14.95	6.4	14.92	6.1	---
8	---	---	---	15.19	6.5	15.65	5.4	15.43	6.0	---
9	---	---	---	14.72	6.4	14.69	8.3	14.70	7.4	---
10	---	---	---	15.08	7.0	14.61	7.6	14.84	7.3	---

**Table E.20. Stiffness and strength summary of CA-6 sand, strip 1, lift 3, 0 roller passes**

Test point	Geogauge		DCP	Portable FWD		
	M	S	DCPI	Force (kN)	$\delta$ ( $\mu\text{m}$ )	E (MPa)
1	---	---	150	---	---	---
2	---	---	168	---	---	---
3	---	---	120	---	---	---
4	---	---	161	---	---	---
5	---	---	149	---	---	---
6	---	---	114	---	---	---
7	---	---	235	---	---	---
8	---	---	250	---	---	---
9	---	---	283	---	---	---
10	---	---	184	---	---	---

**Table E.21. Moisture and density summary of CA-6 sand, strip 1, lift 3, 1 roller pass**

Test point	Coordinates			Nuclear gauge (kN/m <sup>3</sup> , %)						Oven
	X	Y	Z	$\gamma_d^1$	$w_g^1$	$\gamma_d^2$	$w_g^2$	$\gamma_d$	$w_g$	$w_g$
1	45.0	22.0	520.04	16.73	7.4	16.71	7.3	16.73	7.4	---
2	50.0	22.0	519.98	16.48	8.2	16.64	7.2	16.56	7.7	---
3	55.0	22.0	519.94	16.51	6.7	16.12	6.9	16.32	6.8	---
4	61.0	21.0	519.89	16.68	7.5	16.73	7.1	16.71	7.3	---
5	65.0	21.0	519.89	16.73	8.2	16.60	9.0	16.67	8.6	---
6	71.0	20.0	519.89	16.43	7.3	16.59	7.0	16.51	7.2	---
7	75.0	20.0	519.85	16.87	6.8	16.32	7.0	16.60	6.9	---
8	80.0	20.0	519.85	16.70	7.3	16.24	7.5	16.48	7.4	---
9	85.0	20.0	519.80	16.98	8.0	16.04	8.9	16.51	8.5	---
10	89.0	19.0	519.79	16.23	8.5	15.68	7.8	15.96	8.2	---

**Table E.22. Stiffness and strength summary of CA-6 sand, strip 1, lift 3, 1 roller pass**

Test point	Geogauge		DCP	Portable FWD		
	M	S	DCPI	Force (kN)	$\delta$ ( $\mu\text{m}$ )	E (MPa)
1	---	---	48	4.3	594	23
2	---	---	93	4.3	653	21
3	---	---	65	4.3	585	24
4	---	---	64	4.3	525	26
5	---	---	54	4.2	728	19
6	---	---	79	4.3	433	32
7	---	---	104	4.3	704	19
8	---	---	97	4.3	781	18
9	---	---	52	4.3	738	19
10	---	---	53	4.2	886	15

**Table E.23. Moisture and density summary of CA-6 sand, strip 1, lift 3, 2 roller passes**

Test point	Coordinates			Nuclear gauge (kN/m <sup>3</sup> , %)						Oven
	X	Y	Z	$\gamma_d^1$	$w_g^1$	$\gamma_d^2$	$w_g^2$	$\gamma_d$	$w_g$	$w_g$
1	47.0	22.0	520.05	16.62	7.5	16.54	7.3	16.59	7.4	---
2	54.0	22.0	519.98	15.90	7.5	15.85	8.0	15.88	7.8	---
3	59.0	21.0	519.96	17.37	6.7	16.48	7.5	16.93	7.1	---
4	64.0	21.0	519.87	16.79	7.4	16.48	8.5	16.64	8.0	---
5	67.0	20.0	519.94	16.86	6.9	17.63	7.6	17.25	7.3	---
6	73.0	20.0	519.91	16.81	6.8	17.08	6.7	16.95	6.8	---
7	78.0	20.0	519.93	16.68	7.3	16.20	7.6	16.45	7.5	---
8	82.0	19.0	519.84	16.16	7.0	15.98	8.3	16.07	7.7	---
9	87.0	19.0	519.81	16.27	8.2	16.38	7.8	16.34	8.0	---
10	92.0	19.0	519.76	16.53	7.6	16.43	6.9	16.48	7.3	---

**Table E.24. Stiffness and strength summary of CA-6 sand, strip 1, lift 3, 2 roller passes**

Test point	Geogauge		DCP	Portable FWD		
	M	S	DCPI	Force (kN)	$\delta$ ( $\mu\text{m}$ )	E (MPa)
1	---	---	34	4.3	636	22
2	---	---	47	4.3	825	17
3	---	---	35	4.3	619	22
4	---	---	39	4.4	619	23
5	---	---	39	4.3	544	25
6	---	---	33	4.3	422	31
7	---	---	37	4.3	545	25
8	---	---	48	4.3	583	23
9	---	---	11	4.2	526	26
10	---	---	22	4.1	549	25

**Table E.25. Moisture and density summary of CA-6 sand, strip 1, lift 3, 4 roller passes**

Test point	Coordinates			Nuclear gauge (kN/m <sup>3</sup> , %)						Oven
	X	Y	Z	$\gamma_d^1$	$w_g^1$	$\gamma_d^2$	$w_g^2$	$\gamma_d$	$w_g$	$w_g$
1	46.0	22.0	520.11	17.53	8.2	17.74	8.2	17.64	8.2	---
2	50.0	21.0	520.10	17.47	7.7	16.67	7.3	17.08	7.5	---
3	55.0	21.0	519.97	17.26	6.7	16.90	7.3	17.09	7.0	---
4	60.0	21.0	519.97	17.89	6.0	17.70	7.1	17.80	6.5	---
5	65.0	20.0	519.97	18.24	7.4	18.02	8.6	18.13	8.0	---
6	71.0	19.0	519.92	17.96	6.9	17.33	6.9	17.64	6.9	---
7	76.0	19.0	519.87	17.23	7.8	17.22	8.1	17.23	8.0	---
8	80.0	18.0	519.80	16.95	8.0	16.97	7.9	16.97	8.0	---
9	85.0	18.0	519.82	18.18	7.2	17.59	7.9	17.89	7.6	---
10	90.0	18.0	519.82	18.02	7.0	16.71	8.2	17.37	7.6	---

**Table E.26. Stiffness and strength summary of CA-6 sand, strip 1, lift 3, 4 roller passes**

Test point	Geogauge		DCP	Portable FWD		
	M	S	DCPI	Force (kN)	$\delta$ ( $\mu\text{m}$ )	E (MPa)
1	---	---	26	4.3	498	27
2	---	---	24	4.3	415	33
3	---	---	29	4.1	605	21
4	---	---	28	4.3	299	46
5	---	---	22	4.3	431	32
6	---	---	26	4.3	594	23
7	---	---	26	2.3	152	47
8	---	---	24	4.3	331	42
9	---	---	27	4.2	529	26
10	---	---	19	4.1	642	21

**Table E.27. Moisture and density summary of CA-6 sand, strip 1, lift 3, 8 roller passes**

Test point	Coordinates			Nuclear gauge (kN/m <sup>3</sup> , %)						Oven
	X	Y	Z	$\gamma_d^1$	$w_g^1$	$\gamma_d^2$	$w_g^2$	$\gamma_d$	$w_g$	$w_g$
1	48.0	22.0	520.03	18.05	7.0	17.70	6.9	17.88	7.0	---
2	53.0	21.0	519.92	17.20	8.1	17.55	7.0	17.37	7.6	---
3	58.0	21.0	519.95	18.19	6.4	18.22	5.8	18.21	6.1	---
4	63.0	20.0	519.91	18.52	7.1	17.70	8.2	18.11	7.7	---
5	68.0	20.0	519.87	17.89	7.7	17.85	6.9	17.88	7.3	---
6	72.0	19.0	519.90	17.80	7.5	17.48	7.3	17.64	7.4	---
7	77.0	19.0	519.86	18.36	6.9	17.83	6.7	18.10	6.8	---
8	82.0	19.0	519.74	17.64	7.0	18.13	7.2	17.89	7.1	---
9	87.0	18.0	519.79	18.32	8.0	18.46	7.8	18.39	7.9	---
10	92.0	18.0	519.77	17.50	6.9	18.16	7.1	17.83	7.0	---

**Table E.28. Stiffness and strength summary of CA-6 sand, strip 1, lift 3, 8 roller passes**

Test point	Geogauge		DCP	Portable FWD		
	M	S	DCPI	Force (kN)	$\delta$ ( $\mu\text{m}$ )	E (MPa)
1	---	---	26	4.3	330	41
2	---	---	24	4.3	438	31
3	---	---	29	4.3	402	38
4	---	---	28	4.3	661	21
5	---	---	22	4.3	274	50
6	---	---	26	4.3	272	51
7	---	---	26	4.3	323	41
8	---	---	24	4.3	499	27
9	---	---	27	4.2	254	54
10	---	---	19	4.3	342	39

**Table E.29. Moisture and density summary of CA-6 sand, strip 2, lift 3, 0 roller passes**

Test point	Coordinates			Nuclear gauge (kN/m <sup>3</sup> , %)						Oven
	X	Y	Z	$\gamma_d^1$	$w_g^1$	$\gamma_d^2$	$w_g^2$	$\gamma_d$	$w_g$	$w_g$
1	-85.0	7.00	---	14.33	8.0	15.02	9.5	14.67	8.8	10.2
2	-81.0	6.00	---	15.13	6.8	15.13	8.4	15.13	7.6	7.6
3	-75.0	6.00	---	15.35	7.8	14.94	9.6	15.14	8.7	9.7
4	-71.0	5.00	---	14.61	8.3	14.61	8.9	14.61	8.6	7.9
5	-66.0	5.00	---	14.80	6.7	14.83	8.3	14.81	7.5	8.2
6	-61.0	4.00	---	13.64	8.3	13.71	7.0	13.68	7.7	9.5
7	-56.0	4.00	---	14.40	6.6	14.36	7.2	14.39	6.9	7.1
8	-50.0	3.00	---	13.89	7.7	13.71	5.7	13.81	6.7	8.0
9	-46.0	3.00	---	14.26	8.7	14.08	10.8	14.17	9.8	9.5
10	-41.0	2.00	---	14.72	8.7	15.10	7.1	14.91	7.9	7.3

**Table E.30. Stiffness and strength summary of CA-6 sand, strip 2, lift 3, 0 roller passes**

Test point	Geogauge		DCP	Portable FWD		
	M	S	DCPI	Force (kN)	$\delta$ ( $\mu\text{m}$ )	E (MPa)
1	---	---	---	---	---	---
2	---	---	---	---	---	---
3	---	---	---	---	---	---
4	---	---	---	---	---	---
5	---	---	---	---	---	---
6	---	---	---	---	---	---
7	---	---	---	---	---	---
8	---	---	---	---	---	---
9	---	---	---	---	---	---
10	---	---	---	---	---	---

**Table E.31. Moisture and density summary of CA-6 sand, strip 2, lift 3, 1 roller pass**

Test point	Coordinates			Nuclear gauge (kN/m <sup>3</sup> , %)						Oven
	X	Y	Z	$\gamma_d^1$	$w_g^1$	$\gamma_d^2$	$w_g^2$	$\gamma_d$	$w_g$	$w_g$
1	-82.0	6.00	---	17.09	9.4	16.97	10.3	17.03	9.9	---
2	-78.0	6.00	---	16.62	10.9	16.42	10.7	16.53	10.8	---
3	-73.0	5.00	---	16.43	8.9	16.51	10.1	16.48	9.5	---
4	-69.0	5.00	---	16.65	9.6	16.84	9.1	16.75	9.4	---
5	-64.0	4.00	---	15.93	9.0	16.32	9.8	16.13	9.4	---
6	-58.0	4.00	---	16.37	9.2	16.57	9.1	16.48	9.2	---
7	-53.0	3.00	---	16.48	9.5	16.76	8.8	16.62	9.2	---
8	-48.0	2.00	---	16.42	8.9	16.27	10.6	16.35	9.8	---
9	-43.0	2.00	---	16.81	9.0	16.86	7.2	16.84	8.1	---
10	-39.0	2.00	---	17.14	9.1	17.41	7.7	17.28	8.4	---

**Table E.32. Stiffness and strength summary of CA-6 sand, strip 2, lift 3, 1 roller pass**

Test point	Geogauge		DCP	Portable FWD		
	M	S	DCPI	Force (kN)	$\delta$ ( $\mu\text{m}$ )	E (MPa)
1	---	---	57	---	---	---
2	---	---	72	---	---	---
3	---	---	50	---	---	---
4	---	---	40	---	---	---
5	---	---	68	---	---	---
6	---	---	74	---	---	---
7	---	---	61	---	---	---
8	---	---	62	---	---	---
9	---	---	68	---	---	---
10	---	---	81	---	---	---



**Table E.33. Moisture and density summary of CA-6 sand, strip 2, lift 3, 2 roller passes**

Test point	Coordinates			Nuclear gauge (kN/m <sup>3</sup> , %)						Oven
	X	Y	Z	$\gamma_d^1$	$w_g^1$	$\gamma_d^2$	$w_g^2$	$\gamma_d$	$w_g$	$w_g$
1	---	---	---	17.50	9.7	17.61	9.7	17.56	9.7	---
2	---	---	---	17.72	9.2	17.70	9.4	17.72	9.3	---
3	---	---	---	17.88	8.4	17.64	8.3	17.77	8.4	---
4	---	---	---	17.42	8.9	17.20	9.1	17.31	9.0	---
5	---	---	---	17.48	9.9	17.77	9.5	17.63	9.7	---
6	---	---	---	17.04	9.6	16.97	8.9	17.01	9.3	---
7	---	---	---	18.19	8.1	17.58	8.8	17.89	8.5	---
8	---	---	---	17.64	9.1	17.70	9.0	17.67	9.1	---
9	---	---	---	18.52	8.8	18.60	9.4	18.57	9.1	---
10	---	---	---	17.74	9.2	17.97	8.5	17.86	8.9	---

**Table E.34. Stiffness and strength summary of CA-6 sand, strip 2, lift 3, 2 roller passes**

Test point	Geogauge		DCP	Portable FWD		
	M	S	DCPI	Force (kN)	$\delta$ ( $\mu\text{m}$ )	E (MPa)
1	---	---	46	---	---	---
2	---	---	48	---	---	---
3	---	---	56	---	---	---
4	---	---	53	---	---	---
5	---	---	47	---	---	---
6	---	---	76	---	---	---
7	---	---	63	---	---	---
8	---	---	38	---	---	---
9	---	---	30	---	---	---
10	---	---	51	---	---	---

**Table E.35. Moisture and density summary of CA-6 sand, strip 2, lift 3, 4 roller passes**

Test point	Coordinates			Nuclear gauge (kN/m <sup>3</sup> , %)						Oven
	X	Y	Z	$\gamma_d^1$	$w_g^1$	$\gamma_d^2$	$w_g^2$	$\gamma_d$	$w_g$	$w_g$
1	---	---	---	19.23	9.2	19.24	8.8	19.24	9.0	---
2	---	---	---	18.99	8.0	17.92	8.5	18.46	8.3	---
3	---	---	---	17.99	9.2	18.05	8.4	18.02	8.8	---
4	---	---	---	17.77	8.7	16.92	9.9	17.34	9.3	---
5	---	---	---	17.61	9.2	17.52	10.7	17.56	10.0	---
6	---	---	---	17.53	9.4	18.50	8.0	18.02	8.7	---
7	---	---	---	17.75	8.5	17.04	8.8	17.41	8.7	---
8	---	---	---	18.38	9.0	18.11	11.0	18.25	10.0	---
9	---	---	---	17.50	7.9	17.11	10.4	17.31	9.2	---
10	---	---	---	17.48	8.9	17.69	9.8	17.59	9.4	---

**Table E.36. Stiffness and strength summary of CA-6 sand, strip 2, lift 3, 4 roller passes**

Test point	Geogauge		DCP	Portable FWD		
	M	S	DCPI	Force (kN)	$\delta$ ( $\mu\text{m}$ )	E (MPa)
1	---	---	29	---	---	---
2	---	---	31	---	---	---
3	---	---	36	---	---	---
4	---	---	32	---	---	---
5	---	---	49	---	---	---
6	---	---	36	---	---	---
7	---	---	31	---	---	---
8	---	---	37	---	---	---
9	---	---	24	---	---	---
10	---	---	30	---	---	---

**Table E.37. Moisture and density summary of CA-6 sand, strip 2, lift 3, 8 roller passes**

Test point	Coordinates			Nuclear gauge (kN/m <sup>3</sup> , %)						Oven
	X	Y	Z	$\gamma_d^1$	$w_g^1$	$\gamma_d^2$	$w_g^2$	$\gamma_d$	$w_g$	$w_g$
1	---	---	---	18.24	9.4	18.44	8.5	18.35	9.0	---
2	---	---	---	18.85	8.3	17.33	9.3	18.10	8.8	---
3	---	---	---	18.02	8.3	18.49	8.4	18.25	8.4	---
4	---	---	---	18.55	9.4	19.48	6.9	19.02	8.2	---
5	---	---	---	19.29	8.4	19.26	8.6	19.27	8.5	---
6	---	---	---	18.10	8.6	18.30	8.4	18.21	8.5	---
7	---	---	---	18.65	7.7	18.65	8.4	18.65	8.1	---
8	---	---	---	19.24	8.2	19.53	7.5	19.38	7.9	---
9	---	---	---	19.45	8.5	19.67	8.1	19.56	8.3	---
10	---	---	---	19.73	8.0	19.15	8.7	19.45	8.4	---

**Table E.38. Stiffness and strength summary of CA-6 sand, strip 2, lift 3, 8 roller passes**

Test point	Geogauge		DCP	Portable FWD		
	M	S	DCPI	Force (kN)	$\delta$ ( $\mu\text{m}$ )	E (MPa)
1	---	---	14	---	---	---
2	---	---	25	---	---	---
3	---	---	30	---	---	---
4	---	---	33	---	---	---
5	---	---	19	---	---	---
6	---	---	27	---	---	---
7	---	---	22	---	---	---
8	---	---	19	---	---	---
9	---	---	29	---	---	---
10	---	---	25	---	---	---

**Table E.39. Moisture and density summary of CA-6 sand, strip 2, lift 3, 12 roller passes**

Test point	Coordinates			Nuclear gauge (kN/m <sup>3</sup> , %)						Oven
	X	Y	Z	$\gamma_d^1$	$w_g^1$	$\gamma_d^2$	$w_g^2$	$\gamma_d$	$w_g$	$w_g$
1	---	---	---	18.50	8.9	18.87	8.9	18.69	8.9	11.1
2	---	---	---	19.92	7.6	19.59	7.5	19.76	7.6	7.7
3	---	---	---	19.87	7.6	19.87	6.8	19.87	7.2	7.9
4	---	---	---	19.71	7.2	19.48	9.0	19.60	8.1	10.5
5	---	---	---	19.60	6.9	19.68	7.3	19.65	7.1	7.9
6	---	---	---	19.75	7.9	19.20	9.0	19.48	8.5	9.5
7	---	---	---	19.31	7.8	19.51	7.1	19.42	7.5	8.6
8	---	---	---	19.09	8.4	19.40	8.0	19.24	8.2	9.0
9	---	---	---	19.31	8.9	19.31	8.6	19.31	8.8	11.7
10	---	---	---	19.46	8.1	20.12	7.6	19.79	7.9	10.0

**Table E.40. Stiffness and strength summary of CA-6 sand, strip 2, lift 3, 12 roller passes**

Test point	Geogauge		DCP	Portable FWD		
	M	S	DCPI	Force (kN)	$\delta$ ( $\mu\text{m}$ )	E (MPa)
1	---	---	10	---	---	---
2	---	---	19	---	---	---
3	---	---	20	---	---	---
4	---	---	16	---	---	---
5	---	---	18	---	---	---
6	---	---	15	---	---	---
7	---	---	13	---	---	---
8	---	---	16	---	---	---
9	---	---	26	---	---	---
10	---	---	15	---	---	---

**Table E.41. Moisture and density summary of Edwards till, strip 3, 0 roller passes**

Test point	Coordinates			Nuclear gauge (kN/m <sup>3</sup> , %)						Oven
	X	Y	Z	$\gamma_d^1$	$w_g^1$	$\gamma_d^2$	$w_g^2$	$\gamma_d$	$w_g$	$w_g$
1	---	---	---	10.78	7.8	10.78	8.4	10.78	8.1	13.7
2	---	---	---	11.03	9.4	10.84	10.0	10.93	9.7	15.0
3	---	---	---	11.11	9.0	10.93	10.6	11.03	9.8	14.2
4	---	---	---	10.79	9.0	10.57	10.1	10.68	9.6	15.8
5	---	---	---	10.73	10.1	10.51	9.5	10.62	9.8	15.9
6	---	---	---	10.68	10.8	10.70	10.0	10.70	10.4	11.8
7	---	---	---	10.67	9.3	10.46	10.2	10.57	9.8	14.2
8	---	---	---	10.34	9.7	10.57	8.9	5.73	9.3	15.0
9	---	---	---	10.56	8.5	10.48	10.6	10.52	9.6	15.5
10	---	---	---	10.56	8.4	10.26	11.1	10.41	9.8	15.5

**Table E.42. Stiffness and strength summary of Edwards till, strip 3, 0 roller passes**

Test point	Geogauge		DCP	Portable FWD		
	M	S	DCPI	Force (kN)	$\delta$ ( $\mu\text{m}$ )	E (MPa)
1	---	---	---	---	---	---
2	---	---	---	---	---	---
3	---	---	---	---	---	---
4	---	---	---	---	---	---
5	---	---	---	---	---	---
6	---	---	---	---	---	---
7	---	---	---	---	---	---
8	---	---	---	---	---	---
9	---	---	---	---	---	---
10	---	---	---	---	---	---

**Table E.43. Moisture and density summary of Edwards till, strip 3, 1 roller pass**

Test point	Coordinates			Nuclear gauge (kN/m <sup>3</sup> , %)						Oven
	X	Y	Z	$\gamma_d^1$	$w_g^1$	$\gamma_d^2$	$w_g^2$	$\gamma_d$	$w_g$	$w_g$
1	12.0	20.00	---	14.55	13.9	14.81	---	14.69	13.9	---
2	17.0	19.00	---	15.16	15.3	14.94	15.4	15.05	15.4	---
3	22.0	18.00	---	13.89	16.3	14.31	13.7	14.11	15.0	---
4	26.0	19.00	---	14.12	14.4	14.20	15.3	14.17	14.9	---
5	31.0	18.00	---	14.62	16.9	15.03	15.5	14.83	16.2	---
6	36.0	18.00	---	14.37	14.7	14.77	14.7	14.58	14.7	---
7	41.0	18.00	---	14.18	13.5	13.38	15.0	13.79	14.3	---
8	45.0	17.00	---	14.01	16.2	13.95	18.1	13.98	17.2	---
9	50.0	17.00	---	15.22	16.0	14.77	16.7	15.00	16.4	---
10	55.0	16.00	---	14.89	15.4	14.36	15.8	14.62	15.6	---

**Table E.44. Stiffness and strength summary of Edwards till, strip 3, 1 roller pass**

Test point	Geogauge		DCP	Portable FWD		
	M	S	DCPI	Force (kN)	$\delta$ ( $\mu\text{m}$ )	E (MPa)
1	---	---	151	4.1	1080	12
2	---	---	181	4.3	807	17
3	---	---	129	3.1	493	20
4	---	---	116	4.3	387	36
5	---	---	136	4.3	920	15
6	---	---	143	4.3	272	50
7	---	---	101	4.3	801	17
8	---	---	137	4.4	357	39
9	---	---	125	4.1	615	21
10	---	---	128	4.3	241	57

**Table E.45. Moisture and density summary of Edwards till, strip 3, 2 roller passes**

Test point	Coordinates			Nuclear gauge (kN/m <sup>3</sup> , %)						Oven
	X	Y	Z	$\gamma_d^1$	$w_g^1$	$\gamma_d^2$	$w_g^2$	$\gamma_d$	$w_g$	$w_g$
1	8.0	20.00	---	14.42	13.5	13.75	15.0	14.09	14.3	---
2	14.0	19.00	---	15.00	14.9	14.42	16.5	14.72	15.7	---
3	18.0	19.00	---	14.97	15.1	14.36	18.0	14.67	16.6	---
4	23.0	19.00	---	16.02	14.7	16.38	13.7	16.21	14.2	---
5	28.0	18.00	---	15.30	14.2	15.35	14.0	15.33	14.1	---
6	34.0	18.00	---	15.30	15.9	15.69	16.5	15.50	16.2	---
7	39.0	18.00	---	14.58	14.3	14.48	15.7	14.53	15.0	---
8	43.0	17.00	---	15.33	15.4	15.57	14.6	15.46	15.0	---
9	48.0	17.00	---	15.03	16.7	15.39	16.2	15.22	16.5	---
10	53.0	17.00	---	15.76	16.1	16.02	16.0	15.90	16.1	---

**Table E.46. Stiffness and strength summary of Edwards till, strip 3, 2 roller passes**

Test point	Geogauge		DCP	Portable FWD		
	M	S	DCPI	Force (kN)	$\delta$ ( $\mu\text{m}$ )	E (MPa)
1	---	---	84	4.4	368	38
2	---	---	149	4.3	477	29
3	---	---	152	4.4	194	72
4	---	---	128	4.0	153	83
5	---	---	144	4.3	183	76
6	---	---	128	4.3	254	55
7	---	---	118	4.2	469	28
8	---	---	51	4.2	226	59
9	---	---	120	4.2	238	56
10	---	---	138	4.2	150	89

**Table E.47. Moisture and density summary of Edwards till, strip 3, 4 roller passes**

Test point	Coordinates			Nuclear gauge (kN/m <sup>3</sup> , %)						Oven
	X	Y	Z	$\gamma_d^1$	$w_g^1$	$\gamma_d^2$	$w_g^2$	$\gamma_d$	$w_g$	$w_g$
1	---	---	---	15.88	14.2	16.26	14.5	16.07	14.4	---
2	---	---	---	16.64	15.6	16.48	17.9	16.56	16.8	---
3	---	---	---	15.85	15.1	15.13	16.3	15.49	15.7	---
4	---	---	---	15.69	1.9	16.31	15.9	16.01	8.9	---
5	---	---	---	16.04	17.1	16.82	16.5	16.43	16.8	---
6	---	---	---	17.01	15.0	17.23	14.4	17.12	14.7	---
7	---	---	---	15.65	14.2	15.85	14.6	15.76	14.4	---
8	---	---	---	15.91	15.5	16.02	16.2	15.98	15.9	---
9	---	---	---	17.11	17.6	26.80	17.7	21.96	17.7	---
10	---	---	---	---	---	---	---	---	---	---

**Table E.48. Stiffness and strength summary of Edwards till, strip 3, 4 roller passes**

Test point	Geogauge		DCP	Portable FWD		
	M	S	DCPI	Force (kN)	$\delta$ ( $\mu\text{m}$ )	E (MPa)
1	---	---	95	4.3	149	93
2	---	---	136	---	---	---
3	---	---	112	---	---	---
4	---	---	100	---	---	---
5	---	---	131	---	---	---
6	---	---	108	---	---	---
7	---	---	72	---	---	---
8	---	---	62	---	---	---
9	---	---	105	---	---	---
10	---	---	---	---	---	---



**Table E.49. Moisture and density summary of Edwards till, strip 3, 8 roller passes**

Test point	Coordinates			Nuclear gauge (kN/m <sup>3</sup> , %)						Oven
	X	Y	Z	$\gamma_d^1$	$w_g^1$	$\gamma_d^2$	$w_g^2$	$\gamma_d$	$w_g$	$w_g$
1	---	---	---	16.31	13.0	16.46	12.9	16.38	13.0	13.0
2	---	---	---	17.77	13.5	17.45	13.7	17.61	13.6	21.8
3	---	---	---	16.92	15.3	16.84	13.6	16.89	14.5	14.5
4	---	---	---	17.83	12.6	17.55	12.3	17.69	12.5	14.5
5	---	---	---	17.03	13.7	16.95	12.9	17.00	13.3	14.8
6	---	---	---	17.17	15.3	17.41	14.0	17.30	14.7	14.6
7	---	---	---	16.57	13.7	16.64	13.9	16.60	13.8	13.8
8	---	---	---	16.43	14.5	17.04	13.0	16.75	13.8	13.9
9	---	---	---	17.78	14.2	18.10	12.5	17.94	13.4	7.6
10	---	---	---	17.64	13.2	17.88	13.8	17.77	13.5	15.1

**Table E.50. Stiffness and strength summary of Edwards till, strip 3, 8 roller passes**

Test point	Geogauge		DCP	Portable FWD		
	M	S	DCPI	Force (kN)	$\delta$ ( $\mu\text{m}$ )	E (MPa)
1	---	---	65	---	---	---
2	---	---	43	---	---	---
3	---	---	75	---	---	---
4	---	---	29	---	---	---
5	---	---	41	---	---	---
6	---	---	80	---	---	---
7	---	---	35	---	---	---
8	---	---	33	---	---	---
9	---	---	61	---	---	---
10	---	---	49	---	---	---

**Table E.51. Moisture and density summary of Edwards till, strip 4, 0 roller passes**

Test point	Coordinates			Nuclear gauge (kN/m <sup>3</sup> , %)						Oven
	X	Y	Z	$\gamma_d^1$	$w_g^1$	$\gamma_d^2$	$w_g^2$	$\gamma_d$	$w_g$	$w_g$
1	---	---	---	10.71	9.4	10.59	10.0	10.65	9.7	13.4
2	---	---	---	10.96	10.4	10.74	12.5	10.85	11.5	14.9
3	---	---	---	12.16	9.1	12.19	9.3	12.17	9.2	18.1
4	---	---	---	14.20	13.3	14.14	11.0	14.17	12.2	14.2
5	---	---	---	11.03	11.8	11.00	11.7	11.01	11.8	14.5
6	---	---	---	10.98	10.2	10.73	11.7	10.85	11.0	13.1
7	---	---	---	11.50	10.5	11.97	7.8	11.73	9.2	10.8
8	---	---	---	10.79	11.9	11.33	9.8	11.06	10.9	14.3
9	---	---	---	11.67	9.2	11.67	8.7	11.67	9.0	13.1
10	---	---	---	10.48	10.5	10.23	11.1	10.35	10.8	14.1

**Table E.52. Stiffness and strength summary of Edwards till, strip 4, 0 roller passes**

Test point	Geogauge		DCP	Portable FWD		
	M	S	DCPI	Force (kN)	$\delta$ ( $\mu\text{m}$ )	E (MPa)
1	---	---	216	---	---	---
2	---	---	241	---	---	---
3	---	---	215	---	---	---
4	---	---	216	---	---	---
5	---	---	244	---	---	---
6	---	---	233	---	---	---
7	---	---	235	---	---	---
8	---	---	256	---	---	---
9	---	---	219	---	---	---
10	---	---	205	---	---	---

**Table E.53. Moisture and density summary of Edwards till, strip 4, 1 roller pass**

Test point	Coordinates			Nuclear gauge (kN/m <sup>3</sup> , %)						Oven
	X	Y	Z	$\gamma_d^1$	$w_g^1$	$\gamma_d^2$	$w_g^2$	$\gamma_d$	$w_g$	$w_g$
1	-106.0	13.00	---	14.99	11.5	15.28	11.6	15.14	11.6	---
2	-101.0	13.00	---	15.05	11.7	15.35	13.0	15.21	12.4	---
3	-97.0	12.00	---	15.36	14.8	14.97	14.8	15.17	14.8	---
4	-91.0	12.00	---	15.85	16.0	15.66	17.3	15.76	16.7	---
5	-87.0	12.00	---	13.87	11.7	13.90	12.5	13.89	12.1	---
6	-82.0	11.00	---	13.84	12.9	13.67	13.5	13.76	13.2	---
7	-77.0	11.00	---	13.54	12.0	13.71	13.8	13.64	12.9	---
8	-72.0	11.00	---	13.73	10.5	13.64	11.0	13.68	10.8	---
9	-67.0	9.00	---	14.18	10.8	13.97	11.6	14.08	11.2	---
10	-61.0	9.00	---	14.72	12.3	14.53	12.9	14.62	12.6	---

**Table E.54. Stiffness and strength summary of Edwards till, strip 4, 1 roller pass**

Test point	Geogauge		DCP	Portable FWD		
	M	S	DCPI	Force (kN)	$\delta$ ( $\mu\text{m}$ )	E (MPa)
1	---	---	91	---	---	---
2	---	---	85	---	---	---
3	---	---	131	---	---	---
4	---	---	95	---	---	---
5	---	---	122	---	---	---
6	---	---	85	---	---	---
7	---	---	135	---	---	---
8	---	---	102	---	---	---
9	---	---	54	---	---	---
10	---	---	121	---	---	---

**Table E.55. Moisture and density summary of Edwards till, strip 4, 8 roller passes**

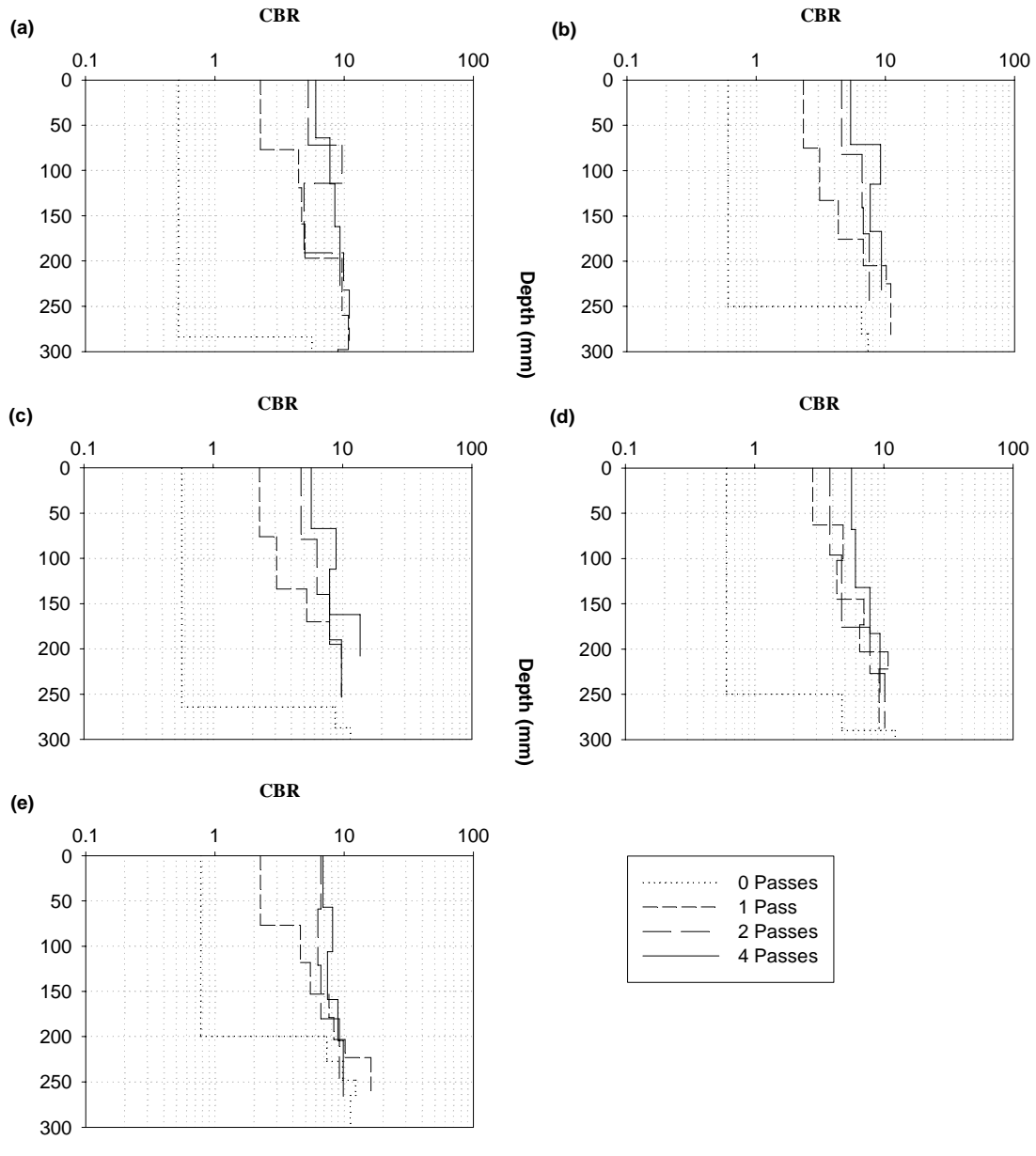
Test point	Coordinates			Nuclear gauge (kN/m <sup>3</sup> , %)						Oven
	X	Y	Z	$\gamma_d^1$	$w_g^1$	$\gamma_d^2$	$w_g^2$	$\gamma_d$	$w_g$	$w_g$
1	---	---	---	17.30	10.7	16.53	8.7	16.92	9.7	---
2	---	---	---	16.92	11.9	17.50	10.6	17.22	11.3	---
3	---	---	---	16.12	10.6	17.22	10.3	16.67	10.5	---
4	---	---	---	15.22	12.7	14.94	14.4	15.08	13.6	---
5	---	---	---	16.45	13.6	16.49	12.2	16.48	12.9	---
6	---	---	---	18.11	11.1	18.41	11.5	18.27	11.3	---
7	---	---	---	17.81	10.6	18.10	11.6	17.96	11.1	---
8	---	---	---	17.22	12.2	16.32	11.1	16.78	11.7	---
9	---	---	---	18.00	11.8	17.80	11.0	17.91	11.4	---
10	---	---	---	18.52	10.3	18.22	11.6	18.38	11.0	---

**Table E.56. Stiffness and strength summary of Edwards till, strip 4, 8 roller passes**

Test point	Geogauge		DCP	Portable FWD		
	M	S	DCPI	Force (kN)	$\delta$ ( $\mu\text{m}$ )	E (MPa)
1	---	---	31	---	---	---
2	---	---	132	---	---	---
3	---	---	23	---	---	---
4	---	---	43	---	---	---
5	---	---	20	---	---	---
6	---	---	39	---	---	---
7	---	---	26	---	---	---
8	---	---	41	---	---	---
9	---	---	49	---	---	---
10	---	---	20	---	---	---

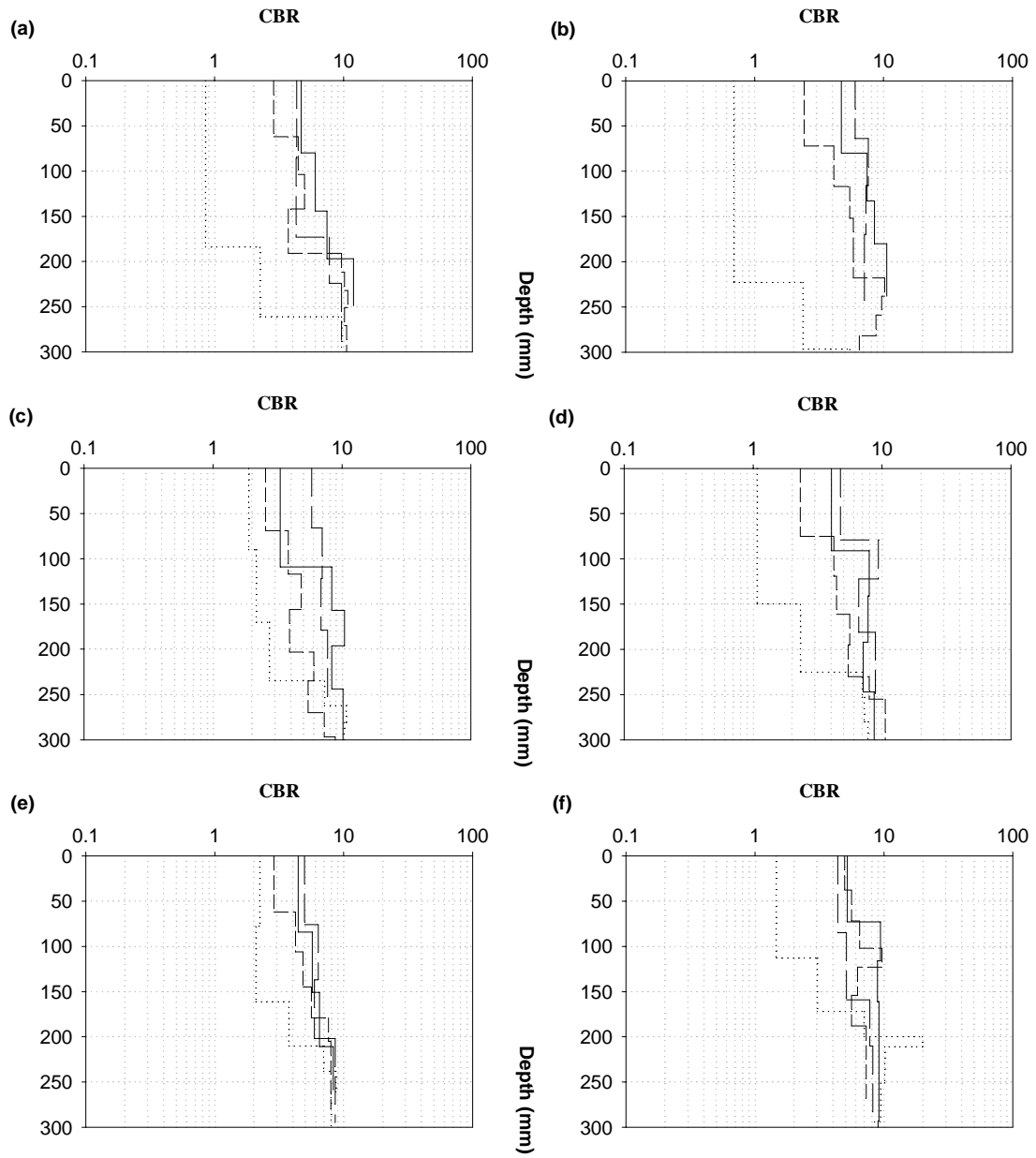


**APPENDIX F. PROJECT 2 DCP PROFILES**



**Figure F.1. CA-6, strip 1, lift 1**

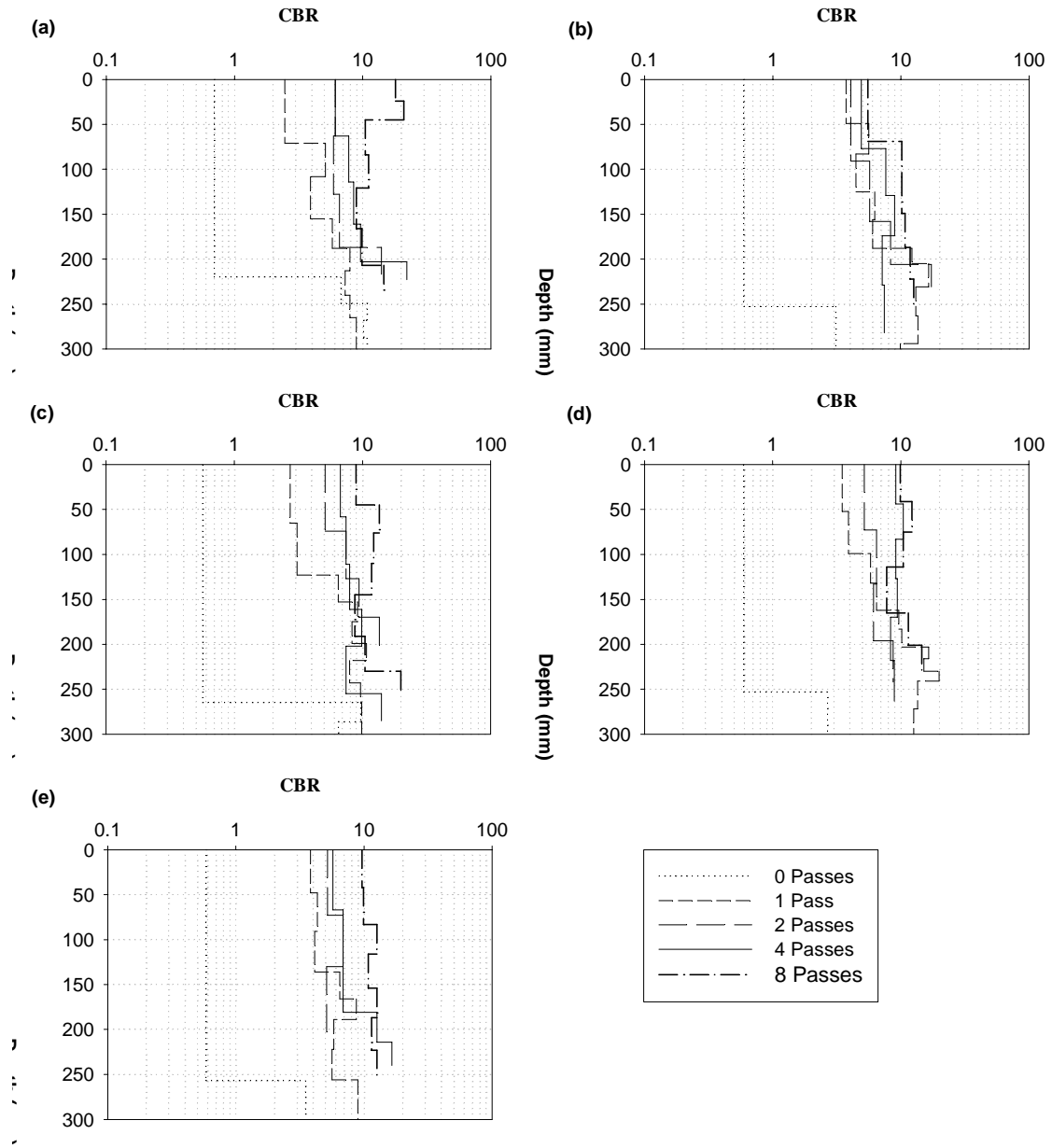
**(a) Pt 1; (b) Pt 2; (c) Pt 3; (d) Pt 4; (e) Pt 5**



**Figure F.2. CA-6, strip 1, lift 1**

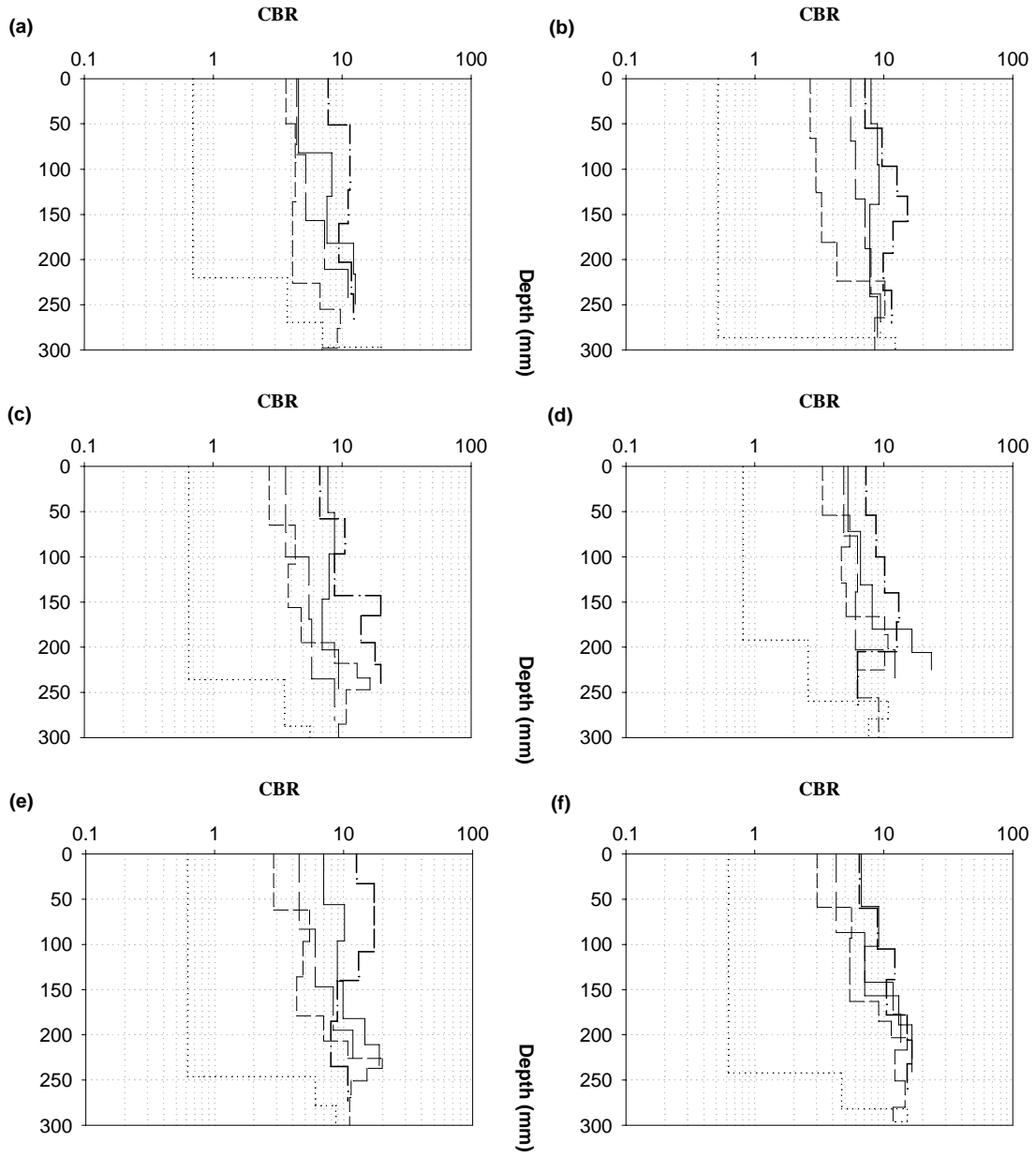
**(a) Pt 6; (b) Pt 7; (c) Pt 8; (d) Pt 9; (e) Pt 10; (f) Pt 11**





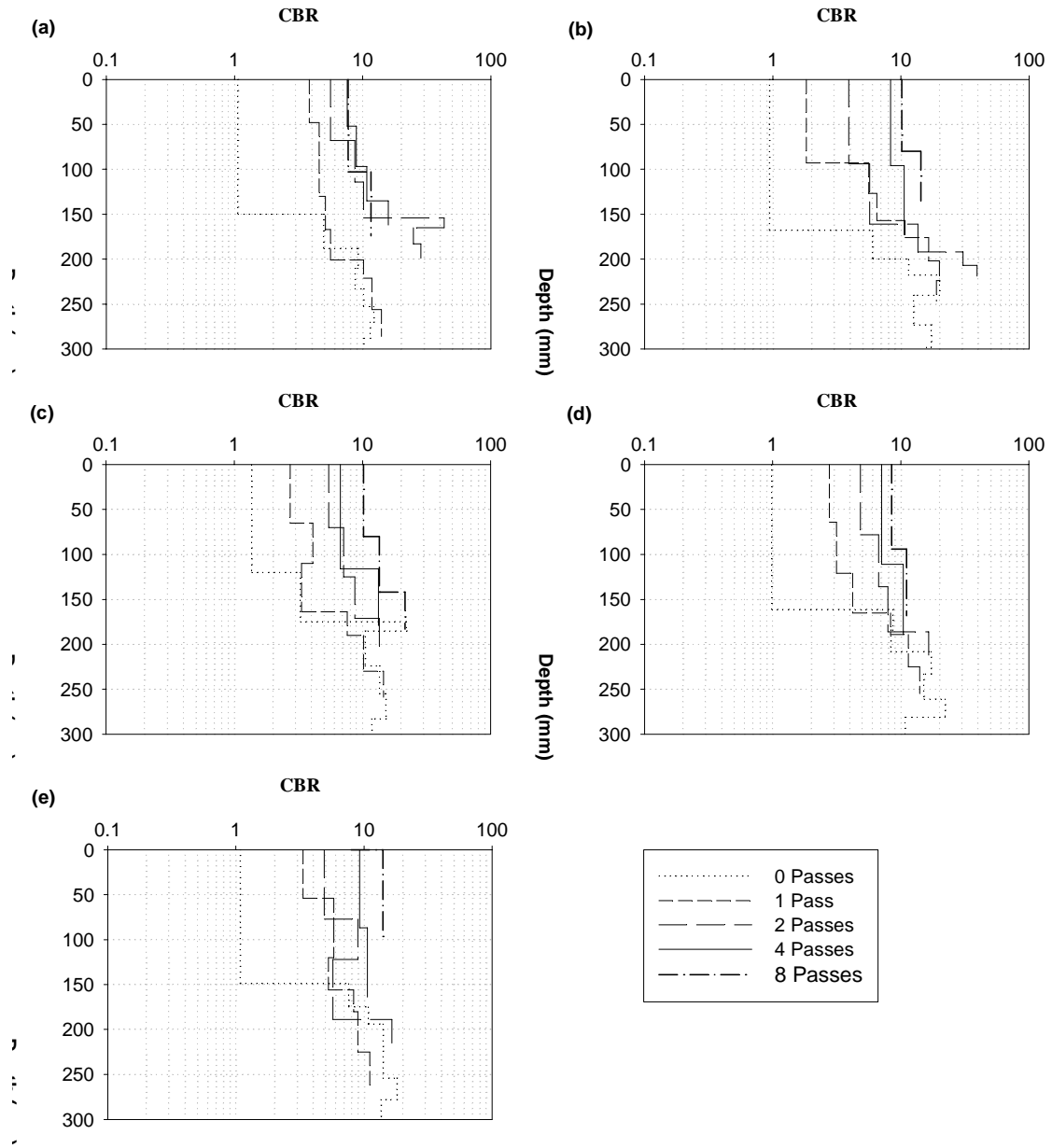
**Figure F.3. CA-6, strip 1, lift 2**

**(a) Pt 1; (b) Pt 2; (c) Pt 3; (d) Pt 4; (e) Pt 5**



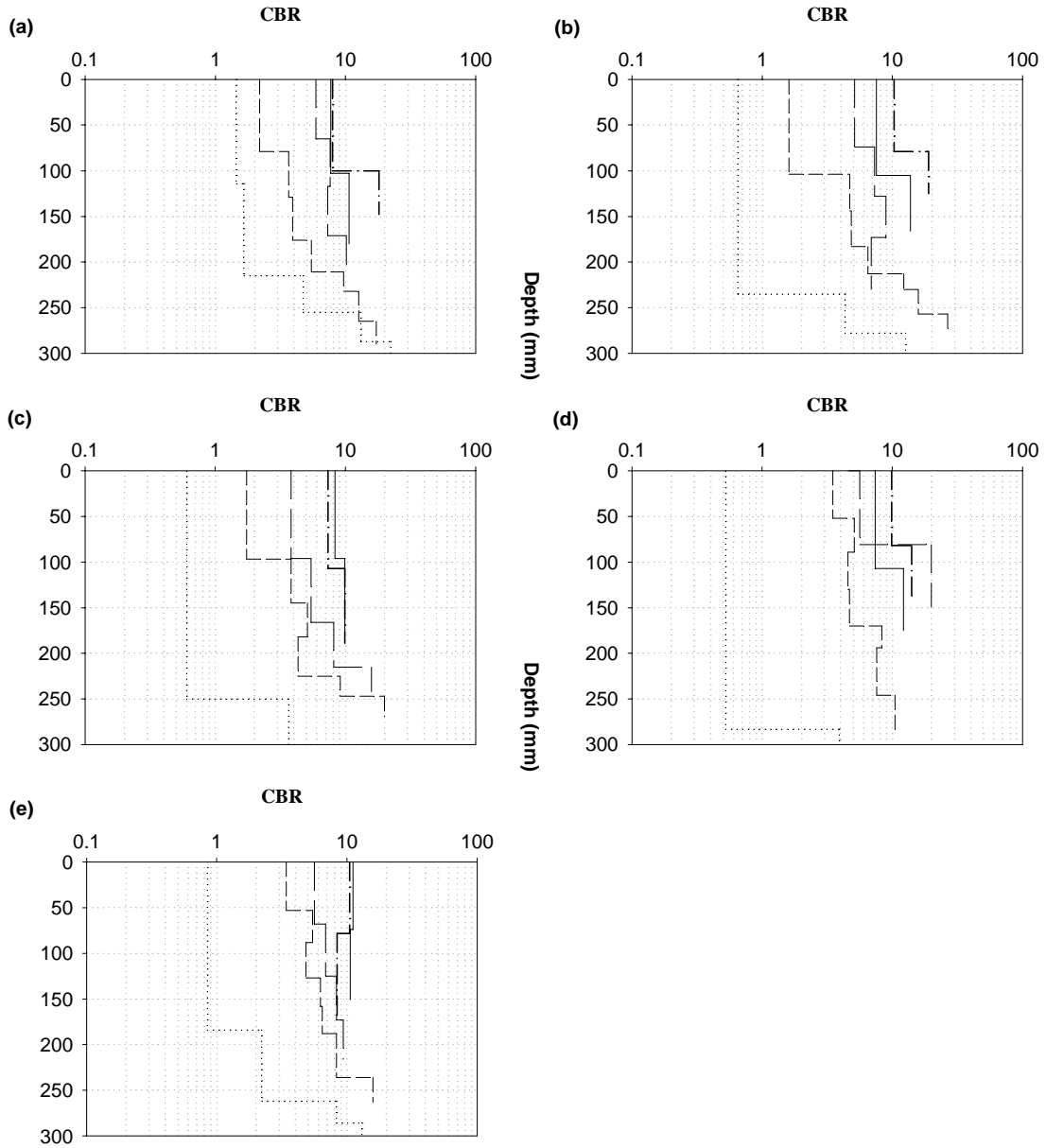
**Figure F.4. CA-6, strip 1, lift 2**

**(a) Pt 6; (b) Pt 7; (c) Pt 8; (d) Pt 9; (e) Pt 10; (f) Pt 11**



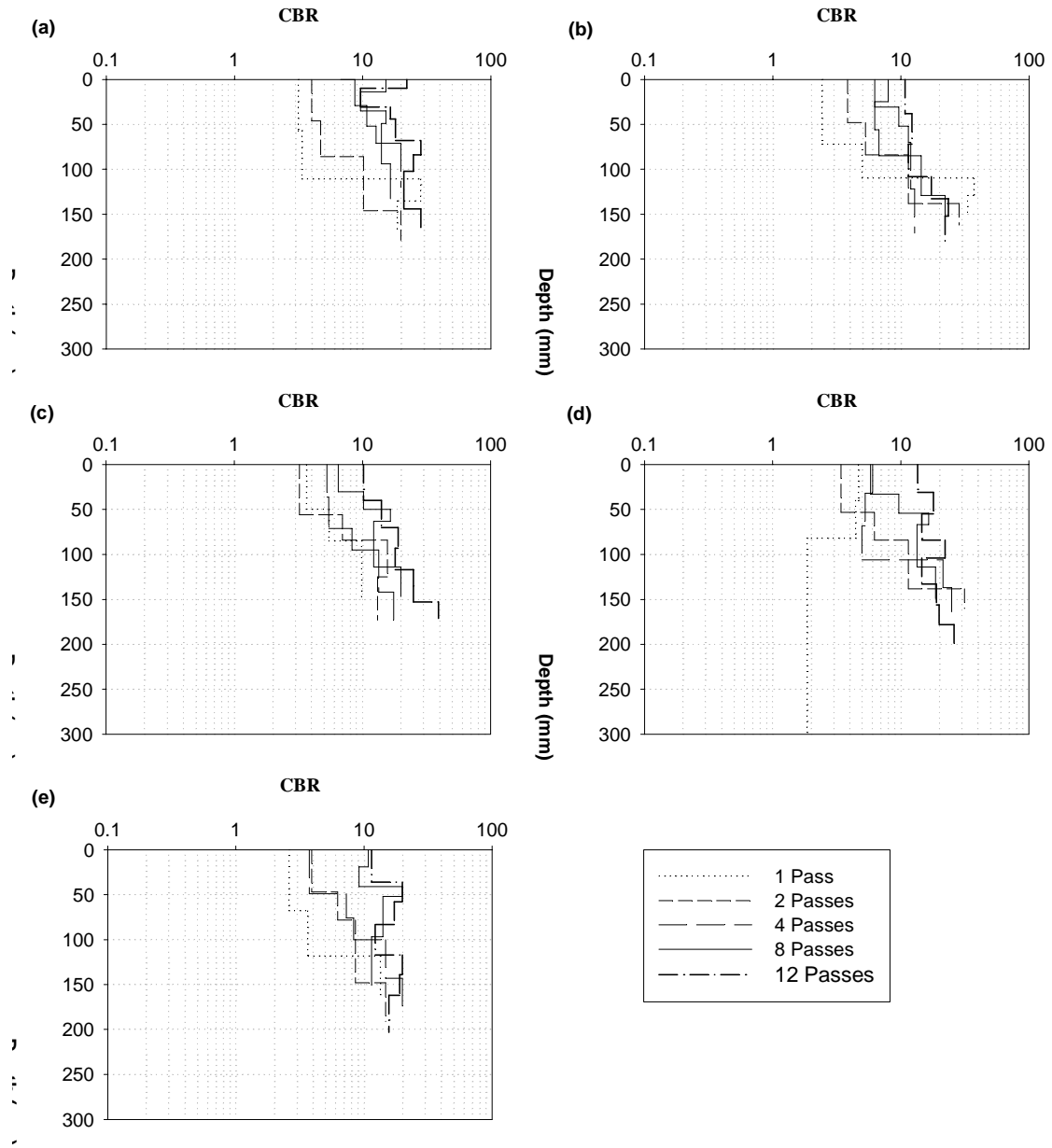
**Figure F.5. CA-6, strip 1, lift 3**

**(a) Pt 1; (b) Pt 2; (c) Pt 3; (d) Pt 4; (e) Pt 5**



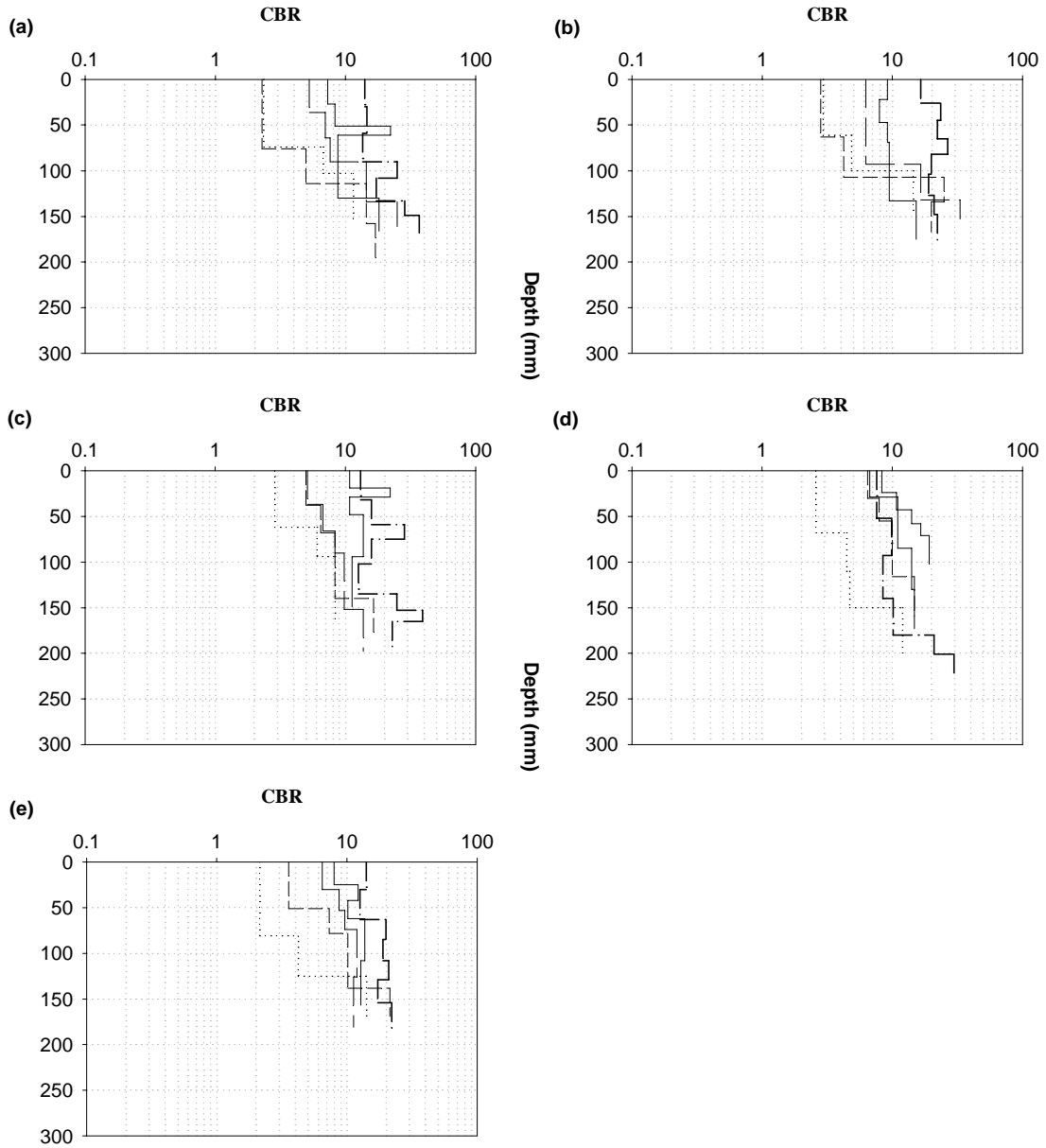
**Figure F.6. CA-6, strip 1, lift 3**

**(a) Pt 6; (b) Pt 7; (c) Pt 8; (d) Pt 9; (e) Pt 10**



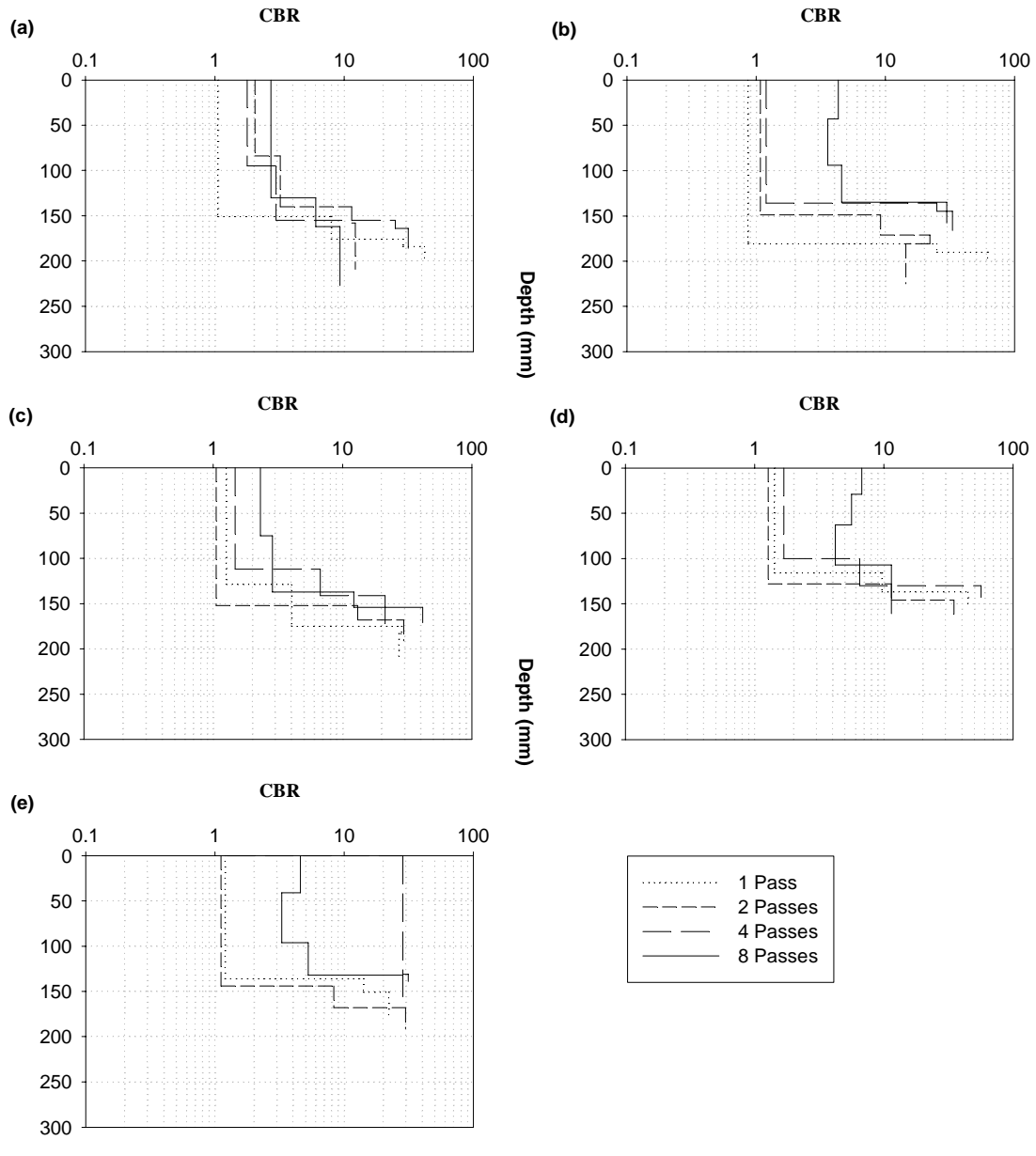
**Figure F.7. CA-6, strip 2, lift 3**

**(a) Pt 1; (b) Pt 2; (c) Pt 3; (d) Pt 4; (e) Pt 5**



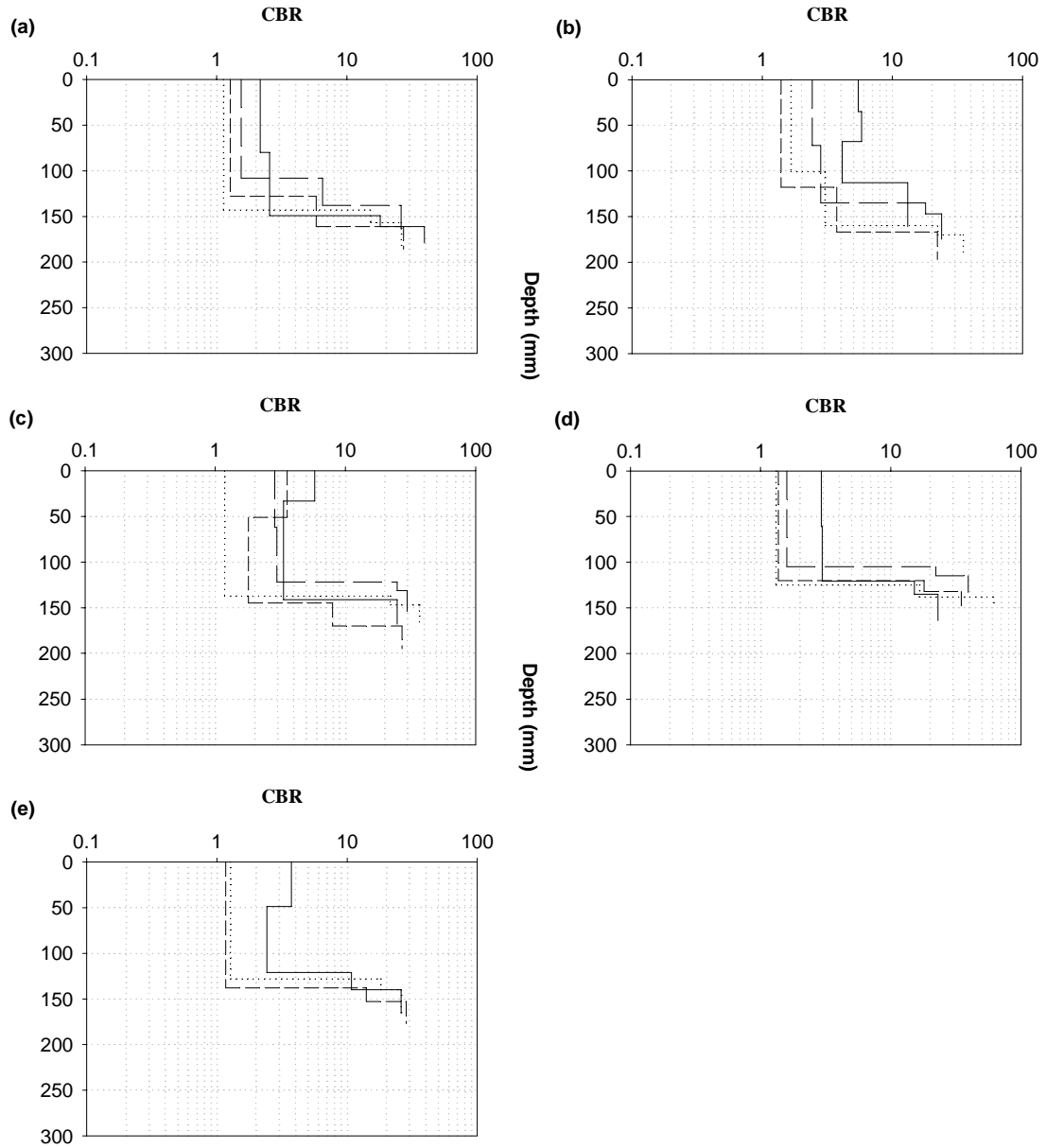
**Figure F.8. CA-6, strip 2, lift 3**

**(a) Pt 6; (b) Pt 7; (c) Pt 8; (d) Pt 9; (e) Pt 10**



**Figure F.9. Edwards till, strip 3**

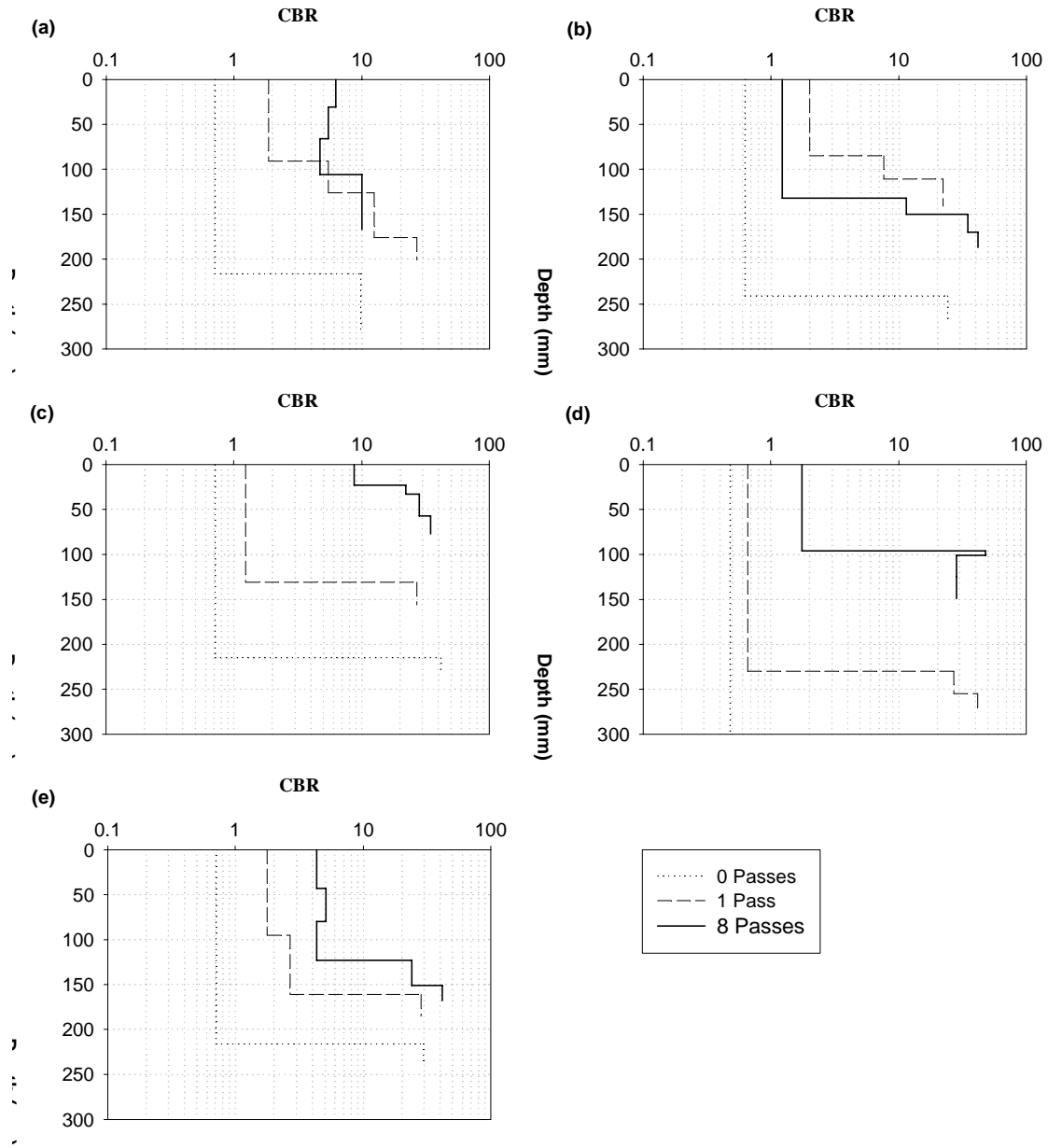
**(a) Pt 1; (b) Pt 2; (c) Pt 3; (d) Pt 4; (e) Pt 5**



**Figure F.10. Edwards till, strip 3**

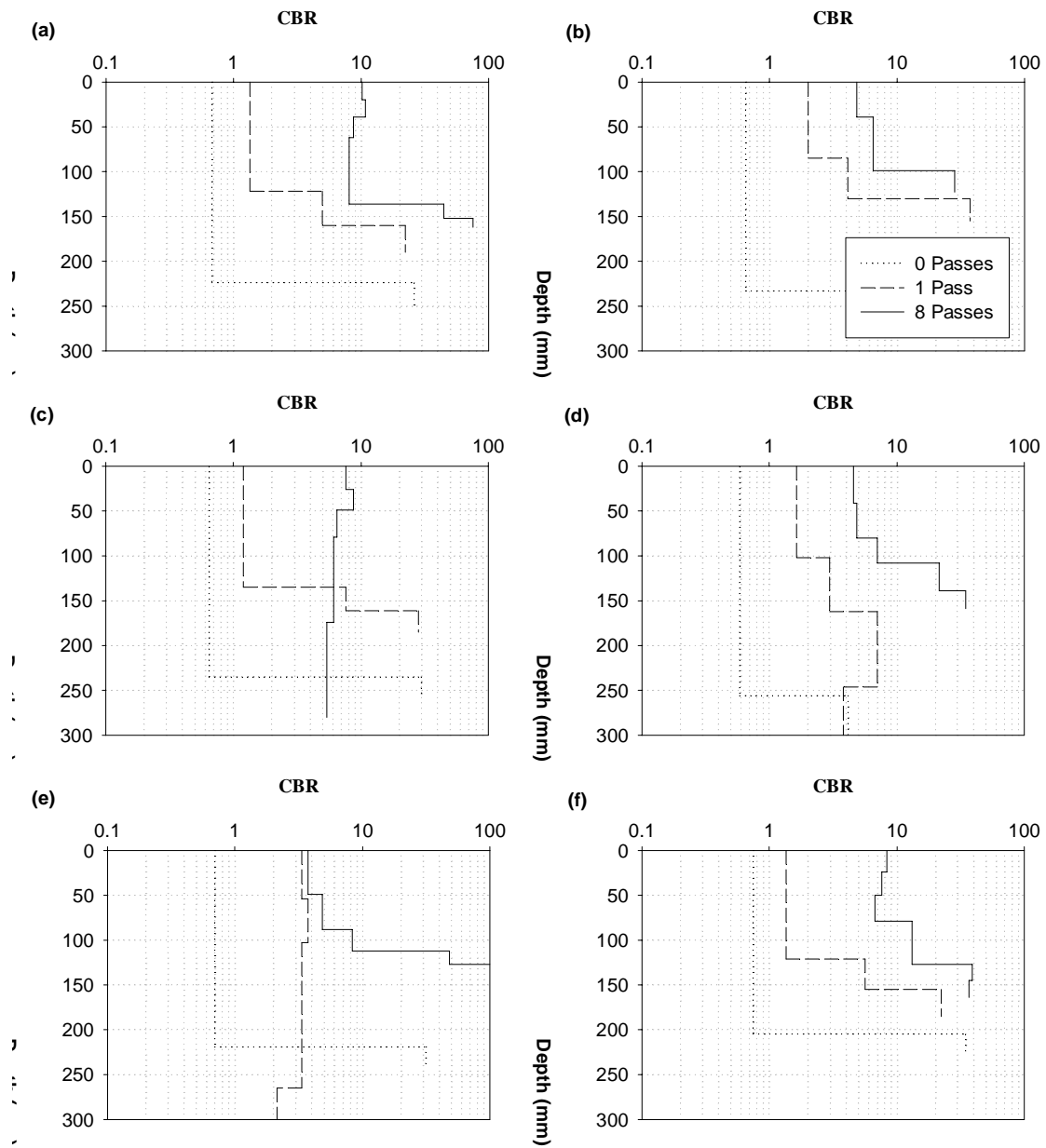
**(a) Pt 6; (b) Pt 7; (c) Pt 8; (d) Pt 9; (e) Pt 10**





**Figure F.11. Edwards till, strip 4**

**(a) Pt 1; (b) Pt 2; (c) Pt 3; (d) Wet point; (e) Pt 4**



**Figure F.12. Edwards till, strip 4**

**(a) Pt 5; (b) Pt 6; (c) Pt 7; (d) Pt 8 (Soft); (e) Pt 9; (f) Pt 10**



**APPENDIX G. PROJECT 3 IN SITU TEST DATA**

**Table G.191. GPS coordinates of WB mainline sand**

Test Point	GPS Coordinates		
	N (deg)	W (deg)	Elevation (ft)
1	---	---	---
2	44.10993151	93.71824418	923.957
3	44.10997610	93.71848173	922.575
4	44.11015815	93.71904703	918.019
5	44.11017422	93.71934982	917.399
6	44.11043310	93.71981294	912.251
7	44.11052573	93.72023227	911.365
8	44.11074266	93.72068213	908.781
9	44.11068061	93.72074450	910.213
10	44.11088576	93.72110435	908.227

**Table G.192. Stiffness and strength summary of WB mainline sand**

Test Point	GeoGauge		Clegg	DCP	Portable FWD: E (MPa)		
	M	S	CIV	DCPI	6	12	24
1	14.59	1.97	3.6	69	---	---	---
2	12.59	1.70	---	116	6	8	9
3	42.06	5.67	6.3	44	8	11	10
4	20.39	2.75	5.4	95	18	23	18
5	19.10	2.58	4.2	96	16	24	21
6	23.62	3.19	4.7	109	9	14	14
7	19.02	2.57	4.7	125	6	9	9
8	16.42	2.21	4.1	177	3	13	16
9	36.74	4.95	4.6	122	5	20	26
10	41.06	5.54	19.3	28	55	64	60

**Table G.193. Nuclear gauge moisture and density summary of WB mainline sand**

Test Point	Nuclear Gauge (pcf, %)											
	$\gamma_d^0$	$w_g^0$	$\gamma_d^2$	$w_g^2$	$\gamma_d^4$	$w_g^4$	$\gamma_d^6$	$w_g^6$	$\gamma_d^8$	$w_g^8$	$\gamma_d^{10}$	$w_g^{10}$
1	106.8	10.1	106.3	10.1	110.9	9.2	114.3	9.2	115.9	8.9	119.1	9.0
2	109.2	12.3	108.2	12.5	109.7	12.1	111.2	12.4	113.1	12.3	115.4	12.1
3	120.6	13.6	112.6	14.7	117.6	13.4	119.6	12.8	121.0	13.0	121.2	13.3
4	116.7	13.7	108.3	13.5	112.6	12.7	114.8	12.7	116.7	12.8	115.9	13.5
5	101.0	10.1	100.1	10.0	104.3	8.8	106.0	9.1	110.5	8.4	110.8	9.2
6	115.4	10.3	106.6	11.2	111.6	11.3	119.8	10.4	124.1	9.6	123.6	9.7
7	111.0	7.2	104.8	8.5	107.8	8.5	108.8	8.6	109.8	8.0	112.5	7.8
8	109.7	8.7	109.0	8.2	110.2	8.1	110.4	8.4	112.1	8.5	115.7	7.2
9	103.1	5.1	101.9	4.8	102.9	4.9	105.9	5.0	109.4	5.0	111.5	4.8
10	115.9	8.6	117.4	7.7	118.8	7.8	117.9	7.9	118.9	8.0	121.4	7.6

**Table G.194. GPS coordinates of EB mainline sand, 0 passes**

Test Point	GPS Coordinates		
	N (deg)	W (deg)	Elevation (ft)
1	44.10977939	93.71882959	932.13
2	44.10984789	93.71908080	931.00
3	44.10994420	93.71941333	929.00
4	44.11002082	93.71967082	930.70
5	44.10089630	93.71990025	928.30
6	44.11020314	93.72020314	928.23
7	44.10302360	93.72050910	927.20
8	44.11038223	93.72070735	926.10
9	44.11051855	93.72082574	923.40
10	44.11057010	93.72093190	922.20

**Table G.195. Stiffness and strength summary of EB mainline sand, 0 passes**

Test Point	GeoGauge		Clegg	DCP	Portable FWD: E (MPa)		
	M	S	CIV	DCPI	6	12	24
1	---	---	---	98	31	61	145
2	---	---	---	238	11	20	22
3	---	---	---	421	9	19	23
4	---	---	---	307	5	22	25
5	---	---	---	200	15	29	35
6	---	---	---	203	10	26	29
7	---	---	---	285	13	64	77
8	---	---	---	258	4	16	19
9	---	---	---	194	5	17	22
10	---	---	---	217	4	19	22

**Table G.196. GPS coordinates of EB mainline sand, 4 passes**

Test Point	GPS Coordinates		
	N (deg)	W (deg)	Elevation (ft)
1	44.10977939	93.71882959	932.13
2	44.10984789	93.71908080	931.00
3	44.10994420	93.71941333	929.00
4	44.11002082	93.71967082	930.70
5	44.10089630	93.71990025	928.30
6	44.11020314	93.72020314	928.23
7	44.10302360	93.72050910	927.20
8	44.11038223	93.72070735	926.10
9	44.11051855	93.72082574	923.40
10	44.11057010	93.72093190	922.20

**Table G.197. Stiffness and strength summary of EB mainline sand, 4 passes**

Test Point	GeoGauge		Clegg	DCP	Portable FWD: E (MPa)		
	M	S	CIV	DCPI	6	12	24
1	---	---	---	122	38	47	25
2	---	---	---	212	5	17	25
3	---	---	---	278	15	34	34
4	---	---	---	312	4	12	15
5	---	---	---	220	9	33	34
6	---	---	---	248	4	12	15
7	---	---	---	261	3	11	12
8	---	---	---	275	3	12	16
9	---	---	---	262	7	15	18
10	---	---	---	242	5	18	23