

TECHNICAL REPORT STANDARD TITLE PAGE

1. Report No. FHWA/TX-04/0-4129-1	2. Government Accession No.	3. Recipient's Catalog No.	
4. Title and Subtitle Development of an Objective Field Test to Determine Tack Coat Adequacy		5. Report Date June 2004	
7. Author(s) I. Deysarkar and V. Tandon		6. Performing Organization Code	
9. Performing Organization Name and Address Center for Transportation Infrastructure Systems The University of Texas at El Paso El Paso, Texas 79968-0516		8. Performing Organization Report No. Research Report TX-0-4129-1	
12. Sponsoring Agency Name and Address Texas Department of Transportation Research and Technology Implementation Office P.O. Box 5080 Austin, Texas 78763		10. Work Unit No.	
		11. Contract or Grant No. Study No. 0-4129	
15. Supplementary Notes "Project performed in cooperation with the Texas Department of Transportation and the Federal Highway Administration" Project Title: Development of an Objective Field Test to Determine Tack Coat Adequacy		13. Type of Report and Period Covered Technical Report September 2002 thru February 2004	
16. Abstract TxDOT has recently experienced a number of pavement failures due to poor quality of tack coat. Currently, there are no field test systems to determine the quality of the tack coat. Hence, a field test set-up is needed to determine the quality of the tack coat before paving operations and was the objective of this study. Several currently available test equipments that had potential for field application were evaluated in the parking lot as well as in the laboratory. The test results indicated that none of the equipment has potential to consistently identify quality of the tack coat. The main reason for failure was the mode of testing. The test setups mainly focused on the shear strength measurement; however, the shear strength measurements also included frictional resistance offered by the tested surface. Based on the lessons learned, a device that measures only the quality of tack and is independent of the surface tested was developed. The developed device "UTEP Pull-off Device" measures quality of tack coat in tension (pull-off) mode rather than shear mode; therefore, is independent of tested surface. The evaluation of the device in the parking lot as well as in the laboratory identified that the device can consistently identify the quality of tested tack coat. Since the strength of the tack coat is dependent on the set time and test temperature, a test system is proposed that can be used to develop relationship in the laboratory. The developed relationship can then be used in the field to identify adequacy of the tack coat. Preliminary field evaluations indicated that the device has the capability of identifying the quality of the tack coat. The developed device is simple, reliable, economical, and could determine the quality of the tack coat in less than 45 minutes.		14. Sponsoring Agency Code	
17. Key Words Tack Coat, UPOD, SPOD, Shear Strength, Cohesion, Direct Shear		18. Distribution Statement No restrictions. This document is available to the public through the National Technical Information Service, Springfield, Virginia 22161, www.ntis.gov	
19. Security Classified (of this report) Unclassified	20. Security Classified (of this page) Unclassified	21. No. of Pages 188	22. Price

Development of an Objective Field Test to Determine Tack Coat Adequacy

By

Indranil Deysarkar, BSCE

and

Vivek Tandon, PhD, PE

Research Report 0-4129-1

Project Number 0-4129

**Project Title: Development of an Objective Field Test to
Determine Tack Coat Adequacy**

Performed in cooperation with the

**Texas Department of Transportation
and the Federal Highway Administration**

The Center for Transportation Infrastructure Systems

The University of Texas at El Paso

El Paso, Texas 79968-0516

June 2004

Disclaimer:

The contents of this report reflect the view of the authors, who are responsible for the facts and the accuracy of the data presented herein. The contents do not necessarily reflect the official views or policies of the Texas Department of Transportation or the Federal Highway Administration. This report does not constitute a standard, specification, or regulation.

**NOT INTENDED FOR CONSTRUCTION, BIDDING, OR PERMIT
PURPOSES**

Indranil Dyserkar, BSCE
Vivek Tandon, PhD, P.E. (88219)

ACKNOWLEDGEMENTS

The satisfactory progress of this project could not have happened without the help and input of many personnel of TxDOT. Dale Rand is the Project Director and Jim Travis was the Project Coordinator. Tomas Saenz and Magdy Mikhail are the advisors to the project. The authors acknowledge for their active participation in the progress of this project. In addition, the authors like to acknowledge Amitis Meshkani for her guidance and support throughout this project.

ABSTRACT

TxDOT has recently experienced a number of pavement failures due to poor quality of tack coat. Currently, there are no field test systems to determine the quality of the tack coat. Hence, a field test set-up is needed to determine the quality of the tack coat before paving operations and was the objective of this study. Several currently available test equipments that had potential for field application were evaluated in the parking lot as well as in the laboratory. The test results indicated that none of the equipment has potential to consistently identify quality of the tack coat. The main reason for failure was the mode of testing. The test setups mainly focused on the shear strength measurement; however, the shear strength measurements also included frictional resistance offered by the tested surface.

Based on the lessons learned, a device that measures only the quality of tack and is independent of the surface tested was developed. The developed device “UTEP Pull-off Device” measures quality of tack coat in tension (pull-off) mode rather than shear mode; therefore, is independent of tested surface.

The evaluation of the device in the parking lot as well as in the laboratory identified that the device can consistently identify the quality of tested tack coat. Since the strength of the tack coat is dependent on the set time and test temperature, a test system is proposed that can be used to develop relationship in the laboratory. The developed relationship can then be used in the field to identify adequacy of the tack coat. Preliminary field evaluations indicated that the device has the capability of identifying the quality of the tack coat. The developed device is simple, reliable, economical, and could determine the quality of the tack coat in less than 45 minutes.

IMPLEMENTATION STATEMENT

The major outcome of this project is the UTEP Pull-off Device that can be used for evaluation of tack coat in the field. The new setup not only will improve the quality of bond between the two layers, it will also assist TxDOT in extending the life of the rehabilitated pavement.

TABLE OF CONTENTS

Acknowledgements.....	iii
Abstract.....	v
Implementation Statement	vi
List of Figures.....	xi
List of Tables	xv

CHAPTER 1 – INTRODUCTION

1.1 Problem Statement.....	1
1.2 Objective and Approach	1
1.3 Organization	2

CHAPTER 2 – BACKGROUND AND LITERATURE REVIEW

2.1 Shearing Devices.....	6
2.1.2 Astra Test Set-Up.....	6
2.1.3 Hachiya and Sato Test Set-Up.....	8
2.1.4 Kansas State Test Set-Up.....	10
2.1.5 LTRC Test Set-Up	12
2.1.6 Florida DOT Test Set-Up	14
2.1.7 Road and Traffic Authority (RTA) Set-Up	16
2.1.8 Koch Materials Equipment.....	17
2.1.9 Instrotek ATACKER™ Shear Device.....	18
2.1.10 UTEP Torque Test Set-Up.....	21
2.2 Tension Devices.....	23
2.2.1 Instrotek ATACKER™ Pull-Off Device.....	23
2.2.2 Pneumatic Adhesion Test Set-Up.....	23
2.2.3 Elcometer106 Mechanical Adhesion Tester.....	25
2.3 Conclusion	27

CHAPTER 3 – EXPERIMENTAL DESIGN AND TEST PROCEDURES

3.1	Experimental Design.....	29
3.1.1	Type of Tack Coat	29
3.1.2	Dilution Levels.....	29
3.1.3	Setting Time of Tack coat.....	30
3.1.4	Testing Time	31
3.1.5	Rate of Application.....	31
3.1.6	Load Levels.....	31
3.1.7	Loading Time.....	31
3.2	Test Procedures	32
3.2.1	UTEP Torque Test Set-Up.....	32
3.2.2	Instrotek ATACKER™ Device	32
3.2.3	Koch Materials Company Shearing Device	33
3.2.4	Elcometer106 Mechanical Adhesion Tester.....	35

CHAPTER 4 – TEST RESULTS AND STATISTICAL ANALYSIS

4.1	Shear Devices Test Results.....	37
4.1.1	Instrotek ATACKER™ Shear	37
4.1.2	UTEP Torque	49
4.1.3	Koch Materials Company Shear	58
4.2	Tension Devices Test Results	67
4.2.1	Instrotek ATACKER™ Tension.....	67
4.2.2	ElCometer106 Mechanical Adhesion Tester	71
4.3	Statistical Analysis.....	71
4.4	Discussion	85

CHAPTER 5 – FIELD EVALUATION OF SELECTED DEVICE FOR PHASE 1 TESTING

5.1	Selected Sites	89
5.2	Test Results	91
5.3	Shortcomings of Test Set-Ups	92

CHAPTER 6 – DEVELOPMENT OF A TACK COAT DEVICE

6.1	Interface Shear Strength.....	95
6.2	UTEP Direct Shear Device	97
6.3	Tension Devices.....	100
6.3.1	UTEP Pull-Off Device (UPOD)	100
6.3.2	Simple Pull-Off Device.....	105
6.4	Calculations.....	108
6.5	Experimental Design.....	108

CHAPTER 7 – TEST RESULTS AND ANALYSIS OF UPOD, SPOD AND DIRECT SHEAR	
7.1 Evaluation of UPOD in Parking Lot.....	113
7.2 Evaluation of SPOD in Parking Lot	122
7.3 Statistical Analysis.....	131
7.4 Direct Shear Test Device	145
7.5 Evaluation of UPOD in Laboratory	152
7.6 Time and Temperature Dependence on DS TME Temperature.....	156
7.7 Field Evaluation of UPOD.....	159
7.8 Suggested UPOD Test Procedure for Field Evaluation.....	162
 CHAPTER 8 – CLOSURE	
8.1 Summary	163
8.2 Conclusions.....	163
8.3 Recommendations for Future Research	164
 REFERENCES	 165
 APPENDIX A	 166

LIST OF FIGURES

Figure	Page
2.1 Separation of Overlay Layer Due to Poor Bonding on US-17 in Florida.....	3
2.2 Example of Uniform and Non-Uniform Tack Coat Application.....	4
2.3 Spray Bar Height to Obtain Desired Coverage.....	5
2.4 A Schematic of ASTRA Direct Shear Test Set-Up.....	7
2.5 Typical Test Results from ASTRA Test Set-Up.....	7
2.6 Schematic of Asphalt Concrete Test Set-Up.....	8
2.7 Schematic of Emulsion Test Set-Up.....	9
2.8 Influence of Emulsion Thickness on Shear Strength.....	9
2.9 Influence of Tack Coat Application on Shear Strength.....	10
2.10 Schematic Diagram of Direct Shear Test Set-Up.....	11
2.11 Shear Stress-Displacement and Normal versus Shear Displacement Curves.....	11
2.12 LTRC Test Set-Up with Molds and Shearing Apparatus.....	12
2.13 Mean Shear Strength versus Tack Coat Type.....	13
2.14 Shear Measurement Set-Up Developed by Florida DOT.....	14
2.15 Shear Strength Test Data for US-90 Project.....	15
2.16 RTA Test Set-Up.....	16
2.17 Koch Materials Company Test Set-Up.....	17
2.18 Test Results from Koch Materials Company Test Set-Up.....	18
2.19 ATACKER™ Test Set-Up.....	19
2.20 ATACKER™ Field Test Set-Up.....	20
2.21 Shear Strength Measurement with Torque Wrench.....	20
2.22 Aluminum Test Cylinders for UTEP Torque Test.....	21
2.23 UTEP Torque Test Field Test Set-Up.....	22

2.24 Dial Gauge Used for Determining Tensile Load.....	23
2.25 Patti 110 Adhesion Tester.....	24
2.26 Cross-Section Schematic of Piston Attached to Stub.....	25
2.27 Effect of Soak Time on Pull-Off Strength of PG Grade Asphalt	26
2.28 Elcometer106 Mechanical Adhesion Tester.....	26
2.29 Different Scales Available for Elcometer106 Adhesion Tester	26
3.1 ATACKER™ Field Test Set-Up	33
3.2 Compaction of Specimen by Marshall Hammer	34
3.3 Field Testing of Koch Materials Company Test Set Up.....	34
3.4 Specimen Preparation for Elcometer106 Test.....	35
3.5 Test Performed using Elcometer106	36
4.1 ATACKER™ Shear Results for CSS-1h Tested at 7AM.....	44
4.2 ATACKER™ Shear Results for CSS-1h Tested at 4 PM	44
4.3 ATACKER™ Shear Results for SS-1 Tested at 7 AM	45
4.4 ATACKER™ Shear Results for SS-1 Tested at 4 PM.....	45
4.5 ATACKER™ Shear Results for PG64-22 Tested at 7 AM.....	46
4.6 ATACKER™ Shear Results for PG64-22 Tested at 4 PM	46
4.7 ATACKER™ Shear Variability Results for SS-1 Tested at 7 AM	48
4.8 ATACKER™ Shear Variability Results for CSS-1h Tested at 4 PM	48
4.9 UTEP Torque Results for CSS-1h Tested at 7 AM.....	55
4.10 UTEP Torque Results for Css-1h Tested at 4 PM.....	55
4.11 UTEP Torque Results for SS-1 Tested at 7 AM	56
4.12 UTEP Torque Results for SS-1 Tested at 4 PM.....	56
4.13 UTEP Torque Results for PG64-22 Tested at 7 AM.....	57
4.14 UTEP Torque Results for PG64-22 Tested at 4 PM	57
4.15 UTEP Torque Variability Results for SS-1 Tested at 7 AM.....	59
4.16 UTEP Torque Variability Results for CSS-1h Tested at 4 PM.....	59
4.17 KMC Device Results for CSS-1h Tested at 7 AM.....	64
4.18 KMC Device Results for CSS-1h Tested at 4 PM	64
4.19 KMC Device Results for SS-1 Tested at 7 AM	65
4.20 KMC Device Results for SS-1 Tested at 4 PM	65
4.21 KMC Device Results for PG64-22 Tested at 7 AM.....	66
4.22 KMC Device Results for PG64-22 Tested at 4 PM	66
4.23 KMC Device Variability Results for SS-1 Tested at 7 AM	68
4.24 KMC Device Variability Results for PG64-22 Tested at 4 PM	68

4.25 Instrotek ATACKER™ Parking Lot results for PG64-22 at 7 AM	70
4.26 Instrotek ATACKER™ Parking Lot results for CSS-1-h at 7 AM	71
5.1 Montana East Bound (East of Loop 375)	90
5.2 Montana West Bound (East of Loop 375)	90
5.3 Alameda at Reynolds West Bound	91
6.1 Results from a Series of Direct Shear Tests	96
6.2 UTEP Direct Shear Test Set-Up	98
6.3 Shear Box for the UTEP Direct Shear Apparatus	98
6.4 Data Acquisition System for Direct Shear Test Set-Up	99
6.5 UTEP Pull-Off Device Test Set-Up.....	100
6.6 Torque Wrench used during UPOD Testing.....	101
6.7 Contact Test Plates for UPOD	101
6.8 Base Plates for UPOD Laboratory Testing.....	102
6.9 Transmission of Forces in UPOD.....	104
6.10 Calibration of UPOD	105
6.11 Simple Pull-off Test Set-Up	106
6.12 Force Dial used in Simple Pull-Off Test.....	107
6.13 Loading Arrangement for Simple Pull-Off Test	107
6.14 Temperature Test Set-Up.....	111
7.1 DS Test Results for Tests Performed at 140° F and 60 Minute Set Time with CSS-1h Tack coat	147
7.2 Relationship between AC and Aluminum Specimens used in Direct Shear Test	149
7.3 DS Test Results for CSS-1h.....	151
7.4 DS Test Results for CSS-1	151
7.5 DS Test Results for PG64-22.....	152
7.6 DS Test Results for SS-1h	152
7.7 UPOD Laboratory Test Results for CSS-1h.....	155
7.8 UPOD Laboratory Test Results for CSS-1	155
7.9 UPOD Laboratory Test Results for PG64-22.....	156
7.10 UPOD Laboratory Test Results for SS-1h	156
7.11 Tack Coat Application at Joe Battle (I-10 Eastbound).....	160
7.12 Field Test Performed at Joe Battle and Loop 375	161

LIST OF TABLES

Table	Pages
2.1 Typical Application Rates.....	4
3.1 Parameters Evaluated in the Initial Phase Testing.....	30
4.1 Typical ATACKER™ Shear Parking Lot Test Results for CSS-1h.....	38
4.2 ATACKER™ Shear Parking Lot Test Results for SS-1	39
4.3 ATACKER™ Shear Parking Lot Test Results for CSS-1h.....	40
4.4 ATACKER™ Shear Parking Lot Test Results for PG64-22.....	41
4.5 ATACKER™ Shear Laboratory Test Results for PG64-22.....	41
4.6 ATACKER™ Shear Laboratory Test Results for SS-1 & CSS-1h	42
4.7 UTEP Torque Parking Lot Test Results for SS-1	50
4.8 UTEP Torque Parking Lot Test Results for CSS-1h	51
4.9 UTEP Torque Parking Lot Test Results for PG64-22	52
4.10 UTEP Torque Laboratory Test Results for PG64-22	52
4.11 UTEP Torque Laboratory Test Results for SS-1 & CSS-1h	53
4.12 KMC Shear Parking Lot Test Results for SS-1	60
4.13 KMC Shear Parking Lot Test Results for CSS-1h	61
4.14 KMC Shear Parking Lot Test Results for PG64-22	62
4.15 KMC Shear Laboratory Test Results for SS-1	62
4.16 ATACKER™ Tension Parking Lot Test Results for CSS-1-h.....	69
4.17 ATACKER™ Tension Parking Lot Test Results for PG64-22	70
4.18 ANOVA for ATACKER™ Shear Parking Lot Tests for SS-1	73
4.19 ANOVA for ATACKER™ Shear Parking Lot Tests for CSS-1-h.....	74
4.20 ANOVA for ATACKER™ Shear Parking Lot Tests for PG64-22	75
4.21 ANOVA for ATACKER™ Shear Laboratory Tests for PG64-22	75
4.22 ANOVA for ATACKER™ Shear Laboratory Tests for SS-1	76
4.23 ANOVA for ATACKER™ Shear Laboratory Tests for CSS-1-h.....	76
4.24 ANOVA for UTEP Torque Parking Lot Tests for SS-1	78
4.25 ANOVA for UTEP Torque Parking Lot Tests for CSS-1-h	79
4.26 ANOVA for UTEP Torque Parking Lot Tests for PG64-22.....	80

4.27 ANOVA for UTEP Torque Laboratory Tests for PG64-22	80
4.28 ANOVA for UTEP Torque Laboratory Tests for SS-1.....	81
4.29 ANOVA for UTEP Torque Laboratory Tests for CSS-1-h.....	81
4.30 ANOVA for KMC Shear Parking Lot Tests for SS-1	83
4.31 ANOVA for KMC Shear Parking Lot Tests for CSS-1-h.....	84
4.32 ANOVA for KMC Shear Parking Lot Tests for PG64-22	85
4.33 Comparison of Three Devices Based on Residual Sum of Squares	86
5.1 Field Evaluation of ATACKER™ and UTEP Devices.....	92
6.1 Parameters used in Parking Lot Evaluation of UPOD and SPOD.....	109
6.2 Parameters used during UPOD Laboratory Testing	110
6.3 Parameters used in Laboratory Evaluation of DS and UPOD.....	112
7.1 UPOD Parking Lot Test Results for CSS-1h Tested at 4PM	114
7.2 UPOD Parking Lot Test Results for CSS-1h Tested at 7AM.....	114
7.3 UPOD Parking Lot Test Results for CSS-1 Tested at 4PM	115
7.4 UPOD Parking Lot Test Results for CSS-1 Tested at 7AM.....	115
7.5 UPOD Parking Lot Test Results for RC-250 Tested at 4PM	116
7.6 UPOD Parking Lot Test Results for RC-250 Tested at 7AM	116
7.7 UPOD Parking Lot Test Results for SS-1h Tested at 4PM.....	117
7.8 UPOD Parking Lot Test Results for SS-1h Tested at 7AM	117
7.9 UPOD Parking Lot Test Results for PG64-22 Tested at 4PM	118
7.10 UPOD Parking Lot Test Results for PG64-22 Tested at 7AM	118
7.11 SPOD Parking Lot Test Results for SS-1 Tested at 4PM	119
7.12 SPOD Parking Lot Test Results for SS-1 Tested at 7AM.....	119
7.13 SPOD Parking Lot Test Results for CSS-1h Tested at 4PM.....	123
7.14 SPOD Parking Lot Test Results for CSS-1h Tested at 7AM.....	123
7.15 SPOD Parking Lot Test Results for CSS-1 Tested at 4PM.....	124
7.16 SPOD Parking Lot Test Results for CSS-1 Tested at 7AM.....	124
7.17 Parking Lot Test Results for RC-250 Tested at 4PM.....	125
7.18 SPOD Parking Lot Test Results for RC-250 Tested at 7AM.....	125
7.19 SPOD Parking Lot Test Results for PG64-22 Tested at 4PM.....	126
7.20 SPOD Parking Lot Test Results for PG64-22 Tested at 7AM.....	126
7.21 SPOD Parking Lot Test Results for SS-1h Tested at 4PM	127
7.22 SPOD Parking Lot Test Results for SS-1h Tested at 7AM.....	127
7.23 SPOD Parking Lot Test Results for SS-1 Tested at 4PM	128
7.24 SPOD Parking Lot Test Results for SS-1 Tested at 7AM.....	128
7.25 UPOD ANOVA for CSS-1h.....	133
7.26 SPOD ANOVA for CSS-1h	134

7.27 UPOD ANOVA for CSS-1	135
7.28 SPOD ANOVA for CSS-1	136
7.29 UPOD ANOVA for SS-1h	137
7.30 SPOD ANOVA for SS-1h	138
7.31 UPOD ANOVA for SS-1.....	139
7.32 SPOD ANOVA for SS-1	140
7.33 UPOD ANOVA for RC-250.....	141
7.34 SPOD ANOVA for RC-250	142
7.35 UPOD ANOVA for PG64-22.....	143
7.36 SPOD ANOVA for PG64-22	144
7.37 Comparison of SPOD and UPOD Devices Based on Residual Sum of Squares	145
7.38 DS Laboratory Test Results of AC Specimens Compacted by Simulating Field Conditions with CSS-1h Tack coat.....	146
7.39 DS Test Results for AC Specimen Tested with CSS-1h Tack coat.....	147
7.40 DS Test Results for Aluminum Specimen Tested with CSS-1h Tack coat.....	148
7.41 DS Laboratory Test Results for CSS-1.....	149
7.42 DS Laboratory Test Results for PG64-22	150
7.43 DS Laboratory Test Results for SS-1h	150
7.44 UPOD Laboratory Test Results for CSS-1h.....	153
7.45 UPOD Laboratory Test Results for CSS-1.....	153
7.46 UPOD Laboratory Test Results for PG64-22.....	154
7.47 UPOD Laboratory Test Results for SS-1h	154
7.48 Time Temperature Correlation Factors	157
7.49 Field vs. Laboratory Test Results for CSS-1h.....	158
7.50 Field vs. Laboratory Test Results for CSS-1	159
7.51 Field vs. Laboratory Test Results for PG64-22.....	159
7.52 Field vs. Laboratory Test Results for SS-1h	159
7.53 UPOD Joe Battle (I-10 Eastbound) Field Test Results	160
7.54 UPOD Joe Battle Loop 375 Field Test Results.....	162

CHAPTER 1 INTRODUCTION

1.1 PROBLEM STATEMENT

To improve performance of flexible pavements, it is quite common to place an overlay on top of the existing surface layer. A bonding agent commonly known as “tack coat” is placed on top of the old layer, before placement of overlay, to ensure proper bonding between the two layers. A good tack coat provides necessary bonding between the two layers to make sure that they act as a monolithic system to withstand the traffic and environmental loads (Mohammad et al., 2002). In recent years, the Texas Department of Transportation (TxDOT) has experienced an increase in the number of premature pavement failures and the main reason for failures has been attributed to debonding between the two layers. The debonding can result from either poor application or inferior quality of tack coat or both. The debonding reduces bearing capacity of the pavement. Insufficient bonding may also cause tensile stresses to be concentrated at the bottom of the wearing course (Mohammad et al., 2002). The concentration of stresses and/or reduced bearing capacity leads to premature failure of overlay layer.

To ensure that tack coat is evenly spread at appropriate application rate, Ohio DOT (Ohio Technical Bulletin, 2001) has developed a procedure that ensures uniform application and has been adopted by TxDOT. However, no reliable field test is available that can quantify the quality of applied tack coat. Currently, TxDOT uses a boot heel test. The procedure suggests that an inspector stands on the applied tack coat area and if his/her boot sticks to the tack coat it is good, otherwise it is not. This field test is subjective and does not ensure that a good quality tack is applied. Hence, a test set up is needed to determine the bonding characteristics of the tack coat before paving.

1.2 OBJECTIVE & APPROACH

The main objective of this research is to develop a field test system that can quantify the quality of the tack coat. The developed test should be simple, economical, easy to use, and able to determine the quality of tack coat within a shorter duration.

To achieve the objectives of this study, an extensive literature search was performed and various DOTS' were contacted to identify the current test procedures followed. Based on the results of the literature review, lists of potential equipments that can quantify the quality of tack coat were identified. The selected equipments were evaluated using commonly used tack coats and application rates. Since the field evaluation of existing equipments did not provide reliable results, new test setups were developed. Therefore, the study was performed in two phases. In the initial phase, the currently available equipments were evaluated. Based on results of evaluation, new test setups were developed and evaluated in the final phase of the study.

1.3 ORGANIZATION

The problem statement, objective and approaches of this research are presented in this chapter. Chapter Two contains the review of literature and setups identified for field evaluation. The experiment design and test procedures followed for the evaluation of devices are discussed in Chapter Three. The test results and data analyses are discussed in Chapter Four along with the statistical analysis. Chapter Five discusses the deficiencies and shortcomings of the existing devices and modifications required.

Based on the lessons learned, three new test setups were developed. The theory behind development of test setups and the experiment design for the evaluation are presented in Chapter Six. The test results and data analysis of the data collected from the new devices are discussed in Chapter Seven. In addition, field validation of new devices is presented in Chapter Seven. The summary, conclusion and recommendations for the future research are included in Chapter Eight.

CHAPTER 2

BACKGROUND AND LITERATURE REVIEW

Tack coat is a light application of emulsion or asphalt binder between existing pavements and the new overlay. The main purpose of the tack coat is to bond the two layers to prevent slippage and efficiently transfer traffic loads from overlay to the existing pavement layers. In the case of poor quality or improper application of the tack coat, the bond between the layers diminishes and the top layer slips away, as shown in Figure 2.1. The end result is the development of various types of distresses in the pavement and the significant reduction of the life of the overlaid pavement system. Highway agencies throughout the nation have traced failure of overlays to tack coat (Mohammad et al., 2002) and TxDOT is no exception.



Figure 2.1 - Separation of Overlay Layer Due to Poor Bonding on US-17 in Florida

To minimize problems associated with improper application of tack coat, TxDOT has adopted a procedure suggested in a Technical bulletin proposed by Ohio DOT (Ohio Technical Bulletin, 2001). The discussion on proper tack coat application is reproduced herein from the Ohio DOT technical bulletin. *The Technical bulletin suggested different application rates depending on the condition of the existing pavement. The typical application rates of tack coat for various pavement conditions are shown in Table 2.1.*

Table 2.1 - Typical Application Rates (Ohio Technical Bulletin, 2001)

<i>Existing Pavement Condition</i>	<i>Application Rate (gallons/ yd²)</i>		
	<i>Residual</i>	<i>Undiluted</i>	<i>Diluted (1:1)</i>
<i>New Asphalt</i>	<i>0.03 to 0.03</i>	<i>0.05 to 0.07</i>	<i>0.10 to 0.13</i>
<i>Oxidized Asphalt</i>	<i>0.04 to 0.06</i>	<i>0.07 to 0.10</i>	<i>0.13 to 0.20</i>
<i>Milled Surface (Asphalt)</i>	<i>0.06 to 0.08</i>	<i>0.10 to 0.13</i>	<i>0.20 to 0.27</i>
<i>Milled Surface (PCC)</i>	<i>0.06 to 0.08</i>	<i>0.10 to 0.13</i>	<i>0.20 to 0.27</i>
<i>Portland Cement Concrete</i>	<i>0.04 to 0.06</i>	<i>0.07 to 0.10</i>	<i>0.13 to 0.20</i>
<i>Vertical Face</i>	<i>*****</i>	<i>*****</i>	<i>*****</i>

In addition, uniformity plays an important role in quality application of tack coat. Since the purpose of tack coat is to promote bond between an existing pavement surface and an overlay, it is very important that the tack coat be applied in a uniform manner with approximately 90% of the surface covered. A good tack coat application would exhibit a uniform layer of bituminous material at the desired rate. Improper application of tack coat leads to cracks along the wheel paths. Examples of proper and improper application of tack coat are shown in Figure 2.2.

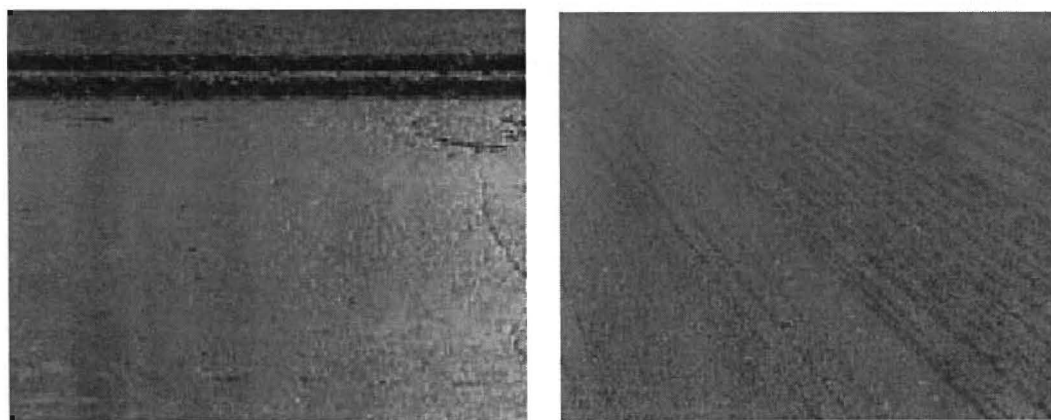

(a) Uniform

(b) Non-uniform

Figure 2.2 - Example of Uniform and Non-uniform Tack Coat Application (Ohio Technical Bulletin, 2001)

Uniform application of tack coat should be ensured by using properly functioning equipment. The tack coat should be sprayed uniformly on the existing pavement with the help of spray bar nozzles creating a fan shape as the materials leave the nozzle. The spray bar nozzles should be placed at a predetermined elevation to get the desired uniformity of tack coat application as shown in Figure 2.3.

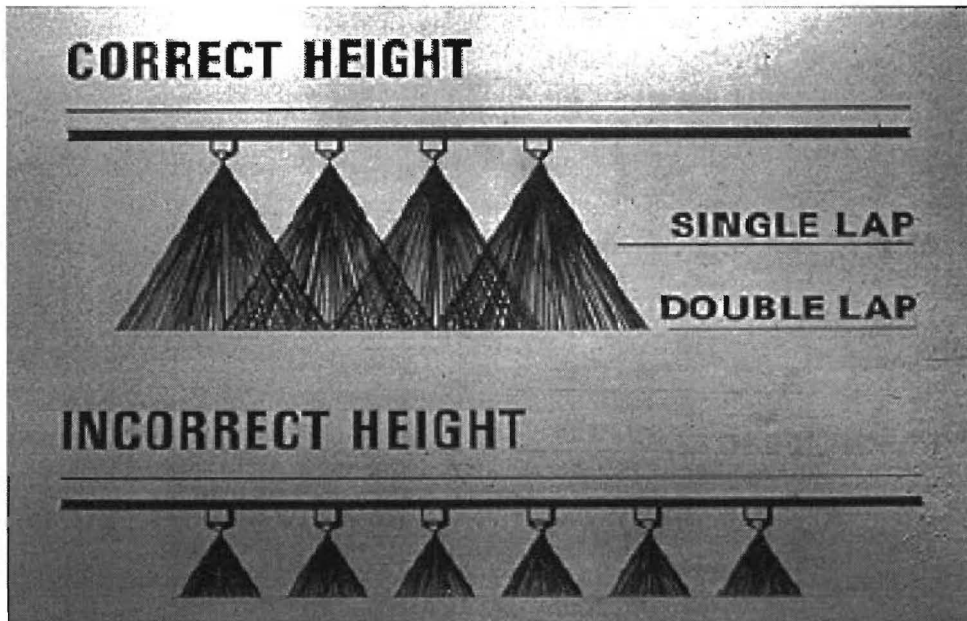

**Figure 2.3 - Spray Bar Height to Obtain Desired Coverage
(Ohio Technical Bulletin, 2001)**

Although the adoption of the application procedure has minimized problems associated with the improper application of tack coat, the procedure does not address the poor tack quality. Generally, a contractor provides TxDOT with a sample of tack coat that will be used in the paving operation. The supplied tack coat can be tested in the laboratory to verify quality of the tack coat. However, there are no test setups or procedures that can be used to identify the quality of the tack coat in the field. Thus, a field test is needed to identify the quality of the tack coat.

An extensive literature search was carried out to identify the availability of field-testing equipments. The results of the review and discussion suggested that agencies have developed laboratory tests to identify which tack coat type and application rate would provide better bonding. However, none of the state highway agencies (within US) have developed field tests to evaluate the same. Only Koch Materials Company and Road and Traffic Authority (RTA) of New South Wales (Australia) developed field test equipment to identify the quality of tack coat. The Koch Materials Company test setup has an additional feature that it can be used in the field as well as in the laboratory.

To identify quality of tack coat, the developed setup either used shear mode or tension mode of failure to estimate bond strength. In the following sections, the shear mode and tension mode test setups have been discussed.

2.1 SHEARING DEVICES

The literature review suggested various laboratory devices and couple of field devices to identify bond strength in shearing mode. In addition, a recently developed field device was identified that can be used in the field. A simple field shear device was also developed at UTEP because one of the objectives of this study was to identify or develop an economical device. In the following sections, the laboratory shear devices are presented first. After words, the available field devices are discussed. In the end, newly developed field devices are presented.

2.1.2 ASTRA TEST SET-UP

Santagata et al. (1993) identified a need for a laboratory tack coat shear strength test setup after premature failure of overlaid pavements in Italy. Santagata et al. (1993) developed a simple shear test device under Anacona Shear Testing Research and Analysis (ASTRA) program. The developed test set-up is shown in Figure 2.4 and the test set-up is based on the concept of the direct shear test commonly used by geotechnical engineers.

For strength testing, specimens were prepared using two different methods. In the first method, two briquettes of asphalt concrete (AC) were prepared. The lower specimen was maintained at ambient temperature while top specimen was heated to 284°F (140°C). A layer of tack coat was applied on top of the lower specimen and the heated specimen was placed on top of tack coat before application of a vertical consolidation load for an adequate period of time. In the second method, the upper layer is statically compacted at a high temperature on the lower one previously prepared by the first method and then cooled. The advantage of the second method is that it simulates the field compaction process.

A horizontal load is applied to the asphalt concrete bonded specimens and the peak load at failure is recorded. The data collection and analysis process is similar to the direct shear device and a typical result is shown in Figure 2.5. The plot on the top left corner shows the relationship between horizontal forces (T) versus axial deformation ($\Delta\epsilon$). The plot on top right corner shows the relationship between tangential mean stresses (τ) versus normal stresses (σ). The graph at the bottom left corner shows the relationship between vertical ($\Delta\eta$) versus horizontal ($\Delta\epsilon$) displacement. The test results suggest that the application of tack coat increases the shear strength of interface bonds. Although more research has been performed by Santagata et al. (1993), further information regarding test set-up and results could not be gathered.

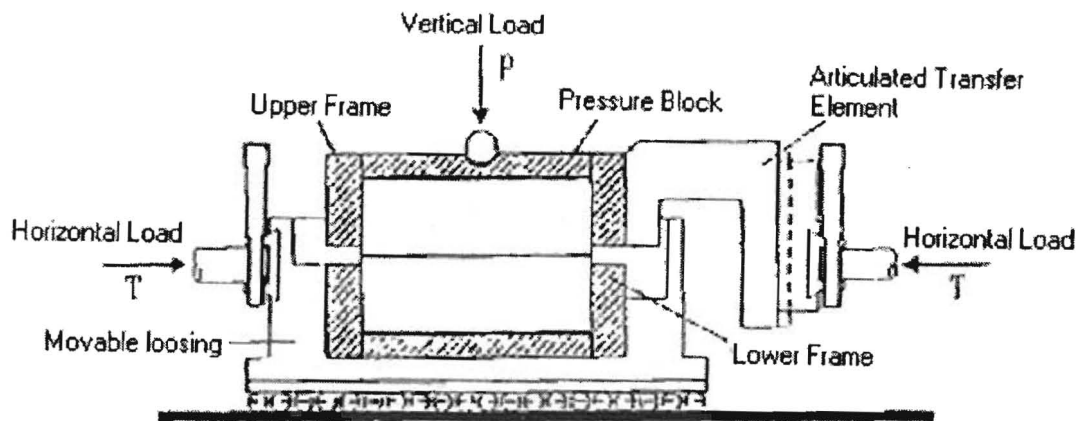

Figure 2.4 - A Schematic of ASTRA Direct Shear Test Set-Up (Santagata et al., 1993)

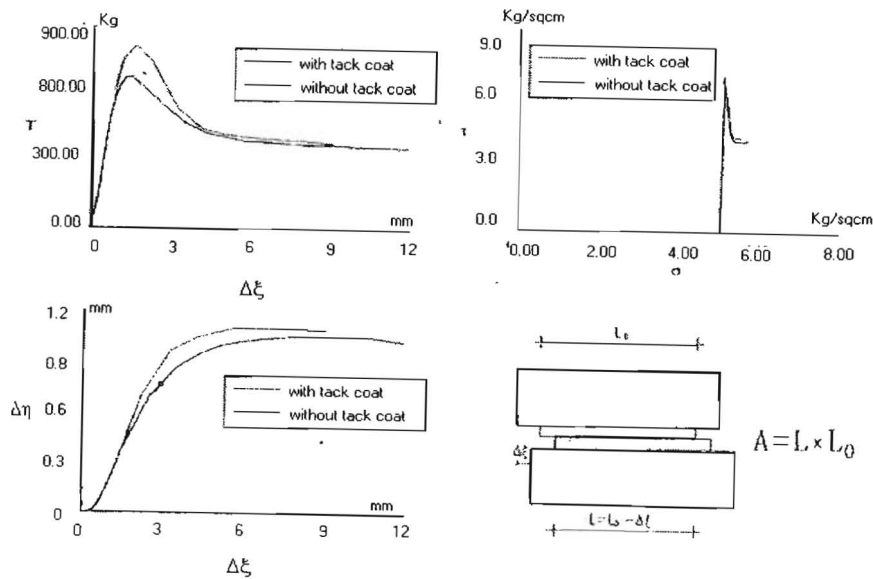

Figure 2.5 - Typical Test Results from ASTRA Test Set-Up (Santagata et al., 1993)

2.1.3 HACHIYA AND SATO TEST SET-UP

Premature failures of overlaid runways, in Japan, lead to the development of a test system by Hachiya and Sato (1997) to measure effect of tack coat on bonding characteristics as shown in Figure 2.6. The developed test setup could be used to measure shear as well as tensile strength.

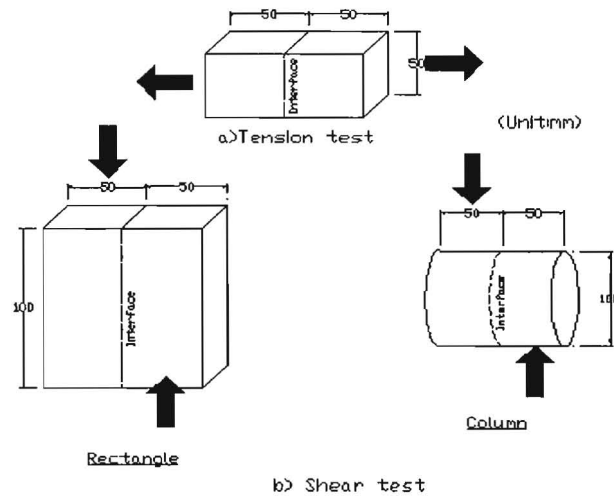
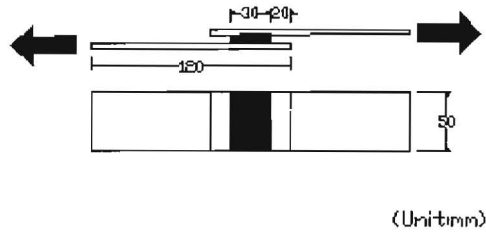

Figure 2.6 - Schematic of Asphalt Concrete Test Set-Up (Hachiya and Sato, 1997)

Asphalt concrete used in the test met the requirements for dense graded asphalt concrete as specified in the airport pavement construction manual for Japan. Specimens for the test were cut from large asphalt concrete blocks 12 in. (300mm) wide, 12 in. (300mm) long and 4 in. (100mm) thick. The size of the specimen for the tension test were 2 in. (50mm) wide, 4 in. (100mm) long and 2 in. (50mm) thick, while those for the flexural test were 2 in. (50mm) wide, 4 in. (100mm) long and 4 in. (100mm) thick.

To evaluate the characteristics of the new emulsified asphalt, both shear and viscosity tests were conducted and the shear test specimen was prepared as shown in Figure 2.7. The emulsified asphalt was evaporated, heated and bonded to stainless plates.

Hachiya and Sato (1997) performed tests at different temperatures, application rates, loading rates, and film thickness on four different types of tack coats. The selected tack coats were PK-80, PK-R80, PK-HR1, and PK-HR2. The PK-80 emulsion had a viscosity of 1630 poise and PK-HR2 had a viscosity of 257,000 poise while the viscosity of the other two was in between these values.



**Figure 2.7 - Schematic of Emulsion Test Set-Up
(Hachiya and Sato, 1997)**

For measuring shear strength of tack coat only, the tests were performed at 32°F (0°C) and 140°F (60°C) temperatures and at loading rates of 0.039 in./min (0.016mm/sec) and 3.94 in./min (1.66 mm/sec). In addition, three-film thickness of 2, 11.8, and 23.6 mils were selected for evaluation purposes. The test results are shown in Figure 2.8 and indicate that an increase in film thickness reduces the shear strength for all tack coat types, test temperatures, and loading rates. In addition, the results suggest that at higher temperatures there are no shear strengths for film thickness higher than 2 mils except for PK-HR-2 emulsion.

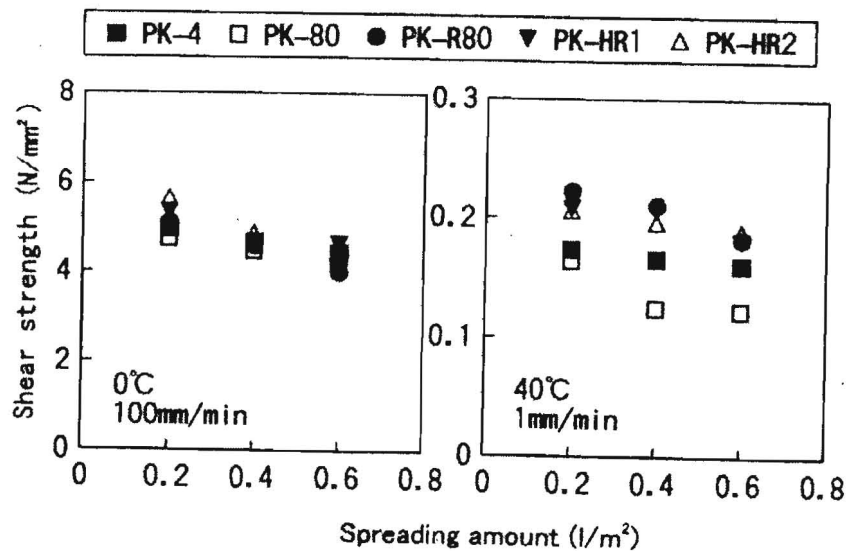

**Figure 2.8 - Influence of Emulsion Thickness on Shear Strength
(Hachiya and Sato, 1997)**

For measuring shear strength of bonded interface between two asphalt concrete layers, the tests were performed at similar loading rates. The tests were performed at 32°F (0°C) and 104°F (60°C) and three application rates of 0.04 (0.18), 0.9 (4.07), 0.13 gal/yd² (0.58 l/m²). The test results are summarized in Figure 2.9. Again the test results show a drop in shear strength with increase in test temperature and an increase in application rate, which eventually translates to an increase in film thickness.

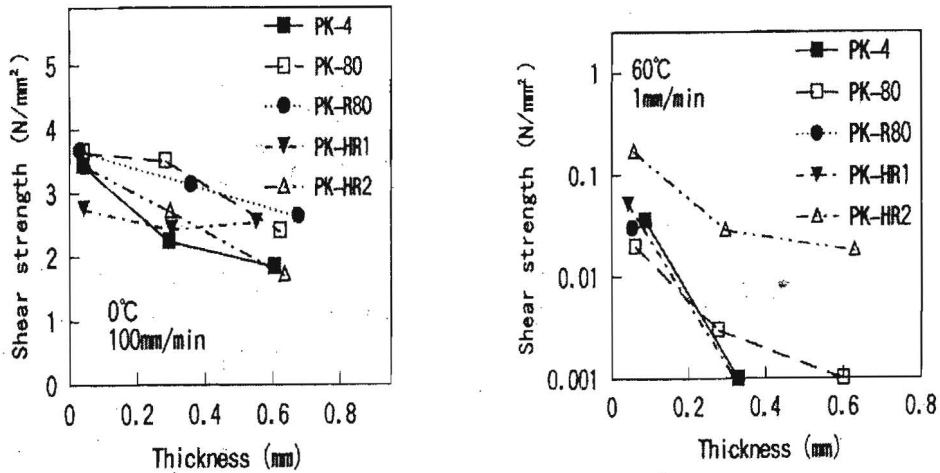

Figure 2.9 - Influence of Tack Coat Application on Shear Strength
(Hachiya and Sato, 1997)

2.1.4 KANSAS STATE TEST SET-UP

Romanoschi and Metcalf (2001) developed a direct shear device to measure interface bond between asphalt concrete specimens. The developed test set-up is shown in Figure 2.10.

Before testing, the asphalt cores were kept for 24 hours in a temperature-controlled chamber at the desired temperature. Since each direct shear test lasted an average of only five minutes, it was assumed that there were no significant changes in the temperature. The tests were conducted for two different interfaces, one without tack coat and the other with tack coat at three different temperatures, 59, 77 and 95°F (15, 25, 35°C). The selected normal stress levels were 20, 40, 60 and 80 psi (138, 276, 414, 522 kPa). Five cores were tested for each combination of the above-mentioned variables. The cores were randomly assigned to each set of conditions.

A typical result is shown in Figure 2.11. The test results are similar to the other studies, i.e., shear strength decreased with temperature and higher shear strength was observed when tack coat was used.

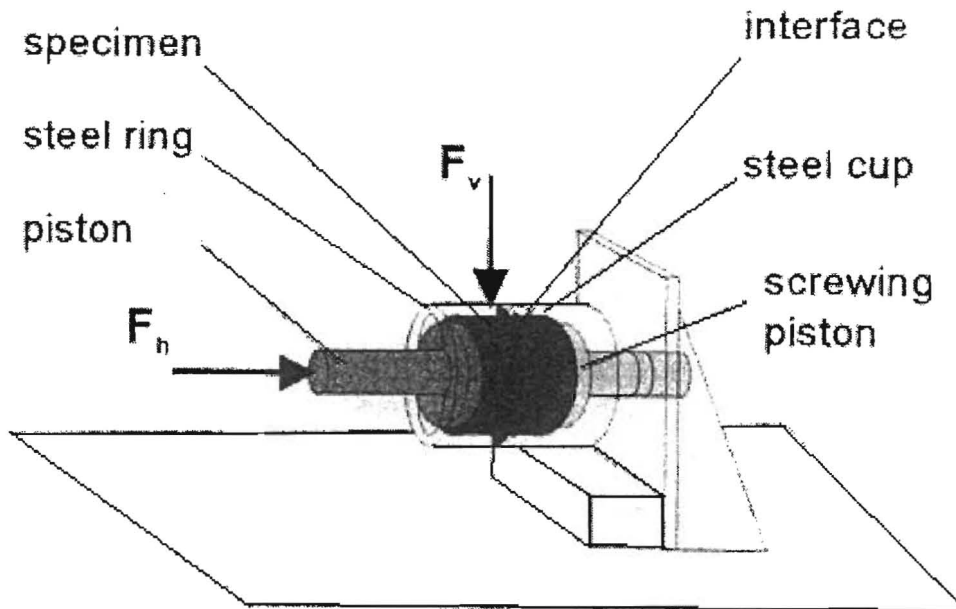

Figure 2.10 - Schematic Diagram of Direct Shear Test Set-Up
(Romanoschi and Metcalf, 2001)

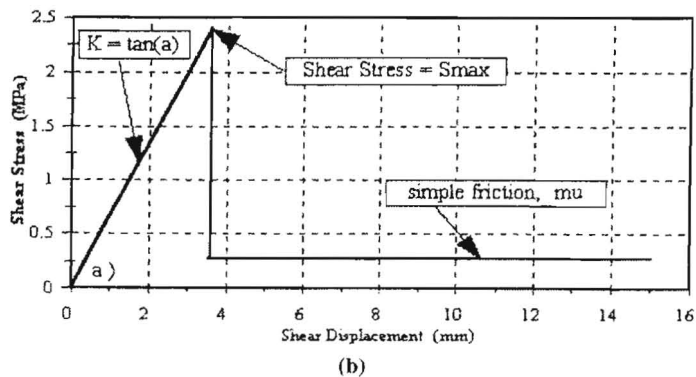
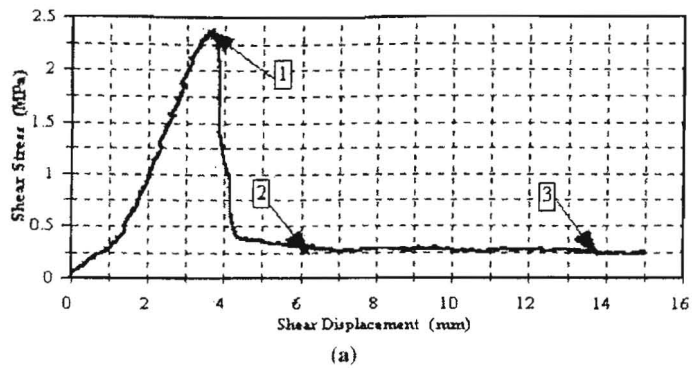

Figure 2.11 - Shear Stress-Displacement and Normal versus Shear Displacement
Curves (Romanoschi and Metcalf, 2001)

The shear displacement increases linearly with the shear stress, as shown in Figure 2.11. Failure of the interface occurs when the shear stress reaches the shear of the interface, S_{max} [1]. Section [1]-[2] indicates the post failure response where two bodies at the interface are not completely separated and the interface still exhibits some shear resistance. Section [2]-[3] indicates the friction when two bodies at the interface are completely separated.

2.1.5 LTRC TEST SET-UP

Mohammad et al. (2002) of Louisiana Transportation Center have developed a test setup to identify the type of tack coat and application rate that provides maximum shearing strength as shown in Figure 2.12. In the top of the figure, the mold used for holding the specimen is shown, while the shearing apparatus is shown at the bottom of the figure. The inside diameter of the mold is 5.9 in. (150mm) and height of the mold is 2 in. (50.8mm).

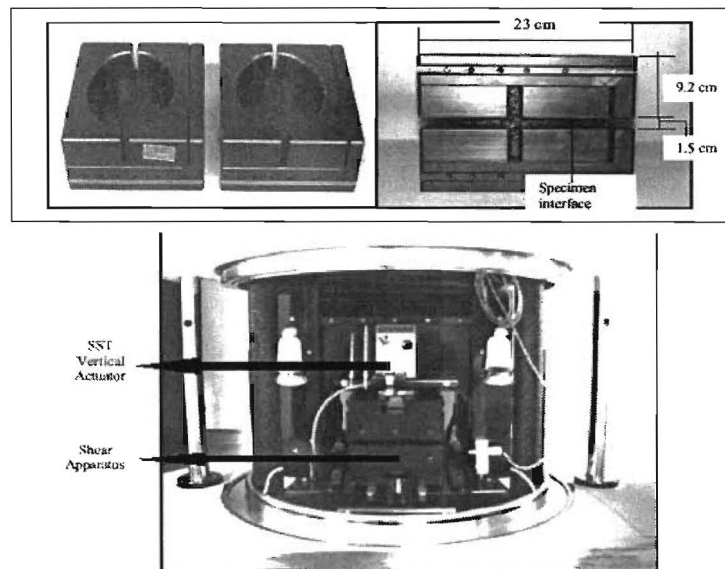

Figure 2.12 - LTRC Test Set-Up with Molds and Shearing Apparatus
(Mohammad et al., 2002)

The specimen used for testing consisted of a top layer and a bottom layer, 5.9 in (150 mm) diameter, with a tack coat at the interface of these layers. The bottom half of the specimen was prepared by compacting the mixture to a height of 2.1 in. (55mm). The hot mix asphalt mixture was obtained from an ongoing overlay project that utilized a 0.75 in. (19mm) Superpave mix design. The compacted specimen was then cooled to room temperature. The asphalt material used as tack coat were then heated to the specified application temperature and then applied on the bottom half of the specimen with proper application rate. The tack coat was then allowed to cure. After curing of the tack coat, the top half of the sample was compacted by placing the bottom half in the Superpave

gyratory compactor (SGC) mold and compacting the loose mix on the top of the tack coated bottom half.

The objective of the Mohammad et al. (2002) study was to identify influence of tack coat types, application rates, and test temperature on the interface shear strength. Four tack coats, CRS 2P, SS-1, CSS-1, and SS-1h, and two asphalt binders, PG 64-22 and PG76-22, were selected for evaluation. The residual application rates considered were 0.00, 0.02, 0.05, 0.1, and 0.2 gal/yd² (0.00, 0.09, 0.05, 0.1, 0.9 l/m²). Simple shear tests were performed at two test temperatures 77°F (25°C) and 131°F (55°C) to determine the interface shear strength.

The results of the study are shown in Figure 2.13. The results presented in Figure 2.13 are based on tests performed on three specimens at each combination of tack coat type, application rate, and test temperature. The results presented in Figure 2.13 are based on multiple comparison procedure known as Fisher’s Least Significant Difference. This procedure ranked the mean shear strength values and placed them in groups designated by A, B, C, D, A/B, etc. The letter ‘A’ is used to rank the group with the highest mean shear strength followed by the other letter grades in the appropriate order. A double letter designation, such as ‘A/B’, indicates that the mean shear strength of that group is not significantly different from either of the groups ‘A’ or ‘B’. The results suggest that maximum shear strength is provided by CRS-2P tack coat applied at an optimum application rate of 0.02 gallons/yd² (0.09 l/m²). The test temperature reduces shear strength significantly and the test setup is not able to discern between well and poor performing tack coat at higher temperatures.

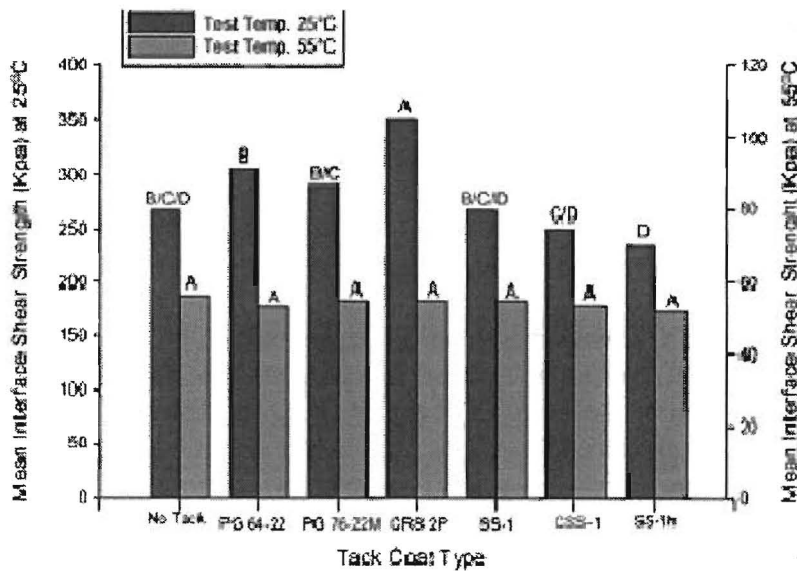

Figure 2.13 - Mean Shear Strength versus Tack Coat Type (Mohammad et al., 2002)

2.1.6 FLORIDA DOT TEST SET-UP

Florida DOT identified a need for the development of a test set-up after premature failure in pavements overlaid on wetted tack coat. The test set-up and procedure was developed after an extensive literature review and laboratory, as well as field investigation (Sholar et al., 2004). The developed test set-up is shown in Figure 2.14.

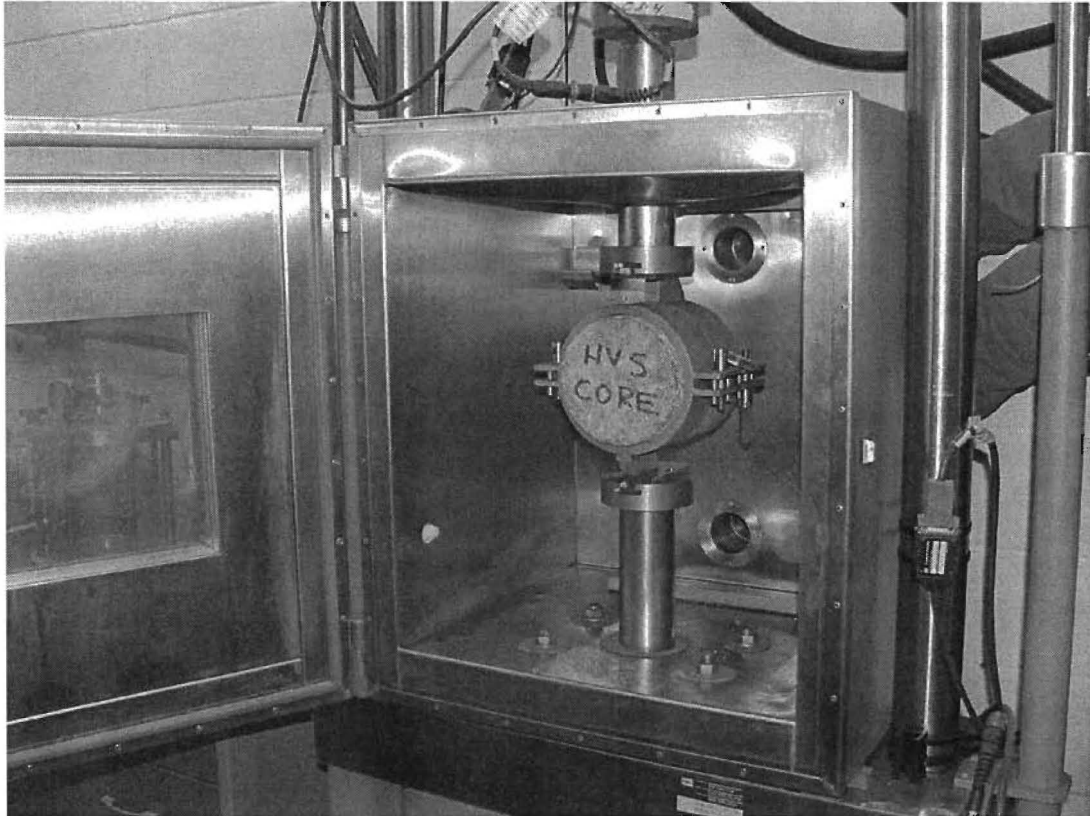

Figure 2.14 - Shear Measurement Set-Up Developed by Florida DOT (Sholar et al., 2004)

The test setup consists of two rings to hold the specimens and is retrofitted into a material and test system (MTS) machine. Two asphalt concrete specimens bonded with tack coat are sheared. The load at the point of break is recorded to identify shear strength of the bond. The main advantage of this test setup is that specimens can be tested at different temperatures because mixes are placed inside the environmental chamber. The other advantage is that rings for holding the specimen can easily be manufactured in any machine shop.

To develop the test procedure, Florida DOT preferred 6-inch (152.4mm) diameter to 4-inch (101.6mm) diameter specimens because more surface is available for shearing and should decrease the variability of test setup. The load application is strain controlled and a strain-loading rate of 2in./min (0.85mm/sec) is used because shear strength will be higher in comparison to lower loading rates, thus, reducing the variability of the test

setup. In addition, this rate of loading can easily be achieved in the Marshall Stability test setup. Since high temperature has an effect on the shear stress of the asphalt specimen, an initial investigation was performed by testing at four different temperatures (77°F [25°C], 100°F [38°C], 120°F [48.8°C], and 140°F [60°C]). The results of the investigation suggest that shear strength reduces by more than 90% for increase in temperature from 77°F (25°C) to 140°F (60°C). Therefore, the procedure suggests performing tests at 77°F (25°C) to obtain higher stresses. The gap between the two rings was selected to be 5/16in. (8mm) to account for the irregular surface of the cored specimens. The tests were performed to quantify the effects of moisture, tack coat application rate, and aggregate interaction on bonding performance-using cores from two different sites.

To evaluate the effect of moisture on the strength characteristics of the tack coat, water was sprinkled on some parts of the sections. A typical result from one of the sites is shown in Figure 2.15. The results suggested that water applied to the surface of the tack coat, representing rainwater, significantly reduced the shear strength in comparison to no water applied.

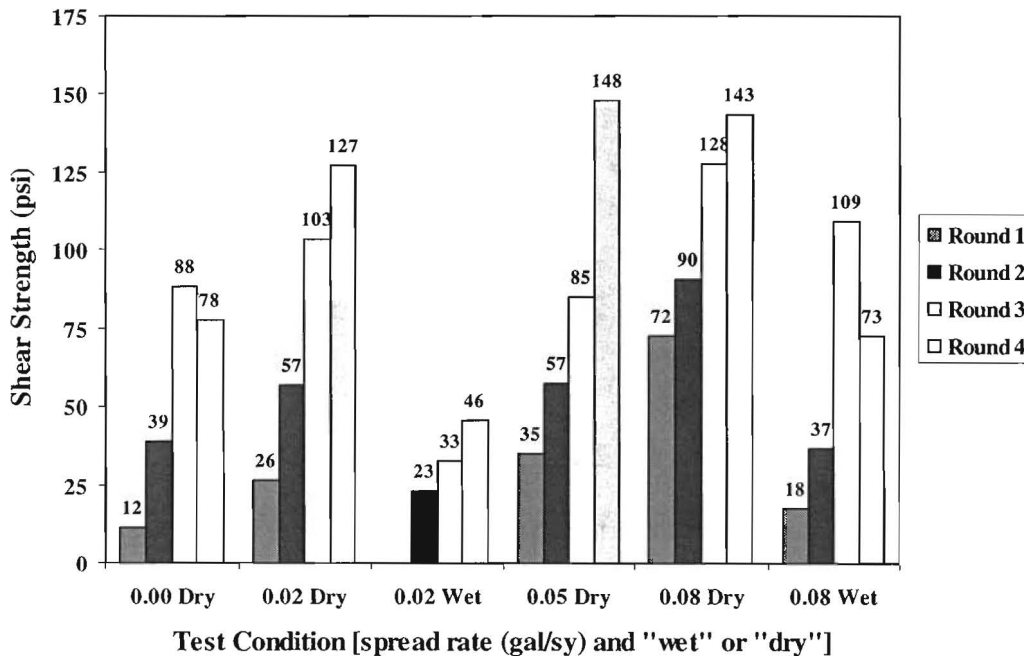

Figure 2.15 - Shear Strength Test Data for US-90 Project (Sholar et al., 2004)

The data also shows that the application of tack coat increases the shear strength and an application rate of 0.08 gal/yd² (0.36 l/m²) showed maximum strength. The study also looked at the combined impact of moisture and aging. The results suggested that water conditioned cores gained strength over time but the level of gain in strength was not similar to the dry condition.

The results of the study suggest that the test set-up is repeatable and has the capabilities of discerning between poor and well performing tack coat. The results also suggest that an AC overlay should not be placed on top of the tack coat that had been wetted by the rain.

2.1.7 ROAD AND TRAFFIC AUTHORITY (RTA) SET-UP

Road and Traffic Authority of New South Wales (Australia) has also developed a test set-up to measure the shear strength at the interface between the existing pavement and the asphalt overlay bonded with tack coat. The schematic diagram of the set-up is shown in Figure 2.16.

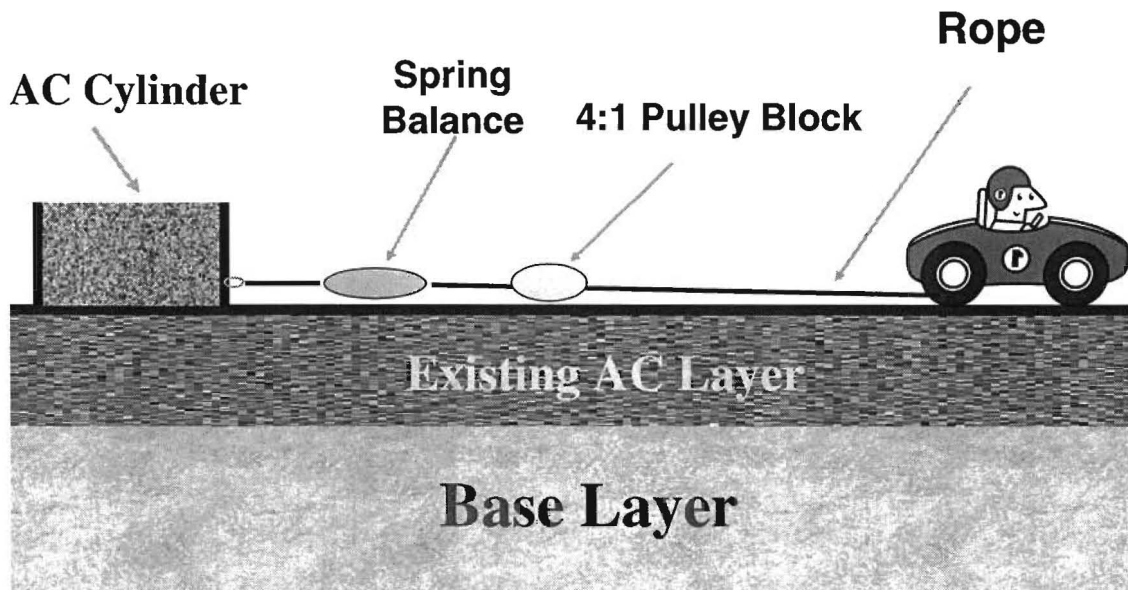

Figure 2.16 - RTA Test Set-Up

The test is performed in accordance to the test method T620. The test method proposes to prepare a section of road surface to be treated by lightly brooming to remove loose gravel or other loose material. A uniform coat of tack is then applied on the road section as specified by the supplier. The tack coat is allowed to cure and a Marshall mold is placed on top of the coated surface. The overlay asphalt concrete material is collected and placed in the Marshall mold. The amount of asphalt concrete should be enough to give compacted cylinder 3-inch (76.2mm) to 4-inch (101.6mm) height. The material is compacted using 25 blows of Marshall hammer. After compaction the briquettes are allowed to cure for a period of one hour. The procedure suggests preparing four briquettes and conditioning two of them with water for a minimum of 30 minutes. All of the briquettes are pulled using the mechanism shown in Figure 2.16 at the rate of 2 lbf (8.9 N) per second. The failure load is recorded from the spring balance for all four briquettes. The shear strength of two dry briquettes is averaged and reported. Similarly, the shear strength of two wet briquettes is averaged and reported. Although this test is a published standard of RTA, no further information could be gathered about the test set-up.

2.1.8 KOCH MATERIALS EQUIPMENT

Koch Materials Company (KMC) has also developed a test set-up as shown in Figure 2.17. The test set-up is portable and can be easily transported from the field to the laboratory.

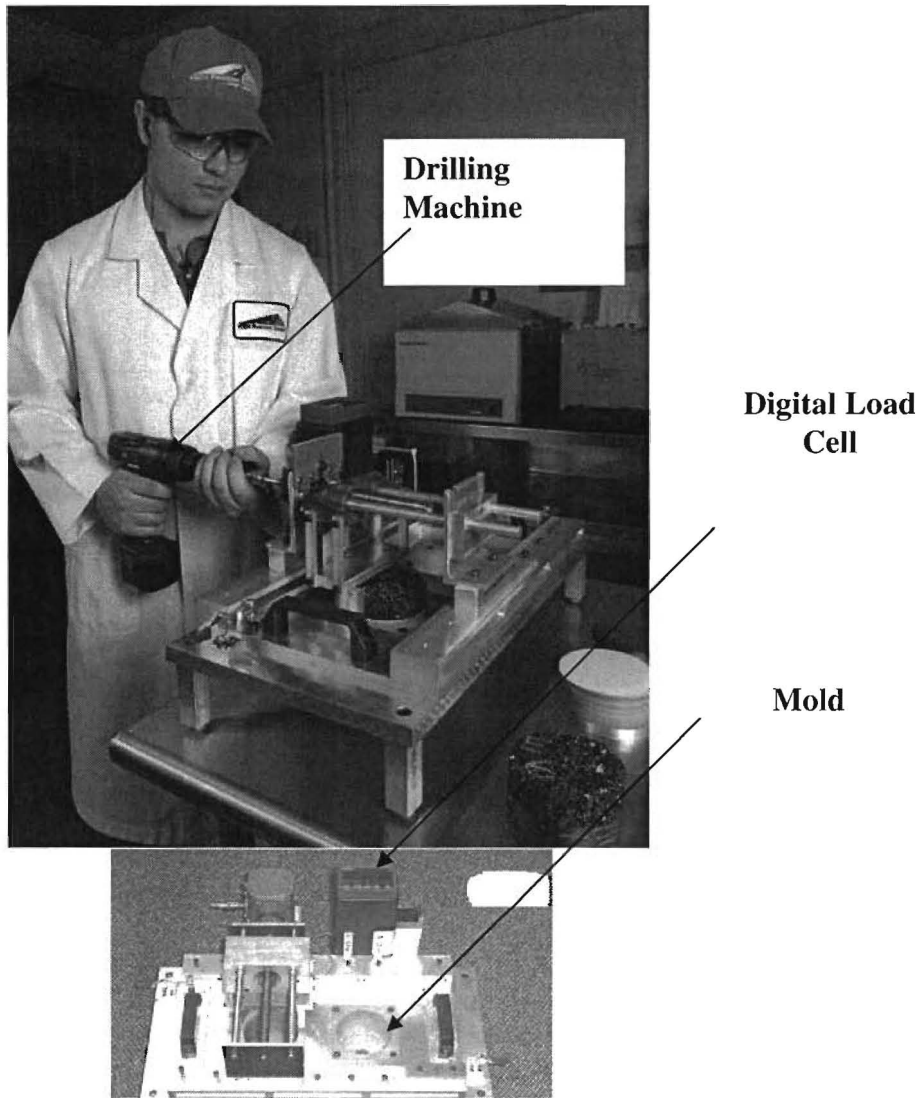

Figure 2.17 - Koch Materials Company Test Set-Up

The test set-up consists of molds to hold specimens and a loading mechanism to apply horizontal shearing load. To apply horizontal load, the setup uses a commercially available 24 Volt cordless drilling machine and can apply loads at the strain rates of 1.7 in./min. The test set-up has a digital load cell that has capabilities of capturing the highest load before de-bonding occurs. This can be converted into interface shear strength.

KMC performed an initial laboratory investigation to identify the effectiveness of the equipment by preparing mixes and testing. A commonly used dense-graded asphalt concrete mix was prepared and subjected to abrasion for field simulation. Then the specimen is placed in the SGC and an ultra thin bonded wearing course (Nova chip™) loose mix is placed on top of it and subjected to 100 gyrations in the SGC. In total six specimens were prepared for the comparison purposes. A polymer modified emulsion (Nova bond™) at the rate of 0.2 gal/yd² (0.9 l/m²) was used for bonding purposes. Three specimens were prepared without tack coat and three specimens were prepared with Nova bond™. The prepared specimens were subjected to a Freeze-Thaw cycle and were tested at 104 °F (40 °C). The results are as shown in Figure 2.18. The test results indicated that the Novabond™ increased the bond strength between existing layer and the overlay material.

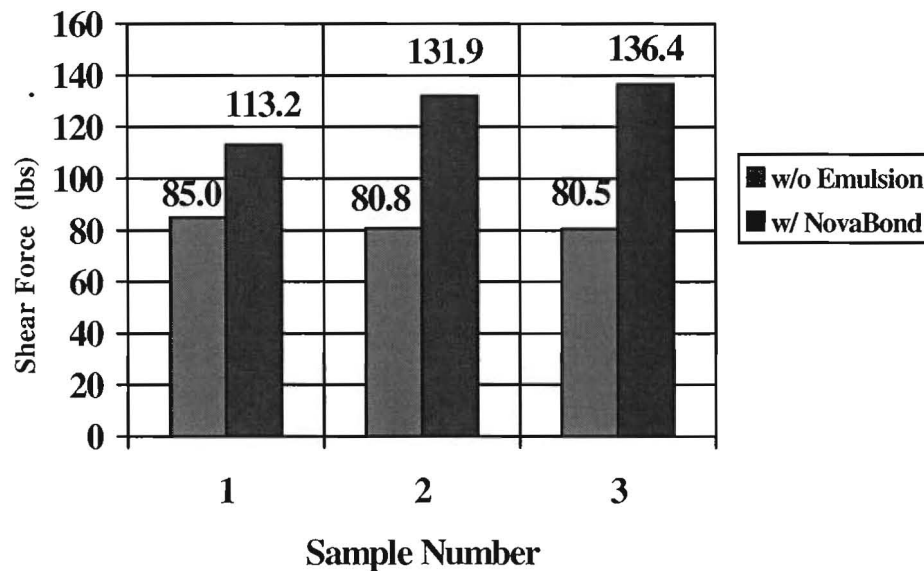

Figure 2.18 - Test Results from Koch Materials Company Test Set-Up

The main advantage of this set-up is that the equipment can be easily transported to the field. For field test, a 4 in. (101.6 mm) diameter, 0.5 in. (12.7 mm) tall, and 1 in. (25.4 mm) wide ring (with a fine wire attached to it) is placed on the existing pavement after application of tack coat. After paving operation, fine wire is used to pull out the ring. A semi-circular ring is placed in the groove formed, and the force is applied using the drill to measure the shear strength.

2.1.9 INSTROTEK ATACKER™ SHEAR DEVICE

The ATACKER™ is a field device which has been recently developed. The device can measure shear as well as tensile strength. Introtek, Inc. has developed this device and at the initiation of this study, UTEP was the first one to evaluate this device. Therefore, no published information about the equipment is available. The device consists of a rod at

the center with a dial gauge attached to it, as shown in Figure 2.19. An aluminum contact test plate 5-inch (127mm) in diameter is attached by screws at the bottom of the rod. The load from the top can be applied through the rod with the help of a lever. The amount of load applied can be controlled by monitoring the dial gauge readings. The balancing loads are used to prevent the device from lifting up from the surface due to the applied shear or tensile loads.

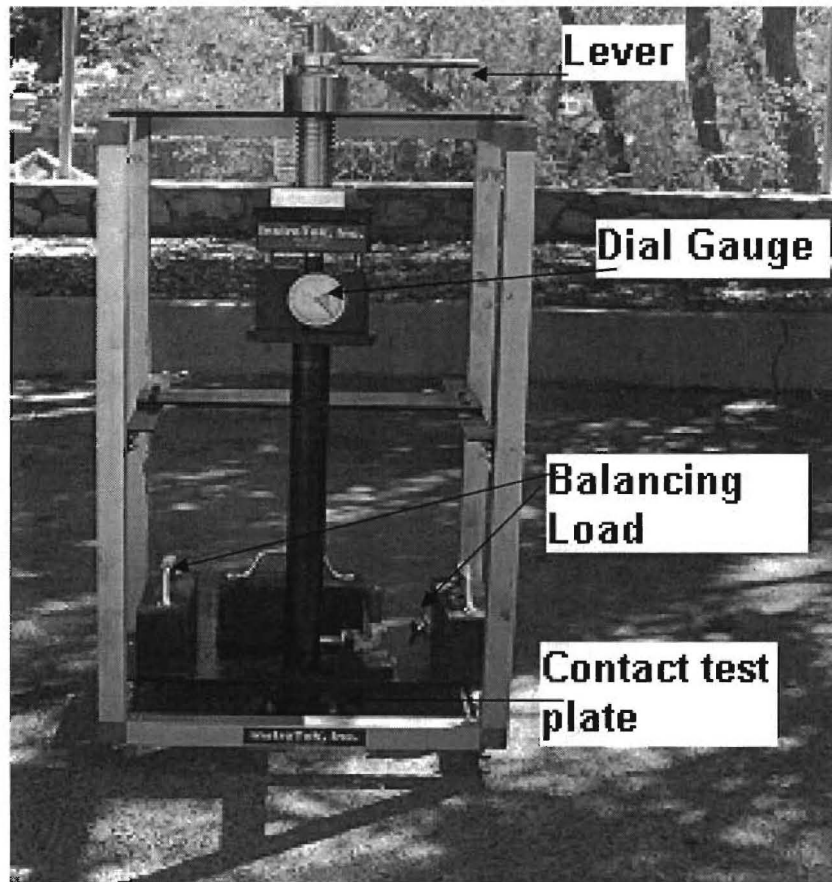

Figure 2.19 - ATACKER™ Test Set-Up

The device operates by applying a known and adjustable force by moving the lever in a clockwise direction (Figure 2.20). The force is applied for a specified period of time. After specified set time, the applied force is removed and the shear force required to break the bond is measured using a torque wrench (Figure 2.21).

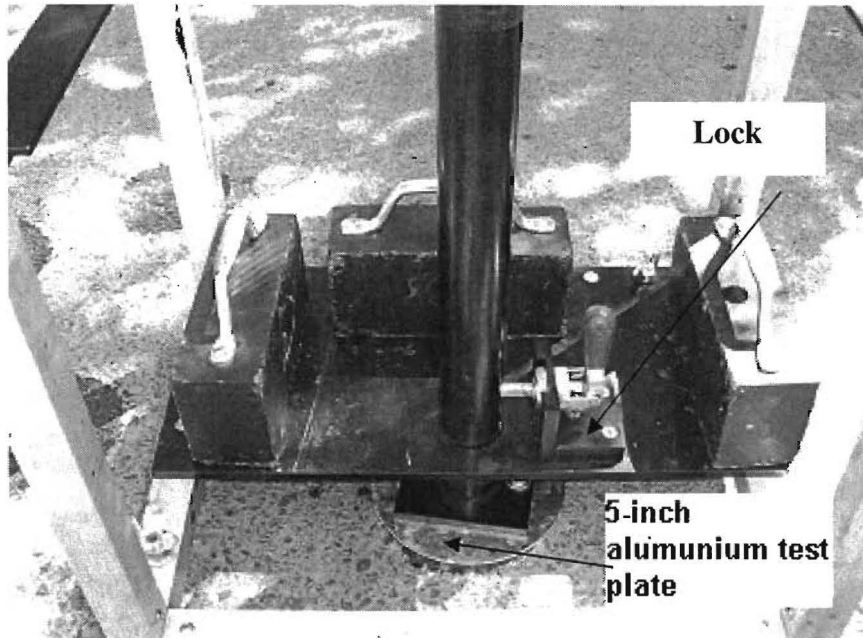

Figure 2.20 - ATACKER™ Field Test Set-Up

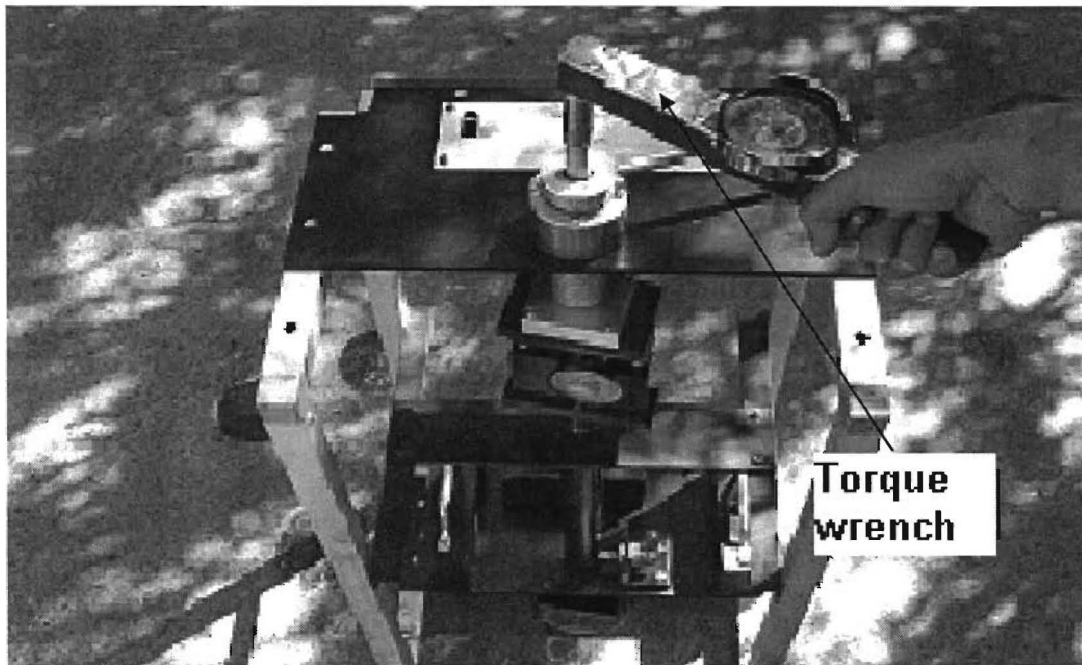

Figure 2.21- Shear Strength Measurement with Torque Wrench

The device has the capability to perform testing in the field as well as the laboratory. In the laboratory test set-up a test plate made of aluminum is used. The laboratory test plate has a groove in the center where the tack coat is applied. For field evaluation, the bottom plate is eliminated and the device is directly placed on top of the pavement.

2.1.10 UTEP TORQUE TEST SET-UP

Although this device was developed for this study, it is appropriate to include the test setup in this chapter. A simple test set up was developed at UTEP to measure shear strength of tack coat in the field as well as in the laboratory. The test system uses a torque wrench to measure shear strength. A solid cylinder made of aluminum was used in this study. The test cylinder is machined to 3 in. (76.2mm) in height and 4-in. (101.6mm) in diameter. Spiral grooves were made at the bottom to provide frictional resistance. The developed test cylinder is shown in Figure 2.22.

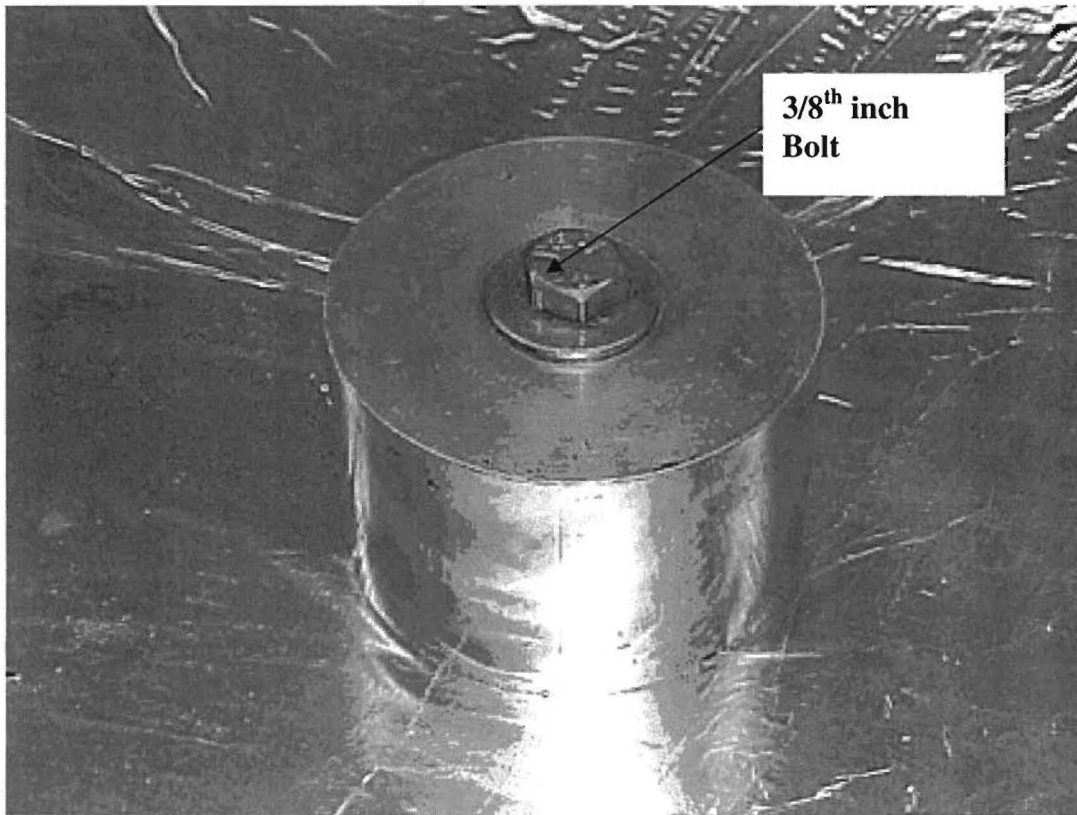

Figure 2.22 - Aluminum Test Cylinders for UTEP Torque Test

To perform testing, specified tack coat rate is applied and the aluminum cylinder is placed on top. On top of cylinder, 40 lbs load is placed to improve contact. After specified set time, the load is removed and a torsional force is applied via a torque wrench (Figure 2.23).

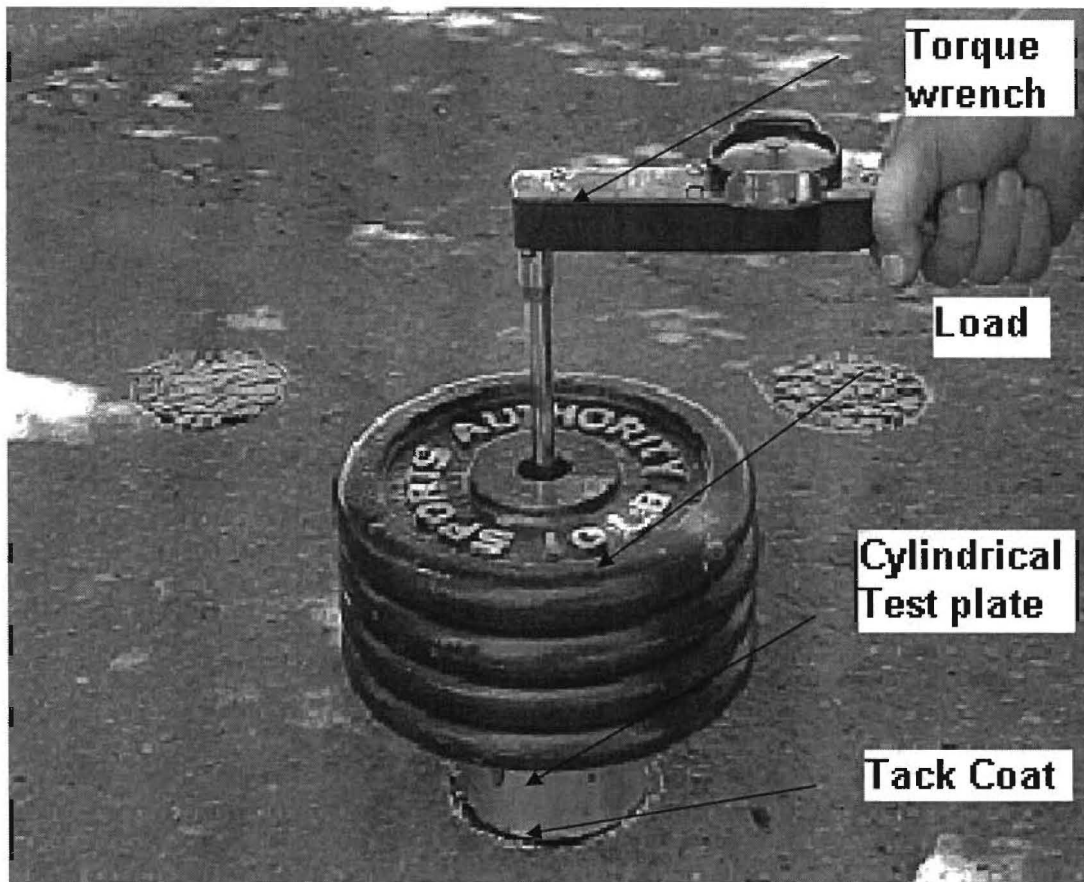

Figure 2.23 - UTEP Torque Test Field Test Set-Up

The maximum torque at the failure can easily be recorded by the torque wrench in inch-pounds. The recorded torque is then converted to shear to identify the bond shear strength.

The main objective of performing the entire test was to measure the shear stress at failure of the tack coat bonding. In the test procedures for the ATACKER™ shear and UTEP Torque test set-up, torsional loads were applied with the help of a torque wrench. Torque is a couple that results from the product of a force applied at a distance. The torque wrench also determines the breaking torque at which the specimen detaches from the pavement. Torque wrench with graduations 2-inch pound increments was used for this purpose. The measured Torque (T) was then related to the corresponding shear stress (τ) by the following equation:

$$\tau = T\rho/J \quad (2.1)$$

Where,

τ = Shear Stress (psi),

T = Maximum Torque applied before failure (inch pound),

ρ = Distance of the axis to the center of the specimen where the Torque is applied, and

J = Polar Moment of Inertia.

For this research ‘ ρ ’ is same as the radius (R) of the specimen since the torsional loads were applied at the center of the specimen. The Polar moment of Inertia J for circular cylindrical specimen is defined by the following relationship,

$$J = (\pi r^4/2) \quad (2.2)$$

Where r = radius of the specimen (inches).

2.2 TENSION DEVICES

In addition to the shear devices, three devices that measure strength using tension mode have been identified and are discussed in the following sections.

2.2.1 INSTROTEK ATACKER™ PULL-OFF DEVICE

The Instrotek ATACKER™ device can be also used in tension mode. The tests are performed similarly according to the procedure discussed in section 2.1.9. During the pull off strength test the locks are engaged to prevent the rod from moving sideways. The readings of the force required to detach the contact plate from the tack-coated surface is obtained in pounds from the dial gauge at the center of the rod, as shown in Figure 2.24.

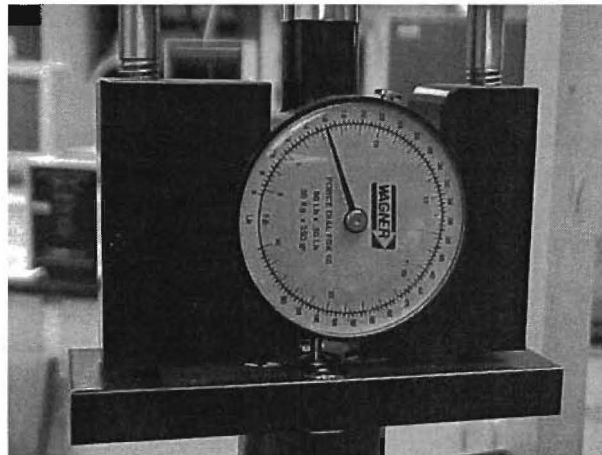

Figure 2.24 - Dial Gauge Used for Determining Tensile Load

2.2.2 PNEUMATIC ADHESION TEST SET-UP

Youtcheff and Aurilio (1997) suggested using pneumatic adhesion test set-up to identify the moisture sensitivity of asphalt binders. Although the test set-up was developed for asphalt binders it can be used for tack coat evaluation as well. The pneumatic adhesion tester was initially developed at National Institute of Standards and Technology (NIST) to test coatings and is now part of the ASTM D4541, “Pull-Off Strength Coatings using

Portable Adhesion Tester.” The test set-up is commercially available for less than \$4,000 and is shown in Figure 2.25.

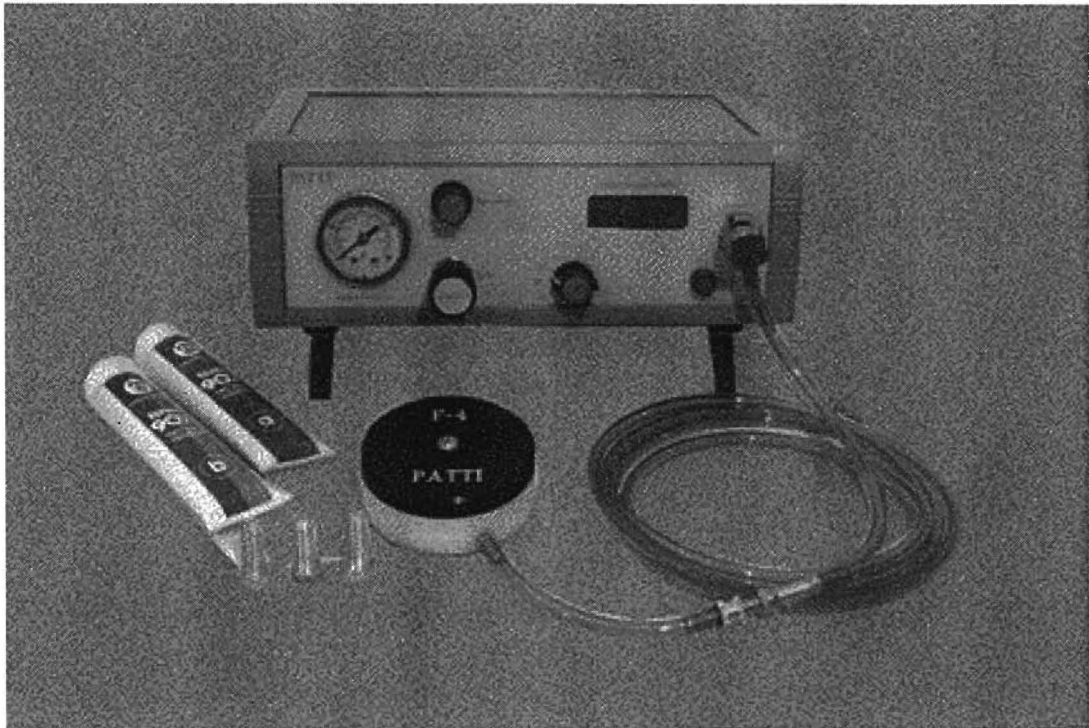

Figure 2.25 - Patti 110 Adhesion Tester

The experimental procedure measures the tensile and bonding strength of asphalt binder applied to a glass plate as a function of time exposed to water. The pressure necessary to debond the conditioned specimen at 77°F (25°C) is measured with pneumatic adhesion tester (Youtcheff & Aurillo, 1997).

To perform the experiment, asphalt is heated at 212°F-266°F (100°C-130°C) on a hot plate to have the consistency of thick syrup. To control the film thickness, 1.0 % wt of 200µm glass beads is added to the asphalt. The asphalt is then applied to the stub and then pressed on the glass plate (Figure 2.26). The glass plate and the stub is then heated at 149°F (65°C) in an oven before use. Specimen is then allowed to set at room temperature for 24 hours before testing or conditioning in water. Conditioned specimens were immersed in distilled water at 77°F (25°C), and then withdrawn from water at set time intervals and immediately tested.

The main features of this device are a portable pneumatic adhesion tester, a piston, and a loading fixture consisting of a porous stub attached to a screw. Performing a test entails placing the piston over the specimen pull-stub and screwing on the reaction plate. Compressed air is introduced to the piston. As the air pressure increases, an airtight seal is formed between the piston gasket and the glass plate. When the pressure in the piston exceeds the cohesive strength of the asphalt or adhesive strength of the asphalt/glass interface, the specimen breaks. The pressure where failure occurs is recorded and

converted to pull-off tensile strength using a calibration curve. Figure 2.26 shows the cross section schematic of piston attached to pull-stub.

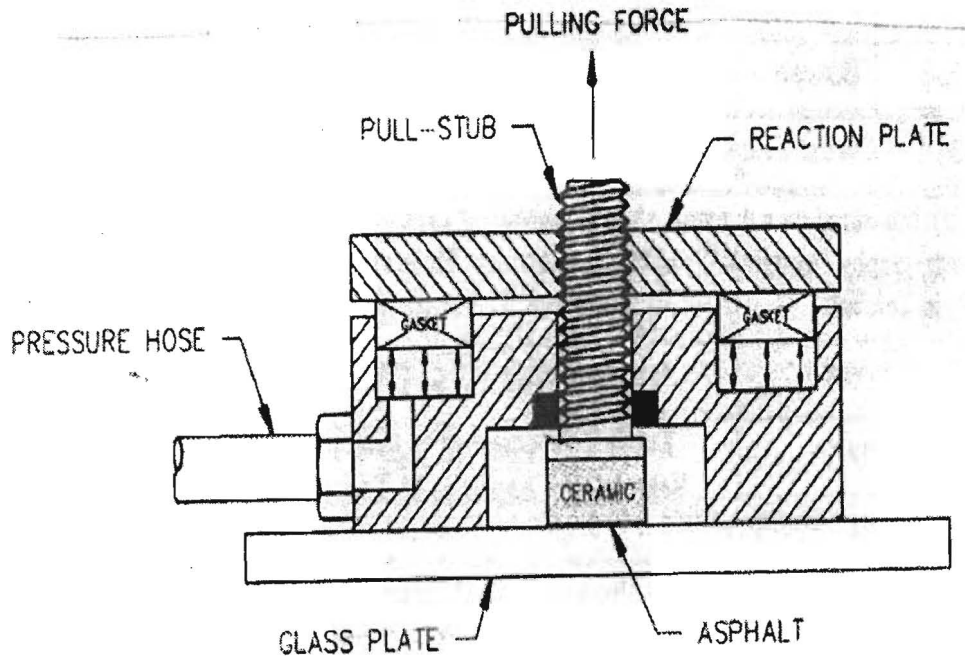

Figure 2.26 - Cross-section Schematic of Piston Attached to Stub (Youtcheff & Aurillo, 1997)

The test data from three performance graded asphalt binders were collected and the tensile strength of these asphalts as a function of soak time is plotted, as shown in Figure 2.27. The results suggest that the soak time significantly influences the bond strength. Although the measured pressure is sensitive to soak time, the device is not suitable because of cost and field limitations as electricity is required to run the tests.

2.2.3 ELCOMETER106 MECHANICAL ADHESION TESTER

Elcometer106 Mechanical Adhesion tester is easy to operate, fully portable and provides a numerical value for adhesion. Figure 2.28 shows the equipment and its accessories.

The device has a spring arrangement that applies an uplift force to the dolly that is bonded to the coating using an adhesive. A numerical value for adhesion is obtained on the scale, when the dolly is pulled off from the surface. The equipment comes in five different scales as shown in Figure 2.29 below.

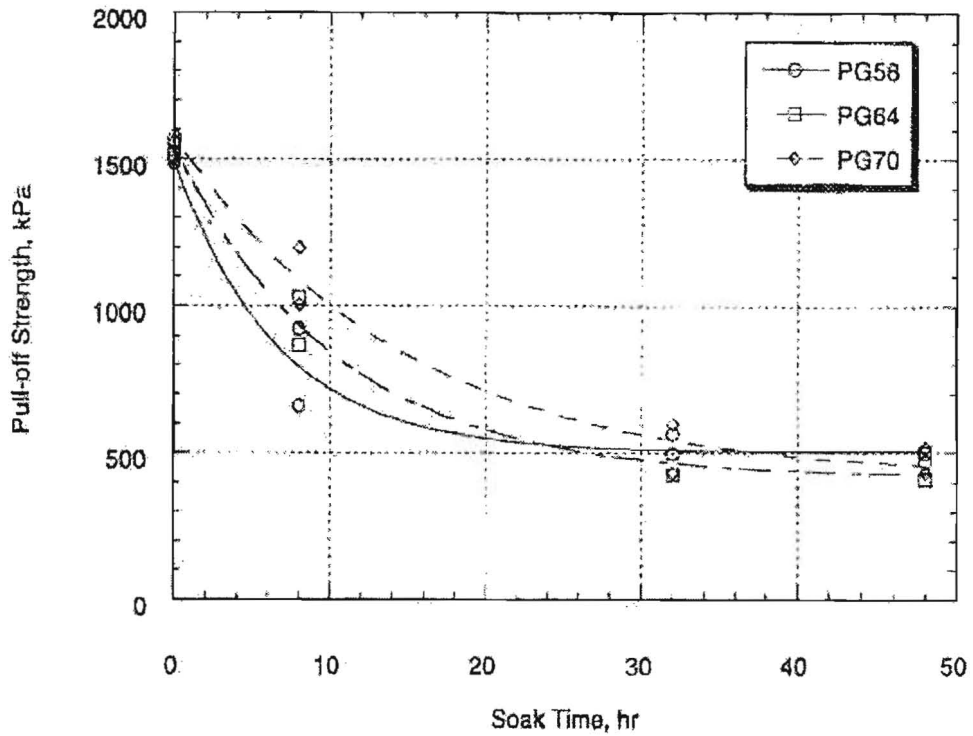

Figure 2.27 - Effect of Soak Time on Pull-Off Strength of PG Grade Asphalt (Youtcheff & Aurillo, 1997)



Figure 2.28 - Elcometer106 Mechanical Adhesion Tester

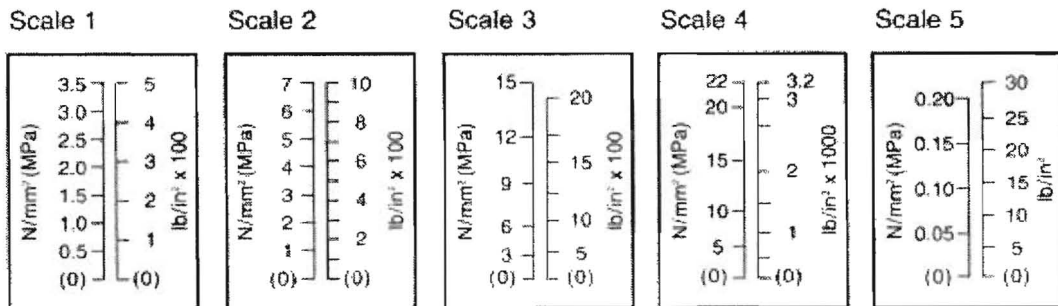

Figure 2.29 - Different Scales Available for Elcometer106 Adhesion Tester

2.3 CONCLUSION

Based on the literature review, the following devices were selected for further evaluations:

- Elcometer106 Mechanical Adhesion Tester device was selected because the cost of the equipment is around \$1,200 and it is commercially available. In addition, this device has been successfully used by the paint industry.
- ATACKER™ device was also selected because it was specifically developed for the purposes of tack coat quality evaluation. In addition, the test setup has the capability of performing tests in the field as well as laboratory.
- UTEP Torque Test device was selected because it can be fabricated with minimal cost and was also developed to identify quality of tack coat.
- Although Koch materials device is expensive (roughly \$5,000), the device was selected because it has been successfully used in the field and operational principal is similar to the RTA test setup.
- Patti device was not selected for further evaluation because of cost as well as the specimen preparation technique would make it impractical.

An experiment design and test procedures followed for testing are included in the next chapter.

CHAPTER 3

EXPERIMENTAL DESIGN AND TEST PROCEDURES

3.1 EXPERIMENTAL DESIGN

The literature review summarized in the Chapter Two suggested that the strength provided by tack coat depends on various factors such as tack coat type, application rates, set time, etc. Based on the parameters identified, an experimental design has been proposed in Table 3.1. The reasons for selecting parameters have been discussed in the following sections.

3.1.1 TYPE OF TACK COAT

The study was performed for TxDOT and the most commonly used tack coat types have been CSS-1h and SS-1. SS-1 is a slow setting anionic emulsion and CSS-1h is a slow setting cationic emulsion. Occasionally, PG64-22 (AC-20) has also been used by some of the TxDOT districts. To minimize the variability, the emulsion and asphalt binder were obtained from same source.

3.1.2 DILUTION LEVELS

Typically, obtained emulsions are diluted before application in the field. The main reason is to increase the flow ability of tack coat in order to cover the desired area. Another advantage is that it increases the set time, which is needed especially during paving operations at higher air temperatures. The emulsions were diluted with various percentages of water before testing. Two different levels of dilution were chosen based on commonly used TxDOT dilution levels. Initially, the emulsion was not diluted to gather base level information for each emulsion type. One level of dilution was with 25% water; thus, the emulsion applied for testing consisted of 25% water and 75% of emulsion. Since the emulsion had some water to begin with, the amount of water present was higher than 25%. This level is denoted by “25/75” (25% water to 75% emulsion) for referencing purposes. In the second level, the emulsion was diluted with 50% water and is denoted by “50/50” (50% water to 50% emulsion) for referencing. Again, the level of water was higher than 50% because of water already present in the emulsion. In general, tests were performed at three different concentrations of emulsion for each parameter

with only one exception, that PG asphalt binder (PG64-22) was not diluted because it is not a practice observed by TxDOT.

Table 3.1 - Parameters Evaluated in the Initial Phase Testing

PARAMETERS	TACK COAT TYPE		
	CSS-1h	SS-1	PG64-22
Dilution Level	None	None	None
	25/75	25/75	
	50/50	50/50	
Setting Time, min	5	5	5
	30	30	30
	60	60	60
Testing Time	Morning (7AM)	Morning (7AM)	Morning (7AM)
	Afternoon (4PM)	Afternoon (4PM)	Afternoon (4PM)
Loading Rate, lbs (kg)	40 (18)	40 (18)	40 (18)
Loading Time, min	10	10	10
Residual Application Rate, gal/yd ² (l/m ²)	0.02 (0.09)	0.02 (0.09)	0.02 (0.09)
	0.06 (0.27)	0.06 (0.27)	0.06 (0.27)
Number of Trials	3	3	3

3.1.3 SETTING TIME OF TACK COATS

Basically, asphalt binder is mixed with water to produce emulsions. The added water reduces viscosity and can be easily sprayed on the pavement and remains fluid before paving operations. After application of the tack coat on pavement, the water of emulsion starts evaporating and strength of tack coat starts increasing. In general, emulsion is said to be broken its color turns from brown to black (indicating all the water has evaporated). The time required for the water to completely evaporate depends on factors like wind velocity, temperature, etc. In general, the paving operation begins quickly after emulsion starts breaking. Therefore, it was decided to perform tests after certain time regardless of break time. Thus, three different setting times were selected; namely: 5, 30, and 60 minutes. The 5 minute setting time was selected to identify the feasibility of performing tests at very early stages. The advantage of this would be that preventive measures can be taken if the quality of tack coat is not met. The 60 minutes set time was selected to

identify the actual bonding strength anticipated after tack coat is completely set (i.e., all of the water has evaporated). The 30 minute set time was selected because it is the maximum time that would be available to perform tests before paving operation can begin.

3.1.4 TESTING TIME

The tack coat will require more time to break at a lower temperature than at a higher temperature. Since the testing has to be performed in the field, i.e., parking lot, a specified temperature could not be maintained. Therefore, the testing was performed at different times of the day knowing that temperatures will be different during different times of day. One set of tests were performed around 7 AM when the temperature is lower and another set were performed around 4 PM having a higher temperature. The ambient temperature was recorded while performing the testing at the two different times.

3.1.5 RATE OF APPLICATION

The proper application rate of tack coat application is a key component for adequate bonding. The rate of tack coat application is usually specified in gal/yd² (l/m²). Since the area of application is fixed, a change in application rate will change the film thickness of tack coat. The literature review presented in Chapter Two suggested that there is an optimum application rate that needs to be followed. An increase in application rate reduces frictional resistance provided by asphalt concrete layers while lower application rates increases chances of debonding. To study the effects of the application rate on the tack coat bond strength, two application rates were selected 0.04 and 0.10 gal/yd² (0.18 and 0.45 l/m²). Usually, TxDOT specifies that the application rates should be within this range; therefore, two extreme values were selected. Since the tack coat consists of water within them to begin with, the residual application rates of 0.02 gal/yd² (0.09 l/m²) and 0.06 gal/yd² (0.27 l/m²) were used for testing purposes. Proper measures were taken to apply the tack coat uniformly.

3.1.6 LOAD LEVELS

After setting of the tack coat the equipments were placed on top of the tack coat and a specified amount of load is applied. This step is necessary to ensure that the test setup can be bonded to the tack coat. A constant load of 40 lbs (18 kg) was placed on top for all tests except for Koch Materials Company device because it was not feasible to perform the test with this equipment.

3.1.7 LOADING TIME

Before performing tests, the test setup with load was placed on the applied tack coat area for 10 minutes. A 10 minute load time was selected because the testing needs to be performed as quickly as possible before paving operations can begin.

3.2 TEST PROCEDURES

Based on discussion presented in Chapter Two, four devices were selected for the field (parking lot) evaluation. The objective of performing the test was to identify the most suitable device; therefore, each device should be evaluated by following similar test procedures. However, the test procedures were little bit different because of test device configurations. The followed procedures are described in the following sections.

3.2.1 UTEP TORQUE TEST SET-UP

To perform the test using the UTEP torque test set-up, a known amount of tack coat is placed on the specified area of the parking lot. Basically, a circle equal to 4 in (100mm) in diameter was drawn by placing aluminum cylinder. After drawing the number of required circles, depending on number of tests to be performed, the aluminum cylinder is moved and specified tack coat is uniformly applied within the circle. After waiting for a specified set time, the cylinder is placed on top of the tack coat and 40 lbs (18 kg) is placed on top of the aluminum cylinder. After placement of the weights, a 10 minute set time is allowed. Initial investigation suggested that the device would not be able to detect any bonding because of lower strength levels. Therefore, it was decided to leave the load on top of the cylinder and a torque at a constant rate is applied at a constant rate until failure. The torque at failure is recorded and converted as per equation 2.1.

3.2.2 INSTROTEK ATACKER™ DEVICE

The ATACKER™ test procedure is similar to the UTEP torque test setup; however, the application of the load is different. For load application, balancing weights greater than 40 lbs (18 kg) are placed on plate as shown in Figure 3.1. A load equal to 40 lbs (18 kg) is applied by rotating the top lever (Figure 2.19) clockwise and monitoring the load gauge. After the application of load and set time, the top lever is replaced with torque wrench as shown in Figure 3.1. The calculations are similar to the UTEP torque tests except that the diameter of contact plate is 5 in. (127 mm) rather than 4 in. (100 mm).

The test procedure for tension mode of testing is similar to the shear mode of testing except the measurement of strength at failure. In the tension mode, the top lever (Figure 2.19) is not removed after set time. The lever is rotated in the counter clockwise direction to remove the applied load and the load dial gauge is set to zero. The lock lever (Figure 2.24) is engaged to prevent the rod from moving sideways. The peak load required to break the bond is recorded and reported as the tensile strength.

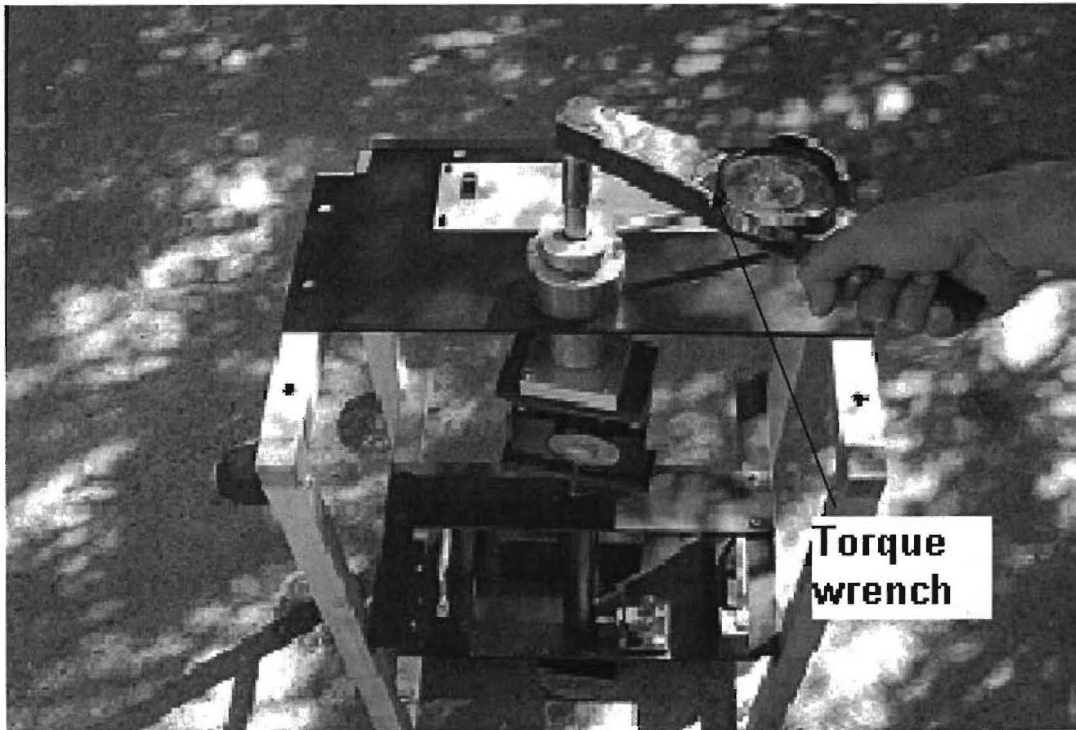

Figure 3.1 - ATACKER™ Field Test Set-Up

3.2.3 KOCH MATERIALS COMPANY SHEARING DEVICE

The Koch Materials Company (KMC) shear test device was evaluated using a different procedure than originally suggested by the manufacture. The manufacturer suggested using an asphalt concrete specimen on top of the applied tack coat, or placement of the asphalt concrete layer, and then performing the tests. Since the main objective of this study was to evaluate the quality of the tack coat only, it was decided to place an aluminum cylinder on top of the applied tack coat and perform tests. The initial evaluation indicated that meaningful results could not be obtained because the equipment did not allow placement of load during shearing. Therefore, it was decided to use Marshall Hammer to apply some loads for proper contact. A 25 number of blows, based on RTA test setup, were selected for evaluation in this study (Figure 3.2). After the blows, the hammer is left on the aluminum plate for a certain period of time before performing tests, as discussed in Chapter Two. The tests performed using a drilling machine is shown in Figure 3.3. The digital Load Cell measures and records the maximum load required to induce shear failure. The maximum load divided by the area is the shear strength at failure.

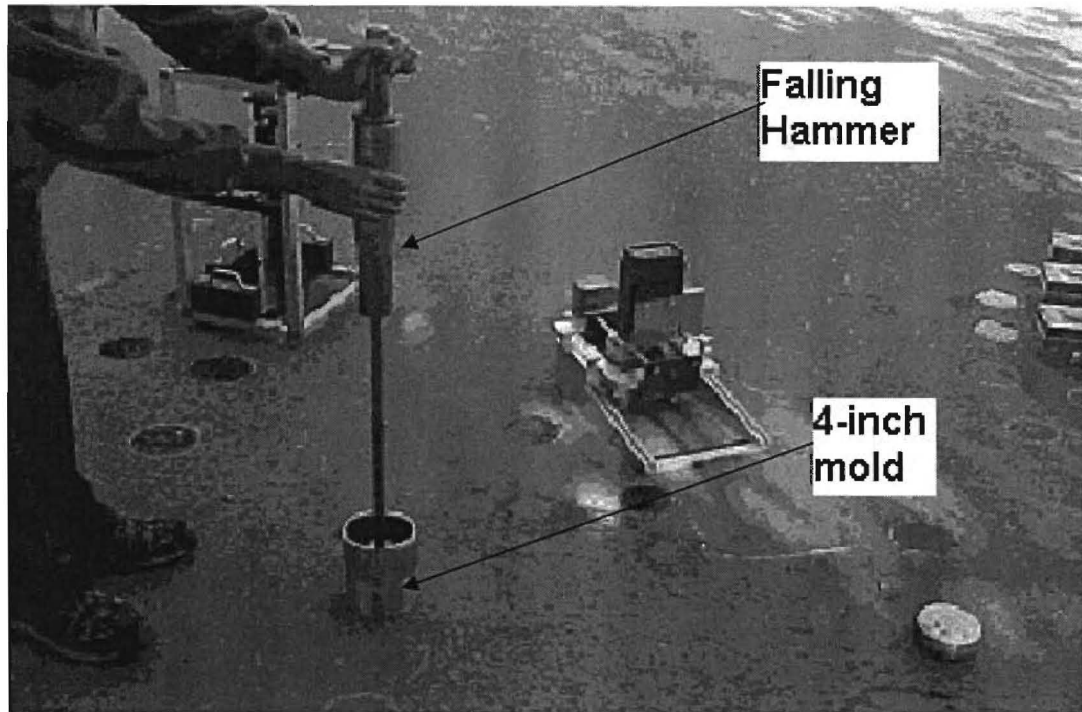

Figure 3.2 - Compaction of Specimen by Marshall Hammer

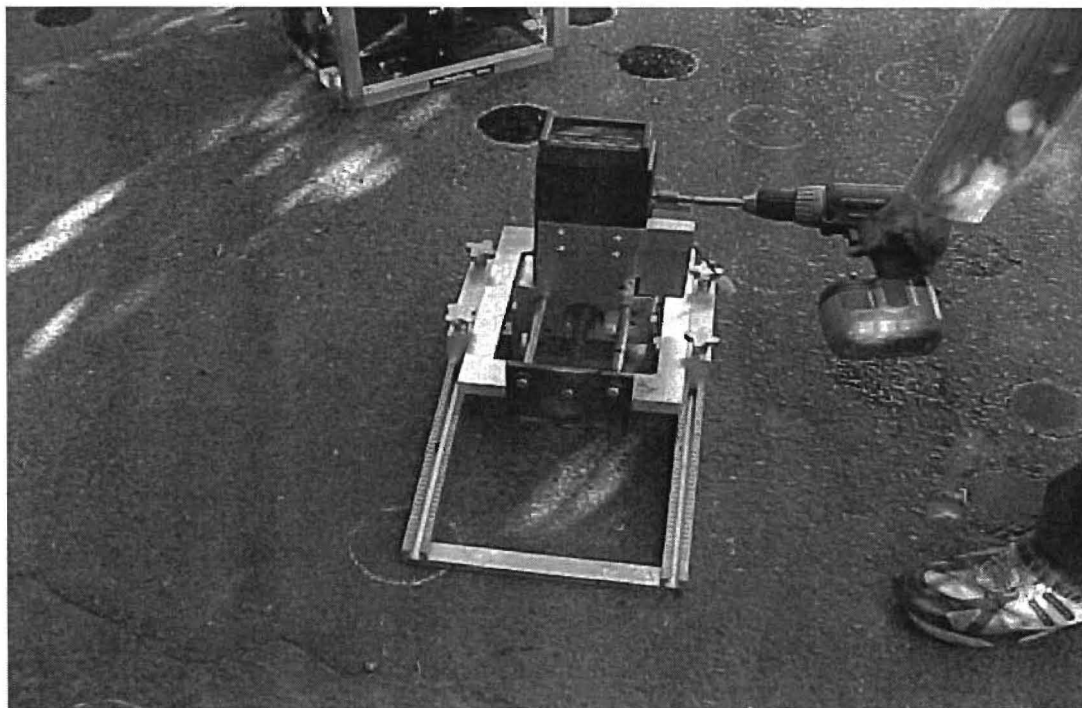

Figure 3.3 - Field Testing of Koch Materials Company Test Set-Up

3.2.4 ELCOMETER106 MECHANICAL ADHESION TESTER

The test procedure followed for performing ELCOMETER106 tests was different from the remaining devices. For ELCOMETER106 tests, a dolly is provided by the manufacturer, as shown in Figure 3.4. The dolly can be attached as shown in Figure 3.5. The knob on top of the device is rotated counterclockwise to measure the bond strength. The reading recorded is compared with the standard scales shown in Figure 2.29.

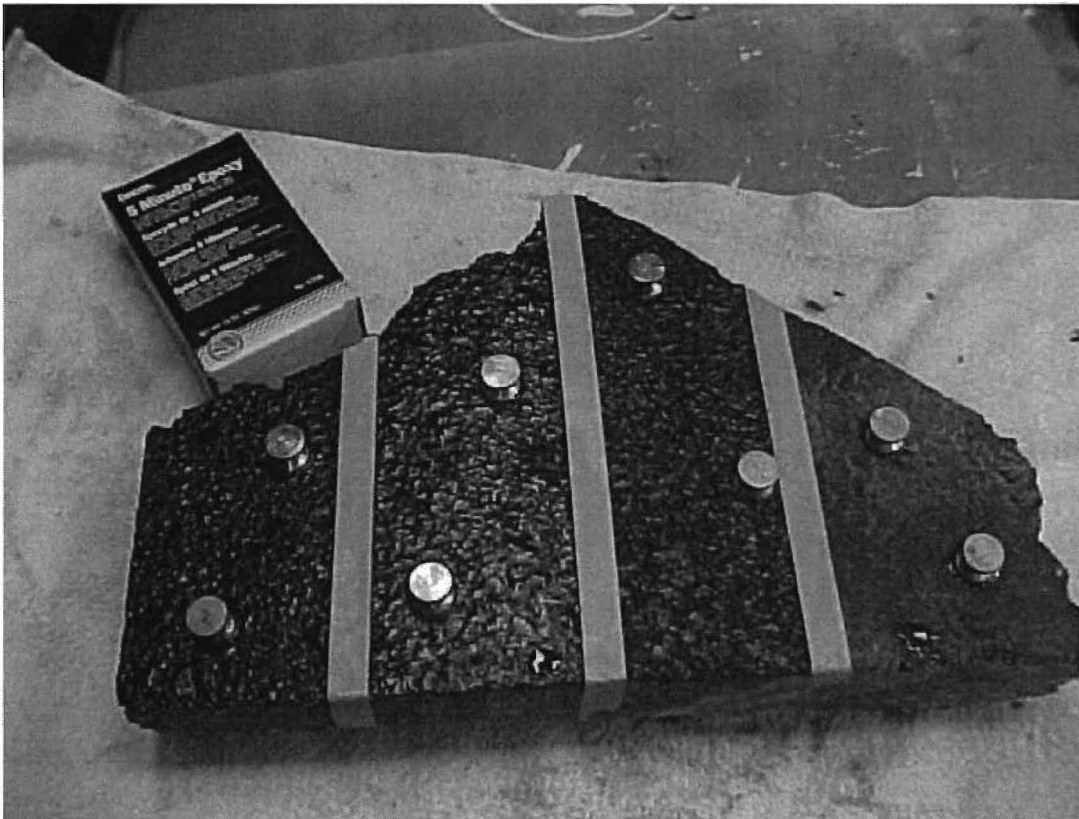

Figure 3.4 - Specimen Preparation for ELCOMETER106 Test



Figure 3.5 - Test Performed using ELCOMETER106

CHAPTER 4

TEST RESULTS & STATISTICAL ANALYSIS

Based on the experiment design proposed in Chapter Three, a series of experiments in triplicates were performed in the parking lot as well as in the laboratory. The measured test results along with statistical analyses are presented in the following sections.

4.1 SHEAR DEVICES TEST RESULTS

Three shear devices were identified in Chapter Two for evaluation purposes. The tests were performed in the parking lot to evaluate the effect of environmental conditions and laboratory tests were performed to identify the equipment variability because laboratory environmental conditions remain relatively constant. In the following sections, the shear device evaluation results are presented.

4.1.1 INSTROTEK ATACKER™ SHEAR

The tests with Instrotek ATACKER™ device were performed in the parking lot as well as in the laboratory. A total of 324 tests were performed in the parking lot and 162 tests were performed in the laboratory. To perform tests, the locks shown in Figure 2.20 are disengaged and the breaking torque is recorded as per the procedure presented in Chapter Three. The raw data collected for a typical test is shown in Table 4.1. The data in the first row identifies the time of test and type of tack coat evaluated. The data in the first column identifies the level of dilution used. In this case, the tack coat was not diluted. The second column shows number of trials and the third column shows set time before testing started. The fourth column shows the time load was maintained for testing. The fifth column shows the residual application rate and sixth column shows the breaking torque. The breaking torque was converted to shear strength using equations 2.1 and 2.2 and is presented in seventh column. In the end, the data was averaged and the standard deviation and coefficient of variation was calculated.

Table 4.1 - Typical ATACKER™ Shear Parking Lot Test Results for CSS-1h

Tack Coat Type: CSS-1h				Test Time: 7:00 AM		
Dilution Level	Trial No.	Set Time, min	Load Time, min	Residual Application Rate, gal/yd ² (l/m ²)	Torque, lb-in. (kg-mm)	Shear Stress, psi (kPa)
None	1	5	10	0.06 (0.27)	32 (369)	0.33 (2.3)
None	2	5	10	0.06 (0.27)	36 (415)	0.37 (2.6)
None	3	5	10	0.06 (0.27)	40 (461)	0.41 (2.9)
Average (psi)						0.37 (2.6)
Standard Deviation (psi)						0.04 (0.28)
Coefficient of Variation (%)						11.1

The data collected for each parameter was analyzed and the parking lot test results are summarized in Tables 4.2 through 4.4 while the laboratory test results are summarized in Tables 4.5 and 4.6. The first column of the tables represents the test time (for parking lot tables) or type of tack coat evaluated (for laboratory evaluation tables). In the second column, the residual application rates (and ambient temperatures for parking lot testing) are summarized and the third column represents levels of dilution used. The set time used for evaluation is reported in the fourth column and average shear strength is reported in the fifth and is based on three replicates. The standard deviation and coefficient of variation (%) is presented in the sixth and seventh columns, respectively.

The parking lot test results for SS-1 tack coat are summarized in Table 4.2. The parking lot ambient temperature varied between 52 and 55°F (11 and 13°C) for testing performed in the morning (7 AM) and varied between 62 and 66°F (17 and 19°C) for testing performed in the afternoon (4 PM). The test results indicate that the magnitude of the measured strength depends on the set time. For example, 0.37 psi (2.55 kPa) strength was measured for 5 minutes set time at residual application rate of 0.06 gal/yd² (0.27 l/m²) with no dilution tested at 7AM. However, 0.67 psi (4.62 kPa) strength was measured for 60 minutes set time under similar conditions. Similarly, an increase in the residual application rate increased the magnitude of measured strength. For example, 0.67 psi (4.62 kPa) strength was measured for 60 minutes set time (no dilution and tested at 7AM) at residual application rate of 0.06 gal/yd² (0.27 l/m²) while 0.59 psi (4.07 kPa) strength was measured at the residual application rate of 0.02 gal/yd² (0.09 l/m²) under similar conditions. However, the differences diminished at 5 minutes set time in comparison to 60 minutes set time.

Table 4.2 - ATTACKER™ Shear Parking Lot Test Results for SS-1

Testing Time	Residual App. Rate gal/yd ² (l/m ²)	Dilution	Set Time, min	Average Strength, psi (kPa)	Std. Dev., psi (kPa)	COV (%)
7AM	0.06 (0.27) Ambient Temperature 51.8°F(11.0°C)	None	5	0.37(2.55)	0.04(0.28)	11.1
			30	0.58(4.00)	0.06(0.41)	10.7
			60	0.67(4.62)	0.07(0.48)	10.8
		25/75	5	0.27(1.86)	0.03(0.21)	11.5
			30	0.46(3.17)	0.04(0.28)	9.2
			60	0.55(3.79)	0.06(0.41)	11.1
		50/50	5	0.18(1.24)	0.02(0.14)	11.1
			30	0.26(1.79)	0.02(0.14)	9.1
			60	0.41(2.82)	0.05(0.34)	11.1
	0.02 (0.09) Ambient Temperature 55.4°F(13.0°C)	None	5	0.33(2.27)	0.04(0.28)	12.5
			30	0.53(3.65)	0.05(0.34)	8.6
			60	0.59(4.07)	0.07(0.48)	11.2
		25/75	5	0.27(1.86)	0.03(0.21)	11.5
			30	0.37(2.55)	0.04(0.28)	11.4
			60	0.47(3.24)	0.04(0.28)	8.8
		50/50	5	0.12(0.83)	0.02(0.14)	16.7
			30	0.23(1.58)	0.03(0.21)	13.5
			60	0.36(2.48)	0.03(0.21)	8.7
4PM	0.06 (0.27) Ambient Temperature 62.4°F(16.8°C)	None	5	0.39(2.69)	0.04(0.28)	10.5
			30	0.63(4.34)	0.04(0.28)	9.2
			60	0.74(5.10)	0.06(0.41)	8.6
		25/75	5	0.29(2.00)	0.04(0.28)	12.4
			30	0.52(3.58)	0.05(0.34)	10.3
			60	0.61(4.20)	0.06(0.41)	9.4
		50/50	5	0.21(1.45)	0.03(0.21)	14.8
			30	0.31(2.14)	0.03(0.21)	12.3
			60	0.45(3.10)	0.04(0.28)	10.7
	0.02 (0.09) Ambient Temperature 65.7°F(18.7°C)	None	5	0.38(2.62)	0.03(0.21)	8.1
			30	0.59(4.07)	0.04(0.28)	6.9
			60	0.7(4.82)	0.06(0.41)	8.1
		25/75	5	0.28(1.93)	0.01(0.07)	4.2
			30	0.44(3.03)	0.05(0.34)	11.6
			60	0.54(3.72)	0.04(0.28)	7.9
		50/50	5	0.16(1.10)	0.02(0.14)	13.3
			30	0.29(2.00)	0.04(0.28)	14.3
			60	0.37(2.55)	0.01(0.07)	3.2

Table 4.3 - ATTACKER™ Shear Parking Lot Test Results for CSS-1h

Testing Time	Residual App. Rate gal/yd ² (l/m ²)	Dilution	Set Time, min	Average Strength. psi (kPa)	Std. Dev., psi (kPa)	COV (%)
7AM	0.06 (0.27) Ambient Temperature 64°F(17.7°C)	None	5	0.43(2.96)	0.03(0.21)	7.2
			30	0.64(4.41)	0.01(0.07)	1.8
			60	0.73(5.03)	0.05(0.34)	7.3
		25/75	5	0.35(2.41)	0.01(0.07)	3.3
			30	0.46(3.17)	0.03(0.21)	6.8
			60	0.59(4.07)	0.02(0.14)	3.4
		50/50	5	0.23(1.58)	0.03(0.21)	13.5
			30	0.36(2.48)	0.03(0.21)	8.7
			60	0.47(3.24)	0.02(0.14)	4.4
	0.02 (0.09) Ambient Temperature 50.9°F(10.5°C)	None	5	0.31(2.14)	0.02(0.14)	7.5
			30	0.60(4.13)	0.03(0.21)	5.2
			60	0.65(4.48)	0.06(0.41)	9.6
		25/75	5	0.29(2.00)	0.03(0.21)	10.7
			30	0.41(2.82)	0.04(0.28)	10.0
			60	0.54(3.72)	0.04(0.28)	7.9
		50/50	5	0.16(1.10)	0.02(0.14)	15.1
			30	0.32(2.20)	0.05(0.34)	16.1
			60	0.39(2.69)	0.05(0.34)	13.0
4PM	0.06 (0.27) Ambient Temperature 86.9°F(30.5°C)	None	5	0.48(3.31)	0.03(0.21)	6.5
			30	0.69(4.75)	0.02(0.14)	2.9
			60	0.75(5.17)	0.04(0.28)	4.7
		25/75	5	0.41(2.82)	0.02(0.14)	5.0
			30	0.52(3.58)	0.04(0.28)	8.1
			60	0.65(4.48)	0.02(0.14)	3.1
		50/50	5	0.29(2.00)	0.02(0.14)	7.1
			30	0.39(2.69)	0.05(0.34)	13.0
			60	0.55(3.79)	0.03(0.21)	4.6
	0.02 (0.09) Ambient Temperature 65.7°F(18.7°C)	None	5	0.35(2.41)	0.02(0.14)	5.9
			30	0.63(4.34)	0.02(0.14)	3.2
			60	0.69(4.75)	0.06(0.41)	8.1
		25/75	5	0.30(2.07)	0.01(0.07)	3.4
			30	0.43(2.96)	0.04(0.28)	9.8
			60	0.56(3.86)	0.03(0.21)	5.6
		50/50	5	0.18(1.24)	0.03(0.21)	17.6
			30	0.33(2.27)	0.02(0.14)	6.3
			60	0.43(2.96)	0.04(0.28)	9.8

Table 4.4 - ATACKER™ Shear Parking Lot Test Results for PG64-22

Testing Time	Residual App. Rate gal/yd ² (l/m ²)	Dilution	Set Time, min	Average Strength. psi (kPa)	Std. Dev., psi (kPa)	COV (%)
7AM	0.06(0.27) Ambient Temperature 64°F(17.7°C)	None	5	0.83(5.72)	0.08(0.55)	9.4
			30	1.85(12.75)	0.08(0.55)	4.2
			60	2.39(16.47)	0.13(0.90)	5.6
	0.02(0.09) Ambient Temperature 64°F(17.7°C)	None	5	0.61(4.20)	0.05(0.34)	8.3
			30	1.72(11.85)	0.08(0.55)	4.5
			60	1.89(13.02)	0.05(0.34)	2.7
4PM	0.06(0.27) Ambient Temperature 74.2°F(23.4°C)	None	5	0.88(6.06)	0.09(0.62)	9.9
			30	1.99(13.71)	0.05(0.34)	2.6
			60	2.51(17.29)	0.08(0.55)	3.1
	0.02(0.09) Ambient Temperature 74.2°F(23.4°C)	None	5	0.75(5.17)	0.08(0.55)	10.4
			30	1.85(12.75)	0.06(0.41)	3.2
			60	2.21(15.47)	0.08(0.55)	3.5

Table 4.5 - ATACKER™ Shear Laboratory Test Results for PG64-22

Tack Type	Residual App. Rate gal/yd ² (l/m ²)	Dilution	Set Time, min	Average Strength. psi (kPa)	Std. Dev., psi (kPa)	COV (%)
PG64-22	0.06(0.27)	None	5	1.12(7.72)	0.15(1.03)	13.6
			30	2.11(14.54)	0.16(1.10)	7.4
			60	2.92(20.12)	0.16(1.10)	5.3
	0.02(0.09)	None	5	0.88(6.06)	0.09(0.62)	9.9
			30	2.00(13.78)	0.13(0.90)	6.4
			60	2.56(17.64)	0.08(0.55)	3.0

Table 4.6 - ATACKER™ Shear Laboratory Test Results for SS-1 & CSS-1h

Tack Type	Residual App. Rate gal/yd ² (l/m ²)	Dilution	Set Time, min	Average Strength. psi (kPa)	Std. Dev., psi (kPa)	COV (%)
SS-1	0.06 (0.27)	None	5	0.56(3.86)	0.01(0.07)	2.1
			30	0.77(5.31)	0.02(0.14)	2.6
			60	0.88(6.06)	0.02(0.14)	2.3
		25/75	5	0.47(3.24)	0.02(0.14)	4.3
			30	0.65(4.48)	0.02(0.14)	3.1
			60	0.76(5.24)	0.01(.07)	1.5
		50/50	5	0.37(2.55)	0.02(0.14)	5.6
			30	0.52(3.58)	0.01(.07)	2.3
			60	0.61(4.20)	0.02(0.14)	3.3
	0.02 (0.09)	None	5	0.39(2.69)	0.01(.07)	1.5
			30	0.65(4.48)	0.02(0.14)	3.1
			60	0.79(5.44)	0.01(.07)	1.5
		25/75	5	0.31(2.14)	0.02(0.14)	6.7
			30	0.57(3.93)	0.02(0.14)	3.6
			60	0.69(4.75)	0.01(.07)	1.7
		50/50	5	0.22(1.52)	0.03(0.21)	14.3
			30	0.39(2.69)	0.02(0.14)	5.3
			60	0.48(3.31)	0.02(0.14)	4.9
CSS-1h	0.06 (0.27)	None	5	0.56(3.86)	0.01(.07)	2.1
			30	0.89(6.13)	0.01(.07)	1.3
			60	1.04(7.17)	0.02(0.14)	2.0
		25/75	5	0.49(3.38)	0.02(0.14)	4.2
			30	0.79(5.44)	0.02(0.14)	2.6
			60	0.94(6.48)	0.02(0.14)	2.2
		50/50	5	0.39(2.69)	0.01(.07)	3.0
			30	0.51(3.51)	0.02(0.14)	4.0
			60	0.64(4.41)	0.01(.07)	1.8
	0.02 (0.09)	None	5	0.49(3.38)	0.02(0.14)	4.2
			30	0.77(5.31)	0.02(0.14)	2.6
			60	0.88(6.06)	0.02(0.14)	2.3
		25/75	5	0.43(2.96)	0.02(0.14)	4.8
			30	0.7(4.82)	0.01(.07)	1.4
			60	0.78(5.37)	0.01(.07)	1.5
		50/50	5	0.35(2.41)	0.01(.07)	3.3
			30	0.46(3.17)	0.01(.07)	2.6
			60	0.51(3.51)	0.02(0.14)	4.0

Although similar residual application rates were used, an increase in dilution levels reduced the magnitude of measured strength. For example, 0.67 psi (4.62 kPa) strength was measured for no dilution (60 minutes of set time and tested at 7AM) with application rate of 0.06 gal/yd² (0.27 l/m²) while only 0.41 psi (2.82 kPa) strength was measured for 50/50 dilution levels under similar conditions. In addition, an increase in ambient temperature increased the magnitude of measured strength. For example, 0.7 psi (4.82 kPa) strength was measured when tested at 4PM (66 °F [19 °C]) for 60 minutes set time and no dilution at application rate of 0.02 gal/yd² (0.09 l/m²) while 0.59 psi (4.07 kPa) strength was measured when tested at 7AM (55 °F [13 °C]) under similar conditions.

Similar trends were observed for the remaining tack coat types. In general, the device is repeatable and estimated coefficient of variation (COV) is generally less than 15%, with few exceptions. An increase in application rate increased the shear strength and an increase in dilution levels reduced the shear strength. The test results also suggested that the shear strength increased with an increase in temperature, and/or increase in set time because higher temperatures, or longer set times, allowed more breaking of tack coat, which increased the strength.

Since laboratory temperatures remained constant at 73 °F (23 °C), the laboratory tests were not performed at two different times. The data presented in Tables 4.5 and 4.6 suggest that the overall repeatability of the equipment increased in comparison to field tests. The results indicate that the changes in the test surface and environmental conditions influence the repeatability of the test setup. The COV values were generally less than 5%, with the rare instance when it went up to 14%. The laboratory test results also indicated similar trends, as shown in Tables 4.2 through 4.4. The standard deviation values were always lower than 0.05 psi for most of the cases. There were rare instances where the standard deviation was more than 0.1 psi (for PG64-22 tack coat).

To show the effect of dilution and residual application rates, a series of graphs were developed and are presented in Figures 4.1 through 4.6. The results presented in Figures 4.1 and 4.2 are for tack coat CSS-1h tested after 60 minutes set time. The results show that the strength gain was lower with an increase in dilution levels for both application rates and test times. In other words, the dilution reduces the shear strength gain and should not be used in the field. The test results also indicate that the device can discriminate between the dilution levels and application rates.

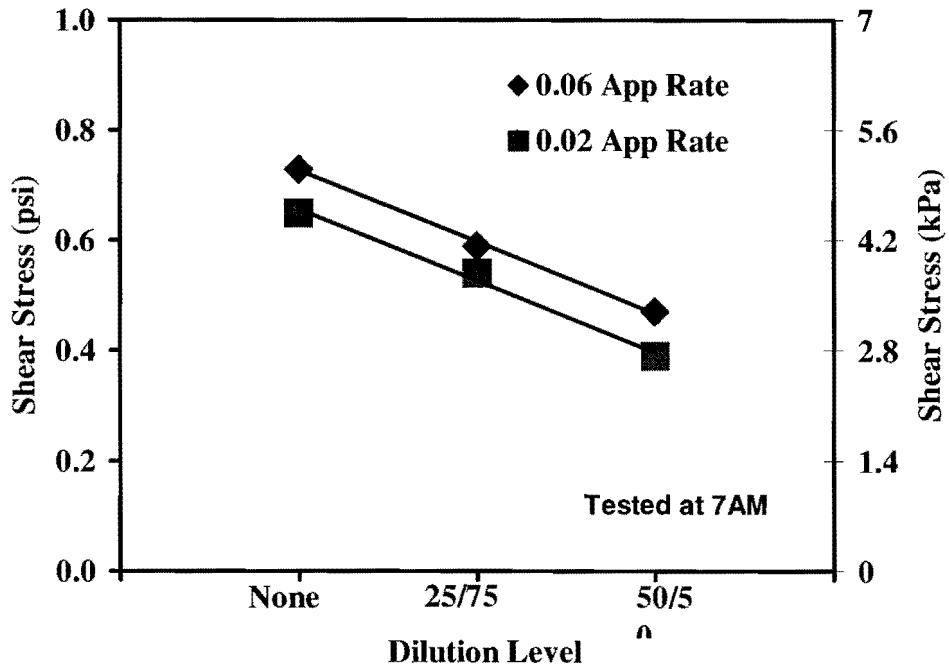

Figure 4.1 - ATACKER™ Shear Results for CSS-1h Tested at 7AM

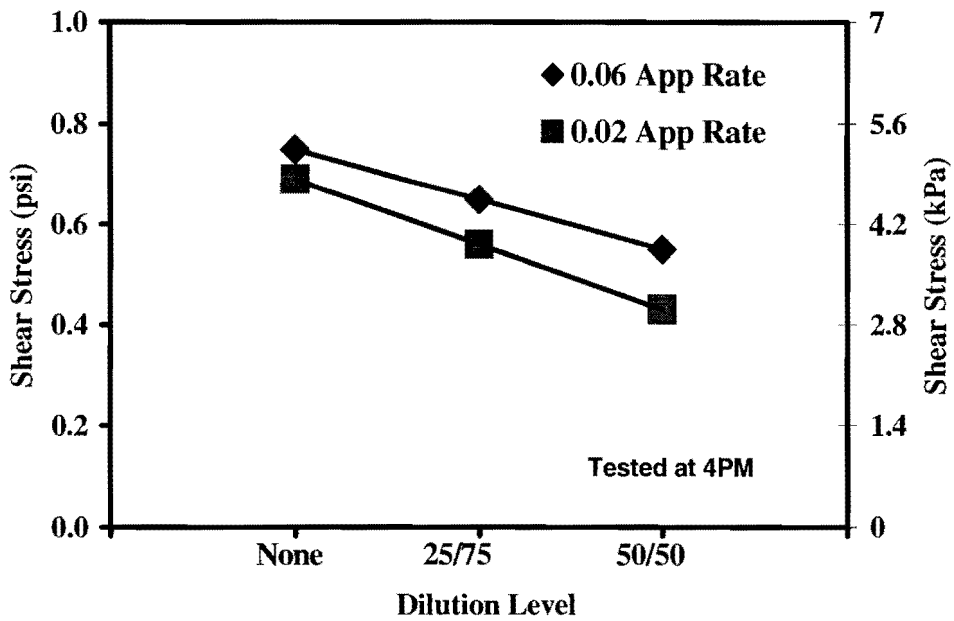

Figure 4.2 - ATACKER™ Shear Results for CSS-1h Tested at 4PM

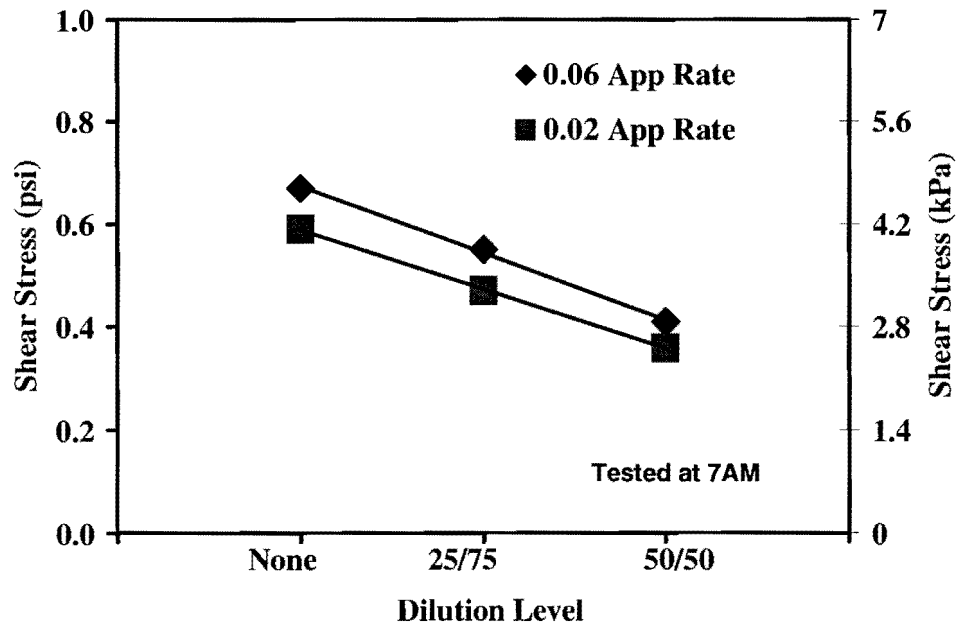

Figure 4.3 - ATACKER™ Shear Results for SS-1 Tested at 7AM

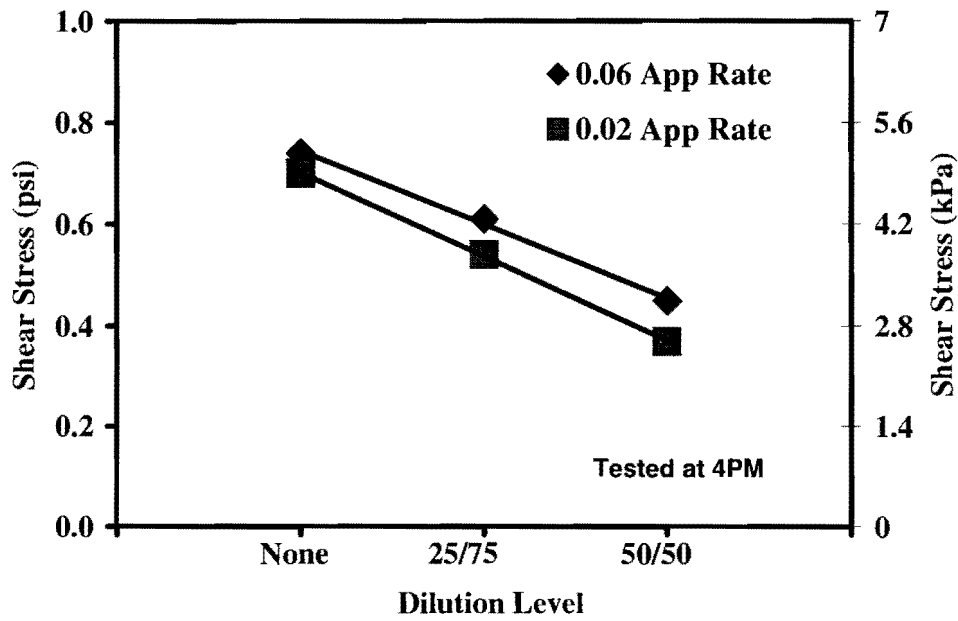

Figure 4.4 - ATACKER™ Shear Results for SS-1 Tested at 4PM

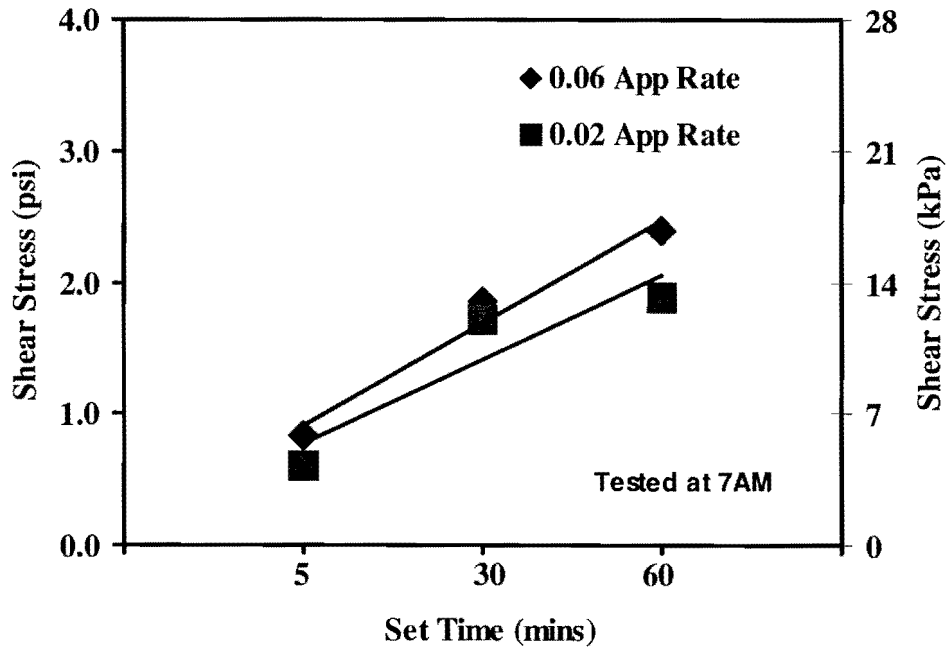

Figure 4.5 - ATACKER™ Shear Results for PG64-22 Tested at 7AM

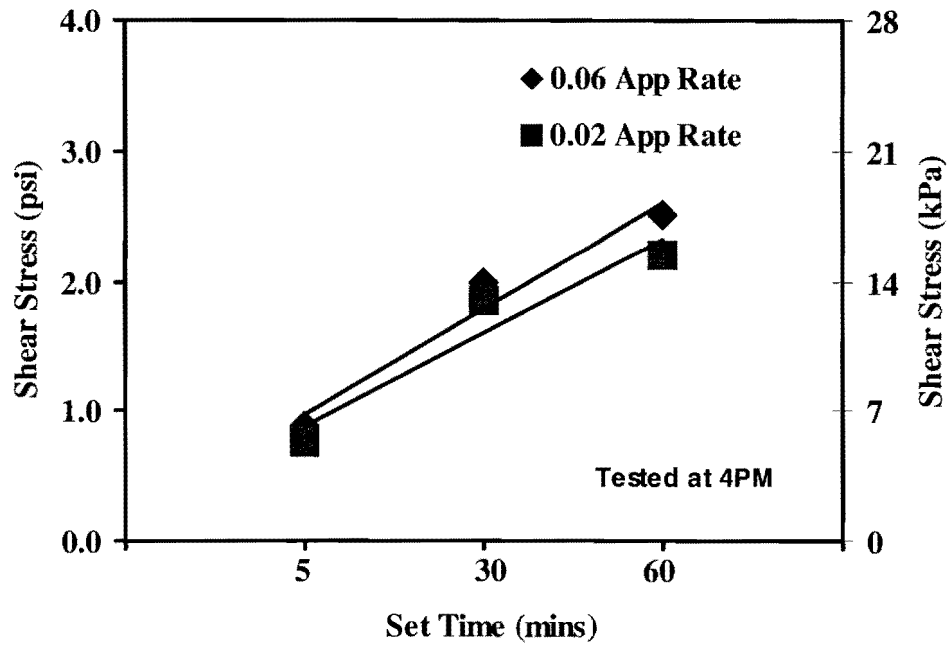

Figure 4.6 - ATACKER™ Shear Results for PG64-22 Tested at 4PM

The test results of SS-1 tack coat tested after 60 minutes set time are shown in Figure 4.3 and 4.4. The test results showed similar trends of decrease in strength gain with increased levels of dilution for both application rates and set times. However, the gains in strength levels were similar at the dilution levels of 50/50 regardless of application rates indicating that the application rates did not have an effect on strength gain at the higher levels of dilution. The test results presented in Figures 4.1 and 4.2 showed that the gained strength depends on the application rates regardless of dilution levels. The reason for this discrepancy can be explained with the help of ambient temperatures. The tack coat CSS-1h was tested at higher ambient temperatures (51 to 87 °F) in comparison to SS-1 (52 to 66 °F) indicating that the strength gain (breaking of tack coat) depends on ambient temperature as well. Similar to the tack coat CSS-1h, the test results of SS-1 indicate that the dilution levels reduce the gain in strength significantly.

The test results of PG64-22 tack coat are presented in Figures 4.5 and 4.6. Since PG64-22 was not diluted, the test results are presented for different set times. The results indicate the the strength is significantly higher than either type of emulsion. For example, the PG64-22 strength gain (2.39 psi [16.47 kPa]) is two to three times higher at 60 minutes of set time in comparison to SS-1 emulsion (0.67 psi [4.62 kPa]). The test results also showed that at lower set times the effect of application rate was minimal. In addition, the test results showed that the strength gain was not linearly dependent on the set time, but rather strength is gained at higher rates from 5 to 30 minutes and then the strength gain is lower. Since the tests were not performed between designated set times, more experiments need to be performed to verify the rate of strength gain dependence on set time.

To see the effect of gained strength on repeatability of the device, typical results for the two tack coats are shown in Figures 4.7 and 4.8. The COV and standard deviation results for SS-1 tack coat applied at the rate of 0.06 gal/yd² (0.27 l/m²) tested at 7:00 AM are shown in Figure 4.7. Similarly, the COV and standard deviation results for CSS-1h tack coat applied at the rate of 0.02 gal/yd² (0.09 l/m²) tested at 4:00 PM are shown in Figure 4.8. In general, it is expected that the repeatability increases with an increase in strength, i.e., lower standard deviation and coefficient of variation. However, the data does show a mixed trend. For example, COV for 60 min set time were lower at higher dilution rates indicating the repeatability increased with a decrease in strength. On the other hand, the COV for 30 minutes of set time were higher at higher dilution rates indicating that the repeatability decreased with decrease in strength. The results presented in Figures 4.7 and 4.8 clearly show that the repeatability is better for 30 minute set times rather than 5 or 60 minutes set times. Similarly, mixed trends were observed for the standard deviation data.

Based on the analysis of ATACKERTM data, it can be concluded that the device is repeatable and the device is sensitive to the tested parameters. The results also indicated that the set time, ambient temperature, and level of dilution affect the strength gain.

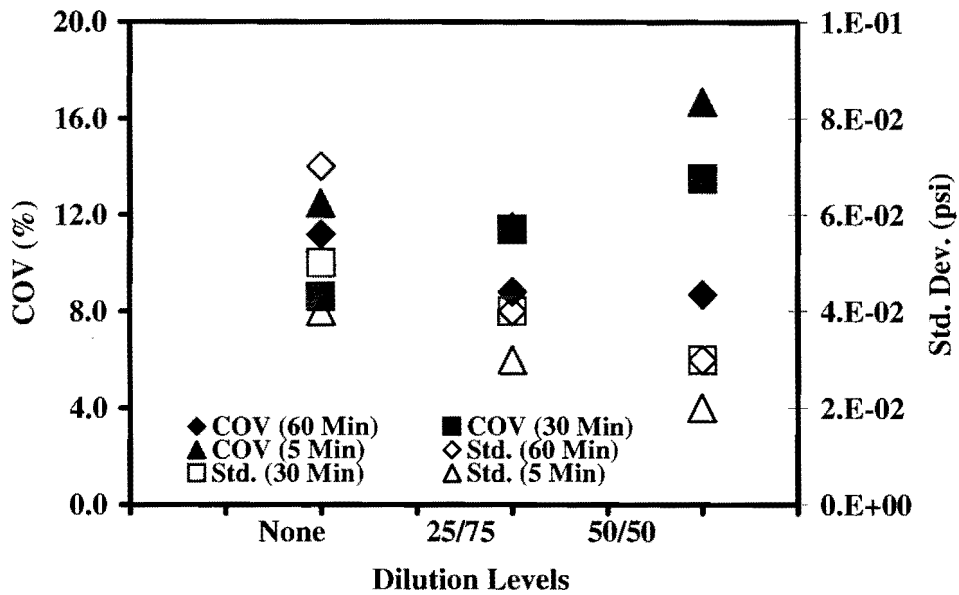

Figure 4.7 - ATACKER™ Shear Variability Results for SS-1 Tested at 7AM

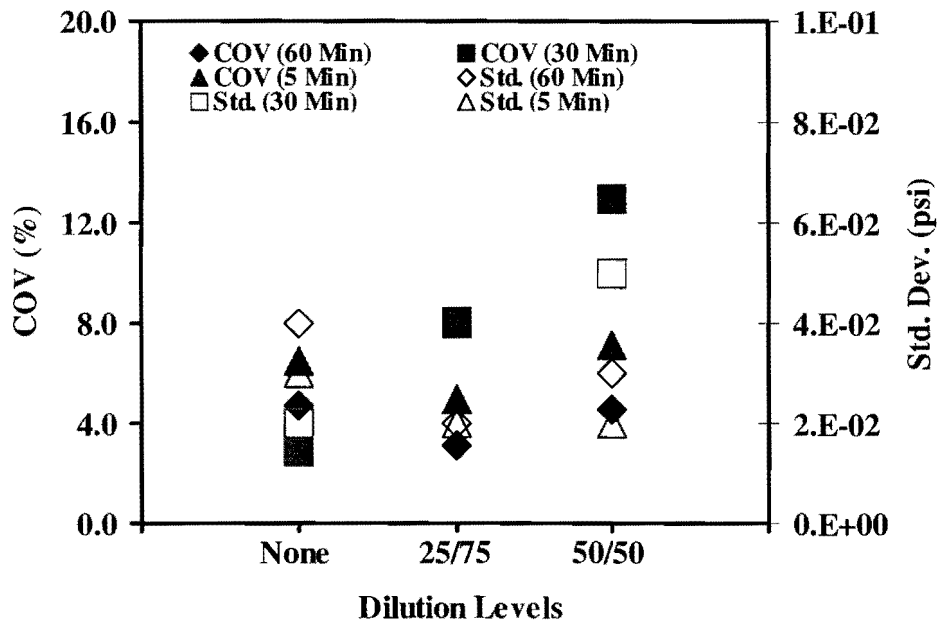

Figure 4.8 - ATACKER™ Shear Variability Results for CSS-1h Tested at 4PM

4.1.2 UTEP TORQUE

Similar to the ATACKER™, the UTEP Torque device was evaluated by performing tests in the field as well as in the laboratory. A total of 324 tests were performed in the parking lot and 162 tests were performed in the laboratory. To perform tests, the tack coat was sprayed and was allowed to set for specified period before performing tests. The main difference between the ATACKER™ and UTEP torque device is that loads are maintained while the torque is measured with the UTEP torque device while the load is removed before torque measurement in the ATACKER™.

The data collected for each parameter was analyzed and the test results, for parking lot evaluations, are summarized in Tables 4.7 through 4.9 while the laboratory test results are summarized in Tables 4.10 and 4.11. The data analysis and organization is similar to that of ATACKER™ device.

The parking lot test results for SS-1 tack coat are summarized in Table 4.7. The parking lot ambient temperature varied between 54 and 57 °F (12 and 14 °C) for testing performed in the morning (7 AM) and varied between 62 and 77 °F (17 and 25 °C) for testing performed in the afternoon (4 PM). The test results indicate that the magnitude of the measured strength depends on the set time. For example, 0.28 psi (1.93 kPa) strength was measured for 5 minutes set time at residual application rate of 0.06 gal/yd² (0.27 l/m²) with no dilution tested at 7AM. However, 0.66 psi (4.55 kPa) strength was measured for 60 minutes set time under similar conditions. Similarly, an increase in the residual application rate increased the magnitude of measured strength. For example, 0.66 psi (4.55 kPa) strength was measured for 60 minutes set time (no dilution and tested at 7AM) at residual application rate of 0.06 gal/yd² (0.27 l/m²) while 0.62 psi (4.27 kPa) strength was measured at the residual application rate of 0.02 gal/yd² (0.09 l/m²) under similar conditions. However, the differences diminished at 5 minutes set time in comparison to 60 minutes set time.

Although similar residual application rates were used, an increase in dilution levels reduced the magnitude of measured strength. For example, 0.66 psi (4.55 kPa) strength was measured for no dilution (60 minutes of set time and tested at 7AM) with application rate of 0.06 gal/yd² (0.27 l/m²) while 0.29 psi (2.00 kPa) strength was measured for 50/50 dilution levels under similar conditions. In addition, an increase in ambient temperature increased the magnitude of measured strength. For example, 0.64 psi (4.41 kPa) strength was measured when tested at 4PM (77 °F [25 °C]) for 60 minutes set time and no dilution at application rate of 0.02 gal/yd² (0.09 l/m²) while 0.62 psi (4.27 kPa) strength was measured when tested at 7AM (57 °F [14 °C]) under similar conditions.

Table 4.7 - UTEP Torque Parking Lot Test Results for SS-1

Testing Time	Residual App. Rate gal/yd ² (l/m ²)	Dilution	Set Time, min	Average Strength. psi (kPa)	Std. Dev., psi (kPa)	COV (%)
7AM	0.06 (0.27) Ambient Temperature 54.3°F(12.3°C)	None	5	0.28(1.93)	0.02(0.14)	8.4
			30	0.41(2.82)	0.02(0.14)	5.0
			60	0.66(4.55)	0.05(0.34)	7.1
		25/75	5	0.20(1.38)	0.02(0.14)	10.0
			30	0.31(2.14)	0.02(0.14)	6.7
			60	0.49(3.38)	0.02(0.14)	4.2
		50/50	5	0.11(0.76)	0.01(0.07)	10.8
			30	0.18(1.24)	0.02(0.14)	11.1
			60	0.29(2.00)	0.02(0.14)	7.1
	0.02 (0.09) Ambient Temperature 57.2°F(14.0°C)	None	5	0.24(1.65)	0.02(0.14)	8.3
			30	0.37(2.55)	0.02(0.14)	5.6
			60	0.62(4.27)	0.03(0.21)	5.0
		25/75	5	0.18(1.24)	0.02(0.14)	11.1
			30	0.26(1.79)	0.02(0.14)	7.7
			60	0.47(3.24)	0.02(0.14)	4.3
		50/50	5	0.11(0.76)	0.02(0.14)	14.8
			30	0.14(0.96)	0.02(0.14)	14.3
			60	0.24(1.65)	0.02(0.14)	8.3
4PM	0.06 (0.27) Ambient Temperature 62.4°F(16.8°C)	None	5	0.31(2.14)	0.02(0.14)	6.7
			30	0.88(6.06)	0.04(0.28)	4.5
			60	0.73(5.03)	0.05(0.34)	7.3
		25/75	5	0.22(1.52)	0.02(0.14)	9.1
			30	0.68(4.69)	0.04(0.28)	5.9
			60	0.59(4.07)	0.02(0.14)	3.4
		50/50	5	0.14(0.96)	0.02(0.14)	14.3
			30	0.42(2.89)	0.06(0.41)	14.3
			60	0.36(2.48)	0.03(0.21)	8.7
	0.02 (0.09) Ambient Temperature 76.8°F(24.8°C)	None	5	0.26(1.79)	0.02(0.14)	7.7
			30	0.39(2.69)	0.03(0.21)	7.9
			60	0.64(4.41)	0.03(0.21)	4.9
		25/75	5	0.20(1.38)	0.01(0.07)	6.0
			30	0.31(2.14)	0.02(0.14)	6.7
			60	0.51(3.51)	0.02(0.14)	4.0
		50/50	5	0.12(0.83)	0.01(0.07)	10.2
			30	0.18(1.24)	0.03(0.21)	14.2
			60	0.26(1.79)	0.03(0.21)	12.1

Table 4.8 - UTEP Torque Parking Lot Test Results for CSS-1h

Testing Time	Residual App. Rate gal/yd ² (l/m ²)	Dilution	Set Time, min	Average Strength. psi (kPa)	Std. Dev., psi (kPa)	COV (%)
7AM	0.06 (0.27) Ambient Temperature 56.3°F(13.5°C)	None	5	0.37(2.55)	0.02(0.14)	5.6
			30	0.53(3.65)	0.02(0.14)	3.8
			60	0.75(5.17)	0.03(0.21)	4.2
		25/75	5	0.24(1.65)	0.02(0.14)	8.3
			30	0.35(2.41)	0.02(0.14)	5.9
			60	0.54(3.72)	0.03(0.21)	5.7
		50/50	5	0.18(1.24)	0.02(0.14)	11.1
			30	0.23(1.58)	0.03(0.21)	13.5
			60	0.35(2.41)	0.02(0.14)	5.9
	0.02 (0.09) Ambient Temperature 57.9°F(14.3°C)	None	5	0.32(2.20)	0.03(0.21)	9.8
			30	0.42(2.89)	0.03(0.21)	7.4
			60	0.68(4.69)	0.02(0.14)	3.5
		25/75	5	0.20(1.38)	0.02(0.14)	10.0
			30	0.31(2.14)	0.02(0.14)	6.7
			60	0.53(3.65)	0.04(0.28)	7.7
		50/50	5	0.14(0.96)	0.02(0.14)	11.2
			30	0.20(1.38)	0.02(0.14)	10.0
			60	0.31(2.14)	0.02(0.14)	6.7
4PM	0.06 (0.27) Ambient Temperature 78.3°F(25.7°C)	None	5	0.41(2.82)	0.03(0.21)	7.5
			30	0.55(3.79)	0.02(0.14)	3.7
			60	0.84(5.79)	0.04(0.28)	4.9
		25/75	5	0.31(2.14)	0.02(0.14)	6.7
			30	0.41(2.82)	0.02(0.14)	5.0
			60	0.65(4.48)	0.02(0.14)	3.1
		50/50	5	0.20(1.38)	0.02(0.14)	10.0
			30	0.29(2.00)	0.02(0.14)	7.1
			60	0.38(2.62)	0.03(0.21)	8.2
	0.02 (0.09) Ambient Temperature 78.3°F(25.7°C)	None	5	0.36(2.48)	0.03(0.21)	8.6
			30	0.51(3.51)	0.02(0.14)	4.2
			60	0.75(5.17)	0.01(0.07)	1.6
		25/75	5	0.26(1.79)	0.02(0.14)	7.7
			30	0.37(2.55)	0.02(0.14)	5.6
			60	0.60(4.13)	0.03(0.21)	5.2
		50/50	5	0.18(1.24)	0.02(0.14)	11.1
			30	0.26(1.79)	0.02(0.14)	7.7
			60	0.33(2.27)	0.03(0.21)	9.4

Table 4.9 - UTEP Torque Parking Lot Test Results for PG64-22

Testing Time	Residual App. Rate gal/yd ² (l/m ²)	Dilution	Set Time, min	Average Strength. psi (kPa)	Std. Dev., psi (kPa)	COV (%)
7AM	0.06(0.27) Ambient Temperature 58.3°F(14.6°C)	None	5	2.06(14.89)	0.08(0.55)	3.8
			30	2.73(18.81)	0.08(0.55)	2.8
			60	3.19(21.98)	0.16(1.10)	4.9
	0.02(0.09) Ambient Temperature 58.3°F(14.6°C)	None	5	1.65(11.37)	0.16(1.10)	9.9
			30	2.41(16.6)	0.11(0.76)	4.4
			60	2.80(19.29)	0.05(0.34)	1.8
4PM	0.06(0.27) Ambient Temperature 69.3°F(20.7°C)	None	5	2.34(16.12)	0.10(0.69)	4.4
			30	2.89(19.91)	0.11(0.76)	3.7
			60	3.48(23.98)	0.19(1.31)	5.5
	0.02(0.09) Ambient Temperature 69.3°F(20.7°C)	None	5	1.78(12.26)	0.13(0.90)	7.6
			30	2.51(17.29)	0.13(0.90)	5.1
			60	2.97(20.46)	0.08(0.55)	2.6

Table 4.10 - UTEP Torque Laboratory Test Results for PG64-22

Tack Type	Residual App. Rate gal/yd ² (l/m ²)	Dilution	Set Time, min	Average Strength. psi (kPa)	Std. Dev., psi (kPa)	COV (%)
PG64-22	0.06(0.27)	None	5	0.90(6.20)	0.08(0.55)	8.7
			30	1.82(12.54)	0.11(0.76)	5.8
			60	2.51(17.29)	0.26(1.79)	10.2
	0.02(0.09)	None	5	0.66(4.55)	0.05(0.34)	7.7
			30	1.36(9.37)	0.13(0.90)	9.4
			60	2.00(13.78)	0.13(0.90)	6.4

Table 4.11 - UTEP Torque Laboratory Test Results for SS-1 & CSS-1h

Tack Type	Residual App. Rate gal/yd ² (l/m ²)	Dilution	Set Time, min	Average Strength. psi (kPa)	Std. Dev., psi (kPa)	COV (%)
SS-1	0.06 (0.27)	None	5	0.41(2.82)	0.02(0.14)	5.0
			30	1.01(6.96)	0.04(0.28)	3.6
			60	1.15(7.92)	0.03(0.21)	2.5
		25/75	5	0.33(2.27)	0.02(0.14)	6.2
			30	0.71(4.89)	0.02(0.14)	2.9
			60	0.87(5.99)	0.05(0.34)	5.9
		50/50	5	0.16(1.10)	0.02(0.14)	12.5
			30	0.41(2.82)	0.01(0.07)	2.8
			60	0.59(4.07)	0.03(0.21)	4.4
	0.02 (0.09)	None	5	0.33(2.27)	0.03(0.21)	7.8
			30	0.78(5.37)	0.03(0.21)	3.4
			60	0.94(6.48)	0.03(0.21)	2.7
		25/75	5	0.22(1.52)	0.02(0.14)	9.1
			30	0.63(4.34)	0.02(0.14)	3.2
			60	0.72(4.96)	0.04(0.28)	5.1
		50/50	5	0.12(0.83)	0.01(0.07)	10.2
			30	0.37(2.55)	0.01(0.07)	3.2
			60	0.49(3.38)	0.03(0.21)	5.3
CSS-1h	0.06 (0.27)	None	5	0.46(3.17)	0.03(0.21)	6.7
			30	1.15(7.92)	0.03(0.21)	2.3
			60	1.26(8.68)	0.05(0.34)	4.3
		25/75	5	0.36(2.48)	0.03(0.21)	8.6
			30	0.93(6.41)	0.08(0.55)	8.3
			60	1.04(7.17)	0.08(0.55)	7.5
		50/50	5	0.20(1.38)	0.02(0.14)	10.0
			30	0.53(3.65)	0.03(0.21)	4.8
			60	0.70(4.82)	0.04(0.28)	5.2
	0.02 (0.09)	None	5	0.45(3.10)	0.04(0.28)	8.2
			30	0.92(6.34)	0.05(0.34)	5.0
			60	1.13(7.79)	0.04(0.28)	3.2
		25/75	5	0.31(2.14)	0.02(0.14)	6.7
			30	0.79(5.44)	0.03(0.21)	3.2
			60	0.87(5.99)	0.05(0.34)	5.9
		50/50	5	0.18(1.24)	0.02(0.14)	13.3
			30	0.47(3.24)	0.02(0.14)	4.4
			60	0.59(4.07)	0.03(0.21)	5.0

Similar trends were observed for the remaining tack coat types. In general, the device is repeatable and the estimated coefficient of variation (COV) is generally less than 15%. In addition, COV is less for no dilution tests (i.e., less than 10%). The observed standard deviation values were lower than 0.05 psi (0.34 kPa) for most of the cases. In some instances, the standard deviation was more than 0.1 psi (0.7 kPa), for PG64-22.

In general, an increase in the application rate increased the shear strength and an increase in dilution levels reduced the shear strength. The test results also suggested that the estimated shear strength increased with an increase in temperature and/or increase in set time because higher temperatures or longer set times allowed breaking of tack coat which increased the strength. The trends were similar to that observed with ATACKER™ device.

Since laboratory temperatures remained constant at 73°F (23°C), the laboratory tests were not performed at two different times. The data presented in the Tables 4.10 and 4.11 suggest that the overall repeatability of the equipment increased in comparison to field tests. The COV values were in general less than 5% with few exceptions where it went up to 14% indicating that the changes in the test surface and environmental conditions influence the repeatability of the test setup. Although repeatability increased in the laboratory, the improvement in repeatability observed was not very significant in comparison to ATACKER™.

The laboratory results also suggested that the PG64-22 provides maximum strength followed by CSS-1h and then SS-1. The field test results also indicated similar trends as shown in Tables 4.7 through 4.9.

To show the effect of dilution and residual application rates, a series of graphs were developed and are presented in Figures 4.9 through 4.14. The results presented in Figures 4.9 and 4.10 are for tack coat CSS-1h tested after 60 minutes set time. The results show that the strength gain was less with increase in dilution levels for both application rates and test times. The test results suggest that the dilution reduces the shear strength significantly. The test results also indicate that the device can discriminate between the dilution levels. However, the difference in application rate was less significant for the testing performed at both test temperatures.

The test results of SS-1 tack coat tested after 60 minutes set time are shown in Figure 4.11 and 4.12. The test results showed similar trends of decrease in strength gain with increased levels of dilution for both application rates and test times. However, the gains in strength levels were similar at the dilution levels of 50/50 regardless of application rates indicating that the application rates did not have an effect on strength gain at higher levels of dilution.

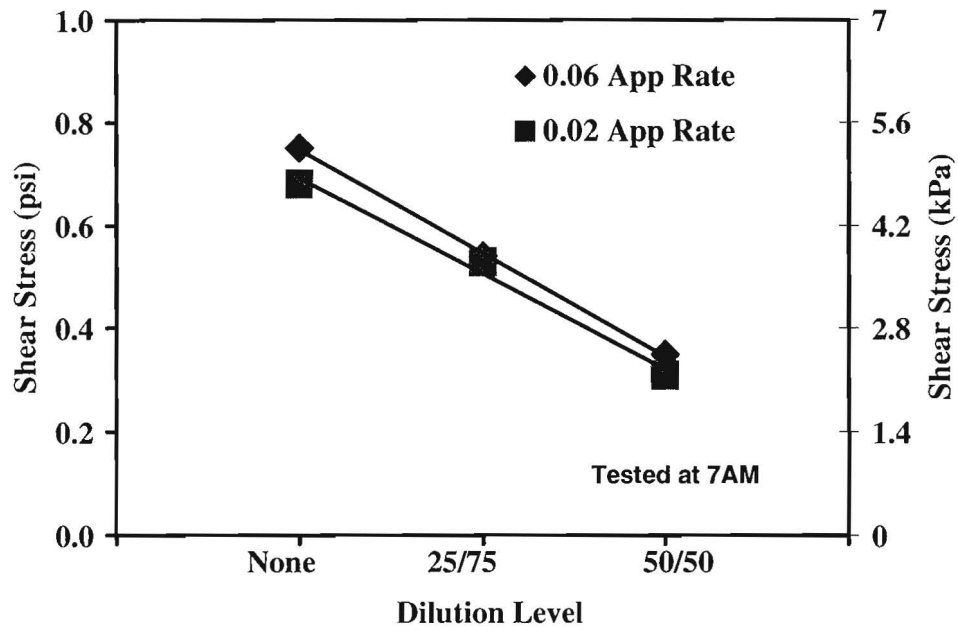

Figure 4.9 - UTEP Torque Results for CSS-1h Tested at 7AM

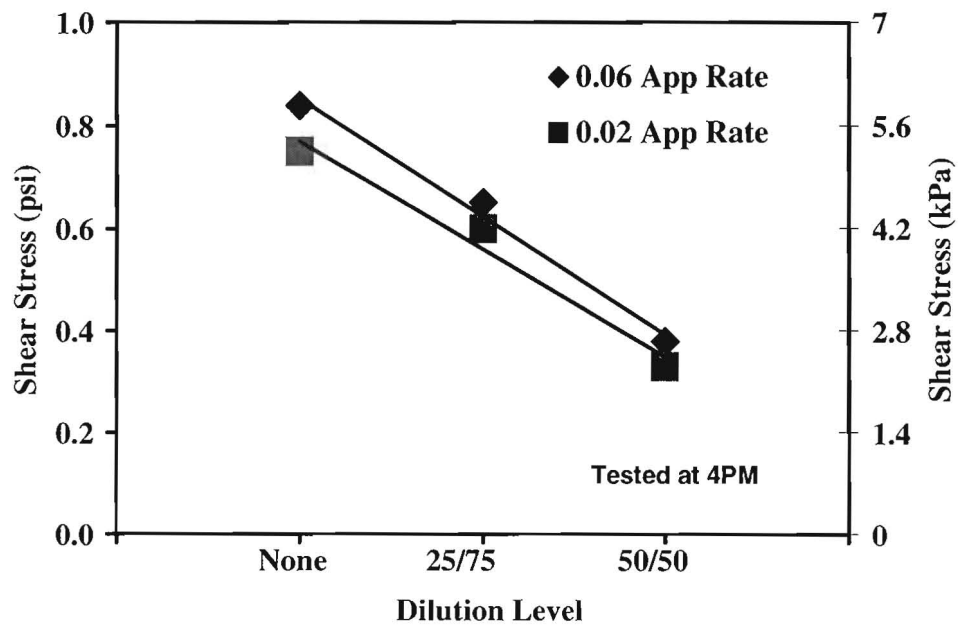

Figure 4.10 - UTEP Torque Results for CSS-1h Tested at 4PM

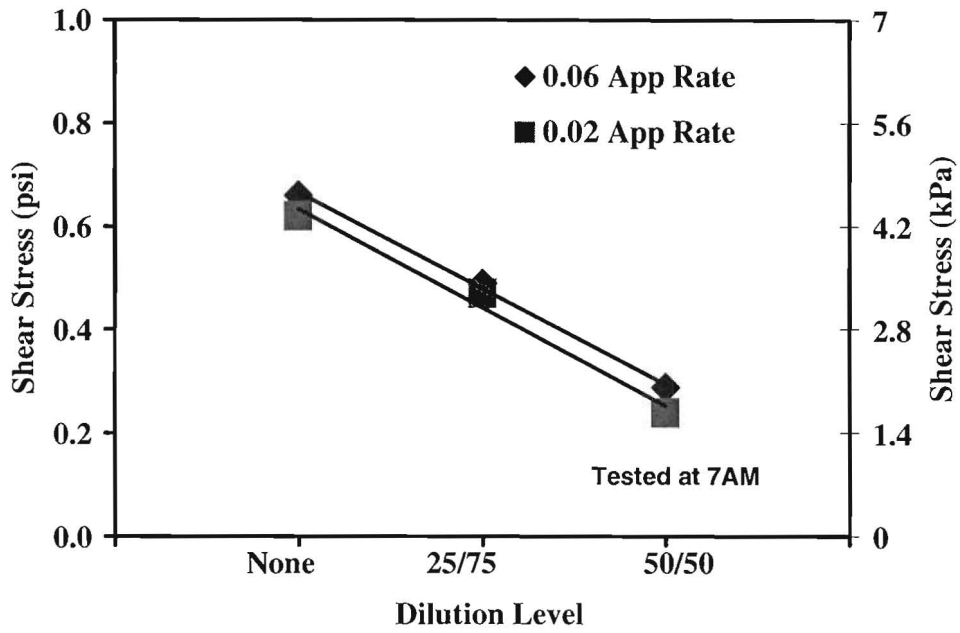

Figure 4.11 - UTEP Torque Results for SS-1 Tested at 7AM

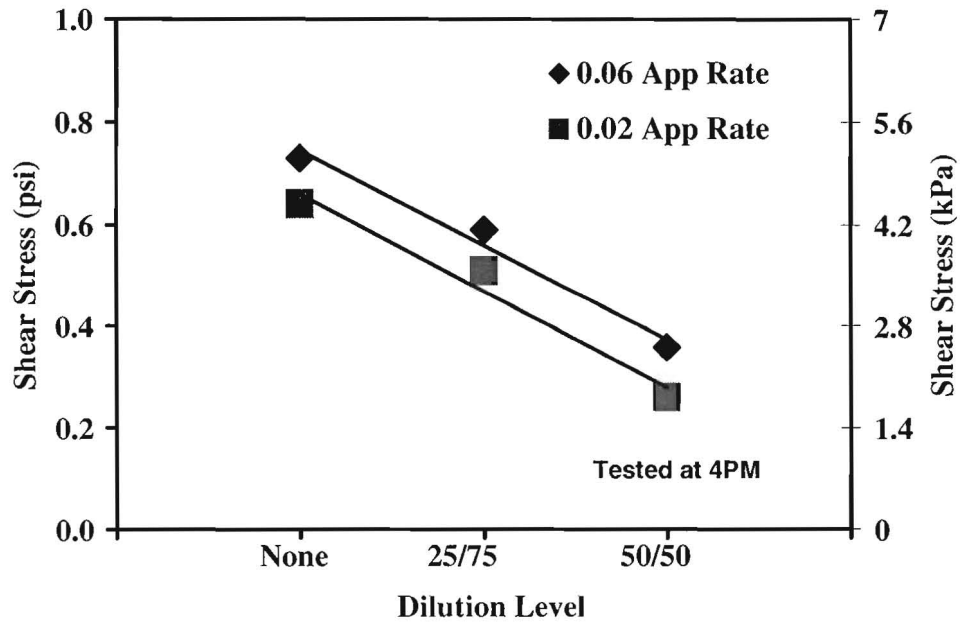

Figure 4.12 - UTEP Torque Results for SS-1 Tested at 4PM

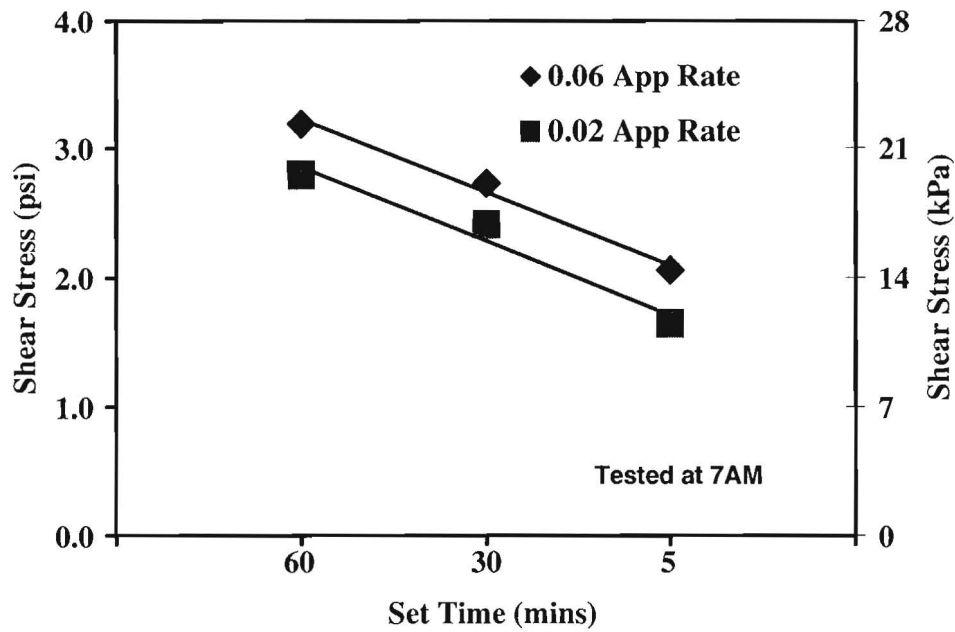

Figure 4.13 - UTEP Torque Results for PG64-22 Tested at 7AM

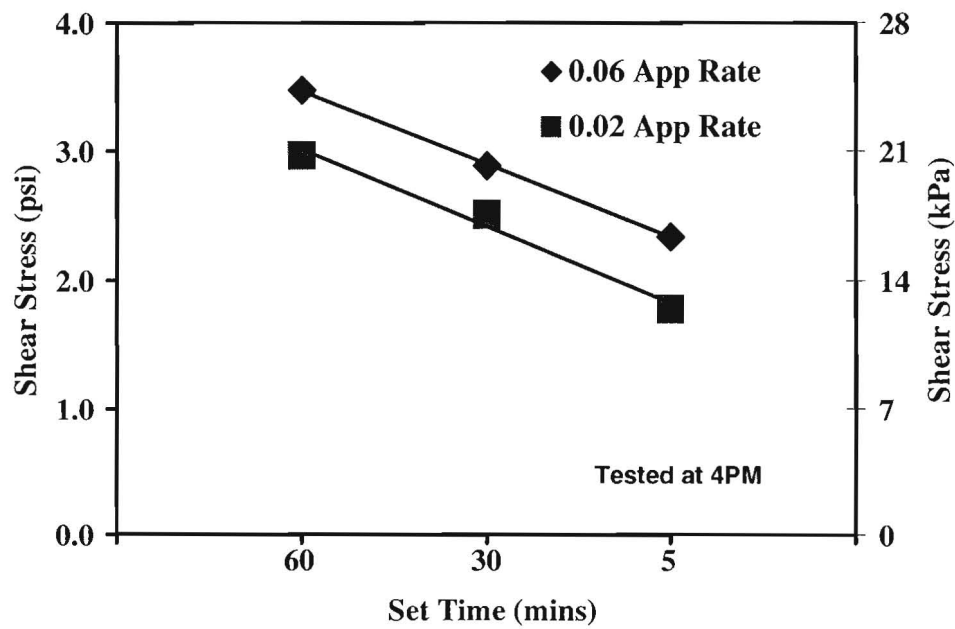

Figure 4.14 - UTEP Torque Results for PG64-22 Tested at 4PM

The test results of PG64-22 tack coat are presented in Figures 4.13 and 4.14. Since binder was not diluted, the test results are presented for different set times. The results indicate the strength is significantly higher than either types of emulsion. For example, the PG64-22 strength gain (3.19 psi [21.98 kPa] for 60 minutes set time) is two to three times higher at 60 minutes of set time in comparison to either of the tack coat types (0.66 psi [4.55 kPa] for 60 minutes set time). The test results also showed that at lower set times the effect of application rate was minimal. The nonlinearity of the strength gain with set time observed with the ATACKER™ device is not apparent with the torque device indicating that more tests at intermediate set times are needed to identify rate of strength gain with set time.

To identify the effect of gained strength on repeatability of the device, typical results for the two tack coats is shown in Figures 4.15 and 4.16. The COV and standard deviation results for SS-1 tack coat applied at the rate of 0.02 gal/yd² (0.09 l/m²) and tested at 7:00 AM are shown in Figure 4.15. Similarly, the COV and standard deviation results for CSS-1h tack coat applied at the rate of 0.06 gal/yd² (0.27 l/m²) and tested at 4 PM are shown in Figure 4.16. The test results presented in the Figures 4.15 and 4.16 indicate that the repeatability increased with increase in set time and decreased with the increase in dilution rate. This trend was different from that observed with the ATACKER™ where the repeatability was higher at the 30 minute of set time.

Based on the analysis of the data of UTEP Torque device, it can be concluded that the device is repeatable and the device is sensitive to the tested parameters. The results also indicated that the set time, ambient temperature, and level of dilution affects the strength gained.

4.1.3 KOCH MATERIALS COMPANY SHEAR

The Koch Materials Company (KMC) shear device was also evaluated in the parking lot as well as in the laboratory. The total number of testing performed in the parking lot was similar to the above discussed test set-ups. However, the number of tests performed in the laboratory was significantly lower due to the equipment constraints. The equipment was borrowed for a month from the KMC; therefore, there was not enough time to perform all laboratory testing. Only 6 tests were performed in the laboratory and 324 tests (similar to ATACKER™ and UTEP) were performed in the parking lot. In the laboratory, the testing was performed on a 3 by 4 ft (0.91 by 1.22 m) pavement section with SS-1 tack coat for 30 minute setting time. The parking lot test results are summarized in Tables 4.12 through 4.14 and the laboratory test results are summarized in Table 4.15. The data analysis and organization was similar to that of the ATACKER™ device.

The trends observed were similar to the ones observed with ATACKER™ or UTEP devices, except the magnitudes were different for emulsion types as well as PG64-22. In general, the CSS-1h and SS-1 measured strengths were lower while PG64-22 strength was higher in comparison to the other devices. For example, only 0.44 psi (3.03 kPa)

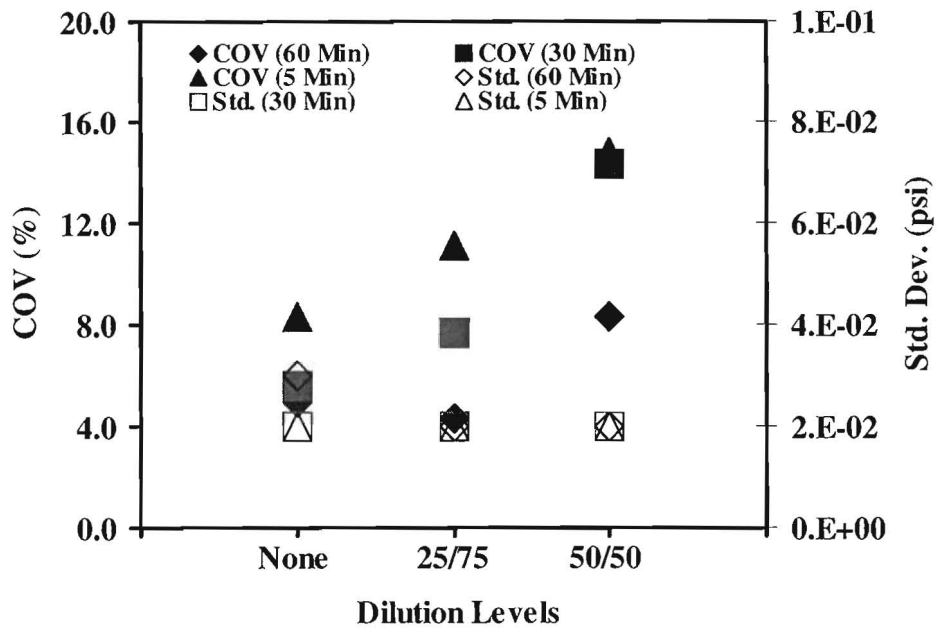

Figure 4.15 - UTEP Torque Variability Results for SS-1 Tested at 7AM

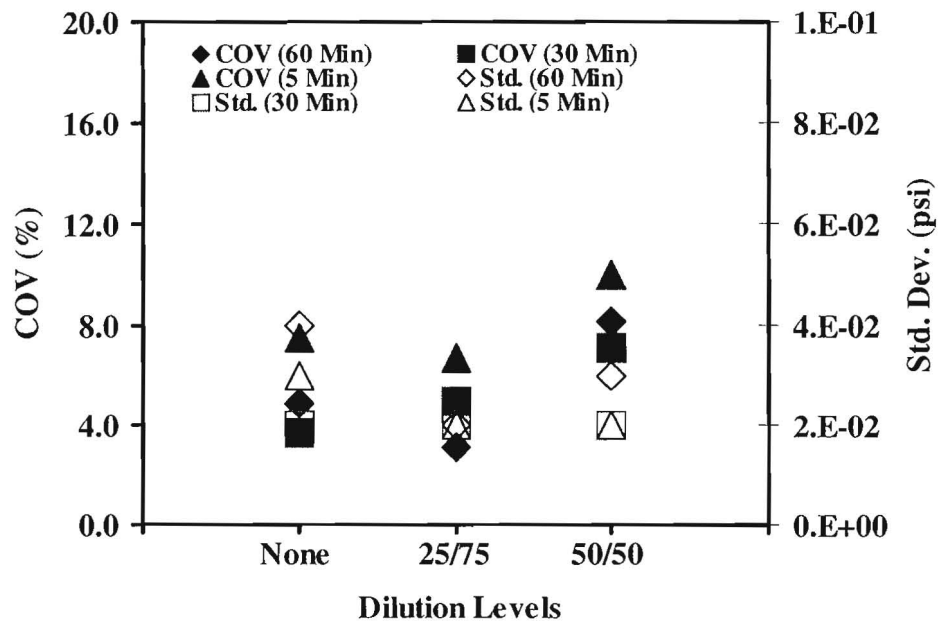

Figure 4.16 - UTEP Torque Variability Results for CSS-1h Tested at 4PM

Table 4.12 - KMC Shear Parking Lot Test Results for SS-1

Testing Time	Residual App. Rate gal/yd ² (l/m ²)	Dilution	Set Time, min	Average Strength. psi (kPa)	Std. Dev., psi (kPa)	COV (%)
7AM	0.06 (0.27) Ambient Temperature 54.3°F(12.3°C)	None	5	0.26(1.79)	0.01(0.07)	4.6
			30	0.34(2.34)	0.03(0.21)	8.3
			60	0.44(3.03)	0.02(0.14)	3.6
		25/75	5	0.17(1.17)	0.01(0.07)	4.7
			30	0.28(1.93)	0.02(0.14)	8.7
			60	0.34(2.34)	0.02(0.14)	4.7
		50/50	5	0.12(0.83)	0.01(0.07)	7.7
			30	0.13(0.90)	0.01(0.07)	6.1
			60	0.26(1.79)	0.02(0.14)	6.1
	0.02 (0.09) Ambient Temperature 57.2°F(14.0°C)	None	5	0.20(1.38)	0.02(0.14)	9.9
			30	0.31(2.14)	0.01(0.07)	4.0
			60	0.37(2.55)	0.02(0.14)	6.5
		25/75	5	0.14(0.96)	0.02(0.14)	11.8
			30	0.24(1.65)	0.02(0.14)	6.7
			60	0.28(1.93)	0.03(0.21)	9.2
		50/50	5	0.10(0.69)	0.01(0.07)	8.0
			30	0.11(0.76)	0.01(0.07)	11.3
			60	0.21(1.45)	0.02(0.14)	11.8
4PM	0.06 (0.27) Ambient Temperature 62.4°F(16.8°C)	None	5	0.27(1.86)	0.01(0.07)	2.9
			30	0.36(2.48)	0.02(0.14)	4.6
			60	0.50(3.45)	0.02(0.14)	4.2
		25/75	5	0.20(1.38)	0.01(0.07)	6.2
			30	0.26(1.79)	0.01(0.07)	3.5
			60	0.42(2.89)	0.02(0.14)	4.8
		50/50	5	0.12(0.83)	0(0)	3.8
			30	0.15(1.03)	0.01(0.07)	8.3
			60	0.28(1.93)	0.02(0.14)	5.9
	0.02 (0.09) Ambient Temperature 76.8°F(24.8°C)	None	5	0.23(1.58)	0.02(0.14)	8.8
			30	0.35(2.41)	0.04(0.28)	10.6
			60	0.44(3.03)	0.03(0.21)	5.8
		25/75	5	0.18(1.24)	0.02(0.14)	9.3
			30	0.24(1.65)	0.01(0.07)	5.0
			60	0.40(2.76)	0.04(0.28)	11.1
		50/50	5	0.09(0.62)	0.01(0.07)	10.5
			30	0.12(0.83)	0.01(0.07)	10.5
			60	0.25(1.72)	0.03(0.21)	12.5

Table 4.13 - KMC Shear Parking Lot Test Results for CSS-1h

Testing Time	Residual App. Rate gal/yd ² (l/m ²)	Dilution	Set Time, min	Average Strength. psi (kPa)	Std. Dev., psi (kPa)	COV (%)
7AM	0.06 (0.27) Ambient Temperature 56.3°F(13.5°C)	None	5	0.24(1.65)	0.02(0.14)	10.2
			30	0.33(2.27)	0.02(0.14)	5.0
			60	0.49(3.38)	0.03(0.21)	6.5
		25/75	5	0.19(1.31)	0.01(0.07)	6.5
			30	0.25(1.72)	0.01(0.07)	4.8
			60	0.37(2.55)	0.03(0.21)	7.6
		50/50	5	0.16(1.10)	0.02(0.14)	10.4
			30	0.18(1.24)	0.01(0.07)	6.6
			60	0.27(1.86)	0.03(0.21)	11.3
	0.02 (0.09) Ambient Temperature 57.9°F(14.3°C)	None	5	0.20(1.38)	0.02(0.14)	9.9
			30	0.29(2.00)	0.02(0.14)	8.3
			60	0.44(3.03)	0.04(0.28)	10.0
		25/75	5	0.17(1.17)	0.01(0.07)	7.3
			30	0.22(1.52)	0.02(0.14)	9.2
			60	0.34(2.34)	0.04(0.28)	11.5
		50/50	5	0.09(0.62)	0.01(0.07)	8.7
			30	0.14(0.96)	0.01(0.07)	8.5
			60	0.23(1.58)	0.02(0.14)	6.9
4PM	0.06 (0.27) Ambient Temperature 78.3°F(25.7°C)	None	5	0.33(2.27)	0.03(0.21)	10.4
			30	0.52(3.58)	0.02(0.14)	3.6
			60	0.59(4.07)	0.02(0.14)	5.8
		25/75	5	0.32(2.20)	0.01(0.07)	3.8
			30	0.36(2.48)	0.03(0.21)	7.1
			60	0.42(2.89)	0.02(0.14)	5.8
		50/50	5	0.20(1.38)	0.01(0.07)	6.0
			30	0.21(1.45)	0.02(0.14)	11.3
			60	0.29(2.00)	0.03(0.21)	9.8
	0.02 (0.09) Ambient Temperature 78.3°F(25.7°C)	None	5	0.26(1.79)	0.02(0.14)	7.6
			30	0.49(3.38)	0.02(0.14)	5.0
			60	0.56(3.86)	0.02(0.14)	3.0
		25/75	5	0.24(1.65)	0.02(0.14)	8.3
			30	0.32(2.20)	0.03(0.21)	10.0
			60	0.41(2.82)	0.03(0.21)	7.9
		50/50	5	0.10(0.69)	0.01(0.07)	8.0
			30	0.16(1.10)	0.01(0.07)	7.5
			60	0.25(1.72)	0.03(0.21)	12.6

Table 4.14 - KMC Shear Parking Lot Test Results for PG64-22

Testing Time	Residual App. Rate gal/yd ² (l/m ²)	Dilution	Set Time, min	Average Strength. psi (kPa)	Std. Dev., psi (kPa)	COV (%)
7AM	0.06(0.27) Ambient Temperature 58.3°F(14.6°C)	None	5	3.70(25.49)	0.09(0.62)	6.3
			30	6.6(45.47)	0.08(0.55)	3.4
			60	8.20(56.50)	0.09(0.62)	2.6
	0.02(0.09) Ambient Temperature 58.3°F(14.6°C)	None	5	2.89(19.91)	0.11(0.76)	3.7
			30	5.78(39.82)	0.08(0.55)	1.4
			60	6.54(45.06)	0.20(1.38)	3.0
4PM	0.06(0.27) Ambient Temperature 69.3°F(20.7°C)	None	5	4.96(34.17)	0.25(1.72)	5.1
			30	7.79(53.67)	0.18(1.24)	2.3
			60	9.01(62.08)	0.18(1.24)	2.0
	0.02(0.09) Ambient Temperature 69.3°F(20.7°C)	None	5	4.03(27.77)	0.20(1.38)	5.0
			30	6.77(46.65)	0.20(1.38)	2.9
			60	7.92(54.57)	0.27(1.86)	3.4

Table 4.15 – KMC Shear Laboratory Test Results for SS-1

Tack Type	Set Time, min	Dilution	Residual Application Rate, gal/yd ² (l/m ²)	Average Strength, psi (kPa)
SS-1	30	None	0.06 (0.27)	2.89 (20.23)
			0.02 (0.09)	2.10 (14.70)
		25/75	0.06 (0.27)	2.27 (15.89)
			0.02 (0.09)	1.78 (12.46)
		50/50	0.06 (0.27)	1.61 (11.27)
			0.02 (0.09)	1.23 (8.61)

was measured for SS-1 tack coat after 60 minutes set time with KMC device while 0.67 psi (4.62 kPa) strength was measured with ATACKER™ under similar conditions. On the other hand, 8.20 psi (56.50 kPa) strength was measured for PG64-22 after 60 minutes set time with KMC device while 2.39 psi (16.47 kPa) strength was measured with ATACKER™ under similar conditions. A reasonable explanation could not be found to explain the differences.

In general, the device is repeatable and the estimated coefficient of variation (COV) is generally less than 12%. The observed standard deviation values were lower than 0.04 psi for most of the cases with few exceptions where the standard deviation was more than 0.1 psi (for asphalt cement tack coat).

In general, an increase in application rate increased the shear strength and an increase in dilution levels reduced the shear strength. The test results also suggested that the estimated shear strength increased with an increase in temperature and/or increase in set time because higher temperatures or longer set times allowed breaking of tack coat which increased the strength. The trends were similar to that observed with the ATACKER™ and UTEP device.

The laboratory tests were performed at one set time of 30 minutes and one emulsion type SS-1. The data presented in the Table 4.15 shows that the strength measured with the KMC device is significantly higher than the ATACKER™ or UTEP Torque device. One of the reasons for the significant difference could be the surface tested. The KMC device tests were performed on AC slab which may offer different resistance in comparison to aluminum surface. Since the number of tests performed was significantly lower, it was decided not to evaluate the repeatability of the equipment.

To show the effect of dilution and residual application rates, a series of graphs were developed and are presented in Figures 4.17 through 4.22. The results presented in Figures 4.17 and 4.18 are for tack coat CSS-1h tested after 60 minutes set time. The results show that the strength gain was less with increase in dilution levels for both application rates and test times. The test results suggest that the dilution reduces the shear strength significantly. The test results also indicate that the device can discriminate between the dilution levels and application rates. However, the difference in application rate was less significant for the testing performed at both temperatures.

The test results of SS-1 tack coat tested after 60 minutes set time are shown in Figure 4.19 and 4.20. The test results showed similar trends of decrease in strength gain with increased levels of dilution for both application rates and test times. However, the gains in strength levels were similar at the dilution levels of 50/50 regardless of application rates indicating that the application rates did not have an effect on strength gain at higher levels of dilution. Similar to the tack coat CSS-1h, the test results of SS-1 indicate that the dilution levels reduce the gain in strength significantly.

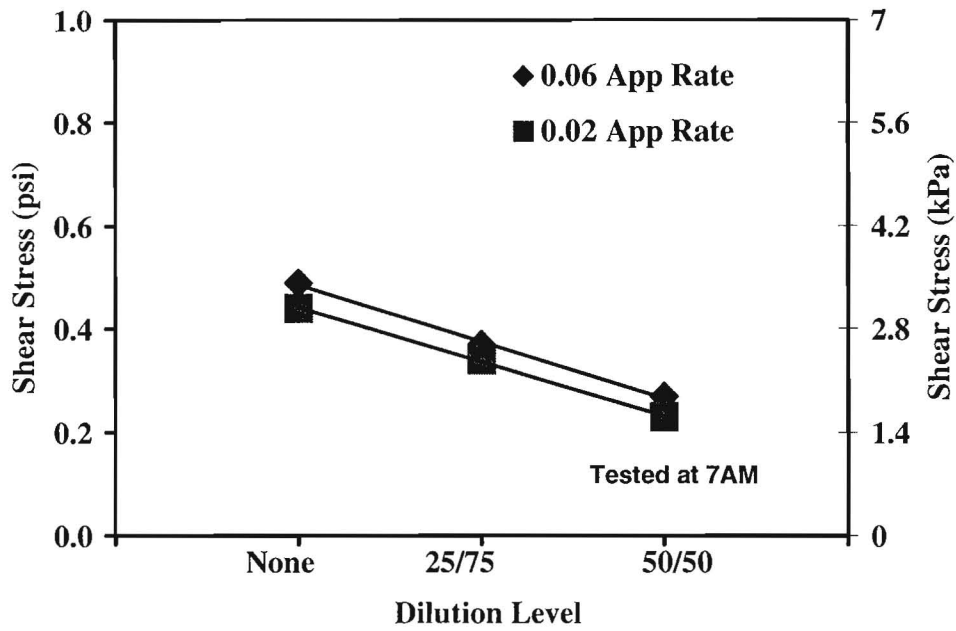

Figure 4.17 - KMC Shear Results for CSS-1h Tested at 7AM

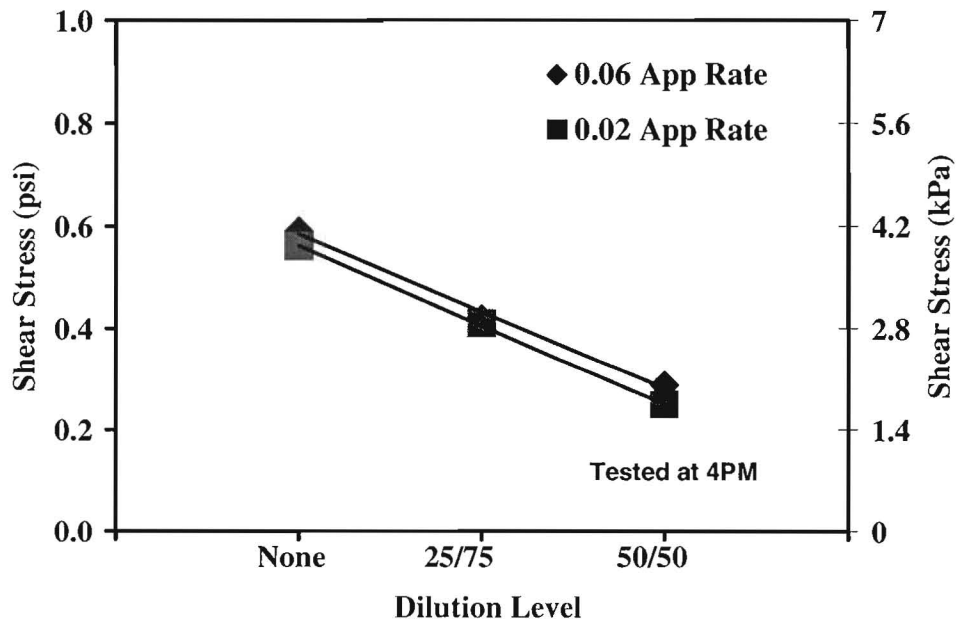

Figure 4.18 - KMC Shear Results for CSS-1h Tested at 4PM

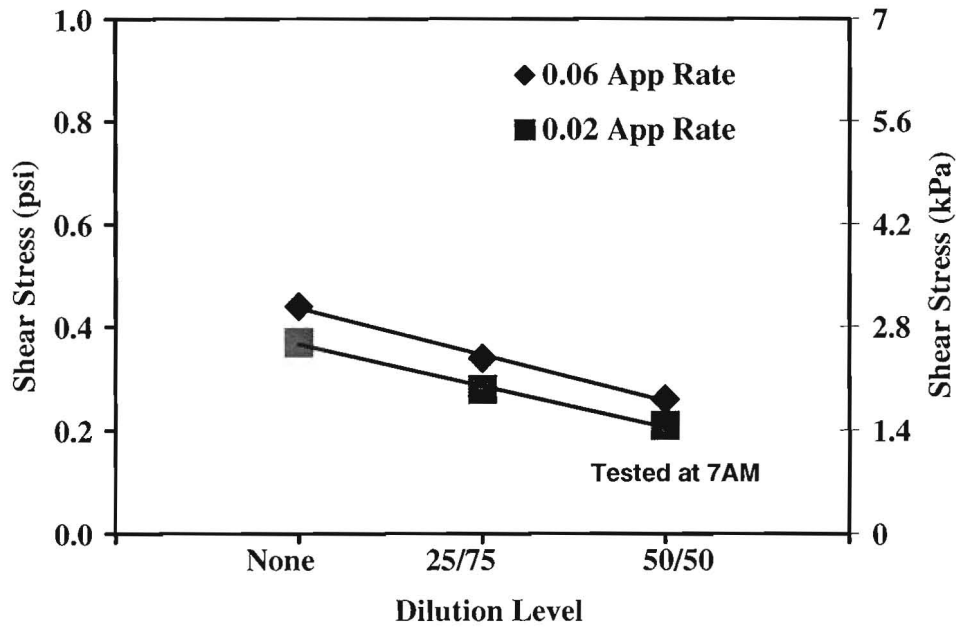

Figure 4.19 - KMC Shear Results for SS-1 Tested at 7AM

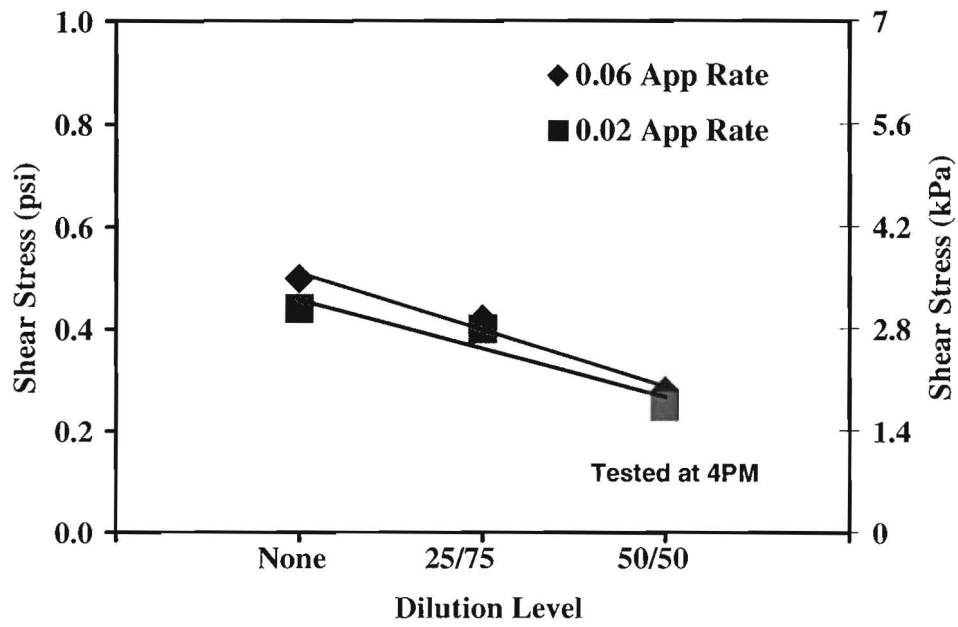

Figure 4.20 - KMC Shear Results for SS-1 Tested at 4PM

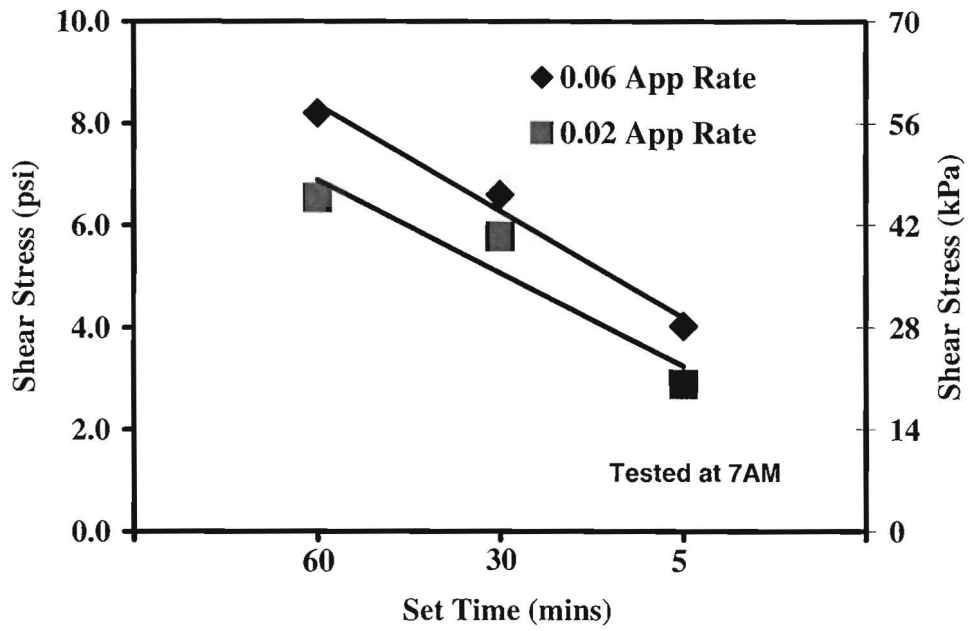

Figure 4.21 - KMC Shear Results for PG64-22 Tested at 7AM

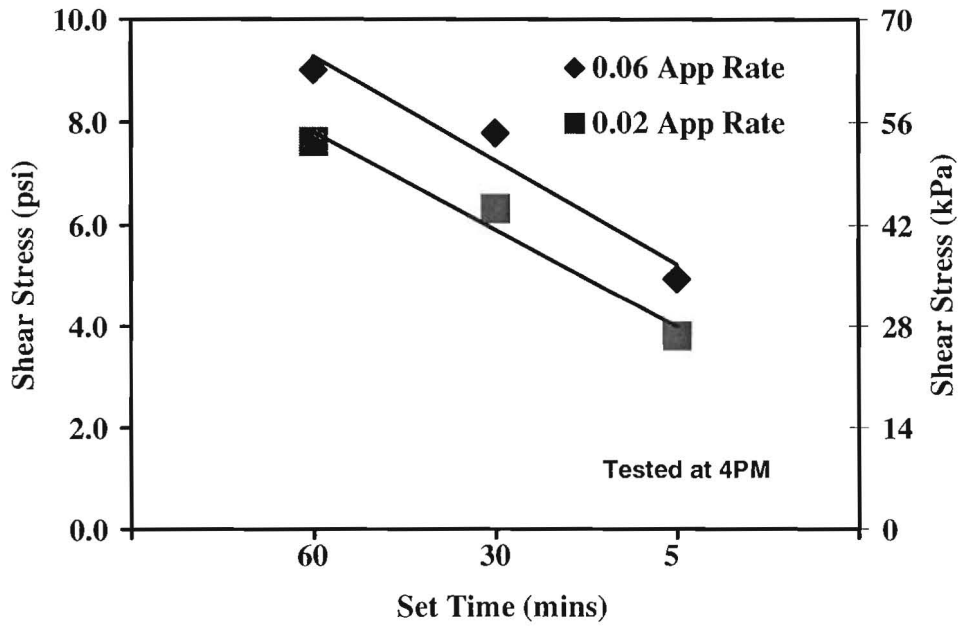

Figure 4.22 - KMC Shear Results for PG64-22 Tested at 4PM

The test results of PG64-22 tack coat are presented in Figures 4.21 and 4.22. Since the asphalt was not diluted, the test results are presented for different set times. The results indicate the strength is significantly higher than either types of emulsion. The test results also showed that at lower set times the effect of application rate was minimal. The nonlinearity of strength gain with set time observed with the ATACKER™ device is apparent with this device as well. Most likely it would be better to perform tests at intermediate test times to identify the strength gain with set time.

To see the effect of gained strength on repeatability of the device, typical results for the two tack coats is shown in Figures 4.23 and 4.24. The COV and standard deviation results for SS-1 tack coat applied at the rate of 0.02 gal/yd² (0.09 l/m²) and tested at 7:00 AM are shown in Figure 4.23. Similarly, the COV and standard deviation results for PG64-22 applied at the rate of 0.06 gal/yd² (0.27 l/m²) and tested at 4:00 PM are shown in Figure 4.24. The test results presented in Figures 4.23 and 4.24 indicate that the repeatability increased with an increase in set time. This trend was different from that observed with the ATACKER™, where the repeatability was higher at the 30 minute set time.

Based on the analysis of the data of the KMC shear device, it can be concluded that the device is repeatable and the sensitive to the tested parameters. The results also indicated that the set time, ambient temperature, and level of dilution affects the strength gained.

4.2 TENSION DEVICES TEST RESULTS

Two tension devices were identified in Chapter Two for evaluation purposes. The tests were mainly performed in the parking lot to evaluate the effect of environmental conditions. Due to poor performance in the field, the laboratory tests were not performed. In the following sections, the tension device evaluation results are presented.

4.2.1 INSTROTEK ATACKER™ TENSION

Although an experiment design was developed to perform tests similar to the previously discussed shear devices, the results of initial investigation indicated that the device is not successful. The test results are shown in Tables 4.16 and 4.17 for CSS-1h and PG64-22. Figures 4.25 and 4.26 shows the graphical representation of the test results.

The result shows that the strength of PG64-22 increased with an increase in set time and loading. The ATACKER™ Pull-Off device could not detect any strength for CSS-1-h and SS-1. This was due to the fact that the contact plate did not properly adhere to the pavement surface. The device also could not record higher strengths due to limitations of the dial gauge, as shown in Table 4.16 for PG64-22 at 4PM.

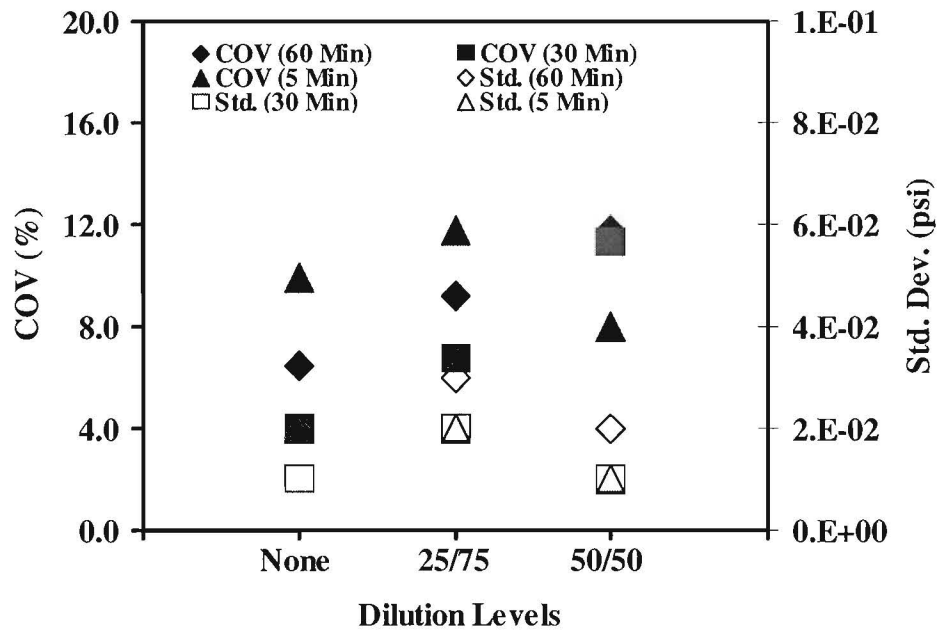

Figure 4.23 - KMC Shear Variability Results for SS-1 Tested at 7AM

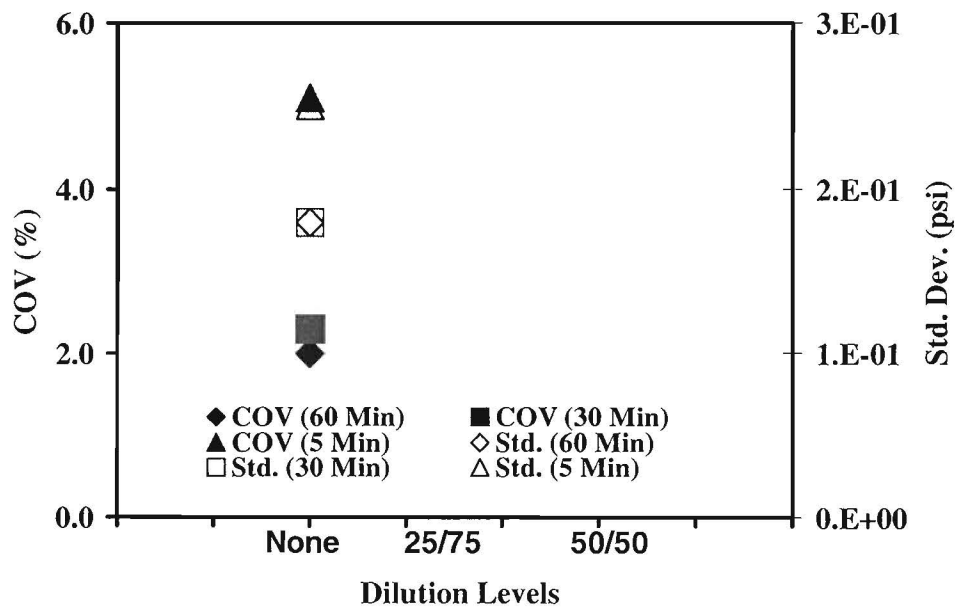

Figure 4.24 - KMC Shear Variability Results for PG64-22 Tested at 4PM

Table 4.16 – ATACKER™ Tension Parking Lot Test Results for CSS-1-h

Testing Time	Residual App. Rate gal/yd ² (l/m ²)	Dilution	Set Time, min	Average Strength. psi (kPa)	Std. Dev., psi (kPa)	COV (%)
7AM	0.06 (0.27) Ambient Temperature 56.3°F(13.5°C)	None	5	0(0)	0(0)	0(0)
			30	0(0)	0(0)	0(0)
			60	0(0)	0(0)	0(0)
		25/75	5	0(0)	0(0)	0(0)
			30	0(0)	0(0)	0(0)
			60	0(0)	0(0)	0(0)
		50/50	5	0(0)	0(0)	0(0)
			30	0(0)	0(0)	0(0)
			60	0(0)	0(0)	0(0)
	0.02 (0.09) Ambient Temperature 57.9°F(14.3°C)	None	5	0(0)	0(0)	0(0)
			30	0(0)	0(0)	0(0)
			60	0(0)	0(0)	0(0)
		25/75	5	0(0)	0(0)	0(0)
			30	0(0)	0(0)	0(0)
			60	0(0)	0(0)	0(0)
		50/50	5	0(0)	0(0)	0(0)
			30	0(0)	0(0)	0(0)
			60	0(0)	0(0)	0(0)
4PM	0.06 (0.27) Ambient Temperature 78.3°F(25.7°C)	None	5	0(0)	0(0)	0(0)
			30	0(0)	0(0)	0(0)
			60	0(0)	0(0)	0(0)
		25/75	5	0(0)	0(0)	0(0)
			30	0(0)	0(0)	0(0)
			60	0(0)	0(0)	0(0)
		50/50	5	0(0)	0(0)	0(0)
			30	0(0)	0(0)	0(0)
			60	0(0)	0(0)	0(0)
	0.02 (0.09) Ambient Temperature 78.3°F(25.7°C)	None	5	0(0)	0(0)	0(0)
			30	0(0)	0(0)	0(0)
			60	0(0)	0(0)	0(0)
		25/75	5	0(0)	0(0)	0(0)
			30	0(0)	0(0)	0(0)
			60	0(0)	0(0)	0(0)
		50/50	5	0(0)	0(0)	0(0)
			30	0(0)	0(0)	0(0)
			60	0(0)	0(0)	0(0)

Table 4.17 – ATACKER™ Tension Parking Lot Test Results for PG64-22

Testing Time	Residual App. Rate gal/yd ² (l/m ²)	Dilution	Set Time, min	Average Strength. psi (kPa)	Std. Dev., psi (kPa)	COV (%)
7AM	0.06(0.27) Ambient Temperature 56.4°F(14.6°C)	None	5	0.39(2.69)	0.03(0.21)	7.53
			30	0.44(3.03)	0.03(0.21)	6.66
			60	0.49(3.38)	0.03(0.21)	5.97
	0.02(0.09) Ambient Temperature 56.4°F(14.6°C)	None	5	0.31(2.14)	0(0)	0
			30	0.32(2.20)	0.03(0.21)	9.12
			60	0.37(2.55)	0.03(0.21)	7.87
4PM	0.06(0.27) Ambient Temperature 86.1°F(27.7°C)	None	5	>75	NA	NA
			30	>75	NA	NA
			60	>75	NA	NA
	0.02(0.09) Ambient Temperature 86.1°F(27.7°C)	None	5	>75	NA	NA
			30	>75	NA	NA
			60	>75	NA	NA

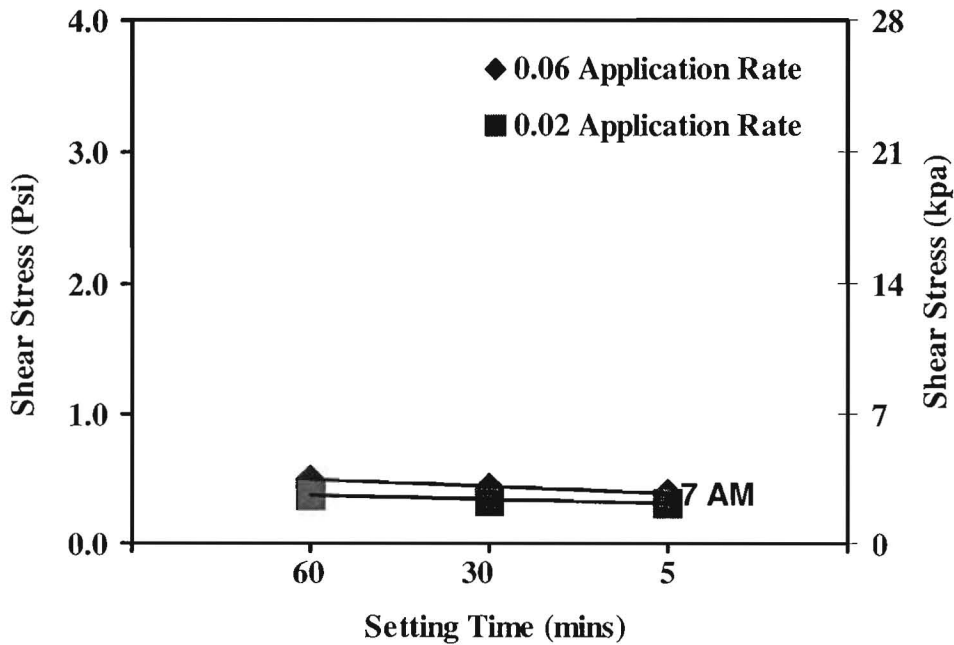

Figure 4.25 - ATACKER™ Parking Lot Test results for PG64-22 Tested at 7AM

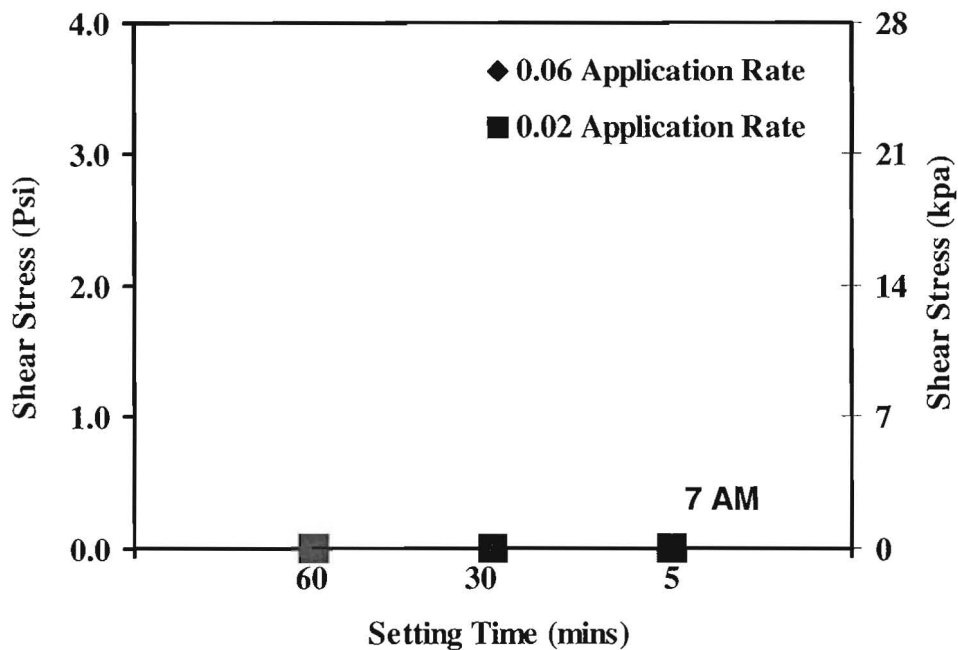

Figure 4.26 - ATACKER™ Parking Lot Test Results for CSS-1-h Tested at 7 AM

The device uses a load gauge that can detect load levels higher than 6 lbs (2.72 kg); therefore, a lesser load could not be detected with this device. For evaluation of this device only 72 tests were performed in the parking lot. Based on the results, the Instrotek ATACKER™ Pull-Off Device was not recommended for future testing.

4.2.2 ELCOMETER106 MECHANICAL ADHESION TESTER

Although an experiment design was developed to perform tests similar to the previously discussed shear devices, the tests were not performed due to the poor performance of the equipment. The tack coat was applied on the pavement surface and the dollies were attached to the pavement after allowing the tack coat to set for a specified interval of time. In the parking lot, the dollies did not attach properly to the pavement surface and showed zero strength based on the scale provided (Figure 2.29). The set time was increased to more than an hour but strength could not be measured. After waiting for 24 hours, some strength could be measured. Since the device could not measure strength within shorter time frame, the device is not recommended for further evaluation.

4.3 STATISTICAL ANALYSIS

To effectively evaluate the ability of tack quality measurement devices, an analysis of variance (ANOVA) was performed using MINITAB® 14.11. The purpose of this

ANOVA was to identify whether the devices can successfully identify the impact of changes in the test parameter. In this study, the measured strength in the field was considered to be the dependent parameter while set time, dilution levels, application rate and test time were considered to be independent parameters. Although tack coat type also affects the strength, it was decided to perform the evaluation for each parameter separately because the effects of the dilution levels were not same for all of the tack coat types. Therefore, a four factor ANOVA was performed in this study. The ANOVA analysis was only performed for shear devices because tension devices were unsuccessful in identifying the impact of parameters on measured strength.

The null hypothesis selected for the ANOVA was that the means measured with the devices are the same. In other words, the measured strength does not depend on the independent parameter. If the null hypothesis is rejected, it can be concluded that the strength is dependent on the independent parameters. Thus, the devices are able to identify the impact of dependent parameters. A confidence level of 95% was assumed for the analysis purpose. The probability factor of falsely rejecting the null hypothesis (p-value) should be less than 0.05 in order to conclude that a difference is significant, since a 95% confidence level was chosen. The null hypothesis was rejected when the p-value was less than 0.05 and was accepted when the p-value was greater than 0.05.

The results of the ANOVA analysis for the ATACKER™ shear device for three different tack coat types are shown in Tables 4.18 through 4.23. The first three tables show ANOVA results for tests performed in a parking lot while the last three tables show ANOVA results for tests performed in the laboratory. Rows Two through Five show the results of the main effects while rows Six through Sixteen show the effects of interactions. The first column shows evaluated factors and their interactions. The second column shows degree of freedom and the third column shows Sum of Squares. The fourth column shows F-statistics and the fifth column shows p-value obtained. The sixth column shows the conclusion of the ANOVA analysis. The Y in the sixth column indicates that the device is able to identify the effect of parameter changes while N in the sixth column indicates that the effect of the parameter is insignificant.

In Table 4.18, the parking lot results for SS-1 tack coat are summarized. The evaluation results indicate that there is no four-way interaction effect of the parameters evaluated. This is true for all of the three-way interactions as well. The results of two-way interactions also indicate no effect except for one case which is set time and dilution levels. In this case, the interaction effect was present indicating that the effect of dilution levels differs according to the levels of set time.

Although the interaction effect of set time and temperature is not significant, the p-value is only slightly above 0.05 indicating that it may not be safe to ignore the interaction effects. The interaction effects suggest that the strength gain significantly depends on set time and the effect of set time is significantly dependent on the dilution levels and test temperatures. All of the evaluated main effects are significant because the p-value is always below 0.05 indicating that the device is able to identify the effects of individual factors on strength gain.

Table 4.18 - ANOVA for ATACKER™ Shear Parking Lot Tests for SS-1

Source	Degree of Freedom	SS	F Stat	P Value	Statistically Significant (Y/N)
Set	2	1.268802	344.3	<0.001	Y
Temp	1	0.043601	23.66	<0.001	Y
Dilution	2	1.261413	342.29	<0.001	Y
Rate	1	0.047712	25.89	<0.001	Y
Set * Temp	2	0.002291	0.62	0.054	N
Set * Dilution	4	0.036354	4.93	<0.001	Y
Set * Rate	2	0.003957	1.07	0.347	N
Temp * Dilution	2	0.002624	0.71	0.494	N
Temp * Rate	1	0.003445	1.87	0.176	N
Dilution * Rate	2	0.001124	0.31	0.738	N
Set * Temp * Dilution	4	0.014009	1.9	0.120	N
Set * Dilution * Rate	4	0.009665	1.31	0.274	N
Temp * Dilution * Rate	2	0.000602	0.16	0.850	N
Set * Temp * Rate	2	0.000557	0.15	0.860	N
Set * Temp * Dilution * Rate	4	0.00132	0.18	0.948	N
Error	72	0.132667			
Total	107				

Table 4.19 - ANOVA for ATACKER™ Shear Parking Lot Tests for CSS-1-h

Source	Degree of Freedom	SS	F Stat	P Value	Statistically Significant (Y/N)
Set	2	1.32518	567.03	<0.001	Y
Temp	1	0.040833	34.94	<0.001	Y
Dilution	2	1.008207	431.4	<0.001	Y
Rate	1	0.171204	146.51	<0.001	Y
Set * Temp	2	0.00035	0.15	0.861	N
Set * Dilution	4	0.053815	11.51	<0.001	Y
Set * Rate	2	0.00868	3.71	0.029	Y
Temp * Dilution	2	0.000089	0.04	0.963	N
Temp * Rate	1	0.0048	4.11	0.046	Y
Dilution * Rate	2	0.00023	0.1	0.907	N
Set * Temp * Dilution	4	0.002744	0.59	0.673	N
Set * Dilution * Rate	4	0.003437	0.74	0.571	N
Temp * Dilution * Rate	2	0.002067	0.88	0.417	N
Set * Temp * Rate	2	0.000117	0.05	0.951	N
Set * Temp * Dilution * Rate	4	0.0007	0.15	0.963	N
Error	72	0.084133			
Total	107				

Table 4.20 - ANOVA for ATACKER™ Shear Parking Lot Tests for PG64-22

Source	Degree of Freedom	SS	F Stat	P Value	Statistically Significant (Y/N)
Set	2	14.1744	1111.2	<0.001	Y
Temp	1	0.204	31.99	<0.001	Y
Rate	1	0.5256	82.42	<0.001	Y
Set * Temp	2	0.0257	2.02	0.155	N
Temp * Rate	1	0.021	3.3	0.082	N
Set * Rate	2	0.1297	10.17	<0.001	Y
Set * Temp * Rate	2	0.0155	1.22	0.314	N
Error	24	0.1531			
Total	35				

Table 4.21 - ANOVA for ATACKER™ Shear Laboratory Tests for PG64-22

Source	Degree of Freedom	SS	F Stat	P Value	Statistically Significant (Y/N)
Set time	2	9.2894	276.84	<0.001	Y
Rate	1	0.245	14.6	<0.001	Y
Set time * Rate	2	0.0496	1.48	0.267	N
Error	12	0.2013			
Total	17				

Table 4.22 - ANOVA for ATACKER™ Shear Laboratory Tests for SS-1

Source	Degree of Freedom	SS	F Stat	P Value	Statistically Significant (Y/N)
Set time	2	0.90818	1325.45	<0.001	Y
Rate	1	0.20535	599.4	<0.001	Y
Dilution	2	0.53596	782.21	<0.001	Y
Set time * Rate	2	0.01043	15.23	<0.001	Y
Set time * Dilution	4	0.017	12.4	<0.001	Y
Rate * Dilution	2	0.00254	3.71	0.034	Y
Set time * Rate * Dilution	4	0.00166	1.21	0.324	N
Error	36	0.01233			
Total	53				

Table 4.23 - ANOVA for ATACKER™ Shear Laboratory Tests for CSS-1-h

Source	Degree of Freedom	SS	F Stat	P Value	Statistically Significant (Y/N)
Set time	2	1.10269	1884.35	<0.001	Y
Rate	1	0.13301	454.58	<0.001	Y
Dilution	2	0.83094	1419.96	<0.001	Y
Set time * Rate	2	0.01971	33.69	<0.001	Y
Set time * Dilution	4	0.1148	98.09	<0.001	Y
Rate * Dilution	2	0.00494	8.44	<0.001	Y
Set time * Rate * Dilution	4	0.00084	0.72	0.585	N
Error	36	0.01053			
Total	53				

The results of CSS-1h tack coat are summarized in Table 4.19 and show similar trends for three-way and four-way ANOVA indicating that interaction effects are absent. However, the two-way interactions are present in some cases and are not present in other cases. The interaction effects are not present for set time and test temperatures, and for temperature and dilution levels. However, interaction effects are present for set time and

dilution levels as well as for set time and application rates. All of the evaluated main effects are significant because the p-value is always below 0.05 indicating that the device is able to identify the effects of individual factors on strength gain.

ANOVA results for PG64-22 tack coat are summarized in Table 4.20. The test results indicate that the interaction effects are present for set time and application rate and interaction effects are not present for the remaining treatment combinations. All of the evaluated main effects are significant because the p-value is always below 0.05 indicating that the device is able to identify the effects of individual factors on strength gain.

ANOVA of laboratory test results presented in Tables 4.21 through 4.23 show similar trends for all types of tack coat. The test results suggest that interaction effects and main effects are present for all parameters. The reasons for presence of interaction effects in the laboratory and absence of interaction effects in the field (Tables 4.18 through 4.20) could be due test temperature. The laboratory temperature tests were performed at 73 °F (23 °C) while parking lot tests were performed at lower temperatures; hence, interaction effects could have been significantly influenced by changes in temperature. The results presented in Section 4.1 showed that the temperature occasionally changed significantly while at other times changed marginally. Therefore, the interaction effects were present in the parking lot but masked due to the test temperature. All of the evaluated main effects are significant because the p-value is always below 0.05 indicating that the device is able to identify the effects of individual factors on gained strength.

The ANOVA analysis indicates that the ATACKER™ shear device is capable of identifying the effect of independent parameters on measured strength and is a suitable device for further field evaluation.

The results of the ANOVA analysis for the UTEP torque shear device for three different tack coat types are shown in Tables 4.24 through 4.29. The first three tables show ANOVA results for tests performed in a parking lot while last three tables show ANOVA results for tests performed in the laboratory. The table organization is similar to that of ATACKER™ device.

In Table 4.24, the parking lot results for SS-1 tack coat are summarized. The evaluation results indicate that there is an interaction effect for all the parameters evaluated. This is true for all of the four-way interactions, three-way interactions, two-way interaction, as well as main effects. The results are different from the ATACKER™ shear device results indicating that the device is better able to discriminate between parameters in comparison to the ATACKER™ shear device.

The results of CSS-1h tack coat are summarized in Table 4.25 and show entirely different trends from the SS-1 tack coat. The evaluation results indicate that the interaction effects are absent for all of the four-way interaction and all of the three-way interactions. However, the two-way interactions are present in some cases and are absent in other cases.

Table 4.24 - ANOVA for UTEP Torque Parking Lot Tests for SS-1

Source	Degree of Freedom	SS	F Stat	P Value	Statistically Significant (Y/N)
Set	2	1.56717	1022.1	<0.001	Y
Temp	1	0.22779	297.12	<0.001	Y
Dilution	2	1.33657	871.68	<0.001	Y
Rate	1	0.26403	344.39	<0.001	Y
Set * Temp	2	0.16079	104.86	<0.001	Y
Set * Dilution	4	0.14881	48.52	<0.001	Y
Set * Rate	2	0.15862	103.45	<0.001	Y
Temp * Dilution	2	0.0068	4.44	0.0150	Y
Temp * Rate	1	0.11735	153.06	<0.001	Y
Dilution * Rate	2	0.00945	6.16	0.0030	Y
Set * Temp * Dilution	4	0.012	3.91	0.0060	Y
Set * Dilution * Rate	4	0.01325	4.32	0.0030	Y
Temp * Dilution * Rate	2	0.00552	3.6	0.0320	Y
Set * Temp * Rate	2	0.12875	83.96	<0.001	Y
Set * Temp * Dilution * Rate	4	0.01506	4.91	0.0010	Y
Error	72	0.0552			
Total	107				

Table 4.25 - ANOVA for UTEP Torque Parking Lot Tests for CSS-1-h

Source	Degree of Freedom	SS	F Stat	P Value	Statistically Significant (Y/N)
Set	2	1.592719	1248.3	<0.001	Y
Temp	1	0.0867	135.9	<0.001	Y
Dilution	2	1.467763	1150.4	<0.001	Y
Rate	1	0.059737	93.64	<0.001	Y
Set * Temp	2	0.001622	1.27	0.2870	N
Set * Dilution	4	0.153393	60.11	<0.001	Y
Set * Rate	2	0.000452	0.35	0.7030	N
Temp * Dilution	2	0.004067	3.19	0.0470	Y
Temp * Rate	1	0	0	0.0010	N
Dilution * Rate	2	0.006585	5.16	0.0080	Y
Set * Temp * Dilution	4	0.003811	1.49	0.2130	N
Set * Dilution * Rate	4	0.001593	0.62	0.6470	N
Temp * Dilution * Rate	2	0.000822	0.64	0.5280	N
Set * Temp * Rate	2	0.002467	1.93	0.1520	N
Set * Temp * Dilution * Rate	4	0.002011	0.79	0.5370	N
Error	72	0.045933			
Total	107				

Table 4.26 - ANOVA for UTEP Torque Parking Lot Tests for PG64-22

Source	Degree of Freedom	SS	F Stat	P Value	Statistically Significant (Y/N)
Set	2	8.08684	290.97	<0.001	Y
Temp	1	0.3249	21.77	<0.001	Y
Rate	1	1.64694	110.37	<0.001	Y
Set * Temp	2	0.01865	0.62	0.544	N
Temp * Rate	1	0.0256	1.72	0.203	N
Set * Rate	2	0.03127	1.05	0.366	N
Set * Temp * Rate	2	0.00362	0.12	0.886	N
Error	24	0.35813			
Total	35				

Table 4.27 ANOVA for UTEP Torque Laboratory Tests for PG64-22

Source	Degree of Freedom	SS	F Stat	P Value	Statistically Significant (Y/N)
Set time	2	6.5746	165.15	<0.001	Y
Rate	1	0.728	36.57	<0.001	Y
Set time * Rate	2	0.0587	1.47	0.268	N
Error	12	0.2389			
Total	17				

Table 4.28 - ANOVA for UTEP Torque Laboratory Tests for SS-1

Source	Degree of Freedom	SS	F Stat	P Value	Statistically Significant (Y/N)
Set time	2	2.74357	2000.49	<0.001	Y
Rate	1	0.18027	263.8	<0.001	Y
Dilution	2	1.55708	1139.33	<0.001	Y
Set time * Rate	2	0.01284	9.4	<0.001	Y
Set time * Dilution	4	0.14794	54.12	<0.001	Y
Rate * Dilution	2	0.02671	19.54	<0.001	Y
Set time * Rate * Dilution	4	0.01438	5.26	<0.001	Y
Error	36	0.0246			
Total	53				

Table 4.29 - ANOVA for UTEP Torque Laboratory Tests for CSS-1-h

Source	Degree of Freedom	SS	F Stat	P Value	Statistically Significant (Y/N)
Set time	2	3.64671	1110.05	<0.001	Y
Rate	1	0.14519	88.39	<0.001	Y
Dilution	2	1.85827	565.65	<0.001	Y
Set time * Rate	2	0.03585	10.91	<0.001	Y
Set time * Dilution	4	0.16171	24.61	<0.001	Y
Rate * Dilution	2	0.00983	2.99	0.063	N
Set time * Rate * Dilution	4	0.01417	2.16	0.094	N
Error	36	0.05913			
Total	53				

The interaction effects are not present for set time and test temperature and temperature and dilution levels. However, interaction effects are present for set time and dilution levels and set time and application rates. All of the evaluated main effects are significant because the p-value is always below 0.05 indicating that the device is able to identify the effects of individual factors on gained strength.

ANOVA results for PG64-22 tack coat are summarized in Table 4.26. The test results indicate that the interaction effects are present for set time and application rate and interaction effects are not present for the remaining interaction levels. All of the evaluated main effects are significant because the p-value is always below 0.05 indicating that the device is able to identify the effects of individual factors on gained strength.

ANOVA of laboratory test results presented in Tables 4.27 through 4.29 show similar trends for all types of tack coat. The test results suggest that interaction effects and main effects are present for all parameters. Since the laboratory tests were performed at one test time (one temperature), it can be concluded that the changes in presence or absence of interaction could be attributed to the ambient temperature difference. The laboratory temperature tests were performed at 73 °F (23 °C) while parking lot tests were performed at lower temperatures; hence, interaction effects could have been significantly influenced by changes in temperature. The results presented in Section 4.1 showed that the temperature occasionally changed significantly while at other times changed marginally. Therefore, the interaction effects were present in the parking lot but masked due to the test temperature. All of the evaluated main effects are significant because the p-value is always below 0.05 indicating that the device is able to identify the effects of individual factors on gained strength.

The ANOVA analysis indicates that the UTEP torque device is capable of identifying the effect of independent parameters on measured strength and is a suitable device for the further field evaluation.

The results of the ANOVA analysis for the KMC shear device for three different tack coat types are shown in Tables 4.30 through 4.32. Since not enough laboratory tests were conducted, the ANOVA was performed only on the parking lot test results. The table organization is similar to that of ATACKER™ device.

The evaluation results show similar trends to that of ATACKER™ shear device with very few exceptions. One exception is for the CSS-1h tested in the parking lot where the device showed the three-way interaction effect. The other exception was for the SS-1 tack coat which showed an interaction effect of test temperature and dilution levels.

In general, the ANOVA analysis indicates that the KMC shear device is capable of identifying the effect of independent parameters on measured strength and is a suitable device for the further field evaluation.

Table 4.30 - ANOVA for KMC Shear Parking Lot Tests for SS-1

Source	Degree of Freedom	SS	F Stat	P Value	Statistically Significant (Y/N)
Set	2	0.529413	672.67	<0.001	Y
Temp	1	0.023408	59.48	<0.001	Y
Dilution	2	0.55303	702.67	<0.001	Y
Rate	1	0.033779	85.84	<0.001	Y
Set * Temp	2	0.00875	11.12	<0.001	Y
Set * Dilution	4	0.020343	12.92	<0.001	Y
Set * Rate	2	0.000613	0.78	0.463	N
Temp * Dilution	2	0.003756	4.77	<0.001	Y
Temp * Rate	1	0.000579	1.47	0.229	N
Dilution * Rate	2	0.001252	1.59	0.211	N
Set * Temp * Dilution	4	0.003094	1.97	0.109	N
Set * Dilution * Rate	4	0.001298	0.82	0.514	N
Temp * Dilution * Rate	2	0.000363	0.46	0.632	N
Set * Temp * Rate	2	0.000069	0.09	0.917	N
Set * Temp * Dilution * Rate	4	0.001731	1.1	0.363	N
Error	72	0.02833			
Total	107				

Table 4.31 - ANOVA for KMC Shear Parking Lot Tests for CSS-1-h

Source	Degree of Freedom	SS	F Stat	P Value	Statistically Significant (Y/N)
Set	2	0.58218	514.53	<0.001	Y
Temp	1	0.177633	313.98	<0.001	Y
Dilution	2	0.739224	653.32	<0.001	Y
Rate	1	0.073633	130.15	<0.001	Y
Set * Temp	2	0.004006	3.54	<0.001	Y
Set * Dilution	4	0.067576	29.86	<0.001	Y
Set * Rate	2	0.001717	1.52	0.226	N
Temp * Dilution	2	0.045706	40.39	<0.001	Y
Temp * Rate	1	0.002315	4.09	<0.001	Y
Dilution * Rate	2	0.000439	0.39	0.680	N
Set * Temp * Dilution	4	0.007806	3.45	<0.001	Y
Set * Dilution * Rate	4	0.001661	0.73	0.572	N
Temp * Dilution * Rate	2	0.000402	0.36	0.702	N
Set * Temp * Rate	2	0.004913	4.34	<0.001	Y
Set * Temp * Dilution * Rate	4	0.001587	0.7	0.594	N
Error	72	0.040733			
Total	107				

Table 4.32 - ANOVA for KMC Shear Parking Lot Tests for PG64-22

Source	Degree of Freedom	SS	F Stat	P Value	Statistically Significant (Y/N)
Set	2	86.1842	667.26	<0.001	Y
Temp	1	9.8282	152.19	<0.001	Y
Rate	1	10.7038	165.74	<0.001	Y
Set * Temp	2	0.4101	3.17	0.060	N
Temp * Rate	1	0.0971	1.5	0.232	N
Set * Rate	2	0.0748	0.58	0.568	N
Set * Temp * Rate	2	0.2783	2.15	0.138	N
Error	24	1.5499			
Total	35				

To compare the precision of evaluated devices, the residual sum of squares obtained from ANOVA were utilized (Table 4.33). The residual sum of squares are denoted as “Error” in the ANOVA tables and reported in the second to last row, third column. The results indicate that the equipment repeatability is site as well as tack coat type dependent. In the field, KMC is most repeatable in the field for tack coat types SS-1 and CSS-1h and is least repeatable for PG64-22. The ATACKER™ is least repeatable for CSS-1h and SS-1; however, it is most repeatable for PG64-22. The repeatability of the UTEP torque device is in between the two devices for all three tack coat types. In the laboratory, the ATACKER™ device showed higher repeatability for all three tack coat types in comparison to UTEP torque device. Thus, the devices repeatability is site and tack coat type dependent in the field; however, similar trend is not observed in the laboratory data.

4.4 DISCUSSION

The Instrotek ATACKER™ shear device, KMC shear device and UTEP torque device used for the testing were able to differentiate between the evaluated parameter with respect to their shear strengths. From the results of the three devices PG64-22 gave the highest value for the shear strength. The SS-1 and CSS-1h tack coats behaved in a very similar way, but under close comparison CSS-1h showed higher strength.

The results showed that there is an effect on the shear strength due to the dilution of the tack coat. PG64-22 was not diluted and was used as original. SS-1 and CSS-1h were diluted in three levels. No dilution gave higher shear strength values than the 75% dilution and the 50% dilution. In all the results 50% dilution gave the least strength.

Table 4.33 - Comparison of Three Devices Based on Residual Sum of Squares

Test Location	Tack Coat Type	Residual Sum of Squares		
		ATACKER™	UTEP	KMC
Field	SS-1	0.13267	0.0552	0.02833
	CSS-1h	0.08413	0.04593	0.040733
	PG64-22	0.1531	0.35813	1.5499
Laboratory	SS-1	0.01233	0.0246	-----
	CSS-1h	0.01053	0.05913	-----
	PG64-22	0.2013	0.2389	-----

The setting time also played an important role on measured shear strength. The tack coats showed an increase in strength with increases in the setting time. The 60 minutes set time gave the highest strength and 5 minutes set time gave the least strength.

The tack coats also showed an increase in their strength with an increase in the application rate. An application rate of 0.1gal/yd² (0.45 l/m²) gave higher values than 0.04 gal/yd² (0.18 l/m²). The tack coats with 5 minutes set time did not show a significant increase in their strength with the increase in application rate, but with 60 minutes and 30 minutes set time, strength showed a considerable change.

The temperature had a major effect on the tack coat bond strength. The tack coats gave higher strength when tested in the afternoon (when the temperature was high) than when tested in the morning (when the temperature was low).

The repeatability of the devices increased with temperature, application rate, set time and decreased with the increase in the dilution levels.

The KMC shear device gave very high repeatable values. This device was useful in determining the bond strength. During testing with KMC shear device, the load could not be kept on the test plates while shearing the plates, hence more modification is necessary. Although the device is quite repeatable, the cost of the device is also very high so it was not recommended for field-testing of the tack coat.

Instrotek ATACKER™ shear device also proved to be highly repeatable. No modification was necessary and was also recommended for field-testing of tack coat.

The results obtained from the UTEP torque device were also very highly repeatable. No modifications were required but it can be modified if necessary. This device was recommended for field-testing.

The Elcometer adhesion tester and ATACKER™ tension devices are not recommended for field testing due to the fact that they are not capable of consistently identifying the quality of applied tack coat.

CHAPTER 5

FIELD EVALUATION OF SELECTED DEVICE FOR PHASE I TESTING

Although testing was performed in the parking lot that represents field conditions, the parking lot testing does not necessarily simulate field variability. For example, the tack coat application rate is accurately applied in the laboratory or parking lot while tack coat application rate varies in the field. To make sure that the tack coat does not run off, a leveled surface in the parking lot was selected while the surface may not be leveled in the field. Therefore, the ATACKER™ and UTEP Torque test setup were evaluated in the field. Two paving sites within the El Paso district were selected and the results of the evaluation are presented in the following sections.

5.1 SELECTED SITES

The first site evaluated was East & West Bound Montana east of Loop 375 in El Paso (Figure 5.1 and 5.2). The existing Type C surface layer was milled and CSS-1h was applied with a dilution level of 25/75. The tack coat was applied at an average residual application rate of 0.04 to 0.1 gal/yd² (0.18 to 0.45 l/m²) and Type C material was placed on top of the milled surface. The ambient temperature on the site was determined to be approximately 80 °F (26.6°C). The testing on East and West Bound Montana was performed in May 2003 and on separate days because of construction scheduling.

The second site evaluated was West Bound Alameda (Texas 20) at Reynolds (Figure 5.3). The existing Type C surface layer was also milled on the site and CSS-1h was applied with a dilution level of 25/75. The tack coat was applied at an average residual application rate of 0.04 to 0.1 gal/yd² (0.18 to 0.45 l/m²) and Type D mix was placed on top of the milled surface. The ambient temperature on the site was determined to be approximately 75 °F (23.8 °C) and it was a cloudy day. The testing was performed in May 2003 as well.



Figure 5.1 - Montana East Bound (East of Loop 375)



Figure 5.2 - Montana West Bound (East of Loop 375)



Figure 5.3 - Alameda at Reynolds West Bound

5.2 TEST RESULTS

The test results from two sites and test devices are presented in Table 5.1. The applied tack coat was also collected and the tests were performed in the laboratory and the results are also reported in Table 5.1. The tests were performed in triplicates at each site and in the laboratory, and the results are reported are based on the average values. The results from the East Bound were highly variable due to improper adhesion of contact plate to the surface; therefore, have not been included in the test results. The reported results are based on 30 minutes set time.

The test results shows trends similar to the ones presented in Chapter Four, i.e., the laboratory strengths (0.71) are higher than field (0.31). In addition, the laboratory measured strength with UTEP Torque device is lower than the ATACKERTM; however, the results presented in Chapter Four showed opposite trends, i.e., UTEP Torque device estimated higher strength. The average shear strength measured with UTEP torque device showed similar strength at both sites; however, the average shear strength measured with ATACKERTM varied from site to site even though same tack coat type was used. The results indicate that the ATACKERTM measurements are site dependent. The UTEP torque device indicated that the test setup has a higher variability in the field because of surface unevenness. In addition, both devices had shortcomings (discussed in Section 5.3) and made them unsuitable for field application. Therefore, none of the devices are recommended for field application.

Table 5.1 – Field Evaluation of ATACKER™ and UTEP Devices

Device		SITE	
		MONTANA	ALAMEDA
ATACKER™	Average Field Strength, psi (kPa)	0.31 (2.1)	0.54 (3.7)
	Average Laboratory Strength, psi (kPa)	0.71 (4.9)	0.71 (4.9)
UTEP	Average Field Strength, psi (kPa)	0.31 (2.1)	0.33 (2.3)
	Average Laboratory Strength, psi (kPa)	0.53 (3.7)	0.53 (3.7)
	Field Temperature	80°F (26.6°C)	75°F (23.8°C)
	Lab Temperature	73°F (23°C)	73°F (23°C)

5.3 SHORTCOMINGS OF TEST SET-UPS

Although tests were performed and the data collected indicated that the testing can be performed in the field, the field tests performed had several problems. In addition, the comparison between field and parking lot test results identified some fundamental problems with shear measuring devices and each one of them are discussed in the following paragraphs.

One of the problems identified with the UTEP Torque test was that the weights placed on top of the aluminum test plates needed to be recessed so as to fit the torque wrench properly. Since surface was uneven, the load plates moved while testing and minimized the contact. This problem was prevalent in the testing of East Bound Montana. Although the load plates were recessed for Alameda testing, the problem persisted.

Instrotek ATACKER™ also had the problem with the contact plates; however, the problem was different. The ATACKER™ device had a problem of leveling because of uneven and sloped surface. A significant amount of time was spent in leveling the unit, such that the contact test plate is parallel to the tack-coated surface.

In addition to the equipment problems, there were some fundamental problems with the selected test setups. One of the identified problems was that the test has to be performed earlier than 60 minutes because of construction issues. Typically, contractors spray tack coat and starts paving operation as soon as tack coat breaks which is less than 60 minutes. Since the test takes 12 minutes of load application, the paving operation can begin at a minimum of 72 hours after application of tack coat. A preliminary investigation to identify feasibility of performing tests at shorter testing time could not provide consistent results.

Another issue identified after comparing the test results was the mode of testing. The test setup applies torque to measure shear strength; however, shear strength obtained will depend on both the quality of tack coat and surface roughness. This was evident from the field data shown in Table 5.1. The ATACKER™ estimated higher strength of tack coat at Alameda in comparison to the Montana even though same quality of the tack coat applied (the laboratory test results of both tack coats are the same).

Based on the discussion presented, it seems that the developed devices are unsuitable for field application. Therefore, new devices were developed to identify tack coat quality. The new devices were developed based on lessons learned from the field tests. The new device should be able to perform tests in the field for less than 60 minutes. The equipment should also have better way of leveling in the field to minimize the testing time. In addition, the equipment should be able to minimize or eliminate influence of surface friction. The developed new device and theory behind the development is presented in the next Chapter.

CHAPTER 6

DEVELOPMENT OF A TACK COAT DEVICE

The initial focus of the research was to evaluate the existing devices rather than developing a new device. However, the results of field evaluation indicated that the existing devices are not able to consistently identify the quality of applied tack coat. Therefore, a new device was developed based on the lessons learned with the evaluation of existing equipments. The theoretical background and the development of the new equipment are presented in the following sections.

6.1 INTERFACE SHEAR STRENGTH

The purpose of tack coat is to minimize the slippage between the two layers due to applied horizontal loads due to vehicular movement. Since the slippage between the two surfaces occurs because of shear, most of the research (Chapter Two) has focused on measuring the shear strength. However, the shear strength between the two layers not only depends on strength of the tack coat but also depends on the friction provided by the material of two layers. In other words, the AC layer, consisting of the coarse mix placed on the AC layer which consists of coarse mix, may have different strength in comparison to fine mix placed on fine mix even though the same quality of tack coat is applied in both cases. Therefore, the shear resistance against slippage is provided by the quality of tack coat as well as the frictional resistance offered by the two surfaces. If the objective of the test is to identify bond strength between the two layers, then Koch Materials Company equipment would be an ideal system to measure strength. However, the objective of this study was to identify the quality of the tack coat and not to estimate the shear strength of the interface. Therefore, it is essential that the tests should be performed such that the friction component can be eliminated from the measurements.

In geotechnical engineering, a direct shear (DS) device is commonly used for the measurements of shear strength of the soil. The tests are typically performed by varying the normal stress, and Mohr-Coulomb failure criterion is used to obtain shear strength (ASTM D3080). For each increment of normal stress, the peak shear strength is recorded and a plot similar to the one shown in Figure 6.1 is developed. The normal stresses (σ)

are plotted on the x-axis and the corresponding maximum shear strength (τ) is plotted on the y-axis. To identify relationship between shear and normal stress, a best fit line is generated. The τ -intercept of the best fit line is termed as cohesive strength of soil 'c', and the slope of the line is termed as the friction angle ' ϕ '.

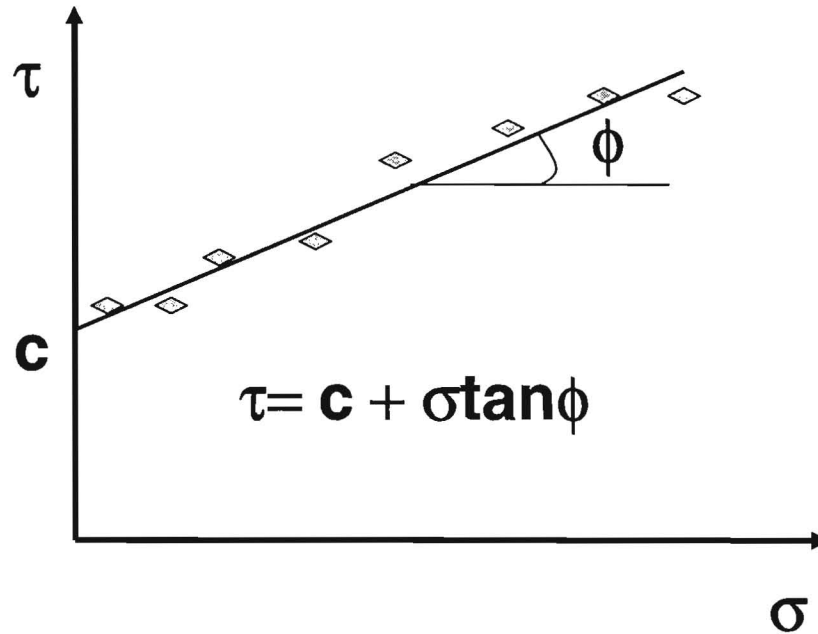

Figure 6.1 - Results from a Series of Direct Shear Tests

An increase in normal stress increases the shear strength, as shown in Figure 6.1. To identify the cohesion as well as frictional resistance component of the shear strength, the following equation is used:

$$\tau = c + \sigma \tan \phi \quad (6.1)$$

where τ is the shear strength, c is cohesion, σ is normal stresses and ϕ is the angle of friction. In the case of tack coat testing, the c value is the cohesive strength of applied tack and $\tan \phi$ is the frictional resistance offered by the two layers. A test performed in this manner could provide information about the quality of the tack coat as well as frictional strength offered by different mix types. However, this test would need longer testing time and would not be a practical field test because cores have to be brought back to the laboratory for testing.

To perform tests in the field, a possibility could be that a pull off test is performed rather than shear strength. The advantage of the pull off test would be that the effect of frictional component is not included. The basic assumption is that the tensile strength measured from the pull-off tests is similar to the cohesive strength expected to be

provided by the tack coat. However, the tension devices evaluated in Chapter Four did not provide any promising results.

The major problem with the Elcometer106 device was that the equipment was not sensitive to the low levels of strength provided by tack coat because the equipment was developed for the paint industry. The problem with the ATACKER™ was that the contact plate was not properly adhered to the pavement surface because of surface roughness. The other problem with this device was that it required leveling efforts to make sure that the contact plate is near parallel to the pavement surface. The third problem was the sensitivity of the dial gauge to the loads. The range of the dial gauge is 6 to 60 lbs and any measurements above and below this range could not be effectively measured.

It is possible that a pull-off device can be developed that provides better contact, can be leveled quickly, and is sensitive to the levels of strength provided by commonly used tack coat types. The measured tensile strength can then be compared to cohesive strength measured from direct shear test to make sure that the representative strength is measured with the pull-off tests. The development of the new shear device and pull-off device is presented in the following sections.

6.2 UTEP DIRECT SHEAR DEVICE

Rather than developing a new system, it was decided to modify the existing system commonly used by geotechnical engineers. The test setup developed by Soil Tests, Inc. was modified for this study and the modified test setup is shown in Figure 6.2.

The modifications include: replacement of load and deformation measuring dial gauges with load cell and linear variable differential transformer (LVDT), specimen holding mold, and a data acquisition system. The horizontal shearing load and vertical load application system was not changed. To measure the applied horizontal load, load cells manufactured by Futek, Inc. were utilized. Three different load cell types were used in this study 0-50 lbs (0-23 kg), 0-300 lbs (136 kg) and 0-1000 lbs (454 kg). The reason for selection of such a range was that the measured strength varied depending on the material uses as explained in the experiment design section of this chapter. A LVDT (model no Schaevitz MP-2000) was used to measure horizontal deformations.

The shear box developed is made of aluminum and has a bottom plate 2 in. (50.8mm) thick and an upper plate 3 in. (76.2mm) thick. It has the capability to test 4 in. (101.6mm) and 6 in. (152.4mm) diameter asphalt specimens. Figure 6.3 shows shear box developed in the laboratory.

Four leveling screws are placed on the corners of the upper plate of the shear box to provide a gap between the shearing plates. Circular solid aluminum cylinders of 4 in. (101.6mm) diameter are used for testing. The cylinders are machined smoothly to provide a frictionless surface.

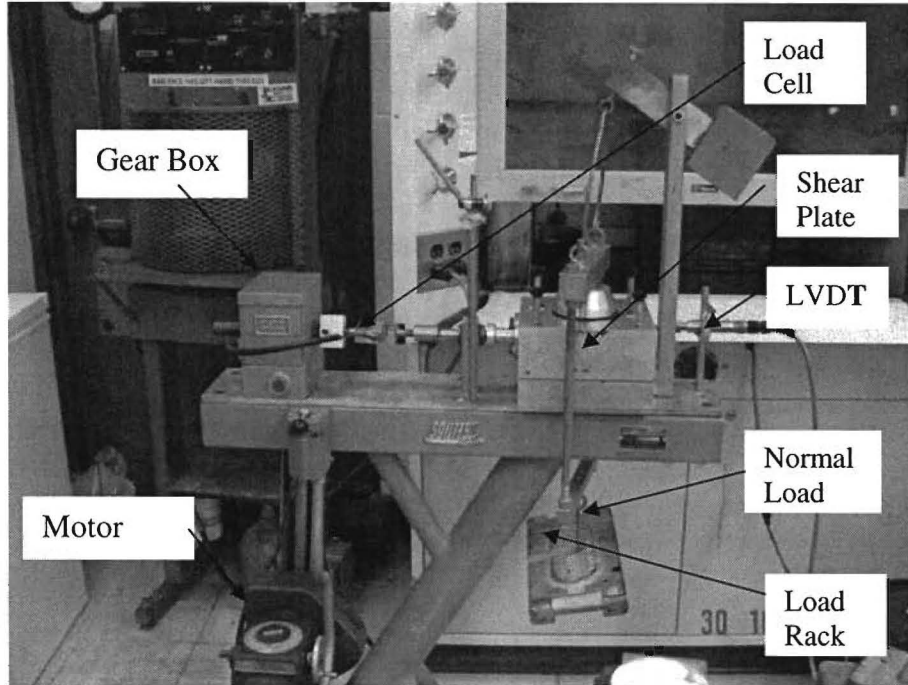

Figure 6.2 - UTEP Direct Shear Test Set-Up

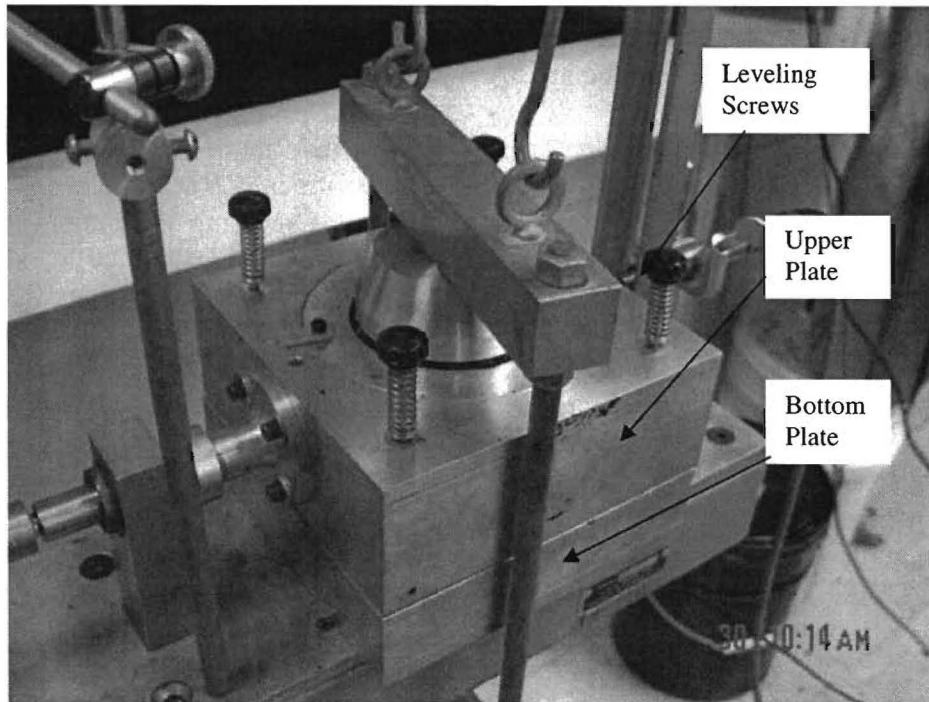

Figure 6.3 - Shear Box for the UTEP Direct Shear Apparatus

The data from LVDT and load cell is acquired through a data acquisition system (Figure 6.4). The data acquisition system consists of a computer, a LVDT breaker box, a load cell box, a cable, and a (NI DAQ A1-16E-4) data acquisition card with sampling speed of 250ksamples/sec. The data is acquired using Bench Logger version 2.1.1 software. The acquired data is then imported in an Excel sheet for further analysis and identification of peak failure shear strength.

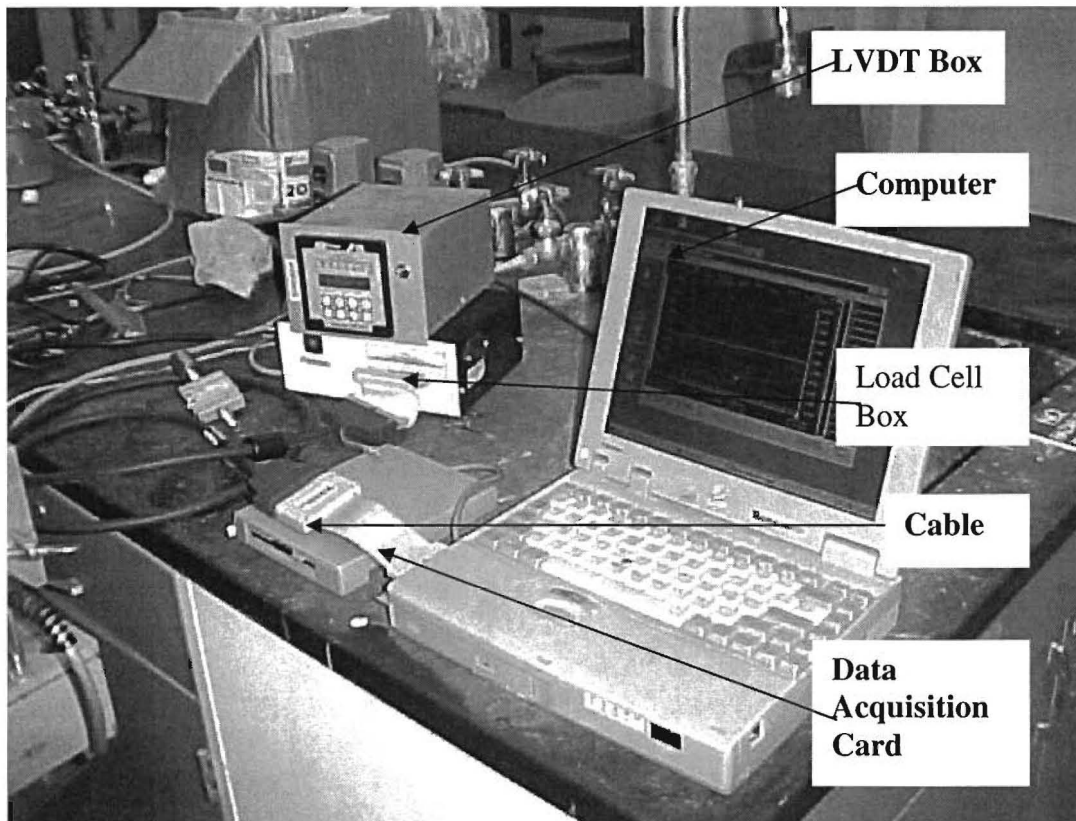

Figure 6.4 - Data Acquisition System for Direct Shear Test Set-Up

To perform test, the prepared specimens are placed inside the mold and the screws are removed. A desired normal vertical load is placed on top of the load rack, which in turn applied normal load to the specimen. The LVDT and load cells are connected to the data acquisition system and zeroed to make sure that the initial readings are zero. To perform the test, a horizontal load at a constant rate (0.05 in./min [1.27mm/min]) is applied in the horizontal direction using gear box, as shown in Figure 6.2. The load and movement of the top box (from LVDT) is recorded with the help of the software. The load cell and LVDT readings are converted and analyzed to get shear strength using Excel.

6.3 TENSION DEVICES

Two pull-off devices have been developed at UTEP to measure the tensile strength. The main difference between the two devices was the method utilized for strength measurement method. Both devices can be used in the field as well as in the laboratory and the developed test setups are discussed in the following sections.

6.3.1 UTEP PULL-OFF DEVICE (UPOD)

This device has been fabricated at UTEP based on Pull-off mechanism and can be used to determine the adhesive properties of tack coat. The developed system is presented in Figures 6.5 through 6.8.

The instrument weighs about 23 lb (10.4kg) and levels itself with the help of pivoting feet (Figure 6.5). It has a weight key on the top, which provides stability while placement of loads. A 3/8th inch nut fits a 3/8th inch drive torque wrench, which is used to pull the plate up from the tack-coated surface, as shown in Figure 6.6. A contact plate that can conform to the rough pavement surface is developed, as shown in Figure 6.7.

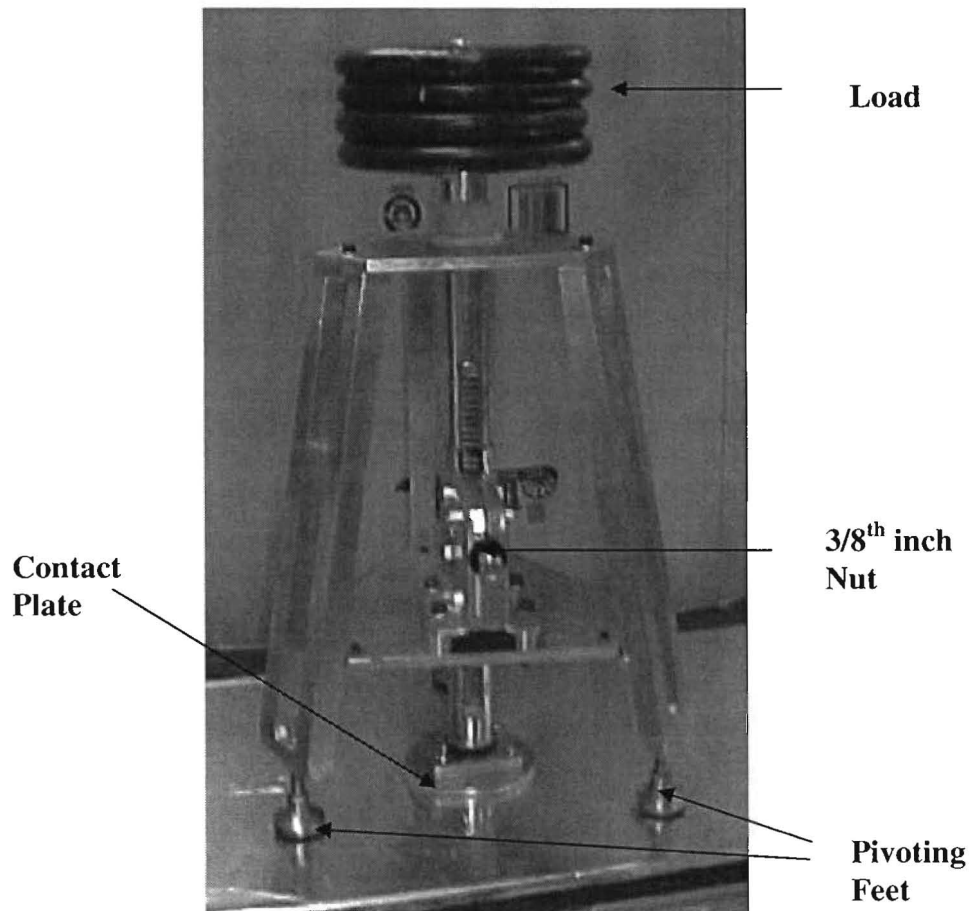

Figure 6.5 - UTEP Pull-off Device Test Set-Up

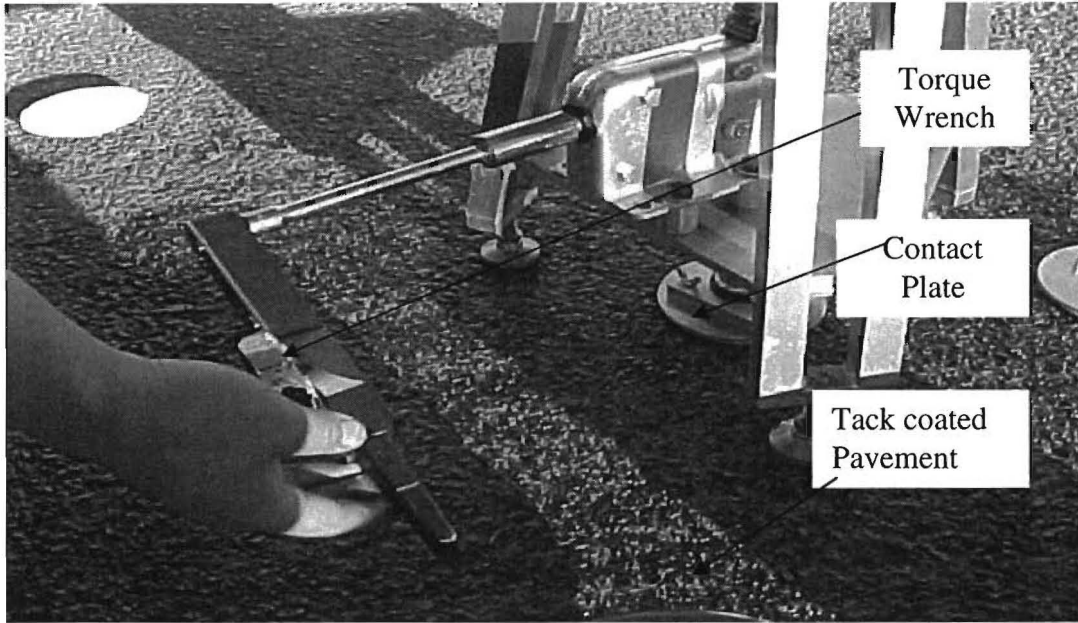

Figure 6.6 - Torque Wrench used during UPOD Testing

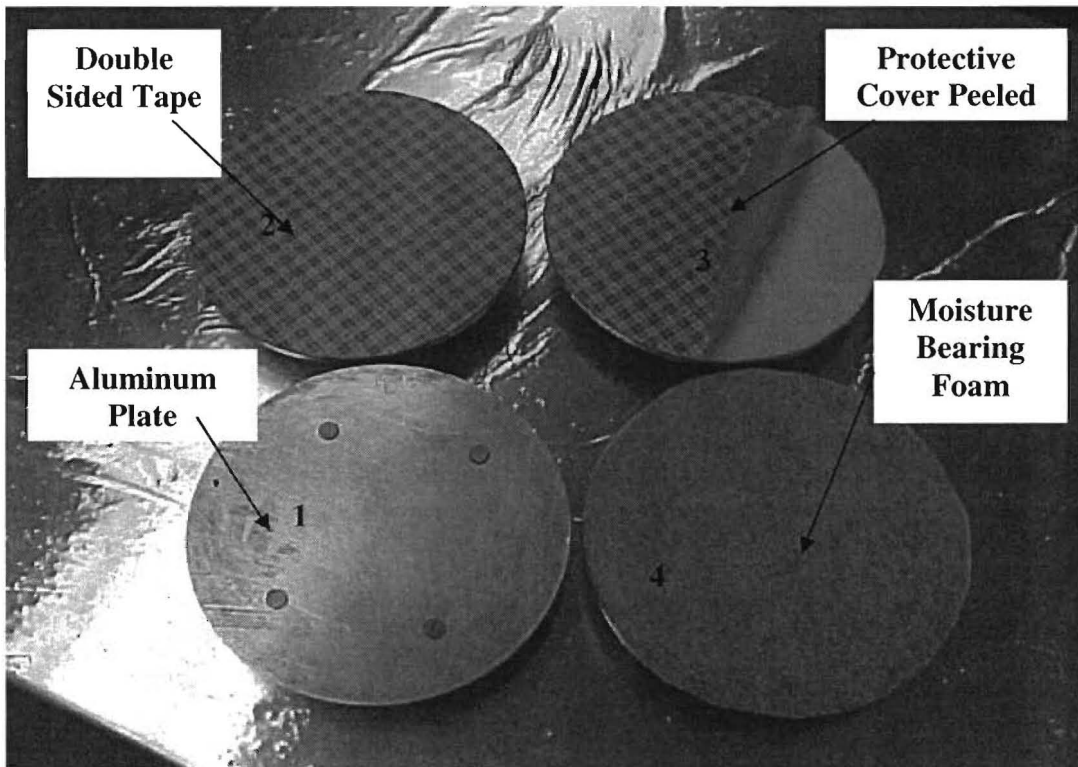

Figure 6.7 - Contact Test Plates for UPOD

In addition, two aluminum plates were fabricated for laboratory testing. One of the plates is a thick solid plate with the dimensions of 16.5(419) by 14.5(368) by 0.25(6.35) in. (mm). The other plate is a thin plate with the dimensions of 15.5(393.7) by 12(305) by

0.031(0.787) in. (mm) and has a hole of 5 inches diameter in the center. The plate with the hole in center is placed on top of the solid plate. This allows the placement of tack coat in the circular area, as shown in Figure 6.8.

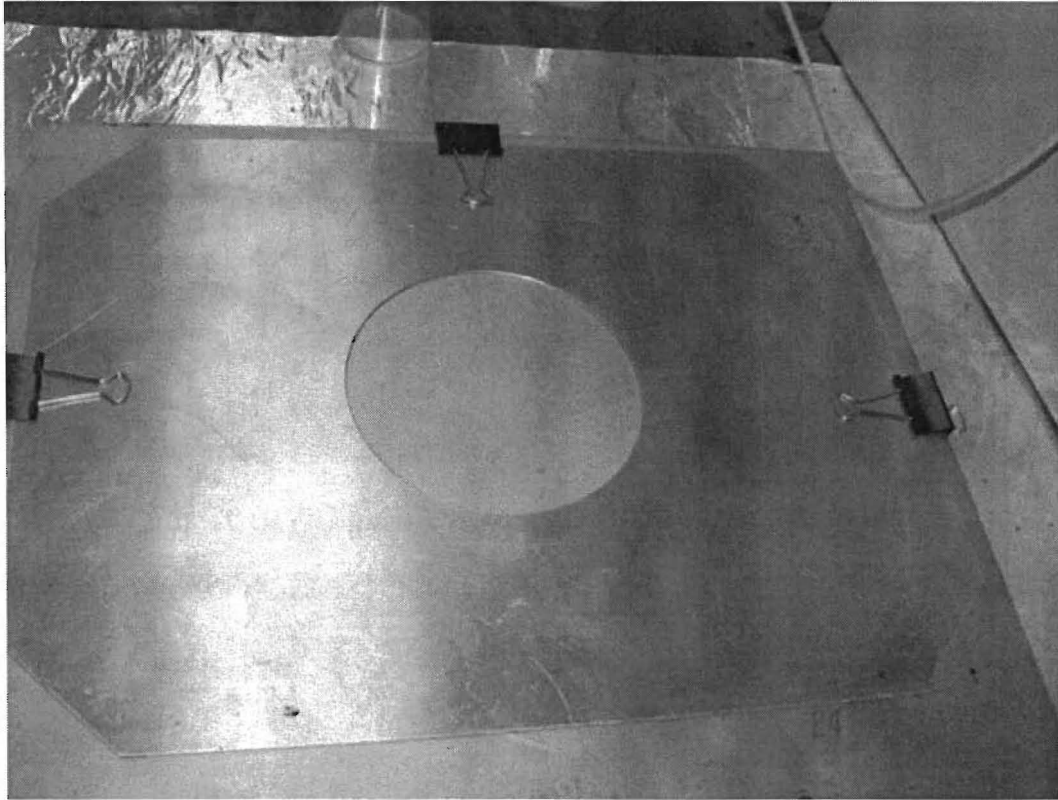

Figure 6.8 - Base Plates for UPOD Laboratory Testing

A 6-150 in.-lb torque wrench is used for measuring pull-off torque that can be converted into pull-off strength. The torque wrench is calibrated in the laboratory for various loadings. The readings recorded in the torque wrench are then related to the normal load required to break the plate from the tack-coated surface. Since the range of the torque wrench is 6-150 in.-lb, the obtained results are subtracted by the value 6 in.-lb to get the corrected reading.

The device consists of a 5-in. (127mm) diameter aluminum contact test plate. Double-sided adhesive tape was first used on the contact plate to adhere properly on the tack surface before testing, but it did not work as it gave very high strength values. In another attempt, a piece of foam was attached to the plates with help of epoxy, but this plan also failed due to the difficulty in cleaning of plates. Finally a 5 in² 3M double-sided tape is used and attached to the aluminum contact plate and 5 in² moisture bearing foam is placed over the tape (Figure 6.7). The advantage of the moisture bearing foam is that it can be easily peeled off the double sided tape and four to five tests can be performed before the adhesive layer (double sided tape) needs replacement. Figure 6.7 shows the 5 in. aluminum contact test plate and placement of adhesive layer as well as moisture bearing foam.

The device consists of three gears namely a worm, a worm gear, (also acts as a pinion) and a rack arrangement. The worm and the worm gear are used to transfer the force that is being applied in the form of a hand cranking (torque) in horizontal direction to the rotational force, as shown in Figure 6.9.

The worm gear also acts as a pinion for the pinion and rack gear that is attached to the vertical shaft through which the load is being applied to the tack coat. The pinion then transfers the rotational force to the rack that moves vertically. The rack contains a horizontal base through which the force is being applied to the tack coat in order to form a good adhesion with the surface. The main purpose of the gear arrangement is to change the direction of the force that is being applied from one end to the other where it needs to be transmitted. Hence there is no change in the force (though, a small amount of force is lost due to the frictional forces between the mating gears, which is negligible) involved during this change of direction of the force.

The gear system allows the application of load to the surface, or pull-off load from the surface depending on the direction of torque wrench movement. If the torque is applied in the clockwise direction to the worm, the worm transmits the force to the worm gear during which the direction of force changes from horizontal to rotational. The pinion and the rack arrangement of gears change the force in the pinion from the rotational direction to the downward direction. Thus, a load is applied to the tack coat. If the torque is applied in the anticlockwise direction, the force pulls the contact plate in the upward direction until the tack coat is separated from the surface. The torque in the gauge is noted in in.-lb and the load required to pull the tack coat from the surface (adhesiveness of the tack coat) is estimated using calibration factor.

The UPOD test procedure is simple. After the tack coat is applied on the pavement, it is allowed to set for a specified time. After waiting for the set time, the UPOD is placed on the tack-coated surface. The torque wrench is rotated clockwise until the contact plate is firmly set on the tack-coated pavement. The loads are placed on the load rack (at the top of the device) for ten minutes prior to testing. The loads are then removed and the torque wrench is rotated in the counter clockwise direction to detach the contact plate from the tack-coated pavement. The torque (T) required to detach the contact plate from the tack coated pavement is recorded in in.-pound. The torque (T) is then converted to the load using a calibration factor. The calibration factor is obtained by placement of loads in uniform increments (Figure 6.10) on the contact plate and torque required to pull the plate is recorded for each load increment. The relationship between the torque and load is developed by fitting a straight line through the data points. For the equipment used in this study, the following calibration factor was obtained:

$$F = 0.6571 * T \quad (6.2)$$

where T is torque in in.-lb and F is load in lbs. For this equipment, theoretically the load should be 0.8 times the torque and the difference could be attributed to the friction or loss of forces during transmission through gears.

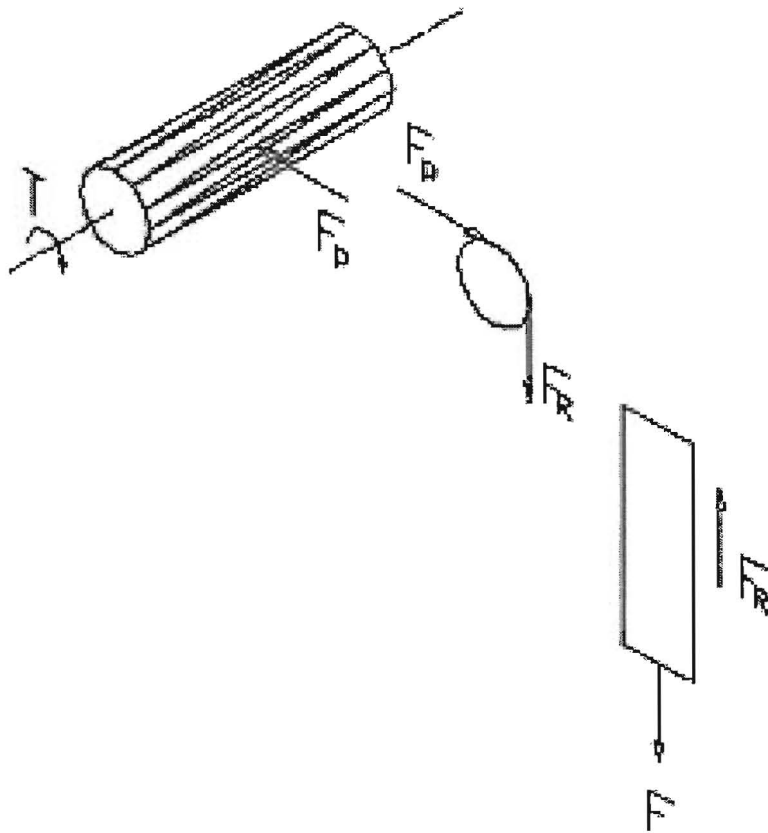

Figure 6.9 -Transmission of Forces in UPOD

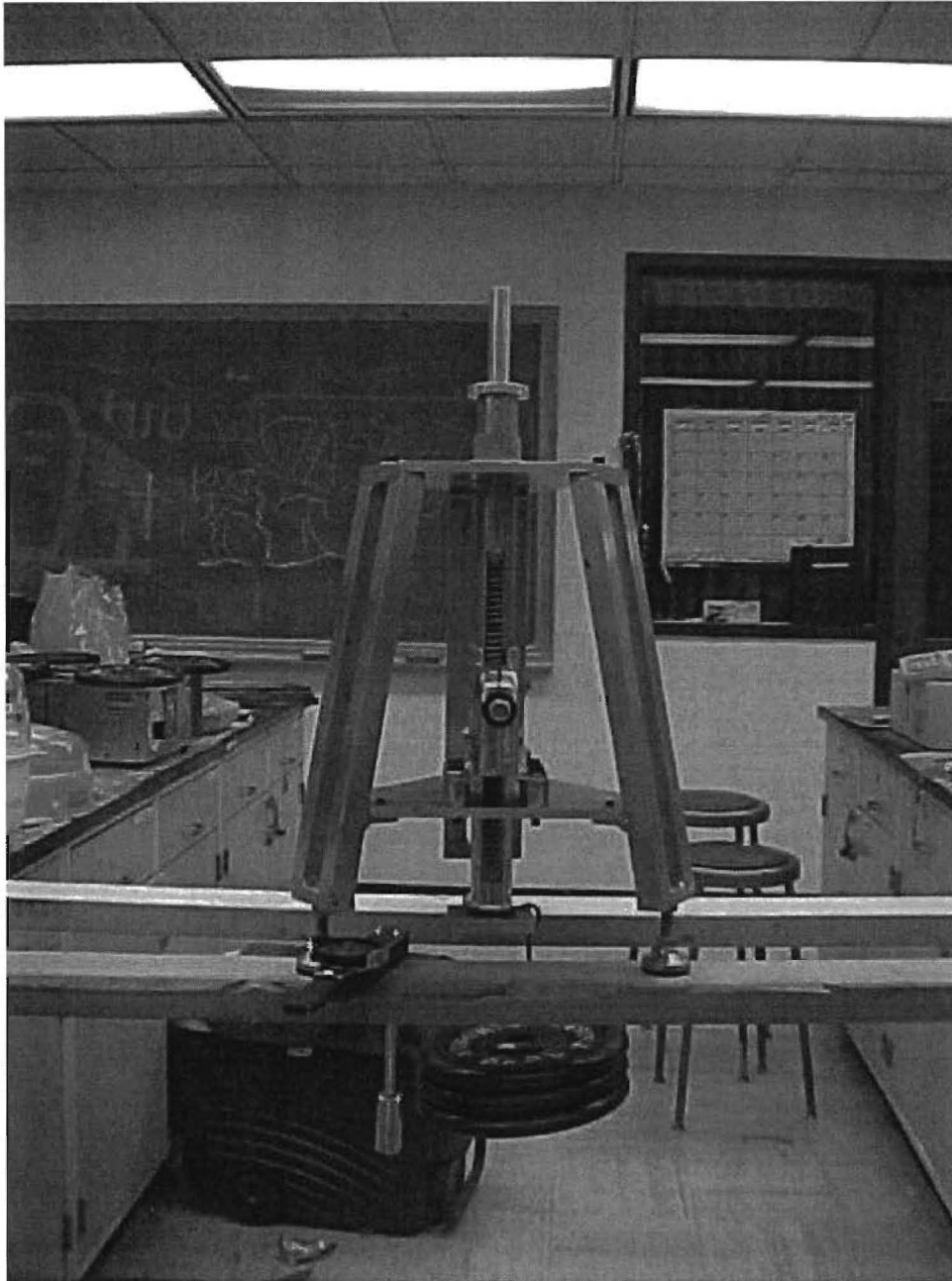

Figure 6.10 - Calibration of UPOD

6.3.2 SIMPLE PULL-OFF DEVICE (SPOD)

The main reason for the development of a simple pull-off device (SPOD) was to develop a device that is cheap and requires minimum training to perform the test. The contact plate concept developed for UPOD was utilized in this device as well. However, rather than torque application, the pull-off strength is measured using a load dial gauge. The setup of this device is very simple and handy, as shown in Figure 6.11.

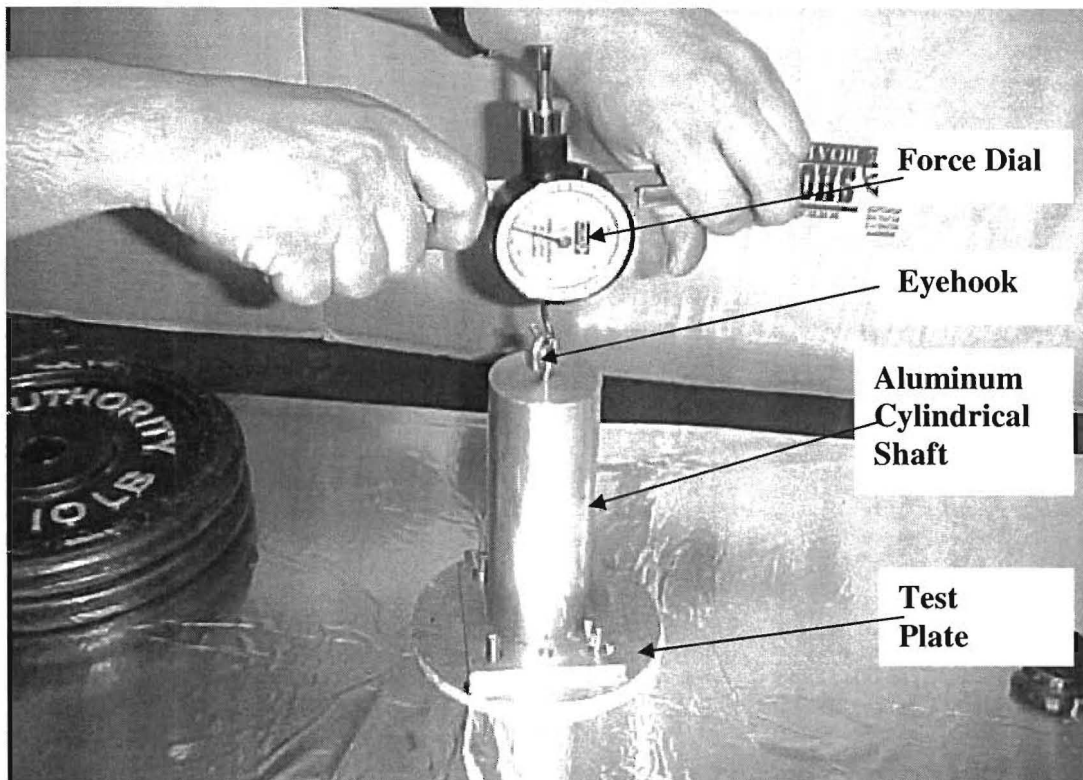

Figure 6.11 - Simple Pull-off Test Set-Up

The device consists of a 2-in. (50.8mm) solid aluminum cylindrical shaft with a bottom plate, which is attached to the contact test plate with $\frac{1}{4}$ -20 wing nuts. On top of the cylinder there is an eyehook where a (6 - 60 lb [2.7 - 27]) force dial is attached. The force dial has handles on either side, which helps in increasing the stability while pulling off the contact plate. Figure 6.12 shows the force dial used in the setup. The results obtained from the force dial are subtracted by a value of 6 lbs (2.7 kg) since the lowest range of the dial is 6 lbs (2.7 kg).

The loads can be applied on the aluminum cylindrical shaft for a period of loading time before testing is performed. Circular weights of 10 lbs (4.5 kg) each are kept on the shaft for loading. Figure 6.13 shows the loading arrangement. The reading recorded by the dial gauge gives the load required to pull off the contact plate from the tack-coated surface. The tensile strength of the bond is then calculated from the relationship proposed in the next section.

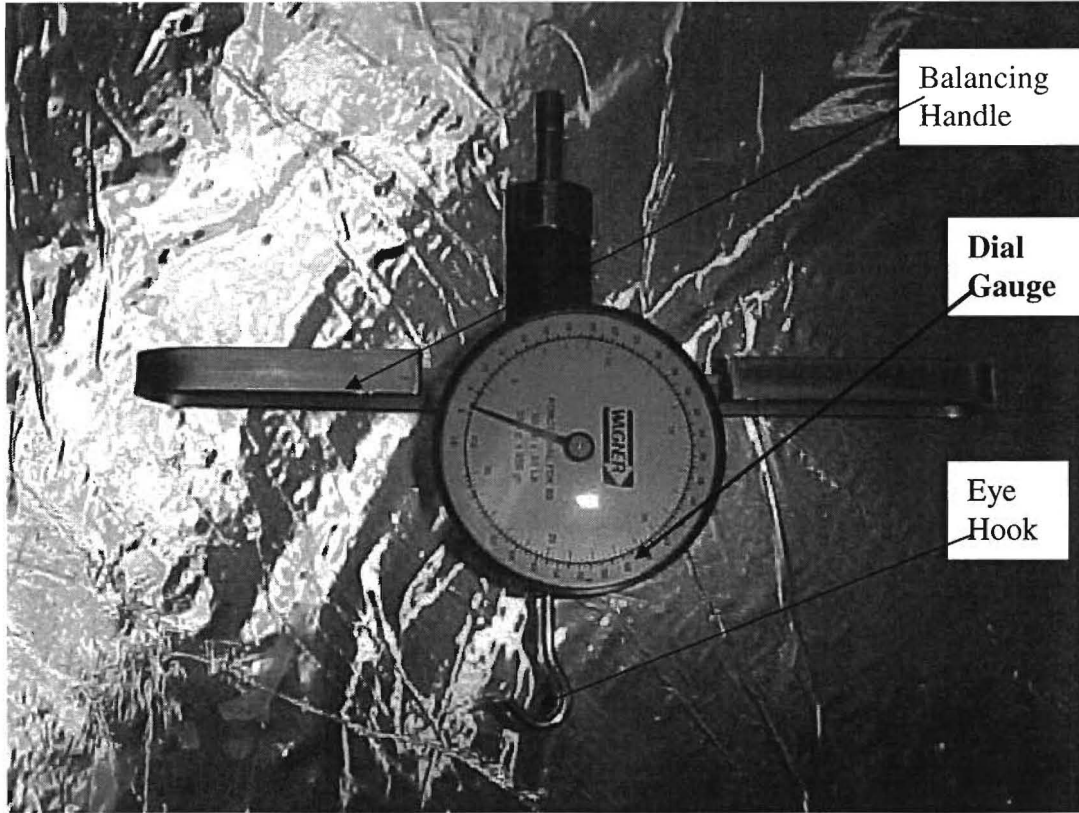

Figure 6.12 - Force Dial used in Simple Pull-Off Test



Figure 6.13 - Loading Arrangement for Simple Pull-Off Test

6.4 CALCULATIONS

The main purpose for the test is to determine the tensile stress at the point of failure. The readings obtained from SPOD gives the load (F) in pounds, required to pull the contact test plate off from the tack coated pavement surface. The load value obtained is then related to the tensile stress by the following relationship,

$$\tau = F/A \quad (6.3)$$

Where,

τ = strength (psi) of the tack coat at failure,
F = Load in pounds required too break the bond,
A = Area of the contact test plate in inch²

The UPOD gives the reading of the torque required to break, which is converted into the breaking load (F) by equation 6.2. The load is then converted to stress by using equation 6.3.

6.5 EXPERIMENTAL DESIGN

Based on the lessons learned during the evaluation of existing devices, a new experimental plan was developed. In an ideal situation, the direct shear tests should have been performed first, and then the laboratory experiments with the new pull-off devices followed by parking lot evaluation. Due to time constraints of the project and emphasis on the field applicability of the devices, it was decided to perform evaluation of the device in the parking lot first. The laboratory evaluation of the UPOD and the direct shear evaluation were performed simultaneously after successful evaluation of UPOD. Therefore, the experiment design of UPOD laboratory evaluation is based on the parking lot evaluation results.

The parking lot evaluation experiment design, for UPOD and SPOD, was developed based on the field applicability and the test results discussed in Chapter Four. The experiment design is presented in Table 6.1. Only testing time parameters of 7AM and 4PM were not changed. The other parameters were changed and a justification for each parameter is provided in the following paragraphs.

One of the constraints of the field test was that the testing needs to be performed as quickly as possible after application of tack coat. Since the time required for testing is approximately 12 minutes (10 minutes of loading and 2 minutes to perform test), it was identified that the test has to be performed in 30 minutes or less. Therefore, two set times of 20 and 30 minutes were selected. For RC250, the set time of 5 and 15 minutes were selected because it is a rapid cure tack coat type. Again, set time means time after tack coat application rather than time required to cure.

Three load levels 20, 30 and 40 lbs (9, 13.6, and 18 kg) were selected for the evaluation purposes. The lowest load level was selected because it would reduce the weight carried

to the site for testing. The 10 minutes load time was not changed because of previous experience presented in Chapter Four and preliminary evaluation indicated that less than 10 minutes of loading time does not allow time for proper bonding between the surface and the contact plate.

Table 6.1 - Parameters used in Parking Lot Evaluation of UPOD and SPOD

Parameters	TACK TYPE					
	CSS-1h	CSS-1	SS-1h	SS-1	PG64-22	RC-250
Dilution level	None	None	None	None	None	None
Set Time, min	20	20	20	20	20	5
	30	30	30	30	30	15
Testing Time	7AM	7AM	7AM	7AM	7AM	7AM
	4PM	4PM	4PM	4PM	4PM	4PM
Load, lbs (kg)	20 (9)	20 (9)	20 (9)	20 (9)	20 (9)	20 (9)
	30 (13.6)	30 (13.6)	30 (13.6)	30 (13.6)	30 (13.6)	30 (13.6)
	40 (18 kg)	40 (18 kg)	40 (18 kg)	40 (18 kg)	40 (18 kg)	40 (18 kg)
Loading Time, min	10	10	10	10	10	10
Residual Application Rate, gal/yd² (l/m²)	0.04(0.18)	0.04(0.18)	0.04(0.18)	0.04(0.18)	0.04(0.18)	0.04(0.18)
	0.1(0.45)	0.1(0.45)	0.1(0.45)	0.1(0.45)	0.1(0.45)	0.1(0.45)
No. of Trials	3	3	3	3	3	3

Since the residual application rates of 0.4 to 1.0 gal/yd² (0.04 to 0.18 l/m²) are specified by the TxDOT, it was decided to use the residual application rates rather than application rates used in the initial evaluation phase. Typically, TxDOT specifies that the residual rate of application should be within the above-mentioned range; therefore, it was decided to select maximum and minimum residual application rates.

In the experiment design presented in Chapter Three, the tack coats were diluted to evaluate the sensitivity of the equipment. However, new TxDOT specifications do not allow for dilution of the tack coat; therefore, it was decided not to dilute the tack coats to perform tests.

Although the number of trials remained the same, i.e., three, the tests were performed by different operators. One of the concerns with the UPOD and SPOD was that the test results could be operator dependent. The rate at which torque wrench is rotated or the rate at which force gauge of SPOD is pulled would govern magnitude of the measured pull-off strength. Therefore, it was decided to train three operators and let them perform the test to include operator variability.

The parking lot evaluation results (presented in Chapter Seven) indicated that SPOD is less repeatable, therefore, was not evaluated in the laboratory. The laboratory evaluation was performed on UPOD and the evaluation parameters are presented in Table 6.2. The

selection of parameters was based on the parking lot test results and how the laboratory data could be utilized for the field evaluation.

The parking lot test results indicated that a set time of less than 30 minutes does not provide repeatable results; therefore, it was decided to eliminate 20 minute set time. The test results presented in Chapter Four and Seven indicated that the gained tack coat strength depends on set time; therefore, it was decided to select 45 minutes as well as 60 minutes set time. Again, the selection of longer set times was to identify the relationship between set time and gained strength.

Table 6.2 – Parameters used during UPOD Laboratory Testing

Parameters	TACK TYPE					
	CSS-1h	CSS-1	SS-1h	SS-1	PG64-22	RC-250
Dilution level	None	None	None	None	None	None
Set Time, min	30	30	30	30	30	30
	45	45	45	45	45	45
	60	60	60	60	60	60
Test Temperature, °F(°C)	50(10)	50(10)	50(10)	50(10)	50(10)	50(10)
	93(34)	93(34)	93(34)	93(34)	93(34)	93(34)
	140(60)	140(60)	140(60)	140(60)	140(60)	140(60)
Load, lbs (kg)	40 (18)	40 (18)	40 (18)	40 (18)	40 (18)	40 (18)
Loading Time, min	10	10	10	10	10	10
Residual Application Rate, gal/yd²(l/m²)	0.04(0.18)	0.04(0.18)	0.04(0.18)	0.04(0.18)	0.04(0.18)	0.04(0.18)
No. of Trials	3	3	3	3	3	3

One of the advantages of the laboratory testing is that the environmental factors can be controlled. Since the gained strength depends on the temperature, a thermal system as shown in Figure 6.14 was developed. Different temperature levels can be maintained by changing the height of the lamps. Three different temperatures were selected for the evaluation purposes. The maximum temperature of 140 °F (60 °C) was selected because that is typically the maximum pavement temperature observed in the field. A minimum temperature of 50 °F (10 °C) was selected because that is the minimum temperature allowed for paving. TxDOT specifications suggest that the pavements can be placed when temperature is around 50 °F (10 °C) and rising. The third temperature of 93 °F (34 °C) was selected because it was in between the two temperatures. The test temperatures were maintained using the device shown in Figure 6.14.

Only one application rate (0.04 gal/yd²) was used in the laboratory evaluations. The main reason for selection of lower rate was applicability of the field device. Since TxDOT specifies the range of residual rate of application to be 0.04 to 0.1 gal/ yd² (0.18 to 0.45 l/m²) the tack coat can only be rejected if the application rate is lower than 0.04 gal/ yd² (0.18 l/m²). Therefore, it was decided to perform the tests at the lowest rate of application.

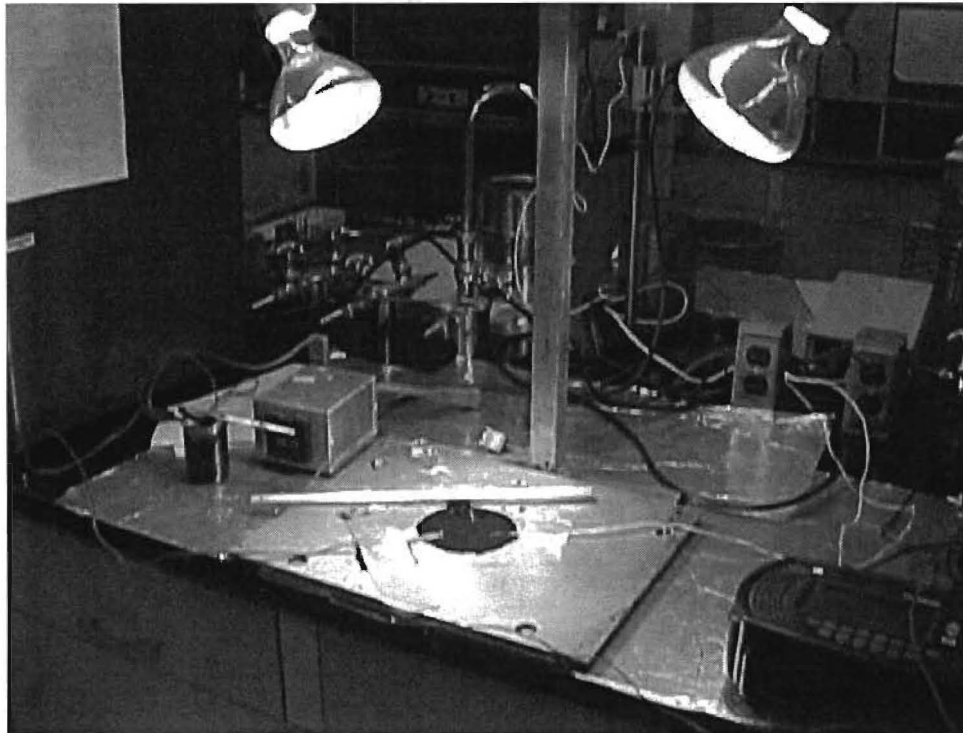

Figure 6.14 - Temperature Test Setup

The amount of load was selected to be 40 lbs (18 kg) because lesser weight did not provide adequate bond between the contact plate and tack coat in the field. The number of trials for evaluation remained the same and is based on only one operator.

The laboratory evaluation of tack coat using direct shear (DS) device was performed using the parameters presented in Table 6.3. The parameters are similar to the laboratory evaluation of UPOD with one exception. Three normal loads were also selected to identify cohesive as well as frictional resistance offered by the surface tested.

The end result of the DS device evaluation would be that the pull-off strength can be correlated to the cohesion offered by the tack coat. The results of the evaluation of these parameters and statistical analysis of the data are presented in Chapter Seven.

Table 6.3 - Parameters used in Laboratory Evaluation of DS and UPOD

Parameters	Tack Coat Type					
	CSS-1h	CSS-1	SS-1h	SS-1	PG64-22	RC-250
Dilution level	None	None	None	None	None	None
Set Time, min	30	30	30	30	30	30
	45	45	45	45	45	45
	60	60	60	60	60	60
Test Temperature, °F(°C)	50(10)	50(10)	50(10)	50(10)	50(10)	50(10)
	93(34)	93(34)	93(34)	93(34)	93(34)	93(34)
	140(60)	140(60)	140(60)	140(60)	140(60)	140(60)
Load, lbs (kg)	40 (18)	40 (18)	40 (18)	40 (18)	40 (18)	40 (18)
Loading Time, min	10	10	10	10	10	10
Normal stress, psi (kPa)	5(34.4)	5(34.4)	5(34.4)	5(34.4)	5(34.4)	5(34.4)
	10(68.9)	10(68.9)	10(68.9)	10(68.9)	10(68.9)	10(68.9)
	15(103.3)	15(103.3)	15(103.3)	15(103.3)	15(103.3)	15(103.3)
Residual Application Rate, gal/yd²(l/m²)	0.04(0.18)	0.04(0.18)	0.04(0.18)	0.04(0.18)	0.04(0.18)	0.04(0.18)

CHAPTER 7

TEST RESULTS AND ANALYSIS OF UPOD, SPOD AND DIRECT SHEAR

After development of new tack coat devices, the devices were evaluated in the parking lot with three operators and six tack coat types. To further evaluate devices, additional laboratory tests were performed and results were compared with the direct shear device results. Based on test results, relationships between gained strength, set time and test temperature were developed for each tack coat type. In addition, two field trials were conducted to verify the developed relationships. The test results and data analysis are presented in this chapter.

7.1 EVALUATION of UPOD in PARKING LOT

To evaluate UPOD, a total of 432 tests were performed in the parking lot and the test results are presented in Tables 7.1 through 7.12. The first column shows the dilution level while the second column shows the residual application rate and ambient temperature at the time of testing. The third column shows the set time and fourth column shows load maintained for 10 minutes. The averaged shear strength is shown in the fifth column. The standard deviation and the coefficient of variation are shown in sixth and seventh column, respectively. The tests were performed in the morning as well as in the afternoon and test results are shown in separate tables. The tests were performed in triplicate but each test was performed by different operator.

The results of CSS-1h tack coat evaluation are summarized in Tables 7.1 and 7.2. The results indicate that the increase in temperature and application rate increased the strength gain. In addition, strength gain was 2 times (0.09 to 0.18 psi) for the temperature increase from 48 to 64°F for the application rates of 0.04 gal/yd². For 0.1 gal/yd² application rates, the strength gain was roughly 1.5 times for similar increases in temperature. The results also indicated that the increase in set time from 20 to 30 minutes increased strength gain between 1 and 1.5 times depending on the application rates and applied load.

Table 7.1 - UPOD Parking Lot Test Results for CSS-1h Tested at 4PM

Dilution	Residual Application Rate, gal/yd ² (l/m ²)	Set Time, min	Load, lb (kg)	Average Strength, psi (kPa)	Std. Dev., psi (kPa)	COV, %
NONE	0.04(0.18) Ambient Temperature 64.1°F(17.8°C)	20	20 (9.10)	0.18(1.26)	0.02(0.14)	10.83
			30 (13.6)	0.22(1.54)	0.02(0.14)	7.69
			40 (18.0)	0.22(1.54)	0.02(0.14)	8.66
		30	20 (9.10)	0.21(1.47)	0.02(0.14)	9.12
			30 (13.6)	0.28(1.96)	0.02(0.14)	6.93
			40 (18.0)	0.31(2.17)	0.02(0.14)	6.19
	0.1(0.45) Ambient Temperature 64.1°F(17.8°C)	20	20 (9.10)	0.22(1.54)	0.02(0.14)	8.66
			30 (13.6)	0.35(2.45)	0.02(0.14)	5.59
			40 (18.0)	0.42(2.45)	0.04(0.28)	9.12
		30	20 (9.10)	0.32(2.24)	0.02(0.14)	5.97
			30 (13.6)	0.37(2.59)	0.03(0.21)	9.09
			40 (18.0)	0.51(3.57)	0.04(0.28)	7.53

Table 7.2 - UPOD Parking Lot Test Results for CSS-1h Tested at 7AM

Dilution	Residual Application Rate, gal/yd ² (l/m ²)	Set Time, min	Load, lb (kg)	Average Strength, psi (kPa)	Std. Dev., psi (kPa)	COV, %
NONE	0.04(0.18) Ambient Temperature 48.4°F(9.1°C)	20	20 (9.10)	0.09(0.63)	0.02(0.14)	21.7
			30 (13.6)	0.1(0.7)	0.02(0.14)	0
			40 (18.0)	0.12(0.84)	0.02(0.14)	15.7
		30	20 (9.10)	0.11(0.77)	0.02(0.14)	17.32
			30 (13.6)	0.12(0.84)	0.02(0.14)	15.75
			40 (18.0)	0.16(1.12)	0.02(0.14)	12.37
	0.1(0.45) Ambient Temperature 48.4°F(9.1°C)	20	20 (9.10)	0.15(1.05)	0.02(0.14)	13.32
			30 (13.6)	0.18(1.26)	0.02(0.14)	10.83
			40 (18.0)	0.21(1.47)	0.02(0.14)	9.12
		30	20 (9.10)	0.18(1.26)	0.02(0.14)	10.83
			30 (13.6)	0.22(1.54)	0.02(0.14)	8.66
			40 (18.0)	0.31(2.17)	0.04(0.28)	12.37

Table 7.3 - UPOD Parking Lot Test Results for CSS-1 Tested at 4PM

Dilution	Residual Application Rate, gal/yd ² (l/m ²)	Set Time, min	Load, lb (kg)	Average Strength, psi (kPa)	Std. Dev., psi (kPa)	COV, %
NONE	0.04(0.18) Ambient Temperature 77°F(25°C)	20	20 (9.10)	0.12(0.84)	0.02(0.14)	15.7
			30 (13.6)	0.18(1.26)	0.02(0.14)	10.8
			40 (18.0)	0.25(1.75)	0.02(0.14)	7.9
		30	20 (9.10)	0.18(1.26)	0.02(0.14)	10.8
			30 (13.6)	0.21(1.47)	0.02(0.14)	9.1
			40 (18.0)	0.29(2.03)	0.02(0.14)	6.7
	0.1(0.45) Ambient Temperature 77°F(25°C)	20	20 (9.10)	0.18(1.26)	0.02(0.14)	10.8
			30 (13.6)	0.31(2.17)	0.02(0.14)	6.2
			40 (18.0)	0.37(2.59)	0.03(0.21)	9.1
		30	20 (9.10)	0.28(1.96)	0.02(0.14)	6.9
			30 (13.6)	0.38(2.66)	0.02(0.14)	5.1
			40 (18.0)	0.46(3.22)	0.04(0.28)	4.2

Table 7.4 - UPOD Parking Lot Test Results for CSS-1 Tested at 7AM

Dilution	Residual Application Rate, gal/yd ² (l/m ²)	Set Time, min	Load, lb (kg)	Average Strength, psi (kPa)	Std. Dev., psi (kPa)	COV, %
NONE	0.04(0.18) Ambient Temperature 70°F(21.1°C)	20	20 (9.10)	0.08(0.56)	0.02(0.14)	24.7
			30 (13.6)	0.11(0.77)	0.02(0.14)	17.3
			40 (18.0)	0.12(0.84)	0.02(0.14)	15.7
		30	20 (9.10)	0.1(0.7)	0	0
			30 (13.6)	0.15(1.05)	0.02(0.14)	13.3
			40 (18.0)	0.18(1.26)	0.02(0.14)	10.8
	0.1(0.45) Ambient Temperature 70°F(21.1°C)	20	20 (9.10)	0.1(0.7)	0	0
			30 (13.6)	0.17(1.19)	0.03(0.21)	20.0
			40 (18.0)	0.20(1.4)	0	0
		30	20 (9.10)	0.15(1.05)	0.02(0.14)	13.3
			30 (13.6)	0.26(1.82)	0.02(0.14)	7.5
			40 (18.0)	0.31(2.17)	0.02(0.14)	6.2

Table 7.5 - UPOD Parking Lot Test Results for RC-250 Tested at 4PM

Dilution	Residual Application Rate, gal/yd ² (l/m ²)	Set Time, min	Load, lb (kg)	Average Strength, psi (kPa)	Std. Dev., psi (kPa)	COV, %
NONE	0.04(0.18) Ambient Temperature 83.1°F(28.3°C)	5	20 (9.10)	0.22(1.54)	0.02(0.14)	8.7
			30 (13.6)	0.29(2.03)	0.02(0.14)	6.7
			40 (18.0)	0.38(2.66)	0.02(0.14)	5.1
		15	20 (9.10)	0.32(2.24)	0.02(0.14)	6.0
			30 (13.6)	0.38(2.66)	0.02(0.14)	5.1
			40 (18.0)	0.42(2.94)	0.04(0.28)	9.1
	0.1(0.45) Ambient Temperature 83.1°F(28.3°C)	5	20 (9.10)	0.36(2.52)	0.02(0.14)	5.4
			30 (13.6)	0.39(2.73)	0.02(0.14)	4.9
			40 (18.0)	0.49(3.43)	0.04(0.28)	7.9
		15	20 (9.10)	0.41(2.87)	0.02(0.14)	4.7
			30 (13.6)	0.42(2.94)	0.04(0.28)	9.1
			40 (18.0)	0.58(4.06)	0.04(0.28)	6.7

Table 7.6 - UPOD Parking Lot Test Results for RC-250 Tested at 7AM

Dilution	Residual Application Rate, gal/yd ² (l/m ²)	Set Time, min	Load, lb (kg)	Average Strength, psi (kPa)	Std. Dev., psi (kPa)	COV, %
NONE	0.04(0.18) Ambient Temperature 80.6°F(27.0°C)	5	20 (9.10)	0.19(1.33)	0.02(0.14)	10.2
			30 (13.6)	0.28(1.96)	0.02(0.14)	6.9
			40 (18.0)	0.35(2.45)	0.02(0.14)	5.6
		15	20 (9.10)	0.28(1.96)	0.02(0.14)	6.9
			30 (13.6)	0.32(2.24)	0.02(0.14)	6.0
			40 (18.0)	0.38(2.66)	0.02(0.14)	5.1
	0.1(0.45) Ambient Temperature 80.6°F(27.0°C)	5	20 (9.10)	0.32(2.24)	0.02(0.14)	6.0
			30 (13.6)	0.37(2.59)	0.03(0.21)	9.1
			40 (18.0)	0.49(3.43)	0.04(0.28)	7.9
		15	20 (9.10)	0.36(2.52)	0.02(0.14)	5.4
			30 (13.6)	0.38(2.66)	0.04(0.28)	10.2
			40 (18.0)	0.52(3.64)	0.02(0.14)	3.7

Table 7.7 - UPOD Parking Lot Test Results for SS-1h Tested at 4PM

Dilution	Residual Application Rate, gal/yd ² (l/m ²)	Set Time, min	Load, lb (kg)	Average Strength, psi (kPa)	Std. Dev., psi (kPa)	COV, %
NONE	0.04(0.18) Ambient Temperature 71°F(21.6°C)	20	20 (9.10)	0.09(0.63)	0.02(0.14)	21.7
			30 (13.6)	0.16(1.12)	0.02(0.14)	12.4
			40 (18.0)	0.26(1.82)	0.02(0.14)	7.5
		30	20 (9.10)	0.16(1.12)	0.02(0.14)	12.4
			30 (13.6)	0.26(1.82)	0.02(0.14)	7.5
			40 (18.0)	0.32(2.24)	0.02(0.14)	6.0
	0.1(0.45) Ambient Temperature 71°F(21.6°C)	20	20 (9.10)	0.18(1.26)	0.02(0.14)	10.8
			30 (13.6)	0.29(2.03)	0.02(0.14)	6.7
			40 (18.0)	0.36(2.52)	0.04(0.28)	10.8
		30	20 (9.10)	0.25(1.75)	0.02(0.14)	7.9
			30 (13.6)	0.35(2.45)	0.02(0.14)	5.6
			40 (18.0)	0.45(3.15)	0.02(0.14)	4.3

Table 7.8 - UPOD Parking Lot Test Results for SS-1h Tested at 7AM

Dilution	Residual Application Rate, gal/yd ² (l/m ²)	Set Time, min	Load, lb (kg)	Average Strength, psi (kPa)	Std. Dev., psi (kPa)	COV, %
NONE	0.04(0.18) Ambient Temperature 61°F(16.1°C)	20	20 (9.10)	0.07(0.49)	0.01(0.07)	13.3
			30 (13.6)	0.12(0.84)	0.04(0.28)	31.5
			40 (18.0)	0.21(1.47)	0.02(0.14)	9.1
		30	20 (9.10)	0.15(1.05)	0.04(0.28)	26.6
			30 (13.6)	0.21(1.47)	0.02(0.14)	9.1
			40 (18.0)	0.28(1.96)	0.02(0.14)	6.9
	0.1(0.45) Ambient Temperature 61°F(16.1°C)	20	20 (9.10)	0.09(0.63)	0.02(0.14)	10.2
			30 (13.6)	0.19(1.33)	0.02(0.14)	10.2
			40 (18.0)	0.29(2.03)	0.04(0.28)	13.3
		30	20 (9.10)	0.19(1.33)	0.02(0.14)	10.2
			30 (13.6)	0.25(1.75)	0.02(0.14)	7.9
			40 (18.0)	0.36(2.52)	0.04(0.28)	10.8

Table 7.9 - UPOD Parking Lot Test Results for PG64-22 Tested at 4PM

Dilution	Residual Application Rate, gal/yd ² (l/m ²)	Set Time, min	Load, lb (kg)	Average Strength, psi (kPa)	Std. Dev., psi (kPa)	COV, %
NONE	0.04(0.18) Ambient Temperature 61°F(16.1°C)	20	20 (9.10)	0.11(0.77)	0.02(0.14)	17.3
			30 (13.6)	0.15(1.05)	0.02(0.14)	13.3
			40 (18.0)	0.18(1.26)	0.02(0.14)	10.8
		30	20 (9.10)	0.16(1.12)	0.02(0.14)	12.4
			30 (13.6)	0.21(1.47)	0.02(0.14)	9.1
			40 (18.0)	0.26(1.82)	0.02(0.14)	7.5
	0.1(0.45) Ambient Temperature 61°F(16.1°C)	20	20 (9.10)	0.16(1.12)	0.02(0.14)	12.4
			30 (13.6)	0.19(1.33)	0.02(0.14)	10.2
			40 (18.0)	0.26(1.82)	0.02(0.14)	7.5
		30	20 (9.10)	0.19(1.33)	0.02(0.14)	10.2
			30 (13.6)	0.28(1.96)	0.02(0.14)	6.9
			40 (18.0)	0.31(2.17)	0.02(0.14)	6.2

Table 7.10 - UPOD Parking Lot Test Results for PG64-22 Tested at 7AM

Dilution	Residual Application Rate, gal/yd ² (l/m ²)	Set Time, min	Load, lb (kg)	Average Strength, psi (kPa)	Std. Dev., psi (kPa)	COV, %
NONE	0.04(0.18) Ambient Temperature 52°F(11.1°C)	20	20 (9.10)	0.08(0.56)	0.02(0.14)	24.7
			30 (13.6)	0.09(0.63)	0.02(0.14)	21.7
			40 (18.0)	0.12(0.84)	0.02(0.14)	15.7
		30	20 (9.10)	0.09(0.63)	0.02(0.14)	21.7
			30 (13.6)	0.12(0.84)	0.02(0.14)	15.7
			40 (18.0)	0.18(1.26)	0.02(0.14)	10.8
	0.1(0.45) Ambient Temperature 52°F(11.1°C)	20	20 (9.10)	0.09(0.63)	0.02(0.14)	21.7
			30 (13.6)	0.12(0.84)	0.02(0.14)	15.7
			40 (18.0)	0.16(1.12)	0.02(0.14)	12.4
		30	20 (9.10)	0.11(0.77)	0.02(0.14)	17.3
			30 (13.6)	0.18(1.26)	0.02(0.14)	10.8
			40 (18.0)	0.25(1.75)	0.02(0.14)	7.9

Table 7.11 - UPOD Parking Lot Test Results for SS-1 Tested at 4PM

Dilution	Residual Application Rate, gal/yd ² (l/m ²)	Set Time, min	Load, lb (kg)	Average Strength, psi (kPa)	Std. Dev., psi (kPa)	COV, %
NONE	0.04(0.18) Ambient Temperature 59.1°F(15°C)	20	20 (9.10)	0.09(0.63)	0.02(0.14)	21.65
			30 (13.6)	0.12(0.84)	0.02(0.14)	15.75
			40 (18.0)	0.19(1.33)	0.02(0.14)	10.19
		30	20 (9.10)	0.12(0.84)	0.02(0.14)	14.29
			30 (13.6)	0.16(1.12)	0.02(0.14)	12.37
			40 (18.0)	0.22(1.54)	0.02(0.14)	7.69
	0.1(0.45) Ambient Temperature 59.1°F(15°C)	20	20 (9.10)	0.11(0.77)	0.01(0.07)	9.12
			30 (13.6)	0.12(0.84)	0.02(0.14)	15.75
			40 (18.0)	0.21(1.47)	0.02(0.14)	9.12
		30	20 (9.10)	0.15(1.05)	0.02(0.14)	13.32
			30 (13.6)	0.22(1.54)	0.02(0.14)	8.66
			40 (18.0)	0.31(2.17)	0.04(0.28)	12.37

Table 7.12 - UPOD Parking Lot Test Results for SS-1 Tested at 7AM

Dilution	Residual Application Rate, gal/yd ² (l/m ²)	Set Time, min	Load, lb (kg)	Average Strength, psi (kPa)	Std. Dev., psi (kPa)	COV, %
NONE	0.04(0.18) Ambient Temperature 57.2°F(14°C)	20	20 (9.10)	0.08(0.56)	0.02(0.14)	24.7
			30 (13.6)	0.1(0.7)	0	0
			40 (18.0)	0.14(0.98)	0.01(0.07)	6.9
		30	20 (9.10)	0.09(0.63)	0.02(0.14)	21.65
			30 (13.6)	0.12(0.84)	0.02(0.14)	15.75
			40 (18.0)	0.18(1.26)	0.02(0.14)	10.83
	0.1(0.45) Ambient Temperature 57.2°F(14°C)	20	20 (9.10)	0.08(0.56)	0.02(0.14)	24.74
			30 (13.6)	0.11(0.77)	0.01(0.07)	9.12
			40 (18.0)	0.15(1.05)	0.02(0.14)	11.11
		30	20 (9.10)	0.11(0.77)	0.02(0.14)	17.32
			30 (13.6)	0.16(1.12)	0.02(0.14)	12.37
			40 (18.0)	0.21(1.47)	0.01(0.07)	4.68

In terms of repeatability of the device, the COV decreased with increase in application rate, test temperature, and set time. For example, a COV of 10.8 is observed for 20 minutes set time, application rate of 0.04 gal/yd² and applied load of 20 lbs (when tested in afternoon) while for similar conditions the COV was 21.7 when tested in the morning.

The COV results indicate that the repeatability is better for 30 minutes set time, therefore, the test should not be performed for set times below 30 minutes. The results also suggest that the loads should be above 20 lbs to get better repeatability.

The results of CSS-1 tack coat evaluation are summarized in Tables 7.3 and 7.4. The results indicate that the increase in temperature and application rate increased the strength gain. For example, strength gain was 1.5 times (0.08 to 0.12 psi) when the temperature increased from 70 to 77 °F for the application rate of 0.04 gal/yd². For 0.1 gal/yd² application rates, the strength gain was roughly 1.8 times for the similar increase in temperature. The results also indicated that the increase in set time from 20 to 30 minutes increased strength gain between 1 and 1.5 times depending on the application rates and applied load.

In terms of repeatability of the device, the COV decreased with increase in application rate, test temperature, set time, and applied load. For example, the COV of 15.7 is observed for 20 minutes set time, an application rate of 0.04 gal/yd² and an applied load of 20 lbs when tested in afternoon while for similar conditions the COV was 24.7 when tested in the morning. The COV results indicate that the repeatability is better for 30 minutes set time; therefore, the tests should not be performed for set times below 30 minutes. The results also suggest that the loads should be above 20 lbs to get better repeatability. In some cases, a better repeatability was observed with 30 lbs load but in general the repeatability was better with 40 lbs load.

The results of RC-250 cut back evaluation are summarized in Tables 7.5 and 7.6. For cut back testing, the set times were changed to 5 and 15 minutes because it was drying quickly and did not attach properly to the contact plate. The results indicate that the increase in application rate increased the strength gain. For example, strength gain was 1.5 times (0.22 to 0.36 psi) when the application rate increased from 0.04 to 0.1 gal/yd². Since the change in temperature was less than 3 °F, the effect of test temperature was not significant as compared to other tack coat types. The test results also indicated that the increase in set time from 5 to 15 minutes increased strength gain between 1 and 1.5 times depending on the application rates and applied load.

In terms of the repeatability of the device, the COV decreased with an increase in application rate, test temperature, set time, and applied load. For example, a COV of 10.2 is observed for 5 minute set time, an application rate of 0.04 gal/yd² and an applied load of 20 lbs when tested in afternoon while for similar conditions the COV was 10.2 when tested in the morning. The COV results indicate that the repeatability is better for 5 minutes set time in comparison to 15 minutes, therefore, the tests should not be performed at higher set times. The results also suggest that the loads should be above 20 lbs to get better repeatability.

The results of SS-1h tack coat evaluation are summarized in Tables 7.7 and 7.8. The results indicate that the increase in application rate increased the strength gain. For example, strength gain was 2 times (0.09 to 0.18 psi) when the application rate increased from 0.04 to 1.0 gal/yd². Since the change in temperature was not significant (less than 7

°F), the strength gain was not significantly higher. The results also indicated that the increase in set time from 20 to 30 minutes increased strength gain between 1 and 1.5 times depending on the application rates and applied load.

In terms of repeatability of the device, the COV decreased with increase in application rate, test temperature, and set time. For example, the COV of 12.4 is observed for set time of 30 min, application rate of 0.04 gal/yd² and applied load of 20 lbs when tested in afternoon while for similar conditions the COV was 26.6 when tested in the morning. The COV results indicate that the repeatability is better for set time of 30 minutes except for one instance; therefore, the tests should not be performed for set times below 30 minutes. The results are mixed in terms of load application. In general, the COV reduced with an increase in load levels when tested in the afternoon. However, similar trends were not observed in the results of tests performed in the morning (Table 7.8).

The results of PG64-22 evaluation are summarized in Tables 7.9 and 7.10. The results indicate that the increase in application rate increased the strength gain. For example, strength gain was 1.5 times (0.11 to 0.16 psi) when the application rate increased from 0.04 to 1.0 gal/yd². The change in temperature from 52 to 61 °F increased the strength gain by 1 to 1.5 times. The results also indicated that the increase in set time from 20 to 30 minutes increased strength gain between 1 and 1.5 times depending on the application rates and applied load.

In terms of repeatability of the device, the COV decreased with increase in application rate, test temperature, and set time. For example, the COV of 17.3 is observed for set time of 20 min, application rate of 0.04 gal/yd² and applied load of 20 lbs when tested in afternoon while for similar conditions the COV was 24.7 when tested in the morning. The COV results indicate that the repeatability is better for 30 minutes set time; therefore, the tests should not be performed for set times below 30 minutes. In general, the COV reduced with an increase in load levels when tested in the afternoon as well as in the morning indicating that the tests need to be performed at higher loads.

The summarized results of SS-1 tack coat evaluation are shown in Tables 7.11 and 7.12. The results indicate that the increase in application rate increased the strength gain. For example, strength gain was 1.2 times (0.09 to 0.11 psi) when the application rate increased from 0.04 to 1.0 gal/yd². Since change in temperature was less than 2 °F, the effect of test temperature was not significant as compared to other tack coat types. The results also indicated that the increase in set time from 20 to 30 minutes increased strength gain between 1 and 1.5 times depending on the application rates and applied load.

In terms of repeatability of the device, the COV decreased with increase in application rate, test temperature, and set time. For example, the COV of 21.65 is observed for set time of 20 min, application rate of 0.04 gal/yd² and applied load of 20 lbs when tested in afternoon while for similar conditions the COV was 24.7 when tested in the morning. The COV results indicate that the repeatability is better for 30 minutes set time; therefore, the tests should not be performed for set times below 30 minutes. The results also

suggest that the loads should be above 20 lbs to get better repeatability. In some cases, a better repeatability was observed with 30 lbs load but in general the repeatability was better with 40 lbs load.

In general, test results indicated that the gained strength increased with an increase in set time, application rate, and test temperature. In addition, the measured strength was higher with an increase in load levels indicating that the compaction efforts during placement of overlay will further increase the bond strength. The test results suggested that the test needs to be performed after the tack coat is set for 30 minutes (5 minutes in the case of cutback). The impact of load changed between 30 and 40 lbs. However, if the set time of 30 minutes is selected, the repeatability increases with 40 lbs of load.

For 30 minutes (15 minutes for RC-250) set time and 40 lbs load, the RC 250 (0.58 psi) gained higher strength in comparison to CSS-1h (0.51 psi) while CSS-1h gained higher strength in comparison to SS-1h (0.45 psi), at similar air temperatures (64 °F). Similar comparison could not be performed with other tack coat types because they were tested at different ambient temperatures.

7.2 EVALUATION of SPOD in PARKING LOT

To evaluate SPOD, a total of 432 tests were performed in the parking lot and the test results are presented in Tables 7.13 through 7.24 for various tack coat types. The table organization is similar to that of UPOD. The tests were performed in triplicate but each test was performed by different operator.

The results of CSS-1h tack coat evaluation are summarized in Tables 7.13 and 7.14. The results indicate that the increase in temperature and application rate increased the strength gain. In addition, strength gain was 3 times higher (0.42 to 1.21 psi) when the temperature increased from 48 to 64 °F for the application rates of 0.1 gal/yd², 30 minutes set time and applied load of 40 lbs. For 0.04 gal/yd² application rates, the strength gain was between 1.3 and 2.0 times for the similar increase in temperature. The results also indicated that the increase in set time from 20 to 30 minutes increased strength gain between 1.3 and 2.5 times depending on the application rates and applied load.

In terms of the repeatability of the device, the COV decreased with increase in application rate, applied load, and set time. However, the COV values increased with increase in test temperature a trend opposite to the UPOD test results. For example, a COV of 72.11 is observed for 20 minutes set time, application rate of 0.04 and applied load of 20 lbs when tested in afternoon while for similar conditions the COV was 50.00 when tested in the morning. In general, the COV are significantly higher than that of UPOD. Overall, test results indicate that the repeatability is better for 30 minutes set time, therefore, the test should not be performed for set times below 30 minutes. The results also suggest that the loads should be above 20 lbs to obtain better repeatability.

Table 7.13 - SPOD Parking Lot Test Results for CSS-1h Tested at 4PM

Dilution	Residual Application Rate, gal/yd ² (l/m ²)	Set Time, min	Load, lb (kg)	Average Strength, psi (kPa)	Std. Dev., psi (kPa)	COV, %
NONE	0.04(0.18) Ambient Temperature 64.1°F(17.8°C)	20	20 (9.10)	0.13(0.88)	0.09(0.63)	72.11
			30 (13.6)	0.39(2.69)	0.08(0.54)	19.92
			40 (18.0)	0.48(3.28)	0.08(0.54)	16.37
		30	20 (9.10)	0.29(1.99)	0.08(0.54)	26.96
			30 (13.6)	0.48(3.28)	0.08(0.54)	16.37
			40 (18.0)	0.65(4.45)	0.08(0.54)	12.06
	0.1(0.45) AT- 64.1°F(17.8°C)	20	20 (9.10)	0.33(2.28)	0.09(0.63)	27.74
			30 (13.6)	0.68(4.68)	0.13(0.88)	18.87
			40 (18.0)	1.10(7.61)	0.21(1.42)	18.65
		30	20 (9.10)	0.66(4.56)	0.13(0.88)	20.35
			30 (13.6)	0.93(6.44)	0.13(0.88)	13.73
			40 (18.0)	1.21(8.31)	0.16(1.13)	13.58

Table 7.14 - SPOD Parking Lot Test Results for CSS-1h Tested at 7AM

Dilution	Residual Application Rate, gal/yd ² (l/m ²)	Set Time, min	Load, lb (kg)	Average Strength, psi (kPa)	Std. Dev., psi (kPa)	COV, %
NONE	0.04(0.18) Ambient Temperature 48.4°F (9.1°C)	20	20 (9.10)	0.10(0.70)	0.05(0.35)	50.00
			30 (13.6)	0.19(1.29)	0.12(0.88)	68.63
			40 (18.0)	0.37(2.57)	0.08(0.54)	20.83
		30	20 (9.10)	0.13(0.94)	0.08(0.54)	57.28
			30 (13.6)	0.20(1.40)	0.05(0.35)	25.00
			40 (18.0)	0.40(2.81)	0.05(0.35)	12.50
	0.1(0.45) Ambient Temperature 48.4°F (9.1°C)	20	20 (9.10)	0.10(0.70)	0.05(0.35)	50.00
			30 (13.6)	0.25(1.76)	0.05(0.35)	20.00
			40 (18.0)	0.32(2.22)	0.08(0.54)	24.12
		30	20 (9.10)	0.20(1.40)	0.05(0.35)	25.00
			30 (13.6)	0.22(1.52)	0.08(0.54)	35.25
			40 (18.0)	0.42(2.93)	0.11(0.73)	24.98

Table 7.15 - SPOD Parking Lot Test Results for CSS-1 Tested at 4PM

Dilution	Residual Application Rate, gal/yd ² (l/m ²)	Set Time, min	Load, lb (kg)	Average Strength, psi (kPa)	Std. Dev., psi (kPa)	COV, %
NONE	0.04(0.18) Ambient Temperature 77°F(25°C)	20	20 (9.10)	0.42(2.93)	0.08(0.54)	18.33
			30 (13.6)	0.54(3.74)	0.06(0.41)	10.83
			40 (18.0)	0.92(6.33)	0.11(0.73)	13.29
		30	20 (9.10)	0.82(5.62)	0.10(0.70)	12.50
			30 (13.6)	1.43(9.83)	0.13(0.93)	9.45
			40 (18.0)	1.56(10.77)	0.16(1.07)	9.96
	0.1(0.45) Ambient Temperature 77°F(25°C)	20	20 (9.10)	0.88(6.09)	0.06(0.41)	6.66
			30 (13.6)	1.07(7.37)	0.05(0.35)	4.76
			40 (18.0)	1.19(8.19)	0.08(0.54)	6.55
		30	20 (9.10)	1.31(9.01)	0.08(0.54)	5.95
			30 (13.6)	1.63(11.23)	0.20(1.40)	12.50
			40 (18.0)	1.80(12.40)	0.16(1.07)	8.65

Table 7.16 - SPOD Parking Lot Test Results for CSS-1 Tested at 7AM

Dilution	Residual Application Rate, gal/yd ² (l/m ²)	Set Time, min	Load, lb (kg)	Average Strength, psi (kPa)	Std. Dev., psi (kPa)	COV, %
NONE	0.04(0.18) Ambient Temperature 70°F(21.1°C)	20	20 (9.10)	0.26(1.81)	0.04(0.27)	14.78
			30 (13.6)	0.51(3.51)	0.05(0.35)	10.00
			40 (18.0)	0.56(3.86)	0.05(0.35)	9.09
		30	20 (9.10)	0.34(2.34)	0.06(0.41)	17.32
			30 (13.6)	0.53(3.63)	0.08(0.54)	14.78
			40 (18.0)	0.73(5.03)	0.08(0.54)	10.66
	0.1(0.45) Ambient Temperature 70°F(21.1°C)	20	20 (9.10)	0.56(3.86)	0.05(0.35)	9.09
			30 (13.6)	0.72(4.97)	0.05(0.35)	7.35
			40 (18.0)	0.83(5.73)	0.06(0.41)	7.07
		30	20 (9.10)	0.65(4.45)	0.06(0.41)	9.12
			30 (13.6)	0.88(6.09)	0.06(0.41)	6.66
			40 (18.0)	1.00(6.90)	0.08(0.54)	7.77

Table 7.17 - SPOD Parking Lot Test Results for RC-250 Tested at 4PM

Dilution	Residual Application Rate, gal/yd² (l/m²)	Set Time, min	Load, lb (kg)	Average Strength, psi (kPa)	Std. Dev., psi (kPa)	COV, %
NONE	0.04(0.18) Ambient Temperature 83.1°F(28.4°C)	5	20 (9.10)	0.07(0.47)	0.06(0.41)	86.60
			30 (13.6)	0.07(0.47)	0.03(0.20)	43.30
			40 (18.0)	0.12(0.82)	0.03(0.20)	24.74
		15	20 (9.10)	0.10(0.70)	0.05(0.35)	50.00
			30 (13.6)	0.14(0.94)	0.06(0.41)	43.30
			40 (18.0)	0.17(1.17)	0.03(0.20)	17.32
	0.1(0.45) Ambient Temperature 83.1°F(28.4°C)	5	20 (9.10)	0.05(0.35)	0.05(0.35)	100.00
			30 (13.6)	0.08(0.59)	0.03(0.20)	34.64
			40 (18.0)	0.12(0.82)	0.06(0.41)	49.49
		15	20 (9.10)	0.08(0.59)	0.03(0.20)	34.64
			30 (13.6)	0.15(1.05)	0.05(0.35)	33.33
			40 (18.0)	0.17(0.17)	0.06(0.41)	34.64

Table 7.18 - SPOD Parking Lot Test Results for RC-250 Tested at 7AM

Dilution	Residual Application Rate, gal/yd² (l/m²)	Set Time, min	Load, lb (kg)	Average Strength, psi (kPa)	Std. Dev., psi (kPa)	COV, %
NONE	0.04(0.18) Ambient Temperature 80.6°F(27.0°C)	5	20 (9.10)	0.03(0.20)	0.03(0.20)	86.60
			30 (13.6)	0.05(0.35)	0.05(0.35)	100.00
			40 (18.0)	0.08(0.54)	0.06(0.41)	69.28
		15	20 (9.10)	0.07(0.47)	0.03(0.20)	43.30
			30 (13.6)	0.08(0.54)	0.08(0.54)	91.65
			40 (18.0)	0.10(0.70)	0.05(0.35)	50.00
	0.1(0.45) Ambient Temperature 80.6°F(27.0°C)	5	20 (9.10)	0.05(0.35)	0.05(0.35)	100.00
			30 (13.6)	0.07(0.47)	0.06(0.41)	86.60
			40 (18.0)	0.10(0.70)	0.05(0.35)	50.00
		15	20 (9.10)	0.07(0.47)	0.06(0.41)	86.60
			30 (13.6)	0.10(0.70)	0.05(0.35)	50.00
			40 (18.0)	0.15(1.05)	0.05(0.35)	33.33

Table 7.19 - SPOD Parking Lot Test Results for PG64-22 Tested at 4PM

Dilution	Residual Application Rate, gal/yd ² (l/m ²)	Set Time, min	Load, lb (kg)	Average Strength, psi (kPa)	Std. Dev., psi (kPa)	COV, %
NONE	0.04(0.18) Ambient Temperature 61°F(16.1°C)	20	20 (9.10)	0.36(2.46)	0.05(0.35)	14.29
			30 (13.6)	0.51(3.51)	0.10(0.70)	20.00
			40 (18.0)	0.61(4.21)	0.05(0.35)	8.33
		30	20 (9.10)	0.46(3.16)	0.05(0.35)	11.11
			30 (13.6)	0.51(3.51)	0.05(0.35)	10.00
			40 (18.0)	0.65(4.45)	0.06(0.41)	9.12
	0.1(0.45) Ambient Temperature 61°F(16.1°C)	20	20 (9.10)	0.53(3.63)	0.08(0.54)	14.78
			30 (13.6)	0.56(3.86)	0.05(0.35)	9.09
			40 (18.0)	0.66(4.56)	0.05(0.35)	7.69
		30	20 (9.10)	0.56(3.86)	0.05(0.35)	9.09
			30 (13.6)	0.58(3.98)	0.08(0.54)	13.48
			40 (18.0)	0.68(4.68)	0.11(0.73)	15.61

Table 7.20 - SPOD Parking Lot Test Results for PG64-22 Tested at 7AM

Dilution	Residual Application Rate, gal/yd ² (l/m ²)	Set Time, min	Load, lb (kg)	Average Strength, psi (kPa)	Std. Dev., psi (kPa)	COV, %
NONE	0.04(0.18) Ambient Temperature 52°F(11.1°C)	20	20 (9.10)	0.02(0.12)	0.03(0.20)	173.21
			30 (13.6)	0.05(0.35)	0(0)	0.00
			40 (18.0)	0.08(0.54)	0.03(0.20)	21.65
		30	20 (9.10)	0.03(0.20)	0.03(0.20)	86.60
			30 (13.6)	0.08(0.54)	0.03(0.20)	34.64
			40 (18.0)	0.12(0.82)	0.03(0.20)	13.32
	0.1(0.45) Ambient Temperature 52°F(11.1°C)	20	20 (9.10)	0.08(0.54)	0.03(0.20)	34.64
			30 (13.6)	0.17(1.17)	0.03(0.20)	17.32
			40 (18.0)	0.19(1.29)	0.03(0.20)	15.75
		30	20 (9.10)	0.08(0.54)	0.03(0.20)	34.64
			30 (13.6)	0.20(1.40)	0.05(0.35)	25.00
			40 (18.0)	0.29(1.99)	0.08(0.54)	26.96

Table 7.21 - SPOD Parking Lot Test Results for SS-1h Tested at 4PM

Dilution	Residual Application Rate, gal/yd ² (l/m ²)	Set Time, min	Load, lb (kg)	Average Strength, psi(kPa)	Std. Dev., psi (kPa)	COV, %
NONE	0.04(0.18) Ambient Temperature 71°F(21.6°C)	20	20 (9.10)	0.03(0.21)	0.03(0.20)	34.64
			30 (13.6)	0.08(0.54)	0.05(0.35)	33.33
			40 (18.0)	0.12(0.82)	0.03(0.20)	15.75
		30	20 (9.10)	0.08(0.59)	0.03(0.20)	34.64
			30 (13.6)	0.1(0.69)	0.03(0.20)	15.75
			40 (18.0)	0.14(9.6)	0.03(0.20)	13.32
	0.1(0.45) Ambient Temperature 71°F(21.6°C)	20	20 (9.10)	0.14(0.94)	0.03(0.20)	21.65
			30 (13.6)	0.19(1.29)	0.03(0.20)	15.75
			40 (18.0)	0.22(1.52)	0.03(0.20)	13.32
		30	20 (9.10)	0.14(0.94)	0.06(0.41)	43.30
			30 (13.6)	0.29(1.99)	0.03(0.20)	10.19
			40 (18.0)	0.32(2.22)	0.03(0.20)	9.12

Table 7.22 - SPOD Parking Lot Test Results for SS-1h Tested at 7AM

Dilution	Residual Application Rate, gal/yd ² (l/m ²)	Set Time, min	Load, lb (kg)	Average Strength, psi(kPa)	Std. Dev., psi (kPa)	COV, %
NONE	0.04(0.18) Ambient Temperature 61°F(16.1°C)	20	20 (9.10)	0.02(0.12)	0.03(0.20)	0.00
			30 (13.6)	0.08(0.54)	0.03(0.20)	34.64
			40 (18.0)	0.10(0.70)	0.05(0.35)	50.00
		30	20 (9.10)	0.03(0.20)	0.03(0.20)	86.60
			30 (13.6)	0.14(0.94)	0.03(0.20)	21.65
			40 (18.0)	0.19(1.29)	0.03(0.20)	15.75
	0.1(0.45) Ambient Temperature 61°F(16.1°C)	20	20 (9.10)	0.07(0.47)	0.03(0.20)	43.30
			30 (13.6)	0.12(0.82)	0.03(0.20)	24.74
			40 (18.0)	0.14(0.94)	0.03(0.20)	21.65
		30	20 (9.10)	0.07(0.47)	0.03(0.20)	43.30
			30 (13.6)	0.19(1.29)	0.03(0.20)	15.75
			40 (18.0)	0.22(1.52)	0.03(0.20)	13.32

Table 7.23 - SPOD Parking Lot Test Results for SS-1 Tested at 4PM

Dilution	Residual Application Rate, gal/yd ² (l/m ²)	Set Time, min	Load, lb (kg)	Average Strength, psi (kPa)	Std. Dev., psi (kPa)	COV, %
NONE	0.04(0.18) Ambient Temperature 59.1°F(15°C)	20	20 (9.10)	0(0)	0(0)	0.00
			30 (13.6)	0.02(0.12)	0.03(0.20)	173.21
			40 (18.0)	0.03(0.23)	0.03(0.20)	86.60
		30	20 (9.10)	0.01(0.06)	0.01(0.10)	173.21
			30 (13.6)	0.03(0.23)	0.03(0.20)	86.60
			40 (18.0)	0.11(0.76)	0.04(0.27)	35.25
	0.1(0.45) Ambient Temperature 59.1°F(15°C)	20	20 (9.10)	0(0)	0(0)	0.00
			30 (13.6)	0.07(0.47)	0.03(0.20)	43.30
			40 (18.0)	0.15(1.05)	0.05(0.35)	33.33
		30	20 (9.10)	0.03(0.23)	0.03(0.20)	86.60
			30 (13.6)	0.08(0.59)	0.03(0.20)	34.64
			40 (18.0)	0.24(1.64)	0.03(0.20)	12.37

Table 7.24 - SPOD Parking Lot Test Results for SS-1 Tested at 7AM

Dilution	Residual Application Rate, gal/yd ² (l/m ²)	Set Time, min	Load, lb (kg)	Average Strength, psi (kPa)	Std. Dev., psi (kPa)	COV, %
NONE	0.04(0.18) Ambient Temperature 57.2°F(14°C)	20	20 (9.10)	0.02(0.12)	0.03(0.20)	173.21
			30 (13.6)	0.06(0.41)	0.01(0.07)	24.74
			40 (18.0)	0.09(0.64)	0.01(0.07)	15.75
		30	20 (9.10)	0.03(0.20)	0.03(0.20)	86.60
			30 (13.6)	0.09(0.64)	0.01(0.07)	15.75
			40 (18.0)	0.18(1.23)	0.04(0.27)	24.74
	0.1(0.45) Ambient Temperature 57.2°F(14°C)	20	20 (9.10)	0.03(0.20)	0.03(0.20)	86.60
			30 (13.6)	0.12(0.82)	0.01(0.07)	12.37
			40 (18.0)	0.22(1.52)	0.03(0.20)	13.32
		30	20 (9.10)	0.05(0.35)	0(0)	0.00
			30 (13.6)	0.17(1.17)	0.03(0.20)	17.32
			40 (18.0)	0.25(1.76)	0.05(0.35)	20.00

The results of CSS-1 tack coat evaluation are summarized in Tables 7.15 and 7.16. The results indicate that the increase in temperature and application rate increased the strength

gain. In some instances, the strength gain was two times higher. For example, the strength gain increased from 0.73 to 1.56 psi, when the temperature increased from 70 to 77 °F for the application rates of 0.04 gal/yd², 30 minutes set time and applied load of 40 lbs. For 0.1 gal/yd² application rates, the strength gain was 1.8 times for the similar increase in temperature. The results also indicated that the increase in set time from 20 to 30 minutes increased strength gain between 1.2 to 2 times depending on the application rates and applied load.

In terms of repeatability of the device, the COV decreased with increase in application rate, applied load, and set time. However, the COV values increased with increase in test temperature a trend opposite to the UPOD test results. For example, a COV of 18.3 is observed for 20 minutes set time, application rate of 0.04 gal/yd² and 20 lbs load when tested in afternoon while for similar conditions the COV was 14.8 when tested in the morning. In general, the COV are slightly higher than that of UPOD. Overall, test results indicate that the repeatability is better for 30 minutes set time, therefore, the test should not be performed for set times below 30 minutes. In terms of applied load, no clear trend could be identified. Therefore, it is difficult to suggest a specific applied load.

The results of RC-250 cut back evaluation are summarized in Tables 7.17 and 7.18. Again for cut back testing, the set times were changed to 5 and 15 minutes because it was drying quickly and did not attach properly to the contact plate. The results suggest that the device is not able to identify the effect of application rates for some load application. For example, strength of 0.07 psi was observed for 0.1 gal/yd² as well as 0.04 gal/yd² application rates for 15 minutes set time and 20 lbs load when tested in the afternoon (Table 7.18). Since change in temperature was less than 3 °F, the effect of test temperature was not significant as compared to other tack coat types. The results also indicated that the increase in set time from 5 to 15 minutes increased strength gain between 1 and 1.5 times depending on the application rates and applied load.

In terms of the repeatability of the device, the COV decreased with increase in application rate, applied load, and set time. Since test temperatures were not significantly different, the COV values did not significantly change as well. The COV values were up to 100% for 5 minutes of set time for both application rates and both test times. In general, COV values were significantly higher in comparison to the CSS-1h and CSS-1 tack coats. In addition, the COV values are significantly higher than that of UPOD. Overall, test results indicate that the repeatability is better for 15 minutes set time, therefore, the test should not be performed for set times below 15 minutes. However, the trend is opposite to the one observed with UPOD that suggested that 5 minutes of set time is better. In terms of applied load, no clear trend could be identified. Therefore, it is difficult to suggest a specific applied load.

The results of PG64-22 tack coat evaluation are summarized in Tables 7.19 and 7.20. The results indicate that the increase in temperature and application rate increased the strength gain. In some instances, the strength gain was 18 times higher. For example, the strength gain increased from 0.02 to 0.36 psi, when the temperature increased from 52 to 61 °F for the application rates of 0.04 gal/yd², 20 minutes set time and 20 lbs load. For

0.1 gal/yd² application rates, the strength gain was between 2 and 6 times for the similar increase in temperature. The results also indicated that the increase in set time from 20 to 30 minutes increased strength gain between 1.3 and 1.5 times depending on the application rates and applied load.

In terms of the repeatability of the device, the COV decreased with increase in application rate, applied load, set time, and test temperature. The COV values were up to 173% for 20 minutes set time for 0.04 gal/yd² application rate when tested in the morning with 20 lbs load. In general, the COV values are significantly higher than that of UPOD. Overall, test results indicate that the repeatability is better for set time of 30 minutes, therefore, the test should not be performed for set times below 30 minutes. In terms of applied load, no clear trend could be identified. Therefore, it is difficult to suggest a specific applied load.

The results of SS-1h tack coat evaluation are summarized in Tables 7.21 and 7.22. The results indicate that the increase in application rate increased the strength gain. In some instances, the strength gain was four times higher. For example, the strength gain increased from 0.03 to 0.14 psi when the application rate increased from 0.04 to 0.1 gal/yd² for 20 minutes set time and 20 lbs load when tested in the afternoon. In addition, the strength increased from 0.22 to 0.32 psi, when temperature increased from 57 to 64 °F for the application rates of 0.04 gal/yd², 30 minutes set time and 40 lbs load. For 0.1 gal/yd² application rates, the strength gain was 2 times for the similar increase in temperature. The results also indicated that the increase in set time from 20 to 30 minutes increased strength gain between 2 and 3 times depending on the application rates and applied load.

In terms of the repeatability of the device, the COV decreased with increase in application rate, applied load, set time, and test temperature. For example, a COV of 34.64 is observed for 30 minutes set time, application rate of 0.04 gal/yd² and 20 lbs load when tested in afternoon while for similar conditions the COV was 86.6 when tested in the morning. In general, the COV are significantly higher than that of UPOD. Overall, test results indicate that the repeatability is better for 30 minutes set time, therefore, the test should not be performed for set times below 30 minutes. In terms of applied load, the results indicate that the applied load of 40 lbs provides better repeatability and should be used for evaluation purposes.

The results of SS-1 tack coat evaluation are summarized in Tables 7.23 and 7.24. A value of 0.0 psi indicates that no reading was recorded. The results indicate that the increase in application rate increased the strength gain. In some instances, the strength gain was 5 times higher. For example, the strength gain increased from 0.03 to 0.15 psi, when the application rate increased from 0.04 to 0.1 gal/yd² for 20 minutes set time and 40 lbs applied load tested in the afternoon (Table 7.23). Since change in temperature was less than 2 °F, the effect of test temperature was not significant as compared to other tack coat types. The results also indicated that the increase in set time from 20 to 30 minutes increased strength gain between 1.5 and 2.0 times depending on the application rates and applied load.

In terms of the repeatability of the device, the COV decreased with increase in application rate, applied load, and set time. In some instances, the COV values were very high. For example, a COV of 173% was observed for 30 minutes set time for 0.04 gal/yd² application rate when tested in the morning at the applied load of 20 lbs. In general, the COV values are significantly higher than that of UPOD. Overall, test results indicate that the repeatability is better for 30 minutes set time, therefore, the test should not be performed for set times below 30 minutes. In terms of applied load, no clear trend could be identified. Therefore, it is difficult to suggest a specific applied load.

In general, test results indicated that the gained strength increased with an increase in set time, application rate, and test temperature. In addition, the measured strength was higher with increase in load levels indicating that the compaction efforts during placement of overlay will further increase the bond strength. The test results suggested that the test needs to be performed after the tack coat is set for 30 minutes (15 minutes in the case of cutback). The effectiveness of load varied between 30 and 40 lbs.

In comparison to UPOD, the SPOD results are highly variable and the variability significantly increased when RC-250 and PG64-22 tack coat types were used. In some instances, the SPOD was not able to differentiate between different application rates. In addition, the strength values varied significantly indicating that the device is less accurate in comparison to the UPOD. Based on the results, it can be concluded that the device is less repeatable and less accurate and can not be used in the field to obtain reliable results.

7.3 STATISTICAL ANALYSIS

To further evaluate the ability of UPOD and SPOD, an analysis of variance (ANOVA) was performed using MINITAB[®] 14.11. The purpose of this ANOVA was to identify whether the devices can successfully identify the impact of changes in the test parameter. In this study, the measured strength in the field was considered to be the dependent parameter while set time, applied load, application rate and test temperature were considered to be independent parameters. Although tack coat type also affects the strength, it was decided to perform the evaluation for each tack coat type separately since each tack coat has different strength levels. Therefore, a four factor ANOVA was performed in this study.

The null hypothesis selected for the ANOVA was that the means measured with the devices are the same. In other words, the measured strength does not depend on the independent parameter. If the null hypothesis is rejected, it can be concluded that the strength is dependent on the independent parameters. Thus, the devices are able to identify the impact of dependent parameters. A confidence level of 95% was assumed for the analysis purpose. The probability factor of falsely rejecting the null hypothesis (p-value) should be less than 0.05 in order to conclude that a difference is significant, since a 95% confidence level was chosen. The null hypothesis was rejected when the p-value was less than 0.05 and was accepted when the p-value was greater than 0.05.

The results of the ANOVA analysis for the UPOD and SPOD devices for six different tack coat types is shown in Tables 7.25 through 7.36. Since the objective of the statistical analyses was to compare the two devices, the tables for UPOD and SPOD for each tack coat types are placed one after the other. In each table, rows Two through Five show the results of the main effects while rows Six through Sixteen show the effects of interactions. The first column shows evaluated factors and their interactions. The second column shows degree of freedom and the third column shows Sum of Squares. The fourth column shows F-statistics and the fifth column shows p-value obtained. The sixth column shows the conclusion of the ANOVA analysis. The Y in the sixth column indicates that the device is able to identify the effect of parameter changes while N in the sixth column indicates that the effect of the parameter is insignificant.

The CSS-1h tack coat evaluation results of UPOD are summarized in Table 7.25. The evaluation results indicate that four-way interaction effects are present. However, the three-way interaction effects are not significant except for interaction effect of application rate, for test temperature and applied load where the interaction effect is significant. In terms of two-way interaction, the effect is significant in four cases and insignificant in two cases (for set time and application rate and set time and test temperature). The results summarized in Table 7.25 also indicate that the main effect is significant. In other words, the device is able to identify the effect of changes in independent parameter. Overall ANOVA of the UPOD data suggests that the device is able to discriminate between parameters since the means are not similar. However, the presence or absence of interaction effect could be due to the masking of one parameter's effect on the other parameter.

The CSS-1h tack coat evaluation results of SPOD are summarized in Table 7.26. The evaluation results indicate that there is no four-way interaction present. In addition, the three-way interaction is significant except for application rate, test temperature and applied load where the interaction effect is insignificant. In terms of two-way interaction, the interaction effect is significant in two cases and insignificant in three cases (for set time and application rate, for set time and applied load, and for application rate and applied load). The results summarized in Table 7.26 indicate that the main effect is significant. In other words, the device is able to identify the effect of changes in independent parameter. Overall ANOVA of the SPOD data suggests that the device is able to discriminate between the parameters since the means are not similar. However, the presence or absence of interaction effect could be due to the masking of one parameter's effect on the other parameter.

Table 7.25 - UPOD ANOVA for CSS-1h

Source	Degree of Freedom	SS	F Stat	P Value	Statistically Significant (Y/N)
Set	1	0.59405	84.15	<0.001	Y
Rate	1	2.8322	401.18	<0.001	Y
Temp	1	4.46009	631.77	<0.001	Y
Load	2	1.63184	115.57	<0.001	Y
Set * Rate	1	0.0128	1.81	0.184	N
Set * Temp	1	0.01742	2.47	0.123	N
Set * Load	2	0.05492	3.89	0.027	Y
Rate * Temp	1	0.10734	15.2	<0.001	Y
Rate * Load	2	0.36461	25.82	<0.001	Y
Temp * Load	2	0.19089	13.52	<0.001	Y
Set * Rate * Temp	1	0.01681	2.38	0.129	N
Set * Temp * Load	2	0.01239	0.88	0.422	N
Rate * Temp * Load	2	0.06367	4.51	0.016	Y
Set * Rate * Load	2	0.02861	2.03	0.143	N
Set * Rate * Temp * Load	2	0.06367	4.28	0.020	Y
Error	48	0.33887			
Total	71				

Table 7.26 - SPOD ANOVA for CSS-1h

Source	Degree of Freedom	SS	F Stat	P Value	Statistically Significant (Y/N)
Set	1	0.22781	23.51	<0.001	Y
Rate	1	0.86023	88.77	<0.001	Y
Temp	1	2.40901	248.6	<0.001	Y
Load	2	1.71661	88.57	<0.001	Y
Set * Rate	1	0.0165	1.7	0.198	N
Set * Temp	1	0.09031	9.32	0.004	Y
Set * Load	2	0.01886	0.97	0.385	N
Rate * Temp	1	0.71401	73.68	<0.001	Y
Rate * Load	2	0.04972	2.57	0.870	N
Temp * Load	2	0.20881	10.77	<0.001	Y
Set * Rate * Temp	1	0.0042	0.43	0.513	N
Set * Temp * Load	2	0.01323	0.68	0.510	N
Rate * Temp * Load	2	0.10681	5.51	0.007	Y
Set * Rate * Load	2	0.00994	0.51	0.602	N
Set * Rate * Temp * Load	2	0.0247	1.27	0.289	N
Error	48	0.46513			
Total	71				

Table 7.27 - UPOD ANOVA for CSS-1

Source	Degree of Freedom	SS	F Stat	P Value	Statistically Significant (Y/N)
Set	1	0.83636	162.05	<0.001	Y
Rate	1	2.26136	438.15	<0.001	Y
Temp	1	2.48645	481.77	<0.001	Y
Load	2	2.22754	215.8	<0.001	Y
Set * Rate	1	0.09102	17.64	<0.001	Y
Set * Temp	1	0.00347	0.67	0.416	N
Set * Load	2	0.02548	2.47	0.095	N
Rate * Temp	1	0.12667	24.54	<0.001	Y
Rate * Load	2	0.18588	18.01	<0.001	Y
Temp * Load	2	0.1236	11.97	<0.001	Y
Set * Rate * Temp	1	0.00005	0.01	0.922	N
Set * Temp * Load	2	0.05458	5.29	0.008	Y
Rate * Temp * Load	2	0.01081	1.05	0.359	N
Set * Rate * Load	2	0.00654	0.63	0.535	N
Set * Rate * Temp * Load	2	0.00923	0.89	0.416	N
Error	48	0.24773			
Total	71				

Table 7.28 - SPOD ANOVA for CSS-1

Source	Degree of Freedom	SS	F Stat	P Value	Statistically Significant (Y/N)
Set	1	2.3328	277.94	<0.001	Y
Rate	1	2.02005	240.68	<0.001	Y
Temp	1	4.31201	513.76	<0.001	Y
Load	2	2.00351	119.36	<0.001	Y
Set * Rate	1	0.01076	1.28	0.263	N
Set * Temp	1	1.08536	129.32	<0.001	Y
Set * Load	2	0.12413	7.4	0.002	Y
Rate * Temp	1	0.04401	5.24	0.026	Y
Rate * Load	2	0.02703	1.61	0.210	N
Temp * Load	2	0.06868	4.09	0.023	Y
Set * Rate * Temp	1	0.045	5.36	0.025	Y
Set * Temp * Load	2	0.07241	4.31	0.019	Y
Rate * Temp * Load	2	0.01481	0.88	0.420	N
Set * Rate * Load	2	0.00974	0.58	0.563	N
Set * Rate * Temp * Load	2	0.0481	2.87	0.670	N
Error	48	0.40287			
Total	71				

Table 7.29 - UPOD ANOVA for SS-1h

Source	Degree of Freedom	SS	F Stat	P Value	Statistically Significant (Y/N)
Set	1	1.15773	174.1	<0.001	Y
Rate	1	1.53417	230.7	<0.001	Y
Temp	1	0.78751	118.42	<0.001	Y
Load	2	4.25816	320.16	<0.001	Y
Set * Rate	1	0.00257	0.39	0.537	N
Set * Temp	1	0.00101	0.15	0.698	N
Set * Load	2	0.00469	0.35	0.705	N
Rate * Temp	1	0.09753	14.67	<0.001	Y
Rate * Load	2	0.02127	1.6	0.213	N
Temp * Load	2	0.03202	2.41	0.101	N
Set * Rate * Temp	1	0.00003	0.01	0.943	N
Set * Temp * Load	2	0.00151	0.11	0.893	N
Rate * Temp * Load	2	0.00484	0.36	0.697	N
Set * Rate * Load	2	0.03969	2.98	0.060	N
Set * Rate * Temp * Load	2	0.00725	0.55	0.583	N
Error	48	0.3192			
Total	71				

Table 7.30 - SPOD ANOVA for SS-1h

Source	Degree of Freedom	SS	F Stat	P Value	Statistically Significant (Y/N)
Set	1	0.042535	38.96	<0.001	Y
Rate	1	0.047535	43.54	<0.001	Y
Temp	1	0.090313	82.73	<0.001	Y
Load	2	0.185644	85.03	<0.001	Y
Set * Rate	1	0.002812	2.58	0.115	N
Set * Temp	1	0.000035	0.03	0.859	N
Set * Load	2	0.018311	8.39	0.001	Y
Rate * Temp	1	0.002813	2.58	0.115	N
Rate * Load	2	0.000311	0.14	0.868	N
Temp * Load	2	0.0007	0.32	0.727	N
Set * Rate * Temp	1	0.002813	2.58	0.115	N
Set * Temp * Load	2	0.000478	0.22	0.804	N
Rate * Temp * Load	2	0.0007	0.32	0.727	N
Set * Rate * Load	2	0.002533	1.16	0.322	N
Set * Rate * Temp * Load	2	0.0007	0.32	0.727	N
Error	48	0.0524			
Total	71				

Table 7.31 - UPOD ANOVA for SS-1

Source	Degree of Freedom	SS	F Stat	P Value	Statistically Significant (Y/N)
Set	1	0.39902	92.35	<0.001	Y
Rate	1	0.15494	35.86	<0.001	Y
Temp	1	0.43245	100.08	<0.001	Y
Load	2	1.60034	185.19	<0.001	Y
Set * Rate	1	0.0648	15.00	<0.001	Y
Set * Temp	1	0.03556	8.23	0.006	Y
Set * Load	2	0.05642	6.53	0.003	Y
Rate * Temp	1	0.02961	6.85	0.012	Y
Rate * Load	2	0.0221	2.56	0.088	N
Temp * Load	2	0.04103	4.75	0.013	Y
Set * Rate * Temp	1	0.01389	3.21	0.079	N
Set * Temp * Load	2	0.00169	0.20	0.823	N
Rate * Temp * Load	2	0.00754	0.87	0.425	N
Set * Rate * Load	2	0.01448	1.68	0.198	N
Set * Rate * Temp * Load	2	0.00795	0.92	0.405	N
Error	48	0.2074			
Total	71				

Table 7.32 – SPOD ANOVA for SS-1

Source	Degree of Freedom	SS	F Stat	P Value	Statistically Significant (Y/N)
Set	1	0.027613	32.92	<0.001	Y
Rate	1	0.066613	79.41	<0.001	Y
Temp	1	0.036901	43.99	<0.001	Y
Load	2	0.224436	133.77	<0.001	Y
Set * Rate	1	0.000001	0.00	0.968	N
Set * Temp	1	0.000001	0.00	0.968	N
Set * Load	2	0.008808	5.25	0.009	Y
Rate * Temp	1	0.000001	0.00	0.968	N
Rate * Load	2	0.027608	16.46	<0.001	Y
Temp * Load	2	0.004803	2.86	0.067	N
Set * Rate * Temp	1	0.000501	0.60	0.443	N
Set * Temp * Load	2	0.001453	0.87	0.427	N
Rate * Temp * Load	2	0.001053	0.63	0.538	N
Set * Rate * Load	2	0.000869	0.52	0.599	N
Set * Rate * Temp * Load	2	0.000836	0.50	0.611	N
Error	48	0.040267			
Total	71				

Table 7.33 – UPOD ANOVA for RC-250

Source	Degree of Freedom	SS	F Stat	P Value	Statistically Significant (Y/N)
Set	1	0.7544	56.23	<0.001	Y
Rate	1	2.3944	178.46	<0.001	Y
Temp	1	0.42167	31.43	<0.001	Y
Load	2	3.64924	136.00	<0.001	Y
Set * Rate	1	0.01711	1.28	0.264	N
Set * Temp	1	0.0115	0.86	0.359	N
Set * Load	2	0.08314	3.10	0.054	N
Rate * Temp	1	0.00867	0.65	0.425	N
Rate * Load	2	0.21268	7.93	0.001	Y
Temp * Load	2	0.02174	0.81	0.451	N
Set * Rate * Temp	1	0.00333	0.25	0.620	N
Set * Temp * Load	2	0.02301	0.86	0.431	N
Rate * Temp * Load	2	0.01734	0.65	0.528	N
Set * Rate * Load	2	0.02623	0.98	0.384	N
Set * Rate * Temp * Load	2	0.01231	0.46	0.635	N
Error	48	0.644			
Total	71				

Table 7.34 – SPOD ANOVA for RC-250

Source	Degree of Freedom	SS	F Stat	P Value	Statistically Significant (Y/N)
Set	1	0.035556	14.63	<0.001	Y
Rate	1	0.000139	0.06	0.812	N
Temp	1	0.023472	9.66	0.003	Y
Load	2	0.036319	7.47	0.001	Y
Set * Rate	1	0.000139	0.06	0.812	N
Set * Temp	1	0.003472	1.43	0.238	N
Set * Load	2	0.000486	0.10	0.905	N
Rate * Temp	1	0.005	2.06	0.158	N
Rate * Load	2	0.005069	1.04	0.360	N
Temp * Load	2	0.000069	0.01	0.986	N
Set * Rate * Temp	1	0.000556	0.23	0.635	N
Set * Temp * Load	2	0.000903	0.19	0.831	N
Rate * Temp * Load	2	0.002708	0.56	0.577	N
Set * Rate * Load	2	0.003403	0.70	0.502	N
Set * Rate * Temp * Load	2	0.000486	0.10	0.905	N
Error	48	0.116667			
Total	71				

Table 7.35 – UPOD ANOVA for PG64-22

Source	Degree of Freedom	SS	F Stat	P Value	Statistically Significant (Y/N)
Set	1	0.59233	111.89	<0.001	Y
Rate	1	0.4917	92.90	<0.001	Y
Temp	1	1.10261	208.31	<0.001	Y
Load	2	1.1725	110.76	<0.001	Y
Set * Rate	1	0.00233	0.44	0.510	N
Set * Temp	1	0.02033	3.84	0.056	N
Set * Load	2	0.08748	8.26	0.001	Y
Rate * Temp	1	0.01051	1.99	0.165	N
Rate * Load	2	0.02748	2.60	0.085	N
Temp * Load	2	0.0172	1.62	0.208	N
Set * Rate * Temp	1	0.00551	1.04	0.313	N
Set * Temp * Load	2	0.01654	1.56	0.220	N
Rate * Temp * Load	2	0.0003	0.03	0.972	N
Set * Rate * Load	2	0.00968	0.91	0.408	N
Set * Rate * Temp * Load	2	0.0084	0.79	0.458	N
Error	48	0.25407			
Total	71				

Table 7.36 – SPOD ANOVA for PG64-22

Source	Degree of Freedom	SS	F Stat	P Value	Statistically Significant (Y/N)
Set	1	0.02801	9.60	0.003	Y
Rate	1	0.11045	37.85	<0.001	Y
Temp	1	3.26827	1120.02	<0.001	Y
Load	2	0.31514	54.00	<0.001	Y
Set * Rate	1	0.00045	0.15	0.690	N
Set * Temp	1	0.00067	0.23	0.633	N
Set * Load	2	0.00464	0.79	0.458	N
Rate * Temp	1	0.00001	0.00	0.965	N
Rate * Load	2	0.00661	1.13	0.331	N
Temp * Load	2	0.00239	0.41	0.667	N
Set * Rate * Temp	1	0.00067	0.23	0.633	N
Set * Temp * Load	2	0.01272	2.18	0.124	N
Rate * Temp * Load	2	0.01414	2.42	0.099	N
Set * Rate * Load	2	0.00228	0.39	0.679	N
Set * Rate * Temp * Load	2	0.00097	0.17	0.847	N
Error	48	0.14007			
Total	71				

Similar patterns were observed with the remaining tack coat types. Typically results indicated that both devices can identify the main effects while the presence and absence of interactions effects depends on the tack coat type. Only SPOD was not able to identify the main effect of application rate for RC-250 tack coat type and the results are consistent with the data presented in Tables 7.17 and 7.18.

To compare the precision of evaluated devices, the residual sum of squares obtained from ANOVA were utilized (Table 7.37). The residual sum of squares are denoted as “Error” in the ANOVA tables and reported in the second to last row, third column. The results indicate that the equipment repeatability is tack coat type dependent. The UPOD is more repeatable for CSS-1h, CSS-1, and RC-250 tack coat types while SPOD is more repeatable for the remaining tack coat types.

Table 7.37 - Comparison of SPOD and UPOD Devices Based on Residual Sum of Squares

Tack Coat Type	Pull-Off Device	
	UPOD	SPOD
CSS-1h	0.33887	0.46513
CSS-1	0.24773	0.40287
SS-1	0.3192	0.0524
SS-1h	0.2074	0.040267
RC-250	0.01231	0.116667
PG64-22	0.25407	0.14007

Based on the test results and analysis presented in Tables 7.1 through 7.37, it can be concluded that SPOD as well as UPOD have the capabilities of identifying effects of changes in parameters. However, SPOD is less accurate in comparison to UPOD. In addition, the SPOD test is performed by directly pulling the equipment and may injure the back of the operator. Therefore, it was decided to perform further evaluations only using UPOD.

7.4 DIRECT SHEAR TEST DEVICE

After the successful field evaluation of UPOD, the laboratory tests were performed to identify the accuracy and applicability of the UPOD. Initially it was decided to simulate the field conditions, where a 4 in. diameter core was obtained from the field and tack coat (at the rate of 0.04 gal/yd²) was placed on top of it. After a specified time interval, the core was placed in the 4 in. diameter mold of Superpave Gyratory Compactor (SGC) and loose hot mix was placed on top of the core and was compacted using 138 gyrations. Then the composite specimen was tested. The specimen did not fail until 89 psi, as shown in Table 7.38. The tests were stopped at 89 psi because the load cell used for testing was less than 1,000 lbs. The composite specimen failed at 62 psi when tested at

50 °F indicating that the higher capacity load cell needed to be used. The significant difference between UPOD and direct shear (DS) test could be attributed to the applied load and the effect of temperature. In preparation of the composite specimen, the hot AC is placed on top increasing the temperature of tack coat and increasing the bond between the two layers. In addition, a 600 kPa stress is applied during compaction and the applied stress also increases the bond strength, as suggested in section 7.1.

Table 7.38 - DS Laboratory Test Results of AC Specimens Compacted by Simulating Field Conditions with CSS-1h Tack coat

Dilution	Test Temperature, °F (°C)	Set Time, min	Shear Strength, psi (kPa)
None	140(60)	60	>89 (613)
	93(34)	30	>89 (613)
	50(10)	30	62 (428)

Although the composite specimens prepared using this method will provide actual bond strength, the idea of preparing specimens in SGC was dropped because the strength measured with UPOD were very low (less than 10 psi) in comparison to DS (more than 62 psi); therefore, could not be used for developing correlations between the two tests. Therefore, a modified strategy was opted to perform DS test with AC specimen without compaction. In this method, the 4 in. diameter cores obtained from the field and a layer of tack coat was applied on top of them. After a specified time interval, a 4 in. diameter specimen was placed on top of it and 40lbs load, similar to UPOD, was applied for ten minutes before performing DS test.

For new strategy, the triplicate tests were performed at three different temperatures of 50°F, 93°F, and 140°F and under three normal loads of 5psi, 10psi and 15psi. The peak load was averaged for the triplicate specimens and a plot between peak stress and normal stress was developed, as shown in Figure 7.1. A linear fit to the data points gave slope and intercept. The intercept is identified as cohesion and slope is identified as a friction angle. The summarized results for each temperature and set time are shown in Table 7.39. The result shows that the cohesion strength increased with increase in temperature and set time. The friction angle values (16 to 21 degrees) were similar for specimens tested at 140 and 93 °F but a higher friction angle was measured at 50 °F. This difference could be because of the fact that the tack coat is more viscous at lower temperature, thus, increases frictional resistance. The total strength increased with increase in set temperature and set time. However, increase in friction angle increased strength at lower temperatures. For example, the total strength of 3.49 psi was observed for 50 °F test temperature and 30 minute set time which is higher than 3.2 psi observed for 93 °F test temperature and 30 minute set time. To minimize the effect of friction angle in the

measurement of strength and reduce testing time, it was decided to replace the AC specimen with aluminum specimens (less friction).

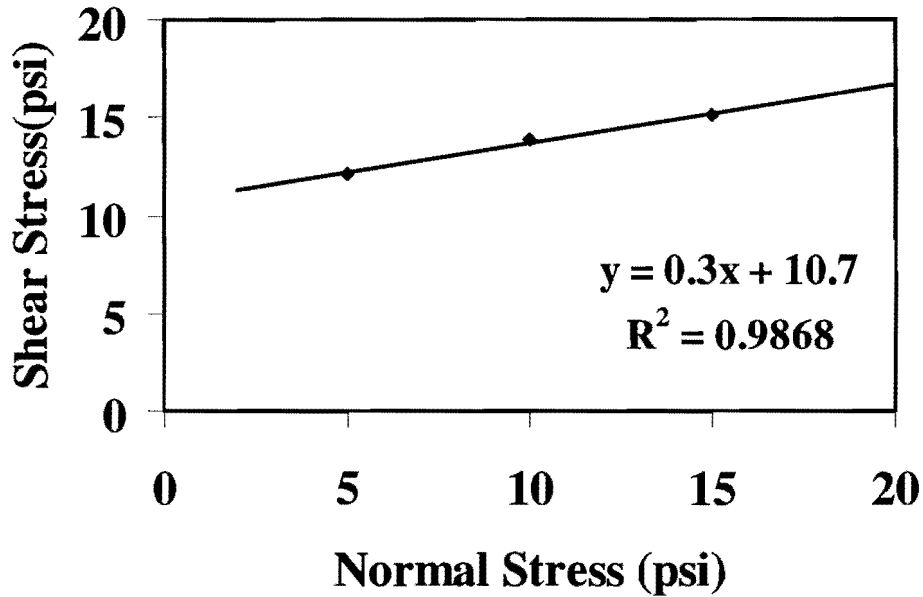

Figure 7.1 - DS Test Results for Tests Performed at 140° F and 60 Minutes Set Time with CSS-1h Tack coat

Table 7.39 - DS Test Results for AC Specimen Tested with CSS-1h Tack coat

Test Temperature, F(°C)	Set Time, min	Asphalt Specimen		
		Friction Angle, ϕ (degrees)	Cohesion, psi (kpa)	Total Strength, psi (kpa)
140(60)	60	16.7	10.7(73.72)	11.65(80.27)
	45	16.8	7.9(54.43)	8.86(61.05)
	30	18.3	6.53(44.99)	7.58(52.23)
93(34)	60	17.7	3.56(24.53)	4.58(31.56)
	45	20.8	2.6(17.91)	3.81(26.25)
	30	16.1	2.2(15.16)	3.2(22.05)
50(10)	60	32.5	2.25(15.50)	4.28(29.49)
	45	29.7	1.3(8.96)	3.11(21.43)
	30	37.6	1.04(7.17)	3.49(24.05)

The tests performed with aluminum specimens are summarized in Table 7.40. The results show similar trends as with AC specimens with few exceptions. One of the exceptions was that very high friction angle was observed at higher temperatures (26 to 29 degrees) in comparison to lower temperatures (2 to 10 degrees). Another observation was that the strength measured at higher temperature was significantly lower with aluminum specimens than with AC specimens. For example, the total strength measured at 140 °F for 60 minutes of set time was 11 psi with AC specimens while only 6 psi strength was measured with aluminum specimens under similar conditions. The total strength at lower temperatures was quite comparable for both specimens. The reason for differences at higher temperature could be attributed to the thermal conductivity of the two materials. Aluminum has a very high thermal conductivity in comparison to AC; therefore, aluminum specimen temperature drops significantly at higher temperature in comparison to AC. The significant drop in temperature could explain increase in friction angle. However, this does not explain increase in bond strength at higher temperatures. The only explanation could be that at higher temperature tack coat is less viscous and allows better penetration of tack coat within the AC specimen. The increase in set time further enhances the bond; thus, increasing bond strength significantly higher at higher temperatures. In this study, the strength values were not measured at higher temperatures for DS tests and are not used for comparison purposes.

The cohesive strength measured using aluminum and AC specimens at 93 and 50 °F is plotted in Figure 7.2. The results show that the cohesion measured using two methods are quite comparable and the measured strength with AC specimen is only 13% higher in comparison to aluminum specimens. Therefore, it was decided to perform DS tests with aluminum specimens and at two lower temperatures (93 and 50 °F) only.

Table 7.40 - DS Test Results for Aluminum Specimen Tested with CSS-1h Tack coat

Test Temperature, °F (°C)	Set Time, min	Aluminum Specimen		
		Friction Angle, ϕ (degrees)	Cohesion, psi (kpa)	Total Strength, psi (kpa)
140(60)	60	28.8	4.70(32.9)	5.77(40.4)
	45	28.3	2.05(14.35)	3.14(22.0)
	30	26.6	1.10(7.7)	2.11(14.8)
93(34)	60	2.1	2.71(18.97)	2.78(19.5)
	45	4.2	1.47(10.29)	1.61(11.3)
	30	4.5	1.10(7.7)	1.25(8.8)
50(10)	60	12.5	0.41(2.87)	0.86(6.0)
	45	11.3	0.26(1.82)	0.66(4.6)
	30	10.4	0.22(1.54)	0.59(4.1)

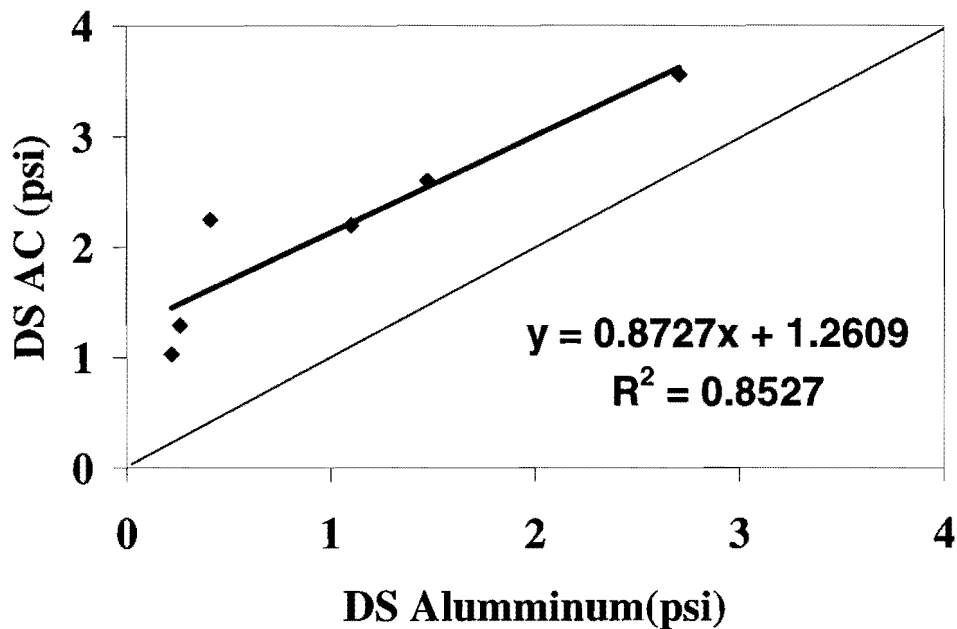

Figure 7.2 - Relationship between AC and Aluminum Specimens used in DS Test

Further DS tests were performed with remaining three tack coat types at two lower temperatures. In addition, the tests were not performed with RC-250 and SS-1 due to the shortage of material. The test results for tack coats are shown in Tables 7.41 through 7.43. The last column in the tables shows the cohesive strength measured for each tack coat type.

Table 7.41 - DS Laboratory Test Results for CSS-1

Dilution Level	Residual Application Rate, gal/yd ² (l/m ²)	Test Temperature, °F(°C)	Set Time, min	Cohesive Strength, psi (kPa)
None	0.04(0.18)	93(34)	60	1.52(10.64)
			45	1.2(8.4)
			30	0.66(4.62)
		50(10)	60	0.4(2.8)
			45	0.2(1.4)
			30	0.15(1.05)

Table 7.42 - DS Laboratory Test Results for PG64-22

Dilution Level	Residual Application Rate, gal/yd ² (l/m ²)	Test Temperature, °F(°C)	Set Time, min	Cohesive Strength, psi (kPa)
None	0.04(0.18)	93(34)	60	1.4(9.8)
			45	1.2(8.4)
			30	0.93(6.51)
		50(10)	60	0.96(6.72)
			45	0.43(3.01)
			30	0.23(1.61)

Table 7.43 - DS Laboratory Test Results for SS-1h

Dilution Level	Residual Application Rate, gal/yd ² (l/m ²)	Test Temperature, °F(°C)	Set Time, min	Cohesive Strength, psi (kPa)
None	0.04(0.18)	93(34)	60	0.93(6.51)
			45	0.52(3.64)
			30	0.45(3.15)
		50(10)	60	0.62(4.34)
			45	0.28(1.96)
			30	0.25(1.75)

The test results indicate that the cohesive strength increased with increase in temperature and set time. The test results also suggest that CSS-1h gained higher strength (2.72 psi) in comparison to other tack coat types (1.52 psi or lower). Although CSS-1h has higher strength in comparison to other tack coats, the difference in strength diminishes at lower temperatures and lower set time (0.22 to 0.15 psi). The SS-1h showed the lowest strength gain (0.93 psi) at 140 °F and 60 minutes set time.

The data presented in Tables 7.40 through 7.43 is graphically presented in Figures 7.3 through 7.6. The data suggests that strength gain is exponentially dependent on set time. The gained strength also depends on the test temperature. However, the test temperature relationship was different for different tack coat types. For example, the strength gained showed a parallel shift between the two temperatures for tack coat types PG64-22 and SS-1h (Figures 7.5 and 7.6) while strength gain was significantly higher at higher temperatures for CSS-1h and CSS-1 (Figures 7.3 and 7.4) tack coat types. Overall, the coefficients of determination (R^2) values were higher than 0.84 indicating that there is a strong relationship between set time and strength gained.

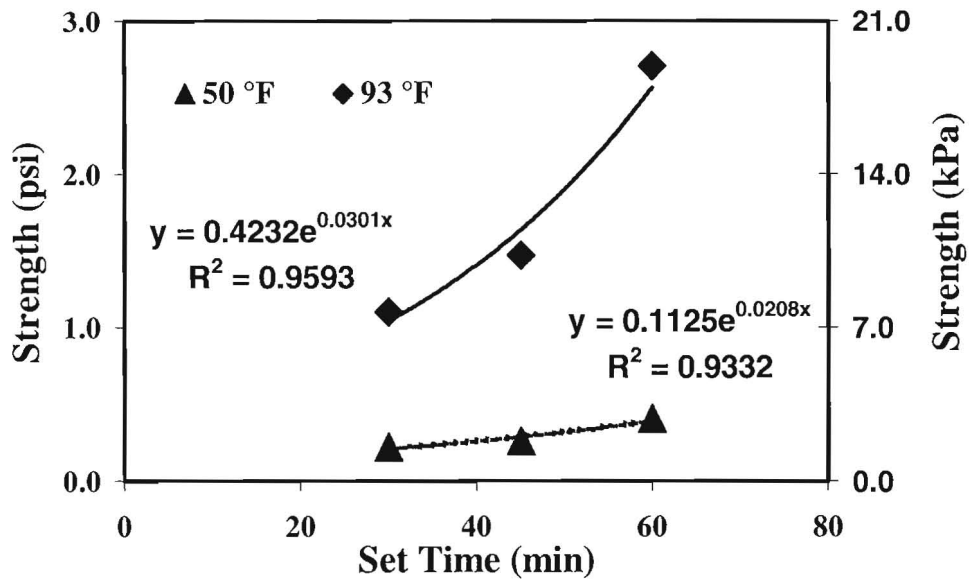

Figure 7.3 - DS Test Results for CSS-1h

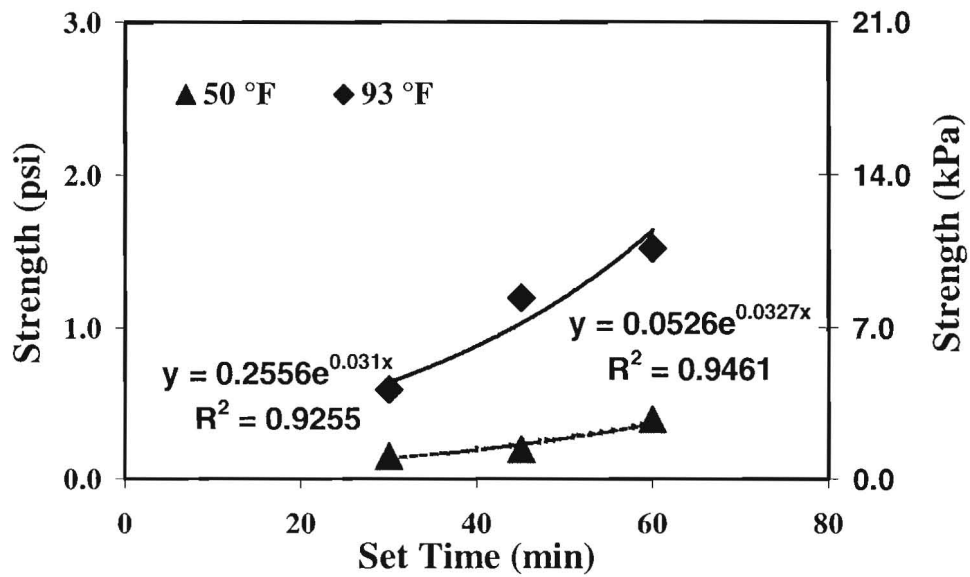

Figure 7.4 - DS Test Results for CSS-1

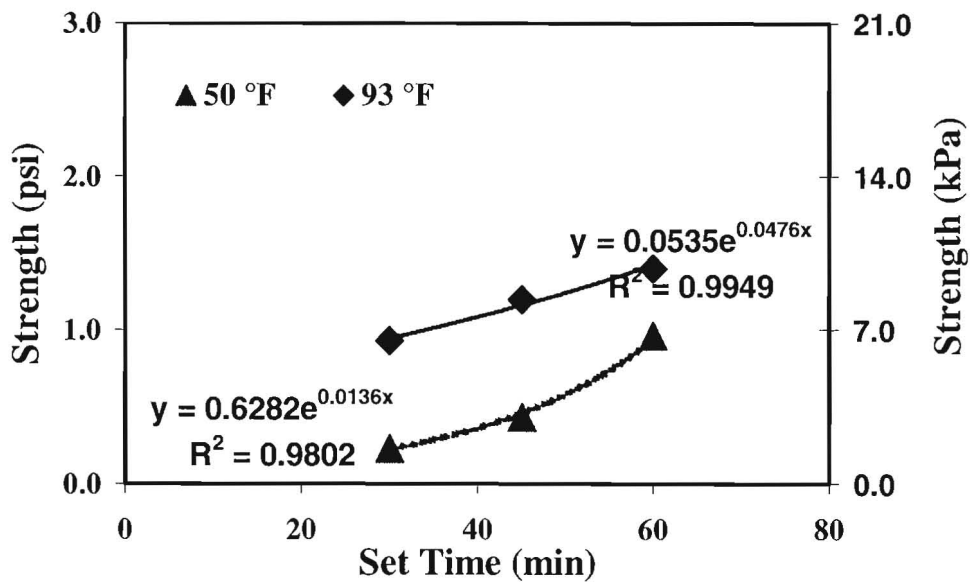

Figure 7.5 - DS Test Results for PG64-22

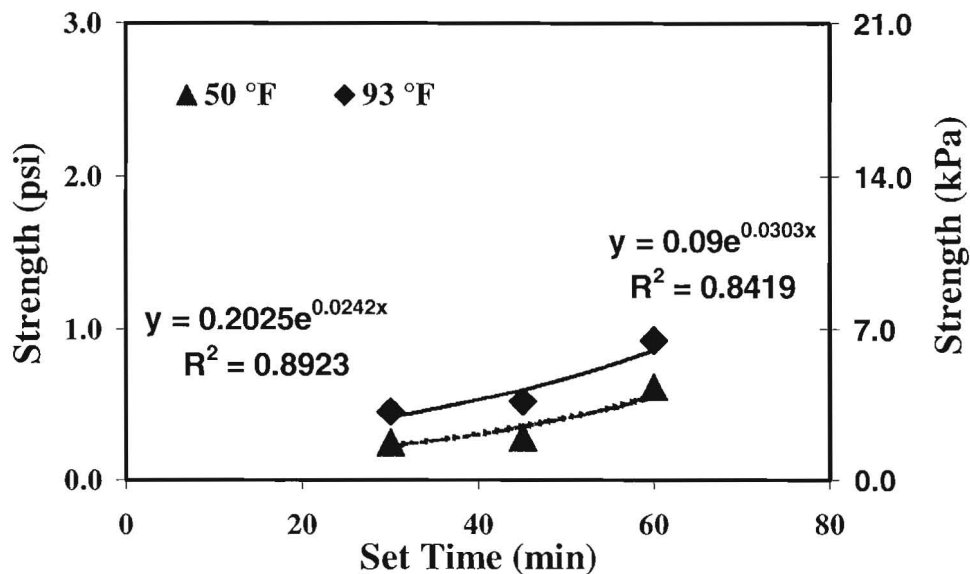

Figure 7.6 - DS Test Results for SS-1h

7.5 EVALUATION OF UPOD IN LABORATORY

After successful evaluation of UPOD in the field, the tests were performed in the laboratory to identify the impact of change in parameters under a controlled environment. Initial investigation suggested that the strength gain depends on set time and temperature at the time of application. Since it is difficult to control temperature in the field, the tests were performed in the laboratory. To maintain temperature in the laboratory, the set up shown in Figure 6.14 was utilized. The tests in triplicates were performed at three

different temperatures and three set times. Again the tests were performed at one application rate of 0.04 gal/yd² and the tack coats were not diluted. The results of the tack coat evaluation are shown in Tables 7.44 through 7.47. The organization of tables is similar to DS test results with the exception that standard deviation and COV were also added in the last two columns. In addition, tests were performed with only four tack coat types due to the shortage of the material.

The test results of CSS-1h tack coat are summarized in Table 7.44. The test results suggest that the strength increased with temperature and set time and varied between 2.74 and 0.13 psi. The standard deviation remained the same at the level of 0.07 psi while COV varied between 3.9 and 15.22 %. At higher temperature, COV value remained constant at around 7% but at lower temperatures and set time it varied significantly. The variability may be due to the insensitivity of the equipment at lower levels.

Table 7.44 - UPOD Laboratory Test Results for CSS-1h

Dilution Level	Residual Application Rate, gal/yd ² (l/m ²)	Test Temperature, °F(°C)	Set Time, min	Average Strength, psi (kPa)	Std Dev, psi (kPa)	COV, %
None	0.04(0.18)	140 (60)	60	2.74(19.18)	0.07(0.49)	7.37
			45	2.07(14.49)	0.07(0.49)	6.51
			30	1.67(11.69)	0.07(0.49)	6.26
		93 (34)	60	0.73(5.11)	0.07(0.49)	9.32
			45	0.63(4.41)	0.07(0.49)	10.83
			30	0.50(3.5)	0.07(0.49)	3.90
		50 (10)	60	0.27(1.89)	0.07(0.49)	8.10
			45	0.20(1.4)	0.07(0.49)	9.97
			30	0.13(0.91)	0.07(0.49)	15.22

Table 7.45 - UPOD Laboratory Test Results for CSS-1

Dilution Level	Residual Application Rate, gal/yd ² (l/m ²)	Test Temperature, °F(°C)	Set Time, min	Average Strength, psi (kPa)	Std Dev, psi (kPa)	COV, %
None	0.04(0.18)	140 (60)	60	2.07(14.49)	0.07(0.49)	7.37
			45	1.67(11.69)	0.07(0.49)	6.51
			30	1.34(9.38)	0.07(0.49)	6.26
		93 (34)	60	0.73(5.11)	0.07(0.49)	9.32
			45	0.60(4.2)	0.07(0.49)	10.83
			30	0.46(3.22)	0.07(0.49)	3.90
		50 (10)	60	0.23(1.11)	0.07(0.49)	8.10
			45	0.13(0.91)	0.07(0.49)	9.97
			30	0.1(0.7)	0.07(0.49)	15.22

Table 7.46 - UPOD Laboratory Test Results for PG64-22

Dilution Level	Residual Application Rate, gal/yd ² (l/m ²)	Test Temperature, °F(°C)	Set Time, min	Average Strength, psi (kPa)	Std Dev, psi (kPa)	COV, %
None	0.04(0.18)	140(60)	60	1.94(13.58)	0.07(0.49)	3.48
			45	1.67(11.69)	0.07(0.49)	4.04
			30	1.34(9.38)	0.07(0.49)	5.07
		93(34)	60	1.40(9.80)	0.07(0.49)	4.82
			45	1.13(7.91)	0.07(0.49)	6.64
			30	0.80(5.60)	0.07(0.49)	8.53
		50(10)	60	0.46(3.22)	0.07(0.49)	9.03
			45	0.33(2.31)	0.07(0.49)	10.57

Table 7.47 - UPOD Laboratory Test Results for SS-1h

Dilution Level	Residual Application Rate, gal/yd ² (l/m ²)	Test Temperature, °F(°C)	Set Time, min	Average Strength, psi (kPa)	Std Dev, psi (kPa)	COV, %
None	0.04(0.18)	140(60)	60	2.07(14.49)	0.07(0.49)	3.25
			45	1.59(11.13)	0.07(0.49)	4.21
			30	1.20(8.4)	0.07(0.49)	5.64
		93(34)	60	0.40(2.8)	0.07(0.49)	17.45
			45	0.33(2.31)	0.07(0.49)	16.74
			30	0.26(1.82)	0.07(0.49)	13.41
		50(10)	60	0.26(1.82)	0.07(0.49)	26.81
			45	0.20(1.40)	0.07(0.49)	22.42
			30	0.16(1.12)	0.07(0.49)	22.53

Similar trends were observed with remaining tack coats with the exception of SS-1h, as shown in Table 7.47. Although strength gains were similar to other tack coat types, the COV values were as high as 27%. Further investigation identified that the tack coat was reaching its shelf life; thus, resulted in higher COV. An attempt to gather new material and perform testing was not possible due to time constraints of the project. Based on the test results, the CSS-1h tack coat showed a maximum gain in strength while PG64-22 showed minimum gain in strength. The trends were similar to the ones observed with DS test results.

The data presented in Tables 7.44 through 7.47 is graphically presented in Figures 7.7 through 7.10. For the UPOD, data analysis it seemed that test temperature on the X-axis provided a better curve fit in comparison to set time. Therefore, it was decided to plot the

data using test temperature on X-axis. The data suggests that strength gain is exponentially dependent on set time. The gained strength also depends on the test temperature. The data also suggests that at lower test temperatures the effect of set time is minimal in comparison to higher temperatures. Overall the coefficients of determination (R^2) values were higher than 0.92 indicating that there is a strong relationship between test temperature, set time, and strength gained.

Although UPOD evaluation test results indicate that the gained strength depends on test temperature as well as set time. However, the magnitude of strength gained is different for different tack coat types a trend similar to DS test results.

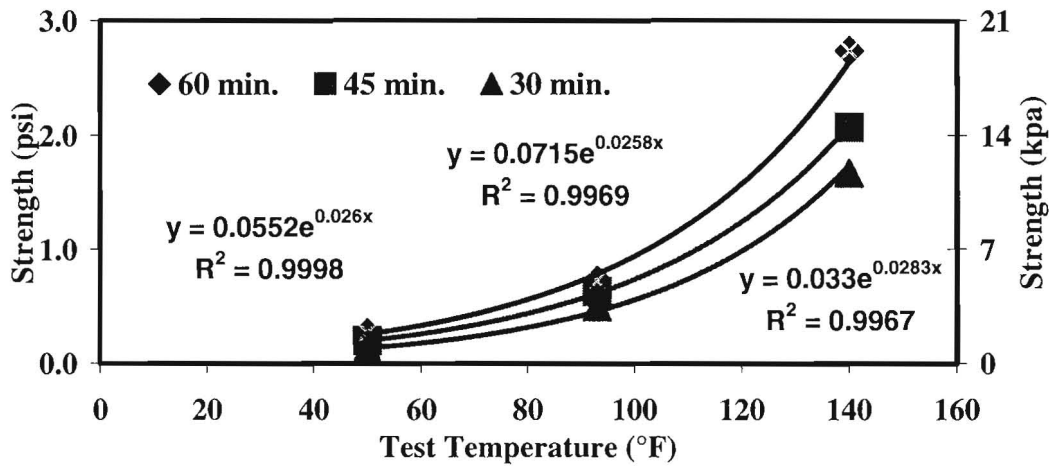

Figure 7.7 - UPOD Laboratory Test Results for CSS-1h

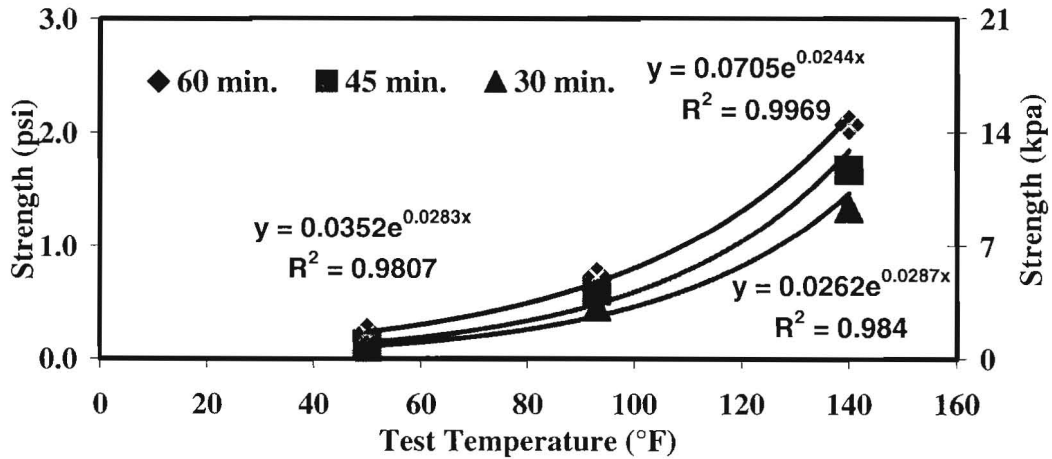

Figure 7.8 - UPOD Laboratory Test Results for CSS-1

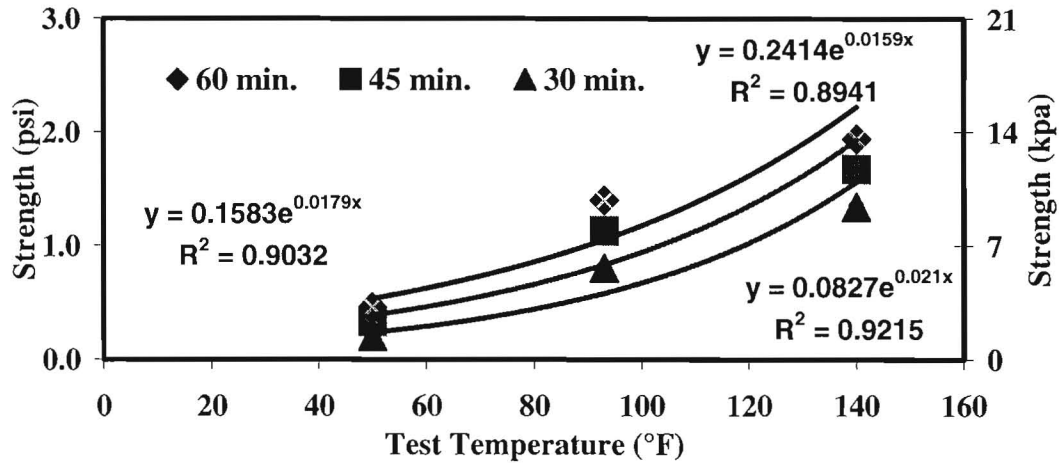

Figure 7.9 - UPOD Laboratory Test Results for PG64-22

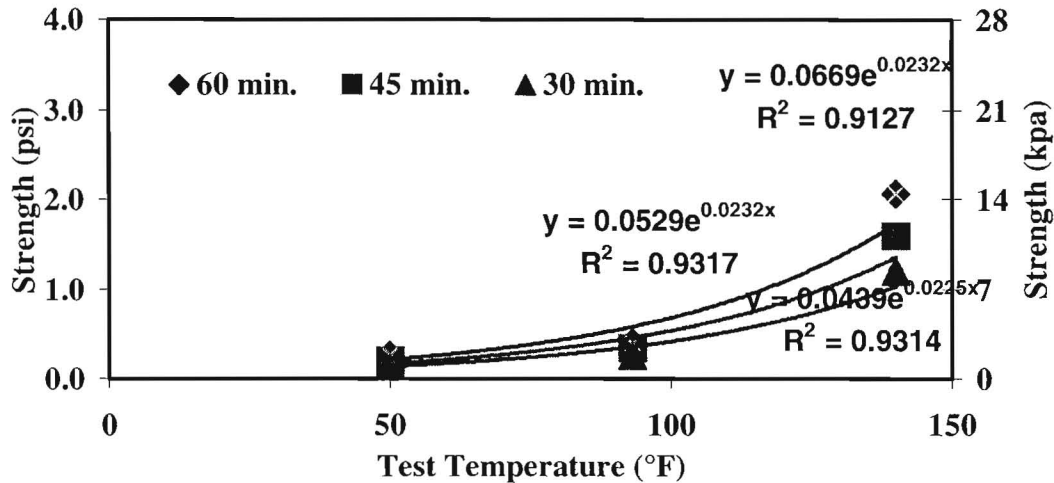

Figure 7.10 - UPOD Laboratory Test Results for SS-1h

7.6 TIME AND TEMPERATURE DEPENDANCE ON DS TME TEMPERATURE

The test results summarized in Figures 7.3 though 7.10 indicate that the strength of the tack coat type is nonlinearly dependent on the set time and test temperatures. The relationship could be mathematically expressed as:

$$\text{Strength} = f(\text{set time}, \text{test temperature}) \quad (7.1)$$

Although the strength depends on other factors such as wind velocity, pavement temperature, relative humidity, it was decided to develop a relationship between the only two of the factors because these two parameters were the only ones evaluated. The data presented in Figures 7.3 through 7.6 indicated that gained strength is exponentially dependent on set time while Figures 7.7 through 7.10 indicated that the gained strength is

exponentially depended on set time. To develop a relationship between gained strength and set time and test temperature, various combinations were evaluated and the following relationship provided the best R² values:

$$\text{Strength} = \text{Set Time} * \text{Time Factor} * e^{(\text{Test Temperature} * \text{Temperature Factor})} \quad (7.2)$$

where set time is in minutes and test temperature is in °F. The time and temperature factors for each tack coat type along with R² values is presented in Table 7.48. Since DS tests were not performed at all temperatures, separate relationships were developed for the two devices. The R² values are higher than 0.84 indicating that a good correlation exists and these relationships could be used for the evaluation of tack coat in the field.

Table 7.48 - Time Temperature Correlation Factors

Tack Coat	UPOD			Direct Shear		
	Time Factor	Temp Factor	R ²	Time Factor	Temp Factor	R ²
CSS-1h	0.001171	0.02668	1.00	0.00087346	0.04032966	0.99
CSS-1	0.000930	0.027128	0.99	0.00092019	0.03498492	0.98
SS-1h	0.001242	0.022992	0.96	0.00434779	0.01249838	0.84
PG64-22	0.003392	0.018231	0.95	0.00356082	0.02171078	0.89

To validate the relationships proposed in equation 7.2 and Table 7.48, the data presented in Tables 7.1 through 7.24 was utilized and shown in Tables 7.48 through 7.51. Since the relationships (Table 7.48) were developed for one level of load and one application rate, the validity of the relationship was evaluated for these conditions only. The results presented in tables show the field test conditions including test temperature and set time. In addition, tables show measured strength in the field using UPOD as well as SPOD and the estimated strength based on relationships presented in Table 7.48.

The CSS-1h tack coat evaluation results are summarized in Table 7.49. The test results indicate that the DS estimated strength closely matches with measured UPOD strength. For example, UPOD measured strength is 0.31 psi while estimated strength is 0.35 and 0.19 psi for DS and UPOD devices, respectively. The results show that UPOD estimated strength is closer to the measured values at lower temperature but are different at higher temperatures. The SPOD results are significantly different from the estimated values indicating that the test is not accurate.

The CSS-1 tack coat test results are summarized in Table 7.50. The test results indicate that the UPOD estimated and measured strength closely matches. For example, the measured strength is 0.18 psi for a set time of 30 minutes and at test temperature of 70 °F while estimated strength is 0.19 psi. However, the estimated strength (0.15 psi) is different from the measured strength (0.25 psi) at test temperature of 77 °F and 20 minutes set time. The test

results also indicate that the DS estimated strength is significantly higher than the measured UPOD strength. Again, SPOD measured strength is significantly different from the estimated UPOD or DS strengths.

The PG64-22 test results are summarized in Table 7.51. The test results show similar trends to that of CSS-1 tack coat. The test results show that the estimated and measured UPOD values are very similar while DS over estimated the strength. The SPOD test results are significantly different from DS or UPOD estimated strengths.

The SS-1h tack coat evaluation results are summarized in Table 7.52. The test results indicate that the DS estimated strength closely matches with UPOD measured strength. For example, DS estimated strength to be 0.32 psi and UPOD estimated strength to be 0.19 psi while measured UPOD strength is 0.32 psi for test temperature of 71 °F and set time of 30 minutes. As explained previously, the SS-1h tack coat was reaching its shelf life when UPOD laboratory tests were performed.

The difference between estimated and measured strength could be due to environmental factors such as pavement temperature, wind velocity, relative humidity, etc. The results suggest that these factors should be monitored as well to see if that can reduce the differences between the measured and estimated strength.

In general, test results indicate that SPOD measured strength is significantly different in comparison to UPOD or DS estimated strengths. In addition, DS test over estimated strength in comparison to UPOD estimates or measurements. The results also indicate that the proposed system can be used in the evaluation of tack coat quality in the field.

Table 7.49 - Field vs. Laboratory Test Results for CSS-1h

Residual App. Rate gal/yd ² (l/m ²)	Load, lb (kg)	Test Temp. °F (°C)	Set Time, min	Average Strengths, psi (kPa)			
				Measured *		Estimated	
				UPOD	SPOD	UPOD	DS
0.04(0.18)	40	48.4(9.1)	20	0.12(0.84)	0.37(2.57)	0.09(0.63)	0.12(0.84)
			30	0.16(1.12)	0.40(2.81)	0.13(0.91)	0.18(1.26)
		64.1(17.8)	20	0.22(1.54)	0.48(3.28)	0.13(0.91)	0.23(1.61)
			30	0.31(2.17)	0.65(4.45)	0.19(1.33)	0.35(2.45)

Table 7.50 - Field vs. Laboratory Test Results for CSS-1

Residual App. Rate gal/yd ² (l/m ²)	Load, lb (kg)	Test Temp. °F (°C)	Set Time, min	Average Strengths, psi (kPa)			
				Measured *		Estimated	
				UPOD	SPOD	UPOD	DS
0.04(0.18)	40 (18)	70(21.1)	20	0.12(0.84)	0.56(3.86)	0.12(0.84)	0.21(1.47)
			30	0.18(1.26)	0.73(5.03)	0.19(1.33)	0.32(2.24)
		77(25)	20	0.25(1.75)	0.92(6.33)	0.15(1.05)	0.27(1.89)
			30	0.29(2.03)	1.56(10.7)	0.23(1.61)	0.41(2.87)

Table 7.51 - Field vs. Laboratory Test Results for PG64-22

Residual App. Rate gal/yd ² (l/m ²)	Load, lb (kg)	Test Temp. °F (°C)	Set Time, min	Average Strengths, psi (kPa)			
				Measured *		Estimated	
				UPOD	SPOD	UPOD	DS
0.04(0.18)	40	52(11.1)	20	0.12(0.84)	0.08(0.56)	0.18(1.26)	0.22(1.54)
			30	0.18(1.26)	0.12(0.84)	0.26(1.82)	0.33(2.31)
		61(16.1)	20	0.18(1.26)	0.61(4.21)	0.21(1.47)	0.27(1.89)
			30	0.26(1.82)	0.65(4.45)	0.31(2.17)	0.40(2.8)

Table 7.52 - Field vs. Laboratory Test Results for SS-1h

Residual App. Rate gal/yd ² (l/m ²)	Load, lb (kg)	Test Temp. °F (°C)	Set Time, min	Average Strengths, psi (kPa)			
				Measured *		Estimated	
				UPOD	SPOD	UPOD	DS
0.04(0.18)	40	61(16.1)	20	0.21(1.47))	0.1(0.7)	0.1(0.7)	0.19(1.33)
			30	0.28(1.96)	0.19(1.29)	0.15(1.05)	0.28(1.96)
		71(21.6)	20	0.26(1.82)	0.12(0.82)	0.13(0.91)	0.21(1.47)
			30	0.32(2.24)	0.14(9.6)	0.19(1.29)	0.32(2.24)

7.7 FIELD EVALUATION OF UPOD

Field evaluations were performed based on the identified test process at two sites within the El Paso District. The first site was at Joe Battle on I-10 Eastbound (Figure 7.11). The tests were performed on the detour section. On this site, CSS-1h tack coat type was used with 90% dilution with water and the residual application rate was 0.25 gal/yd². The results of the evaluation are shown in Table 7.53. The tests results indicate that the measured strength is similar to the estimated strength. For example, the measured shear strength at 30 minutes of set time was 0.20 psi while estimated strength was 0.18 psi.

Overall for all of the set times, the measured strength was slightly higher than the estimated strength indicating that the tack coat quality is adequate.

The second site evaluated was Joe Battle and Loop 375 (Figure 7.12). On this site, CSS-1h tack coat was used with 70% dilution with water and the residual application rate was 0.1 gal/yd². The main difference on this site was that the tack coat was placed as a prime coat rather than tack coat because AC layer was placed on base layer, as shown in Figure 7.12. The test results are shown in Table 7.54 and indicate that the measured strength is less than estimated strength. For example, measured strength was 0.30 psi while estimated strength is 0.43 psi for set time of 60 minutes. The measured and estimated strength are similar for lower set times. However, the measured strength could have been reduced because of the surface. The tack coat was placed on this site was on top of base layer which has different bond strength in comparison to AC layer. In addition, the strength measurements at lower set time are similar to the estimated strength indicating that the tack coat quality may be adequate.



Figure 7.11 - Tack Coat Application at Joe Battle (I-10 Eastbound)

Table 7.53 - UPOD Joe Battle (I-10 Eastbound) Field Test Results

Dilution Level	Application Rate gal/yd ² (l/m ²)	Load, lb (kg)	Set Time, min	Measured Strength, psi (kPa)	Estimated Strength, psi (kPa)
90/10	0.25(1.12) Ambient Temperature, 62°F(16.6°C)	40 (18)	20	0.13(0.91)	0.12(0.84)
			30	0.20(1.4)	0.18(1.26)
			40	0.27(1.89)	0.25(1.75)
			50	0.33(2.31)	0.31(2.17)
			60	0.37(2.59)	0.37(2.59)

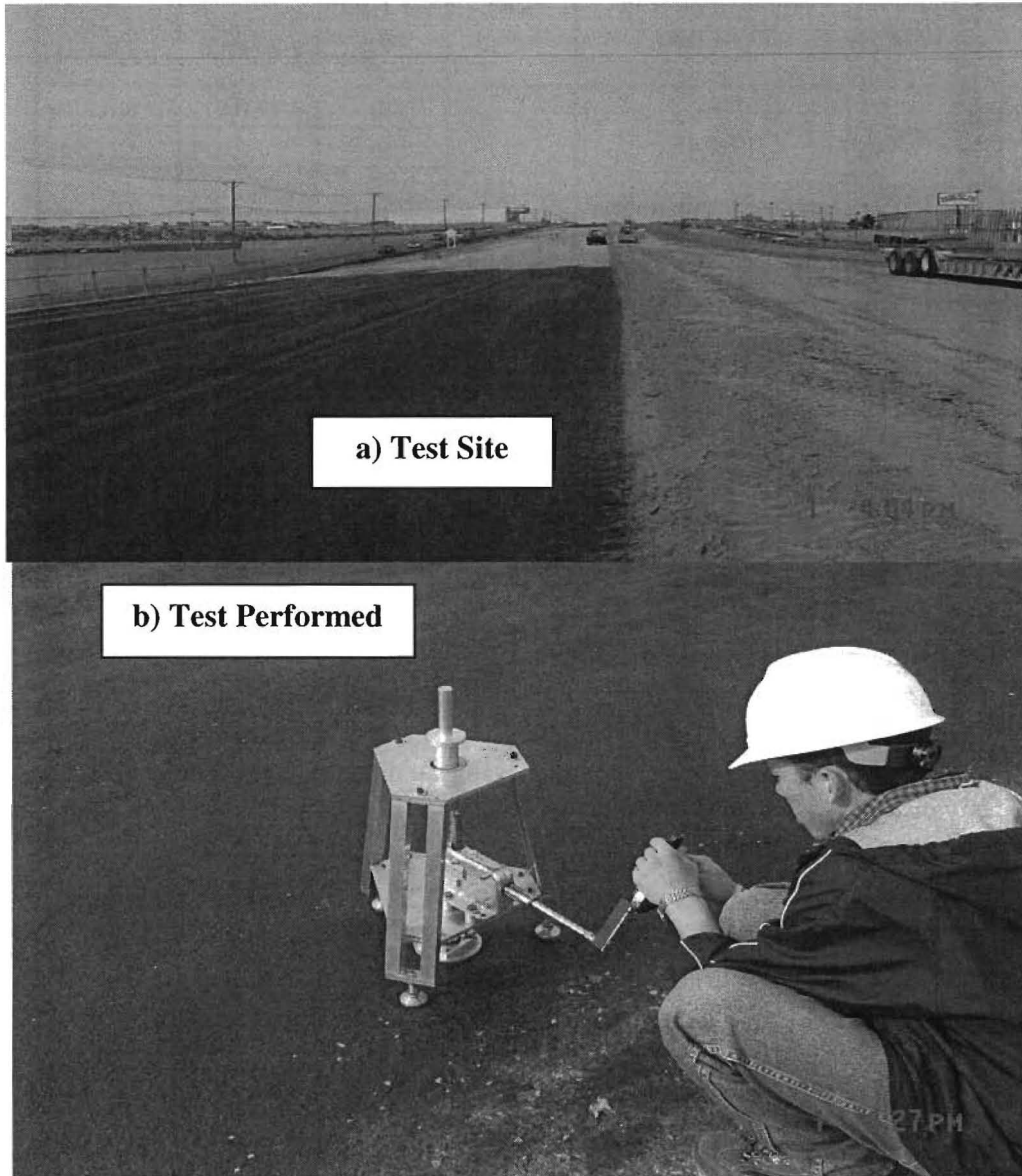

Figure 7.12 - Field Test Performed at Joe Battle and Loop 375

The test results indicate that the UPOD set up and proposed system of performing field and laboratory tests can identify the quality of tack coat in the field. Probably, collection and evaluation of environmental parameters could be beneficial for future validations.

Table 7.54 - UPOD Joe Battle Loop 375 Field Test Results

Dilution Level	Application Rate gal/yd ² (l/m ²)	Load, lb (kg)	Set Time, min	Measured Strength, psi (kPa)	Estimated Strength, psi (kPa)
70/30	0.1(0.45) Ambient Temperature, 72°F(22.2°C)	40 (18)	20	0.13(0.91)	0.14(0.98)
			30	0.20(1.40)	0.22(1.54)
			40	0.27(1.89)	0.29(2.03)
			50	0.33(2.31)	0.36(2.52)
			60	0.30(2.10)	0.43(3.01)

7.8 SUGGESTED UPOD TEST PROCEDURE FOR FIELD EVALUATION

Based on the test results and analysis, the following test procedure is proposed:

- To perform evaluation of tack coat, select an appropriate section of pavement after application of tack coat.
- Document tack coat properties and application rates
- Document the ambient temperature and time of tack coat application
- Wait for 30 minutes after application of tack coat. Although a wait period is specified here, it needs to be further evaluated based on the field data because the curing of tack coat typically depends on the air temperature, pavement temperature, and wind velocity.
- Place UPOD (with contact plate attached) on top of the selected area
- Lower the contact plate with the help of torque wrench (clockwise direction) until it touches the pavement surface
- Place 40 lbs of load on top of the UPOD
- Wait for 10 minutes
- Remove load from UPOD and apply torque (counter clockwise direction) until the contact plate separates from the surface.
- Record peak torque and convert to strength using calibration factor.
- Compare measured strength with estimated strength
- Reject tack coat if measured strength is lower than the estimated strength.

This procedure is also included in Appendix A.

CHAPTER EIGHT CLOSURE

8.1 SUMMARY

Currently, there are no field test systems to determine the quality of the tack coat. Hence, a field test set-up is needed to determine the quality of the tack coat before paving operations and was the objective of this study. Several currently available test equipments that had potential for field application were evaluated in the parking lot as well as in the laboratory. The test results indicated that none of the equipment has potential to consistently identify quality of the tack coat. The main reason for failure was the mode of testing. The test setups mainly focused on the shear strength measurement; however, the shear strength measurements also included frictional resistance offered by the tested surface.

Based on the lessons learned, a device that measures only the quality of tack and is independent of the surface tested was developed. The developed device “UTEP Pull-off Device (UPOD)” measures quality of tack coat in tension mode rather than shear mode; therefore, is independent of tested surface. The developed device is simple, reliable, economical, and could determine the quality of the tack coat in less than 15 minutes. The laboratory as well as field evaluation of the device indicated that the device can consistently identify the quality of tested tack coat.

8.2 CONCLUSIONS

Based on this study, the following can be concluded:

- The developed UPOD device and the proposed system of estimating strength based on set time and test temperature has the potential of identifying quality of applied tack coat.

- The tack coat strength gain depends on the application rate, set time, and test temperature.
- There is good correlation between DS test and UPOD measurements.
- The pull-off mode of testing is independent of the surface tested; therefore, can be used in the field to identify quality of tack coat.
- The test setup is handy, reliable and can measure the quality of tack coat in less than 45 minutes after tack coat has been applied.

8.3 RECOMMENDATIONS FOR FUTURE RESEARCH

Although test results and analysis indicate that the quality of tack coat can be identified in the field, more research is needed to further enhance the measurement system. In this study, only two field tests were performed and tests were performed at lower ends of allowable construction temperatures. To make sure that the system works, it is essential that the more field tests be performed at various temperatures as well as for various tack coat types. The tack coat from these sites can be brought back to the laboratory to perform UPOD laboratory tests to validate the relationships proposed for each tack coat type. In addition, the temperature of aluminum plate (used in the laboratory) needs to be closely monitored to make sure that the specified temperature is maintained during laboratory testing.

The magnitude of strength gain in the field may be influenced by the presence of wind, pavement temperature as well as relative humidity. Therefore, these parameters need to be documented during field testing and level of influence on strength gain needs to be identified. Thus, the differences between measured and estimated strength could be minimized.

Although tests were performed with three different operators in the field, it is essential that the several of these devices be manufactured and evaluated to set up an acceptance or rejection criterion for tack coats.

REFERENCES

- Hachiya, Y. and Sato, K. (1997), "Effect of Tack Coat on Bonding Characteristics at Interface Between Asphalt Concrete Layers," Eight International Conference on Asphalt Pavements Proceedings, Volume 1, pp. 349-362.
- Mohammad, L.N., Raqib, Md. A., and Huang, B. (2002), "Influence of Asphalt Tack Coat Materials on the Interface Shear Strength," Transportation Research Record 1789, Transportation Research Board, Washington, D.C., pp. 56-65.
- Ohio Technical Bulletin, (2001), <[http://www.flexiblepavements.org/images/Tack Coat Application 21May 01.pdf](http://www.flexiblepavements.org/images/TackCoatApplication21May01.pdf)> Accessed June 1, 2004.
- Romanoschi, S.A. and Metcalf, J.B. (2001), "Characterization of Asphalt Concrete Layer Interfaces," Transportation Research Record 1778, Transportation Research Board, Washington, D.C.
- Santagata, E., Canestrari, F., and Santagata, F. A. (1993), "Laboratory Shear Testing of Tack Coat Tack coats," 1st WORLD CONGRESS ON TACK COAT, Paris.
- Sholar, G. Page, G., Musselman, J. Upshaw, R., and Moseleym H. (2004), "Preliminary Investigation of a Test Method to Evaluate Bond Strength of Bituminous Tack Coats" Journal of Asphalt Paving Technologists, Volume 73, 2004, pp. 771-801.
- Youtcheff, J and Aurilio, V. (1997), "Moisture Sensitivity of Asphalt Binders: Evaluation and Modeling of the Pneumatic Adhesion Test Results," Proceedings of the Annual Conference- Canadian Technical Asphalt Association 0068-984X; 1997; Issue 42, pp. 180-200.

APPENDIX A
UPOD TEST PROCEDURE

Tack Coat Adhesion Test Procedure

Overview

Use this method to evaluate the adhesive properties of tack coat for roadway use.

Apparatus

Use the following apparatus:

- ◆ UTEP Pull off Device (UPOD) (see Figure 1)
 - 5 in. diameter contact plate
 - 5 in² 3M double sided tape
 - 5 in² of moisture bearing foam
- ◆ Torque Wrench of 75 lbs-in. capacity
- ◆ Handheld non-contact infrared thermometer capable of measuring temperatures up to 350 °F

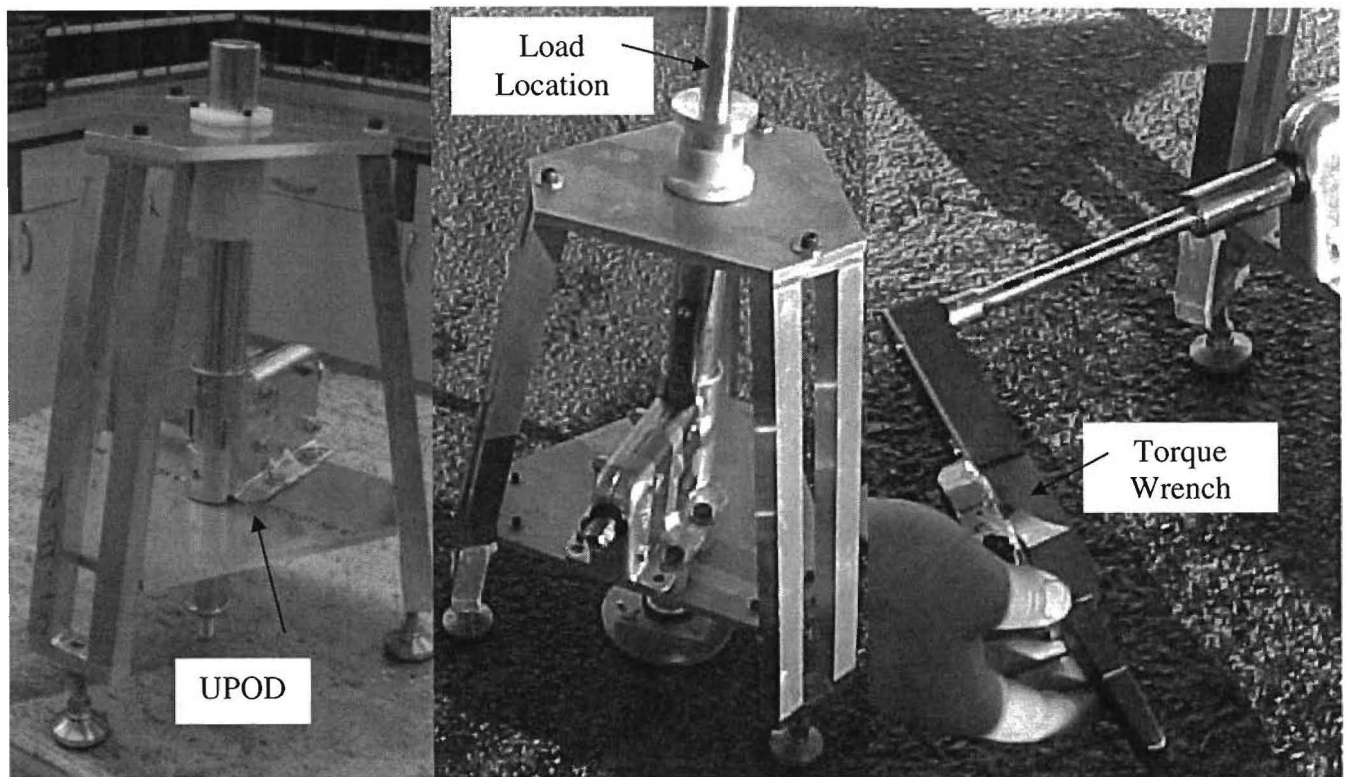

Figure 1. UTEP Pull Off Device

Preparing Apparatus

- ◆ Cut a 5 in.² piece of double sided tape and attach the tape to the contact plate.
- ◆ Remove excess double sided tape with a knife.
- ◆ Cut 5 in² piece of moisture bearing foam and attach to the double sided tape.
- ◆ Remove excess foam with a knife
- ◆ Attach prepared contact plate to the bottom of the device with the help of wing nuts.

Procedure

Follow these steps to determine the adhesive properties of tack coat for roadway use.

Determining Tack Coat Adhesion	
Step	Action
1	<p>Select a section of the pavement surface coated with tack coat.</p> <ul style="list-style-type: none"> ◆ Approximate area of 0.2 m² (2 ft²) ◆ Record the following information: <ul style="list-style-type: none"> • Tack coat type • Application rate • Rate uniformity of application ◆ Ambient and pavement temperatures ◆ Wait for 30 minutes after application of tack coat on the pavement surface
2	<ul style="list-style-type: none"> ◆ Place the testing apparatus onto the surface of the selected section. ◆ Lower the prepared contact plate using torque wrench until it touches the test surface. ◆ Place 40 lbs load on top of the device as shown in Figure 1. ◆ After 10 minutes of load application, remove loads. ◆ Connect torque wrench to the device as shown in Figure 1. ◆ Start applying torque slowly (1 revolution in less than 10 seconds) until contact plate separates from the test surface ◆ Record the maximum torque ◆ Use conversion table to identify adhesive strength of applied tack.
3	<ul style="list-style-type: none"> ◆ If strength is 10% below the identified value then tack coat should be rejected.