FINAL REPORT

Date: January 2012

Contract Title: Evaluation of Dual Cable Signal Support Systems with Pivotal Hanger Assemblies

Contract No.: BDK75 977-37

UF Project No.: 00088226

**EVALUATION OF DUAL CABLE SIGNAL SUPPORT SYSTEMS WITH
PIVOTAL HANGER ASSEMBLIES**

Principal Investigators:

Ronald A. Cook, Ph.D., P.E.
Forrest Masters, Ph.D., P.E.

Graduate Research Assistant:

Jessica L. Rigdon, E.I.

Project Manager:

Trey Tillander, P.E.

Department of Civil & Coastal Engineering
College of Engineering
365 Weil Hall P.O. Box 116580
University of Florida
Gainesville, Florida 32611-6580

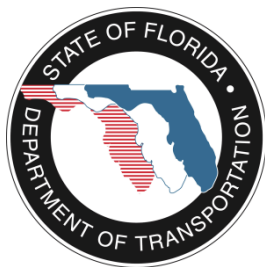

UF | UNIVERSITY *of*
FLORIDA

DISCLAIMER

The opinions, findings, and conclusions expressed in this publication are those of the authors and not necessarily those of the State of Florida Department of Transportation.

METRIC CONVERSION TABLE

<i>Symbol</i>	<i>When You Know</i>	<i>Multiply by</i>	<i>To Find</i>	<i>Symbol</i>
Length				
in	inches	25.4	millimeters	mm
ft	feet	0.305	meters	m
Area				
in ²	square inches	645.2	square millimeters	mm ²
ft ²	square feet	0.093	square meters	m ²
Force				
lbf	pound-force	4.45	newtons	N

TECHNICAL REPORT DOCUMENTATION PAGE

1. Report No. BDK75 TWO 377-97	2. Government Accession No.	3. Recipient's Catalog No.	
4. Title and Subtitle Evaluation of Dual Cable Signal Support Systems with Pivotal Hanger Assemblies		5. Report Date January 2012	
		6. Performing Organization Code	
7. Author(s) R.A. Cook, F. Masters, and J.L. Rigdon		8. Performing Organization Report No. 00088226	
9. Performing Organization Name and Address University of Florida Department of Civil and Coastal Engineering 365 Weil Hall P.O. Box 116580 Gainesville, FL 32611-6580		10. Work Unit No. (TR AIS)	
		11. Contract or Grant No. BDK75 TWO 377-97	
12. Sponsoring Agency Name and Address Florida Department of Transportation 605 Suwannee Street, MS 30 Tallahassee, FL 32399		13. Type of Report and Period Covered Final Report June 2010 – January 2012	
		14. Sponsoring Agency Code	
15. Supplementary Notes			
16. Abstract <p>The primary objective of this project was to identify which dual cable support systems provide the best potential for hurricane resistance. Along with hurricane resistance, the serviceability limit for each system was considered. Systems were evaluated using full-scale tests with the UF Hurricane Simulator. Thirty-three wind load tests were performed to measure signal rotations, cable tensions, and cable displacements. The data was analyzed to determine the effect of signal orientation, wind angle, hanger type, and signal material on system performance during high wind conditions. The results were used to calculate force coefficients for dual cable systems. The force coefficients may be applied to wind loads on traffic signals when designing intersections.</p> <p>Results showed that there is a significant difference in rotations and cable tension among the different support systems. The systems that tend to have greater rotation under relatively low wind loads also reduce the increase in cable tension experienced under high wind loads.</p>			
17. Key Word traffic signal, cable support, wind, cable systems, signal supports, hangers, hurricanes, wind resistant design		18. Distribution Statement No restrictions	
19. Security Classif. (of this report) Unclassified	20. Security Classif. (of this page) Unclassified	21. No. of Pages 174	22. Price

ACKNOWLEDGMENTS

The authors would like to thank the Florida Department of Transportation (FDOT) for providing the funds for this project. The FDOT State Traffic Engineering and Operations Office assisted in planning for numerous full-scale tests and organized the donation of necessary equipment from various traffic hardware manufacturers. We thank the manufacturers that sent the donated equipment and took the time to attend test days. The authors also thank the City of Gainesville Traffic Operations for their unlimited support by providing experienced teams for the installation of traffic signals and changing equipment between tests. Their hard work and patience was greatly appreciated. Finally, thanks are given to all of our fellow researchers at the Powell Hurricane Research Laboratory who gave their time to this project to ensure the Hurricane Simulator and instrumentation worked smoothly.

EXECUTIVE SUMMARY

The performance of dual cable traffic signal support systems during hurricanes has indicated the need to develop vertical signal hangers and disconnect boxes that have an improved resistance to hurricane wind loads. Alternatives for dual cable support systems include using rigid pipe hangers, rigid hangers with pivoting joints, cable material in place of a rigid hanger, and not connecting the messenger cable to the pole.

The objective of this project was to evaluate these support systems under high wind loading to determine hurricane resistance and visibility limits. Full-scale tests were performed at the University of Florida (UF) Powell Hurricane Research Laboratory using the UF Hurricane Simulator. Each system was tested up to 120 mph with oscillating loads at approximately 50 mph and 75 mph. Measurements recorded included signal rotation, catenary and messenger cable tensions, and cable displacements.

The Institution of Transportation Engineers visibility limits when using the pivotal hanger, cable hanger or single cable system were within 5 mph of each other except at the 45° signal and 45° simulator orientation for which the pivotal hanger performed like a rigid pipe hanger. The pipe hanger rotated the least overall and had the highest visibility limit at all orientations.

In all dual cable systems, the catenary cables did little to resist the wind load. Generally, the catenary cable tension decreased with increased wind load. The change in tension experienced in the catenary cables when using the pivotal and cable hangers for the dual cable system was less than when using the pipe hanger or the single cable system. All dual cable systems experienced significant increases in messenger cable tension with increased wind load. Increase in messenger cable tension was reduced in

most cases with the use of pivotal or cable hangers. The single cable system exhibited little change in cable tension with increasing wind load.

The discontinuous messenger system was tested using two signals. The rotation experienced by this system was similar to the use of the dual cable system with a pivotal or cable hanger when wind speeds were less than 60 mph. When wind speeds exceeded 60 mph, the discontinuous messenger cable system experienced rotations similar to the dual cable system with a pipe hanger. Because this system does not have a messenger cable attached to the strain poles, the poles undergo much smaller forces.

TABLE OF CONTENTS

	<u>page</u>
TECHNICAL REPORT DOCUMENTATION PAGE.....	iv
ACKNOWLEDGMENTS.....	v
EXECUTIVE SUMMARY.....	vi
LIST OF TABLES.....	x
LIST OF FIGURES.....	xi
CHAPTER	
1 INTRODUCTION	1
2 LITERATURE REVIEW	4
3 METHODOLOGY	15
3.1 Test Setup.....	15
3.2 Instrumentation	17
3.3 Test Method	18
4 TEST RESULTS	30
4.1 Signal Rotations	30
4.1.1 Effect of Signal and Simulator Orientations on Signal Rotation.....	30
4.1.2 Effect of Hanger Types and Support Systems on Signal Rotation.....	31
4.1.3 Effect of Multiple Signals on Signal Rotation	34
4.1.4 Effect of Signal Weight on Signal Rotation	35
4.1.5 Effect of Messenger Cable Clamp Location on Signal Rotation	36
4.2 Cable Tensions	36
4.2.1 Effect of Signal and Simulator Orientations on Cable Tension	37
4.2.2 Effect of Hanger Types and Support Systems on Cable Tension.....	38
4.2.3 Effect of Multiple Signals on Cable Tension	39
4.2.4 Effect of Signal Material on Cable Tension.....	40
4.2.5 Effect of Messenger Clamp Location on Cable Tension.....	40
4.3 Cable Displacements	41
5 FORCE COEFFICIENTS FOR WIND FORCES	89
6 PERFORMANCE OF EQUIPMENT AND HARDWARE	93
7 CONCLUSIONS, SUMMARY, AND RECOMMENDATIONS.....	101
7.1 Summary.....	101

7.2	Conclusions.....	101
7.3	Recommendations	103
LIST OF REFERENCES		106
APPENDIX		
A	SIGNAL ROTATION VS. WIND VELOCITY GRAPHS	108
B	CABLE TENSIONS VS. WIND VELOCITY GRAPHS.....	124
C	CABLE DISPLACEMENT VS. WIND VELOCITY GRAPHS	140
D	EQUIPMENT CATALOG	152

LIST OF TABLES

<u>Table</u>		<u>page</u>
1-1	Traffic signal statistics for 2004 hurricane season (FDOT 2005).....	3
3-1	Test Schedule.....	29
4-1	Changes in cable tension for Test Series 2.....	86
4-2	Changes in cable tension for Test Series 3.....	86
4-3	Changes in cable tension for Test Series 4.....	87
4-4	Changes in cable tension for Test Series 5.....	87
4-5	Changes in cable tension for Test Series 6.....	88

LIST OF FIGURES

<u>Figure</u>	<u>page</u>
2-1 Signals supported by dual cables failed during Hurricane Andrew	10
2-2 Three test configurations from Cook and Johnson (2007).....	11
2-3 Configuration of signal and cables.....	11
2-4 Limiting rotation for functional visibility of incandescent light signals (Cook 1993)	12
2-5 Limiting values for θ_{Vert} when using LED signals (sideways view of horizontal rotation)	12
2-6 Limiting values for θ_{Horiz} for visibility of LED signals (top view of vertical rotation)	13
2-7 Free body diagram of signal supported by single cable system (Cook and Johnson 2007).....	14
3-1 Spacing and layout of cables.....	20
3-2 Cable support systems	21
3-3 The UF Hurricane Simulator's engines and fans (back)	22
3-4 The UF Hurricane Simulator's fans and wind vanes (front)	22
3-5 Signal and simulator testing orientations	23
3-6 Two-signal test setup	23
3-7 R.M. Young anemometer	24
3-8 Load cells installed in line with catenary and messenger cables	24
3-9 String potentiometer setup	25
3-10 Mounting system for string potentiometers	25
3-11 Orientation sensor installed inside the signal	26
3-12 Types of hangers	27
3-13 Sample of oscillating wind load sequence (Test 4).....	27
3-14 Sample of linear wind load (Test 1)	28

4-1	Rotation for single cable at all orientations (Tests 7, 15, 16, and 33)	43
4-2	Rotation for pipe hanger at all orientations (Tests 4, 9, 10, and 28)	44
4-3	Rotation for pivotal hanger at all orientations (Tests 5, 11, 12, and 29).....	44
4-4	Rotation for cable hanger at all orientations (Tests 6, 13, 14, and 30)	45
4-5	Rotation for systems at 90° signal and 90° simulator orientation (Test Series 2)	46
4-6	Rotation for systems at 90° signal and 45° simulator orientations (Tests 9, 11, 13, 15, and 23)	47
4-7	Adjustable strap hanger with visible yielding in lower section (Test 23)	47
4-8	Rotation for systems at 45° signal and 45° simulator orientations (Tests 10, 12, 14, and 16)	48
4-9	Rotation for systems at 90° signal and 12° simulator orientations (Tests 28, 29, 30, and 33)	49
4-10	Rotation for 5-section signals during Test Series 4 two-at 90° signal and 45° simulator orientations	50
4-11	Rotation for 3-section signals during Test Series 4 two-at 90° signal and 45° simulator orientations	51
4-12	Rotation for single cable system with two signals verses one signal (Tests 15 and 21)	52
4-13	Rotation for pipe hanger with two signals verses one signal (Tests 9 and 17) ...	53
4-14	Rotation for pivotal hanger with two signals verses one signal (Tests 11 and 18)	54
4-15	Rotation for cable hanger with two signals verses one signal (Tests 13 and 19)	55
4-16	Rotation for single cable system with aluminum signal verses polycarbonate signal at 90° signal and 90° simulator orientation (Tests 7 and 8).....	56
4-17	Rotation for single cable system with aluminum verses polycarbonate signal at 90° signal and 45° simulator orientation (Tests 15 and 22)	57
4-18	Rotation for single cable system with aluminum verses polycarbonate signal at 90° signal and 12° simulator orientation (Tests 33 and 32)	58

4-19	Rotation for pivotal hanger with aluminum verses polycarbonate signal at 90° signal and 45° simulator orientation (Tests 11 and 25).....	59
4-20	Rotation for pivotal hanger with aluminum verses polycarbonate signal at 90° signal and 12° simulator orientation (Tests 29 and 31).....	60
4-21	Rotation for cable hanger with aluminum verses polycarbonate signal at 90° signal and 45° simulator orientation (Tests 13 and 26).....	61
4-22	Rotation for pipe hanger with altered messenger clamp location (Tests 9 and 27)	62
4-23	Rotation for pivotal hanger with altered messenger clamp location (Tests 11 and 24)	63
4-24	Change in tension for single cable at all orientations (Tests 7, 15, 16, and 33)..	64
4-25	Change in tension for pipe hanger at all orientations (Tests 4, 9, 10, and 28)....	65
4-26	Change in tension for pivotal hanger at all orientations (Tests 5, 11, 12, and 29)	66
4-27	Change in tension for cable hanger at all orientations (Tests 6, 13, 14, and 30)	67
4-28	Change in tension for all systems at 90° signal and 90° simulator orientations..	68
4-29	Change in tension for all systems at 90° signal and 45° simulator orientations..	69
4-30	Change in tension for all systems at 45° signal and 45° simulator orientations..	70
4-31	Change in tension for all systems at 90° signal and 12° simulator orientations..	71
4-32	Change in tension for all systems with two signals.....	72
4-33	Change in tension for single cable system with two verses one signal (Tests 15 and 21)	73
4-34	Change in tension for pipe hanger with two verses one signal (Tests 9 and 17)	74
4-35	Change in tension for pivotal hanger with two verses one signal (Tests 11 and 18)	75
4-36	Change in tension for cable hanger with two signals verses one signal (Tests 13 and 19)	76

4-37	Change in tension for the single cable system with aluminum verses polycarbonate signal at 90° signal and 90° simulator orientations (Tests 7 and 8)	77
4-38	Change in tension for the single cable system with aluminum verses polycarbonate signal at 90° signal and 45° simulator orientations (Tests 15 and 22)	78
4-39	Change in tension for the single cable system with aluminum verses polycarbonate signal at 90° signal and 12° simulator orientations (Tests 33 and 32)	79
4-40	Change in tension for pipe hanger with altered messenger clamp location (Tests 9 and 27)	80
4-41	Change in tension for pivotal hanger with altered messenger clamp location (Tests 11 and 24)	81
4-42	Cable displacement for pipe hanger at 90° signal and 90° simulator orientation.....	82
4-43	Cable displacement for pivotal hanger at 90° signal and 90° simulator orientation.....	83
4-44	Cable displacement for cable hanger at 90° signal and 90° simulator orientation.....	84
4-45	Cable displacement for single cable system at 90° signal and 90° simulator orientation.....	85
5-1	Free body diagrams for traffic signals.....	91
5-2	Top view of wind force applied to signal with reactions in messenger cable	91
5-3	Force coefficient vs. signal rotation for dual cable systems.....	92
5-4	Force coefficient vs. wind velocity for dual cable systems.....	92
6-1	Failure of the joint between the top signal head and two-way bracket (Test 22)	97
6-2	Worn serrated teeth on two-way bracket which connects to top signal head (Test 22)	97
6-3	Failure at connection for the backplate on polycarbonate signal (Test 22)	98
6-4	Failed backplate material at connection point (Test 27)	98
6-5	Failed sand cast aluminum stabilizer clamp	99

6-6	Span wire clamp with broken piece	100
A-1	Test 1: Pipe Hanger with 90° Signal and 90° Simulator Orientations (Linear Load) (Hanger failure at 115 mph).....	108
A-2	Test 2: Pivotal Hanger with 90° Signal and 90° Simulator Orientations (Linear Load)	108
A-3	Test 3: Direct Connection with 90° Signal and 90° Simulator Orientations (Linear Load)	109
A-4	Test 4: Pipe Hanger with 90° Signal and 90° Simulator Orientations	109
A-5	Test 5: Pivotal Hanger with 90° Signal and 90° Simulator Orientations.....	110
A-6	Test 6: Cable Hanger with 90° Signal and 90° Simulator Orientations	110
A-7	Test 7: Direct Connection with 90° Signal and 90° Simulator Orientations.....	111
A-8	Test 8: Direct Connection with 90° Signal and 90° Simulator Orientations (Polycarbonate Signal) (Backplate failure at 107 mph).....	111
A-9	Test 9: Pipe Hanger with 90° Signal and 45° Simulator Orientations	112
A-10	Test 10: Pipe Hanger with 45° Signal and 45° Simulator Orientations	112
A-11	Test 11: Pivotal Hanger with 90° Signal and 45° Simulator Orientations.....	112
A-12	Test 12: Pivotal Hanger with 45° Signal and 45° Simulator Orientations.....	113
A-13	Test 13: Cable Hanger with 90° Signal and 45° Simulator Orientations	113
A-14	Test 14: Cable Hanger with 45° Signal and 45° Simulator Orientations	114
A-15	Test 15: Direct Connection with 90° Signal and 45° Simulator Orientations.....	114
A-16	Test 16: Direct Connection with 45° Signal and 45° Simulator Orientations.....	114
A-17	Test 17: Pipe Hanger with 90° Signal and 45° Simulator Orientations (Two Signals)	115
A-18	Test 18: Pivotal Hanger with 90° Signal and 45° Simulator Orientations (Two Signals)	115
A-19	Test 19: Cable Hanger with 90° Signal and 45° Simulator Orientations (Two Signals)	116
A-20	Test 20: Discontinuous Messenger with 90° Signal and 45° Simulator Orientations (Two Signals)	116

A-21	Test 21: Direct Connection with 90° Signal and 45° Simulator Orientations (Two Signals).....	117
A- 22	Test 22: Direct Connection with 90° Signal and 45° Simulator Orientations (Polycarbonate Signal) (Signal Head Failure at 118 mph).....	117
A-23	Test 23: Adjustable Strap Hanger with 90° Signal and 45° Simulator Orientations	118
A-24	Test 24: Pivotal Hanger with 90° Signal and 45° Simulator Orientations (Messenger on Front)	118
A-25	Test 25: Pivotal Hanger with 90° Signal and 45° Simulator Orientations (Polycarbonate Signal)	119
A-26	Test 26: Cable Hanger with 90° Signal and 45° Simulator Orientations (Polycarbonate Signal)	119
A-27	Test 27: Pipe Hanger with 90° Signal and 45° Simulator Orientations (Messenger on Front) (Backplate failure at 115 mph)	120
A-28	Test 28: Pipe Hanger with 90° Signal and 12° Simulator Orientations	120
A-29	Test 29: Pivotal Hanger with 90° Signal and 12° Simulator Orientations.....	121
A-30	Test 30: Cable Hanger with 90° Signal and 12° Simulator Orientations	121
A-31	Test 31: Pivotal Hanger with 90° Signal and 12° Simulator Orientations (Polycarbonate Signals)	122
A-32	Test 32: Direct Connection with 90° Signal and 12° Simulator Orientations (Polycarbonate Signals)	122
A-33	Test 33: Direct Connection with 90° Signal and 12° Simulator Orientations.....	123
B-1	Test 1: Pipe Hanger with 90° Signal and 90° Simulator Orientations (Linear Load) (Hanger failure at 115 mph).....	124
B-2	Test 2: Pivotal Hanger with 90° Signal and 90° Simulator Orientations (Linear Load)	124
B-3	Test 3: Direct Connection with 90° Signal and 90° Simulator Orientations (Linear Load)	125
B-4	Test 4: Pipe Hanger with 90° Signal and 90° Simulator Orientations	125
B-5	Test 5: Pivotal Hanger with 90° Signal and 90° Simulator Orientations.....	126
B-6	Test 6: Cable Hanger with 90° Signal and 90° Simulator Orientations	126

B-7	Test 7: Direct Connection with 90° Signal and 90° Simulator Orientations.....	126
B-8	Test 8: Direct Connection with 90° Signal and 90° Simulator Orientations (Polycarbonate Signal) (Backplate failure at 107 mph).....	127
B-9	Test 9: Pipe Hanger with 90° Signal and 45° Simulator Orientations	127
B-10	Test 10: Pipe Hanger with 45° Signal and 45° Simulator Orientations	128
B-11	Test 11: Pivotal Hanger with 90° Signal and 45° Simulator Orientations.....	128
B-12	Test 12: Pivotal Hanger with 45° Signal and 45° Simulator Orientations.....	128
B-13	Test 13: Cable Hanger with 90° Signal and 45° Simulator Orientations	129
B-14	Test 14: Cable Hanger with 45° Signal and 45° Simulator Orientations	129
B-15	Test 15: Direct Connection with 90° Signal and 45° Simulator Orientations.....	130
B-16	Test 16: Direct Connection with 45° Signal and 45° Simulator Orientations.....	130
B-17	Test 17: Pipe Hanger with 90° Signal and 45° Simulator Orientations (Two Signals)	131
B-18	Test 18: Pivotal Hanger with 90° Signal and 45° Simulator Orientations (Two Signals)	131
B-19	Test 19: Cable Hanger with 90° Signal and 45° Simulator Orientations (Two Signals)	132
B-20	Test 20: Discontinuous Messenger with 90° Signal and 45° Simulator Orientations (Two Signals)	132
B-21	Test 21: Direct Connection with 90° Signal and 45° Simulator Orientations (Two Signals).....	133
B-22	Test 22: Direct Connection with 90° Signal and 45° Simulator Orientations (Polycarbonate Signal) (Signal Head Failure at 118 mph).....	133
B-23	Test 23: Adjustable Strap Hanger with 90° Signal and 45° Simulator Orientations	134
B-24	Test 24: Pivotal Hanger with 90° Signal and 45° Simulator Orientations (Messenger on Front)	134
B-25	Test 25: Pivotal Hanger with 90° Signal and 45° Simulator Orientations (Polycarbonate Signal)	135

B-26	Test 26: Cable Hanger with 90° Signal and 45° Simulator Orientations (Polycarbonate Signal)	135
B-27	Test 27: Pipe Hanger with 90° Signal and 45° Simulator Orientations (Messenger on Front) (Backplate failure at 115 mph)	136
B-28	Test 28: Pipe Hanger with 90° Signal and 12° Simulator Orientations	136
B-29	Test 29: Pivotal Hanger with 90° Signal and 12° Simulator Orientations.....	137
B-30	Test 30: Cable Hanger with 90° Signal and 12° Simulator Orientations	137
B-31	Test 31: Pivotal Hanger with 90° Signal and 12° Simulator Orientations (Polycarbonate Signals)	138
B-32	Test 32: Direct Connection with 90° Signal and 12° Simulator Orientations (Polycarbonate Signals)	138
B-33	Test 33: Direct Connection with 90° Signal and 12° Simulator Orientations.....	139
C-1	Test 1: Pipe Hanger with 90° Signal and 90° Simulator Orientations (Linear Load)(Hanger failure at 115 mph).....	140
C-2	Test 2: Pivotal Hanger with 90° Signal and 90° Simulator Orientations (Linear Load)	140
C-3	Test 3: Direct Connection with 90° Signal and 90° Simulator Orientations (Linear Load)	141
C-4	Test 4: Pipe Hanger with 90° Signal and 90° Simulator Orientations	141
C-5	Test 5: Pivotal Hanger with 90° Signal and 90° Simulator Orientations.....	142
C-6	Test 6: Cable Hanger with 90° Signal and 90° Simulator Orientations	142
C-7	Test 7: Direct Connection with 90° Signal and 90° Simulator Orientations.....	143
C-8	Test 8: Direct Connection with 90° Signal and 90° Simulator Orientations (Polycarbonate Signal) (Backplate failure at 107 mph).....	143
C-9	Test 9: Pipe Hanger with 90° Signal and 45° Simulator Orientations	143
C-10	Test 11: Pivotal Hanger with 90° Signal and 45° Simulator Orientations.....	144
C-11	Test 12: Pivotal Hanger with 45° Signal and 45° Simulator Orientations.....	144
C-12	Test 14: Cable Hanger with 45° Signal and 45° Simulator Orientations	145
C-13	Test 15: Direct Connection with 90° Signal and 45° Simulator Orientations.....	145

C-14	Test 16: Direct Connection with 45° Signal and 45° Simulator Orientations.....	146
C-15	Test 17: Pipe Hanger with 90° Signal and 45° Simulator Orientations (Two Signals)	146
C-16	Test 18: Pivotal Hanger with 90° Signal and 45° Simulator Orientations (Two Signals)	147
C-17	Test 19: Cable Hanger with 90° Signal and 45° Simulator Orientations (Two Signals)	147
C-18	Test 23: Adjustable Strap Hanger with 90° Signal and 45° Simulator Orientations	148
C-19	Test 24: Pivotal Hanger with 90° Signal and 45° Simulator Orientations (Messenger clamped to front of hanger).....	148
C-20	Test 27: Pipe Hanger with 90° Signal and 45° Simulator Orientations (Messenger clamped to front of hanger) (Failure of Backplate at 115 mph).....	149
C-21	Test 28: Pipe Hanger with 90° Signal and 12° Simulator Orientations	149
C-22	Test 30: Cable Hanger with 90° Signal and 12° Simulator Orientations	150
C-23	Test 31: Pivotal Hanger with 90° Signal and 12° Simulator Orientations (Polycarbonate Signal)	150
C-24	Test 33: Direct Connection with 90° Signal and 12° Simulator Orientations.....	151

CHAPTER 1 INTRODUCTION

The performance of dual cable traffic signal support systems during hurricanes has indicated the need to develop vertical signal hangers and disconnect boxes that have an improved resistance to hurricane wind loads. During Hurricane Andrew in 1992, there was severe damage to cable-supported traffic signals in Florida. Although the high failure rate encouraged the start of research into the development of hurricane-resistant traffic signal equipment, there was still a high rate of failure of cable-supported signals during the hurricane season of 2004.

An evaluation of damage to traffic signals following the hurricane season of 2004 showed that additional research and development was necessary for improving the performance of traffic signal equipment (FDOT 2005). The report included the number of signals in the state and the number of damaged systems during that season (Table 1-1) and stated “of the losses noted, the main cause was bracket failure, with general span wire failure being a close second, and mast arm failure... being a very distant third.” While most FDOT Districts preferred the mast arm support for its proven ability to resist hurricane conditions, it was also noted that damage to cable-supported systems was repaired much quicker and easier than damage to mast arms. After reviewing the damages from the 2004 hurricanes, there was “ample evidence that the method of installing traffic signals using span wires, strain poles, and hanger devices was insufficient in most cases to withstand the high wind speeds experienced,” and it was determined “that a new hanger design [was] needed to correct this problem.”

Signal failures commonly occur in the vertical hanger nearest to the messenger cable attachment or in the connections at either the top or bottom of the disconnect box.

These failures are likely due to the high moment that exists in the hanger and disconnect box at the connection to the messenger cable.

Alternatives to the standard dual cable system with pipe hangers or adjustable strap hangers are under consideration for improved hurricane resistance of cable-supported signals. The alternatives include a pivotal hanger assembly, a cable hanger, and a discontinuous messenger cable system. Previous research by the University of Florida and the Florida Department of Transportation Structures and Traffic Operations Offices compared the standard dual cable hanger support systems with rigid hangers and a single cable system (Cook and Johnson 2007). The results of this research indicated that a single cable support system would be significantly more hurricane resistant than the current hanger used in the dual cable support system. The results from that research also showed that the single cable system had a lower limit for visibility. The subject of this research was evaluation of the alternatives mentioned above for their potential to improve hurricane resistance and serviceability.

Full-scale hurricane wind tests were performed to evaluate these systems. This report summarizes the data from testing and provides comparison among the results of the systems tested.

Table 1-1. Traffic signal statistics for 2004 hurricane season (FDOT 2005)

District No.	Total no. of signals district-wide	Total mast arm signals district-wide	Total span wire signals district-wide	Mast arm structural damage	Signalized intersections that sustained damage*
1	1,778	802	976	2	496
2	1,585	537	1,048	0	40
3	987	300	687	2	265
4	3,329	1,180	2,149	14	735
5	2,972	458	2,514	2	1,885
6	2,640	1,848	660	0	0
7	2,151	518	1,633	0	102
Sum	15,442	5,643	9,667	20	3,523

* Damage defined as loss of signal due to failure of the span wire, bracket assembly, mast arm mounting hardware or other components

CHAPTER 2 LITERATURE REVIEW

This project is related to previous research topics on dual and single cable support systems for traffic signals that were funded by the Florida Department of Transportation (FDOT) and performed by the University of Florida (UF). The focus of these projects was the resistance of various configurations to high velocity wind events, such as hurricanes. Following hurricanes such as Hurricane Andrew, there were a high number of damaged traffic signals. Intersections with damaged signals primarily consisted of dual cable-supported systems (Figure 2-1). The most recent project tested and compared dual cable and single cable systems with various cable sag, hangers, weights, and signal orientations to learn more about the forces on the signals, cables, and poles and the signal rotation under high speed wind (Cook and Johnson 2007). An earlier multi-phase project developed a computer program to model cable-supported traffic signals under wind loads (Cook et al. 1993; Hoit et al. 1995, 1997). Phase I of the project developed the design standards for cable-supported traffic control devices and the Analysis of Traffic Lights and Signs (ATLAS) program. During Phase II, full scale wind tests were conducted on cable-supported signals and a graphic user interface was incorporated into ATLAS. The final report included changes and enhancements to ATLAS and the ATLAS user's guide.

The ATLAS software is maintained and updated by the Bridge Software Institute at UF. ATLAS predicts the effects of wind loads on various dimensions of signs and signals with differing cable systems, spans, and heights. Currently the program uses rigid hangers, such as the pipe and adjustable strap hangers, in its analyses and allows

the user to select dimensions and material of the bracket and hanger; however, flexible or pivoting hangers are not available design options.

This project reused the 50-foot span at the Powell Family Structures Laboratory from previous testing. The test configurations used by Cook and Johnson (2007) and the available cable locations are presented in Figure 2-2. The span width was determined to be adequate. An analysis using ATLAS to compare a 50-foot span to a 72-foot span showed that differences in results were negligible (Cook and Johnson 2007). Referring to the FDOT *Manual of Uniform Standards for Design, Construction and Maintenance* (2007) confirmed that the 50 foot span represented a realistic intersection width.

Traffic signals supported by single cable systems act as pendulums when subjected to wind loads by swinging freely and do not develop stress in the signal hangers or disconnect boxes (Cook and Johnson 2007). This behavior prevents increased tension in the catenary cable and minimizes hanger and connection failure during extreme wind conditions. When signals are supported by dual cable systems the messenger cable, shown in Figure 2-3, restricts the free swinging movement of the signal and causes high bending moments to build up in rigid hangers. Failure of signal hangers and connections on dual cable support systems is a frequent problem seen throughout Florida following hurricanes and other extreme wind events. With traditional rigid hangers used on single and dual cable systems and with wind perpendicular to the cable span, the orientation of a traffic signal had negligible effect on the tension experienced in the catenary cable. Another result of wind loading was that the

messenger cable in dual cable-supported traffic signals experienced a severe increase in tension.

When a traffic signal experiences rotation due to wind, it eventually reaches a rotation angle where functional visibility is limited. The limiting angle for functional visibility was taken as the point at which only half of a bulb is visible to drivers which was developed by Cook et al. (1993). The limiting vertical rotation was 30° for 12" signal heads and 26° for 8" signal heads (Figure 2-4). These values were calculated with Equation 2-1, which was developed for the by Cook et al. (1993).

$$\text{Limiting Angle} = \tan^{-1} \left[\frac{\frac{1}{2} \text{bulb height} - \text{visor length} * \tan(\text{downward tilt})}{\text{visor length}} \right] \quad (2-1)$$

The average wind speeds at which the 50% visibility was reached for Cook and Johnson in 2007 were 72 miles per hour for dual cable systems and 68 miles per hour for single cable systems (Figure 2-4). The addition of a pivot point on hangers supporting traffic signals could potentially limit the signal serviceability, or functional visibility, because of increased rotations.

Because this project used light emitting diode (LED) signals, the rotation limits were based on limits for finding the minimum maintained luminous intensity (Institute of Transportation Engineers 2005). The minimum maintained luminous intensity varies with signal color and size and is affected by factors for horizontal and vertical rotations. The allowed ranges of rotations for luminous intensity calculations were used as the limiting angles for visibility. The vertical rotation limit was 12.5° forward to 27.5° backward in a direction that was perpendicular to the span (Figure 2-5). The horizontal rotation limit was 27.5° towards either side of the signal (Figure 2-6).

The most recent design standards covering wind loads include the *ASCE 7-10: Minimum Design Loads for Buildings and Other Structures* (ASCE 2010), and the *Standard Specifications for Structural Supports for Highway Signs, Luminaires and Traffic Signals* (AASHTO 2009). These specifications along with information obtained in previous FDOT projects will be taken into consideration to predict wind loads and forces experienced while conducting tests. The ASCE 7-10 provides sufficient information for determining design wind speeds throughout the state of Florida. The ASCE 7-10 uses a wind force coefficient for determining a combined drag and lift coefficient on structures other than buildings, however there are no appropriate values provided for objects suspended on cables. The values provided are for long objects of a constant cross-sectional area for specific cross-sectional shapes.

During past research there has been a concern with determining variable drag and lift coefficients. When traffic signals are placed under wind loads, the rotation that the signals and cables experience causes variability in both drag and lift coefficients. The *AASHTO Standard Specifications for Structural Supports for Highway Signs, Luminaires and Traffic Signals* provides a constant wind drag coefficient of 1.2 for traffic signals and no consideration for lift (AASHTO 2009). This specification notes that experimental data may be used to modify the drag coefficient based on findings from James F. Marchman, III when a traffic signal is free swinging, but when the swinging of the signal is restrained, as with the dual cable system, the full wind load should be taken on the signal. When the results from a series of tests from Cook and Johnson were compared to Marchman's, the drag coefficients were higher (Cook and Johnson 2007). For the tests by Marchman, the signals were attached to a fixed support, but were allowed to

rotate below the support. Cook and Johnson used a single cable system permitting rotation of the support as well as the free-swinging signal. Cook and Johnson determined that the single cable system behaved like a pendulum in which the support system did not experience increased forces. Cook and Johnson suggested that a drag coefficient of 0.7 and a lift coefficient of 0.4 would be reasonable for single cable systems. When calculating drag and lift coefficients from test data, they used Equation 2-2 and Equation 2-3 which coordinate with the free-body diagram found in Figure 2-7 from Cook and Johnson 2007.

$$C_D = \frac{D}{0.00256 \times V^2 \times A} = \frac{T' \times \sin \Phi}{0.00256 \times V^2 \times A} \quad (2-2)$$

$$C_L = \frac{L}{0.00256 \times V^2 \times A} = \frac{W - T' \times \cos \Phi}{0.00256 \times V^2 \times A} \quad (2-3)$$

The cable rotation (Φ) was the rotation of the plane of the catenary cable for the single cable system. The cable rotation was measured separately from the signal rotation (θ) (Figure 2-7). The resultant tension force (T') was determined based on Equation 2-4.

$$T' = 2 * T * \frac{\text{sag}}{\sqrt{\text{sag}^2 + \left(\frac{\text{span}}{2}\right)^2}} - W_{\text{cable}} \quad (2-4)$$

A study in 1997 by the New York State Department of Transportation (NYSDOT) compared AASHTO design procedures from 1983 and 1989 (Alampalli). The design loads were calculated for application to the strain poles of single cable support systems. These loads were compared to measured loads from in-field testing. Throughout the New York State it was common at the time for engineers to use a spanwire program

that was based on 1983 design procedures. Alampalli found that the 1983 design procedure over-designed strain poles when compared to the 1989 design procedures. It was also shown that both AASHTO procedures were conservative when compared to the field tests, especially at higher wind speeds.

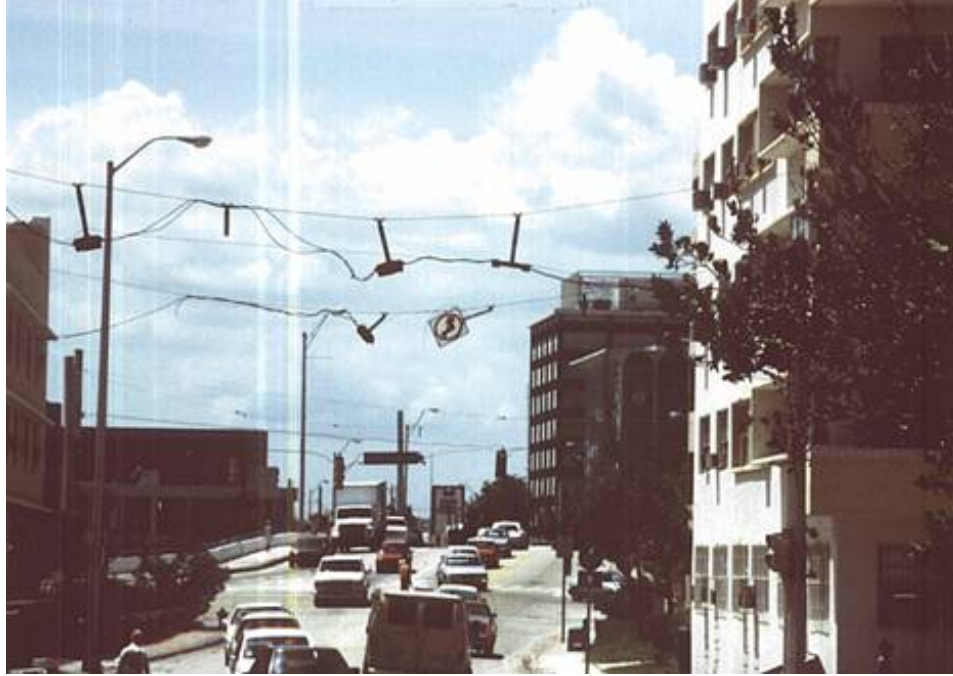

Figure 2-1. Signals supported by dual cables failed during Hurricane Andrew (Photo courtesy of Ronald A. Cook)

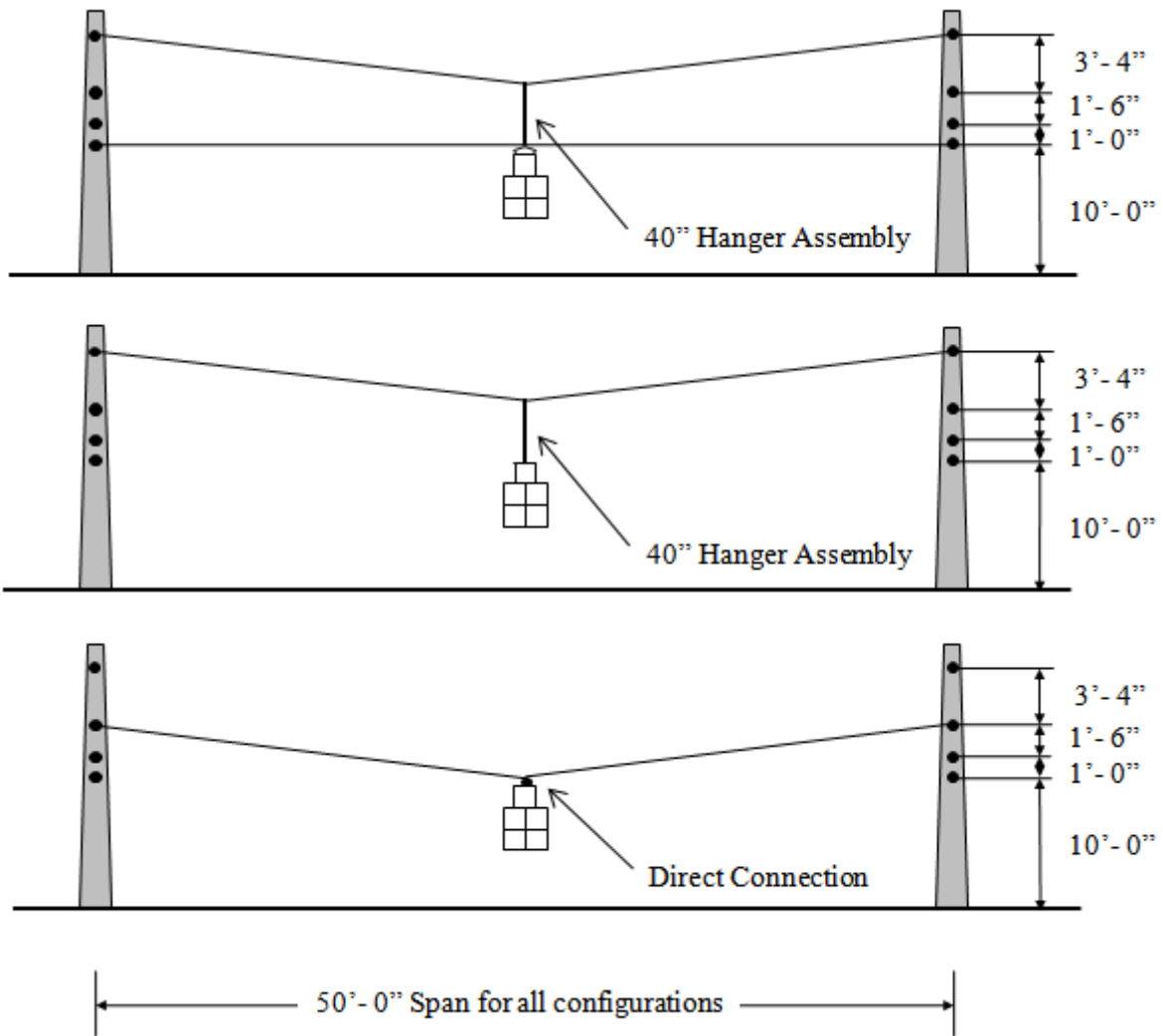

Figure 2-2. Three test configurations from Cook and Johnson (2007)

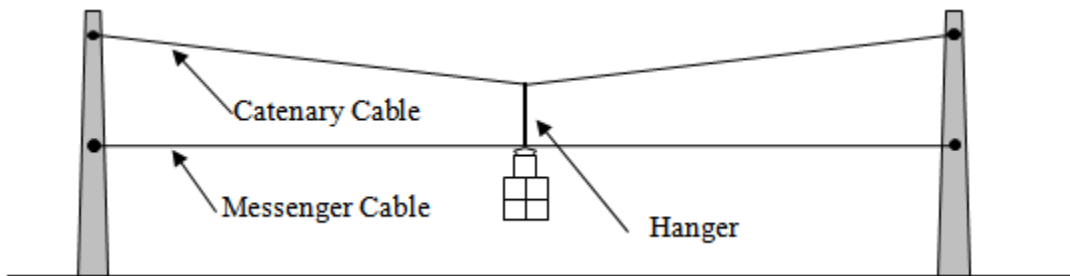

Figure 2-3. Configuration of signal and cables

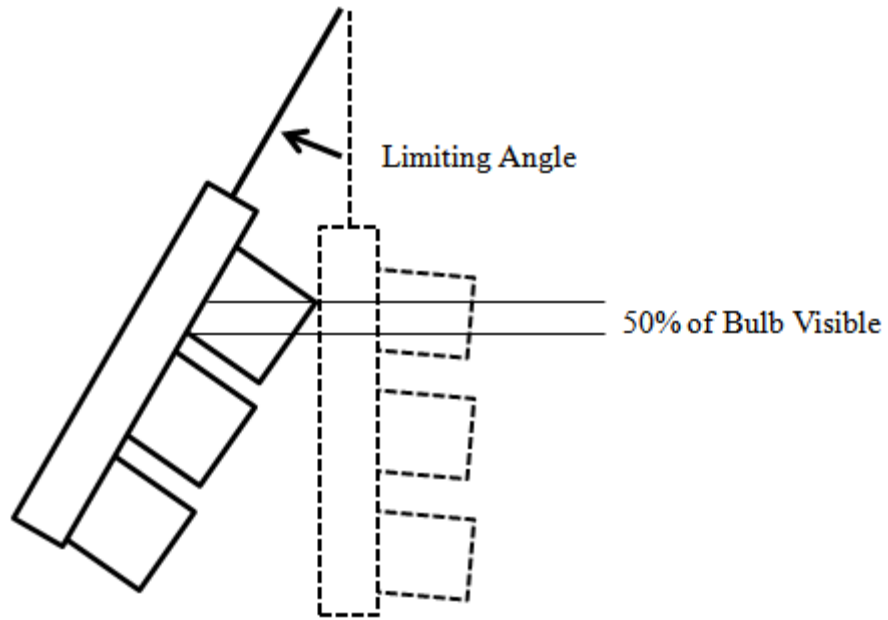

Figure 2-4. Limiting rotation for functional visibility of incandescent light signals (Cook 1993)

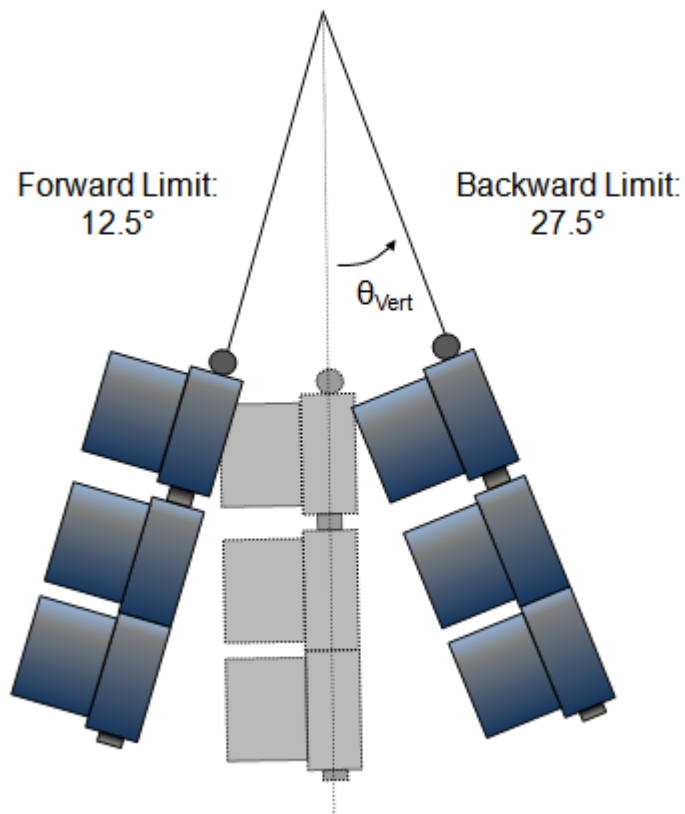
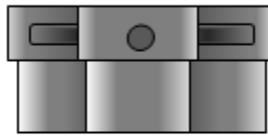
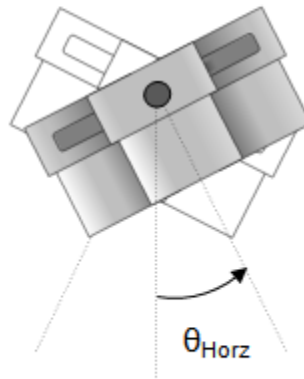

Figure 2-5. Limiting values for θ_{Vert} when using LED signals (sideways view of horizontal rotation)

Top view with no rotation:



Top view with limiting rotation:



Sideway Limit: $\pm 27.5^\circ$

Figure 2-6. Limiting values for θ_{Horiz} for visibility of LED signals (top view of vertical rotation)

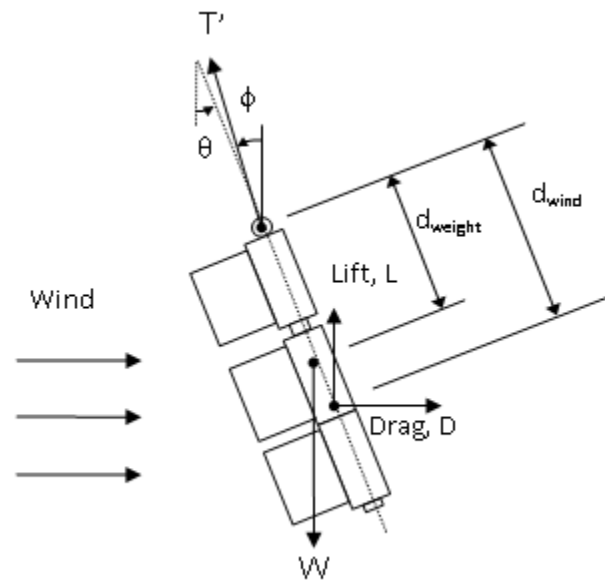

Figure 2-7. Free body diagram of signal supported by single cable system (Cook and Johnson 2007)

CHAPTER 3 METHODOLOGY

3.1 Test Setup

Traffic signals were installed on a 50 foot span with various cable support systems (Figure 3-1). The strain poles used to support the signals were installed during the previous signal-related research project at the University of Florida (UF) in 2005. The strain poles were two 18"x18" Class 6 concrete poles recycled from an intersection in Gainesville, FL. Cook and Johnson used ATLAS to determine that the results for signal rotations and cable displacements were very alike for a 50 foot span and a 72 foot span. The 50 foot span was considered adequate for reuse.

Initially, a 40" separation between the catenary and messenger cables was planned in order to maximize the moment developed on the hangers. Two out of the four hangers being tested featured a design that releases moment. After the first test series, it was determined that an 18" cable separation would be used in order to allow maximum rotations and the most dynamic behavior for signals (Figure 3-1). Backplates are typically used on all signals facing east or west at intersections. All tests used 5-section signals with louvered backplates to maximize the exposed area of the signal in the wind field. The second signal on tests with two signals was a 3-section signal with a louvered backplate. All test configurations were performed with signals of aluminum, and select tests were repeated with polycarbonate signals. The weight of the signals and other equipment can be found in Appendix D.

Dual cable systems were tested with a 5% sag, and single cable systems were tested with 3% sag (Figure 3-1). A discontinuous messenger cable system was also tested using two signals and a 5% sag. In this system, the messenger cable is severed

at the signal on each end of the span so that it is not attached to the strain poles. Figure 3-2 shows diagrams for each system. All systems were supported using 3/8" diameter 7-wire strand for the span wire as specified in Section 634 of the FDOT 2010 Standard Specifications for Road and Bridge Construction. The City of Gainesville Traffic Operations provided and installed the span wires. Come-alongs with a five thousand pound capacity were installed at one end of each cable in order to allow adjustments to cable sag and tension during signal installation.

The wind for testing was generated by the UF Hurricane Simulator (Figure 3-3 and Figure 3-4). The Hurricane Simulator was placed approximately 12 feet away from the signal for each test. During the tests performed by Cook and Johnson, wind loads were at the same angle and location for all tests. The Hurricane Simulator was moved during this project to check the sensitivity of the data to the direction of the wind. In Series 1 and 2, the simulator was angled at 90° to the span during testing. In Series 3 to 5, the simulator was placed at 45° to the span. In Series 6, the simulator was angled at 12° to the span. The target of 10° for the final wind angle could not be met because of the size of the simulator and its proximity to the strain pole and other objects at the test site. The signals were tested facing 90° to the span for all simulator positions, and some tests were repeated with the signal facing 45° to the span for the 45° simulator position. Figure 3-5 shows all of the orientations that were used. The data from Cook and Johnson showed that a forward facing signal had either more rotation or little difference in rotation compared to a backward facing signal. No tests were performed with the signal facing backwards during this project so other variables could be tested.

For tests with one signal on the span, the signal was centered and the simulator was positioned so that the wind field centered on the signal (Figure 3-5). When a second signal was added, the two signals were spaced with five feet between the centers. The two signals were shifted along the span so that the center of the span was between them. The two signals were situated so that they were completely within the wind field (Figure 3-6).

3.2 Instrumentation

The instruments used during testing included an anemometer produced by R.M. Young Company, two LCCA-5K load cells, three string potentiometers, and a model 3DM-GX2 gyro-enhanced orientation sensor.

The anemometer was placed approximately six feet in front of the signal in order to measure the velocity of the wind acting on the signal. In order to avoid creating turbulence directly in front of the signal, the anemometer was shifted two feet to the side of the centerline between the signal and the simulator. The device was mounted on a 1 ¼" steel pole attached to a concrete foundation (Figure 3-7).

One load cell was installed on each of the signal support cables to measure tension of the cables during testing (Figure 3-8). The ends that the load cells were attached to were opposite from a pair of come-alongs installed with the cables for making adjustments to the cable sag and tension. The load cells had a five thousand pound load capacity, and were S-type tension and compression load cells.

There were three string potentiometers (string pots) placed in the layout shown in Figure 3-9. The string pots were mounted on a sliding track placed on a tower ten feet behind the signal (Figure 3-10). The slides allowed adjustments to be made after the signal was installed to ensure that the string pot lines were level. This also allowed for

the string pots to be easily removed for storage when tests were not being performed. The tower was anchored to the ground with guy wire lines to keep it from moving in the wind.

The 3DM-GX2 allowed for the collection of roll, pitch, and yaw measurements to be taken wirelessly. The elimination of wires attached to the signal avoided unnecessary interference with signal movement. The only alteration of the signal was to drill small holes on the internal walls between the heads in order to fasten the sensor. The sensor was mounted inside the casing of the solid yellow signal head (Figure 3-11).

3.3 Test Method

The equipment tested consisted of five types of hangers and a direct connection for attaching signals to support cables. A description of each test can be found in Table 3-1. The 2010 FDOT Design Standards specify the use of 1 ½" diameter pipe for dual cable support systems (Figure 3-12A). Other products used in Florida for dual cable support systems include an adjustable strap hanger (Figure 3-12B) and a cable hanger constructed of ¼" cable with cable clamps and thimble eyes in place of a rigid material (Figure 3-12C). A recently developed product, the pivotal hanger, consists of the top portion of the adjustable strap hanger paired with a pivoting assembly for the bottom portion which attaches to the messenger cable and disconnect box (Figure 3-12D). The adjustable strap hanger was used when testing the discontinuous messenger system to replicate the practice of a Florida county that developed the system. A single cable support system was tested using a direct connection (Figure 3-12E).

An oscillating wind load sequence was developed to test the performance of each support system using the Hurricane Simulator. Oscillations simulated turbulence which would be expected during actual hurricanes. The program began with a ramp-up to

approximately 50 mph over a 30-second period, oscillated through ten cycles at the natural frequency for the system being tested at a mean velocity of 50 mph, ramped to approximately 100 mph over a 30-second period, cycled ten times at the natural frequency at a mean velocity of 75 mph, ramped to 120 mph over a 30-second period, and held that velocity for an additional 30 seconds before the test ended. See Figure 3-13 for a sample of the oscillating wind sequence taken from Test 4. The oscillating sequence was used for Series 2 through 6 (Table 3-1). Test Series 1 had a linear wind load to 120 mph over three minutes. Some variation in loading occurred due to natural wind in the environment and performance of the simulator.

The natural frequency of each system was determined by applying a 20 lb force to the signal and then recording the rotations after releasing. The primary mode for cable-supported signals is in the vertical direction. The primary frequencies for all systems were around 0.5 cycles per second. Frequencies in other directions were two to five times higher than the primary frequencies. Only the primary frequency was used during testing.

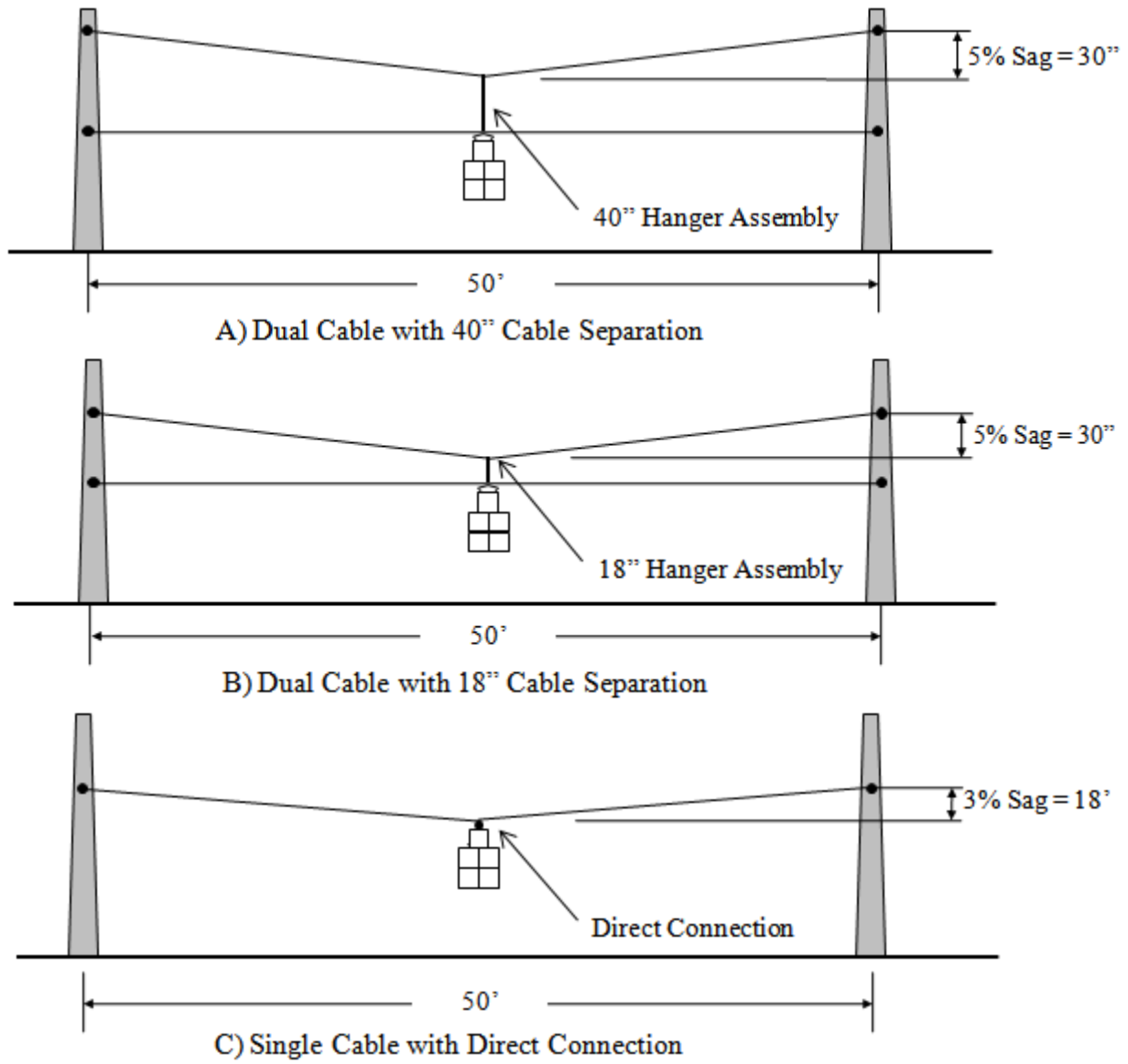

Figure 3-1. Spacing and layout of cables

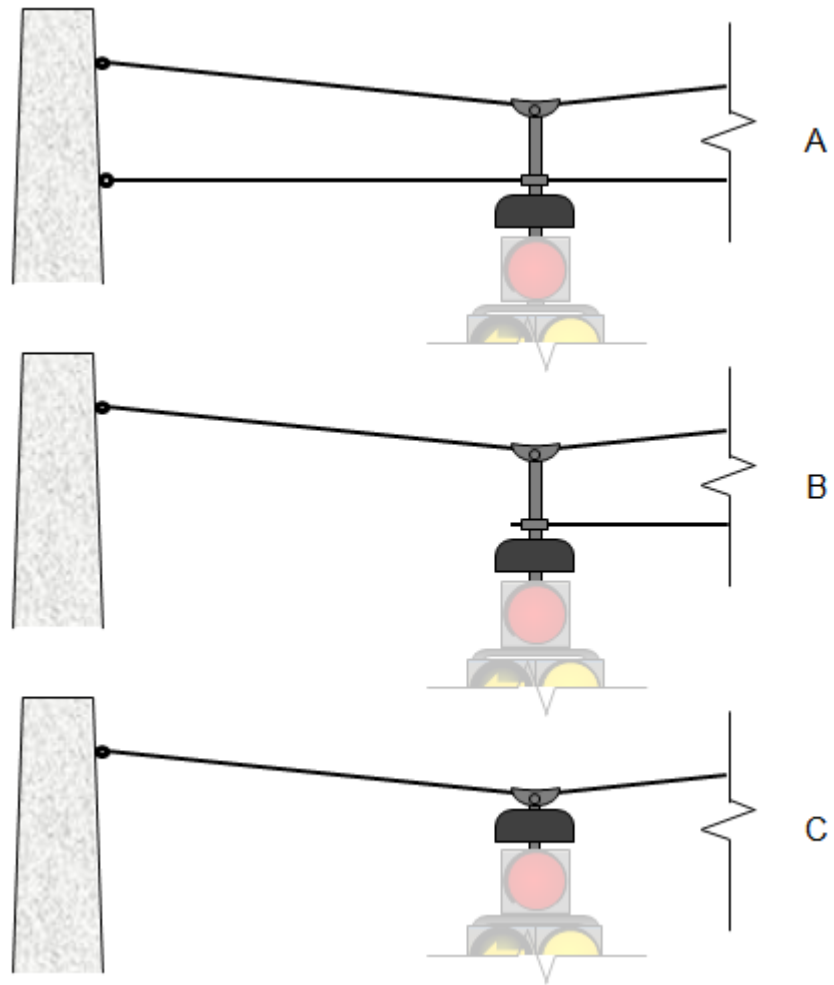

Figure 3-2. Cable support systems: A) Dual Cable Support System; B) Discontinuous Messenger Cable System; C) Single Cable System



Figure 3-3. The UF Hurricane Simulator's engines and fans (back) (Photo courtesy of author)



Figure 3-4. The UF Hurricane Simulator's fans and wind vanes (front) (Photo courtesy of author)

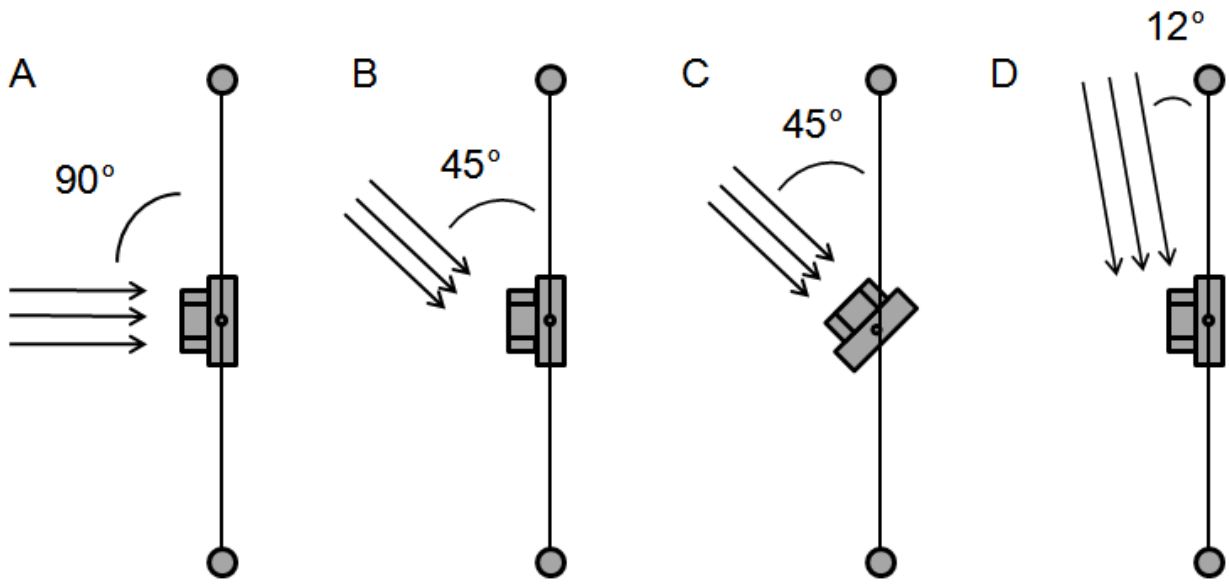

Figure 3-5. Signal and simulator testing orientations



Figure 3-6. Two-signal test setup (Photo courtesy of author)



Figure 3-7. R.M. Young anemometer (Photo courtesy of author)



Figure 3-8. Load cells installed in line with catenary and messenger cables (Photo courtesy of author)

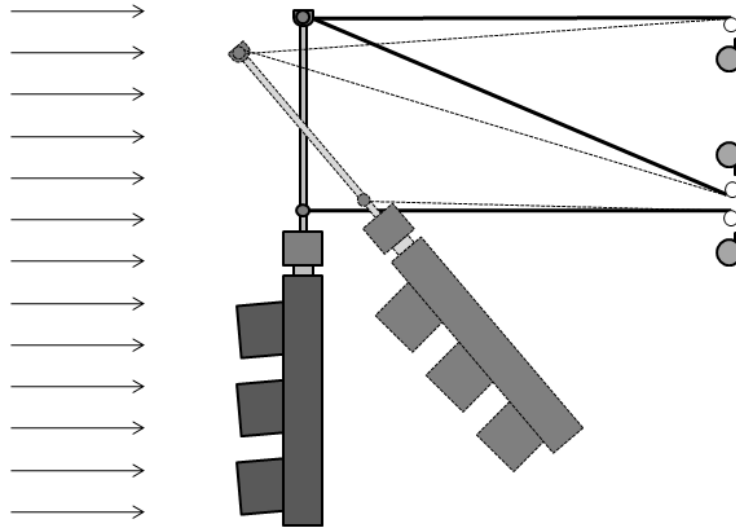

Figure 3-9. String potentiometer setup



Figure 3-10. Mounting system for string potentiometers (Photos courtesy of author)

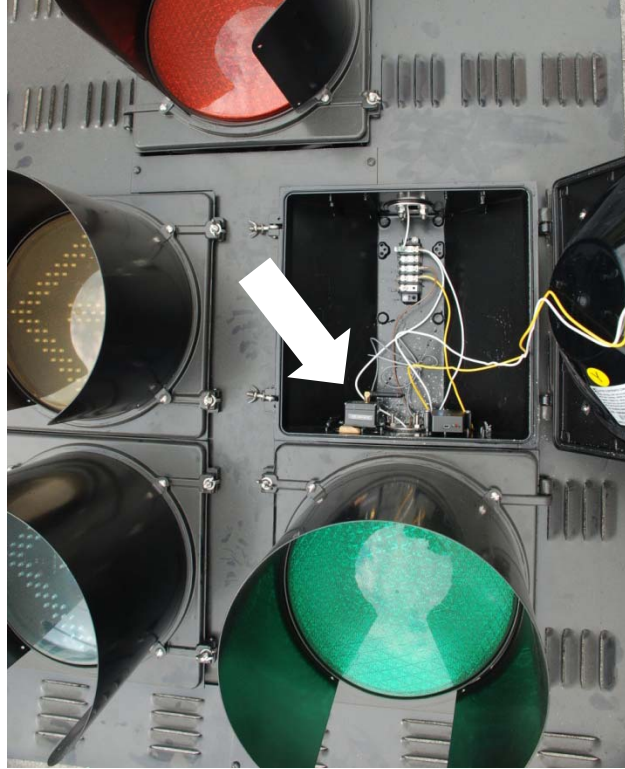

Figure 3-11. Orientation sensor installed inside the signal (Photo courtesy of author)

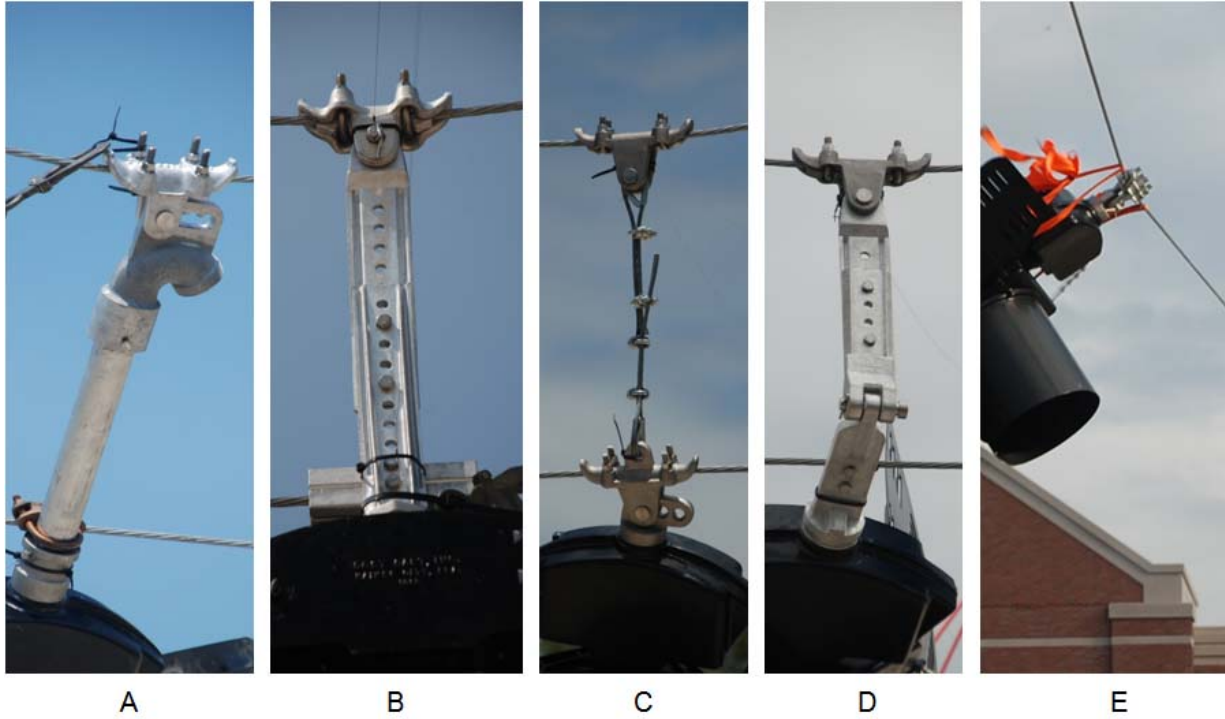

Figure 3-12. Types of hangers: A) Pipe Hanger; B) Adjustable Hanger; C) Cable Hanger; D) Pivotal Hanger; E) Direct Connection (Photos courtesy of author)

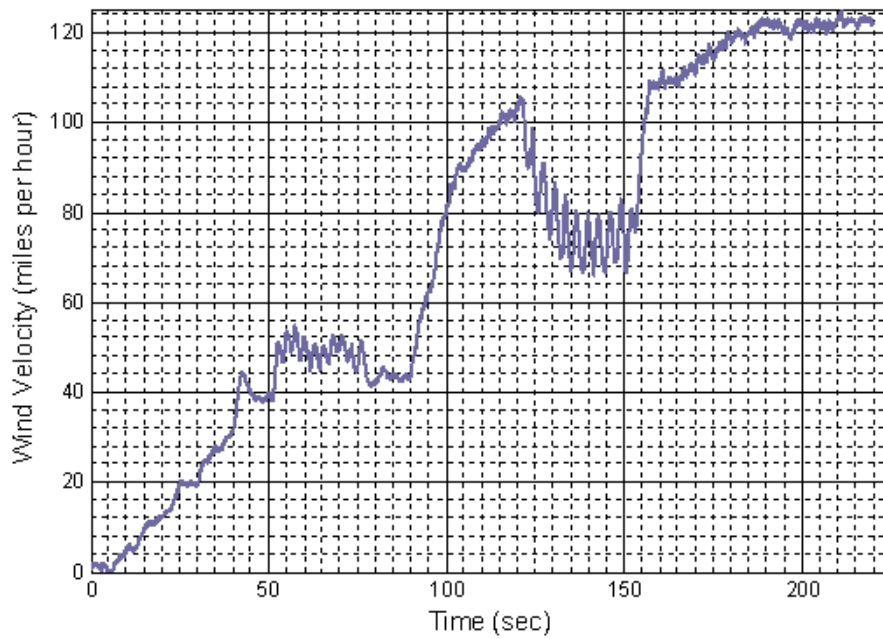

Figure 3-13. Sample of oscillating wind load sequence (Test 4)

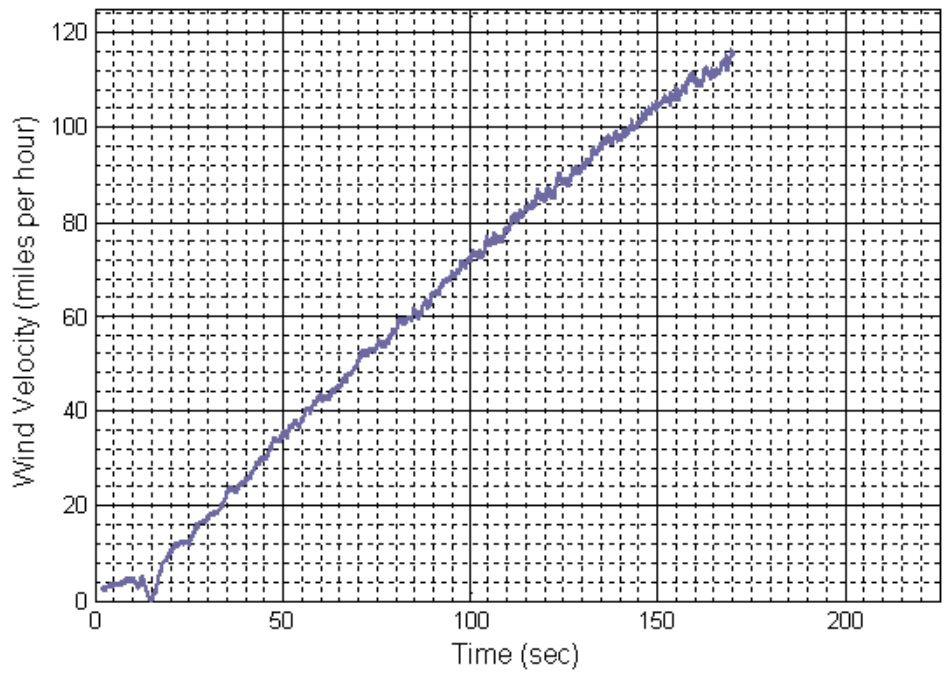

Figure 3-14. Sample of linear wind load (Test 1)

Table 3-1. Test Schedule

Test no.	Wind angle (°)	Signal angle (°)	Cable system	Hanger/ connection	% sag	No. of signals	Date	Series no.
1	90	90	Dual	Pipe	5	1	1/20/2011	1
2	90	90	Dual	Pivotal	5	1	1/20/2011	1
3	90	90	Single	Direct connect.	3	1	1/20/2011	1
4	90	90	Dual	Pipe	5	1	4/28/2011	2
5	90	90	Dual	Pivotal	5	1	4/28/2011	2
6	90	90	Dual	Cable	5	1	4/28/2011	2
7	90	90	Single	Direct connect.	3	1	4/28/2011	2
8	90	90	Single	Direct connect.	3	1(poly.)	4/28/2011	2
9	45	90	Dual	Pipe	5	1	5/1/2011	3
10	45	45	Dual	Pipe	5	1	5/1/2011	3
11	45	90	Dual	Pivotal	5	1	5/1/2011	3
12	45	45	Dual	Pivotal	5	1	5/1/2011	3
13	45	90	Dual	Cable	5	1	5/1/2011	3
14	45	45	Dual	Cable	5	1	5/1/2011	3
15	45	90	Single	Direct connect.	3	1	5/1/2011	3
16	45	45	Single	Direct connect.	3	1	5/1/2011	3
17	45	90	Dual	Pipe	5	2	5/10/2011	4
18	45	90	Dual	Pivotal	5	2	5/10/2011	4
19	45	90	Dual	Cable	5	2	5/10/2011	4
20	45	90	Disc. mess.	Adj. strap	5	2	5/10/2011	4
21	45	90	Single	Direct connect.	3	2	5/10/2011	4
22	45	90	Single	Direct connect.	3	1(poly.)	5/11/2011	5
23	45	90	Dual	Adj. strap	5	1	5/11/2011	5
24	45	90	Dual	Pivotal**	5	1	5/11/2011	5
25	45	90	Dual	Pivotal	5	1(poly.)	5/11/2011	5
26	45	90	Dual	Cable	5	1(poly.)	5/11/2011	5
27	45	90	Dual	Pipe **	5	1	5/11/2011	5
28	12	90	Dual	Pipe	5	1	5/18/2011	6
29	12	90	Dual	Pivotal	5	1	5/18/2011	6
30	12	90	Dual	Cable	5	1	5/18/2011	6
31	12	90	Dual	Pivotal	5	1(poly.)	5/18/2011	6
32	12	90	Single	Direct connect.	3	1(poly.)	5/18/2011	6
33	12	90	Single	Direct connect.	3	1	5/18/2011	6

*Linearly ramped wind load and 40" cable separation

**Messenger cable clamped to front side of hanger instead of back side.

CHAPTER 4 TEST RESULTS

Tests for this project were performed from January 20, 2011, to May 18, 2011. Representatives from the Florida Department of Transportation (FDOT), manufacturers of the equipment being tested, and students and advisors from the University of Florida (UF) were present to view the testing. The key interests for the collection of data were the rotations experienced by the traffic signals, the tension in the catenary and messenger cables, and the displacement of the cables.

4.1 Signal Rotations

The wide coastal exposure and frequency of tropical storms and hurricanes that occur in Florida make the state susceptible to frequent high winds. In addition to the concern of damage to traffic signals in high winds, serviceability related to loss of signal visibility from signal rotation is a concern at lower level winds.

When a signal is blown backwards, it loses visibility at a vertical (backwards) rotation of 27.5° (Institute of Transportation Engineers (ITE) 2005) (Figure 2-5). In all tests, the horizontal (sideways) rotation limit was not met or was exceeded after passing the limit for vertical rotation. The ITE visibility limit shown in the figures in this section is 27.5° because the backward vertical rotation of the signal controls the limit.

4.1.1 Effect of Signal and Simulator Orientations on Signal Rotation

The single cable support system was tested at all of the orientations shown in Figure 3-5 to serve as a baseline to compare other systems. The pipe, pivotal, and cable hangers were also tested at all orientations.

As seen in Figure 4-1, when the wind load was below 45 mph, the single cable system experienced the most rotation when at a 90° signal orientation and a 90°

simulator orientation (Figure 3-5A). This provided the maximum exposed area to wind, and did not restrict the backward rotation of the signal. The single cable system experienced continuous swinging motions above 65 mph wind loads for all orientations.

Figure 4-2 to Figure 4-4 show that the 90° signal and 90° simulator orientation caused the most rotation for the dual cable systems. The pivotal and cable hangers were not as sensitive to orientation as the pipe hangers when wind speeds exceeded 60 mph. Because the dual cable systems experienced less erratic rotations than the single cable system, the figures show cleaner differences in the effects of orientation on rotation. The pivotal hanger only deviated from typical rotation patterns at the 90° signal and 45° simulator orientations.

4.1.2 Effect of Hanger Types and Support Systems on Signal Rotation

The hangers used with the dual cable support system varied in rigidity and flexibility. The standard drop pipe hanger is constructed from a single rigid pipe. The adjustable strap hanger is constructed from two rigid pieces bolted together at two points and may be extended with the addition of a flat bar bolted between the two base pieces. The pivotal hanger consists of two rigid portions attached by a hinge which allows free forward and backward rotation when ignoring the restriction of the messenger cable. The pivotal hanger may also be made larger with the addition of a flat bar bolted between the top and bottom pieces. The cable hanger is flexible along the entire hanger length. A 1/4" 7-wire strand cable was used for the cable hanger; however, only the diameter was specified and not the type of cable. Other cables may have more or less flexibility which could change the behavior of the system.

Test Series 2 included the single cable support system with a direct connection and the dual cable support system with the pipe, pivotal, and cable hangers tested at

90° signal and 90° simulator orientations. Figure 4-5 shows that pivotal and cable hangers with the dual cable system experienced nearly identical rotations. The pipe hanger prevents the distance between the messenger and catenary cables from changing because of the lack of a hinge or flexibility. The high messenger tension also created a resistance to rotation. The single cable system performed the same as the pivotal and cable hangers until wind speeds exceeded 65 mph. Then the single cable system behaved more like the pipe hanger. At the 90° signal and 90° simulator orientation, the pipe hanger, cable hanger, and single cable system exceeded the ITE visibility limit with a wind velocity of approximately 36 mph. The pipe hanger visibility limit occurred above a 40 mph wind velocity.

The adjustable strap hanger was added to the test schedule at the 90° signal and 45° simulator orientations. The adjustable strap hanger performed much like the pipe hanger, but it yielded during testing (Figure 4-7), which may have caused the higher rotations. At the maximum wind speed, there was approximately a 10° difference in rotations between the strap and pipe hangers. At less than 60 mph wind speeds, the difference was negligible between these two hangers. The pivotal and cable hangers performed again with little difference at this orientation. For the pivotal and cable hangers, the ITE visibility limit was met around 45 mph winds, and for the pipe and strap hangers it was met around 50 mph. For all systems, the ITE visibility limit occurred during the oscillating wind loads, so that visibility was lost within a range of wind velocities.

At the 45° signal and 45° simulator orientation, the pivotal hanger no longer behaved like the cable hanger. Because exposed signal area and wind force were

maximized in a direction not parallel with the direction of the hinge on the pivotal hanger, the rotation was significantly reduced. Figure 4-8 shows that for wind speeds below 60 mph, the pivotal hanger behaved like a rigid pipe hanger. Above 60 mph, the rotation was further restricted, and the signal rotation with the pivotal hanger was less than with the pipe hanger. The hinge on the pivotal hanger only frees motion perpendicular to the cable span. At this angle, the signal blew against the hinge.

During the final test series, there was a 90° signal orientation and 12° simulator orientation. This combination had the smallest signal area exposure to the wind. The pipe hanger experienced the lowest rotations (Figure 4-9). The other systems performed with similar rotations to each other throughout the loading sequence. The results at this orientation showed more swinging of the signals during loading, especially at wind speeds higher than 60 mph.

The discontinuous messenger cable system is an alternative cable support system that requires two or more signals. Test Series 4 repeated tests on the dual cable system with the pipe, pivotal, and cable hangers, and with the single cable system at the 90° signal and 45° simulator orientation using two signals in order to compare them with the discontinuous messenger cable system. Figure 4-10 and Figure 4-11 show the rotation results for the two-signal tests. The rotations were measured in both the 5-section signal and the 3-section signal. The severed messenger cable used in the discontinuous messenger cable system prevents the unpredictable rotations that are found in the single cable system. When the wind speeds were less than 60 mph, the discontinuous messenger cable system had rotation behavior similar to the dual cable system with pivotal and cable hangers and the single cable system. Above 60 mph wind speeds, the

rotation in the discontinuous messenger system leveled off until it matched the rotations of the pipe hanger system. The effects of having multiple signals on a single span are discussed in the next section. Figure 4-10 shows that for the 5-section signal the discontinuous messenger cable system and the cable hanger had a visibility limit at 40 mph, the single cable system and the pivotal hanger had a visibility limit of 44 mph, and the pipe hanger had a visibility limit between 50 mph and 55 mph. The 3-section signal shows less difference among the systems.

4.1.3 Effect of Multiple Signals on Signal Rotation

At the 45° simulator and 90° signal orientation, the dual cable system with pipe, pivotal, and cable hangers, and the single cable system were retested with a 3-section signal added to the span. The two signals were adjusted along the span to remain completely within in the wind field. There was a five foot center-to-center separation of the signals.

The single cable system experienced the most significant effects of adding a second signal (Figure 4-12). Signal rotations were more irregular as the wind load increased when an additional signal was added to the span. The 5-section signal during the two-signal test experienced more rotation compared to the one-signal test, while the 3-section signal experienced less rotation compared to the one-signal test. At less than 45 mph wind speeds, there appeared to be negligible difference in the rotation results.

The pipe hanger and pivotal hanger showed no change in rotation when an additional signal was added to the span (Figure 4-13 and Figure 4-14). When a second signal was added to the cable hanger system, the 5-section signal experienced higher rotations (Figure 4-15). The 3-section signal experienced rotations similar to the one-signal test.

4.1.4 Effect of Signal Weight on Signal Rotation

Various tests were repeated using a polycarbonate signal in place of the aluminum signal. The aluminum signal weighed 73.0 lbs, and the polycarbonate signal weighed 53.5 lbs. As well as the difference in weights, the aluminum signal had a front area of 14.2 square feet, while the polycarbonate signal had a front area of 13.1 square feet. The polycarbonate signal consisted of an aluminum top signal head and four polycarbonate signal heads. All five signal heads are aluminum for the aluminum signal.

The single cable support system was tested with the polycarbonate signal at the 90° signal and 90° simulator orientation, the 90° signal and 45° simulator orientation, and the 90° signal and 12° simulator orientation. The results in Figure 4-16 and Figure 4-17 show erratic behavior for the polycarbonate signal at the 90° signal and 90° simulator orientation and at the 90° signal and 45° simulator orientation. The backplate of the polycarbonate signal broke off before the wind speed reached 110 mph (Figure 4-16). The reduced area exposed to the wind dampened the swinging of the signal. With the exposed area of the signal reduced at the 90° signal and 12° simulator orientation, the polycarbonate signal experienced stable rotation (Figure 4-18).

When using the polycarbonate signal with the dual cable system, all of the results maintained stable behavior (Figure 4-19 to Figure 4-21). These tests were conducted using the pivotal hanger and the cable hanger at the 90° signal and 45° simulator orientation and with the pivotal hanger at the 90° signal and 12° simulator orientation. For all of these tests, the polycarbonate signal experienced higher rotations when wind speeds exceeded 45 mph.

4.1.5 Effect of Messenger Cable Clamp Location on Signal Rotation

Tests 9 and 11 were repeated with the same orientation, but installing the messenger clamps on the front of the pipe and pivotal hangers. Figure 4-22 and Figure 4-23 show that there is very little difference in each case. After exceeding 60 mph, the rotations were only slightly higher for the case where the messenger was clamped to the back. The fall in rotation at the end of Test 9 occurred after a repeatedly used backplate failed at one corner.

4.2 Cable Tensions

The tension experienced in the supporting cables is important for calculating moment and stresses experienced in the strain poles. During installation for testing, the workers from the Gainesville Traffic Operations were asked to replicate field practices. Each signal was first hung on the catenary cable, and then the messenger cable was tightened across the span before attaching it to the hanger. Except for the first test series, the tension of the messenger cable was controlled so that all initial messenger tensions were between 750 lbs and 1200 lbs. The sag for all dual cable systems was 5% and for single cable systems was 3%.

Table 4-1 through Table 4-5 summarize the changes in tension during each test from Test Series 2 through 6. The initial tension for each cable and the change in tension at wind speeds of 60 mph and 115 mph are provided. These speeds were selected because in the midrange speeds, behavior of each system was more distinct, and because some tests ended before the wind speeds reached 120 mph.

Note that the tensions reported in these sections are the change in tension during testing. This created a common starting point for each data set which was necessary because initial tensions are not equal on all tests.

For all tests, the catenary cables lost tension as wind speeds increased until approximately 60 mph. At that point, some systems started to recover tension. All of the changes in catenary tension remained very small. The messenger cables for all dual cable systems increased in tension as wind speeds increased. The final change in tension was very high in messenger cables.

4.2.1 Effect of Signal and Simulator Orientations on Cable Tension

Changing the orientation of the signal and simulators had various effects on the cable tensions. Figure 4-24 compares the results for all of the single cable system tests that had no special conditions. Similar to the results for rotation, the 90° signal and 90° simulator orientation caused the highest final tensions for the single cable system. The 90° signal and 12° simulator orientation was the only case for the single cable system that did not regain the full initial tension during testing.

The catenary cable for the dual cable system with a pipe hanger experienced similar results as the single cable support. The 90° signal and 90° simulator orientation caused the highest change in catenary tension, and the 90° signal and 12° simulator orientation caused the lowest change in catenary tension (Figure 4-25). The messenger cable shows more exaggerated effects of changing the orientations of the signal and hurricane simulator. The tensions of the messenger cables all increased throughout testing. The difference became as high as 1500 lbs greater than the initial tension for the 90° signal and 90° simulator orientation and 90° signal and 45° simulator orientation at 120 mph. At the 90° signal and 12° simulator orientation, the limited area of exposure prevented excessive gains in tension and the final change in messenger tension was approximately 700 lbs.

The tensions for the pivotal hanger and the cable hanger were less affected by orientation (Figure 4-26 and Figure 4-27). The catenary cables for these systems did not regain the lost tension as wind speeds increased because these cables became inactive with the system. The final differences for messenger cable tension ranged from 750 lbs to 1000 lbs for the pivotal hanger and from 500 lbs to 1000 lbs for the cable hanger.

4.2.2 Effect of Hanger Types and Support Systems on Cable Tension

The complete rigidity of the pipe hanger caused it to maintain the separation distance between the catenary and messenger cables. As the signal rotated, the cables were forced outward causing the support cables with the pipe hanger to maintain the highest changes in tension in most cases. The freedom of rotation allowed by the pivotal and cable hangers significantly reduced the tension increase experienced in the dual cable system.

For the 90° signal and 90° simulator orientation, the messenger cable for the pipe hanger had a significantly higher change in tension while for the pivotal and cable hangers had the same changes in tension throughout testing at this orientation (Figure 4-28). The same conclusions were found for the 90° signal and 45° simulator orientation (Figure 4-29). The adjustable strap hanger was also tested at this orientation. The strap hanger performed most like the pipe hanger, but the tensions were slightly less. This case yielded the strap hanger, which may have caused the tension to experience less change.

At the 45° signal and 45° simulator orientation, the single cable system experienced sharp fluctuations in the catenary tension at high wind speeds (Figure 4-

30). The cable hanger had the lowest change in catenary and messenger tension. The pipe hanger had the highest change in messenger tension throughout testing.

The 90° signal and 12° simulator orientation did not provide adequate differences to make comparisons among the various systems (Figure 4-31). All results were within a 250 lb range, and most results overlapped. Where results did not overlap, the previous patterns were repeated.

Test Series 4 consisted of tests with two signals. These tests showed that the use of a discontinuous messenger cable provided more stable tension results than the single cable system without causing additional forces on strain poles by the attachment of a messenger cable (Figure 4-32). The catenary tension of the discontinuous messenger cable system decreased more than for the single cable system or the dual cable system with a pipe hanger. The remaining systems continued to perform with the same patterns as with one signal.

4.2.3 Effect of Multiple Signals on Cable Tension

All tests with two signals were performed at the 90° signal and 45° simulator orientation. The changes in tension for all systems were greater when a second signal was added to any system.

When a second signal was added to the cable span of the single cable system, the tension changes developed unpredictable fluctuation at wind speeds higher than 60 mph (Figure 4-33). The mean change in tension followed the same shape as with one signal, but the fluctuation caused tensions to reach as high as 1000 lbs additional force, which is comparable to the forces developed by messenger cables in dual cable systems.

For all of the dual cable systems, the catenary and messenger tensions underwent greater changes with a second signal (Figure 4-34 to Figure 4-36). The pivotal and cable hangers were more affected by the second signal with changes up to 500 lbs higher than with one signal. The change in messenger tension with the pipe hanger was up to 250 lbs higher.

4.2.4 Effect of Signal Material on Cable Tension

The polycarbonate signal and the aluminum signal had a 20 lb weight difference. The use of the polycarbonate signal with the single cable system caused the catenary tension to become very unpredictable in most orientations (Figure 4-37 and Figure 4-38). With the polycarbonate signal at the 90° signal and 90° simulator orientation, the change in tension fluctuated between -250 lbs and 2250 lbs before the backplate failed at 107 mph wind speeds. After the failure of the backplate, change in tension matched that of the aluminum signal. With the 90° signal and 45° simulator orientation, the polycarbonate signal experienced tension fluctuations between -250 lbs and 1250 lbs. At the 90° signal and 12° simulator orientation, the backplate provided much less exposed area and effect of the signal weight was insignificant (Figure 4-39).

The pivotal and cable hangers did not experience significant effects in cable tension with weight change. The messenger cable prevented the irregular fluctuation in tension.

4.2.5 Effect of Messenger Clamp Location on Cable Tension

The location of the messenger clamp for the pipe and pivotal hangers had little effect on the cable tensions (Figure 4-40 and Figure 4-41). The pipe hanger lost less catenary tension when the messenger cable was clamped to the back side of the hanger than when clamped to the front, but the messenger cable experienced no

difference with change in clamp location. The pivotal hanger also experienced smaller changes in catenary and messenger tension with a back clamp instead of a front clamp.

4.3 Cable Displacements

The displacements in the catenary and messenger cables were recorded during testing. Some string pots malfunctioned during some tests. Periodically, the data was not received from the wireless transmitter for the string pots, and during one test a cord was cut by a failed backplate. The following figures show data from Test Series 2. These tests provided complete data sets. The remaining unaffected data can be found in Appendix C. For dual cable systems the messenger cables experienced displacements within a range that was consistent with the elastic behavior of the cables for the cable tension measured. Across the 50-foot length of span wire there was less than a quarter inch difference between the cable elongation based off measured displacements and the elastic elongation calculated from the change in tension. The slight differences were assumed to be caused by slipping of the cables at the clamps on the strain poles.

When testing the pipe hanger, the signal rotation caused the messenger cable to displace backwards. Because of the rigidity of the pipe, the catenary cable was forced to displace forward. The forward displacement of the catenary cable had a five inch maximum. The maximum displacement of the messenger cable was 13 inches.

The pivotal and cable hangers allowed for independent movement of the catenary cable from the messenger cable after the signal weight was removed from the catenary cable by wind lift and transferred to the messenger cable. For both of these systems, the signal pulled the messenger cable into backwards displacement. The displacement caused by the wind on the catenary cable was much smaller (Figure 4-43 and Figure 4-

44). For the pivotal hanger, the maximum catenary cable displacement was six inches and the maximum messenger cable displacement was 12 inches. For the cable hangers, the maximum catenary cable displacement was 8 inches and the maximum messenger cable displacement was 12 inches.

The single cable system experienced the greatest cable displacement. Without the restriction given by the messenger cable on dual cable systems, the single cable swung back freely under wind loading (Figure 4-44). The maximum displacement was approximately 26 inches.

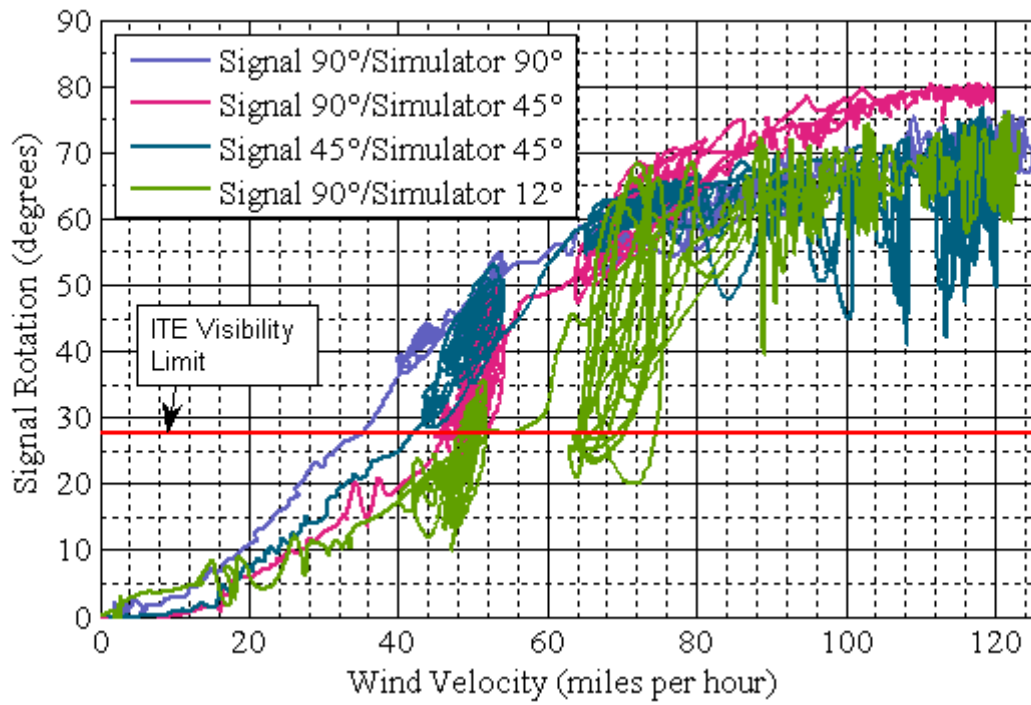

Figure 4-1. Rotation for single cable at all orientations (Tests 7, 15, 16, and 33)

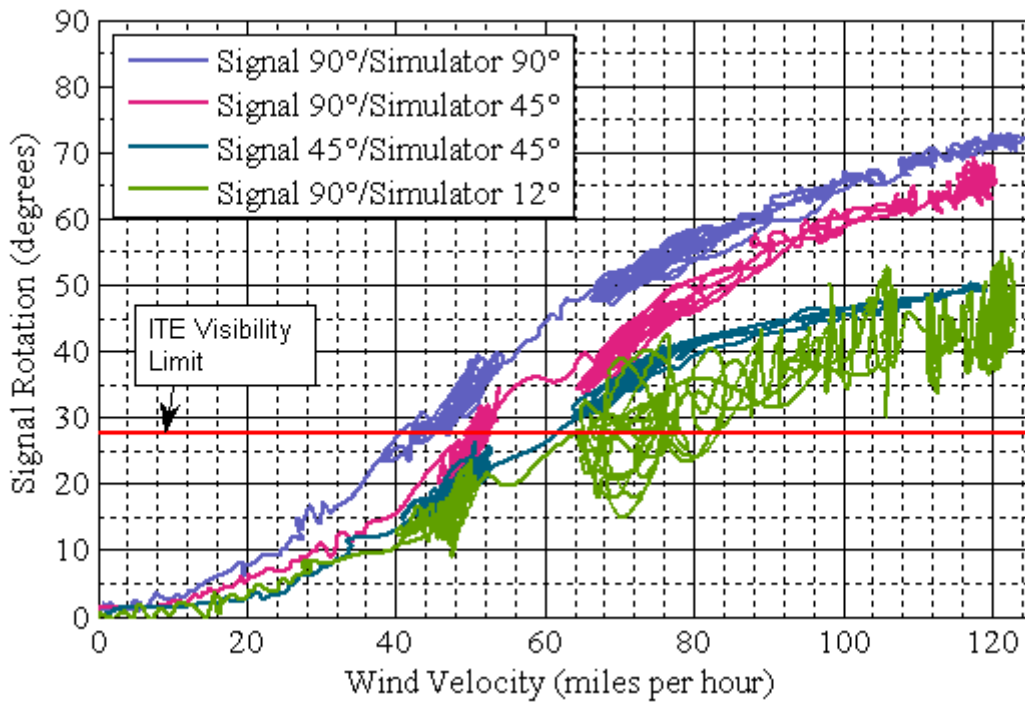

Figure 4-2. Rotation for pipe hanger at all orientations (Tests 4, 9, 10, and 28)

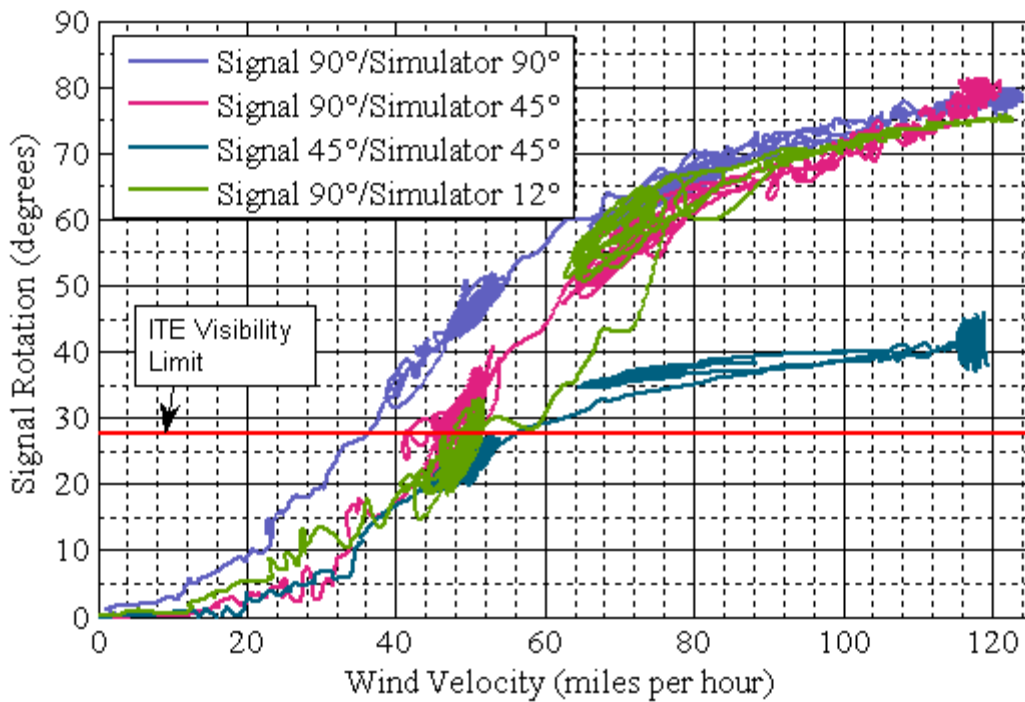

Figure 4-3. Rotation for pivotal hanger at all orientations (Tests 5, 11, 12, and 29)

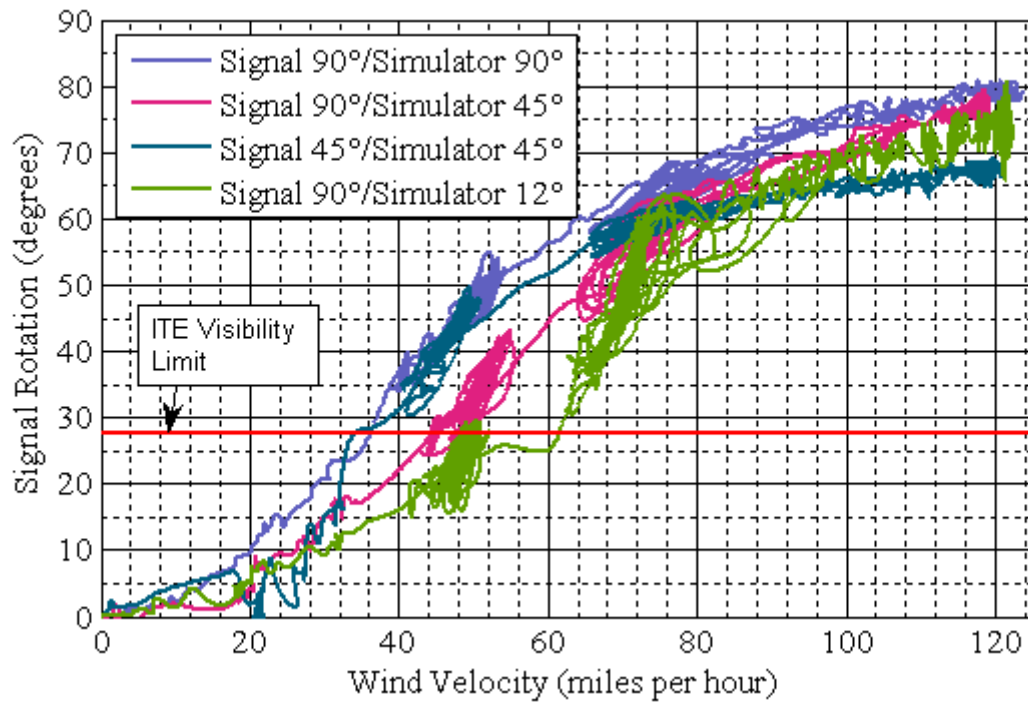

Figure 4-4. Rotation for cable hanger at all orientations (Tests 6, 13, 14, and 30)

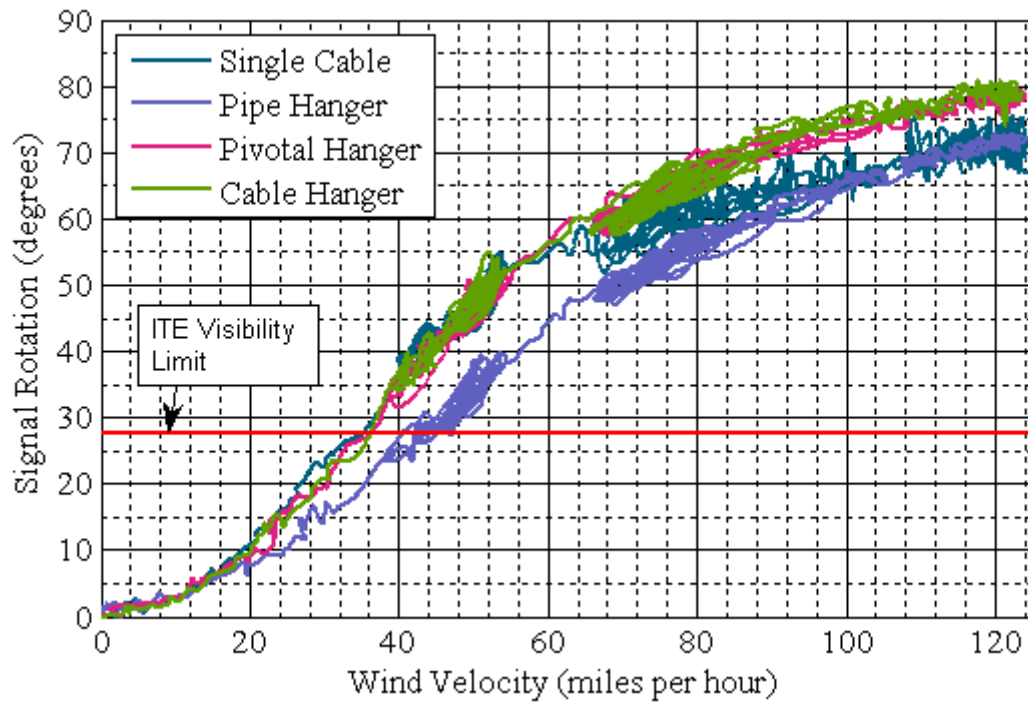

Figure 4-5. Rotation for systems at 90° signal and 90° simulator orientation (Test Series 2)

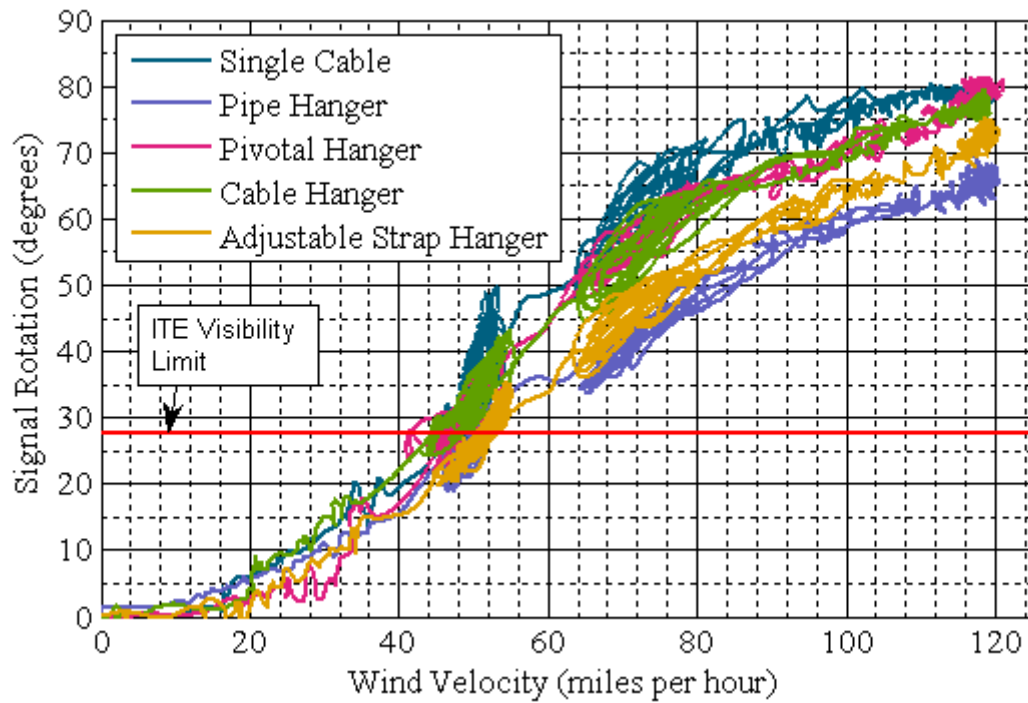

Figure 4-6. Rotation for systems at 90° signal and 45° simulator orientations (Tests 9, 11, 13, 15, and 23)

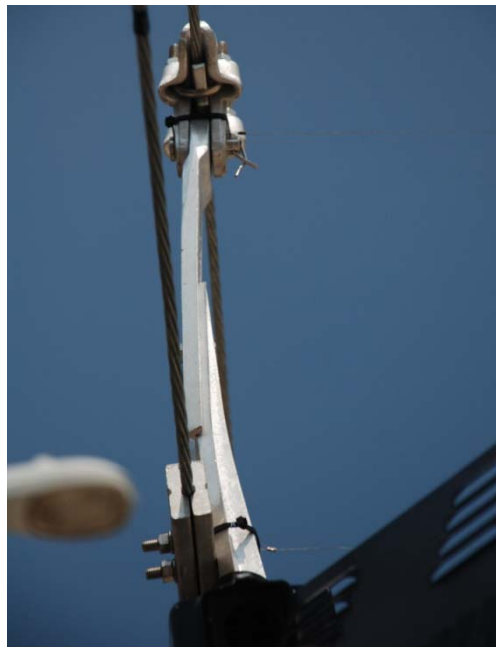

Figure 4-7. Adjustable strap hanger with visible yielding in lower section (Test 23)
(Photo courtesy of author)

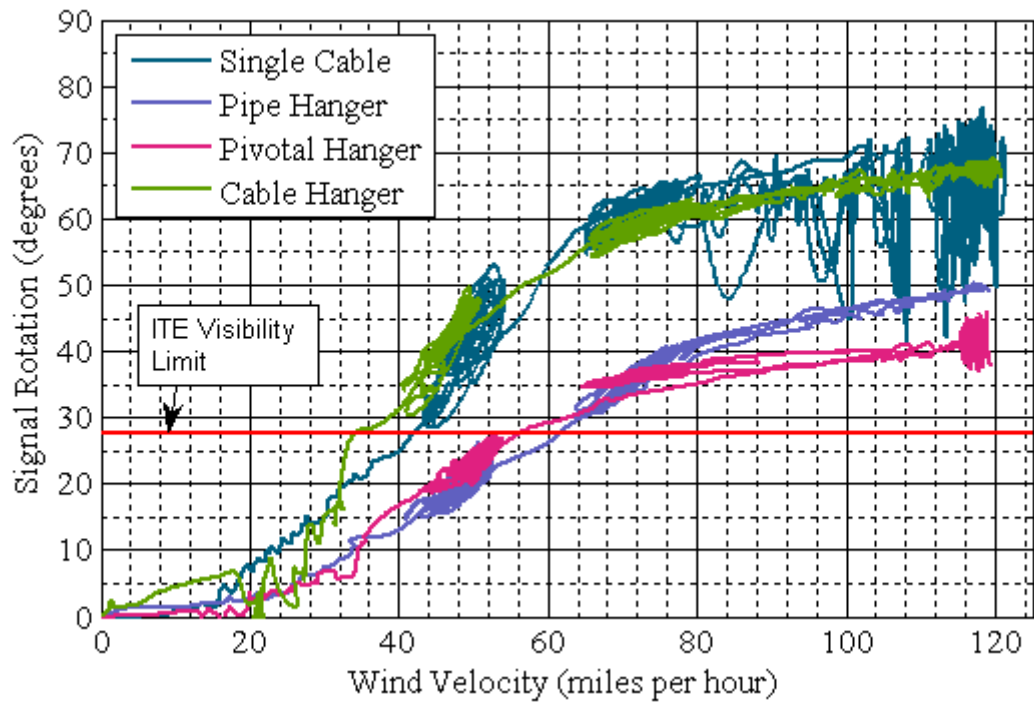

Figure 4-8. Rotation for systems at 45° signal and 45° simulator orientations (Tests 10, 12, 14, and 16)

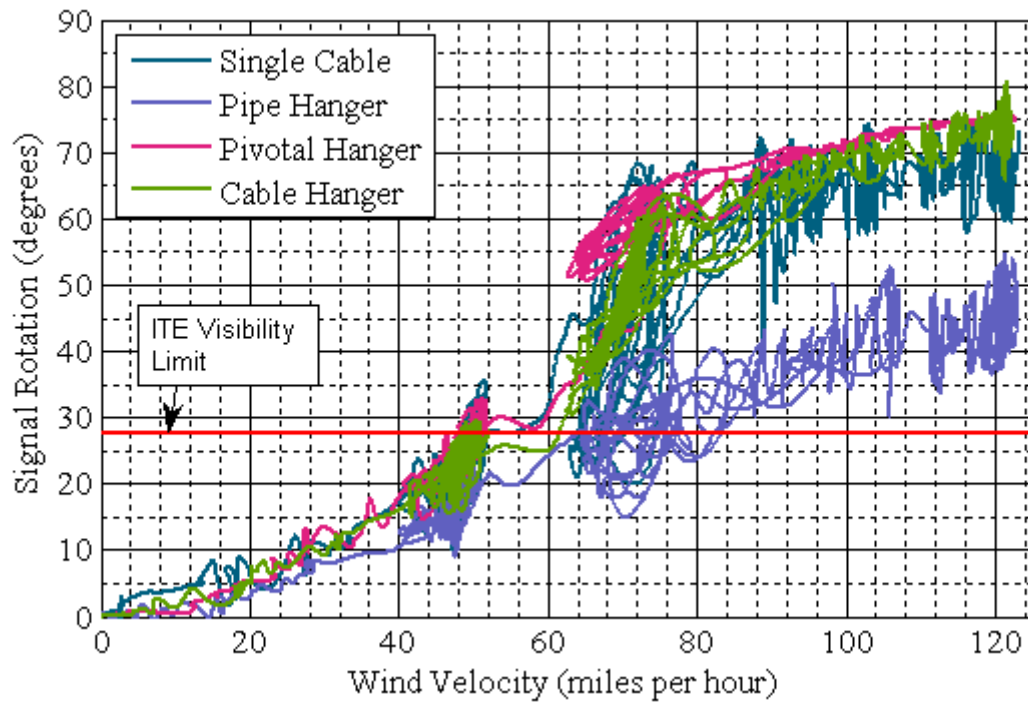

Figure 4-9. Rotation for systems at 90° signal and 12° simulator orientations (Tests 28, 29, 30, and 33)

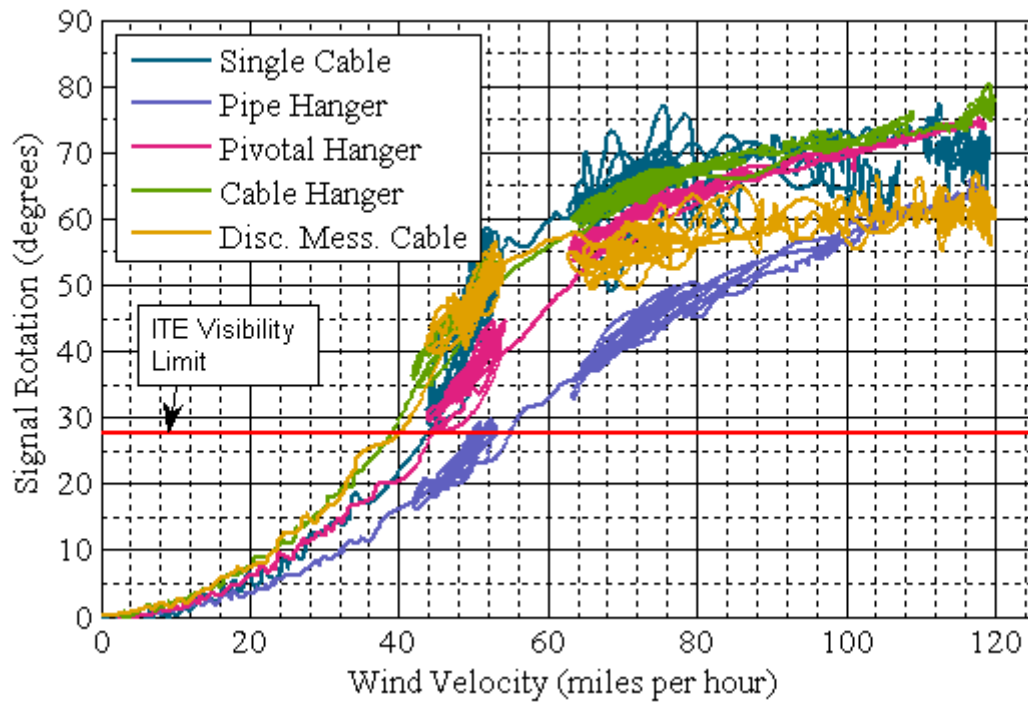

Figure 4-10. Rotation for 5-section signals during Test Series 4 two-at 90° signal and 45° simulator orientations

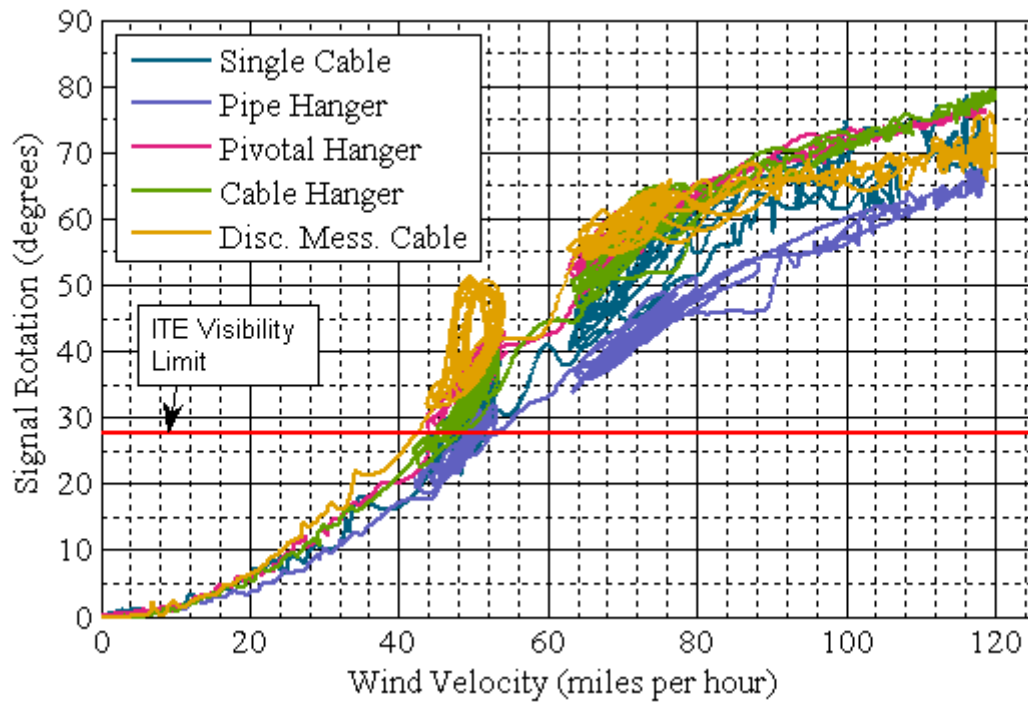

Figure 4-11. Rotation for 3-section signals during Test Series 4 two-at 90° signal and 45° simulator orientations

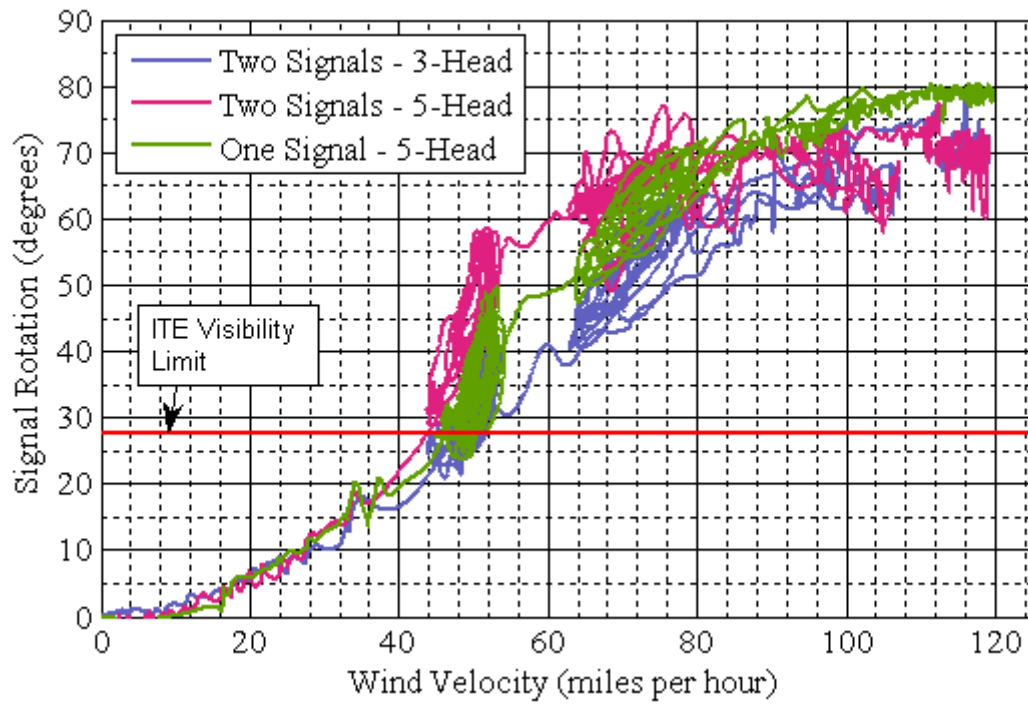

Figure 4-12. Rotation for single cable system with two signals verses one signal (Tests 15 and 21)

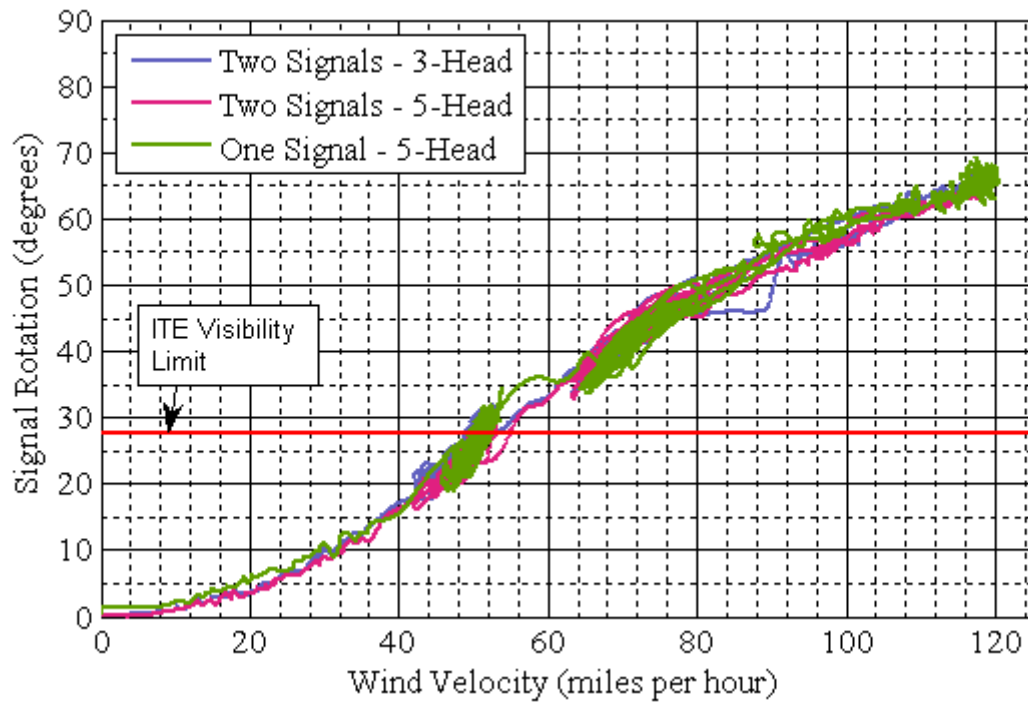

Figure 4-13. Rotation for pipe hanger with two signals verses one signal (Tests 9 and 17)

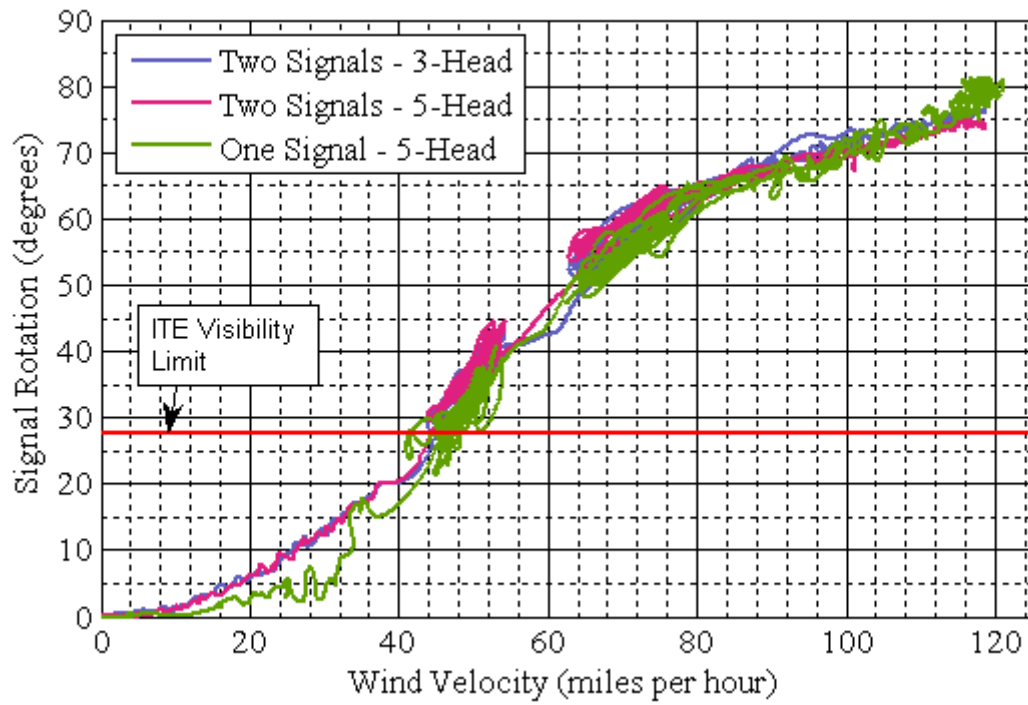

Figure 4-14. Rotation for pivotal hanger with two signals verses one signal (Tests 11 and 18)

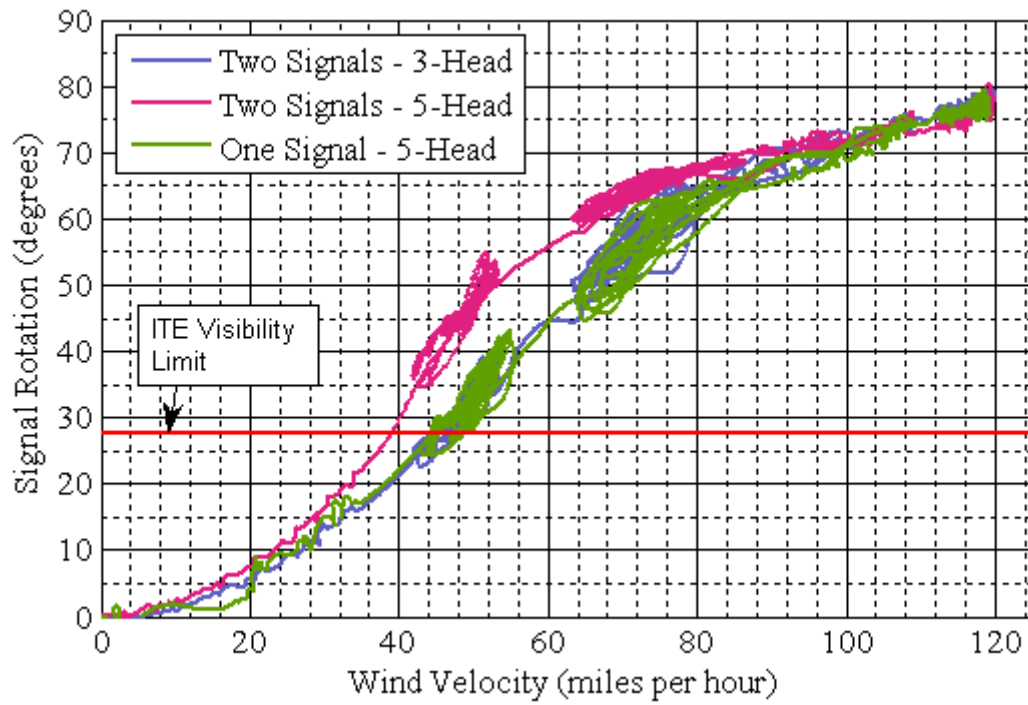

Figure 4-15. Rotation for cable hanger with two signals verses one signal (Tests 13 and 19)

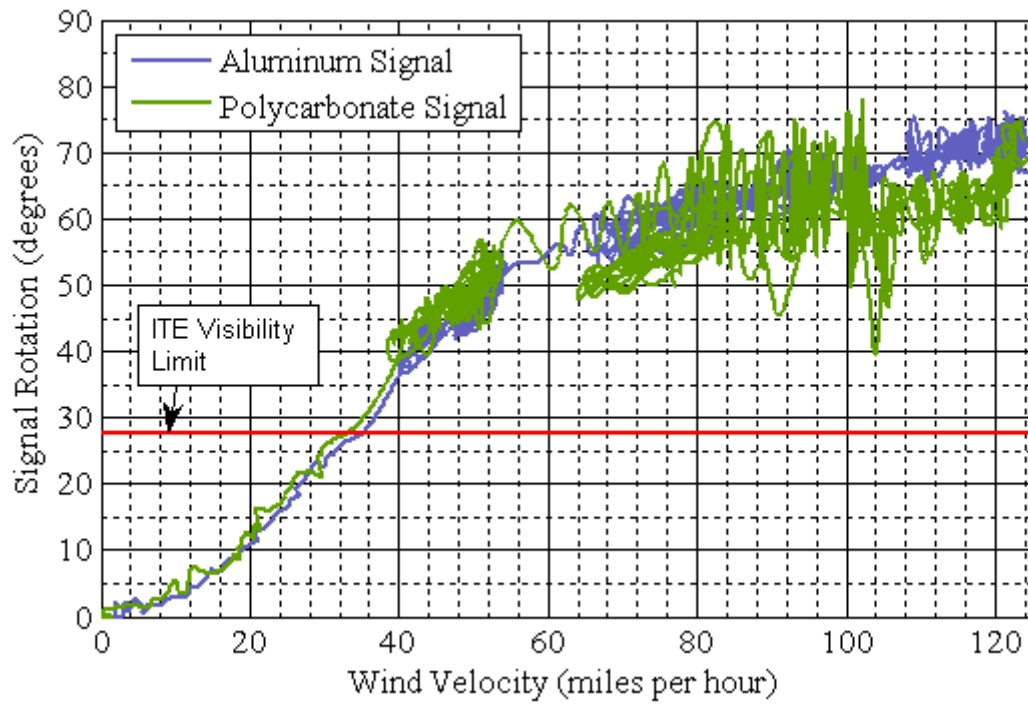

Figure 4-16. Rotation for single cable system with aluminum signal versus polycarbonate signal at 90° signal and 90° simulator orientation (Tests 7 and 8)

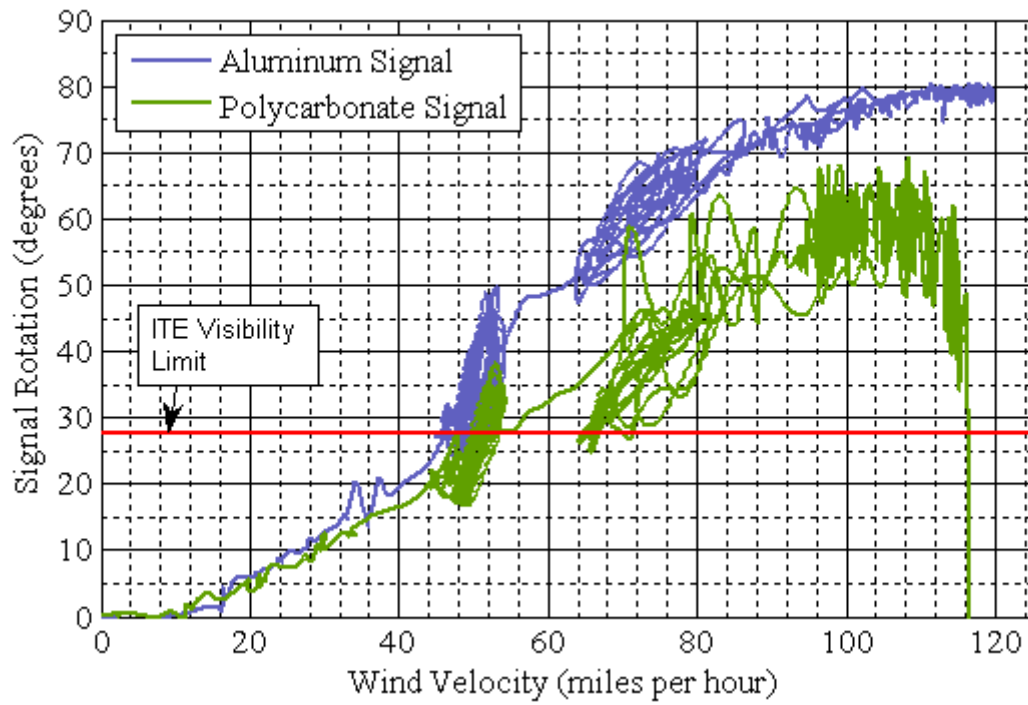

Figure 4-17. Rotation for single cable system with aluminum versus polycarbonate signal at 90° signal and 45° simulator orientation (Tests 15 and 22)

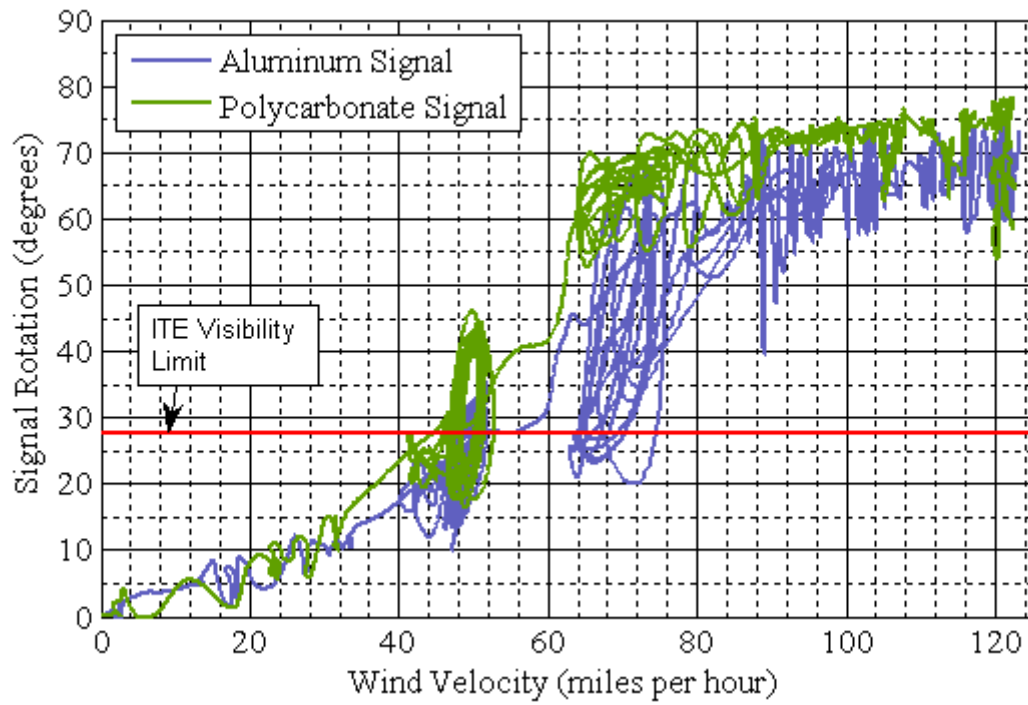

Figure 4-18. Rotation for single cable system with aluminum verses polycarbonate signal at 90° signal and 12° simulator orientation (Tests 33 and 32)

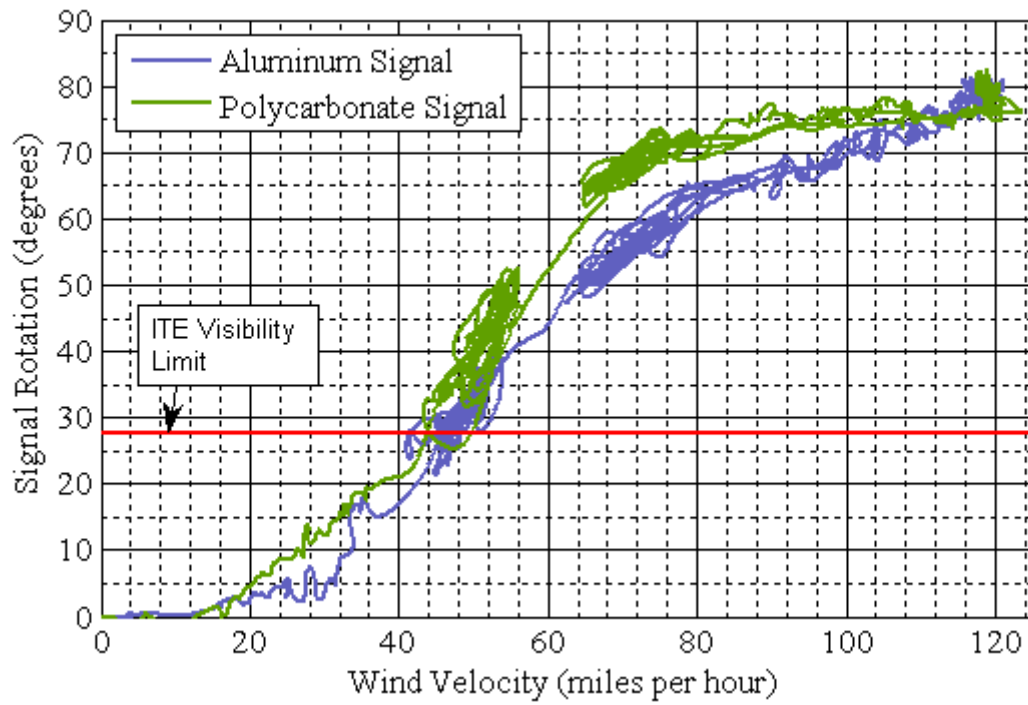

Figure 4-19. Rotation for pivotal hanger with aluminum versus polycarbonate signal at 90° signal and 45° simulator orientation (Tests 11 and 25)

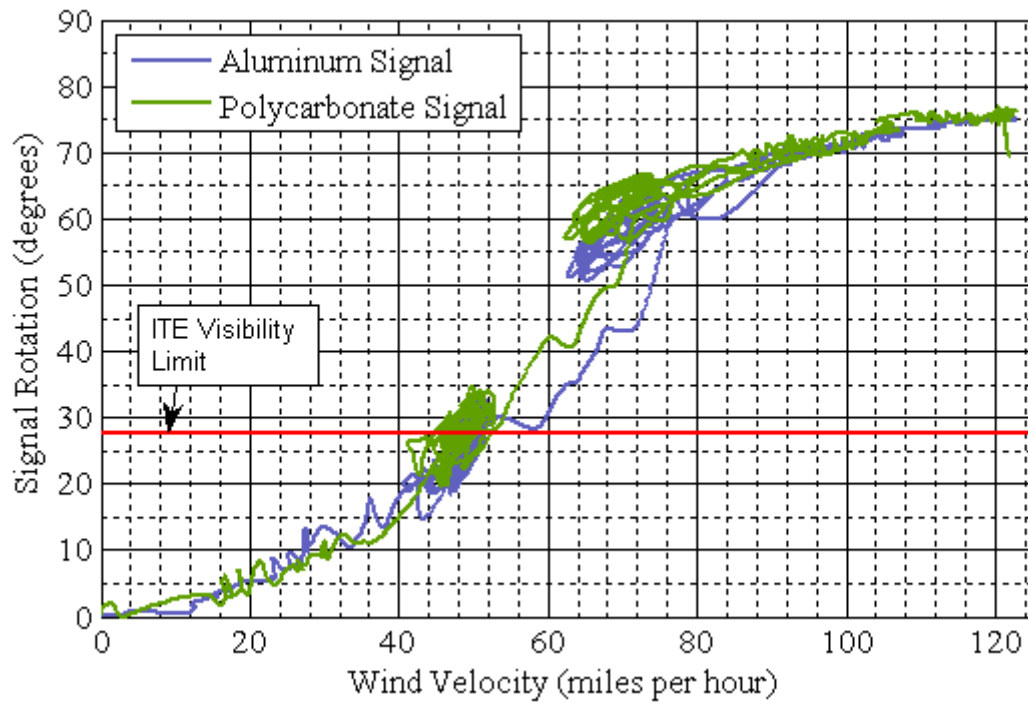

Figure 4-20. Rotation for pivotal hanger with aluminum versus polycarbonate signal at 90° signal and 12° simulator orientation (Tests 29 and 31)

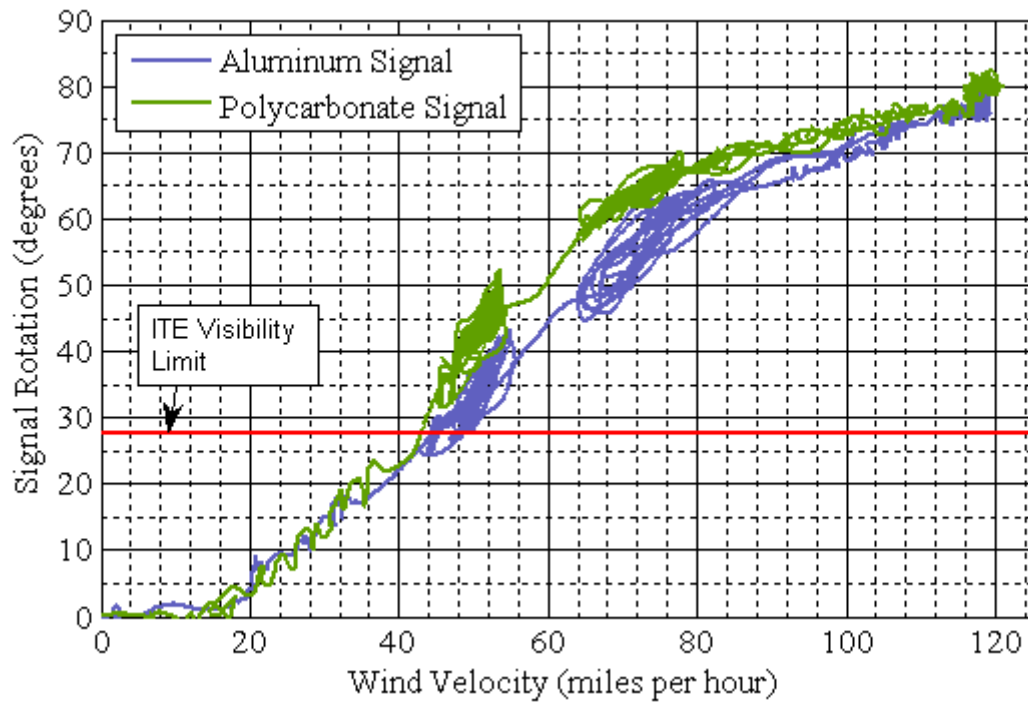

Figure 4-21. Rotation for cable hanger with aluminum versus polycarbonate signal at 90° signal and 45° simulator orientation (Tests 13 and 26)

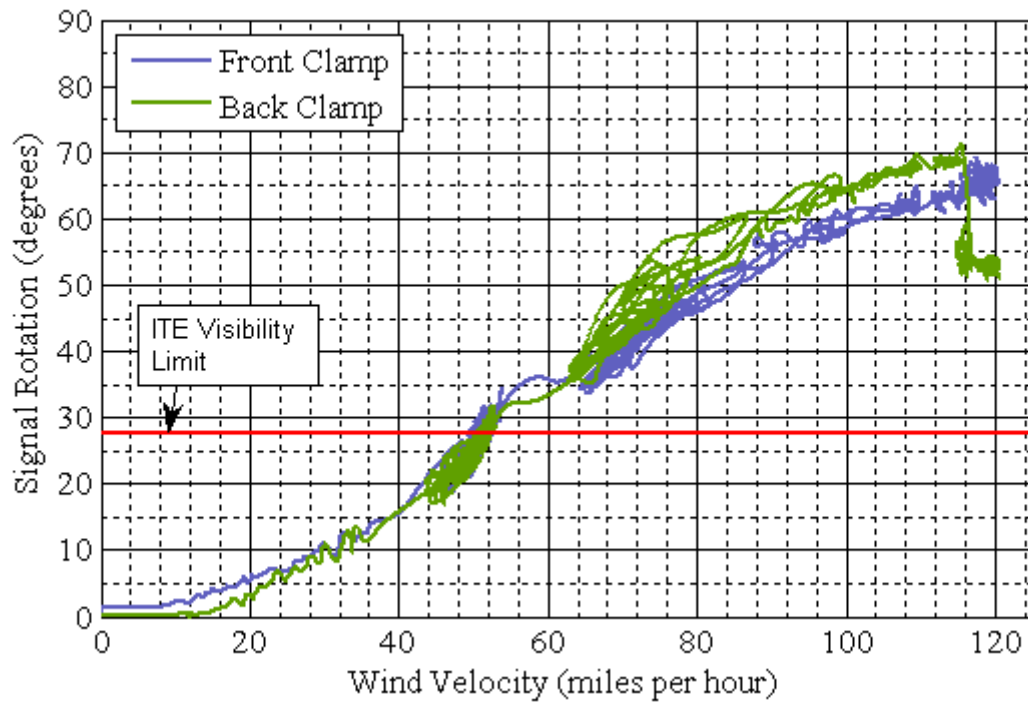

Figure 4-22. Rotation for pipe hanger with altered messenger clamp location (Tests 9 and 27)

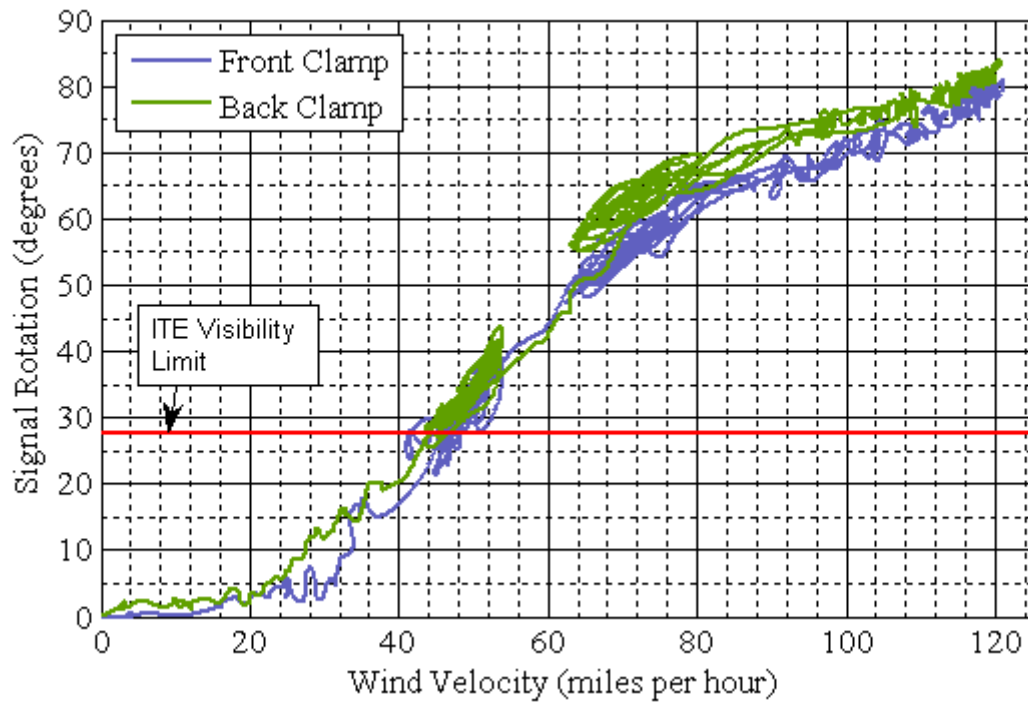

Figure 4-23. Rotation for pivotal hanger with altered messenger clamp location (Tests 11 and 24)

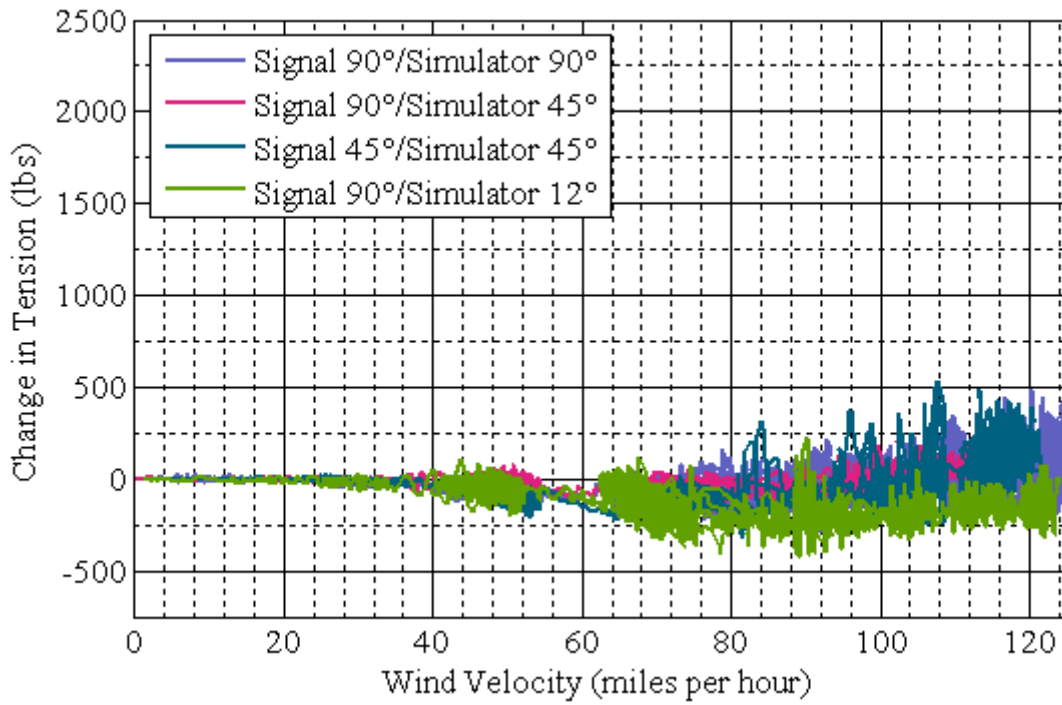

Figure 4-24. Change in tension for single cable at all orientations (Tests 7, 15, 16, and 33)

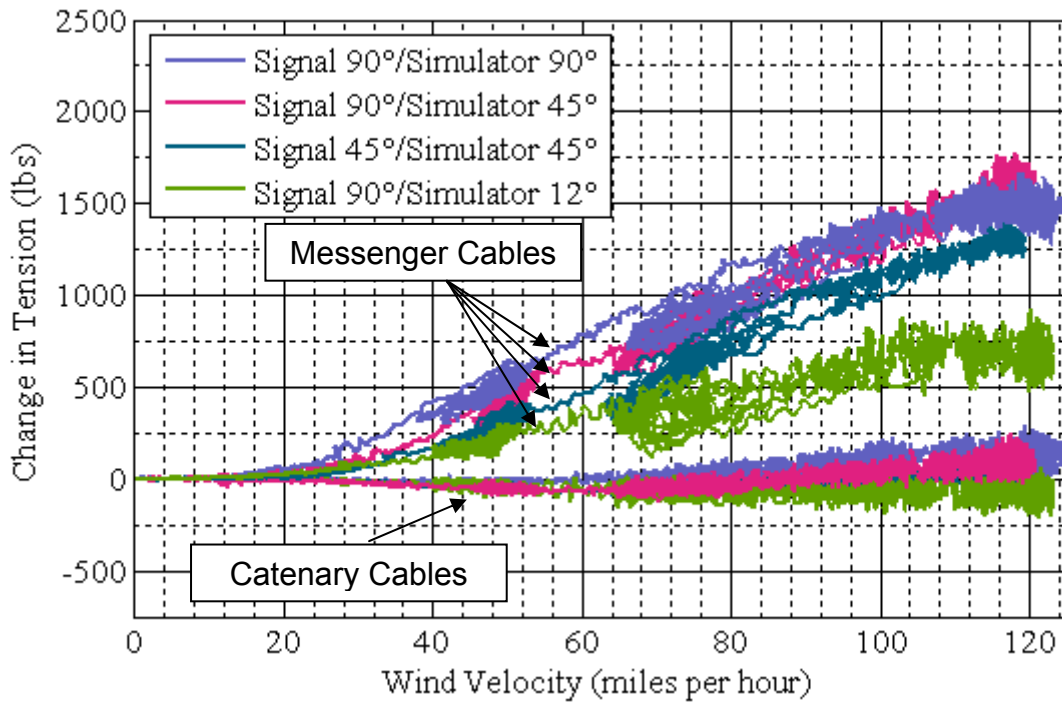

Figure 4-25. Change in tension for pipe hanger at all orientations (Tests 4, 9, 10, and 28)

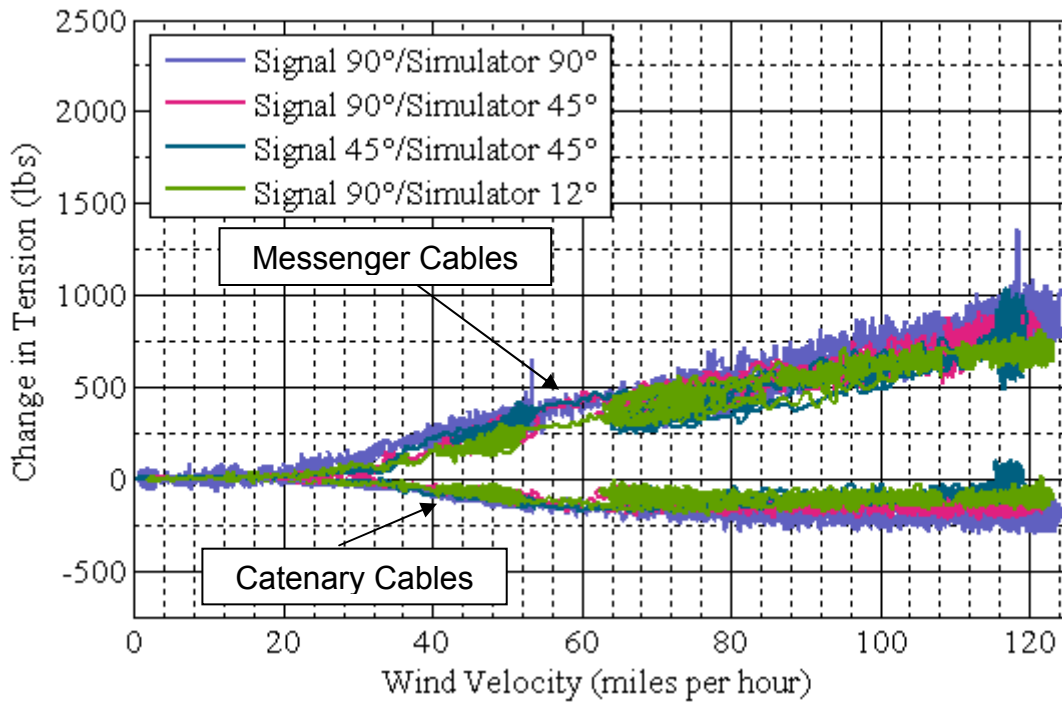

Figure 4-26. Change in tension for pivotal hanger at all orientations (Tests 5, 11, 12, and 29)

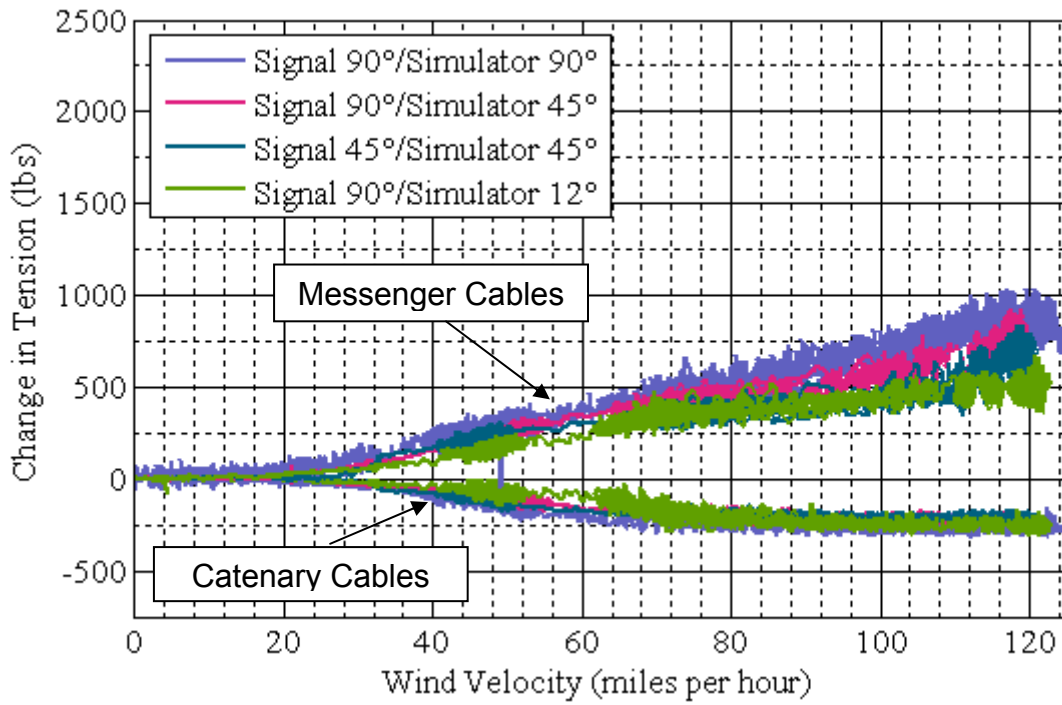

Figure 4-27. Change in tension for cable hanger at all orientations (Tests 6, 13, 14, and 30)

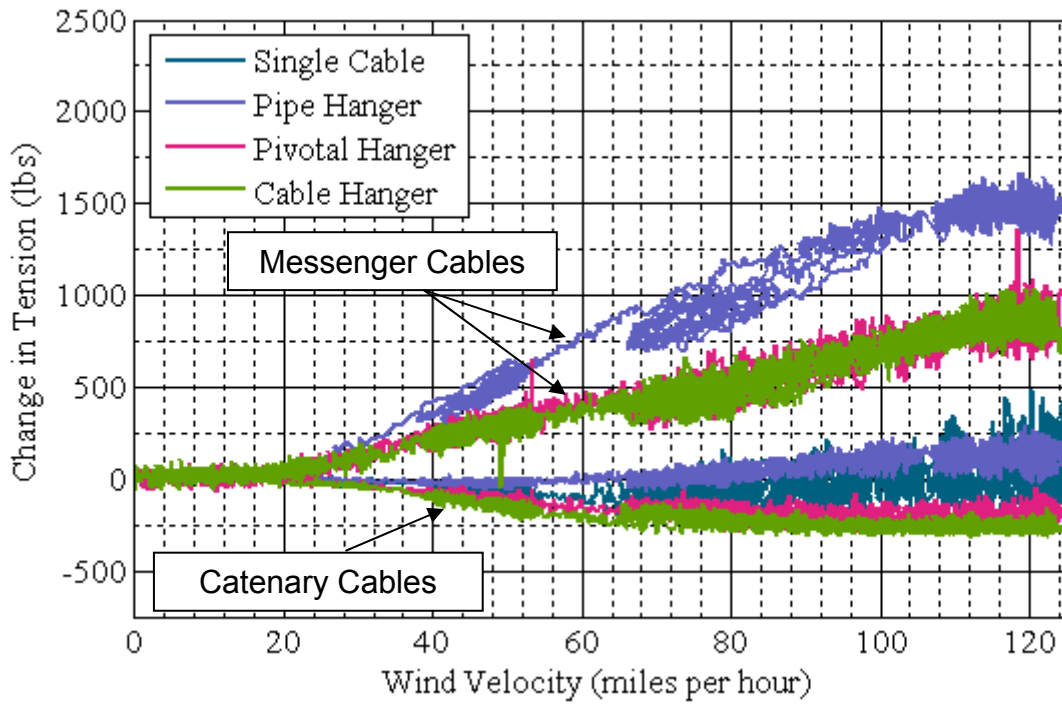

Figure 4-28. Change in tension for all systems at 90° signal and 90° simulator orientations

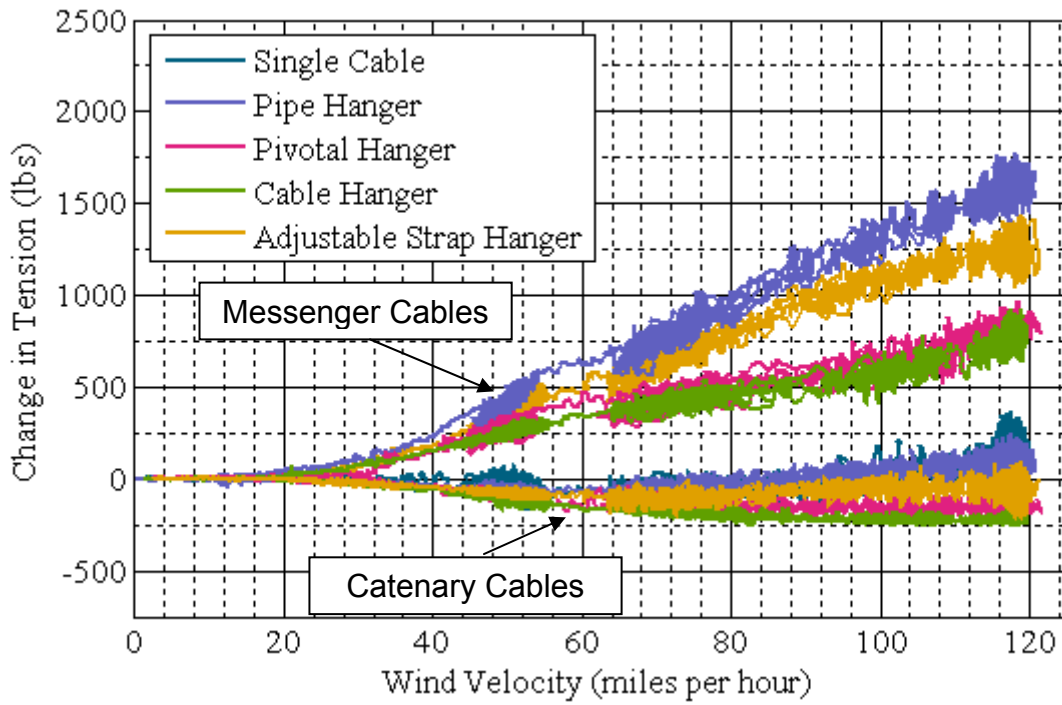

Figure 4-29. Change in tension for all systems at 90° signal and 45° simulator orientations

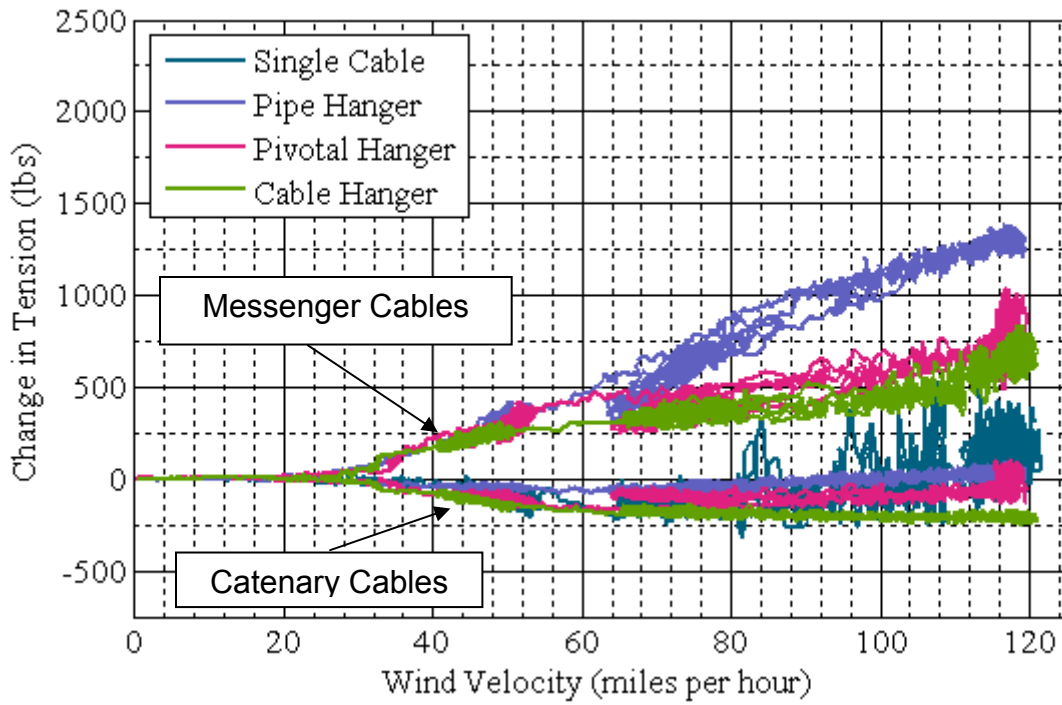

Figure 4-30. Change in tension for all systems at 45° signal and 45° simulator orientations

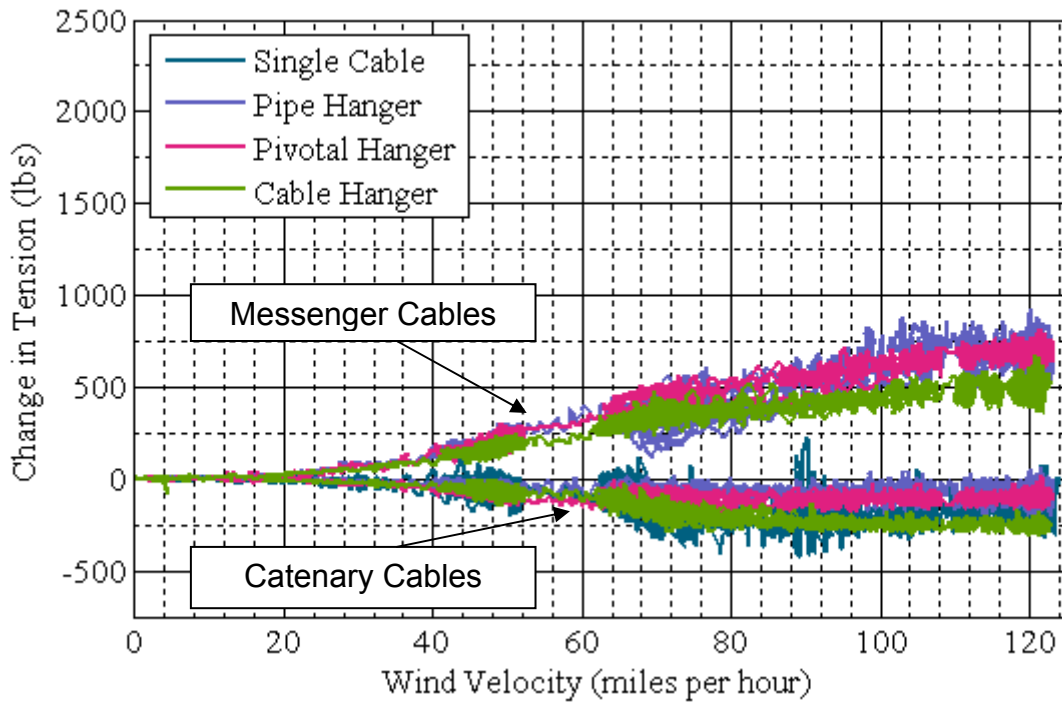

Figure 4-31. Change in tension for all systems at 90° signal and 12° simulator orientations

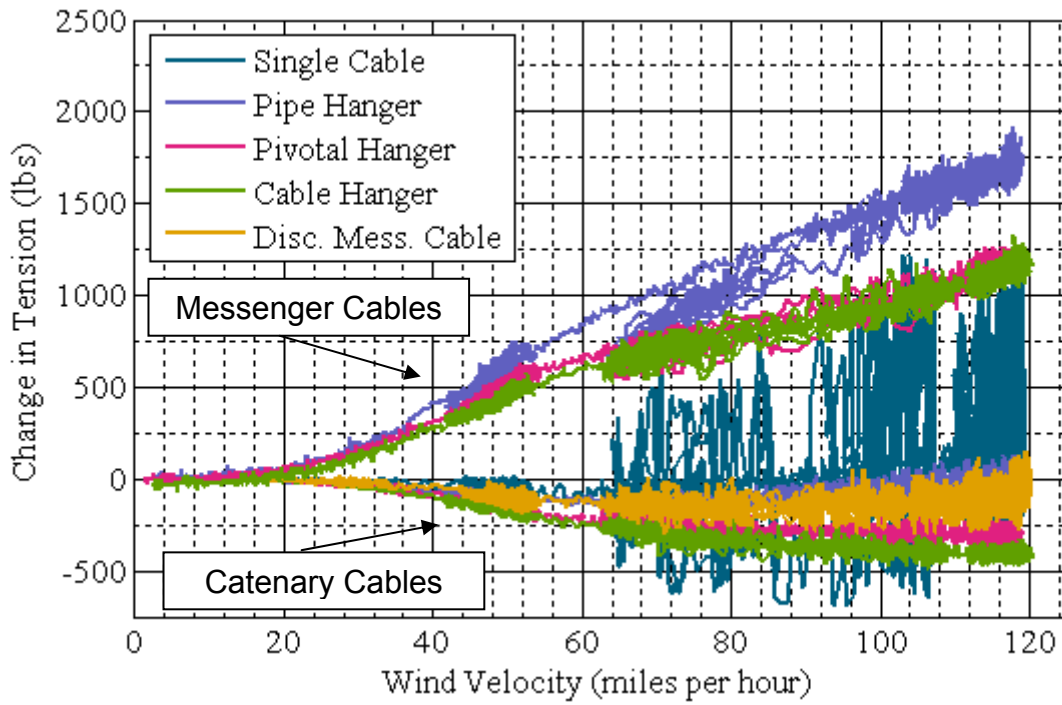

Figure 4-32. Change in tension for all systems with two signals

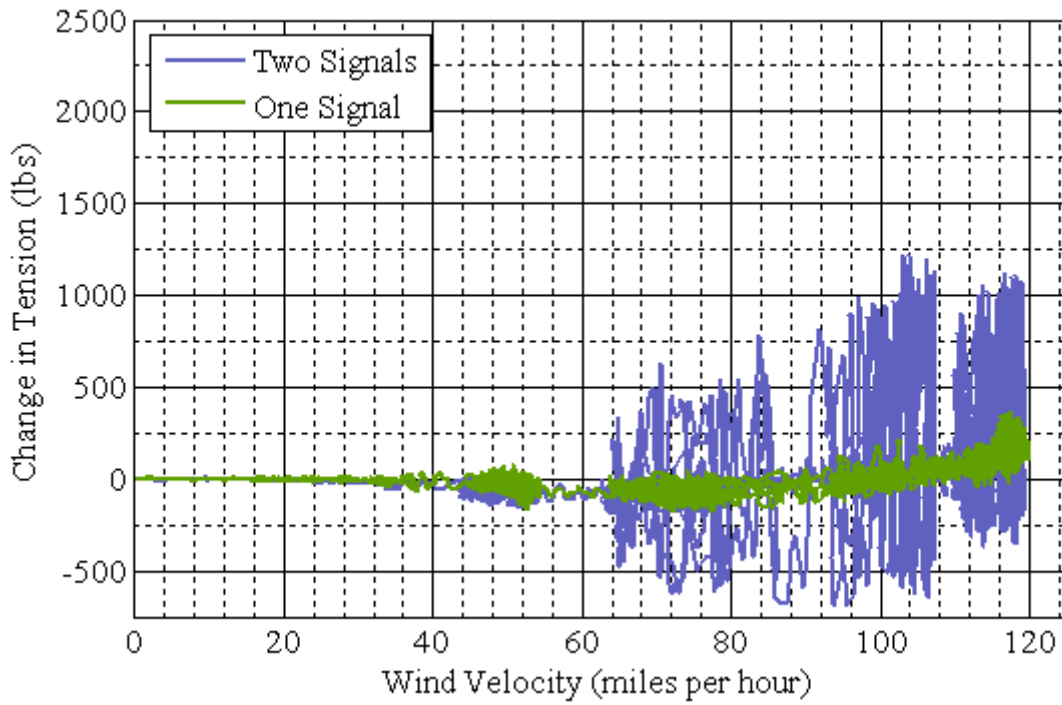

Figure 4-33. Change in tension for single cable system with two verses one signal (Tests 15 and 21)

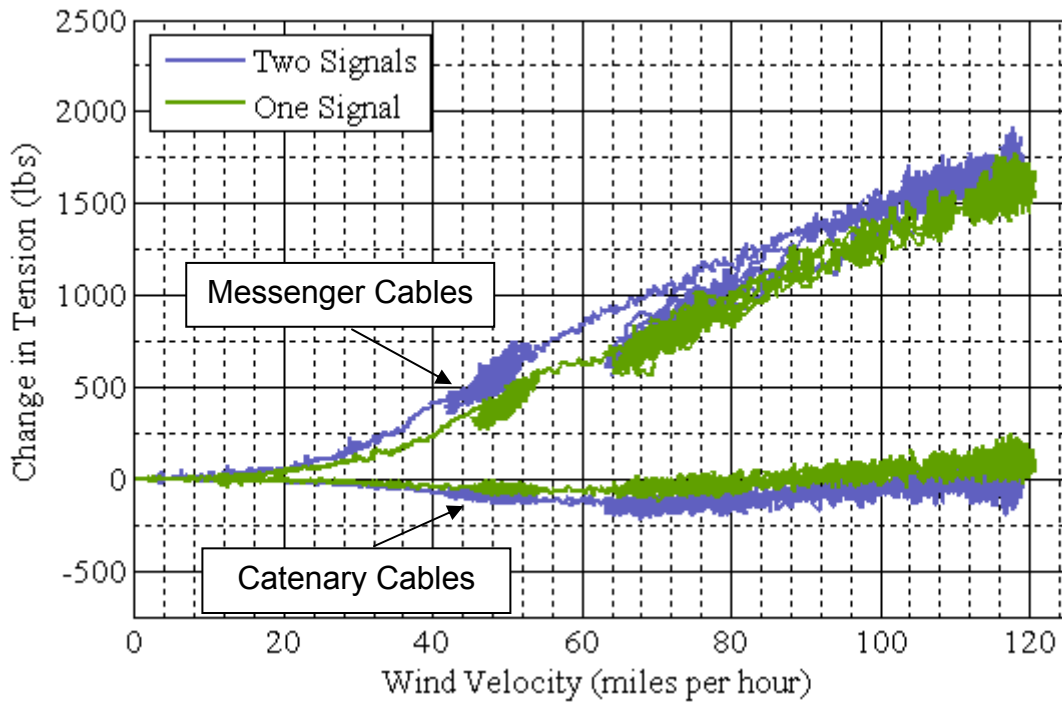

Figure 4-34. Change in tension for pipe hanger with two verses one signal (Tests 9 and 17)

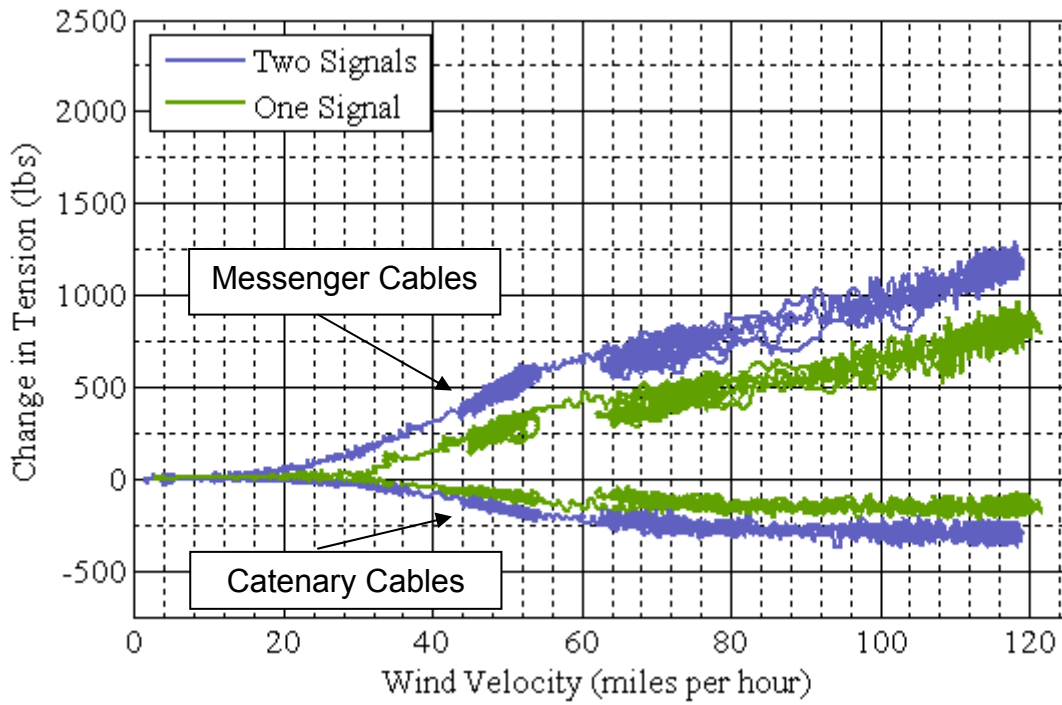

Figure 4-35. Change in tension for pivotal hanger with two versus one signal (Tests 11 and 18)

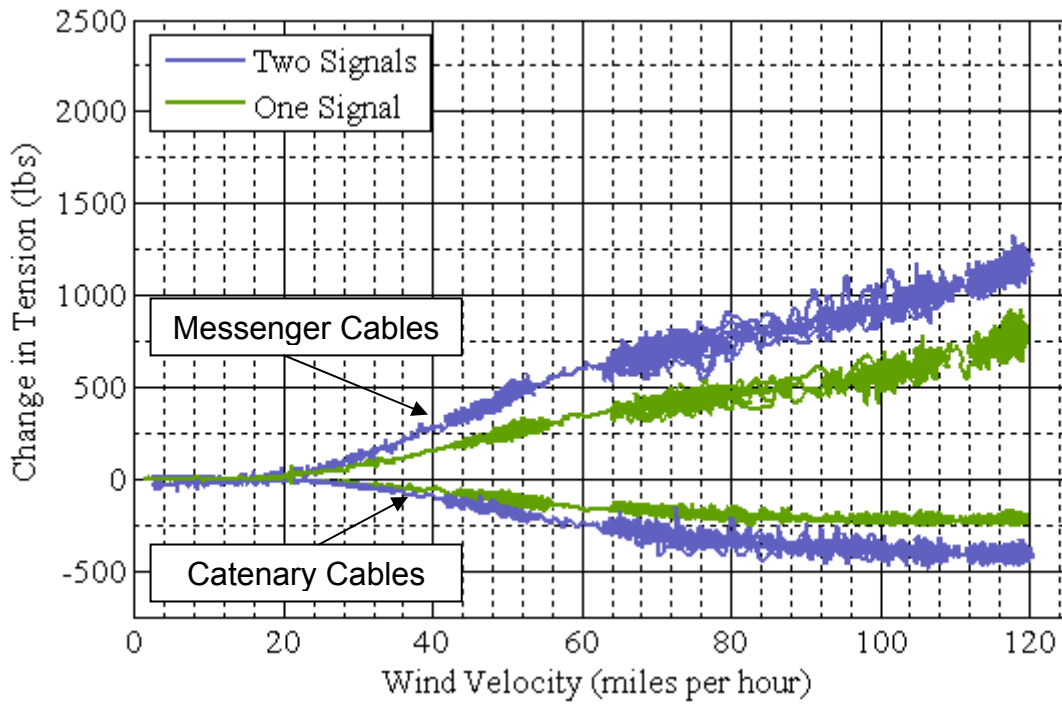

Figure 4-36. Change in tension for cable hanger with two signals verses one signal (Tests 13 and 19)

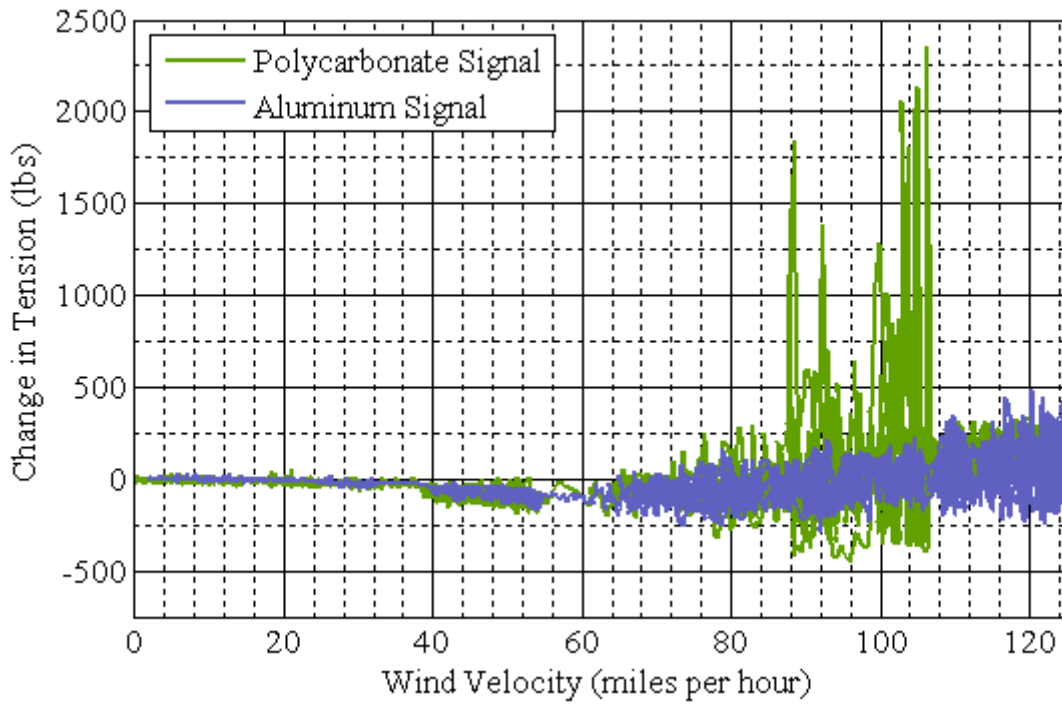

Figure 4-37. Change in tension for the single cable system with aluminum versus polycarbonate signal at 90° signal and 90° simulator orientations (Tests 7 and 8)

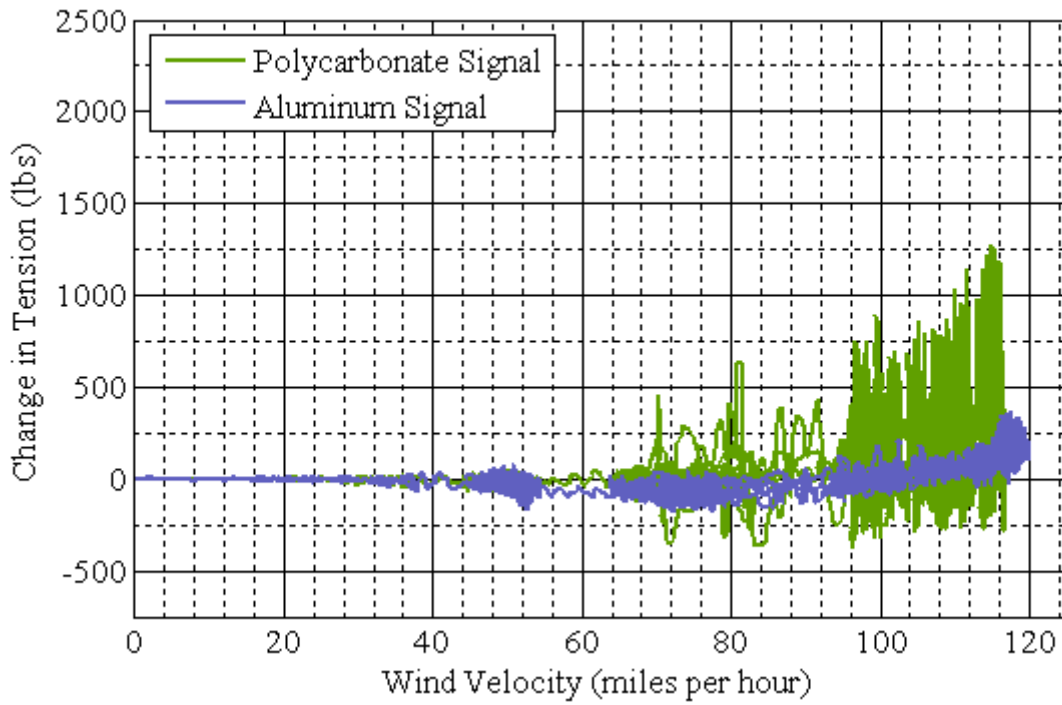

Figure 4-38. Change in tension for the single cable system with aluminum versus polycarbonate signal at 90° signal and 45° simulator orientations (Tests 15 and 22)

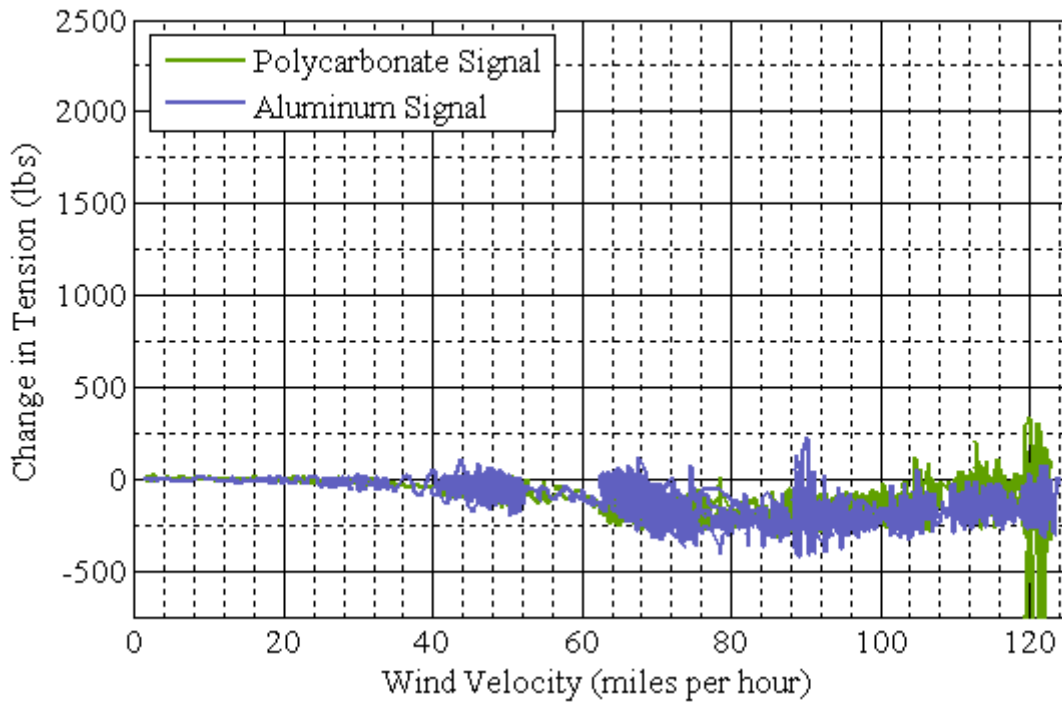

Figure 4-39. Change in tension for the single cable system with aluminum versus polycarbonate signal at 90° signal and 12° simulator orientations (Tests 33 and 32)

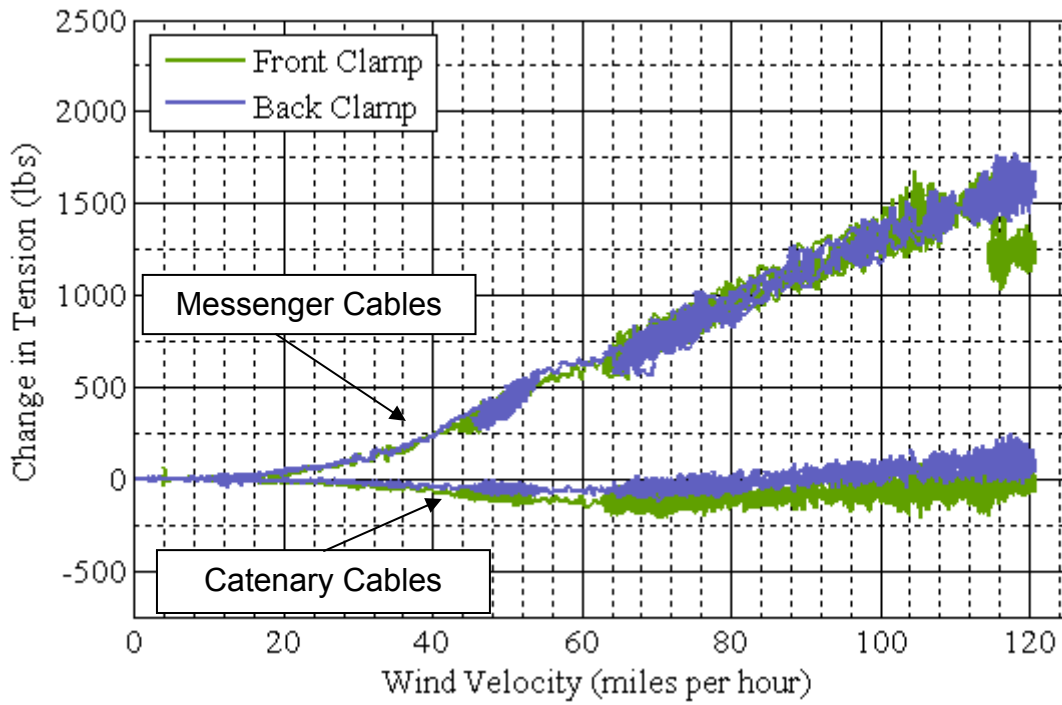

Figure 4-40. Change in tension for pipe hanger with altered messenger clamp location (Tests 9 and 27)

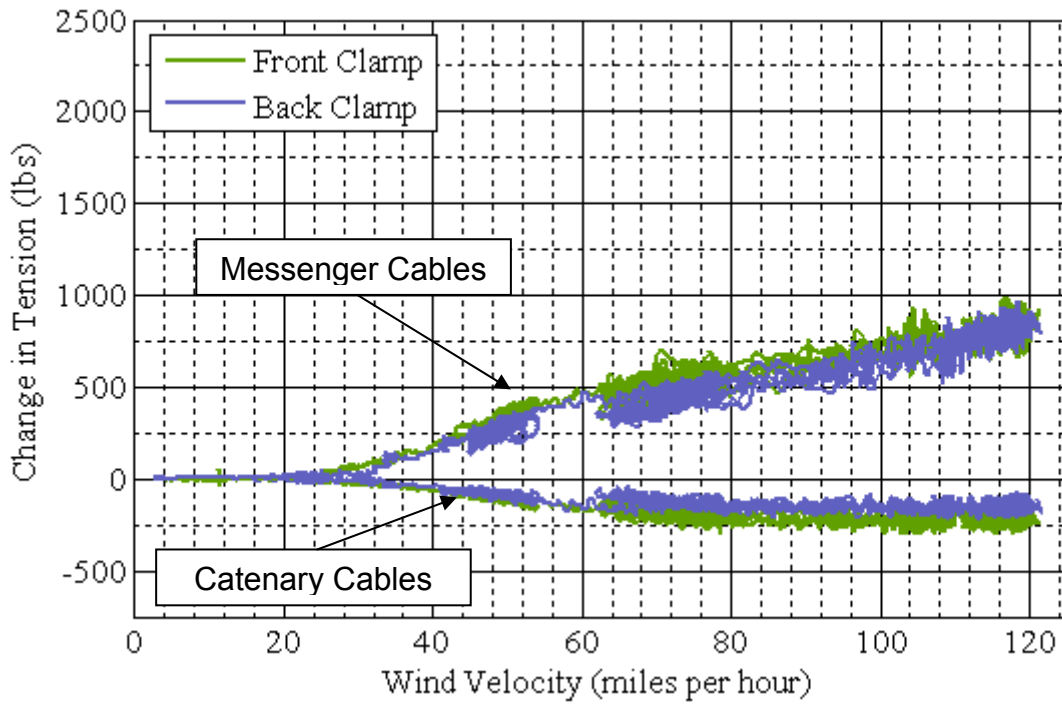

Figure 4-41. Change in tension for pivotal hanger with altered messenger clamp location (Tests 11 and 24)

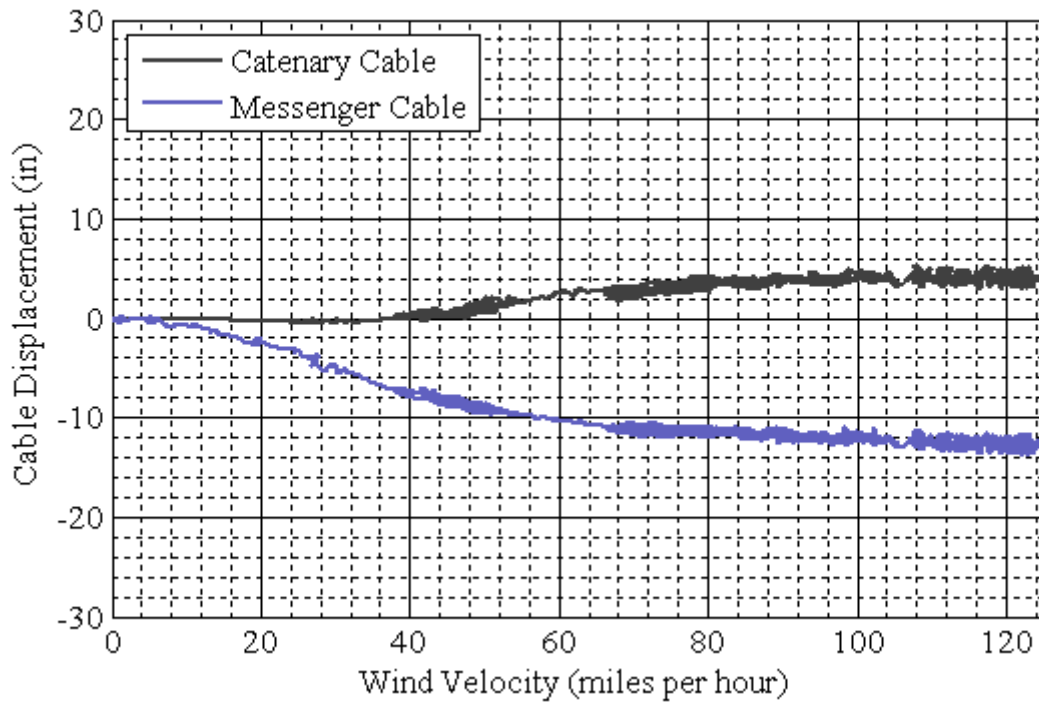

Figure 4-42. Cable displacement for pipe hanger at 90° signal and 90° simulator orientation

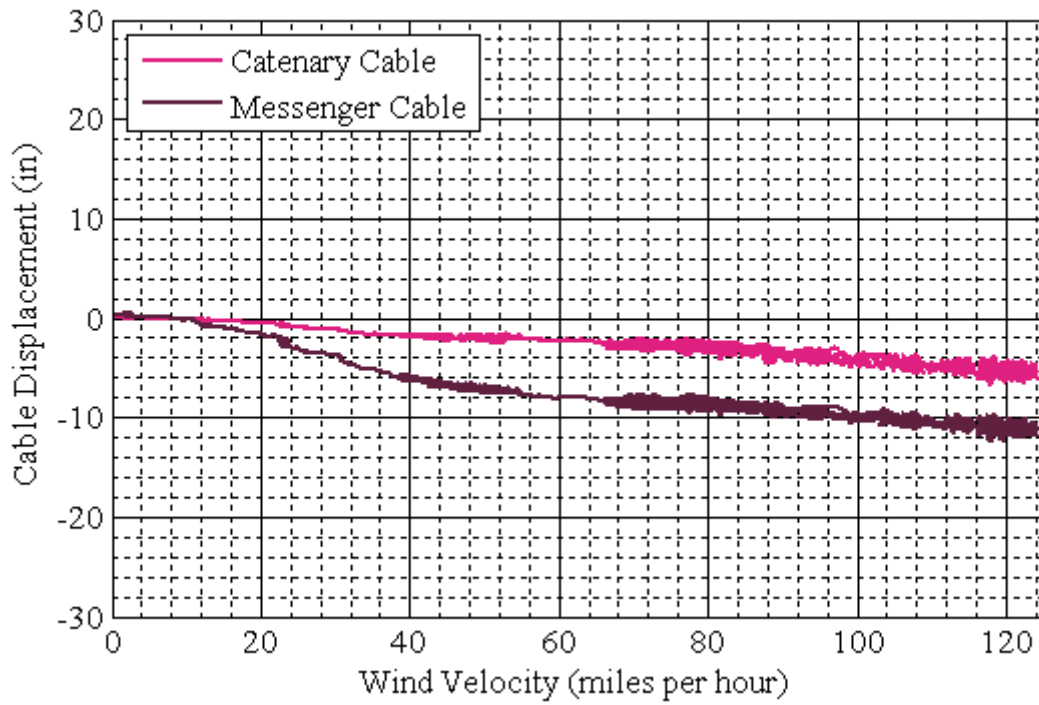

Figure 4-43. Cable displacement for pivotal hanger at 90° signal and 90° simulator orientation

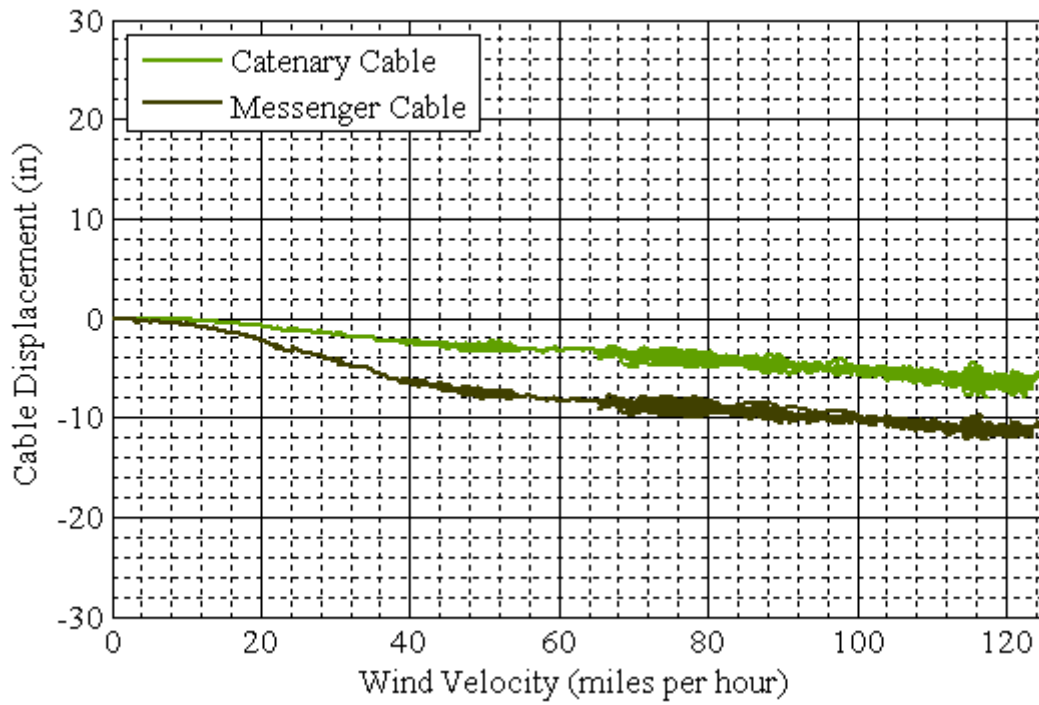

Figure 4-44. Cable displacement for cable hanger at 90° signal and 90° simulator orientation

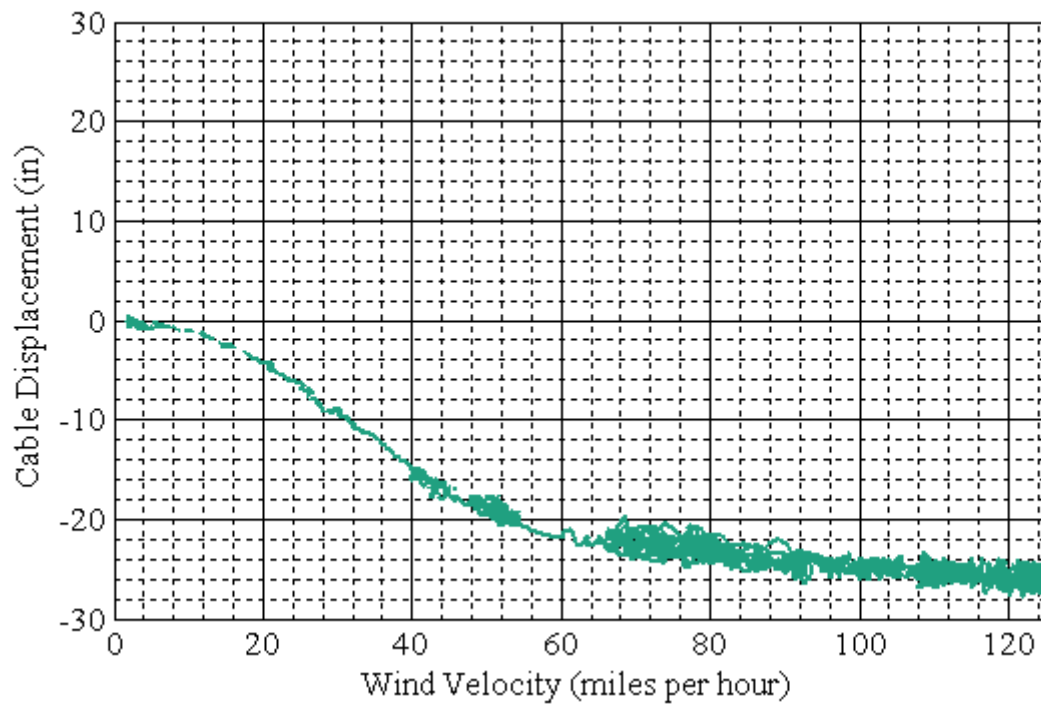

Figure 4-45. Cable displacement for single cable system at 90° signal and 90° simulator orientation

Table 4-1. Changes in cable tension for Test Series 2

Test no.	Hanger	Wind/ signal angles (°)	Cable	Initial tension (lbs)	Tension at 60 mph (lbs)	Tension change at 60 mph (lbs)	Tension at 115 mph (lbs)	Tension change at 115 mph (lbs)	Notes
4	Pipe	90/90	Cat.	429	416	-13	535	106	
			Mess.	835	1622	787	2324	1489	
5	Pivotal	90/90	Cat.	415	280	-135	115	-300	
			Mess.	1179	1565	386	2094	915	
6	Cable	90/90	Cat.	394	179	-215	130	-264	
			Mess.	1167	1535	368	2076	909	
7	Direct connect.	90/90	Cat.	572	461	-111	577	5	
8	Direct connect.	90/90	Cat.	468	356	-112	553	85	Poly. signal

Table 4-2. Changes in cable tension for Test Series 3

Test no.	Hanger	Wind/ signal angles (°)	Cable	Initial tension (lbs)	Tension at 60 mph (lbs)	Tension change at 60 mph (lbs)	Tension at 115 mph (lbs)	Tension change at 115 mph (lbs)	Notes
9	Pipe	45/90	Cat.	398	334	-64	476	78	
			Mess.	817	1436	619	2318	1501	
10	Pipe	45/45	Cat.	266	208	-58	314	48	
			Mess.	1174	1636	462	2515	1341	
11	Pivotal	45/90	Cat.	297	142	-155	151	-146	
			Mess.	875	1317	442	1645	770	
12	Pivotal	45/45	Cat.	299	135	-164	221	-78	
			Mess.	891	1312	421	1588	697	
13	Cable	45/45	Cat.	279	114	-165	46	-233	
			Mess.	889	1230	341	1599	710	
14	Cable	45/45	Cat.	277	99	-178	58	-219	
			Mess.	858	1163	305	1451	593	
15	Direct connect.	45/90	Cat.	540	475	-65	695	155	
16	Direct connect.	45/45	Cat.	547	395	-152	765	218	

Table 4-3. Changes in cable tension for Test Series 4

Test no.	Hanger	Wind/signal angles (°)	Cable	Initial tension (lbs)	Tension at 60 mph (lbs)	Tension change at 60 mph (lbs)	Tension at 115 mph (lbs)	Tension change at 115 mph (lbs)	Notes
17	Pipe	45/90	Cat.	584	468	-116	584	0	2 signals;
			Mess.	1102	1949	847	2780	1678	
18	Pivotal	45/90	Cat.	567	352	-215	286	-281	2 signals;
			Mess.	866	1514	648	2043	1177	
19	Cable	45/90	Cat.	557	299	-258	141	-416	2 signals;
			Mess.	767	1409	642	1875	1108	
20	Adj. strap	45/90	Cat.	571	457	-114	459	-112	2 signals; disc. mess.
21	Direct connect.	45/90	Cat.	863	775	-88	897	34	2 signals;

Table 4-4. Changes in cable tension for Test Series 5

Test no.	Hanger	Wind/signal angles (°)	Cable	Initial tension (lbs)	Tension at 60 mph (lbs)	Tension change at 60 mph (lbs)	Tension at 115 mph (lbs)	Tension change at 115 mph (lbs)	Notes
22	Direct connect.	45/90	Cat.	433	406	-27	654	221	Poly. signal
23	Adj. strap	45/90	Cat.	409	321	-88	376	-33	Mess. clamped to front
			Mess.	1083	1568	485	2296	1213	
24	Pivotal	45/90	Cat.	419	260	-159	204	-215	Mess. clamped to front
			Mess.	871	1339	468	1652	781	
25	Pivotal	45/90	Cat.	350	214	-136	190	-160	Poly. signal
			Mess.	896	1222	326	1571	675	
26	Cable	45/90	Cat.	328	211	-117	130	-198	Poly. signal
			Mess.	881	1151	270	1455	574	
27	Pipe	45/90	Cat.	418	312	-106	457	39	Mess. clamped to front
			Mess.	841	1410	569	2277	1436	

Table 4-5. Changes in cable tension for Test Series 6

Test no.	Hanger	Wind/ signal angles (°)	Cable	Initial tension (lbs)	Tension at 60 mph (lbs)	Tension change at 60 mph (lbs)	Tension at 115 mph (lbs)	Tension change at 115 mph (lbs)	Notes
28	Pipe	12/90	Cat.	324	274	-50	220	-104	
			Mess.	1148	1504	356	1789	641	
29	Pivotal	12/90	Cat.	329	193	-136	222	-107	
			Mess.	1000	1315	315	1674	674	
30	Cable	12/90	Cat.	327	214	-113	77	-250	
			Mess.	955	1187	232	1461	506	
31	Pivotal	12/90	Cat.	251	159	-92	186	-65	Poly. signal
			Mess.	1015	1291	276	1618	603	
32	Direct connect.	12/90	Cat.	441	364	-77	421	-20	Poly. signal
33	Direct connect.	12/90	Cat.	563	471	-92	431	-132	

CHAPTER 5 FORCE COEFFICIENTS FOR WIND FORCES

The data collected during this project was used to calculate force coefficients for the calculation of wind forces on traffic signals. Drag and lift coefficients for single cable systems were calculated by Cook and Johnson. These were appropriate for the single cable system since both the cable and signal rotated in the wind. For the dual cable system, the messenger cable provided a horizontal restraint that prevented sway of the system. As a result, for the dual cable system, a lateral force coefficient for evaluating the reaction of the messenger cable was appropriate. The following information was determined using the 90° signal and 90° simulator orientation.

The resultant force on the messenger cable caused by the wind force was assumed to be a lateral force for the dual cable system, unlike for the single cable system where the resultant force is dependent on the rotation of the plane of the cable (Figure 5-1). In order to calculate the resultant force on the messenger cable, a modification of Equation 2-4 was used (Eq. 5-1).

$$T_M^r = 2 \times T_M \times \frac{D_M}{\sqrt{D_M^2 + \left(\frac{\text{span}}{2}\right)^2}} \quad (5-1)$$

The deflection of the messenger cable (D_M) and the change in messenger cable tension (T_M) were used in place of the sag and actual tension from Eq. 2-4, which was for the single cable system. Another factor left off of Eq. 2-4 was the weight of the cable because only the change in tension was considered.

The force coefficient was determined with equations similar to those for the drag and lift coefficients found by Cook and Johnson. The force coefficient is a ratio of the resultant force on the signal to the wind force on the area of the signal (Eq. 5-2).

$$C_f = \frac{T_M}{0.00256 \times V^2 \times A} \quad (5-2)$$

The catenary cable forces were ignored when considering the dual cable systems because for all cases, the change in tension in the catenary cables was not significant. It was assumed that the catenary cable did not affect the resultant force on the traffic signal. The force coefficient may be applied to Equation 5-3, where P_w is the wind force in pounds, V is the wind velocity in miles per hour, and A is the area of the object undergoing wind loading in square feet (Figure 5-2).

$$P_w = 0.00256 \times V^2 \times A \times C_f \quad (5-3)$$

Figure 5-3 and Figure 5-4 show the force coefficients with respect to signal rotation and to wind velocity, respectively. The maximum force coefficient for the pipe hanger was 0.45, while for the pivotal and cable hangers it was 0.20. The area was not varied with rotation for these calculations. For design purposes, the maximum force coefficients are recommended for use. The pipe hanger, which restricted rotation of the signal, had a much higher force coefficient than the pivotal and cable hangers, which allowed rotation of the signal to occur. This reinforces what was seen from the signal rotations and changes in tension experienced by these systems.

These force coefficients are lower than the current recommended drag coefficients from the American Association of State Highway Transportation Officials (AASHTO) and the Florida Department of Transportation (FDOT). As found by Alampalli in 1997, the recommended values create conservative loads for strain poles.

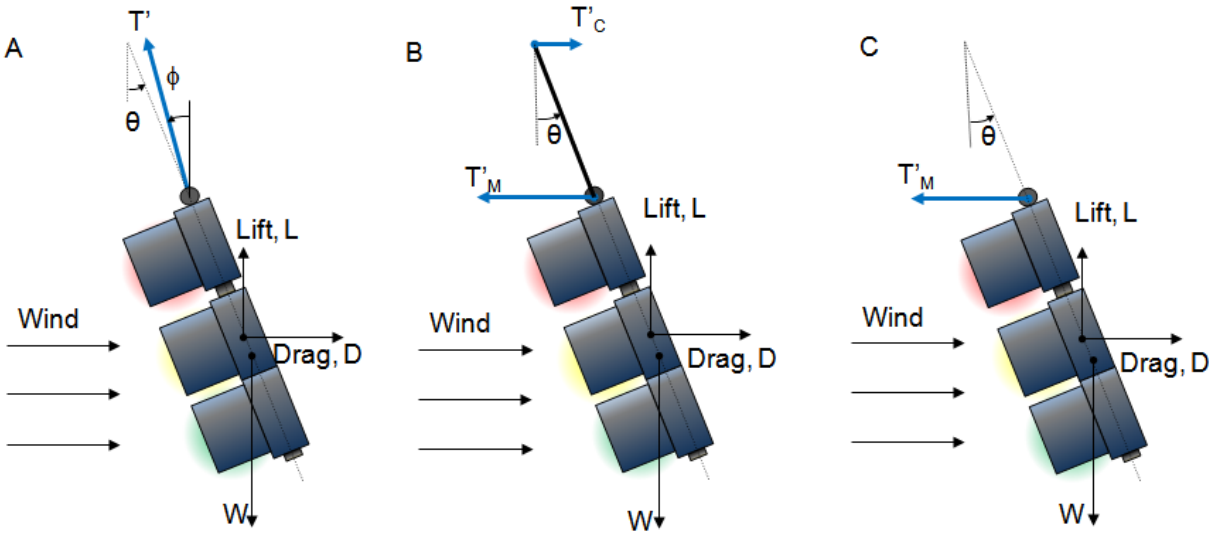

Figure 5-1. Free body diagrams for traffic signals with A) single cable system, B) pipe hanger, and C) pivotal and cable hangers

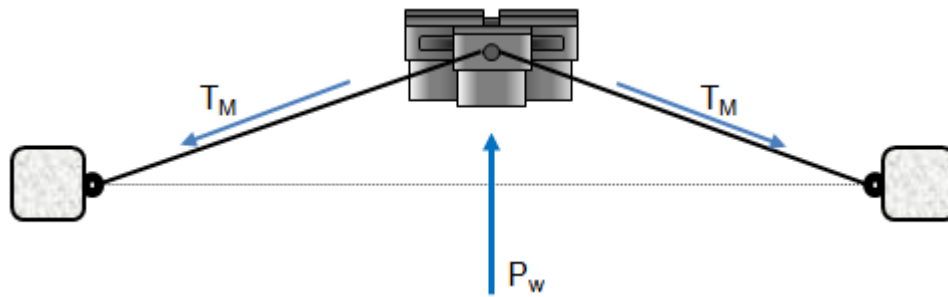

Figure 5-2. Top view of wind force applied to signal with reactions in messenger cable

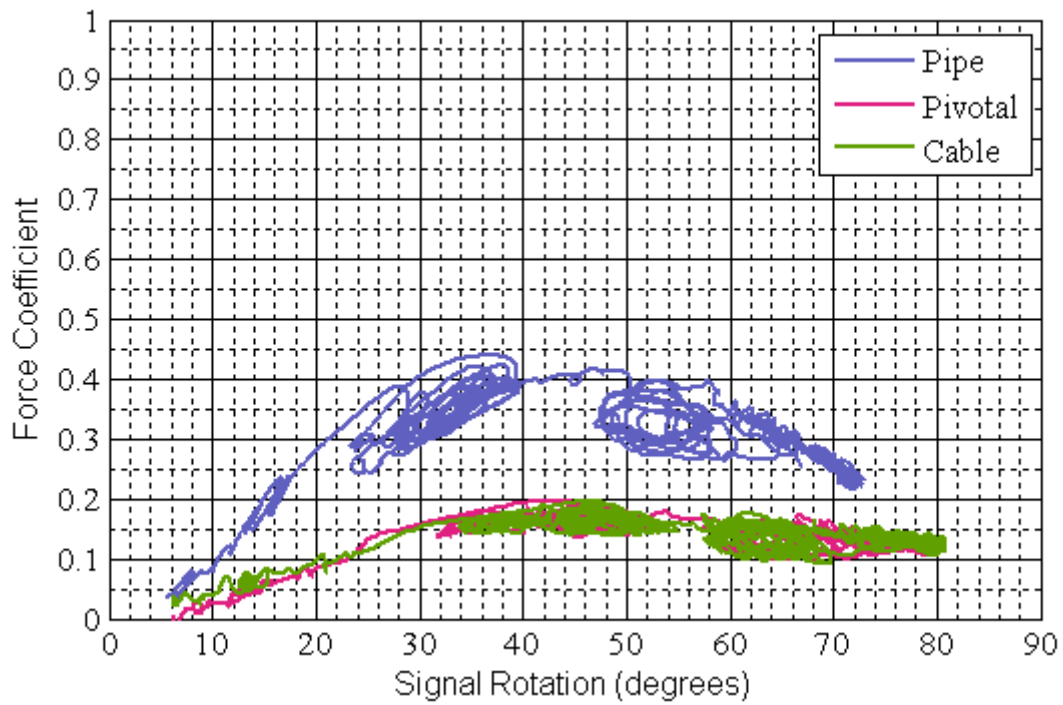

Figure 5-3. Force coefficient vs. signal rotation for dual cable systems

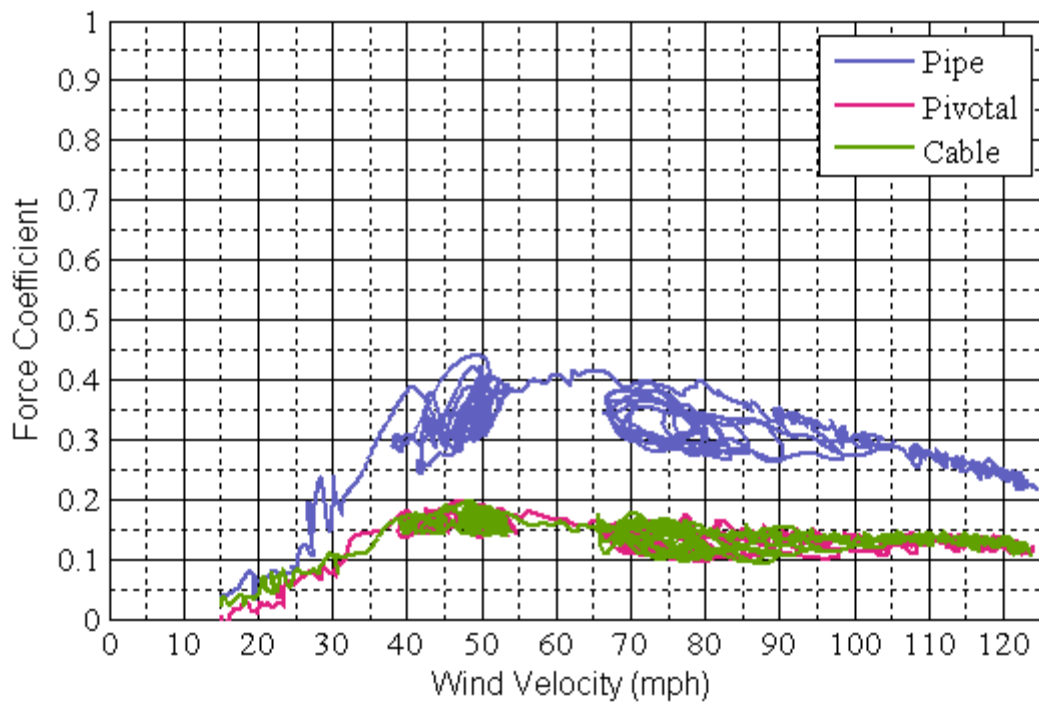

Figure 5-4. Force coefficient vs. wind velocity for dual cable systems

CHAPTER 6 PERFORMANCE OF EQUIPMENT AND HARDWARE

While testing the various support systems, most of the equipment was reused in several tests. A few problems that were encountered included rapid wearing of bolts, fatigue in signal visors and backplates at connections, and other failures that were not part of the research focus. Appendix D contains a catalog of equipment that includes photographs and lists of tests each piece of equipment was used for.

The first failure was encountered during Test Series 1. Schedule 40 aluminum was initially used for the pipe hangers, but the material failed before reaching the target wind speed of 120 mph. The failure occurred at the point where the pipe was threaded for an adapter to fit the disconnect box. The test was repeated with the same material in order to verify that the pipe was properly threaded and installed. When the pipe failed a second time, it was decided to make some changes to the testing schedule in order to maximize the usable data collected without failing the equipment. Schedule 80 aluminum was used for the remaining tests with pipe hanger.

Test 8 was the first to use a polycarbonate signal. During this test, it was discovered that the polycarbonate signal developed very erratic behavior at high wind speeds. The signal was tossed very violently by the wind during this test. The backplate was torn off at approximately 107 mph. The top head of the polycarbonate signal also became loose and twisted slightly in the bracket joining it to the other heads (Figure 6-1). During Test 22, the backplate was again torn away by the wind. A 72-teeth serrated boss was used to join the top head and the two-way bracket. The serrated boss typically prevents twisting at the connection. During Test 22, the teeth were completely worn

down by the parts twisting from the wind force (Figure 6-2). The connection for the backplate also broke away from the signal (Figure 6-3).

During Test 8, the two-way bracket for the polycarbonate signal was attached with 1/4-inch bolts and 7/16-inch nuts. Upon examination it was noticed that the smaller tri-stud nuts had loosened which allowed the top section to become detached from the two-way bracket serrated teeth, allowing twisting. During Test 22, the 1/4-inch bolts and 7/16-inch nuts were replaced with 5/16-inch bolts and 1/2-inch nylon insert lock nuts. The same type of failure occurred for this test, but the nuts appeared to have not loosened. However, the tri-stud washer had yielded and became concave which loosened the connection and allowed the signal head to rotate and damage both the serrated edge of the signal and two-way bracket.

The FDOT determined that the tri-stud bolts should have a 5/16-inch minimum diameter and that the thickness or strength of the tri-stud washer needs to be increased. An additional modification would be to increase the depth of the serrated teeth on the signal and two-way bracket. It is also recommended that the mounting hardware manufacturers provide all connection hardware with their brackets.

While the backplate failure in Test 8 was due to the behavior of the equipment being used, the backplate failure in Test 27 was likely due to overuse of the same backplate. As seen in Figure 6-4, the backplate material yielded during Test 27 after several uses. The failure in Test 8 was similar to this.

Several bolts had to be cut away while changing equipment. After a couple of uses, the messenger cable clamp on a pipe hanger could not be reused because wear in the threads caused the nuts to become stuck to the U-bolt. A similar issue occurred

with the bolt at the base of the pivotal hangers. Many washers, including tri-stud washers, had to be replaced as well due to over-tightening during assembly and installation.

The visors were replaced several times during testing. The small hooks for attaching the visors would typically fail on either side at the bottom of the signal head. There was a visor on all five heads of the 5-section signals and all three heads of the 3-section signals. The visor failures occurred once or twice for every series of tests, but the failures were minor and most likely had no effect on test data because only one or two of the four hooks would break and the visor would stay attached.

The adjustable strap hanger that was used in Test 23 experienced yielding. This was expected because in previous research, strap hangers consistently yielded at high wind speeds. This behavior was not seen while using the discontinuous messenger cable system.

The original stabilizer clamp used during testing cracked in the center of the clamp after multiple tests. This was a sand cast aluminum part that was approximately two inches wide and six inches long (Figure 6-5). After breaking the casted piece, an extruded aluminum part was used as a replacement. The extruded aluminum appeared to be more durable. This extruded stabilizer clamp did not experience any crack or breakages during the remaining tests. The FDOT has requested that manufacturers improve the part by using of extruded aluminum instead of sand cast aluminum for this product, shortening the length of the clamp, or completely redesigning the clamp to remove the long flat area that encouraged the break due to leverage. In the past six

inch lengths were implemented due to reports that the smaller two inch stabilizer clamps were kinking the messenger cable during back and forth movement.

Two span wire clamps were used during testing, each from a different manufacturer. The span wire clamps were of similar construction; however, the set from one manufacturer had a small piece which consistently broke during testing (Figure 6-1). The broken piece was noticeably thinner than the equivalent piece from the other manufacturer. Either the thickness or the material should be changed on this part in order to increase strength.



Figure 6-1. Failure of the joint between the top signal head and two-way bracket (Test 22) (Photo courtesy of author)



Figure 6-2. Worn serrated teeth on two-way bracket which connects to top signal head (Test 22) (Photo courtesy of author)



Figure 6-3. Failure at connection for the backplate on polycarbonate signal (Test 22)
(Photo courtesy of author)

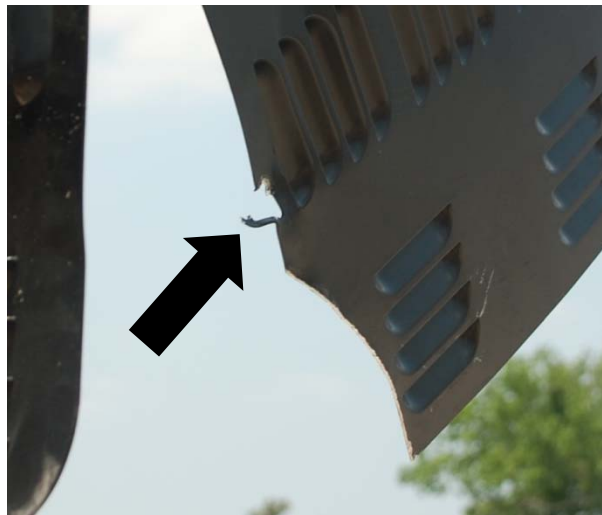

Figure 6-4. Failed backplate material at connection point (Test 27) (Photo courtesy of author)



Figure 6-5. Failed sand cast aluminum stabilizer clamp: A) parts shown lain separated; B) parts shown together (Photos courtesy of author)



Figure 6-6. Span wire clamp with broken piece (Photo courtesy of author)

CHAPTER 7 CONCLUSIONS, SUMMARY, AND RECOMMENDATIONS

7.1 Summary

A total of 33 tests were performed to compare the performance of dual cable systems with pipe hangers, pivotal hangers, and cable hangers and the single cable system with a direct connection. The orientation was varied for the traffic signal and the Hurricane Simulator. The material type and number of the signals was also varied. Data on wind speed, signal rotations, catenary and messenger cable tensions, and cable displacements was collected. The rotations and cable tensions were compared to evaluate the behavior of each system.

7.2 Conclusions

Test results showed that the dual cable system with pivotal or cable hangers experienced similar rotations to the single cable system. However, the single cable system allowed the signal to continuously swing when exposed to high wind loads. The pipe hanger underwent much lower rotations. When an additional signal was added to the span, there was no significant change to the rotations in the dual cable systems. The second signal on the single cable system caused the signals to swing more than with one signal. Using polycarbonate signals caused a slight increase in rotations when wind speeds were between 40 mph and 100 mph. The use of a polycarbonate signal on the single cable system caused very erratic swinging and failure in some cases. The discontinuous messenger system experienced less rotation at high wind speeds than the single cable system and the dual cable system with pivotal and cable hangers. The discontinuous messenger did not sway even though the messenger cable was not whole.

For all dual cable support systems, the catenary cables generally had decreasing tension with increased wind loads, while the messenger cables experienced significant increases in tension with increased wind loads. Messenger cable tension was lower in most cases with the use of pivotal or cable hangers instead of the pipe hanger. The single cable system experienced very little change in the average cable tension, but there were fluctuations in the cable tension while the signal was swinging at higher wind loads. With the addition of a second signal there was very little effect to the cable tensions of the dual cable system, but the single cable system experienced high peaks in tension from the signals swinging.

The polycarbonate signal had minimal effects on the tension of dual cable systems; however, the single cable system experienced high peaks in tension from the erratic swinging during higher wind speeds. The peak tension for the single cable system with a polycarbonate signal exceeded the peak tension of the single cable system with two aluminum signals.

For all cases, the catenary tension of the discontinuous messenger cable system was slightly lower than the single cable system and the dual cable system with the pipe hanger, and higher than the dual cable system with the pivotal and cable hangers.

Cable translation measurements indicated that the pipe hanger forced the catenary cable forward when the signal rotated backwards. The catenary cable for the pivotal and cable hangers blew backwards after the signal weight and wind forces were transferred to the messenger cables. The displacement of the messenger cables significantly exceeded the displacement of the catenary cables due to strains imposed on the messenger cables from the wind load. The single cable system experienced

cable displacements that were much higher than for either cable in the dual cable system due to the single cable system simply moving in the wind as a pendulum. The messenger cable force increase with wind loading on the dual cable system must be considered for strain pole design.

Based on the data collected, a maximum force coefficient of 0.45 was observed for dual cable systems that restrict signal rotation, and a maximum force coefficient of 0.2 was observed for dual cable systems that allow rotation of the signal. These are the maximum values that were calculated and provide a conservative value for calculating design wind forces for single signal systems. The force coefficient should be used to determine a lateral wind force acting on the messenger cable. Future research should focus on localized stresses since this project as well as previous projects show strain pole designs are conservative and failures occur within the components of the traffic signal and support system.

7.3 Recommendations

Based on comments and suggestions following testing, several recommendations can be made for future research. Many limitations met during testing could be addressed with the use of wind tunnel testing. The use of a wind tunnel would eliminate many restrictions and allow for longer spans and more signals on a span. The tests for this project were unable to cause the dynamic behavior experienced in hurricanes. The damage to traffic signals observed after hurricanes suggests that many signals flip over the span wires. There was no evidence of this behavior during the full scale tests performed for this project.

In future related projects, a few additional variables and combinations should be included to better understand the behavior of the various cable support systems. The

discontinuous messenger cable system was a minor consideration during this project. The results show that it may provide an effective remedy to the high messenger cable and strain pole stresses experienced in dual cable systems. The discontinuous messenger cable system required testing with multiple signals; however the use of multiple signals provides more realistic results. This system should be tested at more orientations and with different types of hangers to better understand if it would provide the necessary hurricane resistance to prevent the extensive damage experienced by existing dual cable systems.

The results from using polycarbonate signals with the single cable system show that it is more prone to damage and failure. The data for tests with backplate failure show that without the backplate, the signal behaved more like the aluminum signal with slightly higher rotations. The behavior of both polycarbonate and aluminum signals with and without backplates should be considered to determine if the use of backplates should be reduced.

Discussions with Dan Weisburg, P.E., Director, and Scott Philbrick of the Traffic Division of Engineering and Public Works in Palm Beach County revealed that the cable hanger support system has been used for several decades in Palm Beach County. In the hurricanes of 2004, the predominant traffic signal failures in Palm Beach County occurred in either the bottom of the disconnect box or top of the signals and not in the cable hangers. This indicated that the cable hanger support system significantly reduced failures associated with the hanger (i.e., as opposed to the adjustable strap hanger system). For the cable hanger system and others that reduce hanger failure the next weakest link in the system appears to be the connections at the bottom of the

disconnect box and the top of the signals. Future research should add focus on eliminating these weak points.

Since the drag force coefficients resulting from this project were for single signal systems, it is recommended that additional analytical work be considered regarding application of these results to multi-signal systems.

LIST OF REFERENCES

- Alampalli, S. (1997). "Wind loads on untethered-span-wire traffic-signal poles" *Special Report 126*, New York State Department of Transportation, Albany, NY.
- American Association of State Highway Transportation Officials (AASHTO). (2009). *Standard Specifications for Structural Supports for Highway Signs, Luminaires and Traffic Signals*, 5th Ed., AASHTO, Washington, D.C.
- American Society of Civil Engineers (ASCE). (2010). *ASCE 7-10: Minimum Design Loads for Buildings and Other Structures*, ASCE, Reston, VA.
- Cook, R.A., Bloomquist, D., & Long, J.C. (1996). "Structural Qualification Procedure for Traffic Signals and Signs." *FDOT WPI No. 0510731*, University of Florida, Engineering and Industrial Experiment Station, Gainesville, FL.
- Cook, R.A., Hoit, M.I., Ashley, F.K. Christou, P.M., Drost, K., & Wajek, S.L. (1993). "Computer Aided Design Program for Signal Pole and Span Wire Assemblies with Two Point Connection System." *FDOT WPI No. 0510653, Contract No. C-4430*, University of Florida, Engineering and Industrial Experiment Station, Gainesville, FL.
- Cook, R.A., & Johnson, E.V. (2007). "Development of Hurricane Resistant Cable Supported Traffic Signals." *FDOT Contract No. BD545-57*, University of Florida, Department of Civil and Coastal Engineering, Gainesville, FL.
- Hoit, M.I., Cook, R.A., Christou, P.M., & Adediran, A.K. (1995). "Computer Aided Design Program for Signal Pole and Span Wire Assemblies with Two Point Connection System." *FDOT WPI No. 0510653, Contract No. B-8409*, University of Florida, Engineering and Industrial Experiment Station, Gainesville, FL.
- Hoit, M.I., Cook, R.A., Christou, P.M., & Adediran, A.K. (1997). "Computer Aided Design Program for Signal Pole and Span Wire Assemblies with Two Point Connection System." *FDOT WPI No. 0510653, Contract No. B-9924*, University of Florida, Engineering and Industrial Experiment Station, Gainesville, FL.
- Hoit, M.I., Cook, R.A., Wajek, S.L., & Konz, R.C. (1994). "Static and Dynamic Tests on Traffic Signal and Sign Dual Cable Support Systems." *FDOT WPI No. 0510653, Contract No. C-8409*, University of Florida, Engineering and Industrial Experiment Station, Gainesville, FL.
- Institute of Transportation Engineer's (ITE) Joint Industry and Traffic Engineering Council Committee, (2005). *Vehicle Traffic Control Signal Heads: Light Emitting Diode (LED Circular Signal Supplement)*, ITE, Washington, D.C.

State of Florida Department of Transportation (FDOT). (2005). "Hurricane Response Evaluation and Recommendations: February 11, 2005, Version 5." FDOT, Tallahassee, FL.

State of Florida Department of Transportation (FDOT). (2007). *Manual of Uniform Minimum Standards for Design, Construction and Maintenance for Streets and Highways*, FDOT, Tallahassee, FL.

APPENDIX A
SIGNAL ROTATION VS. WIND VELOCITY GRAPHS

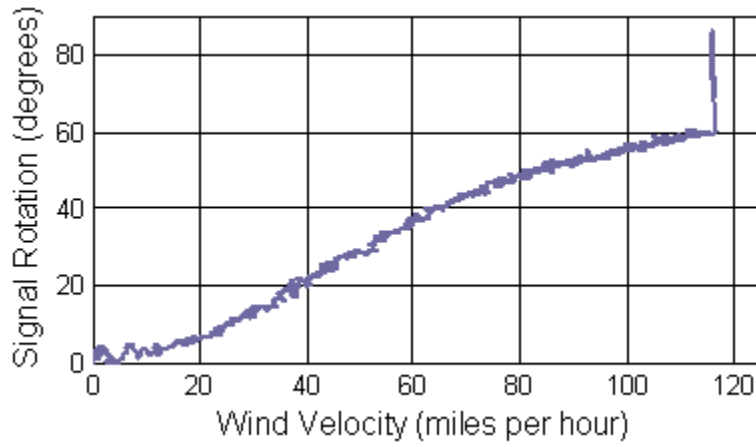

Figure A-1. Test 1: Pipe Hanger with 90° Signal and 90° Simulator Orientations (Linear Load) (Hanger failure at 115 mph)

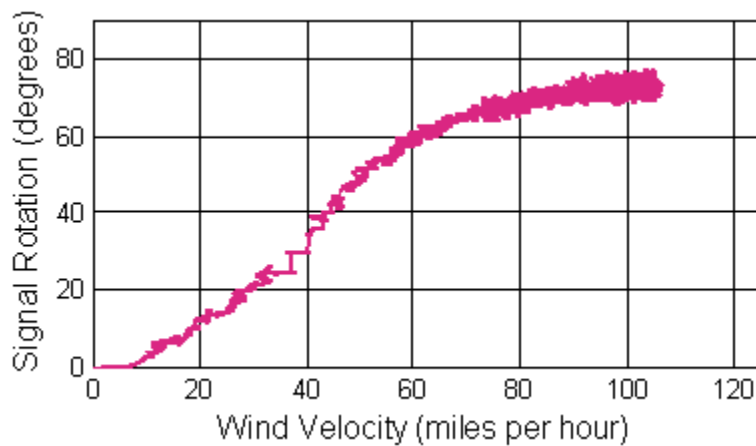

Figure A-2. Test 2: Pivotal Hanger with 90° Signal and 90° Simulator Orientations (Linear Load)

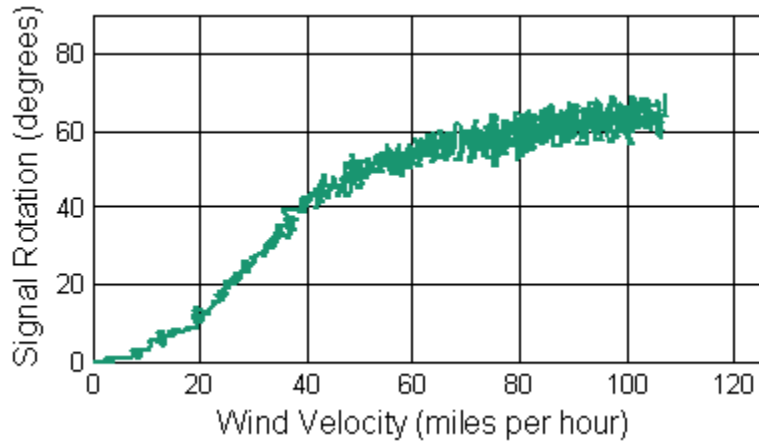

Figure A-3. Test 3: Direct Connection with 90° Signal and 90° Simulator Orientations (Linear Load)

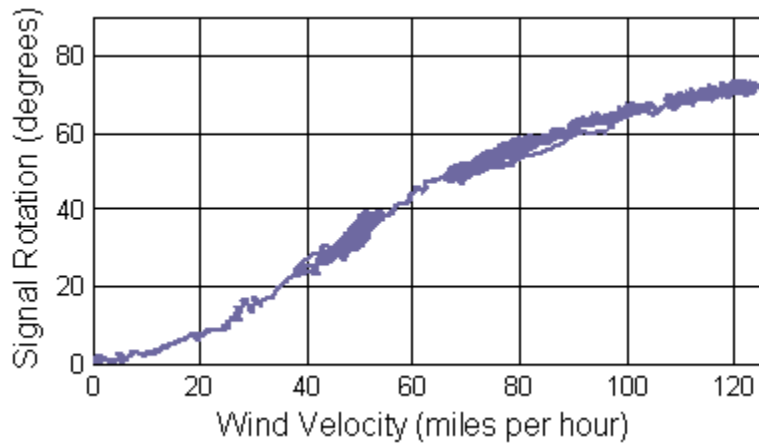

Figure A-4. Test 4: Pipe Hanger with 90° Signal and 90° Simulator Orientations

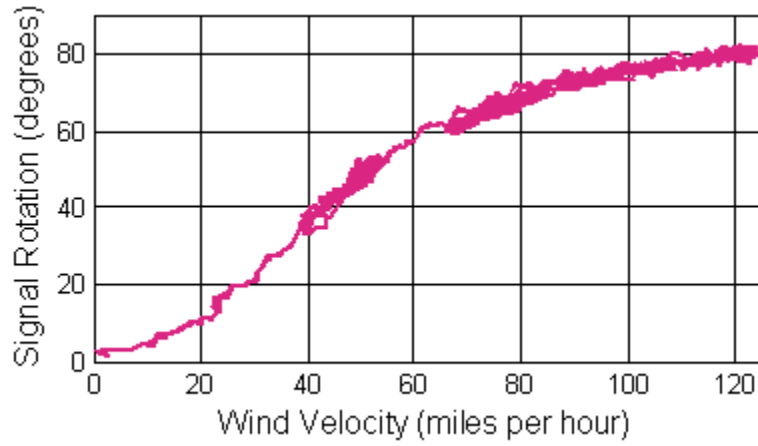

Figure A-5. Test 5: Pivotal Hanger with 90° Signal and 90° Simulator Orientations

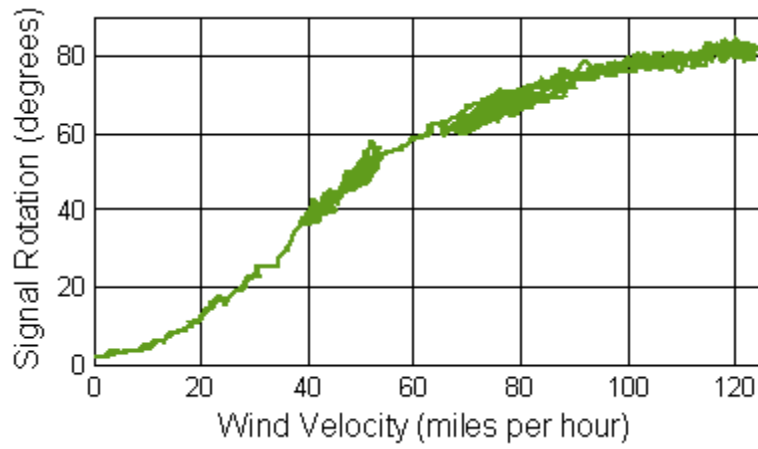

Figure A-6. Test 6: Cable Hanger with 90° Signal and 90° Simulator Orientations

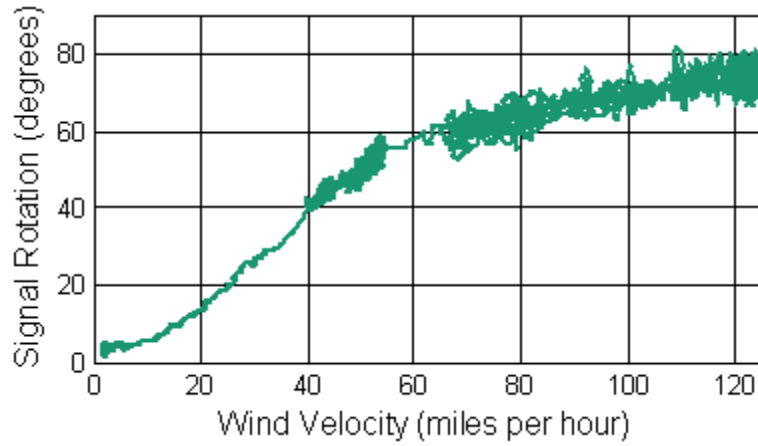

Figure A-7. Test 7: Direct Connection with 90° Signal and 90° Simulator Orientations

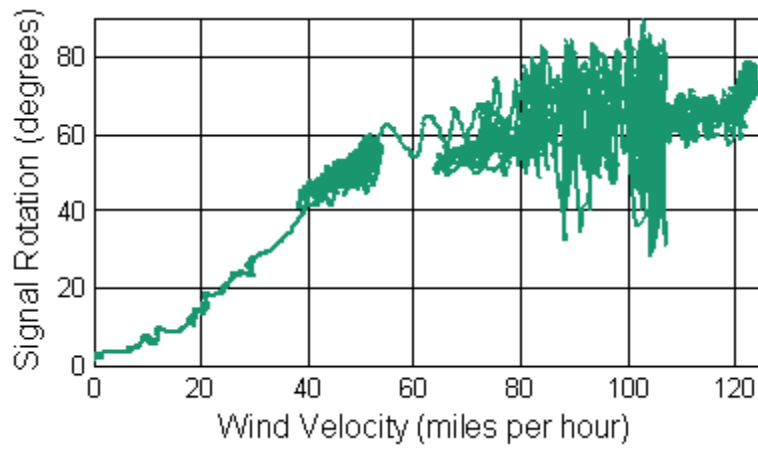

Figure A-8. Test 8: Direct Connection with 90° Signal and 90° Simulator Orientations (Polycarbonate Signal) (Backplate failure at 107 mph)

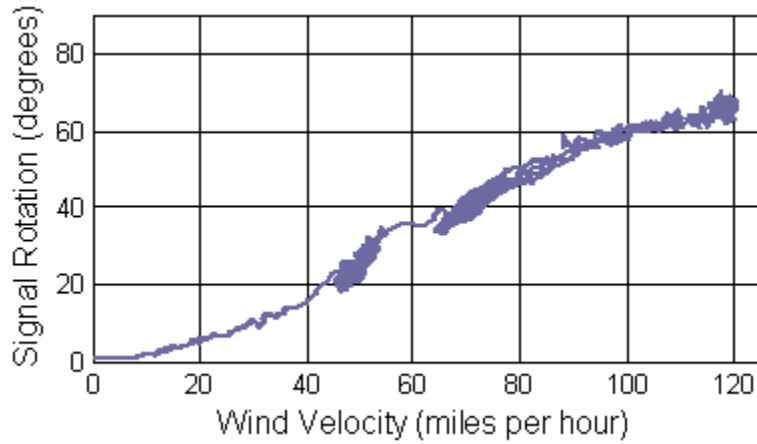

Figure A-9. Test 9: Pipe Hanger with 90° Signal and 45° Simulator Orientations

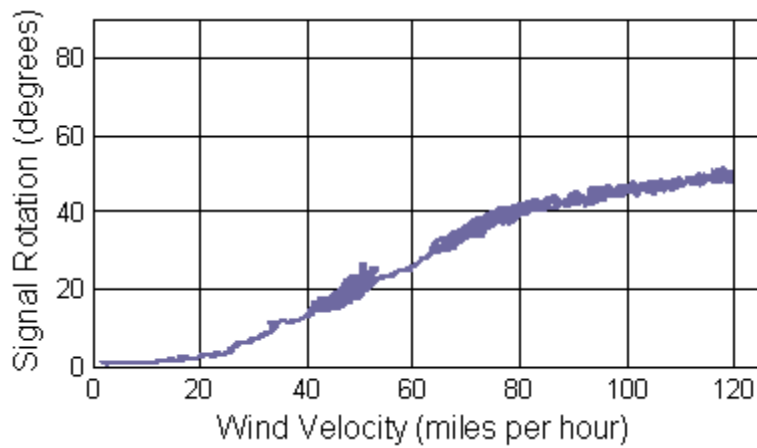

Figure A-10. Test 10: Pipe Hanger with 45° Signal and 45° Simulator Orientations

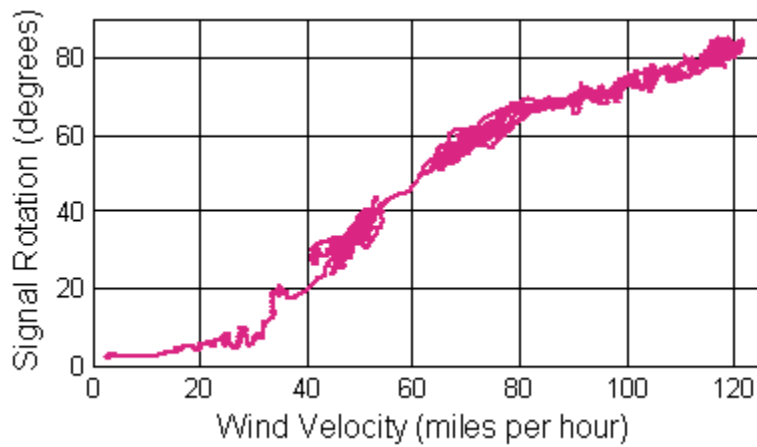

Figure A-11. Test 11: Pivotal Hanger with 90° Signal and 45° Simulator Orientations

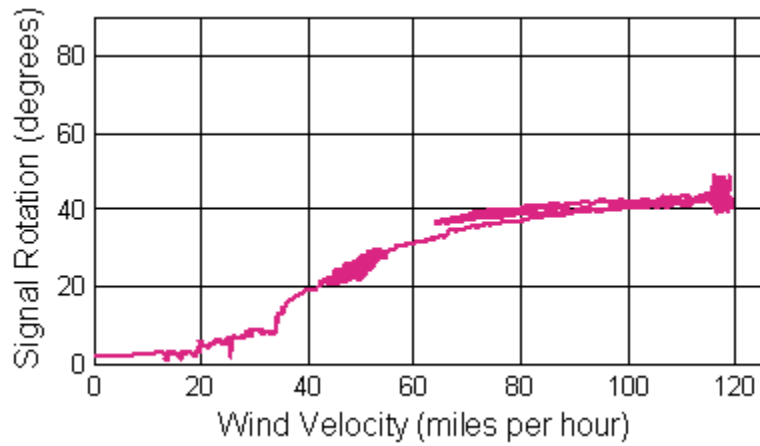

Figure A-12. Test 12: Pivotal Hanger with 45° Signal and 45° Simulator Orientations

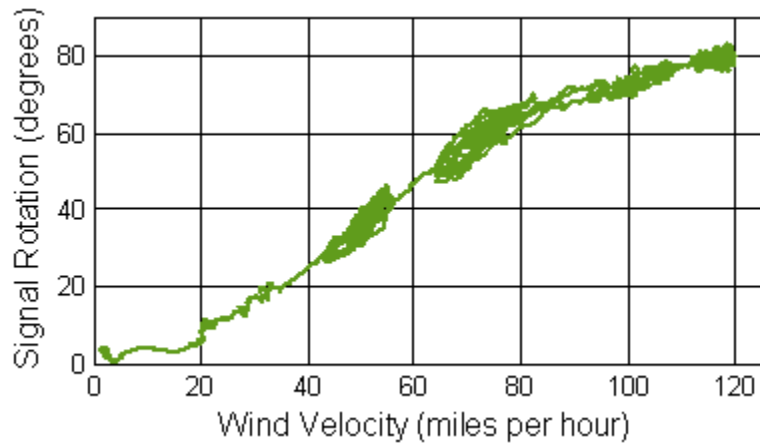

Figure A-13. Test 13: Cable Hanger with 90° Signal and 45° Simulator Orientations

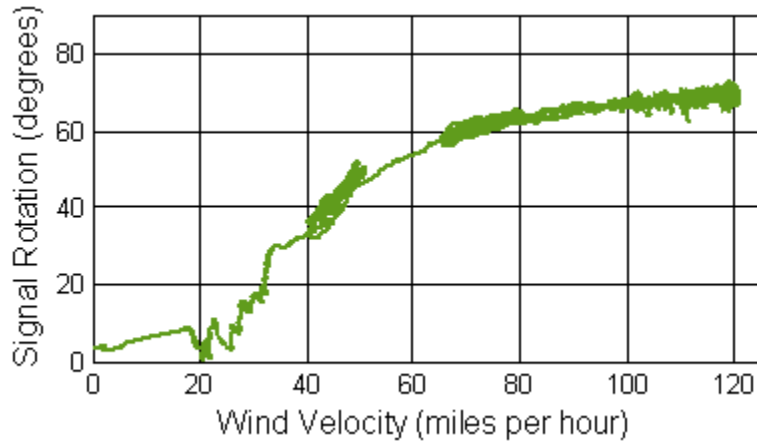

Figure A-14. Test 14: Cable Hanger with 45° Signal and 45° Simulator Orientations

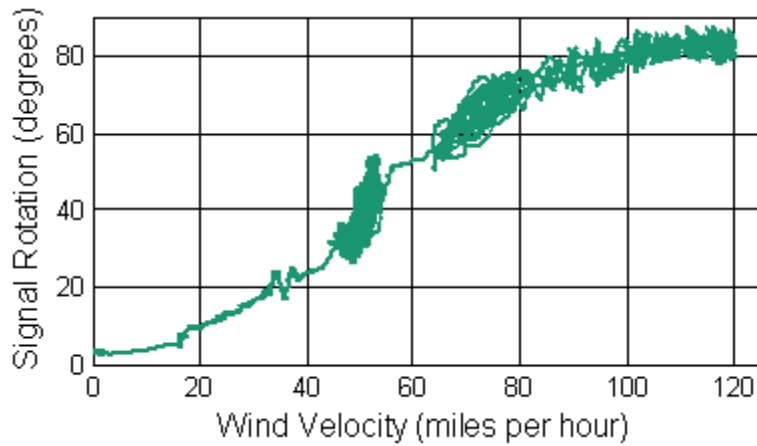

Figure A-15. Test 15: Direct Connection with 90° Signal and 45° Simulator Orientations

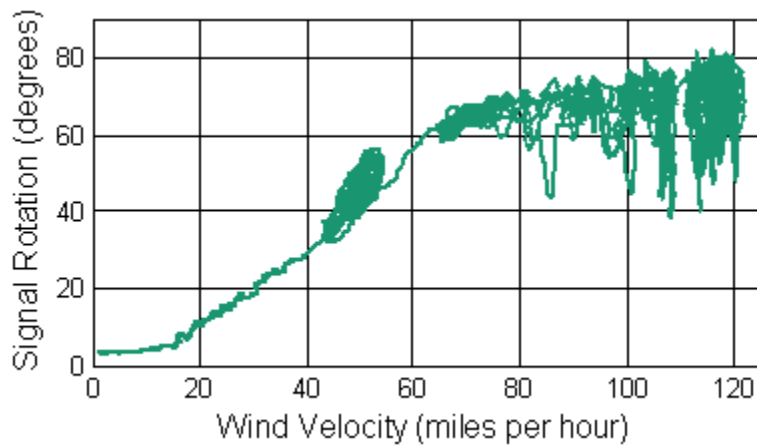

Figure A-16. Test 16: Direct Connection with 45° Signal and 45° Simulator Orientations

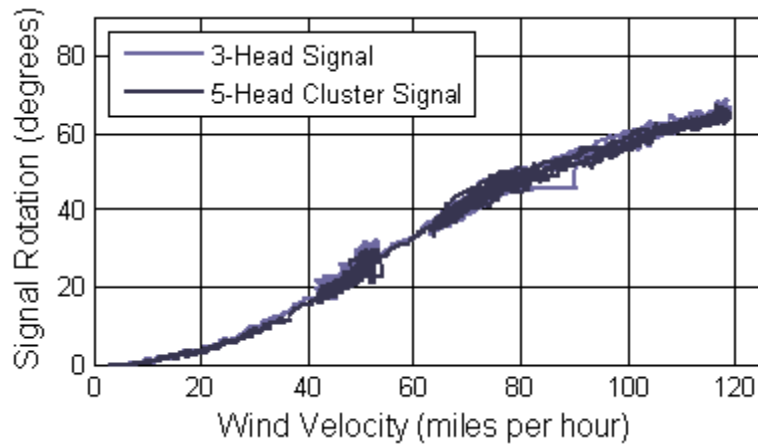

Figure A-17. Test 17: Pipe Hanger with 90° Signal and 45° Simulator Orientations (Two Signals)

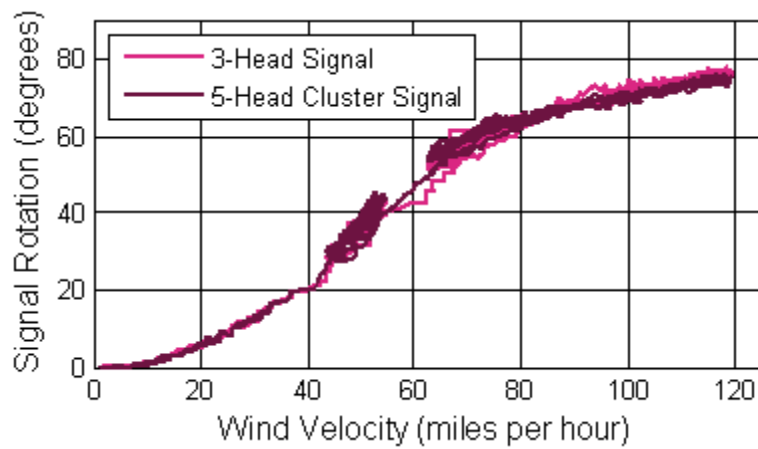

Figure A-18. Test 18: Pivotal Hanger with 90° Signal and 45° Simulator Orientations (Two Signals)

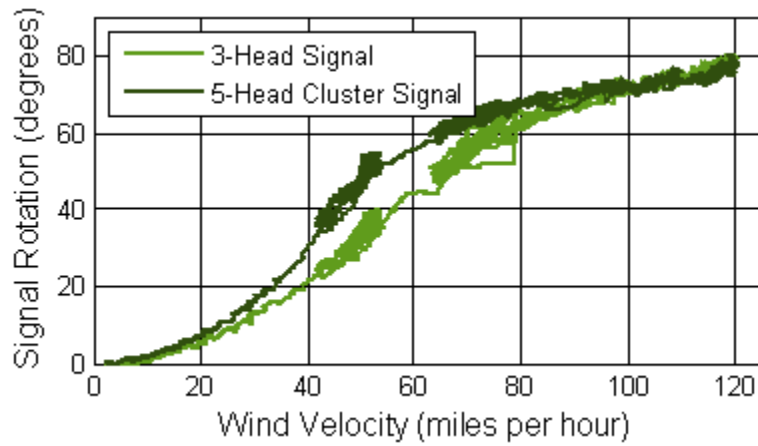

Figure A-19. Test 19: Cable Hanger with 90° Signal and 45° Simulator Orientations (Two Signals)

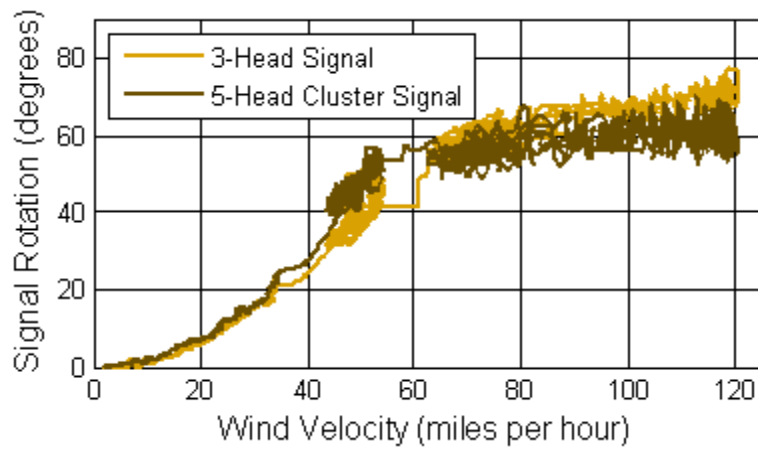

Figure A-20. Test 20: Discontinuous Messenger with 90° Signal and 45° Simulator Orientations (Two Signals)

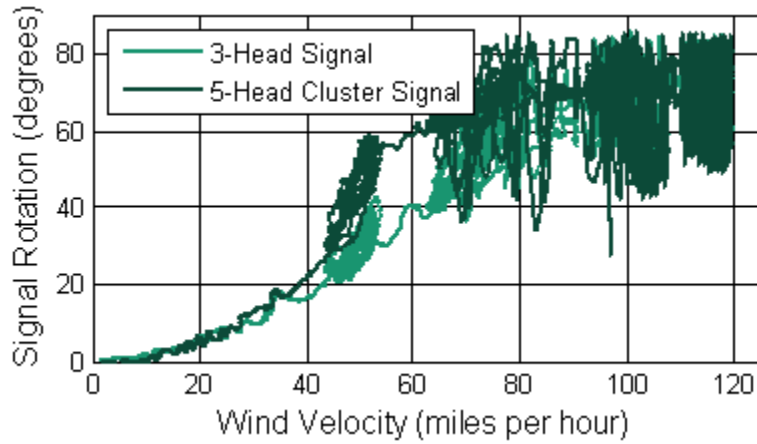

Figure A-21. Test 21: Direct Connection with 90° Signal and 45° Simulator Orientations (Two Signals)

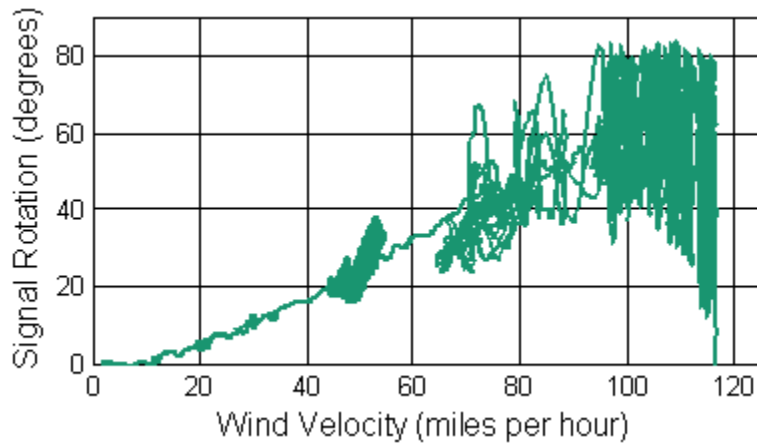

Figure A- 22. Test 22: Direct Connection with 90° Signal and 45° Simulator Orientations (Polycarbonate Signal) (Signal Head Failure at 118 mph)

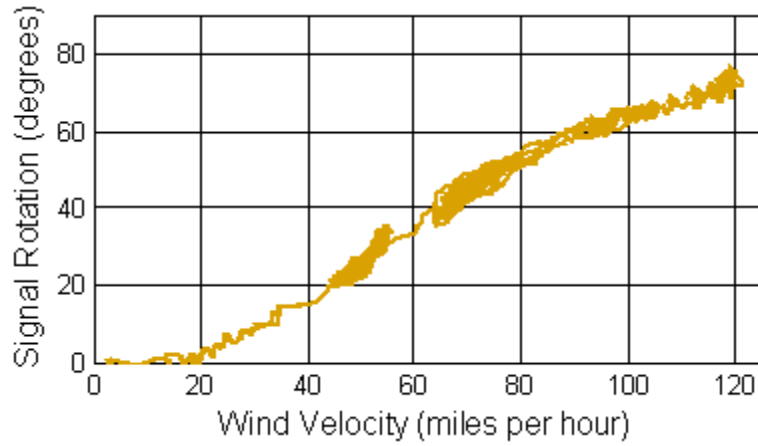

Figure A-23. Test 23: Adjustable Strap Hanger with 90° Signal and 45° Simulator Orientations

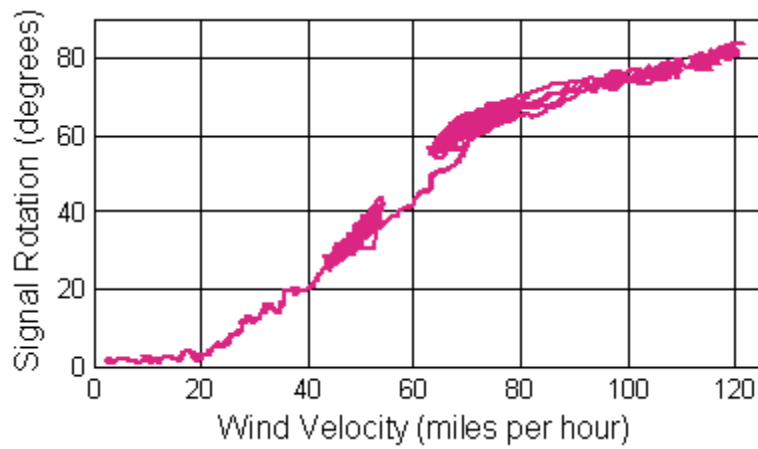

Figure A-24. Test 24: Pivotal Hanger with 90° Signal and 45° Simulator Orientations (Messenger on Front)

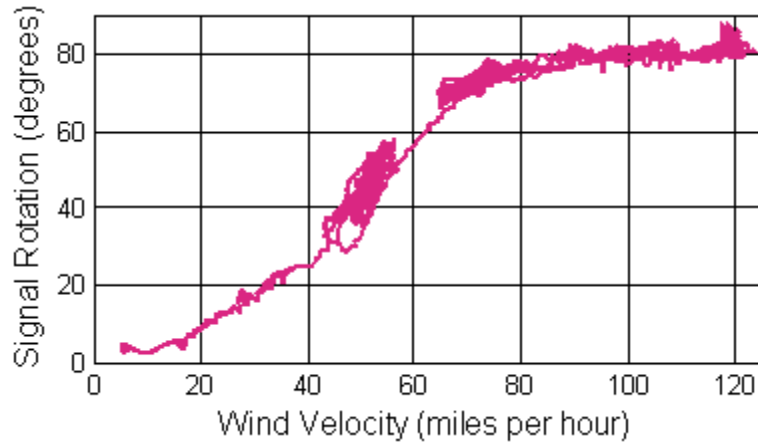

Figure A-25. Test 25: Pivotal Hanger with 90° Signal and 45° Simulator Orientations (Polycarbonate Signal)

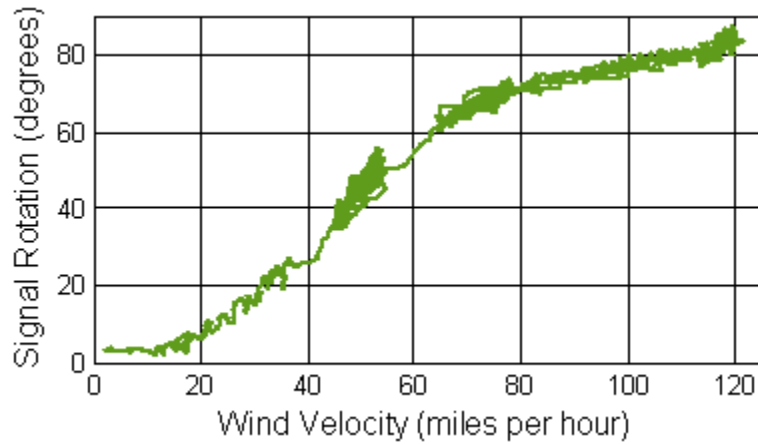

Figure A-26. Test 26: Cable Hanger with 90° Signal and 45° Simulator Orientations (Polycarbonate Signal)

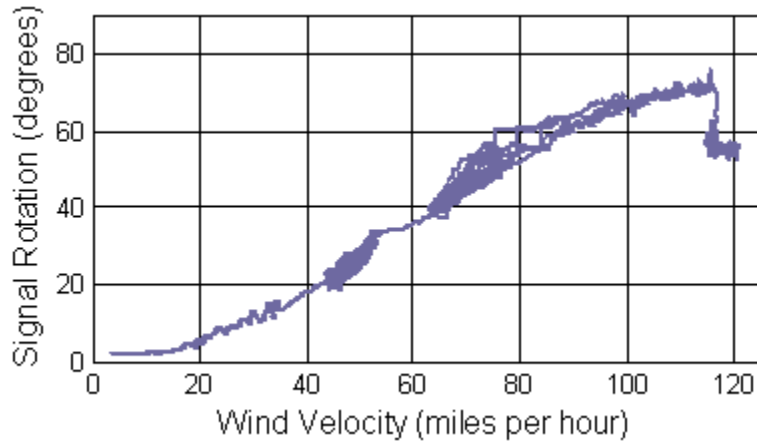

Figure A-27. Test 27: Pipe Hanger with 90° Signal and 45° Simulator Orientations (Messenger on Front) (Backplate failure at 115 mph)

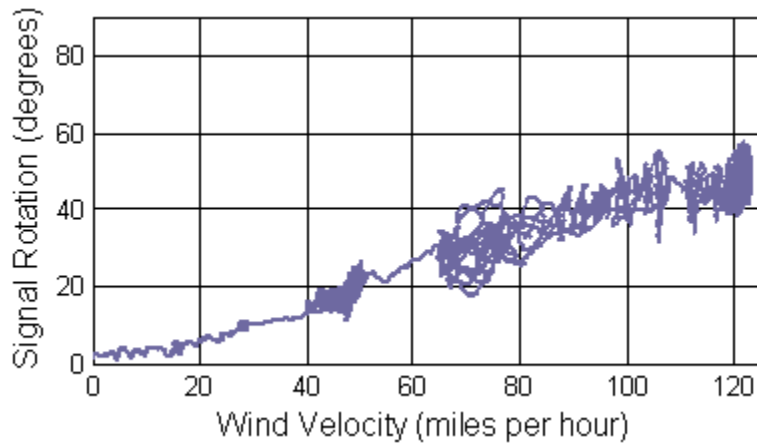

Figure A-28. Test 28: Pipe Hanger with 90° Signal and 12° Simulator Orientations

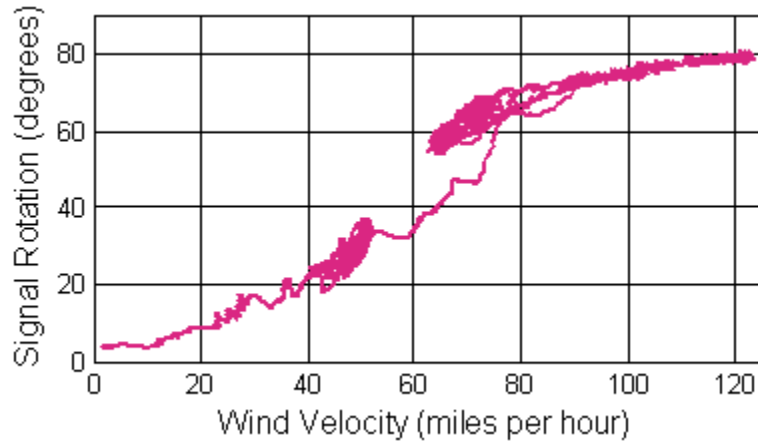

Figure A-29. Test 29: Pivotal Hanger with 90° Signal and 12° Simulator Orientations

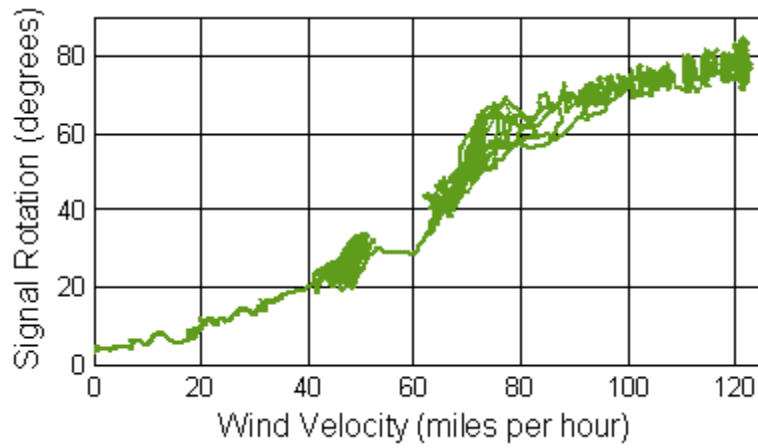

Figure A-30. Test 30: Cable Hanger with 90° Signal and 12° Simulator Orientations

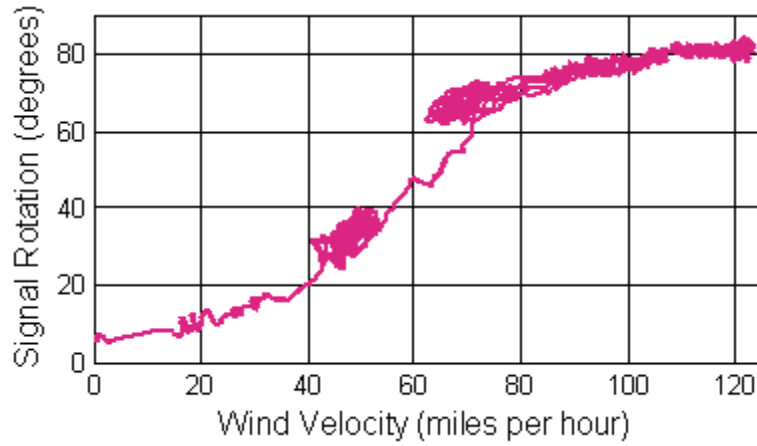

Figure A-31. Test 31: Pivotal Hanger with 90° Signal and 12° Simulator Orientations (Polycarbonate Signals)

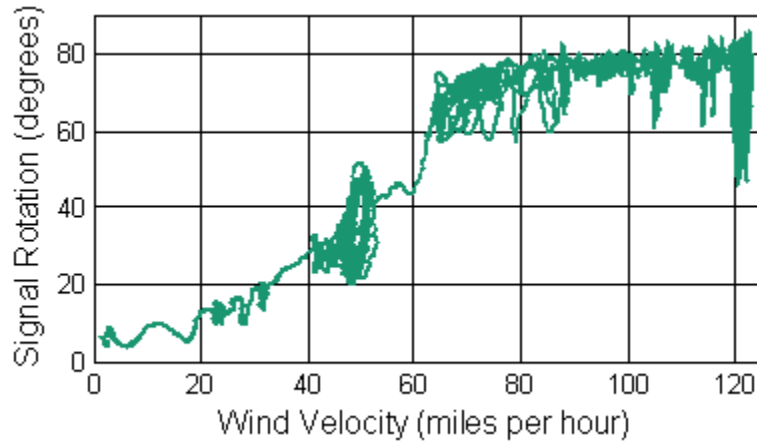

Figure A-32. Test 32: Direct Connection with 90° Signal and 12° Simulator Orientations (Polycarbonate Signals)

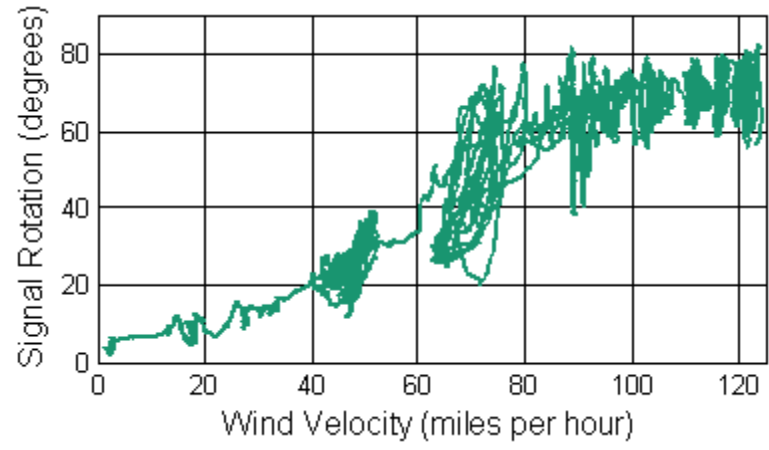

Figure A-33. Test 33: Direct Connection with 90° Signal and 12° Simulator Orientations

APPENDIX B
CABLE TENSIONS VS. WIND VELOCITY GRAPHS

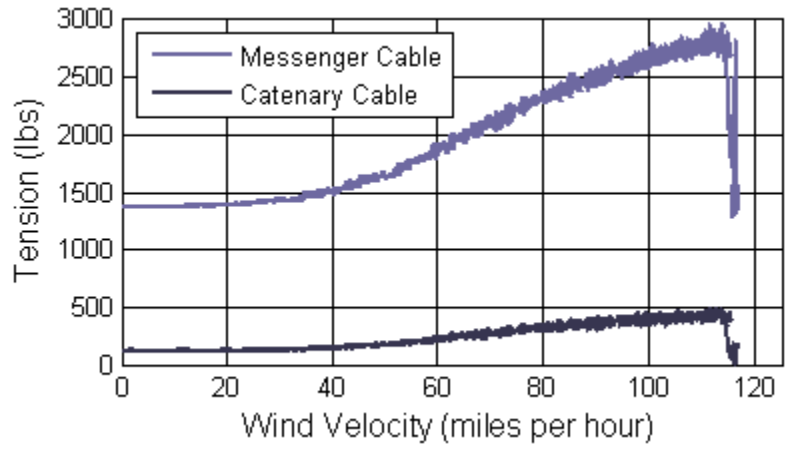

Figure B-1. Test 1: Pipe Hanger with 90° Signal and 90° Simulator Orientations (Linear Load) (Hanger failure at 115 mph)

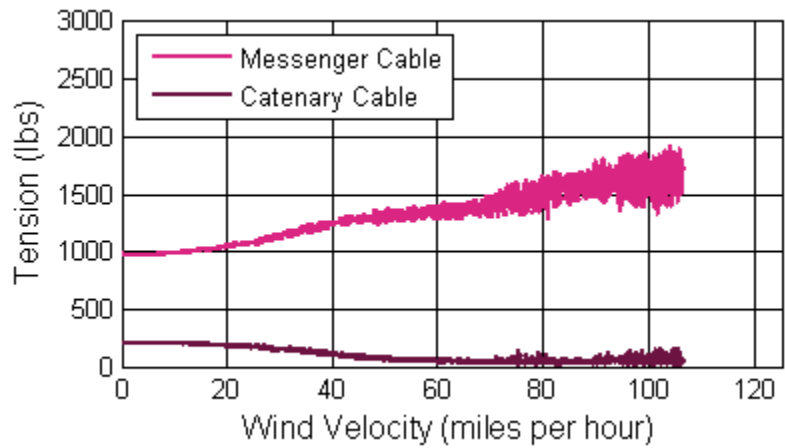

Figure B-2. Test 2: Pivotal Hanger with 90° Signal and 90° Simulator Orientations (Linear Load)

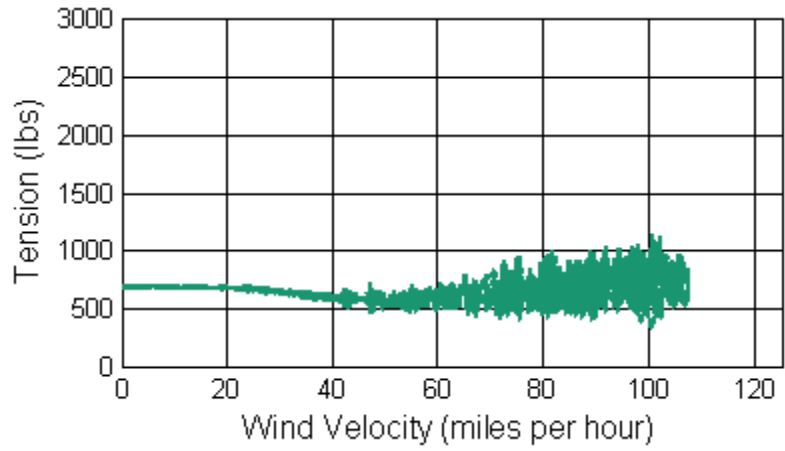

Figure B-3. Test 3: Direct Connection with 90° Signal and 90° Simulator Orientations (Linear Load)

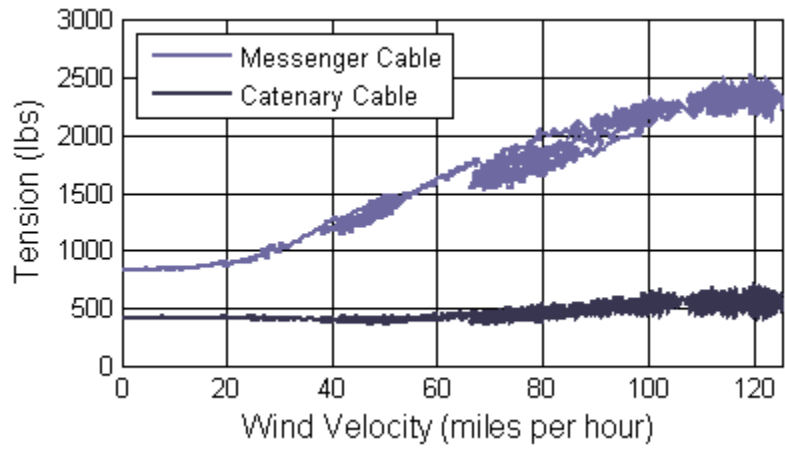

Figure B-4. Test 4: Pipe Hanger with 90° Signal and 90° Simulator Orientations

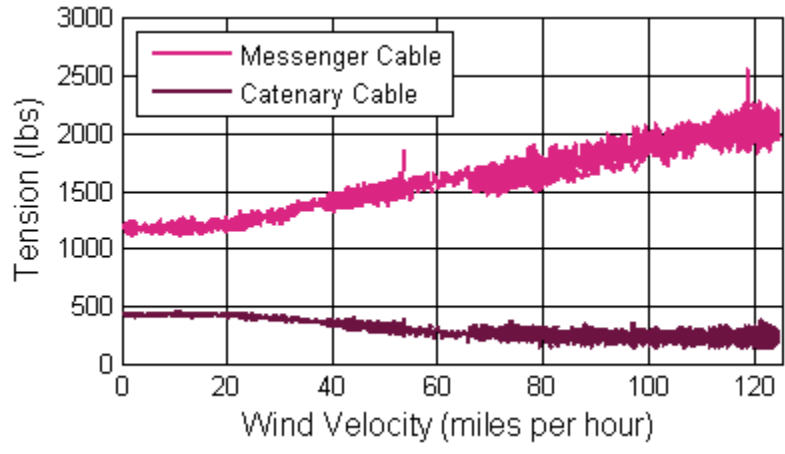

Figure B-5. Test 5: Pivotal Hanger with 90° Signal and 90° Simulator Orientations

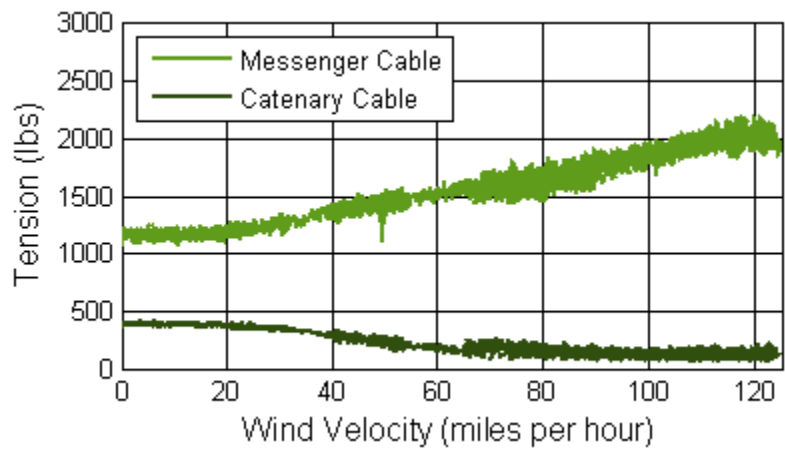

Figure B-6. Test 6: Cable Hanger with 90° Signal and 90° Simulator Orientations

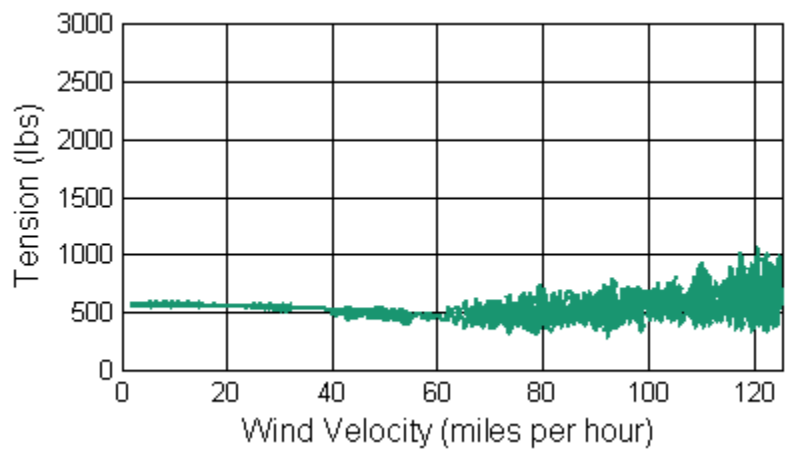

Figure B-7. Test 7: Direct Connection with 90° Signal and 90° Simulator Orientations

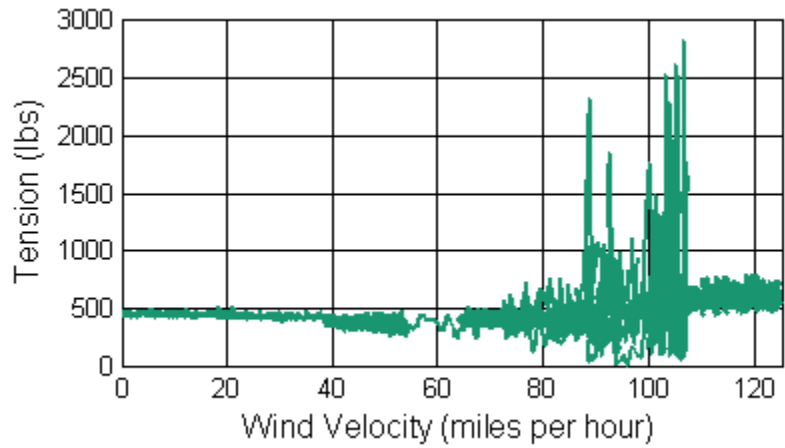

Figure B-8. Test 8: Direct Connection with 90° Signal and 90° Simulator Orientations (Polycarbonate Signal) (Backplate failure at 107 mph)

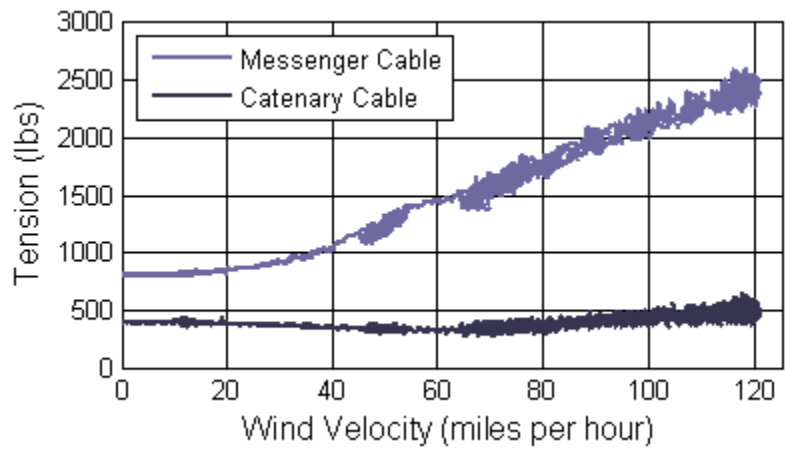

Figure B-9. Test 9: Pipe Hanger with 90° Signal and 45° Simulator Orientations

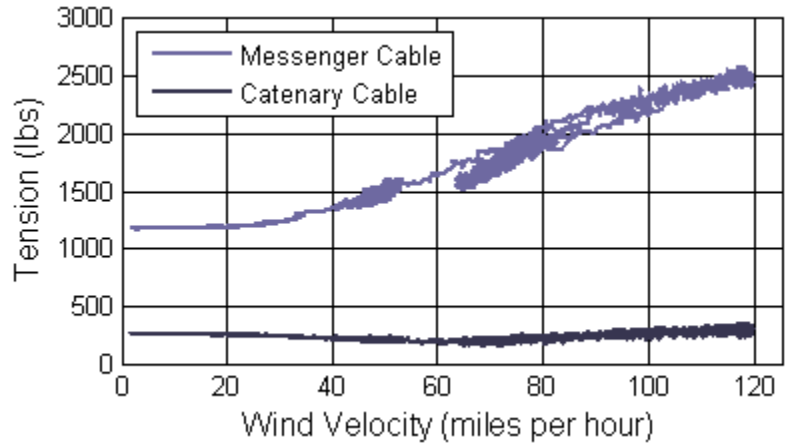

Figure B-10. Test 10: Pipe Hanger with 45° Signal and 45° Simulator Orientations

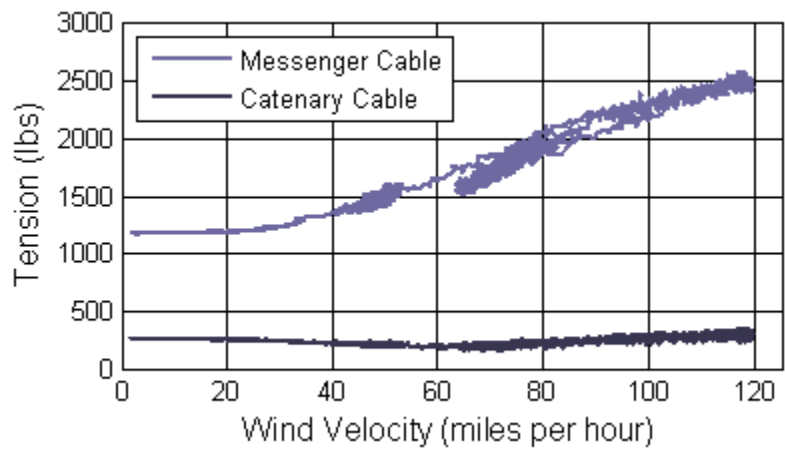

Figure B-11. Test 11: Pivotal Hanger with 90° Signal and 45° Simulator Orientations

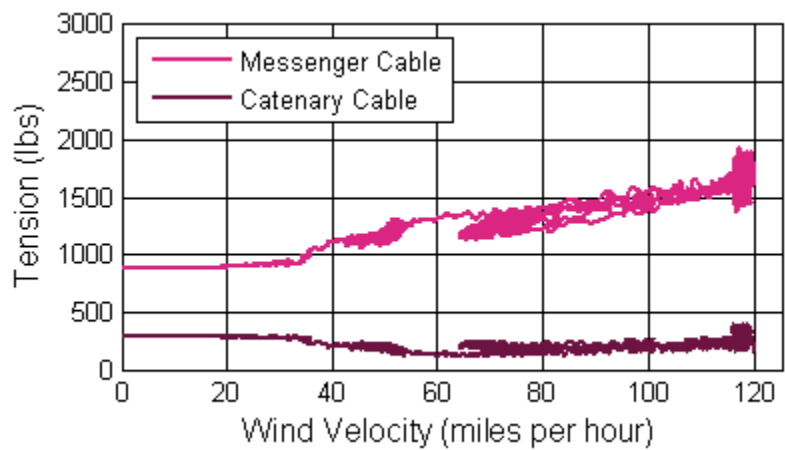

Figure B-12. Test 12: Pivotal Hanger with 45° Signal and 45° Simulator Orientations

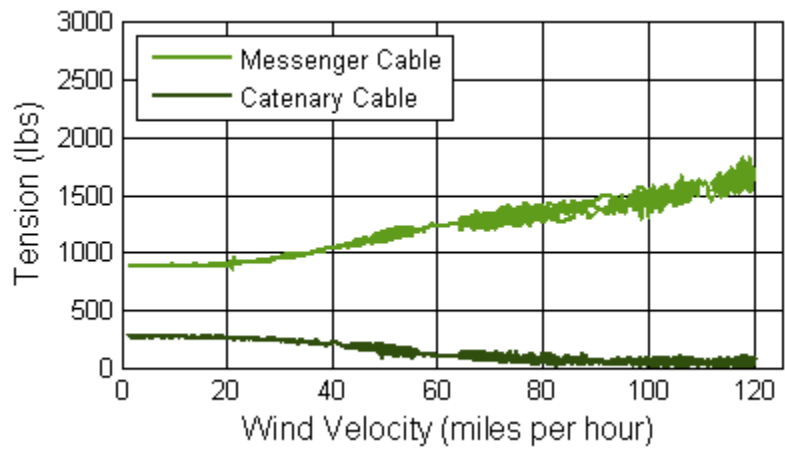

Figure B-13. Test 13: Cable Hanger with 90° Signal and 45° Simulator Orientations

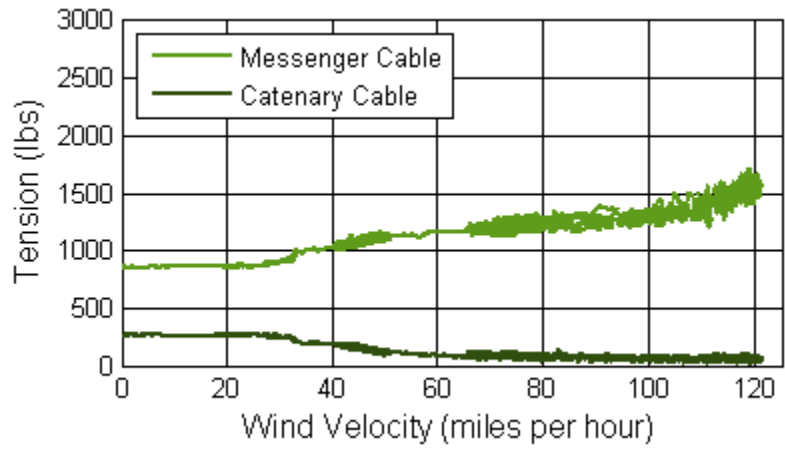

Figure B-14. Test 14: Cable Hanger with 45° Signal and 45° Simulator Orientations

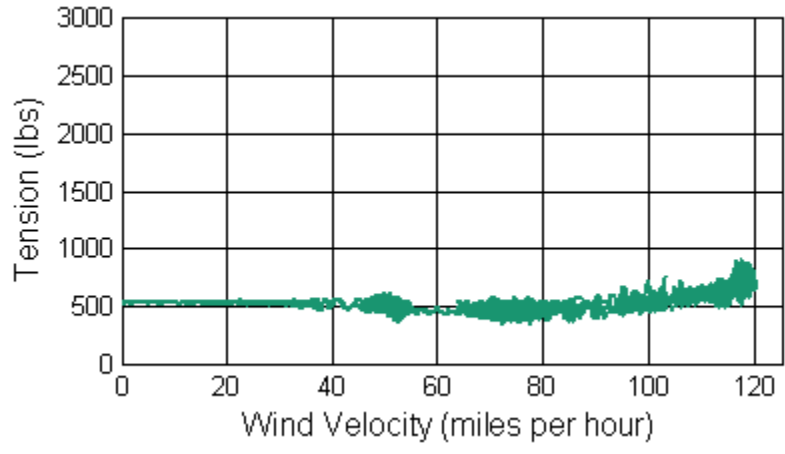

Figure B-15. Test 15: Direct Connection with 90° Signal and 45° Simulator Orientations

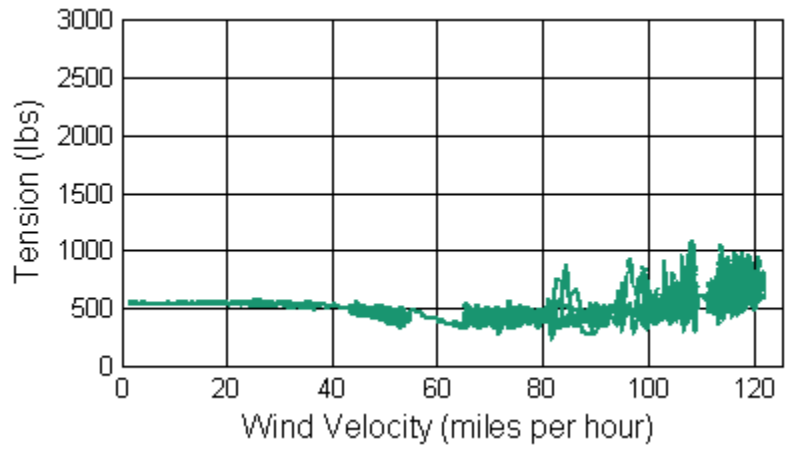

Figure B-16. Test 16: Direct Connection with 45° Signal and 45° Simulator Orientations

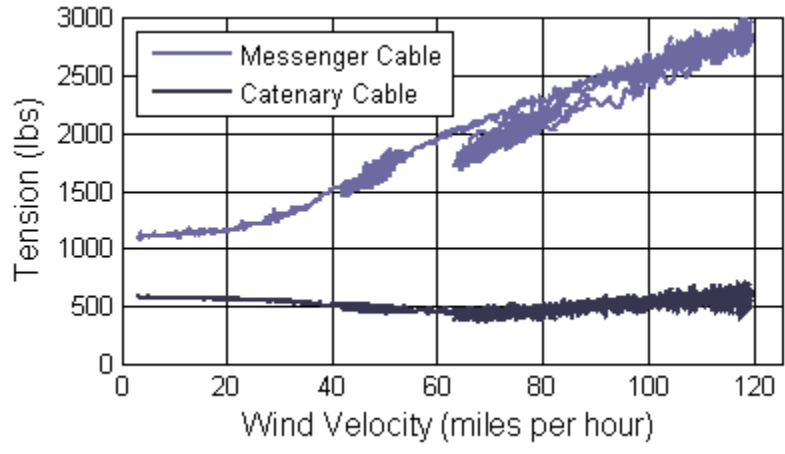

Figure B-17. Test 17: Pipe Hanger with 90° Signal and 45° Simulator Orientations (Two Signals)

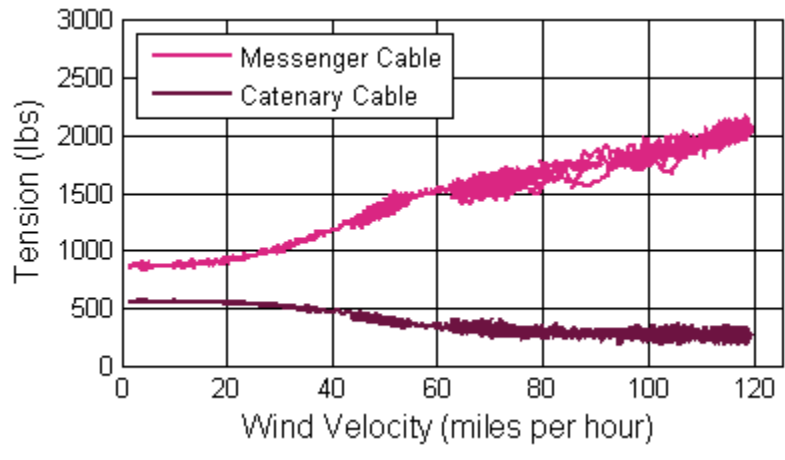

Figure B-18. Test 18: Pivotal Hanger with 90° Signal and 45° Simulator Orientations (Two Signals)

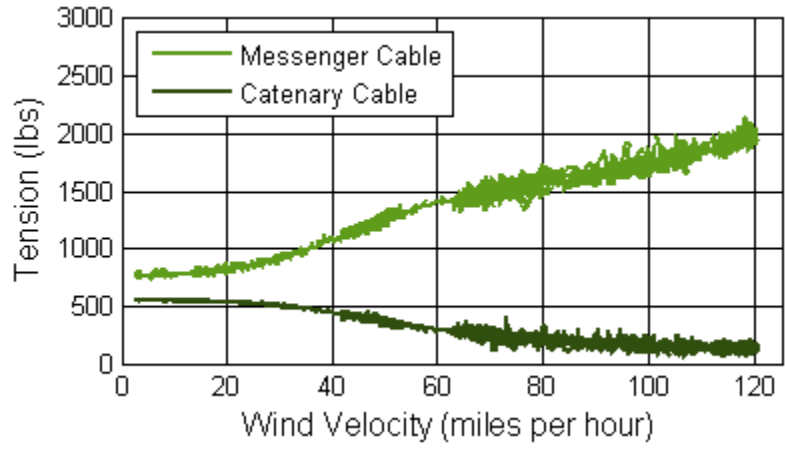

Figure B-19. Test 19: Cable Hanger with 90° Signal and 45° Simulator Orientations (Two Signals)

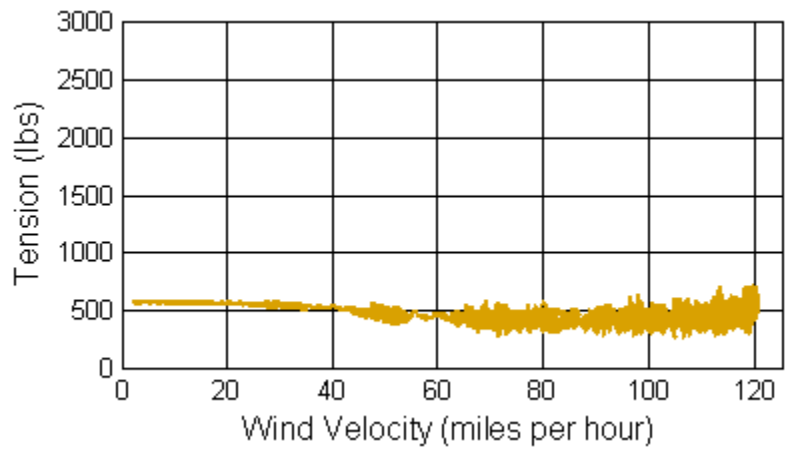

Figure B-20. Test 20: Discontinuous Messenger with 90° Signal and 45° Simulator Orientations (Two Signals)

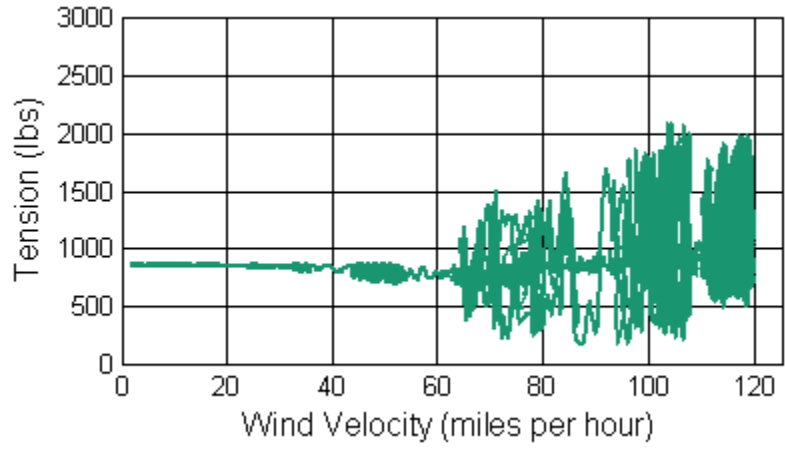

Figure B-21. Test 21: Direct Connection with 90° Signal and 45° Simulator Orientations (Two Signals)

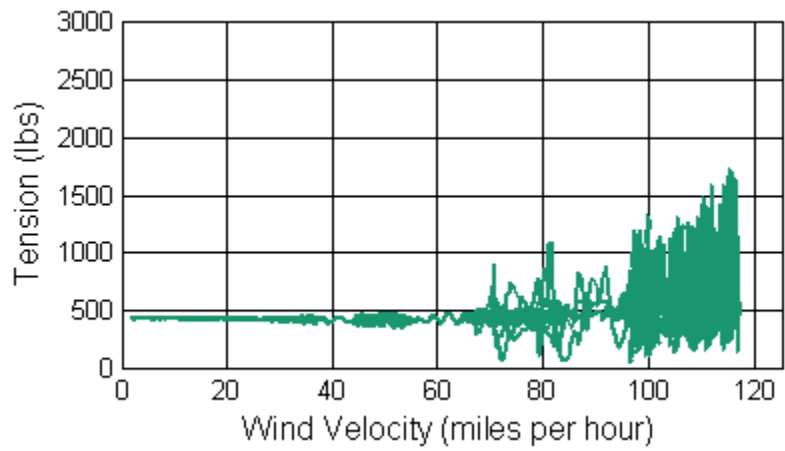

Figure B-22. Test 22: Direct Connection with 90° Signal and 45° Simulator Orientations (Polycarbonate Signal) (Signal Head Failure at 118 mph)

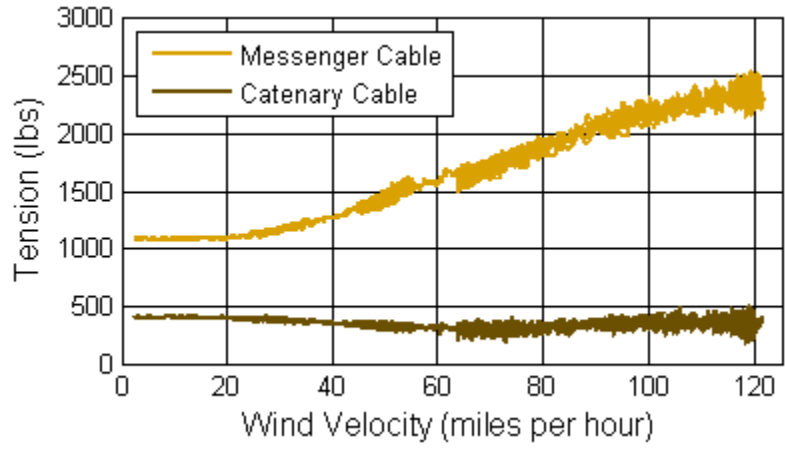

Figure B-23. Test 23: Adjustable Strap Hanger with 90° Signal and 45° Simulator Orientations

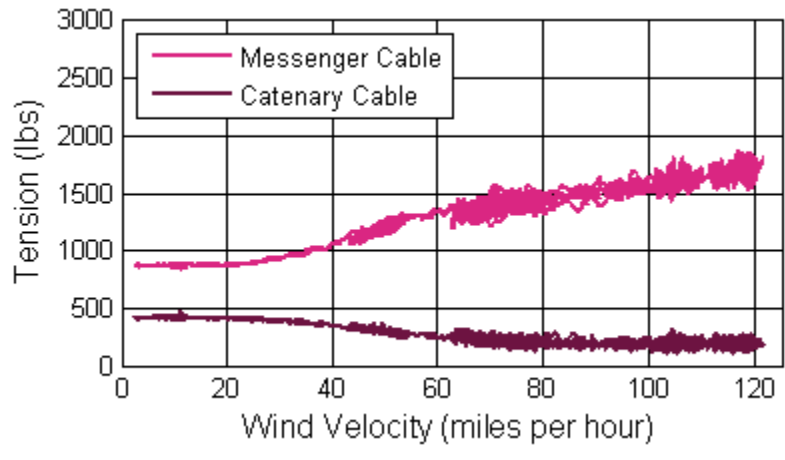

Figure B-24. Test 24: Pivotal Hanger with 90° Signal and 45° Simulator Orientations (Messenger on Front)

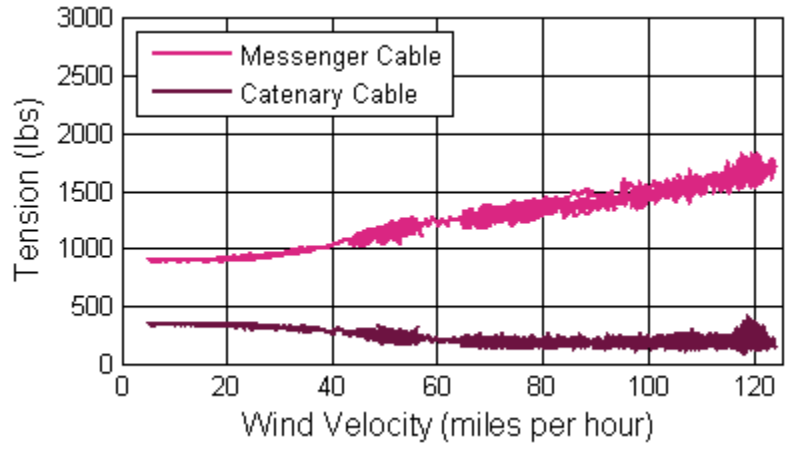

Figure B-25. Test 25: Pivotal Hanger with 90° Signal and 45° Simulator Orientations (Polycarbonate Signal)

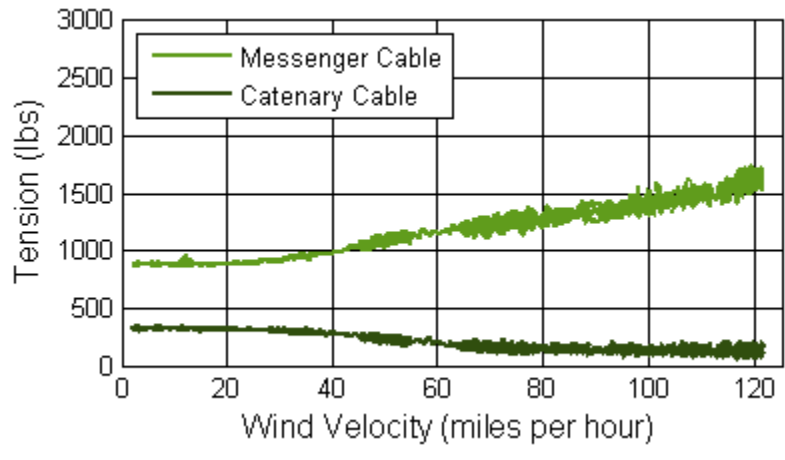

Figure B-26. Test 26: Cable Hanger with 90° Signal and 45° Simulator Orientations (Polycarbonate Signal)

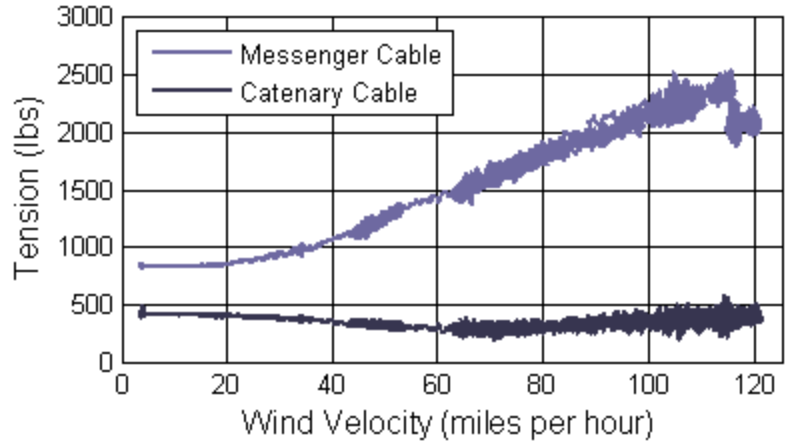

Figure B-27. Test 27: Pipe Hanger with 90° Signal and 45° Simulator Orientations (Messenger on Front) (Backplate failure at 115 mph)

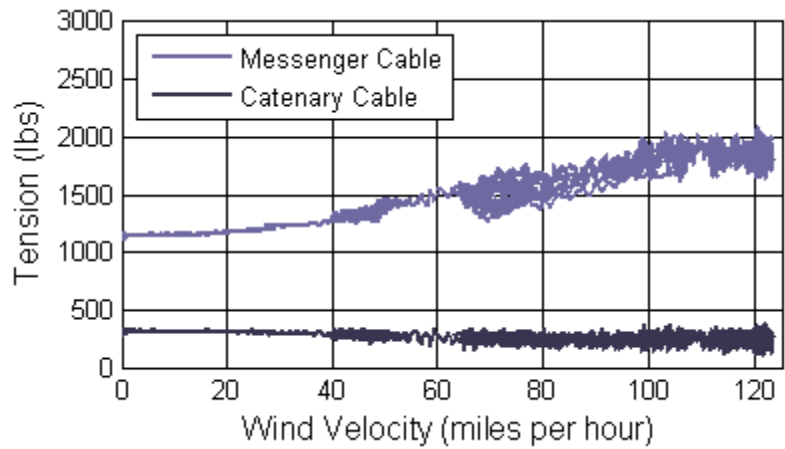

Figure B-28. Test 28: Pipe Hanger with 90° Signal and 12° Simulator Orientations

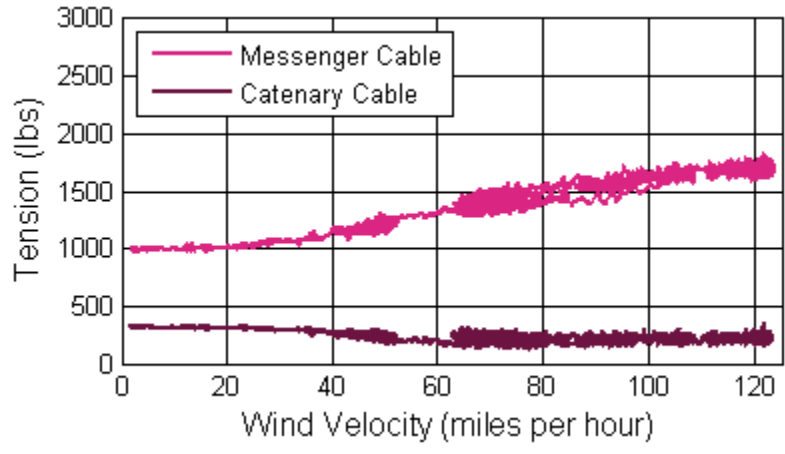

Figure B-29. Test 29: Pivotal Hanger with 90° Signal and 12° Simulator Orientations

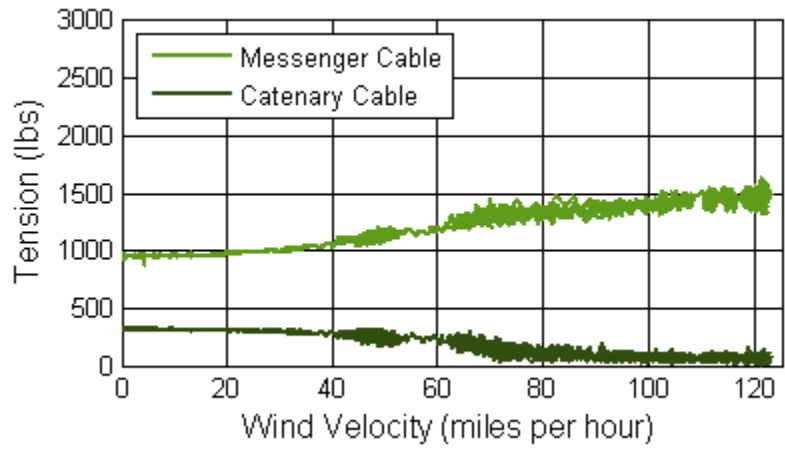

Figure B-30. Test 30: Cable Hanger with 90° Signal and 12° Simulator Orientations

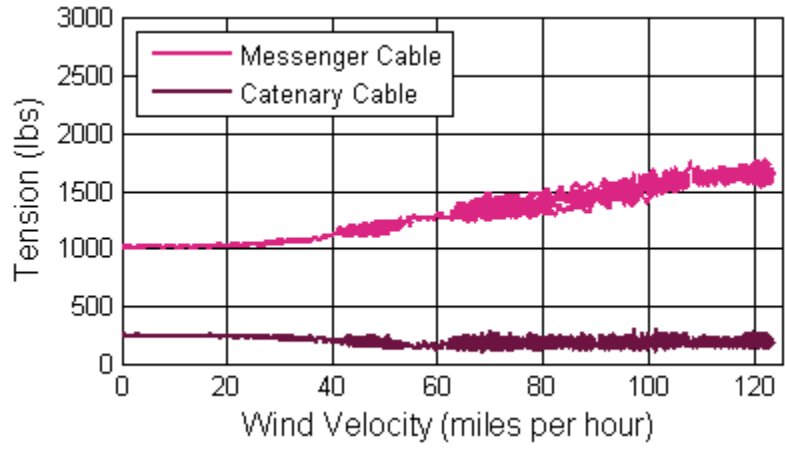

Figure B-31. Test 31: Pivotal Hanger with 90° Signal and 12° Simulator Orientations (Polycarbonate Signals)

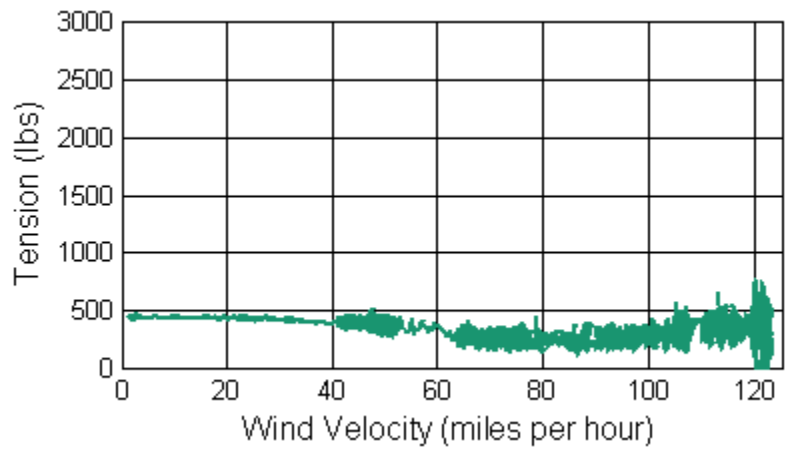

Figure B-32. Test 32: Direct Connection with 90° Signal and 12° Simulator Orientations (Polycarbonate Signals)

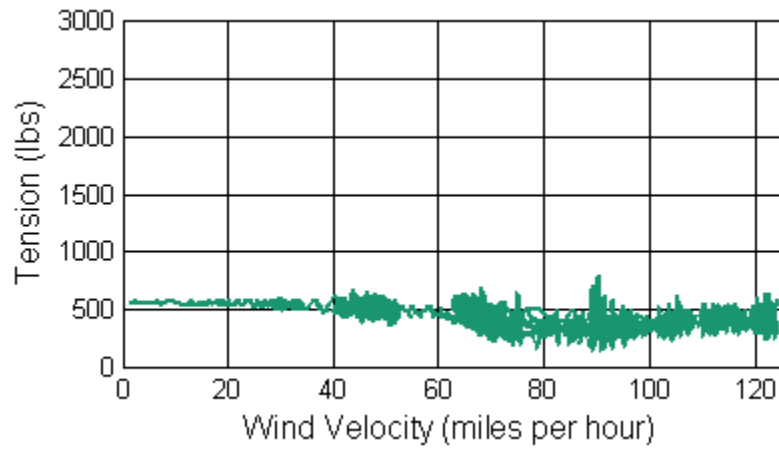

Figure B-33. Test 33: Direct Connection with 90° Signal and 12° Simulator Orientations

APPENDIX C
CABLE DISPLACEMENT VS. WIND VELOCITY GRAPHS

Due to errors with instrumentation, there are no displacement data sets for the following tests: Tests 10, 13, 20, 21, 22, 25, 26, 30, and 32. For Test 24 there is only displacement data for the messenger cable.

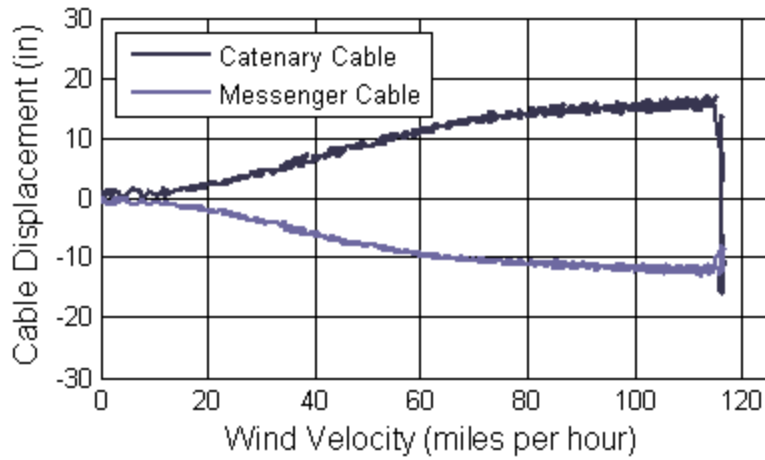

Figure C-1. Test 1: Pipe Hanger with 90° Signal and 90° Simulator Orientations (Linear Load)(Hanger failure at 115 mph)

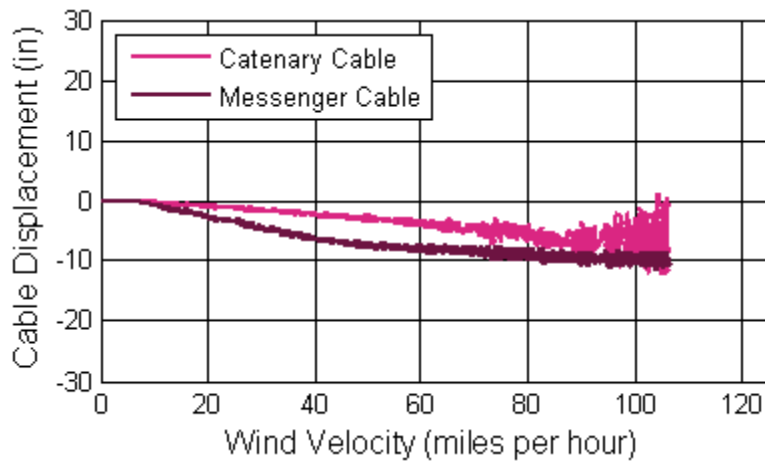

Figure C-2. Test 2: Pivotal Hanger with 90° Signal and 90° Simulator Orientations (Linear Load)

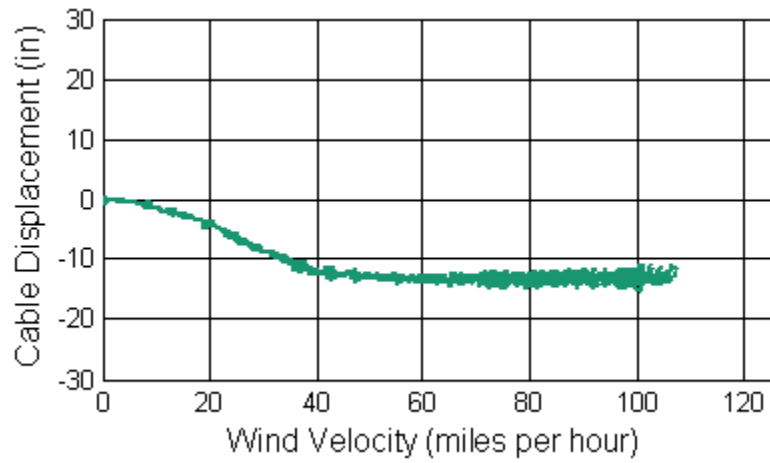

Figure C-3. Test 3: Direct Connection with 90° Signal and 90° Simulator Orientations (Linear Load)

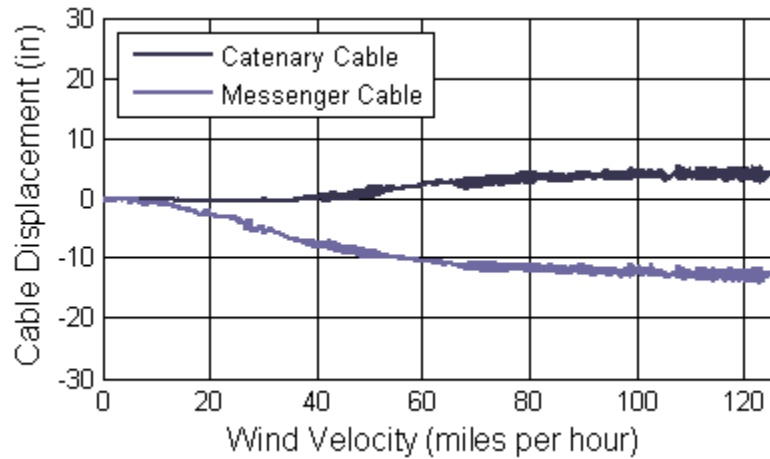

Figure C-4. Test 4: Pipe Hanger with 90° Signal and 90° Simulator Orientations

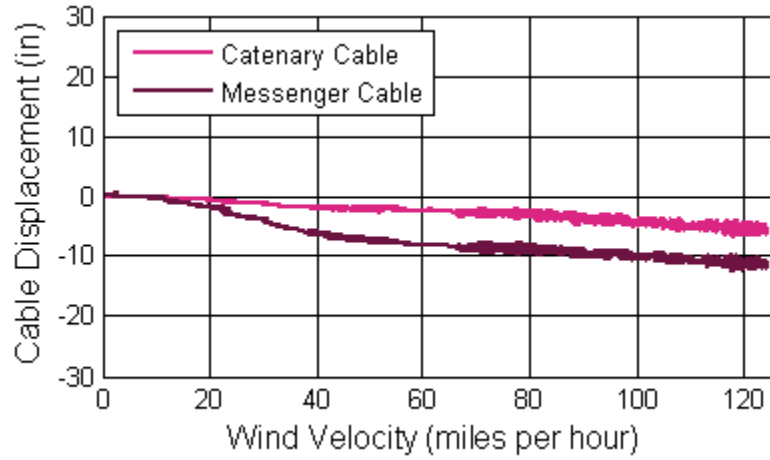

Figure C-5. Test 5: Pivotal Hanger with 90° Signal and 90° Simulator Orientations

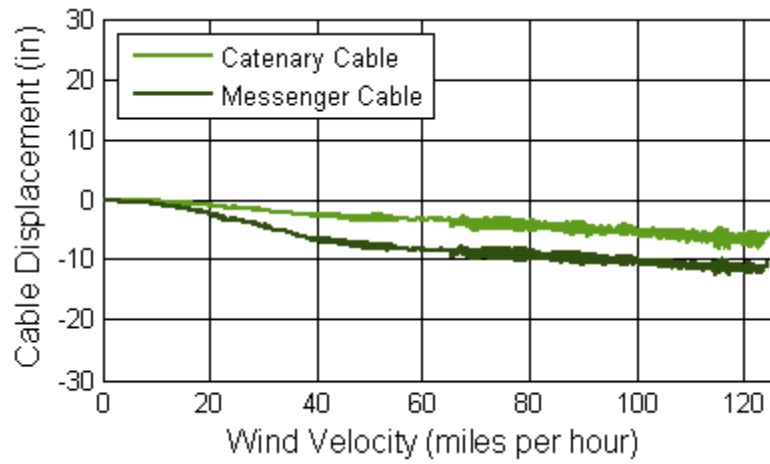

Figure C-6. Test 6: Cable Hanger with 90° Signal and 90° Simulator Orientations

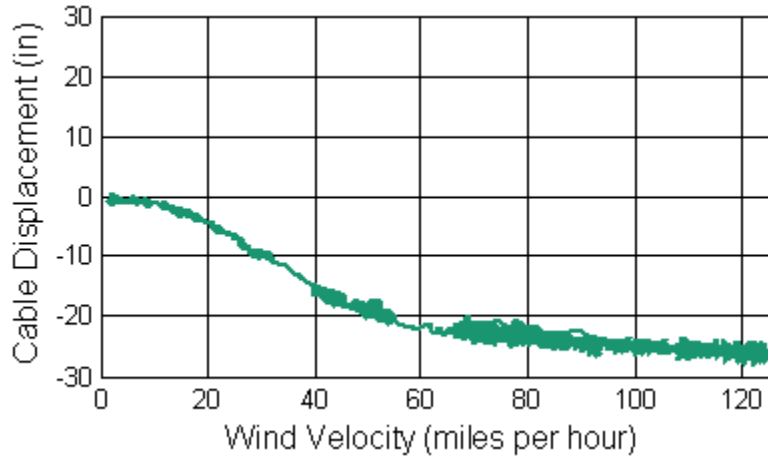

Figure C-7. Test 7: Direct Connection with 90° Signal and 90° Simulator Orientations

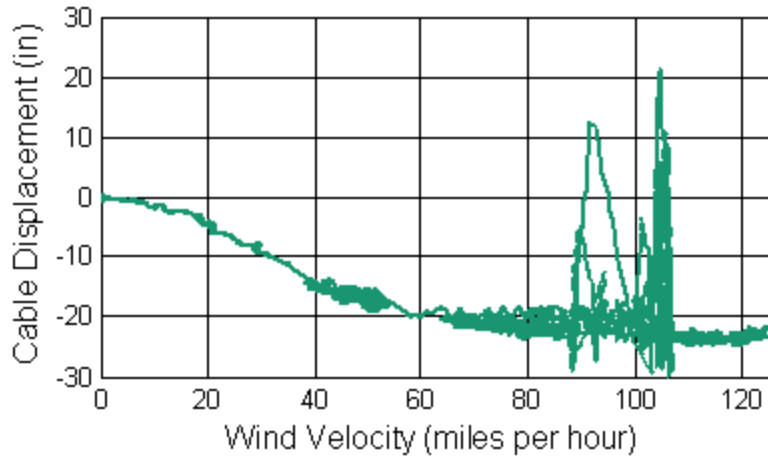

Figure C-8. Test 8: Direct Connection with 90° Signal and 90° Simulator Orientations (Polycarbonate Signal) (Backplate failure at 107 mph)

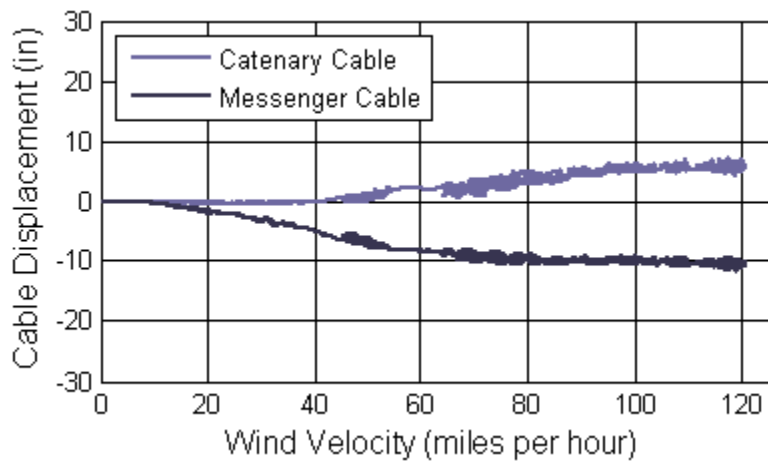

Figure C-9. Test 9: Pipe Hanger with 90° Signal and 45° Simulator Orientations

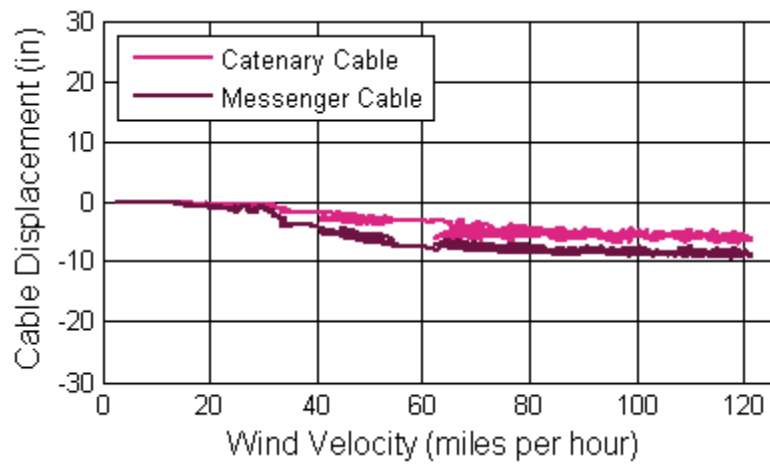

Figure C-10. Test 11: Pivotal Hanger with 90° Signal and 45° Simulator Orientations

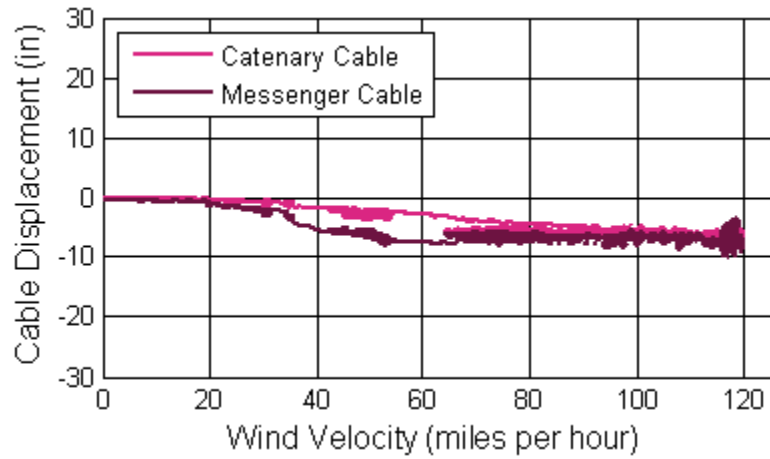

Figure C-11. Test 12: Pivotal Hanger with 45° Signal and 45° Simulator Orientations

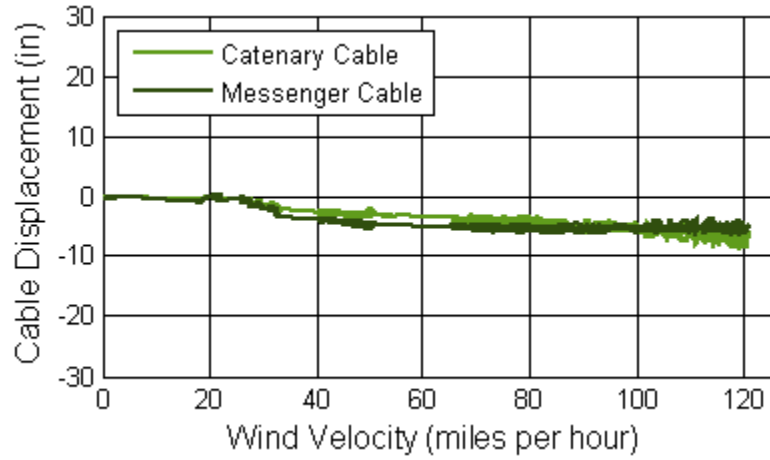

Figure C-12. Test 14: Cable Hanger with 45° Signal and 45° Simulator Orientations

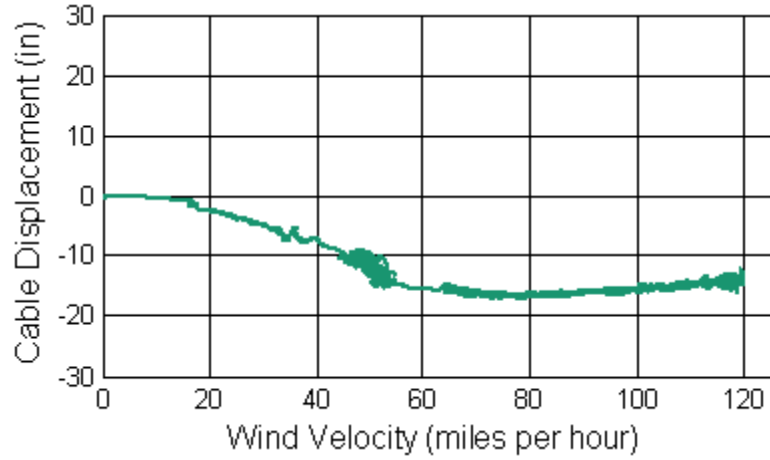

Figure C-13. Test 15: Direct Connection with 90° Signal and 45° Simulator Orientations

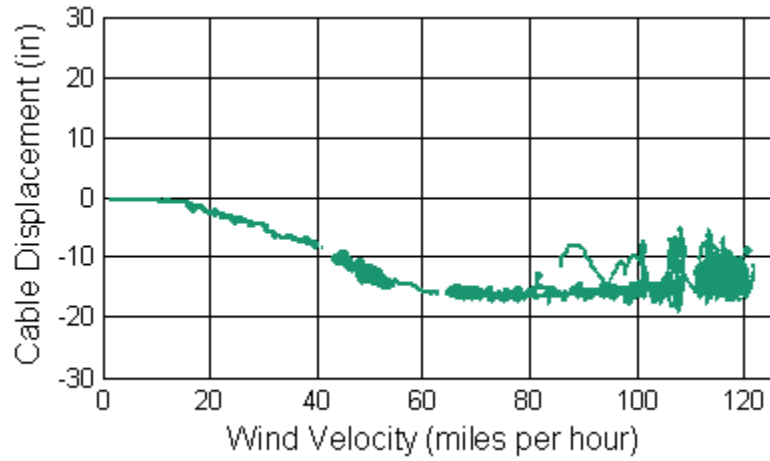

Figure C-14. Test 16: Direct Connection with 45° Signal and 45° Simulator Orientations

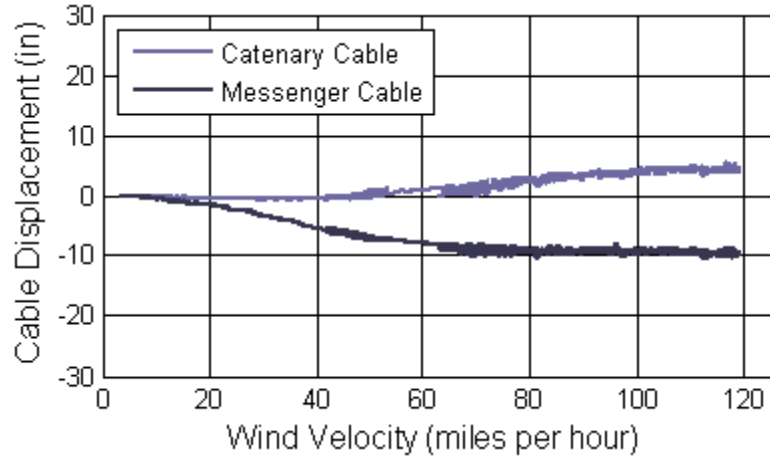

Figure C-15. Test 17: Pipe Hanger with 90° Signal and 45° Simulator Orientations (Two Signals)

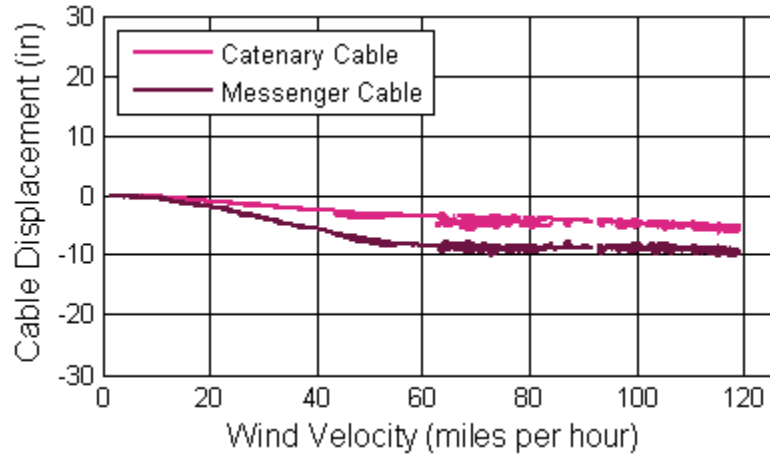

Figure C-16. Test 18: Pivotal Hanger with 90° Signal and 45° Simulator Orientations (Two Signals)

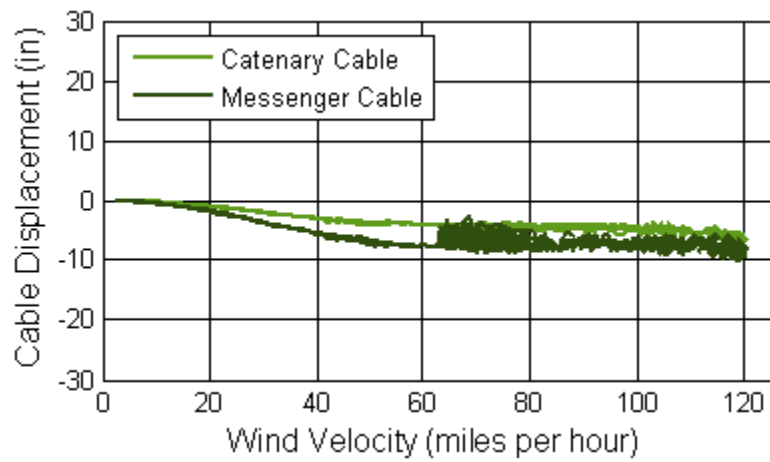

Figure C-17. Test 19: Cable Hanger with 90° Signal and 45° Simulator Orientations (Two Signals)

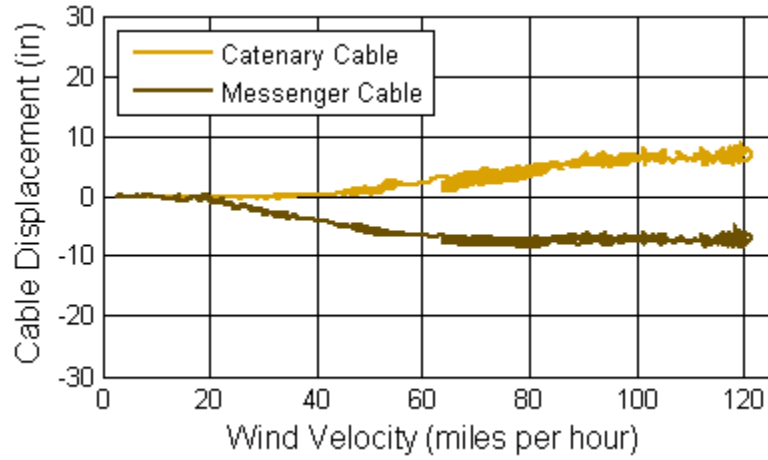

Figure C-18. Test 23: Adjustable Strap Hanger with 90° Signal and 45° Simulator Orientations

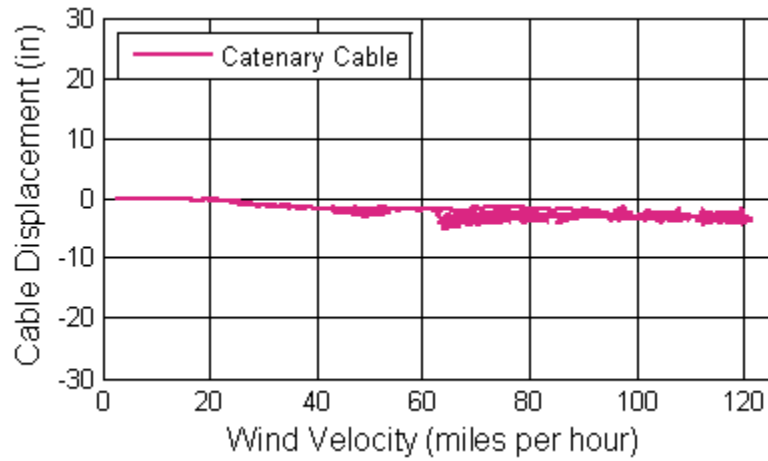

Figure C-19. Test 24: Pivotal Hanger with 90° Signal and 45° Simulator Orientations (Messenger clamped to front of hanger)

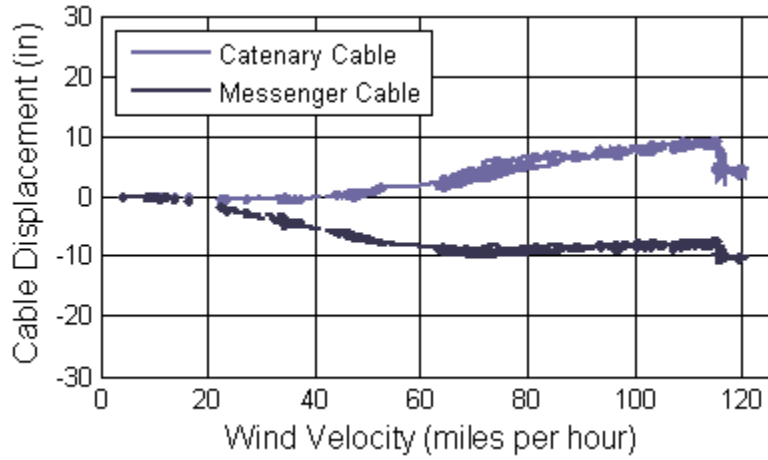

Figure C-20. Test 27: Pipe Hanger with 90° Signal and 45° Simulator Orientations (Messenger clamped to front of hanger) (Failure of Backplate at 115 mph)

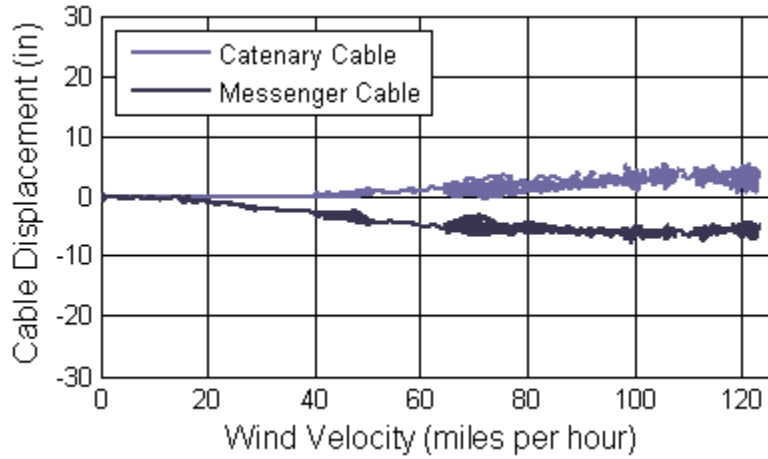

Figure C-21. Test 28: Pipe Hanger with 90° Signal and 12° Simulator Orientations

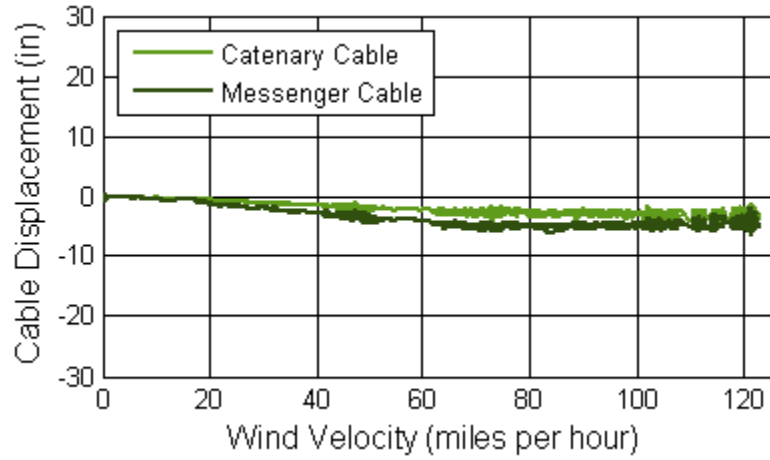

Figure C-22. Test 30: Cable Hanger with 90° Signal and 12° Simulator Orientations

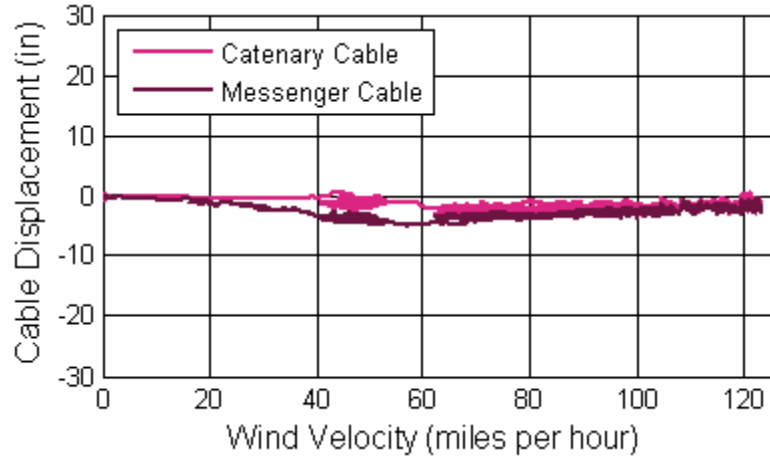

Figure C-23. Test 31: Pivotal Hanger with 90° Signal and 12° Simulator Orientations (Polycarbonate Signal)

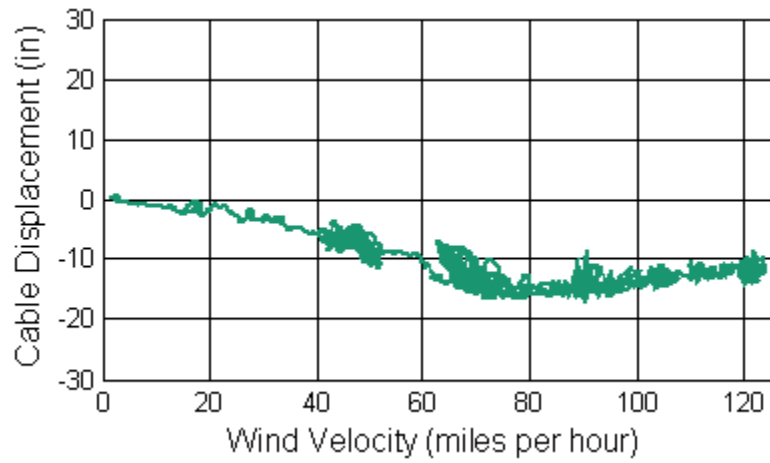





Figure C-24. Test 33: Direct Connection with 90° Signal and 12° Simulator Orientations

APPENDIX D
EQUIPMENT CATALOG

	Part: Pipe
	Manufacturer: Various
	Description: Schedule 40 aluminum; cut and threaded on site; 1.5" nominal diameter; 28" length
	Weight: 2.1 lbs
	Test Used: 1

	Part: Pipe
	Manufacturer: Various
	Description: Schedule 80 aluminum; threaded on site; 1.5" nominal diameter; 12.5" length
	Weight: 1.3 lbs
	Tests Used: 4, 9, 10, 17, 27, 28

	Part: EC 2079 & 2079-B
	Manufacturer: Engineered Castings
	Description: Span wire hanger and hardware
	Weight: 1.3 lbs
	Tests Used: 6, 13, 14, 19, 26, 30

	Part: EC 2079-S & 2079-C
	Manufacturer: Engineered Castings
	Description: Span wire hanger and hardware; modified design for cable hanger
	Weight: 1.4 lbs
	Tests Used: 6, 13, 14, 19, 26, 30

	Part: 1157-BT
	Manufacturer: Engineered Castings
	Description: Multi-eye balancer
	Weight: 1.0 lb
	Tests Used: 3, 6, 7, 8, 13, 14, 15, 16, 19, 21, 22, 26, 30, 32, 33

	Part: EC 2051-T3
	Manufacturer: Engineered Castings
	Description: Thread to tri-stud adapter
	Weight: 0.7 lb
	Tests Used: 1, 4, 9, 10, 17, 27, 28

	Part: 1900
	Manufacturer: Cost Cast
	Description: Disconnect box
	Weight: 7.0 lbs
	Tests Used: All

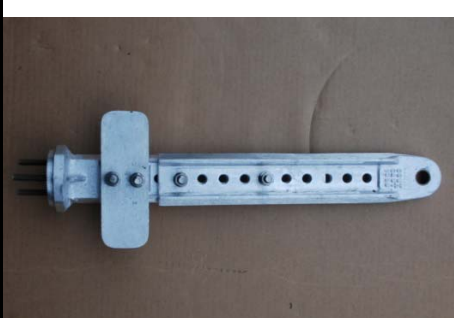
	Part: 1906
	Manufacturer: Cost Cast
	Description: Adjustable strap hanger (6" stabilizer clamp also shown in picture)
	Weight: 2.2 lbs
	Tests Used: 2, 5, 11, 12, 18, 20, 23, 24, 25, 29, 31 (Only top section was used with pivotal hanger tests)



Part: 1976
Manufacturer: Cost Cast
Description: Wire entrance fitting
Weight: 3.0 lbs
Tests Used: 1, 4, 9, 10, 17, 27, 28



Part: 8880
Manufacturer: Cost Cast and Signal Safe
Description: Pivotal assembly
Weight: 3.5 lbs
Tests Used: 2, 5, 11, 12, 18, 24, 25, 29, 31



Part: 6" stabilizer clamps
Manufacturer: Cost Cast, Engineered Castings, and Pelco
Description: Clamps messenger cable to pivotal and strap hangers
Weight: 0.7 lb
Tests Used: 2, 5, 11, 12, 18, 20, 23, 24, 25, 29, 31



Part: Cable hanger
Manufacturer: N/A
Description: 1/4" 7-wire strand cable, 4 1/4" cable clamps, 2 thimble eyes
Weight: 1.0 lb (Not including span wire hangers)
Tests Used: 6, 13, 14, 19, 26, 30



Part: Clamp
Manufacturer: Various
Description: Drop pipe cable clamp
Weight: 0.8 lb
Tests Used: 1, 4, 9, 10, 17, 27, 28

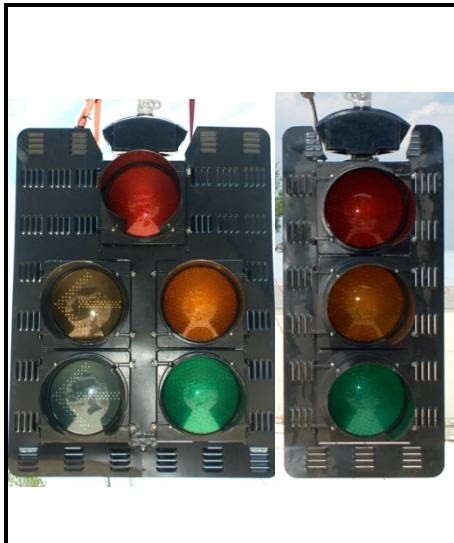

Part: Aluminum Signals assemblies
Manufacturer: Signal head: McCain (provided by Control Technologies) Signal hardware: Cost Cast LED module: Leotek
Description: 5-section cluster and 3-section assembly with louvered backplates, tunnel visors, and LED signal modules
Weight: 5-section: 73 lbs 3-section: 40 lbs
Tests Used: 5-section: 1-7, 9-21, 23, 24, 27-30, 33; 3-section: 17-21



Part: Polycarbonate signal assemblies
Manufacturer: Signal head: Econolite and McCain (provided by Control Technologies) Signal hardware: Cost Cast LED module: Dialight and Leotek
Description: 5-section cluster with louvered backplate, tunnel visors, and LED signal modules; top head constructed of aluminum and remaining heads constructed of polycarbonate
Weight: 53.5 lbs
Tests Used: 8, 22, 25, 26, 31, 32