

# EVALUATION OF THE DYNAMIC LATE LANE MERGE SYSTEM AT FREEWAY CONSTRUCTION WORK ZONES

## FINAL REPORT



**Submitted to:**  
**Michigan Department of Transportation**  
**Construction & Technology Division**  
**Lansing, MI 48909**

**Submitted by:**  
**Wayne State University**  
**Transportation Research Group**  
**Department of Civil & Environmental Engineering**  
**Detroit, MI 48202**

**September 2007**



**EVALUATION OF THE DYNAMIC LATE LANE  
MERGE SYSTEM AT FREEWAY CONSTRUCTION  
WORK ZONES**

**FINAL REPORT**

**Submitted to:**  
**Michigan Department of Transportation**  
**Construction & Technology Division**  
**Lansing, MI 48909**

**Submitted by:**  
**Wayne State University**  
**Transportation Research Group**  
**Department of Civil & Environmental Engineering**  
**Detroit, MI 48202**

**September 2007**

The opinions, findings, and conclusions expressed in this publication are those of the authors and not necessarily those of the Michigan State Transportation Commission, the Michigan Department of Transportation, or the Federal Highway Administration.

|   |  |  |           |
|---|--|--|-----------|
| 1. Report No.<br>Research Report RC-1500  | 2. Government Accession No.                        | 3. MDOT Project Manager<br>Dale Spencley   |           |
| 4. Title and Subtitle<br>EVALUATION OF THE DYNAMIC LATE LANE MERGE SYSTEM AT<br>FREEWAY CONSTRUCTION WORK ZONES   |  | 5. Report Date<br>September 2007   |           |
| 7. Author(s)<br>Tapan Datta, Catherine Hartner, and Lia Grillo  |  | 6. Performing Organization Code  |           |
| 9. Performing Organization Name and Address<br>Wayne State University – Transportation Research Group<br>Department of Civil and Environmental Engineering<br>Schaver Building, 5451 Cass Avenue, Room #208<br>Detroit, MI 48202  |  | 8. Performing Org Report No.   |           |
| 12. Sponsoring Agency Name and Address<br>Michigan Department of Transportation<br>Construction and Technology Division<br>8885 Ricks Road<br>Lansing, MI 48909   |  | 10. Work Unit No. (TRAIS)  |           |
|   |  | 11. Contract Number:<br>2002-0546/A1   |           |
|   |  | 11(a). Authorization Number:   |           |
| 15. Supplementary Notes   |  | 13. Type of Report & Period Covered<br>Final Report  |           |
|   |  | 14. Sponsoring Agency Code   |           |
| 16. Abstract<br>In normal work zones with lane closures, drivers do not merge at any one definite point, thus causing sudden interruption in traffic flow and sometimes higher delay. The dynamic late lane merge system (DLLMS) was used to identify a definite merge point, improve the flow of the congested freeway work zones and reduce queue lengths in the freeway travel lanes. During the 2006 construction season, the DLLMS was implemented on three freeway segments in southern Michigan. Each work zone segment involved a lane closure from two to one lane. Based on the travel time characteristics, queue, merge locations, and throughput, the effectiveness of the DLLMS was evaluated by the Wayne State University Transportation Research Group. Before period data was not available, so a conventional work zone merge system located on EB I-94 was used as a control site for the WB I-94 test site. Since the two I-69 test sites are approximately 150 miles away from the EB I-94 control site, the I-94 control site could not be used as a control for the I-69 sites. When comparing the I-94 control and test sites, the presence of the DLLMS improved the flow of traffic and increased the percentage of merging vehicles that merged at the taper. |  |  |           |
| 17. Key Words<br>Work zone, dynamic late lane merge system (DLLMS), zipper system   |  | 18. Distribution Statement<br>No restrictions. This document is available to the public through the Michigan Department of Transportation. |           |
| 19. Security Classification (report)<br>Unclassified  | 20. Security Classification (Page)<br>Unclassified | 21. No of Pages<br>63  | 22. Price |

## TABLE OF CONTENTS

|  | <b>Page</b> |
|--|-------------|
| EXECUTIVE SUMMARY .....                                  | ES-1        |
| 1.0 INTRODUCTION .....                                   | 1           |
| 2.0 STUDY OBJECTIVES .....                               | 2           |
| 3.0 BACKGROUND OF MERGE SYSTEMS .....                    | 3           |
| 3.1 Early Lane Merge System.....                         | 4           |
| 3.2 Zipper Merge System.....                             | 8           |
| 3.3 Late Lane Merge System in the USA .....              | 10          |
| 4.0 SITE DESCRIPTION .....                               | 17          |
| 5.0 SYSTEM DESCRIPTION.....                              | 18          |
| 6.0 DATA COLLECTION .....                                | 24          |
| 6.1 Travel Time Data .....                               | 25          |
| 6.2 Throughput and Merge Location Data .....             | 27          |
| 6.3 Queue Data.....                                      | 31          |
| 6.4 Spot Speed Data.....                                 | 32          |
| 6.5 Crash Data.....                                      | 32          |
| 7.0 DRIVER BEHAVIOR.....                                 | 38          |
| 7.1 Information Overload.....                            | 39          |
| 7.2 Sign Messages.....                                   | 41          |
| 8.0 STATISTICAL ANALYSIS .....                           | 44          |
| 8.1 Mean Travel Time Delay and Mean Speed Analysis ..... | 44          |
| 8.2 Crash Analysis .....                                 | 47          |
| 9.0 FUEL CONSUPTION AND VEHICLE EMISSIONS .....          | 49          |
| 10.0 BENEFIT-COST ANALYSIS.....                          | 51          |
| 11.0 CONCLUSIONS AND RECOMMENDATIONS .....               | 54          |
| 12.0 ACKNOWLEDGEMENTS .....                              | 61          |
| 13.0 REFERENCES .....                                    | 61          |
| APPENDIX I – AVERAGE MERGE VOLUMES .....                 | I-1         |
| APPENDIX II – CALCULATIONS .....                         | II-1        |
| APPENDIX III – STATISTICAL TABLES .....                  | III-1       |
| APPENDIX IV – TRAFFIC FLOW CHARACTERISTICS .....         | IV-1        |

## LIST OF FIGURES

|   | <b>Page</b> |
|---|-------------|
| Figure 1. Lane Merge Traffic Control System Used by INDOT .....   | 5           |
| Figure 2. Michigan’s DELMTCS Implemented on Two Lane Freeways (Each Direction)<br>Reduced to One Lane During Construction.....    | 6           |
| Figure 3. Michigan’s DELMTCS Implemented on Three Lane Freeways (Each Direction)<br>Reduced to Two Lanes During Construction..... | 7           |
| Figure 4. Zipper Method Merge Sign Used in Germany .....  | 8           |
| Figure 5. Zipping Traffic Control System Used by the Netherlands.....   | 9           |
| Figure 6. Zip Merging Traffic Control System Used by the United Kingdom.....  | 11          |
| Figure 7. Late Lane Merge Traffic Control System Used by PennDOT .....  | 12          |
| Figure 8. Late Lane Merge Traffic Control System Used by Virginia.....  | 13          |
| Figure 9. Dynamic Late Lane Merge Traffic Control System Used by MSHA .....   | 15          |
| Figure 10. Dynamic Late Lane Merge Traffic Control System Used by TxDOT .....   | 16          |
| Figure 11. PCMSs Used in the Advance Warning Area.....  | 18          |
| Figure 12. Traffic Control Plan for the EB I-69 Test Site .....   | 20          |
| Figure 13. Traffic Control Plan for the WB I-69 Test Site .....   | 20          |
| Figure 14. Traffic Control Plan for the WB I-94 Test Site.....  | 22          |
| Figure 15. Traffic Control Plan for the EB I-94 Control Site.....   | 23          |
| Figure 16. Collision Diagram for the EB I-94 Control Site (4/24/06 – 7/16/06).....  | 33          |
| Figure 17. Collision Diagram for the WB I-94 Test Site (7/17/06 – 10/9/06).....   | 34          |
| Figure 18. Collision Diagram for the EB & WB I-69 Test Sites (4/17/06 – 11/3/06).....   | 35          |
| Figure 19. Information Load Diagram for the EB I-69 Test Site (70 MPH) .....  | 40          |
| Figure 20. Information Load Diagram for the WB I-69 Test Site (70 MPH) .....  | 40          |
| Figure 21. Information Load Diagram after Spreading for the EB I-69 Test Site (70 MPH) .....                                      | 42          |
| Figure 22. Information Load Diagram after Spreading for the WB I-69 Test Site (70 MPH) .....                                      | 42          |
| Figure 23. Comparative Parallel Evaluation Plan.....  | 44          |
| Figure 24. Poisson Curve with Calculated Values.....  | 48          |
| Figure 25. B/C Ratio versus Value of Travel Time Savings .....  | 54          |
| Figure 26. Recommended Traffic Control Plan with the DLLMS ON .....   | 60          |
| Figure 27. Recommended Traffic Control Plan with the DLLMS OFF.....   | 60          |

## LIST OF TABLES

|  | <b>Page</b> |
|--|-------------|
| Table ES-1. Comparison of Traffic Operational Characteristics for the I-94 Control and<br>Test Sites ..... | ES-6        |
| Table 1. Annual Daily Traffic for the Work Zone Sites .....  | 18          |
| Table 2. Drive-Through Data for I-69 (Test Sites) .....  | 26          |
| Table 3. Drive-Through Data for WB I-94 (Test Site) .....  | 26          |
| Table 4. Drive-Through Data for EB I-94 (Control Site) .....   | 27          |
| Table 5. Average Approach Volume for the I-69 Test Sites .....   | 28          |
| Table 6. Average Percent of Merges by Distance from Taper for the I-69 Test Sites.....                     | 28          |
| Table 7. Average Approach Volumes for the WB I-94 Test Site.....   | 29          |
| Table 8. Average Percent of Merges by Distance from Taper for the WB I-94 Test Site.....                   | 29          |
| Table 9. Average Approach Volumes for the EB I-94 Control Site .....                                       | 30          |
| Table 10. Average Percent of Merges by Distance from Taper for the EB I-94 Control Site.....               | 30          |
| Table 11. 95 <sup>th</sup> Percentile Queue Data for each Study Site.....                                  | 31          |
| Table 12. Summary of I-94 Spot Speed Data .....  | 32          |
| Table 13. Crash Data for the I-94 Control and Test Sites.....  | 36          |
| Table 14. Crash Data for the I-69 Test Sites.....  | 37          |
| Table 15. Comparison of ADT .....  | 37          |
| Table 16. Crash Rates for the I-94 Control and Test Sites .....  | 38          |
| Table 17. Crash Rates for the I-69 Test Sites .....  | 38          |
| Table 18. Data for Mean Travel Time Delay and Speed Statistical Analysis .....                             | 45          |
| Table 19. Results of Mean Travel Time Delay and Mean Travel Speed Statistical Analysis.....                | 46          |
| Table 20. Crash Data Used for Statistical Analysis.....  | 47          |
| Table 21. Comparison of the Fuel Consumption for the Control and Test Sites .....                          | 50          |
| Table 22. Comparison of the Vehicle Emissions for the I-94 Control and Test Sites.....                     | 51          |
| Table 23. Total Monetary Benefits of the DLLMS for I-94 .....  | 53          |
| Table 24. Total Cost of the DLLMS .....  | 53          |
| Table 25. Comparison of Traffic Operational Characteristics for the I-94 Control and<br>Test Sites.....    | 55          |

## **EXECUTIVE SUMMARY**

### **INTRODUCTION**

The late lane merge system is used to locate a definite merge point near the taper area and improve the flow of the congested freeway in work zones and reduce queue lengths in the freeway travel lane. The Dynamic Late Lane Merge System (DLLMS) directs traffic to stay in their lane until the designated ‘merge point’ located close to the taper. When there is congestion in the open lane, the dynamic signs are activated to advise drivers to “Use Both Lanes to the Merge Point”, thus achieving improved traffic flow and reduced queue. Once the congestion dissipates, the signs are deactivated to allow drivers to travel through the work zone using a traditional merge system (merge when safe to do so).

The DLLMS was implemented at three freeway segments in the State of Michigan during the construction season of 2006. Since this system is new in the State of Michigan, a project was initiated by the Michigan Department of Transportation (MDOT) to study and evaluate the effectiveness of such a system in terms of its capability in reducing delay at the merge point, queue during congested conditions, driver understanding and compliance of the system, as well as increasing the number of vehicles through the work zone.

### **SITE DESCRIPTION**

The DLLMS was implemented and tested at three freeway work zones during the 2006 construction season including eastbound and westbound I-69 in Shiawassee and Genesee Counties, and westbound I-94 in Kalamazoo and Van Buren Counties.

Each of the noted work zones included a left lane closure during the observed construction periods from a two-lane to a one-lane freeway section. The DLLMS was deployed at the same time the work zone was set up at each test site; therefore, a separate site was needed for use as a control to compare the effectiveness of the system. The eastbound direction of the freeway work zone on I-94 in Kalamazoo and Van Buren Counties was used as the control site. This work

zone also included a left lane closure on a two-lane (one direction) freeway section and consisted of the traditional freeway work zone traffic control set up.

## **SYSTEM DESCRIPTION**

The DLLMS consists of the traditional freeway work zone traffic control devices, along with sensors, Portable Changeable Message Signs (PCMSs), and a Master Controller for communication. There are three PCMSs located in advance of the taper section that display relevant messages based on real-time traffic speed and flow characteristics. When there is congestion in the open lane, the system is activated and the PCMSs display appropriate messages to the drivers to use both lanes prior to the lane closure and to merge at the taper by taking turns. During times of low congestion, the system turns OFF and the traditional merge system goes into effect allowing vehicles to merge at any time prior to the taper when it is safe to do so. Even though the system is off, the PCMSs still provide general messages to the freeway users.

Multiple sensors are used in this system to recognize congestion levels. A Remote Traffic Microwave Sensor (RTMS) is located approximately 1,500 feet upstream from the taper and a Doppler radar is located at the taper. The RTMS measures the average speed of the cars traveling in both lanes and the aggregate volume, while the Doppler radar measures speed. These readings are reported every 30 seconds and are used as the trigger parameters for the PCMSs. The PCMSs are activated when the average speed is less than the trigger speed (35 mph or 45 mph) for a period of five minutes. It remains activated until the average speed exceeds the trigger speed for a five-minute period. The I-69 test sites used a trigger speed of 45 mph, while the I-94 test site reduced the trigger speed to 35 mph.

When the DLLMS was ON at the I-69 test sites, the PCMSs for each direction displayed the following messages:

- PCMS 1 (furthest from taper): STOPPED TRAFFIC AHEAD / USE BOTH LANES
- PCMS 2: USE BOTH LANES / STAY IN YOUR LANE
- PCMS 3: TAKE YOUR TURN / MERGE HERE



When the DLLMS was OFF at the I-69 test sites, the PCMSs for each direction displayed the following messages:

- PCMS 1 (furthest from taper): DRIVE SAFELY / WORK ZONE AHEAD
- PCMS 2: DRIVE SAFELY / MERGE 2 MILES AHEAD
- PCMS 3: DRIVE SAFELY / 45 WHERE WORKERS PRESENT

In addition to the typical work zone advance lane closure signs and the PCMSs, the normal static signs, “TRUCKS USE RIGHT LANE”, were also used at the I-69 test sites. This sign was installed in order to help reduce the number of commercial motor vehicles that block and straddle lanes to prevent other vehicles from passing and merging at the taper.

The DLLMS on WB I-94 consisted of six PCMSs. Three of the PCMSs were required as a part of the system (PCMS 3, 5, & 6); the other three (PCMS 1, 2, & 4) were not required, but did display additional information about the DLLMS to the drivers. When the DLLMS was ON, the PCMSs displayed the following messages:

- PCMS 1 (furthest from taper): NEW MERGE SYSTEM / FROM MATTAWAN EXIT
- PCMS 2: DRIVE WITH CARE / LANE CLOSED AHEAD
- PCMS 3: SLOW TRAFFIC AHEAD / USE BOTH LANES
- PCMS 4: ONE LANE OPEN / 7/17/06 THRU 10/15/06
- PCMS 5: USE BOTH LANES / STAY IN YOUR LANE
- PCMS 6: TAKE YOUR TURN / MERGE HERE

When the DLLMS was OFF, the PCMSs displayed the following messages:

- PCMS 1 (furthest from taper): NEW MERGE SYSTEM / FROM MATTAWAN EXIT
- PCMS 2: DRIVE WITH CARE / LANE CLOSED AHEAD
- PCMS 3: LEFT LANE CLOSED / 2.5 MILES AHEAD
- PCMS 4: ONE LANE OPEN / 7/17/06 THRU 10/15/06
- PCMS 5: LEFT LANE CLOSED / 1.5 MILES AHEAD
- PCMS 6: DRIVE WITH CARE / LEFT LANE CLOSED

For the control site located on EB I-94, typical static work zone signs and other traffic control devices were used at this work zone informing drivers that the left lane was closed and they were required to merge right. One PCMS was included in this work zone traffic control plan four miles west of the taper that displayed the message, “AVOID BACKUPS / START MERGING RIGHT”.

## **DATA COLLECTION**

Several members from the WSU-TRG collected data at the test and control sites on weekdays during peak and off-peak periods throughout the daylight hours. The data collection included travel time, number of stops, volume, queue, merge locations, spot speed, and crashes.

The floating car method was used to collect travel time data by driving through the advanced warning area multiple times during peak and off peak periods. The travel time through the advanced warning segment was recorded from the first PCMS to the arrow board located near the taper. The number of times the floating car was forced to stop due to traffic congestion was recorded and the status of the system was also noted. From this data, the average travel speed and delay per vehicle were calculated. The average delay was calculated by subtracting the actual travel time from the expected travel time with the expected travel time being the travel distance times the posted speed limit.

The work zone traffic characteristics and vehicular merge locations were recorded using a digital video camera from an overpass in the proximity of the work zone. The video recording was done during the same time periods as the travel time runs were made. The number of vehicles entering the work zone was extracted from the video in increments of five minutes. This data was used to determine the throughput (vehicles per hour). The commercial vehicles and the passenger vehicles were counted separately from the videos for all time periods of the study. Queue data was also collected from the overpasses. Two designated persons counted and recorded the queue length, number of vehicles in a queue, every minute during the study periods in both the open and closed lanes. One person counted and recorded the number of vehicles in a queue in the open lane and the other person recorded the number of vehicles in a queue in the closed lane in one-minute time intervals. Vehicles were considered to be in a queue when their speed was less than five miles per hour.

Speed data was collected at the I-94 control and test sites using a radar gun at two different locations. The speed study locations included one in the advanced warning area and one at the taper for both the I-94 control and test sites. Also, crash data was collected and analyzed for the control site and test sites. The 2006 UD-10 crash report forms were downloaded from the Michigan Department of Transportation's online database for each crash located within the advance warning area through the end of the work zone.

### **STATISTICAL ANALYSIS**

A statistical analysis was performed in order to quantify the differences in the measures of effectiveness (MOEs), which are attributable to the installation of the DLLMS. The measures of effectiveness included the mean travel time delay, the mean travel speed and the crash frequencies. The t-test was used to determine if there is a significant difference in mean travel time delay and mean travel speed. It was found that there is a statistically significant difference in the mean travel time delay and mean travel speed between the I-94 control site (without the DLLMS) and the I-94 test site (with the DLLMS) at a 95 percent level of confidence.

Since crash frequency is a discrete function, the t-test could not be used to calculate the statistical significance of the difference between crash frequencies of the I-94 control and test sites, so the Poisson Test of significance was used. It was found that there is no statistical significance in change in crash frequencies between the I-94 control and test sites.

### **BENEFIT-COST ANALYSIS**

A benefit-cost (B/C) analysis was performed as a part of this study in order to determine the economic viability of the DLLMS in a freeway construction work zone in Michigan. The data used for the analysis is based on the data collected at the EB I-94 control site and the WB I-94 test site. The benefit was considered as travel time savings and fuel consumption savings due to the installation of the DLLMS. Various values of time were used to determine the benefits due to travel time savings in the form of a sensitivity analysis. The total cost of installing and operating the DLLMS on WB I-94 was considered as the cost in the economic analysis.

The B/C ratios were calculated based on the values of the benefits. Since the calculated change in crash frequency was not statistically significant, this difference was not considered in the B/C analysis. Also, since the DLLMS was implemented for a short duration of time (less than a year), the economic analysis was calculated as the direct ratio of the benefits over the costs. It was found that for a value of time for travel time savings greater than approximately \$4.85/hour, the benefit to cost ratio will be greater than one, indicating that the monetary benefits of the DLLMS at WB I-94 outweigh the cost of the system. If such systems are used in freeways with higher peak period traffic volumes and for longer periods of time, the savings of travel time, fuel consumption and air pollution will be much higher thus, making the use of such a system more economically viable.

## CONCLUSIONS

The conclusions for the DLLMS, as tested in Michigan during the 2006 construction season, include a comparison of the test and control sites for congested periods. The DLLMS was implemented at three sites, which include WB I-94, EB I-69, and WB I-69; however, only the I-94 control and test sites are truly comparable due to the similarities of the sites and the area in which they were located. Table ES-1 shows a comparison of the traffic operational data for the congested period for the I-94 control and test sites. As shown in Table ES-1, the presence of the DLLMS improved the flow of travel and increased the percent of merging vehicles at the taper during congested periods thus, fulfilling the objective of the system.

**Table ES-1. Comparison of Traffic Operational Characteristics for the I-94 Control and Test Sites**

| Description (Congested PM Peak)                  | Control Site  | Test Site   |
|--|---------------|-------------|
|  | EB I-94       | WB I-94     |
| Avg. Travel Time (sec/10,000 ft/veh) (Pre-taper) | 272.44        | 167.46      |
| Avg. Travel Speed (mph) (Pre-taper)              | 29.5          | 47.57       |
| Avg. No. of Stops per 10,000 ft/veh (Pre-taper)  | 1.89          | 1           |
| Avg. Delay (sec/10,000 ft/veh) (Pre-taper)       | 181.25        | 67.58       |
| *Avg. Total Throughput (vph)                     | 990 (269)     | 1207 (172)  |
| *Avg. % of Merges at the taper                   | 49.15 (53.33) | 66.0 (74.1) |
| *Avg. % of Merges prior to the taper             | 50.85 (46.67) | 34.0 (25.9) |

\*Note: Total of all vehicles (Commercial motor vehicles only)

It was found that there is a statistically significant difference in mean travel time delay and mean travel speed between the test and control sites; however, there is no statistically significant difference in traffic crash experience between the test and control sites.

Typically, there is an increase in crash experience due to situations created by the existence of work zones, however, the increase often varies between locations and is not always consistent. The crash data that was presented in this report was for a very short period of time and for only one project. In order to have a better understanding of the effect of the DLLMS on crash reduction, the crashes should be monitored more closely and at multiple sites.

The amount of time that the system was operating was very low, which is primarily due to low traffic volumes at the chosen study sites. It was found that when considering a value of time greater than \$4.85/hour, the benefit to cost ratio will be greater than one, therefore, the benefits of the system outweigh the costs of the system. It is anticipated that the use of the DLLMS at higher volume freeway work zones is expected to yield higher road user and societal benefits.

The DLLMS trigger speed was set at 45 mph for the I-69 test sites and 35 mph for the I-94 test site. When comparing operations of the two work zones, it was found that a larger percentage of vehicles merged closer to the taper at the I-94 test site when the trigger speed was lower. Therefore, the lower the system's trigger speed, the higher the system's conformance will be. However, in such situations, the amount of time the system will be ON is dependent on the traffic volume and peak hour congestion.

- a. The system at the I-69 test sites operated with a trigger speed of 45 mph. The I-69 test sites with the DLLMS ON recorded the following average merge percentages during the congested PM peak hours:
  - i. 54.17% within 500 feet from the arrow board
  - ii. 45.83% greater than 500 feet from the arrow board
  
- b. The DLLMS at the I-94 test site operated with a trigger speed of 35 mph. The average merge percentages during the congested PM peak hours at the I-94 test site with the DLLMS ON are as follows:
  - i. 66.0% within 500 feet from the arrow board
  - ii. 34.0% greater than 500 feet from the arrow board

At the I-69 test sites, the PCMS was placed 500 feet prior to the arrow boards and at the WB I-94 test site, this distance was 1,500 feet. As shown in the above data, there was a higher compliance of drivers merging at the taper at the WB I-94 test site than at either of the I-69 test sites.

## **RECOMMENDATIONS**

Recommendations for future implementation of the DLLMS are as follows:

1. The DLLMS may be implemented in highway construction zones with the closure of one lane out of two travel lanes in one direction. It may be possible to use DLLMS treatment on a highway with a lane closure involving three lanes to two lanes; however, a pilot study may be necessary to determine the effectiveness and the guidelines for using the system for this scenario. Conceptually, use of the DLLMS for a three lane to two lane work zone should also be beneficial to road users.
2. The DLLMS should be used at locations where the highway experiences moderate to high congestion prior to construction because the system works best when congestion occurs. Recommendations are given based on the level of service determined by using the Highway Capacity analysis, traffic flow (shown in Appendix IV) and the performance of the system observations at the I-69 and I-94 work zone test sites. During the congested peak periods, the highest observed average throughput volume was approximately 1,200 vehicles per hour (vph). This shows that the traffic volumes should be at least 1,200 vph in order for the DLLMS system to be operating. Pre-construction traffic volumes on a given highway should be slightly higher than during the construction period, since some drivers often choose to take alternate routes to avoid a construction zone. Because of this, it is recommended that pre-construction traffic volumes be at least **1,800 vph**, per direction, for at least two hours per day and an ADT of at least **22,500 vehicles per day**, per direction. By using the DLLMS at a site with these criteria, the DLLMS will provide improvements in travel time delay and travel speed.
3. Both the early and late lane merge systems were developed for high volumes on freeways that often experience congestion. Prior to construction, the recommended ADT and peak

hour volumes are very similar for the two lane merge systems. For a two to one lane reduction, the **early lane merge system** recommends the following traffic volumes:

- a. Directional ADT: **21,500 to 34,500 vehicles per day**, per direction
- b. Average weekday AM and/or PM peak period volumes prior to construction (2 peak hours per day): **2,000 to 3,000 vehicles per hour**, per direction (3)

It is recommended to use either the late lane merge or the early lane merge system (**not both**) when traffic congestion is experienced in the freeway system. Either system should operate in a default mode (merge when safe to do so) when there is no congestion. The late lane merge system is recommended for use in urban congested freeways when the goal is to minimize delay and queue length in the work zones. Whereas, the early lane merge system is recommended for use in rural congested areas in freeway work zones when the queue length is not an issue and a reduction of delay and aggressive driver action is desired. The early lane merge system requires police enforcement to ensure compliance to the designated no passing zone. Both systems require the existence of high peak period traffic volumes to be effective.

4. Since the system is still relatively new, a media campaign should accompany the implementation of the DLLMS to educate drivers on the purpose and benefits of the system. Emphasis should be made that merging early is **NOT** a Michigan law. It has been common practice in the past, but is not a law. Other countries in Europe use large static signs to explain the ‘zipper’ system. The Michigan Department of Transportation should consider such static informational signs.
5. The Highway Advisory Radio (HAR) station may be used to inform drivers about the work zone and the DLLMS. A static sign may be added to the traffic control plan to advise drivers to tune into the proper station for information about the work zone. Depending on the length of the HAR message, the first sign advising drivers to tune into the proper station should be located far enough so that drivers can turn the station on and listen to the entire message at least once prior to entering the advance warning area. The

HAR could also give real-time information about the work zone to the drivers (e.g. whether congestion is present ahead).

6. The layout of the system should include four PCMSs and the typical lane closure static signs. Two PCMSs should be located near the taper (one on each shoulder) in order to allow drivers in either lane to see the message even if a large vehicle is in front of them. The DLLMS can be used for a right lane or left lane closure; therefore, the messages on the signs should appropriately match with the lane closure. Also, a static sign reading “Trucks Use Right Lane” or “Trucks Use Left Lane”, depending on which lane remains open, should be provided to inform truck drivers to travel in the open lane. By providing this sign, it will avoid having truck drivers block other vehicles from using the closed lane and merging at the taper. The recommended layout is shown in Figures 26 and 27, respectively, for the system ON and OFF positions. The spacing of the signs should follow as shown in Figures 26 and 27. The tapers in the advanced warning area should not be located near entrance ramps or exit ramps.
7. The MMUTCD states that for freeway applications of PCMS, “No more than two displays should be used within any message cycle.” (21) It is recommended to incorporate an arrow on the same display panel as “Merge Here” in order to possibly increase the merge compliance at the taper. This type of display was designed for the early merge system used in Michigan during the 2003 construction season. The PCMSs should display the following messages when the system is ON:
  - PCMS 1 (furthest from taper): SLOW TRAFFIC AHEAD / USE BOTH LANES
  - PCMS 2: STAY IN YOUR LANE / MERGE AHEAD XX MILES
  - PCMS 3 & 4: TAKE YOUR TURN / MERGE HERE

When the system is OFF, or operating in the default mode, the PCMSs should display the following messages:

- PCMS 1 (furthest from taper): \*DRIVE WITH CARE / WORK ZONE AHEAD
- PCMS 2: LEFT (or RIGHT) LANE CLOSED / XX MILES AHEAD
- PCMS 3 and 4: LEFT (or RIGHT) LANE CLOSED



\*If the HAR is used with the DLLMS, the default messages could incorporate the HAR. If the HAR only explains how to use the DLLMS, the recording may not be relevant to the current situation (e.g. no congestion). However, if the HAR incorporates real-time information, as well as the system explanation, it would be more relevant. If the default message incorporates HAR, the PCMSs should read “Tune to XX” instead of “Drive With Care”, where XX refers to the radio station.

8. The sensor should be located at PCMS 3 so that it can read the correct speed of the vehicles and the volume right by the taper. The DLLMS trigger speed should be set at 35 mph in order to have greater conformance to the system by drivers.

## **1.0 INTRODUCTION**

Maintaining safety and mobility in highway construction work zones is of major concern for construction workers, road users, and highway agencies. Work zones often require alignment changes, narrower travelways and lane closures thus, creating a driving environment with a heightened risk of traffic crashes and congestion. The majority of work zone related traffic crashes occur at a lane closure area. The congestion in a work zone often starts at the beginning of the lane drop area and extends backward to create long waiting lines. In a normal work zone, drivers do not merge at any one specific point, instead the traffic in the closed lane(s) merges into the open lane as they feel comfortable thus, causing a sudden interruption in the through traffic flow that causes higher delays. Some drivers demonstrate aggressive driving behavior while merging, thereby causing safety hazards. Following a discipline in the merging behavior at highway work zone related lane closures improves the quality of flow and reduces the risk of traffic crashes and injuries. In order to achieve such merging discipline, highway safety professionals, over the past decade, have tested several treatments including the early lane merge system and the late lane merge system.

The early lane merge system directs drivers to merge far ahead of the taper in highway work zones by creating a longer no passing zone. Early merging often reduces traffic crash risk and achieves smoother traffic flow at the taper. Such traffic control sometimes increases the length of queue and requires enforcement to eliminate passing and merging into the open lane in the lane closure area. The “Dynamic Early Lane Merge Traffic Control System (DELMTCS)” was tested in Michigan in January of 2004 on a 15-mile stretch of Interstate-94 (I-94). During the peak traffic periods, the DELMTCS at the I-94 test site advised vehicles to change lanes at the beginning of congestion, a significant distance away from the taper. The DELMTCS consisted of three static and five dynamic “Do Not Pass” signs to create a longer no passing zone and minimize late lane merges, aggressive driver behavior, and delay at the lane closure area. The signs were equipped with sensors to monitor traffic characteristics and create a variable no passing zone based on the level of congestion.

The late lane merge system is used to locate a definite merge point near the taper area and improve the flow of the congested freeway in work zones and reduce queue lengths in the

freeway travel lanes. The Dynamic Late Lane Merge System (DLLMS) directs traffic to stay in their lane until the designated 'merge point' located close to the taper. When there is congestion in the open lane, the dynamic signs are activated to advise drivers to "Use Both Lanes to the Merge Point" thus, achieving improved traffic flow and reduced queue. Once the congestion dissipates, the signs are deactivated to allow drivers to travel through the work zone using a traditional merge system (merge when safe to do so).

The DLLMS was implemented at three freeway segments in the State of Michigan during the construction season of 2006. Since this system is new in the State of Michigan, a project was initiated by the Michigan Department of Transportation (MDOT) to study and evaluate the effectiveness of such a system. This report describes in detail the DLLMS, the evaluation that took place and the findings of the study.

## **2.0 STUDY OBJECTIVES**

MDOT decided to install and evaluate the effectiveness of the Dynamic Late Lane Merge System (DLLMS) during the construction season of the year 2006. The test sites for the DLLMS were solicited from multiple construction projects planned for the state freeway system. Two different freeway locations in Michigan were selected for DLLMS installation. The WSU-TRG became involved in the project to study the system's applicability and effectiveness to work zone safety and improvements in traffic flow after the implementation of the first DLLMS system on I-69 near Flint. The objectives of the WSU-TRG study were to perform an evaluation of the effectiveness of the DLLMS in freeway construction work zones in Michigan. The following is a list of the specific study objectives:

- Conduct a state-of-the-art literature review with respect to Dynamic Late Lane Merge Systems in terms of their use, effectiveness and application.
- Review functional aspects of the Dynamic Late Lane Merge System (DLLMS).
- Perform an evaluation of the I-69 Dynamic Late Lane Merge System in the field to determine if any modifications to the system are necessary that would improve driver performance and effectiveness of the system.

- Evaluate the effectiveness of the Portable Changeable Message Signs (PCMS) and various messages used in the Dynamic Late Lane Merge System and determine which set of messages are effective in achieving the system goals.
- Recommend messages to be displayed on the PCMSs and appropriate sign distances for use at the I-94 test site.
- Evaluate the use of a dynamic late lane merge system through a comparative parallel study using a control and a test site.
  - Review geometric characteristics of the test site at a multi-lane freeway (I-94) segment in Shiawassee County and Van Buren County.
  - Identify and select an appropriate control site that exhibits similar geometric and traffic flow characteristics as the test site. The control site will have normal static work zone traffic control treatments.
  - Collect and analyze traffic crash data for the test and control sites.
  - Determine the effectiveness of the use of the late lane merge system in preventing targeted crash types.
  - Evaluate the traffic throughput, travel time and delay.
- Provide the results to MDOT for their use in establishing future plans involving the use of the Dynamic Late Lane Merge System in the State of Michigan.
- Evaluate the potential for expanding the Dynamic Late Lane Merge System into a combined early lane merge/late lane merge.

In this study, three test sites and one control site are examined in order to evaluate the effectiveness of the DLLMS, in terms of its capability in reducing delay at the merge point, queue during congested conditions, driver understanding and compliance of the system, as well as increasing the number of vehicles through the work zone.

### **3.0 BACKGROUND OF MERGE SYSTEMS**

As a part of this project, a literature review was performed for lane merge traffic control systems used in work zone lane closures, in order to assess the experiences of the ‘early’ lane merge and the ‘late’ lane merge systems tested in other states. These two systems are very different in that they operate under completely opposite assumptions. The concept of the dynamic ‘early’ lane

merge system was initiated by the Indiana Department of Transportation (INDOT). Modified versions of INDOT's system were also developed and tested by MDOT on two-lane and three-lane (each direction) freeways in Michigan. Other countries including Germany, the Netherlands, and the United Kingdom have used their own version of the 'late' merge system known as the 'zipper' merge system. The Pennsylvania Department of Transportation (PennDOT) initiated and tested the 'late' lane merge system on two-lane (each direction) freeways in the United States. A 'late' lane merge system was also tested on an arterial road work zone in Virginia. Dynamic versions of the 'late' lane merge system were deployed in Kansas, Minnesota, Maryland and Texas. The characteristics of these systems are discussed in the following subsection of this report.

### **3.1 Early Lane Merge System**

The early lane merge traffic control system tested by INDOT (1,2) creates an enforceable no passing zone using a series of "Do Not Pass/When Flashing" signs in advance of the lane closure area to encourage drivers to merge early. This traffic control system was designed to create a smooth and uniform flow of traffic as the vehicles proceed through the taper area. Traffic volumes and occupancy are monitored by sensors on the installed dynamic signs. A signal is transmitted to the next upstream dynamic no passing sign to activate the sign's flashing signal when the traffic density is high and congestion and traffic backups are detected. In this early merge system, the principal warrant for the dynamic system's use is the presence of congestion. If the congested segment is longer than approximately two miles, this system is recommended by INDOT. The sign spacing between any two dynamic signs is a minimum of 500 feet and is based on the time and distance necessary for a driver to respond to any one of the signs. INDOT recommends a signing system using three static "Do Not Pass" signs and a range of two to six dynamic signs based on the length of the congestion, as shown in Figure 1.

One advantage of the INDOT system is that aggressive driver behavior can be altered through the work zone by citing violators for improper driving actions due to an enforceable no passing zone in the construction areas. A safer environment for drivers and construction workers can be provided by mitigating aggressive driver behavior.

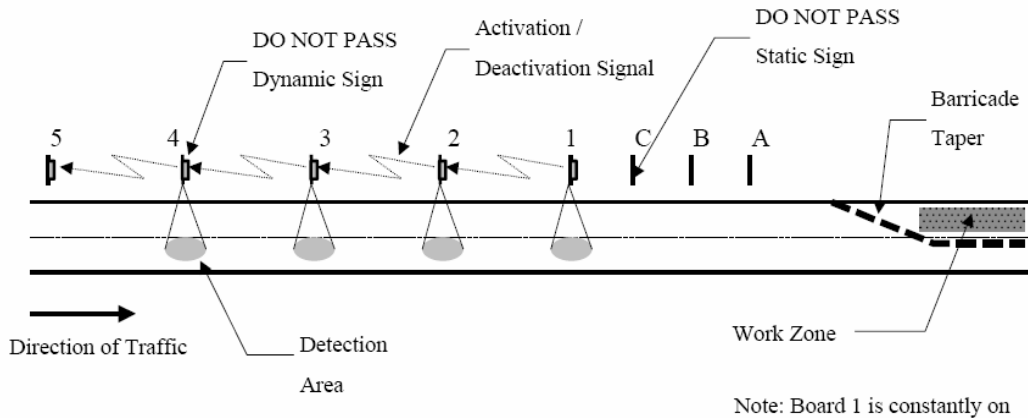
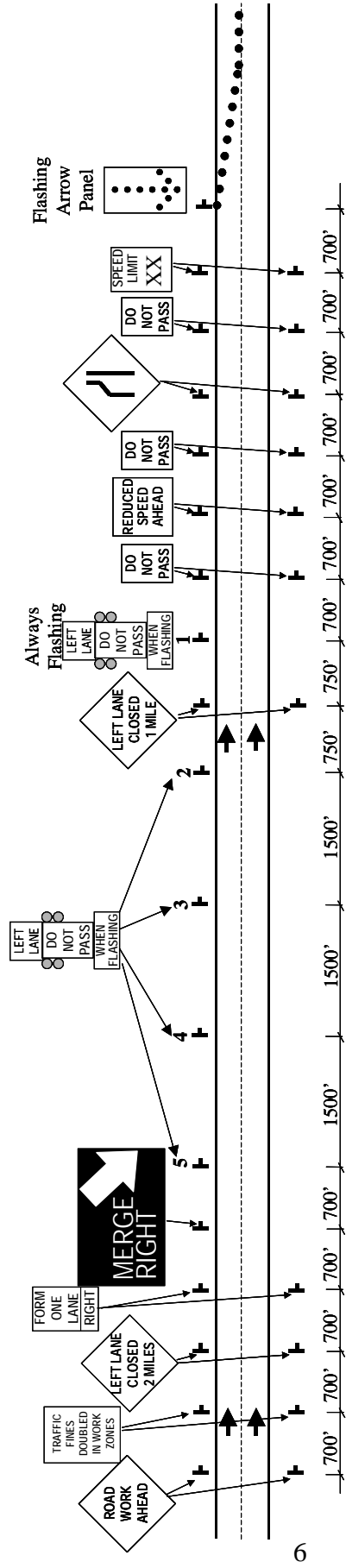

**Figure 1. Lane Merge Traffic Control System Used by INDOT**  
 [Source: Manual of the Indiana Lane Merge Control System- Final Report (1)]

The Michigan Dynamic Early Lane Merge Traffic Control System (DELMTC) (3,4) for both two-lane to one-lane and three-lane to two-lane closures is similar to INDOT’s system and consists of traditional work zone traffic control devices along with a system of three static and five dynamic “Do Not Pass” signs. This system is used to create an enforceable no passing zone and minimize forced lane merges, aggressive driver behavior and delay at the taper area. The site layouts developed and tested in Michigan for two-lane to one-lane and three-lane to two-lane closures are shown in Figures 2 and 3, respectively.

Five dynamic “Do Not Pass/When Flashing” signs are mounted on the sign trailers along with the sensors that can detect and monitor traffic volumes and occupancy. Once traffic slowdowns are detected, the next upstream “Do Not Pass/When Flashing” signs are set to change into the flashing mode; thus, increasing the length of the enforceable no passing zone when congestion on the freeway increases. This prompts drivers to change lanes even earlier, in comparison to the low traffic volume condition where only the sign trailer closest to the taper area is in the flashing mode, by default.

The spacing between the static traditional warning signs is 700 feet. Between the dynamic signs, a distance of 1,500 feet was determined desirable as a result of a driver behavior and human factor analysis. A changeable message sign with text ‘Merge Right’ (or ‘Merge Left’), with an arrow symbol, was also included in the traffic control plan tested in Michigan freeways.



(b) Phase II for a Left Lane Closure

**Figure 2. Michigan's DELMTCS Implemented on Two Lane Freeways (Each Direction) Reduced to One Lane During Construction**  
**[Source: Development and Evaluation of the Lane Merge Traffic Control System at Construction Work Zones (3)]**

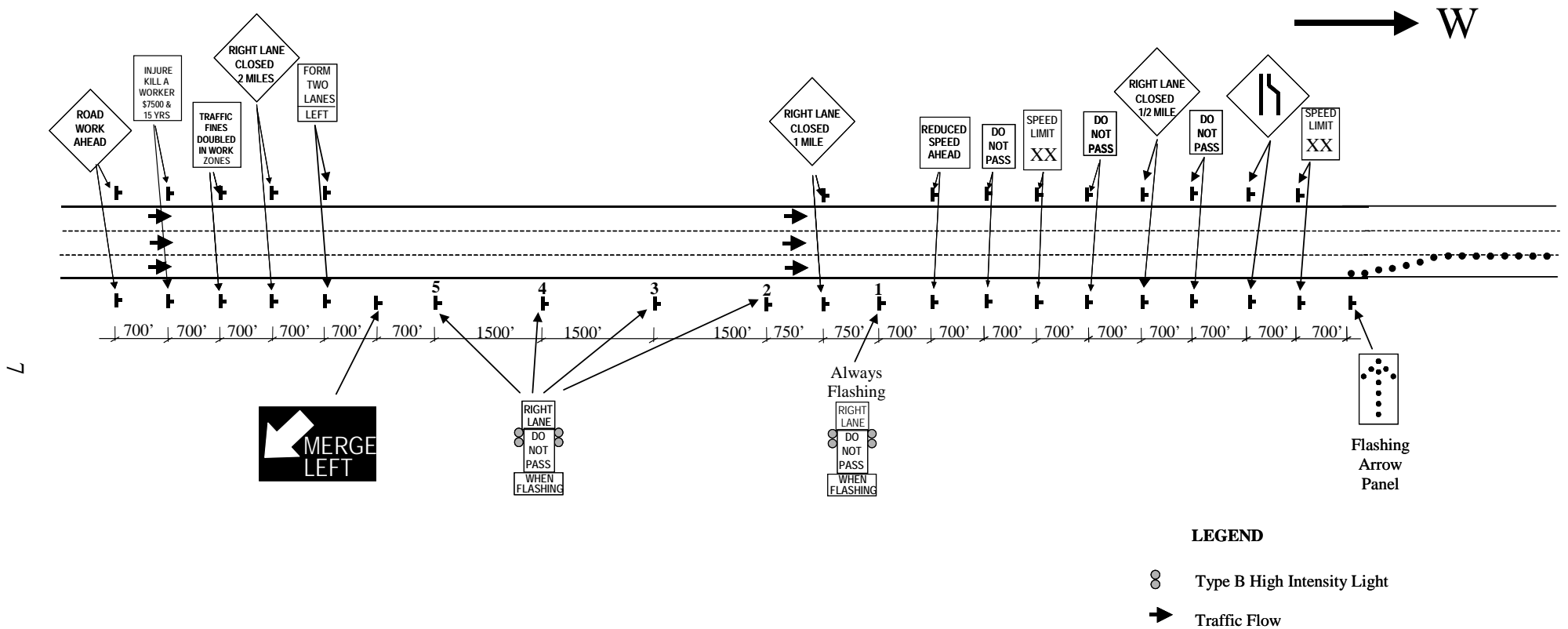

**Figure 3. Michigan's DELMTCS Implemented on Three Lane Freeways (Each Direction) Reduced to Two Lanes During Construction**  
 [Source: Development and Evaluation of an Advanced Dynamic Lane Merge Traffic Control System for 3 to 2 Lane Transition Areas in Work Zones (4)]



### 3.2 Zipper Merge System

Several other countries use a system that is similar to the 'late' lane merge system used in the United States. Germany, the Netherlands, and the United Kingdom use a zipper merge system in highway work zones. It is called the zipper merge system, because the vehicles behave in a way that is similar to a zipper. When there is a lane closure, the vehicles are expected to take turns merging at the taper just like the teeth of a zipper thus, maintaining queue in both closed and open lane(s).

The late lane merge system in Germany is called the 'Zipper Method'. This method uses a static sign that displays a picture of the correct merging pattern to be used at the taper (lane closure). Such a typical sign is shown in Figure 4. The sign also displays the distance from the sign to the merge point. Germany's merging method is to take place directly before the bottleneck in order to prevent any unnecessary extension of the back-up. When a driving lane ends and there is at least one other open lane in the same direction, then the transition to the adjacent lane should be made possible by all vehicles arranging themselves directly before the beginning of the taper. (5)



**Figure 4. Zipper Method Merge Sign Used in Germany**  
[Source: ADAC (6)]

In fact, the zipper principle in Germany became law in February 2001. Merging early is prohibited, but it is not punishable. However, if merging is prevented by another driver, that driver will be fined. (7)

The Netherlands refer to the late lane merge system as ‘Zipping’. It was developed at the Delft University of Technology in the Netherlands and was tested at a lane merge location on a freeway work zone. According to Dijker and Bovy of Delft University, “Zipping means that each driver does not change lanes until he reaches a fixed distance from the lane drop where he yields to exactly one vehicle before changing lanes.” (8) Figure 5 shows the traffic control plan for such a lane merge system. It consists of three sets of static signs. The first set of signs is located 1 km from the taper and informs traffic to merge or ‘zip’ 1 km ahead. The next sign is placed 650 m from the taper and reads ‘zip in 300 m’. The last set of signs is placed at 300 m from the taper. The sign on the side of the road where the lane is closing reads ‘zip here’ and the sign on the side of the road with the open lane reads ‘allow drivers to zip’.

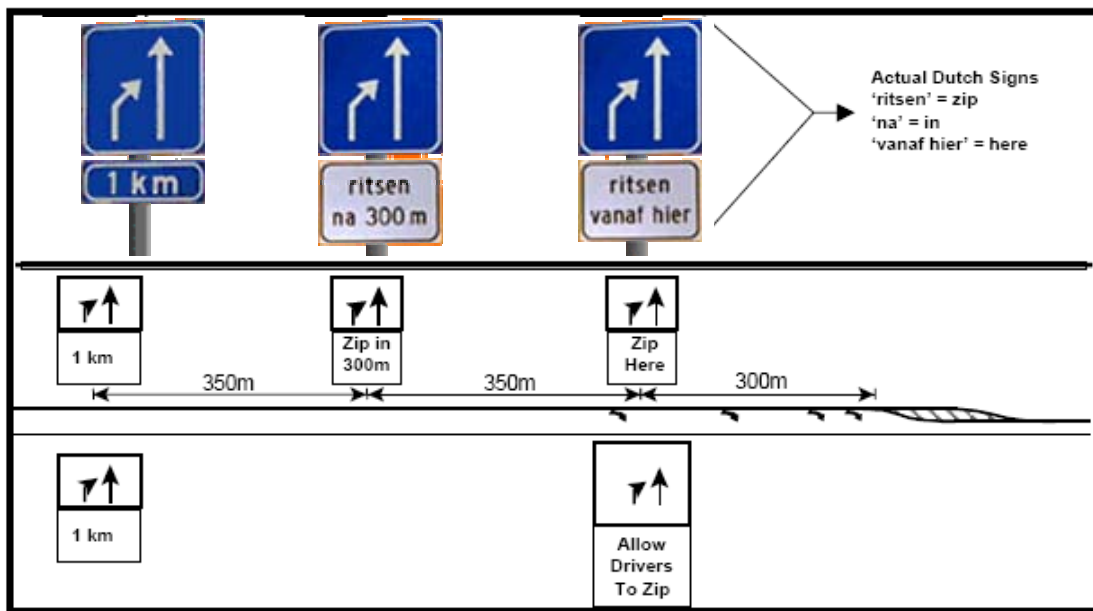

**Figure 5. Zipping Traffic Control System Used by the Netherlands**  
 [Source: Walters and Cooner (9)]

Preliminary research on the effectiveness of this system was done by the researchers at the University of Delft. It was found that the system did not increase the throughput or decrease the length of the queue. It also resulted in more vehicles merging farther upstream of the lane drop. (9)

The United Kingdom refers to the late lane merge system as ‘Zip Merging’. Figure 6 shows the traffic control plan for zip merging in the United Kingdom. There are two different static signs used in this system. The first set of signs are placed 1,000 meters and 600 meters prior to the taper and reads ‘When Queuing Use Both Lanes’. The second set of signs are located 300 meters prior to the taper and read ‘Please Merge in Turn’. Zip merging in the United Kingdom was researched at the Transport Road Research Laboratory. It was found that the throughput did not increase, but the queuing was more efficient and there were less frustrated drivers. (9)

### **3.3 Late Lane Merge System in the USA**

The PennDOT system is opposite of the ‘early’ lane merge systems used by INDOT and MDOT, in that it encourages drivers to merge late at lane closures, using a “Merge Here Take Your Turn” sign. This system is meant to increase capacity in the work zones. (10)

PennDOT developed the ‘late’ merge concept in order to address issues associated with congestion in advance of the lane closure. This system uses the static sign, “Use Both Lanes to Merge Point”, placed in advance of the lane closure on both sides of the roadway followed by “Road Work Ahead” and advance lane-closed signs. Finally, “Merge Here Take Your Turn” static signs were placed on both sides of the roadway near the beginning of the taper, as shown in Figure 7.

The results of field testing by PennDOT indicated that the late merge system has a higher capacity than the traditional lane merge system, and it also “produces fewer traffic conflicts associated with merging operations in advance of lane closures.” (10) However, the authors also noted that “the results of this field study indicate that the concept may not be working to its full potential.” (10) The authors concluded that “some drivers, especially truck drivers, did not follow the directions given by the traffic control signs. Most of them tried to move into the open lane well before the merge point, except when very long queues were formed.” (10)

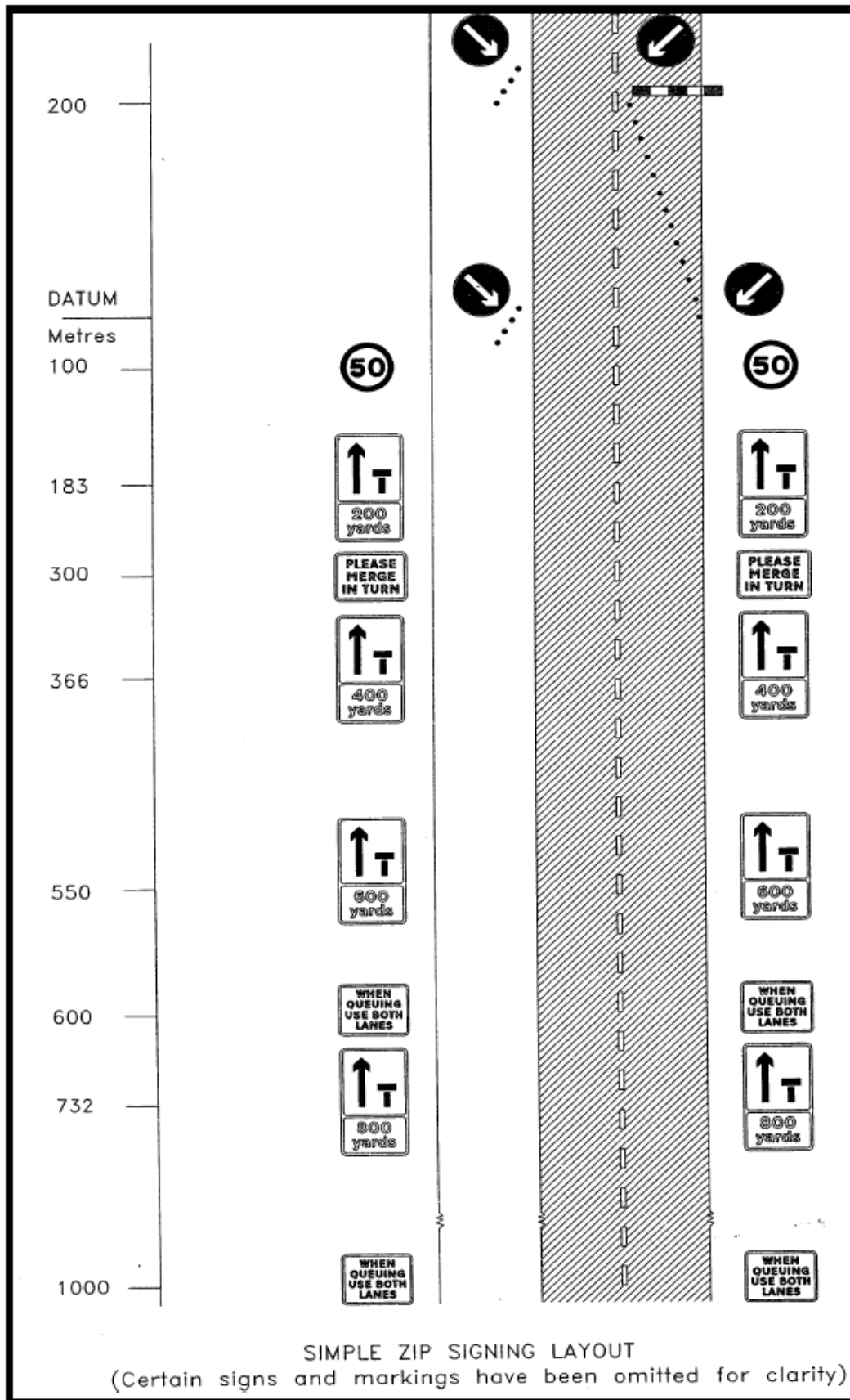

**Figure 6. Zip Merging Traffic Control System Used by the United Kingdom**  
 [Source: Walters and Cooner (9)]

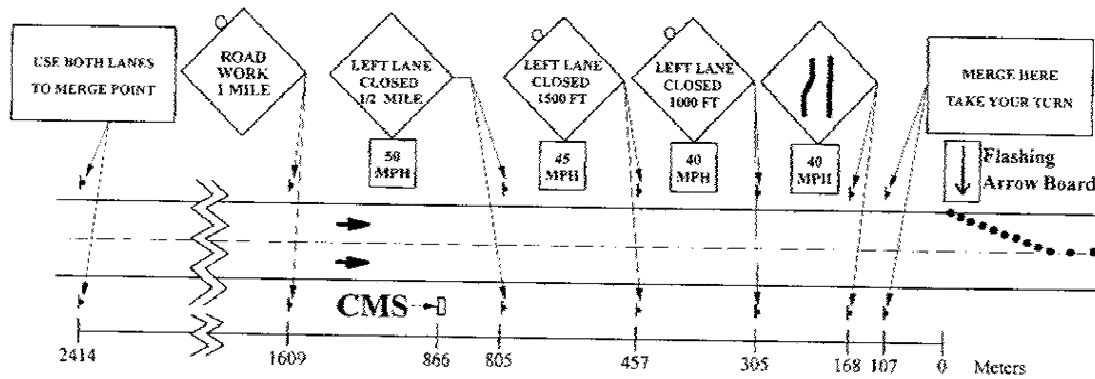

**Figure 7. Late Lane Merge Traffic Control System Used by PennDOT**  
 [Source: Pesti, Jessen, Byrd and McCoy (10)]

During the field testing in Pennsylvania, Byrd, et al. conducted a survey at a rest area within a work zone that utilized the late lane merge system. (11) It was indicated by the survey that the late lane merge concept was not well received, especially by truck drivers. The main reason for this was that some drivers did not believe that having a single merge point would decrease congestion. Of the truck drivers interviewed in this study, 60 percent experienced difficulty merging, whereas only 22 percent of the passenger vehicle drivers experienced difficulty. The most common reason given by truck drivers was, “cars speeding ahead to the merge point in the closed lane”. The most common reasons given by passenger vehicle drivers were, “congestion” and “other drivers not allowing them to merge”. Most drivers believe that drivers typically do not follow the instructions on the late merge signs. Some truck drivers (34 percent) believe that the signs do not prevent drivers from speeding ahead and a few passenger vehicle drivers (19 percent) believe that the “signs were confusing”. (11)

The late lane merge system was also deployed in the State of Virginia. Unlike the Pennsylvania study, which was tested on a limited access freeway, the Virginia study was conducted on an arterial work zone. This site had multiple access points and traffic signals within the work zone and an advanced warning area, as shown in the traffic control plan in Figure 8. Another difference between the Pennsylvania and Virginia traffic control plans is that Virginia chose to change the wording of the sign from ‘Use Both Lanes to Merge Point’ to ‘Stay in Lane to Merge Point 1 Mile’ (12). Beacher, Fontaine, and Garber (12) found that there was an increase in the throughput and a decrease in the queue length; however, the difference was not statistically significant. They also found that the number of vehicles using the closed lane had increased demonstrating that the drivers understood the late lane merge system.

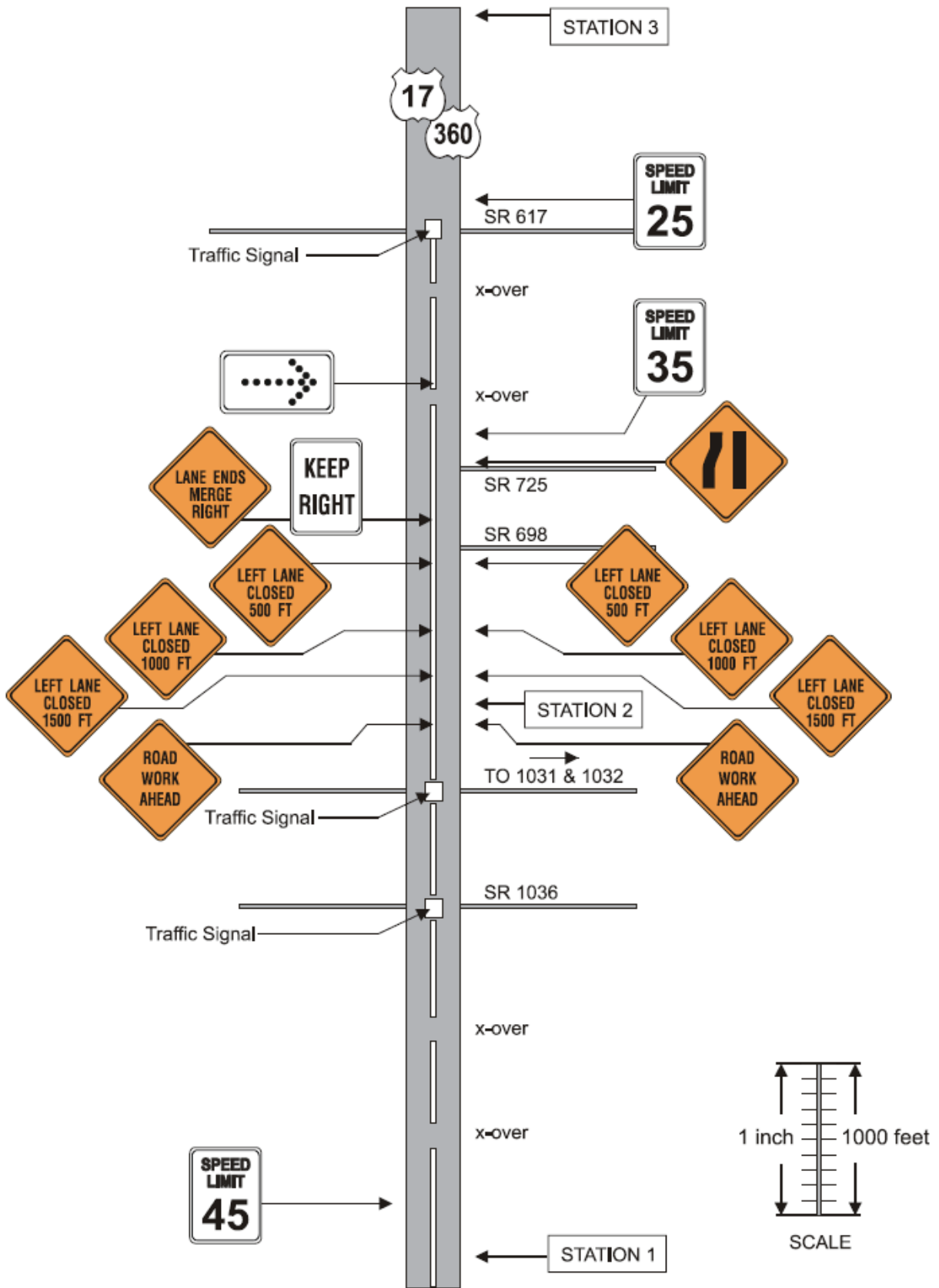

Figure 8. Late Lane Merge Traffic Control System Used by Virginia  
 [Source: Beacher, Fontaine and Garber (12)]

In another study, McCoy and Pesti (13) introduced a new concept, the ‘dynamic late merge’, which incorporates the late lane merge system with a traditional lane merge traffic control system. Driver confusion at the taper area is anticipated to be mitigated by using a “dynamic late merge system”. With the static late lane merge system, there is potential for drivers to be confused at the merge point, especially during uncongested conditions where the travel speed is high, and the traffic volume is low. The dynamic version of the system would switch from the ‘late merge’ system to a traditional lane merge system on the basis of real-time measurements of traffic flow. The authors state that the late lane merge system would be operational during the peak periods, whereas during the off-peak periods, a traditional lane merge system would be functional where the dynamic signs will display general information to the motorists.

The ‘dynamic late merge system’ consists of a series of Portable Changeable Message Signs (PCMSs) that would be activated to direct the drivers to “Use Both Lanes to the Merge Point” when congestion is detected in the open lane. The detection and communication characteristics of this system is similar to that used in the Indiana and Michigan dynamic early lane merge systems. PCMSs are also placed at the merge area to advise drivers to “Merge Here and Take Your Turn”. When the congestion clears, the signs would then be deactivated to inform the drivers to travel through the areas as if using a traditional lane merge system. (13)

In spring 2002, the Scientex Corporation, deployed the Construction Area Late Merge (CALM) System in Kansas. (14) This system appears to be the dynamic version of the Late Merge Concept introduced by PennDOT. This dynamic system utilizes traffic detectors to sense speeds and volumes upstream of a construction lane closure. The traffic data is communicated in real-time to a central controller where proprietary software algorithms determine the critical thresholds of traffic density and speed to activate real-time messages directing drivers to remain in their lanes until they approach the lane closure, where they merge alternately by taking turns. The CALM System is also used to sense incidents within and upstream of the work zone and to advise drivers of any opportunity to take alternate routes. During periods of steady traffic flow the CALM System provides real-time safety alerts to the drivers. Results show that the percentage of drivers in the closed lane was greater than before the system was activated. However, flow did not appear to be significantly affected by the dynamic late lane merge system.

The Minnesota Department of Transportation (MnDOT) deployed the dynamic late lane merge system, similar to the CALM System, during both the 2003 and 2004 construction seasons. Minnesota’s system uses a combination of changeable message signs along with Doppler radar throughout the advanced warning zone, as well as one Remote Traffic Microwave Sensor (RTMS) to detect the speed and volume of approaching vehicles. The data from both of the studies shows that the typical queue length decreased and the lane usage were nearly equal, but the throughput decreased slightly. The incidence of aggressive driver behavior also decreased. Since drivers are not typically use to using the closed lane prior to a work zone, it took some time for the drivers to get used to using the closed lane. MnDOT recommends that this system be used when the traffic volume exceeds 1,500 vehicles per hour during the construction period. (15, 16)

Similar to MnDOT’s system, the Maryland State Highway Administration (MSHA) deployed the dynamic late lane merge system in 2003. MSHA’s system is based on one threshold traffic parameter only, which is occupancy, and was operated with the “All On – All Off” algorithm where all of the PCMSs are activated and deactivated at the same time. (17) This deployment used three video cameras, in addition to RTMSs, to capture the volume data, merging behavior, traffic conflicts, and queue lengths as shown in Figure 9. The results from Maryland’s deployment show an increase in the overall throughput, a reduction of the maximum queue length, and a more even distribution of volume between lanes.

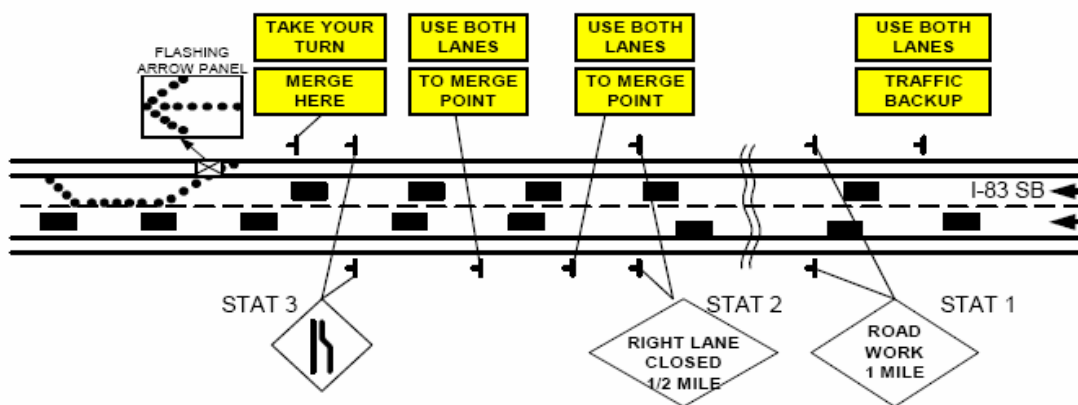

**Figure 9. Dynamic Late Lane Merge Traffic Control System Used by MSHA**  
 [Source: Kang, Chang, and Paracha (17)]



The Texas Department of Transportation (TxDOT) deployed the dynamic late lane merge system in the summer of 2001 on an urban freeway with a three- to two-lane closure in Dallas, Texas. Figure 10 shows the traffic control system used by the TxDOT. The signs are very similar to those used in other states with one modification. Since the system was set up on a three- to two-lane closure work zone, instead of reading “Use **Both** Lanes to Merge Point”, the signs read “Use **All** Lanes to Merge Point.” (9)

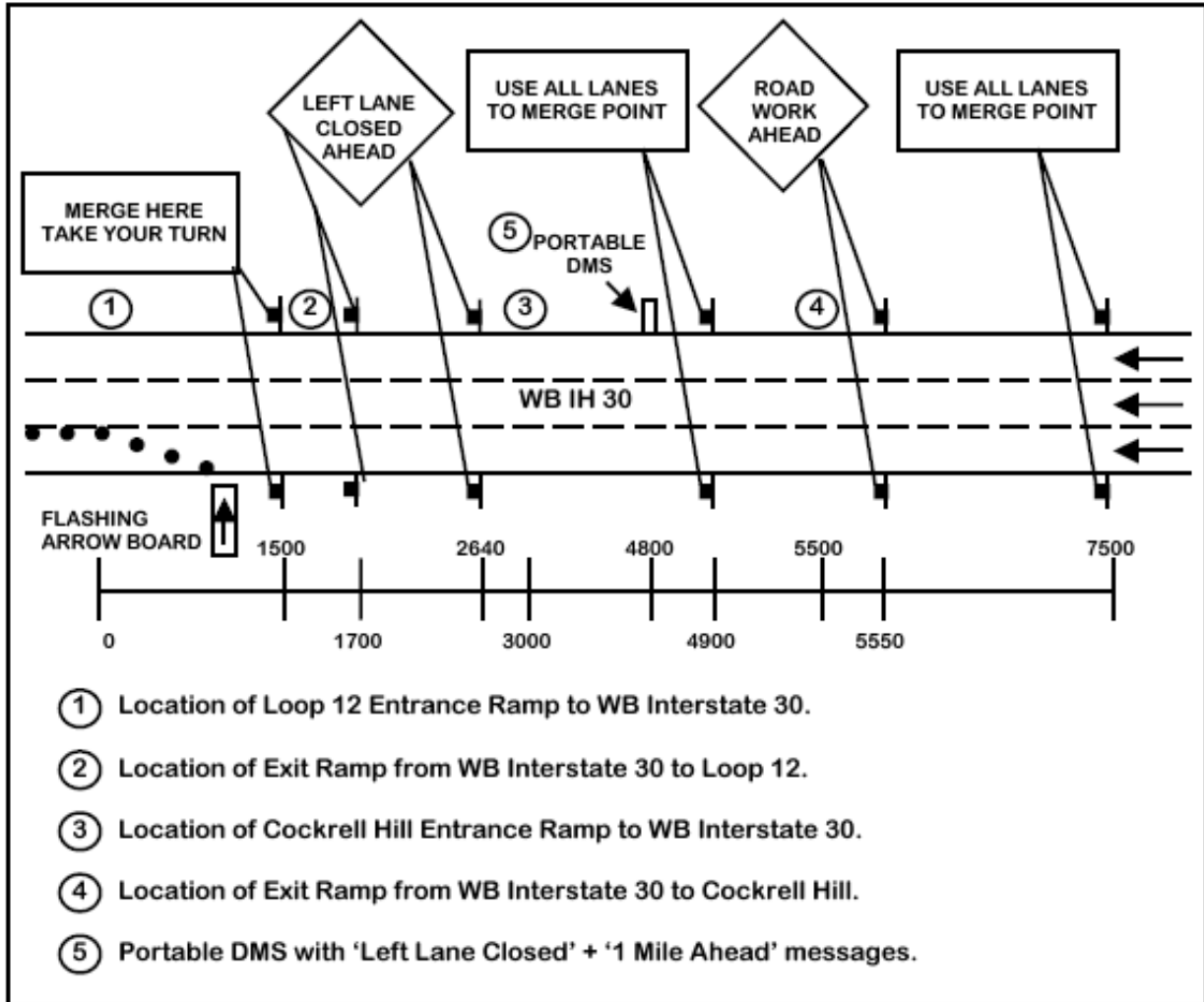

**Figure 10. Dynamic Late Lane Merge Traffic Control System Used by TxDOT**  
 [Source: Walters and Cooner (9)]

Before and after data was collected by the Texas Transportation Institute from the same site in order to compare the results of the field test. Since the Environmental Protection Agency does not allow construction work done in the Dallas metropolitan area during peak hours, because of

air quality issues, the system was deployed from approximately 9:30 am to 3:30 pm. The results of the field test showed that “the Late Lane Merge scenario delayed the onset of congestion at the merge point by approximately 14 minutes” and “the length of the maximum queue was approximately 7,800 feet in the before case versus 6,000 feet in the after case” (9). Only two days worth of data was compared so, therefore, only minimal conclusions could be drawn about the late lane merge system for a three- to two-lane closure freeway work zone scenario. (9)

#### **4.0 SITE DESCRIPTION**

The DLLMS was implemented and tested at three freeway work zones during the 2006 construction season in Michigan at:

- Eastbound I-69 in Shiawassee and Genesee Counties
- Westbound I-69 in Shiawassee and Genesee Counties
- Westbound I-94 in Kalamazoo and Van Buren Counties

Each of the noted work zones included a left lane closure during the observed construction periods from a two-lane to a one-lane freeway section. The I-69 work zone extended from one mile west of the Shiawassee River to one mile east of the Shiawassee County / Genesee County Line. The I-94 work zones extended from three miles west of M-51 to County Road 652. The advanced warning areas were extended an additional three to four miles in each direction.

The DLLMS was deployed at the same time the work zone was set up at each test site. While the work zone was present, the DLLMS was continually in use. Therefore, a separate site was needed for use as a control to compare the effectiveness of the system. The eastbound direction of the freeway work zone on I-94 in Kalamazoo and Van Buren Counties was used as the control site. This work zone also included a left lane closure on a two-lane (one direction) freeway section. The control site consisted of the traditional freeway work zone traffic control set up.

The pre-construction average daily traffic (ADT) for the study locations were similar and are shown in Table 1.

**Table 1. Annual Daily Traffic for the Work Zone Sites**  
 [Source: MDOT's 2005 Annual Average 24-Hour Traffic Volumes (19)]

| Location          | Directional ADT<br>(veh/day/direction) |
|-------------------|--|
| I-94 EB (Control) | 16,150                                 |
| I-94 WB (Test)    | 16,300                                 |
| I-69 EB (Test)    | 13,500                                 |
| I-69 WB (Test)    | 16,250                                 |

## 5.0 SYSTEM DESCRIPTION

The DLLMS consists of the traditional freeway work zone traffic control devices, along with sensors, Portable Changeable Message Signs (PCMSs), and a Master Controller for communication. There are three PCMSs located in advance of the taper section that display relevant messages based on real-time traffic speed and flow characteristics. The PCMSs are mounted on trailers and display a maximum of three lines of messages with a maximum of eight characters per line. Each PCMS can display up to three different messages, but the DLLMS utilizes only two messages per PCMS. When there is congestion in the open lane, the system is activated and the PCMSs display appropriate messages to the drivers to use both lanes prior to the lane closure and to merge at the taper by taking turns. Typical messages are shown in Figure 11. During times of low congestion, the system turns OFF and the traditional merge system goes into effect allowing vehicles to merge at any time prior to the taper when it is safe to do so. Even though the system is off, the PCMSs still provide some general messages to the freeway users.



**Figure 11. PCMSs Used in the Advance Warning Area**

Multiple sensors are used in this system to recognize congestion levels. A Remote Traffic Microwave Sensor (RTMS) is located approximately 1,500 feet upstream from the taper and a Doppler radar is located at the taper. The RTMS measures the average speed of the cars traveling in both lanes and the aggregate volume, while the Doppler radar measures speed. These readings are reported every 30 seconds and are used as the trigger parameters for the PCMSs. The PCMSs are activated when the average speed is less than the trigger speed (35 mph or 45 mph) for a period of five minutes. It remains activated until the average speed exceeds the trigger speed for a five-minute period. The I-69 test sites used a trigger speed of 45 mph, while the I-94 test site reduced the trigger speed to 35 mph.

The DLLMS was installed on both the eastbound and westbound directions of I-69 from April 17, 2006 through November 3, 2006. The traffic control plans for the EB and WB I-69 test sites are shown in Figures 12 and 13, respectively. The eastbound taper was located approximately 3,000 feet east of Grand River Road, while the westbound taper was located approximately 1,500 feet west of Duffield Road. When the DLLMS was ON at the I-69 test sites, the PCMSs for each direction displayed the following messages:

- PCMS 1 (furthest from taper): STOPPED TRAFFIC AHEAD / USE BOTH LANES
- PCMS 2: USE BOTH LANES / STAY IN YOUR LANE
- PCMS 3: TAKE YOUR TURN / MERGE HERE

When the DLLMS was OFF at the I-69 test sites, the same PCMSs displayed the following messages:

- PCMS 1 (furthest from taper): DRIVE SAFELY / WORK ZONE AHEAD
- PCMS 2: DRIVE SAFELY / MERGE 2 MILES AHEAD
- PCMS 3: DRIVE SAFELY / 45 WHERE WORKERS PRESENT

In addition to the typical work zone advance lane closure signs and the PCMSs, the normal static signs, “TRUCKS USE RIGHT LANE”, were also used at the I-69 test sites. This sign was installed in order to help reduce the number of commercial motor vehicles that block and straddle lanes to prevent other vehicles from passing and merging at the taper.

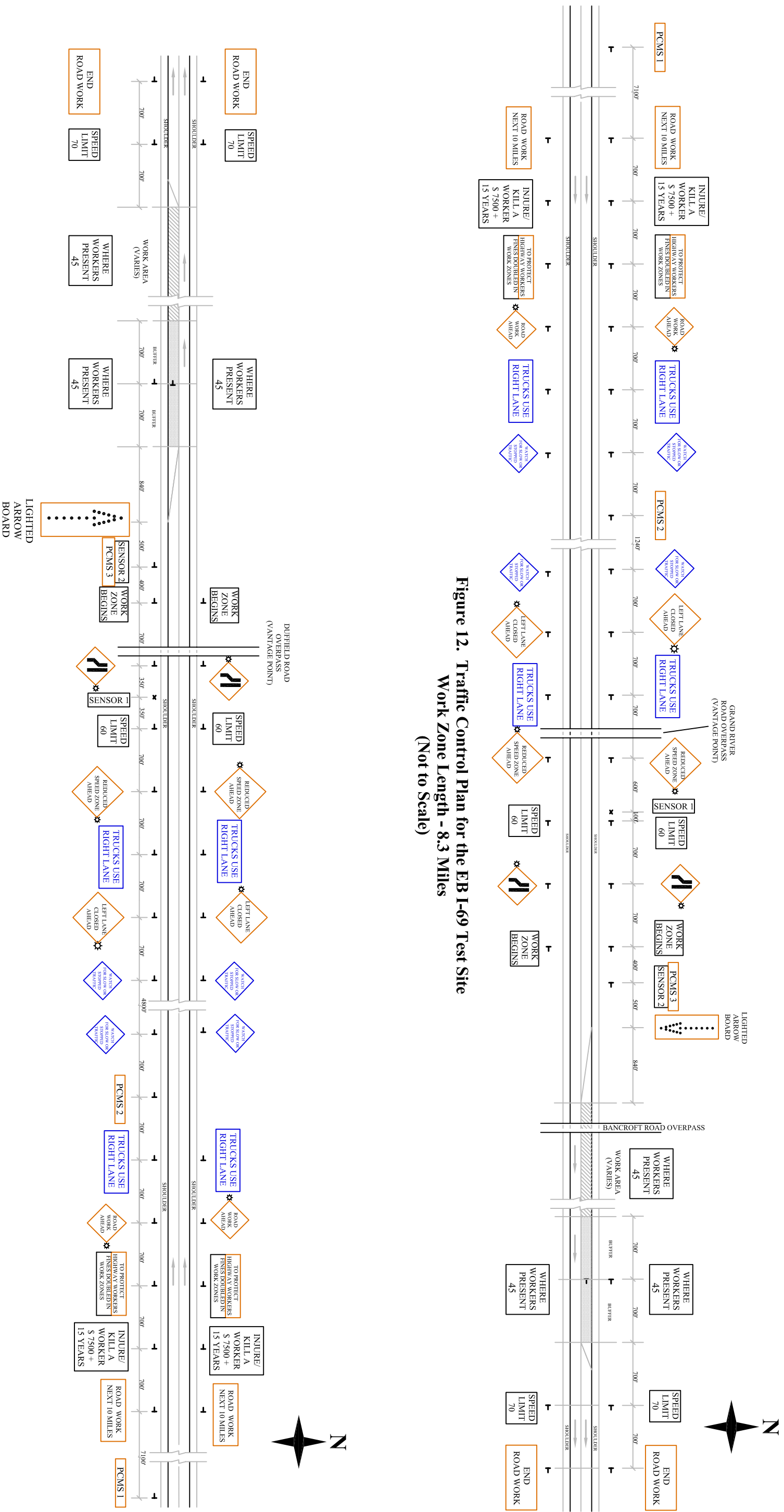

**Figure 12. Traffic Control Plan for the EB I-69 Test Site  
Work Zone Length - 8.3 Miles  
(Not to Scale)**

**Figure 13. Traffic Control Plan for the WB I-69 Test Site  
Work Zone Length - 8.3 Miles  
(Not to Scale)**

The DLLMS was installed on westbound I-94, west of Kalamazoo from July 17, 2006 through October 9, 2006. The DLLMS on WB I-94 consisted of six PCMSs as shown on the traffic control plan in Figure 14. The westbound taper was located approximately 1700 feet east of 24<sup>th</sup> Street. Three of the PCMSs were required as a part of the system (PCMS 3, 5, & 6); the other three (PCMS 1, 2, & 4) were not required, but did display additional information about the DLLMS to the drivers. When the DLLMS was ON, the PCMSs displayed the following messages:

- PCMS 1 (furthest from taper): NEW MERGE SYSTEM / FROM MATTAWAN EXIT
- PCMS 2: DRIVE WITH CARE / LANE CLOSED AHEAD
- PCMS 3: SLOW TRAFFIC AHEAD / USE BOTH LANES
- PCMS 4: ONE LANE OPEN / 7/17/06 THRU 10/15/06
- PCMS 5: USE BOTH LANES / STAY IN YOUR LANE
- PCMS 6: TAKE YOUR TURN / MERGE HERE

When the DLLMS was OFF, the PCMSs displayed the following messages:

- PCMS 1 (furthest from taper): NEW MERGE SYSTEM / FROM MATTAWAN EXIT
- PCMS 2: DRIVE WITH CARE / LANE CLOSED AHEAD
- PCMS 3: LEFT LANE CLOSED / 2.5 MILES AHEAD
- PCMS 4: ONE LANE OPEN / 7/17/06 THRU 10/15/06
- PCMS 5: LEFT LANE CLOSED / 1.5 MILES AHEAD
- PCMS 6: DRIVE WITH CARE / LEFT LANE CLOSED

For the control site located on EB I-94, a traditional merge system was used from April 24, 2006 through July 16, 2006. Typical static signs and other traffic control devices were used at this work zone informing drivers that the left lane was closed and they were required to merge right. The traffic control plan for EB I-94 (control site) is shown in Figure 15. The taper was located approximately 1800 feet east of 46<sup>th</sup> Street. One PCMS was included in this work zone traffic control plan four miles west of the taper that displayed the message, “AVOID BACKUPS / START MERGING RIGHT”.

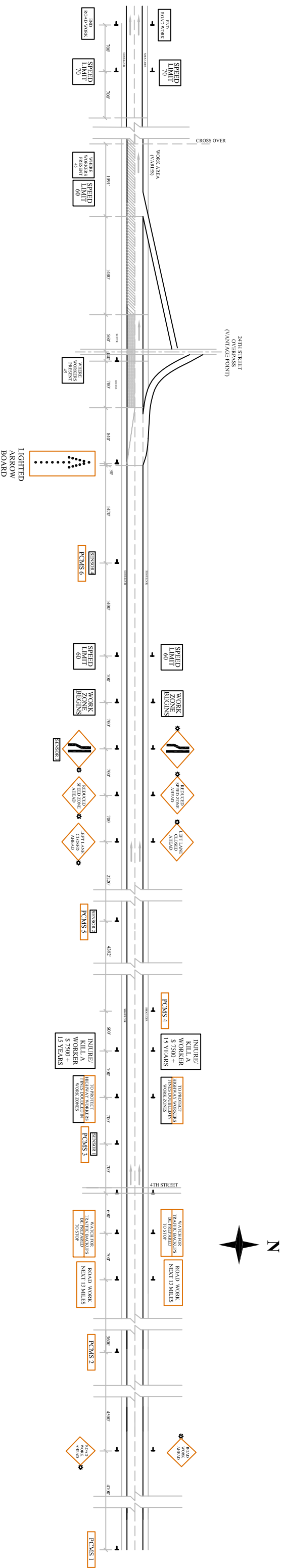

**Figure 14. Traffic Control Plan for the WB I-94 Test Site  
Work Zone Length - 13 Miles  
(Not to Scale)**

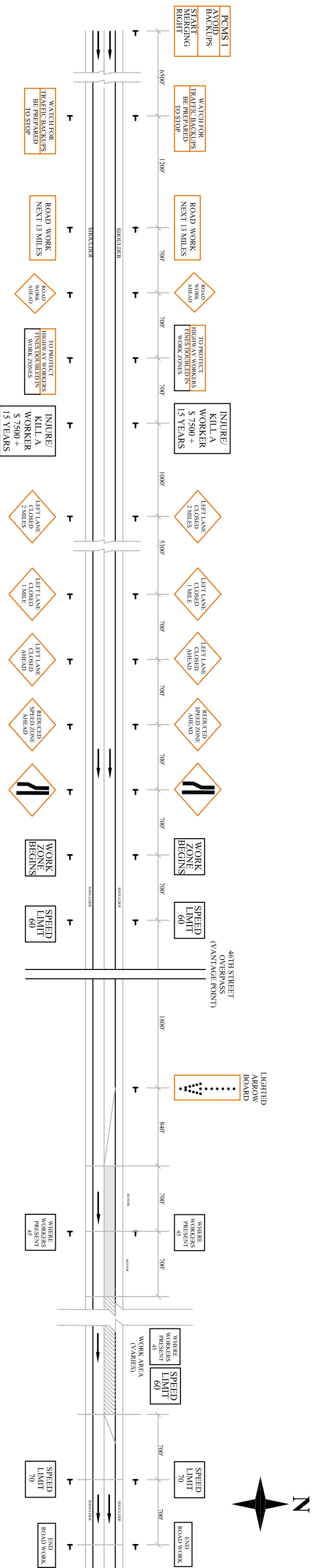

**Figure 15. Traffic Control Plan for the EB I-94 Control Site  
Work Zone Length - 13 Miles  
(Not to Scale)**



## **6.0 DATA COLLECTION**

Several members from the WSU-TRG collected data at the test and control sites on weekdays during peak and off-peak periods throughout the daylight hours. Traffic operational data was collected at various times of the day including the AM peak hours (7:00-9:00 AM), midday peak hour (12:00-1:00 PM), PM peak hours (4:00-6:00 PM), and various off peak periods. The data collection included travel time, number of stops, volume, queue, merge locations, spot speed, and crashes.

The floating car method was used to collect travel time data by driving through the advanced warning area multiple times. The travel time through the advanced warning segment was recorded from the first PCMS to the arrow board located near the taper. The number of times the floating car was forced to stop due to traffic congestion was recorded and the status of the system was also noted. From this data, the average travel speed and delay per vehicle were calculated. The average delay was calculated by subtracting the actual travel time from the expected travel time with the expected travel time being the travel distance times the posted speed limit.

The work zone traffic characteristics and vehicular merge locations were recorded using a digital video camera from an overpass in the proximity of the work zone. The video recording was done during the same time periods as the travel time runs were made. The number of vehicles entering the work zone was extracted from the video in increments of five minutes. This data was used to determine the throughput (vehicles per hour). The locations at which the vehicle were merging, was also noted. The commercial vehicles and the passenger vehicles were counted separately from the videos for all time periods of the study.

Data for the I-69 test sites were collected from the Grand River Road bridge for the eastbound traffic and the Duffield Road bridge for the westbound traffic. The vantage points are shown on the traffic control diagrams in Figures 12 and 13 (page 20). The WB I-94 test site data was collected from the 24th Street bridge as shown in Figure 14 (page 22). The data for the EB I-94 control site was collected from the 46th Street overpass bridge, as shown on the traffic control diagram in Figure 15 (page 23).

The DLLMS was observed ON only during PM peak periods for the I-69 test sites. The system was ON almost throughout the entire PM peak period on Fridays, but only part of the time during other weekday PM peak periods. It was observed that the system was ON more often for the WB I-69 test site, as compared to the EB I-69 test site on a typical weekday; however, the EB I-69 test site experienced higher levels of congestion during the PM peak periods.

The DLLMS was observed ON at the WB I-94 test site only occasionally during the weekday PM peak periods. The system was generally ON during Friday PM peak periods more often than any other day of the week. For the EB I-94 control site, the vehicles experienced congestion during the PM peak periods mostly on Fridays.

## **6.1 Travel Time Data**

The travel time for each site was recorded with the use of a stopwatch following the floating car method using a two-person team. The driver's job was to drive as a floating car in the traffic stream. The data collector recorded the travel time, the number of stops, and other data as necessary. The travel time and number of stops were recorded for the advance warning area from the first PCMS to the beginning of the taper. The average speeds were calculated using the travel times and distances.

The advance warning area of the I-69 test sites are approximately four miles long for the westbound direction and 3.2 miles long for the eastbound direction. The average travel times, speeds, and delay are shown in Table 2 for each time period collected for the I-69 test sites. The travel time and delay data are presented as a unit per 10,000 feet in order to allow comparisons of the control and test site data. Since congestion did not occur during all PM peak periods, the data was separated to show the differences between congested PM peak periods and non-congested PM peak periods. Traffic was considered to be congested if the DLLMS was activated and a queue was present. Congestion levels were found to be higher on Friday evenings as opposed to Monday through Thursday. The status of the DLLMS (ON/OFF) is also shown in Table 2.

**Table 2. Drive-Through Data for I-69 (Test Sites)**

| <b>Travel Direction</b> | <b>Time Period</b> | <b>DLLMS Status</b> | <b>Avg. Travel Time (sec/ 10,000 ft/ veh)</b> | <b>Avg. Travel Speed (mph)</b> | <b>Avg. Delay (sec/ 10,000 ft/ veh)</b> |
|-------------------------|--------------------|---------------------|---|--------------------------------|---|
| EB                      | AM Peak            | Off                 | 101.21  | 67                             | 0                                       |
|                         | Midday Peak        | Off                 | 104.05  | 65                             | 0                                       |
|                         | Off- Peak          | Off                 | 101.56  | 67                             | 0                                       |
|                         | PM Peak            | Off                 | 101.92  | 67                             | 0                                       |
|                         | Congested PM Peak  | On                  | 456.68  | 16                             | 352.63                                  |
| WB                      | AM Peak            | Off                 | 98.58   | 69                             | 0                                       |
|                         | Midday Peak        | Off                 | 103.69  | 66                             | 3.98                                    |
|                         | Off- Peak          | Off                 | 97.16   | 70                             | 0                                       |
|                         | PM Peak            | Off                 | 98.01   | 69                             | 0                                       |
|                         | Congested PM Peak  | On                  | 170.17  | 53                             | 70.45                                   |

The advance warning area for the WB I-94 test site is approximately 3.8 miles long. The average travel times, speeds, and delay are shown in Table 3 for each time period. It was found that the midday and congested PM peak periods experienced the longest travel time and delay and the lowest travel speed.

**Table 3. Drive-Through Characteristics for WB I-94 (Test Site)**

| <b>Travel Direction</b> | <b>Time Period</b> | <b>Avg. Travel Time (sec/ 10,000 ft/ veh)</b> | <b>Avg. Travel Speed (mph)</b> | <b>Avg. Delay (sec/ 10,000 ft/ veh)</b> |
|-------------------------|--------------------|---|--------------------------------|---|
| WB                      | AM Peak            | 99.28   | 68.7                           | 0                                       |
|                         | Midday Peak        | 172.55  | 45.2                           | 72.67                                   |
|                         | Off Peak           | 102.87  | 68.5                           | 2.99                                    |
|                         | PM Peak            | 99.88   | 68.7                           | 0                                       |
|                         | Congested PM Peak  | 167.46  | 47.57                          | 67.58                                   |

The advance warning area for the EB I-94 control site is approximately four miles. The average travel times, speeds, and delay for the advanced warning area of the EB I-94 control site are shown in Table 4 for various time periods for the I-94 control site. Since congestion did not occur during every PM peak period, the congested periods were separated from the non-congested PM peak periods. As expected, the congested PM peak period experienced the longest travel time and delay and the lowest travel speed.

**Table 4. Drive-Through Data for EB I-94 (Control Site)**

| <b>Time Period</b> | <b>Avg. Travel Time (sec/ 10,000 ft/ veh)</b> | <b>Avg. Travel Speed (mph)</b> | <b>Avg. Delay (sec/ 10,000 ft/ veh)</b> |
|--------------------|---|--------------------------------|---|
| AM Peak            | 99.15   | 68.3                           | 7.95                                    |
| Midday Peak        | 98.30   | 68.9                           | 7.10                                    |
| Off Peak           | 98.86   | 68.8                           | 7.67                                    |
| PM Peak            | 101.99  | 67.0                           | 10.80                                   |
| Congested PM Peak  | 272.44  | 29.5                           | 181.25                                  |

When directly comparing the WB I-94 test site with the EB I-94 control site, during the congested PM peak periods, the test site experienced shorter travel times, higher speeds, and less travel delay.

When directly comparing the EB I-94 control site with the I-69 test sites, it was found that the travel times were less, the speeds were higher and the travel delay was less at the WB I-69 test site as compared to the EB I-94 control site; however, the opposite was true for the EB I-69 test site as compared to the EB I-94 control site. It is hard to directly compare the I-94 control site with the I-69 test sites. The characteristics of the two work zones differ since they are approximately 150 miles apart and driver behavior from different areas is not always the same. The freeway alignments were also quite different, therefore, such comparisons may not be appropriate.

## **6.2 Throughput and Merge Location Data**

The throughput and merge locations for each site were video taped in the field and later analyzed in the office. The average approach traffic volumes are shown in Table 5 and the average percentages of merge locations are shown in Table 6 for the I-69 test sites. The highest total throughput occurred during the congested PM peak period for each direction. Throughout the day, WB I-69 had a higher throughput than EB I-69. At the I-69 test sites, the majority of the vehicles used the open lane, rather than the closed lane, except during the congested PM peak period when more vehicles used the closed lane than the open lane in the eastbound direction. As shown in Table 6, out of the vehicles that used the closed lane, approximately 55-70 percent of the eastbound volume merged within 500 feet of the taper, while only 30-45 percent of the westbound volume merged within 500 feet of the taper. The highest average percentage of

merges for EB I-69 occurred within 500 feet of the taper and was 68.5 percent (Table 6) during the congested PM peak period. For WB I-69, 42.98 percent (Table 6) of the merges occurred within 500 feet of the taper during the midday peak period with 23.47 percent just at the taper. PCMS 3, which displayed “Merge Here/ Take Your Turn”, when the DLLMS was ON, was located 500 feet prior to the taper for each direction. The merge locations and average merge volumes for the I-69 test sites are shown in the graphical diagrams included in Appendix I for various time periods.

**Table 5. Average Approach Volume for the I-69 Test Sites**

| <b>Travel Direction</b> | <b>Time Period</b> | <b>*Avg. Merge Volume (vph)</b> | <b>*Avg. Through Lane Volume (vph)</b> | <b>*Avg. Total Volume (vph)</b> |
|-------------------------|--------------------|---------------------------------|--|---------------------------------|
| EB                      | AM Peak            | 204 (6)                         | 487 (163)                              | 691 (169)                       |
|                         | Midday Peak        | 266 (8)                         | 478 (184)                              | 744 (191)                       |
|                         | Off Peak           | 232 (8)                         | 495 (177)                              | 727 (185)                       |
|                         | PM Peak            | 397 (7)                         | 641 (151)                              | 1038 (158)                      |
|                         | Congested PM Peak  | 458 (15)                        | 383 (98)                               | 841 (113)                       |
| WB                      | AM Peak            | 172 (3)                         | 842 (185)                              | 1014 (188)                      |
|                         | Midday Peak        | 127 (1)                         | 745 (188)                              | 872 (189)                       |
|                         | Off Peak           | 182 (2)                         | 794 (196)                              | 976 (198)                       |
|                         | PM Peak            | 220 (1)                         | 934 (175)                              | 1154 (176)                      |
|                         | Congested PM Peak  | 284 (8)                         | 930 (151)                              | 1214 (159)                      |

\*Note: Total of all vehicles (Commercial motor vehicles only)

**Table 6. Average Percent of Merges by Distance from Taper for the I-69 Test Sites**

| <b>Travel Direction</b> | <b>Time Period</b> | <b>*Avg. % of Merges from Beginning of Taper</b> |                         |                           |                     |
|-------------------------|--------------------|--|-------------------------|---------------------------|---------------------|
|                         |                    | <b>0 ft.</b>                                     | <b>0 ft. to 500 ft.</b> | <b>500 ft. to 900 ft.</b> | <b>&gt; 900 ft.</b> |
| EB                      | AM Peak            | NA   | 54.42                   | 12.91                     | 32.67               |
|                         | Midday Peak        | NA   | 59.91                   | 12.12                     | 27.97               |
|                         | Off Peak           | NA   | 62.18                   | 10.68                     | 27.14               |
|                         | PM Peak            | NA   | 60.06                   | 10.99                     | 28.95               |
|                         | Congested PM Peak  | NA   | 68.50                   | 5.89                      | 25.61               |
| WB                      | AM Peak            | 20.88  | 20.44                   | 18.37                     | 40.31               |
|                         | Midday Peak        | 23.47  | 19.51                   | 19.56                     | 37.46               |
|                         | Off Peak           | 23.41  | 18.93                   | 15.60                     | 42.06               |
|                         | PM Peak            | 16.89  | 15.53                   | 13.24                     | 54.34               |
|                         | Congested PM Peak  | 19.89  | 19.95                   | 13.39                     | 46.77               |

\*Note: Percent of all vehicles

The average approach traffic volumes are shown in Table 7 and the average percentages of merge locations are shown in Table 8 for the WB I-94 test site. The highest total throughput occurred during the midday peak period. During each time period for the WB I-94 test site, the majority of the vehicles used the open lane, rather than the closed lane. Out of the vehicles that used the closed lane at the WB I-94 test site, approximately 45-70 percent (Table 8) merged at the taper. PCMS 6, which displayed “Merge Here / Take Your Turn” when the DLLMS was ON, was located 1,500 feet prior to the beginning of the taper. As shown in Table 8, the highest average percentage of merges occurred at the taper and was 68.2 percent during the midday peak period and 66 percent during the congested PM peak period. The merge locations and average merge traffic volumes for the WB I-94 test site are shown in the graphical diagrams included in Appendix I for each time period.

**Table 7. Average Approach Volumes for the WB I-94 Test Site**

| <b>Time Period</b> | <b>*Avg. Merge Volume (vph)</b> | <b>*Avg. Through Lane Volume (vph)</b> | <b>*Avg. Total Volume (vph)</b> |
|--------------------|---------------------------------|--|---------------------------------|
| AM Peak            | 181 (6)                         | 989 (205)                              | 1170 (211)                      |
| Midday Peak        | 236 (36)                        | 1124 (235)                             | 1360 (271)                      |
| Off Peak           | 273 (13)                        | 989 (237)                              | 1262 (250)                      |
| PM Peak            | 338 (10)                        | 988 (242)                              | 1326 (252)                      |
| Congested PM Peak  | 255 (14)                        | 952 (158)                              | 1207 (172)                      |

\*Note: Total of all vehicles (Commercial motor vehicles only)

**Table 8. Average Percent of Merges by Distance from Taper for the WB I-94 Test Site**

| <b>Time Period</b> | <b>*Avg. % of Merges from Beginning of Taper</b> |                           |                       |
|--------------------|--|---------------------------|-----------------------|
|                    | <b>0 ft.</b>                                     | <b>0 ft. to 1,500 ft.</b> | <b>&gt; 1,500 ft.</b> |
| AM Peak            | 54.0 (63.6)                                      | 37.1 (18.2)               | 8.9 (18.2)            |
| Midday Peak        | 68.2 (80.6)                                      | 17.0 (13.9)               | 14.8 (5.5)            |
| Off Peak           | 58.5 (56.9)                                      | 32.4 (30.8)               | 9.1 (12.3)            |
| PM Peak            | 46.8 (45.6)                                      | 36.1 (36.8)               | 17.1 (17.6)           |
| Congested PM Peak  | 66.0 (74.1)                                      | 29.5 (25.9)               | 4.5 (0)               |

\*Note: Percent of all vehicles (Commercial motor vehicles only)

The average approach traffic volumes are shown in Table 9 and the average percentages of merge locations are shown in Table 10 for the EB I-94 control site. The highest total throughput occurred during the PM peak period. At the EB I-94 control site, the majority of the vehicles

used the open lane rather than the closed lane. As shown in Table 10, out of all the vehicles that used the closed lane, prior to the taper, approximately 40-55 percent merged at the taper (near the arrow board). The highest average percentage of merges occurred at the taper and was 54.62 percent (81.48 percent for commercial motor vehicles) during the PM peak period (Table 10). The average merge locations and traffic volumes for the EB I-94 control site are shown in the graphical diagrams included in Appendix I for each time period.

**Table 9. Average Approach Volumes for the EB I-94 Control Site**

| <b>Time Period</b> | <b>*Avg. Merge Volume (vph)</b> | <b>*Avg. Through Lane Volume (vph)</b> | <b>*Avg. Total Volume (vph)</b> |
|--------------------|---------------------------------|--|---------------------------------|
| AM Peak            | 201 (2)                         | 531 (270)                              | 732 (272)                       |
| Off Peak           | 204 (3)                         | 538 (228)                              | 742 (231)                       |
| Midday Peak        | 212 (4)                         | 590 (251)                              | 802 (255)                       |
| PM Peak            | 285 (9)                         | 676 (261)                              | 961 (270)                       |
| Congested PM Peak  | 236 (25)                        | 754 (294)                              | 990 (269)                       |

\*Note: Total of all vehicles (Commercial motor vehicles only)

**Table 10. Average Percent of Merges by Distance from Taper for the EB I-94 Control Site**

| <b>Time Period</b> | <b>*Avg. % of Merges from Beginning of Taper</b> |                        |                           |                     |
|--------------------|--|------------------------|---------------------------|---------------------|
|                    | <b>0 ft.</b>                                     | <b>0 ft to 450 ft.</b> | <b>450 ft. to 900 ft.</b> | <b>&gt; 900 ft.</b> |
| AM Peak            | 38.41 (40.00)                                    | 21.93 (40.00)          | 7.93 (20.00)              | 31.73 (0)           |
| Off Peak           | 50.00 (66.67)                                    | 18.38 (33.33)          | 4.90 (0)                  | 26.72 (0)           |
| Midday Peak        | 45.67 (45.45)                                    | 20.37 (18.18)          | 6.32 (0)                  | 27.64 (36.37)       |
| PM Peak            | 54.62 (81.48)                                    | 15.32 (14.82)          | 4.44 (3.70)               | 25.62 (0)           |
| Congested PM Peak  | 49.15 (53.33)                                    | 19.63 (21.33)          | 9.04 (16.00)              | 20.18 (9.34)        |

\*Note: Percent of all vehicles (Commercial motor vehicles only)

When comparing the I-94 control and test sites, it was found that during the congested PM peak periods, 49.15 percent (Table 10) of the merging traffic executed their merge at the arrow board that is located at the beginning of the taper at the control site, while 66.0 percent (Table 8) of the merging traffic merged at the arrow board at the test (site with DLLMS) site. When comparing the I-94 control site with the I-69 test sites, a lower percentage of the vehicles merged within 500 feet of the taper at the I-69 test sites during each time period.

### 6.3 Queue Data

Queue data was collected at each of the four sites (three test sites and one control site). Two designated people stood on an overpass with the best possible view of the work zone and counted and recorded the queue length, number of vehicles in a queue, every minute during the study periods in both the open and closed lanes. One person counted and recorded the number of vehicles in a queue in the open lane and the other person recorded the number of vehicles in a queue in the closed lane in one-minute time intervals. Vehicles were considered to be in a queue when their speed was less than five miles per hour. The queue data for eastbound I-94 was collected from the overpass at 46<sup>th</sup> Street, westbound I-94 queue data was collected from the overpass at 24<sup>th</sup> Street, eastbound I-69 queue data was collected from the overpass at Grand River Road, and westbound I-69 queue data was collected from the overpass at Duffield Road.

It was observed that PM peak periods were the only times that queuing was present on the EB I-94 control site and the WB I-94 test site. However, there were many weekdays when there were no queues even during the PM peak hours. Similarly, the only time queue were present for the I-69 test sites, was during the PM peak hours when the system was ON.

Table 11 shows a summary of the 95<sup>th</sup> percentile queuing data collected at the study sites. The 95<sup>th</sup> percentile means that during 95 percent of the time, the number of observed vehicles in the queue was less than or equal to the values stated in Table 11. It is important to note that due to sight distance limitations, the observers could only see up to 30 vehicles in each lane at the WB I-94 test site and up to 50 vehicles at the other three sites.

**Table 11. 95<sup>th</sup> Percentile Queue Data for each Study Site**

| Site         |         | 95 <sup>th</sup> Percentile Closed Lane Queue Length (no. of vehicles) | 95 <sup>th</sup> Percentile Open Lane Queue Length (no. of vehicles) | 95 <sup>th</sup> Percentile Total Queue Length (no. of vehicles) |
|--------------|---------|--|--|--|
| Control Site | EB I-94 | 5  | 49   | 54   |
| Test Sites   | WB I-94 | 9  | 30   | 39   |
|              | EB I-69 | 50   | 49   | 99   |
|              | WB I-69 | 7  | 50   | 57   |



Since EB I-94 (control site) operated with a conventional work zone merge system, vehicles merged when it was safe to do so and typically merged early. However, when the DLLMS was activated at the test sites, vehicles were supposed to use both lanes until the merge point. This scenario only occurred at the EB I-69 test site. This may have occurred at the test site on EB I-69 and not at the test sites on WB I-69 or WB I-94 because the service volume of the EB I-69 test site is lower; therefore, both lanes would become congested much faster. It may also be a result of the roadway alignment.

#### 6.4 Spot Speed Data

Speed data was collected at the I-94 control and test sites. Spot speeds were collected using a radar gun at two different locations. The speed study locations included one in the advanced warning area and one at the taper for both the I-94 control and test sites. A summary of the average speeds are presented in Table 12. The speeds are separated by periods when congestion existed and periods when there was no congestion. This table shows that vehicles were traveling at slower speeds when the DLLMS was present at both locations. Please note that speed data for the I-69 test sites was not collected, since there was no control site available.

**Table 12. Summary of I-94 Spot Speed Data**

| Site                            | Time Period            | Average Spot Speed (mph) |          |
|---------------------------------|------------------------|--------------------------|----------|
|                                 |                        | In Advance Warning Area  | At Taper |
| <b>Control Site<br/>EB I-94</b> | Non-Congested Periods  | 63.20                    | 60.53    |
|                                 | Congested Peak Periods | 64.90                    | 41.62    |
| <b>Test Site<br/>WB I-94</b>    | Non-Congested Periods  | 62.07                    | 51.15    |
|                                 | Congested Peak Periods | 22.74                    | 30.93    |

#### 6.5 Crash Data

Crash data was collected and analyzed for the EB I-94 control site and the WB I-94, EB I-69, and WB I-69 test sites. The 2006 UD-10 crash report forms were downloaded from the Michigan Department of Transportation’s online database for each crash located within the advance warning area through the end of the work zone. The crash type and location are displayed in Figures 16 through 18 for the control and test sites. The most frequent crash type that occurred, at each site, was the rear-end crash.

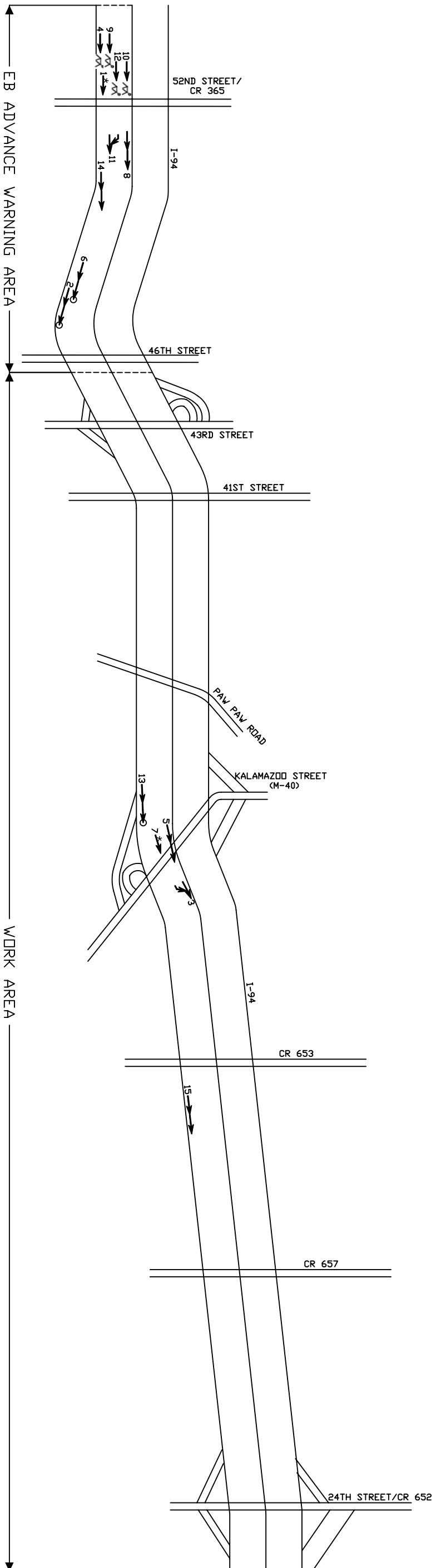

| LEGEND      |    |                   |    |
|-------------|----|-------------------|----|
| Rear-End    | →→ | Left-Turn Head-On | →↗ |
| Backed Into | →← | Sideswipe         | →↘ |
| Head-On     | ←→ | Fixed Object      | →■ |
| Angle       | ↘↗ | Parked Vehicle    | →🚗 |
|             |    | Deer              | →🦌 |
|             |    | Pedestrian        | →🚶 |
|             |    | Other             | →👤 |
|             |    | Injury            | →🚑 |
|             |    | Fatality          | →☠ |
|             |    |                   | ○  |
|             |    |                   | ●  |

Figure 16. Collision Diagram for the EB I-94 Control Site (4/24/06 - 7/16/06)  
(Not to Scale)

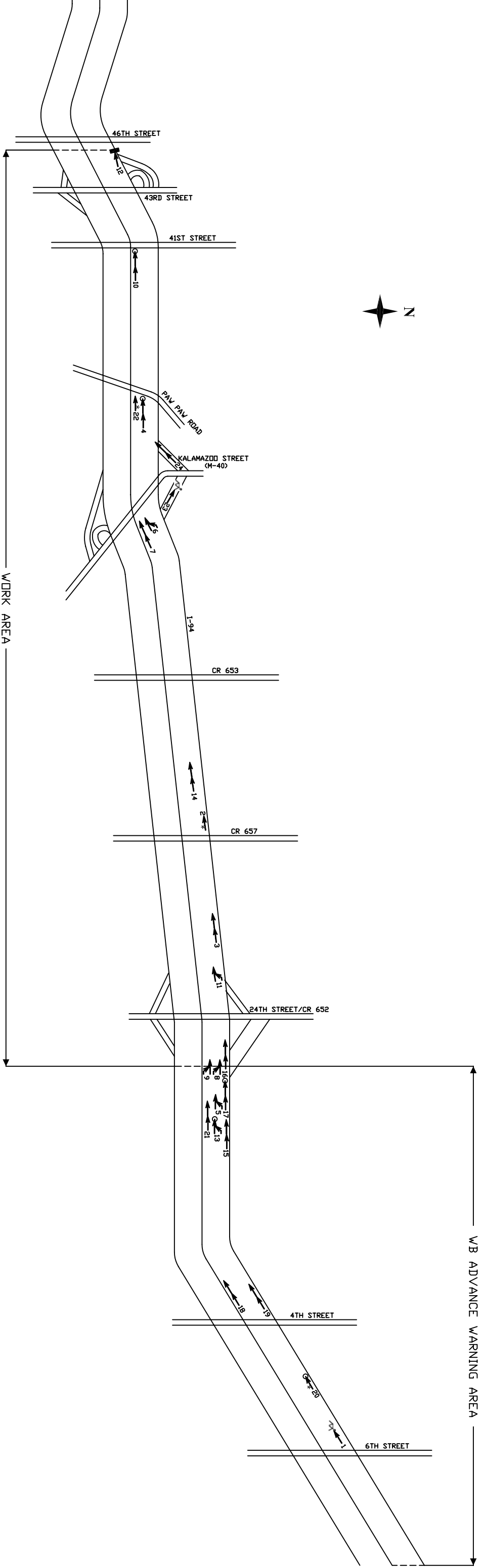

Figure 17. Collision Diagram for the WB I-94  
 Test Site (7/17/06 - 10/9/06)  
 (Not to Scale)

| LEGEND      |     |                   |     |
|-------------|-----|-------------------|-----|
| Rear-End    | →→→ | Left-Turn Head-On | ↔↔↔ |
| Backed Into | ↔↔↔ | Sideswipe         | ↔↔↔ |
| Head-On     | ↔↔↔ | Fixed Object      | ↔↔↔ |
| Angle       | ↔↔↔ | Parked Vehicle    | ↔↔↔ |
|             | ↔↔↔ | Deer              | ↔↔↔ |
|             | ↔↔↔ | Pedestrian        | ↔↔↔ |
|             | ↔↔↔ | Other             | ↔↔↔ |
|             | ↔↔↔ | Injury            | ○   |
|             | ↔↔↔ | Fatality          | ●   |

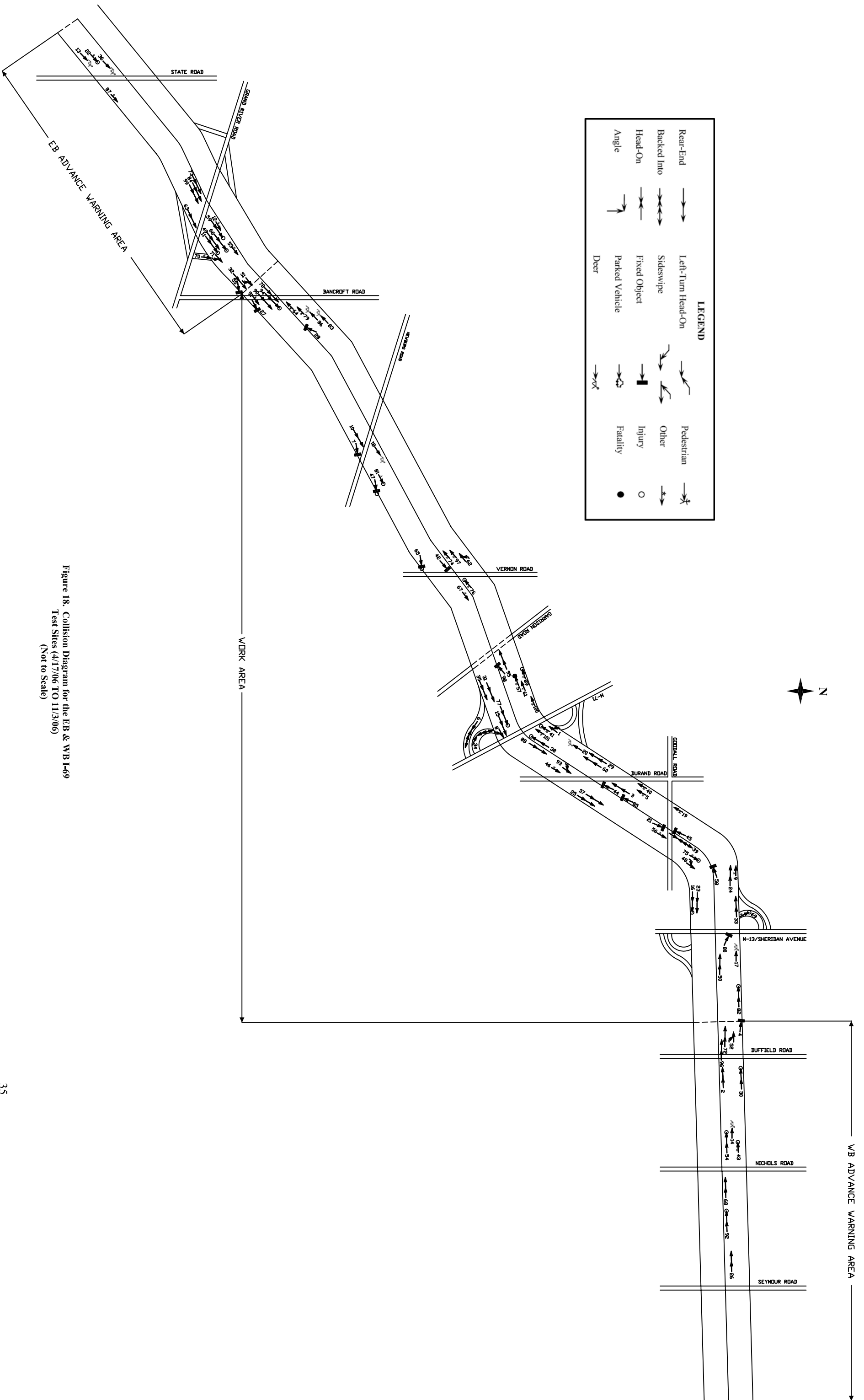

Figure 18. Collision Diagram for the EB & WB I-69 Test Sites (4/17/06 TO 11/3/06)  
(Not to Scale)

Table 13 shows a summary of the crash data for the I-94 control and test sites. It shows the number of crashes occurring on the I-94 control and test sites by the type of crash and also the general location of the crashes. The crash types include rear-end, sideswipe, fixed object, deer, other, injury, and fatal crashes. The location of the crashes include the advance warning area, the transition area, and the work area. Table 13 shows that slightly more crashes occurred within the advance warning area at the EB I-94 control site as compared to the WB I-94 test site.

**Table 13. Crash Data for the I-94 Control and Test Sites**

| <b>Crash Type</b>                              | <b>EB I-94 Control Site</b> | <b>WB I-94 Test Site</b> |
|--|-----------------------------|--------------------------|
| Rear End                                       | 7                           | 12                       |
| Sideswipe                                      | 2                           | 6                        |
| Fixed Object                                   | 0                           | 1                        |
| Deer   | 4                           | 2                        |
| Other  | 2                           | 3                        |
| <b>Total Crashes</b>                           | <b>15</b>                   | <b>24</b>                |
| Injury Crashes                                 | 3                           | 5                        |
| Fatality Crashes                               | 0                           | 0                        |
| <b>Location of Crashes</b>                     | <b>EB I-94 Control Site</b> | <b>WB I-94 Test Site</b> |
| No. of Crashes within the Advance Warning Area | 10                          | 9                        |
| No. of Crashes within the Transition Area      | 0                           | 3                        |
| No. of Crashes within the Work Area            | 5                           | 12                       |

Table 14 shows a summary of the crash data collected for the I-69 test sites including the types of crashes and the location of the crashes. Table 14 shows that more crashes occurred within the advance warning area at the EB I-69 test site as compared to the WB I-69 test site; however, they were both DLLMS test sites.

Crash rates were calculated for each site using the crash frequency, directional ADT, and length of the work zone. During construction, the ADT tends to be lower than the typical ADT, due to diverted traffic. Therefore, to use a more accurate ADT, the highest throughput volume collected from the field was used to estimate the ADT. It was assumed that the highest peak throughput is eight percent of the total ADT. Table 15 shows a comparison between the ADT from the Michigan Department of Transportation before construction and the calculated ADT using the volumes collected in the field during construction.

**Table 14. Crash Data for the I-69 Control and Test Sites**

| <b>Crash Type</b>                              | <b>EB I-69 Test Site</b> | <b>WB I-69 Test Site</b> |
|--|--------------------------|--------------------------|
| Rear End                                       | 22                       | 17                       |
| Sideswipe                                      | 5                        | 3                        |
| Fixed Object                                   | 7                        | 8                        |
| Deer   | 3                        | 5                        |
| Backed Into                                    | 3                        | 0                        |
| Angle  | 0                        | 0                        |
| Other  | 11                       | 17                       |
| <b>Total Crashes</b>                           | <b>51</b>                | <b>50</b>                |
| Injury Crashes                                 | 10                       | 8                        |
| Fatality Crashes                               | 0                        | 1                        |
| <b>Location of Crashes</b>                     | <b>EB I-69 Test Site</b> | <b>WB I-69 Test Site</b> |
| No. of Crashes within the Advance Warning Area | 16                       | 11                       |
| No. of Crashes within the Transition Area      | 1                        | 1                        |
| No. of Crashes within the Work Area            | 32                       | 38                       |

**Table 15. Comparison of ADT**

| <b>Site</b>          | <b>MDOT ADT (veh/day)</b> | <b>Calculated ADT (veh/day)</b> |
|----------------------|---------------------------|---------------------------------|
| EB I-94 Control Site | 16,150                    | 12,375                          |
| WB I-94 Test Site    | 16,300                    | 17,000                          |
| EB I-69 Test Site    | 13,500                    | 12,975                          |
| WB I-69 Test Site    | 16,250                    | 15,175                          |

The equation for calculating the crash rate (crashes per million vehicle miles of travel) is as follows:

$$Crash\ Rate \equiv \frac{Total\ No.\ of\ Crashes \times 10^6}{ADT \times No.\ of\ Days\ System\ Deployed \times Segment\ Length}$$

Where:

ADT = Directional peak hourly flow / 0.08

Segment Length in miles

Table 16 shows the crash rates per million vehicle miles of travel for the I-94 control and test sites. During the 2006 construction season, the crash rate per million vehicle miles of travel was lower for the WB I-94 test site than the EB I-94 control site.

**Table 16. Crash Rates for the I-94 Control and Test Sites**

| Site                 | Directional ADT (veh/day) | Dates System Installed          | No. of Days in Study | Crash Rate (crashes per million vehicle miles of travel) |
|----------------------|---------------------------|---------------------------------|----------------------|--|
| EB I-94 Control Site | 12,375                    | April 24, 2006 – July 16, 2006  | 84                   | <b>1.01</b>  |
| WB I-94 Test Site    | 17,000                    | July 17, 2006 – October 9, 2006 | 85                   | <b>0.99</b>  |

Table 17 shows the calculated crash rates per million vehicle miles of travel for the I-69 test sites. This table shows that the EB I-69 test site experienced a higher crash rate than the WB I-69 test site during the 2006 construction season.

**Table 17. Crash Rates for the I-69 Test Sites**

| Site              | Directional ADT (veh/day) | Dates System Installed            | No. of Days in Study | Crash Rate (crashes per million vehicle miles of travel) |
|-------------------|---------------------------|-----------------------------------|----------------------|--|
| EB I-69 Test Site | 12,975                    | April 17, 2006 – November 3, 2006 | 201                  | <b>1.70</b>  |
| WB I-69 Test Site | 15,175                    | April 17, 2006 – November 3, 2006 | 201                  | <b>1.33</b>  |

## **7.0 DRIVER BEHAVIOR**

Human factor issues including control, guidance, and navigation-related drivers' needs must be considered in the planning, design, and operation of work zone traffic control systems. All events involved in the driver's interaction with the vehicle and its controls are included in the control function. For example, this includes steering and maintaining a reasonable travel speed. The guidance function involves the use of judgment, estimation, and prediction in order to maintain a safe speed and proper path relative to the roadway, roadside environment, and traffic condition. The navigation function includes activities in which trips are pre-planned and routes are selected. While driving, drivers use landmarks and route guidance signs in order to follow their planned travel route. Drivers in a work zone setting gather information from the signs,

markings and other traffic control devices to perform their control and guidance functions. When a sign is new, drivers tend to respond quicker than normal.

### **7.1 Information Overload**

Traffic signs are primary sources of information for freeway drivers and they need to be spaced properly in order for drivers to detect, understand, and react. When traffic signs are too close together, they often provide too much information at one time for drivers to comprehend and take appropriate action. This phenomenon is called “information overload”. Work zone traffic control plans must provide clear and easy messages to allow timely and correct directions for drivers, since the work zone is an unfamiliar area for drivers. If information overload occurs, the driver might incorrectly prioritize the messages. Also, if signs are spaced too close together, there may not be enough time for the driver to respond to the information, which results in a higher potential for a collision to occur. (20)

For the purpose of this study, ‘simple’ signs include the common static signs normally used for freeway work zones and ‘complex’ signs include all freeway work zone signs, which are not common to a typical driver. An example of a ‘simple’ sign is the static “Road Work Ahead” sign whereas, a ‘complex’ sign includes the portable changeable message sign (PCMS) that provides customized information. PCMSs typically give more information than static signs, require a longer time to read and understand, and are less common. They typically appear on one side of the roadway, which may cause them to be blocked by commercial vehicles and may be difficult to see due to sunlight. The position of the PCMSs should be carefully considered so they can be clearly seen by all drivers. Because the PCMSs may be blocked by commercial vehicles, it is recommended that PCMSs be provided on both sides of the roadway to avoid this problem.

Since the DLLMS was deployed at I-69 before the DLLMS at WB I-94 and before WSU-TRG’s involvement, the work zone traffic control plans for both eastbound and westbound I-69 were evaluated to determine the most appropriate traffic control plan for the DLLMS to be implemented at the WB I-94 test site. Both EB I-69 and WB I-69 contained some information overload. This is shown in Figures 19 and 20. The influence area for each sign is circled and



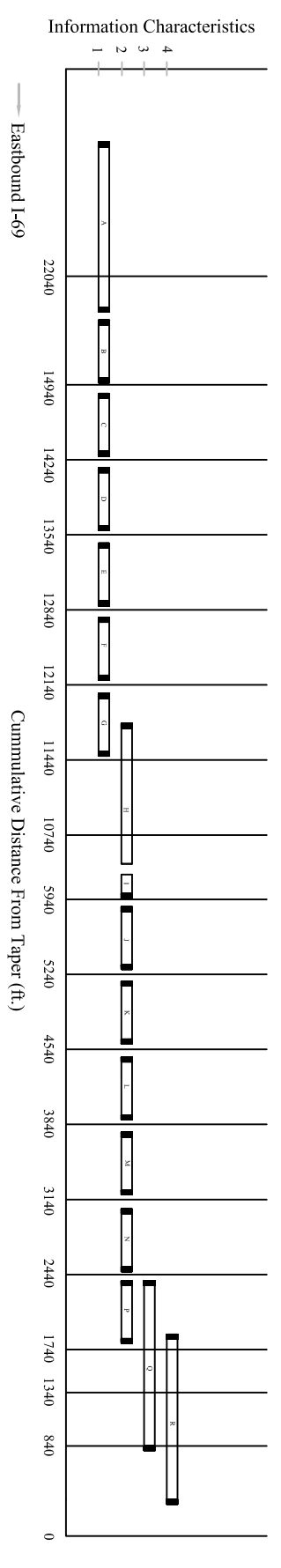
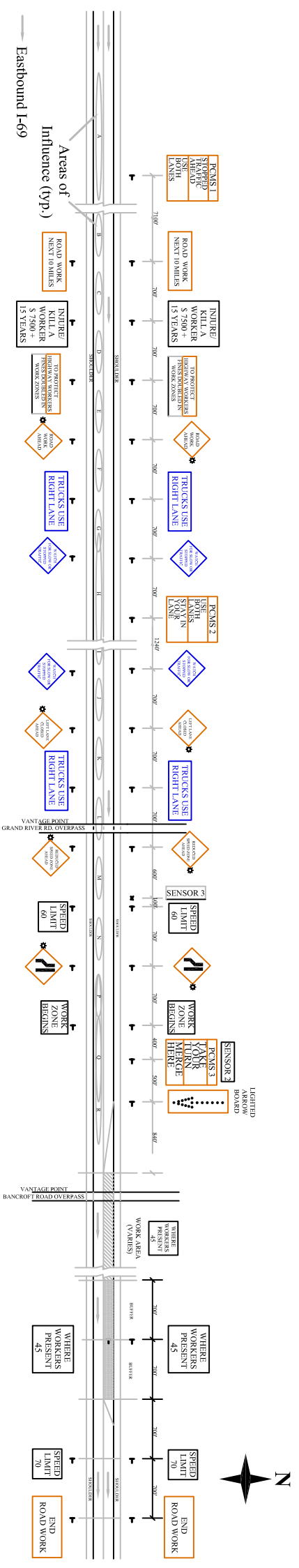

Figure 19. Information Load Diagram for the EB I-69 Test Site (70 mph) (Not to Scale)

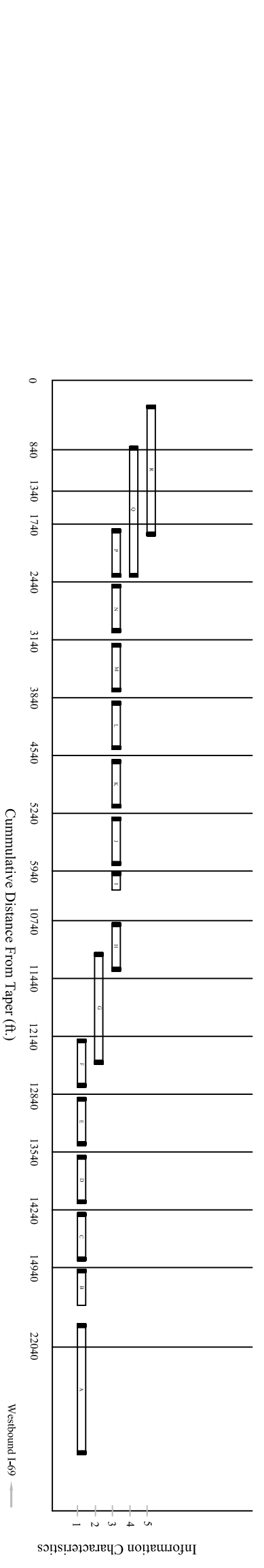
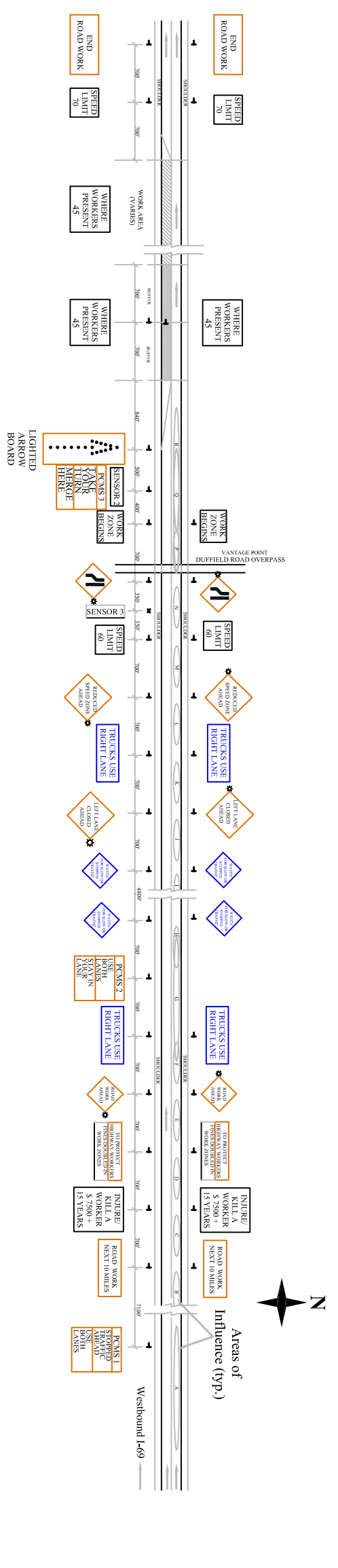

Figure 20. Information Load Diagram for the WB I-69 Test Site (70 mph) (Not to Scale)

labeled as “A”, “B”, etc. on the diagrams for each I-69 freeway segment. The influence area is calculated using the equation for stopping sight distance on level ground, which is equal to the braking reaction distance, plus the braking distance at the operating speed. For simple signs, the length of the influence area is 730 feet at 70 miles per hour. MDOT’s standard uses 700 feet. This 700 or 730 feet spacing does not provide for any lost time due to distractions or inattentiveness.

For complex signs, the reaction time increases and, therefore, the influence area increases. As stated in the 2005 MMUTCD, “The primary purpose of Portable Changeable Message signs in TTC zones is to advise the road user of unexpected situations.” (21) Therefore, drivers need more time to understand and react to complex signs because they violate the driver’s normal expectancy. The decision sight distance formula was used to calculate the influence area. According to the 2004 AASHTO manual, in order to stop on an urban road, the pre-maneuver time or reaction time used to calculate the decision sight distance is 9.1 seconds. (22) For complex signs, the length of the influence area is 1,410 feet at 70 miles per hour.

As shown in Figures 19 and 20 (page 40), for the EB and WB I-69 work zones, respectively, there are overlapping influence areas where the PCMSs are located. This shows that more than one set of information is given at the same time that produces a potential situation for information overload. Therefore, the work zone signs should be spread out further in order to reduce the possibility of information overload. Figures 21 and 22 show the freeway segments after spreading out the EB and WB I-69 work zones, respectively. The calculated stopping sight distance and decision sight distance were used for spreading. Spreading was recommended for use on the WB I-94 test site prior to the deployment of the DLLMS.

## **7.2 Sign Messages**

The message “Drive Safely” was displayed on the PCMSs at the I-69 test sites when the DLLMS was OFF. This message is vague in that drivers should always drive ‘safely’. All drivers think that they drive safely. However, the message, “Drive Carefully” or “Drive with Care”, is more meaningful to all drivers and was used in place of “Drive Safely” at the WB I-94 test site.

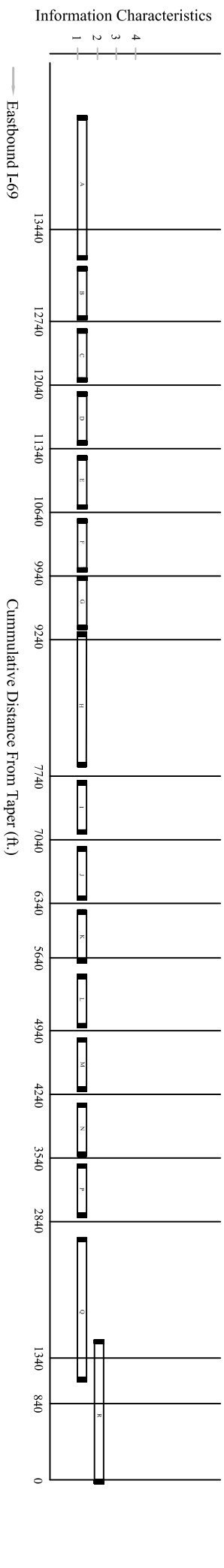
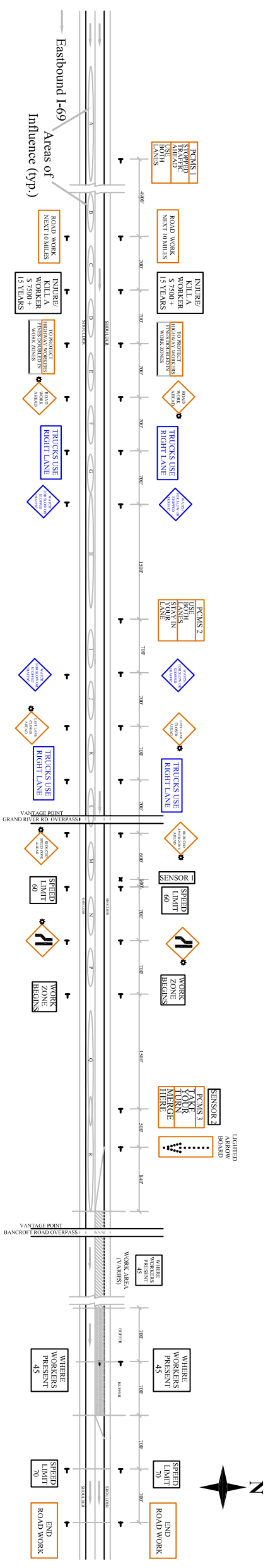

Figure 21. Information Load Diagram After Spreading for the EB I-69 Test Site (70 mph) (Not to Scale)

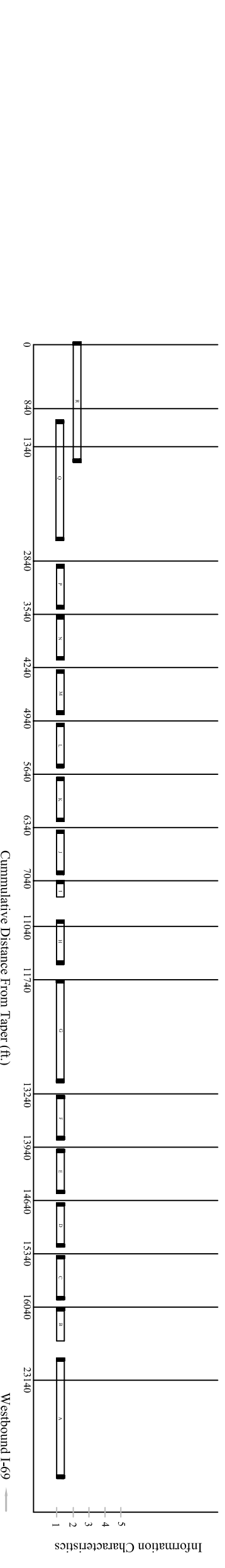

Figure 22. Information Load Diagram After Spreading for the WB I-69 Test Site (70 mph) (Not to Scale)

Another message, “Stopped Traffic Ahead”, was displayed on PCMS 1 at the I-69 test sites when the DLLMS was ON. Traffic may not always be stopped when the system is triggered ON. If people usually drive the same route and do not experience stopped traffic, they will start to disregard the message. It is better to use the term ‘slow’ because the system being ON means that the current speed is slower than normal and not necessarily stopped. The message, “Slow Traffic Ahead”, was also used at the WB I-94 test site instead.

Work zone signs should serve a purpose in order to be displayed. According to the work zone traffic control plans in Figures 12 and 13, on page 21, the static sign, “Watch for Slow or Stopped Traffic”, was displayed on both I-69 test sites. Since it is a static sign, it is always displayed even when traffic congestion is not present. If drivers frequently observe no congestion in the work zone, they may start to think that the sign is not important or true and may disregard this sign and possibly other signs as well. One way to correct this would be to provide a PCMS that gives an accurate message depending on the current conditions. This could be done by using detectors to monitor the congestion and display a message on the PCMS depending on the level of congestion.

Two different signs displaying the same message can be redundant. As shown in Figures 12 and 13, on page 21, the static signs, “Trucks Use Right Lane” and “Watch for Slow or Stopped Traffic”, each appear twice. On a typical freeway without construction, trucks are supposed to use the right lane. One sign reminding truck drivers to use the right lane should be sufficient. Also, within a work zone, it is common to experience slow or stopped traffic, so one sign stating this should be sufficient.

As shown in Figure 19, on page 40 for the EB I-69 test site, there is an information overlap between the first “Watch for Slow or Stopped Traffic” sign and the PCMS 2. Once a driver sees the PCMS, he/she is likely to disregard the previous static sign. The static sign may be removed in order to allow information spreading. A similar situation shown in Figure 20, on page 40 for WB I-69 exists. There is an information overlap between the first “Trucks Use Right Lane” sign, PCMS 2, and the first “Watch for Slow or Stopped Traffic” sign. Since PCMS 2 is most important, the driver may disregard the other two signs. Therefore, these two static signs may be removed in order to allow spreading and was recommended for use on the WB I-94 test site.

## 8.0 STATISTICAL ANALYSIS

A statistical analysis was performed in order to quantify the differences in the measures of effectiveness (MOEs), which are attributable to the installation of the DLLMS. The measures of effectiveness included the mean travel time delay, the mean travel speed and the crash frequencies

The statistical analysis is based on a ‘comparative parallel’ study, since MOEs were not available prior to the implementation of the DLLMS. Figure 23 displays a typical comparative parallel evaluation plan. The MOE of the WB I-94 test site is compared with the expected MOE. The expected MOE is that at the control site (EB I-94). The change in MOE is the difference between the expected MOE (control site without DLLMS) and the actual observed MOE (test site with DLLMS).

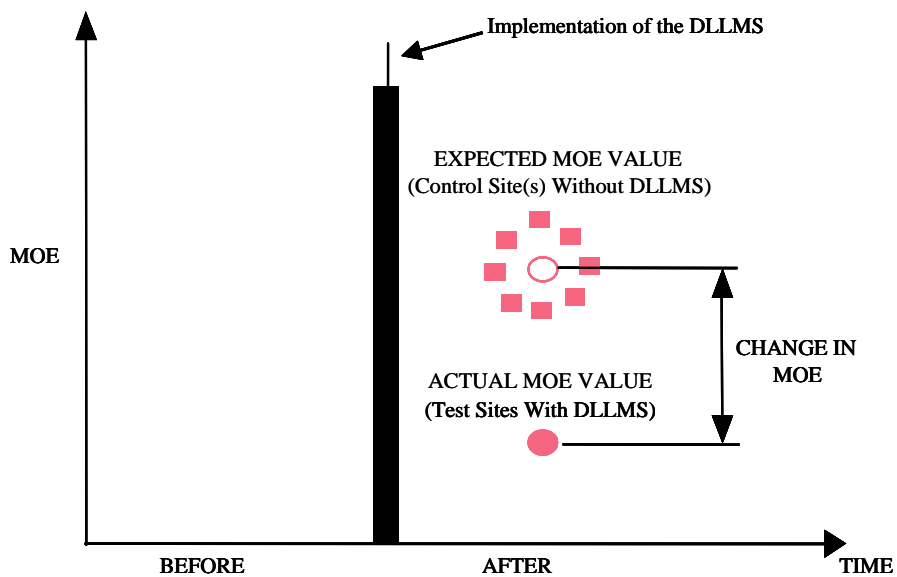

Figure 23. Comparative Parallel Evaluation Plan

### 8.1 Mean Travel Time Delay and Mean Speed Analysis

The statistical analysis for travel time delay and mean speed was done using only the congested PM peak period data (data when DLLMS was operational) at the I-94 test site. The comparable control site (EB I-94) was also analyzed for the congested PM peak periods. The travel time delay was normalized to seconds per 10,000 feet traveled in order to account for the variation in the distance of the advanced warning areas. The data is summarized in Table 18.

**Table 18. Data for Mean Travel Time Delay and Speed Statistical Analysis**

|                                     | <b>I-94 Control Site</b> | <b>I-94 Test Site</b> |
|-------------------------------------|--------------------------|-----------------------|
| Average Delay in secs/10,000 ft/veh | <b>181.25</b>            | <b>67.58</b>          |
| Average Travel Speed (mph)          | <b>29.5</b>              | <b>47.57</b>          |

The t-test [23] was the statistical method used to determine if there is a significant difference in mean travel time delay and mean travel speed with the installation of the DLLMS, as opposed to the traditional work zone traffic control system. The hypotheses tested are as follows:

H<sub>0</sub>: The mean congested travel time delay, or mean travel speed, is the same for the WB I-94 test site with the DLLMS and the EB I-94 control site with the traditional traffic control system.

H<sub>a</sub>: The mean congested travel time delay, or mean travel speed, is not the same for the WB I-94 test site with the DLLMS and the EB I-94 control site with the traditional traffic control system.

Since the DLLMS was rarely observed to be turned ‘ON’ by our data collectors, the amount of data collected while the DLLMS was operating is low resulting in a small sample size. Since the sample size is small (n<30), the t-test can be used assuming that the variances are equivalent. The F-test can be used to prove that the assumption that the variances are equivalent is accurate and is as follows [23]:

$$F_{calculated} = \frac{S_T^2}{S_C^2}$$

$$f_1 = n_T - 1$$

$$f_2 = n_C - 1$$

By using the above equations, F<sub>calculated</sub> for the mean speed is 1.75. The F<sub>critical</sub> is found by using the F-distribution table located in Appendix III. The F<sub>critical</sub> at a 95 percent level of confidence for the mean speed, when the degrees of freedom  $f_1$  is equal to 6 and  $f_2$  is equal to 5, is 4.95. Since F<sub>calculated</sub> is less than F<sub>critical</sub>, the difference between the variances of the mean speed is not statistically significant. Therefore, the following equations for the t-test can be used to calculate the statistical significance of the mean travel time delay and mean travel speed [23]:

$$s_p = \sqrt{\frac{(n_C - 1)S_C^2 + (n_T - 1)S_T^2}{n_C + n_T - 2}}$$

$$t_{\text{calculated}} = \frac{\overline{X}_C - \overline{X}_T}{s_p \sqrt{\frac{1}{n_C} + \frac{1}{n_T}}}$$

$$df = n_T + n_C - 2$$

Where:

$s_p$  = pooled standard deviation of the congested delay or speed data

$S_C$  = Standard deviation of the congested ‘control’ delay or speed data

$S_T$  = Standard deviation of the congested ‘test’ delay or speed data

$n_C$  = Number of congested travel time or speed observations for the ‘control’ period

$n_T$  = Number of congested travel time or speed observations for the ‘test’ period

$t_{\text{calculated}}$  = t-test statistic (calculated)

$\overline{X}_C$  = Mean of the congested ‘control’ delay or speed data

$\overline{X}_T$  = Mean of the congested ‘test’ delay or speed data

$df$  = Degrees of freedom

Conceptually, when using the DLLMS, the travel time delay will decrease and the mean travel speed will increase. Since the direction of change is known, the 1-tail test can be used to determine the statistical significance of the differences instead of the 2-tail test. The t-distribution table shown in Appendix III for the 1-tail test was used to determine  $t_{\text{critical}}$  at a 95 percent level of confidence ( $\alpha=0.05$ ). The results of the statistical analysis for the mean travel time delay and mean travel speed are shown in Table 19.

**Table 19. Results of Mean Travel Time Delay and Mean Travel Speed Statistical Analysis**

| <b>Analysis of Mean Travel Time Delay or Mean Travel Speed</b> | <b>Calculated Degrees of Freedom</b> | <b><math>t_{\text{calculated}}</math></b> | <b><math>t_{\text{critical}}^*</math> @ <math>\alpha=0.05</math> (1-tail test)</b> |
|--|--------------------------------------|---|--|
| Mean Travel Time Delay   | 11                                   | 2.09                                      | 1.796  |
| Mean Travel Speed  | 11                                   | 1.99                                      | 1.796  |

\* At 95% Level on Confidence

This table shows that the  $t_{\text{calculated}}$  values of the mean travel time delay and mean speed are greater than the  $t_{\text{critical}}$  values for the mean travel time delay and mean travel speed; therefore, the null hypothesis ( $H_0$ ) is rejected. This means that there is a statistically significant difference in the mean travel time delay and mean travel speed between the I-94 control site (without the DLLMS) and the I-94 test site (with the DLLMS) at a 95 percent level of confidence.

## 8.2 Crash Analysis

Since crash frequency is a discrete function, the t-test cannot be used to calculate the statistical significance of the difference between crash frequencies of the I-94 test and control sites. The Poisson Test or Chi-Squared Test should be used to determine statistical significance. For this study, the statistical significance in change in crash frequencies between the I-94 control and test sites was determined by performing the Poisson Test of significance. A summary of the data used for the statistical analysis is shown in Table 20.

**Table 20. Crash Data Used for Statistical Analysis**

| Crash Data                | EB I-94 Control Site | WB I-94 Test Site |
|---------------------------|----------------------|-------------------|
| Crash Frequency           | 15                   | 24                |
| Directional ADT (veh/day) | 12,375               | 17,000            |
| Length of time at site    | 84                   | 85                |

In order to adjust for the ADT and time period differences, the expected crash frequency for the WB I-94 test site was calculated. The expected crash frequency was calculated as follows [24]:

$$E_F = C_F \times \frac{\text{Test ADT}}{\text{Control ADT}} \times \frac{T_T}{T_C} \quad [24]$$

Where:

$E_F$  = Expected frequency-related measure of effectiveness (MOE) at the test site had the DLLMS not been implemented

$C_F$  = Control site frequency

$T_T$  = Length of time at test site

$T_C$  = Length of time at control site



The actual crash frequency at the WB I-94 test site is 24 crashes and the expected crash frequency was calculated to be 21 crashes. In order to see if there is a significant difference between the crash frequencies, the percent of change was calculated as follows [24]:

$$\text{Percent Change} \equiv \frac{E_F - A_F}{E_F} \times 100 \quad [24]$$

Where:

$A_F$  = After frequency-related MOE at the test site with the implementation of the DLLMS

The percent change was calculated to be 14 percent. The expected crash frequency with the DLLMS and the percent change indicates that the resulting point lies well below the 95 percent Poisson Curve as shown in Figure 24. Therefore, the crash frequencies observed during the construction period with the DLLMS are not statistically significant at a 95 percent level of confidence. Even though the test site has a higher frequency of crashes, the difference is not statistically significant. In order for the difference to be statistically significant, there needs to be at least a 35 percent change in the MOE.

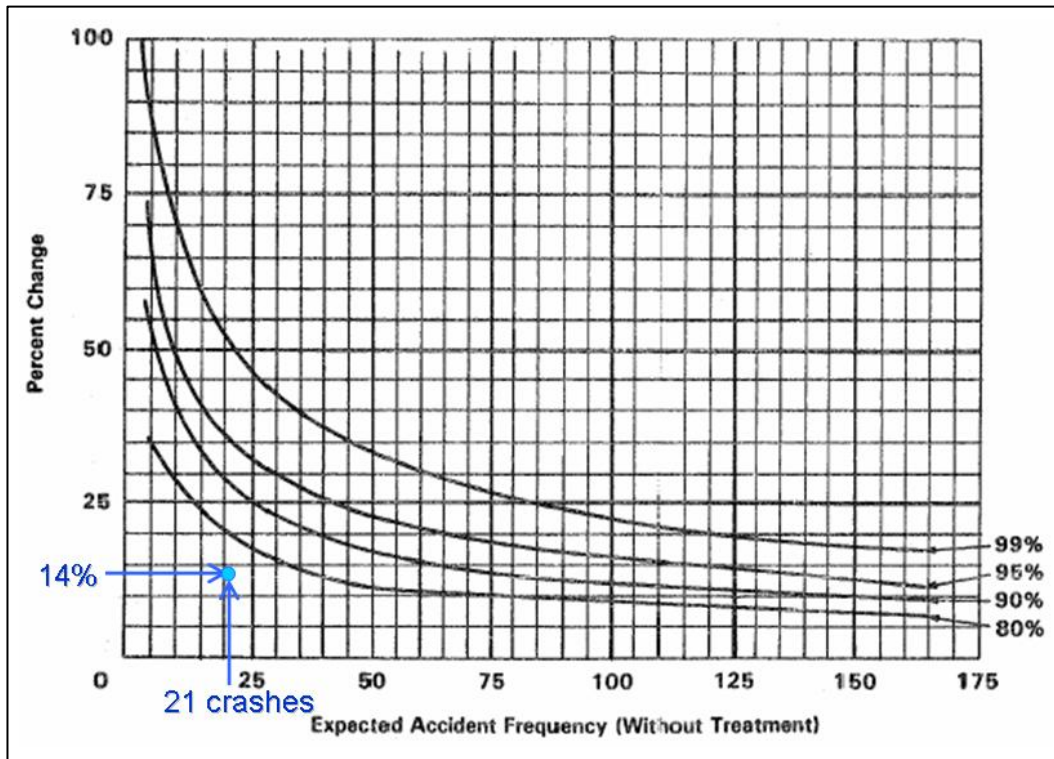

Figure 24. Poisson Curve with Calculated Values  
 [Source: FHWA Highway Safety Improvement Program [24]]

## 9.0 FUEL CONSUMPTION AND VEHICLE EMISSIONS

The purpose of the DLLMS is to improve the flow of traffic through the work zone. There should be less stopping in the advanced warning area and a decrease in the travel time delay with the installation of the DLLMS. This decrease in stops and decrease in travel time results in less congestion, which is directly related to less fuel consumption and air pollution. The following relationship (24) was used to estimate fuel consumption:

$$F = (TTD \times K_1) + (D \times K_2) + (S \times K_3)$$

Where:

TTD = Total travel distance (vehicle-miles) = Avg. flow  $\times$  No. peak hrs/day  $\times$  No. Weekdays DLLMS Operational  $\times$  Length of Advance Warning Area

$$K_1 = 0.075 - 0.0016 \times V + 0.000015 \times V^2$$

$$K_2 = 0.73$$

$$K_3 = 0.0000061 \times V^2$$

F = Fuel consumption (gallons)

V = Operating speed (mph)

Average Delay (sec/veh/10,000 ft) = Avg. delay/veh  $\times$  60 sec/min  $\times$  10,000 ft / Length of Advance Warning Area

D = Total delay (vehicle-hours) = Avg. Delay  $\times$  Avg. flow  $\times$  1 hr/3600 sec  $\times$  No. peak hrs/day  $\times$  No. Weekdays Operational

S = Total stops per hour = Avg. No. of stops per veh.  $\times$  Avg. flow

The analysis of vehicular fuel consumption characteristics is based on the data collected at the control and test sites. This analysis is typically performed for peak traffic periods when volumes are high. When the volumes are low, the operational impact of improvements on fuel consumption may not be fully realized. For all study sites, the volumes were highest during the PM peak (4:00-6:00) period.

Table 21 shows the comparison of fuel consumption data for the PM peak period for the I-94 control and the test sites. These estimates were based on the equation stated above and the flow, delay, number of stops, and travel speed data are as observed in the field.

**Table 21. Comparison of the Fuel Consumption for the Control Site and Test Sites**

| Description   | Control Site  | Test Site     |
|---|---------------|---------------|
|   | EB I-94       | WB I-94       |
| Length of Advance Warning Area (ft)   | 21,120        | 20,064        |
| Average Hourly Volume (veh/hr)  | 990           | 1,207         |
| No. of Weekdays DLLMS was Operational   | 55            | 55            |
| No. of Hours in Peak Period   | 2             | 2             |
| TTD (total travel in veh-miles)   | 435,600       | 504,526       |
| Average Delay (sec/veh/10,000 ft)   | 181.11        | 67.67         |
| D (total delay in veh-hr)   | 5,479         | 2,496         |
| Average No. of Stops per Vehicle  | 4             | 2             |
| S (total stops per hour)  | 3,960         | 2,414         |
| V (average operating speed in mph)  | 29.5          | 47.6          |
| <b>Total Fuel Consumption (gallons)</b>                                       | <b>21,796</b> | <b>18,384</b> |
| <b>Total Fuel Savings for the Work Zone during the Worse Period (gallons)</b> |               | <b>3,412</b>  |

The results of this analysis indicate that vehicles traveling through the WB I-94 test site with the installation of the DLLMS consumed less fuel than those vehicles traveling through the EB I-94 control site with the traditional work zone traffic control system. An estimated total of 3,412 gallons of fuel were saved due to the decreased delay and reduction in number of stops resulting from the installation of the DLLMS for the 11-week construction period.

The main vehicular emissions that were estimated are Carbon Monoxide (CO), Nitrogen Oxides (NOx) and Volatile Oxygen Compounds (VOC). The following equations show the relationships between the vehicular emissions and the fuel consumption [25]:

$$\text{CO (grams)} = F \times 69.9 \text{ (grams/gallon)}$$

$$\text{NOx (grams)} = F \times 13.6 \text{ (grams/gallon)}$$

$$\text{VOC (grams)} = F \times 16.2 \text{ (grams/gallon)}$$

Where:

$$F = \text{Fuel consumption (gallons)}$$

Table 22 shows the comparison of vehicle emissions for the EB I-94 control site and the WB I-94 test site during a congested PM peak period. There was a 15.7 percent reduction in the amount of pollutants produced by vehicle emissions for WB I-94 with the installation of the DLLMS.

**Table 22. Comparison of the Vehicle Emissions for the Control Site and Test Site at I-94**

| <b>Description</b>   | <b>Control Site<br/>EB I-94</b> | <b>Test Site<br/>WB I-94</b> |
|--|---------------------------------|------------------------------|
| Carbon Monoxide Emissions (grams)  | 1,523,540                       | 1,285,042                    |
| Nitrogen Oxide Emissions (grams)   | 296,426                         | 250,022                      |
| Volatile Oxygen Emissions (grams)  | 353,095                         | 297,821                      |
| <b>Total Emissions (grams)</b>   | <b>2,173,061</b>                | <b>1,832,885</b>             |
| <b>Percent Reduction in Total Vehicle Emissions<br/>per congested PM peak period</b> | <b>15.7%</b>                    |                              |

### **11.0 BENEFIT-COST ANALYSIS**

A benefit-cost (B/C) analysis was performed as a part of this study in order to determine the economic viability of the DLLMS in a freeway construction work zone in Michigan. The data used for the analysis is based on the data collected at the EB I-94 control site and the WB I-94 test site. Eastbound I-94 is the control site and westbound I-94 is the test site.

In the economic analysis, the benefit was considered as travel time savings and fuel consumption savings due to the installation of the DLLMS. The travel time savings were calculated as the difference between the recorded delays from the control site and the test site travel time runs. The travel time savings was then converted to a monetary value by assuming a monetary equivalence for the ‘value of time’. The ‘value of time’ may be estimated according to the ‘willingness to pay’ or ‘cost of time’ concepts [26]. The willingness to pay concept considers what monetary value drivers would be willing to pay for travel time savings. The cost of time concept is the actual cost of providing time savings for a project. In this analysis, various values of time were used to determine the benefits due to travel time savings in the form of a sensitivity analysis.

The travel time savings for I-94 in vehicle-hours was calculated as follows:

$$\begin{aligned}
 & (\text{Delay}_{\text{before}} - \text{Delay}_{\text{after}})(\text{sec/veh}/10,000 \text{ ft traveled}) \times \frac{1}{3600} \text{ hr/sec} \times \text{Average Flow (veh/hr)} \\
 & \times (\text{Number of peak hours / day}) \times \text{Number of weekdays DLLMS was installed} \times \text{Number of} \\
 & \text{weeks DLLMS was installed} \times (\text{Length of Advance Warning Area for Test Site}/10,000 \text{ ft}) \\
 & = (181.11 - 67.67 \text{ sec/veh}/10,000 \text{ ft. traveled}) \times \frac{1}{3600} \text{ hr/sec} \times \frac{990 + 1207}{2} \text{ veh/hr} \times \\
 & 2 \text{ peak hours/day} \times 5 \text{ weekdays/week} \times 11 \text{ weeks} \times \frac{20,064}{10,000} \text{ ft} \\
 & = 7,640 \text{ total vehicle hours of travel time savings (based on congested peak period)}
 \end{aligned}$$

The travel time savings can be converted to person-hours of travel time savings. The average vehicle occupancy is considered to be 1.25 persons per vehicle. This results in a total travel time savings during the peak period, due to the installation of the DLLMS, of 9,550 person hours (7,640 vehicle hours  $\times$  1.25 persons).

The total fuel consumption savings for vehicles traveling on westbound I-94, during the installation of the DLLMS during the peak hours, was described earlier and is shown in Table 21 (page 50). The total savings is 3,412 gallons of fuel. This value can be converted to a monetary value by assuming that the average cost of gasoline is \$3.25 per gallon. This results in a total savings of \$11,089 (3,412 gallons  $\times$  \$3.25/gallon).

Table 23 shows the monetary benefits of the DLLMS due to travel time savings based on various values of time and the monetary benefits due to fuel savings. The last column gives the total tangible benefits of the DLLMS for I-94.

**Table 23. Total Monetary Benefits of the DLLMS for I-94**

| Value of Travel Time Savings (\$/hr/person) | Monetary Benefits of DLLMS (\$) |                               |                         |
|---|---------------------------------|-------------------------------|-------------------------|
|   | Due to Travel Time Savings      | Due to Vehicular Fuel Savings | Total Tangible Benefits |
| \$5.00                                      | \$47,750                        | \$11,089                      | \$58,839                |
| \$6.00                                      | \$57,300                        | \$11,089                      | \$68,389                |
| \$7.00                                      | \$66,850                        | \$11,089                      | \$77,939                |
| \$8.00                                      | \$76,400                        | \$11,089                      | \$87,489                |
| \$9.00                                      | \$85,950                        | \$11,089                      | \$97,039                |
| \$10.00                                     | \$95,500                        | \$11,089                      | \$106,589               |
| \$11.00                                     | \$105,050                       | \$11,089                      | \$116,139               |
| \$12.00                                     | \$114,600                       | \$11,089                      | \$125,689               |
| \$13.00                                     | \$124,150                       | \$11,089                      | \$135,239               |
| \$14.00                                     | \$133,700                       | \$11,089                      | \$144,789               |
| \$15.00                                     | \$143,250                       | \$11,089                      | \$154,339               |
| \$16.00                                     | \$152,800                       | \$11,089                      | \$163,889               |
| \$17.00                                     | \$162,350                       | \$11,089                      | \$173,439               |
| \$18.00                                     | \$171,900                       | \$11,089                      | \$182,989               |
| \$19.00                                     | \$181,450                       | \$11,089                      | \$192,539               |
| \$20.00                                     | \$191,000                       | \$11,089                      | \$202,089               |

The total cost of installing and operating the DLLMS on WB I-94 was considered as the cost in the economic analysis. The total cost includes four PCMSs and is shown in Table 24.

**Table 24. Total Cost of the DLLMS**

| Item  | Quantity | Unit Cost | Cost            |
|---|----------|-----------|-----------------|
| Dynamic Late Lane Merge System, Furnished                         | 1        | \$43,552  | \$43,552        |
| Dynamic Late Lane Merge System , Operated                         | 1        | \$36      | \$36            |
| Sign Portable, Changeable, with Wireless Communication, Furnished | 4        | \$2,830   | \$11,320        |
| Sign Portable, Changeable, with Wireless Communication, Operated  | 4        | \$550     | \$2,200         |
| <b>TOTAL</b>  |          |           | <b>\$57,108</b> |

The B/C ratios were calculated based on the values of the benefits. It is important to note that since the calculated change in crash frequency was not statistically significant, this difference was not considered in the B/C analysis. Another important consideration is that since the DLLMS was implemented for a short duration of time (less than a year), the economic analysis was calculated as the direct ratio of the benefits over the costs. The results of the B/C analysis

were then plotted on a graph showing the B/C ratios versus the various values of travel time savings. This graph can be seen in Figure 25.

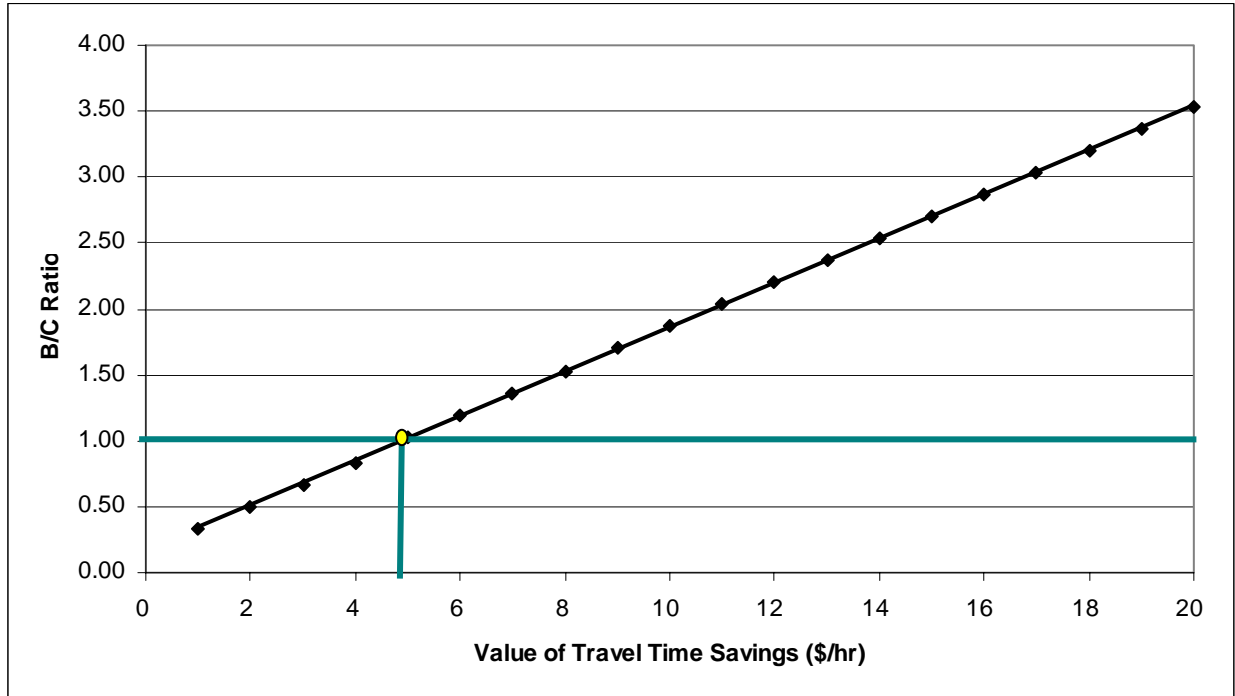

**Figure 25. B/C Ratio versus Value of Travel Time Savings**

This graph shows that for a value of time for travel time savings greater than approximately \$4.85/hour, the benefit to cost ratio will be greater than one, indicating that the monetary benefits of the DLLMS at WB I-94 outweigh the cost of the system. If such systems are used in freeways with higher peak period traffic volumes and for longer periods of time, the savings of travel time, fuel consumption and air pollution will be much higher thus, making the use of such a system more economically viable.

## **11.0 CONCLUSIONS AND RECOMMENDATIONS**

The conclusions for the DLLMS, as tested in Michigan during the 2006 construction season, include a comparison of the test and control sites. One control site (EB I-94) was used to represent the base conditions, since a conventional lane merge traffic control system was used at this site. The DLLMS was implemented at three sites, which include WB I-94, EB I-69, and WB

I-69; however, only the I-94 control and test sites are truly comparable due to the similarities of the sites and the area in which they were located. Table 25 shows a comparison of the traffic operational data for the congested period for the I-94 control and test sites. As shown in Table 25, the presence of the DLLMS improved the flow of travel and increased the percent of merging vehicles at the taper during congested periods thus, fulfilling the objective of the system.

**Table 25. Comparison of Traffic Operational Characteristics for the I-94 Control and Test Sites**

| Description<br>(Congested PM Peak)               | Control Site  | Test Site   |
|--|---------------|-------------|
|  | EB I-94       | WB I-94     |
| Avg. Travel Time (sec/10,000 ft/veh) (Pre-taper) | 272.44        | 167.46      |
| Avg. Travel Speed (mph) (Pre-taper)              | 29.5          | 47.57       |
| Avg. No. of Stops per 10,000 ft/veh (Pre-taper)  | 1.89          | 1           |
| Avg. Delay (sec/10,000 ft/veh) (Pre-taper)       | 181.25        | 67.58       |
| *Avg. Total Throughput (vph)                     | 990 (269)     | 1207 (172)  |
| *Avg. % of Merges at the taper                   | 49.15 (53.33) | 66.0 (74.1) |
| *Avg. % of Merges prior to the taper             | 50.85 (46.67) | 34.0 (25.9) |

\*Note: Total of all vehicles (Commercial motor vehicles only)

It was found that there is a statistically significant difference in mean travel time delay and mean travel speed between the test and control sites; however, there is no statistically significant difference in traffic crash experience between the test and control sites.

Typically, there is an increase in crash experience due to situations created by the existence of work zones, however, the increase often varies between locations and is not always consistent. The crash data that was presented in this report was for a very short period of time and for only one project. In order to have a better understanding of the effect of the DLLMS on crash reduction, the crashes should be monitored more closely and at multiple sites.



The amount of time that the system was operating was very low, which is primarily due to low traffic volumes at the chosen study sites. It was found that when considering a value of time greater than \$4.85/hour, the benefit to cost ratio will be greater than one, therefore, the benefits of the system outweigh the costs of the system. It is anticipated that the use of the DLLMS at higher volume freeway work zones is expected to yield higher road user and societal benefits.

The DLLMS trigger speed was set at 45 mph for the I-69 test sites and 35 mph for the I-94 test site. When comparing operations of the two work zones, it was found that a larger percentage of vehicles merged closer to the taper at the I-94 test site when the trigger speed was lower. Therefore, the lower the system's trigger speed, the higher the system's conformance will be. However, in such situations, the amount of time the system will be ON is dependent on the traffic volume and peak hour congestion.

- a. The system at the I-69 test sites operated with a trigger speed of 45 mph. The I-69 test sites with the DLLMS ON recorded the following average merge percentages during the congested PM peak hours:
  - i. 54.17% within 500 feet from the arrow board
  - ii. 45.83% greater than 500 feet from the arrow board
  
- b. The DLLMS at the I-94 test site operated with a trigger speed of 35 mph. The average merge percentages during the congested PM peak hours at the I-94 test site with the DLLMS ON are as follows:
  - i. 66.0% within 500 feet from the arrow board
  - ii. 34.0% greater than 500 feet from the arrow board

At the I-69 test sites, the PCMS was placed 500 feet prior to the arrow boards and at the WB I-94 test site, this distance was 1,500 feet. As shown in the above data, there was a higher compliance of drivers merging at the taper at the WB I-94 test site than at either of the I-69 test sites.

Recommendations have been prepared as a part of this study and they are as follows:

1. The DLLMS may be implemented in highway construction zones with the closure of one lane out of two travel lanes in one direction. It may be possible to use DLLMS treatment on a highway with a lane closure involving three lanes to two lanes; however, a pilot study may be necessary to determine the effectiveness and the guidelines for using the system for this scenario. Conceptually, use of the DLLMS for a three lane to two lane work zone should also be beneficial to road users.
2. The DLLMS should be used at locations where the highway experiences moderate to high congestion prior to construction because the system works best when congestion occurs. Recommendations are given based on the level of service determined by using the Highway Capacity analysis, traffic flow (shown in Appendix IV) and the performance of the system observations at the I-69 and I-94 work zone test sites. During the congested peak periods, the highest observed average throughput volume was approximately 1,200 vehicles per hour (vph). This shows that the traffic volumes should be at least 1,200 vph in order for the DLLMS system to be operating. Pre-construction traffic volumes, on a given highway, should be slightly higher than during the construction period, since some drivers often choose to take alternate routes to avoid a construction zone. Because of this, it is recommended that pre-construction traffic volumes be at least **1,800 vph**, per direction, for at least two hours per day and an ADT of at least **22,500 vehicles per day**, per direction. By using the DLLMS at a site with these criteria, the DLLMS will provide improvements in travel time delay and travel speed.
3. Both the early and late lane merge systems were developed for high volumes on freeways that often experience congestion. Prior to construction, the recommended ADT and peak hour volumes are very similar for the two lane merge systems. For a two to one lane reduction, the **early lane merge system** recommends the following traffic volumes:
  - a. Directional ADT: **21,500 to 34,500 vehicles per day**, per direction
  - b. Average weekday AM and/or PM peak period volumes prior to construction (2 peak hours per day): **2,000 to 3,000 vehicles per hour**, per direction (3)

It is recommended to use either the late lane merge or the early lane merge system (**not both**) when traffic congestion is experienced in the freeway system. Either system should operate in a default mode (merge when safe to do so) when there is no congestion. The late lane merge system is recommended for use in urban congested freeways when the goal is to minimize delay and queue length in the work zones. Whereas, the early lane merge system is recommended for use in rural congested areas in freeway work zones when the queue length is not an issue and a reduction of delay and aggressive driver action is desired. The early lane merge system requires police enforcement to ensure compliance to the designated no passing zone. Both systems require the existence of high peak period traffic volumes to be effective.

4. Since the system is still relatively new, a media campaign should accompany the implementation of the DLLMS to educate drivers on the purpose and benefits of the system. Emphasis should be made that merging early is **NOT** a Michigan law. It has been common practice in the past, but is not a law. Other countries in Europe use large static signs to explain the ‘zipper’ system. The Michigan Department of Transportation should consider such static informational signs.
5. The Highway Advisory Radio (HAR) station may be used to inform drivers about the work zone and the DLLMS. A static sign may be added to the traffic control plan to advise drivers to tune into the proper station for information about the work zone. Depending on the length of the HAR message, the first sign advising drivers to tune into the proper station should be located far enough so that drivers can turn the station on and listen to the entire message at least once prior to entering the advance warning area. The HAR could also give real-time information about the work zone to the drivers (e.g. whether congestion is present ahead).
6. The layout of the system should include four PCMSs and the typical lane closure static signs. Two PCMSs should be located near the taper (one on each shoulder) in order to allow drivers in either lane to see the message even if a large vehicle is in front of them. The DLLMS can be used for a right lane or left lane closure; therefore, the messages on the signs should appropriately match with the lane closure. Also, a static sign reading

“Trucks Use Right Lane” or “Trucks Use Left Lane”, depending on which lane remains open, should be provided to inform truck drivers to travel in the open lane. By providing this sign, it will avoid having truck drivers block other vehicles from using the closed lane and merging at the taper. The recommended layout is shown in Figures 26 and 27, respectively, for the system ON and OFF positions. The spacing of the signs should follow as shown in Figures 26 and 27. The tapers in the advanced warning area should not be located near entrance ramps or exit ramps.

7. The MMUTCD states that for freeway applications of PCMS, “No more than two displays should be used within any message cycle.” (21) It is recommended to incorporate an arrow on the same display panel as “Merge Here” in order to possibly increase the merge compliance at the taper. This type of display was designed for the early merge system used in Michigan during the 2003 construction season. The PCMSs should display the following messages when the system is ON and are also shown in Figure 26:

- PCMS 1 (furthest from taper): SLOW TRAFFIC AHEAD / USE BOTH LANES
- PCMS 2: STAY IN YOUR LANE / MERGE AHEAD XX MILES
- PCMS 3 & 4: TAKE YOUR TURN / MERGE HERE

When the system is OFF, or operating in the default mode, the PCMSs should display the following messages and are also shown in Figure 27:

- PCMS 1 (furthest from taper): \*DRIVE WITH CARE / WORK ZONE AHEAD
- PCMS 2: LEFT (or RIGHT) LANE CLOSED / XX MILES AHEAD
- PCMS 3 and 4: LEFT (or RIGHT) LANE CLOSED

\*If the HAR is used with the DLLMS, the default messages could incorporate the HAR. If the HAR only explains how to use the DLLMS, the recording may not be relevant to the current situation (e.g. no congestion). However, if the HAR incorporates real-time information, as well as the system explanation, it would be more relevant. If the default message incorporates HAR, the PCMSs should read “Tune to XX” instead of “Drive With Care”, where XX refers to the radio station.

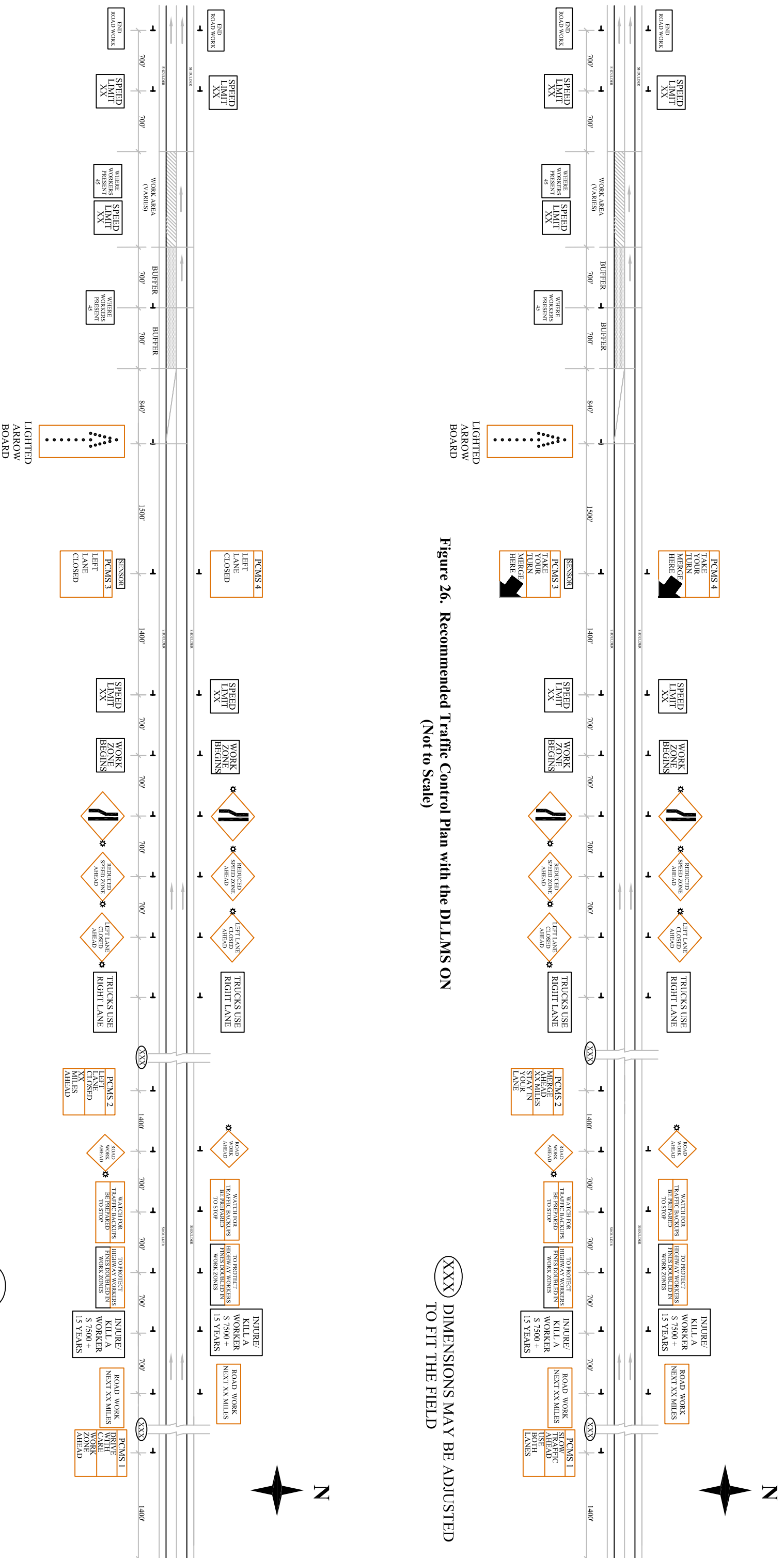

Figure 27. Recommended Traffic Control Plan with the DDLMS OFF (Not to Scale)

XXX DIMENSIONS MAY BE ADJUSTED TO FIT THE FIELD

8. The sensor should be located at PCMS 3 (Figure 27) so that it can read the correct speed of the vehicles and the volume right by the taper. The DLLMS trigger speed should be set at 35 mph in order to have greater conformance to the system by drivers.

## 12.0 ACKNOWLEDGEMENTS

The authors would like to acknowledge the Michigan Department of Transportation for their continued assistance and support in this study. They would also like to personally acknowledge Dale Spencley and Jeff Grossklaus for their continued technical support and assistance.

## 13.0 REFERENCES

1. Tarko, A., S. Kanipakapatnam and J. Wasson, *Manual of the Indiana Lane Merge Control System- Final Report*, FHWA/IN/JTRP-97/12, Indiana Department of Transportation and Purdue University, Joint Transportation Research Program, 1998.
2. Tarko, A. P., D. Shamo and J. Wasson, Indiana Lane Merge System for Work Zones on Rural Freeways. *Journal of Transportation Engineering*, Vol. 125, No. 5, September/October 1999, pp.415-420.
3. Datta, T., K. Schattler, and C. Hill, "Development and Evaluation of the Lane Merge Traffic Control System at Construction Work Zones", Research Report RC-1409, Michigan Department of Transportation, December 2001.
4. Datta, T., K. Schattler, P. Kar, and A. Guha, "Development and Evaluation of an Advanced Dynamic Lane Merge Traffic Control System for 3 to 2 Lane Transition Areas in Work Zones", Research Report RC-1409, Michigan Department of Transportation, January 2004.
5. New Release, LVM Versicherungen, "Back-Up Avoid: Zipper Method". Accessed June 8, 2006. <<http://www.lvm-feuerhake.de>>
6. ADAC, "Reissverschlussverfahren (Section 7 StVO)". May 2005. Accessed June 8, 2006. <<http://www.adac.de/verkehrs-experten>>

7. News Release, koelnerbucht.de, "The Zipper Method". Accessed June 8, 2006. <<http://koelnerbucht.de>>
8. Dijkster, Thomas and Bovy, Piet H.L. "Influencing Lane Changing at Lane Drops." On *Transportation Research Board 1999 Annual Meeting CD-ROM*, TRB National Research Council, Washington D.C., 1999.
9. Walters, Carol H. and Cooner, Scott, A. "Understanding Road Rage: Evaluation of Promising Mitigation Measures." Texas Department of Transportation Report 4945-2, Texas Transportation Institute, November 2001.
10. Pesti, G., D.R. Jessen, P.S. Byrd and P.T. McCoy, "Traffic Flow Characteristics of the Late Merge Work Zone Control Strategy." In *Transportation Research Record 1657*, TRB National Research Council, Washington D.C., 1999, pp. 1-9.
11. Byrd, P.S., D.S. Jessen, and P.T. McCoy, "Driver Survey of the Late-Merge Work Zone Traffic Control Strategy." On *Transportation Research Board 1999 Annual Meeting CD-ROM*, TRB National Research Council, Washington D.C., 1999.
12. Beacher, Andrew G., Fontaine, Michael D., and Garber, Nicholas J. Field Evaluation of the Late Merge Work Zone Traffic Control. On *Transportation Research Board 2005 Annual Meeting CD-ROM*, TRB National Research Council, Washington D.C., 2005.
13. McCoy, P.T. and G. Pesti, "Dynamic Late Merge-Control Concept for Work Zones on Rural Interstate Highways." In *Transportation Research Record 1745*, TRB National Research Council, Washington D.C., 2001, pp. 20-26.
14. Meyer, E., "Construction Area Late Merge (CALM) System", Kansas Department of Transportation, February 2004.
15. URS, "Dynamic Late Merge System Evaluation: Initial Deployment on US-10", Minnesota Department of Transportation, October 2003.

16. URS, "Evaluation of 2004 Dynamic Late Merge System", Minnesota Department of Transportation, December 28, 2004.
17. Kang, K., G. Chang, and J. Paracha, "Dynamic Late Merge Control at Highway Work Zones: Evaluation, Observations, and Suggestions". On *Transportation Research Board 2006 Annual Meeting CD-ROM*, TRB National Research Council, Washington D.C., 2006.
18. "Highway Capacity Manual." *Transportation Research Board*, Washington D.C., 2000.
19. Michigan Department of Transportation, *Michigan 2005 Annual Average 24-Hour Traffic Volumes*.
20. Pellerito, Jr., J.M., Driver Rehabilitation and Community Mobility: Principles and Practice, Elsevier Mosby, St. Louis, 2006.
21. *Michigan Manual on Uniform Traffic Control Devices for Streets and Highways, Part 6 Construction and Maintenance*. Michigan Department of Transportation, 2005.
22. American Association of State Highway and Transportation Officials, *A Policy on Geometric Design of Highways and Streets*, 2004.
23. Pignataro, Louis J. *Traffic Engineering Theory and Practice*, Prentice-Hall, Englewood Cliffs, New Jersey, 1973.
24. U.S. Department of Transportation, Federal Highway Administration, *Highway Safety Improvement Program*, December 1981.
25. Lorick, H.C., Wallace, C.E., and Jarnagin, R.E., "Analysis of Fuel Consumption and Platoon Dispersion Model", University of Florida Research Center, Report No. UF-TCR-U32-TR-02, 1980.
26. Haney, D.G., "Use of Two Concepts of the Value of Time", *Highway Research Board 12*, 1963, pp.1-18.



**APPENDIX I – AVERAGE MERGE VOLUMES**

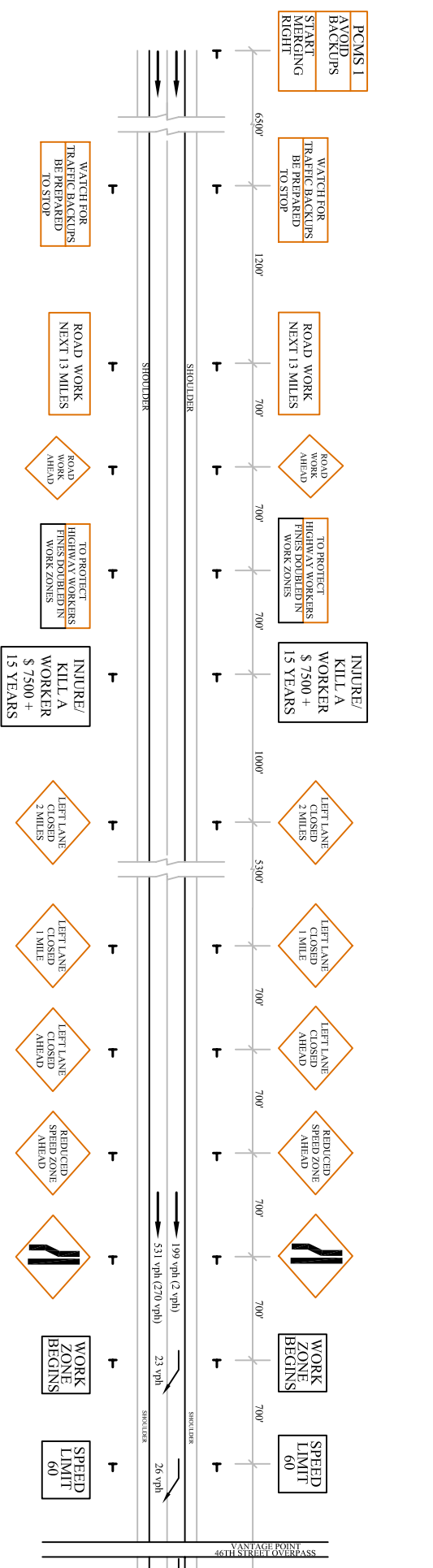

AVERAGE MERGES FOR THE I-94 CONTROL SITE FOR THE AM PEAK PERIOD

NOTE: XX AVERAGE NUMBER OF VEH/HR (XX) AVERAGE NUMBER OF COMMERCIAL VEH/HR

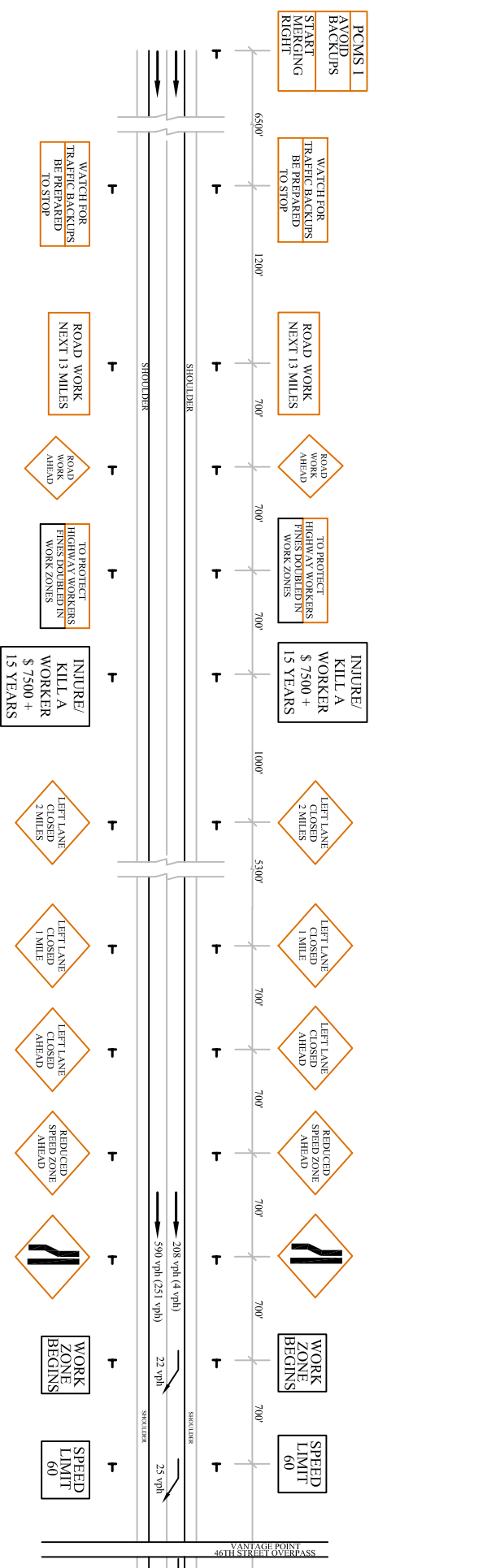

AVERAGE MERGES FOR THE I-94 CONTROL SITE FOR THE MIDDAY PEAK PERIOD

NOTE: XX AVERAGE NUMBER OF VEH/HR (XX) AVERAGE NUMBER OF COMMERCIAL VEH/HR

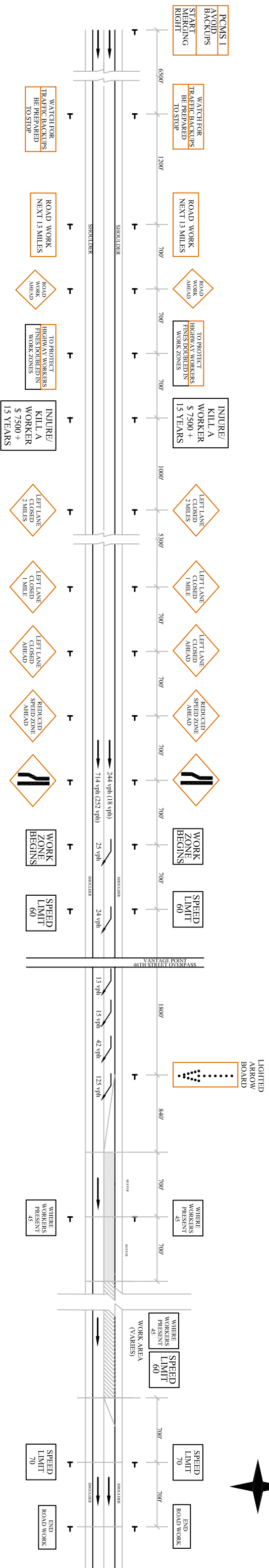

AVERAGE MERGES FOR THE I-94 CONTROL SITE FOR THE PM PEAK PERIOD

NOTE: XX AVERAGE NUMBER OF VEH/HR (XX) AVERAGE NUMBER OF COMMERCIAL VEH/HR

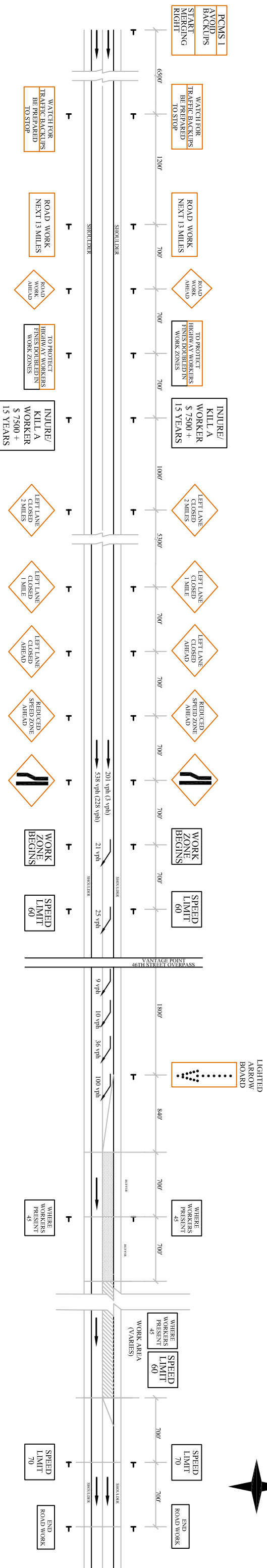

AVERAGE MERGES FOR THE I-94 CONTROL SITE FOR THE OFF-PEAK PERIOD

NOTE: XX AVERAGE NUMBER OF VEH/HR (XX) AVERAGE NUMBER OF COMMERCIAL VEH/HR

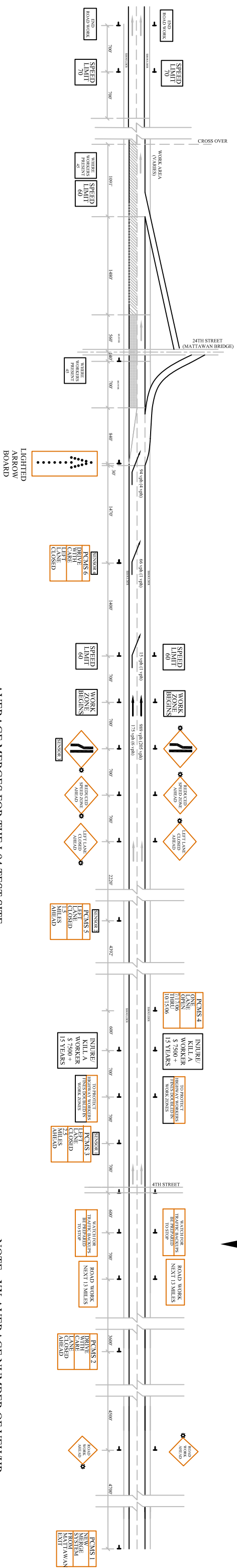

AVERAGE MERGES FOR THE I-94 TEST SITE  
FOR THE AM PEAK PERIOD

NOTE: XX AVERAGE NUMBER OF VEH/HR  
(XX) AVERAGE NUMBER OF COMMERCIAL VEH/HR

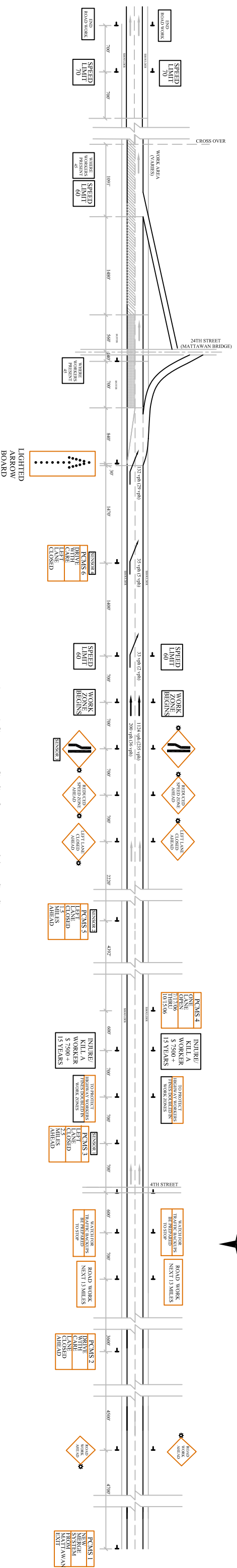

AVERAGE MERGES FOR THE I-94 TEST SITE  
FOR THE MIDDAY PEAK PERIOD

NOTE: XX AVERAGE NUMBER OF VEH/HR  
(XX) AVERAGE NUMBER OF COMMERCIAL VEH/HR