



Development of a Low-Cost Interface between Cell Phone and DSRC-Based Vehicle Unit for Efficient Use of IntelliDriveSM Infrastructure

Final Report

Prepared by:

Beau Roodell
M. Imran Hayee

**Department of Electrical and Computer Engineering
University of Minnesota Duluth**

CTS 10-14

Technical Report Documentation Page

1. Report No. CTS 10-14	2.	3. Recipients Accession No.	
4. Title and Subtitle Development of a Low-Cost Interface between Cell Phone and DSRC-Based Vehicle Unit for Efficient Use of IntelliDrive SM Infrastructure		5. Report Date November 2010	
		6.	
7. Author(s) Beau Roodell, M. Imran Hayee		8. Performing Organization Report No.	
9. Performing Organization Name and Address Department of Electrical and Computer Engineering University of Minnesota Duluth 1023 University Drive Duluth, MN 55812		10. Project/Task/Work Unit No. CTS Project #2009008	
		11. Contract (C) or Grant (G) No.	
12. Sponsoring Organization Name and Address Intelligent Transportation Systems Institute Center for Transportation Studies University of Minnesota 511 Washington Ave S, Suite 200 Minneapolis, MN 55455		13. Type of Report and Period Covered Final Report	
		14. Sponsoring Agency Code	
15. Supplementary Notes http://www.cts.umn.edu/Publications/ResearchReports/			
16. Abstract (Limit: 250 words) Intelligent transportation systems (ITS), a mission of the US Department of Transportation, focuses on intelligent vehicles, intelligent infrastructure and the creation of an intelligent transportation system through integration with and between these two components. Dedicated Short Range Communications (DSRC), a tool approved for licensing by the Federal Communications Commission (FCC) in 2003, promises to partially fulfill this mission. This research proposal intends to utilize DSRC technology to communicate the traffic safety information available at central infrastructure to a driver's cell phone. The specific objective of this research project is to design, build and demonstrate a wireless communication interface device that can act as a traffic-safety-information transportation agent between the DSRC vehicle radio unit and a Bluetooth-enabled cell phone inside a vehicle. By having this interface device along with the DSRC radio unit in a vehicle as a separate entity or integrated with a DSRC unit, any driver will be able to receive the valuable traffic safety messages on a Bluetooth-enabled cell phone. The prototype was demonstrated successfully in multiple road and traffic scenarios by transmitting the traffic safety messages to the Bluetooth-enabled cell phone. The next step is to show effectiveness of this system in a realistic environment for which a workzone environment has been chosen to relay traffic safety messages to vehicles approaching the workzone.			
17. Document Analysis/Descriptors Dedicated short range communications, Vehicle Infrastructure Integration (VII), Traffic safety, Bluetooth technology, Bluetooth, wireless access in vehicular environments, IntelliDrive SM , Intelligent transportation systems		18. Availability Statement No restrictions. Document available from: National Technical Information Services, Alexandria, Virginia 22312	
19. Security Class (this report) Unclassified	20. Security Class (this page) Unclassified	21. No. of Pages 48	22. Price

Development of a Low-Cost Interface between Cell Phone and DSRC-Based Vehicle Unit for Efficient Use of IntelliDriveSM Infrastructure

Final Report

Prepared by:

Beau Roodell
M. Imran Hayee

Department of Electrical and Computer Engineering
Northland Advanced Transportation Systems Research Laboratory
University of Minnesota Duluth

November 2010

Published by:

Intelligent Transportation Systems Institute
Center for Transportation Studies
University of Minnesota
200 Transportation & Safety Building
511 Washington Ave SE
Minneapolis, Minnesota 55455

The contents of this report reflect the views of the authors, who are responsible for the facts and the accuracy of the information presented herein. This document is disseminated under the sponsorship of the Department of Transportation University Transportation Centers Program, in the interest of information exchange. The U.S. Government assumes no liability for the contents or use thereof. This report does not necessarily reflect the official views or policies of the University of Minnesota.

The authors, the University of Minnesota, and the U.S. Government do not endorse products or manufacturers. Any trade or manufacturers' names that may appear herein do so solely because they are considered essential to this report.

Acknowledgments

The authors would like to thank Dr. Eil Kwon, Director of Northland Advanced Transportation Systems Research Laboratory (NATSRL), and Ray Starr from the Minnesota Department of Transportation (Mn/DOT) for their continuous support and cooperation in the development of this project. Also, we would like to thank Dr. Pete Willemsen, assistant professor in the Computer Science Department at the University of Minnesota Duluth, for his valuable help in program development in Linux environment.

The authors would like to acknowledge those who make this research possible. The study was funded by the Intelligent Transportation Systems (ITS) Institute, a program of the University of Minnesota's Center for Transportation Studies (CTS). Financial support was provided by the United States Department of Transportation's Research and Innovative Technologies Administration (RITA). The project was also supported by NATSRL, a cooperative research program of Mn/DOT, the ITS Institute, and Swenson College of Science and Engineering at the University of Minnesota Duluth. We would also like to thank Savari Networks for providing us the working DSRC units in a timely fashion.

Table of Contents

Chapter 1	Introduction.....	1
1.1	Background	1
1.2	Prior Art.....	1
1.3	Project Objective	2
1.4	Report Organization	3
Chapter 2	Overview of Implemented Wireless Technologies	5
2.1	Foreword	5
2.2	Bluetooth	5
2.2.1	Bluetooth Overview	5
2.2.2	Communication.....	6
2.2.3	Bluetooth Profiles	7
2.3	DSRC/WAVE	8
2.4	DSRC and Bluetooth Working Together	9
Chapter 3	System Architecture.....	11
3.1	System Architecture Overview	11
3.2	Existing Mn/DOT Infrastructure	12
3.3	DSRC RSU.....	12
3.4	DSRC OBU	12
3.5	Communication Interface Device (CID).....	12
3.6	User Interface (Cell Phone).....	13
3.7	Prominent Features of the System.....	13
Chapter 4	System Design and Implementation	15
4.1	Introduction	15
4.2	Existing Mn/DOT Infrastructure	15
4.2.1	Overview.....	15
4.2.2	Hardware Implemented.....	15
4.2.3	Software Design	15
4.2.4	Constraints	15
4.3	DSRC Units.....	16
4.3.1	Introduction.....	16
4.3.2	System Components.....	16
4.3.3	Implemented Hardware.....	16
4.3.4	Software Development.....	17

4.3.5	Application Description	17
4.4	Communication Interface Device (CID)	18
4.4.1	Introduction	18
4.4.2	CID Components	18
4.4.3	Implemented Hardware	19
4.4.4	Software Development	20
4.4.5	Application Description	21
4.5	User Interface (Cell Phone)	21
4.5.1	Platform Overview	21
4.5.2	Test Devices	22
4.5.3	Software Development	22
4.5.4	Application Description	23
4.6	Development Hurdles and System Constraints	25
4.6.1	Subsystem Development Hurdles	25
4.6.2	System Constraints	26
4.6.3	Known System Bugs	26
Chapter 5	Final Demo Results and Discussion	27
5.1	Description	27
5.2	V2I Scenario 1 – Elevated Fixed RSU and Mobile OBU	27
5.2.1	Overview	27
5.2.2	Results	28
5.3	V2I Scenario 2: Fixed RSU and Mobile OBU at the Same Elevation	29
5.3.1	Overview	29
5.3.2	Results	29
5.4	V2V Scenario 3 – Mobile OBU and Mobile OBU	31
5.4.1	Overview	31
5.4.2	Results	31
5.5	Discussion	32
Chapter 6	Conclusions and Recommendations	35
6.1	Conclusions	35
6.2	Feasibility of Developing a Simplified DSRC Vehicle Radio Unit	35
6.3	Recommendations for Future Work	36
References	37

List of Figures

Figure 1.1. Project Description	3
Figure 2.1. Example of Bluetooth Topology (Piconets and Scatternets) [13]	5
Figure 2.2. Bluetooth Packet Structure	6
Figure 2.3. DSRC Channel Frequency Assignments.....	8
Figure 2.4. Wave System Components.....	9
Figure 3.1. Traffic Safety Message System Architecture	11
Figure 4.1. DSRC Unit Application Program Flow: a) RSU, and b) OBU	17
Figure 4.2. CID Design Model	18
Figure 4.3. Implementation of CID.....	19
Figure 4.4. CID Application Program Flow	20
Figure 4.5. Cell Phones Used for Testing	22
Figure 4.6. Java ME Cell Phone Application Program Flow	23
Figure 4.7. Windows Mobile Cell Phone Application Program Flow.....	24
Figure 5.1. V2I Scenario 1: Elevated Fixed RSU and Mobile OBU	28
Figure 5.2. V2I Scenario 2, Part 1: Fixed RSU and Mobile OBU at the Same Elevation.....	30
Figure 5.3. V2I Scenario 2, Part 2: Fixed RSU and Mobile OBU at the Same Elevation.....	31
Figure 5.4. Scenario 3: Communication Between Two Mobile OBUs	32

Executive Summary

In the spirit of the Intelligent Transportation Systems (ITS) program of the United States Department of Transportation (USDOT), the integration of intelligent vehicles and intelligent infrastructure is coming to fruition through IntelliDriveSM research. IntelliDriveSM research focuses on crash prevention through active safety applications using wireless communication between vehicles and between vehicles and road infrastructure. Bringing real time traffic safety information to the vehicle is one of the key elements that can potentially prevent many accidents and consequently save lives. For example, if information about an icy bridge or animals on the road can be communicated to an approaching vehicle in a timely fashion, the chance of fatal crashes can be reduced. In addition to directly avoiding fatal crashes, real time traffic safety awareness (e.g., about traffic signal phase and timing, speed zones, work zones, school zones, curve speed warnings, and intersection warnings, etc.) can give drivers more options and keep unnecessary frustration away, which can further decrease the chances of a potentially fatal accident. With these incentives in mind, USDOT and many state counterparts have invested heavily in the ITS initiative for roadside-to-vehicle as well as for vehicle-to-vehicle communication. Such communication is supported by an advanced wireless communication technology called dedicated short range communication (DSRC), which operates around the 5.9 GHz frequency band. This current research project, under the umbrella of the IntelliDriveSM research objectives, utilizes DSRC technology to establish communication between a vehicle and the roadside infrastructure (V2I), and between a vehicle and another vehicle (V2V), bringing a new source of safety-enhancing traffic information to drivers of vehicles via their Bluetooth-enabled cell phones, enabling better decision making while driving.

The overall traffic safety message system architecture was designed around the following two concepts:

- 1) Improving safety and convenience of drivers by taking advantage of the anticipated DSRC roadside infrastructure and abundance of Bluetooth-enabled cell phones in vehicles.
- 2) Low cost, portability and usefulness of the proposed system architecture even in the absence of widespread DSRC roadside infrastructure.

A prototype system was designed and implemented around this architecture. In the specific implementation of this prototype system, traffic safety messages from the roadside are transmitted using a road side unit (RSU) to a vehicle containing an on-board unit (OBU) utilizing DSRC wireless networking protocols, and then transmitting the message from the OBU to a driver's cell phone through the use of a communication interface device (CID), which utilizes a Bluetooth connection with the cell phone user interface. Please note that CID does not have to be a separate device – it can be easily integrated with the DSRC OBU so that a vehicle does not have to carry two units. Guiding principles in the design and development of this system include low-cost, portability, transparency, and security. This article describes in detail the architecture and development of this working prototype system, along with testing results of a final demonstration of the prototype system.

The working traffic safety message system consists of following five major subsystems:

- 1) Mn/DOT infrastructure
- 2) DSRC RSU
- 3) DSRC OBU
- 4) CID
- 5) Cell Phone

The first subsystem is the Mn/DOT infrastructure where the safety messages originate. In this project, to simulate Mn/DOT infrastructure, a software application was developed and executed in a laptop computer that sends traffic safety messages in the form of short text messages to the DSRC RSU over a network connection. The DSRC RSU receives messages over the network connection from the laptop and transmits those messages via DSRC communications to the DSRC OBU, which is resident in the vehicle. The hardware for DSRC units was purchased from Savari Networks, and software was developed as part of this research project. Once a message is received by a DSRC OBU, this message is sent from the OBU to the CID over an RS232 serial communications link. The CID was completely designed and developed both in hardware and software as part of this research project. Please note that CID does not have to be a separate device – it can be easily integrated in the DSRC OBU. The CID connects to a cell phone and sends the safety messages wirelessly over a Bluetooth link. The cell phone is the user interface of the system, which receives and displays the safety messages for the driver of the vehicle. As part of this project, application software for two different cell phone platforms was developed i.e., Java and Windows Mobile platforms. Combined, these two platforms cover about 60% of the cell phones in the market.

After development was complete, the system was tested in different roadway and traffic settings to ascertain the usability and reliability of the system. In the final system demonstration, V2I as well as V2V communication was put to the test. In the first scenario of testing, the system was implemented using an elevated RSU and a mobile OBU in an urban setting, with testing conducted along two different streets. The system performed well, but communication range was diminished by line of sight obstructions, which included buildings and trees along the streets. In the second scenario, the system was implemented using a non-elevated RSU at the edge of the roadway. Here again, tests were performed along two different roadways but this time in a rural setting. The total communication range and communication reliability was greater here, due to the less obstructed line of sight between the RSU and OBU. However, communication became intermittent when the vehicle with the OBU travelled into a trough on the roadway, or experienced traffic, which could block a line of sight with the RSU. In the third testing scenario, V2V communication was put to the test. The two vehicles travelled from a rural setting to an urban one, repeatedly travelling in and out of range of one another. In the dynamic environment of this scenario, line of sight was even more critical than in the first two scenarios, with communication becoming intermittent when the leading vehicle turned a corner, or traffic obstructed the line of sight between the two OBUs.

In conclusion, the system performed well, but with less range than the desired standard of 1 km in DSRC communication in an ideal scenario. The maximum range found in testing was just under 0.5 km. This was found to be due in large part to the omni-directional antenna used for both DSRC units. To expand the communication range of this system, it is recommended that the

antenna implementation of the DSRC units be changed. Especially with a RSU, a directional antenna could be used, thereby increasing the range. For the OBUs, a bi-directional antenna could also extend the range of that unit. Additional recommendations for future work include the following:

- Incorporation of text-to-voice capabilities, enabling traffic safety messages to be read aloud to the vehicle driver. This would allow the driver to keep all attention on the roadway, rather than reading safety messages from a mobile device screen. Also, communication with pictures and symbols can be incorporated in addition to the text.
- Incorporation of GPS positioning into the system to make possible the development of applications that can track vehicle movement. This can make the system useful for various scenarios e.g., workzone traffic safety system, left turn assist on small roads merging with major roadways, etc.

Chapter 1 Introduction

1.1 Background

“Traffic crashes resulted in more than 41,000 lives lost in 2007 and contribute to traffic congestion and increased fuel consumption and emissions.” [1]

The U.S. Department of Transportation (USDOT) has made safety, mobility, and productivity focal points in the way they operate. To achieve these objectives, USDOT has created the Federal Intelligent Transportation Systems (ITS) Program, which focuses on the integration of intelligent vehicles and intelligent infrastructure to create an intelligent transportation system. The ITS program strives for this integration through the support of major initiatives with the potential for advancing safety, mobility, and productivity on the roadways [2]. One of these major initiatives adopted under the ITS program is IntelliDriveSM, which focuses on crash prevention through active safety applications using wireless communication between vehicles and between a vehicle and infrastructure [1].

The wireless networking protocols utilized by IntelliDriveSM research will go far in bringing to realization the three major objectives of IntelliDriveSM: safer, smarter, greener. Through new technology and innovative wireless networking protocols, drivers will be kept abreast of issues which will affect their ability to drive safely and efficiently. By staying informed, they will use this advance warning information to make better driving decisions, ensuring safer and more effective roadways for everyone.

In a nutshell, Dedicated Short Range Communications (DSRC) is a medium range wireless communication protocol designed for use in automotive environments. This can include vehicle to infrastructure (V2I) and vehicle to vehicle (V2V) communication. Possible applications utilizing DSRC communication include:

- Emergency Warning System for Vehicles
- Cooperative Adaptive Cruise Control
- Cooperative Forward Collision Warning
- Intersection Collision Avoidance
- Approaching Emergency Vehicle Warning
- Electronic Toll Collection

These aforementioned applications all are centered around the reliance on a low-latency, medium range wireless protocol, which is DSRC.

1.2 Prior Art

With the approval of DSRC for licensing by the Federal Communications Commission (FCC) in 2003, extensive research in the area of wireless networking in vehicular environments has taken place. University research has been the major source of published material. The University of California’s Partners for Advanced Transit and Highways (PATH) program, the University of Michigan’s Integrated Vehicle Based Safety System (IVBSS) program, and others have

conducted extensive DSRC research and development. In order to aid researchers in the fabrication of operational systems, private industry has recently developed and marketed DSRC onboard and roadside radio units, which have been implemented in research.

The University of California PATH program conducts a great deal of research in the area of DSRC communication. One project entitled “Vehicle to Vehicle Safety Messaging in DSRC” [3] conducts a simulation of a DSRC system, where safety messages are sent to a vehicle onboard radio unit. This project was a study to show the feasibility of highly reliable, low delay message transmission. Another project undertaken by PATH is that of “Mobile Millennium”, where participating GPS-enabled cell phones are anonymously surveyed for location information. This information is then relayed to users, providing information about travel route times [4]. Future work stated by the California PATH program is in many areas, some of which include: travel time data to vehicles, incident information to vehicles, work zone safety warning, intersection collision warning, curve overspeed warning, etc. [5]

The University of Michigan’s Integrated Vehicle Based Safety System (IVBSS) program has also conducted research in the area of DSRC. This organization has developed a predetermined message set for the use of traffic safety messages used in DSRC communications [6]. The University of Michigan has also been working in collaboration with the Michigan Department of Transportation (MDOT) to test the feasibility of implementing DSRC units for the implementation of communication between vehicles and roadways [7]. Furthermore, IVBSS has been conducting research utilizing DSRC communications in the area of Cooperative Intersection Collision Avoidance Systems (CICAS), which inform the driver of a vehicle of likely traffic violations by nearby drivers [8].

To aid researchers in the development of DSRC systems, private industry (Savari Networks, Kapsch TrafficCom Inc.) has recently developed equipment for purchase. These are roadside and onboard DSRC radio units with integrated memory and system resources for the development of application programs which can interface with other devices (for example, RS232, usb, wifi, and Ethernet communications). These products have enabled the changeover from system simulation to system implementation.

Though other work has been conducted in similar traffic safety application areas using DSRC technology, this research project is state of the art. It is the first documented complete and fully operational prototype safety alert message system utilizing a low cost, widely used cell phone user interface. The system is an example of a transparent, secure, portable traffic safety message relay system. In itself, it is a fully functional system, but it will also be used as a key foundational building block for future research applications utilizing DSRC communications.

1.3 Project Objective

The goal of this research is to promote the same ideals as that of the IntelliDriveSM initiative – to make driving safer, smarter, and greener. More precisely, the major objective of this research is to design, develop, and demonstrate a communication interface device (CID) which can act as a safety-traffic-information communication agent between a vehicle DSRC radio unit and a cell phone in a vehicle. By having this CID in a vehicle along with a DSRC radio unit, any driver

will be able to take advantage of the traffic safety data available at the DSRC roadside units and will be receiving that data on his cell phone as shown in Figure 1.1.

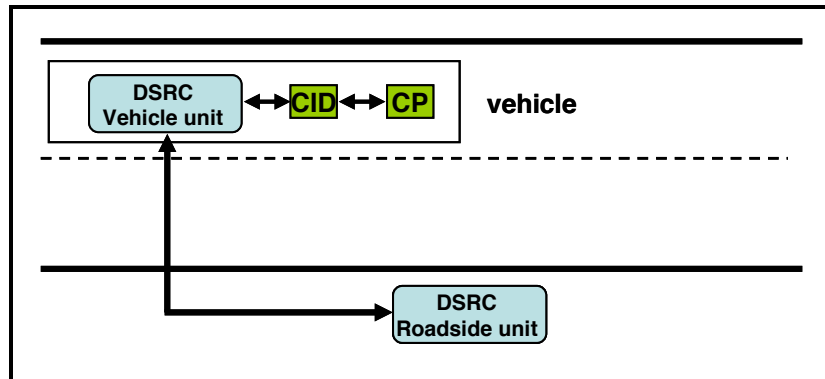

Figure 1.1. Project Description

Thus, in the spirit of the IntelliDriveSM initiative, driving will be:

1. *Safer*, since drivers will be alerted to cautionary driving conditions,
2. *Smarter*, since drivers will be able to make necessary route changes due to advance warning.
3. *Greener*, since driving will be more efficient with preventative traffic information.

1.4 Report Organization

The body of this report consists of six chapters, explaining for the reader all relevant information about the research done in this project. The first chapter is an introduction, which gives the reader background information behind the motivation for the research. Here, current related research is described, followed by a more detailed account of this particular project and its importance to current technology. In the second chapter entitled “Overview of Implemented Wireless Technologies”, the authors give extensive background information pertaining to the wireless protocols implemented in the system, along with explanation of why they were chosen for the project. The third chapter deals with system architecture. This chapter serves as a layout of the system and its parts, describing all major system blocks of the overall system to be implemented. The fourth chapter is entitled “System Design and Implementation”. This is where the authors describe the design and implementation of the system architecture introduced in the previous chapter. The fifth chapter, “Final Demo Results and Discussion,” describes for the user the final demonstration of the working system. The testing methodology is described in detail, with close monitoring of critical system attributes, followed by the results of testing in differing scenarios of use. Discussion of the demo results is given here. The paper concludes with chapter six, “Conclusions and Recommendations,” where conclusions are discussed about the system, as well as recommendations for future work. Following the main body of the report is “References”.

Chapter 2 Overview of Implemented Wireless Technologies

2.1 Foreword

Bluetooth and DSRC are the two wireless technologies implemented in this system. Bluetooth is a wireless protocol which is installed in most cellular phones, while DSRC is the protocol developed for wireless access in vehicular environments. The following sections describe these two technologies.

2.2 Bluetooth

2.2.1 Bluetooth Overview

Bluetooth is a short-range, frequency hopping, wireless technology that replaces cables or wires, creating a radio link between devices, while maintaining a high level of security. Its key features are robustness (designed to operate well in difficult RF environments – many other devices in operation), low power (most devices are Class 2, which specifies 4 dBm max power, with nominal output power of 0 dBm, [10]), low cost (~\$5 for Bluetooth chip in devices), and low complexity (standardized user operation through the implementation of profiles) [11]. The Bluetooth architecture is based upon the Bluetooth Specification Protocol Stack, which is a layered stack illustrating the Bluetooth communication protocol. How Bluetooth will be used is described in the various Bluetooth profiles. These profiles detail how different parts of the specification can be used to fulfill a desired function for a Bluetooth device. For two devices to exchange information with each other, they must support the same Bluetooth profiles [12]. Bluetooth also supports a secure connection, with security being implemented in various ways, such as frequency hopping, encryption, and security keys.

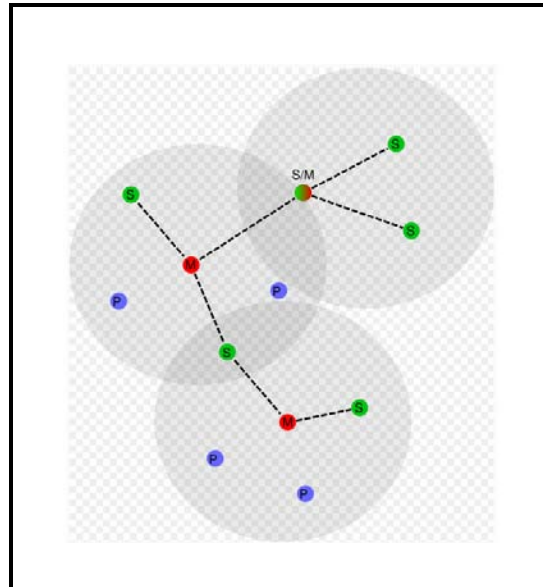

Figure 2.1. Example of Bluetooth Topology (Piconets and Scatternets) [13]

2.2.2 Communication

The Bluetooth technology has been developed as a uniform structure for a wide range of devices to connect and communicate with each other wirelessly through short range, ad-hoc networks known as piconets [12]. A piconet consists of one master device which interconnects with up to seven (due to 3-bit MAC addresses) active slave devices. Up to 255 devices can be “parked,” which the master can bring to active status at any time. Devices can simultaneously be members of different piconets, and a master of one piconet can be slave of another, and vice versa. When membership overlaps, this condition is called a “scatternet.”

In Figure 2.1, the colored dots represent different devices. “M” denotes a master of a piconet, while “S” denotes an active slave device. “P” represents parked or inactive devices.

The basic piconet channel is divided into numbered time slots (full duplex channel), with each time slot corresponding to an RF hop frequency. The master starts its transmission of packets in even-numbered time slots, with the slaves beginning transmission in odd-numbered time slots. See Figure 2.2 below for a general illustration of the structure of a packet [10].

Layer Information

Channel Access Code	Packet Header	Guard & Sync (EDR only)	Payload Header	Payload	CRC
	Physical Channel Access Code	Logical Transport Identifier	EDR Physical layer mode change	LMP messages, L2CAP signals, L2CAP frames or other user data	

Figure 2.2. Bluetooth Packet Structure

The following describes the basic algorithm for connecting two devices in a piconet [10]:

1. Initializing party sends a request via a predefined frequency.
2. Receiving party sends a number, known as a seed.
3. Initiating party uses the “seed” as a variable in a predefined algorithm, which calculates the sequence of frequencies that must be used. Most often, the period of the frequency change is predefined, as to allow a single base station to serve multiple connections.
4. The initiating party sends a synchronization signal via the first frequency in the calculated sequence, this acknowledging to the receiving party it has correctly calculated the sequence.
5. The communication begins, and both the receiving and the sending party change their frequencies along the calculated order, starting at the same point in time.

Bluetooth communication takes place in the 2.4 GHz unlicensed ISM band, which has nearly global availability as an unlicensed frequency band [11]. To limit the effects of interference from other sources in the band, to increase spectral efficiency, and to aid in security, a FHSS (frequency hopping spread spectrum) paradigm is implemented. Here, the frequency is changed with each transmission over 79 channels spaced 1 MHz apart, enabling up to 1600 hops/second. The standard data rate is 1 Mbps (GFSK), with Bluetooth v2.0 allowing for 2 (pi/4-DQPSK) or 3 (8-DPSK) Mbps, depending on the modulation format implemented [10].

2.2.3 Bluetooth Profiles

Profiles have been established to give a Bluetooth-enabled device its personality – they define how the technology (Bluetooth communication) will be used [13]. Their purpose is threefold:

1. To reduce the number of options and set parameter ranges within the protocols
2. To specify the order in which procedures are combined.
3. To provide a common user experience across devices from different manufacturers.

Profiles are used so that a device can operate more efficiently, implementing only the Bluetooth communication features necessary for the intended application. For two devices to communicate successfully with each other, they must both support the same Bluetooth profile(s). The profiles use the various Bluetooth protocols as building blocks.

Common profiles used in mobile information devices (i.e. – cell phones and PDA's) are:

- **HS (Headset)** – This profile provides support for Bluetooth Headsets to be used with cell phones. It allows for minimal controls including the ability to ring, answer a call, hang up and adjust the volume [14].
- **HF (Hands Free)** – This profile is commonly used to allow car hands-free kits to communicate with a mobile phone in a vehicle. It allows a user to make use of some of the phone's features, while the phone is located elsewhere in the vehicle (i.e., in the trunk, suitcase, etc) [14].
- **SPP (Serial Port Profile)** – This profile emulates a serial cable to provide a wireless RS-232 serial connection between two Bluetooth devices (cable replacement) [14].
- **DUN (Dial-Up Networking)** – This profile provides a standard to access the internet and other dial-up services over a Bluetooth connection (i.e. – use phone as a modem) [14].
- **OPP (Object Push Profile)** – This profile is used to send “objects” such as pictures, virtual business cards, and appointment details from a sender (client) to a receiver (server) [14].
- **PBAP (Phone Book Access Profile)** – This profile allows exchange of phone book objects between devices (i.e. – used between a car kit and mobile phone to display caller name by the car kit) [14].

- **FTP (File Transfer Protocol)** – This profile is used to provide access to file systems on another device [14].

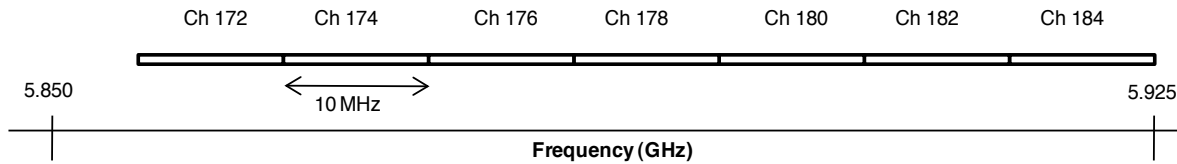

Figure 2.3. DSRC Channel Frequency Assignments

2.3 DSRC/WAVE

DSRC is a short to medium range (< 1 km) high-speed (up to 27 Mbps) wireless communications protocol specifically designed for automotive use (vehicle speeds up to 120 mph), where minimizing latency (50 ms) and isolating relatively small communication zones are important [15]. DSRC is used in vehicle-roadside and vehicle-vehicle communication, and is implemented in the 5.850-5.925 GHz frequency range. It consists of seven 10 MHz channels with data rates available from 3-27 Mbps (also offered is the option of combining two sets of two 10 MHz channels (174/176 and 180/182) into two 20 MHz channels with data rates available from 6-54 Mbps) [16], with the first channel (172) set aside strictly for vehicle safety (see Figure 2.3) [16]. Critical DSRC technology characteristics are specified as follows:

- Bandwidth: 75 MHz (5.850 – 5.925 GHz)
- Modulation: QPSK OFDM (with 16 QAM and 64 QAM options) (BPSK preamble)
- Channels: 7 – 10 MHz channels (optional combinations of 10 and 20 MHz channels)
- Data Rate: 6, 9, 12, 18, 24, and 27 Mbps with 10 MHz channels (3 Mbps preamble)
 - (or 6, 9, 12, 18, 24, 36, 48, and 54 Mbps with 20 MHz channels (6 Mbps preamble))
- Maximum Transmit Power: 28.8 dBm (at the antenna input)
- RSU and OBU Sensitivity: -82 dBm (QPSK) / -65 dBm (64 QAM)

DSRC has many proposed applications, some of which include:

- Emergency warning system for vehicles
- Cooperative Adaptive Cruise Control
- Cooperative Forward Collision Warning
- Intersection collision avoidance
- Approaching emergency vehicle warning
- Electronic toll collection

DSRC/WAVE enables vehicle-to-vehicle and vehicle-to-roadside wireless communications. This communication protocol can be used to alert drivers of traffic hazards or emergencies and notify users of incoming services at high speeds or in high traffic densities. The system (see Figure 2.4) consists of two devices: a RSU (roadside unit) and an OBU (onboard unit). The RSU is stationary and permanently mounted, while the OBU is mobile and typically mounted onboard a vehicle.

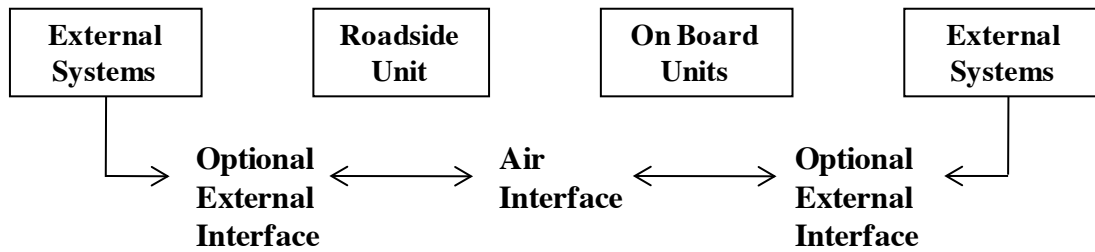

Figure 2.4. Wave System Components

The WAVE architecture consists of two entities – a provider and a user. The provider offers services and the user chooses whether or not to use the offered services. Either device (RSU or OBU) can play the role of provider or user [17].

The complete WAVE/DSRC standards are described collectively in the set of 5 standards implemented by IEEE (as well as IEEE P802.11p Amendment: Wireless Access in Vehicular Environments):

1. **IEEE 1609.0-2008 (draft)** – IEEE Trial Use Standard for Wireless Access in Vehicular Environments (WAVE) – Architecture
2. **IEEE 1609.1-2006** – IEEE Trial-Use Standard for Wireless Access in Vehicular Environments (WAVE) – Resource Manager
3. **IEEE 1609.2-2006** – IEEE Trial-Use Standard for Wireless Access in Vehicular Environments (WAVE) – Security Services for Applications and Management Messages
4. **IEEE 1609.3-2007** – IEEE Trial-Use Standard for Wireless Access in Vehicular Environments (WAVE) – Networking Services
5. **IEEE 1609.4-2006** – IEEE Trial-Use Standard for Wireless Access in Vehicular Environments (WAVE) – Multi-channel Operation

2.4 DSRC and Bluetooth Working Together

This project requires the use of two wireless links. First, the traffic alert message must be transmitted from the roadside (RSU) to the vehicle (OBU) over a wireless link. This is exactly what DSRC was created for – a low latency, secure link in a vehicular environment. Communication can take place between the vehicle and roadside infrastructure (V2I) or between one vehicle and another (V2V). Once the message has been transmitted from the roadside to the vehicle, it must be sent to the user interface. In this project, the user interface has been chosen to be a cell phone. The most convenient way for a user to receive the above mentioned messages on his/her cell phone is over a Bluetooth link. These two wireless protocols work together in this research to bring to a vehicle driver a new source of safety-enhancing information, enabling better decision making while driving.

Chapter 3 System Architecture

3.1 System Architecture Overview

The overall traffic safety message system architecture was designed around the following two concepts:

- 1) Improving safety and convenience of the drivers by taking advantage of the anticipated DSRC roadside infrastructure and abundance of Bluetooth-enabled cell phones in the vehicles.
- 2) Low cost, portability and usefulness of the proposed system architecture even in the absence of wide spread DSRC roadside infrastructure.

The system architecture was designed keeping the above mentioned points in mind and will be described in detail in this chapter. The overall traffic safety message system consists of five major sub-systems as shown in Figure 3.1 and listed below:

- 1) Existing Mn/DOT infrastructure
- 2) DSRC Roadside Unit (RSU)
- 3) DSRC Onboard Unit (OBU)
- 4) Communication Interface Device (CID)
- 5) User interface (Bluetooth capable cell phone)

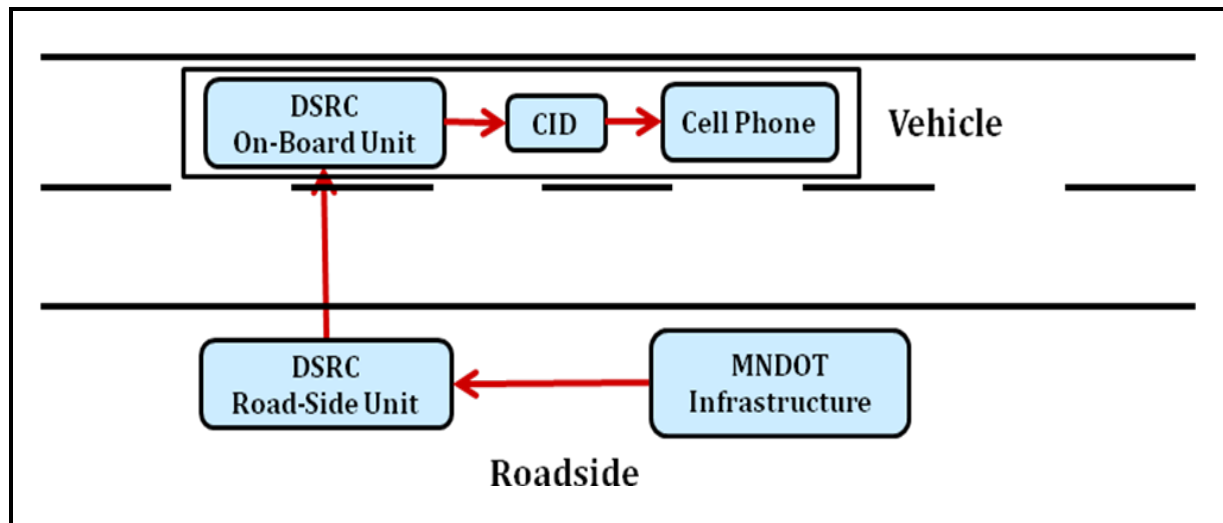

Figure 3.1. Traffic Safety Message System Architecture

In this system, a safety message originates at the existing Mn/DOT infrastructure from a variety of sources including a local conventional detection system or through a central station. That safety message is then transferred to the RSU via local cabled or wireless communication or via internet communication. The RSU then sends the message wirelessly to a vehicle based OBU via DSRC technology. Upon receiving the safety message, the OBU passes the message via hard wire to the CID, which in turn sends the message wirelessly over a Bluetooth link to the paired cell phone in the vehicle. The cell phone then displays the message for the driver of the vehicle

as a text message which updates as new messages arrive. Please note that the CID does not have to be a separate device. It can be made part of the DSRC OBU so that there is only one device in the vehicle.

3.2 Existing Mn/DOT Infrastructure

In the scope of this project, it is assumed that there exists Department of Transportation infrastructure with the capability to create traffic safety messages and transmit them to the DSRC RSU over an Ethernet connection. In the development of this system and for testing and demonstration purposes, a simulated infrastructure was used. A laptop was used as source of safety messages which could be generated asynchronously and be sent to the DSRC RSU.

3.3 DSRC RSU

The DSRC RSU is responsible for receiving traffic safety messages from the existing DOT infrastructure over an Ethernet connection, and then sending them wirelessly to a vehicle based DSRC OBU. In V2I communication, the RSU is a roadside stationary device permanently connected to the existing DOT infrastructure. In a typical installation, the RSU would be placed elevated above the level of the roadway and would utilize a directional antenna in order to optimize range and precision of transmission. For a local application, this DSRC RSU can be installed at any local road where a service is to be provided to the passing vehicles in terms of safety messages provided that the passing vehicles have the DSRC OBU equipped with CID and drivers have Bluetooth-enabled cell phones.

3.4 DSRC OBU

The DSRC OBU is responsible for wirelessly receiving traffic safety messages from the DSRC RSU on the DSRC communications band, and then sending the messages using some sort of hardwire connection to the CID which is resident in the vehicle. The hardwire communication was chosen to ensure that CID can be made part of the DSRC OBU. The DSRC OBU is a mobile unit powered by the vehicle's battery system. It utilizes an omni-directional antenna in order to optimize wireless DSRC communications in a dynamic environment.

3.5 Communication Interface Device (CID)

Based in the vehicle, the CID is a critical system block which makes safety messages available to the user interface of the system (the cell phone). The CID is responsible for receiving traffic safety messages from the vehicle DSRC OBU over a hardwired connection and sending them wirelessly via Bluetooth to a cell phone acting as the user interface for the system. The CID handles the task of monitoring for the paired BT cell phone and automatically establishing a connection with it when it comes into Bluetooth range (for instance, when the user enters the vehicle).

3.6 User Interface (Cell Phone)

The user interface for the system is a Bluetooth-enabled cell phone. The cell phone is responsible for wirelessly receiving traffic safety messages from the vehicle based CID and displaying them for the user. In a typical scenario, the cell phone would be mounted in a phone cradle in the vehicle with the screen easily visible to the driver, ensuring safe and easy reading of incoming messages. From the viewpoint of the user, connection with the system is automatic, with only a one time acceptance prompt for the user in some cell phones when connecting to the system. That one time prompt can be given when a person enters the vehicle.

3.7 Prominent Features of the System

The architecture of this system is such that it is low-cost, transparent, secure and portable. These features have been central principles in the creation of the system architecture and a brief description is as follows:

1) Low Cost:

First, the architecture of this system allows for low cost implementation. A cell phone was chosen for the user interface device due to the fact that drivers commonly also own cell phones. Thus, an additional purchase is not required for the user interface of the system. Also, the CID is designed to be implemented with minimal parts; the components that are used are relatively inexpensive. It is assumed however, that most of the vehicles in the future will be equipped with the DSRC OBUs.

2) Transparency:

Transparency has been a guiding principle in the design of this system. The user of the system should not have to “do” anything. When messages are received by the DSRC unit, the user has only to read them from the screen and adapt his driving to the new information. In future work, we are planning to convert the text messages to speech so that the driver of the vehicle does not have to even read the message. Rather, it can be spoken to him by the cell phone.

3) Security:

Security issues need to be taken into account so that unauthorized access to the cell phone and the navigation system residing inside a vehicle can be avoided. Security is built-in in DSRC technology and also special care was taken to secure the Bluetooth wireless link so that unauthorized devices don't send spurious messages to the cell phones.

4) Portability:

The architecture of this system has been designed with portability and dynamic use in mind; it can be used for standalone operation, or can be easily incorporated into a larger system, where communication can take place between multiple RSU's. Furthermore, the architecture of the system is such that it allows for easy adaptation in either V2I or V2V communication scenarios.

Chapter 4 System Design and Implementation

4.1 Introduction

The architecture of this system utilizes two new wireless technologies to communicate between the roadside infrastructure and a vehicle. DSRC wireless technology is used to implement communication from the roadside to the vehicle, while Bluetooth wireless technology is used for transmitting the message to the driver's cell phone, which is the interface for displaying the traffic safety messages. In the previous chapter, the overall architecture of the traffic safety system was described. In this chapter, the detailed design and implementation of each of the five subsystems will be described.

4.2 Existing Mn/DOT Infrastructure

4.2.1 Overview

As stated in Chapter 3, traffic safety messages entering the system originate in the assumed existing Mn/DOT infrastructure. To make this system usable and testable, a laptop is used as a substitute infrastructure. This serves as a "roadside system" to which the DSRC RSU can be connected. The laptop is then used to send traffic safety messages into the system.

4.2.2 Hardware Implemented

The laptop implemented for the Message Input Interface utilized a Linux operating system, which was able to seamlessly communicate with the DSRC units over User Datagram Protocol (UDP) protocols. This laptop was chosen for its parallel use in both DSRC application development and usability as an existing infrastructure entity. Other factors considered in this choice of hardware were durability, cost, processing power, company reputation.

4.2.3 Software Design

In this part of the design, an application was created as a message input interface for the system. This application utilizes UDP communication between the laptop and the DSRC RSU over a cabled Ethernet link. UDP is one of the core members of the Internet Protocol (IP) Suite, and is used in communication between two hosts on the same IP network. When the system administrator enters a traffic safety message the text is transmitted to the DSRC RSU. After this, the system waits for the next traffic safety message to be entered. Safety messages in the form of text can be generated asynchronously.

4.2.4 Constraints

To fulfill the requirements necessary for the inherent properties of traffic safety messaging in a DSRC environment (low latency, easy reading, to the point), short messages are required to be entered into the system. Messages entered by the system administrator are composed of ASCII text and have a maximum of 100 characters, followed by a carriage return.

4.3 DSRC Units

4.3.1 Introduction

The DSRC units used in this system enable wireless communication from the vehicle to the roadside (V2I) or from one vehicle to another (V2V). Manufacturers of DSRC equipment offer both OBUs and RSUs for implementation.

4.3.2 System Components

In the actual implementation of this system, OBU-type DSRC units were used as both RSUs and OBUs. This choice of a universal DSRC unit enhances portability and versatility of the designed system. With this scheme, the system not only has the capability of V2I communication (2nd OBU is placed at the roadside, just as the RSU would be), but also the capability of V2V communication (2nd OBU is placed in a vehicle, and can then communicate with another vehicle with a DSRC OBU). Thus, the system is more versatile and also portable – the entire system can be adapted for different communication strategies and application scenarios.

This option is possible because the RSU and OBU DSRC units offer the same programming functionality. Differences between the units arise in the unit enclosure and antenna design. The RSU model is designed to be a fixed, wireless gateway, and thus is enclosed in a sturdy NEMA 67 weather-proof enclosure. This differs greatly from the OBU, which occupies a much smaller footprint and is built to be used in a protected environment (inside a vehicle). Likewise, the two models differ in antenna design. The RSU model is built with a directional antenna to ensure proper aiming of transmission signal, whereas the OBU harbors an omni-directional antenna for optimum transmit and receive capabilities in a dynamic environment. However, in the prototype demonstration, the same unit was used for the roadside application because only the DSRC communication was needed and the actual Mn/DOT infrastructure was not a concern.

4.3.3 Implemented Hardware

The DSRC units implemented in this prototype system are manufactured by Savari Networks. These units are built upon an embedded Linux platform (Busybox), which utilize 500 MHz AMD processors, are built with 256 MB DDR DRAM, and have 512 MB Compact Flash memory. They also support a variety of communication protocols for peripheral support, offering USB, serial, and Ethernet ports and WIFI. These DSRC units were chosen for their flexibility and extensive processing power, offering versatility in programming and allowing for the support of potentially large and complex applications. These units can also be used in future phase of our project to connect GPS devices on their USB port and can be controlled through system programming.

Currently, this project utilizes the Ethernet and serial ports of the DSRC OBU for programming. Traffic safety messages are sent to a DSRC OBU via Ethernet connection from Mn/DOT infrastructure (when used as a RSU). On the other side of the DSRC link, the safety messages are sent to the CID over an RS232 serial connection.

4.3.4 Software Development

The DSRC units are built upon a Linux platform, so application development had to be accomplished in a Linux environment. Software development was done in a Fedora 8 Linux environment. Two separate applications were developed – one for DSRC RSU and one for DSCR OBU. Applications were coded and compiled on a separate computer, and then were installed on the DSCR units using an IP network connection. These applications can be run by configuring the DSRC unit to auto start the application upon power up, or by manually starting the application through a remote connection using another Linux machine.

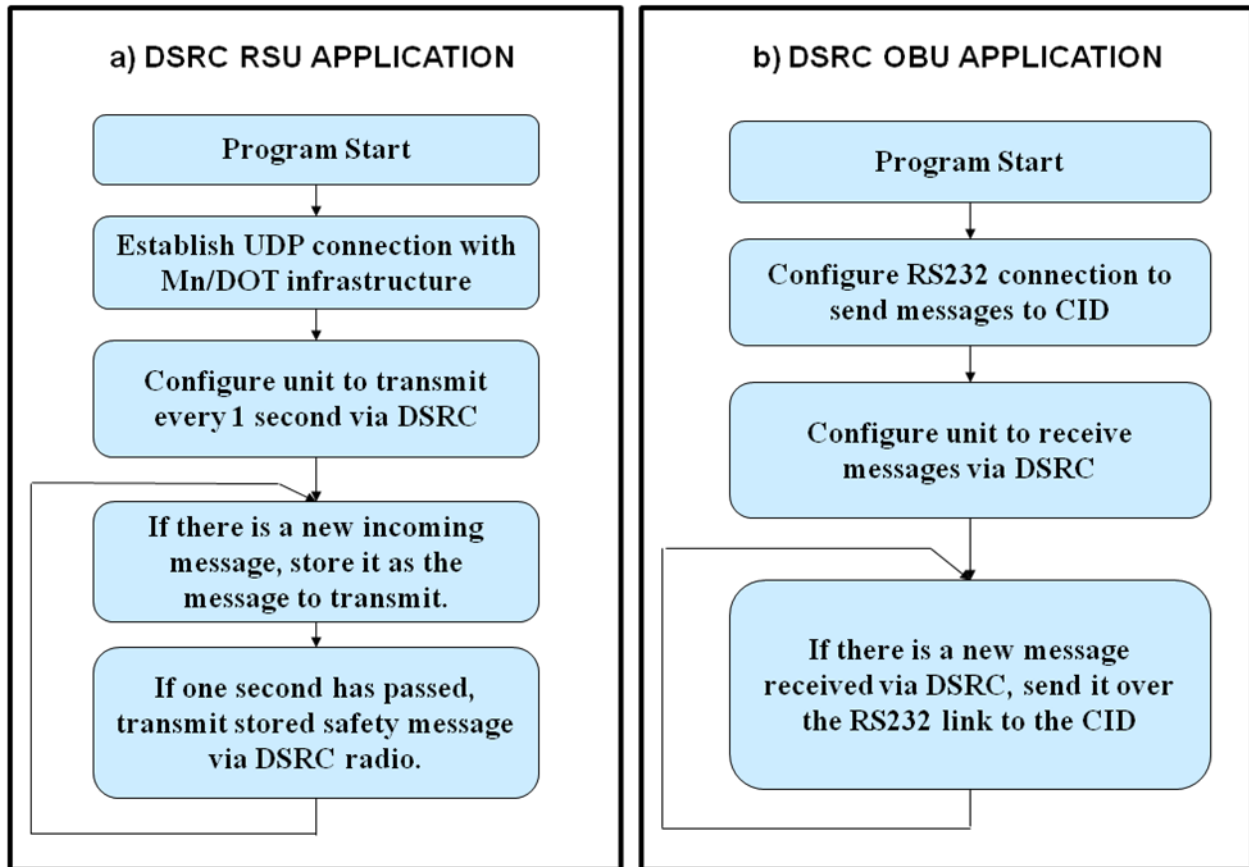

Figure 4.1. DSRC Unit Application Program Flow: a) RSU, and b) OBU

4.3.5 Application Description

The system is set up such that one DSRC unit indicates that it provides a specified service. Then, users are connected to the system if they contain the same service ID as the system provider. Once the network manager of the system recognizes both entities as using the same application, they are able to communicate with each other.

The DSRC RSU application is set up to receive incoming safety messages from the DOT infrastructure over a UDP network connection and send them to the DSRC OBU over the 5.9 GHz DSRC frequency band, repeating the transmission every second. Transmission of the

current safety message is repeated until a new safety message enters the system. For complete program flow chart of the DSRC RSU application, please see Figure 4.1a.

Conversely, the DSRC OBU application is configured to receive incoming messages from the sending DSRC unit and to output the received safety message on the serial port of the DSRC unit. For program flowchart, please see Figure 4.1b.

4.4 Communication Interface Device (CID)

4.4.1 Introduction

The CID is the system component responsible for transmitting safety messages received from the DSRC OBU to the cell phone. These traffic safety messages are received by the CID over RS232 serial communications, and are then sent to the cell phone user interface over a Bluetooth connection to be displayed for the vehicle driver.

4.4.2 CID Components

The CID is composed of two major hardware components (see Figure 4.2):

1. Bluetooth radio module
2. Microcontroller unit (MCU)

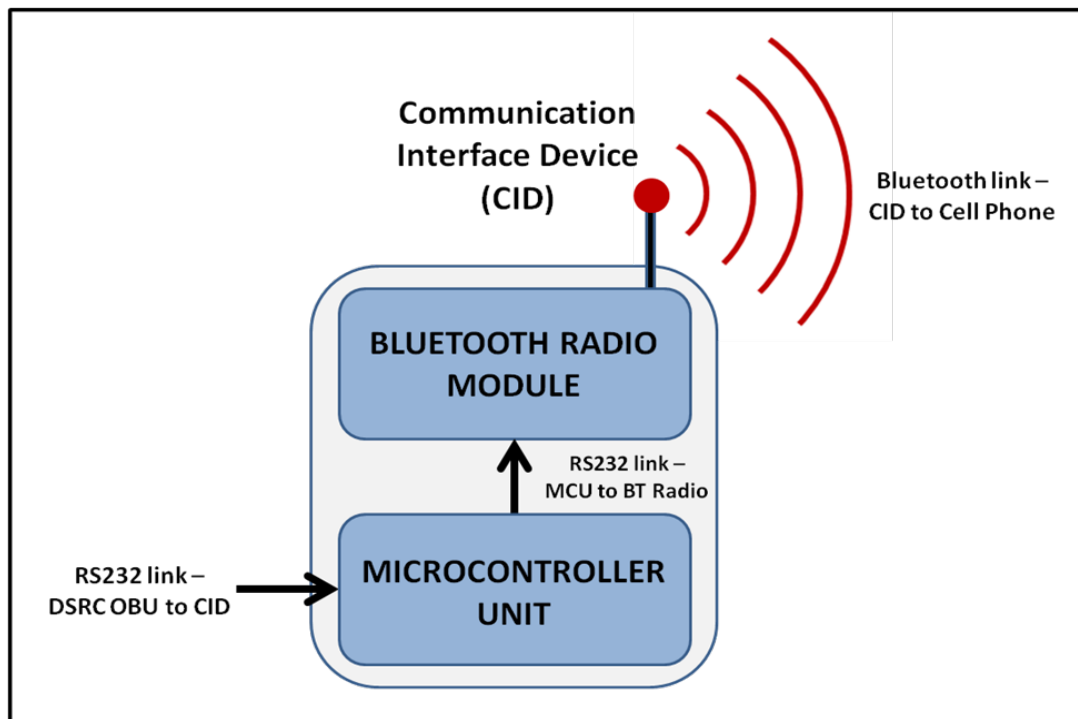

Figure 4.2. CID Design Model

These two components are critical in the design of the CID. The microcontroller has the task of handling two serial connections. The first serial connection is with the DSRC OBU. Here is the connection where the incoming DSRC traffic safety messages are received. They are read from the corresponding serial input buffer, and are stored in the memory of the MCU for transmission

to the Bluetooth radio module. The second RS232 connection is with the Bluetooth radio module. The Bluetooth radio module is controlled and messages are sent to the Bluetooth module through this RS232 serial connection. Once the Bluetooth radio module is connected with the cell phone, the traffic safety messages are sent to the Bluetooth radio module over this RS232 connection. As characters are received by the Bluetooth radio module, they are sent to the cell phone.

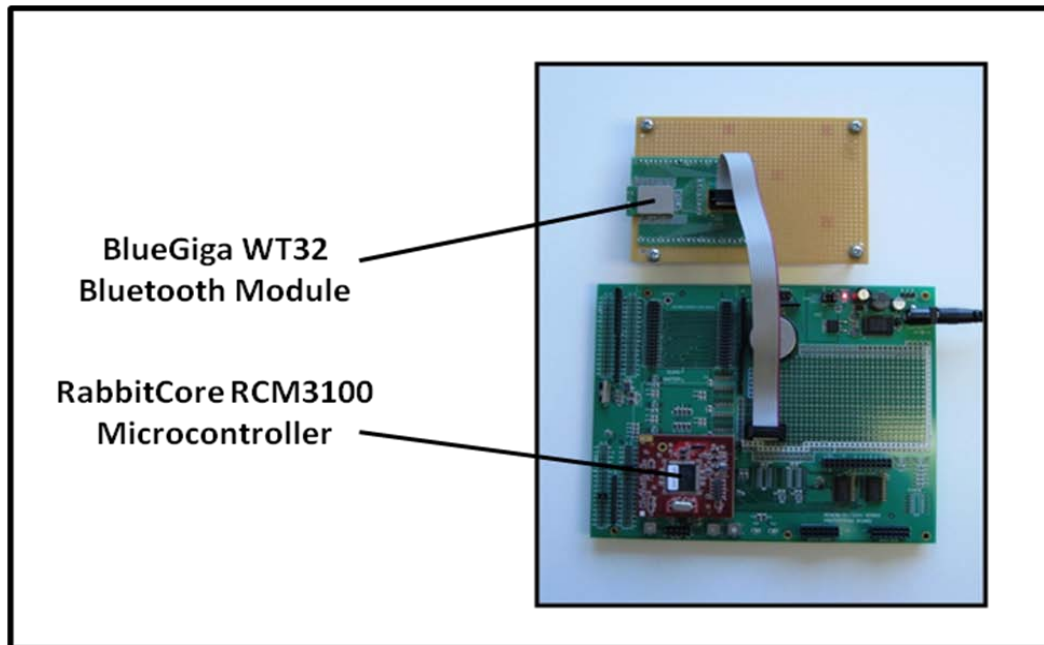

Figure 4.3. Implementation of CID

4.4.3 Implemented Hardware

The CID implementation utilizes two major hardware devices:

- 1) A microcontroller for device control and communication processing
- 2) A Bluetooth radio module for communication with the cell phone.

The MCU chosen was the RabbitCore RCM3100 microcontroller module. It utilizes the Rabbit 3000 microprocessor running at 29.4 MHz, 512 KB of static RAM, and 512 KB of flash memory. Available on the module are 6 serial ports for extensive communication capabilities. The RCM3100 was chosen for its powerful processing power, extensive RAM and flash memory, and multiple serial communication capabilities. For Bluetooth communication, the BlueGiga WT32 Bluetooth Module was used. The WT32 is the latest generation in Bluetooth modules supporting a wide range of Bluetooth profiles, such as A2DP, AVRCP, HFP, HFP-AG, SPP, OPP and HID. It is Bluetooth 2.0 compliant and Bluetooth 2.1 ready, and is a certified Bluetooth End Product, so further FCC certification is not required by OEM's. It is a Class 2 Bluetooth device and is built with an integrated antenna. This Bluetooth module also features BlueGiga's iWRAP firmware, which enables the control of Bluetooth functionality by a remote device via a RS232 serial interface. Therefore, this can be controlled through the RCM3100 module using one of its six serial communication ports. Commands are sent over the serial line

from the RCM3100 to the WT32 Bluetooth module in order to pair devices, establish connections, and send traffic safety messages for transmission to a cell phone user interface. The implemented CID is shown in Figure 4.3.

4.4.4 Software Development

For CID operation, applications were developed to run on the RabbitCore RCM3100 module using the Dynamic C development environment. This development environment is an integrated editor, compiler and debugger that interfaces directly with the target system. Programming is accomplished using the Dynamic C programming language, and then the programs are compiled and installed in the MCU's flash memory. Upon power up, the program begins execution. No software development is required for the WT32 Bluetooth module, since all of its functionality is controlled by the RCM3100 via RS232 communication.

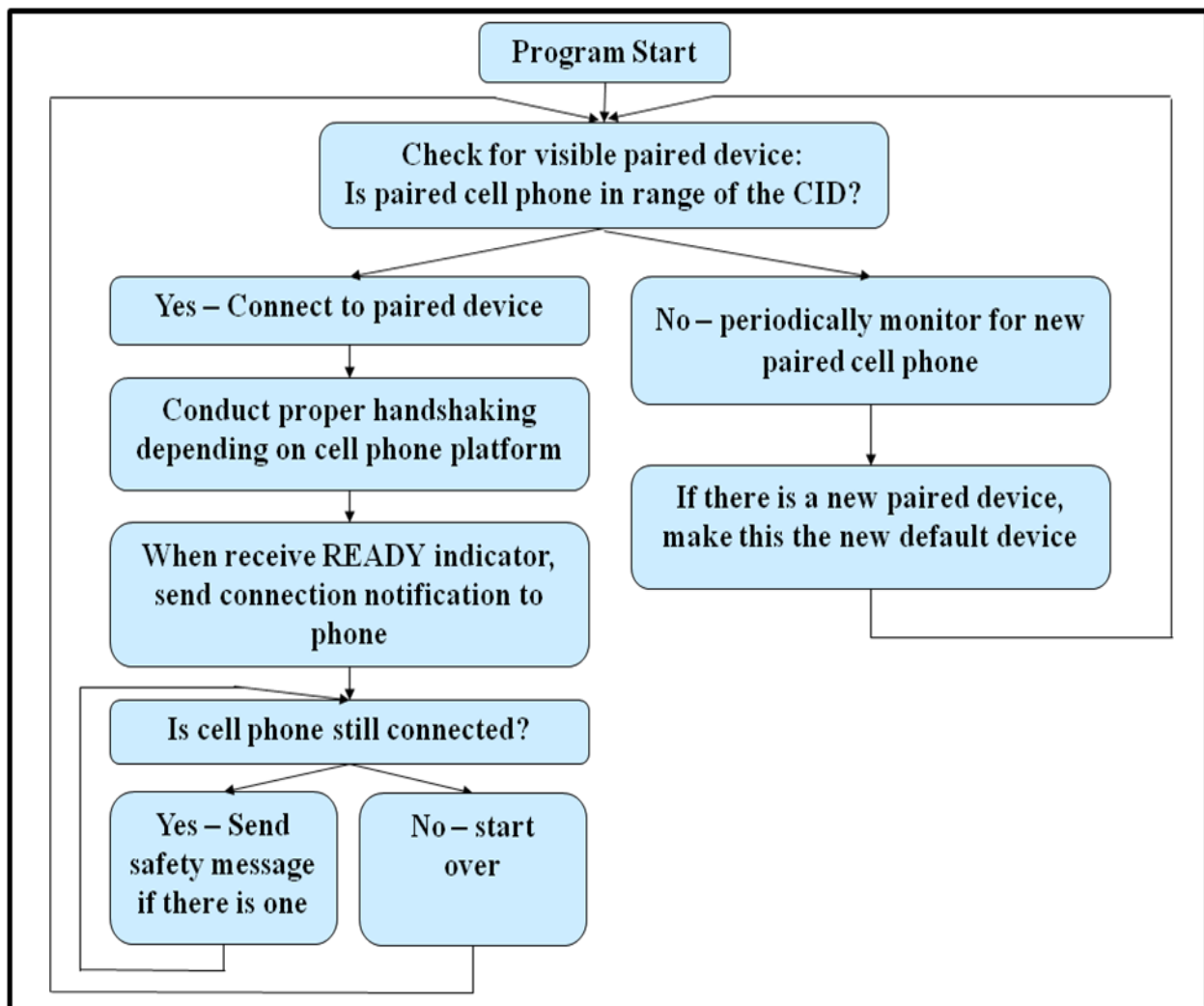

Figure 4.4. CID Application Program Flow

4.4.5 Application Description

The operating application for the CID is shown in the flowchart displayed in Figure 4.4. Upon startup, the CID uses the Bluetooth module to inquire if the paired cell phone is within range (visible). If so, the CID connects to the paired cell phone. Then, the program is in a waiting state. Whenever traffic safety messages are received by the CID, they are sent to the connected cell phone. When the Bluetooth connection is lost (either the cell phone application is closed by the user, or the phone is taken out of range of the CID), the CID reenters the initial state where it is regularly inquiring for the paired cell phone to be in range of the CID. Also, when there is no Bluetooth connection, the CID monitors for a new pairing with a different cell phone. When a new device is paired using the correct security code, it becomes the new device to connect and send traffic safety messages to.

4.5 User Interface (Cell Phone)

4.5.1 Platform Overview

The user interface of the system which displays information for the vehicle driver is a cell phone. While there are a number of system platforms used in cell phones, Java and Windows Mobile are the two platforms supported in the implementation of this system. Among others which could be supported in future work are iPhone, Palm, etc.

Java is one of the most implemented platforms used in cell phones today and most of the phones from multiple vendors would support that platform. More specifically, Java Micro Edition (Java ME) is the version of Java used in mobile devices. It is a compact version of Java designed to run efficiently in the environment of lower processing power and smaller memory inherent to mobile devices (when compared to the processing power and memory of a personal computer). Mobile Java technology is implemented through the Mobile Information Device Profile (MIDP) Java specification which, combined with the Connected Limited Device Configuration (CDLC) Java specification, is the Java runtime environment used in mobile devices such as cell phones and PDAs. MIDP has been deployed on more than 2.1 billion devices worldwide [9]. This environment allows a mobile device to run applications developed using Java Micro Edition. Most Java mobile devices also support the Java Application Programming Interface (API) JSR-82, the set of Java functionality which controls the Bluetooth functionality in a Bluetooth-enabled device. This provides a universal way to access the Bluetooth radio in mobile devices through Java programming. The support of the JSR-82 API is necessary to implement this application.

Another key player in mobile device platforms is Windows Mobile. Due to its widespread use, this is the second platform which the system was designed to support. As with Java Micro Edition, functionality is somewhat condensed in the Windows Mobile environment when compared to the standard Windows environment (for example, Windows XP and Windows Vista). This again is due to the limited processing power and smaller memory size of mobile devices. Otherwise, programming for the Windows Mobile environment is analogous to Windows programming.

4.5.2 Test Devices

For testing of the developed applications, two phones were used (one for each platform). The first is the widely used Nokia 6085. This phone supports Java ME, and thus is used to test and run the Java version of the cell phone user interface application. This phone was used due for its widespread popularity as a “free phone” provided to cell phone users when signing up for a service contract with major cell phone providers. It is a basic phone without the most advanced features, so if this phone operates properly in the system, it is assumed that more advanced phones should too. The second cell phone which is used as a user interface in the implementation and testing of this system is the HTC S310. Similar to the Nokia 6085, the HTC S310 is also a very popular entry level cell phone/personal data analyzer (PDA) running Windows Mobile operating system that meets the basic requirements necessary for this application. These two cell phones are shown in Figure 4.5.



Figure 4.5. Cell Phones Used for Testing

4.5.3 Software Development

Software Development takes place differently for each platform. First, Java ME application development is accomplished in Netbeans, an open source Integrated Development Environment (IDE) for the Java programming language. “Netbeans Mobility Pack” is the add-on package to the Netbeans IDE required for mobile application development. In Netbeans, programs are written in the Java ME programming language, and then compiled. The .jar file that is produced in Netbeans is an executable file that can be transferred to the cell phone for execution. Conversely, Windows Mobile applications are created using Microsoft Visual Studio. Here, too, development for the mobile environment requires an add-on package for Visual Studio

(Windows Embedded CD 6.0). Programming takes place using the Visual C++ programming language. Programs are then compiled in Visual Studio, which creates the necessary .exe executable file which is transferred to the cell phone.

4.5.4 Application Description

The operation of the corresponding Java and Windows Mobile applications differs, due to the different functionality offered by each platform. Though the two applications differ, however, they are both designed to adhere to the traits of transparency and security.

A critical aspect of the Java application in fulfilling the requirement of transparency is the ability to auto start upon an incoming Bluetooth connection. To facilitate this feature, this application utilizes the Push Registry functionality offered in Java ME programming. More specifically, the application runs automatically when a device connects over Bluetooth using a specific Universally Unique Identifier (UUID). Thus, the CID specifies this UUID when making the connection to the paired Java cell phone. To register this functionality in the cell phone, the system user must manually run the application one time, preferably just after the application is loaded onto the phone. This registers the necessary UUID in the phone's Push Registry and links it to the application. Then, the only remaining task is to pair the cell phone with the CID using the phone's menu system. After this, the application will automatically run whenever the phone is in range of the operational CID. A flowchart outlaying the Java ME application operation is shown in Figure 4.6.

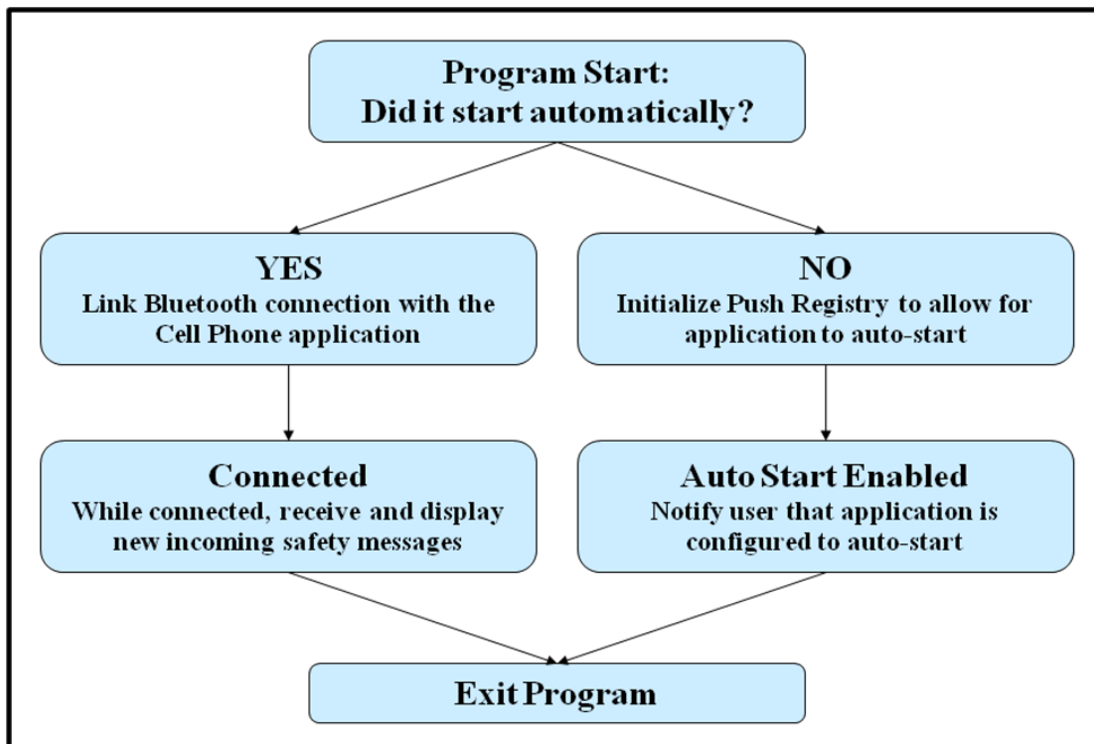

Figure 4.6. Java ME Cell Phone Application Program Flow

The Windows Mobile environment, on the other hand, does not offer the auto start option upon an incoming BT connection. Here, however, when the program is loaded to the phone, it is

placed in the cell phone's startup menu. This way, whenever the phone is powered up, the application starts automatically. The application can run in the background and all of the phone's functionality is available for the user. When the phone is connected to the CID and a new safety message is received, the window of the application is brought to the forefront and the new safety message is displayed on the cell phone's screen. The user can then send the window to the background and use other features of the phone, and the application is designed to show the window again whenever a safety message is received. See Figure 4.7 for a flowchart of the Windows Mobile version of the user interface application.

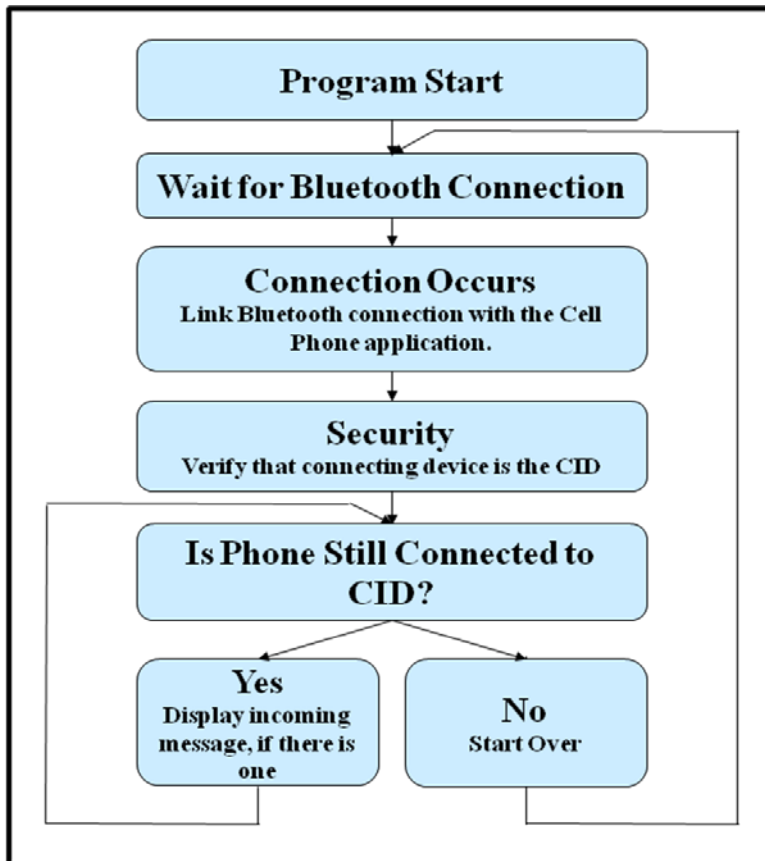

Figure 4.7. Windows Mobile Cell Phone Application Program Flow

Security is another key system objective and is enforced in two ways. First, the custom 128 bit UUID serves as an important system security feature. This ensures that only the connecting CID will invoke the cell phone application on the cell phone. In the Java application, if a connection attempt is made using a different UUID, the application will not autostart and no information will be displayed to the user. In the Windows Mobile application, the connecting device must first send the UUID to the cell phone as a security key. If the wrong code is sent, the Bluetooth connection will end and no information will be displayed for the user. The second way that security is enforced is through Bluetooth pairing. Upon system initialization, the cell phone that is to be used as the user interface is paired with the CID. This is a security feature inherent to Bluetooth protocols in which a user allows Bluetooth communication with a specific Bluetooth device. When the cell phone and the CID are paired, the CID is then allowed to connect to the paired cell phone without further acceptance. On the other hand, if a non-paired device attempts

to connect to the cell phone over Bluetooth, the user is prompted for acceptance of the connection. Here, the user has the opportunity to deny the incoming Bluetooth connection, ensuring that only trusted parties are able to send information to the cell phone. Utilizing these two methods, system security is guaranteed.

4.6 Development Hurdles and System Constraints

4.6.1 Subsystem Development Hurdles

In the development of the system implementation, multiple hurdles were encountered. One such hurdle arose during the development of the CID. The first Bluetooth radio module implemented in the system was the EB506 from A7 Engineering. This module was very user friendly, and seemed to be a match for this system. However, while the device was able to connect to the cell phone, the Push Registry in Java requires a custom UUID to be communicated by the connecting device. This custom UUID is the registered “key” in the Push Registry, and is the data needed to auto start the application. When making a Bluetooth connection using the EB506, protocol does not allow the user to choose a custom UUID. After speaking extensively with A7 Engineering technical support, the only choice was to seek an alternative Bluetooth module that would serve the requirements. The WT32 turned out to be a more powerful Bluetooth module, offering more functionality, including the ability to specify a custom UUID when establishing a Bluetooth connection.

Another hurdle encountered in development was that the communication range of the DSRC units was less than the optimal range of 1 km. In the scope of this research, continuous communication is defined as messages being received every second, whereas in intermittent communication, on average one in every three messages is received. In early trials to establish system continuous and intermittent communication range, the units were found to have a maximum continuous range of approximately 300 m, or 1000 feet, with an intermittent range of 1500 feet. Upon speaking with a representative of Savari Networks, it was found that the transmission range can be maximized through a change in antenna style mounted on the DSRC units. The units are shipped with omni-directional antennas, but will perform at longer ranges if equipped with directional antennas. Also, RSUs could be raised to a height where obstructions in the signal path between units could be minimized or eliminated.

A third major hurdle in development was in the area of Bluetooth functionality in a Windows Mobile application. The two major Bluetooth stacks (firmware controlling all Bluetooth functionality in a device) which are resident in mobile devices are Microsoft and WIDCOMM. To access the Bluetooth stack from an application, development in different programming environments is required for each corresponding stack. Due to its greater popularity, this application was developed for devices utilizing the Microsoft Bluetooth stack. To use this system with a Windows Mobile device employing the WIDCOMM Bluetooth stack, another Windows Mobile application must be developed.

Finally, another major hurdle was that DSRC units purchased from Savari networks did not come with good documentation and a lot of time had to be spent on understanding those units and making them work for our application. Although, Savari networks was kind enough to

provide us a dedicated engineer who was somewhat helpful in accomplishing things in timely fashion.

4.6.2 *System Constraints*

Listing of system constraints, based on specifications of utilized technologies and system design:

- Traffic Safety Message size must be 100 characters or less.
- Cell phone must be less than 30 feet from the CID for proper system functionality
- DSRC units must be less than 1000 feet from each other for reliable communication in an unobstructed setting.
- A cell phone with a Java platform must also support the commonly implemented JSR-82 API
- Since cell phone carriers commonly limit the functionality of 3rd party applications (especially in the area of Bluetooth use), the cell phone user interface application must either:
 - Run on an “unlocked” phone (a phone not limited in functionality by a specific carrier’s programming)
 - Be “signed” by the carrier as a secure application, enabling use by all cell phones on their cellular network.
- The Windows Mobile cell phone user interface application can only run on devices with the Microsoft Bluetooth stack.

4.6.3 *Known System Bugs*

Listing of known system bugs:

- Occasionally, after much travelling in and out of range, the DSRC transmitting unit fails and will no longer transmit messages. The transmitting side of the system must be restarted. This is a bug in DSRC communication which will be resolved with Savari Networks.
- In the Windows Mobile cell phone application, after the phone has connected to the CID, then disconnected, then connected again, the application window will not automatically pop to the front for user reading. The window must be manually selected to read the new messages. This will be resolved soon.

Chapter 5 Final Demo Results and Discussion

5.1 Description

The final demonstration of this system implementation consisted of multiple V2I and V2V communication scenarios. We considered two separate scenarios for V2I communication and one scenario of V2V communication. In both V2I scenarios, a fixed RSU was placed alongside the road, while vehicle was carrying the mobile OBU. In first V2I scenario, a fixed RSU was placed at a higher elevation as compared to the road, and in the second V2I scenario, the RSU was placed either inside a parked vehicle or on a raised open surface along the side of the road i.e., the fixed DSRC RSU was at about the same elevation as the OBU inside the moving vehicle. Regarding V2V scenario, both RSU and OBU were placed inside the traveling vehicle. The V2I communication was demonstrated using well defined cases of various rural and urban roads settings, while the V2V communication demo involved two vehicles travelling from rural to an urban setting. The demonstrations showed the operability of the system in a mobile environment.

For the demonstration and testing purposes, the transmitting DSRC unit application was modified from the original application described in Chapter 4. The modified application was made to continuously transmit a message concatenated by an integer every second. The integer was incremented with every message generated, so the messages being sent by the transmitting unit were all different. This ensured that the cell phone would receive a new message every second, enabling easy monitoring of messages which were actually received by the cell phone. The detailed testing results of the scenarios are described above follows.

5.2 V2I Scenario 1: Elevated Fixed RSU and Mobile OBU

5.2.1 Overview

In this scenario, the transmitting DSRC unit was used as a fixed RSU, and placed not only at an elevated position from the road but also at a considerable distance from the roadside. The transmitting DSRC unit was elevated to provide maximum range of communication. The DSRC OBU, along with the CID and cell phone, was placed in the traveling vehicle. This scenario consisted of two different road settings:

- 1) Oakland Ave
- 2) W College St.

The first area chosen to demonstrate system operability of this scenario involved a heavily obstructed urban street (Oakland Ave). The RSU was set 10 feet above the street level to ensure the maximum possible line of sight with the roadway. In order to find an appropriately elevated position, the RSU was placed 180 feet away from the roadside to find an appropriately elevated position. There were buildings, vehicles, and trees which could cause signal interference as shown in Figure 5.1.

The second area chosen for the elevated RSU and Mobile OBU scenario involved an urban street with sporadic obstruction along the street by trees (W College St). The RSU was set 30 feet above the street level to ensure the maximum possible line of sight with the roadway as shown in

Figure 5.1. In this case, the RSU was placed 430 feet away from the roadside to find an appropriately elevated position (see Figure 5.1). Please note that for Oakland Ave and W College St, the fixed RSU was placed at the same location. On the west side of the RSU was Oakland Ave and on the south side was W College St.

In both cases, the goal of the demonstration was to determine the range of communication with respect to reliable (all transmitted messages were received) and intermittent (some transmitted messages were received) message reception.

5.2.2 Results

In the first part of Scenario 1 (Oakland Ave; see Figure 5.1), the RSU was placed 180 feet away and elevated 10 feet above the roadway. The total range of communication (continuous and intermittent combined) was found to be approximately 1600 feet along Oakland Ave. Communication became intermittent when the vehicle in motion lost a line of sight with the transmitting DSRC unit.

In the second part of Scenario 1 (W College St; see Figure 5.1), the RSU was placed 430 feet away and elevated 30 feet above the roadway. The total range of communication along W College St was found to be approximately 1000 feet. Again, when the vehicle lost a line of sight with the transmitting DSRC unit, communication became intermittent, with some messages not being received by the DSRC OBU.

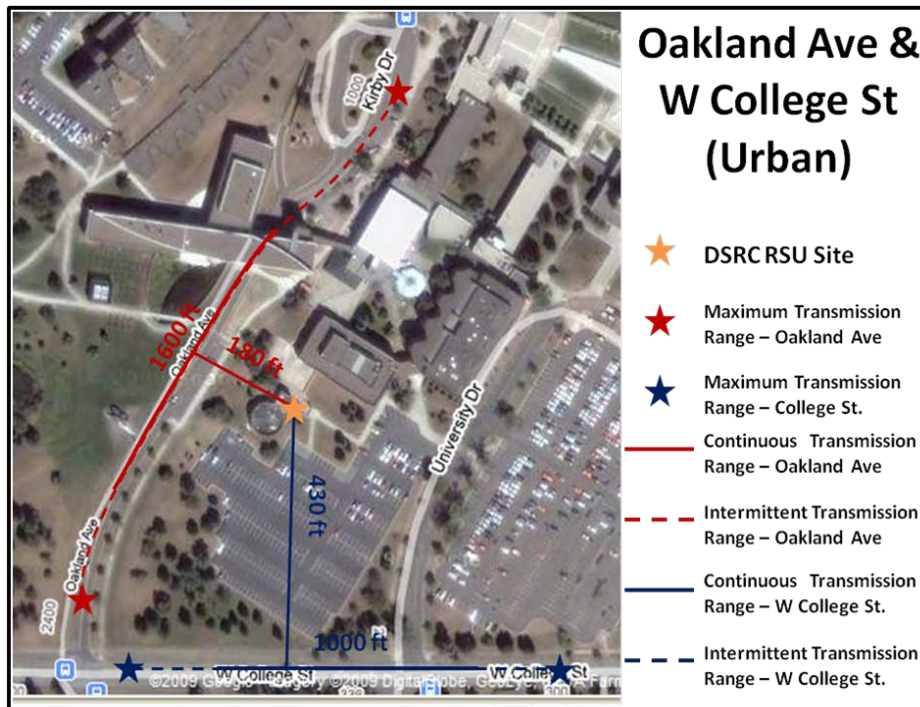

Figure 5.1. V2I Scenario 1: Elevated Fixed RSU and Mobile OBU

5.3 V2I Scenario 2: Fixed RSU and Mobile OBU at the Same Elevation

5.3.1 Overview

In this scenario, the transmitting DSRC unit was used as an RSU as in Scenario 1. However, here the RSU was not elevated, but placed at the edge of the roadway. This scenario also consisted of two road settings:

- 1) State Hwy 47
- 2) W Arrowhead Rd

In the first setting of Scenario 2 (State Hwy 47), the road setting was a straight, rural two lane highway with no obstructions or traffic to interfere with DSRC communications. The RSU was placed at the edge of the highway on a 3 feet high table, and there was a clear line of sight for at least one mile in each direction (see Figure 5.2). In this phase of the demonstration, trials were performed at both 30 mph and 60 mph.

In the second setting of this scenario (W Arrowhead Rd), the transmitting DSRC unit was inside a parked vehicle along the roadway, while the receiving DSRC unit, along with the CID and cell phone, was inside a vehicle in motion. The vehicle carrying the Mobile OBU travelled in and out of range of the stationary DSRC unit to determine the transmission range and communication reliability (see Figure 5.3).

In both of the above cases, the goal of the demonstration was to determine the range of communication with respect to reliable (all transmitted messages were received) and intermittent (on average at least one in three transmitted messages were received) message reception. In the first unobstructed “ideal” case (State Hwy 47), an additional goal was to determine of the average number of messages received at the cell phone during one full pass through the reliable communication range at each specified travel speed.

5.3.2 Results

In the first part of Scenario 2 (State Hwy 47 – see Figure 5.2), the RSU was placed at the shoulder of the road on an open surface, and there was a clear line of sight for at least 1 mile in each direction. Traffic was sparse and had negligible effects on communication between the vehicle and the roadside. The total range of communication along State Hwy 47 was approximately 3000 feet (regardless of travel speed). Please note that the DSRC range was 1500 feet from each side of the RSU. The central 2000 feet of this range experienced continuous communication reliability (i.e., message received every second or all transmitted messages received), while approximately 500 feet on each end of the total communication range experienced intermittent reliability (i.e., message received every 3 seconds on average). When traveling through the total range of communication at a travel speed of 30 mph, 40 contiguous messages were received by the OBU, whereas at 60 mph, 20 contiguous messages were received (near the boundaries of the transmission range, some additional intermittent messages were also received) endorsing the range which was observed in the previous test. For example, 60 mph is 88 feet per second and 20 continuous messages were received. Theoretical computation ($2000 \text{ feet} / (88 \text{ ft/sec}) = 22.7 \text{ seconds}$, or 22 messages) closely aligns with the actual number of messages received in testing (20 messages).

In part 2 of Scenario 2 (W Arrowhead Rd – see Figure 5.3), the total range of communication was found to be approximately 2000 feet along W Arrowhead Rd. Communication became intermittent when line of sight was lost due to vehicles passing between the transmitting and receiving DSRC units. Please note that the total range in this case was smaller than the previous case (State Hwy 47). One of the major reasons for this can be attributed to the fact that in this case, the RSU was placed inside the vehicle, which could cause some scattering of the transmitted signal and also the mobile OBU received either a weaker DSRC signal or experienced multipath interference. In addition, this road was hilly which also played a role in communication range and reliability. Without an elevated RSU (DSRC unit was placed inside a parked vehicle), clear line of sight was lost when the receiving vehicle travelled into a trough of the roadway, causing intermittent communication. As in part 1 of this scenario, noncontiguous messages were received near the boundaries of the total communication range.

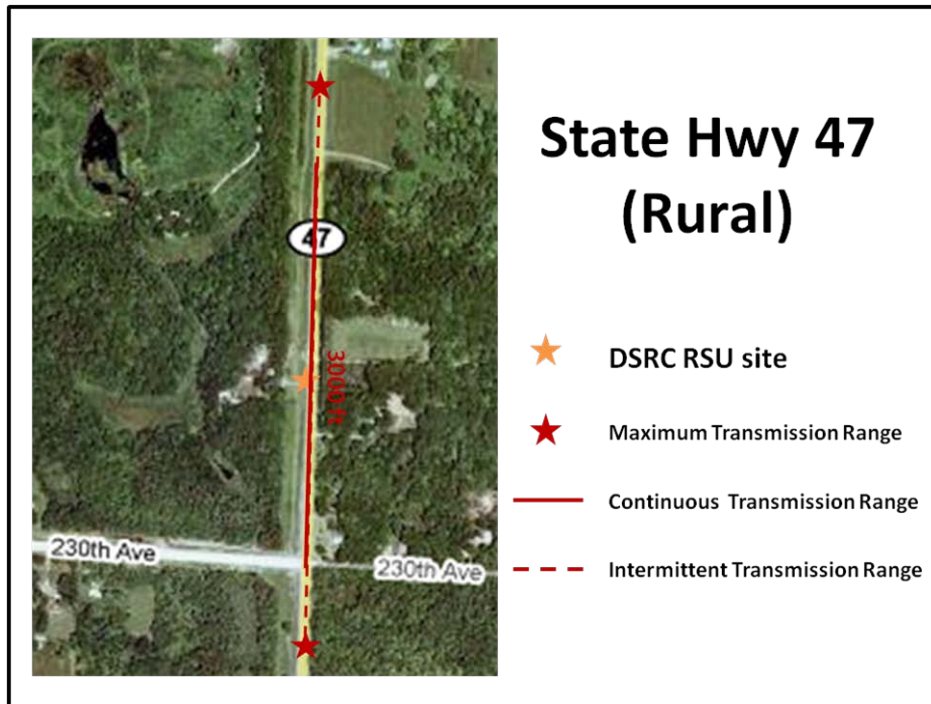

Figure 5.2. V2I Scenario 2, Part 1: Fixed RSU and Mobile OBU at the Same Elevation

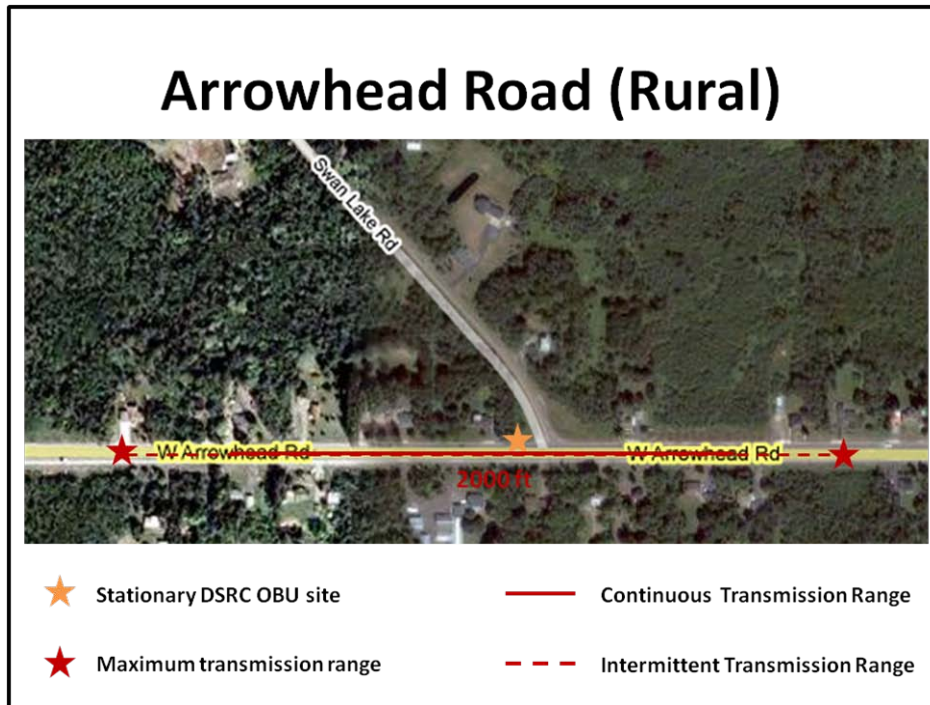

Figure 5.3. V2I Scenario 2, Part 2: Fixed RSU and Mobile OBU at the Same Elevation

5.4 V2V Scenario 3: Mobile OBU and Mobile OBU

5.4.1 Overview

The third scenario demonstrated the portability of the system. Here, the system operability was changed from V2I communication to V2V. The transmitting DSRC unit which had been used only in stationary operation (used as a fixed RSU) was now utilized in a mobile environment (used as a moving RSU i.e., OBU). The two vehicles travelled from a rural setting (W Arrowhead Rd and Haines Rd) to an urban setting (Oakland Ave & W College St) as shown in Figure 5.4, repeatedly taking the DSRC OBUs in and out of range of each other, observing communication ranges and their associated conditions. The total distance traveled was approximately 4.6 miles.

5.4.2 Results

In this scenario (Duluth, MN – see Figure 19), the total range of communication varied greatly. The determining factor for the range of communication was line of sight between the two moving vehicles. When the leading vehicle turned a corner losing the line of sight, or other vehicles came between the two vehicles with DSRC units, communication became intermittent (unless the two vehicles were separated by less than 500 feet, which then yielded continuous communication). The range in this case was considerably less as compared to the fixed RSU scenarios because of multipath interference and loss of line of sight.

an open surface along the roadway. Range is cut down by one third when the transmitting DSRC unit is inside a vehicle. The reasons for this are twofold:

- First, the signal suffers from added signal degradation due to scattering by the parked vehicle infrastructure which further causes multipath interference at the receiving side.
- Second, due to the hilly nature of the roadway in part 2, the line of sight was lost between the transmitting and receiving DSRC units. Elevating the RSU could eliminate much of this problem.

One important point to discuss to aid in the analysis of this system is the relevance of continuous versus intermittent communication. In the scope of this article, continuous communication means that all messages sent by the transmitting DSRC unit (with one second intervals) are received by the receiving DSRC unit. Conversely, intermittent communication means that on average one in three messages is received by the receiving DSRC unit. In this demo, system operation was altered from the norm, with new messages being transmitted every second in order to demonstrate the full system capabilities. In actual implementation, a new message is broadcast repeatedly until the next new message enters into the system. This means that there will be multiple opportunities for the receiving DSRC unit to obtain a traffic safety message (the successful reception of only one transmission of a particular message is necessary); hence intermittent communication is very appropriate in successful system operation.

Chapter 6 Conclusions and Recommendations

6.1 Conclusions

In conclusion, the system displays successful transmission of traffic safety messages generated by Mn/DOT infrastructure to the driver of a vehicle through the utilization of two wireless technologies (DSRC and Bluetooth). The user interface used to display the safety messages for the driver was chosen to be a cell phone, due to their widespread popularity in today's culture. The two major cell phone platforms that were chosen to implement this system were Java and Windows Mobile, since these represent such a large portion of today's cell phone market.

On the area of DSRC communication, the system performed well, with the following important findings:

- With the current implementation, a clear line of sight between DSRC units extends the maximum communication range dramatically. Currently, the range of the system turns out to be 1500 feet (from one side of the RSU), which is almost half of the prescribed range of the DSRC communication. However, this shorter range is partly due to the fact that we used omni-directional antennas in both the RSU and the OBU, which has decreased this range. If we had used the directional antennas with high gain, then the prescribed range could have been achieved. This was discussed with Savari Networks, and the answer was that they have experimented with directional antennas and had been able to obtain more than the prescribed range.
- Intermittent DSRC communication is acceptable in a successful system, since traffic safety messages are broadcast repeatedly. Only one received message is required to inform a vehicle driver.

Thus, the DSRC communication implemented in this system successfully demonstrates the ability to transmit and receive messages at highway speeds.

Bluetooth communication also performed to design expectations. The range necessary for system use (the size of the vehicle containing the CID) was well within the operating capabilities of the implemented Bluetooth hardware.

6.2 Feasibility of Developing a Simplified DSRC Vehicle Radio Unit

An additional objective of this project was to research the feasibility of developing a simplified DSRC vehicle radio unit, which could be used to directly interface with the CID. This was to be done to attempt to alleviate the costs involved in the purchase of DSRC units with full functionality, whose high costs currently make the system inaccessible for widespread implementation.

Research quickly showed that this type of undertaking would be futile. DSRC communication is inherent with traits that cannot be compromised:

- Low latency (~50 ms)

- High Data Rate (up to 27 Mbps with 10 MHz channels)
- Medium Range (< 1 km)
- Communication in automotive environments (vehicle speeds up to 120 mph)
- Security
- Standardization

All points would be easily implemented in a simplified DSRC system with the exception of the last two most crucial ones: Security and Standardization. Ensuring security brings to the system high levels of complexity in processing and communication overhead. The protocols set forth for DSRC communication are specified in their entirety in the IEEE 1609 WAVE standards. For DSRC communication, full functionality is required in keeping with FCC rules. Security is critical in ensuring the prevention of attacks on DSRC communications such as eavesdropping, spoofing, alteration, and replay [19]. Non-secure operation would open the system to the possibility of outside tampering and endanger the lives of those using the roadways. Another secondary concern is the possibility of personal, identifying, or linkable information being leaked to unauthorized parties [19].

Thus, for the protection of all on the roadways, and the security of the personal information of DSRC system users, IEEE has developed standards (IEEE 1609.2: Security Services and Management Messages) for the security techniques that are to be used in making DSRC communication secure. A simplified system which offers partial functionality at a lower cost is not feasible. Besides cost, it may not be convenient either because if this does not conform to the standard, then it may not work with other standardized units.

6.3 Recommendations for Future Work

Future work planned for this system includes the following:

- Incorporation of GPS positioning into the system to make possible the development of applications which can track vehicular movement. This can make the system useful for various scenarios e.g., workzone traffic safety system, left turn assist on small roadways merging with major roadways etc.
- Incorporation of text-to-speech capabilities, enabling traffic safety messages to be read aloud to the vehicle driver. This would allow the driver to keep all attention on the roadway, rather than reading safety messages from a mobile device screen. Also, communication with pictures and symbols can be incorporated in addition to the text.
- Development of user interface applications for all cell phone platforms which are currently unsupported.
- To extend the total DSRC communication range of this system, antenna implementation of the DSRC units could be changed. Especially in the use of a RSU, a directive antenna could be used, thereby increasing range. For the OBUs, a bi-directional antenna could also extend the communication range.

References

- [1] U.S. Department of Transportation (Internet), *IntelliDrive*, 2009 (Accessed July 2009), <http://www.its.dot.gov/intellidrive/index.htm>.
- [2] U.S. Department of Transportation (Internet), *ITS Overview*, 2009 (Accessed July 2009), http://www.its.dot.gov/its_overview.htm.
- [3] California PATH (Internet), *Vehicle to Vehicle Safety Messaging in DSRC*, 2004 (Accessed July 2009), <http://portal.acm.org/citation.cfm?id=1023875.1023879>.
- [4] IEEE Engaging the World (Internet), *Intelligent Transportation Systems, Cell Phone Enhancements Improve Mass Transit*, 2009 (Accessed March 2009), <http://newsmanager.commpartners.com/ieetw/issues/2009-02-23/1.html#top>.
- [5] J.A. Misener, and S.E. Shladover. "PATH Investigations in Vehicle-Roadside Cooperation and Safety: A Foundation for Safety and Vehicle-Infrastructure Integration Research." *ITSC 2006 IEEE*, 9-16.
- [6] Michigan VII Update (Internet), *VII and the Society of Automotive Engineers*, 2007 (Accessed July 2009), <http://www.umtri.umich.edu/content/MIVIIupdate1-1a.pdf>.
- [7] MDOT Office of Research and National Best Practices (Internet), *Communication between Vehicles and Roadways is Next Step in Safety*, 2006 (Accessed July 2009), http://www.michigan.gov/documents/mdot/2_2006_September_ORBP_Newsletter_2400_85_7.pdf.
- [8] Intelligent Vehicle Initiative Final Report (Internet), *Saving Lives through Advanced Vehicle Safety Technology*, 2005 (Accessed July 2009), http://www.itsdocs.fhwa.dot.gov/JPODOCS/REPTS_PR/14153_files/ivi.pdf.
- [9] J. Knudsen. *Kicking Butt with MIDP and MSA: Creating Great Mobile Applications*, Addison-Wesley: New York, 2008.
- [10] Bluetooth SIG (Internet), *Core Specification v2.1+EDR – Specification of the Bluetooth System*, 2007 (Accessed June 2008), http://www.bluetooth.com/NR/rdonlyres/F8E8276A-3898-4EC6-B7DA-E5535258B056/6545/Core_V21_EDR.zip.
- [11] PaloWireless (Internet), *Bluetooth Tutorial*, 2007 (Accessed June 2008), <http://www.palowireless.com/infotooth/tutorial.asp>.
- [12] R. Morrow. *Bluetooth Operation and Use*, McGraw Hill: New York, 2002.
- [13] Wikipedia (Internet), *Scatternet*, 2008 (Accessed August 2008), <http://en.wikipedia.org/wiki/Image:BluetoothScatternet-de.svg>.
- [14] Wikipedia (Internet), *Bluetooth Profile*, 2008 (Accessed August 2008), http://en.wikipedia.org/wiki/Bluetooth_profile.
- [15] Dedicated Short Range Communications (DSRC) Home (Internet), *Dedicated Short Range Communications (DSRC)*, 2008 (Accessed August 2008), <http://www.leearmstrong.com/DSRC/DSRCHomeset.htm>.

- [16] IEEE 802 LAN/MAN Standards Committee (Internet), *5.9 GHz Dedicated Short Range Communication (DSRC) Standards Development Update*, 2008 (Accessed September 2008), http://ieee802.org/802_tutorials/march02/IEEE_DSRC_Std_Tutorial_03-10-02.ppt.
- [17] IEEE Xplore (Internet), *Trial Use Standard for Wireless Access in Vehicular Environments (WAVE) – Security Services for Applications and Management Messages* (Accessed June 2008), http://ieeexplore.ieee.org/xpls/abs_all.jsp?arnumber=1653011.